

FLIGHT DATA FILE

Flight Plan

STS-62

BRANCH CHIEF
B. NUTE
D04
BOND

1

(Rotated Flight Cycle Trajectory)

Mission Operations Directorate Operations Division

Final January 28, 1994

<u>EVENT</u>	<u>CST</u>		
Launch	07:54	Thurs	March 3
KSC Landing	07:00	Thurs	March 17

National Aeronautics and
Space AdministrationLyndon B. Johnson Space Center
Houston, Texas

MISSION OPERATIONS DIRECTORATE

STS-62 FLIGHT PLAN

FINAL
January 28, 1994

PREPARED BY:

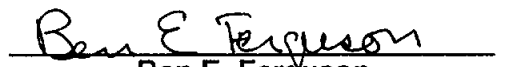

Jennifer Price
Book Manager

APPROVED BY:

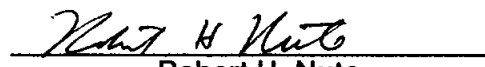
Ben E. Ferguson
Head, Flight Planning and Operations
Section

Robert H. Nute
Chief, Space Shuttle Flight
Planning Branch

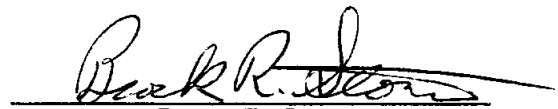
Earl W. Thompson
Chief, Operations Division

Brock R. Stone
Assistant Director
Space Shuttle Operations

This document is under the configuration control of the Crew Procedures Control Board (CPCB). All proposed changes must be submitted on JSC Form 482 to DO4/FDF Manager.

Additional distribution of this book for official use must be requested in writing to DO4/FDF Manager. The request must include justification and requester's name, organization, position, and phone number. Contractor requests are made through the NASA or DOD organization supported. Deletions, reduction in quantity, or change of address may be submitted to DO4/FDF distribution manager, (713) 244-1182.

Incorporates the following:				
482#:	FLT PLN-1588A	FLT PLN-1579	FLT PLN-1604	MULTI-954
	FLT PLN-1589A	FLT PLN-1594	FLT PLN-1605	
	FLT PLN-1592B	FLT PLN-1600	FLT PLN-1606	
	FLT PLN-1593A	FLT PLN-1602	FLT PLN-1607	Exemption #: 58, 60

AREAS OF TECHNICAL RESPONSIBILITY

Book Manager/Lead FAO	DO4/J. Price	244-5872
Nominal Timelines	DO4/W. Chell	244-5868
Contingency Timeline	DO4/P. Bolton	244-1176
Attitude & Pointing	DO4/D. Kaley	244-5786

FLIGHT PLAN
STS-62

LIST OF EFFECTIVE PAGES

	FINAL	01/28/94	
Sign Off	* 62/FIN	3-10	62/FIN
ii	* 62/FIN	3-11	62/FIN
iii	* 62/FIN	3-12	62/FIN
iv	* 62/FIN	3-13	62/FIN
v	* 62/FIN	3-14	62/FIN
vi	* 62/FIN	3-15	62/FIN
vii	62/FIN	3-16	62/FIN
viii	62/FIN	3-17	62/FIN
1-1	62/FIN	3-18	62/FIN
1-2	62/FIN	3-19	62/FIN
1-3	62/FIN	3-20	62/FIN
1-4	62/FIN	3-21	62/FIN
1-5	62/FIN	3-22	62/FIN
1-6	62/FIN	3-23	62/FIN
2-1	62/FIN	3-24	62/FIN
2-2	62/FIN	3-25	62/FIN
2-3	62/FIN	3-26	62/FIN
2-4	62/FIN	3-27	62/FIN
2-5	62/FIN	3-28	62/FIN
2-6	62/FIN	3-29	62/FIN
2-7	62/FIN	3-30	62/FIN
2-8	62/FIN	3-31	62/FIN
2-9	62/FIN	3-32	62/FIN
2-10	62/FIN	3-33	62/FIN
2-11	62/FIN	3-34	62/FIN
2-12	62/FIN	3-35	62/FIN
2-13	62/FIN	3-36	62/FIN
2-14	62/FIN	3-37	62/FIN
2-15	62/FIN	3-38	62/FIN
2-16	62/FIN	3-39	62/FIN
2-17	62/FIN	3-40	62/FIN
2-18	62/FIN	3-41	62/FIN
2-19	62/FIN	3-42	62/FIN
2-20	62/FIN	3-43	62/FIN
2-21	62/FIN	3-44	62/FIN
2-22	62/FIN	3-45	62/FIN
2-23	62/FIN	3-46	62/FIN
2-24	62/FIN	3-47	62/FIN
2-25	62/FIN	3-48	62/FIN
2-26	62/FIN	3-49	62/FIN
2-27	62/FIN	3-50	62/FIN
2-28	62/FIN	3-51	62/FIN
2-29	62/FIN	3-52	62/FIN
2-30	62/FIN	3-53	62/FIN
3-1	62/FIN	3-54	62/FIN
3-2	62/FIN	3-55	62/FIN
3-3	62/FIN	3-56	62/FIN
3-4	62/FIN	3-57	62/FIN
3-5	62/FIN	3-58	62/FIN
3-6	62/FIN	3-59	62/FIN
3-7	62/FIN	3-60	62/FIN
3-8	62/FIN	3-61	62/FIN
3-9	62/FIN	3-62	62/FIN

(*) - Omit from flight book

3-63	62/FIN
3-64	62/FIN
3-65	62/FIN
3-66	62/FIN
3-67	62/FIN
3-68	62/FIN
3-69	62/FIN
3-70	62/FIN
3-71	62/FIN
3-72	62/FIN
4-1	62/FIN
4-2	62/FIN
5-1	* 62/FIN
5-2	* 62/FIN
5-3	* 62/FIN
5-4	* 62/FIN
5-5	* 62/FIN
5-6	* 62/FIN
5-7	* 62/FIN
5-8	* 62/FIN
5-9	* 62/FIN
5-10	* 62/FIN
6-1	* 62/FIN
6-2	* 62/FIN
6-3	* 62/FIN
6-4	* 62/FIN
6-5	* 62/FIN
6-6	* 62/FIN
6-7	* 62/FIN
6-8	* 62/FIN
6-9	* 62/FIN
6-10	* 62/FIN
6-11	* 62/FIN
6-12	* 62/FIN
6-13	* 62/FIN
6-14	* 62/FIN
6-15	* 62/FIN
6-16	* 62/FIN
6-17	* 62/FIN
6-18	* 62/FIN
7-1	* 62/FIN
7-2	* 62/FIN
7-3	* 62/FIN
7-4	* 62/FIN
7-5	* 62/FIN
7-6	* 62/FIN
7-7	* 62/FIN
7-8	* 62/FIN
7-9	* 62/FIN
7-10	* 62/FIN

(*) - Omit from flight book

STS-62 FLIGHT PLAN CUE CARDS

<u>Title</u>	<u>Ref. Page</u>	<u>Card No.</u>
DAP A, DAP B TOC	6-5	FLT PLN-1a/62/O/B
(Blank)	6-5	FLT PLN-1b/62/O/B
DAP A	6-6	FLT PLN-2a/62/O/A
DAP A1	6-6	FLT PLN-2b/62/O/A
A1	6-6	FLT PLN-3a/62/O/A
DAP A2	6-6	FLT PLN-3b/62/O/A
A2	6-7	FLT PLN-4a/62/O/A
DAP A3	6-7	FLT PLN-4b/62/O/A
A3	6-7	FLT PLN-5a/62/O/A
DAP A4	6-7	FLT PLN-5b/62/O/A
A4	6-8	FLT PLN-6a/62/O/A
DAP A5	6-8	FLT PLN-6b/62/O/A
A5	6-8	FLT PLN-7a/62/O/A
DAP A6	6-8	FLT PLN-7b/62/O/A
A6	6-9	FLT PLN-8a/62/O/A
DAP A7	6-9	FLT PLN-8b/62/O/A
A7	6-9	FLT PLN-9a/62/O/A
DAP A8	6-9	FLT PLN-9b/62/O/A
A8	6-10	FLT PLN-10a/62/O/B
DAP A9	6-10	FLT PLN-10b/62/O/B
A9	6-10	FLT PLN-25a/62/O/A
DAP A10	6-10	FLT PLN-25b/62/O/A
A10	6-11	FLT PLN-26a/62/O/A
(Blank)	6-11	FLT PLN-26b/62/O/A
DAP B	6-11	FLT PLN-11a/62/O/A
DAP B1	6-11	FLT PLN-11b/62/O/A
B1	6-12	FLT PLN-12a/62/O/A
DAP B2	6-12	FLT PLN-12b/62/O/A
B2	6-12	FLT PLN-13a/62/O/A
DAP B3	6-12	FLT PLN-13b/62/O/A
B3	6-13	FLT PLN-14a/62/O/A
DAP B4	6-13	FLT PLN-14b/62/O/A
B4	6-13	FLT PLN-15a/62/O/A
DAP B5	6-13	FLT PLN-15b/62/O/A
B5	6-14	FLT PLN-16a/62/O/B
DAP B6	6-14	FLT PLN-16b/62/O/B
B6	6-14	FLT PLN-17a/62/O/B
DAP B7	6-14	FLT PLN-17b/62/O/A
B7	6-15	FLT PLN-18a/62/O/A
DAP B8	6-15	FLT PLN-18b/62/O/A
B8	6-15	FLT PLN-19a/62/O/A
DAP B9	6-15	FLT PLN-19b/62/O/A
B9	6-16	FLT PLN-20a/62/O/A
(Blank)	6-16	FLT PLN-20b/62/O/A
ALT DAP TOC	6-16	FLT PLN-21a/62/O/B
DAP ALT1	6-16	FLT PLN-21b/62/O/A
ALT1	6-17	FLT PLN-22a/62/O/A
DAP ALT2	6-17	FLT PLN-22b/62/O/A
ALT2	6-17	FLT PLN-23a/62/O/B
DAP ALT3	6-17	FLT PLN-23b/62/O/B
ALT3	6-18	FLT PLN-27a/62/O/A
(Blank)	6-18	FLT PLN-27b/62/O/A
UNIV PTG	6-18	FLT PLN-24a/62/O/A

This Page Intentionally Blank

CONTENTS

PAGE

INTRODUCTION	viii
STS-62 OVERVIEW	1-1
SUMMARY TIMELINE	2-1
DETAILED TIMELINE	3-1
72 HR MDF TIMELINE	4-1
ATTITUDE TIMELINE	5-1
STS-62 DAP BOOK	6-1
STS-62 FLIGHT PLAN NOTES	7-1

INTRODUCTION

The STS-62 Flight Plan is the Flight Data File article that contains the on-orbit timeline. It does not contain the detailed timelines that are covered in the Ascent, Post Insertion, Deorbit Prep, and Entry Checklists. For continuity, the summary level timeline includes the entire flight.

This on-orbit timeline satisfies the objectives specified in the Flight Definition and Requirements Directive and the requirements of the STS-62 Flight Requirements Document. The Flight Plan, as part of the Flight Data File, meets the specifications of the STS-62 Flight Initialization Data Pack.

The flight profile used for this Flight Plan is for a launch date of March 3, 1994, at 07:54 CST. Orbiter inertial attitudes are expressed relative to a Mean of 1950 (M50) reference frame.

JSC-22359, Crew Scheduling Constraints (Appendix K, CPMP), Basic, Rev B, January 1992, has been used to build the timelines contained in this Flight Plan. The following Appendix K exemptions have been approved for STS-62:

- #58 - Allows DSO 612 operations to occur immediately after crew wakeup
- #60 - Waives exercise scheduling requirement for PLT and MS2 (FDs 2, 4, and 7) to accommodate LBNP constraints and for PLT and MS1 (FD 14) to accomplish primary and secondary payload objectives.

The S-Band data displayed on the timeline pages are just an approximation and should not be used conclusively. Furthermore, stars of opportunity IMU alignments are not guaranteed which implies that maneuvers may be necessary to perform an alignment.

The timeline formats used in this Flight Plan are based on JSC-19933, Timeline Format Definitions and Standard Notes, Rev C, May 1990.

STS-62 OVERVIEW

OVERVIEW

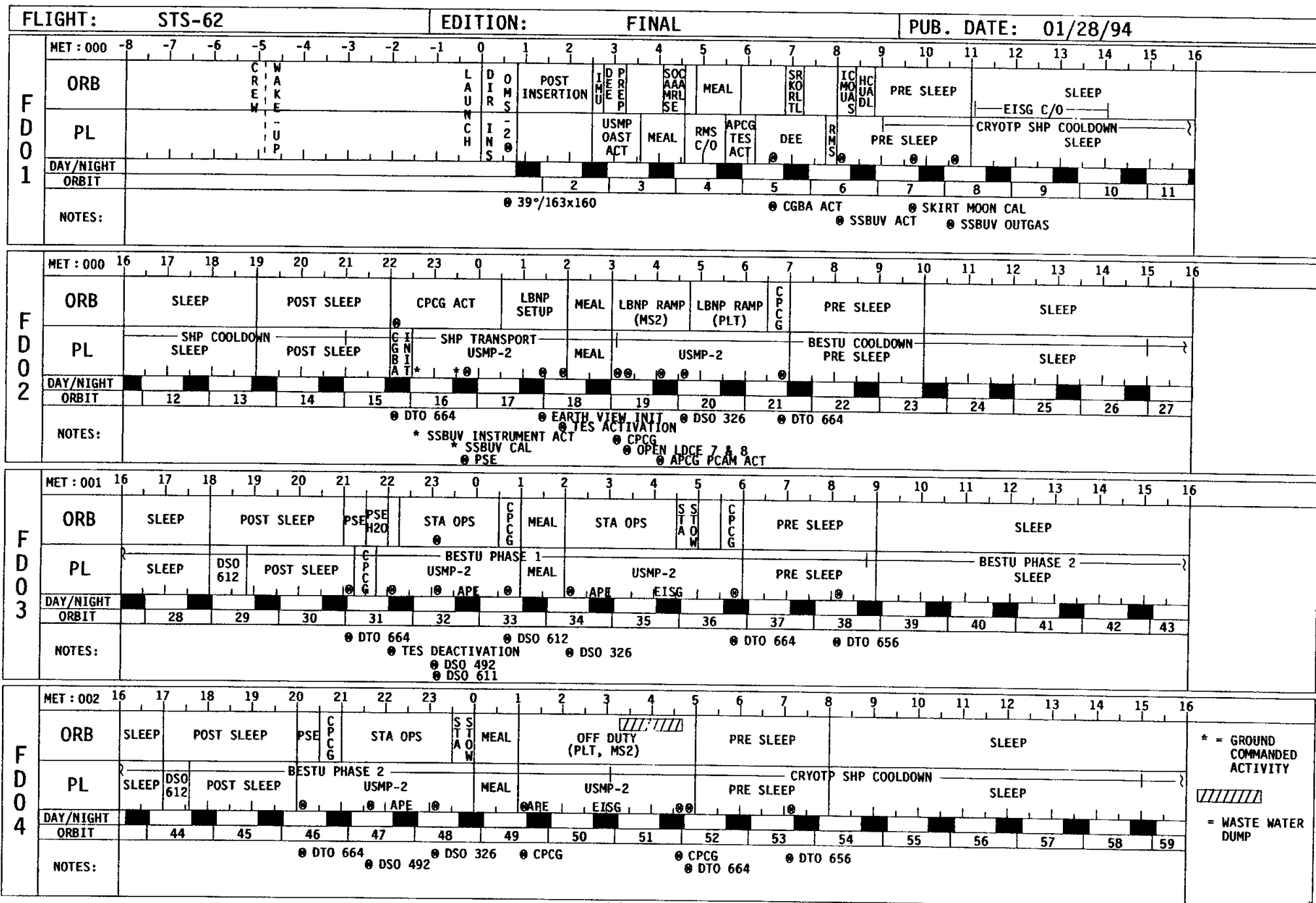

* = GROUND COMMANDED ACTIVITY
 // // // // // = WASTE WATER DUMP

FLIGHT: STS-62		EDITION: FINAL		PUB. DATE: 01/28/94																									
FD05	MET : 003	16	17	18	19	20	21	22	23	0	1	2	3	4	5	6	7	8	9	10	11	12	13	14	15	16			
	ORB	POST SLEEP		OFF DUTY (CDR, MS1, MS3)				MEAL	PSE	STA OPS	STA OPS	CPCG	PRE SLEEP	SLEEP										POST SLEEP					
	PL	DSO 612 492	SHP TRANSPORT POST SLEEP		LBNP RAMP (MS2)		LBNP RAMP (PLT)		MEAL	USMP-2		R-D A-D L-Y	BETSU COOLDOWN USMP-2	PRE SLEEP		BESTU PHASE 3										DSO 612			
	DAY/NIGHT	[Day/Night Cycle]																											
	ORBIT	59	60	61	62	63	64	65	66	67	68	69	70	71	72	73	74	75											
NOTES:	◎ DTO 664 ◎ DSO 326 ◎ DTO 664 ◎ DTO 656 ◎ CPCG ◎ CBGA																												
FD06	MET : 004	16	17	18	19	20	21	22	23	0	1	2	3	4	5	6	7	8	9	10	11	12	13	14	15	16			
	ORB	POST SLEEP		PSE	PSE H20	STA OPS			MEAL	STA OPS			STA OPS	CPCG	PRE SLEEP		SLEEP										POST SLEEP		
	PL	POST SLEEP		USMP-2			BESTU PHASE 3		MEAL	USMP-2			PRE SLEEP		BETUS PHASE 4										DSO 612 492				
	DAY/NIGHT	[Day/Night Cycle]																											
	ORBIT	75	76	77	78	79	80	81	82	83	84	85	86	87	88	89	90	91											
NOTES:	◎ DTO 664 ◎ CPCG ◎ DSO 326 ◎ DTO 664 ◎ DTO 656																												
FD07	MET : 005	16	17	18	19	20	21	22	23	0	1	2	3	4	5	6	7	8	9	10	11	12	13	14	15	16			
	ORB	POST SLEEP		PSE	CPCG	STA OPS			MEAL	STA OPS			STA OPS	CPCG	PRE SLEEP		SLEEP										POST SLEEP		
	PL	POST SLEEP		BETSU PHASE 4			USMP-2		MEAL	USMP-2			CRYOTP SHP COOLDOWN	PRE SLEEP		SLEEP										POST SLEEP			
	DAY/NIGHT	[Day/Night Cycle]																											
	ORBIT	91	92	93	94	95	96	97	98	99	100	101	102	103	104	105	106												
NOTES:	◎ DTO 664 ◎ DSO 326 ◎ DSO 326 ◎ DSO 326 ◎ DSO 326 ◎ CGBA ◎ CPCG ◎ DTO 664 ◎ DLS DEACT ◎ DLS ACT																												
FD08	MET : 006	16	17	18	19	20	21	22	23	0	1	2	3	4	5	6	7	8	9	10	11	12	13	14	15	16			
	ORB	POST SLEEP		LBNP RAMP (MS2)	LBNP RAMP (PLT)	STA OPS			MEAL	STA OPS			STA OPS	CPCG	PRE SLEEP		SLEEP										POST SLEEP		
	PL	POST SLEEP		USMP-2			MEAL		USMP-2	USMP-2		USMP-2	PRE SLEEP		SLEEP										POST SLEEP				
	DAY/NIGHT	[Day/Night Cycle]																											
	ORBIT	107	108	109	110	111	112	113	114	115	116	117	118	119	120	121	122												
NOTES:	◎ PSE ◎ DSO 326 ◎ DSO 611 ◎ DSO 611 ◎ DLS DEACT * SSBV EARTH VIEW TERM ◎ DLS DEACT ◎ CLOSE LDCE 7, OPEN 6 ◎ CGBA TERM ◎ DLS ACT																												

* = GROUND COMMANDED ACTIVITY
 [Hatched Box] = WASTE WATER DUMP

FD09	MET: 007	16	17	18	19	20	21	22	23	0	1	2	3	4	5	6	7	8	9	10	11	12	13	14	15	16			
	ORB	POST SLEEP	PSE H20	STA OPS	MEAL	STA OPS	STA OPS	DLS	CPCG	PRE SLEEP	SLEEP														POST SLEEP				
	PL	POST SLEEP	CALC	SAMPLE; ECT; USMP-2	LDCE MEAL	USMP-2	USMP-2	PRE SLEEP	SAMPLE & ECT														POST SLEEP						
	DAY/NIGHT	[Day/Night Cycle]																											
	ORBIT	123	124	125	126	127	128	129	130	131	132	133	134	135	136	137	138												
NOTES:	◎ DTO 664 ◎ DLS DEACT ◎ CGBA ◎ PILOT DTO 667 ◎ DSO 326 ◎ CPCG ◎ CLOSE LDCE 6 & 8 ◎ DLS DEACT ◎ DLS ACT																												

FD10	MET: 008	16	17	18	19	20	21	22	23	0	1	2	3	4	5	6	7	8	9	10	11	12	13	14	15	16			
	ORB	POST SLEEP	OFF DUTY (ALL)					CPCG	PSE	CREW CONF	//// SIMO	CPCG	PRE SLEEP	SLEEP											POST SLEEP	IMU			
	PL	POST SLEEP	USMP-2		MEAL	SAMPLE & ECT USMP-2						PRE SLEEP	SLEEP											POST SLEEP	IMU				
	DAY/NIGHT	[Day/Night Cycle]																											
	ORBIT	139	140	141	142	143	144	145	146	147	148	149	150	151	152	153	154												
NOTES:	◎ DTO 664 ◎ DTO 670 PCIS STOW ◎ DLS DEACT ◎ DLS ACT ◎ DSO 326																												

FD11	MET: 009	16	17	18	19	20	21	22	23	0	1	2	3	4	5	6	7	8	9	10	11	12	13	14	15	16			
	ORB	POST SLEEP	OMS 3	OMS 4	PSE H20	E1 ISG	SR KRL TL	MEAL	E2 ISG	SR KRL TL	CGBA	CT GR A M	IMU	PRE SLEEP	SLEEP											POST SLEEP	IMU		
	PL	POST SLEEP	CPCG	DEE	DEE	MEAL	DEE	DEE	DEE	DEE	SSBUV SOLAR VIEW	IMU	PRE SLEEP	SLEEP											POST SLEEP	IMU			
	DAY/NIGHT	[Day/Night Cycle]																											
	ORBIT	155	156	157	158	159	160	161	162	163	164	165	166	167	168	169	170												
NOTES:	▼ 163 x 140 ◎ DSO 326 * SSBUV CAL ◎ DTO 664 ◎ DLS DEACT ◎ DLS ACT ◎ DTO 664 ▼ 140 x 140 ○ PRE SLEEP																												

FD12	MET: 010	16	17	18	19	20	21	22	23	0	1	2	3	4	5	6	7	8	9	10	11	12	13	14	15	16			
	ORB	ECT-POST SLEEP	PSE	LBNP RAMP (MS2)	LBNP RAMP (PLT)	MEAL	EISG 3	EISG 4	CPCG	IMU	PRE SLEEP	SLEEP											POST SLEEP	IMU					
	PL	POST SLEEP	DEE	MEAL	DEE	DEE	DEE	SSBUV SOLAR VIEW	IMU	PRE SLEEP	SLEEP											POST SLEEP	IMU						
	DAY/NIGHT	[Day/Night Cycle]																											
	ORBIT	171	172	173	174	175	176	177	178	179	180	181	182	183	184	185	186												
NOTES:	◎ DTO 664 ◎ DSO 326 ◎ PILOT DTO 667 (PLT) ◎ DLS DEACT ◎ DLS ACT ◎ POST SLEEP ○ PRE SLEEP * SSBIV EARTH VIEW INIT																												

* = GROUND COMMANDED ACTIVITY
 //// = WASTE WATER DUMP
 ○ POST SLEEP
 ◎ DLS ACT
 ○ POST SLEEP

FD13	MET : 011	16	17	18	19	20	21	22	23	0	1	2	3	4	5	6	7	8	9	10	11	12	13	14	15	16		
	ORB	POST SLEEP	PSE	OMS 5	APCG PCAM DEACT	EISG 5	MEAL	CPG	CGBA	CPG	IMU	PRE SLEEP	SLEEP										POST SLEEP	IMU				
	PL	MCAL	CPG	DERE	PSE	H2O	DEE OPS	MEAL	DEE	RLT	IMU	PRE SLEEP	SLEEP										POST SLEEP	IMU				
	DAY/NIGHT	[Day/Night Cycle]																										
	ORBIT	187	188	189	190	191	192	193	194	195	196	197	198	199	200	201	202	203										
NOTES:	POST SLEEP 140 X 105 DSO 326 CLOSE LDCE 7 & 8 SSBV SOLAR VIEW DTO 664 OPEN LDCE 6 & 8 PILOT DTO 667 (CDR) DTO 664 DSO 611 CLOSE LDCE 6, OPEN 7 SSBV EARTH VIEW INIT POST SLEEP																											

FD14	MET : 012	16	17	18	19	20	21	22	23	0	1	2	3	4	5	6	7	8	9	10	11	12	13	14	15	16		
	ORB	POST SLEEP	FCS C/O	HRMS	PSE	EISG 6	APCG PCAM DEACT	APRCS	MEAL	EISG 7	SKRLT	CABIN STOW	IMU	PRE SLEEP	ECT SLEEP										POST SLEEP			
	PL	CPCG DEACT	LBNP SOAK (MS2)					CABIN STOW	IMU	PRE SLEEP	SLEEP										DSO 612	IMU						
	DAY/NIGHT	[Day/Night Cycle]																										
	ORBIT	203	204	205	206	207	208	209	210	211	212	213	214	215	216	217	218	219										
NOTES:	SSBV SOLAR VIEW SSBV DEACT APCG TES DEACT DTO 664 POST SLEEP SSBV CAL																											

FD15	MET : 013	16	17	18	19	20	21	22	23	0	1	2	3	4	5	6	7	8	9	10	11	12	13	14	15	16		
	ORB	POST SLEEP	DSO 603 PREP	DEORBIT PREP				DEORBIT	BU	KL																		
	PL	POST SLEEP	USMP OAST DEACT	DEORBIT PREP				BU	KL																			
	DAY/NIGHT	[Day/Night Cycle]																										
	ORBIT	220	221	222	223	224	225	226	227	228	229	230	231	232	233	234	235											
NOTES:	DTO 664 DTO 326 *13/23:06																											

	MET : 014	16	17	18	19	20	21	22	23	0	1	2	3	4	5	6	7	8	9	10	11	12	13	14	15	16		
	ORB																											
	PL																											
	DAY/NIGHT	[Day/Night Cycle]																										
	ORBIT	236	237	238	239	240	241	242	243	244	245	246	247	248	249	250	251											
NOTES:																												
	* = GROUND COMMANDED ACTIVITY [Hatched Box] = WASTE WATER DUMP																											

This Page Intentionally Blank

SUMMARY TIMELINE

SUMMARY TIMELINE

GMT (D:H:M)	MET (D:H:M)	CST (D:H:M)	FD/ DOY	BETA	MOON	HOUSTON DATE	FLIGHT	EDITION	PUB. DATE										
062:13:54/ 063:01:54	000:00:00/ 000:12:00	062:07:54/ 062:19:54	1/062 CST	-45.5		MARCH 3, 1994	STS-62	FINAL	01/28/94										
CST :062 FD :001 MET :000																			
	8	9	10	11	12	13	14	15	16	17	18	19	12						
CDR	PLBD MNV R	PLBD OPPS	IMU MNV R	-ZLV MNV R	AFT CNTLR	SAMS ATT	SAMS/OARS	-ZLV MNV R	MEAL	ACPN HIGRS	SAMS MNV R	-ZLV MNV R	SKIRT ROLL	IMU MNV R	AUTO MNV R	CON MNV R	-ZLV MNV R	SLEEP	
PLT	POST INSERTION		SCS MNV R	OCCAC SETUP	SRAC MNV R	SDAE MNV R	MEAL	OUMAS MNV R	SKIRT ASSIST	CPA OPS	PRE SLEEP		SLEEP						
MS1	POST INSERTION		AADS MNV R	APPC MNV R	MEAL	RMS MNV R	RMS C/O ASSIST	DEE MNV R	DEE MNV R	PRE SLEEP		SLEEP							
MS2	POST INSERTION		KUBD MNV R	P/TV11 MNV R	MEAL	APCG MNV R	TES ACT	DEE MNV R	DEE MNV R	PRE SLEEP		SLEEP							
MS3	POST INSERTION		P/TV10 MNV R	DEE MNV R	MEAL	RMS MNV R	RMS C/O	DEE MNV R	CGBA MNV R	PRE SLEEP		SLEEP							
DAY/NIGHT	ORBIT		TDRS		ATTITUDE		MEPHISTO		AADS		ZENO		IDGE		SAMS		OAST		
E W	ASC		-ZLV, +YVV		-ZLV, +YVV		-ZLV, +YVV		+XROT		-ZLV, +YVV		-ZLV, +YVV		-ZLV, +YVV		-ZLV, +YVV		
COLD OUTGASSING		WARM OUTGASSING		TEMP RAMP UP		ZENO ACTIVATION		MELT/FREEZE POINT		INIT TEMP SEARCH		SAMS 1 & 2		CRYOTP SHP COOLDWN		-ZLV, +YVV		-ZLV, +YVV	
NOTES:		* = GROUND COMMANDED ACTIVITY		* -ZLV, +YVV		* AADS INIT		* -ZLV, +YVV		* SKIRT ACT		* -ZLV, +YVV		* SKIRT MOON CAL		* SSBV OUTGAS INIT		* SKIRT SET 1	

GMT (D:H:M)	MET (D:H:M)	CST (D:H:M)	FD/ DOY	BETA	MOON	HOUSTON DATE	FLIGHT	EDITION	PUB. DATE
063:01:54/ 063:13:54	000:12:00/ 001:00:00	062:19:54/ 063:07:54	2 /062 CST	-44.9		MARCH 3, 1994	STS-62	FINAL	01/28/94
CST :062 20 FD :001 12 MET :000 12	21 13 22 14	23 15 0 16	CST:063 1 17	2 18 3 19	4 20 5 21	6 22 7 23	0 MET:001		

CDR	SLEEP								PG WR RP DB DN WN	EXERCISE	
PLT	SLEEP								P/TV02 SETUP FLTDK	DTG 670 ERG SETUP	
MS1	SLEEP								P ADM S E T U P	POST SLEEP	CPCG ACTIVATION
MS2	SLEEP								FAN & TEMP CHECKS	PSE DAILY OPS	P/TV03 SETUP MDDK
MS3	SLEEP								CGBA INIT		CPCG ASSIST

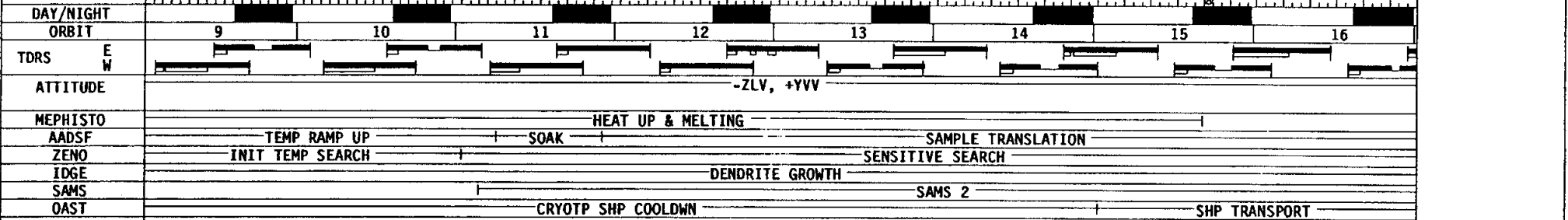

NOTES: * = GROUND COMMANDED ACTIVITY

*MEPH HOLD @GAP SETS 16-21
*SSBUV INSTRUMENT ACT
*SSBUV CAL INIT

GMT (D:H:M)	MET (D:H:M)	CST (D:H:M)	FD/ DOY	BETA	MOON 	HOUSTON DATE	FLIGHT	EDITION	PUB. DATE		
063:13:54 / 064:01:54	001:00:00 / 001:12:00	063:07:54 / 063:19:54	2/063 CST	-44.0		MARCH 4, 1994	STS-62	FINAL	01/28/94		
CST :063 FD :002 MET :001	8 9 10 11 12 13 14 15 16 17 18 19 12										
CDR		DSO 623 LBNP SETUP	MEAL	LP DRCE ACT	FILTER CLEANING	DSO 326	P/TV02 SETUP FLTK	PAO OPPTY	DTO 664	SLEEP	
PLT	DSO 623 LBNP SETUP	MEAL	LBNP ASSIST			LBNP PREP	LBNP RAMP (PLT)	E GRESS	CPCG ASSIST	PRE SLEEP	SLEEP
MS1	C A C T I V A T I O N	EXERCISE	MEAL	P/TV05 OPS CPCG	P/TV11 SETUP APCG	P/TV11 OPS APCG	P/TV05 SETUP CPCG	P/TV05 OPS CPCG		PRE SLEEP	SLEEP
MS2	DSO 623 LBNP SETUP	MEAL	LBNP PREP	LBNP RAMP (MS2)	E GRESS	LBNP ASSIST		LBNP TEMP STOW		PRE SLEEP	SLEEP
MS3	CPCG ASSIST	EXERCISE	MEAL	CPCG ASSIST	APCG PCAM ASSIST			A P C G C H E C K		PRE SLEEP	SLEEP
DAY/NIGHT		* * *									
ORBIT	17	18	19	20	21	22	23	24			
TDRS	E W										
ATTITUDE											
MEPHISTO											
AADSF											
ZENO											
IDGE											
SAMS	SAMS 2							SAMS 1 & 2			
OAST	SHP TRANSPORT							BETSU COOLDOWN			
NOTES:		*CAL TERM	*MEPH RESTART	*OPEN LDCE 7&8	*VIDEO BEFORE PCAM ACT	*VIDEO TOP VDA	*WINDOW IMPACT OBS	*CABIN TEMP SURVEY		* = GROUND COMMANDED AVTIVITY	

GMT (D:H:M)	MET (D:H:M)	CST (D:H:M)	FD/ DOY	BETA	MOON	HOUSTON DATE	FLIGHT	EDITION	PUB. DATE				
064:01:54/ 064:13:54	001:12:00/ 002:00:00	063:19:54/ 064:07:54	3 /063 CST	-43.0		MARCH 4, 1994	STS-62	FINAL	01/28/94				
CST :063 FD :002 MET :001	20 12	21 13	22 14	23 15	0 16	CST:064 17	2 18	3 19	4 20	5 21	6 22	7 23	0 MET:002
STS	SLEEP					PADM SETUP	FAN & TEMP CHECKS	DTO 664	METABOLIC STUDIES				
	POST SLEEP						P/TV05 SETUP	OPS CPCG	TESTS	P/TV07 SETUP	APE	P/TV07	OPS
	METABOLIC STUDIES						PSE DAILY OPS	PSE FILES	P/TV02 SETUP	FLTK	DSO 611	PAO	OPPTY
PL							P/TV09 SETUP	STA	STA SETUP	STA OPERATIONS			
DAY/NIGHT ORBIT													
CONTINGENCY COVERAGE	-IOS -HTS -GTS -GTS -GTS -GTS -MIL -BDA -NHS -IOS -DGS												
TDRS													
ATTITUDE	-ZLV, +YVV												
MEPHISTO	ZONE DETERMINATION												
AADF	SAMPLE TRANSLATION												
ZENO	T1 DATA COLLECT				T2 DATA COLLECT				T3 DATA COLLECT				
IDGE	DENDRITE GROWTH												
SAMS	SAMS 1 & 2												
OAST	BETSU COOLDOWN					BETSU PHASE 1							
NOTES:	@DSO 612 ENERGY UTILIZATION						@VIDEO TOP VDA			@DSO 492 PCB EVAL			
							@CABIN TEMP SURVEY			@MICROBIAL AIR SAMPLER			

GMT (D:H:M)		MET (D:H:M)		CST (D:H:M)		FD/ DOY	BETA	MOON	HOUSTON DATE	FLIGHT	EDITION	PUB. DATE		
064:13:54/ 065:01:54		002:00:00/ 002:12:00		064:07:54/ 064:19:54		3 /064 CST	-41.7		MARCH 5, 1994	STS-62	FINAL	01/28/94		
CST	:064	8	9	10	11	12	13	14	15	16	17	18	19	12
FD	:003	0	1	2	3	4	5	6	7	8	9	10	11	
MET	:002													
STS		STUDIOS METABOLIC	STUDIOS METABOLIC	MEAL	DSO 326			P/TV02 OPS FLTDK		DTO 664				SLEEP
			P/TV05 OPS CPCG		P/TV02 SETUP FLTDK			EXERCISE		PRE SLEEP				
PL		OPERATIONS STA						STA OPERATIONS		STA STOW				
DAY/NIGHT														
ORBIT														
CONTINGENCY COVERAGE														
TDRS														
ATTITUDE														
MEPHISTO														
AADF														
ZENO														
IDGE														
SAMS														
OAST														
NOTES:														

GMT (D:H:M)	MET (D:H:M)	CST (D:H:M)	FD/ DOY	BETA	MOON	HOUSTON DATE	FLIGHT	EDITION	PUB. DATE				
065:01:54/ 065:13:54	002:12:00/ 003:00:00	064:19:54/ 065:07:54	4 /064 CST	-40.3		MARCH 5, 1994	STS-62	FINAL	01/28/94				
CST :064 FD :003 MET :002	20 12	21 13	22 14	23 15	0 16	CST:065 17FD: 004	2 18	3 19	4 20	5 21	6 22	7 23	0 MET:003
STS	SLEEP												
	POST SLEEP												
	METABOLIC STUDIES												
	P/TV05 OPS CPG												
	P/TV07 SETUP APE												
	PSE DAILY OPS												
	PSF/EL TTT VUD OPK 2												
	P/O OPTTY												
PL	STA OPERATIONS												
	MST ADI BOLS												
	P/TV09 SETUP STA												
	STA SETUP												
	STA STOW												
DAY/NIGHT ORBIT	[Bar chart showing day/night cycle]												
CONTINGENCY COVERAGE	-IOS -HTS -GTS -GTS -GTS -GTS -BDA -MIL -BDA -NHS -IOS -DGS												
TDRS	[Bar chart showing TDRS activity]												
ATTITUDE	-ZLV, +YVV												
MEPHISTO	SEEBECK SPEED 3												
AADF	SEEBECK SPEED 2												
ZENO	T6 DATA COLLECT												
IDGE	SAMPLE TRANSLATION												
SAMS	T7 DATA COLLECT												
OAST	DENDRITE GROWTH												
	SAMS 1 & 2												
	BETSU PHASE 2												
NOTES:	@DSO 612 ENERGY UTILIZATION @VIDEO TOP VDA @WINDOW IMPACT OBS @CABIN TEMP SURVEY @DSO 492 PCBA EVAL												

GMT (D:H:M)		MET (D:H:M)		CST (D:H:M)		FD/ DOY	BETA	MOON	HOUSTON DATE	FLIGHT	EDITION	PUB. DATE		
065:13:54/ 066:01:54		003:00:00/ 003:12:00		065:07:54/ 065:19:54		4 /065 CST	-38.8		MARCH 6, 1994	STS-62	FINAL	01/28/94		
CST	:065	8	9	10	11	12	13	14	15	16	17	18	19	12
FD	:004	0	1	2	3	4	5	6	7	8	9	10	11	
MET	:003													
STS	MEAL				WASTE INIT		WASTE TERM	DTG 664	IMU	PCORNFV			SLEEP	
			P/TV05 OPS CPCG		EXERCISE				PRE SLEEP					
				MS1	MS3									
				CDR										
			P/TV07 OPS APE	MTAEMP	P/TV13 OPS EISG	DCILSA	APCG CHECK	P/TV05 OPS CPCG		PADRE				
PL				OFF DUTY (PLT, MS2)										
DAY/NIGHT				*	*		*	*						
ORBIT		49	50	51	52	53	54	55	56					
CONTINGENCY COVERAGE		-VTS -GDS -CTS -MIL -NHS -BDA	-VTS -GDS -CTS -MIL -NHS -BDA	-VTS -GDS -CTS -MIL -NHS -BDA	-HTS -VTS -GDS -CTS -MIL -BDA	-VTS -GDS -CTS -MIL	-GTS -VTS -GDS -CTS -MIL	-DGS -GTS -HTS	-IOS -DGS -HTS					
TDRS	E W													
ATTITUDE														
MEPHISTO		SEEBECK SPEED 2								SEEBECK SPEED 1				
AADSF														
ZENO		T7 DATA COLLECT												
IDGE														
SAMS		SAMS 1 & 2		SAMS 2						SAMS 1 & 2				
OAST		BETSU PHASE 2								CRYOTP SHP COOLDWN				
NOTES:		@VIDEO TOP VDA *MEPH HOLD	*MDA CLOSE		@VIDEO TOP VDA	@CABIN TEMP SURVEY	*MEPH RESTART	*MDA OPEN		@PGSC UPSET MONITORING				

GMT (D:H:M)	MET (D:H:M)	CST (D:H:M)	FD/ DOY	BETA	MOON	HOUSTON DATE	FLIGHT	EDITION	PUB. DATE
066:01:54/ 066:13:54	003:12:00/ 004:00:00	065:19:54/ 066:07:54	5 /065 CST	-37.1		MARCH 6, 1994	STS-62	FINAL	01/28/94
CST :065 FD :004 MET :003	20 21 22 23	0 1 2 3 4 5 6 7	CST:066 FD: 005 17	18 19 20 21 22 23	0				MET:004
STS	SLEEP		POST SLEEP		OFF DUTY (CDR, MS1, MS3)			MEAL	
			METABOLIC STUDIES				P/TV09 SETUP STA		
PL			LBNP PREP	LBNP RAMP (MS2)	LBNP PREP	LBNP RAMP (PLT)	LBNP TEMP STOW		
DAY/NIGHT ORBIT	57 58 59 60 61 62 63 64						*		
CONTINGENCY COVERAGE	-GTS		-GTS	-BDA	-DGS	-MIL -BDA -NHS	-IOS -DGS	-CTS -MIL -NHS -BDA	-IOS
TDRS	E W								
ATTITUDE			-ZLV, +YVV						
MEPHISTO			SEEBECK SPEED 1						
AADF			SAMPLE TRANSLATION						
ZENO			SENSITIVE VERIF						
IDGE			DENDRITE GROWTH						
SAMS			SAMS 1 & 2						
OAST	CRYOTP SHP COOLDWN		SHP TRANSPORT		BETSU COOLDOWN				
NOTES:			0DSO 612/492 ENERGY UTIL & PCBA BLOOD TEST					*MEPH HOLD	

* = GROUND COMMANDED ACTIVITY

GMT (D:H:M)	MET (D:H:M)	CST (D:H:M)	FD/ DOY	BETA	MOON	HOUSTON DATE	FLIGHT	EDITION	PUB. DATE
066:13:54/ 067:01:54	004:00:00/ 004:12:00	066:07:54/ 066:19:54	5/066 CST	-35.3		MARCH 7, 1994	STS-62	FINAL	01/28/94
CST :066 FD :005 MET :004									
STS	P/TV02 SETUP FLTK	PAO OPPTY	DSO 326	DTG 664	PRONF		SLEEP		
	P/TV05 OPS CPG		EXERCISE		PRE SLEEP				
			MS1 PLT MS2 MS3						
	PSE DAILY OPS	P/TV06 OPS CGBA	GBA END	P/TV05 OPS CPG	P/TV06 OPS CPG				
PL	STA SETUP	STA OPERATIONS	STA STOW	FAN & TEMP CHECKS					
DAY/NIGHT									
ORBIT	65	66	67	68	69	70	71	72	
CONTINGENCY COVERAGE	-VTS -GDS -CTS -MIL -NHS -BDA	-VTS -GDS -CTS -MIL -NHS -BDA	-VTS -GDS -CTS -MIL -NHS -BDA	-HTS -VTS -GDS -CTS -MIL	-GDS -CTS	-DGS -HTS -VTS	-IOS	-HTS	
TORS									
ATTITUDE					-ZLV, +YVV				
MEPHISTO	SPEED 6			SEEBECK SPEED 5		SEEBECK SPEED 4		SEEBECK SPEED 3	
AADF				SAMPLE TRANSLATION					
ZENO		SENSITIVE VERIF				T1 DATA COLLECT		T2 DATA COLLECT	
IDGE				DENDRITE GROWTH					
SAMS	SAMS 1 & 2	SAMS 2				SAMS 1 & 2			
OAST			BETSU COOLDOWN					BETSU PHASE 3	
NOTES:	*MEPH RESTART @VIDEO TOP VDA *MEPH HOLD	@WINDOW IMPACT OBS @GAP SET 1 @GAP SET 2	*MEPH RESTART	@PGSC UPSET MONITORING					* = GROUND COMMANDED ACTIVITY

GMT (D:H:M)	MET (D:H:M)	CST (D:H:M)	FD/ DOY	BETA	MOON	HOUSTON DATE	FLIGHT	EDITION	PUB. DATE						
067:01:54/ 067:13:54	004:12:00/ 005:00:00	066:19:54/ 067:07:54	6 /066 CST	-33.4		MARCH 7, 1994	STS-62	FINAL	01/28/94						
CST :066 FD :005 MET :004	20 12	21 13	22 14	23 15	FD: 006	16	17	18	19	20	21	22	23	0	MET:005
STS	SLEEP														
	POST SLEEP														
PL															
DAY/NIGHT	ORBIT														
CONTINGENCY COVERAGE	-GTS														
TDRS	E W														
ATTITUDE	-ZLV, +YVV														
MEPHISTO	SEEBECK SPEED 3														
AADF	SEEBECK SPEED 2														
ZENO	SAMPLE TRANSLATION														
IDGE	T2 DATA COLLECT														
SAMS	T3 DATA COLLECT														
OAST	T4 DATA COLLECT														
	DENDRITE GROWTH														
	SAMS 1 & 2														
	BETSU PHASE 3														
NOTES:	@DSO 612 ENERGY UTILIZATION @VIDEO TOP VDA @VIDEO TOP VDA @WINDOW IMPACT OBS @CABIN TEMP SURVEY ° RAD OUT NRM/NO FES *MEPH HOLD														
	* - GROUND COMMANDED ACTIVITY														

GMT (D:H:M)	MET (D:H:M)	CST (D:H:M)	FD/ DOY	BETA	MOON	HOUSTON DATE	FLIGHT	EDITION	PUB. DATE				
067:13:54/ 068:01:54	005:00:00/ 005:12:00	067:07:54/ 067:19:54	6/067 CST	-31.4		MARCH 8, 1994	STS-62	FINAL	01/28/94				
CST :067 FD :006 MET :005	8	9	10	11	12	13	14	15	16	17	18	19	12
STS	RAD OUT HI		DTG 664	IMU	CPC ORNIN FVF P R I V M E D F A M	SLEEP							
EXERCISE		PRE SLEEP											
MS1 CDR MS3 PLT MS2													
P/TV13 OPS EISG	P/TV13 OPS EISG	P/TV05 OPS CPCG	P A D D O S T U B										
PL	STA OPERATIONS		STA STOW	A P C G C H E C K									
DAY/NIGHT	ORBIT												
ORBIT	80	81	82	83	84	85	86	87	88				
CONTINGENCY COVERAGE	-HTS -VTS -GDS -CTS -MIL -NHS -BDA		-HTS -VTS -GDS -CTS -MIL -NHS -BDA		-GTS NHS -HTS -VTS -GDS -CTS -MIL -BDA		-GTS -HTS -VTS -GDS -CTS -MIL		-DGS -GTS -HTS -VTS -GDS		-IOS -DGS -HTS		-HTS
TDRS	E W												
ATTITUDE	-ZLV, +YVV												
MEPHISTO	SEEBECK SPEED 1												
AADSF	SAMPLE TRANSLATION												
ZENO	T5 DATA COLLECT				T6 DATA COLLECT				T7 DATA COLLECT				
IDGE	DENDRITE GROWTH												
SAMS	SAMS 2						SAMS 1 & 2						
OAST	BETSU PHASE 3						BETSU PHASE 4						
NOTES:	@VIDEO TOP VDA @CABIN TEMP SURVEY *MEPH RESTART o RAD OUT NORM W/FES @PGSC UPSET MONITORING * = GROUND COMMANDED ACTIVITY												

GMT (D:H:M)	MET (D:H:M)	CST (D:H:M)	FD/ DOY	BETA	MOON	HOUSTON DATE	FLIGHT	EDITION	PUB. DATE									
068:01:54/ 068:13:54	005:12:00/ 006:00:00	067:19:54/ 068:07:54	7/067 CST	-29.3		MARCH 8, 1994	STS-62	FINAL	01/28/94									
CST :067 FD :006 MET :005	20 12	21 13	22 14	23 15	0 16	CST:068 17	18	19	20	21	22	23	0 MET:006					
STS	SLEEP					FAN & TEMP CHECKS	DTG 664			DSO 326								
			POST SLEEP			P/TV05 OPS CPCG		P/TV07 SETUP APE	P/TV07 OPS APE	P/TV05 SETUP CPCG	P/TV05 OPS CPCG	MEAL	P/TV07 OPS APE					
		METABOLIC STUDIES				PSE DAILY OPS	P/TV06 SETUP CGBA	P/TV06 OPS CGBA			P/TV13 OPS EISG		P/TV03 SETUP MDDK	PAO OP PTY				
PL						P/TV09 SETUP STA	STA SETUP	STA OPERATIONS					STA OPERATIONS					
DAY/NIGHT ORBIT	88	89	90	91	92	93	94	95	96									
CONTINGENCY COVERAGE		-GTS		-GTS			-BDA	-DGS		-MIL	-IOS	-DGS	-IOS	-DGS				
TDRS										-MIL	-BDA	-NHS	-MIL	-BDA	-NHS	-MIL	-BDA	-NHS
ATTITUDE																		
MEPHISTO																		
AADF																		
ZENO																		
IDGE																		
SAMS																		
OAST																		
NOTES:																		

* - GROUND COMMANDED ACTIVITY

@DSO 612/492 ENERGY UTIL
& PCBA BLOOD TEST

@VIDEO TOP VDA
@CABIN TEMP SURVEY

@WINDOW IMPACT OBS
@VIDEO TOP VDA

*MEPH RESTART
*MEPH HOLD

o RAD OUT NRM/NO FES *MEPH HOLD

GMT (D:H:M)	MET (D:H:M)	CST (D:H:M)	FD/ DOY	BETA	MOON	HOUSTON DATE	FLIGHT	EDITION	PUB. DATE
068:13:54/ 069:01:54	006:00:00/ 006:12:00	068:07:54/ 068:19:54	7/068 CST	-27.1		MARCH 9, 1994	STS-62	FINAL	01/28/94
CST :068 FD :007 MET :006									
STS	WASTE INIT DUMP	WASTE TERM DUMP	DTG 664		CONF PRIV MED		SLEEP		
	EXERCISE MS3 MS1 CDR			PRE SLEEP					
	P/TV13 OPS EISG	P/TV13 OPS EISG	APCG CHECK	P/TV05 OPS CPCG					
PL	STA OPERATIONS	STA STOW	P/TV05 DLS SETUP	DLS ACT	DLS DEACT				
DAY/NIGHT	*			**					
ORBIT	96	97	98	99	100	101	102	103	104
CONTINGENCY COVERAGE	-HTS -VTS -GDS -CTS -MIL -NHS -BDA	-HTS -VTS -GDS -CTS -MIL -NHS -BDA	-GTS -HTS -VTS -GDS -CTS -MIL -BDA	-GTS -VTS -GDS -CTS -MIL	-VTS -GDS -CTS -MIL	-IOS -DGS	-HTS	-IOS	-HTS
TDRS	E W								
ATTITUDE	-ZLV, +YVV								
MEPHISTO	SEEBECK SPEED 5			SEEBECK SPEED 4			SEEBECK SPEED 3		
AADF	SAMPLE TRANSLATION								
ZENO	INIT SEARCH VERIF			SENSITIVE VERIF					
IDGE	DENDRITE GROWTH								
SAMS	SAMS 2			SAMS 1 & 2					
OAST	CRYOTP SHP COOLDWN								
NOTES:	*NDA CLOSE oVIDEO TOP VDA oCABIN TEMP SURVEY *NDA OPEN *MEPH RESTART o RAD OUT NORM W/FES * = GROUND COMMANDED ACTIVITY								

GMT (D:H:M)	MET (D:H:M)	CST (D:H:M)	FD/ DOY	BETA	MOON	HOUSTON DATE	FLIGHT	EDITION	PUB. DATE				
069:01:54/ 069:13:54	006:12:00/ 007:00:00	068:19:54/ 069:07:54	8/068 CST	-24.8		MARCH 9, 1994	STS-62	FINAL	01/28/94				
CST :068 FD :007 MET :006	20 12	21 13	22 14 FD: 008	23 15	0 16	CST:069 17	2 18	3 19	4 20	5 21	6 22	7 23	0 MET:007
STS	SLEEP												
PL	140 HR OF AADSF SAMPLE TRANSLATION COMPLETE												
DAY/NIGHT													
ORBIT	104	105	106	107	108	109	110	111	112				
CONTINGENCY COVERAGE		-GTS	-GTS				-NHS	-IOS	-BDA	-IOS		-NHS	
TDRS													
ATTITUDE													
MEPHISTO													
AADSF													
ZENO													
IDGE													
SAMS													
OAST													
NOTES:													

* = GROUND COMMANDED ACTIVITY

GMT (D:H:M)	MET (D:H:M)	CST (D:H:M)	FD/ DOY	BETA	MOON	HOUSTON DATE	FLIGHT	EDITION	PUB. DATE
069:13:54 / 070:01:54	007:00:00 / 007:12:00	069:07:54 / 069:19:54	8 / 069 CST	-22.5		MARCH 10, 1994	STS-62	FINAL	01/28/94
CST :069 FD :008 MET :007									
STS	RAD STOW	HC UO MN F ST EG P-B	DTG 664	A PC G CHECK	PR IV V MED	CPC ORNIN FVF		SLEEP	
	EXERCISE			PRE SLEEP					
	MS1 MS3 CDR MS2 PLT								
	MT AE TM P C LD AN LK	DC EL SA A BD LN EL K	P / TV07 OPS APE	P / TV05 OPS CPCG					
PL	STA OPERATIONS	STA STOW	P / TV09 DLS	DLS ACT	DLS DLS ACT				
DAY/NIGHT									
ORBIT	112	113	114	115	116	117	118	119	120
CONTINGENCY COVERAGE	-HTS -VTS -GDS -CTS -MIL -NHS -BDA	GTS -HTS -VTS -GDS -CTS -MIL -NHS	-BDA -HTS -VTS -GDS -CTS -MIL -NHS	-GTS -HTS -VTS -GDS -CTS -MIL	-DGS -GTS -HTS -VTS -GDS -CTS	-HTS -HTS -VTS -GDS -CTS	-IOS -DGS -HTS	-IOS -HTS	-GTS
TDRS	E W								
ATTITUDE					-XLV, -ZVV				
MEPHISTO			SEEBECK SPEED 5		SEEBECK SPEED 4		SEEBECK SPEED 3		
AASDF					EXTRA TRANSLATION				
ZENO					ADDITIONAL DATA				
IDGE					DENDRITE GROWTH				
SAMS		SAMS 2					SAMS 1		
OAST					SAMPIE & ECT				
NOTES:			@CABIN TEMP SURVEY @VIDEO TOP VDA *MEPH RESTART						
								* = GROUND COMMANDED ACTIVITY	

GMT (D:H:M)	MET (D:H:M)	CST (D:H:M)	FD/ DOY	BETA	MOON	HOUSTON DATE	FLIGHT	EDITION	PUB. DATE					
070:01:54/ 070:13:54	007:12:00/ 008:00:00	069:19:54/ 070:07:54	9 /069 CST	-20.1		MARCH 10, 1994	STS-62	FINAL	01/28/94					
CST :069 20	21	22	23	0	1	2	3	4	5	6	7	0	MET:008	
FD :008 12	13	14	15	16	17	18	19	20	21	22	23			
MET :007														
STS	SLEEP			PADM SETUP	FAN & TEMP CHECKS	DTG 664	PILOT DTG 667		DSO 326	MEAL				
		POST SLEEP			P/TVO5 OPS CPCG	P/TVO7 SETUP APE	P/TVO7 OPS APE		P/TV13 OPS EISG			P/TVO7 OPS APE		
					PSE DAILY OPS	PRE FILLS	P/TVO6 SETUP CGBA	P/TVO6 OPS CGBA	GBA END	GBA BEGIN		P/TVO5 OPS CPCG	P/TVO3 SETUP MDDK	PAO OPPTY
PL			DLS ACT		P/TVO9 SETUP STA	STA SETUP	STA OPERATIONS						STA OPERATIONS	
DAY/NIGHT ORBIT	120	121	122	123	124	125	126	127	128					
CONTINGENCY COVERAGE		-GTS	-GTS		-BDA		-MIL -BDA -NHS	-IOS -DGS	-CTS -MIL -NHS -BDA	-IOS		-GDS -CTS -MIL -NHS	-HTS -VTS	
TDRS E W														
ATTITUDE					-XLV, -ZVV									
MEPHISTO					SEEBECK SPEED 2									
AADF					EXTRA TRANSLATION									
ZENO					ADDITIONAL DATA									
IDG					DENDRITE GROWTH									
SAMS					SAMS 1									
OAST					SAMPIE & ECT									
NOTES:					@VIDEO TOP VDA	@CABIN TEMP SURVEY	@GAP SET 2	@GAP SET 3	*MEPH HOLD	@VIDEO TOP VDA	@WINDOW IMPACT OBS	@RAD OUT NRM/NO FES		
					* = GROUND COMMANDED ACTIVITY									

GMT (D:H:M)		MET (D:H:M)		CST (D:H:M)		FD/ DOY	BETA	MOON	HOUSTON DATE	FLIGHT	EDITION	PUB. DATE						
070:13:54 / 071:01:54		008:00:00 / 008:12:00		070:07:54 / 070:19:54		9/070 CST	-17.7		MARCH 11, 1994	STS-62	FINAL	01/28/94						
CST	:070	8	9	10	11	12	13	14	15	16	17	18	19	12				
FD	:009																	
MET	:008	0	1	2	3	4	5	6	7	8	9	10	11					
STS		LDCE 668 +ZVV MNVVR DAR DAR			DTG 664	IMU	PRNF MFD				SLEEP							
		EXERCISE			PRE SLEEP													
		MS1	MS3	MS2														
		P/TV07 OPS APE			P/TV05 OPS CPCG													
PL		STA OPERATIONS	STA STOW	P/TV09 DLS	DLS ACT	A P C G C H E C K		D I S D E A C T										
DAY/NIGHT		DAY		NIGHT		DAY		NIGHT		DAY		NIGHT		DAY				
ORBIT		128	129	130	131	132	133	134	135	136								
CONTINGENCY COVERAGE		-HTS -VTS -GDS -CTS -MIL -NHS -BDA	--GTS -HTS -VTS -GDS -CTS -MIL -BDA	--GTS -HTS -VTS -GDS -CTS -MIL -BDA	-GTS -VTS -GDS -CTS -MIL	-HTS -VTS -GDS	-IOS -DGS	-HTS	-IOS						-GTS			
TDRS	E W	E		W		E		W		E		W		E				
ATTITUDE		-XLV, +ZVV																
MEPHISTO		SEEBECK SPEED 1																
AADSF		EXTRA TRANSLATION																
ZENO		ADDITIONAL DATA							T1 DATA COLLECT					T2 DATA COLLECT				
IDGE		DENDRITE GROWTH																
SAMS		SAMS 1																
OAST		SAMPLE & ECT																
NOTES:		◎CLOSE LDCE 6&8 ◎WINDOW EFFECTS ◎-XLV, +ZVV				◎CABIN TEMP SURVEY ◎VIDEO TOP VDA ◎MEPH RESTART				◎ RAD OUT NORM W/FES								

* - GROUND COMMANDED ACTIVITY

GMT (D:H:M)		MET (D:H:M)		CST (D:H:M)		FD/ DOY	BETA	MOON	HOUSTON DATE	FLIGHT	EDITION	PUB. DATE				
071:01:54/ 071:13:54		008:12:00/ 009:00:00		070:19:54/ 071:07:54		10/070 CST	-15.2	●	MARCH 11, 1994	STS-62	FINAL	01/28/94				
CST	:070	20	21	22	23	0	CST:071	1	2	3	4	5	6	7	0	MET:009
FD	:009	12	13	FD: 010	14	15	16	17	18	19	20	21	22	23		
MET	:008															
STS	SLEEP								MEAL	FAN & TEMP CHECKS		CREW CONF	DSC 326			
	POST SLEEP						OFF DUTY (ALL)			P/TV05 OPS CPG		P/TV08 SETUP CONF	P/TV08 OPS CONF	PCIS STOW		
			PADM SETUP							P/TV03 SETUP MDDK		P/TV03 OPS MDDK	P/TV03 MDDK			
PL			DLS ACT									PSE DAILY OPS				
DAY/NIGHT ORBIT	136		137		138		139		140		141		142		143	
CONTINGENCY COVERAGE	-GTS						-BDA		-DGS		-DGS		-CTS -MIL -NHS -BDA		-VTS -GDS -CTS -MIL -NHS -BDA	
TDRS	E		M													
ATTITUDE							-XLV, +ZVV									
MEPHISTO							SEEBECK SPEED 1						PELTIER SPEED 5			
AASDF							EXTRA TRANSLATION									
ZENO	T2 DATA COLLECT				T3 DATA COLLECT						T4 DATA COLLECT					
IDGE							DENDRITE GROWTH									
SAMS							SAMS 1									
OAST							SAMPLE & ECT									
NOTES:													@CABIN TEMP SURVEY @VIDEO TOP VDA *MEPH HOLD *MEPH RESTART *MEPH HOLD		@HARDMOUNT ERG ON MIDDEC @WINDOW IMPACT OBS	
							* = GROUND COMMANDED ACTIVITY									

GMT (D:H:M)	MET (D:H:M)	CST (D:H:M)	FD/ DOY	BETA	MOON	HOUSTON DATE	FLIGHT	EDITION	PUB. DATE	
071:13:54/ 072:01:54	009:00:00/ 009:12:00	071:07:54/ 071:19:54	10/071 CST	-12.8	●	MARCH 12, 1994	STS-62	FINAL	01/28/94	
CST :071										
FD :010										
MET :009										
STS	SDUMP INIT FILTER CLEANING	SDUMP OPS TO EFF	NO A ONLY	DTG 664	PCRO NIN FVF PRIV MED FAM			SLEEP		
	EXERCISE MS1 MS3 CDR MS2 PLT			PADM SETUP				PRE SLEEP		
		P/TV13 OPS EISG		P/TV05 OPS CPCG						
PL				DLS CHNGE DISK	DLS DEACT					
DAY/NIGHT	[Day/Night Cycle: Day (0-12), Night (12-24)]									
ORBIT	144	145	146	147	148	149	150	151	152	
CONTINGENCY COVERAGE	-HTS -VTS -GDS -CTS -MIL -NHS -BDA		-GTS -HTS -VTS -GDS -CTS -MIL		-VTS -GDS -CTS		-DGS -HTS -VTS	-HTS -IOS	-HTS -GTS	-GTS
TDRS	[TDRS Schedule: E (Evening), W (Morning)]									
ATTITUDE	-XLV, +ZVV									
MEPHISTO	PELTIER SPEED 3			PELTIER SPEED 2			PELTIER SPEED 1			
AADF	T5 DATA COLLECT			EXTRA TRANSLATION			T7 DATA COLLECT			
ZENO				T6 DATA COLLECT						
IDGE				DENDRITE GROWTH						
SAMS							SAMS 1			
OAST				SAMPLE & ECT						
NOTES:	@VIDEO TOP VDA @CABIN TEMP SURVEY *MEPH RESTART * = GROUND COMMANDED ACTIVITY									

GMT (D:H:M)	MET (D:H:M)	CST (D:H:M)	FD/ DOY	BETA	MOON	HOUSTON DATE	FLIGHT	EDITION	PUB. DATE
072:01:54/ 072:13:54	009:12:00/ 010:00:00	071:19:54/ 072:07:54	11/071 CST	-10.3	●	MARCH 12, 1994	STS-62	FINAL	01/28/94

CST :071 20	21	22	23	0	1	2	3	4	5	6	7	0
FD :010 12	13	14	15	16	17	18	19	20	21	22	23	0
MET :009		FD: 011										MET:010

Role	20	21	22	23	0	1	2	3	4	5	6	7	0						
CDR	SLEEP					OVS-3 OVS BURN	OVS-4 OVS BURN	-ZLV MNV	AUTO MNV	S326 MNV	MEAL	SKIRT ROLL	AUTO MNV	-XLV MNV	EISG ROLL MNV				
PLT	SLEEP		POST SLEEP			SC SAMS 1	SC SAMS 1	SR AC SR 10N	SD AE MA SC 664		EXERCISE				EISG ASSIST				
MS1	SLEEP		POST SLEEP			P/TV05 OPS CPCG					EXERCISE	P/TV13 SETUP EISG	P/TV13 OPS EISG #1		MEAL	DEE OPS ASSIST	P/TV13 EISG	P/TV13 OPS EISG #2	DEE OPERATIONS
MS2	SLEEP		POST SLEEP	DLS ACT	POST SLEEP		EXERCISE	PSE DAILY OPS	PSE FILES		DEE OPS ASSIST			MEAL	DEE OPS ASSIST	DEE OPERATIONS			DEE OPERATIONS
MS3	SLEEP		POST SLEEP			CPCG ASSIST	MT AER TEMP PS CHECKS & TEMP	P/TV10 SETUP DEE	RMS PWRUP		DEE OPERATIONS			MEAL	DEE OPERATIONS	EXERCISE			P/TV06 SETUP CGBA

DAY/NIGHT	[Shaded]											
ORBIT	152	153	154	155	156	157	158	159	160			

TDRS	[Shaded]																																
ATTITUDE	-XLV, +ZVV			IMU			OVS			-ZLV, +YVV			-XLV, -ZVV			BIAS +XSI			+XROT			-XLV			BIAS +YVV			BIAS +XSI			+XROT		

MEPHISTO	PELTIER SPEED 4											
AADF	EXTRA TRANSLATION											
ZENO	T7 DATA COLLECT											
IDGE	DENDRITE GROWTH											
SAMS	SAMS 1				SAMS 1				SAMS 1			
OAST	SAMPLE & ECT											

NOTES:

- *QUENCH
- ZLV, +YVV
- 160X140
- VIDEO TOP VDA
- 140X140
- ZLV, +YVV
- RMS HTR ACT
- CABIN TEMP SURVEY
- COLD PLATE
- WINDOW IMPACT OBS
- XLV, -ZVV
- XLV, +YVV
- COLD PLATE
- BIAS -XLV, +YVV

GMT (D:H:M)		MET (D:H:M)		CST (D:H:M)		FD/ DOY	BETA	MOON	HOUSTON DATE	FLIGHT	EDITION	PUB. DATE			
072:13:54/ 073:01:54		010:00:00/ 010:12:00		072:07:54/ 072:19:54		11/072 CST	-7.7	●	MARCH 13, 1994	STS-62	FINAL	01/28/94			
CST	:072	8	9	10	11	12	13	14	15	16	17	18	19	12	
FD	:011	0	1	2	3	4	5	6	7	8	9	10	11		
MET	:010														
CDR		-XLV MNVR	SKIRT ROLL	EXERCISE		-ZSI MNVR	PAO OPPTY	IMU MNVR	+ZLV MNVR	SPLY MNVR	DUP INIT	DRIV INFD	COM	SPLY TERM	SLEEP
PLT			SKIRT ASSIST	-ZLV MNVR		DTG 664	A PCG C HECK	PRE SLEEP						SLEEP	
MS1		OPERATIONS	P/TV13 OPS SKIRT	OPERATIONS	DESIST OPS	EXTEND PARK	P/TV05 OPS CPCG	PRE SLEEP	RMS PWRDN	PRE SLEEP				SLEEP	
MS2		DESIST OPS		DEE OPS ASSIST	OPERATIONS	DLS CHNGE DISK	CPCG ASSIST	PRE SLEEP		DLS DEACT	PRE SLEEP			SLEEP	
MS3		P/TV13 SETUP EISG	P/TV10 DEE	P/TV06 OPS CGBA		P/TV05 CPCG	CGBA TERM	PRE SLEEP				SLEEP			
DAY/NIGHT		ORBIT		160	161	162	163	164	165	166	167	168			
TDRS	E W	[Timeline bars for TDRS events]													
ATTITUDE		+XROT	-ZLV, +YVV			-ZSI	IMU	BIAS +ZLV, -YVV							
MEPHISTO		H													
AADF		EXTRA TRANSLATION													
ZENO		ADDITIONAL DATA													
IDGE															
SAMS		SAMS 1													
OAST		ECT													
NOTES:		* -XLV, +YVV *SSBUV CAL TERM *SSBUV SOLAR VIEW TERM *SSBUV CAL INIT *CABIN TEMP SURVEY *BIAS +ZLV, +YVV * -ZLV, +YVV *GAP SETS 10-15 *SSBUV SOLAR VIEW INIT													

* = GROUND COMMANDED ACTIVITY

GMT (D:H:M)	MET (D:H:M)	CST (D:H:M)	FD/ DOY	BETA	MOON	HOUSTON DATE	FLIGHT	EDITION	PUB. DATE					
073:01:54/ 073:13:54	010:12:00/ 011:00:00	072:19:54/ 073:07:54	12/072 CST	-5.2	●	MARCH 13, 1994	STS-62	FINAL	01/28/94					
CST :072 20	21	22	23	0	CST:073	1	2	3	4	5	6	7	0	MET:011
FD :011 12	13	14	FD: 012 15	16	17	18	19	20	21	22	23			
MET :010														
CDR	SLEEP			IMU MNV R	ZLV MNV R	DSO 324 PRCS FIRE	CC HO AN NF GL EG DD AA PP	DSO 326	PAO OP PTY		MEAL	EXERCISE		
PLT	SLEEP		POST SLEEP			DTO 664		LBNP PREP	LBNP RAMP (PLT)	URGENT	CPCG ASSIST	MEAL	LBNP TEMP STOW	AUTO MNV R
MS1	SLEEP		POST SLEEP	PADM SETUP	POST SLEEP	FAN & TEMP CHECKS	RMS ASSIST	OPERATIONS			OPERATIONS	MEAL		P/TV13 SETUP EISG
MS2	SLEEP	POST SLEEP	DLS ACT	POST SLEEP	PSE DAILY OPS	LBNP PREP	LBNP RAMP (MS2)	URGENT		LBNP ASSIST	DEE OPS ASSIST	MEAL		DEE OPS ASSIST
MS3	SLEEP		POST SLEEP		POST SLEEP	P/TV10 SETUP DEE	RMS PWRUP			DEE OPS ASSIST	DEE OPERATIONS	MEAL		DEE OPERATIONS
DAY/NIGHT	[Day/Night Cycle]													
ORBIT	168	169	170	171	172	173	174	175	176					
TDRS	[TDRS Schedule]													
ATTITUDE	BIAS +ZLV, -YVV IMU -ZLV, +YVV BIAS +XSI													
MEPHISTO	[MEPHISTO Schedule]													
AADSF	EXTRA TRANSLATION FURNACE COOLDOWN													
ZENO	[ZENO Schedule]													
IDGE	[IDGE Schedule]													
SAMS	SAMS 1													
OAST	ECT													
NOTES:	* = GROUND COMMANDED ACTIVITY @-ZLV, +YVV @LOW FREQUENCY ENVIRONMENT @VIDEO TOP VDA *SSBUV CAL TERM @RMS HTR ACT @WINDOW IMPACT OBS *SSBUV CAL INIT @COLD PLATE @CABIN TEMP SURVEY													

GMT (D:H:M)	MET (D:H:M)	CST (D:H:M)	FD/ DOY	BETA	MOON	HOUSTON DATE	FLIGHT	EDITION	PUB. DATE				
073:13:54 / 074:01:54	011:00:00 / 011:12:00	073:07:54 / 073:19:54	12/073 CST	-2.6	●	MARCH 14, 1994	STS-62	FINAL	01/28/94				
CST :073 FD :012 MET :011	8	9	10	11	12	13	14	15	16	17	18	19	12
CDR	-ZVV MNV R	AUTO MNV R	-ZVV MNV R	INSI MNV R	IMU MNV R	-ZLV MNV R	CPC ORNI FVF PRIV MED FAM						SLEEP
PLT		EXERCISE		PILOT DTO 667		PRE SLEEP							SLEEP
MS1		P/TV13 OPS EISG #3	OPERATIONS EXTEND PRK		EXERCISE		PRE SLEEP						SLEEP
MS2	DESIST OPS	DEE OPS ASSIST		EXERCISE	DLS CHNGE DISK	PRE SLEEP	DLS DEACT	PRE SLEEP					SLEEP
MS3	OPERATIONS	EXERCISE	P/TV13 EISG	P/TV13 OPS EISG #4	APCG CHECK			PRE SLEEP					SLEEP
DAY/NIGHT	[Bar chart showing day/night cycles]												
ORBIT	176	177	178	179	180	181	182	183	184				
TDRS	[Bar chart showing TDRS activity]												
ATTITUDE	-XLV, -ZVV BIAS +XSI	-XLV, -ZVV	-ZSI	IMU									-ZLV, +YVV
MEPHISTO													
AADF	FURNACE COOLDOWN												
ZENO	ADDITIONAL DATA				T1 DATA COLLECT				T2 DATA COLLECT				+STOW +* +
IDGE													
SAMS	SAMS 1												
OAST	ADDITIONAL EISG												
NOTES:	@-XLV, -ZVV @COLD PLATE *SSBUV VIEW INIT @-ZLV, +YVV *VERIFY STATUS & RESET SCCS RELAYS @-XLV, -ZVV *SSBUV SOLAR VIEW TERM *SSBUV EARTH VIEW INIT * = GROUND COMMANDED ACTIVITY												

GMT (D:H:M)	MET (D:H:M)	CST (D:H:M)	FD/ DOY	BETA	MOON	HOUSTON DATE	FLIGHT	EDITION	PUB. DATE														
074:01:54/ 074:13:54	011:12:00/ 012:00:00	073:19:54/ 074:07:54	13/073 CST	-0.1	●	MARCH 14, 1994	STS-62	FINAL	01/28/94														
CST :073 FD :012 MET :011	20 12	21 13	22 14	23 15	0 16	CST:074 17	18	19	20	21	22	23	0 MET:012										
CDR	SLEEP	STUABOLIC	IMU MNVR	ZLV MNVR	LEIS OUT	AUTO MNVR	DTG 664	OMS-5 OMS BURN	ZLV MNVR	AUTO MNVR	APC UNSTOW	LDCE AACT	ZLV MNVR	LDCE DEACT	ZLV MNVR	LDCE AACT	DSO 326	MEAL					
PLT	SLEEP						FAN & TEMP CHECKS		APCG ASSIST									MEAL	WASTE INIT	WASTE TERM	CPCG ASSIST	EXERCISE	
MS1	SLEEP								P/TV11 OPS APCG									MEAL			P/TV05 OPS CPCG	P/TV05 OPS CPCG	DEE OPS ASSIST
MS2	SLEEP	STUABOLIC		POST SLEEP	DLS ACT			EXERCISE	PSE DAILY OPS									MEAL				DEE OPS ASSIST	P/TV06 CGBA
MS3	SLEEP								EXERCISE									MEAL					DEE OPERATIONS
DAY/NIGHT	*																						
ORBIT	184	185	186	187	188	189	190	191	192														
TDRS																							
ATTITUDE	-ZLV, +YVV			-ZLV		-ZMOON		OMS	-ZLV		+XSI		-ZLV, +YVV										
MEPHISTO																							
AADSF																							
ZENO	T3 DATA COLLECT				T4 DATA COLLECT				T5 DATA COLLECT														
IDGE																							
SAMS																							
OAST	ADDITIONAL EISG																						
NOTES:	* = GROUND COMMANDED ACTIVITY @DSO 610 RENAL STONE @SSBUY EARTH VIEW TERM @SKIRT MOON CAL @CABIN TEMP SURVEY @140X105 @VIDEO AFTER PCAM DEACT @COLD PLATE @OPEN LDCE 6 @OPEN LDCE 8 @-ZLV, +YVV @-XLV, -ZVV @CLOSE LDCE 6 @VIDEO TOP VDA																						

GMT (D:H:M)		MET (D:H:M)		CST (D:H:M)		FD/ DOY	BETA	MOON	HOUSTON DATE	FLIGHT	EDITION	PUB. DATE			
074:13:54/ 075:01:54		012:00:00/ 012:12:00		074:07:54/ 074:19:54		13/074 CST	2.5		MARCH 15, 1994	STS-62	FINAL	01/28/94			
CST	:074	8	9	10	11	12	13	14	15	16	17	18	19	12	
FD	:013	0	1	2	3	4	5	6	7	8	9	10	11		
MET	:012														
CDR		EXERCISE			PILOT DTO 667	I MU M N V R	Z L V M N V R	C O N F P R I V M E D			SLEEP				
PLT	EXERCISE	PAO OPTY	LDCE DEACB	PGSC/HBIA	STOW		DTO 664		PRE SLEEP		SLEEP				
MS1	DEE OPS ASSIST					APCG CHECK			PRE SLEEP		SLEEP				
MS2	P/T/TV06 CGBA	P/TV06 OPS CGBA	GBA END	CGBA DATA XFER	DLS D PREACT	DLS STOW			PRE SLEEP		SLEEP				
MS3	DEE OPERATIONS		EXTEND PRK	DEE CLOSEOUT					PRE SLEEP		SLEEP				
DAY/NIGHT															
ORBIT	192	193	194	195	196	197	198	199	200						
TDRS	E														
ATTITUDE	W	-ZLV, +YVV			IIMJ I				-ZLV, +YVV						
MEPHISTO															
AADF															
ZENO	T6 DATA COLLECT						T7 DATA COLLECT								
IDGE															
SAMS															
OAST	ADDITIONAL EISG														
NOTES:	◎CLOSE LDCE 7&8			◎-ZLV, +YVV											
	◎GAP SET 3			◎CABIN TEMP SURVEY											
				*SSRIV EARTH VIEW INIT									* = GROUND COMMANDED ACTIVITY		

GMT (D:H:M)	MET (D:H:M)	CST (D:H:M)	FD/ DOY	BETA	MOON	HOUSTON DATE	FLIGHT	EDITION	PUB. DATE													
075:01:54/ 075:13:54	012:12:00/ 013:00:00	074:19:54/ 075:07:54	14/074 CST	5.1	☉	MARCH 15, 1994	STS-62	FINAL	01/28/94													
CST :074 FD :014 MET :012	20 12	21 13	22 14	23 15	0 16	CST:075 17	18	19	20	21	22	23	0 MET:013									
CDR	SLEEP		IMU MNV R	-ZSI MNV R	-ZLV MNV R	FCS C/O	RCS HOT	FIRE	AUTO MNV R	LBNP SOAK	-ZVV MNV R	EXERCISE	TRK MNV R	APRCS TEST	MEAL	CD OB LA GLO	-XLV MNV R	EISG ROLL MNV R	-XLV MNV R	SKIRT ROLL	-ZLV MNV R	
PLT	SLEEP	POST SLEEP				FCS C/O ASSIST	HOT FIRE	ASSIST	LBNP ASSIST	SD BUCT	-ZLV MNV R	APCG PCAM ASSIST	AUTO MNV R		MEAL	E ASSIST		SKIRT ASSIST				
MS1	SLEEP	POST SLEEP	PADM SETUP	POST SLEEP		CPCG DEACT		P/TV13 OPS EISG #6	P/TV11 APCG			P/TV11 OPS APCG		MEAL	P/TV13 OPS EISG #7		P/TV11 APCG			APCG TES DEACT		
MS2	SLEEP	POST SLEEP				FCS C/O ASSIST	HOT FIRE	ASSIST	LBNP PREP												LBNP STOW	
MS3	SLEEP	POST SLEEP				FAN & TEMP CHECKS		CPCG ASSIST	RMS PWRDN	PSE DAILY OPS		EXERCISE	P/TV07 APPE		MEAL	CGBA TERM					LBNP ASSIST	
DAY/NIGHT	* * * * *																					
ORBIT	201	202	203	204	205	206	207	208														
TDRS	E	W																				
ATTITUDE	-ZLV, +YVV		IMU	-ZSI	-ZLV, +YVV		BIAS -XSI	-XLV, -ZVV	-ZLV	+XVV -IBS +YVV		IBS -XSI +XROT	+XROT									
MEPHISTO																						
AADF																						
ZENO	T7 DATA COLLECT											ADDITIONAL DATA										
IDGE																						
SAMS																						
OAST	ADDITIONAL EISG																					
NOTES:	* = GROUND COMMANDED ACTIVITY *EARTH VIEW TERM *SOLAR VIEW TERM *COLD PLATE *ZLV, +YVV *BIAS -XLV, +YVV *SOLAR VIEW INIT *SSBUV CAL INIT *VIDEO AFTER PCAM DEACT *XLV, +YVV *APU HTR ACT *ZLV, +YVV *SSBUV CAL TERM & DATA XFER *COLD PLATE *GAP SETS 16-21 *ZLV, +YVV																					

GMT (D:H:M)	MET (D:H:M)	CST (D:H:M)	FD/ DOY	BETA	MOON	HOUSTON DATE	FLIGHT	EDITION	PUB. DATE					
075:13:54/ 076:01:54	013:00:00/ 013:12:00	075:07:54/ 075:19:54	14/075 CST	7.6		MARCH 16, 1994	STS-62	FINAL	01/28/94					
CST :075 FD :014 MET :013	8	9	10	11	12	13	14	15	16	17	18	19	12	
CDR	0	1	2	3	4	5	6	7	8	9	10	11	12	
	08:00-09:00 09:00-10:00 10:00-11:00 11:00-12:00 12:00-13:00 13:00-14:00 14:00-15:00 15:00-16:00 16:00-17:00 17:00-18:00 18:00-19:00 19:00-20:00 20:00-21:00 21:00-22:00 22:00-23:00 23:00-00:00													
PLT	CABIN STOW			PRE SLEEP				SLEEP						
MS1	APCG TES DEACT	CABIN STOW			PRE SLEEP				SLEEP					
MS2	LBNP STOW	CABIN STOW			PRE SLEEP				SLEEP					
MS3	CABIN STOW			PRE SLEEP				SLEEP						
DAY/NIGHT	[Day/Night Cycle: 209-210 (Night), 210-211 (Day), 211-212 (Night), 212-213 (Day), 213-214 (Night), 214-215 (Day), 215-216 (Night)]													
ORBIT	[Orbit Numbers: 209, 210, 211, 212, 213, 214, 215, 216]													
TDRS	[TDRS Events: E, W, W, E, W, E, W, E, W, E, W, E, W, E, W]													
ATTITUDE	-ZLV, +YVV			IIMU I				BIAS +ZLV, -YVV						
MEPHISTO														
AADSF														
ZENO	ADDITIONAL DATA													
IDGE														
SAMS														
QAST	ECT													
NOTES:	⊖-ZLV, +YVV			⊖BIAS +ZLV, -YVV				ECT						

GMT (D:H:M)	MET (D:H:M)	CST (D:H:M)	FD/ DOY	BETA	MOON	HOUSTON DATE	FLIGHT	EDITION	PUB. DATE			
076:01:54/ 076:13:54	013:12:00/ 014:00:00	075:19:54/ 076:07:54	15/075 CST	10.2		MARCH 16, 1994	STS-62	FINAL	01/28/94			
CST :075 FD :014 MET :013	20 21 22 23	0 1 2 3 4 5 6 7 8 9	CST:076	1 2 3 4 5 6 7 8 9 10					MET:014			
CDR	SLEEP	SETUABOLIC	IMU MNAV	ZLV MNAV	PGWRP UBP	XSI MNAV	IMU MNAV	PLBD ALIGNS				
PLT	SLEEP				DTODSO 664326		DEORBIT PREP	DEORBIT BURN	KSC			
MS1	SLEEP				MIZ EDG PEN HEO DDD EEE AAA CCC UUU	S2 A MD SE A IC T	DSO 603 ENTRY PREP	DEORBIT PREP	LANDING*			
MS2	SLEEP	SETUABOLIC			DSO 603 ENTRY PREP	EDOD DEACT		DEORBIT PREP				
MS3	SLEEP				DSO 603 ENTRY PREP	OAST DEACT		DEORBIT PREP				
DAY/NIGHT												
ORBIT	217	218	219	220	221	222	223	224				
TDRS												
ATTITUDE	BIAS +ZLV, -YVV			IMU		-ZLV, -YVV		XSI		IMU/VERIF/COMM	D/O	ENTRY
MEPHISTO												
AADSF												
ZENO	ADDITIONAL DATA											
IDGE												
SAMS												
OAST	ECT											
NOTES:	@DSO 612 ENERGY UTILIZATION @-ZLV, +YVV @CABIN TEMP SURVEY @ORTHOSTATIC FUNCTION @WINDOW IMPACT OBS											

* D/O BURN 13/22:13 * KSC LDG 13/23:06

This Page Intentionally Blank

DETAILED TIMELINE

DETAILED
TIMELINE

DETAILED TIMELINE

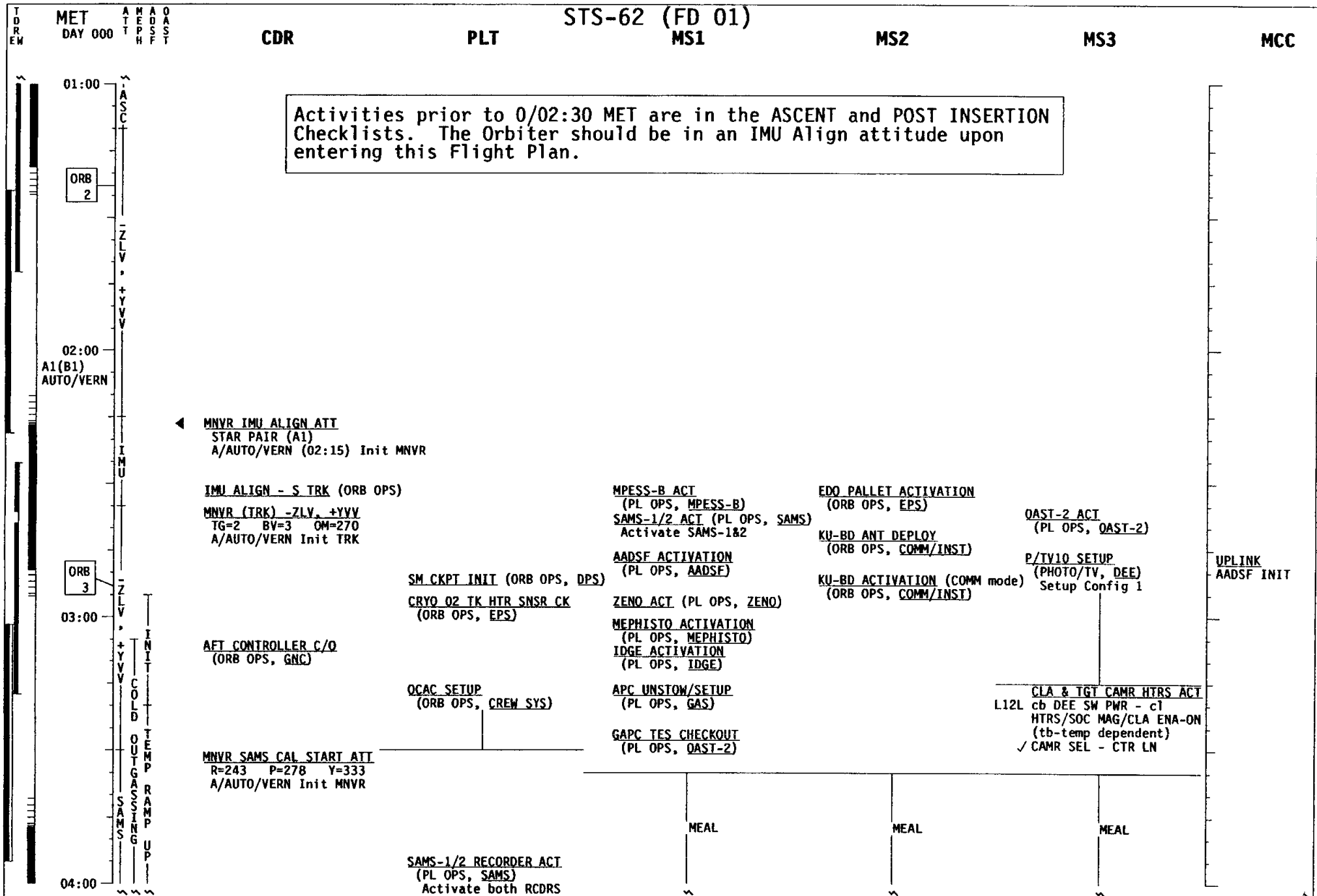

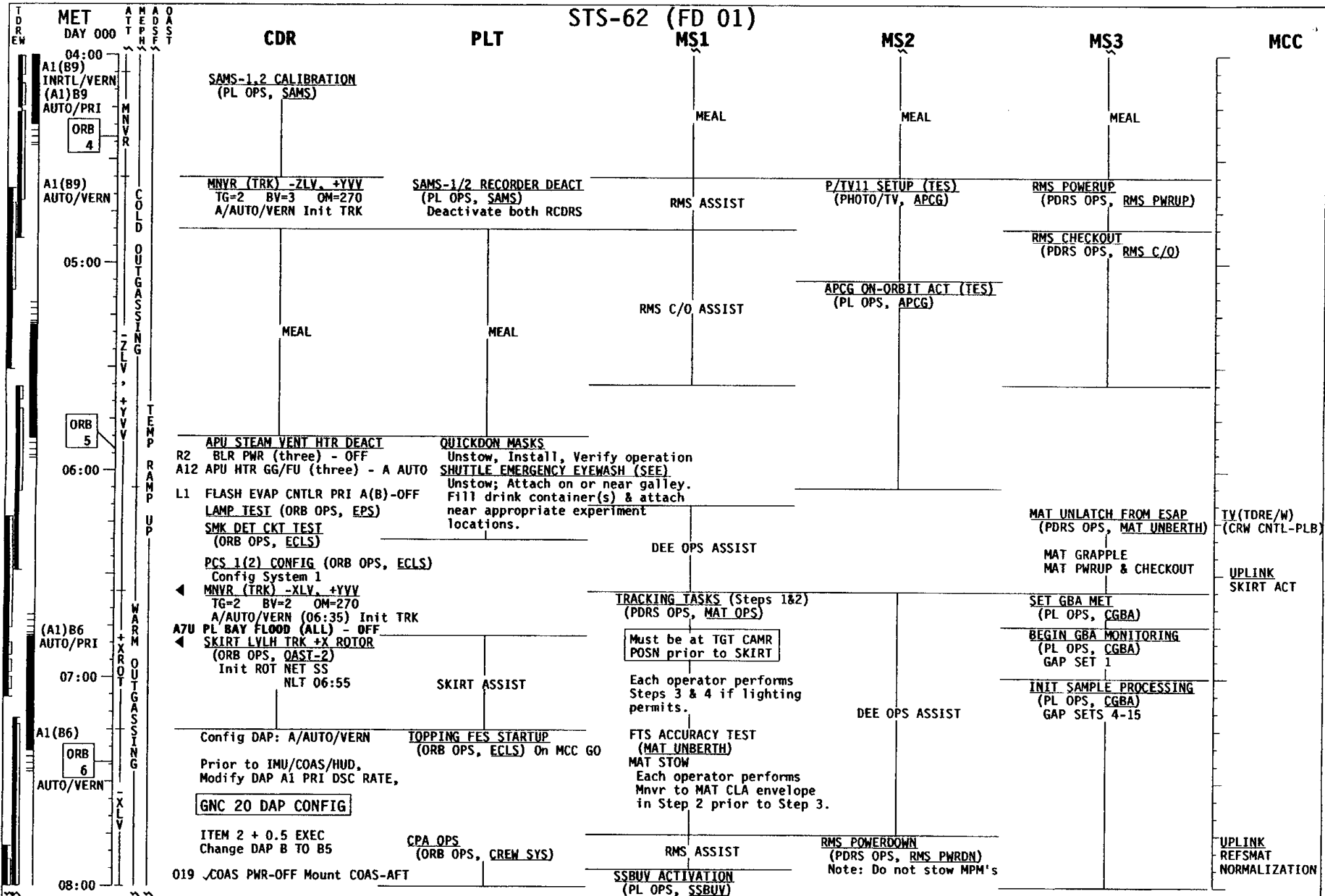

STS-62 (FD 01)

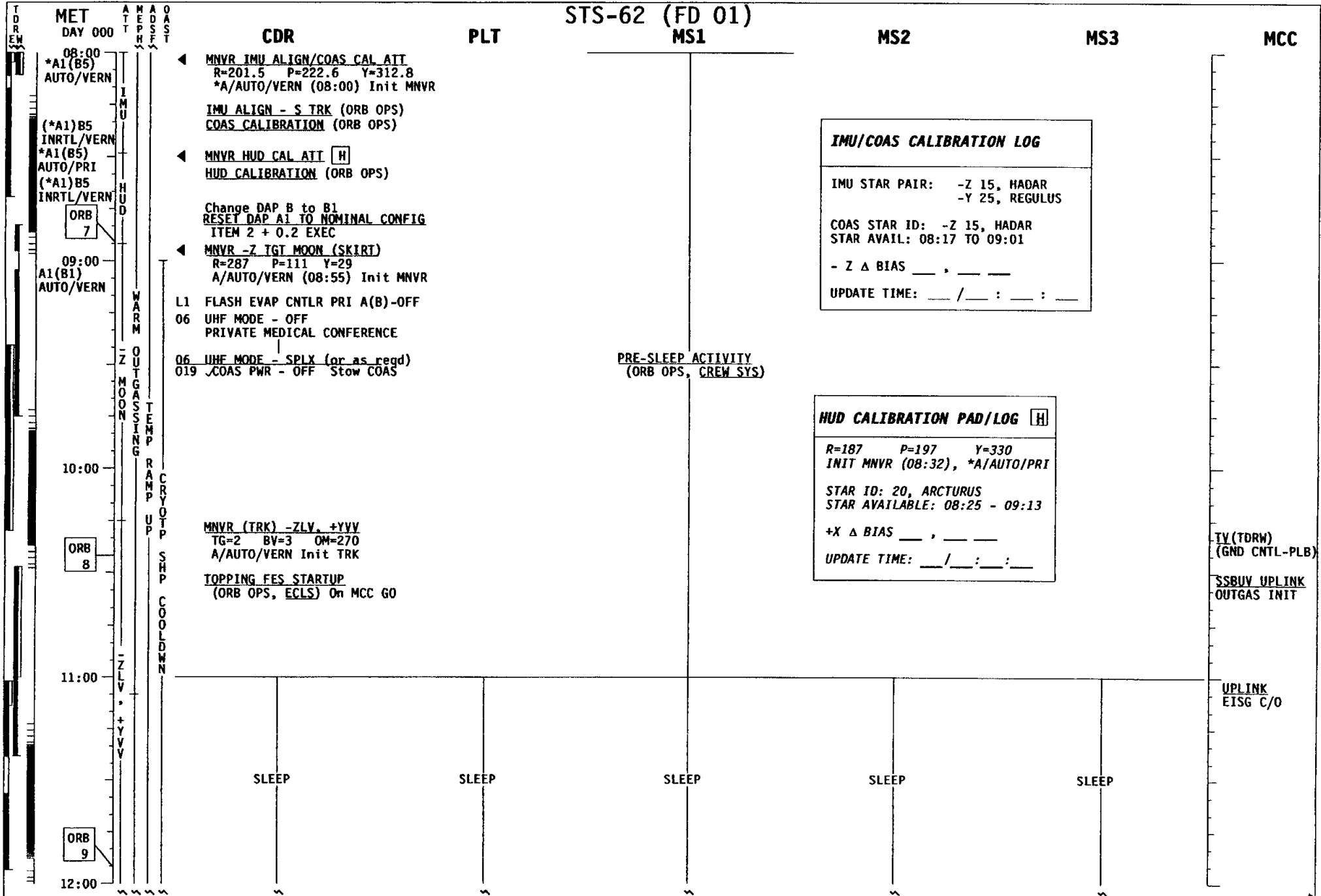

IMU/COAS CALIBRATION LOG

IMU STAR PAIR: -Z 15, HADAR
-Y 25, REGULUS

COAS STAR ID: -Z 15, HADAR
STAR AVAIL: 08:17 TO 09:01

- Z Δ BIAS __ , __

UPDATE TIME: __ / __ : __ : __

HUD CALIBRATION PAD/LOG [H]

R=187 P=197 Y=330
INIT MNVR (08:32), *A/AUTO/PRI

STAR ID: 20, ARCTURUS
STAR AVAILABLE: 08:25 - 09:13

+X Δ BIAS __ , __

UPDATE TIME: __ / __ : __ : __

TV (TORW)
(GND CNTL-PLB)

SSBUV UPLINK
OUTGAS INIT

UPLINK
EISG C/O

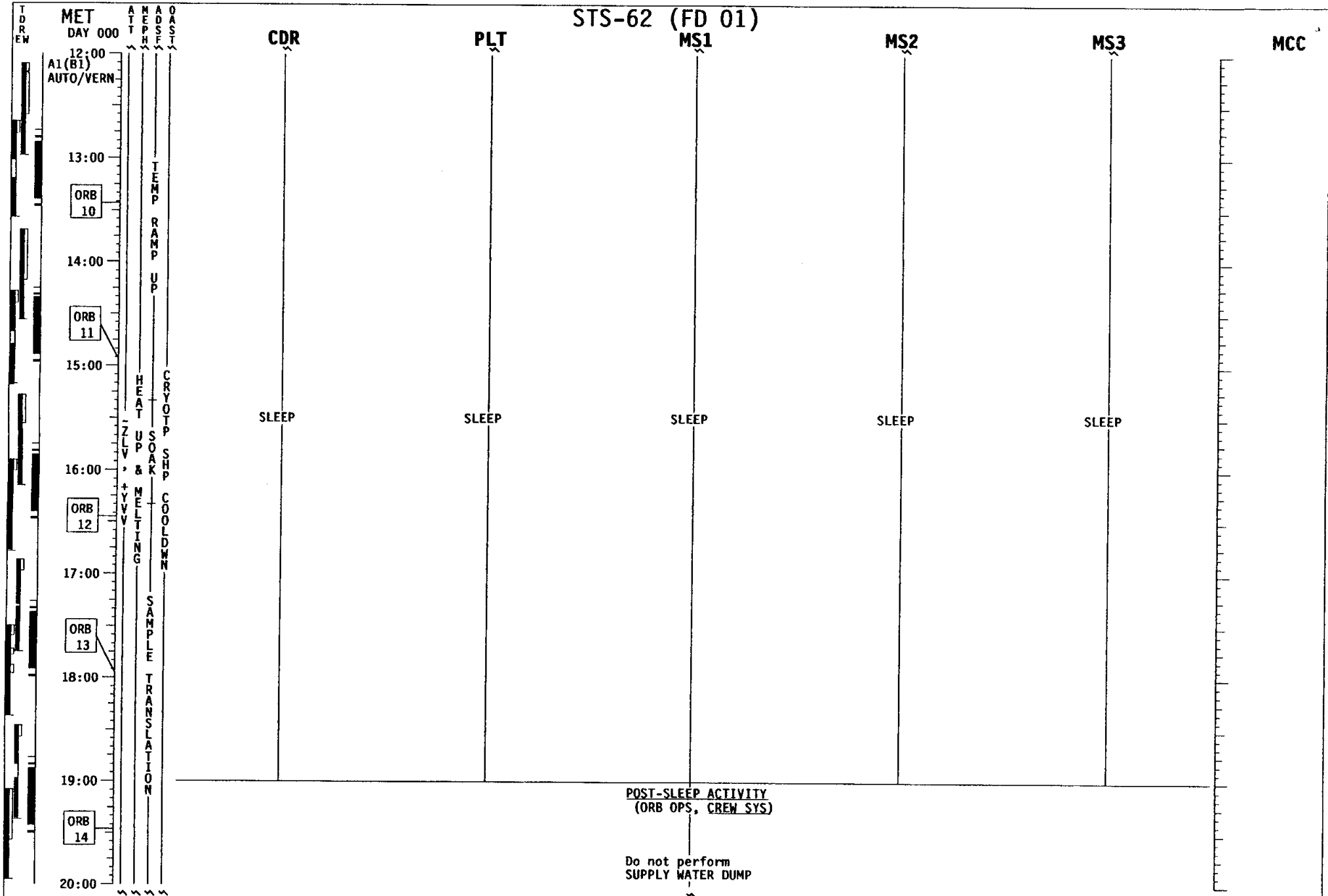

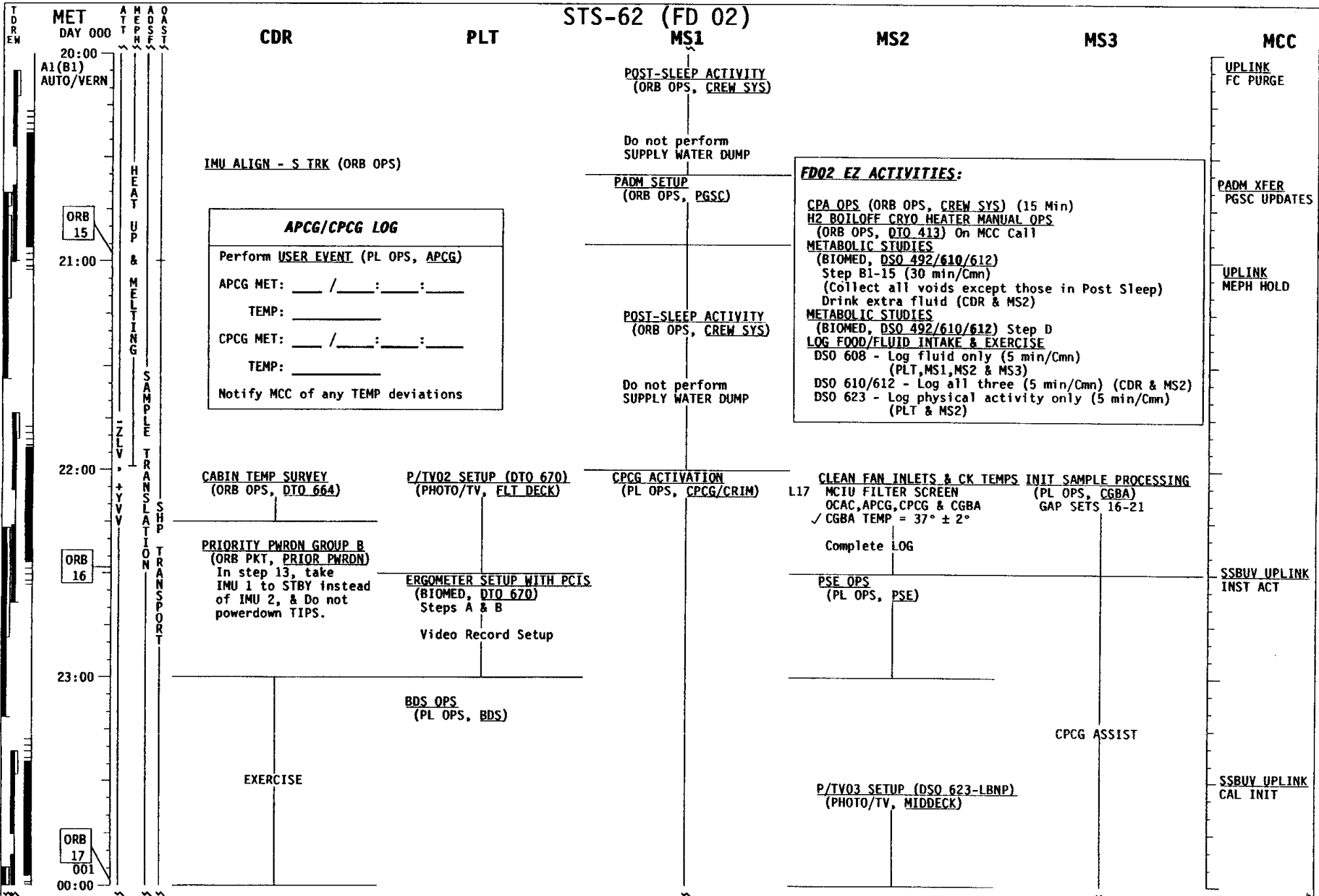

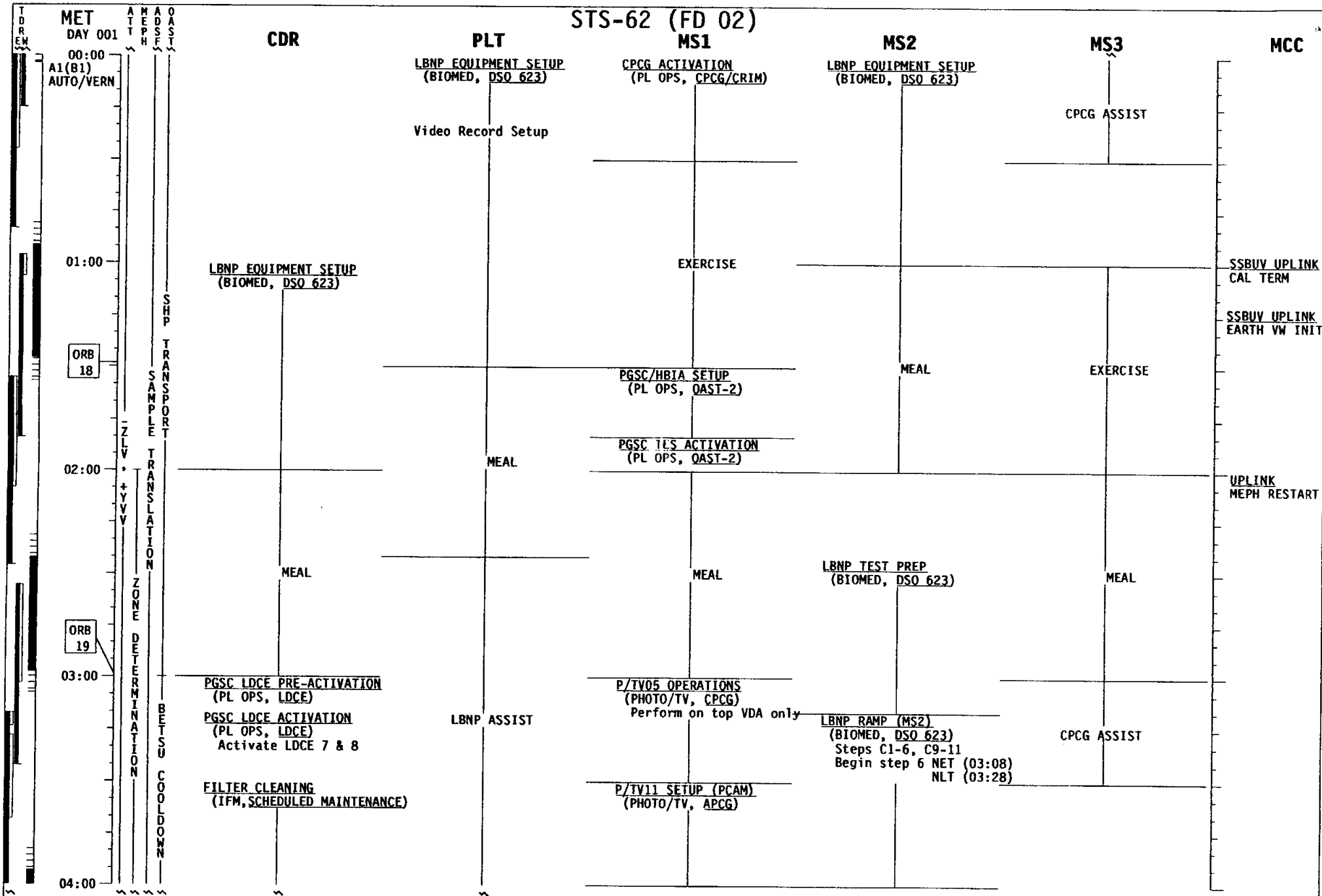

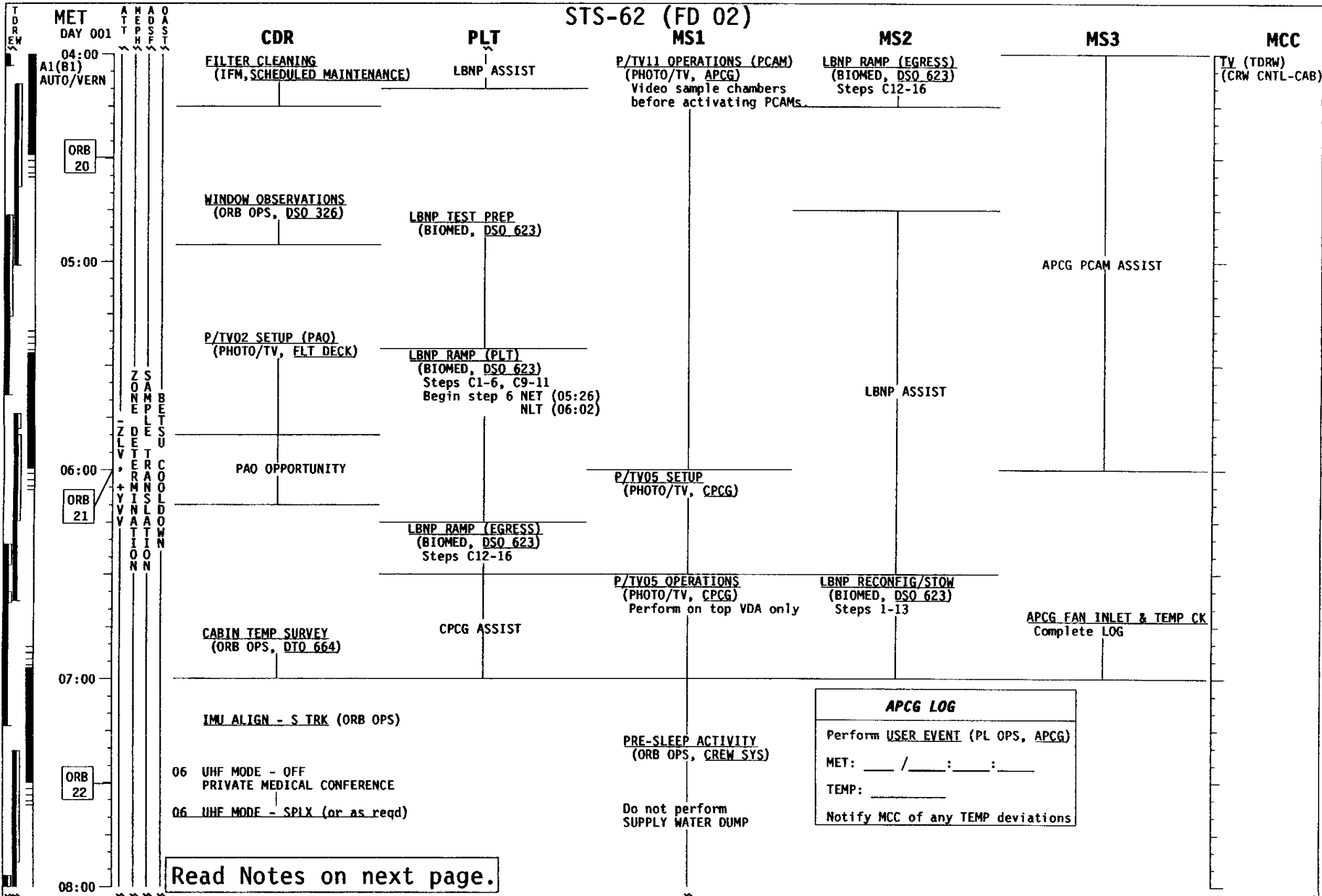

Read Notes on next page.

STS-62 (FD 02)

STS

PL

MCC

MET DAY 001

08:00
A1(B1)
AUTO/VERN

09:00

10:00

11:00

12:00

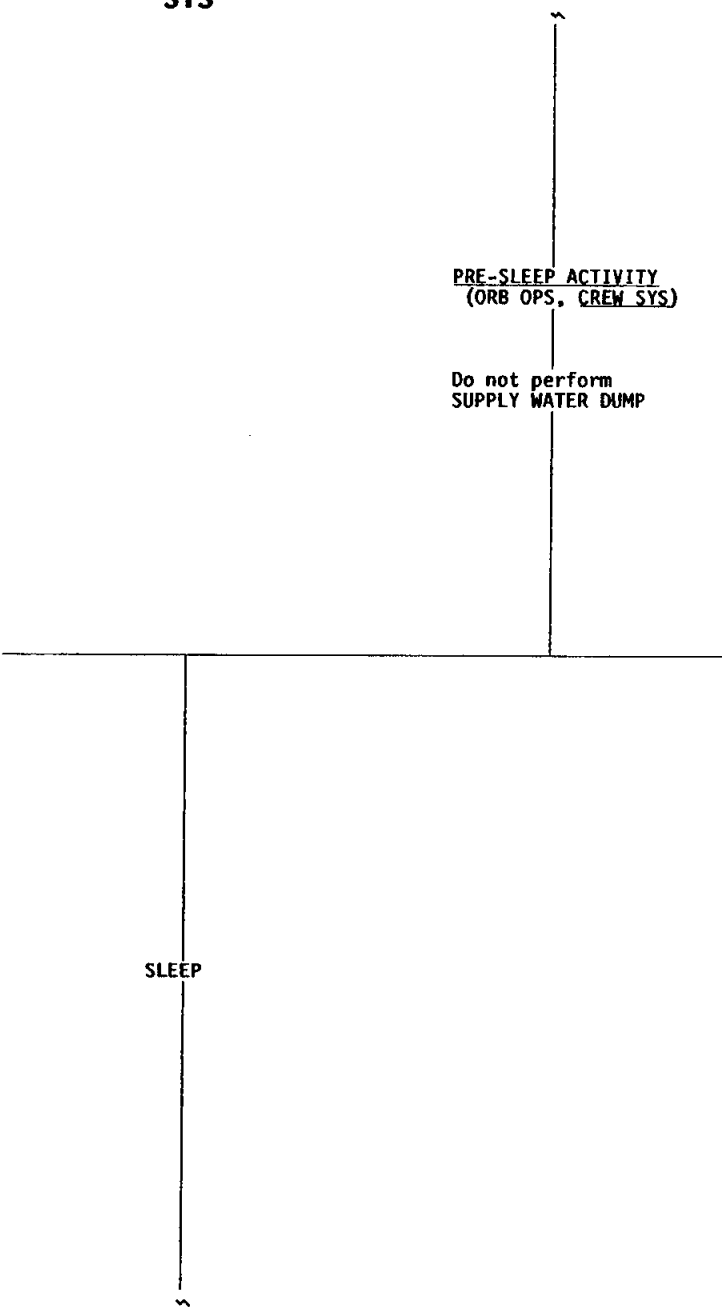

NOTE: If possible, minimize crew motion during Presleep Activity to satisfy the TES low-g (.001) requirement.

REMINDER: DSO 612 morning sample collections require 4 hours of fasting.

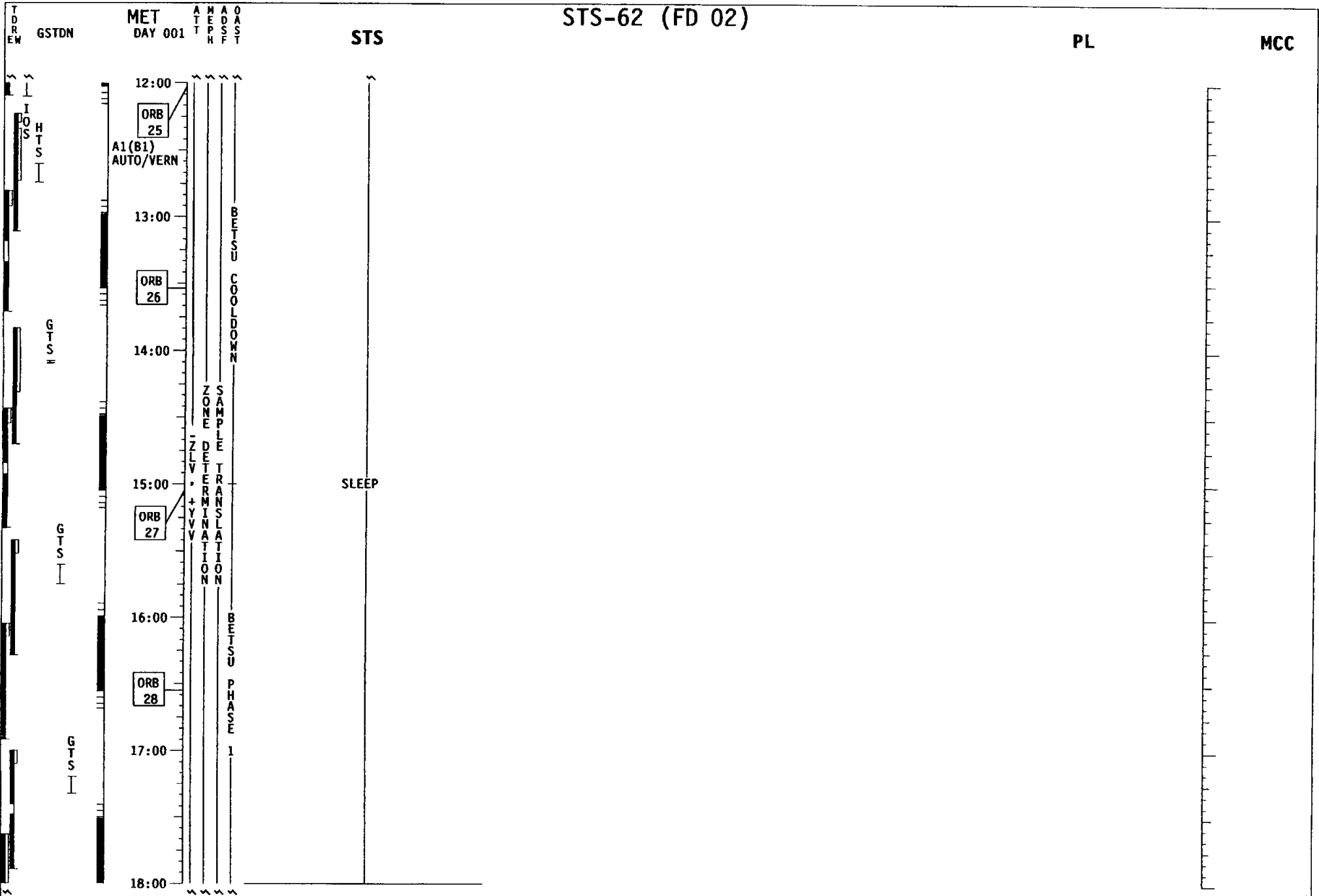

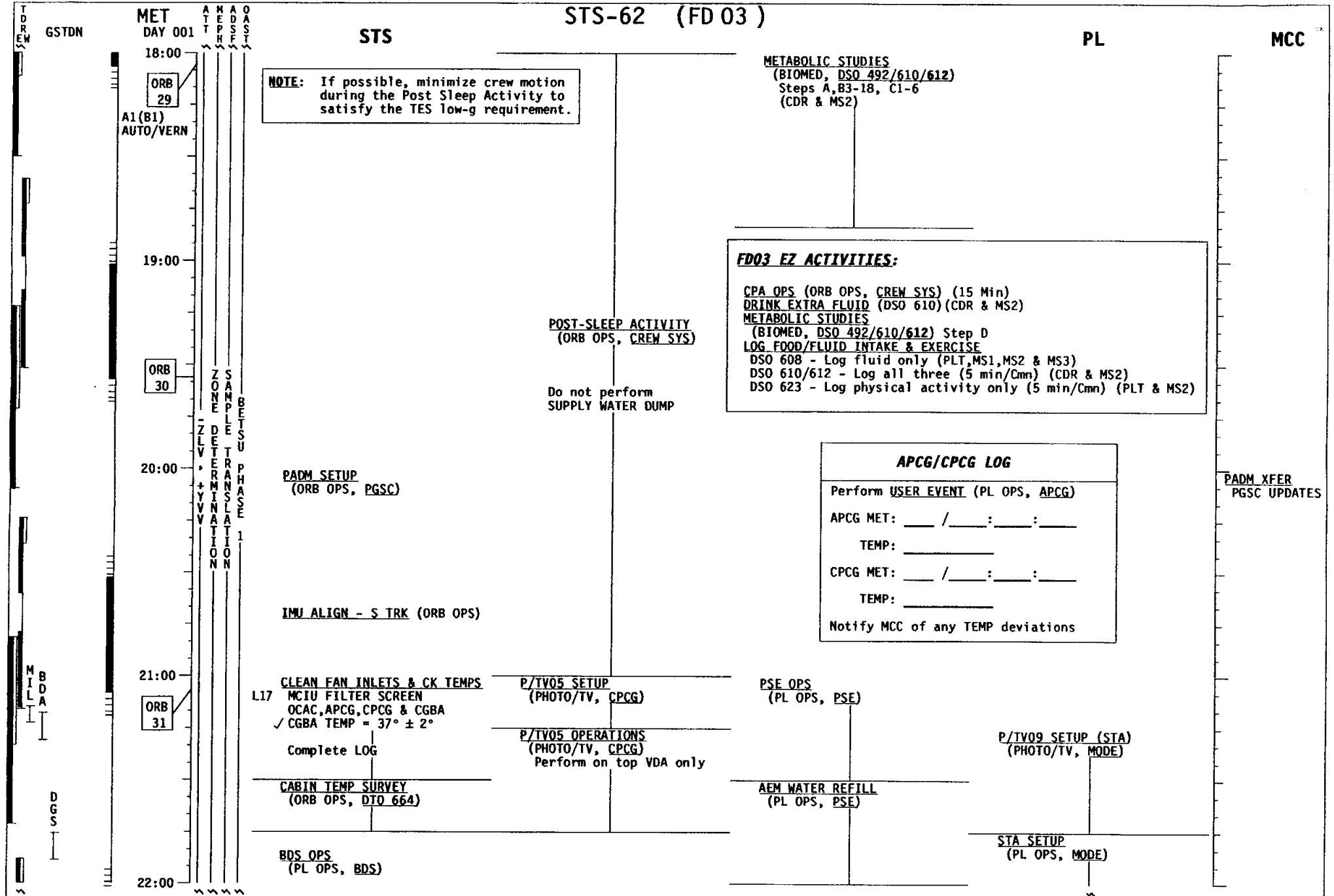

STS-62 (FD 03)

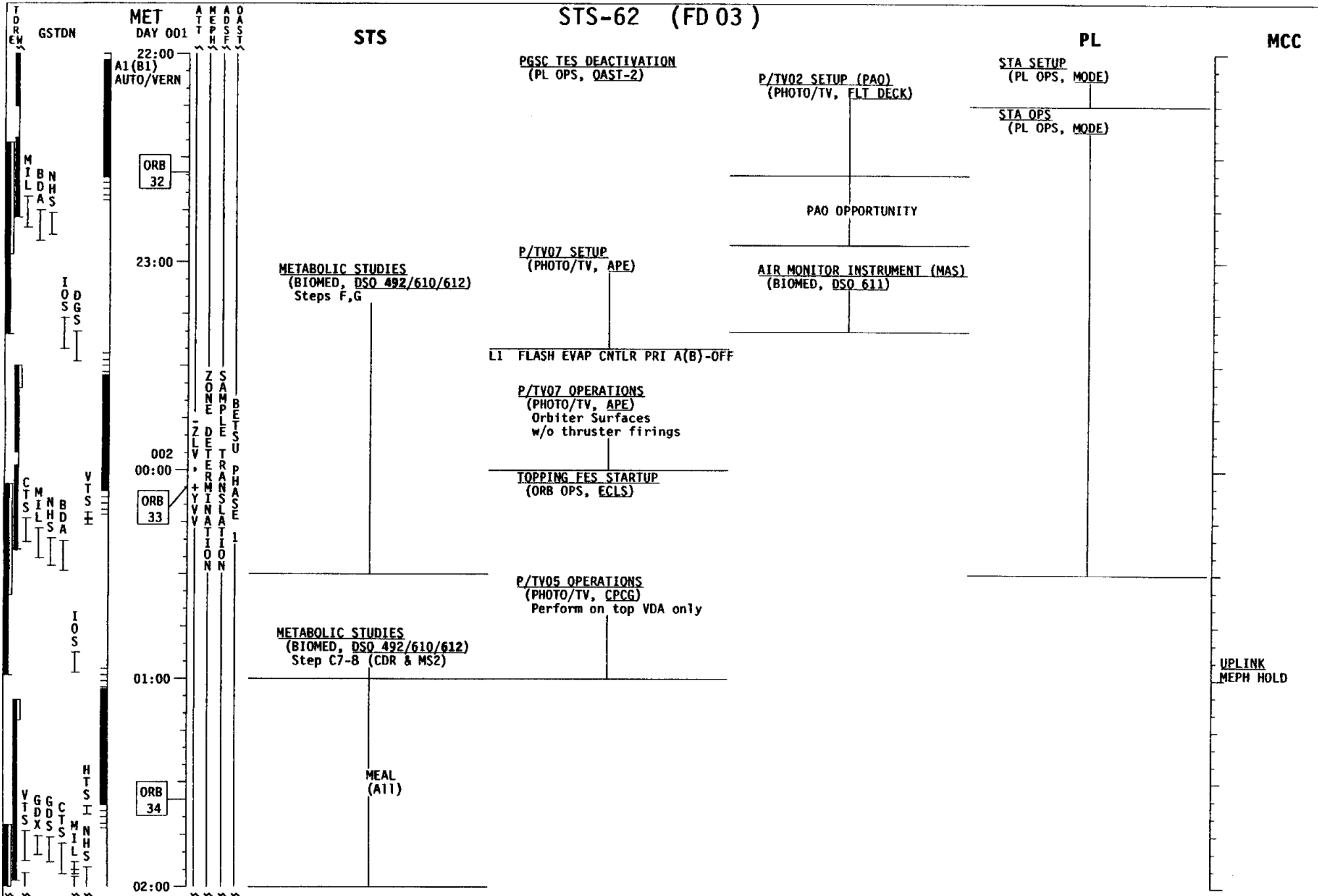

STS-62 (FD 03)

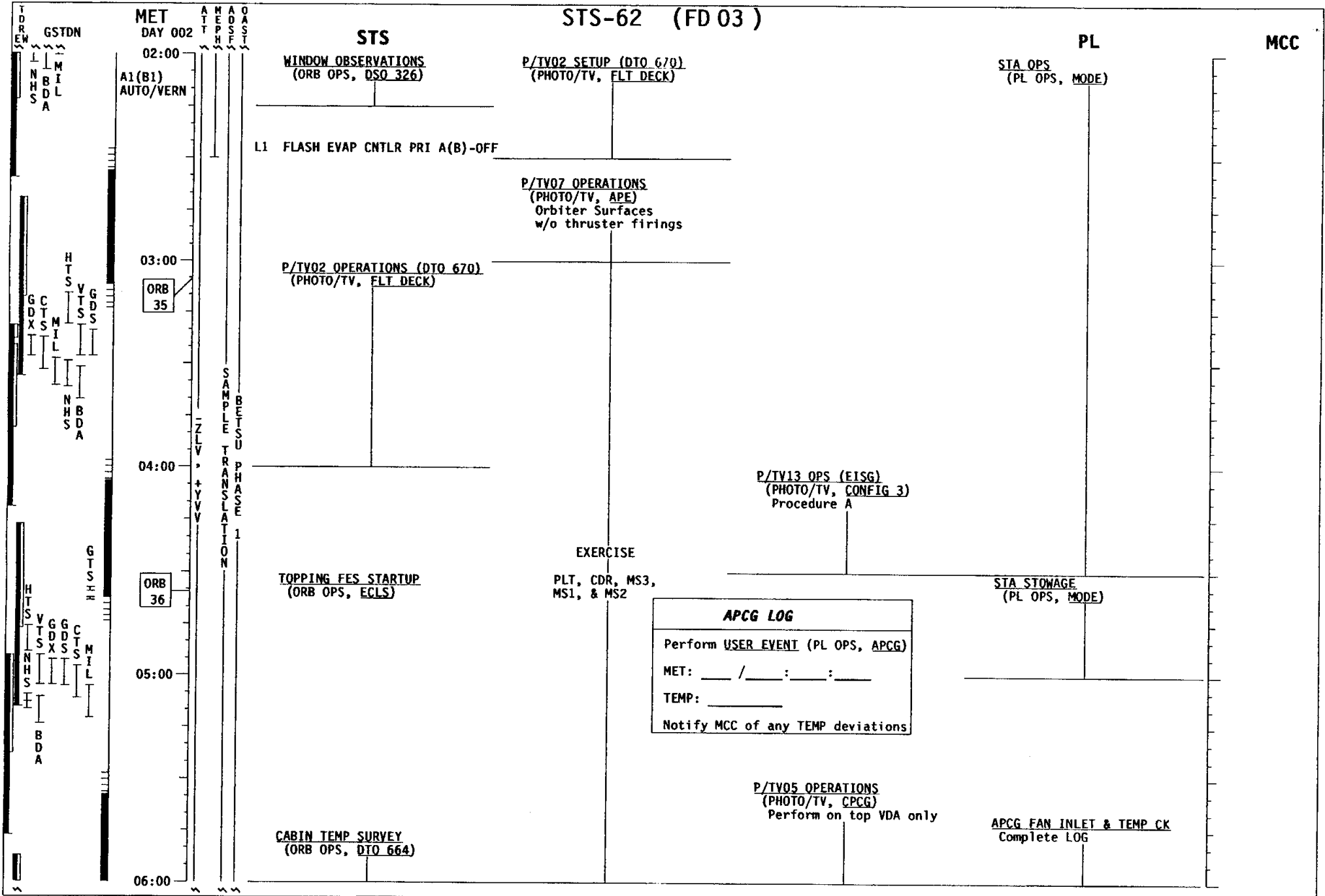

STS-62 (FD 03)

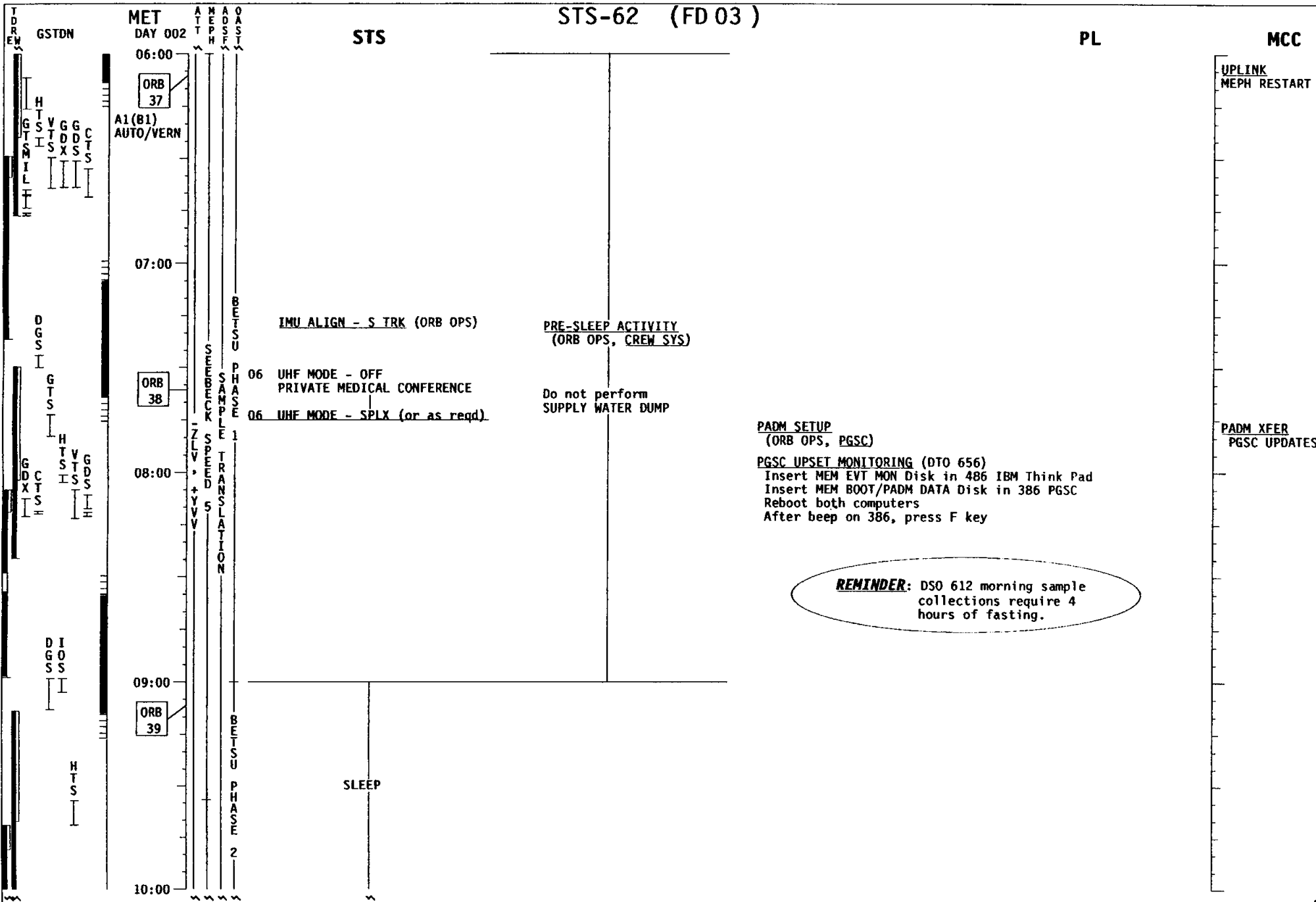

REMINDER: DSO 612 morning sample collections require 4 hours of fasting.

UPLINK
MEPH RESTART

PADM XFER
PGSC UPDATES

STS-62 (FD 03)

PL

MCC

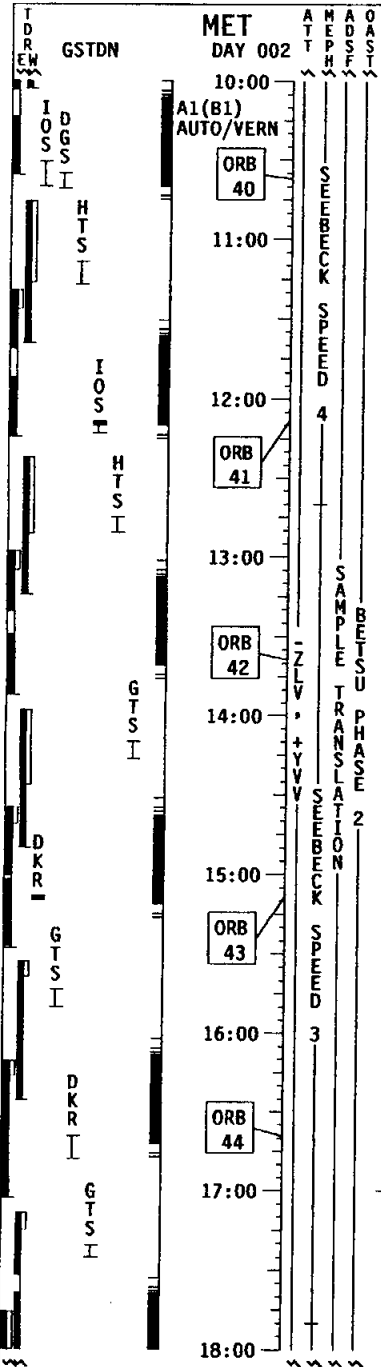

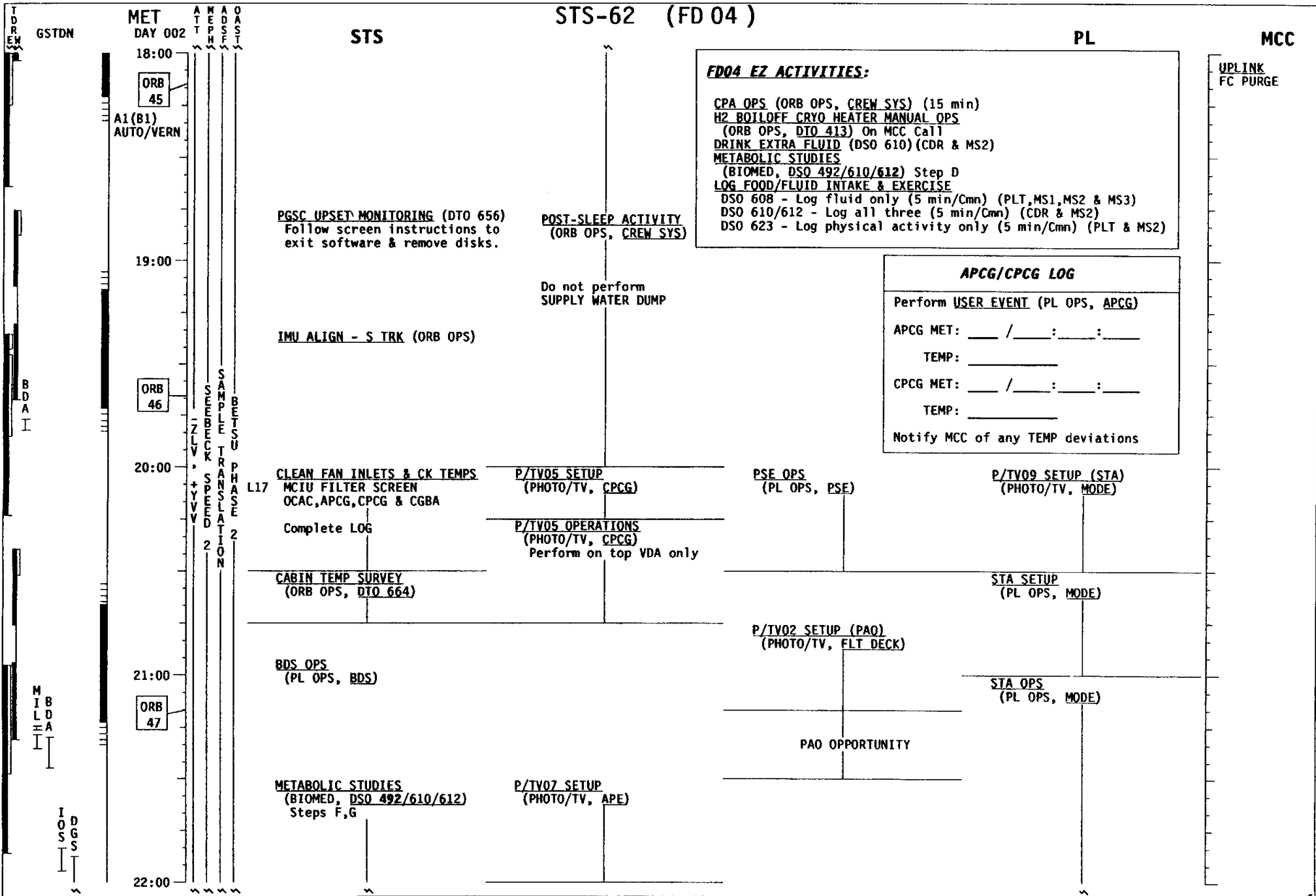

STS-62 (FD 04)

STS

PL

MCC

FD04 EZ ACTIVITIES:

CPA OPS (ORB OPS, CREW SYS) (15 min)
 H2 BOILOFF CRYO HEATER MANUAL OPS
 (ORB OPS, DTO 413) On MCC Call
 DRINK EXTRA FLUID (DSO 610) (CDR & MS2)
 METABOLIC STUDIES
 (BIOMED, DSO 492/610/612) Step D
 LOG FOOD/FLUID INTAKE & EXERCISE
 DSO 608 - Log fluid only (5 min/Cmn) (PLT, MS1, MS2 & MS3)
 DSO 610/612 - Log all three (5 min/Cmn) (CDR & MS2)
 DSO 623 - Log physical activity only (5 min/Cmn) (PLT & MS2)

APCG/CPCG LOG

Perform **USER EVENT** (PL OPS, APCG)
 APCG MET: ___ / ___ : ___ : ___
 TEMP: _____
 CPCG MET: ___ / ___ : ___ : ___
 TEMP: _____
 Notify MCC of any TEMP deviations

PGSC UPSET MONITORING (DTO 656)
 Follow screen instructions to exit software & remove disks.

POST-SLEEP ACTIVITY
 (ORB OPS, CREW SYS)

Do not perform
 SUPPLY WATER DUMP

IMU ALIGN - S TRK (ORB OPS)

CLEAN FAN INLETS & CK TEMPS
 L17 MCIU FILTER SCREEN
 OCAC, APCG, CPCG & CGBA

P/TVO5 SETUP
 (PHOTO/TV, CPCG)

PSE OPS
 (PL OPS, PSE)

P/TVO9 SETUP (STA)
 (PHOTO/TV, MODE)

Complete LOG

P/TVO5 OPERATIONS
 (PHOTO/TV, CPCG)
 Perform on top VDA only

CABIN TEMP SURVEY
 (ORB OPS, DTO 664)

STA SETUP
 (PL OPS, MODE)

BDS OPS
 (PL OPS, BDS)

P/TVO2 SETUP (PAO)
 (PHOTO/TV, FLT DECK)

STA OPS
 (PL OPS, MODE)

PAO OPPORTUNITY

METABOLIC STUDIES
 (BIOMED, DSO 492/610/612)
 Steps F,G

P/TVO7 SETUP
 (PHOTO/TV, APE)

STS-62 (FD 04)

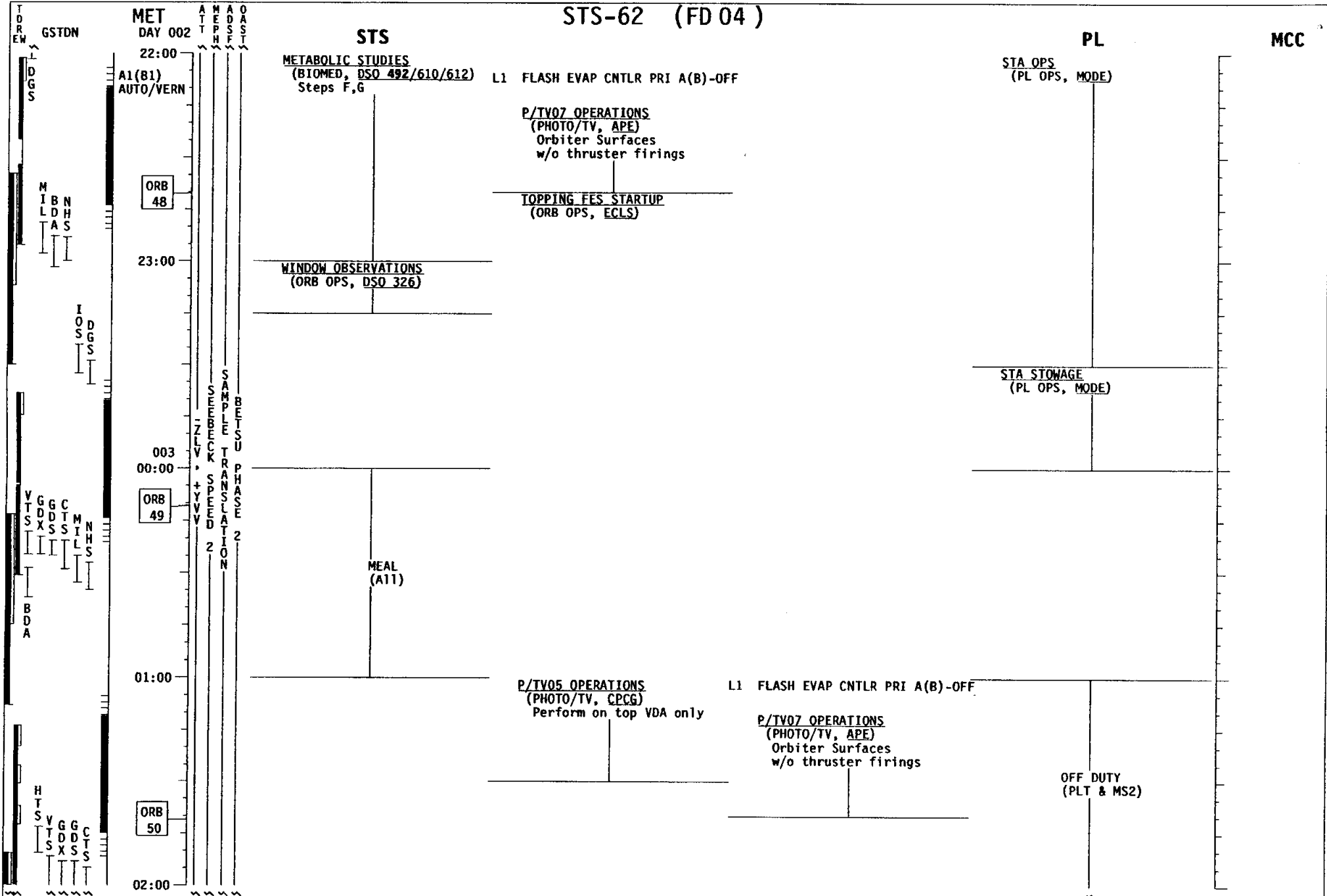

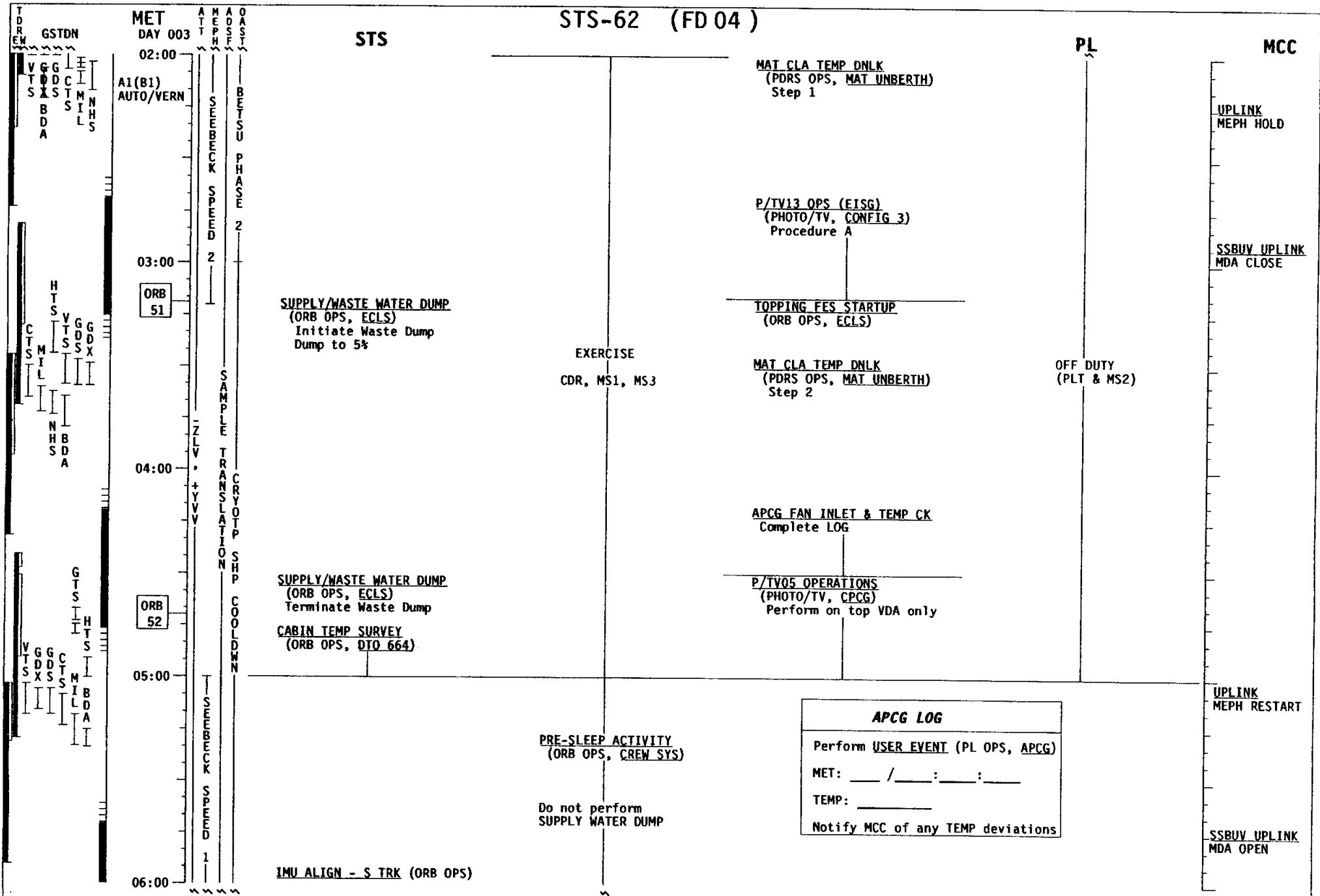

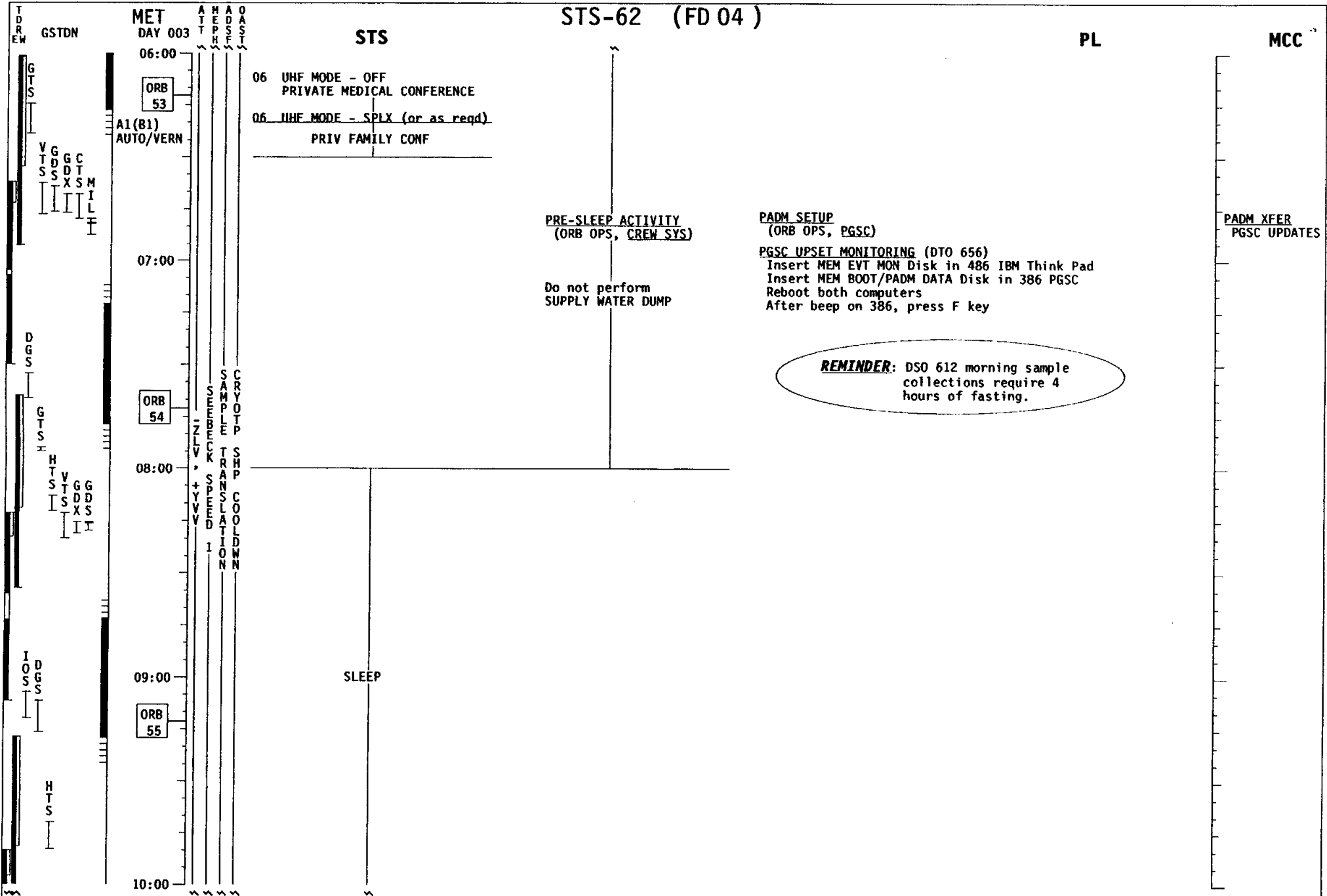

TDR
EM

GSTDN

MET
DAY 003

A
T
H
M
E
P
H
A
D
S
S
T

STS-62 (FD 04)

STS

PL

MCC

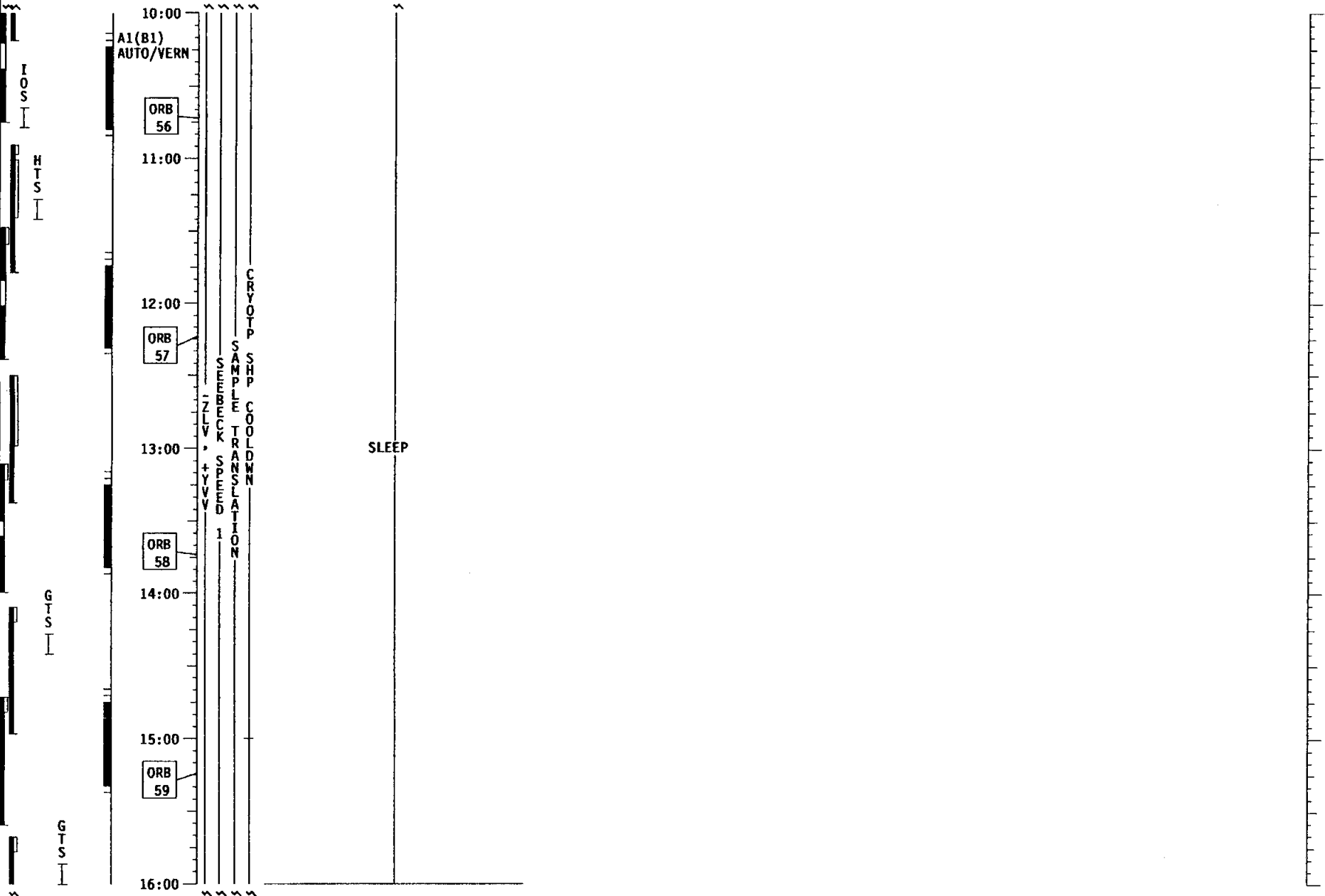

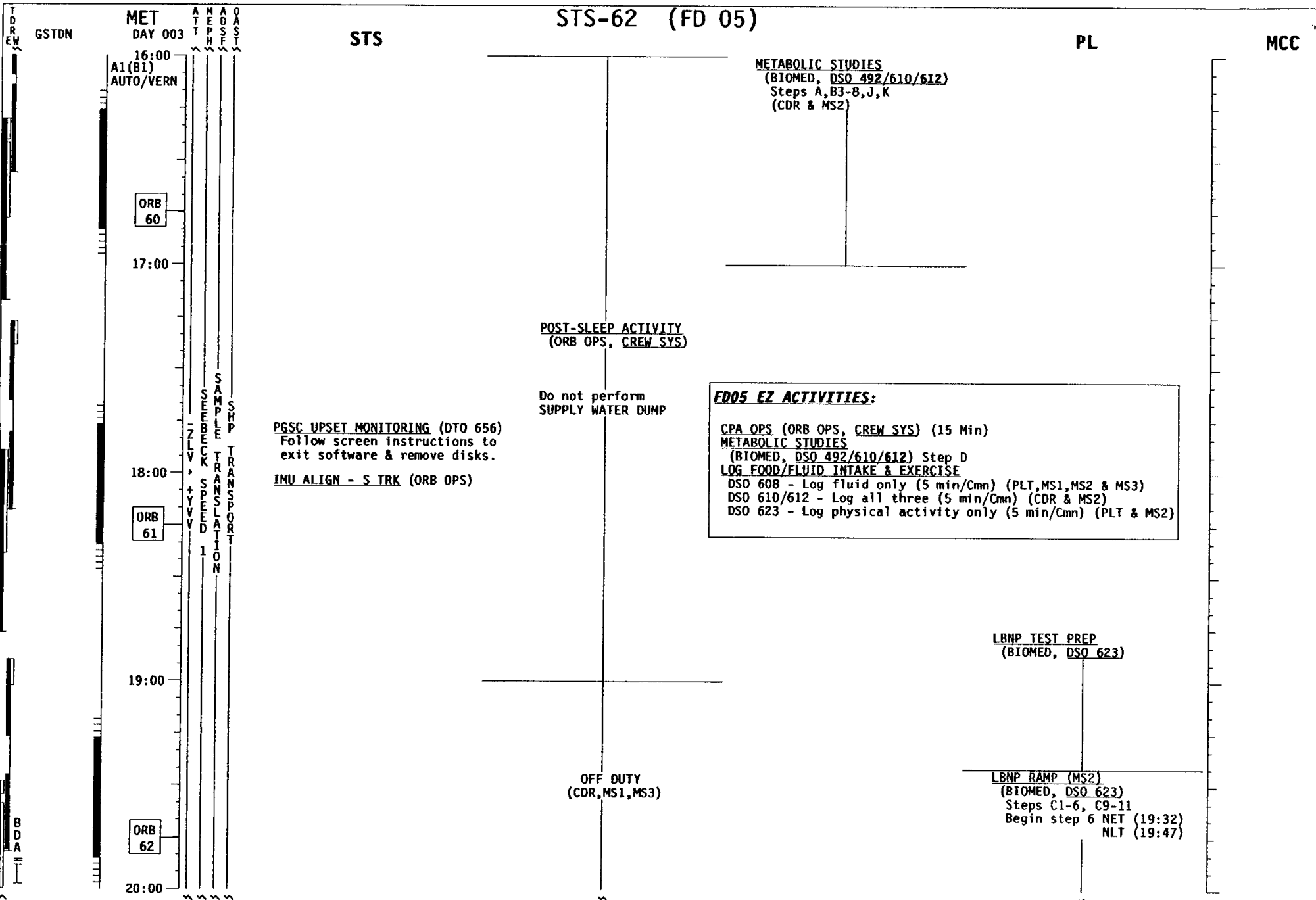

STS-62 (FD 05)

STS

PL

MCC

METABOLIC STUDIES
(BIOMED, DSO 492/610/612)
Steps A, B3-8, J, K
(CDR & MS2)

POST-SLEEP ACTIVITY
(ORB OPS, CREW SYS)

Do not perform
SUPPLY WATER DUMP

FD05 EZ ACTIVITIES:

CPA OPS (ORB OPS, CREW SYS) (15 Min)
METABOLIC STUDIES
(BIOMED, DSO 492/610/612) Step D
LOG FOOD/FLUID INTAKE & EXERCISE
DSO 608 - Log fluid only (5 min/Cmn) (PLT, MS1, MS2 & MS3)
DSO 610/612 - Log all three (5 min/Cmn) (CDR & MS2)
DSO 623 - Log physical activity only (5 min/Cmn) (PLT & MS2)

PGSC UPSET MONITORING (DTO 656)
Follow screen instructions to
exit software & remove disks.

IMU ALIGN - S TRK (ORB OPS)

LBNP TEST PREP
(BIOMED, DSO 623)

OFF DUTY
(CDR, MS1, MS3)

LBNP RAMP (MS2)
(BIOMED, DSO 623)
Steps C1-6, C9-11
Begin step 6 NET (19:32)
NLT (19:47)

MET
DAY 003

16:00
A1(B1)
AUTO/VERN

ORB
60

17:00

18:00

ORB
61

19:00

ORB
62

20:00

OAST
MDSF
MESP
ATTN
A1(B1)
AUTO/VERN
SAMPLE TRANSPORT
ZLV, SPEL
+YVV
1

GSTDN

BDA

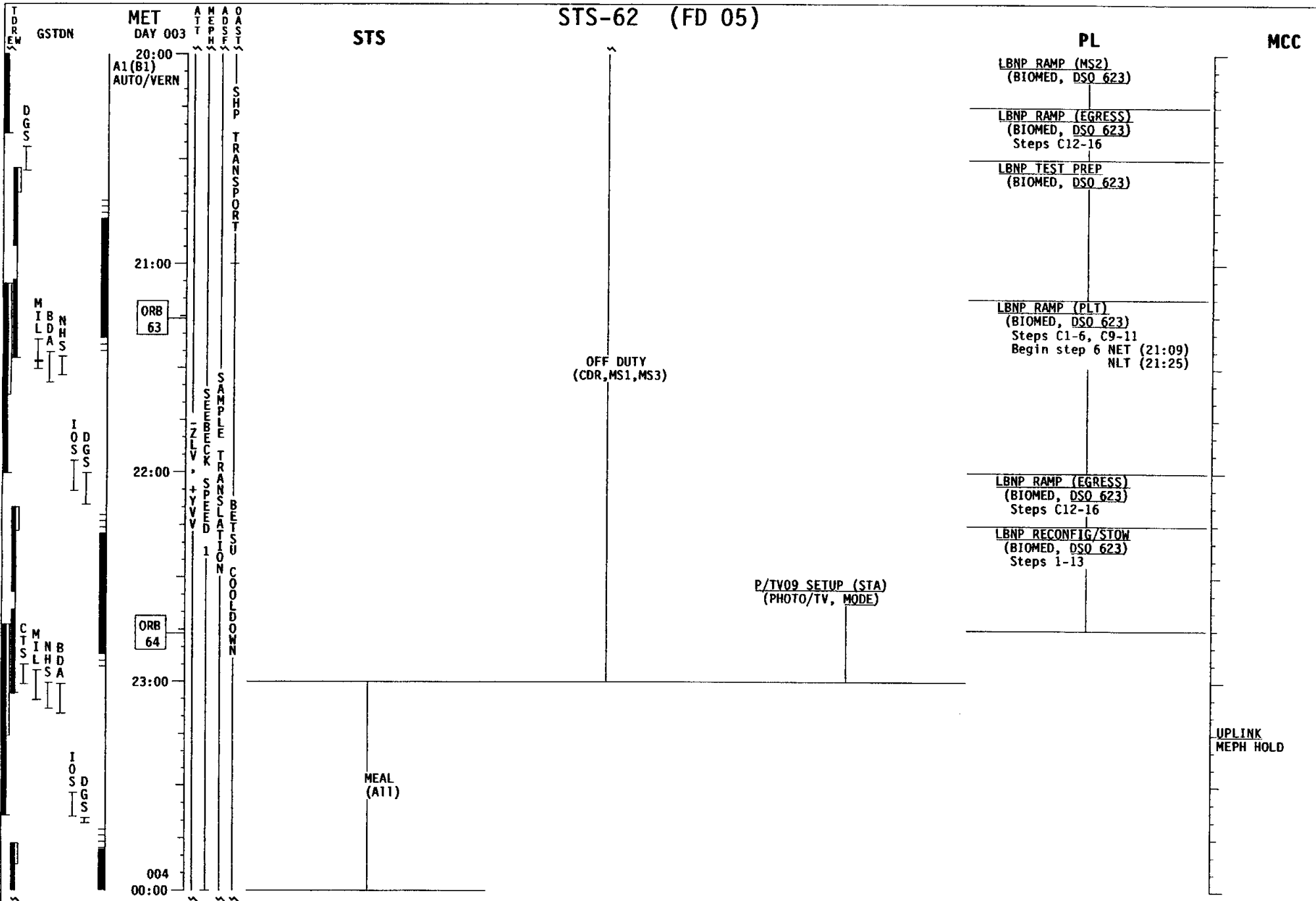

STS-62 (FD 05)

	MET DAY 004	STS	PL	MCC		
<p style="text-align: center;">T D R E M</p> <p style="text-align: center;">GSTDN</p> <p style="text-align: center;">V T S X S G D D S S C T S S M I L L S N H S S</p> <p style="text-align: center;">B D D A</p> <p style="text-align: center;">H T S V T S X S G D D S S C T S S M I L L S N H S S</p> <p style="text-align: center;">B D D A</p> <p style="text-align: center;">G D X S C T S S M I L L S N H S S</p>	<p style="text-align: center;">A1 (B1) AUTO/VERN</p> <p style="text-align: center;">ORB 65</p> <p style="text-align: center;">ORB 66</p> <p style="text-align: center;">ORB 67</p>	<p style="text-align: center;">P/TVO2 SETUP (PAO) (PHOTO/TV, FLT DECK)</p> <p style="text-align: center;">PAO OPPORTUNITY</p> <p style="text-align: center;">BDS OPS (PL OPS, BDS)</p> <div style="border: 1px solid black; padding: 5px;"> <p style="text-align: center;">APCG/CPCG LOG</p> <p>Perform USER EVENT (PL OPS, APCG)</p> <p>APCG MET: ___ / ___ : ___ : ___</p> <p>TEMP: _____</p> <p>CPCG MET: ___ / ___ : ___ : ___</p> <p>TEMP: _____</p> <p>Notify MCC of any TEMP deviations</p> </div> <p style="text-align: center;">DEPLOY RADIATORS (ORB OPS, ECLS)</p> <p style="text-align: center;">WINDOW OBSERVATIONS (ORB OPS, DSO 326)</p> <p style="text-align: center;">CABIN TEMP SURVEY (ORB OPS, DTO 664)</p>	<p style="text-align: center;">P/TVO5 SETUP (PHOTO/TV, CPCG)</p> <p style="text-align: center;">P/TVO5 OPERATIONS (PHOTO/TV, CPCG) Perform on top VDA only</p> <p style="text-align: center;">EXERCISE CDR, MS1, PLT, MS2, & MS3</p> <p style="text-align: center;">P/TVO5 SETUP (PHOTO/TV, CPCG)</p> <p style="text-align: center;">P/TVO5 OPERATIONS (PHOTO/TV, CPCG) Perform on top VDA only</p>	<p style="text-align: center;">PSE OPS (PL OPS, PSE)</p> <p style="text-align: center;">P/TVO6 SETUP (PHOTO/TV, CGBA)</p> <p style="text-align: center;">P/TVO6 OPERATIONS (PHOTO/TV, CGBA)</p> <p style="text-align: center;">END GBA MONITORING (PL OPS, CGBA) GAP SET 1</p> <p style="text-align: center;">BEGIN GBA MONITORING (PL OPS, CGBA) GAP SET 2</p> <p style="text-align: center;">CLEAN FAN INLETS & CK TEMPS MCIU FILTER SCREEN OCAC, APCG, CPCG & CGBA</p> <p style="text-align: center;">Complete LOG</p>	<p style="text-align: center;">STA SETUP (PL OPS, MODE)</p> <p style="text-align: center;">STA OPS (PL OPS, MODE)</p> <p style="text-align: center;">STA STOWAGE (PL OPS, MODE)</p>	<p style="text-align: center;">UPLINK MEPH RESTART</p> <p style="text-align: center;">UPLINK MEPH HOLD</p>
	00:00					
	01:00					
	02:00					
	03:00					
	04:00					

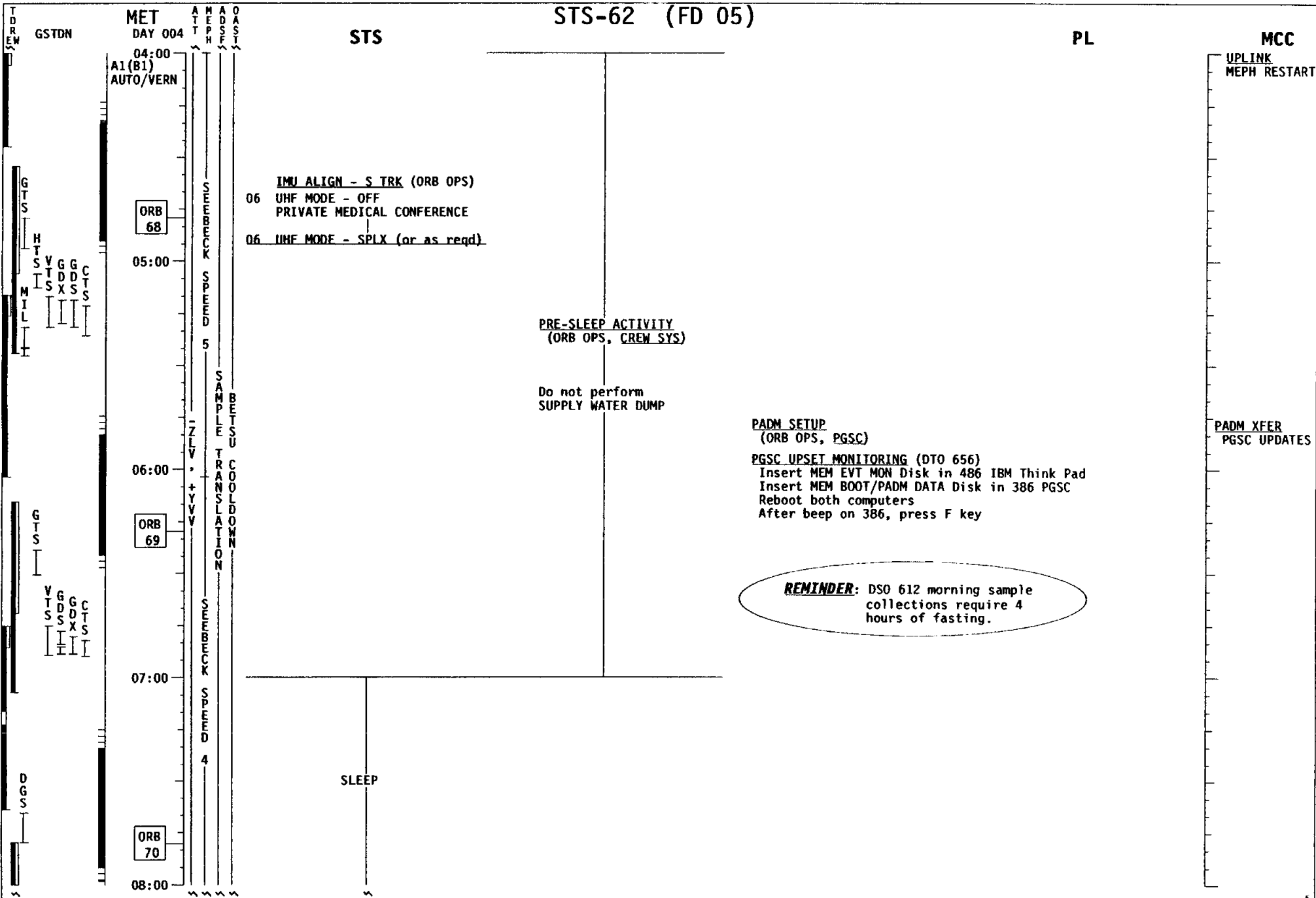

STS-62 (FD 05)

PL

MCC

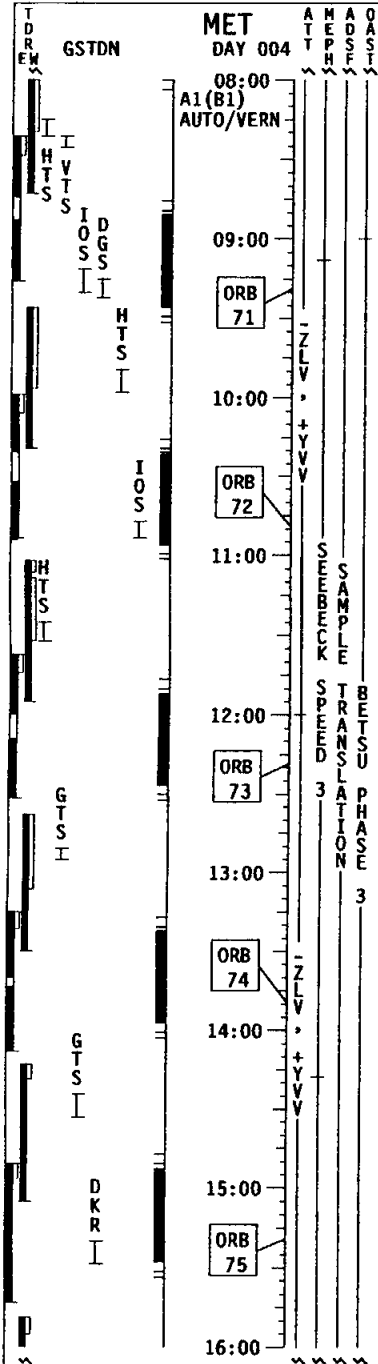

STS

SLEEP

FD06 EZ ACTIVITIES:

CPA OPS (ORB OPS, CREW SYS) (15 Min)
H2 BOILOFF CRYO HEATER MANUAL OPS
(ORB OPS, DTO 413) On MCC Call
DRINK EXTRA FLUID (DSO 610) (CDR & MS2)
METABOLIC STUDIES
(BIOMED, DSO 492/610/612) Step D
LOG FOOD/FLUID INTAKE & EXERCISE
DSO 608 - Log fluid only (5 min/Cmn) (PLT, MS1, MS2 & MS3)
DSO 610/612 - Log all three (5 min/Cmn) (CDR & MS2)
DSO 623 - Log physical activity only (5 min/Cmn) (PLT & MS2)

POST-SLEEP ACTIVITY
(ORB OPS, CREW SYS)

METABOLIC STUDIES
(BIOMED, DSO 492/610/612)
Steps A, B3-8, H, I (CDR, MS2)

Do not perform
SUPPLY WATER DUMP

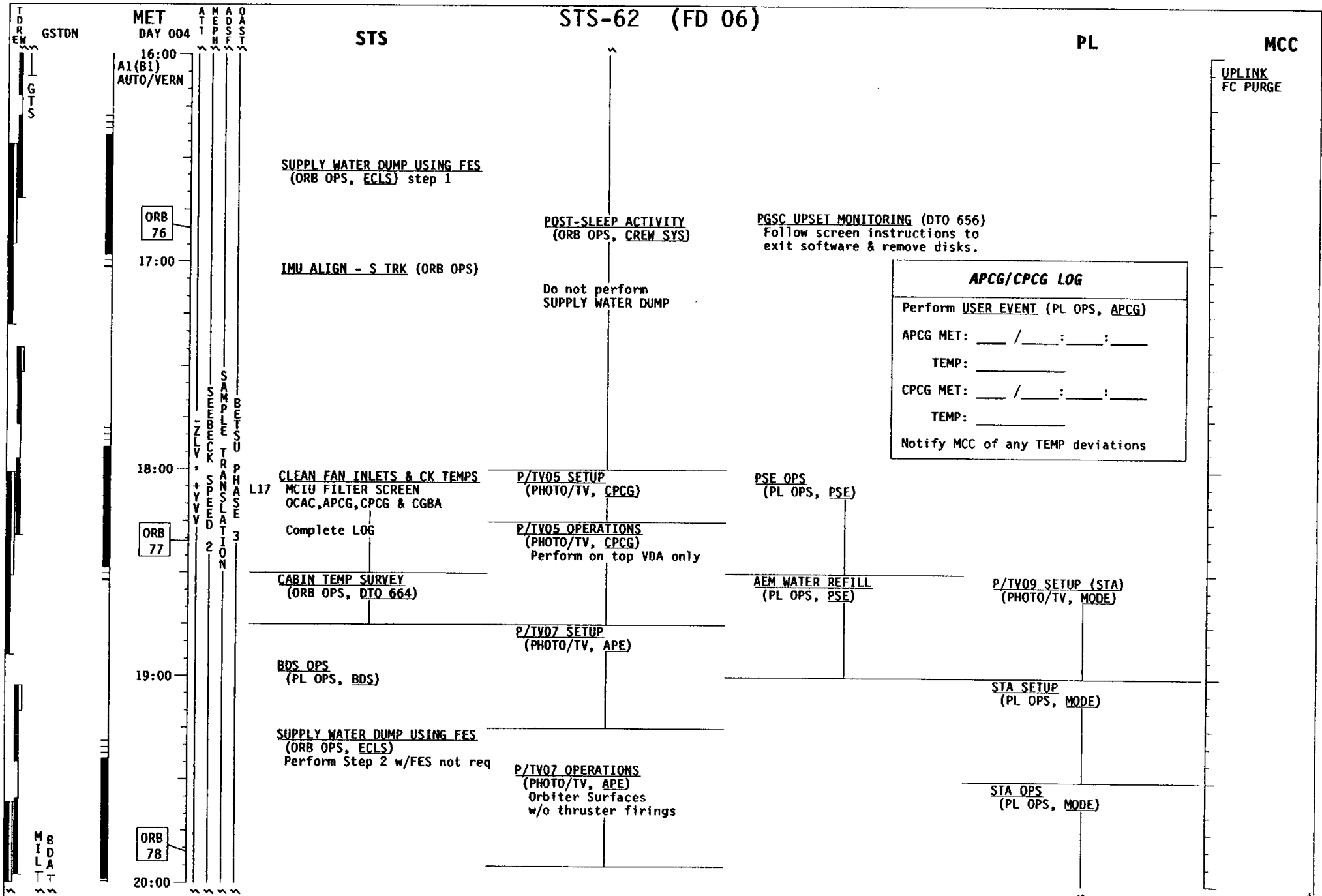

STS-62 (FD 06)

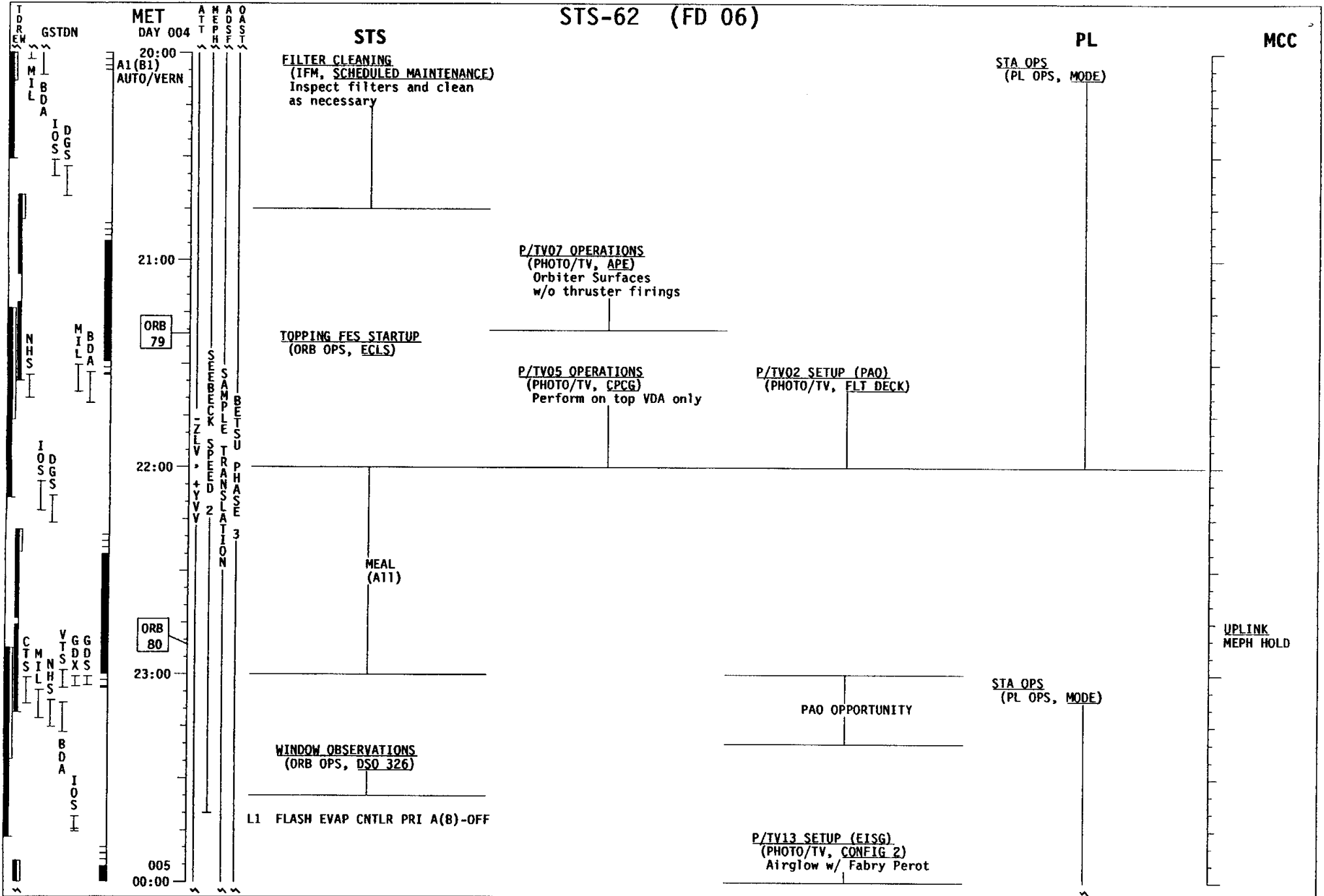

STS-62 (FD 06)

STS

PL

MCC

MET DAY 005
00:00
A1(B1)
AUTO/VERN

GSTDN

HTS
VTS
GDDXS
NHS
MIL

BDA

01:00

HTS
VTS
GDDXS
NHS
MIL

BDA

02:00

HTS
VTS
GDDXS
NHS
MIL

BDA

03:00

GTS
HTS
VTS
GDDXS
NHS
MIL

BDA

04:00

HTS
VTS
GDDXS
NHS

ATT
MTEPH
ADSF
OASST

BESU
PHASE 3
TRANSLATION
ZLV, +VVV

BESU
PHASE 4

NUMBER
SPEED

1

ORB 81

ORB 82

ORB 83

SUPPLY WATER DUMP USING FES
(ORB OPS, ECLS) step 1

EXERCISE
MS1, CDR, PLT,
MS3, & MS2

APCG LOG

Perform USER EVENT (PL OPS, APCG)

MET: ___ / ___ : ___ : ___

TEMP: _____

Notify MCC of any TEMP deviations

CABIN TEMP SURVEY
(ORB OPS, DTO 664)

P/TV05 OPERATIONS
(PHOTO/TV, CPCG)
Perform on top VDA only

PRE-SLEEP ACTIVITY
(ORB OPS, CREW SYS)

Do not perform
SUPPLY WATER DUMP

P/TV13 OPS (EISG)
(PHOTO/TV, CONFIG 2)
Airglow w/Fabry Perot

P/TV13 OPS (EISG)
(PHOTO/TV, CONFIG 2)
Airglow w/Fabry Perot

STA OPS
(PL OPS, MODE)

STA STOWAGE
(PL OPS, MODE)

APCG FAN INLET & TEMP CK
Complete LOG

UPLINK
MEPH RESTART

STS-62 (FD 06)

STS

PL

MCC

MET DAY 005

04:00
A1(81)
AUTO/VERN

ORB 84

05:00

06:00

ORB 85

07:00

ORB 86

08:00

IMU ALIGN - S TRK (ORB OPS)

06 UHF MODE - OFF
PRIVATE MEDICAL CONFERENCE

06 UHF MODE - SPLX (or as reqd)
PRIV FAMILY CONF

PRE-SLEEP ACTIVITY
(ORB OPS, CREW SYS)

Do not perform
SUPPLY WATER DUMP

PADM SETUP
(ORB OPS, PGSC)

PGSC UPSET MONITORING (DTO 656)
Insert MEM EVT MON Disk in 486 IBM Think Pad
Insert MEM BOOT/PADM DATA Disk in 386 PGSC
Reboot both computers
After beep on 386, press F key

PADM_XFER
PGSC UPDATES

SUPPLY WATER DUMP USING FES
(ORB OPS, ECLS)
Perform Step 2 w/FES reqd

REMINDER: DSO 612 morning sample
collections require 4
hours of fasting.

SLEEP

TDR EN
GSTDN
MIDLA
GTS
GDC
MIL
HST
VTS
GDS
DGS
GTS
HST
VTS
GDS
IDGS

A1(81)
AUTO/VERN

ATT
METS
HEADS
OASST

SAMPLE
TRANSPHASE
DISSEMINATION

1 4

STS-62 (FD 06)

PL

MCC

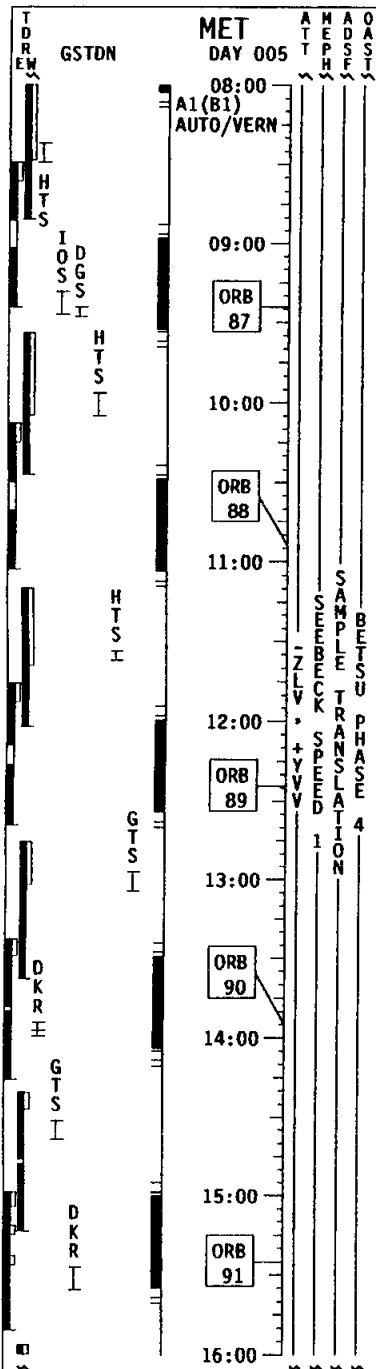

STS

SLEEP

FD07 EZ ACTIVITIES:

CPA OPS (ORB OPS, CREW SYS) (15 Min)
 H2 BOILOFF CRYO HEATER MANUAL OPS
 (ORB OPS, DIO 413) On MCC Call
 DRINK EXTRA FLUID (DSO 610) (CDR & MS2)
 METABOLIC STUDIES
 (BIOMED, DSO 492/610/612) Step D
 LOG FOOD/FLUID INTAKE & EXERCISE
 DSO 608 - Log fluid only (5 min/Cmn) (PLT, MS1, MS2 & MS3)
 DSO 610/612 - Log all three (5 min/Cmn) (CDR & MS2)
 DSO 623 - Log physical activity only (5 min/Cmn) (PLT & MS2)

POST-SLEEP ACTIVITY
 (ORB OPS, CREW SYS)

METABOLIC STUDIES
 (BIOMED, DSO 492/610/612)
 Steps A, B, 3-8, J, K
 (CDR & MS2)

Do not perform
 SUPPLY WATER DUMP

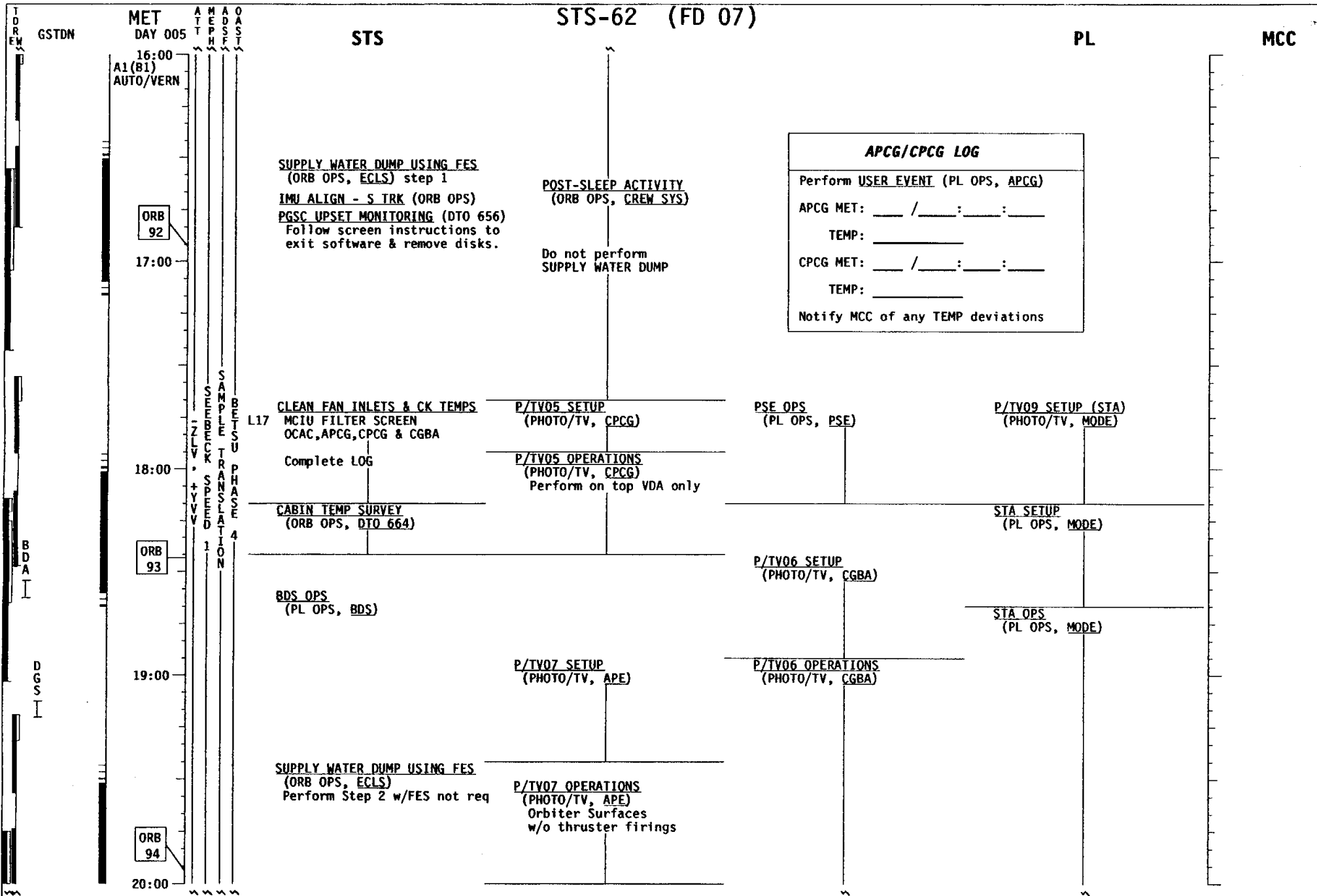

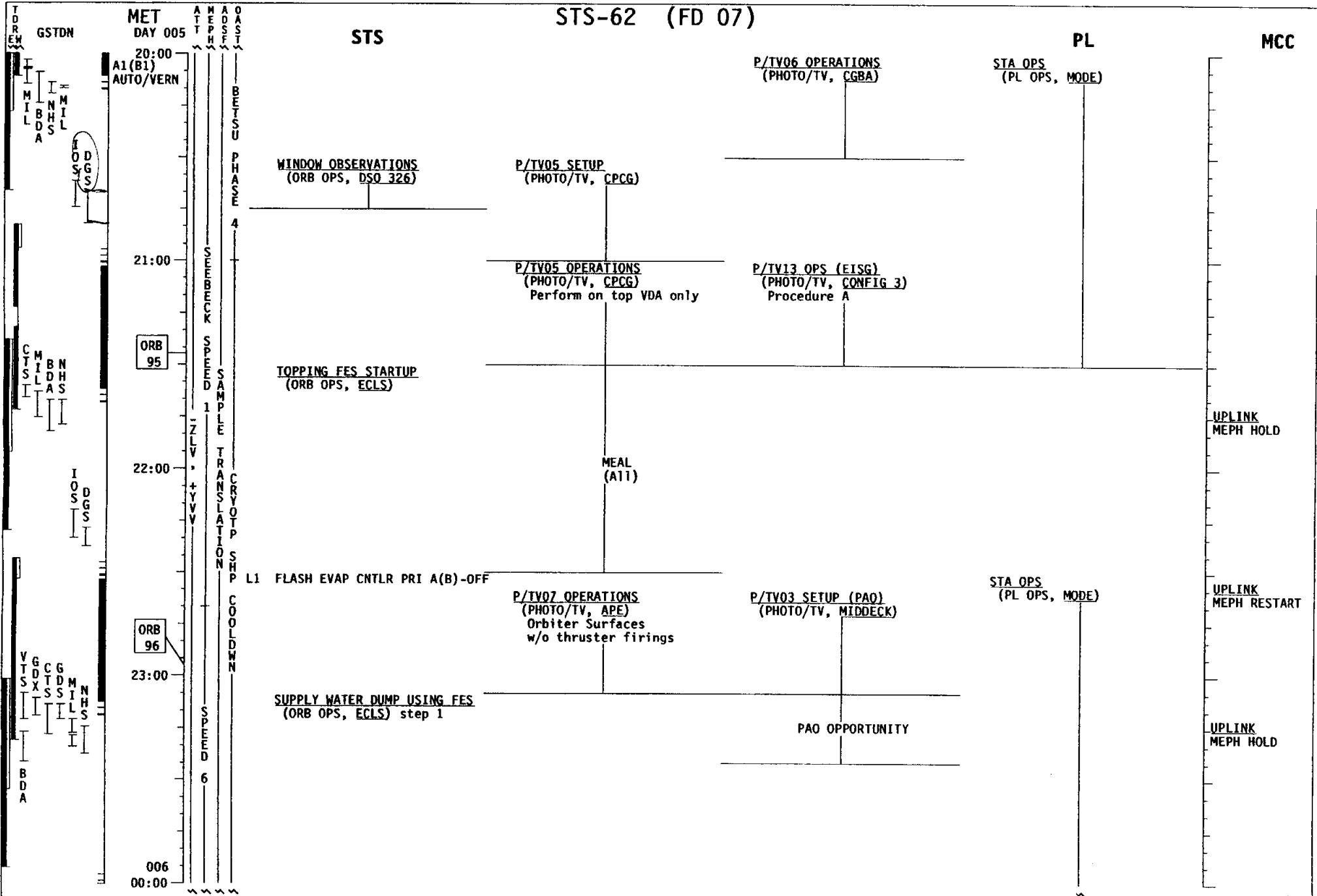

STS-62 (FD 07)

STS

PL

MCC

T D R E W
GSTDN
MET DAY 006
A T T
M E P H
A D A S T

00:00 A1(B1) AUTO/VERN

01:00

02:00

03:00

04:00

HTS

VTS

GDS

CTSS

MIL

NHSA

HTS

VTS

GDS

CTSS

MIL

NHSA

HTS

VTS

GDS

CTSS

MIL

NHSA

HTS

VTS

GDS

CTSS

MIL

NHSA

SAMPLE

TRANSLATION

CRYOPT

SHPCOLDOWN

SEEK

SPEED

SUPPLY/WASTE WATER DUMP
(ORB OPS, ECLS)
Initiate Waste Dump
Dump to 5%

SUPPLY/WASTE WATER DUMP
(ORB OPS, ECLS)
Terminate Waste Dump

CABIN TEMP SURVEY
(ORB OPS, DTO 664)

PRE-SLEEP ACTIVITY
(ORB OPS, CREW SYS)

Do not perform
SUPPLY WATER DUMP

EXERCISE
MS3, MS1, CDR

P/TV13 OPS (EISG)
(PHOTO/TV, CONFIG 3)
Procedure H

APCG LOG

Perform USER EVENT (PL OPS, APCG)

MET: ___ / ___ : ___ : ___

TEMP: _____

Notify MCC of any TEMP deviations

P/TV13 OPS (EISG)
(PHOTO/TV, CONFIG 3)
Procedure H

APCG FAN INLET & TEMP CK
Complete LOG

P/TV05 OPERATIONS
(PHOTO/TV, CPCG)
Perform on top VDA only

STA OPS
(PL OPS, MODE)

STA STOWAGE
(PL OPS, MODE)

P/TV09 SETUP (DLS)
(PHOTO/TV, MODE)

DYNAMIC LOAD SENSOR SETUP
(PL OPS, MODE)

DLS ACTIVATION
(PL OPS, MODE)

SSBUY UPLINK
MDA CLOSE

SSBUY UPLINK
MDA OPEN
UPLINK
MEPH RESTART

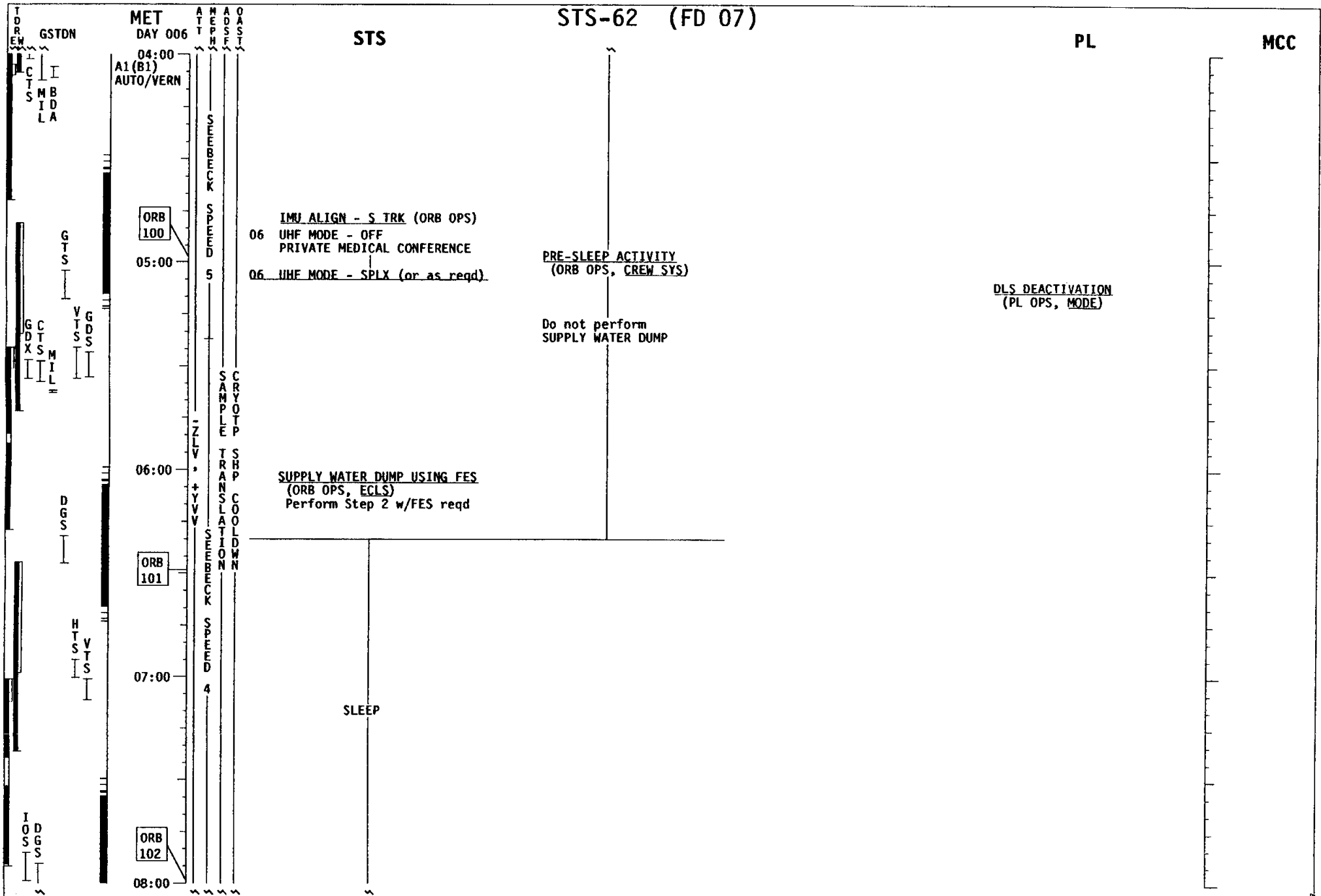

T D R E W
GSTDN
MET
DAY 006
A T T
H E P H
A D S S F
O A S T

STS-62 (FD 07)

STS

PL

MCC

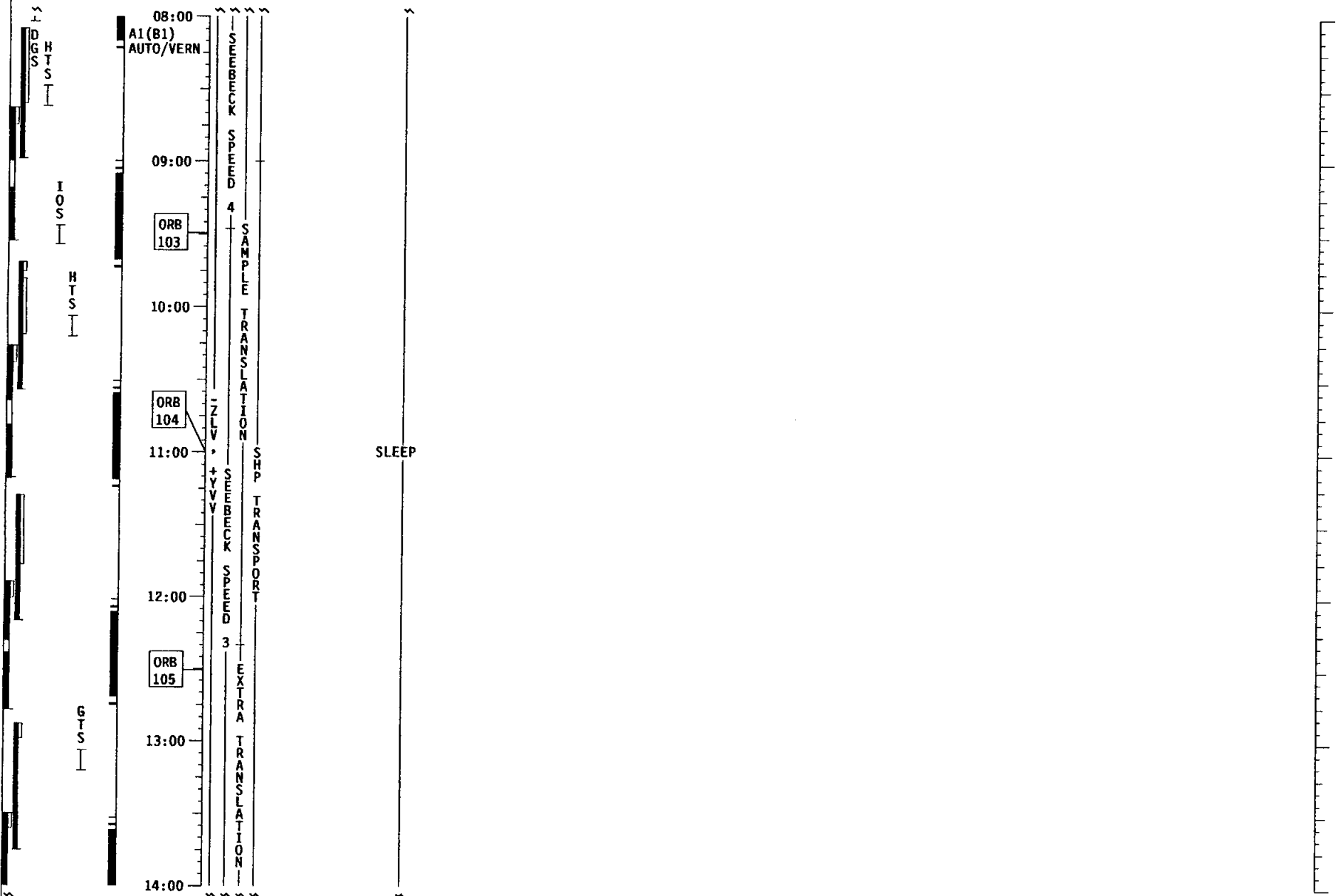

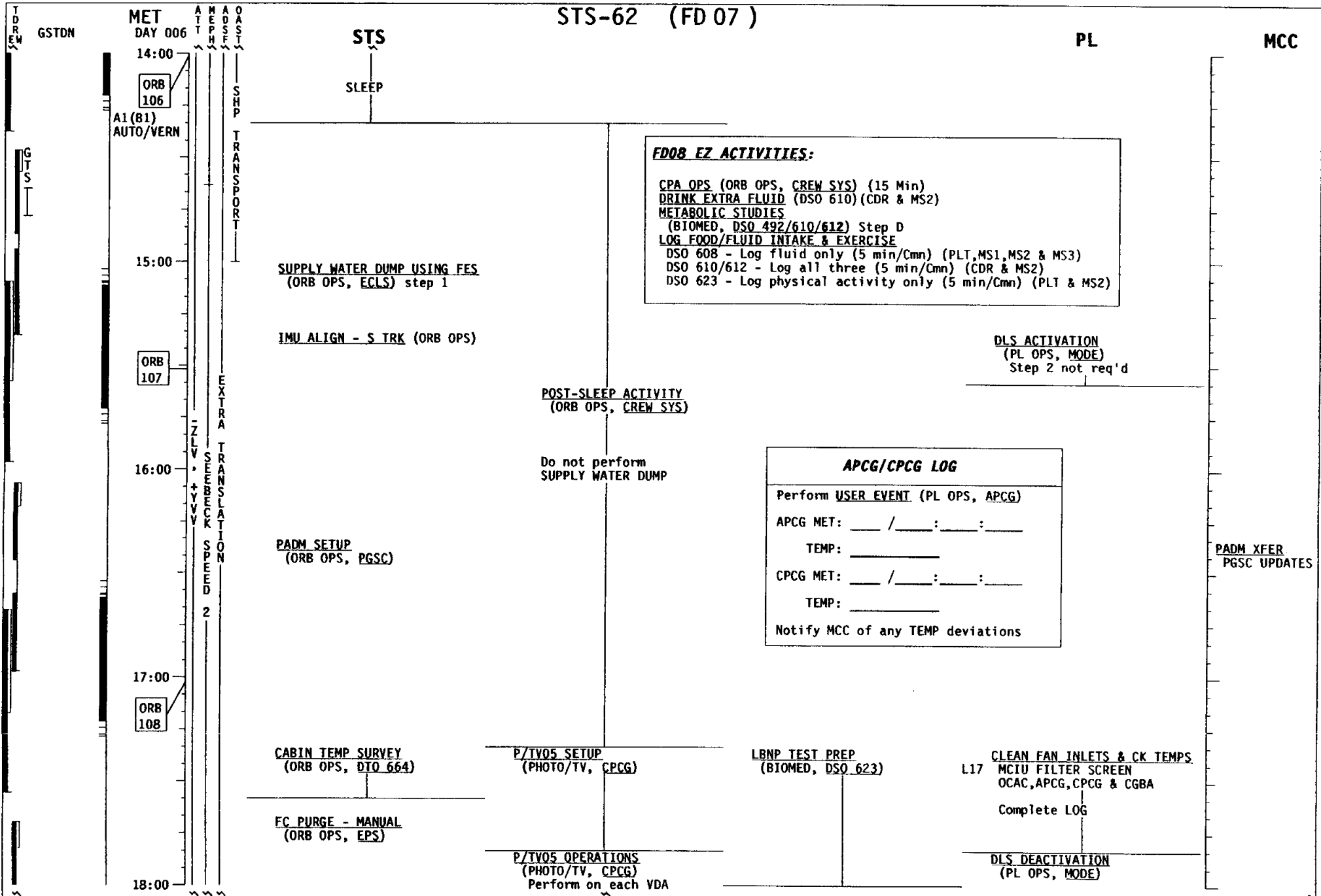

STS-62 (FD 08)

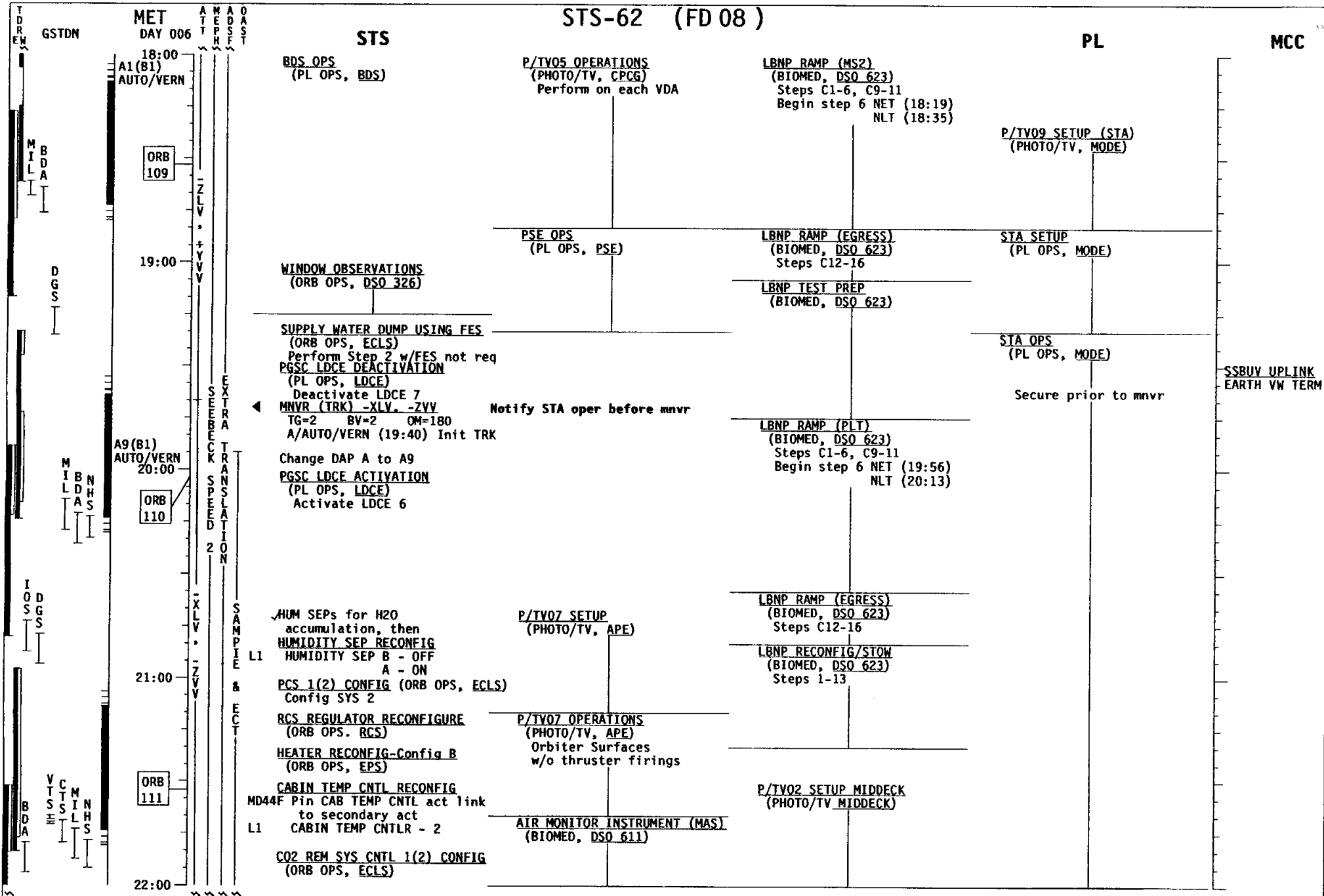

STS-62 (FD 08)

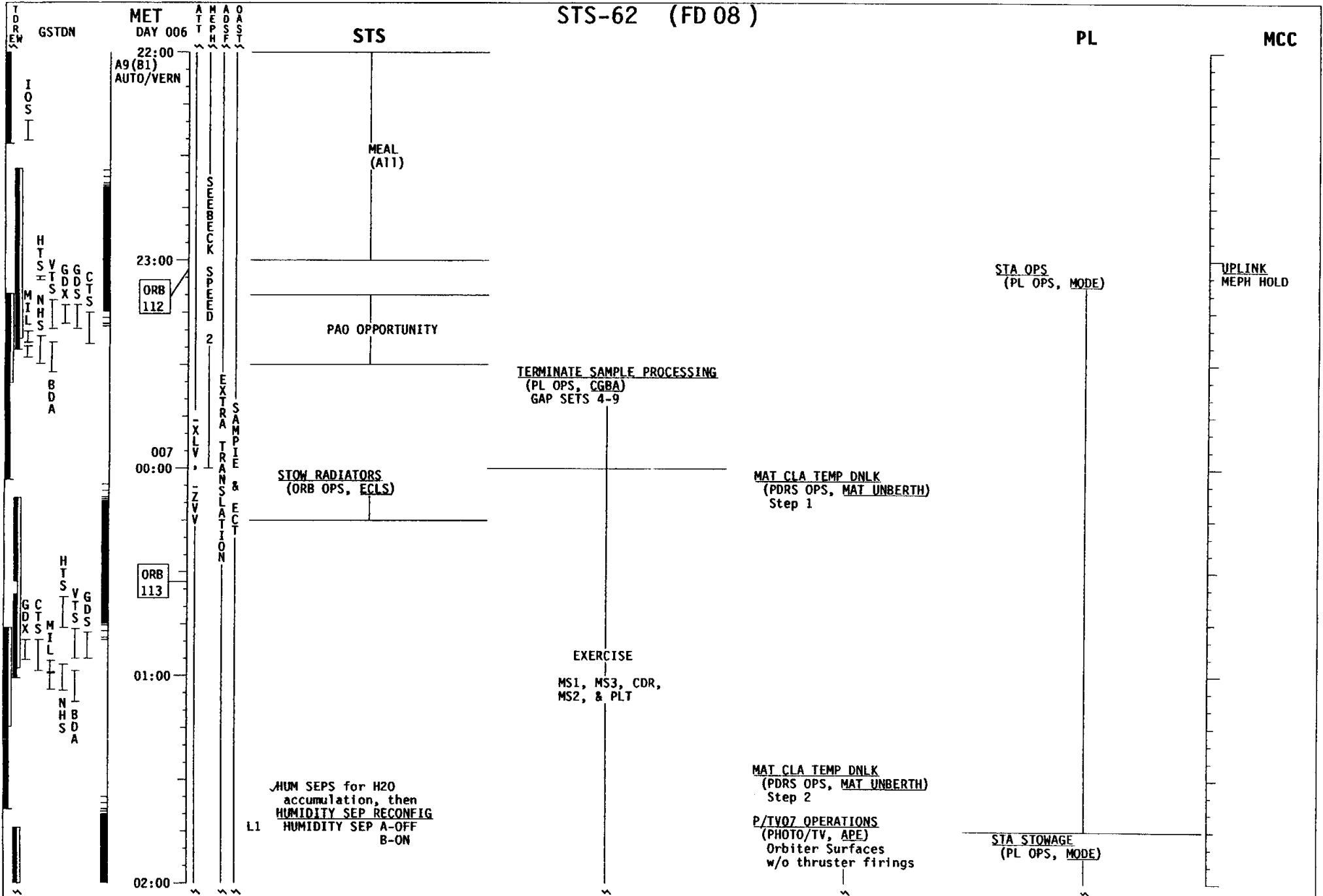

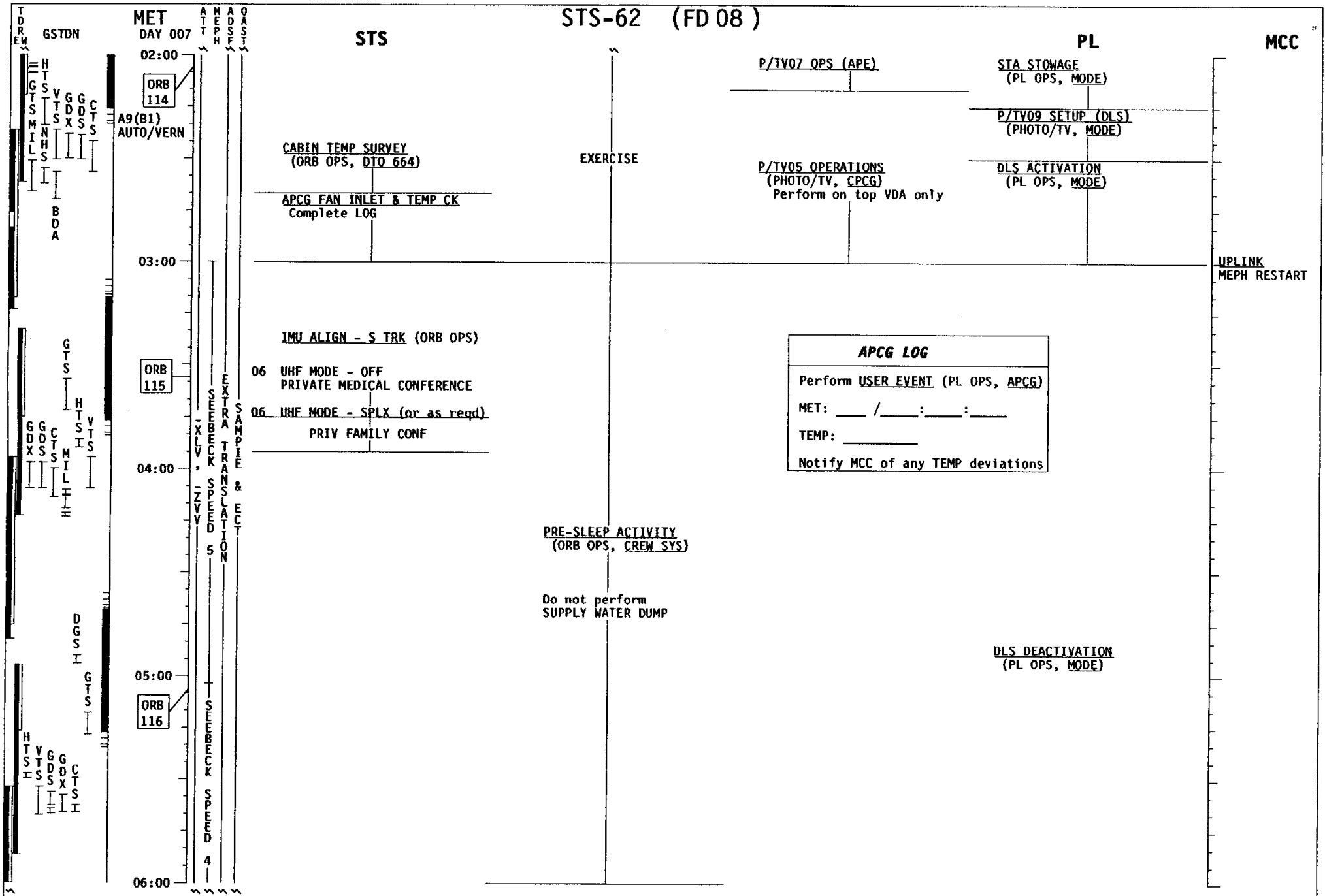

STS-62 (FD 08)

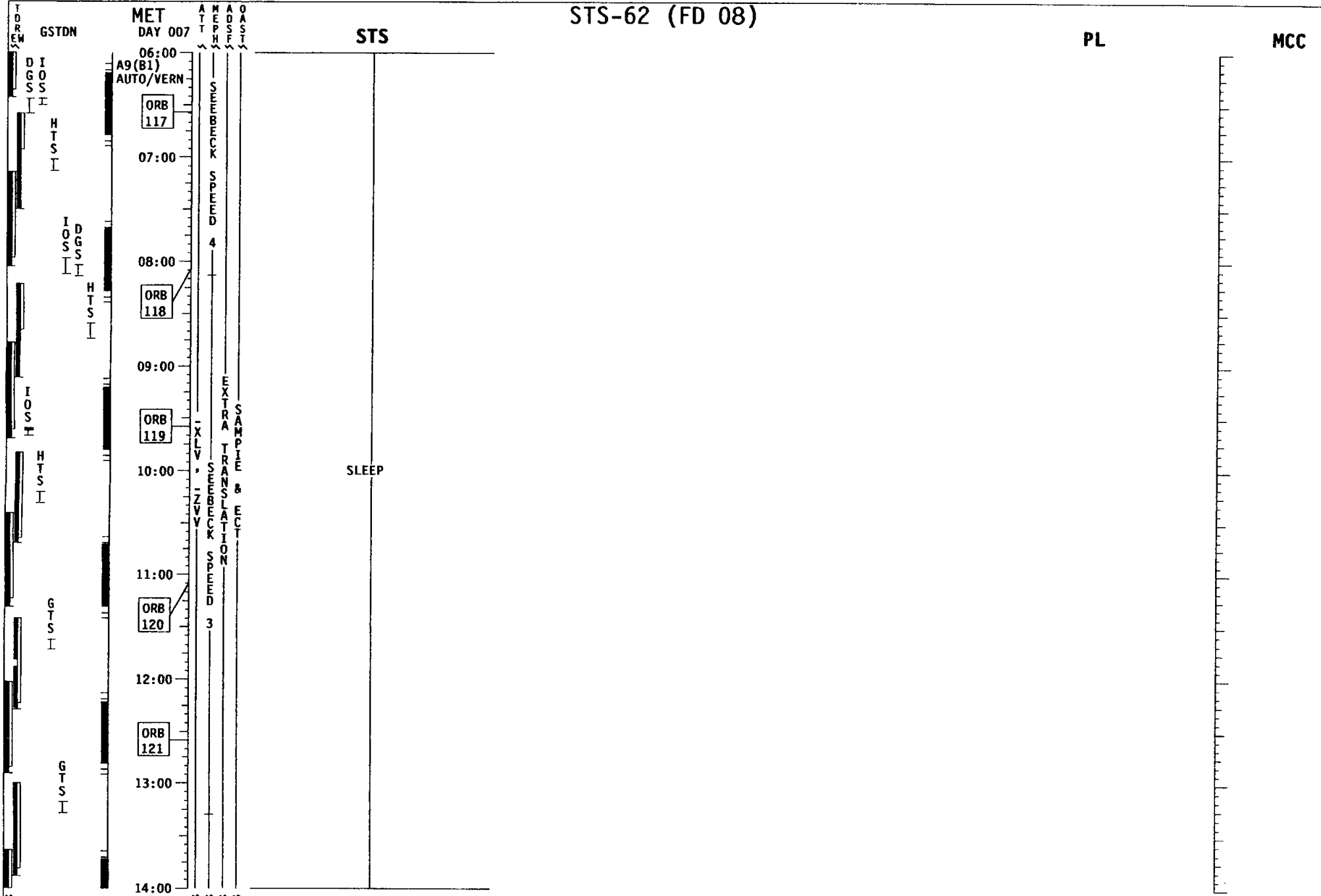

STS-62 (FD 09)

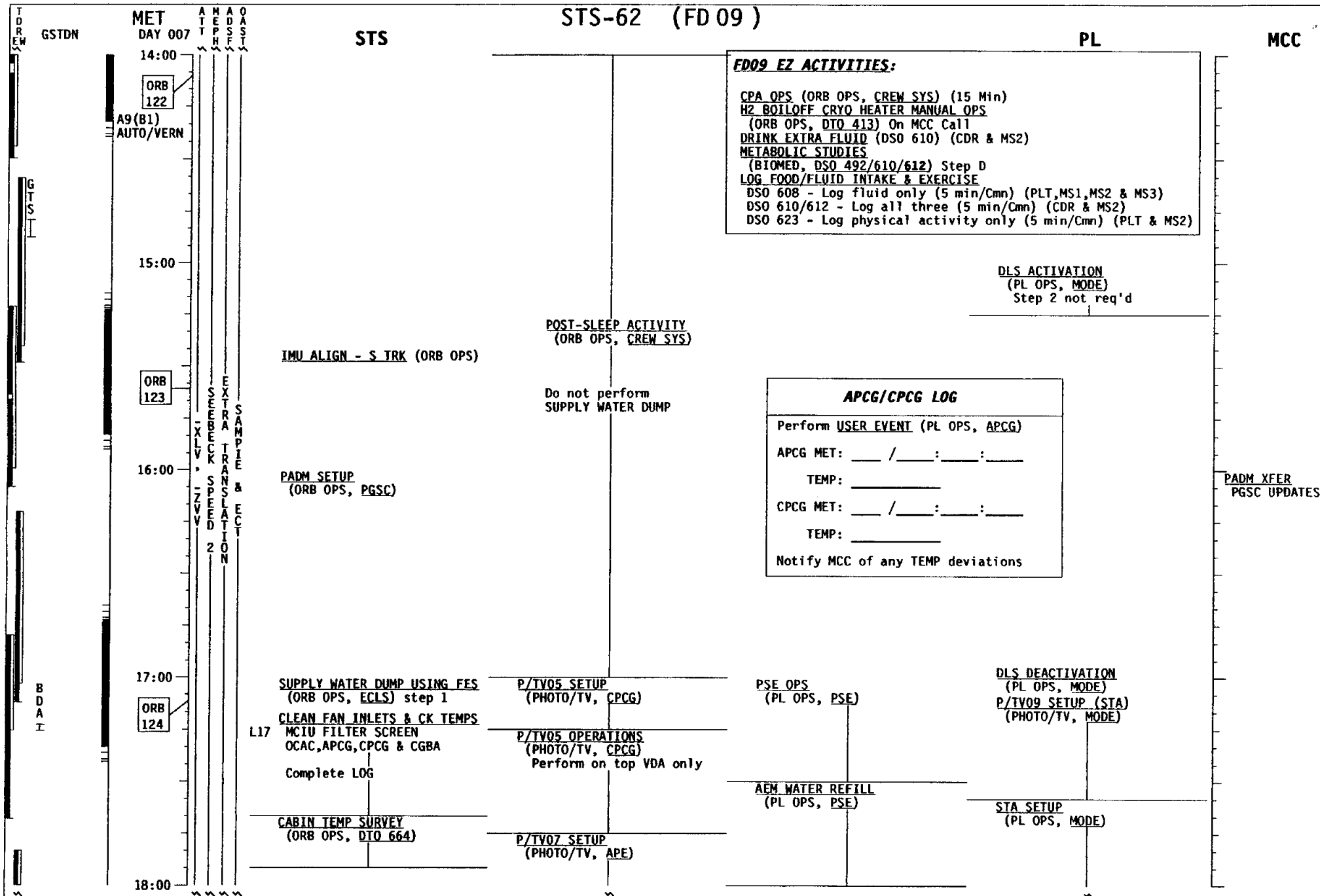

FD09 EZ ACTIVITIES:

CPA OPS (ORB OPS, CREW SYS) (15 Min)
 H2 BOILOFF CRYO HEATER MANUAL OPS
 (ORB OPS, DIO 413) On MCC Call
 DRINK EXTRA FLUID (DSO 610) (CDR & MS2)
METABOLIC STUDIES
 (BIOMED, DSO 492/610/612) Step D
 LOG FOOD/FLUID INTAKE & EXERCISE
 DSO 608 - Log fluid only (5 min/Cmn) (PLT,MS1,MS2 & MS3)
 DSO 610/612 - Log all three (5 min/Cmn) (CDR & MS2)
 DSO 623 - Log physical activity only (5 min/Cmn) (PLT & MS2)

DLS ACTIVATION
 (PL OPS, MODE)
 Step 2 not req'd

APCG/CPCG LOG

Perform **USER EVENT** (PL OPS, APCG)

APCG MET: ___ / ___ : ___ : ___
 TEMP: _____

CPCG MET: ___ / ___ : ___ : ___
 TEMP: _____

Notify MCC of any TEMP deviations

PADM XFER
 PGSC UPDATES

STS-62 (FD 09)

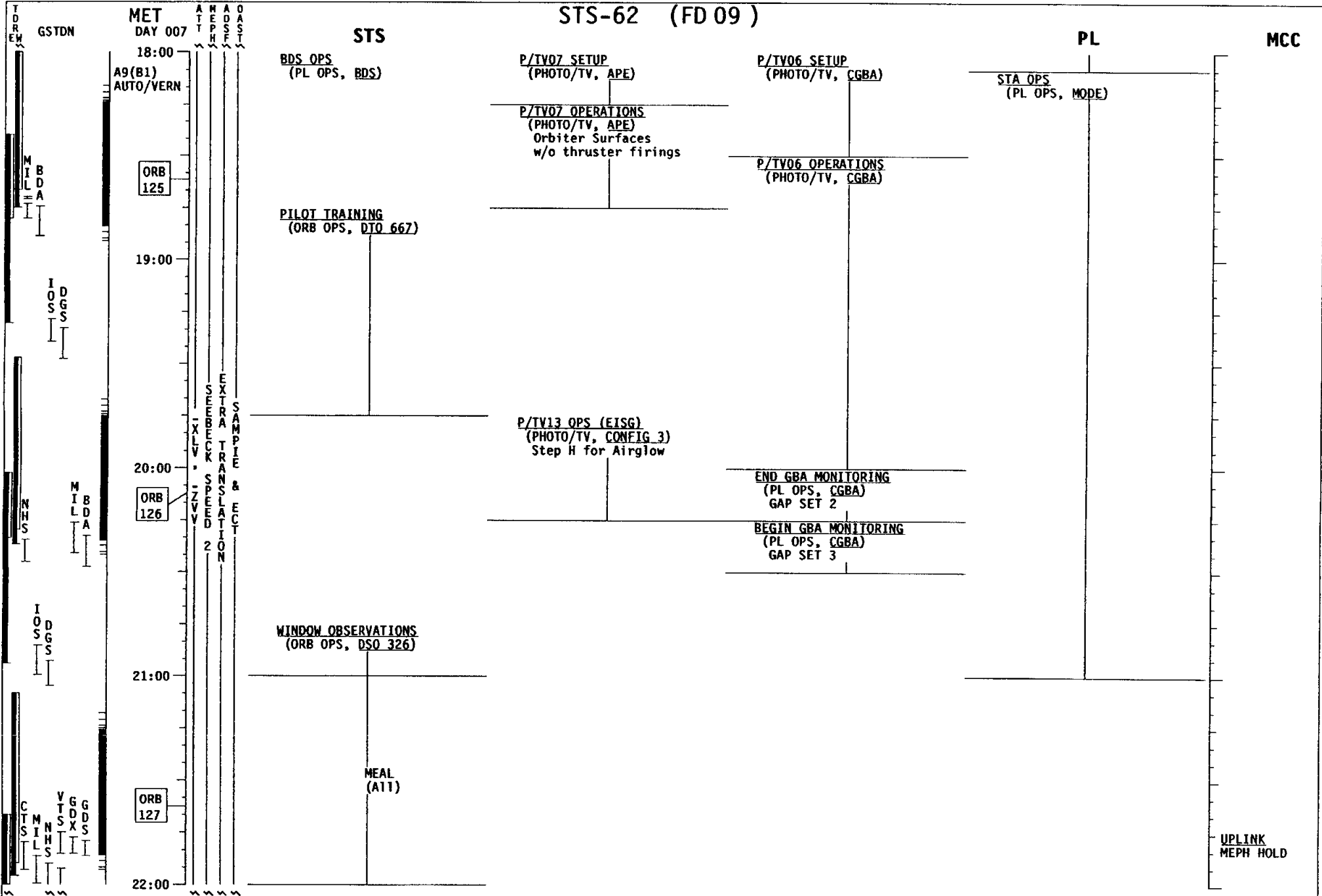

STS-62 (FD 09)

STS

PL

MCC

MET DAY 007
 22:00
 A9(B1)
 AUTO/VERN

23:00
 ORB 128

008
 00:00

01:00
 ORB 129

02:00

DRM
 GSTDN
 LNHSA
 BDA
 IOSH
 HTS
 VTS
 GDS
 GDSX
 MIL
 HTS
 VTS
 GDS
 GDSX
 MIL
 BDA
 HTS
 VTS
 GDS
 GDSX
 MIL
 BDA
 HTS
 VTS
 GDS
 GDSX
 MIL
 NHA

AT
 MESH
 ADSP
 OASU

SAMPLE & ECT
 EXTRA
 TRANSLATION
 SAMPLE & ECT

-XLV, -ZVV
 -XLV, +ZVV

SUPPLY WATER DUMP USING FES
 (ORB OPS, ECLS)
 Perform Step 2 w/FES not req

PGSC LDCE DEACTIVATION
 (PL OPS, LDCE)
 Deactivate LDCE 6 & 8

Notify STA oper before mnvr
MNVR (TRK) -XLV, +ZVV
 TG=2 BV=2 OM=0
 A/AUTO/VERN (00:25) Init TRK

SUPPLY WATER DUMP USING FES
 (ORB OPS, ECLS) step 1

P/TV07 OPERATIONS
 (PHOTO/TV, APE)
 Orbiter Surfaces
 w/o thruster firings

EXERCISE
 MS1, CDR, MS3,
 PLT, & MS2

P/TV05 SETUP
 (PHOTO/TV, CPCG)

P/TV05 OPERATIONS
 (PHOTO/TV, CPCG)
 Perform on top VDA only

P/TV03 SETUP (PAO)
 (PHOTO/TV, MIDDECK)

PAO OPPORTUNITY

P/TV07 OPERATIONS
 (PHOTO/TV, APE)
 WINDOW EFFECTS

STA OPS
 (PL OPS, MODE)

Secure prior to mnvr

STA STOWAGE
 (PL OPS, MODE)

P/TV09 SETUP (DLS)
 (PHOTO/TV, MODE)

STS-62 (FD 09)

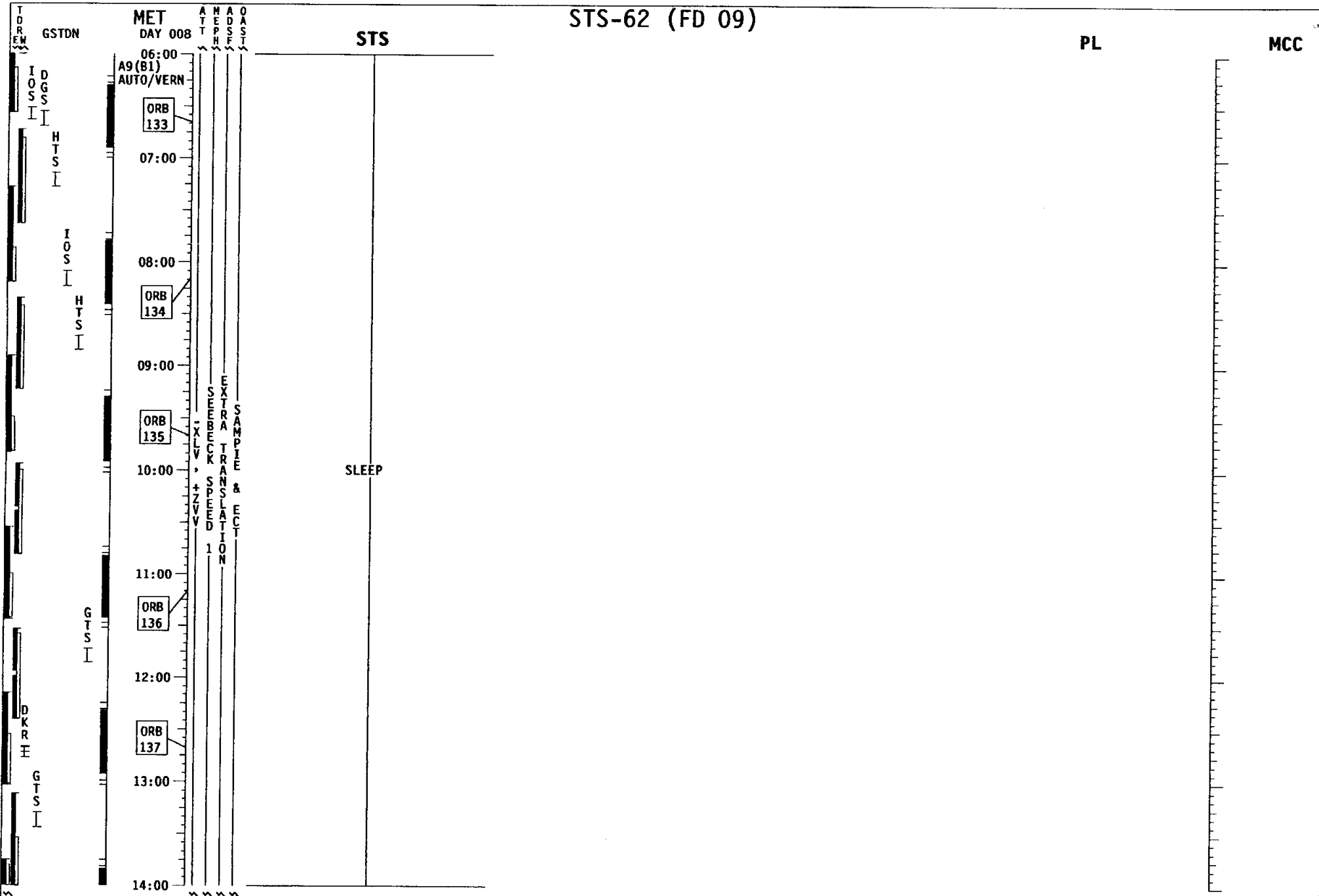

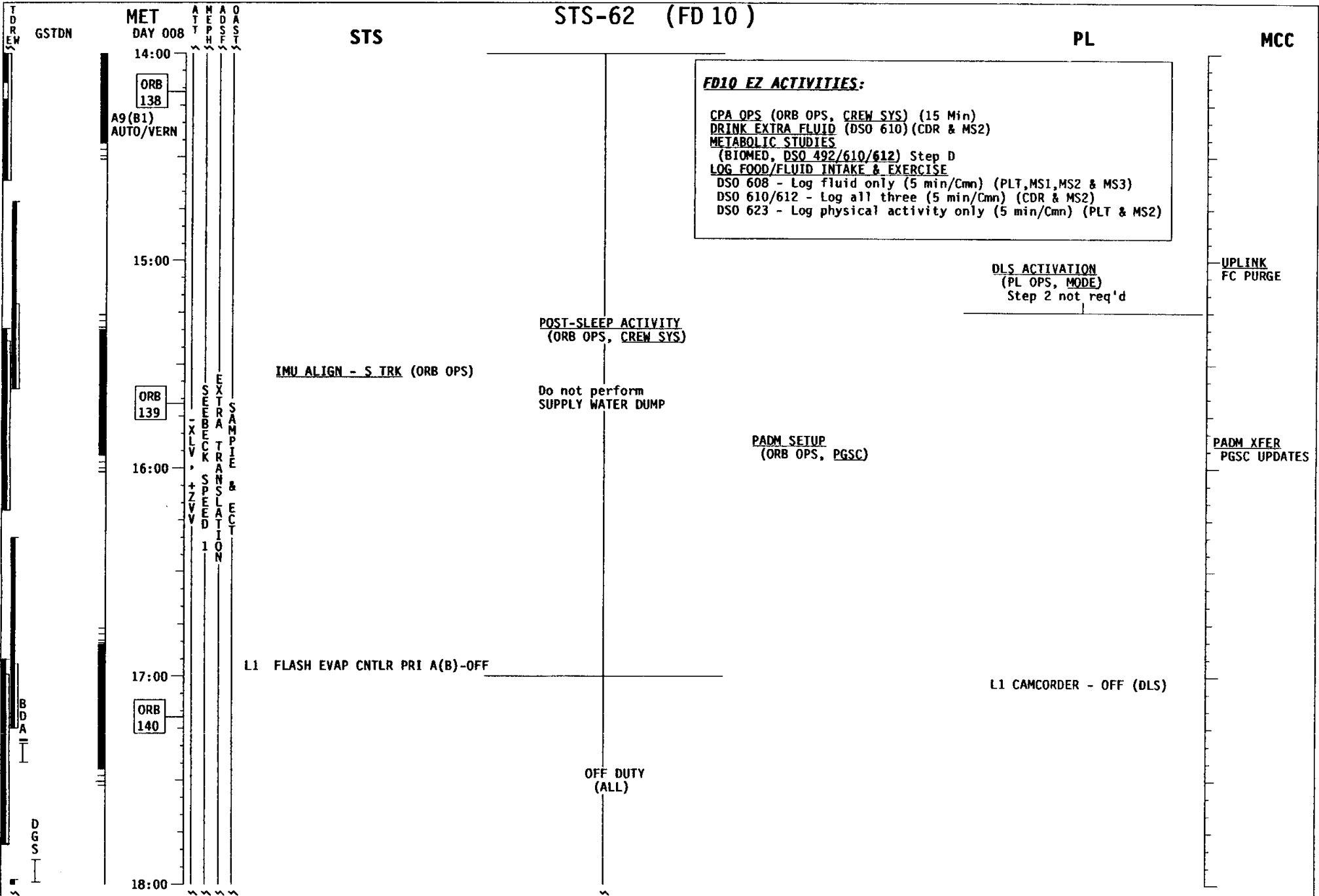

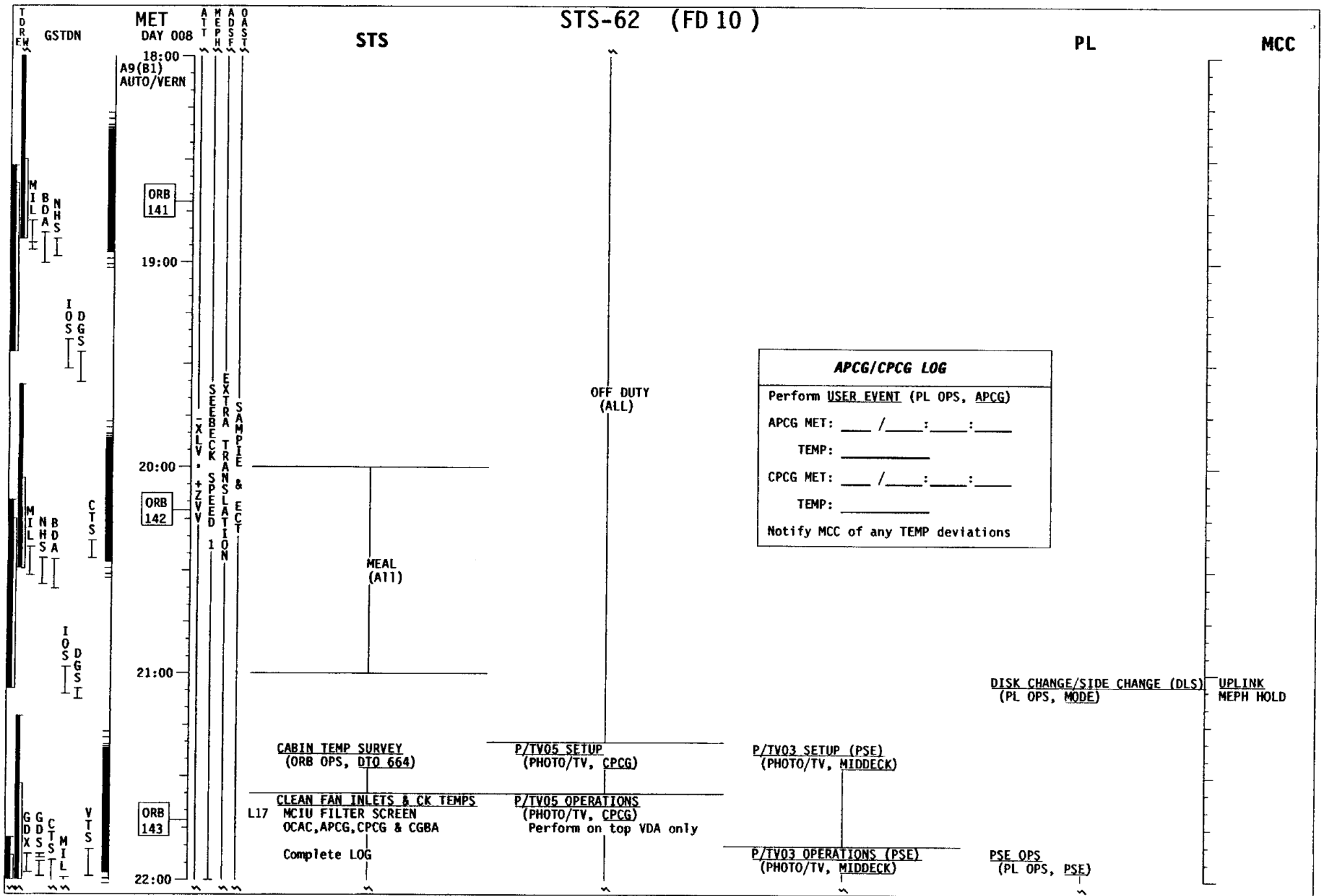

STS-62 (FD 10)

STS

PL

MCC

MET DAY 008

18:00
A9(B1)
AUTO/VERN

ORB
141

19:00

20:00
ORB
142

21:00

ORB
143

22:00

OFF DUTY
(ALL)

MEAL
(A1)

CABIN TEMP SURVEY
(ORB OPS, DTG 664)

P/TV05 SETUP
(PHOTO/TV, CPCG)

P/TV03 SETUP (PSE)
(PHOTO/TV, MIDDECK)

CLEAN FAN INLETS & CK TEMPS
L17 MCIU FILTER SCREEN
OCAC,APCG,CPCG & CGBA

P/TV05 OPERATIONS
(PHOTO/TV, CPCG)
Perform on top VDA only

Complete LOG

P/TV03 OPERATIONS (PSE)
(PHOTO/TV, MIDDECK)

DISK CHANGE/SIDE CHANGE (DLS)
(PL OPS, MODE)

UPLINK
MEPH HOLD

PSE OPS
(PL OPS, PSE)

APCG/CPCG LOG	
Perform <u>USER EVENT</u> (PL OPS, APCG)	
APCG MET:	___ / ___ : ___ : ___
TEMP:	_____
CPCG MET:	___ / ___ : ___ : ___
TEMP:	_____
Notify MCC of any TEMP deviations	

STS-62 (FD 10)

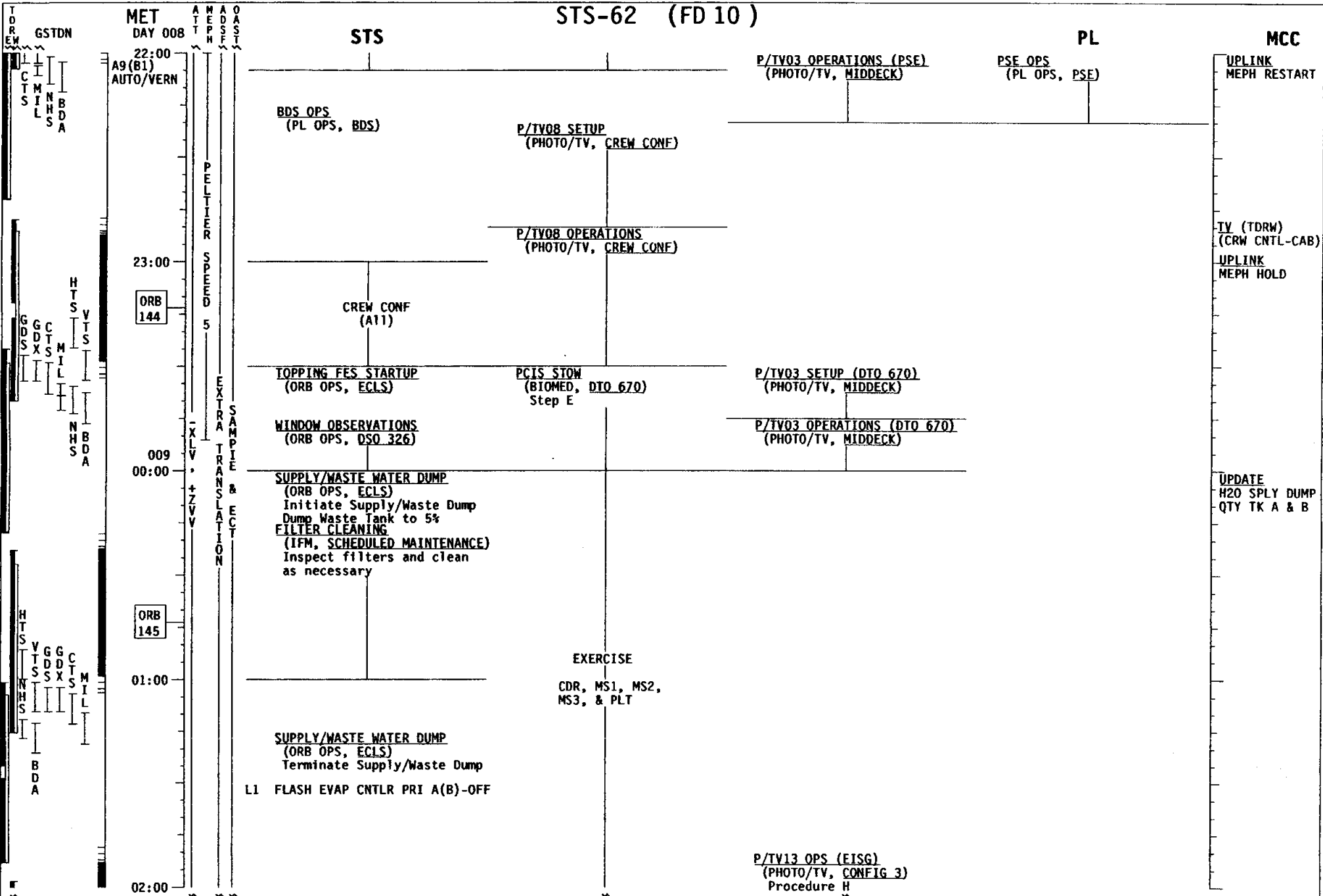

STS-62 (FD 10)

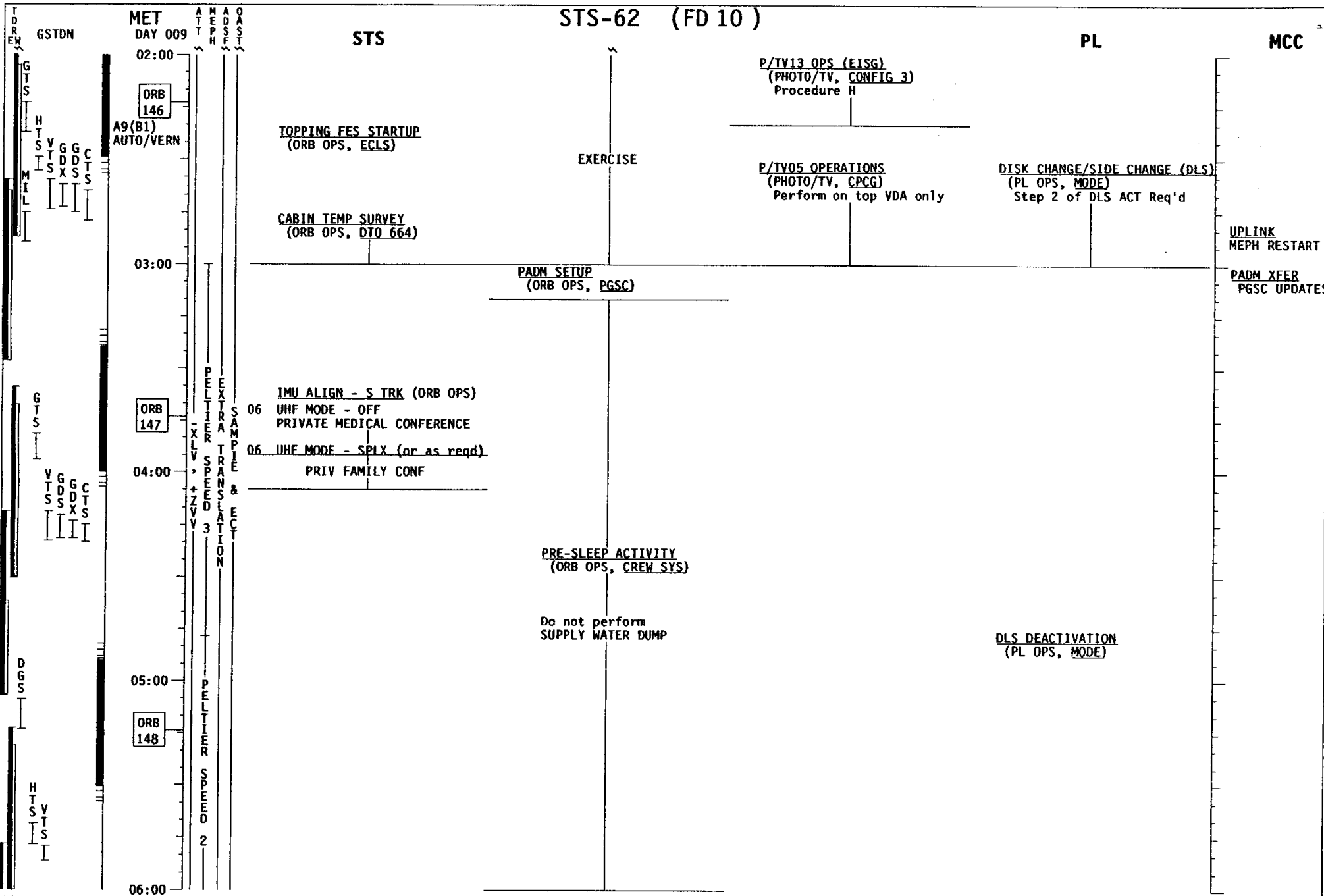

STS-62 (FD 10)

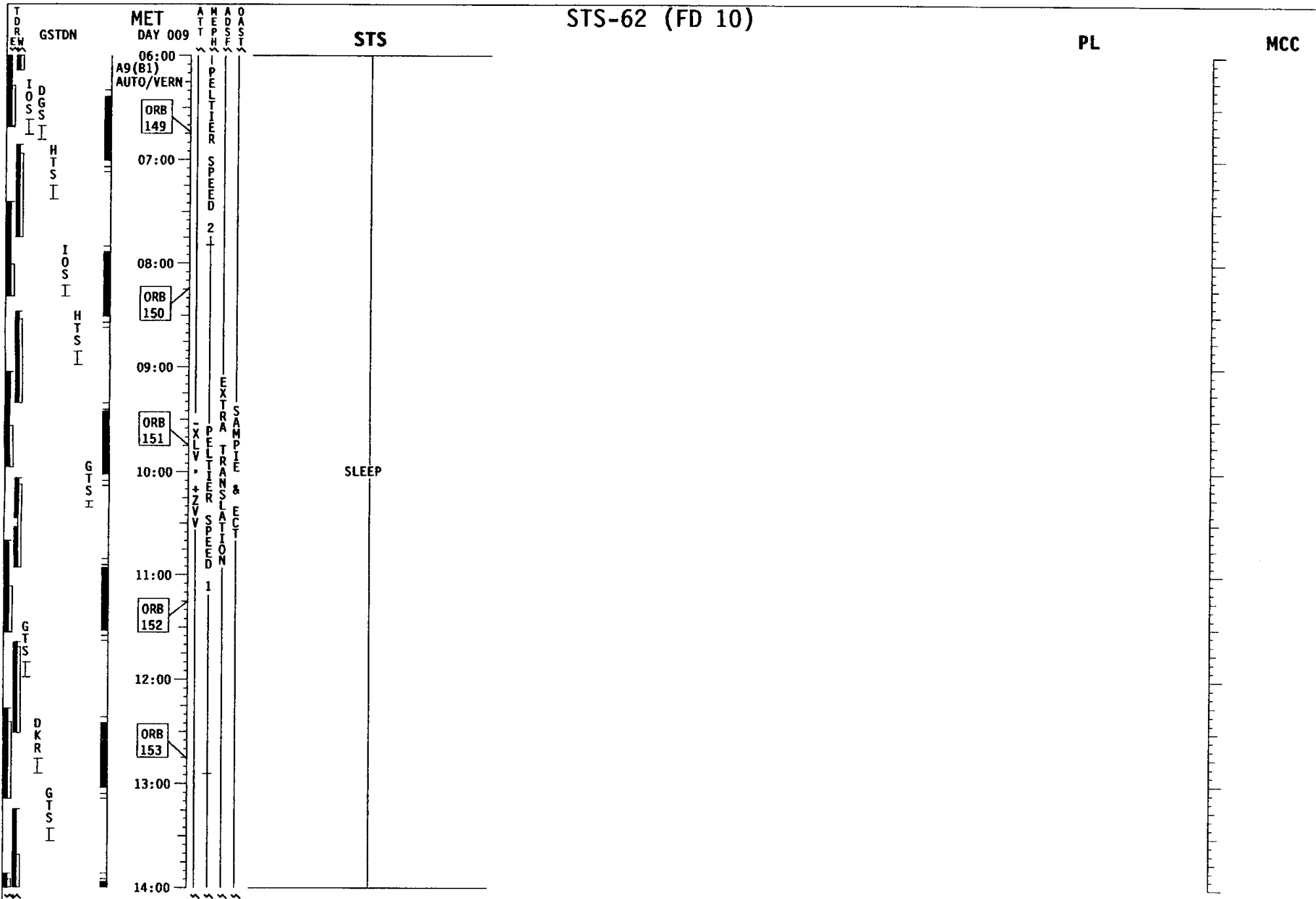

STS-62 (FD 11)

CDR

PLT

MS1

MS2

MS3

MCC

MET DAY 009

ATTENTION
PELTIER SPEED
SAMPLES & ECY
EXTRA TRANSLATION
COOL DOWN
OMS

FD11 EZ ACTIVITIES:
 CPA OPS (ORB OPS, CREW SYS) (15 Min)
 H2 BOILOFF CRYO HEATER MANUAL OPS
 (ORB OPS, DTO 413) On MCC Call
 DRINK EXTRA FLUID (DSO 610) (CDR & MS2)
 METABOLIC STUDIES
 (BIOMED, DSO 492/610/612) Step D
 LOG FOOD/FLUID INTAKE & EXERCISE
 DSO 608 - Log fluid only (5 min/Cmn) (PLT, MS1, MS2 & MS3)
 DSO 610/612 - Log all three (5 min/Cmn) (CDR & MS2)
 DSO 623 - Log physical activity only (5 min/Cmn) (PLT & MS2)

POST-SLEEP ACTIVITY
(ORB OPS, CREW SYS)

DLS ACTIVATION
(PL OPS, MODE)
Step 2 not req'd

Do not perform
SUPPLY WATER DUMP

Change DAP A to A1
 MNVR IMU ALIGN ATT
 STAR PAIR (A1)
 A/AUTO/VERN Init MNVR at SS
 IMU ALIGN - S TRK (ORB OPS)
 MNVR (TRK) -ZLV, +YVV
 TG=2 BV=3 OM=270
 A/AUTO/VERN Init TRK

APCG/CPCG LOG
 Perform USER EVENT (PL OPS, APCG)
 APCG MET: ___ / ___ : ___ : ___
 TEMP: _____
 CPCG MET: ___ / ___ : ___ : ___
 TEMP: _____
 Notify MCC of any TEMP deviations

UPLINK
SAMS-1
GAIN 1.0
UPLINK
PCMNU/PDI
Config 760
UPDATE
ORBITAL MNVR
PAD

014:F, RJD LOGIC, DRIVER (sixteen) - ON
 015:F,
 016:F
 014:E, cb MNA, B DDU L (two) -CL
 015:E
 ON-ORBIT OMS BURN #3
 (ORB OPS, OMS)
 (2 Cmn)

SAMS-1/2 RECORDER ACT
(PL OPS, SAMS)
 ✓ SAMS 1 - ON for OMS burn

TIG (16:45)
 Config DAP: B/LVLH/VERN

SAMS-1/2 RECORDER DEACT
(PL OPS, SAMS)
 SAMS 1 - OFF

P/TV05 SETUP
(PHOTO/TV, CPCG)

ON-ORBIT OMS BURN #4
 (ORB OPS, OMS)
 (2 Cmn)

SAMS 1/2 RECORDER ACT
(PL OPS, SAMS)
 SAMS 1 - ON for OMS burn

P/TV05 OPERATIONS
(PHOTO/TV, CPCG)
 Perform on top VDA only

Complete prior to TIG

CPCG ASSIST

UPDATE
ORBITAL MNVR
PAD

TIG (17:30)
 MNVR (TRK) -ZLV, +YVV
 TG=2 BV=3 OM=270
 A/AUTO/VERN Init TRK

SAMS-1/2 RECORDER DEACT
(PL OPS, SAMS)
 Deactivate both RCDRS
 CABIN TEMP SURVEY
 (ORB OPS, DTO 664)

L1 CAMCORDER - OFF (DLS)

EXERCISE

MAT CLA TEMP DNK
(PDRS OPS, MAT UNBERTH)
 Step 1
 ABL PORT RMS HTR (two)-AUTO
 CLEAN FAN INLETS & CK TEMPS
 L17 MCIU FILTER SCREEN
 OCAC, APCG, CPCG, & CGBA

UPLINK
PCMNU/PDI
Config 762

Complete LOG
 FLT PLN/62/FIN

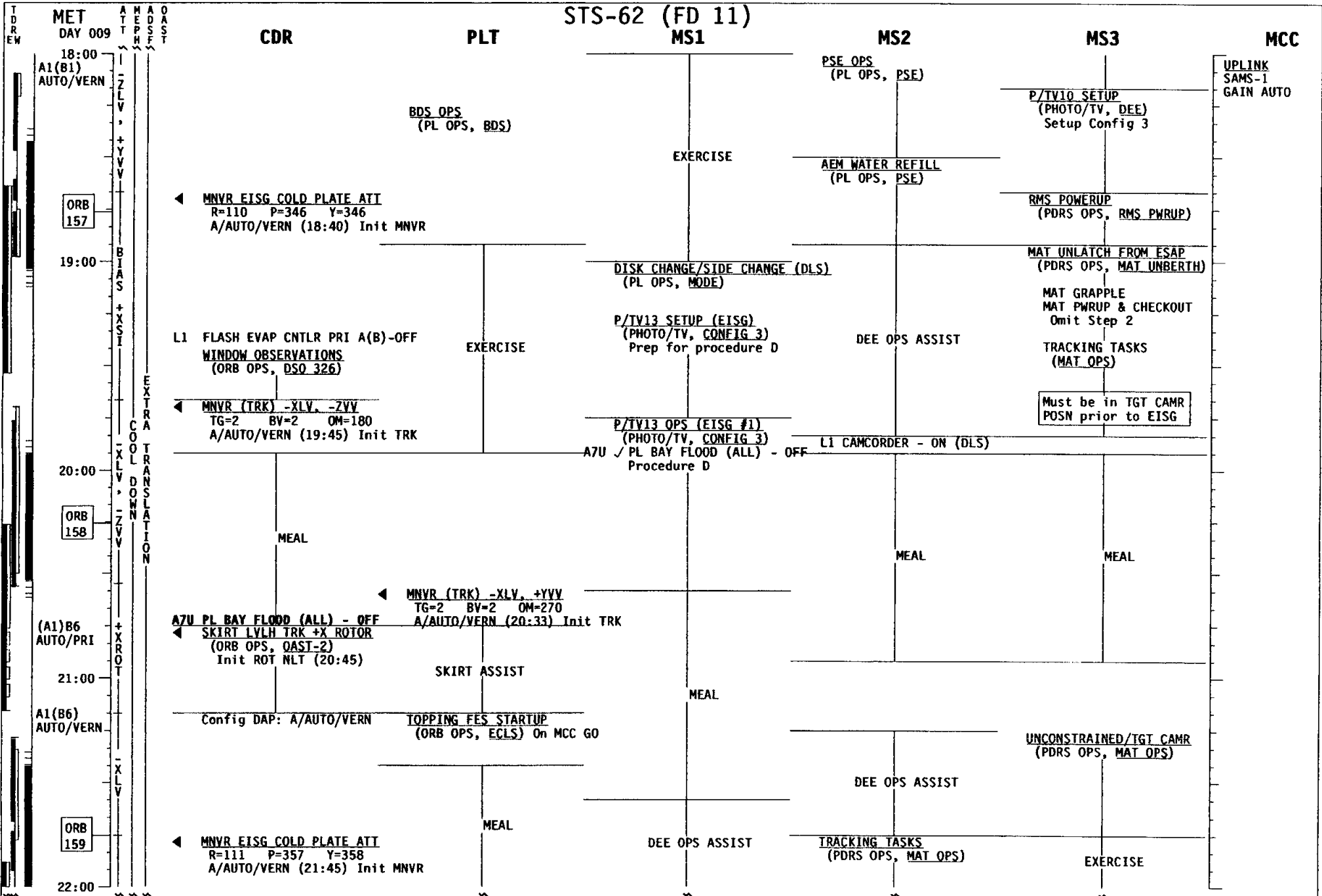

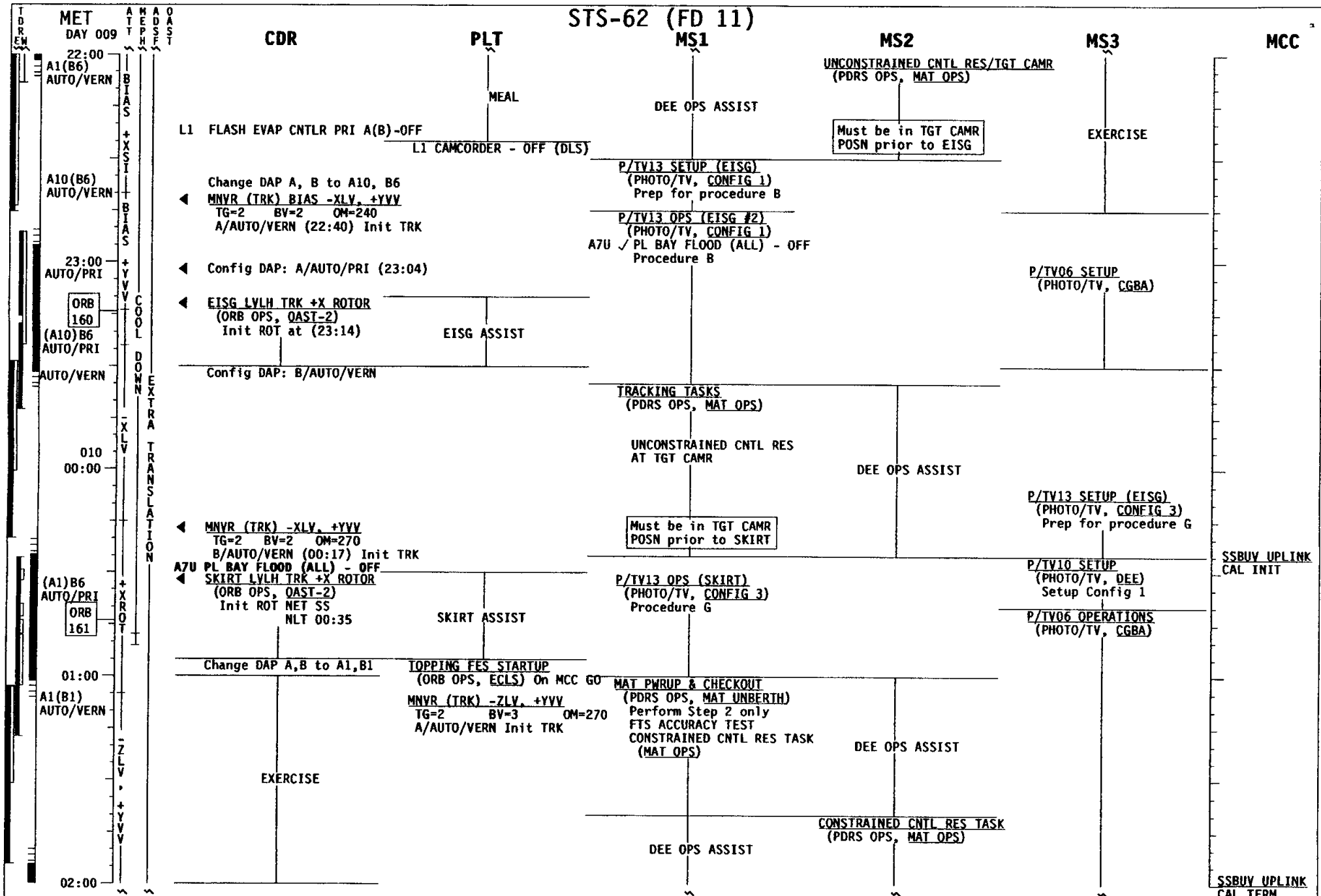

TDR EW	MET DAY 010	STS-62 (FD 11)					
		CDR	PLT	MS1	MS2	MS3	MCC
02:00	A1(B1) AUTO/VERN ORB 162			DEE OPS ASSIST MAT STOW (PDRS OPS, MAT UNBERTH)	DISK CHANGE/SIDE CHANGE (PL OPS, MODE) Step 2 of DLS ACT Req'd	P/TV06 OPERATIONS (PHOTO/TV, CGBA)	
		◀ MNVR (TRK) -ZSI ATT TG=4 BV=3 OM=90 A/AUTO/VERN (02:15) Init TRK	CABIN TEMP SURVEY (ORB OPS, DTO 664)	RMS EXTENDED PARK (PDRS OPS, RMS PARK)		P/TV05 SETUP (PHOTO/TV, CPCG)	
			APCG FAN INLET & TEMP CK Complete LOG	P/TV05 OPERATIONS (PHOTO/TV, CPCG) Perform on top VDA only		TERM SAMPLE PROCESSING (PL OPS, CGBA) GAP SETS 10-15	SSBUY UPLINK SOLAR VW INIT
03:00		PAO OPPORTUNITY VOICE ONLY				CPCG ASSIST	
				PRE-SLEEP ACTIVITY (ORB OPS, CREW SYS)		APCG LOG Perform USER EVENT (PL OPS, APCG) MET: ____ / ____ : ____ : ____ TEMP: _____ Notify MCC of any TEMP deviations	SSBUY UPLINK SOLAR VW TERM
		◀ MNVR IMU ALIGN ATT STAR PAIR (A1) A/AUTO/VERN Init MNVR at SS		RMS POWERDOWN (PDRS OPS, RMS PWRDN) Note: Do not stow MPM's			
04:00	ORB 163	IMU ALIGN - S TRK (ORB OPS) MNVR (TRK) BIAS +ZLV, -YVV TG=2 BV=5 P=250 Y=0 OM=125 A/AUTO/VERN Init TRK SUPPLY/WASTE WATER DUMP (ORB OPS, ECLS) Initiate Supply Dump					UPDATE H2O SPLY DUMP QTY TK A & B
		06 UHF MODE - OFF PRIVATE MEDICAL CONFERENCE				DLS DEACTIVATION (PL OPS, MODE)	
		06 UHF MODE - SPLX (or as reqd)					
05:00	ORB 164			PRE-SLEEP ACTIVITY (ORB OPS, CREW SYS)			
		SUPPLY/WASTE WATER DUMP (ORB OPS, ECLS) Terminate Supply Dump					
06:00							

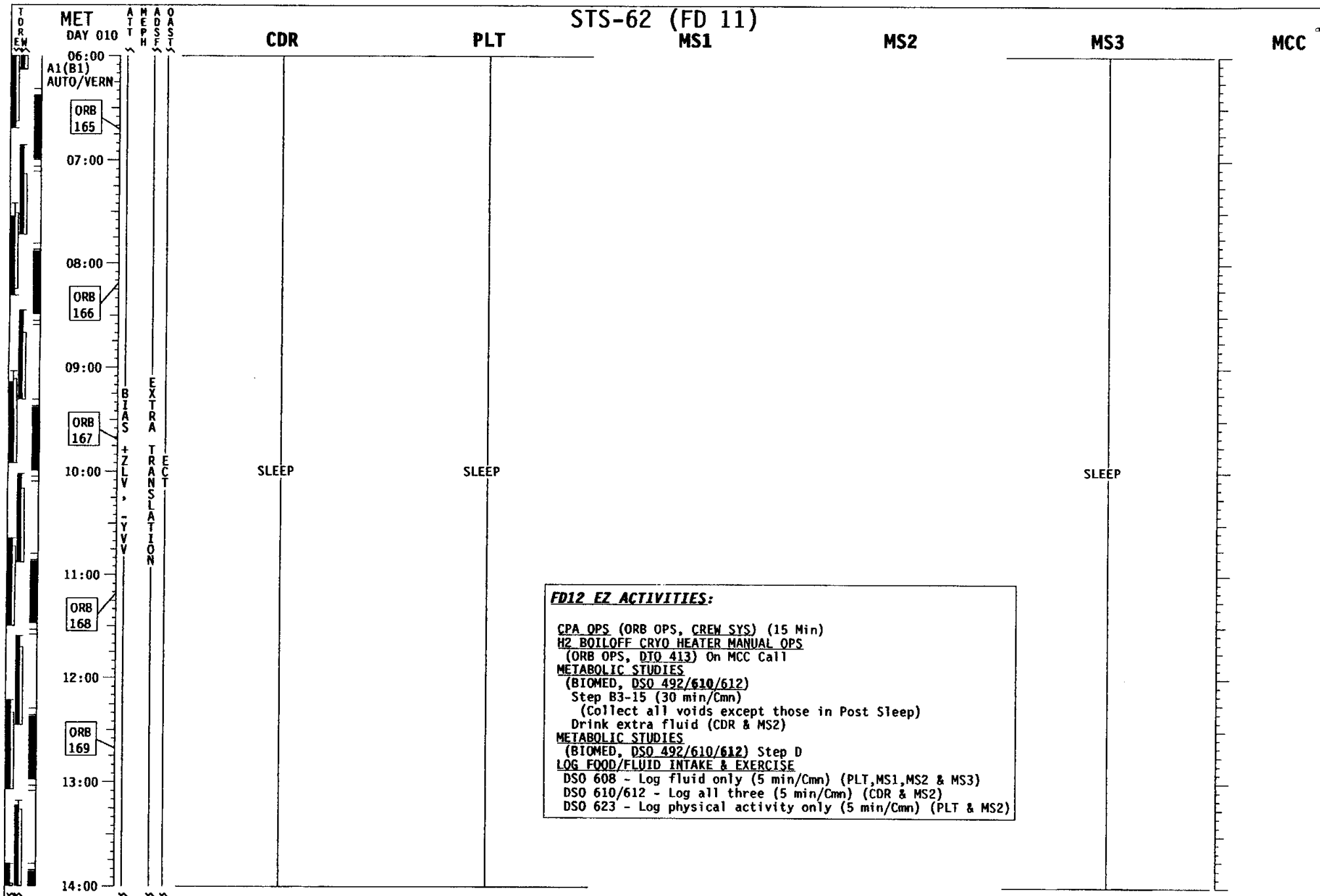

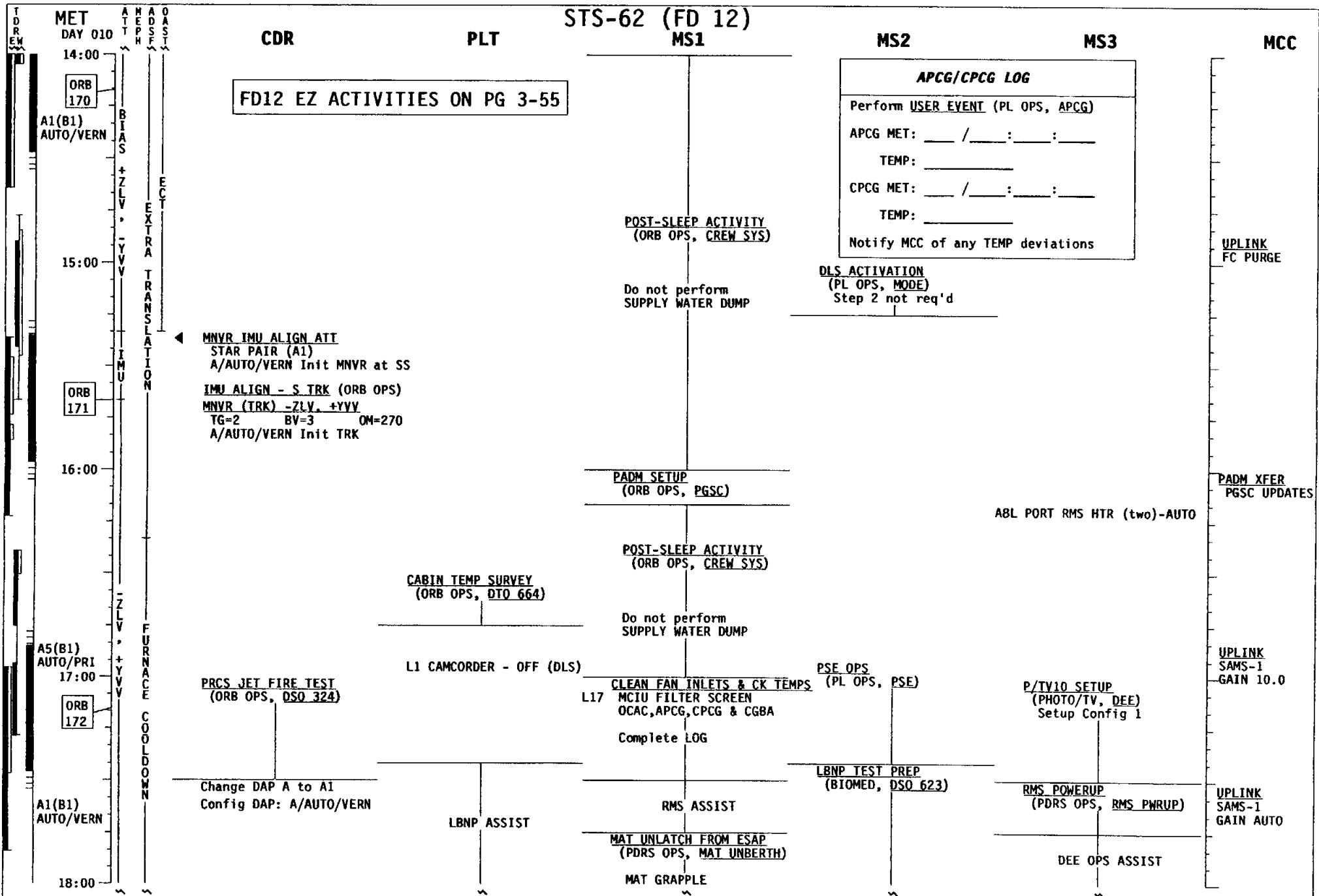

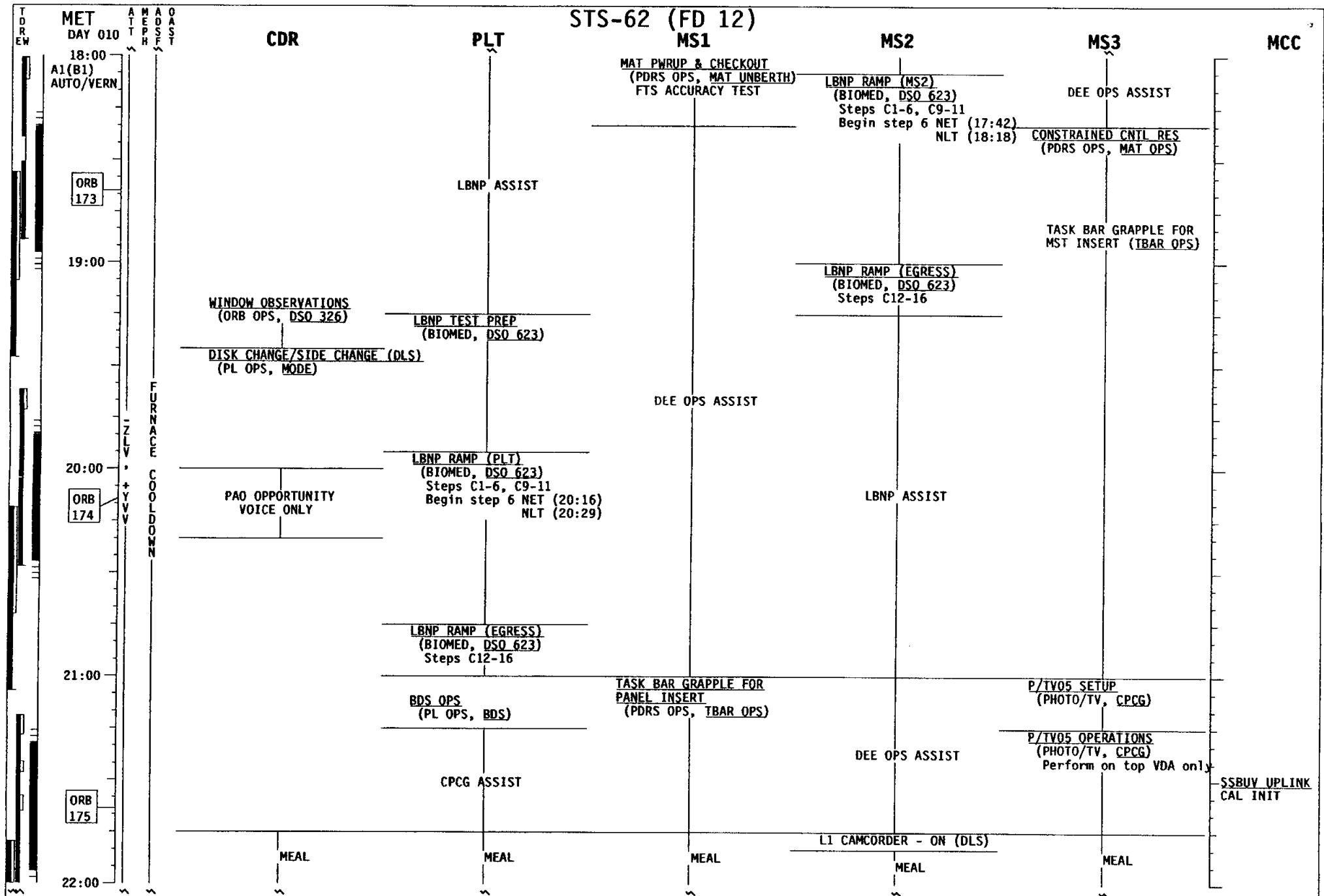

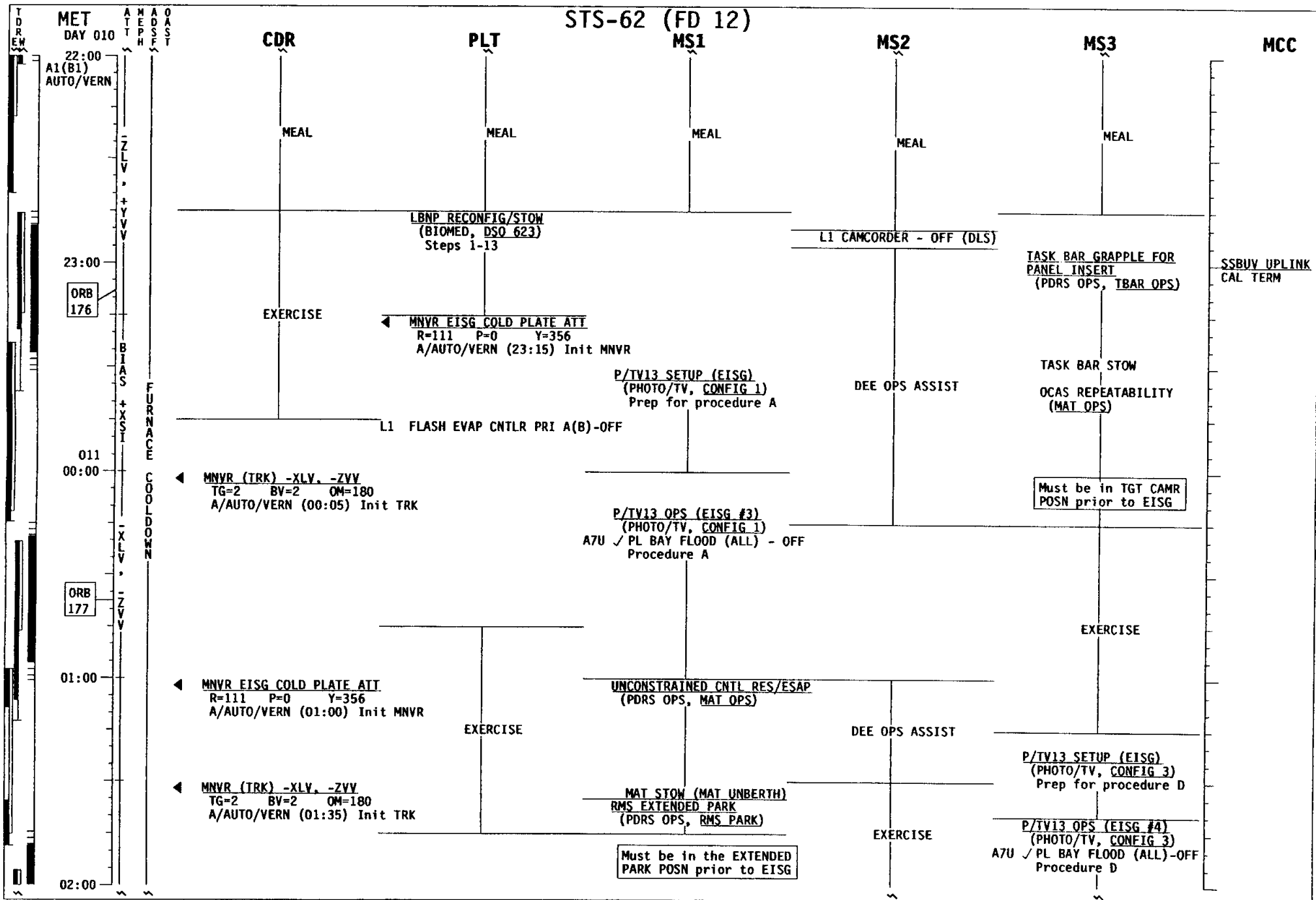

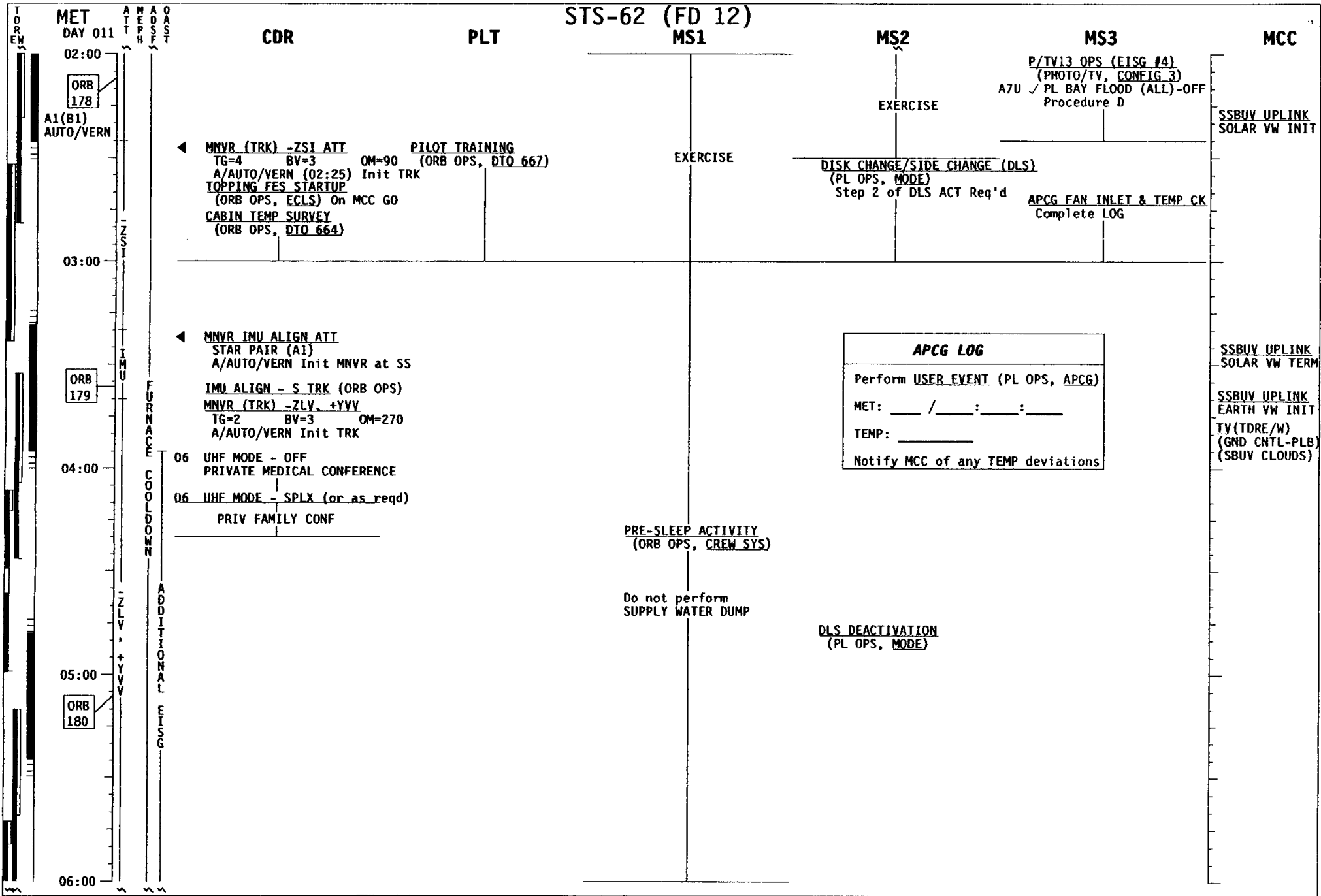

STS-62 (FD 12)

MET
DAY 011

CDR

PLT

MS1

MS2

MS3

MCC

02:00

ORB
178

A1(B1)
AUTO/VERN

◀ MNVR (TRK) -ZSI ATT PILOT TRAINING
 TG=4 BV=3 OM=90 (ORB OPS, DTO 667)
 A/AUTO/VERN (02:25) Init TRK
TOPPING FES STARTUP
 (ORB OPS, ECLS) On MCC GO
CABIN TEMP SURVEY
 (ORB OPS, DTO 664)

EXERCISE

DISK CHANGE/SIDE CHANGE (DLS)
 (PL OPS, MODE)
 Step 2 of DLS ACT Req'd

P/TV13 OPS (EISG #4)
 (PHOTO/TV, CONFIG 3)
 A7U / PL BAY FLOOD (ALL)-OFF
 Procedure D

SSBUY UPLINK
SOLAR VW INIT

APCG FAN INLET & TEMP CK
 Complete LOG

03:00

ORB
179

◀ MNVR IMU ALIGN ATT
 STAR PAIR (A1)
 A/AUTO/VERN Init MNVR at SS
IMU ALIGN - S TRK (ORB OPS)
MNVR (TRK) -ZLY, +YVV
 TG=2 BV=3 OM=270
 A/AUTO/VERN Init TRK

APCG LOG
 Perform USER EVENT (PL OPS, APCG)
 MET: ___ / ___ : ___ : ___
 TEMP: _____
 Notify MCC of any TEMP deviations

SSBUY UPLINK
SOLAR VW TERM

SSBUY UPLINK
EARTH VW INIT
TV(TDRE/W)
(GND CNTL-PLB)
(SBUV CLOUDS)

04:00

06 UHF MODE - OFF
PRIVATE MEDICAL CONFERENCE
 06 UHF MODE - SPLX (or as reqd)
PRIV FAMILY CONF

PRE-SLEEP ACTIVITY
 (ORB OPS, CREW SYS)

Do not perform
SUPPLY WATER DUMP

DLS DEACTIVATION
 (PL OPS, MODE)

05:00

ORB
180

06:00

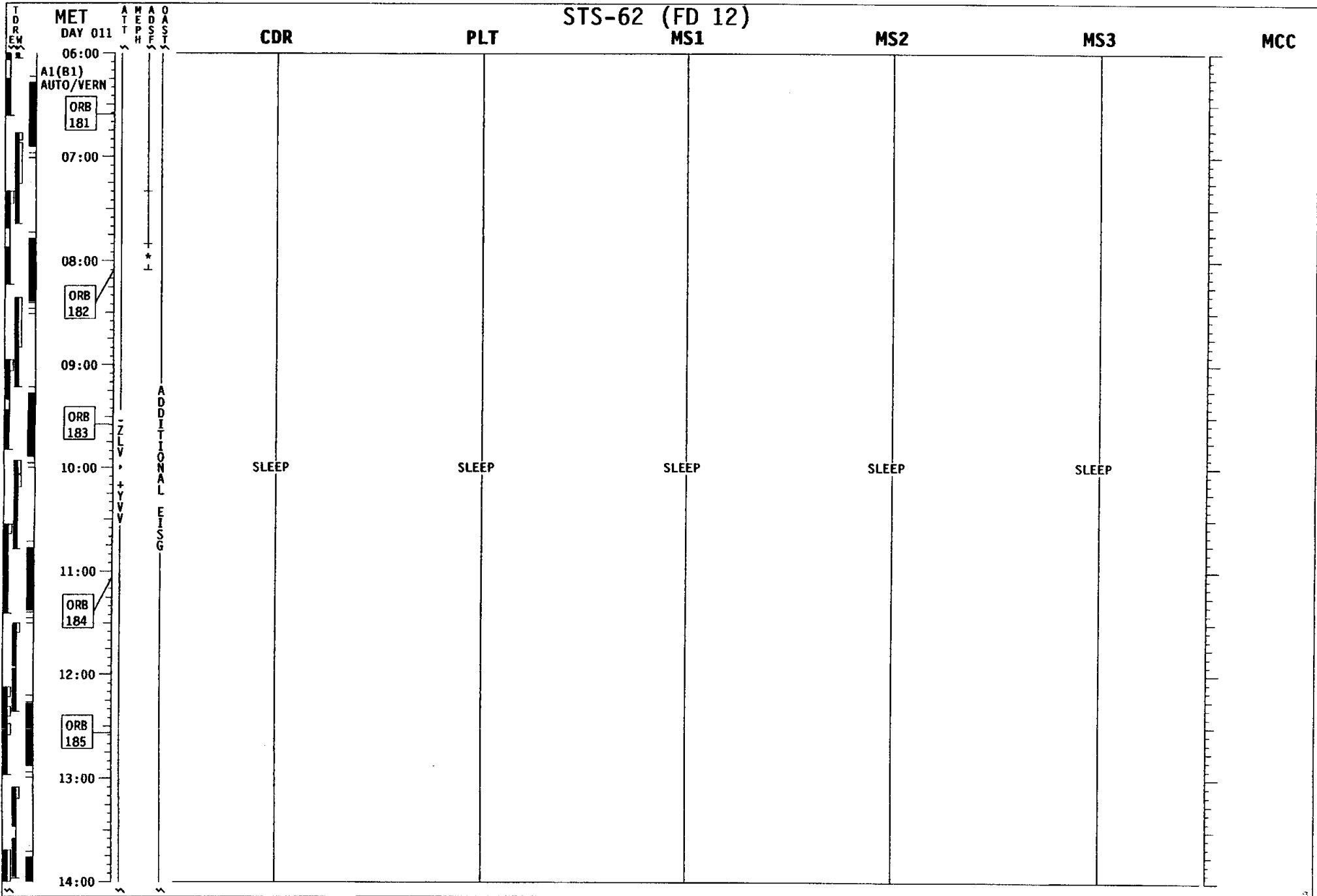

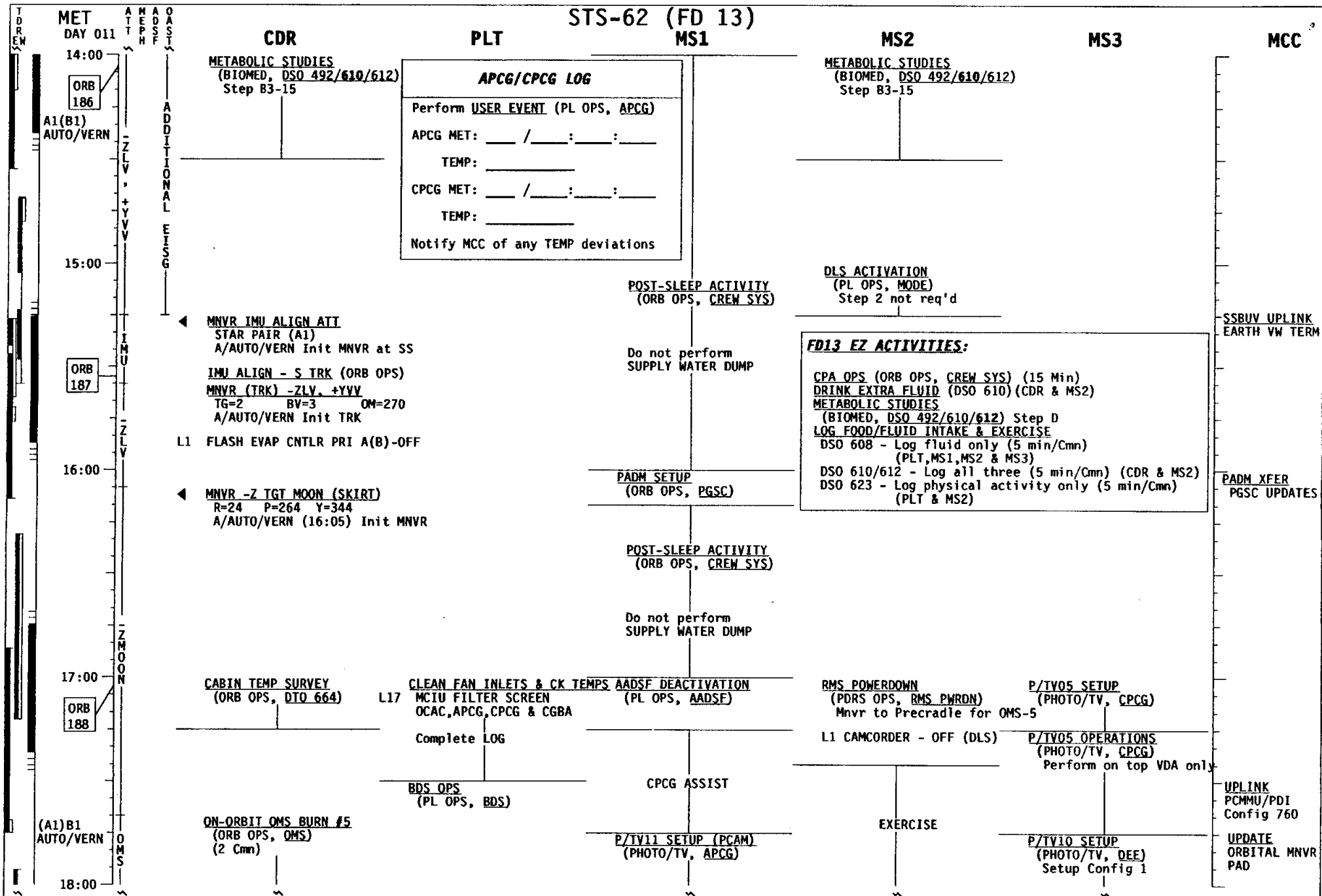

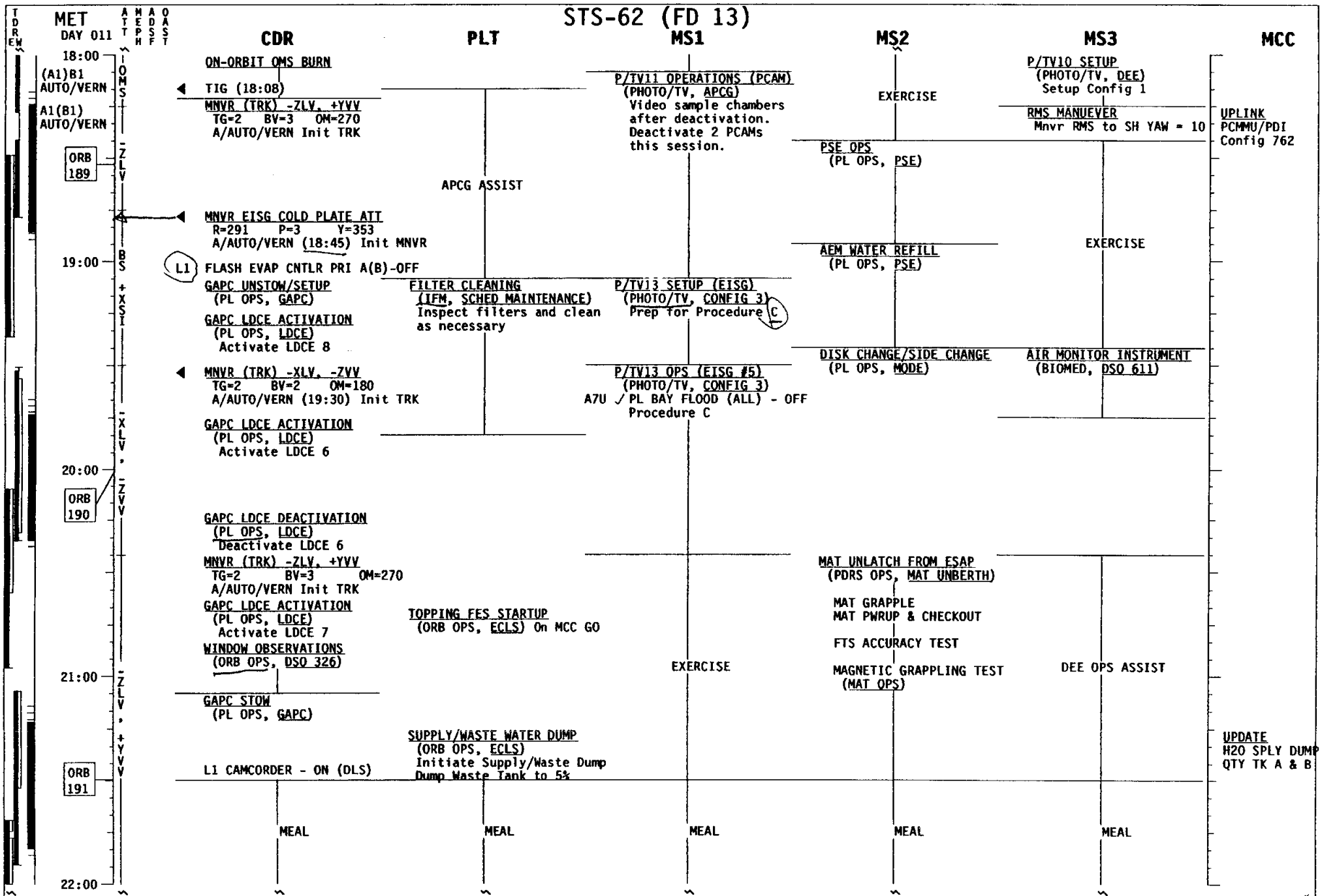

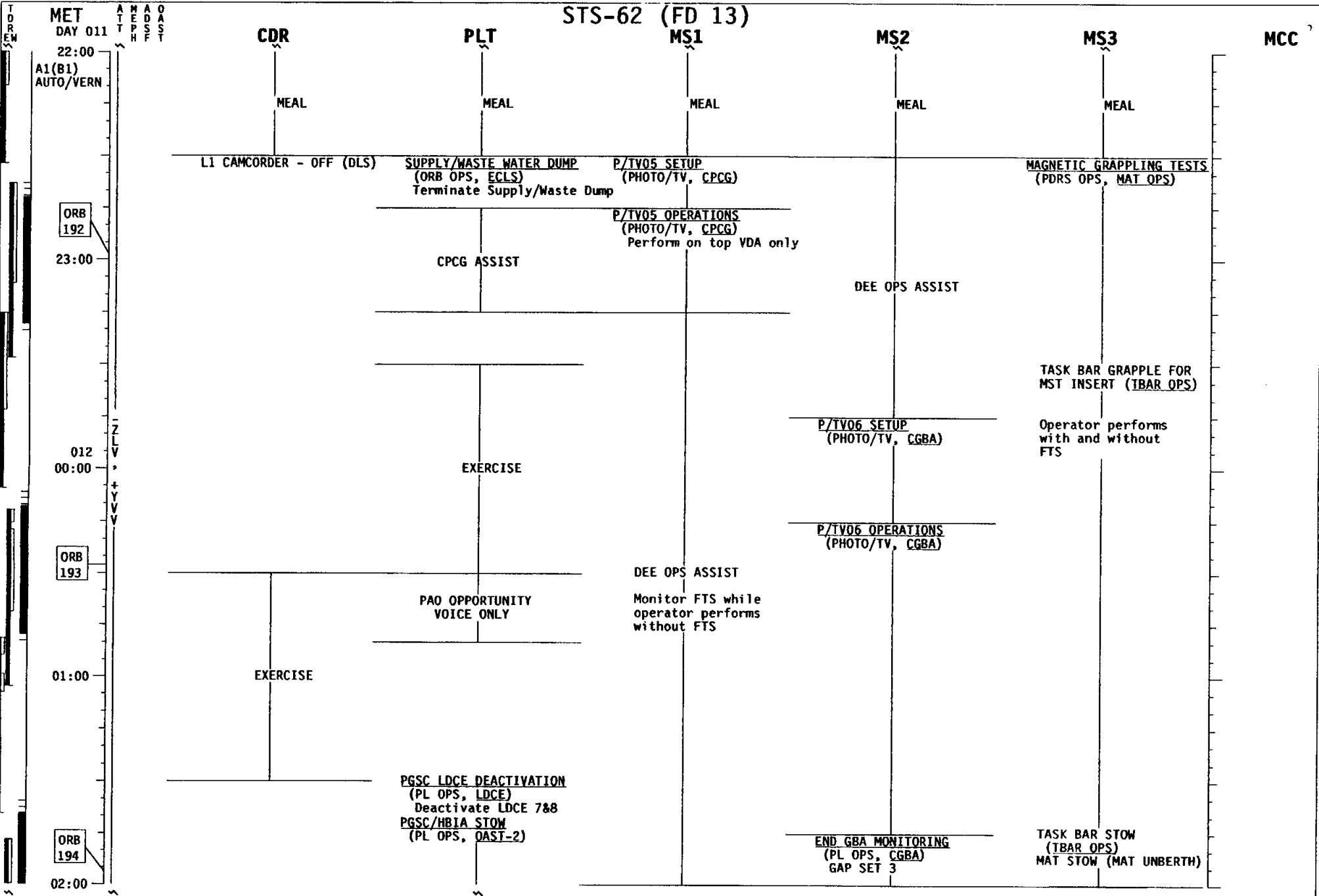

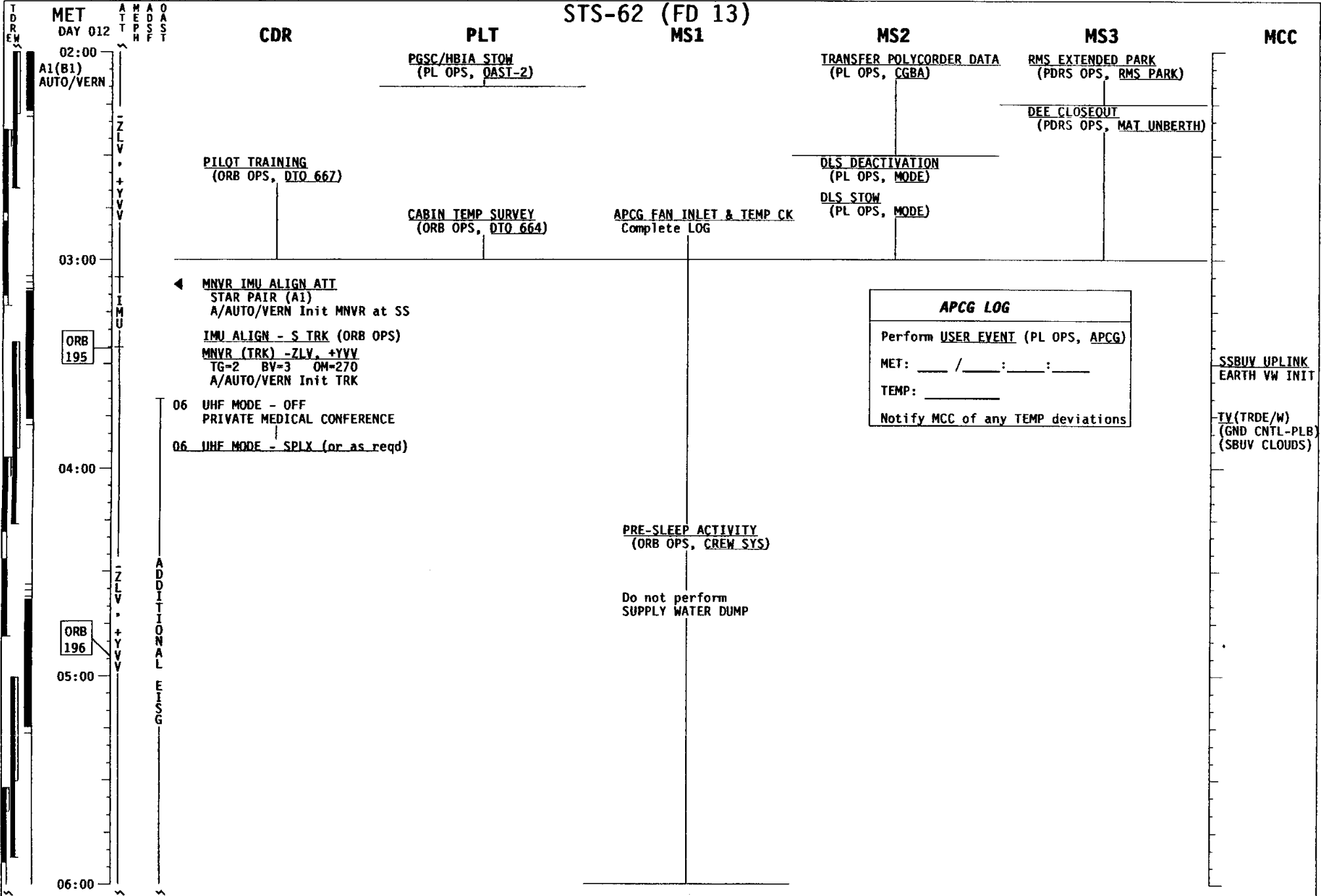

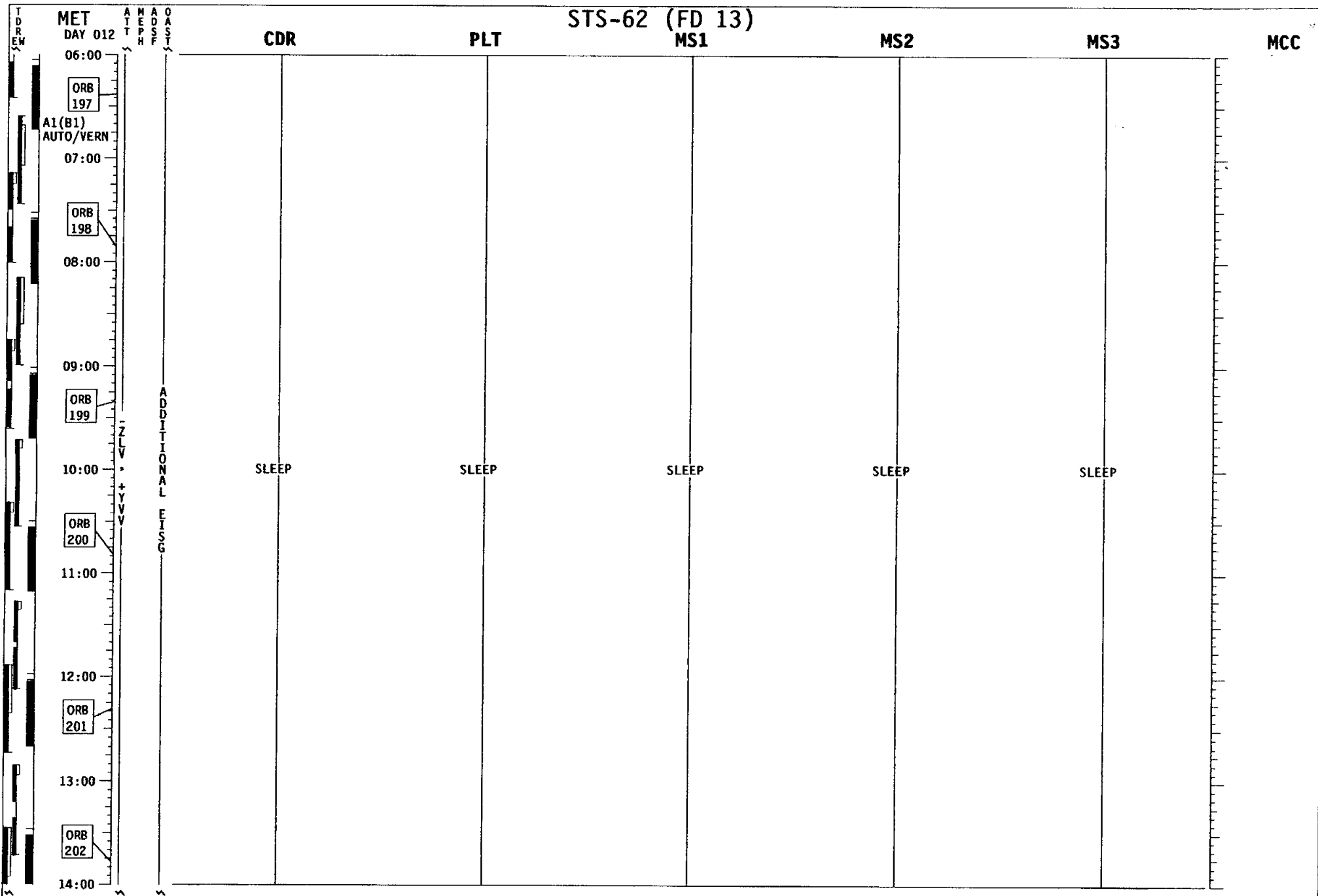

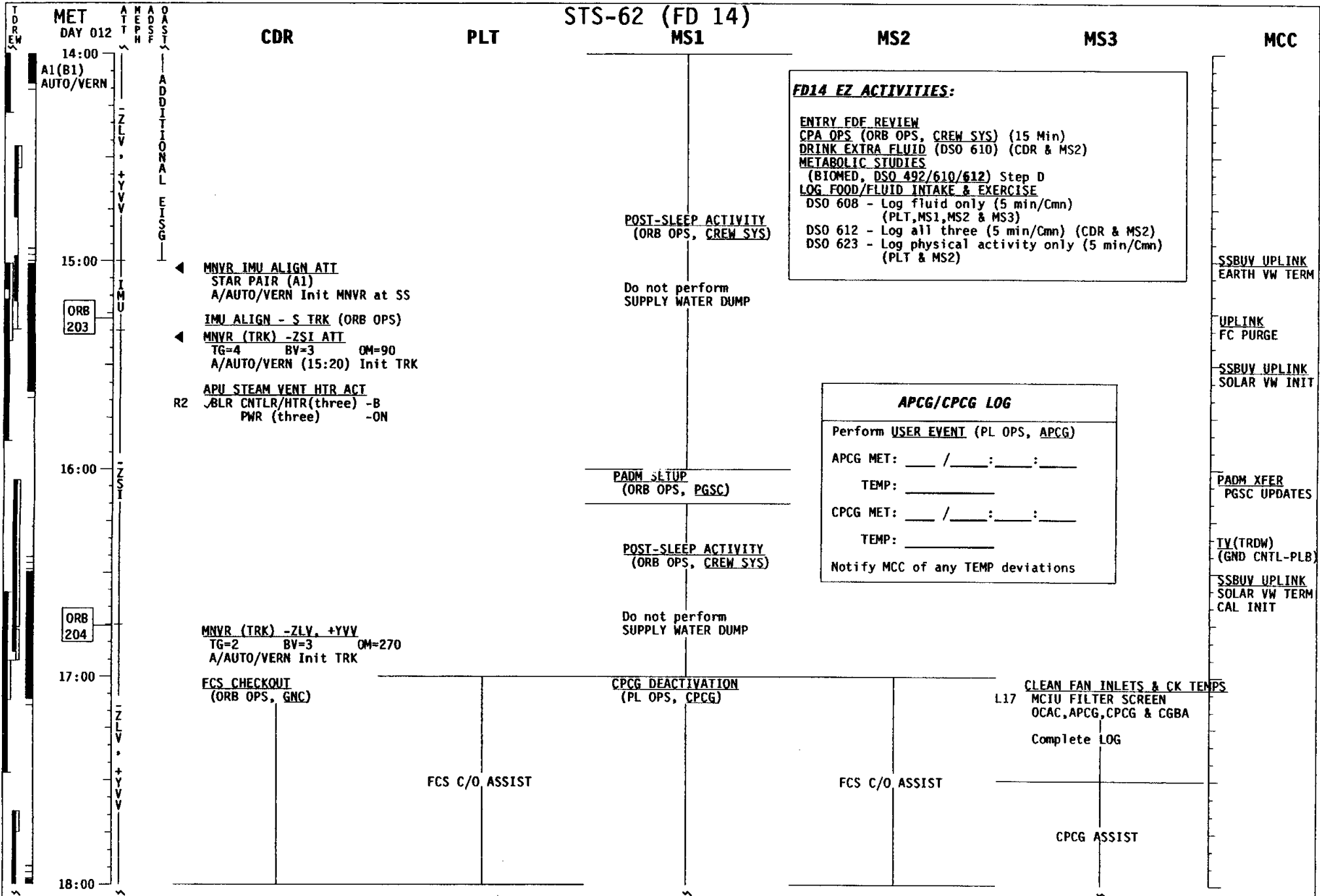

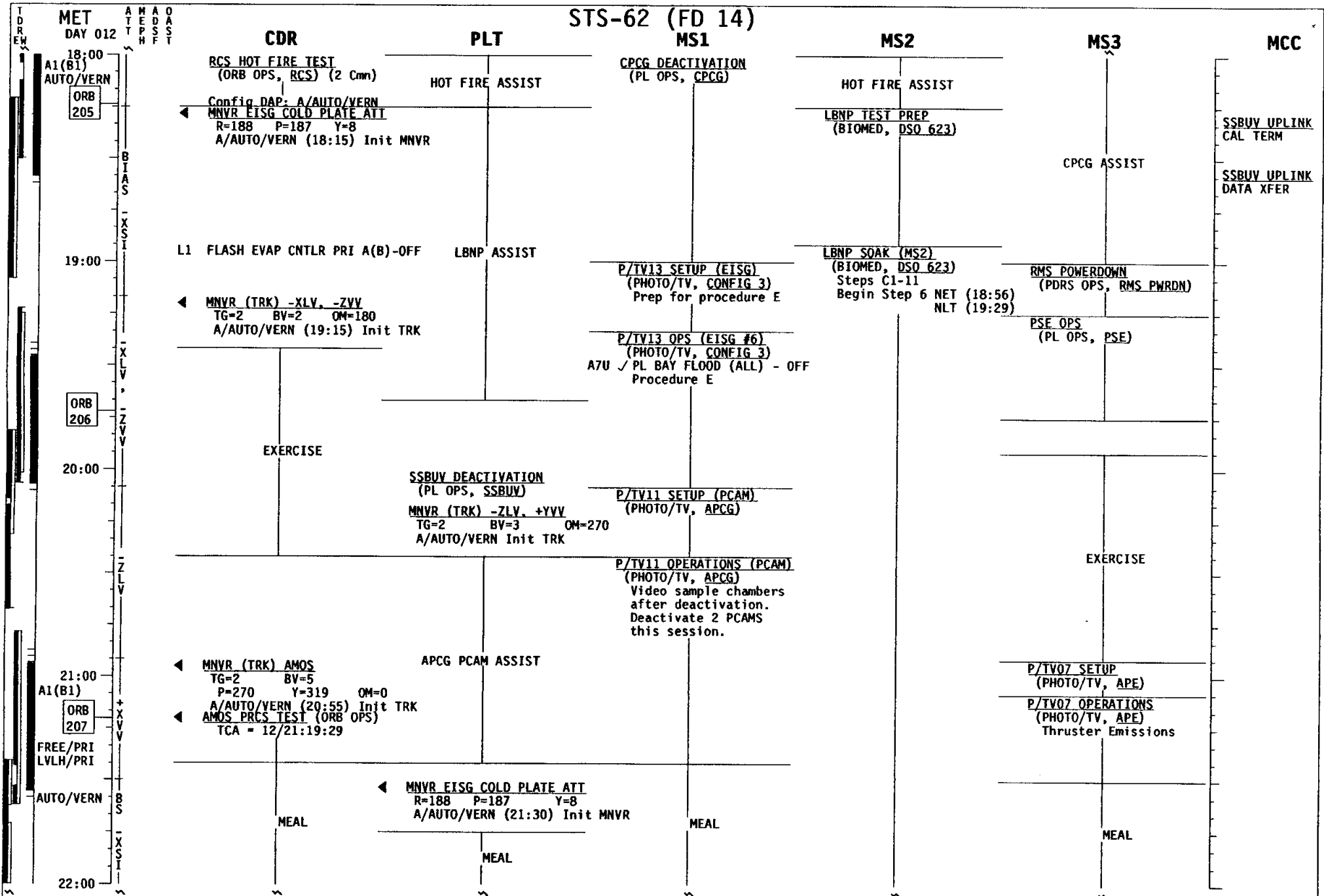

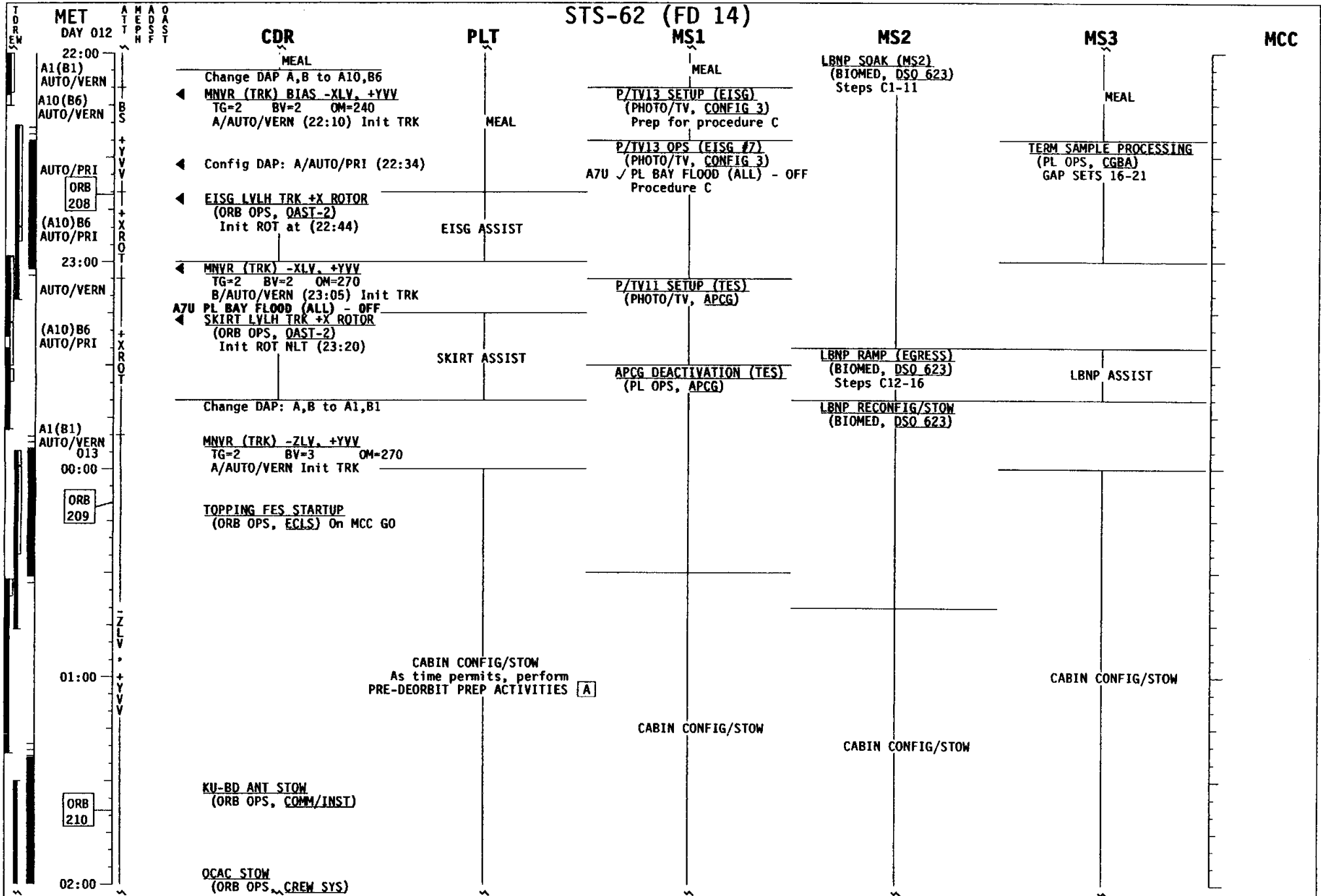

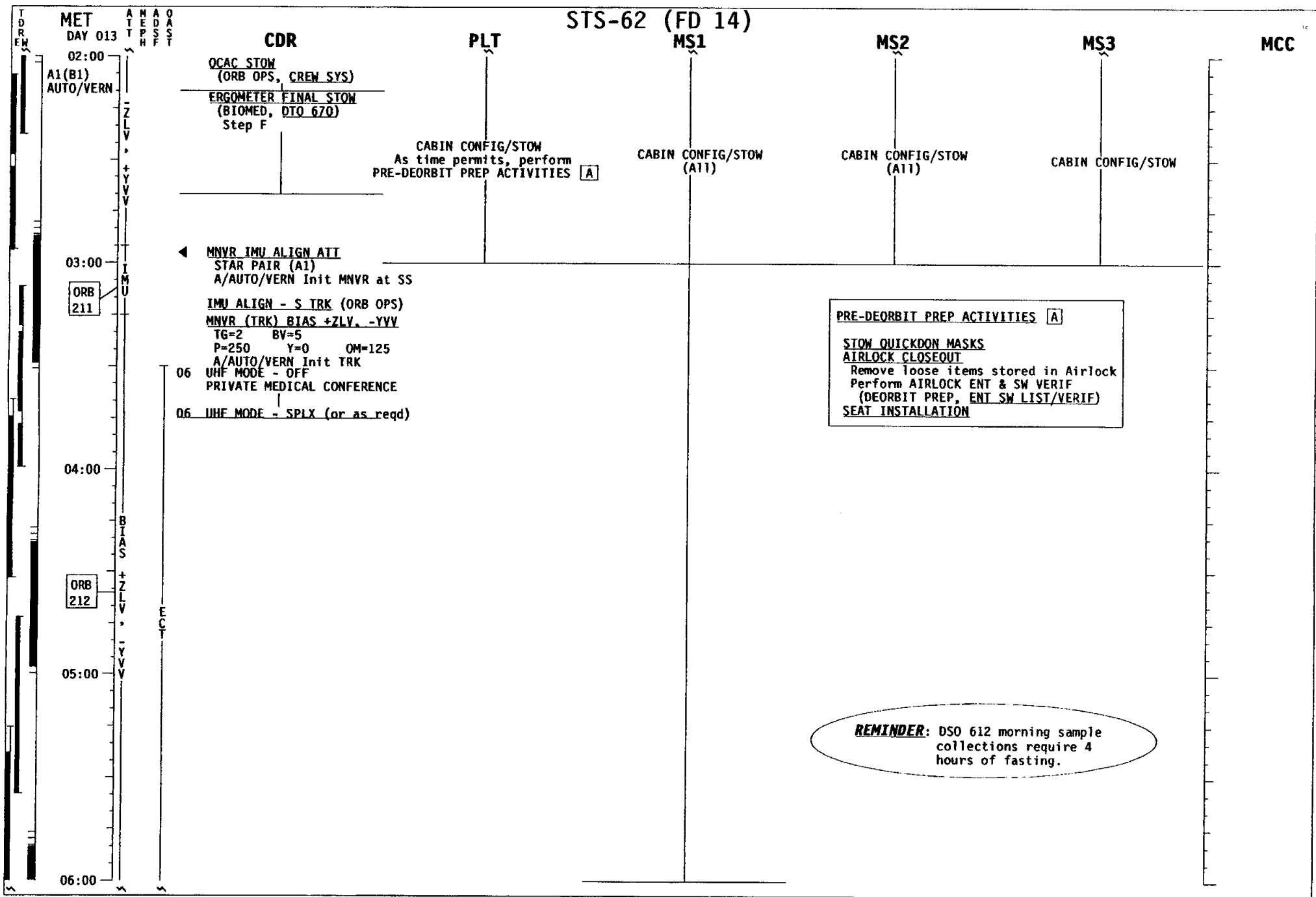

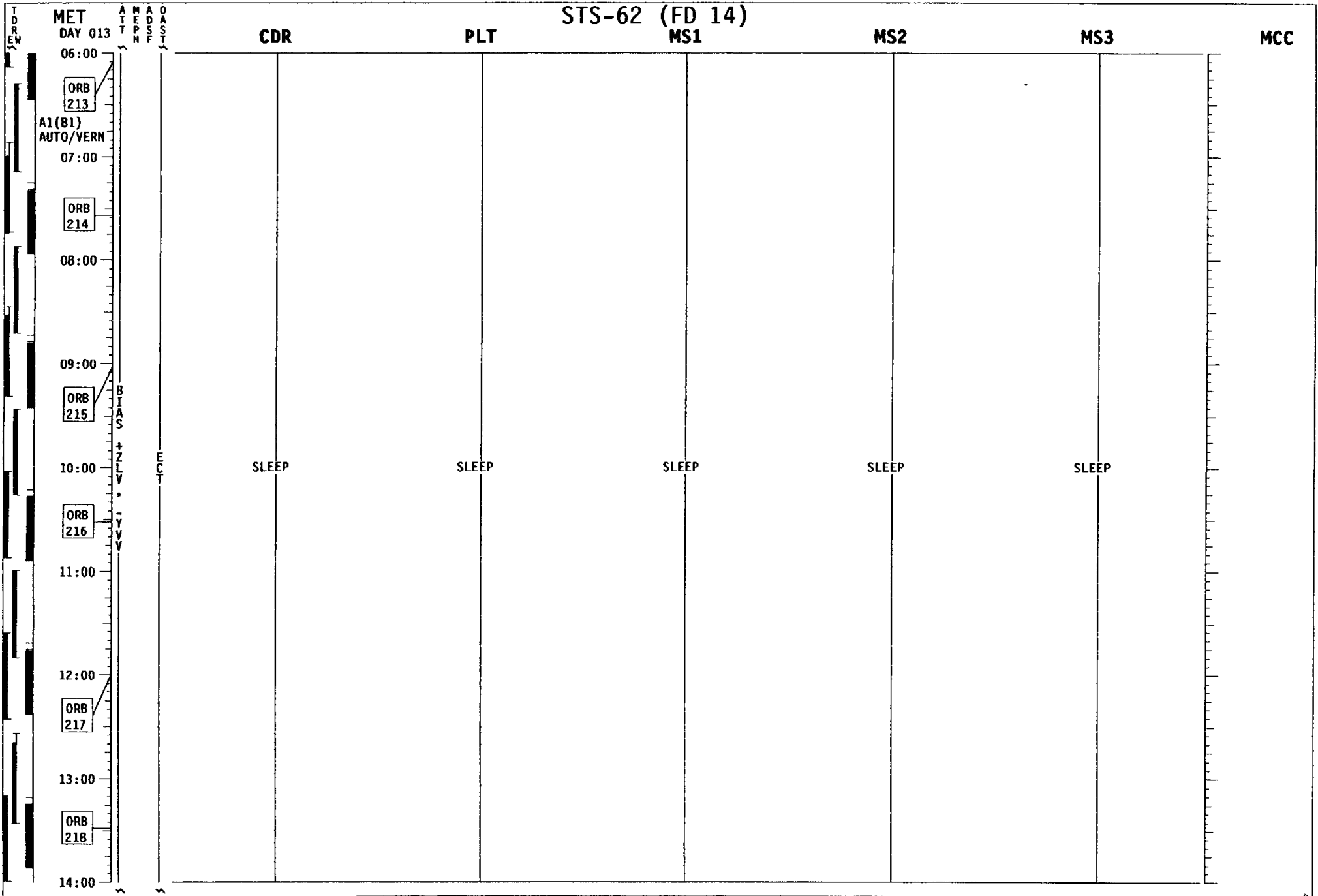

STS-62 (FD 15)

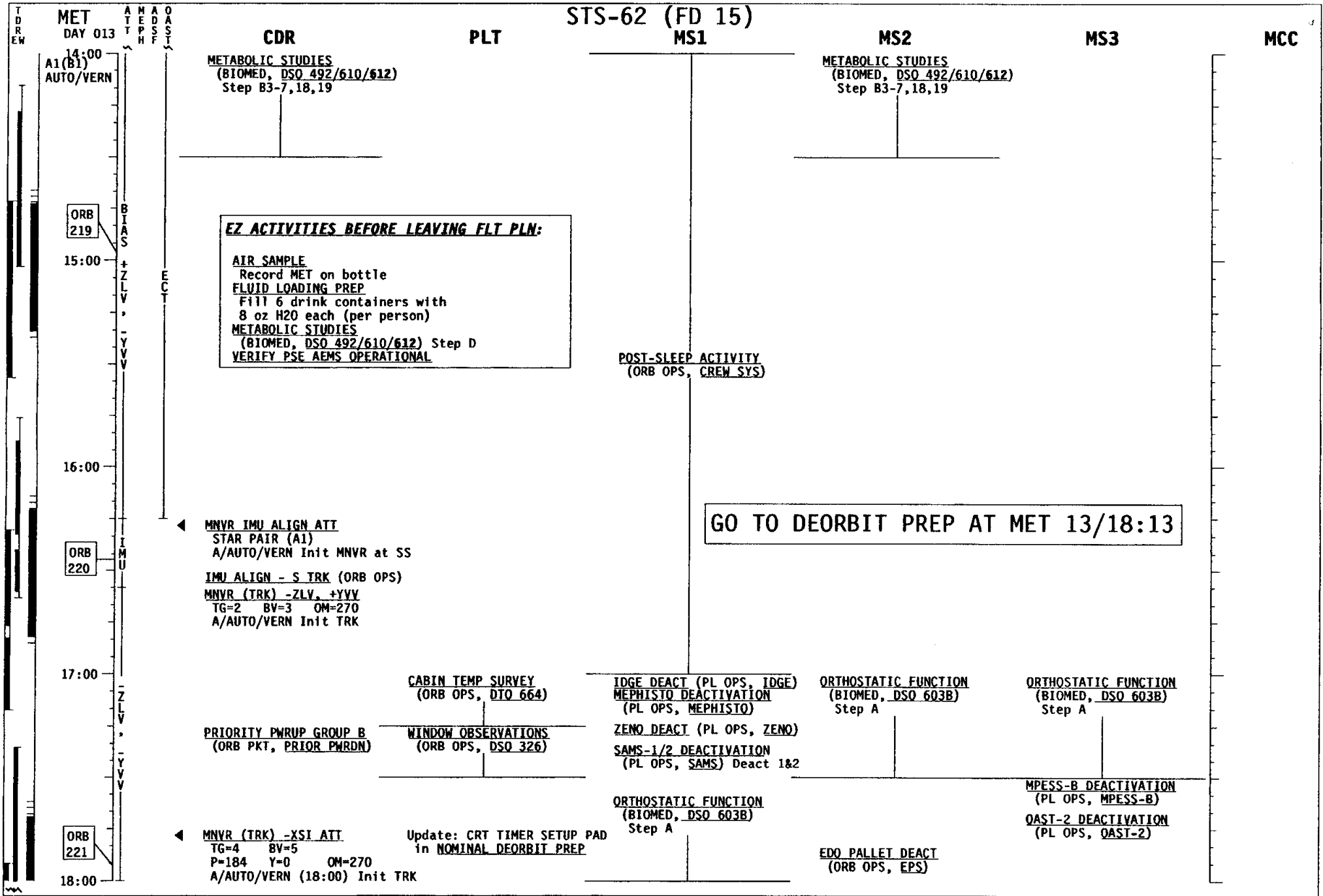

This Page Intentionally Blank

72 HR MDF TIMELINE

This timeline assumes an MDF is declared no later than 0/05:45 MET (just before nominal RMS C/O), OMS burns will be considered real time only, DEE will not be performed and the RMS will remain stowed. The timeline is designed to minimize maneuvers to maintain a low microgravity environment. Landing is scheduled on FD4 for the second of six EDW opportunities. The timeline was built using the rotated flight cycle trajectory.

CONTINGENCY TIMELINES

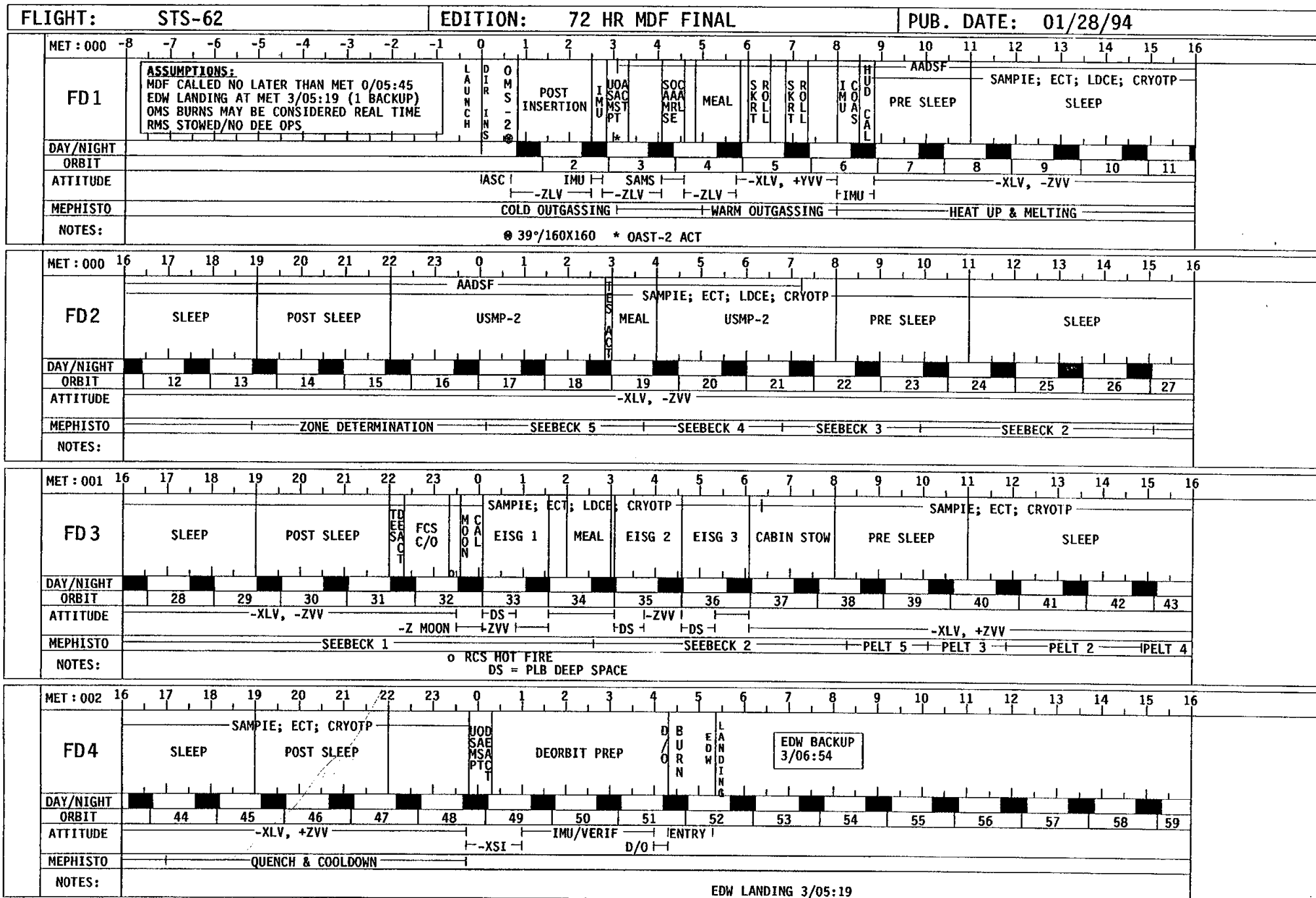

The sections following this divider page will not be included in flight copies.

ATTITUDE TIMELINE

ATTITUDE
TIMELINE

Attitude Timeline

MET/GMT	MNVR OPTION	DAP	E/S	REF ATT/REMARKS	EVENT	
1 000/01:12:00 MET 23:29 062/15:06:00 GMT 17:29	TGT=2 BV=3 P= 90.00 Y= 0.00 OM=270.00	A1 AUTO PRI	DSC 0.200 DB AT 5.00 DB RT 0.20	EARTH R 0 P 90	LVLH R= 0.00 P=180.00 Y= 90.00	-ZLV, +YVV PLBD OPEN ATT
2 000/02:15:00 MET 28:38 062/16:09:00 GMT 22:38	INRTL R=202.00 MNVR P=219.00 Y=312.00	A1 AUTO VERN	DSC 0.200 DB AT 1.00 DB RT 0.02	SUN R 100 P 110	STAR PAIR A1 -Y: 25 -Z: 15	IMU ALIGN
3 000/02:35:00 MET 47:56 062/16:29:00 GMT 41:56	TGT=2 BV=3 P= 90.00 Y= 0.00 OM=270.00	A1 AUTO VERN	DSC 0.200 DB AT 1.00 DB RT 0.02	EARTH R 0 P 90	LVLH R= 0.00 P=180.00 Y= 90.00	-ZLV, +YVV
4 000/03:30:00 MET 40:01 062/17:24:00 GMT 34:01	INRTL R=243.00 MNVR P=278.00 Y=333.00	A1 AUTO VERN	DSC 0.200 DB AT 1.00 DB RT 0.02	SUN R 103 P 82		SAMS START ATT
5 000/04:05:00 MET 062/17:59:00 GMT	INRTL BV=1 ROTR P= 0.00 Y= 0.00 PL OPS C/L	B9 AUTO PRI	DSC 1.000 DB AT 3.00 DB RT 0.10		INRTL R=243.00 P=278.00 Y=333.00	SAMS ROLL
6 000/04:11:00 MET 062/18:05:00 GMT		B9 INRT PRI	DSC 1.000 DB AT 3.00 DB RT 0.10	SUN R 103 P 82	INRTL R=243.00 HOLD P=278.00 Y=333.00	SAMS 360 ROLL COMPLETE
7 000/04:12:00 MET 062/18:06:00 GMT	INRTL BV=5 ROTR P= 0.00 Y= 90.00	B9 AUTO PRI	DSC 1.000 DB AT 3.00 DB RT 0.10		INRTL R=243.00 P=278.00 Y=333.00	SAMS PITCH
8 000/04:18:00 MET 062/18:12:00 GMT		B9 INRT PRI	DSC 1.000 DB AT 3.00 DB RT 0.10	SUN R 103 P 82	INRTL R=243.00 HOLD P=278.00 Y=333.00	SAMS 360 PITCH COMPLETE
9 000/04:19:00 MET 062/18:13:00 GMT	INRTL BV=5 ROTR P=270.00 Y= 0.00 PL OPS C/L	B9 AUTO PRI	DSC 1.000 DB AT 3.00 DB RT 0.10		INRTL R=243.00 P=278.00 Y=333.00	SAMS YAW
10 000/04:25:00 MET 062/18:19:00 GMT		B9 INRT PRI	DSC 1.000 DB AT 3.00 DB RT 0.10	SUN R 103 P 82	INRTL R=243.00 HOLD P=278.00 Y=333.00	SAMS 360 YAW COMPLETE 8 MIN HOLD
11 000/04:35:00 MET 46:48 062/18:29:00 GMT 40:48	TGT=2 BV=3 P= 90.00 Y= 0.00 OM=270.00	A1 AUTO VERN	DSC 0.200 DB AT 1.00 DB RT 0.02	EARTH R 360 P 90	LVLH R= 0.00 P=180.00 Y= 90.00	-ZLV, +YVV
12 000/06:35:00 MET 42:30 062/20:29:00 GMT 36:30	TGT=2 BV=2 P=180.00 Y= 0.00 OM=270.00	A1 AUTO VERN	DSC 0.200 DB AT 1.00 DB RT 0.02	EARTH R 286 P 180	LVLH R= 90.00 P= 90.00 Y= 0.00	-XLV, +YVV SKIRT START ATT

*** ALL ATTITUDES IN MEAN OF 1950 ***
*** PYR EULER SEQUENCE ***

Attitude Timeline

MET/GMT	MNVR OPTION	DAP	E/S	REF ATT/REMARKS	EVENT
1 000/06:49:00 MET 062/20:43:00 GMT	LVLH FREE ROTATION ROTR ABOUT +X AXIS RATE=1.200 ORB OPS C/L	B6 LVLH PRI DSC 1.200 DB AT 3.00 DB RT 0.20		LVLH R= 90.00 P= 90.00 Y= 0.00	SKIRT LVLH +X ROTOR NIGHT
2 000/07:14:00 MET 062/21:08:00 GMT		B6 LVLH PRI DSC 1.200 DB AT 3.00 DB RT 0.20	EARTH R 72 P 180	LVLH R= 90.00 HOLD P= 90.00 Y= 0.00	SKIRT ROTORS COMPLETE (5 ROTATIONS)
3 000/07:50:00 MET 001/00:00:00 GMT	MODIFY DAP A1 PRI DISC RT=0.5				
4 000/08:00:00 MET 12:32 062/21:54:00 GMT 22:06:32	INRTL R=201.50 MNVR P=222.60 Y=312.80	A1* AUTO VERN DSC 0.200 DB AT 1.00 DB RT 0.02	SUN R 105 P 109	SPECIAL ATT -Y: 25 -Z: 15 COAS CAL ID: 15	IMU ALIGN & -Z COAS CAL SS: 8:19
5 000/08:32:00 MET 52 062/22:26:00 GMT 52	INRTL R=187.00 MNVR P=197.00 Y=330.00	A1* AUTO PRI DSC 0.500 DB AT 5.00 DB RT 0.20	SUN R 96 P 133	HUD ROD ID: STAR: 20 ARCTURUS	HUD CALIBRATION ST AOS: 8:25 SR: 8:51 ST LOS: 9:13
6 000/08:54:00 MET 001/00:00:00 GMT	RESET DAP A1 PRI DISC RT=0.2				
7 000/08:55:00 MET 09:06:01 062/22:49:00 GMT 23:00:01	INRTL R=287.00 MNVR P=111.00 Y= 29.00	A1 AUTO VERN DSC 0.200 DB AT 1.00 DB RT 0.02	SUN R 261 P 110		-Z TGT, MOON SKIRT MOON CAL1
8 000/10:15:00 MET 27:36 063/00:09:00 GMT 21:36	TGT=2 BV=3 P= 90.00 Y= 0.00 OM=270.00	A1 AUTO VERN DSC 0.200 DB AT 1.00 DB RT 0.02	EARTH R 0 P 90	LVLH R= 0.00 P=180.00 Y= 90.00	-ZLV +YVV USMP
9 006/19:40:00 MET 50:00 069/09:34:00 GMT 44:00	TGT=2 BV=2 P=180.00 Y= 0.00 OM=180.00	A1 AUTO VERN DSC 0.200 DB AT 1.00 DB RT 0.02	EARTH R 18 P 180	LVLH R=180.00 P= 90.00 Y= 0.00	-XLV, -ZVV MEPHISTO, ECT SAMP1E, LDCE
10 008/00:25:00 MET 40:00 070/14:19:00 GMT 34:00	TGT=2 BV=2 P=180.00 Y= 0.00 OM= 0.00	A9 AUTO VERN DSC 0.200 DB AT 2.00 DB RT 0.02	EARTH R 224 P 180	LVLH R= 0.00 P= 90.00 Y= 0.00	-XLV, +ZVV SAMP1E & ECT
11 009/15:25:00 MET 36:52 072/05:19:00 GMT 30:52	INRTL R=202.00 MNVR P=219.00 Y=312.00	A1 AUTO VERN DSC 0.200 DB AT 1.00 DB RT 0.02	SUN R 108 P 116	STAR PAIR A1 -Y: 25 -Z: 15	IMU ALIGN
12 009/15:45:00 MET 54:51 072/05:39:00 GMT 48:51	TGT=2 BV=3 P= 90.00 Y= 0.00 OM=270.00	A1 AUTO VERN DSC 0.200 DB AT 1.00 DB RT 0.02	EARTH R 0 P 90	LVLH R= 0.00 P=180.00 Y= 90.00	-ZLV +YVV

*** ALL ATTITUDES IN MEAN OF 1950 ***
*** PYR EULER SEQUENCE ***

Attitude Timeline

MET/GMT	MNVR OPTION	DAF	E/S	REF ATT/REMARKS	EVENT	
1 009/16:20:00 MET 30:31 072/06:14:00 GMT 24:31	INRTL R=226.00 MNVR P=336.00 Y=336.00 TIG: 9/16:45	A1 AUTO VERN	DSC 0.200 DB AT 1.00 DB RT 0.02	SUN R 162 P 31		OMS-3 EQUIV to LVLH 180 PITCH
2 009/16:47:00 MET 072/06:41:00 GMT	 LVLH HOLD	B1 LVLH VERN	DSC 0.200 DB AT 1.00 DB RT 0.02	EARTH R 0 P 80	LVLH R=359.53 HOLD P=190.25 Y=359.83	MIN MNVR SETUP
3 009/17:05:00 MET 14:12 072/06:59:00 GMT 07:08:12	INRTL R=133.00 MNVR P=158.00 Y= 23.00 TIG: 9/17:30	A1 AUTO VERN	DSC 0.200 DB AT 1.00 DB RT 0.02	SUN R 18 P 151		OMS-4 EQUIV to LVLH 180 PITCH
4 009/17:35:00 MET 42:41 072/07:29:00 GMT 36:41	TGT=2 BV=3 P= 90.00 Y= 0.00 OM=270.00	A1 AUTO VERN	DSC 0.200 DB AT 1.00 DB RT 0.02	EARTH R 0 P 90	LVLH R= 0.00 P=180.00 Y= 90.00	-ZLV +YVV
5 009/18:40:00 MET 47:50 072/08:34:00 GMT 41:50	INRTL R=110.00 MNVR P=346.00 Y=346.00	A1 AUTO VERN	DSC 0.200 DB AT 1.00 DB RT 0.02	SUN R 270 P 18		BIAS +XSI EISG 1 PLATE COLD SOAK
6 009/19:45:00 MET 53:06 072/09:39:00 GMT 47:06	TGT=2 BV=2 P=180.00 Y= 0.00 OM=180.00	A1 AUTO VERN	DSC 0.200 DB AT 1.00 DB RT 0.02	EARTH R 216 P 180	LVLH R=180.00 P= 90.00 Y= 0.00	-XLV -ZVV EISG 1 ATT
7 009/20:33:00 MET 40:30 072/10:27:00 GMT 34:30	TGT=2 BV=2 P=180.00 Y= 0.00 OM=270.00	A1 AUTO VERN	DSC 0.200 DB AT 1.00 DB RT 0.02	EARTH R 207 P 180	LVLH R= 90.00 P= 90.00 Y= 0.00	-XLV +YVV SKIRT START ATT
8 009/20:45:00 MET 072/10:39:00 GMT	LVLH FREE ROTATION ROTR ABOUT +X AXIS RATE=1.200 ORB OPS C/L	B6 LVLH PRI	DSC 1.200 DB AT 3.00 DB RT 0.20		LVLH R= 90.00 P= 90.00 Y= 0.00	SKIRT LVLH +X ROTOR DAY
9 009/21:10:00 MET 072/11:04:00 GMT	 LVLH HOLD	B6 LVLH PRI	DSC 1.200 DB AT 3.00 DB RT 0.20	EARTH R 299 P 180	LVLH R= 90.00 HOLD P= 90.00 Y= 0.00	SKIRT ROTORS COMPLETE (5 ROTATIONS)
10 009/21:45:00 MET 59:52 072/11:39:00 GMT 53:52	INRTL R=111.00 MNVR P=357.00 Y=358.00	A1 AUTO VERN	DSC 0.200 DB AT 1.00 DB RT 0.02	SUN R 208 P 8		BIAS +XSI EISG 2 PLATE COLD SOAK
11 009/22:40:00 MET 50:27 072/12:34:00 GMT 44:27	TGT=2 BV=2 P=180.00 Y= 0.00 OM=240.00	A10 AUTO VERN	DSC 0.200 DB AT 10.0 DB RT 0.02	EARTH R 323 P 180	LVLH R=120.00 P= 90.00 Y= 0.00	BIAS -XLV -YVV EISG 2
12 009/23:04:00 MET 001/00:00:00 GMT	COLLAPSE DB A/AUTO/PRI					

*** ALL ATTITUDES IN MEAN OF 1950 ***
*** PYR EULER SEQUENCE ***

Attitude Timeline

MET/GMT	MNVR OPTION	DAP	E/S	REF ATT/REMARKS	EVENT	
1 009/23:14:00 MET 072/13:08:00 GMT	LVLH FREE ROTATION ROTR ABOUT +X AXIS RATE=1.200 ORB OPS C/L	B6 LVLH PRI	DSC 1.200 DB AT 3.00 DB RT 0.20		LVLH R=120.00 P= 90.00 Y= 0.00	EISG 2 LVLH +X ROTOR
2 009/23:24:00 MET 072/13:18:00 GMT		B6 LVLH PRI	DSC 1.200 DB AT 3.00 DB RT 0.20	EARTH R 0 P 180	LVLH R=120.00 HOLD P= 90.00 Y= 0.00	EISG 2 LVLH ROTOR COMPLETE (2 ROTATIONS)
3 010/00:17:00 MET 19:30 072/14:11:00 GMT 13:30	TGT=2 BV=2 P=180.00 Y= 0.00 OM=270.00	B6 AUTO VERN	DSC 0.200 DB AT 1.00 DB RT 0.02	EARTH R 34 P 180	LVLH R= 90.00 P= 90.00 Y= 0.00	-XLV +YVV SKIRT START ATT
4 010/00:26:00 MET 072/14:20:00 GMT	LVLH FREE ROTATION ROTR ABOUT +X AXIS RATE=1.200	B6 LVLH PRI	DSC 1.200 DB AT 3.00 DB RT 0.20		LVLH R= 90.00 P= 90.00 Y= 0.00	SKIRT LVLH +X ROTOR NIGHT
5 010/00:51:00 MET 072/14:45:00 GMT		B6 LVLH PRI	DSC 1.200 DB AT 3.00 DB RT 0.20	EARTH R 353 P 180	LVLH R= 90.00 HOLD P= 90.00 Y= 0.00	SKIRT LVLH ROTOR COMPLETE (5 ROTATIONS)
6 010/01:05:00 MET 12:30 072/14:59:00 GMT 15:06:30	TGT=2 BV=3 P= 90.00 Y= 0.00 OM=270.00	A1 AUTO VERN	DSC 0.200 DB AT 1.00 DB RT 0.02	EARTH R 360 P 90	LVLH R= 0.00 P=180.00 Y= 90.00	-ZLV +YVV
7 010/02:15:00 MET 29:57 072/16:09:00 GMT 23:57	TGT=4 BV=3 P= 90.00 Y= 0.00 OM= 90.00	A1 AUTO VERN	DSC 0.200 DB AT 1.00 DB RT 0.02	SUN R 0 P 90	INRTL R=350.92 P=278.75 Y= 38.24	-ZSI SSBUV SOLAR VW
8 010/03:25:00 MET 37:59 072/17:19:00 GMT 31:59	INRTL R=202.00 MNVR P=219.00 Y=312.00	A1 AUTO VERN	DSC 0.200 DB AT 1.00 DB RT 0.02	SUN R 109 P 117	STAR PAIR A1 -Y: 25 -Z: 15	IMU ALIGN
9 010/03:45:00 MET 57:53 072/17:39:00 GMT 51:53	TGT=2 BV=5 P=250.00 Y= 0.00 OM=125.00	A1 AUTO VERN	DSC 0.200 DB AT 1.00 DB RT 0.02	EARTH R 180 P 110	LVLH R=206.03 P=147.60 Y= 50.33	BIAS +ZLV -YVV ECT
10 010/15:20:00 MET 29:53 073/05:14:00 GMT 23:53	INRTL R=202.00 MNVR P=219.00 Y=312.00	A1 AUTO VERN	DSC 0.200 DB AT 1.00 DB RT 0.02	SUN R 109 P 117	STAR PAIR A1 -Y: 25 -Z: 15	IMU ALIGN
11 010/15:40:00 MET 49:30 073/05:34:00 GMT 43:30	TGT=2 BV=3 P= 90.00 Y= 0.00 OM=270.00	A1 AUTO VERN	DSC 0.200 DB AT 1.00 DB RT 0.02	EARTH R 0 P 90	LVLH R= 0.00 P=180.00 Y= 90.00	-ZLV +YVV FOR DSO 324
12 010/23:15:00 MET 22:34 073/13:09:00 GMT 16:34	INRTL R=111.00 MNVR P= 0.00 Y=356.00	A1 AUTO VERN	DSC 0.200 DB AT 1.00 DB RT 0.02	SUN R 209 P 4		BIAS +XSI EISG 3 PLATE COLD SOAK

*** ALL ATTITUDES IN MEAN OF 1950 ***
*** PYR EULER SEQUENCE ***

Attitude Timeline

MET/GMT	MNVR OPTION	DAP	E/S	REP ATT/REMARKS	EVENT	
1 011/00:05:00 MET 11:21 073/13:59:00 GMT 14:05:21	TGT=2 BV=2 P=180.00 Y= 0.00 OM=180.00	A1 AUTO VERN	DSC 0.200 DB AT 1.00 DB RT 0.02	EARTH R 8 P 180	LVLH R=180.00 P= 90.00 Y= 0.00	-XLV -ZVV EISG 3 ATT
2 011/01:00:00 MET 08:42 073/14:54:00 GMT 15:02:42	INRTL R=111.00 MNVR P= 0.00 Y=356.00	A1 AUTO VERN	DSC 0.200 DB AT 1.00 DB RT 0.02	SUN R 209 P 4		BIAS +XSI EISG 4 PLATE COLD SOAK
3 011/01:35:00 MET 41:24 073/15:29:00 GMT 35:24	TGT=2 BV=2 P=180.00 Y= 0.00 OM=180.00	A1 AUTO VERN	DSC 0.200 DB AT 1.00 DB RT 0.02	EARTH R 351 P 180	LVLH R=180.00 P= 90.00 Y= 0.00	-XLV -ZVV EISG 4 ATT
4 011/02:25:00 MET 32:39 073/16:19:00 GMT 26:39	TGT=4 BV=3 P= 90.00 Y= 0.00 OM= 90.00 RA= 353.795 DEC= -2.682S	A1 AUTO VERN	DSC 0.200 DB AT 1.00 DB RT 0.02	SUN R 0 P 90	INRTL R=352.07 P=277.65 Y= 38.49	-ZSI SSBUV SOLAR VW
5 011/03:20:00 MET 33:03 073/17:14:00 GMT 27:03	INRTL R=202.00 MNVR P=219.00 Y=312.00	A1 AUTO VERN	DSC 0.200 DB AT 1.00 DB RT 0.02	SUN R 109 P 117	STAR PAIR A1 -Y: 25 -Z: 15	IMU ALIGN
6 011/03:40:00 MET 48:47 073/17:34:00 GMT 42:47	TGT=2 BV=3 P= 90.00 Y= 0.00 OM=270.00	A1 AUTO VERN	DSC 0.200 DB AT 1.00 DB RT 0.02	EARTH R 0 P 90	LVLH R= 0.00 P=180.00 Y= 90.00	-ZLV +YVV
7 011/15:15:00 MET 28:54 074/05:09:00 GMT 22:54	INRTL R=202.00 MNVR P=219.00 Y=312.00	A1 AUTO VERN	DSC 0.200 DB AT 1.00 DB RT 0.02	SUN R 110 P 117	STAR PAIR A1 -Y: 25 -Z: 15	IMU ALIGN
8 011/15:35:00 MET 44:05 074/05:29:00 GMT 38:05	TGT=2 BV=3 P= 90.00 Y= 0.00 OM=270.00	A1 AUTO VERN	DSC 0.200 DB AT 1.00 DB RT 0.02	EARTH R 0 P 90	LVLH R= 0.00 P=180.00 Y= 90.00	-ZLV +YVV
9 011/16:05:00 MET 19:38 074/05:59:00 GMT 06:13:38	INRTL R= 24.00 MNVR P=264.00 Y=344.00	A1 AUTO VERN	DSC 0.200 DB AT 1.00 DB RT 0.02	SUN R 328 P 97		-Z TGT, MOON SKIRT MOON CAL2
10 011/17:40:00 MET 54:42 074/07:34:00 GMT 48:42	INRTL R=230.00 MNVR P=356.00 Y=345.00 TIG: 11/18:08	A1 AUTO VERN	DSC 0.200 DB AT 1.00 DB RT 0.02	SUN R 185 P 11		OMS-5 EQUIV to LVLH 180 PITCH
11 011/18:15:00 MET 22:48 074/08:09:00 GMT 16:48	TGT=2 BV=3 P= 90.00 Y= 0.00 OM=270.00	A1 AUTO VERN	DSC 0.200 DB AT 1.00 DB RT 0.02	EARTH R 360 P 90	LVLH R= 0.00 P=180.00 Y= 90.00	-ZLV +YVV
12 011/18:45:00 MET 58:54 074/08:39:00 GMT 52:54	INRTL R=291.00 MNVR P= 3.00 Y=353.00	A1 AUTO VERN	DSC 0.200 DB AT 1.00 DB RT 0.02	SUN R 181 P 2		BIAS +XSI EISG 5 PLATE COLD SOAK

*** ALL ATTITUDES IN MEAN OF 1950 ***
*** PYR EULER SEQUENCE ***

Attitude Timeline

MET/GMT	MNVR OPTION	DAP	E/S	REF ATT/REMARKS	EVENT	
1 011/19:30:00 MET 40:35 074/09:24:00 GMT 34:35	TGT=2 BV=2 P=180.00 Y= 0.00 OM=180.00	A1 AUTO VERN	DSC 0.200 DB AT 1.00 DB RT 0.02	EARTH R 131 P 180	LVLH R=180.00 P= 90.00 Y= 0.00	-XLV -ZVV EISG 5
2 011/20:25:00 MET 35:00 074/10:19:00 GMT 29:00	TGT=2 BV=3 P= 90.00 Y= 0.00 OM=270.00	A1 AUTO VERN	DSC 0.200 DB AT 1.00 DB RT 0.02	EARTH R 360 P 90	LVLH R= 0.00 P=180.00 Y= 90.00	-ZLV +YVV WASTE DUMP
3 012/03:05:00 MET 19:38 074/16:59:00 GMT 17:13:38	INRTL R=202.00 MNVR P=219.00 Y=312.00	A1 AUTO VERN	DSC 0.200 DB AT 1.00 DB RT 0.02	SUN R 110 P 118	STAR PAIR A1 -Y: 25 -Z: 15	IMU ALIGN
4 012/03:25:00 MET 34:39 074/17:19:00 GMT 28:39	TGT=2 BV=3 P= 90.00 Y= 0.00 OM=270.00	A1 AUTO VERN	DSC 0.200 DB AT 1.00 DB RT 0.02	EARTH R 0 P 90	LVLH R= 0.00 P=180.00 Y= 90.00	-ZLV +YVV
5 012/15:00:00 MET 13:40 075/04:54:00 GMT 05:07:40	INRTL R=202.00 MNVR P=219.00 Y=312.00	A1 AUTO VERN	DSC 0.200 DB AT 1.00 DB RT 0.02	SUN R 111 P 118	STAR PAIR A1 -Y: 25 -Z: 15	IMU ALIGN
6 012/15:20:00 MET 33:07 075/05:14:00 GMT 27:07	TGT=4 BV=3 P= 90.00 Y= 0.00 OM= 90.00 RA= 355.206 DEC= -2.075S	A1 AUTO VERN	DSC 0.200 DB AT 1.00 DB RT 0.02	SUN R 0 P 90	INRTL R=353.91 P=275.84 Y= 38.02	-ZSI SSBUV SOLAR VW
7 012/16:45:00 MET 59:57 075/06:39:00 GMT 53:57	TGT=2 BV=3 P= 90.00 Y= 0.00 OM=270.00	A1 AUTO VERN	DSC 0.200 DB AT 1.00 DB RT 0.02	EARTH R 0 P 90	LVLH R= 0.00 P=180.00 Y= 90.00	-ZLV +YVV
8 012/18:15:00 MET 22:57 075/08:09:00 GMT 16:57	INRTL R=188.00 MNVR P=187.00 Y= 8.00	A1 AUTO VERN	DSC 0.200 DB AT 1.00 DB RT 0.02	SUN R 206 P 174		BIAS -XSI EISG 6 PLATE COLD SOAK
9 012/19:15:00 MET 27:46 075/09:09:00 GMT 21:46	TGT=2 BV=2 P=180.00 Y= 0.00 OM=180.00	A1 AUTO VERN	DSC 0.200 DB AT 1.00 DB RT 0.02	EARTH R 127 P 180	LVLH R=180.00 P= 90.00 Y= 0.00	-XLV -ZVV EISG 6 ATT
10 012/20:05:00 MET 15:00 075/09:59:00 GMT 10:09:00	TGT=2 BV=3 P= 90.00 Y= 0.00 OM=270.00	A1 AUTO VERN	DSC 0.200 DB AT 1.00 DB RT 0.02	EARTH R 360 P 90	LVLH R= 0.00 P=180.00 Y= 90.00	-ZLV +YVV
11 012/20:55:00 MET 21:07:37 075/10:49:00 GMT 11:01:37	TGT=2 BV=5 P=270.00 Y=319.00 OM= 0.00	A1 AUTO VERN	DSC 0.200 DB AT 1.00 DB RT 0.02	EARTH R 221 P 90	LVLH R=319.00 P= 0.00 Y= 0.00	BIAS -YLV +XVV AMOS 0 DEG TEST TCA 12:21:19:29
12 012/21:30:00 MET 43:35 075/11:24:00 GMT 37:35	INRTL R=188.00 MNVR P=187.00 Y= 8.00	A1 AUTO VERN	DSC 0.200 DB AT 1.00 DB RT 0.02	SUN R 206 P 174		BIAS -XSI EISG 7 PLATE COLD SOAK

*** ALL ATTITUDES IN MEAN OF 1950 ***
*** PYR EULER SEQUENCE ***

Attitude Timeline

MET/GMT	MNVR OPTION	DAP	E/S	REF ATT/REMARKS	EVENT	
1 012/22:10:00 MET 21:53 075/12:04:00 GMT 15:53	TGT=2 BV=2 P=180.00 Y= 0.00 OM=240.00	A10 AUTO VERN	DSC 0.200 DB AT 10.0 DB RT 0.02	EARTH R 315 P 180	LVLH R=120.00 P= 90.00 Y= 0.00	BIAS -XLV -YVV EISG 7
2 012/22:34:00 MET 001/00:00:00 GMT	COLLAPSE DB A/AUTO/PRI					
3 012/22:44:00 MET 075/12:38:00 GMT	LVLH FREE ROTATION ROTR ABOUT +X AXIS RATE=1.200	B6 LVLH PRI	DSC 1.200 DB AT 3.00 DB RT 0.20		LVLH R=120.00 P= 90.00 Y= 0.00	EISG 7 LVLH +X ROTOR
4 012/22:54:00 MET 075/12:48:00 GMT		B6 LVLH PRI	DSC 1.200 DB AT 3.00 DB RT 0.20	EARTH R 90 P 180	LVLH R=120.00 HOLD P= 90.00 Y= 0.00	EISG 7 LVLH ROTOR COMPLETE (2 ROTATIONS)
5 012/23:05:00 MET 07:30 075/12:59:00 GMT 13:01:30	TGT=2 BV=2 P=180.00 Y= 0.00 OM=270.00	B6 AUTO VERN	DSC 0.200 DB AT 1.00 DB RT 0.02	EARTH R 349 P 180	LVLH R= 90.00 P= 90.00 Y= 0.00	-XLV +YVV SKIRT START ATT
6 012/23:15:00 MET 075/13:09:00 GMT	LVLH FREE ROTATION ROTR ABOUT +X AXIS RATE=1.200	B6 LVLH PRI	DSC 1.200 DB AT 3.00 DB RT 0.20		LVLH R= 90.00 P= 90.00 Y= 0.00	SKIRT LVLH +X ROTOR DAY
7 012/23:40:00 MET 075/13:34:00 GMT		B6 LVLH PRI	DSC 1.200 DB AT 3.00 DB RT 0.20	EARTH R 283 P 180	LVLH R= 90.00 HOLD P= 90.00 Y= 0.00	SKIRT ROTORS COMPLETE (5 ROTATIONS)
8 012/23:50:00 MET 57:30 075/13:44:00 GMT 51:30	TGT=2 BV=3 P= 90.00 Y= 0.00 OM=270.00	A1 AUTO VERN	DSC 0.200 DB AT 1.00 DB RT 0.02	EARTH R 360 P 90	LVLH R= 0.00 P=180.00 Y= 90.00	-ZLV +YVV
9 013/02:55:00 MET 03:07:39 075/16:49:00 GMT 17:01:39	INRTL R=202.00 MNVR P=219.00 Y=312.00	A1 AUTO VERN	DSC 0.200 DB AT 1.00 DB RT 0.02	SUN R 111 P 118	STAR PAIR A1 -Y: 25 -Z: 15	IMU ALIGN
10 013/03:15:00 MET 28:36 075/17:09:00 GMT 22:36	TGT=2 BV=5 P=250.00 Y= 0.00 OM=125.00	A1 AUTO VERN	DSC 0.200 DB AT 1.00 DB RT 0.02	EARTH R 180 P 110	LVLH R=206.03 P=147.60 Y= 50.33	BIAS +ZLV -YVV ECT
11 013/16:15:00 MET 25:02 076/06:09:00 GMT 19:02	INRTL R=202.00 MNVR P=219.00 Y=312.00	A1 AUTO VERN	DSC 0.200 DB AT 1.00 DB RT 0.02	SUN R 112 P 119	STAR PAIR A1 -Y: 25 -Z: 15	IMU ALIGN
12 013/16:35:00 MET 48:30 076/06:29:00 GMT 42:30	TGT=2 BV=3 P= 90.00 Y= 0.00 OM= 90.00	A1 AUTO VERN	DSC 0.200 DB AT 1.00 DB RT 0.02	EARTH R 360 P 90	LVLH R= 0.00 P=180.00 Y=270.00	-ZLV -YVV

*** ALL ATTITUDES IN MEAN OF 1950 ***
*** PYR EULER SEQUENCE ***

Attitude Timeline

MET/GMT	MNVR OPTION	DAP	E/S	REF ATT/REMARKS	EVENT	
1 013/18:00:00 MET 14:55 076/07:54:00 GMT 08:08:55	TGT=4 RA= 356.220 BV=5 DEC= -1.637S P=184.00 Y= 0.00 OM=270.00	A1 AUTO VERN	DSC 0.200 DB AT 1.00 DB RT 0.02	SUN R 180 P 176	INRTL R=216.72 P=184.85 Y= 6.18	-XSI COLD SOAK
2 013/19:13:00 MET 23:02 076/09:07:00 GMT 17:02	INRTL R=249.00 MNVR P=307.00 Y=322.00	A1 AUTO PRI	DSC 0.200 DB AT 5.00 DB RT 0.20	SUN R 132 P 60	-Y: 44 -Z: 48	D/O IMU ALIGN
3 013/19:30:00 MET 35:32 076/09:24:00 GMT 29:32	INRTL R= 8.00 MNVR P=211.00 Y= 2.00	B1 AUTO PRI	DSC 0.500 DB AT 3.00 DB RT 0.20	SUN R 348 P 151	-Y: 43 -Z: 38	D/O VERIF
4 013/19:40:00 MET 44:19 076/09:34:00 GMT 38:19	INRTL R=237.00 MNVR P=224.00 Y= 29.00	B1 AUTO PRI	DSC 0.500 DB AT 3.00 DB RT 0.20	SUN R 147 P 133		D/O COMM ATT
5 013/21:55:00 MET 22:00:32 076/11:49:00 GMT 54:32	INRTL R=234.00 MNVR P= 59.00 Y= 4.00	TRN AUTO PRI	DSC 0.500 DB AT 3.50 DB RT 0.50	SUN R 313 P 58	TIG: 13/22:13	D/O BURN ATT

*** ALL ATTITUDES IN MEAN OF 1950 ***
 *** PYR EULER SEQUENCE ***

STS-62 DAP BOOK

DAP A CONFIGURATIONS

	ITEM #	A1*	A2	A3	A4	A5	A6	A7	A8	A9	A10
<u>TRANSLATION</u>											
PULSE ft/sec	1	0.10	0.10	0.10	0.10	0.10	0.10	0.10	0.05	0.10	0.10
<u>ROTATION</u>											
DSC RT NORM °/sec	2	0.200	0.400	0.200	0.500	0.200	0.200	0.200	0.200	0.100	0.200
VERN °/sec	3	0.200	0.400	0.008	0.200	0.200	0.200	0.200	0.200	0.200	0.200
PULSE NORM °/sec	4	0.10	0.10	0.10	0.10	0.04	0.10	0.10	0.10	0.10	0.10
VERN °/sec	5	0.010	0.010	0.010	0.010	0.010	0.010	0.010	0.010	0.010	0.010
COMP NORM °/sec	6	.00	.00	.00	.00	.00	.00	.00	.00	.00	.00
VERN °/sec	7	.000	.000	.000	.000	.000	.000	.000	.000	.000	.000
<u>DEADBAND</u>											
ATT NORM (deg)	8	5.00	1.00	1.00	3.00	1.00	5.00	2.00	2.00	3.00	1.00
VERN (deg)	9	1.000	1.000	0.070	1.000	1.000	1.000	1.000	1.000	2.000	10.000
RATE NORM °/sec	10	0.20	0.20	0.20	0.20	0.20	0.20	0.20	0.20	0.20	0.20
VERN °/sec	11	.020	.020	.010	.020	.020	.020	.020	.020	.020	.020
<u>JET OPT</u>											
P	12	1	1	1	1	2	3	1 or 3	1	1	1
Y	13	1	1	3	1	3	3	1 or 3	1	1	1
CNTL ACCEL	14	0	0	0	0	0	0	0	0	0	0

*I-LOADED OPS-2 DAP Configuration

DAP B CONFIGURATIONS

	ITEM #	B1*	B2	B3	B4	B5	B6	B7	B8	B9
TRANSLATION										
PULSE ft/sec	15	0.10	0.10	0.10	0.10	0.10	0.10	0.05	0.01	0.10
ROTATION										
DSC RT NORM °/sec	16	0.500	0.200	0.200	0.200	0.200	1.200	0.500	0.200	1.000
VERN °/sec	17	0.200	0.200	0.200	0.008	0.016	0.200	0.200	0.200	0.200
PULSE NORM °/sec	18	0.04	0.04	0.04	0.04	0.04	0.04	0.04	0.04	0.04
VERN °/sec	19	0.002	0.002	0.002	0.002	0.002	0.002	0.002	0.002	0.002
COMP NORM °/sec	20	.00	.00	.00	.00	.00	.00	.00	.00	.00
VERN °/sec	21	.000	.000	.000	.000	.000	.000	.000	.000	.000
DEADBAND										
ATT NORM (deg)	22	3.00	3.00	3.00	0.30	3.00	3.00	2.00	2.00	3.00
VERN (deg)	23	1.000	1.000	1.000	0.100	0.033	1.000	1.000	1.000	1.000
RATE NORM °/sec	24	0.20	0.20	0.20	0.20	0.20	0.20	0.20	0.20	0.10
VERN °/sec	25	.020	.020	.020	.010	.020	.020	.020	.020	.020
JET OPT										
P	26	1	3	1	3	3	2	1 or 3	1	1
Y	27	1	3	1	3	3	2	1 or 3	1	1
CNTL ACCEL	28	0	0	0	0	0	0	0	0	0

*I-LOADED OPS-2 DAP Configuration except TRANSLATION PULSE (I-LOAD is 0.02 ft/sec)

ALT DAP CONFIGURATIONS

	ITEM #	ALT1*	ALT2	ALT3
RATE DEADBAND	32	0.200	0.070	0.070
JET OPTION	33	1	1 or 3	1 or 3
NUMBER OF JETS	34	2	1	1
ON TIME	35	0.08	0.08	0.08
DELAY	36	0.00	0.00	1.00

*I-LOADED OPS-2 DAP Configuration



<u>DAP</u>	<u>PURPOSE</u>	<u>DAP</u>	<u>PURPOSE</u>
A1	- NOMINAL IMU ALIGN LOSS OF VERN (NOSE & TAIL)	B1	- NOMINAL PRCS IMU ALIGN OMS & RCS BURNS
A2	- PTC	B2	- LOSS OF VERN (TAIL ONLY)
A3	- GG	B3	- LOSS OF VERN (NOSE & TAIL) GG MNVR
A4	- PRE/POST DEPLOY	B4	- SSUS DEPLOY
A5	- DSO 324	B5	- COAS CAL
A6	- LOSS OF VERN (TAIL ONLY)	B6	- SKIRT/EISG ROTORS
A7	- RENDEZVOUS	B7	- RENDEZVOUS
A8	- PROX OPS	B8	- PROX OPS
A9	- USMP OPS	B9	- SAMS ROTATIONS
A10	- EISG 2,7		

FLT PLN-1a/62/O/B



STS-62 DAP CONFIG

LOSS OF VERN

USMP OPS NOT COMPLETE - A9/ALT3

USMP OPS COMPLETE - B2/ALT2

FLT PLN-1b/62/O/B



(reduced copy)



DAP A

DAP A1

PURPOSE:

NOMINAL
IMU ALIGN
LOSS OF VERN
(NOSE & TAIL)

FLT PLN-2a/62/O/A

FLT PLN-2b/62/O/A

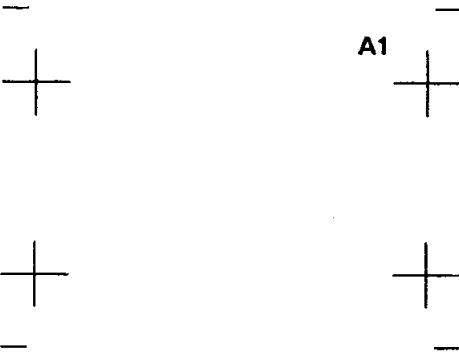

A1

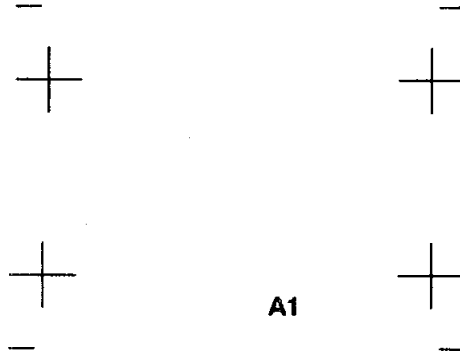

A1

A1

DAP A2

PURPOSE:

PTC

0.10	1	TRANSLATION	
		PULSE	
		ROTATION	
0.200	2	DSC RT	NORM
0.200	3		VERN
0.10	4	PULSE	NORM
0.010	5		VERN
.00	6	COMP	NORM
.000	7		VERN
		DEADBAND	
5.00	8	ATT	NORM
1.000	9		VERN
0.20	10	RATE	NORM
.020	11		VERN
1	12	JET OPT	P
1	13		Y
0	14	CNTL ACCEL	

FLT PLN-3a/62/O/A

FLT PLN-3b/62/O/A

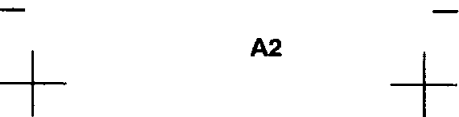

A2



(reduced copy)

A2

0.10	1	TRANSLATION	
		PULSE	
		ROTATION	
0.400	2	DSC RT	NORM
0.400	3		VERN
0.10	4	PULSE	NORM
0.010	5		VERN
.00	6	COMP	NORM
.000	7		VERN
		DEADBAND	
-1.00	8	ATT	NORM
-1.000	9		VERN
0.20	10	RATE	NORM
.020	11		VERN
1	12	JET OPT	P
1	13		Y
0	14	CNTL ACCEL	

FLT PLN-4a/62/O/A

A3

A3

0.10	1	TRANSLATION	
		PULSE	
		ROTATION	
0.200	2	DSC RT	NORM
0.008	3		VERN
0.10	4	PULSE	NORM
0.010	5		VERN
.00	6	COMP	NORM
.000	7		VERN
		DEADBAND	
-1.00	8	ATT	NORM
-0.070	9		VERN
0.20	10	RATE	NORM
.010	11		VERN
1	12	JET OPT	P
3	13		Y
0	14	CNTL ACCEL	

FLT PLN-5a/62/O/A

A4

A2

DAP A3

PURPOSE:
GG

A3

DAP A4

PURPOSE:
PRE/POST DEPLOY

A4

(reduced copy)

+

-

A4

0.1 0	1	TRANSLATION	
		PULSE	
ROTATION			
0.5 0 0	2	DSC RT	NORM
0.2 0 0	3		VERN
0.1 0	4	PULSE	NORM
0.0 1 0	5		VERN
.0 0	6	COMP	NORM
.0 0 0	7		VERN
DEADBAND			
- 3.0 0	8	ATT	NORM
- 1.0 0 0	9		VERN
0.2 0	10	RATE	NORM
.0 2 0	11		VERN
1	12	JET OPT	P
1	13		Y
0	14	CNTL ACCEL	

FLT PLN-6a/62/O/A

+

-

A4

DAP A5

PURPOSE:

DSO 324

FLT PLN-6b/62/O/A

+

-

A5

+

-

+

-

A5

+

-

+

-

A5

0.1 0	1	TRANSLATION	
		PULSE	
ROTATION			
0.2 0 0	2	DSC RT	NORM
0.2 0 0	3		VERN
0.0 4	4	PULSE	NORM
0.0 1 0	5		VERN
.0 0	6	COMP	NORM
.0 0 0	7		VERN
DEADBAND			
- 1.0 0	8	ATT	NORM
- 1.0 0 0	9		VERN
0.2 0	10	RATE	NORM
.0 2 0	11		VERN
2	12	JET OPT	P
3	13		Y
0	14	CNTL ACCEL	

FLT PLN-7a/62/O/A

+

-

A5

DAP A6

PURPOSE:

LOSS OF VERN
(TAIL ONLY)

FLT PLN-7b/62/O/A

+

-

A6

+

-

+

-

A6

+

-

(reduced copy)

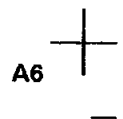

A6

DAP A7

0.10 1 TRANSLATION PULSE

ROTATION

0.200 2 DSC RT NORM

0.200 3 VERN

0.10 4 PULSE NORM

0.010 5 VERN

.00 6 COMP NORM

.000 7 VERN

DEADBAND

5.00 8 ATT NORM

1.000 9 VERN

0.20 10 RATE NORM

.020 11 VERN

3 12 JET OPT P

3 13 Y

0 14 CNTL ACCEL

PURPOSE:
RENDEZVOUS

FLT PLN-8a/62/O/A

FLT PLN-8b/62/O/A



A7

DAP A8

0.10 1 TRANSLATION PULSE

ROTATION

0.200 2 DSC RT NORM

0.200 3 VERN

0.10 4 PULSE NORM

0.010 5 VERN

.00 6 COMP NORM

.000 7 VERN

DEADBAND

2.00 8 ATT NORM

1.000 9 VERN

0.20 10 RATE NORM

.020 11 VERN

1 or 3 12 JET OPT P

1 or 3 13 Y

0 14 CNTL ACCEL

PURPOSE:
PROX OPS

FLT PLN-9a/62/O/A

FLT PLN-9b/62/O/A

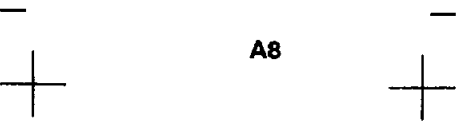

(reduced copy)



A8

A8

DAP A9

- 0.0 5 1 TRANSLATION PULSE
- ROTATION
- 0.2 0 0 2 DSC RT NORM
- 0.2 0 0 3 VERN
- 0.1 0 4 PULSE NORM
- 0.0 1 0 5 VERN
- .0 0 6 COMP NORM
- .0 0 0 7 VERN
- DEADBAND
- 2.0 0 8 ATT NORM
- 1.0 0 0 9 VERN
- 0.2 0 10 RATE NORM
- .0 2 0 11 VERN
- 1 12 JET OPT P
- 1 13 Y
- 0 14 CNTL ACCEL

PURPOSE:
USMP OPS

FLT PLN-10a/62/O/B

FLT PLN-10b/62/O/B

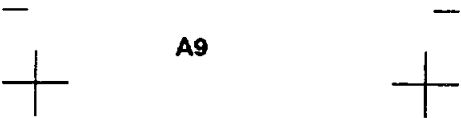

A9



A9

- 0.1 0 1 TRANSLATION PULSE
- ROTATION
- 0.1 0 0 2 DSC RT NORM
- 0.2 0 0 3 VERN
- 0.1 0 4 PULSE NORM
- 0.0 1 0 5 VERN
- .0 0 6 COMP NORM
- .0 0 0 7 VERN
- DEADBAND
- 3.0 0 8 ATT NORM
- 2.0 0 0 9 VERN
- 0.2 0 10 RATE NORM
- .0 2 0 11 VERN
- 1 12 JET OPT P
- 1 13 Y
- 0 14 CNTL ACCEL

DAP A10

PURPOSE:
EISG 2,7

FLT PLN-25a/62/O/A

FLT PLN-25b/62/O/A



A10



(reduced copy)



A10

A10

0.10	1	TRANSLATION	
		PULSE	
ROTATION			
0.200	2	DSC RT	NORM
0.200	3		VERN
0.10	4	PULSE	NORM
0.010	5		VERN
.00	6	COMP	NORM
.000	7		VERN
DEADBAND			
-1.00	8	ATT	NORM
10.000	9		VERN
0.20	10	RATE	NORM
.020	11		VERN
1	12	JET OPT	P
1	13		Y
0	14	CNTL ACCEL	

FLT PLN-26a/62/O/A



DAP B

FLT PLN-26b/62/O/A



DAP B1

PURPOSE:
 NOMINAL
 PRCS IMU ALIGN
 OMS & RCS
 BURNS

FLT PLN-11a/62/O/A

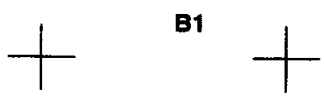

B1

FLT PLN-11b/62/O/A



(reduced copy)

FLT PLN/62/FIN



B1

15	<u>0.10*</u>
16	<u>0.500</u>
17	<u>0.200</u>
18	<u>0.04</u>
19	<u>0.002</u>
20	<u>.00</u>
21	<u>.000</u>
22	<u>-3.00</u>
23	<u>-1.000</u>
24	<u>0.20</u>
25	<u>.020</u>
26	<u>1</u>
27	<u>1</u>
28	<u>0</u>

*NOT I-LOAD

FLT PLN-12a/62/O/A



DAP B2

PURPOSE:
LOSS OF VERN
(TAIL ONLY)

FLT PLN-12b/62/O/A



B2



B2

15	<u>0.10</u>
16	<u>0.200</u>
17	<u>0.200</u>
18	<u>0.04</u>
19	<u>0.002</u>
20	<u>.00</u>
21	<u>.000</u>
22	<u>-3.00</u>
23	<u>-1.000</u>
24	<u>0.20</u>
25	<u>.020</u>
26	<u>3</u>
27	<u>3</u>
28	<u>0</u>

FLT PLN-13a/62/O/A



B2

DAP B3

PURPOSE:
LOSS OF VERN
(NOSE & TAIL)
GG MNVR

FLT PLN-13b/62/O/A

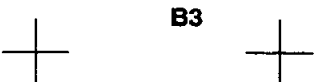

B3



(reduced copy)



B3

DAP B4

15	0.1 0
16	0.2 0 0
17	0.2 0 0
18	0.0 4
19	0.0 0 2
20	.0 0
21	.0 0 0
22	- 3.0 0
23	- 1.0 0 0
24	0.2 0
25	.0 2 0
26	1
27	1
28	0

PURPOSE:
SSUS DEPLOY

FLT PLN-14a/62/O/A

FLT PLN-14b/62/O/A



B4



B4

DAP B5

15	0.1 0
16	0.2 0 0
17	0.0 0 8
18	0.0 4
19	0.0 0 2
20	.0 0
21	.0 0 0
22	- 0.3 0
23	- 0.1 0 0
24	0.2 0
25	- 0.1 0
26	3
27	3
28	0

PURPOSE:
COAS CAL

FLT PLN-15a/62/O/A

FLT PLN-15b/62/O/A



B5



(reduced copy)



B5

15	<u>0.1 0</u>
16	<u>0.2 0 0</u>
17	<u>0.0 1 6</u>
18	<u>0.0 4</u>
19	<u>0.0 0 2</u>
20	<u>.0 0</u>
21	<u>.0 0 0</u>
22	<u>- 3.0 0</u>
23	<u>- 0.0 3 3</u>
24	<u>0.2 0</u>
25	<u>.0 2 0</u>
26	<u>3</u>
27	<u>3</u>
28	<u>0</u>

FLT PLN-16a/62/O/B



B6



B6

15	<u>0.1 0</u>
16	<u>1.2 0 0</u>
17	<u>0.2 0 0</u>
18	<u>0.0 4</u>
19	<u>0.0 0 2</u>
20	<u>.0 0</u>
21	<u>.0 0 0</u>
22	<u>3.0 0</u>
23	<u>1.0 0 0</u>
24	<u>0.2 0</u>
25	<u>.0 2 0</u>
26	<u>2</u>
27	<u>2</u>
28	<u>0</u>

FLT PLN-17a/62/O/B



B7



B5

DAP B6

PURPOSE:

SKIRT/EISG
ROTORS

FLT PLN-16b/62/O/B



B6

DAP B7

PURPOSE:

RENDEZVOUS

FLT PLN-17b/62/O/A



(reduced copy)

FLT PLN/62/FIN



B7

15	<u>0.0 5</u>
16	<u>0.5 0 0</u>
17	<u>0.2 0 0</u>
18	<u>0.0 4</u>
19	<u>0.0 0 2</u>
20	<u>.0 0</u>
21	<u>-0.0 0 0</u>
22	<u>- 2.0 0</u>
23	<u>- 1.0 0 0</u>
24	<u>0.2 0</u>
25	<u>.0 2 0</u>
26	1 or 3
27	1 or 3
28	0

FLT PLN--18a/62/O/A

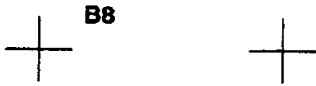

B8



B8

15	<u>0.0 1</u>
16	<u>0.2 0 0</u>
17	<u>0.2 0 0</u>
18	<u>0.0 4</u>
19	<u>0.0 0 2</u>
20	<u>.0 0</u>
21	<u>-0.0 0 0</u>
22	<u>- 2.0 0</u>
23	<u>- 1.0 0 0</u>
24	<u>0.2 0</u>
25	<u>.0 2 0</u>
26	1
27	1
28	0

FLT PLN--19a/62/O/A



B9

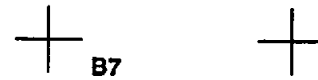

B7

DAP B8

PURPOSE:
PROX OPS

FLT PLN--18b/62/O/A



B8

DAP B9

PURPOSE:
SAMS ROTATIONS

FLT PLN--19b/62/O/A



(reduced copy)

FLT PLN/62/FIN

+ + + B9 +

B9

15	0.10
16	1.000
17	0.200
18	0.04
19	0.002
20	.00
21	.000
22	3.00
23	-1.000
24	0.10
25	.020
26	1
27	1
28	0

Rate
d/h

FLT PLN-20a/62/O/A

Flight + Backup

2

+ + + + +

DAP PURPOSE

ALT1 - NOMINAL I-LOAD

ALT2 - GENERIC LOSS OF VERNIS

ALT3 - USMP LOSS OF VERNIS

FLT PLN-21a/62/O/B

DAP ALT1

PURPOSE:

NOMINAL I-LOAD

FLT PLN-21b/62/O/A

+ ALT1 + + +

+	ALT1	+
	RATE DB	
	32 <u>0.2 0 0</u>	
	JET OPT	
	33 1	
	# JETS	
	34 <u>2</u>	
	ON TIME	
	35 <u>- 0.0 8</u>	
	DELAY	
	36 <u>- 0.0 0</u>	
	FLT PLN-22a/62/O/A	

+	DAP ALT2	+
	PURPOSE:	
	GENERIC	
	LOSS OF VERNs	
	FLT PLN-22b/62/O/A	

+	ALT2	+
---	-------------	---

+	ALT1	+
---	-------------	---

+	ALT2	+
	RATE DB	
	32 <u>0.0 7 0</u>	
	JET OPT	
	33 1 or <u>3</u>	
	# JETS	
	34 1	
	ON TIME	
	35 <u>- 0.0 8</u>	
	DELAY	
	36 <u>- 0.0 0</u>	
	FLT PLN-23a/62/O/B	

+	DAP ALT3	+
	PURPOSE:	
	USMP	
	LOSS OF VERNs	
	FLT PLN-23b/62/O/B	

+	ALT3	+
---	-------------	---

+	ALT2	+
---	-------------	---

(reduced copy)

ALT3

RATE DB
 32 0.0 7 0
 JET OPT
 33 1 or 3
 # JETS
 34 1
 ON TIME
 35 - 0.0 8
 DELAY
 36 - 1.0 0
 FLT PLN-27a/62/O/A

FLT PLN-27b/62/O/A

ALT3

UNIV PTG	
TGT ID = 1 Orbiting Vehicle = 2 Earth ctr = 3 Earth tgt Input LAT (± 90) LON (± 180 , + = East) ALT (-3444.0 to 20000.0 nm) = 4 Sun ctr = 5 Celestial tgt Input RA (0-359.99) DEC (± 90) = 11-110 Nav Stars	
BODY VECT = 1 +X* = 2 -X* = 3 -Z* = 4 -Y Star Tracker* = 5 Optional Input P (0-359.99) Y (270-359.99, 0-90) * input OM \rightarrow OM (0-359.99)	
MON AXIS = 1 +X 2 -X	
CNTL ACCEL = 0 Orbiter Alone = 1 thru 5 not used PRI JET OPT = 1 Normal = 2 Nose only = 3 Tail only ALT JET OPT = 1 Normal = 2 Illegal entry = 3 Tail only	

FLT PLN-24a/62/O/A

FLT PLN-24a/62/O/A is mounted on the back of the DAP Book

(reduced copy)

STS-62
FLIGHT PLAN NOTES

FLT PLN
NOTES

**FLIGHT PLAN NOTES
(CONSTRAINTS AND GUIDELINES)**

A. FLIGHT DESCRIPTION

Orbiter: OV102/Columbia
 Inclination: 39.0°
 Altitude: 163 x 160
 Duration: 14 + 2

B. MAJOR EVENTS

<u>EVENT</u>	<u>MET</u>	<u>DATE</u>	<u>CST</u>	<u>GMT</u>	<u>ΔV</u>	<u>ORBIT</u>
Launch	0/00:00	3/3/94	07:54	62/13:54	--	--
OMS-2	0/00:45	3/3/94	08:39	62/14:39	207.9	163/160
OMS-3	09:16:45	3/12/94	00:39	72/06:39	37.9	157/140
OMS-4	09:17:30	3/12/94	01:24	72/07:24	31.8	140/139
OMS-5	11:18:08	3/14/94	02:02	74/08:02	58.6	138/105
D/O Burn	13:22:13	3/17/94	06:07	76/12:07	209.0	--
Landing	13:23:06	3/17/94	07:00	76/13:00	--	--

C. LANDING OPPORTUNITIES:

		<u>Landing Orbit</u>	<u>Site</u>	<u>Local Time</u>
		<u>No.</u>		
Nominal	Primary	224	KSC	08:00 EST
	1 Rev late	225	KSC	09:33 EST
1 Day Late	Primary	240	KSC	07:41 EST
	1 Rev late	241	KSC	09:14 EST
2 Days Late	Primary	256	KSC	07:21 EST
	1 Rev late	257	KSC	08:54 EST

D. CREW

CDR - John Casper
 PLT - Andrew Allen
 MS1 - Pierre Thuot
 MS2 - Sam Gemar
 MS3 - Marsha Ivins

E. COMMUNICATIONS

TDRS Support: East (41° W), West (174° W)
 Backup Real-Time TV: GDS(GDX), MIL(MLX)
 Contingency GSTDN: MIL(MLX), BDA(BDX), DFR, and GDS(GDX)
 Contingency RTS: HTS, GTS, VTS, IOS, CTS, DGS, OTS, and NHS

Lead time for site call-up: GSTDN - 2 hr, RTS - 4 hr

**FLT PLN
NOTES**

F. PAYLOADS

1. United States Microgravity Payload (USMP-2)

The USMP-2 payload consists of two Multipurpose Equipment Support Structures (MPESs) with supporting subsystems, a bridge structure, and five experiments. The forward MPES with subsystems is the Spacelab MPES-A carrier. The two carriers bridged together is the Spacelab MPES-B carrier.

The USMP-2 consists of the following five experiments:

a. Advanced Automated Directional Solidification Furnace (AADSF)

The AADSF is a furnace designed to conduct materials processing experiments and is a multizone-type furnace capable of establishing very steep thermal gradients as well as long, isothermally heated regions.

b. Material Pour L'Etude Des Phenomenes Interessant La Solidification Sur Terre Et En Orbite (MEPHISTO)

The purpose of the MEPHISTO apparatus is to perform fundamental studies of different parameters which influence crystalline growth, such as the thermal gradient, the solidification rate, and the characteristics of the solidified sample under microgravity.

c. Isothermal Dendritic Growth Experiment (IDGE)

The objective of the IDGE is to develop and verify a mathematical model relating dendrite growth rates and tip radii to tip undercooling.

d. Critical Fluid Light Scattering Experiment (ZENO)

The objective of ZENO is to measure the decay rates and correlation lengths of density fluctuations in Xenon at its critical point as a function of temperature, pressure, and density by a technique of photon correlation light scattering.

e. Space Acceleration Measurement System (SAMS)

The SAMS is capable of measuring acceleration of a variety of space experiments and storing and downlinking large blocks of data. Two separate SAMS units will be flown to support the requirements of the other payload experiments.

All the experiments require a minimum microgravity environment.

2. Office of Aeronautics and Space Technology (OAST-2)

The OAST-2 payload consists of the following five separate experiments mounted on a hitchhiker (HH) cross-bay carrier.

a. **Experimental Investigation of Spacecraft Glow (EISG)/Spacecraft Kinetic Infrared Test (SKIRT)**

This experiment consists of two separate assemblies that measure spacecraft glow intensities as a function of temperature. Some EISG observations require that Nitrogen gas be released from a hole in the center of a sample plate while visible light, far ultraviolet spectrometers, and infrared (IR) detectors record the associated glow phenomena. The SKIRT experiment, which is contained in a standard GAS canister, provides additional imaging of the glow phenomena over a different range than that of EISG.

b. **Solar Array Module Plasma Interaction Experiment (SAMPIE)**

This experiment investigates arcing and current collection behavior of various solar cell materials and geometries in low Earth orbit. The experiment consists of a single box attached to the top of the HH carrier.

c. **Cryogenic Two-Phase Experiment (CRYOTP)**

This experiment measures the zero-gravity performance of a liquid Nitrogen space heat pipe and a thermal storage unit based on a solid-liquid phase change material. This experiment is contained in an HH canister.

d. **Thermal Energy Storage (TES)**

This experiment investigates the formation of voids during cooling of two different thermal storage salts. The experiment occupies two standard GAS canisters and is controlled by a new PGSC interface connected to the canisters by the Hitchhiker bus interface adapter (HBIA).

e. **Emulsion Chamber Technology (ECT)**

This experiment consists of an emulsion chamber container (ECC) and an electronics unit. ECT will study the effects of background particulate radiation in Earth orbit.

3. **Dexterous End Effector (DEE)**

The DEE payload uses the Remote Manipulator System (RMS) to demonstrate increased dexterity and alignment accuracy on orbit. The DEE uses a specifically designed end effector called a Magnetic Attachment Tool (MAT) that is grappled by the RMS standard end effector via the Electrical Flight Grapple Fixture. The MAT utilizes electromagnetic grapping, in combination with a force torque sensor, to simulate space station assembly tasks with a task bar.

4. **Shuttle Solar Backscatter Ultraviolet (SSBUV/A)**

The SSBUV program provides more accurate and reliable readings of global ozone to enhance the calibration of backscatter ultraviolet (UV) instruments flown concurrently on free-flying satellites. The payload configuration consists of two Get-Away Special (GAS) canisters, one of which contains the SSBUV spectrometer and is equipped with a Motorized Door Assembly (MDA). The adjacent support canister contains data, command, and power systems. Payload operations are controlled via ground commanding.

5. Limited Duration Space Environment Candidate Materials Exposure (LDCE)

The primary purpose of LDCE is to introduce developmental composite materials to a flux of atomic oxygen atoms in low-Earth orbit. The candidate materials will have undergone extensive ground-based material performance testing prior to being attached to reusable test fixtures designed for multimission space shuttle use.

6. Advanced Protein Crystal Growth (APCG)

The purpose of the APCG experiment is to gain an understanding of the dynamics involved in the growth of protein crystals in microgravity. The experiment will produce discrete, well-ordered protein crystals to be analyzed by X-ray diffraction post-flight. STS-62 is flying the Block I configuration which includes a Thermal Enclosure System (TES) containing four Vapor Diffusion Apparatuses (VDAs). In addition, STS-62 will be the first flight of four handheld Protein Crystallization Apparatus for Microgravity (PCAM) devices. The PCAMs will be stored and operated inside a middeck locker.

7. Physiological System Experiment (PSE)

The PSE will study the effects of proprietary protein molecules on animal physiological systems in microgravity. The PSE consists of two Animal Enclosure Modules (AEMs), each contained in a middeck locker. The crew will monitor the PSE on a daily basis.

8. Commercial Protein Crystal Growth (CPCG)

The CPCG payload will supply information on the scientific methods and commercial potential for growing large, high-quality protein crystals in microgravity. STS-62 is flying the Block I configuration which includes one Commercial Refrigerator/Incubator Module (CR/IM). This CR/IM contains three Vapor Diffusion Apparatuses (VDAs). The CR/IM will operate at 22 degC.

9. Commercial Generic Bioprocessing Apparatus (CGBA)

CGBA, configuration C, consists of a Generic Bioprocessing Apparatus (GBA) and a stowage locker. The GBA module is a self-contained mixing and heating module used to process biological fluid samples in microgravity. Crew activities consist of mixing samples, incubating samples in the GBA, transferring data to the PGSC, and photographing fluid samples.

10. Middeck 0-Gravity Dynamics Experiments (MODE)

The MODE payload will study the gravity dependent behavior of space structures. The payload will also quantify crewmember induced loads in the middeck. MODE consists of three hardware elements: the Experiment Support Module (ESM), the Structural Test Article (STA), and the Dynamic Load Sensors (DLSs). The ESM contains all of the necessary electronics for the STA and DLS experiments and includes a keypad for crew interface. The STA is a scale model truss consisting of an erectable truss module, two deployable truss modules, two articulated joint modules, and a flexible appendage. The STA will be assembled onorbit in the middeck. The DLSs consist of a touch pad, a handle, and a foot hold device instrumented to measure crewmember induced loads.

11. Bioreactor Demonstration System (BDS)

The BDS payload will perform cell biology experiments under controlled conditions on small samples of material. Experiment applications include mammalian cell cultures, plant cell growth, microbial growth, and radiation biology. A crewmember will perform daily status checks of the BDS hardware.

12. Air Force Maui Optical Site Calibration Test (AMOS)

The primary objective of the AMOS activity is to use the orbiter during cooperative overflights of Maui to obtain imagery and/or signature data to support the calibration of the AMOS groundbased sensors and to observe plume phenomenology. No unique onboard hardware is associated with the AMOS tests; crew and orbiter participation are required to establish the controlled conditions for the Maui cooperative overflight.

13. Orbiter Acceleration Research Experiment (OARE)

The OARE will acquire accurate measurement data of low level aerodynamic acceleration on the orbiter in the free-molecular flow regime of the upper atmosphere. This experiment will be performed as mission energy allowances and payload constraints permit.

G. ONORBIT DTOs

1. onorbit PRSD Cryo H2 Boiloff (DTO 413)

DTO 413 is only manifested on extended duration missions since the Extended Duration Orbiter (EDO) pallet cryo tanks contain the instrumentation necessary to calculate cryo H2 boiloff. The purpose of this DTO is to gain confidence that the Power Reactant Storage and Distribution (PRSD) boiloff rates are predictable on orbit. Accurate determination of onorbit boiloff rates is necessary to verify or enhance the orbiter's capability to support space station utilization flight requirements. A crewmember will perform manual cryogenic heater operations during the pre- and postsleep activities per MCC call.

2. PGSC Single Event Upset Monitoring (DTO 656)

The purpose of this DTO is to evaluate and compare the susceptibility of two Payload and General Support Computers (PGSCs) to single event upsets caused by radiation. The two computers include the standard 386 Grid PGSC and the new 486 IBM Think Pad PGSC. Data will be collected for a minimum of four crew sleep periods.

3. Cabin Temperature Survey (DTO 664)

The goal of DTO 664 is to re-evaluate the optimum location for the cabin temperature sensor due to changes in avionics power and heat loads since STS-2 and STS-3. A temperature profile of the crew cabin will be compiled for varying attitudes and power configurations and correlated with the cabin temperature sensor reading. A crewmember will record temperatures at various test points twice a day using a digital thermometer from the IFM tool kit.

4. Portable In-Flight Landing Operations Trainer (DTO 667)

The purpose of this DTO is to evaluate a simulator's ability to assist the Commander (CDR) and the Pilot (PLT) in maintaining a level of proficiency for approach and landing on EDO missions. The DTO consists of a laptop computer with landing software and a spare rotational hand controller (RHC). The CDR and PLT will each spend 30 min midflight and late in the mission to train with the simulator.

5. Evaluation of the Passive Cycle Isolation System (PCIS) (DTO 670)

The purpose of DTO 670 is to evaluate the ergometer vibration isolation capability of the PCIS. At least one exercise period requires the ergometer to be hard mounted to the middeck. All other sessions utilize the PCIS which will attenuate the ergometer vibration to background levels of shuttle operational vibration. The ultimate goal is to determine the best system that reduces low frequency vibration impacts to microgravity missions, simplifies setup requirements, and improves crew exercise performance.

6. Module Infrared (IR) Thermal Survey (DTO 678)

Occasionally, payload experiments mounted in the middeck have experienced thermal problems resulting in loss of science. Thus, the purpose of DTO 678 is to compile IR thermal data that may assist customers with their payload hardware design. This DTO will characterize thermal hot spots, heat flux, the influence of payload hot-air exhaust, and the influence of the galley and hot water heater on payloads and lockers in their proximity.

7. Ku-Band Communications Adapter (KCA) Demonstration (DTO 679)

The purpose of DTO 679 is to demonstrate the capability of the KCA to provide high speed bi-directional computer communications via the Shuttle Ku-Band system. This high speed data transfer capability will improve the slower Portable Audio Data Modem (PADM) transfer method which links a standard PGSC to the Shuttle S-Band system.

H. ONORBIT DSOs

1. Payload onorbit Low Frequency Environment (DSO 324)

DSO 324 will obtain low frequency (0-50 Hz) payload acceleration data from PRCS jet firings. The DSO must be performed during acquisition of signal (AOS) and when USMP-2's Shuttle Acceleration Measurement System (SAMS) is operating. A crewmember will perform one manual PRCS jet firing at a time, with no less than 10-15 seconds between each firing. This DSO requires a minimum of 9 single jet firings.

2. Window Impact Observations (DSO 326)

The objective of DSO 326 is to isolate orbiter window damage to an approximate time during the mission. A crew will record observations of all the windows once each flight day. This data will be useful in determining whether most of the damage occurs during ascent, onorbit, or entry. Furthermore, if onorbit impacts occur, this data will be useful in determining what particular attitudes and/or altitudes are more damaging.

3. InterMars Tissue Equivalent Proportional Counter (ITEPC) (DSO 485)

ITEPC consists of a spectrometer, radiation detector, and data storage equipment positioned on a Adaptive Payload Carrier in the payload bay. The purpose of the experiment is to demonstrate the ability of the hardware to withstand the radiation environment of spaceflight in preparation for the MARS '94 mission.

4. In-Flight Evaluation Of A Portable Clinical Blood Analyzer (DSO 492)

DSO 492 will validate the Portable Clinical Blood Analyzer's (PCBA) ability to function and measure certain clinical parameters accurately in microgravity. A crewmember will perform an electronics function test, a control fluids study, and a blood sample correlation study.

5. Orthostatic Function During Entry, Landing, and Egress (DSO 603B)

DSO 603B measures changes in orthostatic function of crewmembers during the stress of entry, landing, and egress from the orbiter. Participating crewmembers will don and calibrate equipment prior to deorbit preparation. At LES donning, they will connect cables and power the equipment. Verbal comments will be recorded during entry, landing, and egress. Results from this DSO are used to assess the effectiveness of current and/or proposed in-flight countermeasures to orthostatic intolerance.

6. Effects of Space Flight on Aerobic and Anaerobic Metabolism During Exercise (DSO 608)

Energy is supplied in the human body via aerobic and anaerobic metabolism. Post flight energy metabolism and pulmonary responses during exercise differ from pre-flight values in that most of the energy pool is obtained anaerobically. Therefore, the purpose of DSO 608 is to quantify changes in aerobic and anaerobic metabolism during exercise and to relate any changes to alterations in total body water, dry lean tissue, fat mass, and fluid volume intake. Participating crewmembers will log their daily fluid intake and drink one quart of fluid after each exercise session.

7. In-Flight Assessment of Renal Stone Risk (DSO 610)

DSO 610 aims to define the major metabolic factors contributing to kidney stone formation in orbit. Previous post-flight urine analysis reveals significant changes in the urinary excretion of stone-forming salts or inhibitors of stone formation. Such changes increase the risk of developing kidney stones. On this mission, two crewmembers will collect urine samples on various flight days and complete a daily food, fluid, and exercise log. Post-flight analysis will contribute to the development of countermeasures against kidney stone formation.

8. Air Monitoring Instrument Evaluation and Atmosphere Characterization (DSO 611)

DSO 611 is designed to evaluate and verify air monitoring equipment. The Microbial Air Sampler (MAS) will be used to collect data on the contaminants that affect crew health and safety. On this EDO mission, the MAS will evaluate the effect of the Regenerable CO₂ Removal System (RCRS) on air quality. Air samples from the middeck and flight deck will be collected on an early, mid, and late flight day.

9. Energy Utilization (DSO 612)

Blood glucose and muscle glycogen are the body's primary energy sources, and decreases in their availability may affect a crewmember's physical capacity during entry, landing, and egress. Thus, DSO 612 will be used to develop, verify, and optimize appropriate countermeasures against muscle loss and low blood sugar. Crewmembers will collect urine and saliva samples as well as measure glucose and ketone levels immediately upon wakeup on five consecutive flight days. The crew will also maintain a log of all exercise, food, and fluid intake. All this data will be used to determine onorbit energy utilization requirements.

10. In-Flight LBNP Test of Countermeasures and End-of-Mission Countermeasure Trial (DSO 623)

The primary objective of DSO 623 is to assess the effectiveness of the lower body negative pressure (LBNP) soak countermeasure at the end of the mission. Two crewmembers will be performing ramp sessions about every three flight days while only one crewmember will perform the five-hour soak on the day before entry. LBNP is used to maintain orthostatic tolerance in flight such that entry, landing, and egress performance is not impaired.

11. Educational Activities (DSO 802)

The purpose of this DSO is to use the attraction of space flight to capture the interest of students and motivate them toward careers in science, engineering, and mathematics. On STS-62, Objective 2 will be fulfilled by conducting 'Payload Explanations' that are coordinated and combined with selected daily PAO events provided for by DSO 901.

12. Documentary Television (DSO 901)

This DSO requires live television transmission or VTR dumps of crew activities, payload activities, and spacecraft functions.

13. Documentary Motion Picture Photography (DSO 902)

This DSO requires documentary and public affair motion picture photography of significant activities which best depict the basic capabilities of the space shuttle.

14. Documentary Still Photography (DSO 903)

This DSO requires still photography of crew activities in the orbiter, spacecraft accommodations, and mission-related scenes of general public and historical interest.

This Page Intentionally Blank

ROCKWELL INTERNATIONAL CORP.
ROCKETDYNE DIVISION
6633 CANOGA AVENUE
CANOGA PARK, CA 91303
055-LA38/CONNOR, T.J.

SPAR AEROSPACE
9445 AIRPORT ROAD
BRAMPTON, ONTARIO
CANADA L6S4J3
WOODLAND, C. (2)

TELEDYNE BROWN ENGINEERING
CUMMINGS RESEARCH PARK
300 SPARKMAN DRIVE, NW
P. O. BOX 070007
HUNTSVILLE, AL 35807-7007
MS 172/GILCHRIST, M.
MS 172/PACELEY, P.J. (2)
MS 172/RIEVES, M.
TBE 172/MC MAHON, A.P.
TBE 172/YOUNG, Y.

UAB/CMC
2707 ARTIE STREET
SUITE #1
HUNTSVILLE, AL 35805
ADAMS, W.R. (2)

Total 446
(02/01/94 - TLISTER)

NOTE
* FOR CHANGES *
* IN DISTRIBUTION *
* OR ADDRESS CORRECTIONS *
CONTACT THE FDF MANAGEMENT
* OFFICE AT (713) 244-1182 *
* OR MAIL TO *
DO46/DISTRIBUTION MANAGER,
* HELEN CANADA *
