

# FLIGHT DATA FILE

## Flight Plan

### STS-70

(FRR Cycle Trajectory)

Mission Operations Directorate  
Operations Division

Final  
May 10, 1995

<u>EVENT</u>	<u>CDI</u>		
Launch	09:20	Thursday	June 8
IUS/TDRS-G Deploy	15:33	Thursday	June 8
KSC Landing	07:36	Friday	June 16

BRANCH CHIEF  
R. H. NUTE  
DO4  
BOND

National  
Space Administration

Lyndon B. Johnson Space Center  
Houston, Texas



MISSION OPERATIONS DIRECTORATE

**STS-70 FLIGHT PLAN**



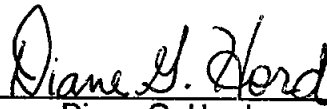

FINAL  
May 10, 1995

PREPARED BY:



Diane G. Hord  
Book Manager

APPROVED BY:

  
Cheevon B. Lau, Lead  
Flight Planning and Pointing Group  
Robert H. Nute, Chief  
Flight Planning Branch  
Earl W. Thompson  
Chief, Operations Division  
Brock R. Stone  
Assistant Director for  
Operations

This document is under the configuration control of the Crew Procedures Control Board (CPCB). All proposed changes must be submitted on JSC Form 482 to DO3/FDF Manager.

Additional distribution of this book for official use must be requested in writing to DO3/FDF Manager. The request must include justification and requester's name, organization, position, and phone number. Contractor requests are made through the NASA or DOD organization supported. Deletions, reduction in quantity, or change of address may be submitted to DO3/FDF distribution manager, (713) 244-1182.

Incorporates the following:				
482#:	FLT PLN-1714	FLT PLN-1723	FLT PLN-1747	FLT PLN- 1753
	FLT PLN-1718	FLT PLN-1724	FLT PLN-1748	FLT PLN- 1754
	FLT PLN-1719	FLT PLN-1725	FLT PLN-1749	
	FLT PLN-1720	FLT PLN-1726	FLT PLN-1750	
	FLT PLN-1721	FLT PLN-1727	FLT PLN-1751	MULTI-1158 <sup>9</sup>
	FLT PLN-1722	FLT PLN-1728	FLT PLN-1752	
Exemption #: NONE				

AREAS OF TECHNICAL RESPONSIBILITY

Book Manager/Lead FAO	DO4/D. Hord	244-0294
Lead Timeliner	DO4/S. Curtis	244-1085
Lead Pointer	DO4/T. Stockdale	244-5758

FLIGHT PLAN  
STS-70

**LIST OF EFFECTIVE PAGES**

FINAL 05/10/95

Sign Off .....	* 70/FIN	3-20 .....	70/FIN
ii .....	* 70/FIN	3-21 .....	70/FIN
iii .....	* 70/FIN	3-22 .....	70/FIN
iv .....	* 70/FIN	3-23 .....	70/FIN
v .....	* 70/FIN	3-24 .....	70/FIN
vi .....	* 70/FIN	3-25 .....	70/FIN
vii .....	70/FIN	3-26 .....	70/FIN
viii .....	70/FIN	3-27 .....	70/FIN
1-1 .....	70/FIN	3-28 .....	70/FIN
1-2 .....	70/FIN	3-29 .....	70/FIN
1-3 .....	70/FIN	3-30 .....	70/FIN
1-4 .....	70/FIN	3-31 .....	70/FIN
2-1 .....	70/FIN	3-32 .....	70/FIN
2-2 .....	70/FIN	3-33 .....	70/FIN
2-3 .....	70/FIN	3-34 .....	70/FIN
2-4 .....	70/FIN	3-35 .....	70/FIN
2-5 .....	70/FIN	3-36 .....	70/FIN
2-6 .....	70/FIN	3-37 .....	70/FIN
2-7 .....	70/FIN	3-38 .....	70/FIN
2-8 .....	70/FIN	3-39 .....	70/FIN
2-9 .....	70/FIN	3-40 .....	70/FIN
2-10 .....	70/FIN	3-41 .....	70/FIN
2-11 .....	70/FIN	3-42 .....	70/FIN
2-12 .....	70/FIN	3-43 .....	70/FIN
2-13 .....	70/FIN	3-44 .....	70/FIN
2-14 .....	70/FIN	3-45 .....	70/FIN
2-15 .....	70/FIN	3-46 .....	70/FIN
2-16 .....	70/FIN	3-47 .....	70/FIN
2-17 .....	70/FIN	3-48 .....	70/FIN
2-18 .....	70/FIN	3-49 .....	70/FIN
3-1 .....	70/FIN	3-50 .....	70/FIN
3-2 .....	70/FIN	4-1 .....	70/FIN
3-3 .....	70/FIN	4-2 .....	70/FIN
3-4 .....	70/FIN	4-3 .....	70/FIN
3-5 .....	70/FIN	4-4 .....	70/FIN
3-6 .....	70/FIN	4-5 .....	70/FIN
3-7 .....	70/FIN	4-6 .....	70/FIN
3-8 .....	70/FIN	4-7 .....	70/FIN
3-9 .....	70/FIN	4-8 .....	70/FIN
3-10 .....	70/FIN	4-9 .....	70/FIN
3-11 .....	70/FIN	4-10 .....	70/FIN
3-12 .....	70/FIN	4-11 .....	70/FIN
3-13 .....	70/FIN	4-12 .....	70/FIN
3-14 .....	70/FIN	4-13 .....	70/FIN
3-15 .....	70/FIN	4-14 .....	70/FIN
3-16 .....	70/FIN	4-15 .....	70/FIN
3-17 .....	70/FIN	4-16 .....	70/FIN
3-18 .....	70/FIN	4-17 .....	70/FIN
3-19 .....	70/FIN	4-18 .....	70/FIN

\* - Omit from flight book

4-19	.....	70/FIN
4-20	.....	70/FIN
4-21	.....	70/FIN
4-22	.....	70/FIN
4-23	.....	70/FIN
4-24	.....	70/FIN
5-i	.....	* 70/FIN
5-ii	.....	* 70/FIN
5-1	.....	* 70/FIN
5-2	.....	* 70/FIN
5-3	.....	* 70/FIN
5-4	.....	* 70/FIN
5-5	.....	* 70/FIN
5-6	.....	* 70/FIN
6-1	.....	* 70/FIN
6-2	.....	* 70/FIN
6-3	.....	* 70/FIN
6-4	.....	* 70/FIN
6-5	.....	* 70/FIN
6-6	.....	* 70/FIN
6-7	.....	* 70/FIN
6-8	.....	* 70/FIN
6-9	.....	* 70/FIN
6-10	.....	* 70/FIN
6-11	.....	* 70/FIN
6-12	.....	* 70/FIN
6-13	.....	* 70/FIN
6-14	.....	* 70/FIN
6-15	.....	* 70/FIN
6-16	.....	* 70/FIN
6-17	.....	* 70/FIN
6-18	.....	* 70/FIN
7-1	.....	* 70/FIN
7-2	.....	* 70/FIN
7-3	.....	* 70/FIN
7-4	.....	* 70/FIN
7-5	.....	* 70/FIN
7-6	.....	* 70/FIN

\* - Omit from flight book

STS-70 FLIGHT PLAN FABRICATED ITEMS

<u>Title</u>	<u>Ref. Page</u>	<u>Item No.</u>
DAP A, DAP B TOC	6-5	FLT PLN-1a/70/O/A
(Blank)	6-5	FLT PLN-1b/70/O/A
DAP A	6-6	FLT PLN-2a/70/O/A
DAP A1	6-6	FLT PLN-2b/70/O/A
A1	6-6	FLT PLN-3a/70/O/A
DAP A2	6-6	FLT PLN-3b/70/O/A
A2	6-7	FLT PLN-4a/70/O/A
DAP A3	6-7	FLT PLN-4b/70/O/A
A3	6-7	FLT PLN-5a/70/O/A
DAP A4	6-7	FLT PLN-5b/70/O/A
A4	6-8	FLT PLN-6a/70/O/A
DAP A5	6-8	FLT PLN-6b/70/O/A
A5	6-8	FLT PLN-7a/70/O/A
DAP A6	6-8	FLT PLN-7b/70/O/A
A6	6-9	FLT PLN-8a/70/O/A
DAP A7	6-9	FLT PLN-8b/70/O/A
A7	6-9	FLT PLN-9a/70/O/A
DAP A8	6-9	FLT PLN-9b/70/O/A
A8	6-10	FLT PLN-10a/70/O/A
DAP A9	6-10	FLT PLN-10b/70/O/A
A9	6-10	FLT PLN-11a/70/O/A
DAP A10	6-10	FLT PLN-11b/70/O/A
A10	6-11	FLT PLN-12a/70/O/B
DAP A11	6-11	FLT PLN-12b/70/O/B
A11	6-11	FLT PLN-23a/70/O/A
(blank)	6-11	FLT PLN-23b/70/O/A
DAP B	6-12	FLT PLN-13a/70/O/A
DAP B1	6-12	FLT PLN-13b/70/O/A
B1	6-12	FLT PLN-14a/70/O/A
DAP B2	6-12	FLT PLN-14b/70/O/A
B2	6-13	FLT PLN-15a/70/O/A
DAP B3	6-13	FLT PLN-15b/70/O/A
B3	6-13	FLT PLN-16a/70/O/A
DAP B4	6-13	FLT PLN-16b/70/O/A
B4	6-14	FLT PLN-17a/70/O/A
DAP B5	6-14	FLT PLN-17b/70/O/A
B5	6-14	FLT PLN-18a/70/O/A
DAP B6	6-14	FLT PLN-18b/70/O/A
B6	6-15	FLT PLN-19a/70/O/A
DAP B7	6-15	FLT PLN-19b/70/O/A
B7	6-15	FLT PLN-20a/70/O/A
DAP B8	6-15	FLT PLN-20b/70/O/A
B8	6-16	FLT PLN-21a/70/O/A
(Blank)	6-16	FLT PLN-21b/70/O/A
UNIV PTG	6-17	FLT PLN-22/70/O/A

**This Page Intentionally Blank**

<u>CONTENTS</u>	<u>PAGE</u>
INTRODUCTION .....	viii
STS-70 OVERVIEW .....	1-1
SUMMARY TIMELINE .....	2-1
DETAILED TIMELINE .....	3-1
CONTINGENCY TIMELINES .....	4-1
7A TDRS INSERTION TIMELINE .....	4-3
16A TDRS INSERTION TIMELINE .....	4-5
18A TDRS (EVA) INSERTION TIMELINE .....	4-9
5 DAY MISSION TIMELINE .....	4-13
ATTITUDE TIMELINE .....	5-1
STS-70 DAP BOOK .....	6-1
STS-70 FLIGHT PLAN NOTES .....	7-1



## INTRODUCTION

The STS-70 Flight Plan is the Flight Data File article that contains the on-orbit timeline. It does not contain the detailed timelines that are covered in the Ascent, Post Insertion, Deorbit Prep, and Entry Checklists. For continuity, the summary level timeline includes the entire flight.

This on-orbit timeline satisfies the objectives specified in the Flight Definition and Requirements Directive and the requirements of the STS-70 Flight Requirements Document. The Flight Plan, as part of the Flight Data File, meets the specifications of STS-70 Flight Initialization Data Pack.

The flight profile used for this Flight Plan is for a launch date of June 8, 1995, at 09:20 CDT (14:20 GMT). Orbiter inertial attitudes are expressed relative to a Mean of 1950 (M50) reference frame.

JSC-22359, Crew Scheduling Constraints (Appendix K, CPMP), Basic, Rev B, January 1992, has been used to build the timelines contained in this Flight Plan. No Appendix K violations are required.

The timeline formats used in this Flight Plan are based on JSC-19933, Timeline Format Definitions and Standard Notes, Rev C, May 1990.

STS-70 OVERVIEW

FLIGHT: STS-70      EDITION: FINAL      PUB. DATE: 05/10/95

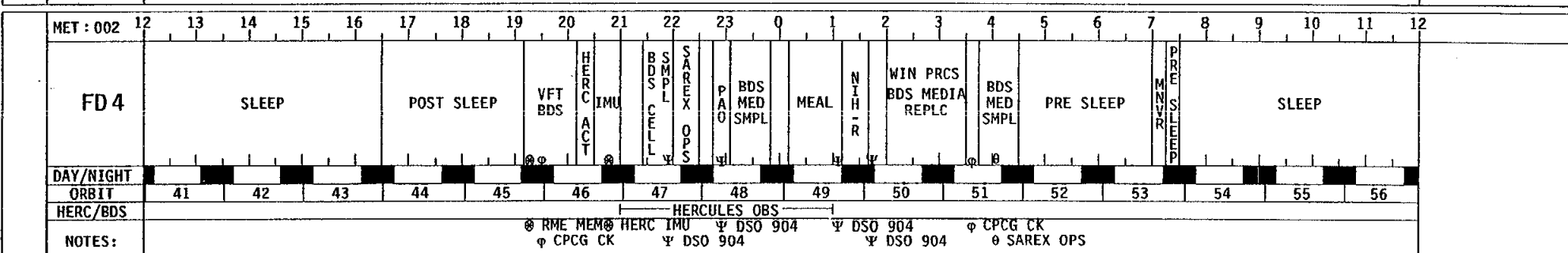
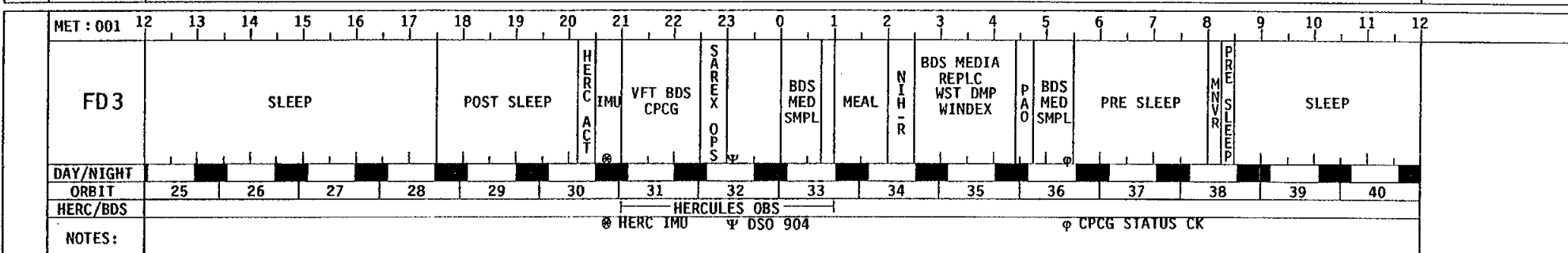
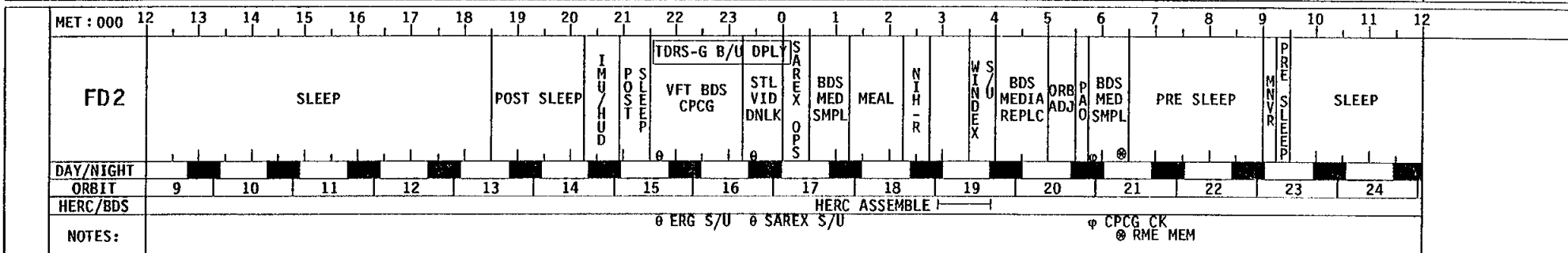
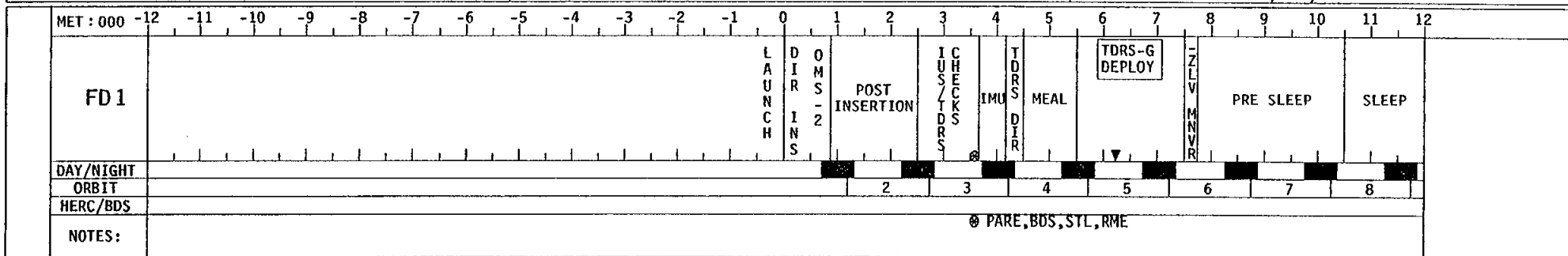

FLIGHT: STS-70      EDITION: FINAL      PUB. DATE: 05/10/95

MET : 003	12	13	14	15	16	17	18	19	20	21	22	23	0	1	2	3	4	5	6	7	8	9	10	11	12	
FD5	SLEEP		POST SLEEP			VFT BDS	HERC ACT	IMU	P A O	SAREX OPS	STL VID	DNLK	P A O	BDS MED SMPL	MEAL	NIH-R	SAREX OPS	WP INCS EXT EST	BDS MEDIA REPLC	WP INCS EXT EST	BDS SMP L	PRE SLEEP			MNVLR	SLEEP
DAY/NIGHT	[Day]		[Night]			[Day]	[Night]	[Day]	[Night]	[Day]	[Night]	[Day]	[Night]	[Day]	[Night]	[Day]	[Night]	[Day]	[Night]	[Day]	[Night]	[Day]	[Night]	[Day]	[Night]	[Day]
ORBIT	57	58	59	60	61	62	63	64	65	66	67	68	69	70	71	72										
HERC/BDS	HERCULES OBS																									
NOTES:	φ CPCG CK    ⊗ HERC IMU												DSO 802						φ CPCG CK    ⊗ RME MEM							

MET : 004	12	13	14	15	16	17	18	19	20	21	22	23	0	1	2	3	4	5	6	7	8	9	10	11	12	
FD6	SLEEP		POST SLEEP			HERC ACT	IMU	VFT BDS	W IN DEX	BDS PHASE II S/U	MEAL	WST DMP WINDEX	SAREX OPS	NIH-R	PRE SLEEP			SLEEP								
DAY/NIGHT	[Day]		[Night]			[Day]	[Night]	[Day]	[Night]	[Day]	[Night]	[Day]	[Night]	[Day]	[Night]	[Day]	[Night]	[Day]	[Night]	[Day]	[Night]	[Day]	[Night]	[Day]	[Night]	[Day]
ORBIT	73	74	75	76	77	78	79	80	81	82	83	84	85	86	87	88										
HERC/BDS	HERCULES OBS												BDS AUTO VIDEO													
NOTES:	⊗ HERC IMU    φ CPCG CK						⊗ SAREX OPS						⊗ BDS PHASE II INIT    φ DSO 904						φ CPCG CK    ⊗ GG MNVR, MIS ACT							

MET : 005	12	13	14	15	16	17	18	19	20	21	22	23	0	1	2	3	4	5	6	7	8	9	10	11	12	
FD7	SLEEP		POST SLEEP			VFT	HERC ACT	IMU	BDS MAN EVAL SETUP	P A O	BDS MAN EVAL SETUP	MEAL	BDS MAN EVAL SETUP	W IN DEX	P R C S T E S T	NIH-R	PRE SLEEP			SLEEP						
DAY/NIGHT	[Day]		[Night]			[Day]	[Night]	[Day]	[Night]	[Day]	[Night]	[Day]	[Night]	[Day]	[Night]	[Day]	[Night]	[Day]	[Night]	[Day]	[Night]	[Day]	[Night]	[Day]	[Night]	[Day]
ORBIT	89	90	91	92	93	94	95	96	97	98	99	100	101	102	103	104										
HERC/BDS	BDS AUTO VIDEO						HERCULES OBS						BDS AUTO VIDEO													
NOTES:	⊗ MIS DEACT, CPCG CK    ⊗ HERC IMU												⊗ SAREX OPS						ψ DSO 904    φ CPCG CK							

MET : 006	12	13	14	15	16	17	18	19	20	21	22	23	0	1	2	3	4	5	6	7	8	9	10	11	12	
FD8	SLEEP		POST SLEEP			IMU	VFT	FCS C/O	H D O / T O	B R I E F I N G	CREW CONF	STL VID DNK	MEAL	P D W E R A B C K T	CABIN STOW			PRE SLEEP			SLEEP					
DAY/NIGHT	[Day]		[Night]			[Day]	[Night]	[Day]	[Night]	[Day]	[Night]	[Day]	[Night]	[Day]	[Night]	[Day]	[Night]	[Day]	[Night]	[Day]	[Night]	[Day]	[Night]	[Day]	[Night]	[Day]
ORBIT	105	106	107	108	109	110	111	112	113	114	115	116	117	118	119	120										
HERC/BDS	BDS AUTO VIDEO																									
NOTES:	φ CPCG CK						⊗ SAREX STOW						⊗ ERGOMETER STOW    ⊗ STL ENT PREP    ⊗ NIH-R													

FLIGHT: STS-70

EDITION: FINAL

PUB. DATE: 05/10/95

MET : 007	12	13	14	15	16	17	18	19	20	21	22	23	0	1	2	3	4	5	6	7	8	9	10	11	12						
FD9	SLEEP											POST SLEEP		DSO 603C	DEORBIT PREP					D E O R B I T ®	B U R N	K S C	L A N D I N G								
DAY/NIGHT	[Day/Night Cycle]																														
ORBIT	121		122		123		124		125		126		127		128		129		130		131		132		133		134		135		136
HERC/BDS																															
NOTES:	® D/O TIG 7/21:08																														

MET : 008	12	13	14	15	16	17	18	19	20	21	22	23	0	1	2	3	4	5	6	7	8	9	10	11	12						
FD																															
DAY/NIGHT	[Day/Night Cycle]																														
ORBIT	137		138		139		140		141		142		143		144		145		146		147		148		149		150		151		152
HERC/BDS																															
NOTES:																															

MET : 009	12	13	14	15	16	17	18	19	20	21	22	23	0	1	2	3	4	5	6	7	8	9	10	11	12		
FD																											
DAY/NIGHT	[Day/Night Cycle]																										
ORBIT	152		153		154		155		156		157		158		159		160										
HERC/BDS																											
NOTES:																											

MET : 010	12	13	14	15	16	17	18	19	20	21	22	23	0	1	2	3	4	5	6	7	8	9	10	11	12	
FD																										
DAY/NIGHT	[Day/Night Cycle]																									
ORBIT																										
HERC/BDS																										
NOTES:																										

**SUMMARY TIMELINE**

# SUMMARY TIMELINE

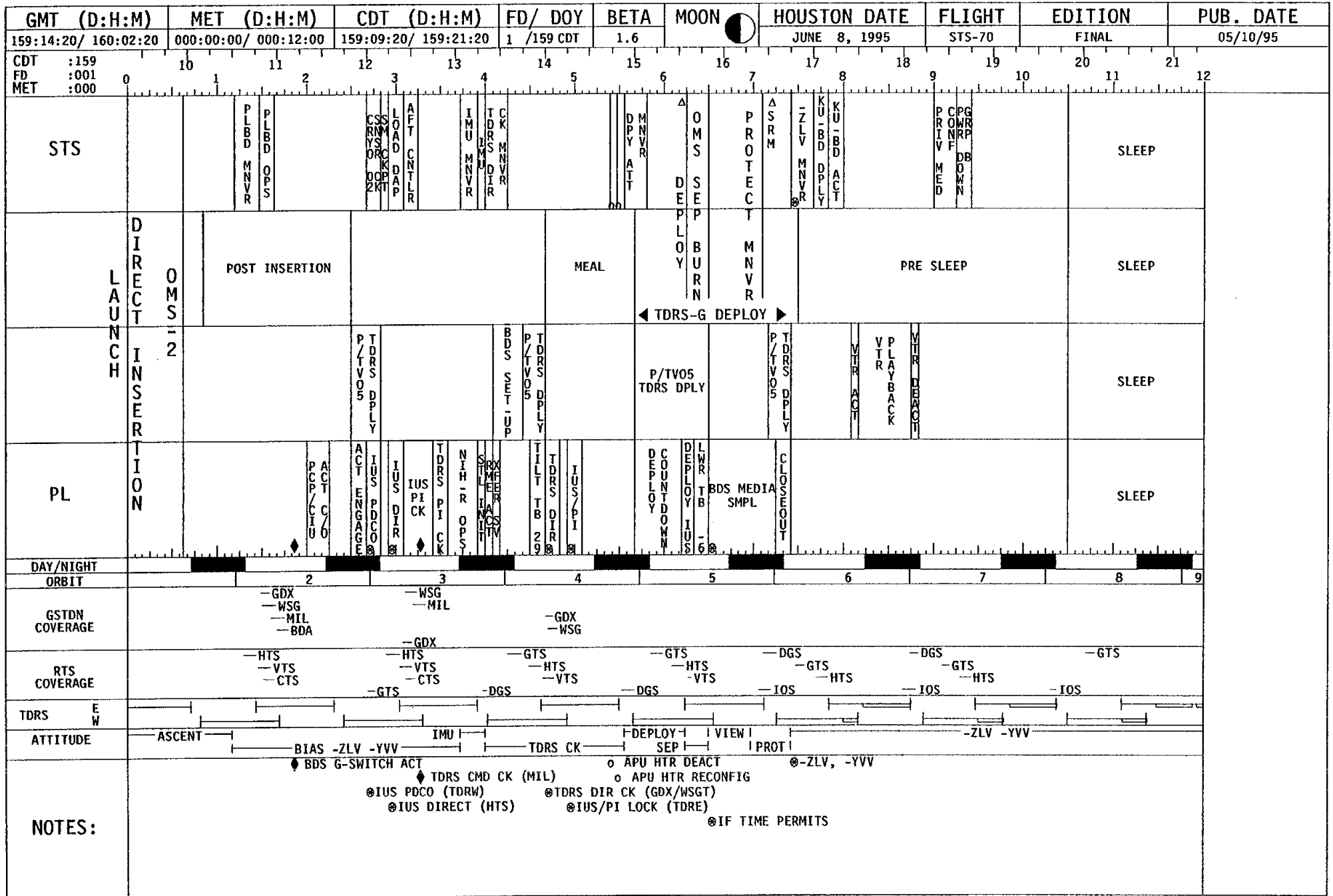

GMT (D:H:M)	MET (D:H:M)	CDT (D:H:M)	FD/DOY	BETA	MOON	HOUSTON DATE	FLIGHT	EDITION	PUB. DATE	
160:02:20 / 160:14:20	000:12:00 / 001:00:00	159:21:20 / 160:09:20	2 / 159 CDT	2.9		JUNE 8, 1995	STS-70	FINAL	05/10/95	
CDT :159 FD :001 MET :000	12 22 23 14	0 15 16	2 17	3 18	4 FD02 19	5 20	6 21	7 22	8 23	9 0 MET:001
CDR HENRICKS	SLEEP	POST SLEEP	IMU MNR HUD MNR HUD CAL ZLV MNR POST STREP	ERGONOMETER SETUP FILTER CLEANING	VFT TESTS	VFT DEBACHT T/S SETUP PSM/ETD VUD OPK 3				
PLT KREGEL	SLEEP	POST SLEEP		ERGONOMETER SETUP FILTER CLEANING	FC PURGE	EXERCISE				
MS1 THOMAS	SLEEP	POST SLEEP	PADM SETUP	POST SLEEP	BDS MEDIA SMPL	EXERCISE	SAREX SETUP	ROCKET OPS		
MS2 CURRIE	SLEEP	POST SLEEP		CPCG SETUP	SAT LST ET LST ET VM IB DLP EYC O	REFR B K PWR B K ACT SEQ STL TV DNLK				
MS3 WEBER	SLEEP	POST SLEEP		BDS MEDIA SMPL	VFT TESTS	EXERCISE				
DAY/NIGHT ORBIT	9	10	11	12	13	14	15	16		
EARTH TRACE										
TDRS E W										
ATTITUDE	-ZLV -YVV IMU HUD -ZLV +YVV									
NOTES:	⊗-ZLV, +YVV ⊗MANUAL ⊗DSO 904 HUMAN FACTORS									



GMT (D:H:M)	MET (D:H:M)	CDT (D:H:M)	FD/ DOY	BETA	MOON	HOUSTON DATE	FLIGHT	EDITION	PUB. DATE															
160:14:20/ 161:02:20	001:00:00/ 001:12:00	160:09:20/ 160:21:20	2 /160 CDT	4.4		JUNE 9, 1995	STS-70	FINAL	05/10/95															
CDT :160 FD :002 MET :001																								
	0	10	1	11	2	12	3	13	4	14	5	15	6	16	17	18	19	10	20	11	21	12		
<b>CDR HENRICKS</b>	PSM/ETD VUD OPK 3	VIS VEST INTEG	MEAL	P/TV02 SETUP FDDK	HERCULES ASSEMBLY	EXERCISE	ORBIT ADJUST BURN	-ZLV MNV R	PAO EVENT	PRE SLEEP	CONF MED	PRE SLEEP	DTOR 779	PRE SLEEP					SLEEP					
<b>PLT KREGEL</b>	EXERCISE	VIS VEST INTEG	MEAL	P/TV03 OPS MIDDK	HERCULES ASSEMBLY	WINDEX SETUP	WINDEX OPS	PAO EVENT	MEM MOD	PRE SLEEP		PRE SLEEP							SLEEP					
<b>MS1 THOMAS</b>	VOICE REX OPS	BDS MEDIA SMPL	MEAL	BDS CELL SMPL	P/TV08 SETUP BDS	VOICE REX OPS	BDS MEDIA RPLC	BDS MEDIA SMPL		PRE SLEEP	VOICE REX OPS	PRE SLEEP							SLEEP					
<b>MS2 CURRIE</b>		P/TV03 OPS MIDDK	MEAL	NIH-R OPS	P/TV02 OPS FDDK	WINDEX SETUP	EXERCISE	CS PT CA GT U S C S		PRE SLEEP		PRE SLEEP							SLEEP					
<b>MS3 WEBER</b>		BDS MEDIA SMPL	MEAL	BDS CELL SMPL	P/TV08 SETUP BDS	P/TV02 OPS FDDK	BDS MEDIA RPLC	BDS MEDIA SMPL		PRE SLEEP		PRE SLEEP							SLEEP					
<b>DAY/NIGHT</b>																								
<b>ORBIT</b>		17		18		19		20		21		22		23		24								
<b>EARTH TRACE</b>																								
<b>TDRS</b>																								
<b>ATTITUDE</b>	-ZLV +YVV BURN -ZLV +YVV +XLV +ZVV																							
<b>NOTES:</b>	@DSO 604A OI-1 VISUAL VESTIBULAR INTEGRATION @-ZLV, +YVV @THRUSTER PLUMES JOINT OPS# 55 @AFD WINDOW (W10) @MEM MOD RPLC																							

GMT (D:H:M)	MET (D:H:M)	CDT (D:H:M)	FD/DOY	BETA	MOON	HOUSTON DATE	FLIGHT	EDITION	PUB. DATE															
161:02:20 / 161:14:20	001:12:00 / 002:00:00	160:21:20 / 161:09:20	3 / 160 CDT	5.9		JUNE 9, 1995	STS-70	FINAL	05/10/95															
CDT :160 FD :002 MET :001									MET:002															
	12	13	14	15	16	17	18	19	20	21	22	23	24	25	26	27	28	29	30	31	32			
CDR HENRICKS	SLEEP						POST SLEEP						IMU MNV R	IMU MNV R	ZLV +YVV	VFT TESTS	VOICE OBS							
PLT KREGEL	SLEEP						POST SLEEP						HERCULES ACT			HERCULES			HERCULES					
MS1 THOMAS	SLEEP						POST SLEEP						HERCULES ACT			EXERCISE			OVERVIEW	VOICE OBS	P/TV08 SETUP BDS	HFTOUCH		
MS2 CURRIE	SLEEP						POST SLEEP						NM UNCONTROLLER	NM UNCONTROLLER	NM UNCONTROLLER	NM UNCONTROLLER	NM UNCONTROLLER	CRUCIAL	PLS	POST NUCL DATA RT	P/TV02 SETUP FDDK			
MS3 WEBER	SLEEP						POST SLEEP						BDS MEDIA SMPL			VFT TESTS			EXERCISE					
DAY/NIGHT ORBIT																								
EARTH TRACE																								
TDRS																								
ATTITUDE	+XLV +ZVV												-IMU-						-ZLV +YVV					
NOTES:																						DSO 904 HUMAN FACTORS		



GMT (D:H:M)	MET (D:H:M)	CDT (D:H:M)	FD/ DOY	BETA	MOON	HOUSTON DATE	FLIGHT	EDITION	PUB. DATE													
162:02:20/ 162:14:20	002:12:00/ 003:00:00	161:21:20/ 162:09:20	4 /161 CDT	9.3		JUNE 10, 1995	STS-70	FINAL	05/10/95													
CDT :161 FD :003 MET :002	12	13	14	15	16	17	18	19	20	21	22	23	24	25	26	27	28	29	30	MET:003		
CDR HENRICKS	SLEEP					POST SLEEP					VFT TESTS	IMU MNR	ZLV MNR	PAO EVENT	P/TV02 SETUP FDDK							
PLT KREGEL	SLEEP					POST SLEEP					HERCULES ACT	HERCULES			HERCULES							
MS1 THOMAS	SLEEP					POST SLEEP					P/TV03 SETUP MIDDK	P/TV03 OPS MIDDK			PAO EVENT	BDS MEDIA SMPL						
MS2 CURRIE	SLEEP					POST SLEEP					MCD SMPL COLLECT	WINDEX SETUP	WINDEX OPS		PAO EVENT	EXERCISE						
MS3 WEBER	SLEEP					POST SLEEP					BDS MEDIA SMPL	VFT TESTS	EXERCISE		BDS CELL SMPL	PAO EVENT	PSM/ET TTD VUD OPK 3					
DAY/NIGHT ORBIT	41		42		43		44		45		46		47		48							
EARTH TRACE																						
TDRS																						
ATTITUDE	+YLV -ZVV										IMU					-ZLV +YVV						
NOTES:	MEM MOD RPLC      ZLV, +YVV DTO 677 EVAL OF MICROBIAL CAPTURE DEVICE SH WINDOW (W11) AIR GLOW# 45,46,47																					

GMT (D:H:M)	MET (D:H:M)	CDT (D:H:M)	FD/ DOY	BETA	MOON	HOUSTON DATE	FLIGHT	EDITION	PUB. DATE
162:14:20 / 163:02:20	003:00:00 / 003:12:00	162:09:20 / 162:21:20	4 / 162 CDT	11.1		JUNE 11, 1995	STS-70	FINAL	05/10/95

CDT :162  
 FD :004  
 MET :003

	0	1	2	3	4	5	6	7	8	9	10	11	12
<b>CDR HENRICKS</b>	MEAL	HFTOUCH		WINDEX PRCS TEST	EXERCISE	PRE SLEEP	PRE SLEEP	PRE SLEEP				SLEEP	
<b>PLT KREGEL</b>	MEAL			VOICE OPS	EXERCISE		PRE SLEEP					SLEEP	
<b>MS1 THOMAS</b>	MEAL	P/TV03 OPS MIDDK		EXERCISE	HFTOUCH	VOICE OPS	PRE SLEEP					SLEEP	
<b>MS2 CURRIE</b>	MEAL	NIH-R OPS	WINDEX SETUP	WINDEX OPS		CS PT CA GT US CK	PRE SLEEP	FAM CONF VIDEO	PRE SLEEP			SLEEP	
<b>MS3 WEBER</b>	MEAL	P/TV08 SETUP BDS		BDS MEDIA RPLC	BDS MEDIA SMPL		PRE SLEEP		PRE SLEEP			SLEEP	

DAY/NIGHT ORBIT

49 50 51 52 53 54 55 56



TDRS E W

ATTITUDE -ZLV +YVV +XLV +ZVV

NOTES: @DSO 904 HUMAN FACTORS @DSO 904 HUMAN FACTORS  
 P/TV03 SETUP MIDDK @AFD WINDOW (W10)  
 @THRUSTER PLUMES NEARFIELD# 8,9,10

GMT (D:H:M)	MET (D:H:M)	CDT (D:H:M)	FD/ DOY	BETA	MOON	HOUSTON DATE	FLIGHT	EDITION	PUB. DATE
163:02:20/ 163:14:20	003:12:00/ 004:00:00	162:21:20/ 163:09:20	5 /162 CDT	12.9		JUNE 11, 1995	STS-70	FINAL	05/10/95
CDT :162 FD :004 MET :003									MET:004
CDR HENRICKS	SLEEP	POST SLEEP			VFT TESTS	HERCULES ACT	HERCULES	HERCULES	MEAL
PLT KREGEL	SLEEP	POST SLEEP			HERCULES IMU MNV R	ZLV MNV R	EXERCISE	EXERCISE	MEAL
MS1 THOMAS	SLEEP	POST SLEEP			BDS MEDIA SMPL	P/TV02 SETUP FDDK	EXERCISE	VOICE OPS	MEAL
MS2 CURRIE	SLEEP	POST SLEEP			EXERCISE	HFTOUCH	STL TV DNLK	PAO EVENT	MEAL
MS3 WEBER	SLEEP	POST SLEEP			VFT TESTS	P/TV08 SETUP BDS	EXERCISE	PAO EVENT	MEAL
DAY/NIGHT ORBIT	57	58	59	60	61	62	63	64	
EARTH TRACE									
TDRS									
ATTITUDE	+XLV +ZVV -IMU- -ZLV -YVV								
NOTES:	@CABIN TEMP CNTL RECONFIG @-ZLV, -YVV @DSO 904 HUMAN FACTORS @DTO 677 EVAL OF MICROBIAL CAPTURE DEVICE								

GMT (D:H:M)	MET (D:H:M)	CDT (D:H:M)	FD/ DOY	BETA	MOON	HOUSTON DATE	FLIGHT	EDITION	PUB. DATE						
163:14:20/ 164:02:20	004:00:00/ 004:12:00	163:09:20/ 163:21:20	5 /163 CDT	14.8	☉	JUNE 12, 1995	STS-70	FINAL	05/10/95						
CDT :163 FD :005 MET :004	0	10	11	12	13	14	15	16	17	18	19	20	21	12	
CDR HENRICKS		PAO EVENT	WINDEX PRCS TEST	EXERCISE	WINDEX PRCS TEST	PRIV SLEP MORNING	PRE SLEEP							SLEEP	
PLT KREGEL	P/TV03 OPS MIDDK	WINDEX	WINDEX OPS		FILTER CLEANING		PRE SLEEP							SLEEP	
MS1 THOMAS	VOICE OPS	VOICE OPS	BDS MEDIA RPLC		FILTER CLEANING	PRE SLEEP	VIDEO FAM CONF							SLEEP	
MS2 CURRIE	NIH-R OPS	REFILL WATER	PAO EVENT	CS CALIBRATION	WINDEX SETUP	WINDEX OPS								PRE SLEEP	SLEEP
MS3 WEBER	P/TV10 OPS 802	PAO EVENT	P/TV02 SETUP FDDK	HFTOUCH	BDS MEDIA SMPL		PRE SLEEP							SLEEP	
DAY/NIGHT	[Day/Night Cycle Diagram]														
ORBIT	[Orbit Diagram]														
EARTH TRACE	[Earth Trace Diagram]														
TDRS	[TDRS Diagram]														
ATTITUDE	-ZLV -YVV / +YLV -ZVV														
NOTES:	@AFD WINDOW (W10) @MEM MOD RPLC @THRUSTER PLUMES NEARFIELD# 8,9,10 @DSO 802 EDUCATIONAL ACTS @AFD WINDOW (W10) @THRUSTER PLUMES NEARFIELD# 11,12,13,14 @DSO 904 HUMAN FACTORS														





GMT (D:H:M)	MET (D:H:M)	CDT (D:H:M)	FD/ DOY	BETA	MOON	HOUSTON DATE	FLIGHT	EDITION	PUB. DATE
164:14:20/ 165:02:20	005:00:00/ 005:12:00	164:09:20/ 164:21:20	6 /164 CDT	18.7	☉	JUNE 13, 1995	STS-70	FINAL	05/10/95

CDT :164	10	11	12	13	14	15	16	17	18	19	20	21	12
FD :006	0	1	2	3	4	5	6	7	8	9	10	11	
MET :005													

CDR HENRICKS	DUMP INIT	P/TV02 SETUP FDDK	GG MNVR	PRE SLEEP	CONV MED	FAM CONF	PRE SLEEP		SLEEP
PLT KREGEL	WINDEX SETUP	WINDEX OPS	SD MM OP	PSM /EIV VUD OPK 3	P/T V02 MID DDK		PRE SLEEP		SLEEP
MS1 THOMAS	SARREX VOICE OPS	BDS CHECK	MIS- B ACT				PRE SLEEP		SLEEP
MS2 CURRIE	EXERCISE	N H - R OPS	CS PT CAT US CK	HFTOUCH			PRE SLEEP		SLEEP
MS3 WEBER	BDS CHECK	BDS CHECK	EXERCISE	BDS CHECK	PRE SLEEP	BDS CHECK	PRE SLEEP		SLEEP

DAY/NIGHT ORBIT	81	82	83	84	85	86	87	88
--------------------	----	----	----	----	----	----	----	----



TDRS	E	W											
------	---	---	--	--	--	--	--	--	--	--	--	--	--

ATTITUDE	-ZLV +YVV												
BDS VIDEO													



NOTES:



- SH WINDOW (W11)
- WATER DUMP# 51
- DSO 904 HUMAN FACTORS
- BDS AUTO FLOW

GMT (D:H:M)	MET (D:H:M)	CDT (D:H:M)	FD/ DOY	BETA	MOON	HOUSTON DATE	FLIGHT	EDITION	PUB. DATE					
165:02:20 / 165:14:20	005:12:00 / 006:00:00	164:21:20 / 165:09:20	7 / 164 CDT	20.7	☉	JUNE 13, 1995	STS-70	FINAL	05/10/95					
CDT :164	22	23	0	1	2	3	4	5	6	7	8	9	0	MET:006
FD :006	12	13	14	15	16	17	18	19	20	21	22	23		
MET :005			FD07											
CDR HENRICKS	SLEEP	POST SLEEP		VFT TESTS	SHOOTING	P/TV03 SETUP MIDDK	PAO EVENT	EXERCISE	MEAL	VIS VEST INTEG		P/TV02 SETUP FDDK		
PLT KREGEL	SLEEP	POST SLEEP			IMU MNR	IMU MNR	ZLV MNR		MEAL	VIS VEST INTEG				
MS1 THOMAS	SLEEP	POST SLEEP		EXERCISE	SHOOTING		PAO EVENT	P/TV03 OPS MIDDK	MEAL	P/TV03 OPS MIDDK				
MS2 CURRIE	SLEEP	POST SLEEP		HERCULES ACT	HERCULES	HERCULES	HERCULES	HERCULES	MEAL	HERCULES				
MS3 WEBER	SLEEP	POST SLEEP		VFT TESTS	BDS STATUS CK		BDS MAN EVAL SETUP		MEAL	BDS MAN EVAL SETUP				
DAY/NIGHT	[Day/Night Cycle Bar]													
ORBIT	[Orbit Bar]													
EARTH TRACE	[Earth Trace Map]													
TDRS	[TDRS Bar]													
ATTITUDE	BIAS+XLV +YVV (GG) IMU -1 -ZLV -YVV													
BDS VIDEO	BDS AUTO FLOW													
NOTES:	MEM MOD RPLC    ZLV, -YVV    DTO 677 EVAL OF MICROBIAL CAPTURE DEVICE    DSO 604A OI-1 VISUAL VESTIBULAR INTEGRATION													

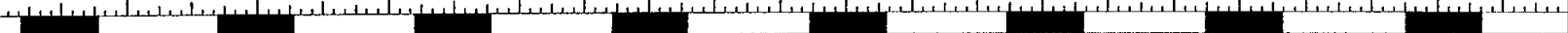
GMT (D:H:M)	MET (D:H:M)	CDT (D:H:M)	FD/ DOY	BETA	MOON	HOUSTON DATE	FLIGHT	EDITION	PUB. DATE	
165:14:20/ 166:02:20	006:00:00/ 006:12:00	165:09:20/ 165:21:20	7 /165 CDT	22.7	☉	JUNE 14, 1995	STS-70	FINAL	05/10/95	
CDT :165 FD :007 MET :006	0 10 11 12 13 14 15 16 17 18 19 10 20 11 21 12									
CDR HENRICKS	FILTER CLEANING	WINDEX PRCS TEST	HERC STOW	PRE SLEEP	PCONF VIDE CONF	PRE SLEEP	SLEEP			
PLT KREGEL	HFTOUCH	EXERCISE		PRE SLEEP	VIDE CONF	PRE SLEEP	SLEEP			
MS1 THOMAS	FILTER CLEANING	SAFETY OPS	P/TVO2 OPS FDDK	PRE SLEEP		SLEEP				
MS2 CURRIE	EXERCISE	WINDEX SETUP	WINDEX OPS	WINDEX STOW	NH - R OPS	CS PT CA GT US CR	PRE SLEEP		SLEEP	
MS3 WEBER	BDS MAN EVAL SETUP	BDS TRANS MAN-AUTO	EXERCISE	PRE SLEEP		SLEEP				
DAY/NIGHT	ORBIT									
EARTH TRACE	96	97	98	99	100	101	102	103	104	
TDRS	E W									
ATTITUDE	-ZLV -YVV									
BDS VIDEO	BDS AUTO FLOW									
NOTES:	@DSO 904 HUMAN FACTORS @AFD WINDOW (W10) @THRUSTER PLUMES NEARFIELD# 4,5,6,7									

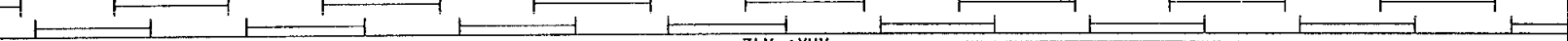

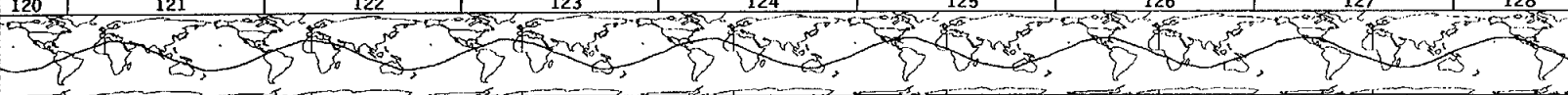
GMT (D:H:M)	MET (D:H:M)	CDT (D:H:M)	FD/ DOY	BETA	MOON 	HOUSTON DATE	FLIGHT	EDITION	PUB. DATE						
166:14:20 / 167:02:20	007:00:00 / 007:12:00	166:09:20 / 166:21:20	8 / 166 CDT	26.8		JUNE 15, 1995	STS-70	FINAL	05/10/95						
CDT :166															
FD :008															
MET :007															
	0	1	2	3	4	5	6	7	8	9	10	11	12		
CDR HENRICKS	CABIN STOW		SD PULM YP	PRE SLEEP	SD PULM YP	PRE SLEEP	PRIV MED	PRE SLEEP						SLEEP	
PLT KREGEL	CABIN STOW		PRE SLEEP						SLEEP						
MS1 THOMAS	CABIN STOW		PRE SLEEP						SLEEP						
MS2 CURRIE	CABIN STOW		PRE SLEEP						SLEEP						
MS3 WEBER	CABIN STOW		PRE SLEEP						SLEEP						
DAY/NIGHT															
ORBIT	112	113	114	115	116	117	118	119	120						
EARTH TRACE															
FDRS															
ATTITUDE	-ZLV +YVV														
BDS VIDEO															
NOTES:															

GMT (D:H:M)	MET (D:H:M)	CDT (D:H:M)	FD/ DOY	BETA	MOON 	HOUSTON DATE	FLIGHT	EDITION	PUB. DATE					
167:02:20/ 167:14:20	007:12:00/ 008:00:00	166:21:20/ 167:09:20	9 /166 CDT	28.9		JUNE 15, 1995	STS-70	FINAL	05/10/95					
CDT :166 FD :008 MET :007	12	13	14 FD09	15	16	17	18	19	20	21	22	23	0	MET:008
CDR HENRICKS	SLEEP	POST SLEEP	CONTRIF MED	POST SLEEP	PWR UP	-XS1 MNV	DEORBIT PREP	IMU MNV	PLBD ALIGNS OPPS	DEORBIT PREP				
PLT KREGEL	SLEEP	POST SLEEP								DEORBIT PREP				
MS1 THOMAS	SLEEP	POST SLEEP	FLORINEF	POST SLEEP	DSO 603C ENT PREP					DEORBIT PREP				
MS2 CURRIE	SLEEP	POST SLEEP								DEORBIT PREP				
MS3 WEBER	SLEEP	POST SLEEP								DEORBIT PREP				
DAY/NIGHT ORBIT	120	121	122	123	124	125	126	127	128					
EARTH TRACE														
TDRS E W														
ATTITUDE	-ZLV +YVV													
BDS VIDEO	D/O IMU -XS1													
NOTES:	◎DSO 621 IN-FLIGHT USE OF FLORINEF ◎DSO 621 IN-FLIGHT USE OF FLORINEF ◎DSO 603C ORTHOSTATIC FUNCTION													
	<div style="display: flex; justify-content: space-between;"> <div style="border: 1px solid black; padding: 2px;">* DEORBIT BURN 7/21:08</div> <div style="border: 1px solid black; padding: 2px;">* KSC LANDING 7/22:16</div> </div>													

**This Page Intentionally Blank**

DETAILED TIMELINE

DETAILED  
TIMELINE



# DETAILED TIMELINE

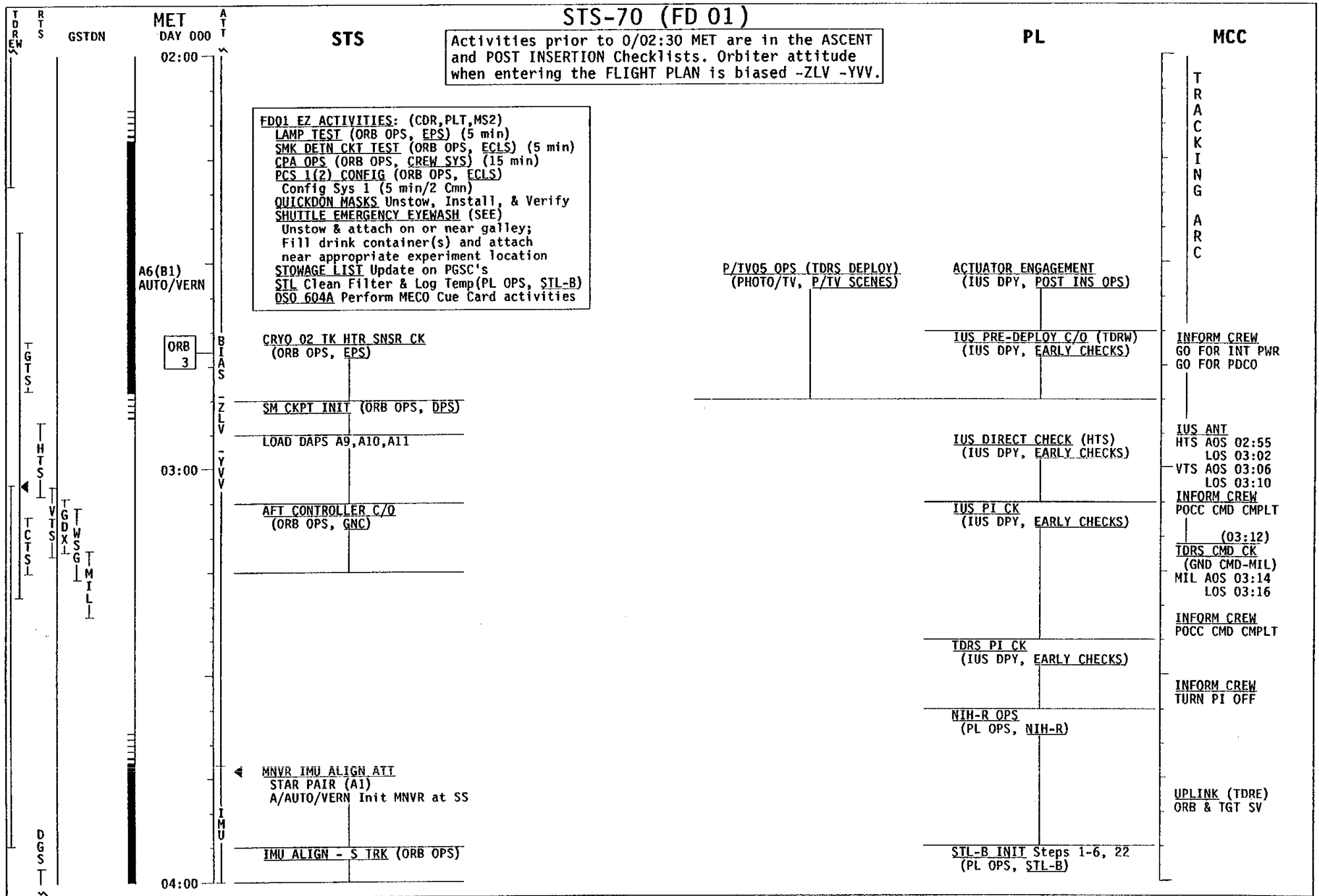

# STS-70 (FD 01)

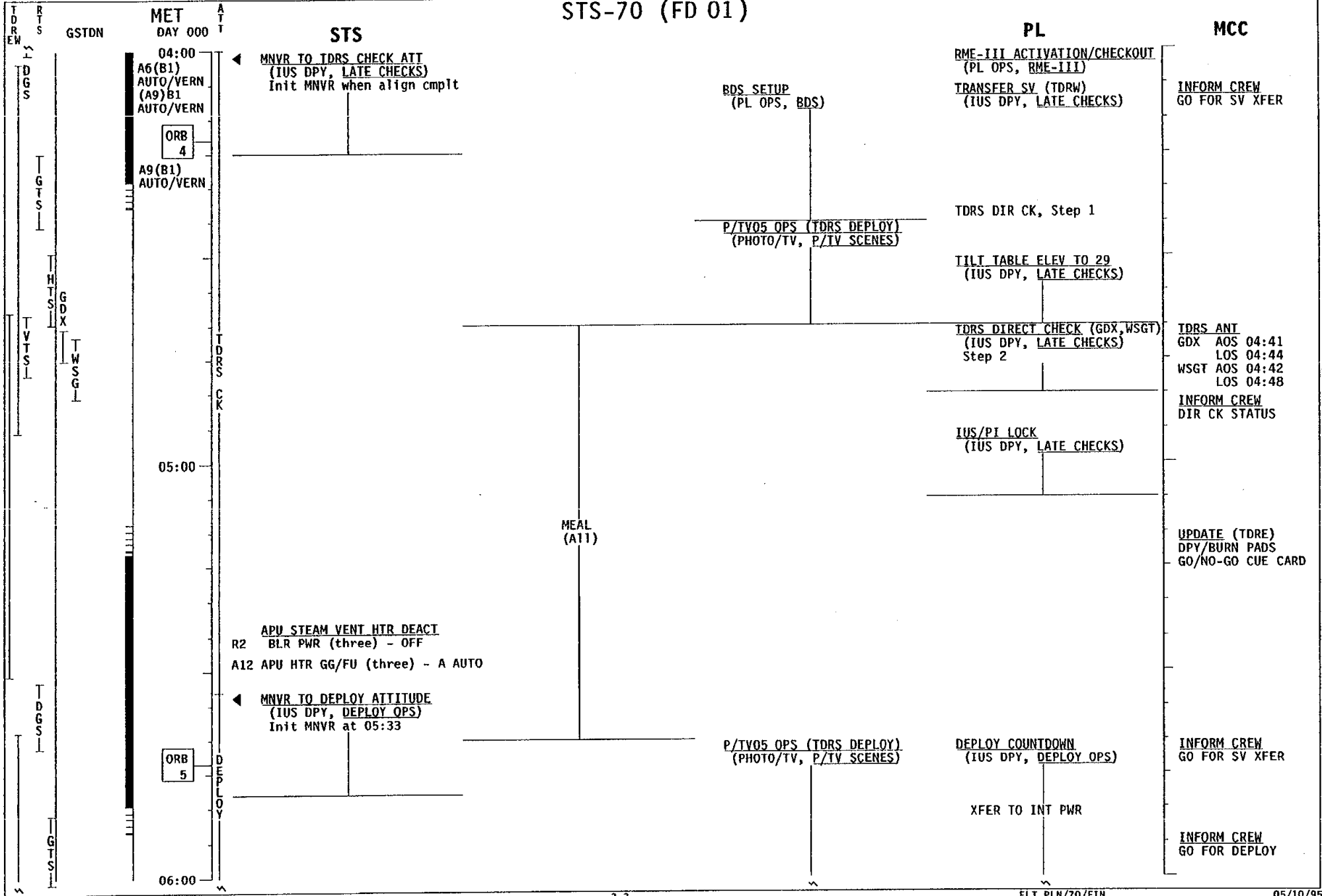

# STS-70 (FD 01)

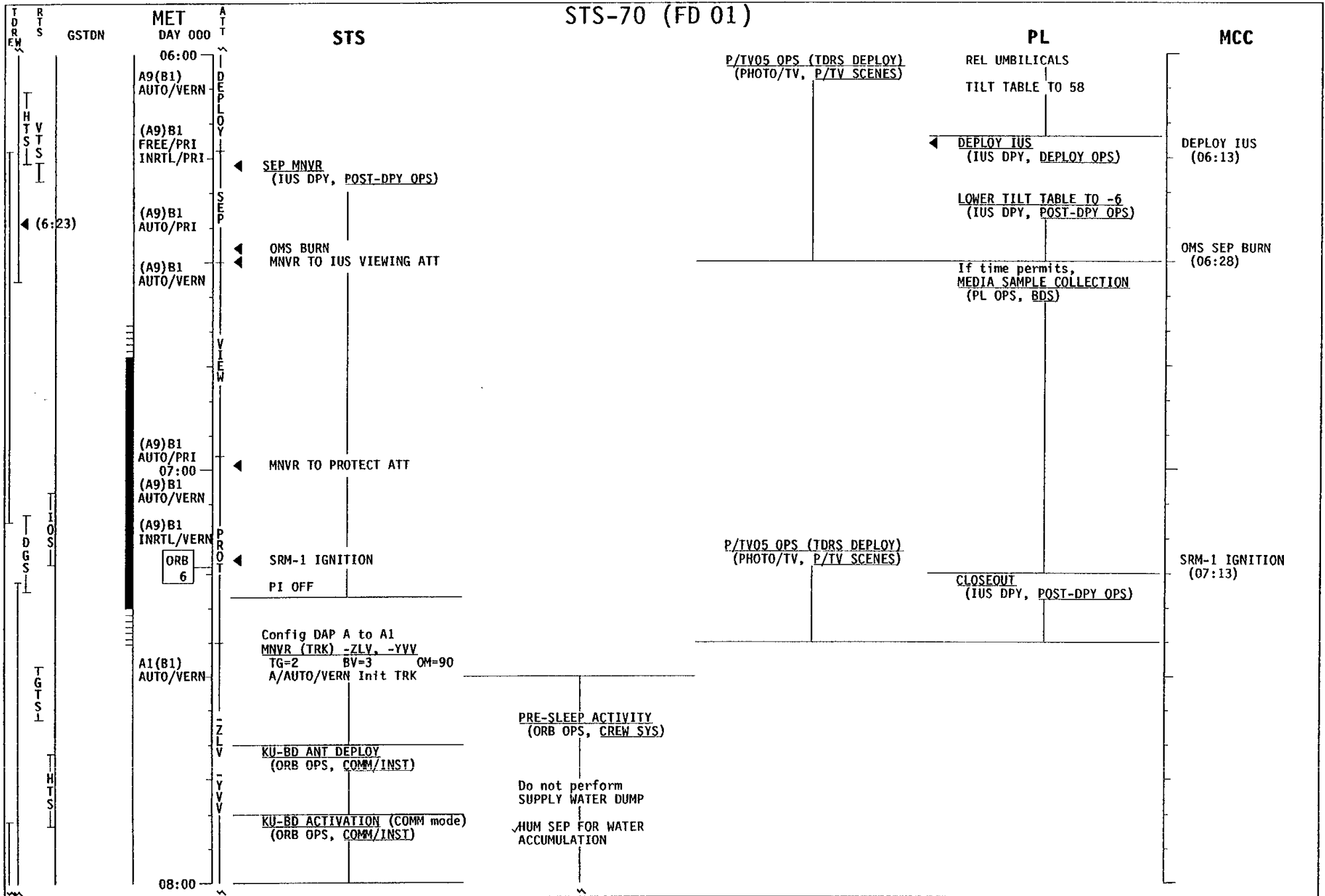

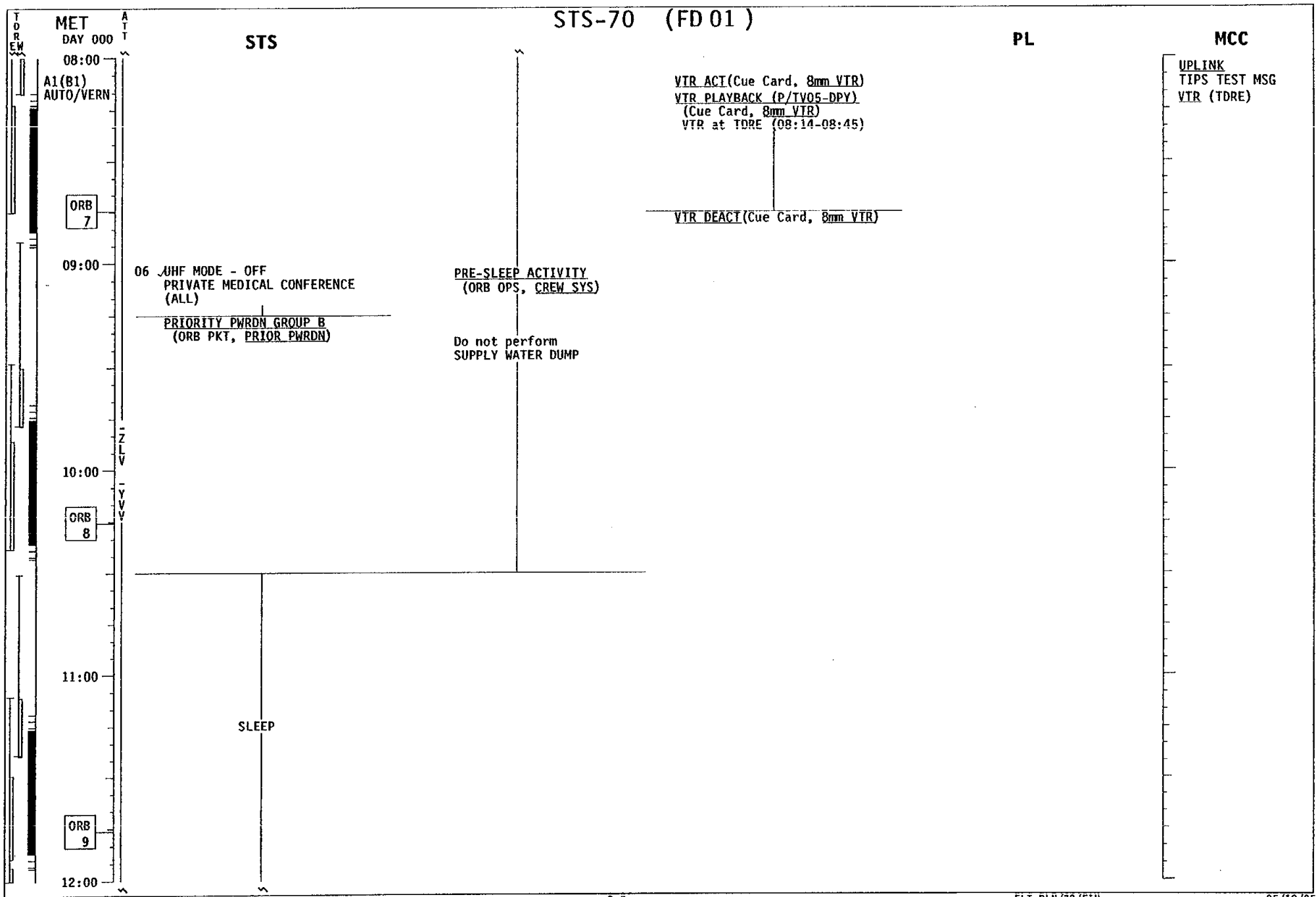

STS-70 (FD 01)

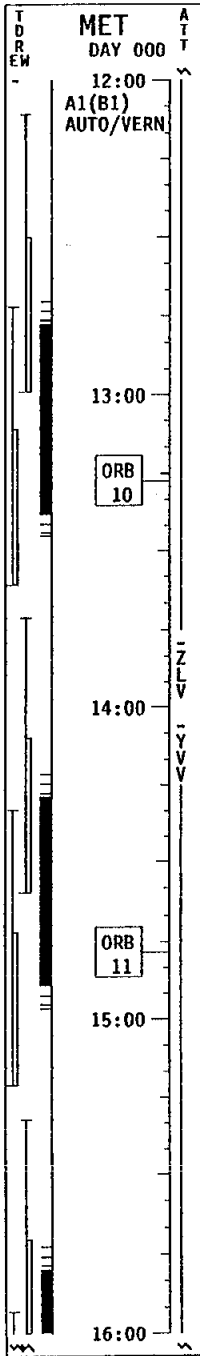

STS

SLEEP

PL

MCC

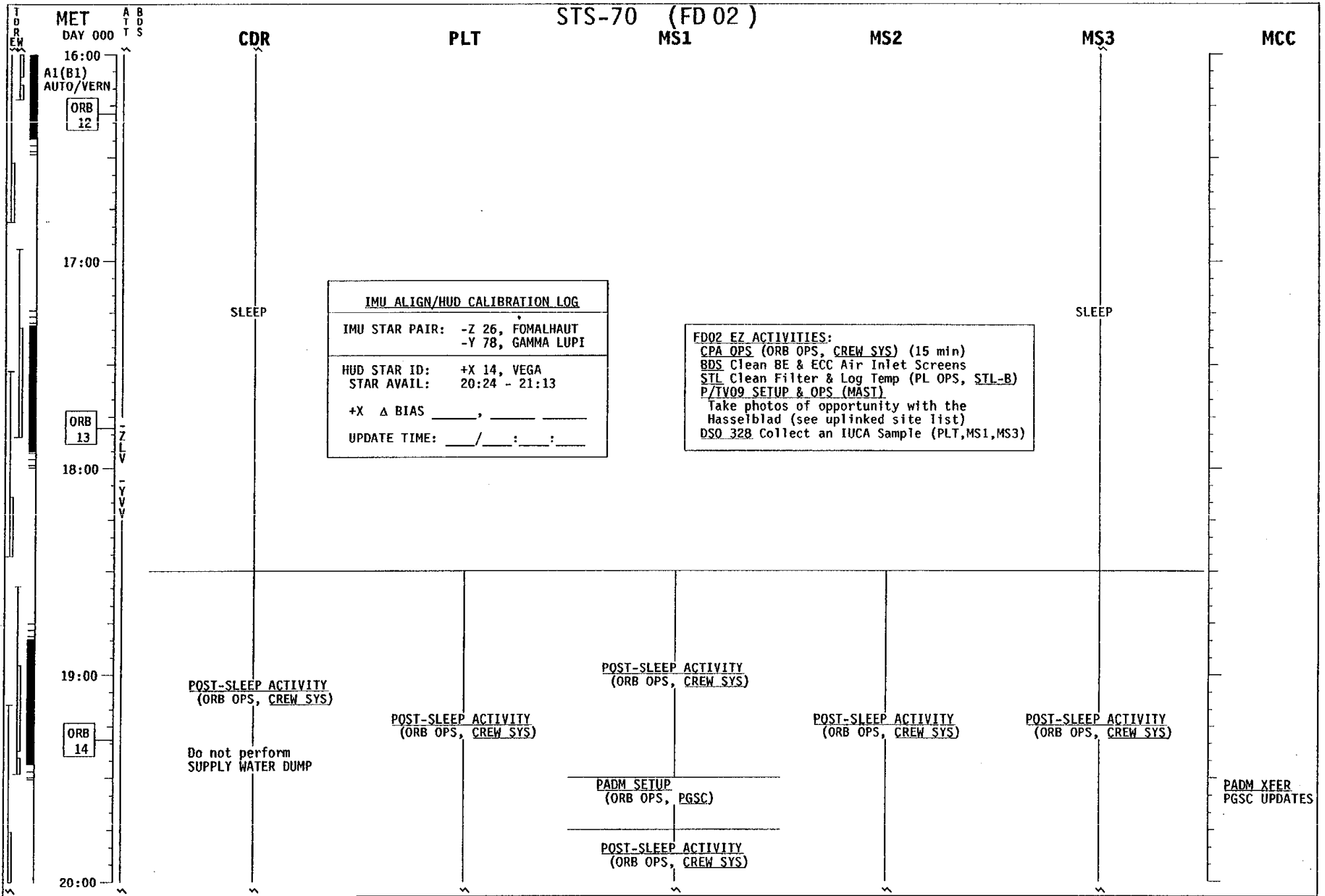

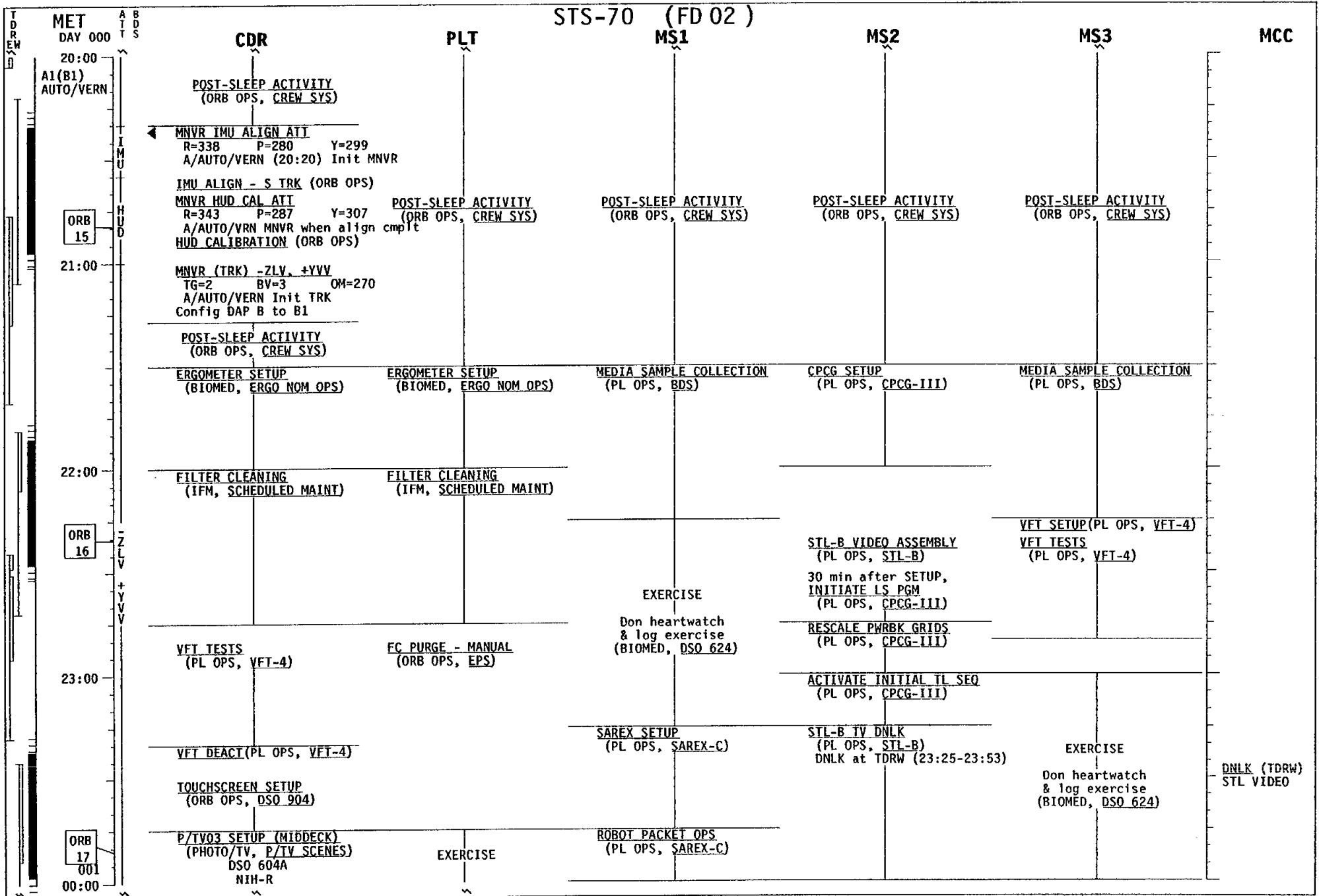

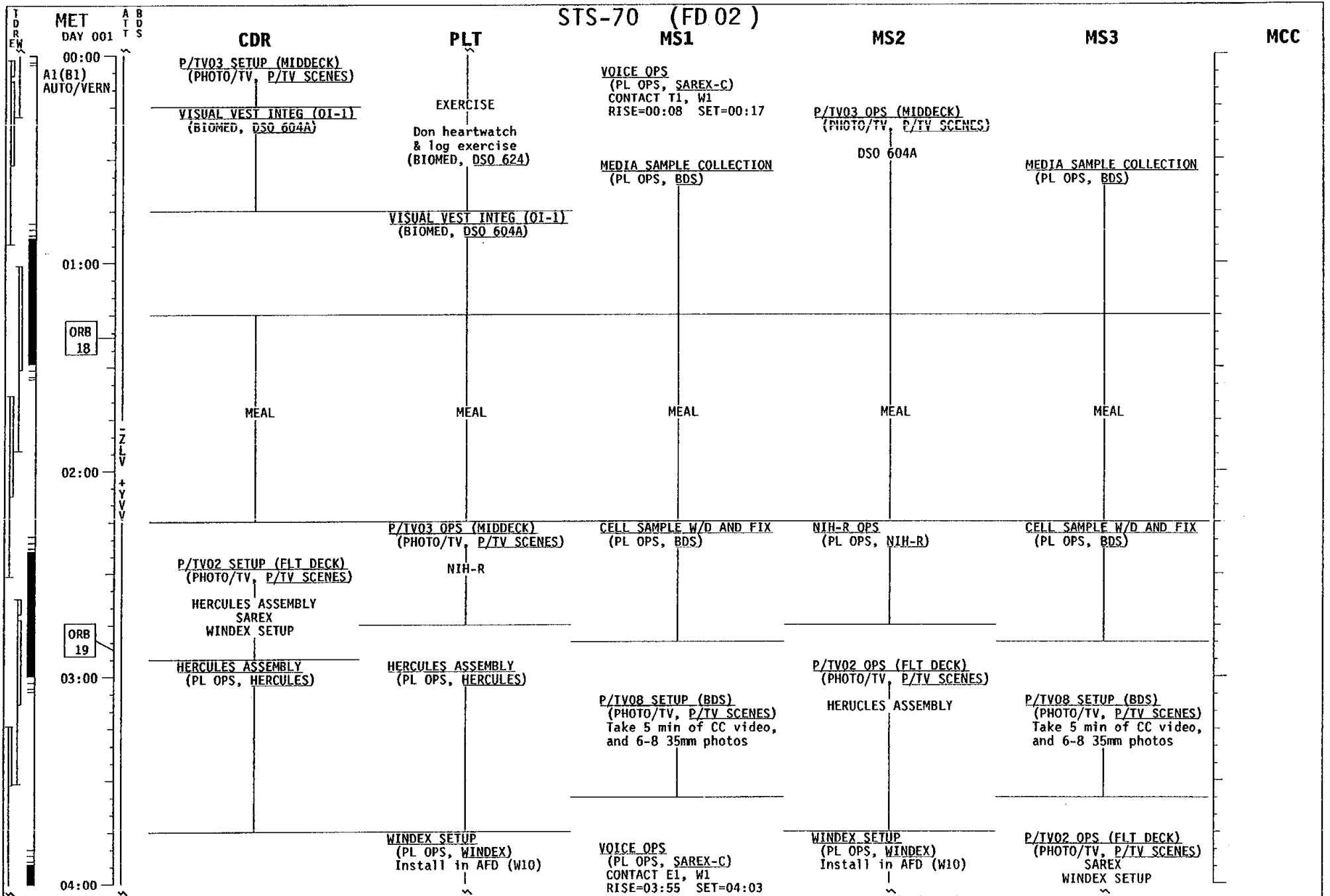



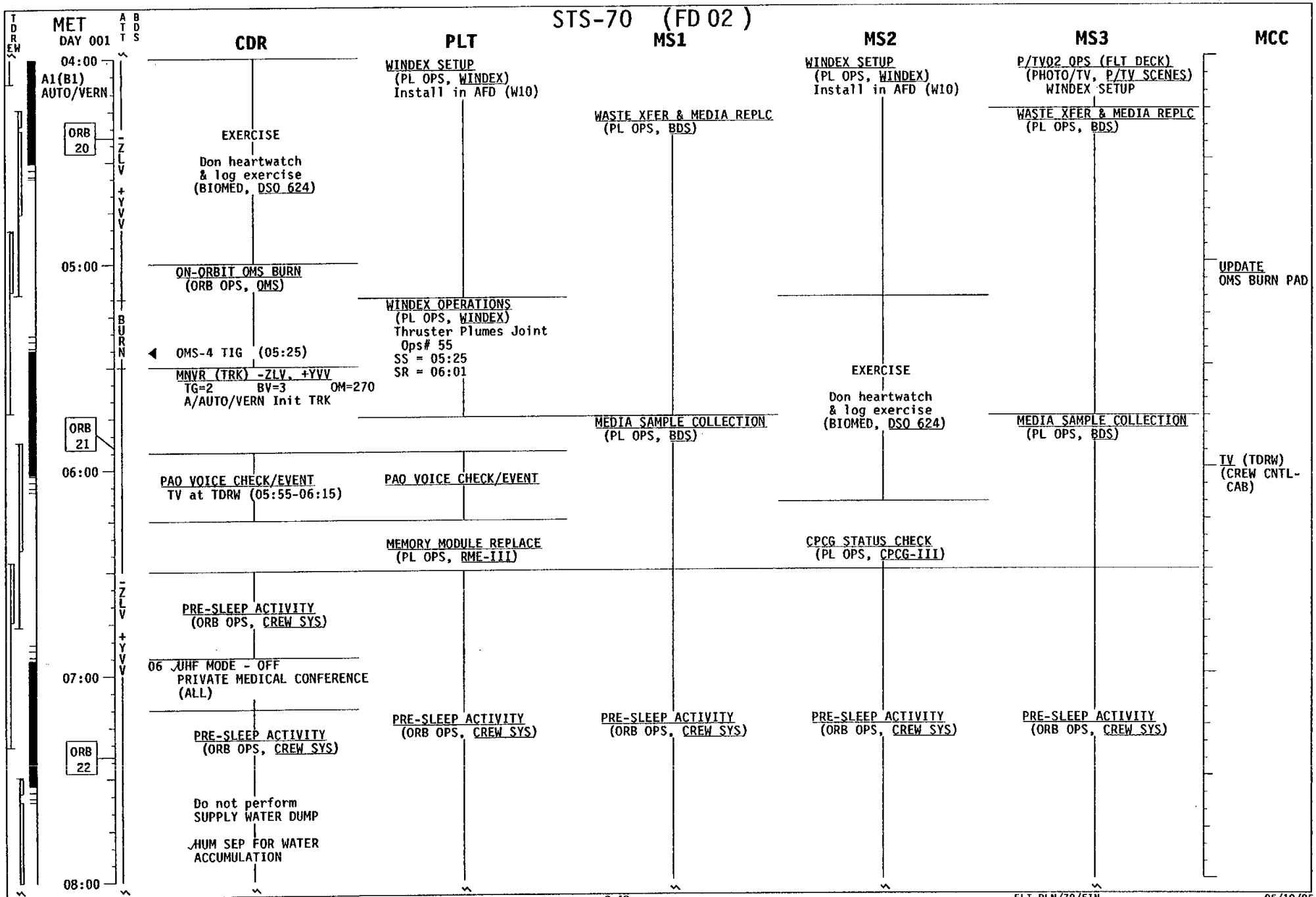

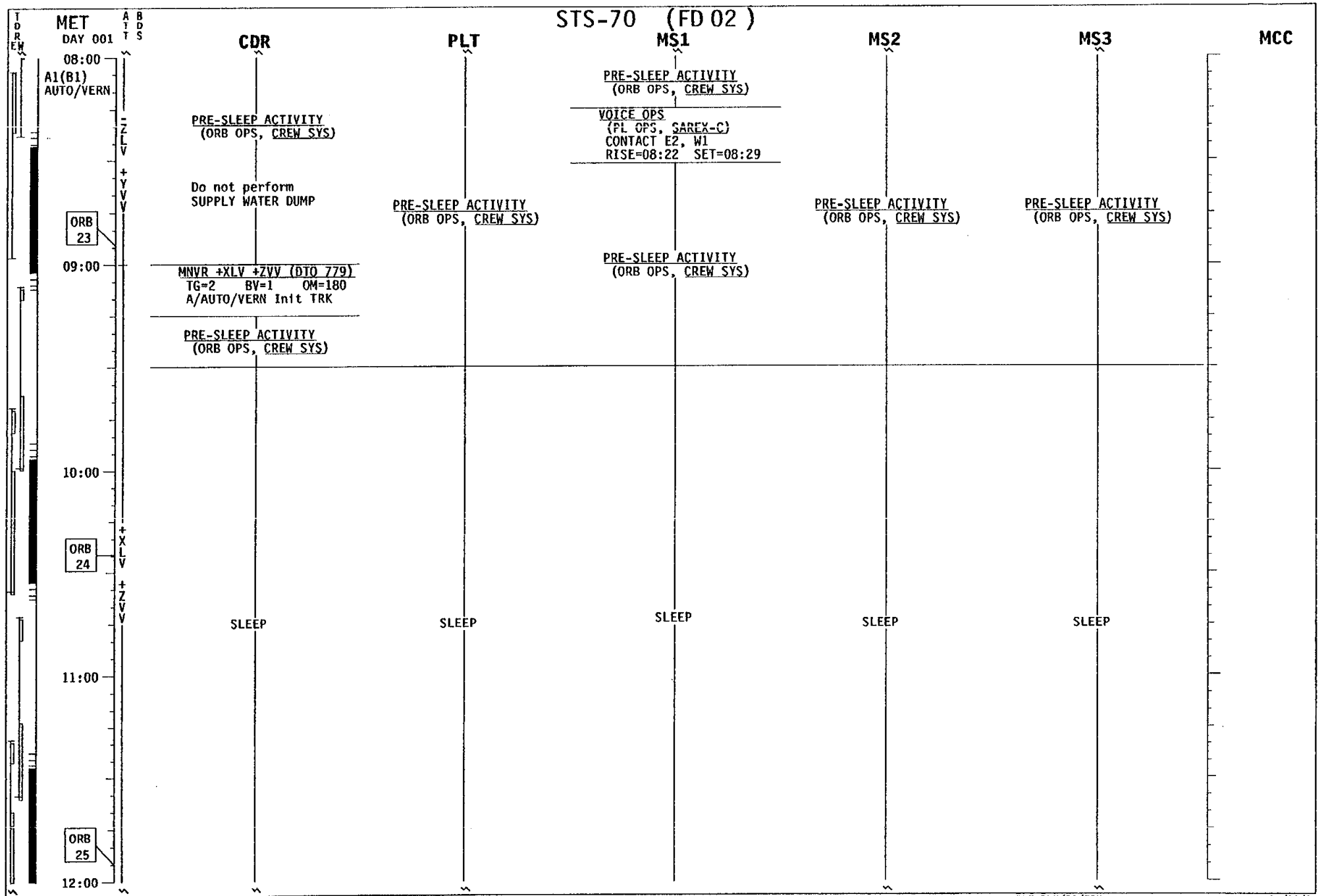

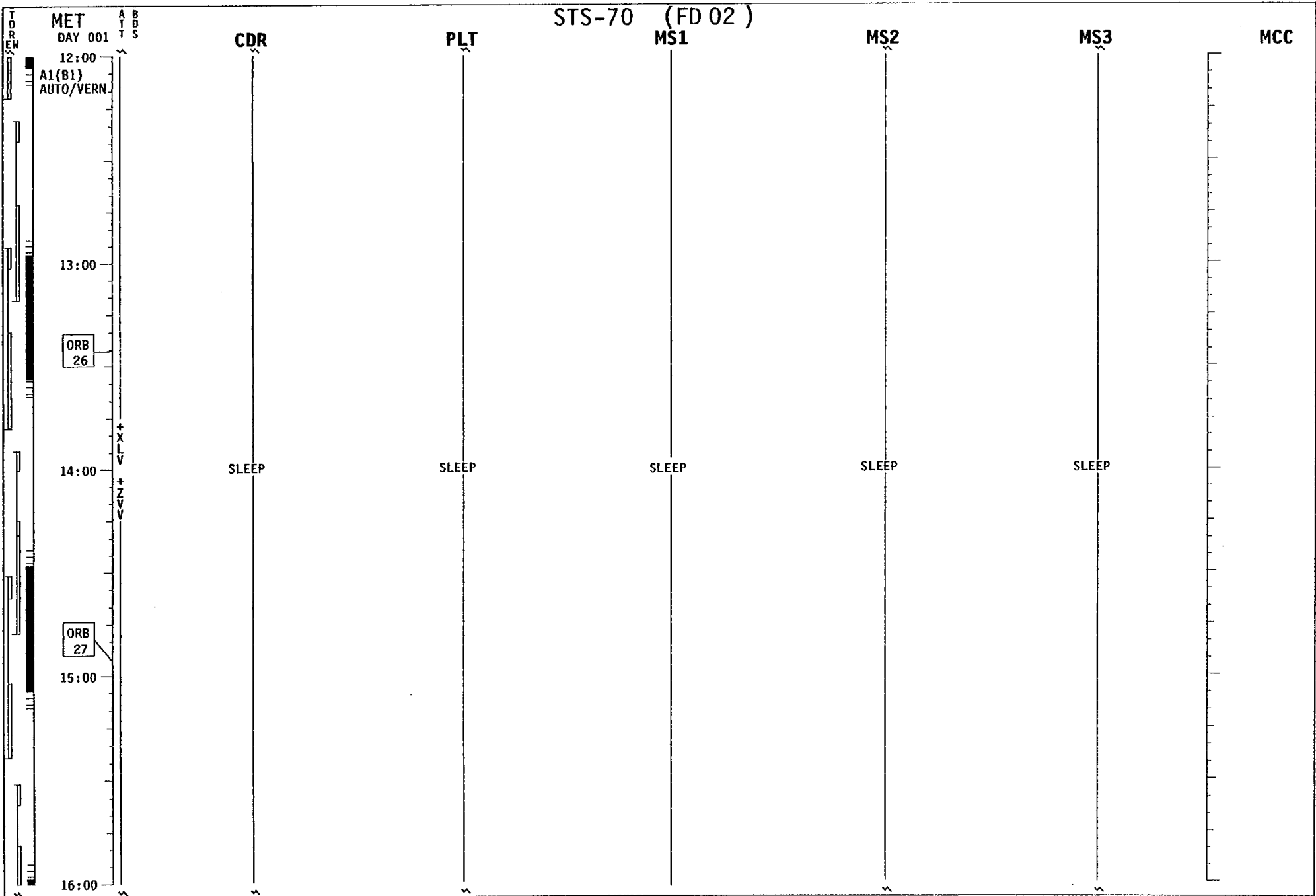

# STS-70 (FD 03)

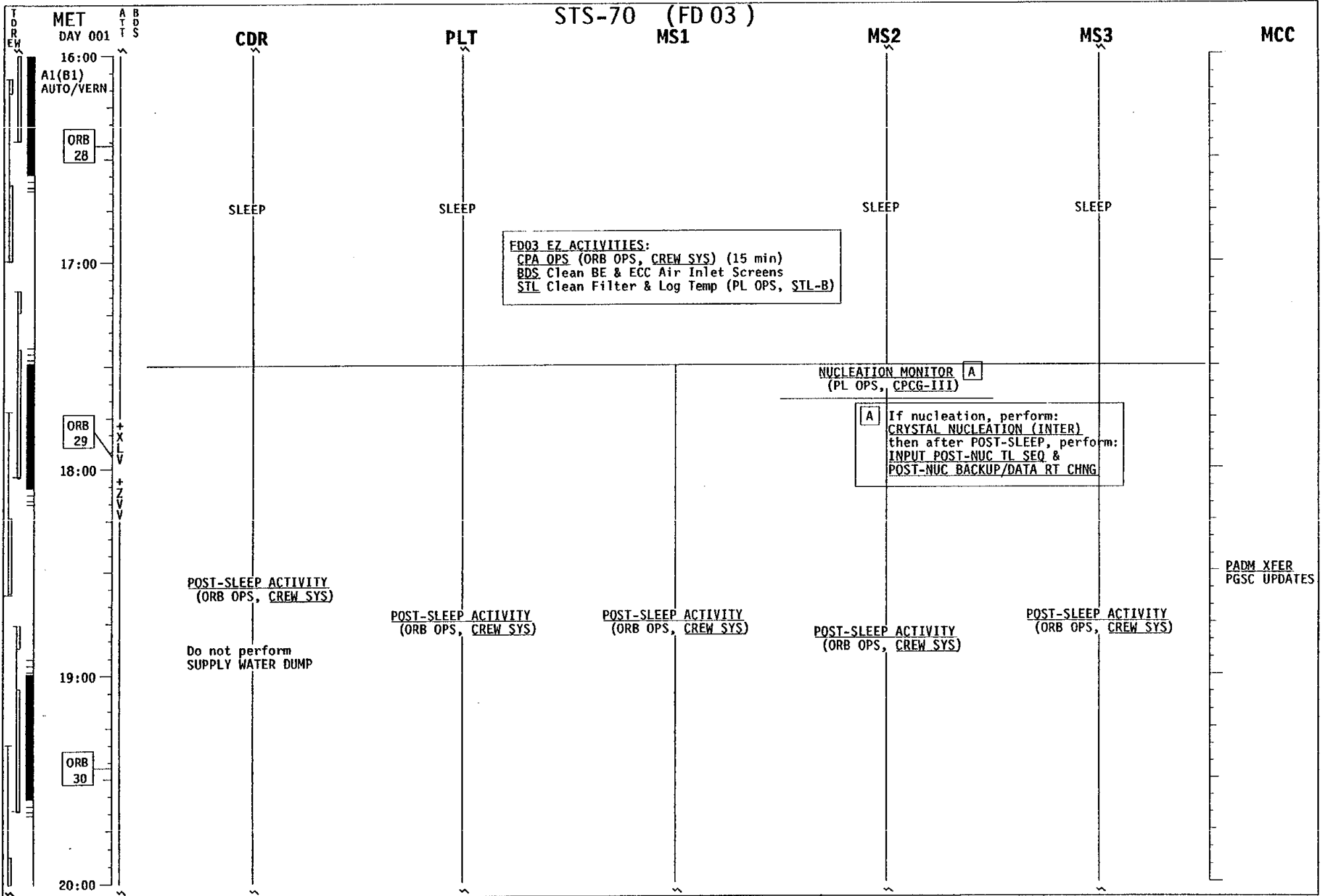

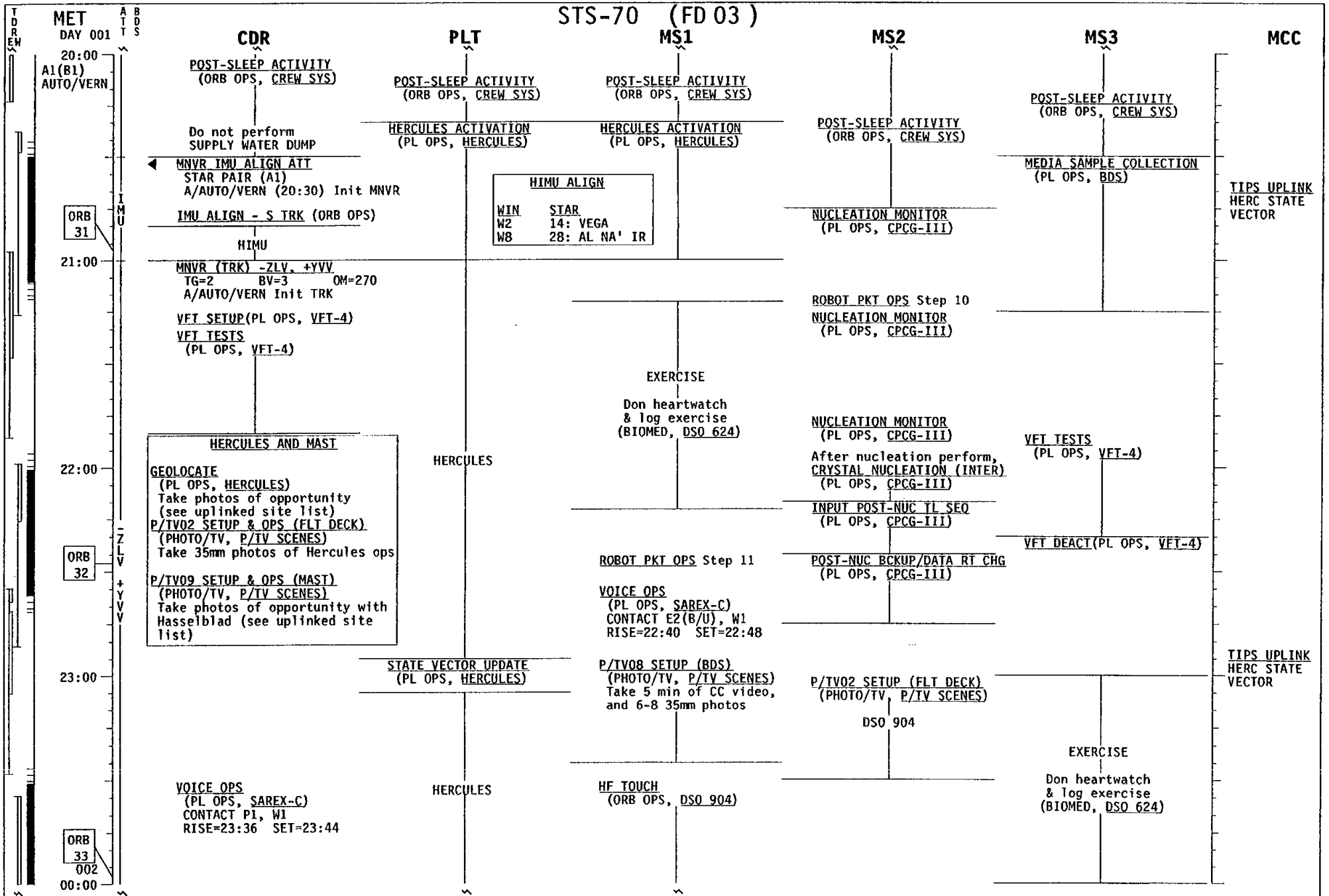

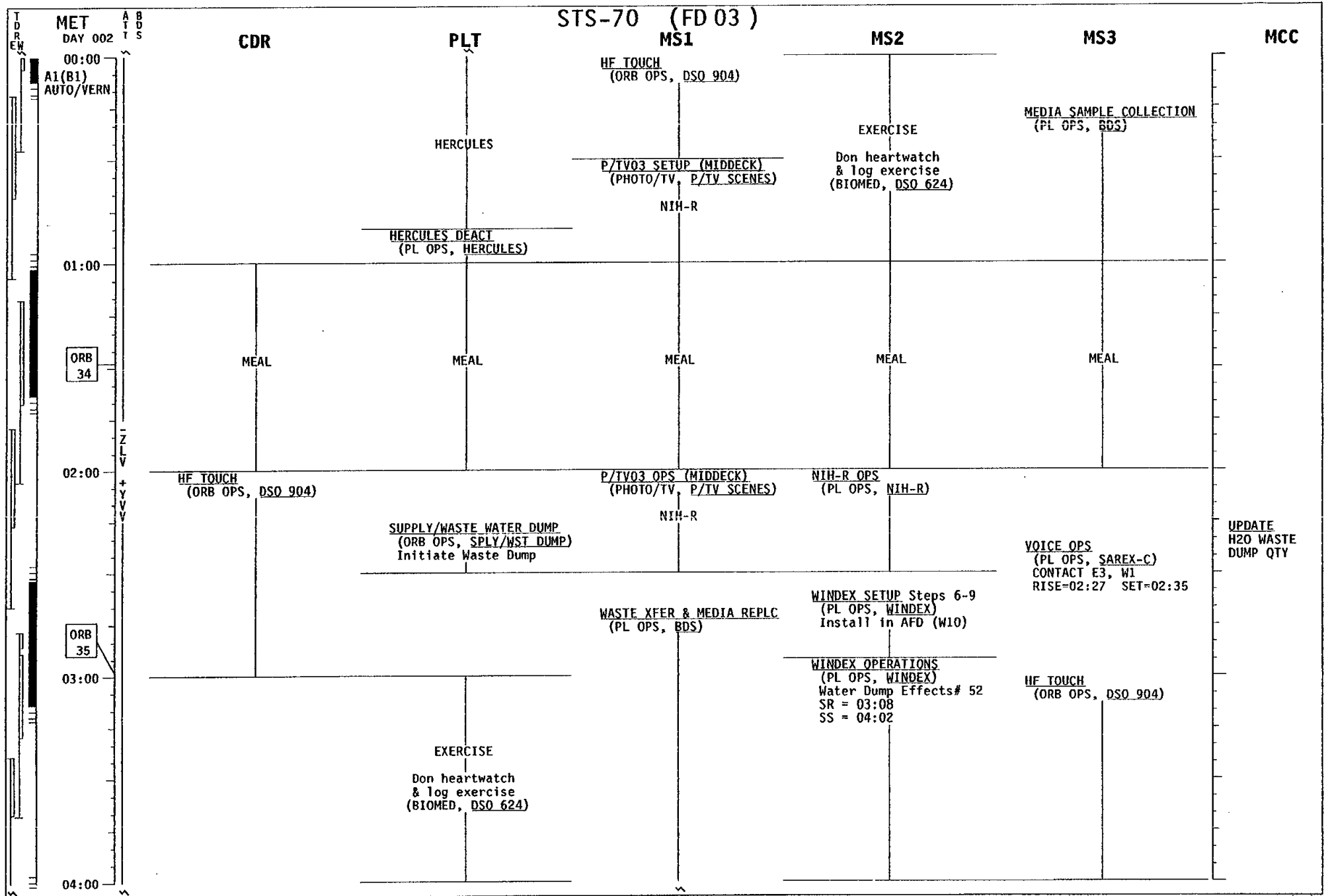

MET		STS-70 (FD 03)				MCC	
DAY 002		CDR	PLT	MS1	MS2	MS3	MCC
04:00	A1(B1) AUTO/VERN	<u>SUPPLY/WASTE WATER DUMP</u> (ORB OPS, SPLY/WST DUMP) Terminate Waste Dump	<u>WINDEX OPERATIONS</u> (PL OPS, WINDEX) Shuttle Glow# 30,31,32 SS = 04:02 SR = 04:38	<u>WASTE XFER &amp; MEDIA REPLC</u> (PL OPS, BDS)			
04:30	ORB 36	<u>EXERCISE</u> Don heartwatch & log exercise (BIOMED, DSQ 624)		<u>PAO VOICE CHECK/EVENT</u> TV at TDRW (04:25-04:45)	<u>PAO VOICE CHECK/EVENT</u>	<u>PAO VOICE CHECK/EVENT</u>	TV (TDRW) (CREW CNTL- CAB)
05:00				<u>MEDIA SAMPLE COLLECTION</u> (PL OPS, BDS)			
05:30		<u>PAO VOICE CHECK/EVENT</u> Audio only			<u>CPCG STATUS CHECK</u> (PL OPS, CPCG-III)		
06:00	ORB 37	<u>PRE-SLEEP ACTIVITY</u> (ORB OPS, CREW SYS)				<u>PRE-SLEEP ACTIVITY</u> (ORB OPS, CREW SYS)	
06:30		06 UHF MODE - OFF PRIVATE MEDICAL CONFERENCE (ALL)					
06:45			<u>PRE-SLEEP ACTIVITY</u> (ORB OPS, CREW SYS)	<u>PRE-SLEEP ACTIVITY</u> (ORB OPS, CREW SYS)	<u>PRE-SLEEP ACTIVITY</u> (ORB OPS, CREW SYS)	<u>FAMILY VIDEO CONFERENCE</u> TV at TDRE (06:36 - 06:53)	
07:00		<u>PRE-SLEEP ACTIVITY</u> (ORB OPS, CREW SYS)					
07:30	ORB 38	Do not perform SUPPLY WATER DUMP				<u>PRE-SLEEP ACTIVITY</u> (ORB OPS, CREW SYS)	
08:00							

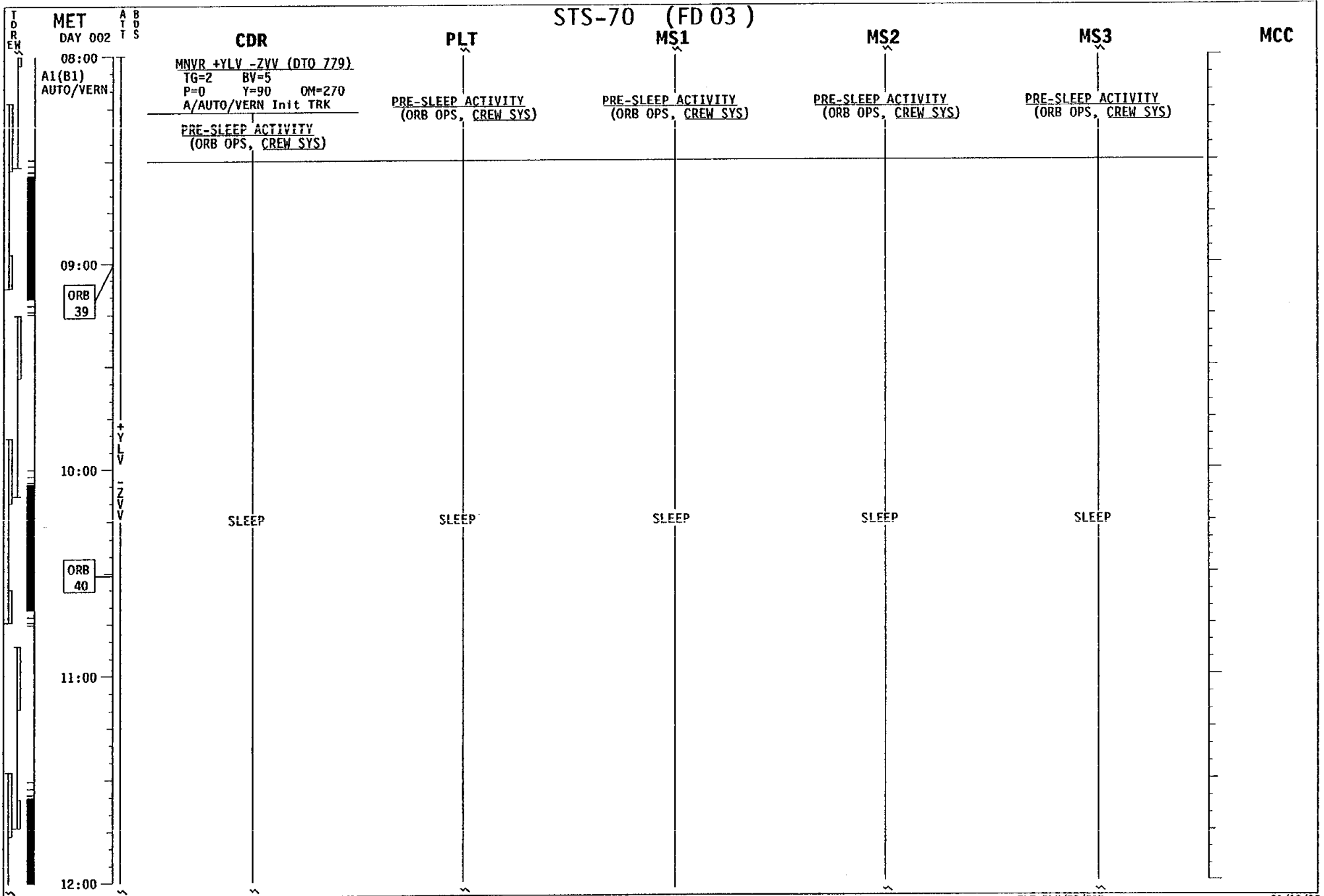



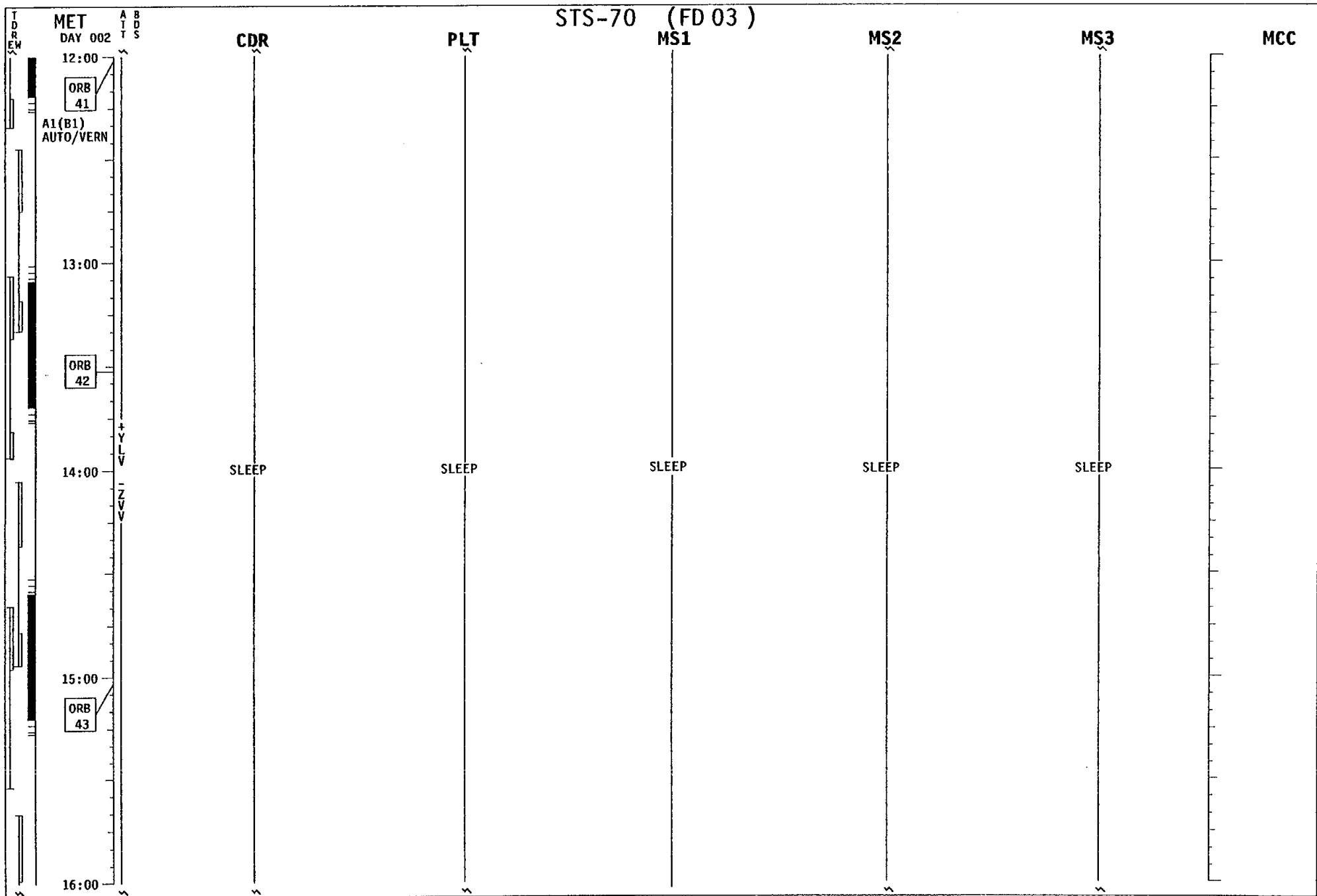

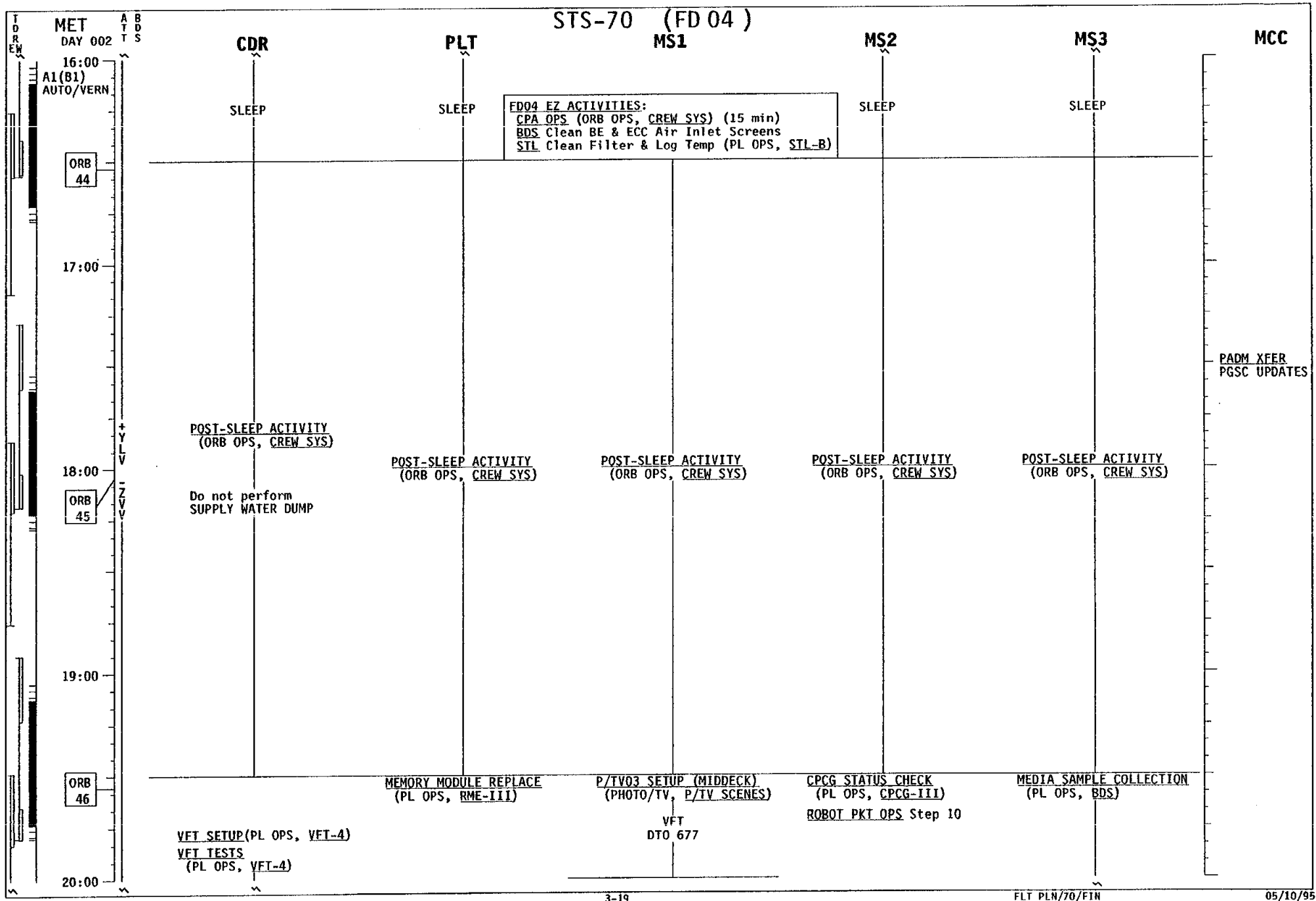

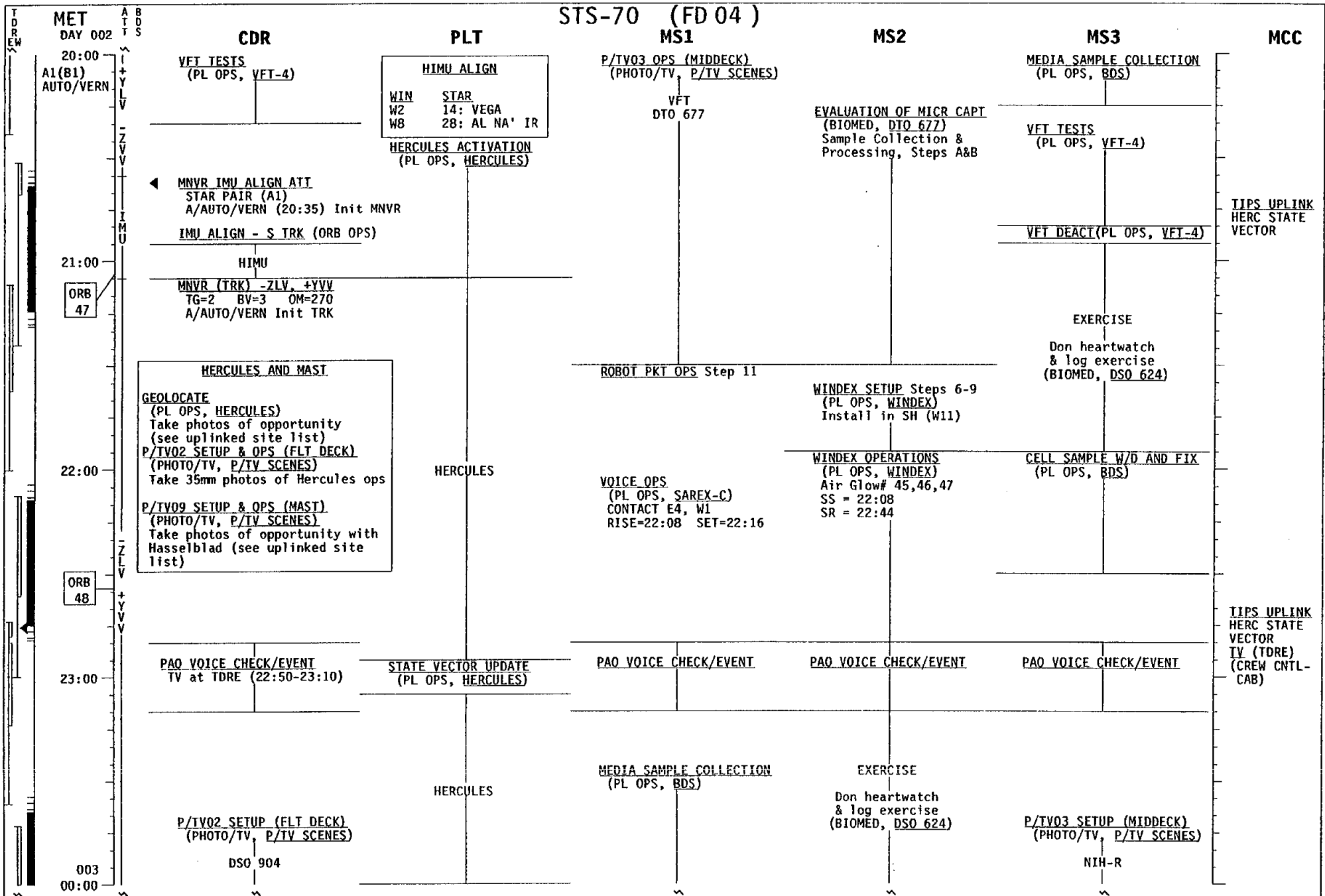

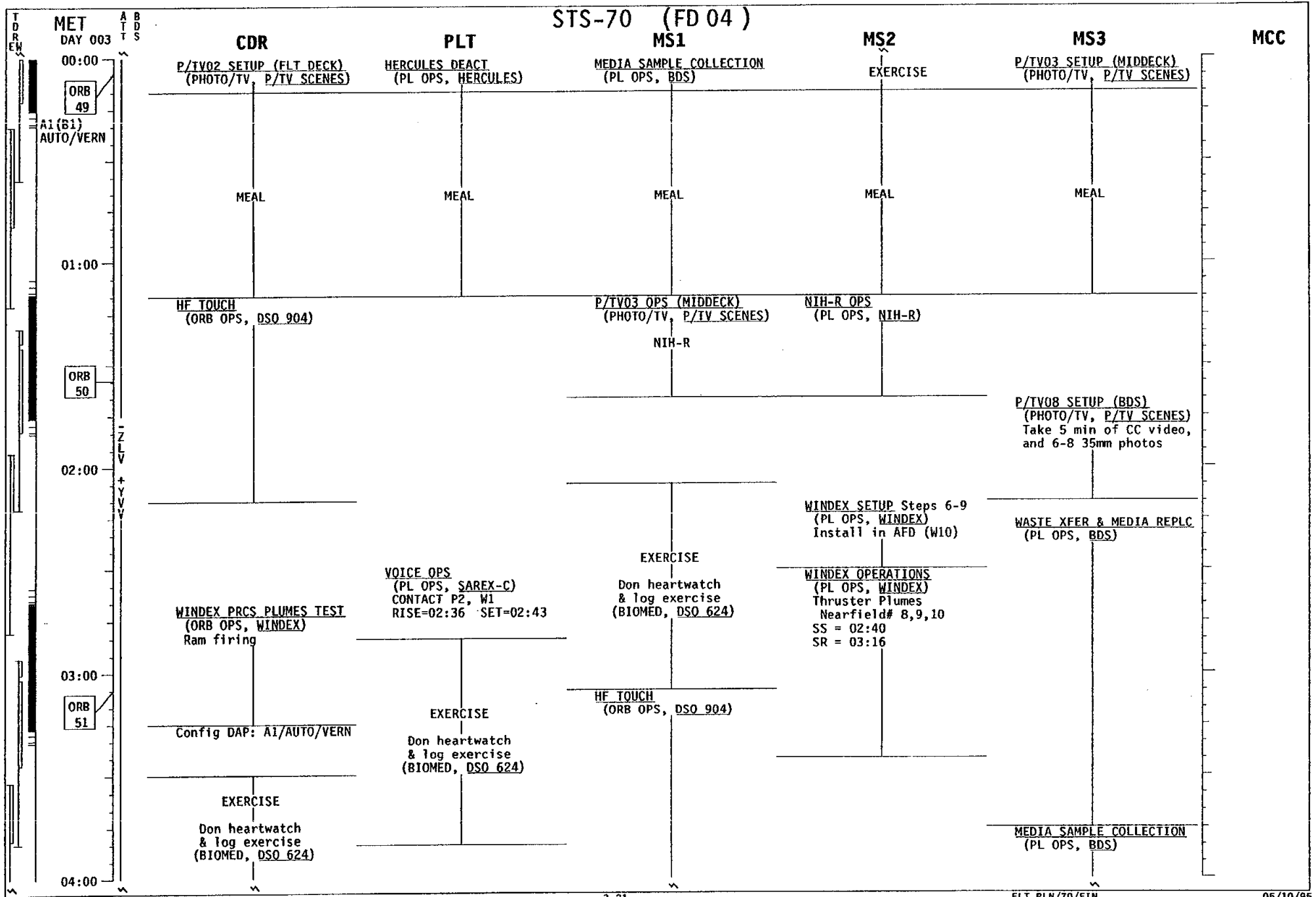

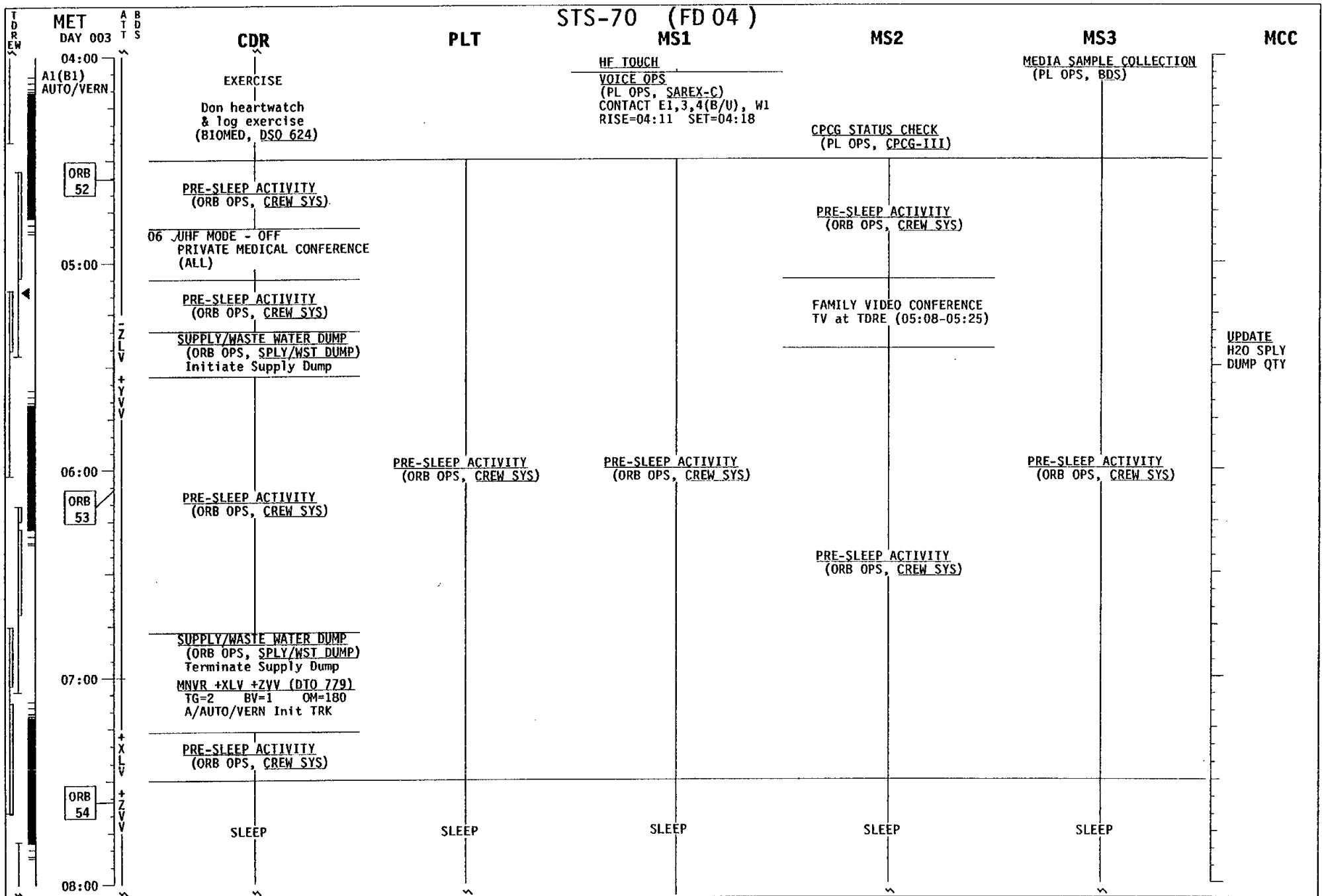

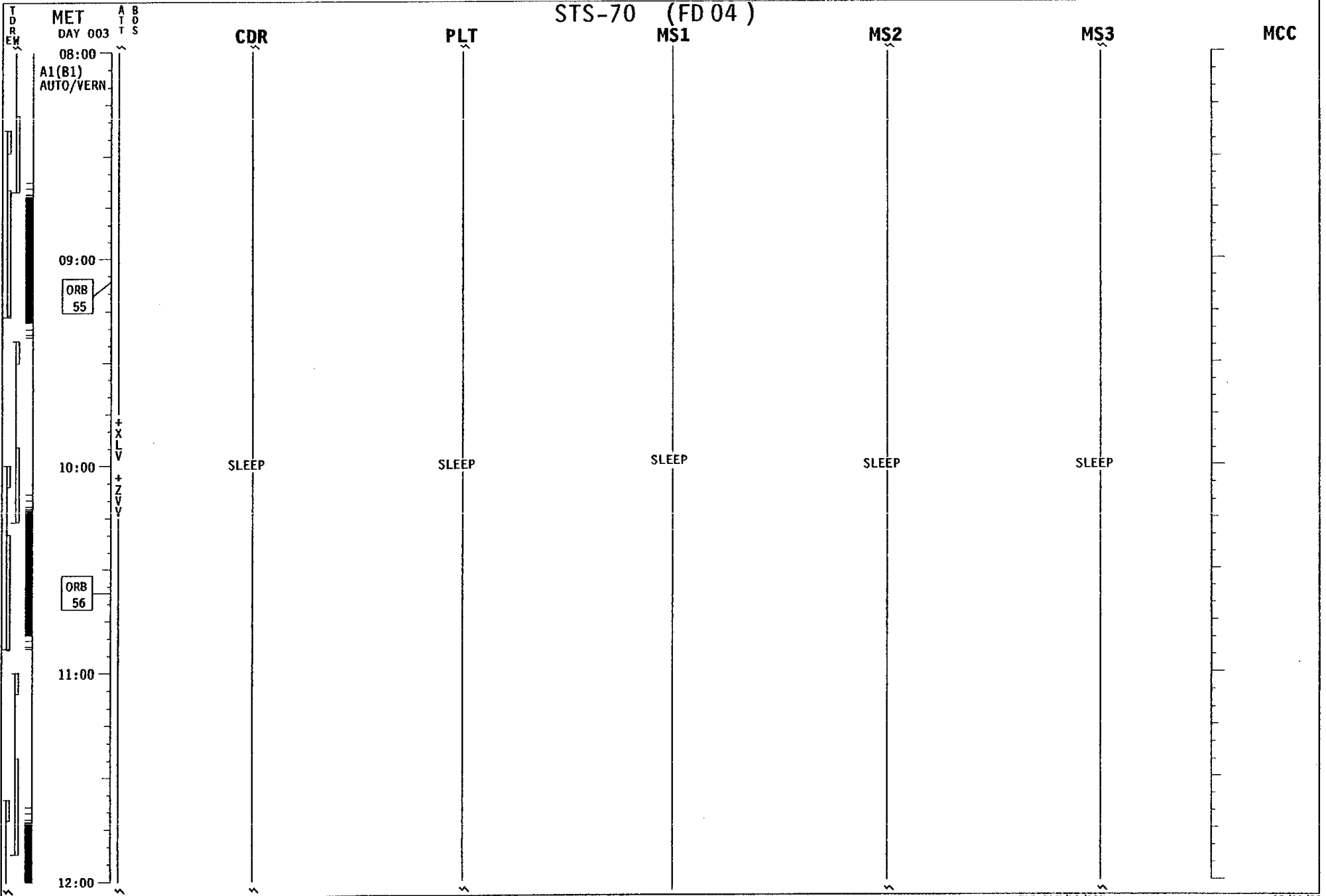

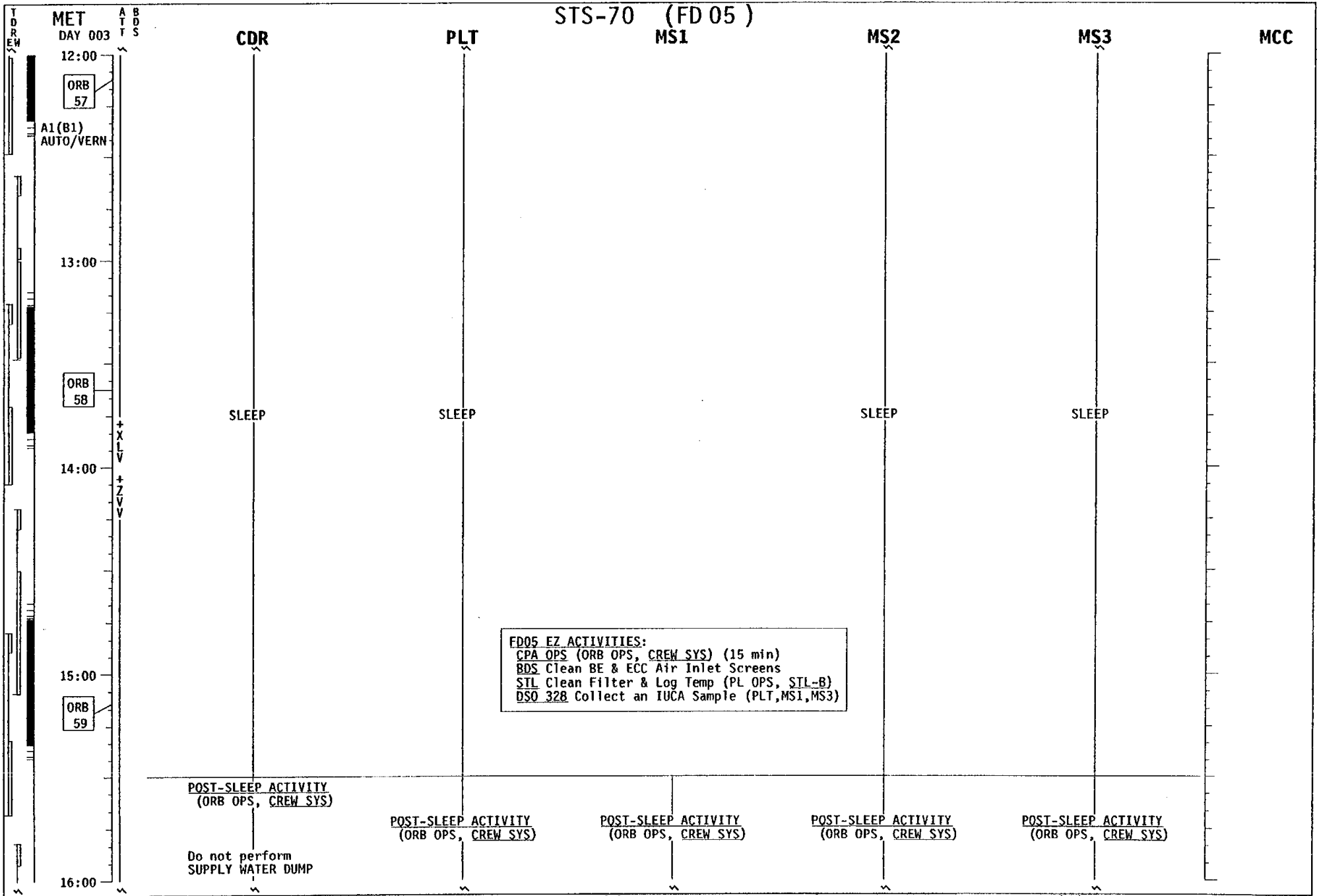

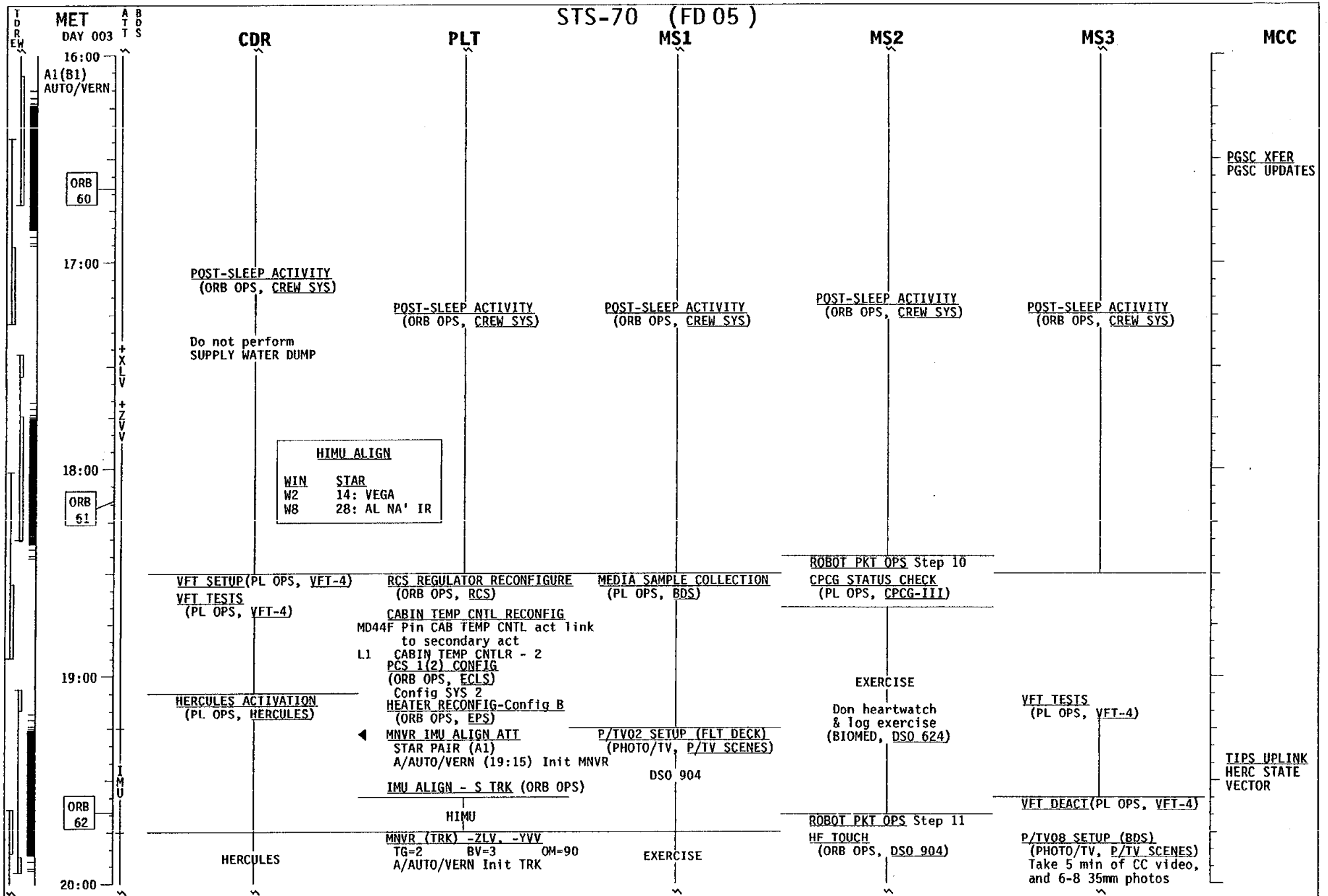



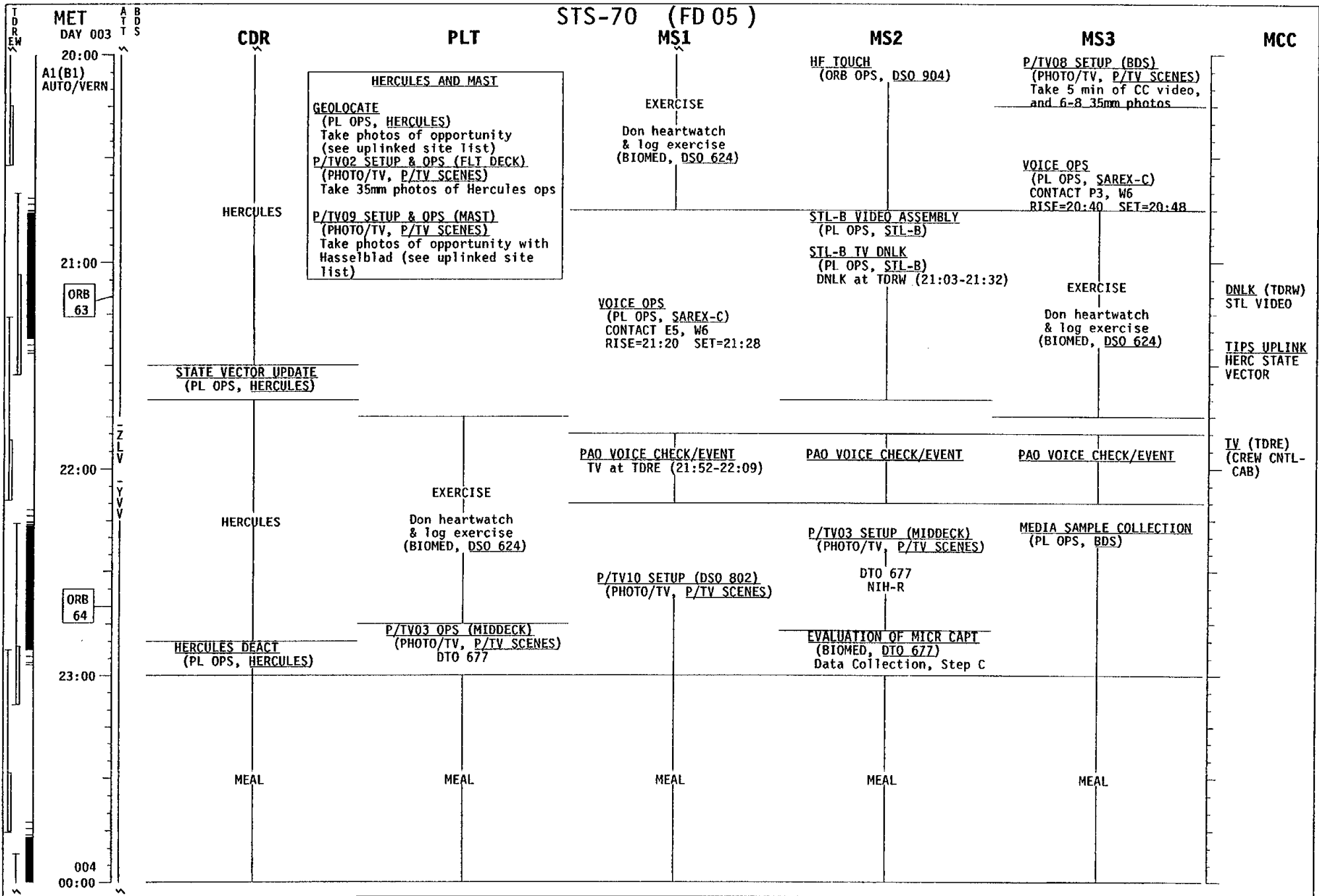

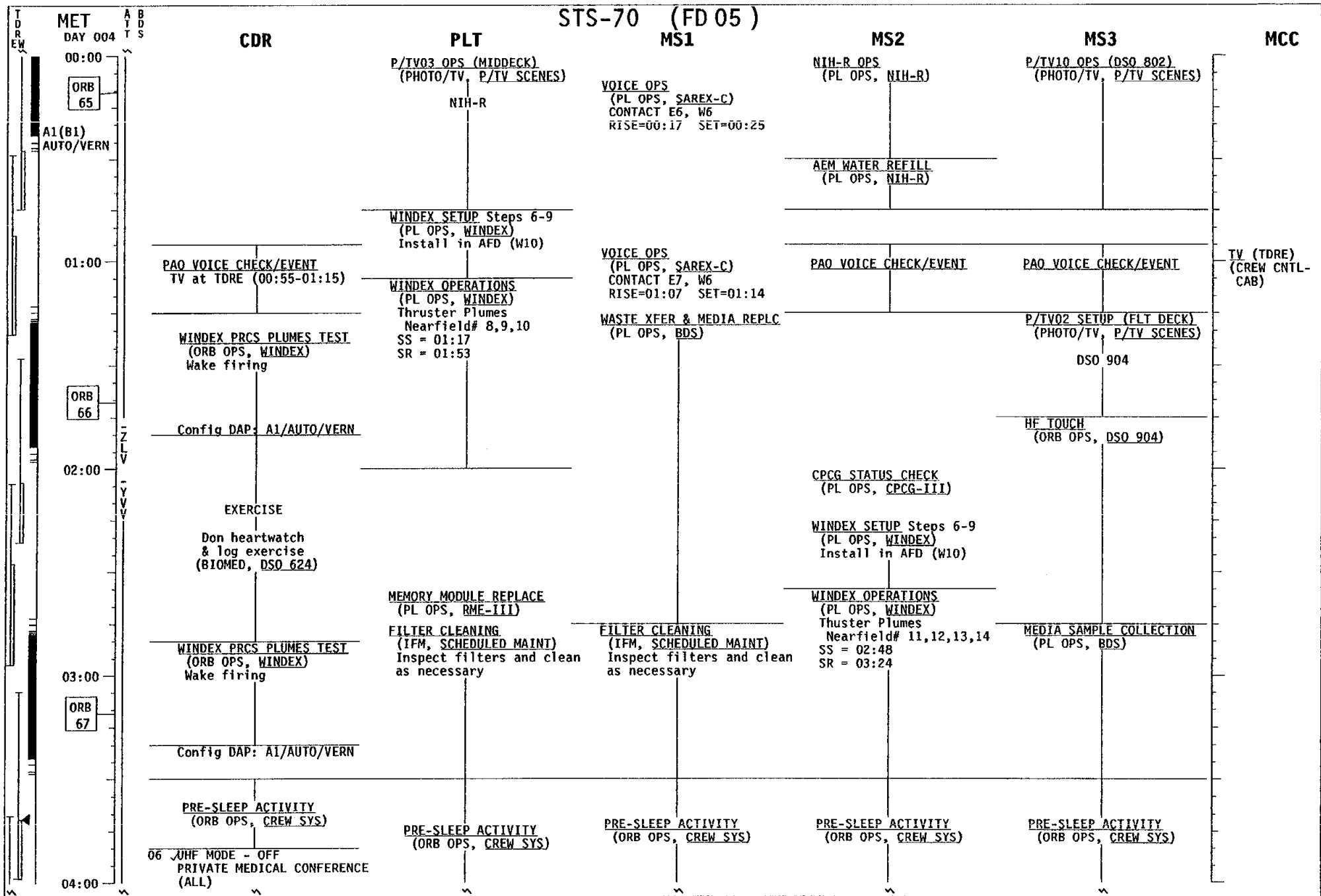

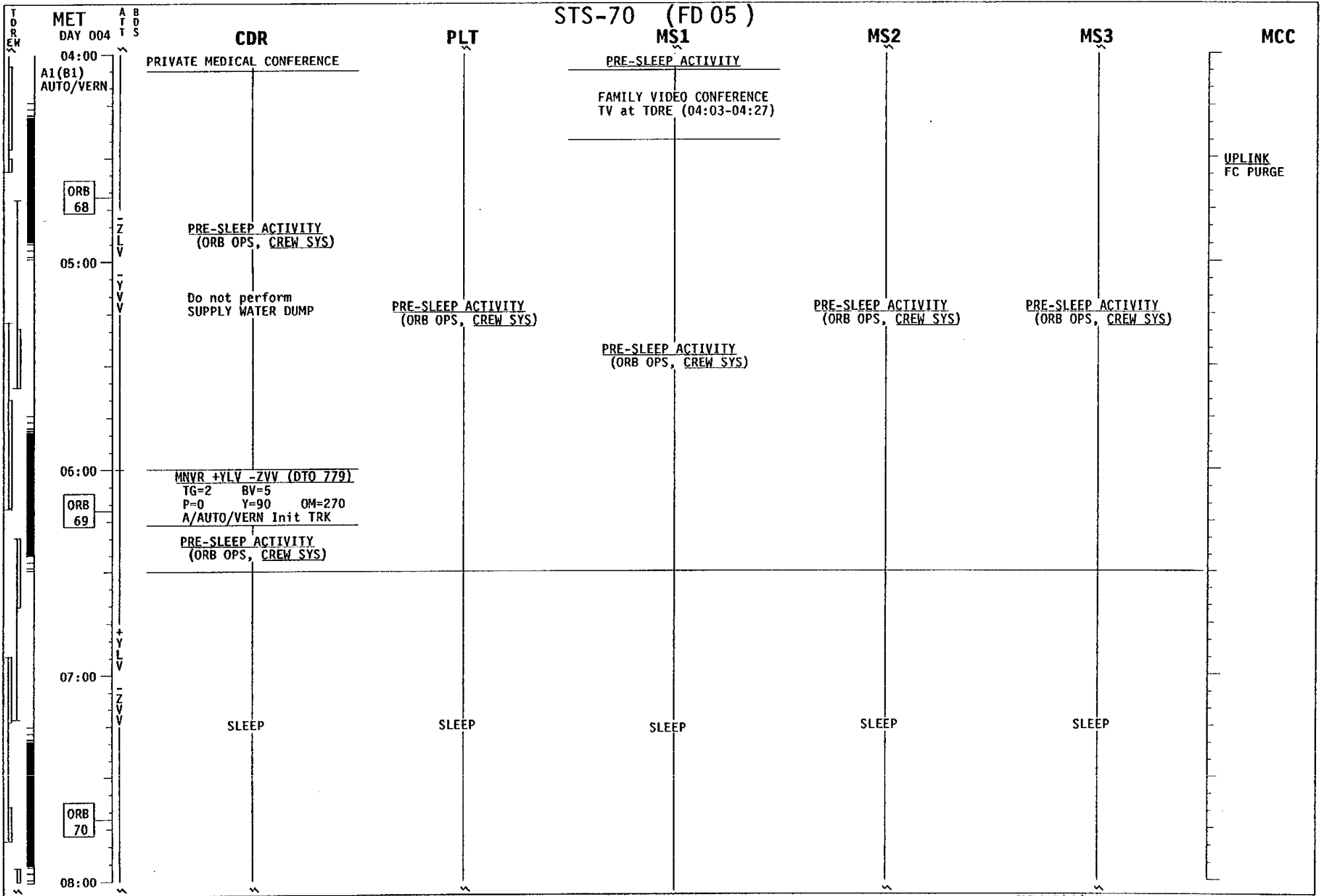

T D R A B  
E H E T S  
MET DAY 004  
08:00  
A1(B1)  
AUTO/VERN  
09:00  
ORB  
71  
10:00  
ORB  
72  
11:00  
12:00

STS-70 (FD 05)

CDR

PLT

MS1

MS2

MS3

MCC

SLEEP

SLEEP

SLEEP

SLEEP

SLEEP

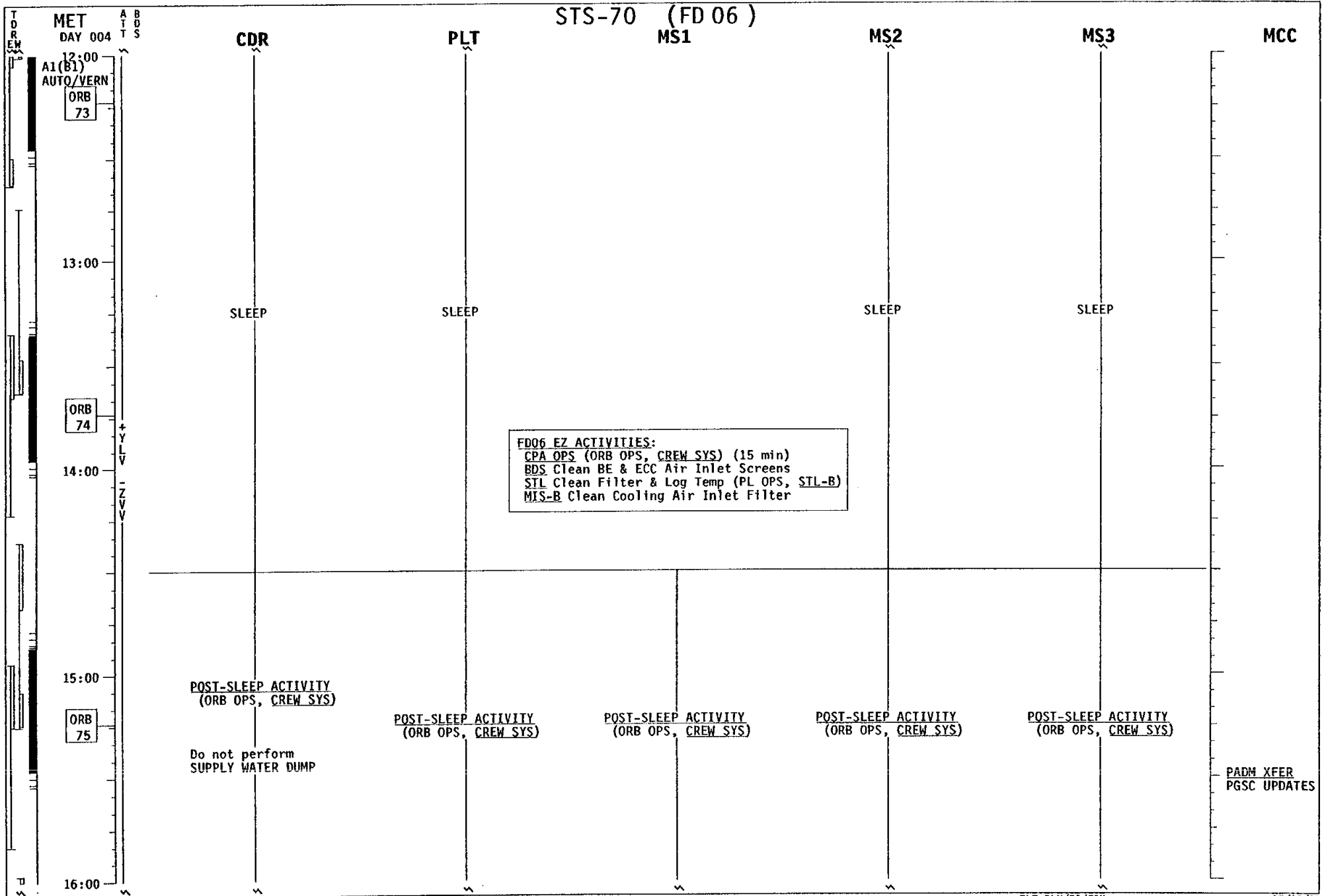

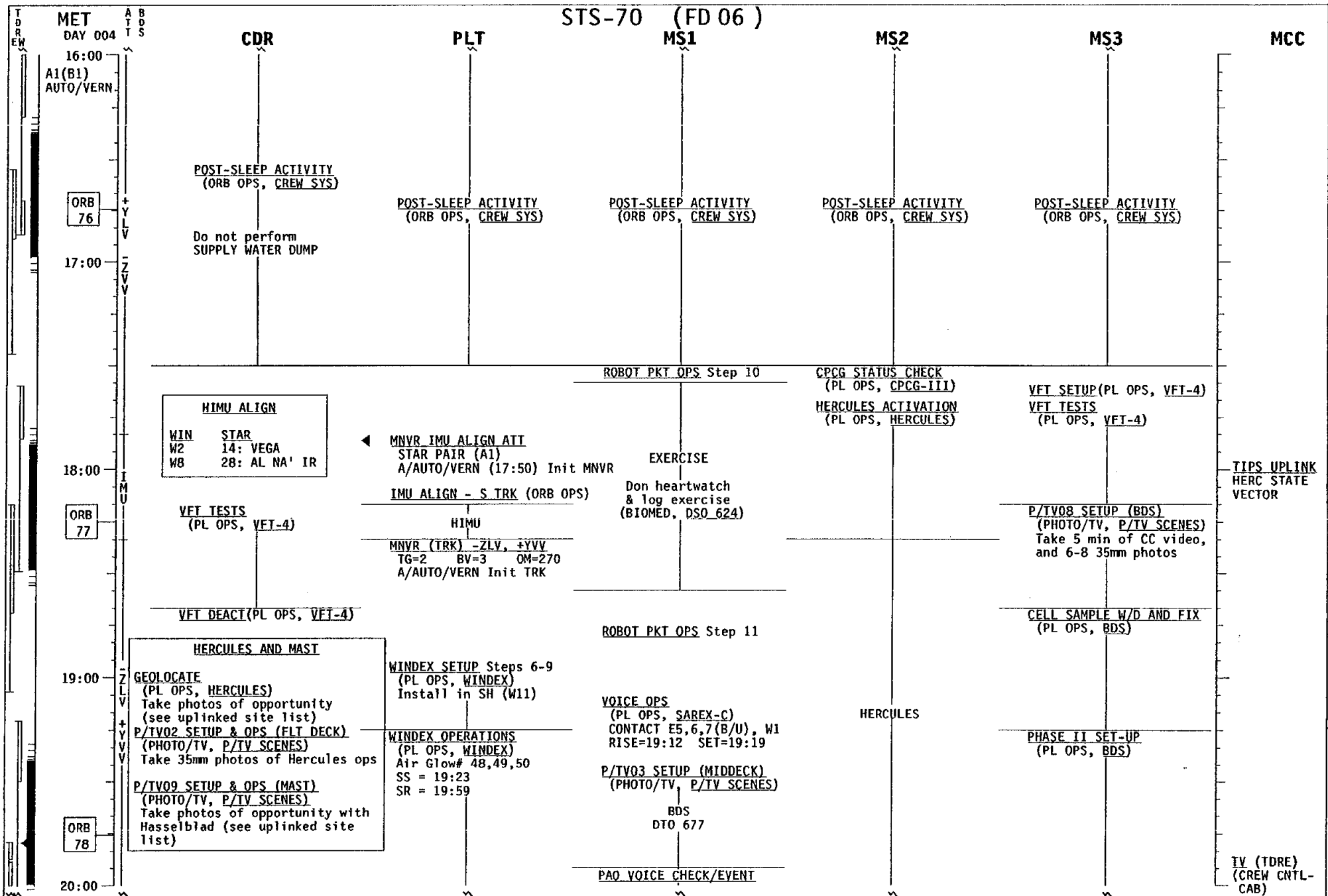

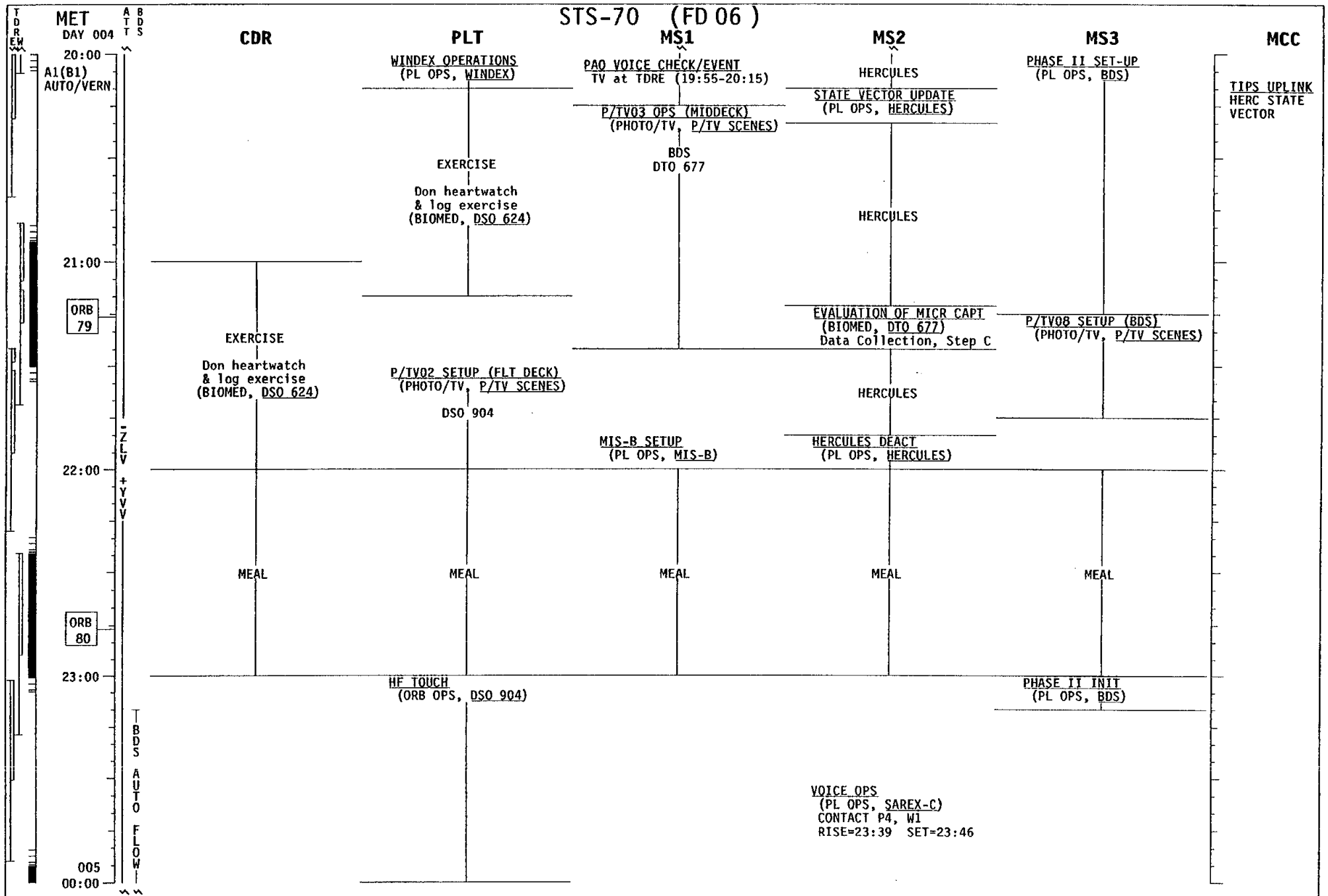

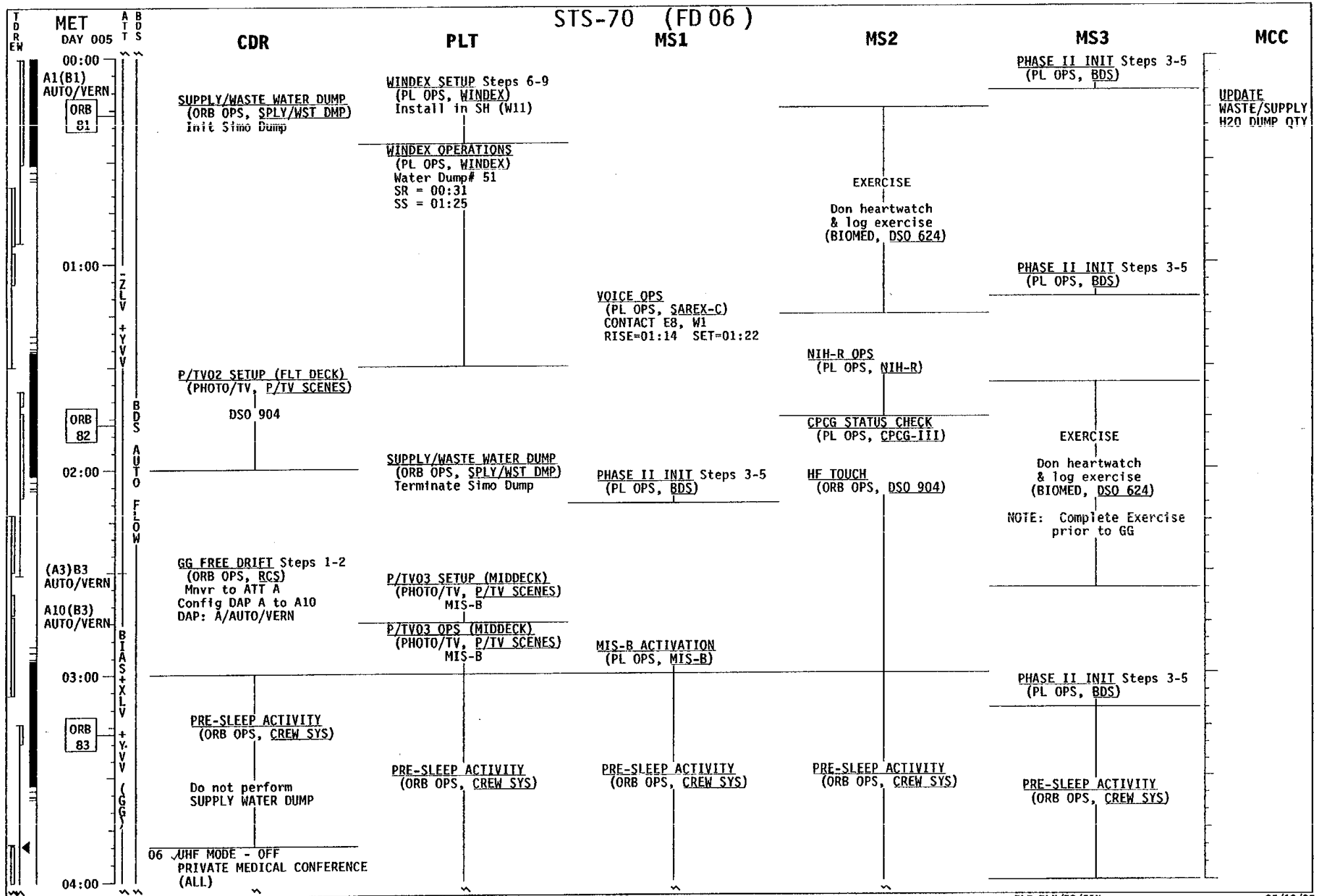



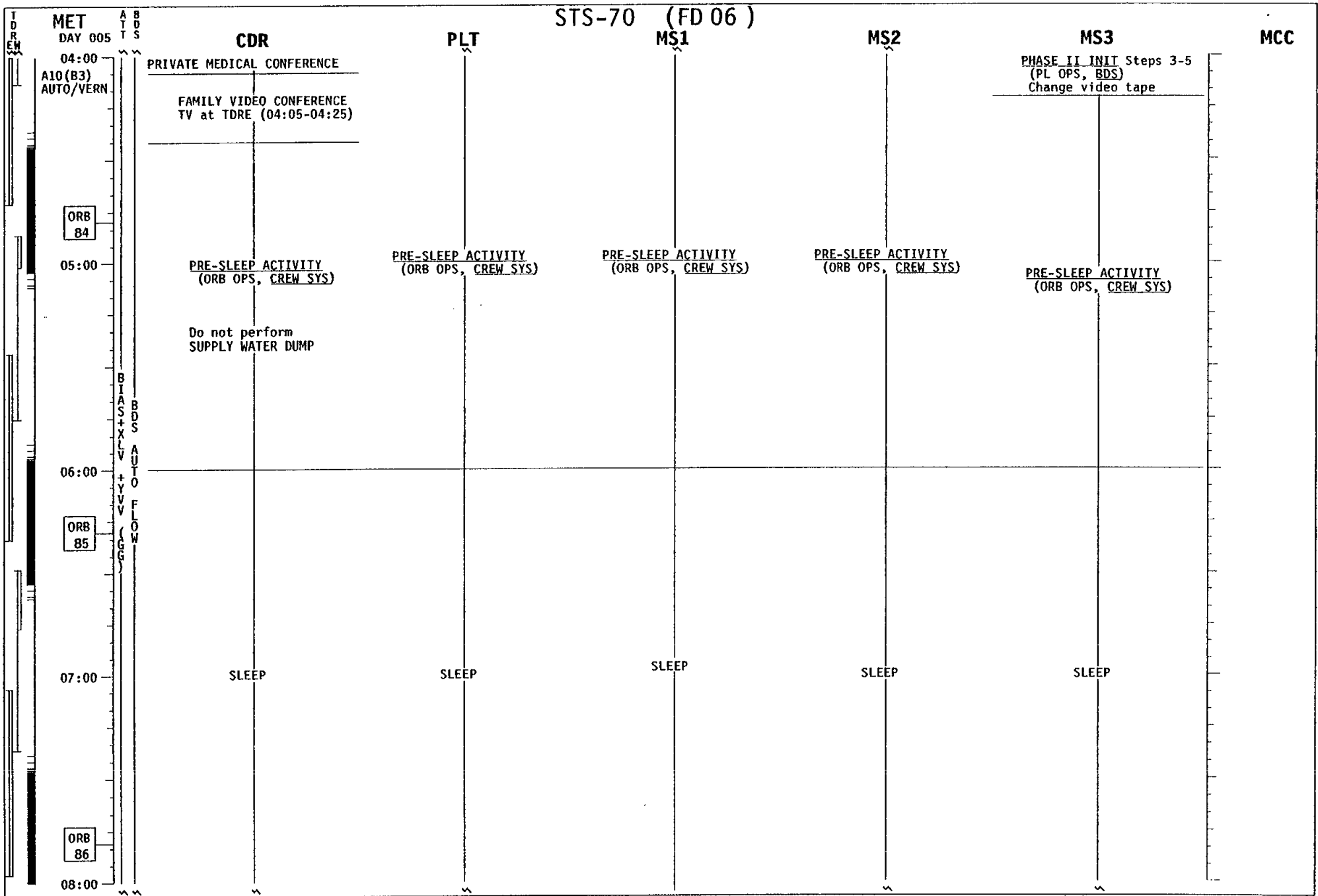

TDR  
EH

MET  
DAY 005

A  
T  
T  
S

# STS-70 (FD 06)

CDR

PLT

MS1

MS2

MS3

MCC

08:00

A10 (B3)  
AUTO/VERN

09:00

ORB  
87

10:00

SLEEP

SLEEP

SLEEP

SLEEP

SLEEP

ORB  
88

11:00

12:00

B  
A  
S  
S  
+  
X  
L  
V  
+  
Y  
V  
V  
C  
G  
P  
B  
D  
S  
A  
U  
T  
O  
F  
L  
O  
W

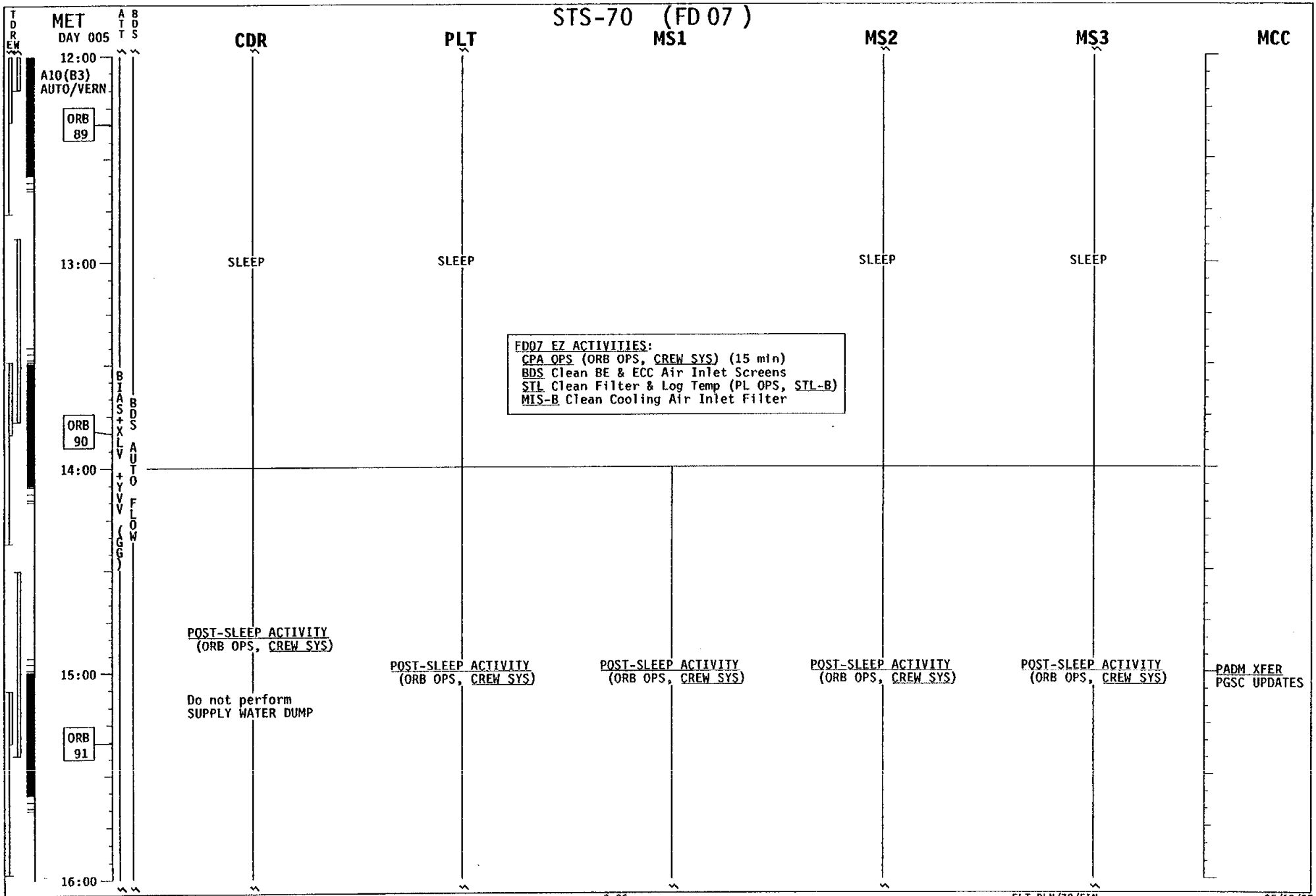

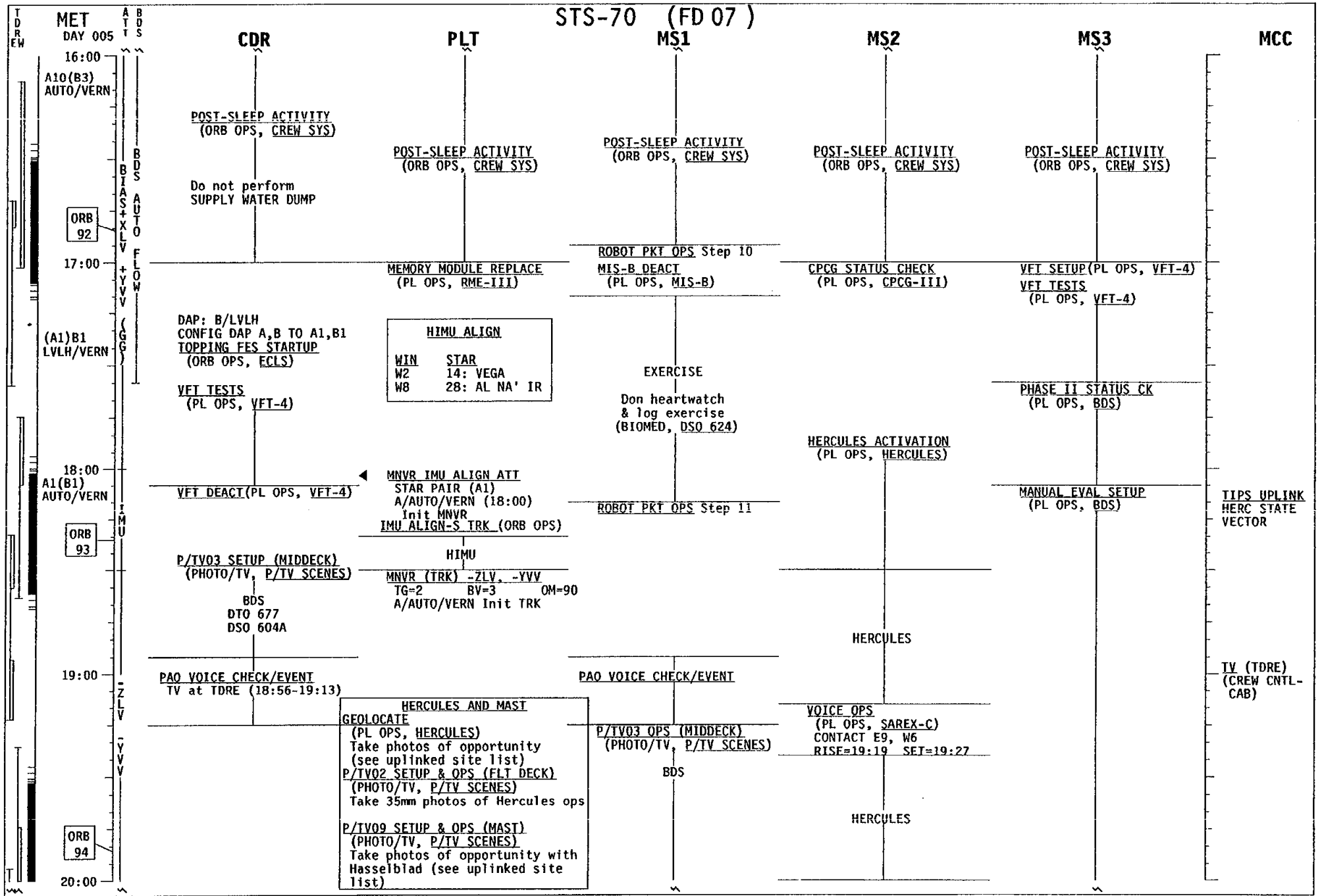

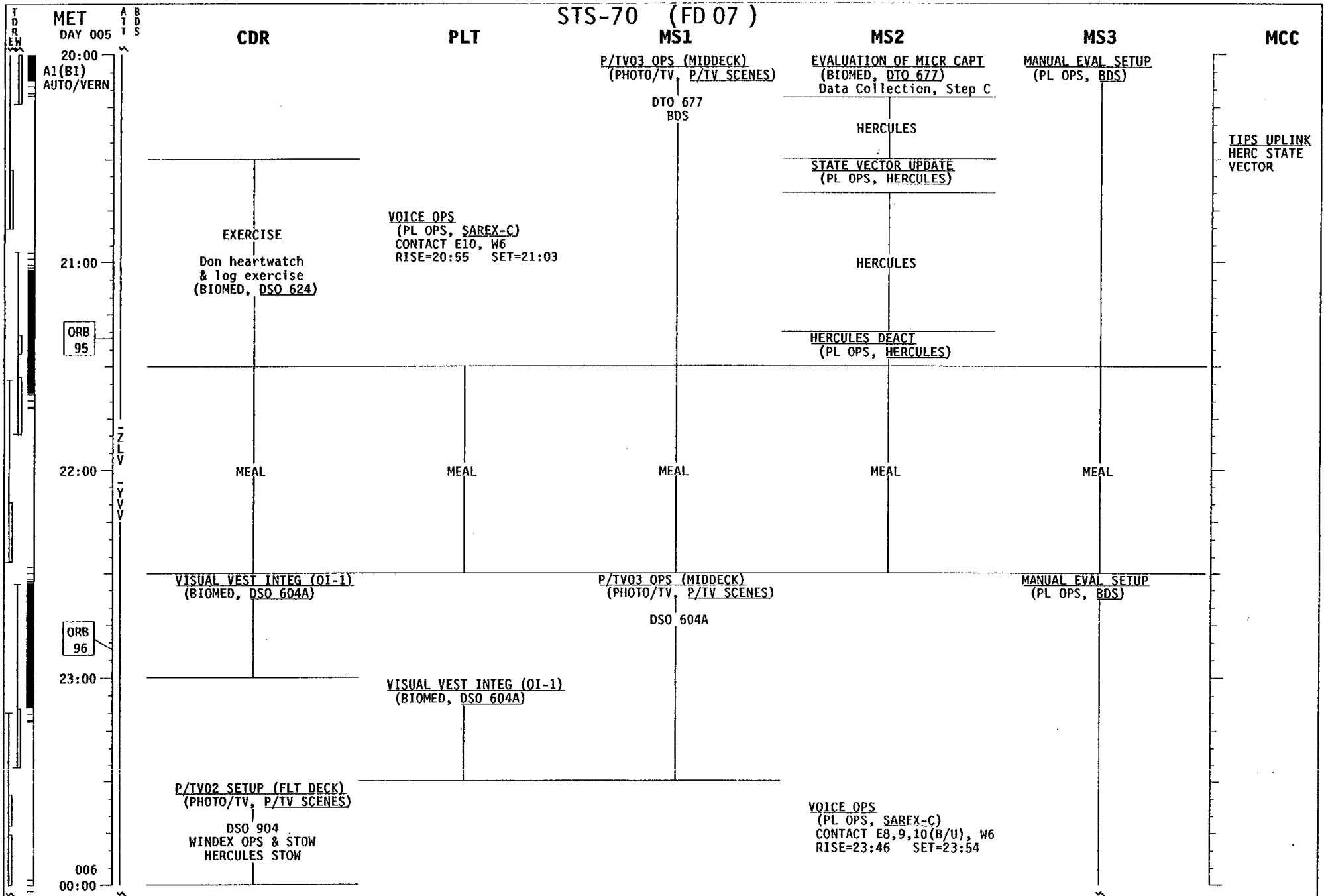

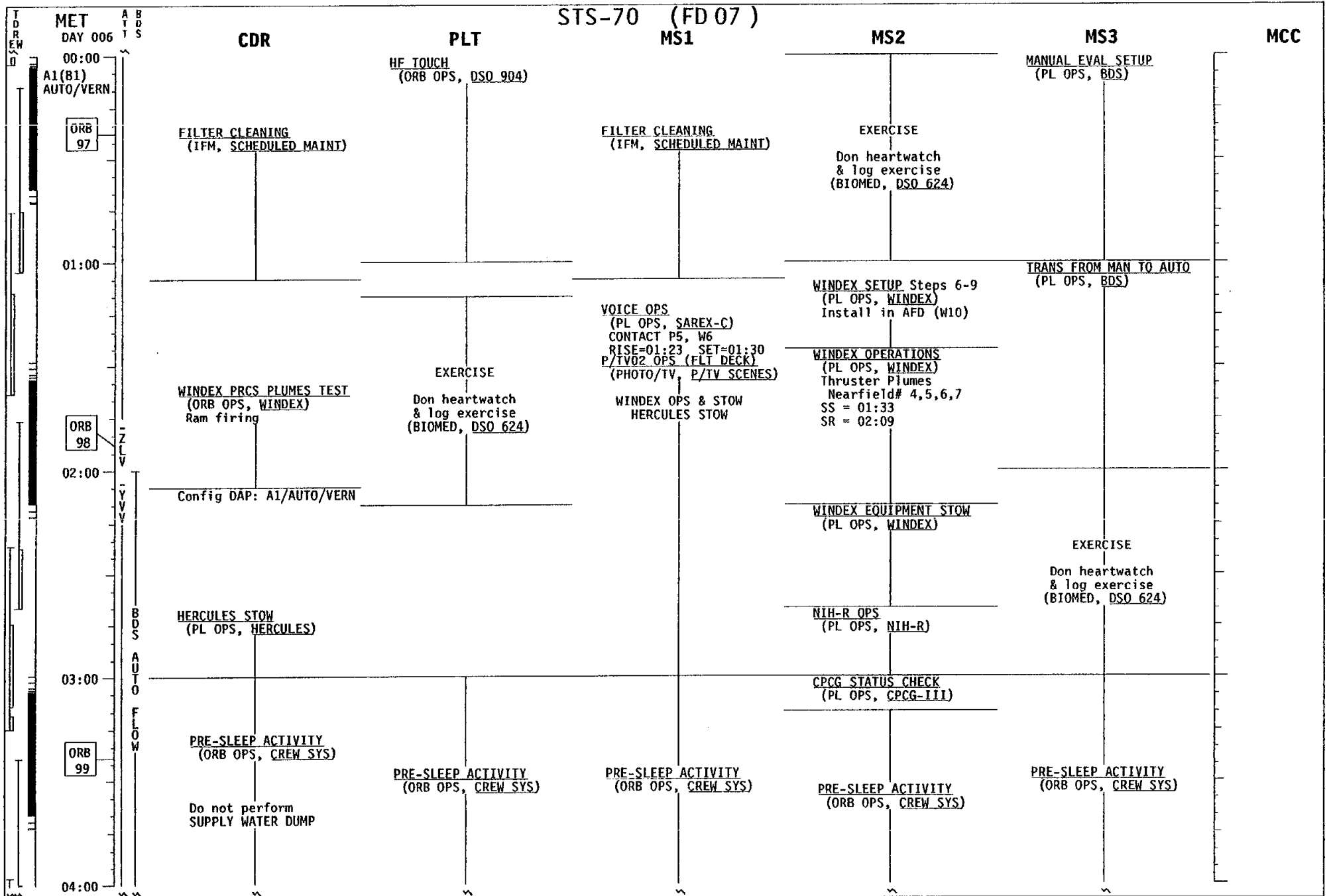

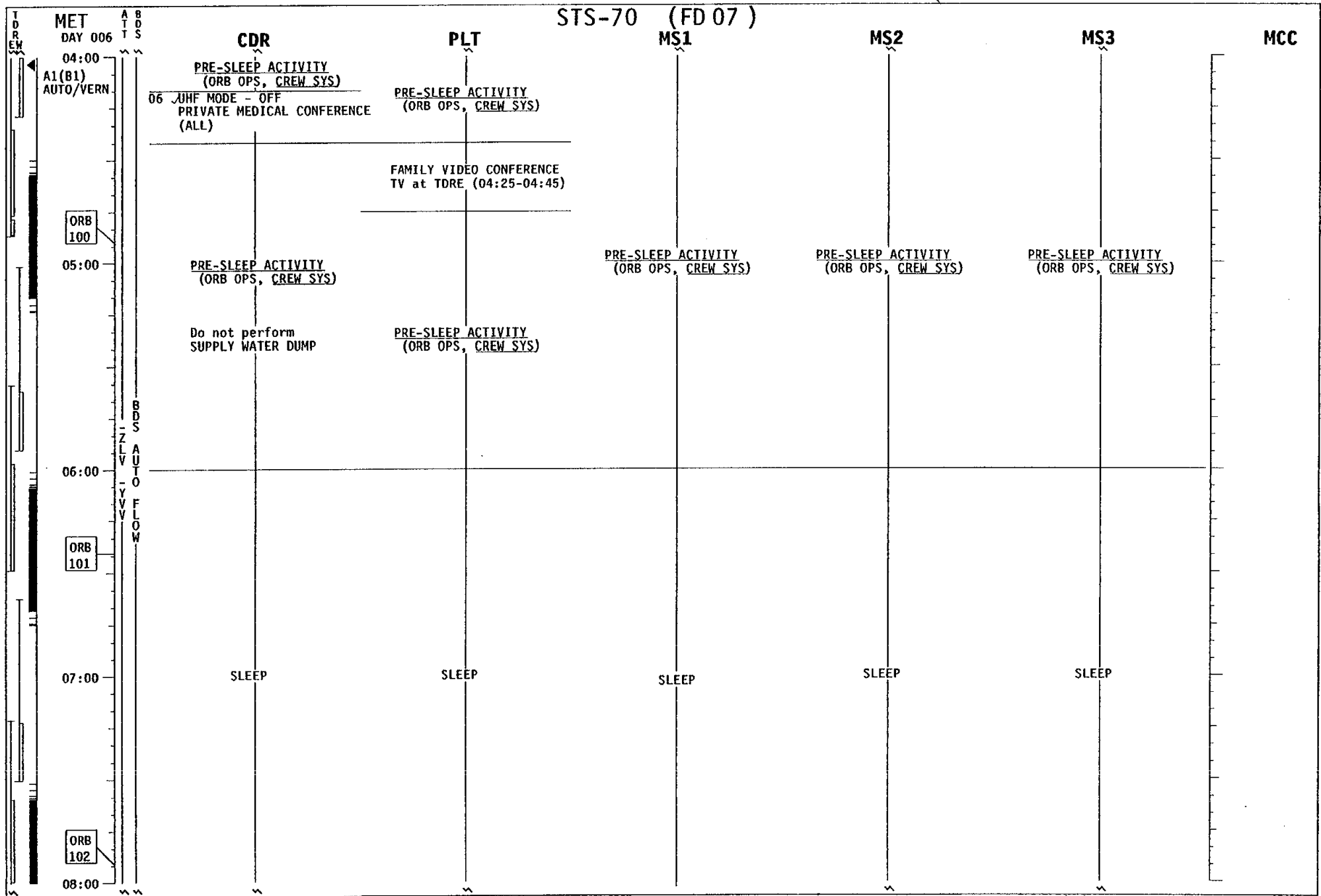

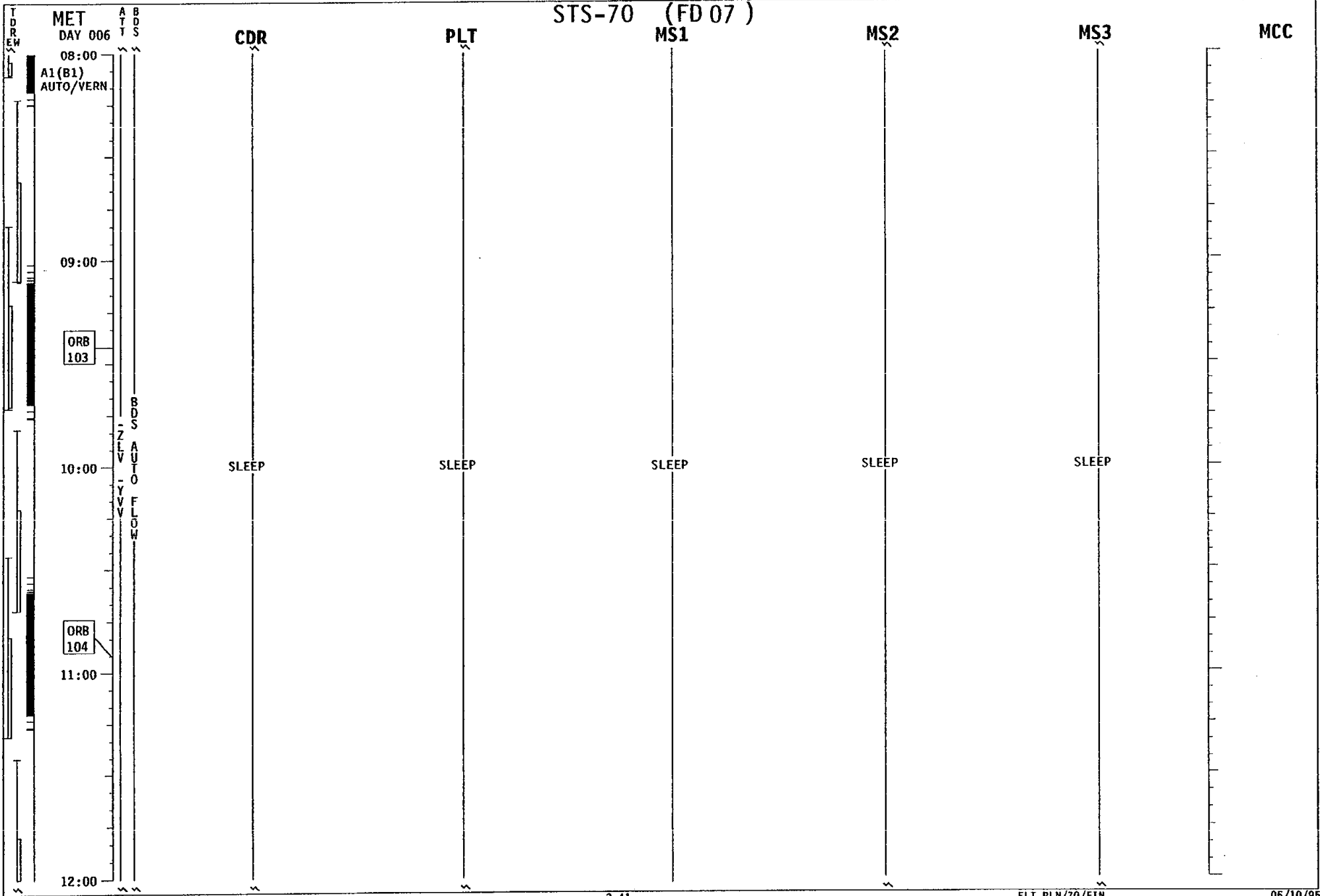



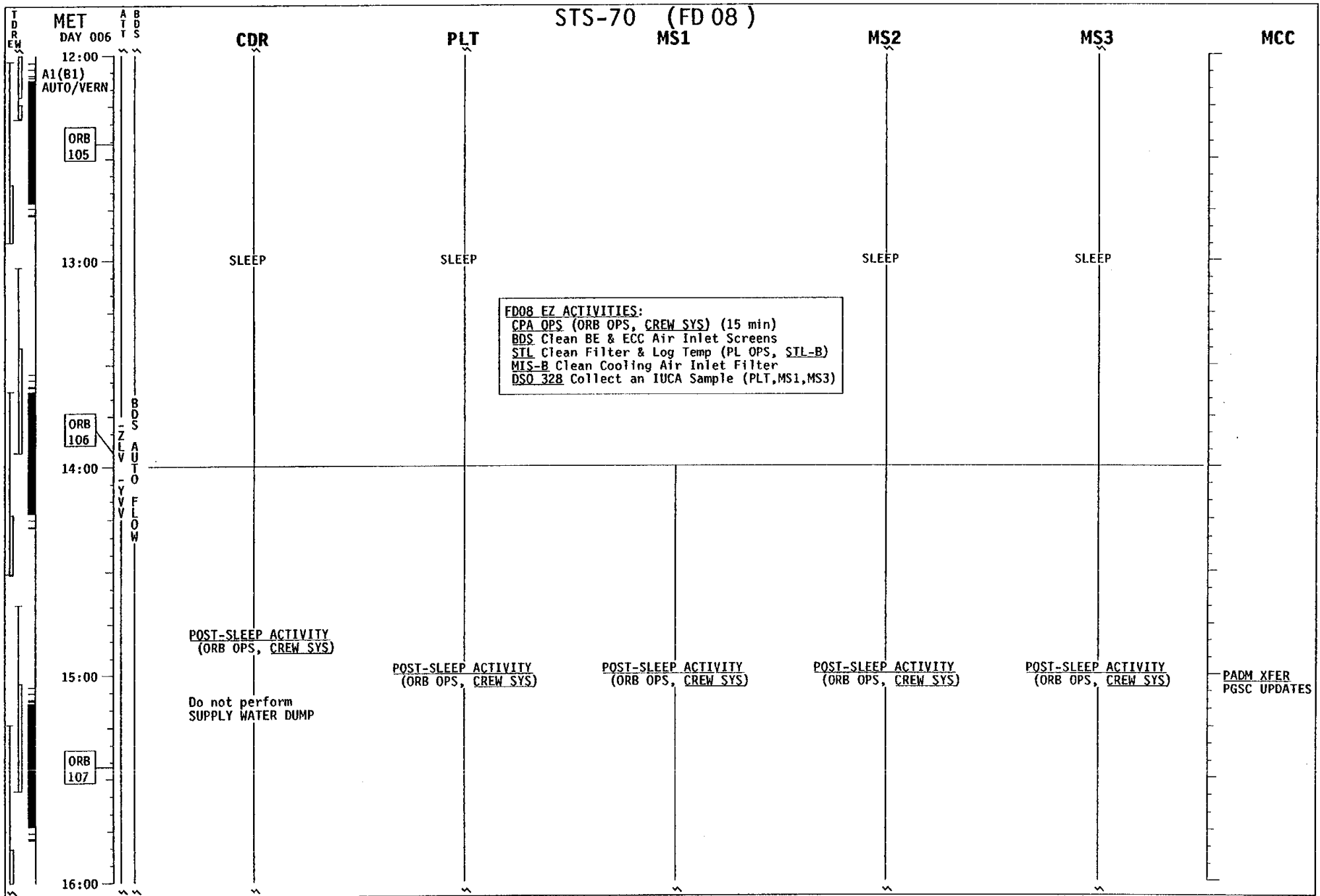

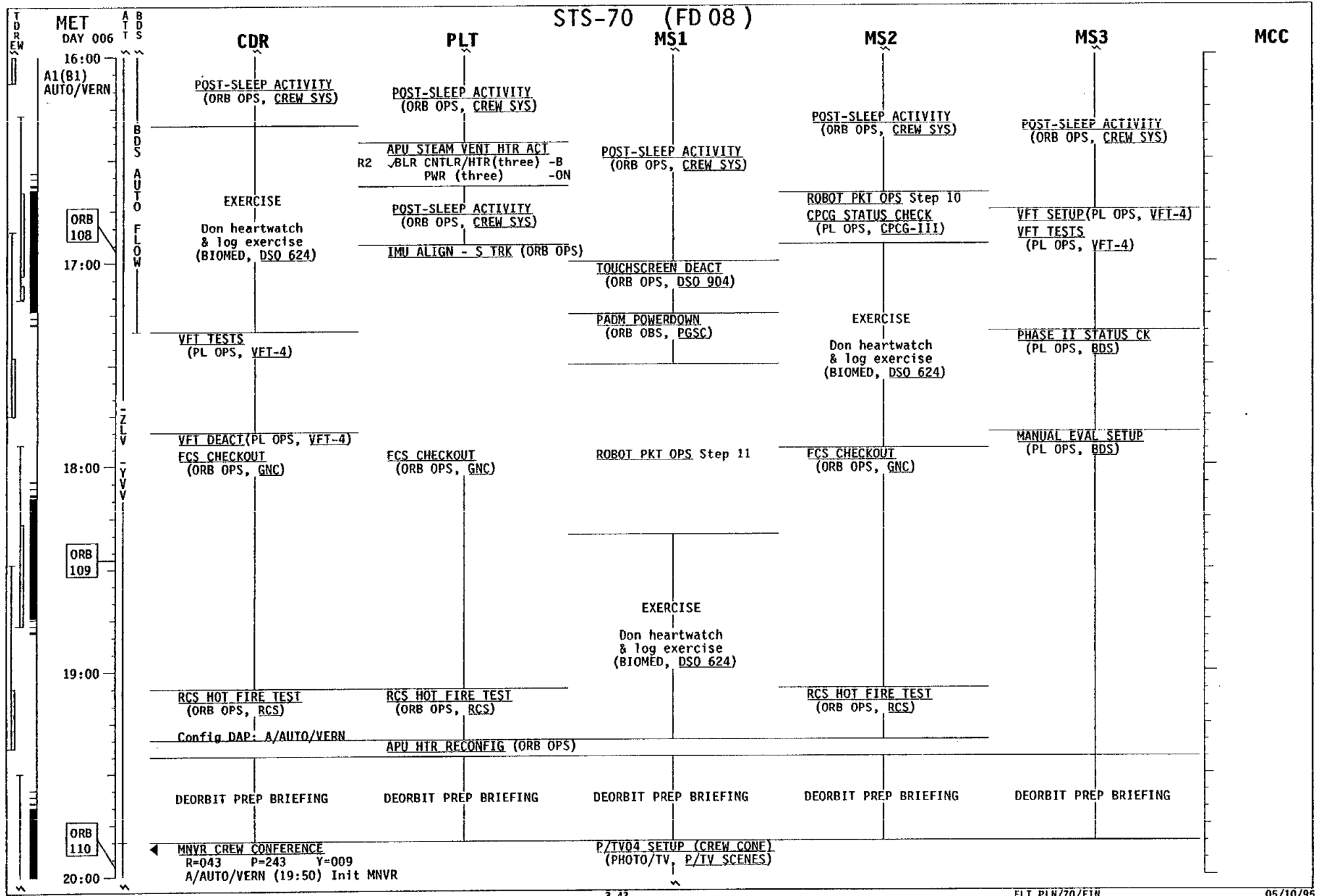

		STS-70 (FD 08)					
		CDR	PLT	MS1	MS2	MS3	MCC
T D R E	MET DAY 006			P/TV04 SETUP (CREW CONF) (PHOTO/TV, P/TV SCENES)			
	20:00 A1(B1) AUTO/VERN	CREW CONF AUDIO/TV CK	P/TV04 OPS (CREW CONF) (PHOTO/TV, P/TV SCENES)				TV (TDRE) (CREW CNTL- CAB)
		CREW CONFERENCE TV at TDRE (20:25-20:55)		CREW CONFERENCE	CREW CONFERENCE	CREW CONFERENCE	
	21:00	MNVR (TRK) -ZLV, +YVV TG=2 BV=3 OM=270 A/AUTO/VERN Init TRK	MEMORY MODULE REPLACE (PL OPS, RME-III)	PACKET PRESTOW SHUTDOWN (PL OPS, SAREX-C)	EVALUATION OF MICR CAPT (BIOMED, DTO 677) Data Collection, Step C		
				SAREX PWRDN (PL OPS, SAREX-C) SAREX STOW (PL OPS, SAREX-C)	EOM DATA RT CHG/TMP RESET (PL OPS, CPCG-III) STL-B VIDEO ASSEMBLY (PL OPS, STL-B) STL-B TV DNLK (PL OPS, STL-B) DNLK at TDRE (21:42-22:11)	EXERCISE Don heartwatch & log exercise (BIOMED, DSQ 624)	DNLK (TDRE) STL VIDEO
			EXERCISE Don heartwatch & log exercise (BIOMED, DSQ 624)				
	22:00				STL-B ENTRY PREP (PL OPS, STL-B)	MANUAL EVAL SETUP (PL OPS, BDS)	
	23:00	MEAL	MEAL	MEAL	MEAL	MEAL	
		ERGOMETER RECONFIG/STOW (BIOMED, ERGO NOM OPS)	ERGOMETER RECONFIG/STOW (BIOMED, ERGO NOM OPS)	BDS DEACT (PL OPS, BDS)	NIH-R OPS (PL OPS, NIH-R)	DEACT PWRBK AND STOW (PL OPS, CPCG-III)	
	007 00:00				KU-BD ANT STOW (ORB OPS, COMM/INST)		

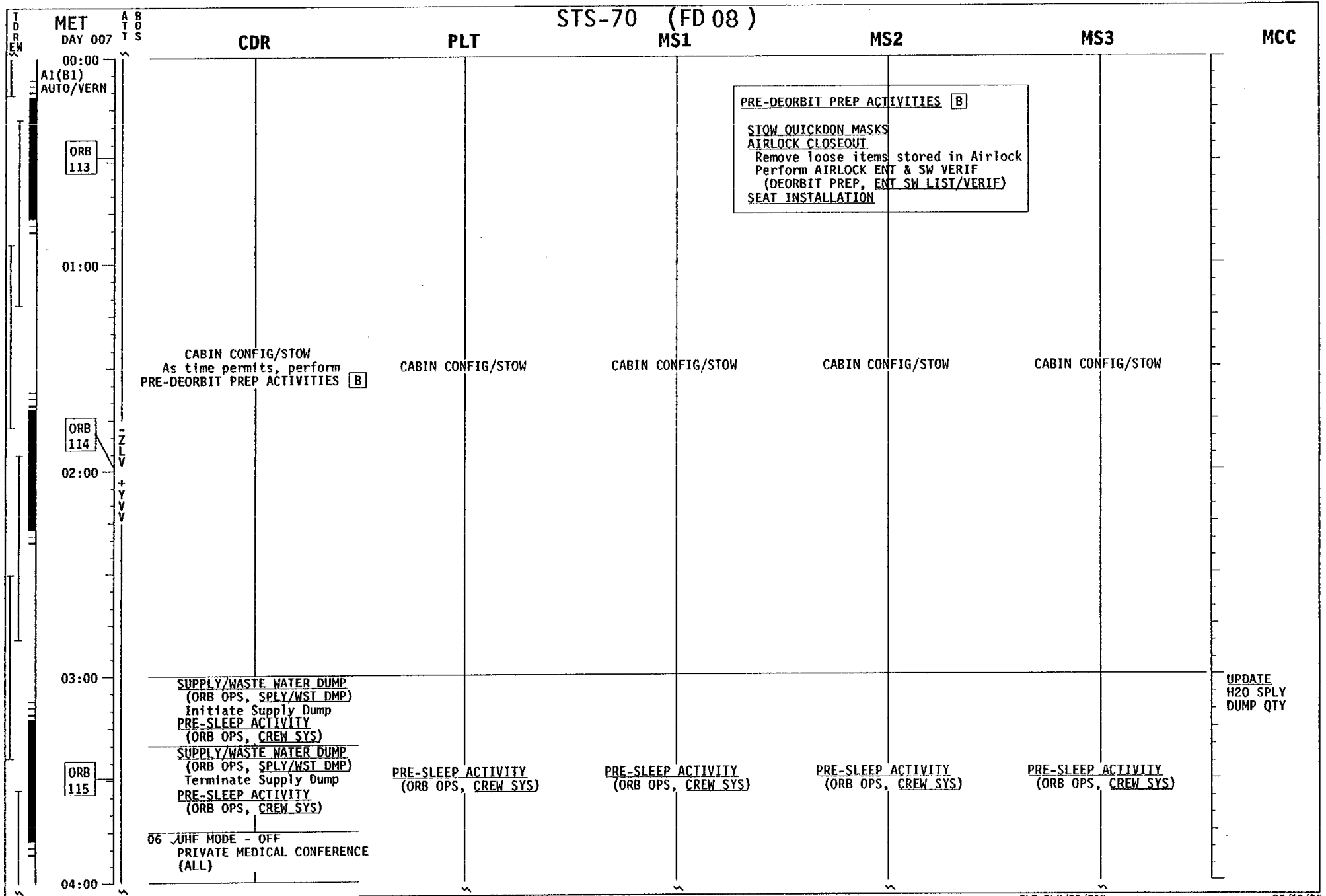

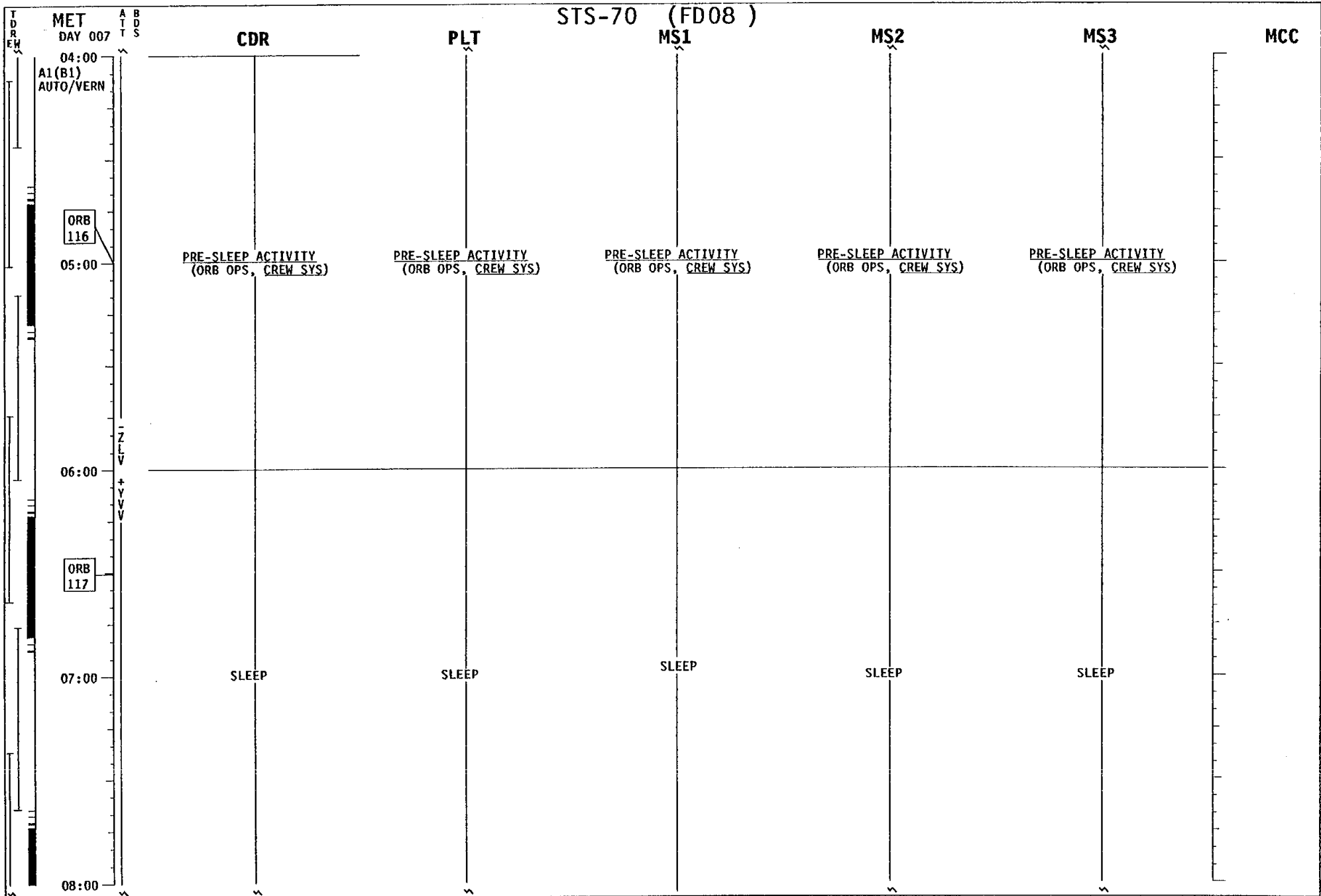

STS-70 (FD 08)

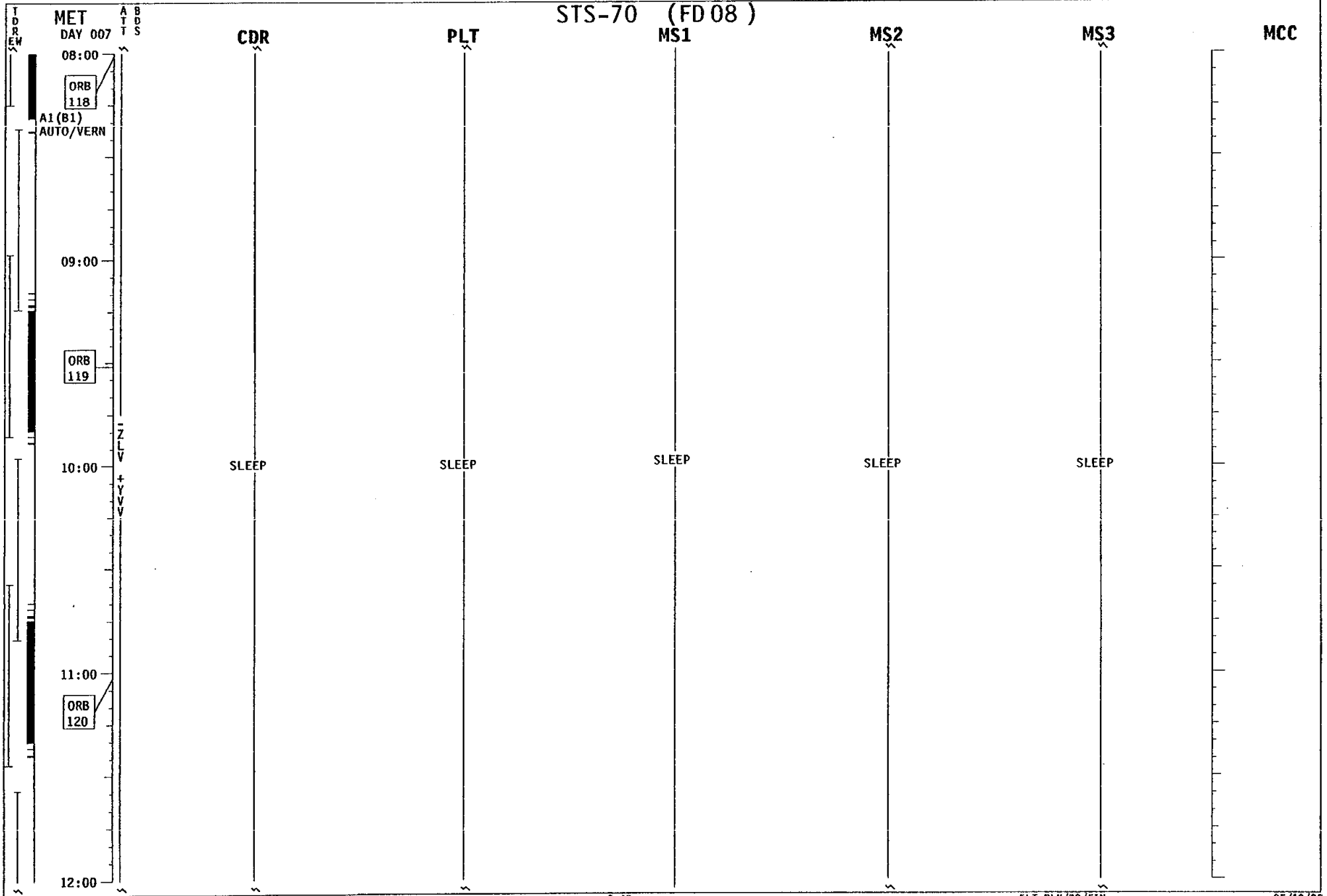



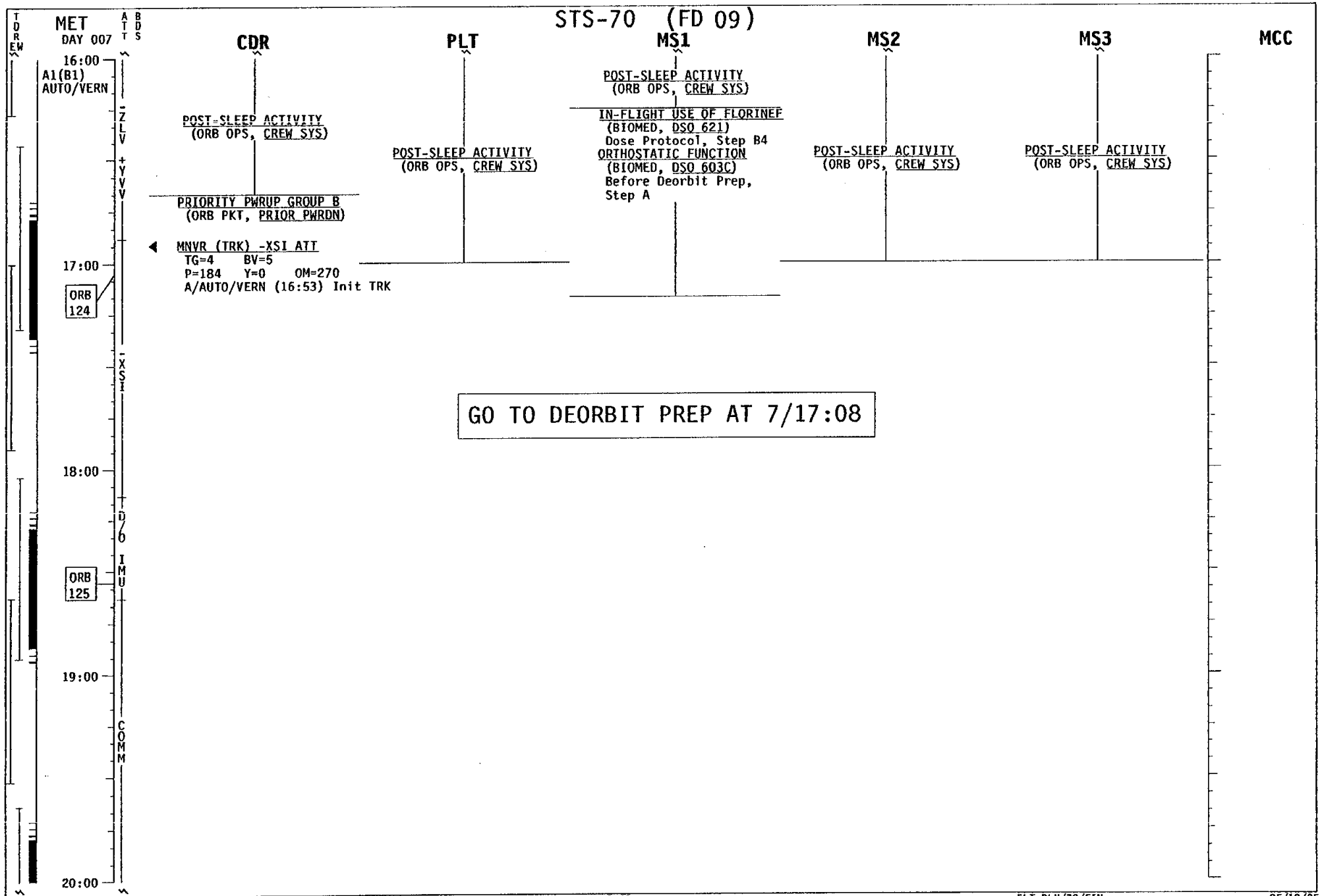



**This Page Intentionally Blank**

CONTINGENCY TIMELINES

7A TDRS INSERTION TIMELINE ..... 4-3  
16A TDRS INSERTION TIMELINE ..... 4-5  
18A TDRS (EVA) INSERTION TIMELINE ..... 4-9  
5 DAY MISSION TIMELINE ..... 4-13

I

**CONTINGENCY  
TIMELINES**

**This Page Intentionally Blank**

## 7A TDRS INSERTION TIMELINE

The 7A TDRS Insertion Timeline is designed to accommodate delaying (6A) deployment of TDRS to the 7A Insertion opportunity. It assumes waveoff occurred after an unsuccessful TDRS Direct Check through GDX/WSGT(4). The timeline is entered with the orbiter in the nominal direct check attitude. An attitude tweak for TDRS-to-GTS Signal Strength verification is required. If the TDRS Direct Check was successful and the 6A delay occurred for other reasons, the "RTS SIG VERIF" and the "2-WAY PI CK" are not required.

Other items to note are:

1. A waveoff could occur as late as the GO/NO-GO point in the deploy countdown for the 6A opportunity. In this case the orbiter will remain in the deploy attitude until the 7A opportunity.
2. The "2-WAY PI CK" and "RTS SIG VERIF" are required to complete TDRS Direct Check requirements assuming the MIL(3) CMD CK was successful.
3. Flight Day 2 wakeup occurs at 0/19:00 MET (vice 0/18:30).



## 16A TDRS INSERTION TIMELINE

The 16A TDRS Insertion Timeline is designed to accommodate delaying (6A) deployment of TDRS to the 16A Insertion opportunity. It assumes waveoff occurred at the GO/NO-GO decision point in the 7A deploy countdown procedure. The timeline is entered with the orbiter in the nominal deploy attitude and the tilt table at 29°.



GMT (D:H:M)	MET (D:H:M)	CDT (D:H:M)	FD/ DOY	BETA	MOON	HOUSTON DATE	FLIGHT	EDITION	PUB. DATE										
160:02:20/ 160:14:20	000:12:00/ 001:00:00	159:21:20/ 160:09:20	1 /159 CDT	2.9		JUNE 8, 1995	STS-70	FINAL	05/10/95										
CDT :159 FD :001 MET :000									MET:001										
STS	SLEEP (7.0)			AMU/IMU SEQ	7LV MNRV	PACMAN SUITUP	TDRS DIR	MNRV	DPY ATT	DMS SEP	PROTECT	ASRM	7LV MNRV	KUI-BD DPLY	KUI-BD ACT	PG	SAREX SETUP	ROCKET OPS	PACKET OPS
	POST SLEEP									DEPLOY	BURN	MNRV			VTR	VTR	VSA	VSA	VSA
										◀ TDRS-G DEPLOY ▶									
						P/TV05 DPY				P/TV05 DPY							VFT TEST CDR	VFT TEST CDR	VFT TEST CDR
PL						IUS PDCO	IUS/PI	TDRS DIR	TDRS DIR	DEPLOY	DEPLOY	DEPLOY	DEPLOY	DEPLOY	DEPLOY	DEPLOY	BDS MEDIUM SMPL	BDS MEDIUM SMPL	BDS MEDIUM SMPL
DAY/NIGHT ORBIT	9	10	11	12	13	14	15	16											
GSTDN COVERAGE				-CAN		--CAN				-MIL -BDA							-MIL -BDA		-CAN
RTS COVERAGE	-GTS		-GTS				-DGS										-GTS		-IOS
TDRS E W																			
ATTITUDE			-ZLV +YVV		AMU/IMU		-ZLV -YVV		TDRS CK		DPLY	VIEW					-ZLV +YVV		
NOTES:	@-ZLV, -YVV @TDRS DIR CK (MIL/BDA) @IUS PDCO (TDRE) @IUS/PI LOCK (TDRE)																		
<b>16A TDRS INSERTION</b>																			



GMT (D:H:M)	MET (D:H:M)	CDT (D:H:M)	FD/ DOY	BETA	MOON	HOUSTON DATE	FLIGHT	EDITION	PUB. DATE								
160:14:20 / 161:02:20	001:00:00 / 001:12:00	160:09:20 / 160:21:20	2 / 160 CDT	4.4		JUNE 9, 1995	STS-70	FINAL	05/10/95								
CDT :160 FD :002 MET :001																	
STS	ERGOMETER SETUP	T/S SETUP	MEAL	VIS VEST INTEG	VIS VEST INTEG	P/TV02 SETUP FDDK	P/TV02 OPS FDDK	FILTER CLEANING	ORB ADJ MNVR	ZLV MNVR	PAO EVENT	PCONF MED	DTOR 779	MNVR	RETURN TO TIME LINE NOMINAL	SLEEP	
	STL TV DNLC			HERCULES ASSEMBLY		WINDEX SETUP	WINDEX OPS										
	VFT TEST MS3	P/TV03 SETUP MDDK		P/TV03 OPS MDDK		SARICX OPS											
PL	SARICX OPS	P/TV08 SETUP BDS		BDS MEDIUM SMPL	NIH-R OPS	BDS CELL SMPL	BDS MEDIA RPLC		BDS MEDIUM SMPL								
DAY/NIGHT ORBIT	17	18	19	20	21	22	23	24									
GSTDN COVERAGE	-GDX -WSG -MIL -BDA	-WSG -MIL -BDA	-MIL	-GDX -WSG	-GDX -WSG	-GDX -WSG	-GDX -WSG	-GDX -WSG	-GDX -WSG	-GDX -WSG	-GDX -WSG	-GDX -WSG	-GDX -WSG	-GDX -WSG	-GDX -WSG	-GDX -WSG	
RTS COVERAGE	HTS -VTS -CTS	-GDX -VTS -CTS	-GDX -VTS -CTS	-GDX -VTS -CTS	-GDX -VTS -CTS	-GDX -VTS -CTS	-GDX -VTS -CTS	-GDX -VTS -CTS	-GDX -VTS -CTS	-GDX -VTS -CTS	-GDX -VTS -CTS	-GDX -VTS -CTS	-GDX -VTS -CTS	-GDX -VTS -CTS	-GDX -VTS -CTS	-GDX -VTS -CTS	
TDRS																	
ATTITUDE			-ZLV +YVV		BURN											+XLV +ZVV (DT0779)	
NOTES:			DSO 604A OI-I VISUAL VESTIBULAR INTEGRATION			MEM MOD											

16A TDRS INSERTION

## 18A TDRS (EVA) INSERTION TIMELINE

The 18A TDRS Insertion Timeline is designed to accommodate delaying deployment of TDRS until the first available opportunity following an EVA to manually raise the tilt table. The decision to perform an EVA must be made by 0/05:00 MET in order to meet EVA preparation and equipment constraints.

Other items to note are:

1. "Go for EVA" occurs following failure to raise the tilt table to 29°.
2. Attempts will be made to raise the IUS/TDRS prior to airlock depress.
3. IUS is restowed prior to cycling of the PRLAs.

GMT (D:H:M)	MET (D:H:M)	CDT (D:H:M)	FD/ DOY	BETA	MOON	HOUSTON DATE	FLIGHT	EDITION	PUB. DATE					
159:14:20/ 160:02:20	000:00:00/ 000:12:00	159:09:20/ 159:21:20	1 /159 CDT	1.6		JUNE 8, 1995	STS-70	FINAL	05/10/95					
CDT :159 FD :001 MET :000	0	10	11	12	13	14	15	16	17	18	19	20	21	12
STS														
PL														
DAY/NIGHT														
ORBIT														
GSTDN COVERAGE														
RTS COVERAGE														
TDRS														
ATTITUDE														
NOTES:														

**18A TDRS (EVA) INSERTION**

GMT (D:H:M)	MET (D:H:M)	CDT (D:H:M)	FD/ DOY	BETA	MOON	HOUSTON DATE	FLIGHT	EDITION	PUB. DATE						
160:02:20/ 160:14:20	000:12:00/ 001:00:00	159:21:20/ 160:09:20	/159 CDT	2.9		JUNE 8, 1995	STS-70	FINAL	05/10/95						
CDT :159 FD :002 MET :000	12	13	14	15	16	17	18	19	20	21	22	23	0	MET:001	
STS	SLEEP (6.5)					ZLV MNV R	PRIV MED	AMU/IMU SEQUENCE	ZLV MNV R	TDRS DIR	TDRS DIR	IUS PI	DPY ATT	MNV R	
	POST SLEEP								P/TV05 OPS DPY						
						10 2 MAINT	EVA PREP	75 min Suit P/B	EVA			A L E G E R S			
PL						IUS PDCO	IUS DIR	PLB PREP 16A DPY	EVA SUPPORT 17A DPY					C O N T R O L S	
DAY/NIGHT ORBIT	9	10	11	12	13	14	15	16							
GSTDN COVERAGE			-CAN		-CAN		-MIL -BDA	-WSG -MIL -BDA	-CAN		-MIL -BDA		-CAN		
RTS COVERAGE	-GTS		-GTS		-DGS		-CAN		-IOS -DGS		-WSG -CTS		-IOS		
TDRS E W							-IOS				-VTS		-HTS		
ATTITUDE	-ZLV +YVV					-ZLV -YVV			AMU/IMU		-ZLV -YVV		TDRS CK IDPLY		
NOTES:						⊙-ZLV, -YVV		⊙IUS PDCO (TDRE)		⊙IUS DIRECT (IOS)		⊙DEPRESS/REPRESS (Cue Card)		⊙TDRS DIR CK (WSG/MIL) ⊙IUS/PI LOCK (TDRE) ⊙IUS MAN ELEV (EVA, IUS MAN ELEV) [2] ELEVATE TO 45° ⊙EVA PREP FOR IUS MAN ELEV [1] (EVA, IUS MAN ELEV)	
<b>18A TDRS (EVA) INSERTION</b>															



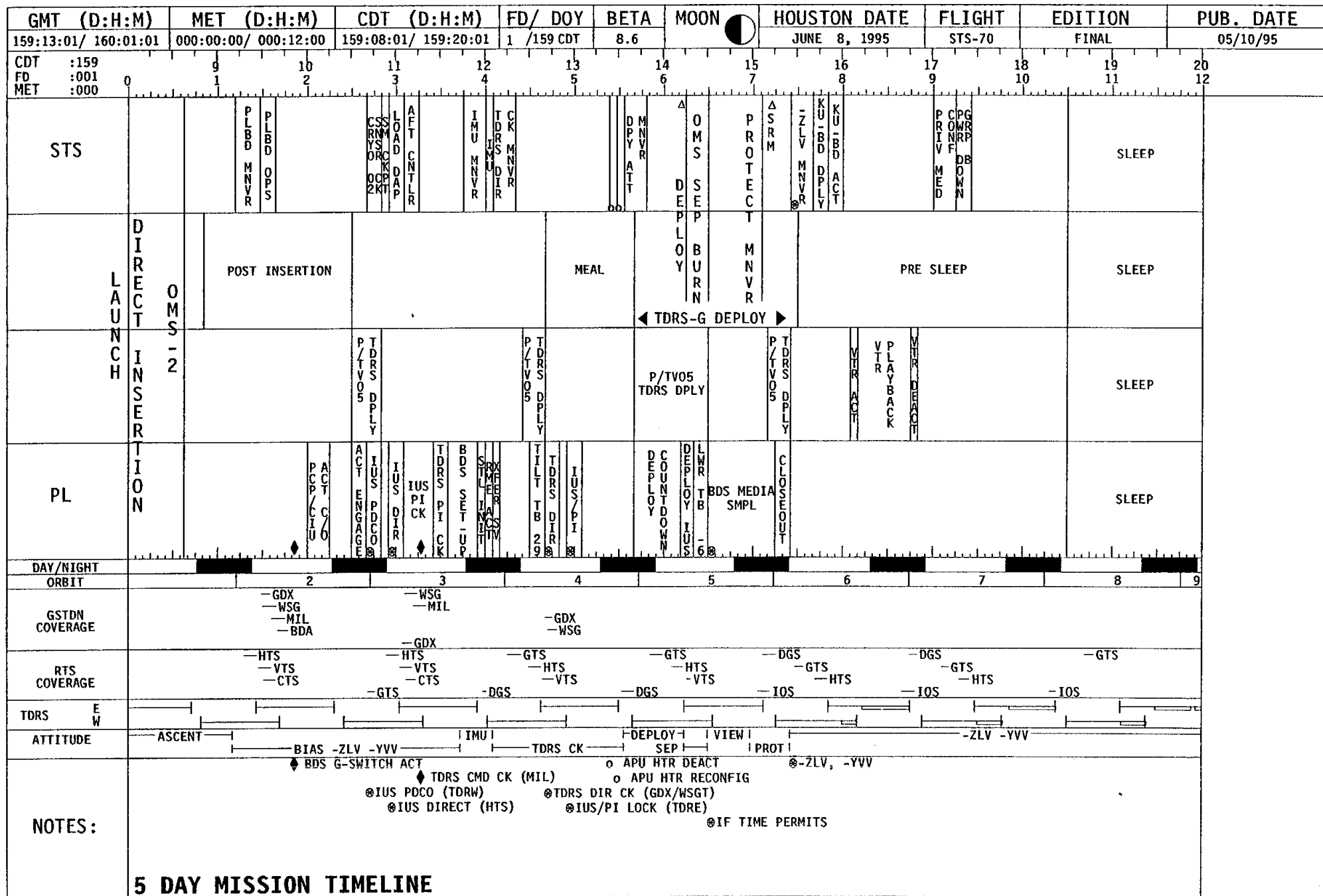

## 5 DAY MISSION TIMELINE

The 5 Day Mission Timeline assumes a June 8, 13:01 GMT lift-off, with landing at MET 4/23:27. The trajectory incorporates a 22 fps burn on FD2. NIH-R (PARE) is not scheduled.





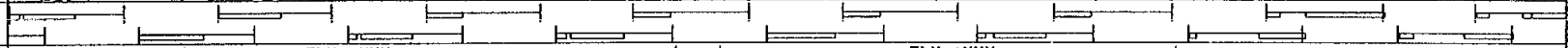

GMT (D:H:M)	MET (D:H:M)	CDT (D:H:M)	FD/ DOY	BETA	MOON 	HOUSTON DATE	FLIGHT	EDITION	PUB. DATE				
160:13:01/ 161:01:01	001:00:00/ 001:12:00	160:08:01/ 160:20:01	2 /160 CDT	12.1		JUNE 9, 1995	STS-70	FINAL	05/10/95				
CDT :160 FD :002 MET :001	0	1	2	3	4	5	6	7	8	9	10	11	12
CDR HENRICKS	VIS VEST INTEG	MEAL	P/TV02 SETUP FDDK	HERCULES ASSEMBLY	EXERCISE	ORBIT ADJUST BURN	ZLV M NVR	PAO EVENT	PRE SLEEP	CONF MED	PRE SLEEP	PRE SLEEP	SLEEP
PLT KREGEL	EXERCISE	VIS VEST INTEG	MEAL	VOICE OPS	HERCULES ASSEMBLY	WINDEX SETUP	WINDEX OPS	PAO EVENT	MEM MOD		PRE SLEEP		SLEEP
MS1 THOMAS	VOICE OPS	MEAL	P/TV03 OPS MIDDK	POPS FDDK	VOICE OPS	P/TV02 OPS FDDK	BDS CHECK			VOICE OPS	PRE SLEEP	PRE SLEEP	SLEEP
MS2 CURRIE	P/TV03 OPS MIDDK	MEAL	MCD SMPL COLLECT		WINDEX SETUP	EXERCISE		CTC STUS			PRE SLEEP		SLEEP
MS3 WEBER	BDS PHASE II SETUP	MEAL	BDS INJ OF BEADS	P/TV08 SETUP BDS	BDS IN PHASE	BDS CHECK	EXERCISE	BDS CHECK		BDS CHECK	PRE SLEEP	PRE SLEEP	SLEEP
DAY/NIGHT ORBIT	17	18	19	20	21	22	23	24					
EARTH TRACE													
TDRS													
ATTITUDE	-ZLV +YVV      BURN      -ZLV +YVV      +YLV -ZVV												
NOTES:	P/TV03 SETUP MIDDK      AFD WINDOW (W10)      -ZLV, +YVV DSO 604A 01-1 VISUAL VESTIBULAR INTEGRATION      THRUSTER PLUMES JOINT OPS# 55 DTO 677 EVAL OF MICROBIAL CAPTURE DEVICE      MEM MOD RPLC												

### 5 DAY MISSION TIMELINE

GMT (D:H:M)	MET (D:H:M)	CDT (D:H:M)	FD/ DOY	BETA	MOON	HOUSTON DATE	FLIGHT	EDITION	PUB. DATE						
161:01:01/ 161:13:01	001:12:00/ 002:00:00	160:20:01/ 161:08:01	3 /160 CDT	14.0		JUNE 9, 1995	STS-70	FINAL	05/10/95						
CDT :160 FD :002 MET :001	21 13	22 14	23 15	0 16	CDT:161 17	2 FD03 18	3 19	4 20	5 21	6 22	7 23	8 0	MET:002		
CDR HENRICKS	SLEEP				POST SLEEP				I MU MNV R	H MV MNV R	VFT TESTS	HFTOUCH	SARTEX VORTEX HFTOUCH		
PLT KREGEL	SLEEP				POST SLEEP				HERCULES ACT	HERCULES			HERCULES		
MS1 THOMAS	SLEEP				POST SLEEP				HERCULES ACT	P/TV02 SETUP FDDK	HERCULES	SARTEX VORTEX	HFTOUCH		
MS2 CURRIE	SLEEP				POST SLEEP				NM UN CN LIT TOR	DOOR S-LIMB	NM UN CN LIT TOR	NM UN CN LIT TOR	POST NUCL EDATA RT	EXERCISE	HFTOUCH
MS3 WEBER	SLEEP				POST SLEEP				VFT TESTS	BDS STATUS CK	BDS MAN EVAL SETUP				
DAY/NIGHT ORBIT															
EARTH TRACE															
TDRS E W															
ATTITUDE															
NOTES:	<p>⊗-ZLV, +YVV      ⊗DSO 904 HUMAN FACTORS</p> <p>⊗DSO 904 HUMAN FACTORS</p>														

**5 DAY MISSION TIMELINE**

GMT (D:H:M)	MET (D:H:M)	CDT (D:H:M)	FD/ DOY	BETA	MOON	HOUSTON DATE	FLIGHT	EDITION	PUB. DATE
161:13:01/ 162:01:01	002:00:00/ 002:12:00	161:08:01/ 161:20:01	3 /161 CDT	15.9		JUNE 10, 1995	STS-70	FINAL	05/10/95

CDT :161	9	10	11	12	13	14	15	16	17	18	19	20	
FD :003	0	1	2	3	4	5	6	7	8	9	10	11	12
MET :002													

CDR HENRICKS	EXERCISE	MEAL	HFTOUCH	WADU SM TP E T E R M	WINDEX PRCS TEST	PAO E V E N T	PRE SLEEP	CON F M E D	PRE SLEEP	DT O V R 7 7 9	PRE SLEEP	SLEEP
PLT KREGEL	HERCULES	MEAL	HERIC DEACT	WAS T E I N I T	EXERCISE	WINDEX OPS	PRE SLEEP	PRE SLEEP	PRE SLEEP	PRE SLEEP	SLEEP	
MS1 THOMAS	MEAL	P/TVO3 SETUP MIDDK	PO TS OM 3 I D D K	PAO E V E N T	EXERCISE	S V O I C E O P S	PRE SLEEP	PRE SLEEP	PRE SLEEP	PRE SLEEP	SLEEP	
MS2 CURRIE	HFTOUCH	MEAL	MC O L L D E A C T I A	W I N D E X S E T U P	WINDEX OPS	S A T S O P E R I B I D E Y O	STL TV DNLK	C S P I C A G T U S C K	PRE SLEEP	S V O I C E O P S	PRE SLEEP	SLEEP
MS3 WEBER	BDS MAN EVAL SETUP	MEAL	BDS MAN EVAL SETUP	S V O I C E O P S	PAO E V E N T	BDS TRANS MAN-AUTO	EXERCISE	PRE SLEEP	PRE SLEEP	PRE SLEEP	SLEEP	

DAY/NIGHT	33	34	35	36	37	38	39	40
-----------	----	----	----	----	----	----	----	----



ATTITUDE	-ZLV +YVV	+YLV -ZVV
----------	-----------	-----------

NOTES:

- @DSO 904 HUMAN FACTORS
- @DSO 904 VIDEO OPTIONAL
- @THRUSTER PLUMES NEARFIELD# 8,9,10
- @DTO 677 EVAL OF MICROBIAL CAPTURE DEVICE
- @AFD WINDOW (W10)
- @WATER DUMP EFFECTS# 52

**5 DAY MISSION TIMELINE**



GMT (D:H:M)	MET (D:H:M)	CDT (D:H:M)	FD/ DOY	BETA	MOON	HOUSTON DATE	FLIGHT	EDITION	PUB. DATE			
162:13:01/ 163:01:01	003:00:00/ 003:12:00	162:08:01/ 162:20:01	4 /162 CDT	19.9		JUNE 11, 1995	STS-70	FINAL	05/10/95			
CDT :162 FD :004 MET :003	9 1	10 2	11 3	12 4	13 5	14 6	15 7	16 8	17 9	18 10	19 11	20 12
CDR HENRICKS	MEAL	VIS VEST INTEG	WINDEX PRCS TEST	GG MNVR	PRE SLEEP	PRIV MED COZ SALUB DUMI INTI	PRE SLEEP	SALY DUMI HORE	PRE SLEEP	SLEEP		
PLT KREGEL	MEAL	VIS VEST INTEG	S VOICE RECE OPS	EXERCISE	P/TVO3 MIDDK		PRE SLEEP			SLEEP		
MS1 THOMAS	MEAL	P/TVO3 OPS MIDDK	EXERCISE	S VOICE RECE OPS	MIS-B ACT		PRE SLEEP			SLEEP		
MS2 CURRIE	MEAL	MC COLL DEACTA	HFTOUCH	WINTUP INDEX	WINDEX OPS	WINDEX STOW	HERC STOW	CS PT CA GT US CK		PRE SLEEP		SLEEP
MS3 WEBER	MEAL	P/TV10 SETUP 802	P/TV10 OPS 802	BDS TRANS MAN-AUTO	EXERCISE		PRE SLEEP	S VOICE RECE OPS	PRE SLEEP	SLEEP		
DAY/NIGHT												
ORBIT	49 50 51 52 53 54 55 56											
EARTH TRACE												
TDRS												
ATTITUDE	-ZLV +YVV BIAS+XIV +YVV (GG)											
NOTES:	<ul style="list-style-type: none"> <li>⊙DSO 604A 01-1 VISUAL VESTIBULAR INTEGRATION</li> <li>⊙DSO 802 EDUCATIONAL ACTS</li> <li>⊙DTO 677 EVAL OF MICROBIAL CAPTURE DEVICE</li> <li>⊙DSO 904 VIDEO OPTIONAL THRUSTER PLUMES NEARFIELD# 11,12,13,14</li> <li>⊙AFD WINDOW (W10)</li> </ul>											

### 5 DAY MISSION TIMELINE

GMT (D:H:M)	MET (D:H:M)	CDT (D:H:M)	FD/ DOY	BETA	MOON	HOUSTON DATE	FLIGHT	EDITION	PUB. DATE					
163:01:01/ 163:13:01	003:12:00/ 004:00:00	162:20:01/ 163:08:01	5 /162 CDT	21.9	☉	JUNE 11, 1995	STS-70	FINAL	05/10/95					
CDT :162 FD :004 MET :003	12	21 13	22 14	23 15	FD05 16	CDT:163 17	2 18	3 19	4 20	5 21	6 22	7 23	8 24	0 MET:004
CDR HENRICKS	SLEEP	POST SLEEP	EXERCISE	VFT TESTS	FCS C/O	RCS HOT FIRIE	BRIEFING D/O PREP	AUTO M NVR CONF	CREW CONF	-ZLV M NVR				
PLT KREGEL	SLEEP	POST SLEEP			FCS C/O	RCS HOT FIRIE	BRIEFING D/O PREP	P/TV04 OPS CONF				EXERCISE		
MS1 THOMAS	SLEEP	POST SLEEP			EXERCISE		BRIEFING D/O PREP	P/TV04 SETUP CONF	CREW CONF	PACKET SHUTDN	SAREX STOW			
MS2 CURRIE	SLEEP	POST SLEEP	EXERCISE		FCS C/O	RCS HOT FIRIE	BRIEFING D/O PREP		CREW CONF	MCOLL DEACTA	SAREX STOW	STL TV DNLK	SPLE ENT	EROT M CH AN TG A
MS3 WEBER	SLEEP	POST SLEEP	VFT TESTS	BDS STATUS CK	BDS MAN EVAL SETUP		BRIEFING D/O PREP		CREW CONF		EXERCISE	BDS MAN EVAL SETUP		
DAY/NIGHT	[Day/Night Cycle: 57-64]													
ORBIT	[Orbit Diagram]													
EARTH TRACE	[Earth Trace Diagram]													
TDRS	[TDRS Diagram]													
ATTITUDE	BIAS+XLV +YVV (GG)      IIMUI      -ZLV -YVV      CREW CONF      -ZLV +YVV													
NOTES:	<p>■ APU HTR ACT      ■ APU HTR RECONFIG      ⊙ -ZLV, +YVV</p> <p>⊙ -ZLV, -YVV      ⊙ MEM MOD RPLC</p> <p>⊙ DSO 904 HUMAN FACTORS      Δ SAREX PWRDN</p> <p>⊙ DTO 677 EVAL OF MICROBIAL CAPTURE DEVICE</p>													
<b>5 DAY MISSION TIMELINE</b>														



GMT (D:H:M)	MET (D:H:M)	CDT (D:H:M)	FD/ DOY	BETA	MOON	HOUSTON DATE	FLIGHT	EDITION	PUB. DATE				
164:01:01/ 164:13:01	004:12:00/ 005:00:00	163:20:01/ 164:08:01	6 /163 CDT	26.0	☉	JUNE 12, 1995	STS-70	FINAL	05/10/95				
CDT :163 FD :005 MET :004	21 13	22 14	23 15	0 16	CDT:164 17	2 18	3 19	4 20	5 21	6 22	7 23	8 0	MET:005
CDR HENRICKS	SLEEP	POST SLEEP	POST SLEEP	POST SLEEP	DEORBIT PREP	DEORBIT PREP	DEORBIT PREP	DEORBIT PREP	DEORBIT PREP	DEORBIT PREP	DEORBIT PREP	DEORBIT PREP	DEORBIT PREP
PLT KREGEL	SLEEP	POST SLEEP	POST SLEEP	POST SLEEP	DEORBIT PREP	DEORBIT PREP	DEORBIT PREP	DEORBIT PREP	DEORBIT PREP	DEORBIT PREP	DEORBIT PREP	DEORBIT PREP	DEORBIT PREP
MS1 THOMAS	SLEEP	POST SLEEP	POST SLEEP	POST SLEEP	DEORBIT PREP	DEORBIT PREP	DEORBIT PREP	DEORBIT PREP	DEORBIT PREP	DEORBIT PREP	DEORBIT PREP	DEORBIT PREP	DEORBIT PREP
MS2 CURRIE	SLEEP	POST SLEEP	POST SLEEP	POST SLEEP	DEORBIT PREP	DEORBIT PREP	DEORBIT PREP	DEORBIT PREP	DEORBIT PREP	DEORBIT PREP	DEORBIT PREP	DEORBIT PREP	DEORBIT PREP
MS3 WEBER	SLEEP	POST SLEEP	POST SLEEP	POST SLEEP	DEORBIT PREP	DEORBIT PREP	DEORBIT PREP	DEORBIT PREP	DEORBIT PREP	DEORBIT PREP	DEORBIT PREP	DEORBIT PREP	DEORBIT PREP
DAY/NIGHT ORBIT	73	74	75	76	77	78	79	80					
EARTH TRACE													
TDRS E W													
ATTITUDE	-ZLV +YVV D/O IMU -XSI COMM D/O ENTRY												
NOTES:	<p>5 DAY MISSION TIMELINE</p> <p>⊙DSO 621 IN-FLIGHT USE OF FLORINEF  ⊙DSO 621 IN-FLIGHT USE OF FLORINEF  ⊙DSO 603C ORTHOSTATIC FUNCTION</p> <p>* DEORBIT BURN 4/22:30  * KSC LANDING 4/23:27</p>												



**This Page Intentionally Blank**

**The sections following this divider page will not be included in flight copies.**

ATTITUDE TIMELINE

ATTITUDE  
TIMELINE

Attitude Timeline

MET/GMT	MNVR OPTION	DAP	E/S	REF ATT/REMARKS	EVENT	
1 000/01:12:00 MET 24:14 159/15:32:00 GMT 44:14	TGT=2 BV=3 P= 90.00 Y= 0.00 OM= 58.00	A6 AUTO ALT	RATE 0.2000 DB AT 5.00 DB RT 0.070	EARTH R 0 P 90	LVLH R= 0.00 P=180.00 Y=302.00	-ZLV Bias -YVV PLBD Opening IUS DIR CHECK
2 000/03:43:00 MET 49:30 159/18:03:00 GMT 09:30	INRTL R=344.00 MNVR P=321.00 Y=352.00  MNVR at SS	A1 AUTO VERN	RATE 0.2000 DB AT 1.000 DB RT 0.020	SUN R 116 P 73	STAR PAIR A1 -Y ST: 43 -Z ST: 28	IMU ALIGN
3 000/04:00:00 MET 07:09 159/18:20:00 GMT 27:09	INRTL R=262.00 MNVR P=285.00 Y=359.00  MNVR post align	B1 AUTO VERN	RATE 0.2000 DB AT 1.000 DB RT 0.020	SUN R 180 P 65		TDRS DIR CHECK
4 000/05:32:49 MET 44:50 159/19:52:49 GMT 20:04:50 DPLY - 40:00	TGT=4 RA= 75.794 BV=5 DEC= 22.803N P=282.80 Y= 0.00 OM= 90.00 DEPLOY 06:12:49	A9 AUTO VERN	RATE 0.2000 DB AT 1.000 DB RT 0.020	SUN R 180 P 77	INRTL R=293.83 P= 58.87 Y= 27.46	IUS/TDRS DEPLOY
5 000/06:13:49 MET 159/20:33:49 GMT DPLY +01:00	INRTL BV=5 ROTR P= 0.00 Y=270.00	B1 FREE PRI	RATE 0.8240 DB AT 3.00 DB RT 0.20		INRTL R=293.82 P= 58.80 Y= 27.45	2.2 FPS -X SEP -70 DEG PITCH
6 000/06:15:14 MET 159/20:35:14 GMT		B1 INRT PRI	RATE 0.5000 DB AT 3.00 DB RT 0.20	SUN R 180 P 7	INRTL R= 23.54 HOLD P=314.98 Y= 66.98	NULL PITCH RATE
7 000/06:19:49 MET 23:30 159/20:39:49 GMT 43:30 DPLY +07:00	INRTL R=167.00 MNVR P=141.00 Y= 5.00	B1 AUTO PRI	RATE 0.5000 DB AT 3.00 DB RT 0.20	SUN R 273 P 110	TIG: ~0/06:27	OMS SEP
8 000/06:29:49 MET 33:15 159/20:49:49 GMT 53:15	TGT=2 BV=5 P=165.00 Y= 0.00 OM= 0.00	B1 AUTO PRI	RATE 0.5000 DB AT 3.00 DB RT 0.20	EARTH R 360 P 165	LVLH R= 0.00 P=105.00 Y= 0.00	IUS Viewing LVLH Equip Tgt Track
9 000/06:34:00 MET 159/20:54:00 GMT	LVLH FREE ROTATION ROTR ABOUT +Y AXIS RATE=0.080	B1 LVLH PRI	RATE 0.5000 DB AT 3.00 DB RT 0.20		LVLH R= 0.00 P=105.00 Y= 0.00	IUS Viewing LVLH Equip Tgt Track
10 000/06:57:49 MET 07:02:30 159/21:17:49 GMT 22:30 DPLY +45:00	TGT=2 BV=5 P=270.00 Y= 0.00 OM= 0.00	B1 AUTO PRI	RATE 0.5000 DB AT 3.00 DB RT 0.20	EARTH R 180 P 90	LVLH R= 0.00 P= 0.00 Y= 0.00	WINDOW PROTECT LVLH Equip Tgt Track
11 000/07:03:00 MET 159/21:23:00 GMT	LVLH FREE ROTATION ROTR ABOUT +Y AXIS RATE=0.028	B1 LVLH PRI	RATE 0.5000 DB AT 3.00 DB RT 0.20		LVLH R= 0.00 P= 0.00 Y= 0.00	WINDOW PROTECT LVLH Equip Tgt Track
12 000/07:12:49 MET 159/21:32:49 GMT DPLY +60:00		B1 INRT VERN	RATE 0.2000 DB AT 1.000 DB RT 0.020	SUN R 182 P 64	INRTL R=284.11 HOLD P=334.01 Y= 4.83	IUS SRM-1

\*\*\* ALL ATTITUDES IN MEAN OF 1950 \*\*\*  
\*\*\* PYR EULER SEQUENCE \*\*\*

Attitude Timeline

MET/GMT	MNVR OPTION	DAP	E/S	REF ATT/REMARKS	EVENT	
13 000/07:25:00 MET 36:18 159/21:45:00 GMT 56:18	TGT=2 BV=3 P= 90.00 Y= 0.00 OM= 90.00	A1 AUTO VERN	RATE 0.2000 DB AT 1.000 DB RT 0.020	EARTH R 360 P 90	LVLH R= 0.00 P=180.00 Y=270.00	-ZLV Nose North VTR Playback
14 000/20:20:00 MET 25:41 160/10:40:00 GMT 45:41	INRTL R=338.00 MNVR P=280.00 Y=299.00	A1 AUTO VERN	RATE 0.2000 DB AT 1.000 DB RT 0.020	SUN R 102 P 125	Special Pair -Z: 26 -Y: 78	IMU ALIGN
15 000/20:35:00 MET 44 160/10:55:00 GMT 44	INRTL R=343.00 MNVR P=287.00 Y=307.00	A1 AUTO VERN	RATE 0.2000 DB AT 1.000 DB RT 0.020	SUN R 101 P 117	HUD Star: 14	HUD CAL
16 000/21:00:00 MET 10:58 160/11:20:00 GMT 30:58	TGT=2 BV=3 P= 90.00 Y= 0.00 OM=270.00	A1 AUTO VERN	RATE 0.2000 DB AT 1.000 DB RT 0.020	EARTH R 360 P 90	LVLH R= 0.00 P=180.00 Y= 90.00	-ZLV Nose South
17 001/05:10:00 MET 18:15 160/19:30:00 GMT 38:15	INRTL R=149.00 MNVR P= 91.00 Y= 88.00	A1 AUTO VERN	RATE 0.2000 DB AT 1.000 DB RT 0.020	SUN R 327 P 28	TIG: 1/05:25:00	OMS 4 Orbit Adjust
18 001/05:30:00 MET 36:33 160/19:50:00 GMT 56:33	TGT=2 BV=3 P= 90.00 Y= 0.00 OM=270.00	A1 AUTO VERN	RATE 0.2000 DB AT 1.000 DB RT 0.020	EARTH R 0 P 90	LVLH R= 0.00 P=180.00 Y= 90.00	-ZLV Nose South
19 001/09:00:00 MET 10:00 160/23:20:00 GMT 30:00	TGT=2 BV=1 P= 0.00 Y= 0.00 OM=180.00	A1 AUTO VERN	RATE 0.2000 DB AT 1.000 DB RT 0.020	EARTH R 13 P 0	LVLH R=180.00 P=270.00 Y= 0.00	+XLV +ZVV DTO 779
20 001/20:30:00 MET 39:28 161/10:50:00 GMT 59:28	INRTL R=344.00 MNVR P=321.00 Y=352.00	A1 AUTO VERN	RATE 0.2000 DB AT 1.000 DB RT 0.020	SUN R 117 P 74	Star Pair A1 -Z: 28 -Y: 43 W2: 14	IMU HERCULES
21 001/21:00:00 MET 10:14 161/11:20:00 GMT 30:14	TGT=2 BV=3 P= 90.00 Y= 0.00 OM=270.00	A1 AUTO VERN	RATE 0.2000 DB AT 1.000 DB RT 0.020	EARTH R 360 P 90	LVLH R= 0.00 P=180.00 Y= 90.00	-ZLV Nose South WINDEX OPS Wste H2O Dump
22 002/08:00:00 MET 15:00 161/22:20:00 GMT 35:00	TGT=2 BV=5 P= 0.00 Y= 90.00 OM=270.00	A1 AUTO VERN	RATE 0.2000 DB AT 1.000 DB RT 0.020	EARTH R 90 P 90	LVLH R= 0.00 P=270.00 Y=270.00	+YLV -ZVV DTO 779
23 002/20:35:00 MET 43:48 162/10:55:00 GMT 11:03:48	INRTL R=344.00 MNVR P=321.00 Y=352.00	A1 AUTO VERN	RATE 0.2000 DB AT 1.000 DB RT 0.020	SUN R 117 P 75	Star Pair A1 -Z: 28 -Y: 43 W2: 14	IMU HERCULES
24 002/21:05:00 MET 15:28 162/11:25:00 GMT 35:28	TGT=2 BV=3 P= 90.00 Y= 0.00 OM=270.00	A1 AUTO VERN	RATE 0.2000 DB AT 1.000 DB RT 0.020	EARTH R 360 P 90	LVLH R= 0.00 P=180.00 Y= 90.00	-ZLV Nose South WINDEX PRCS Tst SPLY H2O Dump

\*\*\* ALL ATTITUDES IN MEAN OF 1950 \*\*\*  
\*\*\* PYR EULER SEQUENCE \*\*\*

Attitude Timeline

MET/GMT	MNVR OPTION	DAP	E/S	REF ATT/REMARKS	EVENT	
25 003/07:00:00 MET 10:00 162/21:20:00 GMT 30:00	TGT=2 BV=1 P= 0.00 Y= 0.00 OM=180.00	A1 AUTO VERN	RATE 0.2000 DB AT 1.000 DB RT 0.020	EARTH R 208 P 0	LVLH R=180.00 P=270.00 Y= 0.00	+XLV +ZVV DTO 779
26 003/19:15:00 MET 23:54 163/09:35:00 GMT 43:54	INRTL R=344.00 MNVR P=321.00 Y=352.00	A1 AUTO VERN	RATE 0.2000 DB AT 1.000 DB RT 0.020	SUN R 118 P 76	Star Pair A1 -Z: 28 -Y: 43 W2: 14	IMU HERCULES
27 003/19:45:00 MET 57:24 163/10:05:00 GMT 17:24	TGT=2 BV=3 P= 90.00 Y= 0.00 OM= 90.00	A1 AUTO VERN	RATE 0.2000 DB AT 1.000 DB RT 0.020	EARTH R 0 P 90	LVLH R= 0.00 P=180.00 Y=270.00	-ZLV Nose North WINDEX PRCS Tst
28 004/06:00:00 MET 07:30 163/20:20:00 GMT 27:30	TGT=2 BV=5 P= 0.00 Y= 90.00 OM=270.00	A1 AUTO VERN	RATE 0.2000 DB AT 1.000 DB RT 0.020	EARTH R 90 P 90	LVLH R= 0.00 P=270.00 Y=270.00	+YLV -ZVV DTO 779
29 004/17:50:00 MET 59:05 164/08:10:00 GMT 19:05	INRTL R=344.00 MNVR P=321.00 Y=352.00	A1 AUTO VERN	RATE 0.2000 DB AT 1.000 DB RT 0.020	SUN R 118 P 76	Star Pair A1 -Z: 28 -Y: 43 W2: 14	IMU HERCULES
30 004/18:20:00 MET 30:01 164/08:40:00 GMT 50:01	TGT=2 BV=3 P= 90.00 Y= 0.00 OM=270.00	A1 AUTO VERN	RATE 0.2000 DB AT 1.000 DB RT 0.020	EARTH R 360 P 90	LVLH R= 0.00 P=180.00 Y= 90.00	-ZLV Nose South WINDEX OPS H2O Simo Dump
31 005/02:30:00 MET 37:51 164/16:50:00 GMT 57:51	TGT=2 BV=5 P=357.50 Y= 1.00 OM=249.20	B3 AUTO VERN	RATE 0.2000 DB AT 1.000 DB RT 0.020	EARTH R 158 P 3	LVLH R=249.19 P=268.18 Y=358.02	+XLV BIAS +YVV (GG-hold) MIS-B
32 005/18:00:00 MET 14:05 165/08:20:00 GMT 34:05	INRTL R=344.00 MNVR P=321.00 Y=352.00	A1 AUTO VERN	RATE 0.2000 DB AT 1.000 DB RT 0.020	SUN R 119 P 77	Star Pair A1 -Z: 28 -Y: 43 W2: 14	IMU HERCULES
33 005/18:30:00 MET 42:02 165/08:50:00 GMT 09:02:02	TGT=2 BV=3 P= 90.00 Y= 0.00 OM= 90.00	A1 AUTO VERN	RATE 0.2000 DB AT 1.000 DB RT 0.020	EARTH R 0 P 90	LVLH R= 0.00 P=180.00 Y=270.00	-ZLV Nose North WINDEX PRCS Tst
34 006/19:50:00 MET 02 166/10:10:00 GMT 02	INRTL R= 43.00 MNVR P=243.00 Y= 9.00	A1 AUTO VERN	RATE 0.2000 DB AT 1.000 DB RT 0.020	SUN R 29 P 64		Crew Conference
35 006/21:00:00 MET 14:59 166/11:20:00 GMT 34:59	TGT=2 BV=3 P= 90.00 Y= 0.00 OM=270.00	A1 AUTO VERN	RATE 0.2000 DB AT 1.000 DB RT 0.020	EARTH R 360 P 90	LVLH R= 0.00 P=180.00 Y= 90.00	-ZLV Nose South SPLY H2O Dump
36 007/16:53:00 MET 59:25 167/07:13:00 GMT 19:25	TGT=4 BV=5 P=184.00 Y= 0.00 OM=270.00 RA= 83.534 DEC= 23.312N	A1 AUTO VERN	RATE 0.2000 DB AT 1.000 DB RT 0.020	SUN R 180 P 176	INRTL R=144.15 P=112.59 Y=291.59	-XSI

\*\*\* ALL ATTITUDES IN MEAN OF 1950 \*\*\*  
\*\*\* PYR EULER SEQUENCE \*\*\*

Attitude Timeline

MET/GMT	MNVR OPTION	DAP	E/S	REF ATT/REMARKS	EVENT
37 007/18:08:00 MET 16:32 167/08:28:00 GMT 36:32	INRTL R=281.00 MNVR P=322.00 Y=323.00	A1 AUTO PRI RATE 0.2000 DB AT 5.00 DB RT 0.20	SUN R 184 P 107	Stars -Y: 29 -Z: 30	D/O IMU ALIGN
38 007/18:23:00 MET 30:17 167/08:43:00 GMT 50:17	INRTL R=298.00 MNVR P=318.00 Y= 49.00	A1 AUTO PRI RATE 0.2000 DB AT 5.00 DB RT 0.20	SUN R 185 P 24	Stars -Y: 49 -Z: 60	D/O IMU VERIF
39 007/18:38:00 MET 49:28 167/08:58:00 GMT 09:09:28	INRTL R=325.00 MNVR P= 69.00 Y=311.00	A1 AUTO PRI RATE 0.2000 DB AT 5.00 DB RT 0.20	SUN R 159 P 155		D/O COMM
40 007/20:53:00 MET 57:56 167/11:13:00 GMT 17:56 TIG -15:00	INRTL R=238.00 MNVR P= 5.00 Y= 66.00	TRN AUTO PRI RATE 0.5000 DB AT 3.50 DB RT 0.20	SUN R 264 P 31	TIG: 7/21:07:59	D/O BURN

\*\*\* ALL ATTITUDES IN MEAN OF 1950 \*\*\*  
 \*\*\* PYR EULER SEQUENCE \*\*\*

**This Page Intentionally Blank**



STS-70 DAP BOOK

## I-LOADED GENERIC DAP A CONFIGURATIONS

	ITEM #	A1	A2	A3	A4	A5	A6	A7	A8
<b>PRI</b>									
ROT RATE	10 (50)	0.2000	0.4000	0.2000	0.5000	0.2000	0.2000	0.2000	0.2000
ATT DB	11 (51)	5.00	1.00	1.00	3.00	5.00	5.00	2.00	2.00
RATE DB	12 (52)	0.20	0.20	0.20	0.20	0.20	0.20	0.20	0.20
ROT PLS	13 (53)	0.10	0.10	0.10	0.10	0.10	0.10	0.10	0.10
COMP	14 (54)	.000	.000	.000	.000	.000	.000	.000	.000
P OPTION	15 (55)	ALL	ALL	ALL	ALL	ALL	TAIL	ALL	ALL
Y OPTION	16 (56)	ALL	ALL	TAIL	ALL	ALL	TAIL	ALL	ALL
TRAN PLS	17 (57)	0.10	0.10	0.10	0.10	0.10	0.10	0.10	0.05
<b>ALT</b>									
RATE DB	18 (58)	0.200	0.200	0.200	0.200	0.070	0.070	0.200	0.200
JET OPT	19 (59)	ALL	ALL	ALL	ALL	ALL	TAIL	ALL	ALL
# JETS	20 (60)	2	2	2	2	1	1	2	2
ON TIME	21 (61)	0.08	0.08	0.08	0.08	0.08	0.08	0.08	0.08
DELAY	22 (62)	0.00	0.00	0.00	0.00	0.00	0.00	0.00	0.00
<b>VERN</b>									
ROT RATE	23 (63)	0.2000	0.4000	0.0080	0.2000	0.2000	0.2000	0.2000	0.2000
ATT DB	24 (64)	1.000	1.000	0.070	1.000	1.000	1.000	1.000	1.000
RATE DB	25 (65)	.020	.020	.010	.020	.020	.020	.020	.020
ROT PLS	26 (66)	0.010	0.010	0.010	0.010	0.010	0.010	0.010	0.010
COMP	27 (67)	.000	.000	.000	.000	.000	.000	.000	.000
CNTL ACC	28 (68)	0	0	0	0	0	0	0	0
PURPOSE		NOMINAL	PTC	GG	PRE/POST DEPLOY	LOSS OF VERNS (NOSE & TAIL)	LOSS OF VERNS (TAIL ONLY)	RNDZ	PROX OPS

STS-70 DAP A CONFIGURATIONS

	ITEM #	A9	A10	A11
<b>PRI</b>				
ROT RATE	10 (50)	0.2000	0.2000	0.2000
ATT DB	11 (51)	<b>1.00</b>	<b>40.00</b>	<b>3.00</b>
RATE DB	12 (52)	0.20	0.20	0.20
ROT PLS	13 (53)	<b>0.05</b>	0.10	<b>1.00</b>
COMP	14 (54)	.000	.000	.000
P OPTION	15 (55)	<b>TAIL</b>	ALL	<b>TAIL</b>
Y OPTION	16 (56)	<b>TAIL</b>	ALL	<b>TAIL</b>
TRAN PLS	17 (57)	<b>0.25</b>	0.10	<b>0.01</b>
<b>ALT</b>				
RATE DB	18 (58)	0.200	<b>0.200</b>	0.200
JET OPT	19 (59)	ALL	<b>TAIL</b>	ALL
# JETS	20 (60)	2	2	2
ON TIME	21 (61)	0.08	0.08	0.08
DELAY	22 (62)	0.00	<b>4.00</b>	0.00
<b>VERN</b>				
ROT RATE	23 (63)	0.2000	0.2000	0.2000
ATT DB	24 (64)	1.000	<b>40.000</b>	1.000
RATE DB	25 (65)	<b>.010</b>	<b>.200</b>	.020
ROT PLS	26 (66)	0.010	0.010	0.010
COMP	27 (67)	.000	.000	.000
CNTL ACC	28 (68)	0	0	0
PURPOSE		IUS DPY	GG-Hold MIS-B	WINDEX PRCS

NOTE: **BOLD-ITALIC** indicates a change from the I-load

I-LOADED GENERIC DAP B CONFIGURATIONS

	ITEM #	B1	B2	B3	B4	B5	B7	B8
<b>PRI</b>								
ROT RATE	30 (50)	0.5000	0.2000	0.2000	0.2000	0.2000	0.5000	0.2000
ATT DB	31 (51)	3.00	3.00	3.00	0.30	3.00	2.00	2.00
RATE DB	32 (52)	0.20	0.20	0.20	0.20	0.20	0.20	0.20
ROT PLS	33 (53)	0.04	0.04	0.04	0.04	0.04	0.04	0.04
COMP	34 (54)	.000	.000	.000	.000	.000	.000	.000
P OPTION	35 (55)	ALL	TAIL	ALL	TAIL	TAIL	ALL	ALL
Y OPTION	36 (56)	ALL	TAIL	ALL	TAIL	TAIL	ALL	ALL
TRAN PLS	37 (57)	0.10	0.02	0.02	0.02	0.02	0.05	0.01
<b>ALT</b>								
RATE DB	38 (58)	0.200	0.070	0.070	0.200	0.200	0.200	0.200
JET OPT	39 (59)	ALL	TAIL	ALL	ALL	ALL	ALL	ALL
# JETS	40 (60)	2	1	1	2	2	2	2
ON TIME	41 (61)	0.08	0.08	0.08	0.08	0.08	0.08	0.08
DELAY	42 (62)	0.00	0.00	0.00	0.00	0.00	0.00	0.00
<b>VERN</b>								
ROT RATE	43 (63)	0.2000	0.2000	0.2000	0.0080	0.0160	0.2000	0.2000
ATT DB	44 (64)	1.000	1.000	1.000	0.100	0.033	1.000	1.000
RATE DB	45 (65)	.020	.020	.020	.010	.020	.020	.020
ROT PLS	46 (66)	0.002	0.002	0.002	0.002	0.002	0.002	0.002
COMP	47 (67)	.000	.000	.000	.000	.000	.000	.000
CNTL ACC	48 (68)	0	0	0	0	0	0	0
PURPOSE		NOM OMS & RCS BURNS	LOSS OF VERNS (TAIL ONLY)	LOSS OF VERNS (NOSE & TAIL) GG-MNVR	SSUS DEPLOY	COAS CAL	RNDZ	PROX OPS

NOTE: DAP B6 is not used in the generic set



<u>DAP</u>	<u>PURPOSE</u>	<u>DAP</u>	<u>PURPOSE</u>
A1	- NOMINAL	B1	- NOMINAL; OMS & RCS BURNS
A2	- PTC	B2	- LOSS OF VERNIS (TAIL ONLY)
A3	- GG	B3	- LOSS OF VERNIS (NOSE & TAIL)
A4	- PRE/POST DEPLOY		GG MNVR
A5	- LOSS OF VERNIS (NOSE & TAIL)	B4	- SSUS DEPLOY
A6	- LOSS OF VERNIS (TAIL ONLY)	B5	- COAS CAL
A7	- RENDEZVOUS	B6	- (blank)
A8	- PROX OPS	B7	- RENDEZVOUS
A9	- IUS DEPLOY	B8	- PROX OPS
A10	- GG-HOLD MIS-B		
A11	- WINDEX PRCS		

CNT ACC = 0 UNLOADED  
= 1-5 NOT USED

FLT PLN-1a/70/O/A

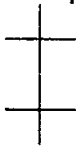

This DAP Book Page Intentionally Blank

FLT PLN-1b/70/O/A



(reduced copy)



**DAP A**



**DAP A1**

PURPOSE:  
NOMINAL

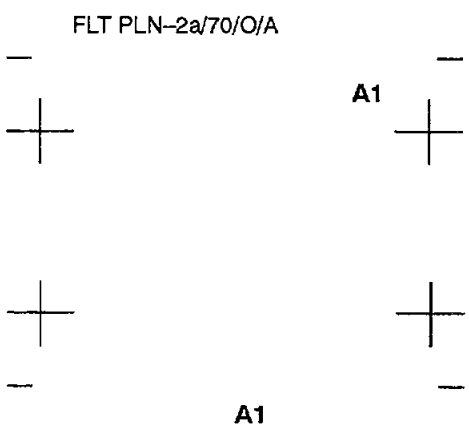

FLT PLN-2a/70/O/A

**A1**

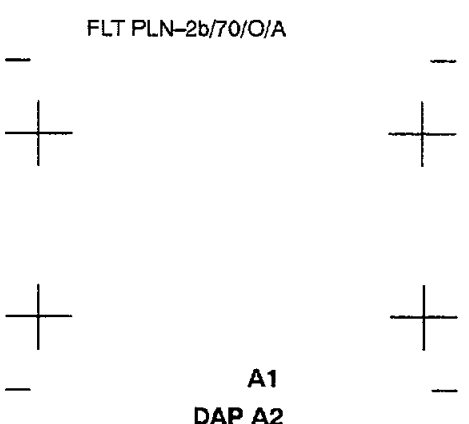

FLT PLN-2b/70/O/A

**A1**

**DAP A2**

PURPOSE:  
PTC

<u>DAP A 0.1</u>		<b>PRI</b>
<u>0.2 0 0 0</u>	10	ROT RATE
<u>- 5.0 0</u>	11	ATT DB
<u>0.2 0</u>	12	RATE DB
<u>0.1 0</u>	13	ROT PLS
<u>.0 0 0</u>	14	COMP
<u>ALL</u>	15	P OPTION
<u>ALL</u>	16	Y OPTION
<u>0.1 0</u>	17	TRAN PLS
		<b>ALT</b>
<u>0.2 0 0</u>	18	RATE DB
<u>ALL</u>	19	JET OPT
<u>2</u>	20	#JETS
<u>0.0 8</u>	21	ON TIME
<u>- 0.0 0</u>	22	DELAY
		<b>VERN</b>
<u>0.2 0 0 0</u>	23	ROT RATE
<u>- 1.0 0 0</u>	24	ATT DB
<u>.0 2 0</u>	25	RATE DB
<u>0.0 1 0</u>	26	ROT PLS
<u>.0 0 0</u>	27	COMP
<u>0</u>	28	CNTL ACC

FLT PLN-3a/70/O/A

**A2**

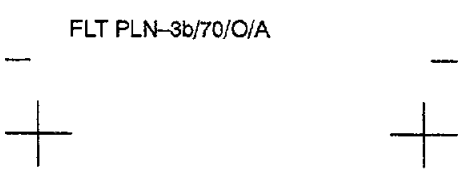

FLT PLN-3b/70/O/A

(reduced copy)

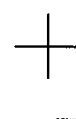

**A2**

**A2**

**DAP A3**

DAP A 0 2	PRI	
0.4 0 0 0	10	ROT RATE
-1.0 0	11	ATT DB
0.2 0	12	RATE DB
0.1 0	13	ROT PLS
0.0 0	14	COMP
ALL	15	P OPTION
ALL	16	Y OPTION
0.1 0	17	TRAN PLS
		ALT
0.2 0 0	18	RATE DB
ALL	19	JET OPT
2	20	#JETS
0.0 8	21	ON TIME
-0.0 0	22	DELAY
		VERN
0.4 0 0 0	23	ROT RATE
-1.0 0 0	24	ATT DB
0.2 0	25	RATE DB
0.0 1 0	26	ROT PLS
0.0 0	27	COMP
0	28	CNTL ACC

PURPOSE:

GG

FLT PLN-4a/70/O/A

FLT PLN-4b/70/O/A

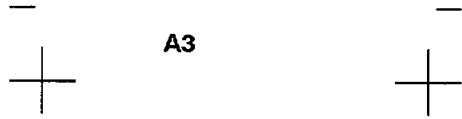

**A3**



**A3**

DAP A 0 3	PRI	
0.2 0 0 0	10	ROT RATE
-1.0 0	11	ATT DB
0.2 0	12	RATE DB
0.1 0	13	ROT PLS
0.0 0	14	COMP
ALL	15	P OPTION
TAIL	16	Y OPTION
0.1 0	17	TRAN PLS
		ALT
0.2 0 0	18	RATE DB
ALL	19	JET OPT
2	20	#JETS
-0.0 8	21	ON TIME
-0.0 0	22	DELAY
		VERN
0.0 0 8 0	23	ROT RATE
-0.0 7 0	24	ATT DB
0.1 0	25	
0.0 1 0	26	ROT PLS
0.0 0	27	COMP
0	28	CNTL ACC

PURPOSE:

PRE/POST DEPLOY

FLT PLN-5a/70/O/A

FLT PLN-5b/70/O/A



**A4**



(reduced copy)



**A4**

**A4  
DAP A5**

DAP A 0 4		PRI
0.5 0 0 0	10	ROT RATE
- 3.0 0	11	ATT DB
0.2 0	12	RATE DB
0.1 0	13	ROT PLS
.0 0 0	14	COMP
ALL	15	P OPTION
ALL	16	Y OPTION
0.1 0	17	TRAN PLS
		ALT
0.2 0 0	18	RATE DB
ALL	19	JET OPT
2	20	#JETS
0.0 8	21	ON TIME
- 0.0 0	22	DELAY
		VERN
0.2 0 0 0	23	ROT RATE
- 1.0 0 0	24	ATT DB
.0 2 0	25	RATE DB
0.0 1 0	26	ROT PLS
.0 0 0	27	COMP
0	28	CNTL ACC

PURPOSE:  
LOSS OF VERN  
(NOSE & TAIL)

FLT PLN-6a/70/O/A

FLT PLN-6b/70/O/A



**A5**



**A5**

**A5  
DAP A6**

DAP A 0 5		PRI
0.2 0 0 0	10	ROT RATE
- 5.0 0	11	ATT DB
0.2 0	12	RATE DB
0.1 0	13	ROT PLS
.0 0 0	14	COMP
ALL	15	P OPTION
ALL	16	Y OPTION
0.1 0	17	TRAN PLS
		ALT
0.0 7 0	18	RATE DB
ALL	19	JET OPT
1	20	#JETS
0.0 8	21	ON TIME
- 0.0 0	22	DELAY
		VERN
0.2 0 0 0	23	ROT RATE
- 1.0 0 0	24	ATT DB
.0 2 0	25	RATE DB
0.0 1 0	26	ROT PLS
.0 0 0	27	COMP
0	28	CNTL ACC

PURPOSE:  
LOSS OF VERN  
(TAIL ONLY)

FLT PLN-7a/70/O/A

FLT PLN-7b/70/O/A



**A6**

(reduced copy)





A6

DAP A7

A6

		PRI
DAP A 0 6		
<u>0.2 0 0 0</u>	10	ROT RATE
- <u>5.0 0</u>	11	ATT DB
<u>0.2 0</u>	12	RATE DB
<u>0.1 0</u>	13	ROT PLS
<u>.0 0 0</u>	14	COMP
TAIL	15	P OPTION
TAIL	16	Y OPTION
<u>0.1 0</u>	17	TRAN PLS
		ALT
<u>0.0 7 0</u>	18	RATE DB
TAIL	19	JET OPT
1	20	#JETS
<u>0.0 8</u>	21	ON TIME
- <u>0.0 0</u>	22	DELAY
		VERN
<u>0.2 0 0 0</u>	23	ROT RATE
- <u>1.0 0 0</u>	24	ATT DB
<u>.0 2 0</u>	25	RATE DB
<u>0.0 1 0</u>	26	ROT PLS
<u>.0 0 0</u>	27	COMP
0	28	CNTL ACC

PURPOSE:  
RENDEZVOUS

FLT PLN-8a/70/O/A

FLT PLN-8b/70/O/A



A7



A7

A7  
DAP A8

		PRI
DAP A 0 7		
<u>0.2 0 0 0</u>	10	ROT RATE
- <u>2.0 0</u>	11	ATT DB
<u>0.2 0</u>	12	RATE DB
<u>0.1 0</u>	13	ROT PLS
<u>.0 0 0</u>	14	COMP
ALL	15	P OPTION
ALL	16	Y OPTION
<u>0.1 0</u>	17	TRAN PLS
		ALT
<u>0.2 0 0</u>	18	RATE DB
ALL	19	JET OPT
2	20	#JETS
<u>0.0 8</u>	21	ON TIME
- <u>0.0 0</u>	22	DELAY
		VERN
<u>0.2 0 0 0</u>	23	ROT RATE
- <u>1.0 0 0</u>	24	ATT DB
<u>.0 2 0</u>	25	RATE DB
<u>0.0 1 0</u>	26	ROT PLS
<u>.0 0 0</u>	27	COMP
0	28	CNTL ACC

PURPOSE:  
PROX OPS

FLT PLN-9a/70/O/A

FLT PLN-9b/70/O/A

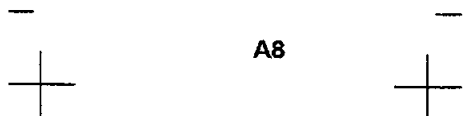

A8

(reduced copy)

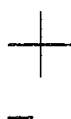

**A8**

**A8**

**DAP A9**

DAP A 0 8		PRI
0.2 0 0 0	10	ROT RATE
- 2.0 0	11	ATT DB
0.2 0	12	RATE DB
0.1 0	13	ROT PLS
0.0 0 0	14	COMP
ALL	15	P OPTION
ALL	16	Y OPTION
0.0 5	17	TRAN PLS
		ALT
0.2 0 0	18	RATE DB
ALL	19	JET OPT
2	20	#JETS
0.0 8	21	ON TIME
- 0.0 0	22	DELAY
		VERN
0.2 0 0 0	23	ROT RATE
- 1.0 0 0	24	ATT DB
0.2 0	25	RATE DB
0.0 1 0	26	ROT PLS
0.0 0 0	27	COMP
0	28	CNTL ACC

PURPOSE:  
IUS DEPLOY

FLT PLN-10a/70/O/A

FLT PLN-10b/70/O/A



**A9**

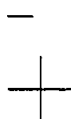
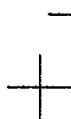

**A9**

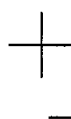

**A9**

**DAP A10**

DAP A 0 9	1/3	PRI
0.2 0 0 0	10/50	ROT RATE
- 1.0 0	11/51	ATT DB
0.2 0	12/52	RATE DB
0.0 5	13/53	ROT PLS
0.0 0	14/54	COMP
TAIL	15/55	P OPTION
TAIL	16/56	Y OPTION
0.2 5	17/57	TRAN PLS
		ALT
0.2 0 0	18/58	RATE DB
ALL	19/59	JET OPT
2	20/60	#JETS
0.0 8	21/61	ON TIME
- 0.0 0	22/62	DELAY
		VERN
0.2 0 0 0	23/63	ROT RATE
- 1.0 0 0	24/64	ATT DB
0.1 0	25/65	RATE DB
0.0 1 0	26/66	ROT PLS
0.0 0 0	27/67	COMP
0	28/68	CNTL ACC

PURPOSE:  
GG-HOLD  
MIS-B

FLT PLN-11a/70/O/A

FLT PLN-11b/70/O/A



**A10**

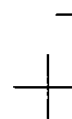
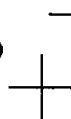

(reduced copy)



A10

A10

DAP A11

DAP A 1 0 1/3 PRI  
 0.2 0 0 0 10/50 ROT RATE  
 4 0.0 0 11/51 ATT DB  
 0.2 0 12/52 RATE DB  
 0.1 0 13/53 ROT PLS  
 0 0 0 14/54 COMP  
 ALL 15/55 P OPTION  
 ALL 16/56 Y OPTION  
 0.1 0 17/57 TRAN PLS  
 ALT  
 0.2 0 0 18/58 RATE DB  
 TAIL 19/59 JET OPT  
 2 20/60 #JETS  
 0.0 8 21/61 ON TIME  
 - 4.0 0 22/62 DELAY  
 VERN  
 0.2 0 0 0 23/63 ROT RATE  
 4 0.0 0 0 24/64 ATT DB  
 .2 0 0 25/65 RATE DB  
 0.0 1 0 26/66 ROT PLS  
 0 0 0 27/67 COMP  
 0 28/68 CNTL ACC  
 FLT PLN-12a/70/O/B

PURPOSE:  
 WINDEX  
 PRCS

FLT PLN-12b/70/O/B

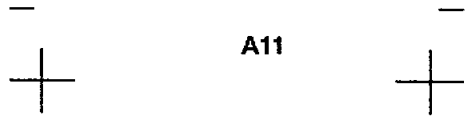

A11

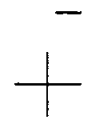
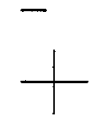

A11



A11

DAP A 1 1 1/3 PRI  
 0.2 0 0 0 10/50 ROT RATE  
 - 3.0 0 11/51 ATT DB  
 0.2 0 12/52 RATE DB  
 1.0 0 13/53 ROT PLS  
 0 0 0 14/54 COMP  
 TAIL 15/55 P OPTION  
 TAIL 16/56 Y OPTION  
 0.0 1 17/57 TRAN PLS  
 ALT  
 0.2 0 0 18/58 RATE DB  
 ALL 19/59 JET OPT  
 2 20/60 #JETS  
 0.0 8 21/61 ON TIME  
 - 0.0 0 22/62 DELAY  
 VERN  
 0.2 0 0 0 23/63 ROT RATE  
 - 1.0 0 0 24/64 ATT DB  
 0 2 0 25/65 RATE DB  
 0.0 1 0 26/66 ROT PLS  
 0 0 0 27/67 COMP  
 0 28/68 CNTL ACC  
 FLT PLN-23a/70/O/A

FLT PLN-23b/70/O/A

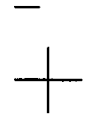
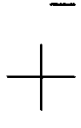

(reduced copy)



**DAP B**



**DAP B1**

PURPOSE:

NOMINAL; OMS &  
RCS BURNS

FLT PLN-13a/70/O/A

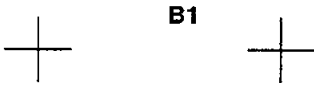

**B1**

FLT PLN-13b/70/O/A



**B1**

2	DAP B 0 1
30	<u>0.5 0 0 0</u>
31	<u>- 3.0 0</u>
32	<u>0.2 0</u>
33	<u>0.0 4</u>
34	<u>.0 0 0</u>
35	ALL
36	ALL
37	<u>0.1 0</u>
38	<u>0.2 0 0</u>
39	ALL
40	2
41	<u>0.0 8</u>
42	<u>- 0.0 0</u>
43	<u>0.2 0 0 0</u>
44	<u>- 1.0 0 0</u>
45	<u>.0 2 0</u>
46	<u>0.0 0 2</u>
47	<u>.0 0 0</u>
48	<u>0</u>



**B1**

**DAP B2**

PURPOSE:

LOSS OF VERNIS  
(TAIL ONLY)

FLT PLN-14a/70/O/A



**B2**

FLT PLN-14b/70/O/A



(reduced copy)

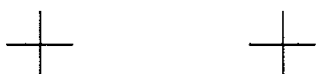

**B2**

2	DAP B 0 2
30	<u>0.2 0 0 0</u>
31	<u>- 3.0 0</u>
32	<u>0.2 0</u>
33	<u>0.0 4</u>
34	<u>.0 0 0</u>
35	TAIL
36	TAIL
37	<u>0.0 2</u>
38	<u>0.0 7 0</u>
39	TAIL
40	1
41	<u>0.0 8</u>
42	<u>- 0.0 0</u>
43	<u>0.2 0 0 0</u>
44	<u>- 1.0 0 0</u>
45	<u>.0 2 0</u>
46	<u>0.0 0 2</u>
47	<u>.0 0 0</u>
48	<u>0</u>

FLT PLN-15a/70/O/A

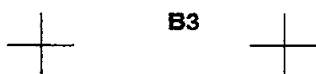

**B3**



**B3**

2	DAP B 0 3
30	<u>0.2 0 0 0</u>
31	<u>- 3.0 0</u>
32	<u>0.2 0</u>
33	<u>0.0 4</u>
34	<u>.0 0 0</u>
35	ALL
36	ALL
37	<u>0.0 2</u>
38	<u>0.0 7 0</u>
39	ALL
40	1
41	<u>0.0 8</u>
42	<u>- 0.0 0</u>
43	<u>0.2 0 0 0</u>
44	<u>- 1.0 0 0</u>
45	<u>.0 2 0</u>
46	<u>0.0 0 2</u>
47	<u>.0 0 0</u>
48	<u>0</u>

FLT PLN-16a/70/O/A



**B4**



**B2**

**DAP B3**

PURPOSE:  
LOSS OF VERNIS  
(NOSE & TAIL)  
GG MNVR

FLT PLN-15b/70/O/A

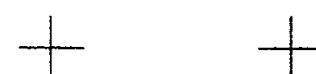

**B3**

**DAP B4**

PURPOSE:  
SSUS DEPLOY

FLT PLN-16b/70/O/A



(reduced copy)



**B4**

2	DAP B 0 4
30	<u>0.2 0 0 0</u>
31	- <u>0.3 0</u>
32	<u>0.2 0</u>
33	<u>0.0 4</u>
34	<u>.0 0 0</u>
35	TAIL
36	TAIL
37	<u>0.0 2</u>
38	<u>0.2 0 0</u>
39	ALL
40	<u>2</u>
41	<u>0.0 8</u>
42	- <u>0.0 0</u>
43	<u>0.0 0 8 0</u>
44	- <u>0.1 0 0</u>
45	<u>.0 1 0</u>
46	<u>0.0 0 2</u>
47	<u>.0 0 0</u>
48	<u>0</u>

FLT PLN-17a/70/O/A



**B5**



**B5**

2	DAP B 0 5
30	<u>0.2 0 0 0</u>
31	- <u>3.0 0</u>
32	<u>0.2 0</u>
33	<u>0.0 4</u>
34	<u>.0 0 0</u>
35	TAIL
36	TAIL
37	<u>0.0 2</u>
38	<u>0.2 0 0</u>
39	ALL
40	<u>2</u>
41	<u>0.0 8</u>
42	- <u>0.0 0</u>
43	<u>0.0 1 6 0</u>
44	- <u>0.0 3 3</u>
45	<u>.0 2 0</u>
46	<u>0.0 0 2</u>
47	<u>.0 0 0</u>
48	<u>0</u>

FLT PLN-18a/70/O/A



**B6**



**B4**

**DAP B5**

PURPOSE:

COAS CAL

FLT PLN-17b/70/O/A



**B5**

**DAP B6**

PURPOSE:

(blank)

FLT PLN-18b/70/O/A



(reduced copy)



**B6**

2	DAP B 0 6
30	---
31	---
32	---
33	---
34	---
35	---
36	---
37	---
38	---
39	---
40	---
41	---
42	---
43	---
44	---
45	---
46	---
47	---
48	---

FLT PLN-19a/70/O/A



**B7**



**B7**

2	DAP B 0 7
30	0.5 0 0 0
31	- 2.0 0
32	0.2 0
33	0.0 4
34	.0 0 0
35	ALL
36	ALL
37	0.0 5
38	0.2 0 0
39	ALL
40	2
41	0.0 8
42	- 0.0 0
43	0.2 0 0 0
44	- 1.0 0 0
45	.0 2 0
46	0.0 0 2
47	.0 0 0
48	0

FLT PLN-20a/70/O/A



**B8**



**B6**

**DAP B7**

PURPOSE:  
RENDEZVOUS

FLT PLN-19b/70/O/A



**B7**

**DAP B8**

PURPOSE:  
PROX OPS

FLT PLN-20b/70/O/A



(reduced copy)



B8

**B8**

2	DAP B 0 8
30	<u>0.2 0 0 0</u>
31	- <u>2.0 0</u>
32	<u>0.2 0</u>
33	<u>0.0 4</u>
34	<u>.0 0 0</u>
35	ALL
36	ALL
37	<u>0.0 1</u>
38	<u>0.2 0 0</u>
39	ALL
40	<u>2</u>
41	<u>0.0 8</u>
42	- <u>0.0 0</u>
43	<u>0.2 0 0 0</u>
44	- <u>1.0 0 0</u>
45	<u>.0 2 0</u>
46	<u>0.0 0 2</u>
47	<u>.0 0 0</u>
48	<u>0</u>

FLT PLN-21a/70/O/A

FLT PLN-21b/70/O/A





UNIV PTG	
TGT ID	= Orbiting Vehicle
	= 2 Earth ctr
	= 3 Earth tgt
	Input LAT ( $\pm 90$ )
	LON ( $\pm 180$ , + = East)
	ALT (-3444.0 to 20000.0 nm)
	= 4 Sun ctr
	= 5 Celestial tgt
	Input RA (0-359.99)
	DEC ( $\pm 90$ )
	= 11-110 Nav Stars
BODY VECT	= 1 +X*
	= 2 -X*
	= 3 -Z*
	= 4 -Y Star Tracker*
	= 5 Optional
	Input P (0-359.99)
	Y (270-359.99, 0-90)
* input OM →	OM (0-359.99)
MON AXIS	= 1 +X
	= 2 -X

FLT PLN-22/70/O/A

FLT PLN-22/70/O/A is mounted on the back of the DAP Book

**This Page Intentionally Blank**

**STS-70  
FLIGHT PLAN NOTES**

FLIGHT PLAN NOTES  
(CONSTRAINTS AND GUIDELINES)

A. FLIGHT DESCRIPTION

Orbiter: OV103/Discovery  
 Inclination: 28.45 deg  
 Altitude: 160 nm  
 Duration: 8 + 2

B. MAJOR EVENTS

<u>EVENT</u>	<u>MET</u>	<u>DATE</u>	<u>CDT</u>	<u>GMT</u>	<u>ΔV</u>	<u>ORBIT</u>
Launch	0/00:00	6/08/95	9:20	14:20	--	--
OMS-2	0/00:42	6/08/95	10:02	15:02	221.7	1
TDRS-G/IUS deploy	0/06:13	6/08/95	15:33	20:33	--	5
RCS-1 (SEP-1)	0/06:14	6/08/95	15:34	20:34	2.2	5
OMS-3 (SEP-2)	0/06:28	6/08/95	15:48	20:48	31.0	5
TDRS Injection	0/07:13	6/08/95	16:33	21:33	--	6a
OMS-4 (Circ)	1/05:25	6/09/95	14:45	19:45	27.4	19
Deorbit	7/21:14	6/16/95	06:34	11:34	--	126
Landing	7/22:16	6/16/95	07:36	12:36	--	127

FLT PLN  
NOTES

C. LANDING OPPORTUNITIES:

		<u>Landing Orbit</u>	<u>Site</u>	<u>Local Time</u>
		<u>No.</u>		
Nominal	Primary	127	KSC	8:36 EST
	1 Rev late	128	KSC	10:12 EST
EOM +1	Primary	142	KSC	7:09 EST
	1 Rev late	143	KSC	8:44 EST
EOM +2	Primary	158	KSC	7:17 EST
	1 Rev late	159	KSC	8:52 EST

D. CREW

CDR - Tom Henricks  
 PLT - Kevin Kregel  
 MS1 - Don Thomas  
 MS2 - Nancy Currie  
 MS3 - Mary Ellen Weber

E. COMMUNICATIONS

Predeploy:  
 Available GSTDN: MIL(MLX), BDA(BDX), and GDS(GDX), CAN  
 Available RTS: HTS, VTS, and GTS, IOS, DGS, CTS

Post deploy:  
 TDRS Support: East (41 degW), West (174 degW)  
 Backup Real-Time TV: GDS(GDX) and MIL(MLX)  
 Contingency GSTDN: MIL(MLX), BDA(BDX), and DFR  
 Contingency RTS: HTS, VTS, GTS, IOS, and DGS  
 Emergency GSTDN: GDS(GDX), CAN, and MAD  
 Lead time for site callup: GSTDN - 2 hr, RTS - 4 hr

## F. PAYLOADS

### 1. Tracking and Data Relay Satellite - G (TDRS-G)

The TDRS-G is a communication satellite which is the seventh spacecraft launched in the process of assembling the Tracking and Data Relay Satellite System. The system will provide a high capacity communication and data link with the STS as well as with other spacecraft and launch vehicles. The nominal TDRS-G/IUS deployment opportunity occurs 60 min prior to node 6A (ascending) at 00/06:12 MET. Backup opportunities occur prior to 7A and 16A. A contingency opportunity occurs 60 min prior to 8D (descending).

### 2. Inertial Upper Stage (IUS)

The IUS is a two-stage solid rocket inertially stabilized upper stage which will place TDRS-G in a geosynchronous orbit. The IUS nominally ignites its first stage (SRM-1) at the 6A node for transfer orbit insertion.

### 3. Physiological and Anatomical Rodent Experiment/National Institutes of Health-Rodents (PARE/NIH-R)

PARE/NIH-R is a series of experiments designed to determine whether exposure to microgravity results in physiological or anatomical changes in rodents. The experiment consists of rodents contained within two Animal Enclosure Modules (AEMs), each of which will occupy one middeck locker with a modified locker door. Electrical power is required for prelaunch through payload removal postlanding. Daily housekeeping and observations are required by the crew.

### 4. Bioreactor Demonstration System (BDS) - Config B

The BDS experiment design consists of two on-orbit phases. Phase one objectives include verifying the suitability of vessel fluid support hardware to support mammalian cell growth for an experiment period of 5 days on-orbit. This will include demonstrating the ability of the system to monitor pH, provide oxygen supply, and remove waste products. Phase two of the experiment will consist of approximately 3 days of fluid dynamic observations to monitor fluid flow and conduct still photography and video recording. BDS requires standard orbiter 28 V dc power during the prelaunch, ascent, and on-orbit phases until completion of phase two of the experiment.

### 5. Commercial Protein Crystal Growth-III (CPCG-III)

The CPCG payload is designed to conduct experiments which will supply information on the scientific methods and commercial potential for growing large high-quality protein crystals in microgravity. The CPCG will be installed and operated in the orbiter middeck. The CPCG payload consists of a Commercial Refrigerator Incubator Module (CRIM), its contents, and several stowed items.

### 6. Space Tissue Loss/National Institutes of Health - B (STL-B)

The STL-B experimental payload is designed to validate models of muscle, bone and endothelial cell biochemical and functional loss induced by microgravity stress and to evaluate cytoskeleton, metabolism, membrane integrity, and protease activity in target cells, and to test tissue loss pharmaceuticals for efficacy. Video of the sample is required through a video microscope.

7. Biological Research In Canister-III (BRIC-III)

This BRIC experiment is designed to investigate the effects of spaceflight on small arthropod animal and plant specimens. No orbiter power or crew interaction is required.

8. Shuttle Amateur Radio Experiment - II (SAREX-II) Config C

SAREX-II is a flight deck payload capable of two-way communication with amateur radio stations in the Line of Sight (LOS) of the orbiter. Antenna is mounted in either Window 1 or 6. Configuration C is capable of operating in a Robot mode and Voice mode. Intermittent voice operations will be performed as time permits.

9. Visual Function Tester - 4 (VFT-4)

The VFT-4 was designed to measure the near and far point of clear vision, as well as the ability to change focus within the range of clear vision. VFT-4 will provide data to evaluate on-orbit refractive and accommodative changes in vision over a period of several days, derive a quantitative model that accurately predicts on-orbit refractive changes in vision, and provide a database for microgravity effects on vision in support of the Hypersonic Crew Station Design Program.

10. Handheld, Earth-oriented, Real-time, Cooperative, User-friendly, Location Targeting, Environmental System (HERCULES) - Config B

The HERCULES experiment will provide the Space Shuttle and crewmembers with real-time, on-orbit capability to geolocate a ground target to 1 nm and take electronic photographs. The hardware configuration consists of HERC inertial measurement unit (HIMU), HERC attitude processor (HAP), Video camera, Video recorder, and HCC (ThinkPad 750C).

11. Microcapsules in Space - B (MIS-B)

The MIS-B experiment will investigate methods to improve yield and technology for producing pharmaceutical microcapsules in a microgravity environment. Ampicillin anhydrate will be the drug microencapsulated in space. Microcapsules will be sprayed into a hardening chamber and drying will occur. The system consists of five modules: Hardening chambers, delivery system for polymer/drug solution, ultrasonic spray nozzles with power supply, forced air cooling system, and control module.

12. Window Experiment (WINDEX)

The WINDEX experiment will obtain spectrally isolated images of thruster plumes, thruster plume effects on the orbiter, shuttle surface glow, water dumps, aurora, and airglow. The WINDEX photography can utilize either the aft flight deck (AFD) or sidehatch windows. Data takes for most of the objectives occur in darkness with minimal moonlight desired; the water dump objectives are performed in daylight conditions.

### 13. Radiation Monitoring Experiment (RME-III)

The RME-III configuration consists of a handheld instrument with replaceable memory modules. The equipment contains a liquid crystal display (LCD) for real-time display and keyboard for controlling its functions. The experiment is self-contained with two zinc air and five AA batteries contained in each memory module, and a zinc air battery in the main module. The equipment takes measurements of the radiation environment at a specified sample rate.

### 14. Military Applications of Ship Tracks (MAST)

The purpose of MAST is to evaluate the characteristics of ship track formation. A Hasselblad camera will be used to study high-resolution effects at track formation, examine cloud topography and induced circulations, and study the regional differences in track formation.

## G. ON-ORBIT DTOs

### 1. PGSC Single Event Upset Monitor (DTO 656) - Config 2

The objective of this DTO is to determine Payload and General Support Computer (PGSC) random access memory susceptibility to single event upset (SEU) caused by cosmic radiation. This data could lead to procedure changes and software or hardware changes to reduce radiation effects. Configuration 2 allows the DTO to run on a 486 in the background.

### 2. STS Orbiter Attitude Control Translational Thrusting (DTO 779)

This test will provide the data necessary to complete the database of vehicle thrusting that is necessary to maintain attitude during various unbiased attitude holds. This data can then be used in the flight design process to refine the predicted trajectory. The data will also be used real-time to improve trajectory prediction in the Mission Operations Computer.

### 3. Evaluation of Microbial Capture Device in Microgravity (DTO 677)

This DTO will demonstrate the zero-gravity operation of water sampling hardware proposed for the microbiological characterization of spacecraft potable water.

## H. ON-ORBIT DSOs

### 1. In-Flight Urine Collection Absorber Evaluation (DSO 328)

This DSO will evaluate a new hardware device for urine sample collection which will significantly reduce sample leakage and stowage requirements. This device will also allow female participation in metabolic investigations requiring urine samples.

### 2. Orthostatic Function During Entry, Landing and Egress (DSO 603C)

The objective of this DSO is to measure changes in orthostatic function of crewmembers during the stress of entry, landing, and egress from the orbiter. Crewmembers will don and calibrate equipment prior to deorbit preparation. At LES donning, they will connect cables and power the equipment. Verbal comments will be recorded during entry, landing, and egress.

3. Visual–Vestibular Integration as a Function of Adaptation (OI–1) (DSO 604)

The purpose of this DSO is to investigate visual–vestibular and perceptual adaptive responses as a function of mission duration. The operational impact of these responses on the crewmembers' ability to conduct entry, landing, and egress procedures will also be investigated.

4. In–Flight Use of Florinef to Improve Orthostatic Intolerance Post Flight (DSO 621)

The purpose of this DSO is to evaluate the efficacy of Florinef on postflight orthostatic tolerance using heart rate, blood pressure, stroke volume, and other cardiovascular responses to orthostatic stress. Crewmembers will ingest a Florinef tablet and a potassium supplement tablet 7 hours prior to landing.

5. Pre and Postflight Measurement of Cardiorespiratory Responses to Submaximal Exercise (DSO 624)

For this DSO each crewmember will wear a heart watch during exercise and log exercise to help evaluate the changes in aerobic capacity pre–, in–, and postflight. These evaluations will help develop optimal exercise protocols to prevent decrements in nominal cardiorespiratory response.

6. Educational Activities (DSO 802)

The purpose of this DSO is to use the attraction of space flight to capture the interest of students and motivate them toward careers in science, engineering, and mathematics. This DSO will support the videotaping of on–orbit educational activities performed by the flight crew.

7. Documentary Television (DSO 901)

DSO 901 provides guidelines for scheduling live television or VTR dumps of on–orbit activities.

8. Documentary Motion Picture Photography (DSO 902)

DSO 902 provides guidelines for scheduling documentary and public affairs motion picture photography of on–orbit activities.

9. Documentary Still Photography (DSO 903)

DSO 903 provides guidelines for still photography of on–orbit activities.

10. Assessment of Human Factors (DSO 904) Config C

This DSO will evaluate factors affecting human productivity and the ability to interface with machines, the environment, and other humans during space flight. Variations between preflight and in–flight performance will be examined. Specific task involves utilizing touchscreen interfaces in micro–g.



FLIGHT DATA FILE  
Distribution  
70 FLT PLN FSP FIN

---

\*\* JSC \*\*

---

AP3/BRANCH DISTRIBUTION (10)  
AP3/PAO DISTRIBUTION (50)  
AP5/SCHOER, R.K.  
CA/LEESTMA, D.C.  
CA44/BERTRAND, O.J.  
CB/CHIEF  
CB/FAMILY ESCORT MGR  
DA2/STONE, B.R.  
DA82/ACTION CENTER  
DF22/DPS FDF REP (7)  
DF24/INCO FDF REP (3)  
DF42/EVA (6)  
DF44/ROBOTICS SECTION (5)  
DF54/CREW SYSTEMS  
DF62/GNC SECTION HEAD  
DF63/PROP  
DF63/SECTION HEAD  
DF73/LEAD EGIL  
DF73/SYSTEMS LIBRARY  
DF8/EECOM LIBRARY (3)  
DJ4/QUICK, T.K. (3)  
DM11/CHIEF  
DM22/FLIGHT DESIGN GROUP  
DM22/HEAD (2)  
DM41/LOWES, F.B.  
DM42/HEAD (7)  
DM43/HEAD  
DM46/ENTRY FDO  
DM46/LSO  
DM46/STS CONT SUPPORT OFF  
DO12/OPS SAFETY OFFICE  
DO35/FDF LIBRARY  
DO4/BOOK MANAGER FLT PLN (20)  
DO4/FAO TEAM (20)  
DO4/SHUTTLE FLT PLANNING (3)  
DO44/HEAD  
DO45/SECTION HEAD  
DO6/LIBRARY (18)  
DP/CHIEF  
DT23/DPS/NAV SECT (4)  
DT33/BORDELON, M.  
DT33/SHUTTLE COMM SECTION (2)  
DT35/PAYLOADS TRAINING (3)

DT35/ROWEN, G.C.  
DT46/SIM SUP OFFICE  
DT48/TRAINING SYS SECTION (2)  
DT66/CONTROL PROP (4)  
DT68/TEAM LEAD  
EA42/MANAGER  
EC/CTSD LIBRARY  
EC3/ROTTER, H.A.  
EC5/CHANG, C.M.  
EC5/COUNTS, B.R. (2)  
EE2/RCA SUPPORT  
EG/CRITELLI, S. (2)  
EG/LIBRARY  
EG1/KANIPE, D.B.  
EG2/STRAHAN, A.  
EP2/JENKINS, L.W.  
ER4/HESS, C. (3)  
ER611/MC FADIN, L. (2)  
ES3/CHANG, Y. PHD  
ES32/SERNA, R.  
ES62/DAVIS, R.  
EV/LIV-16/LIBRARY  
EV14-LIB/ASD-14-LIB  
EV3/LEONARD, A.L. (2)  
EV44-ASD/ASD-44-LIB  
FA22/WAGSTER, L.R.  
FA4/EVA & CREW SYS (3)  
GF/LIEBERGOT, S.A.  
GF/LODEN, H.A.  
HMFP2/SNOW, T.J.  
IA161/BAHR, P.A.  
JL5/SUPPORT (2)  
MA3/MANAGER  
MER-30/LIBRARY (10)  
MS5/LIBRARY  
MT2/CONWELL, J.J.  
MT3/CUSTOMER SUPT SPEC (4)  
MT3/LEAD FIM  
MT3/MANAGER (3)  
NS2/CHIEF  
NS4/LIBRARY (2)  
OA/WARD, D.K.  
PS33/STI LIBRARY (3)  
PS4/CLINTON, S.  
PS4/MCGUYER, M. (2)  
SD/HATCHER, D.  
SD/WATSON, T.L. (5)  
SD24/LAMOREUX, J.A. (4)  
SD26/PANDER, L. (5)  
SD5/CHARLES, J.B.  
SN3/CHRISTIANSEN, E.  
SN3/HARDY, A.C.  
SN5/EOL

SN5/GAUNCE, M.  
SP3/HOLDEN, T.  
SP33/JOHNSON, M.L.  
SP43/CHRISTOPHER, K.  
SP44/KLOERIS, V.  
ZR1/GOLDSTEIN, D. CAPT. (5)  
ZR1/USAF TECHNICAL LIBRARY (3)  
ZS8/ASSGND LEAD FORECASTER

---

\*\* JSC OFFSITE \*\*

---

3700 BAY AREA BLVD  
SUITE 600  
P O BOX 58487  
HOUSTON, TX 77258  
6402A/SILVA, E. (3)

---

ALLIED SIGNAL-HOUSTON  
B33B-555/OSD DOCUMENT CNTL (5)

---

CAE LINK-HOUSTON  
TSC/LIBRARY

---

LOCKHEED-HOUSTON  
C70/KEENER, J.F.

---

MCDONNELL DOUGLAS-HST TWR 1  
16055 SPACE CENTER BLVD  
HOUSTON, TX 77062  
B1/BROUSSARD, A.

---

RSOC-HOUSTON  
R12A/SMITH, W.E.  
R12B-16/SAIL/GN&C  
R16C/PROX OPS LIBRARY  
R16C/RNDZ LIBRARY  
R16C/TRAJECTORY LIBRARY  
R16E/COOPER, D.  
R16E/KOCEN, M.H.  
R16E/NAVIGATION LIBRARY  
R16E/TRAJ OPS SUPPORT (3)  
R16H/FRENCH, J.  
R21M/WARD, P.A.  
ZC01/DISTEFANO, F.J.

ZC01/HIPPS, D.L.  
ZC20/MEREDITH, M.

---

UNISYS GOV'T SYSTEMS GROUP-HST  
B32F/BLD9/GARDNER, J.A.  
U03D/HOPE, A.J.  
U03D/IV&T MANAGER

---

BOEING AEROSPACE-HOUSTON  
P O BOX 58747  
HOUSTON, TX 77058  
HC-18/STOKELD, R.  
HF-10/TRAVLOS, J.A.  
HF-10/WIBLE, L.  
HS-30/WYLIE, S.

---

CALSPAN/JOHNSON OPERATIONS  
P O BOX 580668  
HOUSTON, TX 77258-0668  
F6E4S/GOFFNEY, B.

---

HONEYWELL-HOUSTON  
2525 BAY AREA BLVD  
SUITE 150  
HOUSTON, TX 77058  
GEDERBERG, T.

---

KRUG INTERNATIONAL-HST  
1290 HERCULES DRIVE  
SUITE 120  
HOUSTON TX 77058  
HMFP2/WEDGEWORTH, B.L.

---

ROCKWELL-HOUSTON  
ZC01/ASUNCION, C.  
ZC01/BATTLE, H.H.  
ZC01/WOODALL, J.W.  
ZC01-555/DE VAULT, G.M.  
ZC01-555/TAYLOR, J.T.  
ZC03-17/BRYAN, L.W.

---