

*Shuttle*

# Flight Plan

## STS-79

(Mir L-3 Month Vector)

Mission Operations Directorate  
Operations Division

Final  
July 8, 1996

<u>EVENT</u>	<u>CDT</u>		
Launch	22:30	Wed	July 31
Mir Docking	16:34	Fri	Aug 2
Mir Undocking	13:40	Wed	Aug 7
KSC Landing	19:16	Fri	Aug 9

National Aeronautics and  
Space Administration

Lyndon B. Johnson Space Center  
Houston, Texas



MISSION OPERATIONS DIRECTORATE

STS-79 FLIGHT PLAN

FINAL  
July 8, 1996

PREPARED BY:

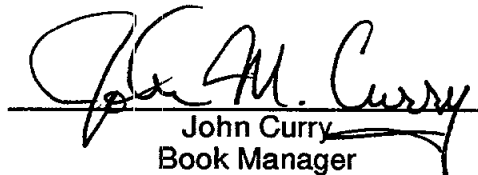
  
John Curry  
Book Manager

APPROVED BY:

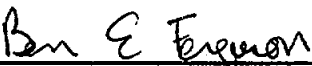
  
Ben E. Ferguson  
Lead, Flight Planning  
and OPS Group

  
Robert H. Nute  
Chief, Flight Planning Branch

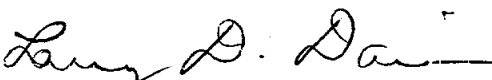
  
Larry Davis  
Chief, Operations Division

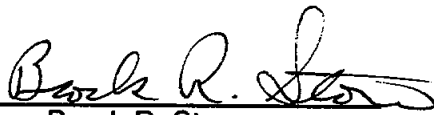
  
Brock R. Stone  
Assistant Director,  
for Operations

This document is under the configuration control of the Crew Procedures Control Board (CPCB). All proposed changes must be submitted on JSC Form 482 to DO3/FDF Manager.

Additional distribution of this book for official use must be requested in writing to DO3/FDF Manager. The request must include justification and requester's name, organization, position, and phone number. Contractor requests are made through the NASA or DOD organization supported. Deletions, reduction in quantity, or change of address may be submitted to DO3/FDF Management Office, (713) 244-1184.

Incorporates the following:			
482#:	FLT PLN-1815	FLT PLN-1818	FLT PLN-1821
	FLT PLN-1816	FLT PLN-1819A	FLT PLN-1822
	FLT PLN-1817	FLT PLN-1820	FLT PLN-1823

FLT PLN-1824

AREAS OF TECHNICAL RESPONSIBILITY

Book Manager/Lead FAO	DO4/J. Curry	244-1029
Lead Timeliner	DO4/P. Bolton	244-1176
Lead Pointer	DO4/B. Kelly	244-1141

FLIGHT PLAN  
STS-79

**LIST OF EFFECTIVE PAGES**

FINAL 07/08/96

Sign Off .....	* 79/FIN	3-21 .....	79/FIN
ii .....	* 79/FIN	3-22 .....	79/FIN
iii .....	* 79/FIN	3-23 .....	79/FIN
iv .....	* 79/FIN	3-24 .....	79/FIN
v .....	* 79/FIN	3-25 .....	79/FIN
vi .....	* 79/FIN	3-26 .....	79/FIN
vii .....	* 79/FIN	3-27 .....	79/FIN
viii .....	* 79/FIN	3-28 .....	79/FIN
1-1 .....	79/FIN	3-29 .....	79/FIN
1-2 .....	79/FIN	3-30 .....	79/FIN
1-3 .....	79/FIN	3-31 .....	79/FIN
1-4 .....	79/FIN	3-32 .....	79/FIN
2-1 .....	79/FIN	3-33 .....	79/FIN
2-2 .....	79/FIN	3-34 .....	79/FIN
2-3 .....	79/FIN	3-35 .....	79/FIN
2-4 .....	79/FIN	3-36 .....	79/FIN
2-5 .....	79/FIN	3-37 .....	79/FIN
2-6 .....	79/FIN	3-38 .....	79/FIN
2-7 .....	79/FIN	3-39 .....	79/FIN
2-8 .....	79/FIN	3-40 .....	79/FIN
2-9 .....	79/FIN	3-41 .....	79/FIN
2-10 .....	79/FIN	3-42 .....	79/FIN
2-11 .....	79/FIN	3-43 .....	79/FIN
2-12 .....	79/FIN	3-44 .....	79/FIN
2-13 .....	79/FIN	3-45 .....	79/FIN
2-14 .....	79/FIN	3-46 .....	79/FIN
2-15 .....	79/FIN	3-47 .....	79/FIN
2-16 .....	79/FIN	3-48 .....	79/FIN
2-17 .....	79/FIN	3-49 .....	79/FIN
2-18 .....	79/FIN	3-50 .....	79/FIN
2-19 .....	79/FIN	3-51 .....	79/FIN
2-20 .....	79/FIN	3-52 .....	79/FIN
3-1 .....	79/FIN	3-53 .....	79/FIN
3-2 .....	79/FIN	3-54 .....	79/FIN
3-3 .....	79/FIN	3-55 .....	79/FIN
3-4 .....	79/FIN	3-56 .....	79/FIN
3-5 .....	79/FIN	3-57 .....	79/FIN
3-6 .....	79/FIN	3-58 .....	79/FIN
3-7 .....	79/FIN	3-59 .....	79/FIN
3-8 .....	79/FIN	3-60 .....	79/FIN
3-9 .....	79/FIN	3-61 .....	79/FIN
3-10 .....	79/FIN	3-62 .....	79/FIN
3-11 .....	79/FIN	3-63 .....	79/FIN
3-12 .....	79/FIN	3-64 .....	79/FIN
3-13 .....	79/FIN	3-65 .....	79/FIN
3-14 .....	79/FIN	3-66 .....	79/FIN
3-15 .....	79/FIN	3-67 .....	79/FIN
3-16 .....	79/FIN	3-68 .....	79/FIN
3-17 .....	79/FIN	3-69 .....	79/FIN
3-18 .....	79/FIN	3-70 .....	79/FIN
3-19 .....	79/FIN	3-71 .....	79/FIN
3-20 .....	79/FIN	3-72 .....	79/FIN

\* - Omit from flight book

3-73	79/FIN	5-46	79/FIN
3-74	79/FIN	5-47	79/FIN
3-75	79/FIN	5-48	79/FIN
3-76	79/FIN	5-49	79/FIN
3-77	79/FIN	5-50	79/FIN
3-78	79/FIN	5-51	79/FIN
4-1	79/FIN	5-52	79/FIN
4-2	‡ 79/FIN	5-53	79/FIN
4-5	79/FIN	5-54	79/FIN
4-6	79/FIN	5-55	79/FIN
4-7	79/FIN	5-56	79/FIN
4-8	79/FIN	5-57	79/FIN
4-9	79/FIN	5-58	79/FIN
4-10	79/FIN	5-59	79/FIN
4-11	79/FIN	5-60	79/FIN
4-12	79/FIN	5-61	79/FIN
4-13	79/FIN	5-62	79/FIN
4-14	79/FIN	5-63	79/FIN
4-15	79/FIN	5-64	79/FIN
4-16	‡ 79/FIN	5-65	79/FIN
5-1	79/FIN	5-66	79/FIN
5-2	‡ 79/FIN	5-67	79/FIN
5-9	79/FIN	5-68	‡ 79/FIN
5-10	79/FIN	6-1	79/FIN
5-11	79/FIN	6-2	79/FIN
5-12	79/FIN	6-3	79/FIN
5-13	79/FIN	6-4	79/FIN
5-14	79/FIN	7-1	79/FIN
5-15	79/FIN	7-2	79/FIN
5-16	79/FIN	7-3	79/FIN
5-17	79/FIN	7-4	79/FIN
5-18	79/FIN	7-5	79/FIN
5-19	79/FIN	7-6	79/FIN
5-20	79/FIN	8-1	79/FIN
5-21	79/FIN	8-2	79/FIN
5-22	79/FIN	8-3	79/FIN
5-23	79/FIN	8-4	79/FIN
5-24	79/FIN	8-5	79/FIN
5-25	79/FIN	8-6	79/FIN
5-26	79/FIN	8-7	79/FIN
5-27	79/FIN	8-8	79/FIN
5-28	79/FIN	8-9	79/FIN
5-29	79/FIN	8-10	79/FIN
5-30	79/FIN	9-i	* 79/FIN
5-31	79/FIN	9-ii	* 79/FIN
5-32	79/FIN	9-1	* 79/FIN
5-33	79/FIN	9-2	* 79/FIN
5-34	79/FIN	9-3	* 79/FIN
5-35	79/FIN	9-4	* 79/FIN
5-36	79/FIN	9-5	* 79/FIN
5-37	79/FIN	9-6	* 79/FIN
5-38	79/FIN	9-7	* 79/FIN
5-39	79/FIN	9-8	* 79/FIN
5-40	79/FIN	10-1	* 79/FIN
5-41	79/FIN	10-2	* 79/FIN
5-42	79/FIN	10-3	* 79/FIN
5-43	79/FIN	10-4	* 79/FIN
5-44	79/FIN	10-5	* 79/FIN
5-45	79/FIN	10-6	* 79/FIN

‡ - Pages 4-3 & 4-4, 4-17 thru 4-20, 5-3 thru 5-9, 5-69 thru 5-78 omitted from book  
 \* - Omit from flight book

10-7 ..... \* 79/FIN  
 10-8 ..... \* 79/FIN  
 11-1 ..... \* 79/FIN  
 CC 11-2 ..... \* 79/FIN

CC 11-3 ..... \* 79/FIN  
 CC 11-4 ..... \* 79/FIN  
 CC 11-5 ..... \* 79/FIN  
 11-6 ..... \* 79/FIN

STS-79 FLIGHT PLAN FABRICATED ITEMS

<u>Title</u>	<u>Ref. Page</u>	<u>Item No.</u>
STS-79 GENERIC DAP A CONFIGURATIONS (Top/Front) .....	CC 11-2	FLT PLN-1a/79/O/A
STS-79 FLIGHT SPECIFIC DAP A CONFIGURATIONS (Bottom/Front) .....	CC 11-3	FLT PLN-1aa/79/O/B
STS-79 GENERIC DAP B CONFIGURATIONS (Top/Back) .....	CC 11-4	FLT PLN-1b/79/O/A
STS-79 FLIGHT SPECIFIC DAP B CONFIGURATIONS (Bottom/Back) .....	CC 11-5	FLT PLN-1bb/79/O/B

**This Page Intentionally Blank**

CONTENTS

PAGE

INTRODUCTION .....	viii
OVERVIEW TIMELINE .....	1-1
SUMMARY TIMELINE (ENGLISH) .....	2-1
DETAILED TIMELINE (ENGLISH) .....	3-1
SUMMARY JOINT TIMELINE (CYRILLIC) .....	4-1
DETAILED JOINT TIMELINE (CYRILLIC) .....	5-1
FD4 DOCKING TIMELINE OVERVIEW .....	6-1
DAP TABLE .....	7-1
ATTITUDE PICTORIALS .....	8-1
ATTITUDE TIMELINE .....	9-1
FLIGHT PLAN NOTES .....	10-1
CUE CARD CONFIGURATION .....	11-1



## INTRODUCTION

The STS-79 Flight Plan is the Flight Data File article that contains the on-orbit timeline. It does not contain the detailed timelines that are covered in the Ascent, Post Insertion, Deorbit Prep, and Entry Checklists. For continuity, the summary level timeline includes the entire flight.

This on-orbit timeline satisfies the objectives specified in the Flight Definition and Requirements Directive and the requirements of the STS-79 Flight Requirements Document. The Flight Plan, as part of the Flight Data File, meets the specifications of the Engineering Cycle version of the STS-79 Flight Initialization Data Pack.

The flight profile used for this Flight Plan is for a launch date of July 31, 1996, at 22:30 CDT. The launch time was derived using a predicted launch minus 3 months Mir vector for August 1, 1996, at midnight, GMT. Orbiter inertial attitudes are expressed relative to a Mean of 1950 (M50) reference frame.

JSC-22359, Crew Scheduling Constraints (Appendix K, CPMP), Basic, Rev B, January 1992 and the Shuttle/Mir Sleep Cycle Guidelines established at WGO September 1995, have been used to build the timelines contained in this Flight Plan.

The timeline formats used in the Flight Plan are based on JSC-19933, Timeline Format Definitions and Standard Notes, Rev C, May 1990.

**OVERVIEW TIMELINE**

**This Page Intentionally Blank**

FLIGHT: STS-79		EDITION: FINAL		PUB. DATE: 07/08/96																					
MET: 000	0	1	2	3	4	5	6	7	8	9	10	11	12	13	14	15	16	17	18	19	20	21	22	23	0
STS-79	ASCENT	POST INSERTION	NCA	PRE SLEEP	SLEEP							POST SLEEP	NCA	SHAB ACT	ARIS SETUP				NPCA						
MIR											PRE SLEEP	SLEEP													
DAY/NIGHT	[Day/Night Cycle]																								
ORBIT	[Orbit Data]																								
DAILY ORB	[Daily Orbit Data]																								
DMT	[DMT Data]																								
MET: 001	0	1	2	3	4	5	6	7	8	9	10	11	12	13	14	15	16	17	18	19	20	21	22	23	0
STS-79	NCA	PRE SLEEP	SLEEP							TIA RENDEZVOUS				ARBAR	POST DK CONFIG	HO SAFETY BRIEF	PRE SLEEP								
MIR	PRE SLEEP	SLEEP										DOCKING PREP				POST DK CONFIG	CN SAFETY BRIEF	SLEEP							
DAY/NIGHT	[Day/Night Cycle]																								
ORBIT	[Orbit Data]																								
DAILY ORB	[Daily Orbit Data]																								
DMT	[DMT Data]																								
MET: 002	0	1	2	3	4	5	6	7	8	9	10	11	12	13	14	15	16	17	18	19	20	21	22	23	0
STS-79	PRE SLEEP	SLEEP							POST SLEEP	JOINT WORKDAY										PRE SLEEP					
MIR	SLEEP							POST SLEEP	JOINT WORKDAY										PRE SLEEP	SLEEP					
DAY/NIGHT	[Day/Night Cycle]																								
ORBIT	[Orbit Data]																								
DAILY ORB	[Daily Orbit Data]																								
DMT	[DMT Data]																								
MET: 003	0	1	2	3	4	5	6	7	8	9	10	11	12	13	14	15	16	17	18	19	20	21	22	23	0
STS-79	PRE SLEEP	SLEEP							POST SLEEP	JOINT WORKDAY										PRE SLEEP					
MIR	SLEEP							POST SLEEP	JOINT WORKDAY										PRE SLEEP	SLEEP					
DAY/NIGHT	[Day/Night Cycle]																								
ORBIT	[Orbit Data]																								
DAILY ORB	[Daily Orbit Data]																								
DMT	[DMT Data]																								
MET: 004	0	1	2	3	4	5	6	7	8	9	10	11	12	13	14	15	16	17	18	19	20	21	22	23	0
STS-79	PRE SLEEP	SLEEP							POST SLEEP	JOINT WORKDAY										PRE SLEEP					
MIR	SLEEP							POST SLEEP	JOINT WORKDAY										PRE SLEEP	SLEEP					
DAY/NIGHT	[Day/Night Cycle]																								
ORBIT	[Orbit Data]																								
DAILY ORB	[Daily Orbit Data]																								
DMT	[DMT Data]																								
MET: 005	0	1	2	3	4	5	6	7	8	9	10	11	12	13	14	15	16	17	18	19	20	21	22	23	0
STS-79	PRE SLEEP	SLEEP							POST SLEEP	JOINT WORKDAY							HATCH	PRE SLEEP							
MIR	SLEEP							POST SLEEP	JOINT WORKDAY							CLOSURE	PRE SLEEP	SLEEP							
DAY/NIGHT	[Day/Night Cycle]																								
ORBIT	[Orbit Data]																								
DAILY ORB	[Daily Orbit Data]																								
DMT	[DMT Data]																								
MET: 006	0	1	2	3	4	5	6	7	8	9	10	11	12	13	14	15	16	17	18	19	20	21	22	23	0
STS-79	PRE SLEEP	SLEEP							POST SLEEP	UNDOCK CONFIG				FLYAROUND	PRE SLEEP										
MIR	SLEEP							POST SLEEP	UNDOCK CONFIG				6/15:10	PRE SLEEP	SLEEP										
DAY/NIGHT	[Day/Night Cycle]																								
ORBIT	[Orbit Data]																								
DAILY ORB	[Daily Orbit Data]																								
DMT	[DMT Data]																								
MET: 007	0	1	2	3	4	5	6	7	8	9	10	11	12	13	14	15	16	17	18	19	20	21	22	23	0
STS-79	PRE SLEEP	SLEEP							POST SLEEP	FCS C/O											CABIN STOW	PRE SLEEP			
MIR	SLEEP																	SLEEP							
DAY/NIGHT	[Day/Night Cycle]																								
ORBIT	[Orbit Data]																								
DAILY ORB	[Daily Orbit Data]																								
DMT	[DMT Data]																								
MET: 008	0	1	2	3	4	5	6	7	8	9	10	11	12	13	14	15	16	17	18	19	20	21	22	23	0
STS-79	PRE SLEEP	SLEEP							POST SLEEP	SHAB DEACT	DEORBIT PREP							K L S N C D G							
MIR	SLEEP	SLEEP										DEORBIT PREP							K L S N C D G						
DAY/NIGHT	[Day/Night Cycle]																								
ORBIT	[Orbit Data]																								
DAILY ORB	[Daily Orbit Data]																								
DMT	[DMT Data]																								

**This Page Intentionally Blank**

**SUMMARY TIMELINE (ENGLISH)**

# SUMMARY TIMELINE

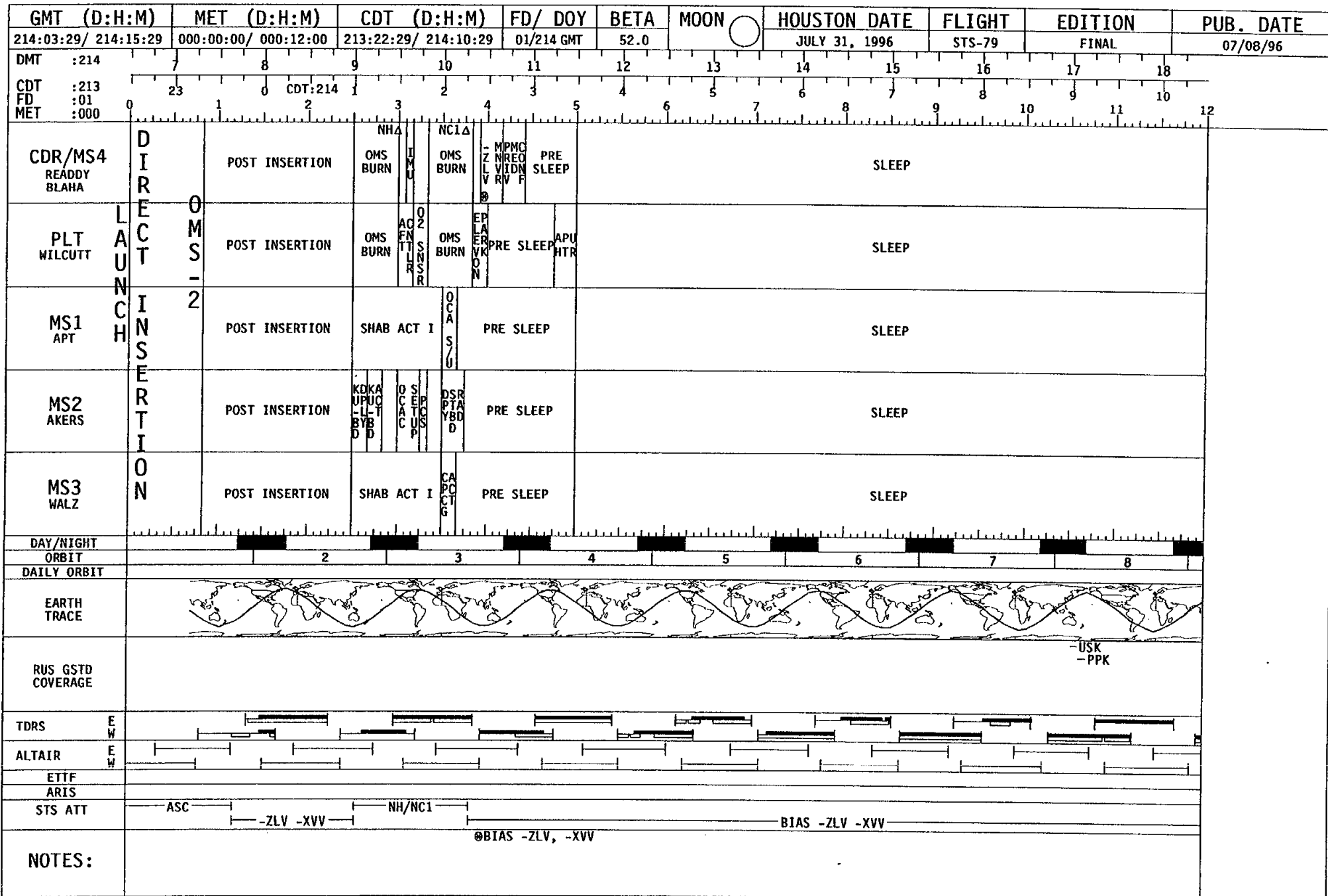

GMT (D:H:M)	MET (D:H:M)	CDT (D:H:M)	FD/ DOY	BETA	MOON	HOUSTON DATE	FLIGHT	EDITION	PUB. DATE								
214:15:29 / 215:03:29	000:12:00 / 001:00:00	214:10:29 / 214:22:29	02/214 GMT	54.1	☉	AUGUST 1, 1996	STS-79	FINAL	07/08/96								
DMT :214	19	20	21	22	23	0	DMT:215	1	2	3	4	5	6				
CDT :214	11	12	13	14	15	16	17	18	19	20	21	22	23	22			
FD :01	12	13	14	15	16	17	18	19	20	21	22	23	24	0			
MET :000		13 FD 2												MET:001			
CDR/MS4 REDDY BLAHA	SLEEP	POST SLEEP	NC2Δ RCS BURN	MZLV LOAD DAPS	EXERCISE	STS AIR (MS4)	I/M CN I OV AR U	COAS CAL	MZLV	STS SURF (MS4)	PAO OPTY	VHF SAREX S/U	NPCΔ MULT AXIS RCS BURN	MEAL	GG MNV BR	IF NILET	BM S M
PLT WILCUTT	SLEEP	POST SLEEP	RCS BURN	ERG G O P T R	H2O INITIAL SETUP	C/L CMR MOUNT	H2O R O M	H2O R O M	EXERCISE	H2O R O M	H2O R O M	MAN G E	MULT AXIS RCS BURN	MEAL	H2O T E R M	RNDZ TOOLS C/O	
MS1 APT	SLEEP	POST SLEEP	DLY MDDK CKS	SHAB ACT II	SHAB MOD SETUP	SH MOD HT CK	ARIS SETUP	MEAL	SAM ACT I	TP EG HS MC	SA AC MT S I I	ESC CHRG	ETTF PREP	E T CSN T F I	A E I C T I O N	T I O N M P M C	P O D N K
MS2 AKERS	SLEEP	POST SLEEP			FILTER CLEANING	C/L CMR MOUNT	IMAX CAMR PREP	PTV09 SETUP PAO	PAO OPTY	MEAL	EXERCISE	HHL C/O	RNDZ CAMR PREP	XFER REPACK			
MS3 WALZ	SLEEP	POST SLEEP	SHAB ACT II	RRMD ACT	ARIS SETUP	MEAL	ARIS SETUP	AV RE IN ST	ARIS PERF C/O	ODS RING EXT	GPS PCGSC CONFIG						
DAY/NIGHT	[Day/Night Cycle Diagram]																
ORBIT	9	10	11	12	13	14	15	16									
DAILY ORBIT	[Daily Orbit Diagram]																
EARTH TRACE	[Earth Trace Diagram]																
RUS GSTD COVERAGE	-USK -PPK	-ULD -USK -PPK	-ULD -USK -PPK	-USK	-DJS -KLP -ULD	-SHK -DJS -KLP -ULD	-SPB -DJS	-SPB -SHK -DJS	-SHK								
TDRS	[TDRS Coverage Diagram]																
ALTAIR	[ALTAIR Coverage Diagram]																
ETTF ARIS	[ETTF ARIS Coverage Diagram]																
STS ATT	BIAS -ZLV -XVV INC2! IMU/COAS -YLV -XVV TEST   A-C/O   A-MEAS VIBR -XLV +YVV																
NOTES:	@BIAS -ZLV, -XVV @AFT STATION (CDR) @-YLV -XVV @INIT @ARIS VENTING @DTP 00-14 SS GPS @ETTF VV OP @-XLV, +YVV ARIS @TERM FREE DRIFT																



GMT (D:H:M)	MET (D:H:M)	CDT (D:H:M)	FD/ DOY	BETA	MOON	HOUSTON DATE	FLIGHT	EDITION	PUB. DATE
215:03:29/ 215:15:29	001:00:00/ 001:12:00	214:22:29/ 215:10:29	02/215 GMT	56.2		AUGUST 1, 1996	STS-79	FINAL	07/08/96

DMT	CDT	FD	MET
:215	:214	:02	:001



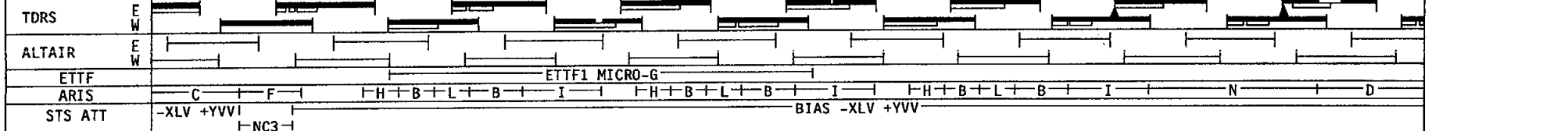

Activity	0	1	2	3	4	5	6	7	8	9	10	11	12
<b>CDR/MS4</b> READDY BLAHA	PMC REC IDMS VF	PRE SLEEP	NC3Δ RCS BURN	-XLV GG MNVR	PRE SLEEP	CRIS							
<b>PLT</b> WILCUTT		PRE SLEEP	RCS BURN		PRE SLEEP								
<b>MS1</b> APT		PRE SLEEP	DLY MDDK CKS	ST RST	PRE SLEEP	DISA TEHM							
<b>MS2</b> AKERS		XFER REPACK			PRE SLEEP								
<b>MS3</b> WALZ	SH MOD CK	SH CNFG			PRE SLEEP								

DAY/NIGHT	ORBIT	DAILY ORBIT
	17	6
	18	7
	19	8
	20	9
	21	10
	22	11
	23	12
	24	13
	25	14



NOTES: ARIS FREE | BIAS -XLV +YVV HOUSTON, TX | FREE DRIFT ARIS | STOW STBD DPLY PORT RME 1302 MIR ELEC FIELDS CHA RME 1302 MIR ELEC FIE | -700-14-

GMT (D:H:M)		MET (D:H:M)		CDT (D:H:M)		FD/ DOY	BETA	MOON	HOUSTON DATE	FLIGHT	EDITION	PUB. DATE										
215:15:29/ 216:03:29		001:12:00/ 002:00:00		215:10:29/ 215:22:29		03/215 GMT	58.2	☉	AUGUST 2, 1996	STS-79	FINAL	07/08/96										
DMT	:215	19	20	21	22	23	0	DMT:216	1	2	3	4	5	6								
CDT	:215	11	12	13	14	15	16		17	18	19	20	21	22								
FD	:03	12	13	14	15	16	17		18	19	20	21	22	23								
MET	:001													0								
STS-79	CDR/PLT REDDY WILCUTT	ANH		ANC4	ANCC	RNDZ	ATI	ARBAR	FINAL APPROACH	IO41 MNVR	DG U2	VTR S/U	VTR P/B	DA	MIR SAFETY BRIEF	STS SAFETY BRF	PD RECS	HX48 2F OE R	F ADF	PRE SLEEP	IO31 MNVR	PMC REO IDN V F
	MS1 APT	VHF COMM ACT		RNDZ				HARDWARE				PRESSURE CKS	AIR DUCT INST	MIR SAFETY BRIEF	ETTF DEACT	T E G S	P E D C	I O N	S H M O D E	S S C H N	D L Y M D D K	PRE SLEEP
	MS2 AKERS	VIEW MIR	RNDZ	VIEW MIR	RNDZ	VIEW MIR	RNDZ	ODS INGR PREP	PRESSURE CKS	HATCH	MIR SAFETY BRIEF	I E L K R M V L S	C 7	X F R	P R E P	PRE SLEEP						
	MS3 WALZ	RNDZ				P/TV03 OPS				PTV09 SETUP PAO	SHAB INGRS	SH CNFG	MIR SAFETY BRIEF	GPS DEACT	AV TGT	R E N X H R	PRE SLEEP					
MS4-UP BLAHA	VHF COMM ACT	AIR TO AIR				AIR TO AIR				OPENING				MIR SAFETY BRIEF	I E L K R M V L X F E R	SEAT INSTALL & C/O		SLEEP				
MS4-DWN LUCID	P/TV CSA				PRE SLEEP				PMC REO IDN V F													
MIR	MIR-CDR	VHF COMM ACT	AIR TO AIR				IO41 MNVR	AIR TO AIR	P/TV SETUP MIR	MIR SAFETY BRIEF	STS SAFETY BRF	SEAT XFER	SEAT INSTALL & C/O		SLEEP							
MIR-ENG	L O N	L O F F	L O N	L O F F	L O N	L O F F	OSC7 MNVR SA FIX	L D A S C R E T R K V	A/G 2 PRESSURE CKS	AIR DUCT INST	MIR SAFETY BRIEF	STS SAFETY BRF	X H R H/O	SLEEP								
DAY/NIGHT	[Day/Night Cycle]																					
ORBIT	25	26	27	28	29	30	31	32														
DAILY ORBIT	14	15	16	1	2	3	4	5														
EARTH TRACE	[Earth Trace Map]																					
RUS GSTD COVERAGE	USK -PPK	-PPK	-USK	-DJSPPK	-KLP	-ULD	-DJS	-KLP	-SHK	-SPB	-DJS	-KLP	-SHK	-DJS	-SPB	-SHK	-DJS	-SPB				
TDRS	[TDRS Coverage]																					
ALTAIR	[ALTAIR Coverage]																					
ETTF	[ETTF Coverage]																					
ARIS	D	E	BRIEF				I-DOCK	H+B	B	I	H+B	L	B	I	H							
STS ATT	RNDZ				OSC-7				I04.1-10+0				I03.1-130+0									
MIR ATT	RNDZ				OSC-7				I04.1-10+0				I03.1-130+0									
NOTES:	WASTE DUMP TERM *DOCKING 1/18:04 @INIT @XFER UPDATED JOINT FF @DTO 700-14 @ARIS VENTING o PRE SLEEP 700-14 TEHM PGSC DATA																					

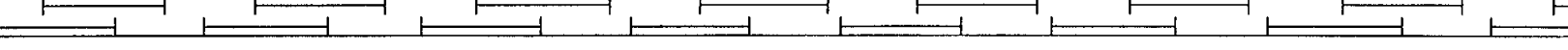
GMT (D:H:M)		MET (D:H:M)		CDT (D:H:M)		FD/ DOY	BETA	MOON 	HOUSTON DATE	FLIGHT	EDITION	PUB. DATE					
216:03:29/ 216:15:29		002:00:00/ 002:12:00		215:22:29/ 216:10:29		03/216 GMT	60.1		AUGUST 2, 1996	STS-79	FINAL	07/08/96					
DMT	:216	7	8	9	10	11	12	13	14	15	16	17	18				
CDT	:215	23	0	1	2	3	4	5	6	7	8	9	10				
FD	:03	0	1	2	3	4	5	6	7	8	9	10	11				
MET	:002	0	1	2	3	4	5	6	7	8	9	10	11				
STS-79	CDR/PLT READDY WILCUTT	PRE SLEEP	SLEEP						I041 MNVR		POST SLEEP	IMU	POST SLEEP	DAILY PLAN	H 2 N 0 1 T		
	MS1 APT	PRE SLEEP	DT TE SH AM	SLEEP						ET NE AH M		POST SLEEP		SCS HN FB G	SH MOD CK	DAILY PLAN	DLY MDK CKS
	MS2 AKERS	PRE SLEEP	SLEEP								POST SLEEP				DAILY PLAN	XFER	
	MS3 WALZ	PRE SLEEP	SLEEP DTO 700-10 OSVS VIDEO								POST SLEEP				DAILY PLAN	MGM SETUP & ACT	
	MS4-DWN LUCID	PRE SLEEP	SLEEP								POST SLEEP	EXER ON MIR		DAILY PLAN	HAND OVER		
MIR	MS4-UP BLAHA	SLEEP (9:00)								POST SLEEP				DAILY PLAN	HAND OVER		
	MIR-CDR	SLEEP (9:00)								POST SLEEP					EXER ON MIR		
	MIR-ENG	SLEEP (9:00)								POST SLEEP	I041 MNVR	POST SLEEP		DAILY PLAN	XFER		
DAY/NIGHT																	
ORBIT	33 34 35 36 37 38 39 40																
DAILY ORBIT	6 7 8 9 10 11 12 13																
EARTH TRACE																	
RUS GSTD COVERAGE	-PPK -USK -PPK -USK																
TDRS																	
ALTAIR																	
ETTF	B + L + B + I + L + L + (.01-.1) + B + I + N																
STACK ATT	I03.1-130+0 I04.1-10+0																
RME 1310	SMASE																
NOTES:	<p style="text-align: right;">◀ EXERCISE</p> <p style="text-align: right;">◀ DAILY PLAN</p> <p style="text-align: center;">TEHM PGSC DATA COLLECTION</p>																

GMT (D:H:M)		MET (D:H:M)		CDT (D:H:M)		FD/ DOY	BETA	MOON	HOUSTON DATE	FLIGHT	EDITION	PUB. DATE				
216:15:29 / 217:03:29		002:12:00 / 003:00:00		216:10:29 / 216:22:29		04/216 GMT	61.8	☉	AUGUST 3, 1996	STS-79	FINAL	07/08/96				
DMT	:216	19	20	21	22	23	0	DMT:217	1	2	3	4	5	6		
CDT	:216	11	12	13	14	15	16	17	18	19	20	21	22	23	22	0
FD	:04	12	13	14	15	16	17	18	19	20	21	22	23	24	25	26
MET	:002															MET:003
STS-79	CDR/PLT READY W/LCUTT	PTV06 SU D1118	PTV06 OPS D1118 SH OVRHD	BTS MED SMPL-SHTL	BTS PWRDN	BTS XFR	BTS EDU-M SETUP	MEAL	CGBA XFR	PAO OPTY	XFR PREP	DLY MDDK CKS	DAILY TAGUP	PMO RED IDN V R	PRIV FAM CONF	PRE SLEEP
	MS1 APT	XFER			COLD STOWAGE XFER	TEHOF DFRST	MEAL	IMAX TO MIR	IMAX S/U (SPEKTR)	PTV09 SETUP PAO	XFER TAGUP	XFR PREP	DAILY TAGUP	PMO RED IDN V R	PRIV FAM CONF	PRE SLEEP
	MS2 AKERS	XFER			COLD STOWAGE XFER	TEHOF DFRST	MEAL	IMAX TO MIR	IMAX S/U (SPEKTR)	PTV09 SETUP PAO	XFER TAGUP	XFR PREP	DAILY TAGUP	PMO RED IDN V R	PRIV FAM CONF	PRE SLEEP
	MS3 WALZ	MGM SETUP & ACT	EXERCISE	BTS MED SMPL-SHTL	MGM TERM		MEAL	CREW CHOICE TV	MEFC ACT (MIR)	PTV06 SU D1118	PTV06 OPS D1118 SH OVRHD	DAILY TAGUP	PRE SLEEP	SACHL	PRE SLEEP	
MS4-DWN LUCID	HANDOVER	BTS ECC PRIRODA SU	COLD STOWAGE XFER	TEHOF DFRST	MEAL	XFER	PAO OPTY	EXER ON MIR			DAILY TAGUP	PRE SLEEP				
MS4-UP BLAHA	HANDOVER	BTS ECC PRIRODA SU	BTS PWRDN	BTS XFR	BTS EDU-M SETUP	MEAL	CGBA XFR	PAO OPTY	XFER TAGUP	PFC RAO IMN V F	PRE SLEEP				SLEEP	
MIR-CDR	EXER ON MIR	XFER				MEAL	IMAX TO MIR	IMAX S/U (SPEKTR)	P/TV SETUP MIR	PAO OPTY	XFER TAGUP	PRE SLEEP				SLEEP
MIR-ENG	EXER ON MIR	BTS ECC PRIRODA SU		BTS EDU-M SETUP	MEAL	CGBA XFR	MEFC ACT (MIR)				PRE SLEEP	I031 MNVR				SLEEP
DAY/NIGHT																
ORBIT		41		42		43		44		45		46		47		48
DAILY ORBIT		14		15		1		2		3		4		5		6
EARTH TRACE																
RUS GSTD COVERAGE	-ULD -USK -PPK	-KLP -ULD -USK -DJSPPK	-DJS -KLP -ULD -USK	-SHKUSK -DJS -KLP -ULD	-KLP -SPB -SHK -DJS	-SPB -SHK -DJS	-SPB -SHK -DJS	-SPB -SHK -DJS	-SPB -SHK -DJS	-SPB -SHK -DJS	-SPB -SHK -DJS	-SPB -SHK -DJS	-SPB -SHK -DJS	-SPB -SHK -DJS	-SPB -SHK -DJS	-SPB -SHK -DJS
TDRS	E															
ALTAIR	E															
ETTF																
ARIS		N		O-ACT REDUND				P-ACCEL REDUN						Q-POSN SNSR		BRIEF
STACK ATT							104.1-10+0									103.1-87+0
RME 1310		SMASE						SMASE								
NOTES:	Ⓞ GYRODYNE, BATTERY, FOOD XFER Ⓞ INIT Ⓞ TERM Ⓞ PRE SLEEP Ⓞ CELINA, OH Ⓞ TERM -MIR A/G RELAY- Ⓞ RME 1302 MIR ELEC FIELD CHAR R-TEHM PGSC DATA   SAMPLE XFER   TEHM PGSC DATA															

GMT (D:H:M)	MET (D:H:M)	CDT (D:H:M)	FD/ DOY	BETA	MOON	HOUSTON DATE	FLIGHT	EDITION	PUB. DATE
217:03:29/ 217:15:29	003:00:00/ 003:12:00	216:22:29/ 217:10:29	04/217 GMT	63.4		AUGUST 3, 1996	STS-79	FINAL	07/08/96

DMT :217	7	8	9	10	11	12	13	14	15	16	17	18
CDT :216	23	0	CDT:217	1	2	3	4	5	6	7	8	9
FD :04	0	1	2	3	4	5	6	7	8	9	10	11
MET :003	0	1	2	3	4	5	6	7	8	9	10	11

STS-79	CDR/PLT READDY WILCUTT	PRE SLEEP	SLEEP ----- DTO 1118 MIR PHOTO SURVEY -----								POST SLEEP	I M U	POST SLEEP	I041 MNVR	POST SLEEP	DAILY PLAN	
	MS1 APT	PRE SLEEP	SLEEP								POST SLEEP		SCS SH HNF MOD FB CK	DAILY PLAN	ARIS FULL UMB		
	MS2 AKERS	PRE SLEEP	SLEEP								POST SLEEP		DAILY PLAN	XFER			
	MS3 WALZ	PRE SLEEP	SLEEP								POST SLEEP		DAILY PLAN	MGM SETUP & ACT			
	MS4-DWN LUCID	PRE SLEEP	SLEEP								POST SLEEP	EXER ON MIR	DAILY PLAN	HAND OVER			
MIR	MS4-UP BLAHA		SLEEP				POST SLEEP					DAILY PLAN	HAND OVER				
	MIR-CDR		SLEEP				POST SLEEP				EXER ON MIR	I041 MNVR	DAILY PLAN	XFER			
	MIR-ENG		SLEEP				POST SLEEP				EXER ON MIR	DAILY PLAN	XFER				

DAY/NIGHT														
ORBIT	48	49	50	51	52	53	54	55	56					
DAILY ORBIT	6	7	8	9	10	11	12	13	14					
EARTH TRACE														
RUS GSTD COVERAGE	<div style="display: flex; justify-content: space-between;"> <span>-USK -PPK</span> <span>-USK -PPK</span> <span>-ULD -USK -PPK</span> </div>													
TDRS														
ALTAIR														
ETTF	BRIEF   L.05 ROT   L(.01-.1) ROT   B   I   N   BRIEF FULL													
STACK ATT	103.1-87+0   I04.1-10+0													
RME 1310	SMASE													

NOTES:

- o HTR CONFIG
- o CABIN TEMP CNTL
- o RECONFIG
- o RCS CONFIG
- o RCS REG
- o ARIS VENTING

GMT (D:H:M)	MET (D:H:M)	CDT (D:H:M)	FD/ DOY	BETA	MOON	HOUSTON DATE	FLIGHT	EDITION	PUB. DATE															
217:15:29 / 218:03:29	003:12:00 / 004:00:00	217:10:29 / 217:22:29	05/217 GMT	64.7		AUGUST 4, 1996	STS-79	FINAL	07/08/96															
DMT :217	19	20	21	22	23	0	DMT:218	1	2	3	4	5	6											
CDT :217	11	12	13	14	15	16	17	18	19	20	21	22	23											
FD :05	12	13	14	15	16	17	18	19	20	21	22	23	0											
MET :003													MET:004											
STS-79	CDR/PLT READY WILCUTT	EXERCISE (CDR)	XFER	IMAX SUBJ	EXERCISE (PLT)	MEAL	XFER	PAO OPTY	XFER TAGUP (PLT)	FILTER CLEANING	DAILY TAGUP	PRE SLEEP	I031 MNVR	PMC RECIDN V F	PRE SLEEP									
	MS1 APT	DLY MDDK CKS	PTV06 SU D1118	PTV06 OPS D1118 FLT OK	CAMR MAIN	PTV09 SETUP PAO	IMAX SUBJ	PAO OPTY	MEAL	STES XFR	TT EE HM MP	PTV09 SETUP PAO	PAO OPTY	EXERCISE	ARIS PART UMB	ETTF SMPL	ETTF ACT2	DAILY TAGUP	D C N L K	DLY MDDK CKS	SH MOD CK	SSCPFC HNRAG B FIMN GV F	PRE SLEEP	
	MS2 AKERS	XFER		IMAX OPER (SPEKTR)			MEAL	XFER			PAO OPTY	XFER TAGUP	EXERCISE		DAILY TAGUP	PRE SLEEP								
	MS3 WALZ	MGM SETUP & ACT	ORLAN SUIT	SUIT XFRSTOW	MEFC DEACT	IMAX SUBJ	MGM TERM	MGM ACT	PAO OPTY	MEAL	MC GK M	IMAX S/U (PRIRODA)	PTV06 SU D1118	PAO OPTY	PTV06 OPS D1118 FLT OK	MGM TERM	GPS PGSC ACT	DAILY TAGUP	PRE SLEEP					
	MS4-DWN LUCID	HANDOVER				IMAX SUBJ		PAO OPTY	MEAL	XFER			PAO OPTY	PFC RAO IMN V F	EXER ON MIR		DAILY TAGUP	PRE SLEEP						
	MS4-UP BLAHA	HANDOVER				IMAX SUBJ	STS AIR	PAO OPTY	MEAL	STES XFR	STS SURF	PAO OPTY	XFER TAGUP	GPS PART	PRE SLEEP	SLEEP								
	MIR-CDR	XFER	ORLAN SUIT	SUIT XFRSTOW	XFER	IMAX SUBJ	EXER ON MIR		PAO OPTY	MEAL	STES XFR		P/TV SETUP MIR	PAO OPTY	XFER TAGUP	PRE SLEEP		SLEEP						
MIR-ENG	XFER	ORLAN SUIT	SUIT XFRSTOW	MEFC DEACT		P/TV SETUP MIR	IMAX SUBJ	PAO OPTY	EXER ON MIR	IMAX S/U (PRIRODA)		PAO OPTY	PRE SLEEP		SLEEP									
DAY/NIGHT																								
ORBIT	56	57	58	59	60	61	62	63	64															
DAILY ORBIT	14	15	1	2	3	4	5	6	7															
EARTH TRACE																								
RUS GSTD COVERAGE	<ul style="list-style-type: none"> <li>-DJS PPK</li> <li>-ULD</li> <li>-KLP</li> <li>-USK</li> </ul>																							
TDRS	<ul style="list-style-type: none"> <li>-USK</li> <li>-ULD</li> <li>-SHK</li> <li>-KLP</li> <li>-DJS</li> <li>-SHK</li> <li>-DJS</li> <li>-SPB</li> </ul>																							
ALTAIR	<ul style="list-style-type: none"> <li>-DJS</li> <li>-SHK</li> <li>-KLP</li> <li>-DJS</li> <li>-SHK</li> <li>-DJS</li> <li>-SPB</li> </ul>																							
ETTF	D-STIFF																							
ARIS	A-PERF C/O																							
STACK ATT	V-COMP SEL																							
RME 1310	L(.05) ALL + PART + D-STIFF																							
	104.1-10+0																							
	103.1-95+0																							
	SMASE																							
NOTES:	<p>⊙RME 1302 MIR ELEC FIELD CHAR</p> <p>⬢ ARIS VENTING</p> <p>⬢ PRE SLEEP</p> <p>⬢ ETTF VENT VLV-OP</p> <p>⬢ VK5AGR</p> <p>⬢ DTO 700-14 SS GPS</p> <p style="text-align: right;">700-14</p>																							

GMT (D:H:M)	MET (D:H:M)	CDT (D:H:M)	FD/DOY	BETA	MOON	HOUSTON DATE	FLIGHT	EDITION	PUB. DATE
218:03:29/ 218:15:29	004:00:00/ 004:12:00	217:22:29/ 218:10:29	05/218 GMT	65.9		AUGUST 4, 1996	STS-79	FINAL	07/08/96

DMT :218	7	8	9	10	11	12	13	14	15	16	17	18				
CDT :217	23	1	0	CDT:218	1	2	3	4	5	6	7	8	9	10	11	12
FD :05	0	1	2	3	4	5	6	7	8	9	10	11	12			
MET :004	0	1	2	3	4	5	6	7	8	9	10	11	12			

S T S - 7 9	CDR/PLT READDY WILCUTT	PRE SLEEP	SLEEP										POST SLEEP	I M U	G044 MNVR	H I N T	
	MS1 APT	PRE SLEEP	SLEEP										POST SLEEP	SCS HNI FB GFC	SH MOD CK	DAILY PLAN	DLY MDDK CKS
	MS2 AKERS	PRE SLEEP	SLEEP										POST SLEEP			DAILY PLAN	XFER
	MS3 WALZ	PRE SLEEP	SLEEP										POST SLEEP			DAILY PLAN	ARIS MIN UMB
	MS4-DWN LUCID	PRE SLEEP	SLEEP										POST SLEEP			DAILY PLAN	EXER ON MIR
M I R	MS4-UP BLAHA		SLEEP					POST SLEEP							DAILY PLAN	XFER	
	MIR-CDR		SLEEP					POST SLEEP					EXER ON MIR		G044 MNVR	XFER	
	MIR-ENG		SLEEP					POST SLEEP					EXER ON MIR		DAILY PLAN	XFER	

DAY/NIGHT	[Day/Night Cycle]															
ORBIT	64	65	66	67	68	69	70	71	7	8	9	10	11	12	13	14
DAILY ORBIT	[Daily Orbit Cycle]															

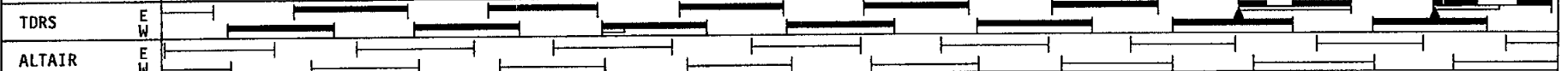

ETTF	ETTF2 MICRO-G																			
ARTS	V-COMP SEL				V-COMP SEL				V-COMP SEL				L.05		B		I		N	
STACK ATT	103.1-95+0																			
RME 1310											SMASE									

NOTES:

o WASTE DUMP INIT  
 o ARIS VENTING

700-14

GMT (D:H:M)		MET (D:H:M)		CDT (D:H:M)		FD/ DOY	BETA	MOON	HOUSTON DATE	FLIGHT	EDITION	PUB. DATE									
218:15:29 / 219:03:29		004:12:00 / 005:00:00		218:10:29 / 218:22:29		06/218 GMT	66.9		AUGUST 5, 1996	STS-79	FINAL	07/08/96									
DMT	:218	19	20	21	22	23	0	DMT:219	1	2	3	4	5	6							
CDT	:218	11	12	13	14	15	16	17	18	19	20	21	22	23	22	MET:005					
FD	:06	12	13	14	15	16	17	18	19	20	21	22	23	24							
MET	:004																				
STS-79	CDR/PLT READDY WILCUTT	XFER	IO41 MNVN	H 2 0 T E R M M I R A T T C N T L	EXER (CDR)	IMAX SUBJ (PLT)	STS ATT C N T L	IMAX SUBJ (CDR)	MEAL	H 2 0 I N I T	XFER	H 2 0 M I R R E V R C S T E S T	PAO O P T Y	EXERCISE (PLT)	H 2 0 I N I T	H 2 0 T E R M	DAILY TAGUP	G033 MNVN I T E	P M C R E Q I D N V F	PRE SLEEP	
	MS1 APT	XFER			IMAX SUBJ	ETTF DEACT	EXERCISE	MEAL	SAMS TSH	S DTT A I E E M S H M S K M P	ARIS R E V R C S T E S T	P T V 0 9 S E T U P P A O	S A R X B	ETTF S M P L	ETTF A C T 3	S H M O D C K	S S C M H N F G	D L Y M D D K C K S	DAILY TAGUP	O D N C A L K	PRE SLEEP
	MS2 AKERS	XFER			IMAX SUBJ		IMAX OPR (PRIRODA)	MEAL	IMAX SU (MIR CORE)		EXERCISE		XFER TAGUP		XFER STOW		DAILY TAGUP	PRE SLEEP	P F C R A O I M N V F	PRE SLEEP	
	MS3 WALZ	XFER			IMAX OPR (PRIRODA)		MIDAS XFR	MEAL	CREW CHOICE TV		AVARIS R E V R C S T E S T		AV R E I N O P T Y	B H D L T O N	EXERCISE	B H D L T O N	DAILY TAGUP	S P A R S N L		PRE SLEEP	
MS4-DWN LUCID	EXER ON MIR			HANDOVER		IMAX SUBJ	MEAL	DOSIMETER EXCHG		HANDOVER		PAO O P T Y	S S A C H L	EXER ON MIR		DAILY TAGUP			PRE SLEEP		
MS4-UP BLAHA	XFER			HANDOVER		MIDAS XFR	MEAL	DOSIMETER EXCHG		HANDOVER		PAO O P T Y	XFER TAGUP	PRE SLEEP					SLEEP		
MIR	MIR-CDR	XFER	IO41 MNVN	MIR ATT C N T L	EXER ON MIR	MIDAS XFR	MEAL	IMAX SU (MIR CORE)		ARIS R E V R C S T E S T		PAO O P T Y	XFER TAGUP	PRE SLEEP					SLEEP		
	MIR-ENG			MIR INERTIAL PLATFORM UPDATE	STS ATT C N T L	IMAX SUBJ	MEAL			XFER		PAO O P T Y		PRE SLEEP					SLEEP		
DAY/NIGHT																					
ORBIT		72	73	74	75	76	77	78	79												
DAILY ORBIT		15	16	1	2	3	4	5	6												
EARTH TRACE																					
RUS GSTD COVERAGE	-ULD -USK -PPK	-KLP -ULD -USK -DJSPPK	-DJSJK -SHK -KLP -ULD	-KLP -SHHLD -SPBUSK -DJS	-SHK -DJS -KLP -SPB	-SHK -DJS -SPB													-SPB -SHK		
TDRS	E W																				
ALTAIR	E W																				
ETTF		A-PERF C/O																			
ARIS		V-COMP SEL																			
STACK ATT		BRIEF																			
RME 1310		J-VRCS																			
		BRIEF																			
		ETTF3 MICRO-G																			
		G04.4																			
		I04.1-10+0																			
		G03.3 (ARIS)																			
		SMASE																			
NOTES:		o WASTE DUMP TERM o EXERCISE o ARIS VRCS (10 min FREE) o ARIS VENTING o ARIS VENTING o ETTF VENT VLV-OP o DTO 700-10 OSVS o DTO 700-10 OSVS o PRE SLEEP o PRE SLEEP o VK6IU o SURREY, ENGLAND SCHOOL o ARIS FREE DRIFT																			
		700-14																			



GMT (D:H:M)	MET (D:H:M)	CDT (D:H:M)	FD/ DOY	BETA	MOON 	HOUSTON DATE	FLIGHT	EDITION	PUB. DATE
219:03:29/ 219:15:29	005:00:00/ 005:12:00	218:22:29/ 219:10:29	06/219 GMT	67.5		AUGUST 5, 1996	STS-79	FINAL	07/08/96

DMT :219	7	8	9	10	11	12	13	14	15	16	17	18
CDT :218	23	0	CDT:219	1	2	3	4	5	6	7	8	9
FD :06	0	1	2	3	4	5	6	7	8	9	10	11
MET :005	0	1	2	3	4	5	6	7	8	9	10	11

STS-79	CDR/PLT READDY WILCUTT	PRE SLEEP	I031 MNVVR	SLEEP								POST SLEEP	I041 MNVVR	I041 MNVVR	H 2 O I I I	I M U	DAILY PLAN	H 2 O R M
	MS1 APT	PRE SLEEP		SLEEP								POST SLEEP			SCS H M F B G F	SH MOD B C K	DAILY PLAN	DMC L O K Y D S K
	MS2 AKERS	PRE SLEEP		SLEEP								POST SLEEP					DAILY PLAN	
	MS3 WALZ	PRE SLEEP		SLEEP								POST SLEEP					DAILY PLAN	AAP O R S D I D S
	MS4-DWN LUCID	PRE SLEEP		SLEEP								POST SLEEP	EXER ON MIR				DAILY PLAN	
MIR	MS4-UP BLAHA			SLEEP				POST SLEEP								DAILY PLAN		
	MIR-CDR			SLEEP				POST SLEEP				EXER ON MIR		I041 MNVVR		DAILY PLAN		
	MIR-ENG USACHEV			SLEEP				POST SLEEP				EXER ON MIR				DAILY PLAN		

DAY/NIGHT	[Day/Night Cycle Diagram]													
-----------	---------------------------	--	--	--	--	--	--	--	--	--	--	--	--	--

ORBIT	80	81	82	83	84	85	86	87
DAILY ORBIT	7	8	9	10	11	12	13	14



RUS GSTD COVERAGE	-PPK -USK -PPK -PPK -USK -PPK -USK -PPK -USK -PPK													
-------------------	---	--	--	--	--	--	--	--	--	--	--	--	--	--

TDRS	E	W	[TDRS Coverage Diagram]													
------	---	---	-------------------------	--	--	--	--	--	--	--	--	--	--	--	--	--

ALTAIR	E	W	[ALTAIR Coverage Diagram]													
--------	---	---	---------------------------	--	--	--	--	--	--	--	--	--	--	--	--	--

ETTF	ETTF3 MICRO-G													
------	---------------	--	--	--	--	--	--	--	--	--	--	--	--	--

ARIS	N	L(.1)	L(.1-1)	L(1-100)	CR-STEP	BRIEF	B	I	N	I				
------	---	-------	---------	----------	---------	-------	---	---	---	---	--	--	--	--

STACK ATT	103.1-106+0													
-----------	-------------	--	--	--	--	--	--	--	--	--	--	--	--	--

RME 1310	SMASE													
----------	-------	--	--	--	--	--	--	--	--	--	--	--	--	--

NOTES:

o POST SLEEP    ▽ HANDOVER

◆ HANDOVER

ARIS FREE DRIFT

700-14

GMT (D:H:M)		MET (D:H:M)		CDT (D:H:M)		FD/ DOY	BETA	MOON	HOUSTON DATE	FLIGHT	EDITION	PUB. DATE								
219:15:29/ 220:03:29		005:12:00/ 006:00:00		219:10:29/ 219:22:29		07/219 GMT	67.9		AUGUST 6, 1996	STS-79	FINAL	07/08/96								
DMT	:219	19	20	21	22	23	0	DMT:220	1	2	3	4	5	6						
CDT	:219	12	11	13	12	14	13	15	14	16	15	17	16	18						
FD	:07																			
MET	:005													0 MET:006						
STS-79	CDR/PLT REDDY WILCUTT	INIT	PRCS TEST	TERM	MEAL	CREW CONF	RSA FOOD XFR(ARIS)	XFER TAGUP	FAREWELL	FINAL XFER	C/L CMR MOUNT	RNDZ TOOLS S/U	I031 MNVR	EXERCISE (CDR)	DAILY TAGUP	PRE SLEEP	PMC REQ IDN V F	PRE SLEEP		
	MS1 APT	IMAX SUBJ	PTV09 SETUP PAO		MEAL	CREW CONF	RSA FOOD XFR(ARIS)	XFER TAGUP	FAREWELL	FINAL XFER	UNDK PREP HATCH CL	ETTF DEACT	DMC SH LDK MOD YDS CK	SSC THN B F G	DAILY TAGUP	PRE SLEEP	OD C N A L K	PRE SLEEP	S S A C R H L	PRE SLEEP
	MS2 AKERS	IMAX OPER (MIR BB)	IMAX SUBJ		MEAL	CREW CONF	IMAX TO STS	XFER TAGUP	FAREWELL	FINAL XFER	ADR TUM RCV TLA	C/L CMR MOUNT	XFR STOW		DAILY TAGUP	PRE SLEEP				
	MS3 WALZ	IMAX SUBJ	IMAX OPER (MIR BB)		MEAL	CREW CONF	RSA FOOD XFR(ARIS)	XFER TAGUP	FAREWELL	FINAL XFER	ARIS PSD RMV	UNDK PREP HATCH CL	PTV06 SU D1118	PTV06 OPS D1118 SH OVHD	DAILY TAGUP	PRE SLEEP	PFC RAO IMV F	PRE SLEEP		
MS4-DWN LUCID	HANDOVER		IMAX SUBJ		MEAL	CREW CONF	HANDOVER	XFER TAGUP	FAREWELL	FINAL XFER	UNDK PREP HATCH CL	EXERCISE		DAILY TAGUP	PRE SLEEP					
MS4-UP BLAHA	HANDOVER		IMAX SUBJ		MEAL	CREW CONF	HANDOVER	XFER TAGUP	FAREWELL	FINAL XFER	UNDK PREP HATCH CL	PRE SLEEP		SLEEP						
MIR-CDR		PRCS TEST	IMAX SUBJ		MEAL	CREW CONF	RSA FOOD XFR(ARIS)	XFER TAGUP	FAREWELL	FINAL XFER	UNDK PREP HATCH CL	PRE SLEEP		SLEEP						
MIR-ENG		P/TV SETUP MIR			MEAL	CREW CONF	RSA FOOD XFR(ARIS)	XFER TAGUP	FAREWELL	ADR TUM RCV TLA	UNDK PREP HATCH CL	PRE SLEEP	I031 MNVR	SLEEP						
DAY/NIGHT	[Bar chart showing day/night cycle]																			
ORBIT	87	88	89	90	91	92	93	94	95											
DAILY ORBIT	14	15	1	2	3	4	5	6	7											
EARTH TRACE																				
RUS GSTD COVERAGE	-DJS PPK      -USK      -ULD      -DJS      -DJS      -SPB -KLP      -DJS      -SHKUSK      -KLP      -SPB      -SHK -ULD      -KLP      -DJS      -SHK      -SHK -USK      -ULD      -KLP      -SPB      -SHK      -DJS																			
TDRS	[Bar chart showing TDRS coverage]																			
ALTAIR	[Bar chart showing ALTAIR coverage]																			
ETTF ARIS	I   A-MEAS ENV   B   I   FOOD XFR   A-PERF C/O   E-M&I   C-I RESP   V-COMP SEL																			
STACK ATT	104.1-10+0      103.1-106+0																			
RME 1310	SMASE																			
NOTES:	@RME 1301 MIR STRUCT DYNAMICS TEST      Δ PTV09 SETUP PAO      o INSTL LGHTS      ▲ PRE SLEEP      @ANDOVER, KS Δ INSTL LGHTS																			

GMT (D:H:M)	MET (D:H:M)	CDT (D:H:M)	FD/ DOY	BETA	MOON	HOUSTON DATE	FLIGHT	EDITION	PUB. DATE
220:03:29/ 220:15:29	006:00:00/ 006:12:00	219:22:29/ 220:10:29	07/220 GMT	68.0		AUGUST 6, 1996	STS-79	FINAL	07/08/96

DMT :220	7	8	9	10	11	12	13	14	15	16	17	18
CDT :219	23	0	1	2	3	4	5	6	7	8	9	10
FD :07	0	1	2	3	4	5	6	7	8	9	10	11
MET :006	0	1	2	3	4	5	6	7	8	9	10	11

S T S - 7 9	CDR/PLT READDY WILCUTT	PRE SLEEP	_____ DTO 1118 MIR PHOTO SURVEY _____	SLEEP		POST SLEEP	I041 MNVR	POST SLEEP	FILTER CLEANING	I M U
	MS1 APT	PRE SLEEP		SLEEP	_____ DTO 700-10 OSVS VIDEO _____	POST SLEEP			SCS SH DMC HM MOD LDK FB CK VDS GF K	
	MS2 AKERS	PRE SLEEP		SLEEP		POST SLEEP				
	MS3 WALZ	PRE SLEEP		SLEEP		POST SLEEP				
	MS4-DWN LUCID	PRE SLEEP		SLEEP		POST SLEEP			EXERCISE	
M I R	MS4-UP BLAHA		SLEEP			POST SLEEP				
	MIR-CDR		SLEEP			POST SLEEP	I041 MNVR			
	MIR-ENG		SLEEP			POST SLEEP				

DAY/NIGHT												
ORBIT	95	96	97	98	99	100	101	102	103			
DAILY ORBIT	7	8	9	10	11	12	13	14	15			

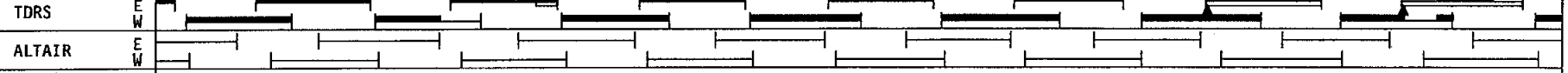





ETT	V-COMP SEL											
ARIS	V-COMP SEL											
STACK ATT	103.1-106+0											
RME 1310	SMASE											



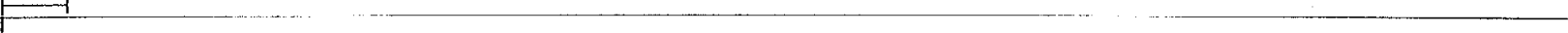

NOTES:

700-14

GMT (D:H:M)		MET (D:H:M)		CDT (D:H:M)		FD/ DOY	BETA	MOON	HOUSTON DATE	FLIGHT	EDITION	PUB. DATE			
220:15:29/ 221:03:29		006:12:00/ 007:00:00		220:10:29/ 220:22:29		08/220 GMT	67.8		AUGUST 7, 1996	STS-79	FINAL	07/08/96			
DMT	:220	19	20	21	22	23	0	DMT:221	1	2	3	4	5	6	
CDT	:220	12	11	13	12	14	13	15	14	16	15	17	16	18	
FD	:08														
MET	:006													0 MET:007	
STS-79	CDR/PLT REDDY WILCUTT		G031 MNVR		Vbar UNDOCK		U2 AL	EXERCISE (CDR)	PAO OPTY PLT		Z N L V R	EXERCISE (PLT)	PRE SLEEP	PMC REQ IDN V F	PRE SLEEP
	MS1 APT		EXERCISE		UNDOCK		GPS PGSC DEACT	ETTF SMPL	ETTF ACT4	PTV09 SETUP PAO	PAO OPTY H S	T P E G H S	S BDMCT P O DS T S D SH SSC A /LKE GIC NA SA I MOD H N R UYD SH SIA LM HM S CK B F G		PRE SLEEP
	MS2 AKERS	EXERCISE	P/TV11 S/U UNDK		UNDOCK		RAD OPS	P/TV05 OPS - IMAX		PAO OPTY		P/TV05 OPS - IMAX			PRE SLEEP
	MS3 WALZ		P/TV05 SETUP IMAX		P/TV05 OPS - IMAX		P/TV05 OPS - IMAX		PAO OPTY	EXERCISE	P/TV05 OPS - IMAX	MEFC ACT		PRE SLEEP	
MS4-DWN LUCID		P/TV11 S/U UNDK		P/TV11 OPS UNDK				PAO OPTY		EXERCISE			PRE SLEEP		
MIR	MS4-UP BLAHA											PRE SLEEP		SLEEP	
	MIR-CDR		G031 MNVR	P/TV SETUP MIR	MIR UNDOCK	P/TV OPS UNDK						PRE SLEEP		SLEEP	
	MIR-ENG				MIR UNDOCK	MMST INUR RVNK R	MONITOR FLYAROUND					PRE SLEEP		SLEEP	
DAY/NIGHT															
ORBIT	103	104	105	106	107	108	109	110							
DAILY ORBIT	15	16	1	2	3	4	5	6							
EARTH TRACE															
RUS GSTD COVERAGE	PPK	-USK -DJSPK -KLP -ULD	-KLP -ULD -SHKUSK -DJS	-SPB -DJS -KLP -SHULD	-SPB -SHK -DJS	-SHK -DJS -SPB									
TDRS	E W														
ALTAIR	E W														
ETTF	ETTF4 MICRO-G														
ARIS	GGG I N														
STACK ATT	I04.1-10+0 G03.1 FLYAROUND -ZLV +YVV -ZLV -XVV														
RME 1310															
NOTES:	<p>*UNDOCK 6/15:10 (SR +1 MIN) (USK LOS -2 MIN)</p> <p>*FINAL SEP (+RBAR) 6/17:06</p> <p>o STOW PORT, DPLY STBD</p> <p>o DTO 700-14</p> <p>o WASTE DUMP INIT</p> <p>o WASTE DUMP TERM</p> <p>o ETTFF VENT VLV-OP</p> <p>o INIT</p> <p>o -ZLV, -XVV</p> <p>o VK6IU, VK5AGR BRIDGE</p> <p>o TERM</p> <p>o RME 1302 MIR ELEC FIELDS CHAR</p> <p>o TEHM PGSC DATA</p>														

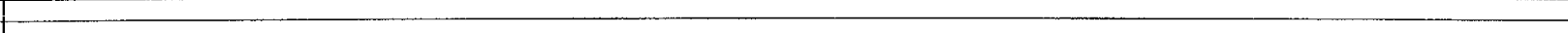

GMT (D:H:M)	MET (D:H:M)	CDT (D:H:M)	FD/ DOY	BETA	MOON 	HOUSTON DATE	FLIGHT	EDITION	PUB. DATE				
221:03:29/ 221:15:29	007:00:00/ 007:12:00	220:22:29/ 221:10:29	08/221 GMT	67.2		AUGUST 7, 1996	STS-79	FINAL	07/08/96				
DMT :221	7	8	9	10	11	12	13	14	15	16	17	18	
CDT :220	23	0	CDT:221	1	2	3	4	5	6	7	8	9	10
FD :08	0	1	2	3	4	5	6	7	8	9	10	11	12
MET :007	0	1	2	3	4	5	6	7	8	9	10	11	12
CDR READDY	PRE SLEEP					SLEEP (9:00)					M-ZLVR SARX	POST SLEEP	PER SNL MEX POST SLEEP
PLT WILCUTT	PRE SLEEP					SLEEP (9:00)							
MS1 APT	PRE SLEEP					SLEEP (9:00)					SARX	POST SLEEP	DMC LDK YDS K
MS2 AKERS	PRE SLEEP					SLEEP (9:00)						POST SLEEP	
MS3 WALZ	PRE SLEEP					SLEEP (9:00)						POST SLEEP	MEE FAC CT
MS4-DWN LUCID	PRE SLEEP					SLEEP (9:00)					POST SARX PER SNL	POST SLEEP	
DAY/NIGHT ORBIT	111	112	113	114	115	116	117	118					
DAILY ORBIT	7	8	9	10	11	12	13	14					
EARTH TRACE													
TDRS													
ETTF													
ARIS													
STS ATT	-ZLV -XVV												
NOTES:	<div style="text-align: right;">           -ZLV +YVV            @ZS6BTD ■ APU HTR ACT            @RME 1302 MIR ELEC FIELD CHAR         </div>												

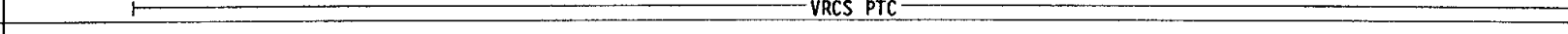
GMT (D:H:M)	MET (D:H:M)	CDT (D:H:M)	FD/ DOY	BETA	MOON	HOUSTON DATE	FLIGHT	EDITION	PUB. DATE										
221:15:29 / 222:03:29	007:12:00 / 008:00:00	221:10:29 / 221:22:29	09/221 GMT	66.4		AUGUST 8, 1996	STS-79	FINAL	07/08/96										
DMT :221	19	20	21	22	23	0	DMT:222	1	2	3	4	5	6						
CDT :221	11	12	13	14	15	16	17	18	19	20	21	22	23	0					
FD :09	12	13	14	15	16	17	18	19	20	21	22	23	0	MET:008					
MET :007																			
CDR READDY	FCS C/O	RCS HOT FIRE HOT M-NVLR -XZLV	D/O PREP BRIEF	PAO OPTY	ELEVON PARK	VRCS BOOST TEST	-ZLV M-NVLR	EXERCISE	MEAL	KS UT-LO BWD	CABIN STOW	COMM CK	CABIN STOW	PRE SLEEP	PMCR RECON IDN V F PRE SLEEP				
PLT WILCUTT	FCS C/O	RCS HOT FIRE HOT	D/O PREP BRIEF			VRCS BOOST TEST		EXERCISE	MEAL		RSS SETUP	CABIN STOW	SARRSNL SARRSNL	CABIN STOW	PRE SLEEP				
MS1 APT	SH MOD CK	ETTF ENTRY CONFG	SAMS DEACT	D/O PREP BRIEF		ARIS STOW		MEAL	SHAB STOW	SARRX	EXERCISE	TT EARR MPX	CABIN STOW	VRS HAT FDO IWO	CABIN STOW	DMC LDK YDS K	SH MOD CK	SH C NFG	PRE SLEEP
MS2 AKERS	FCS C/O	RCS HOT FIRE HOT	D/O PREP BRIEF	PAO OPTY		VRCS BOOST TEST	EXERCISE	MEAL		SARRSNL SARRSNL	CABIN STOW	ERG STOW	CABIN STOW		PRE SLEEP				
MS3 WALZ	MD EE FACT T	EXERCISE	RRMD SAMPLE	D/O PREP BRIEF		ARIS STOW		MEAL	SHAB STOW	RSS SETUP	CD PE CA GC T	RRMD DEACT	CABIN STOW	RH RO ML DD	CABIN STOW		PRE SLEEP		
MS4-DWN LUCID	POST SLEEP	PTV09 SETUP PAO	D/O PREP BRIEF	PAO OPTY	EXERCISE			MEAL		RSS SETUP	EXERCISE	ERG STOW	CABIN STOW		PRE SLEEP				
DAY/NIGHT																			
ORBIT	119	120	121	122	123	124	125	126											
DAILY ORBIT	15	1	2	3	4	5	6	7											
EARTH TRACE																			
TDRS																			
ETTF																			
ARIS																			
STS ATT	-ZLV +YVV      -XLV +ZVV      BIAS -ZLV -XVV																		
NOTES:	@-XLV, +ZVV ■ APU HTR RECONFIG @RME 1302 MIR ELEC FIELD CHAR @DT0 837 +YAW DEMO @BIAS -ZLV -XVV @VK5AGR      @VK6IU																		

GMT (D:H:M)	MET (D:H:M)	CDT (D:H:M)	FD/ DOY	BETA	MOON 	HOUSTON DATE	FLIGHT	EDITION	PUB. DATE					
222:03:29/ 222:15:29	008:00:00/ 008:12:00	221:22:29/ 222:10:29	09/222 GMT	65.3		AUGUST 8, 1996	STS-79	FINAL	07/08/96					
DMT :222	7	8	9	10	11	12	13	14	15	16	17	18		
CDT :221	23	0	CDT:222	1	2	3	4	5	6	7	8	9	10	
FD :09	0	1	2	3	4	5	6	7	8	9	FD 10	10	11	12
MET :008														
CDR READDY	ARRIVAL S L I M A A R R I V E C O M M E N C E P T I O N P R E S L E E P	P R E S L E E P	P R E S L E E P				SLEEP (9:00)				PMC R E C O R D I D N V F	POST S L E E P		
PLT WILCUTT		P R E S L E E P					SLEEP (9:00)					POST S L E E P		
MS1 APT		P R E S L E E P					SLEEP (9:00)					POST S L E E P		
MS2 AKERS		P R E S L E E P					SLEEP (9:00)					POST S L E E P		
MS3 WALZ		P R E S L E E P					SLEEP (9:00)					POST S L E E P		
MS4-DWN LUCID		P R E S L E E P					SLEEP (9:00)					POST S L E E P		
DAY/NIGHT														
ORBIT	126	127	128	129	130	131	132	133	134					
DAILY ORBIT	7	8	9	10	11	12	13	14	15					
EARTH TRACE														
TDRS	E													
ETTF	W													
ARIS														
STS ATT														
		VRCS PTC												
NOTES:														

GMT (D:H:M)	MET (D:H:M)	CDT (D:H:M)	FD/ DOY	BETA	MOON	HOUSTON DATE	FLIGHT	EDITION	PUB. DATE					
222:15:29 / 223:03:29	008:12:00 / 009:00:00	222:10:29 / 222:22:29	10/222 GMT	64.0		AUGUST 9, 1996	STS-79	FINAL	07/08/96					
DMT :222	19	20	21	22	23	0	DMT:223	1	2	3	4	5	6	
CDT :222	11	12	13	14	15	16	17	18	19	20	21	22	23	22
FD :10	12	13	14	15	16	17	18	19	20	21	22	23	24	0
MET :008														MET:009
CDR READDY	POST SLEEP													
PLT WILCUTT	POST SLEEP													
MS1 APT	POST SLEEP	DMC LDK YDS K	SH C N F G	SH MOD	SHAB DEACT									
MS2 AKERS	POST SLEEP	P/TV12 OPS SH DCT												
MS3 WALZ	POST SLEEP	ENTRY MON PREP	SHAB DEACT	ODS ENTRY STOW										
MS4-DWN LUCID	POST SLEEP	ENTRY MON PREP												
DAY/NIGHT														
ORBIT	134	135	136	137	138	139	140	141	142					
DAILY ORBIT		1	2	3	4	5	6	7	8					
EARTH TRACE														
TDRS														
ETTF														
ARIS														
STS ATT	VRCS PTC   IMU/VERIF   D/O   ENTRY													
NOTES:	@ENTRY MON (BIOMED) * D/O BURN 8/19:46 * KSC LANDING 8/20:46													

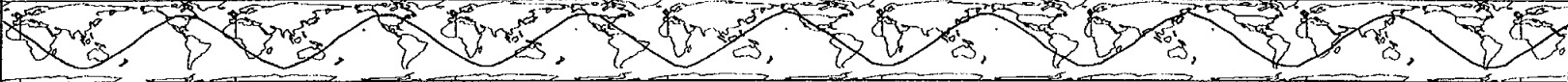
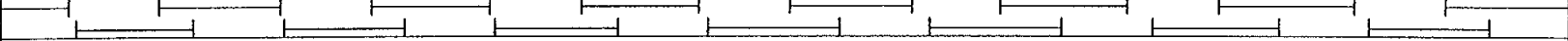

GMT (D:H:M)	MET (D:H:M)	CDT (D:H:M)	FD/ DOY	BETA	MOON	HOUSTON DATE	FLIGHT	EDITION	PUB. DATE
223:03:29/ 223:15:29	009:00:00/ 009:12:00	222:22:29/ 223:10:29	/223 GMT	62.5		AUGUST 9, 1996	STS-79	FINAL	07/08/96
DMT :223									
CDT :222									
MET :009									
CDR READDY									
PLT WILCUTT									
MS1 APT									
MS2 AKERS									
MS3 WALZ									
MS4-DWN LUCID									
DAY/NIGHT									
ORBIT	142	143	144	145	146	147	148	149	
DAILY ORBIT	8	9	10	11	12	13	14	15	
EARTH TRACE									
TDRS									
ETTF									
ARIS									
STS ATT									
NOTES:									

DETAILED TIMELINE (ENGLISH)

DETAILED  
TIMELINE

# DETAILED TIMELINE

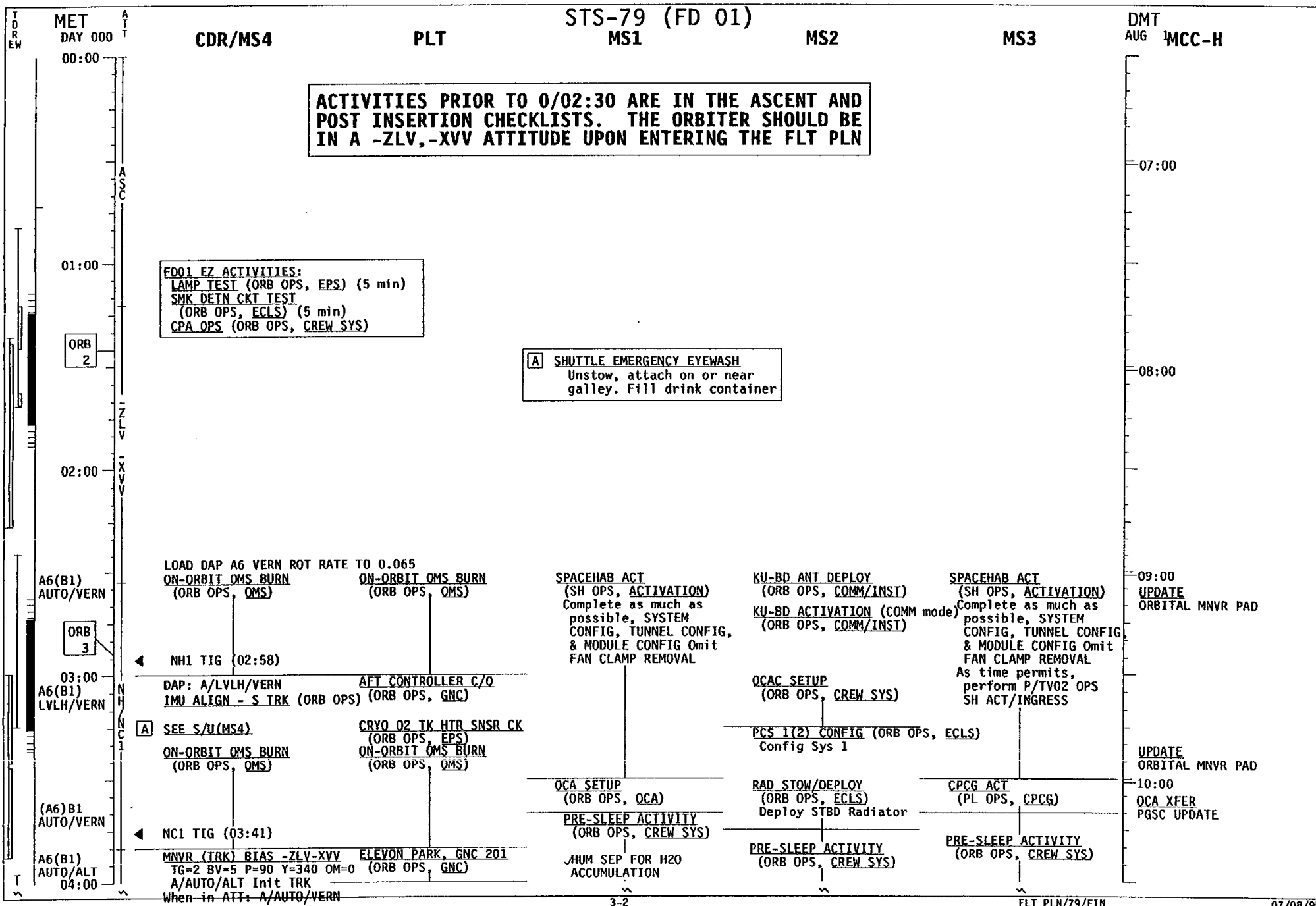

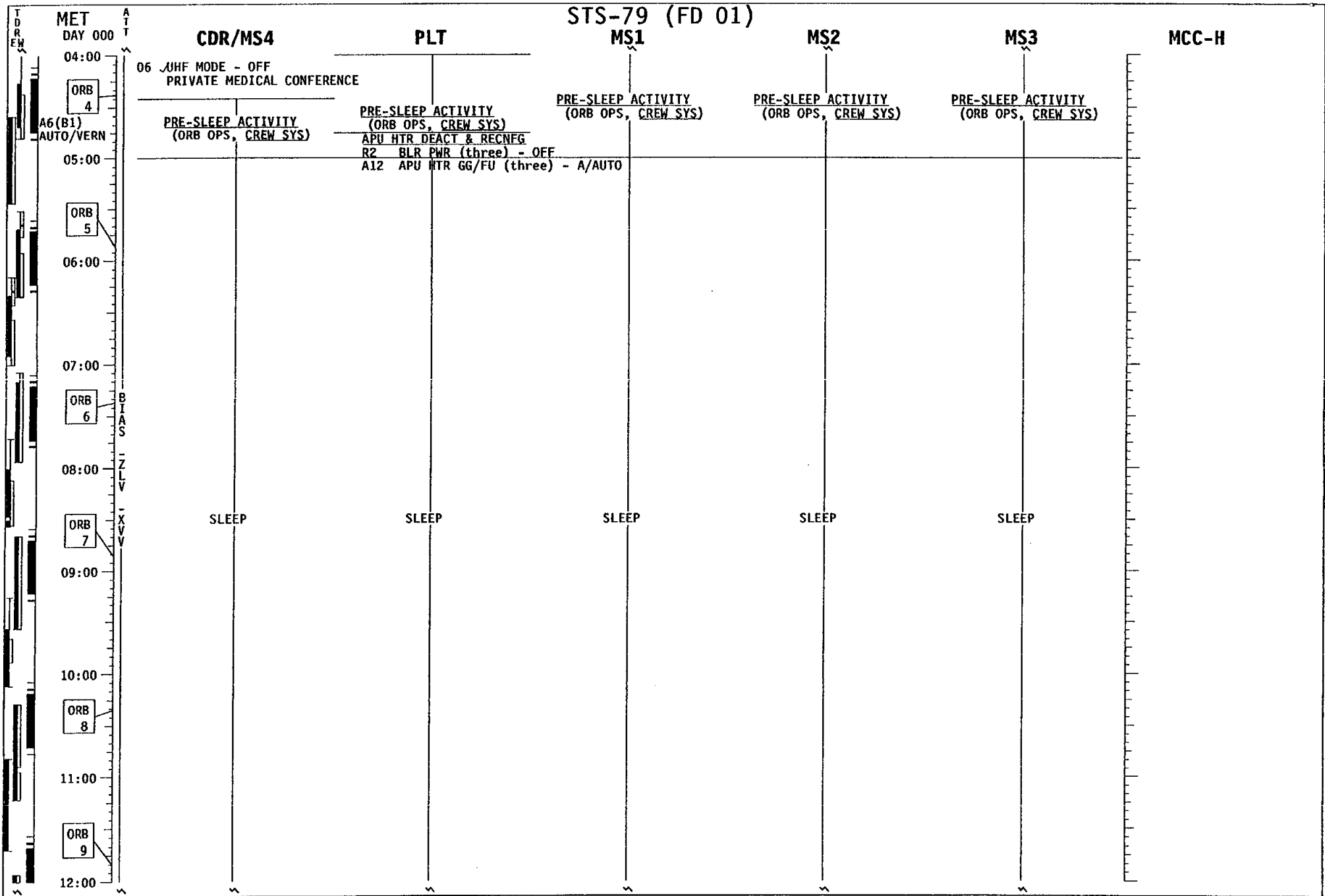

# STS-79 (FD 02)

DMT  
AUG MCC-H

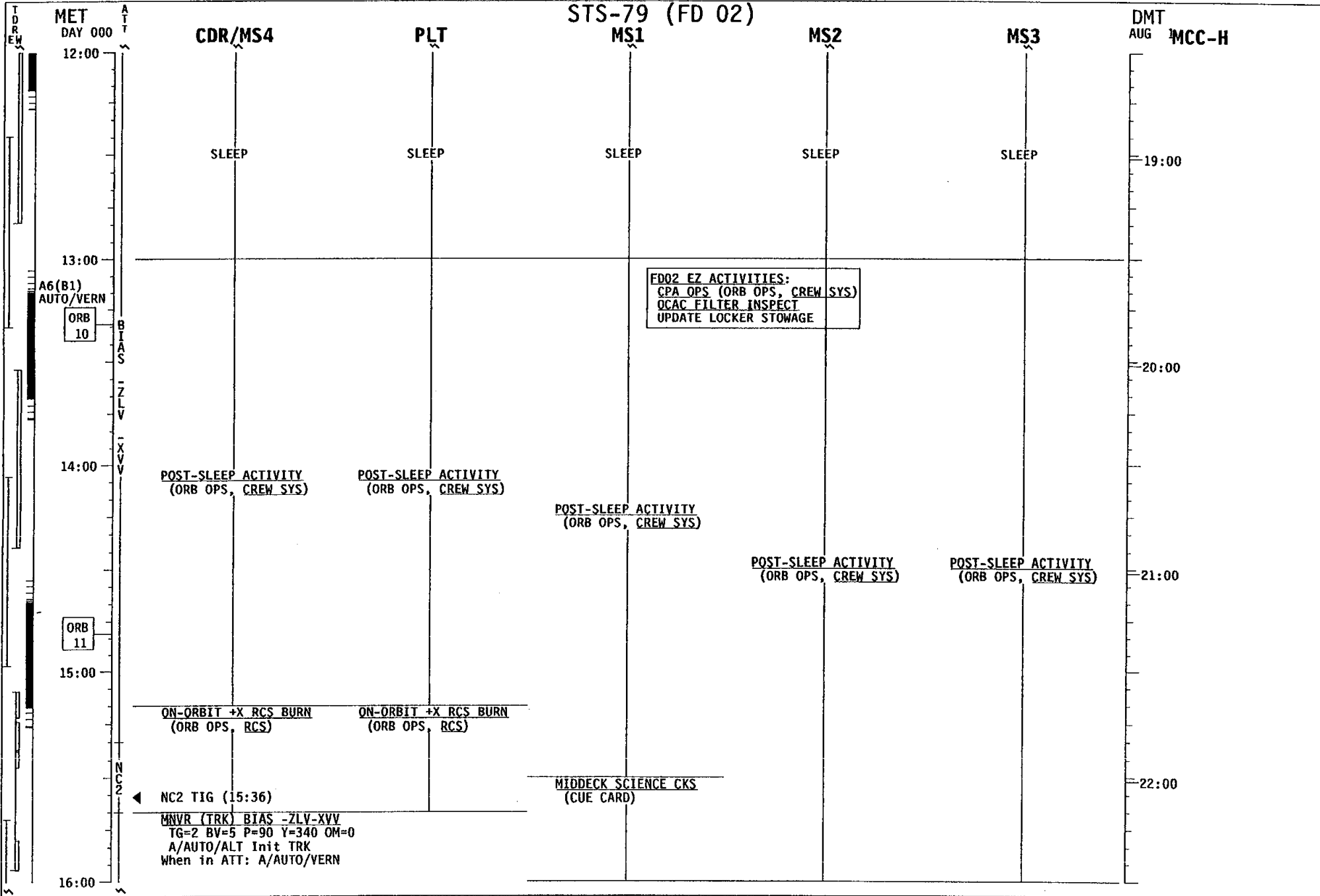

MET  
DAY 000

A6(B1)  
AUTO/VERN

ORB  
10

ORB  
11

16:00

BIAS  
-ZLV  
-XVV  
NC2

NC2 TIG (15:36)  
MNR (TRK) BIAS -ZLV-XVV  
TG=2 BV=5 P=90 Y=340 OM=0  
A/AUTO/ALT Init TRK  
When in ATT: A/AUTO/VERN

FD02 EZ ACTIVITIES:  
CPA OPS (ORB OPS, CREW SYS)  
QCAC FILTER INSPECT  
UPDATE LOCKER STOWAGE

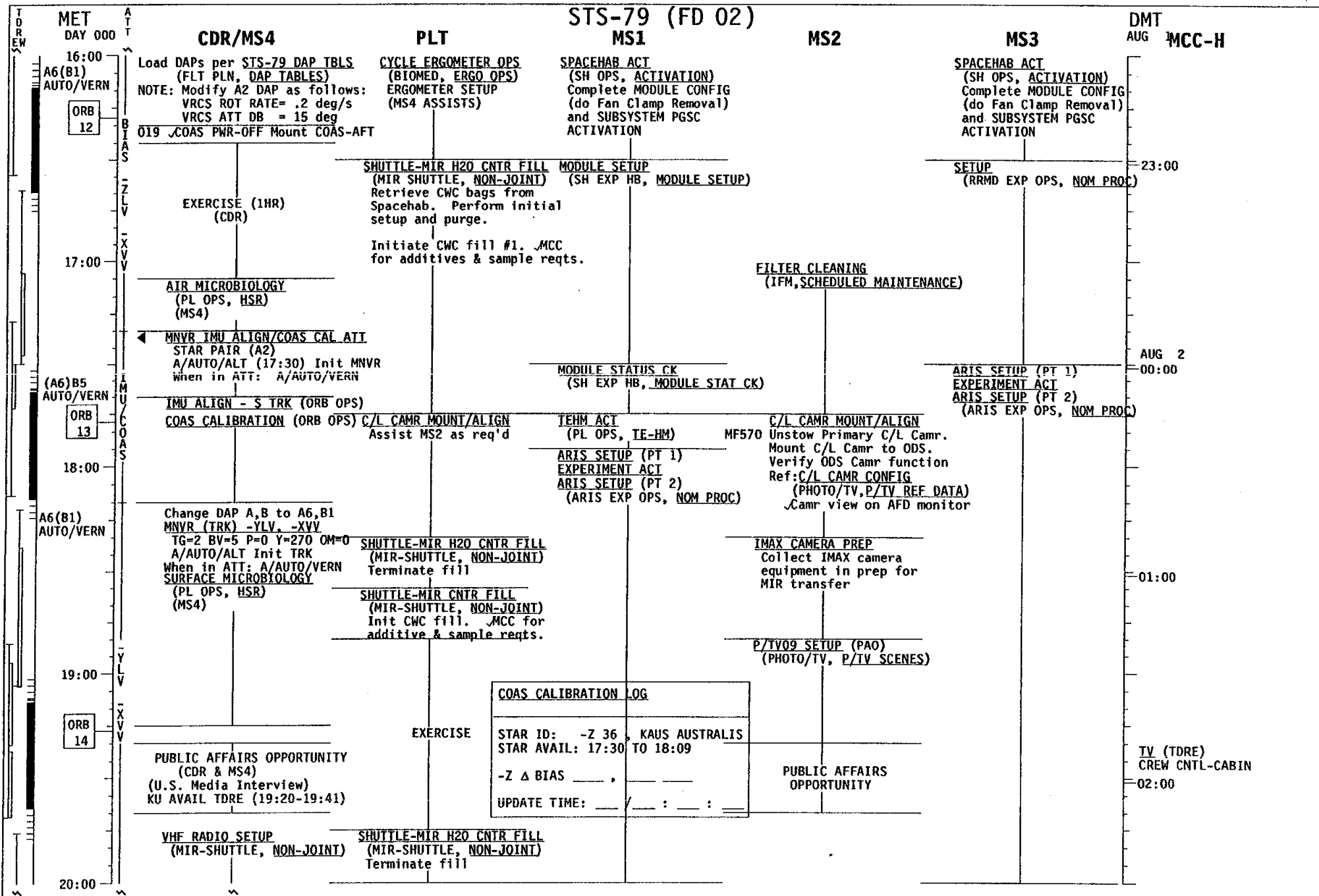

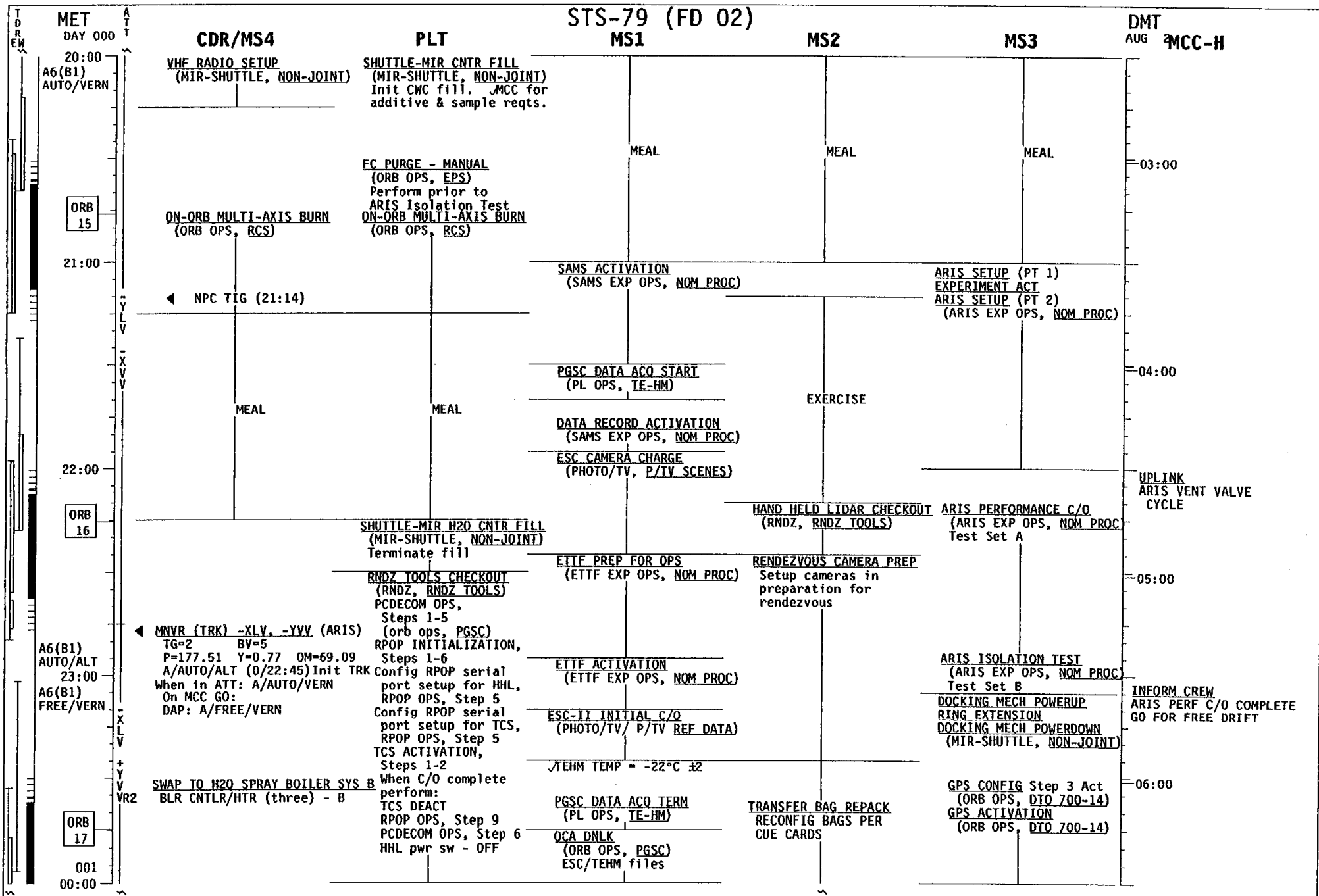

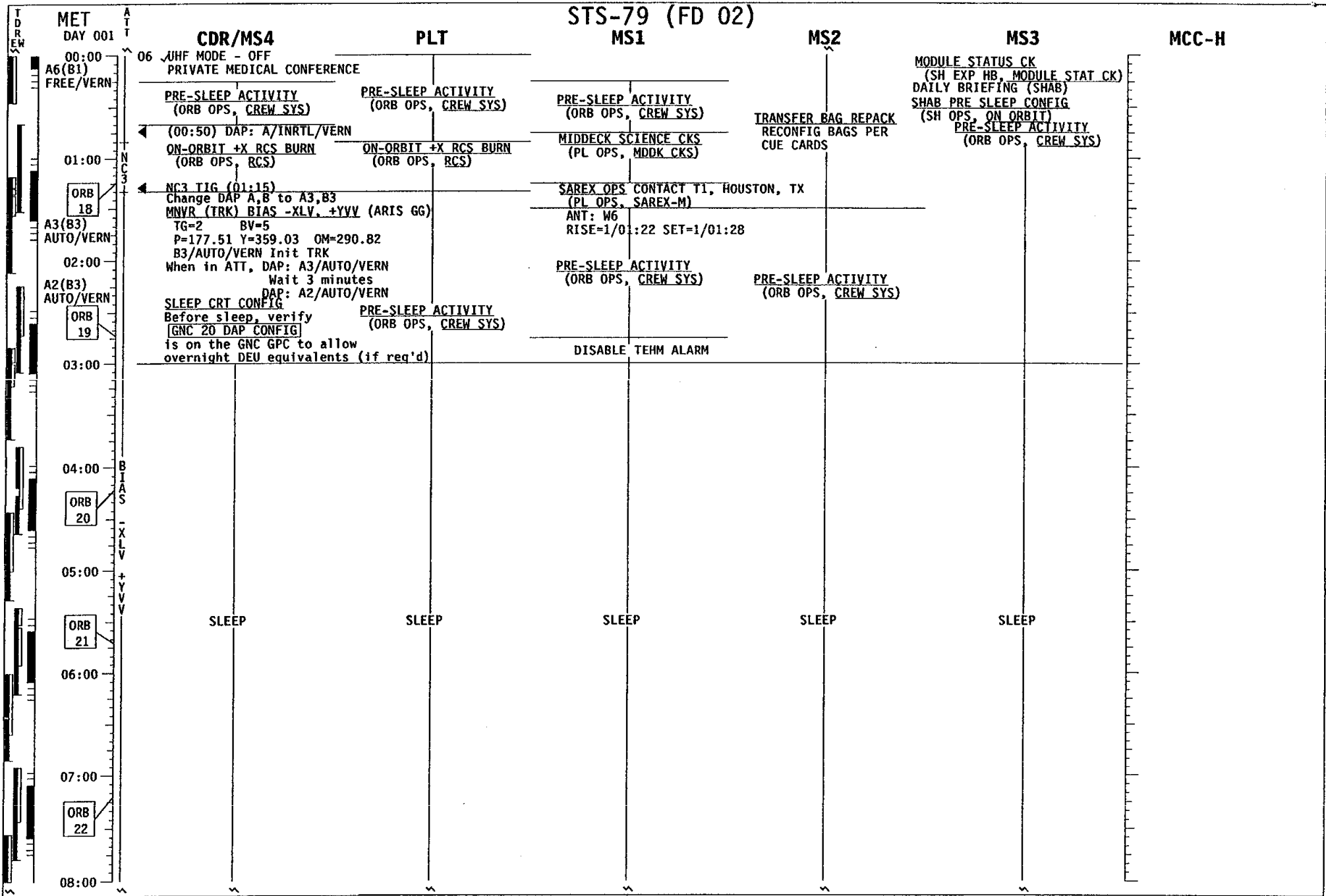



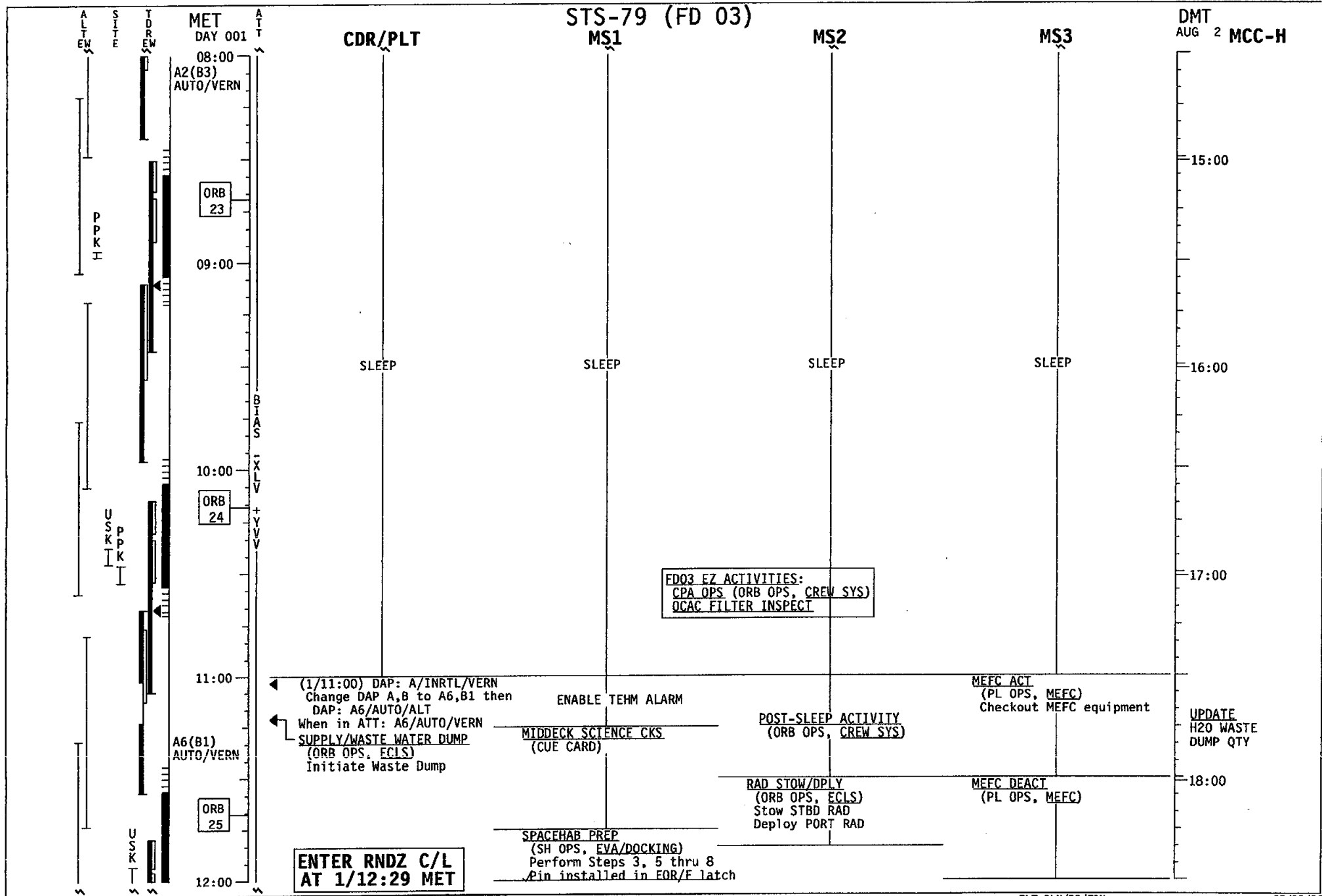

MIR (FD 03)  
LUCID(FE2)

MIR CDR

MIR FE

DMT  
AUG 2 MCC-M

BLAHA

MET  
DAY 001

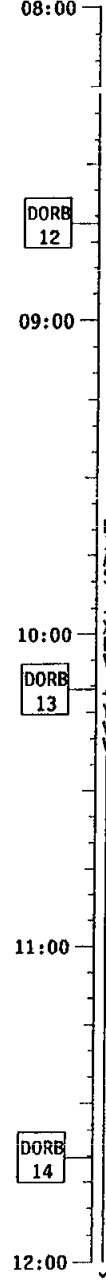

SLEEP  
(SHUTTLE)

POST-SLEEP ACTIVITY  
(ORB OPS, CREW SYS)

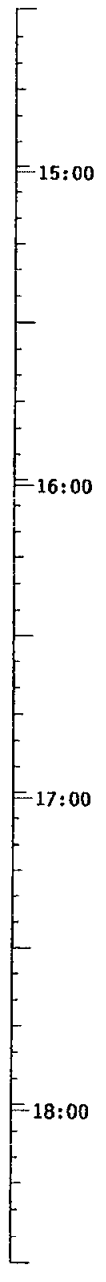

STS-79 (FD 03)  
MS1

MS2

MS3

DMT  
AUG 2 MCC-H

**JOINT TIMELINE BEGINS**

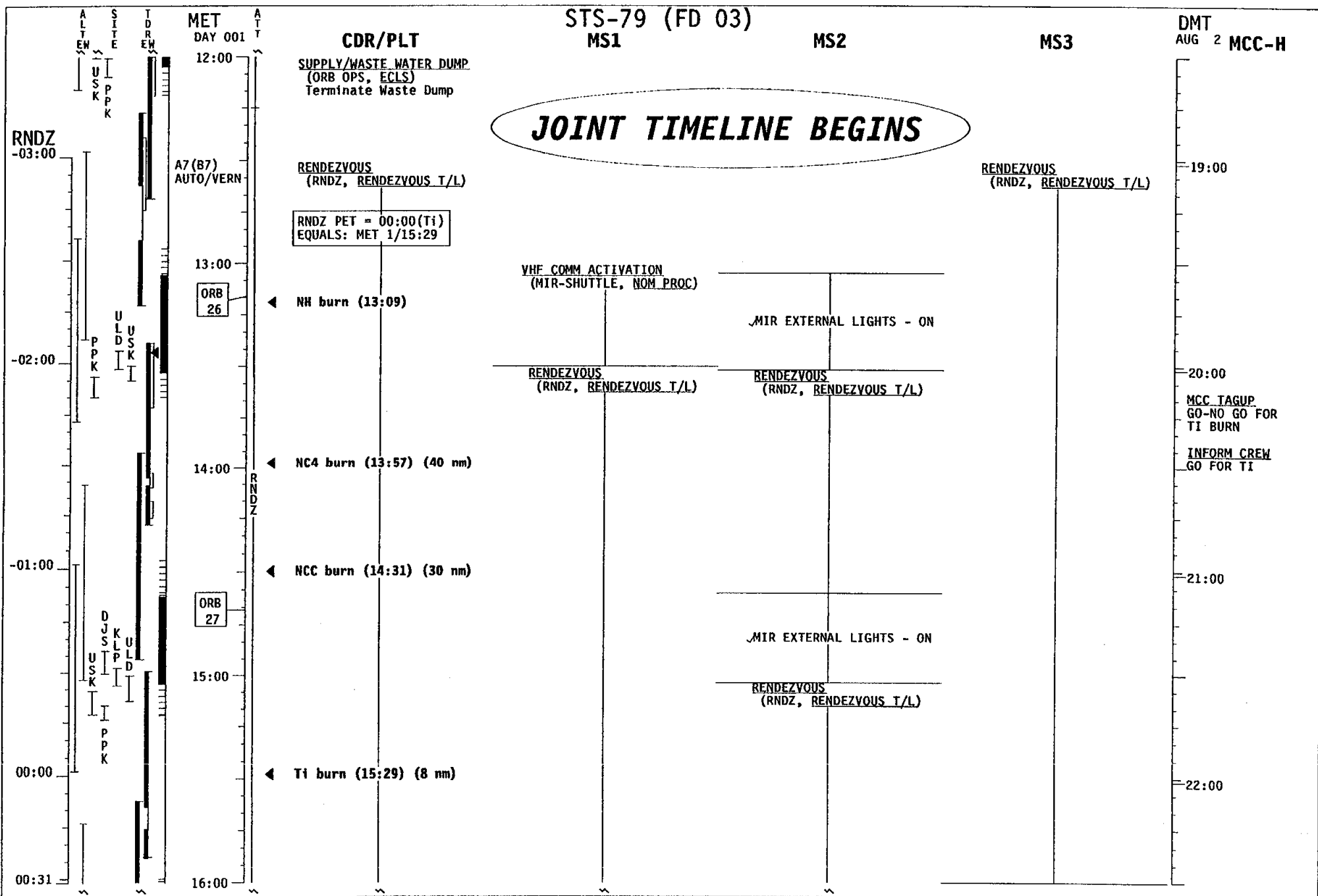

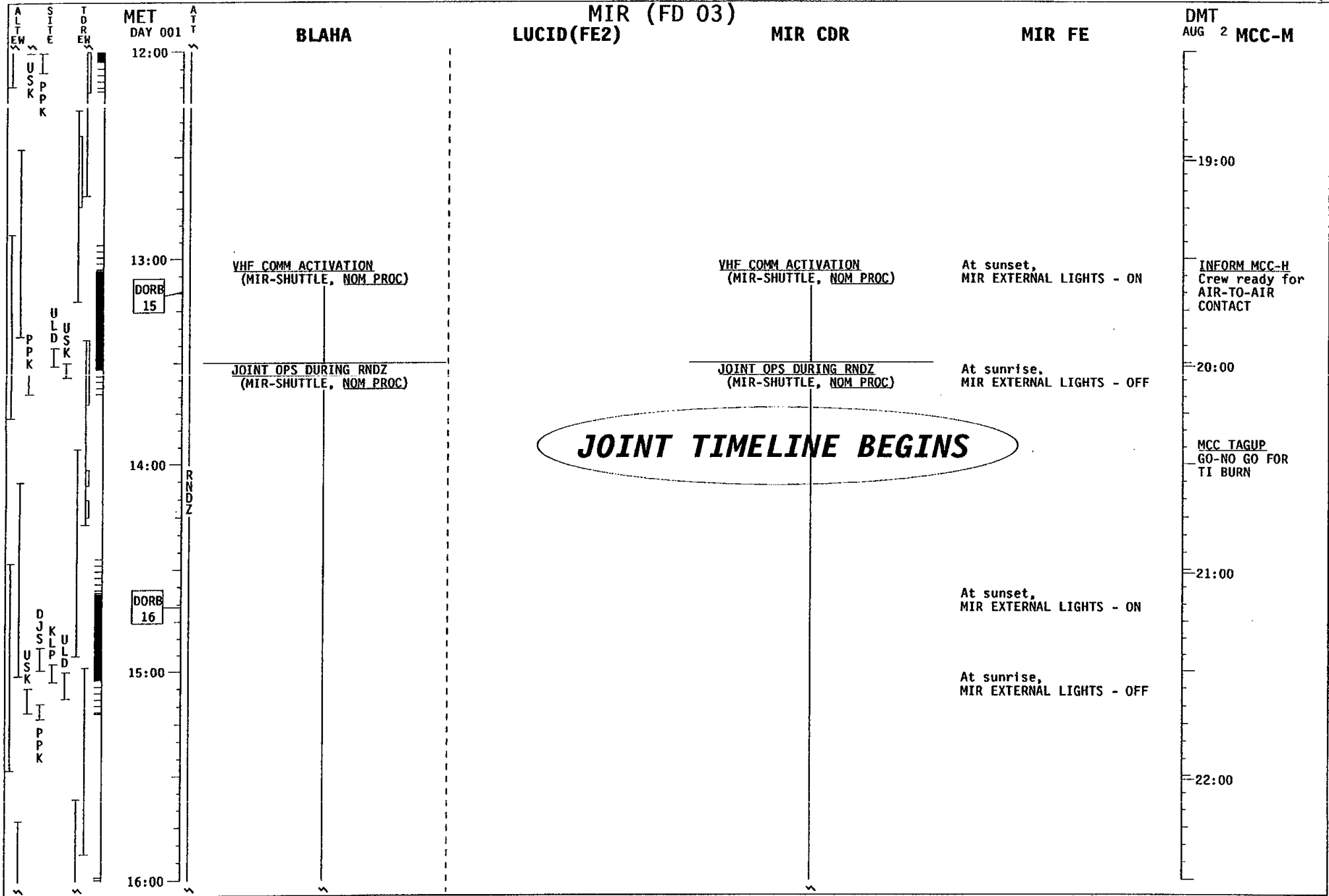

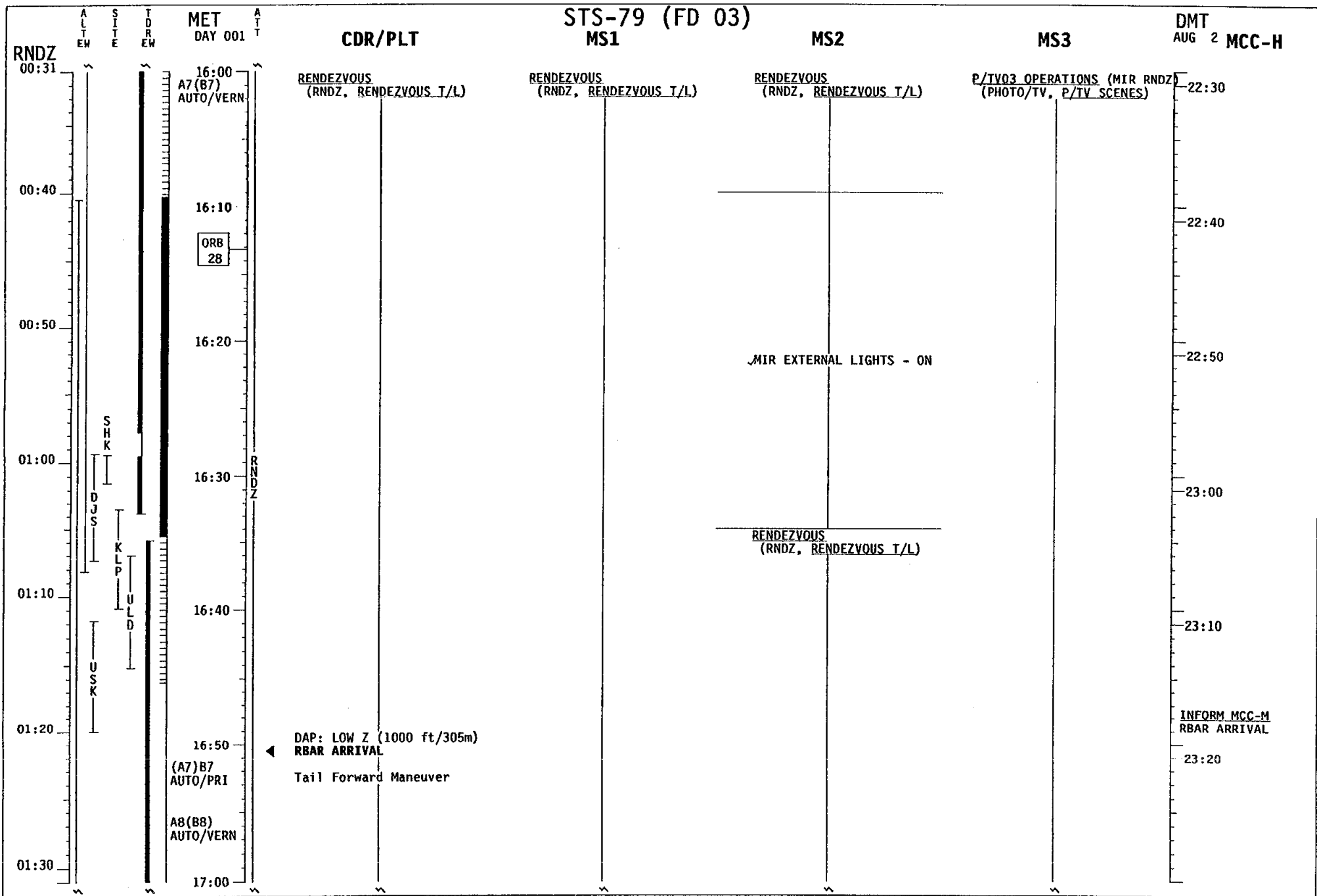

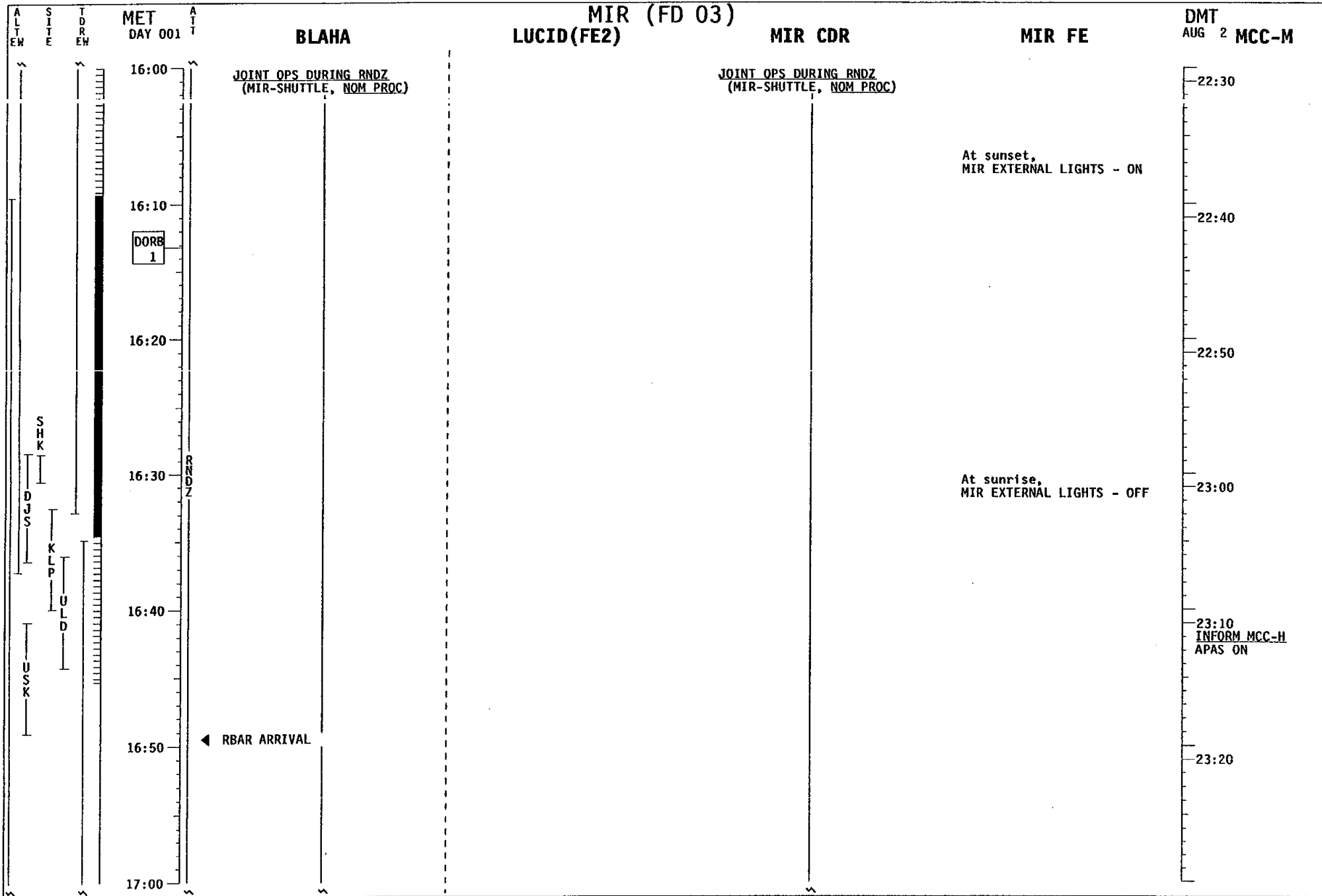

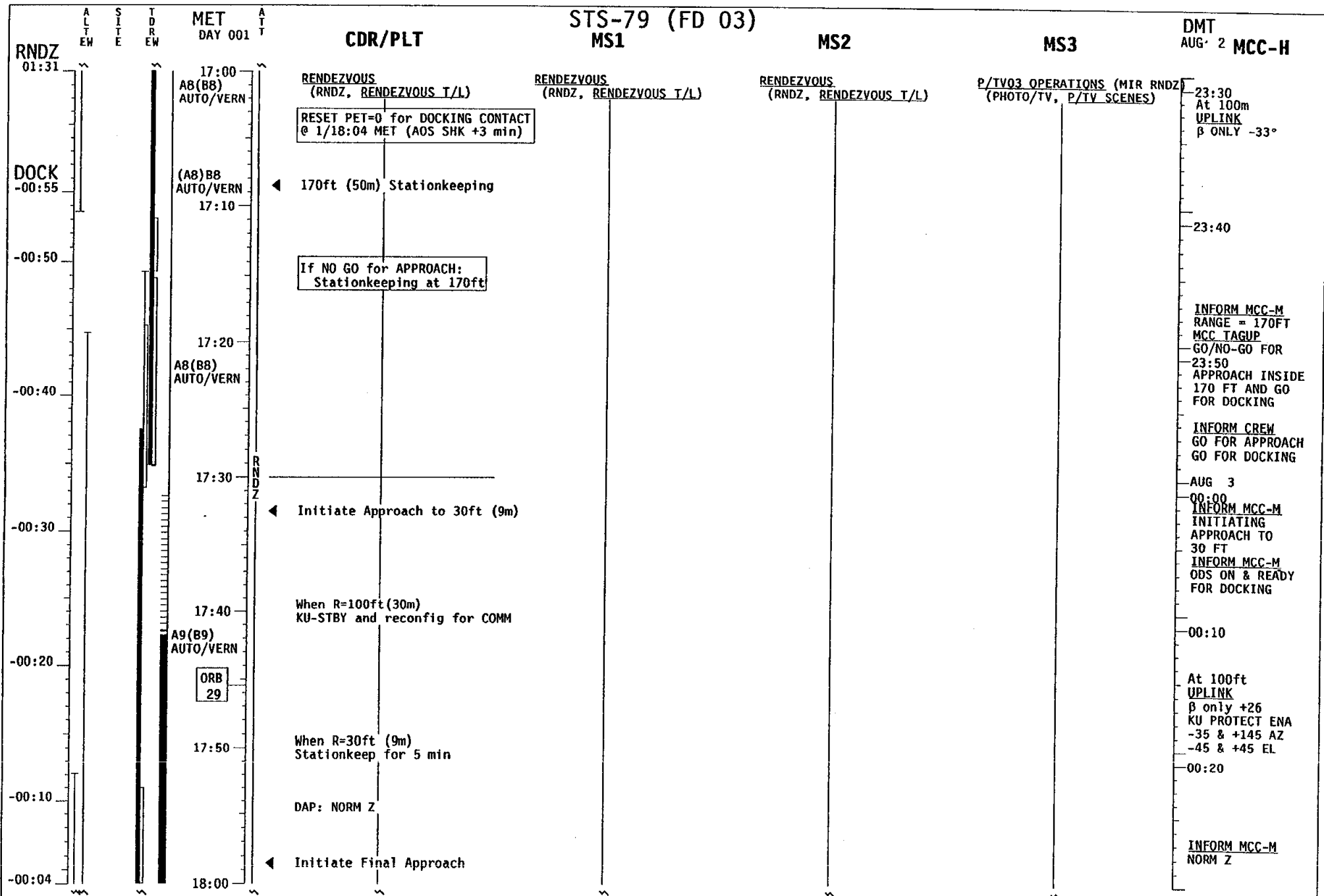

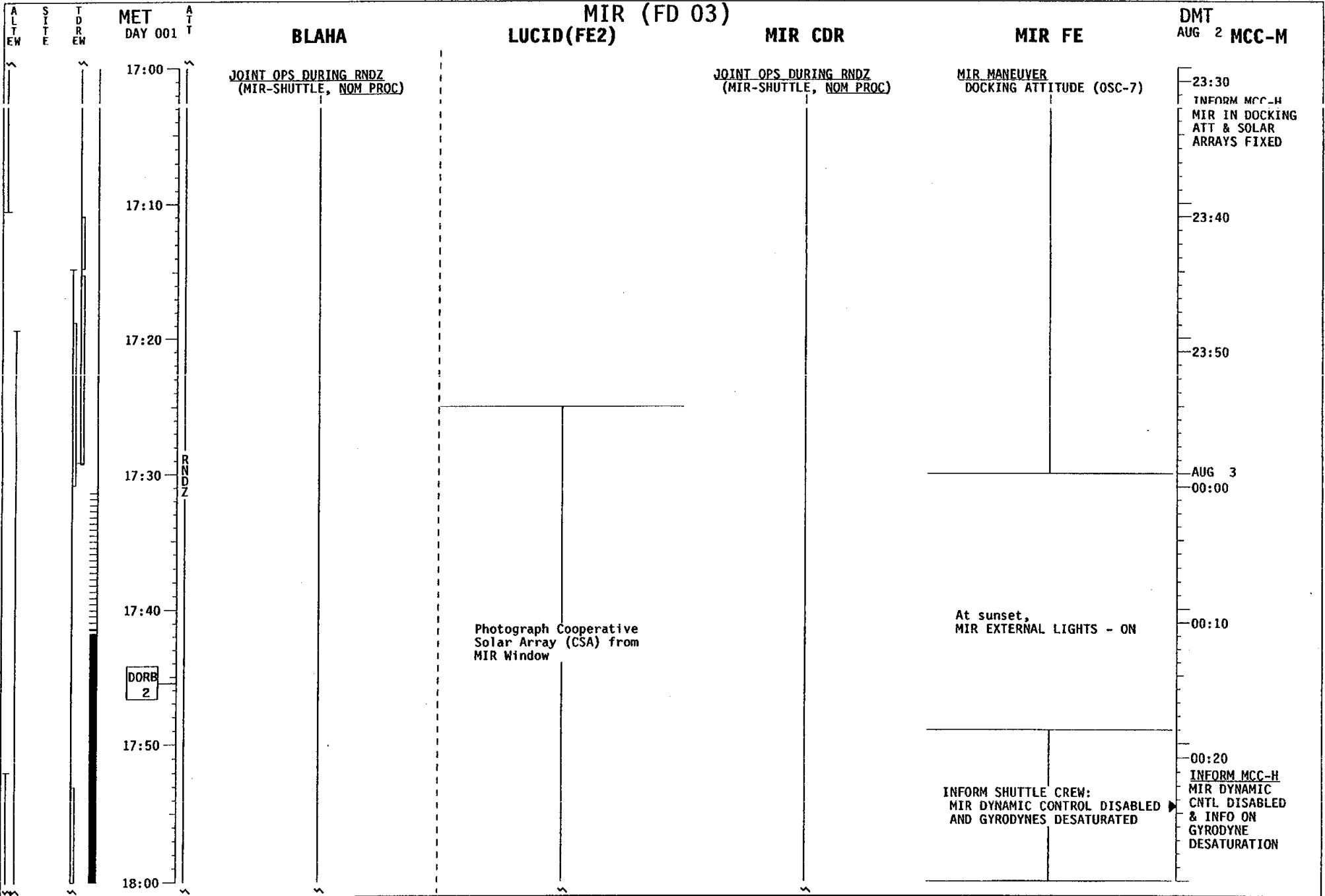



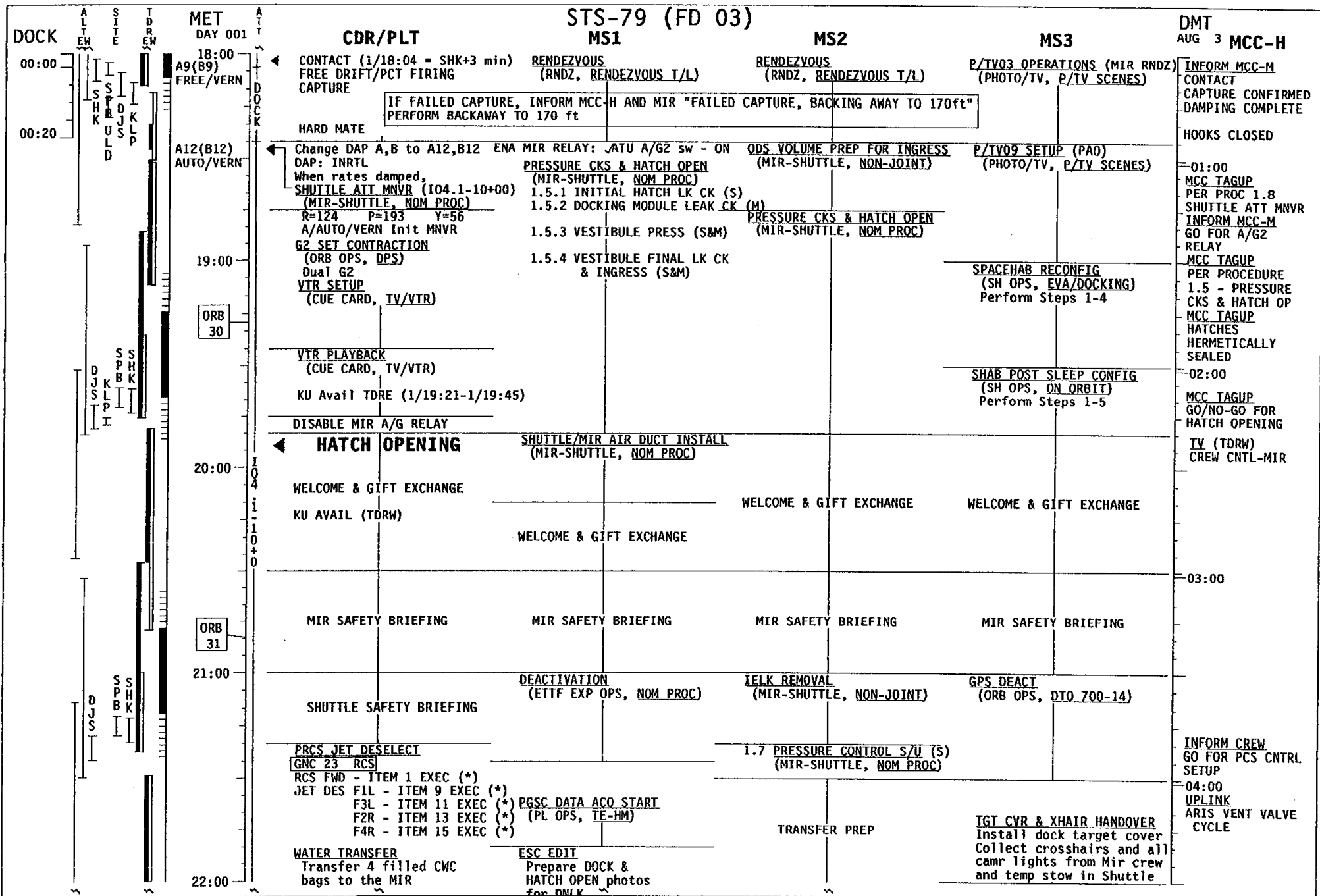

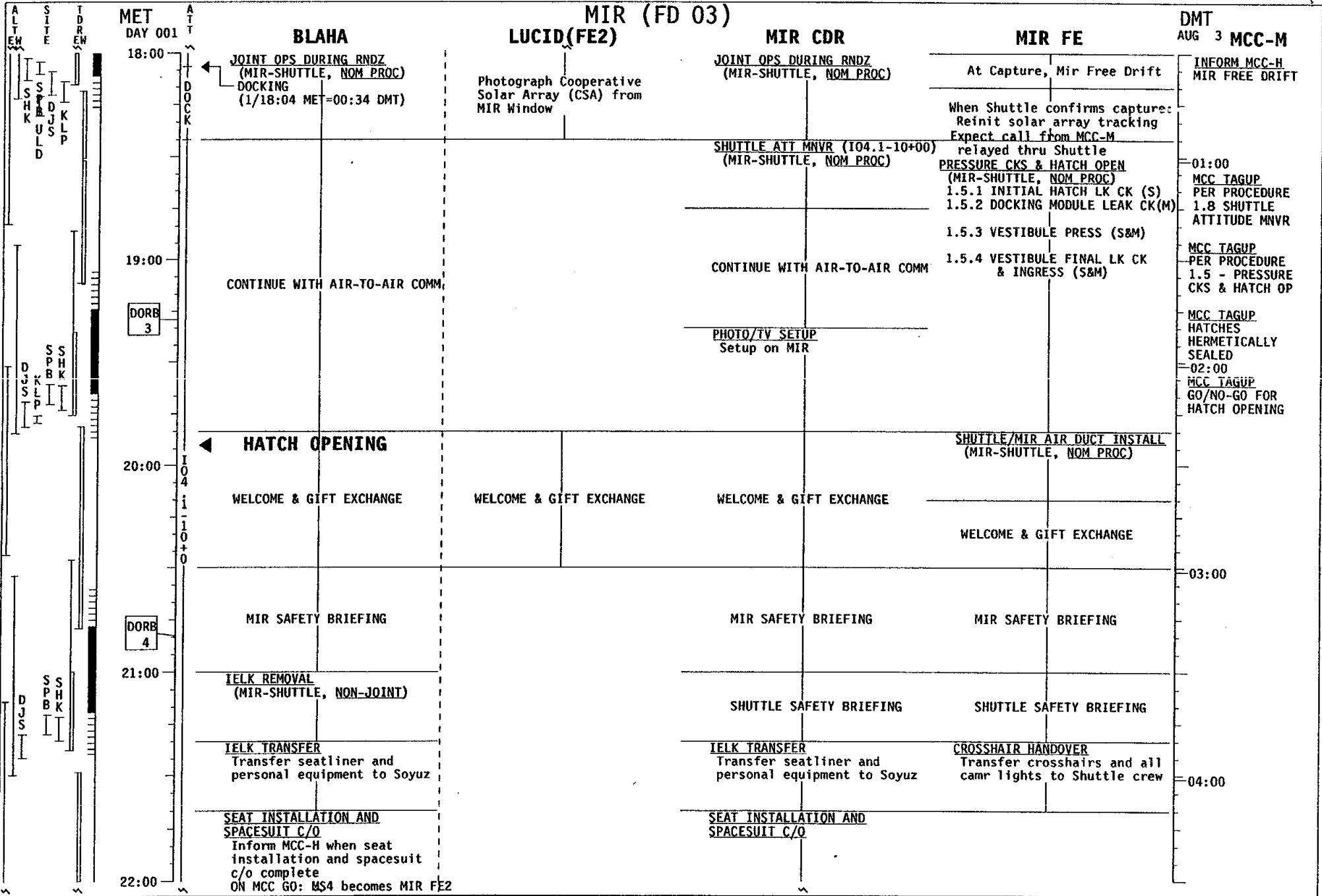

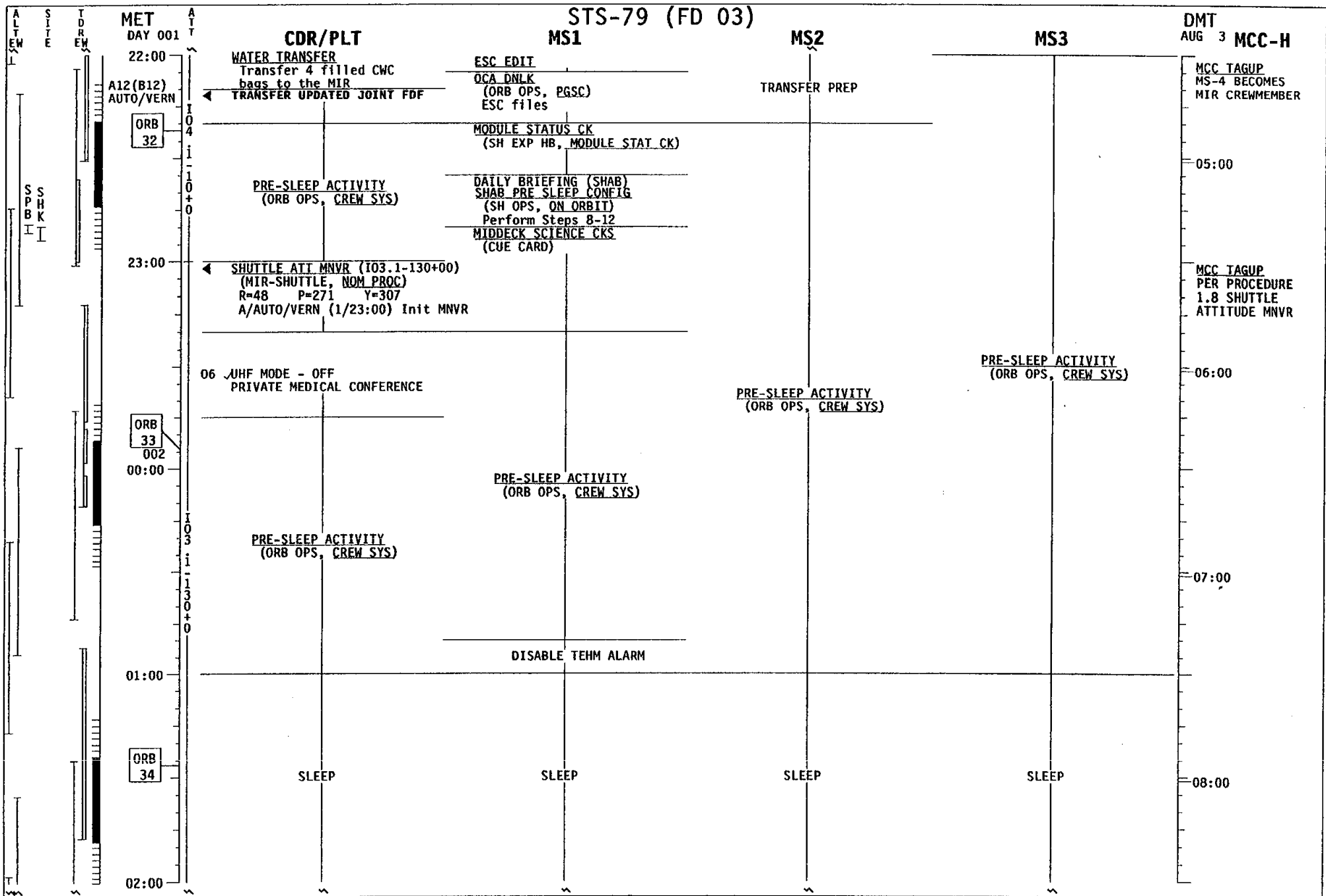

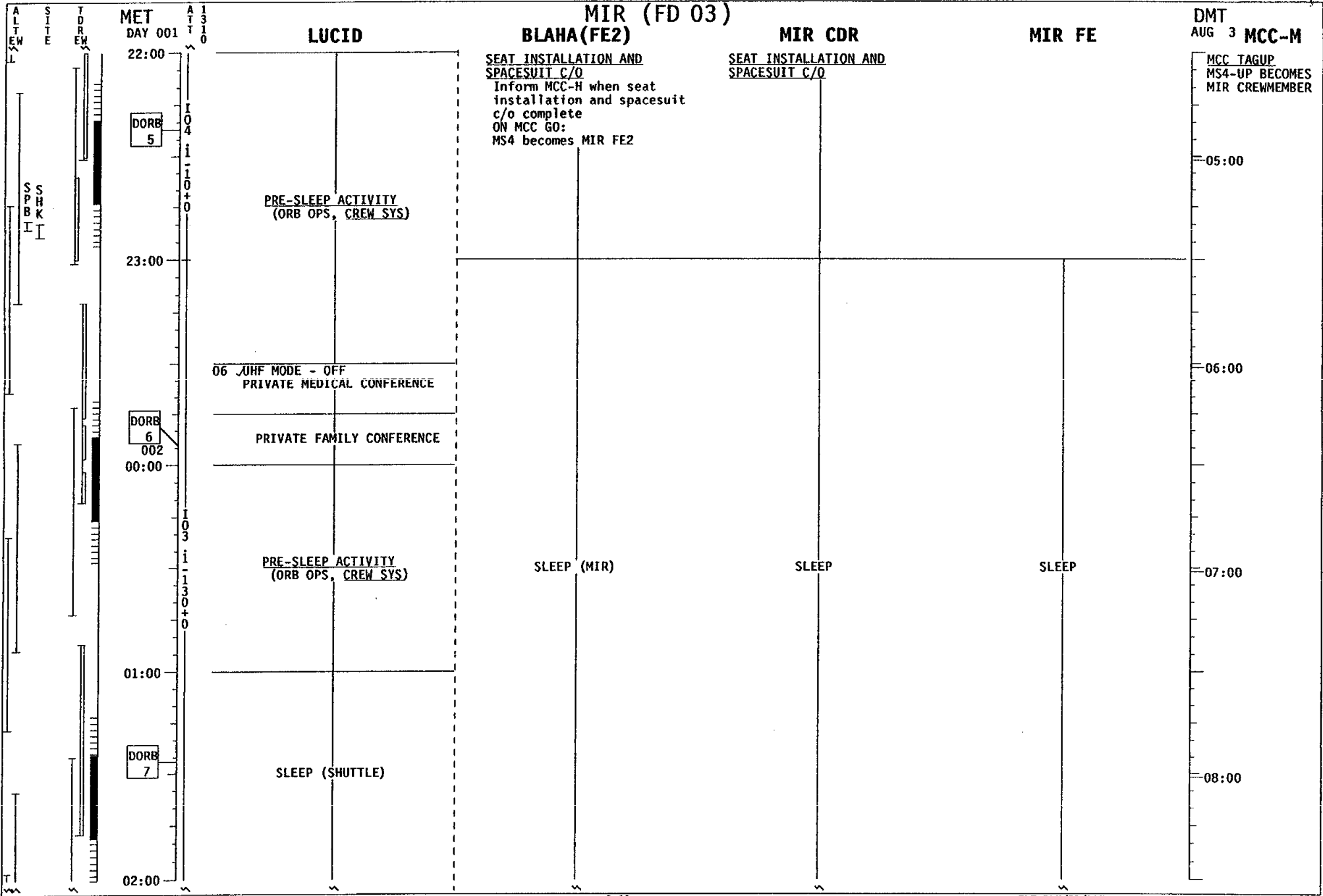

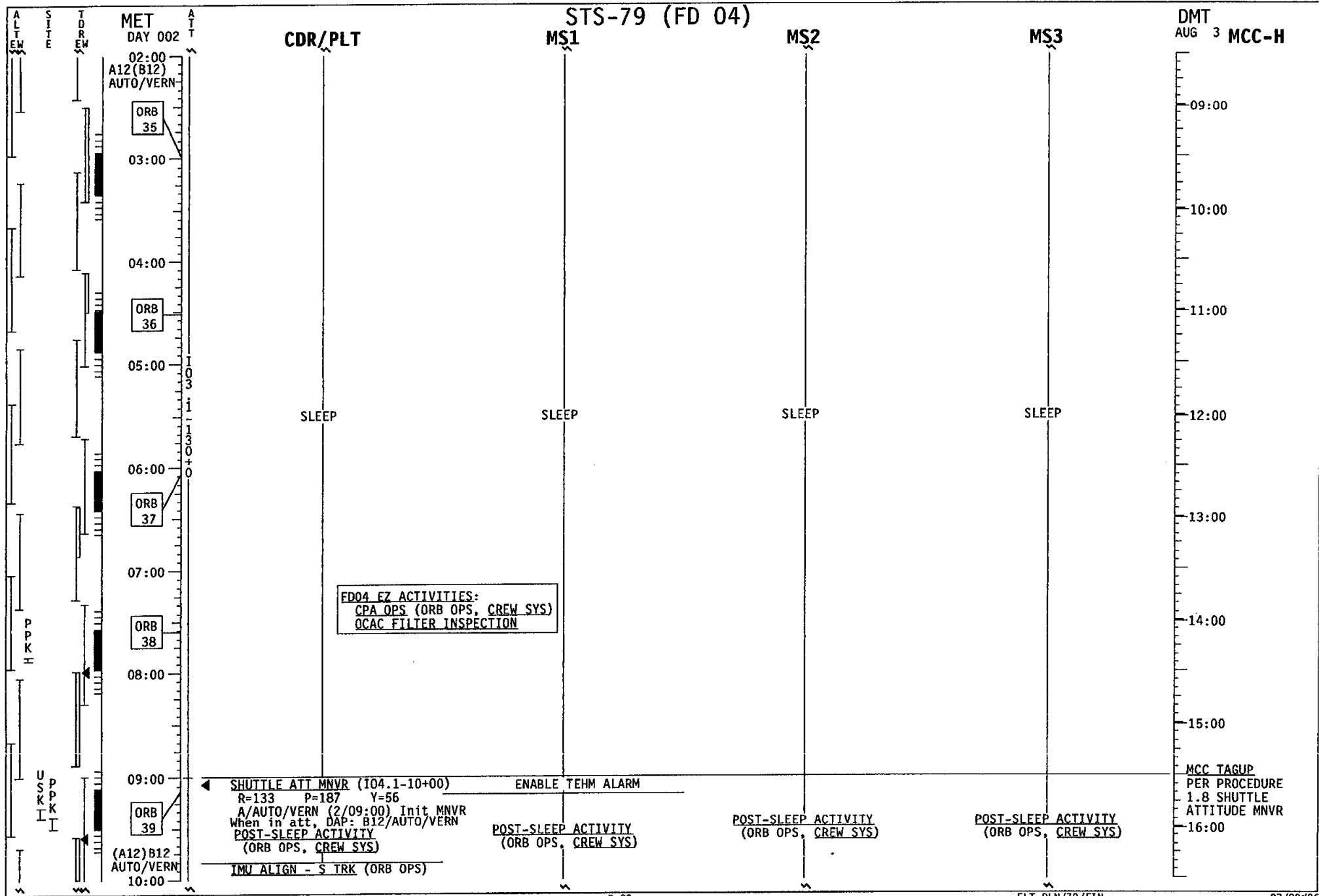

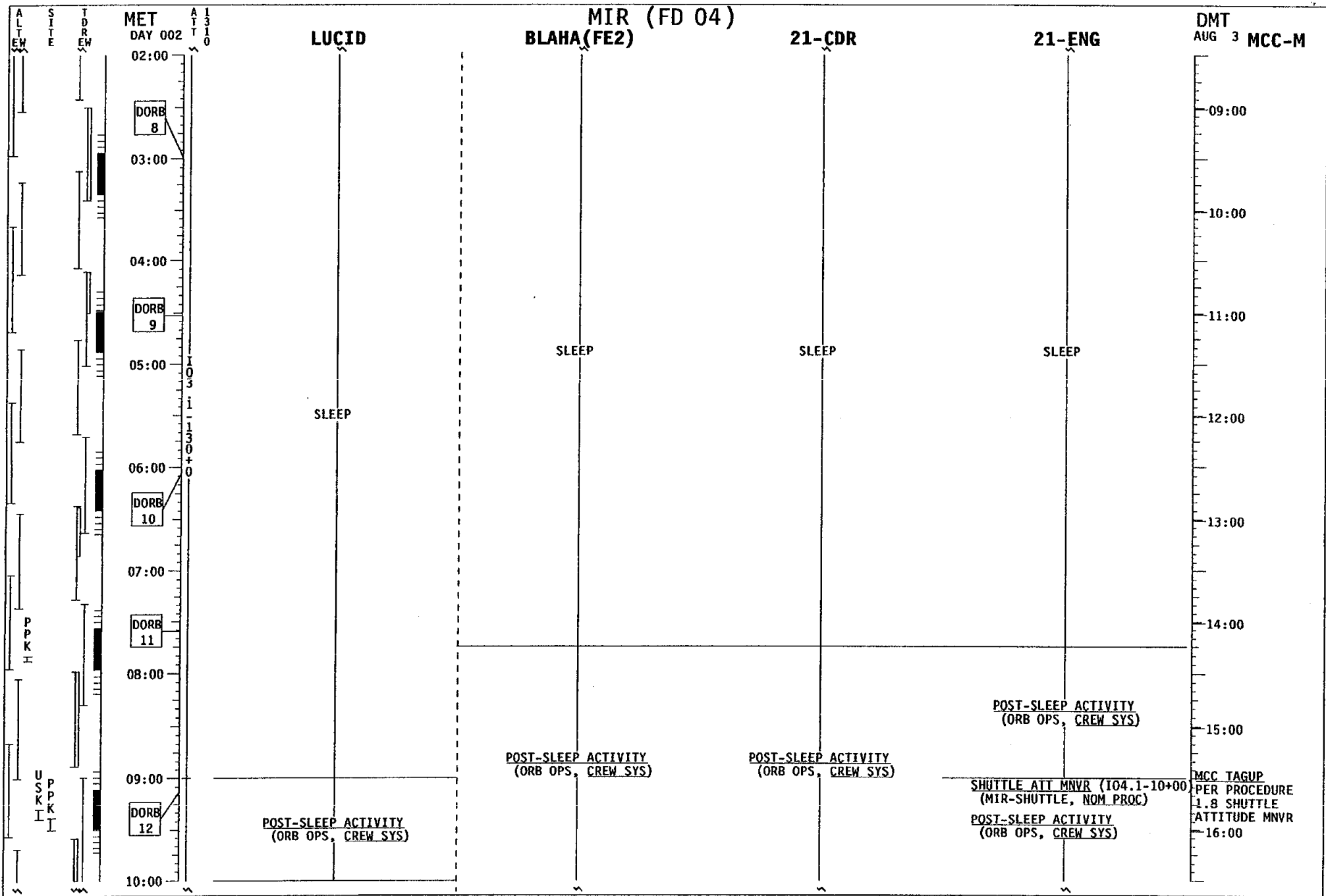

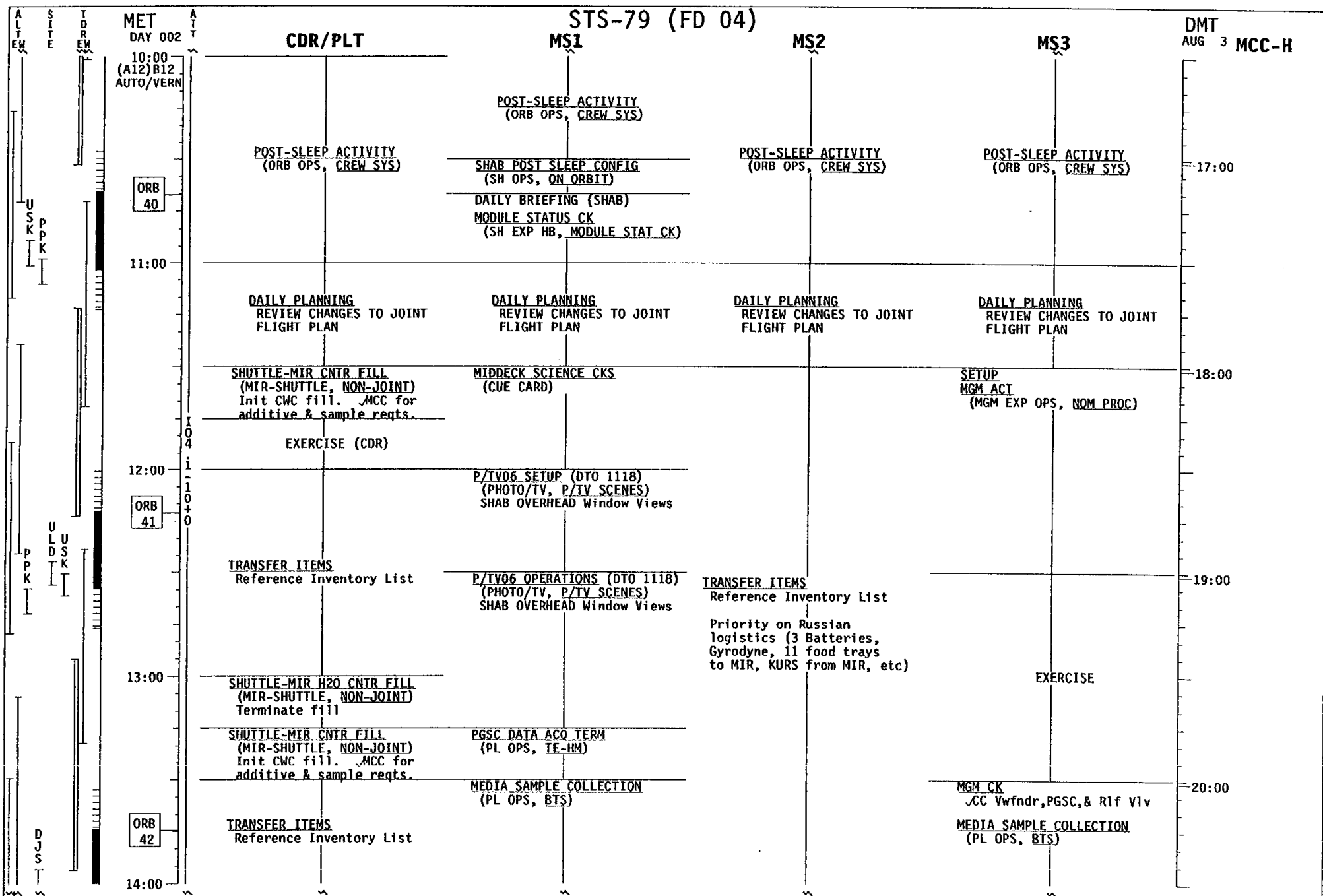

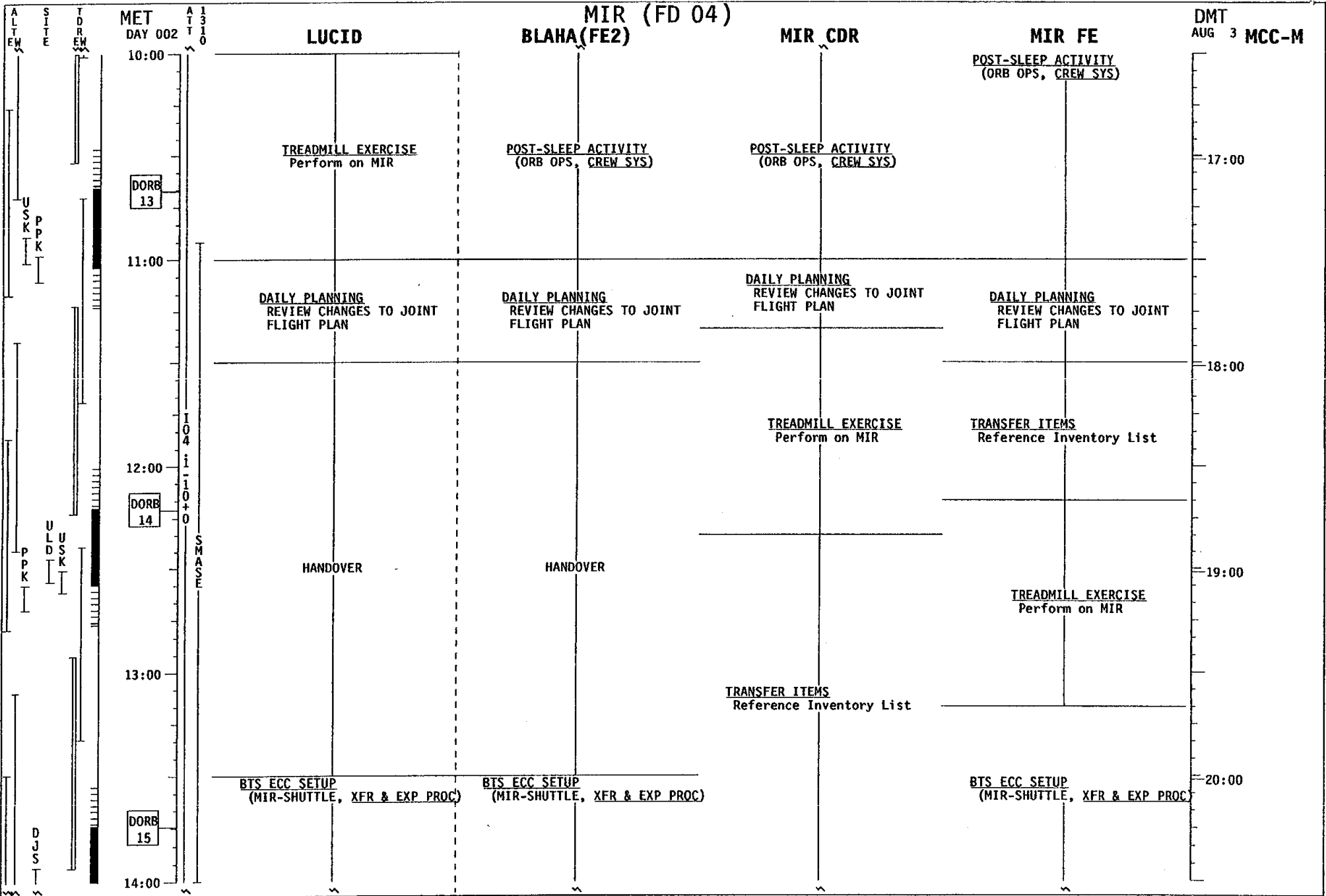



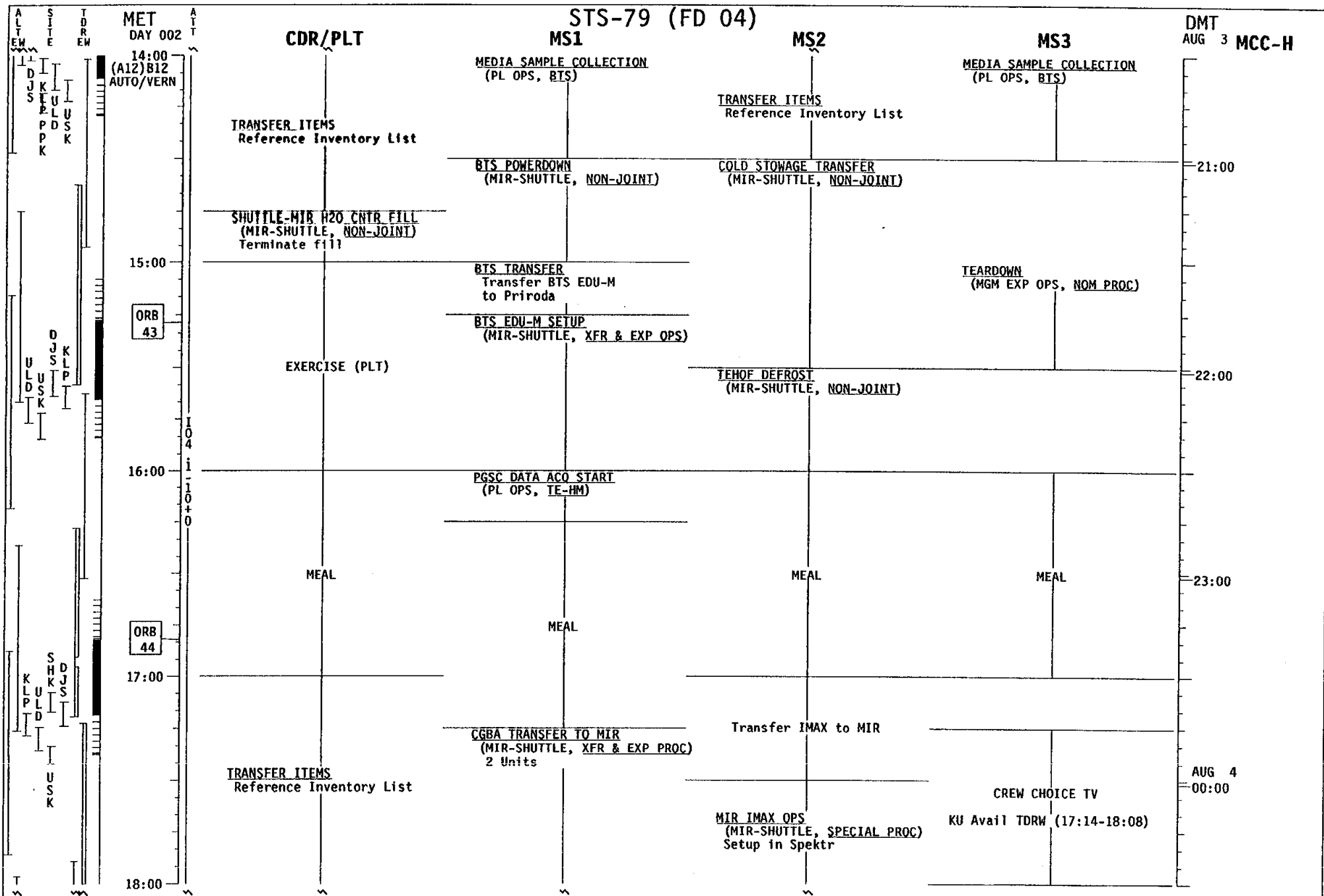

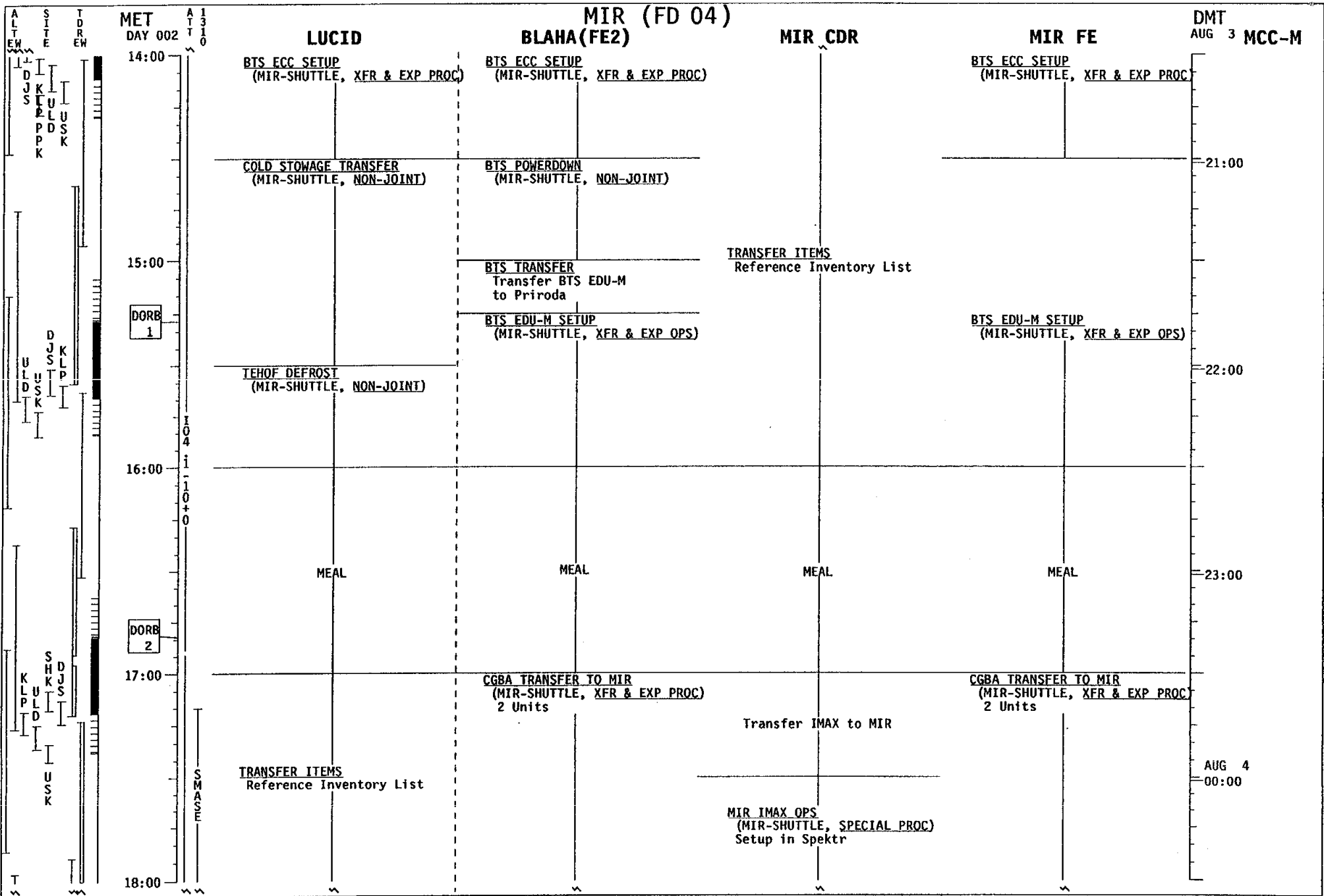

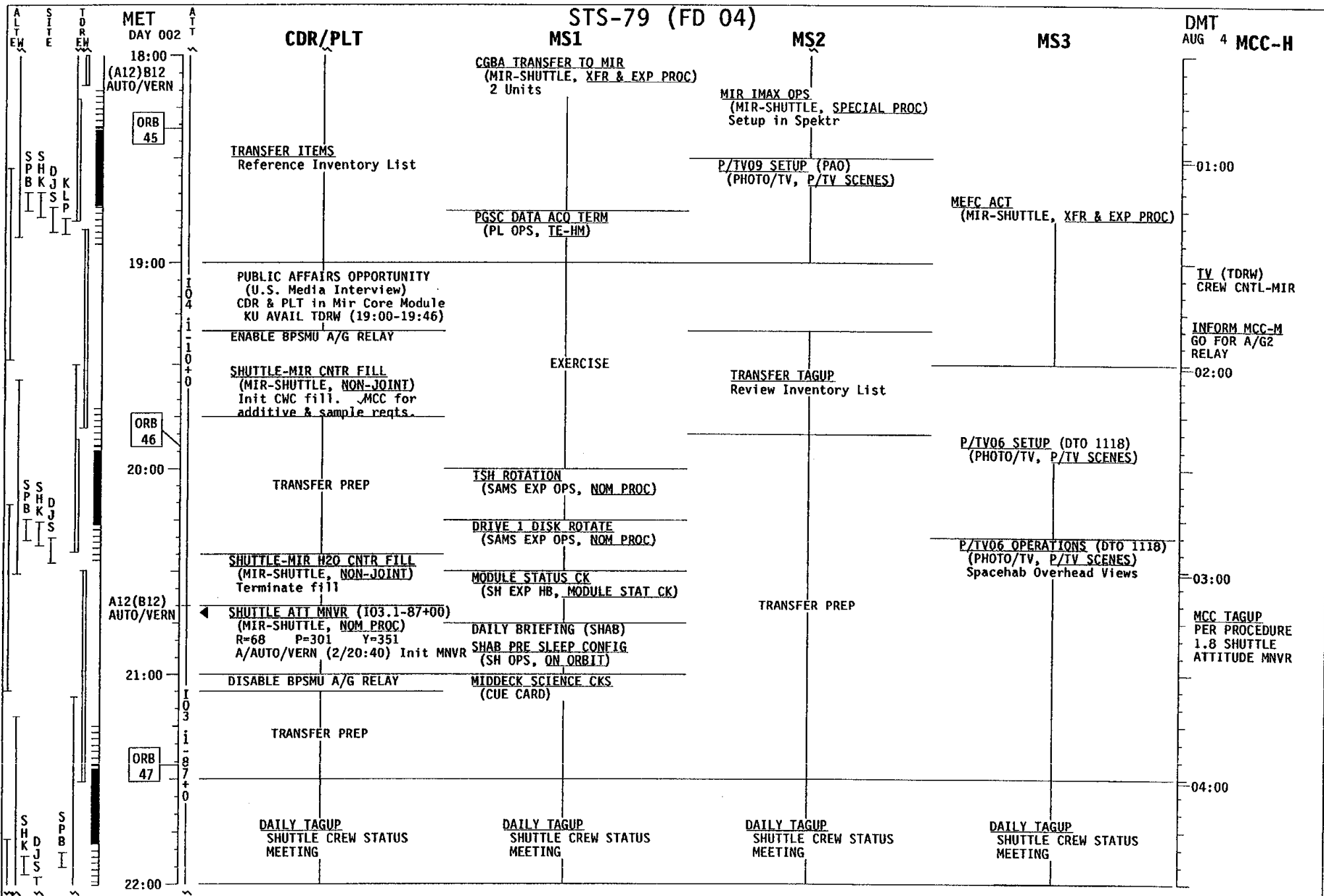

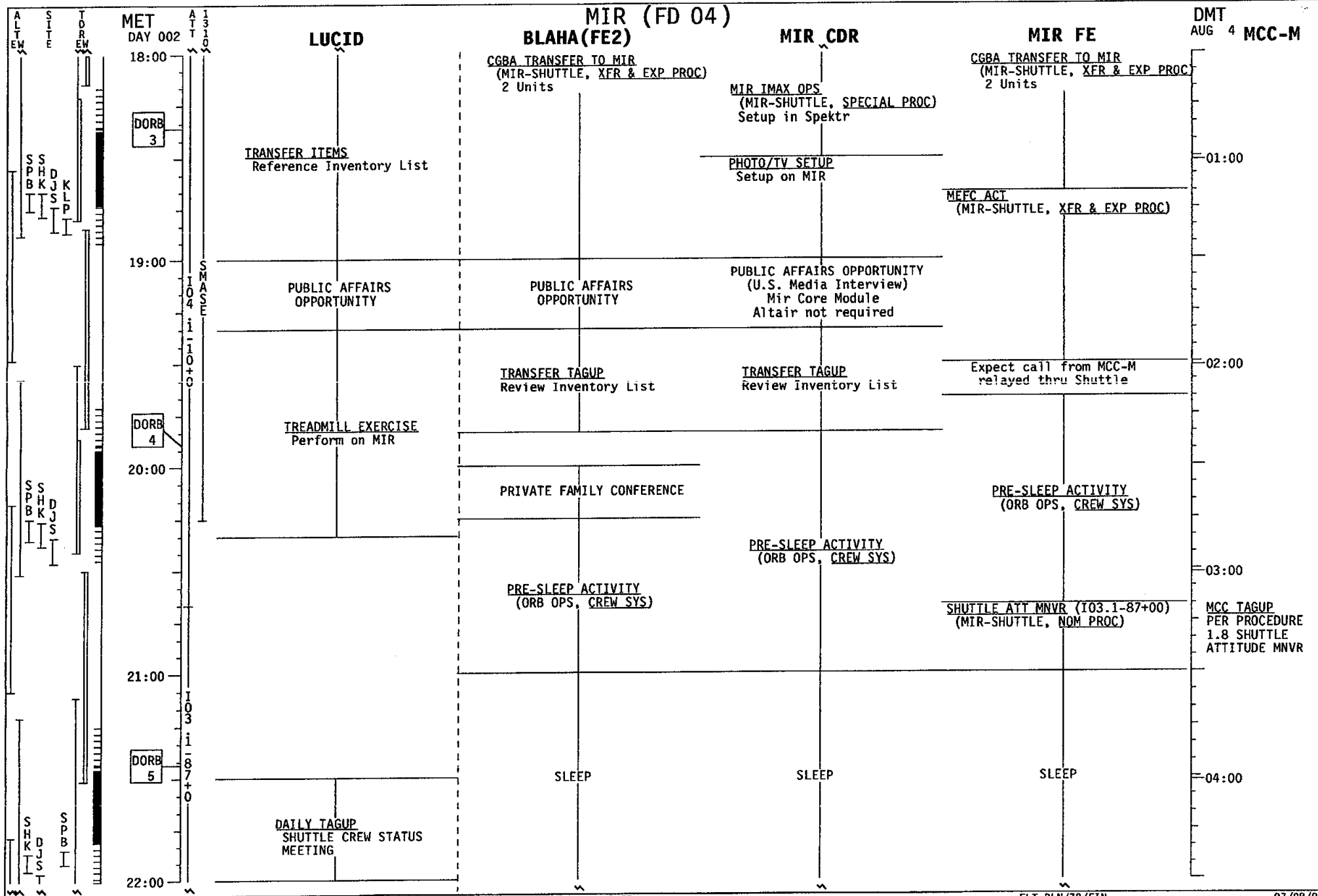

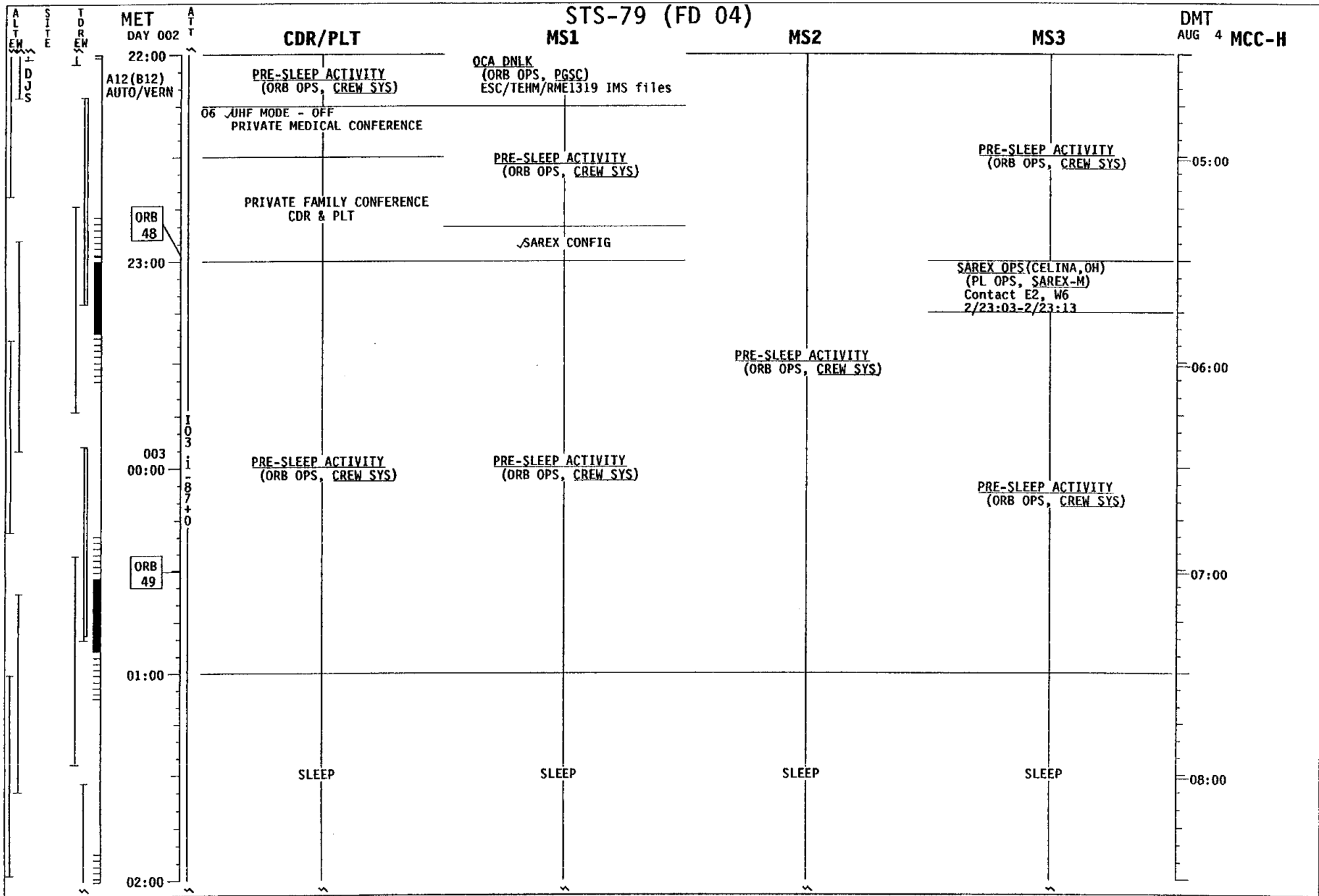

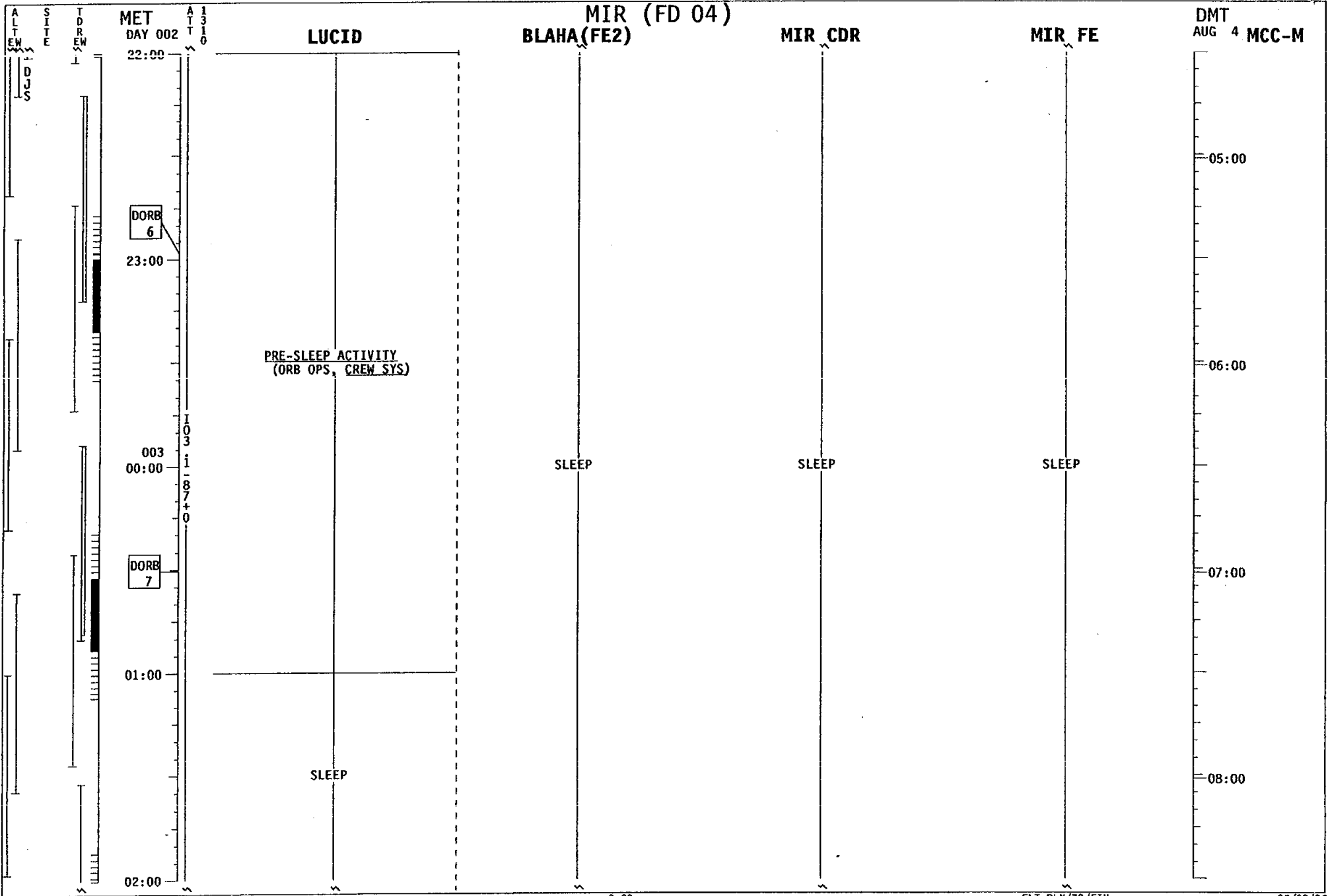

# STS-79 (FD 05)

DMT  
AUG 4 MCC-H

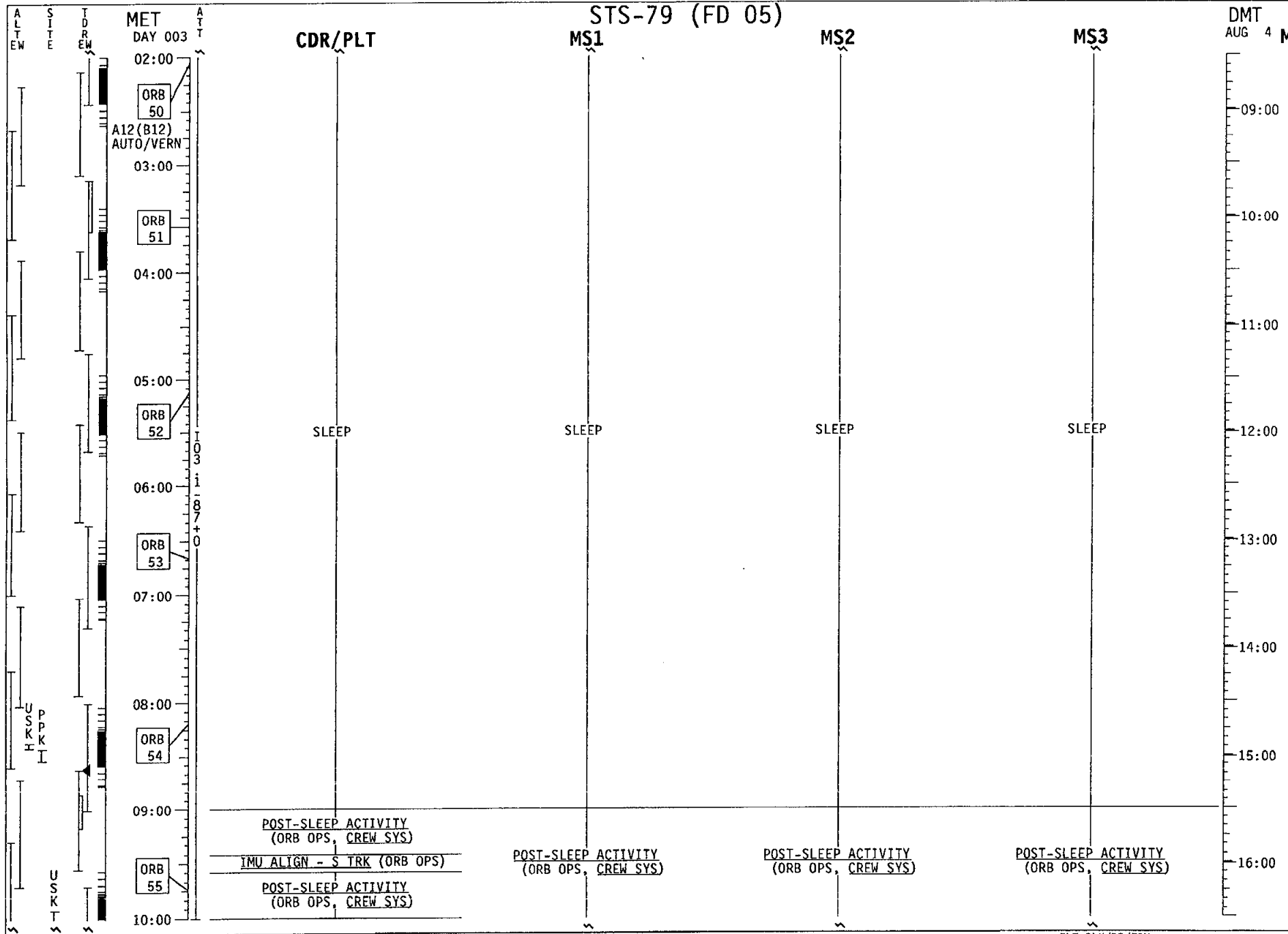

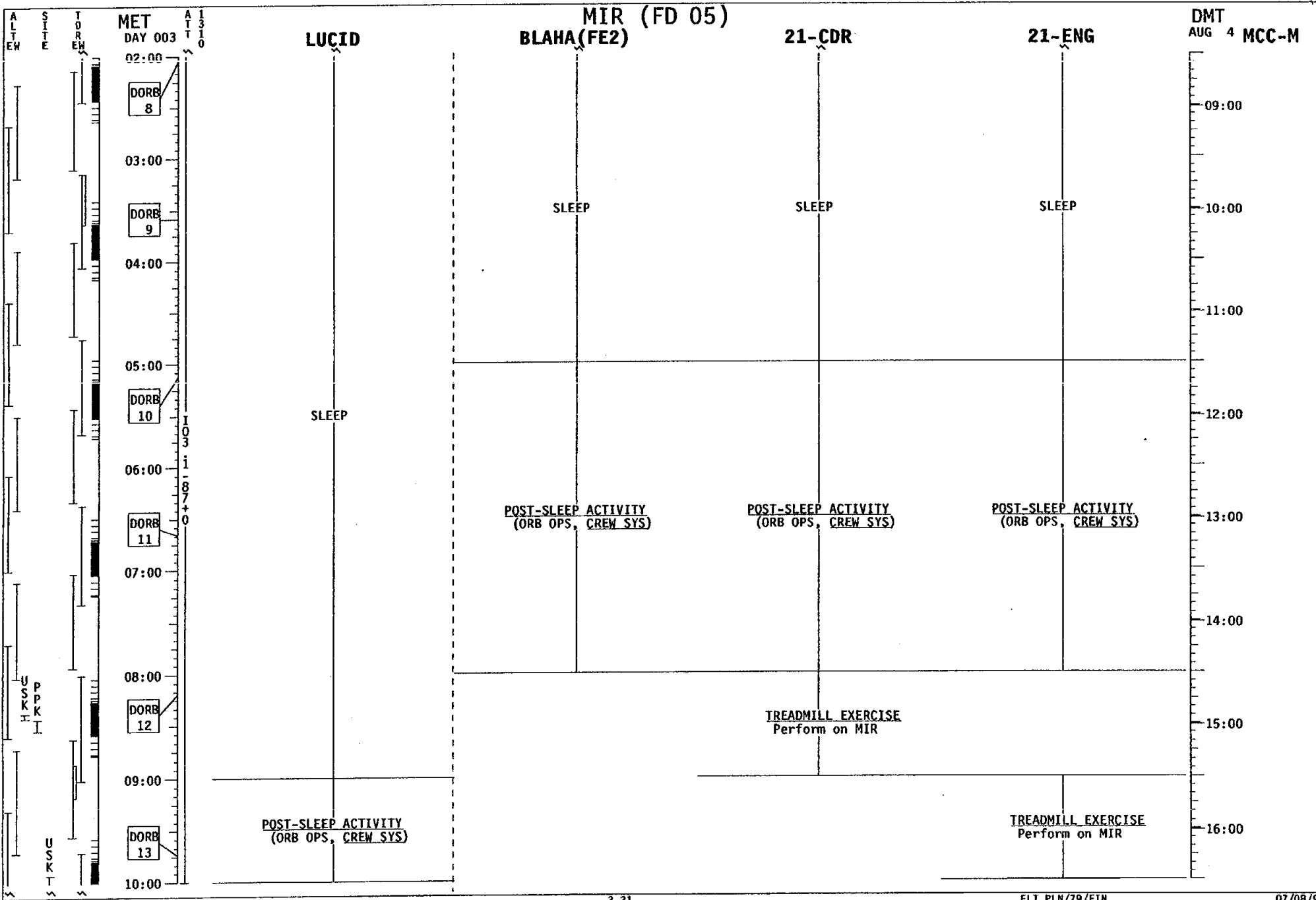



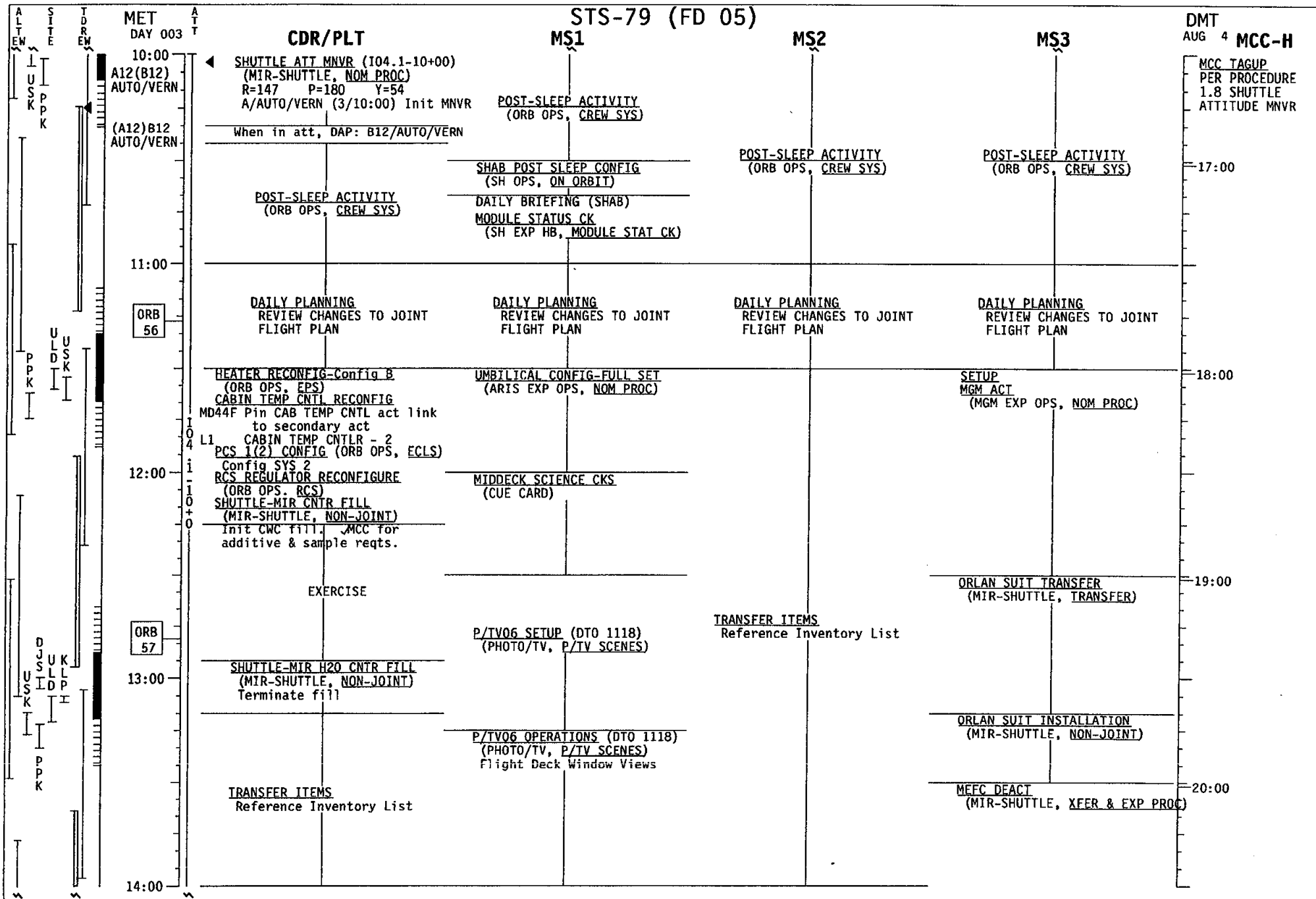

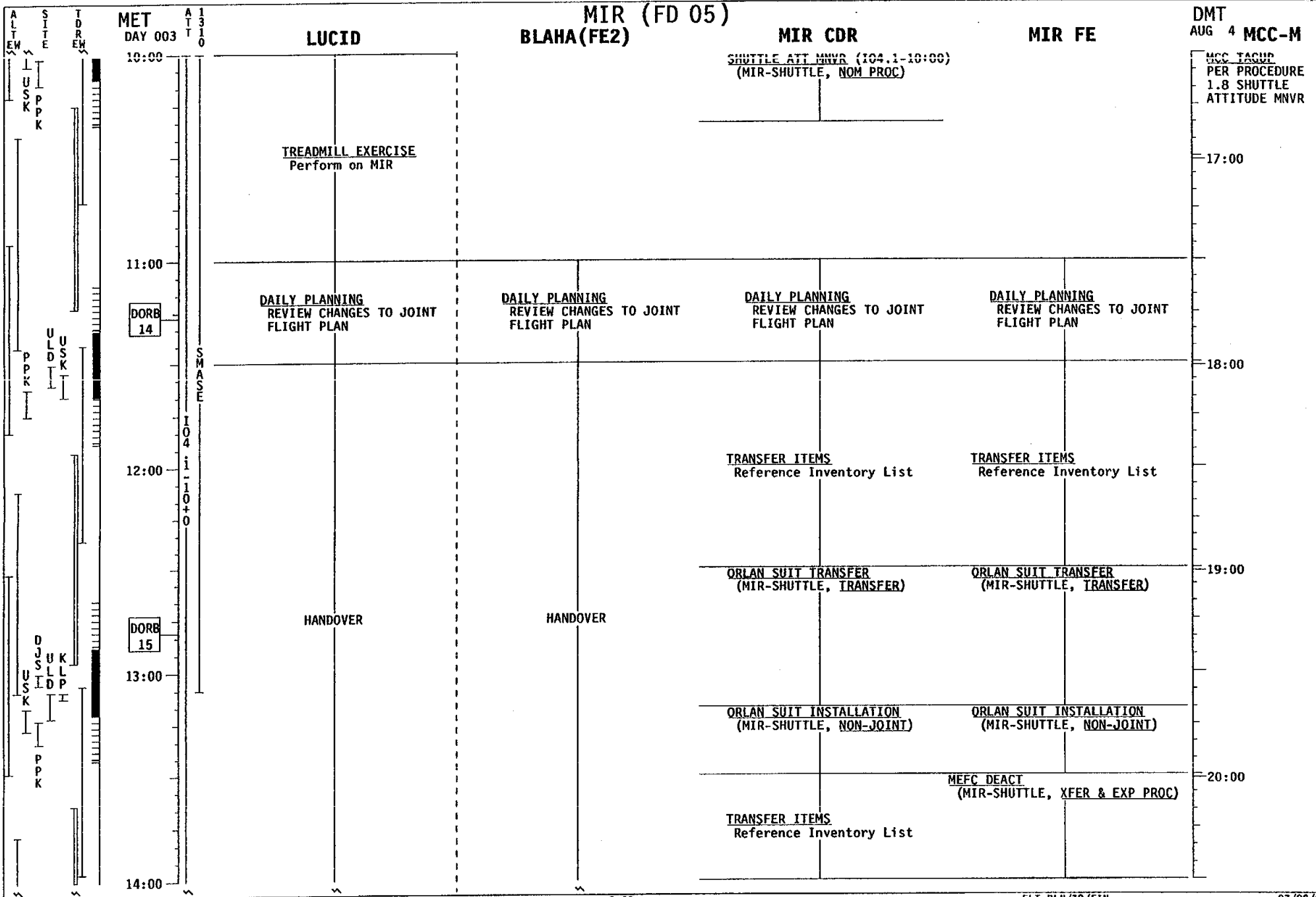

# STS-79 (FD 05)

DMT  
AUG 4 MCC-H

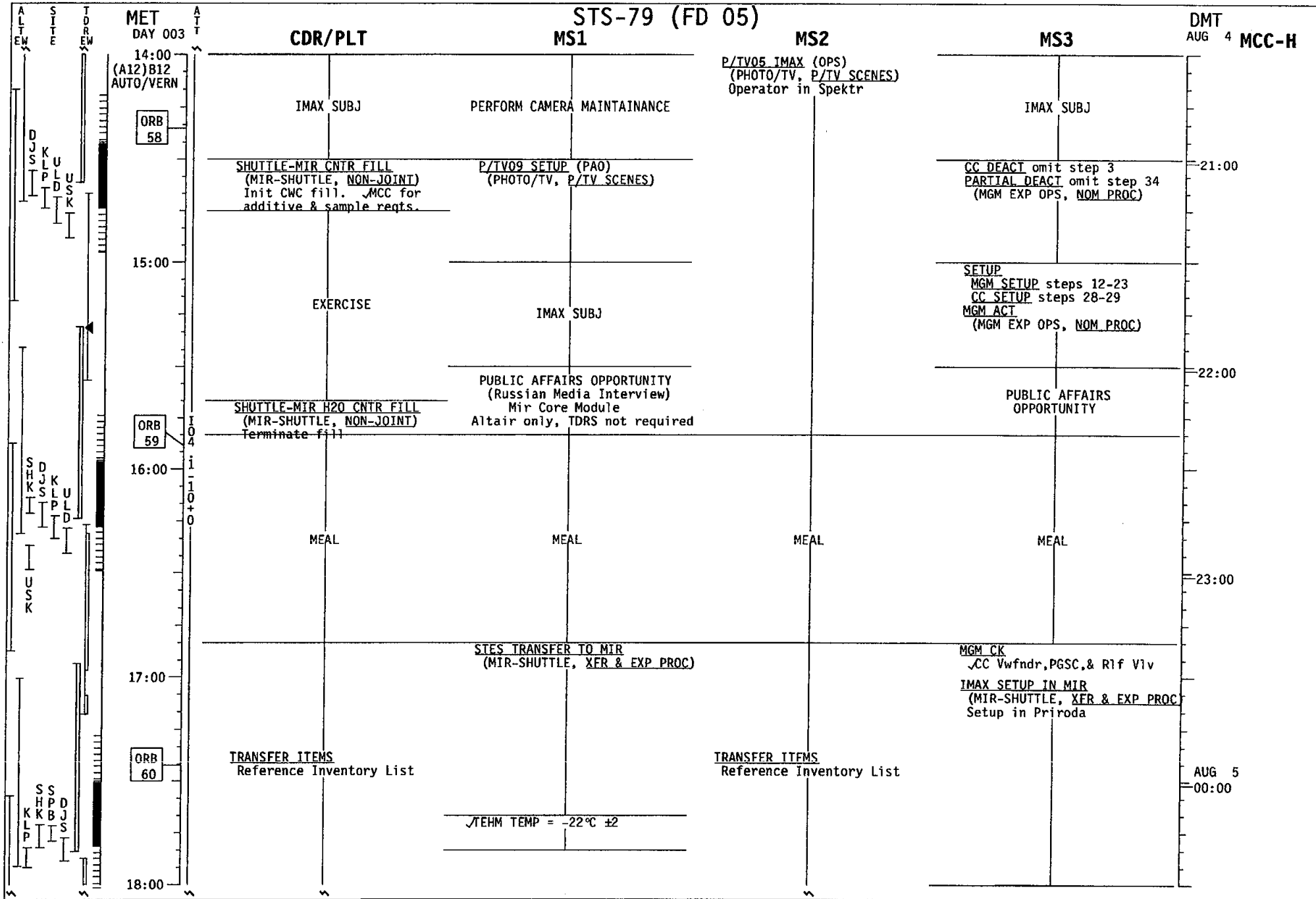

MET  
DAY 003

14:00  
(A12)B12  
AUTO/VERN

ORB  
58

15:00

ORB  
59

16:00

17:00

ORB  
60

18:00

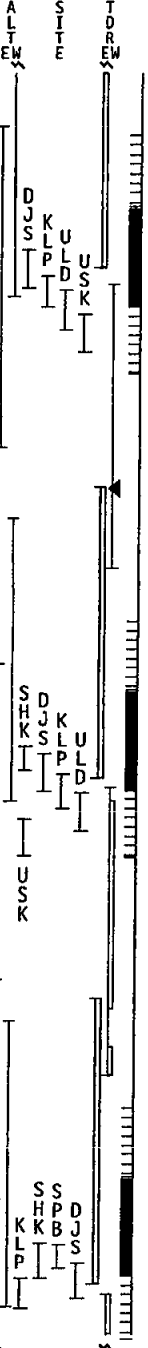

AUG 5  
00:00

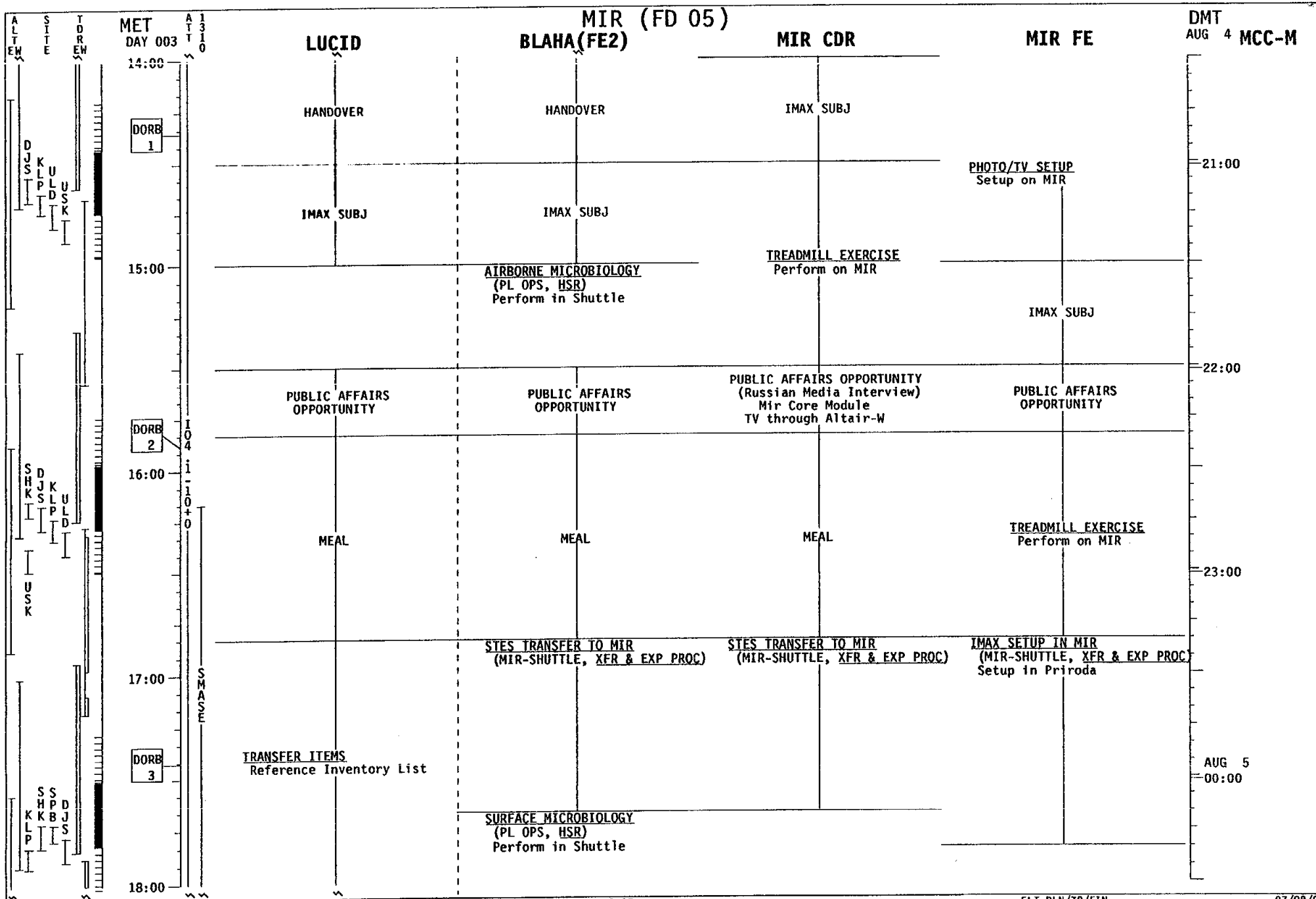

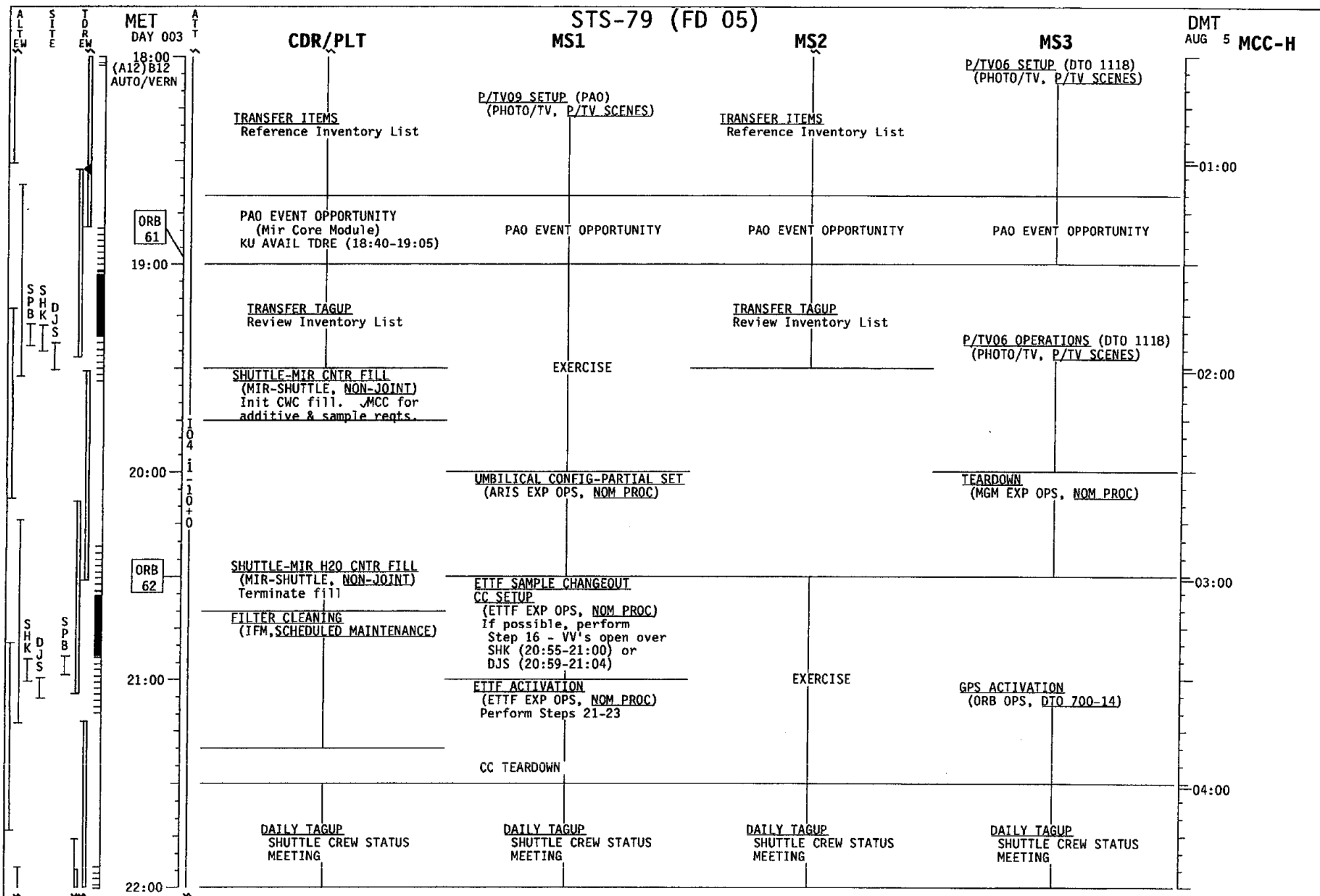

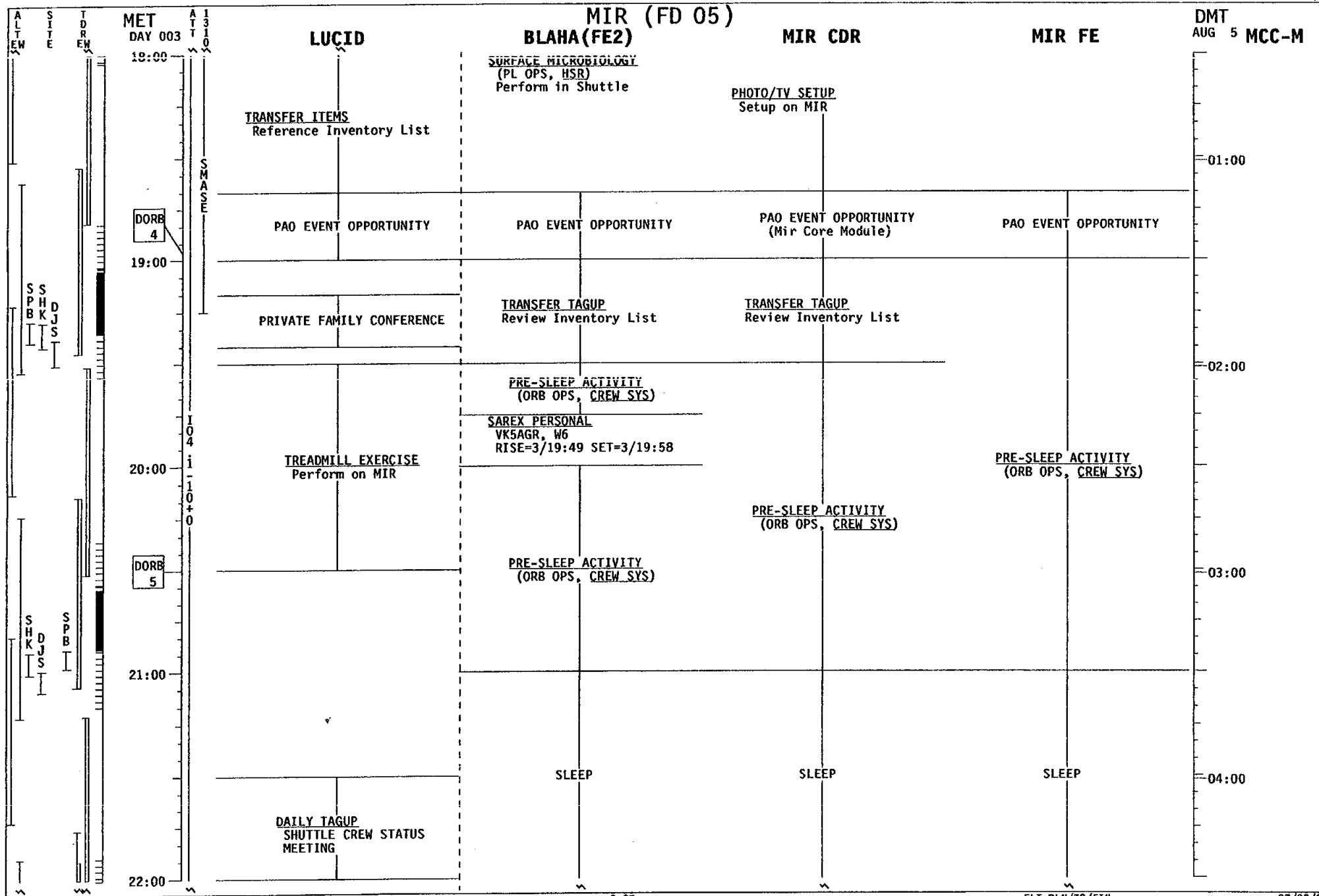

# STS-79 (FD 05)

DMT  
AUG 5 MCC-H

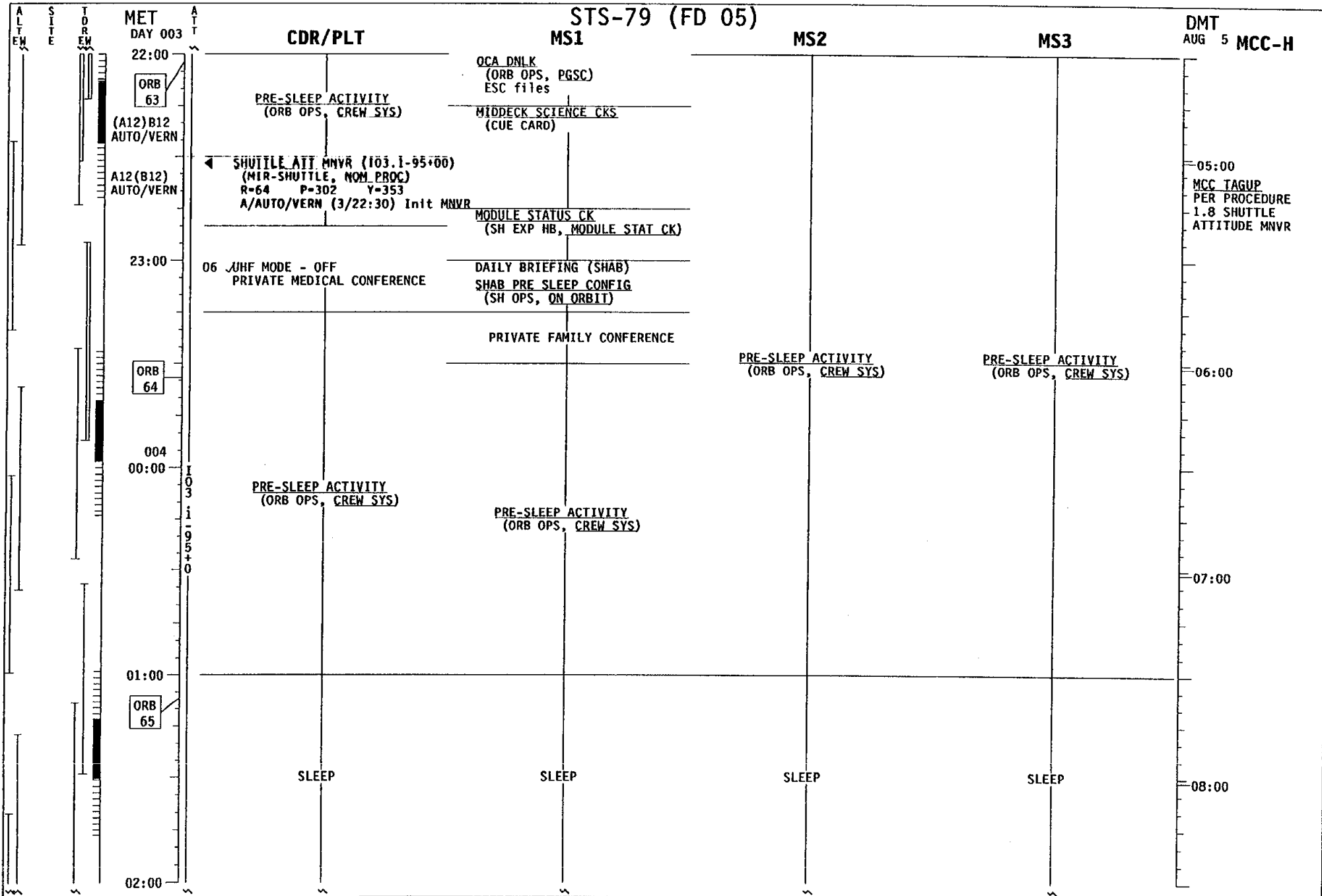

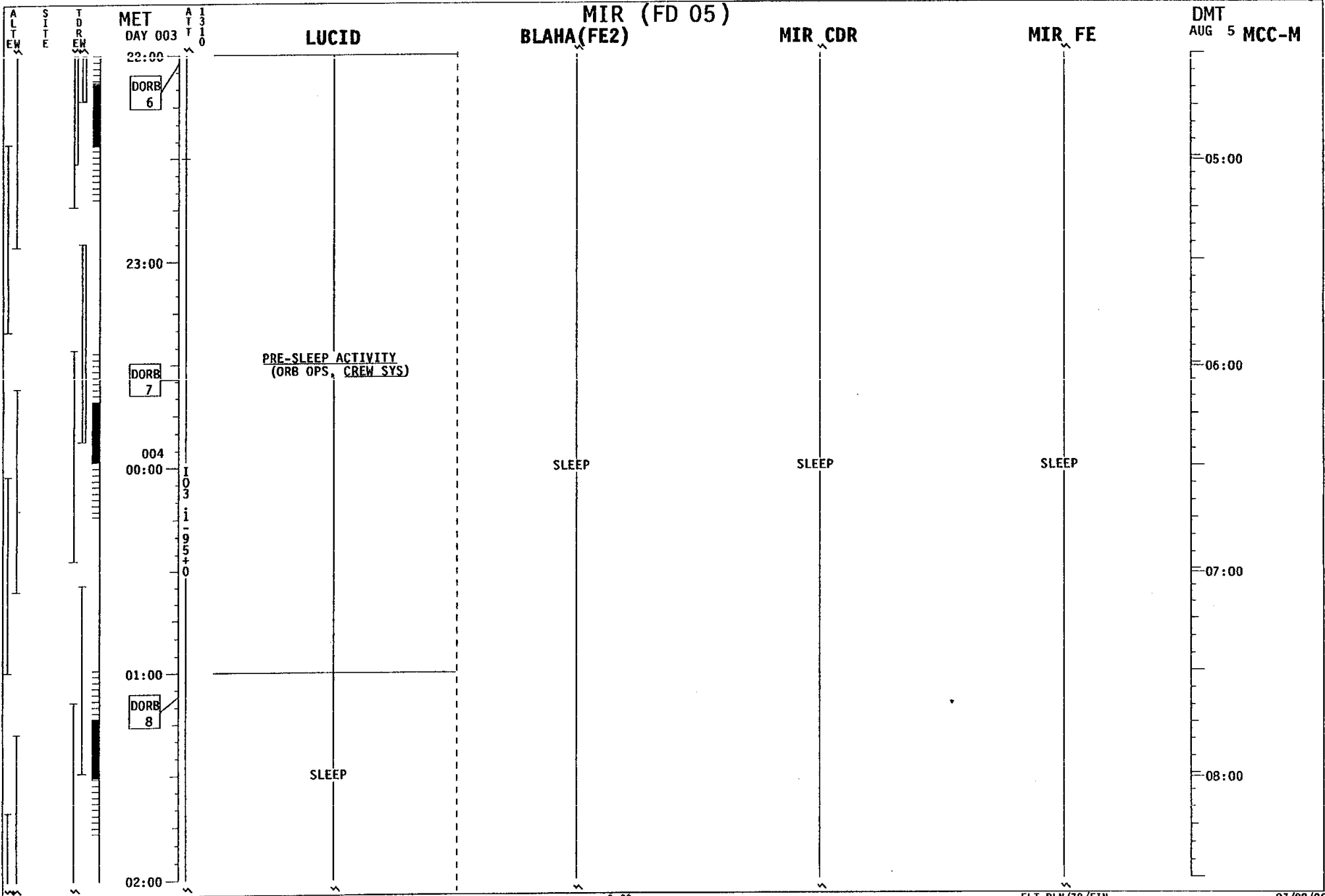



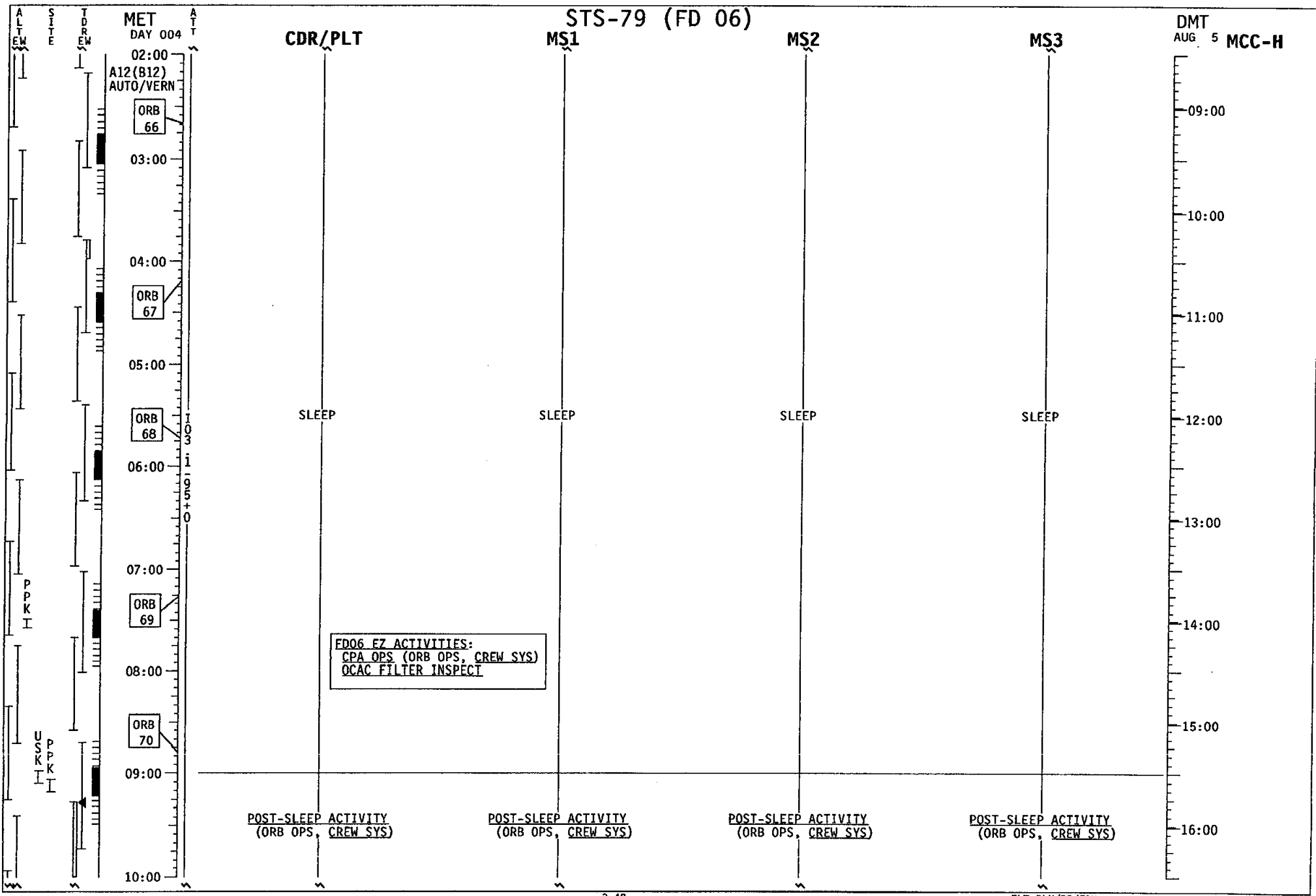

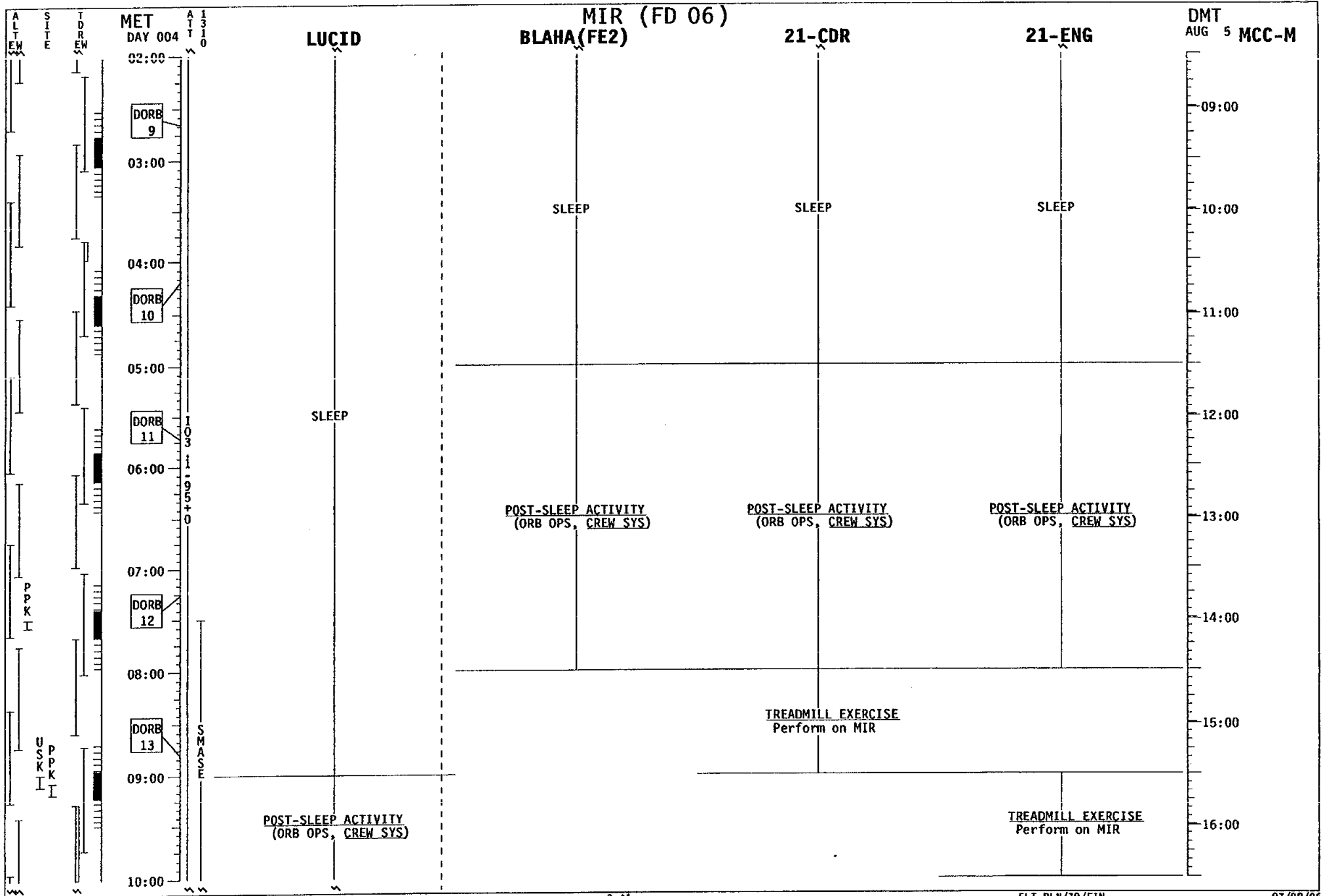

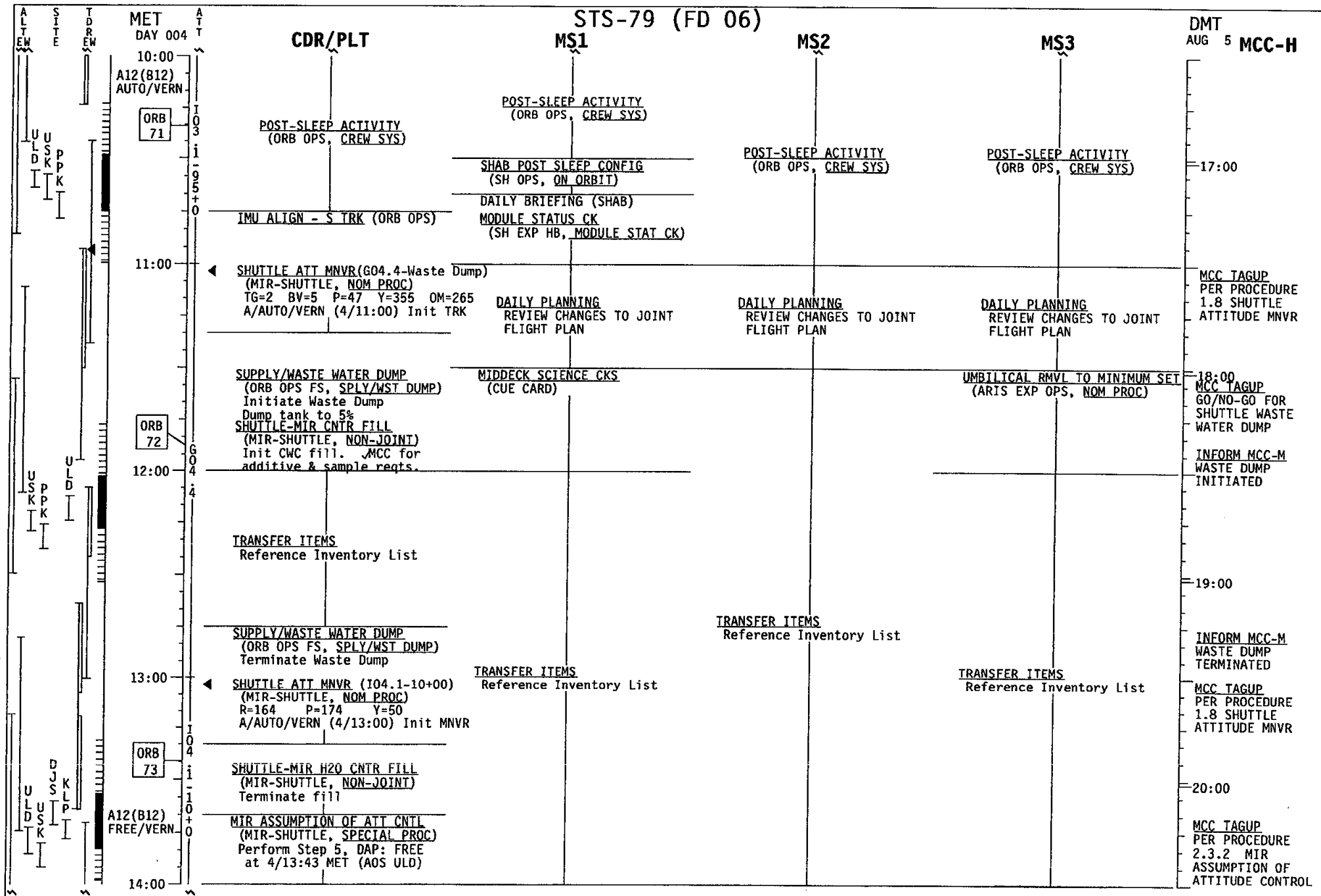

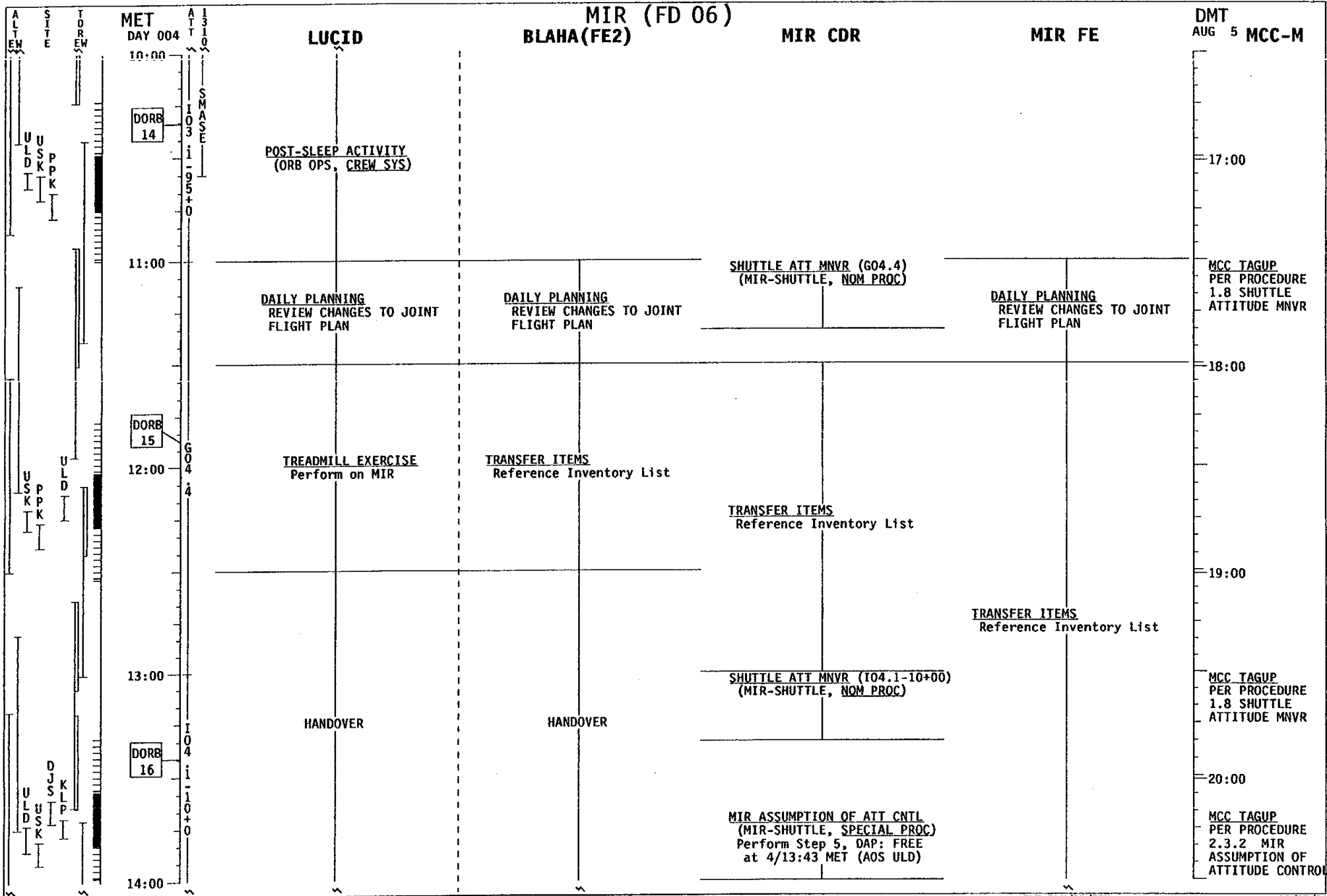

		STS-79 (FD 06)				DMT
MET DAY 004		CDR/PLT	MS1	MS2	MS3	AUG 5 MCC-H
ALT SITE TDRW	14:00		IMAX SUBJECT	IMAX SUBJECT	P/TV05 IMAX (OPS) (PHOTO/TV, P/TV SCENES) Operator in Priroda	
	A12(B12) FREE/VERN	EXERCISE				
		IMAX SUBJECT	DEACTIVATION (ETTF EXP OPS, NOM PROC)			21:00
	ORB 74					
	15:00			P/TV05 IMAX (OPS) (PHOTO/TV, P/TV SCENES) Operator in Priroda	MIDAS TRANSFER TO MIR (MIR-SHUTTLE, XFR & EXP PROC)	
	A12(B12) AUTO/VERN	SHUTTLE ASSUMPTION OF ATT CNTRL (MIR-SHUTTLE, SPECIAL PROC) Perform Step 3, Mir Indicator Mode @ 4/15:20 (ULD AOS)	EXERCISE			MCC TAGUP PER PROCEDURE 2.3.1 SHUTTLE ASSUMPTION OF ATT CONTROL 22:00
		IMAX SUBJECT				
	16:00					
	ORB 75	MEAL	MEAL	MEAL	MEAL	23:00
	17:00	SHUTTLE-MIR CNTR FILL (MIR-SHUTTLE, NON-JOINT) Init CWC fill. MCC for additive & sample reqts.	SAMS ISH ROTATION (SAMS EXP OPS, NOM PROC)  Also perform P/TV01 CC video operations	IMAX SETUP IN MIR (MIR-SHUTTLE, XFR & EXP PROC) Setup in MIR CORE	CREW CHOICE TV  KU Avail TDRW (17:00-17:26)	
		TRANSFER ITEMS Reference Inventory List	DRIVE 2 DISK ROTATE (SAMS EXP OPS, NOM PROC)			
			TEHM TEMP = -22°C ±2			
	18:00					AUG 6 00:00

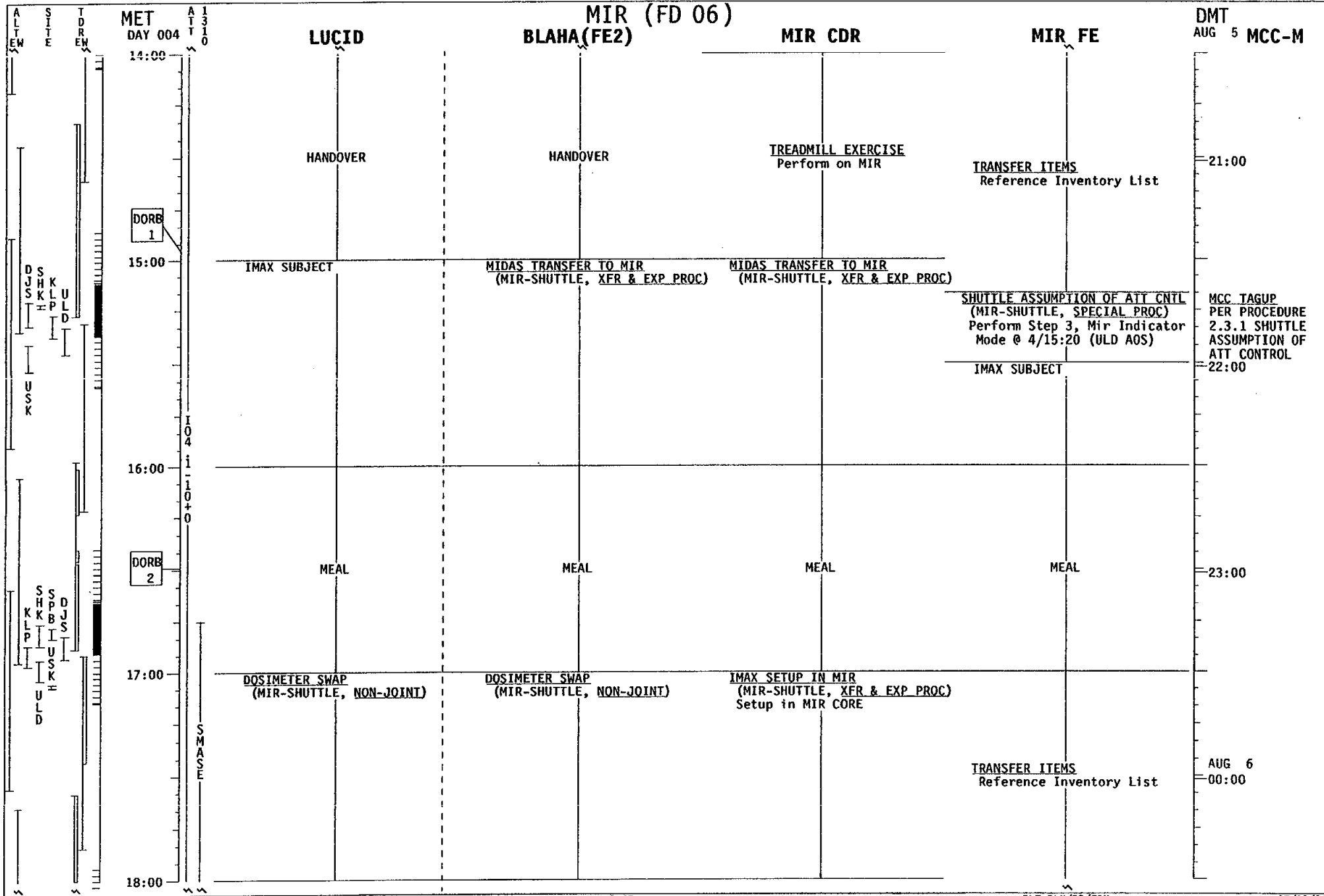

# STS-79 (FD 06)

MET DAY 004	CDR/PLT	MS1	MS2	MS3	DMT AUG 6 MCC-H
<p>18:00</p> <p>ORB 76</p> <p>(A12) B12 AUTO/VERN</p> <p>A12 (B12) AUTO/VERN</p> <p>19:00</p> <p>ORB 77</p> <p>20:00</p> <p>ORB 78</p> <p>21:00</p> <p>22:00</p>	<p><b>SHUTTLE-MIR H2O CNTR FILL</b> (MIR-SHUTTLE, NON-JOINT) Terminate fill</p> <hr/> <p>DAP: B12/AUTO/VERN <b>ARIS VRCS TEST</b> (ORB OPS, ARIS) Init free drift at AOS SHK (4/18:20)</p> <hr/> <p>When test complete, DAP: A12/AUTO/VERN <b>TRANSFER ITEMS</b> Reference Inventory List</p> <hr/> <p><b>PUBLIC AFFAIRS OPPORTUNITY</b> (U.S. Media Interview) CDR &amp; PLT in Shuttle Flt Dk KU AVAIL TDRE (19:00-19:30)</p> <hr/> <p><b>SHUTTLE-MIR CNTR FILL</b> (MIR-SHUTTLE, NON-JOINT) Init CWC fill. MCC for additive &amp; sample reqts.</p> <hr/> <p><b>SHUTTLE-MIR H2O CNTR FILL</b> (MIR-SHUTTLE, NON-JOINT) Terminate fill</p> <hr/> <p><b>DAILY TAGUP</b> SHUTTLE CREW STATUS MEETING</p>	<p><b>ARIS VRCS TEST</b> (ORB OPS, ARIS)</p> <hr/> <p><b>P/TVO9 SETUP (PAO)</b> (PHOTO/TV, P/TV SCENES) Shuttle Flight Deck</p> <hr/> <p><b>JSAREX CONFIG</b></p> <hr/> <p><b>ETTF SAMPLE CHANGEOUT</b> (ETTF EXP OPS, NOM PROC) If possible, perform Step 16 - VV's open over SHK (19:57-20:03) or DJS (20:02-20:08)</p> <hr/> <p><b>ETTF ACTIVATION</b> (ETTF EXP OPS, NOM PROC) Perform Steps 21-23</p> <hr/> <p><b>MODULE STATUS CK</b> (SH EXP HB, MODULE STAT CK)</p> <hr/> <p><b>DAILY BRIEFING (SHAB)</b> <b>SHAB PRE SLEEP CONFIG</b> (SH OPS, ON ORBIT)</p> <hr/> <p><b>MIDDECK SCIENCE CKS</b> (CUE CARD)</p> <hr/> <p><b>DAILY TAGUP</b> SHUTTLE CREW STATUS MEETING</p>	<p><b>EXERCISE</b></p> <hr/> <p><b>TRANSFER TAGUP</b> Review Inventory List</p> <hr/> <p><b>STOW ANY LOOSE OR LATE TRANSFER ITEMS</b></p> <hr/> <p><b>DAILY TAGUP</b> SHUTTLE CREW STATUS MEETING</p>	<p><b>ARIS VRCS TEST</b> (ORB OPS, ARIS)</p> <hr/> <p><b>OSVS TGT NIGHT VIEWS (DTO 700-10)</b> At SS or on MCC GO: FWD BHD LTs-ON At SR or on MCC GO: FWD BHD LTs-OFF</p> <hr/> <p><b>EXERCISE</b></p> <hr/> <p><b>OSVS TGT NIGHT VIEWS (DTO 700-10)</b> At SS or on MCC GO: FWD BHD LTs-ON At SR or on MCC GO: FWD BHD LTs-OFF</p> <hr/> <p><b>DAILY TAGUP</b> SHUTTLE CREW STATUS MEETING</p>	<p><b>UPLINK</b> ARIS VENT VALVE CYCLE</p> <hr/> <p>01:00</p> <hr/> <p><b>TV (TDRX)</b> CREW CNTL-MIR</p> <hr/> <p><b>UPLINK</b> ARIS VENT VALVE CYCLE</p> <hr/> <p>02:00</p> <hr/> <p>03:00</p> <hr/> <p>04:00</p>

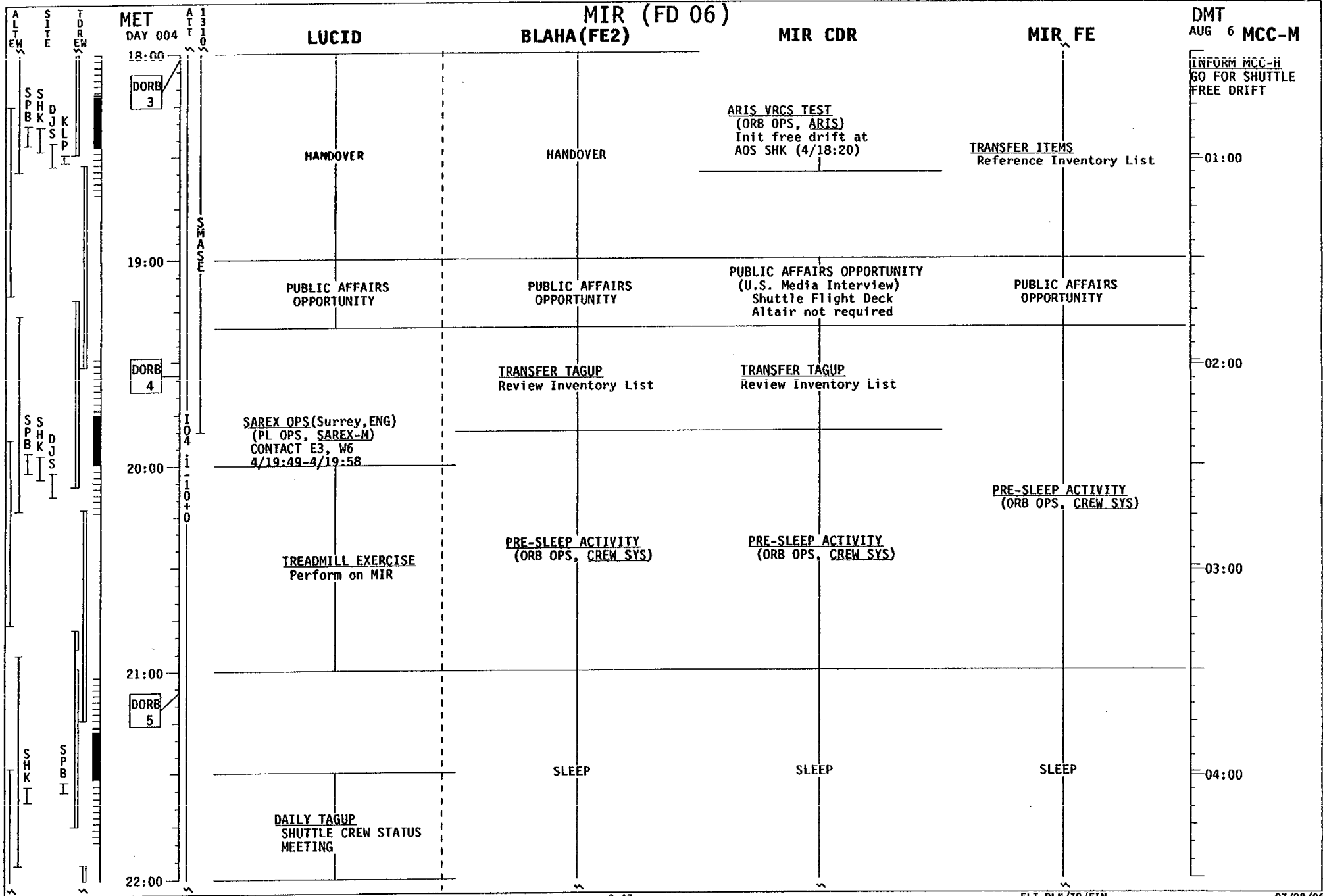



# STS-79 (FD 06)

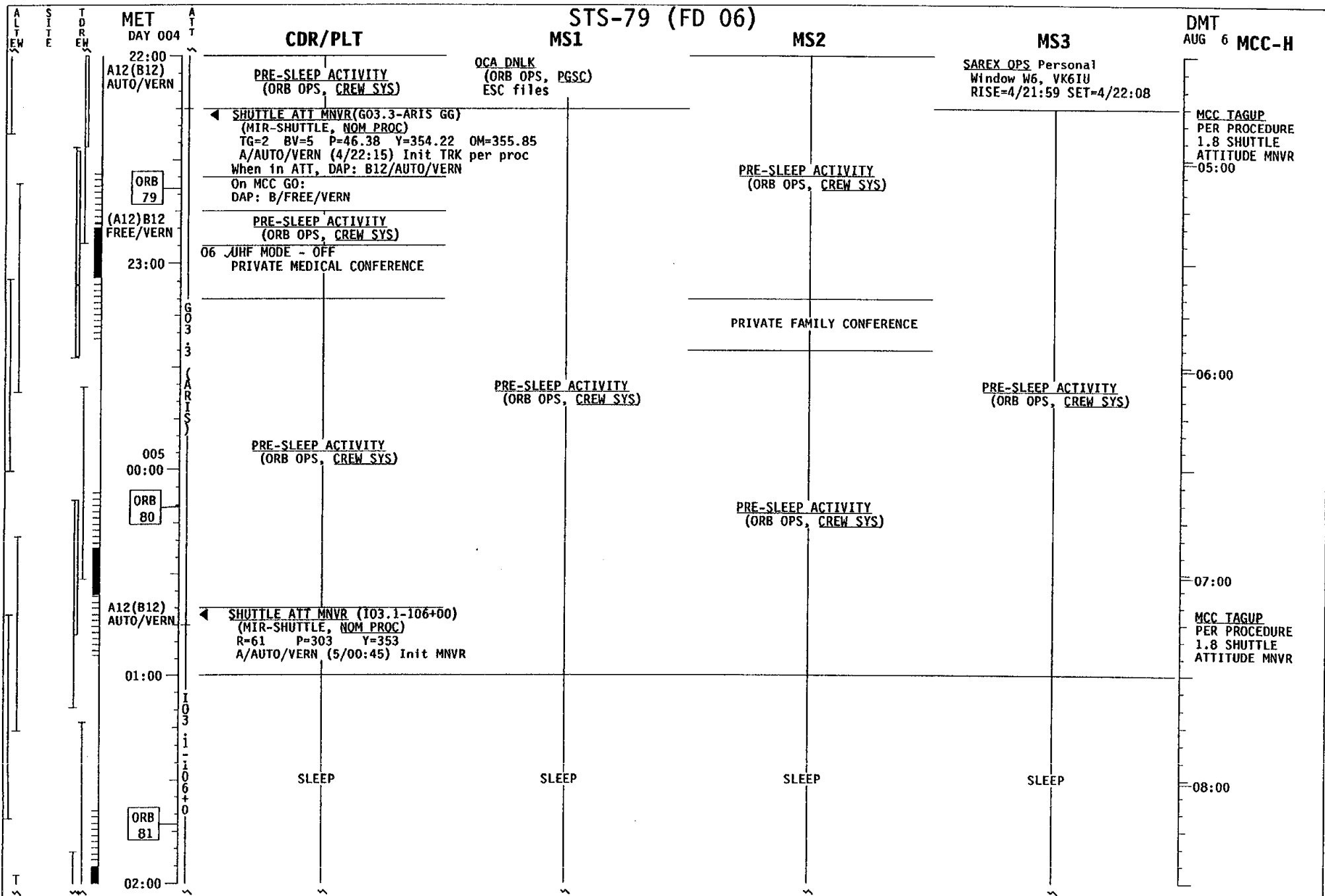

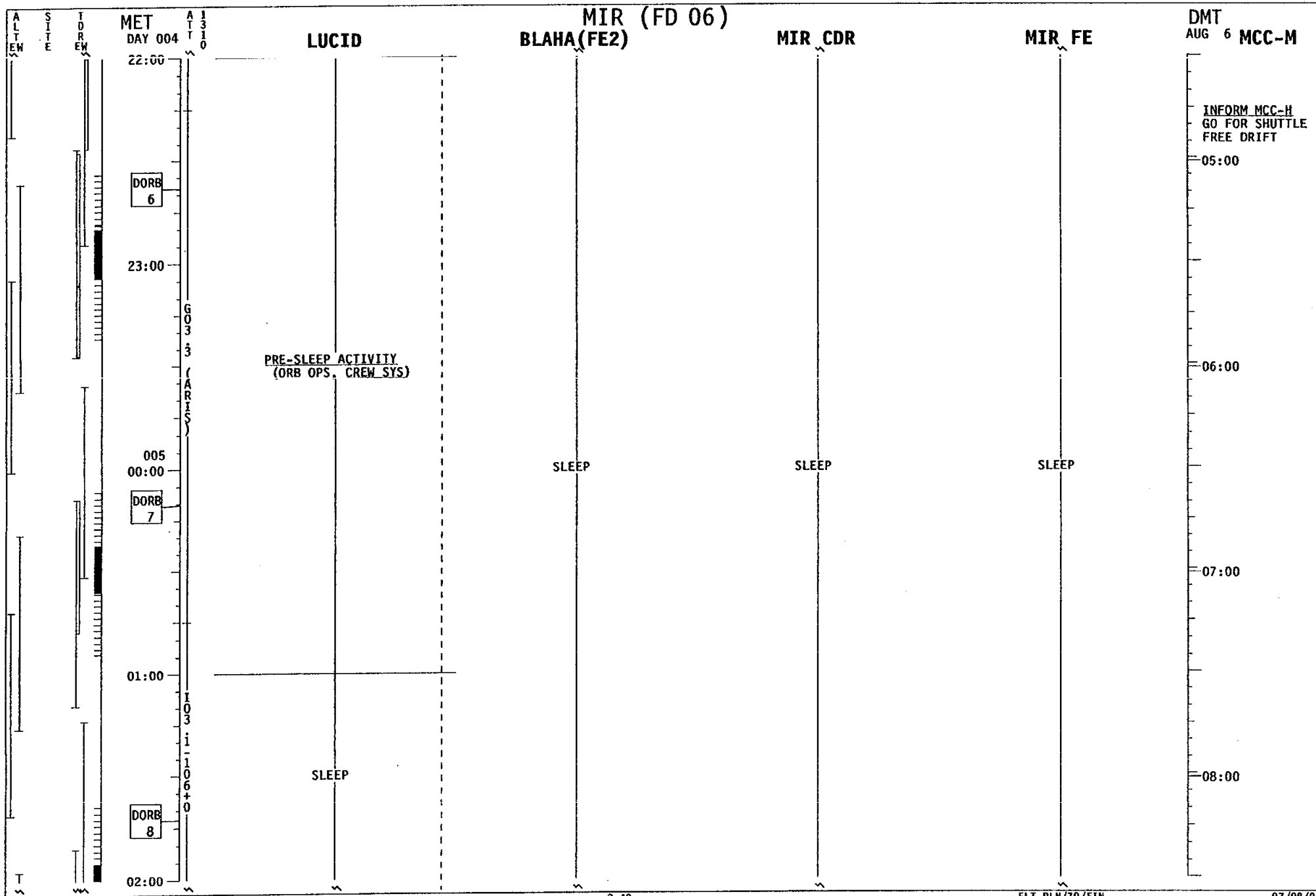

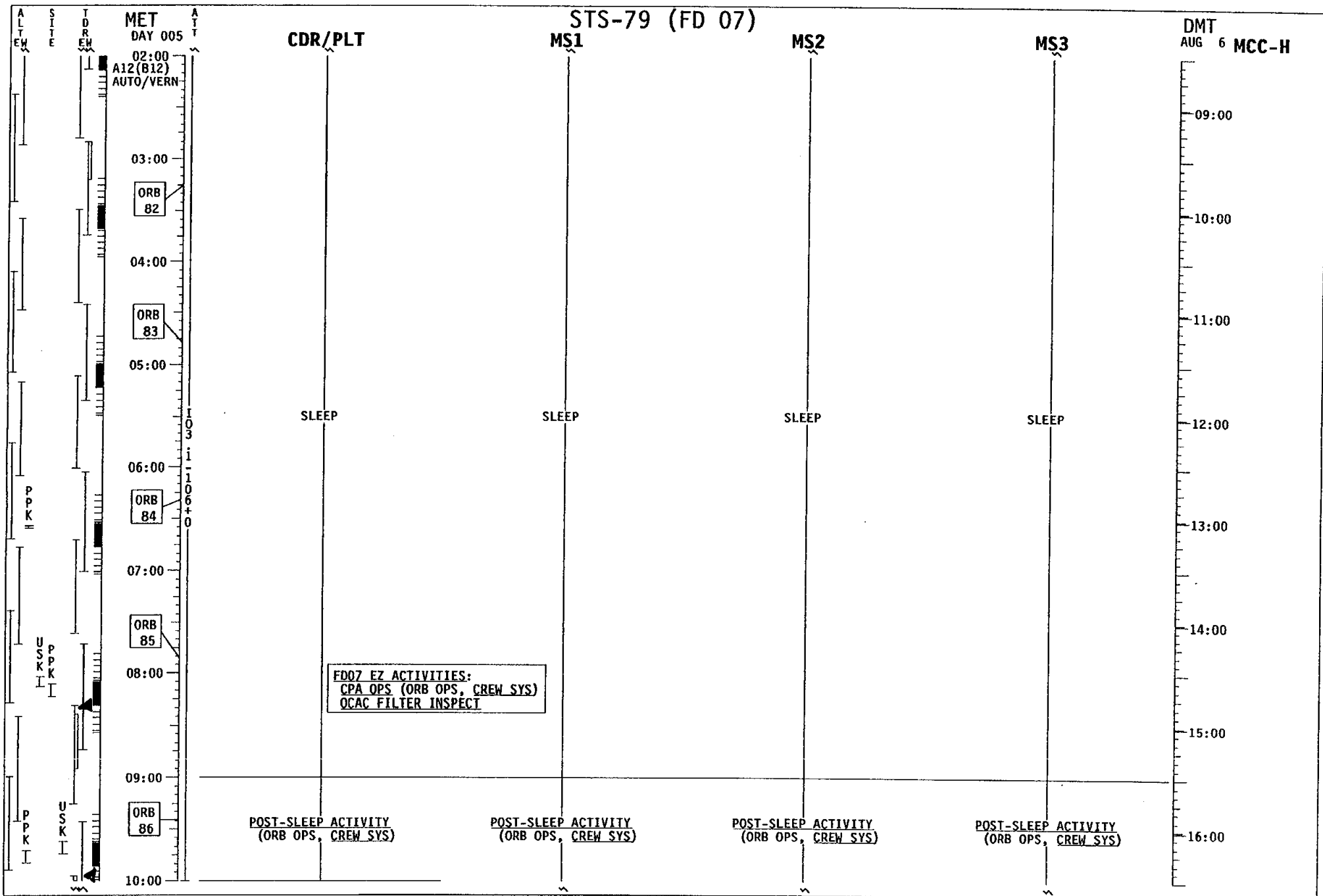

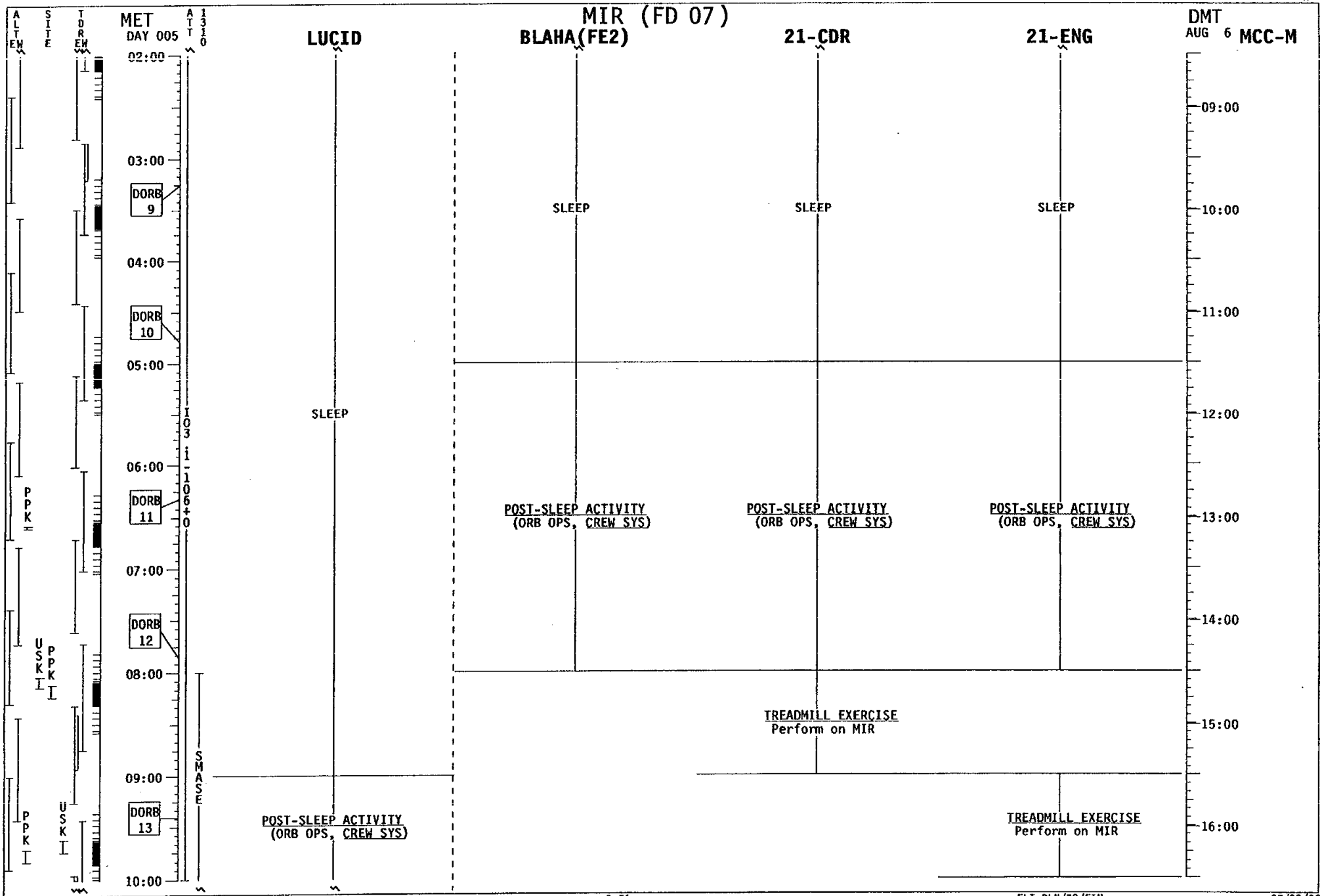

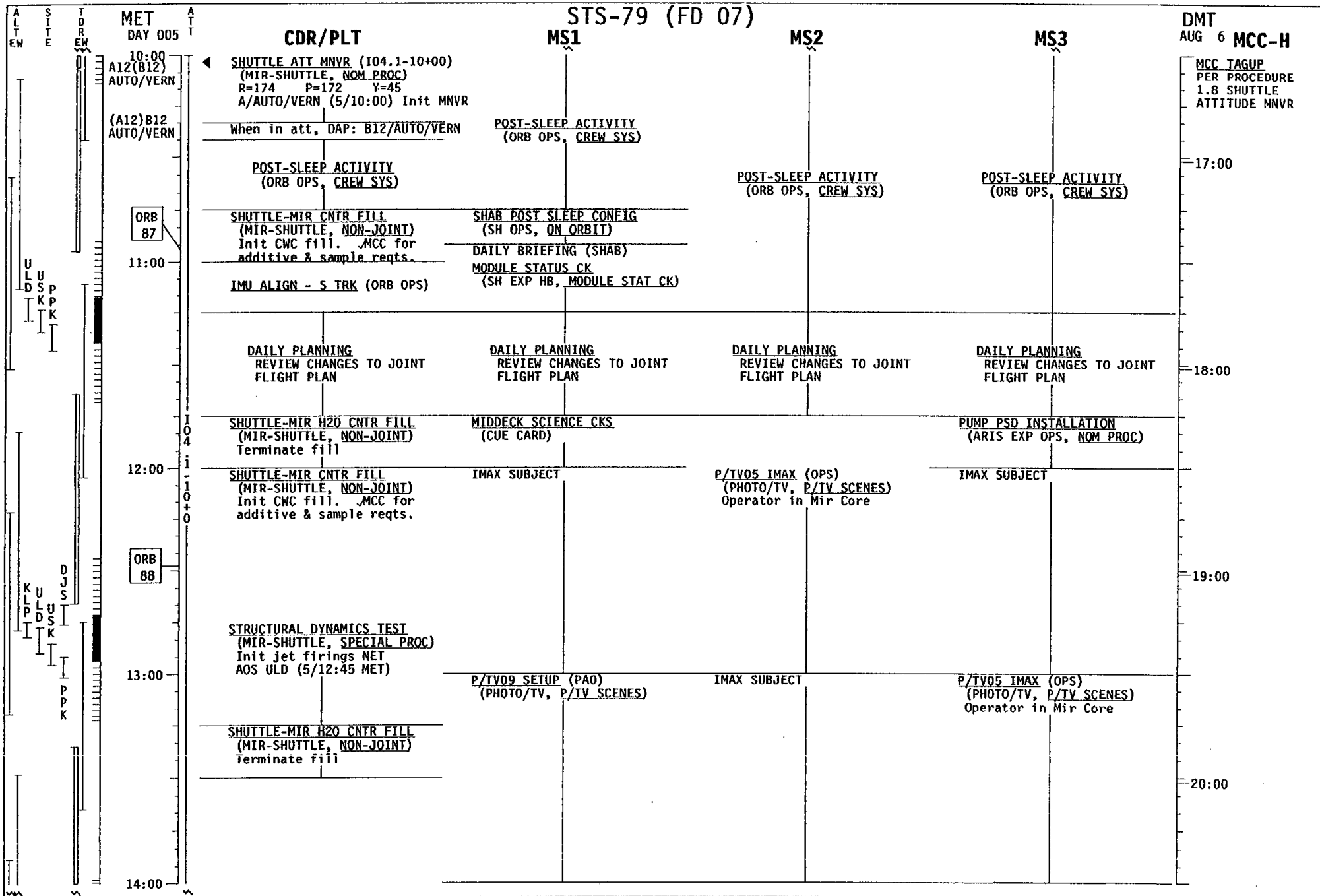

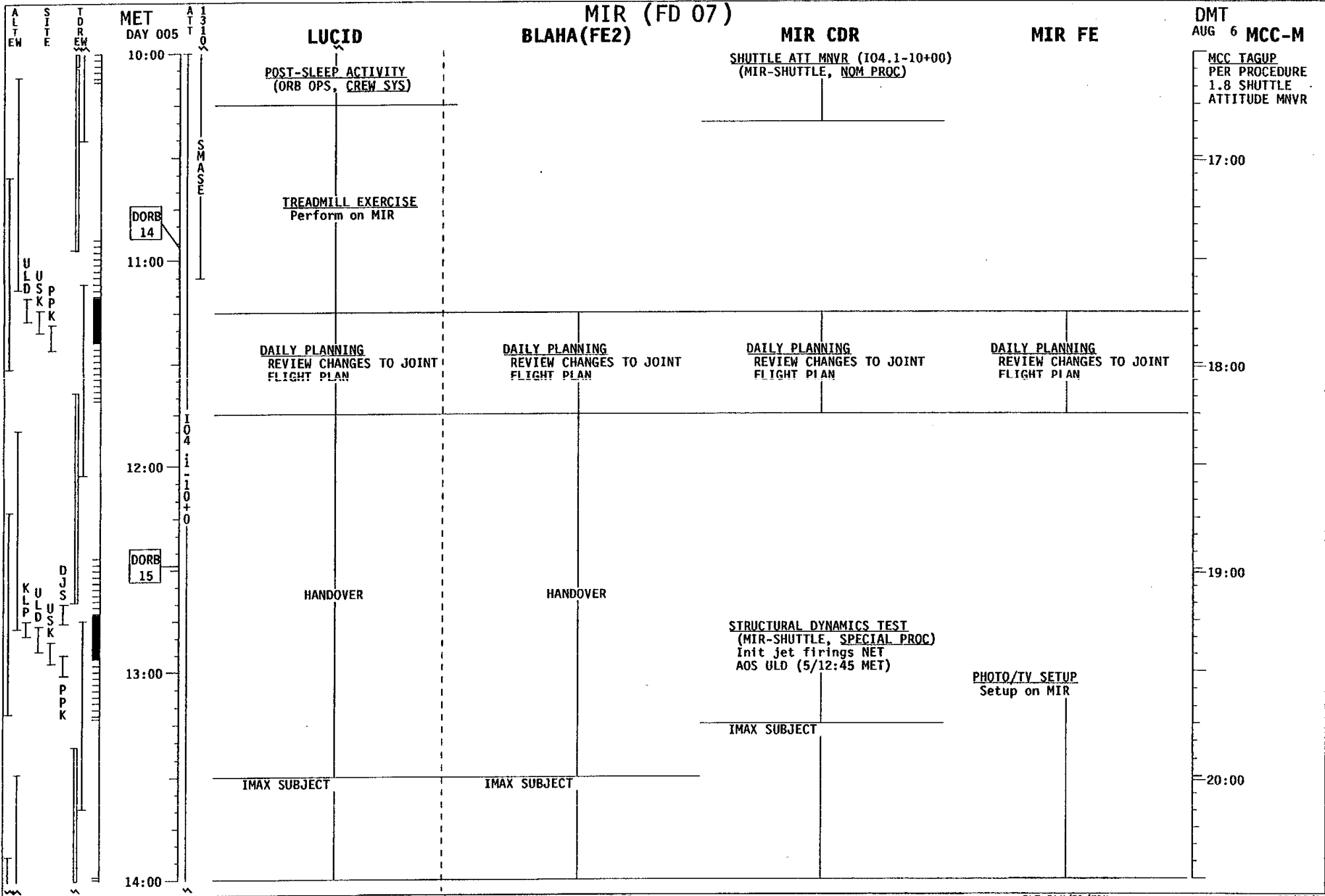

		STS-79 (FD 07)				DMT
		CDR/PLT	MS1	MS2	MS3	AUG 6 MCC-H
MET DAY 005 14:00 ORB 89 (A12)B12 AUTO/VERN 15:00 ORB 90 16:00 17:00 ORB 91 18:00	ALT EW SITE TDR EW D J S K L U S L P L D U S K S H K J S L L K P L D U S K L P S S P B D K L T T J S L P	MEAL (A11)     CREW CONFERENCE (U.S. and Russian News Media) All crewmembers in Mir Core Module KU AVAIL TDRE (15:01-15:56)	MEAL (A11)     CREW CONFERENCE	MEAL (A11)     CREW CONFERENCE    COLLECT IMAX EQUIP AND RETURN TO SHUTTLE   P/TV09 SETUP (PAO) (PHOTO/TV, P/TV SCENES) Farewell in Mir Core	MEAL (A11)     CREW CONFERENCE    RSA FOOD TRANSFER (ARIS)	21:00     22:00     23:00     AUG 7 00:00
		RSA FOOD TRANSFER (ARIS)	RSA FOOD TRANSFER (ARIS) Transfer 25 food containers from ARIS Rack to MIR		RSA FOOD TRANSFER (ARIS)	
		TRANSFER TAGUP Review Inventory List	TRANSFER TAGUP Review Inventory List	TRANSFER TAGUP Review Inventory List	TRANSFER TAGUP Review Inventory List	
		FAREWELL CEREMONY & GIFTS All crewmembers in Mir Core Module KU AVAIL TDRW (17:33-18:05)	FAREWELL CEREMONY & GIFTS	FAREWELL CEREMONY & GIFTS	FAREWELL CEREMONY & GIFTS	

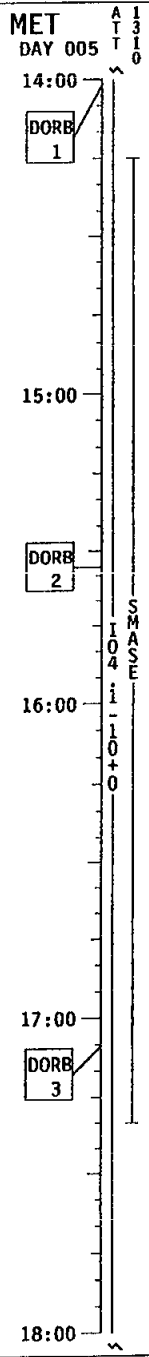
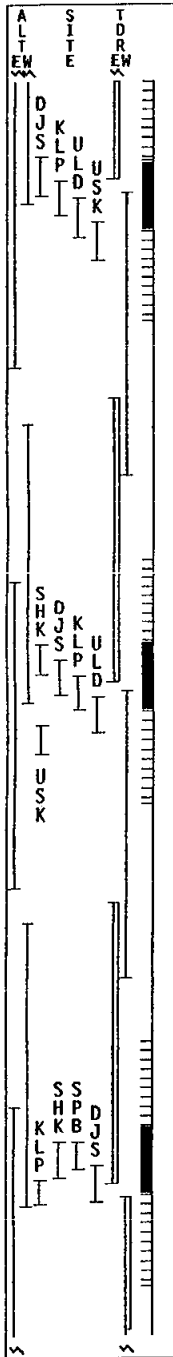
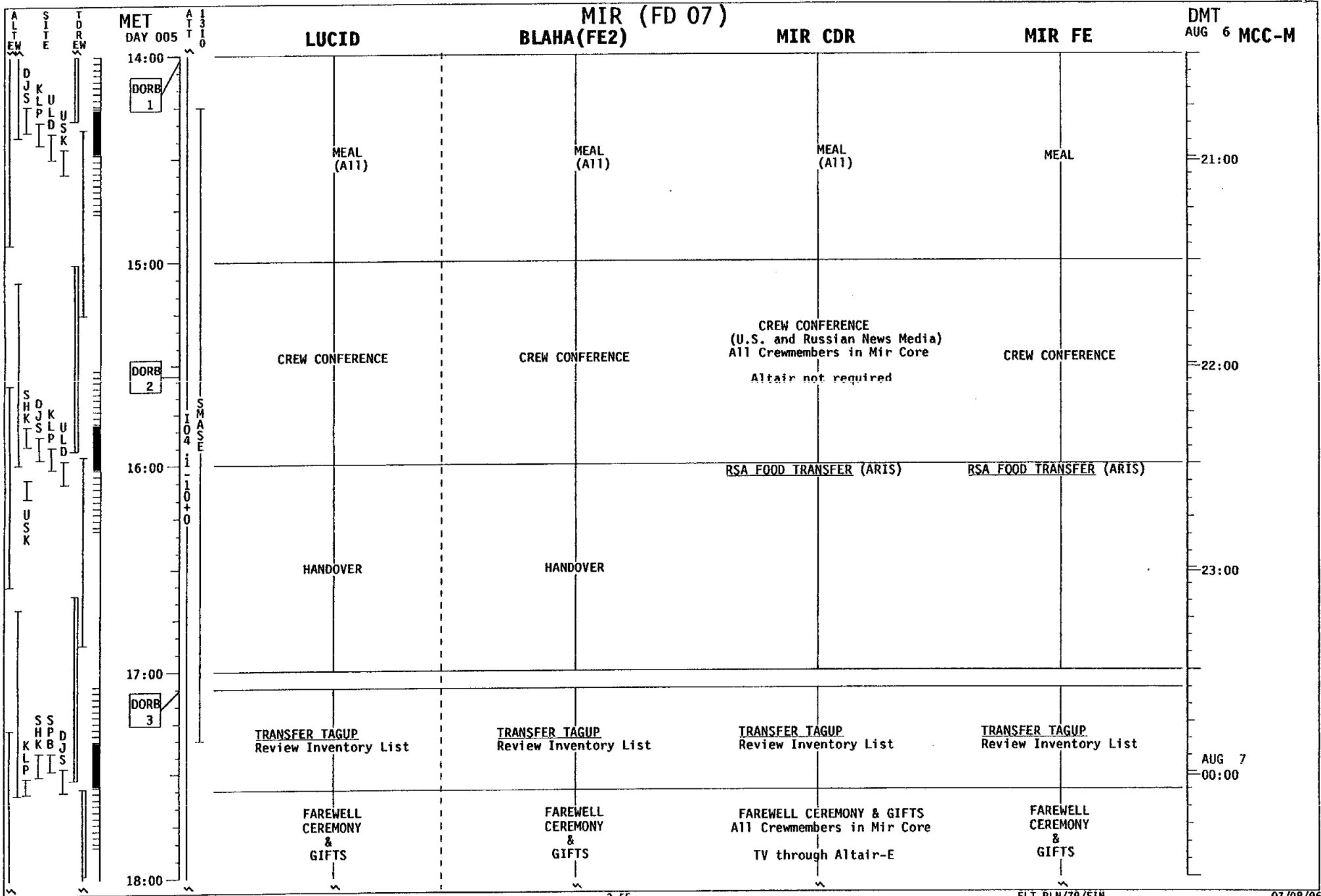



# STS-79 (FD 07)

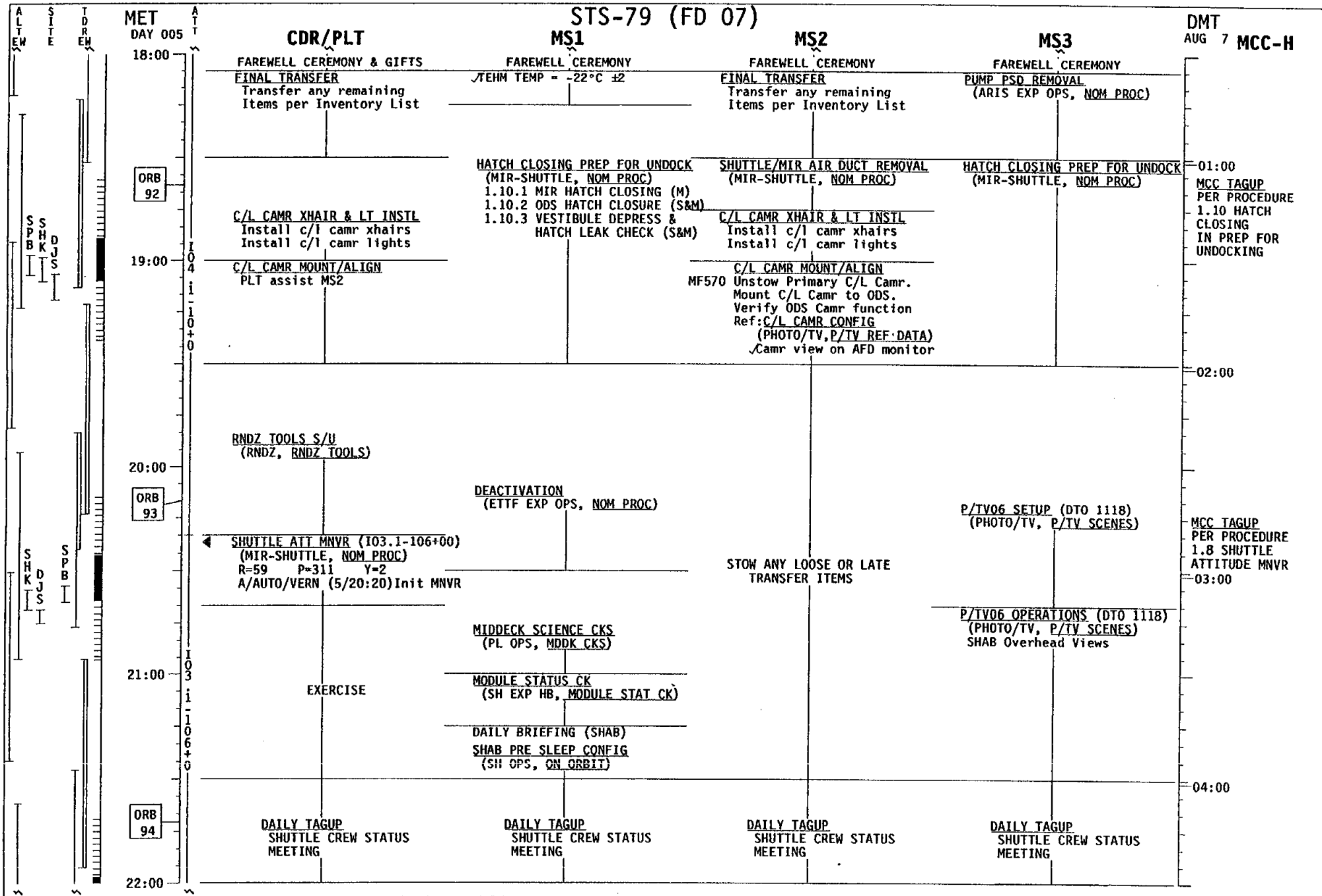

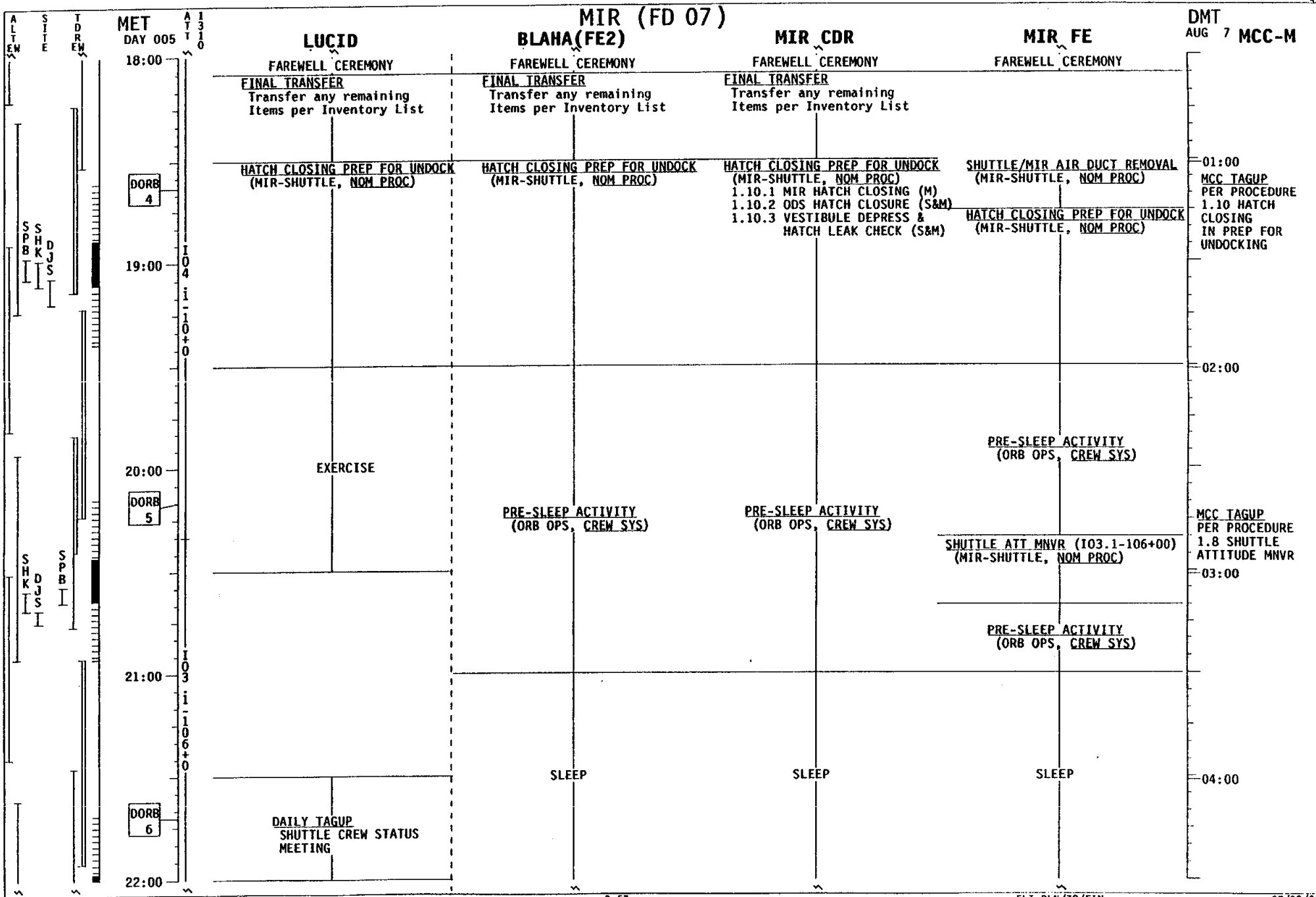

# STS-79 (FD 07)

DMT  
AUG 7 MCC-H

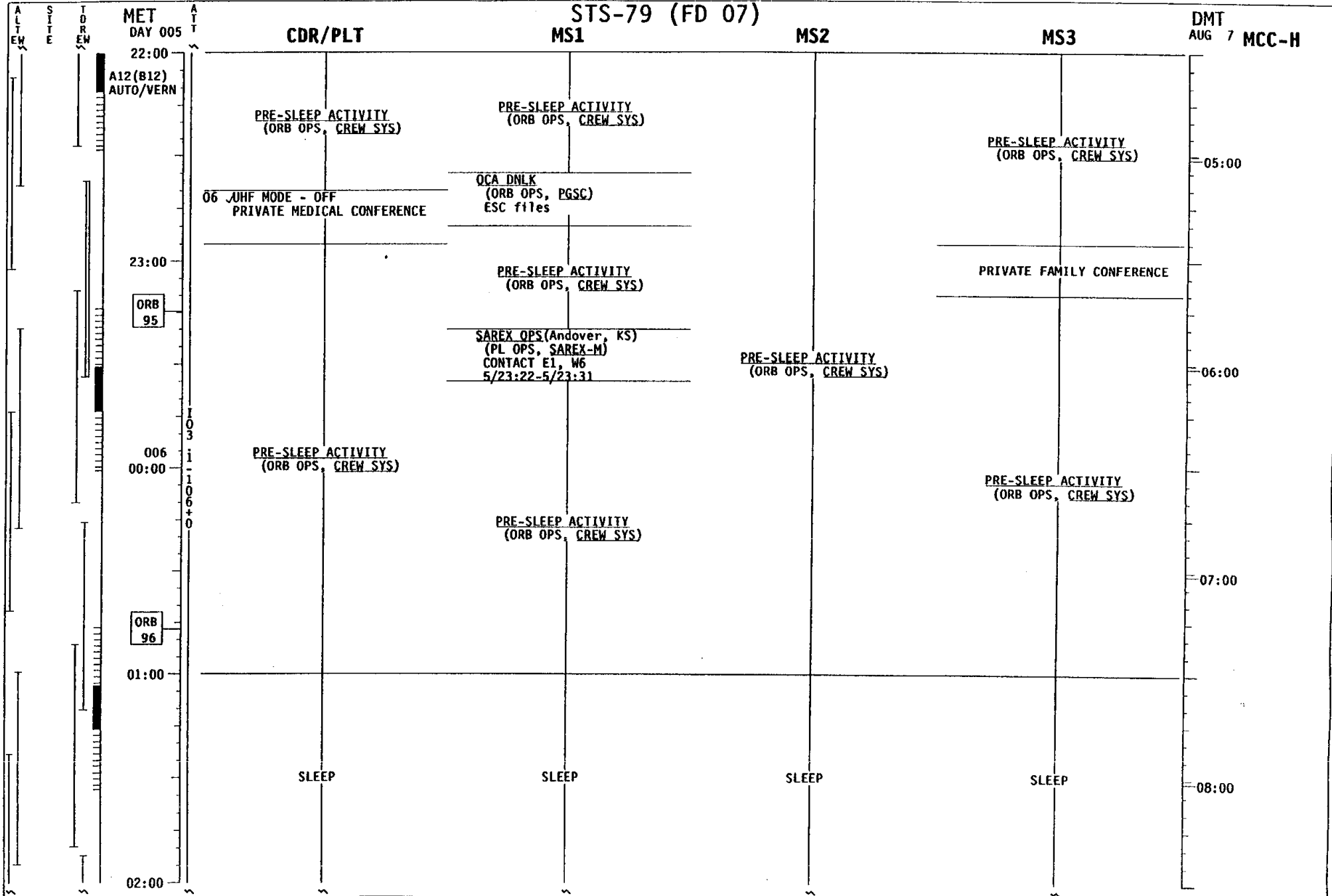

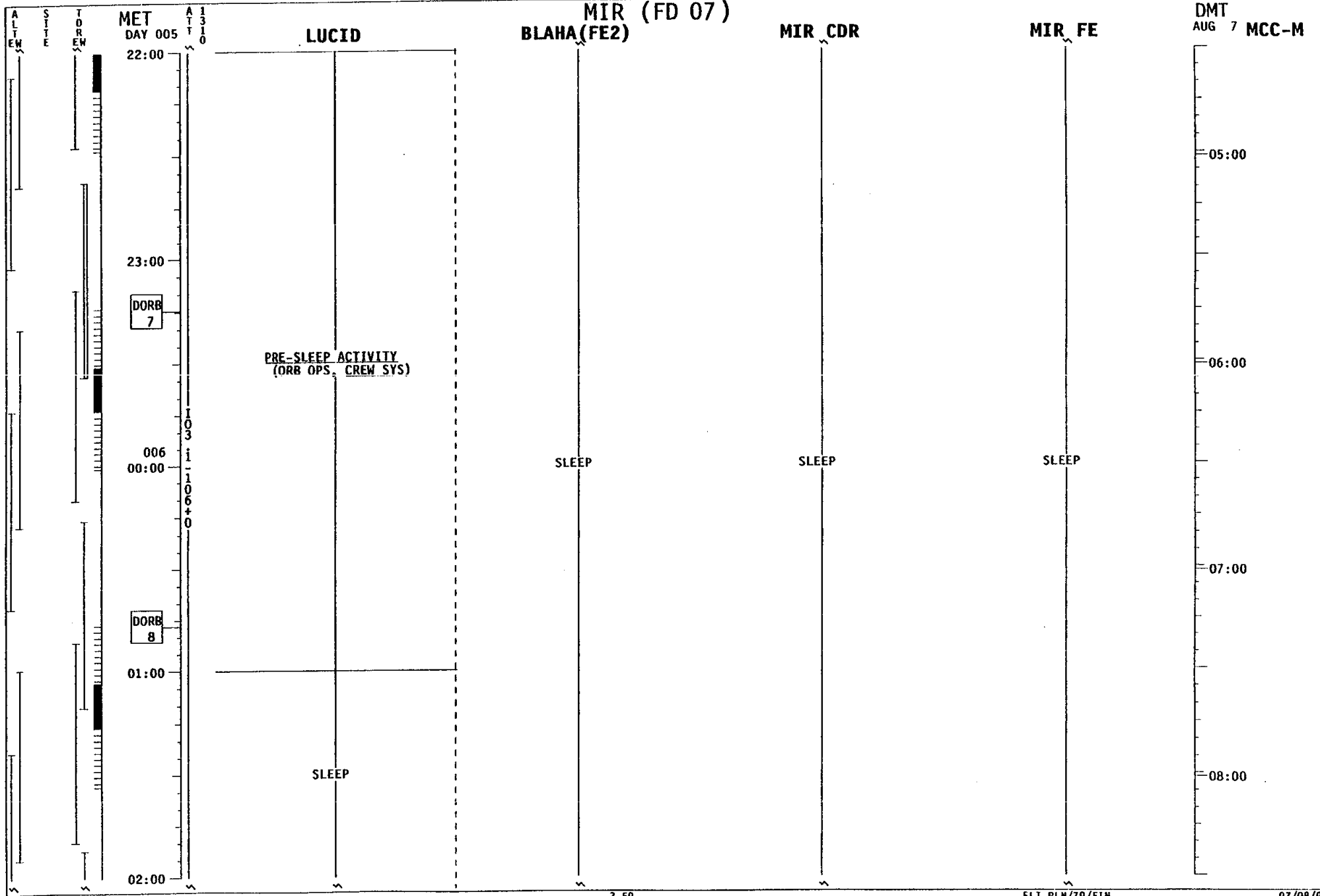

# STS-79 (FD 07)

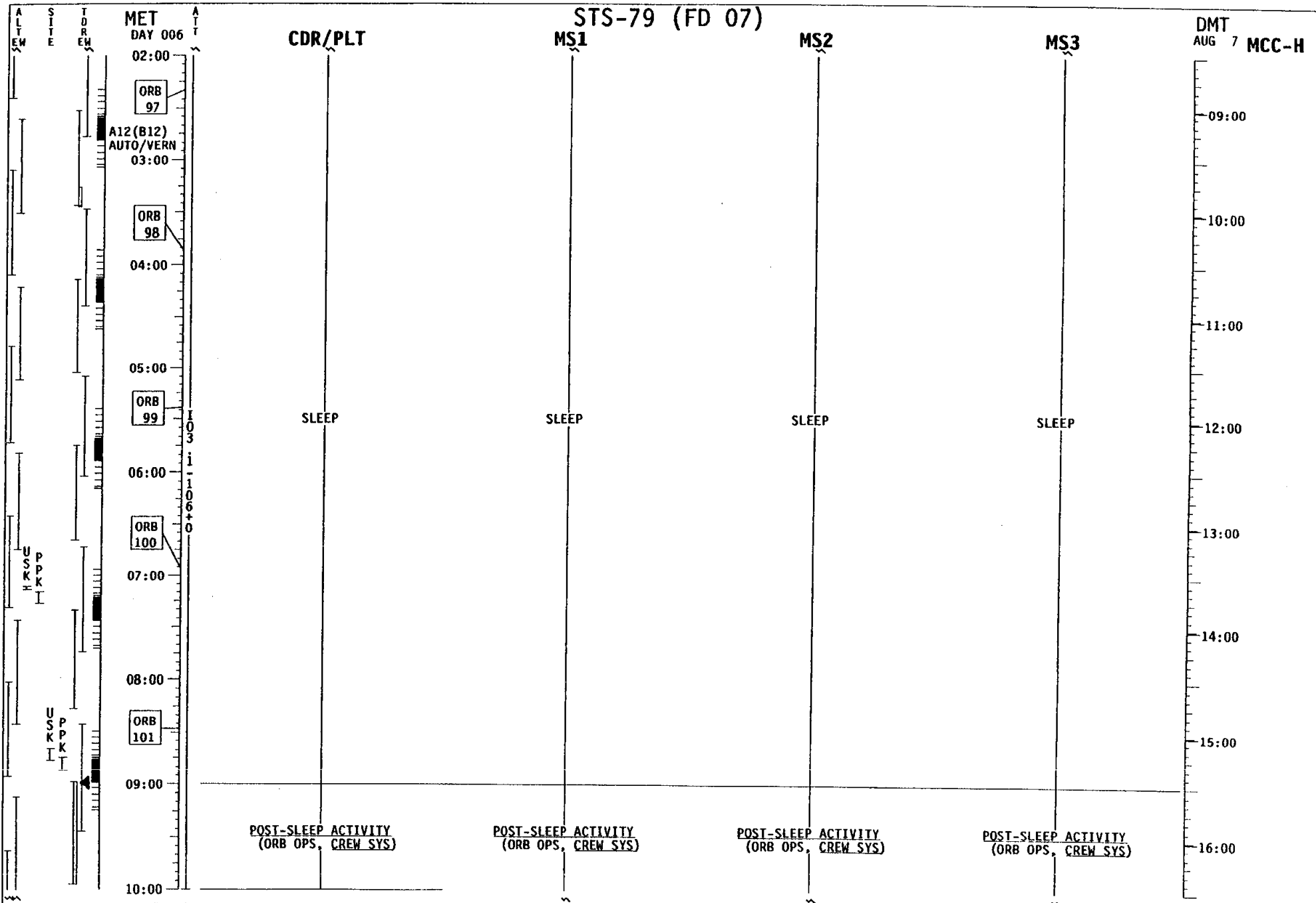

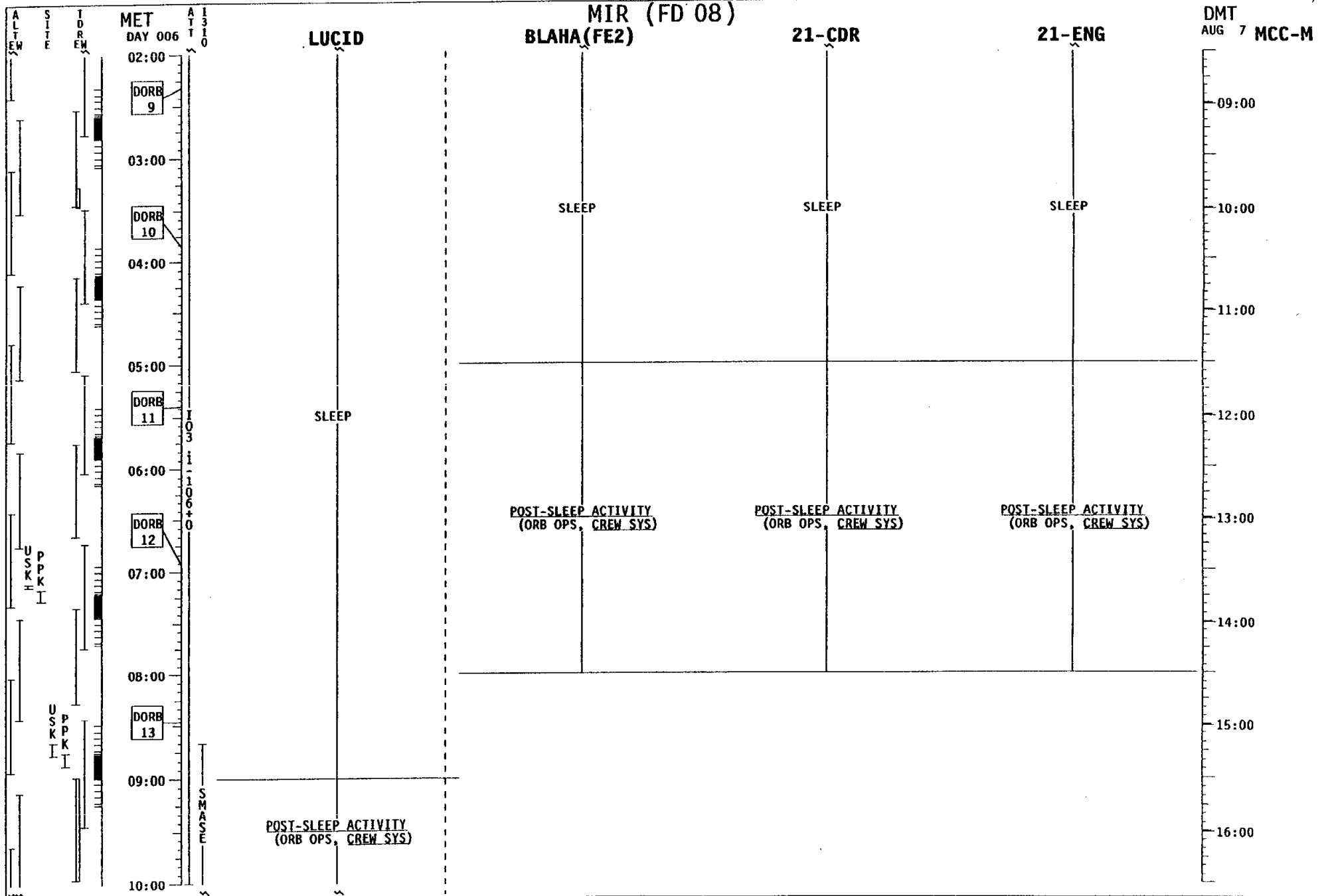

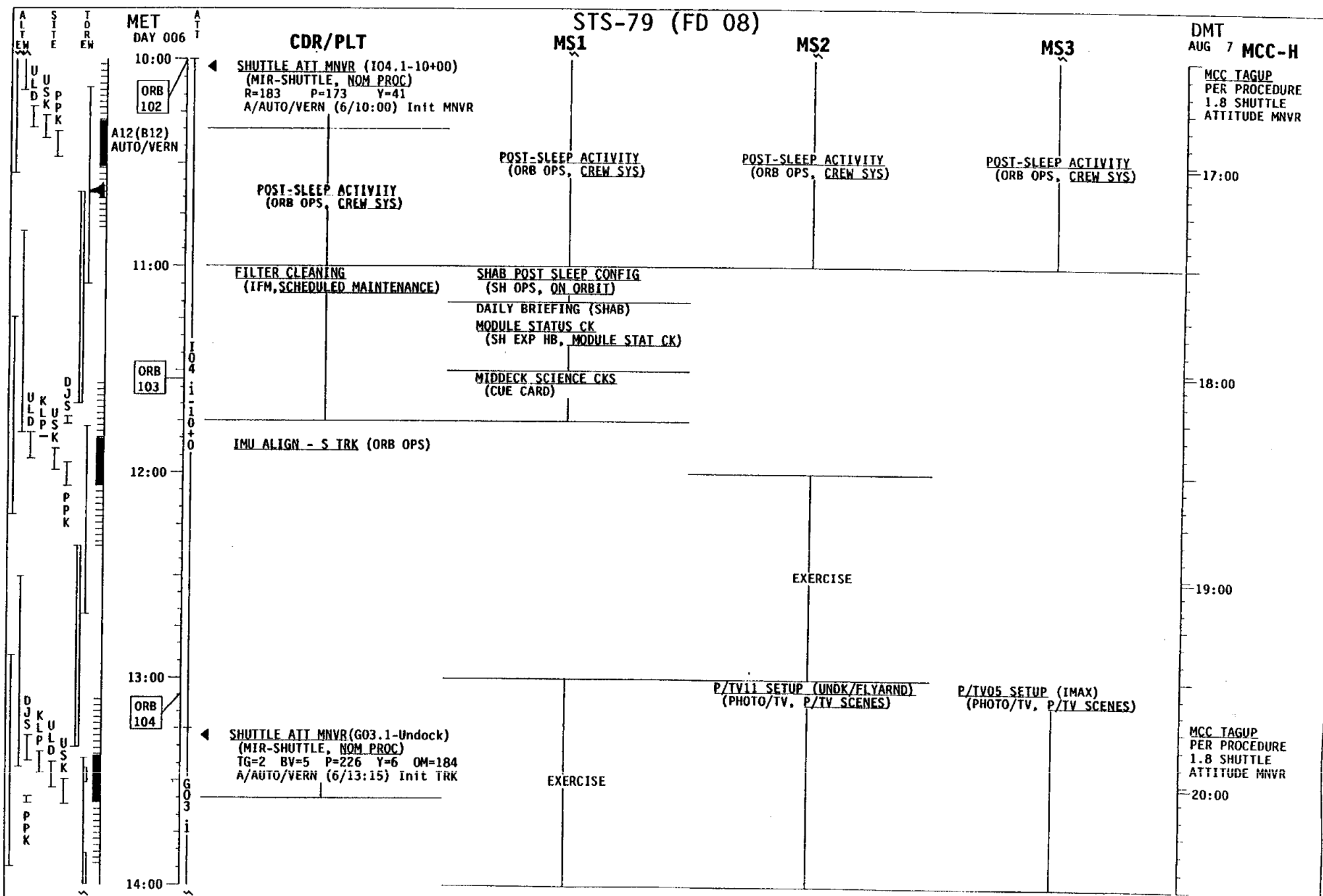

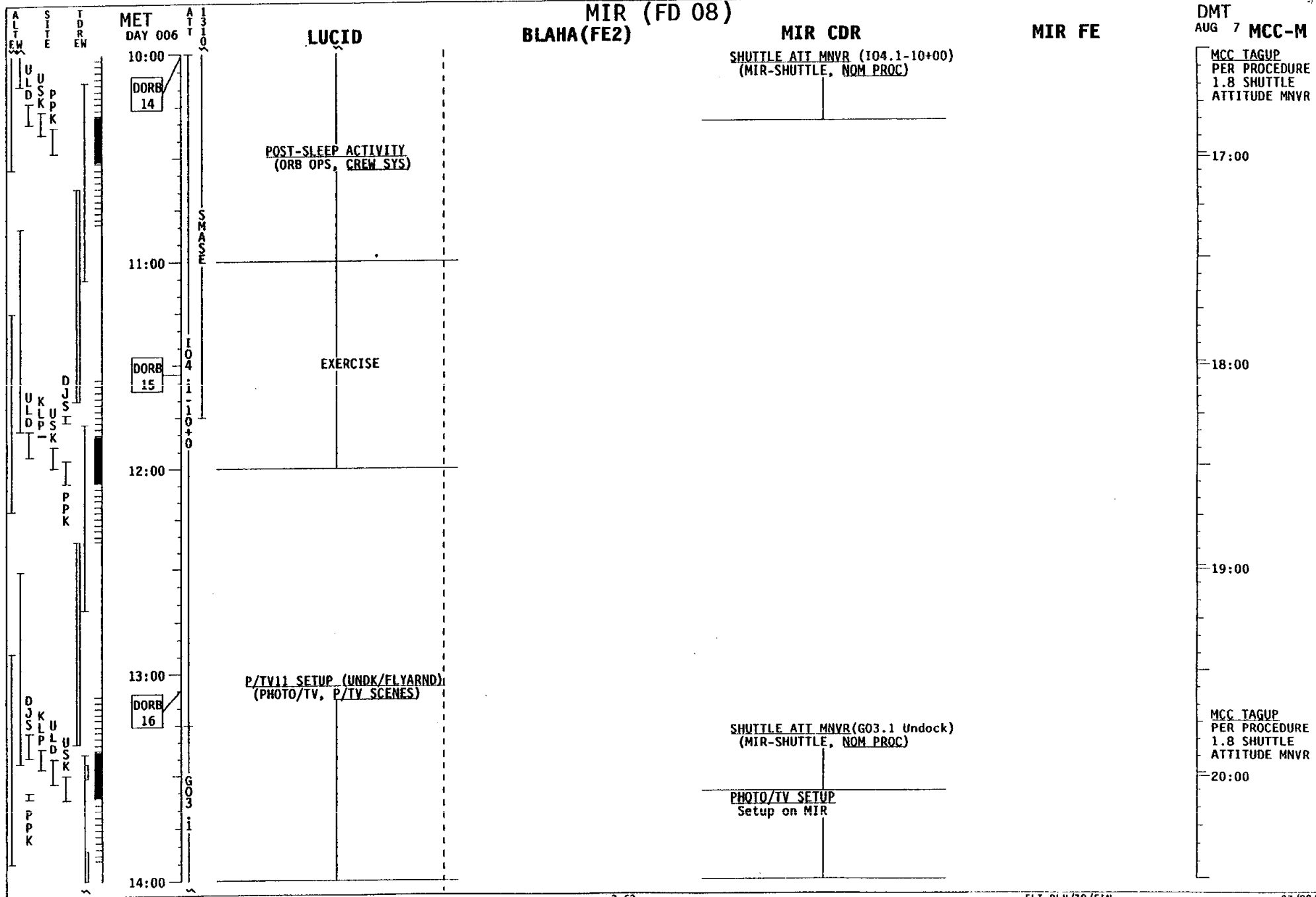



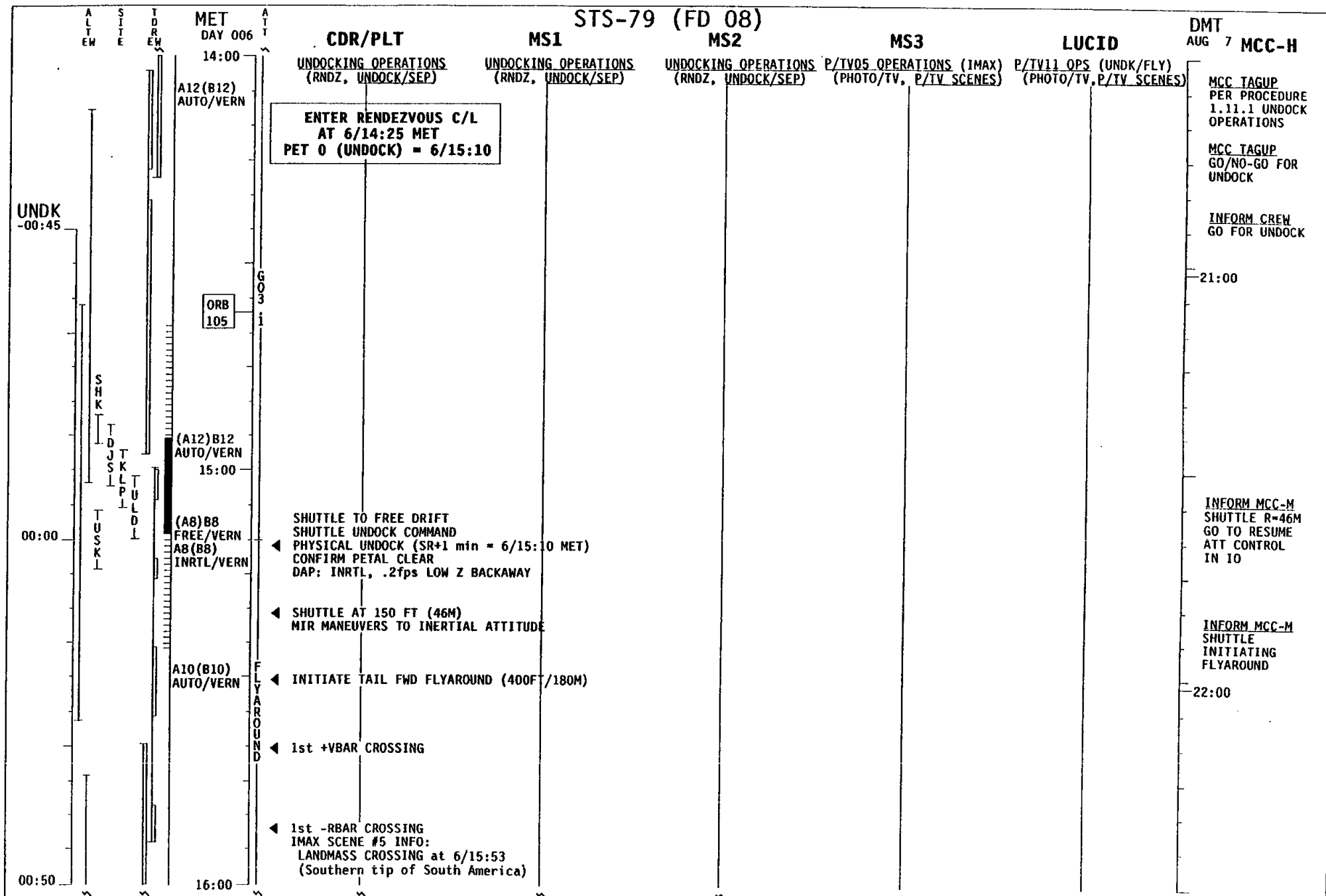

ALT EW  
 SITE  
 TDR EW  
 MET DAY 006  
 14:00  
 DORB 1  
 15:00  
 16:00  
 SHK  
 T D J S L P L  
 T U S K L  
 T U L D L  
 ATT  
 GO 3  
 FLYAROUND

BLAHA (FE2)

MIR (FD 08)  
MIR CDR

UNDOCKING OPERATIONS  
(MIR-SHUTTLE, NOM PROC)

SHUTTLE UNDOCKING COMMAND

PHYSICAL UNDOCKING (6/15:10 MET = 21:40 DMT) ▶

PHOTO TV  
UNDOCKING/FLYAROUND

MIR FE

UNDOCKING OPERATIONS  
(MIR-SHUTTLE, NOM PROC)

WHEN SHUTTLE AT 150ft (46m),  
MIR MNVR TO ATTITUDE  
(SUN TRACK)

MONITOR FLYAROUND  
PHOTO/TV AND AIR-TO-AIR  
COMM WITH SHUTTLE UNTIL  
LOSS OF SIGNAL

DMT  
AUG 7 MCC-M

MCC TAGUP  
PER PROCEDURE  
1.11.1 UNDOCKING  
OPERATIONS

MCC TAGUP  
GO/NO GO FOR  
UNDOCK

INFORM CREW  
GO FOR  
UNDOCK

21:00

INFORM MCC-H  
MIR IN IO  
ATTITUDE

22:00

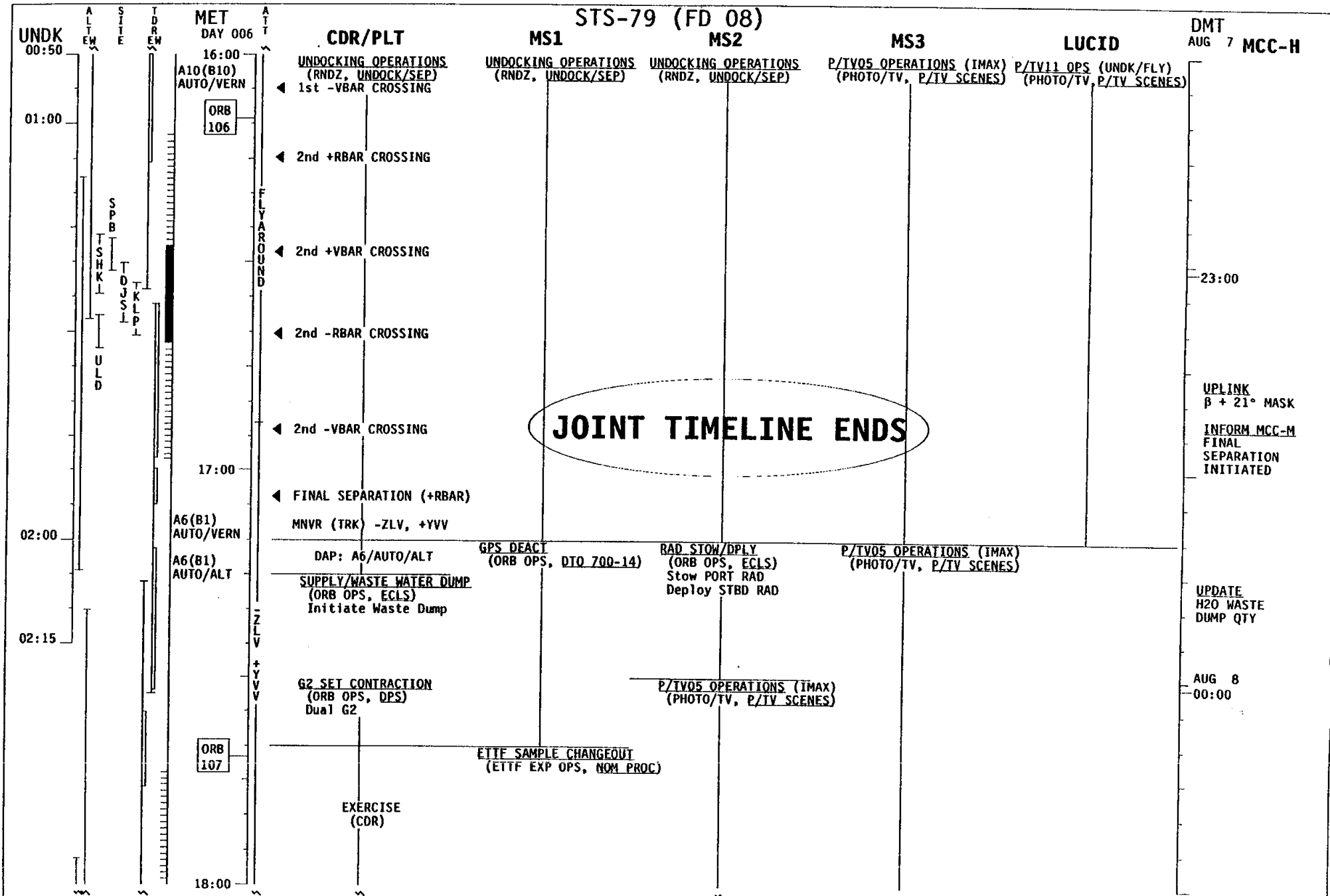

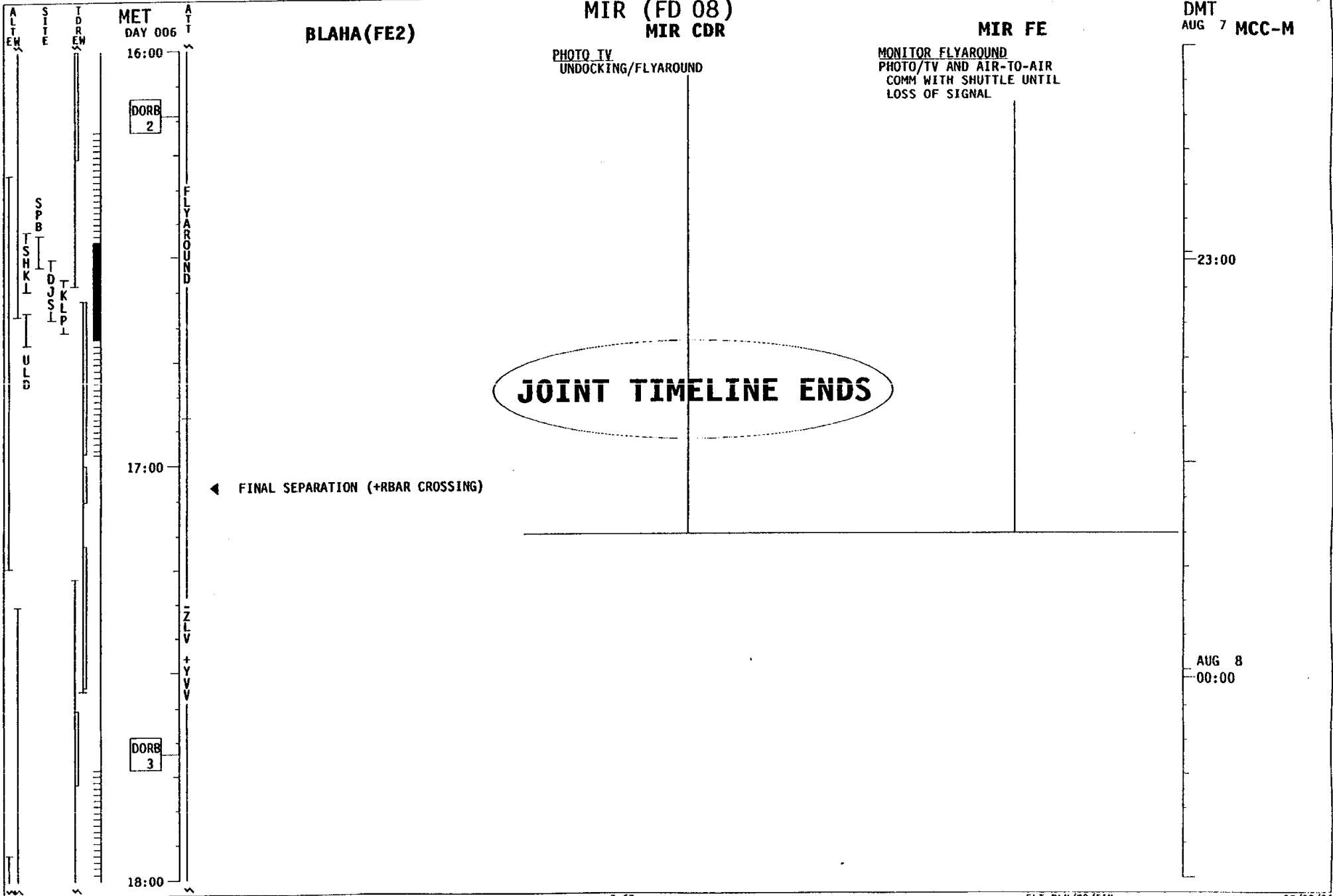

**BLAHA(FE2)**

**MIR (FD 08)  
MIR CDR**

**MIR FE**

**DMT  
AUG 7 MCC-M**

**MET  
DAY 006**

PHOTO TV  
UNDOCKING/FLYAROUND

MONITOR FLYAROUND  
PHOTO/TV AND AIR-TO-AIR  
COMM WITH SHUTTLE UNTIL  
LOSS OF SIGNAL

**DORB  
2**

**JOINT TIMELINE ENDS**

17:00

◀ **FINAL SEPARATION (+RBAR CROSSING)**

23:00

18:00

**DORB  
3**

**AUG 8  
00:00**

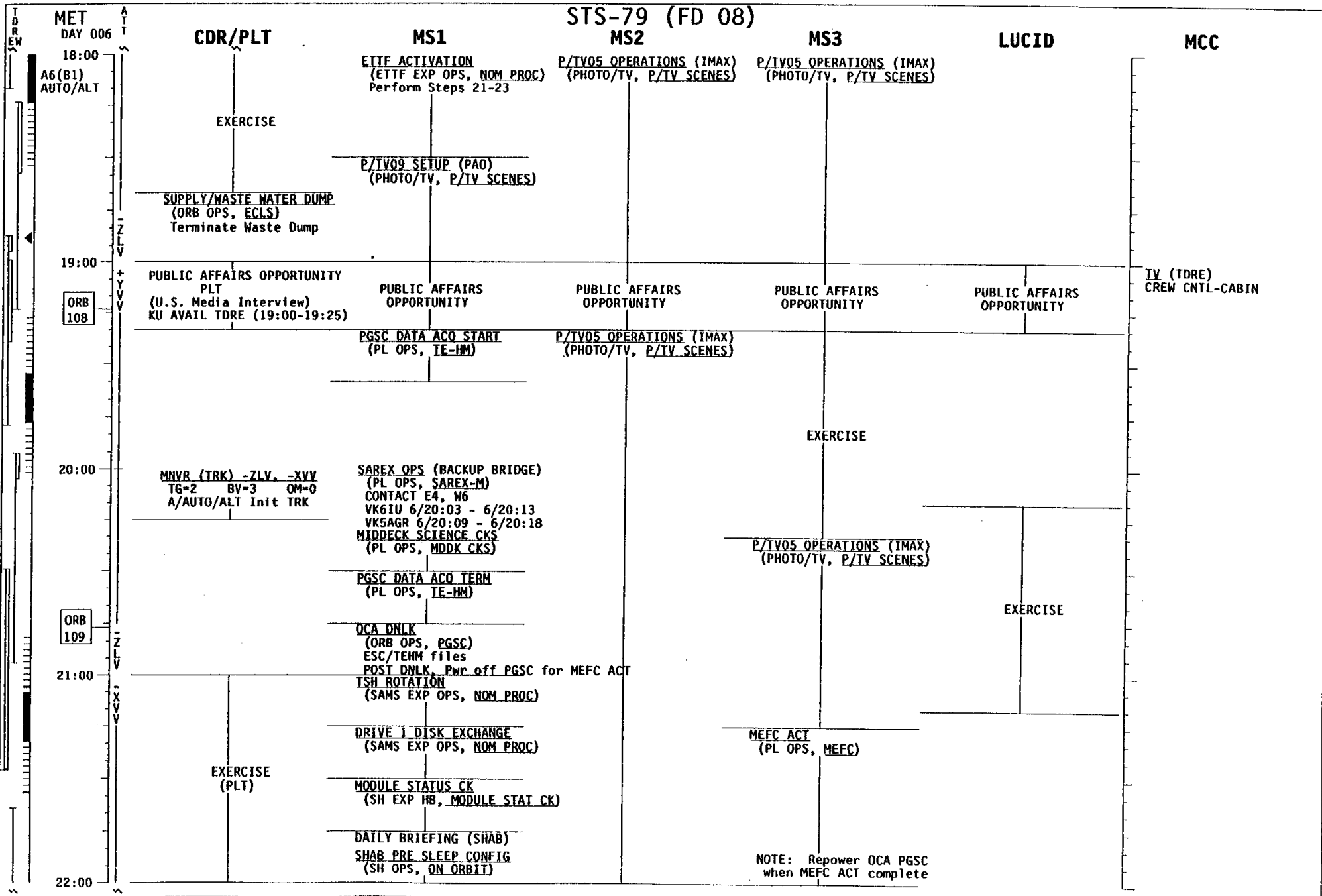

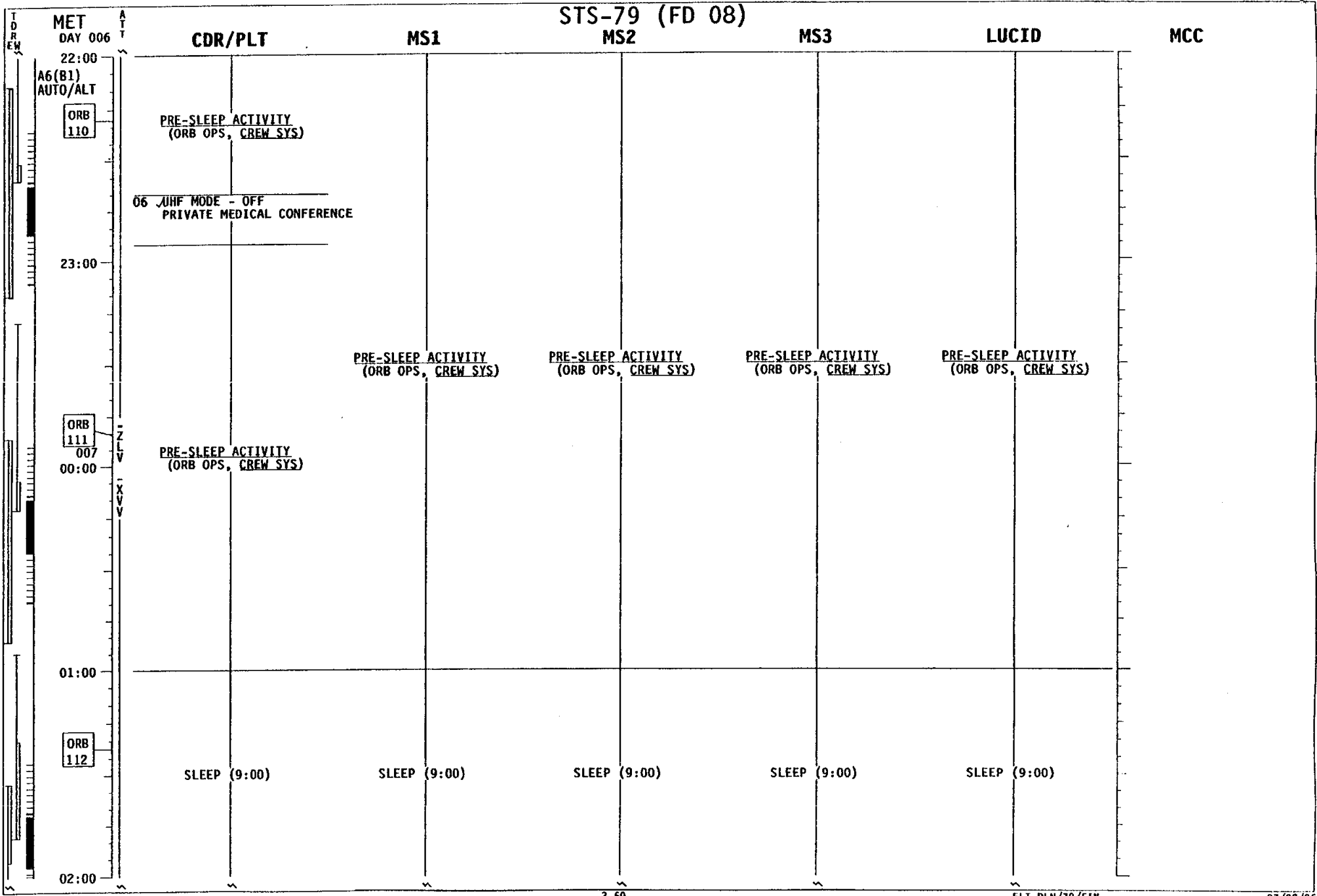

STS-79 (FD 08)

MET  
DAY 007

CDR/PLT

MS1

MS2

MS3

MS4-DWN

MCC

02:00  
A6(B1)  
AUTO/ALT

ORB  
113

03:00

04:00

ORB  
114

05:00

ORB  
115

06:00

07:00

ORB  
116

08:00

09:00

ORB  
117

10:00

SLEEP

SLEEP

SLEEP

SLEEP

SLEEP

# STS-79 (FD 09)

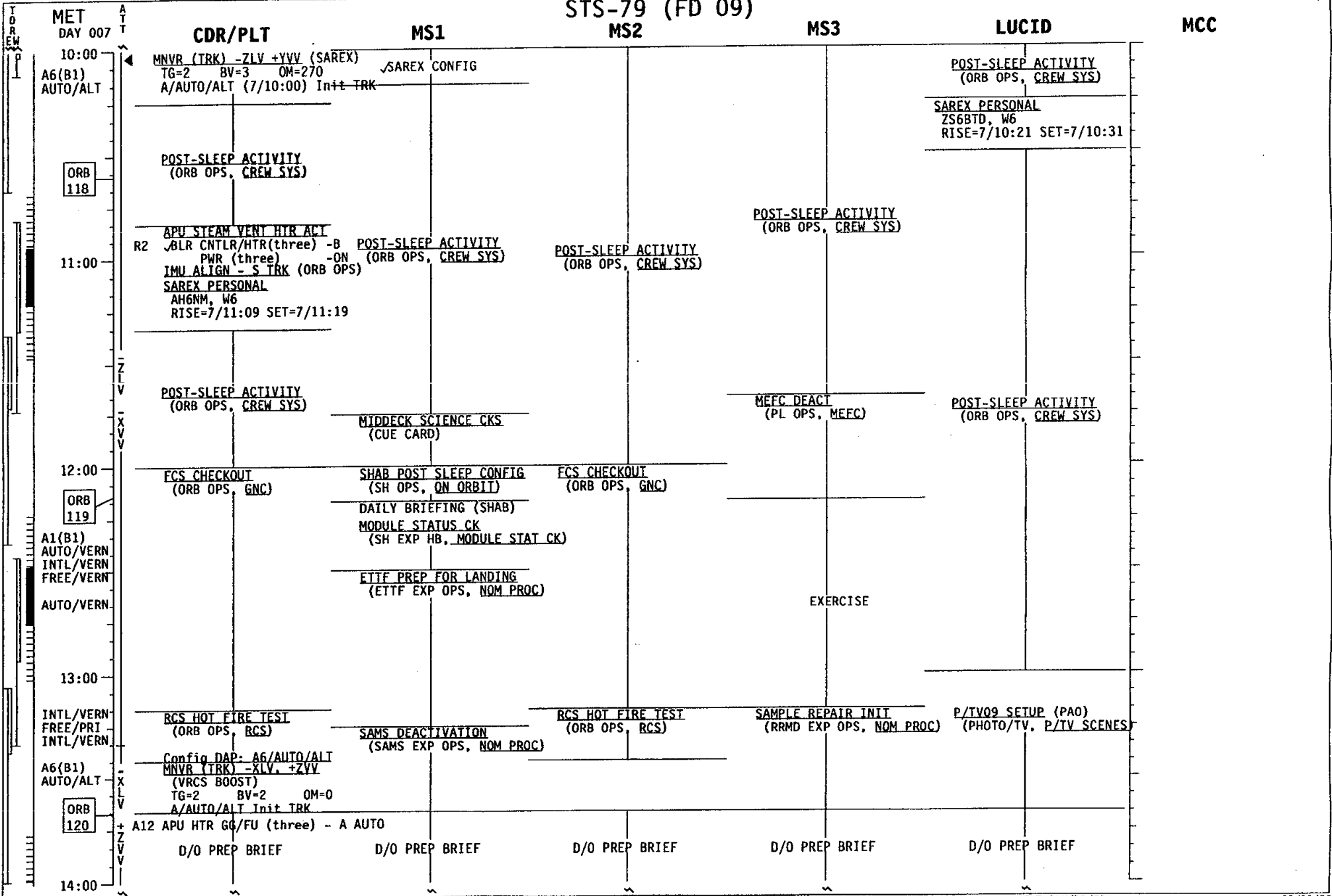



# STS-79 (FD 09)

	CDR/PLT	MS1	MS2	MS3	LUCID	
<b>TDR EW</b> MET DAY 007 14:00 A6(B1) AUTO/ALT 15:00 (A6) B14 AUTO/VERN ORB 121 A6(B1) AUTO/ALT 16:00 ORB 122 17:00 18:00	D/O PREP BRIEF PUBLIC AFFAIRS OPPORTUNITY (CDR) (U.S. Media Interview) KU Avail TDRW (14:10-14:38) ELEVON PARK (GNC 301) (ORB OPS, DTQ 837) YAW VRCS REBOOST (ORB OPS, DTQ 837) Change DAP B to B1 MNVR (TRK) BIAS -ZLV -XVY TG=2 BV=5 P=90 Y=60 OM=0 A/AUTO/ALT Init TRK EXERCISE MEAL	D/O PREP BRIEF ARIS STOW (ARIS EXP OPS, NOM PROC) EXERCISE MEAL	D/O PREP BRIEF PUBLIC AFFAIRS OPPORTUNITY YAW VRCS REBOOST (ORB OPS, DTQ 837) EXERCISE MEAL	D/O PREP BRIEF ARIS STOW (ARIS EXP OPS, NOM PROC) EXERCISE MEAL	D/O PREP BRIEF PUBLIC AFFAIRS OPPORTUNITY EXERCISE MEAL	TV (TDRX) CREW CNTL-MIR

# STS-79 (FD 09)

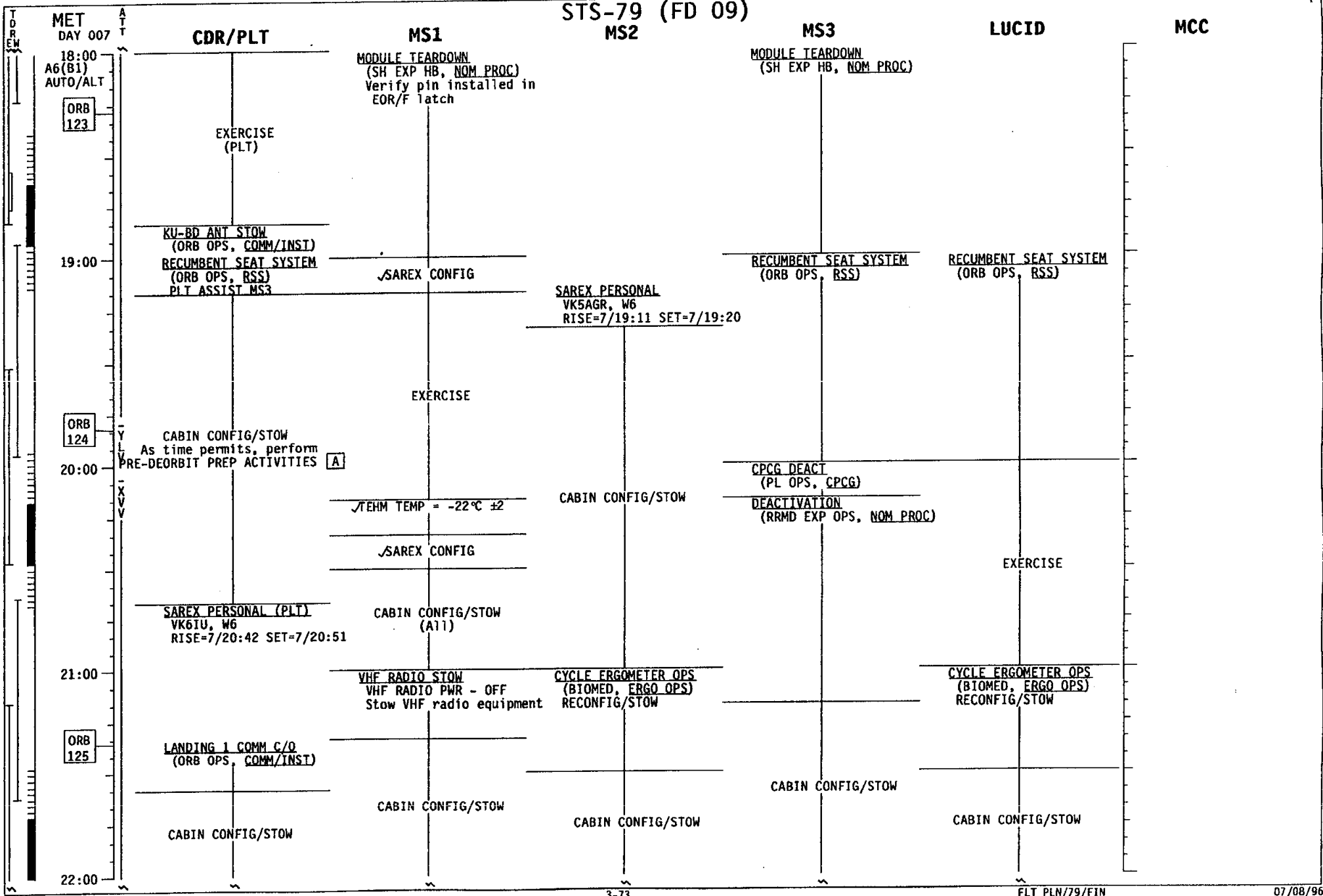

# STS-79 (FD 09)

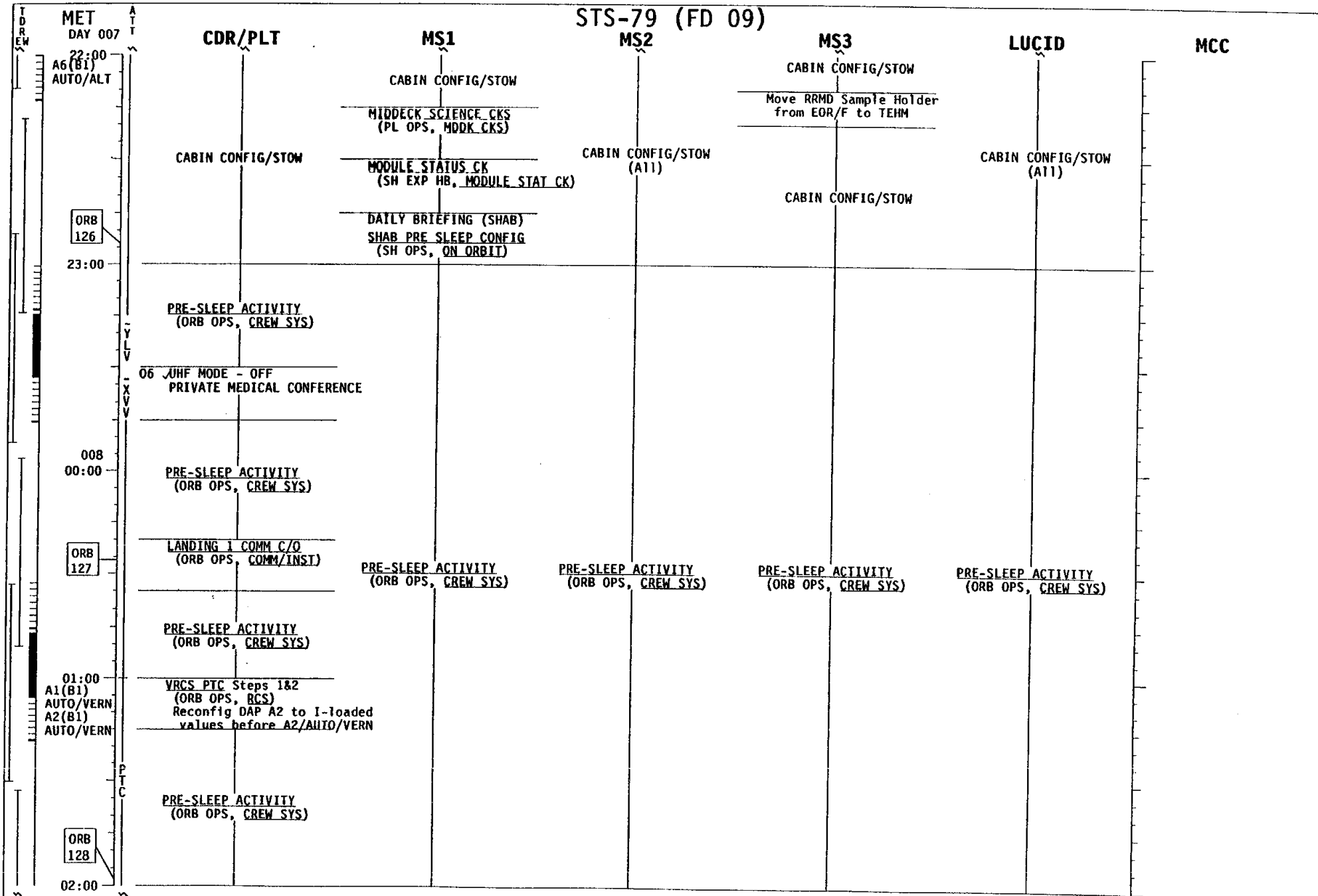

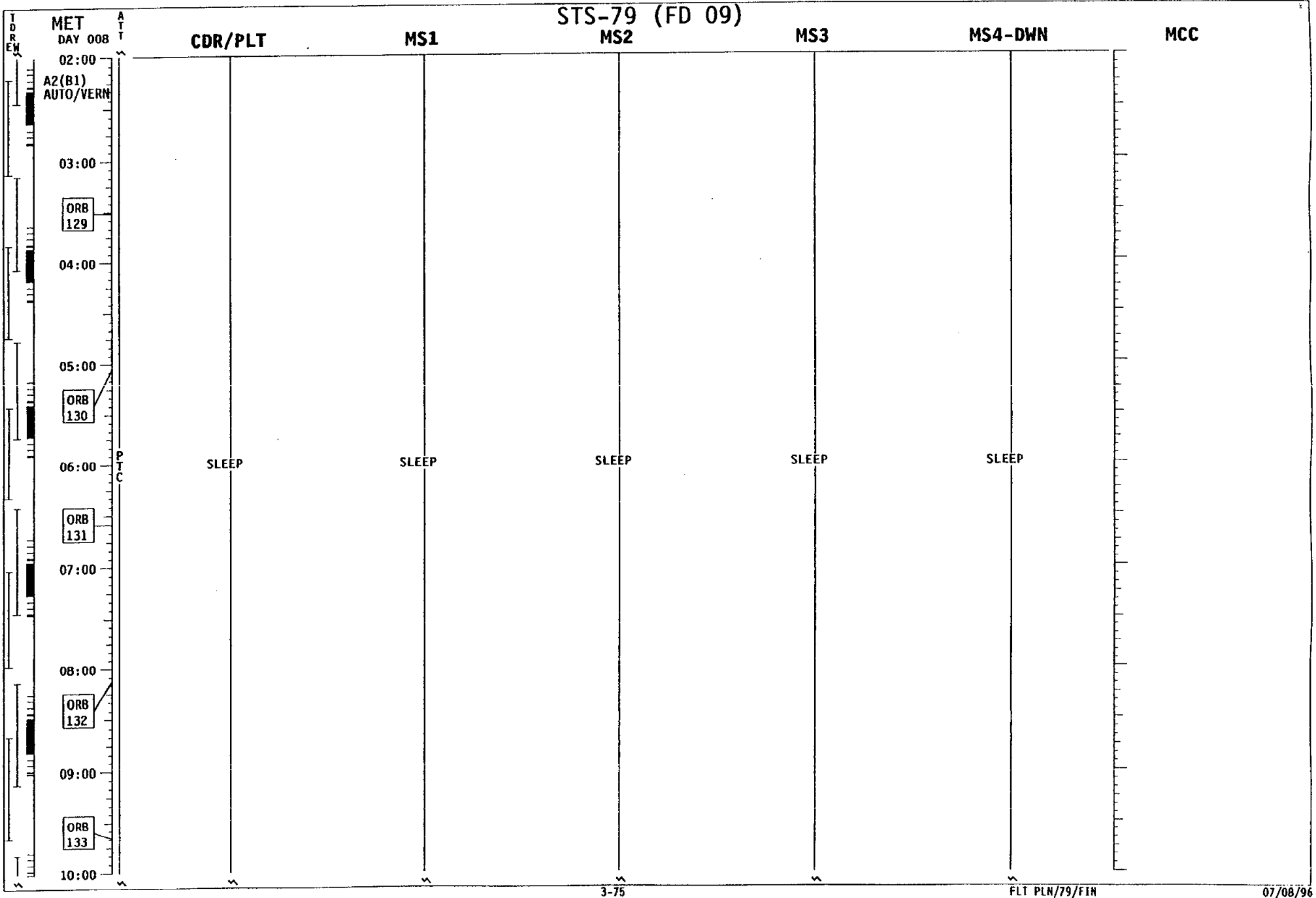

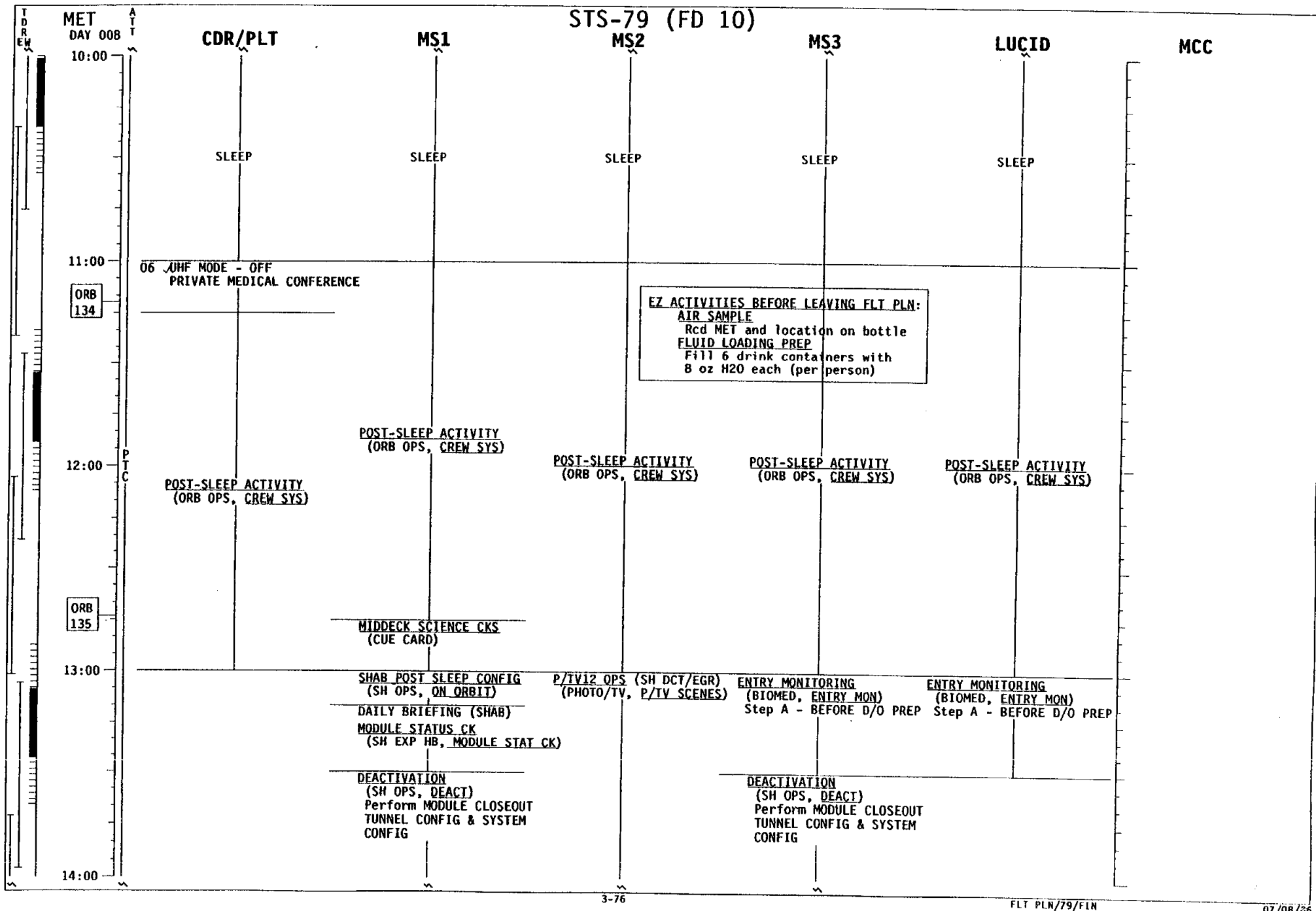

# STS-79 (FD 10)

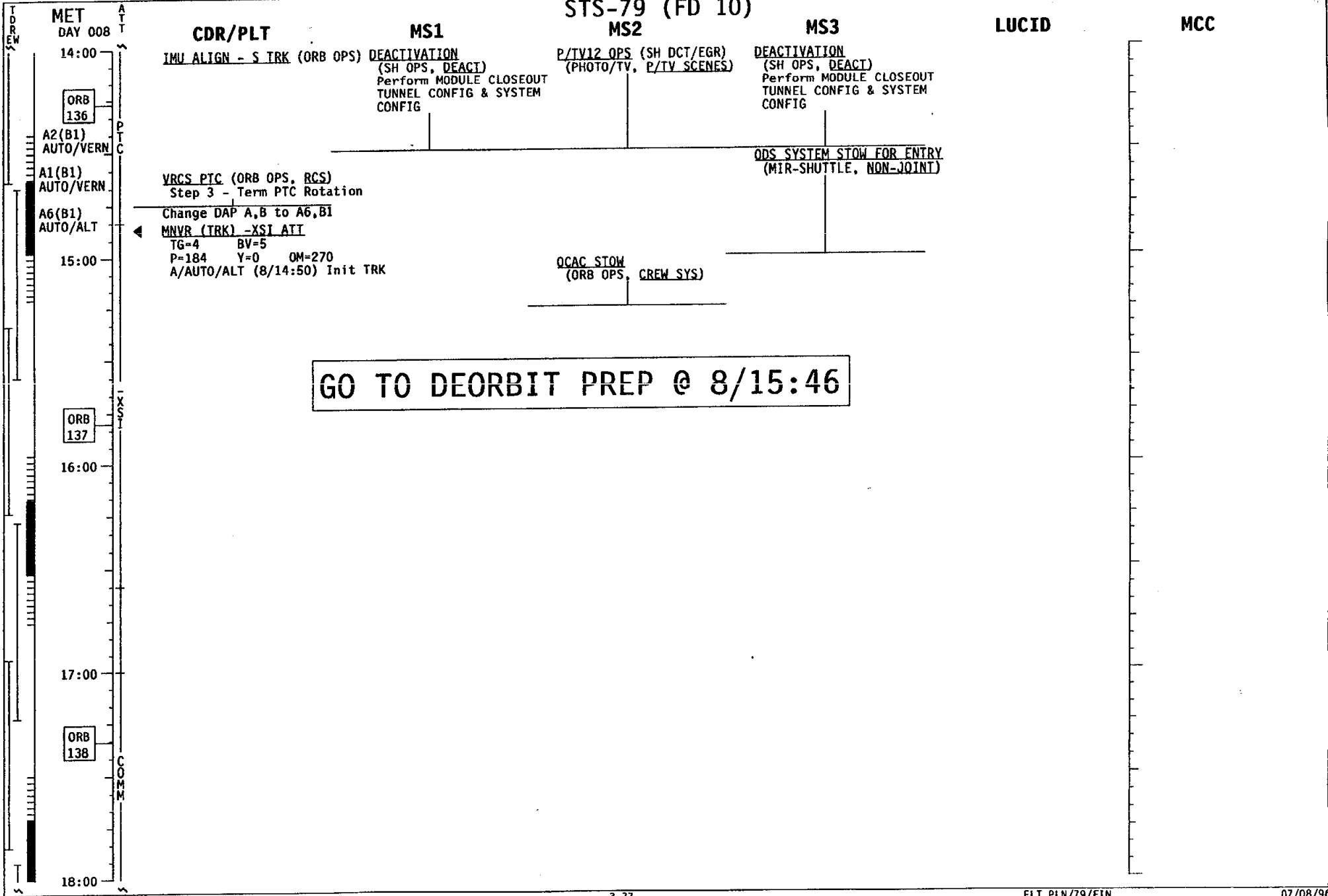

**This Page Intentionally Blank**

**SUMMARY JOINT TIMELINE (CYRILLIC)**

**NOTE**

Timeline pages 4-3 & 4-4, 4-17 thru 4-20 are not included in Cyrillic since they are not part of the joint mission

**SUMMARY  
TIMELINE (CYRILLIC)**



**This Page Intentionally Blank**

ГСВ (Д:Ч:М)	ПВ (Д:Ч:М)	ЦЛВ (Д:Ч:М)	ПД/ДГ	-α	ЛУНА ○	ДАТА В ХЬОСТ	ПОЛЁТ	РЕДАКЦИЯ	ДАТА ИЗД
215:15:29 / 216:03:29	001:12:00 / 002:00:00	215:10:29 / 215:22:29	03 / 215 ГСВ	58.2		АВГ 2, 1996	СТС-79	3241А-4	07/08/96

ДМВ :215	12	19	13	20	14	21	15	22	16	17	0	ДМВ:216	1	19	2	20	3	21	4	22	5	23	6	0	ПВ :002
ПВ :001																									

СТС 79	КЭ/ПЛУГ РИДЛИ/ УИЛИКОТТ	СБЛИЖЕНИЕ										ОКОНЧ СБЛИЖ	И О Р Ц 4 1	▲ П О П	И П Р И	ИНСТ БЕЗО ПАСХ МИР	И Ш Н А С Т Л	П В О Д К У	И О Р Ц 3 1	
	MS1 АПТ	СБЛИЖ										С Т С	И П Р О З Д	Л В Р О З Д	И П БЕЗО ПАСХ МИР	А З Р Г О И				
	MS2 ЭЙКЕРС	НАБЛ МИРА	СБЛИЖ	НАБЛ МИРА	СБЛИЖ	НАБЛ МИРА	СБЛИЖ	СБЛИЖ	НАБЛ МИРА	СБЛИЖ	СБЛИЖ	И П Р О З Д	И П БЕЗО ПАСХ МИР	П У С И Л	Д А В Л	ДЕЙСТВИЯ ДО СНА				
	MS3 УОЛЗ	СБЛИЖ					ФОТО/ТВ					ПОДГ Ф/ТВ	И П БЕЗО ПАСХ МИР	П Р Е И Ц	ДЕЙСТВИЯ ДО СНА					
MS4-UP БЛАХА	ПОДГ СВЯЗ	СВЯЗЬ БОРТ-БОРТ										К А С	БОРТ БОРТ	И П БЕЗО ПАСХ МИР	П У С И Л	П У С И Л	УСТАН УСИЛ	СОИ		
МИР	МИР БИ2 ЛОСИД											Т В С Б Д	И П БЕЗО ПАСХ МИР	ДЕЙСТВИЯ ДО СНА						
	МИР-КЭ	ПОДГ СВЯЗ	СВЯЗЬ БОРТ БОРТ										И О Р Ц 4 1	БОРТ БОРТ	ПОДГ Ф/ТВ МИР	И П БЕЗО ПАСХ МИР	И Ш Н А С Т Л	П У С И Л	УСТАН УСИЛ	СОИ
	МИР-БИ	О Г Н И	О Г Н И	О Г Н И	О Г Н И	О Г Н И	О Г Н И	О Г Н И	О Г Н И	О Г Н И	О Р Ц ОСК7	О Г Н И	И П БЕЗО ПАСХ МИР	И Ш Н А С Т Л	И Ш Н А С Т Л	П Р И Ц	СОИ			

СВЕТ/ТЕНЬ												
ВИТОК	25	26	27	28	29	30	31	32				
СУТОЧН ВИТОК	14	15	16	1	2	3	4	5				



ТР-СА ПОЛЁТА																									
НИП ЗОНЫ РАД ВИД	УСС - ППК	- ДЖС - КЛП	- ДЖС - ШЕЛ	- ДЖС - ШЕЛ	- ШЕЛ - СПБ	- СПБ - ШЕЛ	- ШЕЛ - ДЖС	- ШЕЛ - ДЖС	- ШЕЛ - ДЖС	- ШЕЛ - ДЖС	- ШЕЛ - ДЖС	- ШЕЛ - ДЖС	- ШЕЛ - ДЖС	- ШЕЛ - ДЖС	- ШЕЛ - ДЖС	- ШЕЛ - ДЖС	- ШЕЛ - ДЖС	- ШЕЛ - ДЖС	- ШЕЛ - ДЖС	- ШЕЛ - ДЖС	- ШЕЛ - ДЖС	- ШЕЛ - ДЖС	- ШЕЛ - ДЖС	- ШЕЛ - ДЖС	- ШЕЛ - ДЖС
ТДР	В 3												В 3												
СР-1	В 3												В 3												
СТС ОРЦ	СБЛИЖЕНИЕ											И О 4.1	И О 3.1												
МИР ОРЦ	И О											ОСК-7	И О 4.1												

ПРИМЕЧ.:
 



- ▲ ЗАПРЕТ СУД
- ▲ ИНД РЕЖ
- ▲ ВОЗОБН РАБ СОСЕ

- СВЯЗЬ
- СВЯЗЬ

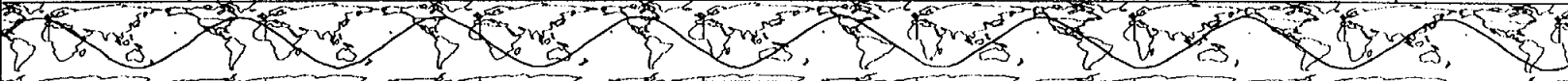

- ⊙ ЕТТГ
- ⊙ 4 АМЕРИК. КОНТЕЙНЕРА
- ⊙ ПЕРЕНОС СОВМЕСТНЫХ ДОКУМЕНТОВ
- ДЕЙСТВИЯ ДО СНА

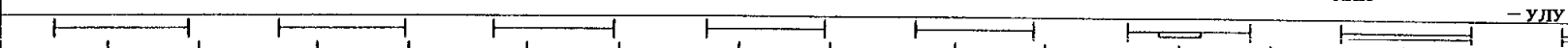
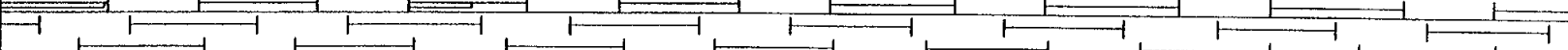

ГСВ (Д:Ч:М)		ПВ (Д:Ч:М)		ЦЛВ (Д:Ч:М)		ПД / ДГ	-α	ЛУНА 	ДАТА В ХЬЮСТ	ПОЛЁТ	РЕДАКЦИЯ	ДАТА ИЗД	
216:03:29 / 216:15:29		002:00:00 / 002:12:00		215:22:29 / 216:10:29		216 ГСВ	60.1		АВГ 2, 1996	СТС-79	3241А-4	07/08/96	
<div style="display: flex; justify-content: space-between; font-size: small;"> <span>ДМВ :216</span> <span>ПВ :002</span> </div>													
СТС 79	КЭ/ПЛГ РИДДИ / УИЛКОТТ	ДЕЙСТВИЯ ДО СНА	СОН						О И Р О Ц 4 1	Б И И	ДЕЙСТВИЯ ПОСЛЕ СНА	СУТ ПЛАН	
	MS1 АПГ	ДЕЙСТВИЯ ДО СНА	СОН						ДЕЙСТВИЯ ПОСЛЕ СНА		СУТ ПЛАН		
	MS2 ЭЙКЕРС	ДЕЙСТВИЯ ДО СНА	СОН						ДЕЙСТВИЯ ПОСЛЕ СНА		СУТ ПЛАН	ПЕРЕ НОС	
	MS3 УОЛЗ	ДЕЙСТВИЯ ДО СНА	СОН						ДЕЙСТВИЯ ПОСЛЕ СНА		СУТ ПЛАН		
	ЛЮСИД	ДЕЙСТВИЯ ДО СНА	СОН						ДЕЙСТВИЯ ПОСЛЕ СНА	ФУ	СУТ ПЛАН	ПЕРЕ СМЕН	
МИР	МИР БИ2 БЛАХА	СОН						ДЕЙСТВИЯ ПОСЛЕ СНА			СУТ ПЛАН	ПЕРЕ СМЕН	
	МИР КЭ	СОН						ДЕЙСТВИЯ ПОСЛЕ СНА			С П У Л Т А Н	ФУ	
	МИР БИ	СОН						ДЕЙСТВИЯ ПОСЛЕ СНА	О И Р О Ц 4 1	ДЕЙСТВИЯ ПОСЛЕ СНА	СУТ ПЛАН	ПЕРЕ НОС	
<div style="display: flex; justify-content: space-between; font-size: x-small;"> <span>СВЕТ/ТЕНЬ</span> <span>ВИТОК</span> <span>СУТОЧН ВИТОК</span> </div>													
<div style="display: flex; justify-content: space-between; font-size: x-small;"> <span>33</span> <span>34</span> <span>35</span> <span>36</span> <span>37</span> <span>38</span> <span>39</span> <span>40</span> </div>													
<div style="display: flex; justify-content: space-between; font-size: x-small;"> <span>6</span> <span>7</span> <span>8</span> <span>9</span> <span>10</span> <span>11</span> <span>12</span> <span>13</span> </div>													
													
<div style="display: flex; justify-content: space-between; font-size: x-small;"> <span>ТР-СА ПОЛЁТА</span> <span>НИП ЗОНЫ РАД ВИД</span> </div>													
<div style="display: flex; justify-content: space-between; font-size: x-small;"> <span>ТДР</span> <span>В 3</span> </div>													
<div style="display: flex; justify-content: space-between; font-size: x-small;"> <span>СР-1</span> <span>В 3</span> </div>													
<div style="display: flex; justify-content: space-between; font-size: x-small;"> <span>ОРЦ</span> <span>ИОЗ.1</span> <span>ИО4.1</span> </div>													
<div style="display: flex; justify-content: space-between; font-size: x-small;"> <span>ЭКСП 1310</span> <span>СД и МГ</span> </div>													
<div style="display: flex; justify-content: space-between; font-size: x-small;"> <span>ПРИМЕЧ:</span> <span>о 1 ГРАДУС</span> <span>о ДЕЙСТВИЯ ПОСЛЕ СНА</span> </div>													

ГСВ (Д:Ч:М)		ПВ (Д:Ч:М)		ЦЛВ (Д:Ч:М)		ПД / ДГ		-α	ЛУНА	ДАТА В ХЬОСТ			ПОЛЁТ		РЕДАКЦИЯ		ДАТА ИЗД									
216:15:29 / 217:03:29		002:12:00 / 003:00:00		216:10:29 / 216:22:29		/216 ГСВ		61.8	☉	АВГ 3, 1996			СТС-79		3241А-4		07/08/96									
ДМВ :216		12	19	13	20	21	15	22	16	23	17	0	ДМВ:217	1	19	2	20	3	21	4	22	5	23	6	0	ПВ :003
ПВ :002																										
СТС 7 9	КЭ/П/ЛГ РИДДИ/ УИЛКОТТ	ПЕРЕ НОС		ПЕРЕ НОС		ОБЕД		ПЕРЕ НОС		ТВ ОБЩ ЕСТ		О И Р Ц 3 1						ДЕЙСТВИЯ ДО СНА								
	MS1 АЛГ			ПРОБА		О Т К Л С Ю		П Е Р Е		УСТАН BTS EDU-M		ОБЕД		ПЕРЕН БЛОКИ 1 и 2 CGVA				ДЕЙСТВИЯ ДО СНА								
	MS2 ЭЙКЕРС	ПЕРЕ НОС		ПЕРЕНОС МЕТАБОЛ		РАЗМО МОРОЗ ТЕНОФ		ОБЕД		П А Й М К С		УСТАН АЙМАКС		ПОДГ Ф/ТВ		СВЕРК ПО ПЕРЕН		ДЕЙСТВИЯ ДО СНА								
	MS3 УОЛЗ			ПРОБА				ОБЕД				ВКЛ. ЭКСПЕ 1302						ДЕЙСТВИЯ ДО СНА								
	ЛЮСИД	ПЕРЕ СМЕН		ПОДГОТ BTS EСС		ПЕРЕНОС МЕТАБОЛ		РАЗМО МОРОЗ		ОБЕД		ПЕРЕ НОС		ТВ ОБЩ ЕСТ		ФУ		ДЕЙСТВИЯ ДО СНА								
МИР	МИР БИ2 БЛАХА	ПЕРЕ СМЕН		ПОДГОТ BTS EСС		О Т К Л С Ю		П Е Р Е		УСТАН BTS EDU-M		ОБЕД		ПЕРЕН БЛОКИ 1 и 2 CGVA		ТВ ОБЩ ЕСТ		СВЕРК ПО ПЕРЕН		ДЕЙСТВИЯ ДО СНА		СОН				
	МИР КЭ	ФУ		ПЕРЕ НОС				ОБЕД		П А Й М К С		УСТАН АЙМАКС		ПОДГ Ф/ТВ МИР		ТВ ОБЩ ЕСТ		СВЕРК ПО ПЕРЕН		ДЕЙСТВИЯ ДО СНА		СОН				
	МИР БИ	ФУ		ПОДГОТ BTS EСС		УСТАН BTS EDU-M		ОБЕД		ПЕРЕН БЛОКИ 1 и 2 CGVA		ВКЛ. ЭКСПЕ 1302		ДЕЙСТВИЯ ДО СНА		О И Р Ц 3 1		СОН								
СВЕТ/ТЕНЬ ВИТОК		41		42		43		44		45		46		47		48										
СУТОЧН ВИТОК		14		15		1		2		3		4		5		6										
ТР-СА ПОЛЁТА																										
НИП ЗОНЫ РАД ВИД		- УЛУ - УСС - ШПК		- УЛУ - УСС - ШПК - ДЖС - КЛП		- УЛУ - УСС - ДЖС - КЛП		- УЛУ - УСС - ШЕЛ - ДЖС - КЛП		- КЛП - ШЕЛ - ДЖС		- СПБ - ШЕЛ - ДЖС		- ШЕЛ - ДЖС		- СПБ										
ТДР																										
СР-1																										
ОРЦ ЭКСП 1310		ИО4.1																								
ПРИМЕЧ:		▲ ПЕРЕ НОС		● ОТКЛЮЧИТЬ BTS EDU-M НА ШАТТЛЕ		● ПЕРЕНОС ИМАХ НА ПРИРОДЕ		● ПЕРЕНОС ИМАХ НА МИР		● ИМАХ В СПЕКТРЕ		○ СВЯЗЬ		○ СВЯЗЬ		○ СВЯЗЬ		○ ДЕЙСТВИЯ ДО СНА		■ ДЕЙСТВИЯ ДО СНА		▶ ДЕЙСТВИЯ ДО СНА				
				● ПЕРЕНОС BTS EDU-M		● РАЗМОРОЗИТЬ МОРОЗИЛЬНИК ТЕНОФ		● МЕФС В ПРИРОДЕ																		

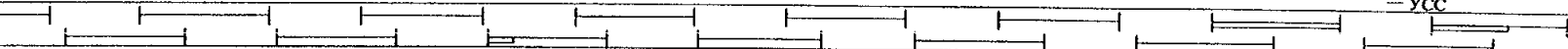
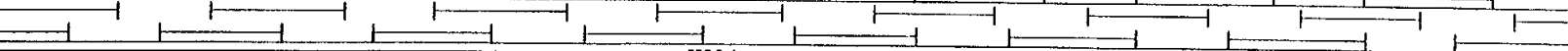

ГСВ (Д:Ч:М)		ПВ (Д:Ч:М)		ЦЛВ (Д:Ч:М)		ПД / ДГ	-α	ЛУНА 	ДАТА В ХЬОСТ	ПОЛЁТ	РЕДАКЦИЯ	ДАТА ИЗД	
217:03:29/ 217:15:29		003:00:00/ 003:12:00		216:22:29/ 217:10:29		/217 ГСВ	63.4		АВГ 3, 1996	СТС-79	3241А-4	07/08/96	
ДМВ :217 7 8 9 10 11 12 13 14 15 16 17 18 ПВ :003 0 1 2 3 4 5 6 7 8 9 10 11 12													
СТС 79	КЭ/ПЛТ РИДДИ/ УИЖКОТТ.	ДЕЙСТВИЯ ДО СНА	СОН						Б И И	О Р Ц 4 1	И О 4 1	СУТ ПЛАН	
	MS1 АЛТ	ДЕЙСТВИЯ ДО СНА	СОН						ДЕЙСТВИЯ ПОСЛЕ СНА		СУТ ПЛАН		
	MS2 ЭЙКЕРС	ДЕЙСТВИЯ ДО СНА	СОН						ДЕЙСТВИЯ ПОСЛЕ СНА		СУТ ПЛАН	ПЕРЕ НОС	
	MS3 УОЛЗ	ДЕЙСТВИЯ ДО СНА	СОН						ДЕЙСТВИЯ ПОСЛЕ СНА		СУТ ПЛАН		
	ЛЮСИД	ДЕЙСТВИЯ ДО СНА	СОН						ДЕЙСТВИЯ ПОСЛЕ СНА	ФУ	СУТ ПЛАН	ПЕРЕ СМЕН	
МИР	МИР БИ2 БЛАХА	СОН		ДЕЙСТВИЯ ПОСЛЕ СНА						СУТ ПЛАН	ПЕРЕ СМЕН		
	МИР КЭ	СОН		ДЕЙСТВИЯ ПОСЛЕ СНА				ФУ	И О 4 1	СУТ ПЛАН	ПЕРЕ НОС		
	МИР БИ	СОН		ДЕЙСТВИЯ ПОСЛЕ СНА				ФУ		СУТ ПЛАН	ПЕРЕ НОС		
СВЕТ/ТЕНЬ ВИТОК 48 49 50 51 52 53 54 55 56 СУТОЧН ВИТОК 6 7 8 9 10 11 12 13 14													
													
НИП ЗОНЫ РАД ВИД - УСС - ШПК - УСС - ШПК - УЛУ													
ТДР	В З												
СР-1	В З												
ОРЦ ЭКСП 1310 ИО3.1 ИО4.1 СД и МГ													
ПРИМЕЧ: о ДЕЙСТВИЯ ПОСЛЕ СНА о ДЕЙСТВИЯ ПОСЛЕ СНА о 1 ГРАДУС о ДЕЙСТВИЯ ПОСЛЕ СНА													

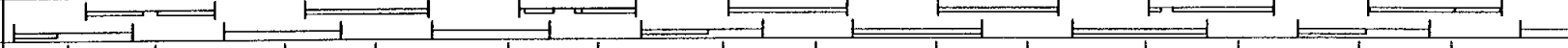
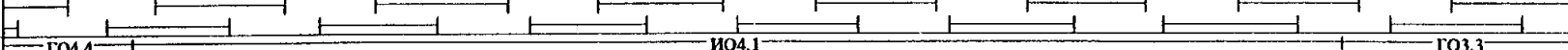

ГСВ (Д:Ч:М)		ПВ (Д:Ч:М)		ЦЛВ (Д:Ч:М)		ПД/ДГ		-α	ЛУНА	ДАТА В ХЬОСТ		ПОЛЁТ		РЕДАКЦИЯ		ДАТА ИЗД											
217:15:29/ 218:03:29		003:12:00/ 004:00:00		217:10:29/ 217:22:29		/217 ГСВ		64.7		АВГ 4, 1996		СТС-79		3241А-4		07/08/96											
ДМВ :217		12	19	13	20	14	21	15	22	16	23	17	0	ДМВ:218	1	19	2	20	3	21	4	22	5	23	6	0	ПВ :004
ПВ :003																											
СТС 7 9	КЭ/П/ЛГ РИДДИ/ УИЛКОТТ	ПЕРЕ НОС		ОБЪЕК СЪЕМК	ОБЕД		ПЕРЕ НОС		Т В О Ф И Ц	СВЕРК ПО ПЕРЕН			О Р Ц 3 1														
	MS1 АПГ			ПОДГ Ф/ТВ	ОБЪЕК СЪЕМК	ТВ ОБЩ ЕСТ	ОБЕД	ПЕРЕНОС STES	ПОДГ Ф/ТВ	Т В О Ф И Ц			АРГОН ОТКР														
	MS2 ЭЙКЕРС	ПЕРЕ НОС		СЪЕМКА ИМАХ В СПЕКТРЕ		ОБЕД		ПЕРЕ НОС		Т В О Ф И Ц	СВЕРК ПО ПЕРЕН			ДЕЙСТВИЯ ДО СНА													
	MS3 УОЛЗ	ПЕРЕНОС ОРЛАН		КЭ1 ОК3 НС0 Е П2 Ш1Е	ОБЪЕК СЪЕМК	ТВ ОБЩ ЕСТ		ОБЕД	УСТАН АЙМАКС	Т В О Ф И Ц			ДЕЙСТВИЯ ДО СНА														
	ЛЮСИД	ПЕРЕ СМЕН		ОБЪЕК СЪЕМК	ТВ ОБЩ ЕСТ		ОБЕД	ПЕРЕ НОС		Т В О Ф И Ц	ФУ		ДЕЙСТВИЯ ДО СНА														
МИР	МИР БИ2 БЛАХА	ПЕРЕ СМЕН		ОБЪЕК СЪЕМК	ПРОБ ВОЗД ШАТТ	ТВ ОБЩ ЕСТ	ОБЕД	ПЕРЕНОС STES	ПРОБА ПОВЕРХ ШАТТЛ	Т В О Ф И Ц	СВЕРК ПО ПЕРЕН	ДЕЙСТВИЯ ДО СНА		СОН													
	МИР КЭ	ПЕРЕ НОС	ПЕРЕНОС ОРЛАН	ПЕРЕ НОС	ОБЪЕК СЪЕМК	ФУ		ТВ ОБЩ ЕСТ	ОБЕД	ПЕРЕНОС STES	ПОДГ Ф/ТВ МИР	Т В О Ф И Ц	СВЕРК ПО ПЕРЕН	ДЕЙСТВИЯ ДО СНА		СОН											
	МИР БИ	ПЕРЕ НОС	ПЕРЕНОС ОРЛАН	КЭ1 ОК3 НС0 Е П2 Ш1Е	ПОДГ Ф/ТВ МИР	ОБЪЕК СЪЕМК	ТВ ОБЩ ЕСТ	ФУ	УСТАН АЙМАКС	Т В О Ф И Ц	ДЕЙСТВИЯ ДО СНА		СОН														
СВЕИ/ТЕНЬ																											
ВИТОК		56	57	58	59	60	61	62	63	64																	
СУТОЧН ВИТОК		14	15	1	2	3	4	5	6	7																	
ТР-СА ПОЛЁТА																											
НИП ЗОНЫ РАД ВИД		-ДЖС -УЛУ -КЛП -УСС -ШК		-ДЖС -КЛП -УЛУ -УСС		-ДЖС -КЛП -УЛУ -УСС -ШЕЛ		-СПБ -ДЖС -КЛП -УЛУ -ШЕЛ		-ШЕЛ -ДЖС		-СПБ -ШЕЛ -ДЖС															
ТДР																											
СР-1																											
ОРЦ		ИО4.1																									
ЭКСП 1310		СД и МГ																									
ПРИМЕЧ:		○ ВЫКЛЮЧЕНИЕ МЕФС ○ ОБЪЕКТ СЪЕМКИ В СПЕКТРЕ ○ ИМАХ В ПРИРОДЕ ○ ЕТТФ ○ ДЕЙСТВИЯ ДО СНА ◆ ДЕЙСТВИЯ ДО СНА ○ ДЕЙСТВИЯ ДО СНА ■ ДЕЙСТВИЯ ДО СНА																									

ГСВ (Д:Ч:М)		ПВ (Д:Ч:М)		ЦЛВ (Д:Ч:М)		ПД / ДГ	-α	ЛУНА 	ДАТА В ХЬОСТ	ПОЛЁТ	РЕДАКЦИЯ	ДАТА ИЗД	
218:03:29 / 218:15:29		004:00:00 / 004:12:00		217:22:29 / 218:10:29		218 ГСВ	65.9		АВГ 4, 1996	СТС-79	3241А-4	07/08/96	
ДМВ :218													
ПВ :004													
СТС 7 9	КЭ/ПЛТ РИДДИ / УИЛКОТТ	ДЕЙСТВИЯ ДО СНА	СОН						ДЕЙСТВИЯ ПОСЛЕ СНА		БИИ	ОРЦ ГО44	
	MS1 АПТ	ДЕЙСТВИЯ ДО СНА	СОН						ДЕЙСТВИЯ ПОСЛЕ СНА			СУТ ПЛАН	
	MS2 ЭЙКЕРС	ДЕЙСТВИЯ ДО СНА	СОН						ДЕЙСТВИЯ ПОСЛЕ СНА			СУТ ПЛАН	ПЕРЕ НОС
	MS3 УОЛЗ	ДЕЙСТВИЯ ДО СНА	СОН						ДЕЙСТВИЯ ПОСЛЕ СНА			СУТ ПЛАН	
	ЛЮСИД	ДЕЙСТВИЯ ДО СНА	СОН						ДЕЙСТВИЯ ПОСЛЕ СНА			СУТ ПЛАН	ФУ
МИР	МИР БИ2 БЛАХА		СОН			ДЕЙСТВИЯ ПОСЛЕ СНА						СУТ ПЛАН	ПЕРЕ НОС
	МИР КЭ		СОН			ДЕЙСТВИЯ ПОСЛЕ СНА			ФУ			ОРЦ ГО44	ПЕРЕ НОС
	МИР БИ		СОН			ДЕЙСТВИЯ ПОСЛЕ СНА			ФУ			СУТ ПЛАН	ПЕРЕ НОС
СВЕТ/ТЕНЬ													
ВИТОК		64	65	66	67	68	69	70	71				
СУТОЧН ВИТОК		7	8	9	10	11	12	13	14				
ТР-СА ПОЛЁТА													
НИП ЗОНЫ РАД ВИД		- ППК - УСС - ППК - УЛУ - УСС											
ТДР	В 3												
СР-1	В 3												
ОРЦ ЭКСП 1310		ИОЗ.1					СД и МГ				ГО4.4		
ПРИМЕЧ:		o НАЧ СБРОСА ВОДЫ											



ГСВ (Д:Ч:М)		ПВ (Д:Ч:М)		ЦЛВ (Д:Ч:М)		ПД / ДГ		-α	ЛУНА 	ДАТА В ХЬЮСТ			ПОЛЁТ	РЕДАКЦИЯ	ДАТА ИЗД	
218:15:29 / 219:03:29		004:12:00 / 005:00:00		218:10:29 / 218:22:29		218 ГСВ		66.9		АВГ 5, 1996			СТС-79	3241А-4	07/08/96	
ДМВ :218		19	20	21	22	23	0	ДМВ:219	1	2	3	4	5	6	ПВ :005	
ПВ :004		12	13	14	15	16	17		18	19	20	21	22	23	0	
СТС 7 9	КЭ/ПЛУТ РИДДИ/ УИЛКОТТ	ПЕРЕ НОС	О И Р Ц 4 1	МИР УПР ОРЦ	О С Б Ъ Е М К	ШАТ УПР ОРЦ	О С Б Ъ Е М К	ОБЕД	ПЕРЕ НОС	В Д Р С У	ПЕРЕ НОС	ТВ ОБЩ ЕСТ		О РЦ ГОЗЗ	И Н Д И К	ДЕЙСТВИЯ ДО СНА
	MS1 АИТ	ПЕРЕ НОС			О С Б Ъ Е М К	А Р Г О Р		ОБЕД	ПЕРЕ НОС	В Д Р С У	ПОДГ Ф/ТВ		АРГОН ОТКР			ДЕЙСТВИЯ ДО СНА
	MS2 ЭЙКЕРС	ПЕРЕ НОС			О Б Ъ Е К С Ъ Е М К	С Ъ Е М К А И М А Х В П Р И Р О Д Е		ОБЕД	У С Т А Н А Й М А К С В Б Б				С В Е Р К П О П Е Р Е Н			ДЕЙСТВИЯ ДО СНА
	MS3 УОЛЗ	ПЕРЕ НОС			С Ъ Е М К А И М А Х В П Р И Р О Д Е	П Е Р Е Н		ОБЕД		В Д Р С У						ДЕЙСТВИЯ ДО СНА
	ЛЮСИД	ФУ		ПЕРЕ СМЕН		О Б Ъ Е К С Ъ Е М К		ОБЕД	ЗАМЕНА ДОЗИМ	ПЕРЕ СМЕН	ТВ ОБЩ ЕСТ		ФУ			ДЕЙСТВИЯ ДО СНА
МИР	МИР БИ2 БЛАХА	ПЕРЕ НОС		ПЕРЕ СМЕН		П Е Р Е Н		ОБЕД	ЗАМЕНА ДОЗИМ	ПЕРЕ СМЕН	ТВ ОБЩ ЕСТ	С В Е Р К П О П Е Р Е Н	ДЕЙСТВИЯ ДО СНА			СОН
	МИР КЭ	ПЕРЕ НОС	О И Р Ц 4 1	МИР УПР ОРЦ	ФУ	П Е Р Е Н		ОБЕД	У С Т А Н А Й М А К С В Б Б	В Д Р С У	ТВ ОБЩ ЕСТ	С В Е Р К П О П Е Р Е Н	ДЕЙСТВИЯ ДО СНА			СОН
	МИР БИ	ПЕРЕ НОС				ШАТ УПР ОРЦ	О С Б Ъ Е М К	ОБЕД	ПЕРЕ НОС		ТВ ОБЩ ЕСТ		ДЕЙСТВИЯ ДО СНА			СОН
СВЕТ/ЛЕНЬ	■		■		■		■		■		■		■		■	
ВИТОК	72		73		74		75		76		77		78		79	
СУТОЧН ВИТОК	15		16		1		2		3		4		5		6	
ТР-СА ПОЛЁТА																
НИП ЗОНЫ РАД ВИД	- УЛУ - УСС - ППК	- УЛУ - УСС - ППК - ДЖС - КЛП	- КЛП - УЛУ - УСС - ДЖС - ШЕЛ	- ДЖС - КЛП - УЛУ - ШЕИСС - СПБ	- ШЕЛ - ДЖС - КЛП	- ДЖС - КЛП - УЛУ - ШЕИСС - СПБ	- ШЕЛ - ДЖС - КЛП	- ДЖС - КЛП - УЛУ - ШЕИСС - СПБ	- ШЕЛ - ДЖС - КЛП	- ДЖС - КЛП - УЛУ - ШЕИСС - СПБ	- ШЕЛ - ДЖС - КЛП	- ДЖС - КЛП - УЛУ - ШЕИСС - СПБ	- ШЕЛ - ДЖС - КЛП	- ДЖС - КЛП - УЛУ - ШЕИСС - СПБ	- ШЕЛ - ДЖС - КЛП	- ДЖС - КЛП - УЛУ - ШЕИСС - СПБ
ТДР	В 3															
СР-1	В 3															
ОРЦ	ГО4.4															
ЭКСП1310	ИО4.1															
ПРИМЕЧ:	СД и МГ															
	o КОНЕЦ СБРОСА ВОДЫ					o ТЕСТ АРИС с ВД РС У					o ДЕЙСТВИЯ ДО СНА					
	o ОБЪЕКТ СЪЕМКИ Б ПРИРОДЕ					o ЕТТФ					o ДЕЙСТВИЯ ДО СНА					
	- ИИДИКАТ РЕЖ АРИС -															

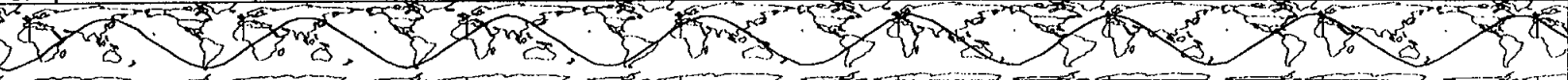

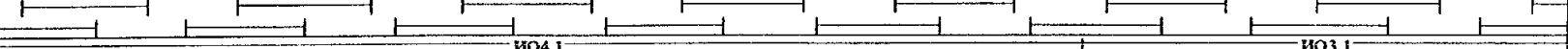
ГСВ (Д:Ч:М)		ПВ (Д:Ч:М)		ЦЛВ (Д:Ч:М)		ПД / ДГ		-α	ЛУНА 	ДАТА В ХЬЮСТ	ПОЛЁТ	РЕДАКЦИЯ	ДАТА ИЗД	
219:03:29 / 219:15:29		005:00:00 / 005:12:00		218:22:29 / 219:10:29		/219 ГСВ		67.5		АВГ 5, 1996	СТС-79	3241А-4	07/08/96	
<div style="display: flex; justify-content: space-between; font-size: small;"> <span>ДМВ :219</span> <span>ПВ :005</span> </div>														
СТС 79	КЭ/ПЛТ РИДДИ/ УИЛКОТТ		О И Р О Ц 3 1	сон						ДЕЙСТВИЯ ПОСЛЕ СНА	О И Р О Ц 4 1		Б И И	СУТ ПЛАН
	MS1 АПТ	ДЕЙСТВИЯ ДО СНА		сон						ДЕЙСТВИЯ ПОСЛЕ СНА			СУТ ПЛАН	
	MS2 ЭЙКЕРС	ДЕЙСТВИЯ ДО СНА		сон						ДЕЙСТВИЯ ПОСЛЕ СНА			СУТ ПЛАН	
	MS3 УОЛЗ	ДЕЙСТВИЯ ДО СНА		сон						ДЕЙСТВИЯ ПОСЛЕ СНА			СУТ ПЛАН	
	ЛЮСИД	ДЕЙСТВИЯ ДО СНА		сон						ДЕЙСТВИЯ ПОСЛЕ СНА	ФУ		СУТ ПЛАН	
МИР	МИР БИ2 БЛАХА			сон				ДЕЙСТВИЯ ПОСЛЕ СНА					СУТ ПЛАН	
	МИР КЭ			сон				ДЕЙСТВИЯ ПОСЛЕ СНА		ФУ	О И Р О Ц 4 1		СУТ ПЛАН	
	МИР БИ			сон				ДЕЙСТВИЯ ПОСЛЕ СНА		ФУ			СУТ ПЛАН	
<div style="display: flex; justify-content: space-between; font-size: x-small;"> <span>СВЕТ/ТЕНЬ</span> <span>ВИТОК</span> <span>СУТОЧН ВИТОК</span> </div>														
														
<div style="display: flex; justify-content: space-between; font-size: x-small;"> <span>НИП ЗОНЫ РАД ВИД</span> <span>ППК</span> <span>- УСС - ППК</span> <span>- УЛУ - УСС - ППК</span> </div>														
<div style="display: flex; justify-content: space-between; font-size: x-small;"> <span>ТДР В 3</span> <span>СР-1 В 3</span> <span>ОРЦ ГОЗ.3</span> <span>ИОЗ.1</span> <span>ИО4.1</span> </div>														
<div style="display: flex; justify-content: space-between; font-size: x-small;"> <span>ЭКСП 1310</span> <span>ДЕЙСТВИЯ ДО СНА</span> <span>СД и МГ</span> </div>														
<div style="display: flex; justify-content: space-between; font-size: x-small;"> <span>ПРИМЕЧ:</span> <span>ИНД РЕЖ ARIS</span> <span>о 1 ГРАДУС</span> <span>о ДЕЙСТВИЯ ПОСЛЕ СНА</span> <span>◆ ПЕРЕ СМЕН</span> <span>∇ ПЕРЕ СМЕН</span> </div>														

ГСВ (Д:Ч:М)		ПВ (Д:Ч:М)		ЦЛВ (Д:Ч:М)		ПД / ДГ	-α	ЛУНА 	ДАТА В ХЬОУСТ	ПОЛЁТ	РЕДАКЦИЯ	ДАТА ИЗД	
219:15:29/ 220:03:29		005:12:00/ 006:00:00.		219:10:29/ 219:22:29		219 ГСВ	67.9		АВГ 6, 1996	СТС-79	3241А-4	07/08/96	
ДМВ :219 19 20 21 22 23 0 ДМВ:220 1 2 3 4 5 6 ПВ :005 12 13 14 15 16 17 18 19 20 21 22 23 0 ПВ :006													
СТС 79	КЭ/ПЛТ РИДДИ/ УИЛКОТТ		ТЕСТ ОДРСУ	ОБЕД	ПРЕС КОНО ЭКИП	ПЕРЕНОС ПИЩИ	СВЕРК ПО ПЕРЕН	ПРОЦ АНИЕ	О П К О Н Ч		О И Р Ц 3 1	ДЕЙСТВИЯ ДО СНА	
	MS1 АПТ	ОБЪЕК СЪЕМК	ПОДГ Ф/ТВ	ОБЕД	ПРЕС КОНО ЭКИП	ПЕРЕНОС ПИЩИ	СВЕРК ПО ПЕРЕН	ПРОЦ АНИЕ		ЗПЛ ПОДГ РАССТ	А Р Г О Р		
	MS2 ЭЙКЕРС	СЪЕМКА В БАЗ БЛОКЕ	ОБЪЕК СЪЕМК	ОБЕД	ПРЕС КОНО ЭКИП	ПЕРЕ АЙМАКС ПО Д Г Т В	СВЕРК ПО ПЕРЕН	ПРОЦ АНИЕ	О П К О Н Ч			ДЕЙСТВИЯ ДО СНА	
	MS3 УОЛЗ	ОБЪЕК СЪЕМК	СЪЕМКА В БАЗ БЛОКЕ	ОБЕД	ПРЕС КОНО ЭКИП	ПЕРЕНОС ПИЩИ	СВЕРК ПО ПЕРЕН	ПРОЦ АНИЕ		ЗПЛ ПОДГ РАССТ		ДЕЙСТВИЯ ДО СНА	ДЕЙСТВИЯ ДО СНА
	ЛЮСИД	ПЕРЕ СМЕН	О С Б Ё Б Е М К К	ОБЕД	ПРЕС КОНО ЭКИП	ПЕРЕ СМЕН	СВЕРК ПО ПЕРЕН	ПРОЦ АНИЕ	О П К О Н Ч	ЗПЛ ПОДГ РАССТ		ДЕЙСТВИЯ ДО СНА	
МИР	МИР БИ2 БЛАХА	ПЕРЕ СМЕН	О С Б Ё Б Е М К К	ОБЕД	ПРЕС КОНО ЭКИП	ПЕРЕ СМЕН	СВЕРК ПО ПЕРЕН	ПРОЦ АНИЕ	О П К О Н Ч	ЗПЛ ПОДГ РАССТ	ДЕЙСТВИЯ ДО СНА	СОН	
	МИР КЭ	ТЕСТ ОДРСУ	ОБЪЕК СЪЕМК	ОБЕД	ПРЕС КОНО ЭКИП	ПЕРЕНОС ПИЩИ	СВЕРК ПО ПЕРЕН	ПРОЦ АНИЕ	О П К О Н Ч	ЗПЛ ПОДГ РАССТ	ДЕЙСТВИЯ ДО СНА	СОН	
	МИР БИ		ПОДГ Ф/ТВ МИР	ОБЕД	ПРЕС КОНО ЭКИП	ПЕРЕНОС ПИЩИ	СВЕРК ПО ПЕРЕН	ПРОЦ АНИЕ		ЗПЛ ПОДГ РАССТ	ДЕЙСТВИЯ ДО СНА	О И Р Ц 3 1	СОН
СВЕТ/ТЕНЬ													
ВИТОК	87	88	89	90	91	92	93	94	95				
СУТОЧН ВИТОК	14	15	1	2	3	4	5	6	7				
ТР-СА ПОЛЁТА													
НИП ЗОНЫ РАД ВИД	- ДЖС - КЛП - УЛУ - УСС - ШК		- ДЖС - КЛП - УЛУ - УСС		- ДЖС - КЛП - УЛУ - УСС - ШЕЛ		- СПБ - ДЖС - КЛП - ШЕЛ		- ДЖС - СПБ - ШЕЛ - ДЖС				
ТДР	В 3												
СР-1	В 3												
ОРЦ	ИО4.1												
ЭКСП 1310	ИО3.1												
ПРИМЕЧ:	⊙ ЭКСПЕРИМЕНТ РМЕ 1301				⊙ ПЕРЕНОС IМАХ В ШАТТЛ				⊙ ЕТТФ		○ ДЕЙСТВИЯ ДО СНА	■ ДЕЙСТВИЯ ДО СНА	
	△ ДЕМОНТ ВОЗДУХОВОДА						▲ ДЕЙСТВИЯ ДО СНА			■ ДЕЙСТВИЯ ДО СНА			
	■ ДЕЙСТВИЯ ДО СНА												

ГСВ (Д:Ч:М)		ПВ (Д:Ч:М)		ЦЛВ (Д:Ч:М)		ПД / ДГ	-α	ЛУНА 	ДАТА В ХЬЮСТ	ПОЛЁТ	РЕДАКЦИЯ	ДАТА ИЗД	
220:03:29/ 220:15:29		006:00:00/ 006:12:00		219:22:29/ 220:10:29		/220 ГСВ	68.0		АВГ 6, 1996	СТС-79	3241А-4	07/08/96	
ДМВ :220 0 1 2 3 4 5 6 7 8 9 10 11 12 13 14 15 16 17 18 19 20 21 22													
ПВ :006 0 1 2 3 4 5 6 7 8 9 10 11 12													
СТС 79	КЭ/ПЛТ РИДДИ/ УИЛКОТТ	ДЕЙСТВИЯ ДО СНА	СОН						ДЕЙСТВИЯ ПОСЛЕ СНА	О Р Ц 4 1	И О 4 1		Б И И
	MS1 АПТ	ДЕЙСТВИЯ ДО СНА	СОН						ДЕЙСТВИЯ ПОСЛЕ СНА				
	MS2 ЭЙКЕРС	ДЕЙСТВИЯ ДО СНА	СОН						ДЕЙСТВИЯ ПОСЛЕ СНА				
	MS3 УОЛЗ	ДЕЙСТВИЯ ДО СНА	СОН						ДЕЙСТВИЯ ПОСЛЕ СНА				
	ЛЮСИД	ДЕЙСТВИЯ ДО СНА	СОН						ДЕЙСТВИЯ ПОСЛЕ СНА				
МИР	МИР БИ2 БЛАХА	СОН						ДЕЙСТВИЯ ПОСЛЕ СНА					
	МИР КЭ	СОН						ДЕЙСТВИЯ ПОСЛЕ СНА					О Р Ц 4 1
	МИР БИ	СОН						ДЕЙСТВИЯ ПОСЛЕ СНА					
СВЕТИТЕЛЬ													
ВИТОК													
СУТОЧН ВИТОК													
ТР-СА ПОЛЁТА													
НИП ЗОНЫ РАД ВИД													
ТДР В 3													
СР-1 В 3													
ОРЦ													
ЭКСП 1310													
ПРИМЕЧ:													

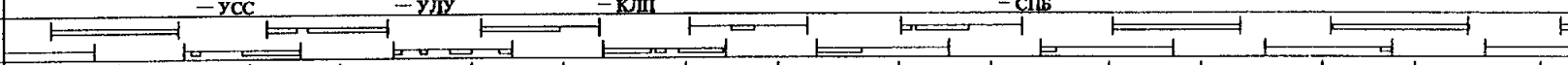
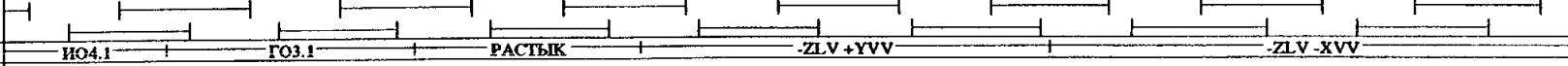
ГСВ (Д:Ч:М)		ПВ (Д:Ч:М)		ЦЛВ (Д:Ч:М)		ПД / ДГ	-α	ЛУНА 	ДАТА В ХЬЮСТ	ПОЛЁТ	РЕДАКЦИЯ	ДАТА ИЗД
220:15:29 / 221:03:29		006:12:00 / 007:00:00		220:10:29 / 220:22:29		/220 ГСВ	67.8		АВГ 7, 1996	СТС-79	3241А-4	07/08/96
ДМВ :220 19 20 21 22 23 0 ДМВ:221 1 19 2 20 3 21 4 22 5 23 6 0												
ПВ :006 12 13 14 15 16 17 18 19 20 21 22 23 0 ПВ :007												
СТС 7 9	КЭ/ПЛТ РИДДИ/ УИЛКОТГ	ОРЦ ГОЗ1	РАССТЫК								ДЕЙСТВИЯ ДО СНА	
	MS1 АПГ	РАССТЫК		РАССТЫК						ДЕЙСТВИЯ ДО СНА		
	MS2 ЭЙКЕРС	РАССТЫК		РАССТЫК						ДЕЙСТВИЯ ДО СНА		
	MS3 УОЛЗ	РАССТЫК		РАССТЫК						ДЕЙСТВИЯ ДО СНА		
	ЛЮСИД	РАССТЫК		РАССТЫК						ДЕЙСТВИЯ ДО СНА		
МИР	МИР БИ2 БЛАХА	РАССТЫК МИР		СЪЕМКА РАССТЫК				ДЕЙСТВИЯ ДО СНА		СОН		
	МИР КЭ	ОРЦ ГОЗ1	ПОДГ Ф/ТВ МИР	РАССТЫК МИР		СЪЕМКА РАССТЫК		ДЕЙСТВИЯ ДО СНА		СОН		
	МИР БИ	РАССТЫК МИР		МИР ОРЦ НО	НАБЛЮД ОБЛЁТА		ДЕЙСТВИЯ ДО СНА		СОН			
СВЕТ/ТЕНЬ ВИТОК 103 104 105 106 107 108 109 110 СУТОЧН ВИТОК 15 16 1 2 3 4 5 6												
ТР-СА ПОЛЁТА												
НИП ЗОНЫ РАД ВИД	ППК	ППК - ДЖС - КЛП - УЛУ - УСС	- ПШЛ - ДЖС - КЛП - УЛУ	- УСС - ПШЛ - ДЖС - КЛП - УЛУ	- УЛУ - ПШЛ - СПБ - ДЖС - КЛП	- СПБ - ПШЛ - ДЖС	- ПШЛ - ДЖС					
ТДР	В 3											
СР-1	В 3											
ОРЦ ЭКСП 1310	ИО4.1 ГОЗ.1 РАССТЫК -ZLV +YVV -ZLV -XVV											
ПРИМЕЧ:												

**This Page Intentionally Blank**

**DETAILED JOINT TIMELINE (CYRILLIC)**

**NOTE**

Timeline pages 5-3 thru 5-10, 5-67 thru 5-78 are not included in Cyrillic since they are not part of the joint mission

**This Page Intentionally Blank**

**This Page Intentionally Blank**



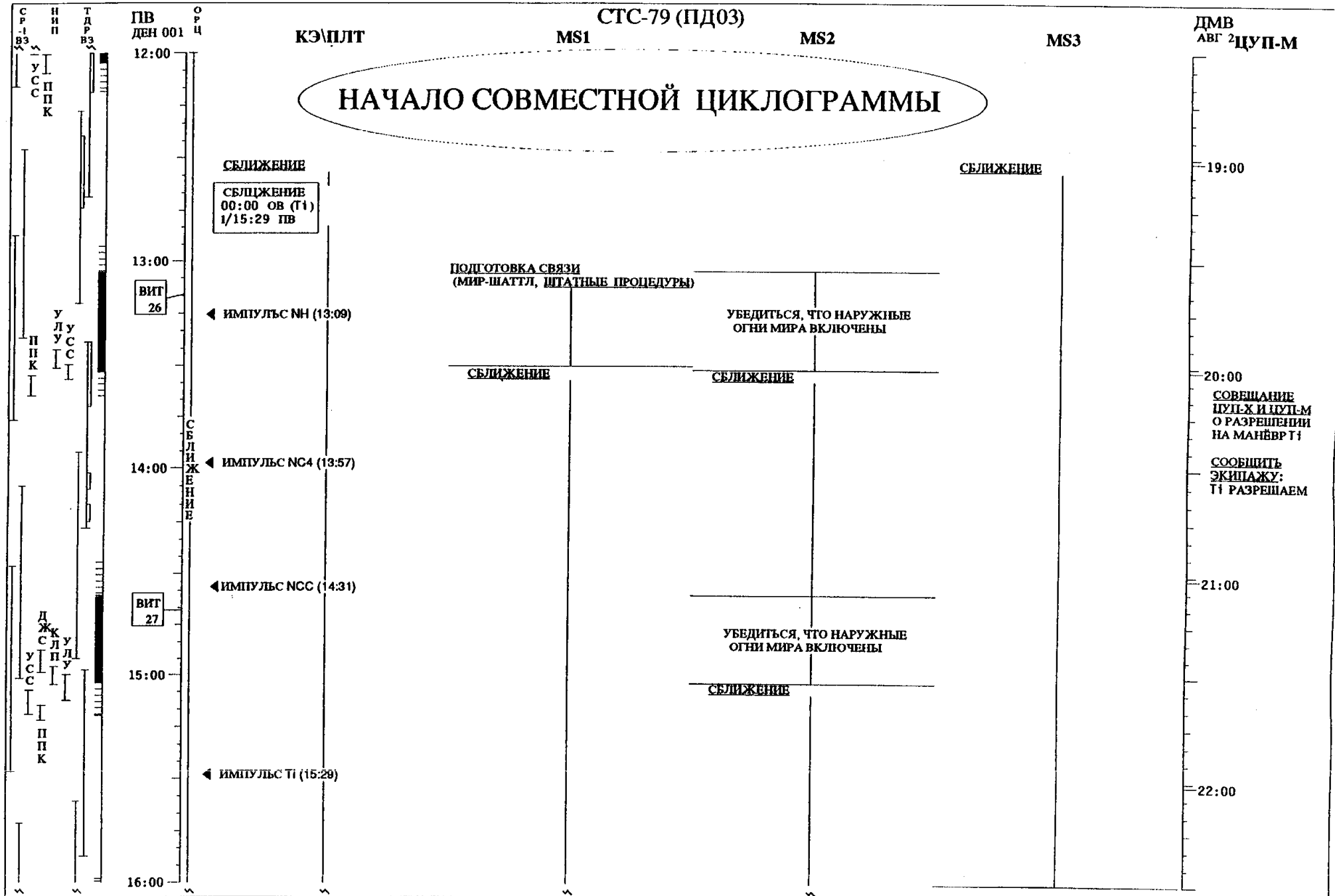

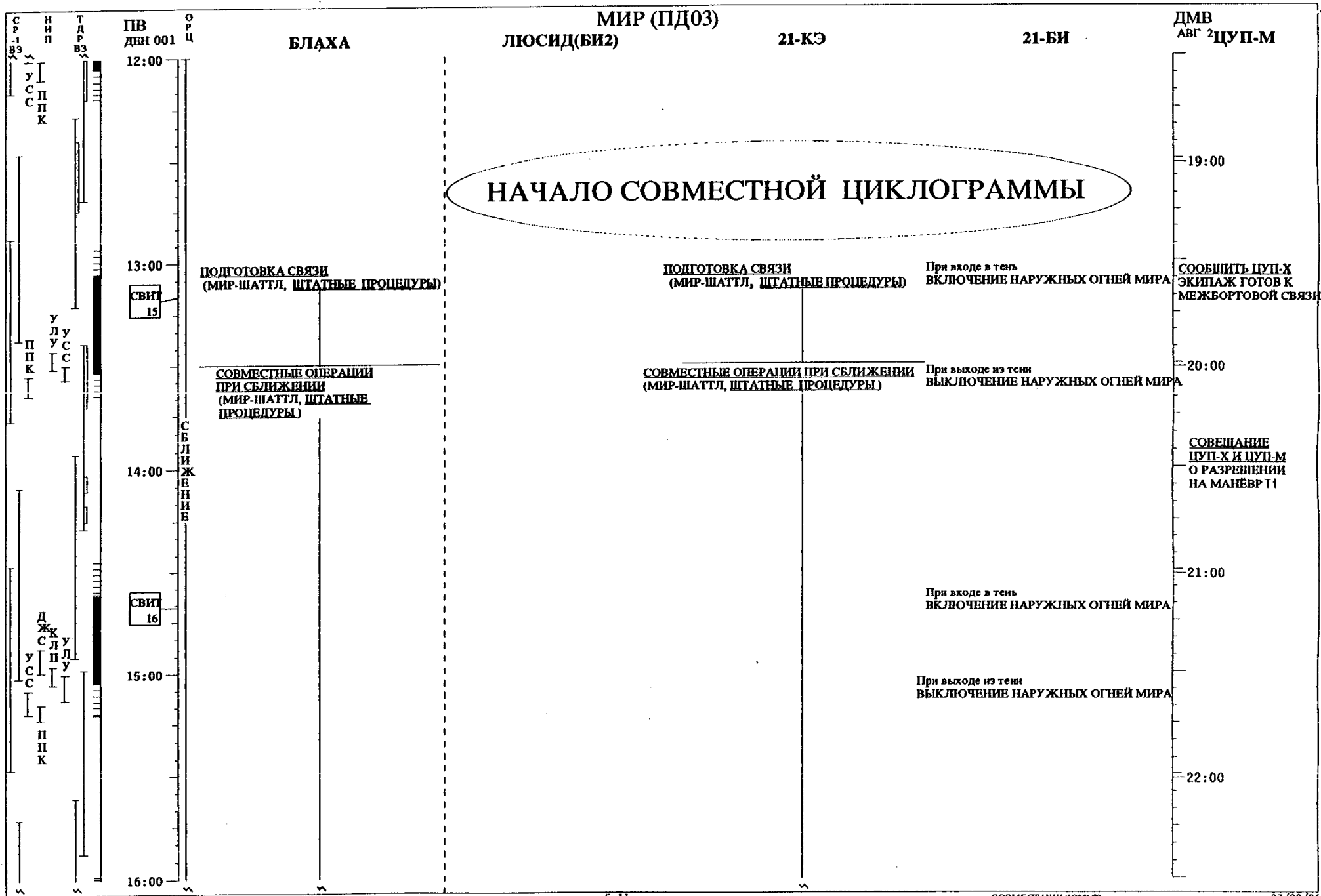

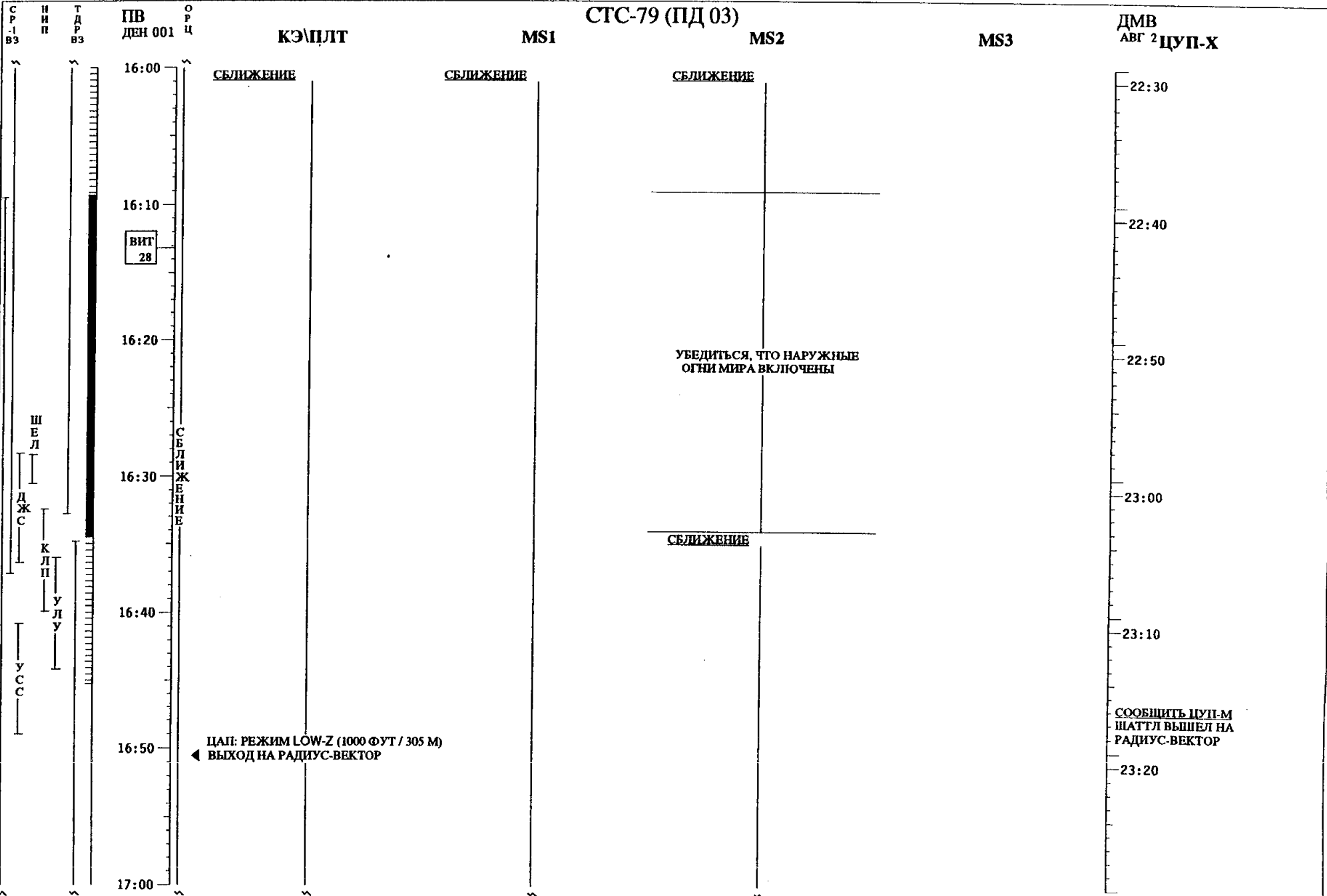

С  
Р  
-1  
В3

Н  
И  
П

Т  
Д  
Р  
В3

ПВ  
ДЕН 001

БЛАХА

МИР (ПД 03)  
ЛЮСИД(БИ2)

21-КЭ

21-БИ

ДМВ  
АВГ 2 ЦУП-М

16:00  
16:10  
16:20  
16:30  
16:40  
16:50  
17:00

СОВМЕСТНЫЕ ОПЕРАЦИИ  
ПРИ СБЛИЖЕНИИ  
(МИР-ШАТТЛ, ЦИТАТНЫЕ  
ПРОЦЕДУРЫ)

СВИТ  
1

Ш  
Е  
Л  
Д  
Ж  
С  
К  
Л  
П  
У  
Л  
У  
У  
С  
С

← ВЫХОД НА РАДИУС-ВЕКТОР

СОВМЕСТНЫЕ ОПЕРАЦИИ ПРИ СБЛИЖЕНИИ  
(МИР-ШАТТЛ, ЦИТАТНЫЕ ПРОЦЕДУРЫ)

При входе в тень  
ВКЛЮЧЕНИЕ НАРУЖНЫХ ОГНЕЙ МИРА

При выходе из тени  
ВЫКЛЮЧЕНИЕ НАРУЖНЫХ ОГНЕЙ МИРА

22:30  
22:40  
22:50  
23:00  
23:10  
23:20

23:10  
СООБЩИТЬ ПУТЬ-Х  
АПСС-ВКЛЮЧЕНА

С  
Р  
-1  
ВЗ  
Н  
И  
П  
Т  
Д  
Р  
ВЗ  
ПВ  
ДЕН 001  
О  
Р  
Ц

СТС-79 (ПД 03)

КЭПЛТ

MS1

MS2

MS3

ДМВ  
АВГ 2 ЦУП-Х

17:00  
17:10  
17:20  
17:30  
17:40  
17:50  
18:00

СБЛИЖЕНИЕ

СБЛИЖЕНИЕ

СБЛИЖЕНИЕ

УСТАНОВИТЬ ОТНОСИТЕЛЬНОЕ  
ВРЕМЯ (ОВ) НА ПОЛЬ ДЛЯ  
СТЫКОВОЧНОГО КОНТАКТА,  
ЗАПЛАНИРОВАВШОГО НА 1/18 04 110  
ПВ (ЧЕРЕЗ 3 МИН ПОСЛЕ ИС ШЛК)

◀ ЗАВИСНУТЬ НА РАССТОЯНИИ 170 ФУТ (50 М)

В СЛУЧАЕ ПОЛУЧЕНИЯ ЗАПРЕТА НА  
ОКОНЧАТЕЛЬНОЕ СБЛИЖЕНИЕ:  
ЗАВИСНУТЬ НА РАССТОЯНИИ  
170 ФУТ

С  
Б  
Л  
И  
Ж  
Е  
Н  
И  
Е

◀ НАЧАТЬ СБЛИЖЕНИЕ до 30фут (9м)

На расстоянии 100 фут (30 м), переключить  
передатчик Ku диапазона в режим готовности  
и подготовить его для связи

ВИГ  
29

С  
Т  
И  
К

ПОДОЙТИ НА 30 фут (9м):  
ЗАВИСНУТЬ НА 5 МИНУТ

ЦАП: NORM-Z

◀ НАЧАТЬ ОКОНЧАТЕЛЬНЫЙ  
ПОДХОД ДЛЯ СТЫКОВКИ

23:30  
ПЕРЕДАТЬ КОМАНДУ  
БОРТОВОМУ  
КОМПЬЮТЕРУ  
Активировать  
защитную маску  
диапазона Ku

СООБЩИТЬ ЦУП-М  
РАССТОЯНИЕ 170 ФУТОВ  
23:40  
СВЕРКА ЦУПов  
О РАЗРЕШЕНИИ НА  
ОКОНЧАТЕЛЬНОЕ  
СБЛИЖЕНИЕ И  
СТЫКОВКУ

23:50  
СООБЩИТЬ  
ЭКИПАЖУ:  
РАЗРЕШАЕМ  
СБЛИЖЕНИЕ  
РАЗРЕШАЕМ  
СТЫКОВКУ

АВГ 3  
00:00  
СООБЩИТЬ ЦУП-М  
ШАТТЛ ПРИСТУПАЕТ  
К СБЛИЖЕНИЮ  
ДО 30 ФУТОВ

00:10

00:20

СООБЩИТЬ ЦУП-Х  
ЦАП NORM Z

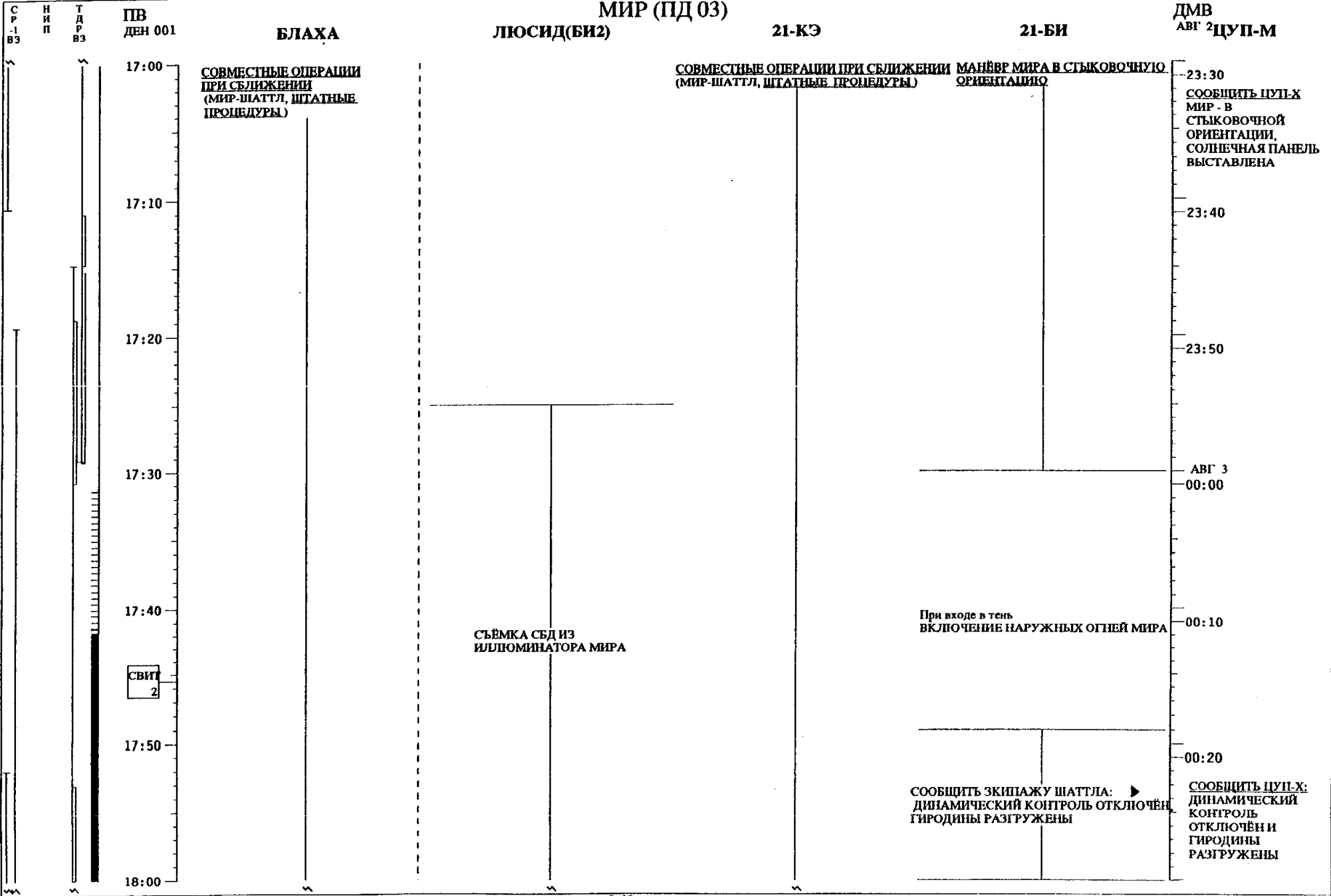

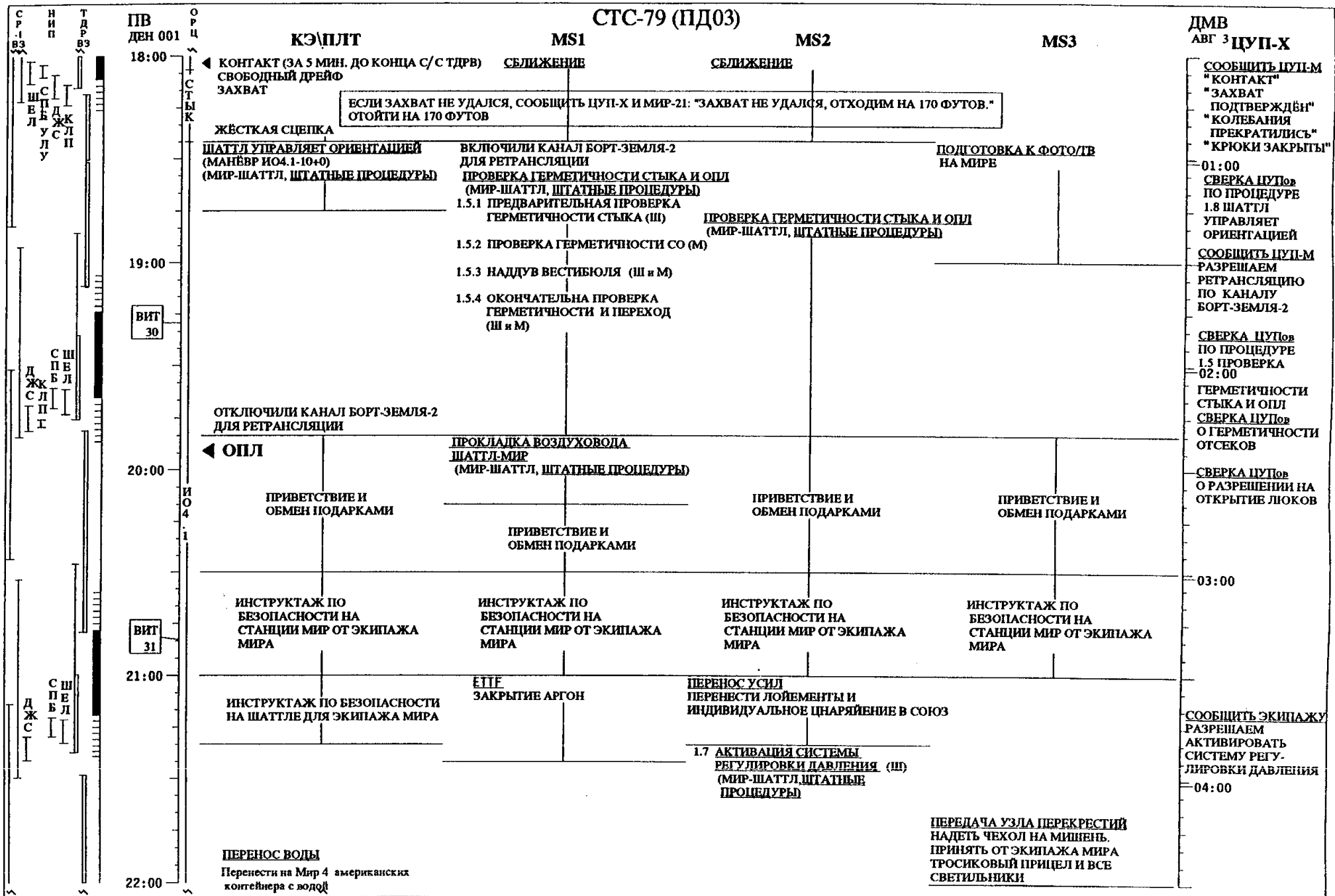

		МИР (ПД03)			ДМВ АВГ 3 ЦУП-М	
		БЛАХА	ЛЮСИД(БИ2)	21-КЭ	21-БИ	
СВ 3 СВ 4 СВ 3 СВ 4 СВ 3 СВ 4 СВ 3 СВ 4	18:00	<b>СОВМЕСТНЫЕ ОПЕРАЦИИ ПРИ СБЛИЖЕНИИ (МИР-ШАТТЛ, ШТАТНЫЕ ПРОЦЕДУРЫ)</b> КОНТАКТ (1/18:04 ПВ - 00:34 ДМВ)	СЪЕМКА СБД ИЗ ИЛЛЮМИНАТОРА МИРА	<b>СОВМЕСТНЫЕ ОПЕРАЦИИ ПРИ СБЛИЖЕНИИ (МИР-ШАТТЛ, ШТАТНЫЕ ПРОЦЕДУРЫ)</b>	<b>ПОСЛЕ ЗАХВАТА, МИР - В ИНДИКАТОРНОМ РЕЖИМЕ</b>  КОГДА ШАТТЛ ПОДТВЕРДИТ ЗАХВАТ, ВОЗОБНОВИТЬ РАБОТУ СОСБ	СООБЩИТЬ ЦУП-Х МИР - В ИНДИКАТОРНОМ РЕЖИМЕ
	19:00	ПРОДОЛЖАТЬ МЕЖБОРТОВУЮ СВЯЗЬ		<b>ШАТТЛ УПРАВЛЯЕТ ОРИЕНТАЦИЕЙ (МАНВР ИО4.1-10+0)</b> (МИР-ШАТТЛ, ШТАТНЫЕ ПРОЦЕДУРЫ)	Примерно в это время ожидать вызова из ЦУПа Москвы, ретранслированного через Шаттл (по УКВ2 дуплекс)	01:00  СВЕРКА ЦУПа ПО ПРОЦЕДУРЕ 1.8 ШАТТЛ УПРАВЛЯЕТ ОРИЕНТАЦИЕЙ
	20:00			ПРОДОЛЖАТЬ МЕЖБОРТОВУЮ СВЯЗЬ	<b>ПРОВЕРКА ГЕРМЕТИЧНОСТИ СТЫКА И ОПЛ (МИР-ШАТТЛ, ШТАТНЫЕ ПРОЦЕДУРЫ)</b> 1.5.1 ПРЕДВАРИТЕЛЬНАЯ ПРОВЕРКА ГЕРМЕТИЧНОСТИ СТЫКА (Ш)	СВЕРКА ЦУПа ПО ПРОЦЕДУРЕ 1.5 ПРОВЕРКА ГЕРМЕТИЧНОСТИ СТЫКА И ОПЛ
	21:00	ПРИВЕТСТВИЕ И ОБМЕН ПОДАРКАМИ	ПРИВЕТСТВИЕ И ОБМЕН ПОДАРКАМИ	ПРИВЕТСТВИЕ И ОБМЕН ПОДАРКАМИ	1.5.2 ПРОВЕРКА ГЕРМЕТИЧНОСТИ СО (М)  1.5.3 НАДУВ ВЕСТИБЮЛЯ (Ш и М)  1.5.4 ОКОНЧАТЕЛЬНА ПРОВЕРКА ГЕРМЕТИЧНОСТИ И ПЕРЕХОД (Ш и М)	02:00  СВЕРКА ЦУПа О ГЕРМЕТИЧНОСТИ ОТСЕКОВ
	22:00	ИНСТРУКТАЖ ПО БЕЗОПАСНОСТИ НА СТАНЦИИ МИР ОТ ЭКИПАЖА МИРА			<b>ПРОКЛАДКА ВОЗДУХОВОДА ШАТТЛ-МИР (МИР-ШАТТЛ, ШТАТНЫЕ ПРОЦЕДУРЫ)</b>	СВЕРКА ЦУПа О РАЗРЕШЕНИИ НА ОТКРЫТИЕ ЛЮКОВ
		ИНСТРУКТАЖ ПО БЕЗОПАСНОСТИ НА СТАНЦИИ МИР ОТ ЭКИПАЖА МИРА		ИНСТРУКТАЖ ПО БЕЗОПАСНОСТИ НА СТАНЦИИ МИР ОТ ЭКИПАЖА МИРА	ПРИВЕТСТВИЕ И ОБМЕН ПОДАРКАМИ	03:00
	<b>ПЕРЕНОС УСИЛ</b> ПЕРЕНЕСТИ ЛОЖЕМЕНТЫ И ИНДИВИДУАЛЬНОЕ СНАРЯЖЕНИЕ В СОЮЗ		ИНСТРУКТАЖ ПО БЕЗОПАСНОСТИ НА СТАНЦИИ МИР ОТ ЭКИПАЖА МИРА	ИНСТРУКТАЖ ПО БЕЗОПАСНОСТИ НА ШАТТЛЕ ДЛЯ ЭКИПАЖА МИРА	ИНСТРУКТАЖ ПО БЕЗОПАСНОСТИ НА СТАНЦИИ МИР ОТ ЭКИПАЖА МИРА	04:00
	<b>ПЕРЕНОС УСИЛ</b> Перенести ложементы и индивидуальное снаряжение в Союз.		<b>ПЕРЕНОС УСИЛ</b> Перенести ложементы и индивидуальное снаряжение в Союз.	ИНСТРУКТАЖ ПО БЕЗОПАСНОСТИ НА ШАТТЛЕ ДЛЯ ЭКИПАЖА МИРА	<b>ПЕРЕДАЧА УЗЛА ПЕРЕКРЕСТИЙ</b> ПЕРЕДАТЬ ТРОСИКОВЫЙ ПРИЦЕЛ И СВЕТИЛЬНИКИ ЭКИПАЖУ ШАТТЛА	04:00
	<b>УСТАНОВКА УСИЛ И ПРОВЕРКА СКАФАНДРА</b> СООБЩИТЬ ЦУП-Х ОБ УСТАНОВКЕ УСИЛ И ПРОВЕРКЕ СКАФАНДРА. С РАЗРЕШЕНИЯ ЦУПа: М54 СТАНОВИТСЯ БИ-2		<b>УСТАНОВКА УСИЛ И ПРОВЕРКА СКАФАНДРА</b>			



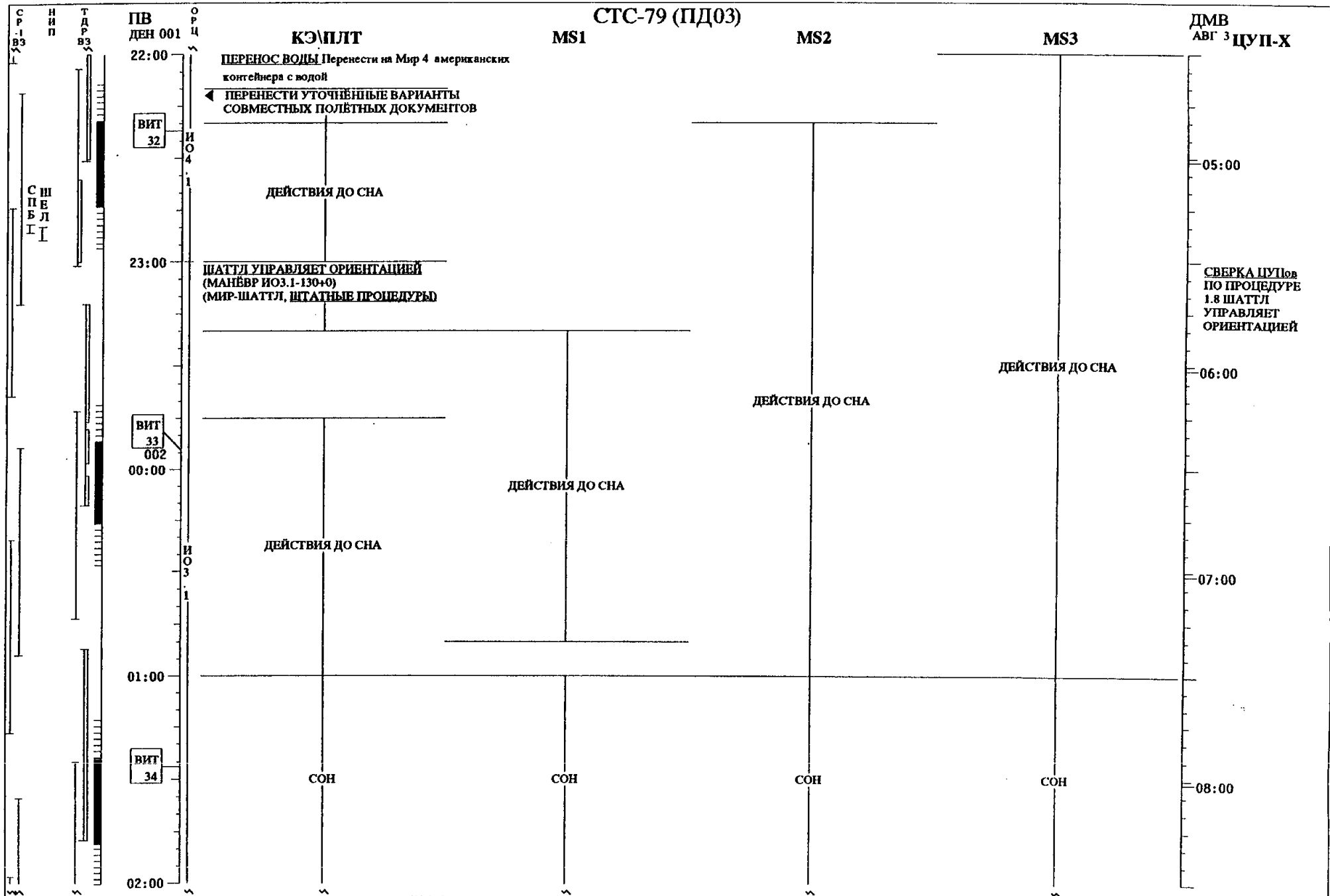

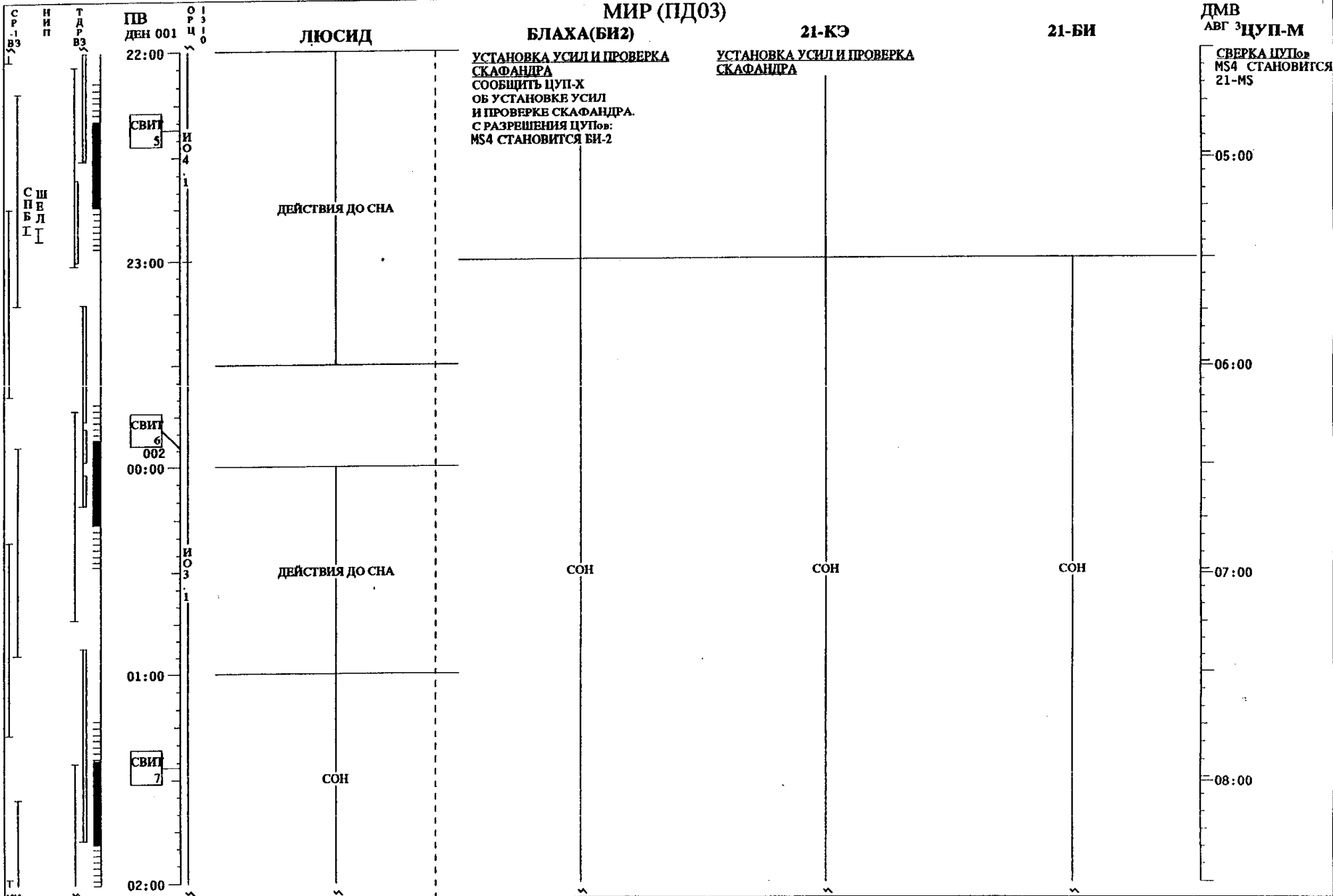

# СТС-79 (ПД04)

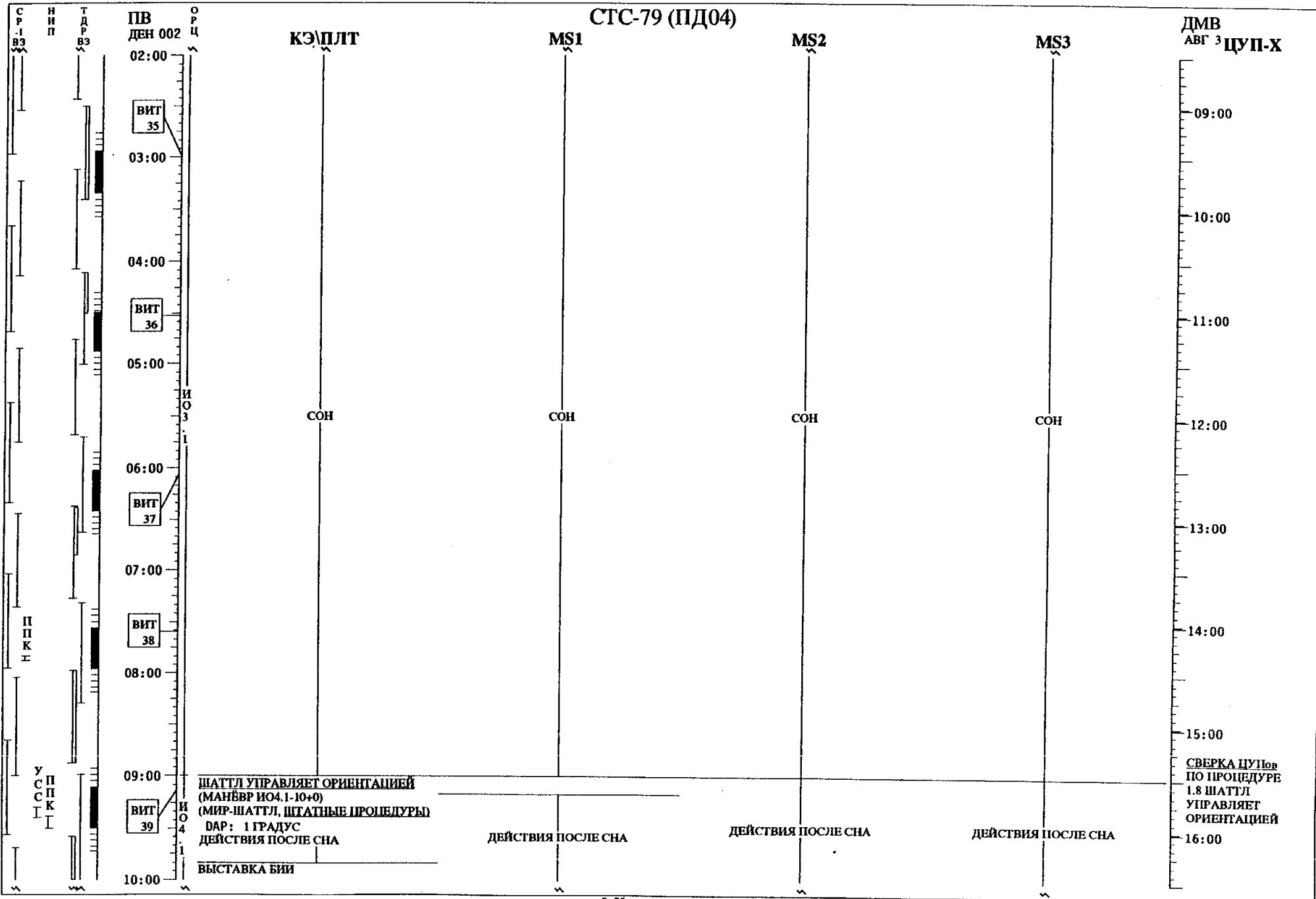

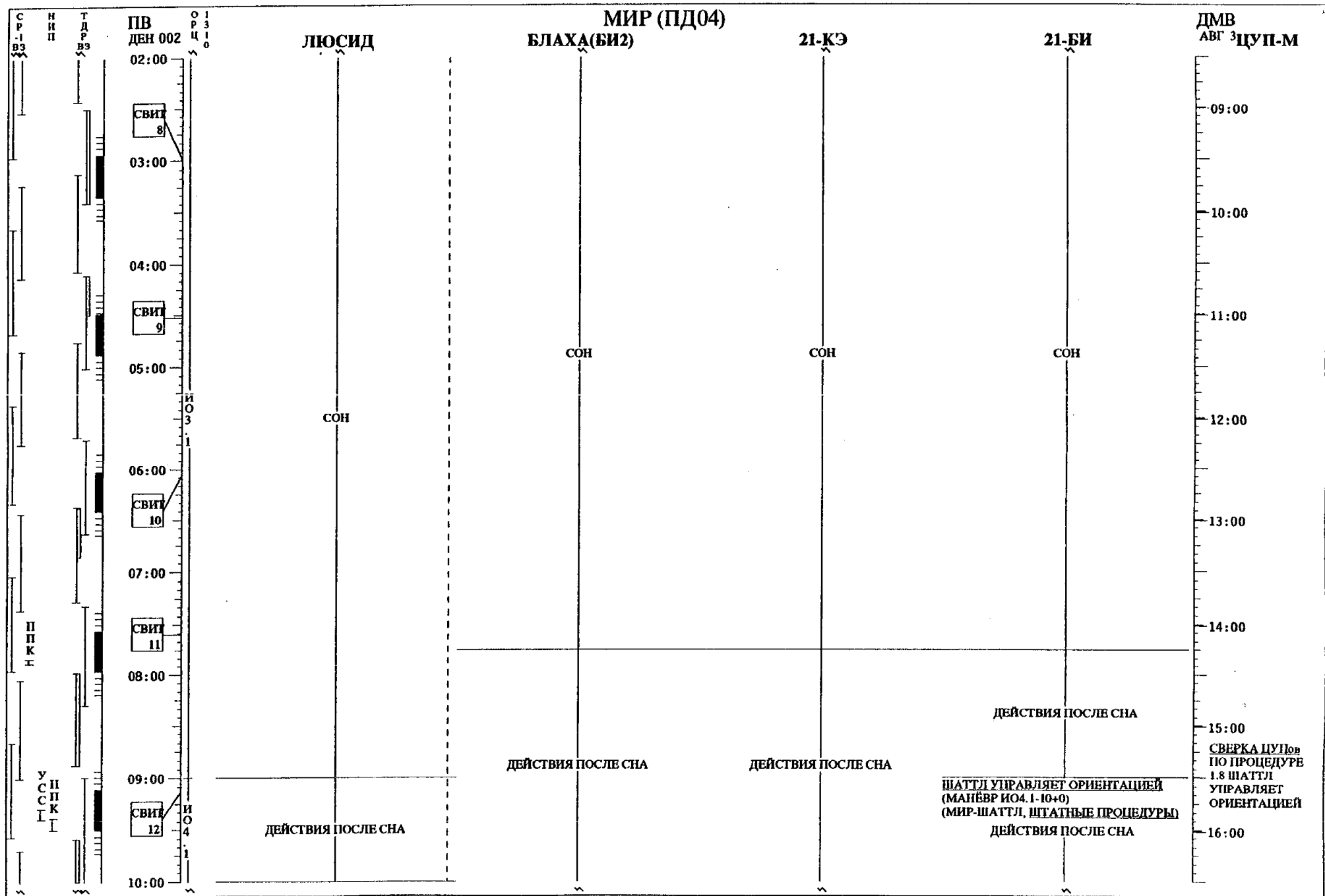

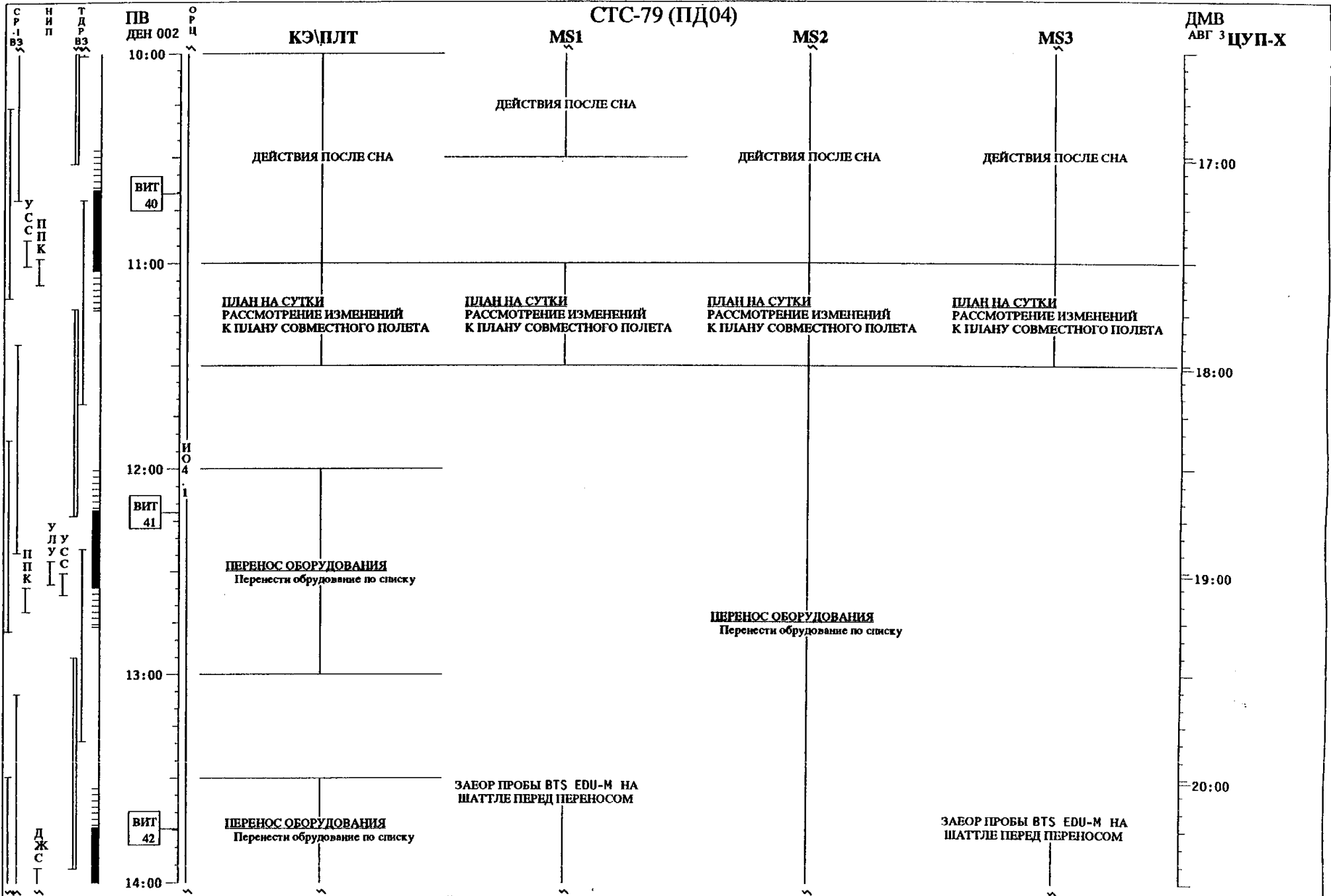

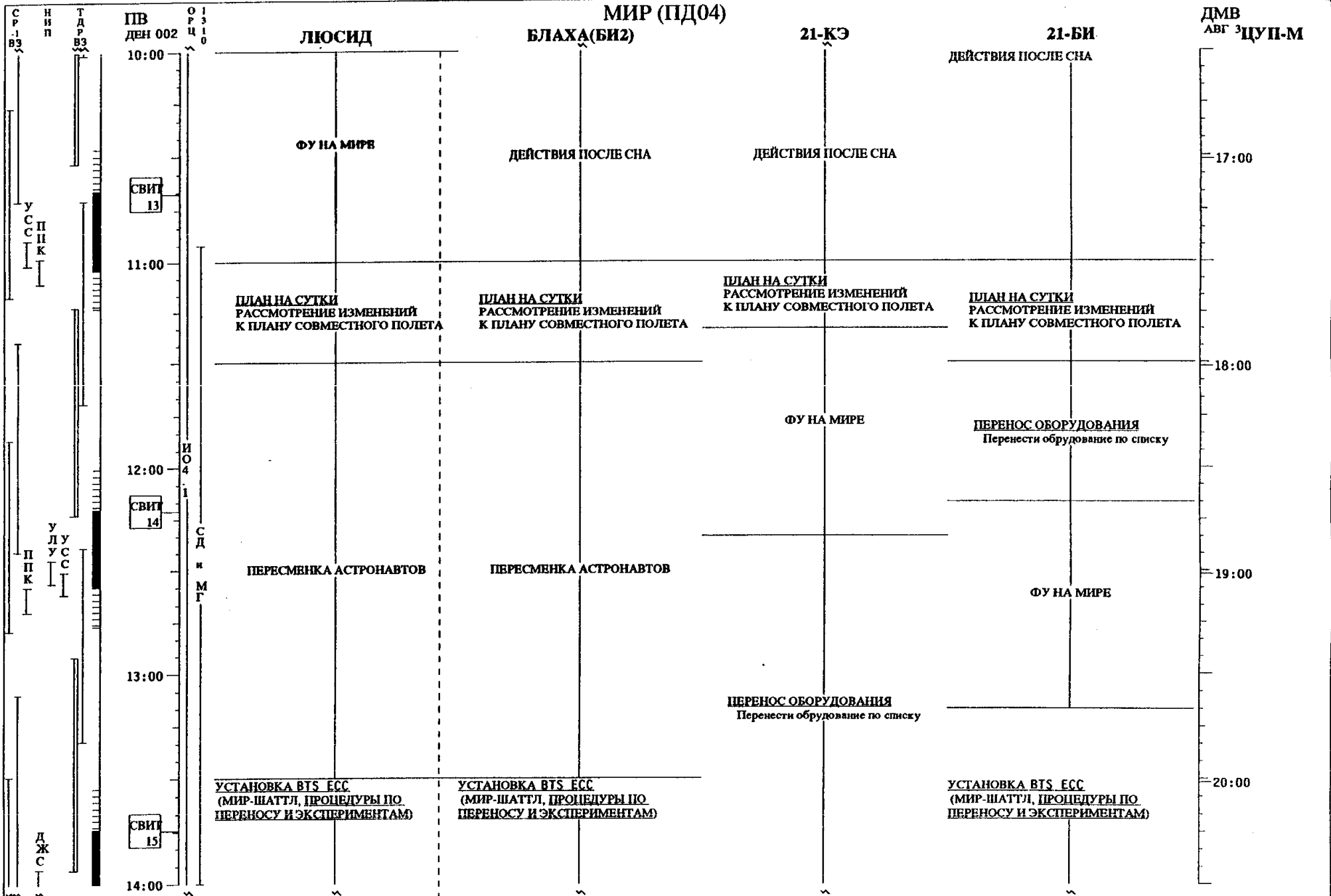

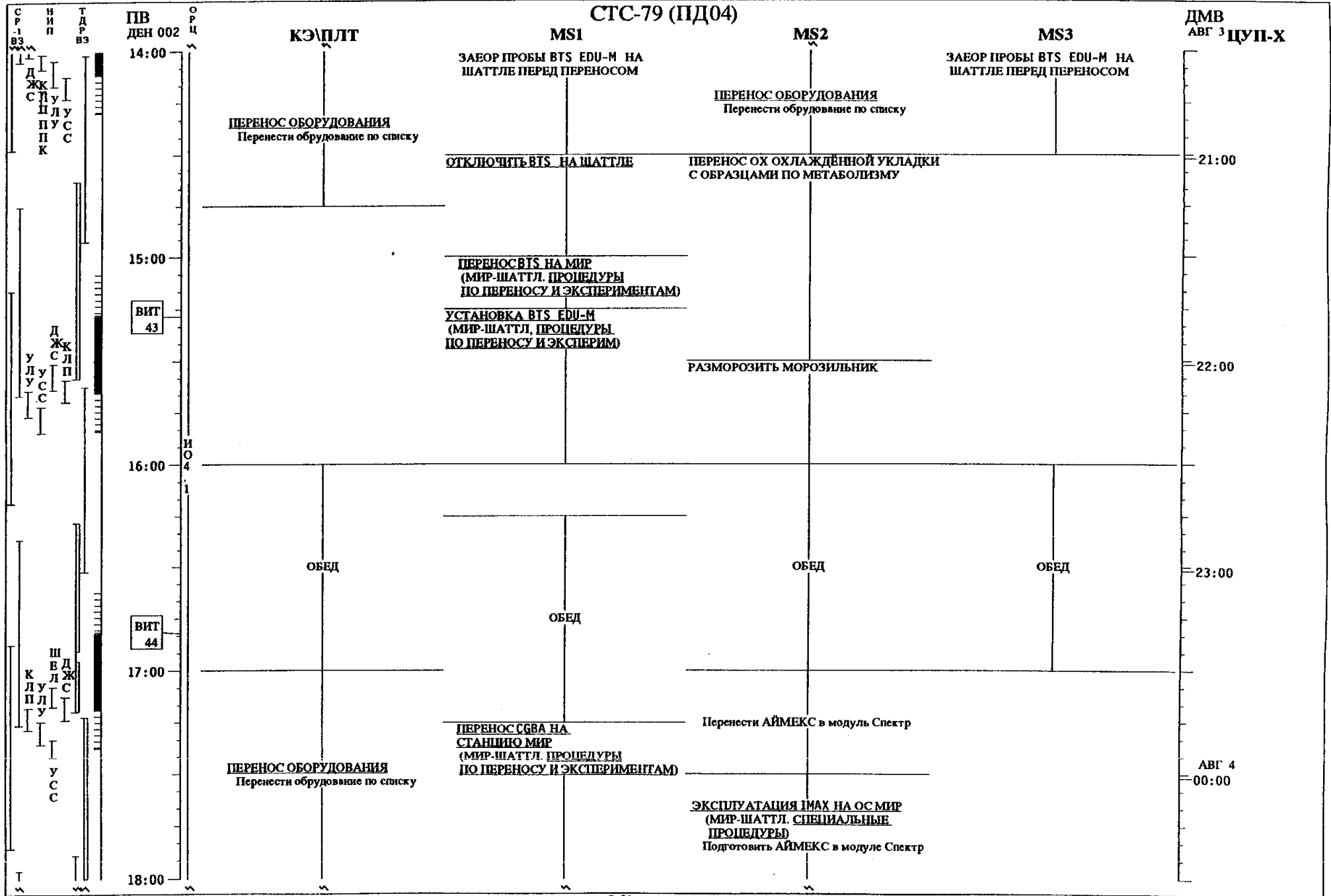

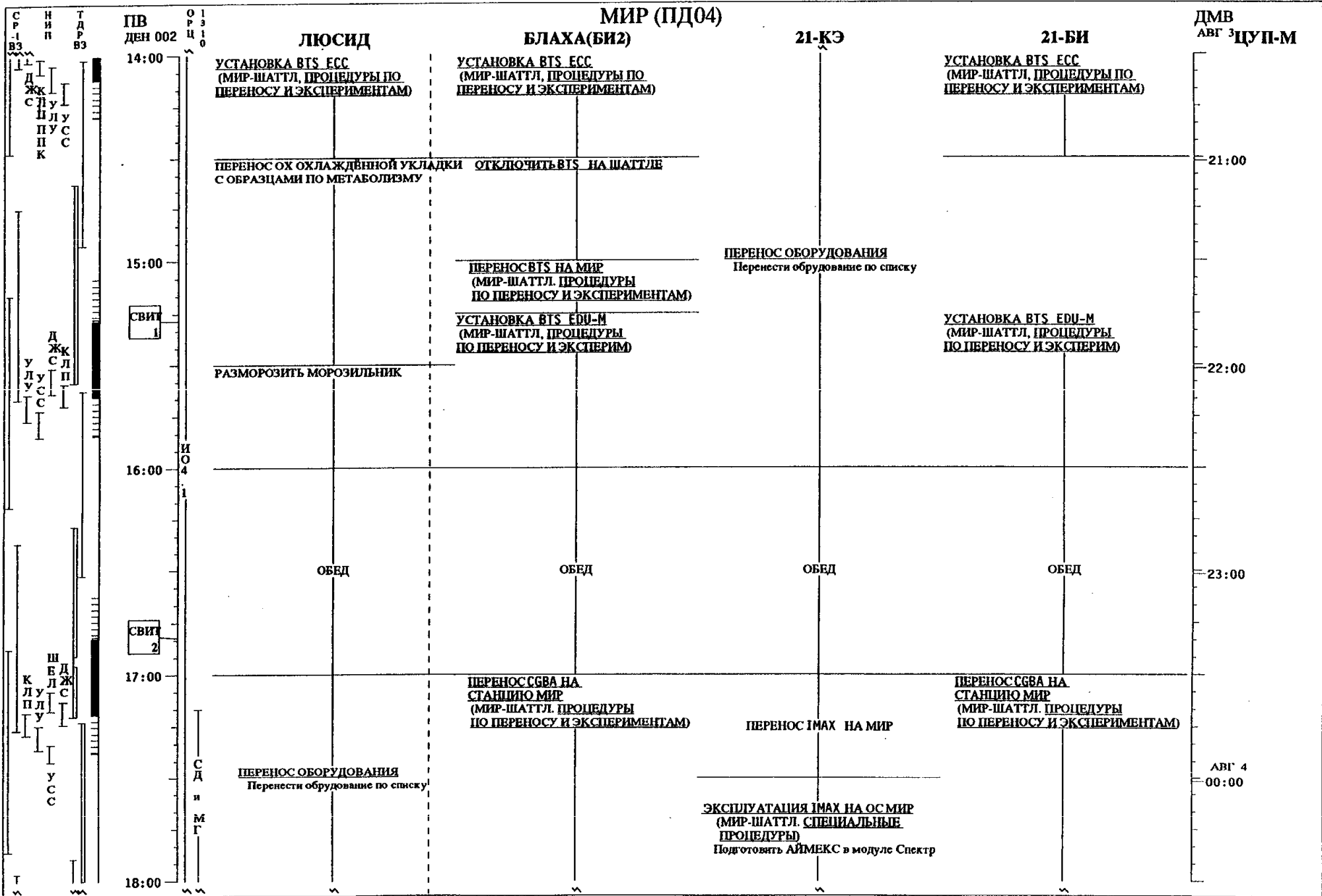



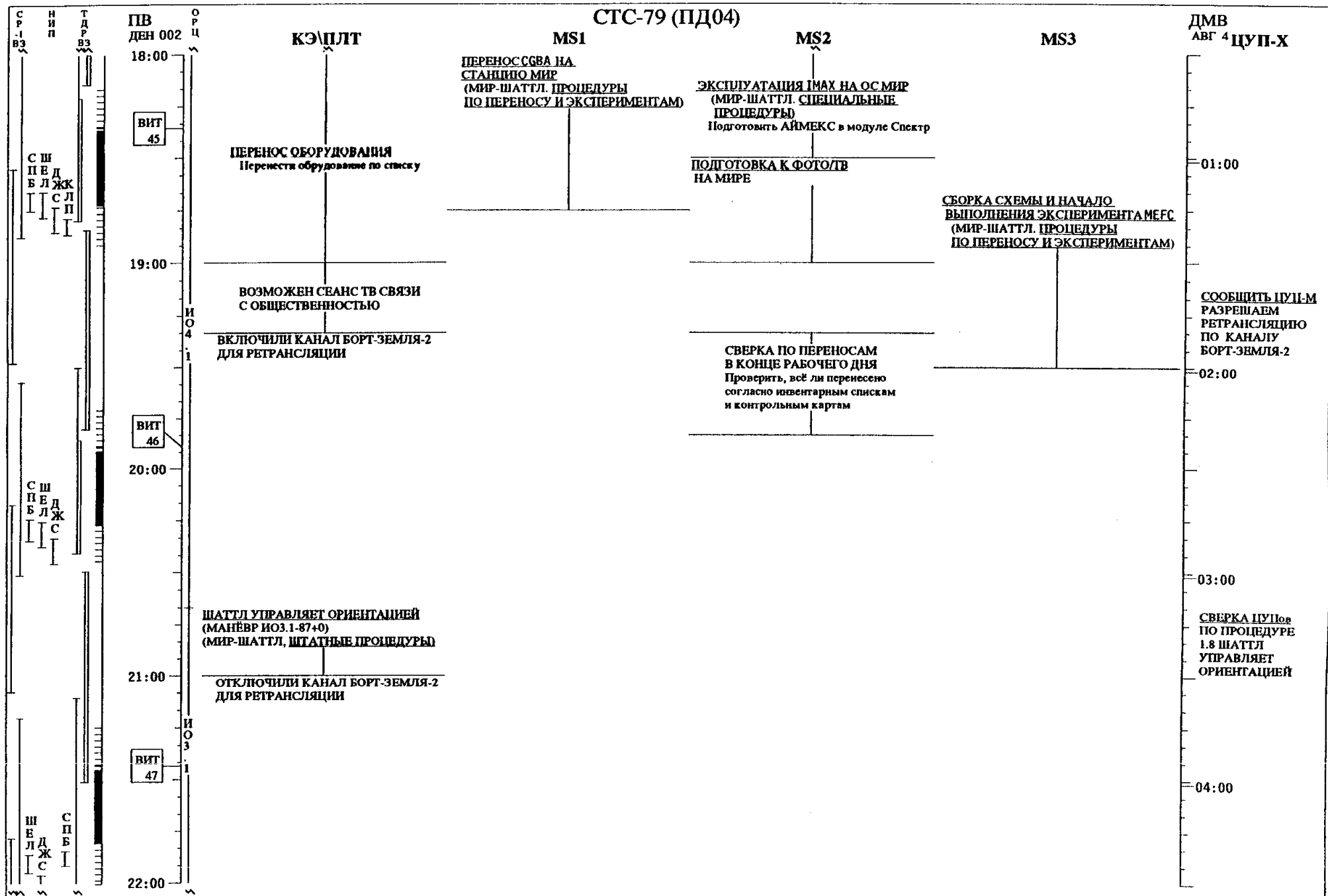

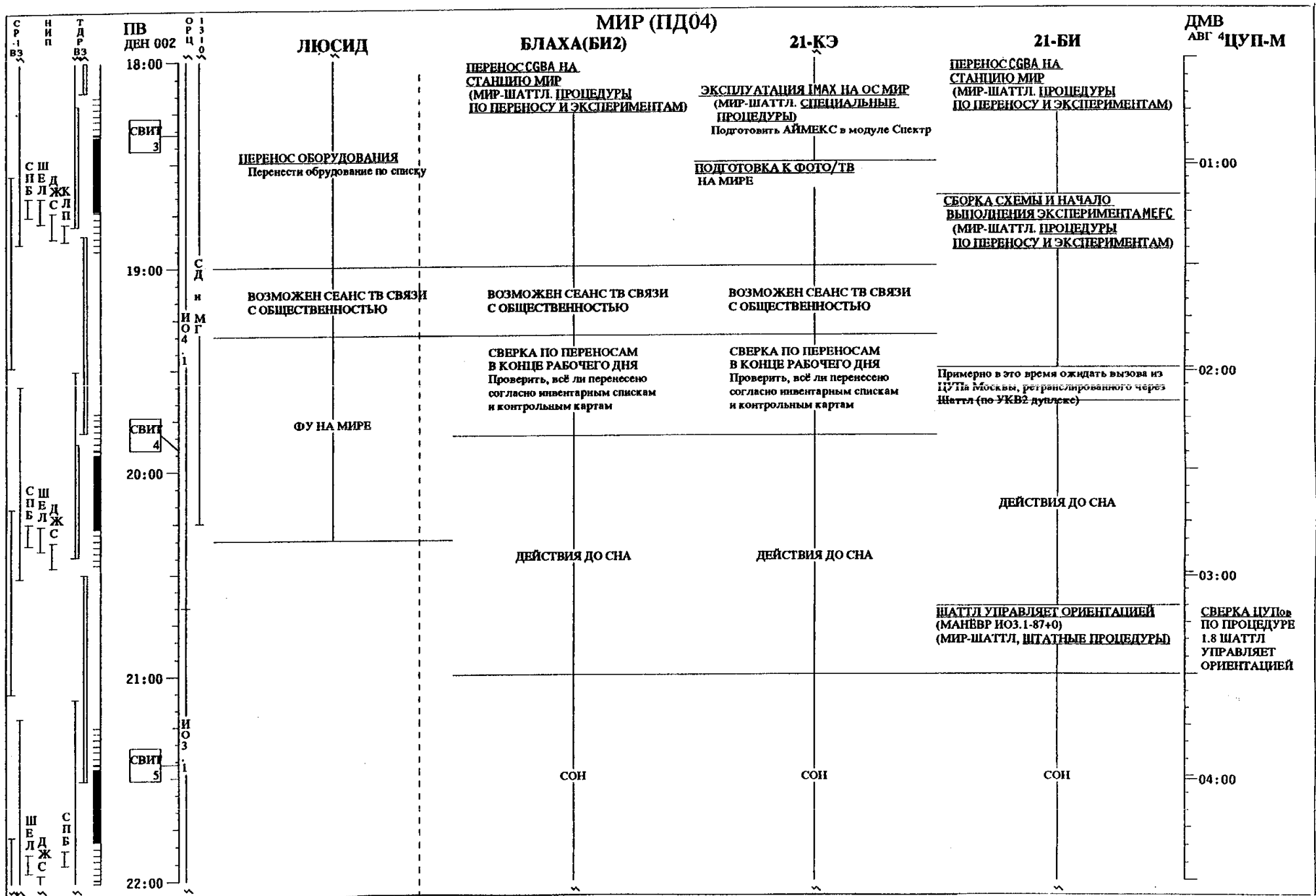

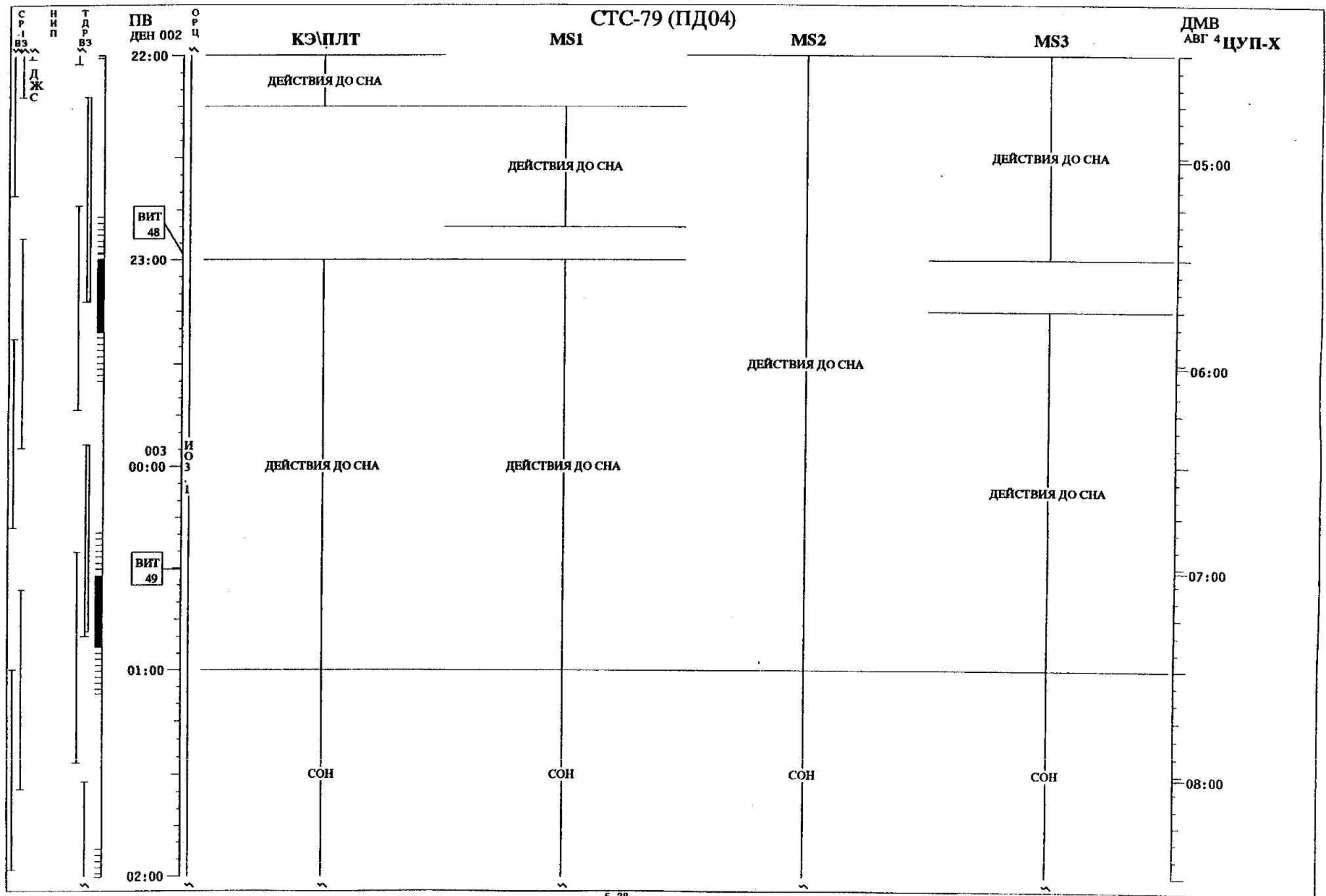

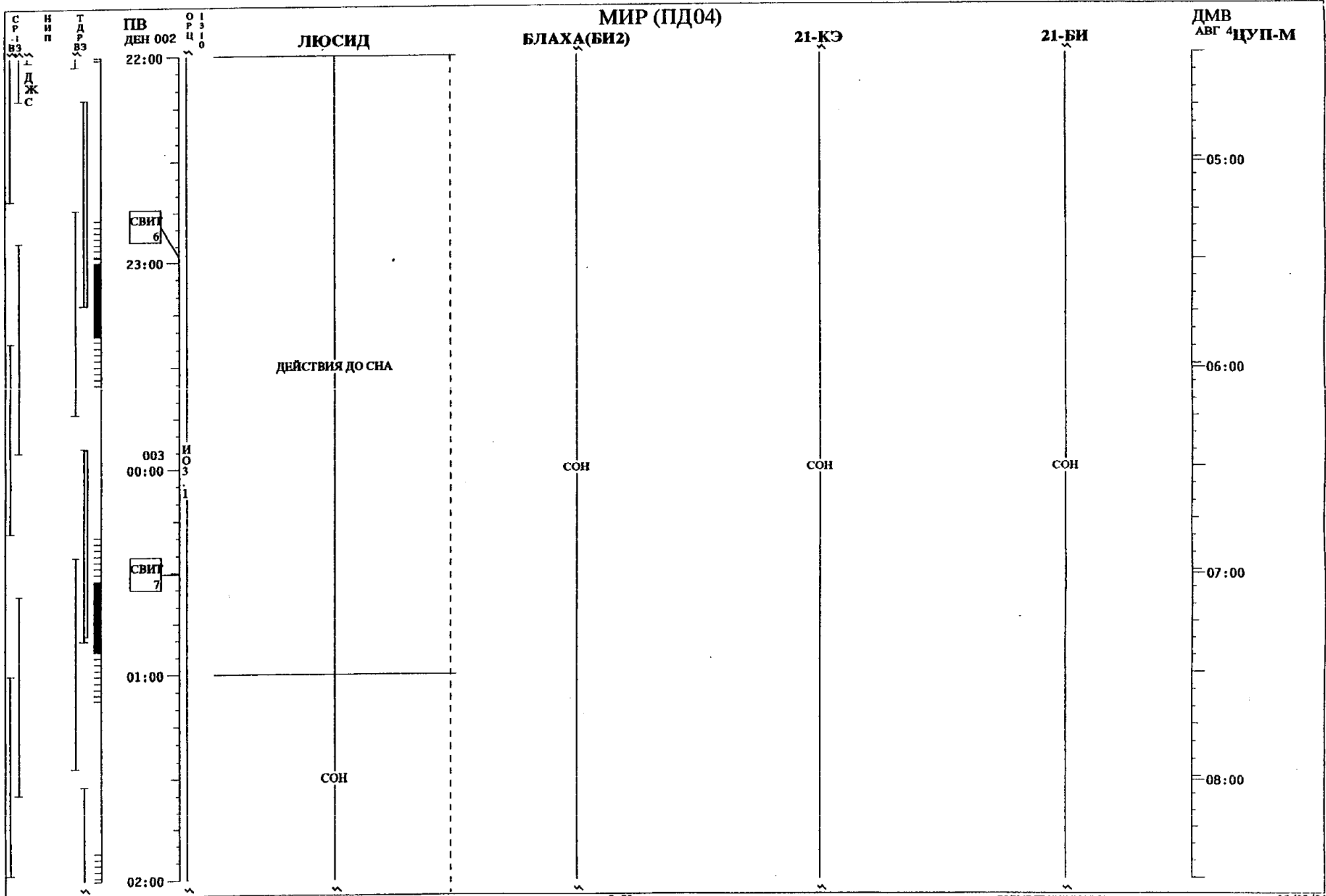

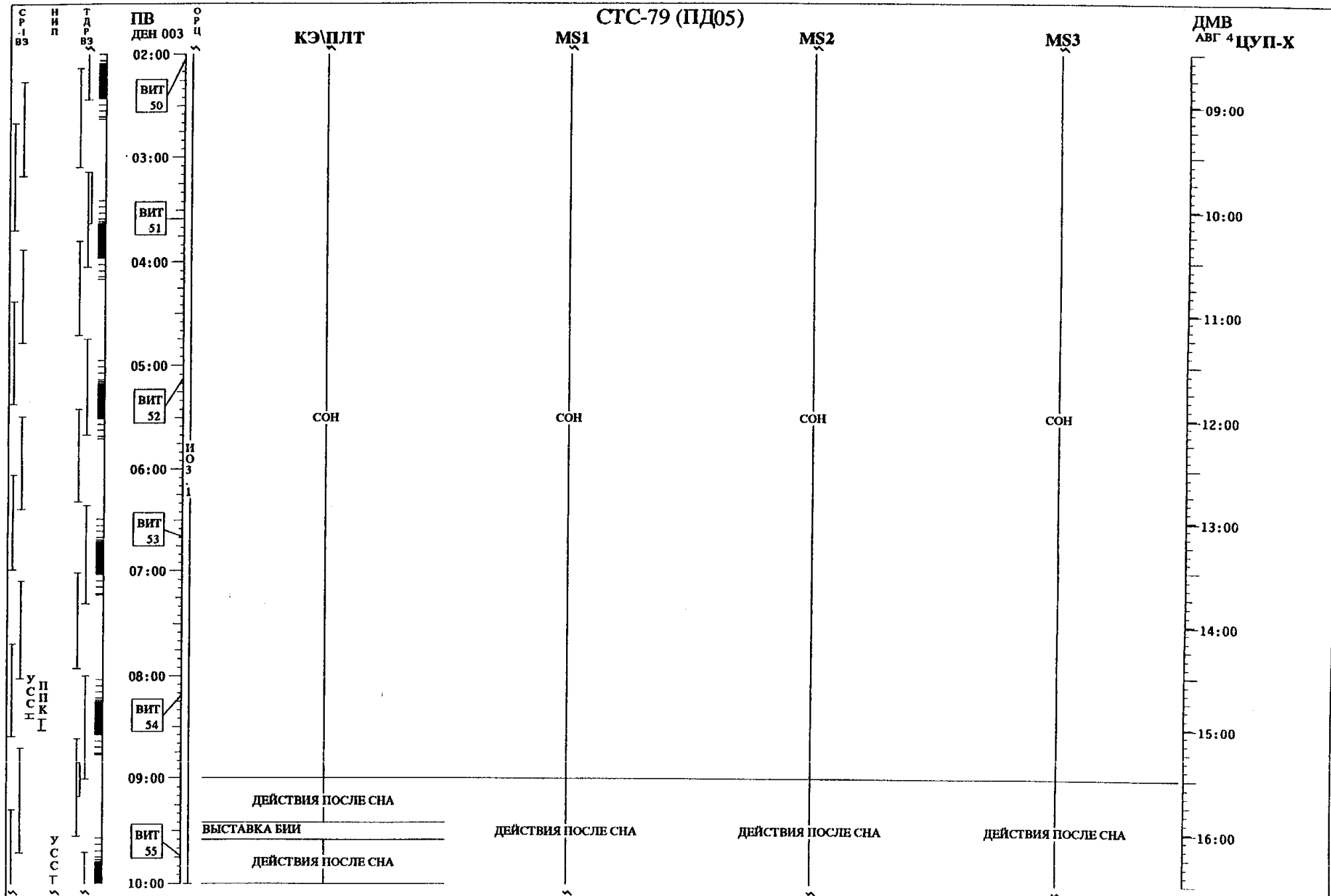

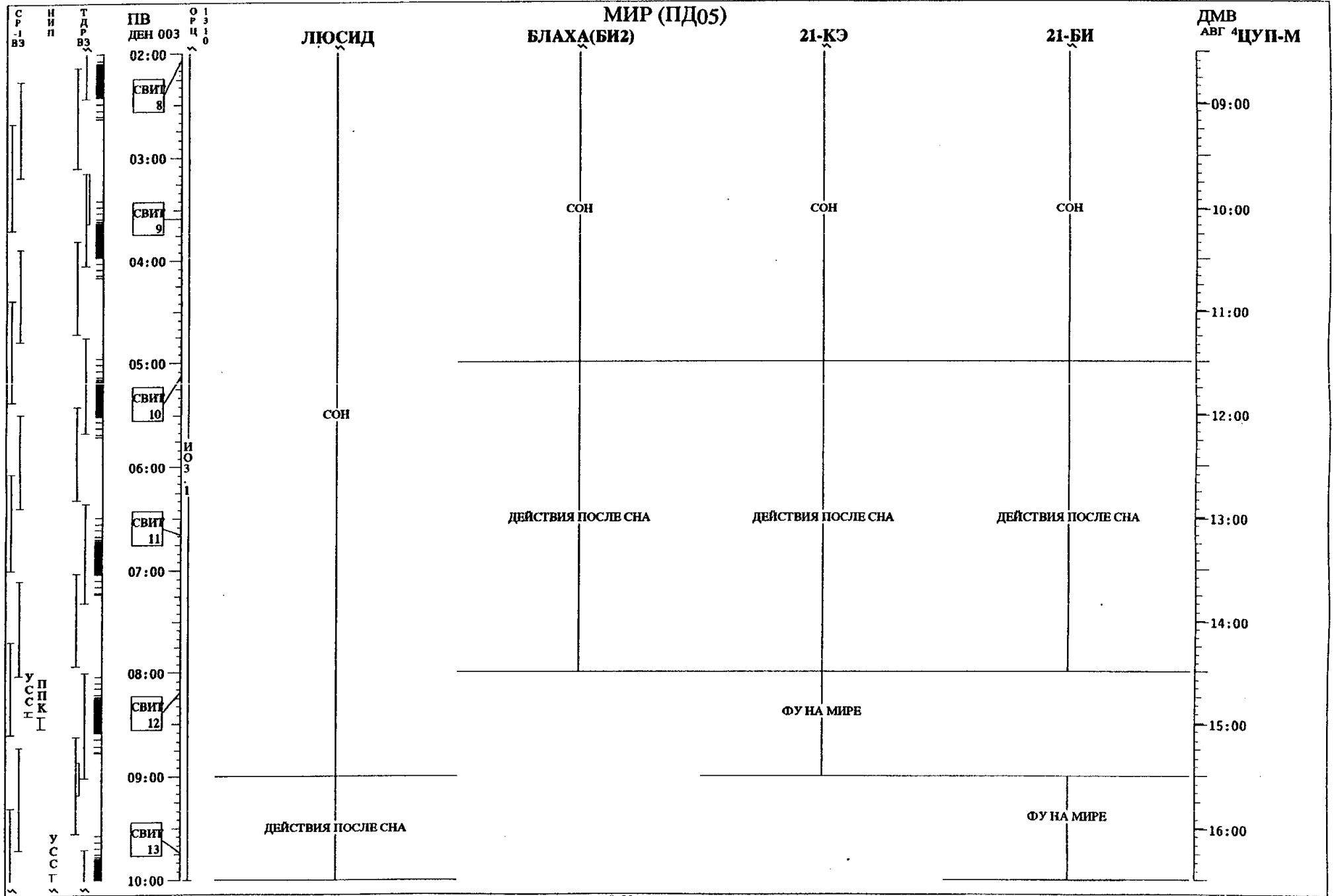

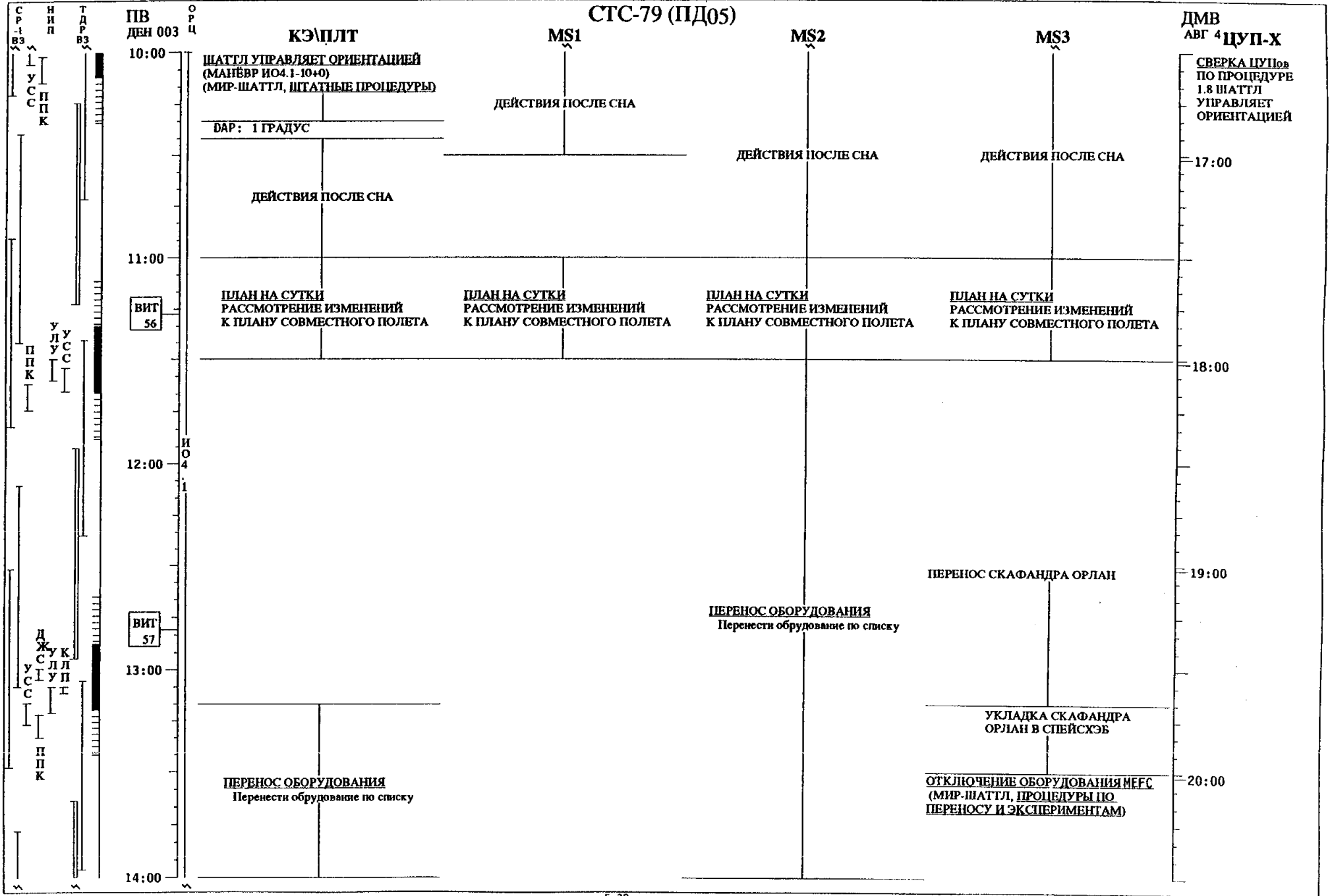

		МИР (ПД05)				ДМВ
ПВ ДЕН 003		ЛЮСИД	БЛАХА(БИ2)	21-КЭ	21-БИ	АВГ 4ЦУП-М
С Р 1 ВЗ Н И П Т Д Р ВЗ У С П П К П П К П П К Д Ж У С С Л Л П У С Л П С Л П П П П К	10:00	ФУ НА МИРЕ		ШАТТЛ УПРАВЛЯЕТ ОРИЕНТАЦИЕЙ (МАНЁВР ИО4.1-10+0) (МИР-ШАТТЛ, ШТАТНЫЕ ПРОЦЕДУРЫ)		СВЕРКА ЦУПов ПО ПРОЦЕДУРЕ 1.8 ШАТТЛ УПРАВЛЯЕТ ОРИЕНТАЦИЕЙ
	11:00	ПЛАН НА СУТКИ РАССМОТРЕНИЕ ИЗМЕНЕНИЙ К ПЛАНУ СОВМЕСТНОГО ПОЛЕТА	ПЛАН НА СУТКИ РАССМОТРЕНИЕ ИЗМЕНЕНИЙ К ПЛАНУ СОВМЕСТНОГО ПОЛЕТА	ПЛАН НА СУТКИ РАССМОТРЕНИЕ ИЗМЕНЕНИЙ К ПЛАНУ СОВМЕСТНОГО ПОЛЕТА	ПЛАН НА СУТКИ РАССМОТРЕНИЕ ИЗМЕНЕНИЙ К ПЛАНУ СОВМЕСТНОГО ПОЛЕТА	
	12:00			ПЕРЕНОС ОБОРУДОВАНИЯ Перенести оборудование по списку	ПЕРЕНОС ОБОРУДОВАНИЯ Перенести оборудование по списку	
	13:00	ПЕРЕСМЕНКА АСТРОНАВТОВ	ПЕРЕСМЕНКА АСТРОНАВТОВ	ПЕРЕНОС СКАФАНДРА ОРЛАН	ПЕРЕНОС СКАФАНДРА ОРЛАН	
	14:00			УКЛАДКА СКАФАНДРА ОРЛАН В СПЕЙСХЭБ	УКЛАДКА СКАФАНДРА ОРЛАН В СПЕЙСХЭБ	
				ПЕРЕНОС ОБОРУДОВАНИЯ Перенести оборудование по списку	ОТКЛЮЧЕНИЕ ОБОРУДОВАНИЯ МЕГС (МИР-ШАТТЛ, ПРОЦЕДУРЫ ПО ПЕРЕНОСУ И ЭКСПЕРИМЕНТАМ)	



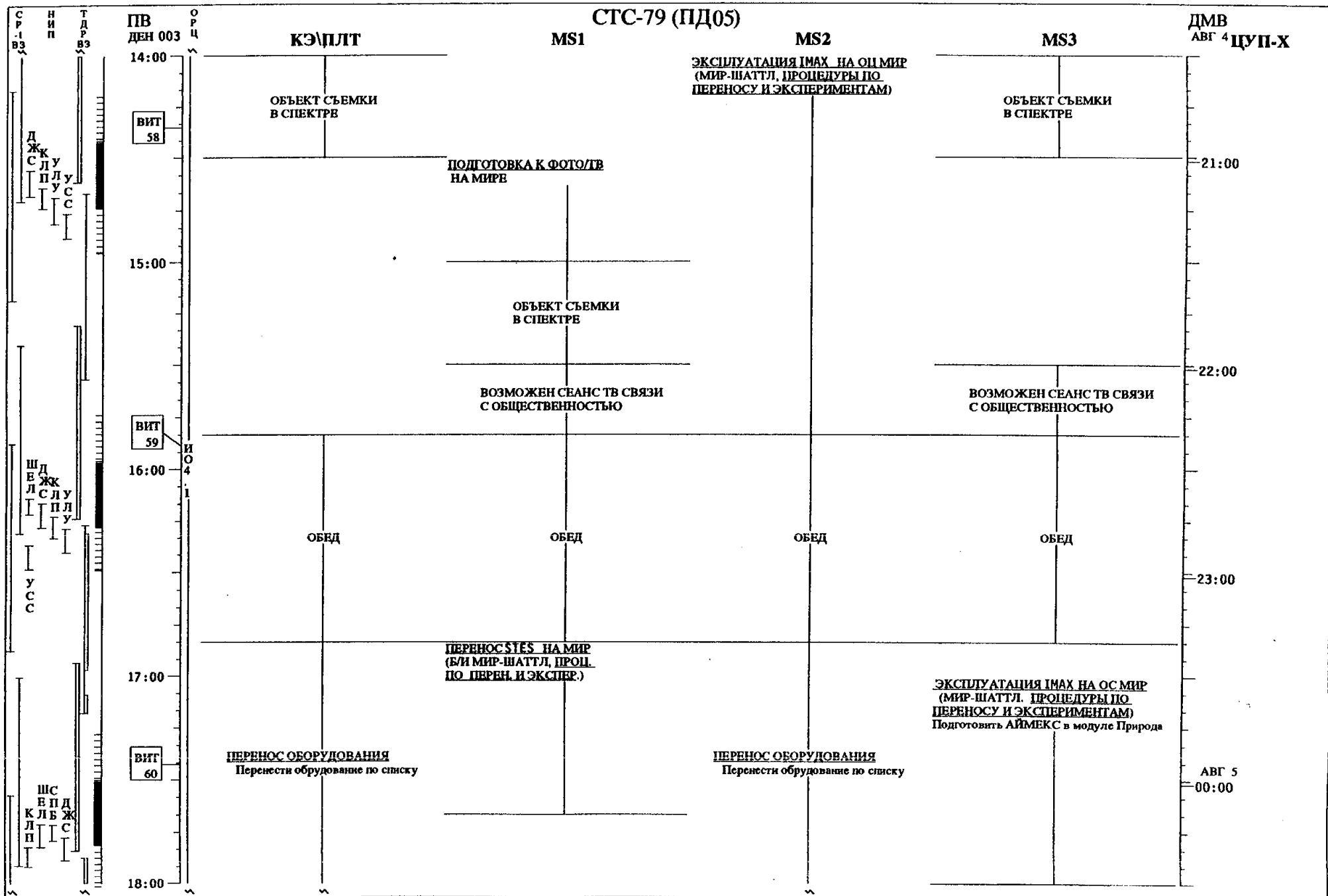

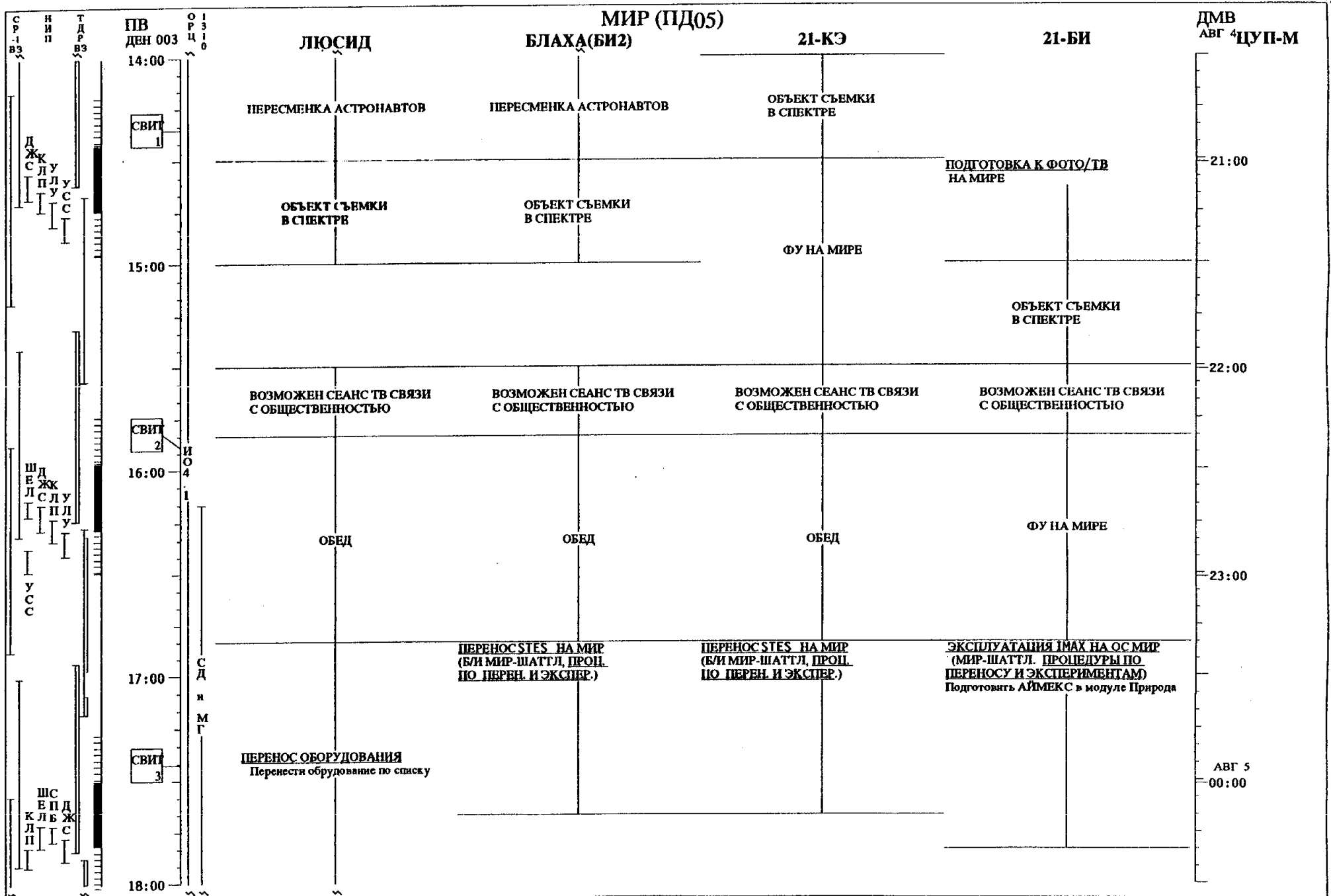

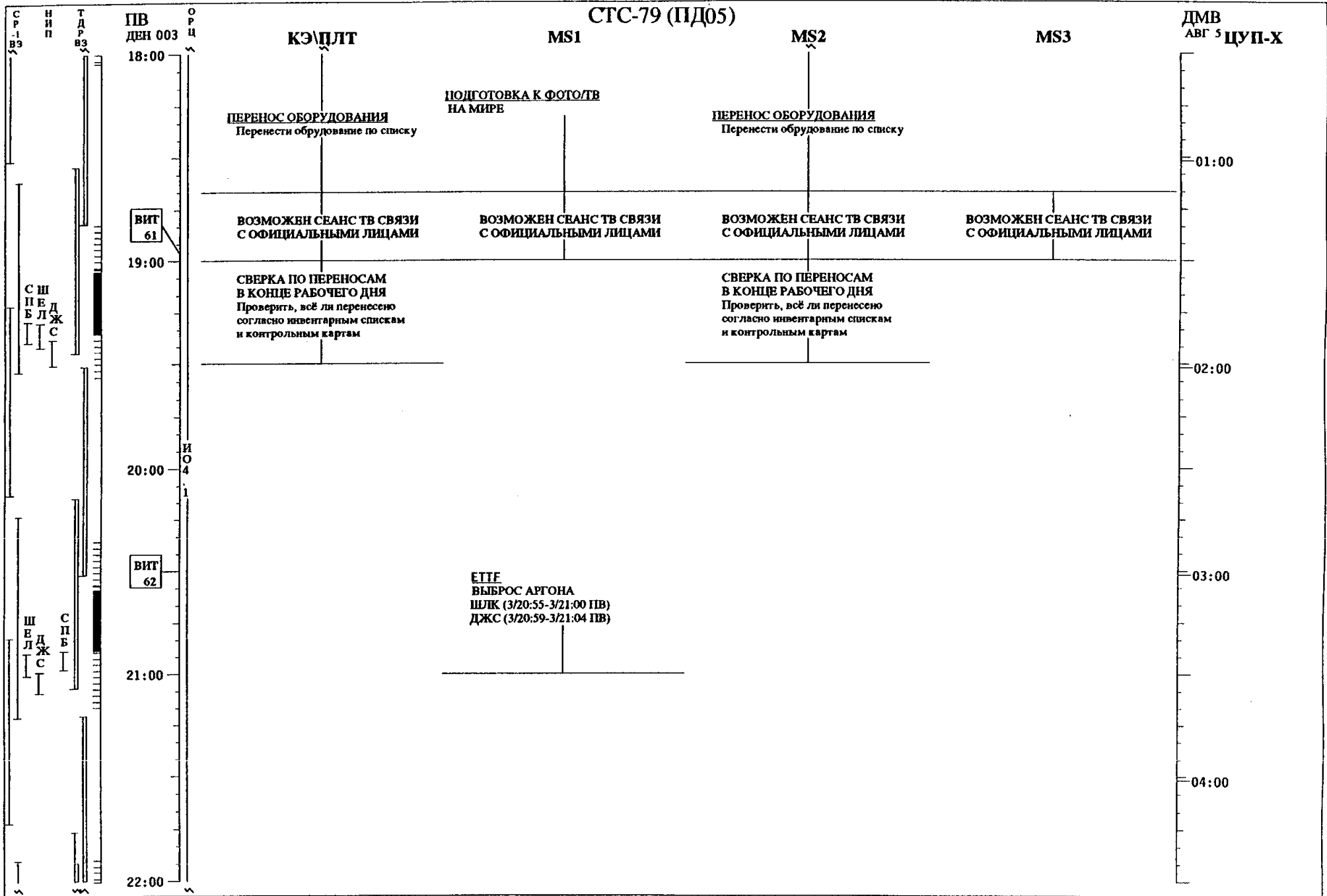

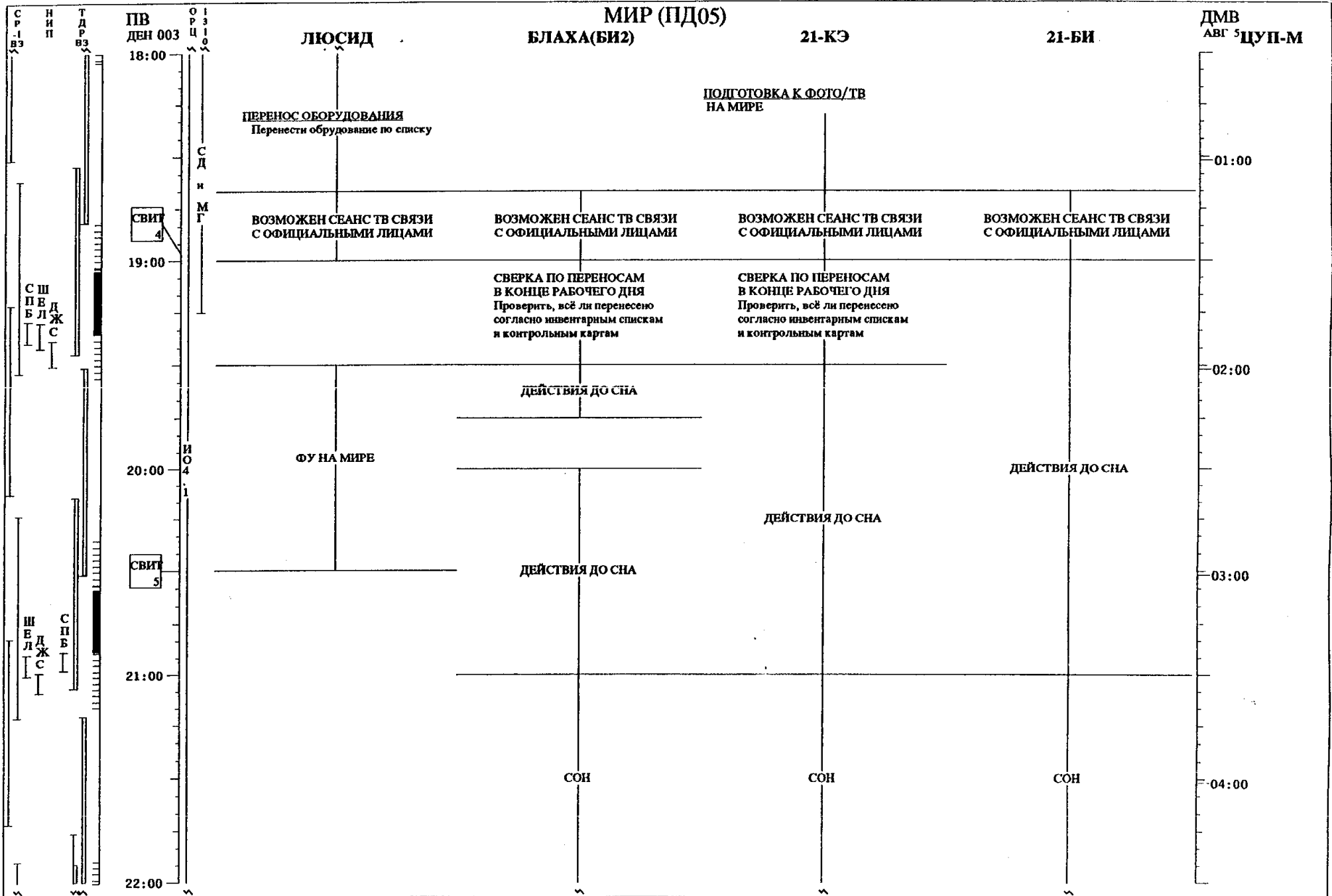

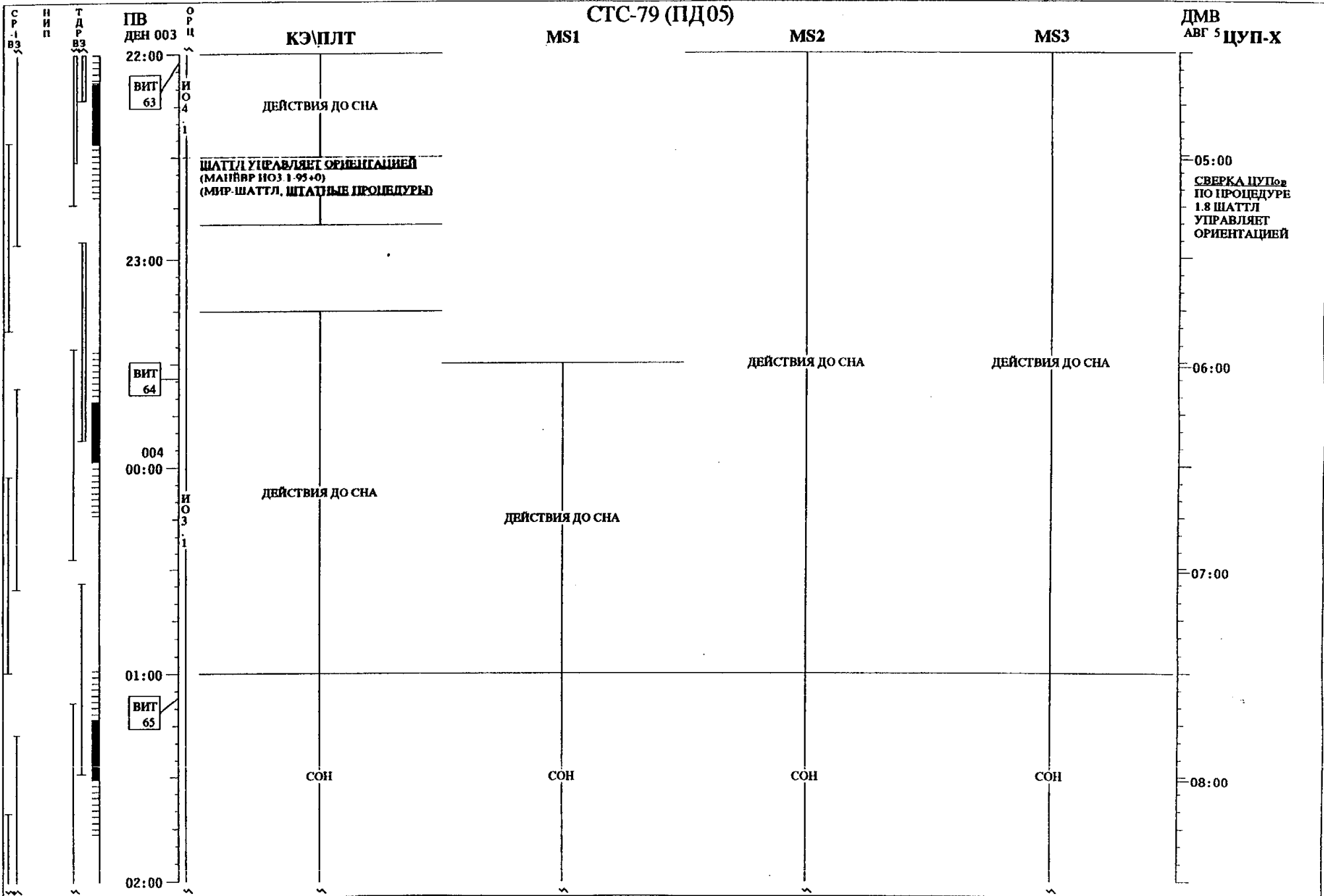

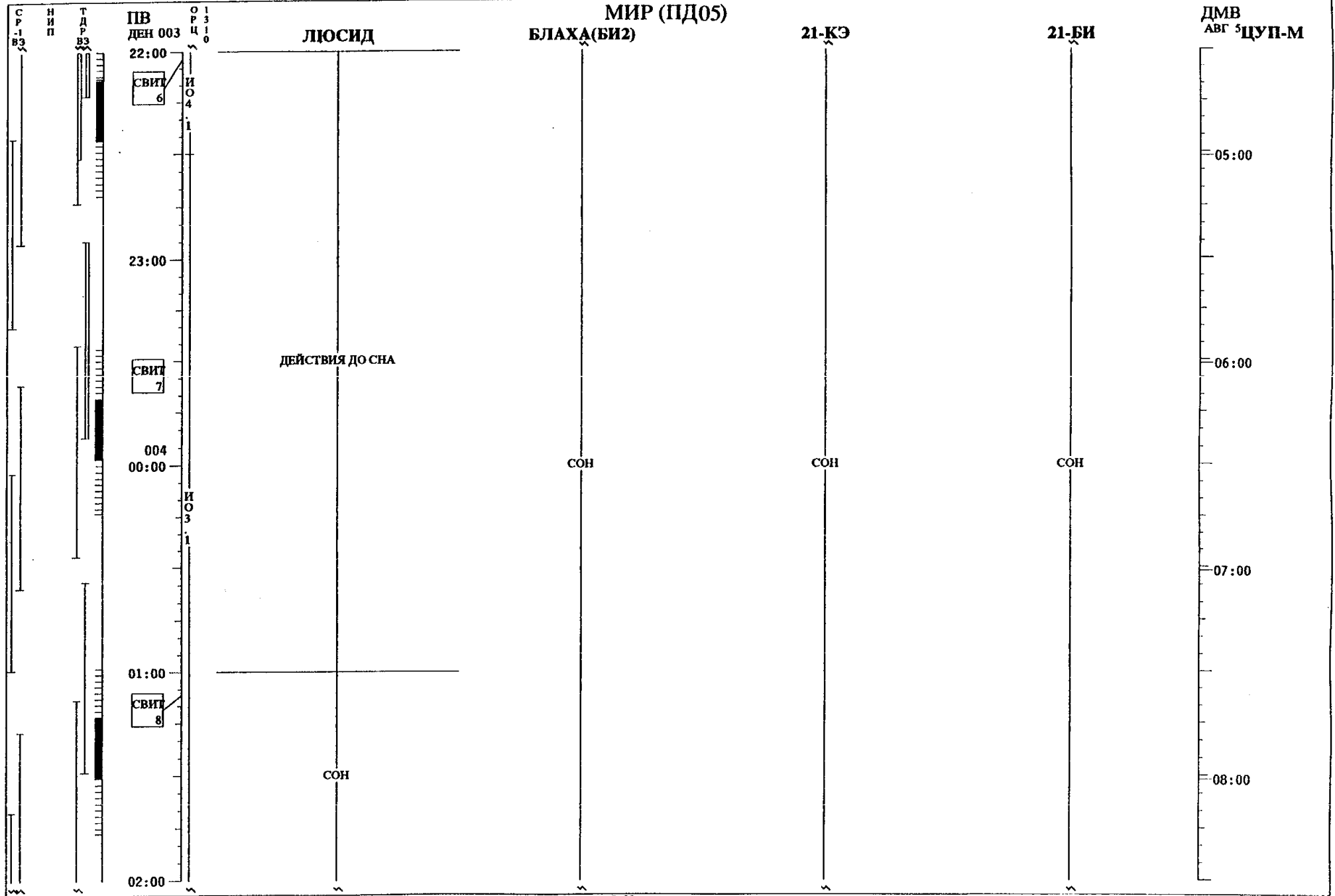

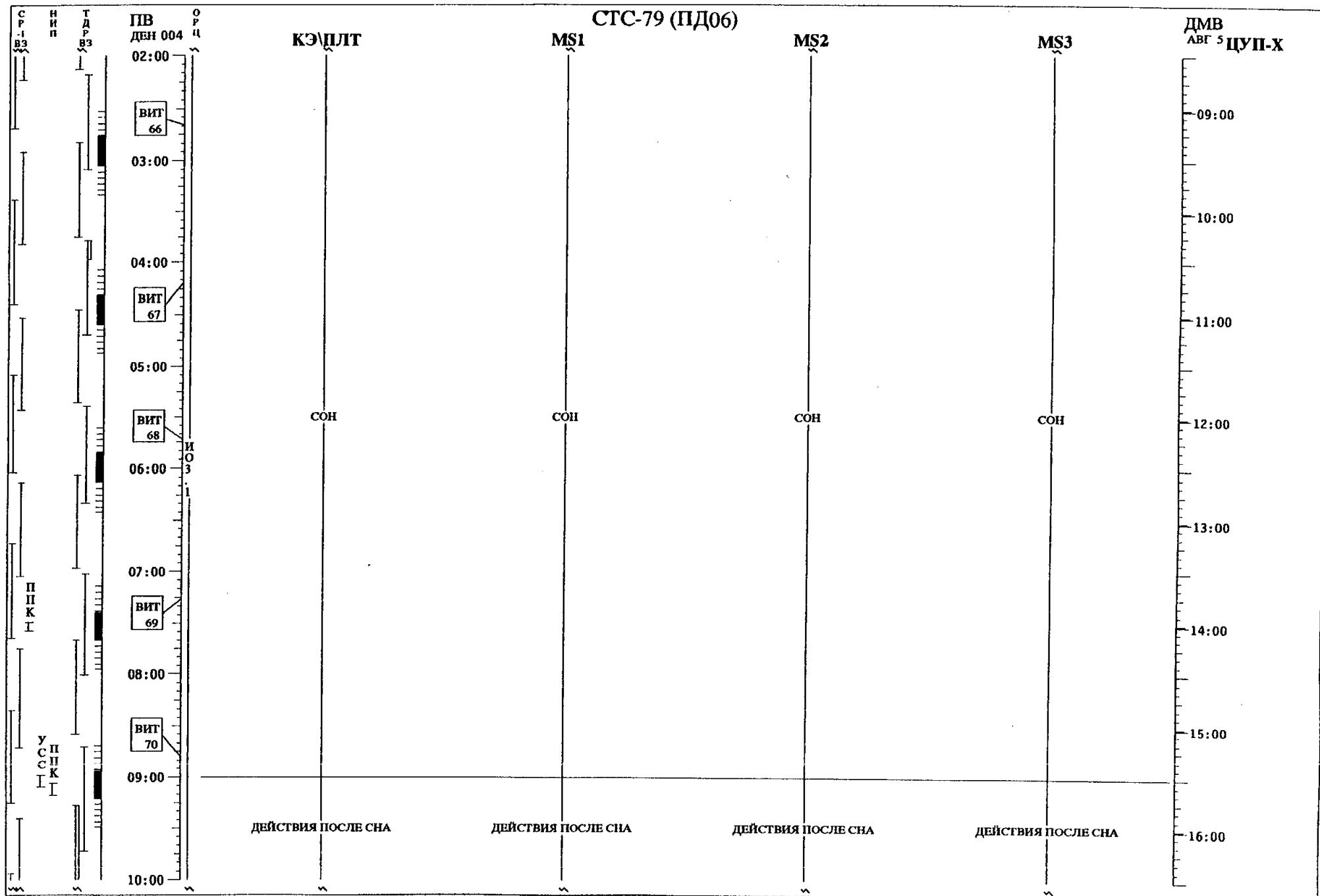

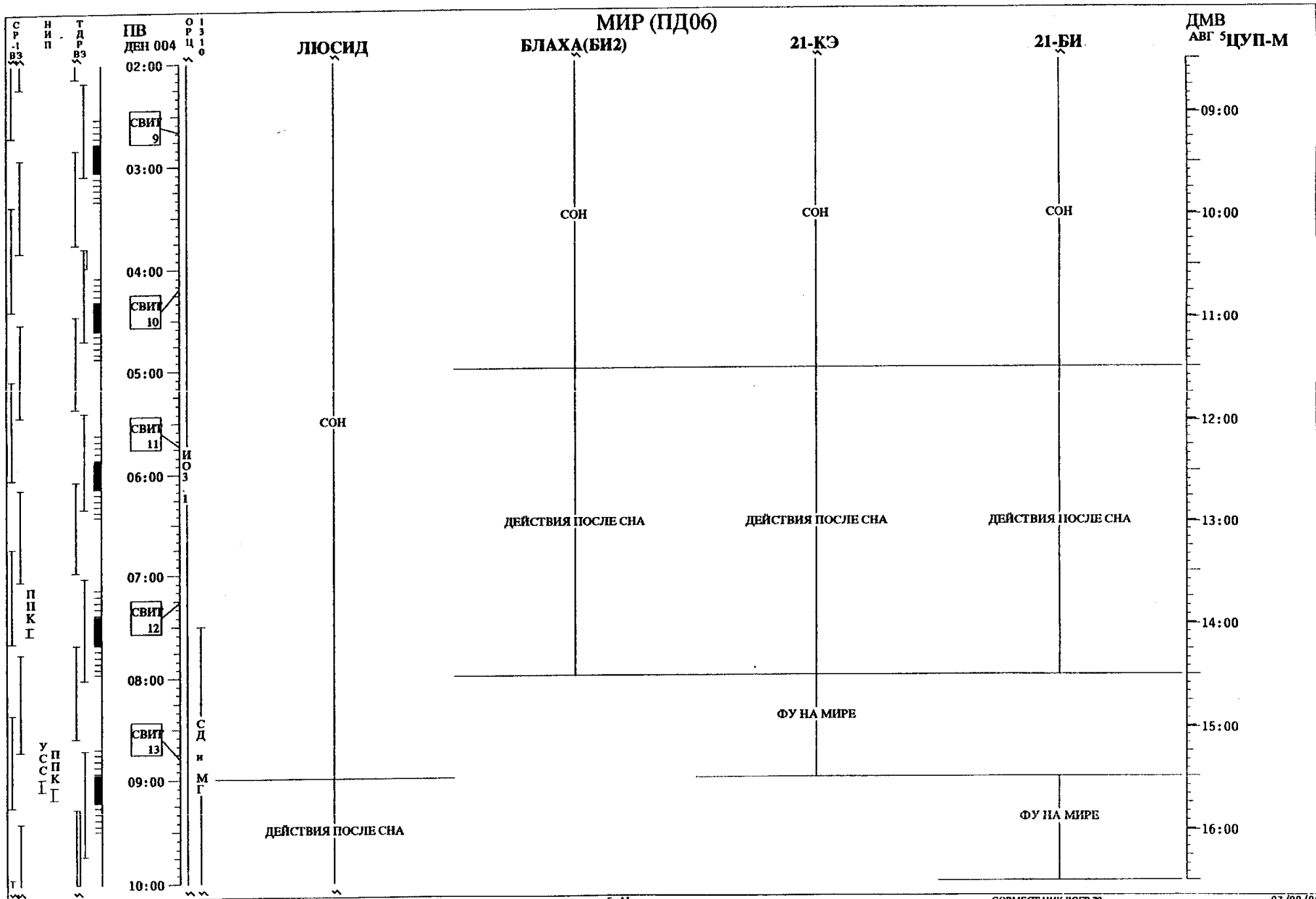



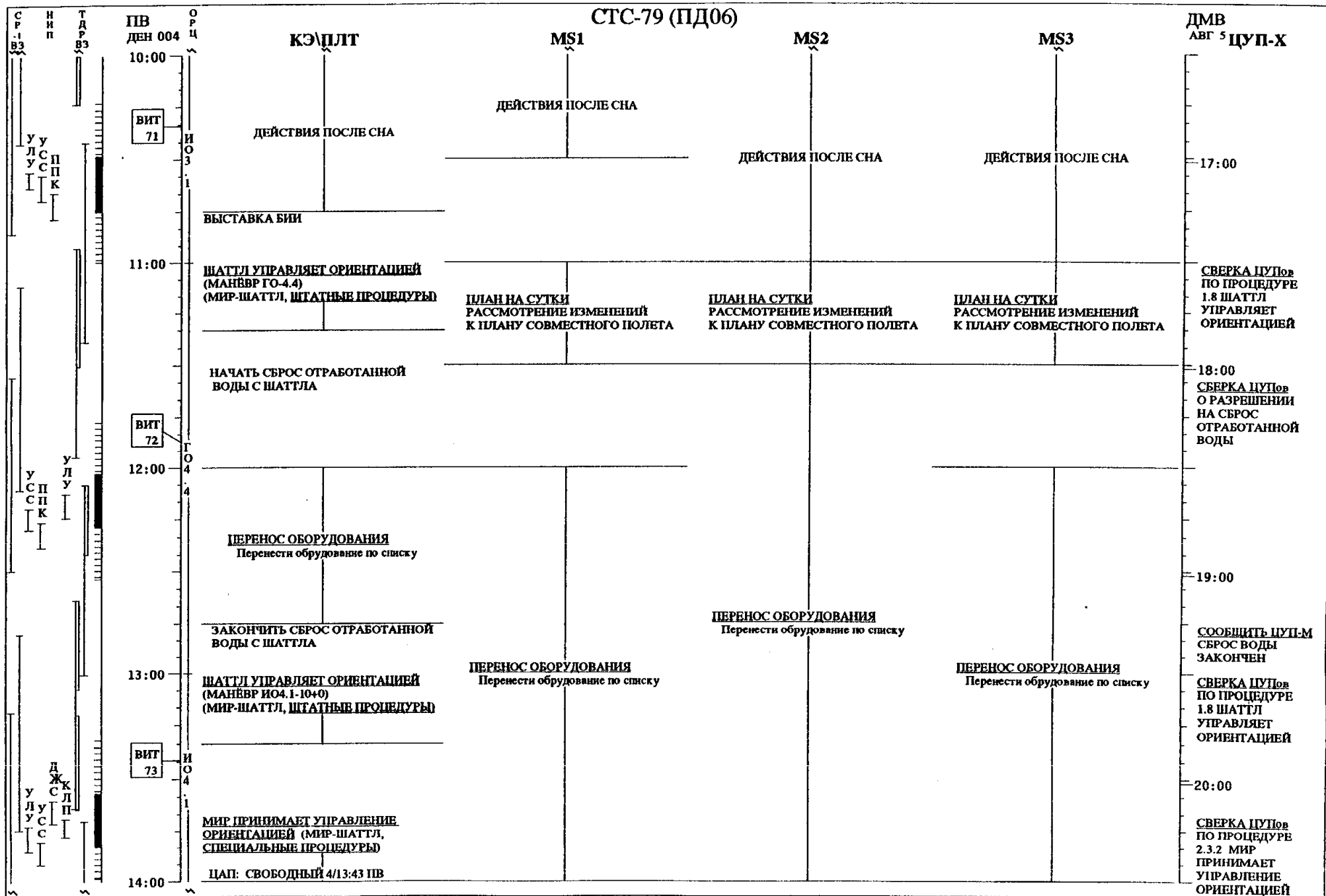

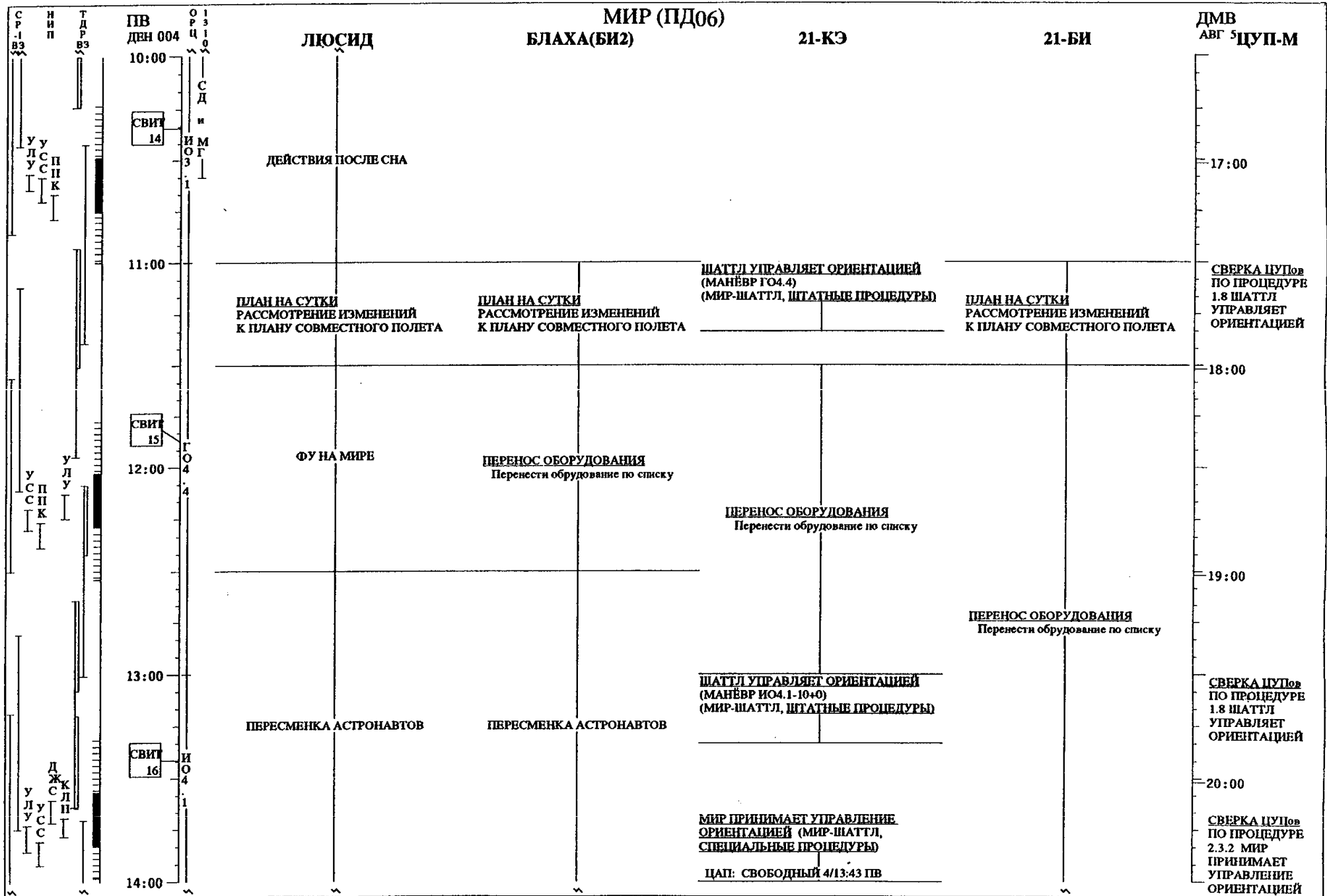

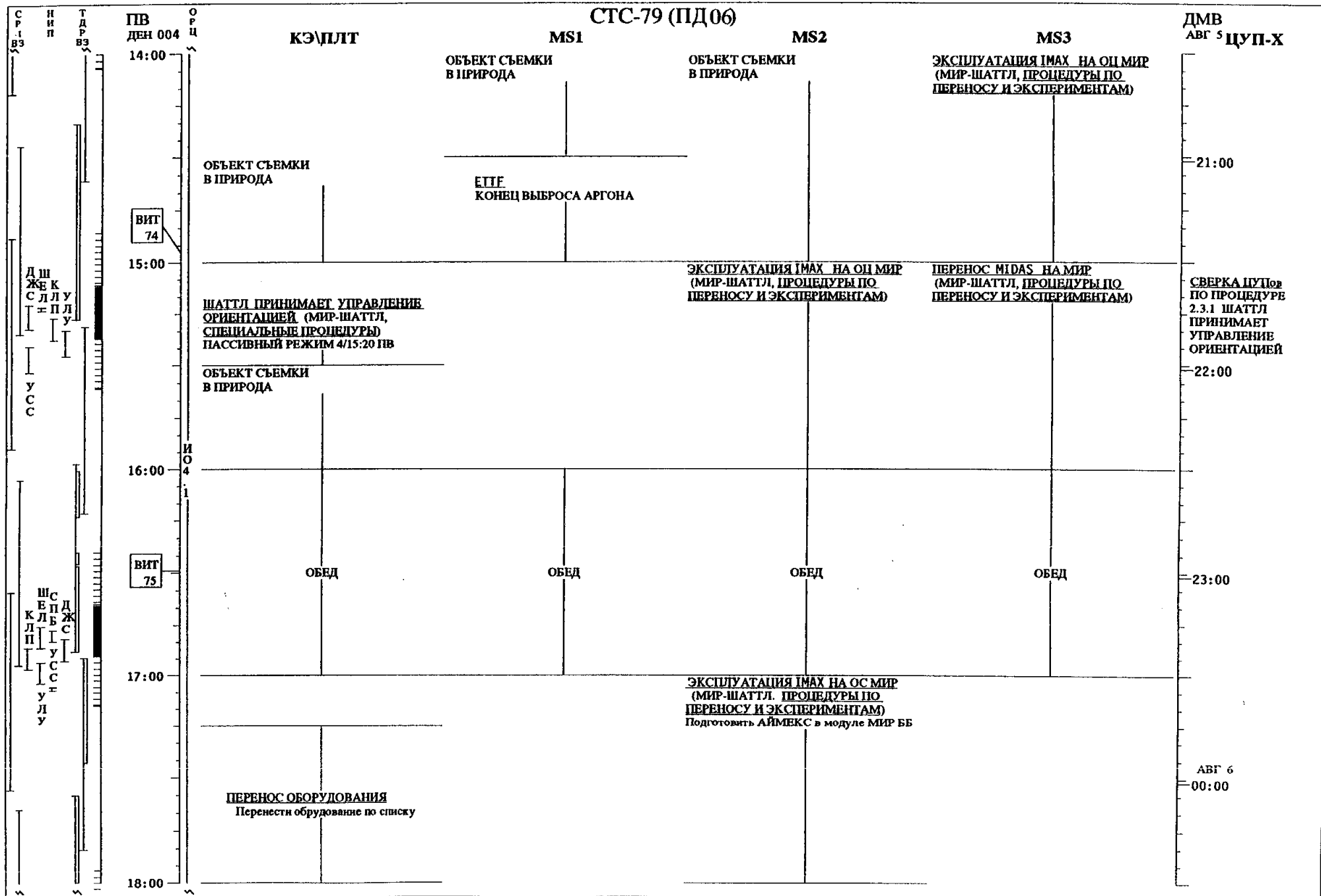

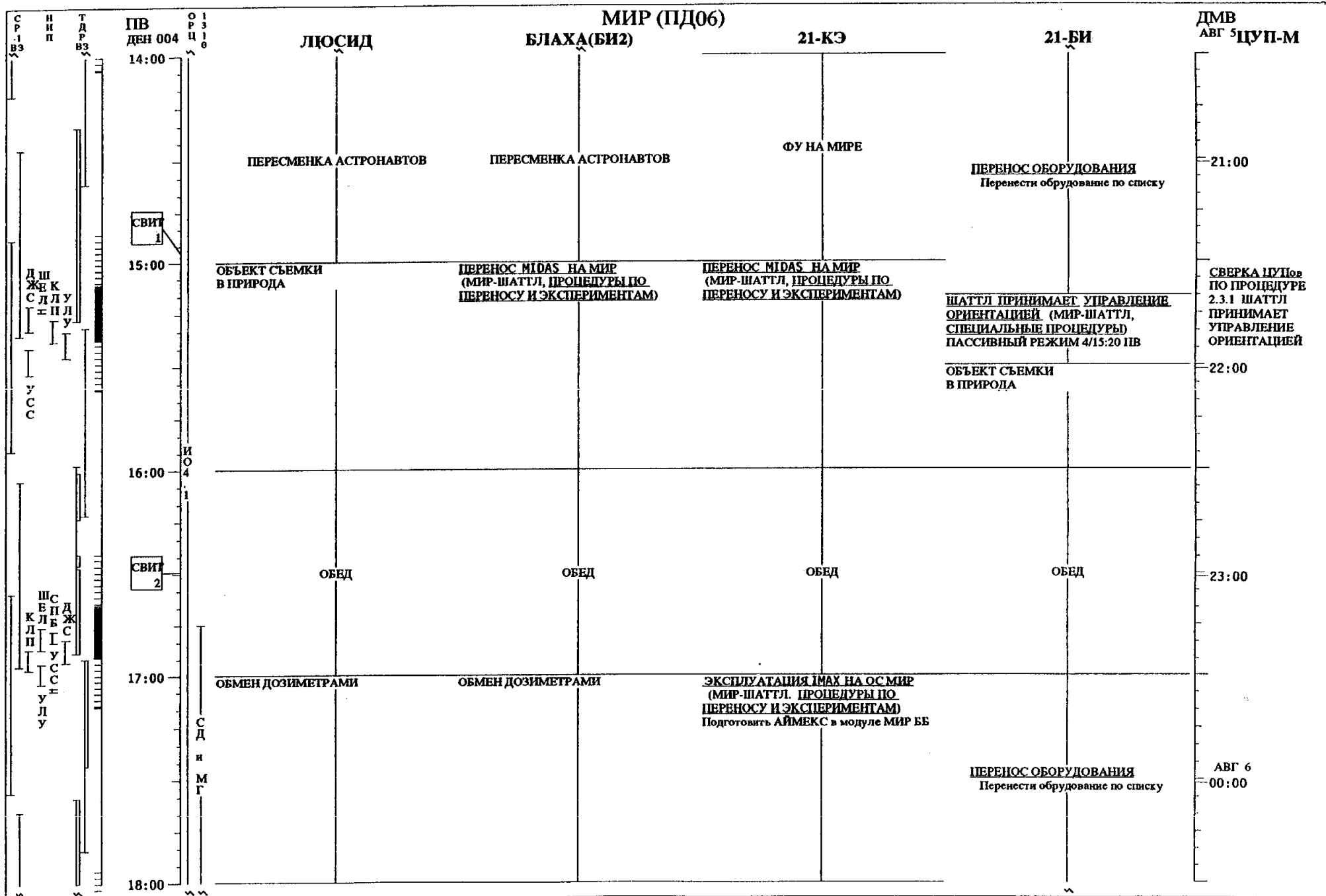

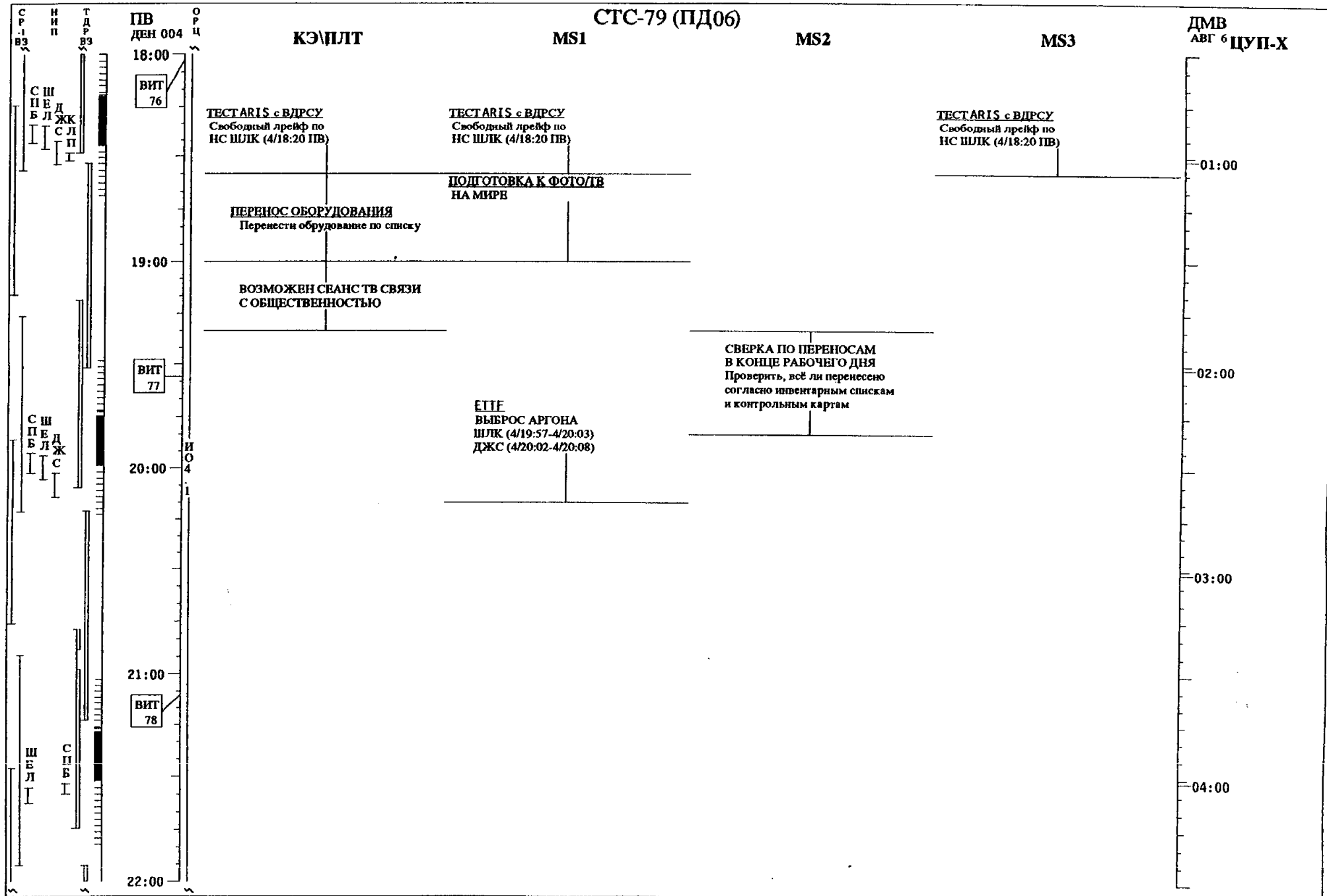

		МИР (ПД06)				
		ЛЮСИД	БЛАХА(БИ2)	21-КЭ	21-БИ	ДМВ АВГ 6ЦУП-М
С Р 1 ВЗ Н И П Т Д Р ВЗ С Ш П Е Д Ж К Л С П Г Б Л Ж С П Г С Ш П Е Д Ж К Л С П Г Б Л Ж С П Г Ш Е Л С П В Г	ПВ ДЕН 004					
	18:00	ПЕРЕСМЕНКА АСТРОНАВТОВ	ПЕРЕСМЕНКА АСТРОНАВТОВ	ТЕСТARIS с ВАРСУ Свободный дрейф по НС ШЛК (4/18:20 ПВ)	ПЕРЕНОС ОБОРУДОВАНИЯ Перенести оборудование по списку	01:00
	19:00	ВОЗМОЖЕН СЕАНС ТВ СВЯЗИ С ОБЩЕСТВЕННОСТЬЮ	ВОЗМОЖЕН СЕАНС ТВ СВЯЗИ С ОБЩЕСТВЕННОСТЬЮ	ВОЗМОЖЕН СЕАНС ТВ СВЯЗИ С ОБЩЕСТВЕННОСТЬЮ	ВОЗМОЖЕН СЕАНС ТВ СВЯЗИ С ОБЩЕСТВЕННОСТЬЮ	
	20:00		СВЕРКА ПО ПЕРЕНОСАМ В КОНЦЕ РАБОЧЕГО ДНЯ Проверить, всё ли перенесено согласно инвентарным спискам и контрольным картам	СВЕРКА ПО ПЕРЕНОСАМ В КОНЦЕ РАБОЧЕГО ДНЯ Проверить, всё ли перенесено согласно инвентарным спискам и контрольным картам		02:00
	21:00	ФУ НА МИРЕ	ДЕЙСТВИЯ ДО СНА	ДЕЙСТВИЯ ДО СНА	ДЕЙСТВИЯ ДО СНА	03:00
22:00			СОН	СОН	СОН	04:00

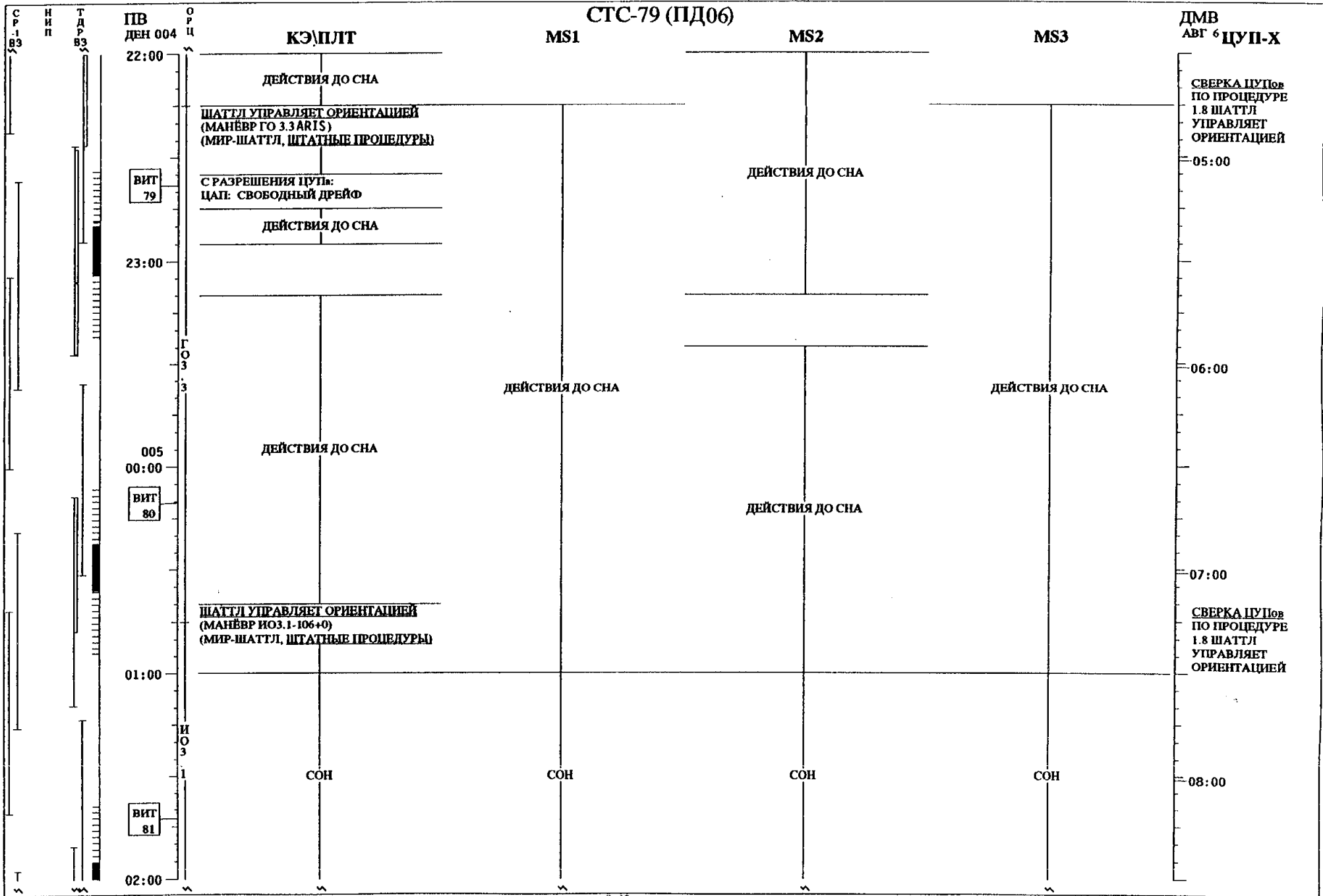

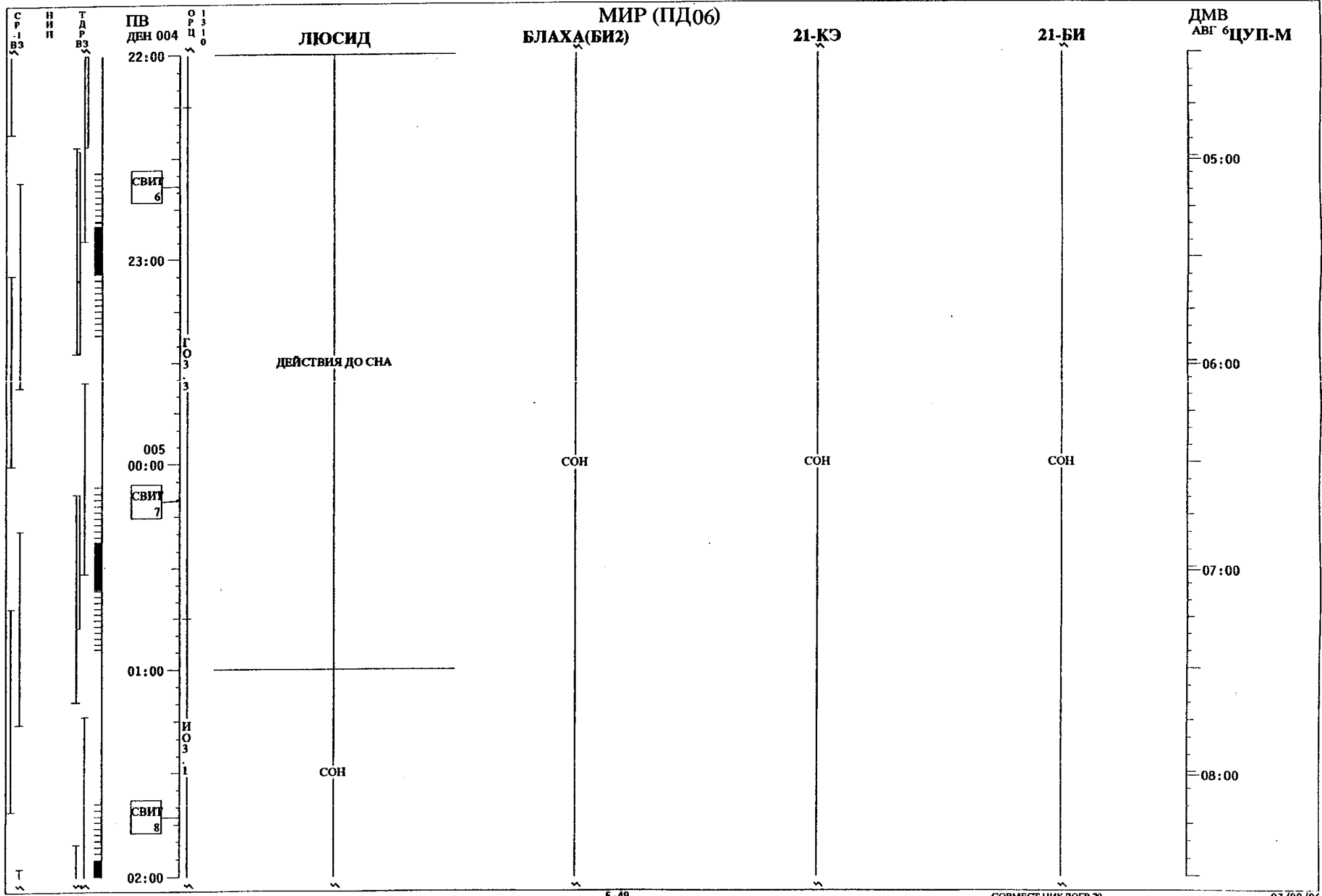



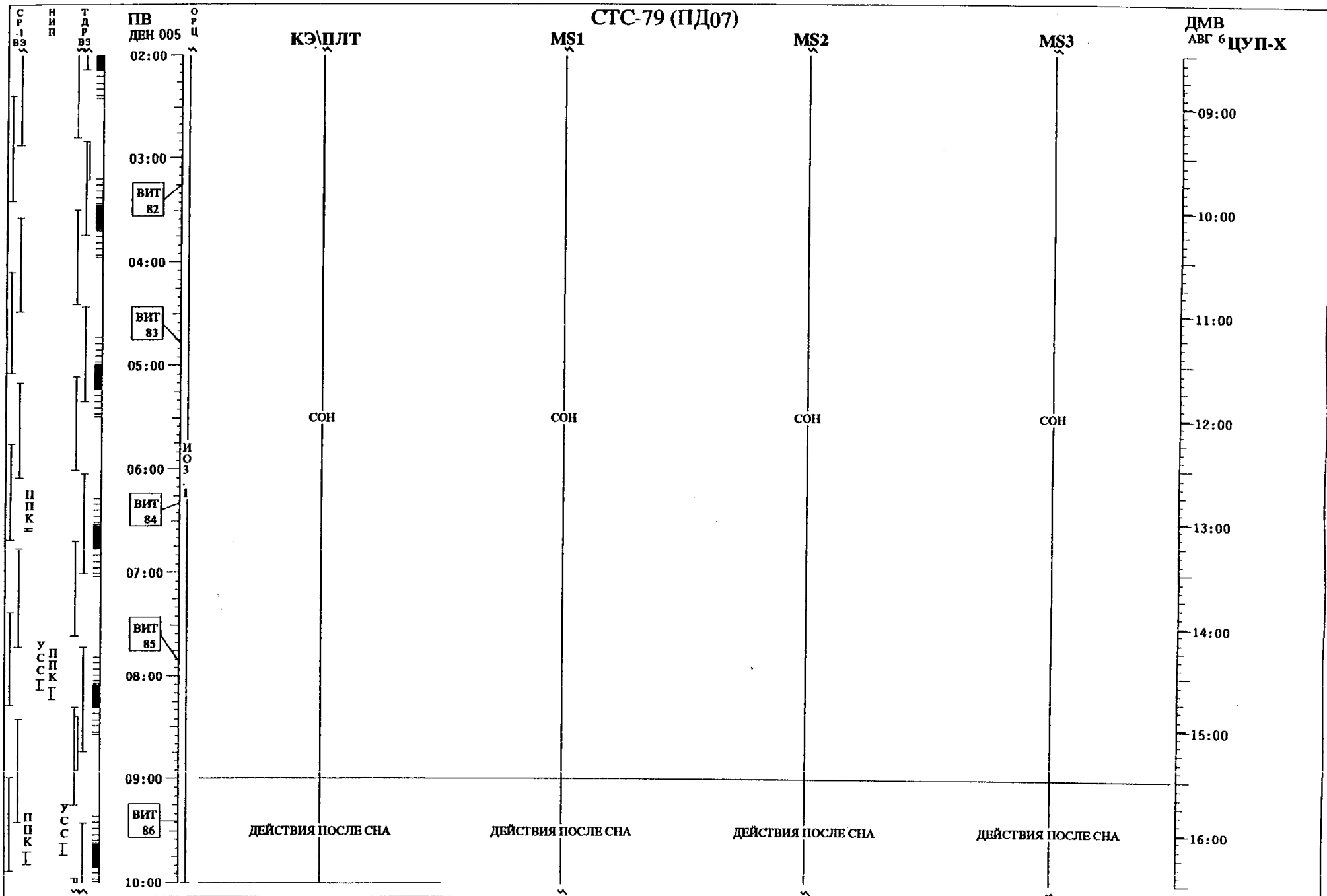

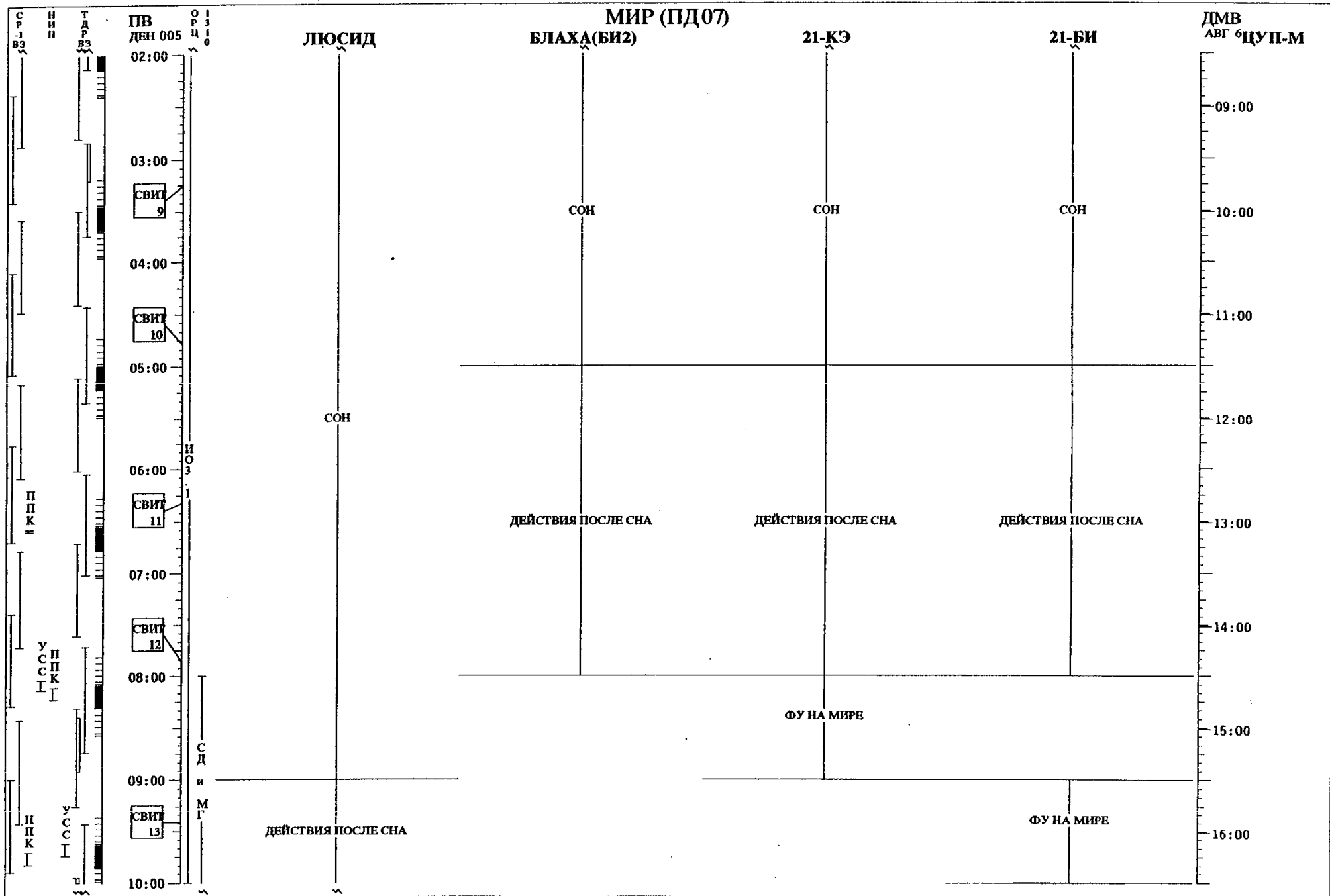

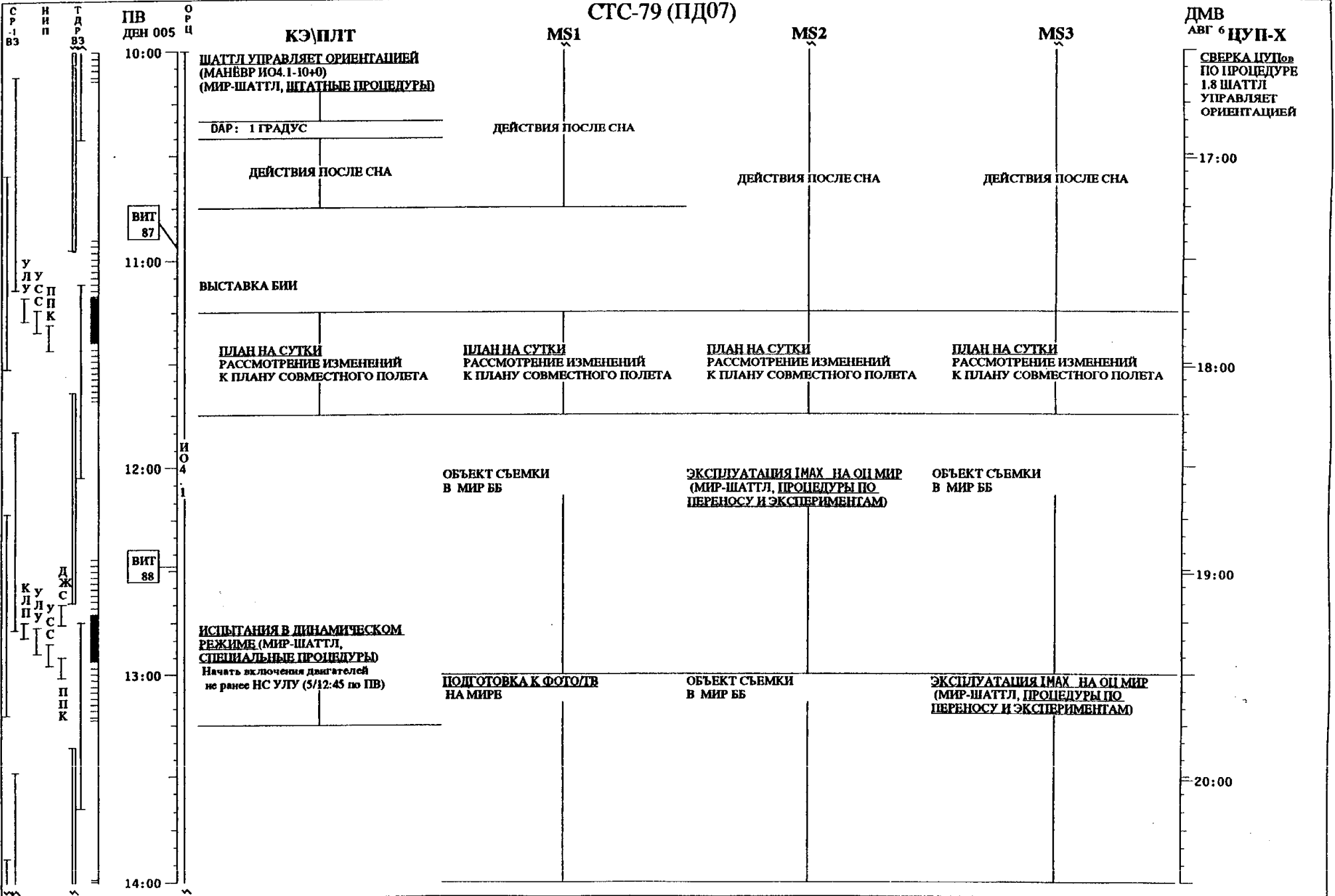

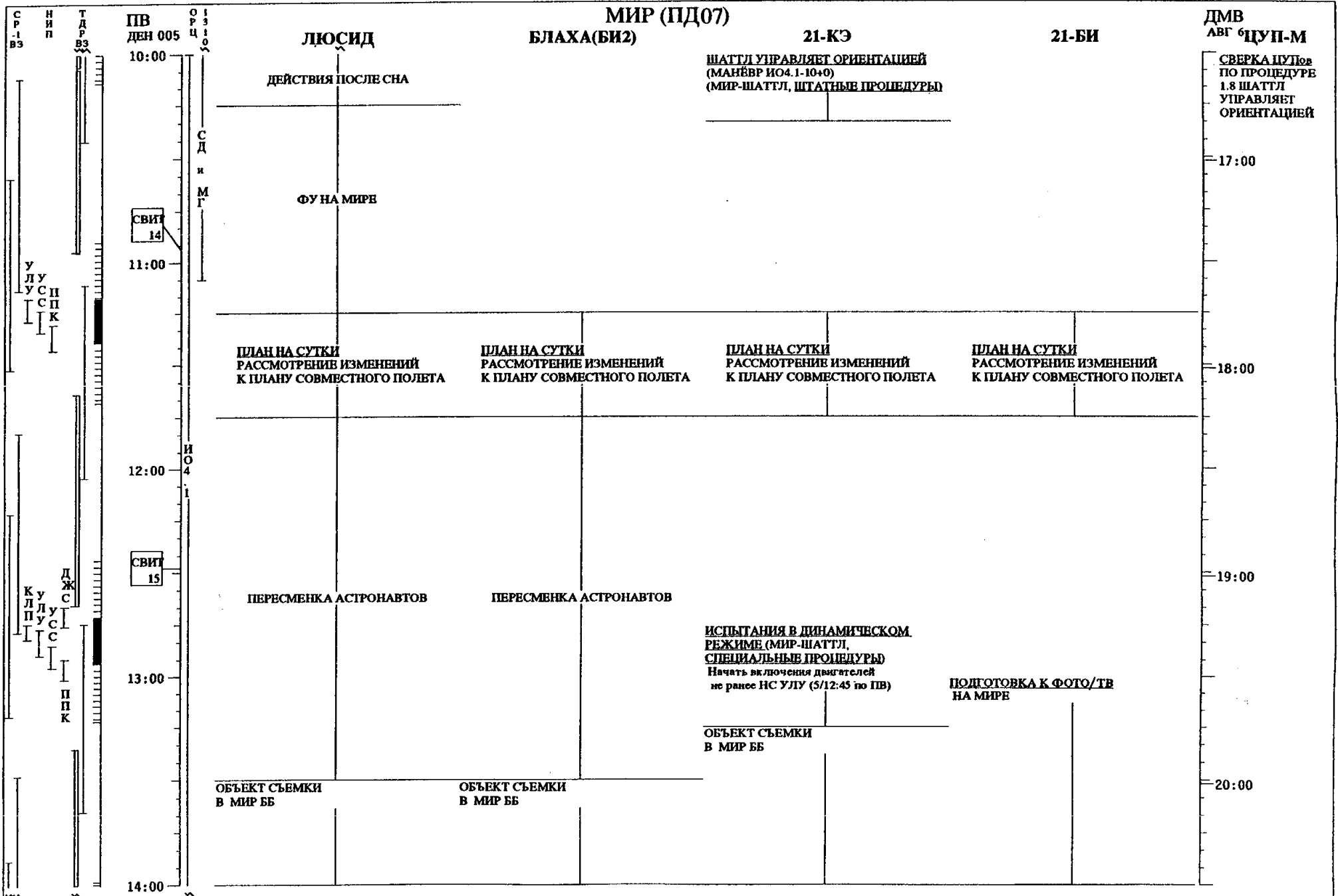

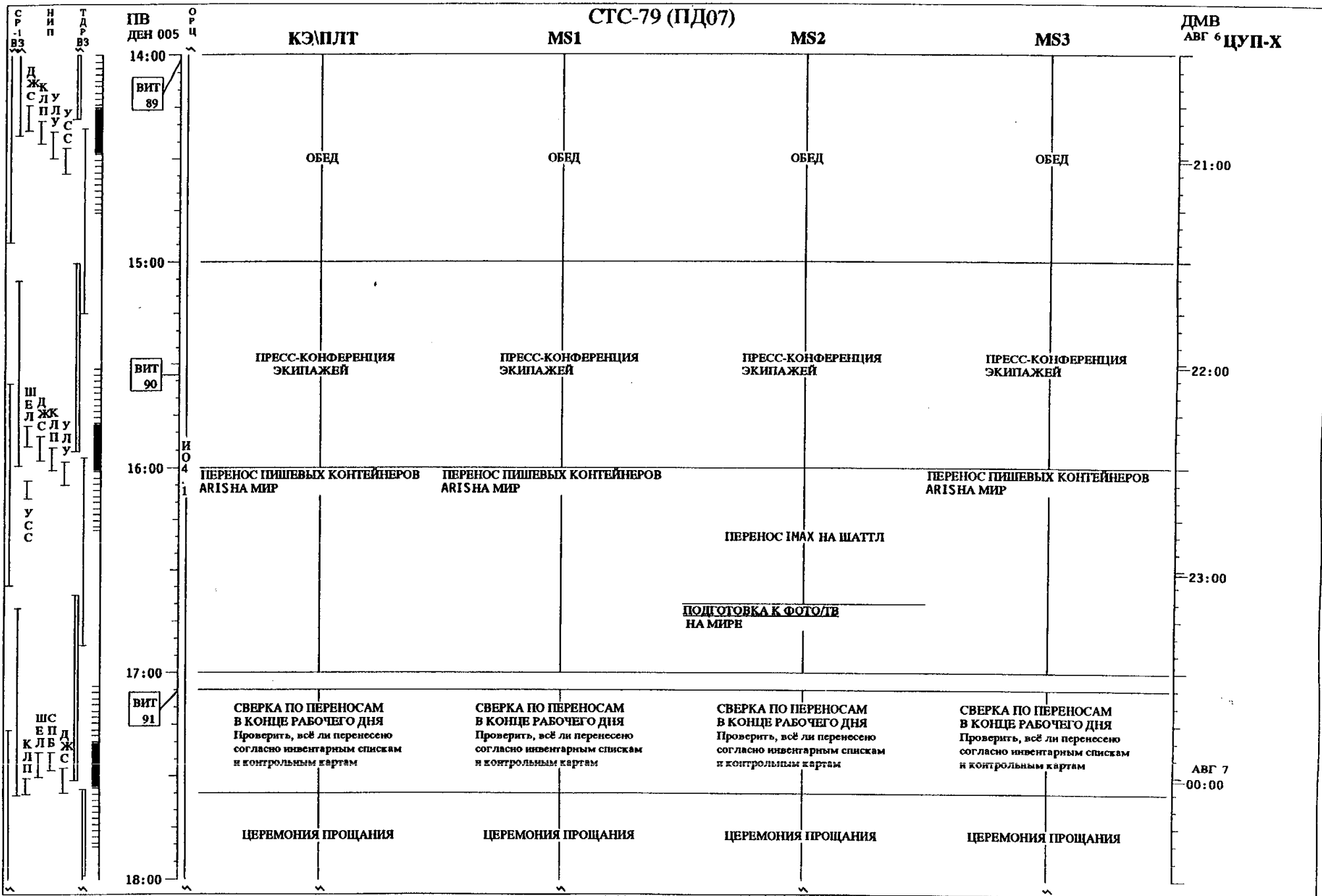

		МИР (ПД07)				ДМВ АВГ 6 ЦУП-М		
ПВ ДЕН 005		ЛЮСИД	БЛАХА(БИ2)	21-КЭ	21-БИ			
СР-1 ВЗ	НИП	ТДР ВЗ	14:00	ОБЕД	ОБЕД	ОБЕД	ОБЕД	21:00
			СВИТ 1					
ДЖ СЛУ	ЖК ПЛУ	УСС	15:00	ПРЕСС-КОНФЕРЕНЦИЯ ЭКИПАЖЕЙ	ПРЕСС-КОНФЕРЕНЦИЯ ЭКИПАЖЕЙ	ПРЕСС-КОНФЕРЕНЦИЯ ЭКИПАЖЕЙ	ПРЕСС-КОНФЕРЕНЦИЯ ЭКИПАЖЕЙ	22:00
			СВИТ 2					
ШЕ ДЖ СЛУ	ЛЖ ПЛУ	УСС	16:00	ПЕРЕСМЕНКА АСТРОНАВТОВ	ПЕРЕСМЕНКА АСТРОНАВТОВ	ПЕРЕНОС ПИЩЕВЫХ КОНТЕЙНЕРОВ ARTISHA МИР	ПЕРЕНОС ПИЩЕВЫХ КОНТЕЙНЕРОВ ARTISHA МИР	23:00
			СВИТ 3					
ШС БНД КЛЕ ЛП	ЖК СЛУ	УСС	17:00	СВЕРКА ПО ПЕРЕНОСАМ В КОНЦЕ РАБОЧЕГО ДНЯ Проверить, всё ли перенесено согласно инвентарным спискам и контрольным картам	СВЕРКА ПО ПЕРЕНОСАМ В КОНЦЕ РАБОЧЕГО ДНЯ Проверить, всё ли перенесено согласно инвентарным спискам и контрольным картам	СВЕРКА ПО ПЕРЕНОСАМ В КОНЦЕ РАБОЧЕГО ДНЯ Проверить, всё ли перенесено согласно инвентарным спискам и контрольным картам	СВЕРКА ПО ПЕРЕНОСАМ В КОНЦЕ РАБОЧЕГО ДНЯ Проверить, всё ли перенесено согласно инвентарным спискам и контрольным картам	АВГ 7 00:00
			СВИТ 4					
			18:00	ЦЕРЕМОНИЯ ПРОЩАНИЯ	ЦЕРЕМОНИЯ ПРОЩАНИЯ	ЦЕРЕМОНИЯ ПРОЩАНИЯ	ЦЕРЕМОНИЯ ПРОЩАНИЯ	

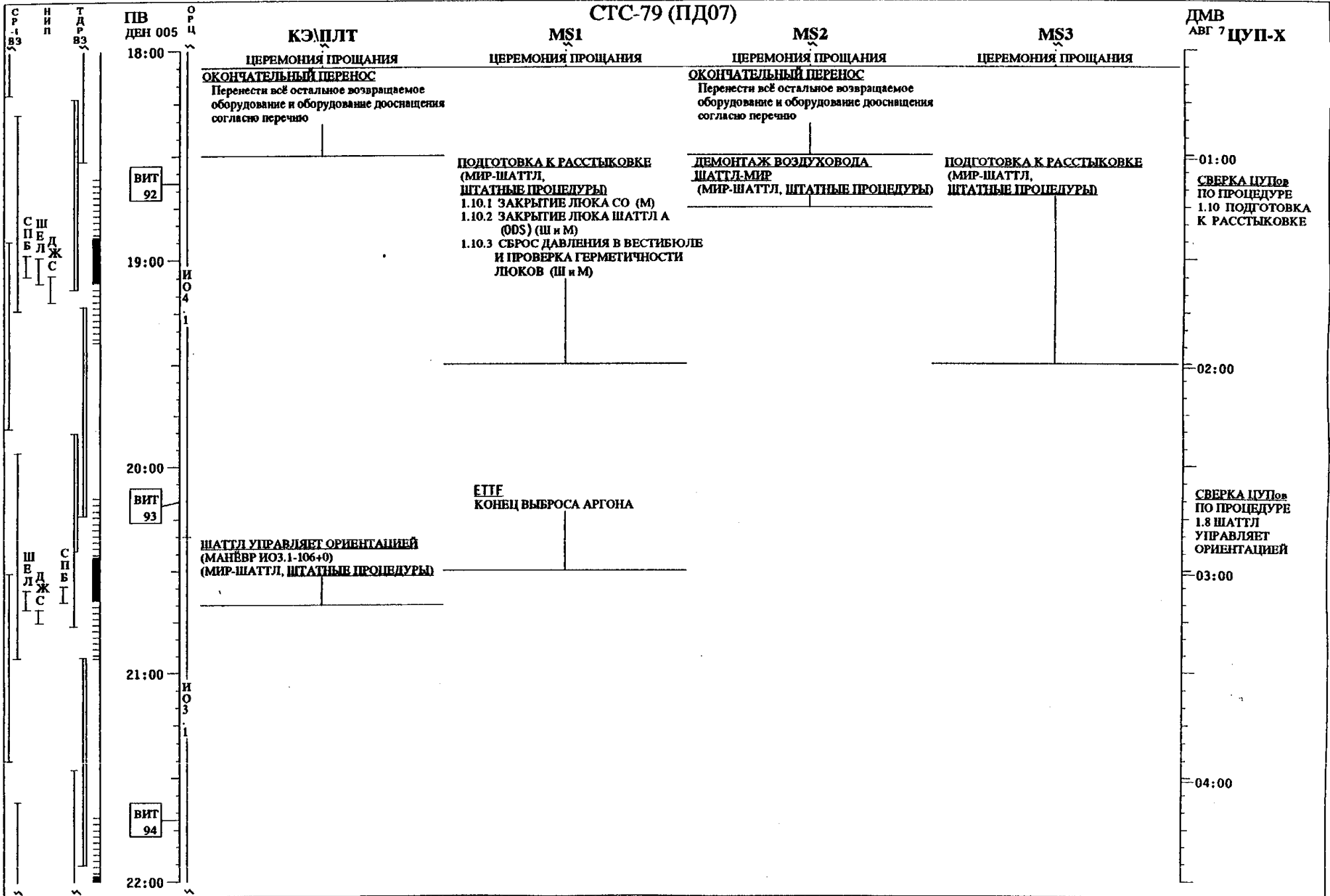

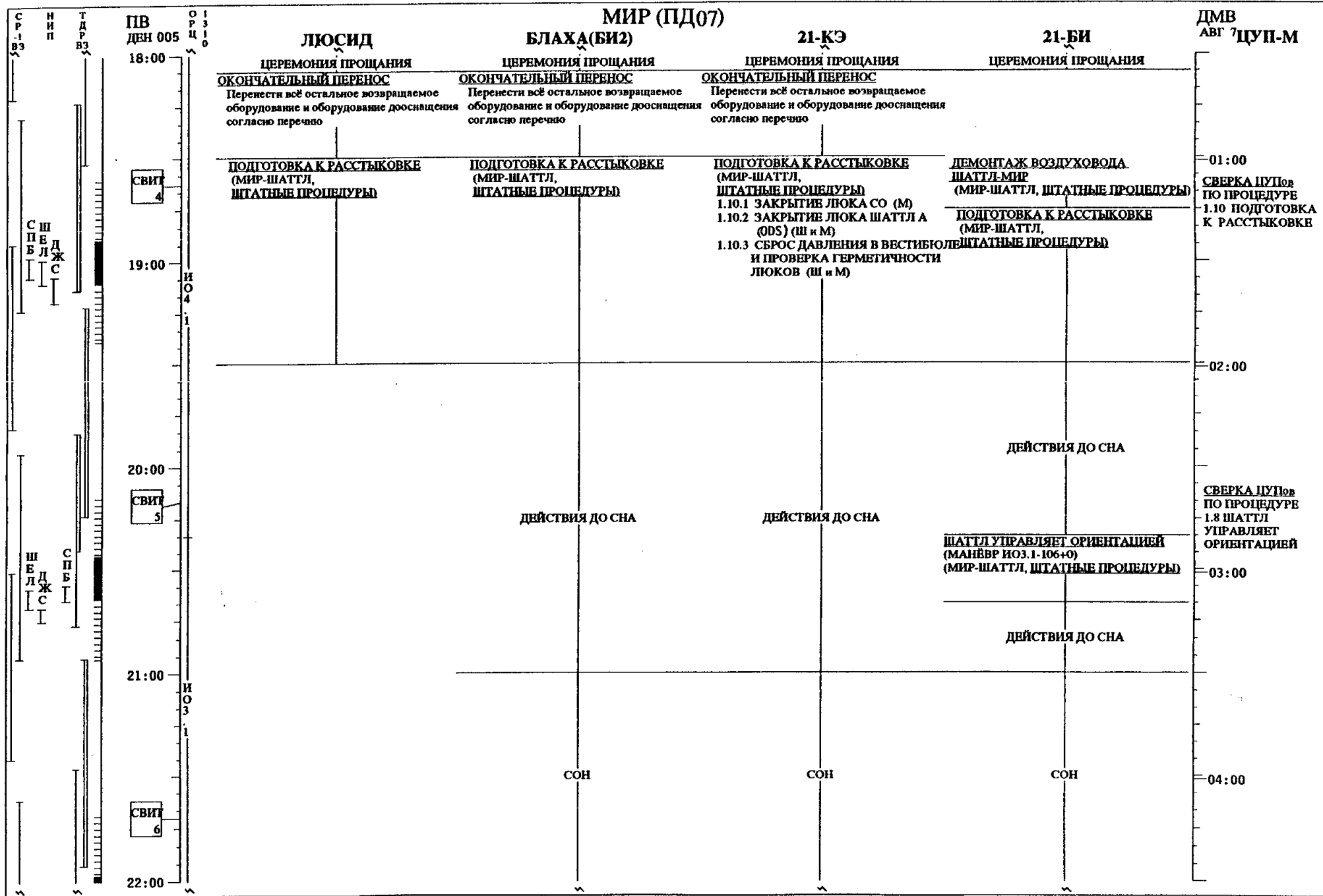



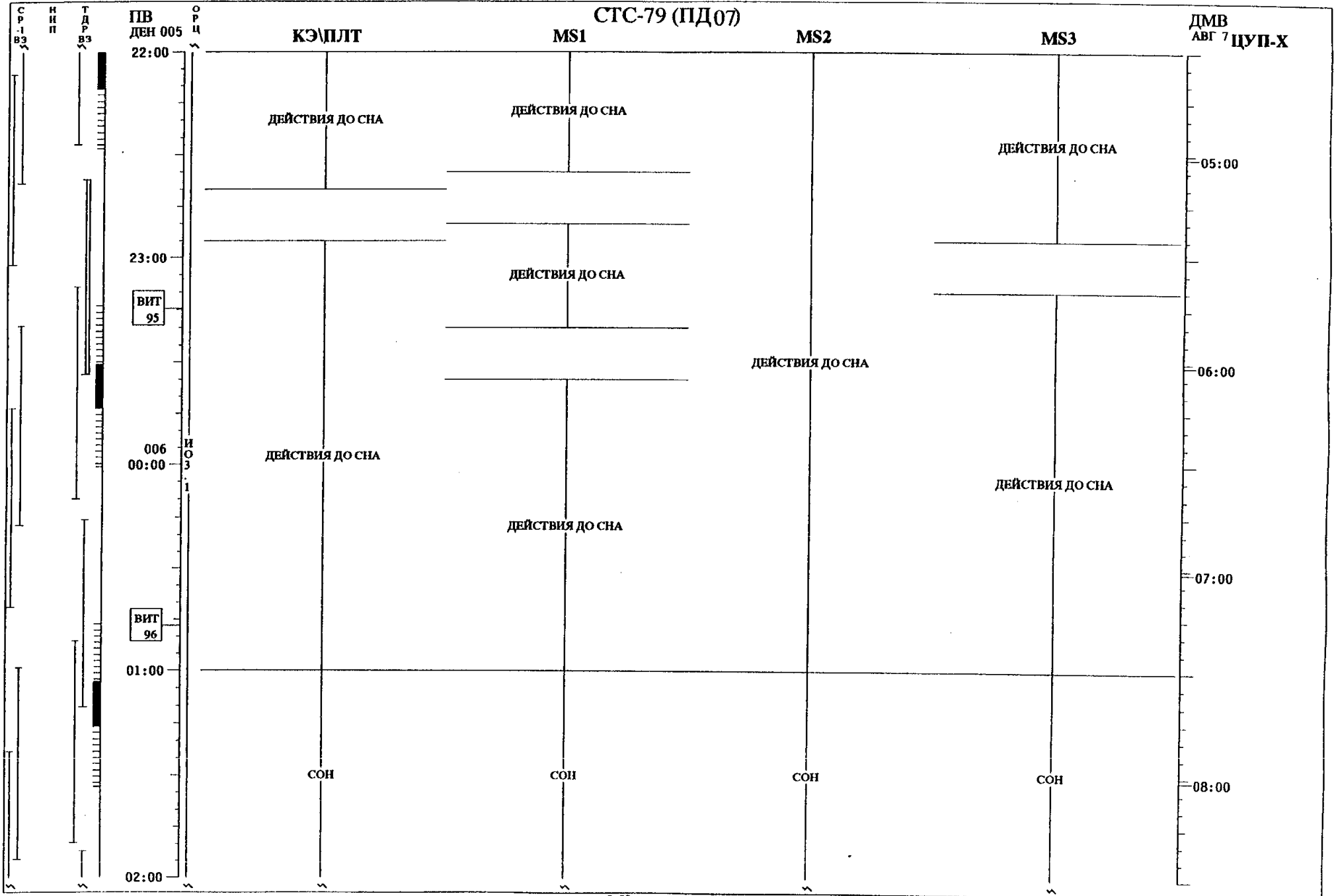

СТС-79 (ПД07)

ДМВ  
АВГ 7 ЦУП-Х

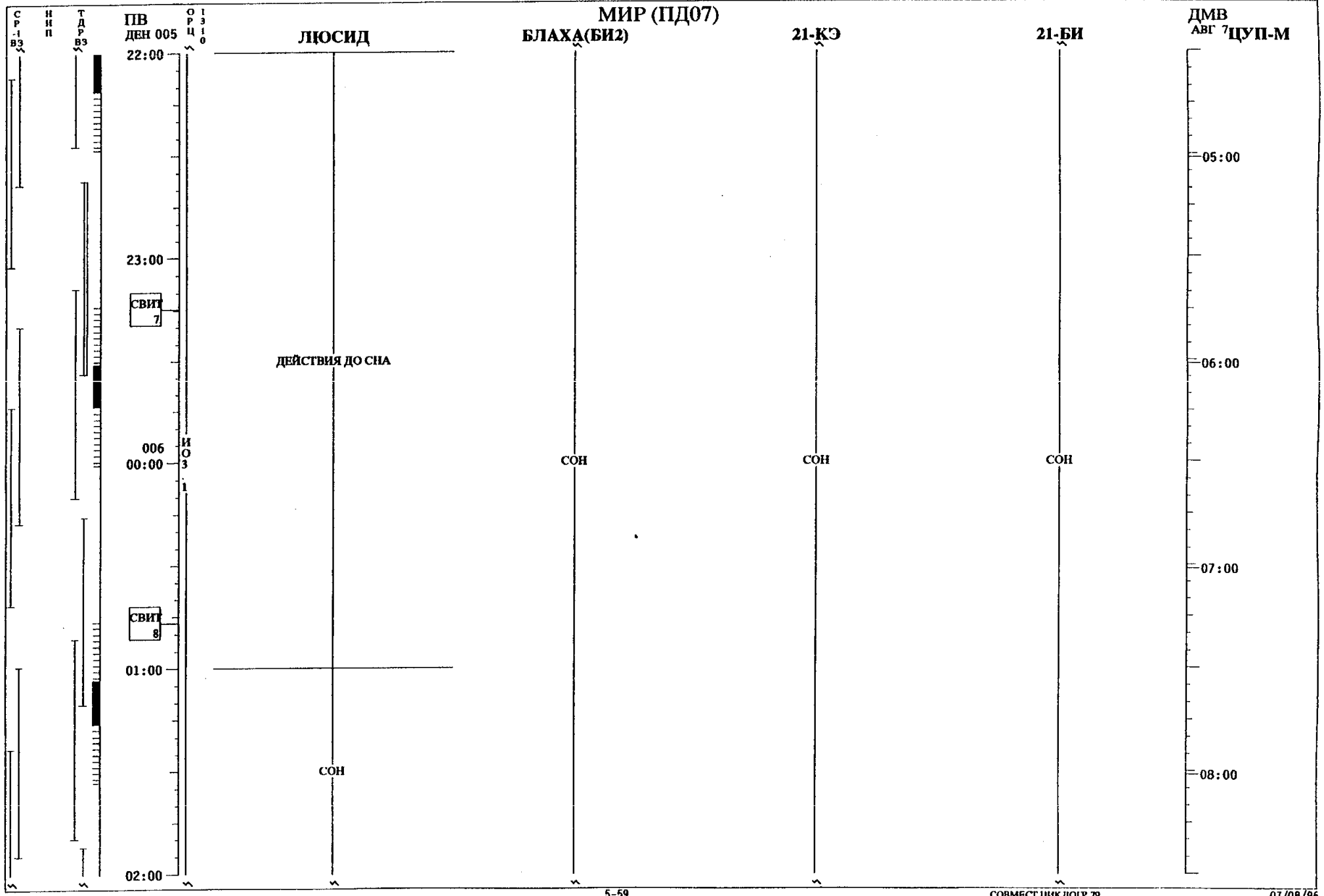

СТС-79 (ПД08)

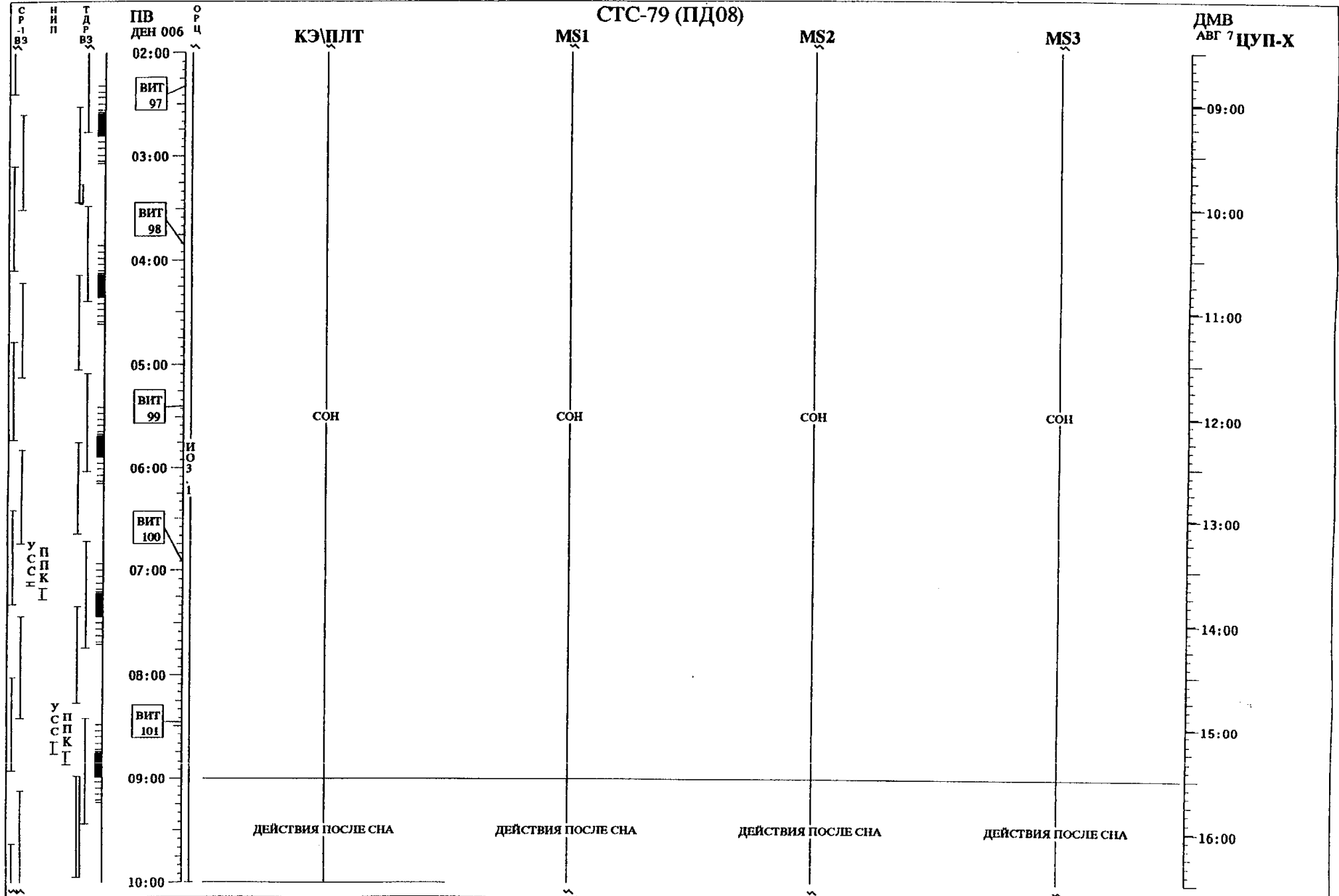

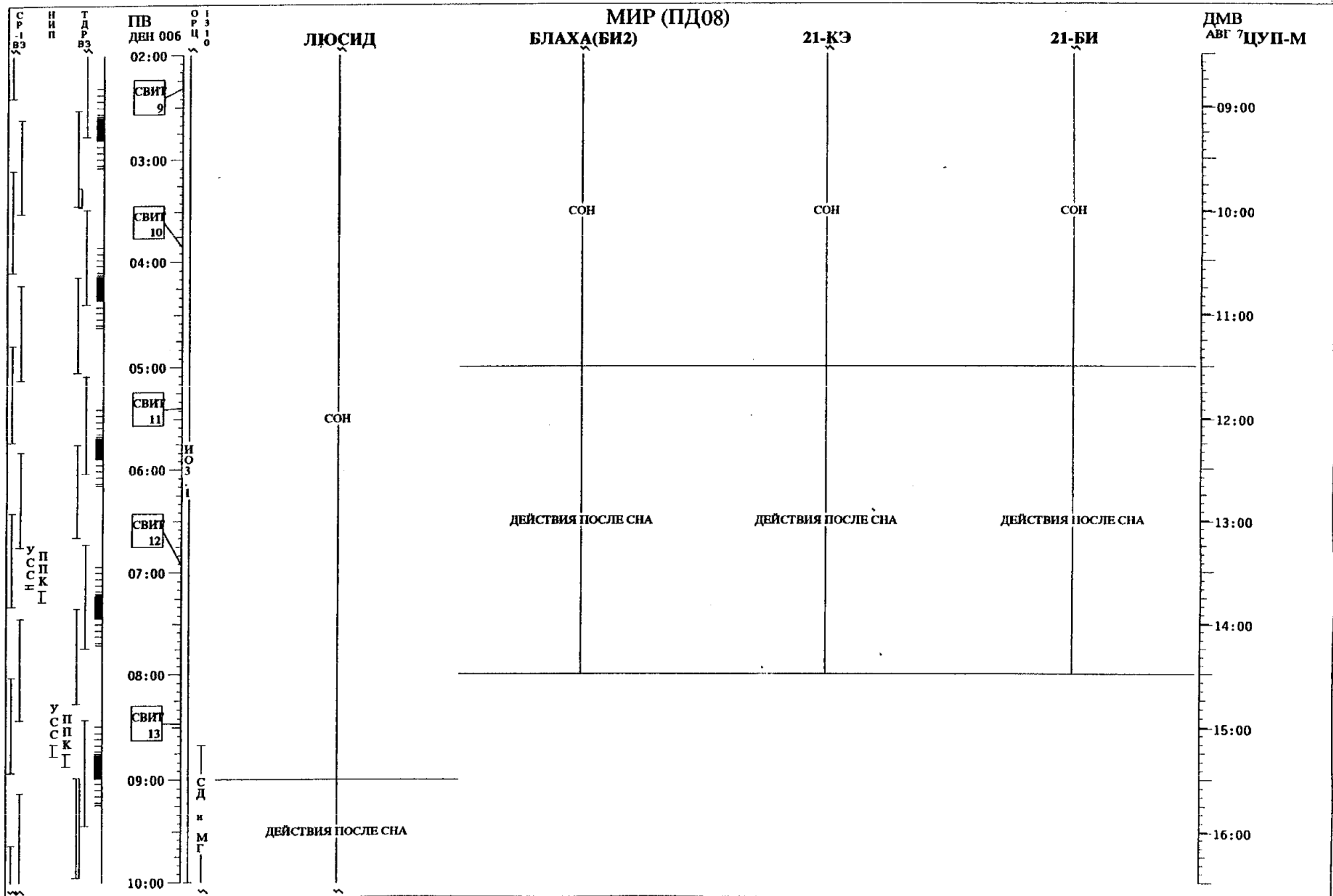

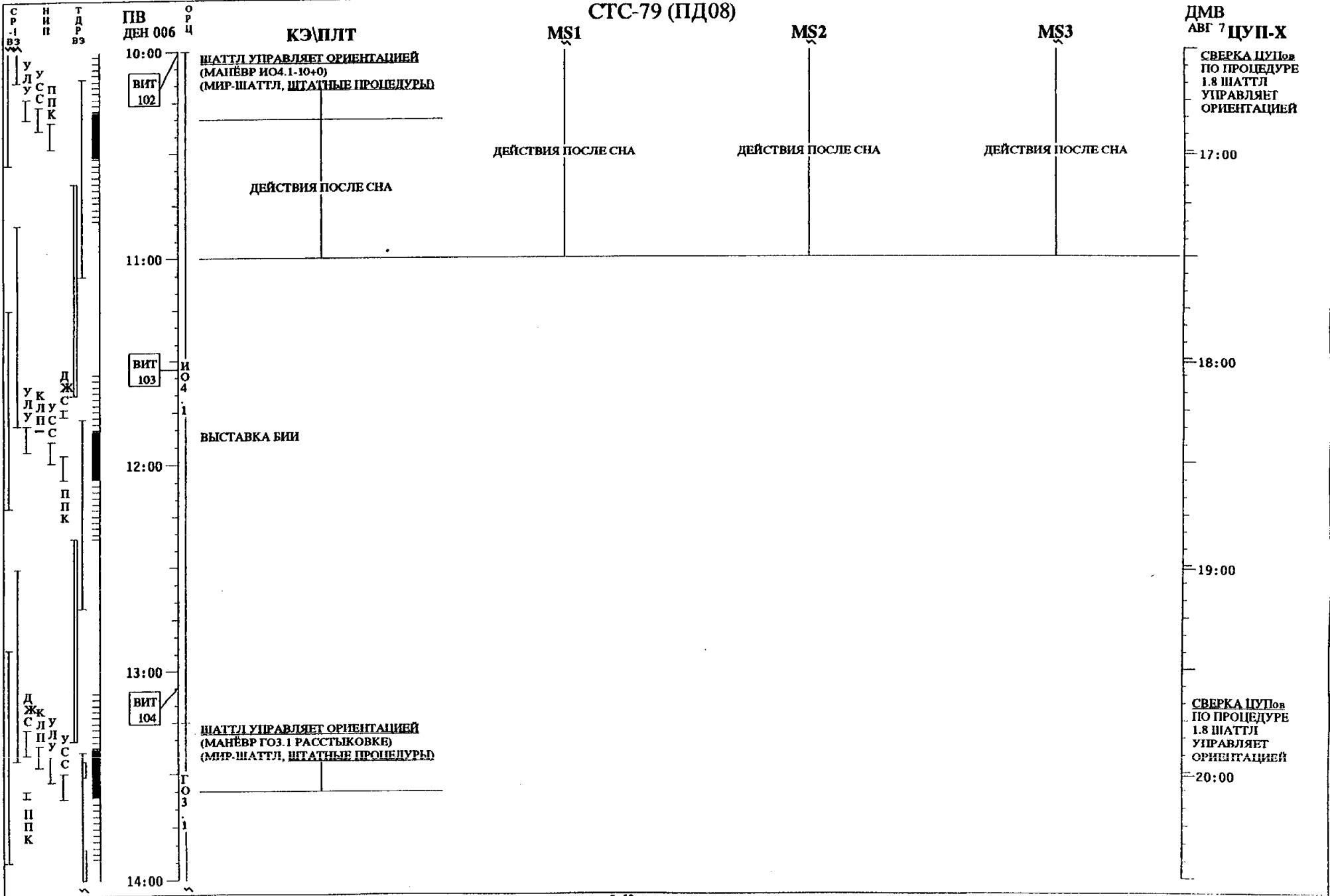

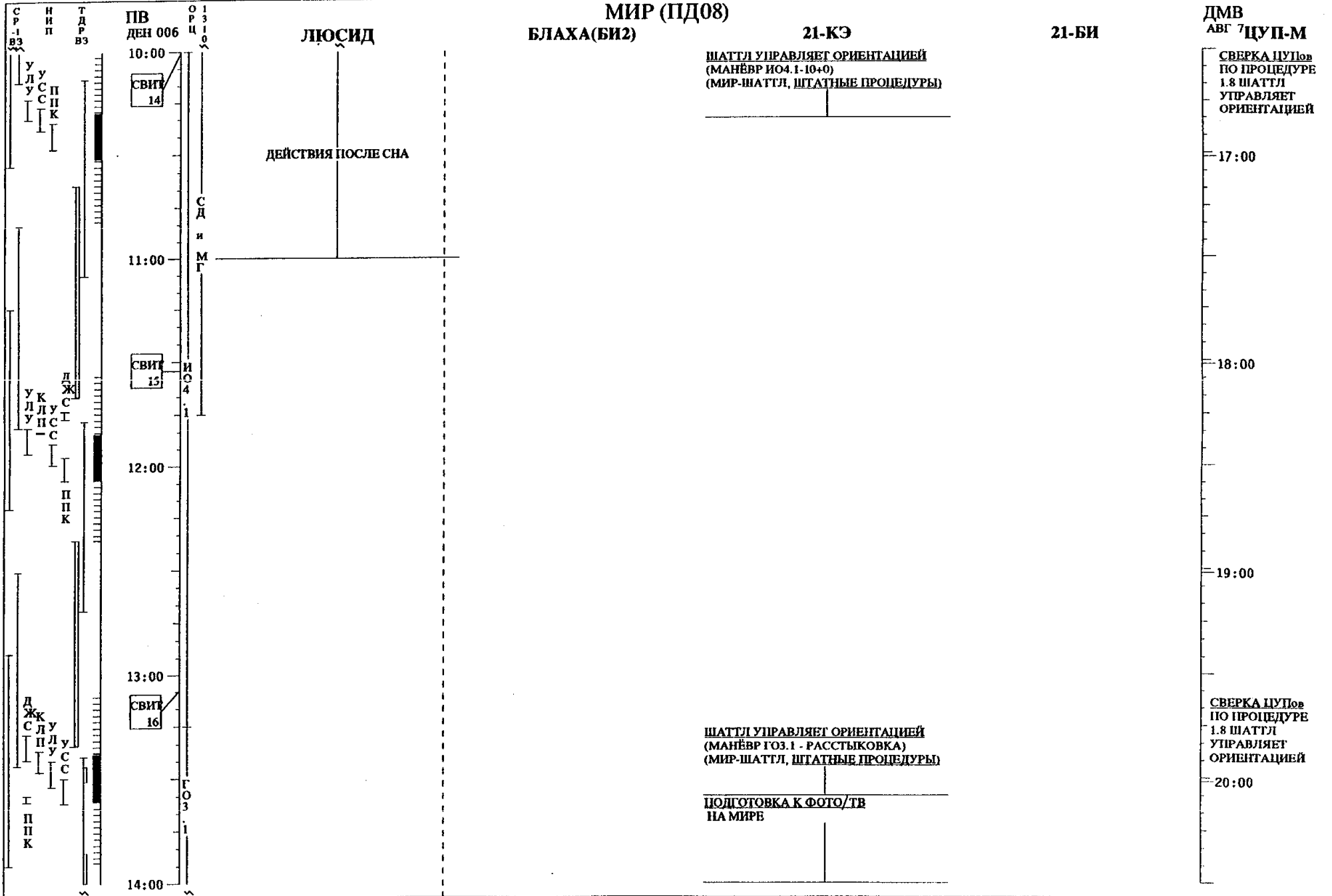

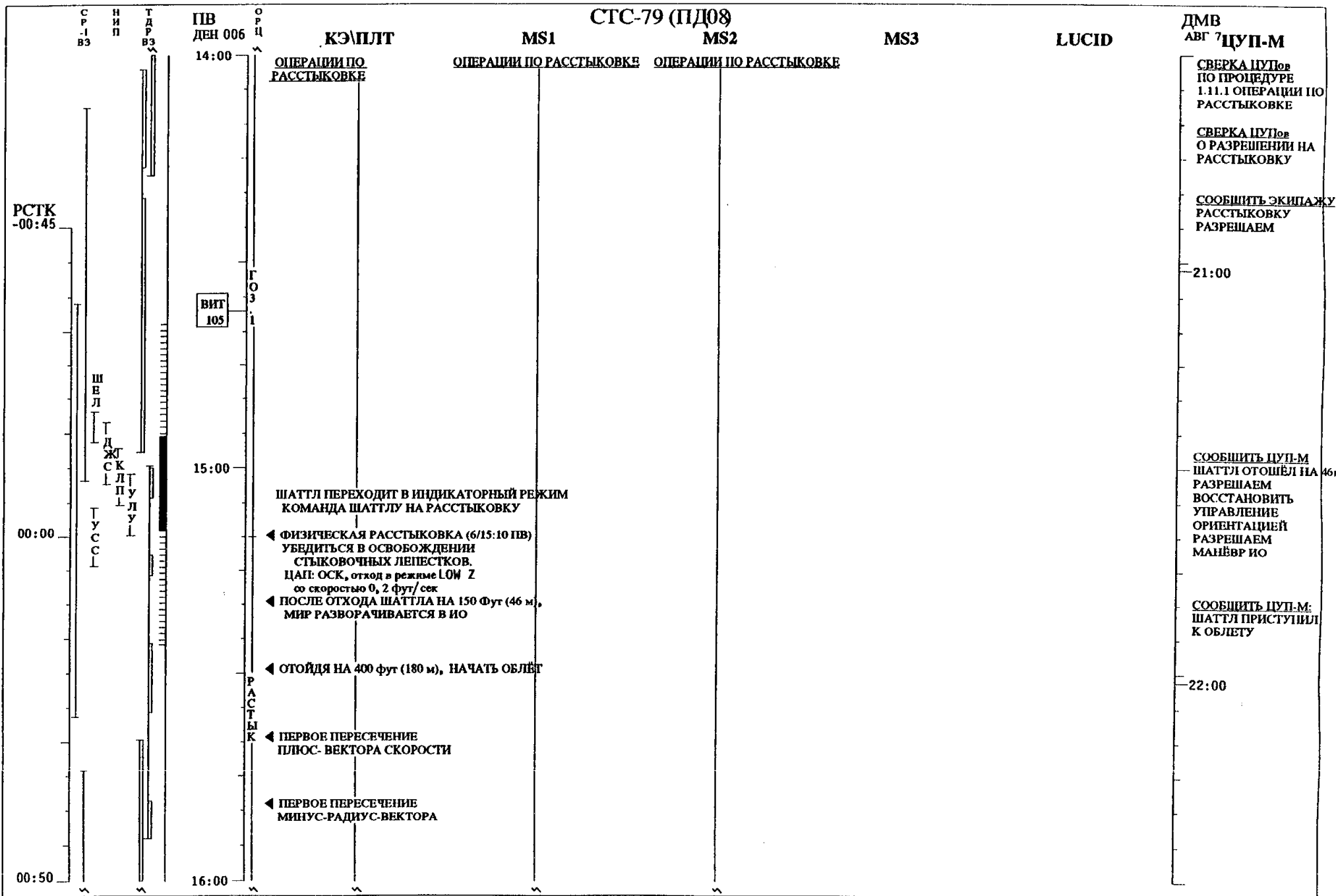

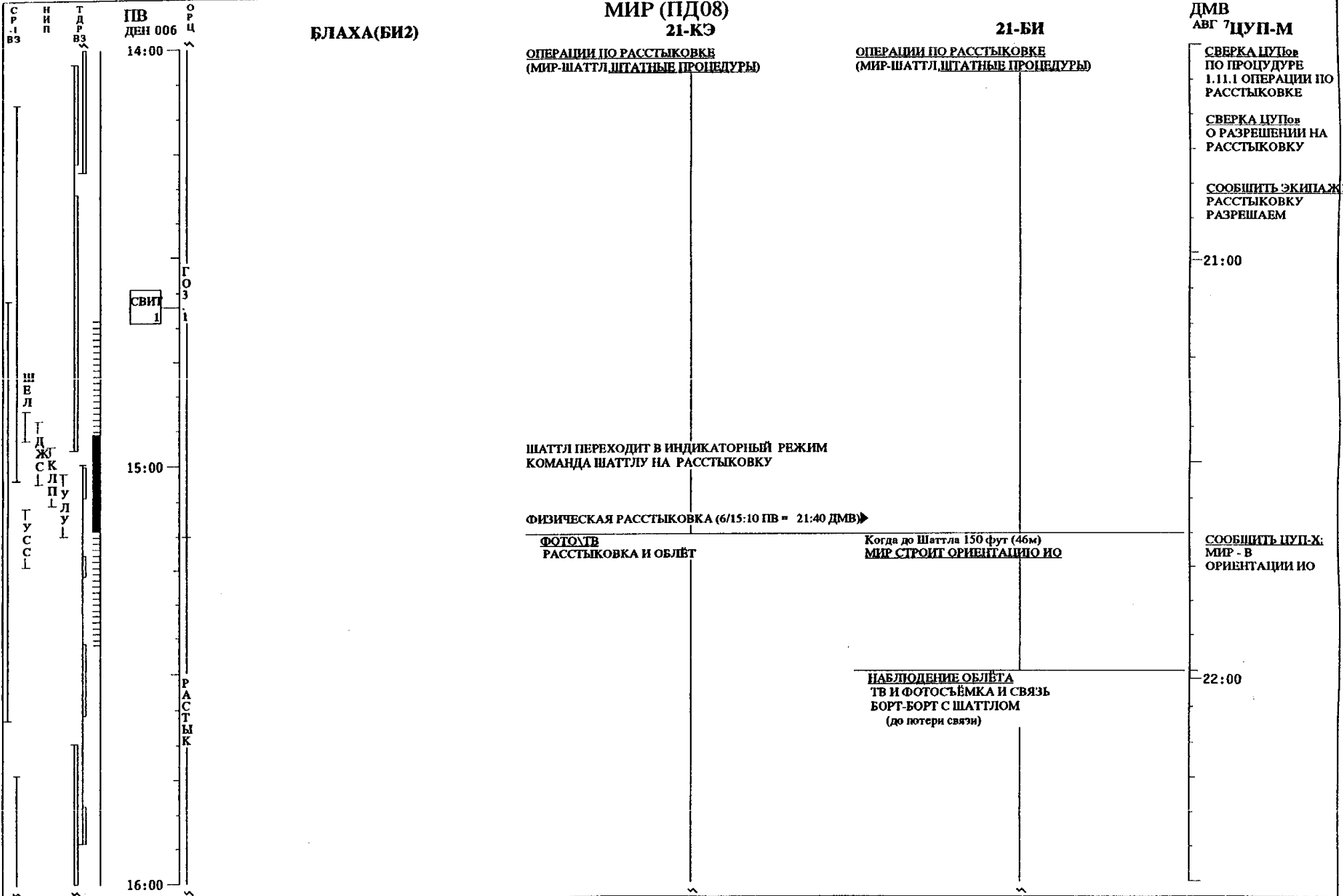



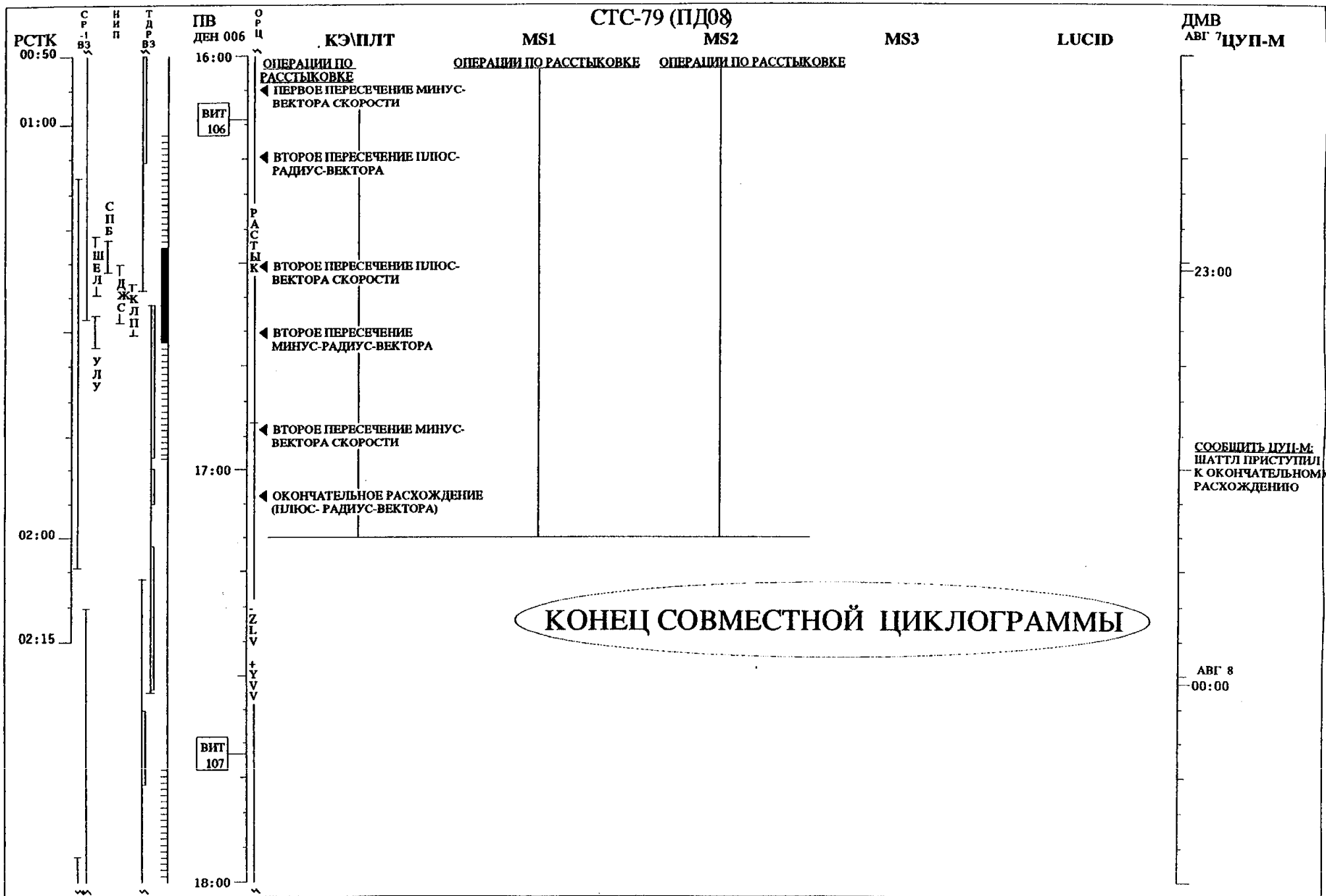

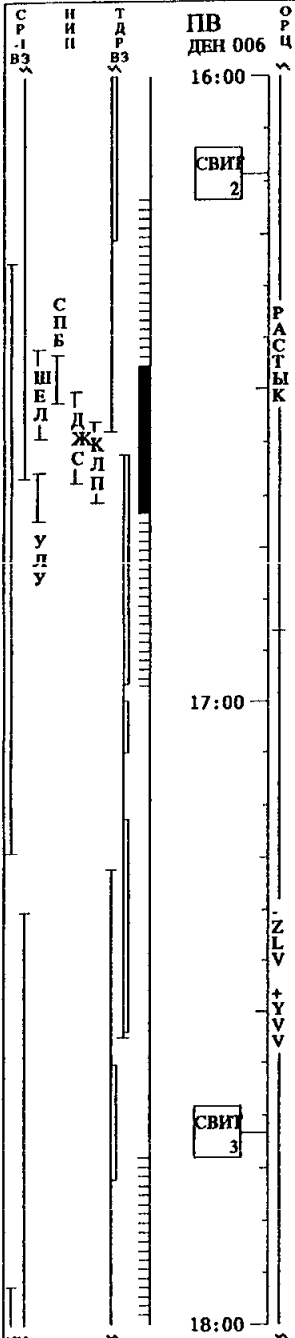

**БЛАХА(БИ2)**

**МИР (ПД08)  
21-КЭ**

**21-БИ**

**ДМВ  
АВГ 7 ЦУП-М**

**ФОТОУТВ  
РАСТЫКОВКА И ОБЛЁТ**

**НАБЛЮДЕНИЕ ОБЛЁТА  
ТВ И ФОТОСЪЁМКА И СВЯЗЬ  
БОРТ-БОРТ С ШАТТЛОМ  
(до потери связи)**

**КОНЕЦ СОВМЕСТНОЙ ЦИКЛОГРАММЫ**

◀ **ОКОНЧАТЕЛЬНОЕ РАСХОЖДЕНИЕ**

23:00

АВГ 8  
00:00

**This Page Intentionally Blank**

**FD4 DOCKING TIMELINE OVERVIEW**

FD 4 DOCKING OVERVIEW																									
MET : 000	0	1	2	3	4	5	6	7	8	9	10	11	12	13	14	15	16	17	18	19	20	21	22	23	0
STS-79		POST INSERTION	SHAB ACT	PRE SLEEP												POST SLEEP	NCA	SHAB S/U		ARIS SETUP	NPCA				
MIR																PRE SLEEP									
DAY/NIGHT																									
ORBIT		2	3	4	5	6	7	8	9	10	11	12	13	14	15	16									
DAILY ORB																									
ATT		ASC		NI/NC1													NC2		SHAB/COAS						
NOTES:		ASCENT																	SHAB ACT						
MET : 001	0	1	2	3	4	5	6	7	8	9	10	11	12	13	14	15	16	17	18	19	20	21	22	23	0
STS-79																									
MIR																									
DAY/NIGHT																									
ORBIT		17	18	19	20	21	22	23	24	25	26	27	28	29	30	31	32								
DAILY ORB		6	7	8	9	10	11	12	13	14	15	16	1	2	3	4	5								
ATT																									
NOTES:																									
MET : 002	0	1	2	3	4	5	6	7	8	9	10	11	12	13	14	15	16	17	18	19	20	21	22	23	0
STS-79																									
MIR																									
DAY/NIGHT																									
ORBIT		33	34	35	36	37	38	39	40	41	42	43	44	45	46	47	48								
DAILY ORB		6	7	8	9	10	11	12	13	14	15	1	2	3	4	5	6								
ATT																									
NOTES:																									
MET : 003	0	1	2	3	4	5	6	7	8	9	10	11	12	13	14	15	16	17	18	19	20	21	22	23	0
STS-79																									
MIR																									
DAY/NIGHT																									
ORBIT		49	50	51	52	53	54	55	56	57	58	59	60	61	62	63									
DAILY ORB		7	8	9	10	11	12	13	14	15	1	2	3	4	5	6	7								
ATT																									
NOTES:																									
MET : 004	0	1	2	3	4	5	6	7	8	9	10	11	12	13	14	15	16	17	18	19	20	21	22	23	0
STS-79																									
MIR																									
DAY/NIGHT																									
ORBIT		64	65	66	67	68	69	70	71	72	73	74	75	76	77	78	79								
DAILY ORB		7	8	9	10	11	12	13	14	15	16	1	2	3	4	5	6								
ATT																									
NOTES:																									
MET : 005	0	1	2	3	4	5	6	7	8	9	10	11	12	13	14	15	16	17	18	19	20	21	22	23	0
STS-79																									
MIR																									
DAY/NIGHT																									
ORBIT		80	81	82	83	84	85	86	87	88	89	90	91	92	93	94	95								
DAILY ORB		7	8	9	10	11	12	13	14	15	1	2	3	4	5	6	7								
ATT																									
NOTES:																									
MET : 006	0	1	2	3	4	5	6	7	8	9	10	11	12	13	14	15	16	17	18	19	20	21	22	23	0
STS-79																									
MIR																									
DAY/NIGHT																									
ORBIT		95	96	97	98	99	100	101	102	103	104	105	106	107	108	109	110								
DAILY ORB		7	8	9	10	11	12	13	14	15	16	1	2	3	4	5	6								
ATT																									
NOTES:																									

**FD 4 DOCKING OVERVIEW**

MET: 007	0	1	2	3	4	5	6	7	8	9	10	11	12	13	14	15	16	17	18	19	20	21	22	23	0
STS-79	PRE SLEEP	[SHADING]							POST SLEEP	UNDOCK U CONFIG			FLYAROUND	[SHADING]							PRE SLEEP				
MIR	[SHADING]							POST SLEEP	UNDOCK U CONFIG			[SHADING]													
DAY/NIGHT	[S]	[S]	[S]	[S]	[S]	[S]	[S]	[S]	[S]	[S]	[S]	[S]	[S]	[S]	[S]	[S]	[S]	[S]	[S]	[S]	[S]	[S]	[S]	[S]	[S]
ORBIT	111	112	113	114	115	116	117	118	119	120	121	122	123	124	125	126									
DAILY ORB	7	8	9	10	11	12	13	14	15	16	17	18	19	20	21	22	23	24	25	26	27	28	29	30	31
ATT	103.1-130+0										603.1			FLYAROUND	-2LV +YVY			-2LV -XVY							
NOTES:	*7/14:19																								

MET: 008	0	1	2	3	4	5	6	7	8	9	10	11	12	13	14	15	16	17	18	19	20	21	22	23	0
STS-79	PRE SLEEP	[SHADING]							POST SLEEP	FCS C/O	[SHADING]							SHAB STOW	CABIN STOW	PRE SLEEP					
MIR	[SHADING]																								
DAY/NIGHT	[S]	[S]	[S]	[S]	[S]	[S]	[S]	[S]	[S]	[S]	[S]	[S]	[S]	[S]	[S]	[S]	[S]	[S]	[S]	[S]	[S]	[S]	[S]	[S]	[S]
ORBIT	127	128	129	130	131	132	133	134	135	136	137	138	139	140	141										
DAILY ORB	8	9	10	11	12	13	14	15	16	17	18	19	20	21	22	23	24	25	26	27	28	29	30	31	32
ATT	-2LV -XVY																								
NOTES:																									

MET: 009	0	1	2	3	4	5	6	7	8	9	10	11	12	13	14	15	16	17	18	19	20	21	22	23	0
STS-79	PRE SLEEP	[SHADING]							POST SLEEP	SHAB DEACT	[SHADING]							DEORBIT PREP	KIL S/A C/D	PRE SLEEP					
MIR	[SHADING]																								
DAY/NIGHT	[S]	[S]	[S]	[S]	[S]	[S]	[S]	[S]	[S]	[S]	[S]	[S]	[S]	[S]	[S]	[S]	[S]	[S]	[S]	[S]	[S]	[S]	[S]	[S]	[S]
ORBIT	142	143	144	145	146	147	148	149	150	151	152	153	154	155	156	157									
DAILY ORB	8	9	10	11	12	13	14	15	16	17	18	19	20	21	22	23	24	25	26	27	28	29	30	31	32
ATT	PTC										-XSI			CONN	ENTRY!										
NOTES:	*9/19:48																								

MET: 010	0	1	2	3	4	5	6	7	8	9	10	11	12	13	14	15	16	17	18	19	20	21	22	23	0
STS-79	[SHADING]																								
MIR	[SHADING]																								
DAY/NIGHT	[S]	[S]	[S]	[S]	[S]	[S]	[S]	[S]	[S]	[S]	[S]	[S]	[S]	[S]	[S]	[S]	[S]	[S]	[S]	[S]	[S]	[S]	[S]	[S]	[S]
ORBIT	[SHADING]																								
DAILY ORB	[SHADING]																								
ATT	[SHADING]																								
NOTES:	[SHADING]																								

MET: 011	0	1	2	3	4	5	6	7	8	9	10	11	12	13	14	15	16	17	18	19	20	21	22	23	0
STS-79	[SHADING]																								
MIR	[SHADING]																								
DAY/NIGHT	[S]	[S]	[S]	[S]	[S]	[S]	[S]	[S]	[S]	[S]	[S]	[S]	[S]	[S]	[S]	[S]	[S]	[S]	[S]	[S]	[S]	[S]	[S]	[S]	[S]
ORBIT	[SHADING]																								
DAILY ORB	[SHADING]																								
ATT	[SHADING]																								
NOTES:	[SHADING]																								

MET: 012	0	1	2	3	4	5	6	7	8	9	10	11	12	13	14	15	16	17	18	19	20	21	22	23	0
STS-79	[SHADING]																								
MIR	[SHADING]																								
DAY/NIGHT	[S]	[S]	[S]	[S]	[S]	[S]	[S]	[S]	[S]	[S]	[S]	[S]	[S]	[S]	[S]	[S]	[S]	[S]	[S]	[S]	[S]	[S]	[S]	[S]	[S]
ORBIT	[SHADING]																								
DAILY ORB	[SHADING]																								
ATT	[SHADING]																								
NOTES:	[SHADING]																								

MET: 013	0	1	2	3	4	5	6	7	8	9	10	11	12	13	14	15	16	17	18	19	20	21	22	23	0
STS-79	[SHADING]																								
MIR	[SHADING]																								
DAY/NIGHT	[S]	[S]	[S]	[S]	[S]	[S]	[S]	[S]	[S]	[S]	[S]	[S]	[S]	[S]	[S]	[S]	[S]	[S]	[S]	[S]	[S]	[S]	[S]	[S]	[S]
ORBIT	[SHADING]																								
DAILY ORB	[SHADING]																								
ATT	[SHADING]																								
NOTES:	[SHADING]																								

**This Page Intentionally Blank**

DAP TABLE



# DAP TABLE

<u>DAP</u>	<u>PURPOSE</u>	<u>DAP</u>	<u>PURPOSE</u>
A1	- NOMINAL	B1	- NOMINAL; OMS & RCS BURNS
A2	- PTC	B2	- LOSS OF VERN (TAIL ONLY)
A3	- GG	B3	- LOSS OF VERN (NOSE & TAIL)
A4	- PRE/POST DEPLOY	B4	- SSUS DEPLOY
A5	- LOSS OF VERN (NOSE & TAIL)	B5	- COAS CAL
A6	- LOSS OF VERN (TAIL ONLY) MIN PROP VERN	B7	- RENDEZVOUS
A7	- RENDEZVOUS	B8	- CORRIDOR
A8	- CORRIDOR	B9	- DOCKING
A9	- DOCKING	B10	- FLYAROUND
A10	- FLYAROUND	B12	- MATED STACK TIGHT CONTROL
A12	- MATED STACK MNVRS & HOLD	B13	- FAILED CAPTURE
A13	- FAILED CAPTURE	B14	- VRCS REBOOST
A14	- VRCS REBOOST	B15	- RME 1301
A15	- RME 1301		

UNIV PTG	
TGT ID	= Orbiting Vehicle = 2 Earth ctr = 3 Earth tgt Input LAT ( $\pm 90$ ) LON ( $\pm 180$ , + = East) ALT (-3444.0 to 20000.0 nm)
	= 4 Sun ctr = 5 Celestial tgt Input RA (0-359.99) DEC ( $\pm 90$ ) = 11-110 Nav Stars
BODY VECT	= 1 +X* = 2 -X* = 3 -Z* = 4 -Y Star Tracker* = 5 Optional Input P (0-359.99) Y (270-359.99,0-90)
*Input OM	→ OM (0-359.99)
MON AXIS	= 1 +X = 2 -X

CNT ACC = 0 UNLOADED  
= 1-5 NOT USED

STS-79 GENERIC DAP A CONFIGURATIONS (A6 STS-79 SPECIFIC)

	ITEM #	A1	A2	A3	A4	A5	A6	A7
<b>PRI</b>								
ROT RATE	10	0.2000	0.4000	0.2000	0.5000	0.2000	0.2000	0.2000
ATT DB	11	5.00	1.00	1.00	3.00	5.00	5.00	2.00
RATE DB	12	0.20	0.20	0.20	0.20	0.20	0.20	0.20
ROT PLS	13	0.10	0.10	0.10	0.10	0.10	0.10	0.10
COMP	14	.000	.000	.000	.000	.000	.000	.000
P OPTION	15	ALL	ALL	ALL	ALL	ALL	TAIL	ALL
Y OPTION	16	ALL	ALL	TAIL	ALL	ALL	TAIL	ALL
TRAN PLS	17	0.10	0.10	0.10	0.10	0.10	0.10	0.10
<b>ALT</b>								
RATE DB	18	0.200	0.200	0.200	0.200	0.070	0.070	0.200
JET OPT	19	ALL	ALL	ALL	ALL	ALL	TAIL	ALL
# JETS	20	2	2	2	2	1	1	2
ON TIME	21	0.08	0.08	0.08	0.08	0.08	0.08	0.08
DELAY	22	0.00	0.00	0.00	0.00	0.00	0.00	0.00
<b>VERN</b>								
ROT RATE	23	0.2000	0.4000	0.0080	0.2000	0.2000	<b>0.0650</b>	0.2000
ATT DB	24	1.000	1.000	0.070	1.000	1.000	1.000	1.000
RATE DB	25	.020	.020	.010	.020	.020	.020	.020
ROT PLS	26	0.010	0.010	0.010	0.010	0.010	0.010	0.010
COMP	27	.000	.000	.000	.000	.000	.000	.000
CNTL ACC	28	0	0	0	0	0	0	0
PURPOSE		NOMINAL	PTC	GG	PRE/ POST DEPLOY	LOSS OF VERN (N/T)	LOSS OF VERN (TAIL ONLY) <b>MIN PROP VERN</b>	RNDZ

Note: **BOLD/ITALICS** = not I-Loaded

STS-79 FLIGHT SPECIFIC DAP A CONFIGURATIONS

	ITEM #	A8	A9	A10	A12	A13	A14	A15
<b>PRI</b>								
ROT RATE	10	0.2000	<b>0.0500</b>	<b>0.1300</b>	<b>0.1000</b>	<b>0.0500</b>	<b>0.0500</b>	<b>0.1000</b>
ATT DB	11	<b>1.00</b>	<b>0.50</b>	<b>2.00</b>	5.00	<b>1.00</b>	<b>3.00</b>	<b>40.00</b>
RATE DB	12	<b>0.10</b>	<b>0.10</b>	<b>0.10</b>	0.20	<b>0.10</b>	0.20	0.20
ROT PLS	13	0.10	0.10	0.10	<b>0.04</b>	0.10	<b>0.04</b>	<b>0.003*</b>
COMP	14	.000	.000	.000	.000	.000	.000	.000
P OPTION	15	<b>TAIL</b>	<b>TAIL</b>	<b>TAIL</b>	<b>TAIL</b>	<b>TAIL</b>	ALL	<b>TAIL</b>
Y OPTION	16	<b>TAIL</b>	<b>TAIL</b>	<b>TAIL</b>	<b>TAIL</b>	<b>TAIL</b>	ALL	<b>TAIL</b>
TRAN PLS	17	<b>0.05</b>	<b>0.05</b>	<b>0.05</b>	<b>0.01</b>	<b>0.05</b>	0.10	0.10
<b>ALT</b>								
RATE DB	18	0.200	0.200	0.200	<b>0.070</b>	0.200	0.200	0.200
JET OPT	19	ALL	ALL	ALL	<b>TAIL</b>	ALL	ALL	<b>TAIL</b>
# JETS	20	2	2	2	<b>3</b>	2	2	<b>3</b>
ON TIME	21	0.08	0.08	0.08	0.08	0.08	0.08	0.08
DELAY	22	0.00	0.00	0.00	<b>10.88</b>	0.00	0.00	<b>10.88</b>
<b>VERN</b>								
ROT RATE	23	0.2000	<b>0.0500</b>	<b>0.1300</b>	<b>0.1500</b>	<b>0.0500</b>	<b>0.4000</b>	<b>0.0500</b>
ATT DB	24	1.000	<b>0.500</b>	<b>2.000</b>	<b>5.000</b>	1.000	1.000	<b>5.000</b>
RATE DB	25	.020	.020	.020	<b>.050</b>	.020	.020	<b>.050</b>
ROT PLS	26	0.010	<b>0.050</b>	<b>0.050</b>	<b>0.002</b>	<b>0.050</b>	<b>0.080</b>	<b>0.001</b>
COMP	27	.000	.000	.000	.000	.000	.000	.000
CNTL ACC	28	0	0	0	<b>7</b>	0	<b>9</b>	<b>7</b>
PURPOSE		CORRIDOR	DOCKING	FLY- AROUND	MATED STACK MNVRS & HOLD	FAILED CAPTURE	VRCS CAPTURE	RME 1301

Note: **BOLD/ITALICS** = not I-Loaded

\*.003 is below SPEC 20 lower limit. Value has been i-loaded and will not show on SPEC 20 display

**STS-79 GENERIC DAP B CONFIGURATIONS**

	ITEM #	B1	B2	B3	B4	B5	B7
<b>PRI</b>							
ROT RATE	30	0.5000	0.2000	0.2000	0.2000	0.2000	0.5000
ATT DB	31	3.00	3.00	3.00	0.30	3.00	2.00
RATE DB	32	0.20	0.20	0.20	0.20	0.20	0.20
ROT PLS	33	0.04	0.04	0.04	0.04	0.04	0.04
COMP	34	.000	.000	.000	.000	.000	.000
P OPTION	35	ALL	TAIL	ALL	TAIL	TAIL	ALL
Y OPTION	36	ALL	TAIL	ALL	TAIL	TAIL	ALL
TRAN PLS	37	0.10	0.02	0.02	0.02	0.02	0.05
<b>ALT</b>							
RATE DB	38	0.200	0.070	0.070	0.200	0.200	0.200
JET OPT	39	ALL	TAIL	ALL	ALL	ALL	ALL
# JETS	40	2	1	1	2	2	2
ON TIME	41	0.08	0.08	0.08	0.08	0.08	0.08
DELAY	42	0.00	0.00	0.00	0.00	0.00	0.00
<b>VERN</b>							
ROT RATE	43	0.2000	0.2000	0.2000	0.0080	0.0160	0.2000
ATT DB	44	1.000	1.000	1.000	0.100	0.033	1.000
RATE DB	45	.020	.020	.020	.010	.020	.020
ROT PLS	46	0.002	0.002	0.002	0.002	0.002	0.002
COMP	47	.000	.000	.000	.000	.000	.000
CNTL ACC	48	0	0	0	0	0	0
PURPOSE		NOM; OMS & RCS BURNS	LOSS OF VERN (TAIL ONLY)	LOSS OF VERN (N & T)	SSUS DEPLOY	COAS CAL	RNDZ

Note: ***BOLD/ITALICS*** = not l-Loaded

STS-79 FLIGHT SPECIFIC DAP B CONFIGURATIONS

	ITEM #	B8	B9	B10	B12	B13	B14	B15
<b>PRI</b>								
ROT RATE	30	<b>0.2000</b>	<b>0.0500</b>	<b>0.1300</b>	<b>0.0500</b>	<b>0.0500</b>	<b>0.5000</b>	<b>0.1000</b>
ATT DB	31	<b>1.00</b>	<b>0.50</b>	<b>2.00</b>	<b>5.00</b>	<b>1.00</b>	3.00	<b>40.00</b>
RATE DB	32	<b>0.10</b>	<b>0.10</b>	<b>0.10</b>	0.20	<b>0.10</b>	0.20	0.20
ROT PLS	33	0.04	0.04	0.04	0.04	0.04	0.04	<b>0.003*</b>
COMP	34	.000	.000	.000	.000	.000	.000	.000
P OPTION	35	<b>TAIL</b>	<b>TAIL</b>	<b>TAIL</b>	<b>TAIL</b>	<b>TAIL</b>	ALL	<b>TAIL</b>
Y OPTION	36	<b>TAIL</b>	<b>TAIL</b>	<b>TAIL</b>	<b>TAIL</b>	<b>TAIL</b>	ALL	<b>TAIL</b>
TRAN PLS	37	<b>0.01</b>	<b>0.01</b>	<b>0.01</b>	<b>0.01</b>	<b>0.01</b>	<b>0.10</b>	<b>0.01</b>
<b>ALT</b>								
RATE DB	38	0.200	0.200	0.200	<b>0.070</b>	0.200	0.200	0.200
JET OPT	39	ALL	ALL	ALL	<b>TAIL</b>	ALL	ALL	<b>TAIL</b>
# JETS	40	2	2	2	<b>3</b>	2	2	<b>3</b>
ON TIME	41	0.08	0.08	0.08	0.08	0.08	0.08	0.08
DELAY	42	0.00	0.00	0.00	<b>10.88</b>	0.00	0.00	<b>10.88</b>
<b>VERN</b>								
ROT RATE	43	0.2000	<b>0.0500</b>	<b>0.1300</b>	<b>0.0500</b>	<b>0.0500</b>	<b>0.4000</b>	<b>0.0500</b>
ATT DB	44	1.000	<b>0.500</b>	<b>2.000</b>	1.000	1.000	1.000	<b>5.000</b>
RATE DB	45	.020	.020	.020	<b>.050</b>	.020	.020	<b>.050</b>
ROT PLS	46	0.002	<b>0.020</b>	<b>0.020</b>	0.002	<b>0.020</b>	<b>0.080</b>	<b>0.001</b>
COMP	47	.000	.000	.000	.000	.000	.000	.000
CNTL ACC	48	0	0	0	<b>7</b>	0	<b>9</b>	<b>7</b>
PURPOSE		CORRIDOR	DOCKING	FLY- AROUND	MATED STACK TIGHT CONTROL	FAILED CAPTURE	VRCS REBOOST	RME 1301

Note: **BOLD/ITALICS** = not I-Loaded

\*.003 is below SPEC 20 lower limit. Value has been i-loaded and will not show on SPEC 20 display

ATTITUDE PICTORIALS

ATTITUDE  
PICTORIALS

# ATTITUDE PICTORIALS

## MATED ATTITUDE FOR MIR SOLAR POWER REQUIREMENTS (GO-3)

### GO 3.1

MAXIMUM MOMENT OF INERTIA  
NORMAL TO PLANE

MINIMUM MOMENT OF INERTIA  
ALONG THE RADIUS VECTOR

SHUTTLE ON BOTTOM

SHUTTLE TAIL FORWARD

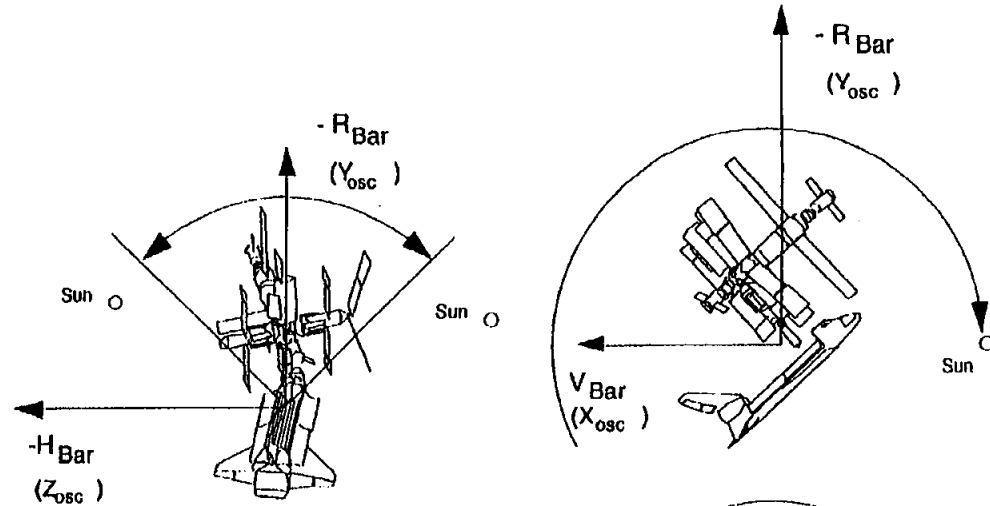

### GO 3.2

MAXIMUM MOMENT OF INERTIA  
NORMAL TO PLANE

MINIMUM MOMENT OF INERTIA  
ALONG THE RADIUS VECTOR

SHUTTLE ON BOTTOM

SHUTTLE NOSE FORWARD

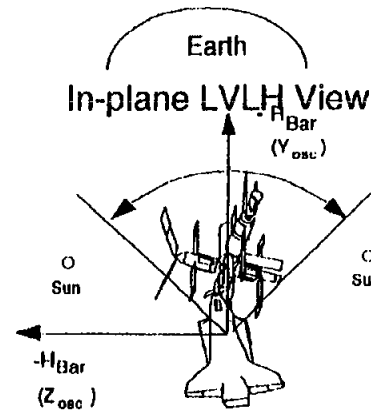

Earth  
In-plane LVLH View

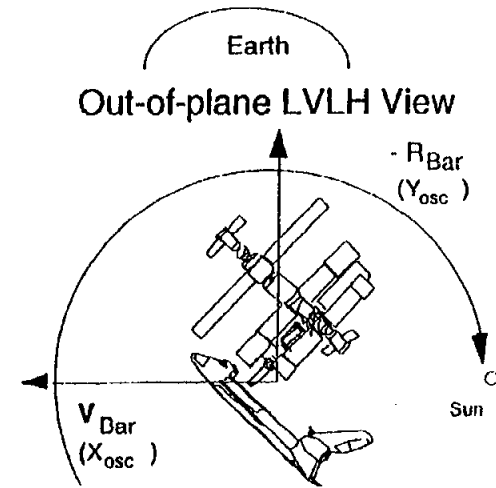

Earth  
Out-of-plane LVLH View

## MATED ATTITUDE FOR MIR SOLAR POWER REQUIREMENTS (GO-3)

### GO 3.3

MAXIMUM MOMENT OF INERTIA  
NORMAL TO PLANE

MINIMUM MOMENT OF INERTIA  
ALONG THE RADIUS VECTOR

SHUTTLE ON TOP

SHUTTLE TAIL FORWARD

SHUTTLE NOSE SOUTH

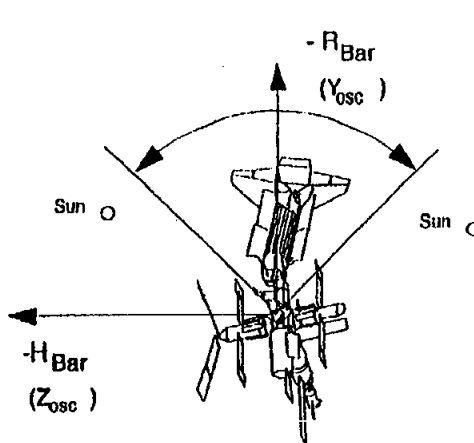

Earth  
In-plane LVLH View

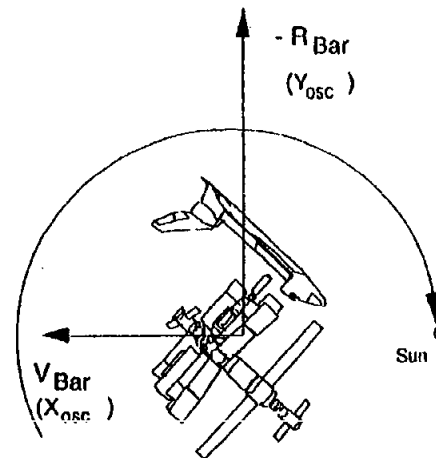

Earth  
Out-of-plane LVLH View

### GO 3.4

MAXIMUM MOMENT OF INERTIA  
NORMAL TO PLANE

MINIMUM MOMENT OF INERTIA  
ALONG THE RADIUS VECTOR

SHUTTLE ON TOP

SHUTTLE NOSE FORWARD

SHUTTLE NOSE NORTH

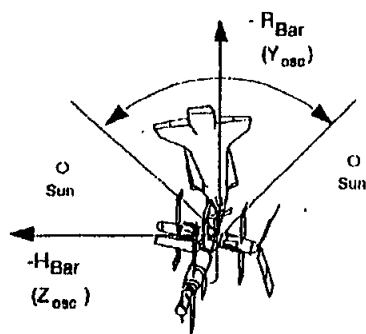

Earth  
In-plane LVLH View

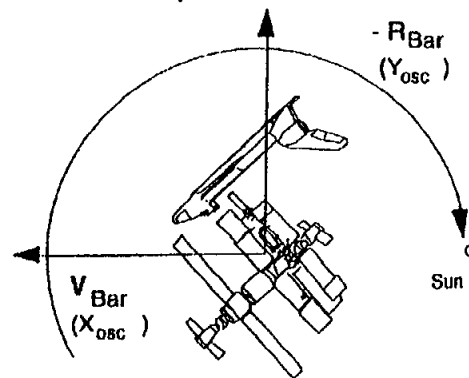

Earth  
Out-of-plane LVLH View



**MATED ATTITUDE FOR MIR SOLAR POWER REQUIREMENTS (GO-4)**

**GO 4.1**

MAXIMUM MOMENT OF INERTIA IN  
+/- VELOCITY VECTOR

MINIMUM MOMENT OF INERTIA ALONG  
THE RADIUS VECTOR

SHUTTLE ON BOTTOM

SHUTTLE NOSE NORTH

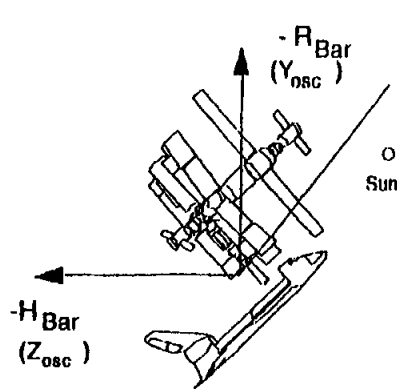

Earth  
In-plane LVLH View

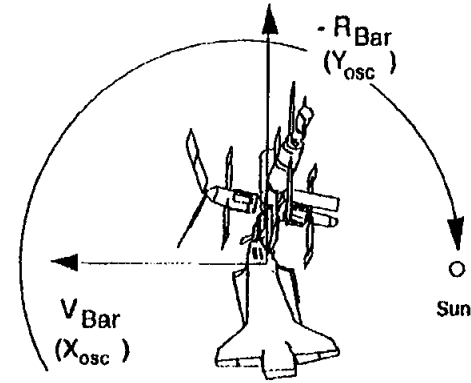

Earth  
Out-of-plane LVLH View

**GO 4.2**

MAXIMUM MOMENT OF INERTIA IN  
+/- VELOCITY VECTOR

MINIMUM MOMENT OF INERTIA  
ALONG THE RADIUS VECTOR

SHUTTLE ON BOTTOM

SHUTTLE NOSE SOUTH

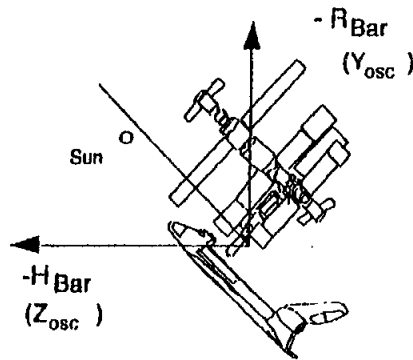

Earth  
In-plane LVLH View

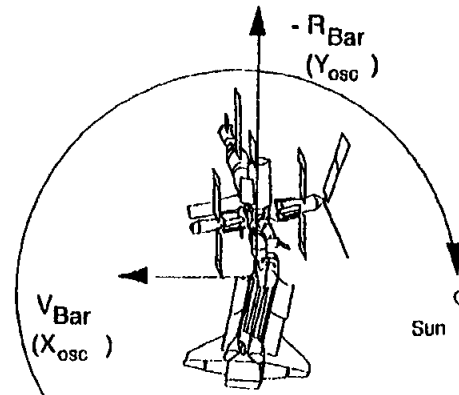

Earth  
Out-of-plane LVLH View

**MATED ATTITUDE FOR MIR SOLAR POWER REQUIREMENTS (GO-4)**

**GO 4.3**

MAXIMUM MOMENT OF INERTIA ALONG  
+/- VELOCITY VECTOR

MINIMUM MOMENT OF INERTIA ALONG  
THE RADIUS VECTOR

SHUTTLE ON TOP

SHUTTLE NOSE NORTH

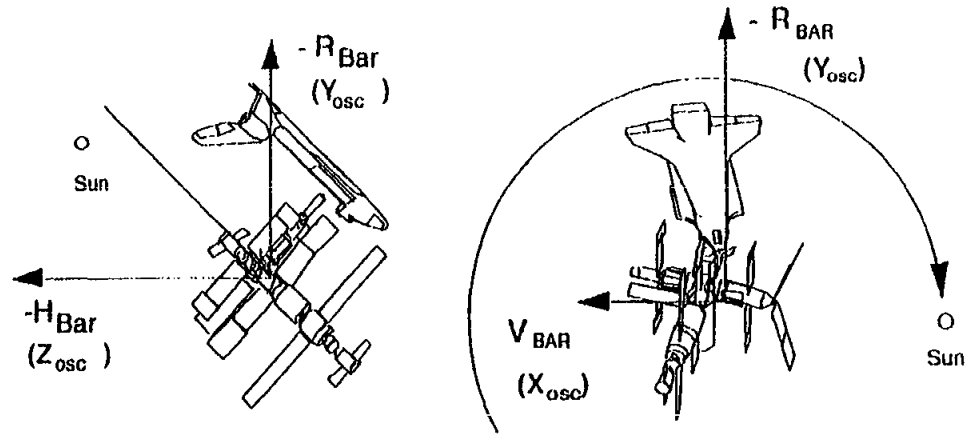

**GO 4.4**

MAXIMUM MOMENT OF INERTIA ALONG  
+/- VELOCITY VECTOR

MINIMUM MOMENT OF INERTIA ALONG  
THE RADIUS VECTOR

SHUTTLE ON TOP

SHUTTLE NOSE SOUTH

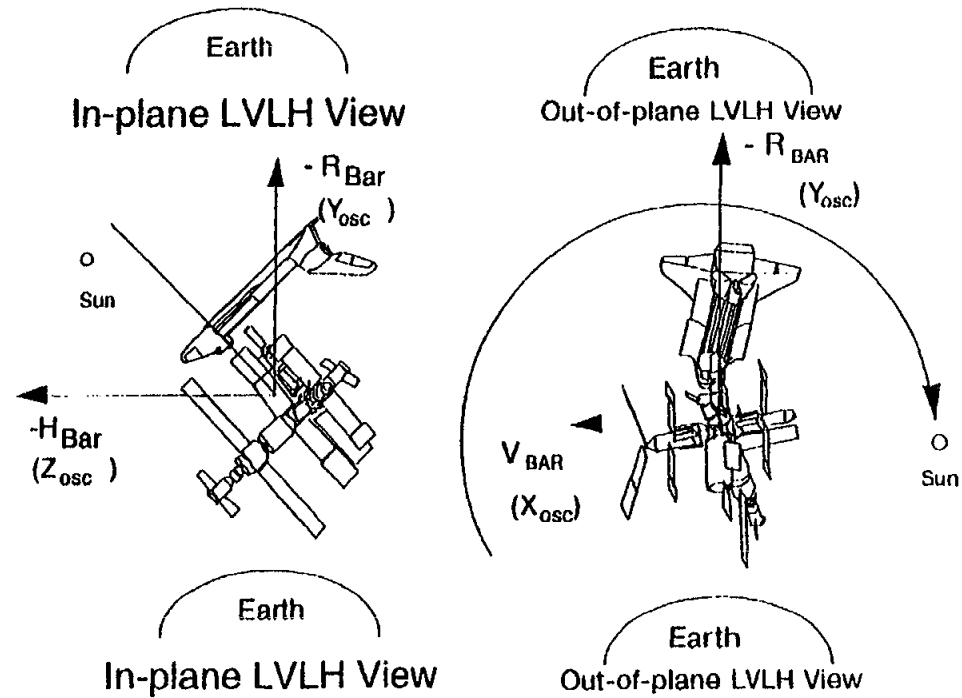

## MATED ATTITUDE FOR MIR SOLAR POWER REQUIREMENTS (GO-5)

### GO 5.1

MAXIMUM MOMENT OF INERTIA IN  
+/- VELOCITY VECTOR

MINIMUM MOMENT OF INERTIA  
PERPENDICULAR TO ORBIT PLANE

SHUTTLE ON TOP

SHUTTLE NOSE SOUTH

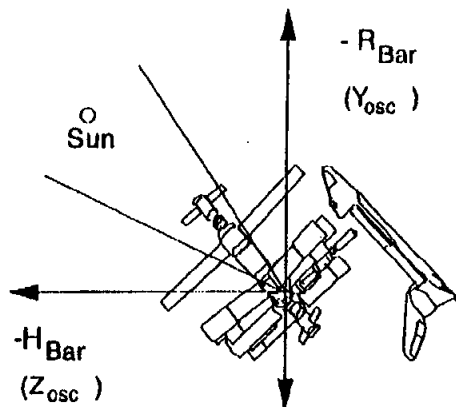

Earth  
In-plane LVLH View

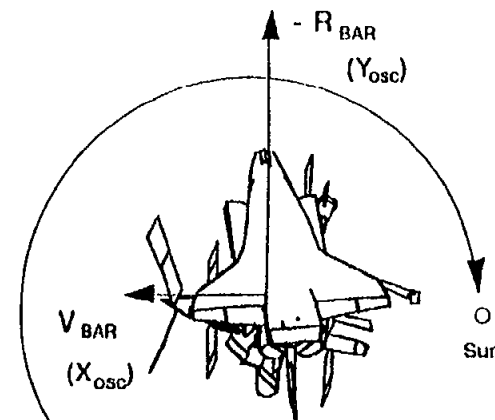

Earth  
Out-of-plane LVLH View

### GO 5.2

MAXIMUM MOMENT OF INERTIA IN  
+/- VELOCITY VECTOR

MINIMUM MOMENT OF INERTIA  
PERPENDICULAR TO ORBIT PLANE

SHUTTLE ON TOP

SHUTTLE NOSE NORTH

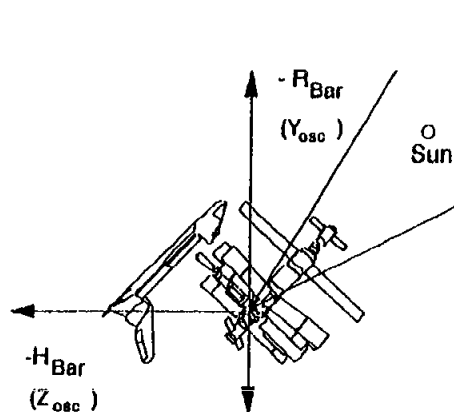

Earth  
In-plane LVLH View

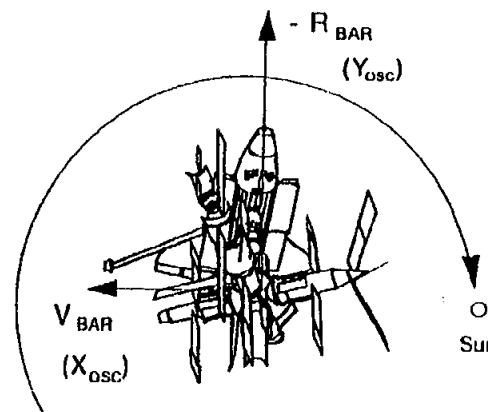

Earth  
Out-of-plane LVLH View

## MATED ATTITUDE FOR MIR SOLAR POWER REQUIREMENTS (GO-5)

### GO 5.3

MAXIMUM MOMENT OF INERTIA IN  
+/- VELOCITY VECTOR

MINIMUM MOMENT OF INERTIA  
PERPENDICULAR TO ORBIT PLANE

SHUTTLE ON BOTTOM

SHUTTLE NOSE NORTH

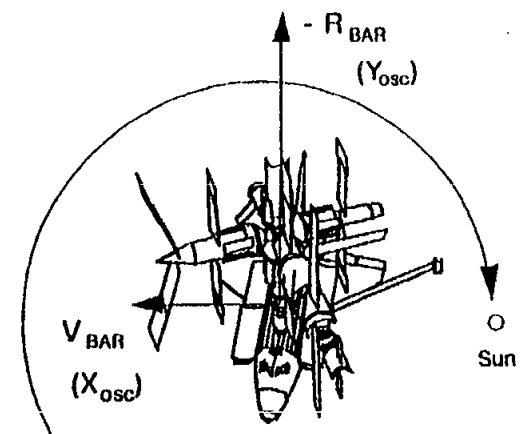
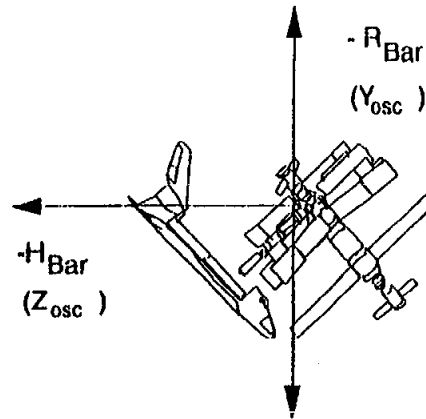

### GO 5.4

MAXIMUM MOMENT OF INERTIA IN  
+/- VELOCITY VECTOR

MINIMUM MOMENT OF INERTIA  
PERPENDICULAR TO ORBIT PLANE

SHUTTLE ON BOTTOM

SHUTTLE NOSE SOUTH

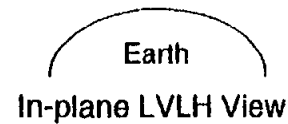
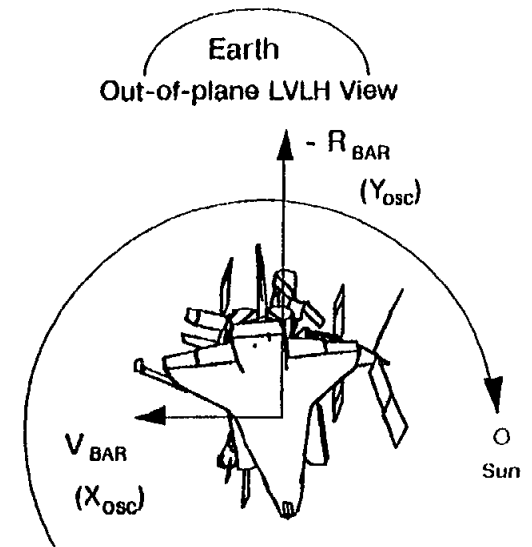
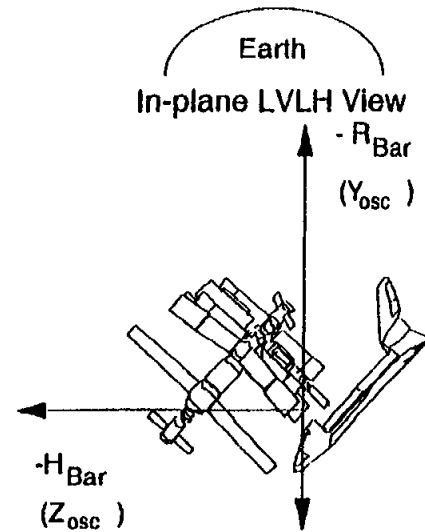

# DEFINING AN IO ATTITUDE

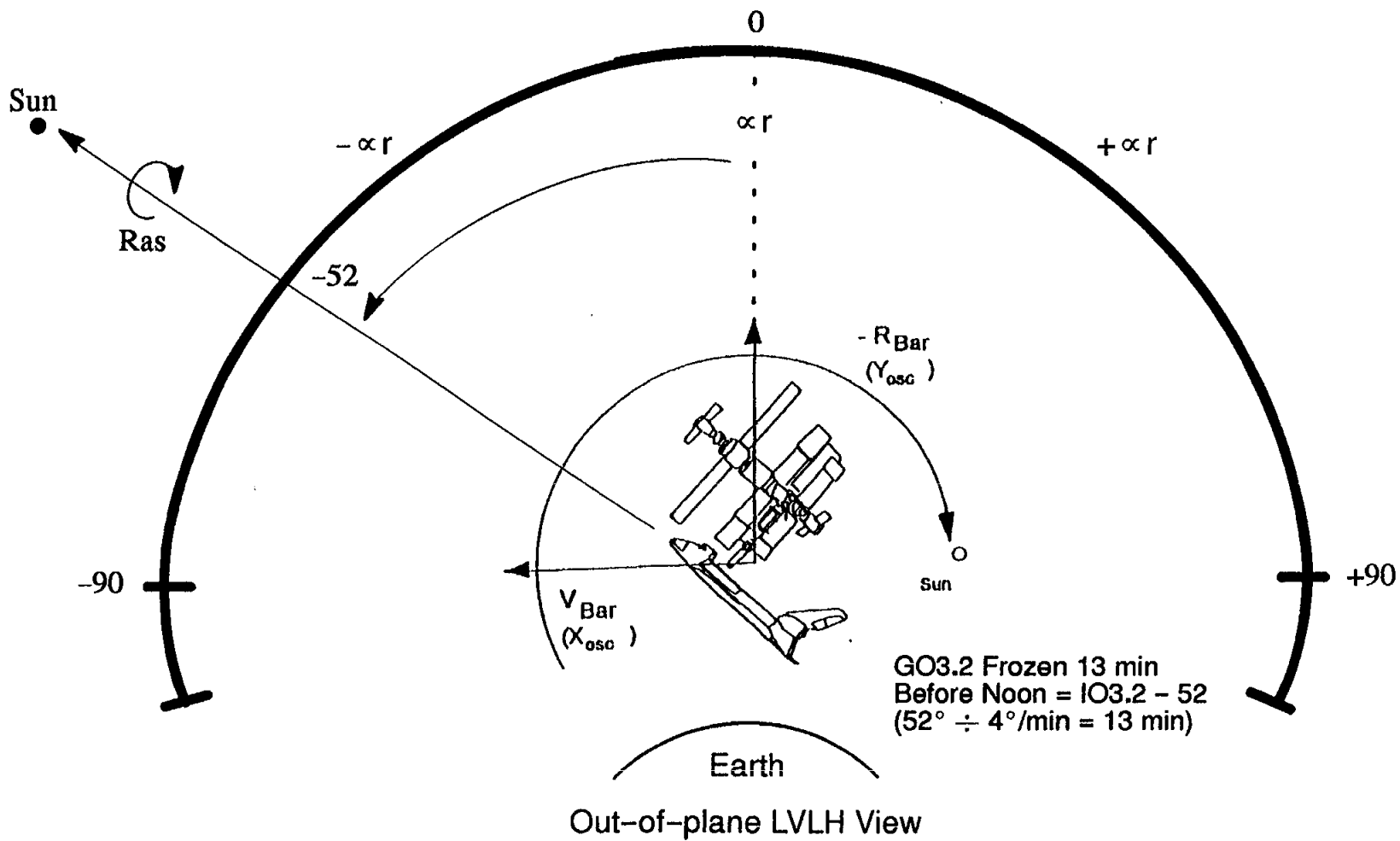

8-8

FLT PLN/79/FIN

# IO3.2-52+00

Type      Alpha/r      RAS

- Type are GO# or IO#
  - IO's are "frozen" GO3's, 4's or 5's
- Alpha sub r (applicable for IO only)
  - angle between -rbar and projection of sun vector onto orbit plane
  - negative before noon, positive after noon
- RAS = Rotation About Sun (IO only)
  - rotate about line of sight to sun
  - 0 = no rotation, positive right hand rule

**This Page Intentionally Blank**

**The sections following this divider page will not be included in flight copies.**



**This Page Intentionally Blank**

**ATTITUDE TIMELINE**

ATTITUDE  
TIMELINE

Attitude Timeline

MET/GMT	MNVR OPTION	DAP	E/S	REF ATT/REMARKS	EVENT
1 000/00:43:00 MET 214/04:12:45 GMT	TGT=2 BV=5 P= 78.00 Y= 0.00 OM=180.00	A6 RATE 0.2000 AUTO DB AT 5.00 ALT DB RT 0.070	EARTH R 0 P 78	LVLH R=180.00 P=348.00 Y= 0.00	OMS-2
2 000/01:12:00 MET 27:00 214/04:41:45 GMT 56:45	TGT=2 BV=3 P= 90.00 Y= 0.00 OM= 0.00	A6 RATE 0.2000 AUTO DB AT 5.00 ALT DB RT 0.070	EARTH R 0 P 90	LVLH R= 0.00 P=180.00 Y= 0.00	-ZLV -XVV
3 000/02:35:00 MET 43:11 214/06:04:45 GMT 12:56	INRTL R=263.00 MNVR P=308.00 Y=356.00	A6 RATE 0.2000 AUTO DB AT 5.00 ALT DB RT 0.070	SUN R 231 P 101		NH +X burn TIG 0/2:58:00
4 000/02:59:00 MET 214/06:28:45 GMT		A6 RATE 0.2000 LVLH DB AT 5.00 ALT DB RT 0.070	EARTH R 177 P 107	LVLH R= 2.88 HOLD P= 16.68 Y=359.43	LVLH BTWN BURNS
5 000/03:30:00 MET 34:01 214/06:59:45 GMT 07:03:46	INRTL R=100.00 MNVR P=128.00 Y= 10.00	A6 RATE 0.2000 AUTO DB AT 5.00 ALT DB RT 0.070	SUN R 305 P 75		NC-1 +X burn TIG 0/3:41:00
6 000/03:50:00 MET 04:01:04 214/07:19:45 GMT 30:49	TGT=2 BV=5 P= 90.00 Y=340.00 OM= 0.00	A6 RATE 0.2000 AUTO DB AT 5.00 ALT DB RT 0.070	EARTH R 340 P 90	LVLH R= 20.00 P=180.00 Y= 0.00	Biased -ZLV -XVV for water
7 000/15:20:00 MET 30:47 214/18:49:45 GMT 19:00:32	INRTL R=102.00 MNVR P=127.00 Y= 10.00	A6 RATE 0.2000 AUTO DB AT 5.00 ALT DB RT 0.070	SUN R 302 P 75		NC-2 +X burn TIG 0/15:36:00
8 000/15:40:00 MET 52:42 214/19:09:45 GMT 22:27	TGT=2 BV=5 P= 90.00 Y=340.00 OM= 0.00	A6 RATE 0.2000 AUTO DB AT 5.00 ALT DB RT 0.070	EARTH R 340 P 90	LVLH R= 20.00 P=180.00 Y= 0.00	Biased -ZLV -XVV for water
9 000/17:20:00 MET 30:07 214/20:49:45 GMT 59:52	INRTL R=263.00 MNVR P=242.00 Y=324.00	A6 RATE 0.2000 AUTO DB AT 5.00 ALT DB RT 0.070	SUN R 211 P 88	STAR PAIR A2 -Y=47 -Z=36	IMU ALIGN los 47=17:55 los 36=18:08 sr=18:09
10 000/18:10:00 MET 14:21 214/21:39:45 GMT 44:06	TGT=2 BV=5 P= 0.00 Y=270.00 OM= 0.00	A6 RATE 0.2000 AUTO DB AT 5.00 ALT DB RT 0.070	EARTH R 270 P 90	LVLH R= 90.00 P=180.00 Y= 0.00	-YLV -XVV
11 000/21:14:00 MET 215/00:43:45 GMT	NPC MULTI-AXIS				
12 000/22:45:00 MET 58:38 215/02:14:45 GMT 28:23	TGT=2 BV=5 P=177.51 Y= 0.77 OM= 69.09	A6 RATE 0.2000 AUTO DB AT 5.00 ALT DB RT 0.070	EARTH R 17 P 177	LVLH R=290.92 P= 91.61 Y=357.95	-XLV -YVV GG BIASED

\*\*\* ALL ATTITUDES IN MEAN OF 1950 \*\*\*  
\*\*\* PYR EULER SEQUENCE \*\*\*

Attitude Timeline

MET/GMT	MNVR OPTION	DAP	E/S	REF ATT/REMARKS	EVENT	
13	000/23:00:00 MET 215/02:29:45 GMT	FREE DRIFT				
14	001/01:00:00 MET 12:23 215/04:29:45 GMT 42:08	INRTL R=255.00 MNVR P=305.00 Y=340.00	A6 AUTO ALT	RATE 0.2000 DB AT 5.00 DB RT 0.070	SUN R 243 P 110	NC-3 +X burn TIG 1/01:14:49
15	001/01:15:00 MET 23:34 215/04:44:45 GMT 53:19	TGT=2 BV=5 P=177.51 Y=359.03 OM=290.82	A6 AUTO ALT	RATE 0.2000 DB AT 5.00 DB RT 0.070	EARTH R 339 P 177	LVLH R= 69.17 P= 91.79 Y= 1.98 -XLV BIASED+YVV
16	001/11:00:00 MET 215/14:29:45 GMT		A2 INRT VERN	RATE 0.4000 DB AT 1.000 DB RT 0.020	SUN R 191 P 62	INRTL R=238.75 HOLD P= 51.11 Y= 72.33 INRT HOLD to kill rates for water dump
17	001/11:05:00 MET 06:39 215/14:34:45 GMT 36:24	TGT=2 BV=5 P=177.51 Y=359.03 OM=290.82	A6 AUTO ALT	RATE 0.2000 DB AT 5.00 DB RT 0.070	EARTH R 339 P 177	LVLH R= 69.17 P= 91.79 Y= 1.98 -XLV BIASED+YVV
18	001/13:09:00 MET 215/16:38:45 GMT	NH MULTI-AXIS DELTA V 0.0ft/s				
19	001/13:35:00 MET 49:08 215/17:04:45 GMT 18:53	INRTL R=107.00 MNVR P=126.00 Y= 16.00	A6 AUTO ALT	RATE 0.2000 DB AT 5.00 DB RT 0.070	SUN R 295 P 71	NC-4 +X burn 1/13:57:00 TIG
20	001/14:00:00 MET 09:26 215/17:29:45 GMT 39:11	TGT=2 BV=5 P= 0.00 Y= 0.00 OM= 0.00	A7 AUTO VERN	RATE 0.2000 DB AT 1.000 DB RT 0.020	EARTH R 0 P 0	LVLH R= 0.00 P=270.00 Y= 0.00 -Z TGT TRACK
21	001/14:30:00 MET 31:40 215/17:59:45 GMT 18:01:25	TGT=2 BV=5 P=340.00 Y= 0.00 OM= 0.00	A7 AUTO VERN	RATE 0.2000 DB AT 1.000 DB RT 0.020	EARTH R 180 P 20	LVLH R= 0.00 P=290.00 Y= 0.00 -Z TGT TRACK
22	001/14:31:00 MET 215/18:00:45 GMT	NCC MULTI-AXIS DELTA V 0.0ft/s				
23	001/15:10:00 MET 40 215/18:39:45 GMT 40:25	INRTL R=107.00 MNVR P=125.00 Y= 17.00	A7 AUTO VERN	RATE 0.2000 DB AT 1.000 DB RT 0.020	SUN R 295 P 71	TI BURN TIG 1/15:29:00
24	001/15:35:00 MET 45:28 215/19:04:45 GMT 15:13	TGT=2 BV=1 P= 0.00 Y= 0.00 OM= 0.00	A7 AUTO VERN	RATE 0.2000 DB AT 1.000 DB RT 0.020	EARTH R 90 P 0	LVLH R= 0.00 P=270.00 Y= 0.00 -Z TGT TRACK

\*\*\* ALL ATTITUDES IN MEAN OF 1950 \*\*\*  
\*\*\* PYR EULER SEQUENCE \*\*\*

Attitude Timeline

MET/GMT	MNVR OPTION	DAP	E/S	REF ATT/REMARKS	EVENT
25 001/15:50:00 MET 50 215/19:19:45 GMT 20:35	TGT=2 BV=5 P=350.00 Y= 0.00 OM= 0.00	A7 RATE 0.2000 AUTO DB AT 1.000 VERN DB RT 0.020	EARTH R 180 P 10	LVLH R= 0.00 P=280.00 Y= 0.00	-2 TGT TRACK
26 001/16:10:00 MET 50 215/19:39:45 GMT 40:35	TGT=2 BV=5 P=340.00 Y= 0.00 OM= 0.00	A7 RATE 0.2000 AUTO DB AT 1.000 VERN DB RT 0.020	EARTH R 180 P 20	LVLH R= 0.00 P=290.00 Y= 0.00	-2 TGT TRACK
27 001/16:25:00 MET 26:40 215/19:54:45 GMT 56:25	TGT=2 BV=5 P=320.00 Y= 0.00 OM= 0.00	A7 RATE 0.2000 AUTO DB AT 1.000 VERN DB RT 0.020	EARTH R 180 P 40	LVLH R= 0.00 P=310.00 Y= 0.00	-2 TGT TRACK
28 001/16:35:00 MET 37:55 215/20:04:45 GMT 07:40	TGT=2 BV=5 P=285.00 Y= 0.00 OM= 0.00	A7 RATE 0.2000 AUTO DB AT 1.000 VERN DB RT 0.020	EARTH R 180 P 75	LVLH R= 0.00 P=345.00 Y= 0.00	-2 TGT TRACK
29 001/16:50:00 MET 51:15 215/20:19:45 GMT 21:00	TGT=2 BV=5 P=270.00 Y= 0.00 OM= 0.00	A7 RATE 0.2000 AUTO DB AT 1.000 VERN DB RT 0.020	EARTH R 180 P 90	LVLH R= 0.00 P= 0.00 Y= 0.00	R-bar arrival
30 001/17:05:00 MET 20:00 215/20:34:45 GMT 49:45	TGT=2 BV=5 P=270.00 Y= 0.00 OM=180.00	A7 RATE 0.2000 AUTO DB AT 1.000 VERN DB RT 0.020	EARTH R 180 P 90	LVLH R=180.00 P=180.00 Y= 0.00	tail fwd for docking
31 001/18:04:00 MET 215/21:33:45 GMT	DOCKING 1/18:04:00				
32 001/18:25:00 MET 39:18 215/21:54:45 GMT 22:09:03	INRTL R=124.00 MNVR P=193.00 Y= 56.00	A12 RATE 0.1500 AUTO DB AT 5.000 VERN DB RT 0.050	SUN R 185 P 14	001/20:10:26	IO 4.1/-10/0 SUN P=346 Y=359 OM=84
33 001/23:00:00 MET 15:14 216/02:29:45 GMT 44:59	INRTL R= 48.00 MNVR P=271.00 Y=307.00	A12 RATE 0.1500 AUTO DB AT 5.000 VERN DB RT 0.050	SUN R 87 P 112	002/04:54:07	IO 3.1/-130/0 SUN P=172 Y=68 OM=175
34 002/09:00:00 MET 15:43 216/12:29:45 GMT 45:28	INRTL R=133.00 MNVR P=187.00 Y= 56.00	A12 RATE 0.1500 AUTO DB AT 5.000 VERN DB RT 0.050	SUN R 188 P 16	002/14:39:27	IO 4.1/-10/0 SUN P=344 Y=358 OM=84
35 002/20:40:00 MET 52:19 217/00:09:45 GMT 22:04	INRTL R= 68.00 MNVR P=301.00 Y=351.00	A12 RATE 0.1500 AUTO DB AT 5.000 VERN DB RT 0.050	SUN R 69 P 101	003/02:39:12	IO 3.1/-87/0 SUN P=119 Y=67 OM=165
36 003/10:00:00 MET 12:48 217/13:29:45 GMT 42:33	INRTL R=147.00 MNVR P=180.00 Y= 54.00	A12 RATE 0.1500 AUTO DB AT 5.000 VERN DB RT 0.050	SUN R 188 P 19	003/15:18:32	IO 4.1/-10/0 SUN P=341 Y=358 OM=84

\*\*\* ALL ATTITUDES IN MEAN OF 1950 \*\*\*  
\*\*\* PYR EULER SEQUENCE \*\*\*

## Attitude Timeline

MET/GMT	MNVR OPTION	DAP	E/S	REF ATT/REMARKS	EVENT
37 003/22:30:00 MET 42:41 218/01:59:45 GMT 02:12:26	INRTL R= 64.00 MNVR P=302.00 Y=353.00	A12 RATE 0.1500 AUTO DB AT 5.000 VERN DB RT 0.050	SUN R 74 P 101	004/04:48:57	IO 3.1/-95/0 SUN P=126 Y=70 OM=164
38 004/11:00:00 MET 19:22 218/14:29:45 GMT 49:07	TGT=2 BV=5 P= 46.38 Y=354.21 OM=265.87	A12 RATE 0.1500 AUTO DB AT 5.000 VERN DB RT 0.050	EARTH R 352 P 47	LVLH R=264.10 P=280.04 Y= 45.81	GO 4.4 Waste dump
39 004/13:00:00 MET 19:58 218/16:29:45 GMT 49:43	INRTL R=164.00 MNVR P=174.00 Y= 50.00	A12 RATE 0.1500 AUTO DB AT 5.000 VERN DB RT 0.050	SUN R 186 P 22	004/19:03:10	IO 4.1/-10/0 SUN P=339 Y=358 OM=85
40 004/22:15:00 MET 32:50 219/01:44:45 GMT 02:02:35	TGT=2 BV=5 P= 46.38 Y=354.22 OM=355.85	A12 RATE 0.1500 AUTO DB AT 5.000 VERN DB RT 0.050	EARTH R 352 P 47	LVLH R= 1.32 P=223.75 Y= 6.99	GO 3.3 ARIS
41 004/22:30:00 MET 219/01:59:45 GMT	FREE DRIFT ARIS TEST				
42 005/00:45:00 MET 01:04:59 219/04:14:45 GMT 34:44	INRTL R= 61.00 MNVR P=303.00 Y=353.00	A12 RATE 0.1500 AUTO DB AT 5.000 VERN DB RT 0.050	SUN R 78 P 102	005/03:53:35	IO 3.1/-106/0 SUN P=138 Y=73 OM=165
43 005/10:00:00 MET 14:01 219/13:29:45 GMT 43:46	INRTL R=174.00 MNVR P=172.00 Y= 45.00	A12 RATE 0.1500 AUTO DB AT 5.000 VERN DB RT 0.050	SUN R 188 P 22	005/15:05:45	IO 4.1/-10/0 SUN P=338 Y=357 OM=85
44 005/20:20:00 MET 33:29 219/23:49:45 GMT 220/00:03:14	INRTL R= 59.00 MNVR P=311.00 Y= 2.00	A12 RATE 0.1500 AUTO DB AT 5.000 VERN DB RT 0.050	SUN R 78 P 103	006/03:01:12	IO 3.1/-106/0 SUN P=138 Y=73 OM=165
45 006/10:00:00 MET 13:54 220/13:29:45 GMT 43:39	INRTL R=183.00 MNVR P=173.00 Y= 41.00	A12 RATE 0.1500 AUTO DB AT 5.000 VERN DB RT 0.050	SUN R 186 P 22	006/11:08:22	IO 4.1/-10/0 SUN P=338 Y=358 OM=84
46 006/13:15:00 MET 31:29 220/16:44:45 GMT 17:01:14	TGT=2 BV=5 P=226.38 Y= 5.78 OM=184.15	A12 RATE 0.1500 AUTO DB AT 5.000 VERN DB RT 0.050	EARTH R 172 P 133	LVLH R=181.32 P=136.25 Y=353.01	GO 3.1
47 006/15:10:00 MET 13:42 220/18:39:45 GMT 43:27	TGT=2 BV=5 P=270.00 Y= 0.00 OM=180.00	A8 RATE 0.2000 AUTO DB AT 1.000 VERN DB RT 0.020	EARTH R 180 P 90	LVLH R=180.00 P=180.00 Y= 0.00	UNDOCKING 6/15:10:00 MNV TAIL FWD FOR FLY AROUND
48 006/15:20:00 MET 220/18:49:45 GMT	LVLH ROTR FREE ROTATION ABOUT -Y AXIS RATE=0.130	A10 RATE 0.1300 LVLH DB AT 2.000 VERN DB RT 0.020		LVLH R=180.00 P=180.00 Y= 0.00	MIR Flyaround 720 deg in LVLH

\*\*\* ALL ATTITUDES IN MEAN OF 1950 \*\*\*  
\*\*\* PYR EULER SEQUENCE \*\*\*

9-5

FLT PLN/79/FIN

Attitude Timeline

MET/GMT	MNVR OPTION	DAP	E/S	REF ATT/REMARKS	EVENT
49 006/15:31:30 MET 220/19:01:15 GMT		A10 LVLH VERN RATE 0.1300 DB AT 2.000 DB RT 0.020	EARTH R 180 P 0	LVLH R=180.00 HOLD P=269.70 Y= 0.00	LVLH for IMAX VBAR HOLD
50 006/15:42:00 MET 220/19:11:45 GMT	LVLH ROTR FREE ROTATION ABOUT -Y AXIS RATE=0.130	A10 LVLH VERN RATE 0.1300 DB AT 2.000 DB RT 0.020		LVLH R=180.00 P=269.70 Y= 0.00	CONT. FLYAROUND
51 006/17:02:48 MET 220/20:32:33 GMT		A10 LVLH VERN RATE 0.1300 DB AT 2.000 DB RT 0.020	EARTH R 180 P 90	LVLH R=180.00 HOLD P=179.94 Y= 0.00	LVLH for sep
52 006/17:05:00 MET 220/20:34:45 GMT		A10 INRT VERN RATE 0.1300 DB AT 2.000 DB RT 0.020	SUN R 79 P 110	INRTL R= 55.43 HOLD P=321.60 Y= 3.66	INRT HOLD FOR SEP BURN @ 6/17:06:00
53 006/17:11:00 MET 14:53 220/20:40:45 GMT 44:38	TGT=2 BV=5 P=270.00 Y= 0.00 OM=180.00	A8 AUTO VERN RATE 0.1000 DB AT 1.000 DB RT 0.020	EARTH R 180 P 90	LVLH R=180.00 P=180.00 Y= 0.00	-Z MIR TRACK TAIL FWD
54 006/17:25:00 MET 40:00 220/20:54:45 GMT 21:09:45	TGT=2 BV=5 P= 90.00 Y= 0.00 OM=270.00	A6 AUTO ALT RATE 0.2000 DB AT 5.00 DB RT 0.070	EARTH R 360 P 90	LVLH R= 0.00 P=180.00 Y= 90.00	-ZLV +YVV (from RNDZ BK )
55 006/20:00:00 MET 07:30 220/23:29:45 GMT 37:15	TGT=2 BV=3 P= 90.00 Y= 0.00 OM= 0.00	A6 AUTO ALT RATE 0.2000 DB AT 5.00 DB RT 0.070	EARTH R 360 P 90	LVLH R= 0.00 P=180.00 Y= 0.00	-ZLV -XVV ARIS & RME1302
56 007/09:55:00 MET 10:02:30 221/13:24:45 GMT 32:15	TGT=2 BV=3 P= 90.00 Y= 0.00 OM=270.00	A6 AUTO ALT RATE 0.2000 DB AT 5.00 DB RT 0.070	EARTH R 360 P 90	LVLH R= 0.00 P=180.00 Y= 90.00	-ZLV +YVV for SAREX
57 007/13:25:00 MET 35:00 221/16:54:45 GMT 17:04:45	TGT=2 BV=2 P=180.00 Y= 0.00 OM= 0.00	A6 AUTO ALT RATE 0.2000 DB AT 5.00 DB RT 0.070	EARTH R 27 P 180	LVLH R= 0.00 P= 90.00 Y= 0.00	-XLV +ZVV for REBOOST TST
58 007/15:30:00 MET 38:42 221/18:59:45 GMT 19:08:27	TGT=2 BV=5 P= 90.00 Y= 60.00 OM= 0.00	A6 AUTO ALT RATE 0.2000 DB AT 5.00 DB RT 0.070	EARTH R 60 P 90	LVLH R=300.00 P=180.00 Y= 0.00	Biased -ZLV -XVV for water and SAREX
59 008/01:00:00 MET 14:18 222/04:29:45 GMT 44:03	TGT=5 BV=5 P=270.00 Y= 0.00 OM=270.00 RA= 138.700 DEC= 16.000N	A1 AUTO VERN RATE 0.2000 DB AT 1.000 DB RT 0.020	SUN R 180 P 90	INRTL R=320.28 P=296.56 Y= 6.86	PTC ATTITUDE
60 008/01:15:00 MET 222/04:44:45 GMT	INRTL ROTR BV=1 P= 0.00 Y= 0.00	A2 AUTO VERN RATE 0.4000 DB AT 1.000 DB RT 0.020		INRTL R=320.28 P=296.59 Y= 6.90	PTC ROTOR INIT

\*\*\* ALL ATTITUDES IN MEAN OF 1950 \*\*\*  
\*\*\* PYR EULER SEQUENCE \*\*\*

Attitude Timeline

MET/GMT	MNVR OPTION	DAP	E/S	REF ATT/REMARKS	EVENT
61 008/14:50:00 MET 15:01:40 222/18:19:45 GMT 31:25	TGT=4 RA= 139.226 BV=5 DEC= 15.813N P=184.00 Y= 0.00 OM=270.00	A6 RATE 0.2000 AUTO DB AT 5.00 ALT DB RT 0.070	SUN R 180 P 176	INRTL R=342.52 P= 15.60 Y=322.17	-XSI COLDSOAK
62 008/16:40:00 MET 46:00 222/20:09:45 GMT 15:45	INRTL R=132.00 MNVR P=147.00 Y=291.00	A1 RATE 0.2000 AUTO DB AT 1.000 VERN DB RT 0.020	SUN R 274 P 115		D/O IMU ALIGN -Y=41 -Z=34
63 008/17:00:00 MET 05:00 222/20:29:45 GMT 34:45	INRTL R=333.00 MNVR P=120.00 Y= 6.00	B1 RATE 0.5000 AUTO DB AT 3.00 PRI DB RT 0.20	SUN R 65 P 79		D/O IMU VERIF STAR PAIR -Y=35-Z=20
64 008/17:20:00 MET 22:36 222/20:49:45 GMT 52:21	INRTL R=280.00 MNVR P= 60.00 Y=318.00	B1 RATE 0.5000 AUTO DB AT 3.00 PRI DB RT 0.20	SUN R 87 P 150		DEORBIT COMM.
65 008/19:31:00 MET 34:11 222/23:00:45 GMT 03:56	INRTL R=228.00 MNVR P=305.00 Y=338.00	B1 RATE 0.5000 AUTO DB AT 3.00 PRI DB RT 0.20	SUN R 278 P 115		DO BURN TIG 8/19:46:00

\*\*\* ALL ATTITUDES IN MEAN OF 1950 \*\*\*  
\*\*\* PYR EULER SEQUENCE \*\*\*



**This Page Intentionally Blank**

**FLIGHT PLAN NOTES**

FLIGHT PLAN NOTES  
(CONSTRAINTS AND GUIDELINES)

A. FLIGHT DESCRIPTION

Orbiter: OV104/Atlantis  
 Inclination: 51.6°  
 Insertion Altitude: 160 nm  
 Mir Docking Altitude: 217 X 210 nm  
 Duration: 9 + 1 + 2 days

B. MAJOR EVENTS

<u>EVENT</u>	<u>ORBIT</u>	<u>DAILY ORBIT</u>	<u>MET</u>	<u>CDT</u>	<u>ΔV (fps)</u>	<u>HP/HA (nm)</u>
Launch	--	--	00/00:00	22:30	--	--
OMS-2	1	--	00/00:43	23:13	75.0	85/160
NH1	2	--	00/02:41	23:28		
NC1	3	--	00/03:41	23:11	36.5	105/160
NC2	11	--	00/15:36	14:06	8.0	109/160
NPC	15	--	00/21:14	19:44	3.0	109/160
NC3	17	--	01/02:02	22:32	3.0	111/159
NH2	25	--	01/13:09	11:39	91.6	111/211
NC4	25	--	01/13:57	12:27	159.1	202/211
NCC	25	--	01/14:31	13:01	0.0	202/211
Ti	26	15	01/15:29	13:59	9.0	207/211
Docking	28	2	01/18:04	16:34	--	209/211
Undocking	104	1	06/15:10	13:40	--	208/212
RCS Sep	105	2	06/16:55	15:25	3.0	206/212
Deorbit	138	--	08/19:46	18:16	331.0	--
Landing	139	--	08/20:46	19:16	--	--

C. LANDING OPPORTUNITIES

		<u>Landing Orbit No.</u>	<u>Site</u>	<u>Local Time (EDT)</u>	<u>MET</u>
Nominal	Primary	140	KSC	20:16	08/20:46
	1 Rev Late	141	KSC	21:52	08/22:22
1 Day Late	Primary	155	KSC	19:18	09/19:48
	1 Rev Late	156	KSC	20:54	09/21:24
2 Days Late	Primary	170	KSC	18:20	10/18:50
	1 Rev Late	171	KSC	19:56	10/20:26

D. CREW

STS-79

CDR - William Readdy  
 PLT - Terry Wilcutt  
 MS1 - Jay Apt (EV2)  
 MS2 - Tom Akers (IV)  
 MS3 - Carl Walz (EV1)  
 MS4 (UP) - John Blaha  
 MS4 (DN) - Shannon Lucid

Mir-22

CDR - Yuri Onufrienko  
 ENG - Yuri Usachev

FLIGHT PLAN NOTES

## E. COMMUNICATIONS

TDRS Support: East (41° W), West (174° W), Z (85° E)  
Backup Real-Time TV: GDS(GDX), MIL(MLX)  
Backup Comm for Russian use: WLP, DFC (Dryden)  
Contingency GSTDN: MIL(MLX)\*, BDA(BDX)\*, GDS(GDX)\*, and WLP  
Contingency RTS: HTS, GTS, VTS, IOS\*, CGS, DGS, OTS\*, and HNS

\*UHF capability

Lead time for site callup: GSTDN - 2 hr, RTS - 4 hr

### MIR

Altair: 16° W, 95° E

Ground Sites: SHK, DJS, KLP, ULD, USK, PPK, and SPB

## F. TELEVISION/PHOTOGRAPHY

The CCTV systems provide one wide-angle camera and one Camcorder for in-cabin coverage. There will be four PLB TV Cameras and two docking CCTV Cameras (mounted on the ODS truss and the centerline). In addition, two Electronic Still Camera will be flown.

## G. PAYLOADS

### 1. Shuttle/Mir Mission-4 (S/MM-04)

S/MM-04 (Spacehab-Mir) is a mission comprised of life and microgravity science investigations, as well as the transfer of equipment, Russian logistics and hardware from the pressurized dual module Spacehab compartment and shuttle middeck to the Mir Space Station. Conversely, return items will be transferred from Mir to Spacehab and the shuttle middeck. Flown on S/MM-04:

#### a. Transfer Items

There are five basic categories of transfers on shuttle/Mir missions:

- Powered Transfers (shuttle to Mir)
- Resupply (shuttle to Mir, Mir to shuttle)
- U.S. Science Return (Mir to shuttle)
- Russian Return (Mir to shuttle)
- ESA Return (Mir to shuttle)

Blocks of time will be scheduled for transfers, instead of scheduling each transfer individually. The crew will use the joint inventory lists to perform the transfers. For the most part, the crew decides when the specific items are transferred. The shuttle has limited stowage space, and therefore resupply items are likely to be transferred to the Mir prior to transferring and stowing the return items.

#### (1) Powered Transfers:

Five experiments during this mission are classified as powered transfers. These will have been powered prior to transfer to the Priroda module of Mir, unpowered for transfer, and then re-powered onboard Mir.

- (a) **Biotechnology System Biology Experiment Module (BTS BEM);** this is also referred as the middeck BTS or Engineering Development Unit - Mir (EDU-M)

Before the BTS BEM/EDU-M can be transferred from shuttle to Priroda, a BTS ECC setup must be completed on Mir. Once completed, the BTS BEM/EDU-M will be powered down in the middeck and transferred to Priroda. Once in Priroda, the EDU-M setup will be performed and the BTS BEM/EDU-M will be repowered. This transfer is scheduled as the first powered transfer for two reasons: 1) The BTS EDU-M runs on its own internal gas supply until it can be hooked up to the Priroda gas supply module. This gas supply (~10 days) must last not only until the EDU-M is connected to the Priroda gas supply module on 79, but also from the time the EDU-M is disconnected from the Priroda gas supply on STS-81 until landing. 2) There are a limited number of power outlets in Priroda and the ECC setup procedure utilizes the MIP laptop which requires the use of a power outlet earmarked for a later powered transfer.

- (b) **Single Locker Thermal Enclosure (STES) Biotechnology System (BTS);** this is also referred to as the SHAB BTS

Prior to beginning the transfer to this item, the power supply at the destination location in Priroda will be verified as functional. The STES will then be powered down on the shuttle and unbolted from the Spacehab bulkhead. Once in Priroda, the STES will be bolted to the wall and powered up. The BTS-STES transfer and the BTS BEM/EDU-M transfers are not related.

- (c) **Commercial Generic Bioprocessing Apparatus (CGBA) Units #1 and #2**

These units are powered down one at a time and removed from their Spacehab locker prior to transfer. In Priroda, the units are placed in a locker and Mir power is applied. The CGBA units are then repowered and returned to their original configuration.

- (d) **Material in Devices as Superconductors (MIDAS)**

Similar to the other powered transfers, MIDAS will be powered down on the shuttle and repowered once transferred to Priroda. MIDAS has an internal battery which provides power to the ion pump during transfer. The internal battery has an 8-hour lifetime. Because this unit will be returned on STS-81, four hours of the internal battery lifetime are reserved for that mission. The unpowered constraint for this unit is therefore 4 hours.

- b. **Enhanced Orbiter Refrigerator/Freezer (EOR/F)**

The EOR/F will be powered as a refrigerator from pre-launch to post-landing and will be used for cold storage of the biological samples which have been transferred from Mir.

- c. **Mechanics of Granular Materials (MGM)**

This experiment will evaluate the behavior of cohesionless granular materials in the dry and saturated states at low confining pressures.

d. **Space Acceleration Measurement System (SAMS)**

The SAMS will measure three axis accelerations within the module environment.

2. **SPACEHAB 05**

The SPACEHAB 05 payload consists of a pressurized module accommodating soft stowage bags, lockers, rack mounted experiments, and supporting subsystems. One independent payload is flown on SPACEHAB 05 and requires crew interaction.

(2) **Extreme Temperature Translation Furnace (ETTF)**

This experiment provides users with the opportunity to investigate the gravitational influences on multiple types of materials and material processing techniques. Planned experiments are the study of high temperature liquid phase sintered materials.

3. **S/MM-04 (Middeck Science)**

S/MM-04 Middeck Science payload complement consists of science hardware and science samples which will be transferred from the Mir to the shuttle middeck. New science hardware and samples requiring on-orbit processing will be transferred from the shuttle to the Mir. The returned middeck science payload complement will be different from the launched payload complement.

a. **Thermo Electric Holding Module (TEHM)**

The TEHM refrigerator/freezer will be activated on-orbit and in the freezer mode will be used both on-orbit and during descent for cold storage of some of the biological samples which have been transferred from Mir. TEHM data parameters will be down loaded to a PGSC for OCA downlink periodically throughout the mission.

b. **Commercial Protein Crystal Growth (CPCG)**

The CPCG payload is designed to grow large, well ordered protein crystals in a microgravity environment. Protein crystals are grown in the Commercial Vapor Diffusion Apparatus (CVDA) which is thermally controlled within the Commercial Refrigeration/Incubation Module (CRIM). X-ray scatter data gathered from the space flight crystals are used to model molecular structures from which more pure pharmaceutical drugs may be designed.

4. **Shuttle Amateur Radio Experiment - II (SAREX-II) (Configuration M)**

SAREX-II consists of a ham radio capable of two-way communication with amateur radio stations within orbiter line of sight. On STS-79, SAREX does not require unique hardware. Communications will occur via the shuttle/Mir VHF voice communication hardware (i.e., without the payload bay antenna) which is used to support shuttle/Mir docking. Five U.S. school contacts are planned.

## H. RISK MITIGATION EXPERIMENT (RME)

### 1. Mated Structural Dynamics Test (RME 1301)

Three shuttle primary RCS jets (2 pitch jets and 1 yaw jet) are fired to characterize their impact upon Mir structure. On STS-79, this test is performed to evaluate structural changes resulting from the addition of the Priroda module and Cooperative Solar Array (CSA).

### 2. Mir Electric Fields Characterization (RME 1302)

Radio frequency interference environments seen by the shuttle and anticipated by the International Space Station (ISS) are of increasing concern due to new ground-based transmitters for communications and radar applications. The higher inclination orbit of the shuttle and Mir will expose the shuttle to large radiation levels (similar to ISS) due to longer travel over populated regions. The purpose of this RME is to collect data on the internal and external radio interference in the 400 MHz to 18 GHz frequency band. Tests will be conducted from both the orbiter and the Mir.

### 3. Shuttle/Mir Experiment Kit Transport (RME 1303)

The primary objective of this RME is to provide a means of transporting different technology demonstration experiments to and from the Russian Mir Space Station via the shuttle. These experiments will provide experience and test data to reduce technical risks for the International Space Station (ISS) construction and operation. Each item(s) assigned on a shuttle mission will be called a "Experiment Kit." Flown on this mission is Shuttle/Mir Experiment Kit Transport (Kit 1 (dn., disks only), 2 (up), and 3 (up)) stowed in the Spacehab.

### 4. Shuttle/Mir Alignment Stability Experiment (RME 1310)

This experiment will utilize available shuttle and Mir attitude data to measure the stability between the shuttle and Mir bodies while the two vehicles are docked and determine causes of any instability. Analysis results from this experiment will help determine the feasibility of exchanging attitude data between mated vehicles, as is planned for the U.S. and Russian segments of ISS. Five 3 hour separate data collection periods are desired.

### 5. Intra-Vehicular Radiation Environment Measurement Experiment (RME 1312 - manifested as part of S/MM-04 complement)

The Intra-Vehicular Radiation Environment Measurement by the Real-time Radiation Monitor (RRMD) measures elemental composition and energy spectra of cosmic radiation levels for ions with high charge and high energy (AZE) as the shuttle orbits the Earth. Collected data is downlinked. The RRMD is partially stowed in the Spacehab with flight unique middeck stowage provided.

6. Active Rack Isolation System Experiment (ARIS) (RME 1313 – manifested as part of S/MM-04 complement)

Studies have indicated that in order to provide the desired microgravity environment for user payloads on the International Space Station (ISS), a rack mounted experiment isolation system is needed. ARIS is an active rack isolation system designed to damp out external forces that would otherwise be imparted to the experiment. ARIS low frequency performance can only be determined on-orbit. During STS-79, the shuttle will be docked with Mir, thus providing an opportunity to measure isolation from low frequency structural vibrations. For comparison and ARIS system characterization, testing will be conducted prior to docking and while docked. ARIS has two active testing environments: Quiet and Noisy. These environments are defined by limits to acceleration pulses in translation and rotation which last greater than twenty seconds and last less than twenty seconds. The experiment is located in the Spacehab.

7. Inventory Management System (IMS) – Test 1 (RME 1319)

This experiment makes use of a Bar Code Reader (BCR) and BCR labels affixed to equipment that will be transferred between the shuttle and Mir and IMS software to evaluate the proposed ISS equipment transfer inventory management concepts. BCR labels affixed to transfer bags will be scanned while on the shuttle. Reference cards used to identify transfer equipment stowage locations on the Mir will also be scanned. The experiment equipment is stowed in the shuttle middeck.

I. ON-ORBIT DTOs

1. Trajectory Control Sensor (TCS) (DTO 700-5)

The TCS configuration consists of a sensor package positioned on the Orbiter Docking System (ODS). The TCS will be activated, initialized, and will acquire and track, in the pulse mode, the reflector mounted on the Mir Docking Module to a maximum distance of 5000 ft.

2. Orbiter Space Vision System Video Taping (DTO 700-10)

The purpose of this DTO is to record camera video of targets mounted on the Docking Module (DM) during approach and separation from Mir. In addition, video will be taken of the targets installed onto the Orbiter Docking System (ODS).

3. Single String Global Positioning System (GPS) – Objective 2 (DTO 700-14)

This DTO evaluates the performance and operation of the GPS during ascent, onorbit, and entry phases of flight. A PGSC hard drive is used to record GPS data during extended on-orbit time.

4. Vernier RCS Reboost Demonstration (DTO 837)

The purpose of this DTO is to evaluate usage of the shuttle VRCS jets to raise the shuttle's orbit. This DTO will be implemented to reboost HST on STS-82. On STS-79, the test performed will evaluate using vernier yaws jets to raise the orbit. The test is performed as a DTO of opportunity post Mir undocking.



5. Hand Held Lidar (HHL) Procedures (DTO 840)

The purpose of this DTO is to evaluate the performance of the HHL as a stand-alone proximity operations tool. HHL range and range rate data will be stored in the onboard Rendezvous and Prox-ops Program (RPOP) PGSC for post flight evaluation.

6. Photographic and Video Survey of Mir Space Station (DTO 1118)

The primary objective of this DTO is to conduct a photographic and video survey of the Mir from the shuttle to assess the condition of the Mir, assess relative motion of the Mir and shuttle, and analyze plume impingement. Downlink of recorded video will be accomplished on a time available basis.

J. ON-ORBIT DSOs

1. Documentary Television (DSO 901)

DSO 901 provides guidelines for scheduling live television or VTR dumps of on-orbit activities.

2. Documentary Motion Picture Photography (DSO 902)

DSO 902 provides guidelines for scheduling documentary and public affairs motion picture photography of on-orbit activities.

3. Documentary Still Photography (DSO 903)

DSO 903 provides guidelines for scheduling still photography of on-orbit activities.

CUE CARD CONFIGURATION

CUE CARD  
CONFIGURATION

# CUE CARD CONFIGURATION

TOP

HOOK  
VELCRO

HOOK  
VELCRO

## STS-79 GENERIC DAP A CONFIGURATIONS (A6 STS-79 SPECIFIC)

	ITEM #	A1	A2	A3	A4	A5	A6	A7
<b>PRI</b>								
ROT RATE	10	0.2000	0.4000	0.2000	0.5000	0.2000	0.2000	0.2000
ATT DB	11	5.00	1.00	1.00	3.00	5.00	5.00	2.00
RATE DB	12	0.20	0.20	0.20	0.20	0.20	0.20	0.20
ROT PLS	13	0.10	0.10	0.10	0.10	0.10	0.10	0.10
COMP	14	.000	.000	.000	.000	.000	.000	.000
P OPTION	15	ALL	ALL	ALL	ALL	ALL	TAIL	ALL
Y OPTION	16	ALL	ALL	TAIL	ALL	ALL	TAIL	ALL
TRAN PLS	17	0.10	0.10	0.10	0.10	0.10	0.10	0.10
<b>ALT</b>								
RATE DB	18	0.200	0.200	0.200	0.200	0.070	0.070	0.200
JET OPT	19	ALL	ALL	ALL	ALL	ALL	TAIL	ALL
# JETS	20	2	2	2	2	1	1	2
ON TIME	21	0.08	0.08	0.08	0.08	0.08	0.08	0.08
DELAY	22	0.00	0.00	0.00	0.00	0.00	0.00	0.00
<b>VERN</b>								
ROT RATE	23	0.2000	0.4000	0.0080	0.2000	0.2000	<b>0.0650</b>	0.2000
ATT DB	24	1.000	1.000	0.070	1.000	1.000	1.000	1.000
RATE DB	25	.020	.020	.010	.020	.020	.020	.020
ROT PLS	26	0.010	0.010	0.010	0.010	0.010	0.010	0.010
COMP	27	.000	.000	.000	.000	.000	.000	.000
CNTL ACC	28	0	0	0	0	0	0	0
PURPOSE		NOMINAL	PTC	GG	PRE/ POST DEPLOY	LOSS OF VERN (N/T)	LOSS OF VERN (TAIL ONLY) <b>MIN PROP VERN</b>	RNDZ

Note: **BOLD/ITALICS** = not I-Loaded

FLT PLN-1a/79/O/A

HINGE

FAB USE ONLY

CC 11-2

FLT PLN/79/FIN

(reduced copy)

FAB USE ONLY

CC 11-3

FLT PLN/79/FIN

(reduced copy)

TOP  
HINGED AT BOTTOM OF  
'STS-79 GENERIC DAP A CONFIGURATIONS'  
HINGE

STS-79 FLIGHT SPECIFIC DAP A CONFIGURATIONS

	ITEM #	A8	A9	A10	A12	A13	A14	A15
<b>PRI</b>								
ROT RATE	10	0.2000	<b>0.0500</b>	<b>0.1300</b>	<b>0.1000</b>	<b>0.0500</b>	<b>0.0500</b>	<b>0.1000</b>
ATT DB	11	<b>1.00</b>	<b>0.50</b>	<b>2.00</b>	5.00	<b>1.00</b>	<b>3.00</b>	<b>40.00</b>
RATE DB	12	<b>0.10</b>	<b>0.10</b>	<b>0.10</b>	0.20	<b>0.10</b>	0.20	0.20
ROT PLS	13	0.10	0.10	0.10	<b>0.04</b>	0.10	<b>0.04</b>	<b>0.003*</b>
COMP	14	.000	.000	.000	.000	.000	.000	.000
P OPTION	15	<b>TAIL</b>	<b>TAIL</b>	<b>TAIL</b>	<b>TAIL</b>	<b>TAIL</b>	ALL	<b>TAIL</b>
Y OPTION	16	<b>TAIL</b>	<b>TAIL</b>	<b>TAIL</b>	<b>TAIL</b>	<b>TAIL</b>	ALL	<b>TAIL</b>
TRAN PLS	17	<b>0.05</b>	<b>0.05</b>	<b>0.05</b>	<b>0.01</b>	<b>0.05</b>	0.10	0.10
<b>ALT</b>								
RATE DB	18	0.200	0.200	0.200	<b>0.070</b>	0.200	0.200	0.200
JET OPT	19	ALL	ALL	ALL	<b>TAIL</b>	ALL	ALL	<b>TAIL</b>
# JETS	20	2	2	2	<b>3</b>	2	2	<b>3</b>
ON TIME	21	0.08	0.08	0.08	0.08	0.08	0.08	0.08
DELAY	22	0.00	0.00	0.00	<b>10.88</b>	0.00	0.00	<b>10.88</b>
<b>VERN</b>								
ROT RATE	23	0.2000	<b>0.0500</b>	<b>0.1300</b>	<b>0.1500</b>	<b>0.0500</b>	<b>0.4000</b>	<b>0.0500</b>
ATT DB	24	1.000	<b>0.500</b>	<b>2.000</b>	<b>5.000</b>	1.000	1.000	<b>5.000</b>
RATE DB	25	.020	.020	.020	<b>.050</b>	.020	.020	<b>.050</b>
ROT PLS	26	0.010	<b>0.050</b>	<b>0.050</b>	<b>0.002</b>	<b>0.050</b>	<b>0.080</b>	<b>0.001</b>
COMP	27	.000	.000	.000	.000	.000	.000	.000
CNTL ACC	28	0	0	0	<b>7</b>	0	<b>9</b>	<b>7</b>
PURPOSE		CORRIDOR	DOCKING	FLY- AROUND	MATED STACK MNVRS & HOLD	FAILED CAPTURE	VRCS CAPTURE	RME 1301

Note: **BOLD/ITALICS** = not I-Loaded

\*.003 is below SPEC 20 lower limit. Value has been i-loaded and will not show on SPEC 20 display

FLT PLN-1aa/79/O/B

HOOK  
VELCRO

HOOK  
VELCRO

TOP

STS-79 GENERIC DAP B CONFIGURATIONS

	ITEM #	B1	B2	B3	B4	B5	B7
<b>PRI</b>							
ROT RATE	30	0.5000	0.2000	0.2000	0.2000	0.2000	0.5000
ATT DB	31	3.00	3.00	3.00	0.30	3.00	2.00
RATE DB	32	0.20	0.20	0.20	0.20	0.20	0.20
ROT PLS	33	0.04	0.04	0.04	0.04	0.04	0.04
COMP	34	.000	.000	.000	.000	.000	.000
P OPTION	35	ALL	TAIL	ALL	TAIL	TAIL	ALL
Y OPTION	36	ALL	TAIL	ALL	TAIL	TAIL	ALL
TRAN PLS	37	0.10	0.02	0.02	0.02	0.02	0.05
<b>ALT</b>							
RATE DB	38	0.200	0.070	0.070	0.200	0.200	0.200
JET OPT	39	ALL	TAIL	ALL	ALL	ALL	ALL
# JETS	40	2	1	1	2	2	2
ON TIME	41	0.08	0.08	0.08	0.08	0.08	0.08
DELAY	42	0.00	0.00	0.00	0.00	0.00	0.00
<b>VERN</b>							
ROT RATE	43	0.2000	0.2000	0.2000	0.0080	0.0160	0.2000
ATT DB	44	1.000	1.000	1.000	0.100	0.033	1.000
RATE DB	45	.020	.020	.020	.010	.020	.020
ROT PLS	46	0.002	0.002	0.002	0.002	0.002	0.002
COMP	47	.000	.000	.000	.000	.000	.000
CNTL ACC	48	0	0	0	0	0	0
PURPOSE		NOM; OMS & RCS BURNS	LOSS OF VERN (TAIL ONLY)	LOSS OF VERN (N & T)	SSUS DEPLOY	COAS CAL	RNDZ

Note: **BOLD/ITALICS** = not |-Loaded

FLT PLN-1b/79/O/A

HINGE

(reduced copy)

FAB USE ONLY

CC 11-5

FLT PLN/79/FIN

(reduced copy)

TOP  
HINGED BOTTOM OF  
'STS-79 GENERIC DAP B CONFIGURATIONS'  
HINGE

STS-79 FLIGHT SPECIFIC DAP B CONFIGURATIONS

	ITEM #	B8	B9	B10	B12	B13	B14	B15
<b>PRI</b>								
ROT RATE	30	<b>0.2000</b>	<b>0.0500</b>	<b>0.1300</b>	<b>0.0500</b>	<b>0.0500</b>	<b>0.5000</b>	<b>0.1000</b>
ATT DB	31	<b>1.00</b>	<b>0.50</b>	<b>2.00</b>	<b>5.00</b>	<b>1.00</b>	3.00	<b>40.00</b>
RATE DB	32	<b>0.10</b>	<b>0.10</b>	<b>0.10</b>	0.20	<b>0.10</b>	0.20	0.20
ROT PLS	33	0.04	0.04	0.04	0.04	0.04	0.04	<b>0.003*</b>
COMP	34	.000	.000	.000	.000	.000	.000	.000
P OPTION	35	<b>TAIL</b>	<b>TAIL</b>	<b>TAIL</b>	<b>TAIL</b>	<b>TAIL</b>	ALL	<b>TAIL</b>
Y OPTION	36	<b>TAIL</b>	<b>TAIL</b>	<b>TAIL</b>	<b>TAIL</b>	<b>TAIL</b>	ALL	<b>TAIL</b>
TRAN PLS	37	<b>0.01</b>	<b>0.01</b>	<b>0.01</b>	<b>0.01</b>	<b>0.01</b>	<b>0.10</b>	<b>0.01</b>
<b>ALT</b>								
RATE DB	38	0.200	0.200	0.200	<b>0.070</b>	0.200	0.200	0.200
JET OPT	39	ALL	ALL	ALL	<b>TAIL</b>	ALL	ALL	<b>TAIL</b>
# JETS	40	2	2	2	<b>3</b>	2	2	<b>3</b>
ON TIME	41	0.08	0.08	0.08	0.08	0.08	0.08	0.08
DELAY	42	0.00	0.00	0.00	<b>10.88</b>	0.00	0.00	<b>10.88</b>
<b>VERN</b>								
ROT RATE	43	0.2000	<b>0.0500</b>	<b>0.1300</b>	<b>0.0500</b>	<b>0.0500</b>	<b>0.4000</b>	<b>0.0500</b>
ATT DB	44	1.000	<b>0.500</b>	<b>2.000</b>	1.000	1.000	1.000	<b>5.000</b>
RATE DB	45	.020	.020	.020	<b>.050</b>	.020	.020	<b>.050</b>
ROT PLS	46	0.002	<b>0.020</b>	<b>0.020</b>	0.002	<b>0.020</b>	<b>0.080</b>	<b>0.001</b>
COMP	47	.000	.000	.000	.000	.000	.000	.000
CNTL ACC	48	0	0	0	<b>7</b>	0	<b>9</b>	<b>7</b>
PURPOSE		CORRIDOR	DOCKING	FLY- AROUND	MATED STACK TIGHT CONTROL	FAILED CAPTURE	VRCS REBOOST	RME 1301

Note: **BOLD/ITALICS** = not I-Loaded

\*.003 is below SPEC 20 lower limit. Value has been I-loaded and will not show on SPEC 20 display

FLT PLN-1bb/79/O/B

**This Page Intentionally Blank**

TELEDYNE BROWN ENGINEERING  
CUMMINGS RESEARCH PARK  
300 SPARKMAN DRIVE, NW  
P. O. BOX 70007  
HUNTSVILLE, AL 35807-7007  
MS 172/GILCHRIST, M.  
TBE-MS172/GEIGER, W. (2)

---

UNIV OF ALABAMA BIRMINGHAM  
1825 UNIVERSITY BLVD.  
ATTN: JOHN NORDESS  
BIRMINGHAM, AL 34294-2010  
MJH-125/NORDNESS, JOHN

---

=====  
Total 422  
(07/09/96 - HCANADA)

---

NOTE

\* FOR CHANGES \*  
\* IN DISTRIBUTION \*  
\* OR ADDRESS CORRECTIONS \*  
\* CONTACT THE \*  
\* PROCEDURES MANAGEMENT \*  
\* OFFICE AT MAILCODE D035 \*  
\* OR (713) 244-1184 \*

---