

# Flight Plan

## STS-82

(FRR Cycle Trajectory)

Mission Operations Directorate  
Operations Division

Final  
January 8, 1997

<u>EVENT</u>	<u>CST</u>		
Launch	01:59	Thursday	February 13
HST Grapple	00:53	Saturday	February 15
HST Release	23:00	Wednesday	February 19
KSC Landing	00:46	Sunday	February 23

National A.  
Space Adm

Lyndon B. Johnson Space Center  
Houston, Texas



MISSION OPERATIONS DIRECTORATE

**STS-82 FLIGHT PLAN**

FINAL  
January 8, 1997

PREPARED BY:

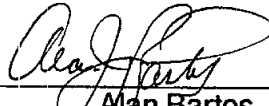
  
\_\_\_\_\_  
Alan Bartos  
Book Manager

APPROVED BY:

  
\_\_\_\_\_  
Gail A. Schneider  
Lead, Flight Planning  
and Pointing Group

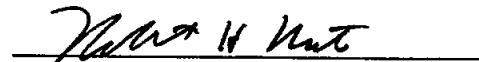
  
\_\_\_\_\_  
Robert H. Nute  
Chief, Flight Planning Branch

  
\_\_\_\_\_  
Larry Davis  
Acting Chief,  
Operations Division

  
\_\_\_\_\_  
Brock R. Stone  
Assistant Director  
for Operations

This document is under the configuration control of the Crew Procedures Control Board (CPCB). All proposed changes must be submitted on JSC Form 482 to DO3/FDF Manager.

Additional distribution of this book for official use must be requested in writing to DO3/FDF Manager. The request must include justification and requester's name, organization, position, and phone number. Contractor requests are made through the NASA or DOD organization supported. Deletions, reduction in quantity, or change of address may be submitted to DO3/FDF Management Office, (281) 244-1184.

Incorporates the following:		
482#:	FLT PLN-1845	MULTI-1301
	FLT PLN-1846	MULTI-1306
	FLT PLN-1847	
	FLT PLN-1848	
	FLT PLN-1849	
Exemption #: 81		

AREAS OF TECHNICAL RESPONSIBILITY

Book Manager/Lead FAO	DO4/A. Bartos	244-1073
Lead Timeliner	DO4/D. Gray	244-1144
Lead Pointer	DO4/S. Remko	244-5658
Backup Pointer	DO4/B. Kelly	244-1141

FLIGHT PLAN  
STS-82

**LIST OF EFFECTIVE PAGES**

	FINAL	01/08/97	
Sign Off .....	* 82/FIN	3-16 .....	82/FIN
ii .....	* 82/FIN	3-17 .....	82/FIN
iii .....	* 82/FIN	3-18 .....	82/FIN
iv .....	* 82/FIN	3-19 .....	82/FIN
v .....	* 82/FIN	3-20 .....	82/FIN
vi .....	* 82/FIN	3-21 .....	82/FIN
vii .....	82/FIN	3-22 .....	82/FIN
viii .....	82/FIN	3-23 .....	82/FIN
1-1 .....	82/FIN	3-24 .....	82/FIN
1-2 .....	82/FIN	3-25 .....	82/FIN
1-3 .....	82/FIN	3-26 .....	82/FIN
1-4 .....	82/FIN	3-27 .....	82/FIN
1-5 .....	82/FIN	3-28 .....	82/FIN
1-6 .....	82/FIN	3-29 .....	82/FIN
2-1 .....	82/FIN	3-30 .....	82/FIN
2-2 .....	82/FIN	3-31 .....	82/FIN
2-3 .....	82/FIN	3-32 .....	82/FIN
2-4 .....	82/FIN	3-33 .....	82/FIN
2-5 .....	82/FIN	3-34 .....	82/FIN
2-6 .....	82/FIN	3-35 .....	82/FIN
2-7 .....	82/FIN	3-36 .....	82/FIN
2-8 .....	82/FIN	3-37 .....	82/FIN
2-9 .....	82/FIN	3-38 .....	82/FIN
2-10 .....	82/FIN	3-39 .....	82/FIN
2-11 .....	82/FIN	3-40 .....	82/FIN
2-12 .....	82/FIN	3-41 .....	82/FIN
2-13 .....	82/FIN	3-42 .....	82/FIN
2-14 .....	82/FIN	3-43 .....	82/FIN
2-15 .....	82/FIN	3-44 .....	82/FIN
2-16 .....	82/FIN	3-45 .....	82/FIN
2-17 .....	82/FIN	3-46 .....	82/FIN
2-18 .....	82/FIN	3-47 .....	82/FIN
2-19 .....	82/FIN	3-48 .....	82/FIN
2-20 .....	82/FIN	3-49 .....	82/FIN
2-21 .....	82/FIN	3-50 .....	82/FIN
2-22 .....	82/FIN	4-1 .....	82/FIN
2-23 .....	82/FIN	4-2 .....	82/FIN
2-24 .....	82/FIN	4A-1 .....	82/FIN
3-1 .....	82/FIN	4A-2 .....	82/FIN
3-2 .....	82/FIN	4A-3 .....	82/FIN
3-3 .....	82/FIN	4A-4 .....	82/FIN
3-4 .....	82/FIN	4B-1 .....	82/FIN
3-5 .....	82/FIN	4B-2 .....	82/FIN
3-6 .....	82/FIN	4B-3 .....	82/FIN
3-7 .....	82/FIN	4B-4 .....	82/FIN
3-8 .....	82/FIN	5-1 .....	82/FIN
3-9 .....	82/FIN	5-2 .....	82/FIN
3-10 .....	82/FIN	5-3 .....	82/FIN
3-11 .....	82/FIN	5-4 .....	82/FIN
3-12 .....	82/FIN	5-5 .....	82/FIN
3-13 .....	82/FIN	5-6 .....	82/FIN
3-14 .....	82/FIN	<del>5-7 .....</del>	<del>82/FIN</del>
3-15 .....	82/FIN	<del>5-8 .....</del>	<del>82/FIN</del>

P+I

\* - Omit from flight book

6-1	.....	*	82/FIN
6-2	.....	*	82/FIN
7-i	.....	*	82/FIN
7-ii	.....	*	82/FIN
7-1	.....	*	82/FIN
7-2	.....	*	82/FIN
7-3	.....	*	82/FIN
7-4	.....	*	82/FIN
7-5	.....	*	82/FIN
7-6	.....	*	82/FIN
7-7	.....	*	82/FIN
7-8	.....	*	82/FIN
8-1	.....	*	82/FIN
8-2	.....	*	82/FIN
8-3	.....	*	82/FIN
8-4	.....	*	82/FIN
9-1	.....	*	82/FIN
9-2	.....	*	82/FIN
9-3	.....	*	82/FIN
9-4	.....	*	82/FIN
9-5	.....	*	82/FIN
9-6	.....	*	82/FIN
9-7	.....	*	82/FIN
9-8	.....	*	82/FIN
9-9	.....	*	82/FIN
9-10	.....	*	82/FIN
9-11	.....	*	82/FIN
9-12	.....	*	82/FIN
9-13	.....	*	82/FIN
9-14	.....	*	82/FIN
9-15	.....	*	82/FIN
9-16	.....	*	82/FIN

\* - Omit from flight book

## STS-82 FLIGHT PLAN FABRICATED ITEMS

<u>Title</u>	<u>Ref. Page</u>	<u>Item No.</u>
DAP A, DAP B TOC .....	9-2	FLT PLN-1a/82/O/B
(Blank) .....	9-2	FLT PLN-1b/82/O/A
DAP A .....	9-3	FLT PLN-2a/82/O/A
DAP A1 .....	9-3	FLT PLN-2b/82/O/A
A1 .....	9-3	FLT PLN-3a/82/O/A
DAP A2 .....	9-3	FLT PLN-3b/82/O/A
A2 .....	9-4	FLT PLN-4a/82/O/A
DAP A3 .....	9-4	FLT PLN-4b/82/O/A
A3 .....	9-4	FLT PLN-5a/82/O/A
DAP A4 .....	9-4	FLT PLN-5b/82/O/A
A4 .....	9-5	FLT PLN-6a/82/O/A
DAP A5 .....	9-5	FLT PLN-6b/82/O/A
A5 .....	9-5	FLT PLN-7a/82/O/A
DAP A7 .....	9-5	FLT PLN-7b/82/O/A
A7 .....	9-6	FLT PLN-8a/82/O/A
DAP A8 .....	9-6	FLT PLN-8b/82/O/A
A8 .....	9-6	FLT PLN-9a/82/O/A
DAP A9 .....	9-6	FLT PLN-9b/82/O/B
A9 .....	9-7	FLT PLN-10a/82/O/B
DAP A10 .....	9-7	FLT PLN-10b/82/O/A
A10 .....	9-7	FLT PLN-11a/82/O/B
(Blank) .....	9-7	FLT PLN-11b/82/O/A
DAP B .....	9-8	FLT PLN-12a/82/O/A
DAP B1 .....	9-8	FLT PLN-12b/82/O/A
B1 .....	9-8	FLT PLN-13a/82/O/A
DAP B2 .....	9-8	FLT PLN-13b/82/O/A
B2 .....	9-9	FLT PLN-14a/82/O/A
DAP B3 .....	9-9	FLT PLN-14b/82/O/A
B3 .....	9-9	FLT PLN-15a/82/O/A
DAP B4 .....	9-9	FLT PLN-15b/82/O/A
B4 .....	9-10	FLT PLN-16a/82/O/A
DAP B5 .....	9-10	FLT PLN-16b/82/O/A
B5 .....	9-10	FLT PLN-17a/82/O/A
DAP B7 .....	9-10	FLT PLN-17b/82/O/A
B7 .....	9-11	FLT PLN-18a/82/O/A
DAP B8 .....	9-11	FLT PLN-18b/82/O/A
B8 .....	9-11	FLT PLN-19a/82/O/A
DAP B9 .....	9-11	FLT PLN-19b/82/O/A
B9 .....	9-12	FLT PLN-20a/82/O/B
DAP B10 .....	9-12	FLT PLN-20b/82/O/B
B10 .....	9-12	FLT PLN-21a/82/O/B
DAP B11 .....	9-12	FLT PLN-21b/82/O/B
B11 .....	9-13	FLT PLN-22a/82/O/B
DAP B12 .....	9-13	FLT PLN-22b/82/O/B
B12 .....	9-13	FLT PLN-23a/82/O/B
DAP B14 .....	9-13	FLT PLN-23b/82/O/B
B14 .....	9-14	FLT PLN-24a/82/O/B
(Blank) .....	9-14	FLT PLN-24b/82/O/B
UNIV PTG .....	9-15	FLT PLN-25/82/O/A

**This Page Intentionally Blank**

CONTENTS

PAGE

INTRODUCTION .....	vi
OVERVIEW TIMELINE .....	1-1
SUMMARY TIMELINE .....	2-1
DETAILED TIMELINE .....	3-1
FD01 .....	3-2
FD02 .....	3-4
FD03 .....	3-9
FD04 .....	3-14
FD05 .....	3-19
FD06 .....	3-24
FD07 .....	3-29
FD08 .....	3-34
FD09 .....	3-39
FD10 .....	3-44
FD11 .....	3-49
CONTINGENCY TIMELINES .....	4-1
STS-82 DAP TABLE .....	5-1
STS-82 EVA TIME PERIOD OVERVIEW .....	6-1
ATTITUDE TIMELINE .....	7-1
STS-82 FLIGHT PLAN NOTES .....	8-1
STS-82 DAP BOOK .....	9-1



## INTRODUCTION

The STS-82 Flight Plan is the Flight Data File article that contains the on-orbit timeline. It does not contain the detailed timelines that are covered in the Ascent, Post Insertion, Rendezvous, EVA, Deorbit Prep, and Entry Checklists. The detailed rendezvous timelines and procedures are contained in the Rendezvous Checklist. The detailed EVA task timelines and procedures are in the EVA Checklist. The Detailed Timeline pages of this Flight Plan show high-level, bulleted comments for general insight during the rendezvous and EVAs. The deploy procedures required during the deploy timeframe are in the STS-82 HST Deploy Checklist. For continuity, the summary level timeline includes the entire flight.

The format of the enclosed timelines is different from those in past Flight Plans because the Consolidated Planning System (CPS) was used in the generation of the timeline pages. The Summary and Detailed pages include an HST Ground Command data band. This band is used to reflect ground commanded activities for the HST. During rendezvous and deploy most of the ground commanded activities are scheduled on the timeline due to the abundance of commands.

The Servicing Mission Integrated Timeline (SMIT), Baseline, dated December 20, 1996, was used in the development of these timelines.

This on-orbit timeline satisfies the objectives specified in the Flight Definition and Requirements Directive, and the requirements of the STS-82 Flight Requirements Document. The Flight Plan, as part of the Flight Data File, meets the specifications of the STS-82 Flight Initialization Data Pack.

The STS-82 FRR Cycle was used for the timeline trajectory. The flight profile used in this Flight Plan is for a launch date of February 13, 1997 at 07:59 GMT. Orbiter inertial attitudes are expressed relative to  $\epsilon$  Mean of 1950 (M50) reference frame.

JSC-22359, Crew Scheduling Constraints (Appendix K, CPMP), Basic, Rev B, January 1992, has been used to build the timelines contained in this Flight Plan. The crew's awake time prior to launch has been increased (launch -7.5 hours) to accommodate crewmembers' circadian rhythm and on-orbit sleep cycles. Appendix K waiver #81 allows crew off-duty time to be delayed to Flight Day 9 (EOM-2) in order to complete all HST servicing and release activities prior to scheduling the crew for off-duty time.

The timeline formats used in the Flight Plan are based on JSC-19933, Timeline Format Definitions and Standards Notes, Rev C, May 1990.

**OVERVIEW TIMELINE**

# OVERVIEW TIMELINE

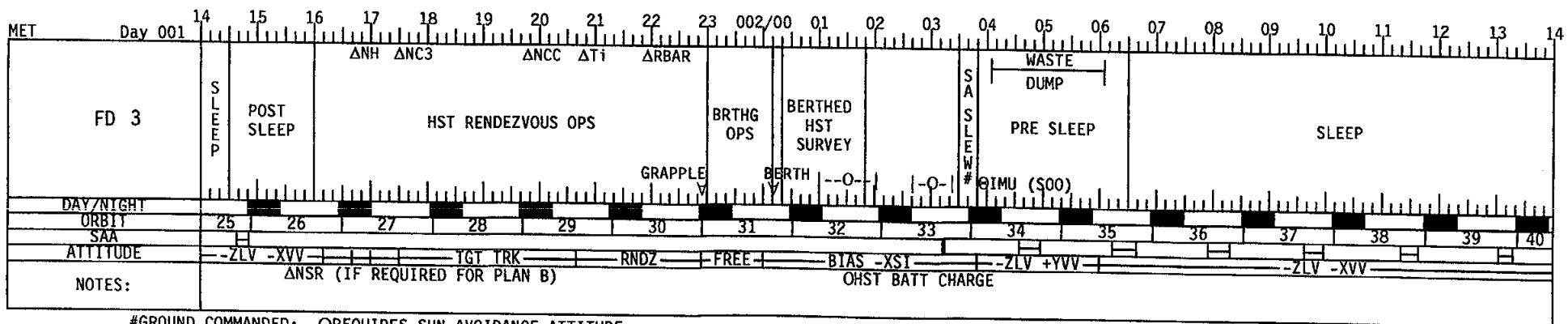
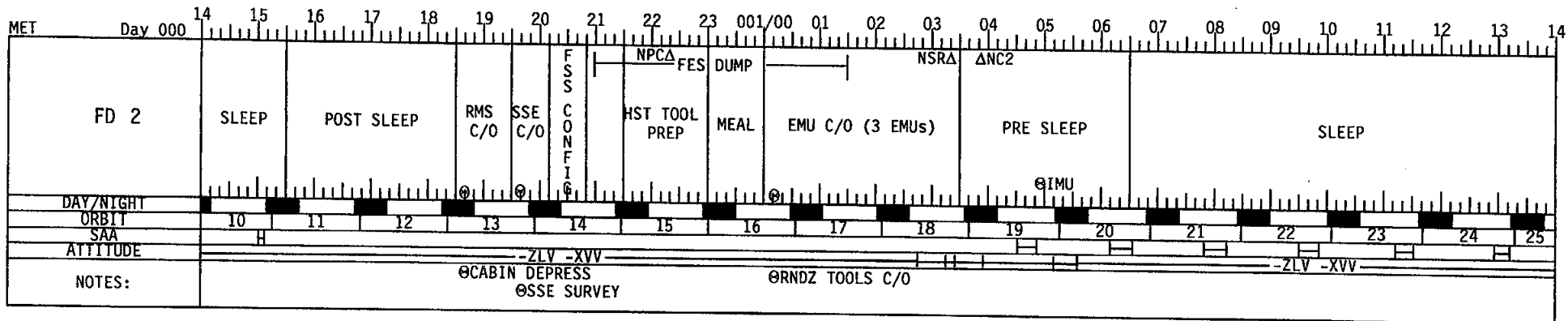
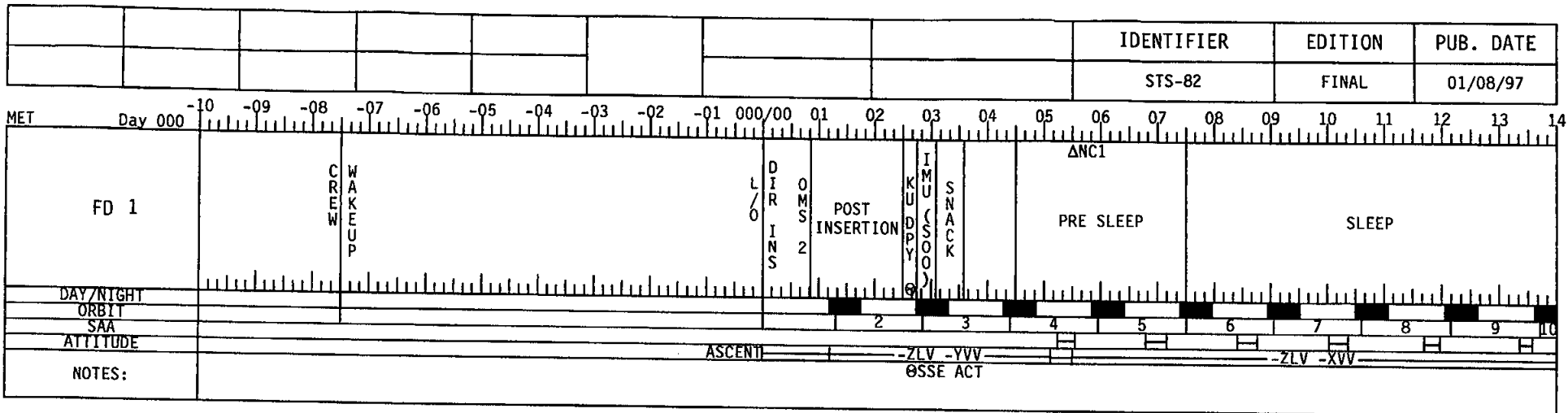

#GROUND COMMANDED; ΩREQUIRES SUN AVOIDANCE ATTITUDE

						IDENTIFIER	EDITION	PUB. DATE
						STS-82	FINAL	01/08/97

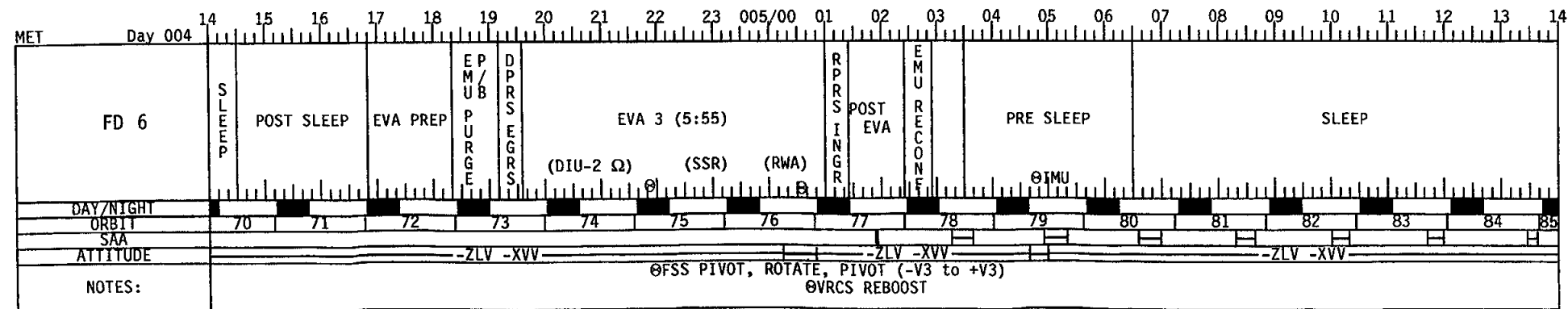
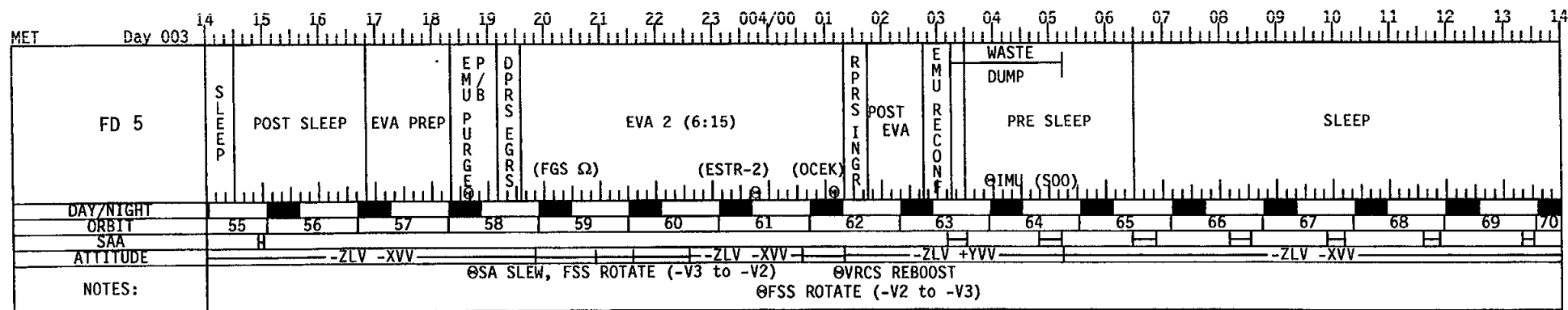
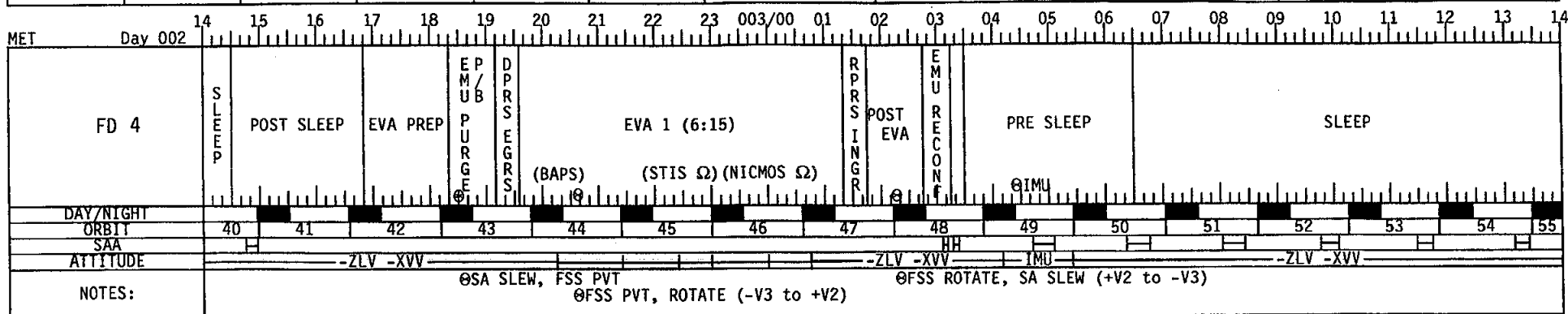

#GROUND COMMANDED; ΩREQUIRES SUN AVOIDANCE ATTITUDE

FLT PLN/82/FIN

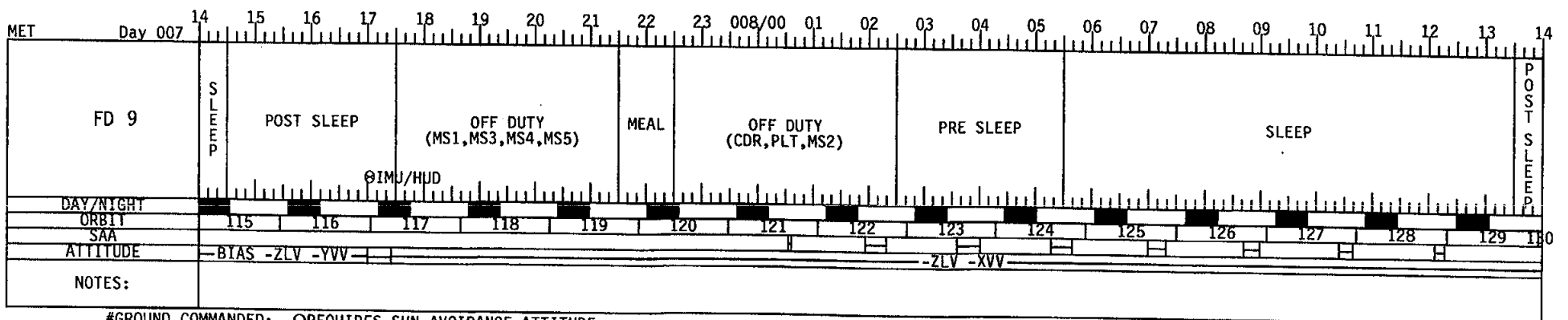
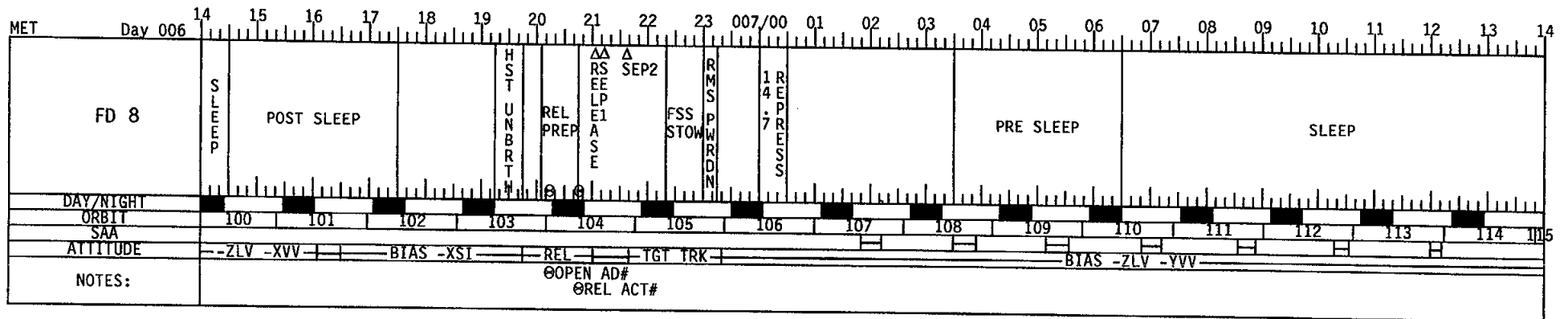
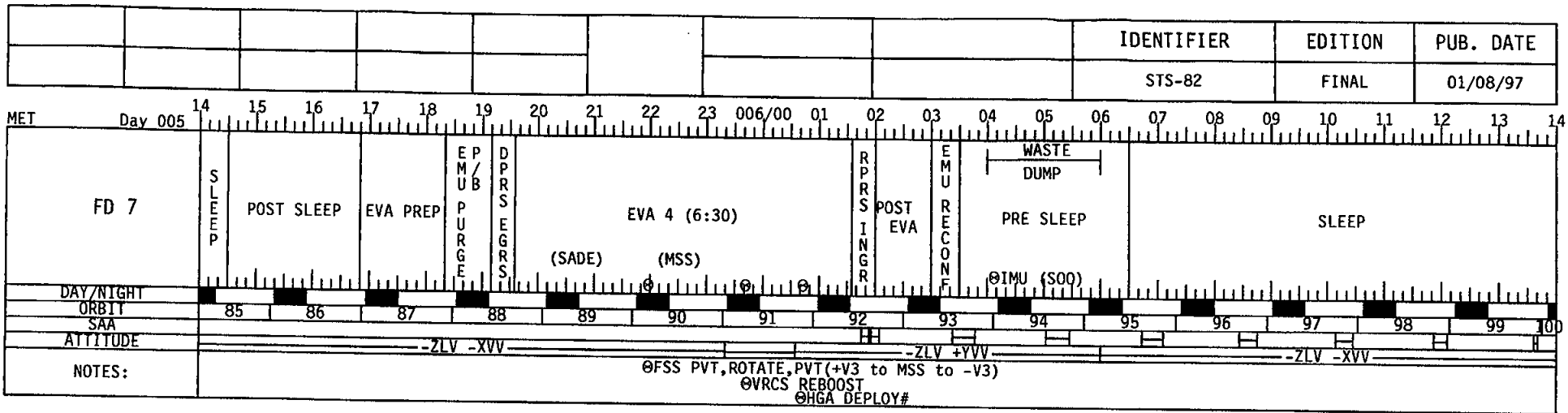

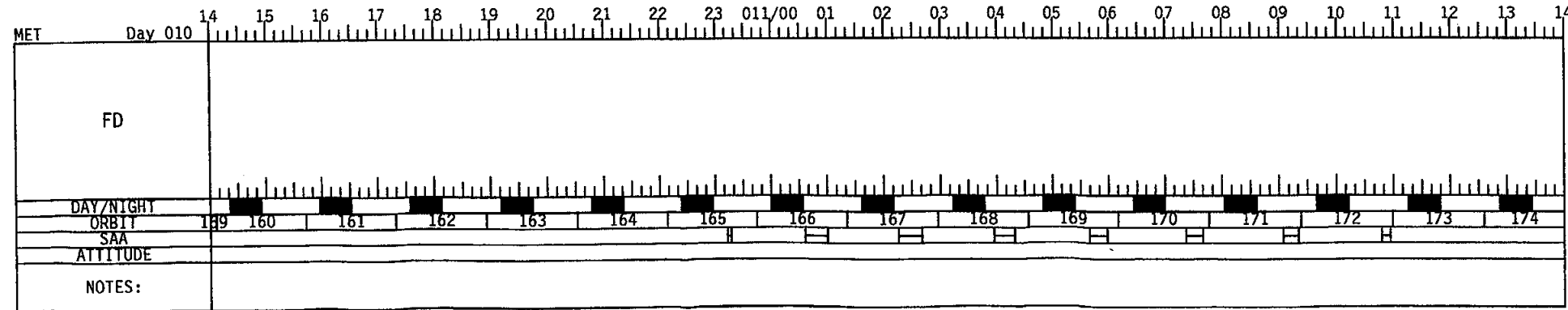
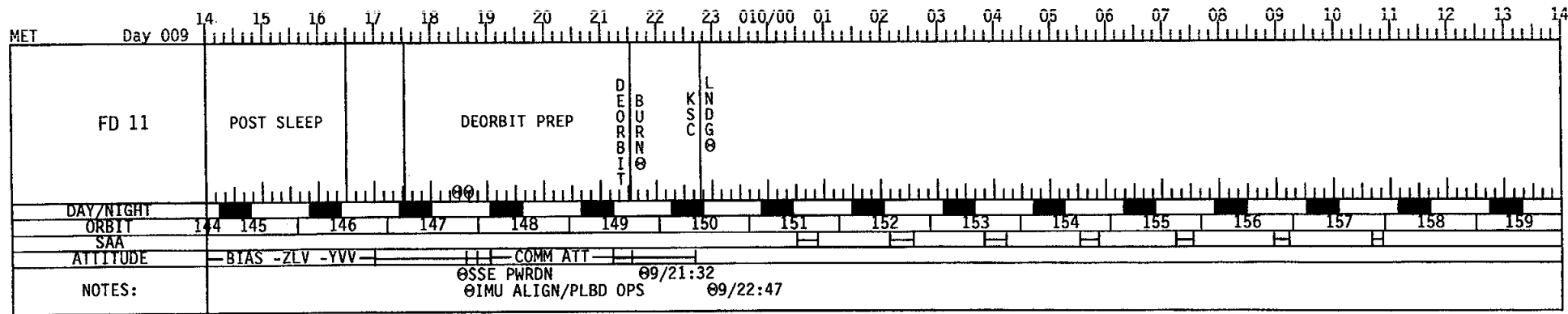
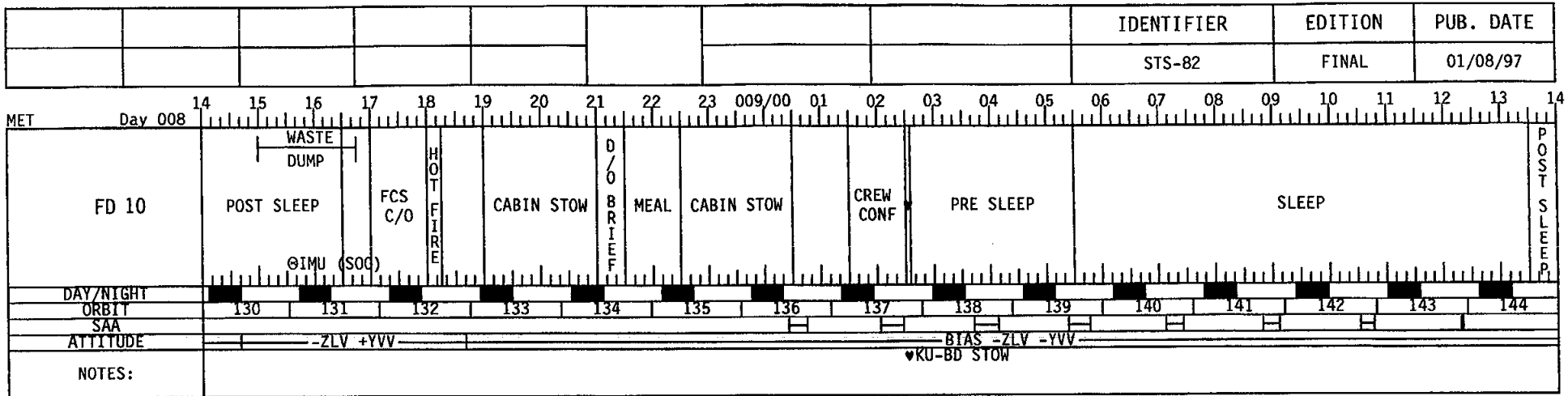

#GROUND COMMANDED; ΩREQUIRES SUN AVOIDANCE ATTITUDE

FLT PLN/82/FIN

**This Page Intentionally Blank**

**SUMMARY TIMELINE**



**This Page Intentionally Blank**



GMT	MET	CT	DOY	BETA	MOON	FLIGHT DAY	HOUSTON DATE	IDENTIFIER	EDITION	PUB. DATE
44/12:59	000/05:00	44/06:59	44 CT	5.55		01	13 Feb 1997	STS-82	FINAL	01/08/97
45/00:59	000/17:00	44/18:59								

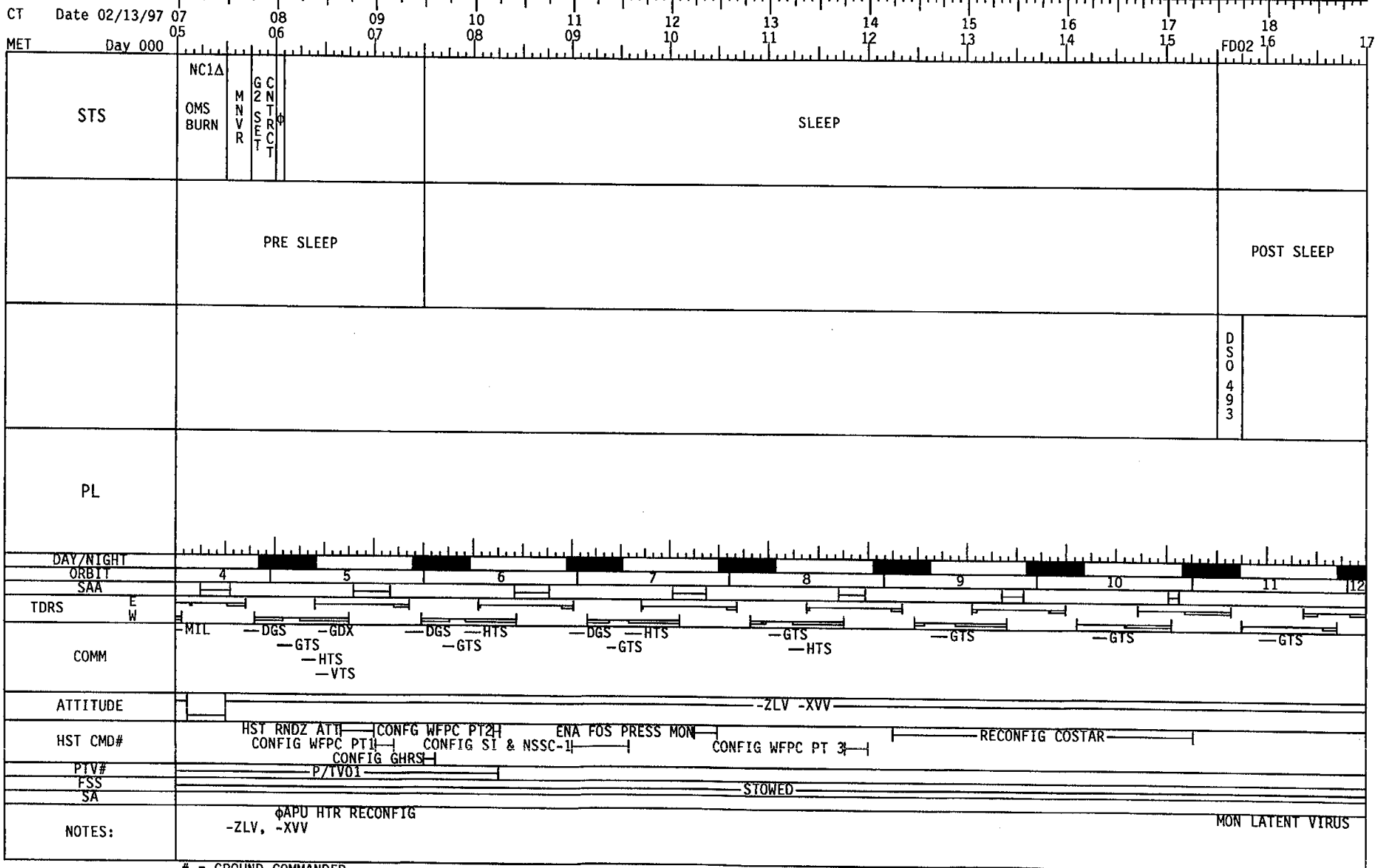

# = GROUND COMMANDED

GMT	MET	CT	DOY	BETA	MOON	FLIGHT DAY	HOUSTON DATE	IDENTIFIER	EDITION	PUB. DATE
45/00:59	000/17:00	44/18:59	44 CT	7.09		02	13 Feb 1997	STS-82	FINAL	01/08/97
45/12:59	001/05:00	45/06:59								

CT Date 02/13/97 19 20 21 22 23 02/14 01 02 03 04 05 06 05  
MET Day 000 17 18 19 20 21 22 23 001/00 01 02 03 04

STS	RMS HTR	10.2 DEPRESS	10.2 CNFG	FLTR CLN	MEAL	RNDZ TOOLS C/O	ERGOM SETUP	NSRA OMS BURN	NC2A RCS BURN	MNV R	G2 SRECT	PMC	OCA D/L	10.2 MNIT
	POST SLEEP	RMS C/O	SSE SURVEY	HST PGSC S/U	RMS PWD	P/TVO3 OPS	P/TVO3 OPS	FC PURG	PRE SLEEP					
	ASPIRIN	P/TVO6 OPS	P/TVO7 OPS	ESC S/U & TEST	AIRLOCK PREP	EMU 2,3 C/O	EMU SWAP (B)	EMU 1 C/O	GLV C/O					
PL		SSE C/O	FSS PREP FOR BRTHG	HST TOOL PREP										
DAY/NIGHT	[Timeline with day/night indicators]													
ORBIT	[Timeline with orbit parameters]													
TDRS	[Timeline with TDRS events]													
COMM	[Timeline with communication links: DGS, BDA, GDX, MIL, HTS, VTS]													
ATTITUDE	[Timeline with attitude control: ZLV, XVV]													
HST CMD#	[Timeline with HST commands: PLYBK ESTR, CONFIG DF-224-I, CONFIG WFPC SAFEH, CL AD]													
PTV#	[Timeline with PTV status]													
FSS SA	[Timeline with FSS status: STOWED, V3]													
NOTES:	RMS HTR ACT/MCIU FILTER CK •WSB CNTLR/HTR AUDIO PAO OPPTY (B) EMU3 TO MDDK; EMU1 TO A/L -ZLV, -XVV													

# = GROUND COMMANDED

GMT	MET	CT	DOY	BETA	MOON	FLIGHT DAY	HOUSTON DATE	IDENTIFIER	EDITION	PUB. DATE
45/12:59	001/05:00	45/06:59	45 CT	8.53		02	14 Feb 1997	STS-82	FINAL	01/08/97
46/00:59	001/17:00	45/18:59								

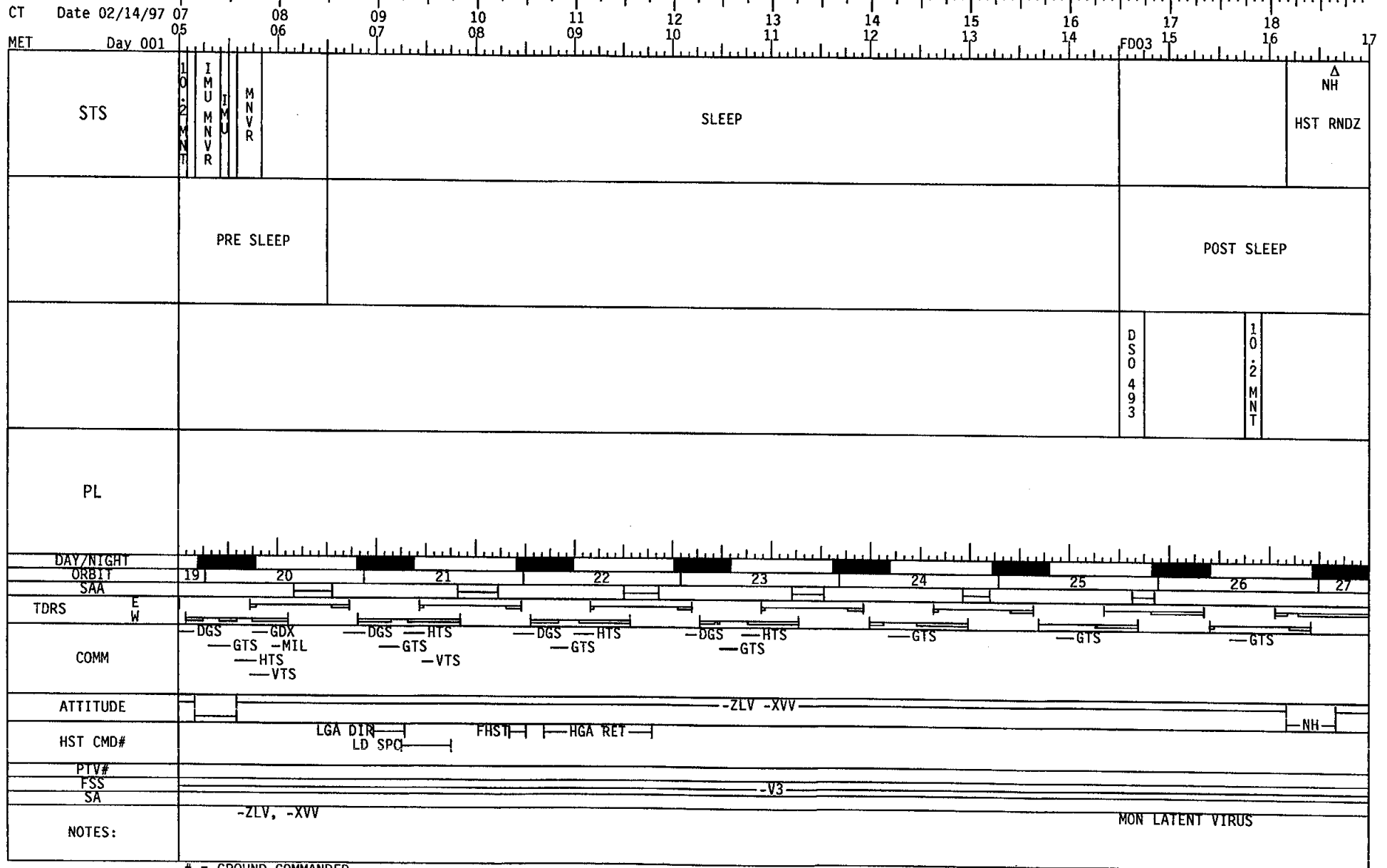

# = GROUND COMMANDED

GMT	MET	CT	DOY	BETA	MOON	FLIGHT DAY	HOUSTON DATE	IDENTIFIER	EDITION	PUB. DATE
46/00:59	001/17:00	45/18:59	45 CT	9.83		03	14 Feb 1997	STS-82	FINAL	01/08/97
46/12:59	002/05:00	46/06:59								

CT Date 02/14/97 19 20 21 22 23 02/15 01 02 03 04 05 06 05  
MET Day 001 17 18 19 20 21 22 23 002/00 01 02 03 04 05

STS	Δ NC3	Δ NCC	Δ TI	Δ RBAR	Δ GRAPPLE	BERTH	TRK MNR	HST EXT PWR	GRPB	P/TV10 SETUP	POP/TSV10	MNR	WINTDM	102 MNT	PMC
	POST SLEEP					BERTHING OPERATION		BERTHED HST SURVEY		EXTDPK		HSTPGSC		PRE SLEEP	
		EVA 1 MDDK PREP				P/TV08 OPS	PSETTUVOP9	P/TV09 OPS	VTR S/U 08	VTR PLBK 08		SA SLEW	NEXT DAY'S EVA RVW		
HST CMD#	SLEW SATO #		GYRO #	FG #	LOADS #	PSP BYPASS TRANS#	CAPTURE	PSEA #	DMODIF #	LGAPI #	HST EXT PWR#	OTA HTR CONFIG #	BATT CHARGE	BATT CHRG	SLEW SATO #
DAY/NIGHT ORBIT	27	28	29	30	31	32	33	34							
TDRS															
COMM		DGS -IOS	MIL -IOS	DGS -MIL	DGS -MIL	DGS -IOS	GDX -MIL	DGS -IOS	GDX -MIL	DGS -IOS	GDX -MIL	GTS -MIL	GTS -MIL	GTS -MIL	GDX -MIL
ATTITUDE	NC3	TGT TRK		RNDZ		FREE				BIAS -XSI					-ZLV +YVV
HST CMD#															HST PGSC TEST #1
PTV#															P/TV9 & 10
FSS															
SA															
NOTES:							90 deg VPSP BYPASS TRANS#			PWR DOWN GRP B				0 deg OOP TRIM RELAY#	BIASED -ZLV, +YVV HST PGSC 4K CONFIG

# = GROUND COMMANDED

GMT	MET	CT	DOY	BETA	MOON	FLIGHT DAY	HOUSTON DATE	IDENTIFIER	EDITION	PUB. DATE
46/12:59	002/05:00	46/06:59	46 CT	11.04		03	15 Feb 1997	STS-82	FINAL	01/08/97
47/00:59	002/17:00	46/18:59								

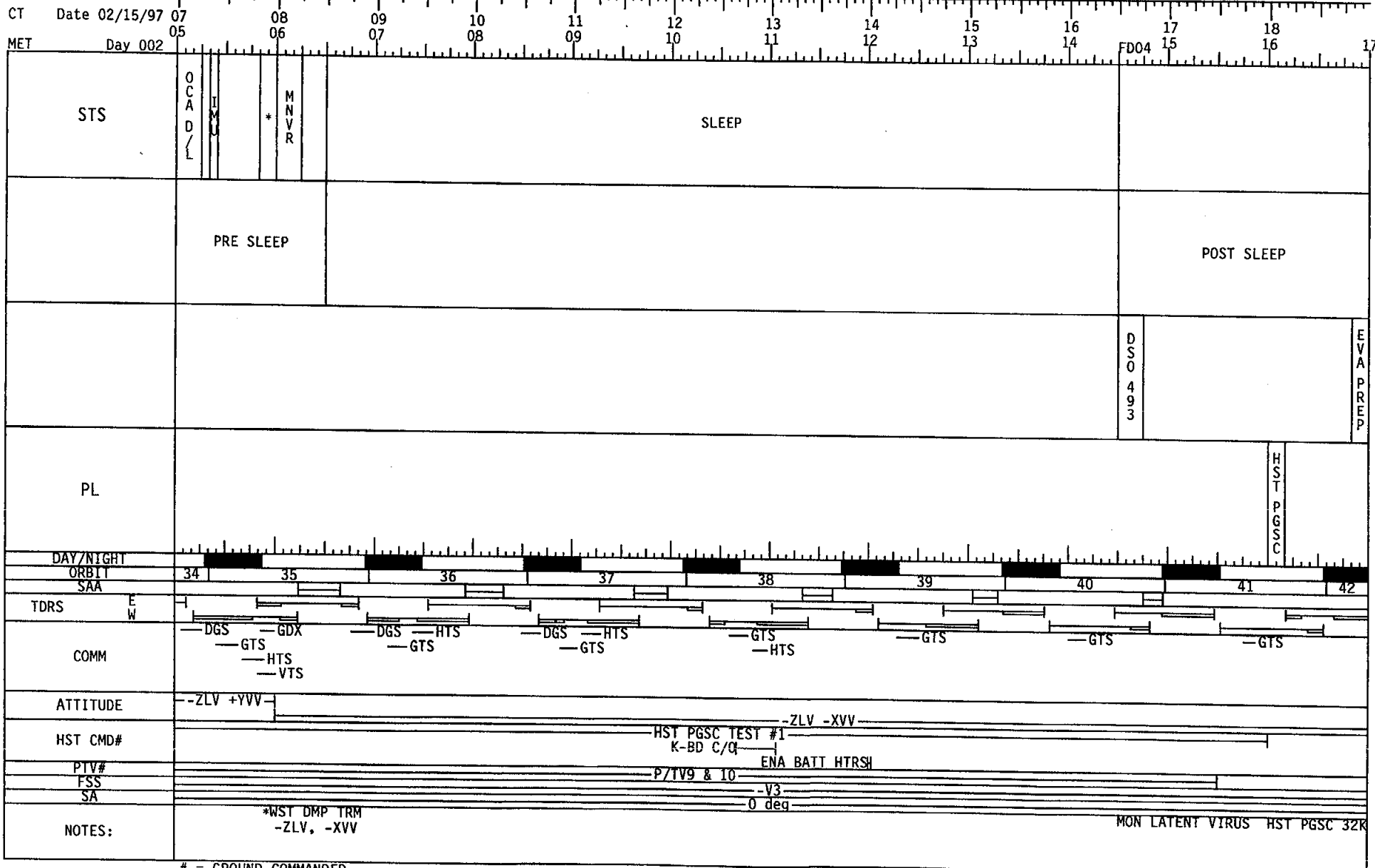

# = GROUND COMMANDED

GMT	MET	CT	DOY	BETA	MOON	FLIGHT DAY	HOUSTON DATE	IDENTIFIER	EDITION	PUB. DATE
47/00:59	002/17:00	46/18:59	46 CT	12.16		04	15 Feb 1997	STS-82	FINAL	01/08/97
47/12:59	003/05:00	47/06:59								

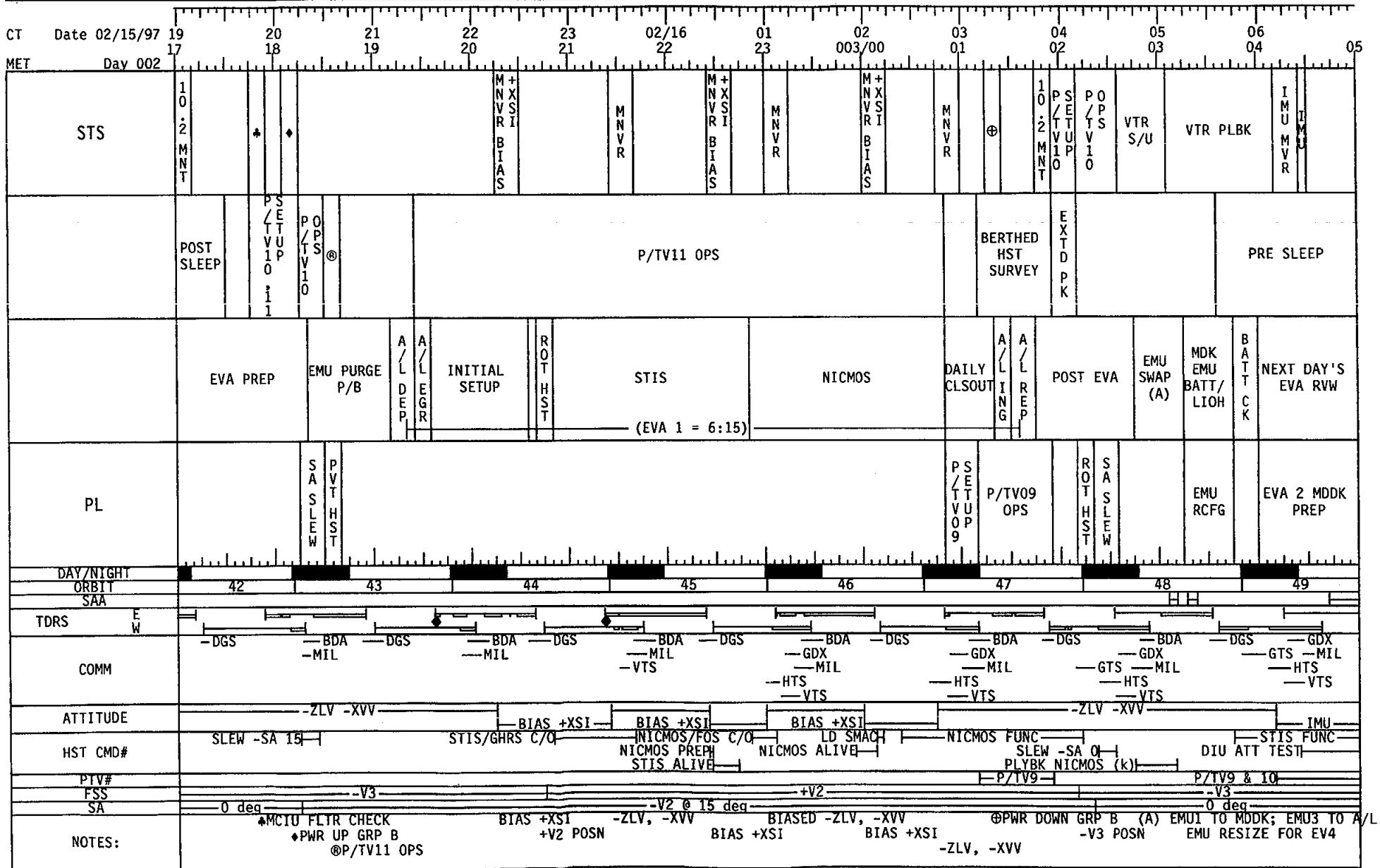

# = GROUND COMMANDED (k) = KU-BAND REQD 2-9

FLT PLN/82/FIN



GMT	MET	CT	DOY	BETA	MOON	FLIGHT DAY	HOUSTON DATE	IDENTIFIER	EDITION	PUB. DATE
47/12:59	003/05:00	47/06:59	47 CT	13.19		04	16 Feb 1997	STS-82	FINAL	01/08/97
48/00:59	003/17:00	47/18:59								

CT Date 02/16/97 07 08 09 10 11 12 13 14 15 16 17 18  
MET Day 003 05 06 07 08 09 10 11 12 13 14 15 16 17

STS	PMC	MNV R	O C A D / L	SLEEP										1 0 . 2 M N T	
PRE SLEEP														POST SLEEP	
		1 0 . 2 M N T											D S O 4 9 3	A S P I R I N	E V A P R E P

PL											
DAY/NIGHT											
ORBIT	49	50	51	52	53	54	55	56	57		
SAA											
TDRS											
COMM	DGS -GDX GTS -HTS HTS -VTS DGS -HTS GTS DGS -HTS GTS GTS -HTS GTS GTS										
ATTITUDE	-ZLV -XVV										
HST CMD#	PLYBK STIS(k)										
PIV#	P/TV9 & 10										
FSS	-V3										
SA	0 deg										
NOTES:	-ZLV, -XVV										
										MON LATENT VIRUS	

# = GROUND COMMANDED (k) = KU-BAND REQD 2-10

GMT	MET	CT	DOY	BETA	MOON	FLIGHT DAY	HOUSTON DATE	IDENTIFIER	EDITION	PUB. DATE
48/00:59	003/17:00	47/18:59	47 CT	14.12		05	16 Feb 1997	STS-82	FINAL	01/08/97
48/12:59	004/05:00	48/06:59								

CT Date 02/16/97 19 20 21 22 23 02/17 01 02 03 04 05 06 05  
 MET Day 003 17 18 19 20 21 22 23 004/00 01 02 03 04 05

STS	POST SLEEP	PS/TTVU P 0	PO/PTS V 1 0	PS/TTVU P 1	P/TV11 OPS				PS/TTVU P 1 2	PO/PTS V 1 2	EXTD PK	10.2 MNT	PS/TTVU P 1 0	PRE SLEEP					
EVA PREP	EMU PURGE P/B	A/L DEP	A/L DEGR	DLY S/U	FGS (EVA 2 = 6:15)				ESTR-2	PFR STOW	CREW SWAP	OCE EK	DAILY CLSOUT	A/L INGP	A/L REPP	POST EVA	EMU SWAP (B)	MDK EMU BATT/LIOH	NEXT DAY'S EVA RWV
PL	SASLEW		ROTHST						SASLEW		VTR S/U	VTR PLBK	EMU RCFG	EVA 3 MDDK PREP					
DAY/NIGHT ORBIT	57		58		59		60		61		62		63		64				
TDRS																			
COMM	DGS	BDA	DGS	BDA	DGS	BDA	DGS	BDA	DGS	GTS	BDA	DGS	BDA	DGS	GDX	GTS	GDX		
ATTITUDE	-ZLV -XVV		BIAS -ZLV -XVV		BIAS +XSI				-ZLV -XVV		-XLV -ZVV		-ZLV +YVV						
HST CMD#	SLEW +SA 15 PREP ESTR2RH		FGS C/OH		FGS ALIVEH		ESTR2R ALIVEH		OCE EK ALIVEH		OCE EK INSTH		SLEW +SA 0H		ESTR2R FUNC (k)				
PTV#	-V3				-V2						-V3		P/TV9 & 10						
FSS	0 deg				+V2 @ 15 deg						0 deg								
SA	0 deg				0 deg						0 deg								
NOTES:	MCIU FLTR CHECK		-V2 POSN		BIAS -ZLV, -XVV		-ZLV, -XVV		-V3 POSN		-ZLV, -ZVV		ΔPWR DOWN GRP B		EMU RESIZE FOR EV2 (B) EMU3 TO MDDK; EMU1 TO A/L				
	PWR UP GRP B		BIAS +XSI		BIAS -ZLV, -XVV														

# = GROUND COMMANDED (k) = KU-BAND REQ 2-11

GMT	MET	CT	DOY	BETA	MOON	FLIGHT DAY	HOUSTON DATE	IDENTIFIER	EDITION	PUB. DATE
48/12:59	004/05:00	48/06:59	48 CT	14.96	☉	05	17 Feb 1997	STS-82	FINAL	01/08/97
49/00:59	004/17:00	48/18:59								

CT Date 02/17/97 07 08 09 10 11 12 13 14 15 16 17 18 17  
MET Day 004 05 06 07 08 09 10 11 12 13 14 15 16 17

STS	φ M N V R	SLEEP						
	PRE SLEEP							POST SLEEP
	1 0 2 M N T							D S O 4 9 3  A S P I R I N  E V A P R E P

PL												
DAY/NIGHT	[Day/Night Cycle]											
ORBIT	64	65	66	67	68	69	70	71	72			
SAA	[SAA Data]											
TDRS	E	[TDRS Data]										
COMM	W	DGS	HTS	DGS	HTS	DGS	HTS	GTS	GTS	GTS	BDA	
ATTITUDE		-ZLV -XVV										
HST CMD#		FGS AMS FUNC										
PTV#		P/TV9 & 10										
FSS		-V3										
SA		0 deg										
NOTES:	φ	WST DMP TRM -ZLV, -XVV								MON LATENT VIRUS		

# = GROUND COMMANDED

GMT	MET	CT	DOY	BETA	MOON	FLIGHT DAY	HOUSTON DATE	IDENTIFIER	EDITION	PUB. DATE
49/00:59	004/17:00	48/18:59	48 CT	15.69		06	17 Feb 1997	STS-82	FINAL	01/08/97
49/12:59	005/05:00	49/06:59								

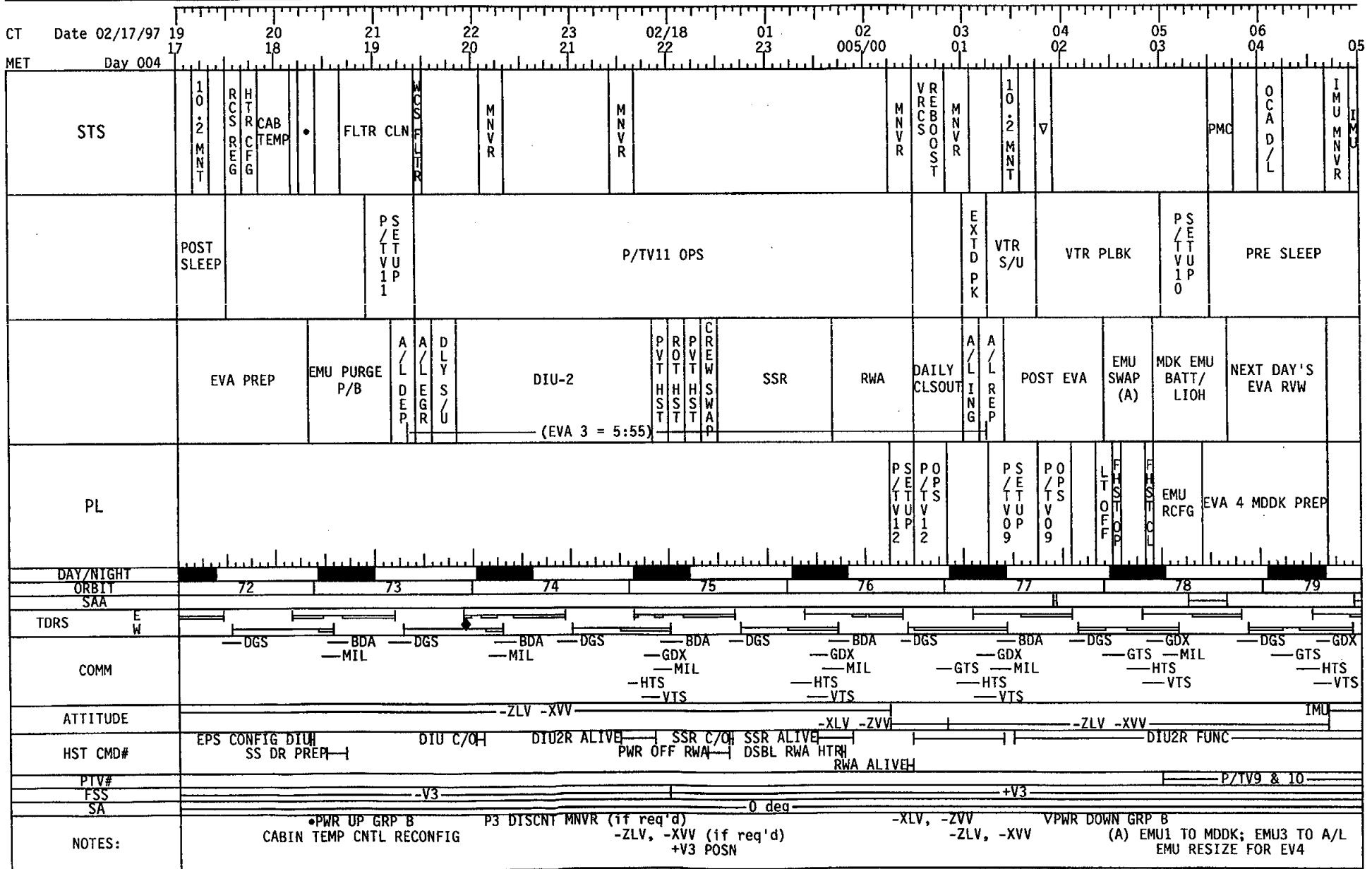

# = GROUND COMMANDED

GMT	MET	CT	DOY	BETA	MOON	FLIGHT DAY	HOUSTON DATE	IDENTIFIER	EDITION	PUB. DATE
49/12:59	005/05:00	49/06:59	49 CT	16.31		06	18 Feb 1997	STS-82	FINAL	01/08/97
50/00:59	005/17:00	49/18:59								

CT Date 02/18/97 07 08 09 10 11 12 13 14 15 16 17 18 17  
MET Day 005 05 06 07 08 09 10 11 12 13 14 15 16 17

STS	M N V R	◇	SLEEP												
	PRE SLEEP												POST SLEEP		
													DSO 4 9 3	ASPIRIN	EVA PREP
PL															
DAY/NIGHT															
ORBIT	79	80	81	82	83	84	85	86	87						
SAA															
TDRS	E	W													
COMM															
ATTITUDE	-ZLV -XVV														
HST CMD#	SSR FUNC (k) SSR ADJ LH														
PTV#	P/TV9 & 10														
FSS	+V3														
SA	0 deg														
NOTES:	◇10.2 MAINT -ZLV, -XVV										MON LATENT VIRUS				

# = GROUND COMMANDED (k) = KU-BAND REQD 2-14

FLT PLN/82/FIN

GMT	MET	CT	DOY	BETA	MOON	FLIGHT DAY	HOUSTON DATE	IDENTIFIER	EDITION	PUB. DATE
50/00:59	005/17:00	49/18:59	49 CT	16.83		07	18 Feb 1997	STS-82	FINAL	01/08/97
50/12:59	006/05:00	50/06:59								

CT Date 02/18/97 19 20 21 22 23 02/19 01 02 03 04 05 06 05  
MET Day 005 17 18 19 20 21 22 23 006/00 01 02 03 04 05

STS	10.2 MNT		VTR S/U		VTR PLBK		MNV R		VRCS REBOOST		MNV R		EXTD PK		FREE		AUTO		FREE		AUTO		HST PGSC		WST ITP		PMC		OCAD/L			
	PS O L S E T P			P/TV11 OPS				P/TV12 OPS		P/TV11 OPS				10.2 MNT				PRE SLEEP														
	EVA PREP		EMU PURGE P/B		A/L D E P		A/L D E G R		D L Y S / U		SADE		P R O T H S T		MSS COVERS (EVA 4 = 6:30)		R O T H S T		P V I H S T		FINAL EVA CLSOUT		A/L I N G		A/L R E P		POST EVA		EMU SWAP (B)		MDK EMU BATT/LIOH	
PL															HGA DPY MON		P/TV10 OPS						EMU RCFG									
DAY/NIGHT																																
ORBIT	87		88		89		90		91		92		93		94																	
SAA																																
TDRS	E		W																													
COMM	BDA MIL		DGS MIL		BDA MIL		DGS MIL		BDA MIL		DGS MIL		BDA MIL		DGS MIL		BDA MIL		DGS MIL		GDX MIL		GDX MIL		GDX MIL		GDX MIL		GDX MIL		GDX MIL	
ATTITUDE					-ZLV -XVV												-XLV -ZVV								-ZLV +YVV							
HST CMD#			SADE C/OH		SADE ALIVE												HGA DPY		SADE 1R FUNC		SADE 2R FUNC		HST PGSC TEST #2									
PTV#																															P/TV9 & 10	
FSS			+V3				-330 deg																									
SA							0 deg																									
NOTES:			*MCIU FLTR CHECK		*PWR UP GRP B				MSS POSN		-XLV, -ZVV		-ZLV, +YVV																*PWR DOWN GRP B			

# = GROUND COMMANDED

HST PGSC 4K CONFIG  
(B) EMU3 TO MDDK; EMU1 TO A/L  
EMU RESIZE FOR EV2  
FLT PLN/82/FIN

GMT	MET	CT	DOY	BETA	MOON	FLIGHT DAY	HOUSTON DATE	IDENTIFIER	EDITION	PUB. DATE
50/12:59 51/00:59	006/05:00 006/17:00	50/06:59 50/18:59	50 CT	17.22	☉	07	19 Feb 1997	STS-82	FINAL	01/08/97

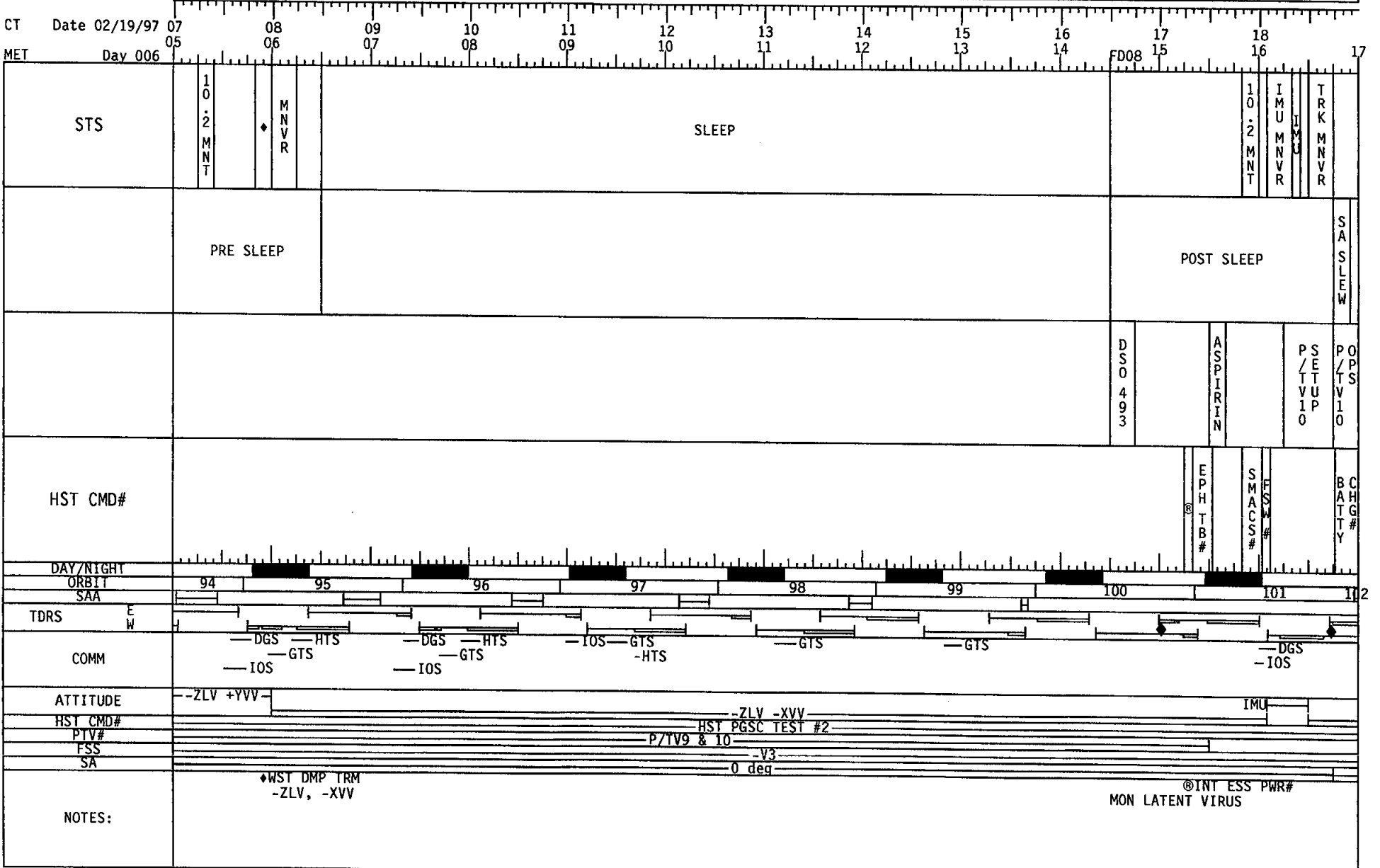

# = GROUND COMMANDED

GMT	MET	CT	DOY	BETA	MOON	FLIGHT DAY	HOUSTON DATE	IDENTIFIER	EDITION	PUB. DATE
51/00:59	006/17:00	50/18:59	50 CT	17.51		08	19 Feb 1997	STS-82	FINAL	01/08/97
51/12:59	007/05:00	51/06:59								

CT Date 02/19/97 19 20 21 22 23 02/20 01 02 03 04 05 06 05  
MET Day 006 17 18 19 20 21 22 23 007/00 01 02 03 04

STS	GRPB	GRPL	HUNBERTH	NNVR	HST RELEASE PREP	REL HST	SEP1 RELEASE OPS	SEP2	MNVR	GRPB	14:7	REPPRESS	PCS CFG	PMC	OCD/L
-----	------	------	----------	------	------------------	---------	------------------	------	------	------	------	----------	---------	-----	-------

	HST PGSC	SA SLEW					HST RELEASE		FSS STOW	RMS PWD		VTR S/U 13	VTR PLBK 13	PSE/TTVUP 4	PAO OPPTY	PRE SLEEP
--	----------	---------	--	--	--	--	-------------	--	----------	---------	--	------------	-------------	-------------	-----------	-----------

	PSE/TTVUP 13				P/TV13 OPS					PGSC STOW						
--	--------------	--	--	--	------------	--	--	--	--	-----------	--	--	--	--	--	--

HST CMD#		BATT CHARGE	PSEA#				OPEN AD#	REL PRP#	LEG CNFG	SA OCB#		FHST FOV CK#	FIRST ATT DETERMINE#		FIRST ATT DETERMINE#
----------	--	-------------	-------	--	--	--	----------	----------	----------	---------	--	--------------	----------------------	--	----------------------

DAY/NIGHT																
ORBIT																
SAA	102		103		104		105		106		107		108		109	

TDRS																
------	--	--	--	--	--	--	--	--	--	--	--	--	--	--	--	--

COMM	MIL	DGS	MIL	DGS	GDX	DGS	GDX	DGS	GDX	DGS	GDX	DGS	GDX	DGS	GDX	DGS	HTS
		IOS		IOS	HTS		HTS		HTS		HTS		HTS		HTS		VTS

ATTITUDE		BIAS -XSI			REL		SEP		TGT TRK				BIAS -ZLV -YVV			
----------	--	-----------	--	--	-----	--	-----	--	---------	--	--	--	----------------	--	--	--

HST CMD#																
PTV#																
FSS																
SA																

NOTES:	105 deg									90 deg						
	ΔMCIU FLTR CHECK															
	•P/TV10 OPS															
	▽BATTY CHG#															
	◇TERM PGSC TEST 2#															
	PWR UP															
	HST PGSC 32K CONFIG															

# = GROUND COMMANDED



GMT	MET	CT	DOY	BETA	MOON	FLIGHT DAY	HOUSTON DATE	IDENTIFIER	EDITION	PUB. DATE
51/12:59	007/05:00	51/06:59	51 CT	17.68	☉	08	20 Feb 1997	STS-82	FINAL	01/08/97
52/00:59	007/17:00	51/18:59								

CT Date 02/20/97 07 08 09 10 11 12 13 14 15 16 17 18  
MET Day 007 05 06 07 08 09 10 11 12 13 14 15 16 17

STS		SLEEP										
	PRE SLEEP											POST SLEEP
												D S O 4 9 3
PL	V											
DAY/NIGHT		[Day/Night Cycle]										
ORBIT		109 110 111 112 113 114 115 116										
SAA		[SAA Data]										
TDRS	E W	[TDRS Data]										
COMM		-DGS -HTS -GTS -DGS -HTS -GTS -GTS -GTS -GTS -GTS -BDA -DGS -MIL										
ATTITUDE		BIAS -ZLV -YVV										
PTV#												
FSS		STOWED										
NOTES:		VFIRST ATT DETERMINE#										MON LATENT VIRUS

# = GROUND COMMANDED

GMT	MET	CT	DOY	BETA	MOON	FLIGHT DAY	HOUSTON DATE	IDENTIFIER	EDITION	PUB. DATE
52/00:59	007/17:00	51/18:59	51 CT	17.73		09	20 Feb 1997	STS-82	FINAL	01/08/97
52/12:59	008/05:00	52/06:59								

CT Date 02/20/97 19 20 21 22 23 02/21 01 02 03 04 05 06  
MET Day 007 17 18 19 20 21 22 23 008/00 01 02 03 04 05

STS	I M U M N V R	FLTR CLN	MEAL	PMC	O C A D / L
-----	---------------------------------	----------	------	-----	----------------------------

POST SLEEP	P F C	P F C	P F C	P F C	P F C	P F C	P F C	P S E T T U O P 4	PAO OPPTY	PRE SLEEP
------------	-------------	-------------	-------------	-------------	-------------	-------------	-------------	---	--------------	-----------

PL	OFF DUTY (MS1, MS3, MS4, MS5)	OFF DUTY (CDR, PLT, MS2)
----	----------------------------------	-----------------------------

DAY/NIGHT	ORBIT	SAA	TDRS	COMM	ATTITUDE	PTV#	FSS	NOTES:
-----------	-------	-----	------	------	----------	------	-----	--------

DAY/NIGHT	ORBIT	SAA	TDRS	COMM	ATTITUDE	PTV#	FSS	NOTES:
-----------	-------	-----	------	------	----------	------	-----	--------

COMM	BDA MIL	DGS	BDA MIL	DGS	BDA GDX MIL HTS VTS	DGS	BDA GDX MIL HTS VTS	DGS	GDX MIL HTS VTS	DGS	GDX MIL HTS VTS	DGS	GDX MIL HTS VTS	DGS	GDX MIL HTS VTS	HTS
------	------------	-----	------------	-----	---------------------------------	-----	---------------------------------	-----	--------------------------	-----	--------------------------	-----	--------------------------	-----	--------------------------	-----

ATTITUDE	-ZLV -XVV													
PTV#	-ZLV -XVV													
FSS	STOWED													

NOTES:	-ZLV, -XVV													
--------	------------	--	--	--	--	--	--	--	--	--	--	--	--	--

# = GROUND COMMANDED

GMT	MET	CT	DOY	BETA	MOON	FLIGHT DAY	HOUSTON DATE	IDENTIFIER	EDITION	PUB. DATE
52/12:59	008/05:00	52/06:59	52 CT	17.67	☉	09	21 Feb 1997	STS-82	FINAL	01/08/97
53/00:59	008/17:00	52/18:59								

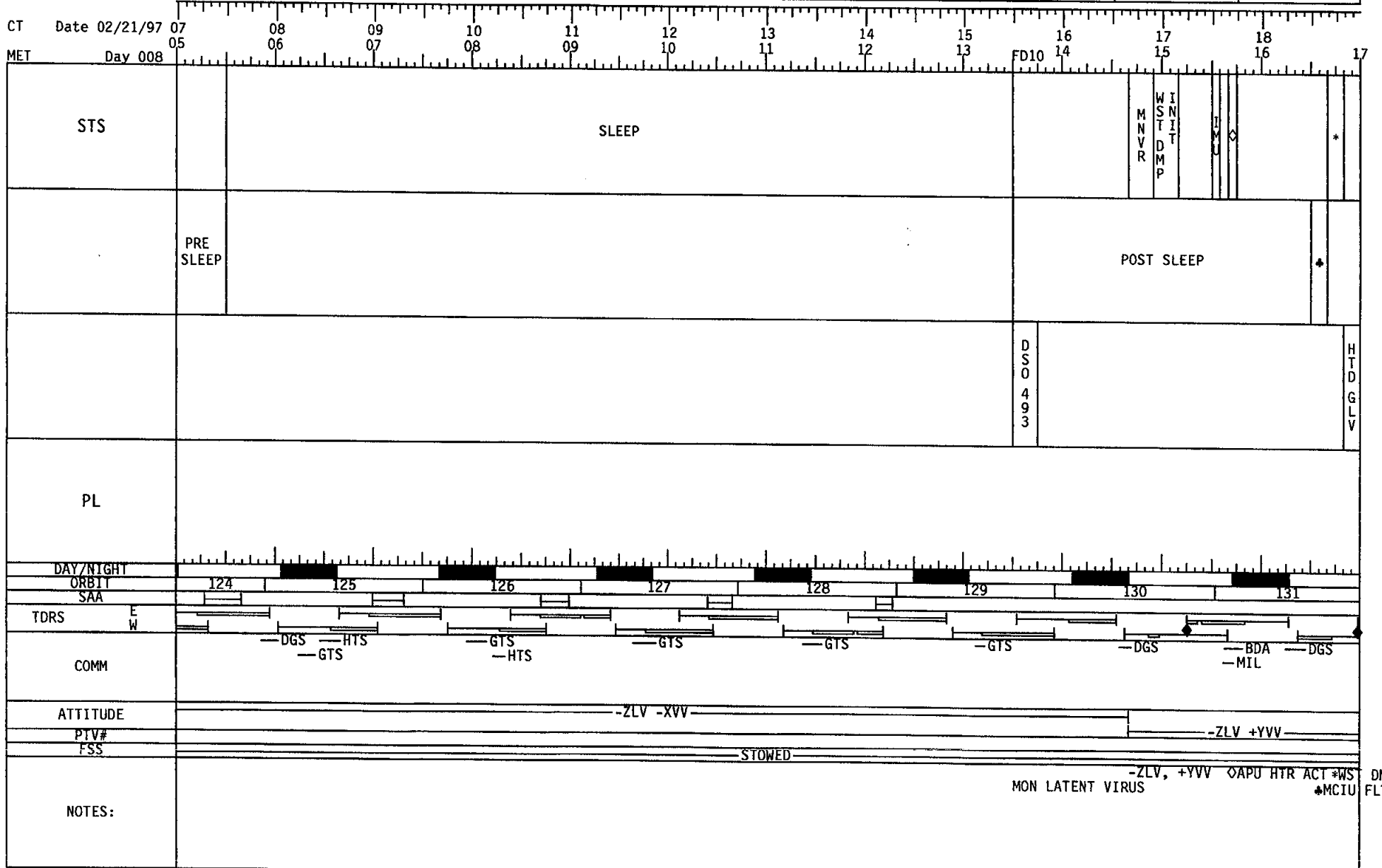

# = GROUND COMMANDED

GMT	MET	CT	DOY	BETA	MOON	FLIGHT DAY	HOUSTON DATE	IDENTIFIER	EDITION	PUB. DATE
53/00:59	008/17:00	52/18:59	52 CT	17.49	☉	10	21 Feb 1997	STS-82	FINAL	01/08/97
53/12:59	009/05:00	53/06:59								

CT Date 02/21/97 19 20 21 22 23 02/22 01 02 03 04 05 06 05  
MET Day 008 17 18 19 20 21 22 23 009/00 01 02 03 04 05

STS	FCS C/O	RFI SR HOT	M N V R	CABIN STOW	D/O BRIEF	MEAL	CABIN STOW	CREW CONF	CREW PHOTO	PMC
				ERGOM STOW			L-1 COMM C/O	PS /E TT VU OP 4	P/TV04 OPS	PRE SLEEP
	POST EVA ENT PREP									O C A S T W
PL										
DAY/NIGHT	[Timeline with alternating shaded and unshaded blocks]									
ORBIT	[Timeline with numerical markers 131-139]									
SAA	[Timeline with numerical markers 131-139]									
TDRS	[Timeline with 'E' and 'W' markers]									
COMM	[Timeline with BDA, DGS, GDX, MIL, HTS, VTS, GTS labels]									
ATTITUDE	[Timeline with -ZLV +YVV and BIAS -ZLV -YVV labels]									
P/V#	[Timeline with STOWED label]									
FSS	[Timeline with STOWED label]									
NOTES:	<p>⊕APU HTR RECONFIG  BIASED -ZLV, -YVV</p> <p>♦KU-BD STOW</p>									

# = GROUND COMMANDED

GMT	MET	CT	DOY	BETA	MOON	FLIGHT DAY	HOUSTON DATE	IDENTIFIER	EDITION	PUB. DATE
53/12:59	009/05:00	53/06:59	53 CT	17.20	☉	10	22 Feb 1997	STS-82	FINAL	01/08/97
54/00:59	009/17:00	53/18:59								

CT Date 02/22/97 07 08 09 10 11 12 13 14 15 16 17 18 17  
MET Day 009 05 06 07 08 09 10 11 12 13 FD11 14 15 16 17

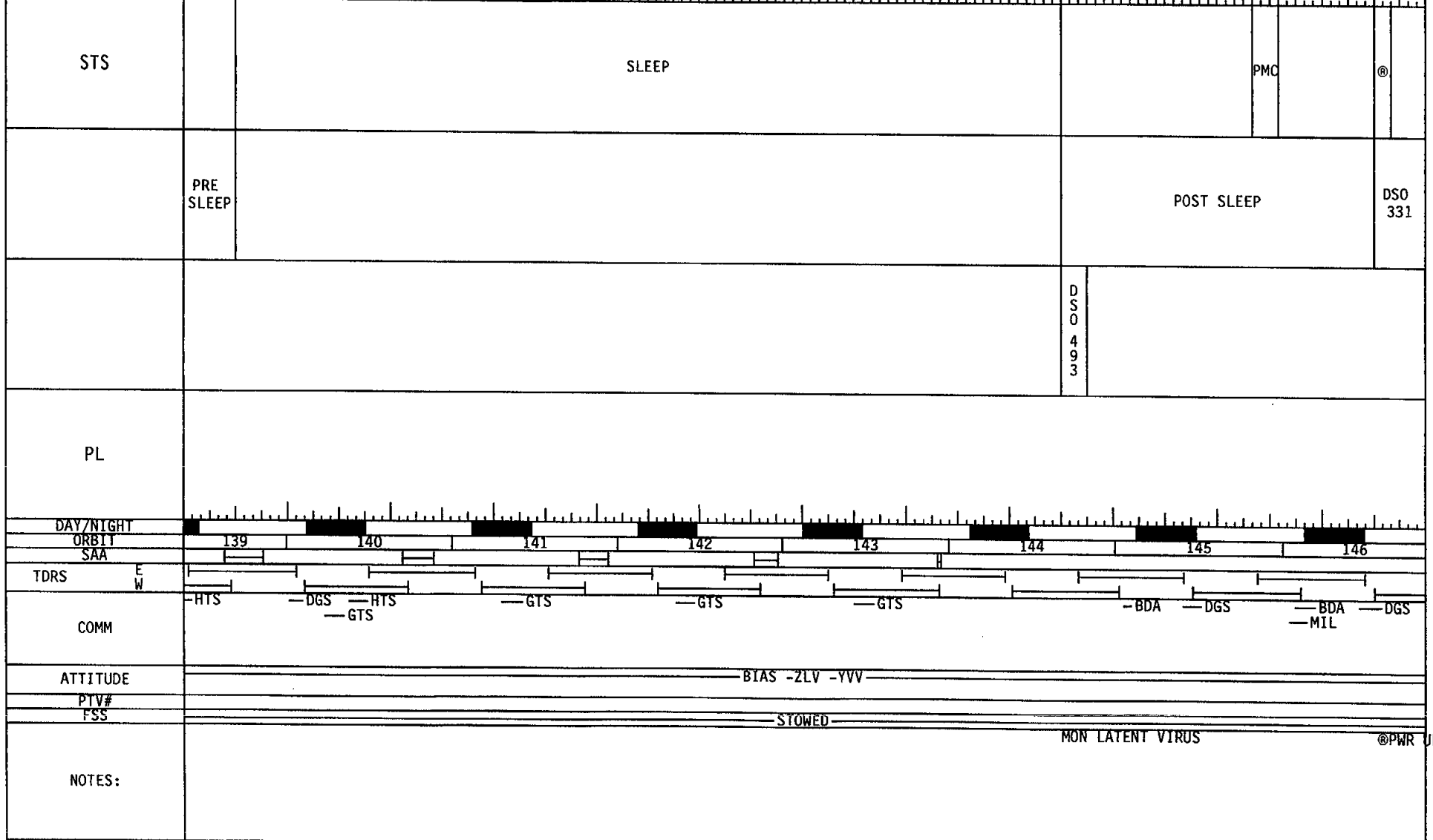

# = GROUND COMMANDED

©PWR UP GRP

GMT	MET	CT	DOY	BETA	MOON	FLIGHT DAY	HOUSTON DATE	IDENTIFIER	EDITION	PUB. DATE
54/00:59	009/17:00	53/18:59			☉					
54/12:59	010/05:00	54/06:59	53 CT	16.79		11	22 Feb 1997	STS-82	FINAL	01/08/97

CT Date 02/22/97 19 20 21 22 23 02/23 01 02 03 04 05 06 05  
MET Day 009 17 18 19 20 21 22 23 010/00 01 02 03 04 05

STS	X S I M N V R		I M U M N V R			B U R N M N V R				
		DEORBIT PREP				D E O R B I T B U R N		K S C		
								L A N D I N G		
PL						*		*		

DAY/NIGHT ORBIT SAA 146 147 148 149 150 151 152 153 154

TDRS E W

COMM  
—BDA —DGS —HTS —BDA —DGS —BDA —DGS—GTS —BDA —DGS —BDA —DGS —GDX —DGS —HTS —DGS —HTS —GTS  
—MIL —GDX —MIL —GDX —MIL —GTS —MIL —GTS —HTS —GTS —HTS —VTS —GTS —HTS —VTS —GTS —HTS —VTS

ATTITUDE BIAS -XSI IMU COMM ATT D/O BURN ENTRY

PTV# FSS STOWED IMU ALIGN/PLBD OPS

NOTES:  
\* DEORBIT BURN 09/21:32  
\* KSC LANDING 09/22:47

# = GROUND COMMANDED

**This Page Intentionally Blank**

DETAILED TIMELINE

DETAILED  
TIMELINE



# DETAILED TIMELINE

## STS-82 (FD 01)

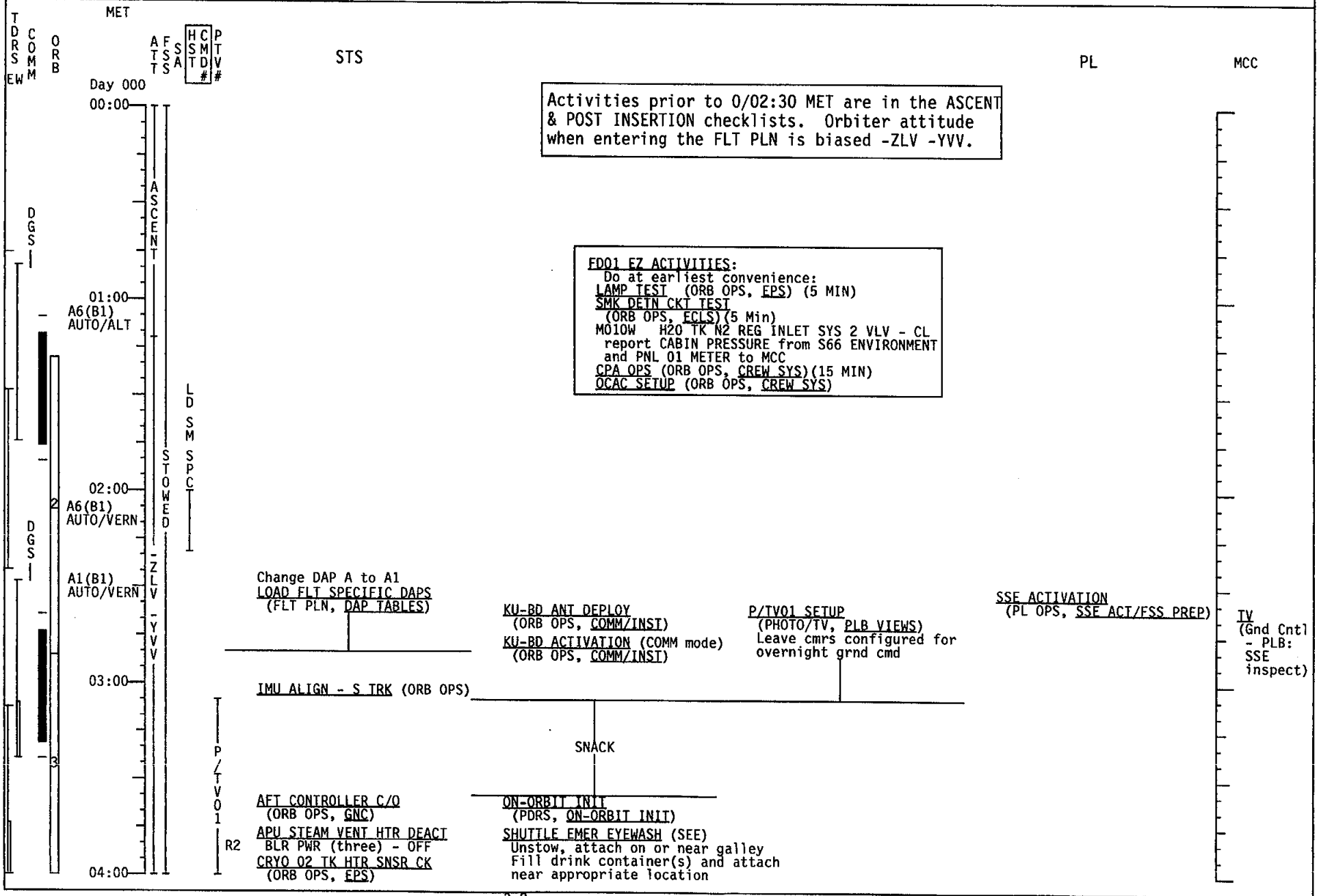

# = GROUND COMMANDED

3-2

FLT PLN/82/FIN

# STS-82 (FD 01)

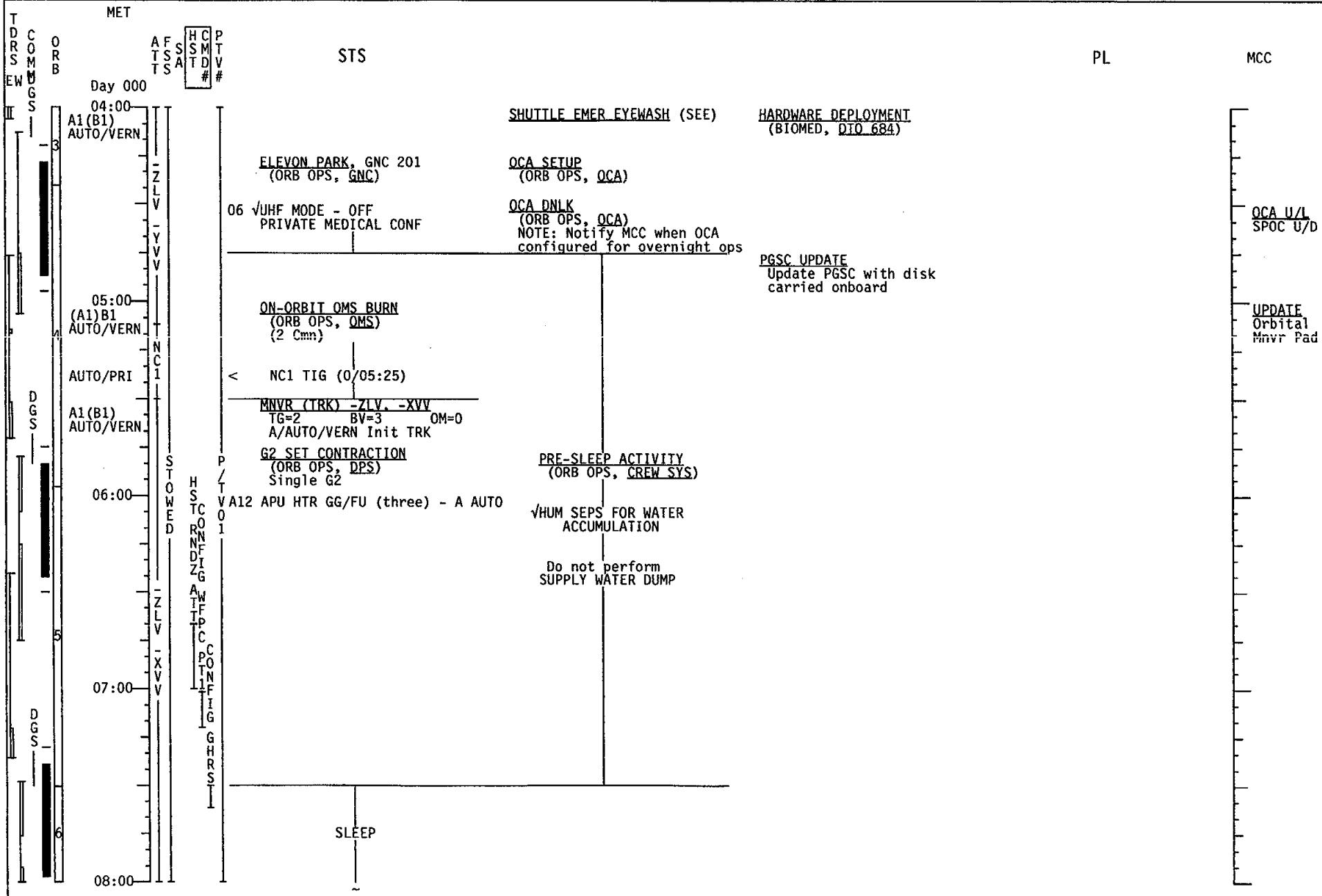

# STS-82 (FD 02)

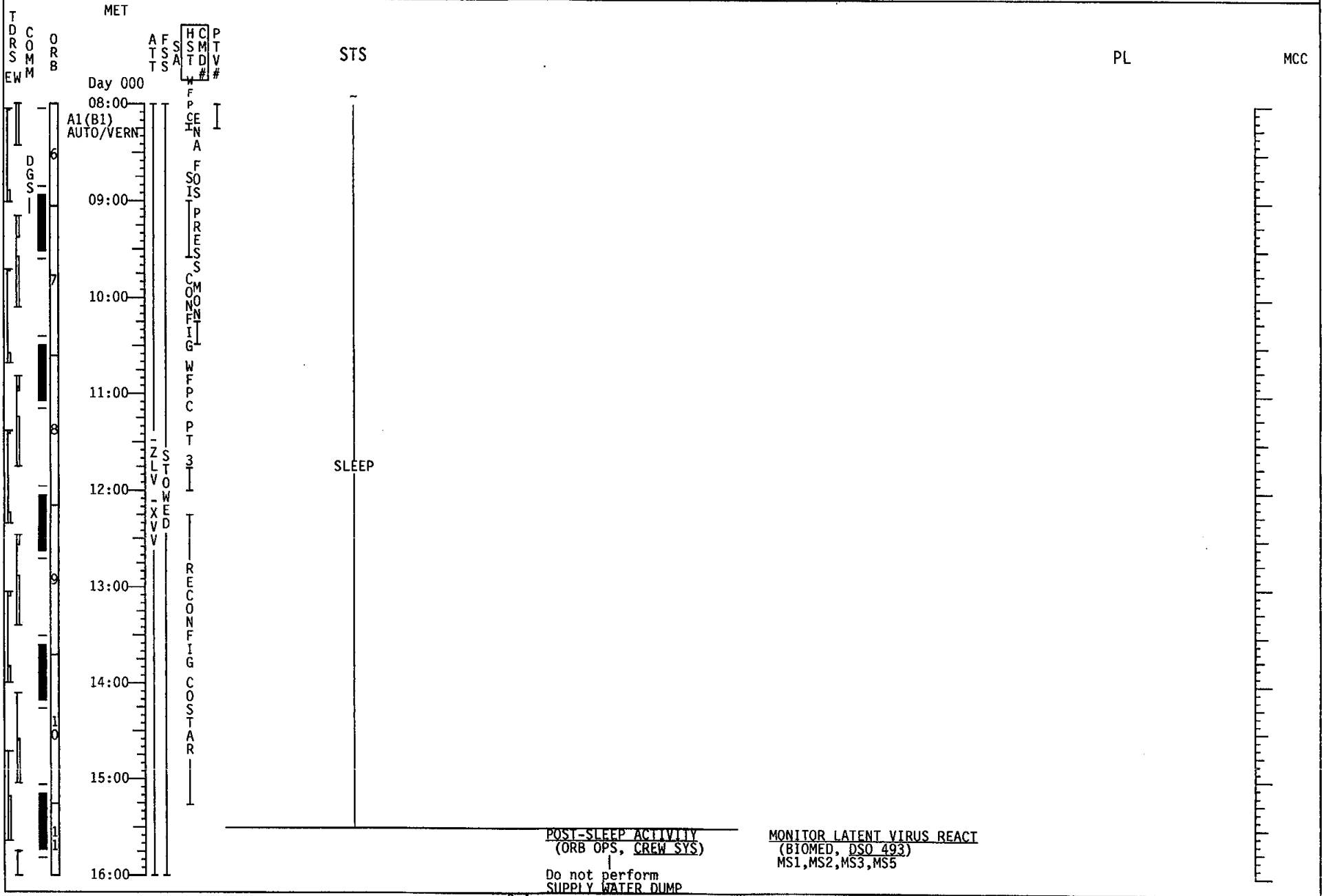

# = GROUND COMMANDED

# STS-82 (FD 02)

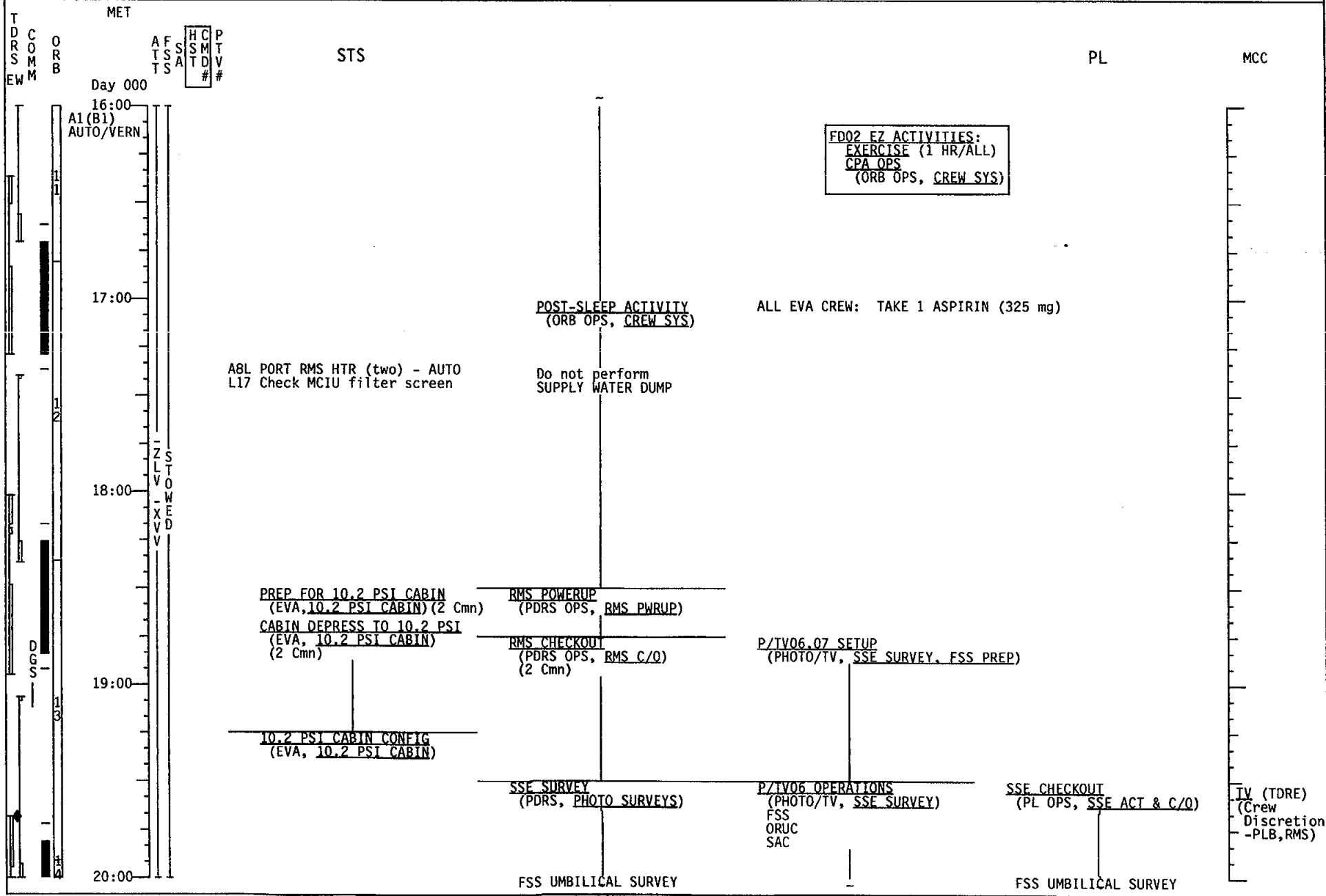

# = GROUND COMMANDED

# STS-82 (FD 02)

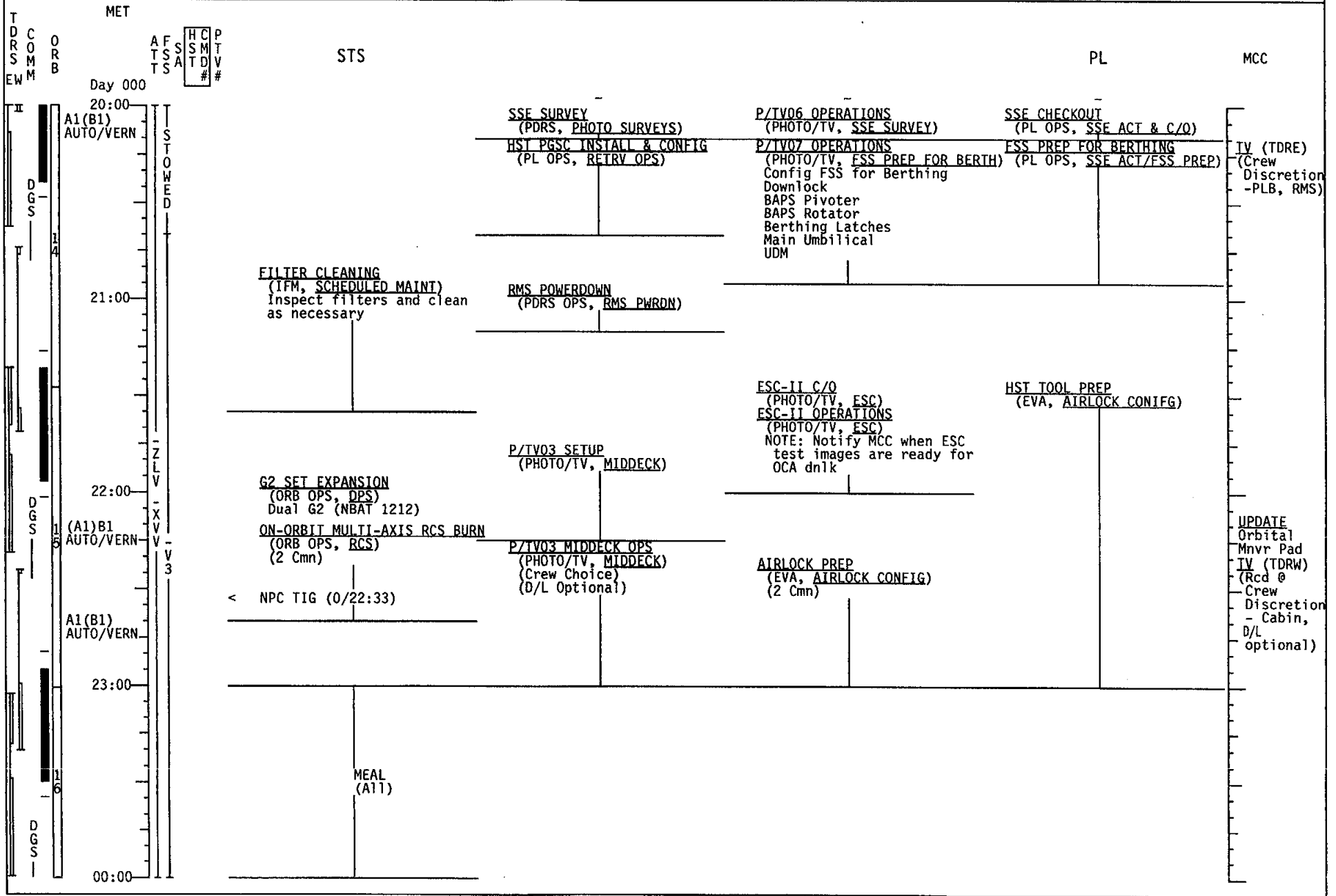

# = GROUND COMMANDED

# STS-82 (FD 02)

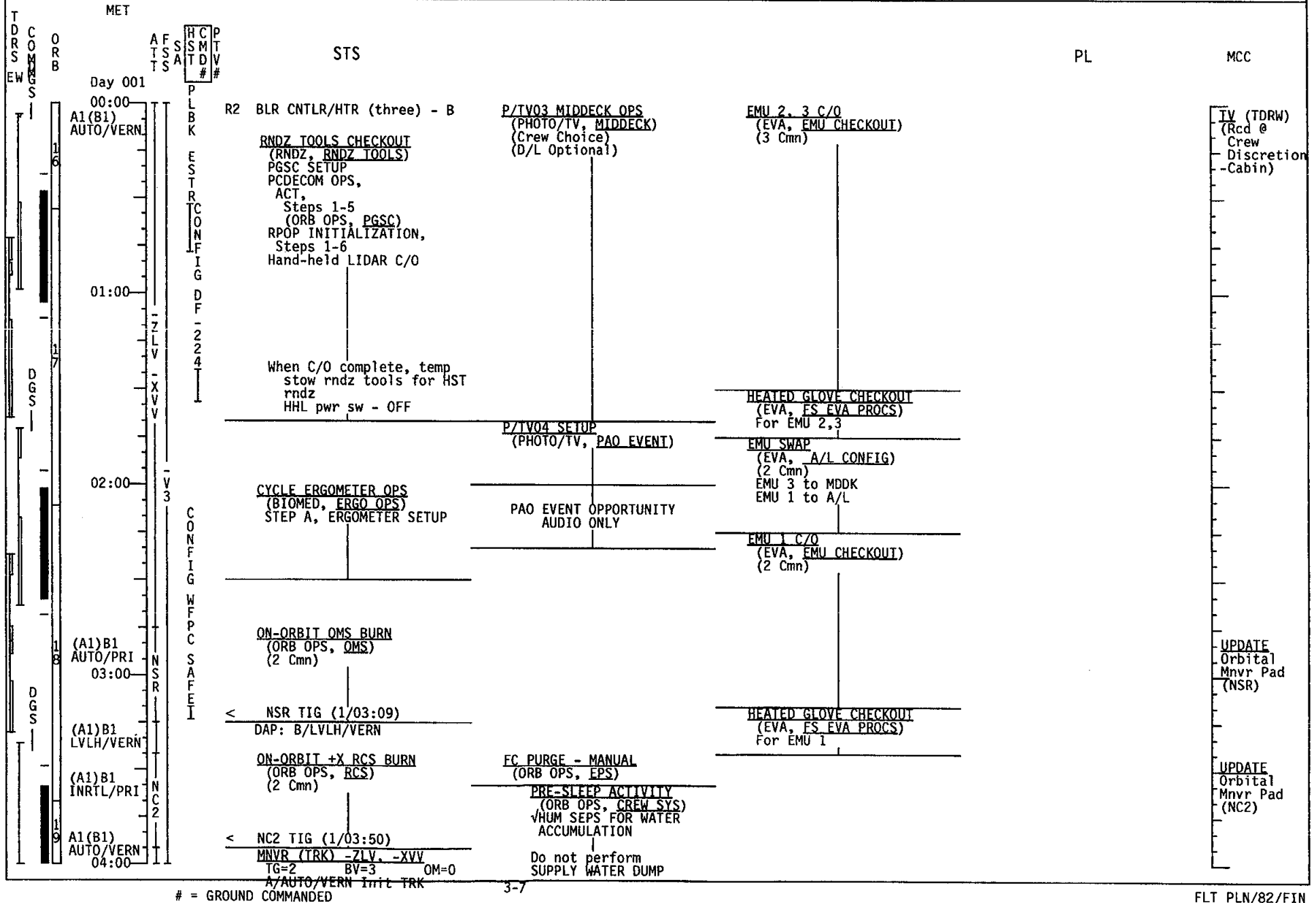

# STS-82 (FD 02)

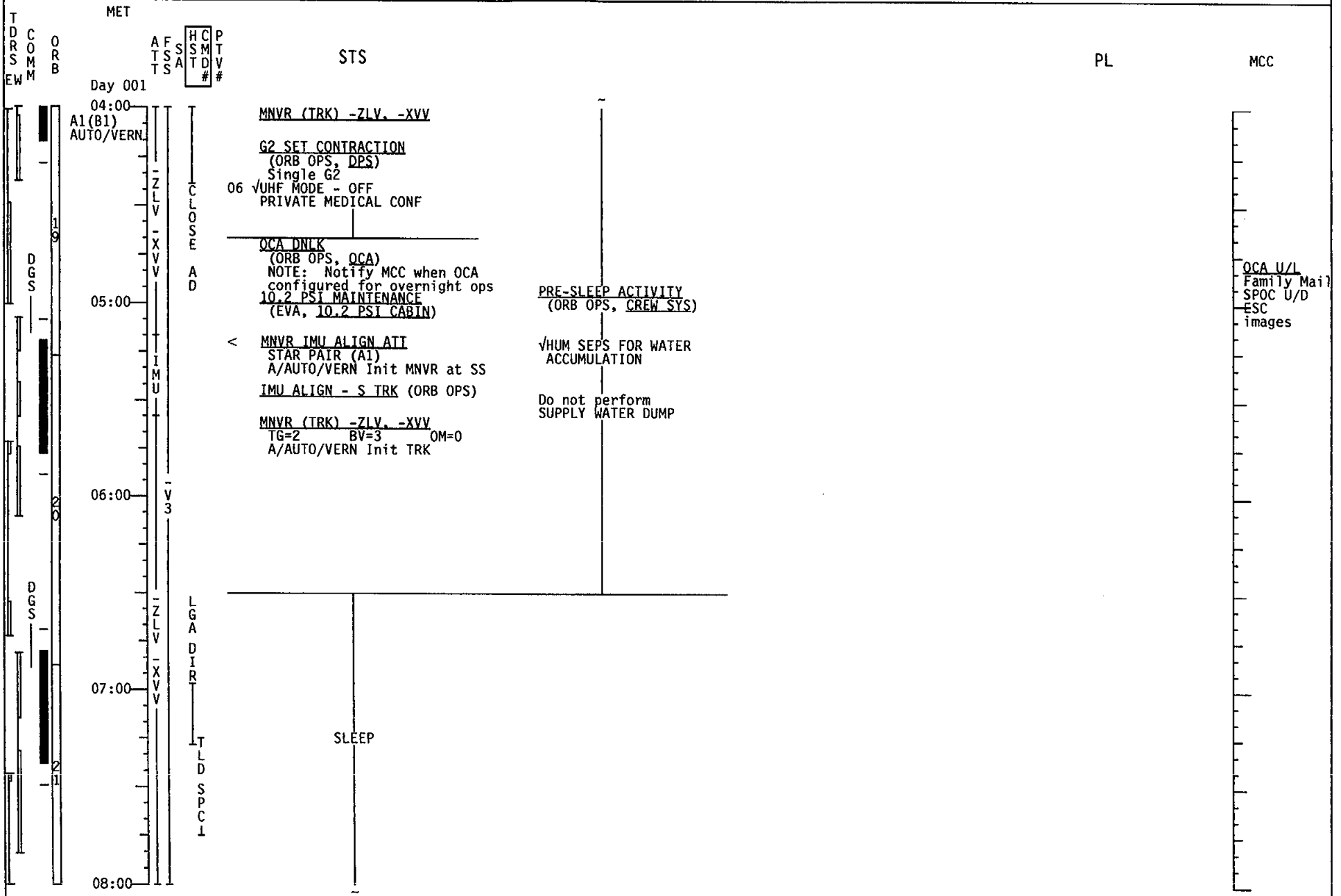

# = GROUND COMMANDED

# STS-82 (FD 03)

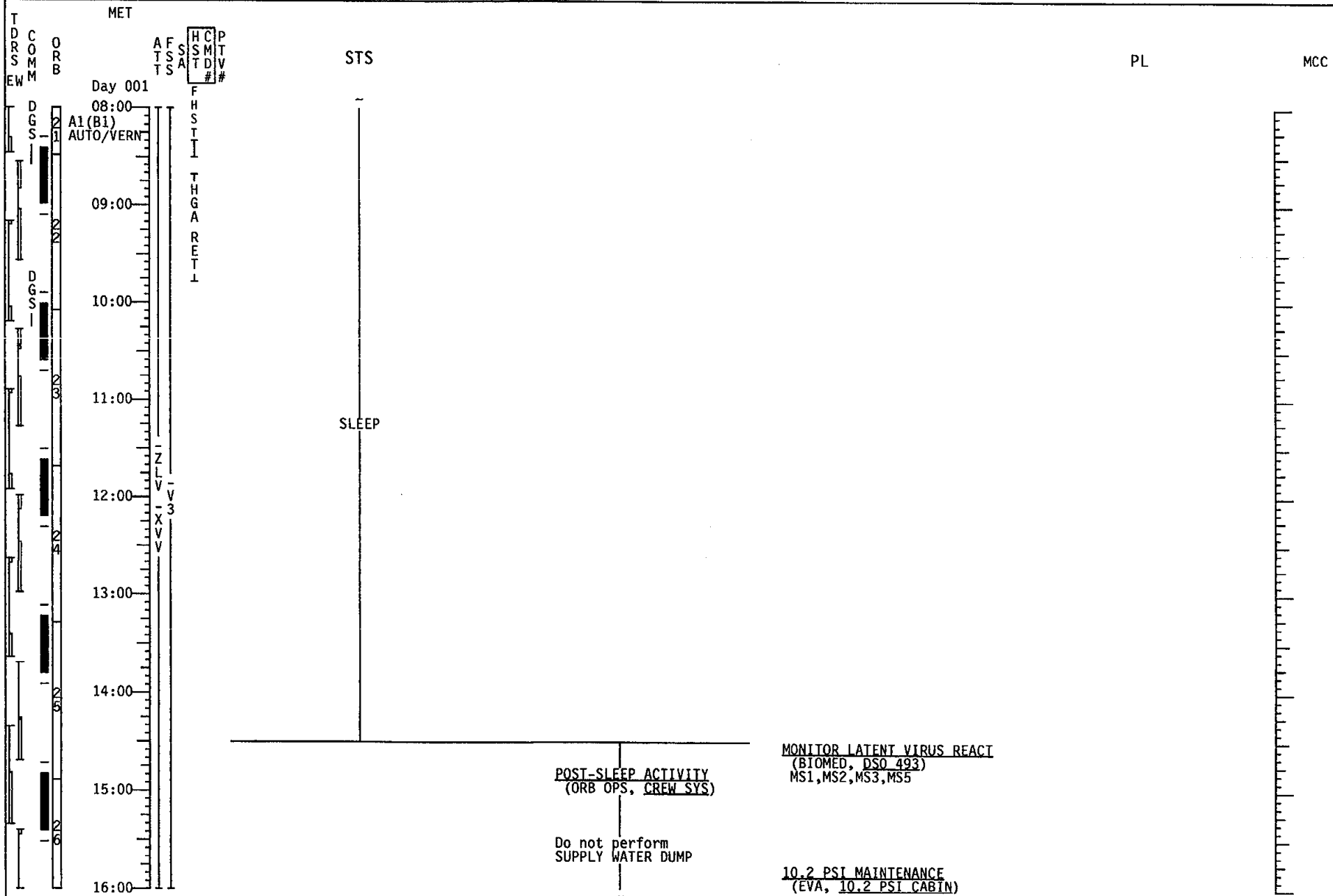

# = GROUND COMMANDED



# STS-82 (FD 03)

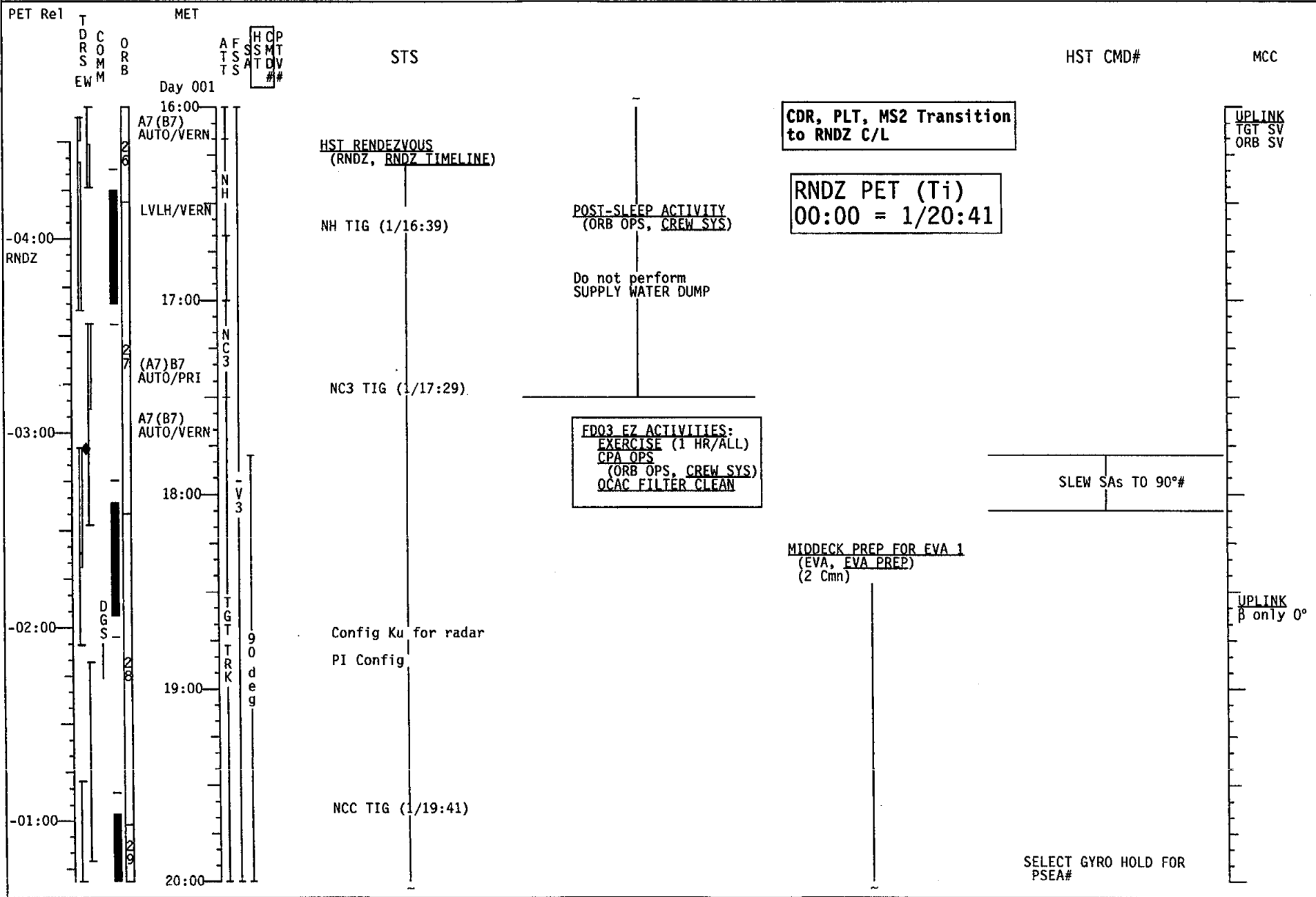

# = GROUND COMMANDED

# STS-82 (FD 03)

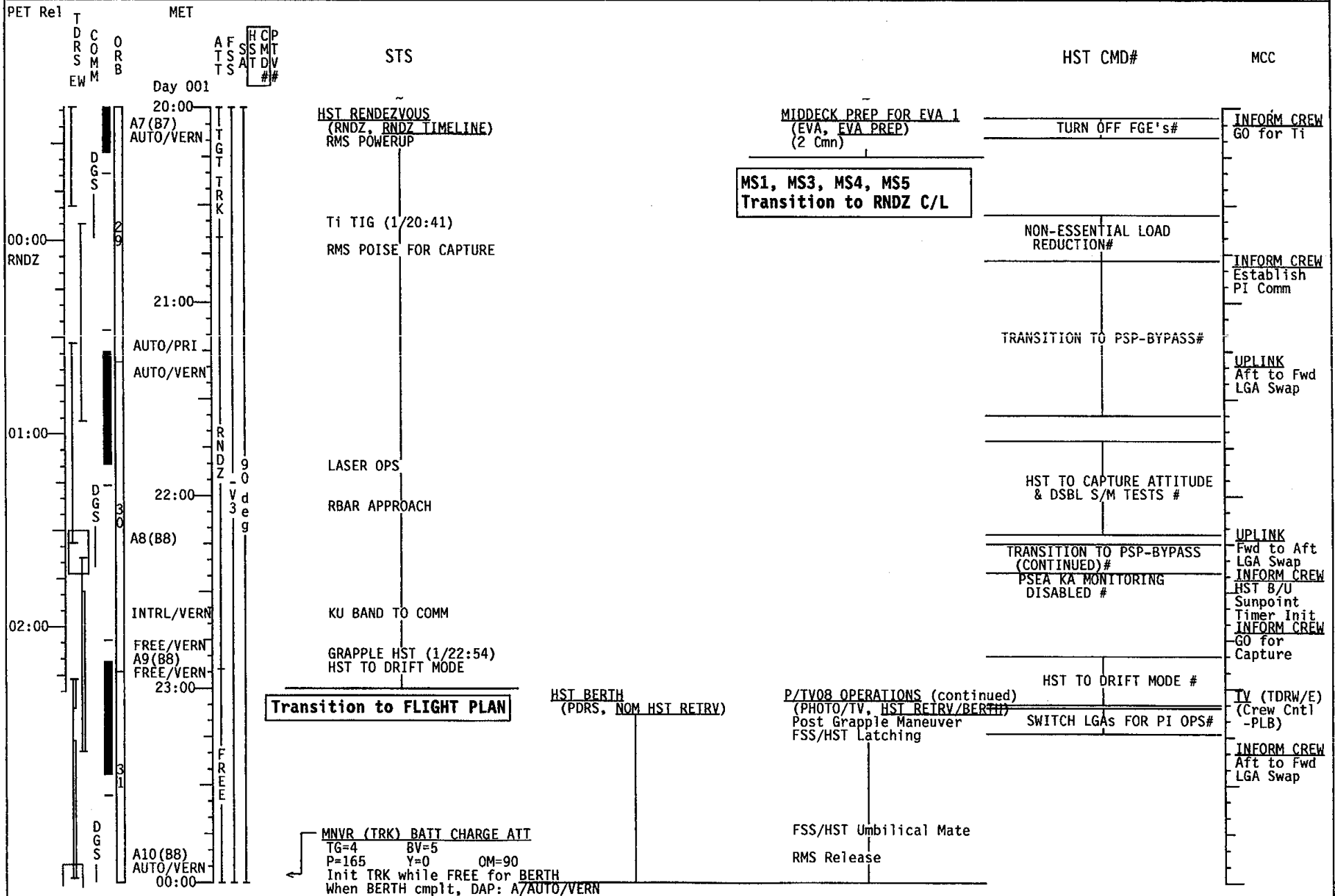

# = GROUND COMMANDED

# STS-82 (FD 03)

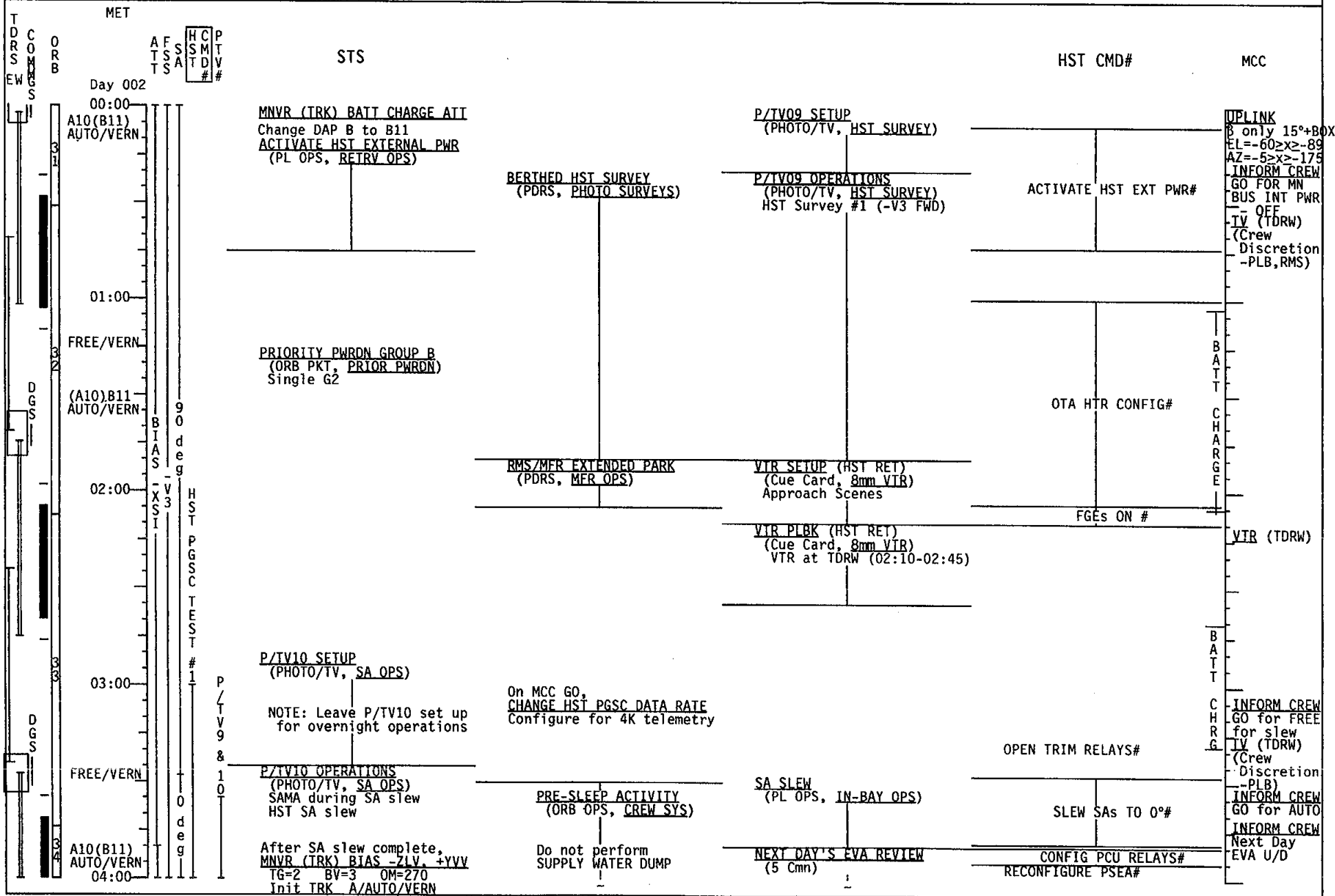

# = GROUND COMMANDED

# STS-82 (FD 03)

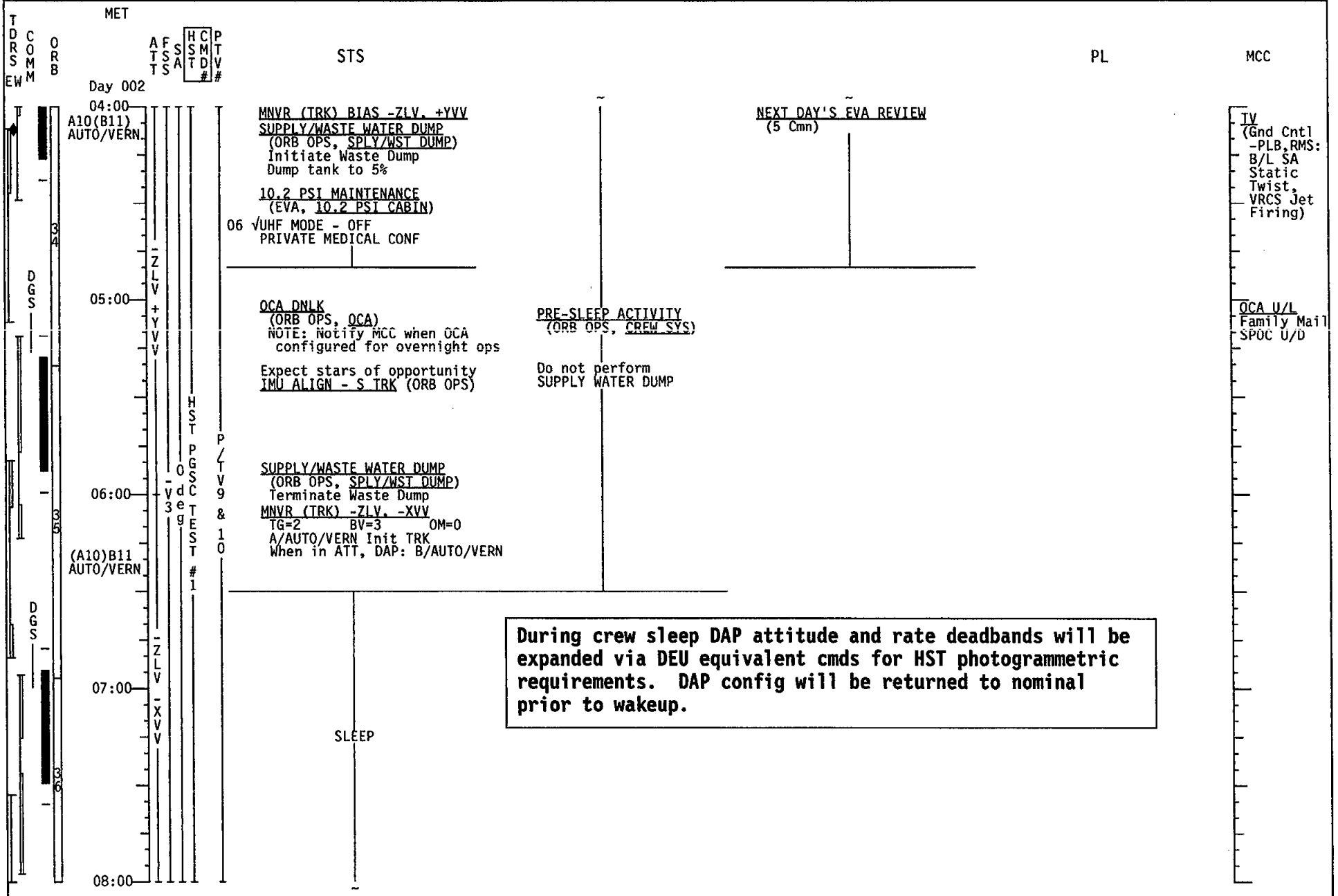

During crew sleep DAP attitude and rate deadbands will be expanded via DEU equivalent cmds for HST photogrammetric requirements. DAP config will be returned to nominal prior to wakeup.

# STS-82 (FD 04)

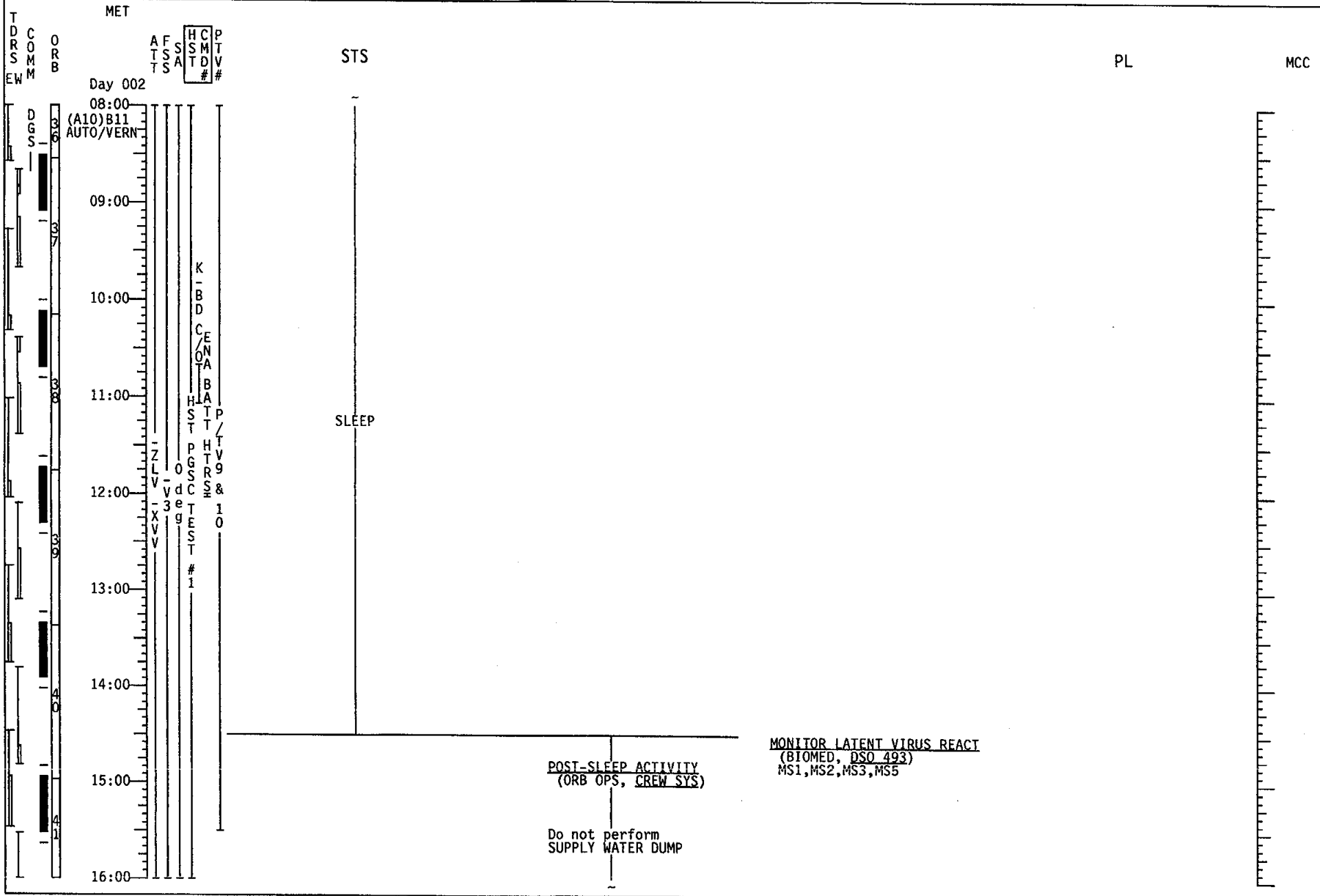

# = GROUND COMMANDED

# STS-82 (FD 04)

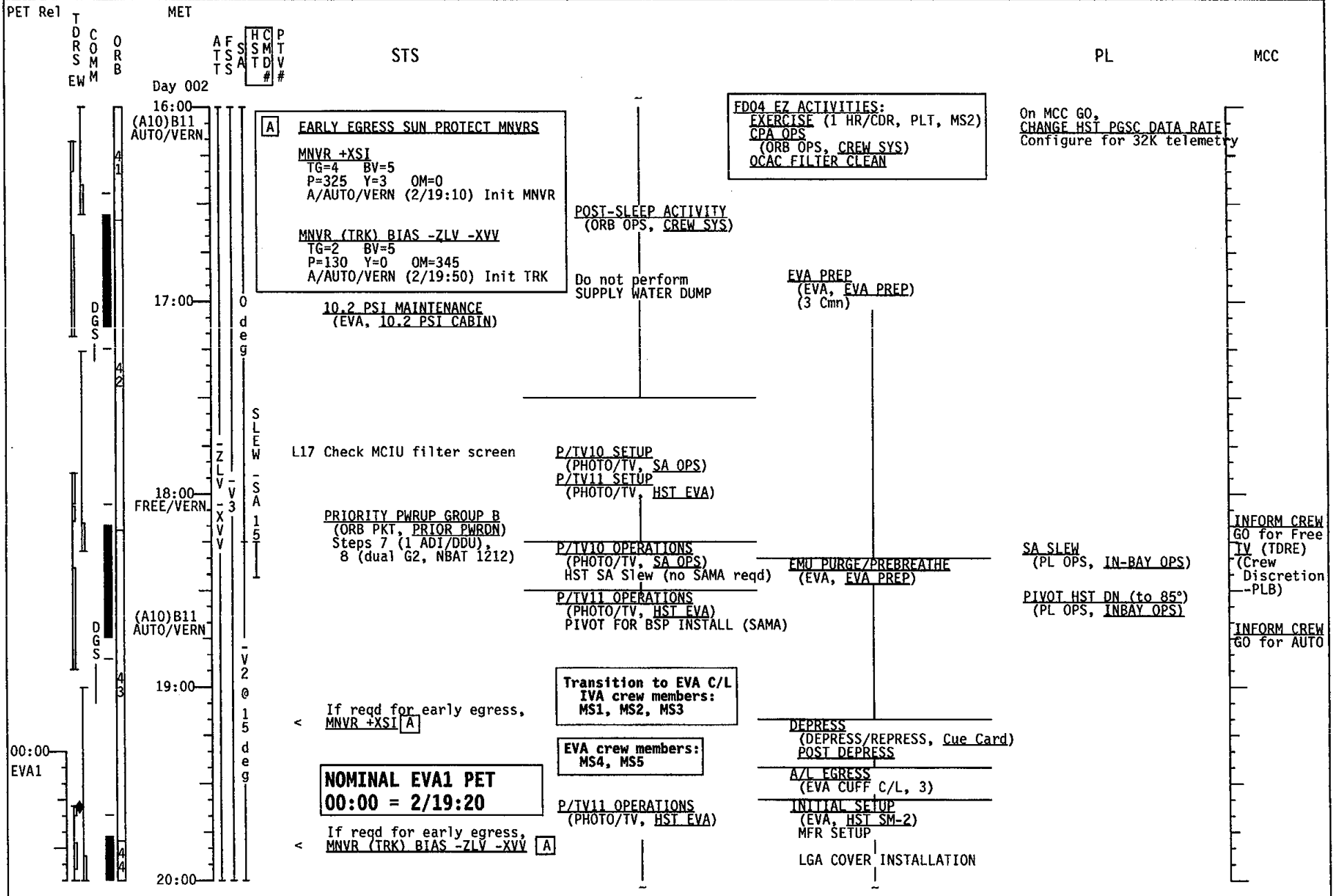

# STS-82 (FD 04)

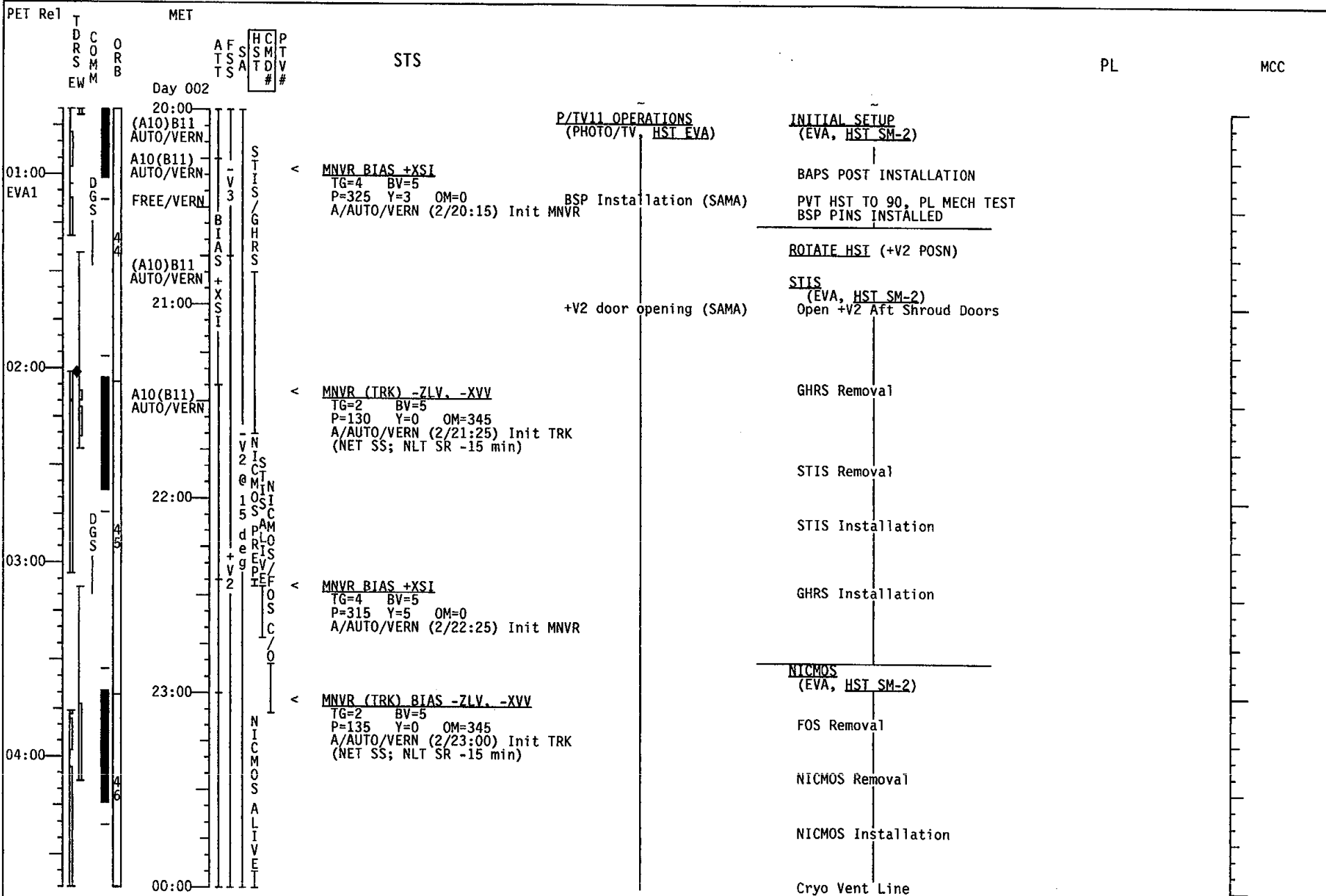

# = GROUND COMMANDED

# STS-82 (FD 04)

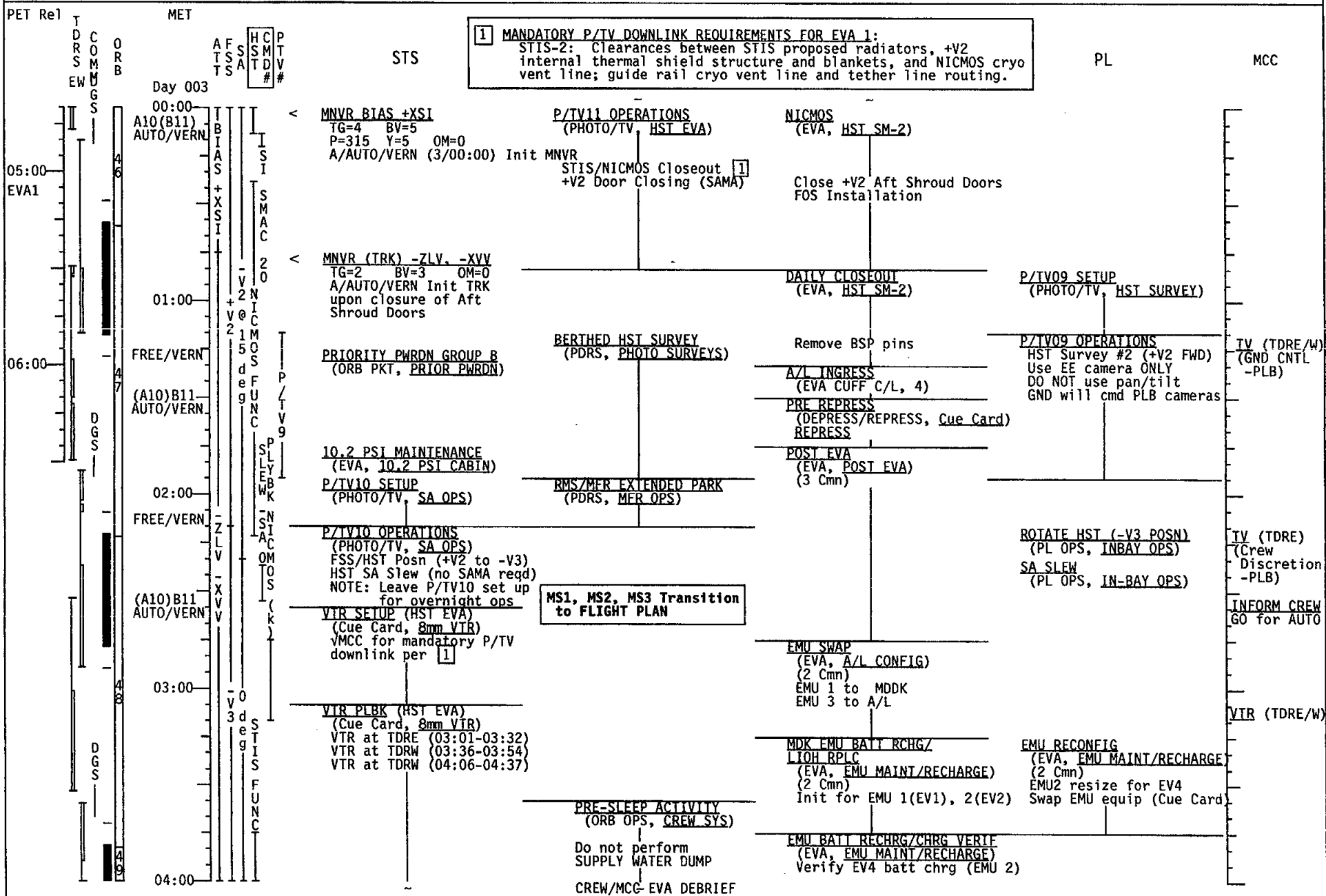



# STS-82 (FD 04)

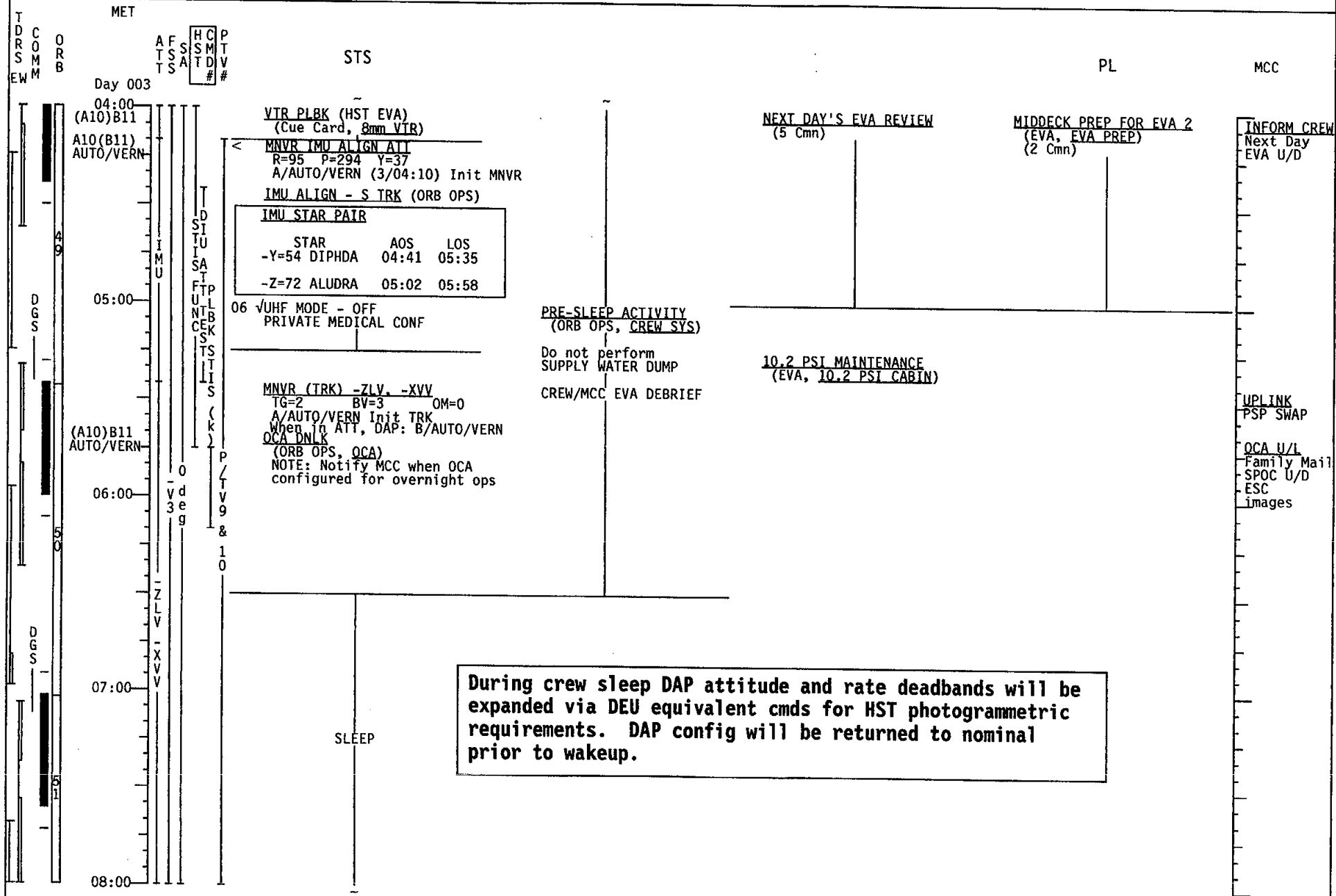

# = GROUND COMMANDED (k) = KU-BAND REQD 3-18

FLT PLN/82/FIN

# STS-82 (FD 05)

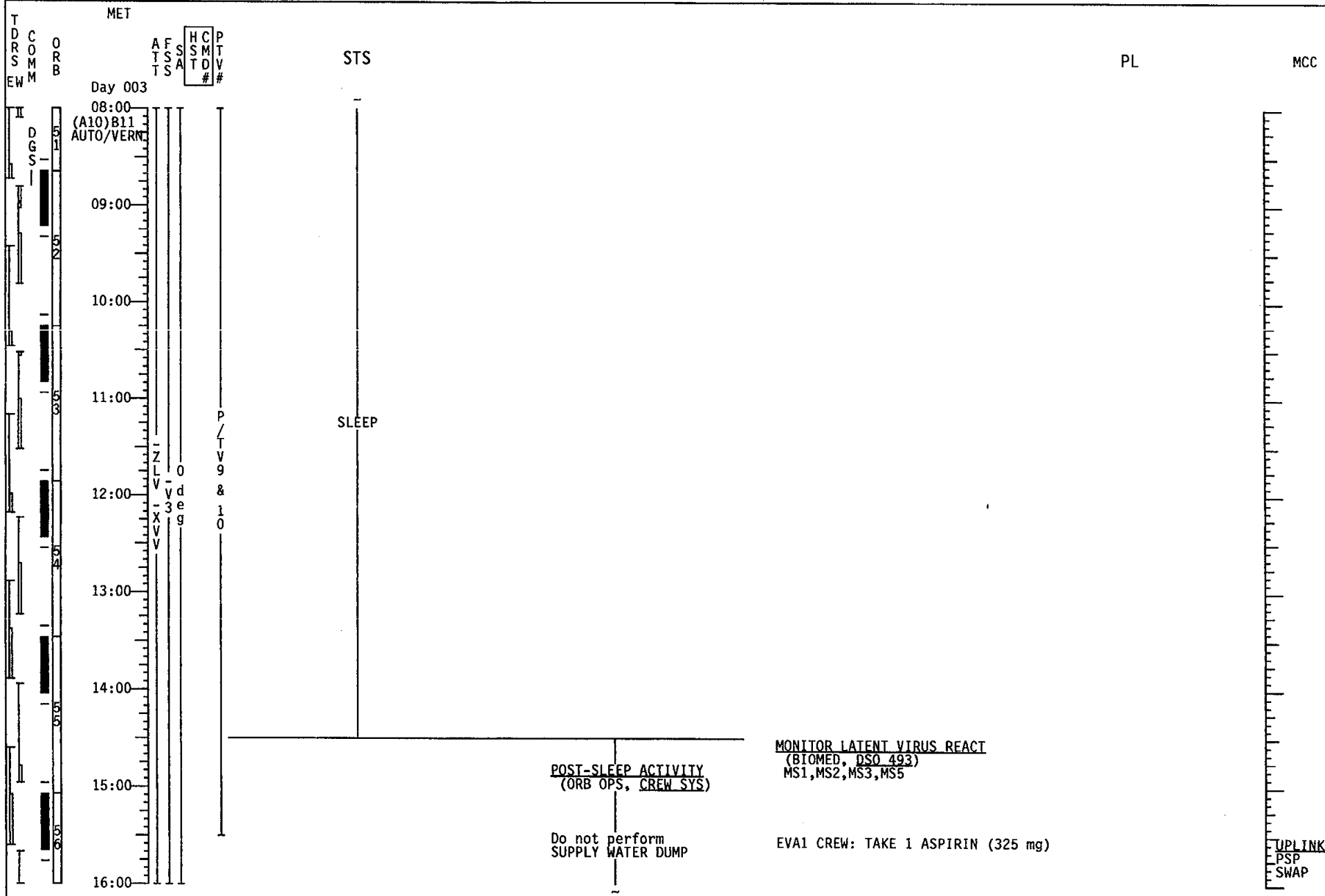

# = GROUND COMMANDED

# STS-82 (FD 05)

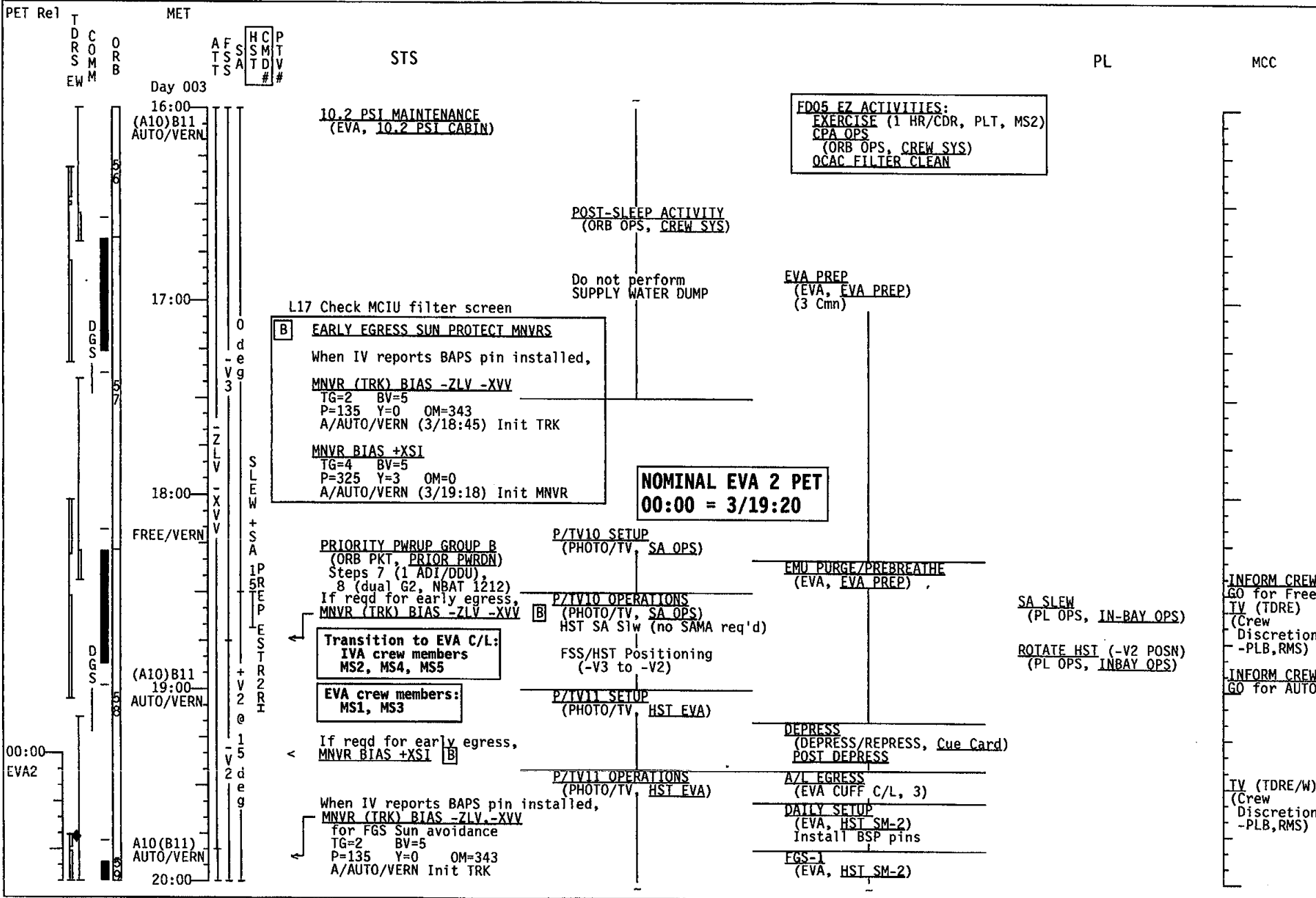

# = GROUND COMMANDED

### STS-82 (FD 05)

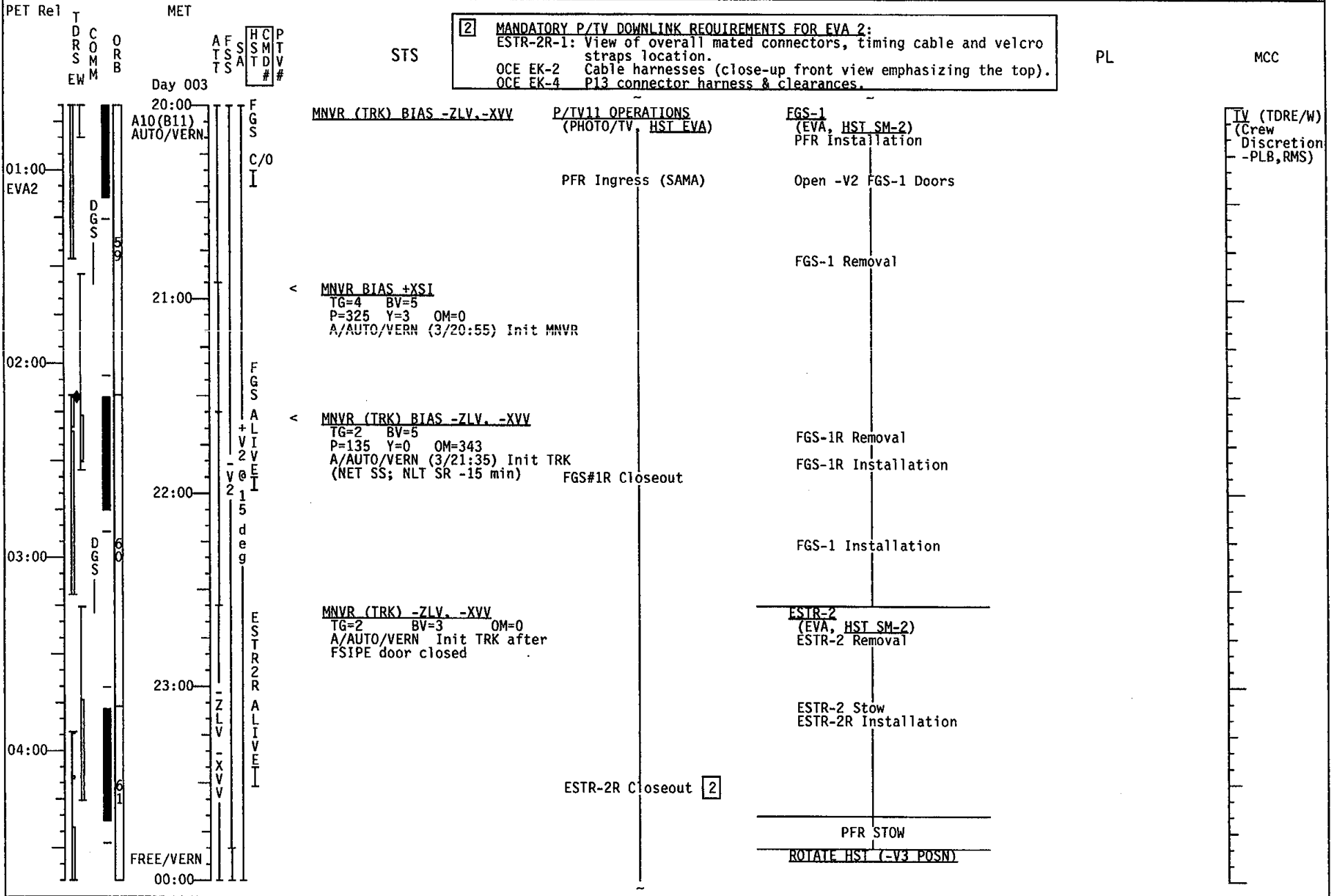

# = GROUND COMMANDED

# STS-82 (FD 05)

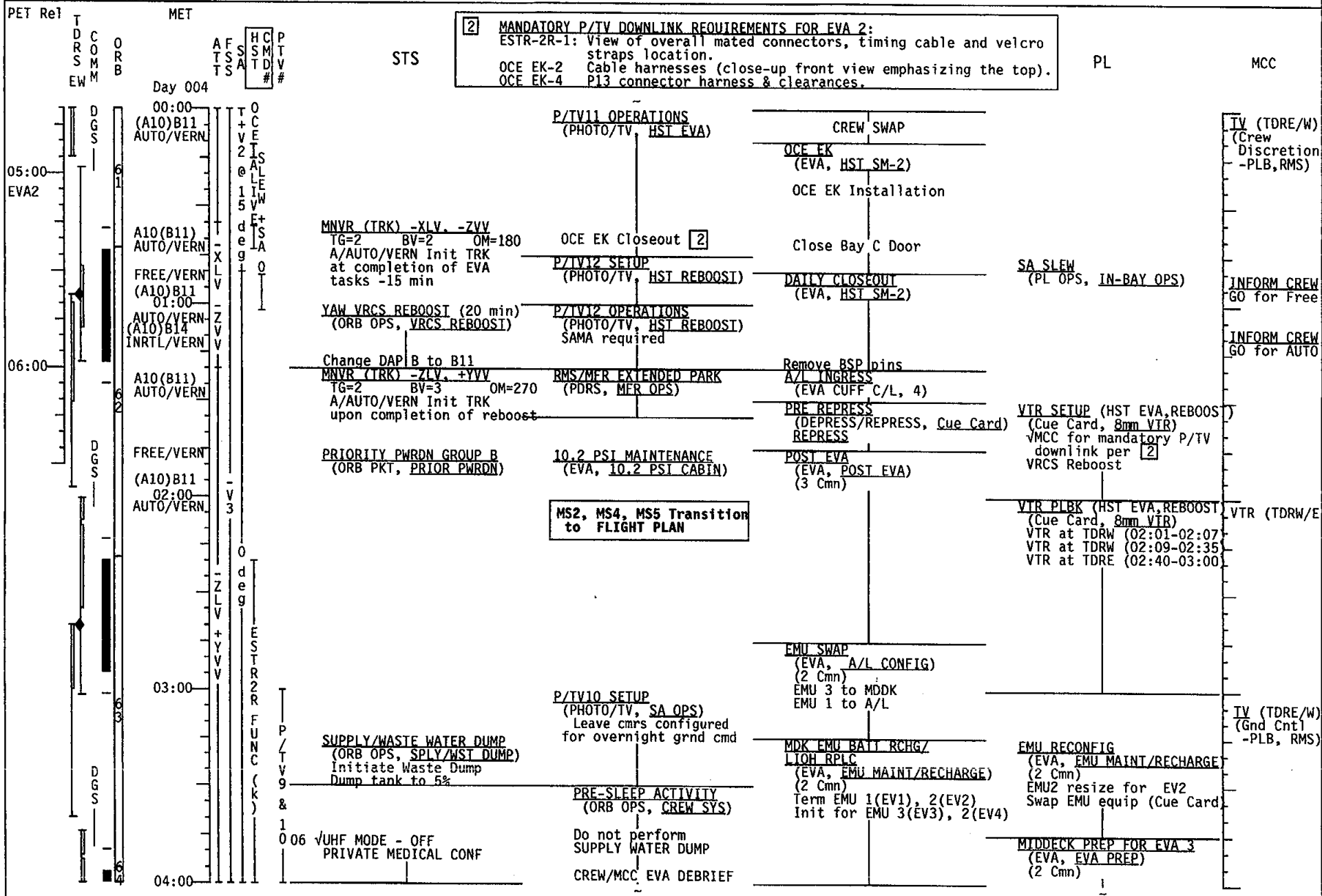

# = GROUND COMMANDED (k) = KU-BAND REQ 3-22

FLT PLN/82/FIN

# STS-82 (FD 05)

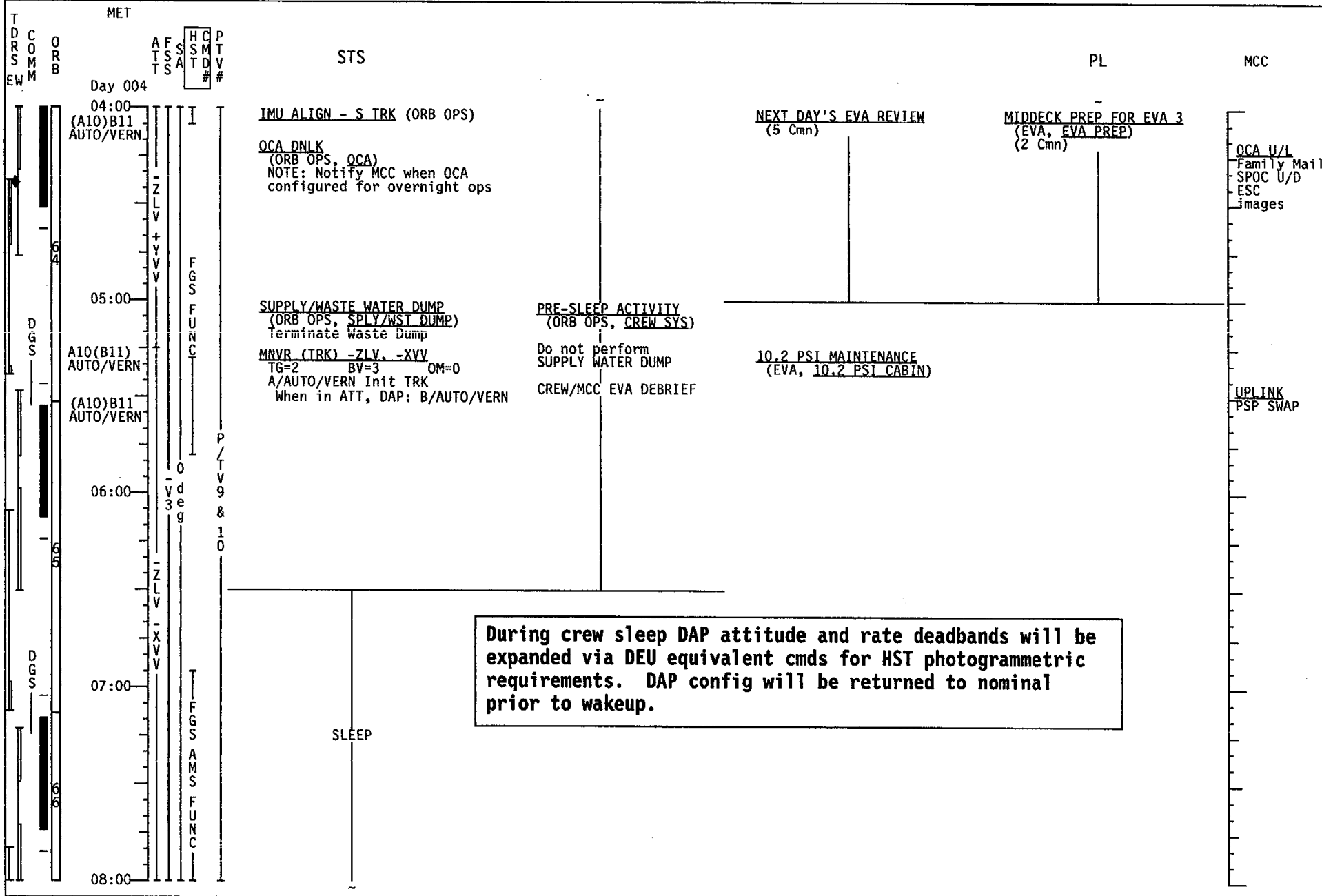

During crew sleep DAP attitude and rate deadbands will be expanded via DEU equivalent cmds for HST photogrammetric requirements. DAP config will be returned to nominal prior to wakeup.

# STS-82 (FD 06)

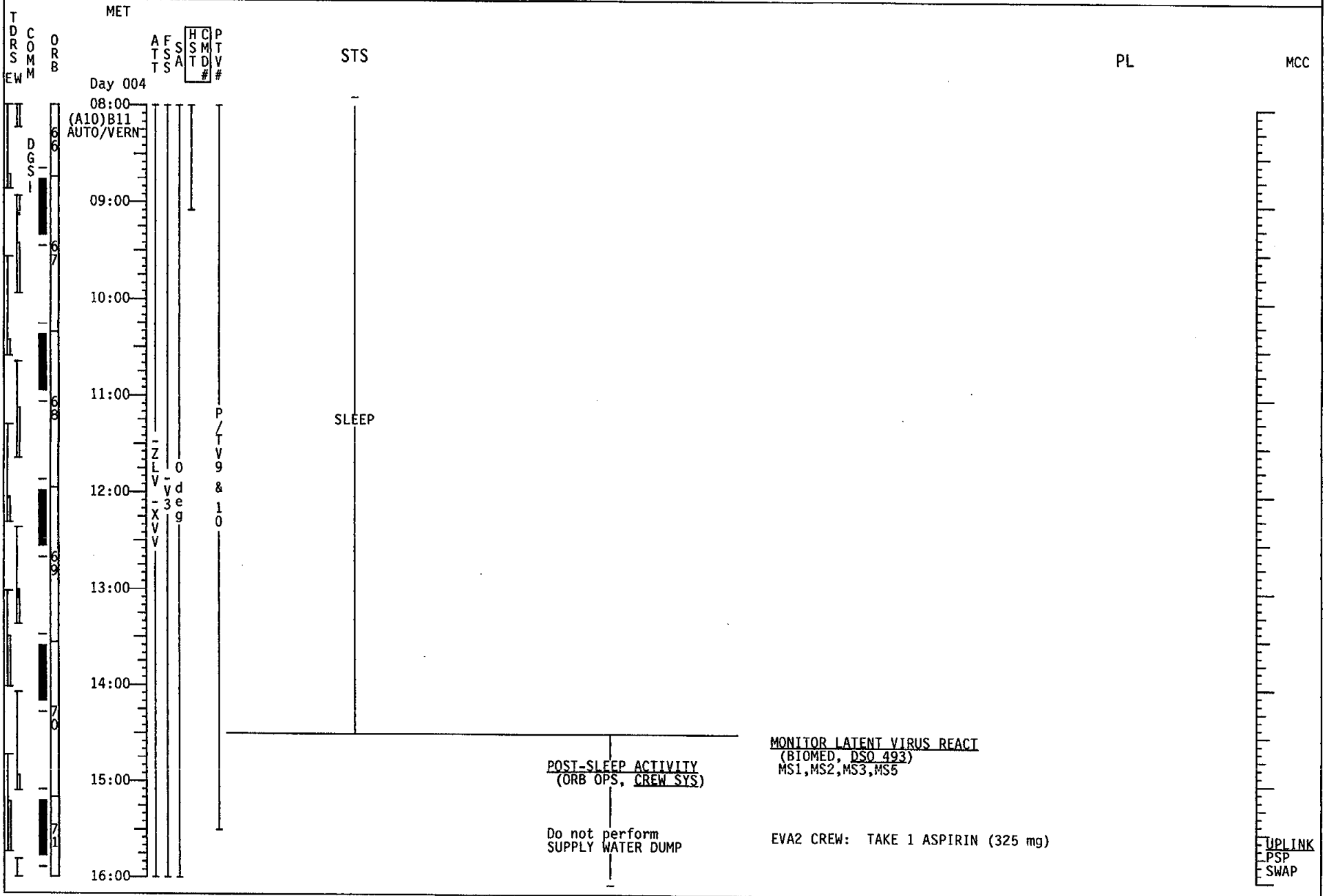

# = GROUND COMMANDED

3-24

FLT PLN/82/FIN

# STS-82 (FD 06)

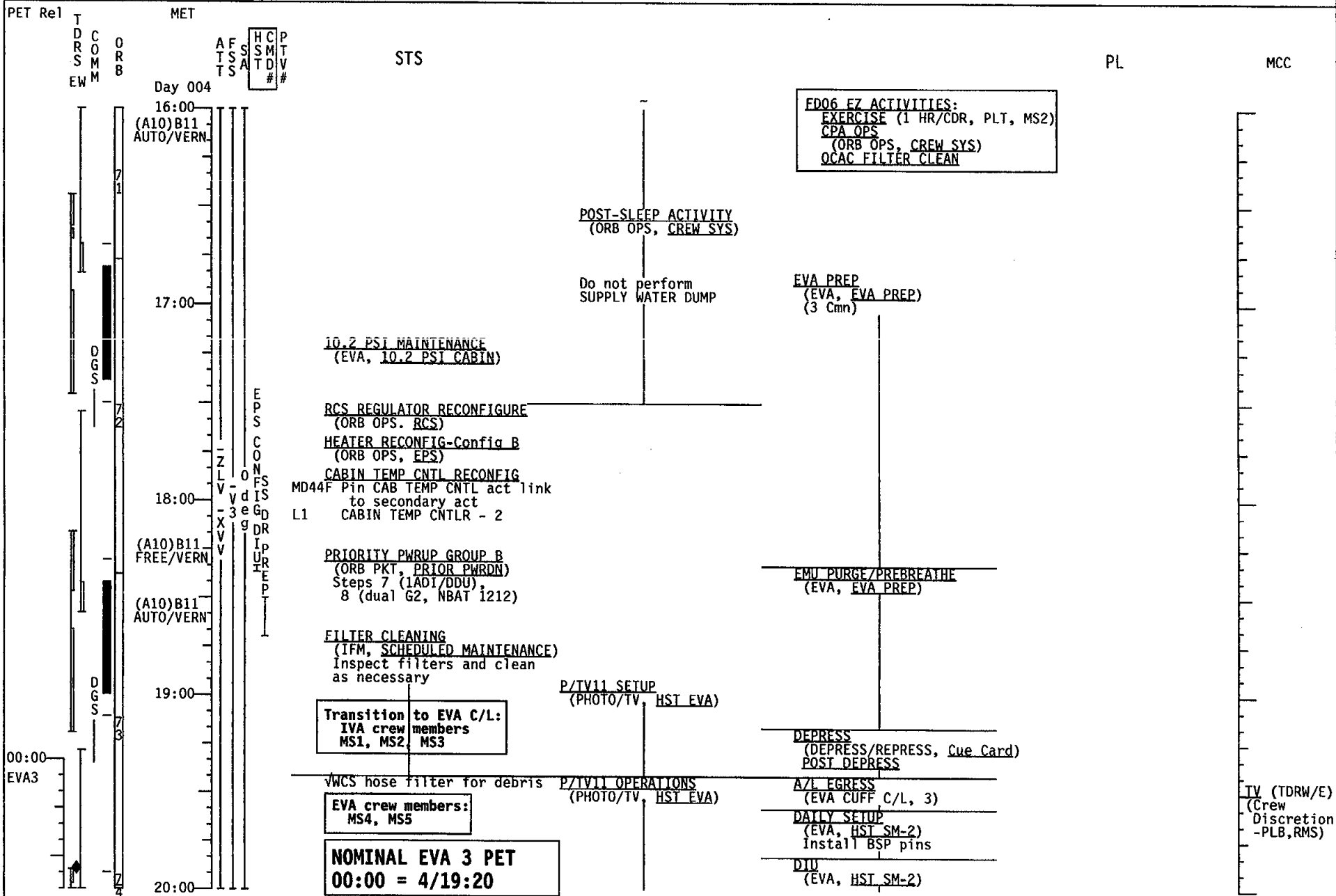



# STS-82 (FD 06)

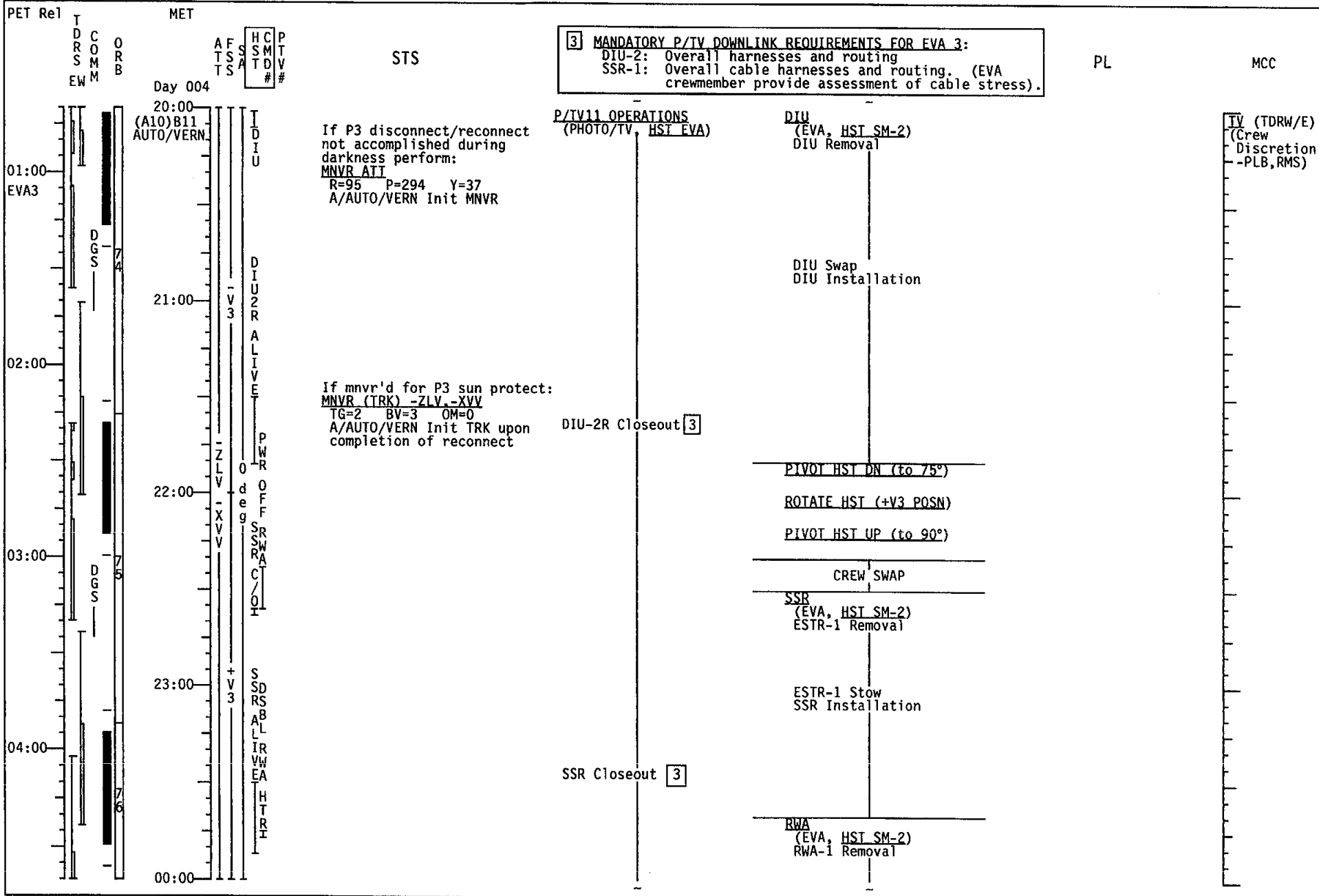

# = GROUND COMMANDED

# STS-82 (FD 06)

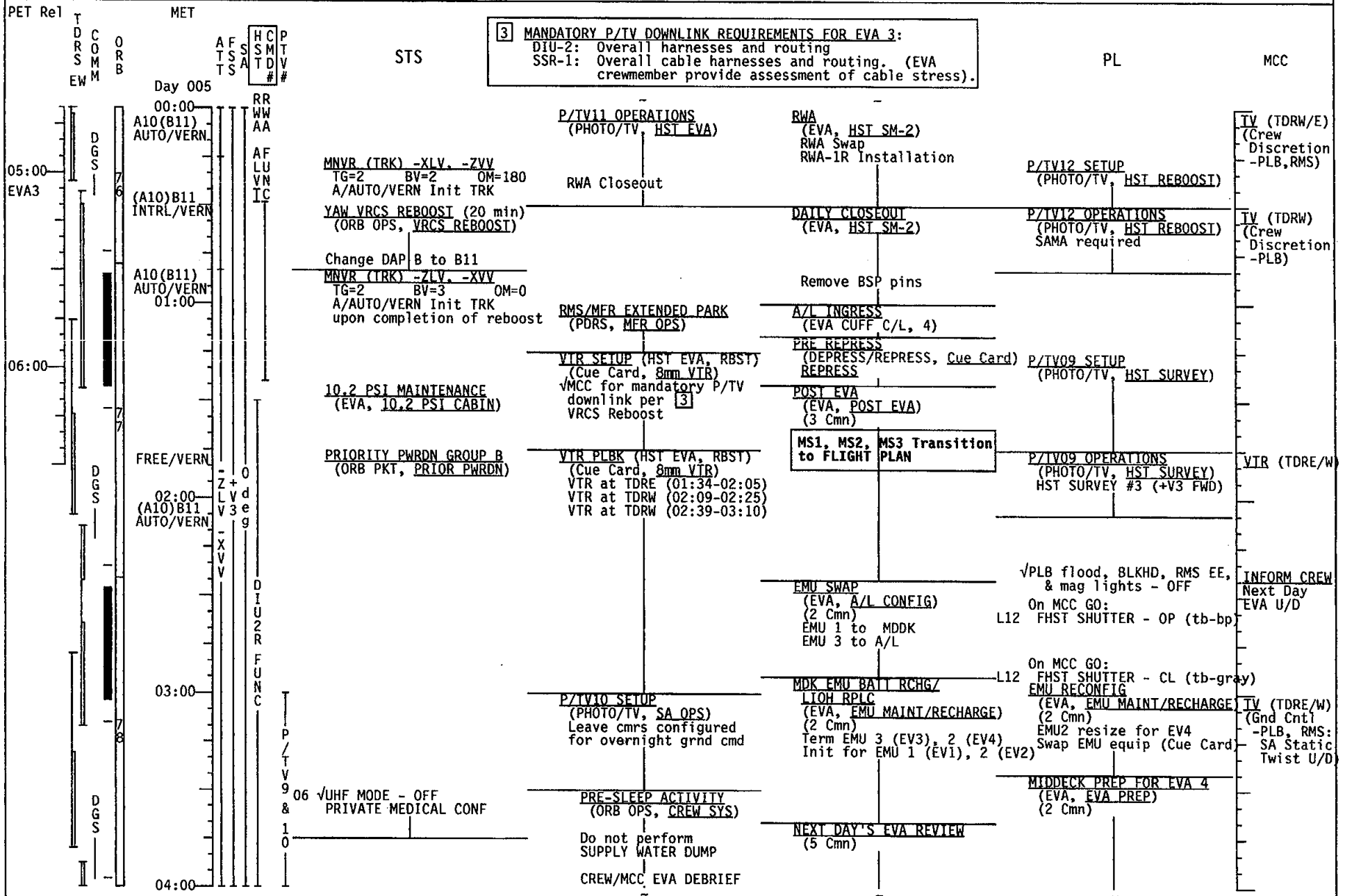

# STS-82 (FD 06)

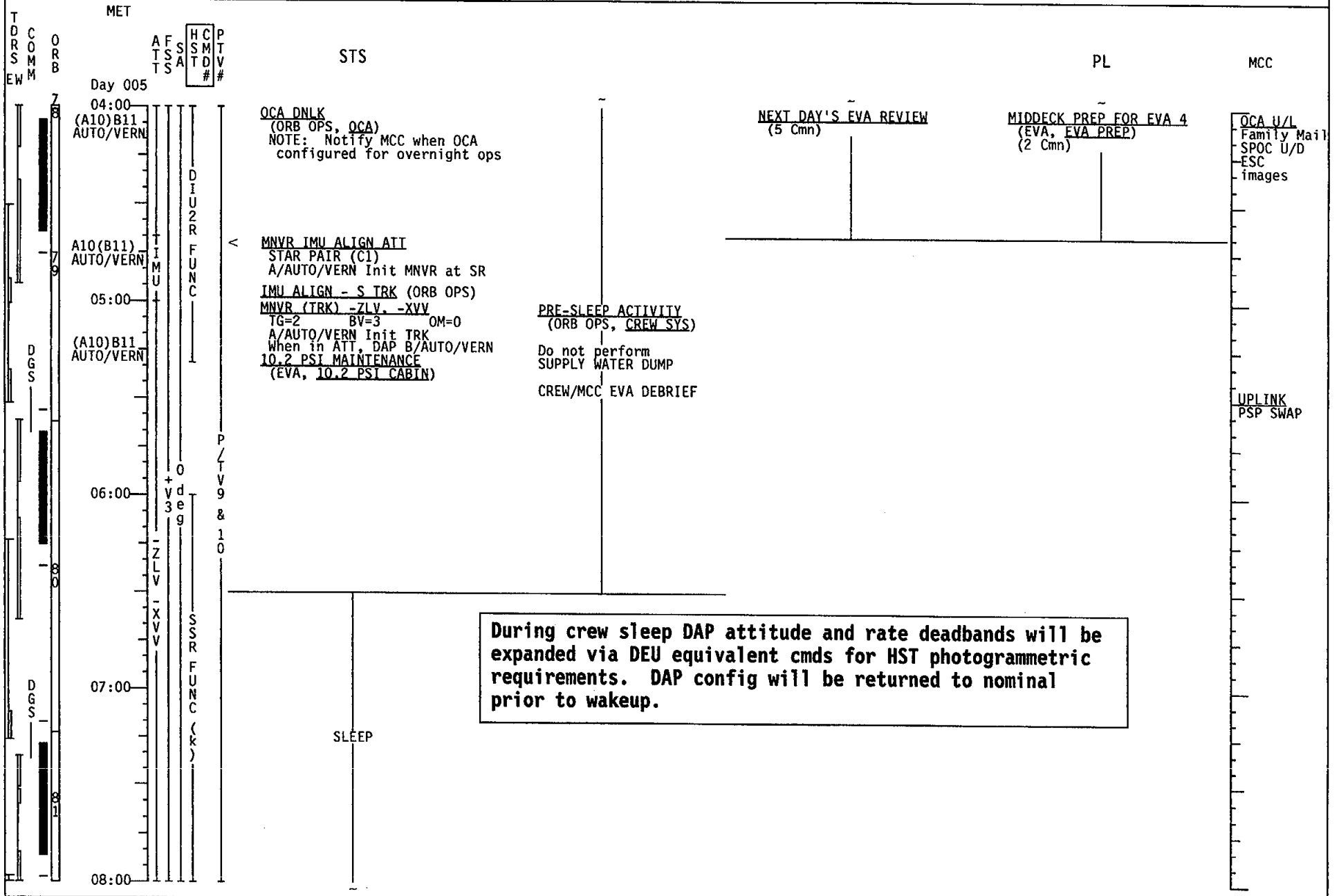

During crew sleep DAP attitude and rate deadbands will be expanded via DEU equivalent cmds for HST photogrammetric requirements. DAP config will be returned to nominal prior to wakeup.

# STS-82 (FD 07)

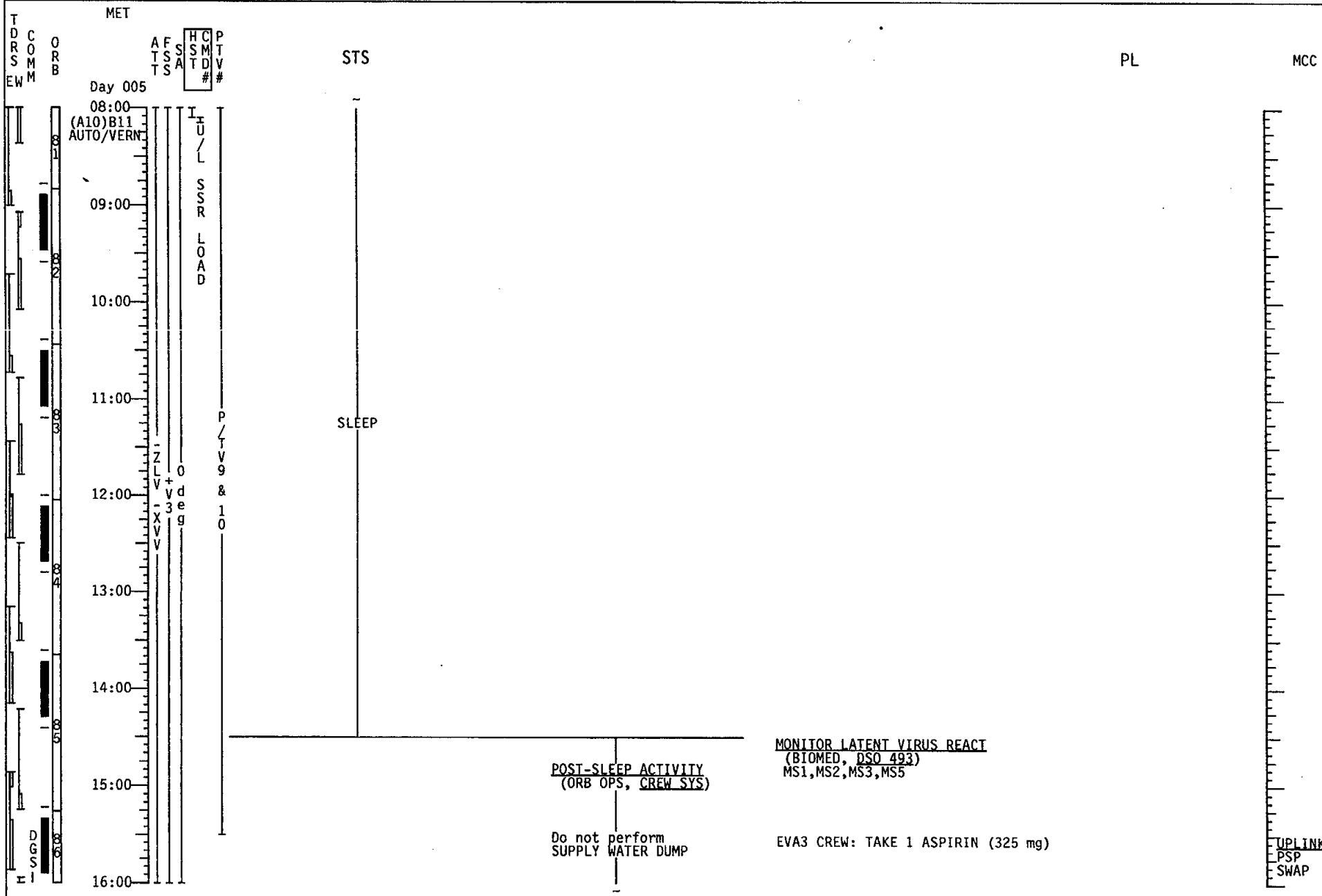

# = GROUND COMMANDED

# STS-82 (FD 07)

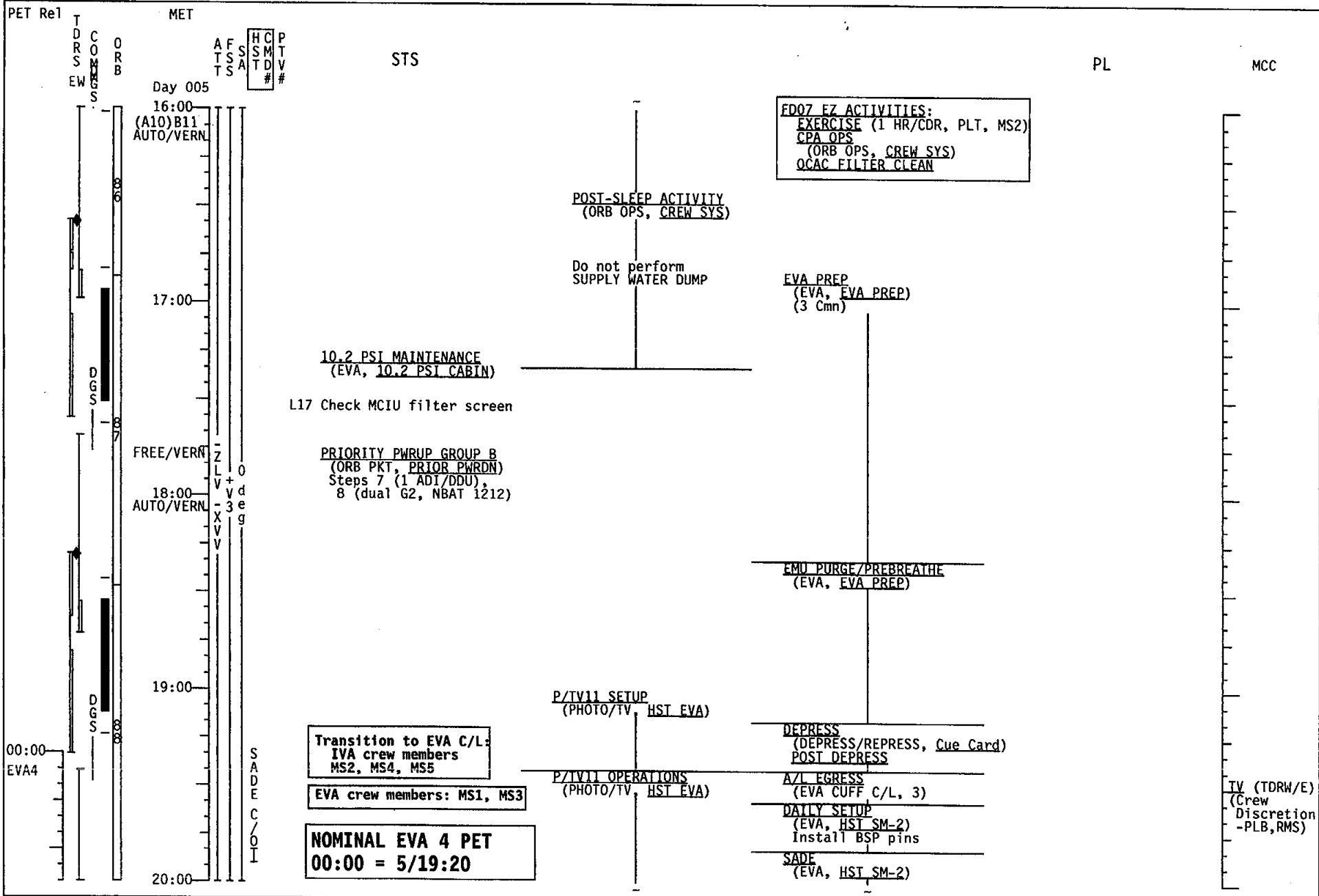

# = GROUND COMMANDED

# STS-82 (FD 07)

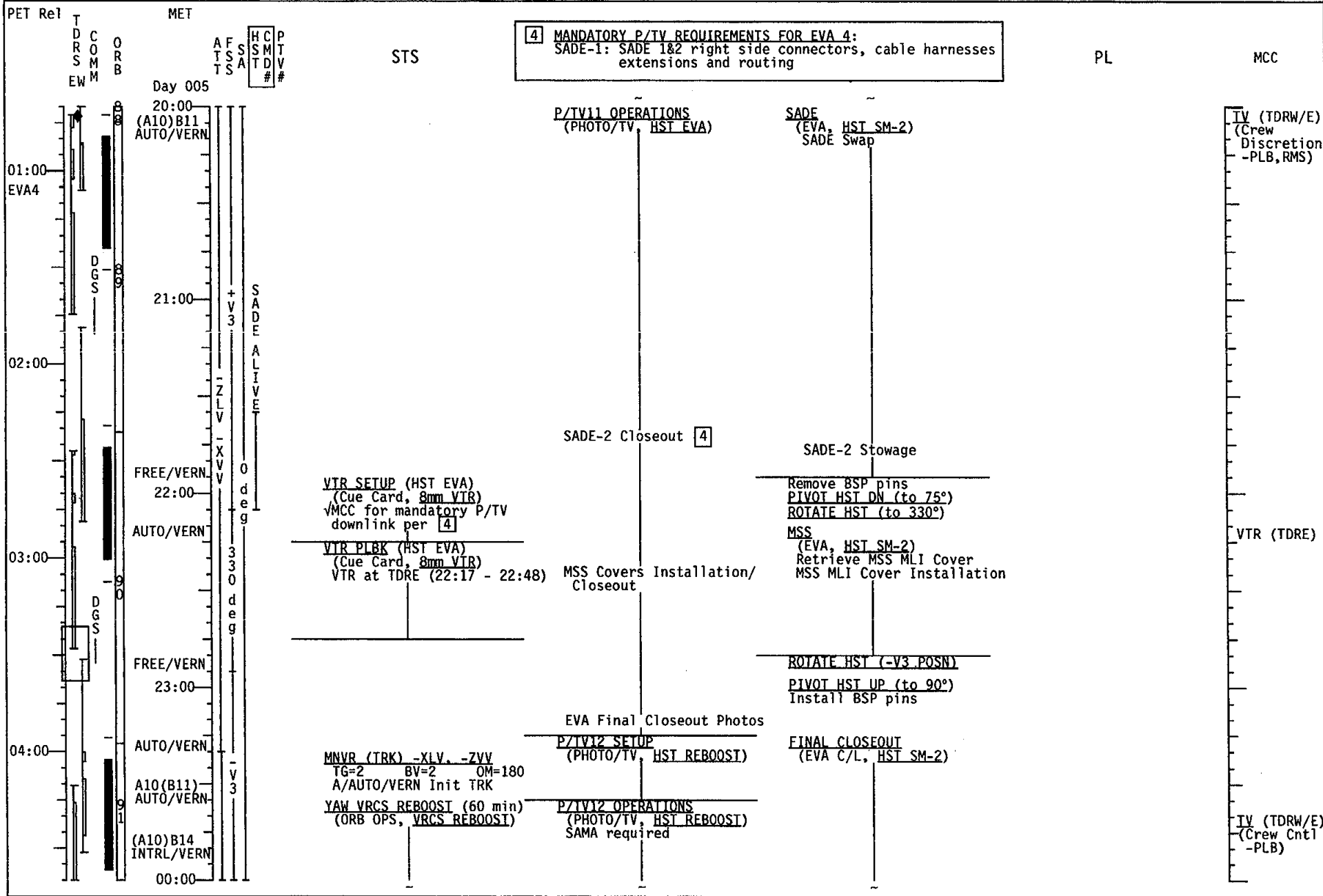

# = GROUND COMMANDED

# STS-82 (FD 07)

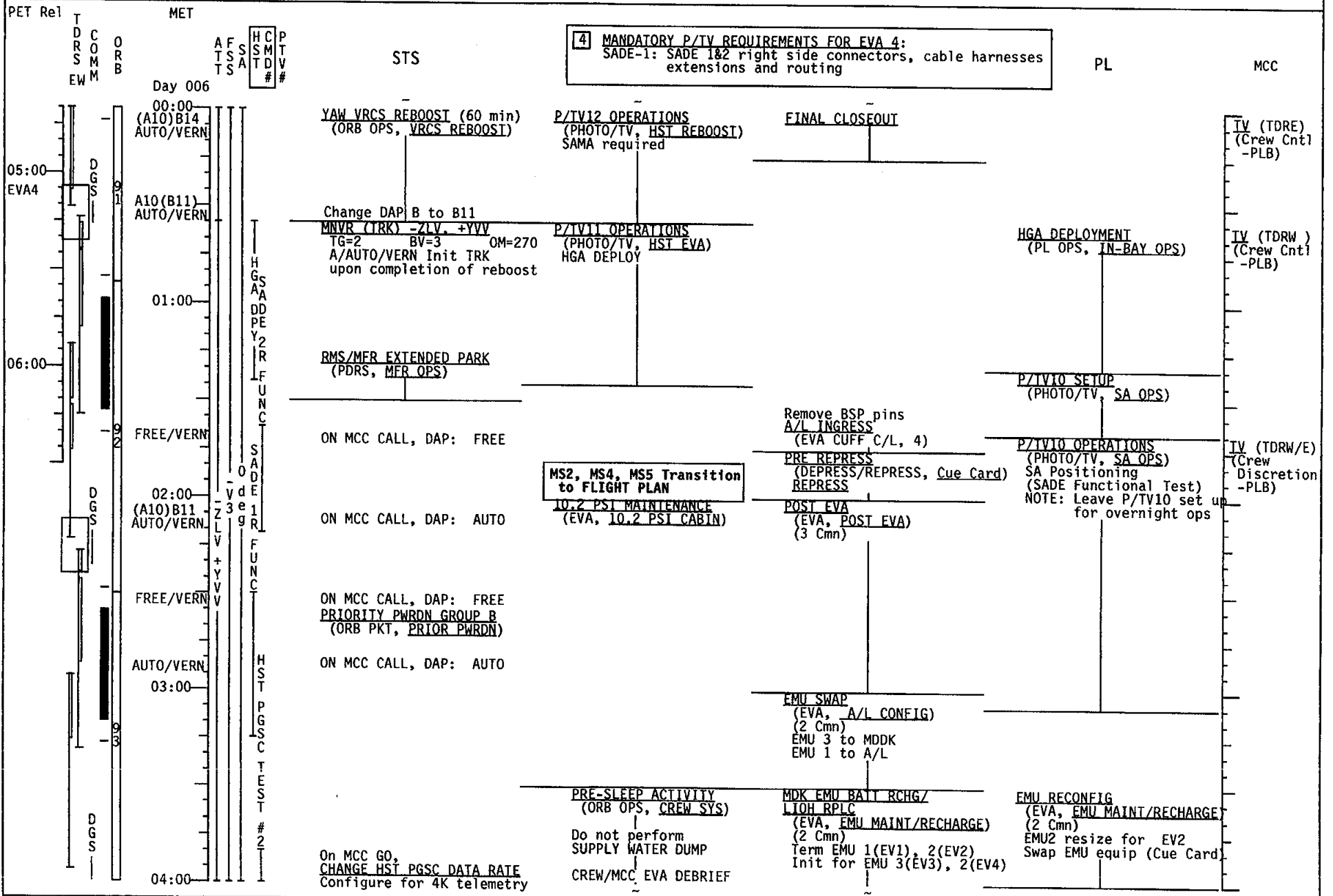

# = GROUND COMMANDED

# STS-82 (FD 07)

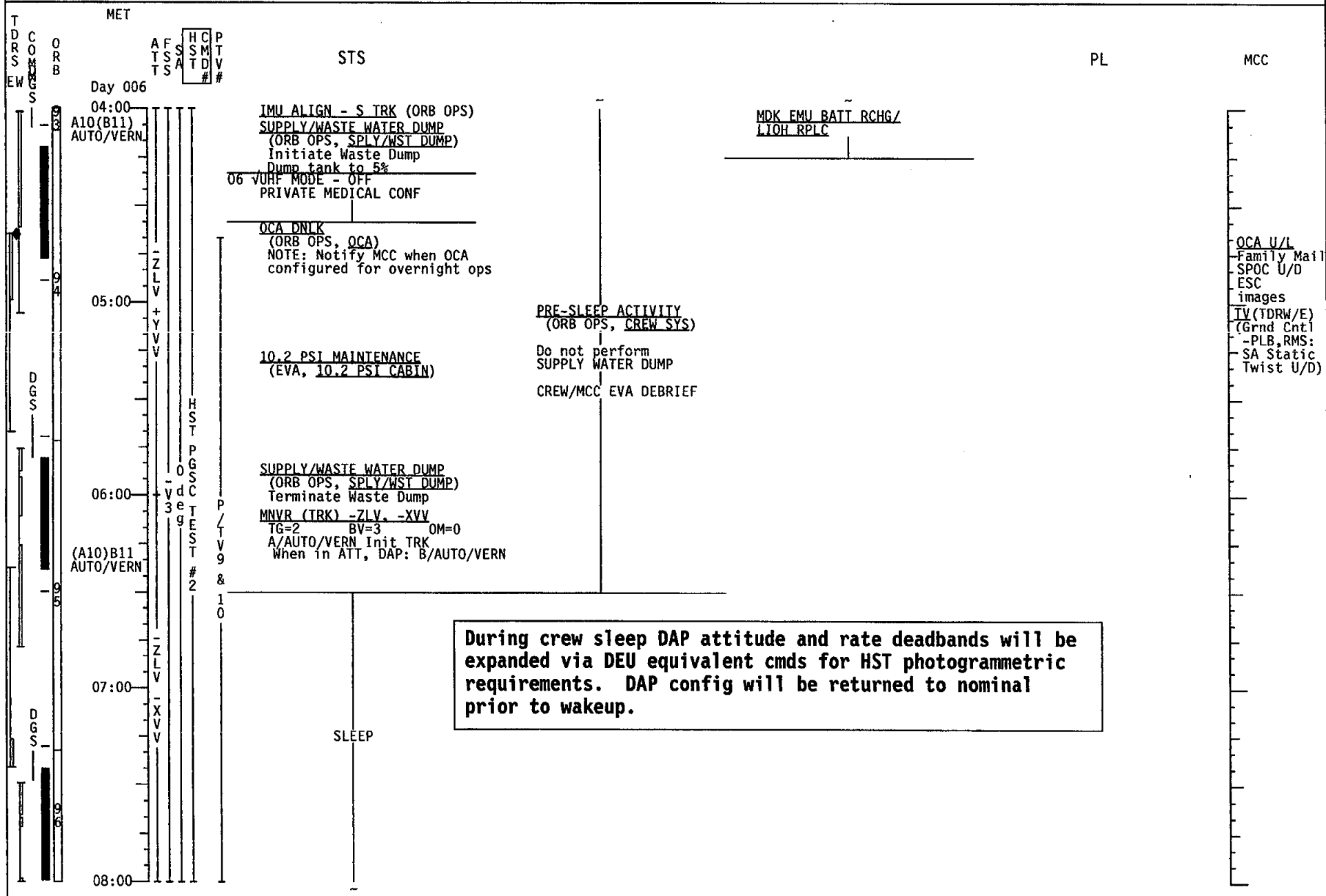



# STS-82 (FD 08)

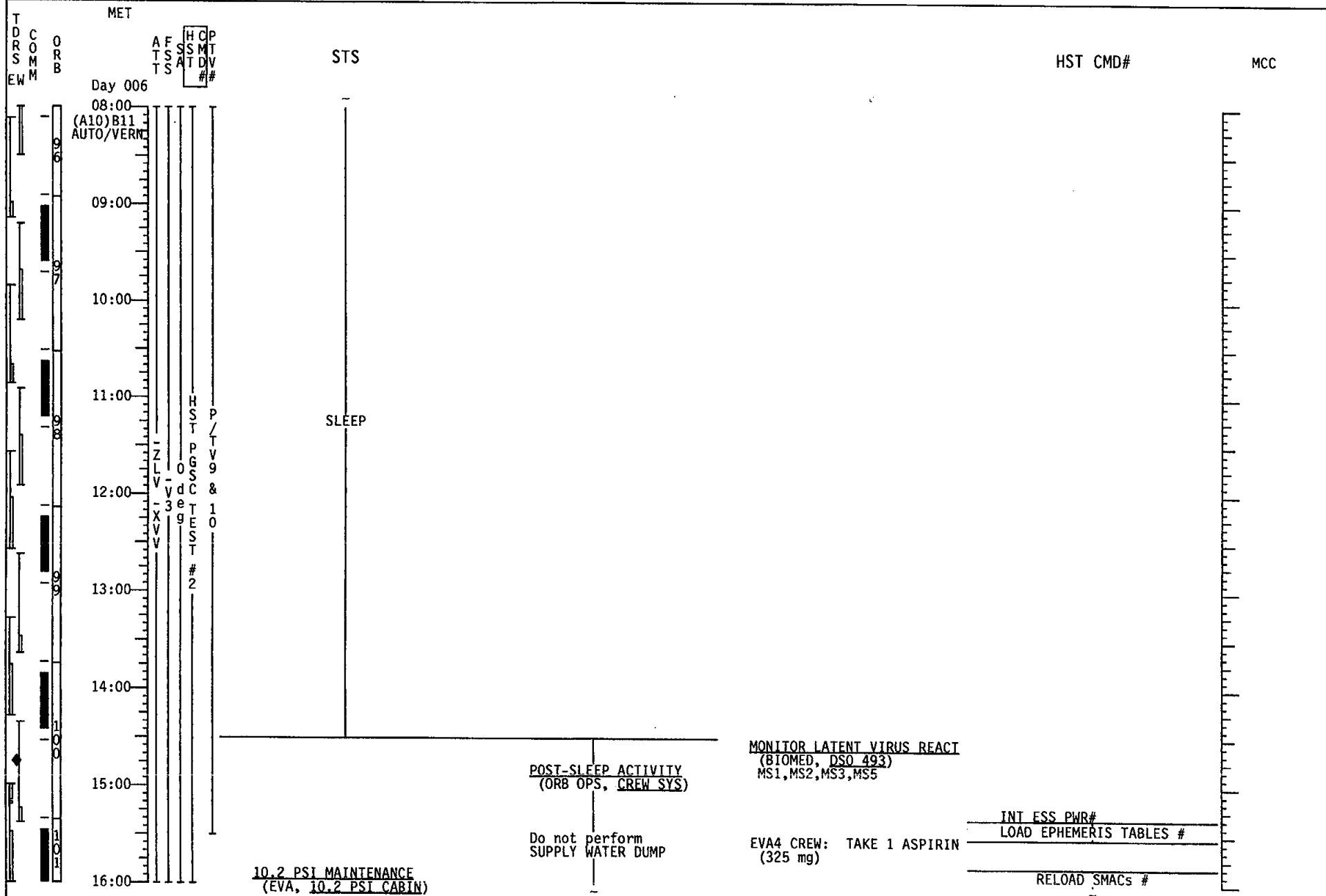

# = GROUND COMMANDED

# STS-82 (FD 08)

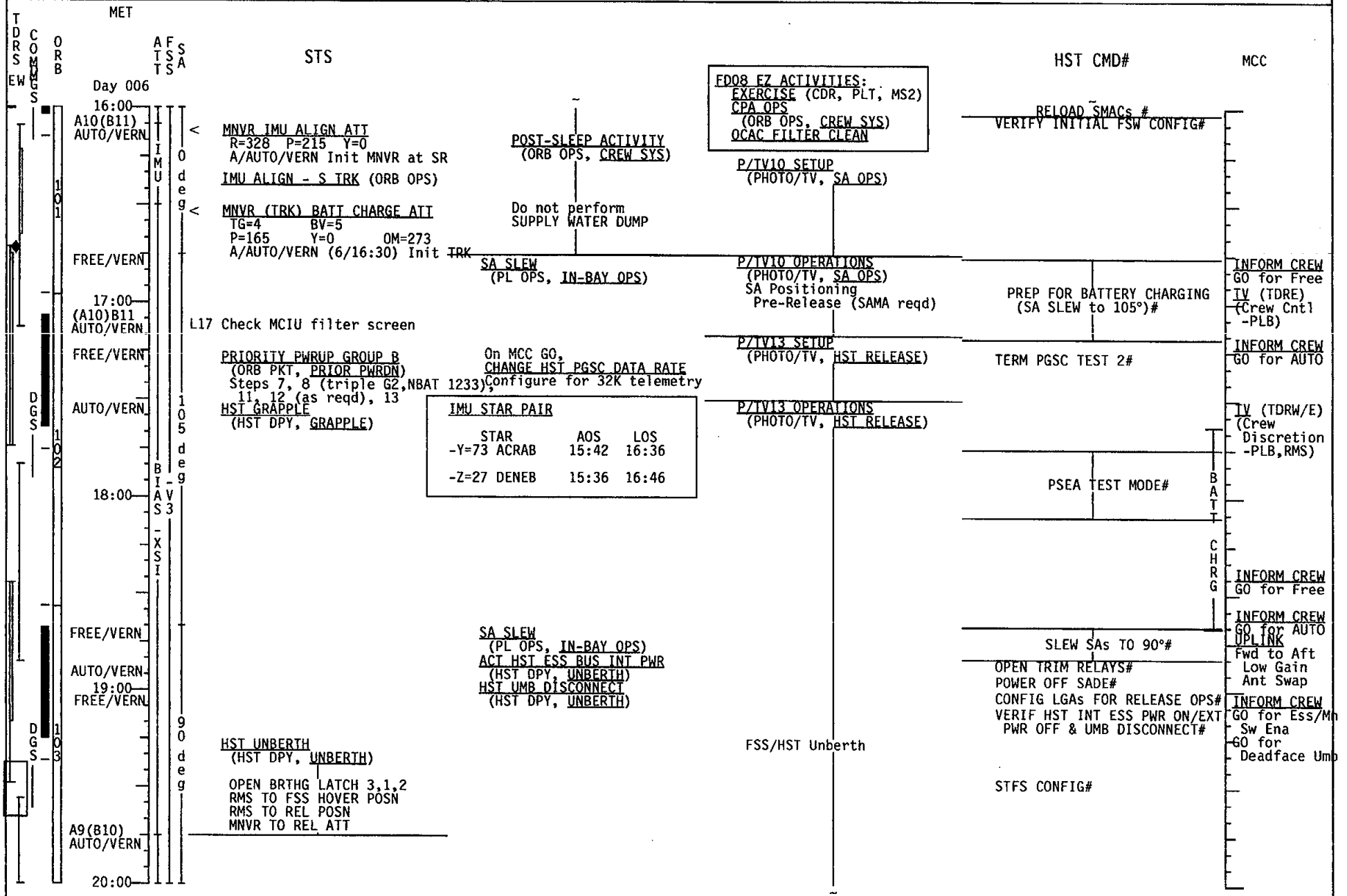

# = GROUND COMMANDED

3-35

FLT PLN/82/FIN

# STS-82 (FD 08)

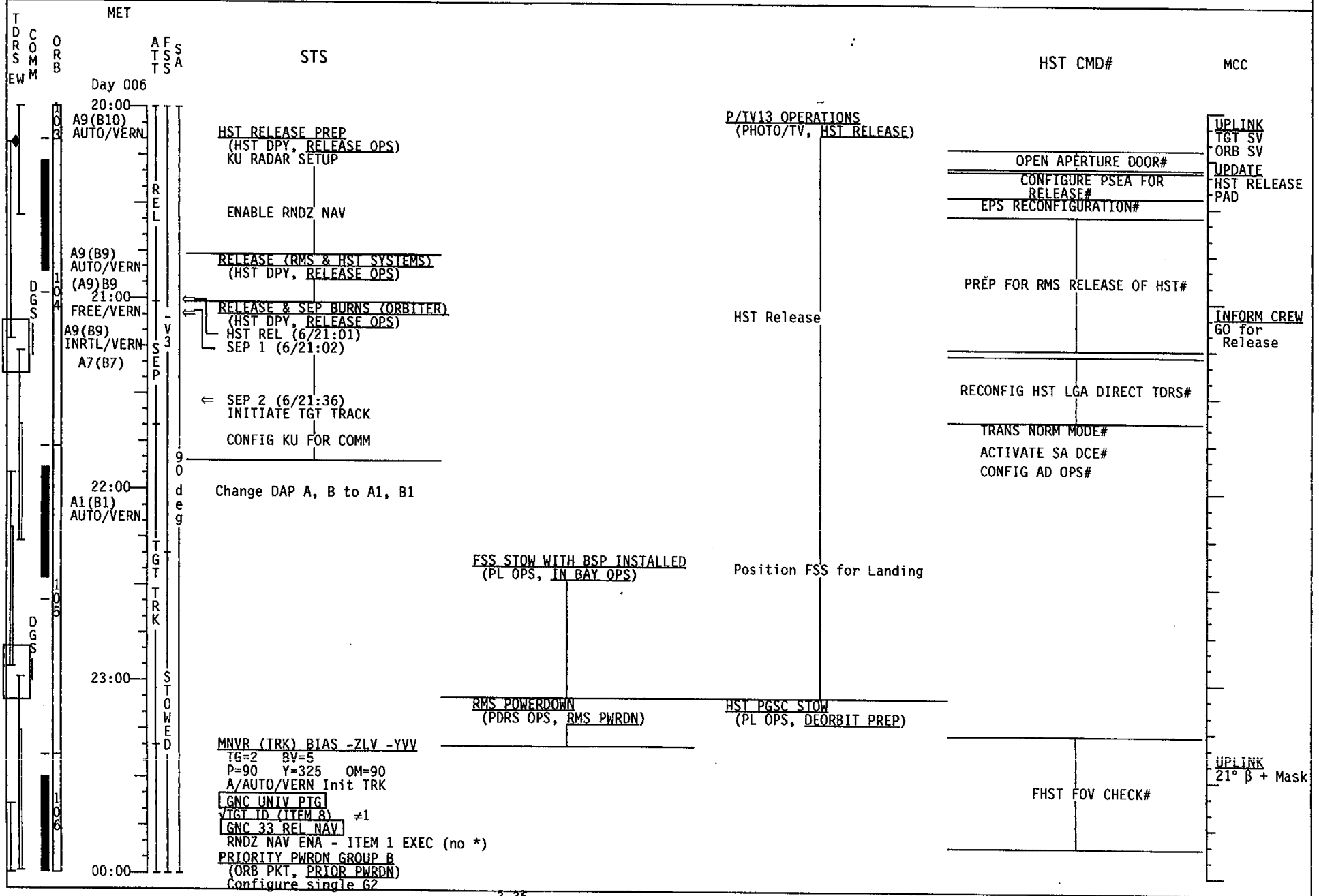

# = GROUND COMMANDED

# STS-82 (FD 08)

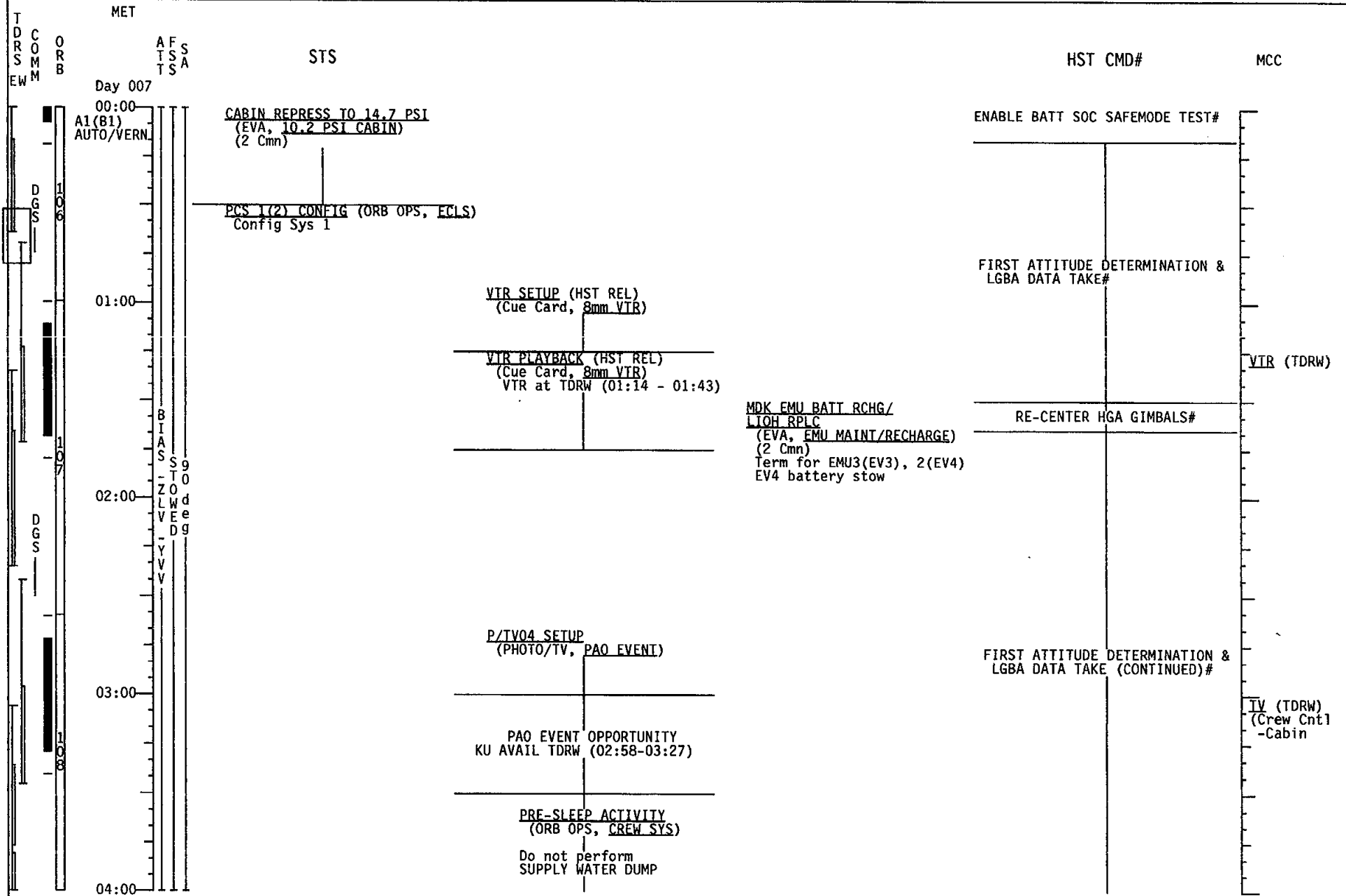

# = GROUND COMMANDED



# STS-82 (FD 09)

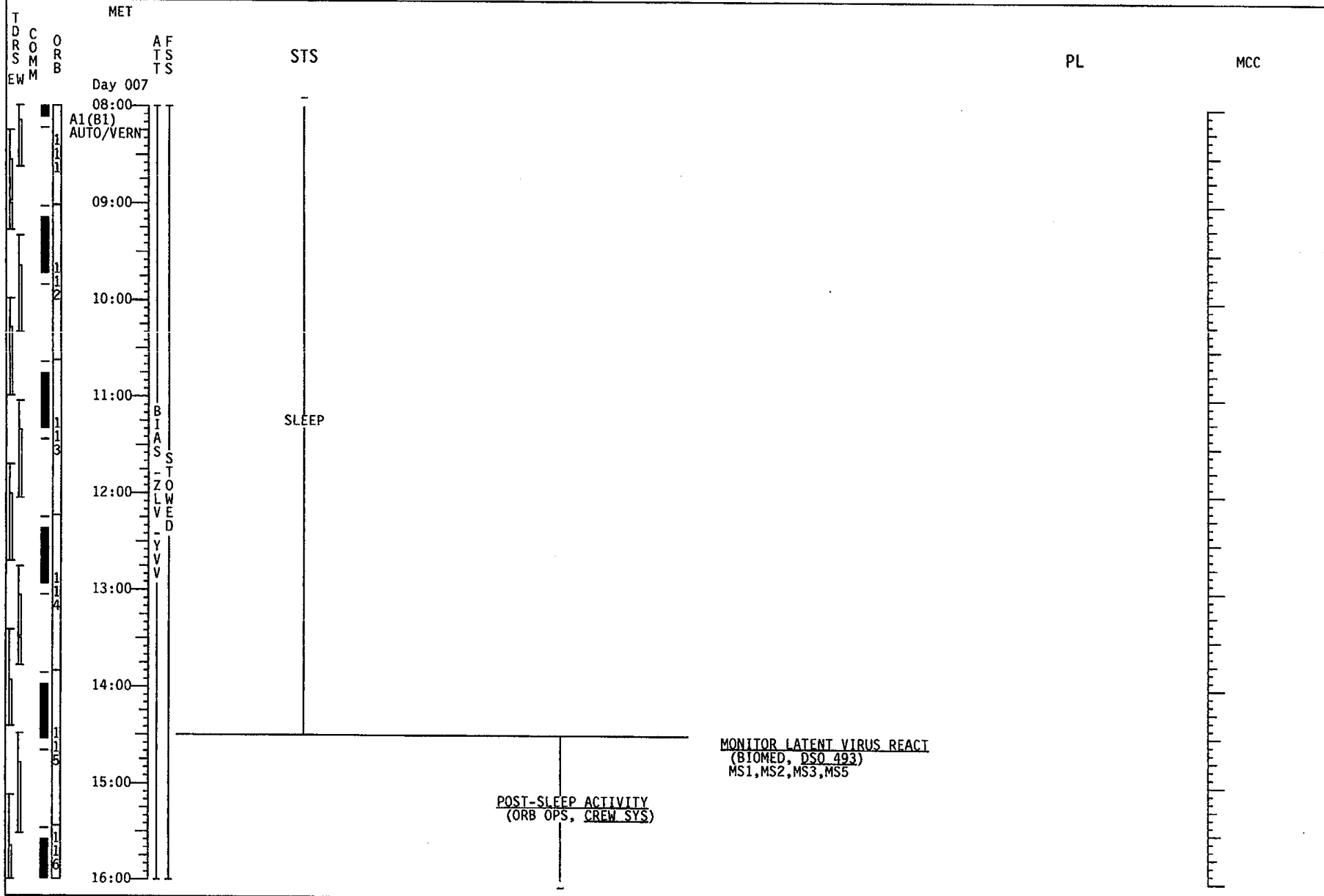

# = GROUND COMMANDED

# STS-82 (FD 09 )

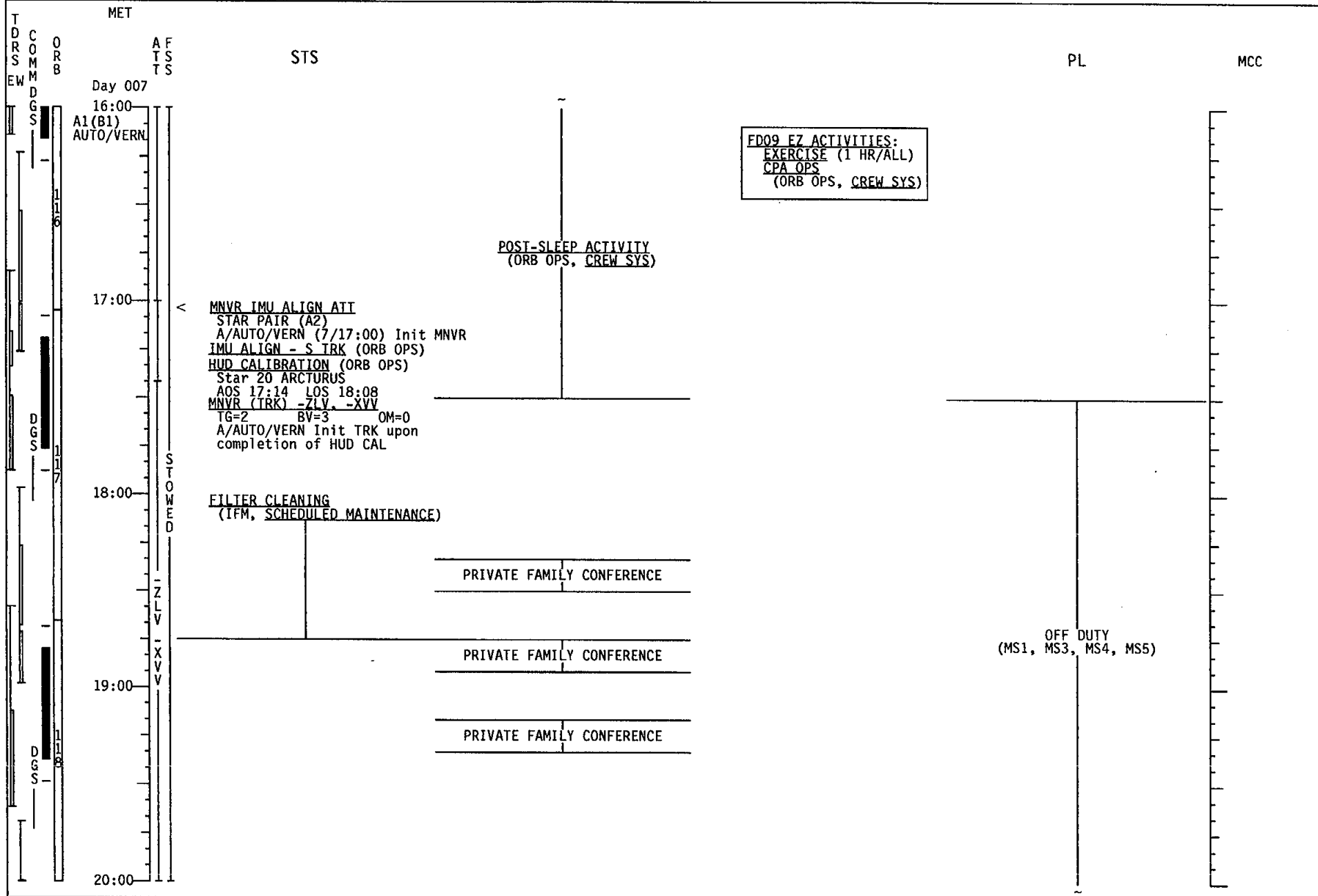

**FD09 EZ ACTIVITIES:**  
 EXERCISE (1 HR/ALL)  
 CPA OPS  
 (ORB OPS, CREW SYS)

# = GROUND COMMANDED





# STS-82 (FD 09 )

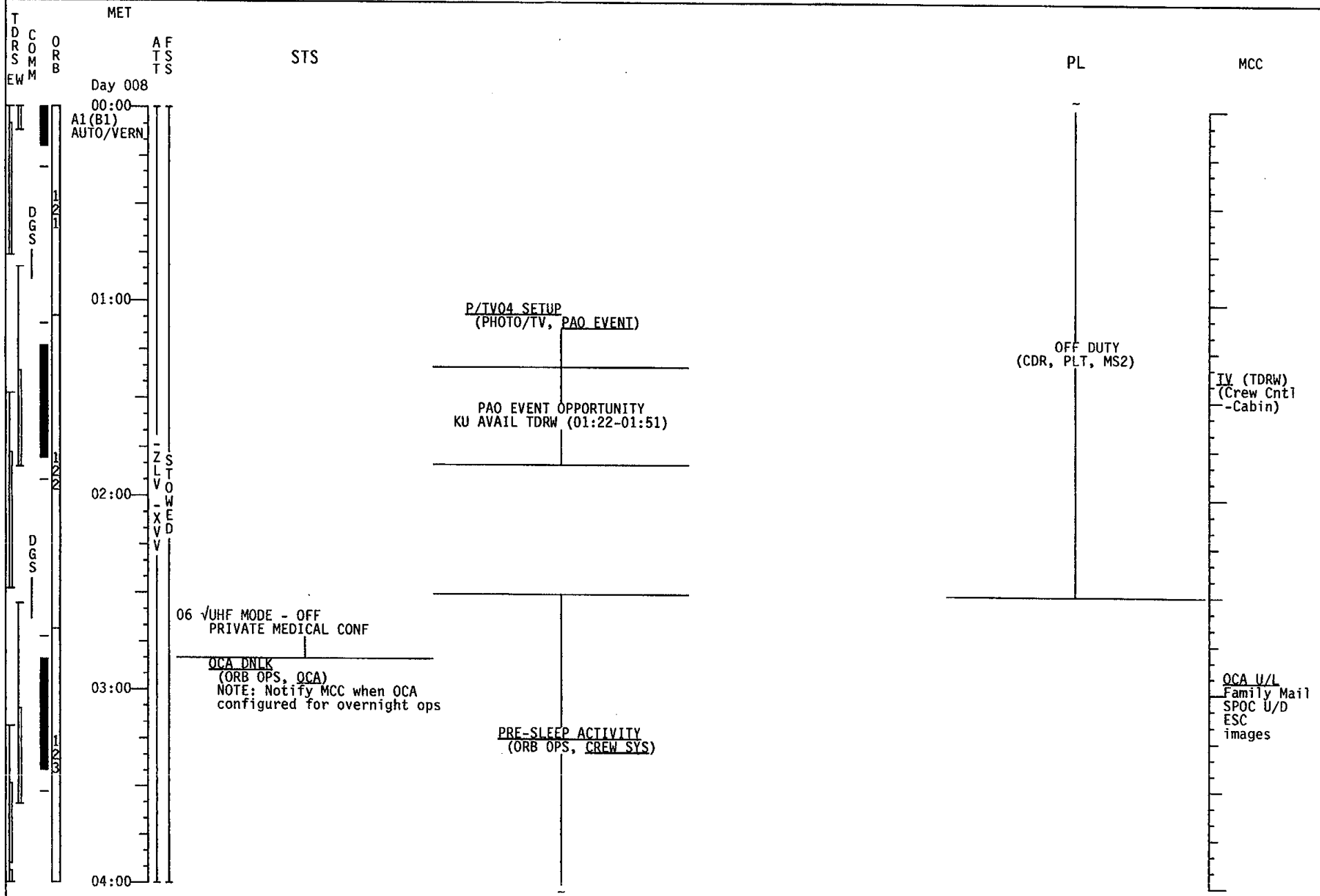

# = GROUND COMMANDED

# STS-82 (FD 09)

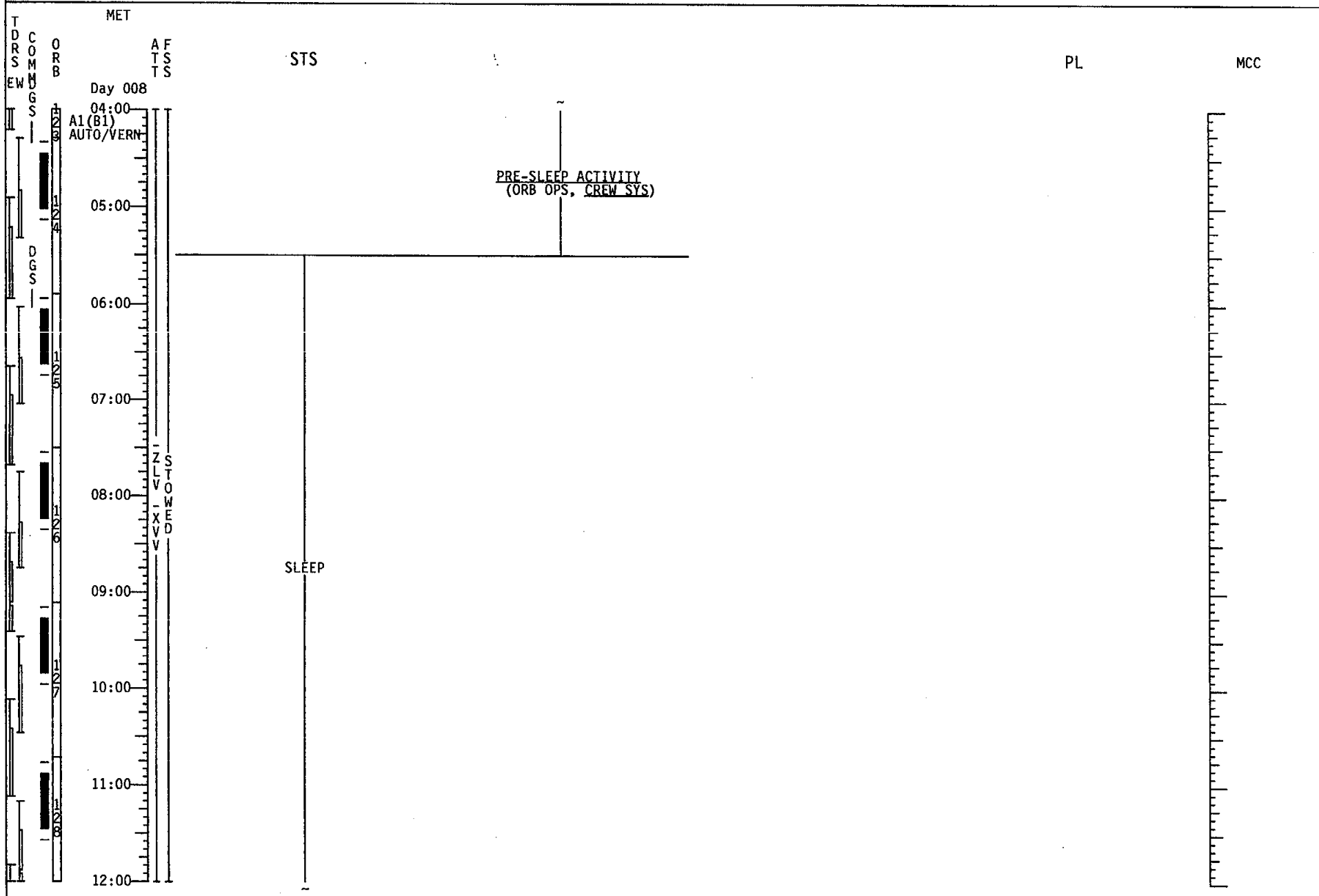

# = GROUND COMMANDED

STS-82 (FD 10 )

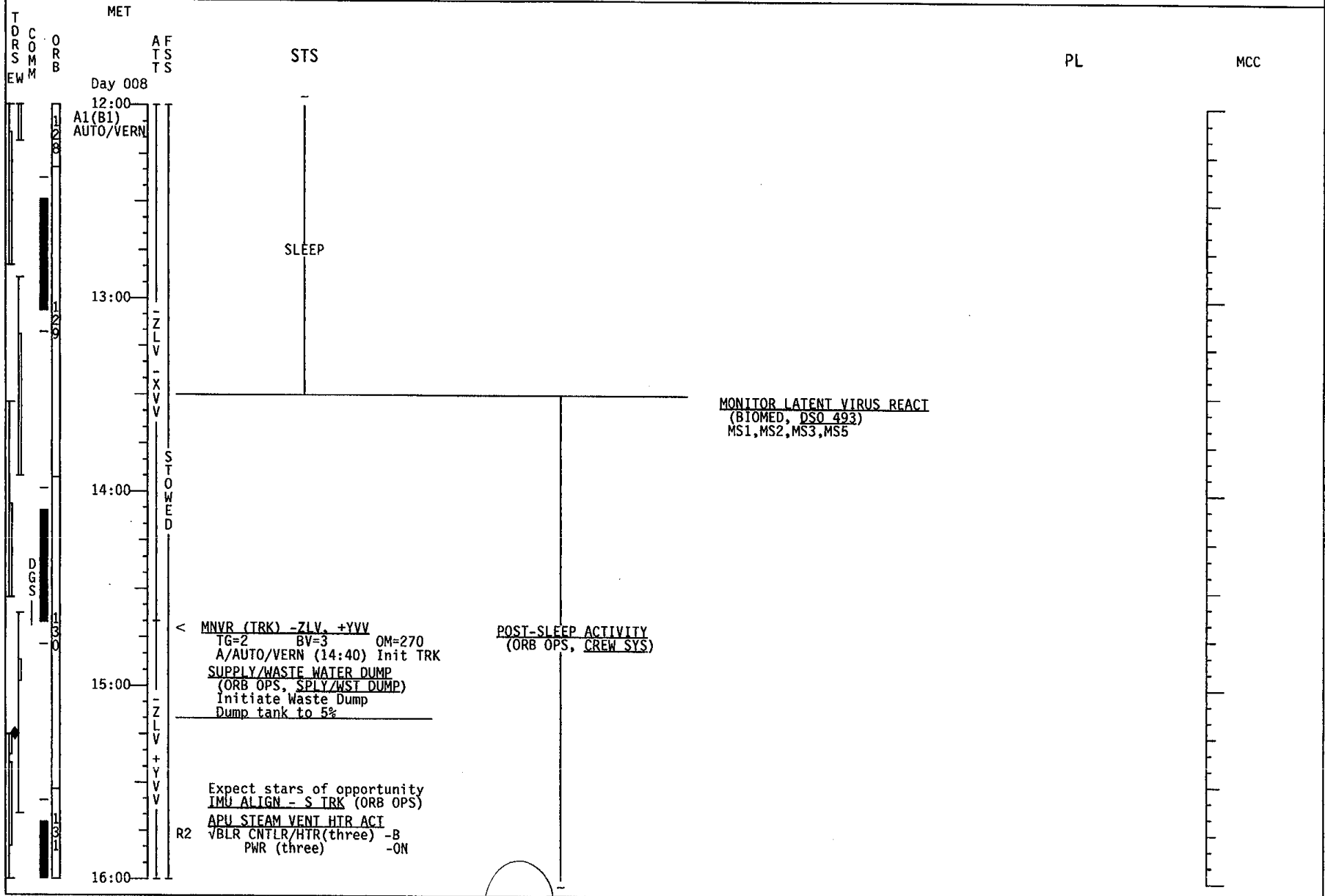

# = GROUND COMMANDED

3-44

STS-82 (FD 10)

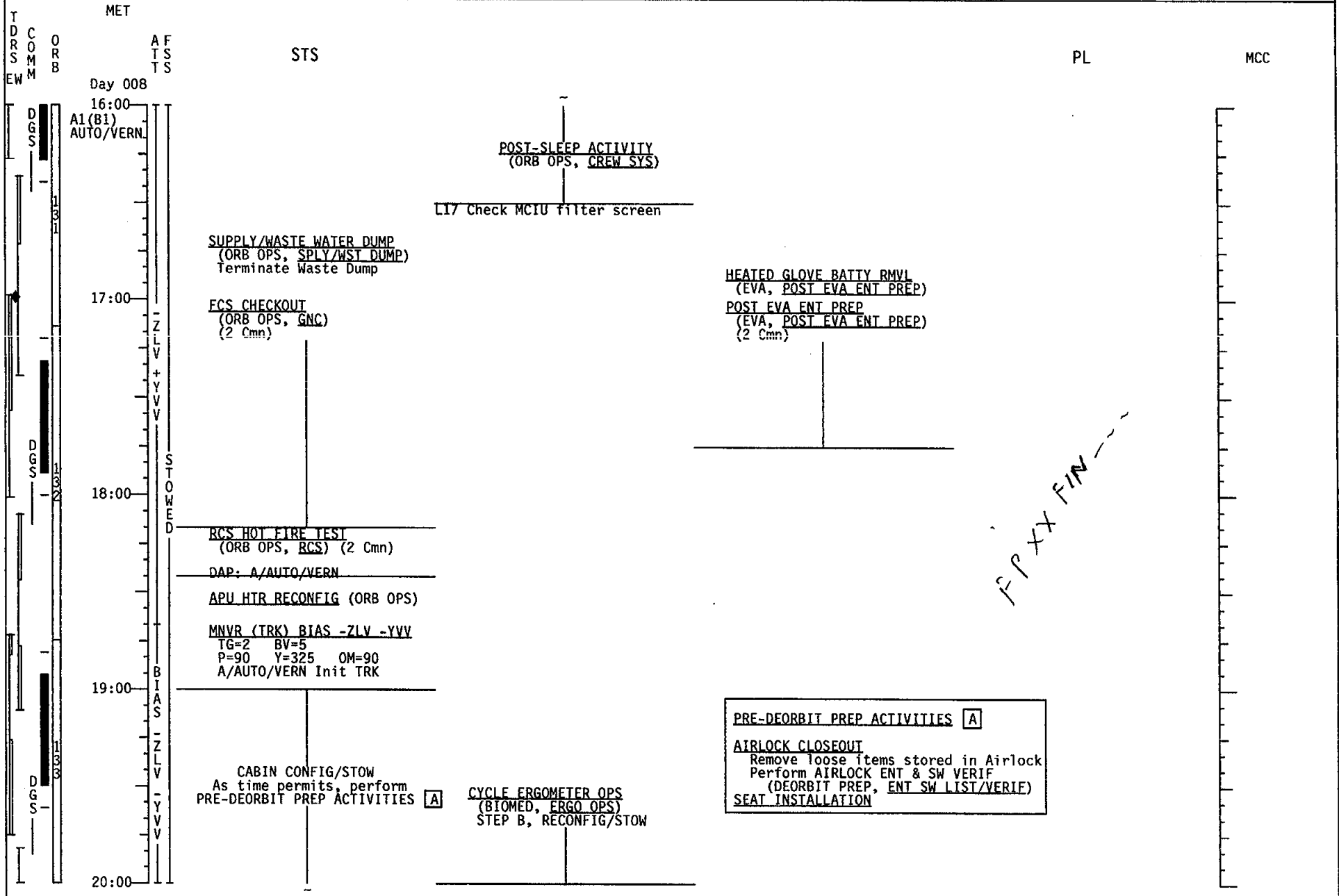

# = GROUND COMMANDED

# STS-82 (FD 10 )

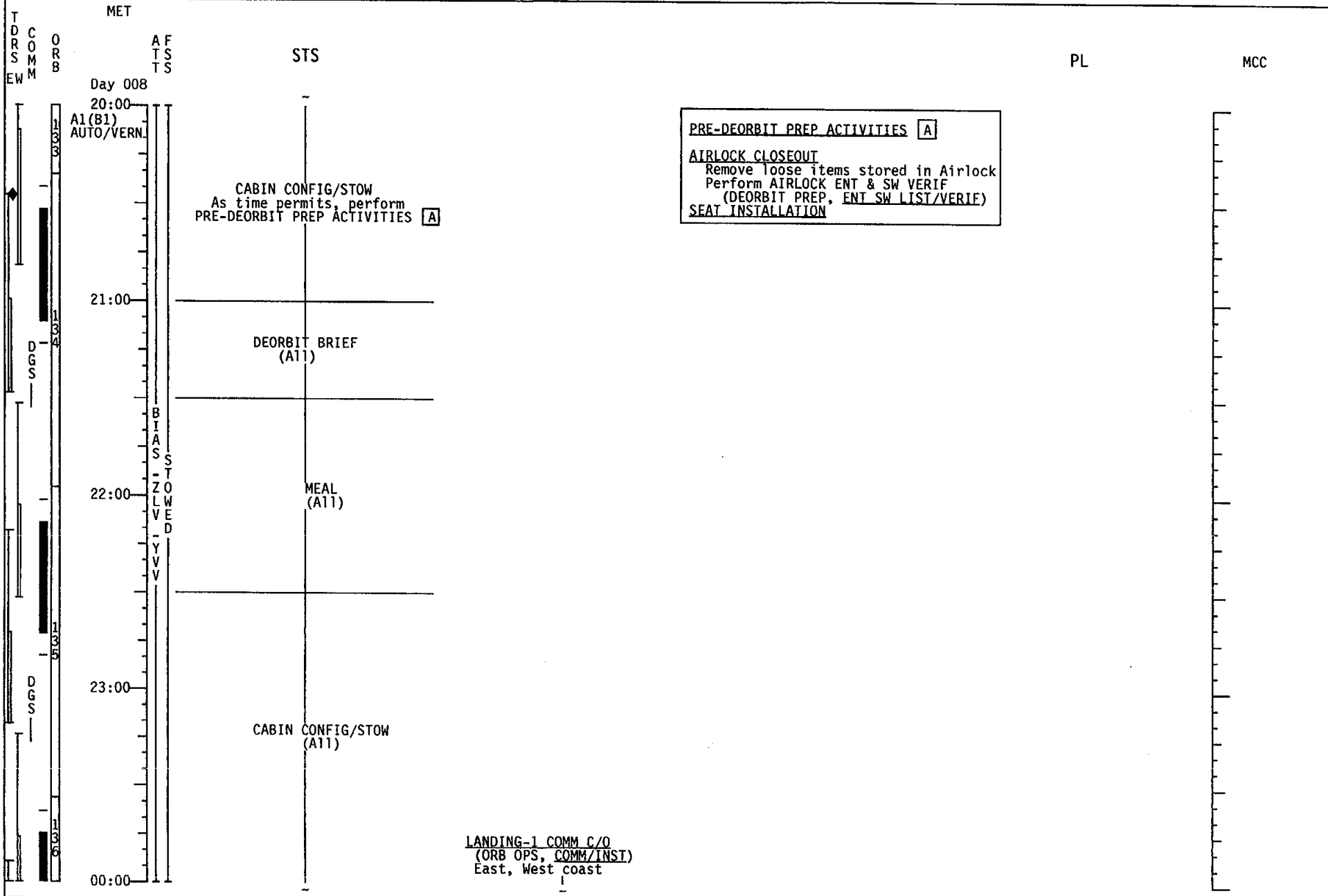

# = GROUND COMMANDED

STS-82 (FD 10)

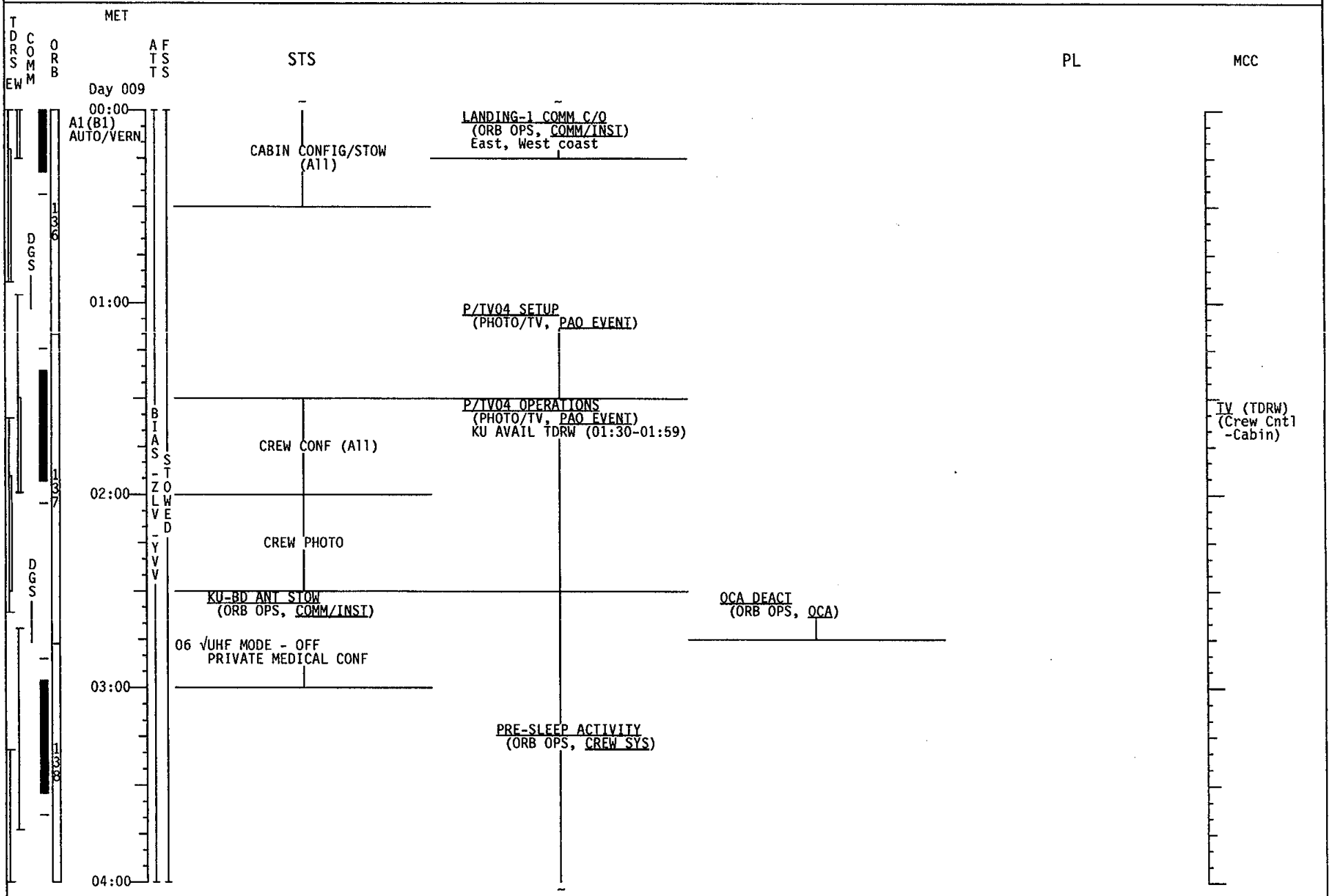

# STS-82 (FD 10)

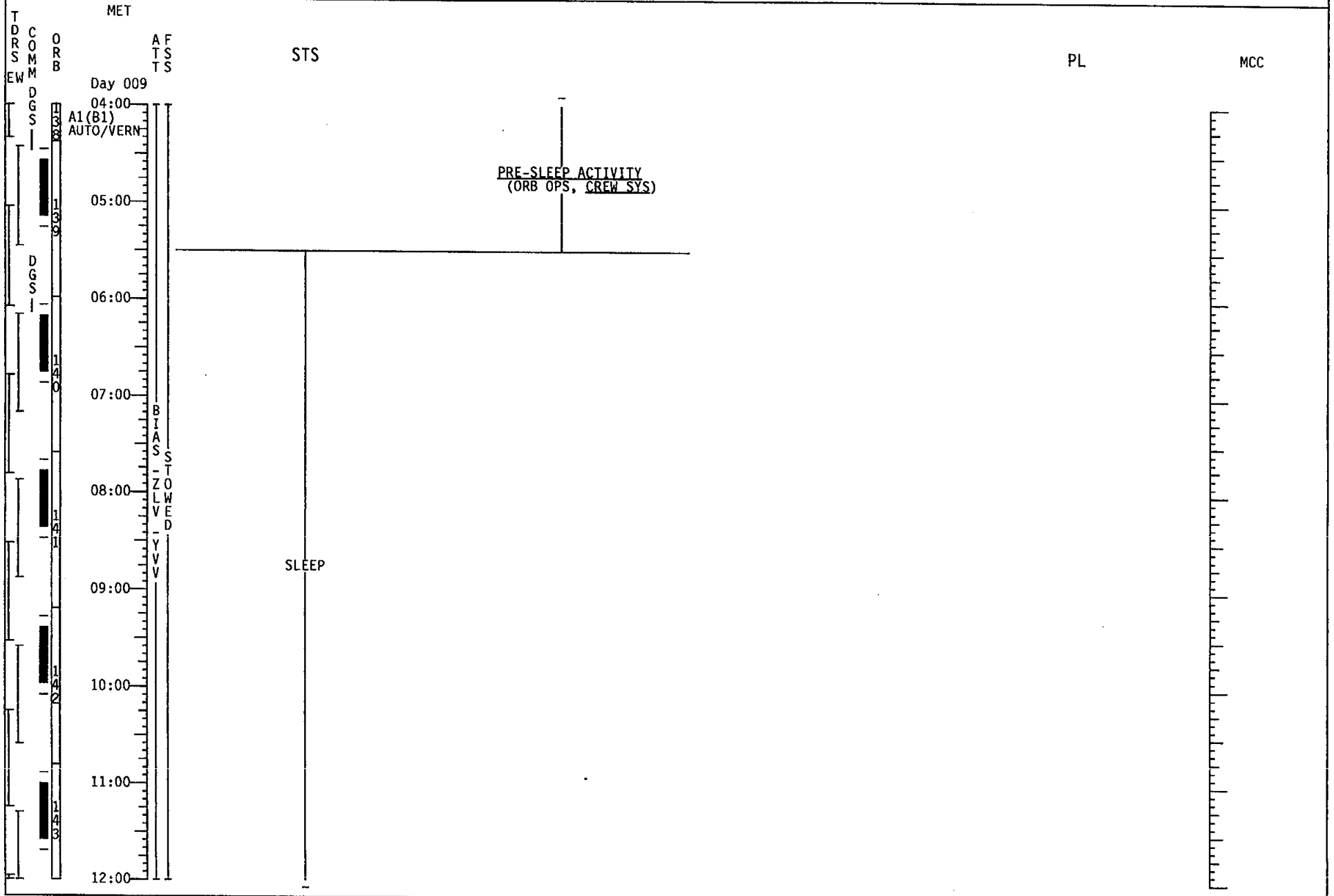

# = GROUND COMMANDED

3-48

FLT PLN/82/FIN

# STS-82 (FD 11)

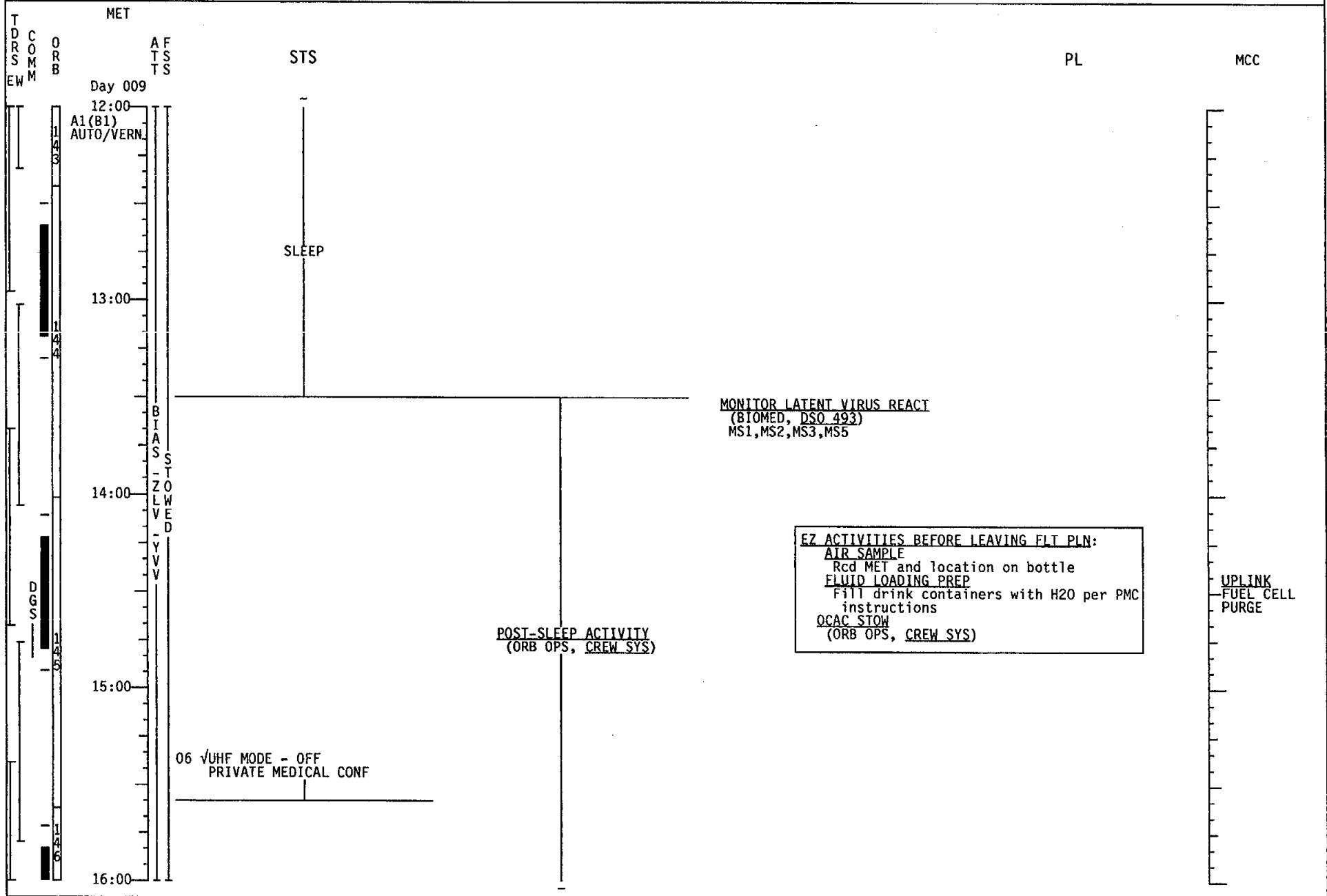



STS-82 (FD 11 )

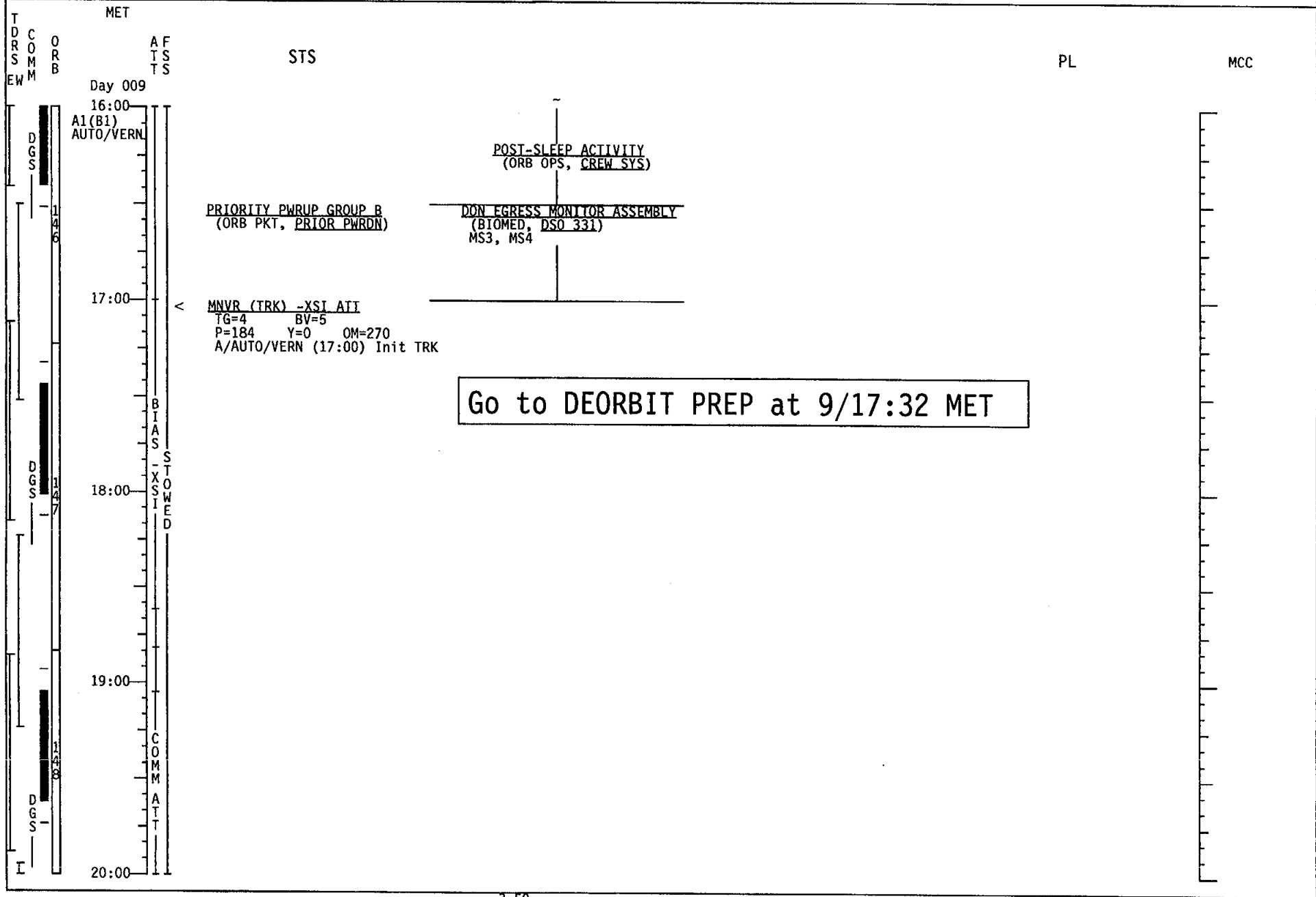

# = GROUND COMMANDED

3-50

FLT PLN/82/FIN

CONTINGENCY TIMELINES

CONTINGENCY  
TIMELINES

**This Page Intentionally Blank**

## **MINIMUM DURATION FLIGHT WITH FD2 RENDEZVOUS**

The intent of this timeline is to perform rendezvous, HST grapple, one EVA, HST release, and then deorbit in the shortest mission possible. The MDF timeline assumes that launch occurred in the portion of the launch window that allows a FD2 rendezvous and that a failure occurred during or shortly after ascent which places the orbiter in an MDF posture. As a result, a mission of approximately 72 hours duration has been designed to achieve the highest priority mission objectives. STS-82 Flight Rule A2.1.2-1, High Priority Flight objectives, allows a mission specific exception to All Flights Rule A15.1.1-14A, Scheduled and Unscheduled EVA Constraints, which allows the EVA to be scheduled on FD3.

The following assumptions apply:

- The MDF is declared prior to OMS 2.
- Liftoff occurs at a time in the launch window that permits a FD2 rendezvous.
- RMS C/O is scheduled earlier at 0/03:35 MET.
- One EVA is scheduled to perform the HST highest priority EVA tasks possible: Setup without BAPS post installation, NICMOS, SSR, and closeout on FD3.
- The EVA and HST release occur on the same flight day.
- Reboost of the HST is not accomplished.
- Aperture Door (AD) is not opened prior to HST release due to the limited time available.

**MDF W/FD2  
RNDZ**

MDF W/FD2  
RNDZ

12/20/96 10:36:29

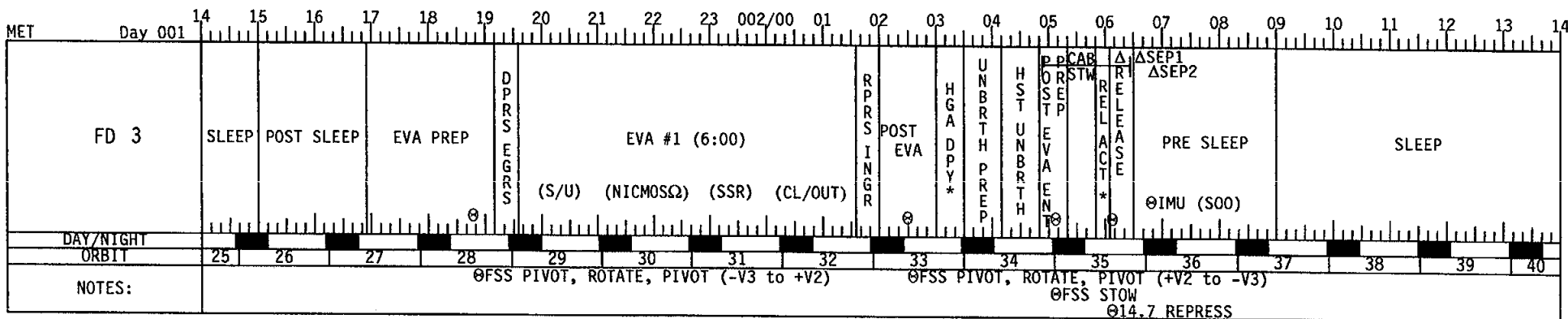
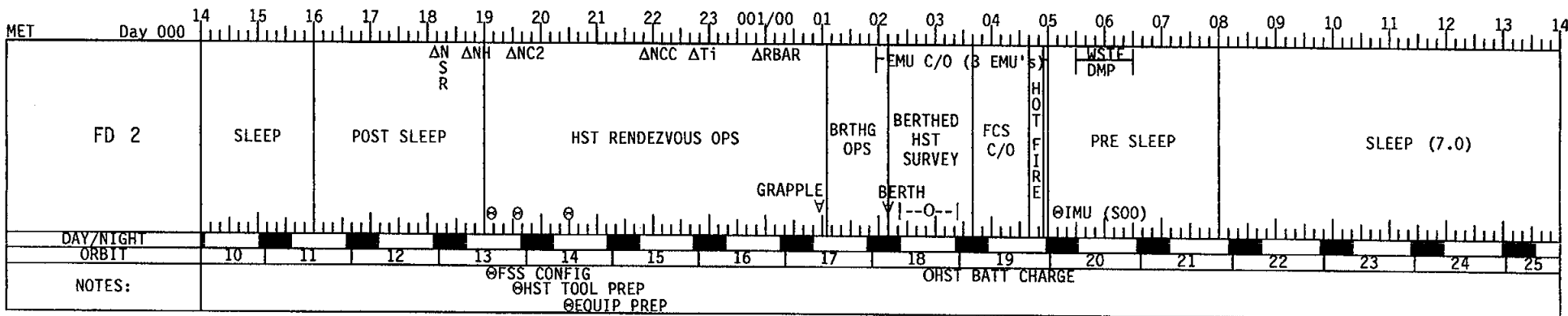
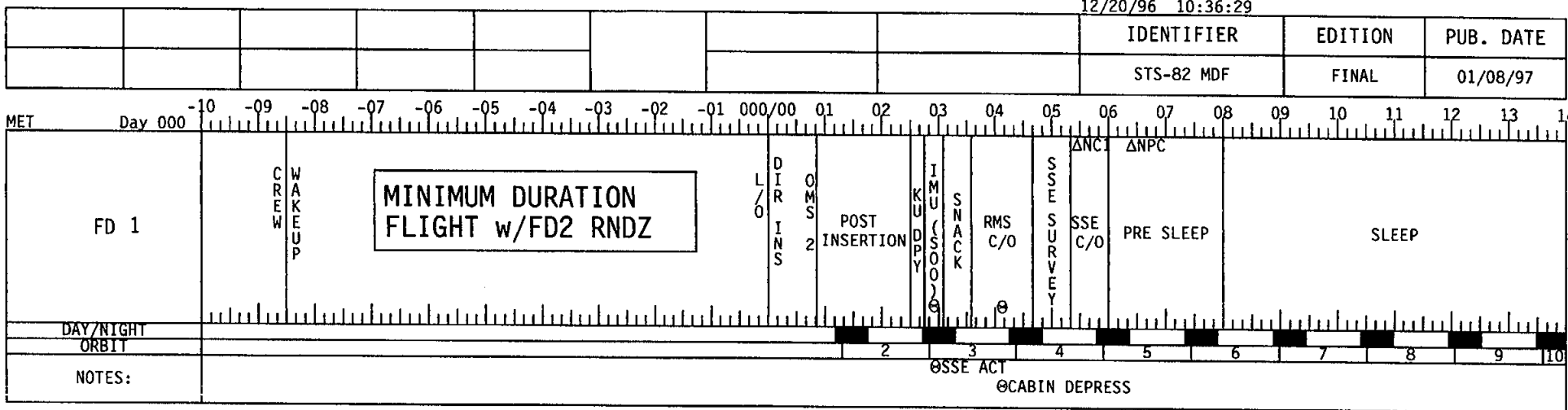

\*GROUND COMMANDED; ΩREQUIRES SUN AVOIDANCE ATTITUDE

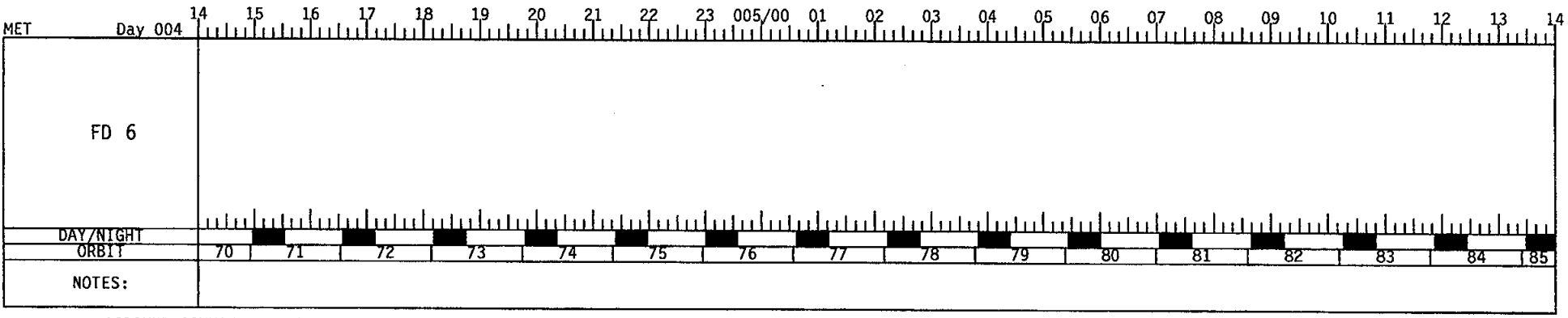
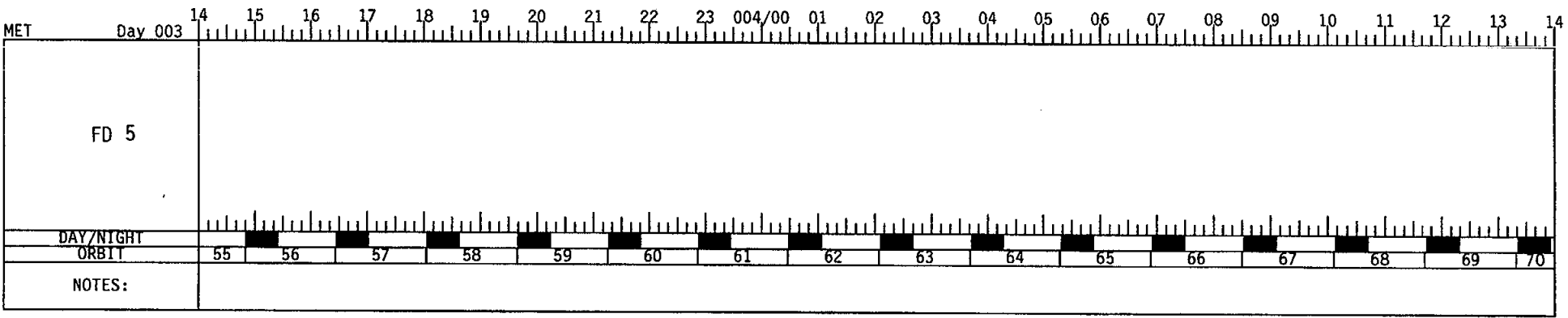
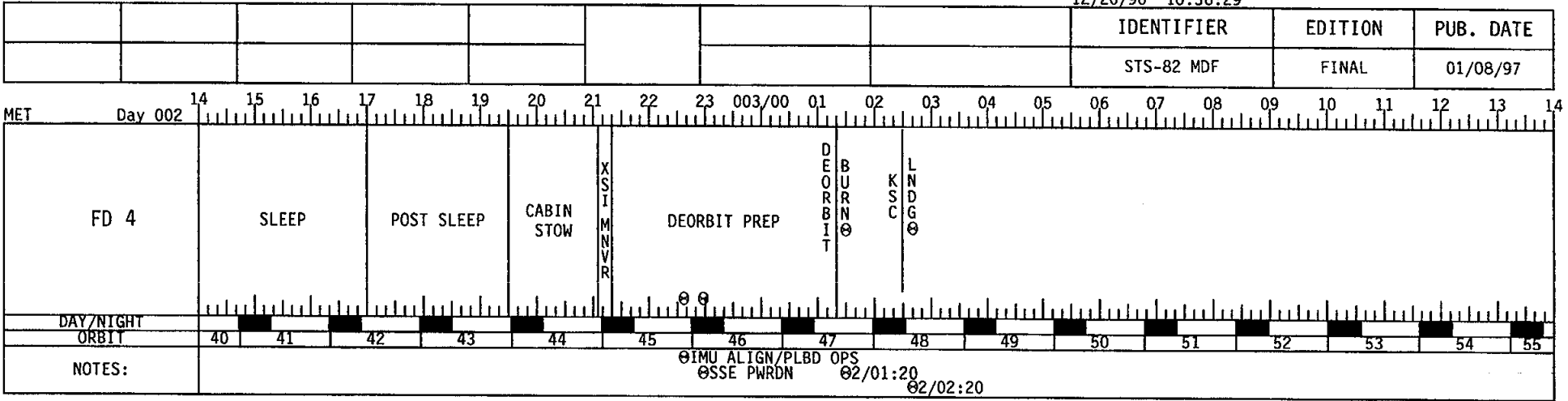

\*GROUND COMMANDED;  $\Omega$ REQUIRES SUN AVOIDANCE ATTITUDE

**This Page Intentionally Blank**

## FD3 RENDEZVOUS WITH ONE EVA

The intent of this timeline is to perform rendezvous, HST grapple, one EVA, HST release, and then deorbit in the shortest mission possible. There are two cases for which this timeline would be applicable. The first case is a launch in the portion of the launch window which only allows for a FD3 rendezvous and a decision is made to shorten the mission duration before approximately 51 hours MET. The other case is for a launch in the portion of the launch window that allows a FD2 rendezvous, but the failure does not occur until after 0/03:35 MET but prior to 2/02:45 MET. The result of either case is an approximately 96 hour timeline. STS-82 Flight Rule A2.1.2-1, High Priority Flight Objectives, allows a mission exception to All Flights Rule A2.1.3-1.B.2, Mission Duration Requirements.

The following assumptions apply:

- The decision to shorten the mission to four days is made prior to 2/02:45 MET.
- One EVA is scheduled to perform the HST highest priority EVA tasks possible:  
Setup without BAPS post installation, NICMOS, SSR, and closeout on FD4.
- The EVA and HST release occur on the same flight day.
- Reboost of the HST is not accomplished.
- Aperture Door (AD) is not opened prior to HST release due to limited time available.



12/20/96 10:56:04

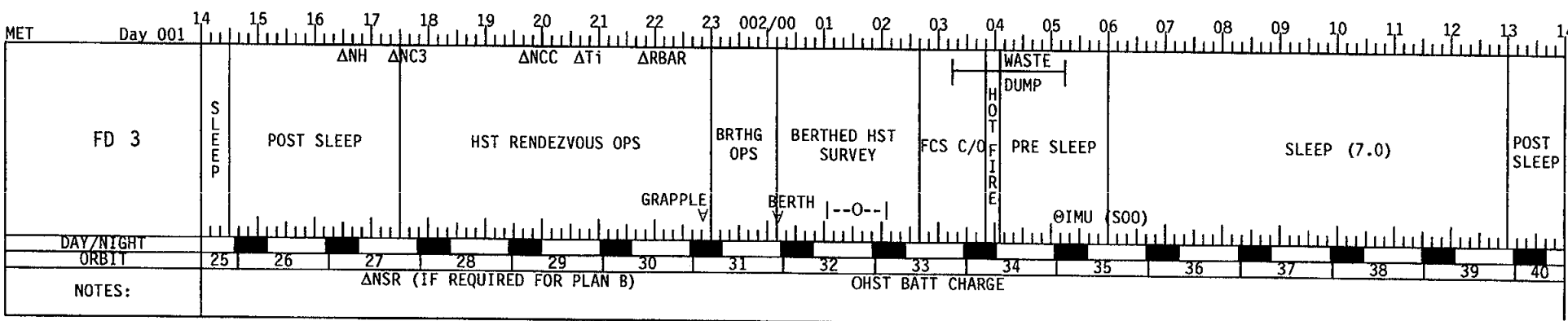
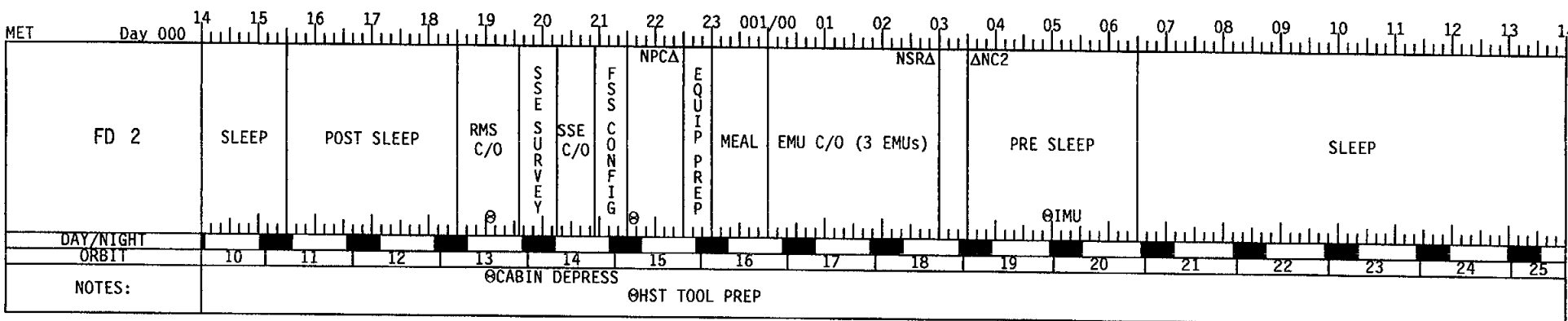
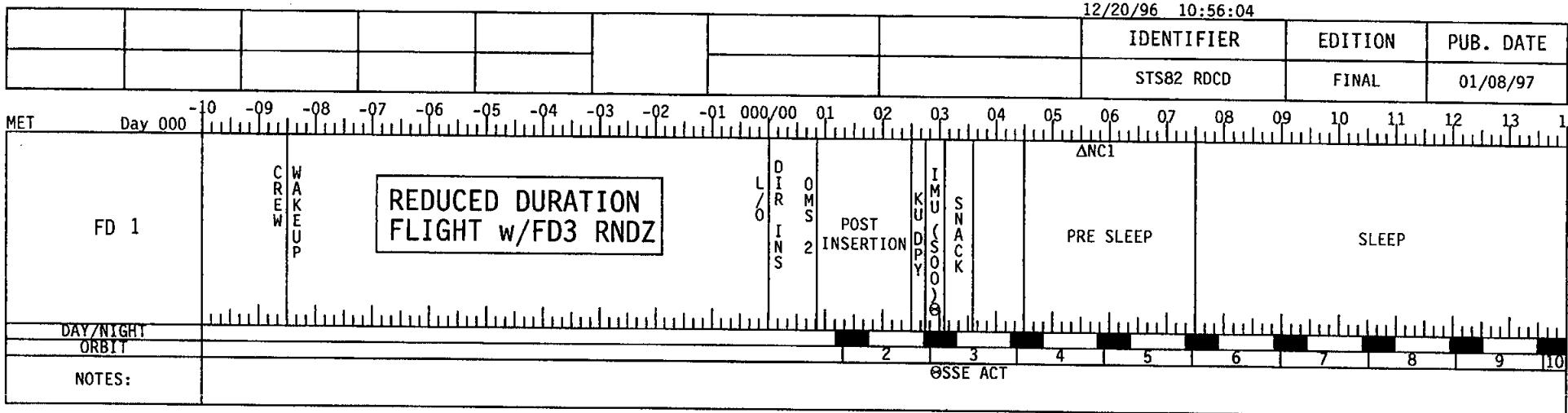

\*GROUND COMMANDED; ΩREQUIRES SUN AVOIDANCE ATTITUDE

4B-2

STS82 RDCD

01/08/97

FLT PLN/82/FIN

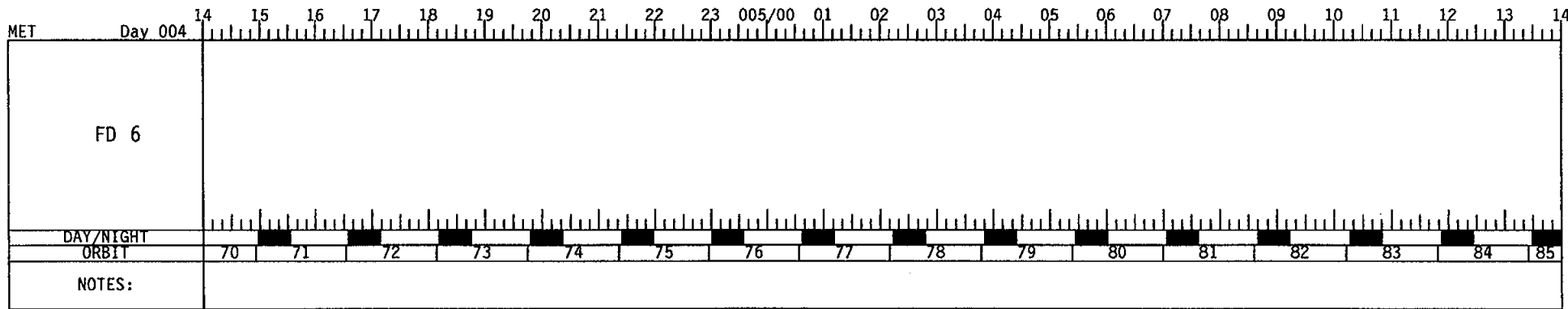
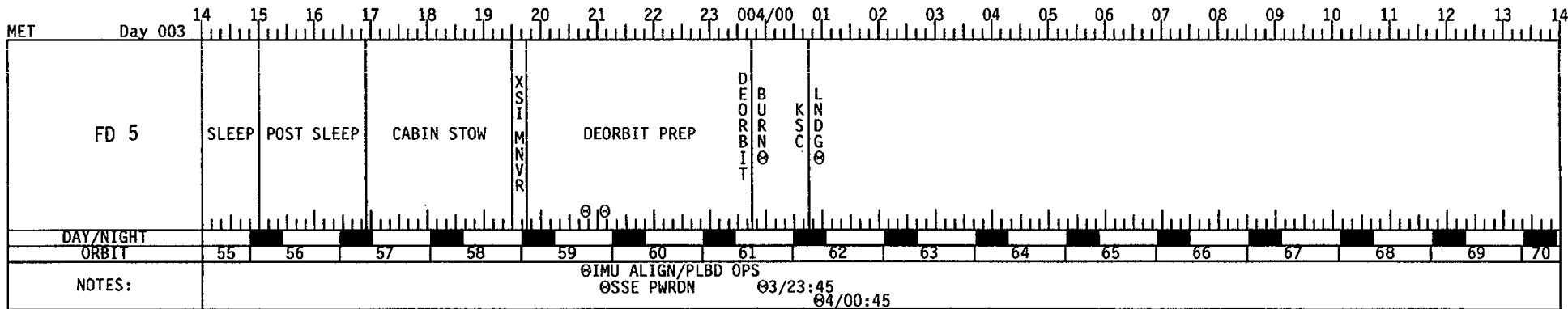
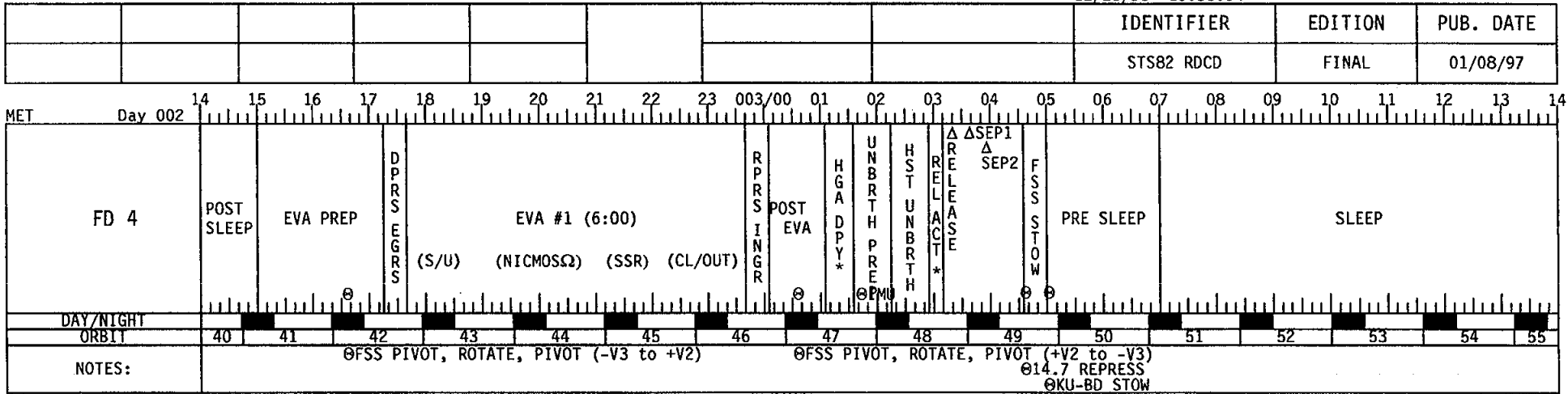

\*GROUND COMMANDED; ΩREQUIRES SUN AVOIDANCE ATTITUDE

**This Page Intentionally Blank**

STS-82 DAP TABLE

DAP TABLE

**DAP TABLE**

**STS-82 DAP A - GENERIC**

	ITEM #	A1	A2	A3	A4	A5	A7	A8
<b>PRI</b>								
ROT RATE	10 (50)	0.2000	0.4000	0.2000	0.5000	0.2000	0.2000	0.2000
ATT DB	11 (51)	5.00	1.00	1.00	3.00	5.00	2.00	2.00
RATE DB	12 (52)	0.20	0.20	0.20	0.20	0.20	0.20	0.20
ROT PLS	13 (53)	0.10	0.10	0.10	0.10	0.10	0.10	0.10
COMP	14 (54)	.000	.000	.000	.000	.000	.000	.000
P OPTION	15 (55)	ALL	ALL	ALL	ALL	ALL	ALL	ALL
Y OPTION	16 (56)	ALL	ALL	TAIL	ALL	ALL	ALL	ALL
TRAN PLS	17 (57)	0.10	0.10	0.10	0.10	0.10	0.10	0.05
<b>ALT</b>								
RATE DB	18 (58)	0.200	0.200	0.200	0.200	0.070	0.200	0.200
JET OPT	19 (59)	ALL	ALL	ALL	ALL	ALL	ALL	ALL
# JETS	20 (60)	2	2	2	2	1	2	2
ON TIME	21 (61)	0.08	0.08	0.08	0.08	0.08	0.08	0.08
DELAY	22 (62)	0.00	0.00	0.00	0.00	0.00	0.00	0.00
<b>VERN</b>								
ROT RATE	23 (63)	0.2000	0.4000	0.0080	0.2000	0.2000	0.2000	0.2000
ATT DB	24 (64)	1.000	1.000	0.070	1.000	1.000	1.000	1.000
RATE DB	25 (65)	.020	.020	.010	.020	.020	.020	.020
ROT PLS	26 (66)	0.010	0.010	0.010	0.010	0.010	0.010	0.010
COMP	27 (67)	.000	.000	.000	.000	.000	.000	.000
CNTL ACC	28 (68)	0	0	0	0	0	0	0
PURPOSE		NOMINAL	PTC	GG	PRE/POST DEPLOY	LOSS OF VERN (NOSE & TAIL)	RNDZ	PROX OPS

5-2

FLT PLN/82/FIN

**STS-82 DAP A CONFIGURATION**

	ITEM #	A9	A10
<b>PRI</b>			
ROT RATE	10 (50)	<b>0.1000</b>	<b>0.1000</b>
ATT DB	11 (51)	<b>5.00</b>	<b>5.00</b>
RATE DB	12 (52)	0.20	0.20
ROT PLS	13 (53)	<b>0.04</b>	<b>0.04</b>
COMP	14 (54)	.000	.000
P OPTION	15 (55)	<b>TAIL</b>	<b>TAIL</b>
Y OPTION	16 (56)	<b>TAIL</b>	<b>TAIL</b>
TRAN PLS	17 (57)	<b>0.05</b>	<b>0.05</b>
<b>ALT</b>			
RATE DB	18 (58)	<b>0.100</b>	<b>0.100</b>
JET OPT	19 (59)	<b>TAIL</b>	<b>TAIL</b>
# JETS	20 (60)	2	2
ON TIME	21 (61)	0.08	0.08
DELAY	22 (62)	<b>13.10</b>	<b>17.40</b>
<b>VERN</b>			
ROT RATE	23 (63)	<b>0.1000</b>	<b>0.2000</b>
ATT DB	24 (64)	<b>2.000</b>	<b>1.000</b>
RATE DB	25 (65)	<b>.050</b>	.020
ROT PLS	26 (66)	<b>0.005</b>	<b>0.005</b>
COMP	27 (67)	.000	.000
CNTL ACC	28 (68)	<b>1(2,3,4)</b>	<b>4(5)</b>
PURPOSE		HST RMS	HST BERTHED

**NOTE: BOLD/ITALICS** indicate a change from the I-load

STS-82 DAP B - GENERIC

	ITEM #	B1	B2	B3	B4	B5	B7	B8
<b>PRI</b>								
ROT RATE	30 (50)	0.5000	0.2000	0.2000	0.2000	0.2000	0.5000	0.2000
ATT DB	31 (51)	3.00	3.00	3.00	0.30	3.00	2.00	2.00
RATE DB	32 (52)	0.20	0.20	0.20	0.20	0.20	0.20	0.20
ROT PLS	33 (53)	0.04	0.04	0.04	0.04	0.04	0.04	0.04
COMP	34 (54)	.000	.000	.000	.000	.000	.000	.000
P OPTION	35 (55)	ALL	TAIL	ALL	TAIL	TAIL	ALL	ALL
Y OPTION	36 (56)	ALL	TAIL	ALL	TAIL	TAIL	ALL	ALL
TRAN PLS	37 (57)	0.10	0.02	0.02	0.02	0.02	0.05	0.01
<b>ALT</b>								
RATE DB	38 (58)	0.200	0.070	0.070	0.200	0.200	0.200	0.200
JET OPT	39 (59)	ALL	TAIL	ALL	ALL	ALL	ALL	ALL
# JETS	40 (60)	2	1	1	2	2	2	2
ON TIME	41 (61)	0.08	0.08	0.08	0.08	0.08	0.08	0.08
DELAY	42 (62)	0.00	0.00	0.00	0.00	0.00	0.00	0.00
<b>VERN</b>								
ROT RATE	43 (63)	0.2000	0.2000	0.2000	0.0080	0.0160	0.2000	0.2000
ATT DB	44 (64)	1.000	1.000	1.000	0.100	0.033	1.000	1.000
RATE DB	45 (65)	.020	.020	.020	.010	.020	.020	.020
ROT PLS	46 (66)	0.002	0.002	0.002	0.002	0.002	0.002	0.002
COMP	47 (67)	.000	.000	.000	.000	.000	.000	.000
CNTL ACC	48 (68)	0	0	0	0	0	0	0
PURPOSE		NOM OMS & RCS BURNS	LOSS OF VERN (TAIL ONLY)	LOSS OF VERN (NOSE & TAIL)	SSUS DEPLOY	COAS CAL	RNDZ	PROX OPS

**STS-82 DAP B CONFIGURATION**

	ITEM #	B9	B10	B11	B12	B14
<b>PRI</b>						
ROT RATE	30 (50)	<b>0.0500</b>	<b>0.1000</b>	<b>0.0500</b>	<b>0.0500</b>	<b>0.1000</b>
ATT DB	31 (51)	<b>2.00</b>	<b>5.00</b>	<b>5.00</b>	<b>5.00</b>	<b>5.00</b>
RATE DB	32 (52)	0.20	0.20	0.20	0.20	0.20
ROT PLS	33 (53)	0.04	0.04	0.04	0.04	0.04
COMP	34 (54)	.000	.000	.000	.000	.000
P OPTION	35 (55)	<b>TAIL</b>	<b>TAIL</b>	<b>TAIL</b>	<b>TAIL</b>	<b>TAIL</b>
Y OPTION	36 (56)	<b>TAIL</b>	<b>TAIL</b>	<b>TAIL</b>	<b>TAIL</b>	<b>TAIL</b>
TRAN PLS	37 (57)	<b>0.01</b>	<b>0.01</b>	<b>0.05</b>	<b>0.05</b>	<b>0.01</b>
<b>ALT</b>						
RATE DB	38 (58)	<b>0.100</b>	<b>0.100</b>	<b>0.100</b>	<b>0.100</b>	<b>0.100</b>
JET OPT	39 (59)	<b>TAIL</b>	<b>TAIL</b>	<b>TAIL</b>	<b>TAIL</b>	<b>TAIL</b>
# JETS	40 (60)	2	2	2	2	2
ON TIME	41 (61)	0.08	0.08	0.08	0.08	0.08
DELAY	42 (62)	<b>13.10</b>	<b>17.40</b>	<b>17.40</b>	<b>13.10</b>	<b>17.40</b>
<b>VERN</b>						
ROT RATE	43 (63)	<b>0.0240</b>	<b>0.1000</b>	<b>0.0160</b>	<b>0.0160</b>	<b>0.4000</b>
ATT DB	44 (64)	<b>0.500</b>	<b>3.000</b>	<b>1.000</b>	<b>2.000</b>	1.000
RATE DB	45 (65)	<b>.030</b>	.020	.020	<b>.050</b>	.020
ROT PLS	46 (66)	<b>0.005</b>	<b>0.005</b>	<b>0.005</b>	<b>0.005</b>	<b>0.040</b>
COMP	47 (67)	.000	.000	.000	.000	.000
CNTL ACC	48 (68)	<b>1</b>	<b>4</b>	<b>4(5)</b>	<b>1(2,3,4)</b>	<b>4</b>
PURPOSE		HST RELEASE	NORMAL HST BERTHED	SLOW HST BERTHED	SLOW HST RMS	VRCS REBOOST

**NOTE: BOLD/ITALICS** indicates a change from the I-load



**This Page Intentionally Blank**

**STS-82 EVA TIME PERIOD OVERVIEW**

# EVA TIME PERIOD OVERVIEW

## STS-82 EVA TIME PERIODS

EVA 1 6:15		de eg	Initial Setup 1:00		STIS 2:00		NICMOS 2:00		Close 00:30	in re	
FSS	-V3		85° Pivot @ -V3	PR			90° @ +V2		Note 1		-V3
SA	0°						-V2 SA @ +15°		Note 1		0°
ATT			-ZLV -XVV				Sun Protect				-ZLV -XVV

EVA 2 6:15		de eg	s/u	FGS 2:45		ESTR-2 01:05	PFR	CS	OCEK 0:40	Close 00:30	in re		
FSS	-V3	R		90° @ -V2			R					-V3	
SA	0°											0°	
ATT			-ZLV -XVV		Sun Protect				-ZLV -XVV		reboost	-zlv +yv	-zlv -xv

EVA 3 5:55		de eg	s/u	DIU-2 2:00		SSR 1:10	CS	RWA 0:50	Close 00:30	in re		
FSS				-V3	pRP						+V3	
SA											0°	
ATT										reboost		-ZLV -XVV

EVA 4 6:30		de eg	s/u	SADE-2 02:05		MSS 00:40		FINAL CLOSEOUT 1:00	TBD	HGA DPLY 00:50	in re	
FSS				+V3	pr	330°	RP				-V3	
SA											0°	
ATT									reboost		-ZLV +YVV	-zlv -xv

Note 1. FSS temporarily left in +V2 for P/TV Survey; when survey is complete, rotate to -V3 and -V2 SA Slew to 0° for overnight.

Note 2: The DIU EVA will be done in -ZLV -XVV unless the P3 demate/mate task is expected to be done in light; in that case a sun avoidance attitude will be used.

Abbreviations: de = last five minutes of airlock depress      eg = egress (airlock)      in = ingress (airlock)      re = first five minutes of airlock repress  
P = FSS pivot up to 90°      p = FSS pivot down to 75°      R = FSS rotation ≥90°      r = FSS rotation <90°  
CS = Crew swap on MFR      PFR = PFR Stow      s/u = daily setup      TBD = margin for optimum orbital placement

**The sections following this divider page will not be included in flight copies.**

ATTITUDE TIMELINE

ATTITUDE  
TIMELINE

Attitude Timeline

MET/GMT	MNVR OPTION	DAP	E/S	REF ATT/REMARKS	EVENT
1 000/00:45:00 MET 044/08:44:00 GMT	INRTL R= 46.00 MNVR P= 71.00 Y= 78.00	A1 RATE 0.2000 AUTO DB AT 5.00 PRI DB RT 0.20	SUN R 174 P 115		OMS 2
2 000/01:12:00 MET 21:57 044/09:11:00 GMT 20:57	TGT=2 BV=3 P= 90.00 Y= 0.00 OM= 90.00	A6 RATE 0.2000 AUTO DB AT 5.00 ALT DB RT 0.070	EARTH R 0 P 90	LVLH R= 0.00 P=180.00 Y=270.00	-ZLV, -YVV PLBD OPEN ATT STAR OF OPP
3 000/05:07:00 MET 16:25 044/13:06:00 GMT 15:25	INRTL R= 44.00 MNVR P= 73.00 Y= 79.00	B1 RATE 0.2000 AUTO DB AT 1.000 VERN DB RT 0.020	SUN R 174 P 116		NC-1 TVR 180 TIG 00/05:25
4 000/05:30:00 MET 45:00 044/13:29:00 GMT 44:00	TGT=2 BV=3 P= 90.00 Y= 0.00 OM= 0.00	A6 RATE 0.2000 AUTO DB AT 1.000 ALT DB RT 0.070	EARTH R 360 P 90	LVLH R= 0.00 P=180.00 Y= 0.00	-ZLV, -XVV CREW SLEEP
5 000/22:24:00 MET 045/06:23:00 GMT					NPC RCS MULTI-AXIS TIG 00/22:33
6 001/02:40:00 MET 55:00 045/10:39:00 GMT 54:00	INRTL R= 43.00 MNVR P= 75.00 Y= 83.00	B1 RATE 0.2000 AUTO DB AT 1.000 VERN DB RT 0.020	SUN R 171 P 118		NSR TVR 180 TIG 01/03:09
7 001/02:57:00 MET 045/10:56:00 GMT		A1 RATE 0.2000 LVLH DB AT 1.000 VERN DB RT 0.020	EARTH R 0 P 33	LVLH R=179.86 HOLD P=302.78 Y= 0.11	LVLH HOLD BETWEEN BURNS
8 001/03:25:00 MET 28:54 045/11:24:00 GMT 27:54	INRTL R=279.00 MNVR P=216.00 Y=304.00	B1 RATE 0.2000 AUTO DB AT 1.000 VERN DB RT 0.020	SUN R 8 P 91		NC-2 RCS TVR 180 TIG 1/03:50
9 001/03:55:00 MET 04:09:59 045/11:54:00 GMT 12:08:59	TGT=2 BV=3 P= 90.00 Y= 0.00 OM= 0.00	A1 RATE 0.2000 AUTO DB AT 1.000 VERN DB RT 0.020	EARTH R 0 P 90	LVLH R= 0.00 P=180.00 Y= 0.00	-ZLV, -XVV
10 001/05:12:00 MET 24:54 045/13:11:00 GMT 23:54	INRTL R=115.00 MNVR P= 16.00 Y= 33.00	A1 RATE 0.2000 AUTO DB AT 1.000 VERN DB RT 0.020	SUN R 154 P 65	STAR PAIR A1 -Y: 50 -Z: 31	IMU ALIGN 50 LOS 05:45 31 LOS 05:48
11 001/05:35:00 MET 48:43 045/13:34:00 GMT 47:43	TGT=2 BV=3 P= 90.00 Y= 0.00 OM= 0.00	A1 RATE 0.2000 AUTO DB AT 1.000 VERN DB RT 0.020	EARTH R 0 P 90	LVLH R= 0.00 P=180.00 Y= 0.00	-ZLV, -XVV CREW SLEEP
12 001/16:10:00 MET 20:02 046/00:09:00 GMT 19:02	INRTL R=264.50 MNVR P= 32.90 Y= 52.90	A7 RATE 0.2000 AUTO DB AT 1.000 VERN DB RT 0.020	SUN R 350 P 85		NH -X BURN heads down TIG 01/16:39

\*\*\* ALL ATTITUDES IN MEAN OF 1950 \*\*\*  
\*\*\* PYR EULER SEQUENCE \*\*\*

Attitude Timeline

MET/GMT	MNVR OPTION	DAP	E/S	REF ATT/REMARKS	EVENT	
13 001/16:27:00 MET  046/00:26:00 GMT		A7 INRT DB AT 1.000 VERN DB RT 0.020	RATE 0.2000 DB AT 1.000 DB RT 0.020	SUN R 350 P 85	INRTL R=264.50 HOLD P= 32.90 Y= 52.90	
14 001/17:10:00 MET 11:45 046/01:09:00 GMT 10:45	INRTL R=266.00 MNVR P= 30.50 Y= 32.00	A7 AUTO DB AT 1.000 VERN DB RT 0.020	RATE 0.2000 DB AT 1.000 DB RT 0.020	SUN R 349 P 65		NC-3 +X BURN heads up TIG 01/17:28
15 001/17:30:00 MET 33:39 046/01:29:00 GMT 32:39	TGT=2 BV=1 P= 0.00 Y= 0.00 OM= 0.00	B7 AUTO DB AT 2.00 PRI DB RT 0.20	RATE 0.5000 DB AT 2.00 DB RT 0.20	EARTH R 243 P 0	LVLH R= 0.00 P=270.00 Y= 0.00	TGT TRK ATT POST NC-3
16 001/19:41:00 MET  046/03:40:00 GMT						NCC BURN 01/19:41:14
17 001/20:41:27 MET  046/04:40:27 GMT						TI BURN 01/20:41:27
18 001/20:43:00 MET 21:58:00 046/04:42:00 GMT 05:57:00	TGT=2 BV=5 P=270.00 Y= 0.00 OM= 0.00	A7 AUTO DB AT 1.000 VERN DB RT 0.020	RATE 0.0200 DB AT 1.000 DB RT 0.020	EARTH R 180 P 90	LVLH R= 0.00 P= 0.00 Y= 0.00	RBAR CROSSING @ SR +8 min 1/21:58:24
19 001/22:40:00 MET  046/06:39:00 GMT		A7 INRT DB AT 1.000 VERN DB RT 0.020	RATE 0.2000 DB AT 1.000 DB RT 0.020	SUN R 331 P 158	INRTL R= 93.91 HOLD P=205.59 Y= 50.97	ESTABLISH INERTIAL FOR GRAPPLE
20 001/22:54:00 MET  046/06:53:00 GMT						HST GRAPPLE
21 002/00:00:00 MET 07:35 046/07:59:00 GMT 08:06:35	TGT=4 BV=5 RA= 328.278 DEC= -12.8463 P=165.00 Y= 0.00 OM= 90.00	A10 AUTO DB AT 1.000 VERN DB RT 0.020	RATE 0.2000 DB AT 1.000 DB RT 0.020	SUN R 0 P 165	INRTL R=359.89 P=212.55 Y= 32.03	BATTERY CHARGE SA SLEW = 90
22 002/03:50:00 MET 04:03:10 046/11:49:00 GMT 12:02:10	TGT=2 BV=3 P= 90.00 Y= 0.00 OM=270.00	A10 AUTO DB AT 1.000 VERN DB RT 0.020	RATE 0.2000 DB AT 1.000 DB RT 0.020	EARTH R 0 P 90	LVLH R= 0.00 P=180.00 Y= 90.00	H2O DUMP ATT
23 002/06:00:00 MET 07:30 046/13:59:00 GMT 14:06:30	TGT=2 BV=3 P= 90.00 Y= 0.00 OM= 0.00	A10 AUTO DB AT 1.000 VERN DB RT 0.020	RATE 0.2000 DB AT 1.000 DB RT 0.020	EARTH R 0 P 90	LVLH R= 0.00 P=180.00 Y= 0.00	-ZLV, -XVV CREW SLEEP
24 002/20:15:00 MET 28:55 047/04:14:00 GMT 27:55	TGT=4 BV=5 RA= 329.100 DEC= -12.5563 P=325.00 Y= 3.00 OM= 0.00	A10 AUTO DB AT 1.000 VERN DB RT 0.020	RATE 0.2000 DB AT 1.000 DB RT 0.020	SUN R 175 P 35	INRTL R=252.66 P=359.78 Y=296.08	BIAS +XSI FOR EVA STIS

\*\*\* ALL ATTITUDES IN MEAN OF 1950 \*\*\*  
\*\*\* PYR EULER SEQUENCE \*\*\*

Attitude Timeline

MET/GMT		MNVR OPTION	DAP		E/S	REF ATT/REMARKS	EVENT
25	002/21:25:00 MET 34:19	TGT=2 BV=5 P=130.00 Y= 0.00 OM=345.00	A10 AUTO VERN	RATE 0.2000 DB AT 1.000 DB RT 0.020	EARTH R 0 P 130	LVLH R= 9.77 P=139.02 Y= 11.44	-ZLV -XVV FOR EVA STIS
	047/05:24:00 GMT 33:19						
26	002/22:25:00 MET 27:23	TGT=4 RA= 329.187 BV=5 DEC= -12.525S P=315.00 Y= 5.00 OM= 0.00	A10 AUTO VERN	RATE 0.2000 DB AT 1.000 DB RT 0.020	SUN R 173 P 45	INRTL R=241.05 P=345.70 Y=287.43	BIAS +XSI FOR EVA STIS/NICMOS
	047/06:24:00 GMT 26:23						
27	002/23:00:00 MET 10:05	TGT=2 BV=5 P=135.00 Y= 0.00 OM=345.00	A10 AUTO VERN	RATE 0.2000 DB AT 1.000 DB RT 0.020	EARTH R 360 P 135	LVLH R= 10.73 P=134.01 Y= 10.55	BIAS -ZLV -XVV FOR EVA NICMOS
	047/06:59:00 GMT 07:09:05						
28	003/00:00:00 MET 02:21	TGT=4 RA= 329.252 BV=5 DEC= -12.503S P=315.00 Y= 5.00 OM= 0.00	A10 AUTO VERN	RATE 0.2000 DB AT 1.000 DB RT 0.020	SUN R 173 P 45	INRTL R=241.58 P=346.09 Y=287.41	BIAS +XSI FOR EVA NICMOS
	047/07:59:00 GMT 08:01:21						
29	003/00:45:00 MET 53:45	TGT=2 BV=3 P= 90.00 Y= 0.00 OM= 0.00	A10 AUTO VERN	RATE 0.2000 DB AT 1.000 DB RT 0.020	EARTH R 360 P 90	LVLH R= 0.00 P=180.00 Y= 0.00	-ZLV -XVV POST EVA
	047/08:44:00 GMT 52:45						
30	003/04:10:00 MET 19:06	INRTL R= 95.00 MNVR P=294.00 Y= 37.00	A10 AUTO VERN	RATE 0.2000 DB AT 1.000 DB RT 0.020	SUN R 236 P 101	special pair -Y=54 -Z=72 AOS 72 5:02 AOS 54 4:41	IMU LOS 54 5:35 LOS 72 5:58
	047/12:09:00 GMT 18:06						
31	003/04:30:26 MET	TERMINATOR RISE					DIU CURRENT TEST IN IMU ATT OVER ENTIRE DAY PASS
	047/12:29:26 GMT	COE R=319 P=60 SUN R=235 P=100					
32	003/05:25:00 MET 38:20	TGT=2 BV=3 P= 90.00 Y= 0.00 OM= 0.00	A10 AUTO VERN	RATE 0.2000 DB AT 1.000 DB RT 0.020	EARTH R 360 P 90	LVLH R= 0.00 P=180.00 Y= 0.00	-ZLV -XVV CREW SLEEP
	047/13:24:00 GMT 37:20						
33	003/19:50:00 MET 54:00	TGT=2 BV=5 P=135.00 Y= 0.00 OM=343.00	A10 AUTO VERN	RATE 0.2000 DB AT 1.000 DB RT 0.020	EARTH R 360 P 135	LVLH R= 12.20 P=133.72 Y= 11.93	BIAS -ZLV -XVV FOR EVA FGS SR PROTECT
	048/03:49:00 GMT 53:00						
34	003/20:55:00 MET 57:59	TGT=4 RA= 330.097 BV=5 DEC= -12.200S P=325.00 Y= 3.00 OM= 0.00	A10 AUTO VERN	RATE 0.2000 DB AT 1.000 DB RT 0.020	SUN R 175 P 35	INRTL R=258.50 P= 3.08 Y=296.43	BIAS +XSI FOR EVA FGS SS PROTECT
	048/04:54:00 GMT 56:59						
35	003/21:35:00 MET 45:30	TGT=2 BV=5 P=135.00 Y= 0.00 OM=343.00	A10 AUTO VERN	RATE 0.2000 DB AT 1.000 DB RT 0.020	EARTH R 0 P 135	LVLH R= 12.20 P=133.72 Y= 11.93	BIAS -ZLV -XVV FOR EVA FGS SR PROTECT
	048/05:34:00 GMT 44:30						
36	003/22:35:00 MET 39:00	TGT=2 BV=3 P= 90.00 Y= 0.00 OM= 0.00	A10 AUTO VERN	RATE 0.2000 DB AT 1.000 DB RT 0.020	EARTH R 360 P 90	LVLH R= 0.00 P=180.00 Y= 0.00	-ZLV -XVV REMAINING EVA
	048/06:34:00 GMT 38:00						

\*\*\* ALL ATTITUDES IN MEAN OF 1950 \*\*\*  
\*\*\* PYR EULER SEQUENCE \*\*\*



Attitude Timeline

MET/GMT	MNVR OPTION	DAP	E/S	REF ATT/REMARKS	EVENT
37 004/00:35:00 MET 50:00 048/08:34:00 GMT 49:00	TGT=2 BV=2 P=180.00 Y= 0.00 OM=180.00	A10 AUTO VERN RATE 0.2000 DB AT 1.000 DB RT 0.020	EARTH R 34 P 180	LVLH R=180.00 P= 90.00 Y= 0.00	-XLV -ZVV VRCS REBOOST
38 004/01:20:00 MET 30:00 048/09:19:00 GMT 29:00	TGT=2 BV=3 P= 90.00 Y= 0.00 OM=270.00	A10 AUTO VERN RATE 0.2000 DB AT 1.000 DB RT 0.020	EARTH R 0 P 90	LVLH R= 0.00 P=180.00 Y= 90.00	-ZLV, +YVV H2O DUMP ATT
39 004/05:15:00 MET 22:30 048/13:14:00 GMT 21:30	TGT=2 BV=3 P= 90.00 Y= 0.00 OM= 0.00	A10 AUTO VERN RATE 0.2000 DB AT 1.000 DB RT 0.020	EARTH R 360 P 90	LVLH R= 0.00 P=180.00 Y= 0.00	-ZLV, -XVV CREW SLEEP
40 005/00:15:00 MET 30:00 049/08:14:00 GMT 29:00	TGT=2 BV=2 P=180.00 Y= 0.00 OM=180.00	A10 AUTO VERN RATE 0.2000 DB AT 1.000 DB RT 0.020	EARTH R 345 P 180	LVLH R=180.00 P= 90.00 Y= 0.00	VRCS REBOOST
41 005/00:50:00 MET 01:05:00 049/08:49:00 GMT 09:04:00	TGT=2 BV=3 P= 90.00 Y= 0.00 OM= 0.00	A10 AUTO VERN RATE 0.2000 DB AT 1.000 DB RT 0.020	EARTH R 0 P 90	LVLH R= 0.00 P=180.00 Y= 0.00	-ZLV -XVV
42 005/04:40:00 MET 53:46 049/12:39:00 GMT 52:46	INRTL R=285.00 MNVR P=186.00 Y=331.00	A10 AUTO VERN RATE 0.2000 DB AT 1.000 DB RT 0.020	SUN R 337 P 123	STAR PAIR C1 -Y: 51 -Z: 22	IMU ALIGN LOS 51 5:28 LOS 22 5:24
43 005/05:00:00 MET 12:23 049/12:59:00 GMT 13:11:23	TGT=2 BV=3 P= 90.00 Y= 0.00 OM= 0.00	A10 AUTO VERN RATE 0.2000 DB AT 1.000 DB RT 0.020	EARTH R 360 P 90	LVLH R= 0.00 P=180.00 Y= 0.00	-ZLV -XVV FOR CREW SLEEP
44 005/23:20:00 MET 35:00 050/07:19:00 GMT 34:00	TGT=2 BV=2 P=180.00 Y= 0.00 OM=180.00	A10 AUTO VERN RATE 0.2000 DB AT 1.000 DB RT 0.020	EARTH R 311 P 180	LVLH R=180.00 P= 90.00 Y= 0.00	-XLV -ZVV VRCS REBOOST
45 006/00:35:00 MET 45:00 050/08:34:00 GMT 44:00	TGT=2 BV=3 P= 90.00 Y= 0.00 OM=270.00	A10 AUTO VERN RATE 0.2000 DB AT 1.000 DB RT 0.020	EARTH R 0 P 90	LVLH R= 0.00 P=180.00 Y= 90.00	-ZLV +YVV FOR WASTE DUMP
46 006/06:00:00 MET 07:30 050/13:59:00 GMT 14:06:30	TGT=2 BV=3 P= 90.00 Y= 0.00 OM= 0.00	A10 AUTO VERN RATE 0.2000 DB AT 1.000 DB RT 0.020	EARTH R 360 P 90	LVLH R= 0.00 P=180.00 Y= 0.00	-ZLV -XVV FOR CREW SLEEP
47 006/16:05:00 MET 14:20 051/00:04:00 GMT 13:20	INRTL R=328.00 MNVR P=215.00 Y= 0.00	A10 AUTO VERN RATE 0.2000 DB AT 1.000 DB RT 0.020	SUN R 339 P 146	SPECIAL PAIR -Y: 73 -Z: 27	IMU ALIGN LOS 73 16:36 LOS 27 16:46
48 006/16:30:00 MET 43:19 051/00:29:00 GMT 42:19	TGT=4 BV=5 P=165.00 Y= 0.00 OM=273.00 RA= 332.814 DEC= -11.2089	A10 AUTO VERN RATE 0.2000 DB AT 1.000 DB RT 0.020	SUN R 360 P 165	INRTL R=180.09 P=175.73 Y= 27.62	BATTERY CHARGE SA SLEW = 105

\*\*\* ALL ATTITUDES IN MEAN OF 1950 \*\*\*  
\*\*\* PYR EULER SEQUENCE \*\*\*

Attitude Timeline

MET/GMT	MNVR OPTION	DAP	E/S	REF ATT/REMARKS	EVENT	
49 006/19:45:00 MET 20:00:55 051/03:44:00 GMT 59:55	TGT=4 BV=5 RA= 332.944 DEC= -11.159S P=180.00 Y= 55.00 OM=270.00	A9 RATE 0.0600 DB AT 2.000 VERN DB RT 0.060	SUN R 90 P 125	INRTL R=174.83 P=187.76 Y=331.69	RELEASE ATT POSITIVE BETA,	
50 006/21:00:39 MET 051/04:59:39 GMT					HST RELEASE 06/21:00:39 NOON -22	
51 006/21:01:39 MET 051/05:00:39 GMT		A9 INRT VERN	RATE 0.1000 DB AT 2.000 DB RT 0.060	SUN R 90 P 125	INRTL R=174.66 HOLD P=187.58 Y=331.66	INERTIAL FOR SEP 1 (REL + 1 MIN)
52 006/21:05:00 MET 19:01 051/05:04:00 GMT 18:01	TGT=2 BV=5 P=270.00 Y= 0.00 OM= 0.00	A7 AUTO VERN	RATE 0.2000 DB AT 1.000 DB RT 0.020	EARTH R 180 P 90	LVLH R= 0.00 P= 0.00 Y= 0.00	+ZLV, +XVV FOR SEP 2 TIG: SEP 1 + 30 MIN 21:35
53 006/21:40:00 MET 47:30 051/05:39:00 GMT 46:30	TGT=2 BV=5 P=270.00 Y= 0.00 OM= 90.00	A7 AUTO VERN	RATE 0.2000 DB AT 1.000 DB RT 0.020	EARTH R 180 P 90	LVLH R= 0.00 P= 0.00 Y= 90.00	-Z TGT TRACK
54 006/23:20:00 MET 35:00 051/07:19:00 GMT 34:00	TGT=2 BV=5 P= 90.00 Y=325.00 OM= 90.00	A1 AUTO VERN	RATE 0.2000 DB AT 1.000 DB RT 0.020	EARTH R 325 P 90	LVLH R= 0.00 P=145.00 Y=270.00	-ZLV -YVV BIAS FOR DEBRIS
55 007/17:00:00 MET 09:50 052/00:59:00 GMT 01:08:50	INRTL R=154.00 MNVR P=189.00 Y=344.00	A1 AUTO VERN	RATE 0.2000 DB AT 1.000 DB RT 0.020	SUN R 112 P 138	STAR PAIR A2 -Y: 31 -Z: 50	IMU ALIGN LOS 31 17:46 LOS 50 17:46
56 007/17:15:00 MET 16:16 052/01:14:00 GMT 15:16	INRTL R=157.50 MNVR P=198.80 Y=331.80	A1 AUTO VERN	RATE 0.2000 DB AT 1.000 DB RT 0.020	SUN R 120 P 126	STAR 20 ARCTURUS	HUD ALIGN LOS 18:08
57 007/17:20:00 MET 32:28 052/01:19:00 GMT 31:28	TGT=2 BV=5 P= 90.00 Y=325.00 OM= 90.00	A1 AUTO VERN	RATE 0.2000 DB AT 1.000 DB RT 0.020	EARTH R 325 P 90	LVLH R= 0.00 P=145.00 Y=270.00	-ZLV -YVV BIAS FOR DEBRIS
58 008/14:40:00 MET 55:00 052/22:39:00 GMT 54:00	TGT=2 BV=3 P= 90.00 Y= 0.00 OM=270.00	A1 AUTO VERN	RATE 0.2000 DB AT 1.000 DB RT 0.020	EARTH R 360 P 90	LVLH R= 0.00 P=180.00 Y= 90.00	-ZLV +YVV FOR WASTE DUMP
59 008/18:40:00 MET 55:00 053/02:39:00 GMT 54:00	TGT=2 BV=5 P= 90.00 Y=325.00 OM= 90.00	A1 AUTO VERN	RATE 0.2000 DB AT 1.000 DB RT 0.020	EARTH R 325 P 90	LVLH R= 0.00 P=145.00 Y=270.00	-ZLV -YVV BIAS FOR DEBRIS
60 009/17:00:00 MET 09:20 054/00:59:00 GMT 01:08:20	TGT=4 BV=5 RA= 335.704 DEC= -10.117S P=184.00 Y= 0.00 OM=270.00	A1 AUTO VERN	RATE 0.2000 DB AT 1.000 DB RT 0.020	SUN R 180 P 176	INRTL R=163.88 P=195.28 Y= 22.84	-XSI ATT

\*\*\* ALL ATTITUDES IN MEAN OF 1950 \*\*\*  
\*\*\* PYR EULER SEQUENCE \*\*\*

Attitude Timeline

MET/GMT	MNVR OPTION	DAP	E/S	REF ATT/REMARKS	EVENT
61 009/18:39:00 MET 44:36 054/02:38:00 GMT 43:36	INRTL R= 92.00 MNVR P=218.00 Y= 17.00	A1 RATE 0.2000 AUTO DB AT 1.000 VERN DB RT 0.020	SUN R 248 P 154	-Y: 38 -Z: 13	IMU ALIGN
62 009/18:51:00 MET 56:55 054/02:50:00 GMT 55:55	INRTL R=195.00 MNVR P=339.00 Y= 32.00	B1 RATE 0.5000 AUTO DB AT 3.00 PRI DB RT 0.20	SUN R 108 P 64	-Y: 21 -Z: 49	IMU VERIF
63 009/19:05:00 MET 16:37 054/03:04:00 GMT 15:37	INRTL R= 98.70 MNVR P=158.30 Y= 22.70	A1 RATE 0.2000 AUTO DB AT 1.000 VERN DB RT 0.020	SUN R 90 P 150		COMM ATT
64 009/21:10:00 MET 23:23 054/05:09:00 GMT 22:23	INRTL R=167.00 MNVR P=305.00 Y= 69.00	A1 RATE 0.2000 AUTO DB AT 1.000 VERN DB RT 0.020	SUN R 163 P 104		D/O BURN ATT TIG 9/21:32

\*\*\* ALL ATTITUDES IN MEAN OF 1950 \*\*\*  
\*\*\* PYR EULER SEQUENCE \*\*\*

**This Page Intentionally Blank**

STS-82 FLIGHT PLAN NOTES

FLIGHT PLAN  
NOTES

FLIGHT PLAN NOTES  
(CONSTRAINTS AND GUIDELINES)

A. FLIGHT DESCRIPTION

Orbiter: OV103/Discovery  
 Inclination: 28.45°  
 Insertion Altitude: 102 X 314 nm  
 HST Capture Altitude: 317 X 322 nm  
 Duration: 10 + 2 days

B. MAJOR EVENTS

<u>EVENT</u>	<u>MET</u>	<u>ΔV</u> (fps)	<u>ORBIT</u> (nm)
Launch	00/00:00	--	--
OMS-2	00/00:45	126.5	102/314
NC-1	00/05:25	8.0	107/314
NPC	00/22:33	2.0	107/314
NSR	01/03:09	352.3	310/316
NC-2	01/03:50	4.0	312/317
NH	01/16:39	6.7	313/320
NC-3	01/17:29	4.3	315/320
NCC	01/19:41	0.0	315/320
Ti	01/20:41	3.1	316/321
HST Grapple	01/22:54	--	317/322
HST Release	06/21:01	--	319/321
SEP-1	06/21:02	0.5	319/321
SEP-2	06/21:36	2.5	318/320
Deorbit	09/21:32	--	--
Landing	09/22:47	--	--

C. LANDING OPPORTUNITIES

		<u>Landing Orbit</u>	<u>Site</u>	<u>Local Time</u>	<u>MET</u>
		<u>No.</u>			
Nominal	Primary	150	KSC	01:46 EST	09/22:47
	1 Rev Late	151	KSC	03:28 EST	10/00:29
1 Day Late	Primary	164	KSC	00:11 EST	10/21:12
	1 Rev Late	165	KSC	01:53 EST	10/22:54
2 Days Late	Primary	179	KSC	00:18 EST	11/21:19
	1 Rev Late	180	KSC	02:01 EST	11/23:02

D. CREW

CDR - Ken Bowersox  
 PLT - Scott Horowitz  
 MS1/EV4 - Joe Tanner  
 MS2 - Steve Hawley  
 MS3/EV3 - Greg Harbaugh  
 MS4/EV1/  
 PL CDR - Mark Lee  
 MS5/EV2 - Steve Smith

FLIGHT PLAN  
NOTES

**EVA Teams:**

- EVA #1 - EV1 and EV2
- EVA #2 - EV3 and EV4
- EVA #3 - EV1 and EV2
- EVA #4 - EV3 and EV4
- HST Unscheduled EVA - EV1 and EV2

**E. COMMUNICATIONS**

TDRS Support: East (41° W), West (174° W), Z (85° E)  
Backup Real-Time TV: GDS(GDX), MIL(MLX)  
Contingency GSTDN: DFR\*, MIL(MLX)\*, BDA(BDX)\*, GDS(GDX)\*, and WLP  
Contingency RTS: HTS, GTS, VTS, CTS, DGS, OTS\*, and HNS

\*UHF capability

Lead time for site callup: GSTDN - 2 hr, RTS - 4 hr

During rendezvous, critical commanding periods, and deploy, DGS will fill the ZOE between the TDRS. These important passes are identified on the summary and detailed timelines by a box which is centered on the applicable ZOE. DGS is also planned to fill the ZOE during the EVAs, but these are not reflected in the Flight Plan.

**F. PAYLOADS**

**1. Hubble Space Telescope Servicing Mission (SM) 2**

The HST SM 2 objective is to retrieve, repair, and release the HST. Four scheduled EVAs are planned to accomplish the following:

- Install the Berthing and Position Support (BAPS) Post
- Exchange the Faint Object Spectrograph (FOS) with the Near Infrared Camera Multi-Object Spectrometer (NICMOS)
- Exchange Goddard High Resolution Spectrograph (GHRS) with the Space Telescope Imaging Spectrograph (STIS)
- Exchange ESTR #1 with Solid State Data Recorder (SSR) #1
- Replace Fine Guidance Sensor (FGS) #1
- Install the Optical Control Electronics Enhancement (OCE) Kit
- Replace the Engineering and Science Tape Recorder (ESTR) #2
- Replace Data Interface Unit (DIU) #2
- Replace Solar Array Drive Electronics (SADE) #2
- Install SADE #1 screws
- Install Magnetic Sensing System (MSS) Covers

The payload complement for this mission includes the FSS, the Orbital Replaceable Unit Carrier (ORUC), and the Solar Array Carrier (SAC). The FSS provides a maneuverable servicing platform for the HST and electrical power interfaces to the orbiter.

Reboost of HST is highly desired for SM 2 and will be accomplished if time and prop margins are available.

## G. SECONDARY MIDDECK PAYLOAD

### Midcourse Space Experiment (MSX)

The MSX objectives include understanding high energy molecular dynamics of plume radiant processes, observing a resident space object, and supporting International Space Station (ISS) risk mitigation. It is a payload of opportunity which has no on-board hardware and has no planned scheduled activities.

## H. ON-ORBIT DTOs

### 1. Radiation Measurements in Shuttle Crew Compartment (DTO 684)

The objectives of this investigation are to measure the linear energy transfer spectrum of the complex space radiation in the shuttle crew compartment, to provide an accurate measurement of biologically effective dose equivalent, and to evaluate risk of single event upsets (SEUs) in shuttle avionics. This is necessary for assessing and managing health risk from exposure to space radiation.

### 2. Handheld Lidar (HHL) Procedures (uses existing manifested flight hardware: Core or HST requirements) (DTO 840)

The purpose of this DTO is to evaluate the performance of the Handheld Lidar (HHL) as a stand-alone proximity operations tool. HHL range and range rate data will be taken and stored in the onboard Rendezvous and Prox-ops Program (RPOP) for postflight evaluation and ground simulator model updates for rendezvous and docking/grapple flights.

## I. ON-ORBIT DSOs

### 1. Interaction of the Space Shuttle Launch and Entry Suit and Sustained Weightlessness on Egress Locomotion (DSO 331)

This study is designed to investigate the effect of the Space Shuttle Launch Entry Suit/Advanced Crew Escape Suit (LES/ACES) on crew locomotion and the emergency egress capacity of crewmembers at wheels stop.

### 2. Immunological Assessment of Crewmembers (DSO 487)

As shuttle missions durations increase, the potential development of infectious illness in crewmembers during flight also increases. This study will improve the understanding of the potential impacts of spaceflight-induced immunological alterations on crewmember health and performance. There are no on-orbit crew activities associated with this DSO.

### 3. Monitoring Latent Virus Reactivation and Shedding in Astronauts (DSO 493)

This DSO will study spaceflight-induced immunocompetence focusing on the potential for reactivation and dissemination (shedding) of latent viruses. Saliva samples will be collected daily from participating crewmembers.



STS-82 DAP BOOK

DAP BOOK



<u>DAP</u>	<u>PURPOSE</u>	<u>DAP</u>	<u>PURPOSE</u>
A1	- NOMINAL	B1	- NOMINAL
A2	- PTC		OMS & RCS BURNS
A3	- GG	B2	- LOSS OF VERN
A4	- PRE/POST DEPLOY		(TAIL ONLY)
A5	- LOSS OF VERN	B3	- LOSS OF VERN
	(NOSE & TAIL)		(NOSE & TAIL)
A7	- RENDEZVOUS	B4	- SSUS DEPLOY
A8	- PROX OPS	B5	- COAS CAL
A9	- HST RMS	B7	- RENDEZVOUS
A10	- HST BERTHED	B8	- PROX OPS
		B9	- HST RELEASE
		B10	- NORMAL HST
			BERTHED
		B11	- SLOW HST
			BERTHED
		B12	- SLOW HST
			RMS
		B14	- VRCS REBOOST

CNT ACC = 0 UNLOADED RMS  
 = 1 ALL HST RMS POSN  
 = 2-5 NOT USED



FLT PLN-1a/82/O/B

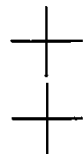

This DAP Book Page Intentionally Blank



FLT PLN-1b/82/O/A



(reduced copy)



**DAP A**



**DAP A1**

PURPOSE:  
NOMINAL

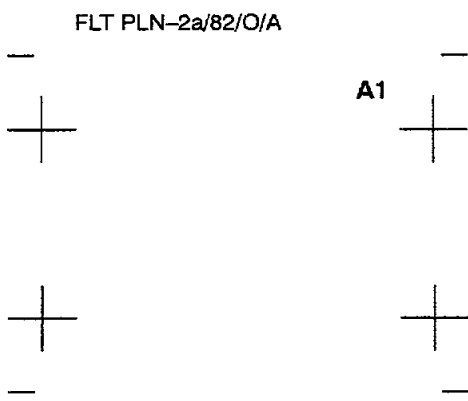

FLT PLN-2a/82/O/A

**A1**

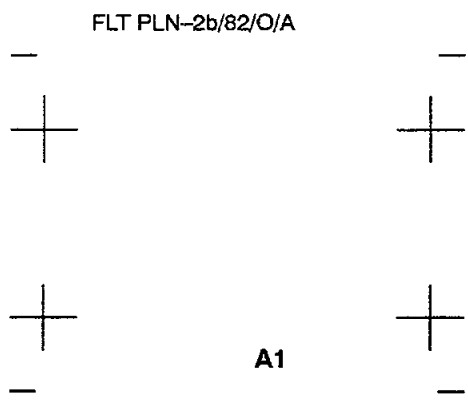

FLT PLN-2b/82/O/A

**A1**

**A1**

**DAP A2**

PURPOSE:  
PTC

DAP A 0 1	1	PRI
0.2 0 0 0	10	ROT RATE
- 5.0 0	11	ATT DB
0.2 0	12	RATE DB
0.1 0	13	ROT PLS
0.0 0	14	COMP
ALL	15	P OPTION
ALL	16	Y OPTION
0.1 0	17	TRAN PLS
		ALT
0.2 0 0	18	RATE DB
ALL	19	JET OPT
2	20	#JETS
0.0 8	21	ON TIME
- 0.0 0	22	DELAY
		VERN
0.2 0 0 0	23	ROT RATE
- 1.0 0 0	24	ATT DB
0.2 0	25	RATE DB
0.0 1 0	26	ROT PLS
0.0 0	27	COMP
0	28	CNTL ACC

FLT PLN-3a/82/O/A

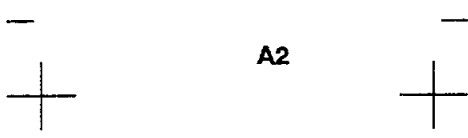

**A2**



FLT PLN-3b/82/O/A

(reduced copy)



DAP A 0 2	1	PRI
<u>0.4 0 0 0</u>	10	ROT RATE
<u>- 1.0 0</u>	11	ATT DB
<u>0.2 0</u>	12	RATE DB
<u>0.1 0</u>	13	ROT PLS
<u>.0 0 0</u>	14	COMP
ALL	15	P OPTION
ALL	16	Y OPTION
<u>0.1 0</u>	17	TRAN PLS
		ALT
<u>0.2 0 0</u>	18	RATE DB
ALL	19	JET OPT
<u>2</u>	20	#JETS
<u>0.0 8</u>	21	ON TIME
<u>- 0.0 0</u>	22	DELAY
		VERN
<u>0.4 0 0 0</u>	23	ROT RATE
<u>- 1.0 0 0</u>	24	ATT DB
<u>.0 2 0</u>	25	RATE DB
<u>0.0 1 0</u>	26	ROT PLS
<u>.0 0 0</u>	27	COMP
<u>0</u>	28	CNTL ACC

FLT PLN-4a/82/O/A

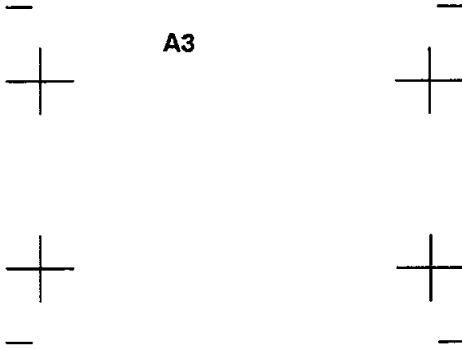

DAP A 0 3	1	PRI
<u>0.2 0 0 0</u>	10	ROT RATE
<u>- 1.0 0</u>	11	ATT DB
<u>0.2 0</u>	12	RATE DB
<u>0.1 0</u>	13	ROT PLS
<u>.0 0 0</u>	14	COMP
ALL	15	P OPTION
TAIL	16	Y OPTION
<u>0.1 0</u>	17	TRAN PLS
		ALT
<u>0.2 0 0</u>	18	RATE DB
ALL	19	JET OPT
<u>2</u>	20	#JETS
<u>- 0.0 8</u>	21	ON TIME
<u>- 0.0 0</u>	22	DELAY
		VERN
<u>0.0 0 8 0</u>	23	ROT RATE
<u>- 0.0 7 0</u>	24	ATT DB
<u>.0 1 0</u>	25	
<u>0.0 1 0</u>	26	ROT PLS
<u>.0 0 0</u>	27	COMP
<u>0</u>	28	CNTL ACC

FLT PLN-5a/82/O/A

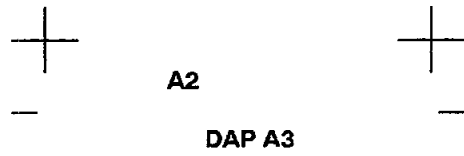

PURPOSE:  
GG

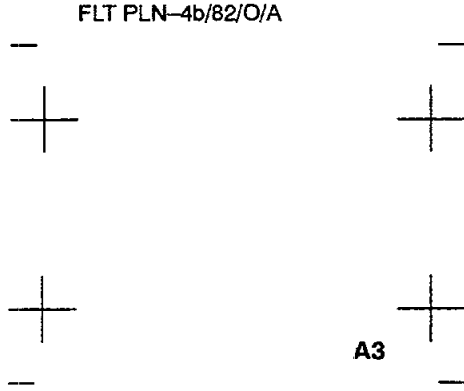

PURPOSE:  
PRE/POST DEPLOY

FLT PLN-5b/82/O/A

(reduced copy)

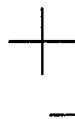

**A4**

DAP A 0 4	1	PRI
<u>0.5 0 0 0</u>	10	ROT RATE
<u>- 3.0 0</u>	11	ATT DB
<u>- 0.2 0</u>	12	RATE DB
<u>0.1 0</u>	13	ROT PLS
<u>0.0 0</u>	14	COMP
ALL	15	P OPTION
ALL	16	Y OPTION
<u>0.1 0</u>	17	TRAN PLS
		ALT
<u>0.2 0 0</u>	18	RATE DB
ALL	19	JET OPT
2	20	#JETS
<u>0.0 8</u>	21	ON TIME
<u>- 0.0 0</u>	22	DELAY
		VERN
<u>0.2 0 0 0</u>	23	ROT RATE
<u>- 1.0 0 0</u>	24	ATT DB
<u>- 0.2 0</u>	25	RATE DB
<u>0.0 1 0</u>	26	ROT PLS
<u>- 0.0 0</u>	27	COMP
0	28	CNTL ACC

FLT PLN-6a/82/O/A

**A4**

**DAP A5**

PURPOSE:  
LOSS OF VERN  
(NOSE & TAIL)

FLT PLN-6b/82/O/A

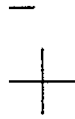
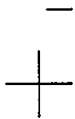
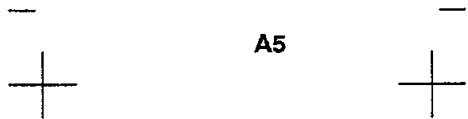

**A5**



**A5**

DAP A 0 5	1	PRI
<u>0.2 0 0 0</u>	10	ROT RATE
<u>- 5.0 0</u>	11	ATT DB
<u>- 0.2 0</u>	12	RATE DB
<u>0.1 0</u>	13	ROT PLS
<u>0.0 0</u>	14	COMP
ALL	15	P OPTION
ALL	16	Y OPTION
<u>0.1 0</u>	17	TRAN PLS
		ALT
<u>0.0 7 0</u>	18	RATE DB
ALL	19	JET OPT
1	20	#JETS
<u>0.0 8</u>	21	ON TIME
<u>- 0.0 0</u>	22	DELAY
		VERN
<u>0.2 0 0 0</u>	23	ROT RATE
<u>- 1.0 0 0</u>	24	ATT DB
<u>- 0.2 0</u>	25	RATE DB
<u>0.0 1 0</u>	26	ROT PLS
<u>- 0.0 0</u>	27	COMP
0	28	CNTL ACC

FLT PLN-7a/82/O/A

**A5**

**DAP A7**

PURPOSE:  
RENDEZVOUS

FLT PLN-7b/82/O/A



**A7**

(reduced copy)



**A7**

**DAP A8**

DAP A 0 7	1	PRI
0.2 0 0 0	10	ROT RATE
- 2.0 0	11	ATT DB
- 0.2 0	12	RATE DB
0.1 0	13	ROT PLS
.0 0 0	14	COMP
ALL	15	P OPTION
ALL	16	Y OPTION
0.1 0	17	TRAN PLS
		ALT
0.2 0 0	18	RATE DB
ALL	19	JET OPT
2	20	#JETS
0.0 8	21	ON TIME
- 0.0 0	22	DELAY
		VERN
0.2 0 0 0	23	ROT RATE
- 1.0 0 0	24	ATT DB
- 0.2 0	25	RATE DB
0.0 1 0	26	ROT PLS
.0 0 0	27	COMP
0	28	CNTL ACC

PURPOSE:  
PROX OPS

FLT PLN-8a/82/O/A

FLT PLN-8b/82/O/A



**A8**

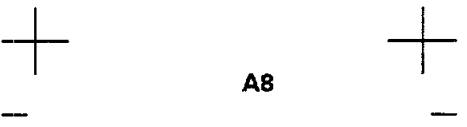

**A8**

**DAP A9**

DAP A 0 8	1	PRI
0.2 0 0 0	10	ROT RATE
- 2.0 0	11	ATT DB
- 0.2 0	12	RATE DB
0.1 0	13	ROT PLS
.0 0 0	14	COMP
ALL	15	P OPTION
ALL	16	Y OPTION
0.0 5	17	TRAN PLS
		ALT
0.2 0 0	18	RATE DB
ALL	19	JET OPT
2	20	#JETS
0.0 8	21	ON TIME
- 0.0 0	22	DELAY
		VERN
0.2 0 0 0	23	ROT RATE
- 1.0 0 0	24	ATT DB
- 0.2 0	25	RATE DB
0.0 1 0	26	ROT PLS
.0 0 0	27	COMP
0	28	CNTL ACC

PURPOSE:  
HST RMS

FLT PLN-9a/82/O/A

FLT PLN-9b/82/O/B

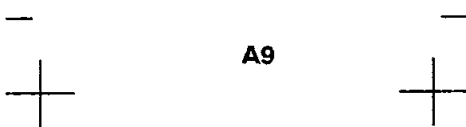

**A9**

(reduced copy)

A9

DAP A10

PURPOSE:

HST BERTHED

DAP A 0 9	1/3	PRI
0.1 0 0 0	10/50	ROT RATE
- 5.0 0	11/51	ATT DB
- 0.2 0	12/52	RATE DB
0.0 4	13/53	ROT PLS
0.0 0	14/54	COMP
TAIL	15/55	P OPTION
TAIL	16/56	Y OPTION
0.0 5	17/57	TRAN PLS
		ALT
0.1 0 0	18/58	RATE DB
TAIL	19/59	JET OPT
2	20/60	#JETS
0.0 8	21/61	ON TIME
1 3.1 0	22/62	DELAY
		VERN
0.1 0 0 0	23/63	ROT RATE
- 2.0 0 0	24/64	ATT DB
- 0.5 0	25/65	RATE DB
0.0 0 5	26/66	ROT PLS
0.0 0	27/67	COMP
1(2,3,4)	28/68	CNTL ACC

FLT PLN-10a/82/O/B

FLT PLN-10b/82/O/A

A10

A10

A10

DAP A 1 0	1/3	PRI
0.1 0 0 0	10/50	ROT RATE
- 5.0 0	11/51	ATT DB
- 0.2 0	12/52	RATE DB
0.0 4	13/53	ROT PLS
0.0 0	14/54	COMP
TAIL	15/55	P OPTION
TAIL	16/56	Y OPTION
0.0 5	17/57	TRAN PLS
		ALT
0.1 0 0	18/58	RATE DB
TAIL	19/59	JET OPT
2	20/60	#JETS
0.0 8	21/61	ON TIME
1 7.4 0	22/62	DELAY
		VERN
0.2 0 0 0	23/63	ROT RATE
- 1.0 0 0	24/64	ATT DB
- 0.2 0	25/65	RATE DB
0.0 0 5	26/66	ROT PLS
0.0 0	27/67	COMP
4(5)	28/68	CNTL ACC

FLT PLN-11a/82/O/B

FLT PLN-11b/82/O/A

(reduced copy)



### DAP B



### DAP B1

PURPOSE:

NOMINAL; OMS &  
RCS BURNS

FLT PLN-12a/82/O/A

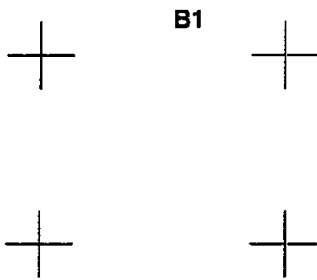

B1

B1

2	DAP B 0 1
30	<u>0.5 0 0 0</u>
31	<u>- 3.0 0</u>
32	<u>0.2 0</u>
33	<u>0.0 4</u>
34	<u>.0 0 0</u>
35	ALL
36	ALL
37	<u>0.1 0</u>
38	<u>0.2 0 0</u>
39	ALL
40	<u>2</u>
41	<u>0.0 8</u>
42	<u>- 0.0 0</u>
43	<u>0.2 0 0 0</u>
44	<u>- 1.0 0 0</u>
45	<u>.0 2 0</u>
46	<u>0.0 0 2</u>
47	<u>.0 0 0</u>
48	<u>0</u>

FLT PLN-13a/82/O/A



B2

FLT PLN-12b/82/O/A

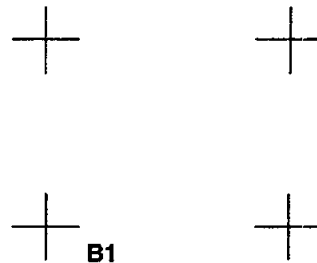

B1

### DAP B2

PURPOSE:

LOSS OF VERN  
(TAIL ONLY)

FLT PLN-13b/82/O/A



(reduced copy)





**B2**

2	DAP B 0 2
30	<u>0.2 0 0 0</u>
31	<u>- 3.0 0</u>
32	<u>0.2 0</u>
33	<u>0.0 4</u>
34	<u>.0 0 0</u>
35	TAIL
36	TAIL
37	<u>0.0 2</u>
38	<u>0.0 7 0</u>
39	TAIL
40	<u>1</u>
41	<u>0.0 8</u>
42	<u>- 0.0 0</u>
43	<u>0.2 0 0 0</u>
44	<u>- 1.0 0 0</u>
45	<u>.0 2 0</u>
46	<u>0.0 0 2</u>
47	<u>.0 0 0</u>
48	<u>0</u>

FLT PLN-14a/82/O/A

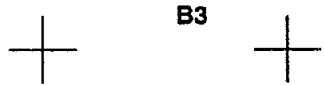

**B3**



**B3**

2	DAP B 0 3
30	<u>0.2 0 0 0</u>
31	<u>- 3.0 0</u>
32	<u>0.2 0</u>
33	<u>0.0 4</u>
34	<u>.0 0 0</u>
35	ALL
36	ALL
37	<u>0.0 2</u>
38	<u>0.0 7 0</u>
39	ALL
40	<u>1</u>
41	<u>0.0 8</u>
42	<u>- 0.0 0</u>
43	<u>0.2 0 0 0</u>
44	<u>- 1.0 0 0</u>
45	<u>.0 2 0</u>
46	<u>0.0 0 2</u>
47	<u>.0 0 0</u>
48	<u>0</u>

FLT PLN-15a/82/O/A

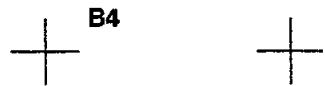

**B4**

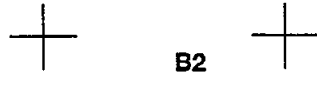

**B2**

**DAP B3**

PURPOSE:  
LOSS OF VERN  
(NOSE & TAIL)

FLT PLN-14b/82/O/A



**B3**

**DAP B4**

PURPOSE:  
SSUS DEPLOY

FLT PLN-15b/82/O/A



(reduced copy)



**B4**

2	DAP B 0 4
30	<u>0.2 0 0 0</u>
31	<u>- 0.3 0</u>
32	<u>0.2 0</u>
33	<u>0.0 4</u>
34	<u>.0 0 0</u>
35	TAIL
36	TAIL
37	<u>0.0 2</u>
38	<u>0.2 0 0</u>
39	ALL
40	2
41	<u>0.0 8</u>
42	<u>- 0.0 0</u>
43	<u>0.0 0 8 0</u>
44	<u>- 0.1 0 0</u>
45	<u>.0 1 0</u>
46	<u>0.0 0 2</u>
47	<u>.0 0 0</u>
48	<u>0</u>

FLT PLN-16a/82/O/A



**B5**



**B5**

2	DAP B 0 5
30	<u>0.2 0 0 0</u>
31	<u>- 3.0 0</u>
32	<u>0.2 0</u>
33	<u>0.0 4</u>
34	<u>.0 0 0</u>
35	TAIL
36	TAIL
37	<u>0.0 2</u>
38	<u>0.2 0 0</u>
39	ALL
40	2
41	<u>0.0 8</u>
42	<u>- 0.0 0</u>
43	<u>0.0 1 6 0</u>
44	<u>- 0.0 3 3</u>
45	<u>.0 2 0</u>
46	<u>0.0 0 2</u>
47	<u>.0 0 0</u>
48	<u>0</u>

FLT PLN-17a/82/O/A



**B7**



**B4**

**DAP B5**

PURPOSE:  
COAS CAL

FLT PLN-16b/82/O/A



**B5**

**DAP B7**

PURPOSE:  
RENDEZVOUS

FLT PLN-17b/82/O/A



(reduced copy)



**B7**

2	DAP B 0 7
30	<u>0.5 0 0 0</u>
31	<u>- 2.0 0</u>
32	<u>0.2 0</u>
33	<u>0.0 4</u>
34	<u>.0 0 0</u>
35	ALL
36	ALL
37	<u>0.0 5</u>
38	<u>0.2 0 0</u>
39	ALL
40	2
41	<u>0.0 8</u>
42	<u>- 0.0 0</u>
43	<u>0.2 0 0 0</u>
44	<u>- 1.0 0 0</u>
45	<u>.0 2 0</u>
46	<u>0.0 0 2</u>
47	<u>.0 0 0</u>
48	0

FLT PLN-18a/82/O/A



**B8**



**B8**

2	DAP B 0 8
30	<u>0.2 0 0 0</u>
31	<u>- 2.0 0</u>
32	<u>0.2 0</u>
33	<u>0.0 4</u>
34	<u>.0 0 0</u>
35	ALL
36	ALL
37	<u>0.0 1</u>
38	<u>0.2 0 0</u>
39	ALL
40	2
41	<u>0.0 8</u>
42	<u>- 0.0 0</u>
43	<u>0.2 0 0 0</u>
44	<u>- 1.0 0 0</u>
45	<u>.0 2 0</u>
46	<u>0.0 0 2</u>
47	<u>.0 0 0</u>
48	0

FLT PLN-19a/82/O/A



**B9**



**B7**

**DAP B8**

PURPOSE:  
PROX OPS

FLT PLN-18b/82/O/A



**B8**

**DAP B9**

PURPOSE:  
HST RELEASE

FLT PLN-19b/82/O/A



(reduced copy)



**B9**

2/4	DAP B <u>0 9</u>
30/50	<u>0.0 5 0 0</u>
31/51	- <u>2.0 0</u>
32/52	<u>0.2 0</u>
33/53	<u>0.0 4</u>
34/54	<u>.0 0 0</u>
35/55	TAIL
36/56	TAIL
37/57	<u>0.0 1</u>
38/58	<u>0.1 0 0</u>
39/59	TAIL
40/60	<u>2</u>
41/61	<u>0.0 8</u>
42/62	<u>1 3.1 0</u>
43/63	<u>0.0 2 4 0</u>
44/64	- <u>0.5 0 0</u>
45/65	<u>.0 3 0</u>
46/66	<u>0.0 0 5</u>
47/67	<u>.0 0 0</u>
48/68	<u>1</u>

FLT PLN-20a/82/O/B



**B10**



**B10**

2/4	DAP B <u>1 0</u>
30/50	<u>0.1 0 0 0</u>
31/51	- <u>5.0 0</u>
32/52	<u>0.2 0</u>
33/53	<u>0.0 4</u>
34/54	<u>.0 0 0</u>
35/55	TAIL
36/56	TAIL
37/57	<u>0.0 1</u>
38/58	<u>0.1 0 0</u>
39/59	TAIL
40/60	<u>2</u>
41/61	<u>0.0 8</u>
42/62	<u>1 7.4 0</u>
43/63	<u>0.1 0 0 0</u>
44/64	- <u>3.0 0 0</u>
45/65	<u>.0 2 0</u>
46/66	<u>0.0 0 5</u>
47/67	<u>.0 0 0</u>
48/68	<u>4</u>

FLT PLN-21a/82/O/B



**B11**



**B9**

**DAP B10**

PURPOSE:

NORMAL HST  
BERTHED

FLT PLN-20b/82/O/B

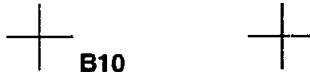

**B10**

**DAP B11**

PURPOSE:

SLOW HST  
BERTHED

FLT PLN-21b/82/O/B

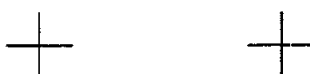

(reduced copy)



**B11**

2/4	DAP B 1 1
30/50	<u>0.0 5 0 0</u>
31/51	- <u>5.0 0</u>
32/52	<u>0.2 0</u>
33/53	<u>0.0 4</u>
34/54	<u>.0 0 0</u>
35/55	TAIL
36/56	TAIL
37/57	<u>0.0 5</u>
38/58	<u>0.1 0 0</u>
39/59	TAIL
40/60	2
41/61	<u>0.0 8</u>
42/62	<u>1 7.4 0</u>
43/63	<u>0.0 1 6 0</u>
44/64	- <u>1.0 0 0</u>
45/65	<u>.0 2 0</u>
46/66	<u>0.0 0 5</u>
47/67	<u>.0 0 0</u>
48/68	4(5)

FLT PLN-22a/82/O/B



**B12**



**B12**

2/4	DAP B 1 2
30/50	<u>0.0 5 0 0</u>
31/51	- <u>5.0 0</u>
32/52	<u>0.2 0</u>
33/53	<u>0.0 4</u>
34/54	<u>.0 0 0</u>
35/55	TAIL
36/56	TAIL
37/57	<u>0.0 5</u>
38/58	<u>0.1 0 0</u>
39/59	TAIL
40/60	2
41/61	<u>0.0 8</u>
42/62	<u>1 3.1 0</u>
43/63	<u>0.0 1 6 0</u>
44/64	- <u>2.0 0 0</u>
45/65	<u>.0 5 0</u>
46/66	<u>0.0 0 5</u>
47/67	<u>.0 0 0</u>
48/68	1(2,3,4)

FLT PLN-23a/82/O/B



**B14**



**B11**

**DAP B12**

PURPOSE:  
SLOW HST  
RMS

FLT PLN-22b/82/O/B



**B12**

**DAP B14**

PURPOSE:  
VRCS REBOOST

FLT PLN-23b/82/O/B



(reduced copy)



B14

**B14**

2/4	DAP B 1 4
30/50	<u>0.1 0 0 0</u>
31/51	- <u>5.0 0</u>
32/52	<u>0.2 0</u>
33/53	<u>0.0 4</u>
34/54	<u>.0 0 0</u>
35/55	TAIL
36/56	TAIL
37/57	<u>0.0 1</u>
38/58	<u>0.1 0 0</u>
39/59	TAIL
40/60	<u>2</u>
41/61	<u>0.0 8</u>
42/62	<u>1 7.4 0</u>
43/63	<u>0.4 0 0 0</u>
44/64	- <u>1.0 0 0</u>
45/65	<u>.0 2 0</u>
46/66	<u>0.0 4 0</u>
47/67	<u>.0 0 0</u>
48/68	<u>4</u>

FLT PLN-24a/82/O/B



FLT PLN-24b/82/O/B



UNIV PTG	
TGT ID =	1 Orbiting Vehicle
	= 2 Earth ctr
	= 3 Earth tgt
	Input LAT ( $\pm 90$ )
	LON ( $\pm 180$ , + = East)
	ALT (-3444.0 to
	20000.0 nm)
	= 4 Sun ctr
	= 5 Celestial tgt
	Input RA (0-359.99)
	DEC ( $\pm 90$ )
	= 11-110 Nav Stars
BODY VECT =	1 +X*
	= 2 -X*
	= 3 -Z*
	= 4 -Y Star Tracker*
	= 5 Optional
	Input P (0-359.99)
	Y (270-359.99, 0-90)
*Input OM →	OM (0-359.99)
MON AXIS =	1 +X
	= 2 -X

FLT PLN-25/82/O/A

FLT PLN-25/82/O/A is mounted on the back of the DAP Book

**This Page Intentionally Blank**



NASA HEADQUARTERS  
ME/PERRY, C.F. (2)  
ME/POSEY, G.  
MZD/MILLER, H.  
PM/MC CULLA, J.W.  
PT/SHAFER, R.  
UO/DOARN, C.  
US/ZWIERKO, R.

---

NASA KSC  
CV-PSD-1/MACKEY, A.J.  
F264/HUNTER, R.  
KSC/KSC TECH LIBRARY-D  
PA-PIB/GRINTER, K.  
TP-LOD-1/SOWASH, S. (2)  
TP-PED-3/VITT OFFICE  
TP-PED-3A/CREW QUARTERS  
USK-215/KELLY, T.E.  
USK-247/HOOPER, J. (2)

---

NASA LERC  
TSC 333-1/CARLISLE-MORGAN, K.L.

---

NASA MSFC  
CA10/BERG, J.  
CN31D/TECH DOC REPOSITORY  
EL23/JOHNSON, DALE  
EO02/MELTON, T. (2)  
EO26/PDFD MGR (2)  
EO46/BRANCH CHIEF  
EO52/CHIEF DATA MGMT  
NTI/MARSHAL OPERATIONS

---

ROCKWELL-DOWNEY  
841-2, AC85/TAYLOR, B.N.  
AA05/WOOLHOUSE, D.L.  
AC28/HARPER, L.  
AD60/MC MILLAN, B.J.  
AD75/STS DATA MGMT  
AE70/GALLARDO, J.A.  
AE85/BRYON, K.  
FA19/FERGUS, E.M.  
FA35/GULSBY, J.A.  
FA43/SINCLAIR, G.M.  
FA43/SMITH, C.W. (2)  
FA99/LARSON, J.J.  
FB13/FRANK, G.  
FB14/ITO, J.K.  
FB75/MC DERMOTT, W.A.

FC94/GOOSSENS, M.H.  
FC94/IMPASTATO, J.  
FC95/FRIEND, R.

---

FALCON AIR FORCE BASE  
LAUNCH OPS  
50 OSS/OSPL  
300 O'MALEY AVENUE  
SUITE 26  
FALCON, CO 80912-5000  
LAUNCH OPERATIONS OFF

---

\*\* U.S. MAIL \*\*

---

LOCKHEED MARTIN HST DATA CENTR  
7474 GREENWAY CENTER DRIVE  
SUITE 200  
GREENBELT  
MD. 20770  
ATTN:/HELMS, B. (6)

---

MCDONNELL DOUGLAS-HUNTSVILLE  
689 DISCOVERY DRIVE  
HUNTSVILLE, AL 35806  
21A1/SPACELAB LIBRARY

---

ALLIED SIGNAL CORPORATION  
GODDARD CORPORATE PARK  
7515 MISSION DRIVE  
LANHAM, MD 20706  
NOG/MMU/SIDOTTIL, J. (2)

---

CANADIAN ASTRONAUT PROGRAM  
CANADIAN SPACE AGENCY  
6767 ROUTE DE L'AEROPORT  
SAINT-HUBERT, QUEBEC  
J3Y 8Y9  
CANADA  
KHAN, F.

---

DRAPER LABORATORIES  
555 TECHNOLOGY SQUARE  
CAMBRIDGE, MA 02139-3539  
81/SARGENT, D.  
KACHMAR, P.

---

GTE GOVERNMENT SYSTEMS CORP-NM  
P O BOX 235  
LAS CRUCES, NM 88004  
GC/GOMEZ, N.

---

HAMILTON STANDARD  
BRADLEY FIELD RD.  
WINDSOR LOCKS, CT 06096  
1A-2-X65/AUMAN, J.

---

INTERMETRICS, INC., HST  
1100 HERCULES SUITE 300  
HOUSTON, TX 77058  
ATTN:/HUTCHINS, J.

---

INTERMETRICS, INC., WA  
2025 112TH AVE.  
SUITE 301  
BELLEVUE, WA 98004  
NIKKEL, G.

---

NASA GSFC-AL  
116 JETPLEX CIRCLE  
MADISON, AL 35758  
442/OLSON, K.

---

ROCKWELL INTERNATIONAL CORP.  
ROCKETDYNE DIVISION  
6633 CANOGA AVENUE  
CANOGA PARK, CA 91303  
055-LA38/CONNOR, T.J.

---

SPAR AEROSPACE  
9445 AIRPORT ROAD  
BRAMPTON, ONTARIO  
CANADA L6S4J3  
WOODLAND, C. (2)

---

TELEDYNE BROWN ENGINEERING  
CUMMINGS RESEARCH PARK  
300 SPARKMAN DRIVE, NW  
P. O. BOX 70007  
HUNTSVILLE, AL 35807-7007  
MS 172/GILCHRIST, M.

---

\*\*\*\*\*  
Total 416  
(01/07/97 - CFERHAND)

---

NOTE  
\* FOR CHANGES \*  
\* IN DISTRIBUTION \*  
\* OR ADDRESS CORRECTIONS \*  
\* CONTACT THE \*  
\* PROCEDURES MANAGEMENT \*  
\* OFFICE AT MAILCODE D035 \*  
\* OR (713) 244-1184 \*

---