

Space Shuttle Operational Flight Rules

Volume A

All Flights

Mission Operations Directorate

Final

June 20, 2002

PCN-8

May 24, 2007

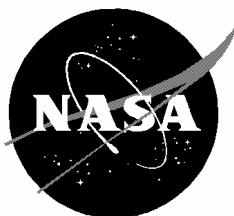

National Aeronautics and
Space Administration

Lyndon B. Johnson Space Center
Houston, Texas

GENERAL, AUTHORITY, AND DEFINITIONS	1
FLIGHT OPERATIONS	2
GROUND INSTRUMENTATION	3
TRAJECTORY AND GUIDANCE	4
BOOSTER	5
PROPULSION	6
DATA SYSTEMS	7
GUIDANCE, NAVIGATION, AND CONTROL (GN&C)	8
ELECTRICAL	9
MECHANICAL	10
COMMUNICATIONS	11
ROBOTICS	12
AEROMEDICAL	13
SPACE ENVIRONMENT	14
EXTRAVEHICULAR ACTIVITY (EVA)	15
POSTLANDING	16
LIFE SUPPORT	17
THERMAL	18
ACRONYMS AND ABBREVIATIONS	A
CHANGE CONTROL	B
WAIVERS	C
HR/CIL CROSS REFERENCE	D

SPACE SHUTTLE OPERATIONAL FLIGHT RULES

ALL FLIGHTS

VOLUME A

FINAL, DATED JUNE 20, 2002
 PCN-1, DATED NOVEMBER 21, 2002
 PCN-2, DATED JUNE 17, 2004
 PCN-3, DATED JANUARY 13, 2005
 PCN-4, DATED APRIL 14, 2005
 PCN-5, DATED FEBRUARY 16, 2006
 PCN-6, DATED JUNE 8, 2006
 PCN-7, DATED NOVEMBER 16, 2006
 PCN-8, DATED MAY 24, 2007

THIS PCN-8 INCORPORATES CHANGES TO THE FOLLOWING RULES BY THE APPLICABLE CHANGE REQUESTS (CR'S).

<u>RULE NO.</u>	<u>CR NO.</u>	<u>RULE NO.</u>	<u>CR NO.</u>	<u>RULE NO.</u>	<u>CR NO.</u>
A1-106	CR 8193A	A3-102	CR 8405A	A5-155	CR 8395B
A1-107	CR 8400	A3-151	CR 8402B	A5-155	CR 8399B
		A3-151	ED	A5-155	ED
A2-1	CR 8411A	A3-152	CR 8402B	A5-156	CR 8395B
A2-1	ED	A3-153	CR 8402B	A5-156	CR 8398
A2-2	CR 8400	A3-154	CR 8402B	A5-156	CR 8399B
A2-2	ED	A3-201	CR 8393	A5-157	CR 8400
A2-4	ED	A3-202	CR 8209A	A5-201	CR 8397A
A2-5	ED	A3-204	CR 8401		
A2-6	CR 8207A			A6-52	CR 8466B
A2-6	ED	A4-5	CR 8387	A6-201	CR 8466B
A2-7	ED	A4-53	CR 8398	A6-305	CR 8466B
A2-51	CR 8368	A4-56	CR 8385B	A6-1001	CR 8466B
A2-52	CR 8208A	A4-56	CR 8399B		
A2-58	CR 8402B	A4-57	CR 8377	A7-3	CR 8489A
A2-58	ED	A4-59	CR 8399B	A7-5	CR 8489A
A2-63	CR 8489A	A4-109	CR 8400	A7-6	CR 8489A
A2-63	ED	A4-112	CR 8480B	A7-53	CR 8400
A2-64	CR 8398	A4-114	CR 8376A	A7-102	CR 8489A
A2-64	CR 8399B	A4-151	CR 8369A	A7-102	ED
A2-68	CR 8394A	A4-154	CR 8371	A7-104	CR 8489A
A2-70	CR 8395B	A4-156	CR 8372	A7-109	CR 8400
A2-70	CR 8399B	A4-203	CR 8389A	A7-109	ED
A2-102	ED	A4-204	CR 8390		
A2-120	CR 8489A	A4-205	CR 8391	A8-1	CR 8400
A2-207	CR 8400	A4-206	CR 8392A	A8-2	CR 8400
A2-207	ED	A4-208	CR 8384	A8-7	CR 8400
A2-254	CR 8489A	A4-212	CR 8381	A8-8	CR 8400
A2-255	CR 8221	A4-259	CR 8402B	A8-52	CR 8373A
A2-264	CR 8222B	A4-260	CR 8400	A8-54	CR 8400
A2-265	CR 8379	A4-260	ED	A8-55	CR 8400
A2-301	CR 8400			A8-55	CR 8489A
A2-301	CR 8466B	A5-5	CR 8395B	A8-61	CR 8400
A2-301	ED	A5-5	CR 8399B	A8-111	CR 8400
A2-1001	CR 8233	A5-9	CR 8395B	A8-111	ED
A2-1001	CR 8466B	A5-9	CR 8399B	A8-115	CR 8382
		A5-102	CR 8399B	A8-1001	CR 8383A
A3-2	CR 7868A	A5-103	CR 8399B	A8-1001	CR 8400
A3-2	CR 8402B	A5-108	CR 8400		
A3-3	CR 8402B	A5-109	CR 8400	A9-1	ED
A3-4	CR 8402B	A5-109	ED	A9-3	CR 8408F
A3-5	CR 8405A	A5-110	CR 8201	A9-51	CR 8478A
A3-51	CR 8400	A5-152	CR 8395B	A9-52	ED
A3-51	CR 8402B	A5-152	CR 8398	A9-55	ED
A3-51	ED	A5-153	CR 8398	A9-56	CR 7823A
A3-54	CR 8400	A5-153	CR 8396A	A9-56	ED
A3-102	CR 8402B	A5-154	CR 8395B	A9-57	ED
		A5-154	ED		

Verify that this is the correct version before use.

<u>RULE NO.</u>	<u>CR NO.</u>	<u>RULE NO.</u>	<u>CR NO.</u>	<u>RULE NO.</u>	<u>CR NO.</u>
A9-58	ED	A10-21	ED	A15-28	CR 8047
A9-61	ED	A10-21	CR 8400	A15-152	CR 8253
A9-101	CR 8408F	A10-23	CR 8400	A15-153	CR 8253
A9-104	CR 8408F	A10-23	ED	A15-154	CR 8253
A9-104	ED	A10-122	CR 8400	A15-156	CR 8253
A9-106	ED	A10-141	ED	A15-157	CR 8253
A9-107	CR 8408F	A10-142	CR 8400	A15-157	ED
A9-107	CR 8478A	A10-142	CR 8472A		
A9-108	ED	A10-142	ED	A16-101	ED
A9-109	ED	A10-207	CR 8400		
A9-152	ED	A10-207	ED	A17-153	CR 7258B
A9-155	ED	A10-209	CR 8400	A17-201	CR 8400
A9-158	CR 8400	A10-209	ED	A17-201	ED
A9-158	ED			A17-254	CR 8400
A9-202	ED	A11-9	CR 7870	A17-254	ED
A9-204	ED	A11-16	CR 8281B		
A9-252	ED	A11-52	CR 8400	A17-405	CR 7366
A9-255	ED	A11-52	ED	A17-757	CR 7136
A9-256	ED	A11-57	CR 7903A	A17-758	CR 7136
A9-260	CR 8400	A11-74	CR 7383A	A17-1001	ED
A9-261	ED				
A9-354	ED	A13-52	CR 8309B	A18-52	CR 8252A
A9-355	ED	A13-53	CR 8400	A18-556	CR 7136
A9-357	ED	A13-54	ED	A18-557	CR 7136
A9-401	CR 8408F	A13-157	CR 8400	A18-604	CR 7136
A9-402	CR 8408F	A13-157	CR 8374B	A18-605	CR 7136
A9-451	CR 8408F	A13-158	CR 8310	A18-606	CR 7136
A9-452	CR 8408F	A13-158	CR 8400		
A9-461	CR 8408F	A13-158	ED		
A9-462	CR 8408F	A13-160	CR 8375		
A9-463	CR 8408F			BOOK MANAGER	JMB 05/24/07
A9-464	CR 8408F			FINAL QA	ned 05/24/07
A9-471	CR 8408F				
A9-1001	CR 8400				
A9-1001	ED				

Verify that this is the correct version before use.

SPACE SHUTTLE OPERATIONAL FLIGHT RULES ANNEX

ALL FLIGHTS

VOLUME A

FINAL, PCN-8

PREFACE

THIS DOCUMENT, VOLUME A, FINAL, PCN-8, DATED MAY 24, 2007, IS THE GENERIC VERSION OF THE SPACE SHUTTLE OPERATIONAL FLIGHT RULES AND IS INTENDED TO BE USED IN CONJUNCTION WITH THE SPACE SHUTTLE OPERATIONAL FLIGHT RULES ANNEX (NSTS-18308) WHICH CONTAINS THE FLIGHT SPECIFIC RULES. INCLUDED IN THIS PUBLICATION ARE FLIGHT RULE CHANGES APPROVED IN FLIGHT RULES CONTROL BOARD (FRCB) MEETINGS #179, 180, 181, AND 182 HELD ON JANUARY 24, FEBRUARY 27, MARCH 28 AND APRIL 25, 2007, RESPECTIVELY.

IT IS REQUESTED THAT ANY ORGANIZATION HAVING COMMENTS, QUESTIONS, OR SUGGESTIONS CONCERNING THESE FLIGHT RULES CONTACT DA8/J. M. BRYANT, FLIGHT DIRECTOR OFFICE, BUILDING 4 NORTH, ROOM 3027, PHONE 281-483-5558.

ALL FLIGHT RULES ARE AVAILABLE ON THE INTERNET. THE URL IS:
HTTP://MOD.JSC.NASA.GOV/DA8. NO ID OR PASSWORD WILL BE REQUIRED TO ACCESS ANY OF THE RULES PROVIDED THE USER IS ACCESSING FROM A TRUSTED SITE (ALL NASA CENTERS, CONTRACTORS, AND INTERNATIONAL PARTNERS). IF UNABLE TO ACCESS, USERS NEED TO SEND AN E-MAIL NOTE TO DA8/M. L. GRIFFITH (MARY.L.GRIFFITH@NASA.GOV) WITH THEIR FULL NAME, COMPANY, IP ADDRESS, AND A JUSTIFICATION STATEMENT FOR ACCESS.

THIS IS A CONTROLLED DOCUMENT AND ANY CHANGES ARE SUBJECT TO THE CHANGE CONTROL PROCEDURES DELINEATED IN APPENDIX B. THIS DOCUMENT IS NOT TO BE REPRODUCED WITHOUT THE WRITTEN APPROVAL OF THE FRCB (CHIEF, FLIGHT DIRECTOR OFFICE), DA8, LYNDON B. JOHNSON SPACE CENTER, HOUSTON, TEXAS.

APPROVED BY:

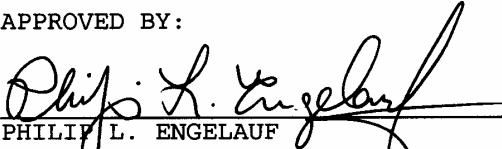
PHILIP L. ENGELAUF
CHIEF, FLIGHT DIRECTOR OFFICE

G. ALLEN FLYNT
DIRECTOR, MISSION OPERATIONS

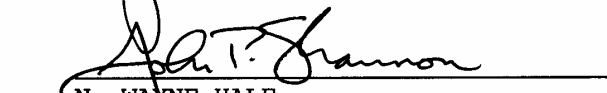
for N. WAYNE HALE
MANAGER, SPACE SHUTTLE PROGRAM

Verify that this is the correct version before use.

FLIGHT RULES

SECTION 1 - OPERATIONS POLICY, GENERAL AND DEFINITIONS

OPERATIONS POLICY

A1-1	FLIGHT RULE PURPOSE.....	1-1
A1-2	REAL-TIME OPERATING POLICY.....	1-1
A1-3	PROGRAM LIFETIME OPERATING POLICY.....	1-2
A1-4	MISSION MANAGEMENT TEAM (MMT) AUTHORITY.....	1-2
A1-5	FLIGHT DIRECTOR AUTHORITY.....	1-3
A1-6	SHUTTLE COMMANDER AUTHORITY.....	1-4
A1-7	FLIGHT CONTROL ROOM (FCR) SURGEON AUTHORITY....	1-4
A1-8	WEATHER DECISION AUTHORITY.....	1-4
A1-9	POSTLANDING DECISION AUTHORITY.....	1-5
A1-10	POSTLANDING EMERGENCY DECLARATION.....	1-7
A1-11	SEARCH AND RESCUE RESPONSIBILITY.....	1-8
A1-12	ORBITER EMERGENCY LANDING SITE (ELS) AUTHORITY.....	1-8
A1-13	MCC REAL-TIME COMMAND COORDINATION POLICY.....	1-9
A1-14	THROUGH A1-50 RULES ARE RESERVED.....	1-12

GENERAL

A1-51	VEHICLE SYSTEM LIMITS.....	1-13
A1-52	INTERIM OR UNCONFIRMED LIMITS.....	1-13
A1-53	MANDATORY INSTRUMENTATION REQUIREMENTS.....	1-13
A1-54	FAILURE DEFINITION APPLICATION.....	1-14
A1-55	CONFLICTING FLIGHT RULES.....	1-14
A1-56	INSTRUMENTATION ONBOARD VS. GROUND READOUT PHILOSOPHY.....	1-15
A1-57	FLIGHT-CRITICAL MODING.....	1-15
A1-58	SHUTTLE OPERATIONAL DATA BOOK (SODB), VOLUME III, DATA USE.....	1-16

FLIGHT RULES

A1-59 ACTIVITIES DURING YEAR END ROLLOVER/LEAP
SECOND INCORPORATION.....1-16

A1-60 THROUGH A1-100 RULES ARE RESERVED.....1-16

GENERAL DEFINITIONS

A1-101 AS SOON AS PRACTICAL (ASAP).....1-17

A1-102 HIGHLY DESIRABLE (HD).....1-17

A1-103 MANDATORY (M).....1-17

A1-104 FLIGHT PHASE.....1-18

A1-105 THROTTLE SETTINGS.....1-19

A1-106 LANDING SITES.....1-19

A1-107 LANDING OPPORTUNITIES.....1-21

A1-108 CREW EGRESS/ESCAPE MODES.....1-22

A1-109 CREW MEDICAL (MED) CONDITIONS.....1-23

A1-110 REMOTE MANIPULATOR SYSTEM (RMS).....1-24

A1-111 TIME REFERENCE DEFINITIONS.....1-25

A1-112 MULTIFUNCTION ELECTRONIC DISPLAY SUBSYSTEM....1-25

FLIGHT RULES

SECTION 1 - OPERATIONS POLICY, GENERAL AND DEFINITIONS

OPERATIONS POLICY

A1-1 **FLIGHT RULE PURPOSE**

THE FLIGHT RULES OUTLINE PREPLANNED DECISIONS DESIGNED TO MINIMIZE THE AMOUNT OF REAL-TIME RATIONALIZATION REQUIRED WHEN NON-NOMINAL SITUATIONS OCCUR FROM THE START OF THE TERMINAL COUNTDOWN THROUGH CREW EGRESS OR GROUND SUPPORT EQUIPMENT (GSE) COOLING ACTIVATION, WHICHEVER OCCURS LATER.

Self-explanatory.

A1-2 **REAL-TIME OPERATING POLICY**

- A. MISSION SUCCESS RELATED REAL-TIME DECISIONS WILL BE MADE WITHIN THE FRAMEWORK OF THE ESTABLISHED SHUTTLE OPERATING BASE DOCUMENTED AS FOLLOWS:
1. PERMISSION DECISIONS - STS OPERATIONAL FLIGHT RULES AND STS OPERATIONAL FLIGHT RULES FLIGHT-SPECIFIC ANNEX DEVELOPED USING THE SYSTEM PERFORMANCE CAPABILITIES DOCUMENTED IN THE SHUTTLE OPERATIONAL DATA BOOK (SODB).
 2. PROGRAM CERTIFIED CAPABILITY - REAL-TIME INTERPRETATION OF THE REQUIREMENTS WILL BE MADE CONSISTENT WITH AUTHORITY DEFINED HEREIN.
- B. CREW SAFETY RELATED DECISIONS WILL BE MADE WITHIN THE FRAMEWORK OF ESTABLISHED SHUTTLE OPERATING BASE (PARAGRAPH A ABOVE) WHEN PRACTICAL. WHEN TIME OR CIRCUMSTANCES DO NOT ALLOW STAYING WITHIN THE OPERATING BASE, THE RESPONSIBLE AUTHORITY MAY CHOOSE TO TAKE ANY NECESSARY ACTION TO ENSURE THE SAFETY OF THE SHUTTLE AND CREW.
- C. WHERE POSSIBLE CONTINGENCY MANAGEMENT WILL BE EMPLOYED TO PROVIDE FOR LANDING AT THE PRIMARY OR SECONDARY LANDING SITE AND TO PROVIDE THE MAXIMUM POSSIBLE GUIDANCE, NAVIGATION, AND CONTROL CAPABILITY FOR ENTRY AND LANDING.

Self-explanatory.

Rule {A1-5}, FLIGHT DIRECTOR AUTHORITY, references this rule.

FLIGHT RULES

A1-3 PROGRAM LIFETIME OPERATING POLICY

SYSTEMS MANAGEMENT FOR NOMINAL OPERATION WILL OBSERVE THE PROGRAM (MULTIPLE FLIGHT) LIFETIME OPERATING LIMITS AND/OR CONSTRAINTS PER THE SODB. HOWEVER, THOSE LIMITS AND/OR CONSTRAINTS MAY BE VIOLATED FOR CONTINGENCY OPERATIONS AS FOLLOWS:

- A. SINGLE-FLIGHT CONTINGENCY MANAGEMENT LIMITS AND/OR CONSTRAINTS MAY BE USED IF AGREED TO PREFLIGHT OR WITH THE CONCURRENCE OF THE MISSION MANAGEMENT TEAM (MMT) IN REAL TIME.
- B. IF THE SINGLE-FLIGHT LIMITS MUST BE VIOLATED, THE BEST ENGINEERING JUDGMENT ON THE LIMITS/CONSTRAINTS THAT PROVIDE THE HIGHEST PROBABILITY OF SUCCESSFUL RECOVERY OF THE CREW AND ORBITER WILL BE USED.

Self-explanatory.

A1-4 MISSION MANAGEMENT TEAM (MMT) AUTHORITY

DURING FLIGHT, THE MMT CHAIRMAN IS RESPONSIBLE FOR NEAR REAL-TIME POLICY DECISIONS AND WILL BE CONSULTED AS SOON AS POSSIBLE WHENEVER OPERATIONS OUTSIDE THE SHUTTLE OPERATING BASE ARE REQUIRED.

Self-explanatory.

FLIGHT RULES

A1-5

FLIGHT DIRECTOR AUTHORITY

- A. THE FLIGHT DIRECTOR IS RESPONSIBLE FOR OVERALL DIRECTION OF SHUTTLE FLIGHTS FROM SOLID ROCKET BOOSTER (SRB) IGNITION UNTIL CREW EGRESS OR GSE COOLING ACTIVATION, WHICHEVER OCCURS LATER:
1. THE FLIGHT DIRECTOR IS RESPONSIBLE FOR REAL-TIME IMPLEMENTATION OF OPERATIONS WITHIN THE FRAMEWORK OF THE SHUTTLE OPERATING BASE (REFERENCE (REF.) RULE {A1-2}, REAL-TIME OPERATING POLICY).
 2. THE FLIGHT DIRECTOR IS RESPONSIBLE FOR PROVIDING RECOMMENDATIONS AND/OR OPTIONS TO THE MMT FOR NEAR REAL-TIME DECISIONS WHEN OPERATING OUTSIDE THE FRAMEWORK OF THE MISSION RULES OR THE SHUTTLE OPERATING BASE.
- B. THE FLIGHT DIRECTOR, AFTER ANALYSIS OF THE FLIGHT CONDITION, MAY CHOOSE TO TAKE ANY NECESSARY REAL-TIME ACTION REQUIRED TO ENSURE THE SAFETY OF THE CREW AND SHUTTLE.
- C. THE FLIGHT DIRECTOR WILL PROVIDE THE DEFINITIVE LAUNCH WINDOW OPEN, CLOSE, RENDEZVOUS PANE CHANGE AND LOX DRAINBACK TIME. @[041097-4911A]
- D. THE FLIGHT DIRECTOR WILL INITIATE THE ABORT REQUEST COMMAND FROM THE MCC.
- E. THE FLIGHT DIRECTOR IS RESPONSIBLE FOR CALLING A LAUNCH "HOLD" FOR ALL PROBLEMS THAT JEOPARDIZE THE ABILITY TO SAFELY MONITOR AND RECOVER THE ORBITER AND CREW AFTER LAUNCH. THIS INCLUDES PROBLEMS IN THE FOLLOWING AREAS: MISSION CONTROL CENTER (MCC), SPACECRAFT TRACKING AND DATA NETWORK (STDN), LANDING AREA FACILITIES, AND ABORT LANDING AREA WEATHER.
- F. THE FLIGHT DIRECTOR IS RESPONSIBLE FOR OVERALL CONTROL OF THE MCC COMMAND UPLINK CAPABILITY.
- G. THE FLIGHT DIRECTOR IS RESPONSIBLE FOR POSTLANDING ORBITER SYSTEMS CONFIGURATION AND SAFING THROUGH CREW EGRESS OR GSE COOLING ACTIVATION, WHICH EVER OCCURS LATER. @[041097-4911A]

Self-explanatory.

FLIGHT RULES

A1-6 SHUTTLE COMMANDER AUTHORITY

- A. THE COMMANDER WILL ASSUME RESPONSIBILITY FOR CONDUCT OF THE FLIGHT WITHIN THE FRAMEWORK OF THE FLIGHT RULES, IF UNABLE TO COMMUNICATE WITH MCC.
- B. THE COMMANDER MAY INITIATE SUCH ACTION AS HE DEEMS ESSENTIAL FOR CREW SAFETY.

Self-explanatory.

Rule {A2-251}, BAILOUT, references this rule.

A1-7 FLIGHT CONTROL ROOM (FCR) SURGEON AUTHORITY

- A. THE FCR SURGEON WILL BE CONSULTED ON ALL CONDITIONS WHICH DEAL WITH CREW HEALTH.
- B. THE FCR SURGEON IS RESPONSIBLE FOR EVALUATION OF ANY CHANGE IN CREW HEALTH STATUS AND MAKING RECOMMENDATIONS TO THE FLIGHT DIRECTOR REGARDING ANY REQUIRED CHANGES IN MISSION DURATION OR CREW ACTIVITIES.

©[022604-6180] ©[ED]

A1-8 WEATHER DECISION AUTHORITY

- A. THE JOHNSON SPACE CENTER (JSC) MCC FLIGHT DIRECTOR IS RESPONSIBLE FOR LAUNCH ABORT LANDING AND END-OF-MISSION WEATHER DECISIONS AND ASSOCIATED RECOMMENDATIONS TO THE MMT CHAIRMAN.
- B. THE KENNEDY SPACE CENTER (KSC) LAUNCH DIRECTOR IS RESPONSIBLE FOR THE LAUNCH DECISION FOR WEATHER ACCEPTABILITY AT THE LAUNCH PAD FOR ASCENT TRAJECTORY AND ASSOCIATED RECOMMENDATIONS TO THE MMT CHAIRMAN.

Self-explanatory.

FLIGHT RULES

A1-9

POSTLANDING DECISION AUTHORITY

A. FLIGHT DIRECTOR

THE FLIGHT DIRECTOR IS RESPONSIBLE FOR POSTLANDING ORBITER SYSTEMS CONFIGURATION AND SAFING THROUGH CREW EGRESS OR GSE COOLING ACTIVATION, WHICHEVER OCCURS LATER. THIS INCLUDES:

1. IN-FLIGHT CONTINGENCIES.
2. OFF-NOMINAL AND CONTINGENCY LANDING OPERATIONS (THROUGH CREW EGRESS) AS LONG AS COMMUNICATIONS EXIST BETWEEN THE ORBITER AND MCC-HOUSTON (MCC-H).

The flight director will support postlanding operations by ensuring correct configuration of orbiter systems to allow convoy activities to proceed. Assessment of the external environment to allow safe crew egress and continued postlanding operations is the responsibility of convoy personnel.

B. CONVOY COMMANDER

THE CONVOY COMMANDER IS RESPONSIBLE FOR THE ORBITER SAFETY INSPECTION/HAZARD ASSESSMENT AND ASSOCIATED IMPACT TO CREW EGRESS AND CONVOY OPERATIONS. THE FLIGHT DIRECTOR WILL BE NOTIFIED OF ANY EXPLOSIVE, FLAMMABLE, OR TOXIC CONDITIONS THAT WILL PRECLUDE/DELAY NORMAL CREW EGRESS.

The orbiter inspection/hazard assessment will be accomplished by on-site convoy personnel who are in the best position to determine if unsafe conditions exist (explosive, flammable, toxic, smoke, etc.). Violation of identified "safe criteria" will result in termination of convoy activities and crew egress as recommended by the convoy commander (reference Postlanding Operations Maintenance Instruction (OMI) for hazard assessment criteria).

THIS RULE CONTINUED ON NEXT PAGE

FLIGHT RULES

A1-9

POSTLANDING DECISION AUTHORITY (CONTINUED)

- C. LANDING RECOVERY DIRECTOR (LRD)/GROUND OPERATIONS MANAGER (GOM)

THE LRD OR THE GOM IS RESPONSIBLE FOR THE COORDINATION OF DECLARED POSTLANDING MODE V THROUGH MODE VII EGRESS/ESCAPE MODES PLUS ORBITER POSTLANDING ACTIVITIES POST-MCC HANDOVER.

Coordinating contingency operations at any time during a mission should be accomplished by the person in charge with the most current, reliable information and communications capabilities that ensure the proper resources are employed to save life and property. During a landing at an augmented landing site (ALS), (primary landing site (PLS), secondary landing site (SLS), or transoceanic abort landing (TAL) site), the LRD/GOM is best able to coordinate this effort. At a Department of Defense (DOD) emergency landing site (ELS), this coordination is best handled by the on-scene commander. In certain situations, however, the Flight Director is in the best position to coordinate contingency operations. These are as follows:

- a. *For in-flight emergencies, the flight director (in conjunction with the flightcrew) is best able to determine when a contingency situation exists and is responsible for conduct of the flight until crew egress.*
- b. *When outside the operating radius of an ALS or DOD ELS, the flight director, again in conjunction with the crew, is in the best position to coordinate contingency operations and to see that the appropriate actions are initiated up to and including crew egress.*

FLIGHT RULES

A1-10

POSTLANDING EMERGENCY DECLARATION

OFFICIAL DECLARATION OF A POSTLANDING EMERGENCY (MODE V THROUGH MODE VII) CAN BE MADE BY THE LRD, FLIGHT DIRECTOR, GOM, CONVOY COMMANDER, OR FLIGHTCREW. IN ADDITION FOR ELS LANDINGS, THIS DECLARATION MAY BE MADE BY THE DOD ON-SCENE COMMANDER. TIME AND CIRCUMSTANCES PERMITTING, COORDINATION WITH THE FLIGHT DIRECTOR WILL BE ACCOMPLISHED.

A postlanding emergency (Mode V through Mode VII) should be declared so that everyone involved is aware of the situation and can take the proper actions or precautions to protect both equipment and life. For this reason, the first of the following individuals that would discover that the emergency exists would make the declaration: LRD, flight director, GOM, convoy commander, on-scene commander, or flightcrew. Any of the above individuals have the communication capabilities to ensure that everyone involved is aware of the emergency. If time is available and the circumstances allow, coordination with the flight director will ensure that the most current information concerning the status of the crew and the orbiter is available for dealing with the emergency.

FLIGHT RULES

A1-11 **SEARCH AND RESCUE RESPONSIBILITY**

FOR MODE VII, SEARCH AND RESCUE RESPONSIBILITY REVERTS FROM THE LOCAL SITE COMMANDER TO THE APPROPRIATE SEARCH AND RESCUE (SAR) PLAN, WHEN IMPACT IS:

- A. FOR EDWARDS (EDW), OUTSIDE THE BOUNDARIES OF THE BASE.
- B. FOR NORTHRUP (NOR), GREATER THAN 25 NM RADIUS OF THE WHITE SANDS SPACE HARBOR (WSSH) TACAN.
- C. FOR KSC, GREATER THAN 25 NM RADIUS OF THE KSC TACAN, EXCLUDING THE ATLANTIC OCEAN.

Within the local contingency area for KSC, the DOD will support NASA's rescue/recovery operations by providing two helicopters configured for Medivac.

At Edwards Air Force Base (EAFB), the Commander of Air Force Flight Test Center (AFFTC) has complete responsibility for all efforts involving astronaut recovery, fire fighting, and security. The DOD will provide support as necessary.

At WSSH, the DOD has varying degrees of responsibility and basically will provide support for search and rescue within the limitations of their equipment.

All of the above support is provided within the limits of the site as described in this rule. Outside of that limit, search and rescue operations will be conducted in accordance with applicable SAR plans. These plans identify the areas of responsibility and the controlling agencies.

A1-12 **ORBITER EMERGENCY LANDING SITE (ELS) AUTHORITY**

FOR ELS LANDINGS, THE FLIGHTCREW HAS ON-SCENE RESPONSIBILITY FOR THE ORBITER UNTIL ARRIVAL OF THE KSC RAPID RESPONSE TEAM (APPROXIMATELY LANDING PLUS 24 HOURS). THE LANDING AND RECOVERY DIRECTOR (LRD) IS RESPONSIBLE FOR ANSWERING ORBITER HANDLING QUESTIONS FROM ELS PERSONNEL.

For a landing at an ELS, the crew will have the responsibility for the orbiter until the KSC Rapid Response Team is able to arrive. The crew will have a checklist to follow and may be able to obtain help from the U. S. Embassy in securing and protecting the orbiter. Communications to the ELS will be provided as best as possible through the JSC Landing Support Officer (LSO), and any questions that the ELS personnel may have regarding the handling of the orbiter will be provided by the person responsible for the recovery, the LRD at KSC.

FLIGHT RULES

A1-13

MCC REAL-TIME COMMAND COORDINATION POLICY

- A. THE FLIGHT DIRECTOR WILL APPROVE ALL COMMAND OPERATIONS.
©[092293-1547]

The flight director is responsible for the integrity of the command system/process and for insuring that all commands to the shuttle are safely and properly executed.

- B. ROUTINE COMMAND OPERATIONS CAN BE PERFORMED WITHOUT A "GO" FROM THE FLIGHT DIRECTOR FOR EACH ROUTINE FUNCTION.

Thousands of routine commands must be sent to the vehicle each flight to manage comm systems, instrumentation systems, recorders, video systems, etc. Requiring flight director approval for these operations continuously is not appropriate and prevents efficient operations. Risk associated with these routine commands is considered low. The flight director may identify critical time periods where even routine commands require coordination.

- C. NONSTANDARD COMMAND ACTIVITY (NOT OPERATING PER A REVIEWED, APPROVED, AND PUBLISHED PROCEDURE OR ANY EXECUTION OF A PROCEDURE THAT IS NOT ROUTINELY PERFORMED EACH MISSION) MUST BE REVIEWED BY THE FLIGHT CONTROL TEAM AND BE APPROVED BY THE FLIGHT DIRECTOR.

Nonstandard command activity contains increased possibilities for command errors. Flight control team review and flight director approval are the techniques used to reduce the possibility of command errors. These techniques must be utilized whenever a procedure is developed or modified in real time because the standard preflight command procedure review has not been accomplished. These techniques must also be used on infrequently used or modified procedures in order to assure that the procedures are current and compatible with recent changes in shuttle hardware and software as well as ground hardware and software.

THIS RULE CONTINUED ON NEXT PAGE

FLIGHT RULES

A1-13

MCC REAL-TIME COMMAND COORDINATION POLICY
(CONTINUED)

- D. ANY REAL-TIME MODIFICATIONS TO PREFLIGHT APPROVED COMMAND PROCEDURES MUST BE REVIEWED BY THE FLIGHT CONTROL TEAM AND APPROVED BY THE FLIGHT DIRECTOR.

Modified procedures need to be reviewed just as the procedures specified in paragraph C above require review.

- E. COMMANDS SHALL ONLY BE BUILT BY CERTIFIED FLIGHT CONTROLLERS AND EXECUTED BY COMMAND CERTIFIED FLIGHT CONTROLLERS.

Command certification is required to reduce command error risk by insuring that personnel are properly trained and certified to accomplish the necessary command functions without error.

- F. ANY ANOMALIES IN COMMAND OPERATIONS WILL BE BROUGHT TO THE ATTENTION OF THE FLIGHT DIRECTOR IMMEDIATELY.

The flight director is responsible for command operations and any deviations from command operations. The flight director is also responsible for maintaining the integrity and safety of command operations. The flight director must be notified immediately of any problems or off-nominal activity with respect to any procedure to assure corrective action coordination and safe resumption of command activity.

- G. THE FLIGHT DIRECTOR WILL EXERCISE POSITIVE CONTROL AND BE DIRECTLY INVOLVED THROUGH STATUS AND APPROVAL AT MAJOR STEPS IN ALL NONSTANDARD COMMAND PROCEDURES.

When executing nonstandard or critical commands which create more risk to the vehicle/command operations than routine commanding, the flight director will provide another level of operational awareness and control to assure the safe and proper execution of the required command functions.

THIS RULE CONTINUED ON NEXT PAGE

FLIGHT RULES

A1-13

MCC REAL-TIME COMMAND COORDINATION POLICY
(CONTINUED)

- H. INCO IS THE PRIME UPLINK OPERATOR AND ALL FLIGHT CONTROL POSITIONS WILL COORDINATE THEIR COMMAND ACTIVITIES THROUGH INCO.

The INCO and the INCO MPSR perform the majority of all commanding to the shuttle and are aware of the systems/uplink and downlink status. Because multiple command operations/operators can lead to command execution problems and errors, all command activities will be coordinated through INCO and the INCO MPSR to reduce the possibility of having command problems.

- I. FLIGHT CONTROLLERS REQUESTING COMMAND ACTIVITIES ARE RESPONSIBLE FOR:
1. PROPERLY GENERATING THE COMMAND DATA
 2. CLEARLY COMMUNICATING THE COMMAND REQUEST AND COMMANDS TO THE FLIGHT CONTROLLER EXECUTING THE COMMANDS (AS WELL AS THE FLIGHT CONTROL TEAM/FLIGHT DIRECTOR IF REQUIRED)
 3. REMAINING IN COMMUNICATION WITH THE EXECUTING FLIGHT CONTROLLER THROUGHOUT THE COMMAND SEQUENCE
 4. VERIFYING THE PROPER EXECUTION OF THE REQUIRED COMMANDS PRIOR TO PROCEEDING TO THE NEXT COMMAND (VIA COMMAND TRACK DISPLAYS OR END ITEM FUNCTIONS)
 5. REPORTING THE RESULTS OF THE COMMAND TO THE FLIGHT DIRECTOR

Responsibilities of the flight controllers must be established to assure that command activities are performed in a safe and proper manner. The INCO and flight control team/flight director may not know all of the ramifications of a particular command sequence and must be informed clearly of the procedure and expectations and risks associated with it.

THIS RULE CONTINUED ON NEXT PAGE

FLIGHT RULES

A1-13

MCC REAL-TIME COMMAND COORDINATION POLICY (CONTINUED)

- J. COMMAND ACTIVITIES TO THE SHUTTLE OR PAYLOADS DURING PERIODS OF CREW SLEEP WILL ONLY BE ALLOWED IN THE FOLLOWING CASES:
1. THE COMMANDS HAVE BEEN PREVIOUSLY COORDINATED WITH THE CREW, EITHER INDIVIDUALLY OR AS PART OF A PAYLOAD COMMAND PLAN.
 2. THE COMMANDS ARE NECESSARY TO PREVENT NUISANCE ALARMS THAT WILL DISTURB THE CREW SLEEP.
 3. THE COMMANDS ARE THE ROUTINE/CONTINUOUS COMMANDS REQUIRED FOR COMMUNICATIONS CONFIGURATION (E.G., RECORDERS, VIDEO, COMM SYSTEMS MANAGEMENT).
 4. STATE VECTOR UPDATES REQUIRED TO MAINTAIN SHUTTLE EMERGENCY DEORBIT CAPABILITY.

In order to mitigate the risk of unanticipated command effects, only necessary commands will be sent during crew sleep periods. Special testing or comm related DTO's are not considered necessary commanding, as well as any other command operations that could result in disturbing the crew and/or disruption of mission activities.

- K. ALL TYPES OF COMMANDS WILL BE COORDINATED WITH THE ORBITER FLIGHTCREW AND MCC FLIGHT DIRECTOR PRIOR TO BEING TRANSMITTED WITH THE EXCEPTION OF:
1. ROUTINE ORBITER COMMUNICATIONS COMMANDS (TRANSPARENT TO CREW).
 2. NONHAZARDOUS PAYLOAD COMMANDS (PREFLIGHT APPROVED).

With the exception of routine communications systems commands and nonhazardous commands, most command uplinks directly affect the systems being used by the flightcrew for control of the vehicle or payload. To ensure that the flightcrew has current status of vehicle or payload systems in the event of loss of communications, and to ensure that the flightcrew and ground are not in competition for use of a particular orbiter or payload facility, the flightcrew shall be informed of the transmission of command uplinks.

A1-14 THROUGH A1-50 RULES ARE RESERVED

FLIGHT RULES

GENERAL

A1-51 VEHICLE SYSTEM LIMITS

SYSTEMS LIMITS LISTED IN THESE RULES INCLUDE THE ACTUAL VEHICLE LIMITS FOLLOWED BY A NUMBER IN () WHICH IS THE NUMBER BIASED FOR INSTRUMENTATION INACCURACIES AND REPRESENTS THE NUMBER ON WHICH FLIGHT CONTROL ACTION WILL BE TAKEN. IN THE EVENT ONLY ONE NUMBER IS INDICATED, IT WILL BE ASSUMED THAT INSTRUMENTATION INACCURACY CANNOT BE INCORPORATED OR IS IRRELEVANT. IN THOSE CASES WHERE TWO SETS OF ENGINEERING UNITS ARE INDICATED, THE SECOND SET WILL BE SEPARATED FROM THE FIRST BY A SLASH; I.E., XX DEG F/YY DEG C (XX DEG F/YY DEG C).

Self-explanatory.

A1-52 INTERIM OR UNCONFIRMED LIMITS

FLIGHT RULE LIMITS THAT ARE CONSIDERED TO BE INTERIM OR UNCONFIRMED NUMBERS WILL BE UNDERLINED IN THIS PUBLICATION AND IN ALL SUBSEQUENT REVISIONS UNTIL THE NUMBERS ARE CONFIRMED BY THE RESPONSIBLE NASA ORGANIZATION.

Self-explanatory.

A1-53 MANDATORY INSTRUMENTATION REQUIREMENTS

UNLESS STATED OTHERWISE, MANDATORY INSTRUMENTATION REQUIREMENTS CAN BE SATISFIED BY EITHER ONBOARD OR TELEMETRY CAPABILITY.

Self-explanatory.

FLIGHT RULES

A1-54

FAILURE DEFINITION APPLICATION

FAILURE DEFINITIONS IN THIS DOCUMENT REFER TO LIMITS TO BE APPLIED FOR GO/NO-GO DECISIONS TO CONTINUE BEYOND A PREFERRED DAILY LANDING OPPORTUNITY. SYSTEMS MAY BE USED IN A DEGRADED MODE AS SPECIFIED BY THE MANAGEMENT RULES OR AS DICTATED BY FLIGHT NEED.

Self-explanatory.

A1-55

CONFLICTING FLIGHT RULES

- A. RULES WHICH ARE KNOWN TO HAVE FLIGHT SPECIFIC EXCEPTIONS OR OPTIONS WILL BE NOTED IN THIS DOCUMENT (NSTS-12820) AND DOCUMENTED IN THE FLIGHT SPECIFIC ANNEX (NSTS-18308).
- B. RULES FROM THE "ALL FLIGHTS" DOCUMENT FOR WHICH EXCEPTIONS ARE PROPOSED WHICH HAVE NOT BEEN PREVIOUSLY IDENTIFIED AS EXCEPTIONS OR OPTIONS MUST BE PROCESSED AND APPROVED AS A PERMANENT CHANGE OR AS A DEVIATION TO THE ALL FLIGHTS DOCUMENT.

Flight-specific exceptions or options to the All Flights rules are at the discretion of the lead flight director provided that the All Flights rules permit them. If the All Flights rule does not make provisions for an exception, a change request (CR) must be written to change the rule, and the CR may be approved as either a change or deviation. The annotation in the Annex rationale should reflect the type of rule approval, i.e., stating, "This rule is a flight-specific exception or option (as applicable) to Flight Rule xx.yy-zz" or, "This rule is a flight-specific deviation from Flight Rule xx.yy-zz."

FLIGHT RULES

A1-56

INSTRUMENTATION ONBOARD VS. GROUND READOUT PHILOSOPHY

WHERE DISCREPANCIES EXIST BETWEEN ONBOARD AND GROUND READOUTS, DEDICATED ONBOARD METERS WILL BE CONSIDERED PRIME OVER GROUND READOUTS. FOR GENERAL PURPOSE COMPUTER (GPC)-DRIVEN DATA, THE MOST REASONABLE (IF IT CAN BE DETERMINED) OR THE MOST CONSERVATIVE READOUT WILL BE USED. LOSS OF INSTRUMENTATION WHICH PRECLUDES IMPLEMENTATION OF A FLIGHT RULE WILL NOT NECESSARILY CAUSE FLIGHT TERMINATION.

The purpose of this rule is to minimize the possibility of invoking a flight rule as a result of transducer failures, shifts, or errors introduced in the communications path from the vehicle to the MCC. In general, if the same transducer drives both an onboard meter and a telemetry input, the onboard meter readout, if reasonable, should be more accurate since it is closer to the source. In cases of GPC-driven data (no meter or other analog display), when two readouts (both onboard or onboard and ground) differ but are still reasonable, the more conservative of the two is used as it results in the safest course of action. If a mandatory instrumentation parameter exists which, if lost, would result in invoking a flight rule, it is specifically identified in these rules. In general, instrumentation failures will not cause flight termination since critical systems failure can be monitored by redundant means.

A1-57

FLIGHT-CRITICAL MODING

WHERE REDUNDANT CAPABILITIES ARE PROVIDED TO EXECUTE FLIGHT-CRITICAL SWITCHING OR MODING, THE PATHS WILL BE CONFIGURED TO PREVENT LOSS OF A TOTAL CAPABILITY FOR LOSS OF A SINGLE GPC, DATA PATH, OR POWER SOURCE.

Self-explanatory.

FLIGHT RULES

A1-58 SHUTTLE OPERATIONAL DATA BOOK (SODB), VOLUME III, DATA USE

IN CONTINGENCY SITUATIONS, SODB, VOLUME III, DATA IS USED WITH THE BEST ENGINEERING JUDGMENT RECOGNIZING THAT SOME OF THE DATA CONTAINS ENGINEERING ESTIMATES FOR NON-NOMINAL PERFORMANCE EVALUATION AND MAY NOT BE SUPPORTED BY TEST DATA.

A1-59 ACTIVITIES DURING YEAR END ROLLOVER/LEAP SECOND INCORPORATION

IF POSSIBLE, CRITICAL PHASES OF MISSIONS WILL NOT BE PERFORMED DURING AN OCCURRENCE OF A MASTER TIMING UNIT (MTU) YEAR END ROLLOVER OR AN INCORPORATION OF A LEAP SECOND.

Whenever an MTU year end rollover or leap second incorporation occurs during a flight, the MCC has to perform several off-nominal procedural workarounds including reconfiguring the data dump handler (DDH) (which directly affects near real-time telemetry (NRT) processing and retrieval), manually processing the GSFC TDRS state vectors, and altering the build process for stored program commands (SPC's). Additionally, the 1-second bias to the data as a result of a leap second incorporation during ascent/entry is deemed undesirable by the ground navigation and tracking personnel. Tracking data in the high speed phases of ascent/entry would be 1 second out of sync with the mission operations computer (MOC), and the MCC would have to manually implement a bias to account for the 1 additional second; if this bias is not implemented, the tracking data would be essentially useless. Per the ground navigation personnel, implementation of this bias is not a trivial task. For year end rollover, the same concerns apply, but to a greater degree. Therefore, because of the dependency of several critical mission phases on accurate time, these phases should not be performed during an MTU year end rollover or leap second incorporation. However, if other factors prevent a rescheduling of these critical phases (e.g., weather, next PLS conditions), the risk of performing these critical phases during MTU year end rollover or leap second incorporation will be accepted.

References: MICB CR R21075-053, Level B Groundrules and Constraints Update: Findings: Year End Rollover and Leap Second Phenomena and Their Effects of STS Mission Support (Document No. STSOC-RT-400141).

A1-60 THROUGH A1-100 RULES ARE RESERVED

FLIGHT RULES

GENERAL DEFINITIONS

A1-101 **AS SOON AS PRACTICAL (ASAP)**

AS SOON AS PRACTICAL (I.E., AS SOON AS POSSIBLE AND REASONABLE)

Self-explanatory.

A1-102 **HIGHLY DESIRABLE (HD)**

A SPACE TRANSPORTATION SYSTEM (STS) OR GROUND SUPPORT ELEMENT THAT ENHANCES ACCOMPLISHMENT OF THE FLIGHT. CONSIDERATION WILL BE GIVEN TO HOLDING THE COUNT FOR THE REPAIR OF AN HD ELEMENT, IF CONVENIENT, BUT IN NO CASE WILL THE LAUNCH BE SCRUBBED.

Self-explanatory.

A1-103 **MANDATORY (M)**

AN STS OR GROUND ELEMENT THAT IS REQUIRED TO ENSURE CREW SAFETY, IMPLEMENT LAUNCH GO/NO-GO CRITERIA, LAUNCH ABORT, OR EARLY FLIGHT TERMINATION FLIGHT RULES.

Self-explanatory.

FLIGHT RULES

A1-104

FLIGHT PHASE

- A. PRELAUNCH - PRIOR TO SRB IGNITION.
- B. ASCENT - SRB IGNITION THROUGH ORBITAL MANEUVERING SYSTEM 2 (OMS-2) CUTOFF.
- C. ORBIT - OMS-2 CUTOFF TO DEORBIT MANEUVER IGNITION.
- D. DEORBIT PREPARATION - FROM DEORBIT TIME OF IGNITION (TIG) -3.5 HRS TO DEORBIT TIG.
- E. EXTRAVEHICULAR ACTIVITY (EVA) - START OF AIRLOCK DEPRESSURIZATION THROUGH REPRESSURIZATION AND VERIFICATION OF AIRLOCK INTEGRITY.
- F. ENTRY - DEORBIT MANEUVER IGNITION THROUGH ROLLOUT.
- G. POSTLANDING - ROLLOUT THROUGH CREW EGRESS.
- H. TURNAROUND OPERATIONS - POST CREW EGRESS.

Self-explanatory.

FLIGHT RULES

A1-105 THROTTLE SETTINGS

- A. NOMINAL THROTTLE - MAXIMUM SPACE SHUTTLE MAIN ENGINE (SSME) THROTTLE SETTING LEVEL THAT IS ALLOWED DURING A NOMINAL (NOT LOW PERFORMANCE) ASCENT.
- B. ABORT THROTTLE - MAXIMUM CERTIFIED SSME THROTTLE SETTING LEVEL TO BE USED FOR OFF-NOMINAL (LOW PERFORMANCE) ASCENT AND INTACT ABORT MODES.
- C. MAX THROTTLE - MAXIMUM SELECTABLE SSME THROTTLE SETTING LEVEL.

Self-explanatory.

A1-106 LANDING SITES

- A. PRIMARY LANDING SITE (PLS) - THE PREMISSION SELECTED, NOMINAL END-OF-MISSION (EOM) LANDING SITE OR THE CONUS (EDW, KSC, NOR) LANDING SITE SELECTED DAILY IF REQUIRED FOR EARLY MISSION TERMINATION ("NEXT PLS"). SEE RULE {A4-107}, PLS/EOM LANDING OPPORTUNITY REQUIREMENTS. @[113095-1800]
- B. SECONDARY LANDING SITE (SLS) - BACKUP TO THE PRIMARY EOM LANDING SITE USED WHEN THE PRIME EOM LANDING SITE DOES NOT MEET ACCEPTABLE CONDITIONS.
- C. EMERGENCY LANDING SITES (ELS) - LANDING SITES, CARRIED IN THE ONBOARD SOFTWARE OR AVAILABLE FOR UPLINK FROM THE MCC, NOT SUPPORTING PLANNED EOM OR INTACT ABORTS. SEE RULE {A2-264}, EMERGENCY LANDING FACILITY CRITERIA. @[113095-1800]
- D. ABORT-ONCE-AROUND (AOA) SITE - THE SITE SELECTED PREMISSION FOR LANDING IN THE EVENT OF AN AOA ABORT. (REF. RULE {A2-2}, ABORT LANDING SITE REQUIREMENTS). @[121593-1590]

THIS RULE CONTINUED ON NEXT PAGE

FLIGHT RULES

A1-106 LANDING SITES (CONTINUED)

- E. ALTERNATE AOA SITE - THE BACKUP TO THE PRIME AOA SITE; USED WHEN THE PRIME AOA SITE DOES NOT MEET ACCEPTABLE CONDITIONS (REF. RULES {A2-1F}, PRELAUNCH GO/NO-GO REQUIREMENTS [HC], AND {A2-2}, ABORT LANDING SITE REQUIREMENTS). @[121593-1590] @[ED]
- F. TRANSOCEANIC ABORT LANDING (TAL) SITE - THE SITE(S) SELECTED PERMISSION FOR LANDING IN THE EVENT OF A TAL ABORT.
- G. ALTERNATE TAL SITE - THE BACKUP TO THE PRIME TAL SITE; USED WHEN THE PRIME TAL SITE DOES NOT MEET ACCEPTABLE CONDITIONS (REF. RULE {A2-1F}, PRELAUNCH GO/NO-GO REQUIREMENTS [HC]). @[ED]
- H. AUGMENTED CONTINGENCY LANDING SITE (ACLS) - A TAL SITE, WHICH IS NO-GO FOR TAL DUE TO WEATHER, REDUNDANCY, OR TOUCHDOWN/ROLLOUT CONDITIONS, THAT IS USED TO FILL CONTINGENCY POWERED FLIGHT PERFORMANCE GAPS AND PROVIDE COVERAGE FOR CERTAIN ASCENT SYSTEMS FAILURES REQUIRING EARLIEST LANDING TIME. WEATHER (EXCEPT AS NOTED BELOW) AND TOUCHDOWN/ROLLOUT CONDITIONS ARE NOT CONSIDERED FOR THESE SITES. MINIMUM REQUIRED NAV/LANDING AIDS ARE REDUCED TO A SINGLE-STRING TACAN/DME OR A SINGLE-STRING OF GPS, WITH SINGLE-STRING MLS REQUIRED FOR REDUCED CEILING AND VISIBILITY LIMITS AS DEFINED IN RULE {A2-6}, LANDING SITE WEATHER CRITERIA [HC]. FOR NIGHT LANDINGS, RUNWAY EDGE LIGHTING IS ALSO REQUIRED. @[102793-1560] @[113095-1800] @[022707-8193A]

Self-explanatory.

FLIGHT RULES

A1-107

LANDING OPPORTUNITIES

- A. ENTER FIRST DAY PLS - THE PLANNED OPPORTUNITY FOR LANDING ON THE DAY OF LAUNCH IF A SITE IS AVAILABLE, REF. RULE {A2-2}, ABORT LANDING SITE REQUIREMENTS, OTHERWISE LAND ON FLIGHT DAY 2 PLS. @[121593-1590]
- B. ENTER NEXT PLS - THE NEXT LANDING OPPORTUNITY AT THE PRIMARY LANDING SITE, WHICH SATISFIES LIGHTING, WEATHER, AND CREW CONSTRAINTS.
- C. ENTER ASAP - ENTER AS SOON AS PRACTICAL TO THE NEXT AVAILABLE LANDING SITE (PLS, SLS, OR ELS).
- D. ENTER IMMEDIATELY - ENTER IMMEDIATELY TO AN UNSPECIFIED LANDING AREA.

For some systems failures, the risk of staying on orbit beyond the first flight day is considered to be high enough to justify the increased risk associated with a day 1 entry. These failures are defined in Rule {A2-301}, CONTINGENCY ACTION SUMMARY [HC]. @[032807-8400]

This set of failures is a subset of the larger group of failures that require entry at the next PLS. This larger set includes all systems failures where deorbit will be planned for the next opportunity to the primary landing site which meets required weather and lighting constraints and allows the crew to have adequate rest and perform a nominal deorbit prep. These failures are listed in the individual sections of this book and are consolidated in Rule {A2-1001}, ORBITER SYSTEMS GO/NO-GO.

Enter ASAP and immediately are self-explanatory. They only apply to the most critical of circumstances where staying on orbit would mean probable loss of the orbiter and crew. These failures are also listed in Rule {A2-301}, CONTINGENCY ACTION SUMMARY [HC]. @[032807-8400]

FLIGHT RULES

A1-108

CREW EGRESS/ESCAPE MODES

- A. MODE I - UNAIDED PRELAUNCH EGRESS AND ESCAPE. @[041196-1881A]
- B. MODE II - AIDED PRELAUNCH EGRESS AND ESCAPE, THE FLIGHT CREW IS ASSISTED BY THE CLOSEOUT CREW.
- C. MODE III - AIDED PRELAUNCH EGRESS AND ESCAPE, THE FLIGHT CREW IS ASSISTED BY FIRE/RESCUE PERSONNEL.
- D. MODE IV - AIDED PRELAUNCH EGRESS AND ESCAPE, THE FLIGHT CREW AND CLOSEOUT CREW ARE ASSISTED BY FIRE/RESCUE PERSONNEL.
- E. MODE V - UNAIDED POSTLANDING EGRESS AND GROUND-AIDED ESCAPE/EVACUATION.
 - 1. HATCH ON MODE V - NORMAL HATCH OPENING.
 - 2. HATCH JETTISON MODE V - PYROTECHNIC HATCH JETTISON (IMMINENT CREW HAZARD).
 - 3. ESCAPE PANEL MODE V - PYROTECHNIC JETTISON OF WINDOW 8 ESCAPE PANEL (HATCH EGRESS IMPOSSIBLE). @[041196-1881A]
- F. MODE VI - AIDED POSTLANDING EGRESS, ESCAPE, AND EVACUATION WITHIN AN AREA ACCESSIBLE BY THE GROUND CONVOY ELEMENTS. @[041196-1881A]
- G. MODE VII - AIDED POSTLANDING EGRESS, ESCAPE, AND EVACUATION AT A LOCATION INACCESSIBLE BY THE GROUND CONVOY ELEMENTS.
- H. MODE VIII - BAILOUT DURING CONTROLLED, GLIDING FLIGHT. @[041196-1881A]

Self-explanatory.

FLIGHT RULES

A1-109

CREW MEDICAL (MED) CONDITIONS

- A. MED 0 - PATIENT SEVERELY INJURED BEYOND REASONABLE EXPECTATION OF SURVIVAL OR DECEASED.
- B. MED 1 - CONDITION CRITICAL, PATIENT REQUIRES IMMEDIATE CARE AND EVACUATION.
- C. MED 2 - CONDITION FAIR TO POOR, PATIENT'S NEED FOR CARE IS NOT SO ACUTE, BUT WILL REQUIRE CARE BEFORE EVACUATION.
- D. MED 3 - CONDITION GOOD TO FAIR, PATIENT WITH INJURIES WHICH DO NOT REQUIRE HOSPITALIZATION; SOME MEDICAL CARE MAY BE NEEDED, BUT NOT ON A TIME CRITICAL BASIS.

These medical codes are the triage codes used by the DOD and KSC triage teams. These triage codes shall be used so accurate reporting of crew medical conditions can occur. @[032504-6181A]

FLIGHT RULES

A1-110

REMOTE MANIPULATOR SYSTEM (RMS)

- A. STOW/DEPLOY - ROLL THE MANIPULATOR POSITIONING MECHANISM (MPM) INBOARD/OUTBOARD WHILE THE RMS IS CRADLED AND LATCHED.
- B. CRADLE/UNCRADLE - MOVE THE RMS TO/FROM ITS RETENTION LATCHES.
- C. BERTH/UNBERTH - USE THE RMS TO ATTACH/DETACH A PAYLOAD TO/FROM THE PAYLOAD BAY OR PALLET STRUCTURE.
- D. CONTROL MODES:
 - 1. MANUAL AUGMENTED - POINT OF RESOLUTION (POR) IS MANEUVERED BY CONTROL INPUTS VIA THE REMOTE HAND CONTROLLERS (RHC'S).
 - 2. AUTO - POR IS MANEUVERED BY THE GPC TO PREPROGRAMMED POINTS.
 - 3. OPERATOR COMMANDED - COMPUTER COMMANDED MODE WITH POR MANEUVERED TO A POINT LOADED BY THE CREW.
 - 4. SINGLE - JOINTS ARE DRIVEN ONE AT A TIME BY "PLUS" AND "MINUS" DRIVE COMMANDS FROM THE DISPLAYS AND CONTROLS (D&C) PANEL. THE UNDRIVEN JOINTS ARE HELD IN POSITION BY THE GPC.
 - 5. DIRECT - SAME AS "SINGLE" WITH THE EXCEPTION THAT THE UNDRIVEN JOINTS ARE HELD IN POSITION BY THE BRAKES.
 - 6. BACKUP - SAME AS "DIRECT" WITH THE EXCEPTION THAT NO DISPLAYS ARE AVAILABLE AND POWER IS SUPPLIED BY MAIN BUS B VICE MAIN BUS A.

Self-explanatory.

FLIGHT RULES

A1-111 **TIME REFERENCE DEFINITIONS**

DAY - ANY 24-HOUR PERIOD

END-OF-MISSION (EOM) ± - TIME REFERENCE RELATING TO THE EOM WHERE THE PLANNED LANDING TIME IS ZERO.

FLIGHT DAY (FD) - TIME REFERENCE RELATING TO A CREWMEMBER'S WORK/REST CYCLE. FD 1 BEGINS AT LAUNCH WITH SUBSEQUENT FD'S BEGINNING AT CREW WAKE UP AND CONTINUING THROUGH CREW SLEEP.

MISSION ELAPSED TIME (MET) - TIME REFERENCE RELATING TO MET, WHERE LAUNCH IS 0/00:00 (D/HH:MM).

Self-explanatory.

A1-112 **MULTIFUNCTION ELECTRONIC DISPLAY SUBSYSTEM**

FOR THE MEDS CONFIGURATION: @[040899-2459B]

FLIGHT RULES THAT REFERENCE MCDS ARE ACTUALLY REFERENCING MEDS.

- A. FLIGHT RULES THAT REFERENCE A DEU ARE ACTUALLY REFERENCING AN IDP.
- B. FLIGHT RULES THAT REFERENCE A DU ARE ACTUALLY REFERENCING AN MDU.
- C. FLIGHT RULES THAT REFERENCE PANEL F6, F7, AND F8 FLIGHT INSTRUMENT TAPES AND SUBSYSTEM METERS ARE ACTUALLY REFERENCING THE FUNCTION OF THOSE TAPES AND METERS DISPLAYED ON AN MDU.
- D. FLIGHT RULES THAT REFERENCE A FLIGHT INSTRUMENT (ADI, HSI, SPI, ETC) ARE ACTUALLY REFERENCING THE FUNCTION OF THOSE INSTRUMENTS DISPLAYED ON AN MDU.

This flight rule allows existing flight rules to be compatible with MEDS configured vehicles and also allows existing rules to be used with a mixed fleet of MCDS and MEDS. @[040899-2459B]

FLIGHT RULES

THIS PAGE INTENTIONALLY BLANK

FLIGHT RULES

SECTION 2 - FLIGHT OPERATIONS

PRELAUNCH

A2-1 PRELAUNCH GO/NO-GO REQUIREMENTS [HC].....2-1

A2-2 ABORT LANDING SITE REQUIREMENTS.....2-7

A2-3 LAUNCH HOLD.....2-11

A2-4 LAUNCH DAY CREW TIME CONSTRAINTS.....2-11

A2-5 PORT MODING/RESTRINGING GUIDELINES.....2-12

A2-6 LANDING SITE WEATHER CRITERIA [HC].....2-14

 TABLE A2-6-I - CEILING AND VISIBILITY LIMITS.....2-15

 TABLE A2-6-II - SURFACE WINDS AND TURBULENCE LIMITS.....2-19

 TABLE A2-6-III - THUNDERSTORM, LIGHTNING, AND
 PRECIPITATION.....2-24

A2-7 DAY-OF-LAUNCH ET LOAD DATA [HC].....2-45

A2-8 LAUNCH TIME SELECTION FOR GROUND-UP
 RENDEZVOUS.....2-47

A2-9 LOSS OF ET LOX LIQUID LEVEL CONTROL SENSORS...2-56

A2-10 THROUGH A2-50 RULES ARE RESERVED.....2-58

ASCENT

A2-51 STS ABORT CRITERIA.....2-59

A2-52 ASCENT MODE PRIORITIES FOR PERFORMANCE CASES..2-60

 FIGURE A2-52-I - SHUTTLE LANDING FOOTPRINT.....2-66

A2-53 FORWARD RCS USAGE GUIDELINES.....2-70

A2-54 RTLS, TAL, AND AOA ABORTS FOR SYSTEMS
 FAILURES [CIL].....2-71

A2-55 ENTRY GUIDANCE SELECTION FOR ABORTS.....2-79

 FIGURE A2-55-I - GENERIC DOWNRANGE ABORT EVALUATOR (DAE)
 FOOTPRINT ($VI \leq 22.8$ KFPS).....2-81

 FIGURE A2-55-II - GENERIC DOWNRANGE ABORT
 EVALUATOR (DAE) FOOTPRINT ($22.8 < VI \leq 25.0$ KFPS).....2-82

 FIGURE A2-55-III - GENERIC DOWNRANGE ABORT
 EVALUATOR (DAE) FOOTPRINT ($VI > 25.0$ KFPS).....2-83

A2-56 ABORT GAP.....2-86

FLIGHT RULES

A2-57 CONTINGENCY ASCENTS/ABORTS.....2-87
 A2-58 ABORT LIGHT.....2-89
 A2-59 BFS ENGAGE CRITERIA.....2-91
 A2-60 NAVIGATION UPDATE CRITERIA.....2-92
 A2-61 Q-BAR/G-CONTROL.....2-93
 A2-62 ET FOOTPRINT CRITERIA.....2-94
 A2-63 ASCENT STRING REASSIGNMENT.....2-97
 A2-64 MANUAL THROTTLE CRITERIA.....2-102
 A2-65 OMS-1 DELAYED TARGET CRITERIA.....2-103
 A2-66 APU SHUTDOWN DELAY CRITERIA.....2-103
 A2-67 ARD UPDATE CRITERIA.....2-103
 A2-68 ET PHOTOGRAPHY.....2-104
 A2-69 REGAIN RCS JETS FOR RTLS ET SEPARATION.....2-108
 A2-70 DELAYED TRANSATLANTIC LANDING (TAL) ABORT...2-109
 A2-71 THROUGH A2-100 RULES ARE RESERVED.....2-110

ORBIT

A2-101 VEHICLE SYSTEMS REDUNDANCY DEFINITIONS.....2-111
 A2-102 MISSION DURATION REQUIREMENTS.....2-112
 A2-103 EXTENSION DAY REQUIREMENTS.....2-117
 A2-104 SYSTEMS REDUNDANCY REQUIREMENTS.....2-121
 A2-105 IN-FLIGHT MAINTENANCE (IFM) [HC].....2-126
 A2-106 PBD OPERATIONS [CIL].....2-136
 A2-107 EVA GUIDELINES.....2-137
 A2-108 CONSUMABLES MANAGEMENT.....2-140
 A2-109 PREFERRED ATTITUDE FOR WATER DUMPS.....2-146
 FIGURE A2-109-I - PREFERRED ATTITUDE FOR WATER DUMPS...2-146
 A2-110 STRUCTURES THERMAL CONDITIONING.....2-149
 A2-111 DPS COMMAND CRITERIA.....2-156
 A2-112 PDRS.....2-158
 A2-113 OMS/RCS DOWNMODING CRITERIA.....2-160
 A2-114 OMS/RCS MANEUVER CRITICALITY.....2-161
 A2-115 ENGINE SELECTION CRITERIA.....2-163

FLIGHT RULES

A2-116 RENDEZVOUS (RNDZ)/PROXIMITY OPERATIONS (PROX OPS) DEFINITIONS.....2-164

A2-117 RNDZ/PROX OPS GNC SYSTEMS MANAGEMENT.....2-165

A2-118 RNDZ/PROX OPS COMMUNICATION SYSTEMS MANAGEMENT.....2-171

A2-119 RNDZ/PROX OPS SENSOR REQUIREMENTS.....2-172

A2-120 RNDZ/PROX OPS DPS SYSTEMS MANAGEMENT.....2-175

A2-121 RNDZ/PROX OPS PROPULSION SYSTEMS MANAGEMENT..2-177

A2-122 RENDEZVOUS MANEUVERS.....2-187

A2-123 RENDEZVOUS MANEUVER SOLUTION SELECTION CRITERIA.....2-188

A2-124 RENDEZVOUS MANEUVER EXECUTION.....2-190

A2-125 RNDZ OPS DELAY.....2-193

A2-126 RNDZ/PROX OPS BREAKOUT**ERROR! BOOKMARK NOT DEFINED.-ERROR! BO**

A2-127 RENDEZVOUS GUIDANCE.....2-205

A2-128 EMCC/TMCC ACTIVATION.....2-209

A2-129 ORBITER ON-ORBIT HIGH DATA RATE REQUIREMENTS [HC].....2-210

A2-130 PAYLOAD OBJECTIVES VS. PAYLOAD DAMAGE POLICY.2-212

A2-131 ATTITUDE RESTRICTIONS FOR ORBITAL DEBRIS.....2-213

A2-132 THERMAL CONDITIONING FOR FLIGHT DAY 1 LANDING2-215

A2-133 POCC THROUGHPUT COMMAND RATES.....2-217

A2-134 ON-ORBIT CRYO MARGIN BUYBACKS.....2-218

A2-135 COMMANDER (CDR) AND PILOT (PLT) PARTICIPATING AS TEST SUBJECTS.....2-225

A2-136 OBSS TPS INSPECTION SENSOR PRIORITIES.....2-225

A2-137 TPS INSPECTION AND IMPACT DETECTION PRIORITIES.....2-227

A2-138 THROUGH A2-200 RULES ARE RESERVED.....2-230

DEORBIT

A2-201 DEORBIT GUIDELINES.....2-231

A2-202 EXTENSION DAY GUIDELINES.....2-233

A2-203 DEORBIT DELAY GUIDELINES.....2-235

A2-204 MDF DEORBIT GUIDELINES.....2-237

FLIGHT RULES

A2-205 EMERGENCY DEORBIT.....2-238
 A2-206 DEROTATION SPEED [HC].....2-246
 A2-207 LANDING SITE SELECTION [HC].....2-248
 A2-208 ACES PRESSURE INTEGRITY CHECK.....2-261
 A2-209 LANDING SITE SELECTION FOR AN INFLIGHT
 EMERGENCY.....2-261
 A2-210 ENTRY THERMAL OPTIONS [HC].....2-263
 A2-211 THROUGH A2-250 RULES ARE RESERVED.....2-268

ENTRY

A2-251 BAILOUT.....2-269
 A2-252 GCA CRITERIA.....2-272
 A2-253 ENERGY MANAGEMENT.....2-273
 A2-254 ENTRY STRING REASSIGNMENT.....2-274
 A2-255 CREW TAKEOVER.....2-279
 A2-256 EARLY POWERDOWN.....2-280
 A2-257 DEORBIT BURN TERMINATION.....2-280
 A2-258 BFS ENGAGE.....2-280
 A2-259 CHASE AIRCRAFT OPERATIONS.....2-281
 A2-260 ENTRY LOAD MINIMIZATION.....2-282
 A2-261 ENTRY DTO/AUTO MODE/CROSSWIND DTO GO/NO-GO...2-283
 A2-262 LANDING DTO'S.....2-297
 A2-263 STA/WEATHER AIRCRAFT RUNWAY APPROACH
 OPERATIONS FOR SITES WITH ONLY ONE RUNWAY...2-298
 A2-264 EMERGENCY LANDING FACILITY CRITERIA [HC]....2-299
 A2-265 RESERVED.....2-301
 A2-266 SUBSONIC PILOT FLIGHT CONTROL.....2-302
 A2-267 THROUGH A2-300 RULES ARE RESERVED.....2-304

CONTINGENCY ACTION SUMMARY

A2-301 CONTINGENCY ACTION SUMMARY [HC].....2-305
 A2-302 THROUGH A2-310 RULES ARE RESERVED.....2-316

FLIGHT RULES

SPACEHAB OPERATIONS MANAGEMENT

A2-311 SPACEHAB SAFETY DEFINITION AND MANAGEMENT....2-317

A2-312 REAL-TIME SAFETY COORDINATION.....2-319

A2-313 GROUND COMMANDING.....2-320

A2-314 SPACEHAB MINIMUM DURATION FLIGHT CRITERIA....2-322

A2-315 POWERING OFF AND REPOWERING SPACEHAB
EQUIPMENT.....2-322

A2-316 ORBITER-TO-SPACEHAB HATCH CONFIGURATION.....2-323

A2-317 EVA CONSTRAINTS.....2-324

A2-318 ORBITAL MANEUVERING SYSTEM/REACTION CONTROL
SYSTEM (OMS/RCS) CONSTRAINTS.....2-325

A2-319 CONTAMINATION AND MICROGRAVITY CONSTRAINTS...2-325

A2-320 COMMAND AND DATA SYSTEM CONSTRAINTS.....2-326

A2-321 SPACEHAB AIR-TO-GROUND (A/G) USAGE.....2-327

A2-322 SPACEHAB CAUTION AND WARNING ANNUNCIATION IN
MODULE.....2-328

A2-323 COMMUNICATIONS CONSTRAINTS.....2-329

A2-324 SPACEHAB IN-FLIGHT MAINTENANCE (IFM)
PROCEDURES.....2-329

A2-325 IFM PROCEDURES ON EXPERIMENTS WITH TOXIC
HAZARDS.....2-330

A2-326 EQUIPMENT EXCHANGE BETWEEN ORBITER CABIN AND
SPACEHAB MODULE.....2-331

A2-327 SPACEHAB MODULE/TUNNEL SLEEP CONSTRAINTS....2-332

A2-328 CREW LIMITATIONS IN THE SPACEHAB MODULE.....2-333

A2-329 SPACEHAB DEACTIVATION/ENTRY PREP.....2-334

A2-330 EXTENSION DAY GROUND RULES.....2-336

A2-331 CONSTRAINTS ON CABLES THROUGH THE SPACEHAB
HATCH AND TUNNEL.....2-337

A2-332 LOSS OF SM GPC DURING SPACEHAB
ACTIVATION/ENTRY PREP.....2-340

A2-333 LOSS OF PAYLOAD MDM DURING SPACEHAB ACT/ENTRY
PREP.....2-341

A2-334 LOSS OF SM MAJOR FUNCTION.....2-342

FLIGHT RULES

A2-335	LOSS OF ORBITER MASTER TIMING UNIT (MTU)/PAYLOAD TIMING BUFFER.....	2-343
A2-336 THROUGH A2-400	RULES ARE RESERVED.....	2-343
ORBITER SYSTEMS GO/NO-GO		
A2-1001	ORBITER SYSTEMS GO/NO-GO [HC].....	2-344

FLIGHT RULES

SECTION 2 - FLIGHT OPERATIONS

PRELAUNCH

A2-1 PRELAUNCH GO/NO-GO REQUIREMENTS [HC] ©[032807-8411A]

LAUNCH WILL BE NO-GO IF THE FOLLOWING CONDITIONS ARE NOT SATISFIED:

- A. MINIMUM STS SUBSYSTEMS CAPABILITY (REF. LAUNCH COMMIT CRITERIA (LCC)).

The vehicle must satisfy certain minimum subsystems capabilities to be GO for launch. Prelaunch OMI's implement checkout requirements specified in the OMRSD. In general, these are designed to demonstrate operation of all testable subsystems within prescribed limits. Any deviation must be accounted for, either by repair, replacement, or a waiver from the MMT. Launch commit criteria are designed to ensure those systems that are monitorable operate within acceptable limits during the final hours in the launch countdown. In certain areas, launch may be permitted with certain equipment losses provided those are well understood to be isolated occurrences and not symptomatic of a potentially generic problem. These instances will be specified in the LCC document.

- B. MINIMUM ONBOARD INSTRUMENTATION REQUIREMENTS (REF. LCC).

The vehicle must satisfy minimum onboard display/control capability via crew display/control equipment as well as minimum telemetry/instrumentation requirements to be GO for launch. These capabilities are required to allow ground and crew monitoring and control of the vehicle systems for critical failures and crew capability to fly the vehicle should it become necessary. These are documented in the Launch Commit Criteria.

- C. VEHICLE PERFORMANCE MARGINS (REF. RULE {A4-1A}, PERFORMANCE ANALYSIS).

The vehicle must satisfy the propellant reserve performance margins (ref. Rule {A4-1A}, PERFORMANCE ANALYSIS) in order to be GO for launch. These margins are protected to assure that sufficient propellant reserves cover loading and systems usage dispersions during ascent.

THIS RULE CONTINUED ON NEXT PAGE

FLIGHT RULES

A2-1 PRELAUNCH GO/NO-GO REQUIREMENTS [HC] (CONTINUED)

- D. ACCEPTABLE STRUCTURAL LOADS AND DAY-OF-LAUNCH I-LOAD UPDATE (DOLILU) ASSESSMENT (REF. NSTS-08329, VOL. VIII, DOLILU OPERATIONS SUPPORT PLAN (DOSP)). @[091098-6622C]

The generation of the DOLILU I-loads must be consistent with certification groundrules and the launch day environment, and vehicle structural loading must remain within acceptable boundaries to be GO for launch. The assessment is performed at several points in the pre-launch timeframe using balloon-measured upper-level wind data. The DOLILU process launch decision criteria applied to this assessment is specified in the DOSP. @[091098-6622C]

- E. MINIMUM GROUND INSTRUMENTATION REQUIREMENTS.

SUFFICIENT GROUND INSTRUMENTATION SUPPORT SHALL BE OPERATIONAL AT LAUNCH TO SATISFY A/G VOICE, TELEMETRY, TRACKING, AND COMMAND REQUIREMENTS FOR ASCENT AND REQUIRED ABORT LANDING SITES, REF. RULE {A2-2}, ABORT LANDING SITE REQUIREMENTS. SPECIFIC EQUIPMENT REQUIREMENTS ARE DEFINED IN FLIGHT RULES SECTION 3.

FOR FIRST DAY PLS LANDING SITES ONLY, EQUIPMENT OUTAGES ARE ALLOWED ONLY IF CRITICAL EQUIPMENT ETRO IS PRIOR TO FIRST DAY PLS DEORBIT DECISION TIME, OR IF FIRST DAY PLS IS NOT REQUIRED, ETRO MUST BE PRIOR TO SECOND DAY PLS DEORBIT DECISION TIME.

Detailed requirements and the facilities necessary to provide support and redundancy for ascent and ascent aborts vary from phase to phase and even within each phase. In general, the requirements are broken down into A/G voice, telemetry, tracking, and command capabilities as high-level requirements. These, in turn, determine the facilities support requirements which are detailed in section 3 for each capability and facility. For mandatory ascent abort landing sites, full capabilities must be functional prior to launch. If an ascent abort landing site is not required, then full capabilities are highly desirable, and loss of any capability will not lead to a launch hold. For a required first day PLS site, equipment outages are allowed if repairs can be guaranteed complete prior to landing. In any event, all required equipment must be planned to be functional at one CONUS site by second day PLS time, or launch is NO-GO.

THIS RULE CONTINUED ON NEXT PAGE

FLIGHT RULES

A2-1 PRELAUNCH GO/NO-GO REQUIREMENTS [HC] (CONTINUED)

F. ACCEPTABLE LANDING CONDITIONS FOR REQUIRED ABORT LANDING SITES, REF. RULE {A2-2}, ABORT LANDING SITE REQUIREMENTS. IF AN ABORT LANDING SITE IS NOT MANDATORY, ACCEPTABLE LANDING CONDITIONS ARE STILL HIGHLY DESIRABLE AT THAT SITE. CONDITIONS WHICH MUST BE MET ARE:

1. NO VIOLATIONS OF THE LANDING SITE WEATHER CRITERIA (REF. RULES {A4-2}, LANDING SITE CONDITIONS, AND {A2-6}, LANDING SITE WEATHER CRITERIA [HC]). @[111094-1622B]
2. FOR ALL LANDINGS BUT FIRST OR SECOND DAY PLS, NO VIOLATION OF ENTRY ANALYSIS LIMITS INCLUDING:
 - a. APPROACH AND LAND TRANSITION (REF. RULE {A4-156}, HAC SELECTION CRITERIA)
 - b. NORMALIZED TOUCHDOWN DISTANCE (REF. RULE {A4-110}, AIMPOINT, EVALUATION VELOCITY, AND SHORT FIELD SELECTION)
 - c. TIRE SPEED/ROLLOUT/BRAKING LIMITS (REF. RULE {A4-108}, TIRE SPEED, BRAKING, AND ROLLOUT REQUIREMENTS [HC]) @[042706-7363A]
 - d. NZ AND Q-BAR CONSTRAINTS (REF. RULE {A4-207}, ENTRY LIMITS) @[072795-1788B]
3. ACCEPTABLE GROUND NAVAIDS (REF. RULES {A3-201}, TACAN REDUNDANCY REQUIREMENTS AND ALTERNATE TACAN SELECTION PHILOSOPHY; {A3-202}, MLS; AND {A2-6}, LANDING SITE WEATHER CRITERIA [HC]). @[111094-1622B]

FOR THREE STRING GPS FLIGHTS ONLY, AN ACCEPTABLE GPS CONSTELLATION CONFIGURATION IS REQUIRED (REF. RULE {A3-204}, GPS CONSTELLATION). @[032807-8411A]

THIS RULE CONTINUED ON NEXT PAGE

FLIGHT RULES

A2-1 PRELAUNCH GO/NO-GO REQUIREMENTS [HC] (CONTINUED)

4. ACCEPTABLE LANDING AND VISUAL AIDS (REF. RULE {A3-203}, LANDING AID REQUIREMENTS).
5. ACCEPTABLE CURRENT AND PREDICTED RUNWAY CONDITIONS (REF. RULE {A4-111}, RUNWAY ACCEPTABILITY CONDITIONS).
@[111094-1622B]
6. ACCEPTABLE COMMUNICATIONS FROM THE MCC TO THE REQUIRED ASCENT ABORT SITES. (REF. RULES {A3-52E}, MCC INTERNAL VOICE, AND {A3-156}, MCC/ASCENT ABORT SITE INTERFACE).
@[111094-1716A]

Prelaunch, the MCC must be able to communicate with the ascent abort landing sites. This insures that there has not been a change in weather or nav/landing aid status. It also insures that anomalies can be passed to the ground support team and that the runway and airspace are clear for a safe landing. This can be accomplished by insuring that at least one of the communications capabilities listed below are available:

- a. Longline (LFPI)
- b. INMARSAT
- c. Commercial Telephone @[111094-1716A]

7. DAYLIGHT LANDING UNLESS CREW SPECIFICALLY TRAINED FOR NIGHT LANDING AND RELATED LANDING AIDS FUNCTIONAL (REF. PARAGRAPHS 3 AND 4 ABOVE). EXCEPTIONS ARE ALLOWED FOR AOA (IF NOT REQUIRED) AND FIRST DAY PLS.

Acceptable landing conditions and aids requirements rationale for each of the requirements may be found in the referenced rule. A TAL site is highly desirable if RTLS/two-engine press capability overlap exists since TAL is preferred over RTLS (ref. Rule {A2-52}, ASCENT MODE PRIORITIES FOR PERFORMANCE CASES) for an engine out performance. TAL capability also provides for performance gap management and extended coverage during ascent for systems aborts that require abort modes other than first day PLS. Rules {A1-106E} and {A1-106G}, LANDING SITES, reference this rule.

THIS RULE CONTINUED ON NEXT PAGE

FLIGHT RULES

A2-1

PRELAUNCH GO/NO-GO REQUIREMENTS [HC] (CONTINUED)

For all abort landings, the entry analysis using the forecast and measured (ref. Rule {A4-112}, UPPER AND LOWER LEVEL MEASURED WIND AND ATMOSPHERIC DATA) environmental data must be predicting a safe landing. For first day PLS, prelaunch analysis is not generally performed due to the length of time from prelaunch data collection until actual landing; similarly, only forecast weather is used for first day PLS status, not prelaunch observations. ©[111094-1622B]

If AOA is not required for performance reasons, then systems AOA is an extreme contingency case and crew pilot pool night training is considered adequate. Lighting at first day PLS is not a design groundrule; lighted launch, TAL, and first day PLS cannot all be accomplished for some high inclination missions. Therefore, pilot pool night training is considered acceptable for systems AOA or first day PLS. Also for first day PLS, crew workday is not protected.

Predictions of weather and or equipment availability at the first day PLS site are less accurate due to the time involved (4.5 to 10.5 hours after launch). The requirements to use a first day PLS site are based on performance and systems redundancy requirements. If a first day PLS site is not available, the single engine out abort boundaries are adjusted to ensure that a stable orbit is achieved which will support a delay in landing until flight day 2 when more landing sites and better conditions will be available. The redundancy requirements are considered an acceptable risk (multiple failures of proven highly reliable equipment occurring in short periods of time). Acceptance of this risk allows an on time launch when all conditions other than those at the first day PLS site are acceptable.

G. THE LAUNCH WILL BE NO-GO IF PRELAUNCH, U.S. SPACE COMMAND ORBIT CONJUNCTIONS (COMBO ANALYSIS), OR EASTERN RANGE (ER) COLLISION AVOIDANCE (COLA) CONFLICTS ARE PREDICTED. LAUNCH HOLD TO THE NEXT EVEN MINUTE IS UTILIZED TO CLEAR CONFLICTS (REF. RULE {A4-3}, ORBIT CONJUNCTIONS/CONFLICTS, AND LCC 5.6). ©[051194-1605]

Responsibility for calling launch holds based on COLA's lies with ER/KSC, while computation of misses between orbits (COMBO) conflict responsibility lies with JSC based on data provided by U. S. Space Command.

U.S. Space Command and ER perform several prelaunch analyses to determine if any such orbital conjunctions may result. The U.S. Space Command COMBO analysis is performed assuming an on-time launch while the ER COLA analysis evaluates the entire launch window. Also, ER analyses are performed only against mannable space vehicles (such as Mir) for the first orbit after liftoff, while U.S. Space Command provides data to JSC for analysis of the entire U.S. Space Command orbiting object catalog for a period of 2 hours after liftoff. If clearance limits are exceeded for a launch at the planned time, the launch must be held until adequate clearance can be assured. For practical considerations, such holds will extend to the even minute. ©[051194-1605]

THIS RULE CONTINUED ON NEXT PAGE

FLIGHT RULES

A2-1 PRELAUNCH GO/NO-GO REQUIREMENTS [HC] (CONTINUED)

H. ACLS'S ARE NOT REQUIRED FOR LAUNCH COMMIT.

These sites are for contingency cases only and are therefore not required for launch.

I. POSTLAUNCH SEARCH AND RESCUE (SAR) OPERATIONS - THE LAUNCH WILL NOT BE HELD BASED ON SAR WEATHER OR THE FAILURE OF ANY EQUIPMENT THAT WOULD BE USED TO SUPPORT A POSTLAUNCH SAR OPERATION.

Establishing weather/sea state criteria across the total trajectory/range for SAR operations is prohibitive, and we would be NO-GO for launch most of the time. Additionally, the weather and sea state along the total trajectory will probably not be known. Delaying the launch to accommodate repair of a SAR aircraft or other piece of equipment, or to allow improvement in weather conditions in areas for which we may not have an adequate forecast anyway, is not the prudent action. The DOD response for bailout support may be affected.

J. MINIMUM CREW ESCAPE EQUIPMENT REQUIREMENTS (REF. RULE, {A10-401}, LOSS OF CREW ESCAPE EQUIPMENT [HC]) @[033006-7190D]

A minimum complement of crew escape equipment is required to satisfy the IAW JSC-23003, Shuttle CEE SAD, December 8, 2000, Section 1.0 requirements for protective survival equipment if a preflight, inflight, and/or postflight emergency occurs requiring environmental protection (e.g., a bailout). These requirements include protection below 100,000 feet altitude, as well as for 24 hours after a water landing.

Reference rule {A10-401}, LOSS OF CREW ESCAPE EQUIPMENT [HC].

Hazard Report INEV-01, Exposure to Natural Environment (NE) Exceeds Capability of the Space Shuttle Vehicle (SSV)/Elements, references this rule. @[033006-7190D]

K. FOR GROUND UP RENDEZVOUS MISSIONS, ADEQUATE RENDEZVOUS TARGET TRACKING (REF. RULE {A4-5}, TARGET STATE VECTOR REQUIREMENTS FOR LAUNCH) . @[032807-8411A]

Hazard Report INEV-01, Exposure to Natural Environment (NE) Exceeds Capability of the Space Shuttle Vehicle (SSV)/Elements, references this rule. This rule is a control for multiple orbiter hazard reports. @[032807-8411A]

Rules {A1-106}, LANDING SITES; {A2-2}, ABORT LANDING SITE REQUIREMENTS; {A4-107}, PLS/EOM LANDING OPPORTUNITY REQUIREMENTS [HC]; and {A4-110}, AIMPOINT, SPEEDBRAKE RETRACT OPTION, AND EVALUATION TOUCHDOWN VELOCITY SELECTION [HC], reference this rule. @[ED]

FLIGHT RULES

A2-2

ABORT LANDING SITE REQUIREMENTS

CONTINUOUS SINGLE SSME OUT INTACT ABORT COVERAGE IS REQUIRED THROUGHOUT POWERED FLIGHT (REF. NSTS 07700, VOLUME X, PARAGRAPHS 3.2.1.1.4 AND 3.2.1.5.1.1 THROUGH 3.2.1.5.1.3). PRELAUNCH ANALYSIS MUST DEMONSTRATE THIS CONTINUOUS SINGLE SSME OUT INTACT ABORT COVERAGE EXISTS OR LAUNCH IS NO GO PER RULE {A2-1}, PRELAUNCH GO/NO-GO REQUIREMENTS [HC]. ©[041196-1801A] ©[ED]

THIS CONTINUOUS SINGLE SSME OUT INTACT ABORT COVERAGE MUST INCLUDE SYSTEMS FAILURE TOLERANCE AND BOTH SYSTEMS AND ENVIRONMENTAL PERFORMANCE DISPERSIONS AS REQUIRED.

THIS CONTINUOUS SINGLE ENGINE OUT INTACT ABORT COVERAGE MUST BE TO A FULLY ACCEPTABLE LANDING SITE THROUGHOUT POWERED FLIGHT. THERE CAN BE NO PRELAUNCH PREDICTED SINGLE SSME OUT ABORT GAP BETWEEN LAST RTLS AND FIRST TAL NOR BETWEEN LAST RTLS OR LAST INTACT TAL CAPABILITY (TO A GO TAL SITE) AND FIRST PRESS CAPABILITY, AND NO GAP IN SINGLE SSME OUT PROTECTION FOLLOWING FIRST PRESS CAPABILITY NO MATTER WHICH OF THE FOLLOWING CRITERIA IS USED TO DEFINE PRESS CAPABILITY. ©[041196-1801A]

- A. AN RTLS LANDING SITE IS REQUIRED FOR LAUNCH COMMIT.
- B. A TAL LANDING SITE IS REQUIRED FOR LAUNCH COMMIT UNLESS THERE IS RTLS AND TWO ENGINE PRESS CAPABILITY OVERLAP. THEN A TAL LANDING SITE IS HIGHLY DESIRABLE.

THIS RULE CONTINUED ON NEXT PAGE

FLIGHT RULES

A2-2

ABORT LANDING SITE REQUIREMENTS (CONTINUED)

- C. AN AOA LANDING SITE IS HIGHLY DESIRABLE. AN AOA LANDING SITE IS REQUIRED FOR LAUNCH COMMIT ONLY IF BOTH OF THE FOLLOWING CONDITIONS ARE MET:
1. AN INTACT SINGLE ENGINE OUT ABORT GAP EXISTS BETWEEN THE LATER OF LAST TWO ENGINE TAL TO A GO TAL SITE OR LAST TWO ENGINE RTLS AND TWO ENGINE PRESS CAPABILITY BASED ON ATO/MINIMUM HP SHALLOW DEORBIT (FD1 OR 2), AND @[012402-5112B]
 2. TWO ENGINE PRESS CAPABILITY BASED UPON AOA STEEP PROVIDES CONTINUOUS SINGLE ENGINE OUT INTACT ABORT COVERAGE THROUGH MECO.

IF AN ASCENT INTACT ABORT LANDING SITE IS REQUIRED, THEN ALL LANDING SITE REQUIREMENTS, AS SPECIFIED IN THE FLIGHT RULES, MUST BE SATISFIED. IN THE CASE OF LAUNCH COMMIT WITHOUT A TAL OR AOA OR FIRST DAY PLS LANDING SITE, OR WITHOUT ANY COMBINATION OF SITES, THEN A CONTINGENCY OR SYSTEMS ABORT REQUIREMENT WILL BE SATISFIED USING EXISTING RTLS, TAL, ACLS, OR ABORT FROM ORBIT (AFO) CAPABILITY, POSSIBLY TO AN ELS. @[041196-1801A] @[012402-5112B]

NOTE: IF FIRST DAY PLS IS NO-GO DUE TO EQUIPMENT OUTAGE (REF. SECTION 3), THEN LAUNCH WILL BE GO ONLY IF ALL REQUIRED EQUIPMENT WILL BE AVAILABLE AT ONE OR MORE CONUS SITES PRIOR TO FD 2 PLS DEORBIT DECISION TIME.

THIS RULE CONTINUED ON NEXT PAGE

FLIGHT RULES

A2-2**ABORT LANDING SITE REQUIREMENTS (CONTINUED)**

Continuous single engine out intact abort capability to a landing site meeting all requirements must be achieved to commit to launch (ref. Rule {A4-1D}, PERFORMANCE ANALYSES). Since the only two engine intact abort mode available for the first 2 to 3 minutes of any flight is the RTLS site, GO conditions are mandatory at the RTLS landing site.

TAL is required unless RTLS/two engine press overlaps. Even in those cases, TAL is the preferred abort mode for an engine out during the RTLS/TAL overlap period. Launching without TAL capability should never be a design goal but a real-time fallback if weather or equipment outages at the TAL sites are the only constraints to launch.

The ATO single SSME out press boundary represents the earliest time at which an engine failure will result in the achievement of an acceptable MECO underspeed based on one of four cases: AOA steep capability; ATO/minimum Hp with shallow deorbit on flight day 1 capability; ATO/minimum Hp with shallow deorbit on flight day 2 capability, including OPS 2 use of Fwd RCS (ref. Rule {A2-53}, FORWARD RCS USAGE GUIDELINES); or ET impact in an acceptable area (ref. Rule {A4-55B}, DESIGN AND CRITICAL MECO UNDERSPEED DEFINITIONS). If the design press boundary is based on AOA steep but no AOA site is available, then intact capability can still be provided as long as no gap exists between last RTLS or TAL and the press boundary based on ATO/minimum Hp for flight day 1/shallow deorbit. If no first day PLS site is available, then continuous single SSME out intact abort capability can still be provided as long as no gap exists between last RTLS or TAL and the press boundary based on AOA steep (press capabilities based on AOA steep and ATO/min Hp/flight day 1 shallow come only a few seconds apart). If neither an AOA or first day PLS site are available, then launch commit may be allowed if there is no gap between last RTLS or TAL and a press boundary based on ATO OMS-1/minimum Hp OMS-2/shallow deorbit on flight day 2. This boundary assumes the use of the Fwd RCS in OPS 2. Analysis has shown that there is no delay in this press boundary with respect to the flight day 1 press boundary when the Fwd RCS is allowed. ©[012402-5112B]

Even if a first day PLS site is not technically available at launch time, equipment outages may be resolved or weather may improve by deorbit decision time.

THIS RULE CONTINUED ON NEXT PAGE

FLIGHT RULES

A2-2

ABORT LANDING SITE REQUIREMENTS (CONTINUED)

If a first day PLS landing site is not available, and systems failures requiring early flight termination occur, landing will be supported by RTLS, TAL, and AFO sites. This means that deorbit/landing might be made under ACLS/ELS type conditions: less than normally acceptable weather; lack of nav aids; etc. Systems failures requiring first day PLS are typically multiple failures or structural failures. In some cases, immediate deorbit is required. Should these type failures occur during the on-orbit timeframe, it has always been acceptable to land under ACLS/ELS conditions. In other cases, loss of redundancy in entry critical equipment is cause for a first day PLS. When a first day PLS site is not available, for loss of redundancy that normally calls for first day PLS, the risk of staying on orbit until the next day for improved landing conditions outweighs the risk of loss of critical equipment during the on-orbit wait for 24 hours.

If an abort landing site is required, the sites must fully meet the requirements listed in the flight rules (ref. Rules {A2-1F-G}, PRELAUNCH GO/NO-GO REQUIREMENTS [HC], and {A4-107A}, PLS/EOM LANDING OPPORTUNITY REQUIREMENTS) for: landing site weather conditions including visibility, clouds, winds, turbulence, precipitation, runway/lakebed surface conditions, and resources necessary to measure low-level winds and atmospheric data (not PLS); crossrange, rollout margin, brake energy, navigation aids, and lighting (not PLS); touchdown margin (not PLS); and tracking (not AOA or PLS), telemetry, command, and air-ground voice (for PLS equipment outage ETRO must be before deorbit decision time). ©[072795-1772] ©[ED]

Rules {A1-106}, LANDING SITES; {A1-107}, LANDING OPPORTUNITIES; {A2-1}, PRELAUNCH GO/NO-GO REQUIREMENTS [HC]; {A2-301}, CONTINGENCY ACTION SUMMARY [HC]; {A3-52}, MCC INTERNAL VOICE; {A3-156}, MCC/ASCENT ABORT SITE INTERFACE; {A3-201}, TACAN REDUNDANCY REQUIREMENTS AND ALTERNATE TACAN SELECTION PHILOSOPHY; {A3-202}, MLS [HC]; {A3-204}, GPS CONSTELLATION; {A4-2}, LANDING SITE CONDITIONS; {A4-55}, DESIGN AND CRITICAL MECO UNDERSPEED DEFINITIONS; and {A4-112}, UPPER AND LOWER LEVEL MEASURED WIND AND ATMOSPHERIC DATA [HC], reference this rule. ©[ED] ©[032807-8400] ©[ED]

FLIGHT RULES

A2-3

LAUNCH HOLD

NO MCC COUNTDOWN HOLD WILL BE CALLED AFTER T-31 SECONDS.

After T-31 seconds, launch holds will not be called by the MCC. T-31 seconds is the latest time that an MCC voice call for a launch hold can realistically be acted on in real time. Calling such a hold for MCC-related/non-ground launch sequencer (GLS) recognized problems does not merit the risk of such a launch hold. Backup onboard crew procedures can accomplish most abort functions should the MCC have a problem in the last few seconds before launch. ©[061396 4005]

A2-4

LAUNCH DAY CREW TIME CONSTRAINTS

A. THE MAXIMUM TIME THE CREW WILL REMAIN IN THE VEHICLE IS 5 HOURS 15 MINUTES (EXCLUDING SAFING AND EGRESS TIME) (REF. LCC 3.2B), WHICH ALLOWS 2.5 HOURS OF HOLD TIME AFTER THE EARLIEST PLANNED LAUNCH TIME.

Remaining in the launch-seat posture for extended periods of time potentially impairs crewmembers' ability to perform launch duties and emergency egress procedures because of orthostatic intolerance and musculoskeletal discomfort. This position can be extremely fatiguing, which can affect cognitive performance. ©[022604-6191]

The crew typically enters the vehicle about 2 hours 45 minutes before launch; thus, a 2.5-hour launch window is preserved with the 5 hour 15 minute limit.

Reference: Shuttle Crew Scheduling Constraints, Revision A, July 2000, NSTS-37326.

B. THE SCHEDULED CREW AWAKE TIME ON LAUNCH DAY WILL NOT NORMALLY EXCEED 16 HOURS. PRELAUNCH HOLD TIME AND POSTLAUNCH ORBITER/PAYLOAD CONTINGENCIES REQUIRING THE USE OF BACKUP TIMELINES WILL BE ACCOMMODATED AS LONG AS THEY DO NOT EXTEND THE CREW DAY BEYOND 18 HOURS.

Abnormally long days will result in crew fatigue and increase the potential for procedural errors that could affect safety or compromise mission success. Without a waiver, crew awake time on launch day will not be premission scheduled for greater than 16 hours. Since the crew is minimally awake about 4 hours 55 minutes before launch, this allows for up to 11 hours 5 minutes of on-orbit activities before the start of the sleep period. If there is a launch hold or orbiter/payload contingencies require the use of backup timelines for deploy opportunities or off-nominal operations, these adjustments will be accommodated as long as the maximum crew day of 18 hours is not exceeded.

DOCUMENTATION: Dinges DF. An overview of sleepiness and accidents. J Sleep Research, 4 (2): 414, 1995. ©[022604-6191]

Rule {A8-57}, PRELAUNCH IMU HOLD, references this rule. ©[ED]

FLIGHT RULES

A2-5

PORT MODING/RESTRINGING GUIDELINES

- A. PORT MODING OR RESTRINGING MAY BE USED PER RULES {A2-254C}, ENTRY STRING REASSIGNMENT; {A2-63B}.2, ASCENT STRING REASSIGNMENT; {A7-5}, PASS GPC BCE FAILURE MANAGEMENT; AND {A7-105}, MDM PORT MODING, TO REGAIN LOST CAPABILITIES DUE TO GPC FLIGHT-CRITICAL BCE FAILURES. THE RECOVERY TECHNIQUE USED WILL DEPEND UPON THE SPECIFIC FLIGHT PHASE AND FAILURE SCENARIO PRESENT IN THE ORBITER. IN GENERAL, PORT MODING WILL BE ATTEMPTED DURING DYNAMIC PHASES OVER RESTRINGING EXCEPT AS NOTED IN THE REFERENCED RULES. ©[ED]

For flight-critical BCE failures, recovery of lost capability may be attempted via port moding or restringing. Port moding will recover the bypassed FC MDM, but will result in the loss of the other FC MDM on the affected string. Restringing will result in the entire recovery of string capability, but GPC redundancy may be given up.

Port moding is preferred over restringing because of the ease of implementation (crew SPEC entry), port mode reconfiguration is considered to be less hazardous to the PASS redundant set than restring reconfiguration, and the desire to maintain GPC redundancy.

In general, restringing will only be attempted when the appropriate restring criteria is satisfied. Otherwise, port moding may be done to recover lost capability.

- B. A RESTRING WILL BE PERFORMED TO MAINTAIN CRITICAL CAPABILITY FOR THE FOLLOWING POWERDOWNS:
1. LOSS OF AV BAY COOLING (TO RECOVER TWO STRINGS)
 2. LOSS OF CABIN PRESSURE
 3. LOSS OF FLASH EVAPORATOR SYSTEM
 4. LOSS OF TWO FREON LOOPS
 5. LOSS OF TWO FUEL CELLS
 6. LOSS OF TWO H₂O LOOPS

THIS RULE CONTINUED ON NEXT PAGE

FLIGHT RULES

A2-5

PORT MODING/RESTRINGING GUIDELINES (CONTINUED)

If powerdowns are required during ascent or entry, the GPC's are intentionally moded to STBY then HALT and powered off to maintain either acceptable orbiter power levels or GPC thermal limits. This rule allows for a restring to be performed for the listed powerdowns.

If GPC failures or multiple LRU failures in a subsystem exist, then the current restring rules will be adhered to. Measures will also be taken to ensure that the least number of strings are reassigned (ref. Rules {A2-63}, ASCENT STRING REASSIGNMENT; and {A2-254}, ENTRY STRING REASSIGNMENT).

Powerdown procedures have been verified and are officially documented as part of the Space Shuttle Flight Data File (FDF).

Rule {A5-209}, ENTRY MPS HELIUM PURGE/MANIFOLD PRESSURIZATION, references this rule.

©[ED]

FLIGHT RULES

A2-6

LANDING SITE WEATHER CRITERIA [HC] ©[052401-4459A]

LIMITS APPLY TO DAY AND NIGHT LANDINGS UNLESS OTHERWISE NOTED. THE WEATHER LIMITS CONTAINED IN THIS RULE MUST BE SATISFIED WITH OBSERVATIONS AT THE GO/NO-GO DECISION TIME AND WITH THE FORECAST FOR THE LANDING TIME WITH THE FOLLOWING EXCEPTIONS: ©[111094-1622B] ©[021998-6490A]

FIRST - PRELAUNCH EVALUATION OF THE FD1 OR FD2 PLS IS BASED ONLY ON THE FORECAST.

The prelaunch PLS evaluations use only the forecast because the landing time is at least 5-10 hours after launch.

SECOND - CONSIDERATION MAY BE GIVEN TO RELAXING THE REQUIREMENT FOR A GO OBSERVATION AT DECISION TIME IF ANALYSIS CLEARLY INDICATES IMPROVING WEATHER CONDITIONS, AND THE FORECAST STATES THAT ALL WEATHER LIMITS WILL BE MET AT LANDING TIME.

In some weather situations, the observed weather at decision time may be NO-GO although weather conditions are improving. If there is a high level of confidence, based upon the observed weather trends, that the forecast for landing time is for weather to be within limits, consideration may be given to relaxing the GO requirement at decision time. Examples include: rain showers exhibiting predictable dissipation or movement away from the landing site at decision time; and crosswinds exceeding limits that are forecast to decrease diurnally for a landing near or after sunset. ©[021998-6490A]

THE APPROACHES TO BOTH THE PRIME AND BACKUP RUNWAYS AT A GIVEN SITE MUST SATISFY THE CEILING, VISIBILITY, PRECIPITATION, AND THUNDERSTORM PROXIMITY LIMITS LISTED BELOW. WHENEVER AVAILABLE, A WEATHER RECONNAISSANCE FLIGHT WILL PROVIDE A LANDING SITE GO/NO-GO RECOMMENDATION. ©[ED]

The weather-related flight rules ensure the vehicle avoids undesirable weather conditions that the orbiter was not designed to encounter including lightning, hail, thunderstorms, etc. This flight rule is the only hazard control for these items, which are documented in Hazard Reports: ORBI 030 Potential Loss Of Orbiter Caused By Vehicle Handling Qualities, ORBI 085 Structural Overheating Caused By Loss/Damage Of Tile Due To Absorption Of Water During Ground Operations, ORBI 086 TPS Damage Caused By Hail/Rain, ORBI 091 Inadvertent Disengage Of Backup Flight Controller (BFC) Due To Lightning Strike, ORBI 211 Landings Which Exceed Design, ORBI 325 Loss Of Control Of The Vehicle Due To Adverse Winds And Turbulence, ORBI 326 Loss of Flight Control During Entry due to Single APU Priority Rate Limiting (PRL), ORBI 333 Sequential Control Unit (SCU) MDM Halts Due To Lightning Upset May Cause Loss Of Critical MDM Control Functions, ORBI 337 Thermal Protection System (TPS) Damage Due To Lightning Strike, and INEV 01 Exposure to Natural Environment Exceeds Capability of the Space Shuttle Vehicle (SSV)/Elements. ©[121604-6533A]

THIS RULE CONTINUED ON NEXT PAGE

FLIGHT RULES

A2-6 LANDING SITE WEATHER CRITERIA [HC] (CONTINUED)

A. CEILING AND VISIBILITY LIMITS

TABLE A2-6-I - CEILING AND VISIBILITY LIMITS

CEILING / VISIBILITY (K FT)/(SM)			REDUNDANT MLS	SINGLE STRING-MLS	NO MLS
KSC, EDW, NOR, AOA, DAILY PLS SELECTION (ALL SITES)	CONCRETE	DAY	≥8/5 (WX RECON REQUIRED)	≥10/7	
		NIGHT		NO-GO	
	LAKEBED	DAY			≥10/7
		NIGHT		≥15/7	NO GO
RTLS, TAL	CONCRETE	DAY	≥5/4 RTLS ≥5/5 TAL (WX RECON REQUIRED)	≥10/7	
		NIGHT		NO GO	
ACLS / ECAL / ELS			0/0		≥8/5
PREDEORBIT: ONE APU FAILED OR ATTEMPT TWO APU'S PROCEDURE				≥10/7	

@[050495-1776A] @[041097-4927A] @[051697-4928B] @[022604-6167A]

1. CEILINGS AND VISIBILITY MUST MEET THE LIMITS LISTED IN TABLE A2-6-I TO BE GO CONDITIONS. THE MLS REQUIREMENTS APPLY TO THE GROUND AND ORBITER EQUIPMENT.
2. FOR EOM AND INTACT ABORTS, WX RECON MUST CONFIRM THAT THE PAPI'S OR AIMPOINT ARE VISIBLE FROM 8K (5K FOR RTLS, TAL) TO PREFLARE AND THE BALL BAR IS VISIBLE FROM PREFLARE TO FINAL FLARE FOR CEILINGS BELOW 10K FT AND/OR VISIBILITY LESS THAN 7 STATUTE MILES (SM). WX RECON GO/NO-GO RECOMMENDATION (BASED ON CURRENT CONDITIONS) IS REQUIRED FOR CEILINGS AT OR BELOW 8K FT. WX RECON IS NOT REQUIRED FOR AN ACLS OR DAILY PLS SELECTION. @[050495-1776A] @[051697-4928B]

THIS RULE CONTINUED ON NEXT PAGE

FLIGHT RULES

A2-6

LANDING SITE WEATHER CRITERIA [HC] (CONTINUED)

3. FOR KSC EOM ONLY, NO-GO CONSIDERATION WILL BE GIVEN TO CLOUD LAYERS BELOW 8K FT BEING REPORTED BY GROUND WEATHER OBSERVERS OR WEATHER AIRCRAFT GREATER THAN 2/8 COVERAGE AND LESS THAN OR EQUAL TO 4/8 COVERAGE (SCATTERED) AT THE DEORBIT BURN GO/NO-GO DECISION TIME. ©[111094-1622B] ©[061396-4008] ©[041097-4927A]

The visibility limits are horizontal distances that correspond to slant range visibility from a point on the outer glide slope to the runway threshold. The 7 and 5 SM visibility limits correspond to the 10K and 8K foot altitude points on the outer glide slope respectively. Ceiling and visibility limits ensure that the crew has sufficient time on the outer and inner glide slopes to acquire the runway and the landing aids during preflare and final flare and correct for any navigation dispersions. Therefore, the minimum limits are a function of MLS availability, lighting conditions, and type of runway. Reference Rule {A8-18}, LANDING SYSTEMS REQUIREMENTS, for orbiter MLS requirements. ©[022604-6167A]

For RTLS and TAL, the ceiling limits can be reduced to 5K minimum altitude. Testing at AMES/VMS in combination with STA test matrices confirmed guidance was able to correct back to glide slope and centerline by approximately 5K feet assuming flight derived 3-sigma navigation errors without GPS (+1100 feet in Z and 1400 feet in Y combined with worse case late MLS incorporation) and KSC design winds. Navigation errors used in the AMES/VMS testing are approximately an order of magnitude larger than navigation errors during GPS incorporation. STA data indicated acceptable landing parameters could be obtained with ceilings of 3K, 4K, or 5K. The primary difference between 3K and 5K consists of reaction time available on the outer glide slope for the pilot to transition from IFR to VFR conditions prior to initiation of the preflare maneuver at 2,000 ft AGL (3K allows 6 seconds and 5K allows 18 seconds prior to the preflare maneuver). Pilot evaluation concluded that 18 seconds was the minimum acceptable reaction time to safely transition from IMC or VMC prior to the preflare. Since the guidance and navigation capability is similar for RTLS and TAL, the testing applies to both RTLS and TAL. The higher visibility requirement of 5 NM for TAL provides a better view of the majority of the runway length when breaking out of a 5K ceiling. This view of the runway is desirable on a TAL since the CDR is less familiar with the TAL site than the SLF. A WX Recon GO/NO-GO recommendation by the STA is required when dealing with reduced ceilings to confirm the visibility and to also factor in other weather conditions (turbulence, crosswinds, etc.). Weather minimums/maximms are defined assuming that parameter is the only condition present. Combinations near the limits of ceilings, crosswinds, turbulence, and/or visibility need to be assessed by the WX Recon to ensure acceptable landing conditions. ©[050495-1776A] ©[051697-4928B] ©[032807-8207A]

Forecast experience and climatological studies indicate that in most KSC weather situations, 2/8 low cloud coverage is a reasonable criteria to expect a continuation of few or scattered (less than or equal to 4/8) low cloud conditions for 1 to 2 hours. Thus, due to the inherent variability and volatility of cloud conditions in the KSC area, strong consideration should be given to this 2/8 low cloud criteria at the deorbit burn GO/NO-GO decision time. However, there are meteorological situations when forecaster confidence of low clouds remaining scattered for touchdown time supports a GO deorbit burn decision when low clouds exceed 2/8 coverage at the deorbit burn GO/NO-GO decision time. ©[061396-4008]

THIS RULE CONTINUED ON NEXT PAGE

FLIGHT RULES

A2-6

LANDING SITE WEATHER CRITERIA [HC] (CONTINUED)*NO MLS*

Without MLS, the incorporation rate of GPS will increase from 42 seconds to 11 seconds at approximately 17 Kft above the runway. When GPS is incorporated and FOM=1, which is typical but not guaranteed, the 1-sigma UVW position differences at the typical MLS acquisition altitude will be approximately 50 ft, 30 ft, and 45 ft, respectively (Reference: The Summary of Navigation Errors through STS-114 (STF NAV-05-48500-022, October 4, 2005). GPS updates will cease below an altitude of 500 ft. Since the Space Shuttle Program will be ending in 2010, there is limited flight experience incorporating GPS into navigation, and a mixed fleet configuration (OV-103/OV-104 single string and OV-105 3-string) will exist until the end of the Program; a decision was made at Ascent/Entry Flight Techniques Panel #214, September 30, 2005 to forgo enhanced performance capabilities such as reduced ceiling/visibility limits that might be gained from the increased navigational accuracy that GPS provides. ©[032807-8207A]

If GPS is not available, visual cues provide the only means to correct navigation dispersions remaining from TACAN/ADTA processing. Flight history has shown that in the absence of GPS the one-sigma position errors in the onboard state vector when using HAINS IMU's (no piloting dispersions included) just before processing MLS (at approximately 17K feet) are 204 ft u, 201 ft v, and 279 ft w. The one-sigma position errors after one cycle of MLS processing are 45 ft u, 45 ft v, and 53 ft w. Reference: The Summary of Navigation Errors through STS-114 (STF NAV-05-48500-022, October 4, 2005). Therefore, the crew can rely on guidance commands to a lower altitude when using MLS before beginning transition to visual cues. ©[070899-6872A] ©[032807-8207A]

REDUNDANT AND SINGLE STRING MLS

The runway and orbiter must have redundant MLS for a night landing except for a lakebed runway. Single string MLS is acceptable because navigation dispersions are more tolerable on the larger area provided by the lakebed environment. If the single-string MLS fails, visual cues provide the only means to correct navigation dispersions. Flight Design and Dynamics personnel in cooperation with the Astronaut Office conducted an analysis to determine the night ceiling limit of 15K feet on the lakebed. The Shuttle Mission Simulator (SMS) and Shuttle Training Aircraft (STA) flew several sessions of night landings with dispersed initial conditions and good navigation. The experience gained from these analyses indicated that a ceiling level of 15K feet would be acceptable. This ceiling level will provide sufficient time for the crew to visually acquire the landing area, assess the need to correct dispersions, and take the necessary actions. If MLS were available, this is the approximate altitude when processing would begin. ©[111094-1622B]

INOPERATIVE MLS COMPONENTS

For purposes of this rule, failure of any of the three MLS ground station measurements (azimuth, elevation, or range) constitutes a total failure of that string. Onboard navigation software will not process MLS data if either azimuth or range is unavailable. Although MLS azimuth and range data will be processed in case of ground elevation equipment failure, onboard altitude errors will not be corrected adequately. ©[070899-6872A] ©[041097-4927A]

THIS RULE CONTINUED ON NEXT PAGE

FLIGHT RULES**A2-6****LANDING SITE WEATHER CRITERIA [HC] (CONTINUED)**

©[ED]

ACLS / ECAL / ELS

The ACLS, ECAL, or ELS limits require accepting additional risk. Emergency deorbit, SSME limits management, and abort gap closure procedures potentially use these sites. Rules {A2-205E} and {A2-205F}, EMERGENCY DEORBIT, and {A4-107}, PLS/EOM LANDING OPPORTUNITY REQUIREMENTS, outline conditions for use of an ELS for emergency deorbit. Rule {A5-103A}.2, LIMIT SHUTDOWN CONTROL, specifies enabling main engine limits at the earliest single-engine capability to reach a prime TAL or ACLS for some cases following an SSME failure. This action precludes exposure to SSME limits-inhibited operation for any longer than necessary. Landing at an ACLS with zero/zero conditions carries less risk than continuing limits-inhibited SSME operation. Rule {A4-56I}.3, PERFORMANCE BOUNDARIES, specifies the use of an ACLS for abort gap closure. It is reasonable to attempt landing at an ACLS with zero/zero conditions if the attempt carries a reasonable probability of success and the only alternative is a bailout.

ONE APU FAILED (OR ATTEMPT TWO APU'S PROCEDURE)

Rules {A2-207}, LANDING SITE SELECTION, and {A10-23}, APU ENTRY START TIME [HC], summarize the conditions and rationale for selecting a landing site with one APU failed and using the ATTEMPT TWO APU's start procedure. With two APU's failed, the loss of hydraulic power causes reduced flight control authority, reduced braking, and loss of nose wheel steering. The APU placards assure safe conditions should the orbiter lose a second APU. ©[111094-1622B] ©[ED]

THIS RULE CONTINUED ON NEXT PAGE

FLIGHT RULES

A2-6 LANDING SITE WEATHER CRITERIA [HC] (CONTINUED)

B. SURFACE WINDS AND TURBULENCE LIMITS @[111094-1622B]

TABLE A2-6-II - SURFACE WINDS AND TURBULENCE LIMITS @[ED]

SURFACE WIND (KNOTS) AND TURBULENCE		CROSS PEAK	HEAD PEAK	TAIL AVG	TAIL PEAK	GUST	TURB
RTLS		≤15 *	≤25	≤10	≤15	≤10	≤MOD
DAY	EOM, TAL, AOA, DAILY PLS SELECTION	≤15					
NIGHT	EOM DAILY PLS SELECTION	≤12					
	TAL, AOA	≤15					
CROSSWIND DTO		≥10					
NOMINAL DRAG CHUTE DEPLOY		≤15					
LANDING ≥ CDR FD19		≤12					
PREDEORBIT: 1 APU FAILED OR ATTEMPT 2 APU'S PROCEDURE		≤10					≤LGT
ECAL/ELS		≤15	N/A				

* REQUIRES AN STA EVALUATION TO 17 KNOTS AND A GO FROM THE STA PILOT. @[041196-1817B] @[041196-1871B] @[041097-4926] @[041097-4890A] @[121400-3866] @[052401-4459A]

1. SURFACE WINDS AND TURBULENCE MUST MEET THE LIMITS LISTED IN TABLE A2-6-II TO BE "GO" CONDITIONS. @[ED]
2. THE LEVEL OF TURBULENCE SHOULD BE THE PROJECTED/ESTIMATED LEVEL FOR THE ORBITER (C130 OR T38 MAY BE COMPARABLE TO THE ORBITER; C12, C21, AND STA WOULD BE LESS FOR THE ORBITER).
3. STA GO FOR RTLS CROSSWINDS GREATER THAN 15 KNOTS WILL BE BASED ON A USABLE HUD BELOW 1000 FEET (HUD NOT CAGED AND SIGNIFICANT DIGITS FOR EAS AND ALTITUDE VISIBLE) AND ACCEPTABLE PILOT WORKLOAD IN THE PRESENCE OF LOW LEVEL SHEARS AS EVIDENCED BY HDOT, X-DISTANCE, Y-DISTANCE AND Y-DOT AT TOUCHDOWN. CDR'S HUD AND REDUNDANT MLS REQUIRED TO ENSURE ACCURATE HUD DATA AVAILABLE TO THE CREW. @[041196-1817B] @[022604-6167A]

THIS RULE CONTINUED ON NEXT PAGE

FLIGHT RULES

A2-6

LANDING SITE WEATHER CRITERIA [HC] (CONTINUED)

GUSTS ©[022604-6167A]

The gust criterion restricts the wind conditions to those that are stable, predictable, and within the orbiter landing performance capability. ©[111094-1622B]

HEADWIND ©[111094-1622B]

The headwind certification limit is 20 knots steady state with a moderate turbulence model (approximately ± 10 knots) (reference ORBITER VEHICLE END ITEM SPECIFICATION FOR THE SPACE SHUTTLE SYSTEM, Part 1, Performance and Design Requirements, Section 10.1.3.3.1.1.3, Orbiter Entry and Landing Phase; Vehicle Design Environment; Steady State Winds (1K - surface), and Section 10.1.3.3.1.2, Design Vehicle Gust Environments). Headwind affects touchdown energy. Flight Rule {A4-110}, AIMPOINT, EVALUATION VELOCITY, AND SHORT FIELD SELECTION, documents the acceptable touchdown distance.

TAILWIND

Tailwind affects the landing by causing a longer touchdown distance, higher touchdown ground speed, loss of roll out margin, and higher brake energy. The tailwind certification limit is one-half the landing steady state design wind speed (reference ORBITER VEHICLE END ITEM SPECIFICATION FOR THE SPACE SHUTTLE SYSTEM, Part 1, Performance and Design Requirements, Section 10.1.3.3.1.1.3, Orbiter Entry and Landing Phase; Vehicle Design Environment; Steady State Winds (1K - surface)).

CROSSWIND

Crosswind limits are set due to concerns in the following areas: tire wear, main gear tire/strut loads, and orbiter handling qualities. Currently, the limiting factor for crosswinds is the vehicle certification limit of 20 knots. Previous concerns with orbiter handling qualities in the two point stance were eliminated with the "cost effective" rudder fix combined with beep trim derotation and significantly reduced lateral aerodynamic uncertainties. ©[041196-1817B] ©[052401-4459A]

The crosswind limit is referenced to peak wind versus average wind, since peak winds tend to persist long enough to be significant with respect to orbiter handling qualities during the final approach, TD, and derotation. ©[022604-6167A]

With the incorporation of the new modified tire (which provided a thicker and more durable tread) and the September 1994 regrinding of the KSC surface, tire wear concerns up to 20 kts have been alleviated for all shuttle CONUS runway surfaces. ©[041196-1817B]

THIS RULE CONTINUED ON NEXT PAGE

FLIGHT RULES

A2-6

LANDING SITE WEATHER CRITERIA [HC] (CONTINUED)

Main gear tire/strut loads have been certified under nominal conditions (pilot technique and crosswind of 15 kts) with dispersions RSS'd for pilot technique and crosswind up to 20 kts (reference Rule {A10-142}, TIRE PRESSURE [CIL]). AMES VMS testing in August 1995 indicated main gear strut loads were exceeded for landing in crosswinds greater than 20 knots. Additionally, the sideslip at landing in crosswinds greater than 20 knots exceeded all test data on tire capability. ©[041196-1817B]

Previous AMES VMS evaluation of orbiter handling qualities as a function of crosswind (no systems failures and no aero uncertainties) have shown HQR's of Level I up to steady state crosswind of 12 kts (plus 2-3 kts of turbulence). HQR's increase from Level I to Level II as crosswind increases from 15 to 17.5 kts. For steady state crosswind in the 20-25 kt region, HQR's range from Level II to Level III. Testing with worse case aerodynamic uncertainties resulted in increased handling qualities rating of approximately 1.

The August 1995 AMES VMS testing used dynamic wind profiles and incorporated the "cost effective" rudder fix. Utilization of dynamic wind profiles (shear and turbulence) can shift HQR's from Level I to Level III for landing. August 1995 AMES VMS testing indicated that the most significant area of vehicle control is main gear touchdown when flown in dynamic wind profiles. Due to the infinite number of potential wind profiles, testing cannot determine acceptable shear or turbulence in the presence of crosswinds between 15 and 20 knots. The only tool available for determining an acceptable wind profile at touchdown with respect to shear and turbulence while remaining within vehicle limits is the STA since it will fly through the existing wind conditions (approximately 40 minutes from predicted RTLS landings). The STA is considered conservative due to the lower wing loading and slower roll response. Since testing at AMES indicated that there are some profiles that provide acceptable HQR's in crosswinds up to 20 knots, utilization of the STA would allow launch on the days where the wind profile is considered acceptable by the STA pilot. The STA GO will be based on usability of the HUD (HUD not caged and significant digits for altitude and airspeed visible) and acceptable pilot work load during landing (low level shears that do not degrade landing parameters Hdot, EAS, X-distance, Y-distance and Y-drift rate). Limited flight test data (STS 51-G, 11 kts peak; STS-30, 11 kts ave, 16-19 kts peak; STS-37, 8 kts ave, 9-10 kts peak) are inconclusive but provide indications of handling qualities degradation with increasing crosswind (STS-30 HQR approximately 5; however, its landing was complicated with a NWS S/W anomaly). ©[111094-1622B] ©[041196-1817B]

THIS RULE CONTINUED ON NEXT PAGE

FLIGHT RULES

A2-6

LANDING SITE WEATHER CRITERIA [HC] (CONTINUED)

Wind forecasting accuracy must also be considered when determining crosswind limits. Analysis of SMG simulation and mission (STS-60 through STS-106) crosswind forecast accuracy presented at AEFTP #173 determined that a 15-kt (17-kt RTLS) peak crosswind limit protected the 20-kt vehicle certification limit in excess of 98 percent of RTLS, TAL, and EOM cases studied. Peak crosswinds exceeding 20 kt were observed in less than 5 percent of all cases (most frequent for KSC mission EOM and RTLS cases, each 4.7 percent). For those rare cases when landing opportunity crosswinds were observed > 20 kts, SMG forecast crosswinds > 15 kts in 89 percent of KSC EOM, 100 percent of KSC RTLS, 80 percent of TAL, and 46 percent of EDW EOM cases. In just over half of the Edwards crosswind forecast "busts," peak wind speed was forecast to be 25 kts or more, and a small wind direction forecast error resulted in observed crosswinds exceeding the 20 kt vehicle certification limit. No reasonable crosswind Flight Rule would have protected the remaining EDW EOM forecast "busted" cases. Analysis presented at AEFTP #173 did not consider the requirement for a "GO" observed crosswind at decision time, which is believed to add further protection from exceeding the 20-kt vehicle certification limit. Limiting peak crosswind to 17 kts for an RTLS (typically 12-14 kts average) and requiring a "GO" from the STA pilot on the wind profile provides adequate allowance for aerodynamic uncertainties and weather forecasting dispersions while maintaining landing within vehicle limits and Level I/II handling qualities. ©[111094-1622B] ©[041196-1817B] ©[021998-6490A] ©[052401-4459A]

Crosswind limits for EDO flights and night landings include a somewhat arbitrary reduction to 12 knots peak to allow for additional piloting margin due to uncertainties in pilot performance degradation from increased exposure to zero-g and reduced depth perception, respectively. AEFTP #138 reviewed flight data for gross landing parameters (Hdot, TD EAS, Y-position, height over threshold, and drift in the two-point attitude) for mission durations out to 18 days (STS-67, STS-78, and STS-80). No degradation was noted; therefore, the EDO duration was set to bracket current flight data. Data previously presented by SD indicated some performance shift for long duration flights; therefore, the AEFTP decided to maintain the crosswind reduction for flights outside of the tested envelope. Night RTLS is allowed to be 17/15 knots peak since zero-g degradation is not a concern and the pilots are very familiar with the landing site. In addition, the CDR/PLT have recent STA flight approaches to the SLF. Although TAL sites have shorter and narrower runways than RTLS, and pilot familiarity of these runways is generally less than RTLS, there are no significant differences between day and night TAL landings with respect to the peak crosswind limit. Simulation data from the Ames VMS 8/00 session showed acceptable piloting/HQR results (Level II or better) for night TAL landings with crosswinds up to 20 kts. The AEFTP #168 and #173 reviewed Ames VMS results, re-reviewed the vehicle structural certification limit of 20-kts crosswind, and reviewed updated SMG crosswind forecast accuracy statistics. The AEFTP subsequently determined that a 15-kt TAL peak crosswind limit (day and night) would provide adequate protection of the 20-kt vehicle certification limit. Additionally, it follows that the AOA crosswind limit should be the same day and night, since there are no significant differences between TAL and AOA landings with respect to the crosswind limit. Although there is some exposure to zero-g on an AOA, it is not considered significant relative to pilot performance degradation. All other intact aborts, other than RTLS, TAL, and AOA, have significant exposure of the pilot to zero-g and therefore maintain the 12-kt limit for night landings. ©[041196-1817B] ©[041196-1871B] ©[041097-4926] ©[021998-6490A] ©[052401-4459A]

THIS RULE CONTINUED ON NEXT PAGE

FLIGHT RULES

A2-6

LANDING SITE WEATHER CRITERIA [HC] (CONTINUED)*CROSSWIND DTO*

Reference Rule {A2-261}, ENTRY DTO/AUTOMODE/CROSSWIND DTO GO/NO-GO, for the crosswind DTO requirements. Even though the crosswind DTO limit is 15 knots peak, the 12-knot peak crosswind limit still applies for night landings and mission landing \geq the CDR's flight day 17. ©[041196-1871B]

DRAG CHUTE CROSSWIND LIMITS

Reference Rules {A10-144}, DRAG CHUTE DEPLOY CONSTRAINTS, and {A2-261}, ENTRY DTO/AUTO MODE/CROSSWIND DTO GO/NO-GO, for the drag chute requirements.

ONE APU FAILED (OR ATTEMPT TWO APU'S PROCEDURE)

Rules {A2-207}, LANDING SITE SELECTION, and {A10-23}, APU ENTRY START TIME [HC], summarize the conditions and rationale for selecting a landing site with one APU failed and using the ATTEMPT TWO APU's start procedure. With two APU's failed, the loss of hydraulic power causes reduced flight control authority and braking and loss of nose wheel steering. The APU placards assure safe conditions should the orbiter lose a second APU. ©[111094-1622B] ©[ED]

TURBULENCE ©[111094-1622B]

Severe turbulence is undesirable due to controllability concerns. Turbulence information comes primarily from WX RECON and TALCOM aircraft or area pilot reports (PIREP). The type of aircraft is a factor when determining the applicability of a PIREP to the orbiter because an aircraft's response to turbulence is a function of wing loading. The shuttle is sensitive to turbulence-caused trajectory deviations below 3000 feet due to the inability to makeup energy loss and achieve the desired touch down point. The PIREP's follow standard definitions for the intensity of the turbulence. (See paragraph D.) ©[041196-1871B] ©[022604-6167A]

THIS RULE CONTINUED ON NEXT PAGE

FLIGHT RULES

A2-6 LANDING SITE WEATHER CRITERIA [HC] (CONTINUED)

C. THUNDERSTORM, LIGHTNING, AND PRECIPITATION

TABLE A2-6-III - THUNDERSTORM, LIGHTNING, AND PRECIPITATION

THUNDERSTORM, LIGHTNING, AND PRECIPITATION PROXIMITY LIMITS (NM)		PRELAUNCH (RTLS, TAL)	PREDEORBIT (EOM, DAILY PLS) PRELAUNCH (AOA)	REDESIG CRITERIA	ELS, ECAL, ACLS
TSTORM (INCLUDING ATTACHED NONTRANSPARENT ANVILS*), AND LIGHTNING*	RADIAL FROM CENTER OF PRIME RUNWAY	>20	>30	>15	NONE AT SITE
	LATERAL ALONG APPROACH PATH OUT TO 30 NM	>10	>20	>5	
	VERTICAL FROM TOP OF CLOUD	>2			
DETACHED NONTRANSPARENT ANVIL < 3 HRS OLD*	RADIAL FROM CENTER OF PRIME RUNWAY	>15	>20	>15	N/A
	LATERAL ALONG APPROACH PATH OUT TO 30 NM	>5	>10	>5	
	VERTICAL FROM TOP OF CLOUD	>2			
PRECIPITATION *	RADIAL FROM CENTER OF PRIME RUNWAY	>20	>30	> 15	N/A
	LATERAL ALONG APPROACH PATH OUT TO 30 NM	>10	>20	> 5	
	VERTICAL FROM TOP OF CLOUD	>2			
CUMULUS CLOUDS PRODUCED BY SMOKE/FIRE UP TO 1 HR AFTER DETACHING	LATERAL ALONG APPROACH PATH	>0			N/A

* EXCEPTIONS EXIST, SEE RULE (A2-6C).3. LANDING SITE WEATHER CRITERIA [HC]. [111298-6734] [ED] [102506-7842]

1. THUNDERSTORMS (INCLUDING ATTACHED NONTRANSPARENT ANVILS), LIGHTNING, DETACHED NONTRANSPARENT ANVILS LESS THAN 3 HOURS OLD, OR PRECIPITATION MUST BE OUTSIDE THE LIMITS LISTED IN TABLE A2-6-III TO ENSURE WEATHER DOES NOT ADVERSELY AFFECT THE ORBITER DURING AN ENTRY AND LANDING. THE LATERAL OR VERTICAL LIMITS MUST BE MET IN ADDITION TO THE RADIAL LIMIT. [ED] [111298-6734] [022604-6167A]
 - a. RADIAL PROXIMITY LIMITS ARE RELATIVE TO THE CENTER OF THE PRIME RUNWAY. [111094-1622B]

THIS RULE CONTINUED ON NEXT PAGE

FLIGHT RULES

A2-6

LANDING SITE WEATHER CRITERIA [HC] (CONTINUED)

- b. LATERAL PROXIMITY LIMITS ARE RELATIVE TO THE ORBITER APPROACH PATH OUT TO A RANGE OF 30 NM FROM THE CENTER OF THE PRIME RUNWAY. @[111094-1622B]
 - c. VERTICAL CLEARANCES ARE FROM THE TOP OF THE THUNDERSTORM OR SHOWER TO THE ORBITER APPROACH PATH.
2. FOR RTLS, THE FOLLOWING EXCEPTIONS EXIST: @[021998-6490A] @[022604-6167A] @[121604-6533A] @[102506-7842]
- a. ATTACHED NONTRANSPARENT ANVILS ARE ACCEPTABLE IF ALL THE FOLLOWING CRITERIA ARE MET:
 - (1) ANVIL IS THE ONLY PORTION OF THE CLOUD WITHIN THE LIMITS LISTED IN TABLE A2-6-III (I.E., NOT THE PARENT THUNDERSTORM).
 - (2) ALL PORTIONS OF THE CLOUD WITHIN THE LIMITS LISTED IN TABLE A2-6-III MEET ALL THE FOLLOWING VOLUME-AVERAGED, HEIGHT-INTEGRATED RADAR REFLECTIVITY (VAHIRR) CRITERIA FOR BOTH THE OBSERVATION AT THE DECISION TIME AND THE FORECAST FOR LANDING TIME:
 - (a) VOLUME SCANNING RADAR DATA ARE AVAILABLE WITH ELEVATION ANGLES SAMPLING THE ENTIRE CLOUD.
 - (b) ADEQUATE SATELLITE AND AIRCRAFT SURVEILLANCE DATA ARE AVAILABLE.
 - (c) NO LIGHTNING ASSOCIATED WITH THE ANVIL OR PARENT CLOUD FOR THE PREVIOUS 30 MINUTES
 - (d) ALL PORTIONS OF THE ANVIL CLOUDS ARE AT ALTITUDES WHERE THE TEMPERATURE IS COLDER THAN ZERO DEGREES CELSIUS.
 - (e) NO EVIDENCE THAT THE ANVIL IS INCREASING IN THICKNESS OR INTENSITY.
 - (f) THE VAHIRR FOR ANVIL CLOUDS IS LESS THAN 33 DBZ-KFT (10 DBZ-KM). @[102506-7842]

THIS RULE CONTINUED ON NEXT PAGE

FLIGHT RULES

A2-6

LANDING SITE WEATHER CRITERIA [HC] (CONTINUED)

- b. DETACHED NONTRANSPARENT ANVILS LESS THAN 3 HOURS OLD ARE ACCEPTABLE FOR A MINIMUM OF TWO APPROACHES IF THE ORBITER CAN MAINTAIN EITHER A 5-NM LATERAL OR A 2-NM VERTICAL CLEARANCE FROM: @[102506-7842]
- (1) ANY PART OF THE ANVIL CLOUD NOT MEETING THE VAHIRR CRITERIA
- OR
- (2) THE NONTRANSPARENT EDGE OF THE ANVIL CLOUD
- c. RAIN SHOWERS (EXCLUDING CUMULONIMBUS) ARE ACCEPTABLE IF ALL OF THE FOLLOWING CONDITIONS ARE MET:
- (1) ADEQUATE SATELLITE, RADAR, AND AIRCRAFT SURVEILLANCE ARE AVAILABLE.
- (2) NO SUBSTANTIAL INCREASE IN EITHER COVERAGE OR INTENSITY IS FORECAST.
- (3) THE OBSERVED AND FORECAST HORIZONTAL MOVEMENT OF INDIVIDUAL RAIN SHOWERS AND OTHER WEATHER FEATURES IS LINEAR OR NEAR LINEAR.
- (4) RULE {A4-111}, RUNWAY ACCEPTABILITY CONDITIONS, IS OBSERVED "GO" AND FORECAST TO REMAIN "GO."
- (5) FOR A MINIMUM OF TWO APPROACHES, THE ORBITER
- (a) SHALL NOT FLY THROUGH PRECIPITATION, AND
- (b) CAN MAINTAIN EITHER A 10-NM LATERAL OR A 2-NM VERTICAL CLEARANCE FROM ANY SHOWER THAT:
@[102506-7842]

THIS RULE CONTINUED ON NEXT PAGE

FLIGHT RULES

A2-6

LANDING SITE WEATHER CRITERIA [HC] (CONTINUED)

- 1 HAS MODERATE OR GREATER PRECIPITATION, OR
@[102506-7842]
 - 2 HAS A CLOUD TOP TEMPERATURE COLDER THAN
+5 DEGREES CELSIUS, OR
 - 3 HAS HAD A CLOUD TOP TEMPERATURE COLDER
THAN -10 DEGREES CELSIUS WITHIN 2.5 HOURS
PRIOR TO LAUNCH
3. FOR TAL, THE FOLLOWING EXCEPTIONS EXIST: @[021998-6490A]
@[022604-6167A] @[121604-6533A]
- RAIN SHOWERS (EXCLUDING CUMULONIMBUS) ARE ACCEPTABLE IF
ALL OF THE FOLLOWING CONDITIONS ARE MET:
- a. ADEQUATE SATELLITE, RADAR, AND AIRCRAFT SURVEILLANCE
ARE AVAILABLE.
 - b. NO SUBSTANTIAL INCREASE IN EITHER COVERAGE OR
INTENSITY IS FORECAST.
 - c. THE OBSERVED AND FORECAST HORIZONTAL MOVEMENT OF
INDIVIDUAL RAIN SHOWERS AND OTHER WEATHER FEATURES IS
LINEAR OR NEAR LINEAR.
 - d. RULE {A4-111}, RUNWAY ACCEPTABILITY CONDITIONS, IS
OBSERVED "GO" AND FORECAST TO REMAIN "GO."
 - e. FOR A MINIMUM OF TWO APPROACHES, THE ORBITER
@[021998-6490A] @[121604-6533A]
 - (1) SHALL NOT FLY THROUGH PRECIPITATION, AND
@[102506-7842]

THIS RULE CONTINUED ON NEXT PAGE

FLIGHT RULES

A2-6

LANDING SITE WEATHER CRITERIA [HC] (CONTINUED)

- (2) CAN MAINTAIN EITHER A 10-NM LATERAL OR A 2-NM VERTICAL CLEARANCE FROM ANY SHOWER THAT:
 @[102506-7842]
- (a) HAS MODERATE OR GREATER PRECIPITATION, OR
- (b) HAS A CLOUD TOP TEMPERATURE COLDER THAN +5 DEGREES CELSIUS, OR
- (c) HAS HAD A CLOUD TOP TEMPERATURE COLDER THAN -10 DEGREES CELSIUS WITHIN 2.5 HOURS PRIOR TO LAUNCH @[121604-6533A]
4. FOR ACLS/ECAL/ELS, PRECIPITATION IS ACCEPTABLE. NO THUNDERSTORMS (INCLUDING ATTACHED NONTRANSPARENT ANVIL) OR LIGHTNING AT THE SITE. @[020196-1808A] @[111298-6734] @[022604-6167A]
5. THE ORBITER SHALL NOT PENETRATE A CUMULUS CLOUD THAT IS ATTACHED TO A SMOKE PLUME PRODUCED BY A FIRE. IF THE CUMULUS CLOUD DETACHES FROM THE SMOKE PLUME, 1 HOUR MUST ELAPSE FROM TIME OF DETACHMENT FOR SAFE PENETRATION BY THE ORBITER. @[111298-6734] @[022604-6167A] @[102506-7842]

The orbiter is not to encounter precipitation on any approach due to decreased visibility, damage to the TPS, and the potential for triggered lightning. Undesirable aspects of thunderstorms include rain (TPS, structure), hail (TPS, structure, control), severe wind shear (structure), turbulence (control, performance, structure), and natural or triggered lightning (structure, electronic/software systems). Environmental design requirements for the orbiter are based on no in-flight penetration of thunderstorms (ref. Appendix 10-10, Volume X, Space Shuttle Level II Program Specification). The participants in the Weather Rules Workshop held at JSC/MSFC in October 1987 developed the thunderstorm, lightning, and precipitation limits based on scientific knowledge, engineering judgment, and experience.

THIS RULE CONTINUED ON NEXT PAGE

FLIGHT RULES

A2-6

LANDING SITE WEATHER CRITERIA [HC] (CONTINUED)

The 20 nm and 15 nm radii around the landing site approximate a 10 nm and 5 nm lateral clearance from all HAC's, respectively. Increasing the radial and lateral limits for EOM, AOA, PLS, and ELS adds protection for the uncertainty associated with a longer forecast. The post-commitment clearances balance the risks associated with a runway redesignation and damage from flying through precipitation or probability of incurring a lightning strike. Clearances are lower for detached nontransparent thunderstorm anvils because the probability for triggered lightning is lower. An attached anvil is part of the thunderstorm and must meet the thunderstorm proximity limits if the anvil is nontransparent. At the January and April 1998 meetings of the Lightning Advisory Panel (LAP), the consensus was that transparent anvil clouds do not pose a triggered lightning threat. Evaluation of anvils is sometimes difficult and inexact, even with modern remote sensing technology. ©[111298-6734] ©[022604-6167A]

At the January and April 1998 meetings of the Lightning Advisory Panel, LAP members stated that applicable research indicated that cumulus clouds formed by fires and smoke pose a threat of triggered lightning if penetrated and should be avoided for up to 1 hour after the cloud detaches from the source fire or smoke. ©[111298-6734] ©[111094-1622B] ©[020196-1808A] ©[022604-6167A]

ACLS/ECAL/ELS LIMITS ©[111094-1622B] ©[020196-1808A]

Weather at the site must be acceptable to provide good visibility during final approach, since lateral and longitudinal margins are minimal at ECAL/ELS sites. As long as visibility and ceiling limits are met, there is no constraint for precipitation. Additional constraints to avoid thunderstorms and lightning apply only to the landing site. The definition for "none at site" used in the Shuttle Program will mean that no thunderstorm is over the landing airfield. Note that operational meteorological reporting standards for weather occurring at a site differs slightly from the definition applied for shuttle landings. For thunderstorm and lightning observations (METAR) and forecasts (TAF) used to evaluate the GO/NO-GO status of an ACLS/ECAL/ELS site prior to launch, meteorological reporting standards define "none at site" as: no thunderstorms or lightning within 5 statute miles of the observing (landing) site. ©[111298-6734]

THIS RULE CONTINUED ON NEXT PAGE

FLIGHT RULES

A2-6

LANDING SITE WEATHER CRITERIA [HC] (CONTINUED)

RTL5 AND TAL PRECIPITATION LIMITS @[121604-6533A]

Intent - Providing a safe approach at the abort landing time is of prime importance. However, additional launch probability may be gained by allowing showers within the precipitation limits specified in Table A2-6-III that do not pose a threat due to lightning, hail, visibility, aerodynamic control, or MLS attenuation. The "rainshower rule" is intended for use with non-hazardous rainshowers that cover a small fraction of the area surrounding the abort landing site on launch day. The rainshower allowance criteria are dependent on the precipitation intensity, the presence of frozen precipitation, and the potential for triggered lightning. Cumulonimbus clouds (either with or without observed lightning) are excluded from consideration under this rule due to the potential for triggered lightning, turbulence, hail, and heavy rainshowers. Rainshowers over the runway may negatively affect runway acceptability conditions; Rule {A4-111}, RUNWAY ACCEPTABILITY CONDITIONS, still applies. Reference A/E FTP: # 109,111,195, 198, 204. @[020196-1808A]

At A/E FTP #198, SMG discussed the potential application of the rainshower rule for TAL abort. SMG determined that European weather satellite and Spanish radar imagery may be adequate to apply the rule at Zaragoza and Moron, under some meteorological conditions. However, the current tools are not sufficient to apply the rule at other TAL sites. It was also noted that the TAL upper air climatology indicates that the rules utility will be limited during all but the summer months since cloud top temperatures will be colder than +5 deg C for much of the year. @[021998-6490A]

Tools needed for application of the rule (Paragraphs C2c(1) and C3a) - For forecast intervals less than 45 minutes, the availability of radar surveillance, satellite imagery, and a weather reconnaissance aircraft may allow improved estimation of rainshower movement, development, and characterization of the cloud type. These meteorological tools and the weather aircraft are critical in determining the stability/predictability of the showers in order to provide a safe approach at the abort landing time. Degradation or lack of any one of these tools may be sufficient to avoid using this rule on a given launch day. In general, the minimum requirements to evaluate the light rainshowers include availability of the following: @[102506-7842]

Visible or infrared satellite imagery every 15 minutes.

A ground based weather radar producing a composite reflectivity product (maximum reflectivity in a column above a point on the ground) that completes a full volume scan at least every 10 minutes.

A weather aircraft capable of flying near the showers of interest such that the NASA Weather Recon astronaut can evaluate the weather conditions including cloud height, thickness, and location; precipitation, virga, or moisture on the windscreen; and slant range visibility of the runway environment, papis, and ball-bar. @[121604-6533A]

THIS RULE CONTINUED ON NEXT PAGE

FLIGHT RULES

A2-6

LANDING SITE WEATHER CRITERIA [HC] (CONTINUED)

Potential for Development (Paragraphs C2c(2) and C3b) - Predicting the development of new areas of convection is the challenge in applying the rainshower rule. It is not likely that extrapolation of showers based on their motion at the launch decision time will accurately predict the locations of showers at the abort landing time. Rather, the conditions at the launch decision should be representative of those conditions expected at the abort landing time. The potential for development should be limited: the character of the clouds and showers should be expected to change little from the observed conditions throughout the forecast period and neither the total cloud cover nor the maximum intensity of the showers should be expected to increase. ©[020296-1808A] ©[121604-6533A] ©[102506-7842]

Movement (Paragraphs C2c(3) and C3c) - Consistent horizontal motion that is linear or near linear and can be tracked is required to accurately forecast future movement and to ensure the synoptic situation is relatively predictable. However, it should be noted that 20-40 minutes is considered the practical limit for extrapolating weather features such as small lines of weak showers. The life cycle for a typical rainshower is about 30 minutes. This rule is being applied near the limits of predictability for these features. The extrapolation of larger features that may cause the development of new showers, such as the sea breeze, is valid over longer periods of time. The size of the phenomena and the limitations of extrapolation need to be considered when applying this rule. ©[020196-1808A]

Runway Acceptability Conditions (Paragraphs C2c(4) and C3d) - Allowing rainshowers within 20 nm of the center of the runway increases the chances of rain occurring on the runway. The runway conditions shall be observed "GO" at the launch decision time. In addition, the runway conditions shall be forecast to remain "GO" after considering the potential accumulation of rainfall on the surface due to the rainshowers.

Requirement for Two Approaches (Paragraphs C2c(5) and C3e) - Removing the requirement for acceptable weather for all four approaches increases launch availability. The requirement for acceptable weather for two approaches maintains the capability for an energy down mode option. To satisfy this requirement for a 39-degree inclination launch, both an overhead and a straight-in approach must be "GO." ©[121604-6533A] ©[102506-7842]

THIS RULE CONTINUED ON NEXT PAGE

FLIGHT RULES

A2-6

LANDING SITE WEATHER CRITERIA [HC] (CONTINUED)

Precipitation Considerations and Avoidance (Paragraphs C2c(5(a) and C3e(1)) - ©[121604-6533A]
 ©[102506-7842]

In 1994, the Shuttle Program stated that the tile damage that occurs if light precipitation is encountered is acceptable. The orbiter would encounter the light rainshowers at altitudes below about 15,000 feet during approach and landing based on typical upper air temperatures at the landing sites. While flight through light precipitation was deemed acceptable, the AEFTP stated rainshower avoidance is still more desirable, if possible. In 2004, AEFTP 204 determined that the orbiter should not be allowed to fly through rainshowers until issues raised at the panel meeting are addressed. These issues include the effects of downdraft winds and wet runway considerations. Therefore, the orbiter shall not fly through any precipitation.

Limiting the application of this rule to rainshowers (stratocumulus and cumulus cloud types) minimizes the total area covered by rain (compared to stratiform clouds) and the likelihood of undesirable weather conditions associated with those showers such as turbulence and downdrafts. Moderate or greater precipitation is to be avoided by adequate distances in order to avoid damage to the thermal protection system and increased likelihood of turbulence, downdraft winds, and visibility reduction.

A retrim to a slightly higher angle of attack would be the primary noticeable response to flight through rain during landing approach. Light precipitation will not damage the structure or control system. Testing indicates that damage to RCC does not occur when flown through light rain at speeds below 0.7 Mach. RCC damage is not desirable due to replacement cost and lead-time. RCC damage caused by precipitation impact would not affect aerodynamic performance. ©[020296-1808A]

Testing of TPS tiles flown through rainfall of 35 to 40 dBZ indicates that significant tile damage will occur if the orbiter encounters ice-free precipitation at velocities below Mach 1 and above touchdown speed. The extent of damage depends on drop size and the angle of incidence between a drop and a tile. Estimates of effects on approach and landing characteristics assuming an estimate of approximately 2000 damaged tiles (nose and canopy/windshield areas, vertical tail and OMS pod leading edges) presented at AEFTP #204 show a loss of up to 1750 ft of touchdown distance (approx 1400 ft due to tile damage, approx 350 ft due to momentum loss to the rain and cloud). The estimate of the touchdown distance loss is based on an increased drag increment of 65 counts for tile damage, 3 counts for momentum loss while flying in rain drops, and 20 counts for momentum loss while flying in cloud drops. As specified in Rule {A4-110}, AIMPOINT, SPEEDBRAKE RETRACT OPTION, AND EVALUATION TOUCHDOWN VELOCITY SELECTION [HC], prelaunch touchdown predictions account for the increased drag increment due to flying through light rain. Consideration should be given to not launching on a low energy day where the capability to avoid showers is low. ©[020196-180]
 ©[121604-6533A]

THIS RULE CONTINUED ON NEXT PAGE

FLIGHT RULES

A2-6

LANDING SITE WEATHER CRITERIA [HC] (CONTINUED)

If the orbiter encounters ice, window damage may occur resulting in reduced visibility (depending on ice population, mass, density, and relative velocity) and RCC coating damage may occur forcing RCC panel replacement. Clouds with tops warmer than +5 deg C thermal layer are warm enough to assure they do not contain hail. Clouds with tops colder than +5 deg C are to be avoided by an adequate distance. ©[121604-6533A]

Water attenuates microwave signals at MLS frequencies; however, MLS performance is not severely affected. Analysis of MLS link performance with a transmitter power output of 1600 W (the minimum acceptable transmitter power output level) shows that MLS acquires at over 9 nm slant range when a rainfall rate of 10 mm/hr (0.4 in/hr) exists along the entire path between the orbiter and the ground MLS station. Since "light" rainfall is less than 0.4 in/hr, nominal MLS acquisition is protected.

Cloud Top Temperatures and Lightning Avoidance (Paragraphs C2c(5)(b)2 and C3e(2)(b)) - Clouds with tops warmer than +5 deg C do not pose a threat of stored electrical charge. Clouds with tops colder than +5 deg C pose a threat of lightning (natural and triggered). Convective clouds that have previously been colder than -10 deg C have probably generated electric charge; these clouds must be avoided for 3 hours to allow the charge to dissipate (See Lightning Launch Commit Criteria for surface based electric field mills). The 3-hour time limit is calculated relative to the abort landing time (approximately 2 1/2 hours prior to launch). A 2-nm vertical clearance or a 10-nm lateral clearance must be maintained along the approach path for showers exceeding these limits. The clearance requirements for lightning potential are the same as those of actual thunderstorms. These criteria are consistent with the Lightning Advisory Panel's recommended Lightning Launch Commit Criteria. ©[021998-6490A] ©[102506-7842]

Relationship to Ceiling and Visibility Limit Criteria - Ceiling and visibility criteria specified in paragraph A of this rule still apply and protect for adequate crew visibility of the PAPI's, aimpoint, and ball bar through clouds and precipitation. WX RECON has primary responsibility for assessing visibility through light precipitation from any showers of concern that do not fall within the field of view used by meteorological observers to evaluate visibility. Ground observers are limited to evaluations using fixed landmarks. ©[121604-6533A]

THIS RULE CONTINUED ON NEXT PAGE

FLIGHT RULES**A2-6****LANDING SITE WEATHER CRITERIA [HC] (CONTINUED)**

RTLS ANVIL LIMITS ©[102506-7842]

The Lightning Advisory Panel (LAP) performed a study of anvil clouds as part of the Airborne Field Mill II Program (NASA/TM-2004-211534). This program utilized an instrumented aircraft to investigate the magnitude and duration of electric fields in anvil clouds, and how these fields and their lifetimes were related to the cloud particle types, particle sizes, and weather radar reflectivity. This study concluded that a Volume-Averaged Height-Integrated Radar Reflectivity (VAHIRR) value had the best trend of an increase in value with an increase in the magnitude of the electric field. The LAP determined that as long as the VAHIRR value in an anvil is below 10 dbz-km or 33 dbz-kft, there is minimal risk for an electric field greater than 3 kV per meter. An electric field value of 3 kV per meter is considered to be a safe value to avoid triggering lightning for launch vehicles such as the Space Shuttle and Titan. Both of these vehicles have large ionized plumes that increase the risk of triggered lightning when compared to the orbiter as a entry vehicle. Due to the limited number of debris cloud cases in the Airborne Field Mill II Program, the VAHIRR rule cannot be applied to debris clouds.

As a result of the Lightning Advisory Panel (LAP) VAHIRR recommendation, the Launch Commit criteria utilizing the aforementioned VAHIRR criteria were developed and approved by the Space Shuttle Program (reference Noon Board June 23, 2005). On August 7, 2006, an A/E FTP Weather Flight Rule Splinter Group was held to review the LCC VAHIRR criteria and determine whether that criteria could be applied to RTLS since the forecast interval is relatively short (35 minutes). Based on a review of the LCC criteria, the meteorological tools available, and the complexity of real-time implementation, the A/E FTP recommended using the VAHIRR criteria for evaluation of anvil clouds for RTLS aborts only. The flight rules developed are consistent with the LAP approved Lightning Launch Commit Criteria. The Panel also concluded that in general these rules are conservative because the orbiter's effective triggering threshold (i.e., the ambient electric field required to produce a triggered lightning stroke) is higher for entry than it is in the launch configuration with the sizeable SRB plume, and the orbiter is, therefore, less likely to trigger a lightning stroke compared to the launch vehicle. Because no additional LAP provided VAHIRR data was available for entry, the A/E FTP agreed to adopt the more conservative launch LCC criteria.

Until an automated VAHIRR product can be obtained, a manual technique can be utilized to estimate VAHIRR using currently available radar products. This procedure is labor intensive and results in a more conservative VAHIRR product. Utilizing the workaround procedure on a day with multiple anvils or multiple weather concerns will be difficult and may not be operationally feasible. The intent of this rule is to allow some additional launch availability on a day where there are one or two anvils in the 20 nm circle that can be safely cleared using the new VAHIRR criteria. ©[102506-7842]

THIS RULE CONTINUED ON NEXT PAGE

FLIGHT RULES**A2-6****LANDING SITE WEATHER CRITERIA [HC] (CONTINUED)**

The August 7, 2006, A/E FTP Weather Flight Rule Splinter Group also concluded that a minimum of two approaches is required for detached anvil clouds for only the RTLS abort forecast/observation. The vehicle will avoid detached anvil clouds for at least two approaches by margins consistent with the LAP approved Lightning Launch Commit criteria. Predictions of the forecasted location of the detached anvil cloud are sufficiently accurate (i.e., as good as those covered by the rain shower rules) if weather satellite, weather aircraft, and radar observations are available. Removing the requirement for acceptable weather for all four approaches increases launch availability while maintaining safety margin by allowing for an energy downmode in the event that an RTLS is required. ©[102506-7842]

Rules {A2-1F}, PRELAUNCH GO/NO-GO REQUIREMENTS; {A2-2}, ABORT LANDING SITE REQUIREMENTS; {A2-103}, EXTENSION DAY REQUIREMENTS; {A2-202}, EXTENSION DAY GUIDELINES; {A2-205}, EMERGENCY DEORBIT; {A2-261}, ENTRY DTO/AUTO MODE/CROSSWIND DTO GO/NO-GO; {A3-202}, MLS; {A4-107}, PLS/EOM LANDING OPPORTUNITY REQUIREMENTS [HC]; {A4-108}, TIRE SPEED, BRAKING, AND ROLLOUT REQUIREMENTS [HC]; {A5-103}, LIMIT SHUTDOWN CONTROL; {A8-18}, LANDING SYSTEMS REQUIREMENTS; and {A8-1001}, GNC GO/NO-GO CRITERIA, reference this rule. ©[111094-1622B] ©[020196-1808A] ©[ED] ©[042706-7363A]

THIS RULE CONTINUED ON NEXT PAGE

FLIGHT RULES

THIS PAGE INTENTIONALLY BLANK

FLIGHT RULES

A2-6

LANDING SITE WEATHER CRITERIA [HC] (CONTINUED)

CEILING / VISIBILITY (K FT)/(SM)			REDUNDANT MLS	SINGLE STRING-MLS	NO MLS
KSC, EDW, NOR, AOA, DAILY PLS SELECTION (ALL SITES)	CONCRETE	DAY	≥8/5 (WX RECON REQD)	≥10/7	
		NIGHT		NO-GO	
	LAKEBED	DAY		≥10/7	NO GO
		NIGHT		≥15/7	
RTLS, TAL	CONCRETE	DAY	≥5/4 RTLS ≥5/5 TAL (WX RECON REQD)	≥10/7	
		NIGHT		NO GO	
ACLS / ECAL / ELS			0/0		≥8/5
PRED/O: 1 APU FAILED OR ATTEMPT 2 APU'S PROCEDURE			≥10/7		

@[022604-6167A]

SURFACE WIND (KNOTS) AND TURBULENCE		CROSS PEAK	HEAD PEAK	TAIL AVG	TAIL PEAK	GUST	TURB
RTLS		≤15 *	≤25	≤10	≤15	≤10	≤MOD
DAY	EOM, TAL, AOA, DAILY PLS SELECTION	≤15					
NIGHT	EOM	≤12					
	DAILY PLS SELECTION TAL, AOA	≤15					
CROSSWIND DTO		≥10 ≤15					
NOMINAL DRAG CHUTE DEPLOY		≤15					
LANDING ≥ CDR FD19		≤12					
PREDEORBIT: 1 APU FAILED OR ATTEMPT 2 APU'S PROCEDURE		≤10					≤LGT
ECAL/ELS		≤15	N/A				

@[121400-3866] @[052401-4459A]

THUNDERSTORM, LIGHTNING, AND PRECIPITATION PROXIMITY LIMITS (NM)		PRELAUNCH (RTLS, TAL)	PREDEORBIT (EOM, DAILY PLS) PRELAUNCH (AOA)	REDESIG CRITERIA	ELS, ECAL, ACLS
TSTORM (INCLUD ATTACH NONTRANS-PARENT ANVILS*), & LIGHTNING*	RADIAL FROM CENTER OF PRIME RUNWAY	>20	>30	>15	NONE AT SITE
	LATERAL ALONG APPROACH PATH OUT TO 30 NM	>10	>20	>5	
	VERTICAL FROM TOP OF CLOUD	>2			
DETACHED NONTRNSPARNT ANVIL < 3 HRS OLD*	RADIAL FROM CENTER OF PRIME RUNWAY	>15	>20	>15	N/A
	LATL ALONG APPROACH PATH OUT TO 30 NM	>5	>10	>5	
	VERTICAL FROM TOP OF CLOUD	>2			
PRECIPITATION *	RADIAL FROM CENTER OF PRIME RUNWAY	>20	>30	> 15	N/A
	LATL ALNG APPRCH PATH OUT TO 30 NM	>10	>20	> 5	
	VERT FRM TOP OF CLD	>2			
CMLUS CLDS PROD BY S/F ≤ 1 HR AFTR DETACHING	LATERAL ALONG APPROACH PATH	>0			N/A

@[ED]

THIS RULE CONTINUED ON NEXT PAGE

FLIGHT RULES

THIS PAGE INTENTIONALLY BLANK

FLIGHT RULES

A2-6

LANDING SITE WEATHER CRITERIA [HC] (CONTINUED)

D. FLIGHT RULE WEATHER DEFINITIONS ©[081497-6278A] ©[022604-6167A]

THE FOLLOWING DEFINITIONS ARE USED WHEN EVALUATING THE WEATHER FLIGHT RULES:

CLOUDS

Ceiling - The height above ground where the cumulative total of cloud cover exceeds 50 percent coverage of sky. The height above the earth's surface of the lowest layer reported as broken or overcast, or the vertical visibility into a surface based obscuration reported as a ceiling.

Cloud edge - The visible edge shall be used whenever possible. If this is not possible, meteorological judgment of available radar and other data shall be used to determine the cloud edge. The maximum radar reflectivity that can be considered to represent the cloud edge is 0 dBZ, although a lower value may be representative on any particular day.

Cloud top - The height of cloud using the visibly determined top. If this is not possible, meteorological judgment of available radar, satellite, and other measurements shall be used to determine the cloud top. The maximum radar reflectivity that can be considered to represent the top is 0 dBZ, although a lower value may be representative on any particular day.

Debris Cloud - Any cloud, except anvil cloud, that has become detached from a parent cumulonimbus or thunderstorm, or that results from the decay of a parent cumulonimbus cloud or thunderstorm. For the purposes of Flight Rule evaluation, debris clouds are considered in the same category as detached anvil clouds.

Nontransparent - Sky cover through which forms are blurred, indistinct, or obscured is nontransparent. It is the opposite of transparent. Sky cover through which forms are seen and identified through breaks in the cloud shall be considered as nontransparent. Clouds with radar reflectivity of 0 dBZ or greater shall be considered nontransparent. ©[ED]

Transparent - Sky cover shall be considered transparent when higher clouds, blue sky, or stars may be seen and identified from below or when terrain, buildings or landmarks may be seen and identified from above. ©[022604-6167A]

THIS RULE CONTINUED ON NEXT PAGE

FLIGHT RULES

A2-6

LANDING SITE WEATHER CRITERIA [HC] (CONTINUED)

CLOUD COVERAGE ©[081497-6278A] ©[022604-6167A]

Clear (SKC) - No clouds or obscurations observed or detected

Few - Total layer sky coverage of 2/8 or less

Scattered (SCT) - Total layer sky coverage of 3/8 to 4/8

Broken (BKN) - Total layer sky coverage of 5/8 to 7/8

Overcast (OVC) - Total layer sky coverage of 8/8

OBSERVATIONS

METAR (Surface Meteorological Airways) - Routine meteorological report using an international coding standard developed by the World Meteorological Organization

None at site - For Flight Rules purposes, none at site shall mean that the designated phenomenon is not directly over the landing airfield. ©[022604-6167A]

THIS RULE CONTINUED ON NEXT PAGE

FLIGHT RULES

A2-6

LANDING SITE WEATHER CRITERIA [HC] (CONTINUED)

PRECIPITATION ©[081497-6278A] ©[022604-6167A]

Precipitation is defined as any of the forms of water particles, liquid or solid, which fall from the atmosphere. Rain droplets observed on the windscreen of weather aircraft, radar reflectivity of 18 dBZ or greater, cumulonimbus clouds, a radar bright band, virga, and visible rain or drizzle shall be considered precipitation for Flight Rules purposes. ©[102506-7842]

Heavy precipitation - Radar reflectivity values greater than or equal to 38 dBZ or rainfall rate greater than 0.30 inches/hr

Light precipitation - Radar reflectivity values greater than or equal to 18 dBZ and less than 30 dBZ, or a rainfall rate of 0.10 inches/hr or less

Moderate precipitation - Radar reflectivity values greater than or equal to 30 dBZ and less than 38 dBZ, or a rainfall rate of 0.11 to 0.30 inches/hr

Radar bright band - Area of enhanced radar reflectivity produced by frozen precipitation falling through the 0 degrees C level and melting

Virga - Visible wisps or strands or precipitation falling from clouds that evaporate before reaching the ground ©[022604-6167A]

THIS RULE CONTINUED ON NEXT PAGE

FLIGHT RULES

A2-6

LANDING SITE WEATHER CRITERIA [HC] (CONTINUED)*THUNDERSTORM* ©[081497-6278A] ©[022604-6167A]

Any cloud producing lightning or one that has produced lightning within the past 15 minutes. Cumulonimbus clouds and the nontransparent portion of attached anvils shall be considered as part of a thunderstorm for Flight Rules evaluation.

Anvil - The flat, fibrous, spreading top of a thunderstorm or cumulonimbus cloud. Stratiform or fibrous ice crystal cloud produced by the upper level outflow or blow-off from thunderstorms or convective clouds. For Flight Rules purposes, an attached anvil shall be considered as part of the thunderstorm.

Cumulonimbus - A dense and vertically developed cloud that appears as huge towers, usually with an upper part that is smooth, fibrous, striated, or almost flattened. Any convective cloud with any part colder than -20 degrees C shall be considered a cumulonimbus cloud and treated like a thunderstorm for Flight Rules purposes.

Detached anvil - An anvil cloud that becomes physically separated from the parent thunderstorm or cumulonimbus cloud. Any cloud resulting from the decay of a thunderstorm or cumulonimbus cloud shall be considered as a detached anvil for Flight Rule purposes.

TRIGGERED LIGHTNING

Lightning that is initiated by placing an object such as a rocket or airplane into an electric field

TURBULENCE

Light - Turbulence that momentarily causes slight, erratic changes in altitude and/or attitude

Moderate - Turbulence that causes changes in altitude and/or attitude, but with the aircraft remaining in positive control

Severe - Turbulence that causes large, abrupt changes in altitude and/or attitude. It usually causes large variations in indicated airspeed. Aircraft may momentarily be out of control.

Extreme - Turbulence in which the aircraft is violently tossed about and is practically impossible to control. It may cause structural damage. ©[022604-6167A]

THIS RULE CONTINUED ON NEXT PAGE

FLIGHT RULES

A2-6

LANDING SITE WEATHER CRITERIA [HC] (CONTINUED)

WIND ©[081497-6278A] ©[022604-6167A]

The forecast wind is a 2-minute average and 10-minute peak at the expected landing time. The observed wind will be the average and peak available from the landing site which may be a 1, 2, or 5 minute average and a 5, 10, or 15 minute peak depending on the site.

Average wind - Wind direction or speed averaged over a period of time. Typically, at landing sites in the continental U.S., a 2-minute average of 1-second measurements is used.

Crosswind - The crosswind is the component of the wind perpendicular to the runway or vehicle flight path.

Gust - For Flight Rules purposes, a gust shall be defined as the difference between the average and peak winds over a specified duration, usually 10 minutes.

Headwind - The headwind is the component of the wind parallel to the runway or vehicle flight path that opposes the intended progress of the vehicle. It is in the opposite direction of the tailwind.

Peak wind - The direction and speed of the maximum instantaneous wind over a specified duration, usually 10 minutes.

Tailwind - The tailwind is the component of the wind parallel to the runway or vehicle flight path that assists in the intended progress of the vehicle. It is in the opposite direction of the headwind.

VISIBILITY

Restrictions to visibility - Any phenomenon that reduces horizontal or slant range visibility such as smoke, haze, fog, dust, clouds, and precipitation.

Vertical visibility - A subjective or instrumental evaluation of the vertical distance into a surface based obscuration that an observer would be able to see. ©[022604-6167A]

THIS RULE CONTINUED ON NEXT PAGE

FLIGHT RULES

A2-6

LANDING SITE WEATHER CRITERIA [HC] (CONTINUED)

VAHIRR ©[102506-7842]

Volume-Averaged, Height-Integrated Radar Reflectivity (VAHIRR) - Product of the Volume-Averaged Radar Reflectivity (VARR) and the average cloud thickness within a specified volume relative to a point (units of dBZ-km). VARR is the arithmetic average (in dBZ) of the cloud radar reflectivity within the Specified Volume. Normally, a radar processor will report reflectivity values interpolated onto a regular, three-dimensional array of grid points. Any such grid point within the specified volume is included in the average if, and only if, it has a radar reflectivity equal to or greater than 0 dBZ.

For calculating VAHIRR, the average cloud thickness is the altitude difference (in kilometers) between the average top and the average base of all clouds within the specified volume. The cloud base to be averaged is the higher of (1) the 0 degree C level and (2) the lowest extent (in altitude) of all cloud radar reflectivities 0 dBZ or greater. Similarly, the cloud top to be averaged is the highest extent (in altitude) of all cloud radar reflectivities 0 dBZ or greater.

Note: The VAHIRR measurement must be made in the absence of significant attenuation by intervening storms or by water or ice on the radome itself. The VAHIRR measurement is invalid at any point that is within 20 km (11 NM) of any radar reflectivity of 35 dBZ or greater at altitudes of 4 kilometers (2 nm) above mean sea level or greater, and at any point that is within 20 km (11 nm) of any type of lightning that has occurred in the previous 5 minutes. The specified volume must not contain either any portion of the cone of silence above the radar. The individual grid-point reflectivities used to determine either the VARR or the average cloud thickness must be meteorological reflectivities.

Specified Volume - The volume bounded in the horizontal by vertical, plane, perpendicular sides located 5.5 km (3 NM) north, east, south, and west of the point on the flight track, on the bottom by the 0 degree C level, and on the top by the upper extent of all clouds. ©[102506-7842]

Rules {A1-106}, LANDING SITES; {A2-1}, PRELAUNCH GO/NO-GO REQUIREMENTS [HC]; {A2-103}, EXTENSION DAY REQUIREMENTS; {A2-202}, EXTENSION DAY GUIDELINES; {A2-264}, EMERGENCY LANDING FACILITY CRITERIA [HC]; {A3-202}, MLS [HC]; {A4-2}, LANDING SITE CONDITIONS; {A4-56}, PERFORMANCE BOUNDARIES; {A4-107}, PLS/EOM LANDING OPPORTUNITY REQUIREMENTS [HC]; {A4-108}, TIRE SPEED, BRAKING, AND ROLLOUT REQUIREMENTS [HC]; {A4-109}, DEORBIT PRIORITY FOR EOM WEATHER; {A5-103}, LIMIT SHUTDOWN CONTROL [HC]; {A8-18}, LANDING SYSTEMS REQUIREMENTS; {A8-111}, GNC AIR DATA SYSTEM MANAGEMENT [CIL]; {A10-23}, APU ENTRY START TIME [HC]; and {A10-144}, DRAG CHUTE DEPLOY CONSTRAINTS [HC], reference this rule. ©[ED]

FLIGHT RULES

A2-7**DAY-OF-LAUNCH ET LOAD DATA [HC]** @[033105-6692A]

- A. ACTUAL DAY OF LAUNCH (DOL) ET LOAD DATA FROM THE PLOAD PROGRAM WILL BE USED TO RE-COMPUTE ASCENT PERFORMANCE MARGIN, ARD MASS PROPERTIES, AND ARD FPR BASED ON L-3.25 HOUR (OR LATER) DATA. TO COMPUTE A VALID ET LOAD AND PERFORM THE ASSOCIATED ARD UPDATES, THE FOLLOWING MINIMUM TIME IS REQUIRED: @[050495-1729D] @[081497-6305A]
1. MINIMUM OF 50 MINUTES AFTER LO₂ STABLE REPLENISH HAS BEEN ESTABLISHED.
 2. MINIMUM OF 25 MINUTES AFTER LH₂ STABLE REPLENISH HAS BEEN ESTABLISHED.
- B. IF PLOAD IS UNAVAILABLE, IF LOAD UNCERTAINTY EXISTS WITH PLOAD, OR IF THERE IS INSUFFICIENT TIME TO EVALUATE, PROCESS, AND INCORPORATE PLOAD DATA:
1. THE ARD WILL BE CONFIGURED TO REFLECT TARGET TDDP LOAD QUANTITIES AND THE ARD FPR WILL BE RE-CALCULATED WITH INCREASED LOAD UNCERTAINTIES TO ACCOUNT FOR ADDITIONAL DISPERSIONS IN THE ACTUAL LOAD
 2. MCC WILL BE NO-GO FOR LAUNCH UNTIL THE PROPULSION SYSTEMS COMMUNITY, AS REPORTED BY THE JSC MER PSIG REPRESENTATIVE, CONFIRMS THE TDDP ET LOAD HAS BEEN ESTABLISHED. THE LO₂ TDDP LOAD IS VALIDATED BY CONFIRMING THAT THE MEASURED ULLAGE PRESSURE DOES NOT EXCEED 0.255 PSI ABOVE THE TDDP NOMINAL LOAD ULLAGE PRESSURE OF 0.781 PSIG
- C. IF AN LO₂ REPLENISH FLOW INTERRUPT WITH ET LO₂ VENT VALVE CYCLING INITIATED OR LH₂ REPLENISH FLOW INTERRUPT HAS OCCURRED, MCC WILL BE NO-GO FOR LAUNCH UNTIL:
1. STABLE REPLENISH HAS BEEN RE-ESTABLISHED.
 2. THE ARD IS PROPERLY CONFIGURED WITH VALID ET LOAD DATA (TDDP OR PLOAD).
 3. A VALID ET LOAD IS OBTAINED VIA THE PLOAD PROCESS PER PARAGRAPH A OR CONFIRMATION BY THE JSC MER PSIG REPRESENTATIVE OF A VALID TDDP LOAD PER PARAGRAPH B.
@[033105-6692A]

THIS RULE CONTINUED ON NEXT PAGE

FLIGHT RULES**A2-7****DAY-OF-LAUNCH ET LOAD DATA [HC] (CONTINUED)**

Launch will not be attempted until a valid ET load can be confirmed and incorporated into the day of launch process. The ET load is nominally based on PLOAD results but can be based on prelaunch TDDP values if the ET load can be verified. The PLOAD program is executed once stable replenish has been established to estimate ET LO₂ and LH₂ loads based on ullage pressures and environmental conditions. A preliminary assessment is completed by approximately L-3.25 hours with later estimates available for the flight dynamics team if required. The predicted end-of-replenish quantities are used to calculate DOL ascent performance margin, fuel bias, ARD Main Engine Propellant (MEP) quantity, and vehicle weights. ARD FPR is also recalculated based on the actual load, since the ET load and mixture ratio component of ARD FPR is a function of predicted fuel bias. ©[033105-6692A]

The minimum stable LO₂ replenish time to obtain a valid PLOAD input following an LO₂ flow interruption in which ET vent valve cycling has been initiated is 50 minutes. This minimum time includes 30 minutes of stable replenish data followed by 20 minutes of analysis to confirm a valid load and adequate ascent performance margin. Note that the ET LO₂ vent valve cycling is initiated as a result of the LO₂ liquid level falling below 98 percent. For an LH₂ replenish flow interrupt, and subsequent re-establishment of LH₂ stable replenish, the total time required is approximately 25 minutes due to processing and ARD reconfiguration requirements. These minimum times are required prior to the flight director giving a "GO" to pick up the count at T-9 min or T-5 min. These procedures were approved at the PRCB, January 14, 1992. ©[050495-1729D] ©[081497-6305A]

When PLOAD is not available, it is assumed that the load fits within statistical limits of previous load quantities, which historically have been very close to the targeted load specified in the Trajectory Design Data Package (TDDP). In this case, ARD FPR must protect for historical deviations of the reported load from the target load as well as normal PLOAD uncertainties. The historical deviations (reference NSTS 08209, Shuttle Systems Design Criteria; Volume I, Shuttle Performance Assessment Databook; Section 8, Flight Performance Reserve; Table 8.1, System Dispersions for FPR Computation) are root sum squared with the normal PLOAD uncertainties to provide a total load uncertainty that is used to recompute ARD FPR. This increases the ARD FPR by approximately 90 lbs. ©[081497-6305A]

For any case involving loss of PLOAD data, a nominal stable replenish timeline is necessary to ensure that the load has reached TDDP target conditions. In the very unlikely event that both an LO₂ replenish flow interrupt occurs (with a vent valve cycle) and the PLOAD program is unavailable, or if for any other reason load uncertainty exists, the propulsion systems community, as reported via the Propulsion Systems Integration Group (PSIG) representative in the MER, must be satisfied that the target MPS inventory has been achieved before a "GO" can be given to pick up the count. The MPS inventory is protected if the ullage pressure is less than 1.036 psi. Ullage pressure above this limit indicates an under-load of a magnitude beyond that covered in the FPR. The value of 1.036 psi is derived by adding the ullage pressure used in deriving the inventory (0.781 psi) to a tolerance that is protected by FPR (0.255 psi). ©[081497-6305A] ©[092602-5668]

Documentation: NSTS 16007 Launch Commit Criteria and Background SEQ-1 references the actions specified in this rule for an LO₂ Replenish Flow Interrupt with the ET LO₂ Vent Valve Cycling Initiated.

THIS RULE CONTINUED ON NEXT PAGE

FLIGHT RULES**A2-7 DAY-OF-LAUNCH ET LOAD DATA [HC] (CONTINUED)**

NSTS-08329 Volume VIII DOLILU Operations Support Plan

Hazard report INTG-03, Incorrect IMPS Configuration During Engine Operations, references this rule. ©[033105-6692A]

Rule {A2-9}, LOSS OF ET LOX LIQUID LEVEL CONTROL SENSORS, references this rule. ©[ED]

A2-8 LAUNCH TIME SELECTION FOR GROUND-UP RENDEZVOUS

THE MCC-H FLIGHT DYNAMICS OFFICER (FDO) IS RESPONSIBLE FOR ALL COMPUTATIONS RELATED TO LAUNCH WINDOW. FINAL CALCULATIONS WILL BE MADE AT APPROXIMATELY L-2 HOURS. THESE WILL USE THE LATEST AVAILABLE BALLOON PERFORMANCE ANALYSIS, LATEST AVAILABLE TARGET TRACKING VECTOR, AND THE FINAL PLOAD ANALYSIS OF ET LOADING. THE FDO SHALL INFORM THE MCC-H FLIGHT DIRECTOR OF THE LAUNCH WINDOW TIMES. THE FLIGHT DIRECTOR SHALL BE THE SINGLE POINT OF COMMUNICATION FOR THE LAUNCH WINDOW TIMES TO KSC VIA THE NTD. THE ASSOCIATED LAUNCH TARGETING/AUTO DEL PSI COMMAND LOADS WILL BE GENERATED AND UPLINKED TO THE VEHICLE IN THIS TIMEFRAME. AFTER THIS TIME, UPDATES TO WINDOW TIMES AND/OR A NEW COMMAND UPLINK WILL BE REQUIRED IF THE PANE SWITCH WINDOW TIME CHANGES BY MORE THAN 5 SECONDS (IN EITHER DIRECTION) BASED ON THE L-2.25 HR BALLOON ANALYSIS AT APPROXIMATELY L-30. ©[081497-6263B] ©[111298-6693]

- A. LAUNCH WINDOW OPEN AND CLOSE TIMES WILL BE COMPUTED TO THE NEAREST SECOND. ON A GIVEN DAY, A RENDEZVOUS LAUNCH WINDOW MAY BE ONLY ONE PLANAR PANE OR THE COMBINATION OF TWO PLANAR PANES. ONLY THE PLANAR PANE WHERE THE PHASE ANGLE IS ACCEPTABLE WILL BE CONSIDERED PART OF THE COMBINED LAUNCH WINDOW. THIS MAY RESULT IN CUTOUTS IN THE LAUNCH WINDOW. CALCULATION OF LAUNCH WINDOW OPEN, CLOSE, AND PANE SWITCH TIMES WILL PROTECT:
1. MPS AND OMS PERFORMANCE MARGIN FOR MISSION SUCCESS AS DEFINED BY THE ANNEX FLIGHT RULE, SHUTTLE TRAJECTORY AND GUIDANCE PARAMETERS, PARAGRAPHS A AND B. THIS IS ZERO PREDICTED MPS USABLE RESIDUALS ABOVE THE FLIGHT PERFORMANCE RESERVE AND THE REQUIRED SIGMA DISPERSION. THE SIGMA DISPERSION IS DEFINED IN THE ANNEX FLIGHT RULE, SHUTTLE TRAJECTORY AND GUIDANCE PARAMETERS. ©[062801-4521]

THIS RULE CONTINUED ON NEXT PAGE

FLIGHT RULES

A2-8

LAUNCH TIME SELECTION FOR GROUND-UP RENDEZVOUS (CONTINUED)

LAUNCH WINDOW OPEN WILL BE BASED ON LOX DRAINBACK START TIME 4 MINUTES 55 SECONDS BEFORE WINDOW OPENING. LAUNCH WINDOW CLOSE WILL BE BASED ON A HOLD THAT DELAYS LOX DRAINBACK START TIME TO THE MAXIMUM EXTENT POSSIBLE, 4 MINUTES 55 SECONDS BEFORE THE CLOSE OF THE WINDOW. @[081497-6263B]

FOR 51.6 DEGREE INCLINATION MISSIONS, IF THE PERFORMANCE MARGIN IS LESS THAN 200 POUNDS AT THE OPENING OF THE LAUNCH WINDOW, AN ADDITIONAL DELAY, IF AVAILABLE, WILL BE ADDED TO WINDOW OPEN TIME TO PROTECT FOR PERFORMANCE VARIATION DUE TO WIND PERSISTENCE. @[081497-6263B] @[111298-6693]

2. PROTECT CONTINUOUS SINGLE SSME OUT INTACT ABORT CAPABILITY FOR A LAUNCH AT ANY TIME DURING THE WINDOW.
3. RANGE SAFETY ET DISPOSAL AS SPECIFIED BY FLIGHT RULE {A2-62}, ET FOOTPRINT CRITERIA.
4. ET YAW STEERING CERTIFICATION LIMIT AROUND INPLANE LAUNCH TIME FOR THE PLANAR WINDOW(S). @[062801-4521]
5. SHUTTLE TO TARGET VEHICLE OMS-2 PHASE ANGLE WINDOW, ASSUMING NOMINAL MECO CONDITIONS, AS DEFINED BY THE RENDEZVOUS PLAN ASSUMPTIONS DOCUMENTED IN THE FLIGHT RULE ANNEX.

THIS RULE CONTINUED ON NEXT PAGE

FLIGHT RULES

A2-8

**LAUNCH TIME SELECTION FOR GROUND-UP RENDEZVOUS
(CONTINUED)**

6. ACCEPTABLE PERFORMANCE AROUND PANE SWITCH. THE UPLINKED PANE SWITCH TIME WHICH DEFINES THE END OF THE FIRST PANE FOR PERFORMANCE AND AN ASSOCIATED OPENING OF THE SECOND PANE WILL BE COMPUTED BASED ON LOX DRAINBACK STARTING 4 MIN 55 SECONDS PRIOR TO THE PREFERRED LAUNCH TIME AS DEFINED IN PARAGRAPH D BELOW. NOTE THAT THERE MAY BE A LAUNCH WINDOW CUTOFF WHERE THERE IS INSUFFICIENT PERFORMANCE FOR LAUNCH. @[081497-6263B]

B. UNPLANNED HOLDS @[081497-6263B] @[062801-4521]

1. PANE 1 CLOSE AND PANE 2 OPEN WILL BE CALCULATED ASSUMING LOX DRAINBACK (T-4 MINUTES 55 SECONDS) STARTS FOR THE PREFERRED LAUNCH TIME AS DEFINED IN PARAGRAPH D BELOW. PANE 1 CLOSE AND PANE 2 OPEN TIMES WILL BE UPDATED IF LAUNCH IS TO BE ATTEMPTED AT THE WINDOW OPEN TIME.
2. LOX DRAINBACK HOLD TIME REPORTED TO THE NTD WILL BE CALCULATED ASSUMING START OF LOX DRAINBACK 4 MIN 55 SEC PRIOR TO THE PREFERRED LAUNCH TIME AS DESCRIBED IN PARAGRAPH D BELOW. LOX DRAINBACK HOLD TIME WILL BE UPDATED IF LAUNCH IS TO BE ATTEMPTED AT THE WINDOW OPEN TIME. FOR HOLDS BEFORE LOX DRAINBACK STARTS, THIS TIME IS NO LONGER VALID AND IN GENERAL DECREASES. FOLLOWING A SERIES OF HOLDS BEFORE OR DURING LOX DRAINBACK, IF REQUIRED, THE FD WILL COORDINATE A HOLD OR CUTOFF WITH THE NTD TO PREVENT A LAUNCH WITH INSUFFICIENT PERFORMANCE.
3. SSME START BOX TEMPERATURE LIMITS ARE NOT CONSIDERED IN THESE CALCULATIONS. ONCE THE SSME CONTROLLER DETECTS AN OUT OF LIMITS THERMAL CONDITION, AN AUTOMATIC HOLD/CUTOFF WILL OCCUR.

THIS RULE CONTINUED ON NEXT PAGE

FLIGHT RULES

A2-8

LAUNCH TIME SELECTION FOR GROUND-UP RENDEZVOUS
(CONTINUED)

C. ON TWO PLANAR WINDOW PANE DAYS:

1. FOR 28.5-DEGREE INCLINATION MISSIONS, THERE WILL BE A 10-SECOND LAUNCH WINDOW CUTOUT AT THE UPLINKED PANE SWITCH TIME TO ENSURE ONBOARD GUIDANCE/GROUND PROCESSOR SYNCHRONIZATION. THIS CUTOUT WILL START 5 SECONDS BEFORE SWITCH TIME AND CONTINUE TO 5 SECONDS PAST SWITCH TIME. FOR SOME PERFORMANCE CASES, THE SECOND PANE OPENING MAY BE FURTHER DELAYED. A COUNTDOWN HOLD WILL BE CALLED TO AVOID LAUNCHING DURING THESE CUTOUTS. ©[062801-4521] ©[022802-5220]
2. FOR 51.6-DEGREE INCLINATION MISSIONS, THERE WILL BE A MINIMUM 10-SECOND LAUNCH WINDOW CUTOUT AT THE UPLINKED PANE SWITCH TIME TO ENSURE ONBOARD GUIDANCE/GROUND PROCESSOR SYNCHRONIZATION AND TO MAXIMIZE THE ASCENT PERFORMANCE MARGIN AT THE OPENING OF THE SECOND PANE. THIS CUTOUT WILL START 5 SECONDS BEFORE SWITCH TIME. ©[081497-6263B] ©[062801-4521] ©[022802-5220]
 - a. IN THE EVENT OF AN UNPLANNED HOLD OUTSIDE OF DRAINBACK, THE CUTOUT WILL END AT THE LATER OF 5 SECONDS AFTER THE SWITCH TIME OR THE PANE 2 INPLANE TIME.
 - b. IN THE EVENT OF A HOLD INSIDE DRAINBACK, THE CUTOUT WILL END AT THE LATER OF 5 SECONDS AFTER THE SWITCH TIME OR AT THE PANE 2 PERFORMANCE OPEN.

A COUNTDOWN HOLD WILL BE CALLED TO AVOID LAUNCHING DURING THESE CUTOUTS.

THIS RULE CONTINUED ON NEXT PAGE

FLIGHT RULES

A2-8

LAUNCH TIME SELECTION FOR GROUND-UP RENDEZVOUS
(CONTINUED)

3. WHENEVER POSSIBLE, FLIGHT DAY 3 RENDEZVOUS CAPABILITY WILL BE MAXIMIZED. FD3 CAPABILITY IS ONLY AVAILABLE IN THE FIRST PANE AND SOMETIMES ONLY A PORTION OF THE FIRST PANE. FD3 CAPABILITY WILL BE MAINTAINED TO THE LAST POSSIBLE TIME IN THE COUNTDOWN. @[081497-6263B] @[062801-4521]
4. FLIGHT DAY 2 RENDEZVOUS CAPABILITY IS HIGHLY DESIRABLE IF MDF OCCURS. REGIONS OF THE LAUNCH WINDOW THAT PRESERVE FD2 RENDEZVOUS WILL BE UTILIZED WHENEVER CONVENIENT.

D. PREFERRED LAUNCH TIME

1. DURING THE T-9 MINUTE HOLD, THE LD, NTD, AND FD WILL MAKE A FINAL DETERMINATION ON THE USE OF PREFERRED LAUNCH TIME. IF THERE ARE INDICATIONS THAT THERE IS A SIGNIFICANT CHANCE OF TROUBLESHOOTING REQUIRED AFTER RESUMPTION OF THE COUNTDOWN AT T-9 MINUTES, THE COUNTDOWN CLOCK WILL BE SET TO WINDOW OPENING AS DEFINED BY PARAGRAPH A OF THIS RULE. OTHERWISE, THE COUNTDOWN CLOCK WILL BE SET TO THE PREFERRED (DELAYED) LAUNCH TIME. IF THE WINDOW OPEN LAUNCH TIME IS SELECTED RATHER THAN THE PREFERRED LAUNCH TIME, A NEW LAUNCH TARGET/OMS TARGET UPLINK MAY BE REQUIRED. PANE 1 CLOSE, PANE 2 OPEN, AND LOX DRAINBACK HOLD TIME UPDATES MAY ALSO BE REQUIRED. @[062801-4521]

THIS RULE CONTINUED ON NEXT PAGE

FLIGHT RULES

A2-8

**LAUNCH TIME SELECTION FOR GROUND-UP RENDEZVOUS
(CONTINUED)**

2. FOR 51.6-DEGREE INCLINATION MISSIONS, PREFERRED LAUNCH TIME MAXIMIZES THE MPS PERFORMANCE MARGIN AVAILABLE IN CASE UNFORESEEN IN-FLIGHT PERFORMANCE PROBLEMS OCCUR. IF SHUTTLE TO TARGET VEHICLE OMS-2 PHASE ANGLE CONSTRAINTS ARE SATISFIED, PREFERRED LAUNCH TIME WILL BE THE INPLANE LAUNCH TIME FOR THE FIRST PANE OF THE LAUNCH WINDOW. UNLESS NOTED AS AN EXCEPTION IN THE FLIGHT RULES ANNEX, THE PREFERRED LAUNCH TIME WILL BE NO EARLIER THAN THE INPLANE TIME OF THE FIRST PANE OF THE LAUNCH WINDOW. BY DEFINITION, THIS WILL RESULT IN A DECREASE OF TOTAL LAUNCH WINDOW TIME AVAILABLE. @[081497-6263B] @[062801-4521]
 3. FOR 28.5 DEGREE INCLINATION MISSIONS, PREFERRED LAUNCH TIME MAY BE EARLIER THAN INPLANE TO MAXIMIZE A TOTAL LAUNCH WINDOW CAPABILITY FOR A HOLD PRIOR TO THE START OF LOX DRAINBACK. @[081497-6263B] @[062801-4521]
- E. THE OMS ASSIST DUMP TIMER MAY BE RECOMPUTED AND UPLINKED BASED ON THE L MINUS 8-DAY TRAJECTORY DESIGN DATA PACK (TDDP) TO MAXIMIZE OMS PROPELLANT AVAILABLE FOR ORBIT OPERATIONS. THE OMS ASSIST DUMP TIMER UPDATE IS DESIGNED SUCH THAT THE RESULTING ASCENT PERFORMANCE MARGIN (APM) IS AT LEAST 1100 LBS ABOVE FLIGHT PERFORMANCE RESERVE (FPR) AND FUEL BIAS TO PROTECT FOR DOL UNCERTAINTIES. THIS MINIMUM APM MUST BE ACHIEVED FOR AT LEAST A 5-MINUTE PERIOD CENTERED NEAR INPLANE TIME.

THIS RULE CONTINUED ON NEXT PAGE

FLIGHT RULES

A2-8

**LAUNCH TIME SELECTION FOR GROUND-UP RENDEZVOUS
(CONTINUED)**

Launch window calculation for ground up rendezvous is a complex series of calculations accommodating various conflicting requirements. Paragraph A of this rule states the mandatory requirements for defining the launch window and is self-explanatory. On launch day, the latest information is used to ensure the maximum precision in calculations. The FD is the single point of contact with KSC to ensure the launch time is set properly. ©[081497-6263B] ©[062801-4521]

Normally, the final launch window times are calculated based on the L-4.5 hour balloon data. These calculations are complete about L-2 hours. An update using the L-2.25 hour balloon is possible at about L-30 minutes. Also, if a revert occurs, new PLOAD calculations may require window time recalculation. New times will be passed and new launch target commands sent only if these calculations result in significant changes. Since a 10-second launch window cutoff exists around the pane switch time to ensure onboard guidance/ground processor synchronization, both the onboard PASS/BFS guidance and the Abort Region Determinator ground processor will always be on the first pane before the cutout, and on the second pane after the cutout. Thus, if the new switch time is more than 5 seconds different than that which is already onboard (i.e., it falls outside the original cutout), either a new command load uplink with a revised pane switch time and associated launch window cutout is required, or the cutout must be extended to the new desired switch time. ©[081497-6263B] ©[022802-5220]

Performance varies through the window as a function of launch time because of the orbital mechanics/rendezvous effects - primarily yaw steering. However, performance decreases with delays after the start of LOX drainback (T-4 min 55 sec). For simplicity, all times transmitted to KSC assume that LOX drainback is started for the selected launch time: in general for the preferred time and in off nominal cases for the window open time. For a combination of problems that result in delays to the start of LOX drainback and also holds after the start of LOX drainback, the FDO calculates new window open/close times based on all factors (ascent performance margin, yaw steering costs, and LOX drainback impact). If the need to use these new times arises, the FD is responsible to ensure that launch will occur only when performance is available to support mission success. It is possible that a combination of launch holds before and after the start of LOX drainback could result in an unanticipated single SSME out abort gap opening. This is especially true if an out-of plane TAL site is used. If this is known prelaunch, it will be avoided. If it is unknown until after launch, then Flight Rule {A4-56I}, PERFORMANCE BOUNDARIES, applies. ©[111298-6693]

THIS RULE CONTINUED ON NEXT PAGE

FLIGHT RULES

A2-8

**LAUNCH TIME SELECTION FOR GROUND-UP RENDEZVOUS
(CONTINUED)**

Beginning with OI-29, a flight software modification was made to prevent the PASS and BFS from targeting different launch panes around the pane switch time. At the Ascent/Entry Flight Techniques Panel # 179 on October 19, 2001, a recommendation was accepted to maintain a 10-second launch window cutout to guarantee launch pane agreement between the onboard PASS/BFS guidance and the Abort Region Determinator ground processor. Also, by maintaining a 10-second launch window cutout around the pane switch time, there is a reduced likelihood that a launch target re-uplink is required at L-30 minutes. ©[081497-6263B] ©[022802-5220]

For high inclination missions, at the direction of the SSP, the launch window management plan was modified to delay launch until the Pane 2 inplane time whenever the Pane 2 inplane time is after the uplinked switch time and a hold outside of drainback moves the T-0 time into the second pane. This is consistent with the SSP philosophy to select the inplane time as the preferred launch time. The Pane 2 inplane time will be passed from JSC to the NTD at L-1:30 with the launch window times. There is no change to the launch window management plan for holds inside of drainback. ©[062801-4521]

Flight Day 3 rendezvous capability (as defined by an acceptable phase angle region inside the orbital plane window pane) is extremely important for most flights. However, FD3 capability does not exist for all launch days. FD4 rendezvous capability is available on every launch day since the longer time allows catch up from greater phase angles. Note that even if launch occurs in a FD3 portion of the window, a FD3 rendezvous can always be cheaply turned into a FD4 rendezvous if time constraints require it. For an MDF mission, a FD2 rendezvous is desirable. However, FD2 phase windows are even shorter than FD3 so they are not generally available. When a FD2 window is available, it should be used providing there are no adverse impacts. ©[081497-6263B]

Since historical data indicates a good track record of on-time launches, and mission success margins are greater at the middle of the window rather than the opening, a preferred launch time is defined so that when there are no overriding considerations, the maximum margin for mission success is available in flight. In addition to maximizing mission success margin, SSP reviews have determined that the inplane time maximizes programmatic safety margins. Note that delaying the launch time also improves multiple SSME out contingency abort landing site coverage which is desirable, but not a window length driver. ©[081497-6263B]

THIS RULE CONTINUED ON NEXT PAGE

FLIGHT RULES

A2-8

**LAUNCH TIME SELECTION FOR GROUND-UP RENDEZVOUS
(CONTINUED)**

For performance limited 51.6 deg inclination missions, the launch window open may actually be based on ascent performance. For these cases, 200 pounds of ascent performance margin is desired at the window open to protect for performance variations between the balloon release and launch time. With FDO's launch window/launch performance application, the window open time will be biased, if there is time available in the launch window, to protect this minimum desired performance margin. ©[111298-6693]

OMS assist timer reduction may be used to trade excess ascent performance margin for increased on-orbit OMS. The minimum change to the dump timer is 1 second, which equates to about 40 pounds less OMS propellant dumped. To maintain the earliest possible Press to ATO, any decrease in the OMS assist timer requires a corresponding increase in the ATO timer. The 1100-lbs bias protects for performance losses from SRB PMBT, weight changes, DOL winds, and DOL atmosphere changes between L minus 8 days and liftoff (ref. PRCB SR#1382, October 19, 2000). This performance bias is required to ensure the OMS assist timer will not need to be increased on DOL. If the OMS assist timer were increased on DOL, PROP products and data would not be sufficiently conservative. Once the OMS assist timer is determined, it cannot be recomputed on DOL. PROP and FDO are responsible to report to LDO that there are no issues with the new OMS assist/ATO timers. ©[062801-4521]

FLIGHT RULES

A2-9

LOSS OF ET LOX LIQUID LEVEL CONTROL SENSORS

IN THE PRELAUNCH TIMEFRAME: @[092602-5669A]

- A. FOR THE LOSS OF THE FIRST 100 PERCENT ET LOX LIQUID LEVEL CONTROL SENSOR, NO MCC ACTION IS REQUIRED, REGARDLESS OF WHEN THE FIRST SENSOR FAILS.
- B. LOSS OF A SECOND 100 PERCENT ET LOX LIQUID LEVEL CONTROL SENSOR WILL RESULT IN THE TRANSFER OF ET LOX LOADING CONTROL TO THE 100.15 PERCENT SENSOR.
 - 1. FOR CONTROL TRANSFER TO 100.15 PERCENT SENSOR PRIOR TO L-25 MINUTES:
 - a. ARD AND LAUNCH WINDOW DATA WILL BE BASED ON A 100.15 PERCENT LOX LOADING ESTIMATE (WITH ADJUSTMENT FOR ADDITIONAL DRAINBACK TIME, AS APPLICABLE).
 - b. IF STABLE REPLENISH USING THE 100.15 PERCENT SENSOR IS REACHED PRIOR TO L-1:20 HOURS, THE LOX LOADING ESTIMATE WILL BE GENERATED USING PLOAD. OTHERWISE, "NO PLOAD" LOADING ESTIMATES WILL BE USED PER RULE {A2-7C}, DAY-OF-LAUNCH ET LOAD DATA, DUE TO MCC OPERATIONAL PROCESSING TIMELINE CONSTRAINTS.
 - c. IF LAUNCH WINDOW UPDATES ARE AVAILABLE PRIOR TO L-39 MINUTES, THE FDO WILL COORDINATE UPDATES TO THE KSC LAUNCH WINDOW DATA. OTHERWISE, THERE WILL BE NO UPDATE TO THE KSC LAUNCH WINDOW TIMES.
 - d. ADDITIONAL DRAINBACK TIME SHALL BE INSERTED INTO THE TIMELINE AFTER THE START OF DRAINBACK AS SPECIFIED BY THE DOLILU OPERATIONS SUPPORT PLAN. FD WILL COORDINATE THE INSERTION OF THE ADDITIONAL DRAINBACK TIME, IF ANY, WITH NTD. @[092602-5669A]

THIS RULE CONTINUED ON NEXT PAGE

FLIGHT RULES

A2-9

**LOSS OF ET LOX LIQUID LEVEL CONTROL SENSORS
(CONTINUED)**

2. FOR CONTROL TRANSFER TO 100.15 PERCENT SENSOR AFTER L-25 MINUTES: ©[092602-5669A]
 - a. LAUNCH WINDOW DATA AND ARD CALCULATIONS WILL NOT BE UPDATED.
 - b. ADDITIONAL DRAINBACK TIME WILL NOT BE INSERTED INTO THE TIMELINE.
 - c. MCC WILL BE NO-GO FOR LAUNCH UNTIL THE PSIG REPRESENTATIVE IN THE MER VALIDATES THAT THE MEASURED ULLAGE PRESSURE DOES NOT EXCEED 0.255 PSI ABOVE THE TDDP NOMINAL LOAD ULLAGE PRESSURE OF 0.781 PSIG.

The ET project has determined that the PLOAD LOX loading estimate based on liquid level control using a 100 percent sensor which subsequently fails will remain valid after a switch to the second 100 percent ET LOX liquid level control sensor. Therefore, switching liquid level control from one 100 percent sensor to the second 100 percent sensor does not invalidate the original PLOAD loading estimate.

The ET project has determined that the PLOAD LOX loading estimate based on liquid level control using either 100 percent sensor is not accurate in the event of a later failure of both 100 percent LOX liquid level control sensors and subsequent fill to the 100.15 percent sensor per LCC ET-10. The ET Project has requested DOSS to rerun PLOAD or revert to 100.15 percent MPS inventory loading estimates. A rerun and QA of PLOAD loading updates, nominal mission performance margin, and launch window impacts requires approximately 40 minutes. KSC Ground Operations is unable to accept launch window updates after L-39 minutes. However, FDO and ARD Support should reflect the best possible estimate of the true LOX loading. Therefore these elements will reconfigure to reflect LOX loading to the 100.15 percent MPS inventory values, if the fail over occurs after the latest time to rerun PLOAD (about L-1:20 hour) and prior to L-25 minutes, regardless of whether or not the KSC launch window is updated.

For any level sensor failure after L-25 minutes, no action is required by the MCC. A late sensor failure (either the first or the second) may result in an underload of approximately 1,100 pounds of LOX, which still meets LCC ET-10 launch requirements. This equates to approximately 15 fps of ascent performance margin. A launch with an underload of this magnitude will result in TAL and ATO abort boundary calls being made approximately 15 fps early and slightly increases the chances of a low level cut-off with a small underspeed. The program accepts this risk due to its low probability of occurrence. ©[092602-5669A]

THIS RULE CONTINUED ON NEXT PAGE

FLIGHT RULES

A2-9**LOSS OF ET LOX LIQUID LEVEL CONTROL SENSORS**
(CONTINUED)

In the event of a failure of both 100 percent sensors and fail-over to a fill to the 100.15 percent sensor failure, no additional drainback time will be added to the countdown. Analysis to clear the ET for flight in this condition is valid only through STS-118. ET LOX tank changes being made subsequent to STS-118 will require additional analysis. ©[092602-5669A]

Late fail-over to a LOX tank fill controlled by the 100.15 percent (after failure of both 100 percent level sensors) will require verification that the LOX loading is consistent with MPS inventory loading estimates. The MPS inventory is protected if the ullage pressure is less than 1.036 psi. Ullage pressure above this limit indicates an under-load of a magnitude beyond that covered in the FPR. The value of 1.036 psi is derived by adding the ullage pressure used in deriving the inventory (0.781 psi) to a tolerance that is protected by FPR (0.255 psi). ©[092602-5669A]

A2-10 THROUGH A2-50 RULES ARE RESERVED

FLIGHT RULES

ASCENT

A2-51 **STS ABORT CRITERIA**

NOMINAL ASCENT WILL BE CONTINUED FOR STS PROBLEMS EXCEPT FOR:

- A. ENGINE PROBLEMS WHERE REQUIRED PERFORMANCE IS NOT AVAILABLE.
- B. LOSS OF DEORBIT MANEUVER CAPABILITY.
- C. LOSS OF ATTITUDE CONTROL.
- D. CONSUMABLES, COOLING, OR SYSTEMS LIFETIME PROBLEMS THAT WILL NOT SUPPORT A FIRST DAY PLS DURATION OF DEORBIT ON ORBIT 3, LANDING ON ORBIT 4. ©[032807-8368]

In order to maximize probability of mission success, nominal ascent will be continued unless a specific problem arises which, if not acted upon, jeopardizes the orbiter and/or crew. In these cases, either a pre-MECO abort (RTLS, TAL, ATO) or a post-MECO abort (AOA) will be selected. The specifics of which abort will be selected and the priority of available modes are contained in Rule {A2-52}, ASCENT MODE PRIORITIES FOR PERFORMANCE CASES, for performance-related failures (paragraph A above) and in Rule {A2-54}, RTLS, TAL, AND AOA ABORTS FOR SYSTEMS FAILURES [CIL], for systems problems (paragraphs B to D). If the capability to support a first day PLS landing opportunity is lost, or the particular failure is such that conditions could deteriorate so rapidly that the landing opportunity could be lost, then an AOA will be performed as specified in Rule {A2-54}, RTLS, TAL, AND AOA ABORTS FOR SYSTEMS FAILURES [CIL].

Orbits 2 and 3 deorbit to Edwards are available for both low and high inclinations. The current IMU configuration (HAINS, continuous OPS 1 align) provides an onboard state vector that is accurate enough to support a rev 2 deorbit. However, the rev 2 deorbit is still undesirable due to timeline constraints and will generally not be utilized as the FD 1 PLS. ©[032807-8368]

FLIGHT RULES

A2-52

ASCENT MODE PRIORITIES FOR PERFORMANCE CASES

- A. DURING POWERED FLIGHT, THE ABORT PRIORITIES FOR PERFORMANCE CASES ARE AS FOLLOWS:
1. PRESS-TO-ORBIT (INCLUDING PRESS-TO-MECO AND PRESS-TO-ATO TRAJECTORIES)
 2. TAL
 3. RTLS
 4. TAL TO AN ACLS (MAY REQUIRE MANUAL SSME SHUTDOWN)
 5. AOA SHALLOW USING ARCS TO THE ARCS PRESS QUANTITY AND CG LIMITED BY THE CONTINGENCY CG ENVELOPE

Powered flight abort priorities were established based on providing the highest probability of safe return of the orbiter and crew. If at all possible, as long as steep deorbit capability can be maintained, the desire is to press to orbit before considering a pre-MECO abort since achieving orbit provides the maximum time to assess and react to problems without incurring additional risks associated with powered flight aborts. Following the option of pressing uphill, the TAL abort (assumed to be flown under auto guidance) is next in priority since it provides the earliest contingency avoidance capability for multiple engine failures and is considered to be more benign than RTLS from an operational point of view. The RTLS abort is next in priority and in the performance case would be used only if TAL were not available (i.e., some systems problems may dictate RTLS over TAL when both modes are available).

Pre-MECO, if TAL capability to the prime site is not available and steep AOA cannot be protected, TAL to an ACLS is selected next in priority since the next lower option (AOA shallow) is considered to be unacceptably sensitive to navigation dispersions, in the absence of GPS. Since the Space Shuttle Program will be ending in 2010, there is limited flight experience incorporating GPS into navigation, and a mixed fleet configuration (OV-103/OV-104 single string and OV-105 3-string) will exist until the end of the Program; a decision was made at Ascent/Entry Flight Techniques Panel #214, September 30, 2005, to forgo enhanced performance capabilities such as formal certification of AOA shallow that might be gained from the increased navigational accuracy that GPS provides. Since an augmented site is required, the abort is not expected to be adversely affected by navigation capability. The tradeoff in this case is that only limited OMS dump time is available for TAL's selected late in powered flight, which may result in violation of the nominal aft CG limit (the contingency limit is still protected) and downweight restrictions. On the other hand, a nominal forward CG violation can result from commitment to AOA shallow, so the CG concern by itself becomes less of a factor. Note that the TAL to an ACLS is still performed under auto guidance, but, in some cases, a manual MECO is performed to achieve the TAL site R-V line with TAL selection occurring post-MECO. ©[032807-8208A]

THIS RULE CONTINUED ON NEXT PAGE

FLIGHT RULES

A2-52

ASCENT MODE PRIORITIES FOR PERFORMANCE CASES
(CONTINUED)

- B. PRESS-TO-ORBIT PERFORMANCE DECISIONS WILL BE BASED ON THE ABILITY TO ACHIEVE MECO UNDERSPEED CONDITIONS WHICH SATISFY ESTABLISHED MINIMUM CONSTRAINTS. INCLUDED IN THESE ARE LIMITATIONS ON ET IMPACT LOCATION, POST-MECO PERFORMANCE CAPABILITY, TRAJECTORY ALTITUDE LIMITS, SSME MINIMUM NPSP CONSTRAINTS, AND PROTECTION OF THE CONTINGENCY CG ENVELOPE (REF. RULE {A4-55}, DESIGN AND CRITICAL MECO UNDERSPEED DEFINITIONS).

Reference Rule {A4-55}, DESIGN AND CRITICAL MECO UNDERSPEED DEFINITIONS, for rationale.

- C. MAXIMUM THROTTLES WILL BE USED TO REGAIN INTACT ABORT CAPABILITY AND TO CONTINUE THE EXECUTED TAL TO THE SELECTED SITE (REF. RULES {A4-53}, USE OF MAXIMUM THROTTLES; AND {A4-56F}, {A4-56H}.2, AND {A4-56H}.3, PERFORMANCE BOUNDARIES). @[092195-1770A]

Maximum throttle capability is used only in limited cases and is the highest power level available on a flight. Use of the maximum setting places additional stress on the engine and seriously reduces engine lifetime and so should be used only if absolutely necessary. In line with this philosophy, the maximum throttle setting will only be used if it allows the orbiter to regain intact abort capability or will allow continuation of a TAL abort to the originally-selected site when two SSME's have failed (continuing to the originally-selected site at maximum throttle is preferred over committing to a sizable attitude maneuver on a single engine).

- D. POST-MECO (OPS 1), THE ABORT PRIORITIES ARE AS FOLLOWS:
@[120894-1744B]
1. NOMINAL, STEEP DEORBIT [1]
 2. ATO/ATO [2], STEEP DEORBIT [3]

THIS RULE CONTINUED ON NEXT PAGE

FLIGHT RULES

A2-52

ASCENT MODE PRIORITIES FOR PERFORMANCE CASES
(CONTINUED)

3. STEEP DEORBIT

- a. ATO/MINIMUM HP [4], STEEP DEORBIT FD1 (IF FD1 PLS SITE IS GO) [3] USING AFT RCS TO THE FD1 AFT RCS STEEP PRESS QUANTITY. [5] [6] [7] @[012402-5112B]

OR

- b. ATO/MINIMUM HP [4], STEEP DEORBIT FD2 (IF FD1 PLS SITE IS NOT AVAILABLE) [3] USING AFT RCS TO THE FD2 AFT RCS STEEP PRESS QUANTITY AND FWD RCS IN OPS 2 TO THE FD2 FWD RCS PRESS QUANTITY. [5] [6] [7]

OR

- c. ATO/ATO [2], STEEP DEORBIT FD2 (IF FD1 PLS IS NOT AVAILABLE) [3] USING AFT RCS TO THE FD2 AFT RCS STEEP PRESS QUANTITY. [5] [6] [7]

THIS RULE CONTINUED ON NEXT PAGE

FLIGHT RULES

A2-52

ASCENT MODE PRIORITIES FOR PERFORMANCE CASES
(CONTINUED)

4. SHALLOW DEORBIT
 - a. ATO/MINIMUM HP [4], SHALLOW DEORBIT FD1 (IF FD1 PLS SITE IS GO) [3] USING AFT RCS TO THE FD1 AFT RCS SHALLOW PRESS QUANTITY. [5] [6] [7]

OR
 - b. ATO/MINIMUM HP [4], SHALLOW DEORBIT FD2 (IF FD1 PLS SITE IS NOT AVAILABLE) [3] USING AFT RCS TO THE FD2 AFT RCS SHALLOW PRESS QUANTITY AND FWD RCS IN OPS 2 TO THE FD2 FWD RCS PRESS QUANTITY. [5] [6] [7]

OR
 - c. ATO/ATO [2], SHALLOW DEORBIT FD2 (IF FD1 PLS IS NOT AVAILABLE) [3] USING AFT RCS TO THE FD2 AFT RCS SHALLOW PRESS QUANTITY. [5] [6] [7] @[012402-5112B]
5. AOA STEEP USING ARCS TO THE AOA AFT RCS STEEP PRESS QUANTITY [5] AND CG LIMITED BY THE CONTINGENCY CG ENVELOPE (IF AOA SITE IS GO). [6] [7] @[012402-5112B]
6. ATO/MINIMUM HP [4], SHALLOW DEORBIT FD1 TO A NO-GO FD1 PLS SITE [3] USING AFT RCS TO THE FD1 AFT RCS SHALLOW PRESS QUANTITY. [5] [6] [7]
7. AOA STEEP USING AFT RCS TO THE AOA AFT RCS STEEP PRESS QUANTITY [5] AND CG LIMITED BY THE CONTINGENCY CG ENVELOPE TO A NO-GO AOA SITE. [6] [7]

THIS RULE CONTINUED ON NEXT PAGE

FLIGHT RULES

A2-52

ASCENT MODE PRIORITIES FOR PERFORMANCE CASES
(CONTINUED)

8. TAL TO A TAL SITE OR ACLS USING NOMINAL GUIDANCE (REFER TO FIGURE A2-52-I, REGION A). @[120894-1744B]
9. AOA SHALLOW USING AFT RCS TO THE AOA AFT RCS SHALLOW PRESS QUANTITY [5], AND CG LIMITED BY THE CONTINGENCY CG ENVELOPE. @[012402-5112B]
10. TAL TO A TAL SITE
 - a. REQUIRING LOW ENERGY GUIDANCE (REFER TO FIGURE A2-52-I, REGION B)
 - b. REQUIRING LOW ENERGY GUIDANCE AND HIGH CROSSRANGE PROCEDURES (REFER TO FIGURE A2-52-I, REGION C)
 - c. REQUIRING HIGH ENERGY PROCEDURES (REFER TO FIGURE A2-52-I, REGION D)
11. TAL TO AN ACLS
 - a. REQUIRING LOW ENERGY GUIDANCE (REFER TO FIGURE A2-52-I, REGION B)
 - b. REQUIRING LOW ENERGY GUIDANCE AND HIGH CROSSRANGE PROCEDURES (REFER TO FIGURE A2-52-I, REGION C)
 - c. REQUIRING HIGH ENERGY PROCEDURES (REFER TO FIGURE A2-52-I, REGION D) @[120894-1744B]

THIS RULE CONTINUED ON NEXT PAGE

FLIGHT RULES

A2-52

ASCENT MODE PRIORITIES FOR PERFORMANCE CASES
(CONTINUED)

12. TAL TO A DOWNRANGE ELS WHICH SATISFIES CRITERIA IN RULE {A2-264}, EMERGENCY LANDING FACILITY CRITERIA @[120894-1744B]
 - a. WITHIN NOMINAL GUIDANCE CAPABILITY (REFER TO FIGURE A2-52-I, REGION A)
 - b. REQUIRING LOW ENERGY GUIDANCE (REFER TO FIGURE A2-52-I, REGION B)
 - c. REQUIRING LOW ENERGY GUIDANCE AND HIGH CROSSRANGE PROCEDURES (REFER TO FIGURE A2-52-I, REGION C)
13. TAL TO ANY SITE WHICH SATISFIES CRITERIA IN RULE {A2-264}, EMERGENCY LANDING FACILITY CRITERIA, BUT LIES OUTSIDE NOMINAL AND LOW ENERGY GUIDANCE CAPABILITY (REFER TO FIGURE A2-52-I, REGIONS D, E, AND F). LANDING ATTEMPTS TO THESE SITES MAY REQUIRE HIGH ENERGY PROCEDURES (REGION D), OR LOW ENERGY GUIDANCE (REGION E), POSSIBLY INCLUDING HIGH CROSSRANGE PROCEDURES (REGION F). THIS DETERMINATION WILL BE MADE IN REAL-TIME BASED ON THE NUMBER OF SITES AND THEIR PROXIMITY TO THE FOOTPRINT IN EACH AREA. @[120894-1744B] @[022405-6607]

THIS RULE CONTINUED ON NEXT PAGE

FLIGHT RULES

A2-52

ASCENT MODE PRIORITIES FOR PERFORMANCE CASES
(CONTINUED)

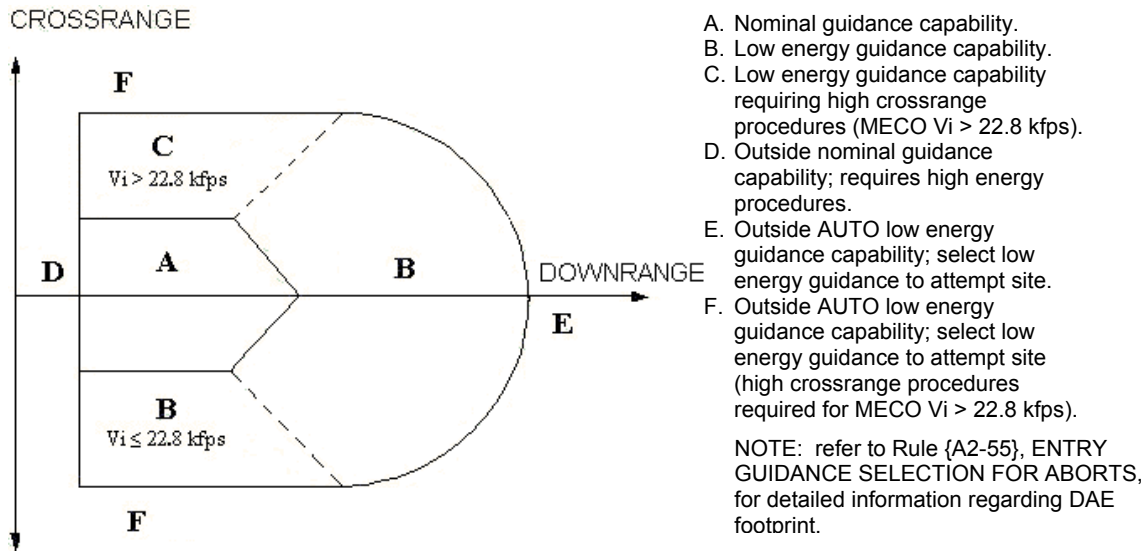

- A. Nominal guidance capability.
- B. Low energy guidance capability.
- C. Low energy guidance capability requiring high crossrange procedures (MECO Vi > 22.8 kfps).
- D. Outside nominal guidance capability; requires high energy procedures.
- E. Outside AUTO low energy guidance capability; select low energy guidance to attempt site.
- F. Outside AUTO low energy guidance capability; select low energy guidance to attempt site (high crossrange procedures required for MECO Vi > 22.8 kfps).

NOTE: refer to Rule {A2-55}, ENTRY GUIDANCE SELECTION FOR ABORTS, for detailed information regarding DAE footprint.

FIGURE A2-52-I - SHUTTLE LANDING FOOTPRINT
(FOR ILLUSTRATION ONLY)

@[120894-1744B] @[022405-6607] @[022405-6609A]

NOTES:

- [1] DEORBIT DELTA V MUST BE PROTECTED FOR FD 1 AND 2 PLS OPPORTUNITIES.
- [2] OMS-1 TARGET/OMS-2 TARGET
- [3] DEORBIT DELTA V MUST BE PROTECTED FOR FD 1 OR 2 PLS (AS REQUIRED). @[121593-1590]
- [4] MINIMUM HP THAT WILL ENSURE ORBITAL LIFETIME (ASSUMING 3 SIGMA DRAG AFFECTS) AT LEAST TWO ORBITS BEYOND THE FD 1 PLS OPPORTUNITY AND WILL PROVIDE ADEQUATE GROUND TRACKING ACCURACIES FOR DEORBIT TARGETING AND STATE VECTOR UPDATE.
- [5] ARCS PRESS QUANTITY CORRESPONDING TO THE EXPECTED X AND Y CG
- [6] OMS-2 MAY BE EXECUTED WITH THE FRCS (REF. RULE {A2-53}, FORWARD RCS USAGE GUIDELINES). FOR FD2 DEORBIT USING THE FWD RCS IN OPS 2 IS PREFERRED OVER OMS-2 SINCE IT REQUIRES LESS AFT RCS FOR ATTITUDE CONTROL. @[120894-1744B] @[012402-5112B]
- [7] IF FRCS USAGE IS ALLOWED BYRULE {A2-53}, FORWARD RCS USAGE GUIDELINES, THEN ARCS ATTITUDE CONTROL MUST BE PROTECTED FOR THE FRCS BURN. @[120894-1744B]

THIS RULE CONTINUED ON NEXT PAGE

FLIGHT RULES

A2-52

ASCENT MODE PRIORITIES FOR PERFORMANCE CASES (CONTINUED)

Post-MECO abort priorities were established to provide the highest probability of safe return of the orbiter and crew. Again, the priorities are set up to allow the orbiter to achieve the most desirable uphill/orbital capability available based on propellant available and the known MECO conditions. The first priority is to achieve the nominal mission orbital parameters while maintaining steep deorbit capability (1). This is followed by reducing the orbital altitude, but still protecting steep deorbit (2). Steep capability is maintained since commitment to shallow deorbit unnecessarily trades off the deorbit/entry propellant and trajectory dispersion protection inherent in steep targeting for achievement of mission objectives that in many cases can be adequately accomplished at a lower-than-nominal altitude. The next option (3) accepts further reduction in orbit perigee (and hence, orbital lifetime and tracking/navigation quality if GPS is unavailable) in order to achieve at least some on-orbit time. Aft RCS is committed for deorbit burn completion (nominal RCS entry redlines are maintained, however). Forward RCS may be committed for OMS-2 and in OPS 2 at this priority level (ref. Rule {A2-53}, FORWARD RCS USAGE GUIDELINES). Again, these trades are made in order to maintain steep deorbit capability. ATO/ATO (Hp approximately 105 nm) gives orbital lifetime for FD2 deorbit without committing the Fwd RCS. The minimum perigee guarantees a safe deorbit for the FD1 PLS opportunity. Time-to-EI constraints do not apply to minimum perigee determinations. At the next priority level (4), shallow FD1 and FD2 deorbits are allowed. The only remaining method of preserving propellant in addition to that already committed is to allow use of ARCS and violation of the CG to the contingency CG box (priorities 5, 7, and 9). This may allow achievement of minimum orbital conditions or may require a steep or shallow AOA, with the potential in any case of requiring use of a no-go site. ©[012402-5112B] ©[032807-8208A]

If an AOA cannot be achieved, the site selection priority will be based on site status (TAL vs ACLS vs ELS) and guidance capability when more than one site satisfies the conditions in Rule {A2-264}, EMERGENCY LANDING FACILITY CRITERIA. Guidance capability will be based on the Descent Design System (DDS) if available or the Downrange Abort Evaluator (DAE). Figure A2-52-I is included for clarity to illustrate the various regions of dissimilar guidance capability. Nominal guidance refers to OPS 3 entry guidance requiring no manual procedures. Low energy guidance refers to the use of automatic low energy guidance, enabled via Item 3 on the Entry TRAJ display. High crossrange procedures consist of enabling low energy guidance and manually flying a 37-degree angle of attack during the second pullout to minimize wing leading edge temperatures. High energy procedures consist of manual pitch and roll inputs during entry and are contained in section 2 of the Ascent Checklist. ©[120894-1774B]

THIS RULE CONTINUED ON NEXT PAGE

FLIGHT RULES

A2-52

**ASCENT MODE PRIORITIES FOR PERFORMANCE CASES
(CONTINUED)**

In general, the regions shown in figure A2-52-I are preferred in the following priority: Nominal entry guidance capability (region A), low energy guidance capability (region B), low energy guidance with high crossrange procedures (region C), and finally high energy procedures (region D). Nominal entry guidance is preferred over low energy guidance since low energy guidance can take the vehicle to its thermal limits. A site in the high crossrange region (region C) is third in priority since it requires the use of low energy guidance to solve the crossrange problem and pitch CSS to prevent potential thermal violations (reference Rule {A2-55}, ENTRY GUIDANCE SELECTION FOR ABORTS). High energy procedures are last in priority since they are more complicated and may take the vehicle to its structural and thermal limits. Usually a TAL site has priority over an ACLS, which has priority over an ELS. However, priority will be given to an ACLS within nominal guidance capability (region A) over a TAL site within low energy guidance capability (regions B or C). The risk associated with landing at an ACLS is considered less than the risk associated with the use of low energy guidance. If no TAL site or ACLS lies within nominal guidance capability (region A), priority will be given to a TAL site within low energy guidance capability (region B), followed by a TAL site within low energy guidance capability requiring high crossrange procedures (region C), followed by a TAL site requiring high energy procedures (region D). If no TAL site is available, the same priorities will be given to an ACLS. The use of high energy procedures to a TAL site or ACLS was given priority over an ELS within nominal guidance capability since those sites will have landing aids, nav aids, and ground support. If no TAL site or ACLS is available, then an ELS within nominal guidance capability (region A) will be selected. If no ELS lies within nominal guidance capability, then the site within low energy guidance capability (region B) will be selected. Otherwise, an ELS within low energy guidance capability requiring high crossrange procedures (region C) will be selected. ©[022405-6607] ©[022405-6609A]

If there is no site within nominal or low energy guidance capability (outside regions A, B, or C), the site (TAL, ACLS, or ELS) with the best chance of a runway landing will be selected. A landing attempt to this site may require the use of high energy procedures (region D), or low energy guidance (region E), possibly including high crossrange procedures (region F) (reference Rule {A2-55}, ENTRY GUIDANCE SELECTION FOR ABORTS). Since all three of these regions require manual procedures and may take the vehicle to its thermal and structural limits, they are given the same priority. Site status, difficulty of manual procedures, and proximity to guidance capability will be considered when choosing between sites in regions D, E, and F. ©[022405-6607] ©[022405-6609A]

Since the Space Shuttle Program will be ending in 2010, there is limited flight experience incorporating GPS into navigation, and a mixed fleet configuration (OV-103/OV-104 single string and OV-105 3-string) will exist until the end of the Program; a decision was made at Ascent/Entry Flight Techniques Panel #214, September 30, 2005, to forgo enhanced performance capabilities that might be gained from the increased navigational accuracy that GPS provides. ©[032807-8208A]

THIS RULE CONTINUED ON NEXT PAGE

FLIGHT RULES

A2-52

ASCENT MODE PRIORITIES FOR PERFORMANCE CASES (CONTINUED)

Note that these choices can be heavily influenced by landing site status. Since determination of the desired site must be made rapidly, in real time, the engineering judgment of the flight control team will be considered due to the significant tradeoffs which must be made. For example, the preference for ACLS in region A over a TAL site in region B, C, or D could be modified if the ACLS has very bad weather, as opposed to the ACLS being no-go as a TAL site simply due to loss of nav aids redundancy. ©[120894-1774B]

Rules {A2-51}, STS ABORT CRITERIA; {A4-56C}, PERFORMANCE BOUNDARIES; {A4-62}, OMS-1/OMS-2 EXECUTION; {A4-63}, OMS/RCS SYSTEM FAILURES DURING ASCENT; and {A6-51}, OMS FAILURE MANAGEMENT [CIL], reference this rule. ©[ED] ©[121505-6938A]

E. POST-MECO (OPS 6 CONTINGENCY ABORT), THE DOWNRANGE SITE HAS PRIORITY WHEN CAPABILITY EXISTS TO MULTIPLE SITES WHICH SATISFY THE CRITERIA IN RULE {A2-264}, EMERGENCY LANDING FACILITY CRITERIA. ©[120894-1744B]

For OPS-6 contingency abort entries (ECAL and Bermuda), powered flight guidance uses an open loop scheme and is therefore not targeted to any particular MECO conditions. In these cases, energy evaluation is not feasible until after the post-MECO pullout maneuver. Even though active guidance begins at transition to OPS 603 at Mach 3.2 (TAEM interface), an accurate energy assessment cannot be made until the trajectory stabilizes. If energy capability overlaps between two sites and both satisfy the criteria in Rule {A2-264}, EMERGENCY LANDING FACILITY CRITERIA, the further downrange site shall be selected to minimize steering requirements caused by large heading errors. ©[120894-1744B]

FLIGHT RULES

A2-53

FORWARD RCS USAGE GUIDELINES

- A. PRE-MECO: FORWARD RCS DELTA V CAPABILITY WILL ONLY BE CONSIDERED FOR OPS-2 BURNS IN SUPPORT OF A FD2 PLS.
 ©[012402-5112B]
- B. POST-MECO: FORWARD RCS WILL BE USED FOR OMS-2 TO OBTAIN THE HIGHEST POSSIBLE ABORT MODE PROVIDED THERE IS SUFFICIENT FORWARD RCS PROPELLANT TO SUPPORT THE TOTAL DELTA V REQUIRED FOR THE BURN.

Pre-MECO, Forward RCS delta V capability is not considered as being available to support or provide an abort capability for AOA or FD1 PLS since flight design and techniques do not assure that time and/or trajectory constraints will not preclude its use. However, it may be considered pre-MECO in support of a FD2 PLS capability, since a FD2 deorbit allows sufficient time to perform OPS-2 Fwd RCS burns and the post-OMS-2 trajectory conditions are better defined (reference A/E Flight Techniques #178). Each Forward RCS burn will be constrained to a maximum burn time of 150 seconds as defined by Rule {A6-153A}, RCS JET MAXIMUM BURN TIME.

Post-MECO, the time and trajectory constraints are mitigated by knowledge of the actual trajectory condition, and hence the Forward RCS may then be committed to help achieve the highest-priority abort option. The basic groundrule in Forward RCS commitment for OMS-2 is that Forward RCS critical-burn redundancy is considered sufficient to commit its use at OMS-2 if such usage will result in at least some on-orbit capability (i.e., avoidance of AOA). It is also desirable to avoid any requirement for a flip-around maneuver to complete a burn begun with the Forward RCS, particularly when the burn is considered critical. Therefore, the Forward RCS will only be used for OMS-2 if it can provide all the delta V necessary to establish a safe perigee. An additional advantage of using the Forward RCS in this manner is that usage at OMS-2 (rather than saving it for deorbit completion) may preclude a fast-flip requirement to complete the deorbit burn since extra OMS/ARCS is made available for that maneuver.
 ©[012402-5112B]

Rules {A2-52D}, ASCENT MODE PRIORITIES FOR PERFORMANCE CASES; and {A6-51}, OMS FAILURE MANAGEMENT [CIL], reference this rule.

FLIGHT RULES

A2-54

RTLS, TAL, AND AOA ABORTS FOR SYSTEMS FAILURES [CIL]

FOR SPECIFIC SYSTEMS FAILURES, AN RTLS, TAL, OR AOA ABORT WILL BE SELECTED TO PROVIDE THE EARLIEST AVAILABLE LANDING TIME OR TO AVOID REQUIRING A LOST CAPABILITY.

NOTE: WHEN THE SAME ITEM APPEARS IN MORE THAN ONE ABORT OPTION, THE EARLIEST ABORT OPTION AVAILABLE IS SELECTED.

A. AN RTLS WILL BE PERFORMED FOR THE FOLLOWING:

1. IMPENDING LOSS OF ALL APU/HYDRAULIC SYSTEMS CAPABILITY.
@[111699-7070B]

At least one APU/HYD system is required to attempt to land the vehicle. If failures are present that are leading to the loss of all systems, the abort mode which affords the earliest landing time is selected (ref. Rule {A10-21A}, 4, LOSS OF APU/HYDRAULIC SYSTEM(S) ACTIONS).

If the third APU/HYD system is nominal, it is preferable to continue to orbit rather than performing an abort. Continuing to orbit allows for time to troubleshoot the two failed systems and possibly regain one or both systems for entry. Additionally, going to orbit will provide the time to take the necessary steps to ensure the best possible conditions (i.e., trajectory, landing site, crew and vehicle health, weather conditions, etc.) for a single APU entry. @[111699-7070B]

2. FAILURE OF A FORWARD WINDSHIELD OR SIDE HATCH THERMAL WINDOWPANE (OUTER PANE) [CIL]. @[021998-6493]

An RTLS abort is selected to minimize the thermal stresses on the remaining windowpanes and surrounding structure. Entry heat loads are less on an RTLS than on other abort modes or during a normal landing. This provides a better chance of the remaining panes and surrounding structure surviving entry.

Reference rule {A10-381}, THERMAL WINDOWPANE FAILURE [CIL]. @[021998-6493]

THIS RULE CONTINUED ON NEXT PAGE

FLIGHT RULES

A2-54

RTLS, TAL, AND AOA ABORTS FOR SYSTEMS FAILURES
[CIL] (CONTINUED)

3. CABIN LEAK RESULTING IN A DP/DT > -0.15 PSIA/MINUTE.

If a cabin leak develops with a leak rate greater than that specified, then there has been a loss of cabin integrity and the abort mode that affords the earliest landing time should be selected. The -0.15 psia/minute value allows the capability to perform an orbit 3 deorbit and land with a cabin pressure of 8 psi. It is also the value that should cover ascent pressure fluctuations so that an erroneous abort is not called. If the leak rate is less than that specified, continue to MECO and attempt leak isolation. If the leak is not isolated, then an AOA will be performed and there should be enough pad so that if the leak increases the abort can be completed.

4. IMPENDING LOSS OF ALL O₂ (H₂) CRYO.

If the pressure cannot be maintained in at least one cryo tank and manifold, the fuel cells will eventually stop producing electrical power, no matter what the quantity is in the cryo tanks. Since the amount of time available before "blowdown" of the tanks is dependent on a large number of variables, specific numbers cannot be defined for the purpose of selecting the most preferred abort. Thus, this condition warrants the selection of the abort mode that affords the earliest landing time (ref. Rule {A9-261}, IMPENDING LOSS OF ALL CRYO).

5. LOSS OF TWO FREON LOOPS.

With the loss of both Freon loops the vehicle has lost all cooling capacity. Fuel cell life becomes the critical factor. Assuming a purge of all three fuel cells and a 12.54 kW (4.18 kW/fuel cell) power level, stack temperature limits will be reached in about 50 minutes and the electrolyte concentration will reach the operational limit of 25 percent in about 75 minutes. At this point, continued operation of the fuel cell is questionable. Without a purge, the fuel cells will flood in about 18 minutes at a power level of 8.0 kW (2.67 kW/fuel cell). The life of the fuel cell would therefore be somewhere between 18 and 50 minutes, thus requiring an abort mode that affords the earliest landing time. This data is supported by Rockwell analysis and the SODB.

THIS RULE CONTINUED ON NEXT PAGE

FLIGHT RULES

A2-54

RTLS, TAL, AND AOA ABORTS FOR SYSTEMS FAILURES
[CIL] (CONTINUED)

6. LOSS OF ANY TWO MAIN BUSES (PRECLUDES EXTERNAL TANK (ET) DOOR CLOSE) .

The loss of two main electrical buses precludes closing the ET doors. An RTLS will be performed for this failure since it provides a more benign entry heating scenario and allows a better chance of accomplishing a successful landing.

B. A TAL WILL BE PERFORMED FOR THE FOLLOWING:

NOTE: FOR THE PURPOSES OF SYSTEMS ABORTS, A TAL WILL ONLY BE EXECUTED TO A TAL SITE OR AN AUGMENTED CONTINGENCY LANDING SITE.

1. TWO OMS PROPELLANT TANKS LEAKING/FAILED, DIFFERENT SIDES.

If two OMS propellant tanks are leaking or have failed (different sides), a TAL abort will be selected since uphill capability is not available. A TAL abort is preferred over an RTLS for the following reasons:

- a. *The TAL entry environment (with the exception of thermal) is less severe than GRTLS. RTLS ET separation is more demanding because of higher aerodynamic loads; trajectory maneuvers post- ET separation are more time-critical (to maintain reasonable energy level and loads on the vehicle); and 50 degrees angle of attack must be established and maintained.*
- b. *NZ is greater during GRTLS than TAL entry. This becomes an important factor if the OMS tank landing weight and maneuver constraints are violated. Structural damage to the OMS tank might occur if the OMS maneuver constraint is violated with high NZ.*
- c. *The TAL post-MECO dump allows the single engine roll control propellant to be dumped. As a result, less residual propellant remains postdump; therefore, the chance of pod freezeup and postlanding fire is decreased.*

THIS RULE CONTINUED ON NEXT PAGE

FLIGHT RULES

A2-54

RTLIS, TAL, AND AOA ABORTS FOR SYSTEMS FAILURES
[CIL] (CONTINUED)

If these failures occur pre-MECO and after last TAL capability to the prime site, a TAL to an ACLS may be performed. If the decision to abort TAL occurs late enough, a manual MECO may be required in order to reach the TAL R/V line. This would be followed by TAL selection post-MECO. There are risks associated with the manual MECO TAL abort not incurred with a pre-MECO TAL selection prior to the last pre-MECO TAL boundary. (1) Manual MECO incurs the risk of missing the targeted MECO VI and creating an under- or over-speed condition. (2) A complete OMS dump is not possible and this may result in violation of landing weight or cg constraints. The risks associated with manual MECO TAL aborts are judged to be less than those associated with continuing toward a nominal MECO with critical systems failures.

If these failures occur after last capability to an ACLS, then post-MECO, if ATO capability does not exist, an AOA or bailout must be performed.

2. LOSS OF TWO OMS HE TANKS THAT WILL NOT SUPPORT HIGHER PRIORITY ABORTS (ATO/SHALLOW, AOA STEEP).

A TAL will be selected for two OMS He tank failures if uphill capability is not available. A TAL abort is preferred over an RTLIS for the reasons listed in a. and b. of paragraph B.1 rationale.

If these failures occur pre-MECO and after last TAL capability to the prime site, a TAL to an ACLS may be performed. If the decision to abort TAL occurs late enough, a manual MECO may be required in order to reach the TAL R/V line. This would be followed by TAL selection post-MECO. There are risks associated with the manual MECO TAL abort not incurred with a pre-MECO TAL selection prior to the last pre-MECO TAL boundary. (1) Manual MECO incurs the risk of missing the targeted MECO VI and creating an underspeed or overspeed condition. (2) A complete OMS dump is not possible and this may result in violation of landing weight or cg constraints. The risks associated with manual MECO TAL aborts are considered much less than those associated with continuing toward a nominal MECO with critical systems failures.

If these failures occur after last capability to an ACLS, then post-MECO, if ATO capability does not exist, an AOA or bailout must be performed.

THIS RULE CONTINUED ON NEXT PAGE

FLIGHT RULES

A2-54

RTLS, TAL, AND AOA ABORTS FOR SYSTEMS FAILURES [CIL] (CONTINUED)

3. TWO ARCS PROPELLANT TANKS LEAKING, DIFFERENT SIDES, SAME PROPELLANT THAT WILL SUPPORT TAL ET SEPARATION AND ENTRY TO A Q-BAR = 20.

If one pod contains > 75 percent propellant ET separation can be performed (ref. Rule {A6-57}, AFT RCS PROPELLANT TANK FAIL/HELIUM INGESTION). The leak rate after ET separation must still support Q-bar = 20 to guarantee control until NO YAW JET can be engaged. If either leak rate supports TAL, the proper course of action is to abort TAL. If the leak rate does not support TAL, this case becomes the same as two propellant tanks failed.

Two propellant tanks failed same propellant does not allow any type of certified control mode from EI to Q-bar = 20. By pressing uphill, time is gained to allow complex procedure and/or software changes to take place to help provide control until a Q-bar = 20 (i.e., Digital Auto Pilot (DAP) or procedure changes that will allow forward RCS control in pitch and yaw). With the OI-8 NO YAW JET software, a certified entry from a Q-bar = 20 to touchdown is now available. An uphill abort cutting off at minimum Hp which requires the least total delta-V for the insertion and deorbit burns, and ensures orbital lifetime at least two orbits beyond the first day PLS is selected to maximize the amount of OMS remaining to protect for interconnect operations post-deorbit burn. [ED]

4. IMPENDING LOSS OF ALL APU/HYDRAULIC SYSTEMS CAPABILITY.
@[111699-7070B]

See rationale for paragraph A.1.

5. CABIN LEAK RESULTING IN A DP/DT > -0.15 PSIA/MINUTE.

See rationale for paragraph A.3.

THIS RULE CONTINUED ON NEXT PAGE

FLIGHT RULES

A2-54

RTLS, TAL, AND AOA ABORTS FOR SYSTEMS FAILURES
[CIL] (CONTINUED)

6. IMPENDING LOSS OF ALL O₂ (H₂) CRYO.

See rationale for paragraph A.4.

7. LOSS OF TWO FREON LOOPS.

See rationale for paragraph A.5.

8. LOSS OF RTLS ET SEPARATION CAPABILITY (WHEN AN RTLS WOULD HAVE BEEN CALLED FOR) BASED ON RCS JET FAILURES WHICH STILL ALLOW ET SEPARATION ON A TAL.

Combinations of failures could result in the loss of RCS jets such that an RTLS ET separation could not be accomplished for an RTLS abort case. In this situation, a TAL would be performed and the additional 11 minutes of flight time would have to be accepted.

9. THREE ET LOW LEVEL SENSORS FAILED DRY IN THE SAME TANK AND ARMING MASS WILL NOT SUPPORT AOA STEEP.

If multiple low level sensors fail indicating the "dry" state in the same tank such that at the time the arming mass is reached MECO would occur in a contingency downrange abort region, a TAL will be performed to avoid the downrange contingency abort. If the arming mass supports an AOA capability, assuming -2-sigma ME performance, then an AOA will be performed.

THIS RULE CONTINUED ON NEXT PAGE

FLIGHT RULES

A2-54

RTLS, TAL, AND AOA ABORTS FOR SYSTEMS FAILURES
[CIL] (CONTINUED)

C. AN AOA WILL BE PERFORMED FOR THE FOLLOWING:

1. TWO OMS PROPELLANT TANKS LEAKING/FAILED, DIFFERENT SIDES, POST-MECO.

See rationale for paragraph B.1.

2. LOSS OF TWO OMS HE TANKS IF ATO SHALLOW CAPABILITY DOES NOT EXIST.

See rationale for paragraph B.2.

3. TWO ARCS PROPELLANT TANKS LEAKING, DIFFERENT SIDES, SAME PROPELLANT, POST-MECO THAT WILL SUPPORT ENTRY TO A Q-BAR = 20.

See rationale for paragraph B.3.

4. IMPENDING LOSS OF ALL APU/HYDRAULIC SYSTEMS CAPABILITY.
@[111699-7070B]

See rationale for paragraph A.1.

5. AN AOA WILL BE PERFORMED FOR A CABIN LEAK RESULTING IN A DP/DT > -0.02 PSIA/MINUTE (GROUND CALL) OR FOR LOSS OF COMMUNICATION A DP/DT > -0.08 PSIA/MINUTE (CREW CALL).

A value of -0.08 psia/minute will be used for crew loss of communication procedures because it creates a C&W alarm, and therefore cues the crew to a possible cabin leak and to crosscheck with a cabin pressure decrease. The C&W dp/dt limit is set at -0.08 psi/minute to prevent nuisance alarms during the period from lift off to MECO when cabin pressure is transient due to ACES helmet flow, thermal and external drop effects. @[062305-6653]

THIS RULE CONTINUED ON NEXT PAGE

FLIGHT RULES

A2-54

RTLS, TAL, AND AOA ABORTS FOR SYSTEMS FAILURES [CIL] (CONTINUED)

A leak rate in the range $-0.02 < -EQdp/dt < -0.15$ psi/minute will allow continuing to orbit and then performing leak isolation procedures to determine whether the leak can be stopped. A leak rate of -0.02 would allow a landing at the next PLS. However, an AOA will be performed to provide additional margin should the leak rate increase. This leak rate is small enough to allow conservatism, but also large enough to not be masked by the post-MECO transient (approximately -0.02) so that a NO-GO call for APU shutdown can be made for a real leak. For leak rates < -0.02 , stay time will be determined by Rule {A17-201B}, CABIN PRESSURE INTEGRITY. @[081497-1873]

6. IMPENDING LOSS OF ALL O₂ (H₂) CRYO.

See rationale for paragraph A.4.

7. LOSS OF TWO FREON LOOPS.

See rationale for paragraph A.5.

8. LOSS OF TWO WATER LOOPS.

An AOA will be performed for the loss of two water loops since the avionics temperatures cannot be managed for the extended period of time required for first day PLS. The avionics can be managed to allow an AOA while maintaining the required temperature levels.

9. THREE ET LOW LEVEL SENSORS FAILED DRY IN THE SAME TANK IF THE EXPECTED -2 -SIGMA CUTOFF VELOCITY SUPPORTS.

See rationale for paragraph B.9.

Rules {A2-51}, STS ABORT CRITERIA; {A2-205}, EMERGENCY DEORBIT; {A4-56C}, PERFORMANCE BOUNDARIES; {A9-261}, IMPENDING LOSS OF ALL CRYO; {A10-21A}.2, LOSS OF APU/HYDRAULIC SYSTEM (S) ACTIONS; and {A16-12A}, EMERGENCY POWERDOWN, reference this rule.

FLIGHT RULES

A2-55

ENTRY GUIDANCE SELECTION FOR ABORTS @[022405-6609A]

- A. IF THE OPS 3 ENTRY PULLOUT LOADS ARE PREDICTED TO EXCEED 3.5 G'S, OPS 6 AUTO CONTINGENCY GUIDANCE WILL BE USED FOR ENTRY. @[120894-1663]
- B. AUTO NOMINAL GUIDANCE WILL BE USED WHENEVER THE LANDING SITE IS WITHIN THE CAPABILITY OF NOMINAL GUIDANCE (REFERENCE FIGURE A2-55-I) (ALPHA PROFILE 43/40).
- C. AUTO LOW ENERGY GUIDANCE WILL BE ENABLED WHENEVER THE LANDING SITE IS OUTSIDE THE DOWNRANGE OR CROSSRANGE CAPABILITY OF NOMINAL GUIDANCE, BUT WITHIN THE CAPABILITY OF LOW ENERGY GUIDANCE (VARIABLE LOW ALPHA PROFILE).
- D. AUTO LOW ENERGY GUIDANCE WILL BE ENABLED, AND A MANUAL PITCH OF ALPHA 37 DEGREES FLOWN DURING THE SECOND PULLOUT IF THE LANDING SITE IS WITHIN THE HIGH CROSSRANGE REGION OF THERMAL CONCERN (VARIABLE LOW ALPHA/MAN 37 PROFILE). THIS IS TO AVOID WING LEADING EDGE TEMPERATURE VIOLATIONS FOR MECO VELOCITIES > 22.8 KFPS (51.6 DEG INCLINATION). THE MCC WILL PERFORM A REAL-TIME THERMAL ASSESSMENT TO DETERMINE IF THE SECOND PULLOUT CAN BE COMPLETED IN AUTO. FOR ALL CASES, PITCH CONTROL MAY BE RETURNED TO AUTO AT THE BOTTOM OF THE SECOND PULLOUT WHEN ALTITUDE ACCELERATION (H-DOUBLEDOT) GOES POSITIVE. (REFERENCE FIGURE A2-55-II).
- E. AUTO LOW ENERGY GUIDANCE WILL NOT BE SELECTED FOR MECO VI'S > 25.3 KFPS (51.6 INCLINATION). NOMINAL GUIDANCE MUST BE UTILIZED TO AVOID VERTICAL TAIL THERMAL VIOLATIONS.

NOTE: THE DAE LOW ENERGY FOOTPRINT IS NOT DISPLAYED FOR VELOCITIES GREATER THAN 25.0 KFPS (REFERENCE FIGURE A2-55-III). @[022405-6609A]

THIS RULE CONTINUED ON NEXT PAGE

FLIGHT RULES

A2-55

ENTRY GUIDANCE SELECTION FOR ABORTS (CONTINUED)

F. FOR BFS ENGAGE: @[022405-6609A]

BFS DOES NOT PROVIDE AN AUTOMATED LOW ENERGY GUIDANCE CAPABILITY, AND CSS IS THE ONLY SUPPORTED MODE DURING ENTRY. FOR THIS REASON, A SIMPLIFIED PITCH AND ROLL/YAW PROFILE MUST BE FLOWN MANUALLY BASED ON LOCATION OF THE LANDING SITE IN THE DAE FOOTPRINT:

1. NOMINAL FOOTPRINT: FLY PITCH (ALPHA 43/40) AND ROLL/YAW PER GUIDANCE COMMANDS.
2. LOW ENERGY FOOTPRINT: FLY ALPHA 42/31 DEG, BANK 2 X DELAZ.

IF DOWNRANGE DISTANCE TO THE LANDING SITE EXCEEDS LOW ENERGY STRETCH CAPABILITY, THE MCC WILL RECOMMEND AN ALPHA OF 40 OR 38 DEGREES FOR THE FIRST PULLOUT TO MAXIMIZE RANGING WHILE SATISFYING THERMAL CONSTRAINTS.

3. HIGH CROSSRANGE REGION OF THERMAL CONCERN: FLY ALPHA 43/37 DEG (MAN 31 CAN BE FLOWN AFTER THE SECOND PULLOUT IS COMPLETE (H-DOT POSITIVE) IF REQUIRED FOR LOW ENERGY), BANK 2 X DELAZ.

GUIDANCE-COMMANDED PITCH CAN BE FOLLOWED JUST PRIOR TO ENERGY CONVERGING TO THE NOMINAL ENERGY LINE ON THE TRAJ DISPLAY, OR AS ALPHA COMMAND DECREASES BELOW THE LAST MANUAL VALUE HELD. GUIDANCE-COMMANDED ROLL/YAW CAN BE FOLLOWED AFTER DELAZ RETURNS WITHIN LIMITS AND ENERGY CONVERGES TO NOMINAL.

NOTE: REFERENCE RULE {A2-209}, LANDING SITE SELECTION FOR AN INFLIGHT EMERGENCY @[120894-1663] @[022405-6609A]

THIS RULE CONTINUED ON NEXT PAGE

FLIGHT RULES

A2-55

ENTRY GUIDANCE SELECTION FOR ABORTS (CONTINUED)

Comment [j1]: Page: 1

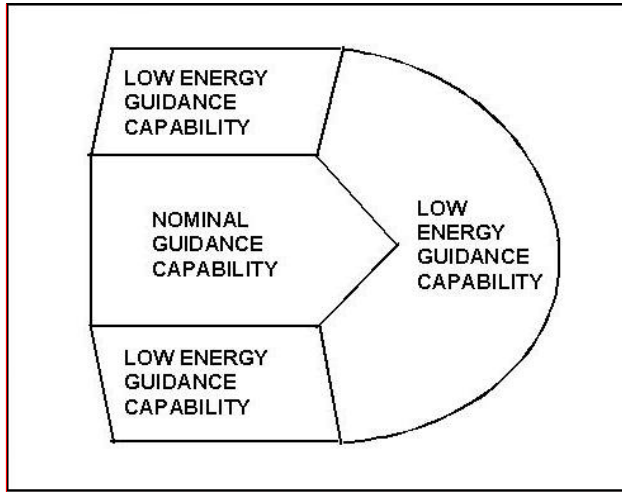

FIGURE A2-55-I - GENERIC DOWNRANGE ABORT EVALUATOR (DAE)
FOOTPRINT (VI ≤ 22.8 KFPS)

©[120894-1663] ©[022405-6609A]

THIS RULE CONTINUED ON NEXT PAGE

FLIGHT RULES

A2-55

ENTRY GUIDANCE SELECTION FOR ABORTS (CONTINUED)

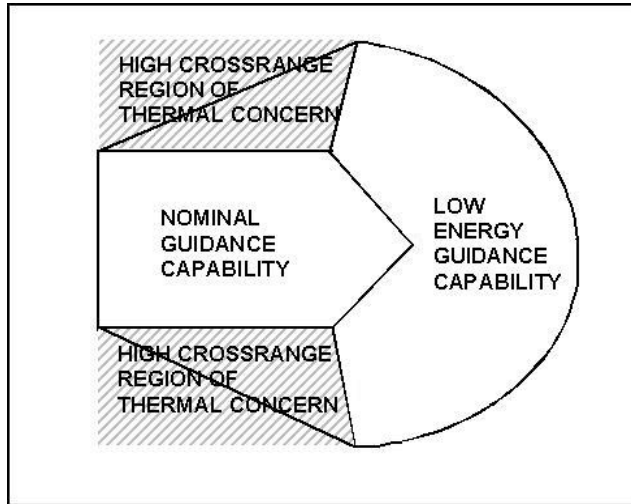

FIGURE A2-55-II - GENERIC DOWNRANGE ABORT EVALUATOR (DAE)
FOOTPRINT ($22.8 < V_I \leq 25.0$ KFPS)

©[022405-6609A]

THIS RULE CONTINUED ON NEXT PAGE

FLIGHT RULES

A2-55

ENTRY GUIDANCE SELECTION FOR ABORTS (CONTINUED)

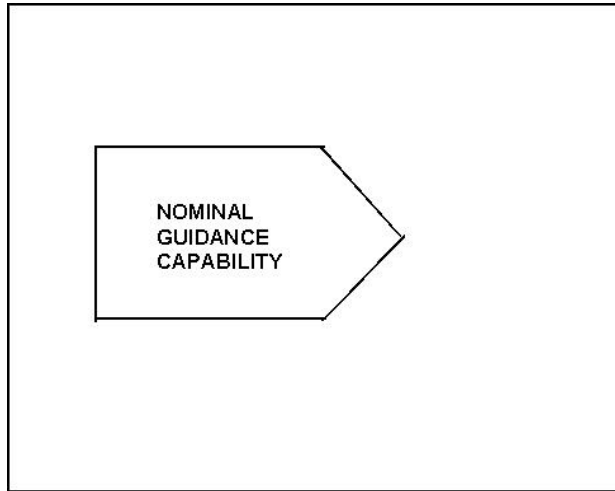

**FIGURE A2-55-III - GENERIC DOWNRANGE ABORT EVALUATOR (DAE)
FOOTPRINT (VI > 25.0 KFPS)**

©[022405-6609A]

OPS 3 VS OPS 6 - For a large MECO underspeed, entry pullout loads determine whether to use OPS 6 Contingency Guidance or OPS 3 Low Energy Guidance. The MCC uses the Downrange Abort Evaluator (DAE) or a real-time plot of flight path angle versus velocity to assess the 3.5 g limit and make a real time call to inform the crew of the best type of entry. For loss of COMM, the crew uses the TAL velocity boundary on the three engine out portion of the contingency abort cue card to determine whether to use an OPS 6 or OPS 3 entry. If three engines fail simultaneously before this velocity boundary, an OPS 6 entry will be used since an OPS 3 entry will result in more than a 3.5 g pullout. This simple velocity boundary is not accurate for performance dispersions or sequential engine failures.

THIS RULE CONTINUED ON NEXT PAGE

FLIGHT RULES

A2-55

ENTRY GUIDANCE SELECTION FOR ABORTS (CONTINUED)

Low Energy Guidance - OPS 3 Low Energy Guidance uses a variable alpha profile and modified roll command logic to extend the orbiter's downrange and crossrange capability during entry to increase the probability of making a landing site that would be unobtainable using nominal entry guidance. Alpha is lowered by guidance as much as possible to extend the downrange capability without exceeding thermal limits. The wing leading edge temperature must not exceed 3320 deg F at any time or 3220 deg F for more than 40 seconds. Furthermore, the vertical tail aluminum spar temperature must not exceed 590 deg F. The range of alpha utilized by low energy guidance is 43 to 31 deg. STSOC Transmittal ADFD-05-003 documents the high inclination variable low alpha thermal assessment. For sequential engine-out and 3 out simo cases, the low energy stretch footprint computed by the Downrange Abort Evaluator (DAE) defines the region where auto low energy guidance will make the site without violating thermal constraints. For 3 out simo cases, the TAL barchart in the ascent checklist provides an alternate prediction of which guidance mode is required as a function of MECO velocity and desired landing site. Reference A/E FTP's #200, April 23, 2004 and #206, October 22, 2004. ©[022405-6609A]

Single Engine Limits and gap management take low energy guidance capability into account when determining performance boundaries. Reference Rules {A4-56}, PERFORMANCE BOUNDARIES, and {A5-103}, LIMIT SHUTDOWN CONTROL.

High Crossrange in Region of Thermal Concern - For landing sites outside the nominal guidance crossrange capability, using the automatic low energy logic will improve the chance of making a site by trading downrange for crossrange, but may exceed thermal limits for MECO VT's greater than 22.8 kfps. While it is known that the area beside the nominal footprint contains small regions that violate thermal limits, the exact definition of the regions is not available. The current version of the DAE shows this general area as a triangle adjacent to the nominal footprint for the inertial velocity region 22.8 to 25.0 kfps. However, it is possible to make sites within a trapezoid which extends from the nominal footprint to the edge of the low energy footprint as denoted by the cross-hatched area in Figure A2-55-II. For sites located in this region, the conservative course of action is to plan to manually fly the second pullout at an alpha of 37 degrees to eliminate the thermal violation. The MCC will perform a real-time thermal evaluation to determine if the second pullout can be completed with auto low energy guidance. If so, then the MCC will call for pitch Auto. Otherwise, the return to auto pitch control will be delayed to the bottom of the second pullout, when altitude acceleration (h-doubledot) goes positive. At MECO velocities greater than 23.3 kfps, thermal problems may occur in the high crossrange region even with manual 37 deg alpha for the second pullout. At this point, the DAE stretch footprint will begin to narrow towards the nominal footprint to exclude these regions of thermal violations. ©[022405-6609A]

THIS RULE CONTINUED ON NEXT PAGE

FLIGHT RULES

A2-55

ENTRY GUIDANCE SELECTION FOR ABORTS (CONTINUED)

High MECO Velocities - The acceptable region of low energy guidance decreases with increasing velocity in order to protect vertical tail thermal limits. By 25.3 kfps, low energy guidance provides no more ranging capability than nominal guidance. To reflect this, the DAE low energy footprint shrinks towards the nominal footprint as velocity increases. The DAE low energy footprint disappears slightly early (at 25.0 kfps) due to processor limitations. Generation of coefficients to fit the low energy footprint in this velocity regime would decrease the accuracy of the curve fit at lower velocities. This is not a significant limitation since ELS sites are present in the nominal guidance footprint in this velocity region for a 51.6 deg inclination mission. These sites have a higher priority than any other ELS sites that would otherwise be in the stretch footprint. Also, AOA-shallow, an even higher- priority abort mode, generally becomes available around 25.1 kfps. ©[022405-6609A]

Acceptable thermal conditions are assured only for landing sites within the DAE nominal footprint. The low energy stretch footprint provides acceptable temperatures, but without dispersion protection. Post-MECO, the MCC will verify satisfactory entry conditions (temperature, ranging, etc.) using the real-time Descent Design Simulator (DDS). It may be possible to have acceptable conditions to sites slightly outside the DAE stretch footprint.

BFS Engage - Since the BFS does not support Auto DAP during entry, the crew must fly manual CSS. Guidance commands may be followed for a landing site in the nominal DAE footprint. However, since low energy guidance is not supported in the BFS, sites beyond nominal guidance capability require special procedures. Rather than attempting to emulate the complex variable alpha profile provided with OI-30, a simplified pitch and roll/yaw profile is employed. For sites in the low energy region of the footprint, 42 deg alpha is flown during the first pullout, followed by 31 deg to maximize ranging while maintaining temperatures within limits. For sites in the high crossrange region of thermal concern, a higher alpha of 37 deg must be maintained through the second pullout in order to avoid exceeding thermal limits. After this pullout is complete (H-dot goes positive), alpha may be decreased to 31 deg if required for ranging. For either case, pitch commands may be followed once energy converges to nominal on the Entry Traj display or after alpha command decreases below the value being held manually. If outside the low energy footprint, a lower alpha profile may be flown during the first pullout to increase downrange capability. The MCC can evaluate the thermal acceptability of alpha 40 and 38 degrees through the first pullout. Reference A/E FTP's #49, September 15, 1988; #79, June 21, 1991; and #87, February 21, 1992. For any landing site outside nominal guidance capability, a bank angle equivalent to approximately two times delta-azimuth is flown to best balance crossrange and energy, with roll direction towards the site. The initiation of the roll should commence toward the end of the first pullout when H-dot is greater than -200 fps and increasing (towards 0 fps). Roll/yaw commands can be followed once delta-azimuth is within limits (< 17.5 deg) and energy is converging towards nominal on the Entry Traj display. ©[022405-6609A]

Rule {A4-56}, PERFORMANCE BOUNDARIES, references this rule. ©[120894-1663]

FLIGHT RULES

A2-56**ABORT GAP**

ASCENTS WILL BE CONTINUED TO ORBIT WITH INTACT ABORT GAPS PROVIDED THREE-SSME UPHILL PERFORMANCE REMAINS ACCEPTABLE. REFERENCE RULE {A4-56I}, PERFORMANCE BOUNDARIES, FOR GAP CLOSURE OPTIONS AND UPHILL PERFORMANCE CRITERIA. ©[ED]

Powered flight can continue through an intact abort gap provided three-engine performance is assured. Mission design and flight rules preclude launching with a known single-engine-out abort gap; however, one may arise during powered flight due to performance problems such as an SSME throttle stuck in the first-stage throttle bucket or Pc sensor shifts. In these cases, if performance with the existing SSME configuration is still able to achieve acceptable MECO conditions, then the risk of losing an SSME in the abort gap is accepted rather than commit to a three-engine pre-MECO abort. This risk is reasonable because the actual need for an abort has not yet arisen; the abort itself (RTLS or TAL) carries risks of its own; and the abort in most cases will not recover single-engine-failure protection. Also, the gap will normally be closed to the extent possible (ref. Rule {A4-56I}, PERFORMANCE BOUNDARIES); hence, any remaining gap will probably be of short duration. ©[ED]

FLIGHT RULES

A2-57

CONTINGENCY ASCENTS/ABORTS

CONTINGENCY ASCENTS/ABORTS RESULT FROM THOSE SITUATIONS WHERE STRUCTURAL FAILURES OR MULTIPLE SYSTEMS/SSME FAILURES HAVE OCCURRED. IN SUCH INSTANCES, ACTION WILL BE TAKEN TO PROVIDE THE HIGHEST PROBABILITY OF A SAFE RETURN OF THE CREW AND ORBITER. THESE CASES WILL USUALLY RESULT IN ONE OR MORE OF THE FOLLOWING:

- A. CREW BAILOUT/ORBITER DITCH DUE TO THE LOSS OF MULTIPLE SSME'S IN A REGION WHERE NO ACCEPTABLE LANDING SITE IS AVAILABLE.
- B. AN ATTEMPT TO LAND AT AN RTLS, TAL, AOA, OR ACLS DUE TO STRUCTURAL OR MULTIPLE ORBITER SYSTEMS PROBLEMS WHICH NECESSITATE LANDING AT THE EARLIEST POSSIBLE TIME.
- C. AN ATTEMPT TO LAND AT AN RTLS, TAL, AOA, ELS, OR ACLS DUE TO MULTIPLE SSME FAILURES OR SINGLE SSME FAILURES COUPLED WITH OTHER ORBITER FAILURES (SUCH AS THE LOSS OF AN OMS ENGINE) WHICH RESULT IN SEVERE ASCENT PERFORMANCE LOSS. CONTINGENCY OR INTACT ABORT PROCEDURES (DEPENDING ON THE PARTICULAR FAILURES AND THE TIME OF EXECUTION) WILL BE PERFORMED AS REQUIRED PER THE ASCENT CHECKLIST AND ASSOCIATED CUE CARDS FOR THE FAILURES DESCRIBED ABOVE, BUT IN ANY CASE, THE OPERATIONS WILL BE CONSIDERED "CONTINGENCY" IN NATURE.

THIS RULE CONTINUED ON NEXT PAGE

FLIGHT RULES

A2-57

CONTINGENCY ASCENTS/ABORTS (CONTINUED)

NOTE: CONTINGENCY ABORTS DUE TO TOTAL SSME THRUST LOSS IN A "BLACK ZONE" OF THE FLIGHT PROFILE, SO DESIGNATED DUE TO THE CHANCES OF SURVIVABILITY, WILL RESULT IN VIOLATION OF VEHICLE Q-BAR, G-LOADING, AND/OR THERMAL LIMITS. LOSS OF TWO SSME'S PRIOR TO EARLIEST SINGLE ENGINE DITCH AVOIDANCE CAPABILITY (REF. RULE {A4-56}, PERFORMANCE BOUNDARIES) MAY RESULT IN VEHICLE LOSS OF CONTROL OR ET RUPTURE DUE TO LOW ALTITUDE TRAJECTORY AND THERMAL CONDITIONS. MANUAL FLIGHT PROCEDURES WILL BE USED IN THESE CASES TO ATTEMPT TO SEPARATE FROM THE ET FOR SUBSEQUENT BAILOUT PRIOR TO ANY LOSS OF CONTROL.

This rule addresses the general conditions and actions that result in contingency ascent/abort cases. These cases involve structural type failures such as the loss of cabin pressure integrity, propellant tank leaks, etc.; or multiple orbiter systems failures such as the loss of both Freon loops, the loss of both water loops, etc.; or the loss of multiple SSME's or single SSME, in conjunction with other orbiter failures such as the loss of an OMS engine. The execution of a contingency ascent/abort may or may not result in the use of intact abort procedures or a landing at an RTL, TAL, or AOA site. While this type of abort would use these sites when possible, landing at an augmented contingency landing site (ACLS) or an ELS may be required. If none of these are available, then a crew bailout may be necessary. While some scenarios will allow an intact abort to be completed after a second SSME failure, these are still considered a contingency abort from a programmatic standpoint.

Crew procedures for flying contingency aborts are contained in the ascent checklist but are only used if intact abort procedures will not suffice for a given situation. In general, contingency abort procedures are not certified/verified to the level of intact abort procedures. Certain regions of the ascent trajectory profile (black zones) may not be survivable if a contingency abort has to be executed due to multiple SSME failures since violations of orbiter or ET constraints on Q-bar, G-level, and heating will occur. Earliest ditch avoidance capability refers to the first time that loss of two SSME's will still allow flight to continue under converged guidance and, at the same time, will not cause the subsequent trajectory to droop below 265,000 feet. This is the altitude below which loss of control may occur or the ET may rupture due to overheating. In these regions, should a contingency abort be required, manual special procedures may be used in an attempt to achieve ET separation and at least a subsequent bailout capability.

Rule {A2-301}, CONTINGENCY ACTION SUMMARY, references this rule. @[081497-6307]

FLIGHT RULES

A2-58

ABORT LIGHT

A. ABORT REQUEST COMMANDS ARE TRANSMITTED FROM MCC, VIA PUSHBUTTONS LOCATED ON THE FD, FDO, AND EASTERN RANGE/45th SPACE WING FCO CONSOLES, WHICH ILLUMINATE THE ABORT REQUEST LIGHT ON THE COMMANDER'S PANEL. THE ABORT COMMAND WILL BE TRANSMITTED AT THE SAME TIME THAT THE ABORT REQUEST IS VOICED TO THE CREW OVER A/G TO INDICATE ONE OF THE FOLLOWING ABORT MODES OR ACTIONS IS REQUIRED: ©[081497-6307]

1. RTLS
2. TAL
3. ATO
4. AOA
5. CONTINGENCY ABORT
6. MANUAL MECO (SECOND STAGE ONLY) ©[081497-6307]

AFTER THE ABORT REQUEST IS RECEIVED AND EXECUTED BY THE CREW, THE ABORT LIGHT WILL BE TURNED OFF VIA GROUND COMMAND.

B. ABORT REQUEST CUES - THE GROUND WILL BASE ABORT REQUEST TRANSMISSIONS ON AT LEAST TWO INDEPENDENT CUES (E.G., TELEMETRY DATA, CREW VOICE REPORTS, FDO PERFORMANCE INDICATIONS, ACTUAL OR IMMINENT RANGE SAFETY LIMIT LINE VIOLATIONS). LIKewise, TWO CUES ARE REQUIRED FOR THE CREW TO TAKE THE NECESSARY ACTION TO ABORT THE FLIGHT (E.G., PHYSIOLOGICAL CUES, ILLUMINATED ABORT LIGHT, VOICE REPORT OVER A/G, COCKPIT INDICATIONS). THIS RULE ASSUMES NO FAILURES WHICH MAY MASK SECONDARY INDICATIONS OF ABORT REQUIREMENT. ©[081497-6307]

THIS RULE CONTINUED ON NEXT PAGE

FLIGHT RULES

A2-58**ABORT LIGHT (CONTINUED)****C. CREW ACTION:**

1. FIRST STAGE - EXECUTE ANY AVAILABLE ABORT MODE (NOTE - AT PRESENT, NO FIRST STAGE ABORT EXISTS).
2. SECOND STAGE - EXECUTE RECOMMENDED ABORT MODE (RTLS, TAL, ATO, CONTINGENCY, MANUAL MECO)
3. POST-MECO - AOA, TAL, DOWNRANGE ABORT/CONTINGENCY

This rule documents the conditions under which the abort light command will be issued, the cue requirements for requesting or initiating an abort, and the actions to be taken during each ascent phase. Assuming no other known failures are present which may mask malfunction indications, two independent cues are required before an abort will be requested or initiated in order to provide at least one confirming indication that an abort is required.

If an abort is necessary, the abort light command will be issued for all ascent abort modes. It was agreed that the abort command would be sent at the time that the abort request is passed to the crew as opposed to the time at which the abort is initiated. In most cases, these events are concurrent; however, in the RTLS/TAL overlap region it is usually desirable to delay abort initiation until close to the last RTLS boundary. The abort light will be reset (turned off) via ground command so that it may be used again if necessary to request a subsequent AOA and also to remove the bright light source in the case of night launches. As part of the 1996 ET Range Safety System removal effort, the Eastern Range/45th Space Wing Flight Control Officer (FCO) was provided with two redundant abort light switches in the event a range safety limit line is violated. Note that in most cases, however, MCC/flight crew action will already have taken place before FCO activation of the light is required. ©[081497-6307]

Paragraph C serves to delineate the abort options available for each ascent flight phase. ©[081497-6307]

Rule {A3-3}, HIGH-SPEED TRACKING LAUNCH AND LANDING REQUIREMENTS, references this rule. ©[ED] ©[032807-8402B]

FLIGHT RULES

A2-59

BFS ENGAGE CRITERIA

A. LOSS OF REDUNDANT SET (REF. RULE {A7-1A}, PASS DPS FAILURE) .

Loss of the redundant set will result in a loss of vehicle control. Control may be regained by engaging the BFS.

B. LOSS OF CONTROL:

1. LOSS OF PASS CAPABILITY TO CONTROL THE VEHICLE DUE TO GPC/MDM/LRU FAILURES (BFS MUST RECOVER CRITICAL CAPABILITY) .

Combinations of GPC/MDM/LRU failures may cause the flight control system to use bad system inputs resulting in loss of vehicle control. The BFS should only be engaged if it will pick up at least one IMU, control over two FCS channels, and satisfy the LRU constraints stated in Rule {A8-56}, BFS LRU REQUIREMENTS.

2. LOSS OF CONTROL DUE TO DIVERGENT TRAJECTORY. AFTER MET 1 MINUTE 30 SECONDS, CONTROL STICK STEERING (CSS) MAY BE ATTEMPTED BEFORE BFS ENGAGE.

During first stage, loss of control may occur very quickly due to the control authority of the SRB's. Early in the STS program it was determined that the crew could not manually control the vehicle during first stage load relief, which occurs during the high Q-bar region, even though CSS is available in PASS. Therefore, prior to high Q-bar, the crew should engage the BFS to regain lost system capability which may recover vehicle control. After MET 1 minute 30 seconds, CSS control is an option the crew has available to regain vehicle control. If CSS does not recover vehicle control, then engaging BFS is the last option available since it will place the vehicle control under different software commands. (Note: only AUTO flight control mode is available in the BFS during powered flight, MM 102 and 103). The FCS downmoding (AUTO to CSS or even BFS engage) is an onboard call. Rule {A8-54}, FIRST STAGE LOSS OF CONTROL DEFINITION, defines the vehicle rates and attitude errors for loss of control.

THIS RULE CONTINUED ON NEXT PAGE

FLIGHT RULES

A2-59 BFS ENGAGE CRITERIA (CONTINUED)

C. ROLL MANEUVER NOT INITIATED AS SCHEDULED.

Since the onboard displays are inadequate for the crew to manually execute the roll/pitch profile through the critical high Q phase with the PASS, the BFS must be engaged if the roll maneuver is not initiated at the planned I-loaded value of relative velocity (ref. Rule {A4-58A}, AUTO GUIDANCE NO-GO). The BFS has an auto capability during powered flight.

D. PRE-MECO, FOR SET SPLITS SUBJECT TO THE CRITERIA LISTED IN RULE {A7-9A}, REDUNDANT SET SPLIT.

PASS GPC set splits are considered to be a low probability failure mode and are also complex to deal with in the short amount of time available or in the presence of other failures. In many instances, BFS engage is the quickest and simplest approach to avoiding catastrophic results (e.g., when they result in multiple command path failures to SSME's near MECO). Circumstances where PASS reconfiguration is preferred over BFS engage are detailed in Rule {A7-9A}, REDUNDANT SET SPLIT, which also contains the procedures required in those cases.

Rule {A7-9}, REDUNDANT SET SPLIT, references this rule.

A2-60 NAVIGATION UPDATE CRITERIA

WHEN AN INDEPENDENT NAVIGATION SOURCE IS AVAILABLE, NAVIGATION UPDATES WILL BE INITIATED TO PROVIDE ACCEPTABLE MECO CONDITIONS AND MAINTAIN THE HIGHEST ASCENT PRIORITY MODE AVAILABLE. IF NAVIGATION UPDATES CANNOT BE PERFORMED, MECO WILL BE COMMANDED MANUALLY (REF. RULE {A4-60}, MANUAL SHUTDOWN CRITERIA). @[121296-4177D]

Orbiter navigation velocity errors not corrected until post-MECO cause an almost one for one OMS penalty during OMS-1. This penalty may cause downmoding to a lower ascent priority mode because of OMS propellant budget limitations. To avoid sacrifice of mission objectives, error limits are established for execution of pre-MECO navigation updates (ref. Rule {A4-57A}, NAVIGATION UPDATES). If a navigation update cannot be performed due to the unavailability of an independent navigation source, loss of command capability, or insufficient time prior to MECO, then the manual shutdown criteria (ref. Rule {A4-60}, MANUAL SHUTDOWN CRITERIA) will be used to ensure an acceptable cutoff. @[121296-4177D]

FLIGHT RULES

A2-61

Q-BAR/G-CONTROL

- A. A FAILURE OF ALL THREE ENGINES TO THROTTLE DOWN FOR Q-BAR CONTROL IN FIRST STAGE OR G-CONTROL IN SECOND STAGE IS CAUSE FOR MANUAL THROTTLE TO OBSERVE THE RESPECTIVE Q-BAR AND G LIMITS. FAILURE OF A SINGLE ENGINE TO THROTTLE IN THE SAME REGIONS REQUIRES NO ACTION. FAILURE OF TWO ENGINES TO THROTTLE IN SECOND STAGE IS CAUSE TO MANUALLY SHUT DOWN ONE OF THE NONTHROTTLING ENGINES.

The ascent profile is designed to constrain the maximum Q-bar and g's to their respective limits. During the thrust bucket, the throttles are reduced to ensure that the maximum dispersed Q-bar will not exceed the structural specification limit (approximately 820 psf). Should all three of the SSME's fail to throttle down, manual throttledown is required to avoid structural damage.

The g-control region of second stage adjusts the throttles to ensure that no more than approximately 3g will be experienced. This limit was selected to protect vehicle and payload structure. Therefore, should none of the SSME's throttle down at initiation of the g-control region, the crew will manually throttle to maintain approximately 3g.

For failure of a single SSME to throttle down in either the thrust bucket or in the g-control regions, no action will be required by the crew to manually throttle. Analysis conducted in 1996 (reference Shuttle Loads and Structural Dynamics Panel Minutes for August 31, 1998) showed that there will be an approximately 4 percent exceedance of the wing certified limit load during maximum Q-bar should a throttle be stuck high before the thrust bucket. This stuck throttle condition is not a design requirement and has been documented with a FMEA/CIL in accordance with NSTS 07700, Volume X requirements. The risk due to the increased loads is acceptable because a safety factor greater than one is maintained. During the g-control region, the healthy SSME's will throttle lower than normal and the maximum g's will be approximately 3.5. This is in violation of NSTS 07700, Volume X. To cover this case, a waiver was approved to accept a one-time high-G exceedance of up to 3.6 g's. Should this occur, post-flight analysis and inspection of the orbiter will be required. ©[041097-4910A] ©[111298-6788]

Failure of two engines to throttle down when the g-control region is reached will definitely lead to a violation of the 3g limit (in excess of 4g). The good engine will only throttle down to the minimum percent (approximately 67 percent). Therefore, one of the appropriate nonthrottling engines will be shut down to allow the remaining good engine to control g's with the other stuck engine.

Refer to the Ascent Flight Techniques meeting #53 minutes, RI/Downey memo 92MA1056, and Shuttle Loads and Structural Dynamics Panel Minutes for August 31, 1998, for further background. ©[041097-4910A] ©[111298-6788]

Rule {A2-64}, MANUAL THROTTLE CRITERIA, references this rule.

FLIGHT RULES

A2-62

ET FOOTPRINT CRITERIA

DESIGN MECO CONDITIONS AND ABORT MODE BOUNDARIES MUST PROVIDE AN ET IMPACT POINT (IP) FOOTPRINT, INCLUDING 3-SIGMA DISPERSIONS, WHICH SATISFIES THE FOLLOWING CONSTRAINTS:

- A. NOMINAL MECO TARGET: THE ET IP FOOTPRINT IS MAINTAINED AT A MINIMUM OF 200 NM FROM ALL FOREIGN LAND MASSES (EXCEPT THE FRENCH-HELD POLYNESIAN ISLANDS, WHERE THE MINIMUM CLEARANCE MAY BE REDUCED TO 60 NM WHEN DICTATED BY MISSION OBJECTIVES) AND 25 NM FROM THE PERMANENT ICE SHELF. ALSO, THE ET IP FOOTPRINT MUST BE MAINTAINED AT LEAST 25 NM FROM U.S. ISLANDS. @[092195-1777A] @[111699-7066]
- B. TAL MECO TARGETS: THE ET IP FOOTPRINT IS MAINTAINED A MINIMUM OF 25 NM OFF ALL FOREIGN LAND MASSES.
- C. RTLS MECO TARGETS: THE ET IP FOOTPRINT IS MAINTAINED A MINIMUM OF 25 NM FROM ANY LAND MASSES.
- D. EARLIEST SINGLE SSME OUT "PRESS" TRAJECTORIES (PRESS-TO-MECO AND PRESS-TO-ATO): THE ET IP FOOTPRINT WILL BE MAINTAINED OFF CRITICAL LAND MASSES. CRITICAL LAND MASSES INCLUDE:
 1. FOR DIRECT INSERTION 28.5-DEGREE INCLINATIONS: AFRICAN MAINLAND AND MADAGASCAR
 2. FOR DIRECT INSERTION 39-DEGREE INCLINATIONS: AFRICAN MAINLAND
 3. FOR DIRECT INSERTION 51.6-DEGREE INCLINATIONS: AFRICAN MAINLAND AND THE MIDDLE EAST @[092195-1777A]
 4. FOR DIRECT INSERTION 57-DEGREE INCLINATIONS: EUROPEAN AND ASIAN MAINLANDS
 5. ALL OTHER INCLINATIONS AND INSERTION TYPES WILL BE ANALYZED ON A MISSION-SPECIFIC BASIS. @[092195-1777A]

THIS RULE CONTINUED ON NEXT PAGE

FLIGHT RULES

A2-62

ET FOOTPRINT CRITERIA (CONTINUED)

- E. ET FOOTPRINT CONSTRAINTS WILL NOT APPLY TO THE FOLLOWING CASES:
1. MULTIPLE SSME-OUT CASES
 2. SINGLE SSME-OUT CASES COUPLED WITH ANY OF THE FOLLOWING:
 - a. ANY LOSS OF OMS DUMP CAPABILITY (PROPELLANT OR ENGINE)
 - b. ANY AFT RCS PROPELLANT LEAK/FAILURES
 - c. ANY OTHER SSME(S) STUCK IN THE THROTTLE BUCKET

The premission-defined MECO targets and design underspeed MECO conditions are selected such that they will not violate Eastern Range (ER) guidelines on ET IP or State Department requirements. These guidelines specify that a 3-sigma dispersion footprint be used for application of the ET IP limitation criteria.

Nominal MECO target: The nominal MECO targets must meet the strictest constraints on the ET IP footprint. The 200 nm limit from any foreign land mass must be satisfied through the ascent flight design process. This limit will preclude infringement of the territorial boundaries of all foreign land masses, ensuring no property or human damage occurs from ET debris. The SSP has received State Department approval to reduce the limit for the French-held Polynesian Islands to 60 nm (reference NSTS 07700 Vol X Section 3.2.1.1.17.2, ET Disposal). This ET disposal relief allows the use of D1 to 122 nm MECO targets for ISS missions. The lower MECO target increases rendezvous phasing capability and significantly improves the possibility of an early rendezvous. Although the minimum is 60 nm, the ET footprint clearance will only be reduced from 200 nm as required to meet mission objectives. The 25 nm limit applies to the permanent ice shelf which, although not very populated, must be avoided for environmental protection. A lateral clearance of 25 nm is used to protect U.S. islands; the potential for high density of shipping vessels and other small craft in these waters makes this margin prudent for a planned ET disposal. This limit was previously 45 nm prior to the incorporation of OI-21 flight software, which eliminated worst-case guided MECO lateral dispersions caused by a side engine out late in the nominal trajectory. The 45 nm ensured a 25 nm clearance for these cases; however, the extra margin is no longer required. ©[092195-1777A] ©[111699-7066]

THIS RULE CONTINUED ON NEXT PAGE

FLIGHT RULES

A2-62

ET FOOTPRINT CRITERIA (CONTINUED)

TAL and RTLS MECO targets: Once an abort or failure has occurred, the ET IP constraints are less strict. The TAL and RTLS restrictions on the ET IP footprint ensure that no land mass impact damage occurs, although with little additional margin.

“PRESS” trajectories: The earliest PRESS, single SSME-out, trajectories (earliest capability to continue the ascent to an orbital condition: AOA, ATO, or nominal mission altitude) must protect only critical land masses from ET IP debris. For these cases, no margin is added to the 3-sigma footprint beyond the critical land mass boundaries. Critical land masses are determined through JSC, ER, and State Department agreements considering the political relations with the U.S. and population density. The 1990 ACTA Incorporated 28.5-degree inclination hazards analysis shows casualty expectation orders of magnitude for Madagascar of 10-2. For this reason, Madagascar is considered a critical land mass. An abort will be recommended if the ET IP footprint violates the PRESS trajectory limitations.

Additionally, if the ET footprint signifies a risk to the eastern U.S. coastline, real-time action will be taken to correct the trajectory (ref. Rule {A4-260}, RANGE SAFETY LIMIT AVOIDANCE ACTIONS).

When multiple performance-related failures occur, as noted above in paragraph E, ET IP constraints will no longer be protected due to substantial risks to the flightcrew and vehicle. With the exception of the OMS engine failure, SSME stuck in the throttle bucket, and multiple SSME-out cases, the remaining cases are the result of a vehicle structural failure (extent unknown).

It is more hazardous to perform a TAL abort (in order to protect ET IP) without some knowledge of the control capability losses due to this failure. By pressing to orbit, there is a greater chance of assessing the damage and determining any new crew procedures, if required. Multiple SSME-out cases are considered to be contingency cases, and for that reason the ET constraints are no longer protected. An OMS engine failure is typically detected after an OMS dump (ATO abort) because ET IP protection has already been initiated. Here, a TAL abort is considered hazardous as a TAL abort would require a second abort declaration and the initiation of a second (contingency) dump which would necessitate manual procedures. These cases are considered in-flight contingencies, outside the program recognized failure cases.

Rules {A4-1}, PERFORMANCE ANALYSES; {A4-55A}, DESIGN AND CRITICAL MECO UNDERSPEED DEFINITIONS; {A4-63}, OMS/RCS SYSTEM FAILURES DURING ASCENT; and {A4-56E}, PERFORMANCE BOUNDARIES, reference this rule. ©[ED]

FLIGHT RULES

A2-63

ASCENT STRING REASSIGNMENT

- A. PRE-MECO, RESTRINGING WILL BE PERFORMED TO REGAIN THE SSME OR OMS CAPABILITY NECESSARY TO AVOID AN RTLS/TAL/CONTINGENCY ABORT OR, FOR ISS MISSIONS, TO REGAIN THE SSME OR OMS CAPABILITY NECESSARY TO RENDEZVOUS/DOCK WITH ISS SUBJECT TO THE FOLLOWING: ©[042507-8489A]
1. WHEN RESTRINGING TO AVOID AN RTLS OR TAL ABORT, EITHER THE BFS MUST BE AVAILABLE OR THE RESTRING MUST BE REQUIRED TO SUPPORT THE ABORT.
 2. WHEN RESTRINGING TO AVOID A CONTINGENCY ABORT, THE BFS IS NOT REQUIRED TO BE AVAILABLE.
 3. WHEN RESTRINGING TO REGAIN CAPABILITY FOR ISS RENDEZVOUS/DOCKING, THE BFS MUST BE AVAILABLE.

NOTE: THE LAST TIME A RESTRING CAN BE COMPLETED TO REGAIN UPHILL OR ISS RENDEZVOUS/DOCKING CAPABILITY WILL BE DETERMINED IN REAL TIME.

The SSME's are throttled down for maximum dynamic pressure control in first stage. If an SSME experiences a command path failure while in the thrust bucket, the ARD will be used to evaluate the effect of the stuck throttle on vehicle performance. On performance critical missions, an RTLS or TAL may be required even though the remaining two SSME's have nominal performance; a contingency abort (as documented on the contingency abort cue cards in the ascent checklist flight data file) may be required when a separate SSME has failed or is operating with off-nominal performance. Therefore, restringing will be performed to regain SSME throttle command capability if doing so will regain uphill capability or avoid an RTLS, TAL, or contingency abort. The BFS is normally required to help mitigate the risks of performing an uncertified restring. If the BFS is not available and a restring is required to support the abort (pre- or post-ET SEP), no advantage exists with aborting RTLS/TAL instead of restringing to regain throttle capability. For these cases, restringing is acceptable to regain throttle command capability and avoid the abort independent of the BFS status. ©[042507-8489A]

THIS RULE CONTINUED ON NEXT PAGE

FLIGHT RULES

A2-63

ASCENT STRING REASSIGNMENT (CONTINUED)

For some loss of performance cases (SSME command path failure, conditions requiring an early SSME shutdown, or loss of OMS dump capability), a safe orbit may be achieved without recovering the SSME or OMS capability; however, the performance impacts will preclude a rendezvous and docking with the ISS. For these cases, the risk associated with performing an uncertified restrung must be weighed against the benefit of gaining the additional ascent debris mitigation capabilities (inspection and repair, CSCS) offered by a successful rendezvous and docking with ISS. Based on the Shuttle Program Probabilistic Risk Assessment, ascent debris is the second highest program risk with the probability of loss of crew and vehicle at approximately 1/400. Additionally, an SSME that has a partial loss of thrust, a stuck throttle, or performance outside of design specifications is not certified per 07700 Volume X Book 1. The use of restrung during dynamic flight phases was not considered during the development of the requirements nor during the coding of the software. It has not been verified within the context of the shuttle operational envelope. It is an uncertified capability. Thus, the probability of encountering the risks associated with its use is unknown. Ascent/Entry Flight Techniques Panel #229, March 30, 2007, reviewed these concepts and concluded that in these cases the benefits gained by regaining ISS rendezvous and dock capability outweighed the risks associated with performing the restrung. @[042507-8489A]

The last time a restrung can be completed to regain uphill or docking capability will be determined by the FDO. This time will change as a function of the winds of the day, SRB performance, SSME performance, and SSME throttle setting of the nonthrottling engine. Therefore, this time will be determined by the ARD in real time.

- B. PRE-MECO, RESTRINGING WILL BE PERFORMED TO REGAIN OMS DUMP CAPABILITY IF REQUIRED TO MEET CENTER OF GRAVITY AND/OR OMS LANDING WEIGHT CONSTRAINTS. THE BFS IS NOT REQUIRED TO BE AVAILABLE FOR THESE RESTRINGS.

In combination with other systems failures (e.g., electrical busses), the loss of a flight critical aft MDM that has been bypassed due to the failure of a GPC will often take ignition capability to an OMS engine. Having this engine unavailable for abort dumps, both intact and contingency, may lead to large violations of the OMS tank landing weight constraint (SODB Vol. 1, paragraph 3.4.3.3.6.f) or of the Y cg envelope (reference Rule {A4-153}, CG PLANNING). If the restrung will likely regain OMS engine ignition capability, it should be performed to minimize the impacts of the off-nominal propellant dump. A/EFTP #229 reviewed and concurred with these concepts on March 30, 2007. @[042507-8489A]

THIS RULE CONTINUED ON NEXT PAGE

FLIGHT RULES

A2-63

ASCENT STRING REASSIGNMENT (CONTINUED)

C. POST-MECO: @[042507-8489A]

1. PRE-ET SEPARATION: RESTRING WILL ONLY BE PERFORMED IF REQUIRED TO REGAIN THE APPROPRIATE NUMBER OF RCS JETS REQUIRED FOR RTLS ET SEPARATION OR NOM/TAL ET SEPARATION.

ET separation cannot be performed without sufficient RCS jet control authority. RTLS ET separation is especially critical because of the increased number of RCS jets required for mated coast and ET separation. Additionally, for either RTLS or TAL, delaying ET separation is not an option. For nominal conditions, ET separation can be delayed allowing more time to configure for the restring.

2. POST-ET SEPARATION:

RESTRINGING WILL NOT BE PERFORMED PRIOR TO ACHIEVING A SAFE ORBIT EXCEPT FOR THE FOLLOWING:

- a. RESTRING TO MAINTAIN SINGLE-FAULT TOLERANCE.
- b. RESTRING TO REGAIN INSIGHT FOR AN UNRELATED CRITICAL SYSTEM FAILURE WHERE THE FAILED STRING MASKS THE SYSTEM PROBLEM ANALYSIS.
- c. IF UNDERSPEED CONDITIONS EXIST SUCH THAT AN OMS-1 BURN IS REQUIRED AT MECO PLUS 2 MINUTES, RESTRING WILL NOT BE PERFORMED PRIOR TO OMS-1 UNLESS REQUIRED TO MAINTAIN BOTH OMS ENGINES. @[042507-8489A]

The desire is to rely upon system fault tolerance capability (BFS is counted as a level of redundancy) during the uphill phases of the mission when a safe orbit has not yet been established and thereby reduce the risks that may be associated with restringing (possible GPC failure, set split, etc.). Additionally, because the timeline is leading into a quiescent orbit phase (versus a more dynamic entry phase), greater emphasis is placed on the existing systems capability, as long as fault tolerance exists, rather than restringing to regain full capability.

For off-nominal MECO conditions where the OMS-1 TIG is required at MECO plus 2 minutes, restring will not be attempted in order to focus attention on the critical OMS-1 burn and preclude restring error from jeopardizing OMS-1 execution. The exception to this rule is when less than two OMS engines are available. Because of the large underspeed, both OMS engines are required in order to overcome large drag effects and achieve the desired targets. Downmoding to the RCS four +X jets may not be an option because of the magnitude of the required delta V and the low thrust/long burn time requirements associated with the RCS.

THIS RULE CONTINUED ON NEXT PAGE

FLIGHT RULES

A2-63

ASCENT STRING REASSIGNMENT (CONTINUED)

- D. RESTRINGING WILL NOT BE PERFORMED WITHOUT PRIOR MCC COORDINATION. @[042507-8489A]

The MCC is prime for determining when restringing is required as a result of multiple failures and the resulting GPC/string assignments required to satisfy critical capability and systems fault tolerance as identified in the preceding rules. The MCC is prime for determining the acceptability of restringing based upon the failure signature and conditions and for determining an acceptable data bus reassignment configuration. As a minimum, voice description of the failure and identification of the proposed bus reassignment must be coordinated with the MCC prior to performing any restring.

- E. RESTRING GPC/STRING COMBINATIONS WILL BE SELECTED WHICH MOVE THE LEAST NUMBER OF STRINGS.

The greater the number of strings moved during a restring attempt, the more complicated the restring process. With this in mind, "good" strings should not be taken from "good" GPC's unless there is no other method of regaining critical capability.

- F. RESTRINGING WILL BE PERFORMED TO REGAIN CRITICAL CAPABILITY INDEPENDENT OF THE BFS STATUS. FOR CASES WHERE RESTRINGING IS ACCEPTABLE TO REGAIN FAULT TOLERANCE (REF. PARAGRAPH B.2.a.(1)), AN ENGAGEABLE BFS MUST BE AVAILABLE.

The BFS is normally required when restringing is performed as a precaution against the low probability occurrence that the restring action may result in loss of the PASS set. However, when the vehicle has sustained failures such that less than critical capability remains (a capability which must be maintained or a loss of crew/vehicle will result), restringing will be performed to regain the needed capability independent of the BFS status in order to maintain the flying status of the orbiter.

If the BFS is not available and less than critical capability remains, restring is allowed to recover the PASS capability to control the orbiter. If the BFS is available and conditions are such that either a BFS engage or a dynamic restring will recover the critical capability, restring will be attempted if time permits completion of the restring while still maintaining the BFS engage option.

- G. RESTRINGING MAY BE PERFORMED FOR THE FOLLOWING:
1. ALL OPS TRANSITIONS, ALL REDUNDANT SET EXPANSIONS, AND ALL REDUNDANT SET CONTRACTIONS.
 2. ANY OPS MODE RECALL THAT DOES NOT CAUSE A BYPASSED ELEMENT TO BE UPMODED. @[042507-8489A]

THIS RULE CONTINUED ON NEXT PAGE

FLIGHT RULES

A2-63

ASCENT STRING REASSIGNMENT (CONTINUED)

The full effects to the applications software of upmoding bypassed elements during any operation other than OPS transitions, redundant set expansions, or a redundant set contractions is not fully understood.
 ©[042507-8489A]

PASS attempts to upmode all bypassed elements on all busses following any OPS transition or OPS mode recall. Upmoding elements during OPS transitions and redundant set expansions/contractions is a designed capability and, thus, is certified. However, upmoding elements outside of these operations was not considered during the development of the PASS requirements, was not considered during the coding of the PASS software, and has not been verified within the context of the shuttle operational envelope. Thus, the use of an OPS mode recall to reassign busses is not certified unless there are no bypassed elements being upmoded.

Since not all OPS mode recalls will cause a bypassed element to be upmoded, it is possible to perform the operation without entering uncertified territory. This includes:

- a. *Using an OPS mode recall to deassign a string. Assuming there are no bypassed elements capable of being upmoded, this is certified. For example, assuming a nominal entry configuration with GPC's 1-4 in a redundant set with FC stringing of 1234, one could perform a certified restrung to 1230 as long as no elements (MDM's, IMU's, etc.) are upmoded during the restrung. An example of where this would not be certified is if an IMU was bypassed due to it having previously moded itself to standby and then, subsequently, the IMU had moded itself back to operate. The restrung would upmode the bypassed IMU, thus, making the operation uncertified.*
- b. *Using an OPS mode recall to move a good FC string from one good GPC to another. Assuming there are no bypassed elements capable of being upmoded, this is certified. For example, assuming a nominal entry configuration with GPC's 1-4 in a redundant set with FC stringing of 1234, one could perform a certified restrung to 1233 as long as GPC 4 is not taken out of the redundant set prior to the restrung.*
- c. *Using an OPS mode recall to reassign the payload busses from one GNC computer to another. Assuming there are no bypassed elements on the flight critical busses capable of being upmoded, this is certified. For this case, it does not matter whether anything on the payload busses is bypassed since the GNC software does not poll any of the LRU's on the payload data busses.*

*Rules {A2-5}, PORT MODING/RESTRINGING GUIDELINES; {A2-69}, REGAIN RCS JETS FOR RTLS ET SEPARATION; {A7-6}, DATA PATH FAILURE; {A7-9}, REDUNDANT SET SPLIT; {A7-102C}.4 and 5, PASS DATA BUS ASSIGNMENT CRITERIA [HC]; {A7-52}, ASCENT/ENTRY BFS MANAGEMENT GUIDELINES; and {A8-55}, ASCENT/ENTRY RCS CONTROL REQUIREMENTS [HC], reference this rule. ©[042904-6239A] ©[042507-8489A]
 ©[ED]*

FLIGHT RULES

A2-64

MANUAL THROTTLE CRITERIA

MANUAL THROTTLE CONTROL WILL BE PERFORMED WHEN REQUIRED TO PROTECT SYSTEMS LIMITS, GUIDANCE SOFTWARE PERFORMANCE, OR MISSION CAPABILITY. REFERENCE RULES {A2-61}, Q-BAR/G-CONTROL; {A4-59}, MANUAL THROTTLE SELECTION [HC]; {A5-112}, MANUAL THROTTLEDOWN FOR LO2 NPSP PROTECTION AT SHUTDOWN; {A5-152D}.1, PRE-MECO MPS HELIUM SYSTEM INTERCONNECTS [CIL] [HC]; AND {A5-155}, LIMIT SHUTDOWN CONTROL, MANUAL THROTTLING, AND MANUAL SHUTDOWN FOR LOW LH2 NPSP [CIL] [HC], FOR SPECIFIC CASES INVOLVING MANUAL THROTTLE. ©[090894-1676A] ©[041097-4910A] ©[ED] ©[032807-8398] ©[032807-8399B]

Normally, all SSME throttling action will be commanded by the flight software. However, manual throttling can relieve certain failure conditions, some potentially catastrophic, which are not protected by software; examples include low SSME NPSP, an unstable guidance solution, or any generic failure of the software throttling logic itself. In addition, manual throttle can be used to maximize performance in propellant-critical TAL cases as well as to avoid a TAL or RTLS abort when design underspeed is limited by NPSP. In these scenarios, the use of manual throttle control is preferred to the alternatives. The referenced rules spell out the background and criteria for manual throttle usage in each case.

FLIGHT RULES

A2-65 **OMS-1 DELAYED TARGET CRITERIA**

THE OMS-1 BURN WILL UTILIZE DELAYED TARGET FOR:

- A. MAIN PROPULSION SYSTEM (MPS) PROPELLANT DISCONNECT VALVE FAILED OPEN.
- B. ANY OMS PROPELLANT FAIL/LEAK OR OMS HE TANK FAIL.
- C. TWO OMS ENGINES FAILED.

NOTE: UNDERSPEED MECO CONDITIONS MAY REQUIRE USE OF ON-TIME (MECO + 2) OMS-1 TARGETS.

Delayed targets are designed for nominal or small underspeed MECO conditions only. Larger underspeeds (mission-dependent) may require on-time targets to remain within orbiter delta V capability.

For OMS propellant or helium tank leaks/failures, significant delta V capability will be lost. Also, loss of two OMS engines implies that all the delta V maneuvers will be accomplished with the RCS 4 +X thrusters. Performing delta V maneuvers with the RCS requires a significant amount of additional propellant to compensate for the reduced engine efficiency of the RCS jets as compared to the OMS engines. For these cases, a delayed ATO OMS-1 burn is performed to minimize delta V requirements for insertion and deorbit and allow time for a thorough assessment of the delta V capability remaining.

A2-66 **APU SHUTDOWN DELAY CRITERIA**

IF ORBIT CAPABILITY IS QUESTIONABLE, THE APU'S WILL REMAIN "ON" WITH THE HYDRAULIC PUMPS DEPRESSURIZED UNTIL THE DECISION IS MADE TO CONTINUE TO ORBIT. [ED]

A2-67 **ARD UPDATE CRITERIA**

FOR SSME FAILURE CONDITIONS CAUSING PERFORMANCE DISPERSIONS, ADJUSTMENTS WILL BE MADE TO MIXTURE RATIO, POWER LEVEL, SPECIFIC IMPULSE, AND/OR FLIGHT PERFORMANCE RESERVE VALUES IN THE MCC ABORT REGION DETERMINATOR (ARD) PROGRAM.

Rule {A4-54}, ABORT MODE RESPONSIBILITY, states that the MCC is prime for abort mode determination. Pre-MECO, the primary tool used to fulfill this responsibility is the ARD processor, which resides in the SDPC computer. Its predictions of abort capability are contingent upon accurate modeling of SSME performance parameters and usable ET propellant remaining. Certain SSME failure conditions such as Pc sensor shifts, valve drift following lockup, etc., can cause the actual SSME performance to vary considerably from that assumed by the ARD; therefore, capability is provided to manually update the applicable performance data in real time. SSME parameters are updated per recommendation from the MCC Booster officer, while FPR adjustments are made by the Flight Dynamics team based on the predicted LOX or LH₂ unusable quantity at MECO. Such adjustments are necessary to preserve protection at the 2-sigma level when propellants are being consumed at a non-nominal mixture ratio.

FLIGHT RULES

A2-68

ET PHOTOGRAPHY

- A. THE ET UMBILICAL WELL PHOTOGRAPHY +X TRANSLATION MANEUVER WILL BE NO-GO FOR THE FOLLOWING: @[102506-7829]
1. OMS/RCS PROPELLANT LEAKS, HELIUM SYSTEM LEAKS, OR TANK FAILURES THAT RESULT IN A PROPELLANT CRITICAL MISSION
 2. MECO UNDERSPEED THAT RESULTS IN AN INABILITY TO SUPPORT A FIRST DAY PLS DEORBIT
 3. AUTOMATIC TRANSITION TO MM 104 UNSUCCESSFUL @[032807-8394A]
- B. THE +X TRANSLATION MAY BE PERFORMED AFTER A DELAYED ET SEPARATION, PROVIDED THAT THE MPS DUMP IS COMPLETE OR HAS BEEN DELAYED UNTIL AFTER THE +X MANEUVER.
- C. THE CREW HANDHELD ET PHOTOGRAPHY PITCH MANEUVER WILL BE NO-GO FOR THE FOLLOWING:
1. NO +X TRANSLATION MANEUVER PERFORMED, UNLESS PITCH MANEUVER IS DELAYED AT LEAST 30 SECONDS FROM MPS DUMP START
 2. FAILURES THAT RESULT IN A PROPELLANT CRITICAL MISSION:
 - a. LOSS OF AN OMS ENGINE
 - b. MECO UNDERSPEED GREATER THAN UNDERSPEED RECOVERY CAPABILITY
 - c. UNPLANNED PRE-MECO OMS DUMP
 - d. PROPELLANT SYSTEM LEAKS/FAILURES THAT CREATE A PROPELLANT CRITICAL MISSION @[032807-8394A]
 3. BFS ENGAGED

THIS RULE CONTINUED ON NEXT PAGE

FLIGHT RULES**A2-68****ET PHOTOGRAPHY (CONTINUED)**

4. ET IN DARKNESS AT PHOTOGRAPHY TIME @[102506-7829]
5. AUTOMATIC TRANSITION TO MM 104 UNSUCCESSFUL @[032807-8394A]

There are two methods of photographing the External Tank. Method 1 utilizes automatic cameras in the ET umbilical wells of the orbiter and requires an 11-second +X translation immediately following the -Z separation burn. The +X maneuver requires about 120 pounds of RCS propellant. This propellant goes directly in-plane and is an aid to achieving the proper orbit for rendezvous flights, so it is not an impact to perform this translation maneuver for such missions. Method 2 utilizes crew handheld cameras and requires an orbiter pitch maneuver using moments provided by the MPS dump. Method 2, if not performed via the MPS dump, requires an additional 70 pounds of aft and 30 pounds of forward RCS propellant. Method 1 is considered primary and Method 2 is considered secondary for obtaining engineering analysis photography of the ET. Method 1 provides the highest resolution photographs of the ET. These priorities are reflected in the constraints of this rule. @[102506-7829]

ET photography is typically scheduled on all flights where at least part of the launch period allows orbital daylight for the photography. Umbilical photography can be performed without regard for orbital daylight because RCS jet firings during the ET sep translation/attitude hold may provide some illumination of the ET. Additionally, external light sources located in the umbilical well are being pursued to augment the photography. ET crew handheld photography in orbital darkness is not useful and therefore will not be performed. If lighting changes during the launch period, ET photography can be planned, trained, and then executed as required on the given launch day, given the specific lighting conditions. @[032807-8394A]

+X Translation Constraints:

Significant failures in the OMS and RCS systems (propellant or helium leaks or tank failures) result in a loss of delta-V capability, and the ET photography propellant may be needed to accomplish flight-critical maneuvers (e.g., OMS-1, deorbit) or for entry control. Each failure will be assessed independently, but in general, failures which severely impact OMS or RCS capabilities will be cause to NO-GO both photography methods so that a safe orbit may still be achieved. Consideration will be given to performing the +X translation maneuver if the failure does not result in a propellant critical mission.

THIS RULE CONTINUED ON NEXT PAGE

FLIGHT RULES

A2-68

ET PHOTOGRAPHY (CONTINUED)

Certain MECO underspeed/OMS remaining combinations result in an AOA shallow. For these cases, we are propellant critical and an uncertified abort is required. Therefore, it is not prudent to perform the +X translation in these cases. For the loss of comm case, the crew uses an HA cue for GO/NO-GO status on the +X. To be conservative, the HA will be based on the design MECO underspeed. Assuming a full ATO dump, if the underspeed is greater than the design MECO underspeed, the result would be an AOA shallow. If time allows, the ground can make the call based on the underspeed/OMS remaining resulting in an ATO/Min Hp or greater orbit.

An orbiter Z translation rate of -4 fps triggers automatic transition to Major Mode 104. Without this separation rate, sufficient ET/orbiter range for +X translation execution cannot be guaranteed. ©[032807-8394A]

For the case of a delayed ET separation (i.e., time to recover separation jets) or MPS feedline disconnect fail, it is acceptable to perform the +X translation and pitch maneuver. However, it is prudent to wait until the MPS dump is complete prior to initiating the +X maneuver or keep the dump inhibited until after the +X has been performed. If the pitch maneuver is to be performed, then a minimum of 1:40 minutes after ET separation is required to provide enough separation distance between the orbiter and ET prior to initiation of the MPS dump and corresponding pitch maneuver. ©[102506-7829]

Pitch-Maneuver Constraints: ©[102506-7829]

Not performing the +X maneuver results in the relative distance between the orbiter and ET decreasing from 688 feet to 461 feet. By delaying the pitch maneuver for at least 30 seconds after MPS dump start, the relative distance between the orbiter and ET at pitch maneuver initiation is increased to 610 ft. The pitch maneuver must be delayed by 30 seconds since a dispersed relative motion analysis of the ET and orbiter relative motion has not been performed. ©[032807-8394A]

The propellant used for the pitch maneuver does not benefit the rendezvous like the +X maneuver does. By not performing the pitch maneuver, approximately 10 fps delta V from the MPS dump can be utilized in plane and posigrade. For propellant critical missions resulting from loss of a single OMS, underspeeds that impact rendezvous capability, unplanned OMS dump, or loss of vernier attitude control for certain missions, it is prudent to utilize this propellant to protect for the rendezvous.

Loss of a single OMS engine results in having to redline propellant for a RCS steep deorbit. This could result in a propellant critical mission and, thus, it is prudent to not perform the pitch maneuver and save the corresponding delta V.

THIS RULE CONTINUED ON NEXT PAGE

FLIGHT RULES

A2-68**ET PHOTOGRAPHY (CONTINUED)**

MECO underspeeds will be evaluated against the mission specific underspeed recovery capability to determine whether the pitch maneuver can be performed. This underspeed capability is computed using the mission specific prop priority table and protects for the nominal rendezvous profile, including three sigma dispersions, the rendezvous pitch maneuver, nominal undock and separation, and 2-2-2 deorbit costs. This value will be computed for both verns failed and verns available in order to assess whether the pitch maneuver should be performed if it is known that the vernier jets are failed post MECO.

An unplanned pre-MECO OMS dump results in loss of budgeted propellant and may result in a propellant critical mission. It is, therefore, prudent not to perform the pitch maneuver and save the corresponding delta velocity.

Significant failures in the OMS and RCS systems (propellant or helium leaks or tank failures) result in a loss of delta-V capability, and the ET photography propellant may be needed to accomplish flight-critical maneuvers (e.g., OMS-I, deorbit) or for entry control. Each failure will be assessed independently, but in general, failures which severely impact OMS or RCS capabilities will be cause to NO-GO both photography methods so that a safe orbit may still be achieved. ©[032807-8394A]

If the BFS were engaged prior to the pitch maneuver being performed, there are two reasons to delete the pitch maneuver. The first is that the BFS DAP will not allow the pitch to be performed via the MPS dump as it does not support a single axis in "free drift." The second is that the mission will more than likely become propellant critical at this point as the post insertion timeline on the BFS will have significantly greater propellant consumption until the PASS is recovered. ©[072398-6530] ©[102506-7829]

An orbiter Z translation rate of -4 fps triggers automatic transition to Major Mode 104. Without this separation rate, sufficient ET/orbiter range for the pitch maneuver cannot be guaranteed. ©[032807-8394A]

FLIGHT RULES

A2-69

REGAIN RCS JETS FOR RTLS ET SEPARATION

DURING RTLS, FOR THE LOSS OF MORE THAN ONE RCS JET USED FOR MATED COAST RATE DAMPING, ET SEPARATION, OR ATTITUDE CONTROL THROUGH THE ALPHA RECOVERY PHASE, RECOVERY WILL BE ATTEMPTED IF THE FAILURE IS DUE TO DPS FAILURES OR LOSS OF RCS RM. RESTRINGING WILL BE PERFORMED POST-MECO/PRE-ET SEP PER RULE {A2-63}, ASCENT STRING REASSIGNMENT. ALL OTHER ACTIONS WILL BE ACCOMPLISHED ASAP (PREFERABLY PRE-MECO).

Recent aerodynamic studies show that early RCS jet aerodynamic models were incomplete with respect to jet failure effects for RTLS ET separation. With worst case aero assumptions and generic mass properties, a successful RTLS ET separation can be accomplished with little more than 1-sigma aero variations, and in that case large attitude errors will be incurred. It is nearly certain that the crew would engage the BFS if large attitude errors occurred in a dynamic time frame.

While either dynamic restringing or the use of RCS jets without redundancy management automatic deselection is subject to certain risks, the probabilities have been judged to be much less likely than the 1-sigma aero variations that are described above. Additionally, BFS engage at ET separation with strings down in the PASS has been documented by several BFS DR's that lead to catastrophic failure.

Therefore, the lowest risk option when multiple RCS jets are lost prior to ET separation on an RTLS is to perform the actions required to regain (or prevent loss of) the jets required for attitude control in the dynamic phases. The jets involved are the down, part of the up, and all of the left and right firing jets (loss of +X, -X, and +Z forward jets is no impact). Actions would include: reselecting jets that have been erroneously deselected for loss of instrumentation (oxidizer or fuel injector temperature, chamber pressure, manifold valved discrettes); or inhibiting RM from deselection in the future; or flight-critical string port mode; or dynamic restring. All actions except restring would be performed ASAP. Restring would be performed immediately post-MECO/pre-ET sep as described in Rule {A2-63B}.1, ASCENT STRING REASSIGNMENT. Rule {A8-55}, ASCENT/ENTRY RCS CONTROL REQUIREMENTS [HC], should be understood to protect only 1-sigma aero variations for RTLS abort ET separation conditions. This rule defines what action will be taken operationally to improve protection for aero variations. ©[042904-6239A]

Only appropriate actions will be taken, e.g., restring is only to be used in the cases where it will restore the jets (GPC failure, GPC port failure).

There are other situations (i.e., MDM total failure, RJD half-box failure, manifold leaks, etc.) that cannot be solved by any of these options. Reference Rules {A2-63}, ASCENT STRING REASSIGNMENT, and {A8-55}, ASCENT/ENTRY RCS CONTROL REQUIREMENTS [HC], and Ascent/Entry Flight Techniques Panel #196, December 17, 2003. ©[042904-6239A]

FLIGHT RULES

A2-70

DELAYED TRANSATLANTIC LANDING (TAL) ABORT

IN THE WINDOW BETWEEN TWO-ENGINE TAL PLUS 10 SECONDS AND PRESS-TO-ABORT TO ORBIT (ATO) FOR 51.6 DEGREE INCLINATION MISSIONS, THE SELECTION OF THE TAL ABORT MAY BE DELAYED. THIS DELAY WILL MAXIMIZE EAST COAST ABORT LANDING (ECAL) ABORT COVERAGE WHILE PRESERVING INTACT TAL ABORT MARGIN. THE FOLLOWING GROUND RULES SHALL APPLY TO THE EXECUTION OF A DELAYED TAL ABORT: @[092602-5667A]

- A. PRIOR TO ABORTING TAL, A MANUAL OMS DUMP WILL BE INITIATED THROUGH A CREW ITEM ENTRY.
- B. THE TAL ABORT SHALL BE SELECTED NO LATER THAN THE 3-SIGMA MAIN PROPULSION SYSTEM (MPS) FLIGHT PERFORMANCE RESERVE (FPR) PERFORMANCE BOUNDARY OR THE SINGLE-ENGINE OPS 3 BOUNDARY (REF. RULE {A4-56G}, PERFORMANCE BOUNDARIES), WHICHEVER COMES FIRST.
- C. DELAYING THE SELECTION OF THE TAL ABORT SHALL NOT APPLY FOR THE FOLLOWING SCENARIOS:
 1. LOSS OF COMMUNICATION
 2. SIGNIFICANT UNCERTAINTY EXISTS IN THE 3-SIGMA MPS FPR PERFORMANCE BOUNDARY.

In accordance with feasibility studies and risk trade assessments brought to the Ascent/Entry Flight Techniques Panel and the Space Shuttle Program Office, delayed TAL shall be implemented on all ISS missions starting with STS-110. The delayed TAL trajectory results in a groundtrack that is closer to the Eastern coast of the United States than if the TAL abort had not been delayed. The benefits of a delayed TAL trajectory include increased ECAL landing opportunities and improved bailout survival/recovery probabilities while maintaining intact TAL performance margins to no less than a 3-sigma confidence level. These benefits come at the expense of delayed single-engine performance boundaries and an extended Space Shuttle Main Engine (SSME) run time that vary as a function of the TAL delay time.

An ITEM 9 OMS propellant dump will be initiated prior to the TAL abort to improve intact TAL performance margins during the TAL delay period. The ECAL trajectory will also benefit from an early ITEM 9 OMS propellant dump because of an overall reduction in orbiter weight that should improve safety margins with respect to External Tank (ET) separation dynamics and overall orbiter load factors.
@[092602-5667A]

THIS RULE CONTINUED ON NEXT PAGE

FLIGHT RULES

A2-70

DELAYED TRANSATLANTIC LANDING (TAL) ABORT (CONTINUED)

The TAL abort shall be initiated at the earlier of the 3-sigma MPS FPR performance boundary for the prime TAL site or the single-engine OPS 3 performance boundary. It is expected for early engine-out cases close to the two-engine TAL performance boundary that TAL aborts will be initiated based on the 3-sigma MPS FPR performance boundary. Later engine-out cases and cases that implement an early ITEM 9 OMS propellant dump are likely to initiate TAL aborts based on the single-engine OPS-3 boundary. ©[092602-5667A]

As discussed with the Flight Director Office and the Space Shuttle Program Office, TAL delay will not be implemented during loss of communication situations, since the crew may not be aware of ground-determined performance boundaries used to terminate the TAL delay. More specifically, if there is no comm at the time of the SSME failure, the crew will follow the normal no-comm mode boundaries and abort as required. For all other cases, if comm is subsequently lost, then the crew will abort TAL at the no comm V_i per the MCC Delayed TAL abort call. Also, TAL delay will not be implemented for any scenario that results in a significant uncertainty in the real-time determination of the 3-sigma MPS FPR performance boundary in the ground Abort Region Determination (ARD) processor. In this instance, where significant uncertainty exists, it is conservative to abort TAL prior to the 3-sigma MPS FPR boundary to ensure adequate performance margin in support of the intact TAL trajectory. ©[092602-5667A]

Rules {A5-155}, LIMIT SHUTDOWN CONTROL, MANUAL THROTTLING, AND MANUAL SHUTDOWN FOR LOW LH2 NPSP [CIL] [HC], and {A5-156}, ABORT PREFERENCE FOR SYSTEMS FAILURES [HC], reference this rule. ©[032807-8395B] ©[032807-8399B]

A2-71 THROUGH A2-100 RULES ARE RESERVED

FLIGHT RULES

ORBIT

A2-101

VEHICLE SYSTEMS REDUNDANCY DEFINITIONS

- A. TWO-FAULT TOLERANT (FAIL OPERATIONAL/FAIL SAFE) - THE CONDITION OF AN ORBITER SYSTEM WHERE IT IS FULLY CAPABLE OF PERFORMING ITS CRITICAL FUNCTIONS WITH THE ABILITY TO SUSTAIN ANY TWO FAILURES (WITHIN THE SYSTEM) AND STILL HAVE THE CAPABILITY TO SAFELY DEORBIT AND LAND THE ORBITER. @[101796-4561A]
- B. ONE-FAULT TOLERANT (FAIL SAFE) - THE CONDITION OF AN ORBITER SYSTEM WHERE IT IS FULLY CAPABLE OF PERFORMING ITS CRITICAL FUNCTIONS WITH THE ABILITY TO SUSTAIN ANY ONE FAILURE AND STILL HAVE THE CAPABILITY TO SAFELY DEORBIT AND LAND THE ORBITER.
- C. ZERO-FAULT TOLERANT (FAIL CRITICAL) - THE CONDITION OF AN ORBITER SYSTEM WHERE THE SYSTEM IS FULLY CAPABLE OF PERFORMING ITS CRITICAL FUNCTIONS BUT IS UNABLE TO SUSTAIN ONE OR MORE ADDITIONAL FAILURES AND STILL HAVE THE CAPABILITY TO SAFELY DEORBIT AND LAND THE ORBITER.
- D. UNFLYABLE - A SYSTEM CONDITION WHERE THE ORBITER IS INCAPABLE OF PERFORMING A SUCCESSFUL ENTRY AND LANDING. @[101796-4561A]

FLIGHT RULES

A2-102

MISSION DURATION REQUIREMENTS

THE FOLLOWING CRITERIA WILL APPLY TO PERMISSION AND REAL-TIME MISSION DURATION DECISIONS:

- A. NOMINAL EOM LANDING WILL OCCUR NO EARLIER THAN THE BEGINNING OF THE FIFTH DAY OF FLIGHT (APPROXIMATELY 96 HOURS) . @[101796-4561A]

To aid in postmission orbiter turnaround planning in support of the number of shuttle flights possible in a year, it was necessary to define the constraints for a nominal mission. For a nominal mission, the minimum duration is designed to ensure a high probability of having a healthy crew for entry and landing, such that an EOM landing would not be attempted or planned prior to FD5. This provides a reasonable amount of exposure of the crew to zero-g for SAS conditioning.

- B. THE FLIGHT WILL NORMALLY CONTINUE TO NOMINAL END OF MISSION (NEOM) FOR THE FIRST FAILURE WHICH IMPACTS AN ENTRY-CRITICAL SYSTEM. IF THE SYSTEM IS NO LONGER FAIL-SAFE, A THOROUGH TECHNICAL REVIEW OF THE FAILURE MODE AND REMAINING SYSTEMS CAPABILITY WILL BE CONDUCTED TO DETERMINE WHETHER NEOM IS APPROPRIATE . @[101796-4561A]

IF THIS ASSESSMENT DETERMINES THAT A GENERIC FAILURE OR GENERIC GROUND PROCESSING PROBLEM HAS OCCURRED AND MAY AFFECT THE REMAINING SYSTEMS, TERMINATE THE FLIGHT PLS.

A single failure in any system which leaves that system with single-fault tolerance is an acceptable configuration to continue to NEOM. For single failures that result in less than fail-safe redundancy, a real-time assessment of the failure mode, remaining systems' capability, health, history, and redundancy will be completed to exonerate generic failures, common ground processing errors, etc. The APU/hydraulic system is not fail safe after the loss of one system since the orbiter is not certified for single APU operations. After the first failure, the IMU and FCS are fail safe with the exception of certain "smart failures" to occur during a certain timeframe during entry. For the IMU, FCS channel, or associated MDM, the risk will be re-assessed based on the latest run-time and failure history.

THIS RULE CONTINUED ON NEXT PAGE

FLIGHT RULES**A2-102****MISSION DURATION REQUIREMENTS (CONTINUED)**

A risk assessment of the IMU, FCS, APU/hydraulic system, and MDM was completed by the AEFTP in 1996 (reference AEFTP #131 and 6/96 AEFTP splinter meeting). This assessment was quantitative for those items which have a sufficient statistical failure database, but relied on engineering judgment for other items. This assessment concluded that the relative risk of remaining on-orbit to NEOM rather than returning MDF for the first failure in these systems is less than the launch risks and orbital debris risks. This risk is acceptable as long as the remaining systems are good and generic problems are exonerated.

The following should be considered when making a flight determination decision: crew and vehicle health, vehicle mass properties, weather, trajectory, and landing site.

Reference Rule {A2-1001}, ORBITER SYSTEMS GO/NO-GO, for the number of failures in each system which result in early mission termination. Reference Rules {A2-207}, LANDING SITE SELECTION; {A10-21A}, LOSS OF APU/HYDRAULIC SYSTEM(S) ACTIONS; and {A10-23A}, APU ENTRY START TIME. @[101796-4561A] @[ED]

C. FOR A SECOND FAILURE AFFECTING ANY ENTRY-CRITICAL SYSTEM
@[101796-4561A]

1. TERMINATE THE FLIGHT NEXT PLS IF THE AFFECTED SYSTEM HAS LOST ALL FAULT TOLERANCE OR IF THE FAILURE IS CONSIDERED TO BE GENERIC.
2. CONTINUE THE FLIGHT TO MDF IF THE ORBITER IS ONLY SINGLE-FAULT TOLERANT IN ORDER TO ACCOMPLISH DEPLOYMENT OF A PRIMARY PAYLOAD AND TO ENSURE CREW ADAPTATION, BOTH OF WHICH REDUCES THE OVERALL RISK TO THE CREW AND ORBITER.

NOTE: AN MDF WILL LAST APPROXIMATELY 72 HOURS AND LANDING WILL OCCUR AT THE PLS PRIOR TO THE END OF THE FLIGHT DAY 4.

Multiple failures in an entry critical system, even though it remains single-fault tolerant, may be indicative of a generic failure; Exposure to additional failures should be minimized by early termination of the mission.

THIS RULE CONTINUED ON NEXT PAGE

FLIGHT RULES

A2-102

MISSION DURATION REQUIREMENTS (CONTINUED)

D. MDF GENERIC PAYLOAD RULES

1. THE DEORBIT OPPORTUNITY WILL NOT BE DELAYED FOR THE PURPOSE OF ACCOMPLISHING PAYLOAD OBJECTIVES.
2. FIRST PRIORITY WILL BE THE ACCOMPLISHMENT OF THE MINIMUM MISSION-SUCCESS OBJECTIVES OF THE PRIMARY PAYLOAD(S).
3. LOWER PRIORITY MISSION OBJECTIVES WILL BE CONSIDERED IN THE PRIORITY ORDER AS STATED FOR A NOMINAL MISSION.
@[101796-4561A]
4. SIGNIFICANT CONTINGENCY OPERATIONS, E.G., AN UNSCHEDULED EVA OR A CONTINGENCY RENDEZVOUS, WILL BE UNDERTAKEN ONLY IF ALL THE FOLLOWING ARE MET: @[101796-4561A]
 - a. IT IS NEEDED TO ACCOMPLISH A MINIMUM MISSION-SUCCESS OBJECTIVE FOR A PRIMARY PAYLOAD.
 - b. THE OPERATION WOULD NOT RESULT IN AN IMPACT TO THE MINIMUM MISSION SUCCESS OF ANOTHER PRIMARY PAYLOAD.
 - c. RULE {A13-101}, SCHEDULED AND UNSCHEDULED EVA CONSTRAINTS, IS SATISFIED.

THIS RULE CONTINUED ON NEXT PAGE

FLIGHT RULES

A2-102

MISSION DURATION REQUIREMENTS (CONTINUED)

- E. A NEXT PLS DEORBIT WILL BE EXECUTED AT THE EARLIEST PRACTICAL TIME TO A CONUS LANDING SITE FOR FAILURES WHICH PLACE THE ORBITER SYSTEM AT THE ZERO-FAULT TOLERANT LEVEL OR RESULT IN A CONDITION WHERE ONE MORE FAILURE CAUSES A SEVERE ORBITER CONFIGURATION MANAGEMENT CONDITION. CONUS LANDING SITE SELECTION SHALL PROVIDE FOR:
1. LANDING SITE PRIORITY (REF. RULE {A2-207}, LANDING SITE SELECTION)
 - a. PLS
 - b. SLS
 - c. ANY CONUS SITE
 2. EOM LANDING CONSTRAINTS (CROSSRANGE, LIGHTING, WEATHER, AND BACKUP OPPORTUNITIES)
 3. CREW SCHEDULE CONSTRAINTS
 4. A NOMINAL DEORBIT PREPARATION TIMELINE IF POSSIBLE; OTHERWISE, A MINIMUM OF 3.5 HOURS DEORBIT PREPARATION
@[101796-4561A]

THIS RULE CONTINUED ON NEXT PAGE

FLIGHT RULES

A2-102

MISSION DURATION REQUIREMENTS (CONTINUED)

F. IF A FAILURE OCCURS THAT WOULD NORMALLY CAUSE AN MDF BUT THE TIME OF FAILURE IS PAST 72 HOURS FLIGHT DURATION, A LANDING WILL BE ACCOMPLISHED AT THE NEXT PLS OPPORTUNITY THAT PROVIDES ADEQUATE TIME FOR THE NORMAL EOM TIMELINE FOR VEHICLE STOWAGE AND ENTRY PREPARATION. @[101796-4561A]

Since a failure that would cause declaration of an MDF is a reason to shorten a normal flight, further operations of a payload/experiment are not sufficient reason to continue. The flight would be terminated at the next PLS that affords time to accomplish adequate stowage for entry and also allow the crew to have a sufficient sleep period.

G. FOR SOME FAILURE SITUATIONS AND/OR VIOLATION OF GO/NO-GO CRITERIA FOR FLIGHT CONTINUATION, IT IS SAFER TO REMAIN IN ORBIT INSTEAD OF ENTERING AT THE NEXT LANDING OPPORTUNITY. THAT IS, IF THE ADDITIONAL TIME CAN BE USED TO:

1. BETTER UNDERSTAND THE FAILURE AND ITS IMPLICATION ON ENTRY
2. VERIFY SYSTEMS CONFIGURATION PROCEDURES AND PERFORMANCE PRIOR TO ENTRY
3. PROVIDE ADEQUATE TIME FOR CREW REST THE NIGHT BEFORE ENTRY
4. PROVIDE THE OPPORTUNITY TO ACCOMPLISH ACTIVITIES THAT COULD ENHANCE ORBITER ENTRY/LANDING CONDITIONS @[101796-4561A]

Rules {A2-202}, EXTENSION DAY GUIDELINES; {A7-1001}, DPS GO/NO-GO MATRIX; {A8-4B}, FAULT TOLERANT PHILOSOPHY; {A8-1001}, GNC GO/NO-GO CRITERIA; {A9-1001}, ELECTRICAL GO/NO-GO CRITERIA [HC]; and {A18-59}, SUPPLY WATER REDLINE/MANAGEMENT, reference this rule. @[ED]

FLIGHT RULES

A2-103

EXTENSION DAY REQUIREMENTS

A. ALL STS FLIGHTS ARE REQUIRED TO HAVE 2 EXTENSION DAYS. EXTENSION DAYS WILL BE UTILIZED AS FOLLOWS:

1. ONE OF THE 2 EXTENSION DAYS IS UTILIZED PRIMARILY FOR ACHIEVING ACCEPTABLE LANDING WEATHER CONDITIONS (REF. RULES {A2-6}, LANDING SITE WEATHER CRITERIA [HC]; {A4-107A}.3, PLS/EOM LANDING OPPORTUNITY REQUIREMENTS; AND {A4-111}, RUNWAY ACCEPTABILITY CONDITIONS). ©[111094-1622B]

An extension day must be allocated in orbiter resources to allow for improvement in weather conditions forecast at the PLS. A 1-day extension on orbit is preferred to preclude loss of postflight payload samples/data and to maintain full postlanding ground processing support at the PLS.

2. THE OTHER EXTENSION DAY (DEORBIT WAVE-OFF) IS UTILIZED FOR AN ORBITER SYSTEMS CONTINGENCY WAVE-OFF.

A second extension day must be allocated to allow for orbiter system problems which cause an unsafe or compromised configuration for entry. The 1-day wave-off (which includes a deorbit preparation) allows time to understand a problem or to arrive at the best entry configuration.

B. REAL-TIME CONSIDERATIONS TO EXTEND THE FLIGHT FOR ADDITIONAL PAYLOAD OPERATIONS MUST INCLUDE 2 EXTENSION DAY CAPABILITY.

The orbiter should not be exposed to unsafe/compromised entry conditions to further payload data return

THIS RULE CONTINUED ON NEXT PAGE

FLIGHT RULES

A2-103

EXTENSION DAY REQUIREMENTS (CONTINUED)

- C. IF ORBITER SYSTEMS CONFIGURATION MEETS EOM CRITERIA, THEN IN ORDER TO PROTECT FOR AN UNSCHEDULED EVA: @[090894-1670B]
1. PAYLOAD OR STS ARTICLES WHICH HAVE DEMONSTRATED STOW REDUNDANCY AND MUST BE MECHANICALLY SECURED FOR A SAFE ENTRY/LANDING WILL BE ALLOWED TO OPERATE UNSECURED UNTIL:
 - a. THE BEGINNING OF THE LAST NON-ENTRY CREW WORKSHIFT PRIOR TO ENTRY FOR CREW DUAL WORKSHIFT (24-HOUR CYCLE) FLIGHTS.
 - b. THE BEGINNING OF PRESLEEP ON THE SLEEP SHIFT PRIOR TO DEORBIT DAY FOR CREW SINGLE WORKSHIFT FLIGHTS (APPROXIMATELY TIG - 19 HOURS).
 2. ARTICLES WHICH HAVE NOT DEMONSTRATED STOW REDUNDANCY WILL BE STOWED AT LEAST 1 DAY EARLIER THAN THE TIMES DEFINED IN PARAGRAPH C.1 IN ORDER TO SUPPORT A LANDING ON THE NOMINAL EOM NO LATER THAN THE BEGINNING OF THE CREW WORKDAY PRIOR TO ENTRY.
 3. (FLIGHT SPECIFIC EXCEPTION) EXCEPTIONS TO THESE TIMELINES, IN ORDER TO ACHIEVE MANDATORY PAYLOAD MISSION OBJECTIVES, MUST BE JUSTIFIED IN THE FLIGHT SPECIFIC ANNEX. @[090894-1670B]

If the orbiter systems meet EOM criteria, it is an acceptable risk to allow a payload to operate late in flight which may require an unscheduled EVA to occur on nominal EOM day to safe that payload for entry. For this case, a landing would occur on the first extension day. If, however, a payload or STS article has had a failure in one of its redundant stow or jettison systems, then it must be mechanically secured on the morning of EOM-1 to allow for the potential of an unscheduled EVA on the end of that day to secure the article. A nominal deploy (release) of a drive mechanism which uses a different actuator/motors/motor windings to deploy and stow (or release/latch) does not verify the integrity of the drive mechanism's stow (latch) capability. Therefore, allowing operation of this type of system late in flight is not warranted.

THIS RULE CONTINUED ON NEXT PAGE

FLIGHT RULES

A2-103

EXTENSION DAY REQUIREMENTS (CONTINUED)

For dual-crew workshift flights, allowing a payload or STS article to operate unsecured until the beginning of the last non-entry team work shift (approximately deorbit TIG-12 hours). This usually allows for sufficient time to begin work on an unscheduled EOM day EVA, with entry occurring on the first extension day. The specific timeline invoked, however, should consider the number of articles to be secured, the time required for the EVA task(s), crew sleep shifting, and assignment of EVA/IVA crews. A 14.7 psi protocol is normally used, and the total EVA task time requires about 12 hours (for a 2-hour EVA, with equipment checks and post-EVA activities). ©[090894-1670B]

On single-crew workshift flights, EVA work to secure an unsafe payload or STS article must begin prior to the last sleep period. EVA would occur on nominal EOM with entry on the first extension day. A 10.2 psi cabin is usually established for 12 hours in support of approximately 9 hours of EVA related tasks (from equipment checks to post-EVA, including a 2-hour EVA). Delaying article stowage until the morning of entry and performing a 14.7 psi EVA may also be possible if required; but this timeline is not the preferred.

Reference Rule {A2-104A.9}, SYSTEMS REDUNDANCY REQUIREMENTS.

Rules {A10-301C}, ANTENNA STOW REQUIREMENT [HC] [CIL], and {A12-4}, RMS ACTIVITY TERMINATION, reference this rule. ©[090894-1670B] ©[090999-6930] ©[042904-6240A]

- D. IF, AT THE BEGINNING OF THE CREW WORKDAY PRIOR TO ENTRY, THE FORECAST FOR THE WEATHER CRITERIA ELEMENTS IN RULE {A2-6}, LANDING SITE WEATHER CRITERIA [HC], VIOLATES THE LIMITS AT EOM PLUS 1 DAY FOR THE PRIME AND SECONDARY LANDING SITES, THEN ALL ARTICLES WHICH MUST BE MECHANICALLY SECURED FOR A SAFE ENTRY/LANDING, WILL BE SECURED FOR THE REMAINDER OF THE FLIGHT. ©[090894-1670B] ©[111094-1622B]

Any forecast for weather criteria that violates the limits given in Rule {A2-6}, LANDING SITE WEATHER CRITERIA [HC], for the landing on EOM plus 1 day at the primary and secondary landing sites makes a potential EVA on EOM unacceptable. Since the EOM plus 1 day deorbit opportunity is not expected to be available, this rule ensures that an EVA to secure mechanical devices does not preclude using the nominal deorbit opportunity, leaving the orbiter with only the one chance to deorbit on EOM plus 2 days. Securing mechanical devices early allows a nominal deorbit with a short contingency EVA on the nominal EOM minus 1 day to secure devices that cannot be made safe for entry using nominal procedures.

THIS RULE CONTINUED ON NEXT PAGE

FLIGHT RULES

A2-103

EXTENSION DAY REQUIREMENTS (CONTINUED)

- E. THE KU-BAND DEPLOYED ASSEMBLY WILL BE STOWED, AND/OR THE MPM'S AND MRL'S WILL BE STOWED AND LATCHED, AS SOON AS PRACTICAL IF SYSTEMS FAILURES HAVE RESULTED IN LOSS OF STOW/LATCH REDUNDANCY. @[090894-1670B]
1. STOW/LATCH OPERATIONS MAY BE DELAYED IN ORDER TO COMPLETE MANDATORY MISSION OBJECTIVES (REF. RULE {A10-301A}, ANTENNA STOW REQUIREMENT [CIL], AND THE FLIGHT SPECIFIC ANNEX). @[090999-6930]
 2. ANY STOW/LATCH OPERATION DELAYS WILL PROTECT FOR AN EOM-1 DAY EVA.

The Ku-Band deployed assembly (antenna dish, gimbal motors, and deployed electronics), and/or the MPM's and MRL's (2 of 3), must be stowed/latched in order to close the Payload Bay Doors for entry. Without redundant stow/latch capability, this equipment is zero-fault tolerant to a jettison scenario. Therefore, if stow/latch redundancy is not available, these mechanisms should be secured as soon as possible in order to minimize the time of exposure to the next failure which would require a jettison.

The Ku-Band is essential in achieving high priority mission objectives during flights, such as for rendezvous operations or when payload data cannot be permanently stored on on-board media. Stowing the antenna immediately after stow redundancy has been lost would preclude downlinking this high priority payload data, and therefore, compromise mission success. Likewise, stowing/latching the MPM's/MRL's immediately after redundancy has been lost could also preclude mission success. For these flights, exceptions may be justified. However, because of the cost and difficulty in replacing these mechanisms, achieving even mandatory payload mission objectives does not warrant the risk of losing an antenna or Remote Manipulator System (RMS). Therefore, Ku-Band and MPM/MRL operations will be discontinued in time to protect for an EOM-1 day EVA. @[090894-1670B] @[090999-6930] @[ED]

Reference Rules {A10-301A}, ANTENNA STOW REQUIREMENT [HC] [CIL]; {A12-72A}, MPM DEPLOY/STOW CONSTRAINTS; and {A12-73}, MRL CONSTRAINTS. @[042904-6240A]

Rules {A6-303A}, OMS REDLINES [CIL]; and {A15-14C}, SCHEDULED AND UNSCHEDULED EVA CONSTRAINTS, reference this rule. @[051194-1612A]

FLIGHT RULES

A2-104

SYSTEMS REDUNDANCY REQUIREMENTS

A. SYSTEMS MANAGEMENT FOR MISSION DURATION

1. EVA WILL BE CONSIDERED AS A LEVEL OF REDUNDANCY FOR THE FOLLOWING ORBITER SYSTEMS FAILURES IN ORDER TO ACCOMPLISH:

- a. HIGH PRIORITY FLIGHT OBJECTIVES (AS DEFINED IN THE FLIGHT SPECIFIC ANNEX).

PAYLOAD DEPLOYMENT RETRIEVAL SYSTEM (PDRS) - END EFFECTOR (EE) RELEASE, MPM STOW, MRL LATCHES, SHOULDER BRACE RELEASE, AND RMS CRADLE (REF. RULE {A2-112C}, PDRS).

- b. MDF

PAYLOAD BAY DOOR (PLBD) - CLOSE DRIVE CAPABILITY DUE TO ELECTRICAL OR MECHANICAL FAILURE (REF. RULE {A10-209H}, PLBD RULE REFERENCE MATRIX). @[121296-3194B]

EVA capability is considered an acceptable backup to system redundancy for completion of high priority flight objectives in the following areas:

- a. *Crews are trained to EVA-release the end effector from a payload. This means that, if all capability to release a payload is lost except one, the activity will be continued relying on the EVA release, should the last remaining mode fail.*

EVA procedures also exist to overcome total electrical failure of the MPM's and MRL's and can back up system redundancy.

In all of the above cases, the orbiter is still fail safe as payload/RMS jettison capability is available should it be required before the EVA could be implemented to fix a problem.

- b. *EVA procedures and tools are available to protect against total failure of PLBD drive and can be used to back up system redundancy. An EVA for these tasks is protected against in all the consumable redlines. Reference Rule {A10-209H}, PLBD RULE REFERENCE MATRIX.*

@[121296-3194B]

THIS RULE CONTINUED ON NEXT PAGE

FLIGHT RULES

A2-104 SYSTEMS REDUNDANCY REQUIREMENTS (CONTINUED)

2. GPC REDUNDANCY REQUIREMENTS:

- a. CONTINUE TO END OF MISSION IF NO MORE THAN ONE GPC HAS FAILED. @[101096-4516]

This will allow a DPS configuration of at least one G2, one SM, a BFS, and one computer left to be configured as a redundant G2 or G3FD, depending on the flight requirements.

- b. MINIMUM DURATION FLIGHT CAN BE SUPPORTED IF NO MORE THAN TWO GPC'S HAVE FAILED. @[101096-4516]

The minimum GPC requirements to sustain orbit activities are a G2 GPC, an SM GPC, and a BFS GPC, i.e., three GPC's total. A subsequent GPC failure leaves only two GPC's, which would be used as a single PASS GPC and a BFS GPC for reentry. Because a BFS GPC is designed as a backup for a generic PASS software failure, a BFS GPC is always maintained as long as two good GPC's exist. The case of three remaining GPC's is considered a fail-safe case; i.e., with an additional failure, a PASS GPC is still available for vehicle control. Spare GPC usage (if manifested) is not considered for meeting requirements because of concerns about potential generic GPC failures that arise when two GPC's have failed. @[092195-1798] @[121296-3194B]

3. FOR FLIGHT-CRITICAL SYSTEM GENERIC FAILURES, TERMINATE THE FLIGHT AT THE NEXT PLS OPPORTUNITY.

If it is determined that there is a generic fault (i.e., two units fail with identical failure signatures) with a flight-critical system, then it is prudent to land at the next PLS opportunity in order to minimize exposure to subsequent failures.

4. OMS PROPELLANT IS NOT REQUIRED TO PROTECT ONE OMS-TO-RCS DOWNMODING IF BOTH OMS ENGINES ARE AVAILABLE. OMS PROPELLANT IS REQUIRED TO PROTECT DEORBIT TO OMS STEEP ENTRY TARGETS.

Protecting one OMS-to-RCS downmoding requires saving additional OMS propellant to compensate for the reduced engine efficiency of the RCS jets as compared to the OMS engines. Programmatic guidelines do not allow loading this additional propellant, so redlining this quantity may result in cancellation of planned on-orbit activities. With two good OMS engines, fail-safe redundancy for the deorbit burn is maintained without requiring RCS deorbit capability. Propellant required to deorbit to steep targets using the OMS engines will be protected.

THIS RULE CONTINUED ON NEXT PAGE

FLIGHT RULES

A2-104

SYSTEMS REDUNDANCY REQUIREMENTS (CONTINUED)

5. ELECTRICAL POWER REDUNDANCY:
 - a. THE FLIGHT WILL CONTINUE FOR A SINGLE FAILURE WHICH RESULTS IN LOSS OF ELECTRICAL POWER REDUNDANCY TO MULTIPLE ENTRY-CRITICAL LRU'S.
 - b. THE FLIGHT WILL BE TERMINATED NEXT PLS IF A SINGLE ELECTRICAL FAILURE IN CONJUNCTION WITH ANY OTHER EXISTING FAILURE WOULD RESULT IN AN UNFLYABLE CONDITION.
6. A NEXT PLS DEORBIT WILL BE EXECUTED FOR INSTRUMENTATION LOSSES WHICH PREVENT MONITORING OF CRITICALITY 1 FAILURES FOR WHICH THE PROGRAM RETENTION RATIONALE REQUIRES MONITORING.

The retention rationale for some criticality 1 failures is the ability to monitor that system and take action prior to a potentially catastrophic event. Therefore, loss of monitoring mandates termination of the flight at the next PLS because rationale for retention of a criticality 1 failure no longer exists.

7. ENTRY CONSUMABLES MUST BE PROTECTED AGAINST WORST CASE ENVIRONMENTAL AND AERODYNAMIC VARIATIONS.
8. ORBITER SYSTEMS TROUBLESHOOTING/IFM'S HAVE PRIORITY OVER PDRS AND PAYLOAD OPERATIONS IF CONFLICTS CANNOT BE AVOIDED (I.E., ACTIVITY SCHEDULING OR INTERRUPTION OF REQUIRED ORBITER SERVICES).

The prime objective on every flight is crew safety.

THIS RULE CONTINUED ON NEXT PAGE

FLIGHT RULES

A2-104

SYSTEMS REDUNDANCY REQUIREMENTS (CONTINUED)

9. STOW REDUNDANCY DEMONSTRATION: @[090894-1670B]
- a. A PAYLOAD OR STS ARTICLE THAT HAS DEPLOYED NOMINALLY ON DUAL MOTORS, AND HAS SUSTAINED NO MECHANICAL, COMMAND, OR ELECTRICAL FAILURES WHICH WOULD PRECLUDE DUAL MOTOR STOW, WILL BE ASSUMED TO HAVE DEMONSTRATED STOW REDUNDANCY.
 - b. STOW REDUNDANCY WILL STILL BE ASSUMED TO HAVE BEEN DEMONSTRATED WHERE A PROCEDURAL WORKAROUND IS AVAILABLE FOR ELECTRICAL/COMMAND PATH FAILURES THAT WOULD NORMALLY PRECLUDE DUAL MOTOR STOW OPERATIONS.

A nominal deploy (release) of a drive mechanism which uses the same actuator/motors/motor windings to deploy and stow (or release/latch) will verify the integrity of that drive mechanism's capability to stow (latch). Although drive mechanisms typically use different switch contacts, motor control assembly (MCA) relays, and electrical/command paths for deploy and stow (release/latch) operations, these unlike components are thoroughly tested during ground turnaround. And due to the nature of mechanical equipment, performing a nominal stow using these stow path components does not necessarily guarantee dual motor operation during the following stow sequence. Therefore, stow redundancy can be sufficiently demonstrated by verifying a nominal deploy, without the requirement to actually perform a stow operation. Failed-on microswitches, or other failure scenarios, which may be overcome by an SSR, malfunction, or IFM procedure (EVA procedures not included), do not actually inhibit dual motor stow capability. Therefore, these type failures will not be cause for early stowage of the affected drive mechanism, or for additional demonstration of stow redundancy.

Rule {A2-103C}, EXTENSION DAY REQUIREMENTS, references this rule. @[090894-1670B]

THIS RULE CONTINUED ON NEXT PAGE

FLIGHT RULES

A2-104 SYSTEMS REDUNDANCY REQUIREMENTS (CONTINUED)**B. PAYLOAD OPERATIONS**

ONCE THE DECISION HAS BEEN MADE FOR EARLY FLIGHT TERMINATION, PAYLOAD OPERATIONS MAY CONTINUE UNTIL DEORBIT MINUS 6 HOURS PROVIDED THAT THE OPERATIONS WOULD NOT JEOPARDIZE DEORBIT CAPABILITY. PAYLOAD OR SPACE SHUTTLE ARTICLES WHICH MUST BE MECHANICALLY SECURED FOR SAFE ENTRY/LANDING WILL BE SECURED PRIOR TO PRESLEEP ON DEORBIT MINUS 2 DAYS. IF STOW REDUNDANCY CAN BE DEMONSTRATED, OPERATIONS WILL BE ALLOWED TO CONTINUE UNTIL THE MORNING OF DEORBIT MINUS 1 DAY.

If a payload activity has no failure mode that could delay PLBD closing, there is no risk associated with allowing it to operate until deorbit minus 6 hours. If, however, the payload or space shuttle article must be mechanically or operationally secured prior to PLBD closure, then this operation should begin early enough to conduct an EVA (if required) without extending beyond the selected deorbit opportunity. This correlates to securing 2 days prior to deorbit which allows for an EVA on deorbit minus 1 day. If the potential of having to do an EVA has been significantly reduced (i.e., by demonstrating stow redundancy), then operation may continue until the morning of deorbit minus 1 day. Stowing in the morning will allow time for troubleshooting any unforeseen difficulties.

Rule {A9-4}, CAUTION AND WARNING (C&W), references this rule. ©[ED]

FLIGHT RULES

A2-105

IN-FLIGHT MAINTENANCE (IFM) [HC] @[121505-7133B]

A. DEFINITIONS:

1. SCHEDULED IN-FLIGHT MAINTENANCE (IFM) IS ACCOMPLISHED ON A PERIODIC (NOT NECESSARILY TIMELINED) BASIS TO KEEP EQUIPMENT OPERATIONAL AND EXTEND ITS LIFE. SCHEDULED IFM TASKS INCLUDE INSPECTION, CLEANING, AND REPLACING FILTERS AND CONSUMABLES. SPECIFICALLY EXCLUDED FROM THIS DEFINITION ARE REPAIR TYPE ACTIVITIES TO CORRECT OR WORK AROUND MALFUNCTIONS.

Examples of this type of maintenance are filter cleaning, LiOH canister replacement, and calibration of equipment.

2. UNSCHEDULED IFM IS UNDERTAKEN AS A RESULT OF ANOMALIES AND SPECIFICALLY INCLUDES TEST, MEASUREMENT, INSPECTION, AND REPAIR TYPE ACTIVITIES TO CORRECT OR WORK AROUND MALFUNCTIONS.

Definitions of categories of maintenance provide common terms for activities which may be constrained by flight rules. For example, scheduled maintenance is planned and approved preflight and usually accomplished without real-time consultation with the MCC-H. Unscheduled maintenance, which is conducted as a result of a hardware malfunction, is usually reviewed real time by the MCC-H whether or not it was preflight approved. This real-time review is conducted to determine orbiter/crew safety impacts.

THIS RULE CONTINUED ON NEXT PAGE

FLIGHT RULES

A2-105

IN-FLIGHT MAINTENANCE (IFM) [HC] (CONTINUED)

B. IMPLEMENTATION OF IFM

1. SCHEDULED IFM:

- a. IN GENERAL, SCHEDULED MAINTENANCE IS PERFORMED AS REQUIRED WITHOUT CONSULTING MCC. EXCEPTIONS TO THIS RULE MAY BE REQUIRED FOR EQUIPMENT WHICH CANNOT BE ISOLATED FROM THE ORBITER ELECTRICAL POWER SYSTEM, AIR REVITALIZATION SYSTEM, PRESSURE CONTROL SYSTEM, OR THERMAL SYSTEM. THOSE SCHEDULED IFM PROCEDURES WHICH REQUIRE MCC NOTIFICATION PRIOR TO IMPLEMENTATION WILL BE NOTED IN THE FLIGHT SPECIFIC FLIGHT RULE ANNEX.

Scheduled maintenance is usually considered a routine task. These procedures are reviewed preflight for impact on orbiter systems. In the interest of safety, some procedures may require MCC notification prior to implementation.

- b. SCHEDULED IFM PROCEDURES ON ORBITER HARDWARE WILL BE PERFORMED BY THE CDR, PLT, OR MISSION SPECIALISTS. PAYLOAD HARDWARE MAY BE MAINTAINED BY PAYLOAD SPECIALISTS.

CDR's, PLT's, and MS's undergo training specific to orbiter scheduled maintenance.

2. UNSCHEDULED IFM:

- a. UNSCHEDULED IFM PROCEDURES ON ORBITER HARDWARE WILL BE PERFORMED BY THE CDR, PLT, OR MISSION SPECIALISTS. REPAIR PROCEDURES ON PAYLOAD HARDWARE MAY BE PERFORMED BY PAYLOAD SPECIALISTS IF THE CDR/PLT OR MS IS COGNIZANT OF THIS ACTIVITY.

CDR's, PLT's, and MS's have an experience and training base to assess the overall impact of a repair procedure on hardware in general and the orbiter in particular.

THIS RULE CONTINUED ON NEXT PAGE

FLIGHT RULES

A2-105

IN-FLIGHT MAINTENANCE (IFM) [HC] (CONTINUED)

- b. UNSCHEDULED IFM PROCEDURES SHALL BE INITIATED ONLY WITH THE APPROVAL OF MCC-H. WHEN COMMUNICATION WITH THE MCC-H IS NOT POSSIBLE AND THE CDR DETERMINES THE SITUATION TO BE CRITICAL, REPAIR MAY BE PERFORMED TO ENSURE THE INTEGRITY OF THE ORBITER OR SAFETY OF THE CREW. SPECIFIC PAYLOAD REPAIR PROCEDURES MAY BE EXEMPTED FROM THIS RULE PREFLIGHT FOR EQUIPMENT ISOLATED FROM THE ORBITER ELECTRICAL POWER SYSTEM, AIR REVITALIZATION SYSTEM, PRESSURE CONTROL SYSTEM, OR THERMAL SYSTEM. THESE EXEMPTIONS WILL BE NOTED IN THE MISSION SPECIFIC FLIGHT RULES ANNEX.

Repair procedures are written preflight assuming particular hardware configurations, interrelationships, and sequences of hardware failures. In the interest of safety, the procedure is reviewed real time by the MCC-H to ensure that the assumptions under which it was written actually exist during on-orbit operations.

- c. UNSCHEDULED IFM PROCEDURES WILL BE PERFORMED ONLY IF ADEQUATE TECHNICAL DOCUMENTATION AND POSSIBLY REPRESENTATIVE HARDWARE ARE AVAILABLE. MCC-H WILL DETERMINE THE ADEQUACY OF THIS DOCUMENTATION/HARDWARE WHICH MAY INCLUDE, BUT IS NOT LIMITED TO, TECHNICAL DRAWINGS, FLIGHT LIKE HARDWARE, AND CLOSEOUT PHOTOS.

IFM procedures are always verified to the maximum extent possible. Past orbiter flight experience has shown that, when working to repair hardware, line drawings and specifications are not adequate to ensure that the final equipment closeout is known. On numerous occasions, preflight closeout photo documentation has revealed the presence of safety wire, ground straps, and other articles which could pose a hazard or cause permanent damage to the hardware. Closeout photos in the context of this rule include interior views of hardware taken during equipment fabrication/assembly as well as final module/pallet installation.

THIS RULE CONTINUED ON NEXT PAGE

FLIGHT RULES

A2-105

IN-FLIGHT MAINTENANCE (IFM) [HC] (CONTINUED)

3. GENERAL:

- a. WHEN MULTIPLE IFM'S ARE REQUIRED, THE FOLLOWING PRIORITY WILL BE USED IN THEIR IMPLEMENTATION. MISSION SPECIFIC EXCEPTIONS WILL BE NOTED IN THE FLIGHT RULE ANNEX.

(1) ORBITER SYSTEMS.

(2) SPACELAB SYSTEMS (WHEN APPLICABLE).

(3) EXPERIMENTS/PAYLOADS.

Self-explanatory

- b. AN IFM WILL BE PERFORMED ASAP TO REGAIN THE REDUNDANCY AND/OR CAPABILITY NECESSARY TO SATISFY THE GO/NO-GO REQUIREMENTS TO CONTINUE PAST THE NEXT PLS OPPORTUNITY. AN IFM TO ESTABLISH ORBITER FAIL-SAFE CAPABILITY WILL HAVE PRIORITY OVER ALL FLIGHT ACTIVITIES AND WILL BE PERFORMED ASAP. FOR EXISTING VALIDATED IFM REPAIR PROCEDURES, IF TIME DOES NOT PERMIT COMPLETION PRIOR TO THE NEXT PLS OPPORTUNITY, A "GO" WILL BE GIVEN ASSUMING A SUCCESSFUL COMPLETION (FOR REAL-TIME DEVELOPED IFM'S, CONSIDERATION WILL BE GIVEN TO DECLARING A "GO" PRIOR TO COMPLETION).

@[011801-3851]

There is a high level of confidence in existing, validated IFM's. Therefore, the orbiter will remain on orbit, assuming the IFM will be successful, rather than terminate the mission for lack of time to complete the IFM. The confidence level may not be as great for real-time developed IFM's; therefore, the GO to stay on orbit is not automatic, but instead, depends on the level of confidence in the procedure.

THIS RULE CONTINUED ON NEXT PAGE

FLIGHT RULES

A2-105

IN-FLIGHT MAINTENANCE (IFM) [HC] (CONTINUED)

- c. ON ENTRY DAY, PRIOR TO BEGINNING DEORBIT PREPARATION (DEORBIT TIG MINUS 4.0 HOURS), AN IFM WILL BE PERFORMED ONLY IF REQUIRED TO REGAIN THE REDUNDANCY AND/OR CAPABILITY NECESSARY TO SATISFY THE MINIMUM ENTRY REQUIREMENTS. AN IFM WILL NOT BE ATTEMPTED DURING DEORBIT PREPARATION EXCEPT FOR THE FOLLOWING SCENARIOS:
- (1) AN RHC OR DDU WILL BE REPLACED IF FAILURES IN THESE SYSTEMS RESULT IN THE LOSS OF TWO RHC CHANNELS PRIOR TO ENTERING OPS 3.
 - (2) ENTRY WILL BE DELAYED TO DO AVIONICS BAY FAN CHANGEOUT IF BOTH FANS HAVE FAILED IN AVIONICS BAYS 1 OR 2 AND A FAN CHANGEOUT MAY RECOVER COOLING IN THAT AVIONICS BAY. @[101096-4516]
 - (3) ENTRY WILL BE DELAYED IF IFM CAPABILITY EXISTS AND IS NEEDED TO MEET ENTRY VENT OPERATION CONSTRAINTS IN RULE {A10-261E}, VENT DOOR MANAGEMENT [HC]: @[102506-7825A]
 - (a) TO REGAIN REDUNDANCY FOR ZERO FAULT TOLERANCE, CONSIDERATION WILL BE GIVEN TO PERFORMING THE IFM IF THE FAILURE OCCURS ANY TIME PRIOR TO THE DEORBIT BURN.
 - (b) TO REGAIN CAPABILITY, THE IFM WILL BE PERFORMED IF THE FAILURE OCCURS AT ANY TIME PRIOR TO ACHIEVING SAFE HP.

IFM's require use of equipment and tools which are normally stowed. Their use affects the stowage timeline and other activities related to preparing the orbiter for entry.

To regain vent door redundancy, consideration will be given to performing an IFM when zero fault tolerant to the next worse failure. However, increasing this fault tolerance will be weighed against deorbit consumables (i.e., propellant, water, O₂, and N₂), available deorbit opportunities, and landing site weather. After the deorbit burn has been initiated, it is not warranted to stop the burn to regain fault tolerance.

Rationale for the remaining exceptions is contained under the appropriate system in paragraph C. @[102506-7825A]

THIS RULE CONTINUED ON NEXT PAGE

FLIGHT RULES

A2-105

IN-FLIGHT MAINTENANCE (IFM) [HC] (CONTINUED)

- d. IFM PROCEDURES ON EXPERIMENTS WITH TOXIC HAZARDS - NO IFM PROCEDURES WILL BE INITIATED ON AN EXPERIMENT KNOWN TO REPRESENT A TOXIC HAZARD WITHOUT MCC-H CONCURRENCE. PROTECTIVE EQUIPMENT MAY BE REQUIRED (REF. RULE {A13-155}, ORBITER HAZARDOUS SUBSTANCE SPILL RESPONSE). PAYLOAD EQUIPMENT THAT REPRESENTS A TOXIC HAZARD WILL BE IDENTIFIED IN THE FLIGHT RULE ANNEX.

A real-time assessment of the possibility of repairing and the risk of exposing the crew to a toxic substance during the repair will be required. The IFM may require that the cleanup equipment specified in Rule {A13-155}, ORBITER HAZARDOUS SUBSTANCE SPILL RESPONSE, be used to minimize risk of crew exposure to toxic substance.

C. SYSTEMS REPLACEMENT CRITERIA:

1. ANY MDU CAN BE REPLACED WITH ANY OTHER MDU. @[101096-4516] @[021397-4763] @[040899-2459B] @[121505-7133B]

Because of the large number of MDU's (11), an IFM to replace a failed aft MDU with a forward MDU may aid the crew in critical aft station operations (RNDZ, dock/undock) without losing any capability in the forward cockpit. Because of the simple and low risk MDU IFM (45 minutes), the MDU can be reinstalled in the forward cockpit after the critical aft operations.

2. A KEYBOARD (1 OR 2) WILL BE REPLACED WITH THE AFT KEYBOARD.

The same rationale is used for the keyboard 1 or 2 IFM as for CRT's and also satisfies the requirement for fail-safe redundancy in entry-critical LRU's.

3. A SPECIFIC KEY ON (KEYBOARD 1 OR 2) WILL BE REPLACED WITH THE "ACK" OR "MSG RST" KEY FROM THE AFT KEYBOARD. @[121505-7133B]

If a specific key in one of the forward keyboards is identified as failed, replacing that key with the ACK key from the aft keyboard can restore the keyboard to full operational status. Since the ACK key is only used to acknowledge fault messages by stopping them from flashing and turning off alarm tones, the aft keyboard may continue to be used even if the ACK key has been removed. As an alternative to the ACK key, the MSG RST key may be used. Forward keyboards are required for entry purposes, while no requirement exists for the aft keyboard. An IFM on a forward keyboard key will be done when required, while an IFM on an aft keyboard may be done.

THIS RULE CONTINUED ON NEXT PAGE

FLIGHT RULES

A2-105

IN-FLIGHT MAINTENANCE (IFM) [HC] (CONTINUED)

4. A DEU (1, 2, OR 3) WILL BE REPLACED WITH DEU 4.
@[121505-7133B]

IFM for DEU replacement rationale is the same as the CRT's except DEU 3, due to its location, is capable of being replaced whereas CRT 3 cannot. @[040899-2459B]

5. AN RHC (LEFT OR RIGHT) WILL BE REPLACED WITH THE AFT RHC IF MORE THAN ONE CHANNEL IS FAILED ON THE SAME CONTROLLER. @[101096-4516]

Although the loss of two RHC channels does not violate minimum entry requirements (system is still fail-safe), an RHC will be changed out to increase redundancy anytime prior to OPS 3 transition due to its criticality in the CSS/takeover role for entry/landing.

6. THE FORWARD THC WILL BE REPLACED WITH THE AFT THC.

An IFM to replace the forward THC with the aft THC is required to ensure at least fail-safe redundancy is available for manual translational control for the deorbit burn.

7. A DDU (LEFT OR RIGHT) WILL BE REPLACED WITH AFT DDU.

An IFM to replace a failed DDU may be required if necessary to regain RHC redundancy (ref. paragraph 5). @[121505-7133B]

THIS RULE CONTINUED ON NEXT PAGE

FLIGHT RULES

A2-105

IN-FLIGHT MAINTENANCE (IFM) [HC] (CONTINUED)

8. THE LEFT OR RIGHT HUD WILL BE REPLACED WITH THE SPARE HUD. FOR FLIGHTS WHICH DO NOT CARRY A SPARE HUD, REPLACEMENT OF THE LEFT HUD WITH THE RIGHT HUD WILL BE PERFORMED, TIME PERMITTING, IF A NIGHT LANDING IS PLANNED. @[040899-2459B] @[121505-7133B]

HUD replacement is considered highly desirable for entry in cases where visibility is restricted on the outer glide slope or for night landings. If a night landing is planned and no spare is available, the right HUD can be moved to the left side to provide the CDR with an operable HUD. The decision to perform the IFM will be based on consideration of the severity of the situation (e.g., weather, day or night, etc.). Reference: Memorandum CB-89-265.

9. AN ACCU (1 OR 2) WILL BE REPLACED WITH BYPASS CONNECTOR J4. @[121505-7133B]

An IFM to bypass a failed ACCU is required to ensure redundant voice links for entry and to determine whether next PLS must be declared. A failed IFM would be cause for next PLS with one ACCU down.

THIS RULE CONTINUED ON NEXT PAGE

FLIGHT RULES

A2-105 **IN-FLIGHT MAINTENANCE (IFM) [HC] (CONTINUED)**

10. TRANSPONDER (1 OR 2) BYPASS WILL BE CONSIDERED IF ONE FAILED. THE BYPASS WILL BE PERFORMED IF BOTH HAVE FAILED. @[121505-7133B]

An IFM to recover S-band downlink telemetry is required if both transponders have failed. If one is failed, consider expenditure of crew time to perform the IFM to ensure redundancy.

11. IF BOTH AVIONICS FANS IN AV BAY 1 OR 2 HAVE FAILED, ENTRY WILL BE DELAYED TO REPLACE ONE FAN WITH A FAN FROM ANOTHER AV BAY. @[040899-2459B]

AV bay fan replacement is done to recover cooling for two GPC's which provide redundancy for entry.

12. THE PF1/PF2 MDM'S WILL BE SWAPPED ONLY IF REQUIRED TO CLOSE PLBD'S. PLBD MOTOR OPERATION UTILIZING THE IFM PIN KIT WILL BE USED IN LIEU OF SWAPPING PL MDM'S IF, AFTER THE MDM'S ARE SWAPPED, THE PLBD MOTOR IFM WOULD STILL BE REQUIRED TO CLOSE AND/OR LATCH THE DOORS. @[101096-4516] @[040899-2459B] @[121505-7133B]

Due to the potential for connector pin damage during demate/mate operations, replacement or swapping of PL MDM's is only considered for PLBD closure. No consideration is made to swap PL MDM's for mission success reasons. The PLBD motor operation IFM is a collection of pin kit procedures to recover PLBD motor functions lost as a result of a failed PL MDM, and the motor driven by the other PL MDM has hard failed. If swapping PL MDM's will not recover all the necessary functions to close and latch the doors, the pin kit procedures will be used to regain the lost functions in lieu of swapping the MDM's.

THIS RULE CONTINUED ON NEXT PAGE

FLIGHT RULES

A2-105

IN-FLIGHT MAINTENANCE (IFM) [HC] (CONTINUED)

13. FOR FLIGHT CRITICAL MDM'S - FF4 WILL BE SWAPPED WITH FF1, FF2, OR FF3 AFTER POWER CYCLING AND PORT MODING FAILS TO CLEAR A NON-GPC CAUSED "I/O ERROR FFX" OR TOTAL OUTPUT CARD FAILURE AND IT RESULTS IN THE LOSS OF: @[101096-4516] @[040899-2459B] @[121505-7133B]
- a. A SECOND IMU
 - b. A SECOND ACCELEROMETER ASSEMBLY (AA) (AA4 MUST BE FAILED)

Where previous LRU failures would cause a loss of at least fail-safe redundancy in an entry critical system, it is considered viable to replace FF1, FF2, or FF3 with FF4. The operation would be accomplished to recover an IMU for redundancy in onboard navigation for entry. The same is true for an AA to regain redundancy for entry control.

Rules {A2-324}, SPACEHAB IN-FLIGHT MAINTENANCE (IFM) PROCEDURES; {A7-5C}, PASS GPC BCE FAILURE MANAGEMENT; {A7-109D}, IN-FLIGHT MAINTENANCE (IFM); {A8-7}, ENTRY SYSTEMS SINGLE-FAULT TOLERANCE VERIFICATION; and {A8-18}, LANDING SYSTEMS REQUIREMENTS, reference this rule. @[ED] @[102506-7825A]

FLIGHT RULES

A2-106

PBD OPERATIONS [CIL]

LAUNCH DAY LANDING PLBD OPS:

- A. IF A LANDING IS REQUIRED AND SUPPLY/WASTE WATER WILL SUPPORT FES OPERATIONS UNTIL ENTRY, NO ATTEMPT WILL BE MADE TO OPEN ONE OR BOTH OF THE PLBD'S. ©[020196-1804A]

For launch day landings at the first available PLS, the supply and waste water tanks are loaded such that there is sufficient water for FES operations; therefore, there is no requirement to incur the risks associated with opening the PLBD's, thus eliminating an increase in the crew workload during this timeframe.

- B. IF A LANDING IS REQUIRED AFTER PREDICTED EXHAUSTION OF SUPPLY AND WASTE WATER FOR THE FES, THE PLBD'S MAY BE OPENED.

For launch day landings after the first PLS opportunity, insufficient supply/waste water may have been loaded to support FES operations to entry. If the first PLS opportunity is NO-GO or likely to be NO-GO, then PLBD opening will be required. This situation may result in having to open the PLBD without close redundancy.

- C. FOR PROBLEMS PROHIBITING NECESSARY HEAT REJECTION, THE PLBD'S MAY BE OPENED (TIME PERMITTING) WITHOUT REGARD TO CLOSE-MOTOR REDUNDANCY, FES WATER SUPPLY AVAILABILITY, OR MET OF LANDING. ©[020196-1804A]

For cases where there are cooling problems and opening the PLBD's is required to alleviate heating of entry-critical equipment, the PLBD's should be opened to provide the increased cooling capability. This may be necessary even though redundant door closure does not exist and/or the timeline/crew workload would be increased.

FLIGHT RULES

A2-107

EVA GUIDELINES

A. EVA WILL NORMALLY BE PERFORMED BY TWO EVA CREWMEMBERS;
HOWEVER, ONE MAN EVA MAY BE PERFORMED IN THESE CIRCUMSTANCES:

1. CONTINGENCY EVA.

Two crewmembers are always required for EVA to ensure that, if one EVA crewmember should experience trouble, the other is available to provide assistance. For contingency EVA, this rule is waived since the safety of the orbiter is involved and the risk of a one man EVA is therefore acceptable.

2. SCHEDULED EVA - A SCHEDULED EVA MAY BE PERFORMED BY A
SINGLE CREWMEMBER IF:

a. A SINGLE CREWMEMBER CAN EXECUTE THE TASK(S) ASSIGNED.

b. THE SECOND CREWMEMBER IS ABLE TO GO TO VACUUM AND
REMAIN ON THE SERVICE AND COOLING UMBILICAL (SCU) FOR
POSSIBLE RESCUE.

c. THE SCHEDULED EVA TASK(S) MUST BE CAPABLE OF BEING
TERMINATED AT ANY POINT AND LEAVE THE PLB IN AN ENTRY
COMPATIBLE CONFIGURATION.

3. UNSCHEDULED EVA - AN UNSCHEDULED EVA TO MEET HIGH
PRIORITY MISSION OBJECTIVES OR TO PREVENT JETTISON OF A
PAYLOAD MAY BE ACCOMPLISHED BY A SINGLE CREWMEMBER IF THE
FOLLOWING CRITERIA ARE MET:

a. A SINGLE CREWMEMBER CAN EXECUTE THE TASK(S) ASSIGNED.

THIS RULE CONTINUED ON NEXT PAGE

FLIGHT RULES

A2-107

EVA GUIDELINES (CONTINUED)

- b. THE SECOND CREWMEMBER MUST BE ABLE TO GO TO VACUUM AND REMAIN ON SERVICE AND COOLING UMBILICAL (SCU) FOR POSSIBLE RESCUE.
- c. THE UNSCHEDULED EVA TASK(S) MUST BE CAPABLE OF BEING TERMINATED AT ANY POINT AND LEAVE THE PLB IN AN ENTRY COMPATIBLE CONFIGURATION.

- 4. AN EVA WILL BE DEFINED IN THE FLIGHT SPECIFIC ANNEX AS BEING CAPABLE OF BEING ACCOMPLISHED BY A SINGLE CREWMEMBER.

- B. IF CONTINGENCY EVA SUCCESSFULLY RESTORES PLBD'S, LATCHES, ETC., TO NORMAL OPERATION (E.G., FOREIGN OBJECT REMOVED), THE EVA WILL BE TERMINATED AND THE FLIGHT COMPLETED AS PLANNED.

If a contingency EVA is successful in restoring complete orbiter capability, there is no added risk to remaining on orbit and accomplishing the full mission duration.

- C. FOR EVA, DENITROGENATION WILL BE ACCOMPLISHED IN ACCORDANCE WITH AEROMED RULE {A13-103}, EVA PREBREATHE PROTOCOL [HC].
@[ED]

Self-explanatory.

- D. EVA/ORBITER ATTITUDE, AND ATTITUDE CONTROL CONSTRAINTS:
 - 1. DURING SIDE-TO-SUN ATTITUDE, THE SUN SIDE FORWARD RADIATOR PANEL WILL BE STOWED.
 - 2. DURING TOP SUN ATTITUDE, CREWMEMBERS WILL AVOID THE AREA WITHIN 15 FEET ABOVE DEPLOYED RADIATORS.

THIS RULE CONTINUED ON NEXT PAGE

FLIGHT RULES

A2-107

EVA GUIDELINES (CONTINUED)

For a side-to-Sun attitude during the EVA, the forward radiators must be stowed to preclude exposing a crewmember to the focusing effect of the Sun shining through the gap between the door and radiator. Short term exposure could produce thermal gradients which could overload the EMU capability to control the thermal environment, and longer term exposure could cause suit degradation. The same type of focusing effects are experienced at approximately 15 feet above the radiator when the vehicle is in a top Sun attitude and are potentially more severe.

E. MINIMUM COMMUNICATIONS REQUIREMENTS FOR SCHEDULED EVA:

IN ORDER TO COMMIT TO OR CONTINUE A SCHEDULED EVA, EACH EVA CREWMEMBER MUST HAVE TWO-WAY COMMUNICATIONS WITH THE ORBITER EITHER DIRECTLY OR VIA THE OTHER EVA CREWMEMBER.

It is difficult to be totally aware of the condition of an EVA crewmember by visual inspection. Minimum communication is required to ensure crew status and safety throughout the EVA period.

F. EVA WILL BE TERMINATED FOR MALFUNCTIONS WHICH RESULT IN SECONDARY OXYGEN PACK (SOP) O₂ FLOW.

Malfunctions which result in SOP flow indicate no other source of oxygen can supply total requirements for continued operation of the suit/EMU. Regardless of whether or not the primary life support system (PLSS) is functioning properly, SOP flow depletes the EVA crewmember's backup source of oxygen and is therefore cause to terminate the EVA. @[021199-6747B]

FLIGHT RULES

A2-108

CONSUMABLES MANAGEMENT

- A. REDLINES WILL BE MANAGED TO ASSURE THAT THE FOLLOWING RESERVES ARE PROTECTED:

In order to achieve acceptable consumables margins (cryo, water, or OMS/RCS propellant, N₂, LiOH, etc.) required to continue on-orbit flight operations, flight activities requiring the limited consumable may be reduced/deleted. The capabilities that must be protected along with the potential activities that are candidates for deletion are identified. ©[092800-7247A]

1. DEORBIT CAPABILITY - OMS/RCS PROPELLANTS WILL NORMALLY BE MANAGED TO PROVIDE THE CAPABILITY TO DEORBIT TO STEEP TARGETS. HOWEVER, SHALLOWING TARGETS IS ALLOWED TO PROTECT ITEMS 2 THROUGH 8 BELOW.

NOTE: OMS PROPELLANT RESERVED TO PROTECT FUTURE EXTENSION DAYS (PARAGRAPHS 9 AND 11 BELOW) MAY BE COMMITTED TO PROVIDE STEEP DEORBIT TARGET CAPABILITY FOR A CURRENT OPPORTUNITY. ©[051194-1612A]

Deorbit capability is protected to allow safe return of the orbiter. This rule addresses consumables limitations and not deorbit methods. Other rules identify actions required for the loss of one OMS, etc.

2. EOM DEORBIT PREPARATION.

Consumables required to successfully perform the nominal EOM deorbit preparation are protected.

3. POST-DEORBIT AND ENTRY USAGE (EXCEPT PTI'S).

Consumables required to support orbiter operations from deorbit burn cutoff through landing are protected. PTI's are not considered as mandatory and, if scheduled, appear as a tradable item in the Flight Rules Annex propellant priority table. ©[092800-7247A]

THIS RULE CONTINUED ON NEXT PAGE

FLIGHT RULES

A2-108

CONSUMABLES MANAGEMENT (CONTINUED)

4. CONTINGENCY RESERVES (SYSTEM MALFUNCTION OR FLIGHT CONTINGENCY) .

Consumables are reserved to protect against certain anomalies in order to guarantee system capabilities. For example, OMS/RCS propellant is redlined to account for attitude dispersions during the deorbit burn associated with an OMS engine failure.

5. X/Y CG BALLAST - RESERVES CONSUMABLES TO MAINTAIN THE ORBITER CG WITHIN ESTABLISHED LIMITS .

Self-explanatory.

6. DISPERSION ALLOWANCE (PERFORMANCE VARIATION) .

Self-explanatory.

7. MEASUREMENT ERROR .

Self-explanatory.

8. TRAPPED RESIDUALS .

Self-explanatory.

9. DEORBIT WAVE-OFF EXTENSION DAY - INCLUDES CONSUMABLES RESERVED TO BACK OUT OF THE DEORBIT BURN CONFIGURATION, MAINTAIN ATTITUDE CONTROL FOR ANOTHER DAY ON ORBIT UTILIZING PRIMARY JETS (ONE IMU ALIGNMENT, -ZLV -XVV OR THERMAL PROTECT ATTITUDE, IF REQUIRED), PLUS ALLOW STANDARD DEORBIT PREPARATION ACTIVITIES. @[051194-1612A] @[092800-7247A]

Deorbit wave-off extension day: Consumables required to support a deorbit backout, one day of orbit stay time on primary jets, plus an additional deorbit preparation are protected. This wave-off extension day is reserved for orbiter contingencies per Rule {A2-103}, EXTENSION DAY REQUIREMENTS. See also Rule {A2-110}, STRUCTURES THERMAL CONDITIONING, for thermal conditioning attitude profiles if required. Note that primary jets are protected for this extension day since many of the failures which require a deorbit wave-off extension day also fail the vernier jets. @[092800-7247A]

THIS RULE CONTINUED ON NEXT PAGE

FLIGHT RULES

A2-108 **CONSUMABLES MANAGEMENT (CONTINUED)**

10. POSTLANDING REQUIREMENTS.

Self-explanatory.

11. WEATHER WAVE-OFF EXTENSION DAY - RESERVES CONSUMABLES FOR ONE DAY OF ORBITER MAINTENANCE ACTIVITIES WITH NORMAL SYSTEMS CONFIGURATION. THIS INCLUDES CONSUMABLES RESERVED TO DELAY ONE ORBIT IN THE DEORBIT BURN CONFIGURATION, BACK OUT OF THE DEORBIT BURN CONFIGURATION, MAINTAIN ATTITUDE CONTROL FOR ANOTHER DAY ON ORBIT UTILIZING VERNIER JETS (ONE IMU ALIGNMENT, -ZLV -XVV OR THERMAL PROTECT ATTITUDE, IF REQUIRED, FOLLOWED BY A NOMINAL (VERNIER) DEORBIT PREPARATION. THE WEATHER WAVE-OFF EXTENSION DAY MAY BE GIVEN UP FOR CRITICAL ACTIVITIES (REF. PARAGRAPH C) . ©[051194-1612A] ©[092800-7247A]

Weather wave-off extension day: Consumables required to support a one-orbit delay in the deorbit burn configuration followed by one day wave-off for adverse weather conditions are protected. Vernier jets are assumed to be available since the weather extension day presumes a normal (non-contingency) systems configuration per Rule {A2-103}, EXTENSION DAY REQUIREMENTS. See also Rule {A2-110}, STRUCTURES THERMAL CONDITIONING, for thermal conditioning attitude profiles, if required.

- B. VIOLATION OF THE RESERVES IDENTIFIED IN PARAGRAPH A WILL BE CAUSE TO SCHEDULE ENTRY AT THE NEXT PLS OPPORTUNITY (EXCEPT FOR LOSS OF THE WEATHER WAVE-OFF EXTENSION DAY CAPABILITY).
- C. FOR CONSUMABLES CONTINGENCIES, FLIGHT ACTIVITIES IN ORDER OF PRIORITY (HIGHEST FIRST) ARE AS FOLLOWS:

THIS RULE CONTINUED ON NEXT PAGE

FLIGHT RULES

A2-108

CONSUMABLES MANAGEMENT (CONTINUED)

PRIORITY	FLIGHT ACTIVITY	
1.	TARGET 45 DEGREES TO 90 DEGREES PREBANK.	
2.	TARGET 0 DEGREES TO 45 DEGREES PREBANK.	
3.	SHORTEN MISSION TO LESS THAN MDF.	[1]
4.	RAISE ORBIT TO MINIMUM ALTITUDE REQUIRED TO ALLOW CRITICAL ON-ORBIT/PAYLOAD ACTIVITIES.	[2]
5.	WEATHER WAVE-OFF EXTENSION DAY.	[3]
6.	FLIGHT SPECIFIC ACTIVITIES (MDF PLUS TWO EXTENSION DAYS REMAIN HIGHER PRIORITY THAN FLIGHT SPECIFIC ACTIVITIES).	[4]

NOTE: EXCEPT FOR THE WEATHER WAVE-OFF EXTENSION DAY, CONSUMABLES RESERVED IN PARAGRAPH A HAVE HIGHER PRIORITY THAN THE ABOVE TABLE. @[092800-7247A]

NOTES:

- [1] SHORTEN IN INCREMENTS OF NEXT DAILY PLS OPPORTUNITIES.
- [2] REFERENCE FLIGHT RULES ANNEX FOR MINIMUM ALTITUDE AND PAYLOAD/MISSION PRIORITIES.
- [3] ASSUMES ONE REV IN THE DEORBIT BURN CONFIGURATION FOLLOWED BY A VERNIER EXTENSION DAY IN -ZLV -XVV OR THERMAL PROTECT ATTITUDE, IF REQUIRED, FOLLOWED BY A NOMINAL (VERNIER) DEORBIT PREP.
- [4] MISSION SPECIFIC CONSUMABLES PRIORITIES ARE DOCUMENTED IN THE FLIGHT RULES ANNEX. @[092800-7247A]

THIS RULE CONTINUED ON NEXT PAGE

FLIGHT RULES

A2-108

CONSUMABLES MANAGEMENT (CONTINUED)

When insufficient consumables are available to complete planned mission activities, the priority table is used to determine the remaining capability by deleting items from the bottom and moving upwards. A discussion of each priority follows:

- Priority 1. Target 45 to 90 degrees prebank: Committing to a prebank greater than 45 degrees introduces considerable impact to the orbiter as a result of the increased thermal environment. Consequently, prebank greater than 45 degrees will only be utilized to protect the minimum requirements established as a higher priority than the priority table.*
- Priority 2. Target 0 to 45 degrees prebank: Flight Techniques concluded that the minimal propellant gained as a result of committing to a prebank for the deorbit burn did not warrant the increased procedural/crew task complexity associated with the prebank (reference Entry Techniques minutes DA8-86-59).*
- Priority 3. Shorten mission to less than MDF: All activities will be deleted to protect MDF requirements.*
- Priority 4. Raise orbit to minimum altitude required to allow critical on-orbit/payload activities: The weather wave-off extension day capability may be deleted in order to accomplish critical on-orbit and/or payload activities which provide a direct orbiter benefit for deorbit and entry, or to accomplish a vital agency goal. One specific example of this would be the requirement to rendezvous with ISS and install/transfer a payload, thereby improving orbiter entry weight, required deorbit consumables, entry cg, and flight control margins, etc. Similar rationale applies for a deployable payload with a minimum deployment altitude. However, the weather wave-off extension day may not be deleted merely to provide an incremental increase in payload science or mission duration. ©[092800-7247A]*

THIS RULE CONTINUED ON NEXT PAGE

FLIGHT RULES

A2-108

CONSUMABLES MANAGEMENT (CONTINUED)

- Priority 5. *Weather wave-off extension day: The weather wave-off extension day provides the capability to delay the deorbit burn for one orbit in the deorbit burn configuration and then wave off for another 24 hours if weather, etc., make landing on the planned day unacceptable. Consumables budgeted for the weather wave-off extension assume VRCS control and minimum orbiter maintenance activities (IMU align, etc.). Combined with the deorbit wave-off extension capability (the latter reserved at a higher level than this table), the weather wave-off extension day provides a total capability of four deorbit attempts with three deorbit preparations. It is the intent to maintain the weather wave-off extension capability at a high priority to account for unforeseen weather problems (due to the unpredictability of the weather and forecasting uncertainty).*
- Priority 6. *Flight-specific activities: All flight specific activities are prioritized in the Flight Rules Annex. The priority of each activity considering specific flight objectives is established prelaunch. Implementation of the Flight Rule Annex propellant priority table must be completed before deleting high priority activities identified in this table.*

The following rules reference this rule:

{A2-121A}, RNDZ/PROX OPS PROPULSION SYSTEMS MANAGEMENT;

{A6-51M,V}, OMS FAILURE MANAGEMENT [CIL];

{A6-351}, OMS PROPELLANT MANAGEMENT MATRIX;

{A6-354}, RCS ENTRY REDLINE PROTECTION;

{A6-355}, OMS PROPELLANT DEFICIENCY FOR DEORBIT;

{A6-303A}, OMS REDLINES [CIL];

{A6-304A}, FORWARD RCS REDLINES;

{A6-305A}, AFT RCS REDLINES [HC]; ©[092800-7247A] ©[042706-7370D]

{A6-358}, VIOLATION OF MISSION COMPLETION REDLINES MATRIX;

{A9-257C}, POWER REACTANT STORAGE AND DISTRIBUTION (PRSD) H2 AND O2 REDLINE DETERMINATION. [ED]

FLIGHT RULES

A2-109 **PREFERRED ATTITUDE FOR WATER DUMPS**

A. TO MINIMIZE RECONTACT POTENTIAL OF HIGH VELOCITY WATER PARTICLES WITH THE ORBITER OR PAYLOADS, SPECIFIC DUMP ATTITUDES ARE PREFERRED DURING SUPPLY/WASTE WATER DUMPS. THE REQUIRED ATTITUDE DEPENDS ON THE ORBITER POSITION RELATIVE TO THE PAYLOAD. THAT POSITION IS DEFINED AS BEING IN ONE OF FOUR REGIONS IN THE PAYLOAD CENTERED LVLH FRAME DEPICTED IN THE FOLLOWING DIAGRAM.

FIGURE A2-109-I - PREFERRED ATTITUDE FOR WATER DUMPS

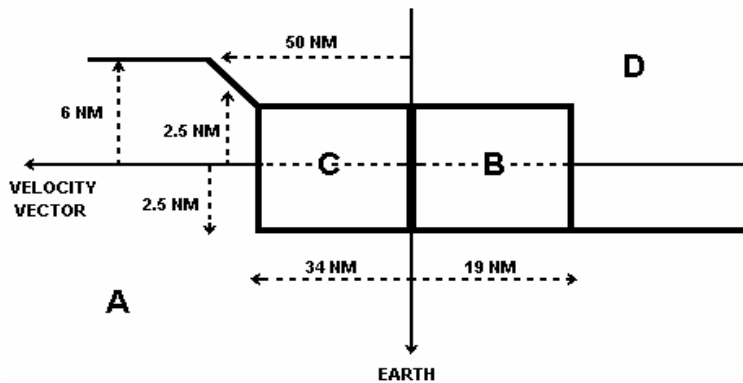

REGION	DUMP ATTITUDE	RESTRICTIONS
A	+YVV (RETROGRADE DUMP)	THE ORBITER RELATIVE APOGEE MUST BE BELOW THE BOUNDARY OF REGION A. THE ORBITER MUST REMAIN WITHIN REGION A FOR THE DURATION OF THE DUMP.
B	+YVV (RETROGRADE DUMP)	THE ORBITER MUST BE IN A STATIONKEEPING OR SLOW SEPARATION SITUATION AND REMAIN WITHIN REGION B FOR THE DURATION OF THE DUMP.
C	+Y 40 DEG OUT OF PLANE FROM VV (BIASED RETROGRADE DUMP)	THE ORBITER MUST BE IN A STATIONKEEPING OR SLOW SEPARATION SITUATION AND REMAIN WITHIN REGION C FOR THE DURATION OF THE DUMP.
D	-Y 20 DEG OUT OF PLANE FROM VV (BIASED POSIGRADE DUMP)	THE ORBITER RELATIVE PERIGEE MUST BE ABOVE THE BOUNDARY OF REGION D. THE ORBITER MUST REMAIN WITHIN REGION D FOR THE DURATION OF THE DUMP.
ORBITER ALONE @[102506-7837]	+YVV (RETROGRADE DUMP)	INCLUDES PAYLOAD ATTACHED CASE

THIS RULE CONTINUED ON NEXT PAGE

FLIGHT RULES

A2-109

PREFERRED ATTITUDE FOR WATER DUMPS (CONTINUED)

- B. THE FOLLOWING GUIDELINES ARE TO BE USED FOR THE CASE OF INTERSECTING ORBITS WHICH DO NOT SATISFY REGIONS A, B, C, OR D ABOVE.
1. IF THE ORBITS INTERSECT WITH THE ORBITER BEHIND THE PAYLOAD AND THE ORBITER IS MOVING AWAY FROM THE PAYLOAD OR CLOSING AT LESS THAN 50 NM/REV, THEN THE DUMP ATTITUDE WILL BE -Y, 20 DEG OUT OF PLANE FROM +VV (BIASED POSIGRADE).
 2. IF THE ORBITS INTERSECT WITH THE ORBITER AHEAD OF THE PAYLOAD AND THE ORBITER IS MOVING AWAY FROM THE PAYLOAD OR CLOSING AT LESS THAN 50 NM/REV, THEN THE DUMP ATTITUDE WILL BE -Y, 20 DEG OUT-OF-PLANE FROM -VV (BIASED RETROGRADE).
 3. DUMPS FOR CASES 1 AND 2 SHOULD BE COMPLETED AT LEAST TWO ORBITS BEFORE THE POINT OF CLOSEST APPROACH.

Intersecting orbits are defined as orbits in which the relative apogee and perigee are such that the orbiter crosses into multiple regions during one orbit. An example of such a case would be the orbiter 40 nmi behind the target, approaching the target with a relative apogee 0.5 nmi above the target and a relative perigee 4.0 nmi below the target. In this scenario the orbiter cannot be considered to be in either region A or D. Part 1 of Paragraph B of this rule instructs that the dump attitude be -Y, 20 deg out of plane from +VV (biased posigrade) in this case. @[102506-7837]

THIS RULE CONTINUED ON NEXT PAGE

FLIGHT RULES

A2-109

PREFERRED ATTITUDE FOR WATER DUMPS (CONTINUED)

C. GENERIC ATTITUDE RECOMMENDATIONS CANNOT BE MADE FOR ORBITAL GEOMETRIES WHICH DO NOT MEET THE CONDITIONS LISTED ABOVE.

These recommendations were approved at the On-Orbit Flight Techniques Panel #120. The major ground rules and assumptions are listed below:

- a. *Particle ejection velocity is assumed to be between 30 and 100 ft/sec. Measurements from an STS-29 supply dump video show particle velocities of 30-75 ft/sec. It is also known that waste dump rates are typically 3.3 lb/min, compared to 2.5 lb/min for supply dumps. Since each dump uses the same type nozzle, the maximum velocity for a waste dump is assumed to increase in proportion to the flowrate. Thus, the maximum velocity is $3.3/2.5 \times 75 = 100$ ft/sec. @[102506-7837]*
- b. *The distribution of particle ejection angles is such that 95 percent of the particles are ejected within a 10 degree half-cone angle of the orbiter -Y axis. An additional 10 degree half-cone angle is protected in these recommendations.*
- c. *The boundaries protect a 1 nm radius sphere of position uncertainty for both the orbiter and payload.*
- d. *All particles are assumed to experience more atmospheric drag than either the orbiter or the payload.*

Retrograde dumps preclude particle recontact because differential drag aids in moving particles downward and forward.

Posigrade dumps may result in an eventual return of particles due to differential drag. Some particles may travel to the vicinity of the payload on the first orbit. The intensity of recontact is minimized by the following effects which act to disperse the particle cloud:

- a. *Differential drag among particles of different sizes.*
- b. *Out-of-plane velocity of particles minimizes time in plane.*
- c. *Particles sublimate over time.*

FLIGHT RULES

A2-110

STRUCTURES THERMAL CONDITIONING

- A. IF ANALYSIS SHOWS THAT ALL THERMAL CONSTRAINTS ARE SATISFIED (THROUGH EI, INCLUDING WAVEOFFS) PRIOR TO EXECUTION OF THE DEORBIT PREP ATTITUDE SEQUENCE DEFINED BELOW, REAL-TIME THERMAL ANALYSIS OF THE NOMINAL AND WAVEOFF DEORBIT ATTEMPTS IS NOT REQUIRED. @[050495-1768A]

NOTE: THE BENDING-EFFECT TEMPERATURE (BET) PROFILE WILL BE PREDICTED ON A FLIGHT-SPECIFIC BASIS TO DETERMINE THE MAXIMUM TIME TO PLBD CLOSURE.

TIG --~4:40 MNVR TO IMU ALIGNMENT AND VERIFICATION ATTITUDES (ANY INERTIAL) @[072398-6645]

TIG - 4:00 MNVR TO TAIL SUN/COLD SOAK ATTITUDE COMPLETE

BIASED -XSI: PITCH +184, YAW 0,

OMICRON 270 FOR + BETA

90 FOR - BETA

TIG - 2:55 RAD BYPASS, FES CHECKOUT @[072398-6645]

TIG - 2:40 PLBD CLOSING

THIS RULE CONTINUED ON NEXT PAGE

FLIGHT RULES

A2-110

STRUCTURES THERMAL CONDITIONING (CONTINUED)

TIG \approx 2:25* MNVR TO THERMAL/COMM ATTITUDE WITH THE
FOLLOWING GENERIC REQUIREMENTS: @[072398-6645]

1. SUN LOS VECTOR AT -X BODY AXIS \pm 30 DEGREES IN
YAW AND \pm 5 DEGREES IN PITCH (SUN TO STARBOARD
DESIRED).
2. ROLL ORIENTATION ABOUT THE SUN VECTOR SELECTED TO
OPTIMIZE S-BAND COMM. DESIRE TO BE PLB TO SPACE
AT NOON. @[050495-1768A]

TIG - :20** MNVR TO DEORBIT BURN ATTITUDE (ANY) @[072398-6645]

TIG + \approx :05 MNVR TO EI ATTITUDE (ANY)

* MNVR TO THE THERMAL/COMM ATTITUDE AT THE EARLIEST
OPPORTUNITY FOLLOWING PAYLOAD BAY CLOSURE TO IMPROVE
ORBITER THERMAL CONDITIONING FOR ENTRY. @[072398-6645]

** FOR WAVEOFFS WHICH ARE DECLARED AFTER THE START OF
DEORBIT PREP, THE ADDITIONAL TIME WILL BE SPENT IN THE
COMM ATTITUDE. IF WAVEOFF IS DECLARED AFTER THE MNVR TO
THE D/O BURN ATTITUDE, MNVR BACK TO THE COMM ATTITUDE
UNTIL THE NEXT D/O TIG-20 MINUTES. @[050495-1768A] @[072398-6645]

THIS RULE CONTINUED ON NEXT PAGE

FLIGHT RULES

A2-110 STRUCTURES THERMAL CONDITIONING (CONTINUED)

B. IF THE ABOVE SEQUENCE IS NOT FOLLOWED, FLIGHT-SPECIFIC ANALYSIS IS REQUIRED. FLIGHT-SPECIFIC ANALYSIS OF NOMINAL DEORBIT PREP PLUS WAVEOFF ATTITUDES WILL EVALUATE THE FOLLOWING SEQUENCES:

1. NOMINAL:

```

|- IMU -|- XSI -|- COMM -|- DEORBIT -|- EI -| @[072398-6645]
          PLBD      EOM
          CLOSE    TIG
    
```

2. NOMINAL + 1 REV:

```

|- IMU -|- XSI -|- COMM -|- COMM -|- DEORBIT -|- EI -|
@[072398-6645]
          PLBD      EOM      EOM+1 REV
          CLOSE    TIG      TIG
    
```

3. NOMINAL + 2 REVS:

```

|- IMU -|- XSI -|- COMM -|- COMM -|- COMM -|- DEORBIT -|- EI -|
@[072398-6645]
          PLBD      EOM      EOM+1 REV  EOM+2 REVS
          CLOSE    TIG      TIG          TIG
    
```

WORST-CASE EI BONDLINE LIMITS (FROM ALL POSSIBLE DEORBIT OPPORTUNITIES) WILL BE USED.

DETAILS REGARDING THE USE OF COMPUTER ANALYSIS TO EVALUATE DEORBIT ATTITUDE SEQUENCES ARE PROVIDED IN FLIGHT RULES {A18-401}, THERMAL PROTECTION SYSTEM (TPS) BONDLINE TEMPERATURES, AND {A18-451}, ORBITER THERMAL CONSTRAINTS AND ATTITUDE MANAGEMENT [CIL].

THIS RULE CONTINUED ON NEXT PAGE

FLIGHT RULES

A2-110 STRUCTURES THERMAL CONDITIONING (CONTINUED)

C. THE FOLLOWING GUIDELINES FOR PRE-ENTRY THERMAL CONDITIONING SHOULD BE USED FOR INITIAL PREFLIGHT PLANNING PURPOSES:

BETA ANGLE AT		
<u>START OF THERMAL</u>		
<u>CONDITIONING</u>	<u>10 HOURS OF:</u>	<u>FOLLOWED BY:</u>
0 TO ~ 60 DEGREES	-ZLV, PTC	NORMAL DEORBIT ATL
	OR	SEQUENCE AS DEFINED
	±XLV, ±ZVV	IN PARAGRAPH A
> ~ 60 DEGREES	PTC	NORMAL DEORBIT ATL
		SEQUENCE AS DEFINED
		IN PARAGRAPH A

@[050495-1768A]

FLIGHT-SPECIFIC ANALYSIS OF THE ON-ORBIT TIMELINE WILL DETERMINE WHETHER SPECIAL THERMAL CONDITIONING IS NEEDED PRIOR TO DEORBIT PREP. IF FLIGHT-SPECIFIC THERMAL CONDITIONING IS REQUIRED, IT WILL BE DOCUMENTED IN THE FLIGHT RULES ANNEX. @[050495-1768A]

Depending on the flight-specific attitude timeline, it is possible that the deorbit prep attitude sequence described in paragraph a will not satisfy all orbiter or payload thermal constraints. This is especially true for high beta or attitude intensive missions. Attitudes during the last sleep and postsleep period are typically -ZLV, unless payload desires drive otherwise. If analysis of an attitude timeline predicts violations, then attitudes prior to deorbit prep may need to be modified to improve the predicted temperatures. Typical conditioning attitudes could be a specific LVLH orientation, solar inertial attitude, PTC, etc. The durations and orientations of these conditioning attitudes will be worked on a flight-specific basis, and the plan will be documented in the flight-specific annex.

THIS RULE CONTINUED ON NEXT PAGE

FLIGHT RULES**A2-110 STRUCTURES THERMAL CONDITIONING (CONTINUED)**

- D. DEORBIT BURN WILL NOT BE DELAYED IF A TPS BONDLINE TEMPERATURE IS ABOVE ITS FLIGHT-SPECIFIC LIMIT, PROVIDED ALL OF THE FOLLOWING ARE MET:
1. NO TPS BONDLINE VIOLATIONS WERE PREDICTED FOR THE PLANNED DEORBIT SEQUENCE.
 2. RADIATOR COLDSOAK AND COMM ATTITUDES IN DEORBIT PREP HAVE BEEN CHOSEN TO MINIMIZE SOLAR EXPOSURE ON THE TPS BONDLINES. (THE COMM ATTITUDE MAY BE BIASED FROM TAIL-SUN AS SPECIFIED IN PARAGRAPH A TO MAINTAIN TDRS COMM.)
@[050495-1768A]
 3. IF, IN DEORBIT PREP, OFF-NOMINAL ATTITUDES AND/OR TIMES ARE REQUIRED DUE TO FAILURES OR OTHER UNEXPECTED SITUATIONS, THE PLANNED ATTITUDE TIMELINE IS RESUMED AS SOON AS CONDITIONS ALLOW. @[050495-1768A]
 4. THE FLIGHT SPECIFIC EXCEEDENCE IS NO GREATER THAN 5 DEG OR HAS BEEN APPROVED BY THE MER.

Flight-specific limits on bondline temperatures at entry interface (EI) are defined in each flight-specific annex. These limits must be met when the attitude timeline is analyzed and bondline temperatures are predicted at EI. However, if a temperature is actually above its limit prior to the deorbit burn, the burn is not waved off, because reasonable actions are taken ahead of time to attempt to preclude violations. Any surprise violations should be very small, possibly even due to instrumentation error (which is not protected).

The flight-specific bondline limits protect orbiter thermal/structural certification envelopes (with 1.4 factor of safety (FOS) during "design entry" mechanical loading). The bondline temperature upper limits are in place to protect a gradient temperature. Since the method of gradient protection is generic, and the limits protect for design cases plus 1.4 FOS, it is considered less risk to proceed with a small violation than to wave off deorbit burn. On STS-55, a 3-degree violation of V09T1012 occurred at entry interface. More detailed assessment by Engineering indicated that in this case there was actually approximately 20 degrees margin at TAEM and touchdown (the points really being protected).

THIS RULE CONTINUED ON NEXT PAGE

FLIGHT RULES

A2-110

STRUCTURES THERMAL CONDITIONING (CONTINUED)

A cold attitude(s) will be used for radiator coldsoak and "comm attitude," to reduce bondline temperatures to the extent possible during deorbit prep. It is typically difficult, however, to satisfy the bondline limits, even when cold attitudes are chosen such as tail-sun or nose-sun. If bondline solar exposure is already minimized, there would be little or no corrective action available so nothing is gained by delaying the deorbit burn. STEP will be the primary tool used by the MCC to analyze the nominal attitude timeline. Any predicted violations (which include STEP accuracy biases) will be resolved either (1) by changing attitudes, including those prior to deorbit prep if necessary, or (2) by comparing STEP predictions to previous flight data in similar beta angles and attitudes, or to other thermal models, and "outvoting" the STEP prediction. The rationale for Rule {A18-401}, THERMAL PROTECTION SYSTEM (TPS) BONDLINE TEMPERATURES, provides more information on STEP analysis and biases.

Instrumentation error is not protected for the bondline temperature sensors. Instrumentation error is not considered in the structural analyses which are used to generate the EI limit models, nor are any other uncertainties. When analyzing structural stress, it is generally not known whether a positive or negative error causes worse structural gradients, so only "actual" temperatures are used. Analysis of all possible uncertainty combinations would require prohibitively large numbers of simulations. Also, inclusion of instrumentation error would cause frequent limit exceedences.

If real-time deviations from the planned attitude timeline are required (for reasons such as single star tracker IMU aligns, missed stars, time taken to troubleshoot a failure, etc.), they will take priority and will not be rushed or canceled in favor of bondline thermal limits. However, the orbiter will return to the planned cold attitude as soon as the situation allows, and deorbit burn will proceed as planned. ©[050495-1768A]

A small limit exceedence of up to 5 degrees is acceptable to the technical community without further discussion. Exceedences greater than 5 degrees should be understood or accepted given whether it could realistically be brought back into tolerance by further activity prior to deorbit. ©[050495-1768A]

Documentation: Ascent/Entry Flight Techniques #111, 3/25/94; Orbiter CCB 6/14/94, 8/9/94; Engineering Judgment. ©[050495-1768A]

THIS RULE CONTINUED ON NEXT PAGE

FLIGHT RULES

A2-110

STRUCTURES THERMAL CONDITIONING (CONTINUED)

- E. ADEQUATE THERMAL CONDITIONING IS PROVIDED FOR EMERGENCY ABORTS FROM ORBIT BY MAINTAINING NORMAL THERMAL LIMITS AND BY ENSURING THAT THE PROJECTED MISSION PROFILE OF BENDING EFFECT TEMPERATURE (BET) REMAINS LESS THAN 200 DEG F. THERE ARE NO BONDLINE TEMPERATURE CONSTRAINTS FOR EMERGENCY DEORBIT.

Maintaining BET < 200 deg F ensures that PLBD closing can be accomplished for anytime deorbit opportunities. Typical bondline temperature constraints for EI protect for a 1.4 factor of safety above design structural loads. Since typical entry loads are well below design loads, it is not necessary to protect the 1.4 factor of safety over design entry loads in the event of an emergency deorbit.

DOCUMENTATION: SODB, pg 3.4.1.1-5, and NASA JSC Memo ES2-93-096.

Reference Rule {A10-206}, PLBD CLOSE GO/NO-GO, for BET definition and constraints.

Rules {A6-305}, AFT RCS REDLINES [HC], and {A18-451}, ORBITER THERMAL CONSTRAINTS AND ATTITUDE MANAGEMENT [CIL], reference this rule. ®[042706-7370D]

FLIGHT RULES

A2-111

DPS COMMAND CRITERIA

- A. GPC MEMORY WRITE PROCEDURES CAN BE USED IN FLIGHT TO MODIFY DATA AND CODE IN BOTH THE PASS AND BFS.

The Orbiter Avionics Software Board (OASCB) has authorized the use of GPC memory write procedures to modify data or code in PASS or BFS. This is allowed to restore orbiter capabilities lost because of real-time orbiter hardware problems or to correct software problems that do not require a recompilation of the software.

- B. THE USE OF GPC MEMORY WRITE PROCEDURES ARE SUBJECT TO THE GUIDELINES DEFINED BY RULE {A7-16}, GPC MEMORY WRITE CRITERIA [CIL].

All GPC memory procedures must adhere to rigorous verification prior to their use to ensure crew and vehicle safety. Reference Rule {A7-16}, GPC MEMORY WRITE CRITERIA [CIL], for such guidelines, as well as the different types of GPC memory write procedures.

- C. DEU EQUIVALENT COMMANDING DURING CREW SLEEP WILL NOT BE PERFORMED UNTIL ALL OF THE FOLLOWING REQUIREMENTS HAVE BEEN MET: ©[072795-1775A]

1. CONFIRMED PERIOD OF AOS AND GOOD COMM BOTH BEFORE AND AFTER SCHEDULED COMPLETION OF THE DEU EQUIVALENT COMMAND LOAD.

A valid downlist is required for the MCC to be able to verify DEU equivalent command execution. In addition, an active downlist is required from the destination GPC or major function for the ground command processing software to verify the uplink and automatically send the buffer execute command. A period of good comm is required so that the crew can be contacted in the event of an off nominal situation. During maneuvers, there may be brief periods of LOS or bad comm while the vehicle changes attitudes. These brief periods are acceptable, as long as the resultant attitude is confirmed to have good comm.

2. THE MCC MUST BE ABLE TO VERIFY ALL DEU EQUIVALENT LOADS VIA METHODS OTHER THAN SCRATCHPAD LINE RESPONSE.

THIS RULE CONTINUED ON NEXT PAGE

FLIGHT RULES

A2-111

DPS COMMAND CRITERIA (CONTINUED)

Due to the timing differences between the downlist cycle and when the GPC polls the DEU, the possibility exists such that all uplinked commands may not be seen on the downlisted scratchpad line. Since there is a requirement for ground confirmation of all DEU loads, there must be an alternate way to verify the uplink through end item telemetry feedback's. ©[072795-1775A]

3. DEU EQUIVALENT LOADS SHOULD AVOID CONTAINING ITEM SERIES WHICH MUST BE UPLINKED AT A SPECIFIC TIME OR WITHIN A SPECIFIC TIME INTERVAL. ©[072795-1775A]

Due to the dynamic nature of commanding and the requirement for good comm and AOS to allow the MCC to properly verify the execution of each DEU equivalent load, there may be times when the ground cannot uplink a required load at a specific time. Therefore, the MCC should not be constrained by specific time requirements for DEU equivalent loads. There may be occasions where this cannot be avoided, but time specific loads need to be closely analyzed for any risks associated with delaying their uplink.

4. IF A SERIES OF DEU EQUIVALENT LOADS ARE PLANNED, THE IMPACT OF NOT COMPLETING ALL UPLINKS MUST BE EVALUATED. FUTURE MANEUVER LOADS, CREW ALERT SPC'S, AND/OR CREW BAILOUT ATTITUDES MUST BE USED AS REQUIRED TO PROVIDE AN APPROPRIATE LEVEL OF PROTECTION FOR UNEXPECTED LOSS OF COMMUNICATION.

Due to the dynamic nature of commanding and the requirement for good comm and AOS to allow the MCC to properly verify the execution of each DEU equivalent load, there may be times when the ground cannot uplink a required load at a specific time. Because of this, there exists the potential to be in a specific orbiter configuration longer than originally intended. The MCC must have evaluated all associated risks (e.g., comm, thermal, payload constraints, etc.) with these situations and analyzed the cost/benefit tradeoff before proceeding with the uplink of the first load.

Based on the complexity of the desired DEU equivalent load(s) there may or may not be a desire to use a crew alert SPC to wake the crew at some time in the future in case an off nominal situation were to occur. The SPC would be set to time out far enough in advance to allow the MCC to clear it once they were able to verify the correct orbiter configuration after the DEU equivalent execution was complete. The crew should be notified prior to sleep of any potential bailout attitudes in the event they are awakened by an SPC and cannot establish communications with the MCC.

5. DPS DEU EQUIVALENT COMMANDING ARE SATISFIED PER RULE {A7-108}, DEU EQUIVALENT CRITERIA. ©[072795-1775A]

FLIGHT RULES

A2-112

PDRS

- A. NORMAL PDRS OPERATIONS WILL CEASE AND THE RMS WILL BE CRADLED IF BACKUP PLUS ONE OTHER SINGLE JOINT MODE IS NOT AVAILABLE TO DRIVE EACH JOINT.

Reference Rule {A12-1}, EVA FOR RMS OPERATION, for rationale.

- B. ANY ORBITER FAILURE THAT REQUIRES A NEXT PLS DEORBIT OPPORTUNITY IS CAUSE TO TERMINATE RMS ACTIVITIES IMMEDIATELY.

In the event of a next PLS situation, the orbiter must be configured for entry as soon as possible, which requires that the RMS be cradled, latched, and stowed prior to PLBD closing. If critical operations are being performed, such as berthing a payload, the situation may allow for those operations to be completed depending on the time available prior to deorbit.

- C. EVA IS CONSIDERED A BACKUP CAPABILITY FOR THE FOLLOWING RMS FUNCTIONS FOR THE ACCOMPLISHMENT OF HIGH PRIORITY OBJECTIVES AS DEFINED IN THE FLIGHT SPECIFIC ANNEX:

1. END EFFECTOR RELEASE.
2. MPM STOW/DEPLOY.
3. MRL LATCHES.
4. SHOULDER BRACE RELEASE.
5. RMS CRADLE.

EVA techniques exist to accomplish the above activities. For high priority objectives, it may be acceptable to continue with the redundant method of accomplishing these operations requiring an EVA. Operating under these conditions is still safe since the arm can be jettisoned if an EVA cannot be performed.

THIS RULE CONTINUED ON NEXT PAGE

FLIGHT RULES

A2-112

PDRS (CONTINUED)

- D. NORMALLY DURING CREW SLEEP PERIODS OF NON-RMS OPERATIONS, THE RMS WILL BE CRADLED AND LATCHED AND THE SYSTEM LEFT IN THE TEMPERATURE MONITOR MODE.

This is the safest configuration should an emergency entry be required and protects against RMS or MRL failures. There is no system constraint against leaving the arm out other than as noted in paragraph E.

- E. CONSIDERATION WILL BE GIVEN TO PARKING THE RMS DURING CREW SLEEP PERIODS IF A PAYLOAD CANNOT BE BERTHED AND DEORBIT IS NOT PLANNED WITHIN 24 HOURS.

In the event of a PRLA failure or some other failure which prevents berthing the payload, the RMS/payload may be positioned and left with the brakes on during crew sleep. Various factors must be considered in order to accept this including payload inertias which have an important effect on DAP stability. In addition, when large payloads are attached to the arm with the brakes on, PRCS control jet firings can result in large arm movements which are not annunciated as failures. MCC must be able to monitor joint movement during the sleep period.

- F. PRIOR TO RMS AND/OR PAYLOAD JETTISON, AN EVA MAY BE PERFORMED TO AID PAYLOAD BERTHING, ARM CRADLE, AND/OR STOWAGE OF THE RMS WHEN ALL OTHER ATTEMPTS HAVE FAILED.

EVA techniques are available for RMS cradle and latch as well as the MPM. In addition, EVA techniques may be possible for releasing, berthing, and latching of the payload in the event of a failed RMS. In essence, this rule gives authority to attempt any method to berth the payload and/or cradle the arm prior to payload and/or arm jettison.

- G. ONCE THE MPM'S ARE DEPLOYED, PROVIDING THERE IS DUAL-MOTOR STOW CAPABILITY, THE MPM'S MAY BE LEFT DEPLOYED UNTIL THE RMS MISSION OPERATIONS ARE COMPLETED.

Reference Rule {A12-72}, MPM DEPLOY/STOW CONSTRAINTS, for rationale. ©[092503-6084]

Rule {A2-104}, SYSTEMS REDUNDANCY REQUIREMENTS, references this rule.

FLIGHT RULES

A2-113

OMS/RCS DOWNMODING CRITERIA

- A. OMS/RCS DOWNMODING IS DEFINED AS THE CHANGING OF THE OMS/RCS ENGINE CONFIGURATION(S) SO AS TO ALLOW CONTINUATION OF A DELTA V MANEUVER:
1. DUAL REDUNDANCY DOWNMODE (TRIPLE DOWNMODE) PROTECTION IS DEFINED AS THE CAPABILITY TO CHANGE THE BURN CONFIGURATION FROM THE OMS ENGINES TO ONE OMS ENGINE AND FURTHER DOWNMODE TO RCS WHILE STILL RETAINING THE ABILITY TO COMPLETE THE PLANNED MANEUVER.
 2. SINGLE REDUNDANCY DOWNMODE IS DEFINED AS TWO OMS, ENGINES DOWNMODE TO ONE OMS ENGINE, ONE OMS ENGINE DOWNMODE TO RCS, OR RCS RM DOWNMODE TO MAINTAIN TWO $\pm X$ JETS.
- B. DOWNMODING FROM TWO OMS ENGINES TO ONE OMS ENGINE IN RESPONSE TO AN ENGINE FAILURE IS ALLOWED UTILIZING OMS CROSSFEED AS REQUIRED.
- C. FOR ONE OMS ENGINE MANEUVER DOWNMODING TO RCS, THE BURN CAN BE CONTINUED USING OMS PROPELLANT (ON-ORBIT ONLY IF RCS WAS INTERCONNECTED DURING THE OMS BURN) OR RCS PROPELLANT TO RCS JETS AS LONG AS DEORBIT PROPELLANT REQUIREMENTS ARE PROTECTED.

Due to lifetime concerns, single OMS engine burns will be planned when possible in order to increase OMS engine lifetime. Additionally, because a sufficiently large TIG slip capability exists during the orbit-critical burns, utilizing the RCS to provide a downmode capability is reasonable as long as sufficient RCS margin is available to perform the minimum required separation delta V. Declaring the RCS as a viable downmode option decreases the number of times two OMS engines will be scheduled for on-orbit-critical burns (i.e., increases lifetime).

Only the minimum separation delta V is obtained by the RCS to complete the burn (subsequent to an OMS engine failure). Minimum propellant resources are expended to satisfy safety criteria while optimizing remaining propellant (OMS and RCS) available to protect RCS steep deorbit requirements.

On-orbit, downmoding from two $\pm X$ jets to a different set of two $\pm X$ jets by RCS RM is allowable for crew safety-critical burns since the downmode provides the same single failure protection as the OMS/OMS and OMS/RCS downmodes.

FLIGHT RULES

A2-114

OMS/RCS MANEUVER CRITICALITY

- A. DELTA V MANEUVERS CRITICAL FOR CREW SAFETY WILL BE TARGETED SUBJECT TO THE FOLLOWING GUIDELINES:
1. OMS-1, OMS-2, AND DEORBIT BURNS WILL BE PERFORMED USING TWO OMS ENGINES UTILIZING DUAL OR SINGLE-DOWNMODE CAPABILITY (AS AVAILABLE) IF REQUIRED TO MEET DELTA V REQUIREMENTS.
 2. SPACECRAFT SEPARATION BURNS WILL BE PLANNED SUCH THAT A SINGLE-DOWNMODE CAPABILITY (OMS OR RCS) EXISTS TO MEET MINIMUM DELTA V REQUIREMENTS.
- B. FLIGHT SUCCESS DELTA V MANEUVERS ARE DEFINED AS THOSE MANEUVERS ESSENTIAL TO FLIGHT SUCCESS WHICH CANNOT BE POSTPONED BEYOND THE SPECIFIED TIG SLIP. A SINGLE DOWNMODE ACTION WILL BE ACCOMPLISHED IF REQUIRED TO COMPLETE A FLIGHT SUCCESS DELTA V MANEUVER IF A PROPELLANT SYSTEM FAILURE DOES NOT EXIST, AND PROPELLANT IS AVAILABLE TO COVER RCS STEEP DEORBIT DELTA V REQUIREMENTS. ©[121296-4213]
- C. NONCRITICAL DELTA V MANEUVERS ARE DEFINED AS ALL THOSE MANEUVERS WHICH DO NOT FALL IN THE CATEGORIES DEFINED IN PARAGRAPHS A AND B. DOWNMODING TO COMPLETE A NONCRITICAL BURN IS NOT ALLOWED.

For all maneuvers critical for crew safety, engine downmode capability is required to maintain fail-safe engine redundancy during the burn. Single OMS engine burns with downmode capability to the RCS +X jets are preferable to dual OMS engine burns, minimizing OMS engine starts, and increasing OMS engine lifetime. Sufficiently large delta V maneuvers such as OMS-1, OMS-2, and the deorbit burn will be performed using two OMS engines in order to avoid any OMS valve reconfiguration during a nominal burn (i.e., crossfeeding halfway through the burn so that OMS propellant remains balanced) and to reduce the amount of OMS propellant required for the burn if the downmode option is utilized.

©[ED]

THIS RULE CONTINUED ON NEXT PAGE

FLIGHT RULES

A2-114

OMS/RCS MANEUVER CRITICALITY (CONTINUED)

For spacecraft separation burns, downmoding will be performed only to satisfy the minimum delta V requirement necessary to avoid any orbiter damage from the spacecraft PKM firing. Following an OMS engine failure, propellant redlines must be redefined to protect RCS steep deorbit capability and propellant may not be available to complete the separation maneuver to the nominal delta V requirement.

Downmoding will be performed on flight success delta V maneuvers only for OMS engine failures providing preburn analysis shows that sufficient propellant is available to protect RCS steep deorbit delta V requirements. For a propellant system failure or an engine failure and insufficient propellant remaining to protect RCS steep deorbit capability, the burn must be terminated and deorbit will be attempted at the next PLS opportunity. The Flight Rules Annex may redefine the deorbit propellant requirement to allow RCS deorbit to 45-degree prebank targets.

Downmoding will not be performed on noncritical burns so that propellant redlines can be redefined prior to committing propellant to a delta V maneuver unnecessarily.

FLIGHT RULES

A2-115

ENGINE SELECTION CRITERIA

ENGINE SELECTION WILL BE BASED UPON OMS/RCS DOWNMODING CRITERIA, MANEUVER CRITICALITY, AND THE SPECIFIC DELTA V REQUIREMENTS FOR THE MANEUVER:

- A. DELTA V < 6 FPS - PERFORM MANEUVER WITH RCS. DOWNMODING PROTECTION IS PROVIDED BY JET REDUNDANCY.
- B. DELTA V >6 FPS - PREFERENCE WILL BE GIVEN TO SELECTING A SINGLE OMS ENGINE CONFIGURATION VERSUS TWO OMS ENGINES, SUBJECT TO MANEUVER CRITICALITY AND PROCEDURAL COMPLEXITY CONCERNS, IN ORDER TO ACCOMMODATE ENGINE LIFETIME CONSIDERATIONS. RCS MAY BE USED IF APPLICABLE.

For large delta V maneuvers (> 6 fps) OMS engines are selected over RCS jets in order to reduce propellant consumption and minimize burn residuals. RCS jets are used for smaller delta V maneuvers (< 6 fps) to avoid unnecessary OMS engine starts when propellant savings will be negligible. Also, for small OMS burns (< 6 seconds) guidance runs open-loop so postburn residuals may be large. If following these guidelines creates unnecessary procedural complexity (e.g., burns planned originally using the RCS system must be switched real time to OMS burns), it is acceptable to use RCS jets for delta V maneuvers of greater than 6 fps provided the additional propellant necessary is available.

Rule {A2-121E}.3, RNDZ/PROX OPS PROPULSION SYSTEMS MANAGEMENT, references this rule.

FLIGHT RULES

A2-116

RENDEZVOUS (RNDZ) / PROXIMITY OPERATIONS (PROX OPS) DEFINITIONS

- A. RNDZ OPS ARE DEFINED TO INCLUDE ALL ORBITER RNDZ MANEUVERS AND ASSOCIATED RNDZ ACTIVITIES TERMINATING WITH THE INITIATION OF PROX OPS.
- B. PROX OPS BEGIN AT THE COMPLETION OF RNDZ OPS WHEN THE ORBITER RANGE TO THE TARGET IS <1000 FEET AND THE LVLH RELATIVE VELOCITY IS <1 FPS IN EACH AXIS.

RNDZ OPS utilize closed loop guidance, navigation, and control to achieve a desired relative state. PROX OPS is a post-RNDZ activity where different techniques used to "control" the orbiter trajectory than those used during RNDZ OPS. These techniques rely on crew visual observations and piloting techniques to achieve a desired relative state. These definitions are provided for reference.

FLIGHT RULES**A2-117****RNDZ/PROX OPS GNC SYSTEMS MANAGEMENT**

FAILURE TO MAINTAIN THE FOLLOWING CAPABILITIES WILL BE CAUSE TO NO-GO TI AND PRECLUDE APPROACH CLOSER THAN 250 FEET FROM A TARGET. HOWEVER, IF THE REQUIRED CAPABILITY CAN BE RECOVERED PRIOR TO 250 FEET WITHOUT IMPACTING RENDEZVOUS OPERATIONS, TI CAN BE PERFORMED. IF THE FOLLOWING CAPABILITY IS NOT MAINTAINED WHILE OPERATING WITHIN 250 FEET OF A TARGET, A MANEUVER TO 250 FEET WILL BE PERFORMED UNTIL THE LOST CAPABILITY CAN BE REGAINED. ©[021199-6798A] ©[022405-6344B]

If the required systems capability is lost prior to Ti, instead of burning Ti, a Ti delay can be performed. The Ti delay is executed to provide more time to evaluate the lost system and work recovery efforts during a benign phase. Ti may be performed if troubleshooting and recovery of the required system capability can be accomplished prior to 250 feet without impeding the actions necessary to accomplish the rendezvous. Once Ti is executed, loss of systems redundancy required within 250 feet for THC, IMU's and GPC stringing is not cause to break out. The rendezvous profile can be safely flown to the next convenient holding point (V-bar) where the problem can be resolved. For example, even though performing Ti places the orbiter on or near an intercept trajectory, Ti may be performed without IMU redundancy because, if the last IMU were to fail, a breakout could be executed by manually using the Earth horizon or COAS line of sight as a reference. ©[022405-6344B]

A. ROTATION AND TRANSLATION CAPABILITY IN EACH AXIS. MINIMUM JET REQUIREMENTS FOR TRANSLATION ARE AS FOLLOWS:

1. +X - ONE AFT-FIRING JET IN EACH AFT POD [1] ©[081497-6283A]
2. -X - ONE FORWARD-FIRING JET
3. ±Y - ONE FORWARD YAW JET PER SIDE, ONE FORWARD DOWN JET PER SIDE, AND ONE AFT YAW JET PER SIDE [3][4]
4. -Z - ONE DOWN-FIRING JET IN THE FORWARD MODULE AND EACH AFT POD [3][4]
5. NORMAL +Z - ONE UP-FIRING JET IN THE FORWARD MODULE AND EACH AFT POD
6. LOW +Z - TWO FORWARD-FIRING JETS AND ONE AFT-FIRING JET PER POD [2]

THIS RULE CONTINUED ON NEXT PAGE

FLIGHT RULES**A2-117 RNDZ/PROX OPS GNC SYSTEMS MANAGEMENT (CONTINUED)**

NOTES:

- [1] IF THE ORBITER IS UNDER ACTIVE ATTITUDE CONTROL, ONLY ONE JET TOTAL IS REQUIRED, BUT PROPELLANT CONSUMPTION WILL BE GREATER DUE TO RESULTANT CROSS-COUPLING.
- [2] LOW +Z IS DESIRABLE BUT NOT NORMALLY REQUIRED LOW Z ATTITUDE CONTROL IS UNAFFECTED BY LOSS OF THESE JETS.
- [3] DAP LOGIC WILL INHIBIT Y TRANSLATIONS IF BOTH FORWARD SIDE-FIRING OR DOWN-FIRING JETS ON EITHER SIDE ARE NOT AVAILABLE. @[081497-6283A]
- [4] FOR DOCKING MISSIONS, POST CONTACT THRUST (PCT) REQUIRES ONE FORWARD DOWN-FIRING JET PER SIDE AND ONE DOWN-FIRING JET IN EACH AFT POD (FOUR JETS TOTAL). THESE JET REQUIREMENTS ARE SATISFIED AS LONG AS $\pm Y$ AND $-Z$ TRANSLATION CAPABILITIES EXIST. @[021199-6798A] @[ED]

If the above capabilities are not maintained outside of 250 feet while approaching a target, proximity operations inside 250 feet will be postponed until reconfiguration regains the lost capability. A minimum range of 250 feet is used because the ISS approach corridor begins at 250 feet, and it would not be prudent to approach within the corridor without full control capability. For other rendezvous targets, this minimum range is somewhat arbitrary, and 250 feet is used for consistency across all rendezvous flights. @[021199-6798A]

Proximity operations within 250 feet of a target vehicle requires complete rotation and translation capability. Rotation is required for attitude control while maneuvering the orbiter to the target vehicle and can be achieved with either VRCS or PRCS. Translation (PRCS only) is required to properly achieve a relative position to the target vehicle. Satisfying the minimum jet requirements for translation listed above also ensures that full PRCS attitude control is available for both Low Z and Norm Z modes (rotational control requires a subset of the jets used for translation). Failure to maintain full capability could jeopardize crew safety, loads margins, and mission success. The number of jets required for each group is specified.

THIS RULE CONTINUED ON NEXT PAGE

FLIGHT RULES

A2-117

RNDZ/PROX OPS GNC SYSTEMS MANAGEMENT (CONTINUED)

Low Z capability is desirable for some target vehicles in order to minimize plume impingement on the target vehicle from the up-firing PRCS jets during attitude hold or +Z translations. @[081497-6283A]

Low Z is defined in terms of two capabilities:

- a. *Translation: Simultaneous plus and minus X jets will fire in response to a +Z THC command.*
- b. *Attitude control: The DAP will not command any up-firing jets (TAIL-ONLY option for pitch control selected on SPEC 20 is overridden by Low Z, resulting in forward down-firing jets being commanded for pitch-up control). Therefore, one forward down-firing jet on each side and one down-firing jet in each aft pod is required to maintain pitch and roll control (yaw requirements are unchanged). The Low Z mode will be deselected and the DAP will mode to FREE if the IMU ATT DG flag is set BAD.*

Docking missions require Post Contact Thrusting (PCT) for successful capture. PCT capability is ensured as long as the minimum jet requirements for translation listed above are satisfied. @[021199-6798A]

B. RHC AND THC CONTROLLERS @[022405-6344B]

1. AFT RHC REQUIRES A MINIMUM OF ONE CHANNEL PER AXIS.

The aft RHC is required to have at least one channel per axis in order to retain complete rotation capability. The loss of the forward RHC is not a constraint due to the difficulty in performing proximity operations from the forward station.

2. AFT THC REQUIRES A MINIMUM OF ONE CONTACT PER AXIS.
ADDITIONAL RESTRICTIONS ARE AS FOLLOWS:

- a. -Z TRANSLATION: IF THE AFT THC IS ZERO FAULT TOLERANT IN -Z AXIS, THE DAP WILL REMAIN IN TRANSLATION PULSE.
- b. +Z TRANSLATION: DURING PERIODS WHERE TIME CRITICAL BRAKING MAY BE REQUIRED, THE AFT THC MUST BE 1 FAULT TOLERANT IN THE +Z AXIS. THE AFT THC'S FAULT TOLERANCE MAY BE PROVIDED BY MANNING THE FORWARD THC. TIME CRITICAL BRAKING IS REQUIRED WITHIN 75 FEET OF ISS. @[022405-6344B]

THIS RULE CONTINUED ON NEXT PAGE

FLIGHT RULES

A2-117

RNDZ/PROX OPS GNC SYSTEMS MANAGEMENT (CONTINUED)

The aft THC is required to have at least one contact per axis per direction (i.e., +X, -X, +Y, -Y, +Z, -Z) in order to retain complete translation capability using normal procedures. Depending on the failure, fault tolerance can be lost after a single failure. For example, if the first contact fails low or is commfaulted, THC control will be lost if the next failure is a fail low contact in the same direction. The second failure places the THC in dilemma until the problem contact is deselected. A majority of the time, zero fault tolerance in the AFT THC is acceptable since time exists (immediate inputs are not required) to work recovery efforts (e.g., deselect bad channel with an item entry). Also, the forward THC can be temporarily used for gross control to either back out or stationkeep so as to provide additional time to troubleshoot the problem. Some cases require additional fault tolerance/restrictions. The final contact in both the AFT and FWD THC's must be protected against a single point failure no-opting both controllers. ©[022405-6344B]

For the aft THC, the -Z axis must be redundant or, if only one contact remains, the DAP must remain in translation PULSE. If the DAP is in translation NORM, a fail "on" of the last remaining -Z translation contact in a powered THC will uncontrollably accelerate the orbiter toward the target with six PRCS jets. If the DAP is in translation PULSE, six PRCS jets will fire in a single pulse to achieve the translation rate increment loaded on the DAP CONFIG display. At OFTP #208 on November 14, 2003, it was determined that a single uncommanded pulse (in one of the rendezvous or prox ops DAP modes) could be managed by the crew and would not result in an uncontrolled acceleration toward the target. Recovery from the scenario that would cause an uncommanded pulse will require the AFT Flight Controller to be powered off and inputs from the FWD THC to null rates and allow for reconfiguration or backout.

+Z translation (braking) redundancy must be retained at all times when in close proximity to a target where time critical braking may be required (e.g., within 75 feet of ISS). If +Z translation redundancy is lost in the aft THC, the forward THC will be manned during the period when time critical braking may be needed. +Z translation can be lost by failure of +Z contacts or a combination of failures such that the -Z axis fails high. With the AFT THC -Z axis failed high, commanding the THC in the +Z direction would not provide the intended braking since opposite commands in the same Z axis would be algebraically summed to zero resulting in no selected output. If braking is needed, and the Aft THC is unresponsive, the crew can brake by turning on the forward flight controller power and inputting the required "down" pulses. The OFTP #208 on November 14, 2003 determined the crew could provide adequate braking capability, if the need arises, from the forward THC. ©[022405-6344B]

THIS RULE CONTINUED ON NEXT PAGE

FLIGHT RULES

A2-117

RNDZ/PROX OPS GNC SYSTEMS MANAGEMENT (CONTINUED)

It will be necessary in some cases to perform THC operations from the forward station due to the loss of functionality of the AFT THC. For the case of the last contact failed high while in VERNS, the AFT THC will be completely no-opted and not accept any inputs due to the Hot Stick upmoding logic. If the DAP is in PRI and the last contact fails high, then only the opposite direction will be locked out from firing jets. It should be noted that in either VERN or PRI if the THC is deflected in the opposite direction of the failed high contact, no jets will fire to null the uncommanded THC input, but a second uncommanded jet firing will occur when the THC is returned to detent. For this case, the crew will need to monitor SPEC 25 for the failed high contact and turn flight control power off before attempting to null the uncommanded rate. If the AFT flight control power is left on, then the FWD THC inputs will not work and aggravate the situation because the AFT will continue to command the DAP to fire in the undesired direction every time the FWD is returned to detent after trying to null the rate. ©[022405-6344B]

Exclusive use of the forward station should not be planned. Per conclusions reached at the OFTP #208 on November 14, 2003, use of the forward THC is allowed for braking and for backout burns (when the AFT THC becomes unexpectedly non-functional). These forward THC actions are relatively simple (down deflection) and, with an established opening rate, the corridor envelope is increasing. An increasing envelope provides additional clearance and plume margins and reduces the likelihood that additional inputs from the forward THC would be required before the AFT THC could be recovered. Flying an approach from the forward THC is not recommended since the scenario requires numerous failures in the AFT THC and also during the approach, the corridor envelope is shrinking, thereby increasing the probability that numerous translational inputs would be required. Flying using the forward THC is more difficult than the AFT THC due to the -Z/+X sense conversions (target view is -Z sense, but forward THC inputs are +X sense).

- C. +Z TRANSLATION MUST BE ONE-FAULT TOLERANT FOR JETS OR MANIFOLDS. EITHER NORMAL +Z OR LOW +Z ARE ACCEPTABLE FOR BRAKING AND SEPARATION MANEUVERS.

+Z translation capability in jets must be retained at all times in order to be able to back away from the target vehicle should failures cause the loss of critical system redundancy. Backing away to 250 feet gives the crew time to reconfigure their systems, if possible, to allow for safe continuation of PROX OPS. Continuing PROX OPS without one-fault tolerance in the +Z translation direction is a risk to the safety of the crew/vehicle should subsequent failures cause the loss of vehicle control in close proximity. ©[022405-6344B]

THIS RULE CONTINUED ON NEXT PAGE

FLIGHT RULES

A2-117

RNDZ/PROX OPS GNC SYSTEMS MANAGEMENT (CONTINUED)

- D. TWO IMU'S. (FOR SMALL PAYLOADS, CONSIDERATION WILL BE GIVEN TO CONTINUING NOMINAL V-BAR OPERATIONS WITH ONE IMU.)
@[022405-6344B]

A good attitude reference is required to correctly perform breakout maneuvers and rendezvous operations within 250 feet of a target. Two IMU's are required for redundancy purposes so that if one fails, one IMU will remain to provide a good attitude reference. Without a proper attitude reference, the breakout could be executed in an incorrect direction, resulting in short/long term collision concerns and catastrophic pluming of the target. Very close to the target, loss of tight attitude control could result in a collision with the target or difficulty grappling the payload. Loss of good attitude reference will occur if the last remaining IMU fails completely or provides a bad attitude reference. Loss of attitude reference will result in the DAP moding to free drift and reselection of Low Z will be required. Failure to reselect Low Z in close proximity to the target will result in pluming of the target with the shuttle RCS jets.

Although PROX OPS can continue with loss of two IMU's, loss of IMU redundancy is cause to invoke next PLS and is reason in itself for terminating PROX OPS. Consideration will be given to continuing nominal V-bar operations on one IMU for small payloads (Spartan/Spas class) if it does not impact next PLS opportunities/operations. The consideration will address the effects of the loss of the last good IMU on the payload control system capability to recover from RCS pluming, payload sensitivity to RCS plume loads, and the potential for collision (check the flight-specific rule for applicability). Unlike large payloads, IMU redundancy is not critical for the small payload breakout burn (assuming posigrade +Z burn), because if the last IMU fails, the breakout can be executed manually. The crew can also use the Earth horizon as a gross reference to check that the IMU is still good and for manual attitude control. For ISS, the breakout requires an initial radial burn followed by a multi-axis burn that cannot be performed correctly with only a gross attitude reference. @[022405-6344B]

THIS RULE CONTINUED ON NEXT PAGE

FLIGHT RULES

A2-117 **RNDZ/PROX OPS GNC SYSTEMS MANAGEMENT (CONTINUED)**

- E. STRINGING SUCH THAT FOR THE LOSS OF ONE GPC THE FOLLOWING FUNCTIONS ARE MAINTAINED:
1. EITHER LOW +Z OR NORMAL +Z TRANSLATION CAPABILITY
 2. IMU REFERENCE (IF TWO IMU'S AVAILABLE)

It is important to remember to string such that a GPC failure can be sustained without loss of +Z translation capability (Low +Z or Normal +Z) for backaway operations or IMU reference.

Two GNC GPC's are required for operations within 250 feet. This requirement is stated in DPS Rule {A2-120}, RNDZ/PROX OPS DPS SYSTEMS MANAGEMENT. While this DPS rule is standalone, the GNC reasons to maintain two GNC GPC's are to retain fail-safe redundancy in the hand controllers and jets. @[022405-6344B]

A2-118 **RNDZ/PROX OPS COMMUNICATION SYSTEMS MANAGEMENT**

- A. THE KU-BAND SYSTEM WILL BE USED IN RADAR MODE DURING RNDZ/PROX OPS, BUT MAY BE USED IN COMMUNICATIONS MODE DURING PERIODS WHEN RADAR DATA IS NOT REQUIRED. @[061396-1961]

The Ku-band system can be switched between radar and communications mode as necessary.

- B. WHILE IN RADAR MODE, IF THE AZIMUTH ANGLE EXCEEDS 30 DEGREES FROM THE ORBITER -Z AXIS, THE KU WILL BE PLACED IN AUTO TRACK. WHILE IN THIS NO-SEARCH ZONE, A MANUAL SEARCH SHOULD ONLY BE INITIATED UPON MCC GO. @[061396-1961]

Radar scans should not be initiated for beta gimbal angles greater than ± 38 degrees (reference SODB, Communications and Tracking Subsystems - Constraints and Limitations page 3.4.5.2-6). An azimuth angle of 30 degrees satisfies this beta gimbal limit, and is independent of the elevation angle. While in this "No Search Zone," a manual search can be initiated upon evaluation by the MCC of the actual beta gimbal angles.

Reference {A11-16}, KU-BAND MANAGEMENT. @[061396-1961]

FLIGHT RULES

A2-119

RNDZ/PROX OPS SENSOR REQUIREMENTS ©[091098-6707B]

- A. DATA FROM THE KU RADAR, -Z/-Y STAR TRACKER, OR COAS (IN ORDER OF PRIORITY FROM HIGHEST TO LOWEST) MUST BE INCORPORATED INTO THE ONBOARD NAVIGATION FILTER DURING DAY OF RENDEZVOUS OPERATIONS BETWEEN NC AND MANUAL TAKEOVER.

The intent of this rule is two fold. First, it identifies that Ku, Star Tracker, and COAS systems are required for rendezvous operations at a higher priority than other users (Comm, IMU align, etc.). Second, it identifies that rendezvous may not be possible within the pre-mission defined limits of the propellant budget without the incorporation of data from one of these systems into the onboard navigation system. Continuation of the rendezvous without having incorporated this data will likely lead to reaching the breakout criteria specified in Rule {A2-126}, RNDZ/PROX OPS BREAKOUT. Rendezvous may be possible without these sensors given a wide margin of error in the propellant budget.

Rendezvous maneuvers prior to the actual day of rendezvous do not require onboard navigation sensors and are targeted strictly off ground-based solutions.

PRIOR TO TI, THE RNDZ MAY BE DELAYED IF REGAINING A HIGHER PRIORITY SENSOR IS POSSIBLE.

Regaining a higher priority sensor will result in a more accurate onboard navigation filter state which will, in turn, result in a higher probability of a successful rendezvous and a more propellant-efficient manual phase. Rendezvous delays up through and including Ti can be achieved with aft propellant usage only and hence may be worthwhile if doing so allows for the recovery of a more accurate rendezvous sensor, resulting in the savings of forward propellant during the manual phase. Rendezvous Delay is described in Rule {A2-125}, RNDZ OPS DELAY.

THIS RULE CONTINUED ON NEXT PAGE

FLIGHT RULES

A2-119

RNDZ/PROX OPS SENSOR REQUIREMENTS (CONTINUED)

- B. THE KU SYSTEM, IF AVAILABLE, WILL BE CONFIGURED FOR RADAR OPERATIONS DURING MANUAL PHASE UNTIL THE CDR DEEMS THAT IT IS NOT REQUIRED TO SUPPORT PILOTING OPERATIONS GIVEN THE AVAILABILITY OF OTHER RANGING SENSORS (HHL OR TCS). AT THIS TIME, THE KU SYSTEM MAY BE CONFIGURED FOR COMM.

The Ku radar system is the prime range/range rate sensor during the manual phase until reliable HHL or TCS data becomes available. ©[091098-6707B]

- C. COAS NAVIGATION CONSTRAINTS ©[031500-7178A]

1. THE -Z COAS MUST BE CALIBRATED PRIOR TO EXECUTING COAS NAV.

COAS mounting errors are significant enough (typically 0.5 deg) to result in unacceptable navigation performance if COAS marks are taken with an uncalibrated COAS. The calibration is no longer valid if the cabin pressure changes significantly, such as a depress from 14.7 to 10.2 psi.

2. VERNIER ATTITUDE CONTROL IS REQUIRED TO PERFORM COAS NAV.

PRI jets provide coarser control than VERN's. The coarse control degrades the performance of COAS nav due to one or more of the following factors: 1) fewer marks can be taken in the limited time available, 2) less accurate marks can be taken, and 3) larger trajectory perturbations due to increased cross coupling of rotation into translation. In addition, PRI control can use significantly more propellant. Given the degraded performance and the potential use, more propellant analysis has shown that it is better to continue the rendezvous without performing COAS nav.

THIS RULE CONTINUED ON NEXT PAGE

FLIGHT RULES

A2-119

RNDZ/PROX OPS SENSOR REQUIREMENTS (CONTINUED)

3. UNLESS THE CREW IS TOLD TO PROCEED WITH COAS NAV ALMOST IMMEDIATELY AFTER COMPLETING THE TI BURN, IT IS NOT AVAILABLE AS A SENSOR DOWNMODE OPTION.

The act of taking COAS NAV marks perturbs the trajectory. To overcome this effect, the COAS NAV pass must be long enough to ensure that an adequate number of marks are taken to converge the onboard nav state. Rather than attempting to determine through analysis the latest time that COAS NAV could be started, an operationally acceptable limit was defined and all analysis was performed using this limit. To be consistent with the analysis, the first COAS NAV mark must be taken no later than $T_i + 10$ minutes. Because there are several events that must happen between T_i and taking the first COAS mark, such as completing the T_i burn, OMS gimbal check, maneuver to -Z axis target track, ground uplink of COAS NAV covariance matrix, and step 1 of the COAS NAV procedure, the crew must be instructed to perform COAS NAV almost immediately after T_i . ©[031500-7178A]

4. IF COAS NAVIGATION IS EXECUTED, DO NOT EXECUTE MC1 OR THE OUT-OF-PLANE NULL. ©[031500-7178A]

There is not enough time between T_i and MC1 to take enough COAS marks to generate a converged nav state in support of MC1. Analysis indicates it is better to forego MC1 and take COAS nav through that time to get a good, converged nav state to support the MC2 burn.

COAS nav is not accurate enough to support execution of an out-of-plane null burn. The Y and Ydot on SPEC 33 will be quite dynamic from one COAS mark to the next and it is best to delay any out-of-plane control until the manual phase where more accurate sensors and visual observation can be used to null the out-of-plane motion.

Constraints 1, 2, 3, and 4 were presented to and approved by Orbit Flight Techniques Panel #175 on July 9, 1999. ©[031500-7178A]

FLIGHT RULES

A2-120

RNDZ/PROX OPS DPS SYSTEMS MANAGEMENT

- A. THREE GNC GPC'S ARE PREFERRED FOR RNDZ/PROX OPS. TWO GNC GPC'S ARE REQUIRED AT TI AND WITHIN 250 FEET OF THE TARGET VEHICLE: ©[021199-6798A]

Three GNC GPC's are preferred for rendezvous/prox ops to simplify recovery procedures if a GNC GPC fails during the period when rendezvous nav is enabled. If a GNC GPC fails, a restrung to the remaining two GPC's recovers all LRU redundancy, still meets rendezvous GPC requirements, and does not affect rendezvous nav functions as long as the target set is not changed.

TI is the starting point for requiring redundant GNC GPC's because this is the first burn which puts the orbiter on an intercept course with the target. This means that continuous control of the orbiter is required to preclude a collision with the target. Single fault-tolerance for control of braking and separation maneuvers is required, and redundant GNC GPC's meet this requirement. Prior to TI, the orbiter is not on an intercept course and momentary loss of control is not critical; therefore, single fault-tolerance is not required.

1. FOR LOSS OF ONE GNC GPC OUT OF A TWO GNC GPC REDUNDANT SET WHEN FURTHER THAN 250 FEET FROM TARGET, RECONFIGURATION TO A TWO-GNC REDUNDANT SET WILL BE DELAYED TO THE NEXT OPERATIONALLY CONVENIENT POINT.

The crew is very busy flying the manual phase of rendezvous operations. Reconfiguration would interfere (and may promote errors) with the manual task and, therefore, will be delayed to the next convenient point as long as the orbiter-to-target distance is greater than 250 feet.

2. LOSS OF ONE GNC GPC OUT OF A TWO GNC GPC REDUNDANT SET DURING PROX OPS WITHIN 250 FEET WILL RESULT IN A BACKOUT MANEUVER AWAY FROM THE TARGET OUT TO A DISTANCE OF 250 FEET UNTIL RECONFIGURATION TO A TWO-GNC REDUNDANT SET IS COMPLETED.

The fail-safe status afforded by two GNC GPC's is required for close proximity of the orbiter to other objects. Loss of one of the two GNC GPC'S within 250 feet is reason to terminate PROX OPS and back away from the target due to the possibility of vehicle contact with the target on the next failure (no longer fail-safe). A distance of at least 250 feet provides a safety margin before attempting to reconfigure.

©[021199-6798A]

THIS RULE CONTINUED ON NEXT PAGE

FLIGHT RULES

A2-120

RNDZ/PROX OPS DPS SYSTEMS MANAGEMENT (CONTINUED)

3. FOR LOSS OF ONE GNC GPC OUT OF A THREE GNC GPC REDUNDANT SET DURING PROX OPS, RESTRING TO REMAINING TWO GNC GPC'S WHEN POSSIBLE.

When starting with a three GNC GPC set, loss of a single GPC is not critical. A simple restrung can be performed to regain the lost string(s) without disruption of rendezvous nav operations. With the standard stringing configuration for three GPC's (ref. Rule {A7-102C}.2.b, PASS DATA BUS ASSIGNMENT CRITERIA [HC]) loss of a single GPC does not require immediate action.
 @[042507-8489A]

- B. IN A TWO GNC GPC SET CONFIGURATION FOR GNC OR SM GPC FAILURES, THE FREEZE-DRY GPC (G2FD) MAY BE RECONFIGURED AS GNC OR SM. IF G3 ARCHIVE HAS BEEN LOST AND A G3FD GPC HAS BEEN CONFIGURED, THE G3FD MAY BE GIVEN UP IF TWO G3 SOURCES (MMU 1, MMU 2) ARE AVAILABLE.

Recovery of a redundant GNC GPC is done to provide fail-safe vehicle control during rendezvous or PROX OPS. Recovery of an SM function is done to provide rendezvous radar antenna initialization, insight into or control of payloads, and GPC control for PDRS usage. The G2FD GPC may be given up without regard to the number of available sources of entry software because of G3 archive capability as long as there are two other sources of PASS G3 software. Two sources are considered to be an adequate level of redundancy for obtaining G3 software.

Reference Rule {A7-201C}, DPS REDUNDANCY REQUIREMENTS.

- C. IN A THREE GNC GPC SET CONFIGURATION FOR AN SM GPC FAILURE, ONE OF THE GNC GPC'S MAY BE RECONFIGURED AS AN SM GPC.

Since only two GNC GPC's are required for providing a fail-safe capability during the critical maneuvers of RNDZ/Prox Ops, it is allowable to give up one of the three GNC GPC's to recover the SM function.

FLIGHT RULES

A2-121

RNDZ/PROX OPS PROPULSION SYSTEMS MANAGEMENT

A. RNDZ/PROX OPS ACTIVITIES WILL BE TERMINATED AND A BREAKOUT MANEUVER WILL BE PERFORMED WHEN PROPELLANT AVAILABLE DECREASES TO THE TOTAL OF:

1. DEORBIT REDLINES:

- a. OMS DEORBIT REDLINE (REF. RULE {A6-303A}, OMS REDLINES [CIL]).
- b. FRCS DEORBIT REDLINE (REF. RULE {A6-304A}, FORWARD RCS REDLINES).
- c. ARCS ENTRY REDLINE (REF. RULE {A6-305}, AFT RCS REDLINES [HC]). ©[042706-7370D]

OMS and RCS deorbit redlines must be protected in order to continue any on-orbit operations. Violation of these redlines is cause to enter at the next PLS opportunity. Note that per Rule {A2-108}, CONSUMABLES MANAGEMENT, the weather wave-off extension day may be deleted in favor of critical on-orbit/payload activities. ©[092800-7247A]

2. PROPELLANT REQUIRED FOR ORBITER MAINTENANCE (ATTITUDE CONTROL -ZLV -XVV OR THERMAL PROTECT ATTITUDE IF REQUIRED, 1 DEGREE VRCS, ONE IMU ALIGN/DAY) FOR 1 DAY. ©[051194-1612A]

Following either a successful or aborted rendezvous, propellant must be available for attitude control until the next PLS deorbit opportunity (which could be up to 24 hours away).

3. RNDZ/PROX OPS BREAKOUT/SEPARATION MANEUVER.

If it is necessary to abort a rendezvous attempt when in close proximity to the target, a breakout maneuver is required in order to establish a safe separation rate from the target. The exact nature of the breakout maneuver is dependent upon the relative position to the target, but the maneuver usually entails several RCS translations. Also, for a successful rendezvous, a separation maneuver (e.g., ISS Joint Expedited Undock and Sep) may be required to safely separate from the target prior to deorbit. Thus, the worst case breakout propellant requirements will be covered in the terminate quantities.

THIS RULE CONTINUED ON NEXT PAGE

FLIGHT RULES

A2-121

RNDZ/PROX OPS PROPULSION SYSTEMS MANAGEMENT
(CONTINUED)

4. HIGHER PRIORITY ACTIVITIES (REF. RULE {A2-108},
CONSUMABLES MANAGEMENT) .

Propellant must be available to complete all post-rendezvous activities of higher priority than the rendezvous in order to continue with the rendezvous. Activities are listed in order of priority in Rule {A2-108}, CONSUMABLES MANAGEMENT. ©[092800-7247A]

5. PROPELLANT REQUIRED TO COVER RETURN OF THE PAYLOAD
INCLUDING: ©[092800-7247A]

- a. X OR Y CG BALLAST (IF REQUIRED) .

For payloads planned on being berthed in the payload bay, either for repair and redeploy or for return to Earth, OMS or RCS propellant may be required as ballast in order to maintain the orbiter CG within the acceptable envelope as outlined in Flight Rule {A4-153}, CG PLANNING.

- b. THERMAL PROTECT ATTITUDE AS REQUIRED.

Certain payloads may have thermal constraints which would necessitate maintaining the orbiter in attitudes and/or deadbands that require more than the nominal -ZLV 1 degree deadband propellant allocation. This item also applies to any payload planned on being berthed in the payload bay either temporarily or for return. ©[051194-1612A]

- c. INCREASED DEORBIT VEHICLE WEIGHT (INCLUDES WEIGHT OF
PAYLOAD) .

OMS propellant required for deorbit will be calculated using the vehicle weight with the payload on board unless the payload is incapable of being returned to earth (in which case the separation maneuver must be protected in paragraph 3 above). This guarantees enough propellant to deorbit safely with the payload onboard. This propellant requirement, if applicable, may be mutually exclusive with the rndz/prox ops breakout maneuver, so only the greater of the two must be protected. ©[092800-7247A]

THIS RULE CONTINUED ON NEXT PAGE

FLIGHT RULES

A2-121

RNDZ/PROX OPS PROPULSION SYSTEMS MANAGEMENT (CONTINUED)

- B. IF EITHER FORWARD OR AFT QUANTITIES DECREASE TO THE RNDZ/PROX OPS TERMINATION QUANTITIES, THEN IT IS ACCEPTABLE TO ADJUST REDLINES BY THE USE OF NOSE-ONLY OR TAIL-ONLY PRCS CONTROL FOR ACTIVITIES (INCLUDING NON-RENDEZVOUS ACTIVITIES) NOMINALLY PLANNED FOR NOSE/TAIL CONTROL.

Certain activities budgeted using nose/tail control may be switched to tail-only control if the aft propellant is available. These activities include the deorbit wave-off extension day included in the OMS/RCS deorbit redlines, deorbit preparation, and one day of attitude control. Nose-only pitch/yaw control may also be utilized when aft propellant is critical. The breakout maneuver may not be adjusted.

©[051194-1612A]

- C. TO CONTINUE RNDZ OPS, PROPELLANT MUST BE AVAILABLE TO COVER THE "GO FOR TI" AS DEFINED IN PARAGRAPH I AND THE MCC PREDICTED REQUIREMENTS FOR THE REMAINING MANEUVERS UP TO TI.

In order to continue a rendezvous, propellant must be available to ensure a reasonable chance of completion. When it is clear that adequate propellant is not available to complete a "best day" rendezvous, RNDZ OPS should be terminated and propellant can be made available for lower priority activities which would have been canceled in order to complete the rendezvous. The "GO for TI" requirements represent the minimum amount of propellant required to complete a rendezvous from TI through target retrieval. Propellant required to complete all of the required phasing maneuvers up to TI is also covered here, based upon maneuver delta V's as calculated by the Flight Dynamics Officer. Because the "Continue RNDZ Ops" quantities are based on minimum propellant requirements from TI through grapple, rendezvous maneuvers may continue to be performed with only a minimal chance of a successful rendezvous.

- D. RENDEZVOUS WILL NOT BE ATTEMPTED IF THE FRCS IS NOT AVAILABLE. ©[092800-7247A]

FRCS propellant is necessary in order to maintain attitude in close proximity to the target (stationkeep). The FRCS is also required to perform a safe breakout maneuver. Without the FRCS it is not safe to remain in close proximity to the target. Additionally, terminal phase requires frequent small multi-axis translations which are not practical without the FRCS.

THIS RULE CONTINUED ON NEXT PAGE

FLIGHT RULES

A2-121

RNDZ/PROX OPS PROPULSION SYSTEMS MANAGEMENT
(CONTINUED)

- E. THE FOLLOWING GUIDELINES WILL BE USED WHEN EXECUTING RENDEZVOUS BURNS UP TO AND INCLUDING TI:
1. IF TOTAL DELTA V IS LESS THAN 4 FPS, BURN WILL BE PERFORMED MULTI-AXIS.
 2. IF TOTAL DELTA V IS BETWEEN 4 AND 6 FPS, A MANEUVER TO BURN ATTITUDE MAY BE PERFORMED AND THE BURN ACCOMPLISHED USING AFT RCS +X JETS.
 3. IF TOTAL DELTA V IS GREATER THAN 6 FPS, THE BURN MAY BE ACCOMPLISHED USING OMS ENGINE(S). OMS ENGINE GUIDELINES ARE ESTABLISHED PER FLIGHT RULE {A2-115B}, ENGINE SELECTION CRITERIA. (AFT RCS +X MAY BE USED IF MARGINS EXIST.)

The above guidelines for rendezvous burn execution have been established to ensure optimum use of OMS and RCS propellant. These guidelines are incorporated in the Rendezvous Flight Data File to assist the crew in burn execution and can be overridden by the MCC depending upon OMS/RCS propellant margins/system problems.

- a. *Because the crew has no way to determining the forward RCS contribution to the rendezvous burn, the 4 fps criteria (equates to 2 fps forward RCS usage) was established to determine if a maneuver to burn attitude is required.*
- b. *With rendezvous burns between 4 and 6 fps the attitude maneuver will be performed and the burn accomplished using aft RCS +X jets. This is performed to increase fwd RCS propellant availability. The OMS engines are not used because guidance is locked out if the OMS burns are 6 seconds or less (6-second countdown is used).*
- c. *OMS engine(s) will be used if delta V requirements are greater than 6 fps (per Rule {A2-115B}, ENGINE SELECTION CRITERIA, guidelines). Aft RCS +X jets may be used straight feed or interconnected if propellant margins exist.*

THIS RULE CONTINUED ON NEXT PAGE

FLIGHT RULES

A2-121

RNDZ/PROX OPS PROPULSION SYSTEMS MANAGEMENT
(CONTINUED)

- F. IF RENDEZVOUS MANEUVERS, UP TO AND INCLUDING TI, ARE TARGETED TO USE MORE THAN 2 FPS (50 LB) FROM THE FORWARD RCS, A MANEUVER TO BURN ATTITUDE MAY BE PERFORMED SO THAT THE BURN WILL BE ACCOMPLISHED USING OMS OR AFT RCS PROPELLANT.

During rendezvous/PROX OPS mission profiles, the forward RCS system is usually propellant-critical with the aft RCS and OMS systems having sufficient margins. It is usually desirable to save as much forward RCS propellant as possible to maximize the chances for mission success (rendezvous completion) without altering the planned mission profile (deletion of mission events). Rendezvous burns that require more than 2 fps (50 lb) from the forward RCS will normally incorporate a maneuver to burn attitude. Burn targets will be computed by onboard software, and the burn performed using aft RCS or OMS propellants to minimize forward RCS use. (Maneuvering to and from the burn attitude takes approximately 6 lb (VRCS) and 17 lb (PRCS).) Since attitude maneuvers can disturb the orbiter state vector, which is critical during rendezvous profiles, the decision to maneuver will be a tradeoff between disturbing the orbiter state and saving forward RCS. If forward RCS mission completion redline margins allow a multi-axis burn, a maneuver to burn attitude may not be required. The 2 fps (50 lb) constraint was selected to provide a compromise between increasing forward RCS propellant availability and avoiding excess maneuvering. ©[092800-7247A]

- G. NOSE/TAIL PRIMARY JET CONTROL WILL BE SELECTED POST-NCC BURN FOR THE LOSS OF VERNIER JET CONTROL CAPABILITY.

Nose/tail control is required post-NCC in order to maintain coupled jet firings for rotational attitude control. With nose-only or tail-only rotational attitude control, translation is induced which may significantly impact predicted TI and midcourse corrections.

THIS RULE CONTINUED ON NEXT PAGE

FLIGHT RULES

A2-121

RNDZ/PROX OPS PROPULSION SYSTEMS MANAGEMENT
(CONTINUED)

- H. TO BE GO FOR TI DELAY, PROPELLANT MUST BE AVAILABLE TO COVER THE TOTAL OF:
1. TERMINATION QUANTITIES AS DEFINED IN PARAGRAPH A.
 2. ORBITER MAINTENANCE FOR THE DELAY PERIOD (USUALLY ONE OR TWO ORBITS) .
 3. MCC PREDICTED TI-DELAY PLUS NEW TI USAGE.
 4. MEAN USAGE FROM POST-TI TO R-BAR, OR AS SPECIFIED IN THE FLIGHT RULE ANNEX. ©[021199-6706B] ©[092800-7247A]
 5. MEAN USAGE FROM R-BAR TO GRAPPLE/DOCK, IF SCHEDULED, OR AS SPECIFIED IN THE FLIGHT RULE ANNEX.

Delaying TI may be desired when time is required to better understand an orbiter problem. From a propellant standpoint, delaying TI is only acceptable when the delay does not significantly impact the chance of a successful rendezvous. For this reason, mean propellant usages are covered in this rule from post-TI through grapple as opposed to the minimum usages covered in the "GO for TI" call. Additional propellant is also required to perform a maneuver (usually at the nominal TI opportunity) to maintain a safe distance from the target for the period of the delay and to perform a subsequent TI burn. If insufficient propellant exists to be GO for TI delay, then either a breakout maneuver must be performed or the reason to delay TI must be waived. It is not acceptable to reduce the TI delay requirement by going to minimum usages for terminal phase and PROX OPS. The Flight Rules Annex is referenced in order to identify the details of the manual phase profile.

THIS RULE CONTINUED ON NEXT PAGE

FLIGHT RULES

A2-121

RNDZ/PROX OPS PROPULSION SYSTEMS MANAGEMENT
(CONTINUED)

- I. TO BE GO FOR TI, PROPELLANT MUST BE AVAILABLE TO COVER THE TOTAL OF
1. TERMINATION QUANTITIES AS DEFINED IN PARAGRAPH A.
 2. USAGE FOR MCC PREDICTED TI.
 3. MEAN MINUS 3 SIGMA USAGE POST-TI TO R-BAR ARRIVAL. ©[021199-6706B] ©[092800-7247A]
 4. MEAN MINUS 3 SIGMA USAGE FROM R-BAR ARRIVAL THROUGH GRAPPLE/DOCK. ©[021199-6706B] ©[092800-7247A]

The "GO for TI" propellant requirements are based upon the minimum amount of propellant required to complete a rendezvous prior to the TI burn. Mean minus 3 sigma protection based on Monte Carlo analysis provides a slim chance at being able to complete the rendezvous. If any chance exists that the rendezvous can be successfully completed, TI will be performed and the rendezvous will be continued until the terminate quantities are violated or violation of the terminate quantities becomes imminent in accordance with this rule and paragraph A. ©[092800-7247A]

- J. POST-TI, IF THE NEXT PLANNED MANEUVER VIOLATES THE TERMINATION QUANTITIES AS DEFINED IN PARAGRAPH A, THE RENDEZVOUS WILL BE TERMINATED.

When it is obvious that termination quantities will be violated before completion of the rendezvous, there is no reason to continue the rendezvous.

THIS RULE CONTINUED ON NEXT PAGE

FLIGHT RULES

A2-121

RNDZ/PROX OPS PROPULSION SYSTEMS MANAGEMENT
(CONTINUED)

- K. FOR DEPLOY/RELEASE MISSIONS TO BE GO FOR FREE FLYER RELEASE/RETRIEVE, PROPELLANT MUST BE AVAILABLE TO COVER THE TOTAL OF:
1. TERMINATION QUANTITIES AS DEFINED IN PARAGRAPH A.
 2. ORBITER MAINTENANCE FOR THE PLANNED DURATION OF FREE FLIGHT.
 3. MCC PREDICTED DELTA V FOR PAYLOAD SEPARATION AND REQUIREMENTS FOR THE REMAINING MANEUVERS THROUGH TI.
 4. AT LEAST MEAN USAGE POST-TI TO R-BAR (UP TO MEAN + 3 SIGMA USAGE PER FLIGHT RULES ANNEX).
 5. AT LEAST MEAN USAGE FROM THE R-BAR THROUGH GRAPPLE (UP TO MEAN + 3 SIGMA USAGE PER FLIGHT RULES ANNEX).

Before releasing a retrievable free flyer (e.g., SPARTAN), propellant must be available to ensure a reasonable likelihood of the return of the free flyer. As such, at least mean usage will be covered for all rendezvous maneuvers and PROX OPS activities. The Flight Rules Annex may redefine this requirement to require enough propellant to complete a rendezvous with up to 3-sigma usage. ©[021199-6706B]

- L. DURING A FAILED GRAPPLE/DOCKING ATTEMPT, TO PROTECT A RE-RENDEZVOUS CAPABILITY ON A SUBSEQUENT FLIGHT DAY, PROPELLANT MUST BE AVAILABLE TO COVER THE TOTAL OF: ©[021199-6706B]

The quantities indicated below are intended to provide guidelines for use after a failure to grapple/dock or during a grapple/docking attempt that is not proceeding smoothly. These quantities are required to entertain the option of a re-rendezvous on a subsequent day. These numbers can be used to generate a "re-rendezvous bingo" quantity at which grapple/dock activities should be terminated for that day and a separation burn performed. Once the separation burn is performed and the re-rendezvous sequence is underway, propellant minimums to complete the re-rendezvous are outlined in Paragraph I of this rule.

THIS RULE CONTINUED ON NEXT PAGE

FLIGHT RULES

A2-121

RNDZ/PROX OPS PROPULSION SYSTEMS MANAGEMENT (CONTINUED)

If propellant quantities are below the re-rendezvous bingos, then re-rendezvous is most likely not possible and the ongoing attempts to grapple/dock should continue until a successful grapple/docking is achieved or the terminate quantities as indicated in Paragraph A of this rule are reached.

1. TERMINATION QUANTITIES AS DEFINED IN PARAGRAPH A.

Propellant must be protected to break out from the subsequent rendezvous, to provide a safe deorbit, and allow for the completion of higher priority mission activities.

2. MCC PREDICTED USAGE TO TERMINATE CURRENT GRAPPLE/DOCK ACTIVITIES AND SEPARATE.

Predicted usage to terminate the ongoing grapple/dock activities is based on a real-time assessment of these activities. For example, if a flyaround alignment is underway in an attempt to grapple a rotating free-flyer, propellant to arrest the orbiter's rotation rate, maneuver to the separation burn attitude, and separate must be protected. The separation burn will consist of the appropriate breakout per Rule {A2-126C}, RNDZ/PROX OPS BREAKOUT.

3. MCC PREDICTED DELTA V FOR THE RE-RENDEZVOUS MANEUVERS THROUGH TI.

Mean re-rendezvous propellant costs are included in the flight specific rendezvous propellant budget (Rndz-03 Flight Design product). ©[021199-6706B] ©[092800-7247A]

4. AT LEAST MEAN USAGE POST-TI THROUGH GRAPPLE/DOCK. BASED ON A REAL-TIME ASSESSMENT OF GRAPPLE/DOCKING ACTIVITIES, UP TO MEAN + 3 SIGMA USAGE MAY BE PROTECTED. ©[021199-6706B]

At least mean usage is protected for all rendezvous maneuvers and prox ops activities to ensure a reasonable chance of being able to re-rendezvous. Protecting only minimum usage post-Ti through grapple/docking is not recommended as it would significantly reduce the probability of being able to re-rendezvous before reaching the propellant terminate quantities while only reducing the propellant requirements by approximately 200 lb (1/3 fwd and 2/3 aft). In fact, depending on propellant availability and a real-time assessment of the ongoing grapple/dock activities, it may be prudent to protect more than mean propellant (up to 3 sigma) for all re-rendezvous maneuvers and prox ops activities. For example, if the ongoing grapple/docking activities have little chance for success due to the nature of the problem, then separating with 3 sigma protection will maximize prop availability for the subsequent grapple/docking attempt after troubleshooting steps have been performed. However, if a successful grapple/docking is imminent, then continuing below 3 sigma protection may allow the grapple/docking to be completed without assuming the risk of a re-rendezvous attempt. Protecting 3 sigma usage post-Ti through grapple/dock increases the propellant minimums by approximately 200 lb over mean usage (1/3 fwd and 2/3 aft). Post-Ti through grapple/dock prop costs (mean and sigmas) are included in the flight specific rendezvous propellant budget (Rndz-03 Flight Design product). ©[092800-7247A]

THIS RULE CONTINUED ON NEXT PAGE

FLIGHT RULES

A2-121

RNDZ/PROX OPS PROPULSION SYSTEMS MANAGEMENT
(CONTINUED)

5. CONTINGENCY PROX OPS PROPELLANT AS APPROPRIATE GIVEN THE NATURE OF THE FAILURE.

Depending on the nature of the difficulty that led to the failure to grapple/dock, additional propellant should be protected for prox ops contingencies during the subsequent grapple/docking attempt (i.e. orbiter/target flyaround alignment, extended stationkeeping, etc.). Propellant requirements for contingency prox ops activities are included in the flight specific rendezvous propellant budget (Rndz-03 Flight Design product).

6. ORBITER ATTITUDE MAINTENANCE FOR THE PLANNED DURATION OF FREE FLIGHT THROUGH GRAPPLE/DOCK.

Propellant for orbiter attitude maintenance during the re-rendezvous sequence must be protected.
@[021199-6706B]

- M. TO BE GO FOR THE RPM (R-BAR PITCH MANEUVER), PROPELLANT MUST BE AVAILABLE TO COVER THE TOTAL OF: @[121604-6491]

1. TERMINATE QUANTITIES AS DEFINED IN PARAGRAPH A.
2. MEAN PLUS THREE SIGMA USAGE PREDICTED FROM POST MC-4 THROUGH DOCKING, INCLUDING THE RPM.
3. MEAN PREDICTED USAGE FOR R-BAR STATIONKEEPING REQUIRED TO MEET RPM LIGHTING CONSTRAINTS.
4. ANY ADDITIONAL ACTIVITIES THAT ARE HIGHER PRIORITY THAN THE RPM AS DEFINED IN THE FLIGHT RULE ANNEX ON-ORBIT PROPELLANT PRIORITIES.

The "GO for RPM" propellant requirements are based on the mean plus three sigma dispersed usage predicted from post MC-4 through docking, including additional dispersions due to previous failures of items such as the TCS, vernier control, or rendezvous radar. In addition, mean predicted usage for any R-bar stationkeeping required on the day of rendezvous for RPM lighting constraints will be included in the GO/NO-GO for the RPM. For propellant critical situations, it is prudent to delete the RPM to increase the likelihood of docking with the ISS. @[121604-6491]

FLIGHT RULES

A2-122

RENDEZVOUS MANEUVERS

- A. THE GROUND WILL COMPUTE TARGETS FOR ALL MANEUVERS UP TO AND INCLUDING TI. ADDITIONALLY, THE GROUND WILL PROVIDE THE INITIAL ORBIT TARGETING BASETIME (TI TIG) USED FOR NCC, TI, AND MC1 MANEUVERS.
- B. THE ORBITER WILL COMPUTE TARGETS FOR NCC AND SUBSEQUENT MANEUVERS. THE ORBITER WILL REDEFINE THE ORBIT TARGETING BASETIME (MC2 TIG) FOR THE MC2, MC3, AND MC4 MANEUVERS.

NOTE: FLIGHT SPECIFIC MANEUVER DEFINITIONS AND TARGETING CRITERIA ARE SPECIFIED IN THE FLIGHT RULE ANNEX (THE ANNEX FLIGHT RULE, ORBITAL MANEUVER CRITICALITY). ©[ED]

Because of its relative navigation capability (ST, COAS, and RR), the orbiter is considered prime for all maneuvers from NCC to intercept. Typical criteria for TIG selection and maneuver targeting are given in the table. It should be emphasized that these data are flight-specific I-loads to orbit targeting (SPEC 34).

For pre-NCC maneuvers, the ground is the only system capable of targeting rendezvous maneuvers; due to software, orbit targeting (SPEC 34) can only target two-impulse maneuvers. The rendezvous maneuver sequence is designed to allow orbit targeting to compute NCC and subsequent maneuvers because the orbiter relative navigation systems can provide the most accurate states for the orbiter and target. For NCC and TI, the ground will provide an independently targeted solution for comparison with the orbiter solution. The solution will be selected per Rule {A2-123}, RENDEZVOUS MANEUVER SOLUTION SELECTION CRITERIA.

The NCC, TI, and MC1 maneuvers are scheduled relative to the initial basetime (TI TIG), which is usually a few minutes prior to orbital noon. This time is provided by the ground because the orbiter does not have the capability to compute it. For MC2, MC3, and MC4, the orbiter will redefine the basetime (MC2 TIG) automatically with orbit targeting. MC2 must be targeted at least once for this to occur.

FLIGHT RULES

A2-123

RENDEZVOUS MANEUVER SOLUTION SELECTION CRITERIA

- A. GROUND SOLUTIONS WILL BE EXECUTED FOR ALL MANEUVERS UP TO NCC.

Reference Rule {A2-122}, RENDEZVOUS MANEUVERS, for rationale.

- B. THE SOLUTIONS FOR THE NCC AND TI MANEUVERS WILL BE SELECTED ACCORDING TO THE FOLLOWING PRIORITIES:

1. ONBOARD FILTER SOLUTION IF, FOR THE PRESENT SENSOR IN ACQUISITION (RR, ST), 40 NAVIGATION MARKS HAVE BEEN ACCEPTED WITH A STATE VECTOR POSITION UPDATE LESS THAN 0.5K FEET FOR THE LAST FOUR MARKS. IF COAS, THIS CRITERION DOES NOT APPLY (REF. PARAGRAPH B.2).

The onboard filtered solution, with sufficient relative navigation data incorporated, consists of the most accurate and current relative state information and, therefore, should be considered the best solution. Sufficient navigation data is indicated by premission analysis to be greater than 40 marks in the current sensor pass and position updates of less than 0.5k feet for the last four measurement cycles. This is not the definition of the absolute best solution, but it ensures that the onboard solution will be more accurate than ground solution. Four consecutive marks with state vector position errors less than 0.5k feet was added to this criterion to eliminate transient effects and to ensure stability in the filtered state.

Obtaining and incorporating 40 COAS navigation marks are unrealistic, time-consuming, manual tasks. Statistical studies show that, after the first few COAS marks, updates to the filtered state are random and do not significantly contribute to the knowledge of the relative state. Therefore, since the COAS can never meet these criteria for sufficient navigation data, proceeding to paragraph B.2 forces a comparison with the ground solution.

2. ONBOARD FILTERED SOLUTION IF IT AGREES WITH THE GROUND SOLUTION.

NOTE: MANEUVER SOLUTIONS ARE DEFINED TO BE IN AGREEMENT IF, FOR EACH AXIS, THE DELTA V DIFFERS BY NO MORE THAN THE PREMISSION ONBOARD MINUS GROUND 3 SIGMA COMPARISONS LIMITS.

THIS RULE CONTINUED ON NEXT PAGE

FLIGHT RULES

A2-123

RENDEZVOUS MANEUVER SOLUTION SELECTION CRITERIA (CONTINUED)

3. ONBOARD PROPAGATED SOLUTION IF IT AGREES WITH THE GROUND SOLUTION.

NOTE: MANEUVER SOLUTIONS ARE DEFINED TO BE IN AGREEMENT IF, FOR EACH AXIS, THE DELTA V DIFFERS BY NO MORE THAN THE PERMISSION ONBOARD MINUS GROUND 3 SIGMA COMPARISONS LIMITS.

The onboard filtered and propagated solutions will be better than the ground solution because they will have been computed on at least the ground initialization state vector plus any IMU-sensed delta velocities. These solutions may contain additional improvements:

- a. *The filtered solution, even without sufficient relative navigation data as defined in paragraph B.1, will be as good or better than the propagated or ground solutions because it may have some relative navigation data incorporated in it.*
- b. *The propagated solution will be as good as or better than the ground solution because it may have been computed on a filtered state vector containing relative navigation data from a previous sensor pass that has been saved via a filter to propagator transfer.*

4. GROUND SOLUTION.

Agreement with the ground solution serves as a gross quality check for the onboard solution and, therefore, only needs to fall within the 3-sigma comparison limits.

The ground solution would be performed as a last resort.

- C. ONBOARD SOLUTIONS WILL BE EXECUTED FOR POST-TI MIDCOURSE MANEUVERS.

The ground has no capability to improve the relative state information between the orbiter and target for the midcourse correction maneuver computations. This is due to ground tracking uncertainties and the relatively close proximity of the two vehicles. Hence, the orbiter solution for these maneuvers will always be selected.

Rule {A2-122}, RENDEZVOUS MANEUVERS, references this rule.

FLIGHT RULES

A2-124

RENDEZVOUS MANEUVER EXECUTION

- A. ALL MANEUVERS COMPONENTS WILL BE TRIMMED TO VGO < 0.2 FPS IN ALL AXES.

Based on flight experience, the required trim, < 0.2 fps, is the best trim accuracy achievable by the crew on a consistent basis. This accuracy is required during rendezvous to keep deviations from premission and real-time planned profiles to a minimum.

- B. MIDCOURSE MANEUVERS, MC1, MC2, AND MC3, AS WELL AS THE OUT-OF-PLANE NULL WILL ALWAYS BE EXECUTED. @[021199-6732]

Midcourse maneuvers are designed to correct the orbiter intercept trajectory based on the most current relative state information. Even with no additional relative state sensor data, these maneuvers correct for trim errors from previous burns and attitude maneuver effects that are sensed via the accelerometers. Additionally, executing MC1 reduces the probability of experiencing targeting alarms and/or significant TIG slips at MC2 as a result of these dispersion effects. Executing MC2 with its elevation angle constraint reduces dispersions at the manual phase take-over point. The radar fail correction burn "rule of thumb" used in the radar fail procedures at MC3 + 2 min is most valid when the MC3 burn is executed, resulting in a more benign manual phase and slightly lower prop usage (ref. Orbit Flight Techniques #166 on June 26, 1998). The out-of-plane null is performed when the orbiter is at the out-of-plane node which is the optimum point to null out-of-plane motion.

This rule is a result of the implementation of the ORBT Rendezvous Profile baselined during Orbit FTP #161, February 14, 1997.

- C. MC4 WILL NOT BE PERFORMED IN RADAR FAILED CASES.

The radar fail procedures have the CDR begin manual piloting immediately after MC3, so MC4 should not be performed in this case. The onboard navigation state is not accurate enough to support a targeted intercept of the R-bar when the radar is failed.

THIS RULE CONTINUED ON NEXT PAGE

FLIGHT RULES

A2-124

RENDEZVOUS MANEUVER EXECUTION (CONTINUED)

IN THE EVENT THAT RADAR DATA BECOMES AVAILABLE POST-MC2, THE DATA MAY BE INCORPORATED INTO THE NAV FILTER BUT WILL NOT BE USED FOR ORBITER POINTING OR TARGETING. RADAR FAILED PROCEDURES WILL CONTINUE TO BE PERFORMED UNLESS MCC DEEMS THAT THE ONBOARD RELATIVE STATE IS SUFFICIENTLY CONVERGED AND THAT THE TRAJECTORY WOULD BENEFIT FROM A TARGETED MC4 BURN.
 ©[021199-6732]

In the event that a previously failed (or unavailable) radar system becomes available after MC2, then radar failed procedures will continue to be executed including the MC3 + 2 minute radar failed correction burn based on target position in the -Z COAS. Since the radar failed correction burn is dependent on orbiter pointing (i.e., position of target in -Z COAS), the radar data may be incorporated into the FLTR vector only if the PROP vector has been selected as the UPP source on RelNav (SPEC 33) so as not to impact the target track attitude. At this point, the radar failed procedures are at least as good as executing MC3 and MC4 off an onboard relative state that may not be completely converged. The ground has the authority to return the crew to nominal MC3 and MC4 targeting making use of the new radar sensor data if it can be shown in real time that the onboard relative state is sufficiently converged and the trajectory would benefit from targeted burns. In general, targeted burns will benefit trajectories that are short of the targeted MC4 point while radar failed procedures are better suited for long trajectories. ©[021199-6732]

This rule is a result of the implementation of the ORBT Rendezvous Profile baselined during Orbit FTP #161, February 14, 1997.

- D. LAMBERT GUIDANCE BURNS MUST BE COMPLETED BY T1 TIG + 90 SECONDS. ©[121296-4112A] ©[021199-6732]
1. IF THE START OF A BURN IS DELAYED SUCH THAT IT CANNOT BE COMPLETED BY T1 TIG + 90 SECONDS, THE BURN WILL BE RETARGETED PRIOR TO STARTING THE BURN.

THIS RULE CONTINUED ON NEXT PAGE

FLIGHT RULES

A2-124

RENDEZVOUS MANEUVER EXECUTION (CONTINUED)

2. IF A BURN IN PROGRESS IS NOT COMPLETE (I.E., VGO'S STILL > 0.2 FPS) BY T1 TIG + 90 SECONDS, THC INPUTS WILL BE STOPPED AND THE BURN WILL BE RETARGETED PRIOR TO COMPLETION.

Due to limitations in the onboard guidance software, Lambert guided burns should be completed within 90 seconds of the T1 TIG. This constraint is necessary because errors in the Lambert guidance solution increase as the time between T1 TIG and burn completion increases. At T1 TIG + 90 seconds, the worst case errors can be slightly larger than trim errors (0.2 fps) and can grow rapidly after that.

@[121296-4112A]

Flight history shows that rendezvous burns are usually complete 30 to 40 seconds after burn start. With rare exceptions, a burn started soon after TIG should be easily completed by T1 TIG + 90 seconds. If the start is delayed to the point its completion by T1 TIG + 90 seconds is in doubt, the burn should be retargeted prior to execution. When retargeted, the onboard software automatically computes a new T1 TIG equal to "current time + 1 minute." The burn must now be completed by the new T1 TIG + 90 seconds. In the unlikely event that a burn was started on time but not completed at T1 TIG + 90 seconds, THC inputs should be terminated and the burn retargeted prior to completion.

Because T1 TIG can be easily reset to a future time by simply retargeting the burn, this rule places no constraint on the total time a burn can slip past the planned TIG. The total slip capability is determined by the MCC on a burn by burn basis and is usually constrained by: 1) excess propellant usage; 2) Lambert targeting/guidance constraints that are not addressed in this rule, such as 180 degree transfers; or 3) links to ground targeted maneuvers such as the link between Ti and Ti delay. Other unique constraints are also possible.

Error in the burn solution arises from the fact that Lambert Cyclic Guidance (LCG) models the effects of gravitational oblateness (J2) in a fashion inconsistent with Lambert Targeting. This inconsistency and its effects on guidance performance are thoroughly documented in the references listed below. Reference Rockwell Transmittal Form # 660-NAV-710-96-037, "Lambert Cyclic Guidance Error Analysis," J.L.Goodman, 13 May 1996; and Rockwell Transmittal Form # D250-300-24, "STS-69 SPARTAN NCC Burn Guidance Performance," J.L.Goodman, 27 Sept 1995. @[121296-4112A]

FLIGHT RULES

A2-125

RNDZ OPS DELAY

- A. FOR DELAYS PRIOR TO TI, IF CONVENIENT, THE NOMINAL MANEUVERS WILL BE ADJUSTED TO SLOW PHASING SO THAT THE ORBITER ARRIVES AT THE TI POINT AT THE DESIRED DELAY TIME. OTHERWISE, THE NOMINAL RENDEZVOUS PLAN WILL BE EXECUTED UNTIL TI WHERE A DELAY WILL BE DONE.

The most efficient way, from a propellant standpoint, to delay a rendezvous is to slow the catch-up rate such that the orbiter will rendezvous with the target at the desired time, in an integral number of orbits. Desirable lighting conditions will be maintained since there is an integral number of orbits. This can be done at any preplanned phasing maneuver (NC), typically with no propellant penalty, or an additional maneuver can be inserted into the rendezvous profile. Mission activities and propellant budgets will determine which option to use.

In order to efficiently perform a phasing adjustment, an apogee point must be available prior to TI where the perigee can be raised and the catchup rates slowed. Any point other than apogee will necessitate a larger burn and fuel consumption. Communication availability and time to adjust the maneuver must also be considered. If any problems in these areas arise, it is no longer convenient to adjust phasing, and a TI delay should therefore be executed.

- B. FOR SHORT TI DELAYS (ONE OR TWO ORBITS), MANEUVERS WILL BE EXECUTED TO RETURN TO THE TI POINT WITH THE DESIRED LIGHTING CONDITIONS. FOR LONG TI DELAYS (GREATER THAN TWO ORBITS), MANEUVERS WILL BE EXECUTED TO GUARANTEE A SAFE OPENING RATE OF AT LEAST 1 NM PER ORBIT.

TI is the last convenient point to delay the rendezvous. This delay may be desirable to recover lost capability prior to committing to intercept. For short delays, the ground will compute a phasing maneuver to return to the TI position based on the most current onboard relative state. Desirable lighting conditions will be maintained since there is an integral number of orbits between the original and new TI maneuvers.

A long delay requires an opening rate to eliminate the need for the crew to continuously monitor the target. Long delays usually involve at least one crew sleep cycle. In this case, if propellant is available, the delay maneuver is targeted to a point in the following morning equivalent to where the original final phasing maneuver was executed. This range minimizes the possibility of awakening the crew to execute a trajectory control maneuver; shorter ranges may require interruption of crew sleep. In this manner, the second rendezvous trajectory will be similar to the original trajectory.

There is a propellant penalty for executing a TI delay. The magnitude of this penalty is dependent on the specific mission profile and delay scenario.

Rule {A2-119}, RNDZ/PROX OPS SENSOR REQUIREMENTS, references this rule. ©[091098-6707B]

THIS RULE CONTINUED ON NEXT PAGE

FLIGHT RULES

A2-125

RNDZ OPS DELAY (CONTINUED)

C. IF AN EXPLICIT GO FOR TI HAS NOT BEEN RECEIVED BY THE CREW PRIOR TO TI TIG MINUS 5 MINUTES, THE CREW WILL PERFORM A TI DELAY. @[032504-6243]

NOTE: IF TI DELAY TARGETS ARE NOT AVAILABLE ONBOARD, THE CREW SHALL ADD 3 FPS TO THE DELTA-VX COMPONENT OF THE THE FINAL LAMBERT TI SOLUTION.

A GO for Ti reported to the crew is required to confirm that all orbiter and target systems are ready for final phase and docking/grapple. For any case where the MCC cannot provide a GO for Ti (i.e., no comm), the crew will not have any way of determining if the target (i.e., ISS) status is acceptable for final phase and approach. Therefore, a Ti Delay maneuver is considered the most reasonable course of action. The Ti Delay results in a loss of timeline of at least one orbit but provides the opportunity to regain communication with MCC without committing to prox ops. Once a GO for Ti is given and acknowledged by the crew, any subsequent loss of comm prior to Ti does not invalidate the original GO for Ti given by MCC.

In order to adequately prepare for the maneuver (i.e., load the Ti Delay PEG-7 targets and maneuver to attitude), the process of beginning the Ti Delay procedures should begin no later than Ti TIG minus 5 minutes. Ti Delay PEG-7 targets cannot be computed directly onboard and are computed by the FDO. If a Ti Delay maneuver is required and Ti Delay PEG-7 targets are not available (i.e., no comm), adding 3.0 fps to the delta VX component of the final Lambert Ti solution is acceptable for safe relative motion. Adding 3.0 fps to delta VX adds enough energy to the orbit to null the closing rate and provide the opportunity for the crew to execute a subsequent NCC maneuver to refine the trajectory. U.S. Monte Carlo analysis indicates that this value is sufficient for all reasonable Ti positions and is adequate even with loss of external sensor data and/or a TIG slip of up to 4 minutes. Ordinarily, the FDO will compute Ti Delay targets with the position of the subsequent Ti position in mind with respect to planar error and minimizing delta V magnitude. However, the addition of 3.0 fps to the Ti solution is sufficient to control energy to the point where safe relative motion is established. These Ti Delay requirements were reviewed at the Orbit Flight Techniques Panel #209. @[032504-6243]

FLIGHT RULES

A2-126

RNDZ/PROX OPS BREAKOUT

- A. PRIOR TO TI, A GROUND-COMPUTED BREAKOUT MANEUVER WILL BE EXECUTED, IF NECESSARY, TO GUARANTEE A SAFE MISS DISTANCE BETWEEN THE ORBITER AND TARGET.

Prior to Ti, dispersions and the lack of a standard rendezvous profile prevent designing a "canned" breakout maneuver. The ground will compute a maneuver, if required, to ensure the orbiter avoids the target by a safe distance. Possibly not executing a preplanned rendezvous maneuver will provide an acceptable miss distance.

- B. BETWEEN TI AND STABLE AT 500 FEET ON THE +RBAR, THE BREAKOUT MANEUVER WILL BE A 3-FPS RETROGRADE MULTI-AXIS MANEUVER. INITIATION OF THIS MANEUVER WILL BE AS FOLLOWS: ©[091098-6705A] ©[040899-6799C]

A single 3-fps retrograde breakout maneuver is required between Ti and the point of stability at 500 feet on the +Rbar to ensure safe relative motion. Prior to visual acquisition of the target and commencement of the manual phase, this maneuver provides an orbiter CG to target CG miss distance of at least 500 feet (to allow for vehicle dimensions) based on Monte Carlo analysis. The 3-sigma dispersion ellipse will maintain at least a 500-foot miss distance if the breakout is initiated due to failure to acquire the target per the sub-parts below.

After visual acquisition of the target, the pilot is allowed to continue the rendezvous to the manual takeover point and begin to affect the relative motion of the orbiter with respect to the target via manual piloting techniques. This breakout should still provide safe relative motion all the way to Rbar arrival assuming the manual phase has been flown in a nominal manner (i.e., the braking gates have been followed and the target has been maintained within the COAS). However, after the manual phase has commenced, it is the responsibility of the CDR to ensure that the breakout is adequate and positive clearance with the target exists. Assuming a nominally flown manual phase, this maneuver provides an orbiter CG to target CG miss distance of approximately 370 ft if executed at the minimum 500 ft range. This satisfies the "rule of halves" groundrule and constraint for separations which, for this case, would require at least a 250 ft miss distance. ©[040899-6799C]

THIS RULE CONTINUED ON NEXT PAGE

FLIGHT RULES**A2-126****RNDZ/PROX OPS BREAKOUT (CONTINUED)**

A maneuver to burn attitude is prohibited because of the delay in initiating the maneuver and the loss of target acquisition while still on an intercept trajectory. Since this retrograde breakout maneuver can occur anytime from T_i through R_{bar} arrival and the orbiter is in a $-Z$ target track attitude, propellant to cover the breakout maneuver for the range of orbiter attitudes during the terminal phase must be protected. Worst case prop usage for this breakout maneuver is 80 lb fwd (at R_{bar} arrival) and 40 lb aft (45 deg below V_{bar}). Prop requirements for the maneuver are independent of the Low Z transition range since the breakout maneuver will be a pure $-X$ burn when the orbiter is in the Low Z regime.

©[091098-6705A]

1. FOR INSUFFICIENT PROPELLANT OR ORBITER CONTINGENCIES REQUIRING BREAKOUT, THE BREAKOUT CAN BE INITIATED ANYTIME POST-TI. IF POSSIBLE, THE BREAKOUT SHOULD BE INITIATED BETWEEN MC1 AND MC2.

Since relative perigee occurs between MC1 and MC2, the effects of the retrograde maneuver will be maximized. ©[091098-6705A]

2. IF NO TARGET SENSOR DATA (RR, ST, COAS) HAS BEEN INCORPORATED INTO NAV AND UTILIZED FOR BURN EXECUTION DURING THE RENDEZVOUS, THE BREAKOUT MANEUVER MUST BE EXECUTED WITH TIG NO LATER THAN MC2+20 MINUTES UNLESS THE TARGET IS ACQUIRED VISUALLY OR WITH THE RADAR.

©[091098-6705A]

With no target sensor data, the actual relative position between the orbiter and the target is not known with sufficient accuracy to warrant completion of the rendezvous. The breakout maneuver may be delayed to a point no later than MC2+20 minutes to allow the maximum time for crew visual acquisition of the target while maintaining the 3 sigma miss distance of 500 ft.

Note that this breakout point will be operationally implemented 2 minutes earlier than defined in this rule to provide enough time for the crew to execute the Rendezvous Breakout procedure such that TIG occurs at MC2+20 min per this rule.

THIS RULE CONTINUED ON NEXT PAGE

FLIGHT RULES

A2-126

RNDZ/PROX OPS BREAKOUT (CONTINUED)

3. IF GOOD TARGET SENSOR DATA (RR, ST, COAS) HAS BEEN INCORPORATED INTO NAV AND UTILIZED FOR BURN EXECUTION DURING THE RENDEZVOUS, THE BREAKOUT MANEUVER MUST BE EXECUTED WITH TIG NO LATER THAN MC2+24 MINUTES UNLESS THE TARGET IS ACQUIRED VISUALLY OR WITH THE RADAR.

With good target sensor data, trajectory dispersions are reduced, and as a result, the breakout maneuver may be delayed beyond MC2+20 min (per paragraph 2) to a point no later than MC2+24 minutes while still providing an acceptable miss distance. "Good" sensor data means that at least one full star tracker pass has occurred prior to MC2 resulting in small state vector updates. The quality of the sensor pass will be evaluated in real time by the MCC, and the go to delay the breakout point from MC2+20 min to MC2+24 min will be per ground call. Note that the MC2+20 min point will always occur in orbital daylight, so this extra 4 minutes is not particularly valuable (it is very unlikely that the target would be visually acquired at MC2+24 min but not visually acquired at MC2+20 min). Time from MC2 is used as a reference since the MC2 TIG is variable.

Note that this breakout point will be operationally implemented 2 minutes earlier than defined in this rule to provide enough time for the crew to execute the Rendezvous Breakout procedure such that TIG occurs at MC2+24 min per this rule. ©[091098-6705A]

4. IF THE TARGET IS ACQUIRED VISUALLY OR WITH THE RADAR PER PARAGRAPHS 2 OR 3 ABOVE AND IT IS MORE THAN 30 DEG FROM THE ORBITER -Z AXIS, THE BREAKOUT MANEUVER SHOULD BE EXECUTED. IF MISSION DURATION DOES NOT ALLOW FOR THE POSSIBILITY OF RERENDEZVOUS, THEN THE MANUAL APPROACH MAY CONTINUE ON A BEST EFFORT BASIS.

THIS RULE CONTINUED ON NEXT PAGE

FLIGHT RULES

A2-126

RNDZ/PROX OPS BREAKOUT (CONTINUED)

Even if the crew visually acquires the target, certain off-nominal cases, particularly no sensor cases, can lead to trajectory dispersions that are unrecoverable via manual piloting techniques, or the manual recovery will expend more prop than a breakout and rendezvous. Target displacement from the orbiter -Z axis is a key indicator to the dispersed nature of the trajectory and hence the flyability of the approach. Target displacement of 30 deg or more is significantly greater than that seen in the 3-sigma radar fail trajectories used in the generation of the rendezvous propellant budget, and it would not be prudent to continue with the rendezvous in this case if a rendezvous capability exists. Rendezvous on another day provides the opportunity to troubleshoot the sensor/systems problems that led to the failure of the first rendezvous or to adjust rendezvous timing and procedures to maximize ground navigation effectiveness in an effort to increase the probability of a successful rendezvous. If mission duration cannot accommodate a rendezvous, the approach may continue on a best effort basis with a high probability that the rendezvous cannot be completed due to exceedance of propellant bingo constraints.

5. DURING THE RBAR PITCH MANEUVER, IF PRCS LOW Z ATTITUDE CONTROL IS AVAILABLE, THE RBAR PITCH MANEUVER WILL BE COMPLETED PRIOR TO PERFORMING THE BREAKOUT. IF PRCS LOW Z ATTITUDE CONTROL IS LOST DURING THE RPM, THE SHUTTLE CREW WILL SELECT FREE DRIFT AND ALLOW THE ORBITER TO COAST AWAY IN A PASSIVE BREAKOUT. SUBSEQUENT BREAKOUT MANEUVERS WILL BE COMPUTED BY THE MCC. @[033105-6717]

While the orbiter is inverted during the RPM, execution of a 3 fps retrograde multi-axis breakout could result in damaging jet firings toward the ISS. Completion of the RPM will align the ISS in a protected position along the orbiter -Z axis so that the breakout can be performed without concern for ISS damage. If PRCS LOW Z attitude control is lost during the RPM, attempting to return to the nominal post-RPM attitude may induce a large closing rate toward ISS. In this case, selecting free drift will allow orbital mechanics to slowly pull the orbiter away from the ISS in a passive breakout trajectory. Loss of any down-firing jet group is considered a loss of LOW Z PRCS attitude control. Reference Orbit Flight Techniques #216, November 19, 2004 and Lockheed memo 4HECES2LX-035, September 29, 2004.

Items 2-4 of Paragraph B are a result of the implementation of the ORBT Rendezvous Profile baselined during Orbit FTP #161, February 14, 1997. @[091098-6705A] @[033105-6717]

- C. THE SHUTTLE NOSE IN-PLANE BREAKOUT MAY BE EXECUTED WHEN THE SHUTTLE STATE SATISFIES THE FOLLOWING CONDITIONS: @[040899-6799C]

SHUTTLE IS WITHIN 500 FT (CG TO CG) OF THE TARGET VEHICLE.

SHUTTLE X AND Z BODY AXES ARE IN THE ORBITAL PLANE OF THE TARGET VEHICLE.

THE TARGET VEHICLE IS IN A STABLE POSITION ON THE SHUTTLE -Z AXIS. @[040899-6799C]

THE IN-PLANE BREAKOUT MANEUVER SEQUENCE WILL BE AS FOLLOWS:
@[040899-6799C]

THIS RULE CONTINUED ON NEXT PAGE

FLIGHT RULES

A2-126

RNDZ/PROX OPS BREAKOUT (CONTINUED)

1. IF WITHIN 75 FT INTERFACE TO INTERFACE, THE SHUTTLE CREW WILL NULL THE CLOSING RATE, THEN BACK OUT BY INITIATING AND MAINTAINING AT LEAST 0.1 FT/SEC OPENING RATE WHILE MAINTAINING THE TARGET VEHICLE POSITIONED NEAR THE SHUTTLE -Z BODY AXIS.

For ranges inside 75 ft, a backout must be initiated to provide adequate clearance to complete the breakout sequence. For ISS flights, this would involve performing a Corridor Backout.

2. WHEN RANGE IS GREATER THAN 75 FT INTERFACE TO INTERFACE, PERFORM AT LEAST A 1.5 FPS BURN IN THE "CLOCKWISE" DIRECTION (+X ORBITER BODY BURN IF OMICRON IS 0, -X ORBITER BODY BURN IF OMICRON IS 180 DEGREES). FOLLOWING THE BURN, MODE TO INERTIAL HOLD.

This X burn results in the orbiter opening from the target vehicle. Moding the DAP to INRTL results in an orbiter attitude profile that, when coupled with the relative motion, maintains the target vehicle near the orbiter -Z body axis. This relative orientation minimizes plume loads on the target when the DAP is in Low Z mode. The 1.5 fps burn was sized to ensure that the orbiter is at least 1000 ft from the target after 22 min at which time Low Z is deselected and the maneuver to attitude for the next burn commences. Since this breakout exposes the target vehicle to possible direct PRCS firings just outside of 1000 ft, it is not adequate for target vehicles that require Low Z protection outside 1000 ft.

3. AT 30 MINUTES AFTER THE $\pm X$ BURN, PERFORM A 3 FPS OUT-OF-PLANE AND 3.5 FPS POSIGRADE/RETROGRADE BURN USING THE +X RCS JETS. AT 22 MINUTES AFTER THE $\pm X$ BURN, DESELECT LOW Z AND INITIATE THE MANEUVER TO BURN ATTITUDE.

This final burn needs to be performed 30 minutes after the $\pm X$ burn to provide a safe trajectory. The size of this burn (4.6 ft/sec RSS) was designed to provide a safe trajectory for all initial conditions that satisfy the conditions of applicability for this breakout. The breakout also allows for the selection of either a posigrade or retrograde component to provide flexibility for subsequent mission objectives. The burn combines the out-of-plane and posigrade/retrograde components and is performed as a +X burn with a maneuver to attitude in order to save propellant. Time is allotted to allow a worst case 180 deg maneuver to attitude at 0.5 deg/sec. ©[040899-6799C]

THIS RULE CONTINUED ON NEXT PAGE

FLIGHT RULES

A2-126

RNDZ/PROX OPS BREAKOUT (CONTINUED)

D. THE RBAR BREAKOUT MAY BE EXECUTED WHEN THE SHUTTLE STATE SATISFIES THE FOLLOWING CONDITIONS: @[040899-6799C]

SHUTTLE IS WITHIN 500 FT (CG TO CG) OF THE TARGET VEHICLE.

SHUTTLE X AND Z BODY AXES ARE IN THE ORBITAL PLANE OF THE TARGET VEHICLE.

THE SHUTTLE IS POSITIONED ON THE ±RBAR WITH THE TARGET VEHICLE IN A STABLE POSITION ON THE SHUTTLE -Z BODY AXIS.

THE RBAR BREAKOUT MANEUVER SEQUENCE WILL BE AS FOLLOWS:

1. IF WITHIN 75 FT INTERFACE TO INTERFACE, THE SHUTTLE CREW WILL NULL THE CLOSING RATE, THEN BACK OUT BY INITIATING AND MAINTAINING AT LEAST 0.1 FT/SEC OPENING RATE WHILE MAINTAINING THE TARGET VEHICLE POSITIONED NEAR THE SHUTTLE -Z BODY AXIS.

For ranges inside 75 ft, a backout must be initiated to provide adequate clearance to complete the breakout sequence. For ISS flights, this would involve performing a Corridor Backout.

2. WHEN RANGE GREATER THAN 75 FT INTERFACE TO INTERFACE, PERFORM A 3 FPS +X OR -X TRANSLATION.

This +X or -X burn results in either retrograde or posigrade motion relative to the target vehicle. The direction of the burn should be selected based on subsequent mission objectives. The burn will result in the orbiter phasing away from the target vehicle at approximately 8 nm/rev. @[040899-6799C]

THIS RULE CONTINUED ON NEXT PAGE

FLIGHT RULES

A2-126

RNDZ/PROX OPS BREAKOUT (CONTINUED)

E. THE VBAR BREAKOUT MAY BE EXECUTED WHEN THE SHUTTLE STATE SATISFIES THE FOLLOWING CONDITIONS: @[040899-6799C]

SHUTTLE IS WITHIN 1000 FT (CG TO CG) OF THE TARGET VEHICLE. @[033105-6717]

SHUTTLE X AND Z BODY AXES ARE IN THE ORBITAL PLANE OF THE TARGET VEHICLE.

THE SHUTTLE IS LOCATED ON THE ±VBAR WITH THE TARGET VEHICLE IN A STABLE POSITION ON THE SHUTTLE -Z BODY AXIS.

THE VBAR BREAKOUT MANEUVER SEQUENCE WILL BE AS FOLLOWS:

1. IF WITHIN 150 FT INTERFACE TO INTERFACE, THE SHUTTLE CREW WILL NULL THE CLOSING RATE, THEN BACK OUT BY INITIATING AND MAINTAINING AT LEAST 0.1 FT/SEC OPENING RATE WHILE MAINTAINING THE TARGET VEHICLE POSITIONED NEAR THE SHUTTLE -Z BODY AXIS.

The minimum range for a Vbar breakout during undock and separation is 150 ft. This is driven by loads from the +X radial burn. These loads are higher than for an approach breakout because the potential for misalignment between the orbiter and ISS is much greater for undocking. To avoid potentially confusing procedural complexities, the Vbar breakout range for approach is also set to 150 ft. Use of the 150 ft minimum breakout range was implemented in the 2004 Vbar Approach Database and 2004-2005 Vbar Approach Contingency Database (reference Orbit Flight Techniques Panel #218, February 25, 2005). The maximum analyzed range for the Vbar Breakout is 1000 ft (reference October 17, 2002 Rendezvous & Proximity Operations Working Group).

2. WHEN RANGE IS GREATER THAN 150 FT INTERFACE TO INTERFACE, PERFORM A 1.5 FPS RADIAL BURN WITH THE +X OR -X JETS. IF THE SHUTTLE IS ON THE +VBAR, PERFORM THE BURN RADIAL UP. IF THE SHUTTLE IS ON THE -VBAR, PERFORM THE BURN RADIAL DOWN. FOLLOWING THE BURN, MODE TO INERTIAL ATTITUDE HOLD. @[033105-6717]

This +X or -X burn results in a trajectory that lofts the orbiter above (for +Vbar) or below (for -Vbar) the target. Moding the DAP to INRTL results in an orbiter attitude profile that, when coupled with the relative motion, maintains the target vehicle near the orbiter -Z body axis in order to protect the target vehicle from jet plume loads during the subsequent burn.

THIS RULE CONTINUED ON NEXT PAGE

FLIGHT RULES

A2-126 **RNDZ/PROX OPS BREAKOUT (CONTINUED)**

3. AT 28 MINUTES AFTER THE RADIAL BURN, PERFORM A 3 FPS POSIGRADE OR RETROGRADE TRANSLATION. @[033105-6717]

The direction of the burn should be selected based on subsequent mission objectives. The burn will result in the orbiter phasing away from the target vehicle at approximately 8 nm/rev. @[040899-6799C] @[033105-6717]

- F. THE FLYAROUND BREAKOUT MAY BE EXECUTED WHEN THE SHUTTLE STATE SATISFIES THE FOLLOWING CONDITIONS:

SHUTTLE IS WITHIN 500 FT (CG TO CG) OF THE TARGET VEHICLE.

SHUTTLE X AND Z BODY AXES ARE IN THE ORBITAL PLANE OF THE TARGET VEHICLE.

THE SHUTTLE IS PITCHING AT A CONSTANT RATE LESS THAN 0.2 DEG/SEC WITH THE TARGET VEHICLE IN A STABLE POSITION ON THE SHUTTLE -Z AXIS.

THE FLYAROUND BREAKOUT MANEUVER SEQUENCE WILL BE AS FOLLOWS:

1. CONTINUE FLYAROUND PROCEDURE TO NEXT RBAR CROSSING.
2. PERFORM A 3 FPS +X OR -X PRCS TRANSLATION.

The simplest and most expedient way to break out from a flyaround is to continue the flyaround to the next Rbar crossing and perform a single +X or -X burn, resulting in either retrograde or posigrade motion relative to the target vehicle. The direction of the burn should be selected based on subsequent mission objectives. If it is desirable to minimize the use of forward propellant when performing the breakout, then performing the Shuttle Nose In-Plane Breakout (paragraph C) may be better depending on the orientation of the orbiter during the flyaround and the desired breakout direction.

THIS RULE CONTINUED ON NEXT PAGE

FLIGHT RULES

A2-126

RNDZ/PROX OPS BREAKOUT (CONTINUED)

G. IF A BREAKOUT IS DESIRED ASAP AND THE SHUTTLE STATE DOES NOT SATISFY THE CONSTRAINTS OF PARAGRAPHS C THROUGH F, THEN PERFORM THE FOLLOWING 1-2-3 BREAKOUT (AKA SEP MANEUVER, ORB OPS CHECKLIST) :

1. MANUALLY ROTATE THE ORBITER SUCH THAT THE TARGET IS VISIBLE THROUGH THE OVERHEAD WINDOW.

The target must be positioned near the orbiter -Z axis so that the crew can acquire it with either the KU radar or the HHL and null any closing rate with orbiter +Z translations. ©[040899-6799C]

2. NULL ANY CLOSING RATE AND ESTABLISH A 1 FPS OPENING RATE IN NORM Z. THIS BURN MAY BE PERFORMED IN LOW Z (ON MCC CALL, IF PROP AVAILABLE) IN ORDER TO PROVIDE PLUME PROTECTION TO THE TARGET VEHICLE. ©[040899-6799C]

This 1 fps opening rate ensures short term relative motion will not result in a collision with the target vehicle. Although use of Low Z for this burn provides plume protection to the target vehicle, the prop requirements are so high that it should only be performed in Low Z if MCC deems that prop is available to support it.

3. 22 MIN AFTER THE 1 FPS OPENING BURN, PERFORM A 2 FPS MULTI-AXIS OUT-OF-PLANE BURN IN NORM Z. IN TIME CRITICAL SITUATIONS, THIS BURN CAN BE PERFORMED 2 MIN AFTER THE OPENING BURN.

Since this 2 fps out-of-plane burn is performed multi-axis, it is possible that a significant component of the burn will be directed at the target vehicle. Waiting 22 minutes to perform this burn maximizes the out-of-plane separation of the orbiter from the target as a result of the initial opening burn, thus minimizing plume impingement on the target vehicle. In time critical situations, however, this out-of-plane burn can be performed almost immediately after the initial opening burn with the possibility of significantly pluming the target vehicle. Use of Norm Z is required to avoid the excessive cross-coupling resulting from performing a multi-axis burn in Low Z.

THIS RULE CONTINUED ON NEXT PAGE

FLIGHT RULES

A2-126

RNDZ/PROX OPS BREAKOUT (CONTINUED)

4. 15 MIN AFTER THE OUT-OF-PLANE BURN, PERFORM A 3 FPS POSIGRADE BURN IN NORM Z.

Coasting 15 min after execution of the 2 fps out-of-plane burn results in the orbiter moving approximately 1500 ft out-of-plane, well outside the Low Z range for most target vehicles. Burning posigrade will then allow the orbiter to phase behind the target to set up for a subsequent rendezvous, if desired. Three fps ensures that the resultant posigrade component after the completion of the 1-2-3 burn sequence is at least 2 fps, which provides a safe separation rate of approximately 5 nm/rev. ©[040899-6799C]

THIS BREAKOUT IS NOT PROTECTED IN THE RNDZ/PROX OPS TERMINATE QUANTITY. ©[040899-6799C]

Plume impingement analysis does not protect for breakout scenarios. However, all the above prox ops breakout sequences have been designed to use "common sense" piloting techniques to minimize plume impingement on the target vehicle and provide safe relative motion. The breakouts outlined in paragraphs C through F are optimized to cover the nominal operating regimes of the orbiter while in proximity operations. If outside these normal regimes, then the breakout procedure described in paragraph G (ref. SEP MANEUVER, Orbit Ops Checklist) will provide safe relative motion for any initial condition at the cost of more propellant and possible plume impingement of the target vehicle. Propellant for this breakout will not be protected given the extremely low probability of requiring such a breakout (ref. Flight Rule {A2-121}, RNDZ/PROX OPS PROPULSION SYSTEMS MANAGEMENT). Furthermore, it is typically more propellant efficient to fly the orbiter to a state that satisfies the constraints of one of the paragraphs C through F, then execute the applicable breakout. The above breakouts were approved at a Splinter Generic Orbit Flight Techniques meeting held on March 26, 1999. ©[040899-6799C]

FLIGHT RULES

A2-127

RENDEZVOUS GUIDANCE

- A. THE ONBOARD ORBITER AND TARGET NAVIGATION STATES WILL BE INITIALIZED BY GROUND UPLINK PRIOR TO INITIATION OF RNDZ NAVIGATION.

An onboard software restriction prohibits enabling rendezvous navigation if the timetag of the target state vector is older than 15 hours. The target state vector timetag I-load is zero; therefore, without a ground uplink of the target state vector, rendezvous navigation cannot be enabled.

It is also desirable for both the ground and the onboard to have the most accurate orbiter and target state vectors available, hence the most accurate relative state vector to initialize rendezvous navigation for the first navigation sensor tracking interval. This allows the filter to rapidly determine the "true" state and prevents undesirable transients caused by large updates.

- B. THE PROPAGATED STATE VECTOR WILL BE SELECTED FOR USER PARAMETER PROCESSING (UPP) STATE VECTOR UNTIL THE BEGINNING OF THE FIRST RELATIVE TRACKING INTERVAL. THE FILTER STATE VECTOR WILL BE SELECTED:
1. IF 10 ST MEASUREMENTS HAVE BEEN ACCEPTED WITH THE LAST STATE VECTOR POSITION UPDATE <1.0K FEET, OR,
 2. IF 10 RR MEASUREMENTS HAVE BEEN ACCEPTED WITH THE LAST STATE VECTOR POSITION UPDATE <0.3K FEET, OR,
 3. IF 3 COAS MEASUREMENTS HAVE BEEN ACCEPTED.

Accepting 10 ST or RR measurements prior to selecting the filtered state vector for the UPP prevents filtered vector transients from reaching the UPP. This delay also allows the crew time to take appropriate action to prevent the use of a filtered state which may have incorporated bad measurements. Since COAS processing takes longer, only three marks are taken prior to selecting the filtered state vector.

THIS RULE CONTINUED ON NEXT PAGE

FLIGHT RULES

A2-127

RENDEZVOUS GUIDANCE (CONTINUED)

- C. FOR ALL TRACKING INTERVALS, MEASUREMENT INCORPORATION WILL BE INHIBITED PRIOR TO SENSOR ACQUISITION.

Inhibiting data prior to sensor acquisition prevents marks from being immediately incorporated. This allows the crew time to assess the quality of the sensor data prior to its incorporation into the filtered state vector.

- D. ST MEASUREMENTS WILL NOT BE INCORPORATED INTO THE FILTERED STATE UNTIL PROPER TARGET LOCK IS VERIFIED. IF AFTER FOUR CONSECUTIVE MEASUREMENT CYCLES (31 SECONDS), THE RESIDUAL VALUES CHANGE <0.05 DEGREE PER CYCLE AND THE RATIO VALUES ARE <1.0 , THEN THE AUTO/INHIBIT/FORCE OPTION FOR ANGLES WILL BE SELECTED TO AUTO.

In target track attitude hold, the target should remain essentially stationary in the ST field of view; a star will have an angular rate of 0.5 degree per cycle. If the residuals are continuously changing by more than 0.05 degree per cycle, the object being tracked is most likely a star. Monitoring four consecutive measurement cycles (31 seconds) allows the data quality to be assessed and ensures that the ST has not locked onto a false target.

- E. RR MEASUREMENTS WILL BE INCORPORATED INTO THE FILTERED STATE AS FOLLOWS. IF AFTER FOUR CONSECUTIVE MEASUREMENT CYCLES (31 SECONDS) THE RESIDUAL VALUES ARE STABLE AND THE RATIO VALUES ARE <1.0 THEN THE AUTO/INHIBIT/FORCE OPTION WILL BE SELECTED TO AUTO. RADAR DATA WILL NOT BE INCORPORATED INTO NAVIGATION AT RANGES GREATER THAN 135K FEET.

Four consecutive measurement cycles (31 seconds) allow transients to settle and the crew to assess the quality of the data. Stable measurements are an indirect indication that the radar sensor is locked onto the target with the main lobe instead of a side lobe. Ratios <1.0 indicate that the measurements, if accepted by selecting AUTO, will not be rejected by the navigation filter. At ranges greater than 135k feet, the radar range becomes biased due to eclipsing of the return signal.

THIS RULE CONTINUED ON NEXT PAGE

FLIGHT RULES

A2-127 RENDEZVOUS GUIDANCE (CONTINUED)

F. WHENEVER EITHER RR ANGLE EXCEEDS 30 DEGREES FROM THE -Z AXIS, RADAR ANGLE MEASUREMENTS WILL BE INHIBITED.

Angle data is considered valid only within a 30-degree half-cone of the -Z axis.

G. THE FOLLOWING PRIORITIZED ACTIONS WILL BE TAKEN IF SUCCESSIVE SENSOR MEASUREMENTS ARE REJECTED BY RESIDUAL EDITING (RATIO VALUES >1.0) AT THE START OF A TRACKING INTERVAL:

1. BREAK LOCK AND REACQUIRE TARGET (ST ONLY) .

If residual editing continuously occurs, most likely the ST has either locked onto a star, has a malfunction, or very large relative state errors are present. To prevent bad measurements from being incorporated into the filtered state vector, breaking lock and reacquiring the target is the desirable first step since it does not update anything in the relative navigation state.

2. REINITIALIZE COVARIANCE .

If the covariance matrix has been reduced (e.g., measurement incorporation, wrong covariance uplinked), reinitializing the covariance will expand it and allow larger updates to be incorporated into the filtered state. Incorporating these larger updates should correct the relative state vector which will stop the residual editing.

3. FORCE UP TO THREE MEASUREMENTS .

If covariance reinitialization is not sufficient to prevent residual editing, data can be forced into the filtered state. Three consecutive measurements should correct the relative state vector sufficiently to stop the residual editing. If measurements continue to be edited, a generic problem may exist; and forcing more measurements, most likely, will not improve the situation.

4. FILTER RESTART (PROPAGATOR TO FILTER TRANSFER) .

A filter restart eliminates all data incorporated into the filtered state vector since the last filtered to propagated state vector transfer. This is a last resort procedure to correct the rendezvous navigation relative state.

THIS RULE CONTINUED ON NEXT PAGE

FLIGHT RULES

A2-127

RENDEZVOUS GUIDANCE (CONTINUED)

- H. FOR ALL BUT THE INITIAL TRACKING INTERVAL, A FILTERED TO PROPAGATED STATE VECTOR TRANSFER WILL BE PERFORMED AFTER SUCCESSFUL SENSOR LOCK-ON TO THE TARGET BUT PRIOR TO DATA INCORPORATION.

A filtered to propagated state vector transfer is done to maintain a good backup state vector (propagated) for restart purposes in the event that the filtered state vector subsequently incorporates bad sensor data. Sensor lock-on is an independent means of evaluating the filtered state vector prior to executing the transfer. A transfer is not required prior to the first sensor pass because the filtered state vector and the propagated state vector are identical at that time.

- I. IF FILTER MINUS PROPAGATOR CHANGES BY MORE THAN 40K FEET WITHIN AN ST PASS, THEN ALL OF THE FOLLOWING WILL BE DONE:
1. SELECT PROPAGATED STATE VECTOR FOR UPP.
 2. INHIBIT ANGLES.
 3. FILTER RESTART (PROPAGATED TO FILTERED STATE VECTOR).
 4. BREAK TRACK AND USE NOMINAL PROCEDURES TO REACQUIRE.

If filtered minus propagated state changes by more than 40k feet during a single ST pass, the ST data is considered bad and has corrupted the filtered state. These actions will recover rendezvous navigation to a point equivalent to the beginning of the ST tracking interval.

FLIGHT RULES

A2-128

EMCC/TMCC ACTIVATION

IN THE EVENT THAT THE EMERGENCY MISSION CONTROL CENTER (EMCC) OR TEMPORARY MISSION CONTROL CENTER (TMCC) MUST BE ACTIVATED, THE FLIGHTCREW WILL BEGIN ORDERLY TERMINATION OF ANY PAYLOAD-RELATED OR HAZARDOUS ACTIVITY. WHEN THE ACTIVITY HAS BEEN TERMINATED, THE ORBITER WILL BE MANEUVERED TO +XVV, -ZLV AND REMAIN IN THIS ATTITUDE UNTIL FURTHER INSTRUCTIONS FROM THE EMCC/TMCC. FLIGHT SPECIFIC EXCEPTIONS AND CRITERIA FOR ORDERLY TERMINATION MAY BE IDENTIFIED IN THE FLIGHT SPECIFIC ANNEX.

When the EMCC or TMCC is required to be utilized, a major portion of the real-time telemetry monitoring, flight planning, and data analysis capability provided by the MCC is not available. In addition, the capability to provide payload data to the POCC/payload customer may be lost. With the loss of these MCC capabilities, the ground cannot provide adequate support to safely execute a nominal flight plan and must use the reduced facilities provided by the EMCC/TMCC to monitor orbiter systems. The selected attitude is thermally benign and restrictions on attitude maneuvers significantly reduces the support required for ground monitoring.

FLIGHT RULES**A2-129****ORBITER ON-ORBIT HIGH DATA RATE REQUIREMENTS [HC]**

@[121604-6535B]

THE ORBITER ON-ORBIT HIGH DATA RATE REQUIREMENTS ARE SUMMARIZED BELOW. PAYLOAD DATA SHALL BE GIVEN UP IF REQUIRED TO SATISFY THE ORBITER HIGH DATA RATE REQUIREMENT. IF HIGH DATA RATE CANNOT BE ACHIEVED DUE TO SYSTEMS PROBLEMS, THE LISTED ACTIVITIES MAY STILL BE ACCOMPLISHED.

ORBITER OPERATION	HIGH DATA RATE REQUIREMENT [1]		
	<u>OI</u>	<u>GNC</u>	<u>SM</u>
<u>GNC/MMACS</u> FCS CHECKOUT	M	M	NR
<u>EECOM</u> BONDLINE TEMP MONITORING	[2]	NR	NR
<u>PROP</u> OMS BURNS (TIG MINUS 5 TO TIG PLUS 5) (SEE RULE {A6-103}, OMS BURN DOWNLIST REQUIREMENT)	NR	M	NR
<u>RMS</u> RMS C/O RMS TROUBLESHOOTING RMS OPS (PORT ARM SELECTED)	NR NR NR	NR NR NR	M M HD
<u>FDO/RNDZ</u> PROX OPS RNDZ OPS (SENSORS, TARGETING)	NR NR	HD HD	NR NR
<u>EVA</u> DURING EVA	HD	NR	NR

@[061297-6200] @[121604-6535B]

(M = MANDATORY, NR = NOT REQUIRED, HD = HIGHLY DESIRABLE)

NOTES:

[1] HIGH DATA RATE MAY BE REQUIRED ANYTIME FOR FAILURE ANALYSIS OR TROUBLESHOOTING.

THIS RULE CONTINUED ON NEXT PAGE

FLIGHT RULES

A2-129

ORBITER ON-ORBIT HIGH DATA RATE REQUIREMENTS [HC]
(CONTINUED)

[2] MUST HAVE HIGH DATA RATE PERIODICALLY TO CHECK TEMPERATURES. ONCE PER ORBIT IS TYPICALLY THE MAXIMUM REQUIREMENT. ACTUAL FREQUENCY DEPENDS ON THE ATTITUDES BEING FLOWN AND THE BETA ANGLE.

GNC - High Rate GNC data is required during FCS checkout in order to capture and thoroughly analyze the condition of the entry critical systems. ©[121604-6535B]

EECOM - All orbiter TPS measurements lost except V09T1524A cabin upper skin center line. Data is used to determine flight rule impacts for:

Payload bay door closing vehicle gradients (Rule {A10-206A}, PLBD CLOSE GO/NO-GO).

Entry prep maximum temperatures (Rule {A18-401A}.a, THERMAL PROTECTION SYSTEM (TPS) BONDLINE TEMPERATURE). ©[ED]

Anytime minimum temperatures for glassy transition of RTV (Rule {A18-451A}, ORBITER THERMAL CONSTRAINTS AND ATTITUDE MANAGEMENT [CIL]).

FDO/RNDZ - Rendezvous loses data required to verify proper configuration. Prime NAV and sensor evaluation job can still be performed. This applies to PROX OPS only if a universal pointing fly-around is being performed. Rendezvous data lost:

Universal pointing - body vector, target ID, MNVR attitude, attitude error.

DAP configuration - attitude and rate deadbands, translational pulse size, discrete MNVR rate.

Guidance mode - Lambert or external delta V, TV roll.

Star tracker status - Shuttle position, track indications, star present.

Navigation - Uplink timetags associated with onboard vectors.

RMS - Virtually all RMS data lost in SM low data rate. This includes all data required to analyze failures.

EVA - Data is highly desirable for biomed.

Reference Orbit Flight Techniques #106 and Ascent/Entry Flight Techniques Panel #204 meetings.

Reference Hazard Control ORBI-305 "Inability to Close and Latch Payload Bay Doors (PLBD's)." ©[121604-6535B]

FLIGHT RULES

A2-130

PAYLOAD OBJECTIVES VS. PAYLOAD DAMAGE POLICY

- A. THE HARDWARE FOR ANY PAYLOAD WILL NOT BE JETTISONED SOLELY TO ACCOMPLISH MISSION SUCCESS OBJECTIVES FOR ANOTHER PAYLOAD.
- B. CONSIDERATION WILL BE GIVEN TO ALLOWING HARDWARE DAMAGE TO A PAYLOAD TO OCCUR IF THIS ALLOWS ACCOMPLISHING MANDATORY MISSION SUCCESS OBJECTIVES OF ANOTHER PAYLOAD AS LONG AS SUCH DAMAGE DOES NOT PRESENT AN ORBITER OR CREW SAFETY CONCERN.

A payload can be reflown if its mission success objectives cannot be met, but this is a significant expense to the program. It may be worth the impact of repairing damage to one payload as opposed to refllying a payload which will not meet its objectives. Such an option should be considered. Each case must be looked at individually to determine if hardware damage is an appropriate tradeoff. The jettisoning of hardware has such severe implications to the agency as a whole that it is judged not appropriate for any mission-success objective gain.

FLIGHT RULES

A2-131

ATTITUDE RESTRICTIONS FOR ORBITAL DEBRIS

- A. TIME IN THE FOLLOWING ATTITUDES WILL BE MINIMIZED IN PREFLIGHT PLANNING AND IN REAL TIME:
1. -ZVV (PAYLOAD BAY FORWARD).
 2. +XVV, +ZLV OR \pm YLV (NOSE FORWARD, PAYLOAD BAY UP OR OUT OF PLANE).
- B. -ZLV WILL BE THE NORMAL ORBITER ATTITUDE UNLESS PAYLOAD OR ORBITER REQUIREMENTS DICTATE OTHERWISE. TIME IN +XVV WILL BE MINIMIZED.

FOR THE PURPOSE OF THIS RULE, THE ORBITER WILL BE CONSIDERED TO BE IN ONE OF THE ABOVE ATTITUDES IF THE -Z (X) AXIS IS CLOSER TO ONE OF THE REFERENCED LVLH AXES (+V, +R, \pm H) THAN TO ANY OTHER.

IF MORE THAN 48 HOURS CUMULATIVE TIME IN THESE ATTITUDES IS PLANNED, FLIGHT-SPECIFIC EXCEPTIONS WILL BE DOCUMENTED IN THE FLIGHT-SPECIFIC ANNEX.

Both the Rockwell orbital debris study and the JSC Space and Life Sciences studies looked at various shuttle attitudes and assessed the risk of catastrophic damage due to orbital debris and micrometeoroids. The JSC study also assessed the probable window replacements and radiator repairs required from various attitudes. Data was presented to Orbit Flight Techniques Panel meeting number 131 on August 14, 1992. Numbers are for a 160 nm orbit. This rule addresses relative risk of different attitudes and not absolute risk. @[ED]

THIS RULE CONTINUED ON NEXT PAGE

FLIGHT RULES

A2-131

ATTITUDE RESTRICTIONS FOR ORBITAL DEBRIS (CONTINUED)

There are two fundamental reasons to restrict attitudes. One is the risk of catastrophic damage from debris; the other is not a catastrophic risk, but will much more likely cause damage that will result in turnaround impacts and increased costs. The major turnaround drivers are the windows and the radiators.

The -ZVV attitude, regardless of the yaw about the Z axis, is the worst attitude from a catastrophic damage perspective. The risk was between three and five times greater in -ZVV than the best attitude which is -ZLV, -XVV (bay down, tail forward). The -ZVV attitudes were noticeably more risky than other attitudes in both studies. Other attitudes fall in between the two, but the uncertainty in the studies was judged great enough to not put any restrictions on other attitudes than -ZVV with regard to critical damage from orbital debris.

The radiator damage is 16 times worse in -ZVV than in -ZLV. Window damage is also worse in -ZVV (20 times worse) with +XVV (nose forward) being a close second. The +XVV attitude is relatively safe from catastrophic damage.

Time in attitude is an important factor. The longer the time in the attitude, the greater the risk. Forty-eight hours was chosen somewhat arbitrarily. Forty-eight hours results in an expectation of less than 0.5 window replacements and 15 radiator dings. Some flights will have objectives that justify the increased risk of these attitudes. These must be documented as exceptions in the flight-specific annex.

Time in the listed attitudes will be minimized in real time, but it is impractical to compute and police the 48-hour number or any other number in real time.

Many attitudes will not be purely in one of the directions spelled out above. Thus the orbiter -Z (and X for part B) axis will be considered to be pointed in the direction of the LVLH axis that it is closest to.

FLIGHT RULES

A2-132

THERMAL CONDITIONING FOR FLIGHT DAY 1 LANDING

IN THE EVENT THAT A FD1 LANDING IS REQUIRED, PRE-ENTRY THERMAL CONDITIONING WILL BE ON A "BEST-EFFORT" BASIS, CONSISTENT WITH OTHER ATTITUDE REQUIREMENTS. FLIGHT-SPECIFIC END-OF-MISSION BONDLINE LIMITS SHOULD BE MET IF POSSIBLE. THE FOLLOWING GENERIC GUIDELINES SHOULD BE USED FOR THE PERIOD BETWEEN OMS-2 AND D/O BURN (BRIEF EXCURSIONS FOR IMU ALIGN, ETC. ARE ACCEPTABLE):

ATTITUDE GUIDELINES *		
	0 < β < 60	60 < β < 90
REV 3 D/O BURN	ORBIT: -ZLV -YVV (+BETA) (1HR 28M) ZLV +YVV (-BETA) D/O COMM: TAIL SI, SUN 45° STBD (1HR 05M) BAY-EARTH AT NOON	ORBIT: -ZLV -YVV (+BETA) (1HR 28M) -ZLV +YVV (-BETA) D/O COMM: NOSE SI, (1HR 05M) BAY-EARTH AT NOON
REV 4 D/O BURN	ORBIT: -ZLV -YVV (+BETA) (1HR 23M) -ZLV +YVV (-BETA) D/O COMM: TAIL SI, SUN 30° STBD (2HR 10M) BAY-EARTH AT NOON	ORBIT: -ZLV -YVV (+BETA) (1HR 23M) -ZLV +YVV (-BETA) D/O COMM: TAIL SI, SUN 40° STBD (2HR 10M) BAY-EARTH AT NOON
REV 5 D/O BURN	ORBIT: -ZLV -YVV (+BETA) (1HR 18M) -ZLV +YVV (-BETA) THEN: ORB RATE, SUN 45° STBD OF TAIL (1HR 30M) D/O COMM: TAIL SI, SUN 30° STBD (2HR 10M) BAY-EARTH AT NOON	ORBIT: -ZLV -YVV (+BETA) (2HR 48M) -ZLV +YVV (-BETA) D/O COMM: TAIL SI, SUN 40° STBD (2HR 10M) BAY-EARTH AT NOON
REV 6 D/O BURN	ORBIT: -ZLV -YVV (+BETA) (1HR 18M) -ZLV +YVV (-BETA) THEN: ORB RATE, SUN 45° STBD OF TAIL (3HR 00M) D/O COMM: TAIL SI, SUN 30° STBD (2HR 10M) BAY-EARTH AT NOON	ORBIT: -ZLV -YVV (+BETA) (2HR 48M) -ZLV +YVV (-BETA) THEN: ORB RATE, SUN 40° STBD OF TAIL (1HR 30M) D/O COMM: TAIL SI, SUN 40° STBD (2HR 10M) BAY-EARTH AT NOON
REV 7 D/O BURN	ORBIT: -ZLV -YVV (+BETA) (1HR 48M) -ZLV +YVV (-BETA) THEN: ORB RATE, SUN 45° STBD OF TAIL (4HR 00M) D/O COMM: TAIL SI, SUN 30° STBD (2HR 10M) BAY-EARTH AT NOON	ORBIT: -ZLV -YVV (+BETA) (3HR 28M) -ZLV +YVV (-BETA) THEN: ORB RATE, SUN 40° STBD OF TAIL (2HR 20M) D/O COMM: TAIL SI, SUN 40° STBD (2HR 10M) BAY-EARTH AT NOON

THIS RULE CONTINUED ON NEXT PAGE

FLIGHT RULES

A2-132

THERMAL CONDITIONING FOR FLIGHT DAY 1 LANDING
(CONTINUED)

For a launch day deorbit, time may not be available to meet all thermal constraints, due to other constraints such as landing opportunity, burn attitudes, IMU alignment and verification, and communications. Within these other constraints, attitudes will be chosen to meet thermal constraints, such as tail-sun for bondlines or biased starboard-sun for OMS Ox Hi Point Bleedline QD and aft-firing RCS thrusters. ©[092195-1787B]

* TABLE NOTES:

ORBIT AND THEN" REFERS TO THE TIME FROM NOMINAL PLBD OPENING ATTITUDE (1:12) UNTIL MANEUVER TO DEORBIT IMU ATTITUDE (OR DEORBIT COMM ATTITUDE FOR REV 3).

TIMES IN PARENTHESES SHOW THE ATTITUDE DURATIONS WHICH WERE ASSUMED AND ANALYZED. THESE TIMES ALSO REFLECT THE DESIRED DURATIONS. IF MORE (LESS) ATTITUDE TIME IS AVAILABLE BETWEEN THE ACTUAL OMS-2 AND DEORBIT COMM ATTITUDES, THE 'ORBIT' ATTITUDE MAY BE LENGTHENED (SHORTENED). IF TWO ATTITUDES ARE SHOWN, I.E., 'ORBIT' AND 'THEN', THE DURATIONS MAY BE ADJUSTED PROPORTIONALLY.

ORB RATE DEFINITION: ORBITER WILL ROTATE ABOUT A SUN POINTING VECTOR OF P=180, Y=40 OR 45 AT ORBIT RATE, KEEPING THE ORBITER BOTTOM TOWARD SPACE DURING ROTATION (I.E., EQUIVALENT TO OMICRON 90 FOR POSITIVE BETA AND OMICRON 270 FOR NEGATIVE BETA AT NOON).

-ZLV AND ORB RATE ATTITUDES REQUIRE GNC OPS 2 SOFTWARE. IF GNC OPS 2 IS NOT AVAILABLE, "THERMALLY SIMILAR" SOLAR INERTIAL ATTITUDES WILL BE SELECTED.

DOCUMENTATION: CCB February 28, 1995, May 16, 1995, SODB Volume V. ©[092195-1787B]

FLIGHT RULES

A2-133**POCC THROUGHPUT COMMAND RATES**

THE GENERIC COMMAND SERVER (GCS) WILL BE CONFIGURED TO ALLOW ONLY ONE POCC THROUGHPUT COMMAND PER SECOND TO BE OUTPUT INTO THE ORBITER UPLINK DATA STREAM. @[121197-6398] @[062702-5513]

The Network Signal Processor (NSP) interface with the Flight Software (FSW) Systems Management (SM) command application may require as much as 960 msec to completely process a single uplinked payload throughput command (PTC) without error. The POCC INPUT RATE CONTROL adjusts the rate at which commands will be accepted into the GCS. By setting this control to one command per second, first word/last word (FW/LW) rejects of commands by the SM GPC caused by too rapid payload commanding can be eliminated. Any setting of this control above one command per second, even if the commands are routed to the same vehicle address, will allow the potential for onboard rejects of commands to exist. See Section 6.2.2.5 of the Space Shuttle Computer Program Development Specifications (CPDS) - SS Downlist/Uplink Software Requirements (SS-P-0002-140). @[062702-5513]

Rejection of commands, for whatever reason, requires analysis of the command system to ensure that it remains intact with no failures. By eliminating this source of command rejects, resources can be more efficiently used. Limitation of payloads to one PTC per second should not present a significant impact if command timelines are planned appropriately. @[121197-6398]

FLIGHT RULES

A2-134

ON-ORBIT CRYO MARGIN BUYBACKS

THE FOLLOWING CRYO MARGIN BUYBACKS CAN BE USED AS SPECIFIED BELOW TO EXTEND MISSION DURATION IF REQUIRED, INCREASE THE NUMBER OF DEORBIT OPPORTUNITIES, INCREASE THE AVAILABLE POWER FOR HIGH PRIORITY MISSION OBJECTIVES, OR IN OTHER SITUATIONS WHICH INCREASE THE OVERALL SAFETY AND SUCCESS OF THE MISSION.
@[052401-4386A]

This rule uses the Group C Powerdown as a starting point for the listed items and assumes that the shuttle is already at a Group B Powerdown level. Some items in the Group C Powerdown have already been unpowered per the Group B Powerdown. Those items were not listed in this rule. The estimated savings is listed next to each item. Paragraphs A through D are not necessarily listed in priority order although paragraphs A and B are considered minimal impact and will be considered first. Specific priorities will depend on flight specific trades.

- A. THE CIRC PUMP THERMAL CONTROL LIMITS MAY BE LOWERED TO REDUCE DUTY CYCLES AND RUN TIME AS LONG AS THE SODB AND FLIGHT RULE LIMITS ARE PROTECTED. CRYO SAVINGS MAY BE BUDGETED PREFLIGHT.

SODB and flight limits for the Hydraulic system will be maintained. Circ pumps can be cycled manually to protect CIRC PUMP INLET TEMP and BODY TEMP > 20 deg (SODB and Flight Rule limit to preclude potential Circ pump cold start). Reference SODB paragraph 3.4.2.4-1c and Rule {A10-74A}.6, HYDRAULIC CIRCULATION PUMP OPERATION [CIL].

- B. THE FOLLOWING ITEMS MAY BE UNPOWERED REAL TIME AND INCLUDED IN THE PREFLIGHT BUDGET:

The following items are not necessarily in priority order since the priority will depend on mission activities but are all minimal impact.

THIS RULE CONTINUED ON NEXT PAGE

FLIGHT RULES

A2-134 ON-ORBIT CRYO MARGIN BUYBACKS (CONTINUED)

1. KU-BAND SYSTEM TO STANDBY WHEN NOT IN USE 160 WATTS

Ku-band system will be commanded to Standby when antenna is in blockage or during a ZOE. While in Standby, the transponder is still transmitting but the power amplifier is not amplifying the signal. The Ku-band draws 370 watts when on but not radiating, and only 210 watts while in Standby, resulting in a 160-watt reduction.

2. MIDDECK LIGHTS (3) 16 WATTS EACH

The Group B Powerdown includes all but three middeck lights. These lights may be powered off at the crew's discretion, but this results in small savings. @[052401-4386A]

3. MDU' S 3 @ 66 WATTS EACH

 IDP 55 WATTS

MDU's will be cycled on only when required; at all other times, they will remain off. Remaining IDP can also be turned off if all MDU's are off. @[052401-4386A]

4. S-BAND PL (PSP & OIU) 54 WATTS @[111705-7043A]

 PDI 25 WATTS

 PI (IF FLOWN) 98 WATTS

The PSP, OIU, and PDI may be required for orbiter, ISS, or payload telemetry and command interface. The PDI will remain off when there are no payload data telemetry processing requirements. With the PDI off, PCMMU element bypass checks will be masked on several SM GPC tables because these tables will be bypassed. Additionally, the PI is typically flown only for deployable payloads such as the Hubble Space Telescope Servicing Missions. @[111705-7043A]

5. S-BAND FM 81 WATTS

The S-band FM system is typically only powered on for about 10 minutes each orbit and only if Ku-band is unavailable (for ops recorder dumps).

THIS RULE CONTINUED ON NEXT PAGE

FLIGHT RULES

A2-134 ON-ORBIT CRYO MARGIN BUYBACKS (CONTINUED)

3. RADIATOR DEPLOY

Radiator deploy can be considered to minimize FES usage, resulting in the savings in paragraphs 1 and 2 for the periods where rad deploy eliminates the need for the FES. Thermal analysis would be required to assess the FES requirements and radiator deploy impacts.

4. RMS D&C 92 WATTS
@[111705-7043A] @[101505-7133A]

RMS HEATERS 627 WATTS MAX (~125 W AVG)

The Port RMS D&C panel and heaters may be powered off as long as the Port RMS heaters are cycled on for approximately 30 minutes when a low temperature message (PDRS PORT TEMP) is annunciated. Heaters will be managed for crew sleep periods to ensure the crew is not awakened by alarms/heater action. All panel A7 D&C lights will be unpowered when the D&C circuit breaker is open. The 125-watt average power for the heaters is based on a 20-percent duty cycle.

5. OCAC 50 WATTS

The OCAC is a crew preference item, which provides white noise for crew sleep, reduces dust and debris particles in the air, and reduces avionics filter cleaning. The OCAC may also be used for air mixing within the orbiter or between the orbiter and ISS. @[052401-4386A]

6. PF MDM 50 WATTS

A PF MDM can be powered off but will result in some loss of commanding and data. PF2 will result in loss of commanding to CCTV, Solid State Recorder (SSR) 2, PSP 2, and commanding through antenna electronics #2. PF1 will result in loss of Ku commanding, SSR 1, PSP 1, and commanding through antenna electronics #1. If MDM PF1 or 2 is powered off for cryo savings, it will be cycled on to regain commanding and data as required. @[052401-4386A] @[111705-7043A] @[121505-7133B]

THIS RULE CONTINUED ON NEXT PAGE

FLIGHT RULES**A2-134****ON-ORBIT CRYO MARGIN BUYBACKS (CONTINUED)**

7. STOW KU-BAND EARLY OR DEPLOY LATE 460 WATTS
 @[111705-7043A] @[121505-7133B]

Although the hardware community is uncomfortable with an additional in-flight power cycle of the Ku-band system, it is acceptable from a hardware perspective to stow the Ku-band early or deploy it late for cryo savings. Prior to Ku-band activation and after deactivation, downlink video and the primary method of OCA capability (KFX) are lost. Furthermore, two-way voice, command, and telemetry redundancies are lost as well as high rate payload telemetry. Reducing Ku-band system use may also require additional recorder dumps and the scheduling of S-band FM ground sites. Stowing the Ku-band early is generally preferred over deploying late since the SSME data is downlinked using the Ku-band system and any problems with the Ku-band system will be identified earlier. However, flight specific requirements could reverse this priority. Depending on mission requirements, changing the nominal Ku-band deploy and stow times may have minimal or significant impacts and may or may not be an acceptable option.

8. S-BAND PM TO STANDBY 310 WATTS (S-BAND PM)
 (KU-BAND ON)
 @[111705-7043A] @[121505-7133B]

Although this is an option that can be considered by the flight control team, it is an undesirable option since it results in the loss of S-band downlink voice and data (uplink still available). If S-band is in Standby and the Ku-band is unavailable, data will be recorded onboard but not available real time. This will result in requirement for additional recorder dumps, the scheduling of FM ground sites, and additional INCO backroom personnel. Furthermore, the S-band PM system is used to obtain TDRS tracking data on the orbiter for state vector maintenance. TDRS tracking may be required for certain mission activities (Post Insertion, Rndz/Docking, etc.). Without TDRS tracking, C-band sites will have to be scheduled if required for onboard state vector update. @[111705-7043A]

THIS RULE CONTINUED ON NEXT PAGE

FLIGHT RULES**A2-134****ON-ORBIT CRYO MARGIN BUYBACKS (CONTINUED)**

9. COMBINATION OF KU-BAND AND S-BAND TO STANDBY ~250 WATTS
 @[111705-7043A] @[121505-7133B]

This is also an option that can be considered by the flight control team but is undesirable since it places a high workload on the INCO position. INCO would manage the comm system manually such that while one system is being used, the other system would be in Standby mode. Although this config would maintain the current level of communications coverage and provide some cryo savings, there would be a significant operational effort required to effectively operate in this configuration. Additional manning (INCO) would be required for this operation. This type of operation may increase the likelihood of loss of communication due to human error. @[052401-4386A]

- D. THE FOLLOWING ITEMS MAY ONLY BE UNPOWERED REAL TIME OR INCLUDED IN THE PREFLIGHT BUDGET WITH PROGRAMMATIC/MMT CONCURRENCE : @[052401-4386A]

The following items are additional orbiter powerdowns included in the Priority Powerdown Group C that have more substantial impacts to hardware or ops. These items will be unpowered only with concurrence from the Program:

1. KU-BAND SYSTEM OFF 460 WATTS

Powering off the Ku-band has operational impacts and potential hardware issues. When the Ku-band system is powered off, downlink video and the primary method of OCA capability (KFX) are lost. Furthermore, two-way voice, command, and telemetry redundancies are lost as well as high rate payload telemetry. Powering off the Ku-band system may also require additional recorder dumps and the scheduling of S-band FM ground sites. The engineering community is concerned that powering off the Ku-band system will increase the likelihood of a gimbal failure, preventing the Ku-band deployed assembly from being stowed. To address these concerns, if the Ku-band is considered as a cryo saving measure, the priority will be to first simply stow the Ku-band radar early or deploy it late, eliminating an additional in-flight power cycle. However, if additional cryo savings are still required, and the Program concurs with an additional power cycle of the Ku-band, the gimbals will be locked prior to powering the Ku system off. If an EVA is available to lock the gimbals, this may also be acceptable risk mitigation to protect against a Ku jettison scenario.

THIS RULE CONTINUED ON NEXT PAGE

FLIGHT RULES

A2-134**ON-ORBIT CRYO MARGIN BUYBACKS (CONTINUED)**

2. MDM'S FF2, FF4, FA4

50 WATTS EACH

When the MDM's are powered off, the corresponding jets are unavailable for use, but more importantly, there is no direct insight into jet leaks using orbiter instrumentation. Although it is expected that there will be other means of detecting a jet leak (crew visual observation or indirect insight via chamber pressure data), the Program deems this an undesirable option. If this option is utilized, the MDM's would be cycled on as required to periodically snapshot PROP RCS data. These MDM's would also be powered on for rendezvous operations, FCS checkout, RCS Hot Fire, and other periods where RCS insight is desirable. When the MDM's are required, they will be powered on at least 15 minutes prior to the desired activity. Note that MDM FF2 is required for single-string MAGR (GPS) data interface and would also be powered on when data is required. ©[052401-4386A]

FLIGHT RULES

A2-135

COMMANDER (CDR) AND PILOT (PLT) PARTICIPATING AS TEST SUBJECTS

THE CDR AND PLT MAY PARTICIPATE AS TEST SUBJECTS ON A VOLUNTEER BASIS AND AS NEGOTIATED PREFLIGHT. THE CDR SHALL NOT PARTICIPATE AS A TEST SUBJECT IN ANY EXPERIMENT OF A PROVOCATIVE OR DISORIENTING NATURE. THE CDR AND PLT SHALL NOT SIMULTANEOUSLY PARTICIPATE IN ANY EXPERIMENT THAT IS PHYSICALLY RESTRAINING.
@[111501-4962A] @[022604-6192]

The CDR shall not participate in any experiment that may compromise the CDR's ability to command and fly the orbiter. Either the CDR or PLT must always be available to handle emergencies or other actions. @[111501-4962A]

DOCUMENTATION: Buckey, J. C. and Jerry L. Homick, ed., The Neurolab Spacelab Mission: Neuroscience Research in Space: Results from STS-90. ISBN 0-9725339-0-7; and Extended Duration Orbiter Medical Project (EDOMP) Final Report, 1989-1995, JSC-28927, NASA-SP 1999-534.
@[022604-6192] @[ED]

A2-136

OBSS TPS INSPECTION SENSOR PRIORITIES

OBSS SENSORS WILL BE USED FOR TPS INSPECTION IN THE FOLLOWING PRIORITY ORDER: @[102506-7845A]

- A. RCC SURVEY (MOTION SCAN)
 - 1. LASER DYNAMIC RANGE IMAGER (LDRI)
 - 2. INTENSIFIED TELEVISION CAMERA (ITVC)
 - 3. ISIS DIGITAL CAMERA (IDC)
 - 4. LASER CAMERA SYSTEM (LCS) @[102506-7845A]

THIS RULE CONTINUED ON NEXT PAGE

FLIGHT RULES

A2-136

OBSS TPS INSPECTION SENSOR PRIORITIES (CONTINUED)

B. FOCUSED INSPECTION ©[102506-7845A]

1. 3-DIMENSIONAL - (USED FOR TILE CAVITY, GAP FILLER, THERMAL BARRIER, ET DOOR CLOSURE)
 - a. LASER CAMERA SYSTEM (LCS)
 - b. LASER DYNAMIC RANGE IMAGER (LDRI)
 - c. ISIS DIGITAL CAMERA (IDC)
2. 2-DIMENSIONAL - (USED FOR RCC, THERMAL BARRIER AND GAP FILLER)
 - a. ISIS DIGITAL CAMERA (IDC)
 - b. INTENSIFIED TELEVISION CAMERA (ITVC)

The RCC motion survey is executed on Flight Day 2 (FD2) and the priorities are based on the ability to maximize the data gathering as well as the sensors resolution capabilities. The LDRI is the primary sensor for the RCC motion scans. The ITVC was selected as the second priority sensor due to the ability to get the complete RCC data set during the allotted inspection time (assuming that the LDRI Mode 2 capability is available to provide required illumination for the scan). The IDC is selected as the third priority due to time limitations caused by the requirement for daylight operations to get the required resolution during an IDC motion scan. Because of these IDC constraints, the procedures cover only RCC Panels 7 through 11 and the Nose Cap in order to acquire as much inspection data on the critical RCC areas in the available time. The LCS is the last priority due to its lack of resolution capability on the RCC.

The focused inspection priorities are based on the required data to thoroughly analyze the Area of Interest (AOI) identified during previous inspections (FD2 RCC Survey, FD2 Digital Still of OMS Pod, Crew Cabin SRMS EE Survey, and FD3 RBAR Pitchover Maneuver (RPM)).

Reference STS-121/ULF1.1 JOP#11, November 29, 2005, NSTS 60540 OIP for TPS Assessment: Orbiter Damage Assessment Process Annex and the OBSS/ISIS Sensors Focused Inspection Template (Rosetta Stone) developed by the Focused Inspection Working Group. ©[102506-7845A]

FLIGHT RULES

A2-137

TPS INSPECTION AND IMPACT DETECTION PRIORITIES

A. RCC MOTION SURVEYS @102506-7844B]

1. INSPECTIONS (FOR EXAMPLE; FLIGHT DAY 2 (FD2) SURVEYS) WILL BE EXECUTED PER THE PLANNED PROCEDURES TO EXPEDITE COLLECTION OF REINFORCED CARBON-CARBON (RCC) IMAGERY DATA REQUIRED TO DETERMINE INTEGRITY OF THERMAL PROTECTION SYSTEM (TPS).
2. INSPECTIONS WILL BE LIMITED TO DOCUMENTED/TRAINED PROCEDURES TO OPTIMIZE DATA COLLECTION AND MINIMIZE RISKS ASSOCIATED WITH THE EXTENSIVE SURVEY OPERATIONS.
3. THE FD2 PORT WLE SURVEY MAY BE REPLACED BY THE CREW CABIN END EFFECTOR (EE) SURVEY IF SUSPECTED TPS DAMAGE ON THE CREW CABIN AREA WARRANTS. THE PORT WING INSPECTION WILL BE RESCHEDULED AS SOON AS PRACTICAL POST DOCKING.
4. ORBITER CAMERAS WILL BE UTILIZED TO PROVIDE A BEST EFFORT INSPECTION FOR TPS AREAS OF CONCERN AT PLANNED PAUSE POINTS IN THE FD2 SURVEYS. NO CHANGES TO THE PROCEDURE PAUSE POINTS WILL BE MADE TO ACCOMMODATE ORBITER CAMERA VIEWS (SEE PARAGRAPH A.2).

The goal of the planned FD2 inspection procedures is to efficiently and expeditiously collect the required RCC data for review in order to determine the integrity of the TPS after exposure to the ascent debris environment. Any deviation from the pre-planned procedures delays collection of RCC data and has a major impact to the subsequent mission timeline to achieve the required data.

The planned FD2 LDRI RCC inspections have no timelined margin for the day. The inspections are sequenced in priority order (STBD WLE, Nose Cap, Port WLE) due to the loss of full inspection capability on the STBD WLE and Nose Cap when docked to the ISS. While docked, the 5 feet clearance cannot be maintained for a Laser Dynamic Range Imager (LDRI) motion scan at the desired resolutions on starboard lower RCC panels 5-13 and starboard upper RCC panels 1-4. The Port LDRI Survey and Nose Cap Survey can be completed docked. With ascent debris contributing 27.1 percent to the Space Shuttle Program probability risk assessment, it is imperative that the full suite of data (at the required resolution) be collected as quickly as possible on FD2 to analyze the health of the RCC. Delaying/moving the inspections from FD2 has major implications to the planned mission objectives (delay in docking to achieve required imagery resolution, or impact docked operation to complete surveys, with reduced resolution in the areas identified). @102506-7844B]

THIS RULE CONTINUED ON NEXT PAGE

FLIGHT RULES

A2-137

TPS INSPECTION AND IMPACT DETECTION PRIORITIES (CONTINUED)

Due to the intensive/extensive crew support required to safely execute the FD2 RCC inspections, the inspections will be limited to the documented/trained LDRI procedures. Since the LDRI sensor provides the highest resolution on the RCC for initial damage detection (80 mil and 20 mil 2 inch crack) during the scan surveys, "focused" stop/stare inspection should not be required with either the LDRI or an alternate sensor. Doing so delays completing the RCC scan surveys and introduces additional risks to the inspection execution. Any changes to the planned RCC scan inspections require procedure verification and validation to ensure they can be safely performed. This cannot be sufficiently completed during real-time execution or prior to planned crew sleep. In addition, the preferred sensor of choice for RCC-focused inspection (Integrated Sensor Inspection System (ISIS) Digital Camera (IDC)) is constrained to daylight operations to achieve the required resolution (80 mil). @[102506-7844B]

For the scenario where there is suspect TPS damage (crew cabin, chin panel, etc.) which can be inspected as part of the Crew Cabin EE Survey and is of immediate concern where inspection cannot wait until FD3, the FD2 Port Survey may be delayed until docking to allow this inspection data to be retrieved. The entire Crew Cabin EE survey will be executed in place of the Port WLE survey to provide not only inspection of the area of concern, but the remainder of the TPS to clear it of ascent debris concerns. During the Crew Cabin EE survey, pause points in the procedure may be utilized to manually move the EE closer to the suspect damage to get better resolution of the damage. This is unique to Remote Manipulator System (RMS) only procedure and can be safely accommodated without impacting the planned execution.

Orbiter camera views, when available, will be used to provide initial inspection views of damaged area.

- B. IF THERMAL PROTECTION SYSTEM (TPS) INSPECTIONS ARE REPLANNED IN FLIGHT, THEY WILL BE PLANNED PER THE FOLLOWING PRIORITIES BEFORE ISS DOCKING:
1. STARBOARD WING LEADING EDGE "BLACK" AND LOW CLEARANCE AREAS
 2. NOSE CAP
 3. PORT WING LEADING EDGE "BLACK" AREAS
 4. REMAINING WING LEADING EDGE AREAS
 5. CHIN PANEL AND ARROW HEAD
 6. TPS SITES WITH SUSPECTED IMPACT OR DAMAGE @[102506-7844B]

THIS RULE CONTINUED ON NEXT PAGE

FLIGHT RULES

A2-137

TPS INSPECTION AND IMPACT DETECTION PRIORITIES
(CONTINUED)

7. LOWER SURFACE DOOR SEALS @[102506-7844B]
8. REMAINING ACREAGE AREA
9. REMAINING EXTERIOR SURFACES

The planned FD2 Reinforced Carbon-Carbon (RCC) inspections have no timeline margin for the day. While docked to ISS, 5-ft clearance cannot be maintained for a Laser Dynamic Range Imager (LDRI) motion scan at the desired resolutions on starboard lower RCC panels 5-13 and starboard upper RCC panels 1-4 (0.25 inch and 1.0 inch resolution, respectively, and an area on the lower, starboard side of the nose cap). Further, there are areas around the orbiter that cannot be imaged at the desired resolutions with only the SRMS end effector camera. Thus, the OBSS must be used to inspect these areas for entry critical damage, or EVA digital still imagery is required with a high crew time and mission objective impact. These areas are referred to as the "black" areas, based on the black and white diagrams used to depict the SRMS end effector camera's ability to inspect TPS at Space Shuttle Vehicle Inspection and Repair OFTP #11, July 1, 2003. The nose cap "black" area can be seen in the STS-114 JOP #23 minutes dated May 24, 2005.

Based on the combination of these constraints, if the TPS inspections are replanned before docking, the revised plan will optimize obtaining the data most difficult to get after docking. The next priority before docking is on the least impact tolerant RCC, any areas with suspected impacts or damage (based on ascent video, ET imagery, or impact sensors), door seals, and tile.

C. AFTER ISS DOCKING, TPS INSPECTION PRIORITIES ARE AS FOLLOWS:

1. TPS SITES WITH SUSPECTED IMPACT OR DAMAGE
2. WING LEADING EDGES, WITH AREAS HAVING THE SMALLEST ACCEPTABLE DAMAGE TOLERANCE ALSO HAVING THE HIGHEST RELATIVE PRIORITY
3. NOSE CAP, CHIN PANEL AND ARROW HEAD
4. LOWER SURFACE DOOR SEALS
5. REMAINING ACREAGE AREA
6. REMAINING EXTERIOR SURFACES @[102506-7844B]

THIS RULE CONTINUED ON NEXT PAGE

FLIGHT RULES

A2-137

TPS INSPECTION AND IMPACT DETECTION PRIORITIES
(CONTINUED)

- D. TPS INSPECTION AND IMPACT DETECTION DATA WILL BE DOWNLINKED ACCORDING TO THE FOLLOWING PRIORITIES: @[102506-7844B]
1. FOCUSED INSPECTION DATA
 2. WLE IMPACT SENSOR ASCENT SUMMARY DATA AND REQUESTED WLE IMPACT SENSOR ASCENT DETAILED DATA
 3. SCHEDULED INSPECTION DATA, WITH RELATIVE PRIORITIES PER PARAGRAPH B
 4. ET UMBILICAL PHOTOS
 5. CREW HAND HELD ET PHOTOS
 6. WLE IMPACT SENSOR ON-ORBIT DATA

It is assumed that any focused inspection data was gathered due to a suspected impact or suspected TPS damage. Thus, once gathered, downlinking that data has the highest priority in order to maximize the ground analysis time. Similarly, WLE impact sensor data has a high relative priority since it may provide a cue for focused WLE inspections which have a higher probability of detecting small RCC damage than a scheduled inspection. ET photos are a lower priority since they are primarily intended to validate the ET certification. Since it is possible that foam loss seen in these photos may provide some cue not seen in any other source, there is still a goal to bring these photos down in flight.

These priorities were approved by the December 6, 2004 FOICB. @[102506-7844B]

A2-138 THROUGH A2-200 RULES ARE RESERVED @[102506-7845A] @[102506-7844B]

FLIGHT RULES

DEORBIT

A2-201

DEORBIT GUIDELINES

- A. LOSS OF ALL REDUNDANCY IN DEORBIT METHODS WILL BE CAUSE TO DEORBIT AT THE NEXT PLS OPPORTUNITY
1. LOSS OF ONE OMS ENGINE AND ONE RCS +X JET
 2. LOSS OF TWO OMS ENGINES
 3. INSUFFICIENT PROPELLANT TO SUPPORT TWO METHODS OF STEEP DEORBIT

When all redundancy in deorbit methods has been lost, the orbiter is fail-critical with respect to deorbit capability. Deorbit must be performed at the next opportunity to avoid prolonged exposure to the failure of the remaining deorbit method.

Three deorbit methods are considered in assessing the ability to remain on orbit: the left OMS engine, the right OMS engine, and the four +X RCS jets. The availability of a deorbit method is based upon two criteria: the health of the hardware and the availability of sufficient propellant to satisfy the deorbit delta V requirements through the respective engine(s).

While a three +X RCS deorbit is possible, the increased burn arc and the imbalance in thrust (creating a yawing moment which must be countered by the RCS yaw jets) make the deorbit propellant requirement prohibitively large.

- B. IF INSUFFICIENT PROPELLANT EXISTS TO PROVIDE TWO METHODS OF STEEP DEORBIT CAPABILITY, MISSION DURATION MAY BE EXTENDED BEYOND THE NEXT PLS IF THE DEORBIT DELTA V CAPABILITY CAN BE IMPROVED AS A RESULT OF THE FOLLOWING (WHILE PROVIDING AT LEAST TWO METHODS OF DEORBIT) :
1. PAYLOAD DEPLOY
 2. DECREASE IN DEORBIT DELTA V REQUIREMENTS

THIS RULE CONTINUED ON NEXT PAGE

FLIGHT RULES

A2-201

DEORBIT GUIDELINES (CONTINUED)

NOTE: IF PAYLOAD DEPLOY IS CONSIDERED AS AN OPTION TO IMPROVE THE OVERALL DELTA V CAPABILITY, SUFFICIENT PROPELLANT MUST BE AVAILABLE TO PROTECT TWO METHODS OF DEORBIT ASSUMING THE PAYLOAD IS NOT DEPLOYED IN ORDER TO PASS THE NEXT PLS OPPORTUNITY.

Consideration should be given to remaining on orbit if two methods (steep or shallow) of deorbit capability will be available and improved deorbit capability guaranteed at the next day PLS and activities beneficial to orbiter safety can be achieved.

The gain in delta V more than makes up the additional propellant cost for an additional 24 hours on orbit plus deploy operations and the minimum separation required for each payload. The net gain in delta V for all deploys is positive thereby adding additional capability for deorbit. The heavier the payload, the greater the increase in delta V.

For an ATO or elliptical orbit, the deorbit delta V may decrease with on-orbit stay time. For some ATO's, the shallow deorbit delta V on day 1 is greater than the steep deorbit delta V on day 2. For this case, staying on orbit 24 hours may gain steep deorbit delta V capability eliminating any risk due to a shallow entry.

C. IF OMS PROPELLANT IS NOT AVAILABLE TO ACCOMPLISH OMS DEORBIT TO STEEP TARGETS, TWO STAGE DEORBIT BURNS ARE ACCEPTABLE TO MAINTAIN DEORBIT STEEP CAPABILITY WHEN SUFFICIENT PROPELLANT IS AVAILABLE (IN ACCORDANCE WITH RCS JET REDUNDANCY REQUIREMENTS AS SPECIFIED IN RULE {A6-355}, OMS PROPELLANT DEFICIENCY FOR DEORBIT).

If propellant is not available in the OMS to complete a steep deorbit burn, a perigee adjust burn may be planned using the forward or aft RCS, reducing the OMS propellant requirement for deorbit. Reserving propellant for a two-stage deorbit is only acceptable when sufficient RCS jet redundancy exists as stated in Rule {A6-355}, OMS PROPELLANT DEFICIENCY FOR DEORBIT.

Rules {A6-51}, OMS FAILURE MANAGEMENT [CIL]; {A6-107}, OMS ENGINE FAILURE MANAGEMENT; and {A8-55}, ASCENT/ENTRY RCS CONTROL REQUIREMENTS [HC], reference this rule. ©[ED]

FLIGHT RULES

A2-202

EXTENSION DAY GUIDELINES

- A. IF MANDATORY LANDING AIDS, GROUND TRACKING, COMMAND, VOICE, OR TELEMETRY EQUIPMENT AT THE PLS (REF. SEC. 3, GROUND INSTRUMENTATION REQUIREMENTS) ARE NOT AVAILABLE OR IF WEATHER CONDITIONS AT THE PLS ARE OBSERVED AND/OR FORECAST TO BE UNACCEPTABLE FOR LANDING, A WAVE-OFF OF 24 HOURS OR MORE MAY BE PERFORMED TO ACHIEVE A LANDING AT THE PRIMARY LANDING SITE IF ALL OF THE FOLLOWING CONDITIONS ARE MET:
1. THE ORBITER EXCEEDS MDF SYSTEMS CONFIGURATION STATUS.
 2. CONSUMABLES PROVIDE FOR AT LEAST A 48-HOUR MISSION EXTENSION (WAVE-OFF 24 HOURS TO THE NEXT PLS OPPORTUNITY WITH AN ADDITIONAL 24 HOURS MORE FLIGHT DURATION TO ALLOW RECOVERY FROM ANY ORBITER SYSTEM FAILURES).
 3. THE WEATHER FORECASTS INDICATE THERE IS A HIGH PROBABILITY THAT THE WEATHER AT THE PRIMARY LANDING SITE (WHILE MAINTAINING REASONABLE OPTIONS AT THE SECONDARY LANDING SITE) WILL BE ACCEPTABLE ON A LANDING OPPORTUNITY PRIOR TO 24 HOURS BEFORE THE EXPIRATION OF CONSUMABLES.
 4. ORBITAL ALTITUDE ALLOWS AT LEAST A 48-HOUR MISSION EXTENSION.
 5. ANY MANDATORY EQUIPMENT OUTAGE HAS AN ETRO THAT WILL SUPPORT A PLS LANDING PRIOR TO 24 HOURS BEFORE EXPIRATION OF CONSUMABLES.

THIS RULE CONTINUED ON NEXT PAGE

FLIGHT RULES

A2-202

EXTENSION DAY GUIDELINES (CONTINUED)

- B. IF THE EXTENSION DAY GUIDELINES ABOVE CANNOT BE MET AND THE PLS IS NOT AVAILABLE, THEN AN SLS LANDING WILL BE IMPLEMENTED.

It is desirable to land at the primary landing site if possible. Mission extension is acceptable to accomplish this goal. If the PLS weather is unacceptable, either observed at the decision time or forecast for landing time (ref. Rule {A2-6}, LANDING SITE WEATHER CRITERIA [HC], and Rule {A4-156}, HAC SELECTION CRITERIA), then consideration will be given to a mission extension to achieve a PLS landing. Similarly, for an outage of mandatory equipment supporting a landing at the PLS (ref. rules in Section 3, GROUND INSTRUMENTATION REQUIREMENTS).

It is programmatically desirable to land at the primary landing site. Diversion to alternate sites results in significant additional postflight work and may involve some risk to orbiter or payload hardware reusability. If the orbiter system status and consumables will support continued flight, then continuing to attempt landings at the PLS is preferable to early diversion to an SLS. However, when orbiter systems status is such that an MDF or PLS is required (systems redundancy is compromised) or if consumables cannot support an additional 48-hour flight extension, then the risk incurred by continuing the flight outweighs the programmatic advantages of a landing at the primary site. The consumables and orbital altitude must support the 24-hour extension to the next PLS opportunity and an additional 24-hour mission lifetime if an orbiter systems problem occurs late in the preparations for deorbit that requires a day to fix.

Reference Rule {A2-102}, MISSION DURATION REQUIREMENTS.

Rules {A4-156}, HAC SELECTION CRITERIA, and {A2-207}, LANDING SITE SELECTION, reference this rule.

FLIGHT RULES

A2-203

DEORBIT DELAY GUIDELINES

- A. DELAY A MAXIMUM OF ONE ORBIT TO UNDERSTAND, VERIFY, RECONFIGURE, OR (WHERE A REASONABLE PROBABILITY EXISTS) TO FIX A PROBLEM ASSOCIATED WITH A BASIC GROUND OR VEHICLE CAPABILITY, INCLUDING ADDITIONAL FAULT TOLERANCE.
- B. CONSIDERATION WILL BE GIVEN TO EXTENDING 1 DAY TO REGAIN REDUNDANCY IN AN ENTRY-CRITICAL SYSTEM PROVIDED FAIL-SAFE REDUNDANCY EXISTS IN ALL OTHER SYSTEMS CRITICAL TO ENTRY/LANDING.
- C. ON ENTRY DAY, DELAY A MAXIMUM OF 1 DAY TO PROVIDE A SINGLE-FAULT TOLERANT PASS SYSTEM, A BFS, ACCEPTABLE NAVIGATION, PLBD CLOSURE, OR MANDATORY GROUND CAPABILITY.
- D. AN INTERNAL OMS, RCS, OR APU LEAK RESULTING IN THE VIOLATION OF MINIMUM THERMAL OPERATING CONSTRAINTS RESULTING FROM THE LOSS OF THE POD OR APU IS CAUSE FOR A DEORBIT DELAY.

THIS RULE CONTINUED ON NEXT PAGE

FLIGHT RULES**A2-203****DEORBIT DELAY GUIDELINES (CONTINUED)**

- E. FOR A SINGLE GPC FAILURE PRIOR TO DEORBIT PREPARATION OR FOR MULTIPLE GPC FAILURES PRIOR TO TIG, UNLESS OTHER FACTORS DICTATE DEORBIT ON THE SCHEDULED DAY, ENTRY WILL BE DELAYED UP TO 24 HOURS TO ALLOW FOR RECOVERY, ANALYSIS, AND POSSIBLE IFM TO INSTALL THE CARRY-ON SPARE GPC (IF MANIFESTED). FOR A SINGLE GPC FAILURE DURING DEORBIT PREPARATION, ENTRY MAY BE DELAYED ONE ORBIT TO ALLOW FOR GPC RECOVERY. @[092195-1798]

It is desired to have all GPC's for use during entry. Some GPC failures may be recovered by an IPL, but such a transient GPC may fail again and therefore use of a transient GPC shall be avoided if possible. It is also undesirable to assign two flight-critical strings to a single GPC which would be required if entering with only three PASS GPC's. During the deorbit preparations, however, backing out of the deorbit preparation requires systems reconfiguration which entails inherent risks of its own. At that point, it is better to use a transient GPC or continue without it if it cannot be recovered. The failure of two or more GPC's is a more serious case that implies a significant loss of redundancy; therefore, entry will be delayed a day to allow for the best attempt at GPC recovery which could include a changeout of one of the failed GPC's if a spare is manifested. @[092195-1798]

Rule {A7-17B}, GPC MEMORY DUMP CRITERIA, references this rule. @[092195-1798]

- F. A CONFIRMED OMS LEAK MAY DELAY DEORBIT.
- G. THE FLIGHT WILL NOT BE EXTENDED PAST THE NEXT PLS OPPORTUNITY UNLESS ORBITAL LIFETIME CAN BE GUARANTEED THROUGH THE LAST PLS OPPORTUNITY OF THE FOLLOWING DAY. A REAL-TIME DETERMINATION OF THE MINIMUM 24-HOUR PERIGEE WILL BE MADE FOR OFF-NOMINAL ORBITS.

The 24-hour minimum orbital lifetime is required to ensure crew and vehicle safety if extending past the next PLS opportunity. As perigee approaches the entry interface altitude, the drag buildup significantly increases orbital decay and is thermally more severe on the vehicle. At these low altitudes, the MCC modeling of the orbit is also greatly deteriorated. Exposure to very low altitudes would eventually result in an uncontrolled reentry, which would likely result in loss of crew and vehicle.

THIS RULE CONTINUED ON NEXT PAGE

FLIGHT RULES

A2-203

DEORBIT DELAY GUIDELINES (CONTINUED)

- H. FOR PROPELLANT LEAKS THAT OCCUR AFTER LOS AND PRIOR TO THE DEORBIT BURN, THE FOLLOWING ACTIONS WILL APPLY:
1. OMS LEAK - A PERIGEE ADJUST MANEUVER WILL BE PERFORMED AT THE NOMINAL DEORBIT TIG.
 2. RCS LEAK - THE DEORBIT BURN WILL BE DELAYED TO ASSESS THE THERMAL ENVIRONMENT.

A perigee adjust is performed on an OMS leak in order to minimize the deorbit delta V. Since the thermal effects of an OMS or RCS leak cannot be predicted, the deorbit burn will be delayed to evaluate whether the pod thermal environment can support deorbit. A leak can result in OMS and RCS feedlines freezing, rendering both systems unusable for deorbit and entry.

- I. DEORBIT MAY BE DELAYED TO ACHIEVE A PLS LANDING IF THE WEATHER CONDITIONS ARE UNACCEPTABLE OR MANDATORY GROUND EQUIPMENT IS NOT AVAILABLE.

It is desirable to land at the primary landing site if possible. Mission extension is acceptable to accomplish this goal.

Rule {A7-17D}, GPC MEMORY DUMP CRITERIA, references this rule.

A2-204

MDF DEORBIT GUIDELINES

AN ENTRY PREPARATION TIMELINE WILL PROVIDE FOR ENTRY STOWAGE AND PREPARATION ON THE AFTERNOON OF ENTRY MINUS 1 DAY FOR THE FOLLOWING:

- A. MDF.
- B. A NEXT PLS IF REQUIRED DUE TO A CONDITION WHICH REQUIRES MDF, BUT AFTER MDF OBJECTIVES HAVE BEEN SATISFIED.

FLIGHT RULES

A2-205

EMERGENCY DEORBIT

A. EMERGENCY DEORBIT IS REQUIRED FOR:

1. LOSS OF TWO FREON LOOPS.

If both loops are lost, an abort from orbit is required because there is absolutely no cooling of the vehicle. The fuel cell stack temperature will reach the specification limit of 250 deg F within approximately 50 minutes. In addition, the electrolyte concentration will reach the 25 percent operational limit in approximately 75 minutes. At this point, continued operation of the fuel cells is questionable. This assumes a simultaneous purge of all three fuel cells and a 12.54 kWh (4.18 kWh/fuel cell) power level. Without the purge, the fuel cells will flood in approximately 18 minutes based on an 8.0 kWh (2.67 kWh/fuel cell) power level (ref. Rule {A2-54}, RTLS, TAL, AND AOA ABORTS FOR SYSTEMS FAILURES [CIL]).

DOCUMENTATION: DUAL FREON LOOP FAILURE ENTRY ANALYSIS, Rockwell International IL # 388-301-79-018, July 21, 1981, and SODB table 3.4.4.1-1.

2. ANY OF THE FOLLOWING THAT WILL NOT SUPPORT A NEXT PLS:

- a. CABIN LEAK.

Cabin pressure integrity is lost when O₂ and N₂ consumables are not enough to maintain the cabin pressure at 14.7 psia to the next PLS opportunity while protecting the 165-minute hole-in-the-cabin contingency requirement. If a cabin leak is such that the consumables will not maintain the minimum metabolic pressure (8.0 psia) until the next PLS, the only option left is an emergency deorbit.

DOCUMENTATION: Engineering judgment.

- b. IMPENDING LOSS OF ALL O₂ (H₂) CRYO.

If the pressure cannot be maintained in at least one cryo tank and manifold, the fuel cells will eventually stop producing electrical power, no matter what the quantity is in the cryo tanks. Therefore, this condition warrants the selection of the earliest abort opportunity (ref. Rule [A9-261], IMPENDING LOSS OF ALL CRYO).

DOCUMENTATION: Engineering judgment.

THIS RULE CONTINUED ON NEXT PAGE

FLIGHT RULES

A2-205

EMERGENCY DEORBIT (CONTINUED)

- c. LEAKING PROPELLANT FROM THE REMAINING DEORBIT BURN SYSTEM.

Capability will be lost to successfully complete the deorbit burn.

- d. TWO ARCS PROPELLANT TANKS LEAKING, SAME PROPELLANT AND EITHER LEAK RATE SUPPORTS ENTRY TO A Q-BAR = 20 FOR A DAYLIGHT LANDING AT AN ELS (IF A NIGHT LANDING AND NO LANDING AIDS DELAY DEORBIT) .

If the leak rate supports entry to a Q-bar = 20 for any ELS, perform an emergency deorbit to that site. This action would provide entry control until NO YAW JET selection. The risk of an ELS landing without landing aids at night is considered to be higher than proposed options of procedure/software changes to provide control from EI to Q-bar = 20. Therefore, for a night landing without landing aids, the deorbit will be delayed.

- e. IMPENDING LOSS OF ALL APU/HYDRAULIC SYSTEMS CAPABILITY. @[111699-7070B]

Loss of all APU/hydraulic systems capability will result in loss of aerosurface control required for entry (ref. Rule {A10-21A}.4, LOSS OF APU/HYDRAULIC SYSTEM (S) ACTIONS). @[111699-7070B]

- f. LOSS OF TWO WATER LOOPS.

Thermal analysis indicates that, if two water loops are lost, cabin conditions will become intolerable within 2 hours of the failure. Cabin temperatures approach 90 deg F and relative humidity reaches 100 percent. Avionics temperatures exceed their loss of cooling operate periods and must be powered down. The cabin conditions can be relieved by performing cabin depress/repress (DEP/REP) cycles. The 4-hour time to landing is based on a crew of seven with an N₂ quantity of 262 lb. Crew exposure to the extreme cabin conditions is the primary driver for terminating the flight. The DEP/REP cycles provide relief from the high heat and humidity by dumping the excessive heat and humidity overboard and replacing the air with cool, dry N₂ and O₂.

DOCUMENTATION: Lockheed Technical memorandum, G189A ECLSS ANALYSIS OF THE LOSS OF TWO WATER LOOPS AFO (TIG >2.5), to be published. Document no. LESC-24843.

Rule {A13-151}, HOT CABIN ATMOSPHERE, references this rule. @[012204-6182]

THIS RULE CONTINUED ON NEXT PAGE

FLIGHT RULES

A2-205

EMERGENCY DEORBIT (CONTINUED)

B. IN THE EVENT AN EMERGENCY DEORBIT IS REQUIRED, ORBITER CONSUMABLES LIFETIME IS THE PRIMARY CONSIDERATION. WHEN CHOOSING BETWEEN VARIOUS ELS OPPORTUNITIES, BOTH OF THE FOLLOWING CRITERIA MUST BE SATISFIED, AS A MINIMUM:

@[120894-1744B]

1. ENTRY CROSSRANGE < UNDISPERSED CROSSRANGE LIMIT.
2. LANDING FACILITY REQUIREMENTS AS SPECIFIED IN RULE {A2-264}, EMERGENCY LANDING FACILITY CRITERIA.

Consumables lifetime will limit the emergency landing site choices available. If no landing site is available within time limits, then a bailout is required.

The undispersed entry crossrange limit represents the total vehicle crossrange capability, assuming perfect onboard navigation, design winds and atmosphere, and nominal vehicle energy, control, and response. Landing sites outside this limit are not achievable on an average (zero sigma) day and; therefore, deorbiting to such a site is not much better than a bailout.

Minimum ground equipment, including night landing equipment, is specified in rule {A2-264}, EMERGENCY LANDING FACILITY CRITERIA.

C. WHEN ALL THE CRITERIA IN PARAGRAPH B ARE MET AND A CHOICE BETWEEN SITES CAN STILL BE MADE, THEN THE FOLLOWING PRIORITIES APPLY (NOTE: IF TIME PERMITS, CONSIDERATION WILL BE GIVEN TO ADDITIONAL CRITERIA AS SPECIFIED IN RULE {A4-107}, PLS/EOM LANDING OPPORTUNITY REQUIREMENTS):

1. NASA CONUS:
 - a. EDW
 - b. KSC
 - c. NOR

THIS RULE CONTINUED ON NEXT PAGE

FLIGHT RULES

A2-205

EMERGENCY DEORBIT (CONTINUED)

NOTE: A NIGHT LANDING AT A NASA CONUS SITE EQUIPPED WITH NAV-LANDING AIDS AND XENON LIGHTS IS PREFERRED OVER A DAYLIGHT LANDING TO ANY OTHER SITE BELOW.

2. TAL SITES PRIOR TO RELEASE FROM LAUNCH SUPPORT @[120894-1744B]
3. DOD: @[120894-1744B]
 - a. HICKAM AFB, HAWAII
 - b. ANDERSEN AFB, GUAM
 - c. MORON, SPAIN (POST-RELEASE FROM TAL SUPPORT)
 - d. DIEGO GARCIA, CHAGOS ISLANDS
 - e. OTHER DOD, LISTED IN NSTS-07700, VOLUME X, BOOK 3
4. NON-DOD WITH UHF COMM AVAILABLE:
 - a. KING KHALID, SAUDI ARABIA
 - b. ZARAGOZA, SPAIN (POST-RELEASE FROM TAL SUPPORT)
 - c. ISTRES AB, FRANCE (POST-RELEASE FROM TAL SUPPORT) @[022405-6624B]
 - d. OTHER NON-DOD WITH UHF, LISTED IN NSTS-07700, VOLUME X, BOOK 3
5. ALL OTHER NON-DOD WITHOUT UHF LISTED IN NSTS-07700, VOLUME X, BOOK 3 @[022405-6624B]

THIS RULE CONTINUED ON NEXT PAGE

FLIGHT RULES

A2-205

EMERGENCY DEORBIT (CONTINUED)

6. OTHER SITES NOT LISTED IN NSTS-07700, VOLUME X, BOOK 3

First priority for emergency deorbit landings are the NASA CONUS sites. The only time a night landing is preferred over daylight for emergency deorbit is when it can be made at a CONUS site equipped with operational nav aids, landing aids, and xenon lights. TAL sites are not staffed after release of launch support; however, for failures very early in the mission which require an emergency deorbit, any TAL site which is still available and staffed would be preferred over an ELS. Sites with permanent DOD presence are next since ELS augmentation for emergency deorbit use has been eliminated. Further priorities are based upon available landing site security, control, and communications. @[120894-1744B] @[022405-6624B]

Entry public risk assessments are not addressed for Emergency Deorbit. The limited number of emergency landing sites available and the inherent limitations due to orbital mechanics, combined with the need to land the orbiter as quickly as possible, are the prime considerations for these cases. @[022405-6624B]

- D. EMERGENCY DEORBIT PROTECTION REQUIREMENTS: @[120894-1744B]

1. SYSTEMS AND PAYLOADS MUST BE CONFIGURED TO PROTECT EMERGENCY DEORBIT WITHIN 1 HR 55 MINUTES FOR ISS DOCKED AND ASSEMBLY OPERATIONS AND WITHIN 30 MINUTES FOR NON-ISS OPERATIONS. @[110900-3758B]
2. IF A CONFIGURATION OR ACTIVITY WILL RESULT IN EXCEEDING THE ALLOTTED TIME ABOVE, THE CONFIGURATION OR ACTIVITY WILL BE TERMINATED OR THE SAFING TIMELINE UPDATED BASED ON MMT CONCURRENCE OR FLIGHT SPECIFIC EXCEPTIONS DOCUMENTED IN THE FLIGHT RULES ANNEX.
3. IF EXTERNAL HARDWARE SAFING TIME EXCEEDS THE ACTUAL TIME AVAILABLE, HARDWARE MAY BE JETTISONED AS REQUIRED FOR CREW SAFETY.

THIS RULE CONTINUED ON NEXT PAGE

FLIGHT RULES

A2-205

EMERGENCY DEORBIT (CONTINUED)

4. EXCEPTIONS TO THIS RULE WILL BE DOCUMENTED IN THE FLIGHT SPECIFIC ANNEX.

It is the policy of the SSP to protect the capability to perform an emergency deorbit. For unmatd shuttle operations, the quickest time the crew can respond to an emergency situation and perform a deorbit burn is 30 minutes. To support this requirement, cabin payloads must be stowed and external payloads must be "safed" to allow payload bay door closure in less than 20 minutes. If the RMS is in use by the payload, only approximately 10 minutes will be available to safe the payload since approximately 10 minutes is required to configure the RMS in preparation for deorbit.

While docked to the ISS, the capability to perform an emergency deorbit within 30 minutes no longer exists. Therefore, the emergency deorbit protection timeline is extended for joint shuttle/ISS operations. The SSP has accepted the slight additional risk of extending the rapid safing duration to 1 hr 45 minutes for ISS to allow payload bay door closure approximately 10 minutes after separation, and deorbit 10 minutes later (minimum time between separation and deorbit burn is approximately 20 minutes). If the RMS is in use by an element or payload, only 1 hr 35 minutes will be available for the element on the RMS to perform safing functions required to clear the PLBD envelope since approximately 10 minutes is required to configure the RMS in preparation for deorbit. ©[110900-3758B]

THIS RULE CONTINUED ON NEXT PAGE

FLIGHT RULES

A2-205

EMERGENCY DEORBIT (CONTINUED)

Non-ISS Timeline: @[110900-3758B]

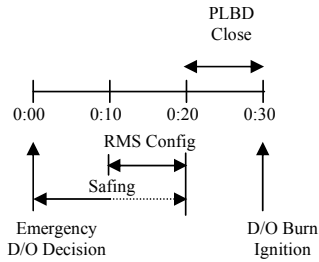

ISS Timeline:

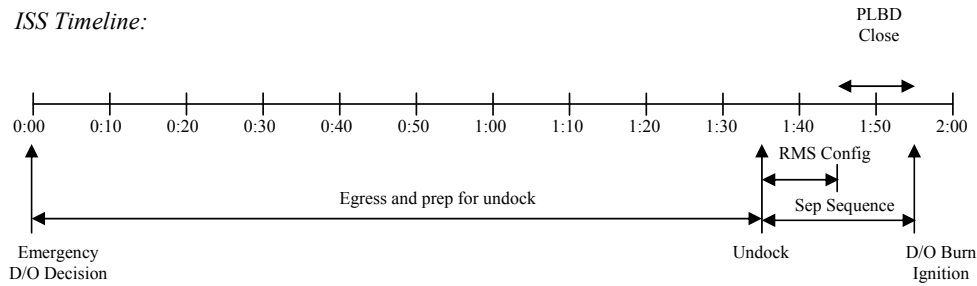

The single failure that drives the requirement to maintain an emergency deorbit capability is an orbital debris impact that results in the loss of cabin pressure integrity. The risk of a debris strike requiring a deorbit within 1 hr 55 minutes for a typical 10-day mission is approximately 1 in 10,000. @[022201-4123]

THIS RULE CONTINUED ON NEXT PAGE

FLIGHT RULES

A2-205**EMERGENCY DEORBIT (CONTINUED)**

This risk is mitigated by maintaining sufficient nitrogen reserves to protect the contingency 165-minute return capability, plus the nitrogen budgeted for the typical 2 days between undocking and nominal end of mission landing. For a typical station trajectory, the 165-minute nitrogen reserve would cover 1 hour 40 minutes prior to the burn, plus 1 hour 5 minutes from burn to landing. To stretch this by 15 minutes, and maintain nitrogen flowing through the 8 psi regulator until landing, requires an additional 12.5 lbm of nitrogen in reserve. This is approximately the amount that is budgeted for the 2 days of standard mission usage between nominal undocking and landing. Reference Rule {A17-202}, 8 PSIA CABIN CONTINGENCY 165-MINUTE RETURN CAPABILITY. ©[022201-4123]

In addition to payload safing, systems must also be configured to support deorbit within the specified time in Paragraph D.1. (e.g., DAP, Ku-band antenna, radiators, APU/HYD, FES, IMU's, payload bay doors). The safing timeline for each flight phase is defined in the flight specific Flight Rules Annex, which defines the actions required during a rapid safing scenario and may include hardware jettison if required to meet the time requirement or a flight specific exception to this rule. If, during real-time operations, a failure or unplanned configuration or activity occurs requiring more safing time than allowed, the activity or configuration will be terminated or the additional risk incurred accepted by the MMT. ©[110900-3758B]

If an event occurs which requires deorbit in less time than allocated per this flight rule or the flight specific Flight Rules Annex, every effort will be made, including hardware jettison if required, to maximize crew safety. ©[110900-3758B]

DOCUMENTATION: SSP 50021 Safety Requirements Document International Space Station Program; DA8-96-039, "Orbit Flight Techniques Panel Meetings #157 and 158 Minutes," MA2-96-157, "Payload Rapid Safing Requirements," MA2-96-190, "Contingency Return and Rapid Safing."

THIS RULE CONTINUED ON NEXT PAGE

FLIGHT RULES

A2-205 **EMERGENCY DEORBIT (CONTINUED)**

E. EMERGENCY LANDING SITE NOTIFICATION: @[120894-1744B]

SHOULD AN EMERGENCY LANDING BE REQUIRED, NOTIFICATION WILL BE PROVIDED AS SOON AS POSSIBLE TO THE INTENDED LANDING SITE BY MCC/GROUND PERSONNEL THROUGH STATE DEPARTMENT-APPROVED CHANNELS. HOWEVER IN SOME CASES, IT MAY NOT BE POSSIBLE TO PROVIDE ADVANCED NOTIFICATION PRIOR TO THE DEORBIT/ATTEMPTED LANDING. WHEN SELECTING THE LANDING SITE, CONSIDERATION WILL BE GIVEN TO THOSE SITES THAT HAVE AN ORBITER COMPATIBLE UHF SYSTEM IN ORDER TO PROVIDE LANDING NOTIFICATION BY THE CREW DURING DESCENT IF POSSIBLE.

SHOULD NOTIFICATION OF THE SELECTED LANDING SITE NOT BE POSSIBLE, THE DECISION ON WHETHER TO ATTEMPT THE LANDING OR BAILOUT WILL BE THE RESPONSIBILITY OF THE CDR BASED ON LANDING SITE CONDITIONS AT THE TIME OF ARRIVAL WITH RESPECT TO WEATHER, AIRCRAFT TRAFFIC, RUNWAY CONDITIONS, ETC.
@[120894-1744B]

In order to reduce the risk to the orbiter crew and the general public/civilian population should an emergency landing be required, it is necessary that an intended landing site be notified of an attempted landing as soon as possible. This will allow the airspace and runways to be cleared as well as emergency equipment to be prepared. Notification may be via state department prearranged channels, NASA agreed to communication channels, or possibly via communication directly with the orbiter. As a last resort, a landing may be attempted at a site that has not been notified, with the final decision on whether to attempt the landing or bailout resting with the CDR based on conditions at the time of arrival.

Rules {A6-52}, RCS FAILURE MANAGEMENT; {A8-1001D}.9, GNC GO/NO-GO CRITERIA, and {A16-12A}, EMERGENCY POWERDOWN, reference this rule. @[110900-3758B]

A2-206 **DEROTATION SPEED [HC]** @[121604-6254C]

- A. NOMINAL DEROTATION WILL BE TARGETED FOR 185 KEAS USING BEEP TRIM.
- B. IN THE EVENT OF A BEEP TRIM FAILURE, THE CDR WILL INITIATE MANUAL DEROTATION BY APPROXIMATELY 175 KEAS AND TARGET FOR A 1-2 DEG/SEC RATE.

THIS RULE CONTINUED ON NEXT PAGE

FLIGHT RULES**A2-206****DEROTATION SPEED [HC] (CONTINUED)**

- C. FOR A FAILED MAIN GEAR TIRE, AUTO-DEROTATION WILL BE INITIATED POST-MAIN GEAR TOUCHDOWN. ©[041097-4009E]

Nominal derotation is initiated by the crew using beep trim at 185 KEAS on both concrete and lakebed runways and for all vehicles. Based on a nominal 195 KEAS lightweight MLG touchdown, the drag chute is deployed immediately after touchdown. Flight data and testing at Ames (1/96 and 7/96) show that, to ensure disreef prior to NGTD, the chute should be deployed 10 knots prior to derotation. If the drag chute is deployed at 195 knots (post MGTD), the chute will be in the full-open configuration just prior to nose gear touchdown, thus reducing the NLG touchdown loads. MLG touchdowns at higher airspeeds result in more time spent in the 2-point attitude hold stance waiting for the airspeed to decrease to the nominal chute deploy/vehicle derotation cues. ©[041097-4009E]

Ames VMS testing in 2003, incorporating the updated "load persistence" tire model, indicates that the main landing gear tire load profile generated by an auto-derotation when the drag chute is deployed at 185 KEAS is less severe than with a beep trim derotation. The testing indicated that landing with the lowest groundspeed (e.g., landing in a headwind) and with a crosswind from the side of the failed tire, initiating auto-derotation (which automatically starts at 180 KEAS and yields lower MLG peak loads due to higher target derotation rates), deploying the drag chute at 185 KEAS, and inputting an immediate full lateral flight control input (RHC roll) in the direction opposite the failed tire at NGTD all contributed to maximizing the probability of survival for the remaining tire on the same strut as the failed tire. Simulations using this technique for typical ISS EOM weights showed a high likelihood of saving the second tire, while heavier abort weights usually showed loss of the second tire on the same strut regardless of the technique applied. A model audit performed in 2004 in support of nose gear tire certification activities resulted in changes that increased tire damage trends from the load persistence model when compared to the version used for the 2003 study. Although the tire failure mitigation procedure is less effective than indicated by the results of the 2003 study, preliminary Ames VMS training session data suggest the procedure still increases the probability of saving the second tire on the same strut for lightweight vehicles. Additional strength is expected with the new main gear tires, which will further increase the probability of saving the second tire.

If auto-derotation is not available (e.g., the BFS has been engaged), a nominal drag chute deploy (at 195 KEAS) will be performed and a beep trim derotation will be delayed to achieve a 10 kt delta from the drag chute deploy airspeed (reference AEFTP #194, October 2003). With the BFS engaged, beep trim derotation is available only via the CDR's RHC.

Reference Rules {A4-108A}, TIRE SPEED, BRAKING, AND ROLLOUT REQUIREMENTS [HC]; {A10-142}, TIRE PRESSURE [CIL] [HC]; and {A10-143}, DRAG CHUTE DEPLOY TECHNIQUES [HC]. ©[050495-1774A] ©[042706-7363A]

Hazard reports ORBI 021, ORBI 030, and ORBI 211 reference this rule. ©[121604-6254C]

Rule{A4-108}, TIRE SPEED, BRAKING, AND ROLLOUT REQUIREMENTS [HC], references this rule. ©[042706-7363A]

FLIGHT RULES

A2-207 **LANDING SITE SELECTION [HC]** @[121604-6254C]

NORMAL LANDING SITE SELECTION WILL BE BASED ON THE FOLLOWING PRIORITIES. ALL REQUIREMENTS FOR ACCEPTABLE WEATHER, LIGHTING CONDITIONS, RUNWAY CONDITIONS, AND ENTRY CONSTRAINTS MUST BE SATISFIED FOR A SITE/RUNWAY TO BE USED. @[102402-5804C]

NOTE: REFERENCE THE FLIGHT-SPECIFIC FLIGHT RULE ANNEX FOR ANY EXCEPTIONS TO THE FOLLOWING LANDING SITE PRIORITIES DUE TO SPECIAL CIRCUMSTANCES/REQUIREMENTS.

A. RTLS/TAL PRIORITIES:

RTLS [1]	
INCLINATION < 39°	INCLINATION > 39°
KSC 15	KSC 33
KSC 33	KSC 15

NOTE:

[1] FOR INCLINATIONS OF EXACTLY 39 DEGREES, THERE IS NO DIFFERENCE IN DOWNMODE RANGING BETWEEN KSC 15/33. RUNWAY WILL BE CHOSEN BASED ON WEATHER, SURFACE WINDS, TOUCHDOWN/ROLLOUT MARGINS, ETC. @[020196-1802A]

TAL			
28.5 DEG	39 DEG	51.6 DEG	57 DEG
MORON (MRN)	ISTRES (FMI)	ZARAGOZA (ZZA)	ZARAGOZA (ZZA)
	MORON (MRN)	MORON (MRN)	MORON (MRN)
	ZARAGOZA (ZZA)	ISTRES (FMI)	ISTRES (FMI)

@[020196-1802A] @[102402-5804C] @[022405-6624B]

RUNWAY SELECTION FOR RTLS OR TAL SHOULD BE IN PRIORITY ORDER OF GO RUNWAYS. HOWEVER, IF A RUNWAY APPROACHES FLIGHT RULE LIMITS OR OTHER CONDITIONS MAKE A RUNWAY LESS DESIRABLE (I.E., SUN GLARE, STA EVALUATION, ETC.), THEN CONSIDERATION MAY BE GIVEN TO SELECTING A LOWER PRIORITY RUNWAY. @[020196-1802A] @[102402-5804C]

Runway priorities for RTLS are based solely on energy downmode capability. For inclinations less than 39 degrees, GRTLS range-to-go analysis has shown that a larger range recovery capability exists for an OVHD KSC 15 downmode to STIN KSC 33 than OVHD KSC 33 downmode to STIN KSC 15.

TAL runway priorities were determined based on the site that provides the best single-engine coverage once a TAL abort has been selected. Entry public risk assessment is not a consideration for RTLS/TAL by direction of the Space Shuttle Program. The analyses and the data necessary to evaluate these cases are not yet available. @[022405-6624B]

THIS RULE CONTINUED ON NEXT PAGE

FLIGHT RULES

A2-207

LANDING SITE SELECTION [HC] (CONTINUED)

B. AOA PRIORITIES @[102402-5804C]

AOA		
28.5/39 DEG	51.6 DEG	57 DEG
EDW 22/04	KSC	NORTHRUP
KSC	NORTHRUP	
NORTHRUP		

@[022405-6624B]

AOA landing site priorities are a function of inclination. For 28.5-degree and 39-degree inclinations, all three CONUS sites are available based on crossrange capability. Since AOA landings are typically heavyweight, the Edwards AFB (EDW) complex provides more margin in the event of landing/rollout or vehicle energy problems. KSC and then Northrup (NOR) are next in priority since KSC has a concrete runway which minimizes nose-gear slapdown loads. For 51.6-degree inclinations, only KSC and Northrup are available since EDW violates crossrange limits. For high inclination missions (57-degree inclination), Northrup is the only AOA landing site available due to the large crossrange required to land at Edwards or KSC. (Ref. Rule {A4-107}, PLS/EOM LANDING OPPORTUNITY REQUIREMENTS).

@[111094-1622B]

Entry public risk assessment is not a consideration for AOA by direction of the Space Shuttle Program. Similar to RTLS and TAL, the analyses and the data necessary to evaluate these cases are not yet available.

@[022405-6624B]

C. EOM PRIORITIES

1. KSC
2. EDWARDS 22/04
3. NORTHRUP

THIS RULE CONTINUED ON NEXT PAGE

FLIGHT RULES

A2-207

LANDING SITE SELECTION [HC] (CONTINUED)

NOTE: WHEN FEASIBLE AND WHILE SATISFYING OTHER LANDING SITE SELECTION PRIORITIES FOR WEATHER, CONSUMABLES, RUNWAY CONDITIONS, AND ENTRY CONSTRAINTS, THE FOLLOWING CROSSRANGES WILL BE AVOIDED IN ORDER TO ABATE RISK TO THE GENERAL PUBLIC: @[022405-6624B]

	ASCENDING LEFT	ASCENDING RIGHT
KSC	NONE	NONE
EDW 22	343-631 NM	NONE
EDW 04	0-20 NM 372-673 NM	0-142 NM
NORTHRUP	NONE	718-733 NM

Due to the advantages in vehicle turnaround, the Space Shuttle Program has directed that nominal end of mission (EOM) landings utilize KSC as the first priority landing site.

After KSC, next in the EOM runway selection priority is Edwards AFB, because of the availability of the concrete runway and because of the significant vehicle post landing and turnaround operations capabilities. NOR is generally last priority because, although it provides an excellent orbiter landing site (laser-leveled runways, crossing runways, significant runway lateral and longitudinal margin, all required landing aids, and NAVAIDS for day and night, etc.), the ability to support the orbiter systems postlanding and for turnaround/ferry operations is much reduced as compared to KSC or Edwards, resulting in the potential for significant (several weeks') shuttle schedule/manifest impacts. @[102402-5804C]

As a result of NASA Range Safety policy (ref. NASA Procedural Requirements, NPR 8715.XX, Range SafetyProgram), entry public risk is a consideration in space shuttle landing site selection. The Space Shuttle Program and the Agency have determined that the entry public risk associated with the highest risk ascending landing opportunity to KSC is acceptable for the remaining space shuttle missions. This is because of the established space shuttle design and operational constraints and, further, because any significant changes to shuttle entry operations could have a negative effect on the crew and mission. Additionally, the combination of STS hardware improvements, launch and orbit imagery capability, and post launch vehicle inspections established for Return to Flight (RTF) provides significant abatement for entry public risk. Finally, since all ascending approaches to KSC from the ISS orbit are of the same order of magnitude relative to entry public risk, there are no entry public risk restrictions for any EOM KSC ascending approach. @[022405-6624B]

THIS RULE CONTINUED ON NEXT PAGE

FLIGHT RULES

A2-207

LANDING SITE SELECTION [HC] (CONTINUED)

When EDW and NOR must be utilized, the level of risk defined by the highest risk KSC opportunity serves as benchmark to define higher risk crossranges that should be given special consideration. For EDW-04, ascending left crossranges from 0-20 nm and 372-673 nm along with ascending right crossranges from 0 to 142 nm exceed the highest risk KSC opportunity. For EDW-22 only ascending left crossranges from 343-631 nm exceed this limit. For Northrup landings, ascending right crossranges from 718-733 nm exceed that of the highest risk KSC opportunity. When Edwards or Northrup is required, the deorbit/entry approach should be selected to avoid these crossranges to the extent feasible and when not precluded by other high priority requirements that provide for a safe entry and landing such as weather, consumables, runway conditions, entry constraints, crew health, etc. ©[022405-6624B]

For PLS planning, the special EDW and NOR crossrange placards will not be utilized to select the daily and/or no comm PLS to maximize operational flexibility and number of landing opportunities available. Once a PLS is declared, this rule will be utilized to determine the correct landing site and deorbit opportunity.

Additionally, EOM descending opportunities are not used operationally on ISS missions because of significant impacts to the crew timeline and sleep shifting, noctilucent clouds concerns during the summer months (June through August), and an additional 15 fps propellant cost for the deorbit burn, which is not budgeted for pre-mission. However, if a descending opportunity were planned for nominal EOM, there are no restrictions for Edwards approaches. KSC opportunities for descending left opportunities from 747-764 nm and descending right 743-760 nm will be avoided to the extent feasible along with Northrup descending left opportunities from 766-783 nm.

Finally, EDW-04 opportunities with ascending left crossranges from 8 nm to 35 nm need to be carefully evaluated using established Flight Dynamics Officer and Entry Support procedures to ensure that initial bank direction is in the expected direction (to the left). Based on this analysis, the EDW-04 crossrange placards for these opportunities may need to be expanded.

Reference: Program Requirements Control Board, December 2, 2004 and AEFTP #209A, January 21, 2005. ©[022405-6624B]

Reference Rule {A4-109}, DEORBIT PRIORITY FOR EOM WEATHER.

Reference Rule {A2-202}, EXTENSION DAY GUIDELINES, for cases where the PLS is NO-GO.

THIS RULE CONTINUED ON NEXT PAGE

FLIGHT RULES

A2-207 LANDING SITE SELECTION [HC] (CONTINUED)

D. SYSTEMS FAILURE PRIORITIES @[102402-5804C] @[062405-6624B]

FOR SYSTEMS FAILURES, THE LANDING SITE PRIORITY SHALL FOLLOW THE EOM PRIORITIES. CONSIDERATION WILL BE GIVEN TO THE FOLLOWING EXCEPTIONS:

SYSTEM FAILURES [1] [3] [5] [6]	PRIORITY [7]
1 OR 2 APU/HYD SYSTEMS	LANDING SITES WITHIN SINGLE APU WX PLACARDS [2]
2 IMU'S 2 NORM/LAT AA'S 2 RGA'S	EDW 22/04 NORTHROP KSC
2 ADTA'S	LANDING SITE WITH MOST FAVORABLE ATMOSPHERIC CONDITIONS [4]
2 FCS CHANNELS (SAME SURFACE)	NORTHROP EDW 22/04 KSC

@[102402-5804C]

NOTE: PARAGRAPH D DOES NOT APPLY FOR SYSTEMS FAILURES RESULTING IN A COMPROMISED ORBITER LIKE THOSE RESULTING FROM COMMON CAUSE (SEE PARAGRAPH E). @[022405-6624B]

NOTES:

- [1] ALL FAILURES OCCUR PRIOR TO DEORBIT BURN.
 - [2] WX PLACARDS ARE AS FOLLOWS:
 - A. CEILING - GREATER THAN OR EQUAL TO 10K FEET
 - B. VISIBILITY - GREATER THAN OR EQUAL TO 7 STATUTE MILES
 - C. CROSSWIND - LESS THAN OR EQUAL TO 10 KNOTS (PEAK)
 - D. NO GREATER THAN LIGHT TURBULENCE
 - E. ACCEPTABLE ROLLOUT MARGIN/BRAKE ENERGY ON HALF BRAKES WITHOUT NOSEWHEEL STEERING (DIFFERENTIAL BRAKING)
- (REF. RULE {A10-23A}, APU ENTRY START TIME [HC].) LANDING SITE PRIORITY SHALL MINIMIZE CROSSWINDS AND TURBULENCE. @[ED]

THIS RULE CONTINUED ON NEXT PAGE

FLIGHT RULES**A2-207****LANDING SITE SELECTION [HC] (CONTINUED)**

- [3] IF THE PRIMARY LANDING SITE IS NO-GO AND IF THE FORECAST CONDITIONS ARE PREDICTED TO IMPROVE, DEORBIT WILL BE DELAYED, IF PRACTICAL.
- [4] UNFAVORABLE ATMOSPHERIC CONDITIONS ARE DEFINED AS UPPER LEVEL HAC WINDS IN EXCESS OF 80 KNOTS, HAC DYNAMICS THAT COULD AFFECT THE VEHICLES ENERGY STATE (I.E., ENERGY DUMP MANEUVERS), OR DENSITY ALTITUDE EFFECTS THAT BIAS THE INDICATED AIRSPEED. PRESENCE OF ANY OF THESE CONDITIONS INCREASES THE WORKLOAD ASSOCIATED WITH MANUALLY FLYING THETA LIMITS, COULD RESULT IN ADDITIONAL ENERGY LOSS, AND INCREASES THE POSSIBILITY OF LANDING FASTER OR SLOWER THAN THE TARGETED AIRSPEED. (REF. RULE {A8-111}, AIR DATA SYSTEM MANAGEMENT). ©[022405-6624B]
- [5] LIGHTED RUNWAY REQUIRED AT NIGHT.
- [6] REFERENCE RULE {A2-202}, EXTENSION DAY GUIDELINES, FOR WAVE-OFF CRITERIA. ©[102402-5804C]
- [7] CONSIDERATION WILL BE GIVEN TO OBSERVING THE CROSSRANGE RESTRICTIONS LISTED UNDER THE EOM PRIORITIES (PARAGRAPH C) AND TO SELECTING LOWER RISK CROSSRANGES (PARAGRAPH E) TO ABATE RISK TO THE PUBLIC. ©[022405-6624B]

The NEOM landing site priority of KSC, EDW 22/04, NOR is driven by Space Shuttle Program directive, based on the cost in time and money for vehicle turn-around. Exceptions to this standard priority order will be reviewed on a case-by-case basis for orbiter systems failures. Factors in selecting the best landing site include, but are not limited to, weather conditions, runway lateral and rollout margins, and touch-down margins for flight control or navigation issues. KSC 15/33 is a 300 ft wide grooved concrete runway with 50 ft loadbearing paved shoulders and has a total length of 17,000 ft including the 1,000 ft underrun and 1,000 ft overrun. The KSC runway is surrounded by a non-loadbearing grassy area and a moat. EDW 22/04 is a 300 ft wide non-grooved concrete runway with 25 ft lakebed material shoulders that are not generally considered loadbearing. EDW 22/04 has a total length of 16,975 ft. The EDW 04 end has a 1,000 ft underrun and an 1,800 ft overrun with the possibility of rollout onto another 9,588 ft of prepared lakebed surface. The EDW 22 end has a 1,800 ft underrun and no overrun. NOR 17/35 and 05/23 are 300 ft wide leveled lakebed runways with 300 ft shoulders of the same hard mantle material. Each runway has a total length of 39,000 ft including a 12,000 ft underrun and 12,000 ft overrun. For all runways, the existence and location of obstructions in the shoulders should be discussed in situations where lateral margins are a factor in landing site selection. ©[102402-5804C]

THIS RULE CONTINUED ON NEXT PAGE

FLIGHT RULES

A2-207

LANDING SITE SELECTION [HC] (CONTINUED)

While not required for these systems failure cases, the crossrange restrictions listed in the EOM priorities (paragraph C of this rule) should be considered when selecting a deorbit opportunity for systems failures. Observing the crossrange restrictions abates risk to the general public should the next worst system failure occur during the entry timeframe. Additionally, when entry fault tolerance has been reduced or eliminated, consideration should be given to selecting lower risk opportunities defined in paragraph E Compromised Orbiter to further reduce risk to the public if it can be done within the other required priority constraints and conditions. ©[022405-6624B]

The following cases have been addressed in the development of this rule (ref AEFTP #187, September 20, 2002; AEFTP #202, June 18, 2004; AEFTP #205, September 17, 2004; and AEFTP #209A, January 21, 2005): ©[022405-6624B]

1 or 2 APU HYD SYSTEMS: For loss of a single APU/hydraulic system, vehicle hydraulic capability is unimpaired. However, loss of a second APU, results in potential system losses (nosewheel steering, braking capability, control effectiveness at derotation, etc.) requiring more stringent weather placards to assure a safe landing. If two APU/hydraulic systems are lost, it is desirable to provide significant lateral and longitudinal margins while providing a surface that is hard enough to allow better control of derotation rate in order to limit nose gear touchdown loads. Concrete runways provide a lower coefficient of friction than lakebeds, including Northrup. A lower coefficient of friction reduces the pitch down moment and, thus, reduces hydraulic load. With only one APU remaining for flight control, an evaluation of appropriate weather conditions, including upper level and surface winds, is critical in the planned landing site selection criteria. Since the control degradation and systems losses would only be apparent with a single operating APU during approach and landing, derotation, and rollout, it is prudent to pick the best runway within the stated weather placards. The stability of the weather, and minimizing cross-winds and turbulence, are the key consideration if more than one landing site is within placards. ©[102402-5804C]

THIS RULE CONTINUED ON NEXT PAGE

FLIGHT RULES

A2-207

LANDING SITE SELECTION [HC] (CONTINUED)

2 IMU's, 2 NORM/LAT AA's, 2 RGA's: The IMU's, AA's, and RGA's provide feedback to the orbiter flight control loops. Specifically, the IMU's are used to propagate the vehicle navigation state vector and provide attitude and attitude rate information to the flight control system. Lateral AA's provide feedback to the flight control system to improve stability during turn coordination and roll reversals, and are used to provide feedback during use of nose wheel steering (NWS) on the runway. Normal AA's are used to sense normal acceleration (Nz) during TAEM to prevent from overstressing the vehicle's structure by maintaining the pitch angle such that the vehicle stays below the Nz limits. The RGA's are used to stabilize the flight control system by providing high frequency rate information between IMU rate samples. The IMU's, AA's, and RGA's are used by the Aerojet DAP during the EI-5 through landing and rollout timeframe (MM304 and MM305). A critical failure in one of these systems could result in degraded vehicle control and/or significant energy loss during the entry profile. The intent of selecting Edwards 22/04 as the primary landing site is to provide the maximum number of contingency energy downmode options in the event the next LRU fails early in the entry profile and results in significant energy loss. Downmode options in the vicinity of Edwards 22/04 include Palmdale, China Lake, the Edwards lakebed, etc. If Edwards is not available, then Northrup provides the next best energy downmode capability because the Northrup landing site complex has multiple runways available, and it is collocated with several other contingency landing sites (i.e., Holloman, etc). If Edwards and Northrup are unavailable, then a KSC landing should be targeted since the probability of the next worst failure is low and it is the prime landing site with significant ground forces available. ©[102402-5804C]

2 ADTA's: The ADTA's are only used during TAEM, provide altitude data to navigation, and determine the Mach number and angle of attack (Alpha) for use by flight control. This limits the window of exposure for another ADTA problem to only the last portion of entry. Next worst failures could include a loss of all air data measurements (due to dilemma or a probe problem). Landing site selection with two ADTA's failed protects for landing without air data. Flying without air data requires use of manual flying techniques (i.e., theta limits). The level of difficulty associated with maintaining theta limits and survivability is significantly affected by the atmospheric conditions. As such, only the landing site with the most benign atmospheric conditions should be targeted. Unfavorable atmospheric conditions that could result in a loss of control, significant energy loss due to flying outside the HAC, or difficulty in maintaining theta limits include high upper level winds on the HAC (i.e., winds in excess of 80 knots) or other HAC dynamics such as an energy dump pull-up maneuver. Density altitude effects should also be considered when targeting a landing site, because the density altitude could bias the indicated airspeed and result in a landing that is considerably faster or slower than the targeted touchdown airspeed. This is due to the fact that the flight control system assumes a standard atmosphere as the default with no air data and that default may differ significantly from the actual atmospheric conditions of the day at the selected landing site. (Ref. rule {A8-111}, AIR DATA SYSTEM MANAGEMENT.) ©[102402-5804C]

THIS RULE CONTINUED ON NEXT PAGE

FLIGHT RULES

A2-207

LANDING SITE SELECTION [HC] (CONTINUED)

2 FCS CHANNELS: *The FCS channels control the orbiter aerosurfaces during the later portion of entry once sufficient atmospheric density has built up to give those aerosurfaces effective control authority. This limits the window of exposure of a next worse failure (i.e., a 1-on-1 force fight, bad feedback going into flight control, etc.) to the later portion of entry. Such a failure could result in a control transient or persistent vehicle control problems that impact the vehicle's energy state. Most flights require a concrete runway landing (or equivalent runway hardness) due to the large mass moment at nose gear touchdown. Northrup provides the most flexibility of the available primary landing sites due to the availability of several runways of sufficient hardness. If Northrup is unavailable, then Edwards should be targeted because it provides the option to downmode to the large lakebed landing complex in the event that it is not possible to reach the concrete runway. The Edwards lakebed would only be used in a contingency. If Edwards and Northrup are unavailable, then a KSC landing should be targeted since the probability of the next worst failure occurring is low and KSC is the prime landing site with significant ground forces available. The landing site selection philosophy for FCS channels assumes that sufficient aft RCS margin is available to perform the entry with Wrap-DAP active. Use of Wrap-DAP provides yaw jet control authority to fight any drag that may be caused by degraded aerosurface movement above Mach 1 (i.e., performing an entry with no-yaw-jet selected does not limit window of exposure to TAEM because sufficient RCS jet control authority does not exist to fight a bad aerosurface).* ©[102402-5804C]

The following cases were considered as possible constraints to landing site selection. However, for these conditions, runway preference does not differ from the nominal EOM priority, so they are not included in the SYSTEMS FAILURE PRIORITIES matrix. ©[121604-6254C]

MLG TIRE PREDICTED TO BE FAILED BEFORE WHEELSTOP: *If a tire pressure is low, due to temperature or leakage, such that sufficient load-carrying capability of that tire may not exist (ref. Rule {A10-142}, TIRE PRESSURE [CIL] [HC]), total loss of that tire may occur at derotation, when the highest tire loading is reached. No quantitative hardness data exists for Northrup. The coefficient of friction on the strut if both tires on a MLG fail is greater than at a concrete runway, indicating that the vehicle may be harder to control on the Northrup lakebed than at KSC or EDW 22/04 (however, Northrup is considered acceptable for blown tire cases). Runway prioritization, consequently, gives preference to concrete runways. Consideration should be given to minimizing crosswind during landing site selection to reduce loads on the remaining tires. Landing with the crosswind on the side of the vehicle with the failed tire will help reduce loads on the affected landing gear, reducing the risk of blowing the remaining tire.*

NWS FAILED: *With the loss of NWS, differential braking remains as the only method of directional control. Sufficient braking system redundancy exists to accept the risk of landing at KSC or EDW vs NOR. Consideration should be given to minimizing crosswind during landing site selection.* ©[102402-5804C]

THIS RULE CONTINUED ON NEXT PAGE

FLIGHT RULES

A2-207

LANDING SITE SELECTION [HC] (CONTINUED)

E. COMPROMISED ORBITER PRIORITIES: @[022405-6624B]

1. FOR THE PURPOSES OF ENTRY PUBLIC RISK, A COMPROMISED ORBITER IS A CONDITION THAT SUBSTANTIALLY REDUCES THE LIKELIHOOD OF A NOMINAL ENTRY INCLUDING:
 - a. LOSS OF ALL FAULT TOLERANCE IN AN ENTRY CRITICAL SYSTEM DUE TO A COMMON CAUSE FAILURE MODE
 - b. APU, OMS, RCS FUEL LEAK WITH RISK OF FUEL COMBUSTION DURING ENTRY
 - c. STUCK OR MECHANICAL DEGRADATION OF ANY AEROSURFACE ACTUATOR (ELEVON, BODYFLAP, SPEEDBRAKE, OR RUDDER)
 - d. ANY THERMAL PROTECTION SYSTEM DAMAGE THAT MEETS REPAIR CRITERIA
 - e. ENTRY CRITICAL STRUCTURAL OR MECHANISM DAMAGE
 - f. ANY CONDITION(S) THAT CAUSE THE ORBITER TO FLY OUTSIDE CERTIFIED ENTRY CAPABILITY @[022405-6624B]

THIS RULE CONTINUED ON NEXT PAGE

FLIGHT RULES

A2-207

LANDING SITE SELECTION [HC] (CONTINUED)

2. IN THE CASE OF A COMPROMISED ORBITER, THE EOM PRIORITIES ARE MODIFIED TO FURTHER ABATE RISK TO THE GENERAL PUBLIC BY SELECTING SPECIFIC LOWER PUBLIC RISK APPROACHES. FOR NORTHROP AND EDWARDS, THE SPECIFIC CROSSRANGES IN THE TABLE WILL BE TARGETED: ©[022405-6624B]
 - a. NORTHROP
 - b. EDW 22/04
 - c. KSC

CROSSRANGE	ASCENDING LEFT	ASCENDING RIGHT
NORTHROP	0-430 NM	0-140 NM 230-630 NM 780-830 NM
EDW 22	NONE	450-610 NM
EDW 04	NONE	410-600 NM
KSC	NONE	NONE

A compromised orbiter is defined as any condition or failure that substantially reduces the likelihood of a nominal entry and landing. A compromised orbiter results from a loss of all fault tolerance in an entry critical system due to a common cause failure mode or known damage in vehicle structures, mechanisms, or thermal protection system (TPS), or any scenario that is predicted to result in conditions that cause the orbiter to fly outside the certified entry capability. In order to meet the compromised orbiter definition, there must be a known pre-deorbit burn condition where there is a significant increased risk of loss of control during entry such as those listed in Paragraph E1. Since it is impossible to list all possible compromised orbiter scenarios, other failures with a significantly increased risk of loss of control during entry may be evaluated in real time.

Loss of Entry Critical Fault Tolerance: Loss of all fault tolerance (i.e., zero fault tolerant configuration) in an entry critical system does not constitute a compromised orbiter scenario unless that loss of fault tolerance is due to a common cause failure mechanism (i.e., generic failure mode). For a loss of all fault tolerance in an entry critical system unrelated to common cause, the EOM priorities shall be followed and are as listed in paragraphs C and D of this rule.

APU, OMS, RCS Fuel Leaks: OMS, RCS, or APU fuel leaks pose a significant risk of combustion and collateral damage in the associated pod or aft part of the vehicle during the subsonic portion of entry. ©[022405-6624B]

THIS RULE CONTINUED ON NEXT PAGE

FLIGHT RULES

A2-207

LANDING SITE SELECTION [HC] (CONTINUED)

Stuck or Mechanically Degraded Aerosurface: These are Crit 1/1 failure modes that the vehicle Flight Control System (FCS) was not designed to accommodate. Other FCS Channel problems are governed by paragraph D. ©[022405-6624B]

Thermal Protection System (TPS) Damage: Until certified TPS repair techniques are developed, any TPS damage that meets repair criteria will be categorized as a compromised orbiter.

Entry Critical Structural Damage: Any damage to structure or mechanisms that provide insufficient thermal or structural margin for entry and landing will be placed in the compromised orbiter category (i.e., multiple vent doors or star tracker doors failed open).

Conditions Outside Certified Entry Capability: When an entry is planned such that the vehicle is flying outside the certified analyzed entry capability, the compromised orbiter landing site considerations apply. One known exception to this category is a landing weight exceedance that is subsequently cleared through thermal and/or structural analysis.

A compromised orbiter entry will be performed to Northrup, Edwards, and KSC, in that order of priority and within the landing site crossrange restrictions listed, in order to abate the public risk to the extent feasible while maintaining a CONUS PLS landing capability. The crossranges identified in paragraph E reduce risk to the general public by approximately one order of magnitude when compared to the highest risk KSC opportunity.

Although descending opportunities are not planned to be used pre-mission, if they are utilized in a compromised orbiter scenario, the following crossranges should be utilized provided mission specific crossrange limits are met.

CROSSRANGE	DESCENDING LEFT	DESCENDING RIGHT
NORTHROP	488-508 NM 146-455 NM	37-177 NM 211-405 NM 506-601 NM
EDW 22	> 807 NM 773-778 NM 698-725 NM	> 834 NM
EDW 04	> 812 NM 673-784 NM	NONE
KSC	NONE	NONE

©[022405-6624B]

THIS RULE CONTINUED ON NEXT PAGE

FLIGHT RULES**A2-207****LANDING SITE SELECTION [HC] (CONTINUED)**

F. PREDEORBIT LANDING SITE EVALUATION @[102402-5804C] @[022405-6624B]

1. AFTER DEORBIT MINUS 2.5 HOURS, IF UNACCEPTABLE WEATHER CONDITIONS EXIST (OBSERVED OR FORECAST) OR ENTRY REQUIREMENTS CANNOT BE SATISFIED (TAEM, A/L, TOUCHDOWN, ROLLOUT, ETC.), THE AFFECTED LANDING SITE MAY BE ELIMINATED AS A PRIMARY OPTION.
2. AFTER DEORBIT MINUS 1.5 HOURS, ONLY A SINGLE LANDING SITE WILL CONTINUE TO BE EVALUATED. OTHER LANDING SITE OPTIONS MAY BE REEVALUATED IN THE EVENT OF A DEORBIT WAVE-OFF.

The above guidelines will allow the evaluation of multiple runways at multiple landing sites for multiple deorbit opportunities without significantly compromising the required evaluation of the actual runway where landing will occur. It is always prudent to eliminate landing site/runway options as they become unlikely to remain within limits. This is especially true after deorbit minus 2.5 hours, the standard time at which deorbit pads will be voiced to the crew. Up until deorbit minus 1.5 hours, sufficient time is available to evaluate multiple landing sites for the nominal deorbit as well as preliminary evaluation of landing sites on the next deorbit. Due to multiple wind sets, landing sites, runways, aimpoints, etc. being evaluated, a total team focus on the primary runway on the last orbit prior to deorbit is necessary.

Hazard Reports ORBI 021 "Loss of Vehicle Control Due to the Failure of the Main Landing Gear/Nose Landing Gear Assembly(s)," ORBI 030 "Potential Loss of Orbiter Caused by Vehicle Handling Qualities," ORBI 211 "Landing Which Exceeds Design Limits Can Result in Loss of Crew and Vehicle," ORBI 325 "Loss of Control of the Vehicle due to Adverse Winds and Turbulence," and ORBI 326 "Loss of Flight Control During Entry/Landing due to Single APU Operation Resulting in Priority Rate Limiting of the Aero Surfaces" reference this rule. @[022405-6624B]

Rules {A2-6}, LANDING SITE WEATHER CRITERIA [HC]; {A2-102}, MISSION DURATION REQUIREMENTS; {A2-202}, EXTENSION DAY GUIDELINES; {A2-261}, ENTRY DTO/AUTO MODE/CROSSWIND DTO GO/NO-GO; {A2-301} CONTINGENCY ACTION SUMMARY [HC]; {A3-201}, TACAN REDUNDANCY REQUIREMENTS AND ALTERNATE TACAN SELECTION PHILOSOPHY [HC]; {A8-59}, IMU BITE FAILURE DEFINITION; {A8-1001}, GNC GO/NO-GO CRITERIA; and {A10-23}, APU ENTRY START TIME [HC], reference this rule. @[032807-8400]

@[ED]

FLIGHT RULES

A2-208 **ACES PRESSURE INTEGRITY CHECK** @[012402-5089]

DEORBIT WILL NOT BE DELAYED FOR FAILURE OF ANY ADVANCED CREW ESCAPE SUIT (ACES) PRESSURE INTEGRITY CHECK.

ACES pressure integrity is not required for the present bailout scenario. In addition, beyond verifying the proper connections, there is little that the crew could do during flight to locate the source of a leak in an ACES or to repair it. @[012402-5089]

A2-209 **LANDING SITE SELECTION FOR AN INFLIGHT EMERGENCY**

A. AN INFLIGHT EMERGENCY WILL BE DECLARED AND AN ATTEMPT WILL BE MADE TO PERFORM AN EMERGENCY LANDING IF A LANDING AT THE TARGETED SITE IS IMPOSSIBLE. @[120894-1744B]

NOTE: THE DETERIORATION OF WEATHER (WINDS, TURBULENCE, CEILING, PRECIPITATION, ETC.) AND/OR LANDING AND ROLLOUT MARGINS, WHICH RESULT IN FLIGHT RULE EXCEEDANCES POST-DEORBIT BURN, ARE NOT CAUSE TO REDESIGNATE FROM THE TARGETED SITE.

B. LANDING WILL BE ATTEMPTED AT AN EMERGENCY LOCATION THAT MEETS THE FOLLOWING CRITERIA:

1. THE LANDING FIELD IS WITHIN THE ENERGY CAPABILITY OF THE ORBITER AS DEFINED IN RULE {A2-251}, BAILOUT.
2. THE LANDING FIELD FACILITIES SATISFY THE REQUIREMENTS DOCUMENTED IN RULE {A2-264}, EMERGENCY LANDING FACILITY CRITERIA.

C. TIME PERMITTING, WITH MULTIPLE SITES OF SIMILAR ENERGY CAPABILITY, SELECTION OF THE EMERGENCY LANDING FIELD WILL BE BASED ON THE FOLLOWING PRIORITY:

1. ANOTHER NASA AUGMENTED LANDING SITE
2. A DOD AIRFIELD WITH COMPATIBLE SHUTTLE UHF COMMUNICATIONS
3. A DOD AIRFIELD WITHOUT COMPATIBLE SHUTTLE UHF COMMUNICATIONS

THIS RULE CONTINUED ON NEXT PAGE

FLIGHT RULES

A2-209

LANDING SITE SELECTION FOR AN INFLIGHT EMERGENCY (CONTINUED)

4. A COMMERCIAL AIRFIELD WITH COMPATIBLE SHUTTLE UHF COMMUNICATIONS
5. A COMMERCIAL AIRFIELD WITHOUT COMPATIBLE SHUTTLE UHF COMMUNICATIONS

Should orbiter or facility problems be encountered which make landing at the designated NASA landing field impossible, the actions to be taken are identified in order of priority in an attempt to save the crew and orbiter (national resource), while at the same time minimizing public exposure to additional risk. During entry should the need arise, an "inflight emergency" (as declared by all aircraft if in trouble) will be declared, and a landing at an ELS will be attempted if energy is sufficient to reach the landing site (reference Rule {A2-251}, BAILOUT) and the facility meets the minimum requirements (reference Rule {A2-264}, EMERGENCY LANDING FACILITY CRITERIA). ©[120894-1744B]

Weather forecasts for shuttle landings are made by well-trained, experienced meteorologists with the best tools available and within 90 minutes of landing. At the A/E FTP #73, the results of a multimonth study of forecasting accuracy showed that these forecasts were extremely accurate and in the very small percentage of cases where a GO prediction turned into a NO-GO situation, the violations were minor and survivable. It is inconceivable that these forecasts would be in error by a degree that would entail greater risk by continuing to the landing site than would be incurred by diverting to an emergency field with its lack of facilities, navigation aids, trained personnel, and flightcrew familiarity.

Diverting from the targeted site will not be done just for deteriorating weather conditions which will violate weather flight rules or landing and rollout margin reductions. We will accept the nonoptimum conditions rather than divert to another site since it is believed that this option provides less risk to the orbiter and crew as well as the general public. ©[120894-1744B]

Should it be necessary to divert from the primary landing field, another NASA augmented landing field will be selected if available. Otherwise, site selection will be based on facility type (DOD vs commercial) and the availability of compatible shuttle UHF communications. The facility priority has been selected to minimize risk to the general public. ©[120894-1744B]

FLIGHT RULES

A2-210

ENTRY THERMAL OPTIONS [HC]

FOR ENTRY WHERE ADDITIONAL THERMAL MARGIN IS DESIRED OR REQUIRED, THE FOLLOWING OPTIONS WILL BE CONSIDERED TO IMPROVE THE VEHICLE ENTRY THERMAL PROFILE. FIRST AND SECOND LEVEL OPTIONS WILL BE CONSIDERED TO PROVIDE MARGIN FOR SUSPECTED TPS DAMAGE, REPAIRED DAMAGE, OR WHERE REPAIR HAS NOT BEEN COMPLETELY SUCCESSFUL. THIRD LEVEL OPTIONS WILL BE CONSIDERED FOR MORE SEVERE TPS CONCERNS WHERE CONTINGENCY SHUTTLE CREW SUPPORT (CSCS) IS NOT AN OPTION. @[022405-6629C]

A. FIRST LEVEL - CERTIFIED ENTRY OPTIONS:

1. REDUCE VEHICLE WEIGHT AS MUCH AS PRACTICAL WHILE MAINTAINING AT LEAST SINGLE FAULT TOLERANCE IN ENTRY-CRITICAL SYSTEMS AND PRESERVING FOUR DEORBIT OPPORTUNITIES ON 2 CONSECUTIVE DAYS.
2. UTILIZE CERTIFIED EQUILIBRIUM GLIDE BOUNDARY MARGIN (EGBM) DEORBIT TARGETING METHODOLOGY.
3. MOVE CG AFT WITHIN THE NOMINAL CG BOX (REF RULE {A4-153}, CG PLANNING).
4. MAXIMIZE LOWER SURFACE COLD SOAKING WHILE NOT VIOLATING OTHER ORBITER THERMAL LIMITS.
5. REDUCE ENTRY AND TOUCHDOWN STRUCTURAL LOADS (REF RULE {A2-260}, ENTRY LOADS MINIMIZATION).

B. SECOND LEVEL - OPTIONS THAT MAINTAIN THE ENTRY PROFILE WITHIN SODB VOLUME V GNC PERFORMANCE LIMITS BUT WITHOUT INTEGRATED VEHICLE CERTIFICATION:

1. REDUCE VEHICLE WEIGHT TO MAXIMUM EXTENT POSSIBLE WHILE MAINTAINING AT LEAST SINGLE FAULT TOLERANCE IN ENTRY-CRITICAL SYSTEMS AND PRESERVING AT LEAST ONE DEORBIT OPPORTUNITY TO TWO DIFFERENT LANDING SITES (NOT ON THE SAME REV) ON EOM ONLY.
2. INCREASE ANGLE-OF-ATTACK DURING ENTRY WITHIN SODB GNC LIMITS (REF RULE {A4-207}, ENTRY LIMITS) UTILIZING GMEM WRITE (PREFERRED) OR MANUAL CSS. @[022405-6629C]

THIS RULE CONTINUED ON NEXT PAGE

FLIGHT RULES

A2-210 ENTRY THERMAL OPTIONS [HC] (CONTINUED)

- C. THIRD LEVEL - OPTIONS THAT ARE UNCERTIFIED, CSCS NOT AVAILABLE, AND DEORBIT/ENTRY IS REQUIRED: ©[022405-6629C]
1. REDUCE VEHICLE WEIGHT TO MAXIMUM EXTENT POSSIBLE.
 2. INCREASE ANGLE-OF-ATTACK DURING ENTRY BEYOND SODB GNC ENVELOPE UTILIZING GMEM WRITE (PREFERRED) OR MANUAL CSS.
 3. UTILIZE MINIMUM DRAG ENTRY TARGETING METHODOLOGY.
 4. CONSIDERATION WILL BE GIVEN TO MAXIMIZE AFT RCS PROPELLANT DEPENDING ON THE DAMAGE SCENARIO.

The intent of this rule is to provide a list of options which are categorized according to their vehicle certification level that can be utilized in any combination to improve the vehicle thermal profile during entry. The levels were grouped in this manner to assist in determining the risk trades as a function of TPS damage. Detailed Boeing aerothermal, thermal, stress, and flight control analysis of the different combination of options will be conducted in real time to determine the appropriate options to select based on damage type, location, and severity.

As a result of the STS-107 accident, extensive analysis was conducted to determine options to reduce heating on the orbiter during entry. This was performed using the 6-DOF Spacecraft Trajectory Analysis and Mission Planning System (STAMPS) simulation for trajectory modeling and the Thermal/Structural Envelope Program (TSEP) to predict temperatures at representative locations. Three body points were analyzed: 5505 (panel 9 wing leading edge (WLE)), 1600 (belly centerline forward of main landing gear door), and 2360 (belly aft of main landing gear door). The results assume a no damage scenario (i.e., standard roughness, nominal aero) and apply to a typical ISS mission (51.6 deg inclination ascending approach into KSC) unless noted otherwise. Techniques identified in the course of the analysis that resulted in a reduction of vehicle heating were organized into the three categories shown in paragraphs A, B, and C.

First Level options - *Using SSP-certified operational techniques, it was found that only slight reductions in WLE temperatures (approximately 5 percent or 150 deg) may be achieved. Better results were found for tile acreage, with approximately 20 percent reduction in heat load and 30-40 percent in heat rate for the body points examined. It was found that the modest WLE benefits were evenly split between aggressive weight reduction (43,440 lbs for this analysis) and EGBM targeting. Nearly all thermal benefits for tile acreage were achieved with weight reduction. Although procedures and tools used to model entry effects of vehicle weight reduction are certified, the actual methods necessary to offload this amount of weight would likely fall outside of normal shuttle/ISS operations.* ©[022405-6629C]

THIS RULE CONTINUED ON NEXT PAGE

FLIGHT RULES

A2-210

ENTRY THERMAL OPTIONS [HC] (CONTINUED)

Level One methods to reduce the orbiter weight include additional transfer of hardware during docked operations and consumables offloads. FCOH SOP 16.11 specifies items that may be offloaded to reduce orbiter mass. Orbiter consumables (prop, cryo, and water) will be managed to minimize landing weight while protecting two deorbit opportunities on both EOM and EOM+1 with minimal dispersion protection. ©[022405-6629C]

Targeting an EGBM of +2 fps² is a certified deorbit burn targeting methodology that maintains adequate margins on entry drag and ranging. EGBM produces a heating profile off the thermal trade-off line (TTOL) and, by itself, results in increased heatload for some locations. Therefore, use of EGBM is dependent on the type and location of TPS damage incurred. It should be noted that OPS 3 ENTRY TRAJ display I-loads are generated for TTOL entry profiles; therefore, the shuttle bug will not track down the nominal line during an EGBM entry.

Aft cg movement provides modest thermal improvements for tile acreage. The analysis showed approximately 10 percent reduction in heat load and 10-20 percent in heat rate for body points 1600 and 2360 when the cg was moved aft by 20.9 inches. This, however, resulted in higher elevon surface temperatures and provided little thermal relief for the WLE. Therefore, use of this technique will be highly dependent on damage location.

STS-107 post-flight analysis showed that maximizing lower surface cold soak time had a small effect on delaying the onset of maximum temperatures. Similar minor thermal effects were observed when approach direction, crossrange, N-CYCLES, and apogee height were varied. Nevertheless, these techniques should be examined on a mission-specific basis as required in order to achieve the maximum effect.

Due to thermal stresses that may result from TPS damage and/or off-nominal entry thermal profiles, entry and landing loads should be minimized to the extent practical when these techniques are utilized. This may also include selection of straight-in HAC. Reference Rule {A2-260}, ENTRY LOADS MINIMIZATION. ©[022405-6629C]

THIS RULE CONTINUED ON NEXT PAGE

FLIGHT RULES

A2-210

ENTRY THERMAL OPTIONS [HC] (CONTINUED)

Second Level options - Additional techniques outside normal operating practices were identified that provide further thermal reductions. Flying a higher angle-of-attack prior to Mach 12 has been shown to reduce WLE temperatures. Simulation of the STS-107 entry with a 45 deg angle-of-attack indicates another 5 percent reduction (150-180 deg) is possible beyond that achieved with Level One techniques. A baseline Level Two alpha profile of 43 deg with no alpha modulation was selected for further analysis (as compared to a nominal entry profile of 40 ± 3 deg). This provides 1 deg margin from the 44 deg GNC limit in NSTS 08934, Shuttle Operational Data Book, Vol V in order to protect against dispersions due to winds, IMU platform misalignment, and flight control. While technically within alpha cert limits, this profile falls outside the integrated vehicle certification envelope for thermal and flight control. It should also be noted that increasing the angle-of-attack moves the stagnation point lower on the WLE; therefore, location of damage along the WLE must be considered in the selection of an off-nominal alpha profile. ©[022405-6629C]

Alpha modulation was disabled in order to fly the highest possible alpha profile, thus maximizing thermal benefit. This also yields a more predictable alpha and thermal profile. An undesirable effect of eliminating alpha modulation was a reduced ability to maintain actual drag on drag reference since alpha modulation provides a short-term drag control channel. This led to larger bank angle oscillations and decreased trajectory damping as guidance attempted to control drag. Another effect of higher alpha was decreased vehicle L/D, which led to a greater tendency towards roll limiting and approximately 100 nm less crossrange capability. Despite this, overall guidance performance was shown to be acceptable. A 500 cycle STAMPS Monte-Carlo study showed a 3-sigma range error at TAEM interface of only 2.2 nm (well within TAEM guidance capability). Since TSEP is not valid outside the nominal range of alpha, further analysis with Boeing aerothermal tools would be required in order to quantify the thermal benefit prior to implementing this technique.

Flying the off-nominal alpha profile would require either manual CSS or a GPS memory write (GMEM) update to overwrite angle-of-attack I-loads in the onboard GPC's. The GMEM option is preferred since it allows auto DAP during entry, resulting in a more predictable alpha and resultant heating profile, as opposed to manual CSS. The PASS I-loads may be modified via uplink to the G3 archive in OPS 2. The BFS can be configured directly by uplinking the GMEM in OPS 3. MCC tools would also require reconfiguration to properly target the deorbit burn and model entry performance. ©[022405-6629C]

THIS RULE CONTINUED ON NEXT PAGE

FLIGHT RULES

A2-210

ENTRY THERMAL OPTIONS [HC] (CONTINUED)

Level Two includes more aggressive weight reduction efforts including offload of payload and orbiter hardware to the maximum extent possible (including jettison of hardware). Consumables management should strive to minimize vehicle weight as much as possible while maintaining consumables to support deorbit opportunities to two different sites on EOM with minimal dispersion protection. Turnaround issues associated with weight reduction or trajectory shaping will not be a consideration in the implementation of Level Two options. ©[022405-6629C]

Third Level options - *Third Level options are used when there is severe TPS damage and no other alternative to deorbit/entry. These would be employed only as a last resort in order to attempt to safely return the crew and vehicle. Analysis indicates more significant reductions in vehicle heating can be achieved utilizing uncertified techniques, such as increasing alpha beyond the SODB GNC limit, and entering below the equilibrium glide boundary. A baseline Level Three trajectory with 50 deg angle-of-attack, no alpha modulation, and EGBM range between -3.5 to -5.0 fps² was assessed in multiple STAMPS Monte-Carlo studies. Preliminary Boeing thermal analysis showed WLE Panel 9 temperature reductions of approximately 17 percent (approximately 500 deg).*

Detailed examination of STAMPS results for Level Three show guidance exhibiting similar, but more pronounced results as those described for Level Two above. As expected, the combination of reduced L/D and very low energy resulted in extended periods of unconverged drag and roll saturation at zero deg for many cases. All sims made the runway, but the 3 sigma range error at TAEM interface was 4.6 nm, with the worst-case error being 20 nm (out of 500 cases). Additional Monte-Carlo runs determined that crossrange must be limited to 200 to 300 nm for EGBM -5.0 and -3.5 respectively, due to reduced L/D. Increased RCS usage, more than 2X the entry redline, was observed in many cases. This was primarily due to two factors: non-optimal guidance gains and occasional guidance roll limiting. The C16 gain used in computing roll command is designed for 40 deg alpha, and makes guidance overly sensitive to drag errors at higher alphas and lower drag levels. This gain may be adjusted via GMEM to remove this effect if desired. The second cause occurs when guidance limits roll commands to a non-zero value when the vehicle is banked towards the landing site. This may result in roll command oscillations between zero deg (for ranging) and 20 or 15 deg (for delta-azimuth control). This "roll jitter" may be avoided by flying roll/yaw CSS during the region of concern. Consideration will be given to maximizing RCS propellant for Level Three options. ©[022405-6629C]

THIS RULE CONTINUED ON NEXT PAGE

FLIGHT RULES

A2-210**ENTRY THERMAL OPTIONS [HC] (CONTINUED)**

Implementing Level Three options requires similar console and crew procedures as those listed in the second level. However, confidence in thermal, trajectory, and flight control predictions is significantly decreased due to use of techniques beyond the vehicle certification envelope. A reduced cg envelope may be required for flight control stability in these cases. Another important caveat to these results is that vehicle aerodynamics and heating assume there is no damage to the vehicle. Localized heating may be higher than predicted if the actual repair moldline is significantly different than the analyzed repair moldline and vehicle roughness. Additionally, the analysis did not factor in any aerodynamic changes such as early boundary layer transition as a result of the damage or damage repair. Extensive mission-specific analysis would be required to better quantify these risks in order to trade this option against CSCS if available. Vehicle reflight will not necessarily be protected for Level Three implementation. ©[022405-6629C]

Reference A/E FTP's #205, September 17, 2004; #206, October 22, 2004; #208, December 10, 2004; and #209B January 25, 2005; and STSOC transmittal ADFD-05-012.

Hazard Report ORBI 007, Debris Impact with the Orbiter, references this rule. ©[022405-6629C]

A2-211 THROUGH A2-250 RULES ARE RESERVED

FLIGHT RULES

ENTRY

A2-251

BAILOUT

- A. THE CDR IS RESPONSIBLE FOR BAILOUT ACTION.
- B. THE MCC WILL EVALUATE ALL POSSIBLE ENERGY MANAGEMENT ACTIONS PRIOR TO RECOMMENDING BAILOUT. @[120894-1744B]
- C. THE FOLLOWING DEFINITIONS APPLY TO THE BAILOUT REGIONS DEFINED BELOW:
1. MCC MAX RANGE LINE: THIS LINE IS GENERATED ON LANDING DAY AND BASED ON A STRAIGHT-IN APPROACH TO THE MINIMUM ENTRY POINT HAC, WITH MAXIMUM L/D STRETCH TECHNIQUES AND ACTUAL WINDS AND ATMOSPHERIC CONDITIONS.
 2. MCC RTLS MINIMUM ENERGY LINE: THIS LINE IS GENERIC FOR ALL FLIGHTS AND ASSUMES A FORWARD CG, MID-WEIGHT, HEAVYWEIGHT I-LOADS, COLD ATMOSPHERE, AND NO WINDS.
 3. MCC BAILOUT LINE: THIS LINE IS GENERIC FOR ALL FLIGHTS AND REPRESENTS A BEST-ON-BEST MAXIMUM CAPABILITY, BASED ON 3 SIGMA FAVORABLE WINDS, MAXIMUM HAC SHRINK, AND MAXIMUM ORBITER L/D.
- D. AN MCC BAILOUT RECOMMENDATION WILL BE MADE BASED ON THE FOLLOWING CRITERIA, USING THE BEST AVAILABLE SITE, RUNWAY, AND STATE VECTOR SOURCE, AND WITHOUT REGARD TO TOUCHDOWN, BRAKE ENERGY AND ROLLOUT MARGIN PLACARDS:

THIS RULE CONTINUED ON NEXT PAGE

FLIGHT RULES

A2-251

BAILOUT (CONTINUED)

1. GREEN: BAILOUT NOT REQUIRED (CALL ONLY REQUIRED IF TRANSITIONING FROM THE "YELLOW" REGION).
 - a. EOM LANDINGS: ORBITER ENERGY/WEIGHT ABOVE THE MAX RANGE LINE.
 - b. ALL OTHER LANDINGS: ORBITER ENERGY/WEIGHT ABOVE THE MCC RTLS MINIMUM ENERGY LINE. @[120894-1744B]
 2. YELLOW: BAILOUT IF DEEMED NECESSARY BY THE CDR; MCC CONTINUES TO MONITOR. @[120894-1744B]
 - a. EOM LANDINGS: ORBITER ENERGY/WEIGHT BELOW THE MAX RANGE LINE AND ABOVE THE MCC BAILOUT LINE.
 - b. ALL OTHER LANDINGS: ORBITER ENERGY/WEIGHT BELOW THE MCC RTLS MINIMUM ENERGY LINE AND ABOVE THE MCC BAILOUT LINE.
 3. RED: MCC RECOMMENDS BAILOUT.

ORBITER ENERGY/WEIGHT BELOW THE MCC BAILOUT LINE.
- E. IF POSSIBLE, BAILOUT WILL BE DECLARED NO LOWER THAN 50K FT ALTITUDE (70K FT FOR ECAL).

THIS RULE CONTINUED ON NEXT PAGE

FLIGHT RULES

A2-251

BAILOUT (CONTINUED)

- F. NORMALLY, ZERO DEGREES OF BANK WILL BE USED FOR BAILOUT GUIDANCE "FREEZE" CONDITIONS. HOWEVER, THE MCC MAY PROVIDE A DESIRED BANK ANGLE (UP TO 10 DEG) IF REQUIRED TO AVOID ORBITER IMPACT IN POPULATED AREAS.
- G. IF BAILOUT IS DECLARED FOR ECAL, A TURN SHALL BE EXECUTED TO A HEADING OF 120 DEG, UNLESS FDO DETERMINES IN REAL TIME A HEADING MORE FAVORABLE FOR SAR OPERATIONS (E.G., PARALLEL THE COAST, ETC.)

Reference Rule {A1-6}, SHUTTLE COMMANDER AUTHORITY, for CDR responsibilities.

The MCC has more accurate evaluation tools with which to determine energy capability and uses radar tracking data (when available) as the prime state vector source. All energy management and recovery procedures will be evaluated prior to any bailout recommendation being issued by the MCC. Three bailout zones, green, yellow, and red, have been identified for MCC bailout recommendation, based on areas delineated on FDO Energy/Weight versus Range-to-go displays.

The bailout green zone is defined as that area above the MCC maximum ranging capability line which is generated for EOM on landing day, based on a straight-in approach to the minimum entry point HAC, with maximum L/D stretch techniques and actual winds and atmospheric conditions. For all other cases, this flight and landing day-specific actual capability line does not exist, and the MCC RTLS minimum energy line will be used. This line is generic for all flights and assumes a forward CG, mid-weight, heavyweight I-loads, cold atmosphere, and no winds. These two lines generally lie very close together. In the green region, bailout is not required. A green zone call is not made unless the vehicle has recovered from the yellow zone below. ©[120894-1744B]

THIS RULE CONTINUED ON NEXT PAGE

FLIGHT RULES

A2-251

BAILOUT (CONTINUED)

The bailout yellow zone is defined as that area below the MCC maximum ranging capability line, described above (again, when a max range line is not available, the generic MCC RTLS minimum energy line will be used), but above the MCC bailout line. The bailout line is generic for all flights and represents a best-on-best maximum capability, based on 3 sigma favorable winds, maximum HAC shrink, and maximum orbiter L/D. In this region, the a "bailout yellow zone" call will be made. Requests are likely to be made for runway/HAC redesignation, stretch techniques, and relaxation of NZ, surface wind, touchdown point, and rollout margin constraints to increase available runways. Below the maximum ranging capability line, there is less than a 50 percent chance of reaching the field. In this region, the MCC will only advise the crew of the energy situation and continue to monitor their progress in making up the energy shortfall. A final bailout decision is the CDR's call. ©[120894-1744B]

The bailout red zone is defined as that area below the MCC bailout line described above. In this region, there is no chance of reaching the runway threshold and the MCC will recommend bailout. To provide adequate time for bailout operations, bailout will be declared at an altitude no lower than 50K ft, if possible. For ECAL trajectories, 70K ft is used to allow adequate time to execute a maximum turn of 180 deg prior to initiating bailout, thus ensuring bailout over water.

The MCC will recommend a bank angle in order to improve recovery effectiveness or to steer away from populated areas. Analysis has shown that a bank angle of greater than 10 deg can cause the vehicle to turn a full 360 deg of heading with impact occurring in the crew bailout landing area. If bailout is required during an ECAL, a turn to a standard heading of 120 deg will be made to avoid orbiter land impact and to provide search and rescue (SAR) forces with a consistent heading with which to begin rescue operations, unless the FDO can determine a more favorable heading based on knowledge of the positions and potential ranging capability of the SAR forces. ©[120894-1744B]

A2-252

GCA CRITERIA

IF THE TRAJECTORY DIVERGES AND APPROACHES ENERGY LIMITS POST-TRACKING, CSS WILL BE SELECTED AND GCA PERFORMED. AUTO GUIDANCE WILL BE RESELECTED WHEN ENERGY AND NAVIGATION ARE WITHIN LIMITS, THE GCA WILL ALSO BE TERMINATED WHEN THE CREW TAKES OVER AFTER VISUAL ACQUISITION OF THE RUNWAY. ©[120894-1663]

Generally, the entry trajectory can get into an off-nominal emergency situation by (1) incorporating erroneous navigation data into guidance and flight control, and (2) selecting an incorrect or invalid landing site. Performing GCA provides a possibility of making the runway.

FLIGHT RULES

A2-253

ENERGY MANAGEMENT

IF INSUFFICIENT OR EXCESS ENERGY EXISTS TO ACHIEVE THE TARGETED APPROACH TO THE SELECTED RUNWAY, THE FOLLOWING OPTIONS WILL BE EVALUATED FOR CORRECTION OF THE ENERGY ERROR.

- A. OVERHEAD/STRAIGHT-IN HAC RESELECTION
- B. NOMINAL/MINIMUM ENTRY POINT SELECTION
- C. RUNWAY REDESIGNATION - MAY RESULT IN VIOLATION OF TOUCHDOWN, BRAKING, AND/OR ROLLOUT MARGIN CONSTRAINTS
- D. GROUND CONTROLLED APPROACH (GCA)

Several options are available to correct a bad energy situation. These options include HAC reselection (overhead/straight-in), runway redesignation, final approach entry point downmoding (NEP/MEP), or GCA. No action will be recommended until data shows that the energy error is large enough that the prime selected runway/HAC cannot be achieved or will cause the vehicle to exceed H-dot or g-limits while following auto guidance.

Runway redesignation or HAC reselection are both very powerful methods of changing the required range-to-go (energy requirements). These two methods are preferred since valid guidance commands are available. Runway redesignation may be recommended over HAC reselection, based on the amount of energy correction required. The approach direction relative to the runway layout will define which is the most effective option for correcting the energy error (range error). Redesignation may result in selection of a runway which violates some of the touchdown, rollout, or brake energy constraints. Reaching the runway final approach within an acceptable energy corridor has priority over satisfying the touchdown and rollout constraints. All efforts will be made to redesignate to runways which satisfy the touchdown and rollout criteria.

Downmoding the final approach entry point (NEP to MEP) does provide valid guidance commands; however, the MEP selection greatly reduces the amount of time available for trajectory corrections on final approach. (NEP intercepts final approach at approximately 12K feet; MEP is at approximately 6K feet.) Once each of the above options has been evaluated and excessive energy error persists, a GCA will be required. The GCA may include HAC or runway reselection and will require action outside of the current guidance capability in order to correct the range error.

FLIGHT RULES

A2-254

ENTRY STRING REASSIGNMENT

- A. PRIOR TO MM 304, RESTRINGING WILL BE PERFORMED TO REGAIN FULL CAPABILITY FOLLOWING A GPC FAILURE.

The timeframe between post-deorbit burn and the transition to MM 304 is generally quiet from a computer point of view and crew workload. As such, the risk of restringing is considered to be low. Consequently, restringing will be performed to regain full capability for the dynamic phases of entry (MM 304/305).

- B. RESTRING GPC/STRING COMBINATIONS WILL BE SELECTED WHICH MOVE THE LEAST NUMBER OF STRINGS WHILE SATISFYING CRITICAL CAPABILITY OR ONE-FAULT TOLERANT REQUIREMENTS AS IDENTIFIED IN PARAGRAPH C.

The greater the number of strings moved during a restring attempt, the more complicated the restring process. With this in mind, "good" strings should not be taken from "good" GPC's unless there is no other method of satisfying the identified requirements in orbiter systems.

- C. DURING ENTRY/GRTLS (MM 304, 305, 602, AND 603), RESTRINGING WILL BE PERFORMED AS FOLLOWS (TIME PERMITTING) TO REGAIN THE FOLLOWING CRITICAL SYSTEMS CAPABILITY:

Certain systems capabilities are required to be maintained for safety considerations where the BFS cannot provide additional systems capability.

1. NOSE WHEEL STEERING (FOR RTLS/TAL/AOA (KSC) OR ANY SITE WITH KNOWN DIRECTION CONTROL PROBLEMS) .

NWS is required to maintain lateral control during rollout at landing sites where the lateral runway environment is limited. BFS engage at touchdown to recover NWS is an option. However, it was determined to attempt restring during entry to regain NWS and accept risk of BFS engage as a result of the restring instead of nominally engaging the BFS for this case at NGTD. Reference Rule {A10-141A}, NOSE WHEEL STEERING (NWS) [HC], for NWS directional control requirements. ©[102506-7825A]

2. ASA COMMAND (MAINTAIN TWO ELEVON, RUDDER, AND SPEEDBRAKE; MAINTAIN ONE BODY FLAP) .

Two elevon, rudder, and speedbrake FCS command channels (each of which have four command channels) are required since flying with only one FCS channel on an actuator is an uncertified flight control mode. Only one of three body flap command channels is required to maintain acceptable drive capability. Control may be available long enough to allow restring procedures to be completed to regain the required FCS channels rather than defaulting over to the BFS.

THIS RULE CONTINUED ON NEXT PAGE

FLIGHT RULES

A2-254

ENTRY STRING REASSIGNMENT (CONTINUED)

3. VENT DOORS:

- a. THE CAPABILITY TO CLOSE ALL VENT DOORS BETWEEN MACH 24 AND MACH 3.5 @[102506-7825A]

For loss of close redundancy, the affected door is closed to limit the exposure to the next failure that would leave the door failed open. Data presented at the Ascent/Entry Flight Techniques Panel (A/E FTP) #218, March 31, 2006, showed that vent box 3, if left open, is predicted to reach a temperature of 1100 deg F during the entry profile. Since the melting point of 2024 aluminum is 935 deg F, a breach of the box is expected to occur, possibly resulting in loss of crew and vehicle. Because the new thermal analysis data shows temperatures very similar to the old thermal analysis, the previous temperature predictions for vent doors 1/2, 5, 6, and 8/9 will be used until the new thermal analysis is complete. Currently, if left open during entry, vent box 1/2 is expected to reach a temperature of 1200 deg F, vent box 5 and 6 will experience 600 to 700 deg F heating, and vent box 8/9 will experience up to 550 deg F heating. Based on these temperatures, vent box 1/2 will surpass the melting point of 2024 aluminum and would result in a breach and possible loss of crew and vehicle. The reusability temperature limit of 2024 aluminum is 350 deg F and soon after reaching this temperature, the aluminum starts to lose structural integrity (around 400 deg F). Therefore, 400 deg F was chosen as the temperature limit for which to protect the vent doors. Even though vent doors 5, 6, and 8/9 do not reach the melting point of 2024 aluminum, they do exceed the structural integrity limit if left open during entry. Additionally, it is important that these doors are closed during entry heating above 400 deg F to protect various components in close proximity to the vent openings from failing, such as electrical wires, freon lines, hydraulic lines, and APU hydrazine lines. The Mach number limits are based on the thermal analysis for vent door 3; between Mach 24 (approximately 7.5 min after EI) and Mach 3.5 (approximately 24 min after EI, or approximately 1 min prior to Vrel = 2400), the vent temperature is predicted to exceed 400 deg F.

- b. THE CAPABILITY TO OPEN THE MINIMUM NUMBER OF VENTS DOORS IN ORDER TO PROVIDE SUFFICIENT VENTING PRIOR TO REACHING AN ALTITUDE OF 70,000 FT: @[051194-1586A]

- (1) FORWARD AND AFT COMPARTMENTS: THE LEFT OR RIGHT SIDE VENTS (SINGLE SIDE) FOR EACH COMPARTMENT, AND
- (2) MIDBODY: ANY FOUR VENTS, OR ANY THREE VENTS IF AT LEAST ONE OF THESE IS LEFT OR RIGHT VENT 3
@[102506-7825A]

THIS RULE CONTINUED ON NEXT PAGE

FLIGHT RULES

A2-254

ENTRY STRING REASSIGNMENT (CONTINUED)

Data presented at the A/E FTP #218, March 31, 2006, showed that adequate venting margins could be maintained if at least one side of the forward compartment, one side of the aft compartment, and any four midbody vent doors are opened by 70,000 ft. If only three midbody vents are open by 70,000 ft, adequate venting margins can be maintained if at least one of the midbody vents open is left or right vent 3. Failures resulting in loss of open capability on both sides of the forward compartment would result in significantly exceeding Performance Enhancement (PE) certification limits for compartment pressures and structural loading resulting in loss of crew and vehicle. Failures resulting in loss of open capability on both sides of the aft compartment would result in compartment pressures very close to the PE certification limits. Therefore, entry with all aft vent doors closed depends on all other vents to open nominally and on the 1307 bulkhead check valve to repressurize the aft compartment. As a result, it is not recommended to enter with all aft vent doors closed due to venting tolerances. Additionally, failures resulting in more than three midbody vent doors failed closed would also result in structural failure and loss of crew and vehicle. ©[051194-1586A] ©[102506-7825A]

Reference Rule {A10-261E}, VENT DOOR MANAGEMENT [HC].

The A/E FTP #87, February 21, 1992, members concluded that a critical bus reassignment should only be performed after loss of more than two midbody vents has occurred for either vehicle configuration. Restraining for these cases provides the most prudent venting management plan, trading the effects of a potentially dispersed entry trajectory with the potential risks of a dynamic restraining of flight-critical buses. ©[102506-7825A]

4. MPS LH₂ MANIFOLD ENTRY PRESSURIZATION (FOR RTLS/TAL) .
©[022802-5221]

There is insufficient time on RTLS and TAL entries to dump all hydrogen from the Main Propulsion System (MPS) LH₂ manifold. The pressurization of the LH₂ manifold with helium prevents air from being ingested into the manifold during entry. The loss of this helium pressurization will result in the creation of an explosive mixture in the LH₂ manifold as air is ingested and mixes with the hydrogen residuals. Although difficult to quantify, the hazard to the flight crew from an explosive mixture in the MPS LH₂ manifold represents an unnecessary risk. At the A/E FTP #168, October 27, 2000, it was decided that the recovery technique for the loss of LH₂ manifold pressurization could be a switch throw, temporary port mode (to latch the LH₂ manifold pressurization commands), or restraining. In general, a switch throw will be attempted before a port mode, which will be attempted before a restraining; however, the recovery technique used will depend upon the specific flight phase and failure scenario present in the orbiter. ©[022802-5221]

- D. RESTRINGING WILL NOT BE PERFORMED WITHOUT PRIOR MCC COORDINATION.

THIS RULE CONTINUED ON NEXT PAGE

FLIGHT RULES

A2-254

ENTRY STRING REASSIGNMENT (CONTINUED)

The MCC is prime for determining when restringing is required as a result of multiple failures and the resulting GPC/string assignments required to satisfy critical capability and systems fault tolerance as identified in the preceding rules. The MCC is prime for determining the acceptability of restringing based upon the failure signature and conditions and for determining an acceptable data bus reassignment configuration. As a minimum, voice description of the failure and identification of the proposed bus reassignment must be coordinated with the MCC prior to performing any restring.

- E. FOR A SINGLE GPC FAILURE, RESTRINGING WILL NOT BE PERFORMED AFTER EI MINUS 5 MINUTES.

EI minus 5 minutes was selected as the last time for which restringing would be performed as a result of a single GPC failure in order to allow recovery time prior to EI to regain PASS capability should the restring be unsuccessful.

- F. RESTRINGING WILL NOT BE PERFORMED AFTER HAC INTERCEPT.

Crew workload increases after HAC acquisition as concentration is directed towards the immediate landing tasks. Restringing will not be performed during this timeframe so as not to divert crew attention away from the critical landing phase tasks. Although no fault tolerance exists, the exposure to the next failure is minimized since the time between HAC intercept and touchdown is relatively short.

- G. RESTRINGING WILL BE PERFORMED TO REGAIN CRITICAL CAPABILITY INDEPENDENT OF THE BFS STATUS. FOR CASES WHERE RESTRINGING IS ACCEPTABLE TO REGAIN FAULT TOLERANCE (REF. PARAGRAPH A), AN ENGAGEABLE BFS MUST BE AVAILABLE.

The BFS is normally required when restringing is performed as a precaution against the low probability occurrence that the restring action may result in loss of the PASS set. However, when the vehicle has sustained failures such that less than critical capability remains (a capability which must be maintained or a loss of crew/vehicle will result), restringing will be performed to regain the needed capability independent of the BFS status in order to maintain the flying status of the orbiter.

If the BFS is not available and less than critical capability remains, restring is allowed to recover the PASS capability to control the orbiter. If the BFS is available and conditions are such that either a BFS engage or a dynamic restring will recover the critical capability, restring will be attempted if time permits completion of the restring while still maintaining the BFS engage option.

- H. RESTRINGING MAY BE PERFORMED FOR THE FOLLOWING: @[042507-8489A]

1. ALL OPS TRANSITIONS, ALL REDUNDANT SET EXPANSIONS, AND ALL REDUNDANT SET CONTRACTIONS @[042507-8489A]

THIS RULE CONTINUED ON NEXT PAGE

FLIGHT RULES

A2-254

ENTRY STRING REASSIGNMENT (CONTINUED)

2. ANY OPS MODE RECALL THAT DOES NOT CAUSE A BYPASSED ELEMENT TO BE UPMODED @[042507-8489A]

The full effects to the applications software of upmoding bypassed elements during any operation other than OPS transitions, redundant set expansions, or redundant set contractions are not fully understood.

PASS attempts to upmode all bypassed elements on all busses following any OPS transition or OPS mode recall. Upmoding elements during OPS transitions and redundant set expansions/contractions is a designed capability and, thus, is certified. However, upmoding elements outside of these operations was not considered during the design of the PASS requirements, was not considered during the coding of the PASS software, and has not been verified within the context of the shuttle operational envelope. Thus, the use of an OPS mode recall to reassign busses is not certified unless there are no bypassed elements being upmoded.

Since not all OPS mode recalls will cause a bypassed element to be upmoded, it is possible to perform the operation without entering uncertified territory. This includes:

- a. Using an OPS mode recall to deassign a string. Assuming there are no bypassed elements capable of being upmoded, this is certified. For example, assuming a nominal entry configuration with GPC's 1-4 in a redundant set with FC stringing of 1234, one could perform a certified restring to 1230 as long as no elements (MDM's, IMU's, etc.) are upmoded during the restring. An example of where this would not be certified is if an IMU was bypassed due to it having previously moded itself to standby and then, subsequently, the IMU had moded itself back to operate. The restring would upmode the bypassed IMU, thus, making the operation uncertified.*
- b. Using an OPS mode recall to move a good FC string from one good GPC to another. Assuming there are no bypassed elements capable of being upmoded, this is certified. For example, assuming a nominal entry configuration with GPC's 1-4 in a redundant set with FC stringing of 1234, one could perform a certified restring to 1233 as long as GPC 4 is not taken out of the redundant set prior to the restring.*
- c. Using an OPS mode recall to reassign the payload busses from one GNC computer to another. Assuming there are no bypassed elements on the flight critical busses capable of being upmoded, this is certified. For this case, it does not matter whether anything on the payload busses is bypassed since the GNC software does not poll any of the LRU's on the payload data busses. @[042507-8489A]*

*Rules {A2-5}, PORT MODING/RESTRINGING GUIDELINE; {A5-209}, ENTRY MPS HELIUM PURGING FOR CRITICAL VEHICLE POWER/COOLING; {A7-1}, PASS DPS FAILURE; {A7-6}, DATA PATH FAILURE; {A7-102}, PASS DATA BUS ASSIGNMENT CRITERIA; {A7-52}, ASCENT/ENTRY BFS MANAGEMENT GUIDELINES; {A8-55}, ASCENT/ENTRY RCS CONTROL REQUIREMENTS [HC]; and {A10-25}, APU HIGH SPEED SELECTION/SHIFT, reference this rule.
@[022802-5221] @[ED] @[ED] @[102506-7825A]*

FLIGHT RULES

A2-255

CREW TAKEOVER

CREW TAKEOVER (DOWNMODING FROM AUTO TO CSS) PRIOR TO NOMINAL TAKEOVER ALTITUDE WILL BE PERFORMED FOR THE FOLLOWING REASONS ONLY (REF. RULE {A4-208}, ENTRY TAKEOVER RULES):

- A. TO AVOID LOSS OF CONTROL OF THE VEHICLE.
- B. TO PRESERVE THE TRAJECTORY WITHIN THE TARGETED RUNWAY LANDING CAPABILITY.

Whenever the crew must override the guidance limitations to maintain adequate energy capability for reaching the prime selected runway, the CSS mode must be selected. Whether under GCA control or manually flying with visual assistance, the crew must select CSS and bypass the onboard guidance commands.

C. DELTA STATE UPDATES:

- 1. ANY POSITION-VELOCITY DELTA STATE. @[032807-8221]
- 2. A POSITION-ONLY DELTA STATE BETWEEN MACH 5 AND TAEM (MACH 2.5 FOR EOM/AOA, MACH 3.2 FOR RTL)S.

CSS mode is required for all position-velocity delta state updates to avoid severe attitude transients once the onboard NAV is updated. For OPS 3 position-only delta states between Mach 5 and TAEM, CSS must be selected to avoid strong attitude transients. MM 304 entry guidance will very aggressively attempt to remove energy errors by TAEM interface (Mach 2.5). Above Mach 5, the guidance has more time to correct energy errors. Therefore, position-only delta states above Mach 5 should not cause severe transients. After the energy has converged close to nominal, the crew can reselect auto. GRTLS guidance is not as aggressive as OPS 3 guidance in removal of energy errors by TAEM interface (Mach 3.2). @[052401-4524A]

D. GPS NAVIGATION UPDATES WHEN PERFORMED WITH METERING OVERRIDE ENABLED.

Metering logic, which limits the size of updates to the user parameter processor state, may be overridden prior to the GPS incorporation (auto or force) to expedite the time required to update the user parameter processor state. If metering is overridden while GPS is being incorporated into the navigation state, then CSS mode is required to avoid severe attitude transients once the user parameter processor state is updated. @[052401-4524A] @[032807-8221]

FLIGHT RULES

A2-256

EARLY POWERDOWN

EARLY POWERDOWNS ARE DEFINED AS REMOVAL OF POWER FROM THE ORBITER ELECTRICAL BUSES PRIOR TO EOM POWERDOWN. EARLY POWERDOWN WILL BE ACCOMPLISHED FOR ELS LANDINGS, FAILURE OF THE COOLING CART, ANY ORBITER MALFUNCTIONS THAT CONSTITUTE A SAFETY HAZARD (E.G., FUEL LEAK), OR THE THREAT OF SIGNIFICANT ORBITER EQUIPMENT DAMAGE. IN ALL CASES, THIS WILL BE WITHOUT REGARD TO THE INTEGRITY OF ANY RETURNED PAYLOAD.

A2-257

DEORBIT BURN TERMINATION

THE DEORBIT BURN WILL BE TERMINATED (PRIOR TO EXCEEDING A SAFE PERIGEE AS PROVIDED ON THE DEORBIT/ENTRY/LANDING (DEL) PAD FOR THE FOLLOWING FAILURES:

- A. OMS PROPELLANT TANK (ABOVE SINGLE TANK COMPLETION HP ON DEL PAD).
- B. PASS REDUNDANT SET FAIL OR RS SPLIT FOR WHICH RECOVERY HAS NOT BEEN ATTEMPTED.
- C. IMU DILEMMA.
- D. TWO MAIN BUSES.
- E. TWO OMS ENGINES (IF RCS DOWNMODE CAPABILITY DOES NOT EXIST).

The deorbit burn will be terminated for systems failures which preclude controllability or the ability to perform a safe entry. Loss of fault-tolerance will not be cause for terminating the deorbit burn.

For failure of both OMS engines, propellant may not be available to complete the deorbit burn with the RCS +X jets to the original targets. The deorbit burn must be terminated and retargeted to shallower targets. This retargeting will require a 24-hour deorbit delay.

A2-258

BFS ENGAGE

BFS WILL BE ENGAGED IN ENTRY FOR THE FOLLOWING:

- A. LOSS OF REDUNDANT SET.
- B. LOSS OF CONTROL.

Reference Rule {A7-1}, PASS DPS FAILURE. ©[071494-1636]

FLIGHT RULES

A2-259

CHASE AIRCRAFT OPERATIONS

- A. T-38 CHASE AIRCRAFT WILL BE UTILIZED ON AN "AS REQUIRED" BASIS.

T-38 chase aircraft can be used to provide photo documentation of orbiter condition and damage prior to touchdown and rollout, visual inspection for fluids, flames, gear door damage, etc., backup for altitude and airspeed, visual call to orbiter crew in case of wind screen obscurations, and downlink TV to NASA/PAO.

- B. T-38 CHASE RENDEZVOUS WILL BE DISCONTINUED IF:
1. VISUAL/RADAR CONTACT NOT ESTABLISHED WITHIN 1 MINUTE OF ORBITER RENDEZVOUS POINT AT 40K FEET MSL
 2. VISUAL CONTACT NOT ESTABLISHED WHEN WITHIN 4 NM AS REPORTED BY RADAR CONTROLLER DIRECTING THE INTERCEPT
 3. CHASE RENDEZVOUS NOT COMPLETE BY PREFLARE
 4. VISUAL CONTACT LOST AFTER RENDEZVOUS

The T-38 chase aircraft will break off from the rendezvous attempt when it is considered unsafe to continue. Attempting a join-up without visual contact could result in vehicle collision or create a situation that would cause the orbiter to maneuver to avoid impact. Chase aircraft procedures are found in Aircraft Operating Procedures, Volume 1, T-38A Aircraft.

- C. CHASE AIRCRAFT WILL MAINTAIN A MINIMUM LATERAL SEPARATION OF 200 FEET FROM THE ORBITER DURING THE AUTOLAND PORTION OF THE LANDING APPROACH.

The orbiter autoland flight path characteristics are unpredictable and may be abrupt. A 200-foot T-38 chase aircraft separation will allow the chase pilot adequate time to safely avoid unexpected orbiter maneuvers.

FLIGHT RULES

A2-260

ENTRY LOAD MINIMIZATION

IF IT IS REQUIRED TO MINIMIZE ENTRY LOADS, THE FOLLOWING STEPS WILL BE CONSIDERED:

- A. DELETE ENTRY TEST MANEUVERS.
- B. SELECT RUNWAY AND HAC TO MINIMIZE TAILWIND COMPONENT AT HAC INTERCEPT.
- C. SELECT AN SLS IF SIGNIFICANT WINDS AND/OR TURBULENCE CANNOT BE AVOIDED AT THE PLS.

Reference Rule {A10-203B}, PLBD CRITICAL LATCHES.

Rule {A2-210}, ENTRY THERMAL OPTIONS [HC], references this rule. ©[ED]

FLIGHT RULES

A2-261

ENTRY DTO/AUTO MODE/CROSSWIND DTO GO/NO-GO

FAILURE OF	AERO PTI DTO NO-GO	AUTO MODE NO-GO [1]	XWIND DTO NO-GO [10]
APU/HYD 1 APU [3] 2 APU [3]	X		X X
DISPLAYS 2 ADI'S CDR HUD (IF NO PAPI'S AND BALL BAR)	X		X
CONTROLLERS RHC: 1 LCH L RHC 2L AND 2R [3] RPTA: 2L OR 2R	X		X X X X [9]
GNC 2 AA'S (LAT) [3] 2 AA'S (NORM) [12] 2 RGA'S [3] 2 IMU (OR 1 IMU + BITE) [3] 2 ADTA'S [5] ADTA NOT INCORP FCS CH: 2 ELEV [3] 2 S/B [3] 2 RUD [3] 2 BF [3] R DDU: 2 POWER SUPPLY (A, B, OR C) LOSS OF WOW/WONG NO SSME REPOSITIONING	X X (<M 2.5) X X X X X X X X X X	X (<M 2.5) X (<M 2) [7]	X X X X X X X X X X X
DPS GPC 1 (NOT RSTNG) GPC 2 (NOT RSTNG) GPC 3 (NOT RSTNG) 2 GPC (RSTNG) 2 GPC (NOT RSTNG) FF1 FF2 FF3 2 FF 2 FA	X X X X X X X X X	X (<M 2.5) [12] X (<M 2.5) [12]	X X X X X X X X X
AFT RCS LEAK 2 YAW JETS ON SAME SIDE 1 YAW JET AND CG OUTSIDE NOM LIMITS 2 P JETS, SAME SIDE, SAME DIR MIN RCS QTY	X X X X (q<40) X		
FWD RCS (FWD RCS DTO ONLY) 2 YAW JETS SAME SIDE MIN FWD RCS QTY [2] LEAK LOSE LK DETECT [8] LOSE FAIL OFF DETECT [8] LOSS OF FRCS GAUGING PROP BULK TK TEMP <70° F	X X X X X X		

@[090894-1562] @[111094-1690B] @[041196-1782A] @[041097-4890A]

THIS RULE CONTINUED ON NEXT PAGE

FLIGHT RULES

A2-261

ENTRY DTO/AUTO MODE/CROSSWIND DTO GO/NO-GO
(CONTINUED)

FAILURE OF	AERO PTI DTO NO-GO	AUTO MODE NO-GO [1]	XWIND DTO NO-GO [10]
LANDING/DECEL			
TIRE (LEAKING/FAILED)			X
ISOL VLV			X
<100% BRAKES			X
NWS			X
XRANGE > DTO XRANGE LIMIT			
• PRIOR TO FIRST ROLL REVERSAL	X		
• AFTER FIRST ROLL REVERSAL	[6]		
TRIM/RATES			
AIL > ±1.5°	X		X
ELEV > 3° (FROM EXPECTED)	X		X
RATES (PTI)			
PITCH > 3 DEG/SEC	[13]		
YAW > 3 DEG/SEC	[13]		
ROLL > 7 DEG/SEC	[13]		
DOWNMODE			
FCS PROBLEM [3]	X	X	X
AOA	X		X
ENERGY OFF NOMINAL			
ROLL REF. ALERT	X		
ABOVE UPPER TRAJ LINE	X		
NAV PROBLEM REQ MCC GCA OR VEL AND POS UPDATE	X	X	
NO A/L BY 6K		X	
PLB			
PLBD LATCHES	X [4]		
DATA			
RECORDERS	X (LOS)		
GROUND SYSTEMS			
NO RUNWAY AIMPOINT			X
XWIND			
<10 KNOTS PEAK			X
>15 KNOTS PEAK			X
>10 KNOTS GUST			X
VENT DOORS (FWD RCS DTO ONLY)			
ANY OPEN VENT DOOR (FWD, MID, AFT)	[20]		

@[111094-1690B] @[041196-1782A] @[041097-4890A] @[121604-6254C] @[121505-7133B]

THIS RULE CONTINUED ON NEXT PAGE

FLIGHT RULES

A2-261

ENTRY DTO/AUTO MODE/CROSSWIND DTO GO/NO-GO
(CONTINUED)

NOTES:

- [1] GROUND OR CREW CALL.
- [2] PROVIDED BY FLIGHT-SPECIFIC ANNEX.
- [3] RETARGET TO REQUIRED RUNWAY IF AVAILABLE (REF. RULE {A2-207}, LANDING SITE SELECTION [HC]).
@[ED]
- [4] CRITICAL LATCH RULE {A10-203B}, PLBD CRITICAL LATCHES, APPLIES.
- [5] PTI's AUTOMATICALLY INHIBITED BELOW M = 2.5 WITHOUT AIR DATA.
- [6] GROUND CALL REQUIRED FOR INITIATION OF PTI's (REF. RULE {A4-209}, AERO TEST MANEUVERS). VALID TELEMETRY REQUIRED FOR EVALUATION OF ORBITER ENERGY STATE AND DRAG PROFILE. @[ED]
- [7] RESERVED @[041196-1782A]
- [8] DESELECT AFFECTED JET.
- [9] RESERVED @[041196-1782A]
- [10] CONSIDER RUNWAY REDESIGNATION (>M 6) TO AVOID CROSSWIND LANDING.
- [11] RESERVED
- [12] PITCH AUTO MODE NO-GO FOR M < 2.5.
- [13] PTI's AUTOMATICALLY TERMINATED WHEN RATE LIMITS EXCEEDED.
- [14] RESERVED
- [15] RESERVED
- [16] RESERVED
- [17] RESERVED @[041097-4890A]
- [18] RESERVED @[111094-1690B]
- [19] RESERVED @[041097-4890A]
- [20] FWD RCS DTO IS GO. H₂ CONCENTRATIONS PREDICTED TO BE WELL BELOW FLAMMABILITY HAZARD.

THIS RULE CONTINUED ON NEXT PAGE

FLIGHT RULES

A2-261

ENTRY DTO/AUTO MODE/CROSSWIND DTO GO/NO-GO
(CONTINUED)a. *AERO PTI DTO NO-GO:*

The AERO PTI and Xwind DTO's will not be performed when navigation or flight control systems are fail critical. Maintaining single-fault tolerance for AUTO flight control, and allowing an acceptable crew workload are required for performing the DTO's. In addition to be GO for the Xwind DTO, single-fault tolerance is required for the CDR's displays and controls.

(1) *APU/HYD*

2 APU - If two APU/HYD systems are lost, the remaining system must supply all necessary loading to perform entry. PRL will limit the available hydraulic power in an optimum management scheme in order to prevent overloading the single remaining system. Data has shown that entry PTI's place a short duration high load on a hydraulic system. For this reason, aero PTI'S should not be performed in order to minimize stress on the single APU/HYD system.

(2) *DISPLAYS*(a) *ADI*

AERO PTI DTO:

The ADI is required to monitor vehicle attitude and rates for crew takeover.

(b) *CDR HUD*

XWIND DTO:

The CDR relies on the HUD for critical landing data and cues. Flying is more difficult without this instrument, and landing in high crosswinds increases the level of difficulty. The CDR's HUD is not required if PAPI's and ball bar are available, since these landing aids provide guidance for the approach and glide slope.

THIS RULE CONTINUED ON NEXT PAGE

FLIGHT RULES

A2-261

ENTRY DTO/AUTO MODE/CROSSWIND DTO GO/NO-GO
(CONTINUED)

(3) CONTROLLERS

(a) RHC

L RHC-ONE CHNL FAILED L RHC FAILED

XWIND DTO:

The left RHC is either zero-fault tolerant or failed. It is very desirable for the CDR to manually control the vehicle during approach and landing. For this reason, the PLT will not execute the DTO. If the PLT must fly (left RHC failed), then it is prudent to redesignate, if possible, to a runway with more nominal conditions.

TWO RHC CHNL'S FAILED EACH SIDE

AERO PTI DTO, XWIND DTO:

The next failure could cause vehicle control problems since the output from the remaining two channels is summed. The additional maneuvers associated with the DTO's increase the possibility of having vehicle control problems with the next failure. For these failures, at least one of the flight controller power switches should be turned OFF, and both when not being used (ref. Rule {A8-105}, CONTROLLERS).

(b) RPTA

TWO RPTA CHNL's FAILED ONE SIDE

XWIND DTO:

The RPTA channels are zero-fault tolerant and the DTO is NO-GO since NWS must be powered off (ref. Rule {A10-141E}, NOSE WHEEL STEERING (NWS)).

THIS RULE CONTINUED ON NEXT PAGE

FLIGHT RULES

A2-261

ENTRY DTO/AUTO MODE/CROSSWIND DTO GO/NO-GO
(CONTINUED)

(4) GNC

(a) AA's

*TWO LATERAL AA's FAILED**AERO PTI DTO:*

The AA lateral feedback is used for turn coordination to reduce the effects of IMU errors. It is also used in the roll/yaw channel to help form the lateral (Ny) command. The next failure could cause bad vehicle control.

XWIND DTO:

The lateral AA feedback is zero-fault tolerant and the DTO is NO-GO since NWS must be powered off (ref. Rule {A10-141E}, NOSE WHEEL STEERING (NWS)).

(b) TWO NORMAL AA's FAILED

AERO PTI DTO, AUTO MODE:

The NORM AA feedback is used by guidance to form the Nz command for flight control in MM 305. After two failures the system is zero-fault tolerant in AUTO. The crew is required to fly CSS in pitch in MM 305 (ref. Rule {A8-5}, ACCELEROMETER ASSEMBLIES (AA) FAULT TOLERANCE), and aero PTI's are automatically inhibited while in CSS.

(c) RGA's

AERO PTI DTO, XWIND DTO:

The system is zero-fault tolerant for feeding bad vehicle rate data to the flight control system. It is not prudent to perform the DTO's since the added maneuvers increase the risk for control problems with the next failure.

THIS RULE CONTINUED ON NEXT PAGE

FLIGHT RULES

A2-261

ENTRY DTO/AUTO MODE/CROSSWIND DTO GO/NO-GO
(CONTINUED)

(d) IMU's

AERO PTI DTO, XWIND DTO:

After the second IMU failure or when one of the remaining two IMU's has a BITE, the system is fail critical. In either case, the next failure can cause navigation and flight control to use bad IMU data. The additional maneuvers associated with the DTO's increase the probability of vehicle control problems with the next failure.

(e) ADTA's

TWO ADTA's FAILED

XWIND DTO:

The system is zero-fault tolerant because the next failure requires the crew to fly theta limits. Manual flying is more difficult with no air data, and the higher crosswinds increase the piloting task.

ADTA NOT INCORPORATED

AERO PTI DTO, AUTO MODE:

If AD is not incorporated into G&C below M=2.5, aero PTI's are automatically inhibited. If below M=2.0 and AD is not incorporated into G&C, the crew is required to fly CSS in the pitch axis to control theta limits. Manual speedbrake is required below 5k feet (ref. Rule {A8-111}, GNC AIR DATA SYSTEMS MANAGEMENT [CIL]). Note that the XWIND DTO is NO-GO if it is known that AD will not be incorporated and it is still possible to redesignate.

(f) FCS CHNL's

AERO PTI DTO, XWIND DTO:

The system is zero-fault tolerant for being in an uncertified flight control mode. The additional maneuvers associated with the DTO's incur more risk with the next failure.

THIS RULE CONTINUED ON NEXT PAGE

FLIGHT RULES

A2-261

ENTRY DTO/AUTO MODE/CROSSWIND DTO GO/NO-GO (CONTINUED)

(g) *RIGHT DDU**XWIND DTO:*

The right DDU provides power for NWS. With two power supplies failed the DTO is NO-GO since NWS must be powered off (ref. Rule {A10-141E}, NOSE WHEEL STEERING (NWS)).

(h) *LOSS OF WOW/WONG**XWIND DTO:*

The crosswinds further complicate the piloting task for loss of WOW or WONG. Both WOW and WONG are required in order to enable NWS, activate AUTO load relief, and enter the rollout DAP mode at nose gear TD. A known loss of WOW or WONG requires the crew to manually set the WOW and WONG discrettes by pushing the SRB or ET Sep pushbutton after nose gear TD. Potential delays in enabling NWS and increased piloting task cause the DTO to be NO-GO.

As a result of OI-21 WOW modifications, the only two-failure scenarios of concern involve the loss of both WONG discrettes (MDM, BUS, or the discrettes themselves).

(5) *AFT RCS*

- (a) *Once a leak is detected, the PTI's will be inhibited. This action prevents the PTI's from occurring while performing leak troubleshooting. The leak procedures isolate a leg of RCS jets at a time thus minimizing the amount of jets available for attitude control. Inhibiting the PTI's ensures that any off-nominal perturbations that could possibly occur during PTI execution will be prevented. If a nonisolatable leak is present or the NO-GO criteria is violated due to isolation of the leak (minimum RCS quantity, loss of jets), no further PTI's will be performed.*
- (b) *Due to the loss of fail-safe redundancy for orbiter control, the PTI's will not be performed.*
- (c) *RCS quantity checks are performed at different points during entry. The minimum quantity includes 3-sigma entry usage at the check and PTI usage to the next check. PTI's will be inhibited to protect 3-sigma entry redlines. ©[041196-1782A]*

THIS RULE CONTINUED ON NEXT PAGE

FLIGHT RULES

A2-261

ENTRY DTO/AUTO MODE/CROSSWIND DTO GO/NO-GO
(CONTINUED)

(6) FWD RCS

- (a) *Loss of two FWD RCS yaw jets on the same side would result in unbalanced jet firings during PTI's. The entry command SOP software will prevent the PTI's from occurring as long as RCS RM has deselected the jets. If the FRCS yaw jets have become unavailable prior to entry, the PTI's will not be enabled* ©[090894-1562].
- (b) *FWD RCS quantity checks are performed at different points during entry. The minimum quantity includes PTI usage to the next check and ensures positive propellant flow from the FWD RCS.*

Tank residual required to prevent screen breakdown

677 lb	<i>(FWD RCS tanks not designed for entry use)</i>
<u>+ 84 lb</u>	<i>Gauge error</i>
761 lb	<i>Total tank</i>
<u>-307 lb</u>	<i>Hardware trapped</i>
454 lb	<i>Minimum usable FWD RCS</i>
<u>+PTI lb</u>	<i>PTI usage</i>
XXX lb	<i>Total quantity check</i>

- (c) *Once a leak is detected, the PTI's will be inhibited. This action ensures that the PTI's will not occur during leak isolation. Leak troubleshooting consists of securing the entire system. If the leak is nonisolatable or the minimum FWD RCS quantity is violated or minimum jets violated, the PTI's will remain inhibited.*
- (d) *For the loss of RCS RM, the jets will be deselected and not utilized for the PTI's. Per Rule {A6-156}, RCS RM LOSS MANAGEMENT, jets with loss of RM will only be selected if required for attitude hold or to maintain fail-safe redundancy. Because of the risk of firing jets without RM and the low priority of FWD RCS PTI's, the jets will not be reselected to perform PTI's.*
- (e) *FWD RCS gaging is required to monitor the propellant quantity to ensure that minimum FWD RCS quantity will not be violated.*
- (f) *The FWD RCS bulk propellant temperature must be 70 deg F or greater at deorbit TIG. This is required to prevent ZOT's from occurring during PTI's. This is an MCC call since the crew has no insight into the parameter during OPS-3.* ©[090894-1562]

THIS RULE CONTINUED ON NEXT PAGE

FLIGHT RULES

A2-261

ENTRY DTO/AUTO MODE/CROSSWIND DTO GO/NO-GO
(CONTINUED)

- (7) TRIM/RATES/CG @[041196-1782A]

TRIM

- (a) AILERON TRIM $> \pm 2.0$ DEGREES @[041196-1782A]

AERO PTI DTO:

The aileron trim saturation limit is 3.0 degrees. When the trim reaches 2.0 degrees, the PTI's should be inhibited to avoid possible control problems or high RCS usage. Based on SES analysis and previous flight data, 2.0 degrees is a comfortable margin for control, while not being too restrictive. @[041196-1872A]

- (b) ELEVON TRIM > 3.0 DEGREES (FROM EXPECTED)

AERO PTI DTO:

The elevator schedule has a 1-degree deadband. Performing PTI's with large elevator trim could increase the level of difficulty in trimming the vehicle. Three degrees off schedule is a sufficiently large elevator trim limit to permit aero maneuvers in any reasonable flight condition, yet provides adequate safety margins for control.

XWIND DTO:

This elevon trim condition indicates that the vehicle is in an off-nominal configuration which may lead to additional problems. It is prudent then to NO-GO the XWIND DTO and avoid complicating the situation during A/L and rollout.

- (c) VEHICLE RATES (PTI)

AERO PTI DTO:

These limits are in the software and will automatically inhibit (terminate) any PTI in progress. The additional maneuvers associated with the PTI's could make it more difficult for the FCS to damp the rates and regain good control.

THIS RULE CONTINUED ON NEXT PAGE

FLIGHT RULES

A2-261

ENTRY DTO/AUTO MODE/CROSSWIND DTO GO/NO-GO
(CONTINUED)

(d) CG

AERO PTI DTO:

With the X or Y CG out of the nominal CG box, continuous firing of ARCS jets may be required to maintain attitude control. To ensure maximum control authority in an uncertified configuration, as well as to save propellant, PTI's will not be performed.
@[041196-1782A]

(8) DOWNMODE

FCS PROBLEM

AERO PTI DTO, AUTO MODE, XWIND DTO:

If the vehicle is experiencing problems with the FCS, due to multiple systems failures and/or unpredicted effects of the environment, then all flight control DTO's are NO-GO, and the crew should fly CSS, if required. The risks associated with performing the DTO's are too great while vehicle control is off-nominal.

(9) PLB

PLBD LATCHES - It is acceptable to perform an entry with any one latch gang (bulkhead or centerline) failed open. Entry loads should be minimized (per Rule {A10-203B}, PLBD CRITICAL LATCHES, and SODB 3.4.2.3). Aero PTI's will not be performed in order to ensure a nominal entry.

(10) DATA

According to the sponsor of the aero PTI DTO, the crew cannot evaluate the results from onboard indications. Either real-time or recorded telemetry is required. This is in agreement with the DTO requirements as documented in NSTS 16725, Flight Test and Supplementary Objectives Document.

THIS RULE CONTINUED ON NEXT PAGE

FLIGHT RULES

A2-261

ENTRY DTO/AUTO MODE/CROSSWIND DTO GO/NO-GO
(CONTINUED)

b. *XWIND DTO NO-GO*

Rule {A10-144}, DRAG CHUTE DEPLOY CONSTRAINTS [HC], references this rule. ©[121604-6254C]

(1) *APU/HYD*

1 APU and 2 APU

Loss of one APU/HYD system places the orbiter a single failure away from performing entry/rollout on a single system. Orbiter handling qualities have been demonstrated to be degraded when only a single APU/HYD system is operating. If only one APU/HYD system remains, conditions that could adversely affect the already degraded handling qualities should be avoided if possible. Therefore, if one or two APU/HYD systems are lost, the crosswind DTO should be NO-GO.

(2) *LANDING/DECEL*(a) *TIRE (LEAKING/FAILED)*

For a failed main gear tire, a landing with a crosswind from the side of the affected tire, while minimizing groundspeed, is required (if the tire is leaking, but predicted to remain above the fail limit through wheelstop, this technique is still highly desirable). If a leak is confirmed in a main or nose gear tire, the load-carrying capability of that tire is reduced. If the tire is already failed, then the adjacent tire is susceptible to failure as well. Performance of the DTO can adversely affect tire survival; this additional risk is not justified. (Reference Rule {A10-142}, TIRE PRESSURE [CIL] [HC].) ©[121604-6254C]

(b) *BRAKE ISOL VLV*

Loss of the ability to open one brake isolation valve puts the orbiter one failure away from having only 50 percent braking capability. Full braking capability is required for the crosswind DTO in order to ensure good control of the vehicle in high crosswind conditions.

THIS RULE CONTINUED ON NEXT PAGE

FLIGHT RULES

A2-261

ENTRY DTO/AUTO MODE/CROSSWIND DTO GO/NO-GO
(CONTINUED)

- (c) <100 PERCENT BRAKES

Full braking capability is required for the crosswind DTO in order to ensure good control of the vehicle in high crosswind conditions.

- (d) NWS

NWS is the primary means of steering the vehicle during rollout. In a strong crosswind, differential braking may not be sufficient to maintain directional control.

- (3) XWIND

- (a) <10 KNOTS PEAK @[041097-4890A]

Winds less than 10 knots are not within the DTO limits and would not produce conditions appropriate for collecting the required DTO data.

- (b) >15 KNOTS PEAK

Crosswinds greater than 15 knots peak violate nominal crosswind limits.

- (c) >10 KNOTS GUST @[041097-4890A]

Crosswinds with gusts greater than 10 knots above the steady-state wind violate nominal limits.

THIS RULE CONTINUED ON NEXT PAGE

FLIGHT RULES

A2-261

ENTRY DTO/AUTO MODE/CROSSWIND DTO GO/NO-GO
(CONTINUED)

c. DPS

In general, DPS failures that cause aero PTI DTO, auto mode, and crosswind DTO to be NO-GO are driven by various failures in the GNC, MMACS, and/or PROP systems.

GPC 1 (NOT RSTNG), GPC 2 (NOT RSTNG), FF1, FF2 - Crosswind DTO is NO-GO due to loss of a left RHC channel, and for vehicles without improved NWS, loss of GPC NWS.

GPC 3 (NOT RSTNG), FF3 - Crosswind DTO is NO-GO due to loss of a left RHC channel.

2 GPC (RSTNG) - Aero PTI DTO is NO-GO due to the inherent risk of another GPC failure which would cause GNC systems violations for the DTO.

2 GPC (NOT RSTNG), 2 FF - Aero PTI DTO, auto mode (<M2.5), and crosswind DTO are all NO-GO due to multiple GNC LRU failures.

2 FA - Aero PTI DTO and crosswind DTO are NO-GO due to multiple GNC LRU failures. The aero PTI DTO is also NO-GO due to two aft jets being down.

For additional technical information concerning the rationale for aero PTI DTO, auto mode, and crosswind DTO NO-GO requirements, refer to the rationale for the GNC, MMACS, and PROP systems. ©[041097-4890A]

FLIGHT RULES

A2-262

LANDING DTO'S

- A. BRAKING OR NOSE WHEEL STEERING DTO TASKS MAY BE PERFORMED ON DAYLIGHT LANDINGS REGARDLESS OF THE WEIGHT/CG OR FLIGHT DURATION. @[111894-1690B]
- B. BRAKING DTO TASKS MAY BE PERFORMED ON NIGHT LANDINGS SO LONG AS THEY INVOLVE ONLY VARIATIONS IN BRAKING PROFILE OR DECELERATION LEVEL. NO DTO STEERING TASKS USING DIFFERENTIAL BRAKING WILL BE PERFORMED ON NIGHT LANDINGS. @[111894-1690B]
- C. NO DTO STEERING TASKS USING DIFFERENTIAL BRAKING OR NWS WILL BE PERFORMED ON NIGHT LANDINGS. @[111894-1690B]
- D. CROSSWIND LANDING DTO'S ABOVE 12 KNOTS PEAK WILL NOT BE PERFORMED ON NIGHT LANDINGS OR EXTENDED DURATION ORBITER (EDO) FLIGHTS. @[111894-1690B]

Braking or nose wheel steering testing is acceptable during daylight landings since vehicle weight and CG have minimal effects on the rollout piloting task, and visual cues are available to the crew to assess test inputs/results. Braking tests at night are acceptable if they only involve basic braking functions such as varying the deceleration levels or specific braking profile. Steering task DTO's involving either differential braking or nosewheel steering are not acceptable at night due to the loss of visual cues and runway shadowing effects which put the crew and orbiter at unnecessary additional risk. The crosswind limit for EDO or night flights has been set at 12 knots regardless of where you land. You may land with a crosswind between 8 and 12 knots and still meet the crosswind DTO requirements, but the peak wind will not be allowed to exceed 12 knots and approach the 15-knot normal crosswind DTO limit. @[ED]

- E. LANDING AND ROLLOUT DTO'S WILL NOT BE PERFORMED ON ABORTS (RTLS, TAL, AOA, FD1 PLS) UNLESS THEY ARE DATA GATHERING ONLY, INVOLVE NO CREW ACTIONS, AND POSE NO ADDITIONAL RISK TO THE CREW OR VEHICLE. HOWEVER, DATA FROM ANY ABORT LANDING MAY BE USED TO SATISFY PROGRAM DTO OBJECTIVES. @[100997-6294A] @[121604-6254C]

Programmatic risk is high during an abort. Additional risk or crew distraction should not be incurred for the sake of engineering data that can more safely be obtained on another flight. However, some DTO's are data gathering only and are transparent to the crew; these are allowed. Some DTO's cannot be avoided (e.g., crosswind landings) during aborts and thus will be accomplished anyway. This rule means that off-nominal crew actions (such as delayed drag chute deploy for the crosswind DTO) will not be performed. @[100997-6294A]

FLIGHT RULES

A2-263

STA/WEATHER AIRCRAFT RUNWAY APPROACH OPERATIONS
FOR SITES WITH ONLY ONE RUNWAY

A. PRELAUNCH (RTL/TAL)/PREDEORBIT (AOA/EOM)

STA AND/OR WEATHER AIRCRAFT APPROACHES TO PLANNED LANDING SITES WITH ONLY ONE RUNWAY (OPPOSITE END MAY OR MAY NOT BE AVAILABLE) MAY BE PERFORMED AS REQUIRED TO ASSESS NAVAID/VISIBILITY STATUS. ONCE THE FINAL GO FOR LAUNCH OR THE DEORBIT BURN HAS BEEN GIVEN, THESE OPERATIONS WILL BE TERMINATED UNLESS REQUIRED PER PARAGRAPH B.

B. POSTLAUNCH (RTL/TAL)/POSTDEORBIT BURN (AOA/EOM)

POSTLAUNCH OR POSTDEORBIT BURN, STA OR WEATHER AIRCRAFT APPROACHES TO THE SELECTED RUNWAY AT LANDING SITES WITH ONLY ONE RUNWAY (OPPOSITE END MAY OR MAY NOT BE AVAILABLE), WILL ONLY BE DONE IF CONDITIONS MAKE SUCH AN APPROACH NECESSARY. APPROACHES WILL BE MINIMIZED AND WILL BE PERFORMED TO REDUCE THE RISK OF RUNWAY LOSS DUE TO AIRCRAFT PROBLEMS ON APPROACH. TO REQUIRE AN APPROACH POSTLAUNCH OR POSTDEORBIT, A CHANGE OR CONCERN IN ONE OR MORE OF THE FOLLOWING AREAS MUST EXIST:

1. VISIBILITY.
2. NAVAID STATUS/CAPABILITY.

For the case where a landing facility has only one runway (availability of its alternate end does not matter), approaches to landing runways are still performed prelaunch or predeorbit burn to aid in assuring that landing flight rules are met with respect to navaid and visibility status. Such approaches are not considered a threat to landing prior to launch or the deorbit burn.

Once committed to a runway, approaches to that runway or its alternate end, should not be done unless necessary to confirm the ability to land on that runway. There is no reason to continue to shoot approaches to the selected runway if conditions have not changed since the commitment to use the runway. If changes are suspected, however, additional approaches may be performed. If required, they will be done such that risk of losing the runway due to approach aircraft problems will be minimized in order to preserve shuttle landing capability. Techniques to accomplish this include breaking off an approach early or runway flybys vice approaches.

FLIGHT RULES

A2-264

EMERGENCY LANDING FACILITY CRITERIA [HC] @[032807-8222B]

THIS RULE DOCUMENTS THE MINIMUM ACCEPTABLE LANDING FACILITY REQUIREMENTS FOR COMMITMENT TO AN EMERGENCY LANDING VERSUS BAILOUT. IT APPLIES FOR ALL LANDINGS. @[120894-1744B]

- A. USABLE RUNWAY AT LEAST 7500 FT LONG AND 130 FT WIDE. USABLE RUNWAY LENGTH IS MEASURED FROM THE THRESHOLD (ACTUAL OR DISPLACED) TO THE END OF THE USABLE OVERRUN. @[110900-3733C]
- B. RUNWAY COORDINATES RESIDENT IN THE ONBOARD SOFTWARE OR AVAILABLE FOR UPLINK.
- C. IF NO GPS IS AVAILABLE ONBOARD, OPERATIONAL TACAN OR DME WITHIN 50 NM OF THE SITE (MAY REQUIRE UPLINK). @[032807-8222B]
- D. AIRSPACE AND RUNWAY CLEAR.
- E. CONFIRMATION OF FACILITY READINESS FOR ORBITER LANDING VIA MCC OR CREW VOICE CONTACT WITH THE AIRFIELD.
- F. ACCEPTABLE WEATHER FOR ORBITER EMERGENCY LANDING OPERATIONS (REFERENCE RULE {A2-6}, LANDING SITE WEATHER CRITERIA [HC]).
- G. ACCEPTABLE LIGHTING FOR ORBITER EMERGENCY LANDING OPERATIONS. IF LANDING AT NIGHT WITHOUT XENONS, THE FOLLOWING MINIMUM REQUIREMENTS APPLY:
 - 1. OPERATIONAL RUNWAY EDGE LIGHTS
 - 2. ONE HUD OPERATIONAL

THIS RULE CONTINUED ON NEXT PAGE

FLIGHT RULES

A2-264

EMERGENCY LANDING FACILITY CRITERIA [HC]
(CONTINUED)

Due to the inherent hazards of an orbiter landing, especially at a non-augmented facility, adequate site readiness must be ensured before a landing will be attempted. The runway to be used must be of sufficient length and width to accommodate a safe orbiter landing. The 130 ft value corresponds to the narrowest approved ELS runways in NSTS-07700, Volume X, Book 3. Although the effects of landing on 130 ft wide runways have not been evaluated directly, examination of data from the 2/00 Ames VMS study on minimum acceptable runway length indicates adequate performance should be expected. This study included crosswinds up to 15 kt on runways between 148 ft to 200 ft wide. The maximum lateral excursions seen in this study were less than that required to stay on a 130 ft wide runway. Rio Gallegos, Argentina, the only Program-approved Emergency Site < 148 ft wide, is considered acceptable given the significant gain in emergency deorbit capability it provides. However, until a minimum runway width study is performed, any new runways less than 148 ft being considered for SSP use should be evaluated on a case-by-case basis. The 7500 ft length is based on studies performed in the 2/00 NASA Ames VMS session that showed acceptable performance can be obtained if additional TD energy is removed from the system. ©[1109-3733C]

Prior to OI-30, a manual speedbrake technique was used to stop the orbiter on a 7500 ft runway assuming the following techniques: short field speedbrake logic selected; Auto speedbrake used down to 3000 ft; manually set the speedbrake to the Auto speedbrake retract command plus 20 percent at 3000 ft; limiting the maximum speedbrake setting to 75 percent; no speedbrake adjustment made at 500 ft; touchdown at 195 KEAS; at maingear touchdown, deploy the chute, derotate, and set the speedbrake to 100 percent; use maximum braking at nosegear touchdown. Starting with STS-114, the OI-30 flight software completely automated the manual speedbrake procedure by allowing for an ELS speedbrake setting that is invoked via SPEC 50. The early chute deploy and derotation at maingear touchdown is still required for short runways with the use of the OI-30 ELS speedbrake setting. ©[032807-8222B]

Rule {A4-110}, AIMPOINT, SPEEDBRAKE RETRACT OPTION, AND EVALUATION TOUCHDOWN VELOCITY SELECTION [HC], defines which speedbrake option is to be employed based on the usable runway length. If no overrun is available, usable runway length is measured to the actual departure threshold. Refer to Ascent/Entry Flight Techniques Panel #165 minutes, from June 16, 2000, for further details. The runway must be resident in the onboard software or available for uplink to allow guidance and navigation aids to be used. ©[110900-3733C] ©[032807-8222B]

THIS RULE CONTINUED ON NEXT PAGE

FLIGHT RULES

A2-264

EMERGENCY LANDING FACILITY CRITERIA [HC]
(CONTINUED)

Either GPS or a TACAN/DME is required to provide sufficient onboard navigation accuracy. The TACAN/DME coordinates must be resident in the onboard software or available for uplink to allow incorporation into the navigation state. Fifty miles distance from the TACAN to the field is based on Monte Carlo analysis of various TAL scenarios. ©[120894-1744B] ©[032807-8222B]

The airspace and the chosen runway must be clear. MCC or crew voice contact with the airfield is required to ensure that the facility is prepared for the landing. In order to reduce the risk to the orbiter, crew, and the general public/civilian population, it is necessary that an intended landing site be notified of an attempted landing as soon as possible. This will allow the airspace and runways to be cleared as well as emergency equipment prepared. Notification may be via State Department prearranged channels, NASA agreed to communication channels, or via communication directly from the orbiter crew. ©[120894-1744B]

Acceptable weather for orbiter landing operations is required. These criteria are documented in rule {A2-6}, LANDING SITE WEATHER CRITERIA [HC].

Restrictions are placed on night landings due to a significant loss of visual cues. As a minimum, runway edge lights and a HUD must be operational to assist in visually acquiring the runway and the outer glide slope (if MLS is not available) and to provide a visual reference during braking and rollout (regardless of MLS status).

Reference: Hazard Report ORBI 211 and ORBI 30, Loss of Orbiter Caused by Vehicle Handling Qualities.

Rules {A2-205}, EMERGENCY DEORBIT; and {A2-209}, LANDING SITE SELECTION FOR AN INFLIGHT EMERGENCY, reference this rule. ©[120894-1744B] ©[ED] ©[042706-7371B] ©[032807-8222B]

A2-265

RESERVED ©[072398-6586A] ©[040899-6847] ©[052401-4525] ©[032807-8379]

FLIGHT RULES

A2-266

SUBSONIC PILOT FLIGHT CONTROL

AT THE DISCRETION OF THE COMMANDER (CDR), THE PILOT (PLT) MAY FLY CONTROL STICK STEERING (CSS) FOR A SINGLE PERIOD (APPROXIMATELY 20 SECONDS) BELOW MACH 1.00 WITH THE FOLLOWING CONSTRAINTS:

@[082202-5636] @[ED]

- A. THE CDR WILL FLY THE ORBITER FROM 15 SECONDS PRIOR TO HAC INTERCEPT THROUGH THE INITIAL ROLL ONTO THE HAC.
- B. THE CDR WILL FLY FROM AN ALTITUDE AGL OF 20,000 FT THROUGH LANDING AND ROLLOUT.
- C. WHEN CSS IS ENGAGED, ONBOARD GUIDANCE COMMANDS WILL BE FOLLOWED.
- D. THE CDR WILL FLY (NO TRANSFER OF CONTROL) FOR THE FOLLOWING CASES:
 1. IF THE MCC RECOMMENDS "DELAYED CSS PREFERRED" PER RULE {A4-156}, HAC SELECTION CRITERIA.
 2. SYSTEMS OR NAVIGATION PROBLEMS THAT REQUIRE CSS, PER RULES {A2-261}, ENTRY DTO/AUTO MODE/CROSSWIND DTO NO-GO, AND {A4-208}, ENTRY TAKEOVER RULES.
 3. VEHICLE ENERGY PROBLEMS REQUIRING A GROUND CONTROLLED APPROACH (GCA).
 4. ANY ABORT LANDING.
 5. BFS ENGAGED. @[082202-5636]

THIS RULE CONTINUED ON NEXT PAGE

FLIGHT RULES**A2-266****SUBSONIC PILOT FLIGHT CONTROL (CONTINUED)**

6. ANY GUIDANCE, NAVIGATION, OR FLIGHT CONTROL SYSTEM(S) FAILURE (E.G., CDR HUD) THAT INCREASES THE PROBABILITY OF A TRAJECTORY TRANSIENT RESULTING FROM THE TRANSFER OF CONTROL (MCC CALL). LOSS OF A SINGLE STRING OF REDUNDANCY IN ANY SYSTEM (E.G., ONE AA, ONE FCS CHANNEL, ONE RHC CHANNEL, ETC.) WITH NO OTHER FAILURES IS NOT CAUSE FOR PRECLUDING TRANSFER OF CONTROL. @[082202-5636]
7. IF THE MCC RECOMMENDS NO-GO FOR PLT FLYING BASED ON HAC DYNAMICS (E.G., HIGH TAIL WINDS AT HAC INTERCEPT).
- E. THE PLT IS THE BACKUP TO THE CDR FOR ANY FLIGHT PHASES REQUIRING CSS CONTROL. IF REQUIRED FOR VEHICLE SAFETY, THE CDR MAY TRANSFER CONTROL TO THE PLT AT ANY TIME.

Allowing the PLT to fly for a short period of time during entry enhances training and better prepares the pilot for future orbiter flying tasks. Regular in-flight exercise of transfer of vehicle control between the CDR and PLT during nominal approaches will better prepare crews for potential off nominal situations where an efficient transfer of control would be required to ensure vehicle and crew safety. The intent of this rule is to allow the PLT to fly for approximately 20 seconds during a single period, either prior to HAC intercept or once established on the HAC. During a normal entry, there is sufficient time below Mach 1.00 to allow the PLT to control the orbiter and still allow the CDR sufficient time to complete the more critical maneuvers, such as the initial roll onto the HAC and lining up on final. For periods prior to HAC intercept, control must be transferred back to the CDR no later than 15 seconds prior to HAC intercept to allow the CDR sufficient time to prepare for the time-critical maneuver to roll onto the HAC. The 15-second limit was chosen based on flight experience (STS-102, 100, 108, 109, and 110) and to make the best use of the onboard cues, primarily the HAC predictor (the HAC predictor begins flashing 20 seconds prior to HAC intercept and begins moving 10 seconds prior to HAC intercept). For periods after HAC intercept, or for straight-in approaches, control must be transferred back to the CDR prior to 20,000 feet altitude above ground level (AGL). For an overhead HAC approach this equates to approximately the 90-degrees to go point on the HAC. When CSS is engaged, onboard guidance will be followed, and no inputs will be made other than those required to fly to the glideslope and course centerline, or otherwise ensure a safe landing. @[082202-5636] @[ED]

THIS RULE CONTINUED ON NEXT PAGE

FLIGHT RULES

A2-266

SUBSONIC PILOT FLIGHT CONTROL (CONTINUED)

There are some cases in which it is not prudent to allow the PLT to have this training time, however. If the 6 degrees of freedom entry simulation as explained in Rule {A4-156}, HAC SELECTION CRITERIA, indicates that delaying CSS until a HAC turn angle of 180 degrees is preferred, the CDR should fly from CSS initiation through rollout. For these HAC cases, energy stops diverging at the 180-degree point and begins to slowly recover. Handing control of the vehicle between the CDR and PLT in this timeframe is not prudent, since the vehicle energy is already lower than typical and the time to correct any energy problems is diminished. Likewise a vehicle problem as outlined in Rules {A2-261}, ENTRY DTO/AUTO MODE/CROSSWIND DTO NO-GO or {A4-208}, ENTRY TAKEOVER RULES, requires significant concentration on the flying task, and a handover of control is inappropriate. Systems failures that would invoke this rule are two AA failures, no or single air data, no yaw jet flight control mode, or a navigation system anomaly that affects the vehicle energy state (GCA). In the event of an abort, flight control handovers between CDR and PLT should be avoided due to the increased risk inherently associated with the abort, and to eliminate the possibility of introducing any handover dispersions to an already challenging abort landing. The transfer of control is assumed to have an insignificant impact on the vehicle trajectory and energy state, although arguably that impact is non-zero. That is, in most cases it is nearly impossible to transfer vehicle control without introducing some very small transient, which for the nominal case is acceptable. However, the transfer of control is not warranted for any guidance, navigation, or flight control system(s) problem(s) that could cause a transfer of control to result in more than an insignificant impact on the trajectory. Additionally, for certain HAC dynamics (e.g., high tail winds at HAC intercept), the flying task requires more setup time prior to HAC intercept, and more time-critical inputs before, during, and after HAC intercept. In these cases, vehicle energy state can be less forgiving for delayed piloting response (at HAC intercept, and for the first 180 deg of HAC) and transfer of vehicle control is not warranted. @[082202-5636]

Flight crews are trained preflight to transfer control positively and verbally in a CRM environment. Any time that a situation occurs that detracts from the CDR's ability to fly the vehicle, it is acceptable for the CDR to hand control of the vehicle over to the PLT, regardless of the constraints imposed by this rule, if required to ensure a safe landing. Ref. A/E FTP #174, March 30, 2001, A/E FTP #184, May 17, 2002 and A/E FTP #185, June 28, 2002. @[082202-5636]

A2-267 THROUGH A2-300 RULES ARE RESERVED @[082202-5636]

FLIGHT RULES

CONTINGENCY ACTION SUMMARY

A2-301

CONTINGENCY ACTION SUMMARY [HC] ©[032807-8400]

FAILURE

	M A N U A L S S M E S / D	F A S T S E P	R T L S	T A L	A O A	A T O	B A I L O U T	ENTER FIRST DAY PLS	ENTER ASAP (PLS, SLS ELS)	ENTER IMMED.	MAX DEORBIT DELAY	
											1 ORB	24 HR
A. GROUND INSTRUMENTATION												
1. <u>REMOTE STATIONS</u>												
a. EDW LANDING												
(1) LOSS OF DFRF, GDS, AND TDR (HDR AND LDR) [2]											X	X
(2) LOSS OF ALL DFRF, GDS, AND TDRS VOICE (S-BAND AND UHF) [2]											X	X
(3) LOSS OF DFRF, GDS, AND TDRS CMD											X	
b. KSC LANDING												
(1) LOSS OF MIL, PDL, AND TDRS TLM (HDR AND LDR) [2]											X	X
(2) LOSS OF MIL, PDL, AND TDRS VOICE (S-BAND AND UHF) [2]											X	X
(3) LOSS OF MIL, PDL, AND TDRS CMD											X	
c. NOR LANDING												
(1) LOSS OF ALL UHF AND TDRS S BAND VOICE [2]											X	X
(2) LOSS OF TDRS TLM [2]											X	X
(3) LOSS OF TDRS CMD											X	
2. <u>TRACK</u>												
LOSS OF DUAL TRACK SOURCES												
											X	X
3. <u>MCC</u>												
a. LOSS OF PRIME AND BACKUP TRAJ SERVERS [3]												
											X	X
b. LOSS OF ALL TPC'S												
											X	X
c. LOSS OF ALL A/G CAPABILITY												
											X	X

©[121593-1590] ©[032807-8400]

THIS RULE CONTINUED ON NEXT PAGE

FLIGHT RULES

A2-301

CONTINGENCY ACTION SUMMARY [HC] (CONTINUED)

FAILURE

	M A N U A L S S M E S / D	F A S T S E P	R T L S	T A L	A O A	A T O	B A I L O U T	ENTER FIRST DAY PLS	ENTER ASAP (PLS, SLS ELS)	ENTER IMMED.	MAX DEORBIT DELAY	
											1 ORB	24 HR
B. TRAJECTORY/GUIDANCE								[84]	[1]	[1]		
1. <u>TRAJECTORY</u>												
a. PERFORMANCE VIOLATIONS [5]			X	X	X	X	X					
b. PROTECT ATO CAPABILITY	X											
c. PROTECT 3 ENGINE RTLS GUIDANCE MECO	X											
d. ONBOARD PREDICTED MECO 2 SEC DIFFERENT THAN GND (CONFIRMED BY NAV VEL ERRORS) (MAN C/O ON GND COMP VALUE)	X											
e. CG OUTSIDE OF NOMINAL BOUNDARY												X
f. CG OUTSIDE CONTINGENCY BOUNDARY				[9]	[9]	[9]						
g. MNVR COMP DOES NOT INCLUDE AT LEAST 1 REPEAT STDN SITE PASS FOLLOWING A PERIGEE ADJUST MNVR										X	X	
h. PREDICTED DOWNTRACK ERROR AT EI >20 NM										X	X	
i. EOM WEATHER FORECAST VIOLATIONS [38]										X	X	
2. <u>RANGE SAFETY</u>												
a. RSO ARM CMD RECEIVED [7]		X					X					
b. DEVIATION TOWARDS LIMIT LINE [7]	X	X	X	X		X	X					

THIS RULE CONTINUED ON NEXT PAGE

FLIGHT RULES

A2-301

CONTINGENCY ACTION SUMMARY [HC] (CONTINUED)

FAILURE

	M A N U A L S S M E S / D	F A S T S E P	R T L S	T A L	A O A	A T O	B A I L O U T	ENTER FIRST DAY PLS	ENTER ASAP (PLS, SLS ELS)	ENTER IMMED.	MAX DEORBIT DELAY	
											1 ORB	24 HR
C. MPS												
1. MANUAL THROTTLE REQUIRED FOR LH ₂ NPSP				X								
2. He TK LOST (<750 PSI) W/LMT S/D INH	X		X	X	X	X		[84]	[1]	[1]		
3. CMD PATH FAIL	X											
4. DATA PATH FAIL WITH UNVERIFIED CMD PATH	X											
5. CMD AND DATA PATH FAIL	X											
6. 2 STUCK THROTTLE W/3 SSME'S ON [8]	X											
7. 1 STUCK THROTTLE W/3 SSME'S ON [6]	X											
8. 3 ET LOW LVL SENS FAIL DRY SAME TNK				X	[31]							
D. OMS/RCS												
1. OMS												
a. LOSS OF 1 OMS He TK PRIOR TO OMS 1						[11]						
b. 2 OMS He TK FAIL												
(1) PRIOR TO OMS 1				X	X	[44]						
(2) BETWEEN OMS 1 AND OMS 2 [12][15]								[62]				
c. 1 OMS PROP TK LK/FAIL OR 2 TKS SAME SIDE LK/FAIL												
(1) BEFORE OMS 2 [25]					[34]	[11]	X					
(2) BEFORE DEORBIT TIG [15][16]											[56]	
(3) AFTER DEORBIT TIG BUT BEFORE HP < PROP FAIL HP [14][15]												X
d. 2 OMS PROP TK LK/FAIL, DIFF SIDE				X	[15]		x	[13]				
continued...					[23]							

®[121593-1590]

THIS RULE CONTINUED ON NEXT PAGE

FLIGHT RULES

A2-301

CONTINGENCY ACTION SUMMARY [HC] (CONTINUED)

FAILURE

	M A N U A L S S M E S / D	F A S T S E P	R T L S	T A L	A O A	A T O	B A I L O U T	ENTER FIRST DAY PLS	ENTER ASAP (PLS, SLS ELS)	ENTER IMMED.	MAX DEORBIT DELAY	
											1 ORB	24 HR
D. OMS/RCS (continued)								[84]	[1]	[1]		
e. 2 OMS ENG FAIL											[56]	
(1) BEFORE OMS 1						[11]		X				
(2) AFTER OMS 1								X				
(3) AFTER DEORBIT TIG BUT BEFORE HP < SAFE HP												[18]
f. 1 OMS FAIL AND 1 + X RCS JET FAIL								X				
g. 1 OMS INLET LINE OR 2 SAME SIDE												
(1) BEFORE OMS-2						[11]		X				
(2) BEFORE DEORBIT TIG											[56]	
h. 2 OMS INLET LINES, DIFF SIDES, SAME PROPELLANT					[15] [23]							
i. 2 OMS INLET LINES, DIFF SIDES, DIFF PROPELLANT						[11]		X			[56]	
2. RCS												
a. 2 AFT RCS He/PROP TK LK/FAIL-DIFF SIDE												
(1) DIFF PROP								X				
(2) SAME PROP					[13]	[13]	X	X	[13]			
b. 2 AFT JETS SAME AXIS/POD FL'D OFF BY RM								[70]			[56]	
c. 1 AFT RCS He/PROP TK LK/FAIL OR 2 TKS SAME SIDE LK/FAIL								X [88]			[56] [59]	

@[121593-1590] @[042507-8466B]

THIS RULE CONTINUED ON NEXT PAGE

FLIGHT RULES

A2-301

CONTINGENCY ACTION SUMMARY [HC] (CONTINUED)

FAILURE

	M A N U A L S S M E S / D	F A S T S E P	R T L S	T A L	A O A	A T O	B A I L O U T	ENTER FIRST DAY PLS	ENTER ASAP (PLS, SLS ELS)	ENTER IMMED.	MAX DEORBIT DELAY	
											1 ORB	24 HR
E. DPS								[84]	[1]	[1]		
1. LOSS OF 1 GPC											X	
2. REDUNDANT SET FAILURE OR GPC SPLITS [20][53]								[4]				X
3. LOSS OF BFS WITH A 2 OR MORE GPC PASS SET												[30]
4. LOSS OF 2 GPC'S (SPARE AVAILABLE)												X
5. LOSS OF 2 PL MDM'S								[41]				
6. LOSS OF 2 FA MDM'S								[65]				
7. LOSS OF 2 FF MDM'S								[66]			X	X
8. GPC BITE (MULTIPLE GPC'S)												X
9. LOSS OF 2 MMU'S [83]												
F. EECOM												
1. FIRE (AV BAY OR CABIN) [58]								X	X			
2. <u>ARS/PCS</u>												
a. LOSS OF 2 CABIN FANS [60][39]								X	X			
b. LOSS OF AV BAY COOLING IN BAY 1 OR 2 [30]											X	X
c. LOSS OF AV BAY COOLING IN BAY 3 [30]											X	
d. LOSS OF 3 OF 6 AV BAY FANS [74]								X				
e. LOSS OF 3 IMU FANS								X				
f. LOSS OF CABIN PRESS INTEGRITY [37]			X	X	X			X		X		
g. LOSS OF PPO ₂ CONTROL [78]								X	X			
h. LOSS OF 1 H ₂ O LOOP								X				
i. LOSS OF 2 H ₂ O LOOPS [28]					X			[77]				

©[090894-1675] ©[102402-5804C]

THIS RULE CONTINUED ON NEXT PAGE

FLIGHT RULES

A2-301

CONTINGENCY ACTION SUMMARY [HC] (CONTINUED)

FAILURE

	M A N U A L S S M E S / D	F A S T S E P	R T L S	T A L	A O A	A T O	B A I L O U T	ENTER FIRST DAY PLS	ENTER ASAP (PLS, SLS ELS)	ENTER IMMED.	MAX DEORBIT DELAY	
											1 ORB	24 HR
F. EECOM (CONCLUDED)								[84]	[1]	[1]		
2. <u>ATCS</u>												
a. LOSS OF 1 FREON LOOP								X				
b. LOSS OF 2 FREON LOOPS			[40]	[40]	[40]				[29]			
c. FREON PUMPS (IF FCL 1 PMP B AND FCL 2 PMP A FAILED) [87]								X				
d. LOSS OF FES (TOPPING AND HI LOAD EVAPS) [24][26]											[57]	[57]
e. LOSS OF HI LOAD EVAP								[49]				
f. RESERVED												
g. FREON TO CABIN H ₂ O LOOP LEAK								X				
h. LOSS OF 2 RFCA'S								[52]				
G. EGIL												
1. <u>CRYO</u>												
a. LOSS OF ALL CRYO O ₂ TANKS OR ALL CRYO H ₂ TANKS IMPENDING [51]			X	X	X				X			
b. H ₂ MANIFOLD OR TANK LEAK [43]											X	X
2. <u>FUEL CELL</u>												
a. LOSS OF 2 FUEL CELLS [32]								X				
b. FC PRIMARY H ₂ O FLOW TO ECLSS (3) [72]								X				
3. <u>EPDC</u>												
a. MN A AND B [46]			X									[53]
b. MN B AND C [46]			X									[53]
c. MN A AND C [46]			X									[53]
d. ANY MN, AC, OR CNTL BUS								[61] [67]				
e. MULTI-F ON AN AC BUS (NOT SHORTED)											X	[69]
f. CNTL CA1 [71]												X

@[020196-1810A] @[092503-5546B] @[032504-6204]

THIS RULE CONTINUED ON NEXT PAGE

FLIGHT RULES

A2-301

CONTINGENCY ACTION SUMMARY [HC] (CONTINUED)

FAILURE

	M A N U A L S S M E S / D	F A S T S E P	R T L S	T A L	A O A	A T O	B A I L O U T	ENTER FIRST DAY PLS	ENTER ASAP (PLS, SLS ELS)	ENTER IMMED.	MAX DEORBIT DELAY	
											1 ORB	24 HR
H. MMACS								[84]	[1]	[1]		
1. <u>APU/HYD/WSB</u>												
a. LOSS OF 2 WSB								[48]				
b. LOSS OF 1 APU/HYD								[47]			[42]	[76]
c. LOSS OF 2 APU/HYD	[82]							[48]				[76]
d. DELETED												
e. IMPENDING LOSS OF ALL APU/HYD CAPABILITY	[82]		X	X	X			X	X			
2. <u>MECHANICAL</u>												
a. PBD CENTERLINE NOT WITHIN LIMITS [50]												X
b. ANY PBD LATCH GANG FAILED CLOSED								X				
c. LOSS OF ONE MOTOR ON TWO DIFFERENT PBD C/L OR BULKHEAD LATCH GANGS (NOT RECOVERABLE BY IFM)								X				
d. PBD C/L OR BULKHEAD LATCH GANG FAILS IN TRANSIT (NOT CLEAR OF ROLLERS)								X				
e. STARBOARD PBD FAILS CLOSED OR IN TRANSIT (READY-TO-LATCH INDICATORS PRESENT OR INSUFFICIENT CLEARANCE TO OPEN PORT DOOR)								X				
f. INABILITY TO CLOSE ET DOORS (NOT RECOVERABLE) [46]			X									
3. <u>LANDING/DECEL</u>												
a. CONFIRMED TIRE LEAK [79]								X				
b. ZERO FAULT TOLERANT FOR LANDING GEAR DEPLOY OR DIRECTIONAL CONTROL [80]								X				
4. <u>STRUCTURAL</u>												
a. THERMAL WINDOWPANE FAILURE			X									
b. PRESSURE OR REDUNDANT WINDOWPANE FAILURE								X				

@[111699-7070B] @[022604-6218]

THIS RULE CONTINUED ON NEXT PAGE

FLIGHT RULES

A2-301

CONTINGENCY ACTION SUMMARY [HC] (CONTINUED)

FAILURE

	M A N U A L S S M E S / D	F A S T S E P	R T L S	T A L	A O A	A T O	B A I L O U T	ENTER FIRST DAY PLS	ENTER ASAP (PLS, SLS ELS)	ENTER IMMED.	MAX DEORBIT DELAY		
								[84]	[1]	[1]	1 ORB	24 HR	
I. COMM													
1. LOSS OF ALL A/G VOICE												X	X
2. LOSS OF BOTH A/G VOICE AND CMD [36]							[64]	X				X	X
3. LOSS OF TLM (HDR AND LDR)												X	X
4. RESERVED													
5. LOSS OF CMD												X	
J. GNC/AERO													
1. TVC PROBLEM RESULTING IN HARDOVER ACTUATOR [35]	X												
2. <u>LOSS OF CONTROL</u>													
a. IN 1ST STG AND NOT REGAINED BY BFS [54]		X					X						
b. IN 2ND STG AND NOT REGAINED BY MAN TVC OR BFS ENGAGE [27]		X					X						
3. LOSS OF 4 OF 6 RHC CH												[21] [56] [76]	[55]
4. LOSS OF 2 AA's (LAT), 2 RGA's, OR 2 ADTA's (CONCRETE RUNWAY)												[76] [56]	
5. LOSS OF 3 AA's (LAT) 3 RGA's, OR 3 ELEV/BF FDBK's (SAME SURFACE)							X					[76] [56]	
6. LOSS OF 2 FCS CHANNELS (SAME SURFACE) (CONCRETE RUNWAY)							X					[76] [56]	
7. LOSS OF 3 ADTA's							X					[75] [76]	
8. LOSS OF 2 IMU's							X					[56] [76]	[22]
9. IMU DILEMMA													[53] [21]
10. LOSS OF 1 IMU, 1 TACAN, OR 1 MLS (1-STRING GPS VEHICLES)												[56] [85] [86]	
11. LOSS OF 1 IMU, 1 GPS, OR 1 MLS (3-STRING GPS VEHICLES)												[85]	

@[041196-1914] @[092602-5640] @[032807-8400] @[042507-8466B]

THIS RULE CONTINUED ON NEXT PAGE

FLIGHT RULES

A2-301

CONTINGENCY ACTION SUMMARY [HC] (CONTINUED)**LEGEND**

X	= PERFORM CONTINGENCY ACTION
[]	= NOTE
()	= QUANTITY

NOTES:

- [1] CERTAIN RAPID ENTRY CONDITIONS COULD REQUIRE ENTRY PRIOR TO MCC AND LANDING SITE NOTIFICATION.
- [2] COMM/DATA LINES TO SUPPORT LISTED REQUIREMENTS ALSO MANDATORY.
- [3] REFERENCE RULES {A3-51}, TRAJECTORY PROCESSING REQUIREMENTS, AND {A3-54}, TRAJECTORY SERVER ERRORS. @[032807-8400]
- [4] ASSUMES THREE UNRECOVERABLE GPC'S.
- [5] ACCEPT HIGHEST ABORT MODE AVAILABLE.
- [6] REFERENCE RULE {A5-108}, MANUAL SHUTDOWN FOR HYDRAULIC OR ELECTRICAL LOCKUP [HC]. @[ED]
- [7] SECOND STAGE ONLY (REF. RULES {A4-260}), RANGE SAFETY LIMIT AVOIDANCE ACTIONS.
- [8] REFERENCE RULE {A5-109}, MANUAL SHUTDOWN FOR TWO STUCK THROTTLES (NOT DUAL APU FAILURES) [HC]. @[ED]
- [9] TAL/AOA IS ACCEPTED TO PROTECT THE CONTINGENCY CG BOX. IF TAL/AOA DUMP MGMT WILL NOT RECOVER CG, CONTINUE UPHILL.
- [10] TO ALLOW TESTING JETS PRIOR TO ENTRY.
- [11] IF PRIOR TO OMS-1, PERFORM DELAYED ATO. FOR DIRECT INSERTION CUTOFF OMS-2 AT MINIMUM HP. FOR DELAYED ATO, THE RAISE ORBIT MANEUVER WILL NOMINALLY BE PLANNED FOR TTA = 2 (TIME TO APOGEE).
- [12] AFTER OMS-1. CUTOFF OMS-2 AT MINIMUM HP.
- [13] WHERE LEAK IN BOTH SIDES SAME PROPELLANT. IF LEAK RATE SUPPORTS (PROPELLANT ONLY) (IF RCS MUST SUPPORT TO A Q-BAR = 20).
- [14] AFTER DEORBIT TIG, TERMINATING BURN FOR THIS FAILURE REQUIRES DEORBIT 24 HOURS LATER.
- [15] SHALLOW ENTRY IF REQUIRED.
- [16] IF LEAK, PERFORM PERIGEE ADJUSTMENT AT PLANNED DEORBIT TIG IF LEAK RESULTS IN PROJECTED VIOLATION OF POD THERMAL CONSTRAINTS.
- [17] THIS HP ALLOWS DEORBIT OPPORTUNITY 24 HOURS LATER WITH WORST CASE ATT PROFILE (PTC).
- [18] DEORBIT DELAY ONLY REQUIRED IF RCS DOWNMODE CAPABILITY DOES NOT EXIST.
- [19] IF BOTH LEAKS IN SAME SIDE OR BOTH SIDES LEAKING BUT DIFFERENT PROPELLANT, PERFORM NOM.
- [20] IF UNABLE TO OBTAIN VIABLE GNC 3 OPERATION, ENTER ON BFS.
- [21] FAILURE PRECLUDES SINGLE FAULT TOLERANCE. DELAY TO VERIFY RM DECLARED FAILURES OR TO RESOLVE A DILEMMA CASE (REF. RULE {A8-7}, ENTRY SYSTEMS SINGLE-FAULT TOLERANCE VERIFICATION; AND RULE {A8-8}, ENTRY SYSTEMS RM DILEMMA).
- [22] A ONE-ORBIT WAVE-OFF MAY OR MAY NOT ALLOW SUFFICIENT TIME TO REGAIN SINGLE-FAULT TOLERANCE. IN MANY CASES, DELAYING UP TO ONE DAY WILL BE NECESSARY IN ORDER TO ALLOW SYSTEM COMPENSATION/RECONFIGURATION (REF. RULE {A8-7}, ENTRY SYSTEMS SINGLE-FAULT TOLERANCE VERIFICATION).
- [23] POST-MECO OMS-1/OMS-2, SHALLOW ENTRY IF REQUIRED.
- [24] IF NECESSARY TO RECONFIGURE TO REDUCED POWER LEVEL.
- [25] AFTER OMS-1, CHECKOUT OMS-2 WHEN MINIMUM HP. NEXT PLS DEORBIT WITH MIXED CROSSFEED IF REQUIRED.

THIS RULE CONTINUED ON NEXT PAGE

FLIGHT RULES**A2-301 CONTINGENCY ACTION SUMMARY [HC] (CONTINUED)**

- [26] GO TO ORBIT AND OPEN PLBD'S ASAP.
- [27] ATTITUDE ERROR (>3 DEGREES IN PITCH OR YAW OR >10 DEGREES IN ROLL) WITHOUT CONVERGING RATES OR RATES GREATER THAN 3 DEG/SEC WITHOUT CORRESPONDING ATTITUDE ERRORS (REF. RULE {A8-1}, FCS DOWNMODE).
- [28] IMMEDIATE POWERDOWN REQUIRED.
- [29] POWER DOWN TO SURVIVAL POWER LEVEL.
- [30] DELAY IF REQUIRED TO RECONFIGURE DPS TO TWO PASS AND ONE BFS OR ALLOW 3.5 HOURS OF GPC COOLDOWN TO REGAIN ALL GPC'S.
- [31] IF A 2-SIGMA CONFIDENCE LEVEL OF ACHIEVING AOA CAPABILITY EXISTS. (REF. RULE {A5-157}, MPS LOW LEVEL CUTOFF SENSORS FAILED DRY [HC]). @[CR 7354A]
- [32] POWER DOWN FOR SINGLE FC ENTRY.
- [33] RESERVED.
- [34] IF INSUFFICIENT DELTA V AVAILABLE TO ACHIEVE ATO, PERFORM AOA SHALLOW OMS-1,-2.
- [35] REFERENCE RULE {A8-2}, SSME THRUST VECTOR CONTROL (TVC) HARDOVER.
- [36] REFERENCE RULES {A11-52A AND B}, LOSS OF BOTH VOICE AND COMMAND.
- [37] WITH CABIN AT 14.7 PSIA AND BOTH 14.7 PSI REGULATORS CLOSED, DP/DT DECAY RATE > 0.15 PSI/MIN, RTLS OR TAL. IF ≤ 0.15 AND > 0.02 PSI/MIN PLS OR AOA (REF. RULE {A17-201}, CABIN PRESSURE INTEGRITY [HC]). @[ED] @[ED]
- [38] OTHER OPTIONS AND PRIORITIES PER RULE {A4-109}, DEORBIT PRIORITY FOR EOM WEATHER.
- [39] LOSS OF BOTH CABIN FANS WILL REQUIRE IMMEDIATE POWERDOWN AND EXTENSIVE HARDWARE CYCLING TO OBTAIN ORBIT AND ENTRY.
- [40] LIMITING TIME OF ~18 MINUTES (BASED ON 2.76 KWH/FC FOR FC FLOOD WITHOUT PURGING).
- [41] ASSUMES PLBD NOT OPEN.
- [42] REF. RULE {A10-23A}, APU ENTRY START TIME [HC]. @[ED]
- [43] DELAY DEORBIT TO DEplete A LEAKING H₂ TANK OF ANY SIZE. IF TANK CANNOT BE DEPLETED OR IF LEAK IS IN MANIFOLD, DELAY DEORBIT TO ALLOW PRESSURE BLOWDOWN TO REDUCE LEAK RATE TO <1 LB/HR. REFERENCE RULE {A9-260C}.1, CRYO SYSTEM LEAKS [CIL].
- [44] DELAYED ATO IF SUFFICIENT PROPELLANT AVAILABLE IN BLOWDOWN. FOR DELAYED ATO, THE RAISE ORBIT MANEUVER WILL NOMINALLY BE PLANNED FOR TTA = 2 (TIME TO APOGEE).
- [45] RESERVED
- [46] RTLS UNTIL NEGATIVE RETURN BECAUSE OF INABILITY TO CLOSE ET DOORS. RTLS PRODUCES THE LEAST HEATING COMPARED TO OTHER ENTRY PROFILES, FOLLOWED BY NOMINAL ENTRY; TAL PRODUCES THE HIGHEST HEATING. @[022604-6218]
- [47] CONTINUE TO NEOM UNLESS A REVIEW OF THE FAILURE MODE AND REMAINING APU/HYDRAULIC SYSTEMS' CAPABILITY DETERMINES EARLY MISSION TERMINATION IS APPROPRIATE (REF. RULE {A10-21}, LOSS OF APU/HYDRAULIC SYSTEM(S) ACTIONS).
- [48] IF DEPLOYABLE PAYLOADS ARE ONBOARD, PERFORM NEXT PLS ENTRY AFTER ATTEMPTS HAVE BEEN MADE TO DEPLOY THE PAYLOADS. OTHERWISE ENTER FIRST DAY PLS (REF. RULES {A10-21}, LOSS OF APU/HYDRAULIC SYSTEM(S) ACTIONS, AND {A10-122}, LOSS OF WSB(S) ACTIONS. @[022604-6218]
- [49] IF FREEZEUP SUSPECTED, REMAIN ON ORBIT TO ATTEMPT TO THAW OUT THE HI-LOAD EVAPORATOR.
- [50] THE SIMULTANEOUS CLOSE PROCEDURE IS AN OPTION FOR THE EXCESSIVE OVERLAP CASE (REF. RULE {A10-207}, PLBD OVERLAP).
- [51] SELECT ABORT MODE WITH SHORTEST RETURN TIME.

THIS RULE CONTINUED ON NEXT PAGE

FLIGHT RULES**A2-301 CONTINGENCY ACTION SUMMARY [HC] (CONTINUED)**

- [52] IF BOTH LOOPS FAILED IN BYPASS OR MEDIUM FLOW
- [53] AFTER DEORBIT TIG, TERMINATE BURN FOR FAILURE IF HP > SAFE HP. REQUIRES DEORBIT 24 HOURS LATER
- [54] RATES > 5 DEG/SEC IN PITCH OR YAW. REFERENCE RULE {A8-54}, FIRST STAGE LOSS OF CONTROL DEFINITION. @[ED]
- [55] AT LEAST ONE CHANNEL REQUIRED EACH SIDE. REFERENCE RULE {A8-1001}, GNC GO/NO-GO CRITERIA.
- [56] IF ONE ORBIT DELAY NOT AVAILABLE, DELAY 1 DAY. FOR PROPELLANT LEAKS, IT MAY BE NECESSARY TO DELAY LONGER THAN ONE ORBIT IN ORDER TO ALLOW POD THERMAL ENVIRONMENT TO SUPPORT ENTRY.
- [57] IF TIG BETWEEN 45 AND 15 MINUTES AND ONE REV LATE DEORBIT IS AVAILABLE, REOPEN PLB DOORS AND WAVE OFF ONE REV. IF RADS ARE COLD SOAKED AND ONE REV LATE DEORBIT NOT AVAILABLE, UTILIZE THE COLD SOAK TO CONTINUE WITH PLANNED TIG. IF RADS ARE NOT COLD SOAKED AND ONE REV LATE IS NOT AVAILABLE, REOPEN PLB DOORS AND WAVE OFF 1 DAY. @[020196-1810A]
- [58] IF TOXIC COMBUSTION PRODUCTS CANNOT BE SATISFACTORILY REMOVED FROM THE CABIN ATMOSPHERE, THE CREW WILL REMAIN ON QDM/ACES UNTIL ORBITER EGRESS. EOM IS BASED UPON AVAILABLE N₂ CONSUMABLES FOR MAINTAINING THE O₂ CONCENTRATION WITHIN ACCEPTABLE LIMITS. REF. RULES {A13-157}, CABIN ATMOSPHERE CONTAMINATION FIRE/SMOKE; {A13-158}, CABIN ATMOSPHERE CONTAMINATION - HALON 1301 [HC]; AND {A17-254}, CABIN O₂ CONCENTRATION. @[070201-4726A] @[062305-6653] @[ED]
- ON ASCENT, FIRST DAY PLS WILL ONLY BE NECESSARY IF THE CABIN ATMOSPHERE CANNOT BE CLEANED UP. IF THE EXTENT OF THE DAMAGE TO EQUIPMENT AND WIRE BUNDLES IS UNKNOWN, EVEN IF THE ATMOSPHERE HAS BEEN CLEANED UP, A NEXT DAY PLS WILL BE PERFORMED TO MINIMIZE THE RISK OF THE OCCURRENCE OF AN ADDITIONAL FIRE OR ARC TRACKING. @[072795-1779] @[070201-4726A]
- [59] PROPELLANT LEAK ONLY
- [60] ELS WILL PROBABLY BE REQUIRED IF THE NEXT PLS OR SLS IS GREATER THAN 8 HOURS. AS LONG AS CABIN ENVIRONMENT IS ACCEPTABLE, A PLS WILL BE TARGETED. @[020196-1810A]
- [61] CAUSES LOSS OF ONE MOTOR IN EACH OF TWO SEPARATE PLBD LATCH GANGS (REF. RULE {A10-209B}), PLBD RULE REFERENCE MATRIX). DC AND AC SUB-BUSES THAT CAUSE THIS FAILURE ARE:
MNA MPC1, MMC1, MMC3
MNB MPC2, MMC2, MMC4
MNC MPC3, MMC2, MMC4
AC1 MMC1, MMC3
AC2 MMC2, MMC4
AC3 MMC2, MMC4
- [62] ENTER FIRST DAY PLS UNLESS DELTA V IMPROVEMENT POSSIBLE.
- [63] PERFORM PERIGEE ADJUST BURN SEPARATION.
- [64] ORBIT 2 DEORBIT REQUIRED. (REF. RULE {A11-52}, LOSS OF BOTH VOICE AND COMMAND.)
- [65] RESULTS IN LOSS OF TWO FCS CHANNELS
- [66] EXCEPT COMBINATION OF MDM'S FF4 AND ANY OTHER FF MDM. OTHERWISE, THE FAILURE OF ANY COMBINATION OF MDM'S FF1, FF2, OR FF3 WILL RESULT IN THE LOSS OF TWO IMU'S. MDM IFM MAY BE PERMITTED TO MEET IMU REQUIREMENT. REFERENCE RULE {A7-109}, IN-FLIGHT MAINTENANCE (IFM). @[090894-1684]
- [67] ONE FAILURE AWAY FROM LOSS OF CAPABILITY TO START/RUN TWO APU/HYD SYSTEMS. DC BUSES THAT CAN CAUSE THIS CONDITION ARE: CNTLAB1, CNTLAB2, CNTLBC1, CNTLBC2, CNTLCA1, CNTLCA2, MNA ALC1, AND MNB ALC2. @[092503-5546B]
- [68] REFERENCE RULE {A9-158B}, AC POWER TRANSFER CABLE.
- [69] IF REQUIRED TO MAINTAIN TWO-FC ENTRY CAPABILITY

THIS RULE CONTINUED ON NEXT PAGE

FLIGHT RULES

A2-301 CONTINGENCY ACTION SUMMARY [HC] (CONTINUED)

- [70] FIRST DAY PLS FOR CONFIRMED, UNRECOVERABLE LOSS OF TWO AFT RCS PITCH JETS, SAME AXIS, SAME POD (N/A YAW JETS).
- [71] LOSS OF CNTL CA1 LOSES BFS ENGAGE CAPABILITY FOR GPC 3 AND 5. A DELAY WILL BE INVOKED TO SWITCH BFS MACHINES. REFERENCE RULE {A7-53B}, ON-ORBIT BFS MANAGEMENT GUIDELINES [HC]. @[ED]
- [72] LOSS OF COMPLETE PRIMARY SYSTEM MAY HAVE RESULTED FROM FREEZING OF THE FC H2O RELIEF PANEL. THIS COULD ALSO CAUSE LOSS OF OVERBOARD RELIEF AND LEAVE ONLY THE ALTERNATE SYSTEM FOR FC H₂O REMOVAL. REFERENCE RULE {A9-1001}, ELECTRICAL GO/NO-GO CRITERIA [HC].
- [73] RESERVED
- [74] ENTER NEXT PLS IF A SINGLE ELECTRICAL FAILURE (AC BUS) COULD CAUSE THE LOSS OF AIR COOLING TO TWO AVIONICS BAYS.
- [75] DELAY TO VERIFY POWER, MDM, AND BITE RELATED FAILURES, AND TO ASSESS THE RISKS OF FLYING THETA LIMITS VS. INCORPORATING THE LAST ADTA (REF. RULE {A8-7}, ENTRY SYSTEMS SINGLE-FAULT TOLERANCE VERIFICATION, AND RULE {A8-111B}, GNC AIR DATA SYSTEM MANAGEMENT [CIL]).
- [76] DELAY TO TARGET FOR REQUIRED RUNWAY (REF. RULE {A2-207}, LANDING SITE SELECTION [HC]).
- [77] A LANDING WILL BE REQUIRED WITHIN 4 HOURS OF THE FAILURE.
- [78] PLS REQUIRED IF AUTO/MANUAL PPO2 CONTROL CANNOT MAINTAIN AEROMED MINIMUM (REF. RULE {A13-53A}.1, MINIMUM PPO2 CONSTRAINTS [HC]) AND LESS THAN 30 PERCENT O₂ AT TOUCHDOWN. ELS REQUIRED IF 40 PERCENT O₂ IS EXPECTED TO BE EXCEEDED PRIOR TO NEXT PLS TOUCHDOWN.
- [79] ENTER NEXT PLS IF TIRE PRESSURE WILL BE BELOW LOSS LIMIT NEXT PLS LANDING OPPORTUNITY PLUS 2 DAYS (REF. RULE {A10-142}, TIRE PRESSURE [CIL] [HC]). @[022604-6218]
- [80] LANDING GEAR DEPLOY METHODS INCLUDE HYDRAULIC AND TWO PYRO SYSTEMS. DIRECTIONAL CONTROL INCLUDES NWS AND BRAKES. @[022604-6218]
- [81] RESERVED @[102402-5804C]
- [82] REFERENCE RULE {A8-61}, SSME SHUTDOWN DUE TO HYDRAULIC SYSTEM FAILURES [HC]. @[ED]
- [83] FOR LOSS OF TWO MMU'S DURING ASCENT, CONSIDERATION WILL BE GIVEN TO PERFORMING THOSE MISSION OBJECTIVES THAT DO NOT REQUIRE MASS MEMORY RESIDENT FUNCTIONS (I.E., GNC 2, SM, SM ROLL-IN DISPLAYS, OR TELEMETRY/DECOM FORMAT LOADS).
- [84] REFERENCE RULE {A2-2}, ABORT LANDING SITE REQUIREMENTS. IF FD 1 LANDING SITE IS GO, LAND FD 1. IF FD 1 LANDING SITE IS NO-GO, IF POSSIBLE, DELAY DEORBIT TO FD 2. @[121593-1590]
- [85] DEORBIT WILL NOT BE DELAYED IF REDUNDANT HIGH SPEED TRACKING IS AVAILABLE PER RULE {A3-3}, HIGH SPEED TRACKING LAUNCH AND LANDING REQUIREMENTS. @[041196-1914] @[ED] @[092602-5640] @[032807-8400]
- [86] GPS PROVIDES REDUNDANCY FOR TACAN LRU 2 ON OV-104 ONLY. @[092602-5640]
- [87] ENTER FIRST DAY PLS IF FCL 1 PUMP B AND FCL 2 PUMP A FAILED. BOTH REMAINING PUMPS ARE POWERED BY AC 1. THE NEXT WORST FAILURE (LOSS OF AC1) WILL RESULT IN LOSS OF BOTH FCL'S AND COULD RESULT IN LOSS OF CREW/VEHICLE. @[032504-6204]
- [88] FOR A HE TANK FAIL, ENTER FIRST DAY PLS IF SINGLE POD QUANTITY REDLINE REQUIREMENT IS VIOLATED @[042507-8466B]

Hazard Reports ORBI 211, Landing Mishaps Due to Failures of Guidance, Navigation and Control (GN&C) Functions/Landing Aids, Adverse Landing Conditions, or Pilot Error; ORBI 321, Crew Incapacitation from Heat Strain; ORBI 344, Water Spray Boiler System Failures Cause Loss of Crew and Vehicle; and ORBI 501, Flammable/Explosive Atmosphere created by External Leakage of Hypergolic Fluids in Reaction Control Subsystem (RCS) and/or in Orbital Maneuvering system (OMS), reference this rule. @[032807-8400]

This rule is referenced by Rules {A1-107}, LANDING OPPORTUNITIES; {A8-55}, ASCENT/ENTRY RCS CONTROL REQUIREMENTS [HC]; and {A8-1001}, GNC GO/NO-GO CRITERIA. @[ED]

A2-302 THROUGH A2-310 RULES ARE RESERVED

FLIGHT RULES

SPACEHAB OPERATIONS MANAGEMENT

A2-311

SPACEHAB SAFETY DEFINITION AND MANAGEMENT

A. DEFINITIONS: @[102793-1552]

1. **RAPID SAFING** - SECURING OF ANY PAYLOAD ELEMENT IN A TIME-CRITICAL MANNER AS DEFINED BY THE SPACE SHUTTLE PROGRAM FOR ABORTS AND CONTINGENCY RETURN OF THE ORBITER. @[111501-4981E]
2. **UNSAFE** - ONLY TWO INHIBITS CAN BE VERIFIED TO A CATASTROPHIC HAZARD.
3. **HAZARDOUS** - ONLY ONE INHIBIT CAN BE VERIFIED TO A CATASTROPHIC HAZARD.
4. **SAFE** - SHALL BE DEFINED AS ANY ONE OF THE FOLLOWING:
 - a. AT LEAST THREE INHIBITS REMAIN TO A CATASTROPHIC HAZARD, TWO OF WHICH MUST BE MONITORABLE.
 - b. RESTRAINT/SECURING OF ANY PAYLOAD ELEMENT CAPABLE OF PENETRATING A MODULE AS A RESULT OF ORBITER INDUCED ENTRY/LANDING LOADS.

Reference: NSTS 18798A, MA2-96-190, "CONTINGENCY RETURN AND RAPID SAFING," memo dated January 9, 1997. @[111501-4981E]

THIS RULE CONTINUED ON NEXT PAGE

FLIGHT RULES

A2-311

SPACEHAB SAFETY DEFINITION AND MANAGEMENT
(CONTINUED)

B. GENERALIZED RESPONSES TO UNSAFE/HAZARDOUS CONDITIONS:

1. **RAPID SAFING** - FOR SPACEHAB, CONTINGENCY DEACTIVATION/EGRESS PROCEDURES ARE USED FOR OFF NOMINAL/EMERGENCY SITUATIONS REQUIRING AN EXPEDITED RESPONSE TO SECURE THE MODULE FOR A SAFE ENTRY AS DEFINED IN RULE {A2-329}, SPACEHAB DEACTIVATION/ENTRY PREP. @[102793-1552] @[111501-4981E] @[ED]
2. **UNSAFE** - NO IMMEDIATE ACTION IS REQUIRED. IF POSSIBLE, RESTORATION OF THE SAFE CONDITION WILL NORMALLY BE ATTEMPTED, BUT SUCH ACTION WILL NOT BE ALLOWED TO JEOPARDIZE MISSION SUCCESS.
3. **HAZARDOUS** - QUICK RESPONSE IS MANDATORY: TAKE POSITIVE ACTION TO RESTORE THE SYSTEM TO NO WORSE THAN AN UNSAFE CONDITION. IF UNSUCCESSFUL, TERMINATE THE EXPERIMENT AS SOON AS POSSIBLE (ASAP). @[111501-4981E]

FLIGHT RULES

A2-312

REAL-TIME SAFETY COORDINATION

- A. ANY SPACEHAB PAYLOAD FAILURE WHICH POSES AN IMMEDIATE THREAT TO ORBITER SYSTEMS OR CREW HEALTH (FOR EXAMPLE: BROKEN GLASS, TOXIC SPILLS, SMOKE/FIRE, ANIMAL WASTE, AND FREE WATER) WILL BE COORDINATED BY THE CREW DIRECTLY WITH HOUSTON FLIGHT THROUGH EECOM AND SURGEON, WITH ASSISTANCE FROM HOUSTON PAYLOADS/ACO. HOUSTON PAYLOADS/ACO WILL IMMEDIATELY NOTIFY THE PAYLOAD OPERATIONS CONTROL CENTER (POCC) AND WILL PROVIDE ANY ADDITIONAL COORDINATION WITH OTHER MCC FCT DISCIPLINES, IF NECESSARY. ©[060800-7124] ©[111501-4981E]

This approach allows the MCC FCT to prioritize, coordinate, and address the immediate health threat to the crew. All payload-specific questions will be relayed to the POCC. It is understood that the crew will work the appropriate onboard contingency procedures to reduce the immediate threat without talking to the ground first. Crew indication of an electrical short is fire/smoke (covered in paragraph A), popped circuit breaker (covered in paragraph B), or maintained increase in current (covered in paragraph B). For coordination of electrical problems/shorts, reference Rule {A9-355}, FUSE/CIRCUIT BREAKER MANAGEMENT. ©[111501-4981E] ©[ED]

- B. ANY PAYLOAD FAILURES, WHICH ORIGINATE FROM PAYLOAD HARDWARE AND DO NOT POSE AN IMMEDIATE THREAT TO ORBITER SYSTEMS OR CREW HEALTH AS DEFINED IN PARAGRAPH A, WILL BE COORDINATED BY THE CREW DIRECTLY WITH THE POCC. THE POCC WILL IMMEDIATELY NOTIFY HOUSTON PAYLOADS/ACO OF ANY SITUATION AFFECTING SAFETY (I.E., LOSS OF CONTAINMENT LEVEL, LOSS OF REDUNDANCY, POTENTIAL SHORT WITHIN PAYLOAD HARDWARE, ETC.). IF THE SITUATION IS NOT WITHIN THE SCOPE OF THE PERMISSION-DEFINED FLIGHT RULES AND PROCEDURES, NO ACTION (OTHER THAN REMOVAL OF THE HAZARD POTENTIAL) WILL BE TAKEN WITHOUT FULL AND PRIOR COORDINATION WITH THE MCC FCT. ©[111501-4981E]

Safety related payload failures which can be addressed directly between the crew and POCC are those which originate in payload equipment and which do not affect the atmosphere leading to an immediate threat to orbiter systems or crew health. These payload-originated failures must be specifically addressed in permission-defined flight rules and procedures. Although the MCC Flight Director is ultimately responsible for the safety of the orbiter/Spacehab and crew, it is recognized that the POCC has the expertise on and sufficient data/insight into the payload hardware. As soon as the POCC is cognizant of a payload safety situation; however, the MCC must be notified for further assessment of orbiter/Spacehab and crew impacts. The only action(s) which may be taken that is (are) not in the scope of the permission defined flight rules or procedures and without prior coordination with the MCC is (are) to eliminate the hazard cause(s) (i.e., remove power, etc.). For coordination of electrical problems/shorts, reference Rule {A9-355}, FUSE/CIRCUIT BREAKER MANAGEMENT. ©[060800-7124] ©[111501-4981E] ©[ED]

FLIGHT RULES

A2-313

GROUND COMMANDING

- A. ALL PAYLOAD COMMANDING WILL BE COORDINATED WITH HOUSTON FLIGHT THROUGH HOUSTON PAYLOADS/ACO. NOMINALLY, POCC COMMANDING WILL BE THROUGHPUT COMMANDS. TWO-STAGE COMMANDING AND CONTINGENCY COMMANDING WILL REQUIRE COORDINATION WITH INCO. ©[060800-7125] ©[111501-4981E] ©[111705-7054]

HOUSTON FLIGHT is responsible for all commanding to the shuttle vehicle, and all commanding must be done with the cognizance of HOUSTON FLIGHT. The specific coordination tasks and configuration authority is usually delegated on Spacehab missions to the Instrumentation And Communications Officer, call sign HOUSTON INCO, HOUSTON PAYLOADS/ACO, and their support personnel. Payload commanding will be identified permission with POCC command windows reflected in the command timeline. Nominally, the Payload Operations Control Center (POCC) will only be enabled during these permission-defined windows. If off-nominal conditions arise real time which necessitate sending commands outside the permission-defined windows, coordination between the POCC and HOUSTON PAYLOADS/ACO will be required to discuss these changes to the Command Timeline during the Tracking and Data Relay Satellite (TDRS) pre-pass briefing and/or just prior to the command sequence. As a minimum, the need to use a permission scheduled command window will be identified to HOUSTON PAYLOADS/ACO during the TDRS pre-pass briefing. ©[111501-4981E] ©[111705-7054]

- B. IF COMMAND VOLUMES ARE SUCH THAT COMMAND COORDINATION IS A SIGNIFICANT DETRIMENT TO MISSION SUCCESS, CONSIDERATION WILL BE GIVEN TO SIMULTANEOUS (SIMO) POCC COMMANDING THROUGHOUT EACH TDRS PASS UNDER THE FOLLOWING CONDITIONS. SIMO COMMANDING MUST BE APPROVED BY HOUSTON FLIGHT.
1. THE COMMANDING PARTY IS RESPONSIBLE FOR DETECTING AND RETRANSMITTING ANY LOST COMMANDS.
 2. ALL POCC HAZARDOUS COMMANDING WILL BE COORDINATED WITH HOUSTON PAYLOADS/ACO PRIOR TO COMMAND INITIATION.

THIS RULE CONTINUED ON NEXT PAGE

FLIGHT RULES

A2-313

GROUND COMMANDING (CONTINUED)

3. LARGE COMMAND BLOCKS WILL BE COORDINATED.

SIMO commanding includes two or more POCC's enabled for commanding. The addition of the payload throughput buffer in the systems management (SM) GPC allows for continuous commanding by both the MCC and the POCC's; therefore, MCC and POCC commanding is not considered SIMO commanding. ©[060800-7125]

SIMO commanding is possible, with the risk of the ground system rejecting commands that have insufficient spacing. The ground system is set to allow a maximum of one command per second. If this rate is exceeded, then the ground system will reject the additional commands. This method of commanding is less desirable than a more structured method where ground system rejects are procedurally avoided. If the overhead of the coordination is judged to be a significant impact to payload operations and the overhead of retransmitting the commands is judged to be less, consideration will be given to SIMO commanding. Due to safety considerations, hazardous commands must always be coordinated. Since large blocks of commands require more command system time, more care must be used to avoid ground system rejects and loss of these types of commands; therefore, large command blocks will still require coordination. ©[060800-7125]

C. IF TWO-STAGE POCC COMMANDING IS REQUIRED, POCC COMMANDING AND MCC COMMANDING TO THE SAME GENERAL PURPOSE COMPUTER (GPC) TWO-STAGE BUFFER WILL BE MANAGED SO THAT ONLY ONE IS COMMANDING AT A TIME. ©[111501-4981E]

A POCC may require two-stage commanding for critical commanding or troubleshooting command problems. To avoid two-stage buffer contention, POCC and MCC commanding will be coordinated. ©[060800-7125]

D. FOR FAILURE OF THE SPACEHAB FAN IN USE OR FAILURE OF A WATER COOLING LOOP PUMP DURING ASCENT/ENTRY, CONTINGENCY COMMANDS WILL BE SENT TO SWAP FANS OR PUMPS ASAP POST MAIN ENGINE CUT OFF (MECO) OR DURING ENTRY PER RULES {A17-706}, SPACEHAB FAN CONFIGURATIONS OR {A18-553}, SPACEHAB SUBSYSTEM PUMP OPERATIONS.

Air circulation is required to maintain module airflow over the Spacehab fire/smoke detectors. Without switching fans following the loss of the fan in use, all fire/smoke detection capability is lost. The Spacehab water-cooling loop is required for achieving thermal control of the module environment. Without switching pumps following a pump failure, all module cooling is lost. Without smoke detection or adequate cooling, the module would need to be powered down. Powering the module down has the potential for a significant mission success impact. No on-board command capability exists in OPS 1 or OPS 3 (SM GPC not available), so reconfiguration during ascent/entry must be performed via ground commands. The water line heaters must be turned ON, to prevent freezing of the PLHX, if the PLBD's are open. ©[111501-4981E]

FLIGHT RULES

A2-314

SPACEHAB MINIMUM DURATION FLIGHT CRITERIA

FOR AN ORBITER FREON LOOP TO SPACEHAB WATER LOOP LEAK, THE SPACEHAB MODULE WILL BE PREPARED FOR ENTRY, EGRESSED, ISOLATED, AND A MINIMUM DURATION FLIGHT (MDF) WILL BE INSTITUTED. @[111501-4981E]

Entry prep and egress of the Spacehab module are performed to configure the module for entry and to avoid the possibility of the crew being exposed to toxic Freon. Although the water loop is compatible with Freon 21, a relatively high pressure in the water loop (caused by Freon leaking into the water loop) increases the chances of the water loop developing a leak into the module and exposing the crew to Freon.

An MDF is called for a heat exchanger leak between dissimilar fluids because the possibility exists that a generic problem, such as corrosion, exists in the heat exchanger. This problem could eventually result in a total loss of the heat exchanger and orbiter due to the subsequent loss of two Freon loops. The risk of losing the heat exchanger does not warrant a next primary landing site (PLS) but does warrant an MDF. @[111501-4981E]

A2-315

POWERING OFF AND REPOWERING SPACEHAB EQUIPMENT

A. SPACEHAB EQUIPMENT/COMPONENTS WILL BE POWERED OFF IF THEY HAVE FAILED AND HAVE ON/OFF CAPABILITY. REFERENCE FAILURE DEFINITIONS IN SECTION 9, SPACEHAB SUPPORT AND SPACEHAB ELECTRICAL POWER SUBSYSTEM (EPS) MANAGEMENT. @[111501-4981E]

Failed equipment will be powered off to prevent possible intermittent operation and/or shorting. Powering off failed equipment also saves power. Equipment powered by the Emergency Bus cannot be powered off unless both the PL AUX and PL AFT B busses are powered off.

B. SPACEHAB EQUIPMENT NOT CONCERNED WITH SAFETY MAY BE OPERATED OUTSIDE THE QUALIFICATION LIMITS BASED ON CUSTOMER CALL.

Operation to the qualification limits may result in unpredictable operation and/or violation of lifetime limits. The Spacehab customer has chosen to allow for equipment operations (ops) outside of qualification limits based on preflight test experience.

C. REPOWERING SPACEHAB EQUIPMENT AFTER FAILURE OR AFTER EXCEEDING QUALIFICATION TEST LIMITS WILL BE ON MCC CALL ONLY.

The MCC has the ability to evaluate data on the equipment. Consideration must be given to possible damage to orbiter systems or further damage to the affected equipment if repowered. MCC may give consideration to an inflight maintenance (IFM) procedure, trend data, etc., after careful review.

FLIGHT RULES

A2-316

ORBITER-TO-SPACEHAB HATCH CONFIGURATION

- A. FOR THOSE OPERATIONS REQUIRING THE ORBITER INNER HATCH OR THE SPACEHAB HATCH TO BE CLOSED AND LATCHED, ALL CREWMEMBERS ARE REQUIRED TO REMAIN ON THE ORBITER SIDE OF THE CLOSED AND LATCHED HATCH. ©[111501-4981E]

There is no air exchange between the orbiter and the Spacehab module with the hatch(es) closed. In addition, conditions could occur, such as an airlock leak or hatch malfunction, which could trap a crewmember in the Spacehab module.

- B. THE SPACEHAB HATCH WILL REMAIN OPEN FOR NOMINAL OPERATIONS, UNLESS REQUIRED TO BE CLOSED FOR EXTRAVEHICULAR ACTIVITY (EVA) OPERATIONS OR DOCKING OPERATIONS.

Reference: Rule {A2-317}, EVA CONSTRAINTS.

- C. THE MODULE WILL BE CONFIGURED FOR A SAFE ENTRY AS REQUIRED BY PAYLOAD SAFETY PRIOR TO CLOSING THE HATCH.

The module is configured for safe entry (i.e., all penetration hazards restrained/stowed) in the event the module cannot be re-entered. ©[111501-4981E]

FLIGHT RULES

A2-317

EVA CONSTRAINTS

- A. PREBREATHING AT 10.2 PSI CAN BE DONE WITH THE SPACEHAB MODULE AT 14.7 PSI AND THE SPACEHAB HATCH CLOSED OR WITH THE SPACEHAB AT 10.2 PSI. THE STRATEGY WILL BE DETERMINED ON A MISSION SPECIFIC BASIS AND DOCUMENTED IN THE FLIGHT SPECIFIC ANNEX. ©[111501-4981E]

The minimum design operating pressure for Spacehab components is 10 psia. Freon flow to the payload heat exchanger will be reduced in order to keep the orbiter cabin within temperature limits. This is accomplished by moving one of the orbiter's Freon flow proportioning valves (FPV's) from the nominal on-orbit payload heat exchanger position to the interchanger position. This will reduce the cooling capability in the Spacehab water loop.

Spacehab may be able to operate at the reduced pressure (and cooling level) of 10.2 psi if these conditions are compatible with experiment science and hardware requirements and if overall module thermal loads allow. The benefit of open hatch operations at 10.2 psi is increased crew access time to the module during prebreathe.

Assessment of 10.2 psi prebreathe strategy will be conducted on a flight specific basis. ©[111501-4981E]

- B. SPACEHAB LEAK DURING EVA ©[111501-4981E]

SCHEDULED/UNSCHEDULED EVA

1. IF A SPACEHAB CABIN LEAK OCCURS DURING AIRLOCK/TUNNEL ADAPTER DEPRESS WHICH IS NOT UNDERSTOOD OR WHICH IS PREDICTED TO REDUCE CABIN PRESSURE BELOW 10.2 POUNDS PER SQUARE INCH ABSOLUTE (PSIA) BEFORE NOMINAL EVA COMPLETION TIME, THE EVA/AIRLOCK DEPRESS WILL BE TERMINATED.
2. IF A SPACEHAB CABIN LEAK OCCURS DURING EVA, THE EVA WILL BE TERMINATED AND THE AIRLOCK/TUNNEL ADAPTER REPRESSURIZED BEFORE THE SPACEHAB IS PREDICTED TO REACH 10.2 PSIA.

THIS RULE CONTINUED ON NEXT PAGE

FLIGHT RULES

A2-317 **EVA CONSTRAINTS (CONTINUED)**

CONTINGENCY EVA

3. IF THE EVA IS AN ORBITER CONTINGENCY EVA, IT WILL CONTINUE AND THE SPACEHAB WILL BE UNPOWERED EXCEPT FOR EMERGENCY POWER (AUX A AND AFT B) PRIOR TO REACHING 10 PSIA.

The Spacehab systems are certified to operate above a cabin pressure greater than or equal to 10 psia. For example, a leak rate of 7.3 lb/hr for 4 hours based on 14.7 equivalent will bring the cabin to 10 psia. PL AUX A and AFT MN B provide redundant power to Spacehab sensors. AFT MN B is the only source of power to the Spacehab water line heaters that protect the Spacehab water line from freezing. Additionally, smoke/fire detection sensors are powered by the emergency circuits.

- C. EXPERIMENT IMPACTS TO A 10.2 PSI PREBREATHE ARE DOCUMENTED IN THE FLIGHT SPECIFIC ANNEX. @[111501-4981E]

A2-318 **ORBITAL MANEUVERING SYSTEM/REACTION CONTROL SYSTEM (OMS/RCS) CONSTRAINTS**

ORBITAL MANEUVERING SYSTEM/REACTION CONTROL SYSTEM (OMS/RCS) CONSTRAINTS ARE EXPERIMENT COMPLEMENT DEPENDENT AND ARE DOCUMENTED IN THE FLIGHT SPECIFIC ANNEX. @[111501-4981E]

A2-319 **CONTAMINATION AND MICROGRAVITY CONSTRAINTS**

ANY CONSTRAINTS SPACEHAB HAS ON WATER DUMPS, FES OPS, OMS/RCS LEAKS, ORBITER LEAKS, OR FUEL CELL PURGES WILL BE DOCUMENTED IN THE FLIGHT SPECIFIC ANNEX. @[111501-4981E]

FLIGHT RULES

A2-320

COMMAND AND DATA SYSTEM CONSTRAINTS

- A. FOR A NONRECOVERABLE LOSS OF THE DATA MANAGEMENT UNIT (DMU), SPACEHAB ACTIVITIES WILL CONTINUE. HOWEVER, THE WATER LINE HEATERS WILL BE TURNED ON TO PREVENT FREEZING. @[111501-4981E]

Loss of the DMU results in loss of all Payload Data Interleaver (PDI) data to the Orbiter Display System, Payload General Support Computer (PGSC) downlink, and all subsystem control capabilities (except that which is routed through the orbiter multiplexer/demultiplexer (MDM)). All experiment data to the DMU would also be lost. However, safety critical monitoring and control is all routed through the PL MDM and Caution and Warning Electronics Assembly (CWEA). Water line heaters are turned on because a DMU failure results in loss of water pump monitoring capability.

- B. FOR LOSS OF THE MODULE SYSTEMS PGSC CAPABILITY, SPACEHAB OPERATIONS WILL CONTINUE.

The PGSC is used for backup monitoring only. Primary monitoring still exists at the Orbiter Display System, as well as through the Fault Detection and Annunciation (FDA) and CWEA systems. Ground monitoring via the PDI downlink is also still available.

- C. PDI DECOM LOSS IMPACTS WILL BE DOCUMENTED IN THE FLIGHT SPECIFIC ANNEX. @[111501-4981E]

FLIGHT RULES

A2-321

SPACEHAB AIR-TO-GROUND (A/G) USAGE

- A. THE STANDARD ORBITER A/G CHANNEL (A/G 1) WILL BE USED FOR ANY DISCUSSIONS RELATED TO SPACEHAB SUBSYSTEMS. THE SSP CAPCOM WILL BE THE GROUND COMMUNICATOR. @[111501-4981E]

Since the module is integrated to the orbiter, it is necessary that any systems issues be discussed on A/G 1, which all Space Shuttle Program (SSP) flight control team members monitor. In addition, this strategy guarantees that emergency/time critical issues are discussed on the prime A/G loop.

- B. EITHER A/G 1 OR A/G 2 WILL BE USED FOR ANY DISCUSSIONS RELATED TO SPACEHAB EXPERIMENTS DEPENDING ON THE AMOUNT OF A/G USAGE. A SPACEHAB CREW INTERFACE COORDINATOR (CIC) WILL BE THE GROUND COMMUNICATOR.

Spacehab is responsible for all experiment procedures and the experiment flight data file. Therefore, the most efficient communication path is directly between the crew and the CIC. The CIC will be in the JSC POCC. The Flight Director will decide which A/G loop is the most appropriate to use. @[111501-4981E]

- C. ANY SAFETY-RELATED ISSUES, INCLUDING THOSE RELATED TO EXPERIMENTS, WILL BE CONDUCTED ON THE PRIME A/G LOOP (A/G 1). @[111501-4981E]

Self-explanatory.

- D. ROUTINE CONVERSATIONS DURING SPACEHAB EXPERIMENTS OPERATIONS BETWEEN THE CIC AND THE CREW ON A/G 1 OR A/G 2 WILL NORMALLY BE INITIATED BY CREW REQUEST. THE FOLLOWING RESTRAINTS SHALL APPLY TO CIC PROTOCOL AND A/G 1 OR A/G 2 USAGE.

THIS RULE CONTINUED ON NEXT PAGE

FLIGHT RULES

A2-321 SPACEHAB AIR-TO-GROUND (A/G) USAGE (CONTINUED)

1. THE VOICE PROTOCOL SHALL BE THE SAME AS THAT USED BY THE JSC CAPCOM.
2. THE SPACEHAB OPERATIONS DIRECTOR (SHOD) IS RESPONSIBLE FOR APPROVING ALL CALLS INITIATED FROM THE GROUND TO THE CREW.
3. DIRECT EXPERIMENTER CALLS TO THE CREW ON A/G 1 OR A/G 2 SHALL BE UPON CREW REQUEST ONLY.
4. THE CALL SIGN FOR THE SPACEHAB POCC SHALL BE "SPACEHAB POCC."
5. OCA S-BAND (MFX) OPERATIONS WILL TAKE PRECEDENCE OVER ROUTINE SPACEHAB A/G 2 USAGE.
6. EXCEPTIONS TO THIS RULE ARE DOCUMENTED IN THE FLIGHT SPECIFIC ANNEX.

Past flight crew comments on overuse of A/G by payloads point out the need for more rigid control of the traffic and voice protocol. In addition, use of the OCA S-Band (OCA Ku-Band is nominal) adds complexity to the scheduled use of one of the A/G links. With the many users as well as the many experimenters on a Spacehab flight, careful definition of the A/G 1 or A/G 2 usage is required. This rule represents an agreed to baseline with the customer for Spacehab flights. ©[111501-4981E] ©[111501-4981E] ©[111501-4976A] ©[092701-4872]

A2-322 SPACEHAB CAUTION AND WARNING ANNUNCIATION IN MODULE

LOSS OF ALL CAUTION AND WARNING ANNUNCIATION CAPABILITY IN THE SPACEHAB MODULE IS NOT CAUSE TO TERMINATE SPACEHAB ACTIVITIES PROVIDED: ©[111501-4981E]

- A. ANNUNCIATION CAPABILITY EXISTS IN THE ORBITER AND,
- B. VOICE COMMUNICATION BETWEEN THE ORBITER AND SPACEHAB IS AVAILABLE.

All emergency safety parameters are redundantly monitored by the orbiter GPC and CWEA. In addition, both of these monitoring systems cause annunciating in both Spacehab and the orbiter. Loss of the Spacehab C&W annunciating capability is therefore only loss of redundancy. The orbiter crew would alert the Spacehab crew of any emergencies. ©[111501-4981E]

FLIGHT RULES

A2-323

COMMUNICATIONS CONSTRAINTS

LOSS OF VOICE COMMUNICATION BETWEEN THE ORBITER AND SPACEHAB CREWMEMBERS IS NOT CAUSE TO TERMINATE SPACEHAB OPERATIONS PROVIDED CAUTION AND WARNING ANNUNCIATION CAPABILITY STILL EXISTS IN SPACEHAB. @[111501-4981E]

Loss of voice communication does not present a hazard to the crew if caution and warning alarms are still available from the audio control system (ACS). Spacehab operations would be impacted, but may be continued in the best possible manner. Coordination can be carried out by voice calls down the tunnel or possibly by using the BPSMU or a wireless crew comm unit (WCCU) connected in the airlock. @[111501-4981E]

A2-324

SPACEHAB IN-FLIGHT MAINTENANCE (IFM) PROCEDURES

A. IN SUPPORT OF RULE {A2-105}, IN-FLIGHT MAINTENANCE (IFM), ALL SPACEHAB UNSCHEDULED IFM PROCEDURES CONTAINED IN THE SPACEHAB MALFUNCTION PROCEDURES AND SYSTEMS DATA CHECKLIST (JSC-48100) HAVE BEEN PERMISSION COORDINATED AND REQUIRE REAL-TIME MCC APPROVAL ONLY PRIOR TO IMPLEMENTATION, EXCEPT THOSE LISTED IN PARAGRAPH B. EXPERIMENT IFM'S ARE DOCUMENTED IN THE FLIGHT SPECIFIC ANNEX. @[111501-4981E] @[111705-7057]

These IFM's have been reviewed preflight and identified as acceptable; however, because of their nature, implementation must be coordinated with the MCC.

B. THE FOLLOWING ARE LISTS OF SPACEHAB SCHEDULED IFM PROCEDURES IN THE SPACEHAB OPERATIONS CHECKLIST (JSC-48089) OR SPACEHAB MALFUNCTION PROCEDURES AND SYSTEMS DATA CHECKLIST (JSC-48100) WHICH DO NOT REQUIRE REAL-TIME APPROVAL OR COORDINATION PRIOR TO IMPLEMENTATION:

NONE IDENTIFIED @[111705-7057]

C. ALL REAL-TIME DEVELOPED SPACEHAB/EXPERIMENT IFM PROCEDURES WILL BE COORDINATED AND APPROVED BY THE MCC.

Implementation of unplanned IFM's may require activities which, if not properly reviewed and coordinated, could result in an array of unsafe conditions. Therefore, unplanned IFM activity must be coordinated with MCC to ensure the safety of the orbiter, payloads, and crew. If no previous IFM work has been done, a minimum of 24 hours may be expected before an experiment IFM may be approved and uplinked. @[111501-4981E]

FLIGHT RULES

A2-325

IFM PROCEDURES ON EXPERIMENTS WITH TOXIC HAZARDS

NO IFM PROCEDURES WILL BE INITIATED BY THE CREW ON AN EXPERIMENT KNOWN TO REPRESENT A TOXIC HAZARD UNTIL CONCURRENCE FOR THE REPAIR PROCEDURE IS OBTAINED FROM THE MCC FLIGHT DIRECTOR. SPACEHAB EVACUATION AND/OR PROTECTIVE EQUIPMENT MAY BE REQUIRED (SEE RULE {A13-156}, SPACEHAB HAZARDOUS SUBSTANCE SPILL RESPONSE). ALL PAYLOAD EXPERIMENTS/SAMPLES CONTAINING HAZARDOUS MATERIALS ARE DEFINED IN THE FLIGHT SPECIFIC ANNEX. @[111501-4981E]

A real-time assessment of the possibility of repairing an experiment and the risk of exposing the crew to a toxic substance during the repair will need to be made. The IFM may require that the cleanup equipment specified in Rule {A13-156}, SPACEHAB HAZARDOUS SUBSTANCE SPILL RESPONSE, be used to minimize risk of crew exposure to toxic substances. @[111501-4981E]

FLIGHT RULES

A2-326

EQUIPMENT EXCHANGE BETWEEN ORBITER CABIN AND
SPACEHAB MODULE

- A. ELECTRICAL EQUIPMENT OR EXPERIMENTS, SELF-POWERED OR FACILITY-POWERED, SHALL NOT BE TRANSFERRED BETWEEN THE ORBITER AND SPACEHAB UNLESS CERTIFIED FOR USE IN BOTH LOCATIONS. APPROVED EQUIPMENT WILL BE IDENTIFIED IN PARAGRAPH B. @[111501-4981E]

Equipment may only be used in areas where it has been approved from an electromagnetic compatibility standpoint. In addition, power budgeting/planning can only be accomplished effectively if equipment movement strategy is coordinated preflight via this rule.

- B. SPACEHAB SUBSYSTEM GENERIC EQUIPMENT
1. WIRELESS CREW COMMUNICATION SYSTEM (WCCS)
 2. ORBITER COMM EQUIPMENT
 3. VACUUM CLEANER AND ACCESSORIES (CABLE AND ATTACHMENT)
 4. ORBITER CAMCORDER AND ACCESSORIES
 5. PAYLOAD AND GENERAL SUPPORT COMPUTER (PGSC) AND ACCESSORIES
 6. ORBITER CAMERA AND ACCESSORIES
 7. ELECTRONIC STILL CAMERA (ESC)

EXCEPTIONS TO THIS RULE ARE DOCUMENTED IN THE FLIGHT SPECIFIC ANNEX. @[111501-4981E]

FLIGHT RULES

A2-327

SPACEHAB MODULE/TUNNEL SLEEP CONSTRAINTS

- A. NO CREWMEMBERS SHALL SLEEP IN THE SPACEHAB-TO-ORBITER TUNNEL.
 ©[111501-4981E]

In the event it was necessary to rapidly evacuate the module, a sleeping crewmember either tethered or in a sleeping bag would pose a hazard. In addition, the tunnel does not offer the same amount of protection for radiation that is provided by the module or orbiter cabin.

- B. CREWMEMBERS MAY SLEEP IN THE SPACEHAB MODULE IF:
1. SPACEHAB SYSTEM DATA IS BEING NOMINALLY TRANSMITTED TO THE ORBITER'S SM GPC AND TELEMETERED TO THE GROUND.
 2. THE CAUTION AND WARNING LINK BETWEEN THE ORBITER AND SPACEHAB IS OPERATIONAL.
 3. AT LEAST ONE SPACEHAB SMOKE SENSOR IS OPERATIONAL.
 4. THE AUDIO LINK BETWEEN THE ORBITER AND SPACEHAB IS OPERATIONAL.
 5. THE ARS FAN AND AT LEAST ONE ARS FAN DELTA PRESSURE SENSOR ARE OPERATIONAL IN ADDITION TO THE FOLLOWING:
 - a. (LDM ONLY) THE AFT MODULE FAN AND ITS ASSOCIATED DELTA PRESSURE SENSOR ARE OPERATIONAL.
 - b. (RDM ONLY) AT LEAST ONE HAB FAN ASSEMBLY (HFA) FAN AND ONE HFA FAN DELTA PRESSURE SENSOR ARE OPERATIONAL.

Nominal safety monitoring is via the SM GPC and the Caution and Warning Electronics Assembly (CWEA). Ground monitoring of safety parameters provides a further safety monitoring capability. The audio link to the Spacehab is desirable for communication in the case of a contingency commencing during sleep. The ARS fan and the ARS fan delta pressure sensor are required to verify that the ARS fan is operating, thus ensuring air exchange with the orbiter. In addition to the ARS fan and ARS fan delta pressure sensor, one HFA fan and one HFA fan delta pressure sensor in the RDM configuration are required for cooling, or the aft module fan and its associated delta pressure sensor in the LDM configuration are required to ensure adequate air flow through the aft module. Any one AC fan (Cabin or ARS) in the SM/LDM or one HFA fan in the RDM is adequate for smoke detection.

Reference: Rule {A17-706}, SPACEHAB FAN CONFIGURATIONS, Boeing memo, 2C-SPACEHAB-01044, A90-SPACEHAB-97088, A90-SPACEHAB-2000192, MDC92W5610, and MDC95W5829.
 ©[111501-4981E]

FLIGHT RULES

A2-328

CREW LIMITATIONS IN THE SPACEHAB MODULE

- A. THE MAXIMUM NUMBER OF CREWMEMBERS PERMITTED IN THE MODULE MAY BE LIMITED BASED ON REAL-TIME EVALUATION OF O₂ AND CO₂ LEVELS, RELATIVE HUMIDITY, AND CABIN TEMPERATURE. @[111501-4981E]

Spacehab SM/LDM is designed to reject 1400/1000 watts (respectively) of waste heat from surface air-cooled experiments with two crewmembers in the module. Spacehab RDM is designed to reject 2000 watts of waste heat from surface air-cooled experiments with three crewmembers in the module. Boeing/Spacehab analysis shows that each additional crewmember over the design value of two will decrease the available experiment air heat rejection accommodations by 115 watts minimum and 265 watts maximum (SM/LDM only). Each additional crewmember is expected to increase module dew point by about 1 deg F. Moisture is not a limiting factor for the Spacehab RDM since it has moisture removal capability. The RDM with the 53 cfm air exchange rate with the orbiter is designed to accommodate three crewmembers continuously. In the RDM, CO₂ generation may be the limiting factor for crew occupancy above its design limit. Increases in oxygen (O₂) consumption show no immediate concern for nominal operations in all module configurations.

- B. ORBITER CREWMEMBERS MAY ASSIST IN OPERATIONS IN THE SPACEHAB MODULE OR SERVE AS TEST SUBJECTS (SUBJECT TO ALL FLIGHTS WILL {A2-135}, COMMANDER (CDR) AND PILOT (PLT) PARTICIPATING AS TEST SUBJECTS) AS NEGOTIATED PREFLIGHT.

Preflight coordination will guarantee that the workloads of the orbiter crewmembers are acceptable and that Rule {A2-135} COMMANDER (CDR) AND PILOT (PLT) PARTICIPATING AS TEST SUBJECTS, is not violated. @[111501-4981E]

FLIGHT RULES

A2-329

SPACEHAB DEACTIVATION/ENTRY PREP @[111501-4981E]

SPACEHAB DEACTIVATION WILL PROCEED BY ONE OF THE FOLLOWING METHODS DEPENDING ON CIRCUMSTANCES: @[111501-4982A]

- A. NOMINAL ENTRY PREP - SECURING OF THE SPACEHAB BY NOMINAL CHECKLIST PROCEDURES. THE NOMINAL ENTRY PREP WILL BE DONE FOR:
1. NOMINAL END-OF-MISSION
 2. ANY FAILURE THAT RESULTS IN A PRIMARY LANDING SITE (PLS) WITH DEORBIT TIME OF IGNITION (TIG) OCCURRING BEYOND 12 HOURS.

Nominal entry prep requires approximately 1-2 hours and is scheduled in the Flight Plan. A PLS TIG greater than 12 hours away will allow the crew to perform the desirable, nominal module entry prep.

The procedure will include equipment stowage, nominal deactivation of experiments, and an orderly reconfiguration to the Spacehab entry configuration.

- B. SPACEHAB 30-MINUTE CONTINGENCY DEACTIVATION - SECURING OF SPACEHAB AND EXPERIMENT HARDWARE IN MINIMUM TIME WITHOUT INCURRING DAMAGE TO SPACEHAB, AND WHEN POSSIBLE, EXPERIMENT EQUIPMENT. SPACEHAB 30-MINUTE CONTINGENCY DEACTIVATION PROCEDURES WILL BE DONE FOR:
1. ANY FAILURE THAT RESULTS IN A PLS WITH DEORBIT TIG OCCURRING BETWEEN 3.5 TO 12 HOURS.
 2. UNRECOVERABLE LOSS OF ALL SPACEHAB AIR CIRCULATION FANS.

Spacehab 30-minute contingency deactivation is intended to perform as much of the normal deactivation of the module as possible. It also provides a balance between deactivating the module in a shorter-than-nominal time and preserving equipment (and science, if possible). The procedure will include critical entry stowage, an abbreviated but orderly Spacehab shutdown, and safing of experiments, if time permits.
@[111501-4982A]

THIS RULE CONTINUED ON NEXT PAGE

FLIGHT RULES

A2-329

SPACEHAB DEACTIVATION/ENTRY PREP (CONTINUED)

- C. SPACEHAB EMERGENCY DEACTIVATION - IMMEDIATE STOW OF ANY PENETRATORS, EGRESS, AND CLOSURE OF THE HATCH WITHOUT ANY OTHER ACTIVITIES WITHIN THE 3-MINUTE CONSTRAINT. IF CIRCUMSTANCES WARRANT, ALL POWER, EXCEPT PL AFT MN B, WILL BE REMOVED. SPACEHAB EMERGENCY DEACTIVATION PROCEDURES WILL BE DONE FOR: @[111501-4982A]
1. ORBITER PROBLEMS REQUIRING EMERGENCY DEORBIT
 2. AN ORBITER/MODULE LEAK (DEACTIVATION STEPS ONLY NEEDED IF LEAK CANNOT BE ISOLATED). IF THE LEAK IS ISOLATED TO THE SPACEHAB MODULE AFTER EGRESS, THE CREW MAY REOPEN THE SPACEHAB TO PERFORM ADDITIONAL DEACTIVATION/ENTRY PREP, IF CONSUMABLES PERMIT PER RULE {A17-751}, MODULE PRESSURE INTEGRITY.
 3. FOR SPACEHAB MODULE FIRE (DEACTIVATION STEPS ONLY NEEDED IF FIRE SUPPRESSION NOT SUCCESSFUL.)
 4. DISCHARGE OF ALL HALON SYSTEM BOTTLES (EGRESS STEPS ONLY)
 5. SPACEHAB MODULE LEVEL-4 TOXIC SPILL (EGRESS STEPS ONLY)

In emergency situations (i.e., fire, depress, or toxic spill), the crew must be able to safe and isolate the module within 3 minutes. Safe return of the crew is paramount in these cases. Only payload procedures required for safe entry (restraint of penetrators, crew module egress, and hatch closure) are allowed in these time critical situations. No attempt is made to prevent damage to the module or experiments, except stowing any penetrators. Reference NSTS 18798A, MA2-96-190, "CONTINGENCY RETURN AND RAPID SAFING," memo dated January 9, 1997. The Spacehab Emergency Deactivation procedure includes steps for egress and power removal. All main AC and DC power, except PL AFT MN B, which is required to power the Spacehab water line heaters, is removed for an emergency deactivation. In some cases, Spacehab emergency egress steps are integrated into the applicable orbiter procedures (i.e., cabin leak) and Payload powerdowns, when it is appropriate. @[111501-4982A]

FLIGHT RULES

A2-330

EXTENSION DAY GROUND RULES

A. POWER LEVELS ©[111501-4981E]

THE SPACEHAB AND ITS EXPERIMENTS WILL BE POWERED DOWN TO THE GREATEST EXTENT POSSIBLE (SURVIVAL POWER CONFIGURATION) AS DEFINED IN RULE {A9-357}, SPACEHAB SURVIVAL POWER CONFIGURATION. ©[ED]

The amount of consumables remaining at the nominal end of flight does not allow for operations of experiments without degrading the capability of the orbiter to remain in orbit. For those cases which require that additional power be provided to allow for preservation of experiment samples/data, the consumable must be allocated preflight and thus affect the mission duration.

B. CONSUMABLES

NO SPACEHAB EXPERIMENT ACTIVITIES WHICH REQUIRE ORBITER CONSUMABLES WILL NORMALLY BE PLANNED. FLIGHT-SPECIFIC OPTIONS ARE DEFINED IN THE FLIGHT SPECIFIC ANNEX.

Extension days would generally be required only for weather, orbiter, and/or landing site problems that would benefit from extra time before landing. To prevent further complications, the Spacehab/experiments should be maintained in a safe, deactivated state. This should not impact the Spacehab/experiments since all payload activities should have already been completed by the nominal end of mission. In addition, the crew must be available to perform necessary orbiter activities to ensure a safe return.

C. SPACEHAB CONSTRAINTS ON EXTENSION DAY ATTITUDE WILL BE DOCUMENTED IN THE FLIGHT SPECIFIC ANNEX.

-ZLV attitude will normally provide a stable thermal environment for the orbiter and Spacehab module during an extension day and is accomplished with a minimum amount of propellant for attitude maintenance. With radiators deployed, the -ZLV attitude will provide sufficient orbiter heat rejection when flying with any beta angle. With radiators stowed, the -ZLV attitude may be acceptable, or a flight-specific attitude can be determined. If a cooler attitude is required, the orbiter can execute passive thermal control (PTC) which gives the advantage of providing a consistent thermal environment for the entire vehicle. ©[111501-4981E]

FLIGHT RULES

A2-331

CONSTRAINTS ON CABLES THROUGH THE SPACEHAB HATCH AND TUNNEL

THE SPACEHAB HATCHWAY AND TUNNEL SHALL BE FREE AND CLEAR OF OBSTRUCTION TO ENSURE THAT THE CREW IS CAPABLE OF SAFING AND ISOLATING THE MODULE WITHIN 3 MINUTES FOR AN EMERGENCY.

@[111501-4984]

Every effort shall be made to preclude routing cables through the Spacehab hatch and tunnel. In emergency situations (i.e., fire, depress, or toxic spill), the crew must be able to secure penetrators and isolate the module within 3 minutes. The hatch closure itself takes approximately 1 minute, which leaves approximately 2 minutes to safe the module and clear the hatchway. Cables, in addition to anything that may pose interference with hatch closure, are considered "drag-throughs."

IN THE EVENT DRAG-THROUGH ROUTING CANNOT BE PRECLUDED, THE FOLLOWING CRITERIA SHALL APPLY:

- A. THE ABILITY TO SAFE AND ISOLATE THE MODULE WITHIN 3 MINUTES SHALL BE RETAINED.

The 3-minute constraint is paramount for the crew to have the ability to respond to any emergency situation (i.e., fire, depress, or toxic spill) and allow the hatch to be closed regardless of whether or not drag-throughs are present across the hatchway. Tests show it takes approximately 10 seconds to break each quick disconnect (QD) by a single crewmember.

- B. IF THE DRAG-THROUGH IS NOT UNDER THE CONTROL OF A CREWMEMBER, IT SHALL BE RESTRAINED TO AVOID CREW ENTANGLEMENT WHILE TRANSLATING THROUGH THE HATCH AND TUNNEL. IF A QUICK DISCONNECT RELATED TO THE DRAG-THROUGH HAS BEEN POSITIONED IN PROXIMITY TO THE HATCH, THE RESTRAINT SHALL NOT BE LOCATED BETWEEN THE DISCONNECT AND THE HATCH.

A drag-through that is under the control of a crewmember implies short-term use and will be taken back through the hatch as a crewmember exits when circumstances dictate hatch closure. A restraint between the hatch and the quick disconnect complicates the effort to clear the hatchway and close the hatch.

THIS RULE CONTINUED ON NEXT PAGE

FLIGHT RULES

A2-331

CONSTRAINTS ON CABLES THROUGH THE SPACEHAB HATCH AND TUNNEL (CONTINUED)

- C. DRAG-THROUGHS SHALL NOT IMPEDE CREW NAVIGATION THROUGH THE HATCHWAY. A TRANSLATION CORRIDOR, SUFFICIENT TO ALLOW A CREWMEMBER TO PASS THROUGH THE HATCH, SHALL BE MAINTAINED.

A 32-inch minimum diameter must be maintained through the Spacehab hatch. ©[111501-4984]

- D. WHERE PRACTICAL, AND WITHIN DESIGN LIMITATIONS AND TIME CONSTRAINTS IMPOSED BY THE HARDWARE AND OPERATIONAL REQUIREMENTS, THE FOLLOWING CONSTRAINTS WILL BE IMPLEMENTED:
©[111501-4984]

1. ALL DRAG-THROUGHS ROUTED THROUGH THE SPACEHAB HATCH SHALL BE CONFIGURED WITHIN A SINGLE 90-DEGREE SECTION OF THE HATCH AS SHOWN BY THE FIGURE BELOW:

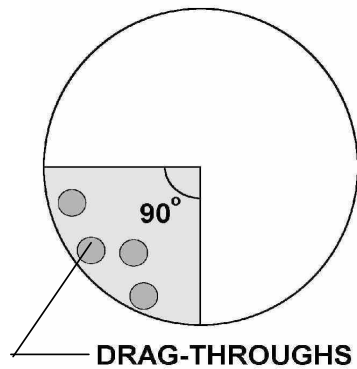

Drag-throughs should be routed within the 90-degree section of the Spacehab hatch to aid in the ability of the crew to quickly locate and remove hatch obstructions.

THIS RULE CONTINUED ON NEXT PAGE

FLIGHT RULES

A2-331

CONSTRAINTS ON CABLES THROUGH THE SPACEHAB HATCH AND TUNNEL (CONTINUED)

2. DRAG-THROUGHS SHOULD BE ROUTED SUCH THAT A QUICK RELEASE CONNECTOR IS LOCATED WITHIN 2 FEET ON EITHER SIDE OF THE SPACEHAB HATCH. DISCONNECT FEATURES FOR ALL DRAG-THROUGHS ROUTED THROUGH THE HATCH SHOULD BE ON THE SAME SIDE OF THE HATCH.

The quick release connector features, and constraints on having all such connectors lie within 2 feet of the Spacehab hatch and on the same side of the hatch for all drag-throughs, allows quick location and removal (tests show at 10 seconds per quick release connector) of drag-through obstructions(s) to hatch closure. @[111501-4984]

3. DRAG-THROUGHS SHOULD BE LIMITED TO NO GREATER THAN FOUR DURING CREW AWAKE TIME AND, IF LEFT IN PLACE DURING THE CREW SLEEP PERIOD, THE NUMBER OF DRAG-THROUGHS ROUTED THROUGH THE SPACEHAB HATCH AND TUNNEL SHOULD BE REDUCED TO TWO. @[111501-4984]

An operational limit of two drag-throughs across the Spacehab hatch during the crew sleep period has a better chance of accommodating the 3-minute constraint on safing and isolating the module. Limiting the number of drag-throughs to a maximum of four drag-throughs, whether temporary or permanent, will minimize the risk in not being able to meet the 3-minute rapid safing constraint.

4. IF TIME ALLOWS, PRIOR TO DEMATING AN ELECTRICAL CONNECTION EXCEEDING 32 VOLTS UPSTREAM, POWER WILL BE REMOVED.
- E. THE BPSMU IS THE ONLY DRAG-THROUGH APPROVED GENERICALLY FOR USE IN SPACEHAB. ADDITIONAL DRAG-THROUGHS MAY BE APPROVED ON A MISSION SPECIFIC BASIS AND LISTED IN THE FLIGHT SPECIFIC ANNEX.

The BPSMU meets the requirements for drag-throughs in this rule and was the only drag-through identified at the time this rule was written. It can be used nominally for communication between the Spacehab and orbiter or Spacehab and ISS when the Spacehab ACS is not available or operational. @[111501-4984] @[111501-4981E] @[111501-4962A] @[111501-4982A]

FLIGHT RULES

A2-332

LOSS OF SM GPC DURING SPACEHAB ACTIVATION/ENTRY

PREP @[111501-4981E]

- A. LOSS OF THE SYSTEMS MANAGEMENT (SM) GPC PRIOR TO ARS FAN ACTIVATION WILL REQUIRE SUSPENSION OF SPACEHAB ACTIVITIES UNTIL THE SM GPC IS RECOVERED OR THE ARS FAN IS POWERED. CONSIDERATION WILL BE GIVEN TO WHICH EXPERIMENTS COULD BE OPERATED IN THE SPACEHAB ASCENT CONFIGURATION. @[060800-7116A]

Nominal Spacehab ARS fan activation and subsystem reconfiguration are achieved via the SM GPC. The ARS fan provides the only means for conditioned air exchange with the orbiter. Therefore, Spacehab operations must be postponed until the ARS fan can be activated. When the Spacehab is powered for ascent, the water pump and several experiment utility outlets are powered in addition to the ARS fan or Cabin/HFA fan. In the SM and LDM configurations, the ARS fan is the preferred fan to operate during ascent. In the RDM configuration, one HFA fan is preferred over the ARS fan. Spacehab RDM is always powered for ascent. Reference Rule {A17-706}, SPACEHAB FAN CONFIGURATIONS.

- B. LOSS OF THE SYSTEMS MANAGEMENT (SM) GPC AFTER SPACEHAB ACTIVATION AND BEFORE ENTRY PREP IS NOT CAUSE TO TERMINATE SPACEHAB ACTIVITIES. @[111094-1733]

Spacehab activities may continue because the module remains in a good configuration for operation. Nominal reconfiguration of Spacehab subsystems during entry prep cannot be achieved without the SM GPC. Consideration will be given to leaving Spacehab equipment configured on orbiter power for entry provided orbiter resources are available. @[111501-4981E]

FLIGHT RULES

A2-333

LOSS OF PAYLOAD MDM DURING SPACEHAB ACT/ENTRY PREP

@[111501-4981E]

A. PAYLOAD MDM FAILURE

LOSS OF PAYLOAD (PL) MDM PL1, PRIOR TO ARS FAN ACTIVATION, WILL REQUIRE SUSPENSION OF SPACEHAB ACTIVITIES UNTIL THE MDM IS RECOVERED OR THE ARS FAN IS POWERED. CONSIDERATION WILL BE GIVEN TO WHICH EXPERIMENTS COULD BE OPERATED IN THE SPACEHAB ASCENT CONFIGURATION. @[060800-7117A]

Spacehab Activation and subsystem reconfiguration are achieved via the Payload MDM 1 (PL1) and otherwise cannot be nominally performed. The ARS fan is important because it provides the only means for conditioned air exchange with the orbiter. Spacehab operations must be postponed until the ARS fan can be activated. Hard failure of PL1 will result in the inability to activate Spacehab. All Flights Rule {A7-109F}, IN-FLIGHT MAINTENANCE (IFM), specifies that a PL MDM will only be swapped to regain PLBD close capability. When the Spacehab is powered for ascent, the water pump and several experiment utility outlets are powered in addition to the ARS fan or Cabin/HFA fan. In the SM and LDM configurations, the ARS fan is the preferred fan to operate during ascent. In the RDM configuration, one HFA fan is preferred over the ARS fan. Spacehab RDM is always powered for ascent. Reference Rule {A17-706}, SPACEHAB FAN CONFIGURATIONS.

B. LOSS OF PAYLOAD MDM PL2 DURING SPACEHAB ACTIVATION WILL NOT REQUIRE SUSPENSION OF SPACEHAB ACTIVITIES. @[111094-1734]

Spacehab activation does not require Payload MDM PL2. @[060800-7117A]

C. LOSS OF EITHER PAYLOAD MDM, PL1 OR PL2, AFTER ACTIVATION AND BEFORE ENTRY PREP IS NOT CAUSE TO TERMINATE SPACEHAB ACTIVITIES.

Caution and warning parameters, which are nominally redundantly monitored by the CWEA directly and via the PL1-GPC-PL2 string, are still monitored by the CWEA if either PL MDM fails. Significant command capability, including that used during the nominal deactivation process (ARS fan, cabin/HFA fan, and water pump reconfiguration for powered entry), is lost if PL1 is lost. However, some operations may still be conducted. Safety-related redundant command capability for fire suppression still exists (Standard Switch Panel and C3A5).

D. IF A CHOICE EXISTS BETWEEN PL1 AND PL2, SPACEHAB PREFERS PL1.

The majority of MDM discrettes are through PL1. The impact of losing PL1 is greater than the impact of losing PL2. @[111501-4981E]

FLIGHT RULES

A2-334

LOSS OF SM MAJOR FUNCTION

TEMPORARY LOSS OF SM MAJOR FUNCTION AFTER SPACEHAB ACTIVATION AND BEFORE SPACEHAB ENTRY PREP IS NOT A CONSTRAINT TO CONTINUING SPACEHAB OPERATIONS IF: @[111501-4981E]

- A. THE SPACEHAB-TO-CWEA INTERFACE IS OPERATING NOMINALLY.
- B. THE FOLLOWING SAFETY SENSORS ROUTED TO THE CWEA ARE OPERATIONAL:
 - 1. FIRE/SMOKE DETECTOR A OR B
 - 2. ARS FAN DELTA P - SENSOR 2
 - 3. (RDM ONLY) HFA FAN DELTA P - SENSOR 2

If the SM interface is down, one of two redundant methods of monitoring safety-critical parameters is lost. Module operations may continue if the CWEA is still monitoring safety parameters and the sensors feeding the CWEA (at least one fire/smoke and the ARS fan) are nominal. Note that monitoring of Spacehab parameters is still available on the ground and via the PGSC in the module. Redundancy for partial pressure of oxygen (PPO₂) and total cabin pressure is provided by the orbiter sensors via hardware caution and warning.

Loss of SM also eliminates a significant amount of command capability; however, redundant methods are still available for fire suppression. @[111501-4981E]

FLIGHT RULES

A2-335

**LOSS OF ORBITER MASTER TIMING UNIT (MTU) /PAYLOAD
TIMING BUFFER**

- A. LOSS OF THE MTU DURING SPACEHAB ACTIVATION OR DEACTIVATION IS NOT A CONSTRAINT TO CONTINUING SPACEHAB ACTIVITIES; HOWEVER, NOMINAL ACTIVATION/DEACTIVATION CANNOT BE PERFORMED. CONSIDERATION WILL BE GIVEN TO WHICH EXPERIMENTS CAN OPERATE IN THE SPACEHAB ASCENT/ENTRY CONFIGURATION. @[111501-4981E]

Loss of the MTU results in loss of a clock signal to the Payload Signal Processor (PSP), which causes loss of commanding to Spacehab. PSP commanding is required to perform a nominal Spacehab activation and deactivation. Operations may still be conducted in the ascent/entry configuration. If Spacehab is unpowered during ascent, operations may still be conducted using SSP and MDM commanding. @[111501-4981E]

- B. LOSS OF THE MTU AFTER SPACEHAB ACTIVATION AND BEFORE SPACEHAB DEACTIVATION IS NOT A CONSTRAINT TO CONTINUING SPACEHAB ACTIVITIES; HOWEVER, THE FOLLOWING IMPACTS OCCUR: @[111501-4981E]

1. LOSS OF PSP UPLINK COMMANDING IS DOCUMENTED IN THE FLIGHT SPECIFIC ANNEX.

PSP commanding is lost when the MTU fails. All nominal uplink commanding to Spacehab subsystem equipment and to some experiments is through the PSP.

2. LOSS OF GREENWICH MEAN TIME (GMT) TIMETAG INFORMATION INSERTED BY THE DMU INTO THE PDI DATA STREAM.

The GMT timetag is inserted into the PDI data stream by the DMU for subsystem information. It is not used onboard Spacehab.

3. LOSS OF GMT AND MISSION ELAPSED TIME (MET) TO SPACEHAB EXPERIMENTS IS DOCUMENTED IN THE FLIGHT SPECIFIC ANNEX.

The MTU is the only source of synchronized GMT and MET to Spacehab and experiments. This could cause degraded experiment results. @[111501-4981E]

A2-336 THROUGH A2-400 RULES ARE RESERVED

FLIGHT RULES

ORBITER SYSTEMS GO/NO-GO

A2-1001

ORBITER SYSTEMS GO/NO-GO [HC] @[121604-6254C]

FOR LOSS OF THE FOLLOWING:	MDF	NXT PLS
PROP		
OMS ENG	-	2↓
OMS PROP TNK LK	-	X↓
OMS ENG and 1 +X PRCS JET	-	X↓
OMS ENG and < RCS STEEP DEORB CAP	-	X↓
OMS/RCS FLOW PATH (XFD)	1↓	2↓
AFT RCS PROP TNK LK/FAIL	-	X↓
AFT PRCS MANIFOLDS	-	2↓ SAME SIDE
OMS INLET LNE LEAK	-	1↓
DPS		
GPC's	2↓	3↓
MDM's SAME TYPE: (FF, FA, or PL)	-	2↓
MMU	2↓	-
FWD KEYBOARD (I)	-	1↓
DEU/CRT (4)	2↓	2FWD ↓ (I)
IDP (4) DPS FUNCTION	2↓	[15] 2FWD ↓ (I)
IDP (4) FLIGHT INSTRUMENT FUNCTION	-	2FWD ↓ (I)
MDU (11)		[14] [15]
ADC (4)		[14] [15]
GNC		
RHC CHAN (LFT OR RT) (I)	2↓ SAME SIDE	5↓
THC (LFT) and OMS ENG (I)	-	3↓ +X ONLY
SBTC CHAN (LFT OR RT)	3↓ ONE SIDE	
	1↓ OTHER SIDE	
FCS MODE AUTO SW	-	2↓ ONE SIDE and 1↓ OTHER SIDE
FCS MODE B/F	2↓	2↓ ONE SIDE and 1↓ OTHER SIDE
SBTC (LFT OR RT) T/O SW	3↓ ONE SIDE and 1↓ OTHER SIDE	
STAR TRACKER (2) and HUD (2)	4↓	3↓ and -Z COAS↓
ADTA	2↓	3↓
AFT RCS	-	2↓ SAME AXIS SAME SIDE
ELEV, RUD, S/B OR BF ACT CHAN	-	2↓ SAME ACT
ELEV OR BF POSN FDBK	2↓	3↓ SAME ACT
ELEV PRI DELTA P	2↓	3↓ SAME ELEV
AA (LAT)	2↓	3↓
IMU	-	2↓
CG ANOMALY AND 1 YAW JET	-	X↓
RGA	2↓	3↓
TACAN	2↓	3↓

@[101796-4561A] @[040899-2459B] @[031500-7172D] @[032807-8233] @[042507-8466B]

THIS RULE CONTINUED ON NEXT PAGE

FLIGHT RULES

A2-1001

ORBITER SYSTEMS GO/NO-GO [HC] (CONTINUED)

FOR LOSS OF THE FOLLOWING:	MDF	NXT PLS
COMM		
VOICE (3) (A/G 1,2,UHF)	-	2↓
COMMAND (2)	2↓	
VOICE + COMMAND	-	ALL↓
PCMMU (2)	1↓	2↓
NSP (2)	1 D/L↓	2↓ (U/L OR D/L)
XPONDER (2) I	2 D/L↓	2 U/L↓ OR 2 D/L+ (1)↓
ACCU (2) (I)	2↓	1↓(I)↓
TELEMETRY	-	ALL↓
EECOM		
FES (TOPPER)	1↓	-
FES (HI-LOAD)	-	1↓
FES PRIMARY CNTLR	2↓	3↓
FES FEED LINE	-	2↓
FREON LOOP	-	1↓
FREON LOOP LEAK	-	[12]
FREON PUMPS	-	2↓ (IF FCL 1 PMP B AND FCL 2 PMP A)
RFCA (FAIL IN BYPASS/MIN FLOW)	-	1↓ [16]
RAD ISOL VALVE (FAILED IN ISOLATE OR LEAK ISOLATED TO THE RADIATOR)	-	1↓ [16]
H ₂ O LOOP	-	1↓
H ₂ O LOOP LEAK	1↓	-
HX LEAK (FREON TO CABIN H ₂ O)	-	1↓
HX LEAK (EXCEPT FREON TO CABIN H ₂ O)	1↓	-
CABIN FANS	1↓	2↓ (LANDING REQUIRED WITHIN 8 HRS)
AV BAY COOLING	[1]	- [3] [4]
IMU FANS	-	2↓
H ₂ O TANKS (SUPPLY)	-	2↓
H ₂ O TANK (WASTE)	-	(ULLAGE WILL DETERMINE EOM)
CAB PRESS INTEGRITY	-	X↓
165 MIN, 8 PSI RTN	-	X↓
PPO ₂ CNTL	-	X↓
CO ₂ CNTL	-	X↓
CAB T CNTL	-	X↓
CAB HUM CNTL	-	X↓
RCRS	[7]	[7]
SPLY H ₂ O DMP	-	X↓ (ULLAGE WILL DETERMINE EOM)
WST H ₂ O DMP	-	X↓ (ULLAGE WILL DETERMINE EOM)
WCS (ALL FECAL OR ALL URINE COLLECTION CAPABILITY)	[6]	[6]
SMOKE DETECTION (AV BAY 3A)	-	2↓ [2]
SMOKE DETECTION (CABIN)	-	3↓ [9]
FIRE DETECTED /SUPPRESSED	-	[10] [11]
HALON DISCHARGE (W FIRE CONFIRMATION)	[11]	
HALON DISCHARGE (W/O FIRE CONFIRMATION)	[11]	

@[020196-1810A] @[061396-3104A] @[050400-7192] @[ED]

THIS RULE CONTINUED ON NEXT PAGE

FLIGHT RULES

A2-1001

ORBITER SYSTEMS GO/NO-GO [HC] (CONTINUED)

FOR LOSS OF THE FOLLOWING:	MDF	NXT PLS
EGIL		
H ₂ OR O ₂ TANKS	-	2↓ [8]
O ₂ , H ₂ MANIFOLDS	1↓	2↓
FUEL CELL	1↓	2↓
FC COMMOM VENT LINE BLOCKAGE	-	X↓
FUEL CELL O ₂ PURGE	-	- (PERFORMANCE WILL DETERMINE EOM)
FUEL CELL PRIMARY H ₂ O FLOW TO ECLSS	2↓	3↓
PRI & B/U C&W	-	2↓
MAIN DC BUSES		
DA1, DA2, OR DA3	-	1↓
FPC1, FPC2, OR FPC3	1↓	-
FLC2 OR FLC3	1↓	-
MPC1, MPC2, OR MPC3	-	1↓
APC4 OR APC5	-	1↓ [19]
ALC1 OR ALC2	-	1↓ [19]
MNA MMC 1 OR 3	-	1↓
MNB MMC 2 OR 4	-	1↓
MNC MMC 2 OR 4	-	1↓
MNC 016	1↓	-
CONTROL BUSES		
AB1, AB2, AB3, BC1, BC2, BC3, CA1, CA2, OR CA3	-	1↓ (I) [17]][18][19]
ESSENTIAL BUSES		
1BC DA1, 1BC MPC1, OR 1BC FD	1↓ (FC1 LOST)	-
2CA DA1, 2CA MPC1, OR 2CA FD	1↓ (FC2 LOST)	-
3AB DA1, 3AB MPC1, OR 3AB FD	1↓ (FC3 LOST)	-
AC INVERTERS OR NONSHORTED BUS (2 OF 3 PHASES)	X(I)	-
AC BUSES		
ANY AC PHASE (SHORT)	-	1↓
AC1 MMC 1 OR 3	-	1↓
AC2 MMC 2	-	X↓
AC2 MMC 4	-	X↓
AC3 MMC 2 OR 4	-	1↓
AC2 OR AC3 (ANY PHASE)	-	1↓ + CAB FAN
MMACS		
APU OR HYD	-	2↓
WSB	-	2↓
LDG GEAR DPLY METHODS	-	2↓
PBD DRIVE MTRS	1 CLS ↓	2 OPEN ↓
PBD NOT OPEN	1 C/L ↓	X↓
PRESS/REDUN WNDW FL	-	X↓
CONFIRMED TIRE LEAK	-	[5]

@[101796-4561A] @[ED] @[011801-3851] @[092503-5546B]

LEGEND	
-	= NO REQUIREMENT
↓	= (DOWN ARROW) SYSTEM/CAPABILITY LOSS
1↓	= ONE SYSTEM INOPERATIVE
X↓	= ANY NUMBER OF SYSTEM/CAPABILITIES LOST
(I)	= IFM CAPABILITY EXISTS

THIS RULE CONTINUED ON NEXT PAGE

FLIGHT RULES**A2-1001****ORBITER SYSTEMS GO/NO-GO [HC] (CONTINUED)**

NOTES:

- [1] MDF FOR LOSS OF COOLING TO TWO GPC'S (DUE TO UNACCEPTABLE TEMPERATURE).
- [2] PLS FOR POWERDOWN OF C&W. C&W MAY REMAIN POWERED IF IT WAS NOT THE SOURCE OF A POTENTIAL FIRE INDICATION AND IF THE AVIONICS BAY IS EXPOSED TO THE CABIN FOR USE OF THE CABIN SMOKE DETECTORS. REF RULES {A17-51A}.3, MANAGEMENT FOLLOWING LOSS OF SMOKE DETECTION, AND {A17-1001A}, LIFE SUPPORT GO/NO-GO CRITERIA. @[090894-1675] @[ED]
- [3] PLS FOR LOSS OF COOLING TO THE C&W.
- [4] ENTER NEXT PLS IF A SINGLE ELECTRICAL FAILURE (AC BUS) COULD CAUSE THE LOSS OF AIR COOLING TO AVIONICS BAYS.
- [5] ENTER NEXT PLS IF TIRE PRESSURE WILL BE BELOW THE FAIL LIMIT AT THE NEXT PLS LANDING OPPORTUNITY PLUS 2 DAYS. @[090894-1675] @[121604-6254C]
- [6] THE NUMBER OF ALTERNATE WASTE COLLECTION BAGS, NUMBER OF CREW AND THEIR DEFECATION/ URINATION RATE WILL DETERMINE EOM.
- [7] QUANTITY OF LITHIUM HYDROXIDE (LIOH) CANISTERS AND CREW SIZE WILL DETERMINE EOM. A MINIMUM OF 2 DAYS OF UNUSED LIOH MUST BE HELD IN RESERVE TO PASS A PLS OPPORTUNITY. REF. RULE {A17-157}, LIOH REDLINE DETERMINATION [HC]. @[092293-15316] @[ED]
- [8] EDO PALLET TANKS ARE EXEMPT FROM THIS RULE UNLESS THE FAILURES ARE DETERMINED TO BE GENERIC.
- [9] PLS, UNLESS AT LEAST ONE CREWMEMBER REMAINS AWAKE IN ORBITER CABIN TO MONITOR SMOKE CONDITIONS AT ALL TIMES. REF RULE {A17-51B}, MANAGEMENT FOLLOWING LOSS OF SMOKE DETECTION.
- [10] ELS OR PLS IS REQUIRED BASED UPON AVAILABLE N₂ FOR O₂ CONTROL SINCE CREW MUST REMAIN ON QDM/ACES IF TOXIC COMBUSTION PRODUCTS CANNOT BE SATISFACTORILY REMOVED FROM THE CABIN ATMOSPHERE. REF RULES {A13-157}, CABIN ATMOSPHERE CONTAMINATION FIRE/SMOKE, AND {A13-158}, CABIN ATMOSPHERE CONTAMINATION - HALON 1301 [HC]. FOR AV BAY FIRES, THE EXTENT OF THE DAMAGE TO EQUIPMENT AND WIRE BUNDLES IS UNKNOWN; THEREFORE, EVEN IF THE ATMOSPHERE HAS BEEN CLEANED UP, A PLS WILL BE PERFORMED TO MINIMIZE THE RISK OF THE OCCURRENCE OF AN ADDITIONAL FIRE OR ARC TRACKING. @[062305-6653] @[ED]
- [11] EOM IS BASED UPON HALON EXPOSURE CRITERIA. REF RULE {A13-158}, CABIN ATMOSPHERE CONTAMINATION - HALON 1301 [HC]. @[090894-1675] @[ED]
- [12] FOR A LEAKING FREON LOOP THAT WILL SUPPORT NEXT PLS BUT NOT THE FOLLOWING PLS. A PLS WILL BE DECLARED IN ORDER TO ACHIEVE A NOMINAL D/O PREP AND ENTRY. A LOSS OF ONE FREON LOOP ENTRY REQUIRES A POWERDOWN TO 14 KW. @[061396-3104A]
- [13] RESERVED @[040899-2459B] @[032807-8233]
- [14] IDP'S ARE REQUIRED FOR PASS AND BFS INTERFACE AND TO DISPLAY THE ADI, AMI, AND AVVI AND HSI. @[040899-2459B] @[031500-7172D]
- [15] LOSS OF EITHER FUNCTION, DPS OR FLIGHT INSTRUMENT, IN ANY THREE SEPARATE IDP'S IS PLS.
- [16] NEXT PLS IS REQUIRED (NOT INCLUDING FIRST DAY PLS), FOR LOSS OF RADIATOR COOLING IN ONE LOOP, IF SUPPLY H₂O QUANTITIES AND MANAGEMENT PLAN WILL NOT SUPPORT THE FOLLOWING PLS WITH THE NEXT WORST FAILURE (LOSS OF THE GOOD FREON LOOP). ASSUMING WATER QUANTITIES WILL SUPPORT THE NEXT WORST FAILURE, THE MISSION MAY BE EXTENDED TO THE SUBSEQUENT PLS OPPORTUNITIES. @[050400-7192] @[092701-4865D]
ELS WILL BE REQUIRED IF THE NEXT WORSE FAILURE OCCURS BEFORE SUPPLY WATER QUANTITIES CAN SUPPORT NEXT PLS. @[050400-7192] @[092701-4865D]
- [17] FOR FAILURES OF CONTROL BUSES AB1, AB2, BC1, BC2, CA1, OR CA2 SUCH THAT A PUBLISHED IFM WOULD RECOVER PLBD FUNCTIONS LOST WITH THE FAILED BUS, THE IFM MAY BE CONSIDERED A LEVEL OF REDUNDANCY FOR MISSION PLANNING PURPOSES. (REF RULE {A9-57}, REUSABLE FC.) @[011801-3851]
- [18] FAILURE OF CNTLAB1 RESULTS IN LOSS OF OMS X-FEED AND REPRESS CAPABILITY. A G-MEM MAY BE SENT TO REGAIN THE LOST FUNCTION. @[011801-3851]
- [19] THE NEXT WORST FAILURE (LOSS OF ANOTHER BUS) RESULTS IN LOSS OF TWO APU/HYD/WSB SYSTEMS FOR ENTRY. REF RULES {A10-21}, LOSS OF APU/HYDRAULIC SYSTEM(S) ACTIONS, AND {A9-1001}, ELECTRICAL GO/NO-GO CRITERIA [HC]. @[092503-5546B] @[ED]

This rule is a control for multiple (seven) orbiter Hazard Reports. @[121604-6254C] @[042507-8466B]

FLIGHT RULES

THIS PAGE IS INTENTIONALLY BLANK

FLIGHT RULES

SECTION 3 - GROUND INSTRUMENTATION REQUIREMENTS

GENERAL

A3-1	GROUND AND NETWORK DEFINITIONS.....	3-1
A3-2	GROUND AND NETWORK OVERALL PHILOSOPHY.....	3-2
A3-3	HIGH-SPEED TRACKING LAUNCH AND LANDING REQUIREMENTS.....	3-5
A3-4	ABORT LIGHT INTERFACE.....	3-9
A3-5	GROUND/NETWORK DETAILED REQUIREMENTS.....	3-10
A3-6 THROUGH A3-50	RULES ARE RESERVED.....	3-14

MCC INSTRUMENTATION PRELAUNCH REQUIREMENTS

A3-51	TRAJECTORY PROCESSING REQUIREMENTS.....	3-15
A3-52	MCC INTERNAL VOICE.....	3-17
A3-53	MCC POWER REQUIREMENTS.....	3-19
	TABLE A3-53-I - MCC POWER DATA TABLE.....	3-20
A3-54	TRAJECTORY SERVER ERRORS.....	3-28
A3-55 THROUGH A3-100	RULES ARE RESERVED.....	3-29

45 SPW/GSFC/STDN PRELAUNCH REQUIREMENTS

A3-101	GSFC.....	3-30
A3-102	INTEGRATED NETWORK FAILURE DECISION MATRIX....	3-32
A3-103	CRITICAL LAUNCH SYSTEMS RECOVERY TIMES.....	3-37
A3-104 THROUGH A3-150	RULES ARE RESERVED.....	3-43

FLIGHT RULES

MCC EXTERNAL INTERFACE (VOICE DATA) PRELAUNCH REQUIREMENTS

A3-151	MCC/KSC/45 SPW INTERFACE.....	3-44
A3-152	GSFC/STDN INTERFACE.....	3-47
A3-153	45 SPW/WESTERN RANGER (WR) INTERFACE.....	3-48
A3-154	45 SPW/WSMR INTERFACE.....	3-48
A3-155	MCC/GSFC/NGT INTERFACE.....	3-49
A3-156	MCC/ASCENT ABORT SITE INTERFACE.....	3-49
A3-157	THROUGH A3-200 RULES ARE RESERVED.....	3-49

NAVAIDS REQUIREMENTS

A3-201	TACAN REDUNDANCY REQUIREMENTS AND ALTERNATE TACAN SELECTION PHILOSOPHY [HC].....	3-50
A3-202	MLS [HC].....	3-58
A3-203	LANDING AID REQUIREMENTS [HC].....	3-59
A3-204	GPS CONSTELLATION.....	3-63

FLIGHT RULES

SECTION 3 - GROUND INSTRUMENTATION REQUIREMENTS

GENERAL

A3-1 GROUND AND NETWORK DEFINITIONS

- A. MCC IS DEFINED AS THE EQUIPMENT AND FUNCTIONALITY PROVIDED BY THE JSC BUILDING 30 COMPLEX AND ASSOCIATED INFRASTRUCTURE AT JSC WHICH PROVIDES POWER, COOLING, AND COMMUNICATIONS TO BUILDING 30. @[062702-5502C]
- B. INTEGRATED NETWORK INCLUDES THE FOLLOWING:
1. THE NASA GROUND TRACKING AND DATA STATIONS AT MILA, DFRC, WLP, PDL, AND INCLUDING JDI.

Even though JDI is part of the Eastern Range operated by the USAF 45th Space Wing at the Jonathan Dickinson Missile Test Annex (JDMTA), for the purposes of this rule it is considered part of the NASA network.

2. THE SPACE NETWORK INCLUDING THE WHITE SANDS COMPLEX (WSC) FACILITY AND FUNCTIONALITY AS WELL AS THE TDRS SATELLITES.
3. GSFC FACILITIES THAT PROVIDE COMMUNICATIONS RELAY AND SCHEDULING: THE MISSION OPS SUPPORT AREA (MOSA), FLIGHT DYNAMICS FACILITY (FDF) AND THE NETWORK CONTROL CENTER (NCC) AND ASSOCIATED INFRASTRUCTURE AT GSFC WHICH PROVIDES POWER, COOLING, AND COMMUNICATIONS TO THOSE FACILITIES.
4. NASA AND USAF RADAR TRACKING SITES AS SHOWN IN THE MATRIX IN RULE {A3-102}, INTEGRATED NETWORK FAILURE DECISION MATRIX. @[ED]
5. COMMERCIAL LINKS CONNECTING JSC, GSFC, WSC, KSC, DFRC, ETC.
6. INTERCONNECTIVITY TO USAF RTS SITES @[062702-5502C]

THIS RULE CONTINUED ON NEXT PAGE

FLIGHT RULES

A3-1 GROUND AND NETWORK DEFINITIONS (CONTINUED)

- C. CRITICAL SHUTTLE FLIGHT PHASES ARE DEFINED AS LAUNCH THROUGH GO FOR ORBIT OPS OR INTACT ABORT LANDING AND GO FOR DEORBIT BURN THROUGH WHEELSTOP. @[062702-5502C]
- D. TRAJECTORY PROCESSING IS DEFINED AS THE CAPABILITY OF THE MCC TO TAKE TRAJECTORY DATA FROM VARIOUS SOURCES (RADAR TRACKING, S-BAND DOPPLER, ONBOARD INERTIAL NAVIGATION, ONBOARD GPS) AND IN REAL TIME COMPUTE CURRENT STATE AND PERFORMANCE CAPABILITY THAT ARE USED TO DETERMINE ABORT MODE CAPABILITY, MANEUVER TARGETS, AND TO MAKE OTHER MISSION CRITICAL DECISIONS. REFERENCE RULE {A3-51}, TRAJECTORY PROCESSING REQUIREMENTS. @[062702-5502C]

A3-2 GROUND AND NETWORK OVERALL PHILOSOPHY

- A. MANDATORY REQUIREMENTS: AIR TO GROUND VOICE, COMMAND, HDR TELEMETRY, AND TRAJECTORY PROCESSING DURING CRITICAL PHASES OF FLIGHT IS MANDATORY. HIGH SPEED TRACKING DURING LAUNCH AND LANDING IS MANDATORY. THE MCC AND INTEGRATED NETWORK EQUIPMENT AND ASSOCIATED SOFTWARE TO PROVIDE THESE MANDATORY FUNCTIONS MUST BE AVAILABLE AND SCHEDULED TO INITIATE A CRITICAL ACTIVITY. @[062702-5502C] @[032807-8402B]

The MCC and network provide the ability to collect, process, and display the information needed to invoke mission rule decision, analyze subsystem performance to prevent failures, and to relieve the flight crew of the need to monitor subsystems in detail. Command provides the means to configure onboard systems for nominal operations as well as for anomaly resolution. Command is required to provide uplink remedies to systems problems which require off-nominal systems configurations that can be most effectively accomplished or in some cases only accomplished from the ground. A/G voice provides the means to communicate between the flight crew and the flight control team for mission activities, abort region definition, anomaly resolutions, and many other activities. Redundant high-speed tracking systems are required to provide the necessary independent source for re-constructing the vehicle trajectory and navigation state for post flight ascent analyses, as well as for providing the MCC with independent real-time navigation state and energy determination for off-nominal operations.

This rule states a general principle which must be understood in the light of what is technically feasible. For example, the mandatory requirement is not meant to imply that there can be no short gaps since site handovers, etc., will lead to momentary outages. Additionally, Rule {A3-5}, GROUND/NETWORK DETAILED REQUIREMENTS, gives greater detail to parts of critical periods when longer outages can be allowed. @[062702-5502C] @[032807-8402B]

THIS RULE CONTINUED ON NEXT PAGE

FLIGHT RULES

A3-2 GROUND AND NETWORK OVERALL PHILOSOPHY (CONTINUED)

B. REDUNDANCY: @[062702-5502C]

1. SCHEDULING: REDUNDANCY IN MANDATORY MCC AND INTEGRATED NETWORK FUNCTIONS SHALL BE SCHEDULED AND PLANNED TO BE AVAILABLE AT THE INITIATION OF A CRITICAL ACTIVITY.

NOTE: REDUNDANCY IS NOT REQUIRED WHEN SCHEDULING FOR THE TDRSS NETWORK.

TDRSS network redundancy is well demonstrated and tying up resources by scheduling redundant services is not required. Loss of TDRSS service has been demonstrated in practice to be very remote and emergency rescheduling using alternate equipment is very rapid. TDRSS network redundancy is based on having multiple satellites in both eastern and western locations, two independent ground stations, multiple communication paths between WSC and MCC, and full redundancy in scheduling and other supporting equipment. The TDRSS network has more users than can be scheduled so it is prudent to not explicitly schedule redundant TDRSS coverage.

2. LOSS OF REDUNDANCY: REDUNDANCY IS NOT REQUIRED TO INITIATE A CRITICAL ACTIVITY. FOLLOWING A FAILURE THAT CAUSES LOSS OF REDUNDANCY, IF FEASIBLE, THE REMAINING SINGLE STRING SHOULD BE DEMONSTRATED TO BE FUNCTIONAL PRIOR TO THE INITIATION OF A CRITICAL ACTIVITY.

It is prudent to support mission critical operations with redundancy. MCC and Network functions are by design very reliable. Operational history has demonstrated that MCC and Network functional reliability is very high. When operating on a single string of equipment that is demonstrated to be functioning, which is not annunciating an alarm or operating in an anomalous manner, there is a very low probability of failure in the short time duration of a shuttle critical phase. Unless there is direct evidence to conclude a failure is imminent on operating equipment, there is no reason to delay a critical scheduled event for failure of a redundant string. Conversely, if analysis of a failed system clearly indicates a threat to the remaining equipment, it is prudent not to initiate a critical activity if possible.

3. RECOVERY OF LOST REDUNDANCY: RECOVERY OF REDUNDANT EQUIPMENT SHOULD NOT BE ATTEMPTED IF THERE IS RISK TO THE PLANNED T=0 OR DEORBIT TIG.

Recovery of redundant equipment or function generally has a non-zero risk of operator error or other reason causing loss of the functioning, mandatory equipment string. At pre-defined times for launch or deorbit, this risk should not be incurred. @[062702-5502C]

THIS RULE CONTINUED ON NEXT PAGE

FLIGHT RULES

A3-2 **GROUND AND NETWORK OVERALL PHILOSOPHY (CONTINUED)**

- C. ON-ORBIT COMMUNICATIONS ASSETS WILL BE SCHEDULED IN THE FOLLOWING PRIORITY ORDER: @[012407-7868A]
1. SPACE NETWORK (SN)
 2. NASA GROUND NETWORK (GN) SITES
 3. AIR FORCE SATELLITE CONTROL NETWORK (AFSCN) , REMOTE TRACKING STATION (RTS) SITES

The Space Network (SN) which includes the Tracking and Data Relay Satellite System (TDRSS) coverage is much greater than are the ground sites; therefore, TDRSS is the primary path for on orbit communications. The NASA ground sites are next in the priority order because they are owned by NASA and do not require any extra funding to schedule for support. The last priority is the AFSCN sites which require contractual agreements between NASA and the Air Force so they are a much more limited asset. Ascent and Entry will use ground site support over TDRSS to increase the communications link margins and failure tolerance during those phases of the mission. @[012407-7868A]

FLIGHT RULES

A3-3

HIGH-SPEED TRACKING LAUNCH AND LANDING REQUIREMENTS @[032807-8402B]

A. ASCENT AND FDI ABORTS

1. ASCENT RADAR TRACKING: DUAL SOURCE HIGH-SPEED GROUND TRACKING FROM KSC AREA ASSETS IS MANDATORY FROM LIFT-OFF THROUGH RADAR LOS. FOR HIGH (51.6 DEGREE) INCLINATION MISSIONS, DUAL SOURCE HIGH-SPEED GROUND TRACKING FROM THE WALLOPS AREA RADARS IS HIGHLY DESIRABLE FROM AOS THROUGH MECO PLUS 1 MINUTE.

Powered Flight Tracking: Dual source high-speed tracking from one S-band system and one C-band radar or from two C-band radars is required during powered flight to provide confirmation of a good MCC ground Kalman filter solution. The MCC ground filter provides the real-time capability to monitor onboard navigation health during powered flight and to perform delta state uplinks for correction of extreme onboard navigation errors which could result in unsafe or mission-limiting MECO conditions for nominal ascent or aborts. Ground tracking also provides an independent navigation source to assess ascent performance for abort boundary calls and public safety.

Range Safety: Upon removal of the ET Range Safety destruct package, the flight crew/MCC assumes responsibility for public safety during second stage ascent. The tracking based navigation state precludes limit line violation due to severe onboard navigation problems (state vector update or manual MECO) and prevents loss of External Tank Impact Point (ETIP) prediction due to telemetry loss/data dropouts. The ETIP no longer endangers North American landmasses or islands after KSC area radar LOS, so tracking beyond this time is not required. Note that the Eastern Range has a similar tracking requirement for public safety purposes ending at the same time.

Wallops Tracking: For high inclination missions (51.6 degree inclination), Wallops area high speed C-band tracking is highly desirable for ascent trajectory evaluation near the northeast coastline after LOS of KSC area assets. Although dual source Wallops tracking is highly desirable, a good MCC ground filter solution can be maintained on a single Wallops radar if confirmed on dual sources prior to KSC area radar LOS. Dual source Wallops C-band tracking will normally be scheduled for ascent support, but the launch shall not be scrubbed for loss of Wallops C-band tracking capability.

Post MECO Tracking: For high inclination missions (51.6 degree inclination), dual source Wallops C-band tracking is highly desirable through MECO plus 1 minute to provide an accurate post-MECO ground filter vector. A minimum of 1 minute of post-MECO high-speed tracking is required for processor convergence after the powered flight ascent phase ends. An accurate post-MECO ground filter vector may be used to update onboard navigation before OMS-2 if required to significantly decrease planar delta-V for ground-up rendezvous missions, or before OMS-1 or OMS-2 if the delta-V capability gain would prevent ascent capability downmoding. @[032807-8402B]

THIS RULE CONTINUED ON NEXT PAGE

FLIGHT RULES

A3-3

HIGH-SPEED TRACKING LAUNCH AND LANDING REQUIREMENTS (CONTINUED)

2. RTLS ENTRY RADAR TRACKING: DUAL SOURCE HIGH SPEED GROUND TRACKING IS MANDATORY FROM RTLS MECO THROUGH TOUCHDOWN. ©[032807-8402B]

Similar to the powered flight and post MECO timeframes, dual source high-speed ground tracking is required to provide an independent ground-based navigation source for MCC real-time operations, post-flight analysis capability, and trajectory reconstruction. Dual source tracking from either one S-band system and one C-band radar or two C-band radars, is required to provide confirmation of a good MCC ground Kalman filter solution. The MCC ground filter provides the real-time capability to monitor onboard navigation health, to perform delta state uplink for correction of navigation error exceeding delta state limits, and to perform Ground Controlled Approaches (GCA) for off-nominal trajectory dispersions. The dual source tracking requirement for RTLS entry can be satisfied with the same S-band systems and C-band radars required for ascent support.

3. AOA/FIRST DAY PLS/NEXT PLS: FOR LAUNCH COMMIT, DUAL SOURCE HIGH-SPEED GROUND TRACKING IS HIGHLY DESIRABLE FROM 130KFT TO TOUCHDOWN. ©[062702-5502C]

For the purposes of launch commit, scheduling high-speed tracking support for AOA, FDI, or next PLS is only highly desirable due to the low probability of failures requiring an AOA or FDI PLS and the associated complexity and additional launch constraints created by scheduling two additional ranges (Western Range (WR) and White Sands Missile Range (WSMR)) for the required support. When tracking is highly desirable, there is a high probability of obtaining support for KSC or EDW area radars on a best effort basis if the ranges are given more than 3 hours advance notice. There is little chance of obtaining such support for a NOR AOA or PLS unless the request is made during normal duty hours. Additionally, for other PLS opportunities, tracking support is virtually assured at all three CONUS sites, given 24 hours notice.

C-band or S-band radars located within about 25 miles of the landing site can provide tracking capability from 130 Kft to touchdown. For Edwards landing, tracking from one Vandenberg and one Dryden radar satisfies the requirement for dual source tracking to touchdown, even though the Vandenberg radars are capable of tracking to only an altitude of approximately 40 Kft. For this situation, the MCC ground filter solution would be confirmed on dual sources prior to the Vandenberg tracking LOS, and a confirmed Dryden single source solution could be maintained until touchdown. This is applicable for any landing at Edwards including FDI PLS, next PLS, or EOM. ©[032807-8402B]

THIS RULE CONTINUED ON NEXT PAGE

FLIGHT RULES

A3-3

HIGH-SPEED TRACKING LAUNCH AND LANDING REQUIREMENTS (CONTINUED)

KSC: Although dual source tracking is not specifically required for AOA, tracking for a KSC AOA will be available since the Eastern Range C-band radars and MILA S-band are already scheduled to support launch. They are effectively scheduled for AOA since they are not released until the "Go for orbit OPS." Thus, support would be extended for a KSC AOA landing and could be extended for a KSC Rev 5 or 6 FDI deorbit. ©[032807-8402B]

EDW: For a FDI PLS to Edwards AFB, the Dryden C-band radars are already scheduled for on-orbit tracking in this timeframe. With pre-launch scheduling of the associated Western Range support, the Dryden C-band radars will be available to provide high speed tracking for a Rev 3 PLS for little additional cost. Thus, although not required for launch commit, the EDW radars will be scheduled for FDI PLS support.

NOR: Due to the low probability of AOA or FDI NOR PLS, and the significant scheduling costs for the WSMR C-band radars, these radars will not normally be scheduled pre-launch. The additional cost is not warranted since high-speed tracking will be available at KSC and EDW.

The specific redundant tracking requirement and benefits of high-speed tracking for an AOA, FDI PLS, or next PLS entry are the same as those discussed for RTLS entry.

4. FDI PLS ONLY: AT LEAST ONE TDRS OR TWO C-BAND RADAR PASSES ARE REQUIRED TO SUPPORT PRE-DEORBIT STATE VECTOR ACCURACY.

Post MECO tracking is required for flight day 1 deorbit in order to ensure the onboard state vector meets deorbit burn accuracy requirements. For high inclination launches (57 deg and 51.6 deg), at least one TDRS is required for orbit 3 deorbit, because the ground track does not permit adequate C-band coverage (reference Rules {A4-101}, ONBOARD NAVIGATION MAINTENANCE, and {A3-102}, INTEGRATED NETWORK FAILURE DECISION MATRIX). ©[ED]

5. EOM RADAR TRACKING FOR LAUNCH COMMIT: FOR LAUNCH COMMIT AND SCHEDULING PURPOSES, EOM DUAL SOURCE HIGH-SPEED TRACKING CAPABILITY FROM 130K FEET TO TOUCHDOWN IS MANDATORY. ©[062702-5502C]

For launch commit, confirmation of the availability of the required tracking resources for the planned nominal End-of-Mission (EOM) site is required. The required tracking resources include the radars, the ER Range Operations Control Center (ROCC), and other resources required for the transmission of the high-speed tracking data. ©[032807-8402B]

THIS RULE CONTINUED ON NEXT PAGE

FLIGHT RULES

A3-3

HIGH-SPEED TRACKING LAUNCH AND LANDING REQUIREMENTS (CONTINUED)

B. DEORBIT/ENTRY ©[032807-8402B]

1. DUAL SOURCE HIGH-SPEED TRACKING FROM 130 KFT TO TOUCHDOWN IS MANDATORY FOR COMMIT TO DEORBIT.

Dual source high-speed ground tracking is required to provide an independent ground-based navigation source for MCC real-time operations, post-flight analysis, and trajectory reconstruction. Real-time operations may include onboard navigation monitoring, delta state uplink for correction of extreme navigation errors, and GCA's for off-nominal trajectory dispersions. Redesignation to another landing site or wave-off to a later deorbit opportunity will be considered to gain dual source tracking for landing.

The specific redundant tracking requirement and benefits of high-speed tracking for an EOM entry are the same as those discussed for RTLS entry

2. FOR PLANNED DEORBIT OPPORTUNITIES, THE SCHEDULING OF GROUND C-BAND TRACKING SUPPORT TO MAXIMIZE THE DURATION OF TRACKING COVERAGE FROM DEORBIT TO 130 KFT IS HIGHLY DESIRABLE. FOR TRACKING COVERAGE BELOW 300 KFT, DUAL SOURCE HIGH-SPEED TRACKING IS HIGHLY DESIRABLE.

C-band tracking along the entry ground track is highly desirable to provide an independent ground-based navigation source for MCC real-time operations, post-flight analysis, and trajectory reconstruction. In real time, the C-band tracking data processing provides additional capability to evaluate the accuracy of other navigation sources (e.g., Primary Avionics Software System (PASS), BFS, GPS, ground ephemeris).

The MCC on-orbit tracking data processor is capable of processing either high-speed or low-speed tracking data to minimum altitude of 300K feet. Below 300K feet, the MCC ground Kalman filter provides the capability to process high-speed tracking data.

For scheduling purposes, only C-band tracking passes with an expected maximum elevation greater than 5 degrees will be scheduled in order to provide a reasonable assurance that the radar will be capable of acquiring valid tracking. Efforts will be made to schedule C-band radars to provide additional tracking coverage following deorbit and prior to the acquisition of the landing area C-band radars, but deorbit delay will not be considered to gain the additional tracking coverage. ©[032807-8402B]

THIS RULE CONTINUED ON NEXT PAGE

FLIGHT RULES

A3-3

HIGH-SPEED TRACKING LAUNCH AND LANDING REQUIREMENTS (CONTINUED)

Test Flight Considerations For High Speed Launch and Landing Tracking: In general, the orbiter is considered a developmental flight vehicle and in many respects, every shuttle mission is a flight test since less than 150 flights have transpired in the life of the Program. For these reasons alone, redundant high-speed entry tracking is required to provide the necessary independent source for re-constructing the vehicle trajectory and navigation state for post flight analyses, as well as for providing the MCC with an independent real-time navigation state and energy determination for off-nominal operations. ©[032807-8402B]

Reference Ascent/Entry Flight Techniques #196 (December 17, 2003) ©[032807-8402B]

A3-4

ABORT LIGHT INTERFACE

ONE ABORT LIGHT COMMAND PATH MANDATORY ©[032807-8402B]

Normally, four paths are available for the ground to transmit the abort request command to illuminate the cockpit abort light on panel F6. The Flight Director and FDO each have abort light hardware switches mounted on their consoles plus supporting software to send the abort command. The Flight Control Officer (FCO) located at the Range Operations Control Center (ROCC) also has two independent abort switches able to transmit the abort request command to the vehicle via the MCC. The ROCC abort switches are connected to the MCC through dual 9.6 KB data circuits which interface with workstations WFCR-28, WFCR-10, or SVO-9 (Ref. Rule {A3-151}, MCC/KSC/45 SPW INTERFACE).

Rule {A2-58}, ABORT LIGHT, requires the crew have two independent cues to initiate an ascent abort. The abort light provides one cue; others include MCC voice call, main engine status light, or physiological sensations. Since the abort light is one of several cues available to notify the crew to abort the mission, at least one string is mandatory for launch commit, but redundancy is not required.

Another function of the abort light is to alert the crew to perform an immediate manual MECO in order to avoid violation of range safety limit lines. This function was added as part of the removal of the ET range safety flight termination system. As part of this removal, the flight crew assumed responsibility for public safety during second stage ascent as agents of the 45th Space Wing Commander. For an extremely off-nominal trajectory in second stage, Rule {A4-259}, FLIGHT TERMINATION/MANUAL MECO ACTION, has the MCC verbally notify the crew 15 seconds prior to manual MECO "Prepare for manual MECO." At the appropriate time, this is followed up by transmission of the abort light command concurrent with voice call "Manual MECO now." For any potential range safety scenario, multiple cues will be available to the crew indicating an off-nominal trajectory (e.g., MCC voice calls and troubleshooting instructions, onboard fault summary, HSI, etc.). Rule {A4-259}, FLIGHT TERMINATION/MANUAL MECO ACTION, requires the crew have two cues to initiate a manual MECO—either the two voice calls noted above, or one voice call plus the abort light, or other appropriate indications. Again, since the abort light is one of several cues available to aid in executing this range safety function, redundancy is not required to commit to launch. ©[032807-8402B]

FLIGHT RULES

A3-5

GROUND/NETWORK DETAILED REQUIREMENTS

A. ASCENT AND INTACT ABORTS @[032807-8405A]

1. NOMINAL ASCENT: CONTINUOUS AIR TO GROUND VOICE, COMMAND, TELEMETRY AND TRAJECTORY PROCESSING ARE MANDATORY FROM LIFTOFF THROUGH GO FOR ORBIT OPS.

IN ADDITION TO MANDATORY S-BAND TWO-WAY VOICE, UHF TWO WAY VOICE IS REQUIRED AS A BACKUP DURING LAUNCH FROM LIFTOFF THROUGH NOMINAL HANDUP TO TDRS AND IS HIGHLY DESIRABLE THROUGH MILA LOS.

Redundant A/G voice is necessary for abort request and abort region calls and to rapidly convey verbal responses to observed subsystem anomalies and rule violations. The availability of both S-band and UHF ensures that SRB plume, station handovers, and most onboard and ground subsystem failures will not result in disruption of A/G voice capability causing critical calls to be missed. Early in ascent, the Tracking and Data Relay Satellite System (TDRSS) is not thought to be acceptable due to antenna look angles, structural blockage, etc. Therefore, MILA, PDL, JDMTA, and WLPS provide communications link capability.

The latter stages of ascent, after TDRS handup at 7 minutes 30 seconds MET, are supported by the TDRSS. To ensure mission success for rendezvous missions and to resolve any anomalies that may have occurred during ascent, it is prudent to have the maximum available communications capability through "Go for Orbit Ops" to ensure timely anomaly resolution and to provide the maximum efficiency and mission success through the complex tasks of early post insertion (OPS 2 transition, opening payload bay doors, initiating radiator cooling, etc.). "Go for Orbit Ops" normally occurs at about 1 hr 30 min MET.

2. INTACT ABORTS (RTLS, TAL, AOA, ATO): CONTINUOUS AIR TO GROUND VOICE, COMMAND, TELEMETRY, AND TRAJECTORY PROCESSING ARE MANDATORY FOLLOWING ABORT DECLARATION THROUGH INTACT ABORT LANDING.

UHF TWO-WAY VOICE AT THE LANDING SITE IS HIGHLY DESIRABLE FOR ABORT LANDINGS.

The declaration of an abort results in procedures that involve additional risk. MCC support is required to provide increased insight into systems performance and additional expertise to significantly increase the probability of a successful landing with a vehicle that has already had a major systems failure. A/G voice is required to coordinate any recommendations to the crew and to relay to the crew final weather, runway, landing aid, and major systems status. This requirement for TAL may be met through the use of TDRS-S or TDRS-E since landing occurs at approximately MET 37 minutes. RTLS requirements may be covered by scheduling MILA with a TDRS as a backup. AOA and ATO aborts require the use of the entire TDRSS network. @[032807-8405A]

THIS RULE CONTINUED ON NEXT PAGE

FLIGHT RULES

A3-5

GROUND/NETWORK DETAILED REQUIREMENTS (CONTINUED)

3. REDUNDANCY FOR ASCENT INCLUDING INTACT ABORTS:
@[032807-8405A]
 - a. REDUNDANCY IN EQUIPMENT AND NETWORK SCHEDULING FOR AIR TO GROUND VOICE, COMMAND, TELEMETRY, AND TRAJECTORY PROCESSING SHALL BE PLANNED AND SCHEDULED FOR LAUNCH THROUGH "GO FOR ORBIT OPS" OR INTACT ABORT LANDING. NOTE: FOR TDRSS SCHEDULING, REDUNDANCY IS NOT REQUIRED.
 - b. CONSIDERATION WILL BE GIVEN TO ATTEMPTING TO REGAIN FAILED REDUNDANT EQUIPMENT IF THE RECOVERY WILL NOT AFFECT THE REMAINING MANDATORY EQUIPMENT AND RECOVERY PROCEDURES ETRO IS PRIOR TO THE NOMINAL PLANNED TIME FOR COMING OUT OF THE T-9 MINUTE HOLD.
 - c. RECOVERY EFFORTS FOR FAILED REDUNDANT EQUIPMENT IN THE MCC AND INTEGRATED NETWORK WILL NOT BE PERFORMED BETWEEN T-9 MINUTES AND COUNTING AND MET 15 MINUTES OR LANDING FOR RTLS OR TAL.
4. SCHEDULING: THE FOLLOWING COMM ASSETS SHALL BE SCHEDULED FROM PRE-LAUNCH THROUGH "GO FOR ORBIT OPS" (REF. RULE {A3-102}, INTEGRATED NETWORK FAILURE DECISION MATRIX):
 - a. ALL AVAILABLE NASA GROUND NETWORK (GN) AND AIR FORCE SATELLITE CONTROL NETWORK (AFSCN) REMOTE TRACKING STATION (RTS) SITES IN VIEW OF EXPECTED GROUNDTRACK.
 - b. THE TRACKING AND DATA RELAY SATELLITE SYSTEM (TDRSS) INCLUDING A TDRS EAST, A TDRS WEST, AND A TDRS-Z SATELLITE.
 - c. ONCE AN ATO ABORT IS DECLARED, IT IS HIGHLY DESIRABLE TO SCHEDULE ALL AVAILABLE NASA GN AND AFSCN RTS SITES THROUGH LANDING ON FLIGHT DAY 1. @[032807-8405A]

THIS RULE CONTINUED ON NEXT PAGE

FLIGHT RULES

A3-5 GROUND/NETWORK DETAILED REQUIREMENTS (CONTINUED)

Nominally, the TDRSS network is prime for comm starting at 7 minutes 30 seconds MET. The GN and AFSCN are highly desirable through the call for "Go for Orbit Ops" which is approximately MET 1 hour 30 minutes as a backup in the event of a TDRSS failure during the critical periods for establishing a safe orbit or executing an abort procedure. GN and AFSCN do not provide complete communications coverage through this time frame but do provide short periods of coverage. TDRSS is required 30 minutes prior to launch to allow for checkout of the interfaces. TDRSS is scheduled continuously to at least "Go for Orbit Ops" call so that any contingencies with the crew or orbiter can be communicated after the ground site support is no longer in view of the orbiter. ©[032807-8405A]

B. DEORBIT/ENTRY:

1. PRE-DEORBIT: IT IS HIGHLY DESIRABLE TO HAVE THE MAXIMUM DURATION OF COVERAGE POSSIBLE FOR AIR TO GROUND VOICE, COMMAND, TELEMETRY AND TRAJECTORY PROCESSING FROM TIG-4 HOUR TO DEORBIT DECISION. REDUNDANCY IS DESIRABLE BUT NOT REQUIRED.

Preparing the orbiter for entry includes a number of complex and critical steps such as moding flight software to OPS 3, closing the payload bay doors, activating FES cooling. MCC communication is required to troubleshoot vehicle anomalies, provide deorbit maneuver target, and to assess landing site readiness including weather. Deorbit decision time is normally TIG - 23 minutes.

2. DEORBIT DECISION: CONTINUOUS AIR TO GROUND VOICE, COMMAND, AND TELEMETRY FROM THE MCC GO FOR DEORBIT TO POST LANDING ARE MANDATORY. REDUNDANCY FOR MANDATORY FUNCTIONS IS HIGHLY DESIRABLE BUT NOT REQUIRED.

UHF TWO-WAY VOICE IS HIGHLY DESIRABLE DURING ENTRY WHEN IN RANGE OF THE GROUND STATION AS A BACKUP TO S-BAND VOICE. S-BAND VOICE IS MANDATORY AS DESCRIBED ABOVE.

Monitoring vehicle systems, energy management, anomaly resolution, and landing site evaluation from touchdown parameters to weather conditions is the primary job of the MCC during shuttle entry. ©[032807-8405A]

THIS RULE CONTINUED ON NEXT PAGE

FLIGHT RULES

A3-5 GROUND/NETWORK DETAILED REQUIREMENTS (CONTINUED)

3. SCHEDULING: THE FOLLOWING COMM ASSETS SHALL BE SCHEDULED FOR THE DEORBIT PREP/ENTRY TIMEFRAME (REF. RULE {A3-102}, INTEGRATED NETWORK FAILURE DECISION MATRIX) : @[032807-8405A]
 - a. ALL AVAILABLE NASA GN AND AFSCN RTS SITES IN VIEW OF THE EXPECTED SHUTTLE GROUND TRACK ARE HIGHLY DESIRABLE FROM 30 MINUTES PRIOR TO DEORBIT BURN THROUGH LANDING.
 - b. FOR TDRSS, ONE TDRS EAST, ONE TDRS WEST, A TDRS-Z SATELLITE CONTINUOUSLY FROM THE START OF DEORBIT PREP THROUGH POST LANDING OR DEORBIT PREP BACKOUT COMPLETE.

The Deorbit/Entry phase is considered to begin at the start of deorbit prep (approximately deorbit burn time of ignition (TIG) - 4 hours). Both GN and AFSCN are highly desirable as backup communications paths, starting at TIG -30 minutes through landing, in case TDRSS fails during this critical period. TDRSS continuous communications is required so that critical deorbit prep and entry operations (OPS 3 transition, payload bay door closure, activating FES cooling deorbit maneuver targets, working anomalous conditions, assess landing site readiness including weather etc.) can be coordinated with the crew. If deorbit is waved off for the day, then the orbiter is considered to be back in the orbit phase of operations once the appropriate deorbit prep back-out activities are complete.

- C. POST LANDING: FOR ALL ABORT AND NOMINAL EOM LANDINGS, MANDATORY GROUND NETWORK EQUIPMENT WILL PROVIDE FOR AIR TO GROUND VOICE, COMMAND, AND TELEMETRY FROM LANDING UNTIL VEHICLE HANDOVER TO THE LANDING RECOVERY DIRECTOR (LRD), NASA CONVOY COMMANDER (NCC), AND/OR THE GROUND OPERATIONS MANAGER (GOM). REDUNDANCY IS NOT REQUIRED

The Landing Recovery Director (LRD) is the KSC representative leading the postlanding support for the orbiter from one of the firing rooms in the Launch Control Center (LCC). The NASA Convoy Commander (NCC) is the KSC representative leading the convoy team on the runway at one of the Primary Landing Sites (PLS) in the continental U.S. (KSC, EDW, and NOR). The Ground Operations Manager (GOM) is the KSC representative leading the convoy team on the runway at one of the TAL landing sites (Zaragoza, Spain, Moron, Spain, and Istres, France). Collectively, these positions are responsible for the orbiter ground operations following completion of Post-Landing. Vehicle safing, including crew egress, initiation of ground cooling and hand over of vehicle control to KSC must be completed safely before communications assets are released by the MCC. @[032807-8405A]

THIS RULE CONTINUED ON NEXT PAGE

FLIGHT RULES

A3-5 GROUND/NETWORK DETAILED REQUIREMENTS (CONTINUED)

D. ORBIT PHASE: @[032807-8405A]

1. FOR ALL "NETWORK CRITICAL" PERIODS:
 - a. TDRSS WILL PROVIDE MANDATORY AIR TO GROUND VOICE, COMMAND, AND TELEMETRY.
 - b. AVAILABLE NASA GN AND AFSCN RTS SITES ARE HIGHLY DESIRABLE TO PROVIDE ADDITIONAL COMM COVERAGE.
2. SCHEDULING: FOR ORBIT PERIODS WITH THE KU-BAND SYSTEM DEPLOYED AND IN COMMUNICATIONS MODE:
 - a. A TDRS EAST AND TDRS WEST SHALL BE SCHEDULED TO OPTIMIZE KU-BAND COVERAGE. A TDRS-Z SATELLITE SHALL BE SCHEDULED AS NECESSARY TO PROVIDE ADDITIONAL COVERAGE FOR PERIODS WHEN THE TDRS EAST OR TDRS WEST SATELLITE IS PREDICTED TO HAVE POOR S-BAND COMMUNICATIONS OR WHEN ADDITIONAL KU-BAND COVERAGE IS REQUIRED.
 - b. AVAILABLE GN AND AFSCN RTS SITES WILL BE SCHEDULED BASED ON MISSION-SPECIFIC REQUIREMENTS.

TDRSS is the primary communications path during orbit operations. The selection of which TDRS to use will include consideration of whether Ku-band has visibility of the TDRS because of the high volume of Ku-band traffic that is now required to support survey operations as well as other Orbiter Communications Adaptor (OCA) operations run continuously through the mission. During network critical phases such as OBSS operations, rendezvous, EVA, undock/flyaround/separation, and deploy/retrieval, continuous communications with the crew is prudent to ensure a successful and safe operation therefore TDRSS coverage is extended even if Ku-band is not available on the satellite.

AFSCN RTS sites are primarily used for recorder dumps during on-orbit operations. However, RTS sites can also be used for two-way comm operations when required. @[032807-8405A]

A3-6 THROUGH A3-50 RULES ARE RESERVED @[032807-8402B] @[032807-8405A]

FLIGHT RULES

MCC INSTRUMENTATION PRELAUNCH REQUIREMENTS

A3-51

TRAJECTORY PROCESSING REQUIREMENTS @[061396-4005A]
@[022802-5198]

- A. HIGH-SPEED TRAJECTORY DETERMINATION:
1. HIGH SPEED S-BAND - HIGHLY DESIRABLE FOR LAUNCH AND LANDING. WILL BECOME MANDATORY FOR LOSS OF REDUNDANT C-BAND CAPABILITY. @[061297-6004] @[032807-8402B]
 2. HIGH SPEED C-BAND - MANDATORY FOR LAUNCH AND LANDING
@[032807-8402B]
 3. KALMAN FILTER PROCESSING - HIGHLY DESIRABLE FOR LAUNCH AND LANDING @[061297-6004]
- B. ARD/AME PROCESSING - MANDATORY FOR LAUNCH @[022802-5198]
- C. EPHEMERIS MAINTENANCE PROCESSING - MANDATORY
- D. ORBIT DETERMINATION PROCESSING:
1. LOW SPEED TRACKING DATA - MANDATORY
 2. BATCH RADAR PROCESSING - MANDATORY

THIS RULE CONTINUED ON NEXT PAGE

FLIGHT RULES

A3-51 TRAJECTORY PROCESSING REQUIREMENTS (CONTINUED)

- E. DEORBIT PLANNING PROCESSING - MANDATORY
- F. ENTRY PROFILE PROCESSING - MANDATORY
- G. COMMAND/TRAJECTORY INTERFACE PROCESSING - MANDATORY
- H. TRAJECTORY/TELEMETRY AND TELEMETRY/TRAJECTORY INTERFACE PROCESSING - MANDATORY
- I. HIGH SPEED ENTRY RGO AND TAEM PROCESSING - MANDATORY FOR LAUNCH AND LANDING @[022802-5198]
- J. RENDEZVOUS TARGETING PROCESSING - MANDATORY FOR RENDEZVOUS FLIGHT @[061396-4005A]
- K. LAUNCH WINDOW/LAUNCH TARGETING PROCESSING - MANDATORY UNTIL THE LAUNCH TARGET COMMANDS HAVE BEEN GENERATED. THIS ONLY APPLIES TO GROUND-UP RENDEZVOUS AND INERTIALLY TARGETED FLIGHTS. @[061396-4005A]

All mandatory trajectory processing is required to be operational prior to launch, including support processors as well. Any loss of trajectory processing will be assessed in real time in order to determine applicability of the lost capability to the flight at hand.

- L. DOLILU STRUCTURAL LOADS AND TRAJECTORY ANALYSIS TOOLS - MANDATORY UNTIL THE DOLILU I-LOAD HAS BEEN TRANSFERRED INTO THE MCC COMMAND SYSTEM; THEREAFTER, HIGHLY DESIRABLE (REF. RULE {A4-4}, DOLILU OPERATIONS). @[091098-6622C]

DOLILU and Loads assessments are nominally run concurrently by JSC and USA/Systems Integration. In the event that JSC fails to complete analysis after the MCC I-load transfer, USA/Systems Integration becomes prime for providing the remaining prelaunch assessments. This contingency condition is considered acceptable to proceed based on the joint system checkouts that have occurred (L-3 week, L-2 day, and completed launch day verifications). @[091098-6622C]

- M. DESCENT DESIGN SYSTEM (DDS) - MANDATORY @[061396-4005A] @[022802-5198]

Rules {A2-301}, CONTINGENCY ACTION SUMMARY [HC]; {A3-1}, GROUND AND NETWORK DEFINITIONS; and {A3-54}, TRAJECTORY SERVER ERRORS, reference this rule. @[032807-8400] @[ED]

FLIGHT RULES

A3-52

MCC INTERNAL VOICE

LOSS OF INTERNAL VOICE LOOPS FD, A/G 1, OIS 232 AND FLIGHT CONTROL OFFICER (FCO), WOULD NOT CAUSE A LAUNCH HOLD BECAUSE OF SUFFICIENT AVAILABLE WORKAROUNDS:

A. MCC FLIGHT CONTROL TEAM COORDINATION CAPABILITY - ONE OF THREE MANDATORY:

1. FD
2. AFD CONF
3. LOOP CONFERENCING

One common voice loop between all MCC flight control team members is required for expedient communication of system conditions/anomalies.

B. A/G TALK CAPABILITY - TWO OF FOUR MANDATORY:

1. A/G 1
2. A/G 2
3. A/G UHF
4. OTHER LOOP WITH KEYING CAPABILITY

Two MCC voice loops with keying capability are required to provide continuous S-band A/G and UHF A/G (ref. Rule {A3-1A}.1.d, GROUND AND NETWORK DEFINITIONS). ®[ED]

C. COMMUNICATIONS INTERFACE WITH LAUNCH TEST DIRECTORS - ONE OF FOUR MANDATORY:

1. OIS 131
2. OIS 232
3. FD (EXTENDED TO LAUNCH SITE)
4. OTHER LOOP PATCHING TO LAUNCH SITE

One MCC voice loop (extended to launch site long lines) is required to call an MCC-initiated countdown hold.

THIS RULE CONTINUED ON NEXT PAGE

FLIGHT RULES

A3-52

MCC INTERNAL VOICE (CONTINUED)

D. COMMUNICATIONS INTERFACE WITH FCO - TWO OF FOUR MANDATORY:
@[101096-4550]

1. FCO PVT LINE
2. FD (EXTENDED TO FCO)
3. FCO PRIME
4. OTHER LOOP PATCHING TO FCO LONG LINE

A minimum of two MCC voice loops, extended to the Eastern Range 45th Space Wing, are required for FD and FDO voice communication with the FCO. Removal of the ET Range Safety Flight Termination System resulted in additional flightcrew responsibility as agents of the 45th Space Wing Commander for public safety during second stage flight, with crew-initiated manual MECO replacing range safety command destruct capability. Redundant FCO/MCC communications is therefore mandatory to provide the interaction and situational awareness necessary to implement this requirement. @[101096-4550]

Rules {A3-151C} and D, MCC/KSC/45 SPW INTERFACE, reference this rule.

E. COMMUNICATIONS CAPABILITY WITH REQUIRED ASCENT ABORT SITES -
1 OF 3 MANDATORY: @[111094-1716A] @[ED]

1. LONGLINE (LFP1)
2. INMARSAT
3. COMMERCIAL TELEPHONE

Prelaunch, the MCC must be able to communicate with the required ascent abort landing sites (ref. Rule {A2-2}, ABORT LANDING SITE REQUIREMENTS). This insures that there has not been a change in weather or nav/landing aid status. It also insures that anomalies can be passed to the ground support team and that the runway and airspace are clear for a safe landing. This can be accomplished by insuring that at least one of the communications capabilities listed above are available. @[111094-1716A] @[051697-6008A]

FLIGHT RULES

A3-53

MCC POWER REQUIREMENTS @[CR 6839A] @[121505-7197A]

A. THE FOLLOWING BUILDING 30 SOUTH POWER BUSES ARE REQUIRED:
@[061396-4006A]

1. TWO POWER SOURCES (ANY COMBINATION OF TWO COMMERCIAL FEEDS AND TWO DIESEL GENERATORS)

The intent of this rule is to define MCC bus loss failures in which it would be safe to continue with launch, deorbit, or to enter into a critical phase. Other than explicitly written, this rule is not designed to address multiple bus loss events in a single building (i.e., loss of 30S AX1 and BX2 power) because, by definition, this implies that the ability for MCC to support is suspect. @[061396-4006A]

Bldg 30S power is supplied through two commercial power feeders. In the event of a commercial power failure, Bldg 48 provides generator power via generators 7 and 9. The nominal configuration for launch/deorbit is dual commercial sources as primary with the generators in auto start mode in the event of loss of either commercial power source. Any single generator or single commercial source can support both the critical and non-critical equipment. However, it is prudent to maintain a single fault tolerant Building 30S source power configuration because if only a single source were remaining, three failures must have occurred, calling into question the reliability of the last remaining power source.

2. AX POWER: ONE OF TWO AX BUSES (AX1/AX2) IF THE FOLLOWING CONDITIONS ARE SATISFIED:
 - a. HIGH CONFIDENCE THAT THE REMAINING BUS IS HEALTHY AND NOT SUBJECT TO THE SAME OR SIMILAR CONDITION
 - b. THE FLIGHT CONTROL TEAM CAN RECONFIGURE RESOURCES TO SUPPORT LAUNCH/DEORBIT OR OTHER CRITICAL PHASE WITH THE REMAINING CAPABILITY
 - c. A REASONABLE EXPECTATION THAT THE FAILED BUS OR REDUNDANT POWER CAN BE REGAINED TO MISSION CRITICAL EQUIPMENT (LAUNCH ONLY)

Loss of a single AX bus significantly reduces the number of workstations and DVIS keysets available and places the MCC one failure away from not being able to support flight operations. This next failure results in a total loss of all MCC critical functions (capability to support mandatory voice, command, telemetry, and trajectory processing functions). @[121505-7197A]

THIS RULE CONTINUED ON NEXT PAGE

FLIGHT RULES

A3-53

MCC POWER REQUIREMENTS (CONTINUED)

In the event of an AX bus loss during the pre-launch/deorbit timeframe, it is mandatory to understand the configuration of the remaining power bus, flight control team capability, as well as understanding when redundancy could be restored prior to committing for launch/deorbit. ©[CR 6839A] ©[121505-7197A]

A full assessment of the impact of the loss will be performed and MCC facility management will make a determination whether there is confidence that the remaining bus will not be impacted by the same or similar conditions that impacted the failed bus. The assessment is mandatory to determine the stability of the remaining bus, MCC capabilities, and timeframe required to restore the failed bus as rationale to proceed into the launch/deorbit or other critical phase on a single AX bus. This protects against proceeding into a critical phase where the next power failure could prevent completion of mission critical activities. Assessment efforts for a single bus loss are expected to take a minimum of 2 hours based on historical evidence from STS-96. During the time of the assessment, the MCC should be considered NO-GO for support with the loss of a single AX bus. ©[CR 6839A]

No attempt will be made to restore the failed bus during the critical period from L-9 minutes and counting through an MET of 15 minutes (or landing for a RTLS/TAL), as defined in Rule {A3-3A}.1 and 2, GROUND AND NETWORK DETAILED REQUIREMENTS.

The Flight Control Team (FCT) has assessed impacts to both the AX1 and AX2 busses via the MCC Power Data Table and will require console reconfiguration and relocation to different consoles not affected by the failed bus for specific disciplines. Examples of this are as follows:

TABLE A3-53-I - MCC POWER DATA TABLE

AX1 BUS IMPACTS IF FAILED	AX2 BUS IMPACTS IF FAILED	COMMENTS
<u>WHITE FCR</u> : EACH DISCIPLINE WILL LOSE HALF OF THEIR WORKSTATIONS AND DVIS.	<u>WHITE FCR</u> : EACH DISCIPLINE WILL LOSE HALF OF THEIR WORKSTATIONS AND DVIS.	
<u>WHITE MPSR</u> : FLIGHT DYNAMICS - PROFILE AND ENTRY SUPPORT CONSOLES EECOM - LIFE SUPPORT AND THERMAL CONSOLES MMACS - MECHANICAL AND IFM CONSOLES EGIL - SL EPS CONSOLE INCO - RF COMM CONSOLE DPS - DPS SUPPORT AND CDMS CONSOLES	<u>WHITE MPSR</u> : FLIGHT DYNAMICS - ARD SUPPORT, TARGET/ABORT SUPPORT, LSO CONSOLES BOOSTER - MAIN ENGINE AND MPS CONSOLES GNC - SENSORS CONSOLE	CONSOLES NOT LISTED LOSE REDUNDANCY ONLY. ALL CONSOLES EXCEPT FOR MECHANICAL WILL HAVE UPS POWER FOR APPROX 15-20 MINUTES AFTER AX POWER FAILS. UPS COVERS BOTH WORKSTATIONS AND DVIS. FLIGHT DYNAMICS ENTRY SUPPORT AND PROFILE CONSOLES WILL LOSE 3 OF 4 WORKSTATIONS AND 2 OF 3 DVIS, WHICH IS NOT A SUPPORTABLE CONFIGURATION.

©[CR 6839A] ©[121505-7197A]

THIS RULE CONTINUED ON NEXT PAGE

FLIGHT RULES

A3-53

MCC POWER REQUIREMENTS (CONTINUED)

For the Flight Dynamics console impacts, even if the bus were lost well before launch, the ability to achieve a safe configuration for launch will be challenging. Once configured, however, proceeding with launch would be acceptable. Impacts to the Booster discipline are that only a single workstation and monitor will be available after AX2 is failed and the local UPS batteries can no longer support (both MPSR positions are powered via AX2). In the event an AX bus fails after launch, equipment will remain operational via local UPS located at the console level for approximately 15-20 minutes. This provides the ability for MCC to support MECO. ©[CR 6839A] ©[121505-7197A]

AX Power Architecture:

AX power originates downstream of the UPS and supplies both critical and noncritical equipment. AX bus redundancy is provided by the UPS source bus power (BX) and UPS batteries. Russelectric transfer switches downstream of the UPS provide a path for the other BX bus to provide power to critical equipment if needed (i.e., to allow transfer from battery power back to a good BX source). However, this switch is manual and, although it can provide power to the downstream loads, these loads would have to be unpowered before the switch was activated and would result in an approximately 1-2 hour impact to repower the affected equipment.

If a single AX bus loses power (i.e., loss of power out of the UPS), the corresponding downstream equipment will be lost due to the power distribution panels tripping off-line. Even when power is restored, the PDU's cannot be reset until the downstream equipment is configured for power to be reapplied. This process can take approximately 1-2 hours.

Critical equipment on each floor of building 30S is provided power via a Russelectric transfer switch. The critical floors are the 2nd, 3rd, 4th, and 5th. As long as the conditions in Paragraphs A, B, and C are satisfied, it is acceptable to continue with loss of a single floor.

Non-critical equipment is also supplied by "AX" power (prime) and is redundantly fed by BX power (alternate). These power sources feed into Power Paragon automated transfer switches that automatically select the best source power for the non-critical equipment. No manual intervention is required and there is no loss of function for downstream equipment.

3. UNINTERRUPTIBLE POWER SYSTEM (UPS): ONE OF TWO UPS

The UPS system provides backup battery power to critical and non-critical equipment on the AX1 and AX2 power busses in the event of an upstream "BX" source power disturbance. If the UPS is on backup battery and a good BX source returns, the UPS automatically switches off battery and back to BX. If the batteries are expended and a BX source upstream of the UPS is available, the internal UPS circuitry fails to bypass, which continues to route source power, thus maintaining power to the critical equipment with no loss of function. ©[CR 6839A] ©[121505-7197A]

THIS RULE CONTINUED ON NEXT PAGE

FLIGHT RULES**A3-53****MCC POWER REQUIREMENTS (CONTINUED)**

While critical equipment function could be maintained without either UPS operational, the susceptibility to commercial power transients is significantly increased. A single power transient could result in loss of both AX1 and AX2 busses without a functional UPS to modulate the voltage load. Therefore, at least one UPS is required to protect for this failure mode. ©[CR 6839A] ©[121505-7197A]

If battery backup power was required with a single UPS (three failures deep), the battery runtime is decreased from approximately 1 hour to approximately 30 minutes due to having to power loads on the failed "AX" power string (i.e., via quick switches).

An out-of-phase condition between AX UPS power could lead to additional power issues affecting quick switches supporting critical equipment bus; however, failures of quick switches encountered in building 30 fail in a state where power to the downstream equipment remains.

4. BX POWER: ONE OF TWO "BX" BUSES (BX1 OR BX2)

BX 1 and BX 2 busses provide power to the AX bus via the UPS. In the event of a BX failure, all loads downstream of the UPS (critical and non-critical hardware) will remain operational via the UPS batteries. This equipment will continue to operate for about 1 hour with no loss of function. When batteries expire, the non-critical equipment will automatically select over to redundant power with no loss of function. The critical equipment will not automatically select over to best source power and will require a powerdown before redundant power can be supplied. This will take approximately 1-2 hours to restore.

The air handlers can be regained quickly via manual transfer switches if alternate power is available or power is regained to the failed bus.

B. THE FOLLOWING BUILDING 30M POWER BUSES ARE REQUIRED:

1. BUILDING 30M POWER SOURCE: TWO POWER SOURCES (ANY COMBINATION OF TWO COMMERCIAL FEEDS AND THREE DIESEL GENERATORS)

The intent of this rule is to define bus loss failures in which it would be safe to continue with launch, deorbit, or to enter a critical phase. Other than explicitly written, this rule is not designed to address multiple bus loss events in a single building (i.e., loss of 30M A1 and B2 power) because, by definition, this implies that the ability for MCC to support is suspect. ©[CR 6839A] ©[121505-7197A]

THIS RULE CONTINUED ON NEXT PAGE

FLIGHT RULES

A3-53

MCC POWER REQUIREMENTS (CONTINUED)

Bldg 30M is supplied source power through commercial power and/or Bldg 48 generator power. Commercial power includes two power feeds and Bldg 48 generator power includes three generator feeds. The nominal configuration for launch/deorbit is dual commercial sources as primary with the generators in an auto start ready mode in the event of loss of either commercial power source. Although the generators will start and supply power in a quick manner if required, the loss of the commercial power feed will result in loss of the respective non-critical equipment which can only be regained with manual intervention. Any single generator or single commercial source can support both the critical and non-critical equipment. ©[CR 6839A] ©[121505-7197A]

The requirement for two power sources maintains full capability on critical equipment, however, depending on the failure scenario, could result in loss of all non critical hardware (SSP MER, MIDDS, MMT Action Center, and ODRC). Once a commercial power source fails, the respective noncritical equipment will trip off line (via power distribution panels) and, even when power is quickly restored via the generators, it will have to be reconfigured before it is repowered (reset of the power distribution panels). The exception to this is the air handlers which can be reset quickly once power is restored. Procedures protect against this scenario by placing Building 30M on diesel generator as prime power with commercial as backup during thunderstorms. This part of the rule protects for source power losses and not the inability to provide power on the "B" bus (i.e., short), which is covered later in this rule.

It is prudent to maintain a single fault tolerant configuration in the building with respect to source power because if down to zero fault tolerance, four failures have occurred, which makes the last remaining power source suspect.

2. A POWER: ONE OF TWO "A" BUSES (A1/A2) IF THE FOLLOWING CONDITIONS ARE SATISFIED:
 - a. HIGH CONFIDENCE THAT THE REMAINING BUS IS HEALTHY AND NOT SUBJECT TO THE SAME OR SIMILAR CONDITION
 - b. A REASONABLE EXPECTATION THAT THE FAILED BUS OR REDUNDANT POWER CAN BE REGAINED TO MISSION CRITICAL EQUIPMENT (LAUNCH ONLY)

Mission critical equipment is powered through the "A1/A2" power busses, including the air-to-ground voice equipment, DVIS, and external voice circuits. These busses are powered through Bldg 30M "B" power and battery power via the uninterruptible power supplies (UPS's). While there are three power sources for each of the "A" busses, single point failures such as loss of the power line or panel failure do exist downstream of the UPS that would result in loss of either A1 or A2 equipment. Some of the critical equipment is configured with "quick switches" which select best source power between the available A1 and A2 power and would, therefore, not be affected if either "A" bus fails. ©[CR 6839A] ©[121505-7197A]

THIS RULE CONTINUED ON NEXT PAGE

FLIGHT RULES**A3-53****MCC POWER REQUIREMENTS (CONTINUED)**

For failures in the A1 or A2 power distribution units (PDU's) that result in equipment being selected to redundant power via quick switches, the MCC hardware engineers will not reconfigure the power system until the building power is verified to be in phase. Failure modes exist with the quick switches that result in arcing and loss of the quick switch if an out-of-phase condition exists and the quick switch is swapped to the redundant power source. ©[CR 6839A] ©[121505-7197A]

Rule {A3-2B}.2, GROUND AND NETWORK OVERALL PHILOSOPHY, states that it is prudent to support critical shuttle phases with redundancy for mandatory functions and that, if redundancy is lost, the remaining capability should be demonstrated to be functioning, if feasible. For the case of critical power busses that would take approximately 1-2 hours to begin restoring voice capability if the second bus failed, a high level of confidence in the remaining bus must be established prior to proceeding into a critical phase.

Following the loss of an "A" power bus, COD and MSOC will perform an assessment of the remaining capability and the GC, MCC facility management, and SFOC mission manager will brief the Flight Director of the status with a recommendation on whether to proceed into the critical phase. Until the assessment has been performed, the MCC must be considered NO GO for entering the critical phase. A bus loss after entering the critical launch phase at T-9 minutes and counting cannot be assessed in the time remaining and the MCC is NO-GO for launch.

3. UNINTERRUPTIBLE POWER SYSTEM (UPS): ONE OF TWO
UPS' S ©[061396-4006B]

The UPS system functions as backup power to critical equipment on the A1 and A2 power busses in the event all "B" source power is lost. As long as either the "B1" or "B2" source power is maintained, a failure of a UPS is transparent to downstream equipment. The internal UPS circuitry fails to bypass, which continues to route source power, thus maintaining power to the critical equipment with no loss of function.

While critical equipment function could be maintained without either UPS operational, the susceptibility to commercial power transients is significantly increased. A single power transient could result in loss of both A1 and A2 busses without a functional UPS to modulate the voltage load. Therefore, a single UPS is required to protect for this failure mode.

If battery backup power was required with a single UPS (three failures deep), the battery runtime is decreased from approximately 1 hour to approximately 30 minutes due to having to power loads on the failed "A" power string (i.e., via quick switches).

An out-of-phase condition between "A" UPS power could lead to additional power issues affecting quick switches supporting critical equipment bus; however, failures of quick switches encountered in building 30 fail in a state where power to the downstream equipment remains. ©[CR 6839A] ©[121505-7197A]

THIS RULE CONTINUED ON NEXT PAGE

FLIGHT RULES

A3-53

MCC POWER REQUIREMENTS (CONTINUED)

4. ONE OF TWO "B" BUSES (B1 OR B2) @[CR 6839A] @[121505-7197A]

The "B1/B2" bus originates with commercial power and/or generator power and is split off to provide single string power to non-critical equipment, half the lighting, and the DVIS air handlers. "B1/B2" bus power is unique in this regard because if failed and then regained, either by commercial or generator, the non critical equipment will not be available until after manual reconfiguration occurs, which may take 1-2 hours.

The mandatory requirement for a single source of "B" power is driven by the necessity to maintain power to the building 30M air handlers and to prevent launching on battery power only.

Loss of either "B1/B2" bus will result in loss of half the non-critical power distribution units (PDU's) and associated downstream equipment, half the lighting, and half of the DVIS air handlers.

DVIS will operate on air hander 13 or 16 for at least 7 hours provided overhead air from two of three air handlers 2, 3, and 18 are available. Additionally, once power redundancy has been restored (i.e., generators) the air handlers are quickly regained.

Non-critical MCC equipment (e.g., portions of the MER, ODRC, MMT command center, MIDDs) may be lost when half of the non-critical PDU's are unpowered. Manual recovery actions to safely restore the lost non-critical equipment may take 1-2 hours to safely configure the equipment for powerup.

There have been failures experienced where one leg of commercial power fails such that the redundant power bus voltage also drops enough to trip all the non-critical equipment PDU's (common point in building 221). While down all the non-critical equipment, the launch/deorbit could proceed if the remaining power requirements (i.e., commercial power, etc.) are met and power to the minimum number of air handlers is regained.

- C. THE FOLLOWING COMPLEMENT OF BUILDING 30M AIR HANDLERS IS REQUIRED TO MAINTAIN OPERATION OF CRITICAL EQUIPMENT:
@[061396-4006A]

1. DVIS AIR HANDLERS:

a. ONE OF TWO DVIS AIR HANDLERS

b. TWO OF THREE AIR HANDLERS 2, 3 OR 18 @[CR 6839A]
@[121505-7197A]

THIS RULE CONTINUED ON NEXT PAGE

FLIGHT RULES**A3-53****MCC POWER REQUIREMENTS (CONTINUED)**

DVIS has a high inherent operating temperature that has been documented to cause damage to the system if proper cooling is not maintained. Both air handlers for DVIS are required, including a thermal barrier enclosing them with the DVIS pallets to provide sufficient cooling to keep DVIS from experiencing destructive heat-related damage. The loss of one air handler can be tolerated for several hours before damage occurs, but temperatures must be closely monitored. If the air handler is not restored to operations prior to DVIS exceeding operational limits, some or all of the system would have to be shut down. The use of portable fans would be employed to extend the time if required, and DVIS pallet 4 could be used to provide limited voice capabilities if the main pallets had to be shut down. These air handlers are configured to have two power sources available and can be quickly reconfigured in the event primary power is lost. @[CR 6839A] @[121505-7197A]

2. BUILDING 30M MAIN AIR HANDLERS:
 - a. TWO OF THREE AIR HANDLERS 2, 3, OR 18
 - b. ONE AIR HANDLER FROM 4 OR 5
 - c. ONE AIR HANDLER FROM 8 OR 9

These air handlers supply cooling to building 30M critical equipment. Air handlers 2, 3, and 18 are configured to have two power sources available and can be quickly reconfigured in the event primary power is lost. Air handlers 4, 5, 8, and 9 have single source power only; however, they are on different power sources, thus maintaining redundancy. @[061396 4006A]

D. THE FOLLOWING COMPLEMENT OF BUILDING 30S AIR HANDLERS IS REQUIRED TO MAINTAIN OPERATION OF CRITICAL EQUIPMENT:

1. BUILDING 30S MAIN AIR HANDLERS:
 - a. ONE AIR HANDLER FROM 1, 2, OR 3
 - b. TWO AIR HANDLERS FROM 4, 5, OR 6

Air handlers provide cooling for mission critical hardware on the 1st, 2nd, 3rd, and 4th floors of Bldg 30S. Without cooling, hardware equipment will be manually shut down to prevent permanent equipment damage. These air handlers are configured to have two power sources available and can be quickly reconfigured in the event primary power is lost. @[CR 6839A] @[121505-7197A]

THIS RULE CONTINUED ON NEXT PAGE

FLIGHT RULES

A3-53

MCC POWER REQUIREMENTS (CONTINUED)

2. BUILDING 30S 5TH FLOOR AIR HANDLERS: @[CR 6839A] @[121505-7197A]
 - a. ROOM 5301 - 8 OF 11 MANDATORY
 - b. ROOM 5318
 - (1) AIR HANDLER 28 AND 32
 - (2) ONE AIR HANDLER FROM 26 OR 27
 - (3) ONE AIR HANDLER FROM 30 OR 31
 - c. ROOM 5326 - ONE OF TWO AIR HANDLERS

Mission critical equipment is located in Bldg 30S on the 5th floor in rooms 5301, 5318, and 5326. Air handlers provide cooling for mission critical hardware in these areas. Without cooling, hardware equipment will be manually shut down to prevent permanent equipment damage. These air handlers are configured to have two power sources available and can be quickly reconfigured in the event primary power is lost. @[CR 6839A] @[121505-7197A]

FLIGHT RULES

A3-54

TRAJECTORY SERVER ERRORS

THE FOLLOWING CRITERIA APPLY FOR ERROR OCCURRENCES IN THE PRIME AND/OR BACKUP TRAJECTORY SERVERS: @[121505-6941A]

- A. SINGLE OR SEVERAL ERRORS IN ONE OR BOTH COMPUTERS THAT CLEAR, OR DO NOT AFFECT REQUIRED PROCESSING - GO.
- B. ERRORS IN ONE OR BOTH COMPUTERS THAT AFFECT REQUIRED PROCESSING - THE AFFECTED COMPUTER IS CONSIDERED SUSPECT.
- C. ERRORS WITH SECONDARY INDICATIONS OF COMPUTER PROBLEMS (SUCH AS ERRORS OF DIFFERENT TYPES, EXCESSIVE CPU USAGE, CORRUPTED TELEMETRY OR TRAJECTORY PROCESSING, ETC.) - THE AFFECTED COMPUTER IS CONSIDERED SUSPECT.

TROUBLESHOOTING WILL BE INITIATED IMMEDIATELY FOR SUSPECT COMPUTERS. IF THE ERROR CANNOT BE CORRECTED IN A TIMELY MANNER, THE AFFECTED COMPUTER WILL BE CONSIDERED FAILED.

IF THE PRIME SERVER IS CONSIDERED FAILED, AND A BACKUP IS AVAILABLE, A SELECTOVER WILL BE PERFORMED. IF NO BACKUP IS AVAILABLE OR IF BOTH SERVERS ARE CONSIDERED FAILED, A TURNAROUND TO A PREVIOUS CHECKPOINT IS REQUIRED. TRAJECTORY PROCESSING PER RULE {A3-51}, TRAJECTORY PROCESSING REQUIREMENTS, WILL BE CONSIDERED UNAVAILABLE UNTIL ERROR RECOVERY IS COMPLETE.

The Trajectory Server is required for processing of mandatory telemetry and trajectory data (reference Rules {A3-1}, GROUND AND NETWORK DEFINITIONS; {A3-2}, GROUND AND NETWORK OVERALL PHILOSOPHY; {A3-3}, GROUND AND NETWORK DETAILED REQUIREMENTS; and {A3-51}, TRAJECTORY PROCESSING REQUIREMENTS). Errors can occur in the prime and backup trajectory server with no impact to processing. If one or more errors occur, and do not affect required processing, the computer is not considered failed. In the presence of errors with secondary indications of computer problems, or those adversely affecting required processing, troubleshooting must be performed in order to identify the error source and take corrective action to ensure that the error does not propagate into a new server. The amount of time available for troubleshooting is a function of flight phase and available recovery options. For nonrecoverable computer errors, options include switching over to an unaffected backup server, or reinitializing to a previous checkpoint if both computers are affected. Alternately, a spare machine may be brought online in order to avoid use of a computer(s) that has previously failed. @[121505-6941A]

THIS RULE CONTINUED ON NEXT PAGE

FLIGHT RULES

A3-54

TRAJECTORY SERVER ERRORS (CONTINUED)

A total of three trajectory servers is available for mission support, with two scheduled for critical and complex phases--one as prime and the other as backup. The third machine is typically configured (but not required) as a “static standby” during critical phases, and can be brought on line in less than 1 minute. During noncritical phases, the third machine may be rebooted and brought on line in 5-10 min if necessary. This action may result in termination of lower priority integrated simulation or comp run activities. Failover from the prime to backup server takes approximately 1 sec once action is initiated, and results in little impact to trajectory processing. Turning around to a previous checkpoint (as would be the case for failover to a static stand-by or re-booted machine) may add an additional approximately 30 min to the recovery process to allow for any necessary trajectory updates to the machine (e.g., catch up on MED inputs, process recent tracking data, etc.). The following table summarizes trajectory server support requirements (ref FCOH section 11.1, and USA002955, MCC Facility Management Policies, sections 3.4 and 3.5): ©[121505-6941A]

Flight Phase Scheduled Traj Servers

*Critical 2**

*Complex 2***

*Other 1***

**No other MCC activities may be scheduled during critical flight phase; therefore, third traj server typically available as “hot spare.”*

***Backup and/or spare traj server(s) may be scheduled based on availability.* ©[121505-6941A]

Rule {A2-301}, CONTINGENCY ACTION SUMMARY [HC], references this rule. ©[032807-8400]

A3-55 THROUGH A3-100 RULES ARE RESERVED ©[121505-6941A]

FLIGHT RULES

45 SPW/GSFC/STDN PRELAUNCH REQUIREMENTS

A3-101**GSFC**

A. NETWORK INTEGRATED SERVICES NETWORK (NISN) @[121593-1582]
@[033006-7294B]

1. NISN NETWORK MANAGEMENT PLATFORM - ONE OF THREE SYSTEMS
HIGHLY DESIRABLE

These computers are used to reconfigure the network routers that route telemetry, command, low-speed tracking, and configuration data between the MCC and the tracking stations (as defined in Rule {A3-102}, INTEGRATED NETWORK FAILURE DECISION MATRIX). Reconfigurations are only required for certain network failures and, once the network is configured, the ability to reconfigure may or may not be required. The NISN network should auto route in most cases, has diverse paths, and can also dial into routers with limited control without a Management Platform, but not for all failure possibilities. There is no immediate impact for the loss of these platforms if the network remains nominal.

2. NISN CONVERSION DEVICE (CD) MANAGEMENT PLATFORM ONE OF
FIVE HIGHLY DESIRABLE

These computers can reconfigure the network devices that use Internet Protocol (IP) encapsulation for telemetry, command, low-speed tracking, and configuration data between the MCC and the tracking stations (as defined in Rule {A3-102}, INTEGRATED NETWORK FAILURE DECISION MATRIX). Reconfigurations are required for certain network failures. Reconfigurations are only required for certain network failures and, once the network is configured, the ability to reconfigure may or may not be required.

B. FLIGHT DYNAMICS FACILITY (FDF) - ONE OF TWO SYSTEMS MANDATORY
@[121593-1582] @[051697-6008A]

In order to allow TDRS Single Access (SA) antenna tracking of the orbiter, acquisition data must be generated and sent to WSC for TDRS antenna pointing. This allows TDRSS to maintain mandatory command, telemetry, and voice with the orbiter during a nominal launch or abort. The FDF systems generate and transmit this acquisition data to WSC. Network backup procedures are in place for nominal and abort case acquisition data. However, if the FDF systems are unavailable, there is no capability to update TDRS acquisition data during aborts that require JSC to generate updated predictions. @[033006-7294B]

THIS RULE CONTINUED ON NEXT PAGE

FLIGHT RULES

A3-101

GSFC (CONTINUED)

The FDF is also prime for providing acquisition data messages to ground C-bands and S-bands during orbit and entry phases. The ER ROCC is backup for ground acquisition data messages in the event that the FDF is not available. @[033006-7294B]

C. DATA SERVICES MANAGEMENT CENTER (DSMC) SPSR COMPUTERS - ONE OF TWO MANDATORY

For TDRSS to support abort scenarios, acquisition data must be generated and sent to WSC for TDRSS SA antenna pointing. The DSMC SPSR computers and associated equipment manage this acquisition message data for forwarding to WSC. @[033006-7294B]

FLIGHT RULES

A3-102

INTEGRATED NETWORK FAILURE DECISION MATRIX

ASCENT AND INTACT ABORT LANDINGS AT KSC							
SITE	STATION ID	TYPE	RQMNT	ASCENT/RTL		TAL	(POST LAUNCH) KSC AOA & 1ST DAY PLS
				28.5 INC	HIGHER INC		
JONATHAN DICKINSON MISSILE TRACKING ANNEX (JDMTA)	JDIS	S-BD	TLM D/L VOICE	1 OF 2 M	1 OF 2 M		
PONCE DE LEON	PDL	S-BD 14	CMD U/L VOICE	1 OF 2 HD [1]	1 OF 2 M [2]		
	FIXED DIPOLE	UHF	VOICE				
MILA	MILS	S-BD 30-1	CMD TLM VOICE	1 OF 2 M	1 OF 2 M		1 OF 2 HD
	MLXS	S-BD 30-2					
	TELTRAC	UHF	VOICE	1 OF 2 M	1 OF 2 M		1 OF 2 HD
	QUAD HELIX						
TDRSS	WSC	S-BD	CMD TLM VOICE	M [3]	M [3]	M	M [6]
			TRK	HD	HD		M [5]
WALLOPS	WLPS	S-BD 34	CMD TLM VOICE		HD		
	QUAD HELIX	UHF	VOICE		1 OF 1 HD		
MERRITT ISLAND	MLAC MLMC MMTC	FPQ-14 MCB-17 MOTR	RADAR TRK	2 OF 7 M	2 OF 7 M		NOT SCHEDULED ACCEPT BEST EFFORT CALLUP
PATRICK	PATC	FPQ-14	RADAR TRK				
CANAVERAL	CNVC	FPS-16	RADAR TRK				
JONATHAN DICKINSON	JDIC	FPQ-14	RADAR TRK				
MILA	MILS OR MLXS	S-BD	RANGING TRK				
WALLOPS	WLPC WLRC WLIC	FPQ-6 FPS-16 FPS-16	RADAR TRK		2 OF 3 HD [4]		

@[072795-1722] @[ED] @[121296-4177D] @[072398-6565A] @[021199-6817] @[070899-6882] @[062702-5502C] @[033006-7294B] @[032807-8402B]

THIS RULE CONTINUED ON NEXT PAGE

FLIGHT RULES

A3-102

INTEGRATED NETWORK FAILURE DECISION MATRIX
(CONTINUED)

ASCENT AND INTACT ABORT LANDINGS AT KSC							
SITE	STATION ID	TYPE	RQMNT	ASCENT/RTLS		TAL	(POST LAUNCH) KSC AOA & 1ST DAY PLS
				28.5 INC	HIGHER INC		
AIR FORCE SATELLITE COMMUNICATIONS NETWORK (AFSCN)	NHS (BOSS)	S-BD	TLM CMD VOICE		HD [11]		
	TCS (LION)						
	DGS (REEF)						

@[032807-8405A]

THIS RULE CONTINUED ON NEXT PAGE

FLIGHT RULES

A3-102

INTEGRATED NETWORK FAILURE DECISION MATRIX (CONTINUED)

INTACT ABORT LANDINGS AT EDWARDS OR NORTHRUP STRIP					
SITE	STATION ID	TYPE	RQMNT	(POST LAUNCH) EDW AOA & 1ST DAY PLS	(POST LAUNCH) WSSH AOA & 1ST DAY PLS
DRYDEN	ATF1	S-BD-21	TLM CMD VOICE	1 OF 2 HD	
	ATF2				
	PARABOLIC DISH	UHF	VOICE	1 OF 3 HD	
TDRSS	WSC	S-BD	CMD TLM VOICE TRK	M [5], [6]	M [5], [6]
WSSH	WSSH	UHF HELIX	VOICE		1 OF 1 HD [9]
PT. PILLAR	PTPC	FPQ-6	RADAR TRK	NOT SCHEDULED ACCEPT BEST EFFORT CALLUP [10]	
VANDENBURG	VDHC	FPQ-14	RADAR TRK		
	VDBC	TPQ-18			
	VDSC	FPS-16			
	VDMC	MOTR			
DRYDEN	FRCC	RIR-716	RADAR TRK		
	FDRC	RIR-716			
WHITE SANDS MISSILE RANGE	HOLC	FPS-16	RADAR TRK		NOT SCHEDULED ACCEPT BEST EFFORT CALLUP
	WSSC	FPS-16			
	WSMC	MOTR			

@[072795-1722] @[061396-3198] @[072398-6565A] @[062702-5502C] @[022405-6626] @[033006-7294B]
@[032807-8402B]

THIS RULE CONTINUED ON NEXT PAGE

FLIGHT RULES

A3-102

INTEGRATED NETWORK FAILURE DECISION MATRIX
(CONTINUED)

END OF MISSION – 2ND DAY PLS THROUGH NOMINAL EOM						
SITE	STATION ID	TYPE	RQMT	KSC	EDWARDS	WSSH
TDRSS	WEST	S-BD	TLM CMD VOICE	M	M	M
	EAST		TRK	M		
	ANY			M	M	M
MILA		RANGING	TRK	HD		
	MILS	S-BD 30-1	TLM CMD VOICE	1 OF 2 HD [7]		
	MLXS	S-BD 30-2				
	TELTRAC QUAD HELIX	UHF	VOICE	1 OF 2 HD		
MERRITT ISLAND	MLAC	FPQ-14	RADAR TRK	2 OF 5 M		
	MLMC	MCB-17				
PATRICK	PATC	FPQ-14				
CANAVERAL	CNVC	FPS-16				
DRYDEN	ATF1	S-BD 12	TLM CMD VOICE		1 OF 2 HD [8]	
	ATF2					
	PARABOLIC DISH	UHF	VOICE		1 OF 3 HD	
PT. PILLAR	PTPC	FPQ-6	RADAR TRK		2 OF 7 M	
VANDENBURG	VDHC	FPQ-14	RADAR TRK			
	VDBC	TPQ-18				
	VDSC	FPS-16				
	VDMC	MOTR				
DRYDEN	FRCC	RIR-716	RADAR TRK		1 OF 2 M	
	FDRC	RIR-716				
WSSH	WSSH	UHF HELIX	VOICE		1 OF 1 HD [9]	[9]
WHITE SANDS MISSILE RANGE	HOLC	FPS-16	RADAR TRK			2 OF 3 M
	WSSC	FPS-16				
	WSMC	MOTR				

Ⓜ[121593-1590] Ⓜ[072795-1772] Ⓜ[121296-4177D] Ⓜ[072398-6565A] Ⓜ[062702-5502C] Ⓜ[022405-6626]
Ⓜ[033006-7294B] Ⓜ[032807-8402B]

THIS RULE CONTINUED ON NEXT PAGE

FLIGHT RULES

A3-102

INTEGRATED NETWORK FAILURE DECISION MATRIX
(CONTINUED)

NOTES:

- [1] FOR MISSIONS WITH AN INCLINATION OF 28.5 DEG, PDL S-BAND AND UHF UPLINK IS HIGHLY DESIRABLE. @[062702-5502C]
- [2] FOR MISSIONS WITH AN INCLINATION GREATER THAN 28.5 DEG, PDL CMD OR UHF UPLINK IS REQUIRED SINCE MIL UHF IS BLOCKED BY THE SRB PLUME.
- [3] ANY TDRS EAST IS MANDATORY.
- [4] WLPC AND WLRC ARE SCHEDULED FOR ALL MISSIONS GREATER THAN 28.5 DEG. WLIC ONLY SCHEDULED FOR 57-DEG MISSIONS OR WHEN WLPC OR WLRC ARE UNAVAILABLE. @[033006-7294B] @[032807-8402B]
- [5] ONE TDRS REQUIRED TO ENSURE PRE-BURN STATE VECTOR ACCURACY FOR 1ST DAY PLS DEORBIT IF ONBOARD GPS IS FAILED.
- [6] ANY TDRS WEST IS MANDATORY FOR AOA AND 1ST DAY PLS.
- [7] ANY TDRS EAST OR MILA IS MANDATORY TO COVER THE LAST PHASE OF KSC LANDING AND POST LANDING SUPPORT UNTIL VEHICLE IS HANDED OVER TO GOM.
- [8] ANY TDRS WEST OR DFRC IS MANDATORY TO COVER THE LAST PHASE OF EDW LANDING AND POST LANDING SUPPORT UNTIL VEHICLE IS HANDED OVER TO GOM.
- [9] FOR ALL WSSH LANDINGS (AOA, PLS, EOM), THE PRIME COMMUNICATION COVERAGE THROUGH WHEELSTOP IS S-BAND COMM THROUGH TDRS. AS A BACKUP COMM SOURCE, THE NASA STEERABLE HELIX UHF AT WSSH IS HIGHLY DESIRABLE. @[022405-6626]
- [10] POINT PILLAR RADAR MAY BE SCHEDULED IN PLACE OF VANDENBURG RADAR WHEN EXPECTED MAXIMUM ELEVATION IS GREATER THAN 5 DEGREES. @[062702-5502C] @[022405-6626] @[033006-7294B]

FLIGHT RULES

A3-103

CRITICAL LAUNCH SYSTEMS RECOVERY TIMES

SYSTEM	SERVICE	DESCRIPTION OF EQUIPMENT	QUANTITY OF EQUIPMENT REQUIRED/ SCHEDULED/ TOTAL	AVERAGE SLECTOVER TIME (AUTO OR MAN)	AVERAGE TIME TO RESTORE REDUNDANCY FOLLOWING REPAIR	ASSESSMENT/ COMMENT
CCF CONSOLIDATED COMMUNICATION FACILITY PROCESSES AND ROUTES ALL DATA COMING IN AND OUT OF THE MCC	CMD & A/G VOICE TLM & A/G VOICE	FEP - UPLINK FEP - DOWNLINK/ REAL TIME	1 OF 2/3 1 OF 2/3	30 SEC (M) 30 SEC (M)	10 MIN 10 MIN	FEP RESTORE TIMES ASSUME REALLOCATION AND REBOOT OF FEP PLATFORMS, (PLATFORM CONSISTS OF U/L, D/L RT, & PLAYBACK)
	TRK DATA	FEP-GROUND- TO-GROUND CDSS	1 OF 2/2	20 SEC (M)	10 MIN	CDSS CRITICAL CIRCUITS HAVE MULTIPLE ROUTING. REPAIR FAILED CIRCUITS AFTER LAUNCH.
	ALL		BUILT IN REDUNDANCY 1 OF 2/2	N/A	BUILT IN REDUNDANCY 15 MIN	NOTE 1 - 30 MINUTES - CALL OUT, 2 HOURS - REPAIR FOR EXTERNAL CARRIER. RETURN TO SERVICE MAY BE LONGER.
	ALL	NASCOM IP EQUIP.	MULTIPLE	1 SEC (A)	SEE NOTE 1	
	ALL	NASCOM IP CIRCUITS				FAILURE OF ONE DISTRIBUTION SWITCH WILL REQUIRE THE REMAINING SWITCH TO ASSUME THE LOAD OF THE FEP RESOURCES ON THE FAILED SWITCH. LOSS OF SERVICE FOR 60 SECONDS FOR AFFECTED FEPS. PRIME AND BACKUP FEPS FOR CRITICAL PHASE SUPPORT SHOULD BE PRIME ON DIFFERENT DISTRIBUTION SWITCHES IF POSSIBLE.
	UPLINK & DOWNLINK	MDM	1 OF 2/2	30 SEC (M)	10 MIN	
	TLM & CMD LAN I/F	OPS FEP DISTRIBUTION SWITCH	1 OF 2/2	30 SEC (A)	REBOOT OR H/W REPAIR TIME WILL VARY FROM 5 MIN TO 4 HRS	FAILURE OF CEM RESULTS IN LOSS OF STATUS AND CONTROL BUT DATA FLOW CONTINUES; CONFIGURATION IS FROZEN.
		CEM (CCF ELEMENT MANAGER)	1 OF 2/2	4 MIN (M)	REBOOT 6 MIN	
VOICE ALL VOICE COMMUNICATIONS IN/OUT OF MCC	S-BAND A/G VOICE	AGVE	1 OF 2/3	5 SEC (M)	HARDWARE REPAIR	ASSUMES ALL 3 STRINGS AVAILABLE.
	UHF A/G VOICE ALL VOICE	UHF DVIS CPU	1 OF 2 BUILT IN REDUNDANCY	1 MIN (M) BUILT IN REDUNDANCY	HARDWARE REPAIR BUILT IN REDUNDANCY	DVIS CPU FAILURE PROHIBITS KEY SET LOG ON AND RECONFIGURATION - NOT REQUIRED FOR LAUNCH.

@[062702-5502C] @[033006-7294B]

THIS RULE CONTINUED ON NEXT PAGE

FLIGHT RULES

A3-103

CRITICAL LAUNCH SYSTEMS RECOVERY TIMES (CONTINUED)

SYSTEM	SERVICE	DESCRIPTION OF EQUIPMENT	QUANTITY OF EQUIPMENT REQUIRED/ SCHEDULED/ TOTAL	AVERAGE SELECTOVER TIME (AUTO OR MAN)	AVERAGE TIME TO RESTORE REDUNDANCY FOLLOWING REPAIR	SYSTEM
MCC LANS	DATA COMMUNICATION TRANSFER FOR WORKSTATIONS	TIER 1 (OPS CORE) TIER 2 (DISTRIBUTION SWITCHES) TIER 3 (ACCESS POINTS)	1 OF 2/2 FOR EACH REQUIRED DISTRIBUTION SWITCH (FLIGHT AND SUPPORT SWITCHES IN TIER 2) MUST MEET THE W/S REQUIREMENTS DEFINED BELOW IN THE W/S SECTION OF THIS TABLE	60 SEC (A)	REBOOT OR H/W REPAIR REQUIRED TIME WILL VARY FROM 5 MIN TO 4 HRS	<p>MCC LAN UPGRADE CONSISTS OF THREE TIERS OF FAST ETHERNET COMPATIBLE HARDWARE AND CONNECTIVITY.</p> <p>REDUNDANT DISTRIBUTION SWITCHES AND ACCESS POINTS SHARE THE LOAD AS OPPOSED TO SERVING IN PRIME AND BACKUP ROLES, WITH EACH DEVICE CAPABLE OF SUPPORTING THE ENTIRE LOAD. IN THE EVENT OF A FAILURE OF ONE DEVICE, ALL CONNECTED EQUIPMENT WILL EXPERIENCE A 60-SECOND LOSS OF SERVICE WHILE THE REMAINING DEVICE ASSUMES CONTROL OF THEIR CONNECTIVITY.</p> <p>TIER 1 USES REDUNDANT DISTRIBUTION SWITCHES TO CONNECT MCC FEPS, SERVERS, AND OTHER SERVICES TO USER WORKSTATIONS.</p> <p>TIER 2 PROVIDES MAIN DISTRIBUTION POINT TO USER W/S'S VIA REDUNDANT DISTRIBUTION SWITCHES GROUPED IN LOGICAL SEGMENTS BY FUNCTION.</p> <p>TIER 3 PROVIDES CONNECTIVITY FROM USER W/S'S AND OTHER MCC RESOURCES TO TIER 2 DISTRIBUTION SWITCHES USING ACCESS POINTS. FCR WORKSTATIONS ARE DIRECTLY CONNECTED VIA REDUNDANT CABLING TO DISTRIBUTION SWITCHES. MPSR AND OTHER W/S'S ARE CONNECTED TO REDUNDANT ACCESS POINTS VIA REDUNDANT CABLING, WHICH ARE THEN CONNECTED TO THE DISTRIBUTION SWITCHES.</p>

@[033006-7294B]

THIS RULE CONTINUED ON NEXT PAGE

FLIGHT RULES

A3-103

CRITICAL LAUNCH SYSTEMS RECOVERY TIMES (CONTINUED)

SYSTEM	SERVICE	DESCRIPTION OF EQUIPMENT	QUANTITY OF EQUIPMENT REQUIRED/ SCHEDULED/ TOTAL	AVERAGE SELECTOVER TIME (AUTO OR MAN)	AVERAGE TIME TO RESTORE REDUNDANCY FOLLOWING REPAIR	SYSTEM
TRAJECTORY SERVER - PROVIDES TRAJECTORY PROCESSING	TRAJECTORY PROCESSING	TRAJECTORY SERVER – HARDWARE/OS TRAJECTORY SOFTWARE APPLICATION – SOFTWARE	1 OF 2/3	1 SEC (M)	REBOOT: 5 MIN	TRAJECTORY SERVER REDUNDANCY RESTORE TIME INCLUDES REBOOT AND ACTIVITY CONFIGURATION OF THE FAILED SERVER.
PLATFORM SERVERS	MCC NETWORK USER SERVICES	MDSC CM SERVERS - PLATFORM SERVICES	1 OF 2/2	45 SEC (A)	REBOOT: 25 MIN	MDSC CM SERVER FAILOVER FOR PARTITIONS IS ~30 SECONDS. NO NEW LOGINS ARE POSSIBLE FOR SOME OPS CM SERVER FAILURE MODES IMPACT SOME USERS BUT NOT OTHERS. IF BOTH OPS CM SERVERS ARE LOST DURING FAILOVER, TO HELP MINIMIZE IMPACTS, USERS SHOULD GO HANDS-OFF W/S'S. SERVICES SPREAD ACROSS TWO SERVERS, EACH CAPABLE OF HANDLING ENTIRE LOAD. LOSS OF ONE SERVER RESULTS IN LESS THAN 60-SECOND OUTAGE AS IMPACTED SERVICES FAIL OVER TO REMAINING SERVER. LOSS OF BOTH SERVERS RESULTS IN UNSTABLE PLATFORM WITH SOME APPLICATIONS NOT COMING UP, OTHERS HANGING UP OVER TIME. NO IMPACT ON LOSS OF PRIME NAME SERVER, AUTOMATIC FAILOVER TO BACKUP. LOSS OF BOTH NAME SERVERS RESULTS IN NO NEW LOGINS AND NO NEW DATA VIEW DISPLAYS. CURRENT W/S CONFIGURATION SHOULD NOT BE IMPACTED.
	CMD, TRAJECTORY & TLM PROCESSING DELAYS	MDSC HA SERVERS (READ/WRITE)	1 OF 1/2	54 SEC (A)	REBOOT: 15 MIN	
		NAME SERVERS (NETWORK SERVICES)	1 OF 2/2	1 MIN (A)	REBOOT: 5 MIN	
	MAAS NETWORK REGISTRATION	VTS SERVER	1 OF 2/4	30 SEC (A)	REBOOT: 5 MIN	
	CLOCK & GROUP DISPLAYS					

@[062702-5502C] @[033006-7294B]

THIS RULE CONTINUED ON NEXT PAGE

FLIGHT RULES

A3-103

CRITICAL LAUNCH SYSTEMS RECOVERY TIMES (CONTINUED)

SYSTEM	SERVICE	DESCRIPTION OF EQUIPMENT	QUANTITY OF EQUIPMENT REQUIRED/ SCHEDULED/ TOTAL	AVERAGE SELECTOVER TIME (AUTO OR MAN)	AVERAGE TIME TO RESTORE REDUNDANCY FOLLOWING REPAIR	SYSTEM
						LOSS OF PRIME VTS SERVER INITIATES AUTOMATIC FAILOVER TO BACKUP. LOSS OF VIDEO SWITCHING CAPABILITY AND LOSS GROUP TIME DISPLAYS FOR 90 SECONDS DURING FAILOVER, MAY LOSE W/S TIMES FOR 20 SECONDS. LOSS OF BOTH SERVERS RESULTS IN LOSS OF ALL GLOBAL AND LOCAL TIMERS, LOSS OF GROUP TIME DISPLAYS, AND LOSS OF VIDEO SWITCHING CAPABILITY.
COMMAND	COMMAND PROCESSING INCO WORKSTATIONS	COMMAND SERVERS COMMAND INTERFACE	1 OF 2/5 1 OF 4/4 MANDATORY	1 MIN (A)	REBOOT: 5 MIN	FOLLOWING THE COMMAND SERVER FAILOVER, USER COMMAND SERVICES RECOVERY IS ESTIMATED AT 5-15 MINUTES. REFERENCE RULE {A3-1}, GROUND AND NETWORK DEFINITIONS.
MCC TIMING SUBSYSTEM	PROVIDES ACCURATE TIMING REFERENCE TO MCC PLATFORM FEPS, SERVERS AND CLOCKS.	GPS RCVRs NTP SRVRS	1 OF 2/2 1 OF 2/2	AUTOMATIC AUTOMATIC		GPS RECEIVERS PROVIDE ACCURATE GMT TIME REFERENCE TO MCC EQUIPMENT VIA THE NETWORK TIMING PROTOCOL SERVERS. NTP SERVERS DISTRIBUTE APPROPRIATE TIME REFERENCE TO ALL MCC EQUIPMENT REQUIRING IT, INCLUDING FEPS, SERVERS, AND W/S'S. LOSS OF TIME REFERENCE DOES NOT CAUSE AN IMMEDIATE IMPACT SINCE ALL EQUIPMENT IS CAPABLE OF CONTINUING FOR EXTENDED PERIODS ON INTERNAL CLOCKS WITHOUT THE EXTERNAL REFERENCE. UNLESS THERE IS REASON TO BELIEVE THE CAPABILITY CANNOT BE RESTORED WITHIN SEVERAL DAYS, THERE WILL BE NO MISSION IMPACTS.

©[033006-7294B]

THIS RULE CONTINUED ON NEXT PAGE

FLIGHT RULES

A3-103

CRITICAL LAUNCH SYSTEMS RECOVERY TIMES (CONTINUED)

SYSTEM	SERVICE	DESCRIPTION OF EQUIPMENT	QUANTITY OF EQUIPMENT REQUIRED/ SCHEDULED/ TOTAL	AVERAGE SELECTOVER TIME (AUTO OR MAN)	AVERAGE TIME TO RESTORE REDUNDANCY FOLLOWING REPAIR	SYSTEM
W/S'S USER I/F DEVICE	USER WORKSTATION	DEC ALPHA STATIONS	MULTIPLE	GO TO B/U POSITION (M)	REBOOT: 15 MIN RIS DL: 30 MIN REPLACE UNIT	<p>USER REBOOTS WORKSTATION AND RESTARTS ACTIVITY TO RECOVER OPERATING SYSTEM (RIS) DOWNLOAD AND REBOOT W/S HARDWARE REPLACEMENT WOULD REQUIRE ~ 1 HOUR.</p> <p>REFERENCE RULE {A3-53}, MCC POWER REQUIREMENTS, FOR POWER BUS LOSS IMPACTS ON MCC WORKSTATIONS.</p>
ABORT PBI FUNCTION (WITH ROCC)	ROCC OR MCC INITIATED CUE TO THE CREW, CONFIRMING ABORT REQUIREMENT	<p>SIGNAL AND COMMAND PATH FROM MCC TO COCKPIT F6 ABORT LIGHT</p> <p>9.6 KB FCO INTERFACE CIRCUITS</p>	<p>1 OF 4/4 MANDATORY</p> <p>1 OF 2/2 HIGHLY DESIRABLE</p>	<p>N/A – MUST USE THE ALTERNATE PBI TO SEND ABORT COMMANDS</p> <p>EITHER CIRCUIT CAN BE USED</p>		<p>RULES {A3-3}, GROUND AND NETWORK DETAILED REQUIREMENTS, AND {A3-151}, MCC/KSC/45 SPW INTERFACE, PROVIDE DETAILED RATIONALE FOR THE ABORT PBI FUNCTION.</p> <p>ABORT PBI'S ARE LOCATED AT FD (1), FDO (1), AND FCO (2) CONSOLES CONNECTED VIA CIRCUITRY, W/S, AND S/W TO THE MCC COMMAND SYSTEM.</p> <p>COMM CONTROL CAN CONNECT EITHER 9.6 KB CIRCUIT TO ANY OF THE THREE PBI'S IN THE MCC.</p>
DOLILU DAY OF LAUNCH I-LOAD UPDATE	DOLILU PROCESSING	IPS W/S'S & FILE SERVERS, COMM CKTS	1 OF 2/2	6 MIN (M)	6 MIN	I-LOAD COMPLETED 1 HR. BEFORE LAUNCH

@[033006-7294B]

THIS RULE CONTINUED ON NEXT PAGE

FLIGHT RULES

A3-103

CRITICAL LAUNCH SYSTEMS RECOVERY TIMES (CONTINUED)

SYSTEM	SERVICE	DESCRIPTION OF EQUIPMENT	QUANTITY OF EQUIPMENT REQUIRED/ SCHEDULED/ TOTAL	AVERAGE SELECTOVER TIME (AUTO OR MAN)	AVERAGE TIME TO RESTORE REDUNDANCY FOLLOWING REPAIR	SYSTEM
EQUIPMENT AIR HANDLERS	BUILDING 30S •MAIN •RM 5301 •RM 5318 •RM 5326 BUILDING 30M •MAIN •DVIS	PROVIDES AIR COOLING FOR MCC COMPLEX EQUIPMENT	1 FROM AH 1, 2, OR 3 2 FROM AH 4, 5, OR 6 8 OF 11 MANDATORY AH 28 & 32 AH 26 OR 27 AH 30 OR 31 1 OF 2 MANDATORY 2 FROM AH 2, 3, OR 18 AH 4 OR 5 AH 8 OR 9 1 OF 2 MANDATORY 2 FROM AH 2, 3, OR 18			RULE {A3-53}, MCC POWER REQUIREMENTS, PROVIDES DETAILED RATIONALE FOR AIR HANDLER REQUIREMENTS.

@[062702-5502C] @[033006-7294B] @[033006-7294B]

THIS RULE CONTINUED ON NEXT PAGE

FLIGHT RULES

A3-103

CRITICAL LAUNCH SYSTEMS RECOVERY TIMES (CONTINUED)

SYSTEM	SERVICE	DESCRIPTION OF EQUIPMENT	QUANTITY OF EQUIPMENT REQUIRED/ SCHEDULED/ TOTAL	AVERAGE SELECTOVER TIME (AUTO OR MAN)	AVERAGE TIME TO RESTORE REDUNDANCY FOLLOWING REPAIR	SYSTEM
EQUIPMENT POWER	BUILDING 30M	SOURCE POWER	2 OF 5 MANDATORY			RULE {A3-53}, MCC POWER REQUIREMENTS, PROVIDES DETAILED RATIONALE FOR POWER BUS REQUIREMENTS. CRITICAL POWER HAS CONDITIONS THAT HAVE TO BE MET PRIOR TO COMMITTING TO LAUNCH AND/OR DEORBIT.
		A BUS POWER	1 OF 2 MANDATORY			
		UPS	1 OF 2 MANDATORY			
	BUILDING 30S	B BUS POWER	1 OF 2 MANDATORY			
		SOURCE POWER	2 OF 4 MANDATORY			
		AX BUS POWER	1 OF 2 MANDATORY			
		UPS	1 OF 2 MANDATORY			
BX BUS POWER	1 OF 2 MANDATORY					

@[033006-7294B]

NOTE: RECOVERY TIMES DO NOT INCLUDE FAULT ISOLATION, HARDWARE, AND SOFTWARE REPAIR TIME. @[062702-5502C]

A3-104 THROUGH A3-150 RULES ARE RESERVED @[062702-5502C]

FLIGHT RULES

MCC EXTERNAL INTERFACE (VOICE DATA) PRELAUNCH REQUIREMENTS

A3-151

MCC/KSC/45 SPW INTERFACE

- A. 7.2-KB LAUNCH/LANDING RADAR CIRCUIT - ONE OF TWO MANDATORY
@[061297-6004] @[032807-8402B]

These circuits provide launch/landing C-band tracking data from 45 SPW/CCC to the MCC. These are redundant circuits providing backup capability; each one capable of carrying the total traffic. @[061297-6004]

- B. 9.6 KB WIND DATA CIRCUIT - ONE OF TWO MANDATORY @[ED]

NOTE: CHANGES TO HD AFTER STRUCTURAL GO/NO-GO DECISION IS MADE
@[ED]

These circuits support processing of ascent structural loads. There are two redundant circuits providing backup capability; each one capable of carrying the total traffic.

- C. 9.6 KB FCO ABORT SWITCH INTERFACE CIRCUITS - ONE OF TWO
HIGHLY DESIRABLE @[101096-4551] @[110900-3701] @[033006-7269]

Removal of the ET Range Safety Flight Termination System resulted in additional flightcrew responsibility as agents of the 45th Space Wing Commander for public safety during second stage flight. During this timeframe, crew-initiated manual MECO replaces range safety command destruct capability. One of the elements agreed upon to satisfy this requirement is to provide the FCO with the ability to illuminate the orbiter cockpit abort light via pushbutton as an independent method for the FCO to communicate a manual MECO requirement to the crew. Since this is a backup to MCC notification to perform a manual MECO, the FCO abort switch is highly desirable rather than mandatory.

A path consists of one abort switch circuit connected to one of three MCC workstations (FD WFCR-28, FDO WFCR-10, and SVO-9) to enable FCO abort light commanding through the MCC Command System. Ref. Rule {A3-3}, GROUND AND NETWORK DETAILED REQUIREMENTS. The two external FCO abort circuits and the MCC-internal lines to the three workstations go to a patch panel to allow any combination of one abort circuit and one workstation to complete an FCO abort light path. @[110900-3701] @[ED] @[033006-7269]

THIS RULE CONTINUED ON NEXT PAGE

FLIGHT RULES

A3-151

MCC/KSC/45 SPW INTERFACE (CONTINUED)

D. FCO INTERFACES:

1. VOICE INTERFACE - TWO OF FOUR MANDATORY:
 - a. FDO/FCO PRIVATE LINE
 - b. FCO PRIME LOOP
 - c. FD LOOP
 - d. OTHER LOOP PATCHING TO FCO LONG LINE
2. CONTROLLABILITY VERIFICATION - TWO OF FIVE MANDATORY:
 - a. 45 SPW RANGE SAFETY TELEMETRY DISPLAY SYSTEM (RTDS)
 - b. CONTROLLABILITY LIGHT (GNC CONSOLE TO FCO)
 - c. FCO PRIME LOOP
 - d. FDO/FCO PRIVATE LINE
 - e. FD LOOP

During second stage flight, removal of the ET Range Safety Flight Termination System resulted in additional flightcrew responsibility as agents of the 45th Space Wing Commander for public safety, with crew-initiated manual MECO replacing range safety command destruct capability. Redundant FCO/MCC communications are therefore mandatory to provide the interaction and situational awareness necessary to implement this requirement. @[101096-4551]

During first stage, range safety mission rules outline flight termination criteria and provide the FCO with the ability to determine shuttle controllability status in the event of complete loss of communication with MCC. For purposes of making the controllability determination, range safety launch commit criteria require at least two pathways by which vehicle control status may be confirmed. The available sources include the items listed under paragraph D.2 of this rule. @[101096-4551]

THIS RULE CONTINUED ON NEXT PAGE

FLIGHT RULES

A3-151

MCC/KSC/45 SPW INTERFACE (CONTINUED)

E. KSC TEST DIRECTORS VOICE INTERFACE - ONE OF THREE MANDATORY:

1. OIS 131
2. OIS 232/212
3. FD

NOTE: OIS 232 IS USED PRIOR TO T MINUS 20 MINUTES AND OIS 212 IS USED AFTER T MINUS 20 MINUTES AS THE PRIMARY VOICE COMMAND CHANNEL.

Same rationale as Rule {A3-52}, MCC INTERNAL VOICE.

Rule {A3-4}, ABORT LIGHT INTERFACE, references this rule. ©[ED] ©[032807-8402B]

FLIGHT RULES

A3-152

GSFC/STDN INTERFACE

A. SITE TO GSFC:

1. MIL/PDL ONLY 224-KB CIRCUIT - ONE OF TWO MANDATORY.
@[072398-6565A]

One of two redundant circuits is required to support mandatory telemetry from MIL/PDL. Reference Rule {A3-102}, INTEGRATED NETWORK FAILURE DECISION MATRIX, for mandatory site requirements and Rules {A3-1A}.1.b and {A3-1A}.2, GROUND AND NETWORK DEFINITIONS, for HDR/LDR telemetry requirements. @[ED]

2. FOR KSC LAUNCH/LANDINGS (RTL5, AOA, PLS, EOM): MIL 9.6-KB S-BAND HIGH SPEED TRACKING DATA CIRCUIT-HIGHLY DESIRABLE. WILL BECOME MANDATORY FOR LOSS OF REDUNDANT C-BAND TRACKING CAPABILITY. @[061297-6004]
@[072398-6565A] @[032807-8402B]

This circuit routes MILA high speed S-band tracking data to GSFC so that it can be transmitted to the MCC. @[032807-8402B]

3. 224-KB CIRCUITS: @[061396-3198]

DFRF - ONE OF ONE MANDATORY. @[092398-6565A] @[ED]

NOTE: MANDATORY ONLY WHEN THE SITE IS THE ONLY SOURCE FOR LANDING TELEMETRY (REF. RULE {A3-102}, INTEGRATED NETWORK FAILURE DECISION MATRIX). @[ED]

One circuit is required from each site which is mandatory for telemetry.

B. GSFC TO SITE:

1. 224-KB/56-KB VOICE/COMMAND CIRCUITS, MIL/PDL ONLY - ONE OF TWO MANDATORY. @[061396-3198] @[072398-6565A]

The prime voice command circuit from GSFC to MIL/PDL is a 224-kb line, with a 56-kb circuit as backup. The circuit is required to provide uplink command and voice.

2. UHF ANALOG A/G VOICE CIRCUITS: @[061396-3198]

MIL - ONE MANDATORY

MIL is the only site which UHF A/G and S-band A/G are both mandatory (ref. Rule {A3-102}, INTEGRATED NETWORK FAILURE DECISION MATRIX). The UHF A/G must be sent to GSFC/STDN via analog circuits. @[072398-6565A] @[ED]

THIS RULE CONTINUED ON NEXT PAGE

FLIGHT RULES

A3-152 **GSFC/STDN INTERFACE (CONTINUED)**

3. DFRF 224-KB COMMAND/VOICE CIRCUIT - ONE OF TWO MANDATORY.
@[072398-6565A] @[ED]

NOTE: MANDATORY ONLY WHEN DFRF IS THE ONLY SOURCE FOR LANDING COMMAND OR S-BAND VOICE (REF. RULE {A3-102}, INTEGRATED NETWORK FAILURE DECISION MATRIX). @[ED]

This circuit provides the data path for command and S-band voice from GSFC to DFRF.

4. WLPS 224 - KB CIRCUIT @[061396-3198] @[072398-6565A]

WLPS TLM/CMD/VOICE MANDATORY PER RULE {A3-102}, INTEGRATED NETWORK FAILURE DECISION MATRIX. @[121593-1579] @[ED]

A3-153 **45 SPW/WESTERN RANGER (WR) INTERFACE** @[032807-8402B]

FOR EDW LANDINGS (AOA, PLS OR EOM): 9.6-KB WR AND 2.4-KB DFRC LANDING RADAR CIRCUITS-EITHER ONE OF TWO WR OR ONE OF ONE DFRC CIRCUITS MANDATORY IF TWO DRYDEN RADARS SCHEDULED FOR SUPPORT. IF EITHER DRYDEN RADAR IS UNAVAILABLE, ONE OF TWO WR CIRCUITS MANDATORY.

Each of two WR circuits is capable of providing high-speed tracking data from four Western Range and/or Dryden C-band radars. The DFRC circuit is capable of providing high speed tracking from only the two Dryden C-band radars. If both Dryden C-band radars are scheduled for support, any of the three circuits is capable of providing mandatory dual source high-speed tracking support for Edwards AOA/PLS. If both Dryden C-band radars are not available, then one of two of the WR circuits is required to provide dual source tracking support. @[032807-8402B]

A3-154 **45 SPW/WSMR INTERFACE**

FOR NORTHRUP LANDINGS (PLS OR EOM) - WSMR 2.4-KB LANDING RADAR CIRCUIT - ONE OF TWO MANDATORY. @[032807-8402B]

Each of these two circuits is capable of providing high-speed tracking data from two WSMR C-band radars. A single circuit is capable of providing mandatory dual source high-speed tracking support for Northrup AOA/PLS. @[032807-8402B]

FLIGHT RULES

A3-155 **MCC/GSFC/NGT INTERFACE**

WB MDM NETWORK (BROADCAST MODE) - ONE OF TWO MANDATORY.

The MCC/GSFC and MCC/NGT satellite data links (WB MDM networks) provide the data interface for the GSTDN and TDRSS networks, respectively. Mandatory telemetry, command, S-band track, and S-band voice are routed via these links. There are two completely redundant MDM systems to provide backup capability. One of two is required to provide mandatory data.

A3-156 **MCC/ASCENT ABORT SITE INTERFACE**

COMMUNICATIONS CAPABILITY WITH REQUIRED ASCENT ABORT SITES - ONE OF THREE MANDATORY: @[111094-1716A]

- A. LONGLINE (LFP1)
- B. INMARSAT
- C. COMMERCIAL TELEPHONE

Prelaunch, the MCC must be able to communicate with the required ascent abort landing site, (ref. Rule {A2-2}, ABORT LANDING SITE REQUIREMENTS). This insures that there has not been a change in weather or nav/landing aid status. It also insures that anomalies can be passed to the ground support team and that the runway and airspace are clear for a safe landing. This can be accomplished by insuring that at least one of the communications capabilities listed above are available. @[111094-1716A]

A3-157 THROUGH A3-200 RULES ARE RESERVED

FLIGHT RULES

NAVAIDS REQUIREMENTS

A3-201

**TACAN REDUNDANCY REQUIREMENTS AND ALTERNATE TACAN
SELECTION PHILOSOPHY [HC]** @[042706-7371B]

A. REDUNDANCY REQUIREMENTS (FOR 1-STRING GPS VEHICLES ONLY)
@[020196-1807B] @[032807-8393]

1. REDUNDANT TACAN TRANSPONDER CAPABILITY IS MANDATORY FOR LAUNCH COMMIT AT THE FOLLOWING SITES:
 - a. RTLS
 - b. PRIMARY TAL IF REQUIRED
 - c. AOA IF REQUIRED
 - d. FIRST DAY PLS IF REQUIRED (ETRO FOR EQUIPMENT OUTAGE MUST BE PRIOR TO DEORBIT DECISION)

NOTE: REF RULE {A2-2}, ABORT LANDING SITE REQUIREMENTS, FOR ABORT SITE LAUNCH COMMIT REQUIREMENTS.

2. REDUNDANT TACAN TRANSPONDER CAPABILITY IS MANDATORY FOR PLS (OTHER THAN FIRST DAY PLS), MDF, AND END OF MISSION DEORBIT COMMIT (REF RULE {A4-107}, PLS/EOM LANDING OPPORTUNITY REQUIREMENTS [HC]). @[ED]
3. THE REDUNDANT TACAN TRANSPONDER REQUIREMENT CAN BE SATISFIED BY ONE GROUND STATION WITH DUAL STRING (DS) TRANSPONDERS, BY TWO STATIONS WITH SINGLE-STRING (SS) TRANSPONDER CAPABILITY, OR BY ONE GROUND STATION WITH SINGLE-STRING (SS) TRANSPONDER CAPABILITY AND A GPS LRU FUNCTIONING PROPERLY (REF. RULE {A8-115}, GPS SYSTEM MANAGEMENT). @[020196-1807B] @[092602 5642] @[121593-1590]

Landing site selection will be based on priorities specified in Rule {A2-207}, LANDING SITE SELECTION [HC]. @[022201-3857] @[ED]

THIS RULE CONTINUED ON NEXT PAGE

FLIGHT RULES

A3-201

TACAN REDUNDANCY REQUIREMENTS AND ALTERNATE TACAN SELECTION PHILOSOPHY [HC] (CONTINUED)

GPS provides acceptable redundancy to a TACAN ground station that has only a single-string transponder. In the event that the single-string transponder becomes unavailable, the onboard GPS LRU will provide a means to keep the onboard state vector within the Guidance constraints. This is contingent upon GPS functioning properly (ref. Rule {A8-115}, GPS SYSTEM MANAGEMENT).

©092602-5642]

Landing sites and TACAN's are loaded in the onboard software and can be changed in OPS 1/6/3. Uplink of an acceptable alternate TACAN may be performed to meet redundancy requirements for OPS 6/3 entries. TACAN requirements for EOM and other landing opportunities are not considered in the decision to launch. ©[020196-1807B] ©[022201-3857]

RTLS

TACAN processing is required to protect the guidance-imposed navigation entry constraints for an RTLS. An offline analysis that assumed a launch on time using IMU's and ADTA with nominal performance characteristics and random noise showed that 3-sigma navigation performance violated the entry guidance constraints of downtrack and crosstrack at altitudes of 85k feet and 40k feet, respectively.

TAL (IF REQUIRED) ©[121593-1590]

TACAN is required to protect against navigation dispersions for TAL because neither delta state nor GCA is available without ground tracking. TACAN is the primary source to correct downtrack and crosstrack errors in the navigation state. ©[020196-1807B]

Redundant TACAN transponder capability near the selected TAL site is mandatory for launch to provide adequate navigation. If weather conditions are unacceptable at the primary TAL site, then redundant TACAN transponder capability becomes mandatory near the secondary site.

AOA/FIRST DAY PLS (IF REQUIRED)

Although an AOA landing site is not normally required for launch commit (ref. Rule {A2-2}, ABORT LANDING SITE REQUIREMENTS), the TACAN requirements are shown in the event that an AOA site is required. Redundant TACAN transponder capability is required for the primary AOA landing site only. The navigation state conditions are worse for AOA compared to RTLS or TAL because the vector is 1 hour older and the vehicle requires one or two OMS burns. For a first day PLS, the site may be considered go if equipment outage resulting in less than single-fault tolerance has an ETRO prior to deorbit decision time. ©[121593-1590] ©[020196-1807B]

THIS RULE CONTINUED ON NEXT PAGE

FLIGHT RULES

A3-201

TACAN REDUNDANCY REQUIREMENTS AND ALTERNATE TACAN
SELECTION PHILOSOPHY [HC] (CONTINUED)

B. IN GENERAL, PROGRAM APPROVED TACAN'S (LISTED BELOW FOR END OF MISSION AND INTACT ABORT SITES; NOT IN ORDER OF PRIORITY) THAT MEET THE CRITERIA IN PARAGRAPH C WILL BE USED TO MEET THE REDUNDANCY REQUIREMENTS. CONSIDERATION WILL BE GIVEN TO OTHER TACAN'S THAT MEET THE CRITERIA IN PARAGRAPH C IF THEY PROVIDE A NAVIGATION IMPROVEMENT OVER AN APPROVED TACAN. @[020196-1807B]

1. KENNEDY SPACE CENTER:

- TITUSVILLE, TTS (DS)
- PATRICK, COF (SS)
- ORMOND BEACH, OMN (SS)
- LAKELAND, LAL (SS) @[020196-1807B]
- ORLANDO, ORL (SS) @[020196-1807B] @[022201-3857]

2. EDWARDS AFB:

- EDWARDS, EDW (SS)
- LAKE HUGHES, LHS (SS)
- CHINA LAKE, NID (DS)
- GORMAN, GMN (SS)
- PALMDALE, PMD (SS)
- POMONA, POM (SS)

THIS RULE CONTINUED ON NEXT PAGE

FLIGHT RULES

A3-201

**TACAN REDUNDANCY REQUIREMENTS AND ALTERNATE TACAN
SELECTION PHILOSOPHY [HC] (CONTINUED)**

3. NORTHROP:
 - WHITE SANDS SPACE HARBOR, SNG (DS) @[121604-6503B]
 - HOLLOMAN AFB, HMN (SS)
 - TRUTH OR CONSEQUENCES, TCS (SS)
4. ISTRES:
 - ISTRES, FMI (DS) @[020196-1807B] @[121604-6503B]
5. MORON @[121604-6503B]
 - MORON, MRN (SS)
 - ROTA, AOG (DS) @[020196-1807B]
6. ZARAGOZA: @[020196-1807B] @[121604-6503B]
 - ZARAGOZA, ZZA (DS)

Program approved TACAN's refer to those TACAN's listed in NSTS 07700, Volume X, Book 3, controlled by the PRCB, approved by the SASCB for use in the onboard I-loads, or contained in this flight rule. When selecting an alternate TACAN station to meet redundancy requirements, priority will generally be given to program approved TACAN's that meet the criteria in paragraph C. If no program approved TACAN's meet the criteria or other TACAN's that meet the criteria provide a navigation improvement, non-program approved TACAN's may be used to meet the redundancy requirements. Note that in most cases, there will be no program approved alternate TACAN station since both NSTS 07700 and the onboard I-loads only include a primary and secondary TACAN for each site. @[022201-3857]

THIS RULE CONTINUED ON NEXT PAGE

FLIGHT RULES

A3-201

TACAN REDUNDANCY REQUIREMENTS AND ALTERNATE TACAN
SELECTION PHILOSOPHY [HC] (CONTINUED)

C. ALTERNATE TACAN'S THAT SATISFY THE FOLLOWING CRITERIA (NOT IN PRIORITY ORDER) MAY BE UPLINKED IN OPS 1/3 TO MEET THE REDUNDANCY REQUIREMENTS IN PART A. @[022201-3857]

NOTE: THESE CRITERIA APPLY TO GROUND STATIONS REQUIRED FOR LAUNCH COMMIT AND COMMIT TO DEORBIT. REFER TO RULE {A2-264}, EMERGENCY LANDING FACILITY CRITERIA, FOR ELS MINIMUM REQUIREMENTS.

1. NO COCHANNEL INTERFERENCE PREDICTED BELOW 130K FT ALTITUDE.

NOTE: IN SOME CASES, COCHANNEL INTERFERENCE MAY BE ELIMINATED BY POWERING OFF THE INTERFERING STATION(S) FOR THE PERIOD OF SHUTTLE OPERATIONS.

2. TACAN MUST BE OPERATING PRIOR TO LAUNCH OR DEORBIT COMMIT AS APPLICABLE PER PARAGRAPH A

3. WITHIN 50 NM OF THE RUNWAY.

4. POWER LEVEL \geq 1.5K WATTS. @[020196-1807B]

EXCEPTION: FOR SPACE SHUTTLE LANDINGS AT EDWARDS AIR FORCE BASE, THE EDWARDS 111X TACAN OPERATING AT 1.0K WATTS POWER IS ACCEPTABLE FOR USE AS THE PRIME TACAN. @[102506-7841]

5. NIMA OR FAA TACAN DATABASE COORDINATES MUST BE AVAILABLE AS A MINIMUM. SURVEY DATA IS HIGHLY DESIRABLE, BUT NOT MANDATORY. @[020196-1807B] @[022201-3857]

6. NASA OR FAA CERTIFIED AND ACCURATE WITHIN 0.3 NM AND 1.0 DEGREE (REF RULE {A8-52}, SENSOR FAILURES). CONSIDERATION WILL BE GIVEN TO THE USE OF A TACAN WHICH HAS BEEN EVALUATED VIA GPS EQUIPPED STA BUT WHICH HAS NOT BEEN COMPLETELY CERTIFIED. @[ED]

THIS RULE CONTINUED ON NEXT PAGE

FLIGHT RULES

A3-201

TACAN REDUNDANCY REQUIREMENTS AND ALTERNATE TACAN SELECTION PHILOSOPHY [HC] (CONTINUED)

Alternate TACAN's may be uplinked in OPS 1/3 to satisfy the redundancy requirements for OPS 6/3 entries. The process of selecting an alternate TACAN begins with the TACAN Cochannel Interference Document (NAV-06-48500-026) which includes several potential TACAN stations for space shuttle landing sites. This document contains cochannel interference data which is generated assuming a nominal range-altitude profile, constant power level of 3.5 KW, and an approximation for the shape of the parabolic TACAN signal propagation. This interference data along with the expected groundtrack can be used to approximate the altitude below which a given TACAN station is clear of interference and to determine which TACAN stations must be powered off to reduce or eliminate interference. In addition to the cochannel interference data, the TACAN Cochannel Interference Document lists the type of station (TACAN, VORTAC, VORDME, or DME), data source (survey or NIMA/FAA database), and the distance and direction from the runway. ©[102506-7841]

Once an acceptable TACAN or VORTAC is identified based on runway proximity and cochannel interference, the operating hours and power level are verified to ensure the TACAN will be available during entry. TACAN's used to meet the redundancy requirements must be operational prior to launch commit for RTLS, TAL (if required), and AOA (if required). If first day PLS is required, the TACAN(s) must have an ETRO prior to deorbit decision time. For PLS, MDF, and end of mission, the TACAN(s) used to meet the redundancy requirements must be operating prior to deorbit commit and until touchdown. The TACAN(s) must be available throughout entry to touchdown to ensure continuous TACAN processing.

A maximum distance of 50 nm from the TACAN to the runway is required to ensure TACAN lock-on until MLS acquisition. The groundtrack proximity may also be considered in the alternate TACAN selection process. ©[042706-7371B]

The minimum power level of 1.5K watts and cochannel interference requirements were chosen to ensure TACAN data can be incorporated prior to 3 sigma downtrack errors exceeding the guidance constraints. Analyses presented in May 2004 (ref A/EFTP #201, May 21, 2004) and in December 2005 (ref A/EFTP #216, December 16, 2005) showed that without TACAN processing, guidance constraints would be exceeded by 3 sigma downtrack errors between 105 and 130 kft altitude, depending on trajectory and atmospheric conditions. For ascending EOM CONUS landings, 1.5K watts provides greater than 30 seconds for evaluation and incorporation of TACAN data before 3 sigma downtrack errors will exceed guidance constraints. Descending cases were not examined in detail, but there were indications that a power setting of 1.5K watts provided slightly less than 30 seconds of evaluation time prior to the required TACAN incorporation altitude. ©[042706-7371B]

An exception to the 1.5K watts minimum power level requirement is the EDW 111X TACAN at Edwards Air Force Base. As part of an Air Force Material Command effort to upgrade their TACAN systems, the Edwards 111X TACAN was replaced in February 2006. The old Edwards TACAN was operated at 3.0K watts transmit power, while the new TACAN is only 1.0K watts transmit power. ©[102506-7841]

THIS RULE CONTINUED ON NEXT PAGE

FLIGHT RULES

A3-201

TACAN REDUNDANCY REQUIREMENTS AND ALTERNATE TACAN SELECTION PHILOSOPHY [HC] (CONTINUED)

Based on Spacecraft Trajectory Analysis and Mission Planning System (STAMPS) analysis, the three most preferred alternate Edwards area TACAN's (Lake Hughes 21X, Gorman 108X, and Pomona 41X) showed good navigation performance at high altitudes/early Mach numbers (above 50 kft), but experienced brief exceedance of downtrack and/or crosstrack guidance constraints by 3-sigma nav errors between 45 kft and 20 kft. Although the new 1.0K watts EDW 111X is below the 1.5K watts power level requirement, the on-field Edwards TACAN provides the best navigation performance in the Terminal Area Energy Management (TAEM), Heading Alignment Cone (HAC), and Approach and Land (A&L) regions. It is more important to have accurate navigation in these regions because of the limited time and capacity to correct for energy problems that can be caused by inaccurate navigation in these final guidance phases. ©[102506-7841]

Based on Dynamic Environment Communications Analysis Testbed (DECAT) radio frequency (RF) analysis, delayed lock-on is expected for the lower power level Edwards TACAN, with 2-LRU lock expected by 133 kft. STAMPS predicts that 3-sigma nav errors will exceed guidance constraints if TACAN's are not processed by 126 kft. So, based on DECAT and STAMPS, there would be approximately 26 seconds (7 kft altitude) to evaluate and incorporate TACAN's on a 3-sigma nav day before guidance constraints are exceeded. However, based on flight history, 3-sigma nav errors do not exceed guidance constraints (if TACAN's are not processed) until 116 kft. So, based on DECAT and flight history, there would be approximately 63 seconds (17 kft altitude) to evaluate and incorporate TACAN's on a 3-sigma nav day before guidance constraints are exceeded. The primary difference between STAMPS and flight history nav error estimates is that STAMPS assumes inertial measurement unit (IMU) accuracy according to specification drift rates while IMU flight performance is significantly better than spec.

This 1.0K watts exception applies only to the Edwards 111X TACAN for ascending approaches and these results cannot be extrapolated to other TACAN's. The Edwards 111X TACAN utilizes improved technology that reduces line losses between the antenna and the transmitter and provides for a more effective antennae pattern allowing for lock on at longer range. Reference: A/EFTP #220, May 19, 2006, for analysis details. ©[102506-7841]

THIS RULE CONTINUED ON NEXT PAGE

FLIGHT RULES

A3-201

TACAN REDUNDANCY REQUIREMENTS AND ALTERNATE TACAN SELECTION PHILOSOPHY [HC] (CONTINUED)

For TAL trajectories, 1.0K watts was found to be the minimum power required to provide acceptable navigation performance. TAL trajectories were found to require lower power than EOM due to the reduced amount of time that navigation errors can propagate since TAL landing occurs approximately 37 minutes after launch. However, the RF analysis did not include any margin and, since ground tracking is not available on a TAL, the Ascent/Entry Flight Techniques community decided to maintain 1.5K watts as the minimum power requirements for alternate TAL TACAN's. Additionally, there are currently no 1.0K watts TAL TACAN's that meet NASA accuracy requirements, so there is no operational benefit to reducing the TAL power requirement. ©[042706-7371B] ©[102506-7841]

In general, the transmit power for primary EOM and TAL TACAN's is maintained at 3K watts. The primary EOM TACAN's operate at a power greater than 2.5K watts (except Edwards), while TAL sites operate at power level greater than 2K watts. The transmit power for the prime EOM and TAL TACAN's operate at a greater power level to provide an additional +3 dB safety margin for entry/landing. Maintaining this additional margin is consistent with the operation of a test vehicle. High level TACAN power maintenance requirements for primary TACAN's are contained in NSTS 07700 Volume X, Book 3. ©[102506-7841]

Although survey data is preferred, it is not required, provided data is available from the NIMA/FAA TACAN database. Non-survey coordinates provided by NIMA/FAA are accurate within about 1000 ft. Past TACAN measurement data quality observed during shuttle missions and flight tests may also be considered in the alternate TACAN selection process. ©[020196-1807B] ©[022201-3857]

The FAA or NASA certification requirements are contained in NSTS 07700, Volume X, Book 3. The FAA accuracy requirements are outside those required by space shuttle navigation. Therefore, an FAA controlled TACAN must also meet the 0.3 nm and 1.0 degree accuracy requirements contained in Rule {A8-52}, SENSOR FAILURES. ©[020196-1807B] ©[022201-3857]

D. IF A TACAN GROUND STATION FAILS AFTER LAUNCH OR DEORBIT AND A TACAN THAT MEETS THE CRITERIA IN PARAGRAPH C DOES NOT EXIST, OTHER ALTERNATES (DME'S INCLUDED) MAY BE CONSIDERED FOR UPLINK TO PROVIDE SOME FORM OF BACKUP CAPABILITY.

The criteria in paragraph C is provided to ensure an acceptable TACAN is used to meet the redundancy requirements for commit to launch or commit to deorbit. However, if a TACAN fails after launch or deorbit and a TACAN that meets the criteria in paragraph C does not exist, the best alternate including DME's may be uplinked. Although this alternate may not protect 3 sigma navigation performance, it provides some form of backup capability. ©[020196-1807B]

Hazard Report ORBI 211, Landing Mishaps Due to Failures of Guidance, Navigation and Control (GN&C) Functions/Landing Aids, Adverse Landing Conditions or Pilot Error, references this rule. ©[042706-7371B]

*Rule {A2-1F}.3, PRELAUNCH GO/NO-GO REQUIREMENTS, references this rule. ©[121593-1590]
©[ED]*

FLIGHT RULES

A3-202

MLS [HC] @[032807-8209A]

REDUNDANT MLS CAPABILITY, INCLUDING AZIMUTH, ELEVATION, AND RANGE DATA, IS REQUIRED FOR THE FOLLOWING: @[070899-6872A]

- A. REDUCED CEILING, VISIBILITY, OR INCREASED RTLS CROSSWIND LIMITS (REF. RULE {A2-6}, LANDING SITE WEATHER CRITERIA [HC]) FOR DAYLIGHT, CONCRETE RUNWAY LANDINGS. @[111094-1622B] @[041196-1817B]

Because MLS provides improved navigation accuracy with respect to the runway, a reduction in ceiling, visibility or an increase in RTLS crosswind requirements is allowed. However, because of the dependence on MLS during the critical landing phase with reduced ceilings/visibility, combined with the more stringent navigation requirements for concrete runways, single-fault tolerant capability must exist to guarantee MLS availability. Redundant MLS capability can be either the standard primary/backup MLS ground station or two collocated single-string MLS Jr. stations. The relatively less stringent navigation requirements for lakebed runways make it possible to relax the redundancy requirement to zero-fault tolerant. In the absence of GPS updates, 1-sigma onboard navigation position errors improve from approximately 400 feet without MLS to approximately 85 feet after the first MLS measurement, decreasing to just over 50 feet 1-sigma by touchdown. When GPS measurements are incorporated and FOM=1, which is typical but not guaranteed, navigation errors prior to MLS processing are approximately the same as during MLS processing. Azimuth and range measurements are required to allow MLS processing, and elevation is required to correct altitude errors. Detailed definitions of ceiling, visibility and RTLS crosswinds are covered in Rule {A2-6}, LANDING SITE WEATHER CRITERIA [HC]. @[111094-1622B] @[041196-1817B]

- B. NIGHT LANDINGS ON ALL CONCRETE RUNWAYS OR NIGHT LANDINGS ON LAKEBED RUNWAYS WITH CEILINGS LESS THAN THOSE SPECIFIED IN RULE {A2-6}, LANDING SITE WEATHER CRITERIA [HC]. @[111094-1622B]

MLS is required due to the loss of visual cues and the related degradation of the crew's ability to visually compensate for navigation dispersions during night landing operations. Because of this requirement, single-fault tolerant capability must exist to guarantee MLS availability (ref. paragraph A rationale) for landings on concrete runways where large lateral dispersions at touchdown are less tolerable than for lakebed runways.

For lakebed landings only, single-string MLS is acceptable if the lowest ceiling is at or above those specified in the Rule {A2-6}, LANDING SITE WEATHER CRITERIA [HC]. The increased ceiling provides additional time for the crew to compensate for navigation dispersions using visual cues. In addition, the larger area provided by the lakebed environment makes navigation dispersions resulting from the possible failure of the single-string MLS more tolerable. @[111094-1622B]

Rules {A2-1F}.3, PRELAUNCH GO/NO-GO REQUIREMENTS; {A2-2}, ABORT LANDING SITE REQUIREMENTS; {A3-203}, LANDING AID REQUIREMENTS; and {A8-1001}, GNC GO/NO-GO CRITERIA, reference this rule. @[111094-1622B] @[070899-6872A]

Hazard Report ORBI 211, Landing Mishaps due to Failures of Guidance, Navigation and Control (GN&C) Functions/Landing Aids, Adverse Landing Conditions or Pilot Error, references this rule. @[032807-8209A]

FLIGHT RULES

A3-203

LANDING AID REQUIREMENTS [HC] @[031705-6677A]

LANDING AIDS (CONCRETE/LAKEBED) @[070899-6881]

	PAPI LIGHTS	AIMPOINT	BALLBAR [1]	XENON LIGHTS [3] [4]	EDGE LIGHTS/ REFLECTORS	ALS	CENTER LINE LIGHTS	RUNWAY REMAINING MARKERS
CDR HUD W/MLS	1 OF 2 HD		HD	RUNWAY LIGHTS AND MARKERS NOT REQUIRED FOR DAYLIGHT LANDINGS				
CDR HUD W/NO MLS	1 OF 2 M		M					
NO CDR HUD	M	HD	M					
NIGHT LANDING	M	N/R	M	M	M	HD	HD [3]	M [2]

@[102402-5786]

- [1] BALLBAR IS MANDATORY FOR TAL.
- [2] RUNWAY REMAINING MARKERS (RRM'S) ARE MANDATORY FOR NIGHT LANDINGS ON CONCRETE ONLY.
- [3] AT KSC ONLY, LOSS OF UP TO 50 PERCENT OF XENON LIGHTING IS ACCEPTABLE IF CENTERLINE LIGHTS ARE OPERATIONAL AND NO GENERIC FAILURE MECHANISM IS SUSPECTED.
- [4] AT ALL OTHER RUNWAYS (EDW, NOR, ZZA, MRN, FMI), LOSS OF A SINGLE XENON LIGHT IS ACCEPTABLE. @[031705-6677A]

PAPI lights are required at the proper aimpoint position (nominal or close in as recommended) for all lighting and surface conditions. The exceptions are daylight landings where the use of an aimpoint and a HUD will substitute for a PAPI, or when the CDR HUD and MLS are available. PAPI lights allow the pilot to visually acquire the proper outer glide slope with a good degree of accuracy. In daylight, the use of an aimpoint and a HUD (visual glide slope information provided by onboard navigation) will provide the crew with similar cues to the outer glide slope. The combination of the HUD and MLS can also provide the necessary cues for flying the outer glide slope in daylight. In this case, either the PAPI lights or aimpoint are only highly desirable. For purposes of this rule, the MLS capability is required. For specific MLS ground station redundancy and LRU requirements reference Rules {A3-202}, MLS, and {A8-18}, LANDING SYSTEMS REQUIREMENTS. If MLS is not available, then either the PAPI lights or aimpoint are mandatory (PAPI lights preferred). Without MLS, navigation accuracy may not be good enough to provide a reliable crosscheck of the HUD runway overlay for confirming and flying the outer glide slope. PAPI lights are mandatory for night landings or landings without the CDR HUD to help offset the loss of visual cues and references and the degraded ability to compensate for navigation errors. @[070899-6881]

THIS RULE CONTINUED ON NEXT PAGE

FLIGHT RULES

A3-203

LANDING AID REQUIREMENTS [HC] (CONTINUED)

Ball bars are mandatory for TAL sites because of the reduced runway length and width (< 300 feet) as compared to CONUS runways. Without the ball bar, the reduced width of the runway can result in a false visual perception of being too high above the glide slope which can lead to descending through the inner glide slope and landing short of the runway.

For daylight CONUS landings where the visual scene is "as trained to," a ball bar is only highly desirable when both the CDR HUD and MLS are available. MLS plus the CDR HUD provides sufficient cues to allow an accurate transition to the inner glide slope. For purposes of this rule the MLS capability is required. For specific MLS ground station redundancy and LRU requirements, reference Rules {A3-202}, MLS, and {A8-18}, LANDING SYSTEMS REQUIREMENTS. Without MLS, the navigation accuracy (primarily the HUD velocity vector) may not be good enough to guide the pilot on the H/Hdot profile required to capture (Pre-Flare) and fly the inner glide slope through threshold crossing; therefore, a ball bar is mandatory. Ball bars are mandatory for night landings or landings without the CDR HUD to help offset the loss of visual cues and references and the degraded ability to compensate for navigation errors. ©[070899-6881]

Runway remaining markers (RRM's) are only mandatory for night concrete landings. The length of concrete runways and night conditions necessitate the need for RRM's due to the reduced margin of error in determining runway remaining. These markers give the pilot a visual cue to the rollout distance remaining and the brake profile required to stop on the field. For KSC night landings, the 13,000 ft RRM is covered in order to eliminate reflections from the Xenon lights that could interfere with the CDR's ability to acquire the ball bar. ©[031705-6677A]

Runway lighting is required for night landings in order for the pilot to see the runway on approach, touchdown, and rollout. The Xenon lights are considered mandatory, as they provide the primary means for lighting the immediate runway area (approach path, threshold, and touchdown point). Runway edge lights/reflectors are mandatory as they provide the primary visual cue for lateral margin during touchdown and rollout. Approach Lighting System (ALS) lights are not mandatory because the Xenon lights, edge lights/reflectors, and PAPI/ball bar requirements suffice for centerline/threshold lighting and targeting cues. Centerline lights are available as a secondary cue at the KSC SLF and are only highly desirable. ©[102402-5786]

THIS RULE CONTINUED ON NEXT PAGE

FLIGHT RULES

A3-203**LANDING AID REQUIREMENTS [HC] (CONTINUED)**

STA flight tests were conducted at KSC from October 2002 to April 2003 to determine the minimum number of Xenon lights required for safe landing. Nineteen CDR's/PLT's (including 10 flown crewmembers) flew 110 approaches under a variety of ambient lighting conditions with nominal and close-in aimpoints. The number of operating Xenon lights was varied during the tests, and STA landing performance data were examined, along with the corresponding pilot evaluations. Acceptable landing conditions were obtained with up to 50 percent of Xenons lost (4 of 8) even if all lights were lost on the same side of the runway. This was the minimum lighting level examined during the tests. The test report concluded that all lighting conditions tested were satisfactory and required only minimum compensation from a normal landing technique (ref Internal Note CB-03-040 "Flight Test Report for Xenon Runway Lights"). These tests were conducted with a fully functional centerline lighting system. Additional tests in December 2003 using the new Xenon lights verified no change to previous conclusions. ©[031705-6677A]

The KSC testing also concluded that the results cannot be extrapolated one for one to other CONUS and TAL landing sites (EDW, NOR, ZZA, MRN, and FMI) due to different ambient lighting environments and terrain, lack of centerline lighting, and the unique Xenon lighting configuration at each of these sites. Thus, it would not be acceptable to lose up to 50 percent of the lighting at any of these sites. However, based on the testing performed at KSC, plus limited testing performed at Edwards and Northrup in 1983, the loss of a single Xenon light (one of six operating lights) is acceptable at Edwards or Northrup or any of the TAL sites. The results of the KSC testing indicated that the loss of a single light was barely perceptible to the pilot and would not be an impact to visually acquiring the touchdown area. The Xenon lighting configuration for the CONUS and TAL sites is summarized in the following table: ©[031705-6677A]

THIS RULE CONTINUED ON NEXT PAGE

FLIGHT RULES

A3-203

LANDING AID REQUIREMENTS [HC] (CONTINUED)

LANDING SITE	NUMBER OF LIGHTS OPERATING EACH SIDE OF RUNWAY	CONFIGURATION	POWER
KSC	4 WITH NO SPARE	FLATBED TRUCK MOUNT 1000 FEET FROM THRESHOLD	ONE GENERATOR PER TWO LIGHTS WITH BACKUP GENERATORS
EDW	3 WITH ONE BACK-UP SPARE	SCISSORS TRUCK MOUNT 1300 FEET FROM THRESHOLD	GENERATOR POWER WITH BACKUP GENERATORS
WHITE SANDS	3 WITH NO SPARE	ENCLOSED TRAILER MOUNT 1300 FEET FROM THRESHOLD	FACILITY FOR TWO LIGHTS ON ONE SIDE AND A SINGLE LIGHT ON OTHER. GENERATOR FOR OTHER LIGHTS WITH ADDITIONAL GENERATOR BACKUP.
ZARAGOZA	3 WITH ONE BACK-UP SPARE	TRUCK MOUNT 1059 FEET FROM THE THRESHOLD	GENERATOR POWER WITH BACKUP GENERATORS
MORON	3 WITH NO SPARE	TRUCK MOUNT 1000 FEET FROM THE THRESHOLD	GENERATOR POWER WITH BACKUP GENERATORS
ISTRES	3 WITH ONE BACK-UP SPARE	TRUCK MOUNT 1300 FEET FROM THE THRESHOLD	GENERATOR POWER WITH BACKUP GENERATORS

NOTE: ALL LIGHTS ARE Laterally LOCATED 50 FEET FROM THE EDGE OF THE RUNWAY.

In general, the Xenon lighting systems, including bulbs, power distribution hardware, generators, etc., are very reliable equipment. Typically, bulb failures occur when the lights are initially activated and, once activated, the lights perform nominally. It is possible that if multiple lights fail on one end of the runway, there is some generic generator, light, or power distribution problem. Time permitting, any generic failure mechanism should be exonerated prior to attempting a landing with only 50 percent of the lighting operational. ©[031705-6677A]

Reference Ascent/Entry Flight Techniques Panels #156, April 16, 1999, and #199, March 26, 2004. ©[070899-6881] ©[031705-6677A]

Hazard Report ORBI 211, Landings Which Exceed Design Limits Can Result in Loss of Crew and Vehicle. ©[031705-6677A]

Rules {A2-1}, PRELAUNCH GO/NO-GO REQUIREMENTS; and {A2-2}, ABORT LANDING SITE REQUIREMENTS, reference this rule. ©[121593-1590]

FLIGHT RULES

A3-204

GPS CONSTELLATION

- A. FOR 3-STRING GPS VEHICLES, THE GPS CONSTELLATION MUST PROVIDE ADEQUATE SATELLITE COVERAGE FOR: @[032807-8401]
1. LAUNCH COMMIT: ANY ABORT LANDING SITE REQUIRED PER RULE {A2-2}, ABORT LANDING SITE REQUIREMENTS.
 2. DEORBIT COMMIT: ANY PLANNED PLS, MDF, OR EOM DEORBIT/LANDING.
- B. ADEQUATE SATELLITE COVERAGE IS DEFINED AS A CURRENT CONSTELLATION THAT PROVIDES A GEOMETRIC DILUTION OF PRECISION (GDOP) VALUE THAT WILL NOT CONTINUOUSLY EXCEED 40 BELOW 140 KFT FOR MORE THAN:
1. 158 SECONDS (APPROX 2.6 MINUTES) WHEN MLS IS NOT AVAILABLE AT THE LANDING SITE.
 2. 303 SECONDS (APPROX 5.0 MINUTES) WHEN MLS IS AVAILABLE AT THE LANDING SITE.
- C. GPS SATELLITES WITH KNOWN PROBLEMS WILL BE DESELECTED ON-BOARD SUCH THAT THEY ARE UNAVAILABLE FOR ORBITER NAVIGATION UNLESS THEY ARE MARKED UNAVAILABLE IN THE GPS ALMANAC.

Although the GPS constellation usually consists of at least 27 healthy satellites, the GPS constellation was designed to provide precise navigation information with a minimum of 24 healthy satellites. The 2nd Space Operations Squadron (2SOPS) at Schriever AFB continuously monitors the GPS constellation performance and will determine if a satellite is unhealthy. That information is passed to the Landing Support Officer (LSO) so that satellites with known problems that have not yet been marked "unavailable" in the GPS almanac can be deselected prior to launch or deorbit burn. Per MOA dated August 17, 1998 and a joint operating instruction dated May 30, 2003, a real-time MCC interface also exists with the 2nd Space Operations Squadron such that a satellite could be deselected during entry should that action be required.

For an intact abort and for PLS, MDF, or EOM, to ensure acceptable GPS satellite coverage, an analysis will be conducted to determine if the theoretical maximum GDOP chimney duration (elapsed time when GDOP > 40) exceeds 158 seconds (303 seconds with MLS) between 140 Kft altitude and main gear touchdown. GDOP rather than Figure of Merit (FOM) is used as the criteria for this rule since FOM cannot be calculated without additional receiver data, which is only available in real time. A GDOP of 40 multiplied by the User Range Accuracy (URA) of 5 meters (which is usually conservative) yields an error of 200 meters, which is the limit of FOM 5. @[032807-8401]

THIS RULE CONTINUED ON NEXT PAGE

FLIGHT RULES

A3-204

GPS CONSTELLATION (CONTINUED)

If the constellation cannot support the 158/303 second requirement, then the launch or deorbit burn shall not be performed for 3-string GPS flights. The 158 second (approx 2.6 minutes) and 303 second (approx 5.0 minutes) criteria is related to paragraph 3.4.4 (GPS Availability Requirements) of NSTS 47003 (System Requirements Document for Orbiter Global Positioning System), which states that FOM chimneys less than 2.3 minutes from 140 Kft altitude through maingear touchdown will result in an acceptable onboard navigation state with 3-sigma dispersions and 95 percent confidence. ©[032807-8401]

The original service outage certification limit of 2.3 minutes is based on an analysis documented in STF AFDDFD-99-48200-127. A careful review of the guidance constraints used for this analysis revealed that the downtrack limit was conservative. STF AFDDFD-02-077 documents the 158/303 second limits based on the corrected downtrack dispersion limit. Monte Carlo analysis using Course Acquisition (CA code) quality GPS and no MLS showed that if GPS is inhibited above 45 Kft, onboard navigation with 3-sigma dispersions could not achieve 95 percent confidence of being acceptable (within guidance constraints) at 10 Kft altitude. The statistical worst case time from the no MLS study for 45 Kft to 10 Kft is 158 seconds (approx 2.6 minutes). This analysis modeled initial nav state uncertainties along with wind and atmosphere, navigation sensor, aerodynamic and mass property dispersions. Navigation dispersions assumed spec IMU performance rather than flight derived IMU performance and thus the analysis is considered conservative.

The MLS available case shows that if CA code quality GPS is inhibited above 90 Kft, onboard navigation with 3-sigma dispersions could not achieve 95 percent confidence of being acceptable (within guidance constraints) at 17 Kft altitude, which corresponds to nominal MLS processing. The statistical worst case time from the MLS available study for 90 Kft to 10 Kft is 303 seconds (approx 5.0 minutes).

Additional information concerning the origins of the 158/303 second GPS loss of service limits can be found in STF AFDDFD-02-077.

Over the 30+ flight history of single-string GPS, including more than a dozen flights for which this analysis has been performed, the conditions necessary to trigger action based on this rule have never been encountered. With the GPS constellation reaching a size of 30 satellites (as of December 13, 2006, NANU 2006161), the likelihood of such a situation continues to decrease. However, to remain consistent with the use of 3-string GPS as a TACAN replacement, it is sensible to have a GPS constellation rule equivalent to TACAN ground station requirements documented in existing rules. Reference Rules {A3-201A}.3, TACAN REDUNDANCY REQUIREMENTS AND ALTERNATE TACAN SELECTION PHILOSOPHY [HC], and {A8-52B}.2, SENSOR FAILURES [CIL] [HC].

Reference Ascent/Entry Flight Techniques Panel #217, January 27, 2006, and Ascent/Entry Flight Techniques Panel #226, January 19, 2007. ©[032807-8401]

FLIGHT RULES

SECTION 4 - TRAJECTORY AND GUIDANCE

PRELAUNCH

A4-1	PERFORMANCE ANALYSES.....	4-1
A4-2	LANDING SITE CONDITIONS.....	4-4
A4-3	ORBIT CONJUNCTIONS/CONFLICTS.....	4-5
A4-4	DOLILU OPERATIONS.....	4-6
A4-5	TARGET STATE VECTOR REQUIREMENT FOR LAUNCH....	4-8a
A4-6 THROUGH A4-50	RULES ARE RESERVED.....	4-8a

ASCENT

A4-51	KALMAN FILTER SOLUTION.....	4-9
A4-52	ARD THRUST UPDATE CRITERIA AND FPR.....	4-10
A4-53	USE OF MAXIMUM THROTTLES.....	4-14
A4-54	ABORT MODE RESPONSIBILITY.....	4-17
A4-55	DESIGN AND CRITICAL MECO UNDERSPEED DEFINITIONS.....	4-18
A4-56	PERFORMANCE BOUNDARIES.....	4-21
A4-57	NAVIGATION UPDATES.....	4-37
A4-58	AUTO GUIDANCE NO-GO.....	4-42
A4-59	MANUAL THROTTLE SELECTION [HC].....	4-43
A4-60	MANUAL SHUTDOWN CRITERIA.....	4-49
A4-61	THRUST LIMITING, HYDRAULIC, OR ELECTRICAL LOCKUP.....	4-49
A4-62	OMS-1/OMS-2 EXECUTION.....	4-52
A4-63	OMS/RCS SYSTEM FAILURES DURING ASCENT.....	4-53
A4-64 THROUGH A4-100	RULES ARE RESERVED.....	4-67

FLIGHT RULES

ORBIT

A4-101	ONBOARD NAVIGATION MAINTENANCE.....	4-68
A4-102	MINIMUM ORBITAL LIFETIME.....	4-68
A4-103	OFF-NOMINAL ORBITAL ALTITUDE RECOVERY PRIORITIES.....	4-69
A4-104	OMS LEAK/PERIGEE ADJUST.....	4-71
A4-105	MINIMUM TIME OF FREE FALL.....	4-78
A4-106	DEBRIS AVOIDANCE CRITERIA FOR PREDICTED CONJUNCTIONS [HC].....	4-79
A4-107	PLS/EOM LANDING OPPORTUNITY REQUIREMENTS [HC]	4-82
A4-108	TIRE SPEED, BRAKING, AND ROLLOUT REQUIREMENTS [HC].....	4-86
A4-109	DEORBIT PRIORITY FOR EOM WEATHER.....	4-91
A4-110	AIMPOINT, SPEEDBRAKE RETRACT OPTION, AND EVALUATION TOUCHDOWN VELOCITY SELECTION [HC]..	4-92
	TABLE A4-110-I - EOM/INTACT ABORT SPEEDBRAKE RETRACT OPTION AND EVALUATION TD VELOCITY SELECTION.....	4-95
	TABLE A4-110-II - ECAL/ELS SPEEDBRAKE RETRACT OPTION AND TD TARGET SELECTION [1].....	4-98
A4-111	RUNWAY ACCEPTABILITY CONDITIONS.....	4-100
A4-112	UPPER AND LOWER LEVEL MEASURED WIND AND ATMOSPHERIC DATA [HC].....	4-102
A4-113	OMS-2 TARGETING.....	4-104
A4-114	SHUTTLE MANEUVER DEFINITION.....	4-104a
A4-115	THROUGH A4-150 RULES ARE RESERVED.....	4-104b

ENTRY PLANNING

A4-151	IMU ALIGNMENT [HC].....	4-105
A4-152	DEORBIT BURN PLANNING PRIORITIES [HC].....	4-106
A4-153	CG PLANNING.....	4-113
A4-154	DOWNTACK ERROR.....	4-118
A4-155	SUN ANGLE LIMITS AND GLARE CRITERIA FOR INNER AND OUTER GLIDE SLOPES.....	4-119
A4-156	HAC SELECTION CRITERIA.....	4-120

FLIGHT RULES

A4-157 ENERGY DOWNMODING.....4-123
 A4-158 MANEUVER EXECUTION MATRIX.....4-123
 A4-159 ORBITER LANDING WEIGHT [HC].....4-125
 A4-160 THROUGH A4-200 RULES ARE RESERVED.....4-127

ENTRY

A4-201 DELTA-T UPDATE CRITERIA.....4-128
 A4-202 DEORBIT BURN COMPLETION [HC].....4-129
 A4-203 ENTRY DELTA STATE UPDATE PHILOSOPHY [HC].....4-132
 A4-204 RESERVED.....4-134
 A4-205 RESERVED.....4-135
 A4-206 NAVIGATION FILTER MANAGEMENT
 AUTO/INHIBIT/FORCE (AIF) [HC].....4-137
 A4-207 ENTRY LIMITS.....4-144
 A4-208 ENTRY TAKEOVER RULES.....4-148
 A4-209 AERO TEST MANEUVERS.....4-149
 A4-210 EOM ENTRY DTO/RUNWAY SELECTION PRIORITIES....4-150
 A4-211 SHUTTLE EOM ORBIT ADJUST BURNS.....4-150
 A4-212 GPS TO G&C MANAGEMENT.....4-150b
 A4-213 THROUGH A4-250 RULES ARE RESERVED.....4-150b

RANGE SAFETY FLIGHT RULES

A4-251 SIGNATURE SECTION.....4-151
 A4-252 POLICY.....4-152
 A4-253 DEFINITIONS.....4-153
 A4-254 FCO TO MCC WARNING NOTIFICATION.....4-157
 A4-255 MCC TO FCO REPORTING.....4-158
 A4-256 CONTROLLABILITY.....4-159
 A4-257 FLIGHT TERMINATION/MANUAL MECO EVALUATION....4-161
 A4-258 FLIGHT TERMINATION/MANUAL MECO CRITERIA.....4-163
 A4-259 FLIGHT TERMINATION/MANUAL MECO ACTION.....4-166
 A4-260 RANGE SAFETY LIMIT AVOIDANCE ACTIONS.....4-167

FLIGHT RULES

THIS PAGE INTENTIONALLY BLANK

FLIGHT RULES

SECTION 4 - TRAJECTORY AND GUIDANCE

PRELAUNCH

A4-1 PERFORMANCE ANALYSES

LAUNCH WILL NOT BE ATTEMPTED IF:

- A. THE PREDICTED USABLE MPS RESIDUALS AT NOMINAL MECO ARE LESS THAN 2 SIGMA PLUS THE MEAN IN-FLIGHT MPS FLIGHT PERFORMANCE RESERVE (FPR).
- B. THE PREDICTED USABLE MPS RESIDUALS PLUS MPS-EQUIVALENT OMS AND RCS ABOVE THE MISSION-SPECIFIC REQUIREMENTS, AS SPECIFIED IN THE FLIGHT-SPECIFIC ANNEX, ARE LESS THAN 3 SIGMA PLUS THE MEAN IN-FLIGHT MPS FPR.

THE PREDICTED USABLE MPS RESIDUALS PLUS MPS-EQUIVALENT OMS AND RCS ABOVE THE MISSION-SPECIFIC REQUIREMENTS, AS SPECIFIED IN THE FLIGHT-SPECIFIC ANNEX, ARE LESS THAN 3 SIGMA PLUS THE MEAN IN-FLIGHT MPS FPR.

NOTE: FOR DIRECT INSERTION FLIGHTS WHERE ALL OF THE PRIMARY MISSION OBJECTIVES (AS DEFINED IN THE FLIGHT-SPECIFIC ANNEX) CAN BE ACHIEVED FROM A 1-SIGMA MECO UNDERSPEED WITHOUT RAISING THE ORBIT, ONLY PARAGRAPH A ABOVE APPLIES.

NOTE: IF THE PRIMARY MISSION OBJECTIVES CANNOT BE ACHIEVED FROM A 1-SIGMA MECO UNDERSPEED WITHOUT RAISING THE ORBIT, RCS (BOTH FORWARD AND AFT) MARGINS MAY BE COMMITTED ALONG WITH THE OMS MARGIN TO RAISE THE ORBIT. IF THIS IS DONE, THE PRIMARY MISSION OBJECTIVES MAY BE DELAYED TO FLIGHT DAY 2 OR LATER. THIS WILL BE EVALUATED ON A FLIGHT-SPECIFIC BASIS AND DOCUMENTED IN THE FLIGHT-SPECIFIC ANNEX.

THIS RULE CONTINUED ON NEXT PAGE

FLIGHT RULES

A4-1 PERFORMANCE ANALYSES (CONTINUED)

C. THE ET IP CONSTRAINTS AS DEFINED IN RULE {A2-62A}, ET FOOTPRINT CRITERIA, ARE NOT SATISFIED.

Trajectory analysis, using day of launch winds and ET loading estimates, provides performance margins and launch hold capability after the initiation of LOX drainback. To be GO for launch, considering the hold capability, this trajectory analysis must not predict use of any of the mean plus 2 sigma in-flight MPS flight performance reserve (FPR). The use of MPS equivalent OMS propellant above that required to accomplish the specific mission will be allowed to cover up to 1 sigma of the required 3 sigma MPS margin. If the predicted MPS equivalent OMS available plus the MPS residuals at MECO are still less than 3 sigma plus the mean in-flight MPS FPR, launch will be NO-GO. The sigma level (2 or 3 as applicable) plus mean FPR is a propellant level that reflects potential uncertainties in all ascent subsystems at the specified sigma level. We are willing to launch with a slightly increased possibility of low level cutoff (2 sigma vs. 3 sigma) provided the extra sigma is covered in excess OMS such that the nominal mission is protected by 3 sigma, but we are not willing to launch with a guided MECO protection level of less than 2 sigma. On direct insertion flights, should a 2-sigma day occur, OMS propellant cannot be used to make up for the 1-sigma.

MPS shortfall at MECO without scheduling at least one additional OMS burn after OMS-2, with its associated mission objective timeline and tracking impacts. Therefore, as long as the mission objectives can be accomplished from the resulting lower orbit, only 2-sigma MPS plus the mean inflight MPS FPR (reference paragraph {A4-1A}, PERFORMANCE ANALYSES) need be protected.

If the primary mission objective cannot be achieved without raising the orbit, one or more maneuvers will be required. OMS and RCS margins may be used to raise the orbit. The addition of RCS increases the hold time available inside of drainback. However, commitment of RCS to making up part of the 1 sigma may require several maneuvers to be executed and may cause the primary mission objective to be delayed past flight day 1. Therefore, a flight-specific assessment must be done preflight to determine whether the impact of committing the RCS margins is acceptable. The commitment of RCS may be the difference between being able to launch and a launch scrub. It is acceptable to commit RCS prelaunch because the probability of actually having to use it are very small (i.e., requires greater than 2 sigma bad day). Margins are defined as the quantities in excess of the mission completion redlines (ref. Rules {A6-303}, OMS REDLINES [CIL]; {A6-304}, FORWARD RCS REDLINES; and {A6-305}, AFT RCS REDLINES [HC]) plus lower priority flight activities as defined in the Flight Specific Rule Annex. ©[042706-7370D]

Independent of the capability to support the designed mission, ET protection must be maintained off land as prescribed by Rule {A2-62A}, ET FOOTPRINT CRITERIA. As MPS performance capability is degraded through day-of-launch loadings/winds, holds within drainback, and/or late mass property updates, the designed ET footprint will move up range.

THIS RULE CONTINUED ON NEXT PAGE

FLIGHT RULES

A4-1 PERFORMANCE ANALYSES (CONTINUED)

- D. ANY SINGLE-ENGINE-OUT INTACT ABORT GAP IS PREDICTED TO EXIST BASED ON LAUNCH DAY WINDS AND PERFORMANCE ASSESSMENTS. GAP CLOSURE METHODS AS OUTLINED IN RULE {A4-56I}, PERFORMANCE BOUNDARIES, SHALL NOT BE EMPLOYED PRELAUNCH TO CLOSE AN EXPECTED GAP. @[ED]

The launch will not be attempted with a known abort gap. If launch is allowed to proceed with a known gap during intact abort coverage, there will be a period of time during which no intact abort mode will be available. Should an engine fail during this time, loss of mission, vehicle, and crew may result. Options exist for closing an abort gap, such as commitment to AOA shallow, maximum SSME throttles, and relaxing dispersion tolerances. These options are intended only to close a gap that arises post-lift-off due to some unanticipated performance difficulty. They should not be used to allow a launch to proceed since a safety compromise arises from each option.

Rules {A2-1C}, PRELAUNCH GO/NO-GO REQUIREMENTS [HC], and {A2-2}, ABORT LANDING SITE REQUIREMENTS, reference this rule. @[121593-1590] @[ED]

FLIGHT RULES

A4-2

LANDING SITE CONDITIONS

LAUNCH WILL NOT BE ATTEMPTED IF ANY REQUIRED ASCENT ABORT LANDING SITE (REF. RULE {A2-2}, ABORT LANDING SITE REQUIREMENTS) RUNWAY AND LANDING CONDITIONS ARE NOT SATISFACTORY. THE LANDING CONDITIONS REQUIRED ARE DEFINED IN RULE {A2-6}, LANDING SITE WEATHER CRITERIA [HC], AND {A4-107A}, PLS/EOM LANDING OPPORTUNITY REQUIREMENTS. REDESIGNATION TO ALTERNATE SITES, IF ANY, MAY BE USED TO SATISFY RUNWAY AND LANDING CONDITIONS. @[121593-1590] @[111094-1622B]

NOTE: TAL, AOA, AND FIRST DAY PLS SITES MAY NOT BE REQUIRED FOR LAUNCH COMMIT (REF. RULE {A2-2}, ABORT LANDING SITE REQUIREMENTS). SHOULD ALL AOA SITES BE NO-GO, PRESS BOUNDARIES WILL BE BASED UPON ATO/MINIMUM Hp/FD1 SHALLOW DEORBIT USING AFT RCS TO THE FD1 AFT RCS SHALLOW PRESS QUANTITY (REF. RULE {A6-305G}, AFT RCS REDLINES [HC]). IF A FIRST DAY PLS LANDING SITE IS UNAVAILABLE, THEN THE PRESS BOUNDARY WILL BE BASED UPON ATO/MINIMUM HP/FD2 SHALLOW DEORBIT USING AFT RCS TO THE FD2 AFT RCS SHALLOW PRESS QUANTITY (REF. RULE {A6-305G}, AFT RCS REDLINES [HC]), AND FWD RCS IN OPS 2 TO THE FD2 FWD RCS PRESS QUANTITY (REF. RULES {A2-53}, FORWARD RCS USAGE GUIDELINES, AND {A6-304D}, FORWARD RCS REDLINES). ANY SYSTEMS ABORT WILL USE EXISTING TAL/ABORT FROM ORBIT (AFO) CAPABILITY. @[012402-5112B] @[042706-7370D]

Continuous single engine out intact abort landing sites must be available to support an abort condition during ascent. Without these sites, the payload, orbiter and crew may be lost in an abort situation. The redesignation provision documents the capability to employ weather alternate landing sites as a means of satisfying weather, runway, and equipment requirements.

The press boundaries are based on AOA, first day, or second day PLS depending on the availability of landing sites. It is assumed that weather would not prevent a second day PLS since all three CONUS sites would be available. Systems failures requiring early flight termination will be supported by TAL and AFO sites. In some cases, systems failures involving loss of redundancy normally requiring first day PLS will result in second day PLS landings incurring additional risk of failure of the last entry critical system. Rule {A2-1F}.1, PRELAUNCH GO/NO-GO REQUIREMENTS [HC], references this rule. @[121593-1590] @[012402-5112B] @[ED]

FLIGHT RULES

A4-3

ORBIT CONJUNCTIONS/CONFLICTS

IF U.S. SPACE COMMAND PRELAUNCH COMPUTATION OF MISSES BETWEEN ORBITS (COMBO) ANALYSIS PREDICTS AN ON-ORBIT CONJUNCTION WITHIN 5 KM IN THE RADIAL AND OUT-OF-PLANE DIRECTIONS AND 15 KM IN THE DOWNTRACK DIRECTION DURING THE FIRST 2 HOURS OF THE NOMINAL MISSION, LAUNCH WILL BE HELD UNTIL THE NEXT EVEN MINUTE TO ASSURE CLEARANCE. FOR LAUNCH SLIPS, ADDITIONAL COMBO ANALYSIS WILL BE REQUESTED AND FURTHER HOLDS WILL BE SCHEDULED IN ACCORDANCE WITH THIS FLIGHT RULE. LAUNCH WILL ONLY BE HELD IF RESULTS ARE AVAILABLE PRIOR TO 5 MINUTES BEFORE THE L-9-MINUTE RESUMPTION OF THE COUNT.

The launch will not be conducted into known conditions of potential conflict with an orbiting object. If such conditions are predicted to occur prior to 2 hours MET for the nominal orbit, it is prudent to delay the lift-off to the next even minute to assure sufficient clearance from the object. This action minimizes risk at a minimal cost prior to picking up the count at L-9 minutes. After that, holding launch for such a low probability event would not be prudent. The 5-minute pad is to allow the conjunction information to be evaluated, passed on to the FD, and a hold requested if required.

Notification of potential conflicts can come as early as L-1 day. Additional tracking is taken on the object(s), and subsequent COMBO runs are made to determine if the risk persists. If the risk does persist, a launch slip to the next even minute will eliminate that risk.

Providing COMBO analysis through 2 hours MET and slipping launch for the predicted misses as specified in the rule are based on orbiter insertion errors and trajectory dispersions. The orbiter state errors beyond that time are so large (until sufficient tracking can be taken) that it makes no sense to perform the analysis. Also, 2 hours was chosen because any potential conjunctions after that would be computed with an actual post OMS-2 state vector that the MCC provides U.S. Space Command. The results of the post OMS-2 COMBO analysis would be available by 1:30 MET, allowing at least 1/2 hour to plan a maneuver if required.

Rule {A2-1G}, PRELAUNCH GO/NO-GO REQUIREMENTS [HC], references this rule. (Reference Ascent/Entry Flight Techniques Panel Meeting #101, June 18, 1993.) ©[051194-1605] ©[ED]

FLIGHT RULES

A4-4

DOLILU OPERATIONS

THE DAY OF LAUNCH I-LOAD UPDATE (DOLILU) OPERATIONS AND STRUCTURAL LOADS EVALUATION WILL BE PERFORMED BY THE MCC-H WITH VERIFICATION FROM USA/SYSTEMS INTEGRATION. THE LOADS AND DOLILU OFFICER (LDO) HAS PRIMARY RESPONSIBILITY TO REPORT FACILITY AND PROCESSOR STATUS AS WELL AS GO/NO-GO EVALUATION TO THE FD AND MOD WHO PROVIDE THAT INFORMATION TO THE NTD OR MMT AS APPROPRIATE. @[091098-6622C]

TO BE GO FOR LAUNCH, THE DOLILU COMMAND LOADS MUST BE BUILT FROM DAY OF LAUNCH JIMSPHERE MEASURED WIND INFORMATION, UPLINKED AND VERIFIED ONBOARD PRIOR TO LAUNCH, AND THE FINAL LAUNCH WIND ANALYSIS PERFORMED PRIOR TO LAUNCH MUST SHOW THAT THE LOADS AND ASCENT TRAJECTORY PARAMETERS ARE WITHIN ESTABLISHED LIMITS. VALID CORRELATION OF MCC-H AND USA/SYSTEMS INTEGRATION RESULTS IS REQUIRED. IT IS HIGHLY DESIRABLE TO HAVE GO EVALUATIONS FROM BOTH MCC-H AND USA/SYSTEMS INTEGRATION FOR ALL WIND ANALYSES, BUT EXCEPTIONS ARE LISTED BELOW:

- A. DISCREPANCIES IN PROCESSOR INTEGRITY RULES OR EXPERIENCE RULES WILL BE RESOLVED BY THE FLIGHT CONTROL TEAM IF POSSIBLE. NOTIFICATION WILL BE MADE TO THE MMT. UNRESOLVED DISCREPANCIES IN THESE RULES REQUIRE A LAUNCH NO-GO.
- B. VIOLATION OF THE SYSTEMS CONSTRAINT RULES IS A LAUNCH NO-GO UNLESS RESOLVED BY THE APPLICABLE PROGRAM ELEMENTS AT THE MMT LEVEL.
- C. DISCREPANCIES BETWEEN THE RESULTS FROM THE MCC-H PROCESSES AND THE USA/SYSTEMS INTEGRATION PROCESSES WILL BE RESOLVED AS FOLLOWS:
 1. FOR ALL DISCREPANCIES THAT FALL WITHIN COMPARISON CRITERIA, MCC-H RESULTS ARE CONSIDERED PRIME FOR MAKING THE GO/NO-GO EVALUATION. @[091098-6622C]

THIS RULE CONTINUED ON NEXT PAGE

FLIGHT RULES

A4-4

DOLILU OPERATIONS (CONTINUED)

2. IF THE DISCREPANCY FAILS COMPARISON CRITERIA AND IS CAUSED BY A WIND FEATURE, A SUBSEQUENT WIND ASSESSMENT SHALL BE USED TO CLEAR THE DISCREPANCY. THE FINAL WIND ASSESSMENT SHALL BE REQUIRED TO PASS COMPARISON CRITERIA PRIOR TO CLEARING THE VEHICLE FOR LAUNCH. @[091098-6622C]
 3. IF THE DISCREPANCY FAILS COMPARISON CRITERIA AND IS CAUSED BY AN ERROR FROM EITHER THE JSC OR USA/SYSTEM INTEGRATION DOLILU SUPPORT ELEMENT, THEN THE GO/NO-GO EVALUATION SHALL BE BASED ON THE CORRESPONDING NON-FAILED ELEMENT.
 4. IF THE CAUSE FOR THE MISCOMPARE IS UNRESOLVED, THE LAUNCH IS NO-GO REGARDLESS OF EITHER SYSTEM'S GO/NO-GO EVALUATION RESULTS.
- D. FOR FAILURE OF MCC-H PROCESSOR AFTER THE DOLILU I-LOAD HAS BEEN TRANSFERRED TO THE MCC COMMAND SYSTEM, LAUNCH MAY PROCEED IF USA/SYSTEMS INTEGRATION IS ABLE TO PROVIDE RESULTS AND THEY ARE GO.
- E. FOR FAILURE OF USA/SYSTEMS INTEGRATION PROCESSOR AFTER THE L-6:15 HR COMPARE WITH MCC-H IS COMPLETE, LAUNCH MAY PROCEED IF THE MCC-H CONTINUES TO BE ABLE TO PROVIDE RESULTS AND THEY ARE GO.

To be GO for launch, the DOLILU I-loads and trajectory must pass all structural loads and trajectory constraints. These constraints are based on SSP vehicle constraints, and there are no means available for the DOLILU process to clear these violations. Therefore, any systems constraint rule or structural loads violation is reported to the MMT as a NO-GO, requiring an MMT waiver for launch to proceed.

Trajectory experience rules are parameter envelopes and are based on the DOLILU-II certification database. Launch day upper wind conditions may cause an experience envelope exceedance. If the reason for the exceedance is identified and acceptable to the flight control team, then rationale to launch may be written by the LDO as a DOLILU exception and processing may proceed. @[091098-6622C]

THIS RULE CONTINUED ON NEXT PAGE

FLIGHT RULES

A4-4**DOLILU OPERATIONS (CONTINUED)**

At JSC only, processor integrity rules evaluate the DOLILU I-load generation processor for convergence and comparison with the trajectory simulation. Singularities inherent in the numerical iteration scheme used to generate the I-loads may result in processor non-convergence and are the result of random wind conditions. If a processor integrity rule fails, DOLILU processing may proceed using an I-load generated from another launch day balloon (L-6:15 or L-3:25) if the reason for the rule failure is understood and no additional processor rule failure occurs (ref. NSTS-08329, Vol. VIII, DOLILU Operations Support Plan (DOSP)). ©[091098-6622C]

A miscompare of USA/Systems Integration and JSC may indicate that there is an error in one of the two processes or that the environment (wind measurement) is not sufficiently stable to allow a valid constraint evaluation to be made. The source of the miscompare must be understood prior to launch.

The DOLILU process uses independent verification (JSC and USA/Systems Integration) of the trajectory and structural loads as one means to control the risks associated with DOLILU operations (ref. Integration Hazard Report INTG-180E). However, a successful launch day comparison between the two for the L-6:15 balloon is sufficient for processing to proceed with only one location's evaluation. This comparison as well as the system verification checkouts that have occurred prior to day of launch are adequate to insure verification integrity. An additional requirement is for JSC to have generated and transferred a DOLILU I-load to the MCC for uplink. ©[091098-6622C]

FLIGHT RULES

A4-5

TARGET STATE VECTOR REQUIREMENT FOR LAUNCH

- A. FOR RENDEZVOUS FLIGHTS, A TARGET VEHICLE STATE VECTOR SOURCE OF SUFFICIENT ACCURACY FOR LAUNCH TARGETING IS REQUIRED TO COMMIT TO LAUNCH. THE STATE VECTOR CAN BE OBTAINED FROM (IN ORDER OF PREFERENCE) : ©[032807-8387]
1. ORBIT DETERMINATION BASED ON C-BAND AND/OR TDRSS TRACKING DATA RECEIVED AT JSC AND PROCESSED IN THE TRAJECTORY SERVER (TRS)
 2. UNITED STATES STRATEGIC COMMAND (USSTRATCOM)
 3. FOR ISS MISSIONS, TRAJECTORY OPERATIONS OFFICER (TOPO) SPACECRAFT POSITION OPTIMAL TRACKING (SPOT)
 4. GODDARD SPACE FLIGHT CENTER (GSFC) FLIGHT DYNAMICS FACILITY (FDF)
- B. IF THE VECTOR USED IS FROM A SOURCE OTHER THAN JSC, A CONSISTENCY CHECK BETWEEN TWO SOURCES OR MULTIPLE VECTORS FROM THE SAME SOURCE IS REQUIRED.

Analysis performed during STS-115 (USA STF # NAV-06-48500-032) has shown that the accuracy of the USSTRATCOM special perturbations, GSFC FDF, and the TOPO SPOT vectors are comparable to the JSC NAV source, with the one-sigma position differences between the sources less than 1000 ft RSS and one-sigma out-of-plane velocity deviations well under 1 ft/s. Since launch and rendezvous targeting software is known to introduce errors on the order of 1 ft/s with respect to ephemeris generation, this accuracy is sufficient to support launch targeting requirements and commit to launch. ©[032807-8387]

A4-6 THROUGH A4-50 RULES ARE RESERVED ©[032807-8387]

FLIGHT RULES

THIS PAGE INTENTIONALLY BLANK

FLIGHT RULES

ASCENT

A4-51

KALMAN FILTER SOLUTION

FOR PURPOSES OF IMPLEMENTING THE LAUNCH - POWERED FLIGHT ONLY - AND LANDING FLIGHT RULES, THE KALMAN FILTER SOLUTION IS CONSIDERED TO BE VALID IF:

The purpose of this rule is to establish quantitative criteria for declaring the Kalman filter solution a valid source for comparing and evaluating the onboard state vector.

- A. AT LEAST TWO AGREEING RADAR SOURCES ARE BEING PROCESSED, OR ONE RADAR HAS BEEN CONFIRMED PRIOR TO THE DUAL SOURCE LOSS.

The Kalman filter processor is designed for multiple radar data processing to achieve accuracy requirements. Since the ground solution is considered the valid source when disagreement occurs between the ground and the onboard, confirmation of data being processed is necessary for confidence in the ground solution.

- B. LESS THAN 20 PERCENT OF THE DATA IS BEING EDITED FROM EITHER SOURCE.

Editing of incoming radar data is indicative of noisy or invalid data. The 20 percent criterion was selected by navigation analysts as a conservative editing limit based on preflight analysis and postflight evaluation for purposes of maintaining the integrity of the ground state solution.

- C. THE STANDARD DEVIATIONS OF ANGLE AND RANGE RESIDUALS ARE LESS THAN THE 2-SIGMA EXPECTED VALUES.

Data statistics are computed in the Kalman processor based upon a prior knowledge about the data sources. The rule criterion was selected by navigation analysts as a conservative standard for solution validity evaluation based on preflight analysis and postflight evaluation.

- D. THE ESTIMATED BIAS IS LESS THAN 300 FEET FOR RANGE AND 0.5 MILLI-RADIAN FOR ANGLES.

Rationale is the same as for paragraph C above.

FLIGHT RULES

A4-52

ARD THRUST UPDATE CRITERIA AND FPR

- A. AN UPDATE TO THE ARD NOMINAL MAIN ENGINE THRUST VALUE WILL BE PERFORMED BY 4:00 MET IF THE ARD ACTUAL MODE NOMINAL MARGIN TREND RATE EARLY IN SECOND STAGE EXCEEDS A REAL-TIME, ARD-COMPUTED DEADBAND. FOLLOWING A THRUST UPDATE, PROTECTION WILL BE MAINTAINED FOR STATISTICAL DISPERSIONS IN ALL ARD FLIGHT PERFORMANCE RESERVE (FPR) COMPONENTS, AS DETAILED IN PARAGRAPH C BELOW. @[050495-1729D]

When properly modeling vehicle performance, the ARD prediction of current nominal capability (nominal delta V margin) does not vary with time. However, when SSME characteristics and/or vehicle mass properties are mismodeled (i.e., when systems dispersions are present), the nominal margin will trend up or down with time. Analysis shows that at the flight-derived 2 sigma level, an SSME thrust dispersion results in a trend which is significantly larger than the trend due to all other performance-related variables combined. Therefore, it is probable that a trend outside this "deadband" is caused by improper SSME thrust modeling. Abort mode boundary accuracy is heavily dependent on accurate systems modeling and; therefore, the ARD thrust value will be updated in real time, using an empirical relationship between thrust error and trend rate. The deadband is derived from the delta V margin trend due to the root sum square (RSS) of 2 sigma inert weight error, 2 sigma ET LH2 loading error, and the thrust error which could be "masked" by the other dispersions. The update does not eliminate the trend; it merely reduces it to the region where the remaining trend could be due to other factors for which protection is maintained via the ARD FPR. Reference paragraph C of this rule and its associated rationale for thrust sigma-level and deadband values. Implementation details are documented in the Ascent FDO Console handbook (JSC-23255, volume V) and the ARD Support Console Handbook (JSC-24541).

- B. THE ARD SOLUTION WILL BE CONSIDERED INVALID IF THRUST UPDATE REQUIREMENTS EXCEED THE 3-SIGMA SPECIFICATION THRUST DISPERSION LEVEL (10,392 LB CLUSTER, OR 0.74 PERCENT PER SSME) AS DEFINED IN NSTS 07700, VOL X, WITHOUT A CONFIRMING INDICATION. IN THIS CASE, THE ARD WILL BE DECLARED NO-GO AND THE PERMISSION CUE CARD VELOCITIES WILL BE USED FOR MODE BOUNDARY DETERMINATION, BASED UPON THE BEST AVAILABLE STATE VECTOR SOURCE.

Use of this update procedure will generally result in the highest-accuracy ARD solution possible. However, dispersions outside the SSME system specification thrust limit ($\pm 6,000$ lbs/eng RSS, or 10,392 lbs for the cluster) without a secondary cue are highly unlikely. It then becomes probable that the mis-modeling seen in the ARD is due to a ground configuration problem. If this occurs, the ARD solution will be bypassed in favor of abort mode boundaries based on pre-mission-computed inertial velocities. Potential secondary cues include: Off-nominal onboard thrust factor, differences between the onboard-computed and the prelaunch-expected MECO times (provided the ARD solution agrees with the prelaunch value), SSME system status and failure conditions reported by the Booster Systems Engineer, etc. @[050495-1729D]

THIS RULE CONTINUED ON NEXT PAGE

FLIGHT RULES

A4-52

ARD THRUST UPDATE CRITERIA AND FPR (CONTINUED)

C. THE ARD FPR IS CONFIGURED TO PROTECT FOR SYSTEM DISPERSIONS THAT ADVERSELY AFFECT ARD MODELING OF VEHICLE PERFORMANCE. PROTECTION IS PROVIDED FOR ITEMS LISTED BELOW AT THE SPECIFIED STATISTICAL DISPERSION LEVELS. SYSTEM DISPERSIONS ARE OBTAINED FROM A HISTORICAL DATABASE OF FLIGHT-DERIVED DISPERSIONS MAINTAINED IN TABLE 8.1 OF THE SHUTTLE PERFORMANCE ASSESSMENT DATABASE (SPAD, NSTS-08209, VOL I). @[050495-1729D]

ARD FPR COMPONENT	PROTECTION LEVEL (MEAN PLUS)	TYPICAL CONTRIBUTION
ET LOAD ERROR, VAPOR PRESSURE, SSME MIXTURE RATIO	2 SIGMA	29 PERCENT
ORBITER AND ET INERT WEIGHT	2 SIGMA	42 PERCENT
SSME SPECIFIC IMPULSE	2 SIGMA	23 PERCENT
SSME THRUST	2 SIGMA UNTIL 4:00 MET; THEN APPROX 1 SIGMA *	7 PERCENT
SSME THRUST SHAPE	2 SIGMA	< 1 PERCENT

* COMPUTED VIA FLIGHT DESIGN/MCC ARD RECONFIGURATION PROCESS @[080896-4209]

EACH ARD FPR COMPONENT IS COMPUTED INDEPENDENTLY FOR AN ENGINE-OUT AT THE PRESS-TO-ATO BOUNDARY ("AOA FPR"), WITH THE TOTAL AMOUNT DETERMINED BY ROOT-SUM-SQUARING THE SIGMA COMPONENTS AND ADDING THE MEANS. OTHER ABORT BOUNDARIES REQUIRING A SIGNIFICANTLY DIFFERENT FPR QUANTITY (E.G., NEGATIVE RETURN, SINGLE-ENGINE PRESS, AND THE PERFORMANCE CALL) ARE ADJUSTED VIA ARD BIASES.

ARD FPR differs from TDDP FPR, used for pre-flight performance assessment, for several reasons. Pre-flight FPR protects for the total performance impact, from liftoff to MECO, of system dispersions that adversely affect the trajectory. ARD FPR, on the other hand, protects for ARD real-time performance prediction errors caused by system dispersions. For each ARD execution cycle (2 sec), the ARD FPR must protect for future performance degradation due to a dispersion, as well as any MPS propellant mass track errors induced by a dispersion up to the current time. This causes ARD FPR to be a function of MET. Sigma components are RSS'ed and the means are added for the total FPR quantity versus time. The FPR at predicted press-to-ATO MET is loaded into the ARD. This closely matches the FPR quantity for two-engine TAL and press-to-MECO boundaries. Adjustments to ARD biases (Flight Design Product ASAB-25) for negative return, single-engine press, performance low/nominal, and other calls are required since the FPR quantity and/or sigma protection levels are different for these calls. Typical values for ARD and TDDP FPR are approximately 2,400 lbs and 3,800 lbs, respectively. @[050495-1729D]

THIS RULE CONTINUED ON NEXT PAGE

FLIGHT RULES

A4-52

ARD THRUST UPDATE CRITERIA AND FPR (CONTINUED)

The SPAD lists flight-derived dispersions that degrade ascent performance in Table 8.1 of Vol 1. These statistics are obtained from post-flight reconstruction analysis of actual systems performance (e.g., SSME thrust, vehicle weight, SRB burn rate, etc.). Pre-flight prediction is compared to post-flight reconstructed performance over multiple flights to obtain dispersion statistics that are used in FPR calculations. The following dispersions listed in SPAD Table 8.1 are not included in ARD FPR since they take place in first stage (i.e., the effects of the dispersions are visible to the ARD through the post-staging state vector): SRB burn rate, SRB Isp, and collectors (forces and moments used to closely match first stage reconstructed trajectory to the best estimated trajectory (BET)). The remaining dispersions are included in ARD FPR, and the effects of each on ARD performance prediction are described below:
 ©[050495-1729D]

ET load, vapor pressure & SSME mixture ratio: This FPR component is identical to pre-flight ET load, vapor pressure, and mixture ratio protection used in generating TDDP FPR. This specifies the total performance impact of a 2 sigma plus mean combination of these dispersions. Therefore, it is not a function of mission elapsed time. The exact value used is a function of fuel bias at MECO, as predicted from pre-launch reported load or ARD real-time propellant imbalance computations during an SSME performance case.

Orbiter & ET inert weight: This component is calculated by determining the effect of a 2 Sigma plus mean inert weight error on delta V available. This is specified by the rocket equation and is a function of MET (i.e., ET propellant remaining). When calculated in this manner, this component protects for future performance degradation caused by the dispersion. The past performance impact of this dispersion is reflected in the state vector used by the ARD each cycle.

SSME specific impulse (Isp): This item protects for ARD delta V available and exhaust velocity (Vex) errors caused by a 2 sigma plus mean Isp dispersion. The rocket equation is used to calculate the delta V available error caused by the flowrate difference up to current time. Also, the effects of Vex error (a function of Isp dispersion) in the rocket equation are determined. The sum of these composes the ARD Isp protection, and is a function of MET.

SSME thrust: This item protects for ARD delta V available errors (caused by flowrate error) computed from the rocket equation as a function of time. Prior to 4:00 MET, 2 sigma plus mean protection is required. After this time, a thrust update is performed for thrust errors beyond a magnitude specified by the thrust update deadband (approx 4 fps/min). Since thrust errors beyond the deadband are modeled after this point, no FPR protection beyond the deadband is required. A study was conducted to determine the maximum thrust error that could be hidden within the deadband. Other dispersions masking the thrust errors were considered also, but only those causing early ARD boundary errors (i.e., FPR consumption scenarios) were analyzed. The maximum combination is determined each time FPR dispersion levels are re-derived and is converted to a thrust sigma level (approximately 1 sigma; past
 ©[050495-1729D] ©[080896-4209]

THIS RULE CONTINUED ON NEXT PAGE

FLIGHT RULES

A4-52**ARD THRUST UPDATE CRITERIA AND FPR (CONTINUED)**

values have ranged from 0.88 to 1.24) which is used in the ARD FPR computation from 4:00 MET to MECO. The actual sigma level is documented in Flight Design product ASCT-22A, ARD MCC Trajectory Inputs and Support Tables, and ASCT-47, Final MCC Trajectory Inputs (the day-of-launch version of ASCT-22A). The Ascent FDO's will informally keep the Flight Director Office aware of any change in this value in the course of standard pre-mission preparation. ©[050495-1729D] ©[080896-4209]

SSME thrust shape: This item is specified in the SPAD for a nominal mission profile only (i.e., no engine out). It accounts for differences between predicted (cubic polynomial) and reconstructed thrust magnitude in the throttle bucket and during 3g throttling and fine countdown. Since it is calculated for pre-flight FPR, it specifies the total performance impact of this dispersion and is not a function of MET. Since no 3g throttle phase occurs on an engine-out trajectory (for which ARD FPR is designed), the quantity specified in the SPAD is multiplied by 1/3 to account for the approximate time that this dispersion is present (i.e., the throttle bucket), since the 3g throttling/fine countdown time is approximately 60 sec in duration, and the throttle bucket is about 30 sec long. SSME thrust shape is the smallest component of ARD FPR. ©[051045-1729D]

Reference: 5/29/91 and 6/25/91 FOIG, 6/27/91 Level II PRCB, and Ascent/Entry Flight Techniques Panel Meeting #80, 7/19/91, #87 2/21/92, and #95 11/20/92. ©[050495-1729D] ©[080896-4209A]

FLIGHT RULES

A4-53

USE OF MAXIMUM THROTTLES

MAXIMUM THROTTLES WILL BE ENABLED (SPEC 51 ITEM 4) FOR THE FOLLOWING CONDITIONS: @[092195-1770A]

- A. IF AN ENGINE-OUT OCCURS DURING FIRST STAGE BUT AFTER THROTTLE UP, WITH THE THROTTLE OF ONE REMAINING SSME STUCK IN THE THRUST BUCKET, MAX THROTTLE WILL BE ENABLED ASAP PROVIDED RTLS CAPABILITY WILL EXIST AFTER MAX THROTTLE ENABLING.
@[092195-1770A]

For an SSME-out during first stage and a remaining engine stuck in the bucket, the resulting trajectory will be depressed and performance will be much lower than normal. To avoid PEG guidance convergence difficulties in the RTLS flyback solution, max throttles should be enabled ASAP. If max throttles are not enabled, the low altitude drag effects can produce an early RTLS flyback, an extended period of nonconverged steering, and/or unstable throttle commands during flyback. Enabling max throttles increases the altitude at RTLS selection, thus reducing the flyback guidance problems. Additionally, the higher altitude and H-dot reduces the SSME plume heating on the aft end of the vehicle. @[092195-1770A]

- B. IF AN ENGINE-OUT OCCURS DURING FIRST STAGE, MAX THROTTLE WILL BE ENABLED PRIOR TO RTLS SELECTION IF THE H-DOT AT SRB STAGING IS LESS THAN THE PRTLS MINIMUM PERFORMANCE CONSTRAINT (SEE H-DOT VS. VREL PLOT). MAX THROTTLE IS REQUIRED TO AVOID TOTAL PRESSURE (P_{TOTAL}) PROBLEMS FOR DEPRESSED STAGING CONDITIONS.

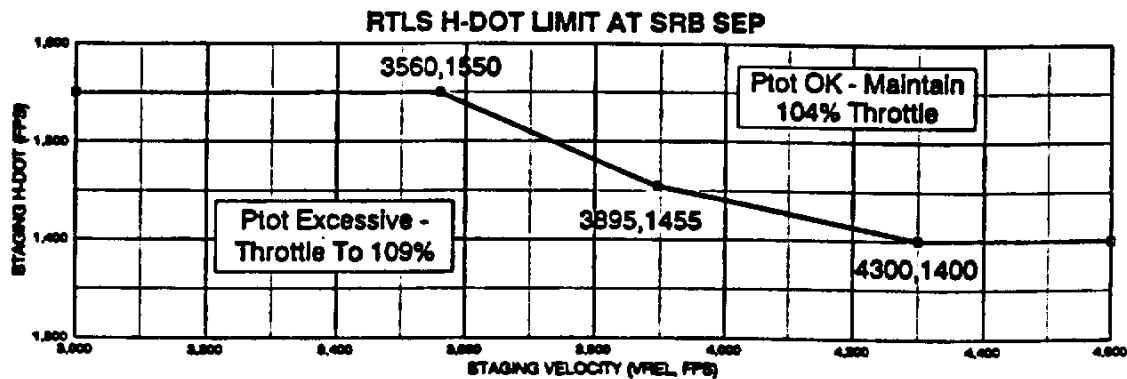

THIS RULE CONTINUED ON NEXT PAGE

FLIGHT RULES

A4-53

USE OF MAXIMUM THROTTLES (CONTINUED)

Initiation of a two-SSME RTLS from a depressed trajectory with low vehicle acceleration requires a large velocity to be gained to satisfy the target MECO conditions. The resultant trajectory drops to low altitudes during flyback phase. The low altitude leads to an increase in dynamic pressure and resultant P_{total} deflecting the SSME plume, which causes heating problems on the aft end of the vehicle. An analysis has been performed to determine altitude rates at SRB jettison which represent the minimal depressed trajectories that would cause PRTLs flyback heating problems on the aft end of the orbiter. The H-dot versus V_{rel} plot shows this region over the range of possible velocities, and is applicable to all flights. This altitude rate is called the PRTLs minimum performance constraint and is based on 20 psf P_{total} during flyback.

The 20 psf criteria applies only to off-nominal contingency situations where engine-out staging conditions are outside the one-sigma systems dispersion boundaries. Single engine-out/one-sigma systems dispersion cases are protected to the dispersed P_{total} limit (4 psf), which provides additional thermal protection for vehicle reusability. The 20 psf criteria was baselined for contingency RTLS aborts in 1982 at Ascent Flight Techniques #5 and approved again at the June 1987 SIR. The abort panel examined contingency RTLS heating concerns during 1989 and found ET umbilical tray heating constraints were violated. However, no ET critical 1 failures were identified with a 20 psf P_{total} . The Orbiter Project Office has not yet assessed orbiter heating with a P_{total} greater than the dispersed (non-contingency) limit. The October 4, 1989, PRCB recommended remaining with the 20 psf P_{total} limit rather than the dispersed limit primarily to reduce the need for throttling up to 109 percent during contingency cases.

Thus, if an SSME failure occurs during first stage and the observed altitude rate at SRB staging is less than the minimum performance constraint, maximum throttle will be enabled by item entry prior to selection of RTLS abort. An increase in vehicle acceleration decreases the flyback interval thereby reducing the gravitational losses which allows more effective thrust to satisfy the target conditions. The heating concerns are reduced by increasing the altitude prior to flyback.

Rule {A2-52C}, ASCENT MODE PRIORITIES FOR PERFORMANCE CASES, references this rule.

C. ABORT GAP CLOSURE @[092195-1770A]

Maximum throttles may be used to eliminate or reduce gaps in "intact abort" capability. Ref. rule {A4-56H}, PERFORMANCE BOUNDARIES, for maximum throttle priority for the specific gap to be closed.

D. TO AVOID POST TAL SELECTION SITE REDESIGNATION WHEN OPERATING ON A SINGLE SSME

Maximum throttles may be used to allow the earliest opportunity to continue to the prime TAL site, rather than redesignating to an inplane ACLS, following the loss of a second main engine. Ref. rules {A4-56F}.2.e, PERFORMANCE BOUNDARIES, and {A2-52C}, ASCENT MODE PRIORITIES FOR PERFORMANCE CASES, for additional rationale.

THIS RULE CONTINUED ON NEXT PAGE

FLIGHT RULES

A4-53

USE OF MAXIMUM THROTTLES (CONTINUED)

E. TO MINIMIZE EXPOSURE TO A CONTINGENCY ABORT OR CREW BAILOUT SITUATION: @[092195-1770A]

For the following cases, the additional risk associated with operating the main engines at 109 percent power level is acceptable in order to provide the crew and vehicle a chance to reach a runway (i.e., SE LIMITS or RTLS SE PRESS). Operationally, the increased internal engine pressures and temperatures at 109 percent do increase the likelihood of having an SSME failure (ref AEFTP #108 charts, 12/17/93; AEFTP #124 charts, 06/02/95; and AEFTP #125 charts, 08/04/95). However, commanding the engines to 109 percent power level while the vehicle is in an abort gap is considered less risky than a contingency abort or crew bailout.

1. DURING A TWO ENGINE RTLS OR TAL ABORT WITH A NON-ISOLATABLE MPS HELIUM LEAK PER RULE {A5-152}, PRE-MECO MPS HELIUM SYSTEM INTERCONNECTS [CIL] [HC]. @[032807-8398]

When one engine has failed and another is suspect, maximum throttles may be enabled to reduce the time to MECO and minimize exposure to a contingency abort. In this case, the risk of the suspect engine failing prior to single engine capability outweighs the increased likelihood of having an SSME failure due to the increased pressures and temperatures associated with operating the engines at 109 percent power level. @[092195-1770A]

2. ECAL, BDA, AND DROOP CONTINGENCY ABORTS

Maximum throttles will be used in contingency abort scenarios to increase the probability of reaching a landing site. The risk of crew bailout outweighs the risk of operating the remaining engine at 109 percent power level.

3. IF THE ENGINES ARE COMMANDED TO 104 PERCENT POWER LEVEL DURING RTLS FLYBACK

Once powered pitcharound is complete, the throttle command is initialized to 100 percent for a two engine RTLS and 72 percent for a three engine RTLS. These values are initial settings only and are adjusted during flyback phase to achieve the desired amount of propellant remaining at MECO. If it appears that there will be too much propellant remaining, the throttle command will be reduced. Conversely, if it appears that there will be too little propellant remaining, the throttle command will be increased but limited to 104 percent. If the throttle command is at the limit of 104 percent, maximum throttles will be enabled to allow guidance to command a power level up to 109 percent. It should be noted that guidance will only command the level required to reach the mass target and may not throttle up to the new limit of 109 percent. @[092195-1770A]

FLIGHT RULES

A4-54**ABORT MODE RESPONSIBILITY**

THE GROUND IS PRIME FOR ABORT MODE DETERMINATION.

Until such time that the orbiter GPC's have the memory capability to contain a completely autonomous version of the ARD program and autonomous navigation, the MCC ARD will remain the prime tool for determining abort capabilities. Current onboard abort mode determination capabilities are based on premission flight design data for predicted ascent performance and groundrule flight performance reserves. The crew is only provided with cue card values of inertial velocity that define designed mode boundaries and two tick marks on the ascent traj display that define negative return and two-engine press-to-MECO; all of which are intended for use only in no-communication situations.

The real-time MCC ARD program was defined and implemented with the flexibility to handle all performance-related ascent abort situations. Those situations include:

- a. Complete failure of one or more SSME at any time.*
- b. Performance dispersions visible in the vehicle state (e.g., dispersions in aerodynamics, atmospherics, SRB, performance, winds aloft, time-variant ISP, guidance/navigation/control, and mass track).*
- c. Performance dispersions not visible in the vehicle state (e.g., SSME performance dispersions, OMS/RCS propellant leaks contained onboard).*

The MCC ARD can define multiple or single SSME abort capabilities throughout ascent for any combination of the above-mentioned situations, utilizing either the HSTD filter or telemetry for the current vehicle state. The MCC ARD can also predict downmode abort capabilities through powered flight.

By virtue of the MCC ARD's flexibility in assessing in real time the orbiter's abort capabilities, the independent ground radar tracking, and the current lack of an equivalent autonomous onboard version of the ARD, the ground is therefore prime for all abort mode determinations.

Rule {A2-67}, ARD UPDATE CRITERIA, references this rule.

FLIGHT RULES

A4-55

DESIGN AND CRITICAL MECO UNDERSPEED DEFINITIONS

- A. PERFORMANCE ASSESSMENTS THAT INDICATE ORBITAL CAPABILITY SHALL BE BASED ON THE ABILITY TO ACHIEVE EITHER THE DESIGN MECO UNDERSPEED OR THE CRITICAL MECO UNDERSPEED. THE FOLLOWING CONSTRAINTS DEFINE THE DESIGN MECO UNDERSPEED:
1. ET IMPACT CONSTRAINTS - CRITICAL LAND MASSES SHALL BE PROTECTED FROM THE 3-SIGMA ET IP FOOTPRINT (REF. RULE {A2-62}, ET FOOTPRINT CRITERIA).
 2. MINIMUM PERFORMANCE CAPABILITY - THE MAXIMUM UNDERSPEED WHICH WILL SUPPORT THE EARLIEST PRESS TIME WITH EITHER:
 - a. AN AOA WITH STEEP TARGETS USING AFT RCS TO THE AOA AFT RCS STEEP PRESS QUANTITY @[012402-5112B]

OR

 - b. AN ATO/MINIMUM HP WITH SHALLOW DEORBIT ON FD 1 USING AFT RCS TO THE FD1 AFT RCS SHALLOW PRESS QUANTITY (REF. RULE {A6-305G}, AFT RCS REDLINES [HC]). @[121593-1590] @[042706-7370D]

OR

 - c. AN ATO/MINIMUM HP WITH SHALLOW DEORBIT ON FD2 USING AFT RCS TO THE FD2 AFT RCS SHALLOW PRESS QUANTITY (REF. RULE {A6-305G}, AFT RCS REDLINES [HC]) AND FWD RCS IN OPS 2 TO THE FD2 FWD RCS PRESS QUANTITY (REF. RULES {A6-304D}, FORWARD RCS REDLINES, AND {A2-53}, FORWARD RCS USAGE GUIDELINES). NOTE: THIS OPTION WILL ONLY BE UTILIZED REAL TIME FOR LOSS OF BOTH AOA AND FD1 LANDING SITES, AND THE PRESS TIME WILL NOT BE EARLIER THAN THE AOA OR FD1 "DESIGN." @[012402-5112B] @[042706-7370D]
- NOTE: REF. RULE {A2-2}, ABORT LANDING SITE REQUIREMENTS, TO DETERMINE THE BASIS FOR DESIGN UNDERSPEED.

ALL OPTIONS WILL PROTECT THE CG TO THE CONTINGENCY CG ENVELOPE. IF AOA DEFINES THE PRESS BOUNDARY, THE LANDING SITE THAT PROVIDES THE EARLIEST PRESS TIME (PROVIDED IT IS "GO") WILL BE ASSUMED REGARDLESS OF THE LANDING SITE PRIORITIES. @[121593-1590]

THIS RULE CONTINUED ON NEXT PAGE

FLIGHT RULES

A4-55

DESIGN AND CRITICAL MECO UNDERSPEED DEFINITIONS
(CONTINUED)

3. MINIMUM ALTITUDE CONSTRAINT - THE MAXIMUM UNDERSPEED SHALL BE LIMITED TO A VALUE WHICH PROTECTS AGAINST LOW-ALTITUDE (< 55 NM) TRAJECTORY CONDITIONS BETWEEN OMS-1 CUTOFF AND OMS-2 TIG. @[012402-5112B]
4. MINIMUM SSME NPSP CONSTRAINTS - THE MAXIMUM UNDERSPEED SHALL BE LIMITED TO A VALUE WHICH PROTECTS AGAINST VIOLATION OF SSME NPSP REQUIREMENTS DURING THE MECO SHUTDOWN SEQUENCE.

NOTE: MANUAL THROTTLING MAY BE USED TO SATISFY NPSP LIMITS IF THE RESULTING ADDITIONAL UNDERSPEED CAPABILITY MAINTAINS ALL OTHER REQUIRED PROTECTION. REF. RULE {A4-59F} AND G, MANUAL THROTTLE SELECTION, FOR MANUAL THROTTLE CRITERIA.

5. CG PROTECTION - THE SPECIFICATION CG ENVELOPE, RULE {A4-153}, CG PLANNING, WILL BE RELAXED TO THE CONTINGENCY ENVELOPE IN ORDER TO CONTINUE TO ORBIT.
- B. CRITICAL UNDERSPEED IS DEFINED AS MAXIMUM UNDERSPEED CAPABILITY WITHOUT REGARD TO ET IMPACT PROTECTION OR FLIGHT SOFTWARE MECO PREP THROTTLING FOR NPSP (I.E., ALLOWS MANUAL THROTTLING). CRITICAL UNDERSPEED IS UNRELATED TO AND DOES NOT PROTECT CRITICAL LAND MASSES.

REFERENCE THE ANNEX FLIGHT RULE, SHUTTLE TRAJECTORY AND GUIDANCE PARAMETERS, FOR THE FLIGHT-SPECIFIC DESIGN AND CRITICAL MECO UNDERSPEEDS. @[ED]

THIS RULE CONTINUED ON NEXT PAGE

FLIGHT RULES

A4-55

DESIGN AND CRITICAL MECO UNDERSPEED DEFINITIONS (CONTINUED)

The design MECO underspeed is usually based on ATO/Min Hp/FD 1 shallow deorbit. In some cases, the design underspeed is based on AOA steep capability. In either case, flight design techniques minimize the time difference between these two boundaries so the loss of an AOA site is not a significant performance risk. The loss of a first day PLS site may require pressing on FD2, but this is a real-time option only and is never part of the "design." Analysis has shown that there is no delay between the FD2 press boundary and the "design" due to being able to commit the Fwd RCS (ref. Rule {A2-53}, FORWARD RCS USAGE GUIDELINES). However, utilizing all of the Fwd RCS above the FD2 Fwd RCS press quantity can result in an earlier press time than the "design." In order to preserve a FD1 PLS option, the press time will not be earlier than the "design" (reference A/E Flight Techniques #178). This modified two engine press boundary would be based on ATO/minimum Hp/FD2 shallow capability, using the Fwd RCS to provide adequate lifetime by raising perigee in OPS 2. RCS press quantities are also modified to include usage to FD2 deorbit. Systems failures requiring early flight termination will be supported by TAL and AFO sites. Reference Rule {A2-2}, ABORT LANDING SITE REQUIREMENTS. ©[121593-1590] ©[012402-5112B]

The landing site that provides the earliest press time is assumed in the minimum performance capability, assuming that the landing site meets all constraints to make it GO. This is done regardless of the landing site priority in order to yield the earliest press time. Since the press calls protect for two-sigma low ascent performance, there is statistically a low probability that an AOA would be required for an SSME-out at the press boundary. Therefore, the Ascent/Entry Flight Techniques Panel determined it appropriate to use the landing site that provides the earliest press time in the assumptions for the press calls, even though it may not be the prime AOA site.

Design underspeed protection of auto MECO prep throttling is provided to satisfy SSME NPSP requirements without any action by the crew. It was determined early in the STS program that, for single-engine-out operation, this underspeed limit is 500 fps, driven by flight software I- and K-loads which determine when the SSME's are commanded to minimum power level. Nominal flight design will protect this constraint in the two-engine press boundaries and associated OMS dump design.

However, if a failure scenario arises in which the 500 fps limit will be exceeded, yet it is still possible to meet the other uphill capability constraints (generally, this requires multiple failures), then manual throttling to minimum power level may be used to assure that NPSP limits are satisfied. This, in turn, avoids a TAL or RTLS abort and may even provide a minimum mission capability. Flights where this technique is available typically involve either high MECO velocity targets or high OMS loads, or both.

Rules {A2-2}, ABORT LANDING SITE REQUIREMENTS; {A2-52B}, ASCENT MODE PRIORITIES FOR PERFORMANCE CASES; and {A4-56}, PERFORMANCE BOUNDARIES, reference this rule. ©[121593-1590] ©[ED] ©[ED]

FLIGHT RULES

A4-56

PERFORMANCE BOUNDARIES

- A. RESERVED @[032807-8385B]
- B. TWO-ENGINE (PRIME TAL) (I.E., TWO-ENGINE ZARAGOZA) @[121604-6503B]

THIS BOUNDARY REPRESENTS THE EARLIEST TIME AFTER WHICH AUTO GUIDANCE WILL ACHIEVE THE DESIRED PRIME TAL RANGE-VELOCITY TARGETS WITHIN CROSSRANGE LIMITATIONS AT MECO. ASSUMPTIONS: SINGLE ENGINE OUT, PROTECTION OF 2-SIGMA MPS FPR, PROTECTION OF 3-SIGMA ENTRY DISPERSIONS, ABORT THROTTLES, AND 15-SECOND ABORT DECISION DELAY.

The first TAL boundary protects 2-sigma FPR as a trade between assurance of a guided MECO and increased exposure to RTLS, which is lower in abort priority. The likelihood of an underspeed is only increased a small amount in backing from 3-sigma to 2-sigma, and the 3-sigma entry protection maintained implicitly in the R-V line can easily accommodate the additional underspeed should a 3-sigma low ascent day actually occur.

THIS RULE CONTINUED ON NEXT PAGE

FLIGHT RULES

A4-56

PERFORMANCE BOUNDARIES (CONTINUED)

C. RTLS BOUNDARIES:

1. NEGATIVE RETURN

THIS BOUNDARY REPRESENTS THE LAST OPPORTUNITY TO ABORT RTLS AND STILL ACHIEVE THE DESIRED MECO RANGE-VELOCITY TARGETS. ASSUMPTIONS: SINGLE ENGINE OUT, PROTECTION OF 3-SIGMA MPS FPR, PROTECTION OF 3-SIGMA ENTRY DISPERSIONS, ABORT THROTTLES, AND 15-SECOND ABORT DECISION DELAY.

The negative return boundary protects 3-sigma MPS FPR in order to ensure that an underspeed is not incurred during an RTLS abort. An underspeed during RTLS can adversely affect the ET separation conditions so severely that this protection is warranted. The single-engine-out, 3-sigma entry dispersions, abort throttles, and 15-second decision delay are self-explanatory and are consistent with other abort mode boundary calls.

2. IF AN ENGINE FAILS PRIOR TO THE TWO-ENGINE TAL CALL, AN RTLS ABORT WILL BE SELECTED AT THE LATER OF THE FOLLOWING:
 - a. 2:30 MET.
 - b. ASAP AFTER THE MCC HAS CONFIRMED THAT TWO-ENGINE TAL CAPABILITY DOES NOT EXIST (IF THE ENGINE FAILED CLOSE TO THE PERMISSION TWO-ENGINE TAL TIME) BUT NOT LATER THAN 3:40 MET.

Onboard software will not initiate RTLS aborts prior to the SRB separation command at approximately 2:05 MET. Initiation of RTLS aborts prior to 2:30 MET causes guidance to fly at a flight control limit until alpha and beta constraints for ET heating control are released at that time. Because of these limits, the only apparent changes seen by the crew are the CRT display titles, which change from ASCENT to RTLS. Delaying selection until 2:30 MET gives the ground time to confirm the engine-out, allows time for transients due to separation to damp out and for second stage guidance to stabilize, and allows sufficient time for completion of the RTLS fuel dissipation phase. If RTLS is clearly the only abort mode available, selection at 2:30 MET (or the engine-out time, if after 2:30 MET) also maximizes RTLS performance capability by lofting the vehicle as soon as possible following the engine failure.

Some missions are designed such that two-engine TAL capability is reached in first stage or very early in second stage (before 2:30 MET). In these cases, it is desirable to wait until after a good second-stage ARD solution can be obtained to evaluate two-engine TAL capability before committing to an RTLS, because ARD margins in first stage may not be indicative of true performance capability due to the open-loop nature of first stage guidance. 3:40 MET was chosen since it is at this time that RTLS aborts are initiated following an engine-out after the two-engine TAL call (ref. paragraph C.3 below). In most cases, however, the ARD should be computing a good solution by 2:30 MET. ©[032807-8385B]

THIS RULE CONTINUED ON NEXT PAGE

FLIGHT RULES

A4-56

PERFORMANCE BOUNDARIES (CONTINUED)

3. FOR RTLS ABORTS AFTER THE TWO-ENGINE TAL CALL, RTLS SELECTION WILL OCCUR AT 3:40 MET.

For any RTLS abort (three-engine or two-engine) after the two-engine TAL call, the RTLS abort will be delayed allowing for any systems problems that may dictate TAL over RTLS. The RTLS selection should be made at least 10 seconds prior to negative return in order to preserve the two-engine RTLS capability as well as keep the TAL option as long as possible. As most all shuttle flights have negative return occurring from approximately 3:50 to 4:05 MET, the 3:40 MET RTLS abort initiation will preserve the two-engine case and provide a standard time for late RTLS selection.

Note: During the RTLS/TAL overlap region, the RTLS abort will be performed for systems failures requiring quick return to ground. The TAL abort will be initiated for performance cases.

4. RTLS AND TAL CAPABILITY.

FOR A FAILURE REQUIRING AN ABORT IN THE REGION WHERE RTLS AND TAL CAPABILITY OVERLAP, THE TAL PREFERENCE OVER RTLS MAY BE REVERSED FOR SPECIFIC SYSTEM FAILURES (REF. RULE {A2-54}, RTLS, TAL, AND AOA ABORTS FOR SYSTEMS FAILURES [CIL]).

There is normally an overlap between first two-engine TAL and last RTLS capabilities. Preference of one abort over the other is dictated by Rule {A2-52}, ASCENT MODE PRIORITIES FOR PERFORMANCE CASES, which is written from a performance standpoint. However, certain failures in orbiter systems may make one mode preferable over the other due to considerations beyond simple performance capability. In these cases, if there is a conflict between the preferred systems abort and the abort priorities rule, the systems abort may be selected since the ability to support the performance abort from a systems standpoint may not exist.

5. SINGLE ENGINE PRESS (RTLS).

THIS BOUNDARY REPRESENTS THE EARLIEST TIME THAT SINGLE ENGINE COMPLETION OF AN RTLS ABORT CAN BE FLOWN VIA AUTO CONTINGENCY ABORT SOFTWARE. THIS BOUNDARY OCCURS WHEN THE VEHICLE H-DOT OF +100 FPS IS REACHED, ASSUMING AN UPRANGE VELOCITY.

The 100-fps positive H-dot is an empirically derived value which protects the orbiter's capability to maintain a positive flight path angle, following a second engine out, such that powered pitchdown and ET separation can be accomplished before dynamic pressure builds up to a point that recontact with the ET would occur after separation.

THIS RULE CONTINUED ON NEXT PAGE

FLIGHT RULES**A4-56 PERFORMANCE BOUNDARIES (CONTINUED)**

D. PRESS-TO-ATO.

THIS BOUNDARY REPRESENTS THE EARLIEST TIME AFTER WHICH AUTO GUIDANCE WILL ACHIEVE THE DESIGN UNDERSPEED (REF. RULE {A4-55}, DESIGN AND CRITICAL MECO UNDERSPEED DEFINITIONS) AT MECO. ASSUMPTIONS: SINGLE ENGINE OUT, PROTECTION OF 2-SIGMA MPS FPR, ABORT THROTTLES, PRE-MECO ATO SELECTION (MAY INVOKE A PRE-MECO OMS DUMP, ABORT MECO TARGETS, AND/OR VARIABLE IY STEERING), AND 15-SECOND ABORT DECISION DELAY.

The design underspeed is used as the criteria that must be met for single engine out cases to "press" uphill. This underspeed protects critical land masses from ET impact per NASA and ESMC agreements. Reference Rule {A2-62}, ET FOOTPRINT CRITERIA, for ET impact constraints.

The MPS FPR assumed is 2 sigma. For most flights, the design underspeed is based on the largest underspeed that can support either AOA steep or ATO/Min Hp with a FD 1 shallow deorbit. Protecting only 1-sigma FPR would not be conservative enough because it would significantly increase the probability of getting an underspeed larger than the design underspeed. @[121593-1590] @[012402-5112B]

If the MECO underspeed is larger than the design underspeed, an AOA shallow may be required. As of March 1990, AOA shallow was still not a certified abort mode. Protecting 3-sigma FPR would be too conservative and would significantly delay picking up "press" capability with only a slight statistical improvement in the likelihood of meeting the design underspeed.

The press-to-ATO boundary is assessed only when flight design has baselined a pre-MECO ATO OMS dump. The I-loads must be in the flight software to allow the ATO dump to occur. The addition of an ATO dump allows earlier "press" capability. Therefore, most flights now have an ATO dump baselined. @[121593-1590] @[012402-5112B]

E. PRESS-TO-MECO.

THIS BOUNDARY REPRESENTS THE EARLIEST TIME AFTER WHICH AUTO GUIDANCE WILL ACHIEVE THE DESIGN UNDERSPEED, (REF. RULE {A4-55}, DESIGN AND CRITICAL MECO UNDERSPEED DEFINITIONS) AT MECO. ASSUMPTIONS: SINGLE ENGINE OUT, PROTECTION OF 2-SIGMA MPS FPR, ABORT THROTTLES.

Reference the rationale for paragraph D for an explanation of why the design underspeed is used and why 2-sigma MPS FPR is protected. The difference between these two boundaries in most cases is the ATO OMS dump.

THIS RULE CONTINUED ON NEXT PAGE

FLIGHT RULES**A4-56****PERFORMANCE BOUNDARIES (CONTINUED)****F. SINGLE ENGINE TAL BOUNDARIES**

NOTE: IN ALL THE TAL ABORT BOUNDARY DEFINITIONS, AN ELS MAY BE REPLACED BY AN ACLS OR PRIME TAL SITE AND AN ACLS MAY BE REPLACED BY A PRIME TAL SITE.

1. IF NO PRIOR TAL ABORT DECLARED OR TAL SELECTED TO AN IN-PLANE SITE:

- a. DROOP (PRIME TAL OR ACLS - 109):

THE DROOP BOUNDARY REPRESENTS THE EARLIEST TIME AFTER WHICH A TWO-SSME-OUT TRAJECTORY WILL NOT FALL BELOW 265,000 FEET AND TAL GUIDANCE WILL CONVERGE TO THE SELECTED/REDESIGNATED SITE'S MECO TARGETS PRIOR TO THE DESIRED MECO TIME. THIS BOUNDARY ASSUMES TWO SSME'S OUT, MAX THROTTLE, AND 15-SECOND ABORT DECISION DELAY. THE WEATHER AT THE SITE WILL NOT BE A CONSIDERATION WHEN ASSESSING THIS BOUNDARY.

This boundary is the earliest time that TAL guidance can be used on a two-engine-out trajectory. It ensures that the minimum droop altitude will not be violated. Analysis has shown that trajectories that droop below 265,000 feet could result in ET rupture due to aerodynamic heating. If, upon TAL droop declaration, guidance is unconverged, the crew's procedures call for flying manually until guidance does converge. (The likelihood of unconverged guidance in this region was significantly reduced by incorporation of the OI-21 low-thrust-to-weight guidance CR.) This boundary does not ensure the capability to reach a runway. Therefore, the weather at the targeted site is not considered when evaluating this boundary.

- b. SINGLE ENGINE LIMITS:

THIS BOUNDARY REPRESENTS THE EARLIEST TIME AFTER WHICH THE DESIRED ACLS OR TAL SITE CAN BE ACHIEVED. ASSUMPTIONS: MAX THROTTLE, A 15-SECOND ABORT DECISION DELAY, MAX RANGING USING LOW ENERGY GUIDANCE (REFERENCE RULE {A2-55}, ENTRY GUIDANCE SELECTION FOR ABORTS) AND 2-SIGMA ASCENT PERFORMANCE, AND UNDISPERSED ENTRY PERFORMANCE. THIS BOUNDARY IS CONTINGENT UPON THE WEATHER/NAVAID STATUS AT THE SITE AS PER RULE {A2-6}, LANDING SITE WEATHER CRITERIA [HC]. @[120894-1663] @[022405-6609A] @[022405-6610]

Self-explanatory.

THIS RULE CONTINUED ON NEXT PAGE

FLIGHT RULES

A4-56

PERFORMANCE BOUNDARIES (CONTINUED)

- c. SINGLE ENGINE (PRIME TAL OR ACLS - 104) (e.g., SINGLE MORON - 104) : @[121604-6503B]

THIS BOUNDARY REPRESENTS THE EARLIEST TIME AFTER WHICH AUTO GUIDANCE WILL ACHIEVE THE DESIRED SITE RANGE-VELOCITY TARGETS WITHIN CROSSRANGE LIMITATIONS AT MECO. (THE DESIRED SITE IS THE ONE THAT PROVIDES THE EARLIEST SINGLE-ENGINE CAPABILITY.) ASSUMPTIONS: PROTECTION OF 2-SIGMA MPS FPR, PROTECTION OF AT LEAST ZERO-SIGMA ENTRY DISPERSIONS, ABORT THROTTLE, AND A 15-SECOND ABORT DECISION DELAY. THE WEATHER AT THE SITE WILL NOT BE A CONSIDERATION WHEN ASSESSING THIS BOUNDARY.

Self-explanatory. These cases, by definition, reach the range-velocity (R-V) target line, however they do so at a lower velocity than the design point. For this reason, entry dispersions are not explicitly protected, although for any given mission the protection level for these constraints (first roll reversal velocity, constant drag phase length, and equilibrium glide boundary margin) may vary from less than 1-sigma to more than 3-sigma (reference 5/18/94 Abort Panel Splinter Meeting). @[120894-1741]

- d. NEGATIVE (PRIME TAL) (e.g., NEGATIVE ZARAGOZA) :

THIS BOUNDARY REPRESENTS THE LAST OPPORTUNITY TO ABORT TO THE PRIME TAL SITE AND STILL ACHIEVE THE DESIRED MECO RANGE-VELOCITY TARGETS WITHIN CROSSRANGE LIMITATIONS. ASSUMPTIONS: TWO SSME'S AT ABORT THROTTLE, PROTECTION OF 2-SIGMA MPS FPR, PROTECTION OF 3-SIGMA ENTRY DISPERSIONS, AND A 15-SECOND ABORT DECISION/TAL RESELECTION DELAY.

Self-explanatory.

2. IF TAL ABORT PREVIOUSLY DECLARED TO AN OUT-OF-PLANE SITE:

- a. DROOP (PRIME TAL OR ACLS - 109) (e.g., DROOP MORON - 109) : @[121604-6503B]

THIS BOUNDARY IS THE SAME AS IN PARAGRAPH F.1 ABOVE.

- b. SINGLE ENGINE LIMITS:

THIS BOUNDARY IS THE SAME AS IN PARAGRAPH F.1 ABOVE.

THIS RULE CONTINUED ON NEXT PAGE

FLIGHT RULES**A4-56****PERFORMANCE BOUNDARIES (CONTINUED)**

- c. SINGLE ENGINE (PRIME TAL OR ACLS - 104) (E.G., SINGLE ENGINE MORON - 104): @[121604-6503B]

THIS BOUNDARY IS THE SAME AS IN PARAGRAPH F.1 ABOVE.

- d. NEGATIVE (ACLS) (E.G., NEGATIVE MORON):

THIS BOUNDARY REPRESENTS THE LAST OPPORTUNITY TO ABORT TO THE ACLS AND STILL ACHIEVE THE ACLS WITHIN CROSSRANGE LIMITATIONS USING LOW-ENERGY GUIDANCE. ASSUMPTIONS: PROTECTION OF 0-SIGMA MPS FPR, PROTECTION OF 0-SIGMA ENTRY DISPERSIONS, MAX THROTTLE, AND A 15-SECOND RESELECTION/ DECISION DELAY. @[120894-1663]

This boundary assumes 0 sigma for both MPS FPR and entry dispersions in order to allow the latest capability to redesignate to make it to an ACLS. Not doing this would possibly create a second engine out gap. This boundary will not be assessed if the SINGLE ENGINE TAL - 109 boundary has been reached.

- e. SINGLE ENGINE (PRIME TAL - 109) (E.G., SINGLE ENGINE ZARAGOZA - 109): @[121604-6503B]

THIS BOUNDARY REPRESENTS THE EARLIEST TIME AFTER WHICH AUTO GUIDANCE WILL ACHIEVE THE RANGE-VELOCITY TARGETS AT MECO FOR THE PRIME SITE. ASSUMPTIONS: PROTECTS 2-SIGMA MPS FPR, PROTECTS AT LEAST ZERO-SIGMA ENTRY DISPERSIONS, AND MAX THROTTLE. @[120894-1741]

This boundary is different from the single engine TAL boundaries for the in-plane cases because it assumes max throttles versus nominal throttles. Using max throttles allows the earliest opportunity to continue to the prime TAL site and not have to risk possible control problems caused by a large yaw maneuver required to head to the ACLS. Reference Flight Rule {A2-52C}, ASCENT MODE PRIORITIES FOR PERFORMANCE CASES, for more details on using max throttles for this case. If this boundary has not been reached yet and the NEGATIVE ACLS boundary has been crossed, this call will be made on 0 sigma MPS to close the gap. These cases, by definition, reach the range-velocity (R-V) target line; however, they do so at a lower velocity than the design point. For this reason, entry dispersions are not explicitly protected, although for any given mission, the protection level for these constraints (first roll reversal velocity, constant drag phase length, and equilibrium glide boundary margin) may vary from less than 1-sigma to more than 3-sigma (reference 5/18/94 Abort Panel splinter meeting). @[120894-1741]

THIS RULE CONTINUED ON NEXT PAGE

FLIGHT RULES**A4-56****PERFORMANCE BOUNDARIES (CONTINUED)**

3. LAST AUTO TAL:

THIS BOUNDARY REPRESENTS THE LAST OPPORTUNITY TO ABORT TO AN ACLS/PRIME TAL SITE, REMAIN IN AUTO, AND STILL ACHIEVE THE DESIRED MECO RANGE-VELOCITY TAL TARGETS (WITHIN CROSSRANGE LIMITATIONS IF APPLICABLE). ASSUMPTIONS: ONE SSME AT ABORT THROTTLE; TWO OR THREE SSME'S AT 65 PERCENT THROTTLE, PROTECTION OF 3-SIGMA ENTRY DISPERSIONS, 15 SECOND ABORT DECISION DELAY, AND PROTECTION OF THE CONTINGENCY CG BOX.

4. LAST LATE TAL:

THIS BOUNDARY REPRESENTS THE LAST OPPORTUNITY TO MANUALLY MECO AT A VELOCITY WHICH WILL ALLOW FOR AN ENTRY TO AN ELS/ACLS. ASSUMPTIONS: MANUAL MECO, PROTECTION OF THE CONTINGENCY CG BOX, AND POST-MECO ROLL TO HEADS-UP.

G. SINGLE ENGINE OPS 3: @[120894-1743A]

THIS BOUNDARY REPRESENTS THE EARLIEST TIME THAT THE CREW WILL PERFORM THE 2 ENGINE OUT DROOP PROCEDURE FOLLOWING A SECOND SSME FAILURE.

1. IF LAST ECAL/BDA CAPABILITY OCCURS AFTER THE DROOP BOUNDARY (REF. PARAGRAPH F.1.a), THE SINGLE ENGINE OPS 3 BOUNDARY WILL BE BASED ON THE EARLIEST OF THE FOLLOWING:
 - a. LAST ECAL/BDA CAPABILITY (WITHOUT REGARD TO WEATHER)
 - b. THE SINGLE ENGINE LIMITS BOUNDARY (REF. PARAGRAPH F.1.b)
 - c. FIRST DOWNRANGE ELS LOW ENERGY CAPABILITY. THIS ELS CAPABILITY ASSUMES THE FOLLOWING:
 - (1) MAXIMUM THROTTLES,
 - (2) 2 SIGMA LOW MPS PERFORMANCE,
 - (3) USE OF AUTO LOW ENERGY GUIDANCE FOR ENTRY (REF. RULE {A2-55}, ENTRY GUIDANCE SELECTION FOR ABORTS), @[022405-6609A] @[022405-6610]

THIS RULE CONTINUED ON NEXT PAGE

FLIGHT RULES**A4-56****PERFORMANCE BOUNDARIES (CONTINUED)**

(4) THE ELS MEETS MINIMUM EMERGENCY LANDING FACILITY CRITERIA (REF. RULE {A2-264}, EMERGENCY LANDING FACILITY CRITERIA. @[120894-1743A]

2. IF LAST ECAL/BDA CAPABILITY OCCURS BEFORE THE DROOP BOUNDARY, THE SINGLE ENGINE OPS 3 BOUNDARY WILL BE BASED ON DROOP. @[120894-1743A]

This boundary allows the use of ECAL capability past the point where droop capability begins, and reflects the priority of ECAL over droop/bailout as set by the A/E FTP in July 1994. This delays the point where the two engine out second stage procedure ends. This option allows the crew to use the ECAL procedures and attempt a landing versus doing the two engine out droop procedure which results in a bailout. This option on a high inclination mission is much preferred over bailout in the North Atlantic Ocean. Another consideration in this boundary is the first ELS capability with "stretch" (use of low energy guidance). However, if the ELS weather does not meet the minimum weather criteria for an ELS, it is unusable as an ELS and the ELS capability will not be considered in the determination of the boundary. A landing at an ELS is considered preferable over landing at ECAL/BDA because of the automated entry procedures and the slightly more benign entry conditions. The Single Engine Limits boundary is the first capability to a TAL or ACLS using "stretch" (use of low energy guidance). This has a higher priority over an ECAL.

If ECAL/BDA capability ends prior to droop then this call will be based on droop capability.
@[120894-1743A]

H. SINGLE ENGINE PRESS-TO-MECO: @[120894-1743A]

THIS BOUNDARY REPRESENTS THE EARLIEST TIME AFTER WHICH AUTO GUIDANCE WILL ACHIEVE THE CRITICAL UNDERSPEED (REF. RULE {A4-55}, DESIGN AND CRITICAL MECO UNDERSPEED DEFINITIONS) AT MECO. ASSUMPTIONS: TWO ENGINES OUT, PROTECTION OF 2-SIGMA MPS FPR, AND ABORT THROTTLE.

The single-engine press-to-MECO (SEPTM) boundary is based on critical, rather than design, underspeed since ET impact constraints protected in the design underspeed do not apply to multiple-engine-out scenarios (ref. Rule {A2-62E}, ET FOOTPRINT CRITERIA). Abort throttles are assumed since Rule {A2-52C}, ASCENT MODE PRIORITIES FOR PERFORMANCE CASES, implies that we will not use max throttle to avoid a TAL downmode as long as auto TAL is available, and normally SEPTM occurs well prior to the last TAL. 2-sigma FPR is protected per the rationale for the other uphill boundaries.

THIS RULE CONTINUED ON NEXT PAGE

FLIGHT RULES**A4-56****PERFORMANCE BOUNDARIES (CONTINUED)**

I. PERFORMANCE DISPERSIONS/GAPS: @[120894-1743A]

1. UPHILL CAPABILITY CONSISTS OF HAVING AN ARD-PREDICTED UNDERSPEED WHICH IS LESS THAN EITHER THE DESIGN OR CRITICAL UNDERSPEED, WHICHEVER APPLIES TO THE GIVEN CASE AS PROVIDED BY RULE {A2-62E}, ET FOOTPRINT CRITERIA. ASSESSMENT ASSUMES ABORT THROTTLES, PROTECTION OF 2-SIGMA MPS FPR, AND MAY INCLUDE A PRE-MECO ATO ABORT OR AN EXTENDED OMS ASSIST (ITEM 9 CREW INPUT) IF APPLICABLE.
@[032807-8385B]

Uphill capability as defined will guarantee AOA steep or ATO day 1 or day 2 shallow D/O capability as well as the other items listed in Rule {A4-55}, DESIGN AND CRITICAL MECO UNDERSPEED DEFINITIONS, and will keep the ET from impacting on critical land masses as defined in Rule {A2-62D}, ET FOOTPRINT CRITERIA. An RTLS or TAL abort will be required if the ARD predicted underspeed is greater than that which protects critical land masses or the critical underspeed, whichever is most constraining. As in the press boundaries (ref. paragraphs D and G), protection of 2-sigma MPS FPR is required in order to account for possible ascent performance dispersions. @[121593-1590] @[032807-8385B]

2. TAL/RTLS GAP MANAGEMENT FOR LOSS OF UPHILL CAPABILITY WITH THREE ENGINES OPERATING:
 - a. IF AN ENGINE IS STUCK IN THE THROTTLE BUCKET OR IF MORE THAN ONE ENGINE IS SUSPECT, A TAL ABORT TO THE PRIME SITE WILL BE INITIATED UPON REACHING THE EARLIER OF THE FOLLOWING:
 - (1) TWO-ENGINE PRIME TAL CAPABILITY (TWO AT 104 PERCENT) PLUS EITHER OF THE FOLLOWING:
 - (a) TWO-ENGINE ACLS TAL CAPABILITY, EVALUATED FOR A GOOD ENGINE OUT (ASSUMPTIONS: 2-SIGMA MPS FPR, MAX THROTTLES, MAX RANGING USING LOW ENERGY GUIDANCE. @[120894-1663]
 - (b) TWO-ENGINE NEGATIVE RETURN, EVALUATED FOR A GOOD ENGINE OUT (ASSUMPTIONS: 3-SIGMA MPS FPR, MAX THROTTLES, MAX UNDERSPEED TO THE R/V LINE)

OR

THIS RULE CONTINUED ON NEXT PAGE

FLIGHT RULES

A4-56

PERFORMANCE BOUNDARIES (CONTINUED)

(2) NEGATIVE RETURN MINUS 10 SECONDS (TWO AT 104 PERCENT)

NOTE: EVALUATION OF THE CAPABILITY TO THE ACLS WILL BE INDEPENDENT OF THE ACLS GO/NO-GO STATUS.

A TAL or RTLS abort will be required for loss of uphill capability. In the TAL/RTLS overlap region either of the two abort modes may be utilized. If more than one engine is suspect, there is considerable risk of multiple engine failures. Therefore, TAL is the preferred abort mode because of reduced powered flight time and earlier single engine completion capability.

For cases with an engine stuck in the throttle bucket, an RTLS is undesirable for several reasons. With three engines operating, the RTLS fuel dissipation attitude is not readjusted for subsequent engine failures, and the resulting altitude versus range profile and time of powered pitcharound may be incorrect, with the most significant contributor being the impact on the altitude profile during fuel dissipation phase. Therefore, the failure of a healthy engine during the RTLS fuel dissipation phase may result in a MECO underspeed. For the failure of a healthy engine after powered pitcharound, sufficient performance may not be available on the remaining 1-2/3 engines, again resulting in a MECO underspeed. For example, analysis showed that late in the STS-26 RTLS profile (at approximately 9 minutes MET) there existed only a 10- to 20-second window where a single engine failure would result in acceptable MECO conditions.

For these reasons, a TAL abort will be performed. RTLS capability will be maintained as long as operationally practical, without affecting subsequent TAL performance, by delaying TAL selection until both 1-2/3 engine ACLS TAL capability and 2 good engine prime TAL capability are available.

The ACLS evaluation will be made assuming maximum throttles and low-energy guidance in order to allow TAL selection, and therefore avoid an RTLS, at the earliest possible time while still protecting for any one engine failure. The low-energy guidance capability correlates directly to a specific underspeed for each TAL site and inclination. Two-sigma MPS performance will be protected to provide a level of confidence that an acceptable underspeed will result. @[120894-1663]

If 1-2/3 engine negative return occurs prior to 1-2/3 engine ACLS TAL capability, the TAL abort call will be based on that time since a contingency abort is then the only option should a good engine fail. This evaluation is made using maximum throttles and the maximum allowable underspeed to the R/V line in order to extend 1-2/3 engine RTLS capability as long as possible prior to entering the single-engine-out abort gap. This underspeed, 300 fps, correlates to the minimum time constraint of 12 seconds from powered pitchdown to MECO, ensuring acceptable ET SEP conditions. Three-sigma MPS FPR is protected to provide confidence that this underspeed will not be exceeded, since the data used to determine this boundary is produced during the design cycle and does not account for day-of-launch conditions. The consequences of violating RTLS ET SEP constraints can be catastrophic.

When an abort gap exists between negative return and two-engine prime TAL capability, the TAL abort is still preferred and the gap will be accepted since the RTLS would result in an abort gap a few seconds after initiation, as explained above.

THIS RULE CONTINUED ON NEXT PAGE

FLIGHT RULES

A4-56

PERFORMANCE BOUNDARIES (CONTINUED)

This rule is only applicable during powered flight; therefore, the GO/NO-GO status of the ACLS is not a factor since pre-MECO selection of this site serves only to minimize exposure to a pre-MECO contingency abort (similar to the droop criteria). The actual landing site will be selected post-MECO.

- b. FOR ALL OTHER CASES, IF A TAL/RTLS ABORT GAP EXISTS (TWO-SSME CAPABILITY) AT NEGATIVE RETURN MINUS 10 SECONDS, AN RTLS ABORT WILL BE EXECUTED AT THAT TIME. OTHERWISE, A TAL ABORT WILL BE INITIATED AT TWO-ENGINE TAL CAPABILITY.

An RTLS abort will be required for single engine failures which occur prior to two-engine TAL capability as the performance loss will not support any other intact abort mode. With the loss of uphill capability, an RTLS or TAL abort will have to be performed. If two-engine prime TAL capability is not achieved prior to negative return, an RTLS abort is executed in order to avoid flying a single-engine-out intact abort gap. Without stuck throttles or suspect engines, the RTLS profile is flown without the problems outlined in paragraphs H.2a. A post-RTLS abort engine failure will be handled by guidance successfully with no single-engine-out intact abort gaps. The abort decision is made 10 seconds prior to negative return in order to provide time for the TAL capability evaluation to be made. With two-engine TAL capability, the TAL abort will be executed at the two-engine TAL boundary. In this case, the systems RTLS capability is traded away in order to provide earliest two-engine-out capability.

Reference Ascent FTP # 42, March 1988.

3. GAP MANAGEMENT FOR POSITIVE UPHILL CAPABILITY:

NOTE: IF APPLICATION OF THE FOLLOWING MEASURES FAILS TO CLOSE THE GAP, IT WILL STILL BE FLOWN THROUGH PROVIDED UPHILL CAPABILITY REMAINS ON THE CURRENT ENGINE CONFIGURATION. SHOULD AN ENGINE(S) SUBSEQUENTLY FAIL IN THE GAP, A CONTINGENCY PROCEDURE WILL BE REQUIRED SUCH AS ACCEPTING PLS LANDING AT A NO-GO SITE, AN AUTO TAL TO ANY AVAILABLE SITE EVEN IF THE SITE HAS BEEN DECLARED NO-GO FOR INTACT ABORT PURPOSES, ACCEPTING TAL/LATE TAL TO AN ELS, ATTEMPTING AN ABORT TO AN EAST COAST SITE OR BERMUDA ISLAND, OR BAILOUT.
 @[121593-1590]

THIS RULE CONTINUED ON NEXT PAGE

FLIGHT RULES

A4-56

PERFORMANCE BOUNDARIES (CONTINUED)

HYPOTHETICAL SSME CONFIGURATION	GAP BEING CLOSED	ACLS STATUS	PRIORITIES
<p>[1]</p> <p style="text-align: center;">O N E E N G I N E D O W N</p>	<p>LAST RTLS TO 1ST PRIME TAL</p>	<p>DOWN</p>	<ol style="list-style-type: none"> 1. MAX THROTTLES [2] 2. MAX RANGING USING LOW ENERGY GUIDANCE TO PRIME TAL SITE 3. NOMINAL PERFORMANCE
		<p>UP</p>	<ol style="list-style-type: none"> 1. ACLS AT ABORT THROTTLES [2] 2. MAX THROTTLES [2] 3. MAX RANGING USING LOW ENERGY GUIDANCE 4. NOMINAL PERFORMANCE
	<p>LATER OF: LAST RTLS OR LAST PRIME TAL TO 1ST PRESS</p>	<p>DOWN</p>	<ol style="list-style-type: none"> 1. ACCEPT CRITICAL USPD 2. COMMIT OMS BALLAST TO CONTINGENCY CG LIMIT 3. ACCEPT AOA/PLS TO NO-GO SITE 4. MAX THROTTLES [2] 5. ACCEPT UNDERSPEED TO AOA SHALLOW LIMIT 6. MAX RANGING USING LOW ENERGY GUIDANCE TO PRIME TAL SITE 7. NOMINAL PERFORMANCE
		<p>UP</p>	<ol style="list-style-type: none"> 1. ACCEPT CRITICAL USPD 2. COMMIT OMS BALLAST TO CONTINGENCY CG LIMIT 3. ACCEPT AOA/PLS TO NO-GO SITE 4. ACCEPT ACLS TO EXTEND INTACT TAL COVERAGE [2] 5. MAX THROTTLES [2] 6. ACCEPT UNDERSPEED TO AOA SHALLOW LIMIT 7. MAX RANGING USING LOW ENERGY GUIDANCE TO ACLS OR PRIME 8. NOMINAL PERFORMANCE

©[121593-1590] ©[120894-1663]

THIS RULE CONTINUED ON NEXT PAGE

FLIGHT RULES

A4-56

PERFORMANCE BOUNDARIES (CONTINUED)

HYPOTHETICAL SSME CONFIGURATION	GAP BEING CLOSED	ACLS STATUS	PRIORITIES
[1] [3] T W O E N G I N E S D O W N	LAST AUTO TAL (PRIME OR ACLS) TO 1ST SINGLE ENGINE PRESS	DOWN	1. COMMIT OMS BALLAST TO CONTINGENCY CG LIMIT 2. ACCEPT AOA/PLS TO NO-GO SITE 3. MAX THROTTLE [2] 4. ACCEPT UNDERSPEED TO AOA SHALLOW LIMIT 5. NOMINAL PERFORMANCE
		UP	1. COMMIT OMS BALLAST TO CONTINGENCY CG LIMIT 2. ACCEPT AOA/PLS TO NO-GO SITE 3. MAX THROTTLE [2] 4. ACCEPT LATE TAL OUT TO LAST LATE TAL VI [2] 5. ACCEPT UNDERSPEED TO AOA SHALLOW LIMIT 6. NOMINAL PERFORMANCE

©[121593-1590]

NOTES:

- [1] IN ALL CASES, IT IS PRESUMED THAT SSME SHUTDOWN NPSP CONSTRAINTS WILL BE PROTECTED VIA EITHER THE FLIGHT SOFTWARE MECO PREPARATION THROTTLING OR THE PRE-MECO MANUAL THROTTLEDOWN PROCEDURE.
- [2] THESE OPTIONS WILL BE EXECUTED PRE-MECO, ALL OTHERS WILL BE SELECTED BASED ON POST-MECO EVALUATION.
- [3] FOR THE TWO-ENGINE-OUT CASE, CRITICAL UNDERSPEED IS ALREADY COMMITTED IN THE SINGLE-ENGINE PRESS BOUNDARY PER PARAGRAPH {A4-56H}, PERFORMANCE BOUNDARIES, AND, HENCE, DOES NOT CONTRIBUTE TO SINGLE-ENGINE GAP CLOSURE PRIORITIES. ©[ED]

Gap closure priorities are established to balance exposure to contingency abort against acceptance of flight conditions which otherwise are undesirable for a variety of individual reasons. Gaps in intact abort capability may arise during powered flight due to a number of possible systems or environmental problems including stuck throttles, degraded SSME performance (i.e., Pc sensor shift), low-performing SRB's, unacceptable TAL weather, etc. In such cases, options which increase available delta V are brought into play in order to either close or minimize the gap. These options include both pre-MECO and post-MECO commitments. In general, the post-MECO options and pre-MECO "theoretical" options (those whose effects cannot be directly measured pre-MECO but are related to assumed capabilities) are preserved as long as some other directly-measurable option exists such as use of maximum throttles, commitment of OMS ballast, or acceptance of larger MECO underspeed; otherwise,

THIS RULE CONTINUED ON NEXT PAGE

FLIGHT RULES

A4-56

PERFORMANCE BOUNDARIES (CONTINUED)

we would be relying on capabilities that are not certain to exist until the true MECO state is determined. This general rule is traded against factors such as weather, program-approved abort site usage, and risk to vehicle and crew in order to establish the precise priorities for the individual gap closure scenarios. Specifically,

- a. Auto TAL to the ACLS (if available per rules and performance) may be utilized to close any intact abort gap before committing to maximum throttles (per Program Office agreement that we will not use maximum throttles to avoid the ACLS). Otherwise, if the ACLS is down, it reverts to ELS status and becomes the lowest-priority option.*
- b. ET footprint encroachment on critical land masses will be accepted before any other direct gap closure action is taken (such as use of max throttles or commitment of OMS ballast); however, if a TAL option exists to a Space Shuttle Program-recognized TAL site, TAL will be accepted before allowing the ET footprint to impact critical areas. The additional stress placed on the SSME's by operation at maximum throttle is considered more hazardous than the concerns associated with possible ET impact on critical land masses.*

Note that waiving ET constraints is a no-impact decision in terms of risk to the shuttle vehicle itself; therefore, when applicable, this is the first option used.

- c. OMS ballast may be committed after ET impact limits are waived but prior to use of maximum throttle. Use of OMS ballast can result in a vehicle CG outside the nominal envelope limits to which operation is certified, but keeps it within the contingency envelope which preserves adequate thermal and control margins. Thus, this mode is considered safer than maximum throttle operation. It is, however, an action that directly affects the shuttle itself (albeit a relatively benign effect); therefore, it is prioritized after waiver of ET impact constraints.*
- d. Accept press to a less than fully GO AOA or PLS site. ®[121593-1590]*
- e. Maximum throttle is the last pre-MECO directly-measurable option in terms of recovery of programmatic "intact abort" capability. Since other options involve post-MECO commitments, revert to contingency (non-intact abort) operations and/or trade off probability of success. Use of maximum throttle is allowed at this point to minimize exposure to these other regimes. This is consistent with the groundrule that maximum throttles will only be utilized to regain intact capability or to avoid a post-TAL-selection site redesignation.*
- f. Since the remaining options all involve only post-MECO commitments (with the exception of Late TAL execution), their priority regarding pre-MECO gap closure is fairly meaningless - in reality, no commitment of any kind is made until the true MECO condition is evaluated. Therefore, operationally, the total delta-V effect of the remaining priorities will be committed all at once if it becomes necessary to further close a gap. However, to determine the total gap closure delta V available, the individual items considered are as follows, in the order in which we would prefer to have to utilize them:*

THIS RULE CONTINUED ON NEXT PAGE

FLIGHT RULES

A4-56

PERFORMANCE BOUNDARIES (CONTINUED)

- (1) *Late TAL capability to either a prime TAL site or ACLS will be utilized to close a gap between last Auto TAL and earliest steep AOA; i.e., prior to commitment to AOA-Shallow. Therefore, if AOA-Shallow and Late TAL capabilities overlap, the “press” boundary will be based on reaching the end of the Late TAL window. The Late TAL will not, of course, be actually executed unless the assumed performance loss occurs.*
- (2) *When applicable, allowable MECO underspeed will be increased to the AOA-Shallow limit. AOA-Shallow is highly undesirable due to the more severe entry thermal environment and the sensitivity to navigation dispersions (target line is close to skipout boundary and ranging becomes highly sensitive to flight path angle). While it nominally results in recovery of vehicle and crew, AOA-Shallow is not considered a certified intact abort from a programmatic point of view.*
- (3) *Low energy guidance extends TAL capability to MECO underspeed conditions off the R-V line. AOA-Shallow is considered higher priority than low energy guidance because AOA-Shallow has been subjected to much more thorough engineering analysis, is less stressful thermally, provides for help from the MCC in dealing with entry navigation dispersions in the event that a single string of GPS is unavailable, and the AOA-Shallow boundary is more clearly defined. A decision was made at Ascent and Entry Flight Techniques Panel #214, held September 30, 2005, to forgo enhanced performance capabilities such as formal certification of AOA shallow that might be gained from the increased navigational accuracy that GPS provides. This decision was due to the Space Shuttle Program ending in 2010, the limited flight experience incorporating GPS into navigation, and the mixed fleet configuration (OV-103/OV-104 single string and OV-105 3-string) that will exist until the end of the Program. ©[120894-1663] ©[032807-8385B]*
- (4) *All MPS performance reserves will be assumed available for delta-V purposes (“nominal performance”). To this point, performance boundaries have been predicated on protection of 2-sigma reserves, thus providing a high confidence that we do not commit to a mode which statistically probable systems and performance dispersions will not allow to be successfully completed. Committing to boundaries on nominal performance assures only a 50 percent chance of being correct; thus it forms the lowest-priority option.*

Rules {A2-6}, LANDING SITE WEATHER CRITERIA [HC]; {A2-52C}, ASCENT MODE PRIORITIES FOR PERFORMANCE CASES; {A2-55}, ENTRY GUIDANCE SELECTION FOR ABORTS; {A2-56}, ABORT GAP; {A2-57}, CONTINGENCY ASCENTS/ABORTS; {A4-1B}, PERFORMANCE ANALYSES; {A4-2}, LANDING SITE CONDITIONS; {A4-53}, USE OF MAXIMUM THROTTLES; {A4-63}, OMS/RCS SYSTEM FAILURES DURING ASCENT; {A5-103}, LIMIT SHUTDOWN CONTROL; {A5-155}, LIMIT SHUTDOWN CONTROL, MANUAL THROTTLING, AND MANUAL SHUTDOWN FOR LOW LH2 NPSP [CIL] [HC]; and {A5-157}, ET LOW LEVEL CUTOFF SENSOR FAILED DRY, reference this rule. ©[120894-1663] ©[071494-1646A] ©[111094-1622B] ©[ED] ©[022405-6609A] ©[022405-6610] ©[ED] ©[032807-8399B]

FLIGHT RULES

A4-57

NAVIGATION UPDATES

A. ASCENT PRE-MECO

WHEN AN INDEPENDENT NAVIGATION SOURCE IS AVAILABLE, A NAVIGATION UPDATE WILL BE EXECUTED TO ALLOW ITS INCORPORATION PRIOR TO MECO MINUS 30 SECONDS TO PRESERVE MECO CONDITIONS NECESSARY FOR A NOMINAL FLIGHT. DELTA STATE UPDATES WILL BE INITIATED FOR THE FOLLOWING GROUND MINUS ONBOARD VELOCITY DIFFERENCES: @[121296-4177D]

- | | |
|--------------------------|---|
| 1. DELTA U DOT > 50 FPS | 3. DELTA V DOT > 40 FPS |
| 2. DELTA U DOT < -50 FPS | 4. DELTA V DOT < -NOMINAL
(REF. THE ANNEX FLIGHT
RULE, TRAJECTORY AND
GUIDANCE PARAMETERS) |

@[ED]

To the extent possible, it is desirable to maintain the onboard navigated state to provide MECO conditions acceptable for nominal flight execution. However, it is undesirable to update the onboard navigation with a reasonable probability of degrading the onboard state. The onboard powered flight navigation evaluation is performed by the delta state processor which determines the ground filter minus onboard state differences. Preflight analysis has established a 3-sigma uncertainty in the delta state velocity differences of 30 fps per axis. Estimated onboard velocity error at MECO resulting from a 3-sigma IMU performance is 20 fps worst axis. Definition of update limits equal to the sum of the 3-sigma delta state and IMU uncertainties provides reasonable assurance that an update will improve the onboard state. Because of the OMS budget limitation, nominal flight execution is most sensitive to downtrack velocity errors (i.e., underspeed MECO). To reduce the probability of ascent downmoding, the downtrack velocity update limit is defined by the RSS of the 3-sigma delta state and IMU uncertainties. For ascent performance critical missions, the downtrack velocity update limit is defined by the underspeed magnitude at MECO which would allow continuation of a nominal orbit insertion. Nominal flight execution is relatively insensitive to crosstrack errors, requiring no update limit. Thus, a delta state update will be initiated for apparent radial velocity errors exceeding ± 50 fps or downtrack velocity errors exceeding +40 fps or -X fps where X represents the allowable underspeed magnitude for nominal insertion with a maximum value of -40 fps. The update will be incorporated at least 30 seconds prior to MECO to allow the second stage guidance to adjust the steering solution to regain the desired target conditions.

Rule {A2-60}, NAVIGATION UPDATE CRITERIA, references this rule.

THIS RULE CONTINUED ON NEXT PAGE

FLIGHT RULES

A4-57

NAVIGATION UPDATES (CONTINUED)

B. PRTLS @[032807-8377]

WHEN AN INDEPENDENT NAVIGATION SOURCE IS AVAILABLE, A NAVIGATION UPDATE WILL BE EXECUTED PRIOR TO POWERED PITCHDOWN (MINUS 20 SECONDS) TO PRESERVE MECO CONDITIONS NECESSARY FOR ET SEPARATION AND GLIDE RETURN TO LAUNCH SITE. A DELTA STATE UPDATE WILL BE INITIATED FOR ANY OF THE FOLLOWING GROUND MINUS ONBOARD POSITION AND VELOCITY DIFFERENCES: @[121296-4177D]

- | | |
|---------------------------|---------------------------|
| 1. DELTA U > +11,000 FT | 5. DELTA V > +27,000 FT |
| 2. DELTA U < -7000 FT | 6. DELTA V < -7000 FT |
| 3. DELTA U DOT < +100 FPS | 7. DELTA V DOT > +100 FPS |
| 4. DELTA U DOT > -50 FPS | 8. DELTA V DOT < -40 FPS |

The powered flight phase of an RTLS must deliver the vehicle to a state from which the glide phase can be successfully performed to return to the runway and land. Thus, during flyback phase of an RTLS, the onboard navigation must be maintained to preserve an acceptable energy condition at MECO.

Analytical studies have been performed to determine the maximum position and velocity errors allowable to obtain cutoff within the 3-sigma energy boundaries of the target range/velocity line. The energy boundaries allow for wind and aero dispersions during the glide return. Deviation of the allowable navigation errors are documented in MDTSCO Transmittal Memo 1.4-TM-D1332-152, dated June 16, 1980. The resulting error envelope is defined by limits in radial and downtrack position and velocity. The position error limits are +11,000/-7,000 feet in the radial axis and +27,000/-7,000 feet in the downtrack axis. The velocity error limits are +100/-50 fps in the radial axis and +100/-40 fps in the downtrack axis. If any ground minus onboard position or velocity difference exceeds the corresponding limit, a delta state update will be executed at least 20 seconds prior to powered pitchdown to allow adjustment of the steering solution to satisfy target conditions at pitchdown initiation.

C. BFS

1. A STATE VECTOR TRANSFER SHALL BE PERFORMED IF THE BFS STATE VECTOR ERRORS EXCEED LIMITS DEFINED IN THIS RULE.
2. IF BFS ENGAGED AND STATE VECTOR ERRORS EXCEED LIMITS DEFINED IN THIS RULE,
 - a. GPS SHALL BE USED TO UPDATE THE BFS STATE VECTOR.
 - b. IF GPS IS UNAVAILABLE (REF. RULE {A8-115}, GPS SYSTEM MANAGEMENT [HC]), THE BEST AVAILABLE GROUND SOURCE SHALL BE USED TO UPDATE THE BFS STATE VECTOR. @[032807-8377]

THIS RULE CONTINUED ON NEXT PAGE

FLIGHT RULES

A4-57**NAVIGATION UPDATES (CONTINUED)**

During powered ascent, the PASS and BFS independently compute the current vehicle state vector. Because of differences in IMU selection logic, the resultant states may not agree. Consequently, it is also possible for the PASS state vector to have significant errors (e.g., averaging a degraded IMU) while the BFS state vector does not have significant errors (e.g., prime selecting a good IMU). It is conceivable then that transferring a PASS state vector that has just been updated via a delta state could degrade an otherwise healthy BFS navigation state. ©[032807-8377]

Again, considering the differences in IMU selection logic, if a BFS update is required, the uplinked deltas may not be appropriate for correcting the BFS state, since the delta state processor nominally uses PASS data. To properly correct the BFS via uplink would require switching the telemetry input to the delta state processor, a minimum delay of 20 seconds to allow the back difference logic to determine the BFS velocity deltas, and an additional delay of 15 to 20 seconds for command generation and uplink execution. Should a BFS engage be required during this time, vehicle transients would likely occur. To avoid disruption of the PASS monitoring and reduce the exposure to potential vehicle transients, it is desirable to perform a state vector transfer to the BFS to correct state vector errors that exceed rule limits.

In OPS 1 and Major Mode (MM) 601, GPS is available for incorporation only in the BFS. The current PASS configuration is unable to process GPS during OPS 1 and MM 601. If the BFS is engaged, then GPS is preferred over a delta state uplink for correcting the onboard navigation error because GPS can correct the onboard error faster. It is desirable to correct the BFS onboard errors quickly since the crew cannot fly manually during powered flight and to maximize the amount of time available to guidance to fly out the trajectory dispersions due to the onboard errors. Although incorporation of GPS in the BFS during powered flight is not certified, incorporation of GPS data is acceptable due to the combination of BFS engage and bad onboard navigation during powered flight. User Note B27863 explains that GPS should not be processed in the BFS during MM 101 and MM102. ©[032807-8377]

THIS RULE CONTINUED ON NEXT PAGE

FLIGHT RULES**A4-57****NAVIGATION UPDATES (CONTINUED)**

D. POST-MECO PRIOR TO A COMMIT TO ORBIT: @[032807-8377]

A NAVIGATION UPDATE SHALL BE PERFORMED PRE-OMS-2 IF THE FOLLOWING CRITERIA ARE MET: @[072601-4528]

1. THE ONBOARD AND A VALID INDEPENDENT SOURCE DIFFER IN SEMI-MAJOR AXIS BY MORE THAN 12,000 FEET AT MECO PLUS 12 MINUTES, AND
2. ANY OF THE FOLLOWING ARE TRUE:
 - a. THE SEMI-MAJOR AXIS DIFFERENCE BETWEEN THE ONBOARD AND A VALID INDEPENDENT SOURCE GROWS BY 6000 FEET BETWEEN MECO AND MECO PLUS 12 MINUTES.
 - b. THE ONBOARD STATE VECTOR DEVIATES FROM THE HIGH SPEED TRAJECTORY DETERMINATION SOLUTION DURING POWERED FLIGHT.
 - c. THE ONBOARD STATE VECTOR DEVIATES FROM GPS.

THE MCC SHALL DETERMINE THE STATE VECTOR SOURCE TO BE USED FOR THE NAVIGATION UPDATE (EITHER GROUND FILTER OR GPS) . @[072601-4528]

A navigation update should be performed prior to OMS-2 to protect an onboard downtrack error exceeding 20 NM at entry interface in the event an AOA is required (Ref. Rule {A4-154}, DOWNTRACK ERROR). At MECO +12 minutes, a 12,000 ft semi-major axis error will propagate into a 20 NM downtrack error at entry interface, if GPS is unavailable. The onboard error can be confirmed by observing continued semi-major axis error growth, a deviation from high speed tracking during powered flight, or a deviation from GPS.

E. FOR RENDEZVOUS MISSIONS, A STATE VECTOR UPDATE SHALL BE PERFORMED PRIOR TO OMS-2 FOR MECO CROSSTRACK VELOCITY (WDOT) DIFFERENCES BETWEEN THE ONBOARD AND A VALID INDEPENDENT SOURCE GREATER THAN 6 FT/SEC, PROVIDED THAT THE FOLLOWING CRITERIA ARE MET:

1. THE ONBOARD CROSSTRACK VELOCITY ERROR IS VERIFIED BY EITHER: @[032807-8377]

THIS RULE CONTINUED ON NEXT PAGE

FLIGHT RULES

A4-57

NAVIGATION UPDATES (CONTINUED)

- a. A MINIMUM OF 30 SECONDS OF GOOD QUALITY POST-MECO TRACKING DATA IN THE HIGH SPEED TRACKING DETERMINATION PROCESSOR, OR @[032807-8377]
 - b. AN INCREASING ONBOARD CROSSTRACK VELOCITY ERROR TREND OBSERVED DURING POWERED FLIGHT USING GPS AS THE REFERENCE.
2. DETERMINATION THAT THE STATE VECTOR UPDATE WILL DECREASE THE NPC DELTA V BY 6 FT/SEC OR MORE.

For rendezvous missions, the OMS propellant budget provides for a nominal plane change (NPC) maneuver to correct out-of-plane dispersions. Out-of-plane dispersions resulting from navigation errors incurred during ascent can be partially corrected by OMS-2 steering, resulting in a savings of propellant required for the NPC maneuver. In-plane dispersions are far less costly to the propellant budget, since they can be corrected with later phasing maneuvers. In an attempt to minimize the NPC propellant requirement and thus increase the propellant margins for rendezvous, a state vector update may be performed prior to OMS-2.

Flight data has shown the post-MECO ground state vector accuracy to be within 5.5 ft/sec(mean plus 1-sigma) in the crosstrack velocity component, provided that no anomaly in the ground tracking or the ground navigation processing occurred after MECO. The standard deviation of the onboard state vector crosstrack error at MECO computed from flight data is about 3.5 ft/sec (mean plus 1-sigma). If telemetry is available during powered flight, onboard crosstrack differences in both position and velocity can be observed during ascent. This, together with the confirmation of a good post-MECO ground or GPS state vector, provides a good assurance that the state vector update will improve the onboard state vector in the crosstrack component.

The ground navigation HSTD processor requires time to converge to a good state vector solution after the change to free flight processing mode following MECO. Sixty seconds of tracking data processing is desirable to provide an accurate state vector for onboard uplink. If the convergence time is less than 30 seconds, the HSTD should not be used to perform a state vector update for the purpose of removing out-of-plane dispersions. It should be noted that while a ground uplink based on the HSTD can reduce onboard crosstrack velocity error, it also has the potential at the same time to increase the onboard in-plane velocity error. If an acceptable HSTD solution is not available post-MECO, a GPS state vector may be used to evaluate and update the onboard state. @[032807-8377]

FDO procedures performed pre-OMS-2 include the determination of the differences in the NPC delta V between using the onboard and ground state vector. The 6 ft/sec threshold was based on the ground state vector accuracy. @[012694-1555]

FLIGHT RULES

A4-58**AUTO GUIDANCE NO-GO**

AUTO GUIDANCE WILL BE DECLARED NO-GO AND BFS ENGAGE INITIATED FOR CONDITION A, MANUAL GUIDANCE/THROTTLE WILL BE INITIATED FOR CONDITIONS IN PARAGRAPHS B THROUGH D:

Within ascent guidance, multiple tasks and subtasks are executed in a designed sequence. The execution may be based on time, sensed trajectory condition, or mission event. Some tasks have an internal check to ensure the logical solution is reasonable and within a predefined tolerance of desired target conditions. If a task or subtask fails to get executed in the design sequence, the ascent guidance function is considered unreliable. Likewise, if a task fails to satisfy an internal solution check for an unreasonable number of consecutive cycles, the guidance function is considered failed.

Rule {A2-59}, BFS ENGAGE CRITERIA, references this rule.

A. ROLL MANEUVER NOT INITIATED AS SCHEDULED.

Initially in first stage flight, the boost guidance task will command a constant pad attitude. The constant command is maintained until the relative velocity exceeds the I-load value for PPOLY2. The termination of vertical rise is indicated by a command roll maneuver to rotate the Orbiter tail downrange. Failure to initiate the roll maneuver at the corresponding relative velocity indicates incorrect subtask sequencing within the boost guidance task. For this failure, the BFS will be engaged since the onboard displays are inadequate for the crew to manually execute the roll/pitch profile through the critical high Q-bar regime.

B. GUIDANCE NOT CONVERGED FOR 10 SECONDS DURING MM 103 AND MM 601 AFTER INITIAL CONVERGENCE.

During the standard ascent mode (MM 103) and the return-to-launch site mode (MM 601), internal checks are made with the PEG task to ensure the current steering solution and resultant predicted burnout state are converged within an acceptable envelope of the desired target conditions. At the initiation of each mode, the convergence checks are nominally passed within two or three guidance cycles (4 to 6 seconds). After initial convergence, a sudden change in the actual acceleration (engine failure) will cause the convergence checks to nominally fail for one guidance cycle. Allowing two guidance cycles as pad, 10 seconds is the longest reasonable interval for PEG to fail convergence. Failure to achieve convergence for more than 10 seconds indicates an internal problem which prevents the PEG solution from satisfying the target conditions. Manual guidance/throttle will be initiated for this failure.

C. THROTTLE COMMAND NOT DECREASED TO MAINTAIN 3g ACCELERATION.

During second stage guidance, the g-limiting task determines the average acceleration experienced since the previous guidance cycle. If the sensed acceleration exceeds an I-load limit value ALIM2, g-limiting is activated to decrease the throttle command proportional to the acceleration error. The throttle command is decremented until the sensed acceleration decreases below another I-load limit, ALIM1.

THIS RULE CONTINUED ON NEXT PAGE

FLIGHT RULES

A4-58 AUTO GUIDANCE NO-GO (CONTINUED)

A constant throttle command with acceleration exceeding ALIM2 indicates the g-limiting task is not being executed. Manual guidance/throttle will be initiated for this failure.

Rules {A2-64C}, MANUAL THROTTLE CRITERIA, and {A4-59}, MANUAL THROTTLE SELECTION, reference this rule. ©[092195-1770A]

- D. STATIC OR INCREASING T_{GO} FOR 10 SECONDS DURING MM 104 AND MM 105.

During the orbit insertion guidance, there is no direct onboard indication of a PEG convergence problem. If the PEG solution is not obtaining the desired target conditions, the solution is modified to determine a new required velocity change. An increasing time-to-go (TGO) for five guidance cycles indicates unreasonable modifications within the PEG solution. A static TGO for 10 seconds indicates the PEG task has not been executed for five guidance cycles. Manual guidance will be initiated for this failure.

Rule {A2-64A}, MANUAL THROTTLE CRITERIA, references this rule.

A4-59 MANUAL THROTTLE SELECTION [HC] ©[121505-7209A]

MANUAL THROTTLE WILL BE INITIATED FOR THE FOLLOWING CONDITIONS:

- A. FAILURE TO INITIATE/TERMINATE THRUST BUCKET COMMANDS FOR FIRST STAGE q CONTROL.

During first stage flight, the boost throttling task provides an open-loop throttle command to limit maximum dynamic pressure and gain desired performance. When the relative velocity exceeds an I-load value of QPOLYJ, the throttle command is set to an I-load value of THROTJ if SRB performance is nominal, and the segment index J is incremented by 1. For off-nominal SRB performance, adaptive guidance throttling adjusts either THROT2 or THROT3 depending on whether performance is high or low. If SRB performance is high, the THROT2 level (throttle command between about Mach 0.4 and 0.7) is reduced (approximately 21 percent for 3 sigma hot SRB's). If SRB performance is low, the THROT3 level (throttle command between about Mach 0.7 and Mach 1.3) is increased (approximately 6 percent for 3 sigma cold SRB's). Since there is no crew insight onboard into SRB performance, manual throttles should not be invoked at QPOLY2 or QPOLY3 simply to match the nominal throttle bucket based on the THROTJ I-loads. ©[092195-1770A]

Manual throttles shall only be invoked if guidance fails to throttle back at QPOLY3 or fails to throttle up to maximum power level at QPOLY4. If manual throttles are invoked during the throttle bucket, throttles shall remain under manual control until second stage guidance has been evaluated and declared GO. ©[092195-1770A]

THIS RULE CONTINUED ON NEXT PAGE

FLIGHT RULES**A4-59****MANUAL THROTTLE SELECTION [HC] (CONTINUED)**

- B. FAILURE TO ACHIEVE FUEL DISSIPATION THROTTLE COMMAND ON INITIATION OF RTLS.

The current throttle command for the fuel dissipation phase of powered RTLS is established by the SSME-out safing task or the RTLS initialization task depending on the number of active SSME's. If a SSME failure has previously occurred, the throttle command should have been set to an I-load value KMAX by the SSME-out safing task. If no engine failure has occurred, the RTLS initialization task sets the throttle command to a level equal to two thirds of KMAX. Thus, if the current throttle command in the RTLS fuel dissipation phase is not equal to KMAX (two SSME's active) or two thirds KMAX (three SSME's active), then the SSME-out safing task or RTLS initialization task was not properly executed. ©[092195-1770A]

- C. INITIATION OF A TWO-SSME RTLS WITH ONE SSME THROTTLE STUCK IN THE THRUST BUCKET. RETURN TO AUTO THROTTLE WILL BE INITIATED DURING FLYBACK PHASE ON GROUND CALL AFTER CONFIRMATION OF GUIDANCE CONVERGENCE.

During the fuel dissipation phase of an RTLS, the PEG flyback predictions assumes a vehicle thrust acceleration equivalent to a desired throttle command. With two engines active with one throttle stuck at the thrust bucket level, the actual vehicle acceleration is less than assumed. After the powered pitcharound (i.e., flyback initiation), the PEG guidance senses the lower acceleration and becomes unconverged as it attempts to adjust the steering solution. During this interval, it is possible (although unlikely) for PEG to issue an erroneous MECO command. As a precaution to protect against an inadvertent shutdown, manual throttle must be selected prior to flyback initiation. Since there is no direct indication of when flyback initiation will occur, manual throttle should be selected at initiation of RTLS. To avoid a manual MECO, a ground call for return to AUTO throttle will be made after guidance has reconverged with a stable solution.

- D. INCORRECT THROTTLE COMMAND FOR TAL OMS DUMP CONTROL.
©[092195-1770A]

Beginning with OI-8D, flight software provides for an automatic throttledown following TAL abort selection in order to maximize capability to complete the pre-MECO OMS dump. This throttling action is cued by two site-specific I-loads that define the threshold throttledown velocities for either two- or three-engine operation. If the appropriate throttledown command is not issued, the software is not performing correctly, and manual throttle will be exercised to perform the same function. Alternately, when an SSME failure is not recognized by guidance, the throttle-down may be erroneously commanded based on the three-engine throttle down velocity. Manual throttles may be used to prevent or correct this erroneous throttle-down. This philosophy is consistent with paragraphs A and B above. ©[092195-1770A]

THIS RULE CONTINUED ON NEXT PAGE

FLIGHT RULES**A4-59****MANUAL THROTTLE SELECTION [HC] (CONTINUED)**

E. THROTTLE COMMAND NOT DECREASED TO MAINTAIN 3-G ACCELERATION.

The 3-g acceleration-limiting logic is provided to assure that vehicle loads do not exceed design constraints. Therefore, manual throttle will be invoked to protect this limit if the flight software fails to do so. Reference the rationale for Rule {A4-58C}, AUTO GUIDANCE NO-GO, for further background.

F. ANY TIME CSS IS SELECTED.

As a conservative guideline, any time the AUTO guidance is unacceptable for vehicle attitude control, it should not be allowed to control the main engines. If the vehicle attitude is not maintained to satisfy the guidance solution, the guidance may go unconverged and potentially could issue an undesired MECO command. Thus, to avoid an inadvertent shutdown, manual throttle should be selected whenever CSS takeover is initiated.

Rule {A2-64A}, MANUAL THROTTLE CRITERIA, references this rule.

G. THROTTLES WILL BE MANUALLY COMMANDED TO THE MINIMUM POWER LEVEL AT 2 PERCENT PROPELLANT REMAINING IF THE EXPECTED MECO UNDERSPEED EXCEEDS THE VALUE ASSURING EXECUTION OF FLIGHT SOFTWARE MECO PREP THROTTLING:

1. TWO OR THREE ENGINES ON: 500 FPS
2. ONE ENGINE ON: 250 FPS @[092195-1770A]

Flight software MECO preparation throttling is triggered by K-loaded timing values. When the guidance-computed TGO becomes less than TGO_FCD K-load, the MPS guidance cutoff task begins cyclic execution. This task determines when to command the SSME's to the cutoff power level, and assumes that they will remain at that setting for K-load DT_MIN_K seconds. However, the software also assumes a guided MECO will result and has no way of compensating for an impending early (low-level) cutoff. Therefore, for predicted MECO underspeeds greater than a threshold value, a low-level shutdown may be commanded before the engines reach the desired cutoff throttle setting. In such instances, the throttles will be manually retarded to the minimum power level shortly before MECO to provide the required safe shutdown configuration.

Under most circumstances, the onboard propellant remaining computation is sufficiently accurate to use as a throttledown cue. Ascent/Entry Flight Techniques #62 determined in January 1990 that 2 percent propellant remaining provided a generic value that covered both the pre-MECO dump and no-dump cases. However, the flight software computation is inaccurate when off-nominal mixture ratios are involved, due to the buildup of unusable LOX or LH₂; the software senses the extra mass but does not recognize it as unusable. Likewise, the onboard mass estimation algorithm in first stage assumes all

THIS RULE CONTINUED ON NEXT PAGE

FLIGHT RULES

A4-59

MANUAL THROTTLE SELECTION [HC] (CONTINUED)

engines are operating at the commanded power level; therefore, an engine locked before the bucket will consume more propellant than the mass tracking function accounts for. This leads to the second stage software believing it has more propellant than is actually available.

Although the resultant mass dispersions are a function of the size and direction of the mixture ratio upset or the depth and length of the bucket, the 2 percent propellant remaining cue still provides sufficient time to throttle down. (Reference Flight Rule {A5-112}, MANUAL THROTTLEDOWN FOR LO2 NPSP PROTECTION AT SHUTDOWN.) ©[ED]

H. FOR LOW LH2 NPSP PER FLIGHT RULE {A5-155}, LIMIT SHUTDOWN CONTROL, MANUAL THROTTLING, AND MANUAL SHUTDOWN FOR LOW LH2 NPSP [CIL] [HC]. ©[032807-8399B]

Rule {A5-155}, LIMIT SHUTDOWN CONTROL, MANUAL THROTTLING, AND MANUAL SHUTDOWN FOR LOW LH2 NPSP [CIL] [HC], addresses scenarios requiring manual throttles. Manual throttles will be maintained and a manual MECO required for the flow control valve anomaly case. Uphill capability will be evaluated at each throttle setting. Two-engine and single-engine performance boundaries will be made based on minimum power level as time permits. Since this dynamic throttle profile is difficult to model, two-engine and single-engine capability may not be evaluated accurately until the failure actually occurs. ©[032807-8399B]

Manual throttles will be selected prior to aborting TAL for a LH2 leak. OI-8D software (STS-38 and subs) automatically throttles the engines down if TAL is selected above an I-loaded inertial velocity. To prevent the software from throttling the engines down when there is an LH2 tank leak, manual throttles are selected prior to selecting TAL. Once TAL is selected, the throttles will be returned to auto where they will stay at 104 percent until 3 g's are reached. Three-g throttling may cause engine failures but this is an accepted risk to avoid vehicle structural damage. Operating the SSME's at 104 percent results in a higher inertial velocity at MECO than if the SSME's had been throttled down to 67 percent. ©[092195-1770A]

I. A TAL UNDERSPEED IS PREDICTED AND CAN BE REDUCED BY FLYING AT A LOWER THROTTLE SETTING. THROTTLES WILL BE RETARDED TO MINIMUM POWER LEVEL WHEN THE PERFORMANCE GAIN IS MAXIMIZED.

The slope of the TAL range-velocity target line results in a point in the powered flight trajectory where MPS propellant margins may be increased by flying at a reduced throttle setting. As the throttle is retarded, the powered flight time is extended which in turn results in a MECO position which is farther downrange than would have occurred at a higher power level. The farther downrange position equates to less distance to the TAL site at MECO, and hence, a lower MECO target velocity. This in turn translates to increased MPS margin since less delta V is required to reach the smaller target velocity. Early in powered flight, gravity losses at the lower throttle are large and offset any R-V target benefit; however, eventually sufficient velocity is achieved such that the inverse is true; i.e., the smaller target velocity offsets the gravity losses, which diminish with time and the square of the current velocity.

THIS RULE CONTINUED ON NEXT PAGE

FLIGHT RULES**A4-59****MANUAL THROTTLE SELECTION [HC] (CONTINUED)**

In real time, the MCC ARD can determine when this boundary condition is reached, and subsequently when the performance gain is maximized. The FDO will then call for throttledown to minimize the R-V underspeed. Improving proximity to the R-V line in this manner reduces the likelihood of requiring low-energy guidance during entry, and is especially critical for out-of-plane sites where high crossrange severely limits underspeed tolerance. ©[120894-1663]

Note that this procedure will not be utilized unless an underspeed is predicted at the current power level.

Rules {A4-55}, DESIGN AND CRITICAL MECO UNDERSPEED DEFINITIONS; and {A5-112}, MANUAL THROTTLE DOWN FOR LO2 NPSP PROTECTION AT SHUTDOWN, reference this rule. ©[ED]

- J. THREE ENGINES RUNNING AND TWO STUCK THROTTLES PRIOR TO TAL OR RTLS ABORT.
1. TAL: SELECT MANUAL THROTTLES, ABORT TAL, SELECT AUTO THROTTLES.
 2. RTLS: SELECT MANUAL THROTTLES, MINIMUM THROTTLES, AUTO THROTTLES, WAIT 10 SECONDS, ABORT RTLS. IF BOTH ENGINES WITH STUCK THROTTLES ARE AT NOMINAL POWER LEVEL (104.5 PERCENT), THESE RTLS STEPS ARE NOT NECESSARY. ©[121505-7209A]

For TAL, it is undesirable to throttle down the good engine due to the guidance transients which may occur and the fact that little time would be gained to perform the abort dump. Therefore, manual throttles will be selected to prevent an automatic throttledown when TAL is declared. This action is not required if TAL is declared early enough that automatic throttling will not occur at abort selection. However, since there is no disadvantage to selecting manual throttles for this short period of time, manual throttles will always be selected for consistency. AUTO throttles will be reselected after TAL is declared.

For three-engine RTLS cases with two stuck throttles, minimum throttles will be selected prior to abort selection for any engine stuck at a power level below the nominal 104.5 percent. Doing so will allow guidance to converge on the correct average thrust level and will reduce the probability of an early PPA. For guidance to have enough time to converge, minimum throttle levels must be achieved at least 10 seconds prior to RTLS selection. If not, an early PPA may occur, resulting in MECO conditions that are not optimized, since additional propellant above the 2 percent target may remain in the ET at MECO. AUTO throttles should be reselected immediately after the minimum throttles is selected. Doing so ensures that RTLS guidance fine mass control is maintained. If manual throttles is active at PPA or enabled anytime after PPA, then guidance fine mass control is disabled. ©[121505-7209A]

THIS RULE CONTINUED ON NEXT PAGE

FLIGHT RULES

A4-59

MANUAL THROTTLE SELECTION [HC] (CONTINUED)

If both stuck engines are at the nominal power level (104.5 percent), these steps are unnecessary since the chances of an early PPA are eliminated. In this case, a late PPA is possible since the guidance turnaround velocity limit (VLATE) is being approached and the man/min/auto throttle steps could cause the crew to exceed this velocity limit prior to aborting RTLS. (Reference Ascent/Entry Flight Techniques Panel #215, October 28, 2005.) ©[121505-7209A]

Reference Rules {A5-109}, MANUAL SHUTDOWN FOR TWO STUCK THROTTLES (NOT DUAL APU FAILURES); and {A8-61}, SSME SHUTDOWN DUE TO HYDRAULIC SYSTEM FAILURES. ©[ED]

K. TO MAINTAIN THROTTLES AT 109 PERCENT POWER LEVEL DURING THE FLYBACK PHASE OF AN RTLS ABORT.

When maximum throttles are enabled (SPEC 51 Item 4), guidance replaces the maximum power level (KMAX) of 104 percent with 109 percent. However, during the flyback phase, the commanded power level (KCMD) is not simply set to KMAX but is adjusted to achieve the desired mass conditions at MECO (assuming CSS or manual throttles did not occur anytime during flyback). For two engines running, the typical throttle command during flyback is about 100 percent and is unaffected by KMAX. Therefore, if 109 percent power level is desired during the flyback phase of an RTLS abort, manual throttles are required.

Reference Rule {A4-53E.1}, USE OF MAXIMUM THROTTLES; and Rule {A5-151D}.3, PRE-MECO MPS HELIUM SYSTEM LEAK ISOLATION [CIL].

L. IF A LOWER SSME POWER LEVEL IS REQUIRED SUBSEQUENT TO ENABLING MAXIMUM THROTTLES.

When maximum throttles are enabled (SPEC 51 Item 4), guidance replaces the maximum power level (KMAX) of 104 percent with 109 percent. If throttle selection is auto and 3-g throttling is not active, the commanded power level (KCMD) is set to the new maximum power level of 109 percent (except during RTLS flyback phase, see paragraph K. above). If a lower power level is required subsequent to enabling maximum throttles, manual throttles must be selected and the lower power level commanded manually. (Note, if throttle selection is auto, the fine count throttle setting will be commanded regardless if maximum throttles have been enabled). A second SPEC 51 Item 4 will not reset the maximum or commanded power level to 104 percent. Therefore, the lower power level must be commanded manually. Once the desired power level is reached, throttles can be returned to auto. However, a subsequent engine failure with auto throttles selected will result in the commanded power level being reset to 109 percent.

Hazard Reports IMPS-08, Underpressurization of the Integrated MPS O2 System, and IVLD-01, Exposure to Induced Environment Exceed Structural Capability of SSV, are controlled by this rule. ©[121505-7209A]

Rule {A2-64A}, MANUAL THROTTLE CRITERIA, references this rule.

FLIGHT RULES

A4-60

MANUAL SHUTDOWN CRITERIA

IF THE ONBOARD PREDICTED MET OF MECO IS 2 SECONDS DIFFERENT THAN THE GROUND PREDICTED MET OF MECO AND IF CONFIRMED BY OBSERVED NAVIGATION VELOCITY ERRORS, A MANUAL SHUTDOWN WILL BE INITIATED AT THE GROUND-COMPUTED TIME.

If the ground predicted MET of MECO is 2 seconds different than the onboard predicted MET of MECO, a manual shutdown will be initiated on the ground-computed value to maintain the capability to achieve a nominal mission. A difference in the onboard and ground predicted times indicates an auto MECO will not achieve the target cutoff conditions. An early cutoff may require downmoding because of OMS performance limitations. A late cutoff may cause the desired thrust direction for OMS-1 to be radially downward and/or retrograde. The uncertainty in the ground prediction is estimated to be ± 0.9 second. This value is the RSS of the computational uncertainties of ± 0.6 second for 3-sigma ground navigation accuracy, and ± 0.5 second for onboard response to throttledown commands. Allowing a 1-second pad to ensure detection of a true onboard error and rounding to a whole number, a 2-second tolerance is enforced.

Reference: CA4-79, Ascent Flight Techniques Meeting #35, dated March 27, 1979.

Rule {A2-60}, NAVIGATION UPDATE CRITERIA, references this rule.

A4-61

THRUST LIMITING, HYDRAULIC, OR ELECTRICAL LOCKUP

- A. BASED ON RECOMMENDATION FROM THE BOOSTER SYSTEM ENGINEER, AN ABORT REGION DETERMINATOR (ARD) ADJUSTMENT WILL BE MADE FOR:
1. THRUST LIMITING FLAG SET.
 2. Pc SENSOR SHIFT.
 3. ELECTRONIC LOCKUP.
 4. HYDRAULIC LOCKUP.
 5. HPOT EFFICIENCY LOSS.
 6. LH₂ FLOW METER SENSOR SHIFT.
 7. LPFT DISCHARGE TEMPERATURE SHIFT.
 8. NOZZLE LEAKS.

The ARD FPR is designed to cover only those SSME failures that are not detectable with engine instrumentation, but are sufficient to cause performance degradation. Therefore, it is necessary to model in the ARD those failures with performance impacts that exceed FPR coverage. Reference Rule {A5-110}, SSME PERFORMANCE DISPERSION. ©[ED]

THIS RULE CONTINUED ON NEXT PAGE

FLIGHT RULES

A4-61

THRUST LIMITING, HYDRAULIC, OR ELECTRICAL LOCKUP
(CONTINUED)

B. A PERFORMANCE-LIMITED SSME WILL BE SHUT DOWN EARLY, OR A MAIN ENGINE CONTROLLER CHANNEL TURNED OFF, BASED ON BOOSTER SYSTEMS ENGINEER (BSE) CONFIRMATION OF THE FAILURE AND ARD PERFORMANCE EVALUATION FOR THE FOLLOWING CASES:

1. LOW MIXTURE RATIO:

Preservation of the ATO region by early shutdown of an SSME has priority over a possible abort downmode to an AOA.

IF THE FOLLOWING CRITERIA ARE MET, THE AFFECTED SSME WILL BE SHUT DOWN EARLY TO PROTECT 3-SIGMA ATO CAPABILITY OR THE DESIGN UNDERSPEED, WHICHEVER IS THE MOST CONSTRAINING:

a. THE ACTUAL NOMINAL MARGIN INDICATES LOSS OF ATO CAPABILITY.

The ARD's actual mode nominal margin is a prediction of MECO underspeed on a 2-sigma bad day. This prediction can be used to determine if ATO capability exists. This rule refers to the design underspeed as a criterion for pressing uphill with a performance-limited SSME. In addition, the dispersed-performance protection level (3-sigma) is stated explicitly for uphill capability assessment.

b. THE HYPOTHETICAL AOA MARGIN (REFLECTING THE SICK ENGINE OUT) IS DECREASING.

The ARD's hypothetical mode AOA margin is the indicator of when continued sick engine operation will degrade performance. As long as the margins are increasing, the three-engine configuration is improving MECO conditions. When the margins start trailing off, the sick engine is degrading uphill capability. If the hypothetical nominal margin is greater than the actual nominal value; i.e. it is better to have two healthy engines than two healthy and one sick, the bad engine will be shut down.

c. THE HYPOTHETICAL NOMINAL MARGIN IS GREATER THAN THE ACTUAL NOMINAL MARGIN.

Rationale is the same as for paragraph b above.

THIS RULE CONTINUED ON NEXT PAGE

FLIGHT RULES

A4-61

THRUST LIMITING, HYDRAULIC, OR ELECTRICAL LOCKUP (CONTINUED)

2. Pc SENSOR SHIFT (HIGH OR LOW)

FOR A Pc SENSOR SHIFT THE AFFECTED MAIN ENGINE CONTROLLER CHANNEL WILL BE TURNED OFF BY THE CREW TO PROTECT 3-SIGMA ATO CAPABILITY (i.e., AVOID AOA) OR THE DESIGN UNDERSPEED, WHICHEVER IS THE MOST CONSTRAINING. THIS PROCEDURE WILL NOT BE IMPLEMENTED IF IT WILL CAUSE ENGINE SHUTDOWN OR NOT CORRECT THE PERFORMANCE DISPERSION (REF. RULE {A5-110}, SSME PERFORMANCE DISPERSION, FOR CASES THAT CAUSE ENGINE SHUTDOWN). @[ED]

Large Pc shift can cause mixture ratio excursions that will result in a LOX or LH₂ depletion prior to ATO capability. Generally, the bad Pc sensor can be isolated and turned off with the other sensor returning the mixture ratio to a nominal value. This rule refers to the design underspeed as a criterion for pressing uphill with a performance-limited SSME. In addition, the dispersed-performance protection level (3-sigma) is stated explicitly for uphill capability assessment.

3. HYDRAULIC OR ELECTRICAL LOCKUP

AN SSME IN HYDRAULIC OR ELECTRICAL LOCKUP WHEN COUPLED WITH LOW VEHICLE PERFORMANCE MAY BE MANUALLY SHUT DOWN TO PREVENT A VIOLATION OF THE ENGINE LO₂ NET POSITIVE SUCTION PRESSURE (NPSP) REQUIREMENTS NEAR MECO. IF THE ARD PREDICTED DELTA V MARGIN AFTER SRB SEPARATION INDICATES LOW PERFORMANCE, THE NON-THROTTLING ENGINE WILL BE SHUT DOWN AT $V_I > 23K$ FPS. @[061297-4892]

For low performance in first stage with one or more engines in hydraulic or electrical lockup, there is potentially insufficient LOX at MECO to support the stuck engine's shutdown from the higher throttle level. This results in a LOX depletion and subsequent uncontained engine damage.

C. FOR A THREE-ENGINE RTLS, AUTO GUIDANCE WILL BE PRESERVED BY SHUTTING DOWN PERFORMANCE-LIMITED SSME WHEN THE PROBLEM IS IDENTIFIED BUT NOT LATER THAN POWERED PITCHDOWN (PPD) MINUS 40 SECONDS TO PROTECT A 3-SIGMA GUIDED MECO (RTLS MARGIN > 0 FPS). CRITERIA FOR ET SEPARATION PROPELLANT CONDITIONS WILL NOT BE CONSIDERED WHEN DETERMINING SSME SHUTDOWN REQUIREMENTS DURING AN RTLS.

Manual throttle, manual guidance, and early manual turnaround during an RTLS is more risky than shutdown of a performance-limited SSME. There is no real-time determination of propellant conditions at ET separation currently available. It is highly desirable to protect a 3-sigma guided MECO. This will be done at the possible expense of executing an RTLS ET separation with a slightly heavier tank.

FLIGHT RULES

A4-62**OMS-1/OMS-2 EXECUTION**

THE OMS-1 AND/OR OMS-2 TARGETS AND TIG WILL BE SELECTED TO ACHIEVE THE HIGHEST PRIORITY MISSION MODE POSSIBLE. ALLOWABLE UNDERSPEEDS FOR EXECUTION OF NOMINAL TARGETS WILL ENSURE ACCOMPLISHMENT OF HIGH PRIORITY MISSION OBJECTIVES. THE AME WILL BE USED TO DETERMINE THE HIGHEST PRIORITY MISSION MODE THAT CAN BE ACHIEVED.

For standard insertion flights, the nominal OMS-1 and OMS-2 targets are designed to be performance optimized. The nominal targets will be executed and the nominal flight profile flown only if there is sufficient fuel available to perform the required on-orbit burns and the deorbit burn. Otherwise, the highest priority mission mode that can be supported by the fuel available will be executed. (Reference Rule {A2-52D}, ASCENT MODE PRIORITIES FOR PERFORMANCE CASES.)

For direct insertion flights, a range of underspeeds will result in no OMS-1 being required but the apogee is lower than nominal. For these cases, assuming no OMS leaks have occurred, it is desired to circularize at the resulting pre-OMS-2 apogee altitude with the OMS-2 burn. The details for this case with and without OMS propellant problems are in Flight Rule {A4-103}, OFF-NOMINAL ORBITAL ALTITUDE RECOVERY PRIORITIES, and its rationale.

The AME will be used in real time to determine the highest priority mission mode that can be achieved. Actual post-MECO state vectors and actual OMS quantities are used by the AME. Should the MOC be unavailable, the backup method for determining the correct targets is the crew chart in the Ascent Checklist.

FLIGHT RULES

A4-63

OMS/RCS SYSTEM FAILURES DURING ASCENT @[121505-6938A]

THE FOLLOWING ACTIONS ARE REQUIRED FOR AN OMS/RCS FAILURE DURING ASCENT: @[121505-6938A]

A. OMS HELIUM TANK LEAK, PRE-MECO DUMP NOT REQUIRED: @[121604-6520A]

NOTE: A PRE-MECO HELIUM LEAK DUMP WILL NOT BE PERFORMED IF THE LEAK RATE WILL SUPPORT ALL POST-MECO REQUIREMENTS FOR ANY UNDERSPEED BETWEEN NOMINAL (ZERO UNDERSPEED) AND CRITICAL UNDERSPEED.

1. THE NOMINAL TWO-ENGINE OMS ASSIST BURN WILL BE PERFORMED UNLESS THE PROPULSION SYSTEMS OFFICER REQUESTS AN OMS ASSIST REDUCTION. IF AN OMS ASSIST REDUCTION IS PERFORMED, 3-SIGMA NOMINAL ASCENT PERFORMANCE WILL BE PROTECTED.
2. ALL STANDARD ABORT CALLS WILL BE MADE.
3. POST MECO, IF AN OMS-1 BURN IS REQUIRED WITH A TIG EARLIER THAN 20 MINUTES MET, THEN BURN OMS-1 ON TIME. OTHERWISE, TARGET A POSIGRADE DUMP AT A TIG OF 20 MINUTES MET USING THE TOTAL DELTA V PROVIDED BY THE PROPULSION SYSTEMS OFFICER TO ACHIEVE THE PROPER POST-DUMP BLOWDOWN. THE DUMP WILL BE COMPUTED TO SATISFY THE FOLLOWING CONSTRAINTS:
 - a. THE POST-DUMP APOGEE MUST BE HIGH ENOUGH TO SATISFY THE MINIMUM ORBITAL LIFETIME CONSTRAINTS ESTABLISHED IN RULE {A2-52}, ASCENT MODE PRIORITIES FOR PERFORMANCE CASES.
 - b. THE ALTITUDE INCREASE WILL BE MAXIMIZED; HOWEVER, THE POST DUMP APOGEE MUST NOT BE HIGHER THAN THE DESIRED FINAL MISSION/RENDEZVOUS TARGET ALTITUDE.
 - c. THE RADIAL COMPONENT WILL BE MINIMIZED WHILE MEETING THE OTHER CONSTRAINTS. @[121604-6520A]

THIS RULE CONTINUED ON NEXT PAGE

FLIGHT RULES

A4-63

OMS/RCS SYSTEM FAILURES DURING ASCENT (CONTINUED)

As documented in Rule {A2-62}, ET FOOTPRINT CRITERIA, an uphill abort is preferred over TAL for an SSME failure combined with any loss of OMS dump capability, which may or may not be the case for an OMS helium tank leak. If the leak rate is slow enough to provide the full post-MECO capability, as defined below, then there has been effectively no loss of OMS dump capability and the ET footprint criteria still apply. Other than the exceptions noted in this rule, the fact that no pre-MECO helium leak dump is required is assumed to mean that all necessary post-MECO capability will be available to correctly call the abort mode boundaries listed in Rule {A4-56}, PERFORMANCE BOUNDARIES. In order for the FDO to execute these procedures correctly, the Propulsion Systems Officer must notify FDO that there is an OMS helium leak. ®[121604-6520A]

When little or no performance has been lost and ET FOOTPRINT CRITERIA apply, the nominal OMS Assist burn is an important part of powered flight ascent. For that reason, the OMS Assist burn should be performed in this case. However, in cases where some loss of capability is anticipated, it is reasonable to trade excess powered flight margin for additional post-MECO capability by adjusting the duration of the OMS Assist burn, as long as 3-sigma nominal ascent performance is protected.

As mentioned above, if no pre-MECO helium leak dump is required, then the leak will support all of the standard performance boundaries documented in Rule {A4-56}, PERFORMANCE BOUNDARIES. This means that for an uphill abort based on critical underspeed, the leak must support the earliest OMS-1 burn to a quantity such that the total post OMS-1 delta V remaining, including the leaking system blowdown, is sufficient to ensure that OMS-2 and/or the Deorbit Burn(s) can be successfully completed.

For an ATO abort that achieves design underspeed after a full ATO dump, there must be sufficient post-dump delta V capability to complete the required OMS-1, OMS-2 and/or Deorbit Burn(s) without violating any OMS constraints. If the leaking OMS is not at full blowdown after the full ATO dump, any propellant trapped in the leaking system may be substituted for ballast allocated elsewhere (e.g., aft RCS) in order to provide additional delta V capability. ®[121604-6520A]

THIS RULE CONTINUED ON NEXT PAGE

FLIGHT RULES

A4-63

OMS/RCS SYSTEM FAILURES DURING ASCENT (CONTINUED)

For a nominal MECO or for an underspeed less than design, with or without an ATO dump, the leak must support a targeted posigrade burn with a TIG of 20 minutes MET from the leaking OMS. That targeted posigrade burn must be able to satisfy the following three constraints: First, the posigrade burn must place the orbiter in an acceptable orbit. Second, post burn, there must be sufficient delta V capability remaining in the good OMS plus the blowdown in the leaking OMS plus the Aft RCS to complete the required OMS-2 and/or Deorbit Burn(s) without violating any OMS constraints. Third, there must be sufficient blowdown available in the leaking system to ensure that there will be no subsequent violation of OMS tank landing weight constraints or orbiter landing weight constraints. It should be noted that, even for a nominal MECO, this posigrade burn does not guarantee a successful mission in all cases, but it does provide a better chance of a successful mission than any other helium leak management technique.

@[121604-6520A]

The reason for specifying 20 minutes MET as the TIG of the posigrade burn is that experience has shown that this is the earliest time by which the Flight Dynamics Officer can successfully compute and voice up targets which satisfy all of the required constraints. The process by which this burn is targeted is as follows: First, the Flight Dynamics Officer takes the dump delta V to maximum blowdown supplied by the Propulsion Officer and performs an initial modeling of that entire delta V as a posigrade (+X) burn with a 20-minute TIG. If the post-burn apogee of this initial posigrade burn meets both the minimum and maximum apogee constraints, then the targeting process is complete. Note: Because this burn is likely to occur somewhere between apogee and perigee, both apogee and perigee may be increased.

However, if the post-burn apogee is not high enough to satisfy orbital lifetime constraints (usually 105 nm, ref. Rule {A2-52}, ASCENT MODE PRIORITIES FOR PERFORMANCE CASES), then the posigrade component of the burn is increased until the required apogee is achieved.

On the other hand, if the post-burn apogee of the initial posigrade burn was too high, then the magnitude of the posigrade burn component is reduced until the desired, final orbital altitude is achieved, while the radial (down) component is increased to maintain the total delta V recommended by the Propulsion Officer. Note, however, that the radial component should not be increased any more than the minimum required not to exceed the planned, nominal orbit altitude. Arbitrarily increasing the radial component in order to lower the final altitude may result in excessive propellant wastage if the helium leak does not support the full targeted dump.

@[121604-6520A]

THIS RULE CONTINUED ON NEXT PAGE

FLIGHT RULES

A4-63 **OMS/RCS SYSTEM FAILURES DURING ASCENT (CONTINUED)**

- B. OMS HELIUM TANK LEAK, PRE-MECO DUMP REQUIRED: @[121604-6520A]
1. A SINGLE OME DUMP OF THE LEAKING SYSTEM TO MAXIMUM BLOWDOWN WILL BE PERFORMED. THE NON-LEAKING OME WILL BE TURNED OFF. THE ARD WILL BE UPDATED TO REFLECT THE AMOUNT OF PROPELLANT ACTUALLY BURNED IN BOTH OMS SYSTEMS.
 2. 'PRESS TO ATO' WILL NOT BE CALLED. HOWEVER, AN ATO ABORT WILL BE DECLARED BY THE MCC IF THE ARD SHOWS THAT SELECTING ATO WOULD PROVIDE UPHILL CAPABILITY. @[121505-6938A]
 3. 'PRESS TO MECO' WILL BE CALLED BASED ON CAPABILITY ALONE. DESIGN UNDERSPEED WILL NOT BE PROTECTED IN THE 'PRESS TO MECO CALL'.
 4. PER MCC REQUEST, THE NON-LEAKING OME MAY BE TURNED ON AND/OR THE INTERCONNECT MANUALLY ENABLED ONBOARD IF THE LEAKING OME DUMP TO BLOWDOWN ALONE IS INSUFFICIENT TO ACHIEVE DESIGN UNDERSPEED.

NOTE: IF OMS HELIUM TANK FAILURE SHOULD OCCUR PRIOR TO COMPLETION OF THE PRE-MECO DUMP, THEN REFER TO PARAGRAPH C OF THIS RULE, OMS HELIUM TANK FAIL.

If the OMS Assist dump was different than planned in either OMS system, the ARD must be adjusted accordingly or the ARD predicted abort boundaries will be incorrect. @[121604-6520A]

THIS RULE CONTINUED ON NEXT PAGE

FLIGHT RULES

A4-63

OMS/RCS SYSTEM FAILURES DURING ASCENT (CONTINUED)

As documented in Rule {A2-62}, ET FOOTPRINT CRITERIA, an uphill abort is preferred over TAL for an SSME failure combined with any loss of OMS dump capability, which may or may not be the case for an OMS helium tank leak. If the leak rate is not slow enough to provide full post-MECO capability, then a pre-MECO dump of the leaking system is required. For this case, as specified in Rule {A2-62}, ET footprint criteria, OMS dump capability has been lost, ET footprint criteria do not apply, and an uphill abort is preferred over TAL. Unless predicted otherwise, the pre-MECO dump to maximum blowdown will be assumed to be successful. ©[121604-6520A]

'PRESS TO ATO' will not be called since no additional dump would be performed without MCC direction and the ongoing blowdown dump could be reduced by the onboard ATO ramp dump calculation. The onboard configuration in most cases will be the non-leaking OMS engine turned off and the leaking OMS performing a lengthy blowdown dump. Aborting ATO would override the max blowdown item 9 dump with the ATO dump and may require another Item 9 to restore the blowdown dump. To achieve the earliest uphill capability or protect ET footprint, an ATO abort may be selected at MCC direction in order to freeze the orbital insertion plane. However, if the blowdown dump alone is insufficient to protect design underspeed, the FDO may request an additional dump to include the non-leaking OME and/or enabling the interconnect manually onboard.

'Press to MECO' will be called based on critical underspeed only; design underspeed will not be protected. The 'Press to MECO' call assumes the current onboard configuration which in most cases will be the non-leaking OME turned off and the leaking OME performing a lengthy blowdown dump.

If the helium tank fails (i.e., depletes) before the pre-MECO dump is completed, then it becomes an OMS helium tank fail as described in paragraph C of this rule. In that case, the Propulsion Officer will update the Flight Dynamics Officer with new values for the total OMS propellant lost. ©[121604-6520A]

THIS RULE CONTINUED ON NEXT PAGE

FLIGHT RULES

A4-63

OMS/RCS SYSTEM FAILURES DURING ASCENT (CONTINUED)

C. OMS HELIUM TANK FAIL: @[121604-6520A]

1. IF AN OMS ASSIST OR ATO DUMP IS IN PROGRESS, IT WILL BE TERMINATED. THE OMS/RCS INTERCONNECT WILL BE INHIBITED FOR ANY SUBSEQUENT DUMP.
2. THE ARD WILL BE UPDATED TO REFLECT THE AMOUNT OF OMS PROPELLANT BURNED PRIOR TO DUMP TERMINATION AS WELL AS THE AMOUNT OF PROPELLANT LOST DUE TO THE HELIUM TANK FAILURE. BASED ON RECOMMENDATION FROM THE PROPULSION SYSTEM OFFICER, PROPELLANT LOST DUE TO THE HELIUM TANK FAILURE SHALL INCLUDE BOTH THE PROPELLANT TRAPPED IN THE AFFECTED OMS SYSTEM, AS WELL AS PROPELLANT IN THE GOOD OMS SYSTEM WHICH CANNOT BE USED WITHOUT VIOLATING THE CONTINGENCY CG BOX, IF APPLICABLE. BALLAST COMPUTATIONS WILL ASSUME A FULL POST MECO FRCS DUMP. @[121505-6938A]

NOTE: NO RCS TO OMS BALLAST SHIFTING WILL BE PERFORMED IN THE COMPUTATION OF GOOD SYSTEM PROPELLANT TRAPPED BY THE CONTINGENCY CG BOX.

3. 'PRESS TO ATO' WILL NOT BE CALLED. HOWEVER, AN ATO ABORT WILL BE DECLARED BY THE MCC IF THE ARD SHOWS THAT SELECTING ATO WOULD PROVIDE UPHILL CAPABILITY. PER MCC DIRECTION, THE UNAFFECTED OMS ENGINE MAY BE TURNED ON ONBOARD TO SUPPORT THE ATO DUMP. @[121505-6938A]
4. 'PRESS TO MECO' WILL BE CALLED BASED ON CAPABILITY ALONE. DESIGN UNDERSPEED WILL NOT BE PROTECTED IN THE 'PRESS TO MECO CALL.' @[121604-6520A]

THIS RULE CONTINUED ON NEXT PAGE

FLIGHT RULES

A4-63

OMS/RCS SYSTEM FAILURES DURING ASCENT (CONTINUED)

As documented in Rule {A2-62}, ET FOOTPRINT CRITERIA, an uphill abort is preferred over TAL for an SSME failure combined with any loss of OMS dump capability, which includes OMS helium tank failure. However, it is preferred to perform a TAL abort if going uphill would result in a Y cg outside of the contingency cg box and a TAL abort would result in a Y cg inside the contingency box. For this reason, if OMS Assist or an ATO dump is in progress, that dump will be terminated in such a way that the OMS engines can be safely restarted later if required. ©[121604-6520A]

The ARD must be updated with the amount of propellant used prior to the helium tank failure as well as the propellant lost because of the helium tank failure, which will be provided by the Propulsion Officer. The amount of propellant modeled as lost should include any propellant in the good OMS system which cannot be used without violating the contingency cg box. Ballasting is done to the contingency cg box instead of the nominal cg box because in most cases the nominal cg box cannot be protected even if downmode to TAL is performed. This is because the amount of ballast required to protect the nominal cg box would result in the non-leaking OMS tank being above the Tank Landing Constraint for a TAL abort. Ballast is based on uphill capability which allows for a full post-MECO FRCS dump. Downmode to TAL may result in an increased ballast requirement since the post MECO FRCS dump is limited to an I-loaded value that is a function of the FRCS load and, therefore, may result in more constrained Y cg contingency limits. However, the OMS dump amount for uphill cases is also limited by post-MECO delta V requirements. Therefore, propellant is available for a subsequent TAL downmode to protect the increased ballast requirement. ©[121505-6938A]

Trapped OMS propellant could be used for X and or Y cg ballast, which might free up propellant previously earmarked as ballast in the aft RCS system. However, it should be noted that shifting ballast in this way does not automatically increase the amount of capability available, because the contingency cg box is not rectangular. Ballast shifting is a very complicated problem and there is very little time available during ascent to perform the necessary calculations. For this reason, ballast shifting will not be attempted during powered flight. ©[121604-6520A]

THIS RULE CONTINUED ON NEXT PAGE

FLIGHT RULES

A4-63

OMS/RCS SYSTEM FAILURES DURING ASCENT (CONTINUED)

'PRESS TO ATO' will not be called since no additional dump would be performed without MCC direction since the unaffected OMS engine is turned off. However, the Flight Dynamics Officer can determine what ATO dump is possible that protects both the ballast requirement and the post MECO delta V requirement. Therefore, an ATO abort may be declared by the MCC if freezing the plane and/or performing the reduced ATO dump would provide uphill capability. @[121604-6520A] @[121505-6938A]

The crossfeed valves are closed for a helium tank fail, so an OMS/RCS interconnect is not possible for any subsequent dump. @[121604-6520A]

D. OMS ENGINE FAIL:

1. THE ARD WILL BE UPDATED TO REFLECT THE AMOUNT OF PROPELLANT USED DURING OMS ASSIST IF DIFFERENT THAN PREDICTED.
2. IF AN ABORT IS PERFORMED, THE MCC MAY REQUEST THAT AN I-LOADED STRAIGHT-FEED DUMP BE INTERCONNECTED. OMS ASSIST IS NOT REQUIRED TO BE INTERCONNECTED, BUT MAY BE PER MCC REQUEST.

NOTE: IF ANY ABORT DUMP IS STRAIGHTFED, THEN AN INTERCONNECTED DUMP WILL BE NORMALLY MODELED IN THE ARD.

3. 'PRESS TO ATO' WILL BE CALLED BASED ON CAPABILITY ALONE. DESIGN UNDERSPEED WILL NOT BE PROTECTED IN THE 'PRESS TO ATO' CALL.
4. 'PRESS TO MECO' WILL BE CALLED ON AN UNDERSPEED THAT PROTECTS AGAINST AN EARLY OMS-1 WITH A DELTA-V THAT VIOLATES SINGLE OMS ENGINE CAPABILITY.

As documented in Rule {A2-62}, ET FOOTPRINT CRITERIA, an uphill abort is preferred over TAL for an OMS engine failure combined with an SSME failure, even at the expense of design underspeed protection. Calling 'PRESS TO ATO' on capability results in the earliest possible uphill capability by freezing the orbital insertion plane. For RTLS and TAL, interconnect is required in order to dump propellant from the affected system and to reduce or eliminate violations of the cg box, OMS tank landing constraints, and orbiter landing weight constraints. @[121505-6938A]

THIS RULE CONTINUED ON NEXT PAGE

FLIGHT RULES

A4-63**OMS/RCS SYSTEM FAILURES DURING ASCENT (CONTINUED)**

For ATO, these mass property issues do not apply but, unfortunately, the ARD computation of post-MECO capability is based on the assumption of two OMS engines and may not produce correct results for the case of a large underspeed combined with a single engine OMS burn. Manually forcing an interconnected dump for an ATO reduces the post-MECO underspeed to a region where the ARD post-MECO capability computation is again usable. There is one exception to this requirement: If flight specific analysis shows that the TIG for the earliest OMS-1 burn resulting from a single OMS engine ATO dump can be optimized for a single OMS engine such that no required delta V capability is lost, then manually forcing an interconnected dump is not required. @[121505-6938A]

In certain circumstances, ET footprint criteria can be protected by performing an extended interconnected dump alone. Freezing the plane precludes rendezvous. If the dump amount does not preclude potential rendezvous capability which may otherwise be achievable, then performing an extended interconnected OMS assist dump is desirable.

Once uphill capability is assured, 'PRESS TO MECO' should not be called until the resulting underspeed ensures that an early OMS-1 will not be not required. An early OMS-1 is operationally complex and with only a single OMS engine available, significant delta V can be lost due to the low orbit and long burn arc effects. Unless there are other complicating SSME or MPS performance factors, it is desirable that OMS-1 occur no earlier than MECO plus 8-10 minutes. @[121505-6938A]

THIS RULE CONTINUED ON NEXT PAGE

FLIGHT RULES

A4-63**OMS/RCS SYSTEM FAILURES DURING ASCENT (CONTINUED)**

E. OMS PROPELLANT FAIL: @[121505-6938A]

1. IF AN OMS ASSIST OR ATO DUMP IS IN PROGRESS, IT WILL BE TERMINATED. THE OMS/RCS INTERCONNECT WILL BE INHIBITED FOR ANY SUBSEQUENT DUMP.
2. THE ARD WILL BE UPDATED TO REFLECT THE AMOUNT OF OMS PROPELLANT BURNED PRIOR TO DUMP TERMINATION AS WELL AS THE AMOUNT OF OMS PROPELLANT LOST DUE TO THE PROPELLANT FAILURE. BASED ON RECOMMENDATION FROM THE PROPULSION SYSTEM OFFICER, PROPELLANT LOST DUE TO THE PROPELLANT FAILURE SHALL INCLUDE BOTH THE PROPELLANT TRAPPED IN THE AFFECTED OMS SYSTEM, AS WELL AS PROPELLANT IN THE GOOD OMS SYSTEM, WHICH CANNOT BE USED WITHOUT VIOLATING THE CONTINGENCY CG BOX, IF APPLICABLE. BALLAST COMPUTATIONS WILL ASSUME A FULL POST-MECO FRCS DUMP.

NOTE: NO RCS TO OMS BALLAST SHIFTING SHOULD BE REFLECTED IN THE COMPUTATION OF GOOD SYSTEM PROPELLANT TRAPPED BY THE CONTINGENCY CG BOX.

3. 'PRESS TO ATO' WILL NOT BE CALLED. HOWEVER, AN ATO ABORT WILL BE DECLARED BY THE MCC IF THE ARD SHOWS THAT SELECTING ATO WOULD PROVIDE UPHILL CAPABILITY. @[121505-6938A]
4. 'PRESS TO MECO' WILL BE CALLED BASED ON CAPABILITY ALONE. DESIGN UNDERSPEED WILL NOT BE PROTECTED IN THE 'PRESS TO MECO' CALL.

As documented in Rule {A2-62}, ET FOOTPRINT CRITERIA, an uphill abort is preferred over TAL for an SSME failure combined with any loss of OMS dump capability, which includes OMS propellant failure. However, it is preferred to perform a TAL abort if going uphill would result in a Y cg outside of the contingency cg box versus a TAL abort with a Y cg inside the contingency box. For this reason, if OMS Assist or an ATO dump are in progress, that dump will be terminated. @[121505-6938A]

THIS RULE CONTINUED ON NEXT PAGE

FLIGHT RULES

A4-63

OMS/RCS SYSTEM FAILURES DURING ASCENT (CONTINUED)

The ARD must be updated with the amount of propellant used prior to the propellant failure as well as the propellant lost because of the propellant failure, which will be provided by the Propulsion Officer. The amount of propellant modeled as lost should include any propellant in the good OMS that cannot be used without violating the contingency cg box. Ballast is based on a full post-MECO FRCS dump. Downmode to TAL may result in an increased ballast requirement since the post MECO FRCS dump is limited to a maximum load dependent value, which may result in more constrained Y cg contingency limits. However, the OMS dump amount for uphill cases is limited to protect post-MECO delta V requirements. Therefore, propellant is available for a subsequent TAL downmode to protect the increased ballast requirement. @[121505-6938A]

Trapped OMS propellant could be used for X and/or Y cg ballast, which might free up propellant previously earmarked as ballast in the Aft RCS system. However, it should be noted that shifting ballast in this way does not automatically increase the amount of capability available, because the contingency cg box is not rectangular. Ballast shifting is a very complicated problem and there is very little time available during ascent to perform the necessary calculations. For this reason, ballast shifting will not be attempted during powered flight.

'PRESS TO ATO' will not be called since the ATO dump may not protect post-MECO delta V requirements and the unaffected OMS engine will most likely be turned off. However, an ATO abort may be declared by the MCC if freezing the plane and/or performing the reduced ATO dump would provide uphill capability. The Flight Dynamics Officer can determine what ATO dump is possible that protects both the ballast requirement and the post-MECO delta V requirement. @[121505-6938A]

THIS RULE CONTINUED ON NEXT PAGE

FLIGHT RULES**A4-63****OMS/RCS SYSTEM FAILURES DURING ASCENT (CONTINUED)**

F. OMS PROPELLANT LEAK @[121505-6938A]

1. A SINGLE OME DUMP OF THE LEAKING SYSTEM TO DEPLETION WILL BE PERFORMED. THE NON-LEAKING OME WILL BE TURNED OFF. THE OMS/RCS INTERCONNECT WILL BE INHIBITED UNLESS REQUIRED FOR A SUBSEQUENT DUMP.
2. THE ARD WILL BE UPDATED TO REFLECT THE AMOUNT OF PROPELLANT LOST DUE TO THE PROPELLANT LEAK. THIS INCLUDES PROPELLANT EXPECTED TO BE DUMPED PRIOR TO MECO AS WELL AS PROPELLANT IN THE GOOD OMS SYSTEM WHICH CANNOT BE USED WITHOUT VIOLATING THE CONTINGENCY CG BOX, IF APPLICABLE. BALLAST COMPUTATIONS WILL ASSUME A FULL POST-MECO FRCS DUMP. THE AMOUNT OF PROPELLANT PREDICTED TO BE LOST WILL BE SUPPLIED BY THE PROPULSION SYSTEMS OFFICER.
3. THE LEAKING OMS SYSTEM WILL BE ASSUMED TO HAVE NO POST-MECO CAPABILITY FOR THE PURPOSES OF UPHILL CAPABILITY ASSESSMENT OR THE 'PRESS TO MECO' CALL.
4. 'PRESS TO ATO' WILL NOT BE CALLED. HOWEVER, AN ATO ABORT WILL BE DECLARED BY THE MCC IF THE ARD SHOWS THAT SELECTING ATO WOULD PROVIDE UPHILL CAPABILITY.
5. 'PRESS TO MECO' WILL BE CALLED BASED ON CAPABILITY ALONE. DESIGN UNDERSPEED WILL NOT BE PROTECTED IN THE 'PRESS TO MECO' CALL.
6. PER MCC REQUEST, THE NON-LEAKING OME MAY BE TURNED ON IF THE LEAKING OME DUMP TO DEPLETION ALONE IS INSUFFICIENT TO ACHIEVE DESIGN UNDERSPEED.

As documented in Rule {A2-62}, ET FOOTPRINT CRITERIA, an uphill abort is preferred over TAL for an SSME failure combined with any loss of OMS dump capability, which an OMS propellant leak certainly is. After an SSME failure, the leaking system (only) will be dumped to the greatest possible extent. This is done in order to burn the leaking system propellant in a useful manner before it can leak out. This not only reduces the amount of the resulting underspeed, but provides assured capability of the leaking system. However, sufficient propellant must be reserved for post-MECO delta V requirements if going uphill. For this reason, if an OMS Assist or ATO dump is in progress, the non-leaking OME will be turned off. @[121505-6938A]

THIS RULE CONTINUED ON NEXT PAGE

FLIGHT RULES

A4-63

OMS/RCS SYSTEM FAILURES DURING ASCENT (CONTINUED)

The ARD must be updated with the amount of propellant used prior to the propellant leak as well as the propellant predicted to be lost due to the propellant leak, which will be provided by the Propulsion Officer. The amount of propellant modeled as lost should include any propellant in the good OMS which cannot be used without violating the contingency cg box. Ballast is based on a full post-MECO FRCS dump. Downmode to TAL may result in an increased ballast requirement since the post MECO FRCS dump is limited to maximum load dependent value, which may result in more constrained Y cg contingency limits. However, the OMS dump amount for uphill cases is limited to protect post-MECO delta V requirements. Therefore, propellant is available for a subsequent TAL downmode to protect the increased ballast requirement. @[121505-6938A]

Post-MECO dump capability of the leaking OMS system is not assured due to the unknown characteristics of uncontained propellant on the pod thermal and structural environment as well as the possibility of not having sufficient helium to pressurize the propellant tanks. Thus, for ARD modeling purposes, no capability from the leaking system will be counted on post MECO. However, procedures may still attempt to utilize the leaking propellant for post-MECO OMS burns.

'PRESS TO ATO' will not be called since the ATO dump may not protect post-MECO delta V requirements and the unaffected OMS engine will most likely be turned off. However, an ATO abort may be declared by the MCC if freezing the plane and/or performing an OMS dump with available good-side propellant would provide uphill capability. The Flight Dynamics Officer can determine what ATO dump is possible that protects the post-MECO delta V requirement. In the event of a subsequent ATO abort with a propellant leak, the Propulsion Systems Officer will call to update the Item 9 dump quantity to restore the leaking OMS depletion dump and will manage the good-side dump on/off times to achieve the additional good-side dump requested by the Flight Dynamics Officer. The interconnect will be manually enabled if necessary to provide uphill capability, since it would be manually enabled for a downmode to TAL abort.

G. AFT RCS LEAK (HELIUM OR PROPELLANT)

1. IF THE LEAK IS ISOLATED, THE ABORT BOUNDARIES WILL BE BIASED BY THE AMOUNT OF AFT RCS DELTA V LOST, AS PROVIDED BY THE PROPULSION SYSTEMS OFFICER. IF THE LEAK CANNOT BE ISOLATED, THEN ALL AFT RCS DELTA V WILL BE ASSUMED TO BE LOST UNLESS THE PROPULSION SYSTEMS OFFICER INDICATES OTHERWISE.
2. IF ADDITIONAL OMS BALLAST IS REQUIRED TO REPLACE LOST AFT RCS BALLAST, THEN THE ARD WILL BE UPDATED WITH THE AMOUNT OF OMS PROPELLANT THAT IS NO LONGER AVAILABLE, AS PROVIDED BY THE PROPULSION SYSTEMS OFFICER. @[121505-6938A]

THIS RULE CONTINUED ON NEXT PAGE

FLIGHT RULES

A4-63

OMS/RCS SYSTEM FAILURES DURING ASCENT (CONTINUED)

3. UNLESS THE PROPULSION SYSTEMS OFFICER INDICATES OTHERWISE, IT SHALL BE ASSUMED THAT AN AFT RCS LEAK DOES NOT SUPPORT INTERCONNECTED DUMPS. STRAIGHT-FEED (NON-INTERCONNECTED) ATO DUMP CONFIGURATION WILL SUBSEQUENTLY BE SELECTED IN THE ARD, REGARDLESS OF THE NOMINAL, I-LOADED CONFIGURATION. IF AN ATO ABORT IS SUBSEQUENTLY PERFORMED, THE INTERCONNECT WILL BE MANUALLY INHIBITED ONBOARD. @[121505-6938A]
4. 'PRESS TO ATO' WILL NOT BE CALLED. HOWEVER, AN ATO ABORT WILL BE DECLARED BY THE MCC IF THE ARD SHOWS THAT SELECTING ATO WOULD PROVIDE UPHILL CAPABILITY.
5. 'PRESS TO MECO' WILL BE CALLED BASED ON CAPABILITY ALONE. DESIGN UNDERSPEED WILL NOT BE PROTECTED IN THE 'PRESS TO MECO' CALL.

If the aft RCS leak has been isolated, then the amount of propellant usable for delta V from the aft RCS will be reduced by the amount that was leaked. If the leak cannot be isolated, then no aft RCS delta V will be available since all of the propellant in the remaining aft RCS system will be required for attitude control. Furthermore, if (additional) OMS ballast is required to make up for lost aft RCS ballast, then the appropriate updates must be made to the ARD.

Interconnecting the OMS propellant to the RCS jets would not be prudent in a situation where the source of an aft RCS leak is not yet known. However, if the leak has been isolated and allows for an interconnected dump to occur without feeding the leak, then the interconnect may be configured in the ARD and onboard.

'PRESS TO ATO' will not be called since the full ATO dump does not protect post-MECO delta V requirements. However, an ATO abort may be declared by the MCC if freezing the plane and/or performing the reduced ATO dump would provide uphill capability and prevent a TAL abort in accordance with Rule {A-2-62}, ET FOOTPRINT CRITERIA. The Flight Dynamics Officer can determine what ATO dump is possible that protects the post-MECO delta V requirement.

H. FWD RCS LEAK (HELIUM OR PROPELLANT)

1. IF AN INCREASE IN OMS BALLAST IS REQUIRED, 'PRESS TO ATO' WILL NOT BE CALLED. HOWEVER, AN ATO ABORT WILL BE DECLARED BY THE MCC IF THE ARD SHOWS THAT SELECTING ATO WOULD PROVIDE UPHILL CAPABILITY. @[121505-6938A]

THIS RULE CONTINUED ON NEXT PAGE

FLIGHT RULES

A4-63

OMS/RCS SYSTEM FAILURES DURING ASCENT (CONTINUED)

2. IF AN INCREASE IN OMS BALLAST IS REQUIRED, 'PRESS TO MECO' WILL BE CALLED BASED ON CAPABILITY ALONE. DESIGN UNDERSPEED WILL NOT BE PROTECTED IN THE 'PRESS TO MECO' CALL. ©[121505-6938A]

No 'Press to ATO' call will be made if a fwd RCS leak results in an increase in the required OMS ballast to protect the CG box, because the I-loaded ATO dump may exceed the ballast requirement. However, the MCC may still call for an ATO abort with a reduced ATO dump, because the FDO can determine the amount of OMS dump that is allowable while protecting ballast requirements. An increase in the OMS ballast requirement results in loss of OMS dump capability and thus the design underspeed is not required to be protected per Rule {A2-62}, ET FOOTPRINT CRITERIA.

Reference Rules {A2-52}, ASCENT MODE PRIORITIES FOR PERFORMANCE CASES; {A2-62}, ET FOOTPRINT CRITERIA; {A4-56}, PERFORMANCE BOUNDARIES; and {A6-51}, OMS FAILURE MANAGEMENT [CIL] [HC]. ©[121604-6520A] ©[121505-6938A]

A4-64 THROUGH A4-100 RULES ARE RESERVED

FLIGHT RULES

ORBIT

A4-101 ONBOARD NAVIGATION MAINTENANCE

ADEQUATE NAVIGATION AND MANEUVER DEFINITION WILL BE MAINTAINED ONBOARD TO PROVIDE RUNWAY LANDING CAPABILITY AFTER LOSS OF COMMUNICATION.

This rule reflects a management decision to provide for safe deorbit and landing capability in the event of a total loss of communications between the vehicle and the ground. The on-orbit navigation state must be maintained within the defined uncertainty. The maximum acceptable downtrack error is 20 nm, predicted to deorbit TIG. Twenty nm is thought to be the maximum safe energy error that can be steered out after 130,000 feet altitude (see rationale for Rule {A4-151}, IMU ALIGNMENT). The current onboard state vector is propagated to the next day prime deorbit TIG to determine if the resulting state is within limits. Periodic state vector updates are uplinked to the vehicle whenever the propagated downtrack error approaches the limit.

A4-102 MINIMUM ORBITAL LIFETIME

THE DEORBIT MANEUVER WILL BE SCHEDULED AT LEAST 48 HOURS PRIOR TO ORBITAL DECAY TO EI TO PROVIDE 24-HOUR WAVE-OFF CAPABILITY. THE ATTITUDE PROFILE WILL BE PLANNED AND ORBIT ADJUST MANEUVERS SCHEDULED, AS REQUIRED, TO MEET THE DESIRED ORBITAL LIFETIME. THE PERIGEE ALTITUDE AT DEORBIT TIG SHALL NOT BE LESS THAN 80 NM.

Uncertainties in the MCC atmospheric model and onboard state vector integration make it difficult to model orbital decay at low altitudes. Planning a deorbit within 24 hours of decay to EI is considered unsafe due to these uncertainties. Protecting 48 hours beyond the deorbit TIG provides a 1 day wave-off capability to cover potential systems problems or forecasted bad weather at the time of the deorbit/landing.

Although perigee altitudes less than 80 nm may be acceptable based on orbital lifetime if the apogee altitude were high enough, uncertainties in the models and vector integration resulted in the determination of 80 nm as the lowest acceptable perigee at the planned time of deorbit.

When a time-critical estimation of the minimum perigee is required, the determination of the minimum perigee will be made utilizing a generic H_a versus H_p plot using the following "worst case" decay assumptions: 30 percent drag uncertainty, 200,000 lb orbiter weight, 2500 ft² frontal area, 28.5 degree inclination, 0 degree argument of perigee, and 240 by 10⁻²² watts/m²/hertz solar flux (f10.7).

If time permits, a real-time assessment of the minimum perigee altitude will be performed based on the actual apogee, orbiter weight, inclination, planned attitude timeline, solar flux, and a 30 percent drag uncertainty.

(Ref. Entry Flight Techniques Panel Minutes #34.)

FLIGHT RULES

A4-103

OFF-NOMINAL ORBITAL ALTITUDE RECOVERY PRIORITIES

NOTE: IF THE PROPELLANT MARGINS ALLOW FOR THE COMPLETION OF THE RENDEZVOUS PROFILE FOLLOWING INSERTION TO AN OFF-NOMINAL ORBIT, THEN THIS RULE DOES NOT APPLY.

A. RECOVERY OPTIONS FROM A 105 NM CIRCULAR ATO ORBIT, IN ORDER OF PRIORITY ARE:

1. USE OMS-3 AND OMS-4 TO OBTAIN NOMINAL ORBIT IF PROPELLANT IS AVAILABLE. STEEP DEORBIT CAPABILITY MUST BE PROTECTED FROM THE NOMINAL ORBIT.
2. CIRCULARIZE AS HIGH AS POSSIBLE AT AN ORBITAL ALTITUDE WHICH PROTECTS STEEP DEORBITS AND SATISFIES MISSION CONSTRAINTS. REFERENCE THE FLIGHT RULES ANNEX FOR FLIGHT-SPECIFIC ALTITUDE REQUIREMENTS.
3. RAISE ORBIT ELLIPTICALLY ONLY IF MANDATORY PAYLOAD CONSTRAINTS HAVE JUSTIFIED PREFLIGHT THAT THIS IS REQUIRED. IN THIS CASE, STEEP DEORBIT CAPABILITY TO ALL CONUS OPPORTUNITIES MUST BE PROTECTED THROUGH EOM PLUS 2 DAYS AND ELS DEORBIT OPPORTUNITY GAPS MUST NOT EXCEED 4.5 HOURS.

B. RECOVERY OPTIONS FOR DIRECT INSERTION INTO LOWER THAN NOMINAL ORBITS:

1. IF NO PROPELLANT PROBLEMS EXIST, CIRCULARIZE AT APOGEE ALTITUDE WITH OMS-2 (105 NM MINIMUM). FOR LARGER MECO UNDERSPEEDS WHICH REQUIRE AN OMS-1, CIRCULARIZE AT 105 NM. USE THE PRIORITIES IN PARAGRAPH A TO RECOVER FROM THE LOWER ORBIT.
2. IF PROPELLANT PROBLEMS DO EXIST, RAISE PERIGEE TO THE MINIMUM PERIGEE WITH OMS-2. CONSIDERATION WILL BE GIVEN TO RAISING PERIGEE ABOVE THE MINIMUM, DEPENDING ON PROPELLANT AVAILABILITY, MISSION REQUIREMENTS, AND DEORBIT REQUIREMENTS. REFERENCE THE ANNEX FLIGHT RULE, TRAJECTORY AND GUIDANCE PARAMETERS, FOR THE FLIGHT-SPECIFIC MINIMUM HP. @[ED]

THIS RULE CONTINUED ON NEXT PAGE

FLIGHT RULES

A4-103

OFF-NOMINAL ORBITAL ALTITUDE RECOVERY PRIORITIES (CONTINUED)

The above is the Space Shuttle Program position on recovering from insertion into an ATO orbit and was agreed upon at the On-orbit Flight Techniques Meeting #78. It is much more desirable from the STS operations point of view to raise the orbit to a circular orbit. This eliminates the large variations in deorbit delta V that are possible from an elliptical orbit. It is quite possible not to have the delta V available to deorbit to an emergency landing site (ELS) from an elliptical orbit which has been optimized for a continental United States (CONUS) landing. Also, the deorbit delta V varies from one opportunity to the next as well as one day to the next due to the apsidal rotation. The deorbit delta V from a circular orbit is fairly constant throughout the flight. The fairly constant deorbit cost makes it much easier to handle propellant budget redlines in real time. For relatively small MECO underspeeds on a direct insertion, if there are no propellant problems, the plan to circularize at the current apogee altitude with OMS-2 was recommended for two reasons. First, it allows us to execute the STS preference of going into a circular orbit. Also, it is more efficient to circularize at the apogee altitude and deorbit from there than it is to fly the nominal mission. Therefore, for the MECO underspeed cases with apogee greater than 105 nm, the plan to use OMS-2 to circularize at the apogee altitude results in "creating" more OMS propellant for on-orbit activities. If propellant problems do exist, the rule calls for raising perigee to the minimum perigee (min Hp) in order to minimize propellant usage. The min Hp guarantees orbit stay capability up through the flight day 1 PLS opportunity. If the perigee is only raised to the min Hp, it may have to be raised higher at a later time to satisfy Rule {A4-102}, MINIMUM ORBITAL LIFETIME.

The elliptical orbit constraints were reviewed and approved at the Entry Flight Techniques Panel Meeting #40. Because of the large amount of analysis required to support flying in an elliptical orbit, it was recommended that this be done only in cases where the mandatory payload requirements have justified preflight that this is required. It was determined that a 4.5-hour gap in ELS deorbit capability was an acceptable compromise since "anytime" deorbit capability from the resulting elliptical orbit may not be available. Typical gaps in ELS deorbit opportunities from a circular orbit average 1 hour long. It was felt by the community that, for mandatory payload requirements, we could increase the exposure to gaps to three orbits without an ELS deorbit opportunity. The three orbits were then converted to time to make it easier to implement. It was agreed that we should protect steep deorbit capability to all CONUS sites from the elliptical orbits. This would allow the standard protection desired for a thermally safe entry and protect for deorbit to one of the other CONUS sites should weather make the PLS NO-GO. This deorbit capability must be provided for all the possible days of the mission to allow for an early or delayed landing.

DOCUMENTATION: Orbit Flight Techniques Panel Meeting #78 and Entry Flight Techniques Panel Meeting #40.

Rule {A4-62}, OMS-1/OMS-2 EXECUTION, references this rule.

FLIGHT RULES

A4-104

OMS LEAK/PERIGEE ADJUST

- A. FOR THE CASE OF AN OMS PROPELLANT TANK LEAK, AN OMS BURN TO DEPLETION WILL BE EXECUTED AS FOLLOWS:
1. IF PROPELLANT FROM THE GOOD POD CAN SUPPORT NEXT PLS DEORBIT WITH STEEP TARGETS FROM THE CURRENT ORBIT, THE LEAKING PROPELLANT WILL BE BURNED OUT OF PLANE IMMEDIATELY.
 2. IF PROPELLANT FROM THE GOOD POD CAN SUPPORT AT LEAST ONE CONUS DEORBIT OPPORTUNITY WITH SHALLOW TARGETS BUT NOT WITH STEEP TARGETS FROM THE CURRENT ORBIT, A PERIGEE ADJUST MANEUVER WILL BE PERFORMED IMMEDIATELY IF:
 - a. IT WILL REDUCE THE DEORBIT DELTA V ON THE PRIME AND BACKUP (IF AVAILABLE) DEORBIT OPPORTUNITIES TO THE PLS WITHIN THE NEXT 48 HOURS (MINIMUM OF ONE PLS OPPORTUNITY EACH DAY FOR THE NEXT 2 DAYS), AND
 - b. THE DEORBIT DELTA V AFTER THE PERIGEE ADJUST MANEUVER IS SUPPORTABLE WITH THE NONLEAKING OMS PLUS ARCS ABOVE AFT QUANTITY 1 (NO FRCS).
- OTHERWISE, AN OUT-OF-PLANE MANEUVER WILL BE PERFORMED IMMEDIATELY.
3. IF THE PROPELLANT FROM THE GOOD POD CANNOT SUPPORT AT LEAST ONE CONUS DEORBIT OPPORTUNITY WITH SHALLOW TARGETS FROM THE CURRENT ORBIT, A PERIGEE ADJUST MANEUVER WILL BE PERFORMED IMMEDIATELY WITH THE FOLLOWING EXCEPTION:

IF THE LEAK RATE IS EXTREMELY SLOW AND BOTH THE LEAK RATE AND POD THERMAL ENVIRONMENT ARE STABLE, PERFORM PERIGEE ADJUST AT THE OPTIMUM PERIGEE ADJUST TIG. HOWEVER, ANY INCREASE IN LEAK RATE OR CHANGE IN THERMAL ENVIRONMENT INDICATIVE OF POD FREEZEUP REQUIRES AN IMMEDIATE BURN.
 4. THE PROPELLANT FROM THE GOOD POD INCLUDES OMS FROM THE NON-LEAKING SIDE PLUS ARCS TO OMS TANK FAIL QUANTITY FOR SHALLOW OR AFT QUANTITY 1 FOR STEEP (PROTECTING FOR 48-HOUR ON-ORBIT STAY ON VRCS, ONE DEORBIT PREPARATION, AND TWO 15-SECOND ULLAGE BURNS), PLUS FRCS. FRCS WILL NOT BE CONSIDERED FOR USE DURING THE DEORBIT BURN, BUT MAY BE USED DURING A PERIGEE ADJUST.

THIS RULE CONTINUED ON NEXT PAGE

FLIGHT RULES

A4-104**OMS LEAK/PERIGEE ADJUST (CONTINUED)**

5. FOR THE CASE OF AN OMS PROPELLANT TANK LEAK WITHIN FOUR ORBITS OF DEORBIT, COMPLETION OF THE PERIGEE ADJUST WITH THE FRCS WILL BE AN MCC CALL.
6. FOR THE CASE OF AN OMS PROPELLANT TANK LEAK WITHIN TWO ORBITS OF DEORBIT, IF THE MCC IS UNABLE TO CONFIRM A VALID ONBOARD STATE VECTOR AFTER THE BURN (FROM EITHER IMU DATA OR GPS), DEORBIT WILL BE DELAYED UNTIL THE GROUND TRACKING STATE VECTOR USED FOR THE DEORBIT MANEUVER COMPUTATION INCLUDES AT LEAST ONE REPEAT OF ANY TRACKING STATION. @[072601-4529]
- B. FOR THE CASE OF AN OMS PROPELLANT TANK LEAK DURING THE TIMEFRAME OF A PAYLOAD DEPLOY, THE ACTIONS FOR THE DIFFERENT UPPER STAGES ARE LISTED BELOW:
 1. IUS DEPLOY:
 - a. IF THE LEAK IS DETECTED PRE-UMBILICAL RELEASE, RESTOW AND BURN THE LEAKING SYSTEM TO DEPLETION PRIOR TO CONTINUING DEPLOY OPERATIONS. PARAGRAPH A OF THIS RULE WILL BE USED TO DETERMINE THE REQUIRED BURN. THE DETERMINATION OF SHALLOW DEORBIT CAPABILITY WILL ASSUME THAT THE PAYLOAD WILL BE DEPLOYED PRIOR TO DEORBIT.
 - b. IF THE LEAK IS DETECTED POST-UMBILICAL RELEASE, PERFORM EMERGENCY DEPLOY PROCEDURES UP TO EXECUTING THE MANEUVER TO THE SEPARATION BURN ATTITUDE. THEN:
 - (1) IF THE GOOD SYSTEM WILL SUPPORT DEORBIT TO SHALLOW TARGETS FROM THE POSTDEPLOY/MINIMUM SEPARATION ORBIT, PERFORM MINIMUM SEPARATION ASAP FROM THE LEAKING SYSTEM (SEND MASTER SAFE IF MINIMUM SEPARATION NOT COMPLETED). THEN, BURN LEAKING SYSTEM TO DEPLETION ASAP OUT-OF-PLANE.
 - (2) IF THE GOOD SYSTEM WILL NOT SUPPORT DEORBIT TO SHALLOW TARGETS FROM THE POSTDEPLOY/MINIMUM SEPARATION ORBIT, SEND "MASTER SAFE". THEN PERFORM "RECOVERY FROM MASTER SAFE" THROUGH RCS ENABLE. THEN:

THIS RULE CONTINUED ON NEXT PAGE

FLIGHT RULES

A4-104

OMS LEAK/PERIGEE ADJUST (CONTINUED)

- (a) IF THE LEAK IS EXTREMELY SLOW AND THERE ARE NO POD THERMAL EFFECTS BEING SEEN (BOTH ARE MCC CALLS), REPLACE THE NOMINAL/MINIMUM SEPARATION WITH AN ASAP 2 FPS RETROGRADE MANEUVER. THEN PERFORM PERIGEE ADJUST AT THE OPTIMAL PERIGEE ADJUST TIG.
 - (b) IF THE CREW HAS NO CONTACT WITH MCC, OR IF MCC DETERMINES THE LEAK IS FAST OR POD THERMAL EFFECTS ARE SEEN, PERFORM PERIGEE ADJUST ASAP.
 - (c) ASAP FOLLOWING THE PERIGEE ADJUST (EITHER AT OPTIMAL TIG OR THE ASAP TIG), IF THE PERIGEE ADJUST WAS ≥ 57 FPS, MANEUVER TO IUS VIEWING ATTITUDE AND COMPLETE "RECOVERY FROM MASTER SAFE" PROCEDURE TO RESTART MISSION SEQUENCING. IF IN CONTACT WITH MCC, CONSIDERATION WILL BE GIVEN TO LOWERING PERIGEE BELOW 95 NM (90 NM MINIMUM) TO OBTAIN 57 FPS FROM THE LEAKING POD.
 - (d) IF PERIGEE ADJUST DELTA V IS < 57 FPS, MASTER SAFE RECOVERY WILL ONLY BE ON MCC CALL.
2. PAM-D, PAM-D2, OR FRISBEE DEPLOY:
- a. IF THE LEAK IS DETECTED PREDEPLOY, ABORT THE DEPLOY AND PERFORM OMS BURN TO DEPLETION. PARAGRAPH A WILL BE USED TO DETERMINE THE REQUIRED BURN. THE DETERMINATION OF SHALLOW DEORBIT CAPABILITY WILL ASSUME THE PAYLOAD WILL BE DEPLOYED PRIOR TO DEORBIT.

THIS RULE CONTINUED ON NEXT PAGE

FLIGHT RULES

A4-104

OMS LEAK/PERIGEE ADJUST (CONTINUED)

- b. IF THE LEAK IS DETECTED POSTDEPLOY, BURN THE LEAKING OMS PROPELLANT ACCORDING TO THE FOLLOWING GUIDELINES. PARAGRAPH A WILL BE USED TO DETERMINE THE REQUIRED BURN. IF THE LEAKING OMS IS TO BE BURNED OUT OF PLANE, PERFORM A MINIMUM SEPARATION MANEUVER ASAP AFTER DEPLOY, THEN PROCEED TO BURN THE LEAKING PROPELLANT OUT OF PLANE IMMEDIATELY. IF THE LEAK RATE IS FAST AND THE LEAKING OMS PROPELLANT IS TO BE BURNED RETROGRADE, TIG CAN BE NO EARLIER THAN DEPLOY PLUS 15 MINUTES AND A MINIMUM DELTA V OF 18 FPS IS REQUIRED. CONSIDERATION WILL BE GIVEN TO LOWERING PERIGEE BELOW 95 NM (90 NM MINIMUM) TO OBTAIN 18 FPS. IF THE LEAK RATE IS EXTREMELY SLOW AND THE GOOD POD CANNOT SUPPORT ANY CONUS DEORBIT TO SHALLOW TARGETS, THE FOLLOWING ACTIONS WILL BE PERFORMED:
- (1) FOR ASCENDING NODE DEPLOYMENTS, REPLACE SEPARATION MANEUVER WITH A MINIMUM SEPARATION MANEUVER, GO TO WINDOW PROTECTION ATTITUDE (WPA), AND THEN BURN RETROGRADE AT THE NEXT OPTIMUM PERIGEE ADJUST TIG.
 - (2) FOR DESCENDING NODE DEPLOYMENTS, REPLACE SEPARATION MANEUVER WITH A PERIGEE ADJUST MANEUVER AT THE NEXT OPTIMUM PERIGEE ADJUST TIG (18 FPS MINIMUM).

3. RMS DEPLOY: TBD

The basic philosophy that is reflected in these rules is that the safety of the orbiter and the crew are first priority. Since the leak rate and thermal effects of an OMS propellant tank leak cannot be reliably predicted, the leaking propellant must be dumped ASAP. Reliable leak rates cannot be predicted because of the inability to determine or predict whether helium and/or propellant is leaking from the tank. In addition, if the propellant tank pressure decays to below the tank fail limit (fuel = 216 psia, oxidizer = 151 psia), there is no guarantee (regardless of the leak rate) that the tank can be repressurized to above these limits. If the repressurization does not work, the tank is considered failed and is unusable for the perigee adjust. Since thermal effects of a leak cannot be predicted, the propellant must be dumped to prevent the pod from the possibility of freezing, thus rendering both the OMS and RCS systems unusable. The rate of propellant sublimation varies as a function of which propellant is leaking, the location of the leak, the distribution of the propellant within the pod, and the thermal environment. As a result, the sublimation rate cannot be reliably predicted. Therefore, if the pod were to freeze there is no way to determine when the RCS will be available for entry.

THIS RULE CONTINUED ON NEXT PAGE

FLIGHT RULES

A4-104**OMS LEAK/PERIGEE ADJUST (CONTINUED)**

The determination of steep capability includes OMS from the nonleaking side, FRCS, and ARCS to AFT quantity 1. Flight Rule {A2-108}, CONSUMABLES MANAGEMENT, indicates that deorbit will be shallowed to protect entry usage. Therefore, for steep capability to exist, the full entry usage must be protected. For determination of shallow deorbit capability, the ARCS may be used to the OMS tank fail quantity. OMS tank fail quantity does not protect the total entry requirements. However, this propellant will be used to achieve a shallow deorbit to CONUS, if required.

If the good pod can support deorbit to a CONUS site using steep targets, the leaking OMS should always be burned out of plane (OOP) regardless of the leak rate as soon as possible. This will result in having many CONUS deorbit opportunities available that can be supported (to steep targets) with the remaining propellant after the leaking OMS burn.

The delta V of the perigee adjust maneuver is intended to obtain $H_p = 95$ nm and to reduce the propellant to the point where leakage into the pod will be minimized. This technique will usually result in one of two cases: (a) propellant not depleted at targeted H_p or (b) depletion of propellant and engine cutoff before reaching 95 nm. If the fuel is depleted before the perigee reaches 95 nm, the FRCS may be used to attempt to achieve the target perigee altitude at a later time.

If fuel remains after reaching the 95 nm target, an out-of-plane burn will be performed to reduce the propellant to the minimum safe quantity.

If the propellant available in the "good pod" can support a PLS deorbit with shallow targets but not steep targets, the leaking propellant may be burned either out-of-plane or retrograde. An out-of-plane burn everywhere in the orbit would guarantee at least shallow deorbit capability to the PLS. However, if the perigee adjust is performed in the right portion of the orbit, the deorbit delta V can be decreased. This would then allow a steeper than a shallow entry.

Therefore, a retrograde window is computed by determining where a perigee adjust will decrease the deorbit delta V to the PLS on the prime and backup opportunities. This window is also constrained by the amount of propellant available in the nonleaking OMS and the ARCS above AFT quantity 1 which will be used to support the deorbit. FRCS is not included in determining the window because it would require the use of a "fast flip" during the deorbit burn which is highly undesirable. The inverse of the retrograde window, the OOP TIG window, is what is actually provided to the crew on the trajectory message. If the "good pod" can support shallow but not steep deorbit and TIG for the leaking OMS burn is in the OOP TIG window, the crew will burn out-of-plane.

For high altitude flights, all the OMS on the leaking side may not be enough to get perigee down to 95 nm. In these cases, the maximum delta V available from the OMS will be used to lower perigee as much as possible and this value will be used in determining the OOP TIG window.

THIS RULE CONTINUED ON NEXT PAGE

FLIGHT RULES

A4-104

OMS LEAK/PERIGEE ADJUST (CONTINUED)

However, if shallow deorbit capability does not exist from the good OMS pod, it is imperative that a perigee adjust be performed from the leaking pod. The perigee adjust burn must be performed immediately in order to guarantee deorbit with one exception: If the leak rate is "slow" enough to guarantee supporting the optimum perigee adjust opportunity, and the pod thermal environment will also support, the burn will be performed at the optimum point to enhance CONUS landing capability. For this case, a maneuver to an LVLH retrograde burn attitude will be performed immediately and maintained. If there is any uncertainty in the leak rate computations or pod thermal environment will not support the opportunity, the perigee adjust will be performed immediately in order to guarantee deorbit to a landing site. Any leaks detected by the crew through the FDA is considered a fast leak. It is possible that the only deorbit capability available after the perigee adjust is performed is to a southern hemisphere ELS. The crew will be informed whether shallow deorbit capability currently exists.

The ground will also send up the delta times from the ascending node for the opening and the closing of the OOP TIG window. The crew will use this information for the case of an OMS leak while out of communications coverage with the ground. If the TIG is inside the OOP TIG window, the crew will execute the OMS burn out of plane. Otherwise, the OMS burn will be a perigee adjust maneuver. If the OMS burn is performed out of plane, the FRCS may be burned retrograde at the optimum perigee adjust TIG on a later orbit.

If the engine cutoff occurs before the desired perigee, it may or may not be desirable to complete the burn with the FRCS if deorbit will occur within the next four orbits. This is dependent upon the position in the orbit where the perigee adjust is executed. If perigee is in the wrong place in the orbit, completing the burn with the FRCS may actually increase the deorbit delta V . However, if the perigee adjust is executed near the optimum TIG, it will be better to complete in order to lower the deorbit delta V . The FDO will have to determine in real time whether completion on the FRCS is required.

If the orbiter state is well known at the perigee adjust maneuver, the onboard guidance and navigation will properly model the maneuver with sensed velocity changes from the IMU's. A confirmation of the maneuver will be performed by the MCC. In this case, onboard GNC is believed to be good and one orbit of tracking is not required to obtain a state vector for the deorbit maneuver computation. @[072601-4529]

GPS provides an accurate state vector shortly after an orbit adjust maneuver as long as it is verified to be functioning properly (no hardware problems or comm faults, low FOM, tracking 4 satellites). Caution should be taken when using GPS state vectors with FOM's >5 (650 feet position error one sigma) since the estimated position error increases rapidly with higher FOM values. Possible deorbit delays due to ground navigation requirements can be avoided by using GPS for the post-burn state vector confirmation and deorbit maneuver computation. @[072601-4529]

Experience has shown that one orbit of tracking data will provide a state vector of sufficient quality upon which to compute a deorbit maneuver. Therefore, if after completion of the perigee adjust burn insufficient time is available to obtain the necessary tracking, the deorbit maneuver will be slipped to provide enough time to obtain the vector.

THIS RULE CONTINUED ON NEXT PAGE

FLIGHT RULES

A4-104

OMS LEAK/PERIGEE ADJUST (CONTINUED)

For the case of an OMS leak during the timeframe of a deploy, the most expedient means of dumping the leaking propellant will be executed. With a deployed payload, concern is not only with the actual perigee adjust maneuver and the resulting deorbit considerations, but must also take into consideration the separation dynamics between the payload and the orbiter. When possible, restowing or aborting the deploy eliminates having to solve critical problems simultaneously. Therefore, the procedures have been written to use the most conservative approach in all cases to optimize the chances of getting the orbiter ready to perform the OMS burn ASAP. For the cases where the deploy is aborted, the same logic discussed above will be used in determining whether to burn out of plane retrograde. The reason for assuming the payload will be deployed prior to deorbit is that it is not justified to protect for multiple payload failures that will not allow for deployment or jettison while working an OMS leak. Also, the delta V available increases due to decreased orbiter weight. This serves to increase the chance that shallow deorbit capability will exist from the current orbit and not force a retrograde burn. A retrograde burn performed in the wrong phase in the orbit could force a southern hemisphere landing. This maximizes the chance for a deorbit to a CONUS site. For the cases where the payload is ready for deploy, it was determined that it is best to proceed with the deploy in order to decrease the orbiter weight and therefore increase the efficiency of the remaining propellant.

*For the IUS cases, once the payload is elevated at 29 degrees, restowing the IUS uses functions that have just been verified to operate while deploy requires the additional use of umbilical release and SUPER*ZIP functions. Once the umbilicals have been released, however, it is best to proceed with the deploy since the payload is almost ready for deploy. Performing the perigee adjust postdeploy places the orbiter in front of and below the IUS at SRM-1 TIG. A minimum of 57 fps is required from the perigee adjust in order to ensure orbiter safety. This minimum delta V would ensure a closest-point-of-approach (CPA) distance of no less than 30 nm between the orbiter and the IUS post-SRM-1. This assumes a worst case pointing error at SRM-1 of 1.8 degrees for the IUS. Failure to obtain the minimum delta V would place the orbiter closer than 30 nm to the IUS at CPA and would require the IUS to be master safed.*

When an OMS leak is detected postdeploy for a spin-stabilized deployable (PAM-D, PAM-D2, and Frisbee), separation dynamics must be considered. If the leaking OMS is to be burned out of plane, performing a minimum separation burn (posigrade) ASAP after the deploy will provide acceptable separation dynamics. The leaking OMS can then be burned out of plane with no consequences. If the leaking OMS is to be burned retrograde, separation dynamics dictate that a retrograde burn not be performed prior to deploy plus 15 minutes. If the leak rate is fast, the separation burn is replaced with a perigee adjust burn of at least 18 fps (to protect for the 10X tile erosion limit) at the nominal separation TIG. If the leak rate is extremely slow, the perigee adjust should be burned at the optimum TIG to enhance the CONUS landing capability. For a descending deploy, this can be accomplished by replacing the nominal separation burn with a perigee adjust (18 fps minimum) at the optimum TIG. For an ascending deploy, the optimum perigee adjust TIG is after PKM ignition. Therefore, a minimum separation burn must be performed at the nominal separation TIG to protect for the 10X tile erosion limit, and a perigee adjust can be performed at the next optimum perigee adjust TIG.

THIS RULE CONTINUED ON NEXT PAGE

FLIGHT RULES

A4-104

OMS LEAK/PERIGEE ADJUST (CONTINUED)

If executing the perigee adjust after a deploy requires less than the above stated minimum delta V's to reach 95 nm, consideration will be given in real time to taking perigee as low as 90 nm using delta V from the leaking pod in order to achieve the minimum delta V. This consideration will protect for 48-hour orbit lifetime from the resulting orbit and will not normally be exercised if it jeopardizes the ability to deorbit to a CONUS site by increasing the required deorbit delta V.

Rules {A6-51P}, OMS FAILURE MANAGEMENT [CIL], and {A6-305}, AFT RCS REDLINES [HC], reference this rule. ©[042706-7370D]

A4-105

MINIMUM TIME OF FREE FALL

TIME BETWEEN DEORBIT MANEUVER CUTOFF AND 400K FEET MUST BE \geq 9 MINUTES.

The minimum time required for execution of the checklist procedures between deorbit burn cutoff and EI is 9 minutes. These procedures include maneuvering to the EI minus 5 minute attitude, powering down the OMS gimbals, executing the FRCS dump (when required), verifying switch positions, and starting the remaining APU's.

FLIGHT RULES

A4-106

DEBRIS AVOIDANCE CRITERIA FOR PREDICTED
CONJUNCTIONS [HC] @[070899-6888A] @[022201-3911A]

A. A DEBRIS AVOIDANCE MANEUVER MAY BE PERFORMED IF THE RISK OF COLLISION IS GREATER THAN THE OPERATIONAL IMPACT OF PERFORMING THE MANEUVER. THE CRITERIA FOR DETERMINING THE RELATIVE RISK OF COLLISION VERSUS THE OPERATIONAL IMPACT OF THE MANEUVER IS OUTLINED BELOW:

1. YELLOW THRESHOLD

FOR A PROBABILITY OF COLLISION (P_c) GREATER THAN 10^{-5} BUT LESS THAN 10^{-4} :

A MANEUVER WILL BE PERFORMED UNLESS IT RESULTS IN MORE THAN MINIMAL IMPACTS TO OPERATIONS OR MISSION OBJECTIVES. THE REQUIREMENT FOR THE MANEUVER WILL BE BASED ON THE PROBABILITY OF COLLISION VS THE IMPACT OF THE MANEUVER.

IF COVARIANCE DATA IS UNAVAILABLE, THE YELLOW THRESHOLD WILL BE BASED ON A PREDICTED MISS DISTANCE BETWEEN ± 1 KM X ± 7 KM X ± 7 KM (± 0.5 NM X ± 3.8 NM X ± 3.8 NM) AND ± 0.5 KM X ± 4 KM X ± 4 KM (± 0.3 NM X ± 2.2 NM X ± 2.2 NM) (DEFINED IN UVW COORDINATES RELATIVE TO THE SHUTTLE AS RADIAL X ALONG-TRACK X OUT-OF-PLANE).

2. RED THRESHOLD

FOR A PROBABILITY OF COLLISION GREATER THAN 10^{-4} :

A MANEUVER WILL BE PERFORMED UNLESS IT RESULTS IN SHUTTLE REFLIGHT, VEHICLE HARDWARE DAMAGE, ADDITIONAL EVA, OR CREATES ADDITIONAL RISK FOR THE CURRENT OR FUTURE CREW OR VEHICLE. THE REQUIREMENT FOR THE MANEUVER WILL BE BASED ON PROBABILITY OF COLLISION VS THE IMPACT OF THE MANEUVER. @[070899-6888A] @[022201-3911A]

THIS RULE CONTINUED ON NEXT PAGE

FLIGHT RULES

A4-106

DEBRIS AVOIDANCE CRITERIA FOR PREDICTED CONJUNCTIONS [HC] (CONTINUED)

IF COVARIANCE DATA IS UNAVAILABLE, THE RED THRESHOLD WILL BE BASED ON A PREDICTED MISS DISTANCE LESS THAN ± 0.5 KM X ± 4 KM X ± 4 KM (± 0.3 NM X ± 2.2 NM X ± 2.2 NM) (DEFINED IN UVW COORDINATES RELATIVE TO THE SHUTTLE AS RADIAL X ALONG-TRACK X OUT-OF-PLANE) . ©[022201-3911A]

USSPACECOM predicts close conjunctions between the shuttle and any other orbiting object that can be tracked and periodically transfers state vector and at-conjunction object position covariance matrices to JSC for those conjunctions within an "alert box" defined by a 2 km radial distance from the shuttle, 25 km along track, and 25 km out-of-plane. JSC uses this data along with the shuttle covariance and state vector to compute the probability of collision (Pc). ©[070899-6888A]

A Pc between 10^{-5} and 10^{-4} is considered high enough commensurate with other program risks that a maneuver will be performed unless the operational and mission impacts are more than minimal. Examples of minimal operations impacts include but are not limited to:

- a. Minor consumables usage*
- b. Minor rearrangement of the timeline*
- c. Interruption of pre- or post-sleep*

A Pc greater than 10^{-4} is considered high enough that a maneuver should be performed unless it would result in the loss of high priority objectives, which have reflight implications, or increase the overall risk to the current or future crew or vehicle. Examples of potential risk increases, which should be considered, include but are not limited to: ©[022201-3911A]

- a. Loss of high priority objectives as defined in the flight specific flight rules annex which may have reflight implications*
- b. Vehicle hardware damage or damage to payloads that may require reflight*
- c. Additional EVA*
- d. Critical consumables usage*
- e. Interruption of crew sleep prior to EVA, RNDZ, entry or other critical activity ©[070899-6888A]*

THIS RULE CONTINUED ON NEXT PAGE

FLIGHT RULES

A4-106

DEBRIS AVOIDANCE CRITERIA FOR PREDICTED CONJUNCTIONS [HC] (CONTINUED)

Note that because collision avoidance maneuvers are small in magnitude, typically 1 or 2 m/sec, such a maneuver can normally be included in the plan without causing loss of primary objectives, hardware damage, additional EVA, or excessive use of consumables. For those rare instances where a maneuver cannot be performed without significant impact, the flight control team must trade those operational impacts of the maneuver versus the estimated risk of collision. Note that the Pc may be high enough that a maneuver will be performed even when there are operational impacts, if the risk of collision is deemed higher than the risk associated with the operational impact. This means that an EVA could be terminated early, consumables margins may be used, or crewmembers awakened if the risk of collision warrants these operational impacts. ©[070899-6888A] ©[022201-3911A]

If covariance data is unavailable, the red and yellow thresholds will be based on predicted miss distance. For a predicted miss distance of 1 km x 7 km x 7 km, the risk of collision is commensurate to the yellow threshold. For a predicted miss distance of 0.5 km x 4 km x 4 km, the risk of collision is commensurate to the red threshold. When using miss distance as the collision avoidance criteria, the flight control team will consider trends in miss distances, shuttle state vector updates, and object state vector updates to qualitatively assess the uncertainty in the miss distances at the time of the conjunction. The requirement for a maneuver will be based on the magnitude of and confidence in the predicted miss distances compared to the estimated risk associated with the operational impact of the maneuver.

- B. IF A DEBRIS AVOIDANCE MANEUVER IS PERFORMED, THE RESULTANT PROBABILITY OF COLLISION WITH THE DEBRIS OBJECT BEING AVOIDED WILL BE LESS THAN 10^{-7} . IF COVARIANCE DATA IS UNAVAILABLE, THE DEBRIS AVOIDANCE MANEUVER WILL ENSURE THAT THE MISS DISTANCE WITH THE DEBRIS OBJECT LIES OUTSIDE OF THE YELLOW THRESHOLD MANEUVER BOX.

Performing a debris avoidance maneuver can be a significant impact to operations; therefore, when one must be executed, there should be a sufficient assurance that another will not be necessary immediately afterward. When calculating the post-debris-avoidance-maneuver probability of collision with the debris object, only the change in miss distance should be incorporated. The increase in shuttle uncertainty due solely to the debris avoidance maneuver should not be included in the calculation. If the change in uncertainty due solely to the debris avoidance maneuver is included in the post maneuver calculation, it is possible that a debris avoidance maneuver could be accomplished which does not sufficiently increase the miss distance with the debris object even though the probability of collision is less than 10^{-7} .

The collision avoidance maneuver may be performed even if it introduces a future conjunction with another object. A future conjunction, although undesirable, does not diminish the need to avoid the present conjunction. ©[022201-3911A]

FLIGHT RULES

A4-107

PLS/EOM LANDING OPPORTUNITY REQUIREMENTS [HC] @[121604-6503B]

A. ALL OF THE FOLLOWING CRITERIA ARE REQUIRED FOR A PLS (OTHER THAN FIRST DAY PLS, REF. RULE {A2-1F}, PRELAUNCH GO/NO-GO REQUIREMENTS [HC]) MDF, OR EOM LANDING OPPORTUNITY (NOT IN PRIORITY ORDER): @[ED]

1. NASA CONUS SITE: KSC, EDW, NOR. FOR NO-COMM PLS PLANNING, EDW IS PREFERRED.

Only the three prime NASA CONUS sites should be considered for PLS or EOM. The daily PLS planning results in a crew message for no-comm execution if total communications are lost; ref. Rule {A11-52}, LOSS OF BOTH VOICE AND COMMAND. In the case of other problems, ground evaluation of the landing site can be made very shortly before deorbit burn. However, for the no-comm case, the crew may be required to execute a deorbit to a site that was picked many hours previously. Since EDW weather is in general much more stable than KSC and additional lateral and longitudinal margins are available in the case of poor navigation (likely for a no-comm entry) or other orbiter systems problems, EDW is the preferred no-comm PLS site when all other considerations are equal. @[ED]

2. WIND AND WEATHER CONDITIONS (REF. RULE {A2-6}, LANDING SITE WEATHER CRITERIA [HC]) @[120894-1622B]

3. ACCEPTABLE ENTRY ANALYSIS INCLUDING:

NOTE: ENTRY ANALYSIS IS NOT PERFORMED FOR DAILY NO-COMM PLS SELECTION.

- a. APPROACH AND LAND TRANSITION (REF. RULE {A4-156}, HAC SELECTION CRITERIA).
- b. NORMALIZED TOUCHDOWN DISTANCE (REF. RULE {A4-110}, AIMPOINT, EVALUATION VELOCITY, AND SHORT FIELD SELECTION). @[072795-1788A]
- c. MAXIMUM TIRE SPEED, ROLLOUT MARGIN, AND BRAKE ENERGY CONSTRAINTS (REF. RULE {A4-108}, TIRE SPEED, BRAKING, AND ROLLOUT REQUIREMENTS [HC]). @[042706-7363A]

THIS RULE CONTINUED ON NEXT PAGE

FLIGHT RULES

A4-107

PLS/EOM LANDING OPPORTUNITY REQUIREMENTS [HC]
(CONTINUED)

- d. NZ AND Q-BAR CONSTRAINTS (REF. RULE {A4-207}, ENTRY LIMITS) . @[072795-1788A]

Rule {A4-112}, LOWER LEVEL MEASURED WIND AND ATMOSPHERIC DATA, requires accurate lower level atmospheric data that is used for analysis of the entry trajectory to ensure safety. The main gear tires are certified to 225 knots groundspeed. This constraint may limit the allowable tailwind based on the predicted EAS and density altitude. Violation of brake energy and rollout constraints may result, in dispersed cases, in runway departure or excessive braking requirements that could lead to tire fires. Rule {A2-6A}, LANDING SITE WEATHER CRITERIA [HC], references this rule. Since the no-comm PLS landing would be executed many hours after the site had been selected, entry analysis using environmental observations are not relevant and therefore will not be performed. @[071494-1621A] @[120894-1622B] @[ED]

4. ENTRY CROSSRANGE LESS THAN DISPERSED OR THE THERMAL CROSSRANGE LIMIT, WHICHEVER IS MORE CONSTRAINING.

The dispersed crossrange limit represents the vehicle capability to converge to nominal conditions by TAEM interface (Mach 2.5) assuming 3-sigma combinations of navigation, atmosphere, energy, and winds. All planned and acceptable entries must have a crossrange which is less than the dispersed crossrange limit. Landing sites with crossrange between the dispersed and undispersed limits should not be considered. (Ref. the Annex Flight Rule, TRAJECTORY AND GUIDANCE PARAMETERS.) @[ED]

The flight specific thermal crossrange limit protects the upper surface thermal constraints for high crossrange entries. During high crossrange entries, the orbiter maintains a roll angle for a long period of time to reduce crossrange prior to the first roll reversal. Heading rates incurred by non-zero roll attitudes will be sensed by the FCS pitch rate gyros as small positive pitch rates. As a result, the FCS will maintain an angle of attack somewhat less than that desired as it attempts to compensate for this pseudo pitch rate. This results in increased heating to the upper surface, which may result in excessive structural temperatures. The actual thermal crossrange limit is flight specific. (Ref. the Annex Flight Rule, TRAJECTORY AND GUIDANCE PARAMETERS.) @[071494-1621A] @[ED]

5. SUFFICIENT GROUND EQUIPMENT SUPPORT INCLUDING REDUNDANCY MUST BE PROVIDED TO SATISFY A/G VOICE, TELEMETRY, TRACKING, AND COMMAND REQUIREMENTS AND FULL REDUNDANCY TO NAVIGATION AIDS AS SPECIFIED IN SECTION 3. NOTE: TRACKING SUPPORT IS NOT SCHEDULED FOR THE DAILY PLS OPPORTUNITY. IF A PLS IS REQUIRED, TRACKING SUPPORT WILL BE ON A "BEST EFFORT" BASIS.

THIS RULE CONTINUED ON NEXT PAGE

FLIGHT RULES

A4-107

PLS/EOM LANDING OPPORTUNITY REQUIREMENTS [HC] (CONTINUED)

6. DAYLIGHT LANDING (SUNRISE MINUS 15 MINUTES TO SUNSET PLUS 15 MINUTES) UNLESS THE CREW IS SPECIFICALLY TRAINED FOR NIGHT LANDING.

All crews receive pilot pool training for night landing, and an emergency landing at an augmented landing site is reasonably assured of success. However, unless the crew is specifically trained for night landing, the additional risk should be avoided.

7. CREW SCHEDULING CONSTRAINTS MUST BE MET FOR PLS PLANNING, AT LEAST 7 HOURS BUT NOT GREATER THAN 16 HOURS, BETWEEN THE SCHEDULED WAKE-UP AND LANDING TIME FOR BOTH SHIFTS IF THE FLIGHT IS DUAL SHIFT. FOR DAILY PLS SELECTION, THE CONSTRAINT MAY BE RELAXED TO AT LEAST 5 HOURS BETWEEN SCHEDULED WAKEUP (CDR AND PLT ONLY) AND LANDING TIME IF THIS GIVES A BACKUP (ONE ORBIT LATE) OPPORTUNITY.

The Crew Scheduling Constraints Document (Appendix K of the Space Shuttle Crew Procedures Management Plan) contains the 7 to 16 hour wakeup-to-landing workday limit. That same document also gives limits to shifting crew sleep times. For next PLS situations, a backup opportunity is important since the use of the PLS will be driven by a systems failure that dictates coming out of orbit that day. Therefore, the orbit late increases the probability of landing on that day, allowing a wave-off for further systems anomalies, vehicle configuration, or weather violations. The minimum of 5 hours between scheduled wakeup and landing ensures the full deorbit preparation timeline (4 hours) plus the additional hour between deorbit and landing. Other activities, such as cabin stowage and postsleep would have to overlap with the deorbit preparation or be provided by a shift in the crew sleep period.

- B. RULE {A2-207}, LANDING SITE SELECTION, WILL BE USED TO CHOOSE BETWEEN SITES THAT MEET ALL REQUIREMENTS IN PART A. THE FOLLOWING ADDITIONAL CRITERIA LISTED BELOW, IN ORDER OF PRIORITY, WILL BE USED TO FURTHER CHOOSE BETWEEN LANDING SITES/OPPORTUNITIES:

1. BACKUP (ONE ORBIT LATE) OPPORTUNITY TO ANY CONUS SITE.

A one-orbit late landing opportunity to any of the three CONUS landing sites is particularly important in determining the daily PLS site since next PLS rules are driven by orbiter system failures that dictate coming out of orbit that day.

2. BACKUP OPPORTUNITY TO THE PLS.

A backup opportunity to the PLS is desirable since all of the ground facilities and team are on station and prepared for the landing and the higher priority site would be achieved in the event of a wave-off for one orbit.

THIS RULE CONTINUED ON NEXT PAGE

FLIGHT RULES

A4-107

PLS/EOM LANDING OPPORTUNITY REQUIREMENTS [HC] (CONTINUED)

3. POSTLANDING OPERATIONS.

If all of the above criteria are met at more than one site, the site will be selected based on the post-landing convoy, payloads, and vehicle turnaround support. Also note that many orbiter malfunctions in entry critical systems have specific landing site requirements and this may drive the landing selection at a higher priority than this rule.

4. ENTRY CROSSRANGE < DTO CROSSRANGE LIMIT.

On flights which have entry aerodynamic DTO's/PTI's manifested, the site or opportunity that will allow these tests to be performed is desired. The DTO crossrange is more constraining than the dispersed crossrange limit in an attempt to account for the dispersion imposed on the crossrange due to guidance lockout during the execution of the PTI's. The DTO crossrange limit is last on the priority list due to the maturity of the aerodynamic data base resulting from a long history of successful entry DTO flights. Reference the Annex Flight Rule, TRAJECTORY AND GUIDANCE PARAMETERS, for the limit.

Ⓜ[ED]

Rule {A2-6}, LANDING SITE WEATHER CRITERIA [HC], references this rule. Ⓜ[120894-1622B]

C. FOR DAILY PLS FOR NO-COMM DEORBIT PLANNING, TO MAINTAIN A CONUS LANDING SITE, CONSIDERATION MAY BE GIVEN TO THE FOLLOWING: RELAXATION OF WEATHER CRITERIA TO ACLS CONDITIONS (REF. RULE {A2-6}, LANDING SITE WEATHER CRITERIA [HC]), REASONABLE MODIFICATIONS TO CREW SCHEDULING CONSTRAINTS, NIGHT LANDING, AND SMALL VIOLATIONS OF DISPERSED CROSSRANGE. Ⓜ[120894-1622B]

Relaxation to ACLS weather conditions, small variances to crew sleep scheduling, acceptance of night landing, and small exceedances of dispersed crossrange may be allowed to pick a CONUS site for the no-comm next PLS opportunity. Since the weather forecasts are for several hours in the future, there is the opportunity for improvement. Landing at one of the CONUS sites (ref. Rule {A2-207}, LANDING SITE SELECTION) generally provides communications, command, tracking, landing aids, and ground site support. Also, facilities are available to mate the orbiter to the SCA, thereby minimizing any vehicle turnaround and scheduling impacts. Additionally, CONUS landings avoid the political and logistical ramifications of landing in a foreign country. Somewhat degraded conditions are acceptable for daily PLS planning rather than picking a non-CONUS site. Ⓜ[121604-6503B]

Reference Hazard Controls ORBI-021 "Loss of Vehicle Control Due to Failure Due to MLG/NLG Tire/Wheel Assembly(s)," ORBI-030 "Potential Loss of Orbiter Caused by Vehicle Handling Qualities," ORBI-211 "Landings Which Exceed Design Limits Can Result in Loss of Crew and Vehicle," ORBI-333 "Sequential Control Unit (SCU) MDM Halts Due to Lightning Upset May Cause Loss of Critical MDM Control Functions," and ORBI-337 "Thermal Protection System (TPS) Damage Due to Lightning Strike." Ⓜ[121604-6503B]

FLIGHT RULES**A4-108****TIRE SPEED, BRAKING, AND ROLLOUT REQUIREMENTS [HC]**

@[042706-7363A]

TIRE SPEED, BRAKE ENERGY, AND ROLLOUT MARGIN CONSTRAINTS ARE DEFINED AS FOLLOWS: @[072795-1788B]

Rollout margin and brake energy limits are identified in order to ensure that the orbiter can stop within the runway limitations. The touchdown tire speed limit, in combination with the crosswind limits (ref. Rule {A2-6}, LANDING SITE WEATHER CRITERIA [HC]), provides protection against tire failure during touchdown and rollout. Rollout margin is meant to account for the environmental and procedural variations that can directly impact the vehicle stopping distance. Brake energy limits protect the capability of the brakes to stop the orbiter (ref. Entry FTP Meeting #35, September 11, 1987).

@[072795-1788B]

A. CALCULATION ASSUMPTIONS:

1. THE PREDICTED TOUCHDOWN TIRE SPEED IS COMPUTED AT THE EVALUATION TOUCHDOWN EAS. @[072795-1788B]
2. DRAG CHUTE IS NOT CONSIDERED. @[050495-1745D]
3. DEROTATION IS ASSUMED AT 180 KEAS AT 2.2 DEGREES/SEC, REF RULE {A2-206}, DEROTATION SPEED [HC]. @[050495-1745D]
4. BRAKING INITIATION IS AFTER MIDFIELD AT 140 KGS OR AT 5000 FEET REMAINING, WHICHEVER IS FIRST, AT A MAXIMUM DECELERATION OF 9 FT/SEC/SEC. THE FOLLOWING EXCEPTIONS ARE ALLOWED:
 - a. IF BRAKE ENERGY IS VIOLATED, IT IS ACCEPTABLE TO DELAY BRAKE APPLICATION TO 120 KGS AS LONG AS ROLLOUT MARGIN ALLOWS AND BRAKE APPLICATION IS NOT DELAYED PAST 5000 FT REMAINING. THIS IS PREFERRED OVER RUNWAY REDESIGNATION.
 - b. IF ROLLOUT MARGIN IS VIOLATED, IT IS ACCEPTABLE TO BEGIN BRAKE APPLICATION AS SOON AS NOSE GEAR TOUCHDOWN OCCURS BUT NOT EARLIER THAN 225 KGS, AND AS LONG AS BRAKE ENERGY IS NOT VIOLATED. @[050495-1745D]

- B. TIRE SPEED - PREDICTED GROUND SPEED NOT TO EXCEED 214 KGS AT THE EVALUATION TOUCHDOWN EAS. (REF RULE {A4-110}, AIMPOINT, EVALUATION VELOCITY, AND SHORT FIELD SELECTION). @[072795-1788B]

THIS RULE CONTINUED ON NEXT PAGE

FLIGHT RULES

A4-108

TIRE SPEED, BRAKING, AND ROLLOUT REQUIREMENTS [HC] (CONTINUED)

The Improved Main Landing Gear (IMLG) tire is designed and certified to handle a peak vertical tire load of 171 klbs and maximum touchdown groundspeed of 250 kts in a crosswind up to 20 kts. The 250 kts groundspeed certification limit provides 36 kts of margin above the operational groundspeed limit of 214 kts, which equates to 3 sigma protection. The 3 sigma protection is computed from the RSS of 3 sigma dispersions in air data (10 kts), surface wind (8 kts), atmosphere (3 kts), and piloting (31 kts) (ref. A/EFTP #216, December 16, 2005). For predicted touchdown groundspeed greater than 214 kts, the targeted runway is NO-GO for landing. In this case, short field speedbrake may be used to reduce groundspeed by 10 kts and potentially recover acceptable touchdown conditions. However, selecting short field speedbrake to avoid touchdown groundspeed violations comes at the expense of reducing tailscrape margin (ref. A/EFTP #121, January 9, 1995). ©[042706-7363A]

For touchdown near the certification groundspeed limit of 250 kts, the IMLG tire is expected to handle the landing and rollout loads but suffer severe outer tread damage. Dynamometer testing at Wright Patterson AFB showed that under worst-on-worst conditions (172 klbs max load profile, 250 kts touchdown groundspeed, 20 kts crosswind, and 110 degrees ambient temperature), significant tread loss occurs, but the tire carcass continues to maintain its structural integrity and pressure throughout the touchdown, derotation, and rollout. ©[072795-1788B] ©[042706-7363A]

C. BRAKE ENERGY - ALL CASES MUST MEET THE BRAKE ENERGY LIMITS BELOW (WORST BRAKE) : ©[072795-1788B]

NOTE: FOR APPLICATION OF THIS RULE, ABORTS INCLUDE RTLS, TAL, AND AOA. ©[050496-1774A] ©[050495-1745D]

1. OPERATIONAL NWS - BOTH CONSTRAINTS BELOW MUST BE SATISFIED:
 - a. 42M FT-LB WITH NWS (82M FT-LB FOR ABORTS) .
 - b. 70M FT-LBS WITHOUT NWS (ASSUMING DIFFERENTIAL BRAKING) ON AT LEAST ONE "GO" RUNWAY AT THE LANDING SITE (82M FT-LB FOR ABORTS) .
2. TOTAL FAILURE OF NWS:
 - a. IF PRE-DEORBIT - 42M FT-LB ASSUMING DIFFERENTIAL BRAKING.
 - b. IF POST-COMMIT TO DEORBIT AND EXPECTED BRAKE ENERGY PREDICTED TO EXCEED 42M FT-LB, THEN RUNWAY REDESIGNATION (SAME COMPLEX) WILL BE CONSIDERED PRIOR TO MACH 6 IN ORDER TO REDUCE THE CROSSWIND.

THIS RULE CONTINUED ON NEXT PAGE

FLIGHT RULES

A4-108

TIRE SPEED, BRAKING, AND ROLLOUT REQUIREMENTS [HC] (CONTINUED)

To be conservative, the drag chute shall not be used in the brake energy calculations. ©[050495-1745D]
©[121902-5802A]

Flight experience shows a potential of about 5 KEAS delay on the initiation of derotation from the desired speed of 185 KEAS using beep trim. Derotation initiation is assumed to be 180 KEAS. Desired commanded rate is 1.5 deg/sec, but actual results from flight data show that 2.2 deg/sec average derotation rate results. Together, these constants define the earliest nose gear touchdown speed and, thus, the earliest speed at which brakes should be applied. Failure of beep trim resulting in a delayed manual derotation is an additional failure that is not considered in this analysis but is thought to be a small effect in any case that can be covered by either drag chute or other dispersions. ©[050495-1745D]

Brake energy must not exceed limits for the same cases that the rollout margin has been met. Flight experience on STS-39 demonstrated an average maximum deceleration rate of 9.5 ft/sec² with the carbon-carbon brakes. The 9.0 ft/sec² assumption is conservative to allow for systems variations. Crews train for braking initiation at 140 knots or midfield, whichever is later. Exceptions to this is when braking has not begun and the vehicle reaches the 5k feet remaining marker. The crew will always begin braking at the 5k-foot marker, regardless of groundspeed. From flight experience, it has been demonstrated that the crew can safely delay braking initiation until 120 knots groundspeed. Also, the orbiter brakes and associated equipment (anti-skid) are certified to 225 (ref. CR 26-621-0055) kgs so under extreme circumstances braking may be allowed up to that speed provided the nose gear is down. ©[050495-1745D]

The 42M ft-lb limit for EOM was determined to protect against tire blowout plug deflating the tire shortly after wheel stop (ref. BF Goodrich Engineering Report ER-5448, FSC 97153). The 82M ft-lb limit for aborts allows for the generally heavier weight of payload return and shorter abort runways (ref. Specification - Structural Carbon Brake Assembly, MLG, Orbiter MC621-0075). This higher limit is also allowed for a contingency return on FD 1 with the typically heavyweight vehicle. The risk of a tire fire is incurred for brake energies above 70M ft-lb (ref. Carbon Brake Development Test Summary - Engineering Report 6055, August 21, 1987). This limit will be used for the non-abort case where a late failure takes away nosewheel steering capability. Brake energy capability of 82M ft-lb has been demonstrated in testing.

THIS RULE CONTINUED ON NEXT PAGE

FLIGHT RULES

A4-108

TIRE SPEED, BRAKING, AND ROLLOUT REQUIREMENTS [HC] (CONTINUED)

Impacts due to brake energy violations are as follows for the IMLG Tire/Wheel Brake, Axle, and Wheel (ref. Edwards Ascent/Entry Flight Techniques Splinter, January 19, 2006): ©[042706-7363A]

ENERGY LEVEL (MILLION FT-LBS)	DAMAGE	DISPOSITION
42-45	POSSIBLE FUSE PLUG MELTED, POSSIBLE FLAT TIRE ON RUNWAY	REPLACE WHEEL/TIRE ON RUNWAY, INSPECT WHEEL AND REPLACE FUSE PLUGS.
45-55	WHEEL OVERHEAT, BRAKE ACTUATOR DAMAGE	RETURN WHEEL TO VENDOR FOR INSPECTION, INSPECT BRAKE ON RUNWAY, MAY REQUIRE VENDOR OVERHAUL.
>55	WHEEL OVERHEAT, BRAKE ACTUATOR, AND HEAT SINK	MAY NEED TO SCRAP WHEEL AND BRAKE (VENDOR DISCRETION)
>64	AXLE MATERIAL PROPERTIES	SCRAP AXLE IF TEMP EXCEEDS 450 DEG. F.
>70	POSSIBLE TIRE FIRE	SCRAP TIRE
82	ALL BRAKE PARTS	SCRAP BRAKE

©[042706-7363A]

Crosswinds directly increase the brake energy when differential braking is used for lateral control during rollout. Also, for loss of NWS, brake application at speeds above 140 knots will be required for lateral control which also adds to the brake energy.

After commitment to the deorbit burn, the options available for reducing the brake energy are limited. Should the NWS fail after this commitment, runway redesignation will be considered prior to Mach 6. Redesignation will not be considered if the brake energy reduction is not significant or if the alternate runway is less desirable for other reasons (no landing aids, runway conditions, etc.). Runway redesignation will not be recommended later than Mach 6 in order to protect against inducing a trajectory energy error which is not corrected by TAEM interface.

- D. ROLLOUT MARGIN - PREDICTED ROLLOUT MARGIN MUST BE \geq 1500 FEET MEASURED FROM THE END OF THE USABLE OVERRUN. ©[072795-1788B]
©[121902-5802A]

NOTE: FOR ROLLOUT MARGIN VIOLATIONS, SHORT FIELD SPEED BRAKE SHOULD BE USED IF IT WILL MAKE A RUNWAY GO FOR ROLLOUT MARGIN, AND IT REMAINS GO FROM THE BRAKE ENERGY, TOUCHDOWN MARGIN, AND TOUCHDOWN SPEED REQUIREMENTS. ©[050495-1745D]

THIS RULE CONTINUED ON NEXT PAGE

FLIGHT RULES

A4-108

TIRE SPEED, BRAKING, AND ROLLOUT REQUIREMENTS [HC] (CONTINUED)

Monte Carlo analysis in April 1992 and reconfirmed in October 1994 determined that less than 1000 feet (600 feet) are required to protect for the environmental and procedural variations in order to prevent crossing the end of the usable runway, including any load-bearing overrun surface. This analysis accounted for landing gear deploy altitude variations, trajectory errors at preflare, 3-sigma ADTA errors, density altitude variations, surface wind changes, and variations in the design head/tail upper level wind profile. Also assumed was perfect execution of the braking procedures as described in paragraph A.4. [050495-1745D] [121902-5802A]

At the Ascent/Entry Flight Techniques Panel #187 on September 20, 2002, the removal of the TAL site barriers (Shuttle Orbiter Arresting System) was addressed. The Space Shuttle Program Office proposed the removal of the TAL barriers as a cost savings measure. In support of this proposal, data from previous studies were revisited that showed that the current rollout margin protection of 2000 ft was adequate. Historical TAL predictions since 1990 have never shown that the rollout margin was such that the barrier would be engaged or that rollout margin at a TAL site has ever constrained a launch. However, to mitigate any reduction in launch probability caused by the removal of the TAL barriers, the AEFTP agreed to lower the rollout margin requirement from 2000 ft to 1500 ft (measured to the end of the usable overrun). The studies that were made to support this rollout margin reduction included a reverification of the assumptions and results from the 1992 Monte Carlo analysis, a rollout margin study that examined EOM winds in the presence of extrapolated orbiter mass properties and runway length to mimic TAL conditions, and the examination of historical TAL rollout margin data from 52 flights that showed only one flight (STS-73) with a rollout margin prediction less than 2000 ft. In addition to this supporting data, a worst-on-worst study using a 248,000 lb vehicle rolling out on an 11,729 ft runway with nominal braking procedures showed that No-Go touchdown groundspeed conditions (> 214 knots) must be present in order to produce a rollout margin under 1500 ft. Although a rollout margin of 1000 ft would have provided greater than 3-sigma protection for touchdown and rollout dispersions, it was decided that an additional 500 ft of rollout margin will protect for other procedural variations and dispersions outside of those used in the 1992 Monte Carlo analysis. [121902-5802A]

Reference Hazard Reports ORBI 021, Structural Failure and/or Loss of Vehicle Control from Failure of Wheel/Tire and/or Landing Gear; ORBI 050, Fire/Explosion Caused by Orbiter's Hot Brakes; and ORBI 211, Landing Mishaps Due to Failures of Guidance, Navigation and Control (GN&C) Functions/Landing Aids, Adverse Landing Conditions or Pilot Error. [042706-7363A]

Rules {A2-1}, PRELAUNCH GO/NO-GO REQUIREMENTS [HC]; {A2-206}, DEROTATION SPEED [HC]; {A4-107}, PLS/EOM LANDING OPPORTUNITY REQUIREMENTS [HC]; {A4-110}, AIMPOINT, SPEEDBRAKE RETRACT OPTION, AND EVALUATION TOUCHDOWN VELOCITY SELECTION [HC]; {A10-23A}, APU ENTRY START TIME [HC]; {A10-71}, HYDRAULIC SYSTEMS CONFIGURATION [HC]; and {A10-143}, DRAG CHUTE DEPLOY TECHNIQUES [HC], reference this rule. [050495-1745D] [072795-1788B] [042706-7363A] [ED]

FLIGHT RULES

A4-109

DEORBIT PRIORITY FOR EOM WEATHER

FORECAST VIOLATIONS (REF. RULE {A2-6}, LANDING SITE WEATHER CRITERIA [HC]) AT THE NOMINAL EOM TIME WILL RESULT IN SELECTION OF ONE OF THE FOLLOWING OPTIONS LISTED IN ORDER OF PRIORITY:
@[120894-1622B]

- A. DEORBIT TO PLS AT NOMINAL EOM TIME OR ONE OR MORE ORBITS LATE TO ALTERNATE RUNWAYS (IF REQUIRED FOR WINDS, SUN ANGLE, OR ISOLATED CLOUD COVERAGE) .
- B. DEORBIT TO PLS EARLY ON EOM DAY.
- C. DEORBIT TO PLS 24 HOURS LATE.
- D. DEORBIT TO PLS DAILY OPPORTUNITY PRIOR TO NOMINAL EOM DAY.
- E. DEORBIT TO SLS.
- F. RELAX WEATHER CRITERIA.

Deorbit to the primary landing site is always desirable due to convoy/ground operations support and crew familiarity. Options A through D provide a priority list of options to deorbit to the primary landing site. Should it not be possible to deorbit to the primary site, the secondary landing site will be utilized (option E). Weather criteria will be relaxed real time should both the primary and secondary landing sites be unacceptable.

Rule {A2-207}, LANDING SITE SELECTION, and Rule {A2-301}, CONTINGENCY ACTION SUMMARY [HC], reference this rule. @[032807-8400]

FLIGHT RULES

A4-110

AIMPOINT, SPEEDBRAKE RETRACT OPTION, AND EVALUATION TOUCHDOWN VELOCITY SELECTION [HC]

©[082604-6339D]

- A. AIMPOINT SELECTION - AIMPOINT EVALUATION WILL ASSUME AUTO SPEEDBRAKE AND WILL NOT MODEL ANY MANUAL PROCEDURES DESIGNED TO INCREASE TOUCHDOWN DISTANCE. ©[072795-1788B]
1. IF THE PREDICTED TOUCHDOWN POINT USING THE NOMINAL AIMPOINT IS < 1000 FEET PAST THE RUNWAY THRESHOLD, THEN THE CLOSE-IN AIMPOINT WILL BE SELECTED.
 2. IF THE PREDICTED TOUCHDOWN POINT IS < 1000 FEET PAST THE RUNWAY THRESHOLD FOR BOTH THE NOMINAL AND CLOSE-IN AIMPOINTS, THE RUNWAY IS NO-GO. FOR DAYLIGHT LAKEBED LANDINGS ONLY, IF AFTER APPLYING ALL TECHNIQUES (CLOSE-IN AIMPOINT, ALTERNATE RUNWAY) THE PREDICTED TOUCHDOWN POINT IS STILL < 1000 FEET, CONSIDERATION SHALL BE GIVEN TO RELAXING THE 1000-FOOT CONSTRAINT RATHER THAN DELAYING DEORBIT OR SELECTING AN ALTERNATE LANDING SITE.
 3. FOR RTLS WITH LIGHT RAIN SHOWERS IN THE APPROACH CORRIDOR (RULE {A2-1C}.4, PRELAUNCH GO/NO-GO REQUIREMENTS [HC]), IF THE PREDICTED TOUCHDOWN POINT IS < 2000 FEET PAST THE RUNWAY THRESHOLD FOR BOTH NOMINAL AND CLOSE-IN AIMPOINTS, THE RUNWAY IS NO-GO. ©[ED] ©[ED]

NOTE: MANUAL SPEEDBRAKE RETRACTION AT 3000 FEET AGL MAY BE CONSIDERED TO ACHIEVE THE 2000-FOOT MINIMUM TOUCHDOWN ENERGY.
©[020196-1808A]

This rule is designed as a planning guide and represents crew and flight controller inputs developed over many flights. All of these criteria were discussed at Flight Techniques and other meetings.

A TD point 1000 feet from the runway threshold was selected to accommodate variations in actual TD point from prelanding predictions due to off-nominal EAS, landing gear deploy altitude, and deviations from the forecast wind profile. With the increased margins available on a lakebed runway, the risks of landing closer to the threshold are significantly reduced. Therefore, engineering judgment may be used to accept a TD point of less than 1000 feet in order to avoid an otherwise NO-GO situation on a lakebed runway if no increased risk is identified. Factors involved in making this assessment include visibility restrictions, underrun characteristics (hardness, surface conditions, obstructions, etc.), the availability of landing aids, wind persistence predictions, and pilot (e.g., STA) judgment and recommendations. Due to visibility restrictions at night, however, the 1000-foot criterion always applies to night landings on lakebed runways.

THIS RULE CONTINUED ON NEXT PAGE

FLIGHT RULES

A4-110

**AIMPOINT, SPEEDBRAKE RETRACT OPTION, AND
EVALUATION TOUCHDOWN VELOCITY SELECTION [HC]
(CONTINUED)**

There are two aimpoints used to locate the base of the outer glide slope, one at 7500 feet from the threshold (nominal) and one at 6500 feet from the threshold (close-in). Aimpoint selection is based on an evaluation of the predicted TD point and speedbrake setting using current and forecast winds, density altitude, and orbiter weight. The descent design system (DDS) and the Approach and Landing Plan (ALP) processor are used to compute these parameters. ®[072795-1788B]

Tile damage due to showers encountered during fly back could result in a loss of up to 1000 feet of touchdown distance. Typical touchdown distances carry adequate margin to protect this type of energy loss. A dispersed entry that is flown through a shower on a day that predicted touchdown conditions are at the limits specified in Rule {A4-110}, AIMPOINT EVALUATION VELOCITY, AND SHORT FIELD SELECTION, could result in a vehicle touchdown on the edge of the underrun. The touchdown distance is increased for RTLS to handle the tile damage combined with the other dispersions. ®[020196-1808A] ®[062801-4307C]

4. IF THE PREDICTED SPEEDBRAKE RETRACT CALCULATION INDICATES THAT THE SPEEDBRAKE WILL BE COMMANDED CLOSED (15 PERCENT) AT BOTH 3000 FEET AGL AND 500 FEET AGL USING THE NOMINAL AIMPOINT, THEN THE CLOSE-IN AIMPOINT MAY BE SELECTED TO ACHIEVE A PREDICTED TOUCHDOWN POINT CLOSER TO THE GUIDANCE TARGET (NOMINALLY 2500 FEET) AND POSSIBLY GAIN ADDITIONAL SPEEDBRAKE, PROVIDED THAT ROLLOUT MARGIN AND BRAKE ENERGY CONSTRAINTS (REF. RULE {A4-108}, TIRE SPEED, BRAKING, AND ROLLOUT REQUIREMENTS [HC]) ARE STILL SATISFIED. ®[072795-1788B] ®[020196-1808A] ®[101096-4210] ®[042706-7363A]

Approach and landing guidance was designed to control the orbiter's TD energy state by modulating the speedbrake. Using the speedbrake retract I-loads, guidance will command a speedbrake position that should result in a targeted energy state at TD of 195 knots EAS (205 KEAS heavyweight) at 2500 feet past the runway threshold. At 3000 feet AGL, if guidance predicts that the TD energy state will be less than that targeted, the speedbrake will be commanded fully closed. In this case, selecting the close-in aimpoint will provide an additional 1000 feet of energy margin at TD and may result in carrying a small amount of speedbrake for energy control. The preference for open speedbrake and touchdown as close as possible to the 2500 foot guidance target does not preclude considering either aimpoint for other reasons, such as conditions which result in a different aimpoint recommendation from the STA. Rollout margin and brake energy requirements, as specified in Rule {A4-108}, TIRE SPEED, BRAKING, AND ROLLOUT REQUIREMENTS [HC], must still be satisfied after selection of the close-in aimpoint. If selection of the close-in aimpoint results in violation of these criteria, the nominal aimpoint will be used. ®[101096-4210] ®[042706-7363A]

THIS RULE CONTINUED ON NEXT PAGE

FLIGHT RULES

A4-110

**AIMPOINT, SPEEDBRAKE RETRACT OPTION, AND
EVALUATION TOUCHDOWN VELOCITY SELECTION [HC]
(CONTINUED)**

5. IF THE PREDICTED DYNAMIC PRESSURE BELOW 3000 FEET AGL EXCEEDS THE ALLOWABLE LIMIT (REF. RULE {A4-207}, ENTRY LIMITS), THEN THE CLOSE-IN AIMPOINT MAY BE SELECTED IN CONJUNCTION WITH THE NOMINAL SPEEDBRAKE RETRACT OPTION TO REDUCE THE DYNAMIC PRESSURE TO WITHIN ALLOWABLE LIMITS. AS A LOWER PRIORITY OPTION, CONSIDERATION WILL BE GIVEN TO SELECTING THE CLOSE-IN AIMPOINT IN CONJUNCTION WITH THE SHORT FIELD SPEEDBRAKE RETRACT OPTION IF IT IS REQUIRED TO REDUCE DYNAMIC PRESSURE TO WITHIN ALLOWABLE LIMITS. FOR EITHER CASE, THE TOUCHDOWN POINT, ROLLOUT MARGIN, AND BRAKE ENERGY CONSTRAINTS MUST BE SATISFIED.
@[062801-4307C]

Selection of the close-in aimpoint may be used as a method for reducing the maximum dynamic pressure (q-bar) under 3000 ft AGL. When the speedbrake retracts and adjusts at 3000 ft/500 ft AGL respectively, it is possible for the maximum dynamic pressure to increase above limits specified in Rule {A4-207}, ENTRY LIMITS, under unique wind conditions. A reduction in the peak q-bar may be achieved by inducing a lower equivalent airspeed profile with larger speedbrake settings from the selection of the close-in aimpoint. If the close-in aimpoint alone does not reduce the peak q-bar below the limit, then the short field speedbrake may be selected in conjunction with the close-in aimpoint to further increase the speedbrake setting to meet the q-bar constraint provided that doing so does not make a NO-GO runway GO based on touchdown margin. The short field option cannot be used to improve touchdown conditions since it removes touchdown energy. Since the short field option removes touchdown energy, the close-in aimpoint/nominal speedbrake option is preferred over the close-in aimpoint/short field option to clear a q-bar violation. If selection of the close-in aimpoint with either the nominal or short field option results in any rollout margin violation or brake energy constraint violation as specified in Rule {A4-108}, TIRE SPEED, BRAKING, AND ROLLOUT REQUIREMENTS [HC], the runway will be NO-GO. @[062801-4307C] @[042706-7363A]

THIS RULE CONTINUED ON NEXT PAGE

FLIGHT RULES

A4-110

**AIMPOINT, SPEEDBRAKE RETRACT OPTION, AND
EVALUATION TOUCHDOWN VELOCITY SELECTION [HC]
(CONTINUED)**

B. EOM/INTACT ABORT SPEEDBRAKE RETRACT OPTION AND EVALUATION VELOCITY SELECTION - THE THREE EVALUATION TOUCHDOWN VELOCITIES ASSOCIATED WITH THE TWO SPEEDBRAKE RETRACT OPTIONS ARE DEFINED IN THE FOLLOWING TABLE: @[082604-6339D]

**TABLE A4-110-I - EOM/INTACT ABORT SPEEDBRAKE RETRACT OPTION AND
EVALUATION TD VELOCITY SELECTION**

SPDBRK RETRACT OPTION	CONDITIONS/SELECTION CRITERIA	EVALUATION TD EAS-KTS			
	I-LOAD SET:	-20°OGS (LIGHTWEIGHT)		-18°OGS (HEAVYWEIGHT)	
	LANDING WEIGHT - KLB:	WT<200	200≤WT≤222 [3]	222 [3]<WT<245	WT ≥ 245
NOMINAL	NOMINAL EVALUATION TD EAS	195 [1]		205 [1]	
	IF THE TD POINT AT 195 KEAS <1000 FT FOR BOTH NOMINAL AND CLOSE-IN AIMPOINTS	185	N/A	N/A	
	IF ASCENT INTACT ABORT SITE TD MARGIN IS THE ONLY FACTOR CONSTRAINING LAUNCH	185		195	N/A
SHORT FIELD	WILL BE SELECTED TO ACHIEVE THE NECESSARY ROLLOUT MARGIN, BRAKE ENERGY, TIRE SPEED LIMITS, OR Q-BAR LIMITS (MAY BE USED WITH CI AIMPT FOR Q-BAR VIOLATION).	185 [1]		195 [1]	205 [2]

@[062801-4307C] @[ED]

- [1] TOUCHDOWN AIRSPEED DESIGNED TO LAND THE VEHICLE 2500 FT PAST THE RUNWAY THRESHOLD.
- [2] THIS OPTION CANNOT BE USED FOR TIRE SPEED MARGIN, BUT MAY BE USED FOR ROLLOUT MARGIN, DYNAMIC PRESSURE MARGIN, OR BRAKE ENERGY. FOR THIS WEIGHT ONLY, THE TOUCHDOWN TARGET IS 1500 FEET DOWNRANGE.
- [3] GLIDESLOPE IS BASED ON THE WEIGHT SWITCHPOINT I-LOAD WHICH IS NOMINALLY 222 KLBS. @[072795-1788B]

The intent of modeling the touchdown (TD) prediction so that it assumes auto speedbrake and does not model manual procedures such as high EAS on the outer glide slope is to ensure that nonstandard procedures are not used in order to make the TD conditions GO. @[072795-1788B] @[082604-6339D]

THIS RULE CONTINUED ON NEXT PAGE

FLIGHT RULES

A4-110

**AIMPOINT, SPEEDBRAKE RETRACT OPTION, AND
EVALUATION TOUCHDOWN VELOCITY SELECTION [HC]
(CONTINUED)**

There are two speedbrake retract options used for EOM and intact aborts, nominal and short field, which are used to control TD tire speed, rollout margin, brake energy, and maximum dynamic pressure under 3000 ft AGL. The short field logic dissipates 1000 feet of TD energy, which can be equated to a reduction of approximately 10 KEAS in TD speed. The rollout margin, brake energy, maximum dynamic pressure, and tire speed parameters are also computed by DDS and ALP during real-time approach and landing analysis. ©[062801-4307C] ©[082604-6339D]

The designed TD target airspeed is a function of the I-load set (heavyweight or lightweight) selected by onboard guidance and the speedbrake retract option (nominal or short field). Guidance selects the appropriate I-load set by comparing the guidance vehicle mass against the weight switch point I-load, which is normally 222,000 lbs. With the nominal speedbrake retract option selected, the TD airspeed targets are 195 and 205 KEAS for lightweight and heavyweight vehicles, respectively. With the short field speedbrake retract option selected, the TD airspeed targets are 185 and 195 KEAS for lightweight and heavyweight vehicles, respectively. The intent is to use the designed TD target airspeeds as the flight rule evaluation TD airspeeds in approach and landing analysis. The TD airspeed design targets provide an energy reserve that takes into account such factors as tailscrape, nose gear slapdown limits, atmospheric effects, manual procedures, and orbiter center-of-gravity. Evaluation speeds may vary from the designed targets for very light or very heavy vehicles, and for other operational concerns as discussed below.

The short field speedbrake retract logic was designed to permit landing and stopping safely on the shorter TAL runways. It may also be selected on any landing opportunity to provide additional tire speed margin on hot or tailwind days. When the short field option is selected, guidance will decrease the targeted TD energy by 1000 ft, which is approximately equivalent to landing 10 KEAS slower at the nominal 2500 ft downrange TD distance. For operational and training reasons, selecting the short field option during an EOM or intact abort landing for any reason should cue the CDR to target TD airspeed at 185 KEAS for lightweight landings, or 195 KEAS for heavyweight landings (provided that the weight is < 245,000 lbs).

Because of the reduced nose gear slapdown loads with weights less than 200,000 lbs, planning for a TD of 185 KEAS rather than 195 KEAS is acceptable. Operationally, however, landing at 195 KEAS is preferable to landing at 185 KEAS for lightweight cases so that the crew can train to fewer landing speeds. For this reason, with an orbiter weight less than 200,000 lbs, both the nominal and close-in aimpoints will be evaluated at 195 KEAS prior to evaluation of 185 KEAS as the targeted TD velocity. Use of 185 KEAS is preferable to delaying deorbit (Ascent/Entry Splinter Flight Techniques Panel, Landing/Rollout #1, June 20, 1990). ©[072795-1788B] ©[082604-6339D]

THIS RULE CONTINUED ON NEXT PAGE

FLIGHT RULES

A4-110

AIMPOINT, SPEEDBRAKE RETRACT OPTION, AND
EVALUATION TOUCHDOWN VELOCITY SELECTION [HC]
(CONTINUED)

If inadequate TD margin is achieved for intact abort landing weights < 245,000 lb, then reducing the evaluation velocity by 10 KEAS is preferred, rather than delaying a launch. For landing weights \geq 245,000 lbs, TD evaluations must use an evaluation velocity of 205 KEAS due to orbiter tailsrape restrictions. ®[072795-1788B] ®[082604-6339D]

The short field logic should only be selected to achieve the necessary tire speed margin, rollout margin, dynamic pressure margin, or brake energy limits, and not to improve TD margin. Using short field to improve TD conditions essentially reduces the TD energy, which is in conflict with the decisions of the 1991 landing performance panel.

If entry analysis shows a TD ground speed > 214 kts using the short field option, that runway will be NO-GO for landing.

Under unique wind conditions, the short field speedbrake logic may be selected in conjunction with the close-in aimpoint to clear dynamic pressure violations above the limits specified in Rule {A4-207}, ENTRY LIMITS, provided that an adequate TD margin is maintained. The reduction of the maximum dynamic pressure is a byproduct of the larger speedbrake retract commands that result from the selection of the short field speedbrake option with the close-in aimpoint. Selecting the short field option with the close-in aimpoint is preferable over manual speedbrake techniques. ®[062801-4307C]

*Reference Rule {A4-108}, TIRE SPEED, BRAKING, AND ROLLOUT REQUIREMENTS [HC].
®[042706-7363A]*

*Rules {A2-6}, LANDING SITE WEATHER CRITERIA [HC], and {A4-108}, TIRE SPEED, BRAKING, AND ROLLOUT REQUIREMENTS [HC], reference this rule. ®[072795-1788B] ®[082604-6339D]
®[042706-7363A]*

THIS RULE CONTINUED ON NEXT PAGE

FLIGHT RULES

A4-110

**AIMPOINT, SPEEDBRAKE RETRACT OPTION, AND
EVALUATION TOUCHDOWN VELOCITY SELECTION [HC]
(CONTINUED)**

C. ECAL/ELS SPEEDBRAKE RETRACT OPTION AND TD TARGET SELECTION - THE THREE SPEEDBRAKE RETRACT OPTIONS AND THEIR CORRESPONDING TD TARGETS ARE A FUNCTION OF USABLE RUNWAY LENGTH AND I-LOAD SET AS DEFINED IN THE FOLLOWING TABLE: @[082604-6339D]

TABLE A4-110-II - ECAL/ELS SPEEDBRAKE RETRACT OPTION AND TD TARGET SELECTION [1]

USABLE RUNWAY LENGTH - FT [2]	SPEEDBRAKE RETRACT OPTION [3] TD TARGET - FT @ KEAS	
	-18° OGS (HEAVYWEIGHT)	-20° OGS (LIGHTWEIGHT)
≥ 7500 TO < 8500	ELS 1000 @ 195	SHORT FIELD 1500 @ 195
≥ 8500 TO < 10,000	SHORT FIELD 1500 @ 205	
≥ 10,000 TO < 11,000		
≥ 11,000	NOMINAL 2500 @ 205	

- [1] ALL SPEEDBRAKE RETRACT OPTIONS REQUIRE EARLY CHUTE DEPLOY AND IMMEDIATE DEROTATION. IF THE DRAG CHUTE IS UNAVAILABLE, ALL USABLE RUNWAY LENGTHS IN THE LEFT MOST COLUMN SHOULD BE INCREASED BY 1000 FT.
- [2] USABLE RUNWAY LENGTH IS DEFINED AS THE DISTANCE MEASURED FROM THE APPROACH THRESHOLD (ACTUAL OR I-LOAD DISPLACED) TO THE END OF THE USABLE OVERRUN (IF A USABLE OVERRUN EXISTS).
- [3] ELS AND SHORT FIELD OPTIONS REQUIRE MAXIMUM BRAKING AT NGTD. @[082604-6339D]

THIS RULE CONTINUED ON NEXT PAGE

FLIGHT RULES

A4-110

AIMPOINT, SPEEDBRAKE RETRACT OPTION, AND
EVALUATION TOUCHDOWN VELOCITY SELECTION [HC]
(CONTINUED)

The ELS retract option was developed to stop heavyweight vehicles on very short runways. Results from the February 2000 Ames VMS study show that this option, when used with chute deploy at main gear touchdown, immediate derotation, and maximum braking at nose gear touchdown, will stop a 250,000 lb orbiter on a 7500 ft runway (Ascent/Entry Flight Techniques Panel #165, June 16, 2000). When the ELS retract option is selected, approximately 30 degrees of speedbrake is added to the nominal retract and adjust commands at 3000 ft and 500 ft, respectively. The additional speedbrake dissipates approximately 2500 ft of TD energy, resulting in a reduced TD target 1000 ft from the runway threshold at 195 KEAS. Because the reduced TD target and the lack of environmental data required to make a TD prediction elevate the risk of touching down short of the runway, the runway length criterion used to trigger this retract option was selected to ensure that the technique is used only when necessary for stopping capability. An ELS abort does not require use of the ELS retract option, unless the runway length criterion has been satisfied. ©[082604-6339D]

Analysis of VMS and DDS simulation data determined that the short field retract option would provide acceptable stopping capability with a more desirable TD energy state for heavyweight vehicles landing on runways of usable length equal to or greater than 8500 ft. The ELS option is not required for lightweight vehicles since the short field option achieves acceptable stopping capability and more desirable TD energy conditions for a 7500 ft runway (ref. Ascent/Entry Flight Techniques Panel #183, August 16, 2002).

Although the short field option calls for maximum braking, runway lengths approaching the short field/nominal speedbrake switchpoint will allow the crew to back off the maximum braking profile. The runway length values used to trigger the nominal speedbrake option were selected in order to balance the risk of touching down short of the runway with the reduced lateral handling capability resulting from the maximum braking procedure. DDS simulations with the nominal speedbrake retract option, chute deploy at main gear TD, immediate derotation, and nominal braking at nose gear TD achieved acceptable TD energy conditions and stopping capability for runways of usable length greater than 11,000 ft and 10,000 ft for heavy and lightweight vehicles, respectively.

Reference Rule {A2-264}, EMERGENCY LANDING FACILITY CRITERIA. Reference ORBI 211, LANDINGS WHICH EXCEED DESIGN LIMITS. ©[082604-6339D]

Rules {A2-1}, PRELAUNCH GO/NO-GO REQUIREMENTS [HC]; {A2-6}, LANDING SITE WEATHER CRITERIA [HC]; {A2-264}, EMERGENCY LANDING FACILITY CRITERIA [HC]; {A4-107}, PLS/EOM LANDING OPPORTUNITY REQUIREMENTS [HC]; {A4-108}, TIRE SPEED, BRAKING, AND ROLLOUT REQUIREMENTS [HC], and {A10-143}, DRAG CHUTE DEPLOY TECHNIQUES [HC], reference this rule. ©[032504-6223B] ©[ED]

FLIGHT RULES

A4-111

RUNWAY ACCEPTABILITY CONDITIONS

A. THE FOLLOWING CONDITIONS WILL NO-GO USE OF ANY EOM OR INTACT ABORT RUNWAY TO WHICH THEY APPLY. CONDITIONS ARE ASSESSED OVER THE ENTIRE SURFACE OF THE RUNWAY. @[111094-1622B] @[062702-5149C]

1. ALL RUNWAYS (GROOVED, UNGROOVED, LAKEBED) :

STRUCTURAL FAILURES (BREAKTHROUGH, POTHOLE, FISSURE),
STANDING WATER, SNOW, OR ICE

2. UNGROOVED RUNWAYS:

VISIBLE MOISTURE

3. LAKEBEDS:

WET OR SLUSHY SURFACE MATERIAL

THE FOLLOWING CHART CATEGORIZES THE APPROVED EOM AND INTACT ABORT RUNWAYS:

RUNWAY	SURFACE
KSC	GROOVED
EDW22/04	UNGROOVED
MRN	UNGROOVED
FMI	UNGROOVED
ZZA	GROOVED
NOR	LAKEBED

@[062702-5149C] @[ED] @[121604-6503B]

THIS RULE CONTINUED ON NEXT PAGE

FLIGHT RULES

A4-111

RUNWAY ACCEPTABILITY CONDITIONS (CONTINUED)

- a. *Due to the large load bearing requirements of the orbiter, structural failures are not acceptable on any runway surface. Fissures or cracks, which may lead to or be evidence of structural failures, are not allowable. Potholes are not acceptable owing to the possibility of tire or strut damage caused by impact. Standing water, snow or ice on any runway surface may result in hydroplaning, loss of traction, and loss of brake effectiveness.* ©[062702-5149C]

Grooves on a runway are designed to provide drainage of water from the runway surface. Flooding occurs when the water cannot be shed quickly enough and the grooves fill. Any depth of water above this point is defined as standing water (depth of water above the runway surface, not including groove depth). The Shuttle Landing Facility at KSC is considered grooved although the 3500 feet at each end of the runway are ungrooved and treated with a Skidabrader™ Shotpeening Process. The A/E FTP#176 members concluded that the effects of landing in the ungrooved region and/or rolling across the grooved/ungrooved transition zones on a wet KSC runway (grooves not flooded) were not significant enough to alter the desired landing profile. These conclusions were based on LRC tire track testing, SES evaluations, and the assumption that significant lateral excursions could not occur since the time spent in the ungrooved region at high speeds was of a very short duration and occurred with light main gear loading.

- b. *Visible moisture on an ungrooved concrete runway may also result in a loss of lateral directional control. The orbiter MLG tires can lose up to 75 percent of the dry friction value at high speeds on a wet ungrooved runway. Ref A/E FTP #176.*
- c. *Wet, slushy lakebed surface materials thrown up during landing and roll out can result in orbiter damage. Reference Entry FTP #42 and A/E FTP #176.*

- B. FOR EMERGENCY LANDINGS, THE CONDITIONS IN PARAGRAPH A WILL BE CONSIDERED IN RUNWAY SELECTION IF MORE THAN ONE SITE IS AVAILABLE.

Contingency aborts (e.g., ECAL, emergency deorbit) do not require the same level of dispersion protection as NEOM or Intact Abort landings. In addition, emergency landings typically only have capability to one site, so runway NO-GO criteria are not appropriate. In the event overlapping coverage does exist (e.g., ECAL), runway condition should be considered when selecting the landing site. Emergency landings include, but are not limited to, ACLS, ECAL, and ELS sites. Ref A/E FTP #176.
 ©[062702-5149C] ©[102402-5804C]

Rules {A2-1}, PRELAUNCH GO/NO-GO REQUIREMENTS [HC]; {A2-2}, ABORT LANDING SITE REQUIREMENTS; {A2-103}, EXTENSION DAY REQUIREMENTS; and {A4-107}, PLS/EOM LANDING OPPORTUNITY REQUIREMENTS, reference this rule. ©[111094-1622B] ©[ED]

FLIGHT RULES

A4-112

UPPER AND LOWER LEVEL MEASURED WIND AND
ATMOSPHERIC DATA [HC] @[062801-4423] @[121604-6503B]

A. UPPER LEVEL WIND DATA @[042507-8480B]

UPPER LEVEL MEASURED WIND DATA (10K FEET TO HAC ACQUISITION) ARE USED TO ASSESS HAC SELECTION OPTIONS AND TRANSITION TO APPROACH AND LANDING GUIDANCE.

1. PRELAUNCH: A SOURCE FOR ACCURATE UPPER LEVEL MEASURED WIND DATA OBTAINED NO MORE THAN 6.5 HOURS FROM LAUNCH FOR ALL REQUIRED ABORT LANDING SITES (REF. RULE {A2-2}, ABORT LANDING SITE REQUIREMENTS) IS HIGHLY DESIRABLE.
2. PREDEORBIT: A SOURCE FOR ACCURATE UPPER LEVEL MEASURED WIND DATA OBTAINED NO MORE THAN 6.5 HOURS FROM TOUCHDOWN IS HIGHLY DESIRABLE.

B. LOWER LEVEL WIND DATA @[111094-1622B]

LOWER LEVEL MEASURED WINDS (0 TO 10K FEET) ARE USED TO ASSESS TOUCHDOWN, ROLL OUT, AND BRAKE ENERGY CONDITIONS IN ORDER TO SUPPORT COMMIT TO LAUNCH OR DEORBIT DECISIONS.

1. PRELAUNCH: A SOURCE FOR ACCURATE LOWER LEVEL MEASURED WIND DATA OBTAINED NO MORE THAN 4.5 HOURS FROM LAUNCH FOR ALL REQUIRED ABORT LANDING SITES (REF. RULE {A2-2}, ABORT LANDING SITE REQUIREMENTS) IS MANDATORY. FOR LAUNCH COMMIT, CONSIDERATION WILL BE GIVEN TO THE USE OF THE FORECAST WINDS IF DEEMED ACCEPTABLE BASED UPON SMG ANALYSIS OF SUPPLEMENTARY METEOROLOGICAL DATA. @[020196-1799A] @[121604-6503B]
2. PREDEORBIT: A SOURCE FOR ACCURATE LOWER LEVEL MEASURED WIND DATA OBTAINED NO MORE THAN 4.5 HRS FROM TOUCHDOWN IS MANDATORY FOR FD1 OR FD2 PLS, NEXT PLS, AND EOM.

NOTE: FOR AOA OR FD1 PLS TO NORTHRUP, IF STANDARD BALLOON DATA IS NOT AVAILABLE, WIND PROFILER DATA AND FORECAST WINDS WITH THE 62 STANDARD ATMOSPHERE MAY BE USED FOR TOUCHDOWN AND ROLLOUT ANALYSIS. @[020196-1799A] @[042507-8480B]

THIS RULE CONTINUED ON NEXT PAGE

FLIGHT RULES

A4-112

UPPER AND LOWER LEVEL MEASURED WIND AND ATMOSPHERIC DATA [HC] (CONTINUED)

C. ATMOSPHERIC CONDITIONS @[062801-4423]

A SOURCE FOR ACCURATELY MEASURING ATMOSPHERIC CONDITIONS FROM 0 TO 10K FEET IS MANDATORY WHEN INVERSIONS ARE SUSPECTED IN ORDER TO OBTAIN A MORE DETAILED AND RELIABLE FORECAST NEEDED TO SUPPORT COMMIT TO LAUNCH AND DEORBIT DECISIONS FOR EOM AND INTACT ABORT SITES.

A source of accurately measured upper level wind conditions at the landing site is highly desirable to support detailed landing analysis of the dynamics that can be expected while flying the HAC and the expected transition altitude from TAEM guidance to Approach and Landing guidance. Sources that can provide this type of detailed wind measurements include radio theodolites, rawinsondes, and radar tracked/GPS jimspheres. Other resources, such as the STA, T-38, and balloon releases from surrounding areas, may be used to confirm the detailed wind measurements. It is highly desirable that the measured wind data encompass altitudes from HAC acquisition and below to analyze the expected guidance transition altitude, the expected maximum dynamic pressure on the HAC, and the expected HAC altitude errors, specifically the Altitude Error Low parameter. Wind measurements taken 6.5 hours prior to touchdown are not expected to change beyond the wind accuracies that assure acceptable TAEM performance and acceptable guidance transition. TAEM wind accuracy requirement studies have shown wind measurement errors of approximately 35 knots at HAC altitudes can be tolerated. Under all circumstances, wind measurement accuracies and the applicability of upper wind measurements taken up to 6.5 hours from touchdown will remain an SMG decision. @[062801-4423] @[042507-8480B]

A source of accurately measured lower level wind conditions at the landing site is necessary to support detailed landing analysis of touchdown, roll out, and brake energy conditions as part of the prelaunch GO/NO-GO decision process. The measured wind data at the landing site is also crucial to support an accurate and detailed forecast of the low-level altitude winds (0 to 10K feet). Sources that can provide this type of detailed wind measurements include radio theodolites, rawinsondes, and radar tracked/GPS jimspheres. Since wind persistence is a function of the dynamics of the atmosphere, the age of wind and atmospheric (thermodynamic) measurements required will remain an SMG decision. Supplementary data which may be used to support a consideration to use forecast winds in the event upper winds from the landing site are unavailable within 4.5 hours of launch include: nearby upper wind measurements and analysis from the National Weather Service, DoD weather detachment, foreign national weather services, research project, and other sources. Rawinsondes (balloons), PIBAL's (pilot balloons), Doppler radar wind profilers, aircraft wind reports, satellite observed cloud drift winds, numerical data assimilation models, and scientific conceptual models of the atmosphere are some of the possible types of supplementary upper and lower wind data and analysis that may be available. When temperature inversions or wind shears between the surface and 10K ft are suspected, a source for accurately measuring atmospheric conditions may be needed to support a more detailed vertical wind profile forecast. @[042507-8480B]

THIS RULE CONTINUED ON NEXT PAGE

FLIGHT RULES

A4-112

UPPER AND LOWER LEVEL MEASURED WIND AND ATMOSPHERIC DATA [HC] (CONTINUED)

A statistical analysis of postflight data from STS-26 to STS-103 shows that touchdown energy predictions from the touchdown-4.5 hour balloon are representative of the actual touchdown conditions. The change in the 3-sigma dispersions that can be expected from the touchdown-4.5 hour balloon to the touchdown-1 hour balloon is less than 150 ft. The statistics from these flights were taken on day of landing where meteorological conditions were benign enough to allow deorbit. To invoke the minimum wind measurement requirements in this rule implies that trajectory and touchdown predictions from the last available balloon are benign and sufficient touchdown margins exist. Other resources, such as the STA, may be used to confirm the last available trajectory and touchdown predictions. [062801-4423]

The detailed landing analysis of both forecast and current conditions is critical for short runways such as TAL sites. If weather conditions are favorable in that no low-level shears are suspect, the requirement for measured atmospheric data is waived, but detailed wind measurements are still required to support the landing analysis. [111094-1622B] [121604-6503B]

If Northrup is the prime AOA and/or FDI PLS site, touchdown and rollout analysis will be based on the forecast and observed wind data collected from GPS based balloon systems released near the Northrup lakebed. If available, the White Sands wind profiler data may be used for the touchdown and rollout analysis in the event no balloon data are available. Furthermore, analysis showed that the 62 standard and the monthly mean atmosphere showed only slight differences in the touchdown and rollout constraints. Therefore, for procedural simplicity, the 62 standard atmosphere may be used. [020196-1799A] [042507-8480B]

Reference Hazard Report ORBI-325, Loss of Control of the Vehicle Due to Adverse Winds and Turbulence, and INEV-01, Exposure to Natural Environment Exceeds Capability of the Space Shuttle. [121604-6503B]

Rules {A2-1}, PRELAUNCH GO/NO-GO REQUIREMENTS [HC], and {A4-107}, PLS/EOM LANDING OPPORTUNITY REQUIREMENTS, reference this rule. [111094-1622B] [042507-8480B] [ED]

A4-113

OMS-2 TARGETING

FOR GROUND UP RENDEZVOUS MISSIONS, OMS-2 TARGET PERIGEE WILL BE USED TO OPTIMIZE RENDEZVOUS PHASING. OMS-2 PERIGEE MAY BE AS LOW AS 105 NM (OR 85 NM WITH SSP APPROVAL). [022201-3801]

OMS-2 is used for orbital insertion as well as the first rendezvous phasing maneuver. In order to accomplish this, orbital perigee post OMS-2 can range from 105 nm to 307 nm. OMS-2 can also compensate for small MECO underspeeds and still preserve the rendezvous. With Space Shuttle Program approval, post OMS-2 perigee can go as low as 85 nm in order to improve launch window duration, but with a propellant penalty due to drag. [022201-3801]

FLIGHT RULES

A4-114

SHUTTLE MANEUVER DEFINITION

- A. MANEUVERS FOR THE NOMINAL FD3 (BACKUP FD4) DOCKING RENDEZVOUS PROFILE ARE CLASSIFIED AS "CRITICAL" OR "NONCRITICAL" PER THE FOLLOWING TABLE. APPROPRIATE VGO TRIMS ARE ALSO INCLUDED.
@[032807-8376A]

MANEUVER	CRITICALITY	VGO TRIMS (FPS)
OMS-2	CRITICAL FOR CREW SAFETY	$ VGOX < 0.2; VGOY/Z < 2$
NC-1	NONCRITICAL *	$ EACH VGO < 0.2$
NC-2	NONCRITICAL *	$ EACH VGO < 0.2$
NPC	NONCRITICAL (IF REQUIRED)	$ EACH VGO < 0.2$
NC-3	NONCRITICAL *	$ EACH VGO < 0.2$
NC-4	CRITICAL FOR MISSION SUCCESS (FD3 RNDZ); NONCRITICAL FOR FD4 RNDZ	$ EACH VGO < 0.2$
NC-5	NONCRITICAL AND ONLY REQUIRED FOR FD4 RNDZ *	$ EACH VGO < 0.2$
NH	CRITICAL FOR MISSION SUCCESS (IF REQUIRED)	$ EACH VGO < 0.2$
NC-6	CRITICAL FOR MISSION SUCCESS AND ONLY REQUIRED FOR FD4 RNDZ	$ EACH VGO < 0.2$
NCC	CRITICAL FOR MISSION SUCCESS	$ EACH VGO < 0.2$
TI	CRITICAL FOR MISSION SUCCESS	$ EACH VGO < 0.2$
SEP	CRITICAL FOR CREW SAFETY	N/A
ORBIT ADJUST	NONCRITICAL (IF REQUIRED)	$ EACH VGO < 0.2$
DEORBIT	CRITICAL FOR CREW SAFETY	$ VGOX/Z < 2; DO NOT TRIM VGOY$

* THESE BURNS MAY BE CLASSIFIED "CRITICAL FOR MISSION SUCCESS" BECAUSE THE TIMELINE MAY BE TOTALLY FILLED WITH CREW ACTIVITIES AND A ONE ORBIT SLIP MAY IMPOSE SERIOUS IMPACTS.

- B. A PROP, GNC, OR DPS SYSTEM FAILURE ENCOUNTERED DURING A NONCRITICAL BURN WILL BE CAUSE FOR IMMEDIATE BURN TERMINATION AND VGO'S WILL NOT BE TRIMMED IF THE FAILURE AFFECTS THE BURN. @[032807-8376A]

THIS RULE CONTINUED ON NEXT PAGE

FLIGHT RULES

A4-114

SHUTTLE MANEUVER DEFINITION (CONTINUED)

The criticality of a burn will be indicated on the maneuver Preliminary Advisory Data (PAD) that is uplinked to the crew. A critical burn is one that cannot be rescheduled while non-critical burns can be rescheduled without major impact to the mission. This distinction affects crew procedures during the burn as far as continuing the burn after a systems failure and it affects the number of downmode options that are protected. Generally, noncritical phasing and plane change burns can be slipped at least one orbit without impact to crew safety or mission success. However, each such burn possesses an optimal TIG for propellant consumption and relative motion during a given orbit. In addition, any two phasing burns should be separated by a period of time sufficient to permit post-burn tracking of the first burn to be reflected in targeting of the second. Perturbations due to attitude maneuvers, water dumps, etc., should also be minimized for the phasing burn prior to crew sleep preceding day-of-rendezvous. In this way, target range deviations from 40 nm at the final phasing burn can be minimized to standardize subsequent relative motion. ©[032807-8376A]

OMS-2, SEP, and deorbit are always critical to crew safety because they may result in uncontrolled atmospheric entry or orbiter/ISS recontact if TIG is slipped or an underburn is performed (ref Rule {A4-158}, MANEUVER EXECUTION MATRIX).

All rendezvous burns will trim each VGO < 0.2 fps in magnitude per Rule {A2-124}, RENDEZVOUS MANEUVER EXECUTION. This includes crew-safety-critical rendezvous and prox ops breakout burns. Trim error magnitude < 0.2 fps in each VGO axis is assumed by rendezvous burn sequence design such that navigation errors will not drive any burn retrograde. This design is particularly sensitive to VGOX residuals. Covering greater VGOX residuals by design would result in a smaller rendezvous launch window maximum phase angle limit. On a ground-up rendezvous, OMS-2 is considered the first rendezvous burn. OMS-2 VGOX should be trimmed to < 0.2 fps in magnitude (reference Rule {A2-124}, RENDEZVOUS MANEUVER EXECUTION). Because of limited navigation precision at the time of the OMS 2 burn, VGOY and VGOZ for OMS 2 need only be trimmed to < 2.0 fps in magnitude. Note that trimming the sep burn is an exception because it is completed based on time; not VGO's. Noncritical orbit adjusts will also trim each VGO < 0.2 fps in magnitude because tight margins on end-of-mission landing or payload objectives are typically targeted, and orbit navigation generally supports this precision.

Occasionally, burns which are usually classified as non-critical are reclassified as critical. For specific flights or for certain OMS-2 phase angles for rendezvous missions, NC-1, NC-2, etc., may be classified as critical because to slip them might result in later retrograde burns or in a failed rendezvous. Also, burns that if slipped would interfere with timeline critical mission activities or with crew sleep may be classified as critical. For example, missions with FD2 TPS inspection may require that NC-2 be critical because to slip it one orbit might cause activities to move into the pre-sleep or sleep periods.

Day-of-rendezvous burns are classified "critical for mission success" because major flight objectives would be in jeopardy if they slipped one orbit. Although these burns are part of a rigidly scheduled sequence of events, this sequence may be slipped by one or two orbits early in the mission such that lighting at the corresponding Ti burn is preserved. There are generally at most a few minutes of TIG slip for day-of-rendezvous burns, and any TIG slip which occurs can lead to non-standard relative motion entailing increased propellant usage for subsequent burns. ©[032807-8376A]

A4-115 THROUGH A4-150 RULES ARE RESERVED ©[032807-8376A]

FLIGHT RULES

ENTRY PLANNING

A4-151

IMU ALIGNMENT [HC] ©[032807-8369A]

DEORBIT WILL NOT BE ATTEMPTED IF THE IMU ATTITUDE ERROR AT ENTRY INTERFACE IS PREDICTED TO BE GREATER THAN 0.5 DEGREE FOR NOMINAL DEORBIT. DEORBIT WILL BE DELAYED IF THE ERROR IS > 0.25 DEGREE, IN ORDER TO PERFORM AN IMU ALIGNMENT TO CORRECT ERRORS TO < 0.25 DEGREE. FOR CONTINGENCY SITUATIONS, ERRORS BETWEEN 0.25 DEGREE AND 0.5 DEGREE ARE ACCEPTABLE.

Acceptable IMU attitude errors for entry were derived based on two factors, the downtrack state vector error at approximately 150 Kft altitude (in the absence of GPS) and the angle of attack errors.

- a. *Navigation downtrack error - An analysis presented at Entry Flight Techniques Panel Meeting #6, on November 9, 1977, established IMU alignment error limits as follows:*
 - (1) *For a contingency in which exceeding system performance margins is necessary during entry, the maximum IMU RSS misalignment allowed at EI is 0.5 degree (flight safety limit; STS-4, EFTP 3). A misalignment at EI of 0.5 degree would result in navigation errors that, although corrected at TACAN acquisition (~M7), would result in adjustments to the entry trajectory that could exceed the venting control limit of 300 psf in the transonic region (ref. Rule {A4-207A}.2, ENTRY LIMITS). Errors greater than 0.5 degree will violate the 342 psf flight control design limit for dynamic pressure in the M5 to M3 region. The 0.5 degree misalignment corresponds to a downrange error of 10 nm at an altitude of 130,000 feet, which violates the delta state update limits (ref. Rule {A4-203}, ENTRY NAVIGATION UPDATE PHILOSOPHY), but is within the TACAN capability to correct. ©[ED] ©[032807-8369A]*
 - (2) *The 0.25 degree RSS limit is intended to protect system performance margins during entry. A maximum misalignment at EI of 0.25 degree under worst case conditions protects the limiting parameter, a dynamic pressure of 300 psf, that conforms to compartment venting constraints in the transonic region. The 0.25 degree misalignment corresponds to a downrange error of approximately 6 nm at an altitude of 130,000 feet, which is within TACAN capability to correct and does not violate the delta state update criteria.*
- b. *Angle of attack errors - Another consideration was angle of attack error. An extensive series of runs was made on the SPS Ø1 and FSL to define the loss of control boundary as a function of angle of attack errors. Results of these studies were presented at Flight Techniques. Angle of attack errors can come from IMU alignment errors and winds. Tolerance to angle of attack errors is a function of aerodynamic variations, FCS response, and RCS jet authority/availability. With worst case winds, three-sigma AERO variations, and two yaw RCS jet failures, simulation runs indicated a potential loss of control. Therefore, it was required to minimize the IMU contribution to angle of attack error, 0.5 degree was deemed to be the maximum allowable with 0.25 degree highly desirable.*

THIS RULE CONTINUED ON NEXT PAGE

FLIGHT RULES

A4-151**IMU ALIGNMENT [HC] (CONTINUED)**

Although redundant 3 string GPS navigation capability might improve the navigation performance such that IMU misalignments greater than 0.5 degrees might be tolerated, an extensive analysis effort would be required to evaluate an expansion of the angle of attack errors and associated flight control system performance. A decision was made at Ascent and Entry Flight Techniques Panel #214, held September 30, 2005, to forgo an expansion of vehicle performance capabilities that might be gained from the increased navigational accuracy that GPS provides. This decision was due to the Space Shuttle Program ending in 2010, the limited flight experience incorporating GPS into navigation, and the mixed fleet configuration (OV-103/OV-104 single string and OV-105 3-string) that will exist until the end of the Program. ©[032807-8369A]

Rules {A4-101}, ONBOARD NAVIGATION MAINTENANCE; {A4-154}, DOWNTRACK ERROR; {A8-12}, HEADSUP DISPLAY AND CREW OPTICAL ALIGNMENT SIGHT (COAS) ALIGNMENT; {A8-108E}, HUD/COAS SYSTEM MANAGEMENT; and {A8-110} B, E, G, H, I, and J, IMU SYSTEM MANAGEMENT, reference this rule.

Reference Hazard Report ORBI 211. ©[032807-8369A]

FLIGHT RULES

THIS PAGE INTENTIONALLY BLANK

FLIGHT RULES

A4-152**DEORBIT BURN PLANNING PRIORITIES [HC]** @[121604-6494A]

- A. THE DEORBIT BURN WILL BE TARGETED TO MEET AS MANY OF THE FOLLOWING OBJECTIVES AS POSSIBLE, IN ORDER OF PRIORITY FROM HIGHEST TO LOWEST, USING THE AVAILABLE OMS PROPELLANT, WHILE KEEPING THE CG IN THE NOMINAL BOX AS DEFINED BY RULE {A4-153}, CG PLANNING: @[081497-4178B]
1. OMS TANK LANDING CONSTRAINTS (< 21.2 PERCENT OX, 21.1 PERCENT FU)
 2. STEEP TARGETS WITH 3-SIGMA N-CYCLES
 3. POST BURN OMS QUANTITIES \geq 5 PERCENT PER POD
 4. LANDING WEIGHT \leq FLIGHT RULE LIMIT
 5. ONE DOWNMODE OPTION FROM TIG THROUGH CUTOFF (OR AS EARLY AS POSSIBLE, IF NOT FROM TIG)
 6. OMS TANK FAIL HPS \geq SAFE HP (OR AS CLOSE TO SAFE HP AS POSSIBLE, IF LESS THAN SAFE HP)
 7. RCS COMPLETION AT SAFE HP (OR AS CLOSE TO SAFE HP AS POSSIBLE, IF LESS THAN SAFE HP)
 8. MAXIMIZE TIG SLIP UP TO 5 MINUTES PROTECTING ONE DOWNMODE OPTION (IF DOWNMODE TIG SLIP UNAVAILABLE, THEN PROVIDE UP TO 5 MINUTES OF NO FAIL TIG SLIP).
 9. POST BURN OMS QUANTITIES RESULTING IN A POST-LANDING PROPELLANT WEIGHT BELOW THE OMS POD LIFTING LIMIT OF 2575 POUNDS PER POD (OMS AND RCS)
 10. AOS DURING THE BURN @[121604-6494A]

THIS RULE CONTINUED ON NEXT PAGE

FLIGHT RULES

A4-152 DEORBIT BURN PLANNING PRIORITIES [HC] (CONTINUED)

- B. IF STEEP TARGETS CANNOT BE ACHIEVED WITH THE AVAILABLE OMS, THE FOLLOWING ACTIONS WILL BE TAKEN IN ORDER OF PRIORITY TO ACHIEVE STEEP TARGETS WITH 3-SIGMA N-CYCLES:
1. PERFORM A MULTI-STAGE DEORBIT BY EXECUTING A FORWARD RCS AND/OR AFT RCS PERIGEE ADJUST WITH PROPELLANT ABOVE THE MISSION COMPLETION REDLINE PER RULE {A6-355}, OMS PROPELLANT DEFICIENCY FOR DEORBIT. IT IS REQUIRED THAT THIS MANEUVER(S) OCCUR AT LEAST TWO ORBITS PRIOR TO DEORBIT TIG, UNLESS TELEMETRY COVERAGE WILL BE AVAILABLE TO CONFIRM A MANEUVER THAT WOULD OCCUR LESS THAN TWO ORBITS BEFORE DEORBIT. @[081497-4178B] @[121604-6494A]
 2. CG MANAGEMENT TECHNIQUES SHOULD BE UTILIZED TO MAXIMIZE THE AVAILABLE PROPELLANT WHILE MAINTAINING THE CG WITHIN NOMINAL LIMITS (REF RULE {A4-153}, CG PLANNING). @[081497-4178B]
 3. COMPLETE THE BURN WITH AFT RCS PROPELLANT DOWN TO AFT QUANTITY 1 PLUS THE AFT HP QUANTITY. OPERATIONALLY, FOR A DUAL OME DEORBIT BURN, THE AFT RCS ABOVE AFT QUANTITY 1 MAY BE BURNED SIMULTANEOUSLY WITH THE OMS. FOR A SINGLE OMS ENGINE DEORBIT BURN, THE AFT RCS WILL NOT BE BURNED SIMULTANEOUSLY WITH THE OMS.
 4. CONSIDER OTHER CONUS DEORBIT OPPORTUNITIES IF THE REQUIRED DEORBIT DELTA-V WOULD ALLOW THE ACHIEVEMENT OF STEEP TARGETS. @[121604-6494A]

THIS RULE CONTINUED ON NEXT PAGE

FLIGHT RULES

A4-152 DEORBIT BURN PLANNING PRIORITIES [HC] (CONTINUED)

- C. IF STEEP TARGETS TO A CONUS SITE CANNOT BE ACCOMPLISHED, THE FOLLOWING ACTIONS WILL BE TAKEN TO ACHIEVE SHALLOW TARGETS: ©[121604-6494A]
1. TARGET PREBANK UP TO 90 DEGREES WITH 3-SIGMA N-CYCLES.
 2. COMPLETE THE BURN WITH FORWARD RCS.
 3. TARGET PREBANK OF 90 DEGREES WITH LESS THAN 3-SIGMA N-CYCLES (MINIMUM N-CYCLES OF 2 TO PREVENT SKIPOUT).
 4. IF INSUFFICIENT DELTA V IS AVAILABLE TO ACHIEVE SHALLOW TARGETS WITH MINIMUM N-CYCLES, THEN TARGET USING MINIMUM N-CYCLES AND EXERCISE THE OPTIONS IN RULE {A4-202}, DEORBIT BURN COMPLETION, TO COMPLETE THE BURN. ©[081497-4178B]
- D. CONTINGENCIES REQUIRING RAPID TARGETING WILL BE TARGETED TO THE PRIMARY THRUSTERS OPTIMUM SOLUTION, OR THE 2 OMS/1 OMS CROSSOVER POINT IF 2 OMS ARE AVAILABLE.

This rule establishes the methods that will be used to target the deorbit burn in order to achieve an acceptable entry. The order has been established to minimize the impact to crew safety and maximize vehicle integrity.

All targeting in paragraphs A and B uses 3-sigma N-cycles. An N-cycle is defined as the number of guidance cycles after the initiation of closed loop guidance before the first non-zero roll command. Three sigma N-cycles are flight specific since the inclination and seasonal effects are factors used to define the specific N-cycle. The 3-sigma N-cycle provides protection from getting zero N-cycles with a minimum initial bank of 25 degrees at closed loop guidance initiation, in the presence of 3-sigma dispersions. Targeting with steep targets and the 3-sigma N-cycles will assure nominal entry heating levels, correct convergence onto the drag profile, and protection of recovery prebank capability. ©[121604-6494A]

THIS RULE CONTINUED ON NEXT PAGE

FLIGHT RULES

A4-152

DEORBIT BURN PLANNING PRIORITIES [HC] (CONTINUED)*Paragraph A:*

The deorbit maneuver TIG will be chosen to meet as many of the objectives listed in paragraph A as possible, in order of priority. The TIG will occur no earlier than RCS optimum minus 1 minute, and no later than the two OMS optimum.

OMS propellant quantities at landing should be less than 21.2 percent oxidizer, 21.1 percent fuel to prevent exceeding OMS/RCS pod structural loads. (Ref. SODB, Volume I, Shuttle Systems Performance and Constraints Data, Section 3.4.3.3, OMS Constraints/Limitations.) Violation of the tank landing weight constraint may cause structural damage. ©[081497-4178B] ©[121604-6494A]

The deorbit burn should be targeted such that at least 5 percent OMS propellant per pod remains post burn to prevent OMS engine damage due to fuel or oxidizer depletion. This strategy is consistent with Rule {A6-356}, DEORBIT PLANNING CRITERIA, which specifies that protecting the 5 percent post burn limit is a higher priority than RCS downmode capability or vehicle landing weight unless it is the only means to protect landing weight. Therefore, when possible, other techniques should be employed to reduce landing weight below the Rule {A4-159}, ORBITER LANDING WEIGHT [HC], limits rather than burning below the 5 percent OMS limit. Per SSP direction, preserving OMS to 5 percent is higher priority than protecting the landing weight limit because the additional weight penalty is only 150-200 lbs. ©[ED]

Orbiter landing weight limits should be protected per Rule {A4-159}, ORBITER LANDING WEIGHT [HC], since violating these limits may result in additional thermal loading during entry. Entry thermal loading is a function of many factors including crossrange, altitude, X-CG, and vehicle weight. When the FDO vehicle landing weight predictions indicate that the flight rule limits may be violated, a flight specific thermal analysis should be performed to quantify the increased temperatures and thermal stresses. ©[ED]

One downmode option from TIG through cutoff means that the burn can be completed in the event that the primary deorbit method is lost (i.e., 2 OMS to 1 OMS, or 1 OMS to RCS). If downmode protection is unavailable from TIG, the TIG should be planned to provide downmode protection at the earliest possible point after TIG.

The OMS tank fail Hp's are the altitudes at which an OMS tank can fail and the targets can still be achieved using all of the remaining resources (remaining good OMS, Aft RCS to Aft Qty 1, Forward RCS, and recovery prebank to the wing leading edge temperature limit). If the tank fail Hp is below Safe Hp, there is a window where the orbiter is too low to stop the burn (Safe Hp), but too high to complete the burn using the remaining acceptable resources. It is desirable that this window not exist; therefore, Tank Fail Hp should remain above Safe Hp if possible. If this is not possible, then this window should be minimized by raising tank fail Hp's as high as possible while still protecting all higher priority targeting criteria. ©[121604-6494A]

THIS RULE CONTINUED ON NEXT PAGE

FLIGHT RULES

A4-152 DEORBIT BURN PLANNING PRIORITIES [HC] (CONTINUED)

Protection of RCS completion at Safe Hp ensures the burn can be completed with the +X RCS jets, if both OMS engines are failed below Safe Hp. If the failure(s) occurs prior to Safe Hp, the shuttle would be in an orbit with at least 48 hours of lifetime, and the deorbit burn could be retargeted to optimize for the +X RCS jets. If the RCS completion Hp is below Safe Hp, there is a window where the orbiter is too low to stop the burn (Safe Hp), but too high to complete the burn using the remaining propellant through the RCS jets. It is desirable that this window not exist; therefore, RCS completion Hp should remain above Safe Hp if possible. If this is not possible, then this window should be minimized by raising the RCS completion Hp as high as possible while still protecting all higher priority targeting criteria. ®[081497-4178B] ®[121604-6494A]

TIG slip protects for minor anomalies or switch misconfigurations that occur close to TIG. TIG slip with downmode is preferred since the crew procedure is to continue the burn for the first OME failure for a 2 OME burn. If TIG slip with downmode is unavailable, then no fail TIG slip is desirable and the crew will have to be informed to stop the burn for an OME fail above safe Hp.

There is a structural limitation to the lifting points on the OMS pod. These points are used for removing the pod from the orbiter. If the weight of the post-landing propellant residuals in the pod (both OMS and RCS) exceeds 2575 lbs, then KSC will be required to drain propellant if pod removal is required. To prevent this KSC processing impact, it is desired to keep the OMS pod weight below the structural lifting limits.

The priorities in paragraph A are written primarily for the nominal 2 OME burn configuration, but should be followed as applicable for other deorbit burn engine configurations. For example, if attempting a single OME deorbit burn, RCS completion is higher priority than OMS tank fail since both situations only require one failure and tank fail is less likely. However, RCS completion for a single OME burn is also addressed in priority A5 "one downmode option from TIG through cutoff" since the downmode from a single OME burn is RCS completion. ®[121604-6494A]

THIS RULE CONTINUED ON NEXT PAGE

FLIGHT RULES

A4-152

DEORBIT BURN PLANNING PRIORITIES [HC] (CONTINUED)*Paragraph B:*

The actions in paragraph B allow steep targets to be achieved while still protecting the nominal RCS entry propellant redlines. ©[121604-6494A]

Performing an Aft RCS and/or Forward RCS perigee adjust at least two orbits prior to deorbit allows both burn confirmation and collection of some tracking data to take out the resulting trajectory dispersions. The RCS perigee adjust is acceptable within two orbits of deorbit if a valid burn confirmation can be performed. Accurate ground modeling of the burn is achievable with this confirmation, assuring valid state vector confidence to target the subsequent deorbit burn.

CG management techniques, utilizing both propulsive and non-propulsive consumables, as defined in Rule {A4-153}, CG PLANNING, may allow more propellant to be made available for the deorbit burn. For planning purposes, the CG at Mach 3.5 must be maintained within the nominal box. ©[091098-6717]

Targeting a steep deorbit burn with planned Aft RCS completion using propellant down to Aft Quantity 1 plus the Aft Hp quantity is preferred over targeting a shallow entry because it preserves steep targets with no impact to vehicle integrity. If the deorbit burn is a dual OMS engine burn, the Aft RCS down to Aft Quantity 1 may be burned using the +X jets simultaneously with the OMS to prevent OMS depletion. If the deorbit burn is a single OMS engine burn, the Aft RCS should not be burned simultaneously with the OMS due to inefficiencies in burning the +X jets in the single OMS engine burn attitude. While it is acceptable to target a burn using Aft Hp Quantity propellant, it is not acceptable to burn the Aft Hp Quantity propellant prior to OMS cutoff in order to protect for fast flip and/or prebank completion in the event of early OMS termination. ©[081497-4178B]

Prior to targeting a shallow entry, it may be best to deorbit to another CONUS opportunity if steep targets can be achieved. Wave off capability and orbital geometry will be the deciding factors in whether this is a feasible option. ©[121604-6494A]

THIS RULE CONTINUED ON NEXT PAGE

FLIGHT RULES

A4-152 DEORBIT BURN PLANNING PRIORITIES [HC] (CONTINUED)

Paragraph C: ©[081497-4178B]

The actions in paragraph C allow for shallow targets which reduce the propellant required for deorbit. ©[081497-4178B]

Targeted prebank up to 90 degrees shallows the targets and reduces the propellant required for deorbit. This targeting priority assures drag profile convergence, but results in higher vehicle heat loads and compromises recovery prebank capability. The heat load induced by a shallow entry increases with crossrange; therefore, low crossrange opportunities should be utilized if a heat load analysis cannot be performed.

In a time critical situation, once it has been determined that some amount of prebank is required, targeting 90 degrees prebank should be considered because pre-mission products are already available. If a prebank other than 90 degrees is selected, then recovery prebank tables must be generated in real time, using a time consuming and rarely exercised procedure.

Planned fast-flip completion using all available Forward RCS propellant is preferred over reducing N-cycles due to the risk of skipout. ©[121604-6494A]

The use of reduced N-cycles in conjunction with a targeted prebank of 90 degrees will further reduce the deorbit delta-V. The use of a minimum of two N-cycles provides protection from skipout, which is defined as zero N-cycles with an initial bank of 60 deg at closed loop guidance initiation, in the presence of 3-sigma dispersions. The resulting entry is thermally more severe and converges on the drag profile later in the entry phase.

If propellant is not available to complete shallow targets with minimum N-cycles, additional options are available for completing the deorbit burn, but they do not result in a change in planned delta V available for the deorbit targets. These options are listed in Rule {A4-202}, DEORBIT BURN COMPLETION.

Paragraph D:

In emergency targeting or contingency targeting cases, the primary thrusters optimum solution, or the 2 OMS/1 OMS crossover solution, will be used because it can be quickly executed within the limitations of the current deorbit targeting processor. Time may not be available for a detailed analysis of the targeting. ©[081497-4178B]

Hazard report ORBI 136, Excessive TPS Temperature Due to Abort Heating Issues, references this rule. ©[121604-6494A]

Rule {A4-159}, ORBITER LANDING WEIGHT [HC], references this rule. ©[ED]

FLIGHT RULES

A4-153

CG PLANNING

A. CG ENVELOPE:

1. CONTINGENCY CG ENVELOPE.
2. NOMINAL CG ENVELOPE: @[091098-6715]

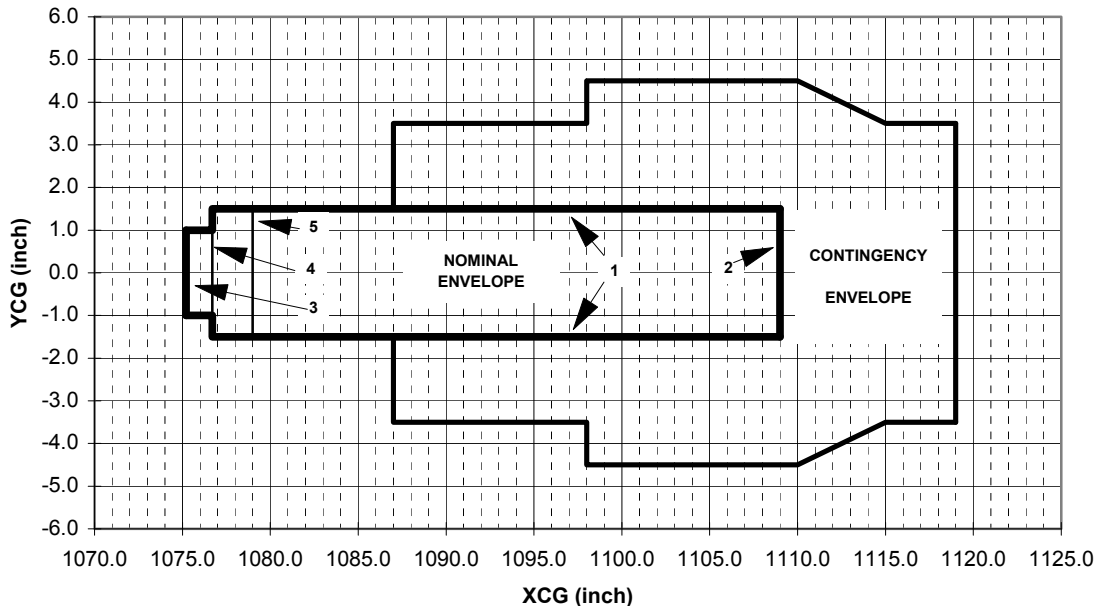

NOTES:

- [1] VERIFIED AERO BOUNDARY.
- [2] DESIGN ENVELOPE AFT LIMIT.
- [3] FORWARD LIMIT FOR EOM, ATO, AND AOA (X=1075.2 INCHES).
- [4] FORWARD LIMIT FOR GRTLs FOR ANGLE OF ATTACK < 30 DEGREES AND FOR TAL (X=1076.7 INCHES).
- [5] FORWARD LIMIT FOR GRTLs FOR ANGLE OF ATTACK > 30 DEGREES (X=1079.0 INCHES).
- [6] NOMINAL CG ENVELOPE REFLECTS A 1-INCH UNCERTAINTY FOR X CG AND A 0.5-INCH UNCERTAINTY FOR Y CG. @[091098-6715]

The contingency CG envelope represents the loss of control CG boundary for OMS tank fail cases. Vehicle control beyond the nominal CG envelope, yet within the contingency CG boundary, assumes all four yaw jets are available. Due to elevon saturation, there must be no jet failures to ensure vehicle control within the contingency envelope.

No structural or thermal assessments of the vehicle have been made for CG conditions beyond the nominal envelope. Entry at these conditions could result in significant damage to the airframe and/or thermal protection system even when the vehicle is within limit flight conditions.

THIS RULE CONTINUED ON NEXT PAGE

FLIGHT RULES

A4-153

CG PLANNING (CONTINUED)

The X CG values which correspond to the Y CG values of 3.5 inches and 4.5 inches represent the breakpoints of the generic elevon schedules. The boundaries of the contingency CG box include an uncertainty of ± 1.0 inch for X CG at the forward end of the contingency box. The uncertainty for the Y CG is ± 0.5 inch.

The contingency CG envelope boundaries were derived from an analysis matrix which included: fixed mass properties; light and heavyweight vehicles; 0 and 30 percent turbulence models; and aero variations of nominal LVAR 9, LVAR 19, bent airframe, and pitching moment.

This rule also contains the nominal CG envelope that was developed to trade off the X vs. Y CG location, when required during real-time operations, in conjunction with orbiter CG management rules. In addition, the CG envelope is used preflight to evaluate the projected end of mission CG location and, if required, adjust planning to assure that the CG is within the given boundaries. The nominal CG envelope reflects the prelaunch measurement errors (± 1 inch for X, ± 0.5 inch for Y).

The CG boundaries, as they exist today, have evolved since prior to STS-1 and are a result of many iterations of analyses performed by both the JSC and Rockwell International Corporation (RIC) aerodynamic communities, and of numerous Entry Flight Techniques discussions. The shape and dimensions of the boundaries have changed many times as a function of the assumptions made and the orbiter aerodynamic data used in their generation, and they may continue to change and expand as more is learned about the orbiter capabilities.

In general, the Y limits plus and minus are constrained by lateral trim requirements. The forward X limits represent lateral-directional stability constraints and the aft X limits represent longitudinal trim requirements as constrained by thermal limits on the body-flap and elevons. The lateral trim and stability requirements for Y CG were based on flight control system performance with the following aerodynamics stress case: 1.5 yaw jets for trim, 3-sigma lateral variation set 19, L/D tolerance, auto bodyflap, $+0.00025$ Clo and -0.00025 Cno bent airframe coefficients, 3-degree aileron trim, 15-degree angle of attack, and 275 psf dynamic pressure at Mach 3.5, using Flight Assessment AERO Data (FAD) 14 from STS 41-D. ©[081497-4178B]

AERO/FCS stress testing has certified the CG limits to ± 2 inches Y CG for X CG's from 1075.7 to 1110 inches and to ± 1.5 inches Y CG for X CG's from 1074.2 to 1075.7, thus exceeding the original certified end item (CEI) CG specification. However, because of mass properties uncertainties of approximately ± 1 inch in X CG and ± 0.5 inch in Y CG, the CG boundaries depicted in the flight rule nominal CG envelope are observed at Mach 3.5 for planning purposes; that is, ± 1.5 inches Y CG for X CG's from 1076.7 to 1109 inches and ± 1 inch Y CG for X CG's from 1075.2 to 1076.7. ©[081497-4178B] ©[091098-6715]

The increase to the forward X CG limit and the associated Y CG limit was a result of analysis presented by Boeing North American Flight Control and Loads groups at the 145th Ascent/Entry Flight Techniques on December 19, 1997. ©[091098-6715]

THIS RULE CONTINUED ON NEXT PAGE

FLIGHT RULES**A4-153****CG PLANNING (CONTINUED)**

- B. THE PLANNED ORBITER CG THROUGHOUT THE ENTRY PROFILE MUST BE WITHIN THE CG LIMITS. THE COMPUTATION OF THE CG ASSUMES NOMINAL CONSUMABLE USAGE, ENTRY MANEUVERS, AND A FORWARD SHIFT OF OMS PROPELLANT DURING ENTRY.

For real-time and preflight planning purposes, this rule states the assumptions involved for computation of the nominal EOM orbiter CG's (SODB, Volume II, section 3.0, Constraints and Limitations). The CG is to be calculated using a typical consumables profile which reflects the most realistic entry conditions.

- C. EOM PLANNING - ONLY THE CG MANAGEMENT TECHNIQUES LISTED IN PARAGRAPHS D THROUGH F WILL BE USED TO MANAGE THE EOM CG WITHIN THE CONTINGENCY CG ENVELOPE (REF. PARAGRAPH A). CONSIDERATION WILL BE GIVEN TO EXTENDING THE FLIGHT, IF ADDITIONAL MANAGEMENT WILL MINIMIZE VIOLATION OF THE NOMINAL CG ENVELOPE. @[081497-4179B]

Paragraph A represents the certified operational envelope, and analysis of performance beyond this envelope is not complete. It is of the highest priority to contain the entry CG within the orbiter control trim capability. All CG management techniques will be used to protect this constraint.

Staying in orbit longer will allow use of orbit management techniques. These tools include generation of extra water and use of additional ARCS propellant.

- D. X CG MANAGEMENT TECHNIQUES INCLUDE THE FOLLOWING:

1. RETAINING OR DUMPING ADDITIONAL POTABLE WATER.

Keeping/dumping potable water can move the X CG about 1 inch for every 375 lb of water retained/dumped for a 220,000-lb orbiter. Water dumps move the X CG further aft.

2. OPTIMIZING THE CRYO MANAGEMENT PLAN (REF. RULE {A9-256}, CRYO O2/H2 TANK QUANTITY BALANCING)

The cryo management plan can be optimized to produce a more aft CG. This is accomplished by maintaining mission margin in the center manifold, or by using the forward tanks earlier than planned.

3. RETAINING OR DUMPING FRCS. WHEN CG AND LANDING WEIGHT CONSTRAINTS ARE MET, THE FRCS WILL BE DUMPED TO ZERO.
@[081497-4179B]

Since the FRCS tanks are significantly forward of the vehicle X CG, retaining/dumping forward propellant is a powerful tool for control of the X CG. For a 220,000-lb orbiter, the X CG can be changed by about 1 inch for every 280 lb of FRCS retained/dumped. FRCS dumps move the X CG aft. If an FRCS dump does not cause the CG envelope to be violated, then the dump should be performed. Dumping the FRCS to zero will keep landing weight to a minimum and aid in vehicle processing time.

THIS RULE CONTINUED ON NEXT PAGE

FLIGHT RULES**A4-153****CG PLANNING (CONTINUED)**

4. MANAGEMENT OF OMS PROPELLANT USAGE IN DEORBIT TARGETING (REFERENCE RULE {A4-152}, DEORBIT BURN TARGETING PRIORITIES, FOR PRIORITIES): @[081497-4179B]
 - a. INCREASE OMS PROPELLANT USAGE TO MOVE THE CG FORWARD.

Backing up TIG from the optimum one OMS or two OMS TIG will use extra OMS propellant and move the X CG forward. For a 220,000-lb orbiter, 620 lb of OMS propellant usage will move the X CG forward by 1 inch. If additional propellant usage is required for CG control, the out-of-plane wasting technique can also be used to increase propellant usage.

- b. DECREASE OMS PROPELLANT USAGE TO MOVE THE CG AFT.

OMS propellant can be retained by burning at the optimum OMS time. Burning at the optimum leaves most OMS available in the aft, short of targeting with a prebank. Targeted prebank can be used to decrease the deorbit propellant usage even more. For a 220,000-lb orbiter, 620 lb of OMS propellant retention moves the X CG aft by 1 inch. (Reference Rule {A4-152}, DEORBIT BURN TARGETING PRIORITIES, for priorities.) @[081497-4179B]

5. OMS BALLAST MANAGEMENT - OMS BALLAST WILL BE RETAINED TO PROTECT THE FORWARD LIMIT OF THE CG ENVELOPE AT ANY POINT IN THE ENTRY PROFILE. THE AMOUNT OF OMS USED FOR BALLASTING WILL BE DETERMINED ASSUMING:
 - a. OMS PROPELLANT USED TO THE BALLAST BASELINE QUANTITY (REF A/E FLIGHT TECHNIQUES #67, MAY 1990).
 - b. ARCS PROPELLANT USED TRAPPED PLUS GAUGE ERROR (REF RULE {A6-305}, AFT RCS REDLINES [HC]). @[042706-7370D]
 - c. FRCS DUMPED TO ZERO, UNLESS THE CAPABILITY TO PERFORM THE DUMP IS LESS THAN SINGLE FAULT TOLERANT.

OMS ballast is required when the X CG violates the forward end of the CG envelope. The OMS ballast required for forward X CG protection may not be used for the deorbit burn. Usage beyond the nominal profile will move the X CG forward. Therefore, the forward CG limit will be protected for the full entry redline. The OMS ballast is nominally computed assuming the FRCS is dumped to zero. Consideration should be given to depleting the FRCS prior to the deorbit burn if the post burn dump has been jeopardized by previous failures. @[081497-4179B]

THIS RULE CONTINUED ON NEXT PAGE

FLIGHT RULES

A4-153

CG PLANNING (CONTINUED)

E. Y CG MANAGEMENT TECHNIQUES INCLUDE THE FOLLOWING:

1. MANAGING THE ARCS PROPELLANT BY UTILIZING THE RCS CROSSFEED CAPABILITY. RCS CROSSFEED WILL NOT BE USED TO IMPROVE THE ORBITER CG DURING DEORBIT AND ENTRY.

Use of the RCS crossfeed capability is effective for lateral control of the CG. Propellant from one aft pod may be used to feed the thrusters of both aft pods. RCS crossfeed is also used to balance RCS propellants or null the Y CG. For a 220,000-lb orbiter, 225 lb of ARCS can change the Y CG by 0.1 inch. To preclude tying OMS and RCS tanks, the RCS crossfeed will not be done during the deorbit burn and entry because the same set of propellant crossfeed lines would need to be used in the case of OMS engine failure or an RCS downmode during the deorbit burn.

2. MANAGING THE OMS PROPELLANT BY UTILIZING THE FOLLOWING PROCEDURES:
 - a. USING OMS CROSSFEED DURING SINGLE OMS ENGINE BURNS.

NOTE: OMS CROSSFEED MAY BE USED TO MANAGE OMS PROPELLANT WHEN DOWNMODING FROM A TWO-ENGINE BURN TO A SINGLE ENGINE AS A RESULT OF AN ENGINE FAILURE.

Using the OMS crossfeed capability allows control of the Y CG at a rate of about 0.1 inch for every 225 lb of OMS for an orbiter weighing 220,000 lb.

- b. USING OMS MIXED CROSSFEED FOR OMS PROPELLANT TANK FAILURES. THIS REQUIRES MEMORY READ/WRITE PROCEDURES.

If fuel or oxidizer is trapped in a tank, it is possible to control the Y CG by using fuel or oxidizer from a good pod with fuel or oxidizer from the failed pod. However, a memory read/write procedure is required to properly control the valves.

- c. PERFORMING A PORTION OF A TWO ENGINE BURN FROM A SINGLE POD FOR A SPECIFIED DELTA V.

This provides a powerful means of CG control, and procedurally, the crew can reconfigure to straight feed for the remaining portion of the burn.

THIS RULE CONTINUED ON NEXT PAGE

FLIGHT RULES

A4-153 CG PLANNING (CONTINUED)

F. COMBINATION X CG AND Y CG MANAGEMENT TECHNIQUES INCLUDE THE FOLLOWING:

1. USING THE OMS PROPELLANT TO ALTER THE CG'S BY MODIFYING THE PROPELLANT PLAN OR MAGNITUDE OF THE SCHEDULED OMS MANEUVERS.

Changing the tanks which are used for a given burn controls the propellant imbalance and lateral CG, while changing the magnitude of the burn alters the total propellant load. For an orbiter weighing 220,000 lb, each 225 lb of left-right imbalance causes a Y CG shift of about 0.1 inch. Each 620 lb of OMS will change the X CG by about 1 inch. ©[081497-4179B]

2. USING THE OMS/RCS INTERCONNECT.

The left and right pod interconnect schedule can be modified to achieve the desired Y CG. OMS imbalance can be managed by feeding OMS to RCS to minimize the Y CG imbalance. Recall that, for a 220,000-lb orbiter, 225 lb of OMS retention can shift the Y CG by about 0.1 inch. X CG management can be affected via interconnect of RCS with OMS for attitude control maneuvers, thus controlling the X CG using nominal mission ops. OMS usage affects the X CG more than the RCS. For a 220,000-lb orbiter, 620 lb of OMS interconnect will affect the X CG by about 1 inch. ©[120393-ED] ©[081497-4179B]

Rules {A2-210}, ENTRY THERMAL OPTIONS [HC]; {A6-305}, AFT RCS REDLINES [HC]; {A8-55}, ASCENT/ENTRY RCS CONTROL REQUIREMENTS [HC]; and {A8-1001}, GNC GO/NO-GO CRITERIA, reference this rule. ©[ED] ©[ED] ©[042706-7370D]

A4-154 DOWNTRACK ERROR

DEORBIT WILL NOT BE ATTEMPTED WITH ORBITER STATE VECTOR DOWNTRACK ERRORS IN EXCESS OF 20 NM.

Prior to STS -1, an analysis was performed and presented to Flight Techniques that indicated a 20 NM downtrack state vector error was the maximum that could be steered out by AUTO guidance between 130,000 feet and TAEM interface in the presence of three-sigma lift-to-drag variations and worst case winds. The requirement to recover the energy error between 130,000 feet and TAEM interface was chosen because, in the absence of GPS, neither TACAN acquisition nor a delta state update could be guaranteed to occur above 130,000 feet and because of large uncertainties in energy recovery capability (due to winds and lift-to-drag variations) after TAEM interface. This rule and Rule {A4-151}, IMU ALIGNMENT [HC], are correlated. A decision was made at Ascent/Entry Flight Techniques Panel #214, on September 30, 2005, to forgo an expansion of the allowable downtrack error at deorbit TIG that might be gained from the increased navigational accuracy that GPS provides. This decision was due to the Space Shuttle Program ending in 2010, the limited flight experience incorporating GPS into navigation, and the mixed fleet configuration (OV-103/OV-104 single string and OV-105 3-string) that will exist until the end of the Program. ©[032807-8371]

Rule {A11-52}, LOSS OF BOTH VOICE AND COMMAND, references this rule. ©[ED] ©[ED]

FLIGHT RULES

A4-155

SUN ANGLE LIMITS AND GLARE CRITERIA FOR INNER AND OUTER GLIDE SLOPES

A. SUN ANGLE LIMITS

FOR A RUNWAY TO BE GO, SUN POSITION ON FINAL MUST NOT BE WITHIN 10 DEGREES OF CENTERLINE IN AZIMUTH AND FROM 0 TO 20 DEGREES ELEVATION.

These criteria were established to preclude direct sunlight from obstructing the crew's vision on final approach.

B. SUN GLARE CRITERIA

FOR INNER AND OUTER GLIDESLOPES, SUN GLARE PREDICTIONS WILL BE CONSIDERED IN RUNWAY SELECTION IF MORE THAN ONE ACCEPTABLE RUNWAY IS AVAILABLE. THE PRESENCE OF SUN GLARE DOES NOT MAKE A RUNWAY NO-GO.

Sun glare occurs when the film of dirt from SRB separation and Sun angle on cabin windows causes diffuse forward scattering of sunlight. The worst scattering occurs when the Sun is at an angle of 40 degrees from the normal to the window. Glare drops in intensity for angles greater than or less than this. Sun glare is predicted if the Sun position on final approach is between 30 and 50 degrees from the normals to the CDR's or the PLT's front windows. Flight experience indicates that glare may be a problem, and it may in some cases create enough of a nuisance to justify trying to avoid it, assuming winds and weather permit and nav aids and landing aids criteria are met. Sun glare should, therefore, be considered in runway selection when more than one choice of runway is available, but it should not have the weight of a GO/NO-GO criterion. The very large angular extent of the glare zones and the impossibility of accurately predicting its severity would restrict landing opportunities if Sun glare were a GO/NO-GO criterion.

FLIGHT RULES

A4-156

HAC SELECTION CRITERIA

A. FOR THOSE APPROACHES THAT TRANSITION TO APPROACH AND LANDING GUIDANCE BY 9,000 FT ALTITUDE, THE OVERHEAD HAC APPROACH IS GENERALLY PREFERRED OVER THE STRAIGHT-IN HAC APPROACH. ©[021998-6510]

USE TABLE A4-156-I BELOW TO DETERMINE IF OTHER HAC SELECTION OPTIONS SHOULD BE CONSIDERED. THE 6-DEGREE-OF-FREEDOM (DOF) SIMULATION RESULTS (WHEN AVAILABLE) WILL TAKE PRECEDENCE OVER 3-DOF RESULTS.

TABLE A4-156-I - OVERHEAD HAC EVALUATION CRITERIA

3-DOF		6-DOF		HAC SELECTION OPTION
MAX HAC ALT ERROR LOW (FT)	MAX QBAR (PSF)	MAX HAC ALT ERROR LOW (FT)	MAX QBAR (PSF)	
≥ 3,700	≥ 290 [1]	≥ 4,500	≥ 315 [1]	OVERHEAD HAC NO-GO [2]
≥ 2,700	N/A	≥ 3,500	N/A	STRAIGHT-IN HAC PREFERRED [3]
≥ 1,700	N/A	≥ 2,500	N/A	DELAYED CSS PREFERRED [4]
< 1,700	< 290 [1]	< 2,500	< 315 [1]	NO RESTRICTIONS

NOTES:

- [1] THE QBAR CRITERION APPLIES ONLY TO HAC'S ≥ 300 DEG, FROM HAC INITIATION TO 20,000 FT ALTITUDE AGL.
- [2] THE OVERHEAD HAC IS NO-GO IF EITHER THE ALTITUDE ERROR OR QBAR CRITERION IS VIOLATED.
- [3] THE STRAIGHT-IN HAC IS PREFERRED OVER THE OVERHEAD HAC TO PROVIDE A MORE BENIGN TRAJECTORY. HOWEVER, IF THE OVERHEAD HAC IS SELECTED, REFER TO [4] BELOW.
- [4] NOMINAL CSS ACTIVATION SHOULD BE DELAYED UNTIL THE ONBOARD HAC ALTITUDE ERROR LOW IS NO LONGER DIVERGING (APPROXIMATELY 180 DEG HAC TURN REMAINING).

The approach and landing guidance transition altitude is an indication of the ability to control energy around the HAC based on the input upper level winds and atmosphere. Before transitioning to approach and landing guidance, four constraints must be satisfied. These constraints are altitude, lateral position, Qbar, and flight path angle limits referenced to the outer glideslope profile. The earliest altitude to transition is 10,000 ft, and 9,000 ft is considered high enough to preclude significant trajectory deviations on the outer glideslope. The evaluation will be performed by Flight Dynamics Entry Analysis tools using measured and forecasted wind data and AUTO flight control/AUTO speedbrake.

THIS RULE CONTINUED ON NEXT PAGE

FLIGHT RULES

A4-156

HAC SELECTION CRITERIA (CONTINUED)

Overhead HAC's are generally preferred over straight-in HAC's because they provide the best geometry for allowing clean-up of the onboard navigation state by TACAN (in the absence of GPS) and because they provide an energy downmode option. However, Table A4-156-I provides special considerations for HAC selection that provide margin to compensate for the severe conditions of the day. These conditions and corresponding criteria were presented to the Ascent/Entry Flight Techniques Panel #137 on February 27, 1997, and were developed in response to an analysis that showed TAEM guidance may be unable to limit HAC max Qbar and/or altitude error low for larger HAC's (over approximately 300 degrees) due to Nz limiting. ©[021998-6510] ©[032807-8372]

The Qbar limit for HAC's ≥ 300 deg specified in Table A4-156-I is an additional constraint to the Qbar limit for Mach < 1 specified in Flight Rule {A4-207A}.2, ENTRY LIMITS. These constraints provide 3-sigma protection against violating the certified structural and GN&C Qbar limit of 375 psf (333 KEAS) in the subsonic region as defined in SODB Volume V. For smaller HAC turns (under 300 degrees), Flight Rule {A4-207A}.2, ENTRY LIMITS, provides adequate Qbar protection because the vehicle will not encounter Nz command limiting, and Qbar will stay within the guidance I-loaded Qbar limit of 350 psf (321 KEAS).

The altitude error low constraints defined in Table A4-156-I were the result of an analysis done using a modified Monte Carlo technique that varied the vehicle navigation state, navigation sensor inputs and atmosphere, but did not vary the winds. This analysis did not use GPS. The 6-DOF 50-cycle Monte Carlo results showed that at a predicted altitude error low of 5,000 ft or more, all 50 cases experienced a HAC shrink, a significant percentage of which were full HAC shrink, and some cases were seen where the HAC phase was delayed. Although many of the cases were able to achieve a nominal approach and landing guidance transition, an altitude error low of 5,000 ft is being set as the limit of entry guidance capability due to the extremely dynamic nature of the resulting trajectory and its sensitivity to additional dispersions. Exceeding the 4,500 ft (6-DOF) maximum altitude error low criteria results in greater than an approximately 80 percent chance of triggering a HAC shrink at KSC 15 (approximately 50 percent at EDW 04), but provides 500 ft of protection from the 5,000 ft limit. Exceeding the 3,500 ft (6-DOF) maximum altitude error low criterion results in greater than 35 percent chance (approximately 1-sigma protection) of triggering a HAC shrink, but provides 1,500 ft of protection from the 5,000 ft limit. These backoffs provide margin to protect for limitations in the analysis which cannot take into account wind persistence or the full range of real-world HAC geometries, runway directions, and wind direction and magnitudes. The 3,700 ft overhead NO-GO and 2,700 ft straight-in preferred 3-DOF limits from Table A4-156-I are based on an average 3-DOF to 6-DOF TAEM simulation bias of 800 ft determined during this same analysis. ©[032807-8372]

The intent of delaying nominal CSS activation is to avoid unnecessary trajectory perturbations for HAC's that are predicted to be dynamic and/or have low performance margin. Analysis of HAC altitude errors from a small sample of flights (four) with large HAC's indicates CSS flight results in trajectories with maximum HAC altitude errors low approximately 2,000 ft greater than 3-DOF real-time predictions. The 1,700 ft limit (3-DOF) in Table A4-156-I provides 2,000 ft of CSS dispersion protection against exceeding the 3,700 ft maximum altitude error low limit (3-DOF) used to NO-GO overhead HAC's. ©[021998-6510]

THIS RULE CONTINUED ON NEXT PAGE

FLIGHT RULES

A4-156

HAC SELECTION CRITERIA (CONTINUED)

Predicted altitude errors low in excess of 2,500 ft (6-DOF) are indicative of guidance Nz limiting which results in a nose-low pitch attitude. Any additional nose-low pitch attitude errors beyond the guidance Nz command while guidance is Nz limited will likely result in substantial performance degradation (faster airspeed, higher Nz, greater altitude rate, more roll, steeper flight path angle, etc.). The most performance-critical region of TAEM is HAC initiation, so it is especially prudent to minimize deviations from guidance during the initial portion of the HAC. Once the guidance Nz command is no longer limited, the vehicle's pitch attitude will get shallower and the HAC altitude error will stop diverging and soon begin to converge. However, it is not necessary to wait until the HAC altitude error is converging to engage CSS, since substantial performance degradation is unlikely after the vehicle's pitch attitude has shallowed. The best tools for determining if the altitude is diverging from its reference are onboard, so identifying when CSS can be taken is best performed by the crew. ©[021998-6510]

The 3-DOF evaluation will be accomplished with the Descent Design System (DDS) and the 6-DOF evaluation will be accomplished with the Spacecraft Trajectory Analysis and Mission Planning Simulation (STAMPS). In the event that there is a conflict in meeting the criteria in Table A4-156-I between the 3-DOF and 6-DOF evaluations, the results of the 6-DOF evaluation will be favored due to the higher fidelity of the processor (reference STF no. DFD-97-4235-016, dated March 12, 1997).

Note: Adjusting for the nose-low pitch attitude due to guidance Nz command limiting by manually biasing the guidance Nz command and pitching up is not recommended because of the potential for violating the GN&C upper angle of attack defined in the SODB Volume V. ©[021998-6510]

- B. IF NONE OF THE OPTIONS IN PARAGRAPH A ALLOWS TRANSITION TO APPROACH AND LANDING GUIDANCE BY 9,000 FEET ALTITUDE, THEN CONSIDER A 24-HOUR WAVE-OFF AND/OR USE OF THE SECONDARY LANDING SITE TO ACHIEVE NOMINAL APPROACH AND LANDING GUIDANCE TRANSITION, CONSISTENT WITH RULE {A2-202}, EXTENSION DAY GUIDELINES. ©[021998-6510]

Delaying 1 day increases the probability of going to the PLS and of having acceptable heading alignment phase guidance capability.

- C. IF NONE OF THE OPTIONS IN PARAGRAPH A OR B ALLOW TRANSITION TO APPROACH AND LANDING GUIDANCE BY 9,000 FEET ALTITUDE, THEN CONSIDER USE OF THE HIGHEST PRIORITY RUNWAY/HAC OPTION THAT MEETS THE TRANSITION CRITERIA BY 6,000 FEET ALTITUDE. ©[021998-6510]

Transition to approach and landing guidance is forced at 5,000 feet altitude, whether or not the four transition constraints have been met. A 6,000-foot transition altitude indicates the AUTO system satisfied the four constraints late in the transition period, which should allow for acceptable landing conditions even with additional dispersions. ©[061297-6006]

Rule {A2-202}, EXTENSION DAY GUIDELINES, references this rule. ©[061297-6006]

FLIGHT RULES

A4-157 ENERGY DOWNMODING

THE STRAIGHT-IN OR MINIMUM ENERGY POINT (MEP) OPTION WILL BE SELECTED WHEN A VALID KALMAN FILTER SOLUTION OF ENERGY CROSSES THE ENERGY VERSUS R-GO DOWNMODE CRITERIA. THE MEP SHOULD NOT BE SELECTED BETWEEN HAC INTERCEPTION AND REACHING THE 180-DEGREE POINT ON THE SPIRAL. THE ONBOARD ALERT WILL BE HONORED IF THE MCC SOLUTION IS UNAVAILABLE.

MEP selection is an energy downmode option which will decrease R-GO by approximately 6 miles. This call should be made only when the ground Kalman filter solution is valid. The ground solution is prime for calling the straight-in or MEP options. If MEP is selected between HAC intercept and 180-degree point on the HAC, guidance may add 360 degrees to the HAC causing unexpected approach geometry and more energy problems.

A4-158 MANEUVER EXECUTION MATRIX

MODE	MNVR	OVERBURN SHUTDOWN CRITERIA	EARLY C/O MNVR COMP CRITERIA	RCS TRIM ALL AXES	MNVR INHIBIT OR TERMINATION CRITERIA [1]	MANUAL TAKEOVER CRITERIA [1]
NOM & ATO	OMS-1	T _{GO} = 0	ALWAYS COMPLETE	≤ 2 FPS	NONE	IGN ATTITUDE ERROR > 5 DEG OR 5 DEG DEVIATION DURING MNVR
	OMS-2		H _p > MIN H _p	NONE		
AOA	OMS-1	T _{GO} = 0	ALWAYS COMPLETE	STEEP: ≤ 2 FPS TGT PREBANK: ≤ 0.5 FPS	NONE	IGN ATTITUDE ERROR > 5 DEG OR 5 DEG DEVIATION DURING MNVR
	OMS-2	[2] T _{GO} = 0				
ORBITAL CRITICAL	ALL	T _{GO} = 0	[3] COMPLETE	≤ 0.2 FPS	DELAY UNTIL IGN ATT ERROR < 5 DEG BUT BURN NO LATER THAN END OF TIG SLIP WINDOW	IGN ATTITUDE ERROR > 5 DEG OR 5 DEG DEVIATION DURING MNVR
ORBITAL NON-CRITICAL	ALL	T _{GO} = 0	NONE	≤ 2 FPS	IGN ATTITUDE ERROR > 5 DEG OR 5 DEG DEVIATION DURING MNVR	NONE
DEORBIT	ALL	[2] T _{GO} = 0	ALWAYS COMPLETE IF H _p < SAFE H _p	STEEP: ≤ 2 FPS TGT PREBANK: ≤ 0.5 FPS	IGN ATTITUDE DEVIATION > 5°	5 DEG ATTITUDE DEVIATION DURING MNVR

@[011295-1691]

NOTES:

[1] ENGINE OUT TRANSIENTS NOT INCLUDED.

[2] IF ANY IMU ACCELEROMETER FAILED, SHUTDOWN:

2 OMS

1 OMS

BT + 5 SECONDS

BT + 10 SECONDS

@[011295-1691]

[3] FOR PAYLOAD SEPARATION MANEUVERS, ALWAYS COMPLETE TO AT LEAST MINIMUM SEPARATION DELTA VELOCITY. AFTER MINIMUM SEPARATION DELTA V IS ACHIEVED, BURN IS NONCRITICAL.

THIS RULE CONTINUED ON NEXT PAGE

FLIGHT RULES

A4-158

MANEUVER EXECUTION MATRIX (CONTINUED)

OVERBURN SHUTDOWN CRITERIA - December 1979 Flight Techniques determined that a 3-sigma low OMS engine performance would increase a nominal deorbit 2-OMS burn duration by approximately 3 seconds (6 seconds for 1-OMS) and that a 2000 micro-G accelerometer error would increase the maneuver time by 5 seconds (10 seconds for 1-OMS). The onboard guidance will account for off-nominal OMS engine performance and adjust the burn time as necessary to achieve the targeted conditions assuming a good navigation state. However, if IMU accelerometer errors are present, the velocity to be gained will be updated incorrectly such that the targeted conditions may not be met. If the accelerometer error is in the direction to result in an underburn, the burn will be completed using the RCS jets. If the accelerometer error is in the direction to result in an overburn, a manual shutdown will be performed at the pre-burn TGO plus 5 seconds for 2-OMS (10 seconds for 1-OMS) to avoid overburns greater than 20 fps. ©[011295-1691]

Terminating at $T_{GO} = 0$ is sufficient for on-orbit and uphill maneuvers. If the maneuver is targeted and cannot be overburned, any residuals will need to be trimmed.

EARLY C/O MNVR COMP CRITERIA - Nominal, ATO, and AOA OMS-1 maneuver completion is required to attain a safe insertion orbit. Nominal OMS-2 completion to a perigee of Min Hp (ref. the Annex Flight Rule, TRAJECTORY AND GUIDANCE PARAMETERS) is required for a safe orbital lifetime of 24 hours, assuming OMS-1 apogee of 150 nm or, 3 orbits assuming OMS-1 apogee of 105 nm. An AOA OMS-2 is a deorbit and, since perigee is already less than Safe Hp, the maneuver must be completed to attain EI targets. ©[ED]

Any orbital maneuvers considered critical should be completed due to the criticality. Also, based on the definition of a critical maneuver, it cannot be rescheduled. Therefore, if the maneuver is not completed at that time, severe consequences may result. A payload separation maneuver is critical for crew safety. Therefore, the maneuver should be completed to at least a minimum separation to guarantee less than 10X tile damage.

A noncritical maneuver should not be completed manually since it can be rescheduled if necessary. Also, this allows time to determine the failure which caused the maneuver to terminate early.

Deorbit burns that cut off at a perigee greater than Safe Hp will be retargeted for a subsequent deorbit one orbit later or up to 24 hours later since the orbital lifetime allows the delay. Deorbit burns that cut off at perigee less than Safe Hp should be completed at all costs to attain EI conditions since the perigee is unsafe for orbital lifetimes of reasonable lengths to retarget.

RCS TRIM - Ascent and deorbit burns are large and all uphill and EI targets will be met within allowable tolerances if the delta V imparted is within 2 fps. Specifically, a 2 fps underburn for deorbit equates to a 30 nm energy error at EI, which is an acceptable error, well within guidance capability to converge by $M = 12$. Uphill delta-V accuracy requirements are even less critical, and 2 fps is deemed very achievable.

THIS RULE CONTINUED ON NEXT PAGE

FLIGHT RULES

A4-158**MANEUVER EXECUTION MATRIX (CONTINUED)**

Critical orbital maneuvers should be completed to 0.2 fps due to their criticality and since the maneuver cannot be rescheduled to make up for the trim errors. Additionally, it is important to trim payload separation maneuvers to within 0.2 fps of the design limit to meet tile damage limit criteria.

It is not necessary to trim noncritical orbital maneuvers precisely. Two fps was selected since PEG-7 guidance can achieve this for an OMS burn without any RCS trimming.

MANUAL TAKEOVER, MNVR INHIBIT, OR TERMINATION CRITERIA - A 5-degree attitude deadband is the largest available, and an ignition attitude error or deviation greater than this indicates flight control malfunction. Nominal ATO and AOA OMS-1 and -2 are time-critical burns sequenced such that the ignition attitude may not have been attained. For out-of-attitude cases or attitude deviations during the maneuver, the maneuver should still be performed (i.e., not inhibited or terminated), but performed manually. The deorbit burn attitude is entered in a controlled, timely manner, and the maneuver can be postponed for an unacceptable attitude error. A maneuver inhibit should be accomplished for attitude errors greater than 5 degrees. If ignition has occurred, maneuver completion is important, and a manual takeover should be performed for deviations greater than 5 degrees.

Critical maneuvers should be completed once started. Payload separation maneuvers should be completed to at least minimum separation delta-velocity. This is due to the definition of a critical burn. Critical maneuvers should not be executed until the vehicle attitude error is less than 5 degrees or until the end of the TIG slip window, whichever occurs first. If the attitude error during the maneuver drifts outside 5 degrees, the crew should take over and manually steer the vehicle towards the correct attitude.

Noncritical orbital maneuvers should not be executed if the vehicle is not in attitude. Also, if the vehicle drifts out of attitude during the maneuver, the maneuver should be terminated. A later maneuver can be scheduled to correct errors imparted to the trajectory if necessary.

A4-159**ORBITER LANDING WEIGHT [HC]** ®[111705-7042B]

A. THE FOLLOWING CONDITIONS ARE ASSUMED FOR THE CALCULATION OF THE ORBITER EOM LANDING WEIGHT: ®[081497-4179B]

1. THE PLANNED DEORBIT BURN IS SUCCESSFUL AND THE DESIRED OMS BALLAST REMAINS ONBOARD AS THE RESIDUAL.

®[081497-4179B] ®[111705-7042B]

THIS RULE CONTINUED ON NEXT PAGE

FLIGHT RULES

A4-159

ORBITER LANDING WEIGHT [HC] (CONTINUED)

2. THE NOMINAL ARCS QUANTITY IS USED DURING ENTRY. @[081497-4179B] @[111705-7042B]
3. A SUCCESSFUL FRCS DUMP, IF PLANNED.
4. NOMINAL EOM NON-PROPELLANT CONSUMABLES USAGE.

The orbiter landing weight computation will be based on the Flight Control Team's best estimates of the expected usages during the flight.

B. LANDING WEIGHT CONSTRAINTS:

IF THE CALCULATED LANDING WEIGHT EXCEEDS THE FOLLOWING LIMITS, AVAILABLE OPTIONS WILL BE EXERCISED TO BRING THE ORBITER WEIGHT WITHIN LIMITS. IF THE WEIGHT CANNOT BE REDUCED BELOW THE WEIGHT LIMIT, A THERMAL ASSESSMENT WILL BE PERFORMED AND A REAL-TIME FLIGHT RULE WILL BE WRITTEN TO DOCUMENT THE EXCEPTION. FLIGHT SPECIFIC EXCEPTIONS IDENTIFIED PRE-FLIGHT TO ANY OF THE ABORT OR END-OF-MISSION LANDING WEIGHT LIMITS WILL BE DOCUMENTED IN THE FLIGHT SPECIFIC ANNEX. @[041196-1789B]

1. ASCENT ABORT AND EOM LANDING WEIGHT LIMITS:

FLIGHT PHASE:	INCLINATION			
	28.5 DEG	39.0 DEG	51.6 DEG	57.0 DEG
RTLS	248K LBS	248K LBS	245K LBS	242K LBS
TAL	248K LBS	248K LBS	244K LBS	241K LBS
AOA/ATO	248K LBS	248K LBS	242K LBS	239K LBS
NOMINAL EOM	233K LBS	233K LBS	233K LBS	233K LBS

@[101096-4211A] @[081497-4179B] @[111705-7042B]

THIS RULE CONTINUED ON NEXT PAGE

FLIGHT RULES

A4-159

ORBITER LANDING WEIGHT [HC] (CONTINUED)

2. FOR EARLY MISSION TERMINATION/UNPLANNED PAYLOAD RETURN CASES, AVAILABLE OPTIONS WILL BE EXERCISED TO BRING THE LANDING WEIGHT \leq THE ATO LANDING WEIGHT, AND DEORBIT OPPORTUNITIES MUST BE EVALUATED AGAINST THE ORBITER THERMAL CRITERIA FOR NOMINAL EOM. ©[041196-1789B] ©[081497-4179B] ©[111705-7042B]

The primary methods of reducing the orbiter landing weight in the event of a violation would be FRCS dump, reduction of OMS remaining (not to exceed the minimum tank constraint), reduction of other orbiter consumables, and evaluation of the return payload (if applicable). If OMS ballast techniques are required for CG management, the first priority is protecting the forward X CG limit; therefore, the OMS ballast required for protecting forward X CG may not be reduced to achieve the landing weight limit. OMS propellant in excess of the ballast may be used to reduce the orbiter landing weight. (Ref. PRCB S40522J.)

In the event that an entry violates the landing weight limit where the weight cannot be reduced below the limit, the Flight Dynamics Officer (FDO) will document the prospective landing weight using the Mission Action Request (aka CHIT) process. Engineering will then use that published weight to conduct thermal evaluations of the available deorbit opportunities (i.e., next PLS or MDF) to identify those deorbit opportunities that result in thermally acceptable entries. If none of the available deorbit opportunities are within thermal limits, the opportunity with the minimum thermal violation will be selected. A real-time Flight Rule that reflects the analysis will be written to document the exception.

For early mission termination/unplanned payload return cases, a thermal evaluation will always be conducted for the available deorbit opportunities, time permitting, to ensure that the entries are within the envelope defined by the certified set of trajectories.

The landing weight capability limits are defined in NSTS 07700 Space Shuttle Program Definition and Requirements, Volume X, Space Shuttle Flight and Ground System Specification, Book 1, Requirements, Section 3.3.1.1.9., Orbiter Vehicle Landing Weight. The orbital thermal limits are documented in NSTS 08934 Shuttle Operations Data Book, Volume V, Orbiter Flight Capability Envelopes. ©[041196 1789B] ©[101096-4211A] ©[081497-4179B] ©[042403-5937]

Rule {A4-152}, DEORBIT BURN PLANNING PRIORITIES [HC], references this rule. ©[081497-4179B] ©[111705-7042B]

A4-160 THROUGH A4-200 RULES ARE RESERVED

FLIGHT RULES

ENTRY

A4-201**DELTA-T UPDATE CRITERIA**

A DOWNTRACK CORRECTION TO THE STATE VECTOR AND A BFS NAVIGATION VECTOR TRANSFER WILL BE PERFORMED BETWEEN DEORBIT AND 300,000 FEET IF A VALID DELTA-T SOLUTION EXISTS, NAVIGATION SYSTEM ANOMALIES INDICATE A HIGH LIKELIHOOD OF NAVIGATION ERRORS, AND THE INSTANTANEOUS DOWNTRACK ERROR COMPUTED BY THE DELTA-T PROCESSOR IS GREATER THAN 8 NM. FOR ERRORS LESS THAN 8 NM, NO UPDATE WILL BE REQUIRED.

An entry navigation Monte Carlo analysis performed from TIG through touchdown, utilizing the Oracle entry navigation simulation, indicated that there is no onboard navigation requirement for delta-T update for navigation downtrack error less than 8 nm (see minutes for Ascent/Entry Flight Techniques Panel Meeting #71 held September 21, 1990). Eight nm is the expected 3-sigma downrange error resulting from the sensor error models and initial navigation error assumptions selected for this study. These initial conditions have been used consistently for Oracle studies since before STS-1. The maximum downtrack error observed at EI for STS-1 through STS-31 was 2 nm.

Studies performed using the Entry Navigation Reconstruction program indicate that, due to unmodeled aerodynamic accelerations, the incorporation of large delta-T corrections several minutes after initial IMU processing can result in a diverging navigation state. This study indicated that 300,000 feet represents a minimum safe altitude for incorporating delta-T updates.

At least one C-band radar is required for the generation of the delta-T downtrack correction. In order for the computed delta-T to be considered valid, agreement between the AOS and LOS computed values is required. Data processed from a second independent C-band source, if available, can be used to confirm the presence of a large onboard state error. The accuracy of the delta-T solution is degraded by the presence of large radial or crosstrack errors. The Ground Navigation Officer will analyze the C-band tracking data residuals and signature to determine whether the delta-T correction will be valid.

Large onboard navigation state errors observed during the delta-T tracking pass can be caused by an inaccurate onboard navigation state vector prior to deorbit, multiple IMU failures, poor IMU performance, or the erroneous execution of navigation related crew procedures. The presence of a large onboard navigation state error should be presaged by such a problem.

FLIGHT RULES

A4-202

DEORBIT BURN COMPLETION [HC] @[121604-6495B]

- A. THE FOLLOWING TECHNIQUES, IN ORDER OF PRIORITY, WILL BE UTILIZED IN THE EVENT OF OMS DELTA V DEFICIENCY FOR THE DEORBIT MANEUVER PRIOR TO OMS CUTOFF:
1. FOR A DUAL OMS ENGINE DEORBIT MANEUVER, THE AFT RCS ABOVE AFT QUANTITY 1 MAY BE BURNED SIMULTANEOUSLY WITH THE OMS.
 2. INCREASE THE AVAILABLE PROPELLANT BY EXPANDING THE CG LIMITS TO THE CONTINGENCY BOX AND BURN THE OMS TANKS TO DEPLETION.
- B. THE FOLLOWING TECHNIQUES, IN ORDER OF PRIORITY, WILL BE UTILIZED IN THE EVENT OF DELTA V DEFICIENCY AT OMS CUTOFF FOR THE DEORBIT MANEUVER:
1. TRIM WITH THE ARCS, NOT TO EXCEED ARCS QUANTITY 1. THE AFT HP QUANTITY (REFERENCE RULE {A6-305}, AFT RCS REDLINES [HC]) CAN ALSO BE USED, IF SUFFICIENT TO COMPLETE THE BURN. @[042706-7370D]
 2. TRIM WITH THE FORWARD RCS TO DEPLETION.
 3. PREBANK UP TO THE PLS REDESIGNATION LIMIT (2950 DEG F BASED ON THE TPS-91 THERMAL MODEL).
 4. REDESIGNATE TO THE BACKUP SITE (IF AVAILABLE) (NORTHROP PLS FOR EDWARDS PLS).
 5. PREBANK UP TO THE ELS REDESIGNATION LIMIT (3020 DEG F BASED ON THE TPS-91 THERMAL MODEL).
 6. REDESIGNATE TO THE BACKUP SITE (IF AVAILABLE) (NORTHROP ELS FOR EDWARDS PLS).
 7. PREBANK UP TO THE CONTINGENCY LIMIT (3120 DEG F BASED ON THE TPS-91 THERMAL MODEL).
 8. REDESIGNATE TO DOWNRANGE ELS. @[033006-7293A]
 9. TRIM WITH THE AFT RCS TO CAPTURE HP, NOT TO EXCEED AFT QUANTITY 2. @[121604-6495B] @[033006-7293A]

Section A defines options for utilizing propellant reserves or dispersions in the event of an OMS delta V deficiency for the deorbit maneuver. These options may be exercised prior to OMS cutoff.
@[121604-6495B]

THIS RULE CONTINUED ON NEXT PAGE

FLIGHT RULES

A4-202

DEORBIT BURN COMPLETION [HC] (CONTINUED)

If the deorbit burn is a dual OME burn with insufficient OMS propellant available, the aft RCS may be burned simultaneously to prevent OMS depletion. If the deorbit burn is a single OME burn, the aft RCS should not be burned simultaneously with the OMS due to inefficiencies in burning the RCS in the single OME burn attitude. In burning the aft RCS simultaneously with the OMS, aft quantity 1 should not be exceeded to allow for fast flip and/or prebank completion in the event of an early OME termination.

Expanding the cg box out to the contingency limits may allow access to propellant that was previously limited by the Y cg limit. The contingency box allows expansion from the nominal Y cg limit except for the forward end of the X cg box, where the nominal and contingency limits are the same.

Burning the OMS tanks to depletion may damage the OMS engines. Therefore, it is the last priority prior to OMS cutoff.

Paragraph B defines the procedures for completing the deorbit burn after all OMS downmode options have been exercised and aft RCS propellant to the aft RCS entry redline has been used. The deorbit burn completion cue cards incorporate the techniques, according to the defined priorities.

If the targets can be accomplished using the propellant down to aft RCS quantity 1 plus the aft Hp quantity, the vehicle integrity and crew safety have not been compromised. This aft RCS option is preferred over the forward RCS because no large attitude change is required, nor is the execution of the more complicated forward RCS burn procedure required.

Use of the forward RCS propellant is preferred over an equivalent prebank. This propellant, if not used for trimming the burn, is either dumped prior to entry or maintained for ballast. The thermal effects of the prebank are considered more severe than execution of the forward RCS trim procedures.

Options B3 through B7 incorporate the use of prebank to obtain atmospheric capture while maintaining aft RCS quantity 1 reserves. Use of the prebank stresses the TPS. Option B3 limits the prebank to the PLS redesignation limit of 2950 degrees while maintaining the capability to land at the prime site. If Northrup meets the PLS landing site criteria, then redesignation to Northrup is higher priority than giving up thermal margin and continuing towards an Edwards landing. ©[121604-6495B]

However, if Northrup only meets the ELS landing site criteria, then it is prudent to give up a small amount of Edwards thermal margin to offset the additional risk associated with an ELS landing. The ELS redesignation limit is defined as 3020 degrees F based on the on-console prebank scanner processor which utilizes the TPS-91 thermal model. This provides 200 degrees of margin under the actual limit of 3220 degrees F. This 200-degree margin includes 100 degrees of margin to account for limitations in the on-console evaluation of the peak CP3 temperature for a worst case mission profile. Limitations in the on-console thermal profile evaluation include differences between the TPS-91 and the TSEP version 3.6 thermal models, differences between the nominal and mean entry trajectories, differences between the DDS and STAMPS entry trajectory simulations, and differences between the generic and trajectory-specific atmospheres. The remaining 100 degrees of margin provides 2 sigma protection in the on-console evaluation of the thermal profile. ©[121604-6495B] ©[033006-7293A]

THIS RULE CONTINUED ON NEXT PAGE

FLIGHT RULES

A4-202

DEORBIT BURN COMPLETION [HC] (CONTINUED)

In order to reduce the exposure to high thermal Edwards entries and using propellant reserved for aft quantity 2, Northrup is considered available as the backup site as long as it meets ELS conditions. Landing under ELS conditions introduces risk, but this risk is minimized at Northrup due to crew familiarity, possible availability of MLS, and the large underrun/overrun and lateral margins of the Northrup lakebed.

In order to minimize exposure to usage of aft RCS down to aft quantity 2, which does not guarantee a successful entry, option B7 calls for prebank up to the contingency thermal limit of 3120 degrees F. The contingency thermal limit is based on the on-console prebank scanner processor and protects for a mean entry equivalent to 3220 degrees F. This provides 100 degrees of margin to account for limitations in the on-console evaluation of the peak CP3 temperature for a worst case mission profile. At this point in the deorbit burn completion options, a successful entry is expected with very little margin in the propulsion or TPS system above the mean.

At aft RCS quantity 1, if the current Hp is too high to allow the prime, backup, or downrange landing site to be achieved using options B2-B8, the burn will be continued to either Capture Hp or aft quantity 2, whichever comes first. Capture Hp is the maximum perigee height that provides for aerocapture, which, for the purpose of this rule, is defined as no positive H-dot after EI (approximate 2 sigma protection level). Burn termination above Capture Hp would likely result in skipout and eventual loss of control due to aft RCS propellant starvation. The Capture Hp value read up on the DEL PAD will include any available delta Hp capability in the FRCS per option B2 above. Following achievement of Capture Hp, the resultant high energy entry will require redesignation to a downrange ELS in order to avoid violation of the contingency thermal limit. Pre-bank up to 180 deg per B7 will be utilized to minimize surface temps to the ELS. ©[033006-7293A]

Option B9 uses propellant below the aft RCS entry redline, down to aft RCS quantity 2. This provides enough propellant for attitude control to $Q\text{-bar} = 20$ psf. After $Q\text{-bar} = 20$, aerodynamic control is possible but risky without the yaw jets. NO YAW JET is now a certified entry mode. Aft Quantity 2 does not protect the aft RCS ON ORBIT TANK FAIL limit (ref. Rule {A6-7}, RCS PROPELLANT TANK (OXIDIZER OR FUEL)). Below 20 percent remaining, with $Nz < 0.05g$, the aft RCS tanks may not be able to supply propellant to the RCS jets.

Reference Ascent/Entry Flight Techniques Panel #206, October 22, 2004.

*Hazard Reports ORBI 247, Structural Overheating Caused by Non-Impact Related RCC Failures, and ORBI 249, Structural Overheating Caused by TPS Failure, reference this rule. ©[121604-6495B]
©[033006-7293A]*

FLIGHT RULES

A4-203

ENTRY DELTA STATE UPDATE PHILOSOPHY [HC] ©[072601-4530B]
 ©[032807-8389A]

A. THE ONBOARD STATE VECTOR ERRORS SHALL BE EVALUATED USING THE MCC HIGH SPEED TRAJECTORY DETERMINATION PROCESSOR. DELTA STATE UPDATES SHALL BE PERFORMED AS SPECIFIED BELOW. IF PROCESSING GPS, GPS SHALL BE TAKEN TO INHIBIT PRIOR TO STARTING THE UPDATE PROCESS.

1. POSITION-ONLY UPDATE SHALL BE PERFORMED WHENEVER A POSITION ERROR, IN ANY COMPONENT, EXCEEDS THE LIMITS DEFINED IN TABLE A4-203-I.

TABLE A4-203-I - POSITION DELTA STATE LIMITS

	GRTLS			EOM			
	DELTA POSITION (FT)			DELTA POSITION (FT)			
	X	Y	Z	X	Y	Z	
H > 100K FT	18K	18K	6K	H > 130K FT	48K	48K	12K
H < 100K FT	6K	6K	3K	H < 130K FT	6K	6K	6K
				H < 90K FT	6K	6K	3K

2. A POSITION-VELOCITY UPDATE SHALL BE PERFORMED WHENEVER A VELOCITY ERROR, IN ANY COMPONENT, EXCEEDS 75 FPS. IF A POSITION-VELOCITY UPDATE IS REQUIRED, ALL NAVAIDS SHALL BE INHIBITED PRIOR TO STARTING THE DELTA STATE PROCESS.
3. A DELTA STATE UPDATE (POSITION-ONLY OR POSITION-VELOCITY) MAY BE PERFORMED TO AVOID A GROUND CONTROLLED APPROACH (GCA).

It is extremely unlikely that if GPS is being processed a delta state update would be required. However, if this situation occurs, GPS must be inhibited prior to calculating and executing the update. If GPS is not inhibited, the delta state update could be computed incorrectly and GPS could overwrite the update once it is onboard.

The position update limits were set to meet guidance imposed navigation accuracy requirements (ref. STS 81-0366, appendix A, Navigation Performance Requirements). The guidance constraints were designed to ensure auto guidance capability to achieve the runway after correcting the onboard navigation state. The guidance constraint requirements do not guarantee a nominal transition to the approach and land guidance phase. The guidance requirements are ramp functions of altitude that can easily be monitored with the current MCC displays. However, at the beginning of the shuttle program, ground operators could not easily observe the constantly changing guidance constraints. Therefore, it was necessary to simplify the update criteria for easy memorization. The current delta state limits were developed as a result. Due to the step function of the delta state limits, it is possible for decreasing onboard navigation errors to momentarily exceed the delta state limits. For cases where the onboard error is converging to a level within delta state limits, a delta state uplink does not need to be performed. ©[032807-8389A]

THIS RULE CONTINUED ON NEXT PAGE

FLIGHT RULES

A4-203

ENTRY DELTA STATE UPDATE PHILOSOPHY [HC] (CONTINUED)

The velocity update limits were chosen to meet a flight control system requirement when the FCS is using navigation-derived air data, while at the same time, considering the radar 3-sigma velocity uncertainty of 60 fps. In addition, velocity errors greater than 75 fps can lead to sizable energy errors even though navigated position errors may still be within delta state limits. ©[032807-8389A]

For GRTLS, the two tier set of limits was chosen with a breakpoint at 100,000 feet altitude, since it is desired to remove state errors before TAEM initiation. The limits above 100,000 feet altitude are tighter than for EOM, since there is little ranging control exercised in GRTLS until TAEM, which is initiated at $M=3.2$ or around 92,000 feet altitude. For EOM, the guidance requirements dictate that the errors be under control and decreasing with altitude by around 130,000 feet. Therefore, this point was chosen as the breakpoint for the EOM three-tier update criteria.

Since the delta state processor assumes linear error growth and the velocity errors are computed from changes in position, any external update, such as drag altitude updating, will mask the true state error and cause the velocity deltas to be wrong. Therefore, external navigation aids must be inhibited prior to computing a position-velocity delta state update. Anytime a velocity update is required, a position and velocity delta state update will be executed, since velocity errors will also cause position errors. The MCC does not currently have an automated capability to perform a velocity-only update.

Performing a ground controlled approach (GCA) is inherently risky and should be avoided if possible. Therefore, a delta state may be executed to avoid a GCA. Usually, when a GCA needs to be performed due to onboard navigation errors, a delta state update is performed simultaneously with the GCA, so that the GCA may be terminated. Performing these two procedures simultaneously can be particularly difficult and risky. If a delta state update must be performed, it is better to perform it prior to initiating a GCA rather than concurrently with a GCA.

Crew takeover will be performed prior to the delta state update (Ref. Rule {A2-255}, CREW TAKEOVER and Rule {A4-208}, ENTRY TAKEOVER RULES).

Rule {A4-151}, IMU ALIGNMENT, and Rule {A4-206}, NAVIGATION FILTER MANAGEMENT AUTO/INHIBIT/FORCE (AIF), reference this rule.

B. DELTA STATE UPDATES SHOULD BE AVOIDED AFTER HAC ACQUISITION. HOWEVER, IF VISUAL CONTACT WITH THE RUNWAY CANNOT BE MAINTAINED BY THE CREW, DELTA STATE UPDATES SHOULD BE CONTINUED AS LONG AS THE ONBOARD STATE VECTOR IS OUTSIDE FLIGHT RULE LIMITS AND CAN BE IMPROVED WITH THE DELTA STATE UPDATES.

After HAC intercept, a delta state update will normally not be performed if the crew has visual contact with runway because transients caused by a delta state could be distracting to the crew. Also, inhibiting the external data sources (TACAN, BARO, MLS) to properly compute the delta state update could distract the crew.

Hazard report ORBI 211 references this rule. ©[032807-8389A]

FLIGHT RULES

A4-204

RESERVED ©[032807-8390]

FLIGHT RULES

A4-205

RESERVED ©[032807-8391]

FLIGHT RULES

THIS PAGE INTENTIONALLY BLANK

FLIGHT RULES

A4-206

NAVIGATION FILTER MANAGEMENT AUTO/INHIBIT/FORCE (AIF) [HC] ©[032807-8392A]

A. GPS (IN ORDER OF PRIORITY)

1. THE GPS NAV AIF CONTROL SHALL BE SET TO INHIBIT IF NO GPS RECEIVERS ARE FUNCTIONING PROPERLY (REF. RULE {A8-115}, GPS SYSTEM MANAGEMENT [HC]).
2. THE GPS NAV AIF CONTROL SHALL BE SET TO INHIBIT FOR TARGETED BURNS.
3. DURING MM 301, THE GPS NAV AIF CONTROL MAY BE SET TO AUTO IF GPS CONFIRMED GOOD WITH AN INDEPENDENT NAV SOURCE.
4. DURING ENTRY, THE GPS NAV AIF CONTROL SHALL BE SET TO AUTO AFTER CONFIRMATION WITH HIGH-SPEED TRACKING IF THE GPS RATIO < 1 .

IF HIGH-SPEED TRACKING IS NOT AVAILABLE, THE GPS STATE VECTOR MAY BE CONFIRMED BY VERIFYING THAT THE GPS SELECTED STATE IS BEING UPDATED AND GPS QA3 POSITION RATIOS FROM THE SELECTED RECEIVER(S) ARE LESS THAN 0.3.

5. DURING ENTRY, THE GPS NAV AIF CONTROL SHALL BE SET TO FORCE IF THE GPS RATIO > 1 AND GPS HAS BEEN CONFIRMED GOOD (SEE PARAGRAPH A.4 ABOVE). THIS ACTION TAKES PRIORITY OVER PERFORMING A DELTA STATE UPLINK (REF. RULE {A4-203}, ENTRY DELTA STATE UPDATE PHILOSOPHY [HC]).

a.1 Self-explanatory.

a.2 GPS is not certified to be incorporated into onboard navigation during targeted burns, therefore GPS must be inhibited prior to targeted burns. GPS data is certified to be processed as soon as the targeted burn is complete.

a.3 For nominal operations, GPS will be incorporated into onboard navigation via auto during MM 301. GPS confirmation can be performed using any of several independent sources. Some examples of independent sources are PASS/BFS navigation state vector, TDRS residuals, and GPS QA4 ratios.
©[032807-8392A]

THIS RULE CONTINUED ON NEXT PAGE

FLIGHT RULES

A4-206

NAVIGATION FILTER MANAGEMENT AUTO/INHIBIT/FORCE
(AIF) [HC] (CONTINUED)

a.4 *For nominal operations, GPS will be incorporated into onboard navigation via auto after confirmation with high-speed tracking. The GPS ratio, which is also known as the GPS nav edit check, must be less than 1 for GPS to be incorporated while in auto. The ground filter provides an accurate estimate of the GPS and onboard navigation errors once the filter has been declared good for energy and groundtrack. The differences between GPS and the HSTD should be less than 3000 ft when above 130 Kft altitude and less than 1000 ft when below 130 Kft altitude for all position components. These thresholds were established based on ground filter errors at initial low elevation tracking angles and the ability of the other navigation aids to maintain the onboard state vector after a biased GPS state vector has been incorporated (Ref. AEFTP #182, February 2002). ©[032807-8392A]*

For 3-string GPS vehicles, GPS should be processed by at least 130 Kft altitude, even if high-speed tracking is not available, to ensure acceptable onboard navigation for a safe landing. GPS QA3 position ratios greater than 0.3 indicate a bias in the GPS receiver state vector. For 3-string GPS vehicles, QA4 ratios help confirm the accuracy of the GPS state vector. For 1-string GPS vehicles, TACAN's may be used as an additional nav source to evaluate GPS.

a.5 *It is possible that the differences between GPS and the onboard state vectors may cause the GPS ratio to be greater than one even though GPS is functioning properly. This situation might be a result, for example, of a degraded state vector uplink or degraded IMU performance. If such a situation occurs, then GPS should be forced to nav. The GPS AIF will automatically return to its previous setting (auto or inhibit) following the force command. Forcing GPS to nav has higher priority than uplinking a delta state since the GPS action is simpler and more expedient in correcting the navigation errors (Reference AEFTP #173, March 1, 2001).*

B. THE DRAG AIF CONTROL SHALL BE INITIALLY SET TO AUTO.

Drag altitude should remain in Auto to bind the navigation errors. The Drag altitude measurement does a good job bounding nav errors caused by IMU acceleration biases. IMU attitude errors (primarily resolver errors) can cause large, erroneous updates on the order of tens of thousands of feet. For these cases, Drag AIF should be moded to inhibit. Forcing Drag is not addressed because Kalman filter theory, flight history, and entry reconstruction techniques all show that editing good Drag altitude measurements is virtually impossible. ©[032807-8392A]

THIS RULE CONTINUED ON NEXT PAGE

FLIGHT RULES

A4-206

NAVIGATION FILTER MANAGEMENT AUTO/INHIBIT/FORCE
(AIF) [HC] (CONTINUED)

- C. TACAN (1-STRING GPS VEHICLES ONLY) @[032807-8392A]
1. THE TACAN AIF CONTROL SHALL INITIALLY BE SET TO INHIBIT.
 2. THE TACAN AIF CONTROL SHALL BE CHANGED TO AUTO IF THE FOLLOWING ARE TRUE:
 - a. TACAN RANGE AND BEARING ERRORS CONFIRMED WITH A VALID INDEPENDENT DATA SOURCE TO BE LESS THAN 0.3 NM AND 1 DEGREE, RESPECTIVELY
 - b. TACAN RATIOS ≤ 1
 3. THE TACAN AIF CONTROL SHALL BE MODED TO FORCE IF THE FOLLOWING ARE TRUE:
 - a. TACAN RANGE AND BEARING ERRORS CONFIRMED WITH A VALID INDEPENDENT DATA SOURCE TO BE LESS THAN 0.3 NM AND 1 DEGREE, RESPECTIVELY
 - b. TACAN RATIOS > 1
 4. THE TACAN AIF CONTROL SHALL BE MODED TO INHIBIT IF A VALID INDEPENDENT DATA SOURCE SHOWS THE TACAN RANGE OR BEARING ERRORS TO BE GREATER THAN 0.3 NM OR 1 DEGREE, RESPECTIVELY.
 5. THE TACAN AIF CONTROL SHALL BE MODED TO INHIBIT PRIOR TO SELECTING A TACAN STATION THAT HAS NOT BEEN PREVIOUSLY EVALUATED. @[032807-8392A]

THIS RULE CONTINUED ON NEXT PAGE

FLIGHT RULES

A4-206

NAVIGATION FILTER MANAGEMENT AUTO/INHIBIT/FORCE
(AIF) [HC] (CONTINUED)

Having the TACAN AIF control initially set to INHIBIT allows the crew and the ground to evaluate the TACAN data before processing it in the onboard navigation filter. The crew will evaluate TACAN data using the onboard TACAN-NAV deltas displayed on SPEC 50. The ground will evaluate the TACAN data using whatever valid independent data is available at the time (e.g., GPS, HSTD, onboard state vector). The range and bearing limits of 0.3 NM and 1 degree, respectively, are the TACAN toggle limits. Analysis shows that if GPS is not incorporated, TACAN range and bearing errors greater than 0.3 NM and 1.0 degree, respectively, can result in guidance constraint violations (Ref. Rule {A4-203}, ENTRY DELTA STATE UPDATE PHILOSOPHY [HC]). ©[032807-8392A]

Conditions can exist where the TACAN data is good, but due to other circumstances, the onboard navigation state vector is in error resulting in TACAN ratios > 1. In this instance, the TACAN AIF should be set to FORCE to clean up the onboard state vector. Usually, if the ratios are > 1 prior to initial processing, then the onboard state vector is likely to be outside the delta state update limits (Ref. Rule {A4-203}, ENTRY DELTA STATE UPDATE PHILOSOPHY [HC]). The delta state update will be performed prior to any TACAN actions. If, however, a delta state update is either not required or not available, then the TACAN AIF should be set to FORCE.

It is self-evident that if an independent data source shows that the TACAN data is in error, then the data should not be processed. See Rule {A8-52}, SENSOR FAILURES [CIL] [HC], for more information on how to identify bad TACAN data.

It is prudent to inhibit TACAN measurements prior to switching to a secondary (or alternate) TACAN station so that the data can be evaluated prior to incorporation into the onboard navigation system.

Previous post-convergence TACAN management techniques recommended using a zero delta state update to increase the covariance in the event that good TACAN data was being edited. This technique is not useful since the delta state covariance is not significantly larger than typically seen after initial TACAN processing in the absence of GPS incorporation. ©[032807-8392A]

THIS RULE CONTINUED ON NEXT PAGE

FLIGHT RULES

A4-206

NAVIGATION FILTER MANAGEMENT AUTO/INHIBIT/FORCE
(AIF) [HC] (CONTINUED)

D. ADTA @[032807-8392A]

1. THE ADTA TO NAV AIF CONTROL SHALL BE INITIALLY SET TO INHIBIT.
2. THE ADTA TO NAV AIF CONTROL SHALL BE CHANGED TO AUTO IF THE FOLLOWING ARE TRUE:
 - a. THE ADTA ALTITUDE ERROR IS CONFIRMED WITH A VALID INDEPENDENT DATA SOURCE TO BE LESS THAN THE HISTORICAL 3-SIGMA ERROR, AND
 - b. ADTA RATIO ≤ 1
3. THE ADTA AIF CONTROL SHALL BE CHANGED TO FORCE IF THE FOLLOWING ARE TRUE:
 - a. ADTA ALTITUDE ERROR CONFIRMED WITH A VALID INDEPENDENT DATA SOURCE TO BE LESS THAN THE HISTORICAL 3-SIGMA ERROR, AND
 - b. ADTA RATIO > 1
4. THE ADTA TO NAV AIF CONTROL SHALL BE CHANGED TO INHIBIT IF A VALID INDEPENDENT DATA SOURCE SHOWS THE ADTA ALTITUDE ERROR TO BE CONSISTENTLY GREATER THAN THE HISTORICAL 3-SIGMA ERROR. @[032807-8392A]

THIS RULE CONTINUED ON NEXT PAGE

FLIGHT RULES

A4-206

NAVIGATION FILTER MANAGEMENT AUTO/INHIBIT/FORCE
(AIF) [HC] (CONTINUED)

Having the ADTA AIF control initially set to INHIBIT allows the crew and the ground to evaluate the data before processing it in the onboard navigation filter. The crew will evaluate ADTA data using the onboard ADTA ratios displayed on SPEC 50. The ground will evaluate ADTA data using whatever valid independent data is available at the time (e.g., GPS, HSTD, onboard state vector). ©[032807-8392A]

The selected air data measurement should be incorporated into the onboard navigation system if the performance is within the 3-sigma historical trend. Incorporation of 3-sigma quality measurements will not cause the onboard navigation state to exceed delta state limits. Measurements that consistently (e.g., more than 30 seconds) lie outside the 3-sigma trend indicate a problem with the air data system; these measurements should not be incorporated. The actual historical error trend is neither constant nor is it centered around zero. At 90 Kft altitude, the 3-sigma selected air data measurement error is about 3700 ft. At 80 Kft altitude, the 3-sigma selected air data measurement error is about 5000 ft. At 70 Kft altitude, the upper 3-sigma selected air data measurement error is about 2200 ft, while the lower 3-sigma error is about 3100 ft.

Conditions can exist where the ADTA data is good, but due to other circumstances, the onboard navigation state vector is in error resulting in an ADTA ratio > 1 . In this instance, the ADTA AIF should be set to FORCE to clean up the onboard state vector. Usually, if the ADTA ratio is > 1 prior to initial processing, then the onboard state vector is likely to be outside the delta state update limits (Ref. Rule {A4-203}, ENTRY DELTA STATE UPDATE PHILOSOPHY [HC]). The delta state update will be performed prior to any ADTA actions. If, however, a delta state update is either not required or not available, then the ADTA AIF should be set to FORCE. ©[032807-8392A]

THIS RULE CONTINUED ON NEXT PAGE

FLIGHT RULES

A4-206

NAVIGATION FILTER MANAGEMENT AUTO/INHIBIT/FORCE
(AIF) [HC] (CONTINUED)

E. MLS (3-STRING GPS VEHICLES ONLY) ©[032807-8392A]

1. THE MLS AIF CONTROL SHALL BE INITIALLY SET TO AUTO.
2. THE MLS AIF CONTROL SHALL BE CHANGED TO FORCE IF THE FOLLOWING ARE TRUE:
 - a. MLS RANGE, AZIMUTH, AND ELEVATION ERRORS CONFIRMED WITH A VALID INDEPENDENT DATA SOURCE TO BE LESS THAN THE REDUNDANCY MANAGEMENT LIMITS.
 - b. $MLS\ RATIO > 1$
3. THE MLS AIF CONTROL SHALL BE CHANGED TO INHIBIT IF A VALID INDEPENDENT DATA SOURCE SHOWS THE MLS RANGE, AZIMUTH, OR ELEVATION ERRORS OF THE SELECTED DATA TO BE GREATER THAN THE REDUNDANCY MANAGEMENT LIMITS.

For vehicles equipped with 3-string GPS, the flight software allows the MLS AIF to be changed via item entry. Initially, the MLS AIF should be set to AUTO, which has been the standard setting since the beginning of the shuttle program. For vehicles equipped with 1-string GPS, the MLS AIF flag is hardcoded to AUTO in the flight software.

Conditions can exist where the MLS data is good, but due to other circumstances, the onboard navigation state vector is in error resulting in MLS ratios > 1 . In this instance, the MLS AIF should be set to FORCE to clean up the onboard state vector.

It is self-evident that if an independent data source shows that the MLS data is in error, then the data should not be processed. The Redundancy Management (RM) limits for the MLS are 0.329 NM for range, 0.5 deg for azimuth, and 0.4 deg for elevation.

Reference Ascent/Entry Flight Techniques #217, January 27, 2006.

Reference Hazard Report ORBI 211. ©[032807-8392A]

FLIGHT RULES

A4-207

ENTRY LIMITS

A. THE FOLLOWING LIMITS ARE APPLICABLE TO THE ENTRY AND LANDING FLIGHT PHASES. THE CG MUST BE KEPT WITHIN NORMAL LIMITS (REFERENCE RULE {A4-153}, CG PLANNING). THE MCC WILL MONITOR THE PARAMETERS BELOW AND ADVISE THE CREW TO PREVENT EXCEEDENCES. ©[050495-1531B]

1. NZ LIMITS (THE MOST CONSTRAINING OF THE FOLLOWING):
©[091098-6716A]

- a. ORBITER WEIGHT \leq 211 KLB: THE NZ LIMIT IS 2.5 G.
- b. ORBITER WEIGHT $>$ 211 KLB: THE NZ LIMIT IS DETERMINED AS FOLLOWS:

$$NZMAX = 4.563 - (9.778 \times 10^{-6} \times WT)$$

- c. $1076.7 > \text{ORBITER XCG} \geq 1075.2$, $QBAR \geq 325$, $MACH < 1$, THE NZ LIMIT IS DETERMINED AS FOLLOWS:

$$NZMAX = 4.71 - (0.0068 \times QBAR), \text{ WHERE } QBAR \text{ IS DETERMINED FROM PREDICTIONS MADE BY 6-DOF STAMPS SIMULATION.}$$

NOTE: FOR PRE-DEORBIT PLANNING PURPOSES, A 0.2 g LOAD FACTOR BIAS IS SUBTRACTED FROM THE ABOVE STRUCTURAL LIMITS TO PROTECT FOR DISPERSIONS AND ASYMMETRY DURING A ROLLING MANEUVER.

Orbiter normal load factor limits are defined in the SODB (JSC-08934) Volume V. The MCC will evaluate the planned entry profile to ensure these load factor limits are not exceeded. When in the CSS, the crew must implement active load factor monitoring and avoidance procedures when required. The MCC will advise the crew of what limits to protect. To protect for wind dispersions on the heading alignment cone (HAC), the operational Nz limit is reduced by a bias for planning purposes. The value of the bias is derived by averaging differences between flight and real-time predicted data.

The analysis performed by Boeing North American Flight Control and Loads groups (presented at the 145th Ascent/Entry Flight Techniques on December 19, 1997) to expand the forward X CG limit resulted in an additional constraint on orbiter NZ limit. For flights predicted to be in this region, the NZ limit is also a function of Qbar. The operational NZ limit will be the most constraining. The X CG is evaluated at Mach=3.5. ©[091098-6716A]

THIS RULE CONTINUED ON NEXT PAGE

FLIGHT RULES

A4-207

ENTRY LIMITS (CONTINUED)

ORBITER NORMAL LOAD FACTOR LIMITS

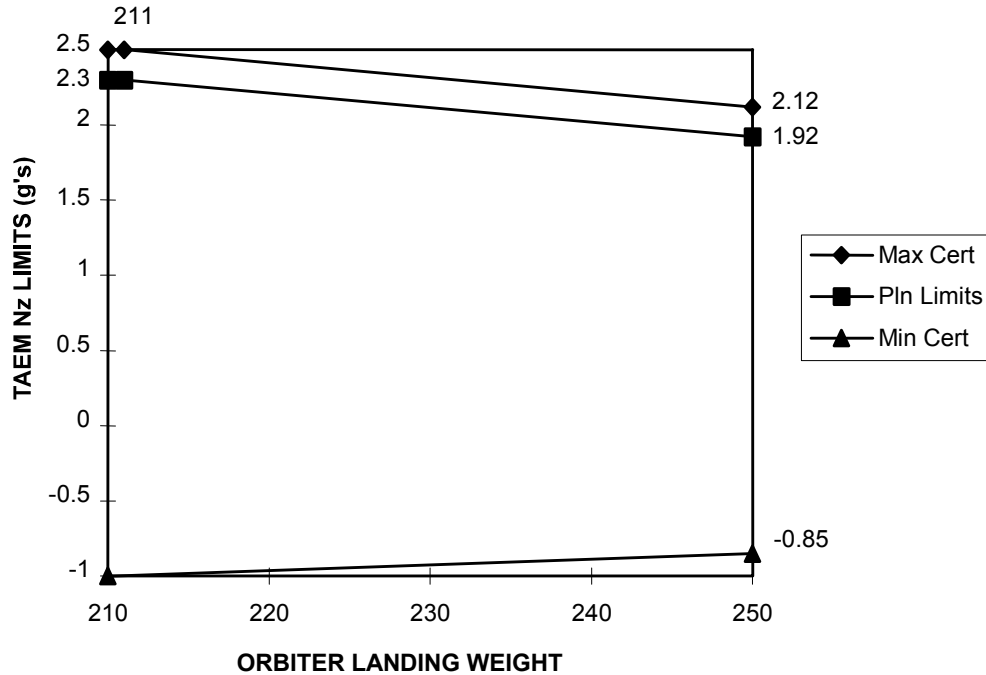

2. $Q\text{-BAR} < 350 \text{ PSF (321 KEAS)}$ FOR MACH < 1

$Q\text{-BAR} < 330 \text{ PSF (312 KEAS)}$ DURING LANDING GEAR DEPLOYMENT

The Q-bar restrictions are designed to protect the structural integrity of the orbiter and to ensure flight within the integrated guidance, navigation, and control envelopes. The Q-bar profile gives a good indication of whether or not the guidance is being stressed in trying to fly the reference profile. For real-time evaluation purposes, evaluation of the subsonic region is important because it includes the dynamics of flying the HAC with the winds of the day. The certified Q-bar limit of 375 psf in the subsonic region is documented in SODB Volume V. The TAEM guidance will limit normal acceleration commands to stay within the maximum Q-bar limit which is I-loaded to 350 psf. This provides for the 25 psf Air Data System accuracy listed in the SODB. The 350 psf limit is used DOL/DOE because it indicates a stressed trajectory, protects for events not being simulated (CSS, wind persistence), and it protects against flying a trajectory which could indicate an airspeed > 321 KEAS (350 psf).

During approach and landing, guidance indirectly controls dynamic pressure by controlling the equivalent airspeed, which is related to dynamic pressure. The 330 psf (312 KEAS) limit on maximum dynamic pressure at gear deploy is covered in the SODB 3.4.2.1-6.

THIS RULE CONTINUED ON NEXT PAGE

FLIGHT RULES

A4-207

ENTRY LIMITS (CONTINUED)

Angle of Attack Boundaries - MM304 Only

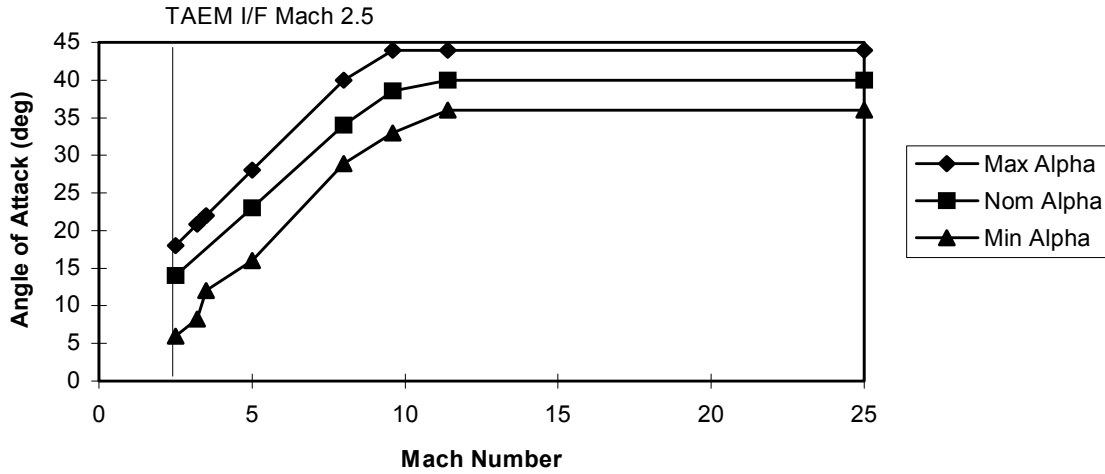

MACH	MAX ALPHA	MIN ALPHA	MACH	MAX ALPHA	MIN ALPHA
2.5	18.0	6.0	0.0	20.0	-4.0
3.2	20.8	8.2	0.2		-4.0
3.5	22.0	12.0	0.5		0.0
5.0	28.0	16.0	0.6	20.0	
8.0	40.0	28.9	0.8	15.0	
9.6	44.0	33.0	1.1		4.0
11.4	44.0	36.0	2.0	15.0	4.0
25.0	44.0	36.0	2.5	18.0	6.0

Angle of Attack Boundaries - MM305 Only

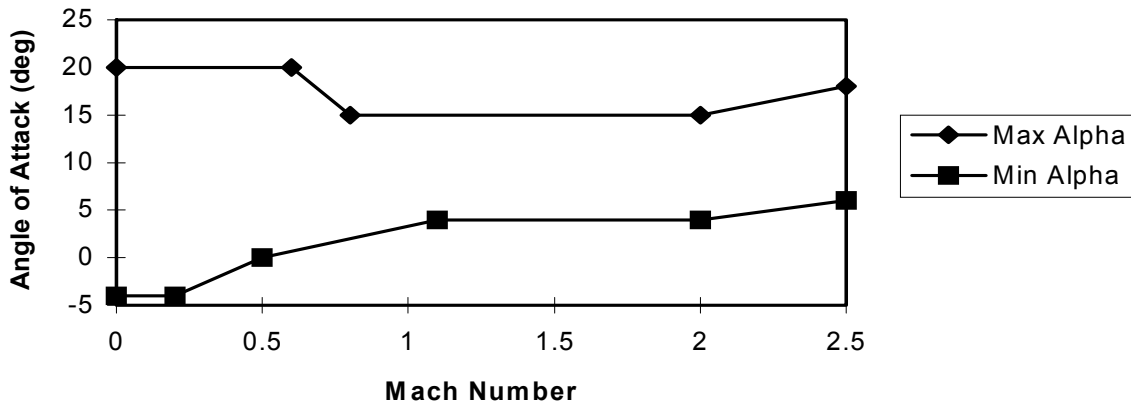

THIS RULE CONTINUED ON NEXT PAGE

FLIGHT RULES

A4-207

ENTRY LIMITS (CONTINUED)

- B. THESE ATTITUDE CONSTRAINTS WILL NOT BE EXCEEDED IN AUTO OR CSS MODE. THE MCC WILL MONITOR THESE PARAMETERS AND ADVISE THE CREW TO PREVENT EXCEEDENCES.
1. ANGLE OF ATTACK (ALPHA DEG) VERSUS MACH NUMBER.
 2. IF STEADY STATE SIDESLIP EXCEEDS 2 DEGREES AND ONE OR MORE YAW JETS FIRE CONTINUOUSLY OR IF THE SIDESLIP EXCEEDS THE TWO-JET CAPABILITY PER THE "BETA ESTIMATOR" (SCALED AY), THE CREW WILL MANUALLY TRIM TO REDUCE RCS JET FIRING ($2 < M < 12$).

The orbiter must be operated within the specified angle of attack constraints to maintain control in pitch and roll/yaw axes, to meet structural requirements during venting, to assure hinge moment limits for aerosurfaces are not exceeded, and to remain within guidance limits due to interaction with roll angle in solving range and drag equations.

Large steady state sideslip can lead to loss of control. If jets are required to maintain vehicle trim, they will have reduced effectiveness during dynamic flight phases where their force is required; reduced stability margins and control problems may result. Also, there will be a large increase in RCS propellant usage. @[050495-1531B]

Rules {A2-210}, ENTRY THERMAL OPTIONS [HC]; {A4-107}, PLS/EOM LANDING OPPORTUNITY REQUIREMENTS; and {A6-305}, AFT RCS REDLINES [HC], reference this rule. @[ED] @[042706-7370D]

FLIGHT RULES

A4-208

ENTRY TAKEOVER RULES

CONDITION	ACTION	CRITERIA FOR AUTO RE-ENGAGE[1]
A. ROLLREF < ROLLREF LIMIT (↓) PRIOR TO THE FIRST BANK REVERSAL	CSS ROLL/YAW; INITIATE FIRST BANK REVERSAL WHEN DELTA AZIMUTH ≥ 5°	FIRST BANK REVERSAL COMPLETION
B. GROUND TRACKING AOS TO CREW VISUAL ACQUISITION OF RUNWAY: TRAJECTORY DISPERSIONS WHICH EXCEED FDO GCA LIMIT LINES OR ENTRY GUIDANCE CAPABILITY FOR THE SELECTED RUNWAY	CSS ROLL/YAW (ENTRY) OR PITCH AND ROLL/YAW (TAEM); FOLLOW GCA COMMANDS; REDESIGNATE HAC/RUNWAY	TRAJECTORY RETURNED TO WITHIN GUIDANCE CAPABILITY
C. FOUR (4) YAW JETS FAILED (SAME SIDE); AFTER QBAR > 10 AND PRIOR TO MACH 1.	CSS ROLL/YAW (NO YAW JET ROLL MODE)	RECOVERY OF A YAW JET AND SELECTION OF AUTO ENTRY ROLL MODE
D. PRIOR TO: 1. DELTA STATE UPDATES INCLUDING VELOCITY COMPONENTS ANYTIME, OR POSITION-ONLY COMPONENTS IF M=5 TO TAEM 2. FORCED AIR DATA TO NAV 3. AIR DATA INCORPORATION TO GNC AFTER M=2.5 4. GPS INCORPORATION WITH METERING OVERRIDE ON	1. CSS PITCH, ROLL/YAW 2. CSS PITCH, ROLL/YAW 3. CSS PITCH 4. CSS PITCH, ROLL/YAW	COMPLETION OF EVENT AND MANUALLY CENTERED GUIDANCE NEEDLES
E. PRIOR TO MSBLS ACQ IF MCC HAS TM AND CONFIRMS LATERAL NAV ERRORS > 8000 FT OR H ERRORS > 500 FT	CSS PITCH, ROLL/YAW	INCORPORATION OF MSBLS AND MANUALLY CENTERED GUIDANCE NEEDLES
F. FAILURE OF APPROACH & LAND GUIDANCE TRANSITION PRIOR TO 6000 FT AGL	CSS PITCH, ROLL/YAW	NONE
G. FOR UNEXPLAINED OR UNCOMFORTABLE TRANSIENTS OR TRAJECTORY CONDITIONS	CSS PITCH, ROLL/YAW	CREW OPTION
H. TO AVOID LOSS OF CONTROL OF THE VEHICLE	CSS PITCH, ROLL/YAW	CREW OPTION

@[021998-6513A] @[032807-8384]

NOTE: [1] AUTO RE-ENGAGE IS NOT CONSIDERED TO BE A REQUIREMENT AFTER TAEM INTERFACE (M=2.5).

- a. *Crew takeover is required to protect against the target moving out of the toe of the footprint for low L/D entry. The crew is responsible for identifying this condition.*
- b. *Crew takeover is required to maintain a trajectory that achieves a safe landing at an acceptable runway. The criteria for changing runways will be based on loss of manual capability to achieve the targeted runway (approx 25 NM dispersion at M=2.5). The ground is responsible for identifying this condition.*
- c. *CSS is forced upon No Yaw Jet Entry Roll mode selection. Auto No Yaw Jet is not a certified flight control mode and may result in low-frequency bank oscillations.*
- d. *Crew takeover is required to protect against potential transients into the flight control system (FCS).*
- e. *Crew takeover is required to protect against potential transients into the flight control system (FCS).*
- f. *Autoland is not a certified system; therefore, the crew should takeover (CSS) prior to a forced approach and landing transition.*
- g. *The crew has the option to manually fly the vehicle anytime they are uncomfortable with the behavior of the guidance system.*
- h. *Self-explanatory.* @[032807-8384]

FLIGHT RULES

A4-209

AERO TEST MANEUVERS

AERO TEST MANEUVERS WILL NOT BE ATTEMPTED IF THE CROSSRANGE AT ENTRY INTERFACE IS GREATER THAN THE DTO CROSSRANGE LIMIT (REF. THE ANNEX FLIGHT RULE, TRAJECTORY AND GUIDANCE PARAMETERS) UNTIL THE FIRST ROLL REVERSAL HAS BEEN COMPLETED AND THE ORBITER ENERGY STATE AND DRAG PROFILE ARE NOMINAL. VALID TELEMETRY IS REQUIRED FOR EVALUATION OF THE ORBITER ENERGY STATE. @ED]

For the purposes of this rule, any PTI that inhibits entry guidance is considered an aero test maneuver. Since entry guidance is locked out, there is no attempt to follow the optimal energy profile or to respond to roll reversals. High crossrange at entry interface requires optimum bank angle and energy control to ensure a manageable energy state at TAEM interface. If energy is nominal and the orbiter is on the nominal drag profile, guidance will be able to manage energy properly, even under given dispersions. Valid telemetry is needed to verify that the energy and drag profiles are within limits.

Rule {A2-261}, ENTRY DTO/AUTO MODE/CROSSWIND DTO GO/NO-GO, references this rule.

FLIGHT RULES

A4-210

EOM ENTRY DTO/RUNWAY SELECTION PRIORITIES

DTO 805, CROSSWIND LANDING PERFORMANCE, WILL BE EXECUTED AS A DTO OF OPPORTUNITY. DTO 805 WILL NOT BE A CONSIDERATION IN SELECTING LANDING SITES OR RUNWAYS. IF CROSSWINDS ARE OBSERVED TO BE 10 KNOTS OR GREATER AS THE ORBITER APPROACHES THE HAC, DRAG CHUTE DEPLOY WILL BE DELAYED UNTIL POST NOSE GEAR TOUCHDOWN TO ACCOMPLISH DTO 805. @[022201-3801]

No drag chute, braking, or nose wheel DTO's are scheduled. Drag chute deploy will be per nominal flight rules (ref Rules {A10-143}, DRAG CHUTE DEPLOY TECHNIQUES, and {A10-144}, DRAG CHUTE DEPLOY CONSTRAINTS), unless the crosswind DTO is likely to be performed. In this case, drag chute deploy will be delayed until post nose gear touchdown to allow for pilot handling evaluation of the orbiter without any complications that drag chute dynamics may induce. Nominal touchdown speed is 195 keas with derotation performed using the beep trim switch at 185 keas, or manually (if beep trim fails) at 175 keas. Drag chute nominal deploy is immediately prior to the initiation of derotation. However, the drag chute DTO program has cleared drag chute deploy as early as 15 keas prior to the initiation of derotation. @[102402-5804C]

All ISS rendezvous flights have a probability of a night landing which would mean that the crosswind limit is 12 knots. Therefore, DTO 805, Crosswind Landing Performance Evaluation, which requires a crosswind of 10 knots or greater at touchdown, is not likely to be achieved. With this small window of environmental conditions, it is not prudent to change landing sites (e.g., from KSC to EDW) to attempt DTO 805. Also, programmatic priorities make it highly desirable to land at KSC to avoid the cost and risk associated with ferry operations. Since a decision to change from KSC to EDW would have to be made approximately 2 to 4 hours before landing, it is unlikely that confidence in wind forecasts would be such that landing at EDW solely to achieve DTO 805 is prudent. @[022201-3801] @[102402-5804C]

FLIGHT RULES

A4-211

SHUTTLE EOM ORBIT ADJUST BURNS

- A. IF PROPELLANT IS AVAILABLE, ORBIT ADJUSTS MAY BE PERFORMED TO INCREASE THE NUMBER OF DEORBIT OPPORTUNITIES AVAILABLE. IF AN ELLIPTIC ORBIT IS TARGETED FOLLOWING THE ADJUST, STEEP DEORBIT CAPABILITY SHALL BE RETAINED TO SATISFY RULE {A4-103A}.3, OFF-NOMINAL ORBITAL ALTITUDE RECOVERY PRIORITIES. @[102506-7840A]

- B. THE ORBIT ADJUST PLAN WILL ATTEMPT TO ACHIEVE THE FOLLOWING COMBINATIONS OF LANDING OPPORTUNITIES STATED IN ORDER OF DECREASING PRIORITY. ONLY OPPORTUNITIES WHICH SATISFY THE CREW DAY CONSTRAINTS (REF RULE {A4-107A}.7, PLS/EOM LANDING OPPORTUNITY REQUIREMENTS [HC]), WILL BE CONSIDERED (7 HRS < AWAKE TIME BEFORE LANDING < 16 HRS). AN ORBIT ADJUST PLAN WHICH WOULD RESULT IN LOSS OF OPPORTUNITIES AT A HIGHER PRIORITY THAN THOSE GAINED WILL NOT BE PERFORMED EVEN IF DAYLIGHT OPPORTUNITIES ARE PROVIDED BY THE PLAN.

PRIORITY	SITE	EOM	EOM + 1	EOM + 2
1	KSC EDW	1 1	1 1	1 1
2	KSC	2		
3	KSC		2	
4	EDW		2	
5	KSC			2
6	EDW			2

- C. THE ORBIT ADJUST WILL BE PLANNED TO ENSURE SAFE RELATIVE MOTION WITH THE ISS, OTHER VISITING VEHICLES, AND DEPLOYED PAYLOADS.

Since no propellant is budgeted for orbit adjust burns, they are limited in magnitude to predicted margins above mission completion redlines or the propellant must originate from the reduced deorbit cost by optimum TIG placement. Due to trajectory dispersions arising from ISS departure, prudent orbit adjust burn planning will consider burn trim errors and major sources of perturbations to ensure safe relative motion between the shuttle, ISS, visiting vehicles, and other deployed payloads. If the final sep from the ISS was retrograde, a retrograde orbit adjust should be delayed until the shuttle is far enough ahead so that a large retrograde burn does not result in relative motion back into the ISS. If the final sep was posigrade, the shuttle may perform a posigrade orbit adjust burn as soon as it is beyond the ISS OMS burn limits for single or dual OMS engines. @[102506-7840A]

FLIGHT RULES

A4-212**GPS TO G&C MANAGEMENT**

GPS SHALL BE INITIALIZED TO INHIBIT FOR G&C IN THE PASS. GPS MAY BE FORCED TO G&C FOR INSTANCES WHEN PROCESSING GPS IN NAV IS UNABLE TO CONTAIN A RUNAWAY NAV STATE. ONCE GPS TO G&C AIF HAS BEEN MODED TO FORCE, THE AIF SHALL REMAIN IN FORCE FOR THE REST OF THE ENTRY. @[032807-8381]

There are remote scenarios (e.g., prime-selecting a degraded IMU or no IMU available) where processing GPS in Auto in the PASS navigation system will not contain the navigation errors. Forcing GPS to NAV in the PASS is a one-shot process, and continually forcing GPS to NAV in the PASS is not practical. For these cases, it is appropriate to force GPS to G&C. This will cause the UPP to ignore the navigation state and to reset directly to the current GPS state vector. If GPS to G&C is in Auto, the UPP gives MLS higher priority than GPS. This will result in the UPP being reconnected to NAV upon MLS processing (NAV will most likely be severely degraded for this scenario). Therefore, forcing GPS to G&C is preferred over using Auto so that the UPP is never again reconnected to the navigation system.

The BFS has no capability to directly process GPS in the G&C system. However, forcing GPS to NAV in the BFS is essentially the same as forcing GPS to G&C in the PASS. Rule {A4-206}, NAV FILTER MANAGEMENT, addresses processing GPS in the BFS. @[032807-8381]

A4-213 THROUGH A4-250 RULES ARE RESERVED @[032807-8381]

FLIGHT RULES

RANGE SAFETY FLIGHT RULES

A4-251

SIGNATURE SECTION

THE ENCLOSED RANGE SAFETY FLIGHT RULES HAVE BEEN JOINTLY NEGOTIATED AND AGREED TO BY NASA AND THE EASTERN RANGE. ANY SUBSEQUENT CHANGES TO THESE RULES WILL REQUIRE RE-EXECUTION OF THIS CONCURRENCE PAGE. @[053096 PRCB-4001]

@[081497-6306A]

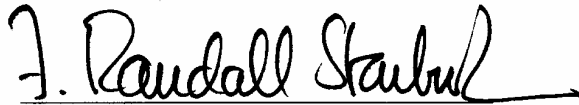
COMMANDER, 45TH SPACE WING
F. RANDALL STARBUCK
Brigadier General, USAF
Commander

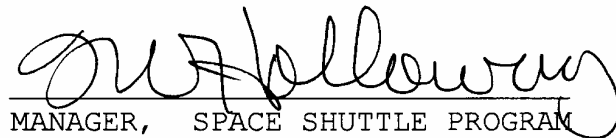
MANAGER, SPACE SHUTTLE PROGRAM

22 Sp 97
DATE

9-5-97
DATE

FLIGHT RULES

A4-252

POLICY

- A. MEMORANDUM OF AGREEMENT (MOA) 15E-2-8, BETWEEN THE 45TH SPACE WING (45 SW) AND THE JOHN F. KENNEDY SPACE CENTER (KSC) FOR MISSILE/SPACE VEHICLE SAFETY ON KSC AND THE EASTERN RANGE (ER), EFFECTIVE NOVEMBER 2, 1995, DELINEATES THE AGENCY RESPONSIBLE FOR MISSILE/SPACE VEHICLE FLIGHT AND GROUND SAFETY FOR LAUNCHES FROM THE ER AND KSC AND IDENTIFIES CERTAIN RESPONSIBILITIES ASSOCIATED WITH MISSILE/SPACE VEHICLE MISHAPS. RANGE SAFETY REQUIREMENTS ARE CONTAINED IN EWR 127-1, MARCH 31, 1995. @[053096 PRCB-4001]
- B. RANGE SAFETY POLICIES AND PROCEDURES ARE SPECIFIED IN SECTION 1 OF EWR 127-1. CONSISTENT WITH SECTION 1.4, SPECIFICALLY PARAGRAPHS 1.4.1 AND 1.4.1.3, THE 45 SW COMMANDER HAS AUTHORIZED REMOVAL OF THE RANGE SAFETY SYSTEM (RSS) FROM THE EXTERNAL TANK (ET) FOR PRESENTLY DESCRIBED STS FLIGHT CONFIGURATIONS, PAYLOADS, AND TRAJECTORIES, BASED ON A RISK ASSESSMENT WHICH ASSUMES THE VEHICLE IMPACT POINT WILL BE STOPPED BEFORE REACHING WELL DEFINED LIMIT LINES. ANY FUTURE STS FLIGHT VEHICLE MODIFICATIONS AND/OR NEW TRAJECTORIES MUST BE ANALYZED TO ENSURE PUBLIC RISKS HAVE NOT INCREASED BEYOND ACCEPTABLE LEVELS. IN THE EVENT OF AN UNACCEPTABLE PUBLIC RISK INCREASE, FLIGHT DESIGN MODIFICATIONS OR INSTALLATION OF A RANGE SAFETY FLIGHT OR THRUST TERMINATION SYSTEM WILL BE REQUIRED TO REDUCE THE RISK TO AN ACCEPTABLE LEVEL. THE 45 SW COMMANDER RETAINS OVERALL RESPONSIBILITY FOR PUBLIC SAFETY IN ACCORDANCE WITH EWR 127-1, SECTION 1.3.1. THE FLIGHT CREW COMMANDER (CDR) AND PILOT (PLT) BECOME AGENTS OF THE 45 SW COMMANDER FOR PUBLIC SAFETY DURING THE PORTION OF FLIGHT AFTER SOLID ROCKET BOOSTER SEPARATION AND PRIOR TO MAIN ENGINE CUTOFF. THIS AGENT RELATIONSHIP NECESSITATES THAT ALL CDR'S AND PLT'S RECEIVE INITIAL AND RECURRING TRAINING THAT IS APPROVED BY THE 45 SW AND DOCUMENTED AS PART OF THE NASA CERTIFICATE OF FLIGHT READINESS (COFR) PROCESS. 45 SW RANGE SAFETY FLIGHT PLAN APPROVAL IS CONTINGENT UPON APPROVED AND DOCUMENTED TRAINING AS EVIDENCED IN THE COFR PROCESS.
- C. THE FOLLOWING MISSION RULES SUPPLEMENT EWR 127-1 AND THE RANGE SAFETY OPERATIONS REQUIREMENTS DOCUMENT AND OPERATIONS SUPPLEMENT. THESE RULES IMPLEMENT THE U.S. AIR FORCE (USAF) POLICY OF ADVANCING THE NATION'S COMMITMENT TO LEADERSHIP IN THE EXPLORATION AND USE OF SPACE AT MINIMUM RISK TO THE FLIGHT CREWS, GENERAL PUBLIC, AND PROPERTY. THEY PROVIDE ACTION GUIDANCE TO PERSONNEL RESPONSIBLE FOR EXECUTING THIS POLICY. @[053096 PRCB-4001]

FLIGHT RULES

A4-253

DEFINITIONS @[081497-6306A]

THIS SECTION CENTRALIZES DEFINITIONS RELATED TO THESE FLIGHT RULES TO FACILITATE CLARITY IN THE RULES THEMSELVES. @[053096 PRCB-4001]

- A. FLIGHT TERMINATION SYSTEM (FTS): THE FTS NEUTRALIZES SOLID ROCKET BOOSTER (SRB) THRUST WITH A SINGLE LINEAR SHAPED CHARGE PER SRB WHICH SPLITS THE SOLID ROCKET MOTOR CASES. ANALYSIS SHOWS THAT THIS ACTION ALSO CAUSES DISPERSAL OF THE EXTERNAL TANK (ET) PROPELLANTS. THE FLIGHT TERMINATION SYSTEM IS PROTECTED FROM UNAUTHORIZED COMMANDS BY THE DIGITAL RANGE SAFETY COMMAND SYSTEM (DRSCS). THE DRSCS "ARM" AND "FIRE" COMMANDS ARE FORMATTED BY CRYPTO HARDWARE IN THE ER RANGE OPERATIONS CONTROL CENTER (ROCC). THE COMMANDS ARE RECEIVED AND DECODED BY FLIGHT INTEGRATED RECEIVER DECODERS (IRD'S) IN EACH SRB. THE CODES FOR A PARTICULAR FLIGHT BECOME UNCLASSIFIED AT SRB SPLASHDOWN OR UPON TRANSMISSION OF COMMANDS ANY TIME AFTER SRB IGNITION. THE "ARM" COMMAND, WHICH IS PREPARATORY TO THE "FIRE" COMMAND, ACTIVATES A WARNING LIGHT IN THE ORBITER AND IRREVERSIBLY CHARGES THE PYROTECHNIC INITIATOR CONTROLLERS (PIC'S). WHEN FLIGHT TERMINATION ACTION IS REQUIRED, THE FCO WILL TRANSMIT THE "FIRE" COMMAND IMMEDIATELY AFTER THE "ARM" COMMAND.
- B. VEHICLE PERFORMANCE DATA: FOR THE PURPOSE OF THESE RULES, VEHICLE PERFORMANCE DATA ARE DEFINED AS FOLLOWS:
1. VEHICLE BEHAVIOR DATA
 - a. PRIMARY CUE: REMOTE TELEVISION PRESENTATION TO FCO
 - b. SECONDARY CUE: RADAR SKIN TRACK A-SCOPE DISPLAY (MINIMUM OF TWO CONFIRMING SITES), OR VERBAL BREAKUP REPORT FROM EITHER THE AIRBORNE OR GROUND VISUAL OBSERVERS.
 - c. TERTIARY CUES: REAL-TIME TELEMETRY (HIGH ATTITUDE RATES OR PREMATURE SEPARATION INDICATORS FOR SRB'S OR ET), THE SOLID ROCKET BOOSTER TRACKING SYSTEM (INDICATIONS OF SEPARATION RATES BETWEEN SRB'S AS SHOWN BY TRAJECTORY DETERMINATION DATA), OR SIMULTANEOUS LOSS OF S-BAND DOWNLINK AND AT LEAST ONE C-BAND TRANSPONDER. @[053096 PRCB-4001]

THIS RULE CONTINUED ON NEXT PAGE

FLIGHT RULES

A4-253**DEFINITIONS (CONTINUED)** @[081497-6306A]

2. TRAJECTORY DETERMINATION DATA: TRAJECTORY DETERMINATION WILL BE BASED ON RADAR TRACKING, OPTICAL TRACKING, AND TELEMETRY (NAVIGATION AND GUIDANCE) DATA THAT HAVE BEEN SELECTED BY THE ROCC REAL-TIME PROCESSORS. @[053096 PRCB-4001]
- C. CONTROLLABILITY LIMITS: THE VEHICLE IS DEFINED TO BE UNCONTROLLABLE IF PITCH OR YAW RATES GREATER THAN FIVE DEGREES/SECOND ARE EXPERIENCED FOR FIVE SECONDS.
- D. CONTROLLABILITY WARNING LIGHT: A WARNING LIGHT ON THE FCO CONSOLE ACTIVATED BY THE JSC GUIDANCE, NAVIGATION AND CONTROL (GNC) OFFICER WHEN THE VEHICLE IS DETERMINED TO BE OUT OF CONTROL. THE LIGHT SERVES TO MINIMIZE FCO RESPONSE TIME IN SITUATIONS INVOLVING AN UNCONTROLLABLE VEHICLE, AND IS APPLICABLE ONLY DURING FIRST STAGE.
- E. ABORT REQUEST COMMAND: THE ABORT REQUEST SWITCH, LOCATED ON THE FD, FDO, AND FCO CONSOLES, INITIATES TRANSMISSION OF COMMANDS FROM THE MCC COMMAND SYSTEM TO ILLUMINATE THE ABORT LIGHT IN THE ORBITER COCKPIT.
- F. ABORT LIGHT: A WARNING LIGHT IN THE ORBITER COCKPIT, ILLUMINATED VIA THE ABORT REQUEST COMMAND, WHICH SERVES AS A CUE FOR THE FLIGHT CREW TO TAKE SOME ABORT ACTION. FOR IMMINENT RANGE SAFETY MECO LINE VIOLATIONS, THE REQUIRED CREW ACTION IS A MANUAL MECO PER THE PROCEDURES DESCRIBED IN THESE RULES.
- G. FIRST STAGE: ORBITER POWERED FLIGHT FROM SRB IGNITION THROUGH SRB SEPARATION.
- H. SECOND STAGE: ORBITER POWERED FLIGHT AFTER SRB SEPARATION.
- I. AMBER ZONE: CALLED BY THE FCO WHEN THE TRAJECTORY EXCEEDS THE 3-SIGMA VERTICAL OR LATERAL ENVELOPE IN FIRST STAGE. INVOKES THE CONTROLLABILITY RULE, AND IS ONLY APPLICABLE IN FIRST STAGE.
- J. IIP: INSTANTANEOUS, VACUUM IMPACT POINT.
- K. ILL: IMPACT LIMIT LINE. THE PRIMARY AND SECONDARY ILL'S PROTECT THE IMMEDIATE LAUNCH AREA AND OTHER LAND MASSES AGAINST DEBRIS FOOTPRINT ENCROACHMENT DURING FIRST STAGE. @[053096 PRCB-4001]

THIS RULE CONTINUED ON NEXT PAGE

FLIGHT RULES

A4-253**DEFINITIONS (CONTINUED)** @[081497-6306A]

- L. SRB NLE: THAT TIME FROM LIFTOFF ON A NOMINAL TRAJECTORY (i.e., WITHIN THE 3-SIGMA TRAJECTORY ENVELOPE) BEYOND WHICH BREAKAWAY SRB'S CAN "NO LONGER ENDANGER" LAND UNDER ANY SUBSEQUENT SRB BEHAVIOR. @[053096 PRCB-4001]
- M. FCO: FCO IN THESE RULES REFERS TO EITHER THE ER FLIGHT CONTROL OFFICER (FCO) OR THE SENIOR FCO (SFCO). WHERE APPLICABLE, THE SPECIFIC INDIVIDUAL POSITION IS IDENTIFIED IN THESE RULES.
- N. MCC: THE MISSION CONTROL CENTER AT JSC. AS USED IN THESE RULES, MCC ALSO REFERS TO THE FLIGHT DIRECTOR (FD), SPACECRAFT COMMUNICATOR (CAPCOM), AND/OR FLIGHT DYNAMICS OFFICER (FDO) PERSONNEL LOCATED IN THE MCC. PRIMARY COMMUNICATION BETWEEN THE FCO AND THE MCC IS CARRIED OUT WITH THE FDO. WHERE APPLICABLE, THE SPECIFIC INDIVIDUAL POSITION IS IDENTIFIED IN THESE RULES.
- O. MECO LINES AND GATES: MECO LINES, WHICH ARE APPLICABLE ONLY IN SECOND STAGE, IDENTIFY AREAS UPON WHICH THE VEHICLE'S IIP MAY NOT ENCROACH. THEY ARE REPRESENTED AS SOLID LINES ON FCO AND MCC DISPLAYS. SINCE OVERFLIGHT OF SOME LAND MASS IS ALWAYS REQUIRED FOR THE STS VEHICLE TO ACHIEVE ORBIT, SOME MECO LINES WHICH STRICTLY PROTECT ALL AREAS OF THESE LAND MASSES ARE PRESENTED AS DASHED LINES ON THE DISPLAYS AND ARE REFERRED TO AS GATES. FOR STS FLIGHTS, THREE GATES ARE APPLICABLE, AS DESCRIBED BELOW:
1. HATTERAS GATE (APPLICABLE FOR HIGH-INCLINATION MISSIONS ONLY): THE HATTERAS GATE PROTECTS POPULATED ISLANDS AND EXTENSIVE MARITIME TRAFFIC OFF THE COAST OF NORTH CAROLINA.
 2. NEWFOUNDLAND GATE (APPLICABLE FOR HIGH-INCLINATION MISSIONS ONLY): THE NEWFOUNDLAND GATE PROTECTS THIS LOW POPULATION CANADIAN PROVINCE. NOMINAL OR NEAR-NOMINAL FLIGHTS WILL ROUTINELY PASS THROUGH THIS GATE.
 3. AFRICAN GATE (APPLICABLE FOR ALL MISSIONS): THE AFRICAN GATE PROTECTS THE LAND MASSES OF AFRICA, EUROPE, AND SOUTH AMERICA. NOMINAL OR NEAR-NOMINAL FLIGHTS WILL ROUTINELY PASS THROUGH THIS GATE. @[053096 PRCB-4001]

THIS RULE CONTINUED ON NEXT PAGE

FLIGHT RULES

A4-253**DEFINITIONS (CONTINUED)** @[081497-6306A]

- P. DESTRUCT LINES: EQUIVALENT TO MECO LINES, BUT APPLICABLE DURING THE SHORT TIME LATE IN FIRST STAGE (FROM T+120 SEC TO SRB SEP) WHEN THE FTS IS STILL AVAILABLE FOR USE. THESE LINES ALSO APPLY IN FIRST STAGE IF VALID FOOTPRINT DATA IS LOST PER RULE {A4-258}, FLIGHT TERMINATION/MANUAL MECO CRITERIA, PART C.4. @[053096 PRCB-4001]
- Q. CODEWORDS: THERE ARE THREE STS-RELATED CODEWORDS, AS DESCRIBED BELOW. CODE WORDS, WHEN USED, ARE EXCHANGED OVER THE FD AND FCO PRIME LOOPS.
1. UNCONTROLLABLE: THIS UNIQUE CODE WORD WILL BE USED BY THE FD TO ADVISE THE FCO THAT THE VEHICLE IS UNCONTROLLABLE.
 2. MANUAL MECO: THIS UNIQUE CODE WORD WILL BE USED BY THE FCO TO ADVISE THE MCC THAT AN IMMEDIATE MANUAL MECO IS REQUIRED.
 3. ARM/FIRE: THIS UNIQUE CODE WORD WILL BE USED BY THE FCO TO ADVISE THE MCC THAT THE FTS HAS BEEN ACTIVATED.
- R. COMMUNICATION CIRCUITS: THREE PRIMARY COMMUNICATION CIRCUITS ARE USED BETWEEN THE FCO AND THE MCC: THE FD LOOP, THE FCO PRIME LOOP, AND THE FCO PRIVATE LINE. WHERE TWO REDUNDANT LOOPS ARE LISTED IN THESE RULES, OTHER LOOP/LONG LINE PATCHING MAY BE USED TO PROVIDE THIS REDUNDANCY IF NECESSARY. @[081497-6306A]
- S. VEHICLE BREAKUP: SEPARATION OF VEHICLE PARTS AS DETERMINED VISUALLY OR BY RADAR TRACK OF MULTIPLE TARGETS.
- T. CATASTROPHIC FAILURE: VEHICLE PITCHES OVER OR BREAKS UP, AS SHOWN BY VEHICLE PERFORMANCE DATA.
- U. VARIABLE IY: AN ABORT-TO-ORBIT (ATO) TARGETING METHOD USED ON SOME MISSIONS IN WHICH THE VEHICLE STEERS TO AN ORBITAL PLANE/INCLINATION LOWER THAN THE NOMINAL TO IMPROVE DOWNRANGE PERFORMANCE. IF EXCURSION TOWARD A RANGE SAFETY LIMIT LINE OCCURS DUE TO THE ORBITAL PLANE TARGET BEING CORRUPTED, AN ATO ABORT WHICH INVOKES VARIABLE IY CAN POTENTIALLY ELIMINATE THE RANGE SAFETY PROBLEM.
- V. CSS: MANUAL SHUTTLE FLIGHT CONTROL (CONTROL STICK STEERING), AS OPPOSED TO AUTO-GUIDANCE FLIGHT CONTROL.

THIS RULE CONTINUED ON NEXT PAGE

FLIGHT RULES

A4-253 **DEFINITIONS (CONTINUED)** ©[081497-6306A]

W. BFS ENGAGE: FLIGHT CREW ACTIVATION OF THE BACKUP FLIGHT SYSTEM (BFS), USED FOR TOTAL FAILURE OF THE QUAD-REDUNDANT PRIMARY AVIONICS SOFTWARE SYSTEM (PASS). ©[053096 PRCB-4001]

A4-254 **FCO TO MCC WARNING NOTIFICATION**

THE VEHICLE'S FLIGHT MAY DEVIATE SIGNIFICANTLY FROM NOMINAL AND STILL REMAIN WITHIN SAFE LIMITS. IF THE CRITERIA BELOW ARE EXCEEDED, THE FCO WILL WARN THE MCC, AND THE MCC WILL RESPOND WITH CALLS OR REQUESTED CREW ACTION. VIOLATION OF THESE CRITERIA INDICATES THAT THE VEHICLE IS DEVIATING SIGNIFICANTLY FROM ITS NOMINAL TRAJECTORY. ©[053096 PRCB-4001]

A. TRAJECTORY EXCEEDS 3-SIGMA (LATERAL OR VERTICAL) IN FIRST STAGE:

1. FCO MAKES AN "AMBER ZONE" CALL ON BOTH THE FD AND FCO PRIME LOOPS. THE CONTROLLABILITY RULE IS INVOKED.
2. AFTER AN AMBER ZONE CALL, A PROMPT CONTROL STATUS RESPONSE IS REQUIRED FROM THE FD TO THE FCO ON THE FD LOOP. IF THE VEHICLE IS UNDER CONTROL, THE FD WILL RESPOND "GOOD CONTROL." IF THE VEHICLE IS UNCONTROLLABLE, THE FD WILL RESPOND VIA CODEWORD, AND THE JSC GNC OFFICER WILL RESPOND WITH THE CONTROLLABILITY WARNING LIGHT.

B. POST-SRB SEP, TRAJECTORY EXCEEDS 3-SIGMA LATERAL:

1. FCO MAKES TRAJECTORY DEVIATION CALLS ON THE FCO PRIME LOOP.
2. FDO RESPONDS WITH TRAJECTORY ASSESSMENT CALLS.
3. IF THE TRAJECTORY CONTINUES TO DEVIATE TOWARD A MECO LINE, THE PROXIMITY TO THE LINE WILL BE EVALUATED:
 - a. FCO WILL CALL "HALFWAY TO THE LINE" WHEN THE IIP IS APPROXIMATELY HALFWAY BETWEEN THE 3-SIGMA LEFT/RIGHT TRAJECTORY AND THE NEAREST MECO LINE.
 - b. FREQUENT ESTIMATES OF TIME REMAINING UNTIL MECO LINE VIOLATION WILL BE PROVIDED BY FDO ON THE FD LOOP BASED ON MCC PREDICTOR BUG SOFTWARE.

THIS RULE CONTINUED ON NEXT PAGE

FLIGHT RULES

A4-254

FCO TO MCC WARNING NOTIFICATION (CONTINUED)

4. IF TRAJECTORY DEVIATIONS CONTINUE AFTER ACTION BY THE MCC (REFERENCE RULE {A4-260}, RANGE SAFETY LIMIT AVOIDANCE ACTIONS), MANUAL MECO PROCEDURES WILL BE INITIATED BY THE MCC WHEN THE IIP IS 30 SEC FROM THE MECO LINE. @[053096 PRCB-4001] @[081497-6306A]
5. IF MECO HAS NOT YET OCCURRED UPON IIP CONTACT WITH A MECO LINE, FCO WILL INITIATE THE ABORT REQUEST COMMAND (ABORT LIGHT) AS AN INDICATION TO THE CREW THAT AN IMMEDIATE MANUAL MECO IS REQUIRED. THE MANUAL MECO CODEWORD WILL BE VERBALLY TRANSMITTED TO THE MCC SIMULTANEOUSLY ON THE FD AND FCO PRIME LOOPS. @[053096 PRCB-4001]

A4-255

MCC TO FCO REPORTING

THE MCC WILL ADVISE THE FCO OF OFF-NOMINAL VEHICLE PERFORMANCE OR OF EVENTS THAT SIGNIFICANTLY AFFECT RANGE SAFETY AS THEY OCCUR. THE INFORMATION WILL BE PROVIDED BY THE FDO ON THE FCO PRIME LOOP WITH THE FCO PRIVATE LINE AS BACKUP, EXCEPT AS SPECIFICALLY NOTED BELOW:

- A. CONTROLLABILITY STATUS (FIRST STAGE ONLY): MADE BY FD ON THE FD LOOP, USING EITHER THE WORDS "GOOD CONTROL," IF THE VEHICLE IS UNDER CONTROL, OR USING THE CODEWORD TO INDICATE UNCONTROLLABLE. IF THE VEHICLE IS UNCONTROLLABLE, THE JSC GNC OFFICER WILL ALSO RESPOND WITH THE CONTROLLABILITY WARNING LIGHT.
- B. ANY DECISION TO ABORT THE FLIGHT: ATO, TAL, RTLS, ANY CONTINGENCY ABORT, FAST SEPARATION, ETC.
- C. ANY SSME FAILURE.
- D. ANY CONDITIONS WHICH COULD RESULT IN ET LAND IMPACT, PLUS A PREDICTED IMPACT LOCATION, IN AS NEAR REAL-TIME AS POSSIBLE.
- E. WHEN RANGE SAFETY LIMIT AVOIDANCE ACTIONS ARE BEING IMPLEMENTED (RULE {A4-260}, RANGE SAFETY LIMIT AVOIDANCE ACTIONS), FREQUENT ESTIMATES OF TIME TO VIOLATION WILL BE PROVIDED BY THE FDO ON THE FD LOOP. WHEN THE IIP IS 30 SEC FROM THE MECO LINE, MANUAL MECO PROCEDURES WILL BE INITIATED. @[081497-6306A]
- F. ANY OTHER PERTINENT INFORMATION. @[053096 PRCB-4001]

FLIGHT RULES

A4-256

CONTROLLABILITY

- A. THIS RULE APPLIES ONLY DURING THE SRB THRUSTING PERIOD, AFTER LAUNCH TOWER CLEARANCE. @[053096 PRCB-4001]
- B. THE USAF AND NASA, IN CONSIDERING THE NATIONAL INTERESTS IN THE SHUTTLE PROGRAM AND THE CONSEQUENCES OF FLIGHT TERMINATION ACTION, HAVE JOINTLY AGREED TO THE FOLLOWING (REFERENCE MOA 15E-2-8):
1. THE NON-PUBLIC RISKS ASSOCIATED WITH CONTINUED FLIGHT OF A CONTROLLABLE VEHICLE IF THE PRIMARY IMPACT LIMIT LINE IS VIOLATED HAVE BEEN ASSESSED BY THE USAF AND ACCEPTED BY NASA FOR KSC, AND BY THE 45 SW FOR CAPE CANAVERAL AIR STATION (CCAS).
 2. THE PUBLIC RISKS ASSOCIATED WITH FLIGHT BEYOND THE SECONDARY ILL ARE UNACCEPTABLE.
 3. IF THE VEHICLE IS DECLARED TO BE UNDER CONTROL AND IS SUBSEQUENTLY DECLARED UNCONTROLLABLE, THE FCO WILL TAKE ACTION WHEN THE APPLICABLE FLIGHT TERMINATION LINE IS VIOLATED (PRIMARY OR SECONDARY).
- C. GENERAL
1. ALTHOUGH THE ACTUAL TRAJECTORY MAY DEVIATE SIGNIFICANTLY FROM THE NOMINAL DURING THE SRB THRUSTING PERIOD, THE VEHICLE MAY NOT EXCEED CONTROLLABILITY LIMITS.
 2. AS LONG AS THE MCC CAN CONFIRM TO THE FCO THAT THE CONTROLLABILITY LIMITS HAVE NOT BEEN EXCEEDED, OR IN THE CASE OF LOSS OF COMMUNICATION BETWEEN THE MCC AND THE FCO, THE FCO CAN DETERMINE THAT THESE LIMITS HAVE NOT BEEN EXCEEDED, THE FCO WILL ALLOW THE FLIGHT TO CONTINUE EVEN IF THE PRIMARY ILL IS VIOLATED.
 3. IF NEITHER THE MCC NOR THE FCO CAN DETERMINE THE PITCH OR YAW RATES, THE FCO WILL ASSUME THAT THE LIMITS HAVE NOT BEEN EXCEEDED AND ALLOW THE FLIGHT TO CONTINUE EVEN IF THE PRIMARY ILL IS VIOLATED.
 4. FLIGHT TERMINATION ACTION WILL BE TAKEN BY THE FCO WHEN, BASED ON ASSESSMENT OF ALL AVAILABLE DATA, THE SECONDARY ILL FLIGHT TERMINATION CRITERIA ARE VIOLATED, REGARDLESS OF THE CONTROLLABILITY STATUS. @[053096 PRCB-4001]

THIS RULE CONTINUED ON NEXT PAGE

FLIGHT RULES

A4-256

CONTROLLABILITY (CONTINUED)

- D. DECLARATION OF LOSS-OF-CONTROL: THERE ARE TWO EQUIVALENT METHODS BY WHICH THE MCC CAN COMMUNICATE LOSS OF CONTROL TO THE FCO, AS FOLLOWS: @[053096 PRCB-4001]
1. THE CONTROLLABILITY WARNING LIGHT. VERBAL CONFIRMATION OF LOSS-OF-CONTROL WILL ACCOMPANY LIGHT ACTIVATION.
 2. VERBAL NOTIFICATION OF LOSS-OF-CONTROL, GIVEN BY THE FD VIA CODE WORD TO THE FCO OVER THE FD LOOP.
- E. LOSS OF TWO SSME'S: UNDER THE FOLLOWING CONDITIONS THE FCO WILL USE DISCRETION, BIASED TOWARDS NO ACTION:
1. LOSS OF TWO SSME'S IS CONFIRMED EARLY IN FLIGHT.
 2. THE VEHICLE REMAINS CONTROLLABLE.
 3. THE VEHICLE STAYS WITHIN THE MISSION-SPECIFIC TWO-ENGINE-OUT DELTA-AZIMUTH ENVELOPE.
 4. THE VEHICLE TRANSITIONS THROUGH THE REGION OF MAXIMUM DYNAMIC PRESSURE (MAX Q) WITHOUT BREAKUP.
 5. THE DEBRIS FOOTPRINT APPROACHES OR JUST CROSSES THE SECONDARY ILL LATE IN THE SRB BURN.
 6. THE FCO CONFIRMS THAT THE VEHICLE IIP IS STILL MOVING DOWN RANGE. @[053096 PRCB-4001]

FLIGHT RULES

A4-257

FLIGHT TERMINATION/MANUAL MECO EVALUATION

A. GENERAL @[053096 PRCB-4001]

1. THE FCO WILL EVALUATE ALL DATA SOURCES (E.G., RADARS, TELEMETRY, OPTICAL TRACKERS, FORWARD OBSERVER, TV, ETC.) PLUS INFORMATION RECEIVED FROM THE MCC TO DETERMINE THE REQUIRED ACTION.
2. TIME PERMITTING, A DECISION TO INITIATE FLIGHT TERMINATION WILL BE REACHED AFTER COORDINATION BETWEEN THE FCO AND THE SFCO.
3. TIME PERMITTING, THE MCC WILL BE ADVISED OF IMPENDING FLIGHT TERMINATION PRIOR TO INITIATION OF THE FLIGHT TERMINATION COMMANDS.
4. IN ALL INSTANCES, THE FCO WILL MAKE A DECISION CONCERNING CONTINUED FLIGHT OR TERMINATION BASED ON INTERPRETATION OF REAL-TIME EVENTS AND STS MISSION RULES, ALL AVAILABLE DATA SOURCES, AND SOUND JUDGMENT.

B. LOSS OF DATA/COMMUNICATIONS

1. TOTAL LOSS OF ALL FCO VEHICLE PERFORMANCE DATA: THE FCO WILL BE UNABLE TO DETERMINE IF FLIGHT TERMINATION/MANUAL MECO CRITERIA ARE VIOLATED AND WILL NOT TAKE FLIGHT TERMINATION/MANUAL MECO ACTION. IF MCC STILL HAS DATA, RANGE SAFETY LIMIT AVOIDANCE ACTIONS (RULE {A4-260}, RANGE SAFETY LIMIT AVOIDANCE ACTIONS) WILL CONTINUE TO BE TAKEN, INCLUDING MANUAL MECO IF NECESSARY.
2. TOTAL LOSS OF ALL MCC DATA: THE MCC WILL BE UNABLE TO DETERMINE THE VEHICLE STATUS.
 - a. IF FCO STILL HAS DATA, FCO WILL PROVIDE MCC WITH ESTIMATES OF TIME TO MECO LINE VIOLATION, INCLUDING "30 SEC TO THE LINE." AT THAT TIME, IF COMM IS AVAILABLE, MCC WILL INITIATE MANUAL MECO PROCEDURES.
@[053096 PRCB-4001] @[081497-6306A]

THIS RULE CONTINUED ON NEXT PAGE

FLIGHT RULES

A4-257

FLIGHT TERMINATION/MANUAL MECO EVALUATION
(CONTINUED)

- b. FCO WILL INITIATE THE ABORT REQUEST COMMAND (ABORT LIGHT) IF THE IIP CONTACTS A MECO LINE AS AN INDICATION TO THE CREW THAT AN IMMEDIATE MANUAL MECO IS REQUIRED. THE MANUAL MECO CODEWORD WILL BE VERBALLY TRANSMITTED TO THE MCC SIMULTANEOUSLY ON THE FD AND FCO PRIME LOOPS AS A SECOND INDICATION, IF COMM IS AVAILABLE. @[053096 PRCB-4001]
3. AFTER TOWER CLEAR AND PRIOR TO SRB SEP
 - a. AMBER ZONE AND LOSS OF FCO/MCC COMM: THE FCO WILL DETERMINE BY REAL-TIME TELEMETRY IF THE VEHICLE IS CONTROLLABLE AND ACT IN ACCORDANCE WITH RULE {A4-256}, CONTROLLABILITY.
 - b. LOSS OF TELEMETRY AT MCC AND ROCC: THE VEHICLE WILL BE ASSUMED TO BE UNDER CONTROL AND VIOLATION OF THE PRIMARY ILL WILL BE ALLOWED. MCC WILL ATTEMPT TO CONFIRM CONTROLLABILITY WITH THE ORBITER CREW AND ADVISE THE FCO.
 - c. LOSS OF FCO/MCC COMM AND FCO TELEMETRY: THE VEHICLE WILL BE ASSUMED TO BE UNDER CONTROL AND VIOLATION OF THE PRIMARY ILL WILL BE ALLOWED.
 4. LOSS OF FCO/MCC COMM AFTER SRB SEP: FCO WILL REQUIRE MCC/CREW ACTION IN ACCORDANCE WITH RULES {A4-258}, FLIGHT TERMINATION/MANUAL MECO CRITERIA, PART E, AND {A4-259}, FLIGHT TERMINATION/MANUAL MECO ACTION.
 5. RADAR INDICATES BREAKUP AND TELEMETRY INDICATES VEHICLE UNDER CONTROL: THE VEHICLE WILL BE ASSUMED TO BE INTACT AND THE FCO WILL ACT IN ACCORDANCE WITH RULE {A4-256}, CONTROLLABILITY.
- C. CONFLICTING DATA: IN THE EVENT OF A CONFLICT IN MECO LINE PROXIMITY ASSESSMENT BETWEEN THE MCC AND FCO WHEN BOTH HAVE VALID TRAJECTORY DETERMINATION DATA, THE FCO IS PRIME FOR DETERMINATION OF BOTH THE PROXIMITY TO THE LINE AND THE POTENTIAL REQUIREMENT FOR MANUAL MECO. @[053096 PRCB-4001]

FLIGHT RULES

A4-258

FLIGHT TERMINATION/MANUAL MECO CRITERIA

FLIGHT TERMINATION ACTION AND FLIGHT TERMINATION CRITERIA, AS SPECIFIED IN EWR 127-1, ARE SUPERSEDED BY THIS RULE. FLIGHT TERMINATION WILL BE INITIATED, OR A MANUAL MECO REQUESTED, BY THE FCO ONLY IF CONTINUATION OF THE FLIGHT VIOLATES THE CRITERIA SPECIFIED IN THIS RULE. ©[053096 PRCB-4001]

- A. PRIOR TO SRB IGNITION: AFTER SSME IGNITION, PAD ABORTS ARE POSSIBLE. FIRE OR OTHER CATASTROPHIC EVENTS MAY BE APPARENT FROM VEHICLE BEHAVIOR DATA. UNDER NO CIRCUMSTANCES WILL THE FCO TAKE FLIGHT TERMINATION ACTION PRIOR TO SRB IGNITION.
- B. SRB IGNITION TO TOWER CLEAR (7 SEC): IF A CATASTROPHIC FAILURE OCCURS, THE FCO WILL TAKE FLIGHT TERMINATION ACTION TO PREVENT INTACT IMPACT, CONTAIN THE SRB'S, AND DISPERSE THE ET PROPELLANTS.
- C. TOWER CLEAR TO SRB NLE:
 - 1. THE FCO WILL TAKE FLIGHT TERMINATION ACTION WHEN TRAJECTORY DETERMINATION SOURCES INDICATE THAT THE VEHICLE HAS VIOLATED FLIGHT TERMINATION CRITERIA, SUBJECT TO RULE {A4-256}, CONTROLLABILITY.
 - 2. IF A CATASTROPHIC FAILURE OCCURS, THE FCO WILL TAKE FLIGHT TERMINATION ACTION TO PREVENT INTACT IMPACT, CONTAIN THE SRB'S, AND DISPERSE THE ET PROPELLANTS.
 - a. FOR VEHICLE PITCH OVER, A FLIGHT TERMINATION DECISION WILL BE BASED ON TRAJECTORY DETERMINATION DATA CONFIRMED WITH MCC INDICATION OF NEGATIVE HDOT (DOWNWARD ALTITUDE RATE), OR THE PRIMARY VEHICLE BEHAVIOR DATA CUE.
 - b. FOR VEHICLE BREAKUP, A FLIGHT TERMINATION DECISION WILL BE BASED ON THE PRIMARY VEHICLE BEHAVIOR DATA CUE, TWO SECONDARY VEHICLE BEHAVIOR DATA CUES, OR BOTH ONE SECONDARY AND ONE TERTIARY VEHICLE BEHAVIOR DATA CUE. ©[053096 PRCB-4001]

THIS RULE CONTINUED ON NEXT PAGE

FLIGHT RULES

A4-258

FLIGHT TERMINATION/MANUAL MECO CRITERIA
(CONTINUED)

3. FOR STS MISSIONS EQUIPPED WITH THE SRB RADAR BEACON TRACKING SYSTEM (SRBTS), FLIGHT TERMINATION ACTION WILL BE DELAYED TO ALLOW MAXIMUM SEPARATION OF THE ORBITER AND THE SEPARATED ELEMENTS IF POSITIVE TRACK OF BOTH SRB'S CONFIRMS THE SRB'S ARE NOT ENDANGERING PUBLIC SAFETY AND THE DEBRIS ELLIPSE HAS MOVED OFF LAND. @[053096 PRCB-4001]
 4. IF CONSIDERED VALID BY THE FCO, THE DEBRIS ELLIPSE DISPLAY WILL BE THE SOLE CRITERIA FOR DETERMINING FLIGHT TERMINATION LINE VIOLATION. IF THE DEBRIS ELLIPSE DISPLAY IS CONSIDERED TO BE INVALID BY THE FCO, ALL OTHER VALID DISPLAYS MUST CONFIRM THE FLIGHT TERMINATION CRITERIA VIOLATION. FLIGHT TERMINATION ACTION UNDER THESE CRITERIA IS SUBJECT TO RULE {A4-256}, CONTROLLABILITY.
- D. SRB NLE TO SRB SEPARATION: THE FCO WILL TAKE FLIGHT TERMINATION ACTION WHEN TRAJECTORY DETERMINATION SOURCES INDICATE THAT THE VEHICLE HAS VIOLATED FLIGHT TERMINATION CRITERIA, SUBJECT TO RULE {A4-256}, CONTROLLABILITY.
- E. SRB SEPARATION TO MECO: THE FCO WILL CALL FOR MANUAL MECO ONLY WHEN VALID TRAJECTORY DETERMINATION SOURCES INDICATE A MECO LINE IS VIOLATED. A MANUAL MECO CALL WILL BE PRECEDED BY NOTIFICATION IN ACCORDANCE WITH FLIGHT RULE {A4-254}, FCO TO MCC WARNING NOTIFICATION, AND WILL BE EXECUTED PER RULE {A4-259}, FLIGHT TERMINATION/MANUAL MECO ACTION.
- F. LANDMASS OVERFLIGHT GATES
1. A NOMINAL VEHICLE THAT VIOLATES A GATE WILL NOT REQUIRE MANUAL MECO ACTION, AND THE IIP WILL BE ALLOWED TO PASS THROUGH THE GATE.
 2. WHILE LIMIT LINE AVOIDANCE ACTIONS ARE BEING TAKEN, MANUAL MECO WILL NOT BE INVOKED UNTIL VIOLATION OF A SOLID MECO LINE. @[053096 PRCB-4001]

THIS RULE CONTINUED ON NEXT PAGE

FLIGHT RULES

A4-258

FLIGHT TERMINATION/MANUAL MECO CRITERIA
(CONTINUED)

3. IF THERE IS IRREFUTABLE EVIDENCE THAT THE VEHICLE IS NON-NOMINAL AND CANNOT PROCEED TO AN ACCEPTABLE INTACT OR CONTINGENCY ABORT MODE AS DETERMINED BY THE MCC, THE MCC/CREW WILL REACT PER RULE {A4-260}, RANGE SAFETY LIMIT AVOIDANCE ACTIONS. IF, AFTER EXECUTION OF AVAILABLE RECOVERY OPTIONS, THE VEHICLE STATUS IS CONFIRMED UNRECOVERABLE, MANUAL MECO WILL BE INITIATED TO PRECLUDE VIOLATION OF THE GATE. @[053096 PRCB-4001]
 4. IF THE VEHICLE STATUS IS UNKNOWN OR RECOVERABLE OR PROCEEDING TO AN ACCEPTABLE INTACT OR CONTINGENCY ABORT, THE IIP WILL BE ALLOWED TO PASS THROUGH THE GATE.
- G. EXCLUSIONS FOR GUIDANCE MODE TRANSITION
1. THIS RULE IS DESIGNED TO PROTECT A VEHICLE AGAINST FLIGHT TERMINATION ACTION DURING THE TRANSITION FROM USE OF THE DEBRIS FOOTPRINT DESTRUCT CRITERIA, WITH ITS ASSOCIATED ILL'S, TO THE USE OF THE IIP/DESTRUCT LINE CRITERIA, WHICH OCCURS AT APPROXIMATELY T + 120 SEC. THE FTS IS STILL AVAILABLE FOR USE UNTIL SRB SEP (APPROXIMATELY T + 125 SEC), AT WHICH TIME THE DESTRUCT LINES BECOME MANUAL MECO LINES.
 2. A CONTROLLABLE VEHICLE NOT IN VIOLATION OF EITHER THE BACKUP ILL IN THE IMMEDIATE LAUNCH AREA OR THE SINGLE ILL'S WHICH EXTEND UP THE COAST FROM THE LAUNCH AREA MAY SUBSEQUENTLY BE IN VIOLATION OF THE IIP DESTRUCT/MECO LINE AFTER IT IS DISPLAYED AT APPROXIMATELY T + 120 SECONDS. NEITHER FLIGHT TERMINATION ACTION NOR MANUAL MECO ACTION WILL BE REQUIRED IF THE FOLLOWING CRITERIA ARE SATISFIED:
 - a. VEHICLE ATTITUDES ARE STABLE.
 - b. THE IIP IS NOT MOVING FURTHER INTO THE VIOLATION REGION.
 - c. THE IIP BEGINS TO MOVE TOWARD THE NON-VIOLATION REGION FOLLOWING SRB SEPARATION AND INITIATION OF SECOND STAGE GUIDANCE. @[053096 PRCB-4001]

FLIGHT RULES

A4-259

FLIGHT TERMINATION/MANUAL MECO ACTION

- A. FLIGHT TERMINATION ACTION: FLIGHT TERMINATION ACTION IS APPLICABLE DURING FIRST STAGE ONLY AND IS ACCOMPLISHED VIA FCO COMMAND ACTIVATION OF THE FTS. @[081497-6306A]
- B. MANUAL MECO PROCEDURE: MANUAL MECO ACTION IS APPLICABLE DURING SECOND STAGE ONLY AND IS PERFORMED BY THE FLIGHT CREW UPON DIRECTION FROM THE MCC OR FCO, AS SPECIFIED BELOW. @[053096 PRCB-4001]
1. THE FDO WILL CALL "15 SEC TO MANUAL MECO" WHEN THE IIP IS 30 SECONDS FROM THE MECO LINE.
 2. AT THAT TIME, CAPCOM WILL CALL TO CREW "15 SECONDS TO MANUAL MECO, RETURN TO AUTO (IF CSS), PREPARE FOR MANUAL MECO." THE RETURN TO AUTO FLIGHT CONTROL ALLOWS ACTIVATION OF AUTO THREE-SSME OUT CONTINGENCY LOGIC.
 3. ONCE A GOOD ONBOARD CONFIGURATION IS CONFIRMED, MCC WILL CALL FOR "MANUAL MECO NOW." FD AND/OR FDO WILL SEND THE ABORT REQUEST COMMAND (ABORT LIGHT) AS AN ADDITIONAL CUE.
 4. IF FOR ANY REASON, THE IIP CONTACTS THE MECO LINE, THE FCO WILL INITIATE THE ABORT REQUEST COMMAND (ABORT LIGHT) AND WILL TRANSMIT THE MANUAL MECO CODEWORD (REF. PARAGRAPH D, BELOW) TO THE MCC AT THAT TIME.
- C. TWO CUES ARE REQUIRED FOR THE CREW TO INITIATE MANUAL MECO. IMMEDIATE MANUAL MECO ACTION IS REQUIRED WHEN ANY OF THE FOLLOWING CRITERIA ARE MET:
1. "FIFTEEN SEC TO MANUAL MECO" CALL AND "MANUAL MECO NOW" CALL.
 2. "FIFTEEN SEC TO MANUAL MECO" CALL AND ABORT LIGHT. NOTE: IF THE ABORT LIGHT WAS ALREADY ON WHEN "15 SEC TO MANUAL MECO" CALL WAS MADE, MANUAL MECO ACTION WILL BE TAKEN AFTER 15 SEC.
 3. ABORT LIGHT ON AND "MANUAL MECO NOW" CALL. @[053096 PRCB-4001]
 4. ANY OTHER CUES AS APPROPRIATE. @[081497-6306A]

THIS RULE CONTINUED ON NEXT PAGE

FLIGHT RULES

A4-259 **FLIGHT TERMINATION/MANUAL MECO ACTION (CONTINUED)**

D. MANUAL MECO CODEWORD @[081497-6306A]

1. THE MANUAL MECO CODEWORD IS USED BY THE FCO TO INDICATE TO THE MCC THAT AN IMMEDIATE MANUAL MECO IS REQUIRED. WHEN USED, IT IS TRANSMITTED VERBALLY OVER BOTH FD AND FCO PRIME LOOPS SIMULTANEOUSLY.
2. UPON MCC RECEIPT OF THE CODEWORD, CAPCOM WILL IMMEDIATELY NOTIFY THE CREW WITH THE FOLLOWING CALL: "MANUAL MECO NOW, MANUAL MECO NOW." @[053096 PRCB-] @[081497-6306A]

Rule {A3-3}, HIGH-SPEED TRACKING LAUNCH AND LANDING REQUIREMENTS, references this rule. @[ED] @[032807-8402B]

A4-260 **RANGE SAFETY LIMIT AVOIDANCE ACTIONS**

THE FOLLOWING PRIORITIZED ACTIONS WILL BE TAKEN BY THE MCC AND/OR CREW IN ORDER TO PRECLUDE VIOLATION OF RANGE SAFETY DESTRUCT CRITERIA. @[053096 PRCB-4001]

A. FIRST STAGE:

1. STATE VECTOR UPDATE, IF TRAJECTORY DEVIATION IS DUE TO ERRONEOUS ONBOARD NAVIGATION.
2. ENGAGE CSS (APPLICABLE ONLY AFTER 90 SECONDS MET) AND MANUALLY FLY AWAY FROM LIMIT LINES AS DESCRIBED UNDER PART B.3 BELOW.
3. BFS ENGAGE, IF TRAJECTORY DEVIATION IS DUE TO ERRONEOUS GUIDANCE.

NOTE: BFS ENGAGE WILL ONLY BE USED IF IT IS KNOWN THAT IT WILL CORRECT THE DEVIATION. BFS ENGAGE SEVERELY LIMITS POTENTIAL SECOND STAGE ACTIONS.

THIS RULE CONTINUED ON NEXT PAGE

FLIGHT RULES

A4-260 RANGE SAFETY LIMIT AVOIDANCE ACTIONS (CONTINUED)

B. SECOND STAGE:

1. STATE VECTOR UPDATE, IF TRAJECTORY DEVIATION IS DUE TO ERRONEOUS ONBOARD NAVIGATION.
2. PRE-MECO ATO ABORT SELECTION, IF VARIABLE IY IS ENABLED.
3. ENGAGE CSS AND MANUALLY FLY AWAY FROM LIMIT LINES. MCC WILL PROVIDE YAW STEERING COMMANDS OVER AIR-TO-GROUND. FDO IS PRIME FOR DETERMINATION OF YAW STEERING COMMANDS. NOTE: THIS OPTION IS NO LONGER AVAILABLE AFTER A BFS ENGAGE.
4. PRE-MECO TAL OR RTLS ABORT SELECTION (SELECT HIGHEST APPLICABLE ABORT PRIORITY MODE).

NOTE: PRIORITY OF CSS AND TAL/RTLS SELECTION OVER BFS IN SECOND STAGE MAY BE WAIVED IF IT IS KNOWN THAT BFS WILL RECOVER AUTO GUIDANCE TO CORRECT TARGET CONDITIONS. @[053096 PRCB-4001]

5. BFS ENGAGE. @[053096 PRCB-4001]

NOTE: BFS ENGAGE WILL ONLY BE CONSIDERED IF IT IS KNOWN THAT IT WILL CORRECT THE DEVIATION AND IF MORE THAN ONE SSME IS RUNNING. SINGLE-SSME FLIGHT ON THE BFS IS NOT POSSIBLE, AND AUTO, THREE-SSME OUT CONTINGENCY LOGIC IS NOT AVAILABLE IN THE BFS.

6. MANUAL MECO: REFERENCE RULE {A4-259}, FLIGHT TERMINATION/MANUAL MECO ACTION. @[081497-6306A]

Rules {A2-61}, Q-BAR/G-CONTROL; {A2-62}, ET FOOTPRINT CRITERIA; {A2-301}, CONTINGENCY ACTION SUMMARY [HC]; {A4-254}, FCO TO MCC WARNING NOTIFICATION; {A4-255}, MCC TO FCO REPORTING; {A4-257}, FLIGHT TERMINATION/MANUAL MECO EVALUATION; and {A4-258}, FLIGHT TERMINATION/MANUAL MECO CRITERIA, reference this rule. @[032807-8400] @[ED]

FLIGHT RULES

SECTION 5 - BOOSTER

FAILURE DEFINITIONS

A5-1	LOSS OF SRB THRUST VECTOR CONTROL (TVC).....	5-1
A5-2	SPACE SHUTTLE MAIN ENGINE OUT.....	5-1
A5-3	STUCK THROTTLE.....	5-16
A5-4	DATA PATH FAILURE.....	5-18
A5-5	SUSPECT ENGINE [HC].....	5-19
A5-6	SSME REDLINE SENSOR FAILED.....	5-21
A5-7	SSME ONE REDLINE SENSOR FAILURE AWAY FROM AN ERRONEOUS SHUTDOWN.....	5-23
A5-8	RESERVED.....	5-25
A5-9	LH2 ULLAGE LEAK [HC].....	5-25
A5-10	SIGNIFICANT ENGINE HELIUM SYSTEM LEAK.....	5-27
A5-11	SIGNIFICANT PNEUMATIC SYSTEM HELIUM LEAK.....	5-28
A5-12	INSUFFICIENT PNEUMATIC HELIUM ACCUMULATOR PRESSURE.....	5-28
A5-13	MPS DUMPS AND VACUUM INERTING DEFINITIONS [HC].....	5-29
A5-14	THROUGH A5-50 RULES ARE RESERVED.....	5-30

SRB SYSTEMS MANAGEMENT

A5-51	LOSS OF SRB THRUST VECTOR CONTROL (TVC).....	5-31
A5-52	THROUGH A5-100 RULES ARE RESERVED.....	5-31

SSME SYSTEMS MANAGEMENT

A5-101	ABORT CUE REQUIREMENT.....	5-32
A5-102	AUTO/MANUAL SHUTDOWN [HC].....	5-32
A5-103	LIMIT SHUTDOWN CONTROL [HC].....	5-32
A5-104	DATA PATH FAIL/ENGINE-ON LIMIT SHUTDOWN CONTROL.....	5-43
A5-105	DATA PATH FAIL/ENGINE-OUT ACTION.....	5-47

FLIGHT RULES

A5-106 MANUAL SHUTDOWN FOR COMMAND/DATA PATH FAILURES [HC].....5-48

A5-107 MANUAL SHUTDOWN FOR SUSPECT COMMAND PATH FAILURES.....5-51

A5-108 MANUAL SHUTDOWN FOR HYDRAULIC OR ELECTRICAL LOCKUP [HC].....5-52

A5-109 MANUAL SHUTDOWN FOR TWO STUCK THROTTLES (NOT DUAL APU FAILURES) [HC].....5-54

A5-110 SSME PERFORMANCE DISPERSION.....5-58

A5-111 AC BUS SENSOR ELECTRONICS CONTROL [CIL].....5-65

A5-112 MANUAL THROTTLEDOWN FOR LO2 NPSP PROTECTION AT SHUTDOWN [HC].....5-66

A5-113 MANUAL MECO/MECO CONFIRMED.....5-68

A5-114 SSME HYDRAULIC REPRESSURIZATION/POSTLANDING SSME REPOSITIONING.....5-70

A5-115 THROUGH A5-150 RULES ARE RESERVED.....5-70

MPS MANAGEMENT: PRELAUNCH THROUGH MECO

A5-151 PRE-MECO MPS HELIUM SYSTEM LEAK ISOLATION [CIL].....5-71

A5-152 PRE-MECO MPS HELIUM SYSTEM INTERCONNECTS [CIL] [HC].....5-72

A5-153 PRE-MECO SHUT DOWN OF ENGINES DUE TO MPS HELIUM LEAKS [HC].....5-84

A5-154 LH2 TANK PRESSURIZATION [CIL] [HC].....5-95

A5-155 LIMIT SHUTDOWN CONTROL, MANUAL THROTTLING, AND MANUAL SHUTDOWN FOR LOW LH2 NPSP [CIL] [HC].....5-97

A5-156 ABORT PREFERENCE FOR SYSTEMS FAILURES [HC]...5-100

A5-157 MPS LOW LEVEL CUTOFF SENSORS FAILED DRY [HC].5-102

A5-158 THROUGH A5-199 RULES ARE RESERVED.....5-102

FLIGHT RULES

MPS MANAGEMENT: POST-MECO

A5-200	MPS PROPELLANT DUMP/ET SEPARATION MANAGEMENT [HC].....	5-103
A5-201	MPS DUMP INHIBIT [CIL] [HC].....	5-104
A5-202	ET SEPARATION INHIBIT FOR 17-INCH DISCONNECT FAILURE [CIL].....	5-105
A5-203	MPS PROPELLANT MANIFOLD OVERPRESSURE [CIL] [HC].....	5-108
A5-204	MANUALLY DELAYED MPS DUMP.....	5-113
A5-205	NOMINAL, AOA, AND ATO MPS DUMP FAILURES [HC].	5-114
A5-206	MANUAL VACUUM INERTING REQUIREMENTS (NOMINAL, ATO, AOA) [HC].....	5-118
A5-207	LH2 PRESSURIZATION VENT CONTROL.....	5-120
A5-208	POST-MECO AND ENTRY HELIUM ISOLATION [HC]....	5-121
A5-209	ENTRY MPS HELIUM PURGE/MANIFOLD PRESSURIZATION.....	5-125
A5-210	ENTRY MPS PROPELLANT DUMP FAILURES [CIL] [HC]	5-127

FLIGHT RULES

THIS PAGE INTENTIONALLY BLANK

FLIGHT RULES

SECTION 5 - BOOSTER

FAILURE DEFINITIONS

A5-1 **LOSS OF SRB THRUST VECTOR CONTROL (TVC)** ©[012402-4987]

SRB TVC IS LOST WHEN THE HYDRAULIC SUPPLY PRESSURES OF BOTH HPU'S ON THE SAME SRB ARE 1000 PSIG OR LESS. ©[041196-1874A]

The SRB TVC system has a lock-out style valve which will actuate to the lock position when the hydraulic supply pressure is 1000 to 600 psig. Two hydraulic power units (HPU's) are installed per SRB, and both can supply hydraulic power to the TVC actuators. Actuator source pressure is switched from the primary HPU to the secondary HPU when the hydraulic supply pressure on a single HPU reaches 2050 ±150 psig. This switchover is indicated by an Actuator Primary Pressure OK discrete value of False and it effectively loses one HPU. However, TVC is not lost until neither HPU can deliver hydraulic supply pressure of 1000 psig to the actuators. (Reference System Handbook Drawing 9.14 and USBI documents 10SPC-0055, rev B, section 4.2.2.10, and 10MNL-0045, Rev D). ©[012402-4987] 7

Note: Above 1000 psig, the lock-out valve opens, and TVC is still available. ©[041196-1875A]

A5-2 **SPACE SHUTTLE MAIN ENGINE OUT** ©[121197-6472A]

PREMATURE ENGINE SHUTDOWN IS CAUSED BY AN ENGINE LIMIT EXCEEDED, DUAL CONTROLLER ELECTRONICS FAILURES, OR A COMBINATION OF A SINGLE CHANNEL LIMIT EXCEEDED AND A CONTROLLER ELECTRONIC FAILURE. DSP FAILURES DO NOT COUNT AS CONTROLLER ELECTRONIC FAILURES. ©[102506-7855]

THE CUES FOR DETERMINING AN ENGINE SHUTDOWN ARE DEFINED IN PARAGRAPHS A, B, C, AND D OF THIS RULE. THE SHUTDOWN SOFTWARE LIMITS ARE DEFINED IN PARAGRAPH E. THE AVIONIC FAILURE COMBINATIONS ARE DEFINED IN PARAGRAPH F.

If both engine controller electronics are failed or all qualified sensors are voting for shutdown with limit monitoring enabled, then the SSME will shut down. Combinations of sensor fails and electronic failures can also cause an engine to shut down. Digital Signal Processor (DSP) failures do not count as electronics failures because the only functionality that is lost when a DSP fails or is disqualified is the loss of vibration redline protection. Loss of a DSP cannot cause an engine to shut down.

ENGINE OUT DETERMINATION WILL BE BASED ON THE FOLLOWING CUES:

- A. ONBOARD (WITH VALID SSME DATA):
1. RED MAIN ENGINE STATUS LIGHT IS ILLUMINATED.
 2. PC < 30 PERCENT (MEDS DISPLAY) ©[102506-7855]

THIS RULE CONTINUED ON NEXT PAGE

FLIGHT RULES**A5-2****SPACE SHUTTLE MAIN ENGINE OUT (CONTINUED)**

3. SSME FAIL C (L,R) PASS OR BFS FAULT MESSAGE @[102506-7855]

Two cues are required for calls that may cause an abort. The MPS dedicated display driver sequence in the flight software illuminates the red status light if the SSME is in the shutdown or post-shutdown phase. The SSME operations sequence in the flight software uses power level less than 30 percent as the indication that the SSME has shut down for the purpose of establishing MECO confirmed. The 30 percent value represents a power level below which the engine cannot operate. The PASS and BFS "SSME FAIL" messages are generated when the engine fail flag is set by the SSME OPS sequence. The engine fail flag is set when either the engine status word shows shutdown or post shutdown phase, or a data path failure has occurred and the engine safing command flag has been set.

B. MCC (WITH VALID SSME DATA) :

AT LEAST TWO OF THE FOLLOWING CUES ARE REQUIRED:

1. SSME FAILURE IDENTIFIER (FID) "013" OR "017" INDICATING SSME SHUTDOWN FOR REDLINE VIOLATION (PASS ONLY) .
2. SHUTDOWN OR POST-SHUTDOWN PHASE (REFLECTED IN ENGINE STATUS WORD) .
3. PC < 900 PSIA.
4. SSME FAIL C (L,R) PASS OR BFS FAULT MESSAGE

Two cues are required for calls that may cause an abort. A FID 013 or 017 issued by the SSME controller represents an engine shutdown due to a redline exceedance. The 013 FID represents an engine shutdown due to engine redline parameter exceedance. The 017 FID represents an engine shutdown due to vibration redline exceedance. The specific redline that was exceeded is defined by the combination of the Failure ID and delimiter part of the Failure Identification (FID) Word. The FID word is only available on the PASS. Shutdown and post-shutdown phases are set in the engine status word when the SSME controller commands shutdown. Pc of 900 psia corresponds to approximately 30 percent power level. The PASS and BFS "SSME FAIL" messages are generated when the engine fail flag is set by the SSME OPS sequence. The engine fail flag is set when either the engine status word shows shutdown or post shutdown phase, or a data path failure has occurred and the engine safing command flag has been set. @[121197-6472A]

C. ONBOARD (WITH SSME DATA PATH FAILURE) :

AT LEAST THREE OF THE FOLLOWING ARE REQUIRED:

1. G-LEVEL DECREASE IN SECOND STAGE ON FLIGHT INSTRUMENT G-METER OR BFS TRAJECTORY DISPLAY G SCALE) . @[102506-7855]

THIS RULE CONTINUED ON NEXT PAGE

FLIGHT RULES

A5-2

SPACE SHUTTLE MAIN ENGINE OUT (CONTINUED)

2. MPS HE P C (L,R) BFS FAULT MESSAGE FOR HIGH DP/DT FOLLOWED BY CONSTANT ENGINE HELIUM TANK PRESSURE, IF NOT ALREADY ANNUNCIATING A FAULT MESSAGE FOR A HELIUM LEAK. @[102506-7855]
3. MPS H₂ OUT P L (C,R) BFS FAULT MESSAGE
4. MPS O₂ OUT T L (C,R) BFS FAULT MESSAGE

During second stage when the first, second, and third engines shut down in sequence, the g-level decreases by 33, 50, and 100 percent, respectively. During first stage, the SRB thrust far exceeds the SSME thrust making it difficult to detect an engine shutdown based upon changes in vehicle acceleration. At the time of failure, if the engine was not already annunciating a helium leak, and shuts down behind a data path failure, the crew will get an "MPS HE P C (L, R)" BFS fault message for DP/DT, followed by constant helium tank pressure on the affected engine after 15.5 seconds once all the shutdown purges have completed. If the tank pressure remains constant, no helium is being used and; therefore, the engine has shut down. In OI-22 and subsequent, the crew will get BFS fault messages for both the GH₂ outlet pressure and GO₂ outlet temperature dropping below 1050 psia and 125 deg F, respectively. Both the GH₂ out P and GO₂ out T limits are set to correspond to an engine power level of approximately 30 percent or lower. This is well below the power level that an engine can operate. Because both of these parameters are channelized through the same OI MDM and powered from the same OI DSC, the two fault messages could be generated by a single MDM or DSC failure. For this reason, the crew must use three of the four cues when determining an engine out behind a data path failure. @[020196-1812] @[121197-6472A]

D. MCC (WITH SSME DATA PATH FAILURE) :

AT LEAST TWO OF THE FOLLOWING CUES ARE REQUIRED:

1. A SUDDEN DROP IN ACCELERATION OR THRUST FACTOR IN SECOND STAGE AS DETERMINED FROM TELEMETRY DATA.
2. ORBITER GH₂ OUTLET PRESSURE < 800 (1050) PSIA OR ORBITER GO₂ OUTLET TEMPERATURE < 260 (300) DEG F WHEN THROTTLE SETTING IS AT MISSION POWER LEVEL.
3. MPS HE P C (L,R) BFS FAULT MESSAGE FOR HIGH DP/DT FOLLOWED BY CONSTANT ENGINE HELIUM TANK PRESSURE, IF NOT ALREADY ANNUNCIATING A FAULT MESSAGE FOR A HELIUM LEAK. @[102506-7855]
4. A DROP IN SECOND STAGE PERFORMANCE AS DETERMINED BY THE ARD.

THIS RULE CONTINUED ON NEXT PAGE

FLIGHT RULES

A5-2

SPACE SHUTTLE MAIN ENGINE OUT (CONTINUED)

Two cues are required for calls that may cause an abort. For an engine shutdown in second stage, an abrupt drop in vehicle acceleration will result. The GH_2 outlet pressure and GO_2 outlet temperature are orbiter parameters that can be used to determine the status of an engine. The GH_2 out P limit is set to correspond to an engine power level of approximately 30 percent. This is well below the power level that an engine can operate. Flight data from STS 51-F indicates the GO_2 outlet temperature was < 125 deg F for about 15 seconds post engine shutdown. The GO_2 outlet temperature did rise again post shutdown to a value of approximately 300 deg F, which corresponds to a power level of approximately 90 percent. The value of 300 deg F was selected so an engine can still be declared out after the temperature has risen post shutdown, but this limits the use of this cue to only when the throttle setting is at mission power level. Since both orbiter parameters are channelized through the same OI MDM and powered from the same OI DSC, the two are grouped together as one engine out cue. ©[102506-7855]

If an engine did not previously have a helium leak and shuts down behind a data path failure, the crew will get an "MPS HE P C (L,R)" BFS fault message for high DP/DT while the engine initiates shutdown purges. Once the helium purges have terminated after 15.5 seconds, the engine will no longer use helium and; therefore, the helium tank pressure will remain constant. Thrust factor (FT FACTOR) is a second stage guidance downlisted parameter from the vehicle and is calculated by dividing the expected thrust by the calculated thrust. If an engine shuts down in second stage behind a data path failure, the thrust factor will drop to a value less than 1.0. If an engine shuts down in first stage, thrust factor is not available, but the second stage performance as determined by the ARD would reflect the loss in performance from the engine shutdown. ©[032395-1765A] ©[020196-1812] ©[121197-6472A] ©[102506-7855]

THIS RULE CONTINUED ON NEXT PAGE

FLIGHT RULES

A5-2 SPACE SHUTTLE MAIN ENGINE OUT (CONTINUED)

E. ENGINE LIMIT EXCEEDED AND SHUTDOWN SENSOR FAILURE DEFINITIONS:

PARAMETERS <i>(a)</i>	REDLINE QUALIFICATION/ REASONABLENESS TESTING <i>(c)</i>	REDLINE SHUTDOWN LIMITS <i>(d)</i>	NOTES <i>(b)</i>
HPFTP TURBINE DISCH TEMP THERMOCOUPLE SENSORS A2, A3, B2 & B3 (°R)	A2 (A3,B2,B3) > 2650° R A2-A3 > 50° R (D/Q LWR) B2-B3 > 50° R (D/Q LWR) DOWN TO 1 ON BOTH/EITHER: (B AVG - AX) > 150° R (D/Q AX) (A AVG - BX) > 150° R (D/Q BX) AX-BY > 150° R (D/Q LWR)	CH A > 1860° R CH B > 1860° R NO LOWER LIMIT	[1] [3] [7] [4] [9] [11]
HPOTP TURBINE DISCH TEMP THERMOCOUPLE SENSORS A2, A3, B2 & B3 (°R)	A2 (A3,B2,B3) > 2650° R A2-A3 > 50° R (D/Q LWR) B2-B3 > 50° R (D/Q LWR) DOWN TO 1 ON BOTH/EITHER: (B AVG - AX) > 150° R (D/Q AX) (A AVG - BX) > 150° R (D/Q BX) AX-BY > 150° R (D/Q LWR)	> 1660° R < 720° R	[1] [3] [9] [4] [11]
HPOTP INTERMEDIATE SEAL PRESSURE SENSORS A & B (PSIA)	> 650 PSIA < 0 PSIA	NO UPPER LIMIT < 159 PSIA	[1] [5] [3] [4]
MCC PC SENSOR AVERAGE SENSORS A & B (PSIA)	BRIDGE 1 - BRIDGE 2 > 125 PSI PC CHANNEL AVG > 3500 PSIA > 1000 PSIA	NO UPPER LIMIT PC CHANNEL AVG < PC REF - 200 PSI (STEADY STATE) AND PC REF - 400 PSI (DURING THROTTLING OR WHEN ≤ 75% RPL)	[1] [8] [3] [4]
HPFTP RTVMS PUMP END ACCELEROMETER SYNCHRONOUS (1N) VIBRATION SENSORS 1, 2, 3 (G)		> 8 G (HMII ISSUED BY DSP) NO LOWER LIMIT	[2] [3] [5]
HPOTP RTVMS PUMP END ACCELEROMETER SYNCHRONOUS (1N) VIBRATION SENSORS 1, 2, 3 (G)		> 4 G (HMII ISSUED BY DSP) NO LOWER LIMIT	[2] [3] [5]

@[111094-1732] @[032395-1765A] @[092195-1792B] @[020196-1812] @[121197-6472A] @[102506-7855]

THIS RULE CONTINUED ON NEXT PAGE

FLIGHT RULES

A5-2

SPACE SHUTTLE MAIN ENGINE OUT (CONTINUED)

NOTES:

[1] MUST EXCEED LIMIT OR FAIL REASONABLENESS FOR 60 MSEC.

A turbine discharge temperature, intermediate seal pressure, or MCC PC pressure parameter must be outside its redline or reasonableness limit for three consecutive 20 msec controller DCU cycles before action is taken by the controller. This requirement prevents action from being taken on a single data hit.
@[102506-7855]

[2] MUST EXCEED LIMIT OR FAIL REASONABLENESS FOR 100 MSEC @[032395-1765A] @[121197-6472A]

An RTVMS accelerometer parameter must be outside its redline or reasonableness limit for two consecutive 50 msec DSP cycles before action is taken by the controller. This requirement prevents action from being taken on a single data hit while maintaining a fast response time.

[3] SHUTDOWN FOR AN OUT-OF-LIMIT CONDITION INITIATED BY MAIN ENGINE CONTROLLER IF LIMIT ENABLED. LIMIT INHIBIT/ENABLE OPERATIONS DEPENDENT ON ORBITER FLIGHT SOFTWARE FUNCTION LIMIT STATUS AND THE POSITION OF THE MAIN ENGINE LIMIT SHUTDOWN SWITCH.

This indicates that, if the limit shutdown logic is enabled, then a redline violation will result in an SSME shutdown.

[4] IF ALL SENSORS FAIL REASONABLENESS, THAT REDLINE IS DELETED. @[092195-1792B]

Turbine discharge temperature, intermediate seal pressure, or MCC PC pressure redline monitoring is no longer performed because the redline sensors have failed.

[5] IF TWO SENSORS FAIL REASONABLENESS, THAT REDLINE IS DELETED. @[032395-1765A] @[020196-1812]

RTVMS vibration redline monitoring is no longer performed because two redline sensors have failed and a single accelerometer will not be relied upon for redline shutdown.

[6] RESERVED @[111094-1732] @[092195-1792B] @[121197-6472A] @[102506-7855]

THIS RULE CONTINUED ON NEXT PAGE

FLIGHT RULES

A5-2

SPACE SHUTTLE MAIN ENGINE OUT (CONTINUED)

- [7] THIS REDLINE MAY BE REVISED ON A FLIGHT-BY-FLIGHT BASIS TO ENSURE COMPARABLE MARGIN ON CHANNEL A AND CHANNEL B BETWEEN THE PREDICTED NOMINAL VALUE AND THE REDLINE VALUE. IF A CHANNEL A TO B BIAS IS ADDED, THEN THIS BIAS IS CARRIED OVER INTO THE REASONABLENESS CALCULATIONS FOR THE INTERCHANNEL CHECKS. ®[092195-1792B] ®[102506-7855]

Some flight SSME HPFTP's may operate at a lower temperature. Engines with these turbopumps may have their channel A redline adjusted downward to provide the same 100 deg R difference between the main stage operating temperature and the redline as present on other HPFTP's. ®[111094-1732]

- [8] THE INTRACHANNEL CHECK AND THE CHANNEL AVERAGE MUST BE WITHIN THE SPECIFIED LIMITS IN ORDER TO BE PROCESSED BY THE CONTROLLER'S SHUTDOWN LIMIT LOGIC. THESE REASONABLENESS CHECKS ARE IN ADDITION TO THE NORMAL SENSOR MONITORING PERFORMED FOR IGNITION CONFIRMED AND CONTROL LOOP PROCESSING QUALIFICATION.

The MCC Pc channels will be disqualified for control purposes for an intrachannel difference of greater than 75 psi. The MCC Pc redline logic incorporates two reasonableness criteria to ensure that only valid pressures will be used.

- [9] THE LOGIC FOR THE HPFTP AND THE HPOTP TURBINE DISCHARGE TEMPERATURE WAS MODIFIED BY THE IMPLEMENTATION OF THE THERMOCOUPLES. THE THERMOCOUPLE MODIFICATION UTILIZES TWO SENSORS PER CHANNEL FOR A TOTAL OF FOUR SENSORS PER REDLINE. ®[092195-1782B] ®[092195-1782B]

The sensor processing logic was modified to accommodate the different failure modes for the thermocouple sensors (versus the previous resistive thermal devices-RTD's) and to handle the additional number of sensors. The additional sensors were added to increase reliability against sensor failures resulting in pad aborts, erroneous in-flight shutdown, or the loss of redline protection. ®[121197-6472A]

- [10] RESERVED ®[121197-6472A]

- [11] A COLD JUNCTION REFERENCE TEMPERATURE (T_{CJ}) IS PROVIDED FOR EACH CONTROLLER CHANNEL TO PROCESS THE HOT GAS THERMOCOUPLE SENSOR DATA. THE T_{CJ} IS USED TO CALIBRATE THE TEMPERATURE MEASUREMENT INPUT. EACH CHANNEL HAS A SINGLE RTD T_{CJ} WHICH IS USED FOR BOTH THE HPOTP AND HPFTP TURBINE DISCHARGE TEMPERATURE MEASUREMENTS. IF ONE CHANNEL'S T_{CJ} IS DISQUALIFIED, THE OTHER CHANNEL'S T_{CJ} WILL BE USED FOR BOTH CHANNELS. IF BOTH T_{CJ} S ARE DISQUALIFIED, A DEFAULT VALUE WILL BE USED.

Thermocouple measurements require a cold junction reference temperature to provide accurate readings. The controller and its software was modified to accommodate the addition of these two transducers, which are required for use of the thermocouples. ®[102506-7855]

THIS RULE CONTINUED ON NEXT PAGE

FLIGHT RULES

A5-2

SPACE SHUTTLE MAIN ENGINE OUT (CONTINUED)

- a. *PARAMETERS - This table covers parameters which the SSME controller qualifies, monitors, and uses to shut down the engine.*
- b. *CONTROLLER REDLINE SHUTDOWN PROCESSING - All qualified sensors must vote for shutdown for action to proceed. @[092195-1792B] @[102506-7855]*
- c. *REDLINE QUALIFICATION/REASONABLENESS TESTING - Qualification, also known as reasonableness testing, is required to qualify the sensors for application to shutdown logic. The values chosen screen out sensors with identified sensor problems. @[121197-6472A]*
- d. *REDLINE SHUTDOWN LIMITS - Redline parameters are monitored to assure that the engine is performing within safe operating conditions. Limits are set to guard against uncontained SSME damage. The limits are based upon test stand data, flight experience, and engineering analysis. The engine redline design criteria was defined by MSFC and approved by Level II.*
- e. *Reserved @[092195-1792B]*
- f. *HPFTP TURBINE DISCHARGE TEMPERATURE @[092195-1792B]*

The limit was derived from analysis and protects against stress rupture of the HPFTP turbine blades due to high temperature operation. This redline was developed following uncontained failures on engines 0204 and 2013 during ground testing. These failures were attributed to turbine blade failure which resulted in HPFTP seizure and low pressure fuel duct rupture. Subsequent analysis determined a 2160 deg R maximum turbine blade root temperature capability for 109 percent power level. This temperature equates to a 2060 deg R turbine exhaust temperature. The 1860 deg R limit provides a 200 deg R margin. This leaves satisfactory margin from nominal operating conditions to the redline (reference Ascent/Entry Flight Techniques Panel, August 15, 1997). The channel A location on some HPFTP's may run cooler, thus necessitating a lower redline value (potentially as low as 1750 deg R). @[111094-1732] @[121197-6472A] @[102506-7855]

THIS RULE CONTINUED ON NEXT PAGE

FLIGHT RULES

A5-2

SPACE SHUTTLE MAIN ENGINE OUT (CONTINUED)

The upper reasonableness limit of 2650 deg R guards against open circuits and analog-to-digital (A/D) converter failures. The intrachannel and interchannel reasonableness limits are screens for internal short circuits. An absolute lower limit is not feasible since a short will result in an in-range failure signature. If only one sensor remains, only the open circuit failure mode is detectable. ©[092195-1792B] ©[121197-6472A]

g. *HPOTP TURBINE DISCHARGE TEMPERATURE* ©[092195-1792B] ©[102506-7855]

The upper redline limit was derived from analysis to protect the heat exchanger from overheating and rupturing leading to catastrophic failure. The limit of 1660 deg R provides a 200 deg R margin. This leaves satisfactory margin from nominal operating conditions to the redline (reference Ascent/Entry Flight Techniques Panel, August 15, 1997). The lower redline limit of 720 deg R provides protection against inadvertent deep throttling of the engine, which causes ice formation in the HPOTP turbine, subsequent turbine imbalance, and potential catastrophic HPOTP failure. ©[121197-6472A]

The reasonableness limit of 2650 deg R guards against open circuits and A/D converter failures. The intrachannel and interchannel reasonableness limits are screens for internal short circuits. An absolute lower limit is not feasible since a short will result in an in-range failure signature. If only one sensor remains, only the open circuit failure mode is detectable. ©[121197-6472A]

h. *Reserved* ©[032395-1765A] ©[092195-1792B] ©[121197-6472A] ©[102506-7855]

THIS RULE CONTINUED ON NEXT PAGE

FLIGHT RULES

A5-2

SPACE SHUTTLE MAIN ENGINE OUT (CONTINUED)

i. *HPOTP INTERMEDIATE SEAL PRESSURE -*

The redline limit was derived from analysis to prevent LO₂ from the alternate HPOTP pump combining in the purge cavity with H₂ from the fuel cooled roller and ball bearing package. This redline guards against excessive seal wear or loss of helium purge by ensuring that the HPOTP intermediate seal cavity pressure is greater than the HPOTP O₂ cavity and secondary H₂ cavity pressures by 10 psi during main stage under the worst seal gap condition. Both reasonableness tests provide protection against avionics failures of the pressure sensor system. ©[032395-1765A] ©[092195-1792B] ©[121197-6472A] ©[102506-7855]

- j. *MCC PC SENSOR AVERAGE - The redline was initially added to protect the engine against the type of failure seen on engine 2106, in which a burnthrough of the bellows section of the high pressure oxidizer turbopump turbine section occurred. This failure was caused by an oxidizer preburner failure and resulted in a bypass of hot gas flow from the turbine directly into the hot gas manifold which caused a massive drop in MCC Pc. The original redline limit of 400 psi below the commanded Pc was chosen based upon the amount of damage sustained by the engine 2106 high-pressure oxidizer turbopump at the time the engine was shut down by a facility redline. The MCC Pc redline was updated for STS-89 and subsequent flights to 200 psi below the commanded Pc during steady state operations, while retaining the 400 psi during throttling and when power level is less than or equal to 75 percent RPL. This update was based upon the amount of damage sustained by engine 0524 which experienced a nozzle failure and uncontained shutdown during test 901-933. ©[121197-6472A]*

The intrachannel reasonableness limit ($|Bridge\ 1 - Bridge\ 2| \leq 125\ psi$) protects against single-bridge failures. Due to hardware and software limitations in the controller for sampling sensor inputs, the delta value must be set large enough to account for differences in the actual MCC Pc if the actual MCC Pc is decreasing rapidly due to a real engine combustion problem. If the value is set too tight, the actual MCC Pc could drop greater than the reasonableness limit between sampling the bridge 1 and bridge 2 sensor measurements. A smaller value could allow one or both MCC Pc channels to be erroneously disqualified. If both channels are disqualified, the MCC Pc redline is disabled at a time it is most needed. The redline qualification limit was increased from 75 psi to 125 psi in response to the catastrophic failure of development SSME 0212 (test 904-44), during which the actual decay rate of the MCC Pc was 105 psi between input samples of the A1/A2 and B1/B2 Pc pairs. The channel average upper reasonableness limit protects against an off-scale high sensor pair or input electronics failure. The lower limit protects against a failed low sensor pair or input electronics failure. ©[121197-6472A]

THIS RULE CONTINUED ON NEXT PAGE

FLIGHT RULES

A5-2

SPACE SHUTTLE MAIN ENGINE OUT (CONTINUED)

- k. *If a Pc channel fails the Pc discriminator logic test, that channel is no longer qualified for shutdown limit monitoring. ©[102506-7855]*

If the first Pc channel fails the Pc REF channel reasonableness test, subsequent checking is needed to determine the failed component and failure response. If the A and B channels are within 50 psi (125 psi during throttling) of each other, then the offending channel will be permanently disqualified for control. If the A and B channel averages disagree by more than 50 psi (125 psi during throttling), then it is necessary to perform the Pc Discriminator Test to determine which is the bad channel.

For this check, the controller uses the HPFP and/or HPOP discharge pressure(s) to determine which direction the MCC Pc is drifting. Therefore, it will only be performed if either the HPFP or HPOP discharge sensors are qualified. The test calculates a Pc Discriminator Intercept, which is a function of Pc Average and either the HPFP or HPOP discharge pressure, which is then used to calculate the MCC Pc Discriminator. The discriminator is calculated using either the HPFP or HPOP-based intercepts, or takes an average of the two if both are qualified. The software then determines which channel more closely agrees with the discriminator and considers that channel to be the good channel. The channel that least agrees with the discriminator is considered bad and is then disqualified for both control and redline limit shutdown processing.

Reference CP406R0021 Computer Program Contract End Item, Block II SSMEC Operational Programs, Part I, Volume 1: Requirements Text - Section 3.2.3:4.2.2 - Control Parameter Qualification to "3.2.3:4.2.2 Control Parameter Qualification" for more details. Pc discriminator logic testing is also mentioned in Rule {A5-6}, SSME REDLINE SENSOR FAILED.

- l. *HPFTP REAL TIME VIBRATION MONITORING SYSTEM (RTVMS) PUMP END ACCELEROMETER SYNCHRONOUS (IN) VIBRATION -*

This RTVMS redline was added as part of the SSME Advanced Health Management System (AHMS) Phase I. This redline can be set to a monitor mode or an active mode. In monitor mode, the redline is not active and FID's are not posted. In active mode, the redline is allowed to shut down an engine. The redline limit was derived from analysis of actual Pratt and Whitney HPFTP hardware failures on the test stand and is intended to prevent/mitigate catastrophic events while avoiding unnecessary shutdowns of functional engines. Examples of tests with a functional engine after a hardware failure include test 904-231 which had a turbine nozzle vane support failure causing heavy rubbing, and test 904-322 which had a turbine blade airfoil failure. Examples of tests where a shutdown at 8 g would prevent/mitigate a catastrophic event include test 901-853 which had turbine nozzle vane and turbine blade failures, test 904-283 which had a second stage turbine blade attachment failure, and test 902-772 which had turbine nozzle vane, turbine blade, and roller bearing failures caused by "LOX tape" contamination. The value of 8 g is 13.2 sigma above the 109 percent RPL greenrun limit, well above levels of confirmed hardware failures, consistent with significant hardware damage prior to "runaway" levels, and consistent with Rocketdyne HPFTP experience with failed hardware. The derivation of this redline value was discussed in detail at A/E FTP #167 on August 25, 2000. ©[102506-7855]

THIS RULE CONTINUED ON NEXT PAGE

FLIGHT RULES

A5-2

SPACE SHUTTLE MAIN ENGINE OUT (CONTINUED)

- m. *HPOTP RTVMS PUMP END ACCELEROMETER SYNCHRONOUS (1N) VIBRATION* - @[102506-7855]

This RTVMS redline was added as part of the SSME AHMS Phase 1. This redline can be set to a monitor mode or an active mode. In monitor mode, the redline is not active and FIDs are not posted. In active mode the redline is allowed to shut down an engine. The redline limit was derived from analysis of the one Pratt and Whitney HPOTP hardware failure (and several Rocketdyne HPOTP failures) experienced on the test stand and is intended to prevent/mitigate catastrophic events while avoiding unnecessary shutdowns of functional engines. Test 904-149 experienced a Pratt and Whitney HPOTP turbine side inducer blade failure at approximately 98 seconds into a planned 520 second test. This test was terminated at 110 seconds due to high preburner vibration levels. Analysis of test 904-149 concluded that a cutoff at 4 g on the pump end accelerometers would have resulted in a safe shutdown. Examples of Rocketdyne HPOTP tests with a functional engine after a hardware failure include test 902-116 which had a heavy turbine rub. Examples of Rocketdyne HPOTP tests where a shutdown at 4 g would prevent/mitigate a catastrophic event include test 901-103 which had a heavy pump rub and a heavy turbine rub, and test 901-136 which had a bearing failure. The value of 4 g is 5.25 sigma above the 104.5% RPL greenrun limit, above levels of confirmed hardware failures, is consistent with the HPOTP inducer failure experienced on test 904-149, and is consistent with Rocketdyne HPOTP experience with failed hardware. The HPOTP maintains a smaller margin to the synchronous vibration redline than the HPFTP due to the uncertainties associated with the potential for fires in the LO2 environment. The derivation of this redline value was discussed in detail at A/E FTP #167 on August 25, 2000. @[102506-7855]

THIS RULE CONTINUED ON NEXT PAGE

FLIGHT RULES

A5-2

SPACE SHUTTLE MAIN ENGINE OUT (CONTINUED)

n. *RTVMS QUALIFICATION LIMITS:* ©[102506-7855]

The conditions outlined in the table below are used in various combinations to determine the condition of the sensors and engine.

PUMP	SYNCHRONOUS VIBRATION HIGH	SYNCHRONOUS NOISE FLOOR HIGH	FIXED NOISE BAND HIGH	COMPOSITE VIBRATION LOW	SIGNAL TO NOISE RATIO HIGH
	START+5.80 SEC THROUGH MAINSTAGE				
HPFTP	<u>8</u> G	<u>3</u> G	<u>3</u> G	<u>0.35</u> G	<u>19</u> dB
HPOTP	<u>4</u> G	<u>3</u> G	<u>3</u> G	<u>0.35</u> G	<u>19</u> dB

The following cases (or rules) are applied to the conditions outlined above for each of the three HPOTP or HPFTP accelerometers. The cases are executed in order from Case 1 through Case 6 until a failure is detected.

CASE	TYPE OF FAILURE	SYNCHRONOUS VIBRATION HIGH	SYNCHRONOUS NOISE FLOOR HIGH	FIXED NOISE BAND HIGH	COMPOSITE VIBRATION LOW	COMPOSITE COMPARISON HIGH	SIGNAL TO NOISE RATIO HIGH
1	PUMP	YES	NO	NO	(1)	(1)	(1)
2	SENSOR	NO	YES	YES	(1)	(1)	(1)
3	SENSOR	(1)	(1)	(1)	YES	(1)	(1)
4(A)	PUMP	YES	YES	NO	(1)	(1)	YES
4(A)	SENSOR	YES	YES	NO	(1)	(1)	NO
4(B)	PUMP	YES	NO	YES	(1)	(1)	YES
4(B)	SENSOR	YES	NO	YES	(1)	(1)	NO
5	SENSOR	YES	YES	YES	(1)	YES (2)	(1)
6	PUMP	YES	YES	YES	(1)	NO	YES
6	SENSOR	YES	YES	YES	(1)	NO	NO

Note (1) - these are cases where the failure condition is not used.

Note (2) - Composite Comparison High is when the composite vibration is greater than two times the larger composite vibration of the other qualified sensors on that pump.

Reference CP406R0021 Computer Program Contract End Item, Block II SSMEC Operational Programs, Part I, Volume 3: DSP Requirements Text - for more details. ©[102506-7855]

THIS RULE CONTINUED ON NEXT PAGE

FLIGHT RULES

A5-2 SPACE SHUTTLE MAIN ENGINE OUT (CONTINUED)

F. SSME INSTRUMENTATION/ELECTRONICS FAILURE MATRIX:

CHANNEL A [1]	CHANNEL B [1]										
	DCU/ CIE B [3]	IE B [3][4]	OE B [3]	PS B [3][4]	DSP B [4]	HPFTP TURB DISCH T CH B2 & B3 (TC) [2]	HPOTP TURB DISCH T CH B2 & B3 (TC) [2]	HPOTP IMSL P B [2]	MCC PC B AVG [2]	HPFTP RTVMS PUMP END 1N VIB 1, 2, OR 3 [2][5]	HPOTP RTVMS PUMP END 1N VIB 1, 2, OR 3 [2][5]
DCU/CIE A [3][4]	X			X							
IE A [3][4]		X		X		☒	☒	☒	☒		
OE A [3]			X	X							
PS A [3][4]	X	X	X	X		☒	☒	☒	☒		
DSP A [4]											
HPFTP TURB DISCH T A2 & A3 (TC) [2]		☒		☒		☒					
HPOTP TURB DISCH T A2 & A3 (TC) [2]		☒		☒			☒				
HPOTP IMSL P A [2]		☒		☒				☒			
MCC PC A AVG [2]		☒		☒					☒		
HPFTP RTVMS PUMP END 1N VIBRATION 1, 2, OR 3 [2][5]										☒	
HPOTP RTVMS PUMP END 1N VIBRATION 1, 2, OR 3 [2][5]											☒

@[030994-1614A] @[032395-1765A] @[092195-1792B] @[121197-6472A] @[102506-7855]
 LEGEND:

- X SHUTDOWNS THAT CANNOT BE INHIBITED. PNEUMATIC SHUTDOWN WILL OCCUR BEHIND A DATA PATH FAILURE. @[030994-1614A]
- ☒ SHUTDOWNS THAT CAN BE INHIBITED USING MAIN ENGINE LIMIT SHUTDOWN SWITCH.

THIS RULE CONTINUED ON NEXT PAGE

FLIGHT RULES

A5-2

SPACE SHUTTLE MAIN ENGINE OUT (CONTINUED)

NOTES:

- [1] CHANNEL A FAILURES WHEN ALIGNED WITH SPECIFIC CHANNEL B FAILURES THAT CAUSE SHUTDOWN ARE DENOTED BY X OR ☒.
- [2] ALL QUALIFIED SENSORS EXCEED REDLINE LIMIT. @[030994-1614A] @[092195-1792B] @[121197-6472A]
- [3] LOSS OF CONTROLLER REDUNDANCY.
- [4] LOSS OF RTVMS REDLINE CAPABILITY. RTVMS REDLINE NOT LOST FOR DCU B DISQUALIFICATION NOT DUE TO POWER LOSS. RTVMS REDLINE NOT LOST FOR OE FAILURES. @[032395-1765A] @[102506-7855]
- [5] 3 OF 3 OR 2 OF 2 VOTING REQUIRED FOR SHUTDOWN @[121197-6472A]

This matrix identifies failures which result in loss of controller redundancy and in premature engine shutdown. Shutdown caused by dual controller failures (excluding DSP's) cannot be prevented even if the limit shutdown monitoring is inhibited. In these cases when the second failure occurs, the engine will immediately shut down via the controller's fail-safe pneumatic shutdown sequence. Shutdowns caused by redline violations can be inhibited manually by the limit shutdown monitoring switch or automatically by the GPC software after an engine out or data path failure.

Rules {A5-5}, SUSPECT ENGINE [HC]; {A5-6}, SSME REDLINE SENSOR FAILED; {A5-7}, SSME ONE REDLINE SENSOR FAILURE AWAY FROM AN ERRONEOUS SHUTDOWN; {A5-110}, SSME PERFORMANCE DISPERSION; and {A5-111}, AC BUS SENSOR ELECTRONICS CONTROL [CIL] [HC], reference this rule. @[121197-6482B] @[121197-6472A] @[111298-6785A] @[ED] @[042706-7348] @[102506-7856] @[102506-7855]

FLIGHT RULES

A5-3**STUCK THROTTLE**

FAILURE OF A MAIN ENGINE TO THROTTLE COULD BE CAUSED BY COMBINATIONS OF ENGINE AND AVIONICS FAILURES WHICH CAUSE THE ENGINE OPERATING MODE TO CHANGE TO ELECTRICAL OR HYDRAULIC LOCKUP, OR BY ORBITER AND MAIN ENGINE AVIONICS FAILURES CAUSING A COMMAND PATH FAILURE.

A. ELECTRICAL LOCKUP

THE ENGINE PROPELLANT VALVES ARE ACTIVELY CONTROLLED AT THEIR LAST COMMANDED POSITION THAT EXISTED PRIOR TO LOSS OF ALL FOUR LH₂ FLOWMETER SENSORS OR BOTH CHANNELS OF THE MAIN COMBUSTION CHAMBER PRESSURE TRANSDUCER PAIRS. @[042706-7347]

The SSME valves are controlled to their last commanded values to minimize mixture ratio excursions. Mixture ratio is a function of measured main combustion chamber pressure (Pc) and LH₂ flowrate. The mass flowrate is calculated from measured volumetric flowrate and calculated fuel density (as calculated from LPFP discharge pressure and temperature). Should the LPFP discharge pressure or temperature be disqualified, a "fixed" density value for the LH₂ will be used. Should both channels of the measured Pc or all four sensors of the volumetric flowrate flowmeter be disqualified, or a combination of loss of controller redundancy and a loss of the remaining channel's Pc or volumetric flowrate, the engine enters into the "electrical lockup" mode and all valves are maintained at their last commanded position until shutdown is commanded. If the controller implements the shutdown, it will be a hydraulic shutdown. If the crew must manually shut down the engine (ref. Rules {A5-108}, MANUAL SHUTDOWN FOR HYDRAULIC OR ELECTRICAL LOCKUP, and {A5-109}, MANUAL SHUTDOWN FOR TWO STUCK THROTTLES (NOT DUAL APU FAILURES), the shutdown will be a hydraulic shutdown. Reference Computer Program CEI, Block II, SSME Controller Operational Program, CP406R0021. @[030994-1614A] @[ED] @[042706-7347]

THIS RULE CONTINUED ON NEXT PAGE

FLIGHT RULES

A5-3

STUCK THROTTLE (CONTINUED)

B. HYDRAULIC LOCKUP

ALL FIVE ENGINE PROPELLANT VALVES ARE HYDRAULICALLY ISOLATED AT THEIR LAST POSITION WHEN BOTH CHANNELS OF SERVOACTUATORS HAVE BEEN DISQUALIFIED FOR ANY COMBINATION OF THE FOLLOWING FAILURES: ISSUANCE OF A SERVOACTUATOR ERROR INDICATION INTERRUPT (SEII), FAILURE OF THE DIGITAL-TO-ANALOG CONVERTER (DAC) TEST, FAILURE OF THE SERVOACTUATOR MODEL, OR LOSS OF CONTROLLER REDUNDANCY. THE SEII LIMIT IS 6 PERCENT FOR CHANNEL A AND 10 PERCENT FOR CHANNEL B.

Hydraulic isolation of the valves minimizes, but does not prevent, valve drift which could result in further deviations from nominal valve positions causing loss of performance and/or possible engine shutdown. One hydraulic system supplies hydraulic actuation to the five engine valves (a different hydraulic system for each engine). Each valve has a redundant servocontrol system. Channel A is normally controlling unless it has been disqualified. Channel A disqualification could be due to loss of channel A power, loss of channel A input or output electronics, failure of the SEII 6 percent test (expressed in terms of percent full range valve travel), failure of the output electronics (OE) DAC test, or failure of the channel A servoactuator model. The SEII test compares the actual valve position to the expected valve position based on an internal servoactuator model. The OE DAC test verifies that each DAC's output voltage level is equal to its last commanded value, and that the command decoder addresses the correct OE DAC by proper decoding of the four LSB's of the OE storage register. The servoactuator model/monitor test verifies proper operation of the hardware and software associated with SEII's. Channel B disqualifications could be due to the same type of failures listed for channel A, except channel B uses an SEII test limit of 10 percent error comparison instead of 6 percent to take into account the switchover transient from channel A to B. Should both channels be disqualified, the SSME enters into "hydraulic lockup." In this mode, the engine might experience loss of performance due to valve drift. If this occurs and a redline limit is exceeded, the engine will be pneumatically shut down. If a redline is not exceeded, then shutdown of the engine will be accomplished by engine pneumatics when a manual or commanded shut down occurs. Reference Computer Program CEI, Block II, SSME Controller Operational Program, CP406R0021. @[042706-7347]

THIS RULE CONTINUED ON NEXT PAGE

FLIGHT RULES

A5-3 STUCK THROTTLE (CONTINUED)

C. COMMAND PATH FAILURE

LOSS OF COMMAND CAPABILITY FROM THE GPC TO AN SSME ON AT LEAST TWO COMMAND CHANNELS. @[030994-1614A]

Without GPC commands, the SSME will not be able to accomplish the following functions: change throttle settings, inhibit/enable shutdown limits, respond to shutdown commands, or perform an LO₂ dump. Shutdown commands could be issued by guidance software, from a low level cutoff, or from a manual shutdown pushbutton. Each controller normally requires two of three valid command paths from the GPC's to control the SSME (start commands require three of three functional command paths). SSME controller software change RCN 4354 implemented in version OI-6 and subs added the capability for the engine to accept a shutdown enable/shutdown command pair on a single channel under special circumstances: an internal timer has expired (reference Rule {A5-103H}, LIMIT SHUTDOWN CONTROL); limits have never been inhibited; the shutdown enable/shutdown command pair come in on the same channel, sequentially (with no other command in-between); and a valid command is not concurrently being received on the other two channels. Shutdown of the SSME without GPC control is accomplished by the removal of ac power to the controller. This action activates the fail-safe engine pneumatic system, shutting the engine down safely. A data path failure will also result from this action, requiring the crew to push the affected engine's shutdown pushbutton to inform guidance of an engine out and to safe the engine by closing the LH₂ and LO₂ prevalues. Reference Computer Program CEI, Block II, SSME Controller Operational Program, CP406R0021. @[030994-1614A] @[042706-7347]

A5-4 DATA PATH FAILURE

LOSS OF ALL PRIMARY AND SECONDARY DATA FROM THE SSME CONTROLLER TO GPC'S.

Since TREF, engine status word and average Pc values are present in both the primary and secondary data, the loss of both data types from the controller is required for the GPC to acknowledge a data path failure. This failure is identified by the GPC SSME SOP software. The loss of both data paths will prevent onboard and ground monitoring of all SSME data. (Ref. FSSR for SSME SOP).

FLIGHT RULES

A5-5 SUSPECT ENGINE [HC] @[102506-7856]

ONE OR MORE ENGINES SHALL BE DECLARED SUSPECT AS A RESULT OF ANY OF THE FOLLOWING FAILURE CONDITIONS:

- A. ALL QUALIFIED REDLINE SENSORS ON A PARAMETER SHIFT IN THE SAME DIRECTION, WITH AT LEAST ONE, BUT NOT ALL, QUALIFIED SENSORS VIOLATING THE REDLINE LIMIT(S) WITH SHUTDOWN LIMITS MONITORING ENABLED. @[092195-1795]

If at least two redline sensors on a parameter pass their reasonableness limits, at least one, but not all, are violating their redline limit(s), and all qualified non-voting sensors have shifted toward their redline(s), the SSME can continue to operate but will shut down if the remaining qualified sensors exceed their shutdown limits with limits enabled. The fact that all qualified sensors have moved toward their redlines indicates that something is wrong with the engine and that shutdown could occur at any moment. Reference rule {A5-2E}, SPACE SHUTTLE MAIN ENGINE OUT, for reasonableness/qualification limits and redline limits. @[ED]

- B. ALL QUALIFIED SENSORS EXCEED THE LIMITS FOR A PARTICULAR REDLINE AFTER SHUTDOWN LIMITS MONITORING IS INHIBITED.

If all qualified sensors exceed limits with the shutdown monitoring inhibited, the SSME is approaching the failure situation which the limits were designed to prevent. While the limits are inhibited, the engine may fail at any moment with uncontained engine damage and loss of vehicle and crew, since the shutdown limit protection is not available. Reference rule {A5-2E}, SPACE SHUTTLE MAIN ENGINE OUT, for redline limits. Reference rule {A5-103}, LIMIT SHUTDOWN CONTROL [HC], for re-enabling boundaries. @[092195-1795] @[ED]

- C. NONISOLATABLE MPS HELIUM LEAK

Using the MPS helium leak isolation procedure, the crew can determine if isolating a given leg will stop the leak. If the procedure does not stop the leak, it is nonisolatable and may result in SSME shutdown due to HPOTP intermediate seal pressure dropping below the redline. The SSME with a helium leak is considered suspect since its leak rate could increase at any time and thus could cause the engine to shut down earlier than predicted by the MCC. Reference rule {A5-153}, PRE-MECO SHUT DOWN OF ENGINES DUE TO MPS HELIUM LEAKS [HC]. @[032395-1766]

- D. LOW LH₂ NPSP

If LH₂ NPSP is low enough to require manual throttling due to a GH₂ pressurization system anomaly or require a TAL/ACLS abort due to an LH₂ tank ullage leak or three failed closed GH₂ flow control valves, at least one, and likely all SSME's may be approaching a redline limit shutdown due to high HPFTP turbine discharge temperatures. In this case, all engines are considered suspect. Reference Rules {A5-155}, LIMIT SHUTDOWN CONTROL, MANUAL THROTTLING, AND MANUAL SHUTDOWN FOR LOW LH₂ NPSP [CIL] [HC], and {A5-156}, ABORT PREFERENCE FOR SYSTEMS FAILURES [HC]. @[102506-7856] @[032807-8399B] @[032807-8395B]

THIS RULE CONTINUED ON NEXT PAGE

FLIGHT RULES

A5-5

SUSPECT ENGINE [HC] (CONTINUED)

- E. DRIFTING PERFORMANCE WITH ALL QUALIFIED SENSORS OF EITHER THE HPOTP OR HPFTP TURBINE DISCHARGE TEMPERATURES OR THE PC REDLINE PARAMETERS APPROACHING THEIR REDLINE LIMITS. ©[102506-7856]

An engine in hydraulic lockup is expected to drift. This performance drift should elevate HPOTP turbine discharge temperatures which may eventually exceed the redline causing the engine to shutdown. Nozzle leaks and HPOTP efficiency loss cases may cause redline exceedance and subsequent shutdown due to violation of one of the turbine temperature redlines or the MCC Pc low redline. MCC Pc shifts and FFM shifts may cause a redline exceedance (probably one of the turbine temperatures) and subsequent shutdown. Electric lockups due to large FFM shifts can cause a redline exceedance (due to turbine temperatures or the MCC Pc redline). Reference rule {A5-2}, paragraph E, SPACE SHUTTLE MAIN ENGINE OUT, for redline limits. ©[ED]

- F. AN ENGINE WILL NOT BE DECLARED SUSPECT BASED ON VIBRATION DATA FOR ANY OF THE FOLLOWING:
1. RTVMS VIBRATION REDLINE SYSTEM IS IN MONITOR MODE.
 2. RTVMS COMPOSITE VIBRATION HAS REPLACED THE RTVMS SYNCHRONOUS VIBRATION IN THE DOWNLIST.
 3. FASCOS COMPOSITE VIBRATION DATA IS AVAILABLE IN THE DOWNLIST.

Until the Real-Time Vibration Monitoring System (RTVMS) is approved by the Shuttle Program for active redline processing, it will remain in monitor mode. FASCOS composite vibration data has never been approved by the Shuttle Program for redline use due to the inability to discern between a sensor failure and a turbomachinery failure. Only the RTVMS synchronous vibration system can discern between a sensor failure and a turbomachinery failure and, thus, be used to declare an engine suspect. The RTVMS composite vibration data replaces the RTVMS synchronous vibration data when two or more accelerometers on a particular pump (HPOTP or HPFTP) has been disqualified by the RTVMS. Electronics or other sensor failures can also cause synchronous vibration data to be replaced with the composite vibration data. Unless the controller is modified for RTVMS, then the accelerometer information that is displayed is the FASCOS composite vibration data. ©[092195-1770A] ©[092195-1795] ©[102506-7856]

FLIGHT RULES

A5-6

SSME REDLINE SENSOR FAILED

- A. AN SSME TURBINE DISCHARGE TEMPERATURE REDLINE SENSOR OR HPOTP INTERMEDIATE SEAL PRESSURE REDLINE SENSOR IS DECLARED FAILED IF IT WAS DISQUALIFIED BY THE SSME CONTROLLER DUE TO VIOLATION OF ITS REDLINE QUALIFICATION LIMIT DURING THE START PREP (PRELAUNCH), START, OR MAINSTAGE PHASE. @[092195-1794] @[121296-4624] @[102506-7857]

AN SSME PC SENSOR THAT HAS FAILED ITS REDLINE INTRACHANNEL QUALIFICATION LIMIT OR ITS CONTROL INTRACHANNEL QUALIFICATION LIMIT IS CONSIDERED A SINGLE FAILED REDLINE PRESSURE SENSOR. @[111699-7096]

Once an SSME redline sensor has been disqualified, it can no longer be used by the SSME controller software for redline monitoring (reference Rule {A5-2E}, SPACE SHUTTLE MAIN ENGINE OUT, for qualification limits). Redline pressure sensors that fail during start prep (prelaunch) will generate a major component failure (MCF), that is not resumed, and will preclude launching. However, because of the quadruple redundancy scheme, a redline temperature sensor can fail during start prep (prelaunch) without generating an MCF and without an LCC violation. For the purpose of limits management, this is considered a single failed redline temperature sensor. Note: A second redline temperature sensor failure on the same SSME in start prep or start will post an MCF that is non-resumable and will preclude launching. (Ref. Rule {A5-103}, LIMIT SHUTDOWN CONTROL [HC]). @[111699-7096]

A failure of the MCC Pc redline intrachannel qualification monitor (pressure delta between the two bridges exceeds 125 psia) is indicative of a single redline pressure sensor failure. A failure of the MCC Pc control intrachannel qualification monitor (pressure delta between the two bridges exceeds 75 psia) is also indicative of a single redline pressure sensor failure, even though the Pc channel is still used for redline monitoring. The redline intrachannel qualification delta is larger (125 psia) to account for the case of a real engine failure dropping the Pc so quickly that the delta between bridges could exceed the 75 psia in the time it takes the controller to read in the two values. The control intrachannel check is included in the failure criteria because it is indicative of a single redline pressure sensor failure and also that channel could degrade at any time and violate the redline intrachannel check. @[111699-7096]

- B. AN HPOP DISCHARGE PRESSURE SENSOR OR AN HPFP DISCHARGE PRESSURE SENSOR SHALL BE CONSIDERED A FAILED REDLINE PRESSURE SENSOR IF IT WAS DISQUALIFIED BY THE SSME CONTROLLER DUE TO VIOLATION OF ITS QUALIFICATION LIMIT DURING THE START PREP (PRELAUNCH), START, OR MAINSTAGE PHASE. @[102506-7857]

NOTE: THE DISCHARGE PRESSURES DO NOT HAVE AN ASSOCIATED REDLINE BUT ARE ELECTRONICALLY THE SAME AS THE REDLINE PRESSURE SENSORS.

THIS RULE CONTINUED ON NEXT PAGE

FLIGHT RULES

A5-6

SSME REDLINE SENSOR FAILED (CONTINUED)

The HPOP and HPFP discharge pressure sensors are electronically the same as the redline pressure sensors and thus are operationally considered the same as a redline sensor. Qualification limits were added to these parameters when the Pc discriminator logic was introduced post STS-91 (ref. SSME Controller Software Requirement Change Notices # 6503 & 6524). Once an HPOP DP or HPFP DP sensor is disqualified, it is no longer used in the controller's Pc discriminator logic. The first of these two sensors to fail will not generate an MCF and will not cause an LCC violation. Therefore, if this sensor fails in the start prep (prelaunch), start, or mainstage phase, it is considered a failed redline pressure sensor for the purpose of limits management (ref. Rule {A5-103}, LIMIT SHUTDOWN CONTROL [HC]). Note: a second discharge pressure sensor failure on the same SSME in start prep (prelaunch) or start will post an MCF and will preclude launching. @[111699-7096] @[102506-7857]

- C. IF THE FLIGHT CONTROLLERS CAN POSITIVELY IDENTIFY THE SENSOR FAILURE MODE(S) AS BEING THE CAUSE OF AN ENGINE SHUTDOWN, THE AFFECTED SSME REDLINE SENSOR(S) WILL BE DECLARED FAILED.
@[092195-1794] @[111699-7096]
- D. THE FOLLOWING ARE NOT CONSIDERED REDLINE SENSOR FAILURES:
1. AN SSME PC CHANNEL THAT HAS FAILED ITS CONTROL REFERENCE TEST, CHANNEL REASONABLENESS CHECK, OR CONTROL AND REDLINE DISCRIMINATOR LOGIC TEST
 2. AN RTVMS REDLINE ACCELEROMETER THAT HAS FAILED QUALIFICATION

The SSME controller performs a Pc control reference (ref) check as part of the Pc control logic. The Pc control ref logic evaluates the health of the Pc channel, as opposed to the individual sensors, by comparing the Pc channel averages to the reference Pc. The controller checks to see if the Pc channel average is greater than 75 psi from the reference Pc (200 psi when throttling or below 75 percent RPL). In order for sensors to cause this check to fail, both sensors would have to fail simultaneously and in the same direction. It is more likely that there is a channel failure causing the Pc control ref limits to be violated and, thus, this is not considered a failed redline sensor. Similarly, if a channel fails the Pc channel reasonableness check or the Pc control and redline discriminator logic check, it is considered a channel failure, not a sensor failure. (Ref. Rule {A5-2}, SPACE SHUTTLE MAIN ENGINE OUT).

Since the RTVMS system requires a minimum of two qualified accelerometers for redline shutdown voting, the system can never be "one redline sensor failure away from erroneous shutdown" (Ref. Rule {A5-7}, SSME ONE REDLINE SENSOR FAILURE AWAY FROM AN ERRONEOUS SHUTDOWN) and, thus, for the purpose of limits management, failed RTVMS accelerometers are not considered "failed redline sensors." (Ref. Rule {A5-103}, LIMIT SHUTDOWN CONTROL [HC]).

Rules {A5-2}, SPACE SHUTTLE MAIN ENGINE OUT, and {A5-7}, SSME ONE REDLINE SENSOR FAILURE AWAY FROM AN ERRONEOUS SHUTDOWN, reference this rule. @[121296-4624] @[ED]
@[102506-7857]

FLIGHT RULES

A5-7

SSME ONE REDLINE SENSOR FAILURE AWAY FROM AN ERRONEOUS SHUTDOWN [ED]

- A. AN SSME WILL BE DECLARED ONE REDLINE SENSOR FAILURE AWAY FROM AN ERRONEOUS SHUTDOWN IF ONLY ONE OF THE HPOTP INTERMEDIATE SEAL PRESSURE TRANSDUCERS IS QUALIFIED FOR REDLINE SHUTDOWN PROCESSING. [121296-4624] [042706-7364]

NOTE: AN SSME IS NOT DECLARED ONE REDLINE SENSOR FAILURE AWAY FROM AN ERRONEOUS SHUTDOWN IF ONLY ONE OF THE TWO SSME PC CHANNELS IS QUALIFIED FOR REDLINE SHUTDOWN PROCESSING.

The intermediate seal pressure redline has two pressure transducers (single transducer per controller channel). Therefore, if one transducer is disqualified due to either a controller failure (input electronics or power supply, reference Rule {A5-2}, SPACE SHUTTLE MAIN ENGINE OUT) or a sensor failure (reference Rule {A5-6}, SSME REDLINE SENSOR FAILED), causing the intermediate seal pressure redline to have a single qualified transducer, the engine will be considered one redline sensor failure away from an erroneous shutdown. This definition is used by Rule {A5-103}, LIMIT SHUTDOWN CONTROL, but only after the criteria outlined there (e.g., one engine is out and at least one redline sensor has failed) has been met. [121296-4624] [ED]

No single main combustion chamber pressure (MCC Pc) transducer failure can cause an engine to shut down on the MCC Pc redline when only one channel is qualified. Engine shutdown is prevented because the MCC Pc transducers are qualified and vote for shutdown as pairs on a channel. An MCC Pc channel must have a channel average between 1000 and 3500 psia, and the two transducers on the channel must be within 125 psia of each other, for the channel to be qualified to vote for shutdown, reference Rule {A5-2}, SPACE SHUTTLE MAIN ENGINE OUT. The channel is disqualified for redline processing if either of these conditions is not met. The redline is violated if all qualified channel averages are 200 psia (400 psia during throttling or when ≤ 75 percent RPL) less than reference Pc (defined by the SSME controller for a given SSME power level). If one of the Pc transducers drifts high, with only one channel remaining, the controller channel's two Pc sensors will be disqualified for thrust control processing. This disqualification will occur when the delta between the two channels reaches 75 psia. If all Pc sensors are disqualified for thrust control processing, the SSME operating mode will change to electrical lockup. Additionally, if the sensor continues to drift such that delta between the two sensors is 125 psia, the controller channel's Pc transducers will be disqualified for redline shutdown processing. This disqualification will occur prior to the 200/400 psia redline being violated. For cases where both transducers on the remaining channel drift, (thermal isolator problem or lee jet/sense tube problem), the engine will continually rebalance in response to the drifting Pc. If the drift is severe enough, the engine may exceed the 200/400 psia engine redline. In either case, SSME redline limits should be managed as specified in Rule {A5-103}, LIMIT SHUTDOWN CONTROL. [ED] [042706-7364]

THIS RULE CONTINUED ON NEXT PAGE

FLIGHT RULES

A5-7

SSME ONE REDLINE SENSOR FAILURE AWAY FROM AN ERRONEOUS SHUTDOWN (CONTINUED)

- B. AN SSME IS DECLARED ONE REDLINE SENSOR FAILURE AWAY FROM AN ERRONEOUS SHUTDOWN IF ONLY ONE HPOTP TURBINE DISCHARGE TEMPERATURE TRANSDUCER IS QUALIFIED FOR REDLINE SHUTDOWN PROCESSING. @[042706-7364]
- C. AN SSME IS NOT DECLARED ONE REDLINE SENSOR FAILURE AWAY FROM AN ERRONEOUS SHUTDOWN IF ONLY ONE HPFTP TURBINE DISCHARGE TEMPERATURE TRANSDUCER IS QUALIFIED FOR REDLINE SHUTDOWN PROCESSING.

Once a sensor has been disqualified, it can no longer be used by the SSME controller software for redline monitoring. Reference Rule {A5-2E}, SPACE SHUTTLE MAIN ENGINE OUT, for information on qualification/reasonableness testing. There are known thermocouple failure modes that can cause a sensor to fail below the lower HPOTP turbine discharge temperature redline, but above the qualification limit. Therefore, the HPOTP turbine discharge temperature redline will be considered one redline sensor failure away from an erroneous shutdown if only one qualified HPOTP turbine discharge temperature sensor is qualified. Because there is no lower HPFTP turbine discharge temperature redline limit, an SSME is not declared one redline sensor failure away from an erroneous shutdown if only one qualified HPFTP turbine discharge temperature transducer is qualified for shutdown.

@[121296-4624] @[ED]

A failure causing one turbine discharge temperature to remain qualified, but vote for shutdown on the upper redline, can result in SSME shutdown if there are three or less qualified transducers at the redline location. This can occur because the redline logic disqualifies the "lower" transducers. Reference Rule {A5-2E}, SPACE SHUTTLE MAIN ENGINE OUT, for information on qualification/reasonableness testing. The only known thermocouple failure mode, where the thermocouple fails in-qualification-range high while violating the upper redline limit, is a "smart" failure in the SSME controller thermocouple sensor signal conditioning pre-amp circuit. This failure mode has a very low probability of occurrence (reference the special Rocketdyne briefing on this topic to the Shuttle Program Manager on November 9, 1995). The entire thermocouple turbine discharge temperature redline processing philosophy of disqualifying the "lower" transducer depends on this low probability. Since the redline processing philosophy does not protect for this case, this flight rule does not protect for this case either. @[ED]

- D. AN SSME IS NOT DECLARED ONE REDLINE SENSOR FAILURE AWAY FROM AN ERRONEOUS SHUTDOWN IF ANY RTVMS REDLINE ACCELEROMETER TRANSDUCERS HAVE BEEN DISQUALIFIED FOR REDLINE SHUTDOWN PROCESSING.

Since the RTVMS system requires a minimum of two qualified accelerometers for redline shutdown voting, the system can never be "one redline sensor failure away from erroneous shutdown." @[042706-7364]

Rules {A5-2}, SPACE SHUTTLE MAIN ENGINE OUT; {A5-6}, SSME REDLINE SENSOR FAILED; and {A5-103}, LIMIT SHUTDOWN CONTROL, reference this rule. @[121296-4624] @[ED]

FLIGHT RULES

A5-8 RESERVED ©[ED] ©[042706-7348]

A5-9 LH2 ULLAGE LEAK [HC] ©[ED] ©[042706-7349]

WITH THREE SSME'S RUNNING AT 104.5 PERCENT POWER LEVEL, AN ET LH₂ ULLAGE LEAK IS CHARACTERIZED BY ALL OF THE FOLLOWING: ©[040899-6818A] ©[102501-4880A]

- A. LH₂ ULLAGE PRESSURE IS STEADILY DECAYING AND:
1. HAS DROPPED BELOW 32.6 (32.2) PSIA PRIOR TO AN MET OF 2 MINUTES 30 SECONDS, OR
 2. HAS DROPPED BELOW 31.0 (30.6) PSIA AFTER AN MET OF 2 MINUTES 30 SECONDS
- B. THE GH₂ 2-INCH DISCONNECT PRESSURE IS GREATER THAN 444 (414) PSIA WITH THREE ENGINES AT 104.5 PERCENT POWER LEVEL. ©[042706-7349]

The ET LH₂ ullage pressure is maintained by the three flow control valves (FCV's) in the orbiter GH₂ pressurization system. The set point for the GH₂ FCV signal conditioners is 33.0 psia. A 0.4 psi signal conditioner deadband encompassing the set point results in actual activation values as low as 32.6 psia or as high as 33.4 psia. A significant LH₂ ullage leak or an orbiter GH₂ pressurization system anomaly (reference Rule {A5-155}, LIMIT SHUTDOWN CONTROL, MANUAL THROTTLING, AND MANUAL SHUTDOWN FOR LOW LH₂ NPSP [CIL] [HC]) will cause the LH₂ ullage pressure to drop below the set point for the GH₂ FCV signal conditioner. The orbiter GH₂ pressurization system will then respond by opening the three GH₂ FCV's in an attempt to increase ullage pressure. The FCV's have been shimmed, such that an open FCV provides 70 percent flow through the valve and 31 percent flow when the valve is commanded closed. These settings are also referred to as the 'high flow' and 'low flow' positions, respectively. ©[032807-8399B]

Data provided by Lockheed Martin/Michoud (reference PSIG telecon May 22, 2001) indicates that a GH₂ pressurization system operating at -3 sigma could cause the ullage pressure to decay to a minimum pressure of 31.0 psia (30.6 indicated when a 0.4 psi worst case transducer bias is included). To avoid erroneously declaring an ullage leak when the GH₂ pressurization system is functioning nominally, an ullage leak will not be declared unless the ullage pressure is decaying and has dropped below 32.6 (32.2) psia prior to an MET of 2 minutes 30 seconds or below 31.0 (30.6) psia after an MET of 2 minutes 30 seconds. These ullage pressures (during the specified time periods) are the lowest that could possibly occur for a nominally operating GH₂ pressurization system (reference PSIG telecon May 22, 2001). ©[102501-4880A]

THIS RULE CONTINUED ON NEXT PAGE

FLIGHT RULES

A5-9

LH2 ULLAGE LEAK [HC] (CONTINUED)

It is important to establish the difference between an ullage leak and an orbiter GH₂ pressurization system anomaly since the required actions are different (reference Rule {A5-156}, ABORT PREFERENCE FOR SYSTEMS FAILURES [HC]). The 2-inch disconnect pressure cue is sufficient to distinguish between an ullage leak and an orbiter GH₂ pressurization system anomaly once the LH₂ ullage pressure has decayed below 32.6 (32.2) psia or 31.0 (30.6) psia (depending on the MET that it occurs) with all three GH₂ FCV's open. If the GH₂ 2-inch disconnect pressure is consistent with the expected value for three engines running at 104.5 percent power level and three open FCV's (high flow position), then the LH₂ ullage pressure problem is determined to be the result of an LH₂ ullage leak. If the GH₂ 2-inch disconnect pressure is below that expected for three open FCV's, then the cause of the low ullage pressure is an orbiter GH₂ pressurization system anomaly. ©[102501-4880A] ©[042706-7349] ©[032807-8395B]

A value for the 2-inch disconnect pressure was chosen at the lowest expected value for three flow control valves open with three engines running at 104.5 percent power level and not less than the predicted value for one flow control valve failed closed (low flow position) to avoid erroneously calling an ullage leak. Flight data for the first four flights of a Block II cluster was presented/approved at the November 10, 2004 PSIG. Data showed that the lowest 2-inch disconnect pressure seen to date for three flow control valves open at mission power level was 448. Subtracting out a one sigma dispersion (4 psia) and a 3 percent instrumentation error (30 psia) yields a 2-inch disconnect pressure value of 414 psia. Therefore, the disconnect pressure of 444 (414) psia can be used to determine the presence of an ullage leak. The disconnect pressure cue is only valid at 104.5 percent power level with three SSME's running. ©[102501-4880A]

Rule {A5-155}, LIMIT SHUTDOWN CONTROL, MANUAL THROTTLING, AND MANUAL SHUTDOWN FOR LOW LH₂ NPSP [CIL] [HC], references this rule. ©[040899-6818A] ©[032807-8399B]

Hazard Report IMPS-06, Underpressurization of the Integrated MPS H₂ System, references this rule. ©[042706-7349]

FLIGHT RULES

A5-10

SIGNIFICANT ENGINE HELIUM SYSTEM LEAK [ED]

TANK PRESSURE DECAY RATE (DP/DT) > 20 PSIA OVER 3 SECONDS, OR AN INDICATED HELIUM USAGE WHICH IS GREATER THAN 0.055 LBM/SEC AFTER AN MET OF 1 MINUTE. [090894-1676A]

NOTE: DECAY RATE CORRESPONDS TO THE BFS DECAY RATE COMPUTATION AND THE INDICATED HELIUM USAGE IS BASED ON MCC MASS FLOW RATE COMPUTATIONS.

Tank pressure decay rate (DP/DT) > 20 psia/3 seconds is twice the nominal value of approximately 10 psia/3 seconds. This value takes into account normal data noise and the 10 psi data granularity and represents the minimum value usable to detect helium leaks on board the vehicle. In addition to the DP/DT computation, the MCC uses a mass flow rate computation (lbm/sec) in order to detect helium leaks. The maximum nominal mainstage usage for the engine HPOTP IMSL purge is 0.047 lbm/sec (ref. SSME-to-Orbiter ICD 13M15000). Usage above 0.047 lbm/sec is indicative of an off-nominal condition in the associated MPS helium system supply.

Small leaks which are above 0.047 lbm/sec and below the crew alarm criteria (approximately 0.087 lbm/sec) will not be isolated prior to an MET of 1 minute. Action to isolate small helium leaks is not taken within the first minute after liftoff because the ground computation requires 20 seconds of data after liftoff for proper initialization and because additional time is required by the MCC for leak evaluation. Also, a leak of this size which is isolated shortly after an MET of 1 minute will probably not violate the single regulator zero-g shutdown requirements. However, continued usage at this rate may significantly reduce the helium available to support engine shutdown at MECO.

Even though helium usage above 0.047 is off nominal, MCC action is only taken for leaks with a usage above 0.055 lbm/sec or greater. This number accounts for noise in the ground computation and protects nominal MECO helium requirements.

Rule {A5-151}, PRE-MECO MPS HELIUM SYSTEM LEAK ISOLATION [CIL], references this rule.
[090894-1676A]

FLIGHT RULES

A5-11 SIGNIFICANT PNEUMATIC SYSTEM HELIUM LEAK [ED]

ANY LEAK IN THE PNEUMATIC TANK SYSTEM OR PNEUMATIC ACCUMULATOR WHICH WILL ANNUNCIATE THE CREW SYSTEMS MANAGEMENT (SM) ALERT (PNEU TK P < 3800.0 PSIA) PRIOR TO MECO -30 SECONDS. [090894-1676A] [021199-6790]

An attempt is made to isolate leaks in the MPS pneumatic helium supply in order to conserve helium for LO₂ prevalve closure at MECO. Furthermore, if the leak is isolated, the pneumatic helium supply will be available to support the operation of a leaking MPS helium engine supply.

Isolation will only be performed if the leak is large enough to annunciate the crew SM Alert prior to MECO -30 seconds. [021199-6790]

Rule {A5-151}, PRE-MECO MPS HELIUM SYSTEM LEAK ISOLATION [CIL], references this rule. [090894-1676A]

A5-12 INSUFFICIENT PNEUMATIC HELIUM ACCUMULATOR PRESSURE [ED]

A PNEUMATIC ACCUMULATOR PRESSURE WHICH IS LESS THAN 700 PSIA. [090894-1676A]

Seven hundred psia is the minimum actuation pressure which will ensure proper LO₂ and LH₂ prevalve closure timing at MECO. Pressures of 400 to 500 psia will fully position the valves; however, timing requirements may not be satisfied (ref. SODB, Vol. ii, Section 4.3.1). Four of six test cases of three engine prevalve closures at an initial pressure of 400 psia were within the timing specification of 1.15 seconds maximum closing time. Of the two that violated requirements, one was 0.03 seconds slow and the other was 0.06 seconds slow (reference PSIG telecon charts, May 19, 1993).

It is critical that the LO₂ prevalues close within timing constraints at MECO. LO₂ prevalve closure and the injection of helium into the pogo accumulator are used to maintain pressure on the engine high pressure oxidizer turbopump, preventing pump cavitation during the shutdown sequence.

Rule {A5-151}, PRE-MECO MPS HELIUM SYSTEM LEAK ISOLATION [CIL], references this rule. [090894-1676A]

FLIGHT RULES

A5-13**MPS DUMPS AND VACUUM INERTING DEFINITIONS [HC]**

@[092701-4867A] @[ED] @[022405-6578A]

A. MPS DUMP

A PRESSURIZED MPS LO₂ AND UNPRESSURIZED LH₂ DUMP PERFORMED IN MM 104 FOR NOMINAL, ATO, AND AOA MISSIONS THAT IS NORMALLY AUTOMATIC AT MECO + 2 MINUTES, BUT CAN BE STARTED OR DELAYED MANUALLY. @[092195-1791]

B. MPS GH₂ INERT @[092195-1791]

A MANUAL INERTING OF GH₂ THROUGH THE PRESS LINE VENT VALVE PERFORMED AFTER THE MPS POWERDOWN AND ISOLATION PROCEDURE FOR NOMINAL, ATO, AND AOA MISSIONS. @[111094-1719]

C. FIRST AUTOMATED VACUUM INERT @[092195-1791]

AN AUTOMATIC INERTING OF THE LH₂ AND LO₂ FEEDLINE SYSTEMS THROUGH THE LH₂ BACKUP DUMP VALVES AND THE LO₂ FILL/DRAIN VALVES RESPECTIVELY. THIS INERT IS PERFORMED AFTER THE MPS DUMP FOR NOMINAL, ATO, AND AOA MISSIONS AT MPS DUMP START + 17 MINUTES (APPROXIMATELY MECO + 19 MINUTES). @[042706-7350A]

D. MANUAL VACUUM INERT @[092195-1791]

A MANUAL INERTING OF THE LH₂ OR LO₂ FEEDLINE SYSTEM WHICH IS PERFORMED DUE TO INEFFICIENT AUTOMATED VACUUM INERT(S). THE MANUAL VACUUM INERT IS PERFORMED PER RULE {A5-206}, MANUAL VACUUM INERTING REQUIREMENTS (NOMINAL, ATO, AOA) [HC]. THE LO₂ FEEDLINE SYSTEM IS MANUALLY INERTED THROUGH THE LO₂ FILL/DRAIN VALVES. THE LH₂ FEEDLINE SYSTEM IS MANUALLY INERTED THROUGH EITHER THE LH₂ BACKUP DUMP VALVES OR THROUGH THE LH₂ FILL/DRAIN VALVES. @[042706-7350A] @[102506-7358]

THIS RULE CONTINUED ON NEXT PAGE

FLIGHT RULES

A5-13 MPS PROPELLANT DUMPS AND INERTING DEFINITIONS [HC] (CONTINUED)

E. SECOND AUTOMATED VACUUM INERT

AN INERTING OF THE LH₂ FEEDLINE SYSTEM THROUGH THE LH₂ BACKUP DUMP VALVES PERFORMED AFTER THE FIRST AUTOMATED VACUUM INERT FOR NOMINAL AND ATO MISSIONS THAT IS AUTOMATICALLY STARTED AT THE MM 106 TRANSITION. ©[092701-4867A] ©[042403-5896A] ©[042706-7350A]

F. ENTRY MPS DUMP ©[092195-1791] ©[092701-4867A]

AN MPS LH₂ AND LO₂ PROPELLANT DUMP/INERTING STARTED AUTOMATICALLY IN MM 303 FOR NOMINAL, ATO, AOA, AND TAL MISSIONS, AND IN MM 602 FOR AN RTLS ABORT.

The non-contingency dumping and inerting of propellants are done to ensure there are no propellants in the manifolds prior to landing. The orbiter center of gravity is affected by dumping the residual MPS propellants. The hazard from venting LH₂ during entry and ingesting it into the aft compartment is removed by dumping the residual LH₂.

G. NEGATIVE INERT

AN INCOMPLETE MPS LH₂ DUMP THAT RESULTS IN OFF-NOMINAL RESIDUALS ON TAL/RTLS ABORTS OR FAILURE OF ALL MPS LH₂ DUMP PATHS ON AOA ABORTS. OFF-NOMINAL H₂ RESIDUALS ARE DEFINED AS ANY RESIDUALS ABOVE THOSE PREDICTED FOR THE ABORT MODE.

Negative inerts are a concern for crew and convoy safety because analysis shows that venting of H₂ may occur as early as 10.8 minutes after touchdown (reference Boeing Internal Letter SHA0-01-043 dated April 26, 2001). Any H₂ residual on an RTLS or TAL abort above the nominal residual predicted in the Boeing Internal Letter SHA0-01-043 dated April 26, 2001, is a concern for crew and convoy safety. Failure of all dump paths on an AOA abort will lead to residuals similar to the TAL case. Negative inerts require an expedited powerdown, mode V egress per Rule {A16-11F}, EXPEDITED POWER [HC]. ©[042403-5896A] ©[022405-6578A]

Rule {A16-205A}.1, EARLY APU SHUTDOWN [HC], references this rule. ©[052704-6255B]

Hazard Reports ORBI 035, Hydrogen Accumulation in the Orbiter Compartment During RTLS or TAL Abort, and ORBI 306, Fire/Explosion in the Orbiter Aft Compartment Caused by MPS Propellant Leakage/Component Rupture, reference this rule. ©[022405-6578A] ©[042705-7350A]

A5-14 THROUGH A5-50 RULES ARE RESERVED

FLIGHT RULES

SRB SYSTEMS MANAGEMENT

@[021694-ED]

A5-51 **LOSS OF SRB THRUST VECTOR CONTROL (TVC)** @[012402-4987]

FOR THE LOSS OF TVC ON ONE SRB, THE FLIGHT WILL BE CONTINUED UNTIL LOSS OF VEHICLE CONTROL.

The loss of two Hydraulic Power Units (HPU's) on one SRB results in no TVC control on that SRB. This may result in loss of control depending on nozzle position. There is no manual control available; therefore, there is no crew action that can be taken. @[012402-4987]

A5-52 THROUGH A5-100 RULES ARE RESERVED

FLIGHT RULES

SSME SYSTEMS MANAGEMENT

A5-101 ABORT CUE REQUIREMENT

ANY ENGINE CONDITION THAT CAUSES AN ABORT DECISION WILL BE CONFIRMED USING TWO CUES.

Two cues are required so that a single instrumentation failure will not cause an erroneous abort decision.

A5-102 AUTO/MANUAL SHUTDOWN [HC] @[102506-7858B]

- A. MANUAL SHUTDOWN OF AN ENGINE WILL NOT BE ATTEMPTED IF AUTOMATIC LIMIT SHUTDOWN CAPABILITY IS ENABLED AND AN ENGINE IS APPROACHING A SHUTDOWN LIMIT. THERE ARE TWO EXCEPTIONS TO THIS RULE: @[032395-1766]
1. WHEN EXCESSIVE HELIUM LEAKAGE REQUIRES A MANUAL ENGINE SHUTDOWN AS DISCUSSED IN RULE {A5-153}, PRE-MECO SHUT DOWN OF ENGINES DUE TO MPS HELIUM LEAKS [HC]
 2. WHEN ENGINES ARE MANUALLY SHUT DOWN TO PROTECT NPSP, PER RULE {A5-155}, LIMIT SHUTDOWN CONTROL, MANUAL THROTTLING, AND MANUAL SHUTDOWN FOR LOW LH2 NPSP [CIL] [HC] @[032807-8399B]
- B. MANUAL SHUTDOWN OF AN ENGINE BASED ON VIBRATION DATA WILL NOT BE ATTEMPTED IF ANY OF THE FOLLOWING ARE TRUE:
1. RTVMS VIBRATION REDLINE SYSTEM IS IN MONITOR MODE
 2. RTVMS COMPOSITE VIBRATION HAS REPLACED THE SYNCHRONOUS VIBRATION IN THE DOWNLIST
 3. FASCOS COMPOSITE VIBRATION DATA IS AVAILABLE IN THE DOWNLIST @[102506-7858B]

The automatic limit shutdown system was designed to prevent a catastrophic failure of an engine. Due to response times and the complexity of the SSME, the ground and crew will not try to interfere with this system.

THIS RULE CONTINUED ON NEXT PAGE

FLIGHT RULES**A5-102 AUTO/MANUAL SHUTDOWN [HC] (CONTINUED)**

Until the Real Time Vibration Monitoring System (RTVMS) is approved by the Shuttle Program for active redline processing, it will remain in monitor mode. FASCOS composite vibration data has never been approved by the Shuttle Program for redline use due to the inability to discern between a sensor failure and a turbomachinery failure. Only the RTVMS synchronous vibration system can discern between a sensor failure and a turbomachinery failure and thus cannot be used for manual shutdown in monitor mode. The RTVMS composite vibration data replaces the RTVMS synchronous vibration data when two or more accelerometers on a particular pump (HPOTP or HPFTP) has been disqualified by the RTVMS. Electronics or other sensor failures can also cause synchronous vibration data to be replaced with the composite vibration data. Unless the controller is modified for RTVMS, then the accelerometer information that is displayed is the FASCOS composite vibration data. @[102506-7858B]

Hazard Report IMPS-17, Inadvertent SSME Shutdown, is controlled by this rule. @[102506-7858B]

A5-103 LIMIT SHUTDOWN CONTROL [HC] @[102506-7859]**A. PREMATURE MAIN ENGINE SHUTDOWN @[121296-4625]**

THE MAIN ENGINE LIMIT SHUTDOWN CONTROL CAPABILITY WILL BE MANAGED AS FOLLOWS: @[121296-4625] @[111298-6785A]

1. INHIBITED AT ONE ENGINE-OUT

GPC AUTOMATICALLY COMMANDS INHIBIT TO THE REMAINING TWO ENGINES.

The main engine limit shutdown switch is a three-position switch: ENABLE, AUTO, and INHIBIT. At lift-off, the switch is in the AUTO position, and the limit shutdown control logic is enabled on all three engines. After one engine-out occurs, the main engine limit shutdown control capability on the two remaining engines is automatically inhibited. @[111298-6785A]

2. WITH ONE ENGINE OUT AND BFS NOT ENGAGED, THE MAIN ENGINE LIMIT SHUTDOWN SOFTWARE WILL BE REENABLED BY PLACING THE MAIN ENGINE LIMIT SHUTDOWN SWITCH TO "ENABLE" THEN "AUTO." REENABLING WILL BE BASED UPON THE FOLLOWING CONDITIONS:**a. THE CREW WILL MANUALLY REENABLE THE LIMITS AS SOON AS POSSIBLE FOLLOWING THE ENGINE OUT. @[111298-6785A]**

THIS RULE CONTINUED ON NEXT PAGE

FLIGHT RULES

A5-103

LIMIT SHUTDOWN CONTROL [HC] (CONTINUED)

The reenabling of the main engine limit shutdown software is required to regain, as soon as possible, the engine redline shutdown protection in the event of a second engine failure. The reenabling of the main engine limit shutdown software will be accomplished by taking the main engine limit shutdown switch to ENABLE then to AUTO. INHIBIT then AUTO may also work if the enable function of the switch is inoperative. This allows one of the running engines to shut down due to a limit violation while automatically inhibiting the main engine limit shutdown control capability on the one remaining engine. Single-engine flight control capability would then take the vehicle to MECO. @[102506-7859]

The philosophy of when to reenable the main engine limit shutdown software attempts to balance the risk of an engine failing catastrophically while the limits are inhibited against the risk associated with a two engine-out contingency abort.

A meeting was held with the Shuttle Program Manager on September 10, 1998, to discuss the risks. Insufficient data is available to perform a risk trade since 1) The likelihood of an SSME running safely above a redline limit is unknown, and 2) The likelihood of surviving a contingency abort and the associated ET separation, flight control, thermal, crew bailout, and rescue is also unknown. The two engine-out contingency abort risks were accepted over running an SSME with limits inhibited. The risk of running an SSME with limits inhibited was accepted over the three engine-out contingency abort. Based on this philosophy, the main engine limit shutdown software will remain enabled (or reenabled) for one engine-out cases and inhibited for all two engine-out cases. @[121296-4625] @[111298-6785A]

The September 15 and November 18, 1987, and June 2, 1995, Ascent/Entry Flight Techniques panels reviewed the failure history of the redline sensors and came to the conclusion that the engine redline sensors are reliable and should, in general, be trusted to not cause an inadvertent shutdown.

- b. IF THE MCC DETERMINES ONE OF THE REDLINE SENSORS IS FAILED AND:
- (1) EITHER OF THE REMAINING ENGINES IS ONE REDLINE SENSOR FAILURE AWAY FROM AN ERRONEOUS SHUTDOWN ON THE SAME TYPE OF REDLINE SENSOR, THE MAIN ENGINE LIMIT SHUTDOWN SOFTWARE WILL BE INHIBITED UNTIL THE FOLLOWING BOUNDARY IS REACHED AND THEN REENABLED: @[121296-4625] @[111298-6785A] @[102506-7859]

RTLS - SINGLE ENGINE RTLS BOUNDARY

THIS RULE CONTINUED ON NEXT PAGE

FLIGHT RULES

A5-103

LIMIT SHUTDOWN CONTROL [HC] (CONTINUED)

TAL, ATO, NOM - SINGLE ENGINE LIMITS BOUNDARY FOR A PRIME TAL SITE OR OTHER AUGMENTED TAL/CONTINGENCY SITE IF WEATHER OR LANDING AIDS PERMIT (REFERENCE RULE {A2-6}, LANDING SITE WEATHER CRITERIA [HC]). IF WEATHER AND/OR LANDING AIDS DO NOT PERMIT, REENABLE AT SINGLE ENGINE PRESS. @[092195-1793] @[102506-7859]

- (2) NEITHER OF THE REMAINING ENGINES IS ONE REDLINE SENSOR FAILURE AWAY FROM AN ERRONEOUS SHUTDOWN, REENABLE THE MAIN ENGINE LIMIT SHUTDOWN SOFTWARE AS SOON AS POSSIBLE.

NOTE: THIS RULE DOES NOT APPLY TO RTVMS REDLINE ACCELEROMETERS

The MCC is responsible for evaluating sensor failures since the flight crew has no visibility into the sensor health. Software flags issued by the onboard main engine controller sensor qualification logic or previously observed failure modes would be used by the MCC as criteria to say that a sensor had failed. If, previous to the first engine shutdown, a sensor failure were detected and then the engine shut down based on the remaining redline sensor, that second failure would not be counted as a sensor failure unless the flight controllers could positively identify the sensor failure mode; otherwise, a subsequent sensor failure on another running engine would have to occur before two sensor failures could be counted. This type of situation occurred on STS 51-F. All sensor failures on STS 51-F were detected by the onboard main engine sensor qualification logic. This software also informed the flight controllers of the failures via the downlisted failure identifier data words. @[111298-6785A] @[102506-7859]

The main engine limit shutdown software will be enabled at an appropriate boundary with one sensor failure on one of the three engines, because one sensor failure does not indicate a trend for a generic failure of the sensors. If either of the remaining two engines is one sensor failure away from an erroneous shutdown, limits will remain inhibited until an abort boundary is reached. The limits will be reenabled when an abort boundary (as defined in Rule {A4-56}, PERFORMANCE BOUNDARIES) is reached such that a single-engine abort can be accomplished to the desired site. On an RTLS, this abort boundary is Single Engine RTLS (which is designated by the "two-out red on the TRAJ display" call). If neither of the remaining engines is one sensor failure away from an erroneous shutdown, limits can be reenabled as soon as possible. This allows the redlines to provide the earliest protection against a real engine hardware failure. @[111298-6785A]

THIS RULE CONTINUED ON NEXT PAGE

FLIGHT RULES**A5-103****LIMIT SHUTDOWN CONTROL [HC] (CONTINUED)**

On a TAL, ATO, or nominal profile, this abort boundary is Single Engine Limits if weather or landing aids permit. Otherwise, the limits will be reenabled at Single Engine Press (ref. Rule {A2-6}, LANDING SITE WEATHER CRITERIA [HC]). With one sensor failure and either of the remaining engines one sensor failure away from an erroneous shutdown, the risk of an engine shutdown due to another sensor failure is higher than that due to an actual engine failure if the limits were reenabled. Because of this increased risk of an engine shutdown caused by sensor failures, the exposure to bailout is not acceptable unless the next sensor failure will not cause an erroneous shutdown. For these reasons, the limits are inhibited until the single engine limits boundary to minimize the need for a contingency abort and crew bailout. @[121296-4625] @[102506-7859]

c. IF THE MCC DETERMINES TWO OR MORE OF THE SAME TYPE OF ENGINE REDLINE SENSORS HAVE FAILED AND:

(1) EITHER OF THE REMAINING ENGINES IS ONE REDLINE SENSOR FAILURE AWAY FROM AN ERRONEOUS SHUTDOWN ON THAT SAME TYPE OF SENSOR, THEN THE MAIN ENGINE LIMIT SHUTDOWN SOFTWARE WILL BE INHIBITED THROUGH MECO.

(2) NEITHER OF THE REMAINING ENGINES IS ONE REDLINE SENSOR FAILURE AWAY FROM AN ERRONEOUS SHUTDOWN, REENABLE THE MAIN ENGINE LIMIT SHUTDOWN SOFTWARE AS SOON AS POSSIBLE:

NOTE: THIS RULE DOES NOT APPLY TO RTVMS REDLINE ACCELEROMETERS

The shutdown sensors on the same type of redline will be suspected of having a generic problem if more than one sensor fails (two or more sensors failed on the same type of redline). If either remaining engine is one sensor failure away from an erroneous shutdown on the same type of redline sensor that has failed, limits will remain inhibited through MECO in order to prevent the next sensor failure from shutting down a good engine. The two failures could occur on one or more engines including the failed engine. If neither engine is one redline sensor failure away from an erroneous shutdown, then limits are reenabled as soon as possible. This allows the earliest possible protection by the redline sensors against a real engine hardware failure. Since the RTVMS system requires a minimum of two qualified accelerometers for redline shutdown voting, the system can never be "one redline sensor failure away from erroneous shutdown" (ref. Rule {A5-7}, SSME ONE REDLINE SENSOR FAILURE AWAY FROM AN ERRONEOUS SHUTDOWN) and, thus, RTVMS redline accelerometers are excluded in this rule. @[121296-4625] @[111298-6785A] @[102506-7859]

THIS RULE CONTINUED ON NEXT PAGE

FLIGHT RULES**A5-103****LIMIT SHUTDOWN CONTROL [HC] (CONTINUED)**

3. WITH ONE ENGINE OUT AND BFS ENGAGED, THE MAIN ENGINE LIMIT SHUTDOWN SOFTWARE WILL BE INHIBITED THROUGH MECO BY THE BFS AUTOMATIC COMMAND. @[121296-4625] @[111298-6785A]

The main engine limit shutdown control will be inhibited on two remaining engines if the BFS is engaged. The BFS does not have single-engine flight control software and therefore cannot control the vehicle with two engines shut down. If the engine shuts down after the BFS is engaged, the BFS will automatically command inhibit to the remaining engines. If the engine shuts down while on the PASS, limits subsequently reenabled, and then BFS engaged, the BFS will again automatically command inhibit to the remaining engines since the BFS reevaluates and responds to engine out status when engaged.

4. WITH TWO ENGINES OUT, THE MAIN ENGINE LIMIT SHUTDOWN SOFTWARE WILL REMAIN INHIBITED THROUGH MECO.

Since three engine-out contingency aborts contain "black zones" and are more severe than the two-engine contingency aborts, limits will remain inhibited on the last running engine.

Rules {A2-6}, LANDING SITE WEATHER CRITERIA [HC]; {A2-55}, USE OF LOW-ENERGY GUIDANCE; and {A5-104}, DATA PATH FAIL/ENGINE-ON LIMIT SHUTDOWN CONTROL, reference this rule. @[120894-1663]

B. STUCK THROTTLE IN THE THRUST BUCKET

IF A STUCK THROTTLE CONDITION OCCURS DURING MAX Q THROTTLING SUCH THAT THE POWER LEVEL IS LESS THAN THE NOMINAL FLIGHT POWER LEVEL, THE MAIN ENGINE LIMIT SHUTDOWN SOFTWARE WILL REMAIN ENABLED.

When an engine experiences a stuck throttle in the thrust bucket, performance may be reduced sufficiently that an abort gap may occur between RTLS capability and any downrange abort capability. Uphill capability may also be lost. Main engine limit shutdown software remains enabled to allow for the stuck engine to shut down if it exceeds redline limits. In the case of a hydraulic lock-up, valve drift may occur resulting in potential redline limit exceedance; therefore, the main engine limit shutdown software remains enabled. It has been accepted that the loss of a good engine could result in a 1 and 2/3 RTLS contingency abort.

- C. WITH ONE ENGINE OUT AND ONE OF THE REMAINING ENGINES HAS A NON-ISOLATABLE MPS HELIUM LEAK, THE MAIN ENGINE LIMIT SHUTDOWN SOFTWARE WILL BE INHIBITED BASED ON THE FOLLOWING: @[111298-6785A]

THIS RULE CONTINUED ON NEXT PAGE

FLIGHT RULES

A5-103

LIMIT SHUTDOWN CONTROL [HC] (CONTINUED)

1. PRIOR TO THE SINGLE ENGINE LIMITS (TAL ABORT) OR SINGLE ENGINE RTLS (RTLS ABORT) BOUNDARY: @[111298-6785A]

WHEN THE PNEUMATIC HELIUM AND/OR PREVIOUSLY SHUT DOWN ENGINE'S MPS HELIUM TANK PRESSURE REACHES 1150 PSIA AFTER INTERCONNECTING TO THE LEAKING SYSTEM'S HELIUM OR WHEN BOTH LEAKING ENGINE'S HELIUM REGULATOR PRESSURES ARE BELOW 715 (679) PSIA @[102506-7859]

IF THE SINGLE ENGINE LIMITS (TAL ABORT) OR SINGLE ENGINE RTLS (RTLS ABORT) BOUNDARY IS REACHED WITHOUT INTERCONNECTING TO THE NON-LEAKING, RUNNING ENGINE'S HELIUM, THE MAIN ENGINE LIMIT SHUTDOWN SOFTWARE WILL BE REENABLED.

IF HELIUM FROM THE NON-LEAKING, RUNNING ENGINE IS REQUIRED TO SUPPORT THE LEAKING ENGINE'S OPERATION (REF. RULE {A5-152}, PRE MECO MPS HELIUM SYSTEM INTERCONNECTS [CIL] [HC]), THE MAIN ENGINE LIMIT SHUTDOWN SOFTWARE WILL REMAIN INHIBITED THROUGH MECO. @[090894-1676A] @[121296-4625]

2. OTHERWISE, NO ACTION REQUIRED. @[102506-7859]

THIS RULE CONTINUED ON NEXT PAGE

FLIGHT RULES**A5-103****LIMIT SHUTDOWN CONTROL [HC] (CONTINUED)**

For the case of two engines running (one with a non-isolatable MPS helium leak), the main engine limit shutdown software will be reenabled by the crew per paragraph A.2.a. If the leaking engine cannot support the SE Limits or SE RTLS boundary with an interconnect from pneumatic and/or the failed engine's helium, the leaking engine will be allowed to operate below the HPOTP IMSL redline to avoid a two engine-out contingency abort (per Rules {A5-152}, PRE-MECO MPS HELIUM SYSTEM INTERCONNECTS [CIL] [HC], and {A5-153}, PRE-MECO SHUTDOWN OF ENGINES DUE TO MPS HELIUM LEAKS [HC]). To operate below the redline, limits must be inhibited. The MCC will call for the main engine limit shutdown switch to INHIBIT when the pneumatic helium and/or previously shut down engine's helium tank pressure reaches 1150 psia following the interconnect of the pneumatics system and the previously shut down engine's helium (i.e., not waiting until the second time the pneumatic tank pressure reaches 1150 psia after the interconnect of the non-leaking, running engine's helium) to the leaking system or when the leaking system's regulator pressures are below 715 (679) psia. The 1150 psia tank pressure cue was selected as the operational cue corresponding to the crew's MPS helium tank pressure C&W (not the pneumatic helium tank pressure C&W) while ensuring that the HPOTP IMSL redline limit is not exceeded prior to inhibiting the limits. It also minimizes the amount of time that the remaining engines are exposed to main engine limits being inhibited. The 715 (679) psia regulator pressure cue was selected as a backup cue for large MPS helium leaks to ensure that the HPOTP IMSL redline limit is not exceeded before main engine shutdown limits are inhibited. The main engine limit shutdown software will be reenabled upon reaching the first single engine abort landing site capability, which is either SE Limits or SE RTLS (ref Ascent/Entry Flight Techniques Panel #107, November 4, 1993), if an interconnect from a running engine has not been performed. This represents the earliest time after which an attempt can be made to reach a landing site with a good engine out. ©[111298-6785A] ©[102506-7859]

The main engine limit shutdown software will remain inhibited if the non-leaking, running engine's helium has been interconnected to a leaking engine (no three engine-out abort capability). Keeping limits inhibited in this configuration will allow the main engine with the leaking MPS helium supply to continue to operate below the normal HPOTP IMSL redline. Running the engine below the normal redline is an acceptable risk while the vehicle is in an abort gap since the only alternative is an early MECO and the loss of the vehicle and crew. ©[121296-4625] ©[111298-6785A]

Reference Rule {A5-153}, PRE-MECO SHUT DOWN OF ENGINES DUE TO MPS HELIUM LEAKS [HC]. ©[090894-1676A]

- D. IF AN ORBITER GH₂ PRESSURIZATION SYSTEM ANOMALY DUE TO FLOW CONTROL VALVE FAILURES OR AN LH₂ ULLAGE LEAK CAUSE A LOW LH₂ NPSP CONDITION, THE MAIN ENGINE LIMIT SHUTDOWN SOFTWARE WILL BE MANUALLY ENABLED BY PLACING THE MAIN ENGINE LIMIT SHUTDOWN SWITCH TO "INHIBIT" AND THEN "ENABLE" IN ORDER TO DISABLE THE SINGLE COMMAND CHANNEL SHUTDOWN LOGIC AND ENSURE THAT THE LIMITS REMAINS ENABLED FOR POSSIBLE ENGINE FAILURES. ©[121296-4625] ©[102506-7859]

THIS RULE CONTINUED ON NEXT PAGE

FLIGHT RULES**A5-103****LIMIT SHUTDOWN CONTROL [HC] (CONTINUED)**

Reference Rule and rationale {A5-155}, LIMIT SHUTDOWN CONTROL, MANUAL THROTTLING, AND MANUAL SHUTDOWN FOR LOW LH2 NPSP [CIL] [HC]. Keeping limits enabled protects for multiple engines failing too quickly for the crew to react and re-enable limits. For the two flow control valve failed closed case, MECO will be extended well beyond the nominal MECO time due to the manual throttling actions required to protect NPSP. For an ullage leak, engines will be manually shut down at a specific NPSP causing the MECO time to move out. If limits were in hard ENABLE prior to the engine failures, then single command channel shutdown logic would never be disabled. So in order to disable it without interfering with the limit status late in the ascent, limit shutdown software will be toggled to INHIBIT and then to ENABLE once the condition is recognized. This action will cancel the single command channel shutdown logic to protect for a single GPC failing to sync late in the ascent and causing an early MECO. See Paragraph H below. @[102506-7859] @[032807-8399B]

- E. IF A DATA PATH FAILURE OCCURS ON AN ENGINE THAT IS CONFIRMED RUNNING, THE MAIN ENGINE LIMIT SHUTDOWN SOFTWARE WILL BE REENABLED PER FLIGHT RULE {A5-104}, DATA PATH FAIL/ENGINE-ON LIMIT SHUTDOWN CONTROL [HC].

Reference Rule and rationale {A5-104}, DATA PATH FAIL/ENGINE-ON LIMIT SHUTDOWN CONTROL [HC].

- F. IF A GPC SET SPLIT OCCURS AND THE MAIN ENGINE LIMIT SHUTDOWN SOFTWARE ON TWO ENGINES IS INHIBITED AUTOMATICALLY, THE MAIN ENGINE LIMIT SHUTDOWN SOFTWARE WILL BE MANUALLY ENABLED UNTIL THE PASS SET IS RECONFIGURED OR BFS IS ENGAGED.

IF THE PASS SET IS RECONFIGURED OR BFS IS ENGAGED PER RULE {A7-9}, REDUNDANT SET SPLIT, AFTER THE SET SPLIT, LIMITS WILL BE MANAGED PER PARAGRAPH A.3 ABOVE AND PER RULE {A5-104}, DATA PATH FAIL/ENGINE-ON LIMIT SHUTDOWN CONTROL [HC].

In a set split condition, at least two GPC's will not see data from one of the engines and will automatically inhibit the main engine limit shutdown software on the other two engines. If limits are reenabled by taking the main engine limit shutdown switch to ENABLE then AUTO, the limits would be automatically inhibited on the next cycle while the set split condition persists. Therefore, the main engine limit shutdown switch will only be taken to ENABLE. Reference Rule and rationale {A5-104}, DATA PATH FAIL/ENGINE-ON LIMIT SHUTDOWN CONTROL [HC]. For a set split during ascent, it is expected that either the BFS will be engaged or the PASS set will be reconfigured before the above limits action can be taken - reference Rule {A7-9} REDUNDANT SET SPLIT. In these events, limits will be managed per paragraph A.3 above and per Rule {A5-104}, DATA PATH FAIL/ENGINE-ON LIMIT SHUTDOWN CONTROL [HC]. @[102506-7859]

THIS RULE CONTINUED ON NEXT PAGE

FLIGHT RULES**A5-103****LIMIT SHUTDOWN CONTROL [HC] (CONTINUED)**

G. LOSS OF TVC CONTROL ON AN OPERATING MAIN ENGINE @[102506-7859]

1. FOR THREE ENGINES RUNNING, IF THE LOSS OF TVC IS DUE TO HYDRAULIC SYSTEM FAILURES, THE MAIN ENGINE LIMIT SHUTDOWN SOFTWARE WILL BE INHIBITED UNTIL TWO-ENGINE TAL CAPABILITY IS ACHIEVED OR, ON AN RTLS, UNTIL AFTER POWERED PITCH AROUND (PPA) IS COMPLETE.

The risk of running an engine with the main engine limits inhibited is accepted over the risk of loss of control during the RTLS powered pitch around (PPA) as a result of losing an engine with a functional TVC. If one SSME has lost TVC capability, the failure of one of the gimbaling engines could result in a loss of control, even if single-engine roll control (SERC) is active. From a flight control standpoint, an RTLS trajectory is much more demanding than an uphill or TAL trajectory; therefore, avoiding an RTLS abort is highly desirable. Additionally, if the loss of TVC is due to hydraulic system failures, the engines in hydraulic lockup could fail due to valve drift, so a trajectory that provides the earliest possible single-engine capability is desirable. If a three-engine RTLS is performed, the main engine limit shutdown software will be inhibited until after PPA, since a loss of control is very possible if PPA is attempted with one gimbaling and one non-gimbaling engine. @[121296-4625] @[111298-6785A]

Reference Rule {A8-61}, SSME SHUTDOWN DUE TO HYDRAULIC SYSTEM FAILURES.

2. FOR TWO ENGINES RUNNING, IF THE LOSS OF TVC IS DUE TO HYDRAULIC SYSTEM FAILURES, THE MAIN ENGINE LIMIT SHUTDOWN SOFTWARE WILL BE INHIBITED THROUGH MECO.

With two engines running, one non-gimbaling, vehicle control is marginal even with SERC enabled. The loss of the gimbaling engine will result in an immediate loss of control. Keeping the redline shutdown limits inhibited through MECO prevents the good engine from shutting down automatically and, hence, prevents a loss of control. If the non-gimbaling engine is shut down to maintain vehicle control, keeping the shutdown limits inhibited through MECO is required since only a single engine will remain.

Reference Rule {A8-61}, SSME SHUTDOWN DUE TO HYDRAULIC SYSTEM FAILURES [HC].

3. IF THE LOSS OF TVC IS DUE TO A HARDOVER TVC ACTUATOR, THE MAIN ENGINE LIMIT SHUTDOWN SOFTWARE WILL REMAIN ENABLED IF THE ENGINE WITH THE HARDOVER TVC ACTUATOR WILL BE SHUT DOWN PRIOR TO A MET OF 1:40. IF THE ENGINE WITH THE HARDOVER TVC ACTUATOR WILL BE ALLOWED TO RUN BEYOND A MET OF 1:40, THE LIMIT SHUTDOWN SOFTWARE WILL BE INHIBITED UNTIL THE ENGINE WITH THE HARDOVER TVC ACTUATOR IS SHUT DOWN. @[102506-7859]

THIS RULE CONTINUED ON NEXT PAGE

FLIGHT RULES

A5-103

LIMIT SHUTDOWN CONTROL [HC] (CONTINUED)

The shutdown time or boundary, as determined by Rule {A8-2}, SSME THRUST VECTOR CONTROL (TVC) HARDOVER, is based on the direction of the hardover actuator, the SSME affected by the hardover, and the phase of flight in which it occurs. The shutdown requirements were chosen based on the ability of the two gimbaling engines to maintain vehicle control following a hardover actuator failure. ©[102506-7859]

There are two major cases for SSME redline limits management for a hardover TVC actuator. One set of cases requires an engine to be manually shutdown prior to an MET 1:40 and the other set requires the engine to be manually shut down later in the ascent profile.

For the set of main engine TVC failures that require the SSME with the hardover actuator to be shut down prior to an MET of 1:40, the SRB TVC has sufficient control authority, even in the case of a subsequent SSME failure with a fully functional TVC. After MET 1:40, the decaying SRB thrust will reduce control authority from the SRB's and will lead to rapid loss of control if no action is taken (see Rule {A8-2}, SSME THRUST VECTOR CONTROL (TVC) HARDOVER). Once the SSME with the hardover actuator is shut down, the remaining SSME(s) will have sufficient control authority independent of the SRB's. Due to the short timeframe between the TVC hardover and engine shutdown time in first stage, as well as the ability for the SRB TVC to maintain vehicle control prior to the shutdown, keeping the SSME redline limits enabled minimizes team workload and allows a second SSME to shut down safely if it violates a redline shutdown limit.

For the set of failures where the SSME with the hardover actuator will be allowed to run until the single engine press boundary or an MET of 7:00, the loss of either gimbaling engine following SRB thrust tail-off will result in a rapid loss of vehicle control. The rapid loss of vehicle control was verified by Spacecraft Trajectory Analysis and Mission Planning Simulation (STAMPS) simulator testing conducted by JSC/DM in November 2005. The risk tradeoff between the loss of crew and vehicle due to an engine failing catastrophically with limits inhibited versus the loss of crew and vehicle due to a rapid loss of control resulting from allowing a gimbaling SSME to shutdown automatically on the redline limits was discussed at the Ascent/Entry Flight Techniques Panel # 212 on June 14, 2005. The determination was made that allowing a gimbaling engine to shut down would result in the loss of crew and vehicle regardless of whether the engine shut down safely or catastrophically. It was also acknowledged that allowing an SSME to run beyond a shutdown redline limit most likely will result in the loss of crew and vehicle due to a catastrophic engine failure. However, there is a small set of failure conditions where an SSME may continue to run beyond a redline limit. Keeping the redline limits inhibited until the SSME with the failed actuator is shut down takes advantage of this small set of failures and minimizes the global risk of a loss of crew and vehicle for any subsequent SSME failure given the hardover TVC actuator.

Reference Rule {A8-2}, SSME THRUST VECTOR CONTROL (TVC) HARDOVER. ©[102506-7859]

THIS RULE CONTINUED ON NEXT PAGE

FLIGHT RULES

A5-103 LIMIT SHUTDOWN CONTROL [HC] (CONTINUED)

H. WITH THREE ENGINES RUNNING AND MECO EXTENDED BEYOND THE NOMINAL MECO TIME FOR AN RTLS, TAL, OR UPHILL, THE MAIN ENGINE LIMIT SHUTDOWN SWITCH WILL BE TOGGLED TO INHIBIT, ENABLE, AND BACK TO AUTO, TIME PERMITTING. THIS ACTION WILL BE DELAYED AS LONG AS POSSIBLE, BUT MUST BE COMPLETED PRIOR TO AN MET OF 8 MINUTES. @[121296-4625] @[111298-6785A] @[102506-7859]

A GPC or manual toggle of the main engine limit shutdown software to inhibit will be required with three engines running and MECO extended beyond the nominal MECO time due to the incorporation of single command channel shutdown logic in the main engine controller software. The intent of this logic is to protect the vehicle and crew from exposure to a latent orbiter/main engine command path failure at MECO (catastrophic). This is accomplished by reducing the normal 2 of 3 shutdown command channel agreement criteria to 1 of 3 shutdown command channel acceptance processing. The software, which is invoked after a mission specific timer has expired, will allow acceptance and execution of the following two sequential commands, shutdown-enable followed by a shutdown command on a single command channel. Should a limit inhibit command be processed and accepted by the controller prior to the execution of the single command channel logic, single command channel processing will no longer be performed. A generic timer of 505.2 seconds from engine start has been selected to cover most missions. This timer will be evaluated for every mission and may be adjusted if proper protection is not afforded by the generic timer. The mission specific timer is calculated by subtracting 5.5 seconds (3 sigma dispersion) from the predicted MECO time referenced to SSME start. That is, the predicted MECO time in MET plus the time from the last SSME start (6.36 seconds) minus 3 sigma dispersion (5.5 seconds). @[091098-6710A]

Toggling of the main engine limit shutdown switch on a three engine ascent or abort is performed in order to preclude the possibility of losing all main engines due to a failed-to-sync GPC after the controller timer has expired. Normally, exposure to this condition is minimized since the timer expires a few seconds prior to the projected nominal MECO. This condition is also eliminated when an engine fails since the software will command INHIBIT on the remaining engines, thereby cancelling the timer. However, for three engine running cases on a TAL, RTLS, or uphill with extended MECO, the time of exposure to a three engine out condition due to a fail-to-sync GPC may be well beyond the normal 5-second protection. This can be significant on a systems RTLS abort where MECO can be approximately 630 seconds. Consequently, the main engine limit shutdown software will be manually toggled to INHIBIT/ENABLE/AUTO in order to minimize exposure to a failed-to-sync GPC. This action will be delayed as long as possible in order to retain main engine shutdown capability, and to possibly eliminate an unnecessary action, should a main engine shutdown occur prior to the expiration of the controller timer. The cue of 8 minutes provides margin prior to expiration of the timer. @[090894-1679A] @[121296-4625] @[091098-6710A]

Hazard Reports IMPS-03, Improper IMPS Configuration During Engine Operation, and ME-FG4M, Loss of Thrust, are controlled by this rule.

Rules {A2-6}, LANDING SITE WEATHER CRITERIA [HC]; {A2-55}, ENTRY GUIDANCE SELECTION FOR ABORTS; {A5-5}, SUSPECT ENGINE [HC]; {A5-6}, SSME REDLINE SENSOR FAILED; {A5-7}, SSME ONE REDLINE SENSOR FAILURE AWAY FROM AN ERRONEOUS SHUTDOWN; and {5-104}, DATA PATH FAIL/ENGINE-ON LIMIT SHUTDOWN CONTROL, reference this rule. @[120894-1663] @[102506-7856] @[102506-7859]

FLIGHT RULES

A5-104**DATA PATH FAIL/ENGINE-ON LIMIT SHUTDOWN CONTROL**

WITH A DATA PATH FAILURE AND THE ENGINE CONFIRMED ON BY THE MCC, THE MAIN ENGINE LIMIT SHUTDOWN CONTROL CAPABILITY WILL BE MANAGED IN THE FOLLOWING MANNER: @[121296-4594A]

A data path failure occurs when the GPC's (PASS or BFS) either do not see the main engine time reference word (TREF) updating or when the two main engine identification words (ID words 1 & 2) are not one's complements. If this occurs in the controlling GPC's, the controlling GPC's will automatically inhibit the main engine limit shutdown software on the other two main engines. However, the GPC software will not inhibit the limits on the engine with the data path failure. This response occurs because the GPC's assume the engine has failed behind the data path failure for limits management purposes but not for guidance purposes. @[042706-7351]

A. BFS NOT ENGAGED:

1. THE MAIN ENGINE LIMIT SHUTDOWN SOFTWARE WILL BE REENABLED BY PLACING THE MAIN ENGINE LIMIT SHUTDOWN SWITCH TO "ENABLE" THEN "AUTO."

Once the MCC confirms that the engine with the data path failure is running, the crew will remove the inhibits by manually placing the main engine limit shutdown switch to ENABLE, then AUTO. This switch movement causes the main engine limit shutdown software to be reenabled on all running engines.

2. FOR A SUBSEQUENT ENGINE OUT: @[111298-6785A] @[042706-7351]
 - a. IF THE ENGINE THAT SHUT DOWN WAS THE ONE THAT HAD THE DATA PATH FAILURE, THE MAIN ENGINE LIMIT SHUTDOWN SOFTWARE WILL REMAIN ENABLED.

If the engine that shuts down is the engine with the data path failure, the GPC's will not automatically inhibit the main engine limit shutdown software. The main engine limit shutdown software will remain enabled to allow for a second engine out (ref Rule {A5-103}, LIMIT SHUTDOWN CONTROL).

@[121296-4594A] @[111298-6785A]

THIS RULE CONTINUED ON NEXT PAGE

FLIGHT RULES

A5-104

DATA PATH FAIL/ENGINE-ON LIMIT SHUTDOWN CONTROL (CONTINUED)

- b. IF THE ENGINE THAT SHUT DOWN WAS NOT THE ONE WITH THE DATA PATH FAILURE, THE PASS WILL AUTOMATICALLY INHIBIT LIMITS. LIMITS WILL REMAIN INHIBITED UNTIL MECO.
 @[121296-4594A] @[111298-6785A]

If the engine that shuts down did not have the data path failure, the limit shutdown control capability of the two remaining engines will automatically be inhibited by the PASS GPC's. In this case, however, the limits will remain inhibited until MECO. The reason is that, if the limits were reenabled and the remaining engine with the good data path exceeds a redline and shuts down, MECO confirmed conditions would be satisfied by having two engines with main combustion chamber pressure less than 30 percent power level and one engine with a data path failure. This shutdown could also be catastrophic in the case of a command and data path failure since the prevalves would be commanded closed while the engine is still running. This early MECO could result in an unacceptable underspeed.
 @[121296-4594A] @[042706-7351]

B. BFS ENGAGED:

1. THE MAIN ENGINE LIMIT SHUTDOWN SOFTWARE WILL BE ENABLED BY PLACING THE MAIN ENGINE LIMIT SHUTDOWN SWITCH TO "ENABLE" (UNLESS THE BFS AUTOMATICALLY REENABLED LIMITS UPON BFS ENGAGE) . @[111298-6785A]

If the data path failure occurs before BFS engage, when the BFS is engaged, all data path failure flags are reset in the BFS software. The BFS immediately attempts to establish communication with the engines. However, if this is not successful a data path failure is annunciated on that engine. At this point, the BFS software automatically inhibits the main engine limit shutdown software on the other two engines. If the data path failure occurs after BFS engage, the BFS will inhibit limits on the other two engines. Once the MCC confirms the engine with the data path failure is running, the crew will remove the inhibits by manually placing the main engine limit shutdown switch to ENABLE to prevent running the engines for the remainder of the flight with limits inhibited. The BFS main engine limit shutdown switch logic does not work the same way it does in the PASS (in the BFS, ENABLE/AUTO will cause the limits to go back to inhibit).

The BFS will automatically reenable limits if the data path failure is recovered when the BFS is engaged.
 @[121296-4594A]

THIS RULE CONTINUED ON NEXT PAGE

FLIGHT RULES

A5-104

DATA PATH FAIL/ENGINE-ON LIMIT SHUTDOWN CONTROL
(CONTINUED)

2. FOR A SUBSEQUENT ENGINE OUT: @[121296-4594A]

THE MAIN ENGINE LIMIT SHUTDOWN SOFTWARE WILL BE INHIBITED BY PLACING THE MAIN ENGINE LIMIT SHUTDOWN SWITCH TO "INHIBIT" (UNLESS THE BFS AUTOMATICALLY INHIBITED LIMITS AT ENGINE OUT). LIMITS WILL REMAIN INHIBITED UNTIL MECO.

If the BFS has been engaged, a subsequent engine shutdown will require the limits to be inhibited because BFS does not have single engine roll control logic (ref Rule {A5-103}, LIMIT SHUTDOWN CONTROL). BFS will automatically inhibit limits if the engine that shut down did not have a previous data path failure, had a data path failure at shutdown, or had a previous data path failure prior to BFS engage but was recovered upon BFS engage. Limits will have to be manually inhibited by taking the main engine limit shutdown switch to INHIBIT if the engine that shut down had a non-recovered data path failure prior to shutdown.

Rules {A5-102}, AUTO/MANUAL SHUTDOWN, {A5-103}, LIMIT SHUTDOWN CONTROL, and {A5-113}, MANUAL MECO/MECO CONFIRMED, reference this rule. @[121296-4594A]

FLIGHT RULES

A5-105

DATA PATH FAIL/ENGINE-OUT ACTION

IF THE MCC CONFIRMS THAT AN ENGINE WITH A DATA PATH FAILURE HAS SHUT DOWN, THAT ENGINE'S SHUTDOWN pb WILL BE PUSHED TO MODE THE GUIDANCE AND FLIGHT CONTROL LOGIC AND TO CLOSE THE ASSOCIATED PREVALVES.

SHOULD THE SAFING FUNCTION OF THE pb BE INOPERATIVE DUE TO SHUTDOWN pb OR CONTROL BUS PROBLEMS, THE APPROPRIATE MDM PER THE TABLE BELOW WILL BE POWER CYCLED FOR 1 SECOND TO ALLOW THE pb TO OPERATE. THE POWER CYCLED MDM MAY BE REGAINED VIA AN I/O RESET POST SAFING. @[021397-4823]

<u>S/D pb CONTACT</u>	<u>CONTROL BUS</u>	<u>MDM</u>
CTR A	AB1	FF1
CTR B	BC1	FF2 @[111699-7140]
LEFT A	BC2	FF2
LEFT B	CA2	FF3
RT A	CA3	FF3
RT B	BC3	FF4

The GPC guidance software will not know an engine has shut down prematurely if the data path from that engine has also failed. Pushing the corresponding shutdown pb will set the safing command in the GPC for that engine. When the safing command is set, the SSME OPS sequence will close the prevalues and set the engine fail flag for that engine. Closing the prevalues is essential to isolate the failed engine if the engine failure caused damage to the engine propellant supply lines. There is a potential for a fire or propellant loss with the prevalues open. The engine fail flag is used by the ascent guidance software to mode the guidance and targeting functions to correspond to the number of SSME's that are operating. This is required for proper control of the vehicle.

If the two contacts on the shutdown pb disagree, the safing command will not be set. A contact disagreement can be caused by a failure of a contact, the loss of the fuse to a contact, or the loss of the control bus providing power to a contact. Power cycling the MDM associated with that contact will cause the failed contact to be comm faulted; this will allow the safing command to be set when the pb is pushed. For FF 1, 2 or 3, the power cycle must be of approximately 1 second in duration before moding guidance. This is to ensure that the MDM is off long enough to be comm faulted, yet repowered quickly to avoid caging the associated IMU. The comm faulted MDM can be recovered with an I/O reset after the appropriate shutdown pb is pushed and guidance has been moded. @[021397-4823]

FLIGHT RULES

A5-106

MANUAL SHUTDOWN FOR COMMAND/DATA PATH FAILURES
[HC] @[102506-7352]

MANUAL SHUTDOWN OF AN AFFECTED ENGINE WILL BE PERFORMED PRIOR TO MECO FOR THE FOLLOWING COMMAND AND/OR DATA PATH FAILURE CASES:

A. COMMAND PATH FAILURE.

1. NOMINAL/ATO:

- a. THREE ENGINES ON - SHUT DOWN AT VI = 23K FPS USING THE AC POWER SWITCHES AND SHUTDOWN PB.
- b. TWO ENGINES ON - SHUT DOWN AT VI = 24.5K FPS USING THE AC POWER SWITCHES AND SHUTDOWN PB.

MCC CONFIRMS COMMAND PATH FAILURE BY NO THROTTLING OF AFFECTED ENGINE WHEN THE ENGINES ARE COMMANDED TO THROTTLE.

2. RTLS:

TWO OR THREE ENGINES ON - SHUT DOWN DURING POWERED PITCHDOWN AT ALPHA = -1 USING THE AC POWER SWITCHES AND SHUTDOWN PB. @[032395-1759]

3. TAL:

TWO OR THREE ENGINES ON - SHUT DOWN AT VI = 22.5K FPS USING AC POWER SWITCHES AND SHUTDOWN PB.

THE SHUTDOWN CUE FOR NOMINAL/ATO/TAL FOR BFS ENGAGE SHALL BE MECO-30 SECONDS.

In the case of a command path failure, the only way to shut down an engine is with the engine ac power switches. Shutting down with the ac power switches also creates a data path failure. Therefore, the shutdown pushbutton is pushed to tell guidance that an engine is out. The engine is shut down approximately 30 seconds before MECO to prevent depleting LO₂ and LH₂ through an SSME, causing uncontained engine damage. A velocity which equates to MECO minus 30 seconds also gives guidance time to compensate for late engine out and converge to the proper MECO targets. The only exception is an RTLS where the engine is shut down during powered pitchdown at alpha = -1 degrees. On a three- or two-engine abort RTLS, if an engine is shut down at TGO ≤ 60 seconds, guidance will not mode to the target set corresponding to the remaining number of engines. @[032395-1759A] @[102506-7352]

THIS RULE CONTINUED ON NEXT PAGE

FLIGHT RULES

A5-106

MANUAL SHUTDOWN FOR COMMAND/DATA PATH FAILURES [HC] (CONTINUED)

The cue of alpha = -1 degree (approx MECO-5 sec) was chosen to allow SSME shutdown to begin prior to predicted MECO while the LO₂ is still under G's from the other engine(s). For BFS, alpha can be found on the RTLS Traj display since the flight instruments are blanked upon BFS engage. This alleviates LO₂ net positive suction pressure concerns for the high pressure oxidizer turbopump (HPOTP). Alpha = -1 degree also protects for 1-sigma aerodynamic dispersions. Although sizable transients can be expected subsequent to engine shutdown, flight control has been demonstrated to null these transients prior to ET separation (in some cases ET separation inhibits of approximately 1 second will occur, reference AEFTP #87 and #122 minutes). On a three-engine press-to-MECO case, MECO minus 30 seconds occurs at a VI = 23 kfps. On a two-engine press-to-MECO case, MECO minus 30 seconds occurs at a VI = 24.5 kfps. On a TAL abort, MECO minus 30 seconds occurs at a VI = 22.5 kfps. @[032395-1759A] @[102506-7352]

B. DATA PATH FAILURE

1. MCC DECISION (PRIME)

NOMINAL/ATO/TAL/RTLS:

- a. NO ACTION REQUIRED.
- b. MCC CONFIRMS COMMAND PATH OPERATIONAL BY GH₂ OUTLET PRESSURE COMPARISON TO POWER LEVEL COMMAND.

2. ONBOARD DECISION (NO COMMUNICATION)

NOMINAL/ATO/TAL/RTLS:

CREW ACTION SAME AS FOR COMMAND PATH FAILURE.

For a data path failure, the engine will accept throttling and MECO commands so no action is required. The crew cannot tell the difference between a data path failure and a command/data path failure. The two failures that caused the data path failure may also have caused a command path failure (i.e., two controller interface adapters (CIA's), or a CIA and a multiplexer interface adapter (MIA) in the EIU). Unless the command capability is verified by the MCC, the crew will assume a command and data path failure and will take the same action as a command path failure. The MCC can verify the command path status by observing that the GH₂ outlet pressure changes with the throttle command. If an engine throttles down when commanded, its command path is operational. @[102506-7352]

THIS RULE CONTINUED ON NEXT PAGE

FLIGHT RULES

A5-106

MANUAL SHUTDOWN FOR COMMAND/DATA PATH FAILURES [HC] (CONTINUED)

C. COMMAND AND DATA PATH FAILURE.

1. MCC DECISION (PRIME)

NOMINAL/ATO/TAL/RTLS: @[102506-7352]

a. ACTION SAME AS COMMAND PATH FAIL

b. MCC CONFIRMS CASE BY NO CHANGE IN GH2 OUTLET PRESSURE ON THE AFFECTED ENGINE WHEN ENGINE COMMANDED TO THROTTLE.

2. ONBOARD DECISION (NO COMMUNICATION)

NOMINAL/ATO/TAL/RTLS:

CREW ACTION SAME AS FOR COMMAND PATH FAILURE.

The loss of an EIU or the loss of an MIA and a CIA or the loss of two CIA's will cause a data path failure and a command path failure on the same engine.

This is a very serious failure mode because this failure will close the prevalues on an operating engine at MECO if preventative action is not taken. A water-hammer effect will occur which will rupture the LO₂ feedline and result in uncontained engine damage and loss of crew and vehicle. At MECO, the GPC logic assumes an engine with a data path failure does not have a command path loss (i.e., the GPC assumes the engine accepted and complied with the shutdown command); therefore, the prevalues are commanded closed. To prevent this catastrophic shutdown of the engine at MECO, the engine ac power switches must be used to shut down the engine before MECO is commanded. The ac power switches will shut down the engine; the pushbutton is then pressed to mode guidance.

Hazard Report IMPS-17, Inadvertent SSME Shutdown, is controlled by this rule.

Rules {A5-109}, MANUAL SHUTDOWN FOR TWO STUCK THROTTLES (NOT DUAL APU FAILURES [HC]); {A5-110}, SSME PERFORMANCE DISPERSION; {A5-107}, MANUAL SHUTDOWN FOR SUSPECT COMMAND PATH FAILURES; and {A7-9}, REDUNDANT SET SPLIT, reference this rule.
@[032395-1766] @[061296-6147A] @[ED] @[102506-7352]

FLIGHT RULES

A5-107**MANUAL SHUTDOWN FOR SUSPECT COMMAND PATH FAILURES**

AN ENGINE WITH SUSPECT COMMAND CAPABILITY FOR SHUTDOWN WILL BE MANUALLY SHUT DOWN PRIOR TO MECO USING THE SAME CUES LISTED FOR A COMMAND PATH FAILURE IN RULE {A5-106}, MANUAL SHUTDOWN FOR COMMAND/DATA PATH FAILURES [HC]. @[102506-7352]

If a transient failure observed during powered flight results in the temporary loss of a command channel, the respective command channel will be considered suspect since the failure could return at any time. If another avionics failure and a reoccurrence of the previously observed transient failure results in a command path failure (per Rule {A5-3}, STUCK THROTTLE), the command capability of this engine will be considered suspect even if the engine reacts to the 3g throttle back command. Therefore, this engine will be shut down pre-MECO per Rule {A5-106}, MANUAL SHUTDOWN FOR COMMAND/DATA PATH FAILURES [HC]. The engines have single command channel shutdown logic that allows the engine to shut down by accepting shutdown commands on only one out of three command channels. Operationally, this logic is only relied upon for late, unexpected failures.

@[111501-4939] @[102506-7352]

One example of a transient failure is an EIU power-on-reset failure. A power-on-reset failure causes the temporary loss of a single power supply in an EIU. Since the EIU MIA ports 1 and 3 are on the same power source (MIA ports 2 and 4 are on another), this failure will cause the temporary loss of command and data transfer capability on two MIA ports (ground data only shows the status of MIA ports 1 and 4; therefore, MIA ports 3 and 2 are assumed bypassed with ports 1 and 4, respectively). After this failure has occurred, the command transfer capability will be regained automatically while the data transfer capability will be regained via an I/O Reset. The following scenario is an example of the concern that this failure raises: If an engine has a command channel B failure and a power-on-reset failure on MIA ports 1 and 3, the engine will be considered to have suspect command capability even if the engine responds to throttle commands and will be shut down pre-MECO. @[111501-4939]

FLIGHT RULES

A5-108

MANUAL SHUTDOWN FOR HYDRAULIC OR ELECTRICAL LOCKUP [HC] @[022405-6614]

AN SSME IN HYDRAULIC OR ELECTRICAL LOCKUP MAY HAVE TO BE MANUALLY SHUT DOWN TO PREVENT A VIOLATION OF THE ENGINE LO₂ NPSP REQUIREMENTS NEAR MECO AND/OR TO PREVENT VIOLATION OF THE 3.0 G VEHICLE ACCELERATION LIMIT. MANUAL SHUTDOWN WILL BE REQUIRED UNDER THE FOLLOWING CONDITIONS FOR ANY ENGINE LOCKED UP ABOVE THE MINIMUM POWER LEVEL (KMIN). @[061297-6171] @[090999-7052A]

A. NOMINAL/ATO: @[ED]

1. THREE ENGINES ON:

- a. ONE STUCK THROTTLE - SHUT DOWN THE AFFECTED ENGINE AT $VI \geq 23K$ FPS USING THE SHUTDOWN PB.
- b. TWO STUCK THROTTLES - (REF. RULE {A5-109}, MANUAL SHUTDOWN FOR TWO STUCK THROTTLES (NOT DUAL APU FAILURES), AND RULE {A8-61}, SSME SHUTDOWN DUE TO HYDRAULIC SYSTEM FAILURES). @[ED]

2. TWO ENGINES ON - NO ACTION REQUIRED.

B. RTLS AND TAL - NO ACTION REQUIRED.

An LO₂ depletion cutoff at power levels greater than that accounted for by the low level cutoff (LLCO) logic could cause high pressure oxidizer turbopump overspeed resulting in a potentially catastrophic engine shutdown. The OI-30 LLCO logic includes an I-load (MPS_STUCK - currently set at 75 percent) to identify if any SSME is stuck high and, if equal to or greater than this value, the LLCO delay timer is set to 0.0 seconds, maximizing the net positive suction pressure (NPSP) and post shutdown LO₂ mass. Even at 0.0 seconds delay, however, the NPSP and post shutdown mass requirements may be violated if the stuck SSME power level is greater than 80.5 percent power level when the remaining two SSME's are at 67 percent (reference Shuttle Systems Engineering Integration Group meeting, November 15, 2004). Given the potentially catastrophic nature of the shutdown and given that an LO₂ low level cutoff cannot always be predicted (reference the STS-93 unpredicted LO₂ low level cutoff which was caused partially by an SSME nozzle leak which was smaller than the minimum criteria of Rule {A5-110}, SSME PERFORMANCE DISPERSION, and therefore not modeled in the Abort Region Determinator (ARD)), it was decided to accept the operational impacts of always shutting down a locked up engine when three engines are on as opposed to relying on the ARD to make a real-time performance evaluation (reference Ascent Flight Techniques Panel Meeting #160, August 27, 1999). @[022405-6614]

THIS RULE CONTINUED ON NEXT PAGE

FLIGHT RULES

A5-108

MANUAL SHUTDOWN FOR HYDRAULIC OR ELECTRICAL LOCKUP [HC] (CONTINUED)

*Pre-MECO shutdowns of SSME's stuck at more than the minimum power level also has the secondary effect of preventing excessive vehicle acceleration, thus allowing the retirement of NSTS 07700 Vol X, Book 4, Waiver 451, Flight Personnel Flight Loads (reference PRCB **TBD**). Hence, for power levels up to 79 percent, a pre-MECO shutdown of the stuck engine prevents exceeding 3.0 g's of acceleration. At power levels above 79 percent, a pre-MECO shutdown of the stuck engine is required to prevent NPSP violations and to limit vehicle acceleration. ©[022405-6614]*

The performance impacts of this rule are dependent on the power level of the stuck SSME and the resulting value of the LLCO delay timer. If the stuck engine power level is below the MPS_STUCK I-load, the "NOM_LO2_LOW_LVL_TIME_DELAY_L" delay timer is used (currently 0.358 seconds), resulting in up to 55 feet per second of lost performance due to the pre-MECO shutdown of the stuck SSME. If the delay timer is set to 0.0 seconds (as would be the case if the engine was stuck at or above the MPS_STUCK I-Load power level but less than or equal to the 79 percent NPSP requirement), then the pre-MECO shutdown results in only 25 feet per second of lost performance. Additionally, the pre-MECO shutdown may cause a planar error at MECO of up to 10 feet per second (some planar error is inevitable for these cases even if the stuck engine is not shut down). ©[090999-7052A] ©[092701-4819A] ©[ED]

By shutting down the stuck engine prior to MECO, the two remaining engines will throttle to 91 percent power level for fine count. The low level cutoff delay timer for the two engines on at 91 percent power level case is zero, thereby maximizing the NPSP and LO₂ residual mass for two engines shutting down from 91 percent power level.

If a single stuck throttle occurs on a three engine RTLS or TAL abort, the LO₂ residuals should be sufficient to prevent an LO₂ low level shutdown. In this scenario, however, the vehicle will experience acceleration greater than 3.0 g's at MECO. Due to the relative complexity of these cases, and since these aborts are not certified, the Ascent/Entry Flight Techniques Panel determined that this rule should not protect acceleration violations in these scenarios (reference Ascent/Entry Flight Techniques Panel #208, December 10, 2004). ©[061297-6171] ©[090999-7052A]

For the two-engine-on case with stuck throttles at any power level, the technical community determined that the NPSP would not be severely violated and the minimum post shutdown LO₂ mass requirements would be satisfied. Therefore, no action was required (reference PSIG #24 in November 1983 and Ascent Flight Techniques on May 21, 1984).

Shutdown of an engine in either a hydraulic or electric lockup will be performed by the shutdown pushbutton only. The shutdown pushbutton method for manual shutdown of an engine in either hydraulic or electric lockup minimizes the exposure to the unnecessary risk of a pneumatic shutdown in the case of the electrically locked-up engine and simplifies crew procedures in the case of the hydraulically locked-up engine. ©[090999-7052A]

Hazard Reports INTG-042 and INTG-072 are controlled by this rule. ©[022405-6614]

Rule {A2-301}, CONTINGENCY ACTION SUMMARY [HC], references this rule. ©[032807-8400]

FLIGHT RULES

A5-109

MANUAL SHUTDOWN FOR TWO STUCK THROTTLES (NOT DUAL APU FAILURES) [HC] @[121505-7209A]

A. THREE ENGINES RUNNING:

1. NOMINAL/ATO - MANUALLY SHUT DOWN ONE ENGINE AT $V_I \geq 23K$ FPS.
2. TAL - MANUALLY SHUT DOWN ONE ENGINE AT $V_I \geq 22.5K$ FPS. ENABLE MANUAL THROTTLES PRIOR TO ABORT SELECTION TO MAINTAIN NOMINAL POWER LEVEL. AFTER ABORT SELECTION, THROTTLE CONTROL WILL BE RETURNED TO AUTO. @[082593-1464C]
3. RTLS - BEFORE SELECTING RTLS, MANUAL THROTTLES WILL BE ENABLED AND MINIMUM THROTTLES SELECTED, FOLLOWED BY A RETURN TO AUTO THROTTLES. AT LEAST 10 SECONDS OF MINIMUM THROTTLE LEVEL IS DESIRED PRIOR TO RTLS ABORT SELECTION. @[082593-1464C]
 - a. IF BOTH ENGINES WITH STUCK THROTTLES ARE AT NOMINAL POWER LEVEL (104.5 PERCENT), THEN MANUAL THROTTLE ACTIONS ARE NOT REQUIRED PRIOR TO RTLS ABORT SELECTION.
 - b. IF BOTH ENGINES WITH STUCK THROTTLES ARE AT MORE THAN 85 PERCENT, MANUALLY SHUT DOWN ONE OF THE ENGINES AT MECO -2 MINUTES.

SHUTDOWN PRIORITY: (1) COMMAND PATH FAIL, (2) HYDRAULIC LOCKUP, (3) ELECTRICAL LOCKUP

B. TWO ENGINES RUNNING - NO ACTION REQUIRED

For dual command path failures, reference Rule {A5-106}, MANUAL SHUTDOWN FOR COMMAND/DATA PATH FAILURES [HC]. For dual hydraulic failures, ref. Rule {A8-61}, SSME SHUTDOWN DUE TO HYDRAULIC SYSTEM FAILURES [HC]. @[121505-7209A] @[102506-7352]

THIS RULE CONTINUED ON NEXT PAGE

FLIGHT RULES

A5-109

MANUAL SHUTDOWN FOR TWO STUCK THROTTLES (NOT DUAL APU FAILURES) [HC] (CONTINUED)

If two of three operating engines have stuck throttles, manual shutdown of an engine will be required to prevent violation of the 3.5g acceleration limit. The chosen shutdown time is MECO minus 30 seconds which is equivalent to a VI of 23K fps on uphill trajectories and a VI of 22.5 fps on a TAL. These VI cues are normally used by the crew for the engine shutdown; however, MECO minus 30 seconds is used for BFS engage cases since the VI information is not available. ©[121505-7209A]

The 3.5g limit cannot be violated with only two engines operating. Also, this limit cannot be violated on a three-engine RTLS if at least one of the stuck throttles is less than or equal to 85 percent. Above 85 percent, shutting down an engine 2 minutes prior to MECO ensures that the 3.5g acceleration limit will not be violated. ©[110900-7242]

For RTLS cases with two stuck throttles, minimum throttles will be selected prior to abort selection for any engine stuck at a power level below the nominal 104.5 percent. Doing so will allow guidance to converge on the correct average thrust level and will reduce the probability of an early PPA. For guidance to have enough time to converge, minimum throttle levels must be achieved at least 10 seconds prior to RTLS selection. If not, an early PPA may occur, resulting in MECO conditions that are not optimized since additional propellant above the 2 percent target may remain in the ET at MECO. AUTO throttles should be reselected immediately after minimum throttles is selected. Doing so ensures that RTLS guidance fine mass control is maintained. If manual throttles is active at PPA or enabled anytime after PPA, then the guidance fine mass control is disabled. ©[082593-1464C] ©[121505-7209A]

THIS RULE CONTINUED ON NEXT PAGE

FLIGHT RULES

A5-109

**MANUAL SHUTDOWN FOR TWO STUCK THROTTLES (NOT DUAL
APU FAILURES) [HC] (CONTINUED)**

If both stuck engines are at the nominal power level (104.5 percent), these steps are unnecessary since the chances of an early PPA are eliminated. In this case, a late PPA is possible since the guidance turnaround velocity limit (VLATE) is being approached and the man/min/auto throttle steps could cause the crew to exceed this velocity limit prior to aborting RTLS. (Reference Ascent/Entry Flight Technique Panel #215, October 28, 2005). ©[121505-7209A]

For the contingency case resulting in a three-engine RTLS with two SSME throttles stuck at high power level, it is possible for acceleration forces to get as high as 3.9g. Therefore, if both stuck throttles are above 85 percent, an engine must be shut down before MECO-20 seconds in order to avoid the possibility of exceeding 3.5g. In this scenario, analysis has shown that shutting down a stuck engine within 85 seconds of MECO leaves more than 2 percent propellant remaining in the ET at MECO, resulting in orbiter/ET recontact after ET SEP. Therefore, MECO-2 minutes was selected as an operationally convenient shutdown cue that would eliminate both the recontact and the g-load concerns. (Reference Rule {A8-61}, SSME SHUTDOWN DUE TO HYDRAULIC SYSTEM FAILURES [HC], and Ascent/Entry Flight Techniques Panel #105, October 22, 1993.)

The 85 percent throttle level provides an operationally convenient breakpoint which ensures that a shutdown will never be performed if the engine is needed to achieve the desired MECO targets, while also ensuring that an engine will always be shut down if any threat of exceeding 3.5g exists. ©[121505-7209A]

THIS RULE CONTINUED ON NEXT PAGE

FLIGHT RULES

A5-109

MANUAL SHUTDOWN FOR TWO STUCK THROTTLES (NOT DUAL APU FAILURES) [HC] (CONTINUED)

For TAL, it is undesirable to throttle down the good engine due to the guidance transients which may occur and the fact that little time would be gained to perform the abort dump. Therefore, manual throttles will be selected to prevent an automatic throttledown when TAL is declared. This action is not required if TAL is declared early enough that automatic throttling will not occur at abort selection. However, since there is no disadvantage to selecting manual throttles for this short period of time, manual throttles will always be selected for consistency. AUTO throttles will be reselected after TAL is declared. ®[082593-1464C]

Shutdown priorities are established to protect against the maximum risk. A command path failure means the engine will not automatically shut down at MECO, which is catastrophic. A hydraulic lockup means shutdown requires the nonredundant pneumatic system. Electric lockup results in a nominal shutdown. ®[121505-7209A]

Shutdown will be performed on the command path failed engine using the ac power switches and shutdown pushbutton. Shutdown of an engine in either a hydraulic or electric lockup will be performed by shutdown pushbutton only. The shutdown pushbutton method for manual shutdown of an engine in either hydraulic or electric lockup minimizes the exposure to the unnecessary risk of a pneumatic shutdown in the case of the electrically locked-up engine and simplifies crew procedures in the case of the hydraulically locked-up engine.

Hazard Reports IMPS-17, Inadvertent SSME Shutdown, and IVLD-01, Exposure to Induced Environment Exceed Structural Capability of SSV, are controlled by this rule.

Rules {A2-301}, Note 8, CONTINGENCY ACTION SUMMARY [HC]; {A4-59}, MANUAL THROTTLE SELECTION [HC]; and {A5-3}, STUCK STHROTTLE, reference this rule. ®[092195-1770A] ®[121505-7209A] ®[032807-8400] ®[ED]

FLIGHT RULES

A5-110

SSME PERFORMANCE DISPERSION @[070899-6819]

- A. SHOULD AN SSME PERFORMANCE DISPERSION ARISE, THE ABORT REGION DETERMINATOR (ARD) PROGRAM IN THE MCC WILL BE ADJUSTED ASAP WITH THE FOLLOWING INFORMATION: @[070899-6819]
1. AFFECTED SSME CAUSING THE PERFORMANCE DISPERSION
 2. TIME OF OCCURRENCE
 3. MODE AND LEVEL OF THE PERFORMANCE DISPERSION CONDITION INCLUDING INSTANTANEOUS PERFORMANCE INFORMATION.

The SSME performance dispersion rule defines the failures and the minimum criteria which must be met prior to updating the ARD with an SSME performance case. The Booster Main Engine Tables quantify each of the performance cases and include the minimum criteria for calling the performance cases. These tables are generated using the SSME Power Balance Model data provided by Rocketdyne in response to a Shuttle Operational Data Book (SODB) Request. The Engine Status Word (ESW), MCC Pc, HPOT/HPFT turbine discharge temperatures, LPFP discharge temperature, OPOV/FPOV position, and/or HPOP/HPFP discharge pressures are the primary cues used for determining performance cases. Updates to the ARD consist of changes in power level (thrust), mixture ratio (MR), and specific impulse (Isp). The ARD uses these SSME performance parameters to predict abort mode capabilities real time. A change in any of these parameters could affect the abort boundaries significantly. @[022707-8201]

- B. AN SSME PERFORMANCE EVALUATION CAN ONLY BE MADE WHEN THE SSME COMMANDED POWER LEVEL IS BETWEEN 100 PERCENT RPL AND 109 PERCENT RPL AND THE SSME IS IN A STEADY-STATE CONDITION. QUANTIFIABLE PERFORMANCE DISPERSIONS ARE AS FOLLOWS:

Performance case impacts are generally quantified at 104.5 percent power level; however, it is possible to use the 104.5 percent impacts ("deltas") to call performance cases between 100 percent and 109 percent power level without significant errors. @[022707-8201]

1. SINGLE MCC PC CHANNEL SHIFT HIGH OR LOW WILL BE CALLED IF THE DELTA BETWEEN MCC PC CHANNEL A AND MCC PC CHANNEL B IS ≥ 50 PSI:
 - a. FOR PC SHIFT HIGH ACTUAL LOW, THE LOWEST MCC PC CHANNEL WILL BE USED FOR PERFORMANCE EVALUATION.
 - b. FOR PC SHIFT LOW ACTUAL HIGH, THE HIGHEST MCC PC CHANNEL WILL BE USED FOR PERFORMANCE EVALUATION.

THIS RULE CONTINUED ON NEXT PAGE

FLIGHT RULES

A5-110

SSME PERFORMANCE DISPERSION (CONTINUED)

- c. FOR A SINGLE MCC PC CHANNEL SHIFT THAT RESULTS IN LOSS OF RENDEZVOUS CAPABILITY WITH ISS OR LOSS OF ATO CAPABILITY, THE AFFECTED MAIN ENGINE CONTROLLER CHANNEL WILL BE POWER CYCLED FOR 1 SECOND BY THE CREW ONLY IF THE ACTION WILL RECOVER THE DESIRED CAPABILITY. @[022707-8201]

THIS PROCEDURE WILL NOT BE IMPLEMENTED IF IT WILL CAUSE AN ENGINE SHUTDOWN OR NOT CORRECT THE PERFORMANCE DISPERSION AS DEFINED BELOW: @[061297-6147A] @[070899-6819]

- (1) LIMIT EXCEEDED ON ANY REMAINING SHUTDOWN SENSOR(S) ON OTHER CHANNEL SO THAT IT CAUSES ENGINE SHUTDOWN.
- (2) LOSS OF OTHER CHANNEL'S DCU, INPUT ELECTRONICS, OR OUTPUT ELECTRONICS SINCE POWER CYCLING THE REMAINING ELECTRONICS WOULD CAUSE THE ENGINE TO SHUT DOWN. @[070899-6819]
- (3) WHEN IN ELECTRICAL LOCKUP OR WHEN CHANNEL POWER CYCLE CAUSES ELECTRICAL LOCKUP. @[061297-6147A]
- (4) WHEN IN HYDRAULIC LOCKUP OR WHEN CHANNEL POWER CYCLE CAUSES HYDRAULIC LOCKUP. @[061297-6147A]

NOTE: IT IS ACCEPTABLE TO CAUSE A MOMENTARY OR PERMANENT SSME COMMAND PATH FAILURE, BECAUSE THE SSME CAN STILL REBALANCE TO CORRECT FOR THE PERFORMANCE CASE. IT IS ALSO ACCEPTED THAT POWER CYCLING WILL CAUSE LOSS OF THE RTVMS VIBRATION REDLINE FUNCTION. @[061297-6147A] @[022707-8201]

The SSME thrust is controlled using the MCC Pc channel average. A single MCC Pc channel erroneously shifting high or low will cause the SSME to shift in the opposite direction in an attempt to rebalance the SSME. That is, for an MCC Pc channel shift high case, the SSME will actually shift low. The good MCC Pc channel will shift in the direction of the actual SSME shift causing a delta between the two MCC Pc channels. The good MCC Pc channel will be used for performance evaluation. A difference of 50 psi between the two MCC Pc channels is the minimum detectable single MCC Pc channel shift, and it equates to an actual MCC Pc error of 25 psi (level 1, MCC Pc Shift Tables).

THIS RULE CONTINUED ON NEXT PAGE

FLIGHT RULES**A5-110****SSME PERFORMANCE DISPERSION (CONTINUED)**

A shifted MCC Pc channel can so adversely impact SSME performance that an ATO or rendezvous capability cannot be achieved. For such a case, the Booster will call for the controller channel with the malfunctioning MCC Pc channel to be power cycled for 1 second. Booster must be ready to identify the switch to be cycled by the crew (e.g., "ENGINE POWER, CTR, AC1" - for Center DCU A). The controller channel that has been power cycled will remain available for command and data transfer, but the controller IE (sensor data to the controller) and OE (control to the valve servo-actuators and servo-switches) on that channel will be disqualified. Disqualification of a shifted Pc sensor's IE will restore engine operation to nominal thrust, mixture ratio, and Isp conditions. Originally, this action was only performed to protect ATO, but this was expanded to protect rendezvous capability with the International Space Station (ISS) at the Ascent/Entry Flight Techniques Panel #223 on October 24, 2006. The decision was based on a probabilistic study that showed the risk of loss of crew and vehicle due to an ascent debris event outweighed the risk of losing the crew and vehicle due to the redundant controller failing after performing the controller power cycle and subsequently resulting in an abort (RTLS or TAL). The difference between these risks is primarily due to the limited inspection and uncertified TPS repair techniques available independent of the ISS versus the suite of techniques available when docked to ISS up to and including safe haven. @[022707-8201]

This action should not be taken if it will cause engine shutdown or not correct the performance dispersion. Cases consist of redline shutdown sensor(s) violating redline limits on the remaining channel causing engine shutdown or loss of the remaining channel's DCU, IE, or OE causing engine shutdown. Reference Rule {A5-2}, SPACE SHUTTLE MAIN ENGINE OUT, paragraphs E and F. However, this does not apply to RTVMS Redline Accelerometers. If the SSME is in electrical or hydraulic lockup or when channel power cycle causes electric or hydraulic lockup, disqualifying the faulty sensor (channel) will not correct the dispersion since the engine valves cannot be repositioned. It is acceptable to create a momentary or permanent command path failure because it is not necessary for the controller to have good GPC commands in order for the SSME to rebalance. However, permanent command path failures are unlikely since the SSME command channel is expected to be regained once the controller power is turned back on. If a permanent command path failure does occur, the affected SSME must be shut down prior to MECO at the cues listed in Rule {A5-106}, MANUAL SHUTDOWN FOR COMMAND/DATA PATH FAILURES [HC]. @[070899-6819] @[102506-7352]

Power cycling will cause loss of the RTVMS vibration redline function since RTVMS is only a fail-safe system. Loss of this redline protection on one SSME is accepted to regain ATO capability. The PRCB opted for a fail-safe system on April 11, 1999 - reference PRCBD S071886A.

2. A DUAL MCC PC CHANNEL SHIFT HIGH OR LOW CASE WILL BE CALLED WHEN THE MCC PC ERROR IS ≥ 37.5 PSI. A MINIMUM MCC PC ERROR OF 37.5 PSI IS DEFINED BY THE BOOSTER MAIN ENGINE TABLES WHEN ALL THREE TELEMETRY PARAMETER DELTAS (HPOTP TURBINE DISCHARGE TEMPERATURE, HPOP DISCHARGE PRESSURE, AND HPPFP DISCHARGE PRESSURE) EXCEED THE LEVEL 1.5 CRITERIA PER THE MCC PC SHIFT TABLES. A DELTA BETWEEN THE MCC PC CHANNELS MAY OR MAY NOT BE PRESENT.

@[070899-6819] @[022707-8201]

THIS RULE CONTINUED ON NEXT PAGE

FLIGHT RULES

A5-110

SSME PERFORMANCE DISPERSION (CONTINUED)

Actual MCC Pc error can also result from shifts in both the MCC Pc channels (shifting by the same or different amounts) or a shift in one MCC Pc channel with the other channel previously disqualified; this is defined as a dual MCC Pc channel shift. For this case, the actual SSME MCC Pc error will be determined using the HPOTP turbine discharge temperature, HPOP discharge pressure, and HPFP discharge pressure. A dual MCC Pc channel shift will be assessed when all three of these telemetry parameter deltas exceed the minimum criteria (SSME MCC Pc error ≥ 37.5 psi) listed in the Booster Main Engine Tables (approved at the A/EFTP # 152 on September 18, 1998). Both the single and the dual MCC Pc channel shift cases will use the same MCC Pc Shift Tables for the ARD updates, and the level in both cases will be based on the actual MCC Pc error. For a dual MCC Pc shift case, waiting for MCC Pc error of 37.5 psi (level 1.5) protects against erroneously calling the case due to prediction deviations, and it reliably differentiates this case from other cases that have similar SSME temperature and pressure movements. ©[022707-8201]

3. LPFT DISCHARGE TEMPERATURE SHIFT CASE WILL BE CALLED WHEN THE LPFT DISCHARGE TEMPERATURE SENSOR SHIFTS LOW ≥ 2 DEG R.

A shift in LPFT discharge temperature sensor will cause an error in the fuel density calculation. This error in fuel density will propagate into an error in the mixture ratio calculation. The SSME controller will then attempt to return the calculated mixture ratio to the nominal value by adjusting the SSME valves causing an off-nominal engine performance dispersion. A performance adjustment to the ARD will only be made for a shift low of the LPFT discharge temperature sensor because the LPFT discharge temperature cannot realistically get colder. The minimum detectable error is 2 deg R to cover instrumentation accuracy, run to run variations, and to ensure sufficient change in the SSME parameters for failure identification.

4. ELECTRICAL LOCKUP WILL BE CALLED WHEN THE ENGINE STATUS WORD (ESW) INDICATES THAT THE SSME IS IN ELECTRICAL LOCKUP.
 - a. IF THE MCC PC OR THE LH₂ FLOWMETER SENSORS SHIFT PRIOR TO ELECTRICAL LOCKUP AND IF THE SSME IS LOCKED UP BETWEEN 100 PERCENT RPL AND 109 PERCENT RPL, AN ARD ADJUSTMENT WILL BE MADE USING THE MCC PC SHIFT TABLES OR LH₂ FLOWMETER SHIFT TABLES. ©[070899-6819]
 - b. OTHERWISE, IF THERE IS NO QUANTIFIABLE SHIFT IN THE MCC PC OR THE LH₂ FLOWMETER SENSORS PRIOR TO ELECTRICAL LOCKUP, OR THE SSME IS NOT BETWEEN 100 PERCENT RPL AND 109 PERCENT RPL, AN ARD ADJUSTMENT WILL BE MADE USING THE BACKUP ELECTRICAL LOCKUP TABLES. ©[070899-6819] ©[022707-8201]

THIS RULE CONTINUED ON NEXT PAGE

FLIGHT RULES

A5-110

SSME PERFORMANCE DISPERSION (CONTINUED)

An electrical lockup will be called when the ESW mode indicates that the SSME is in electrical lockup. Electrical lockup is caused by disqualification of both channels of either the MCC Pc or the LH₂ flowmeter sensors (reference Rule {A5-3}, STUCK THROTTLE). If the MCC Pc or LH₂ flowmeter sensor shift caused an SSME to rebalance prior to disqualification, an ARD adjustment will be made using the MCC Pc shift tables or the LH₂ flowmeter shift tables. If there is no quantifiable shift in the SSME performance prior to an electrical lockup, or the SSME is not between 100 percent RPL and 109 percent RPL, then an ARD adjustment will be made using the backup electrical lockup tables. ©[022707-8201]

The fuel flow meter and Pc shift tables are only valid between 100 percent and 109 percent power level. For electrical lockups that do not occur in this range, the backup electrical lockup tables are used. The backup electrical lockup tables adjust thrust, MR, and Isp for LO₂ inlet pressure at the time of the lockup.

5. AN LH₂ FLOWMETER SHIFT HIGH OR LOW WILL BE CALLED WHEN THE FUEL FLOW ERROR IS ≥ 450 GPM. A MINIMUM FUEL FLOW ERROR OF 450 GPM IS DEFINED BY THE BOOSTER MAIN ENGINE TABLES WHEN ALL FOUR TELEMETRY PARAMETER DELTAS (HPOTP TURBINE DISCHARGE TEMPERATURE, HPOP DISCHARGE PRESSURE, HPFP DISCHARGE PRESSURE, AND FPOV POSITION) EXCEED THE LEVEL 1 CRITERIA.

The SSME mixture ratio is controlled using the measured volumetric flowrate from the LH₂ flowmeter. A shift in the LH₂ flowmeter will cause the SSME controller to calculate incorrect values for LH₂ mass flowrate, propagating into a mixture ratio error. The controller will then attempt to return the calculated mixture ratio to the nominal value by adjusting the SSME valves. This will cause the real thrust, MR, and Isp to be off-nominal. A flowmeter shift low will cause the controller to increase LH₂ flow, "shift low actual high," causing the real mixture ratio to be low. An LH₂ flowmeter shift high will cause the controller to decrease the LH₂ flow, "shift high actual low," causing the real mixture ratio to be high. The LH₂ flowmeter shift case will be assessed only when all four telemetry parameter deltas (HPOTP turbine discharge temperature, HPOP discharge pressure, HPFP discharge pressure, and FPOV position) exceed the level 1 criteria (SSME fuel flow error ≥ 450 GPM) listed in the Booster Main Engine Tables.

6. HYDRAULIC LOCKUP WILL BE DECLARED WHEN THE HYDRAULIC SUPPLY PRESSURE DROPS BELOW 1500 PSIA OR WHEN THE ESW INDICATES HYDRAULIC LOCKUP. THE INSTANTANEOUS AND DRIFT PERFORMANCE WILL BE COMPUTED IN REAL TIME, AND THE ARD WILL BE ADJUSTED ACCORDINGLY. HYDRAULIC LOCKUPS CAN BE EVALUATED AT ANY POWER LEVEL. ©[070899-6819] ©[022707-8201]

THIS RULE CONTINUED ON NEXT PAGE

FLIGHT RULES**A5-110****SSME PERFORMANCE DISPERSION (CONTINUED)**

The SSME propellant valves will not properly actuate with the hydraulic supply pressure below 1500 psia and will begin to drift due to flow torque effects. As the SSME propellant valves drift and as the SSME controller also attempts to adjust the valves to account for vehicle acceleration/inlet pressure effects, the SSME controller will disqualify both servo-actuators and mode the SSME into hydraulic lockup as indicated by the ESW. The SSME controller can also mode the SSME into hydraulic lockup for reasons other than loss of hydraulic supply pressure (reference Rule {A5-3}, STUCK THROTTLE). For either case, the ARD will be updated with an instantaneous thrust, MR, and Isp. If the performance is changing with time due to valve drift, the drifting performance during lockup will be calculated real time via an algorithm in the Booster Operational Support Software. The algorithm functions at all power levels. Once the drift performance can be quantified, the drift level and the drift time (15:00 MET) used in these calculations will be passed to the Trajectory Officer for ARD update. The drift rate is assumed to be linear (based on SSME test stand data). Ground testing of hydraulic lockup has shown that significant valve drift can occur on an engine in hydraulic lockup. Design changes to the SSME valve actuators have been incorporated to minimize valve drift in case of hydraulic lockup. ©[070899-6819] ©[022707-8201]

7. PRE-THRUST LIMITING NOZZLE LEAK WILL BE CALLED AT LEAK RATES ≥ 7 LBM/SEC. A MINIMUM LEAK RATE OF 7 LBM/SEC IS DEFINED BY THE BOOSTER MAIN ENGINE TABLES WHEN ALL FOUR TELEMETRY PARAMETER DELTAS (HPOTP TURBINE DISCHARGE TEMPERATURE, HPFTP TURBINE DISCHARGE TEMPERATURE, HPFP DISCHARGE PRESSURE, AND OPOV POSITION) EXCEED THE LEVEL 1 CRITERIA.

Leakage from the nozzle tubes is the most likely source of a fuel leak based upon SSME experience, but Booster will call any fuel leak downstream of the fuel flowmeter a nozzle leak. During a nozzle leak, fuel is lost overboard causing a decrease in thrust, and the SSME will command the OPOV open in an attempt to maintain a constant SSME thrust. As the leak rate gets larger, the OPOV will continue to open causing the actual SSME mixture ratio and thrust to increase. When the maximum OPOV command limit is exceeded, the SSME will enter a mode called thrust limiting where the OPOV will no longer be commanded to open further. If the leak rate continues to increase after thrust limiting, the actual SSME mixture ratio and thrust will start to decrease. Due to the difference in performance parameter trends for pre-thrust limiting and post-thrust limiting nozzle leaks, the Booster Main Engine Tables consider them separate performance cases for the ARD update. ©[070899-6819]

Pre-thrust limiting nozzle leaks will be assessed for an ARD update only when all four telemetry parameter deltas (HPOTP turbine discharge temperature, HPFTP turbine discharge temperature, HPFP discharge pressure, and OPOV position) exceed the level 1 criteria (fuel leak rate ≥ 7 lbm/sec) listed in the Booster Main Engine Tables (approved at the A/EFTP # 152 on September 18, 1998). The minimum criteria protects against erroneously calling the case due to prediction deviations, and it reliably differentiates this case from other cases that have similar SSME temperature, pressure, and valve movements. ©[070899-6819] ©[022707-8201]

THIS RULE CONTINUED ON NEXT PAGE

FLIGHT RULES

A5-110

SSME PERFORMANCE DISPERSION (CONTINUED)

8. POST-THRUST LIMITING NOZZLE LEAKS WILL BE CALLED WITH THRUST LIMITING FLAG SET.
9. AN HPOTP EFFICIENCY LOSS WILL BE CALLED WITH THRUST LIMITING FLAG SET. @[022707-8201]

An ARD update will be made for a post-thrust limiting nozzle leak or HPOTP efficiency loss case only when the SSME has entered the thrust-limiting mode. Subsequent to thrust limiting, the two cases are differentiated by using the HPOTP turbine discharge temperature. The HPOTP turbine discharge temperature will rise in both of the thrust limiting cases, but the delta value is much greater in the case of a nozzle leak. In order to differentiate between the two cases, the HPOTP discharge temperature delta cue was developed as the breakover value for each of these cases. The HPOTP efficiency loss will not result in off-nominal SSME performance prior to thrust limiting; therefore, it is only assessed after thrust limiting is initiated.

The SSME Project Office acknowledges that there are "Overall Call Uncertainties" associated with each of the off-nominal SSME performance cases. Uncertainties exist in thrust, mixture ratio, and Isp values. Subsequent to the quantification of an off-nominal performance case, thrust, mixture ratio, and Isp are passed to the Flight Dynamics Officer and are used to update the ARD. The "level to level" uncertainties associated with each of these parameters, for each of the performance cases, are documented in MSFC letter EE21/095-016 (Review of Booster Real-time Software (BRTS) Algorithm's, D.R. Goslin to B.R. Stone, March 17, 1995). On February 6, 1996, the Integration Control Board (ICB) made the decision not to protect these uncertainties due to the low probability of off-nominal SSME performance occurring (ICB Item WACMO0167, Booster Console Uncertainty on ARD Performance). Therefore, ARD Flight Performance Reserve (FPR) does not reflect these uncertainties. Likewise, FPR does not reflect thrust, mixture ratio, and Isp uncertainties that may exist in the presence of a less than "level 1" performance case which is the smallest real-time detectable performance case. FPR has protection for flight derived dispersions of thrust, mixture ratio, and Isp. @[041196 1877]

Rules {A4-61}, THRUST LIMITING, HYDRAULIC, OR ELECTRICAL LOCKUP, and {A5-108}, MANUAL SHUTDOWN FOR HYDRAULIC OR ELECTRICAL LOCKUP [HC], reference this rule. @[061297-6147A] @[ED]@[070899-6819] @[102506-7352] @[022707-8201]

FLIGHT RULES

A5-111

AC BUS SENSOR ELECTRONICS CONTROL [CIL]

THE ORBITER AC BUS SENSOR ELECTRONICS POWER SWITCH WILL BE PLACED TO "OFF" FOR THE FOLLOWING ENGINE FAILURE CASES:

- A. ENGINE OUT (REF. RULE {A9-152}, AC BUS SENSORS SWITCH MANAGEMENT) @[121296-4624]
- B. CONFIRMED LOSS OR SUSPECTED LOSS OF SSME CONTROLLER REDUNDANCY (REF. RULE {A5-2}, SPACE SHUTTLE MAIN ENGINE OUT) @[ED] @[042706-7365]
- C. BFS ENGAGE WITH AN UNEXPLAINED MAJOR COMPONENT FAILURE (MCF) POSTED IN THE ENGINE STATUS WORD
- D. ALL QUALIFIED REDLINE SENSORS ON A SINGLE REDLINE, ON A SINGLE CHANNEL, VOTING FOR SHUTDOWN EXCEPT FOR RTVMS REDLINE ACCELEROMETERS @[121296-4624] @[042706-7365]

There are single point failures in the ac bus sensor electronics that can cause loss of a single phase of an ac bus which powers the SSME controllers. After an engine failure, electrical/avionics/sensor failures, or suspected failures that leave an engine one failure away from shutdown, the bus overvoltage protection is less important than keeping an engine running. Therefore, the sensor monitoring electronics power is terminated by moving three switches (AC BUS SNSR) on panel R1 to OFF. An electrical/avionics/sensor failure is confirmed by the appropriate Failure Identifier (FID) posted by the SSME controller (for example, DCU A disqualification or OE B disqualification). If the cause of an SSME data path failure is suspected to be due to the loss of controller redundancy, the controller channel will be assumed failed. Since the FID word is not downlisted by the BFS, unexplained MCF's posted after BFS engage will be assumed to be loss of controller redundancy. If all qualified redline sensors on a single redline, on a single channel, are voting for shutdown, the loss of the other controller channel will result in the SSME shutting down. For this reason, the AC BUS SNSR switches are taken to OFF in order to avoid the loss of the controller channel with the redline sensors not voting for shutdown. Paragraph D above does not apply to the Real-Time Vibration Monitoring System (RTVMS) Redline Accelerometers since loss of a single phase of an ac bus will cause loss of the RTVMS vibration redline function (rather than cause a shutdown). RTVMS is only a fail-safe system. @[042706-7365]

FLIGHT RULES**A5-112****MANUAL THROTTLEDOWN FOR LO₂ NPSP PROTECTION AT SHUTDOWN [HC]** @[102506-7860B]

MANUAL THROTTLING TO THE MINIMUM SSME POWER LEVEL WILL BE PERFORMED TO PROTECT MECO LO₂ NPSP REQUIREMENTS FOR A SINGLE ENGINE RUNNING OR WHEN LO₂ LOW-LEVEL CUTOFF IS PREDICTED TO OCCUR BEFORE FINE COUNT THROTTLEDOWN FOR TWO OR THREE ENGINES RUNNING. MANUAL THROTTLING TO THE MINIMUM POWER LEVEL WILL BE PERFORMED WHEN THE ONBOARD PROPELLANT REMAINING COMPUTATION REACHES 2 PERCENT FOR THE FOLLOWING CASES: @[071494-1645] @[121296-4630B]

- A. TWO OR THREE ENGINES ON: WHEN THE MCC FLIGHT DYNAMICS OFFICER (FDO) IS PREDICTING A VELOCITY UNDERSPEED AT MECO WHICH IS GREATER THAN 500 FT/SEC
- B. ONE ENGINE ON: THE CREW WILL ALWAYS PERFORM MANUAL THROTTLING EXCEPT FOR CERTAIN CONTINGENCY ABORT CASES AS DOCUMENTED ON THE CONTINGENCY ABORT CUE CARDS IN THE ASCENT CHECKLIST FLIGHT DATA FILE OR UNLESS INSTRUCTED TO DO OTHERWISE BY MCC. @[071494-1645] @[121296-4630B]

ONCE MANUAL THROTTLING IS INITIATED FOR NPSP PROTECTION, THE CREW WILL MAINTAIN MANUAL THROTTLES AND THEN PERFORM A MANUAL MECO AT THE DESIRED CUTOFF VELOCITY.

If AUTO throttles are selected and a low-level cutoff occurs for a single engine running, or if FDO is predicting a low-level cutoff prior to the guidance software issuing the fine count command for two or three engines running (ref. rationale of Rule {A4-59G}, MANUAL THROTTLE SELECTION [HC]), the engine(s) will shut down at an unsafe power level due to a low LO₂ NPSP condition. The LO₂ NPSP violation during shutdown may cause uncontained engine damage.

For the two or three engine running cases, analysis indicates that the vehicle acceleration near MECO will be sufficient to prevent SSME shutdown prior to fine count as long as the predicted underspeed (based on 2 sigma MPS propellant protection) is no greater than 500 ft/sec. If left in AUTO, the fine count throttle setting of 91 percent for one engine running will create an NPSP violation if the engine experiences a low level cutoff. The two/three engine running case assumes a vehicle mass of 379,000 lbs at MECO minus 10 seconds. Both cases assume that the thrust provided by a single engine at 104 percent is 488,800 lbf. The 500 ft/sec cue is derived from using the $F = M \cdot A$ equation, as well as those used by the fine count throttle logic in the guidance software (reference NASA memorandum DF6-94-08, dated May 11, 1994). If the predicted underspeed for two or three engines running is greater than 500 ft/sec, manual throttling will be performed to the minimum power level, thereby reducing the NPSP requirements prior to reaching a low-level cutoff condition. @[102506-7860B]

THIS RULE CONTINUED ON NEXT PAGE

FLIGHT RULES

A5-112

MANUAL THROTTLEDOWN FOR LO2 NPSP PROTECTION AT SHUTDOWN [HC] (CONTINUED)

For the single engine case, it is assumed that there will be a low-level cutoff, so the crew will manually throttle to the minimum power level, except for certain contingency abort cases or unless crew workload is high and the MCC can predict with confidence that there will be zero underspeed. The minimum throttle level was selected because it provides the best LO₂ NPSP shutdown conditions. The throttledown cue of 2 percent propellant remaining was selected to allow sufficient time to perform the manual throttling while minimizing any performance impact. ®[102506-7860B]

Analysis (reference Ascent/Entry Flight Techniques Panel #91, July 17, 1992) shows that most of the error in the onboard propellant remaining computation occurs on the two-engine-out press-to-MECO abort when no OMS dump is performed. Engine performance problems also contribute to the propellant remaining error. The worst case engine problem is low specific impulse (Isp). Worst-on-worst analysis with two engines out simultaneously at the press-to-MECO boundary and the third engine running with an Isp which is 10 seconds below nominal shows that the 2 percent cue still provides sufficient time to throttle the engine down before low-level cutoff occurs. ®[071494-1645]

After manual throttledown, the crew will be prepared to perform a manual MECO at the desired MECO velocity should it be reached prior to the low-level cutoff.

The crew will not always throttleback for the one engine-on case. For certain contingency aborts, the software determines and performs fine count throttles (throttleback) as required for MECO. No manual throttles are required in these cases as documented on the contingency abort cue cards in the ascent checklist flight data file. ®[121296-4630B]

Hazard Report IMPS-08, Underpressurization of the Integrated MPS O₂ System, is controlled by this rule.

Rules {A2-64}, MANUAL THROTTLE CRITERIA; {A4-59}, MANUAL THROTTLE SELECTION [HC]; and {A5-152}, PRE-MECO MPS HELIUM SYSTEM INTERCONNECTS [CIL] [HC], reference this rule. ®[102506-7860B]

FLIGHT RULES

A5-113

MANUAL MECO/MECO CONFIRMED @[110900-7230A]

A. PERFORMING MANUAL MECO

MANUAL MECO IS PERFORMED BY PRESSING ALL THREE MAIN ENGINE SHUTDOWN PUSHBUTTONS SIMULTANEOUSLY. IF FAILURE(S) CAUSE THE MAIN ENGINE SHUTDOWN PUSHBUTTONS TO NOT COMMAND MECO, THEN THE MANUAL MECO WILL BE PERFORMED VIA THE ALTERNATE METHODS FOR SETTING THE MECO CONFIRMED FLAG OUTLINED IN PARAGRAPH B.

If required, manual MECO is usually performed by pressing the three SSME shutdown pushbuttons simultaneously. The crews are trained to perform manual MECO using all three pushbuttons rather than just the pushbuttons of running engines because pushing all three pushbuttons protects against certain failure scenarios without creating any additional risk. However, under certain conditions, pressing all three pushbuttons will not command MECO. If a failed contact (i.e., due to control bus or bad contact) on any pushbutton cannot be comm-faulted prior to MECO or if both contacts have either failed or are comm-faulted, MECO will not be commanded when all three pushbuttons are pushed. These failures will result in two engines being shut down while the engine associated with the bad pushbutton will continue to run. If such a failure is recognized prior to MECO and manual MECO is required, the crew will be instructed to command MECO by setting the MECO confirmed flag via the appropriate alternate method outlined in paragraph B.

Performing a manual MECO on any trajectory is very time critical, and it must be recognized ahead of time if the three pushbuttons will not work so that alternate methods may be employed at the required moment.

B. SETTING THE MECO CONFIRMED FLAG

THE THREE MAIN ENGINE SHUTDOWN PUSHBUTTONS WILL BE PUSHED POST MECO FOR MULTIPLE COMMAND/DATA PATH FAILURE CASES TO SET THE MECO CONFIRMED FLAG. IF THE MECO CONFIRMED FLAG WILL NOT BE SET WHEN THE SHUTDOWN PUSHBUTTONS ARE PRESSED, IT WILL BE OBTAINED VIA THE FOLLOWING ALTERNATE METHODS:

1. NOMINAL/ATO/TAL: MANUALLY PROCEEDING TO OPS 104
2. RTLS: PERFORMING A FAST SEP FROM THE EXTERNAL TANK
@[110900-7230A]

THIS RULE CONTINUED ON NEXT PAGE

FLIGHT RULES

A5-113

MANUAL MECO/MECO CONFIRMED (CONTINUED)

The SSME operations sequence will set the MECO confirmed flag for chamber pressure less than 30 percent on all three engines or a data path failure on one engine and the chamber pressure less than 30 percent on the other two engines. If two engines experience a data path failure, the software will never pass this check and MECO confirmed flag will not be set. To work around this problem, the crew can push the three shutdown pushbuttons after MECO to set the MECO confirmed flag. Prior to OI-22, all three SSME pushbuttons had to be pressed simultaneously in order to set the MECO confirmed flag in the BFS. In OI-22 and subsequent, the SSME pushbuttons can be pressed individually to set the MECO confirmed flag (CR# 89203A). The MECO confirmed flag must be set to start the ET separation sequence. ©[110900-7230A]

In the event that multiple avionics failures or a failed pushbutton contact has disabled a shutdown pushbutton, alternate methods of setting the MECO confirmed flag must be performed. On nominal ATO and TAL trajectories, the MECO confirmed flag can be set by manually keying in OPS 104 PRO. Since the OPS 104 transition is not legal on an RTLS trajectory, the MECO confirmed flag must be set by performing a fast sep from the external tank. A fast sep is performed by taking the ET SEPARATION switch to MAN and pressing the ET SEPARATION pushbutton. In PASS, fast sep logic is only supported in major modes 102, 601, or in major mode 103 when the Second SSME Fail Confirm flag had been set. BFS only supports fast sep logic in major mode 102. ©[110900-7230A]

The above steps are taken post MECO because setting the MECO confirmed flag at or before MECO causes MECO to be commanded. On uphill and TAL trajectories, setting the MECO confirmed flag to allow the ET separation sequence to proceed is not particularly time critical so the three pushbuttons can be tried first before other methods. However, setting MECO confirmed on an RTLS trajectory is very time critical. In time critical situations, it must be recognized ahead of time if the three pushbuttons will not work so that alternate methods may be employed at the required moment. ©[110900-7230A]

*Reference Rule {A5-104}, DATA PATH FAIL/ENGINE-ON LIMIT SHUTDOWN CONTROL.
©[121296-4594A]*

FLIGHT RULES

A5-114 **SSME HYDRAULIC REPRESSURIZATION/POSTLANDING SSME REPOSITIONING**

A. ON-ORBIT/ENTRY-1 DAY REPRESSURIZATION

APPLICATION OF MPS HELIUM TO SSME VALVE ACTUATORS IS NOT REQUIRED DURING HYDRAULIC REPRESSURIZATION AND SSME REPOSITIONING WHEN THE TVC ACTUATORS DRIFT OUT OF POSITION PER FLIGHT RULE {A8-106}, TVC-SSME STOW/ACTUATOR FLUID FILL (REPRESSURIZATION).

B. ENTRY/POSTLANDING REPOSITIONING

MPS HELIUM WILL BE PROVIDED TO THE ENGINES DURING HYDRAULIC REPRESSURIZATION AND SSME REPOSITIONING. THIS ENSURES THAT ENGINE VALVES DO NOT DRIFT OPEN. HOWEVER, LACK OF HELIUM IS NOT A CONSTRAINT AGAINST PERFORMING EITHER PROCEDURE.

Hydraulic pressure is applied to the TVC actuators to prevent SSME movement during on-orbit, entry, and postlanding operations. Maintaining helium pressure on the closed side of the engine valves will keep the valves from opening when hydraulic pressure is applied to the TVC actuators. Keeping the valves closed prevents engine contamination during entry and postlanding. On-orbit SSME contamination is unlikely; therefore, the application of helium for on-orbit TVC drift is not required. This will also reduce MPS helium regulator cycles.

A5-115 THROUGH A5-150 RULES ARE RESERVED

FLIGHT RULES

MPS MANAGEMENT: PRELAUNCH THROUGH MECO

A5-151 PRE-MECO MPS HELIUM SYSTEM LEAK ISOLATION [CIL]

- A. MPS ENGINE SYSTEM HELIUM LEAK ISOLATION WILL BE PERFORMED FOR ANY SIGNIFICANT LEAK (PER RULE {A5-10}, SIGNIFICANT ENGINE HELIUM SYSTEM LEAK) AS LONG AS THE ATTEMPT TO ISOLATE THE LEAK WILL NOT CAUSE THE ENGINE TO SHUT DOWN. @[090894-1676A] @[ED]

If an MPS engine helium system experiences a helium leak the crew will perform a helium leak isolation procedure. However, since certain power bus failures will result in helium leg A isolation valves failing closed (MNA, APC4 or ALC1; MNB, APC5 or ALC2; or MNC, APC6 or ALC3 failure will close the center, left, or right SSME isolation valve, respectively), the crew must be reminded not to attempt leak isolation for these cases. The closing of the leg B isolation valve will stop helium flow to the engine and cause an SSME redline limit shutdown due to low HPOTP intermediate seal (IMSL) purge pressure. The shutdown may cause engine damage since both regulator isolation valves are closed. No helium will be available for SSME IMSL purging during the shutdown sequence.

- B. AN ATTEMPT WILL BE MADE TO ISOLATE ANY SIGNIFICANT PNEUMATIC SYSTEM LEAK (REF. RULE {A5-11}, SIGNIFICANT PNEUMATIC SYSTEM HELIUM LEAK). @[ED]

A significant pneumatic system helium leak could result in insufficient pressure for prevalve actuation at MECO. The LO₂ prevalves are required to close at MECO in order to maintain pressure at the HPOTP pump inlet. This prevents pump cavitation and overspeed which could result in uncontained SSME damage. An attempt is made to isolate the pneumatic helium supply so the remaining helium can be used to pressurize the pneumatic accumulator and support prevalve closure at MECO.

- C. IF AN MPS PNEUMATIC HELIUM SYSTEM LEAK/ISOLATION CAUSES INSUFFICIENT PNEUMATIC HELIUM ACCUMULATOR PRESSURE (REF. RULE {A5-12}, INSUFFICIENT PNEUMATIC HELIUM ACCUMULATOR PRESSURE), THE SYSTEM WILL BE RECONFIGURED AT MECO-30 SECONDS. @[ED]

Seven hundred psia in the pneumatic accumulator is the minimum non-resupplied pressure which will close all the LO₂ prevalves within timing constraints at MECO. If the pneumatic helium supply has been isolated due to a leak or is used to support the mainstage operation of an engine with a helium leak, the pneumatic accumulator pressure may fall below 700 psia. Should the accumulator pressure fall below 700 psia for any reason, the pneumatic helium isolation valves, the left engine helium crossover valve and, if necessary, the engine interconnect valves, will be reconfigured to repressurize it. This will be accomplished at MECO minus 30 seconds and ensures that 700 psia is available in the pneumatic accumulator until the start of prevalve closure at MECO.

Note: Taking the interconnect out-open to open on an engine when the pneumatic tank is depleted will not cause a large enough flow transient to cause the engine to shut down (documented by RI Downey internal letter number 287-100-93-259, dated November 9, 1993). @[090894-1676A]

FLIGHT RULES

A5-152

PRE-MECO MPS HELIUM SYSTEM INTERCONNECTS [CIL]
[HC] @[032807-8398]

- A. TO SUSTAIN THE OPERATION OF AN ENGINE WITH AN MPS HELIUM LEAK, FOR SINGLE REGULATOR OPERATION, OR FOR EXTENDED BURN TIME, HELIUM SYSTEM INTERCONNECTS WILL BE PERFORMED AT THE FOLLOWING CUES: @[090894-1676A] @[050400-7195A]

If a helium leak develops and the decay rate is such that the engine will not meet zero-g shutdown requirements or will cause an early shutdown, the helium system of another engine and/or the pneumatic helium system will be interconnected to that engine's system. This action may allow the engine to meet the zero-g shutdown requirements and will maintain engine operation as long as possible. Similar action is taken if the leak has been isolated and the system will not meet shutdown requirements.

A tank pressure of 920 psia (900 psia required +20 psia instrumentation error) is the minimum value, including instrumentation error, which will support the normal operating range of the helium system regulators. The difference between the actual requirement, 920 psia, and the C&W value, 1150 psia, results from a change in the estimated instrumentation error of the helium tank pressure transducers as a result of vehicle specific calibration curves. With calibration curve coefficients unique to each helium tank pressure transducer, the accuracy of each reading is 0.15 percent. An accuracy of 0.15 percent over the 5000 psia transducer range equates to an error of 7.5 psia. To account for any potential degradation in accuracy (e.g., transducer replacements where the new transducer is less accurate or calibration equipment changes), one PCM count (10 psia) was added to the 7.5 psia error. This new instrumentation error of 17.5 psia was then rounded to the nearest PCM count resulting in 20 psia instrumentation error used by the MCC and incorporated into crew procedures. The interconnect cues shown in the subsequent paragraphs are used as guidelines to ensure sufficient helium to sustain SSME operation with a helium leak. It is important to note that the interconnect must be performed above the minimum tank pressure required to support the shutdown mode. The tank pressure of 920 is quoted as the "no later than" cue in order to provide the absolute minimum tank pressure above which the interconnect must be performed. Since there is not one tank pressure interconnect to satisfy all cases (leak types, shutdown mode, leak size, etc.), the C&W cue of 1150 is sufficient for the crew to use in no-comm cases. The change in calculated instrumentation error did not warrant a change to the onboard software or hardware caution and warning. @[050495-1767B] @[100997-6298] @[110900-7239] @[032807-8398]

THIS RULE CONTINUED ON NEXT PAGE

FLIGHT RULES

A5-152

**PRE-MECO MPS HELIUM SYSTEM INTERCONNECTS [CIL]
[HC] (CONTINUED)**

Since the helium tank and regulator pressure requirements were derived using vehicle specific calibration curves, it must be noted that the onboard readings will vary between the BFS GNC SYS SUMM 1 display and the OMS/MPS MEDS display. The BFS GNC SYS SUMM 1 data is based on vehicle specific calibration curve coefficients; whereas due to system limitations, the OMS/MPS MEDS display is based on generic calibration curve coefficients. When the MCC calls for an interconnect or SSME shutdown based on a helium tank or regulator pressure, it is understood that the crew will use the data available on the BFS GNC SYS SUMM 1 display. This understanding was accepted by CB, DT, and DA8 (reference AEFTP #152, September 18, 1998). If the BFS has failed and the MEDS display is required to be used, a +100 psia instrumentation error bias will be added to the pressure cue. ©[110900-7239] ©[032807-8398]

Dropping helium system regulator outlet pressure is also used to detect potential SSME HPOTP intermediate seal (IMSL) purge pressure violations. If both helium regulators have been in steady state operation between 715 psia and 785 psia outlet pressure, a sudden decrease in outlet pressure may be indicative of a system failure. Action is taken as soon as both regulator outlet pressures fall below 715 (679) psia in an attempt to prevent the engine from shutting down. Six hundred and seventy nine psia was derived from the minimum normal regulator outlet pressure, 715 psia, minus 36 psia instrumentation error prior to OI-26B. For OI-26B and subsequent flights, the instrumentation error was reduced to 5 psia. However, the Caution and Warning limit remains at 679 psia because the change to 5 psia would result in a Caution and Warning value very close to the nominal control band of the regulator (regulator is psig, instrumentation is psia) and was not considered worth the effort in updating Caution and Warning. With regard to helium system leaks, a regulator outlet pressure below 715 psia does not indicate that the regulator is malfunctioning. Low outlet pressures are indicative of helium system leaks which result in high helium mass flow rates or supply tank depletion resulting in low inlet pressures to the system regulators. Taking action at 679 psia not only prevents premature helium system interconnecting, but also gives some assurance that another helium system can be interconnected to the leaking supply before the engine interface pressure reaches the expected shutdown value of 576 psia for the BLOCK II SSME (reference SODB data request R1-1640) even with the reduction in instrumentation error with OI-26B. ©[050495-1767B] ©[020196-1812] ©[121197-6472A] ©[050400-7195A] ©[110900-7239] ©[032807-8398]

THIS RULE CONTINUED ON NEXT PAGE

FLIGHT RULES

A5-152

**PRE-MECO MPS HELIUM SYSTEM INTERCONNECTS [CIL]
[HC] (CONTINUED)**

1. FOR A NON-ISOLATABLE UPPER SYSTEM LEAK: @[050400-7195A]
 - a. WITH THREE ENGINES ON, HELIUM SYSTEM INTERCONNECTS WILL BE PERFORMED AS LATE AS PRACTICAL, BUT ABOVE THE MINIMUM ENGINE TANK PRESSURE REQUIRED TO SUPPORT THE ENGINE SHUTDOWN MODE PER RULE {A5-153}, PRE-MECO SHUTDOWN OF ENGINES DUE TO MPS HELIUM LEAKS, AND NO LATER THAN 900 PSIA (920 PSIA) TANK PRESSURE ON THE AFFECTED ENGINE OR WHEN BOTH HELIUM SYSTEM REGULATOR PRESSURES ARE BELOW 715 (679) PSIA. @[050495-1767B] @[110900-7239]

When a non-isolatable upper system leak occurs, it is best to perform helium interconnects as close to the minimum shutdown requirement as possible. If the interconnect is performed too early and the system leak is a tank leak, helium in the leaking tank will no longer be used to support engine operation and will therefore be wasted.

- b. WITH LESS THAN THREE ENGINES ON, HELIUM SYSTEM INTERCONNECTS WILL BE PERFORMED AS SOON AS PRACTICAL BUT ABOVE THE CUES GIVEN IN PARAGRAPH A.1.a.

When a non-isolatable upper system leak exists after a different engine has shut down, helium interconnects can be performed as soon as practical. An upper system leak could be either a leak in the engine's helium tank or an upper system leak above the helium regulators. If the leak is an upper system leak, then interconnecting as soon as practical does not waste any helium. If the leak is in the tank, interconnecting as soon as practical will result in the helium from the leaking tank being wasted. However, a good interconnect from a previously shutdown engine will provide a nominal feed rate to the engine with the tank leak and will allow it to support a zero-g shutdown. Interconnecting early not only allows the reconfiguration to take place while the crew is in a low g environment, but also allows for an earlier assessment of the shut down requirements of the leaking engine. @[050400-7195A] @[032807-8398]

THIS RULE CONTINUED ON NEXT PAGE

FLIGHT RULES

A5-152

**PRE-MECO MPS HELIUM SYSTEM INTERCONNECTS [CIL]
[HC] (CONTINUED)**

2. FOR A NON-ISOLATABLE LOWER SYSTEM LEAK, HELIUM SYSTEM INTERCONNECTS WILL BE PERFORMED AS SOON AS PRACTICAL, BUT ABOVE THE MINIMUM ENGINE TANK PRESSURE REQUIRED TO SUPPORT THE ENGINE SHUTDOWN MODE PER RULE {A5-153}, PRE-MECO SHUTDOWN OF ENGINES DUE TO MPS HELIUM LEAKS, AND NO LATER THAN 900 PSIA (920 PSIA) TANK PRESSURE ON THE AFFECTED ENGINE OR WHEN BOTH HELIUM SYSTEM REGULATOR PRESSURES ARE BELOW 715 (679) PSIA. @[050495-1767B] @[050400-7195A] @[110900-7239]

For non-isolatable lower system leaks, helium interconnects can be performed immediately after leak identification, but must be performed above the minimum tank pressure needed to support engine shutdown. A leak below the regulator will have the same mass flow rate after the interconnect that it had prior to the interconnect. Interconnecting early allows the reconfiguration to take place while the crew is in a low g environment.

3. WITH TWO ENGINES OPERATING: FOR A NON ISOLATABLE LEAK ON AN OPERATING ENGINE THAT REQUIRES INTERCONNECTING THE HELIUM SYSTEM OF THE NON-LEAKING RUNNING ENGINE, THE INTERCONNECT WILL BE PERFORMED WHEN THE TANK PRESSURES ON ALL PREVIOUSLY INTERCONNECTED SYSTEMS REACH 500 PSIA OR THE LEAKING SSME HPOTP IMSL PRESSURE REACHES 70 PSIA.

NOTE: THIS INTERCONNECT IS NOT PERFORMED IF THE NON-LEAKING ENGINE HAS ALREADY SUPPORTED A RUNNING INTERCONNECT.

If the leaking engine supply, the previously shut down engine supply, and the pneumatic supply are insufficient to obtain single engine abort capability to a landing site, interconnecting is also allowed, within certain limits, from the remaining engine which has a good MPS helium supply in an attempt to regain landing site abort capability per paragraph B.2.a. Because an attempt is being made to avoid a contingency abort due to insufficient MPS helium, the interconnect from a non leaking running SSME helium supply to an engine with a leaking helium supply will be performed as late as is reasonably possible. The interconnect will be performed once the leaking system reaches 500 psia (500 psia is a generic tank pressure which, with SSME limits inhibited, should ensure that crossover margin is maintained in the SSME HPOT IMSL package) or an HPOTP IMSL pressure of 70 psia (70 psia provides 10 psia interconnect margin against the Block II SSME limit of 60 psia in Rule {A5-153C}.2.a, PRE-MECO SHUT DOWN OF ENGINES DUE TO MPS HELIUM LEAKS). An interconnect cue of 500 psia in the tank or 70 psia in the IMSL package should also prevent the SSME HPOTP IMSL pressure from decaying below 60 psia while the SSME is operating. @[050400-7195A] @[032807-8398]

THIS RULE CONTINUED ON NEXT PAGE

FLIGHT RULES

A5-152

**PRE-MECO MPS HELIUM SYSTEM INTERCONNECTS [CIL]
[HC] (CONTINUED)**

If the non-leaking engine has already supported a running interconnect (either a two or three engine operational running interconnect), an additional running interconnect should not be performed since this may cause the non-leaking engine to violate its zero-g helium requirement. ©[032807-8398]

4. FOR SINGLE REGULATOR OPERATION OF THE MPS HELIUM SYSTEM, HELIUM SYSTEM INTERCONNECTS WILL BE PERFORMED AS SOON AS PRACTICAL, BUT ABOVE THE MINIMUM TANK PRESSURE REQUIRED TO SUPPORT THE SINGLE REGULATOR SHUTDOWN MODE PER RULE {A5-153}, PRE-MECO SHUTDOWN OF ENGINES DUE TO MPS HELIUM LEAKS, AND NO LATER THAN 900 PSIA (920) OR WHEN BOTH HELIUM SYSTEM REGULATOR PRESSURES ARE BELOW 715 (679) PSIA. ©[050495-1767B] ©[050400-7195A] ©[110900-7239]

If a helium system is operating on a single regulator, due to an isolated leak or any other system failure, the resulting mass flow rate of helium through the system is nominal. Therefore, helium system interconnects may be accomplished as soon as convenient. When operating on a single regulator, all shut down modes must protect for single regulator operation. A single regulator providing helium flow to an engine must flow the equivalent helium of two operating regulators. Higher pressures must be maintained at the regulator inlet in order to ensure that shutdown pressure and mass flow rate requirements are satisfied.

5. FOR AN ENGINE REQUIRING EXTENDED ENGINE BURN TIME, HELIUM SYSTEM INTERCONNECTS WILL BE PERFORMED AS SOON AS PRACTICAL, BUT ABOVE THE MINIMUM ENGINE TANK PRESSURE REQUIRED TO SUPPORT THE ENGINE SHUTDOWN MODE PER THE HELIUM CURVES FOR A NON-ISOLATABLE LOWER SYSTEM LEAK WITH NOMINAL FLOW RATE GIVEN IN RULE {A5-153E}.1, PRE-MECO SHUTDOWN OF ENGINES DUE TO MPS HELIUM LEAKS, AND NO LATER THAN 900 PSIA (920 PSIA) TANK PRESSURE ON THE AFFECTED ENGINE OR WHEN BOTH HELIUM SYSTEM REGULATOR PRESSURES ARE BELOW 715 (679) PSIA. ©[110900-7239]

If the predicted MECO time is extended due to low ascent performance or an abort requirement such that interconnecting is necessary to meet shutdown requirements, the pneumatic system and the helium system of any failed engine can be interconnected to a running engine as soon as practical. The minimum tank pressure which will support a zero-g shut down of an engine with two good regulators and no helium leak is given in the helium curves for a non-isolatable lower system leak with nominal flow rate in rule {A5-153E}.1, PRE-MECO SHUTDOWN OF ENGINES DUE TO MPS HELIUM LEAKS. Since an engine with extended burn time has a constant helium usage, the curve for an engine with a non-isolatable lower system helium leak is used to define the minimum zero-g requirement. ©[090894-1676A] ©[050400-7195A]

THIS RULE CONTINUED ON NEXT PAGE

FLIGHT RULES

A5-152

PRE-MECO MPS HELIUM SYSTEM INTERCONNECTS [CIL]
[HC] (CONTINUED)

6. IN THE NO-COMM CASE, THE CREW WILL PERFORM HELIUM SYSTEM INTERCONNECTS AT A SYSTEM PRESSURE OF 1150 PSIA OR WHEN BOTH HELIUM SYSTEM REGULATOR PRESSURES ARE BELOW 715 (679) PSIA. @[050400-7195A]

In the loss of comm case, crew action is taken at 1150 psia. 1150 psia is the C&W limit. The alarms and tones annunciated at 1150 psia are a good reminder to the crew that action needs to be taken. If the tank pressure reaches this value and continues to fall, the engine HPOTP IMSL purge redline limit may be violated. Action is taken at 1150 psia to preclude an early engine out situation while making as much use of available helium as possible. The engine IMSL seal limit should not be violated until the pressure decays below approximately 576 psia at the engine interface for the BLOCK II SSME (ref. SSME test 901-835 and the 09-13-95 PSIG). @[050495-1767B] @[020196-1812] @[100997-6298] @[121197-6472A] @[110900-7239] @[032807-8398]

- B. IF THE INTERCONNECT CUES IN PARAGRAPH A ARE MET, THE INTERCONNECT OF THE PNEUMATIC HELIUM SYSTEM OR THE HELIUM SYSTEM OF ANOTHER ENGINE WILL BE PERFORMED PER THE FOLLOWING CONDITIONS: @[090894-1676A] @[100997-6298]

If an engine helium supply is depleting due to a leak, or helium shut down requirements are not met due to extended burn times or single regulator operation, interconnecting other helium systems will be allowed in some situations to sustain the operation of an engine.

1. WITH THREE ENGINES ON:
- a. NOMINAL/ATO:
- (1) IF THE LEAKING SYSTEM IS PREDICTED TO RUN PAST VI=23K, THEN ONLY THE PNEUMATIC SYSTEM WILL BE INTERCONNECTED AND THE ENTIRE PNEUMATIC TANK WILL BE USED IF REQUIRED. @[032807-8398]

THIS RULE CONTINUED ON NEXT PAGE

FLIGHT RULES

A5-152

**PRE-MECO MPS HELIUM SYSTEM INTERCONNECTS [CIL]
[HC] (CONTINUED)**

- (2) IF THE LEAKING SYSTEM IS NOT PREDICTED TO RUN PAST VI=23K WHILE INTERCONNECTED TO THE PNEUMATIC SYSTEM, THEN THE PNEUMATIC SYSTEM AND A PORTION OF THE HELIUM IN ONE NON-LEAKING MPS HELIUM SYSTEM WILL BE INTERCONNECTED TO THE LEAKING SYSTEM. AT THE APPROPRIATE INTERCONNECT CUE, AS DEFINED IN PARAGRAPH A, THE IN-OPEN INTERCONNECT VALVE FROM THE LEAKING ENGINE AND THE OUT-OPEN INTERCONNECT VALVE FROM THE NON-LEAKING ENGINE SHALL BE OPENED SIMULTANEOUSLY. FOLLOWING A PREDETERMINED PERIOD OF TIME, AS DETERMINED BY THE BOOSTER CONSOLE TEAM, AND PRIOR TO THE SHUTDOWN OF THE LEAKING ENGINE, THE OUT-OPEN INTERCONNECT VALVE SWITCH FOR THE NON-LEAKING ENGINE SHALL BE RETURNED TO THE GPC POSITION. THE REST OF THE PNEUMATIC TANK MAY BE USED IF REQUIRED. @[032807-8398]

NOTE: IMMEDIATELY FOLLOWING THE INTERCONNECT FROM THE NON-LEAKING ENGINE, IF THE LEAK IS DETERMINED TO BE AN UPPER SYSTEM TANK LEAK, THE OUT-OPEN INTERCONNECT VALVE FROM THE NON-LEAKING ENGINE MAY BE LEFT IN THE OUT-OPEN POSITION LONGER THAN THE PREVIOUSLY DETERMINED INTERCONNECT TIME, BUT MUST BE RETURNED TO THE GPC POSITION PRIOR TO SHUTTING DOWN THE LEAKING ENGINE.

b. TAL/RTLs:

ONLY THE PNEUMATIC HELIUM SYSTEM WILL BE INTERCONNECTED AND THE ENTIRE PNEUMATIC TANK WILL BE USED IF REQUIRED.

An engine-to-engine helium interconnect can be used to increase the run time of a leaking engine at the expense of helium margin in a non-leaking, running engine. Each main engine helium system is loaded with more helium than a nominally operating SSME requires to make it to orbit. By using this extra helium, the run time of the leaking SSME will be extended – potentially past a critical abort boundary. It is unlikely that a running interconnect could provide the leaking SSME with enough helium to satisfy its zero-g requirement, so this procedure is only used to extend the operation of the leaking SSME out to the nominal pre-MECO shutdown cue, if possible. @[032807-8398]

THIS RULE CONTINUED ON NEXT PAGE

FLIGHT RULES

A5-152

PRE-MECO MPS HELIUM SYSTEM INTERCONNECTS [CIL] [HC] (CONTINUED)

The duration of the running interconnect is determined by the Booster Console team, who obtain the data from a pre-flight derived cue card. The interconnect duration data found on this cue card was derived with the following assumptions: The leak rate will not increase, the donor engine must be left with enough helium following the interconnect to support a zero-g shutdown at 10:00 MET (approximately 30 seconds longer than the longest ATO trajectory), the quantity of helium in each MPS system at liftoff is greater than or equal to an average flight minus one-sigma, the nominal helium flow rate is one sigma larger than the flight average, and the "simultaneous" in-open and out-open interconnects occur within 5 seconds of each other. If the interconnects are not performed simultaneously, a shorter duration interconnect may be used if time permits. The duration of this shorter interconnect is also available on the cue card and was derived using similar assumptions, except that the donor engine's out-open interconnect valve is not opened until immediately before the SSME fails its redline. The determination of which non-leaking engine to use for the interconnect is left up to the console team. The derivation of the cue card was reviewed and approved at the PSIG, November 29, 2006. ©[032807-8398]

If the leak location turns out to be in the MPS helium tank, the donor engine will feed the leaking engine at a nominal usage rate instead of the leak rate. Hence, the extra helium in the donor engine's MPS system can maintain the operation of the leaking engine until the nominal pre-MECO shutdown cue without over compromising the donor engine's helium supply.

The running interconnect procedure should only take excess helium from one non-leaking system. If the margin in both remaining helium systems is consumed, then the remaining engines will not have enough helium to support operation throughout a long range abort, if additional failures make that abort necessary. Multiple interconnect events increase the probability that the procedure could be compromised by a failed-on interconnect valve, a broken switch, or other additional failure that could deplete a non-leaking engine's helium tank. If an additional failure happens on only one non-leaking SSME, then at least one full helium tank remains to support operation throughout a long-range abort.

The entire pneumatic helium tank will be used to sustain the operation of an engine, since sufficient helium margin should be available in the other two helium systems and the pneumatic accumulator to satisfy the zero-g requirements for pre-valve actuation, SSME pogo system post-charge, shutdown purges, and entry MPS manifold pressurization. If this procedure is performed, sufficient helium may not remain in the MPS helium tanks to support the full entry aft compartment purge. A reduced duration purge during entry is an appropriate trade for increasing engine run time during ascent. ©[090894-1676A]

This procedure was approved by the Ascent/Entry Flight Techniques Panel (A/EFTP) #218, March 31, 2006, with actions to verify the cue card use to determine the duration of the interconnect from the non-leaking engine and to perform analysis to ensure the non-leaking engine will not shut down when its helium system is interconnected to the leaking engine. The derivation of the running interconnect cue card was reviewed and approved at the PSIG, November 29, 2006. Analysis to ensure that the non-leaking engine will not shut down when its helium system is interconnected to the leaking engine was reviewed and approved at the PSIG, February 1, 2007. Open actions were completed and final approval was obtained at A/EFTP #227, February 16, 2007. ©[032807-8398]

THIS RULE CONTINUED ON NEXT PAGE

FLIGHT RULES

A5-152

PRE-MECO MPS HELIUM SYSTEM INTERCONNECTS [CIL]
[HC] (CONTINUED)

2. WITH TWO ENGINES ON: @[050400-7195A]
- a. INTERCONNECTING THE PNEUMATIC HELIUM SYSTEM AND THE HELIUM SYSTEM OF THE PREVIOUSLY SHUT DOWN ENGINE WILL BE PERFORMED.

For the two engine running case, interconnecting is allowed from the previously shut down engine and the pneumatic system. This will not only maximize the leaking engine run time but may also re-establish zero-g shutdown capability. @[110900-7239] @[032807-8398]

- b. INTERCONNECTING THE HELIUM SYSTEM OF THE NON-LEAKING RUNNING ENGINE WILL BE PERFORMED BY TAKING THE INTERCONNECT VALVE OF THE NON-LEAKING RUNNING ENGINE TO OUT OPEN FOR 15 SECONDS (ONE TIME ONLY) AND THEN BACK TO THE GPC POSITION IF ALL OF THE FOLLOWING CONDITIONS ARE SATISFIED:
- (1) THE INTERCONNECTS PER PARAGRAPH B.2.a WILL NOT ALLOW THE LEAKING ENGINE TO SUPPORT SINGLE ENGINE ABORT CAPABILITY TO A LANDING SITE (SINGLE ENGINE LIMITS OR SINGLE ENGINE RTLS BOUNDARY), AND
- (2) THE TOTAL FLOWRATE OF THE LEAKING SYSTEM HAS NEVER BEEN GREATER THAN 0.30 LBM/SEC.

Margin in the non-leaking, running SSME MPS helium supply will be used to support the operation of another SSME with a leaking supply. Interconnecting in this case will result in one MPS helium supply supporting two SSME's, one at an off-nominal flowrate. Consequently, the interconnect of a running supply will only be performed if the total flowrate of the leaking supply has never been greater than 0.30 lbm/sec. The 0.30 lbm/sec total flowrate requirement is a generic value which will provide at least 15 seconds, and at most 1.5 minutes, of additional runtime for the SSME with the leaking supply. Total flow rates above 0.30 lbm/sec make it extremely likely that either a second SSME will fail prior to reaching a certified abort boundary, or that helium available to the last SSME will be depleted to a level which is below MECO requirements. By not interconnecting for large leaks, three SSME out contingency aborts are avoided and a crew survival path is maintained by two SSME out abort coverage. @[100997-6298] @[121197-6472A] @[050400-7195A]

THIS RULE CONTINUED ON NEXT PAGE

FLIGHT RULES

A5-152

PRE-MECO MPS HELIUM SYSTEM INTERCONNECTS [CIL]
[HC] (CONTINUED)

Numerous assumptions had to be made in order to cover this case with a generic rule. All the variables were assigned generic values and discussed at Ascent Entry Flight Techniques #135 on October 18, 1996. The assumptions were as follows. The maximum allowable flowrate of the leaking system was derived for the RTLS abort case since three out black zones occur at a later MET than on a TAL. The first SSME shuts down at liftoff and a non isolatable lower system leak develops on one of the remaining engines at the same time. There is a total of 134 pounds of helium available from both the leaking engine and the one that shut down. Of an initial 13 pounds of helium in the pneumatic system, 10 are available to support the leaking system. Single engine operation of the last engine must be maintained, while preserving the zero g shutdown helium requirement, until an RTLS MECO time of 10:45 MET, which assumes 109 SSME throttles. Given this MECO time, there are 14 excess pounds of helium available from the running engine to support the leaking helium supply, resulting in a total of 158 pounds of helium available for the leaking engine. Assuming 2 1/2 minutes is the maximum run time needed for single engine completion of an RTLS contingency abort, the leaking engine must support a run time of 8:15 MET (MECO time minus 2 minutes 30 seconds). Assuming that 8 pounds of helium are required to support the shutdown of the leaking engine, the remaining 150 pounds would support the engine's operation until 8:15 MET as long as the leak rate is not greater than 0.30 lbm/sec. AEFTP was also made aware that a real-time or non-real-time redefinition of any of these variables might result in an outcome which varies from current predictions. However, in any case it is agreed that helium from the last SSME should be interconnected to a leaking supply in an attempt to reach a runway, as long as three SSME out black zones are protected. ®[100997-6298] ®[032807-8398]

The running, non-leaking SSME supply will only be interconnected for 15 seconds. This will keep the SSME running while the pneumatic system is repressurized. The interconnect action also increases the likelihood that the last running SSME with a non-leaking MPS helium supply will retain sufficient helium in its supply to support guided MECO once the second SSME with a leaking MPS helium supply shuts down. ®[121197-6472A] ®[050400-7195A]

The interconnect is broken by taking the interconnect switch of the engine with the non-leaking helium system to the GPC position. If the leaking helium supply has been depleted due to a tank leak, or an upper system leak exists, breaking the interconnects in this manner allows the pneumatic system to remain interconnected to the engine with a leaking helium supply in order to support its shutdown. ®[100997-6298]

THIS RULE CONTINUED ON NEXT PAGE

FLIGHT RULES

A5-152

PRE-MECO MPS HELIUM SYSTEM INTERCONNECTS [CIL]
[HC] (CONTINUED)

3. WITH ONE ENGINE ON: @[050400-7195A]

INTERCONNECTING THE PNEUMATIC HELIUM SYSTEM AND THE HELIUM SYSTEMS OF ALL PREVIOUSLY SHUT-DOWN ENGINES WILL BE PERFORMED.

- C. THROTTLE MANAGEMENT FOR TWO ENGINES ON WITH A NON-ISOLATABLE MPS HELIUM LEAK IN ONE OF THE RUNNING SSME'S WILL BE PERFORMED PER THE FOLLOWING: @[050495-1753A] @[100997-6298] @[032807-8398]

With three engines on, there are no regions where a subsequent engine out will not allow the remaining engines to perform an abort to a landing site. Therefore, 109 percent SSME throttles are not required for that case.

1. NOMINAL/ATO:

109 PERCENT SSME THROTTLES IS NOT REQUIRED FOR THESE CASES.

The only region where an abort cannot be performed to a landing site with the leaking engine out usually occurs between the PRESS-TO-ATO boundary and the SINGLE ENGINE LIMITS boundary. Since the time between these boundaries is less than 1.5 minutes, it is extremely unlikely that an interconnect from a running engine to a running engine will be required. Consequently, the maximum time spent at 109 throttles (at most 1.5 minutes) will not significantly reduce the predicted MECO time. @[050495-1753A] @[050400-7195A]

THIS RULE CONTINUED ON NEXT PAGE

FLIGHT RULES

A5-152

**PRE-MECO MPS HELIUM SYSTEM INTERCONNECTS [CIL]
[HC] (CONTINUED)**

2. TAL:

THE SSME'S WILL BE IMMEDIATELY THROTTLED TO 109 PERCENT POWER LEVEL AFTER THE ISOLATION PROCEDURE IS COMPLETED AND THE MPS HELIUM LEAK IS DETERMINED TO BE NON-ISOLATABLE. IF SINGLE ENGINE TAL 104 ABORT CAPABILITY IS ACHIEVED OR IS PREDICTED TO BE ACHIEVED WITHOUT INTERCONNECTING A RUNNING ENGINE SUPPLY, SSME THROTTLES MAY BE RETURNED TO 104 PERCENT POWER LEVEL. @[100997-6298] @[050400-7195A] @[032807-8398]

For this case, the additional risk associated with operating the main engines at 109 power level is acceptable in order to provide the crew and vehicle a chance to reach a runway (i.e., SE LIMITS). Commanding the engines to 109 percent power level, while the vehicle is in an abort gap with a helium leak on one of two running SSME supplies, maximizes the use of the remaining helium by reducing the time required to achieve abort capability to a landing site. Furthermore, the increased power level does not increase helium usage in the engine HPOTP IMSL purge package (usage remains unchanged from 67-109 percent power level) and should have no negative effect on the size of the leak in the MPS helium system. Operationally, the increased internal engine pressures and temperatures at 109 percent do increase the likelihood of having an SSME failure (ref. AEFTP #108 charts, December 17, 1993). However, because the run time remaining on the last engine to MECO cannot be determined (its helium supply was compromised), the main engines will remain at 109 percent power level until fine count is reached and the software throttles back the engines, the crew initiates manual throttles at the 2 percent propellant remaining in the ET cue (reference rule {A5-112}, MANUAL THROTTLEDOWN FOR LO₂ NPSP PROTECTION AT SHUTDOWN,), or until the manual MECO (reference rule {A5-153}, PRE-MECO SHUT DOWN OF ENGINES DUE TO MPS HELIUM LEAKS). @[090894-1676A] @[ED]

If single engine TAL 104 abort capability is achieved, or is predicted to be achieved, after throttling the SSME's to 109 percent power level and without interconnecting a running, non-leaking SSME helium supply, sufficient helium will be available in the non-leaking MPS helium system to complete a single engine abort at 104. Additionally, since the time between the single engine limits and single engine TAL 104 boundaries is short, it is advisable to leave the throttles at 109 percent to preclude additional work for the crew should an engine fail in this region. Single engine TAL 104 is when the Flight Dynamics Officer determines that 109 percent power level is no longer required for single engine abort completion. Per the rationale above, it is desirable that the SSME throttle setting be returned to 104 percent whenever possible. @[ED] @[050495-1767B] @[050400-7195A] @[032807-8398]

THIS RULE CONTINUED ON NEXT PAGE

FLIGHT RULES

A5-152

PRE-MECO MPS HELIUM SYSTEM INTERCONNECTS [CIL]
[HC] (CONTINUED)

3. RTLS:

THE SSME'S WILL BE IMMEDIATELY MANUALLY THROTTLED TO 109 PERCENT POWER LEVEL AFTER THE ISOLATION PROCEDURE IS COMPLETED AND THE MPS HELIUM LEAK IS DETERMINED TO BE NON-ISOLATABLE. IF IT IS DETERMINED BY THE MCC THAT THE ABORT CAN BE COMPLETED WITHOUT COMPROMISING THE NON-LEAKING SUPPLY OF A RUNNING SSME, MAIN ENGINE THROTTLES WILL BE RETURNED TO AUTO PRIOR TO POWERED PITCH AROUND INITIATION. OTHERWISE, AUTO SSME THROTTLES WILL BE RESELECTED AT THE COMPLETION OF POWERED PITCH AROUND.

@[050495-1753A] @[100997-6298] @[050400-7195A]

If a non-isolatable MPS helium leak exists in the supply of one of two running SSME's while performing an RTLS abort, the likelihood that the associated SSME will shut down early, prior to reaching single engine abort capability, increases significantly. The probability that the shut down requirements of the last SSME are violated at MECO also increases significantly. Both possibilities are further compounded on the RTLS case by predicted MECO times which may extend by as much as 3 minutes longer than the nominal uphill MECO. Furthermore, since the maximum SSME operating time is defined at liftoff by the prelaunch loading of MPS helium, extending the SSME burn time exacerbates these concerns. The only available option is to use a higher main engine power level in order to minimize the predicted MECO time.

@[032807-8398]

Analysis by Flight Design indicates that using 109 percent throttles on an RTLS abort can decrease the MECO time by as much as 55 seconds, assuming 109 is maintained throughout the trajectory (reference Ascent Abort Panel briefing charts, October 6, 1994, "RTLS MECO Time Reduction for MPS Helium Leaks"). The resulting decrease in predicted MECO time may be the difference between a crew bailout and an intact abort landing. However, it must be noted that the trade off of using 109 percent throttles during the RTLS flyback phase is that, the ET separation dynamic pressure is decreased by approximately 1.5 psf with respect to the designed RTLS condition, and the ET separation MPS propellant residuals are increased by approximately 0.5 percent over the designed RTLS condition. Since manual throttles must be maintained until the initiation of powered pitch around in order to stay at 109 throttles during flyback, the GPC's will not perform mass control throttling (auto throttles required) and the resulting separation conditions are slightly off-nominal. These conditions are considered acceptable when compared to violations which may occur on an alternative contingency abort.

@[050400-7195A] @[032807-8398]

THIS RULE CONTINUED ON NEXT PAGE

FLIGHT RULES

A5-152

PRE-MECO MPS HELIUM SYSTEM INTERCONNECTS [CIL]
[HC] (CONTINUED)

To minimize violations of the designed dynamic pressure and residual constraints for this case, SSME throttles will be returned to the AUTO position prior to powered pitch around initiation if the MCC determines that the abort can be completed without compromising the non-leaking helium supply of a running SSME while in auto throttles. This action allows the GPC's to perform mass control throttling during flyback, thereby controlling ET separation conditions. If the MCC cannot determine abort capability prior to powered pitch around initiation, then manual throttles at 109 percent are maintained until powered pitch around is complete. Although fine mass control will not be performed, returning to auto throttles after powered pitch around completion minimizes crew actions during the pitch around maneuver and allows the engines to remain at 109 percent power level until the fine count throttle command is received from guidance near MECO. ©[050400-7195A] ©[032807-8398]

Flight design analysis indicates that for cases involving manual throttling after powered pitch around initiation, the ET separation dynamic pressure and MPS residual violations are minimized when the 109 percent SSME throttle setting is used during flyback. For these cases, there are no LO₂ NPSP concerns since there are always MPS residuals in the ET, and significant NPSP violations only occur during LO₂ low level cutoff. Consequently, SSME shut down from the fine count throttle setting is a preferred, not a mandatory, condition. ©[050495-1753A] ©[050400-7195A]

Hazard Report IMPS-16, Loss of MPS Helium Supply, is controlled by this rule.

Rules {A2-64}, MANUAL THROTTLE CRITERIA; {A4-53}, USE OF MAXIMUM THROTTLES; {A5-103}, LIMIT SHUTDOWN CONTROL; {A5-153}, PRE-MECO SHUT DOWN OF ENGINES DUE TO MPS HELIUM LEAKS [HC]; and {A5-156}, ABORT PREFERENCE FOR SYSTEM FAILURES [HC], reference this rule. ©[092195-1770A] ©[ED] ©[100997-6298] ©[032807-8398] ©[032807-8395B]

FLIGHT RULES**A5-153****PRE-MECO SHUT DOWN OF ENGINES DUE TO MPS HELIUM
LEAKS [HC]** @[033105-6606A]

A. IF ALLOWABLE HELIUM INTERCONNECTS, PER RULE {A5-152}, PRE-MECO MPS HELIUM SYSTEM INTERCONNECTS [CIL] [HC], WILL NOT SATISFY ZERO-G SHUTDOWN REQUIREMENTS PER PARAGRAPH E, BUT WILL SATISFY SHUTDOWN REQUIREMENTS AT THE CUES BELOW, THE AFFECTED ENGINE WILL BE SHUT DOWN MANUALLY (PUSH-BUTTON ONLY IF POSSIBLE), AS FOLLOWS:
@[090894-1676A] @[032807-8398]

1. MCC DECISION (PRIME)

a. NOMINAL/ATO

(1) THREE ENGINES ON: VI > 23 KFPS @[032807-8396A]

(2) TWO ENGINES ON: VI > 24.5 KFPS

b. TAL

TWO OR THREE ENGINES ON VI > 22.5 KFPS
@[032807-8396A]

c. RTLS

TWO OR THREE ENGINES ON: ALPHA = -1 DEGREES
@[032395-1759A]

In this case, the engine will run with the helium system leak, but the helium supply pressure may not be able to support the zero-g shutdown requirements at MECO. The required helium supply pressure for a safe shutdown will depend upon the number of helium regulators operating, the helium leak rate, and type of shutdown (i.e., hydraulic or pneumatic). If the requirements for a pre-MECO hydraulic, pneumatic, or single regulator shutdown will be satisfied subsequent to the cues mentioned in paragraph C, manual action is taken to shut the engine down while still protecting shutdown requirements. The engine is shut down at a velocity which equates to approximately MECO minus 30 seconds. This gives guidance time to adjust to the late engine out and converge on the proper MECO targets. The only exception to this is the RTLS abort where the engine is shut down during powered pitch down (alpha equals -1 degree). @[032395-1759A] @[033105-6606A]

THIS RULE CONTINUED ON NEXT PAGE

FLIGHT RULES

A5-153

PRE-MECO SHUT DOWN OF ENGINES DUE TO MPS HELIUM LEAKS [HC] (CONTINUED)

The shutdown pushbutton is used for engine shutdown instead of the ac power switches in order to shut the engine down hydraulically. A pre-MECO hydraulic shutdown requires less helium than a pre-MECO pneumatic shutdown and also retains post-MECO LO₂ dump capability through the affected engine. It also avoids the zero fault tolerant pneumatic shutdown mode. ©[090894-1676A]

2. ONBOARD DECISION (NO COMMUNICATION) ©[090894-1676A]

- a. IF A NON-ISOLATABLE MPS HELIUM LEAK EXISTS, THE CREW WILL SHUT DOWN THE AFFECTED ENGINE AT THE APPROPRIATE BOUNDARY LISTED IN PARAGRAPH A1.

If a leak develops in an engine helium supply and the crew cannot communicate with the MCC, shutting the affected engine down early may prevent the violation of shutdown helium requirements on that engine. With no communication with the ground the crew has no way to tell when the helium requirements will be violated. The helium margin which exists in each supply at liftoff will very likely keep shutdown requirements from being violated at the cues listed.

- b. IF AN MPS HELIUM SYSTEM IS OPERATING ON A SINGLE REGULATOR, THE CREW CANNOT COMMUNICATE WITH THE MCC, AND THE HELIUM SYSTEM TANK PRESSURE ON THAT SUPPLY IS LESS THAN 2163 (2200) PSIA AT MECO-60 SECONDS, THE CREW WILL SHUT DOWN THE AFFECTED ENGINE AT THE APPROPRIATE CUE LISTED ABOVE IN PARAGRAPH A1. ©[110900-7239]

1963 psia is the minimum engine system tank pressure which will support MECO requirements while operating on a single regulator (ref. paragraph E). In this configuration, approximately 200 psia of helium (10 psia/3 sec x 60 sec) is used between the velocity cues mentioned in paragraph A1 and MECO. Therefore, if the affected engine tank pressure is less than 2163 psia (1963 psia + 200 psia) at MECO minus 1 minute, MECO shutdown requirements will not be satisfied and the engine is shut down pre-MECO. The crew shutdown cue of 2200 psia is derived by adding 20 psia instrumentation error and rounding up to the nearest hundred (1963 psia + 200 psia + 20 psia instrumentation error + 17 psia rounding = 2200 psia). ©[110900-7239]

THIS RULE CONTINUED ON NEXT PAGE

FLIGHT RULES

A5-153

PRE-MECO SHUT DOWN OF ENGINES DUE TO MPS HELIUM
LEAKS [HC] (CONTINUED)

- B. IF AN ENGINE HELIUM SUPPLY DEVELOPS A LEAK WITHIN 60 SECONDS OF MECO, WITH OR WITHOUT COMMUNICATION WITH THE MCC, THE CREW WILL USE THE SHUTDOWN PUSHBUTTON TO SHUT DOWN THE AFFECTED ENGINE PRIOR TO MECO. @[041196-1876]

When helium system leaks develop late in flight, sufficient time to evaluate MECO capability may not exist. Since pre-MECO engine shutdowns consume less helium than zero-g shutdowns, it is safer to shut the affected engine down prior to MECO. Shutting the engine down soon after a helium system leak occurs also gives guidance software time to converge on the correct MECO velocity targets. @[090894-1676A]

- C. IF ENGINE AND PNEUMATIC HELIUM SYSTEMS INTERCONNECTS TO AN ENGINE WITH A LEAKING MPS HELIUM SUPPLY ARE INSUFFICIENT TO SUPPORT ENGINE SHUT DOWN AT THE CUES OUTLINED IN PARAGRAPH A1, ENGINE SHUTDOWN PRIOR TO THOSE CUES MUST BE ACCOMPLISHED IN THE FOLLOWING MANNER WHILE TWO OR THREE ENGINES ARE RUNNING: @[090894-1676A] @[ED]

1. IF NO RUNNING ENGINE SUPPLIES HAVE BEEN INTERCONNECTED:

- a. THE LEAKING ENGINE WILL BE ALLOWED TO SHUT DOWN ON THE ENGINE HPOTP INTERMEDIATE SEAL (IMSL) PURGE REDLINE AS LONG AS THE ENGINE HYDRAULIC SYSTEM IS FUNCTIONAL, THE SSME REDLINE LIMITS ARE ENABLED, AND THE IMSL REDLINE IS FUNCTIONING. @[033105-6606A] @[032807-8396A]

If two engine abort capability to a landing site exists, while three engines are running, or single engine abort capability to a landing site exists, while two engines are running, a leaking engine will be allowed to shut down on the HPOTP IMSL purge redline. Although minor engine erosion may occur during the shutdown sequence due to reduced helium pressure, the shutdown will be contained and engine run time is maximized. @[050495-1767B] @[050495-1767B] @[020196-1812] @[121197-6472A] @[033105-6606A]

THIS RULE CONTINUED ON NEXT PAGE

FLIGHT RULES

A5-153

PRE-MECO SHUT DOWN OF ENGINES DUE TO MPS HELIUM LEAKS [HC] (CONTINUED)

- b. IF A HYDRAULIC SHUTDOWN CANNOT BE PERFORMED, MANUAL SHUTDOWN WILL BE PERFORMED AT THE MINIMUM REQUIRED PNEUMATIC SHUTDOWN HELIUM INTERFACE PRESSURE PER PARAGRAPH E1 OR E2 OF THIS RULE.

If hydraulic shutdown capability is lost for any reason, the pneumatic shutdown requirements must be manually protected in order to prevent a catastrophic shutdown from occurring. @[090894-1676A] @[100997-6298]

2. IF A RUNNING SSME WITH A NON-LEAKING HELIUM SUPPLY HAS BEEN INTERCONNECTED TO A RUNNING SSME WITH A LEAKING MPS HELIUM SUPPLY. @[090894-1676A] @[032807-8396A]
- a. FOR THREE ENGINES OPERATING, THE LEAKING ENGINE WILL BE ALLOWED TO SHUT DOWN ON THE ENGINE HPOTP INTERMEDIATE SEAL (IMSL) PURGE REDLINE (NO LATER THAN THE CUES IN PARAGRAPH A.1) AS LONG AS THE ENGINE HYDRAULIC SYSTEM IS FUNCTIONAL, THE SSME REDLINE LIMITS ARE ENABLED, AND THE IMSL REDLINE IS FUNCTIONING.

An engine-to-engine helium interconnect can be used to increase the run time of a leaking engine at the expense of helium margin in a non-leaking, running engine. Each main engine helium system is loaded with more helium than a nominally operating SSME requires to make it to orbit. By using this extra helium, the run time of the leaking SSME will be extended – potentially past a critical intact abort boundary. It is unlikely that a running interconnect could provide the leaking SSME with enough helium to satisfy its zero-g requirement, so this procedure is only used to extend the operation of the leaking SSME out to the nominal pre-MECO shutdown cue, if possible. @[033105-6606A]

- b. FOR TWO ENGINES OPERATING, IF THE NON-LEAKING RUNNING ENGINE HAS BEEN INTERCONNECTED, THE LEAKING ENGINE WILL BE SHUT DOWN AT AN HPOTP IMSL PURGE PRESSURE (ON ALL QUALIFIED SENSORS) OF 60 PSIA, BUT NO LATER THAN THE APPROPRIATE VELOCITY CUE OF PARAGRAPH A.1. @[100997-6298] @[121197-6472A] @[050495-1767B] @[033105-6606A] @[032807-8396A]

THIS RULE CONTINUED ON NEXT PAGE

FLIGHT RULES

A5-153

PRE-MECO SHUT DOWN OF ENGINES DUE TO MPS HELIUM LEAKS [HC] (CONTINUED)

For this case, the desired single engine abort capability is unattainable. However, a contingency abort may still be performed. Getting as far down range as possible prior to MECO improves ET separation conditions and decreases orbiter pull-out loads; hence, both engines will be allowed to run as long as possible. Shutting the leaking engine down before the good engine may allow both engines to shut down in a contained manner, since the leaking engine will be shut down under positive g's and therefore require less helium during the shutdown sequence. @[032807-8396A]

Shutting down the engine with the leaking supply at an HPOTP IMSL purge pressure of 60 psia keeps that engine running as long as feasible while the vehicle is in an abort gap, but still maintaining a positive pressure barrier in the IMSL between the O₂ and H₂ cavities. 60 psia, as measured by the IMSL transducers, equates to approximately 42 psia in the IMSL cavity. The nominal pressure in the O₂ cavity is 16 psia and the nominal pressure in the H₂ cavity is 25 psia. This results in a pressure differential of 26 and 17 psia across the carbon seals. Allowing the engine with the leaking MPS helium supply to run to an IMSL pressure of 60 psia is a worst case scenario which assumes that the desired abort boundary has not been achieved and that the engine seal packages are intact. @[050495-1767B] @[020196-1812] @[100997-6298] @[121197-6472A] @[033105-6606A]

- c. THE NON-LEAKING, RUNNING ENGINE WILL BE ALLOWED TO RUN UNTIL MECO OR 1150 PSIA, WHICHEVER COMES FIRST. IF A MANUAL SHUTDOWN IS REQUIRED, IT WILL BE WITH THE SHUT DOWN PUSHBUTTON ONLY. @[090894-1676A] @[100997-6298] @[032807-8396A]

Although 1288 psia is the minimum helium system tank pressure which will support zero-g shut down of an engine with two good regulators and no helium system leak, the last engine will be allowed to run until the MPS supply pressure reaches the crew C&W limit of 1150 psia. Allowing the engine to run to 1150 psia provides a clear engine shutdown cue for the crew (C&W alarm at 1150) and also takes advantage of any instrumentation error/margin which may exist in the onboard measurement system and the ground predicted shut down requirements respectively. @[100997-6298]

Reference Rule {A5-152}, PRE-MECO MPS HELIUM SYSTEM INTERCONNECTS [CIL] [HC], for interconnect procedures. @[032807-8398]

- d. IF AN MPS HELIUM SYSTEM IS OPERATING ON A SINGLE REGULATOR AND DOES NOT MEET THE ZERO-G SHUTDOWN REQUIREMENTS OF THE ASSOCIATED ENGINE AS PREDICTED BY THE MCC, THE ENGINE WILL BE SHUT DOWN PER PARAGRAPHS A OR C ABOVE, WHILE PROTECTING THE SINGLE REGULATOR SHUTDOWN REQUIREMENTS OF PARAGRAPH E.6 BELOW.

When an MPS helium system is operating on a single helium regulator, the supply may not meet the MECO (zero-g) shutdown requirements of the affected engine. If it is predicted that the MECO requirements, as stated in paragraph E.6 below, will be violated, the engine must be shut down early according to paragraphs A.1, C.1 or C.2 above. @[090894-1676A]

THIS RULE CONTINUED ON NEXT PAGE

FLIGHT RULES

A5-153

PRE-MECO SHUT DOWN OF ENGINES DUE TO MPS HELIUM LEAKS [HC] (CONTINUED)

E. HELIUM SYSTEM REQUIREMENTS FOR ENGINE SHUTDOWN @[090894-1676A]

1. MINIMUM SHUTDOWN PRESSURES FOR AN ENGINE WITH A LOWER SYSTEM MPS HELIUM LEAK.

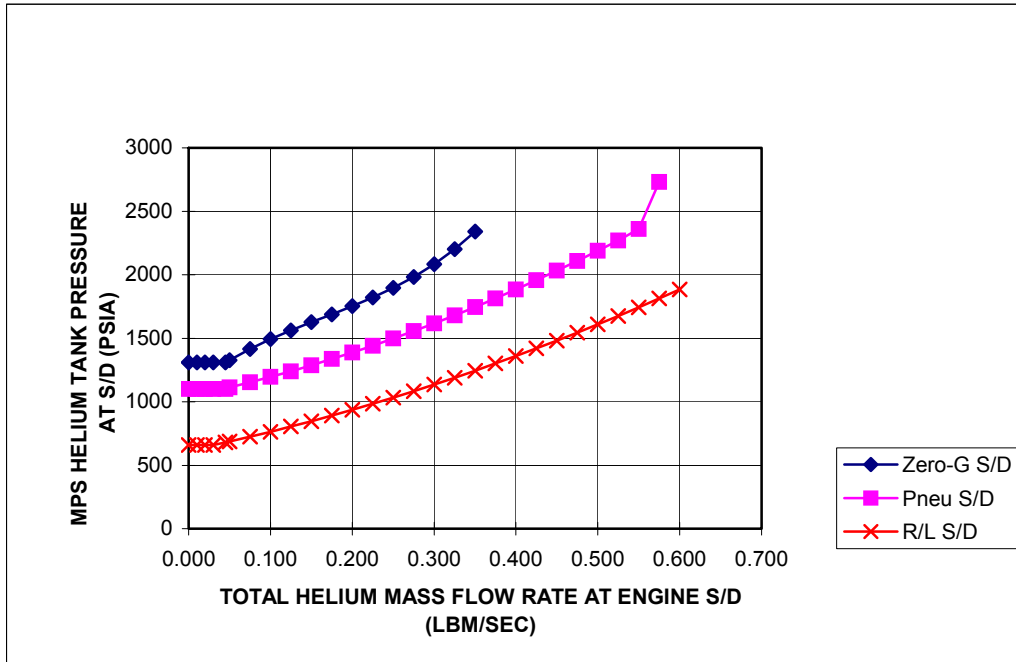

@[110900-7239] @[033105-6606A]

- ◆ ZERO G S/D, 630 PSIA AT S/D +7 SEC @[110900-7239]
- PNEU S/D, 529 PSIA AT S/D +7 SEC
- x REDLINE S/D, 576 PSIA AT S/D

@[050495-1767B] @[020196-1812] @[121197-6472A] @[110900-7239] @[033105-6606A]

THIS RULE CONTINUED ON NEXT PAGE

FLIGHT RULES

A5-153

**PRE-MECO SHUT DOWN OF ENGINES DUE TO MPS HELIUM
LEAKS [HC] (CONTINUED)**

A lower system MPS helium leak is a leak downstream of the system regulators. The resulting leak rate should be constant (unless the leak rate increases). Lower system leaks are isolatable only when they occur between the regulator and the downstream check valve. ©[033105-6606A]

The zero-g line represents the minimum supply pressure to support a hydraulic or pneumatic shutdown at MECO (zero-g) with two system regulators, with or without a lower system MPS helium leak. This requirement is the ICD value of 630 psia interface pressure at shutdown plus 7 seconds (ref. SSME-to-Orbiter ICD 13M15000). The pneumatic shutdown line represents the minimum supply pressure to support a pre-MECO pneumatic shutdown with two system regulators, with or without a lower system leak. This requirement is based on an analytical value of 529 psia interface pressure at shutdown plus 7 seconds. The redline shutdown curve is the minimum supply pressure at which the HPOTP IMSL purge redline will be violated with one or two system regulators, with or without a lower system leak. This value is 576 psia interface pressure at shutdown and is based on SSME test 901-835 (reference SODB data request R1-1640). The minimum pressure which will support the expected shutdown mode and mass flow rate should always be protected. These curves include 20 psia instrumentation error. ©[090894-1676A] ©[020196-1812] ©[121197-6472A] ©[110900-7239] ©[033105-6606A]

THIS RULE CONTINUED ON NEXT PAGE

FLIGHT RULES

A5-153

PRE-MECO SHUT DOWN OF ENGINES DUE TO MPS HELIUM LEAKS [HC] (CONTINUED)

2. MINIMUM SHUTDOWN PRESSURES FOR AN ENGINE WITH AN UPPER SYSTEM MPS HELIUM LEAK. @[090894-1676A]

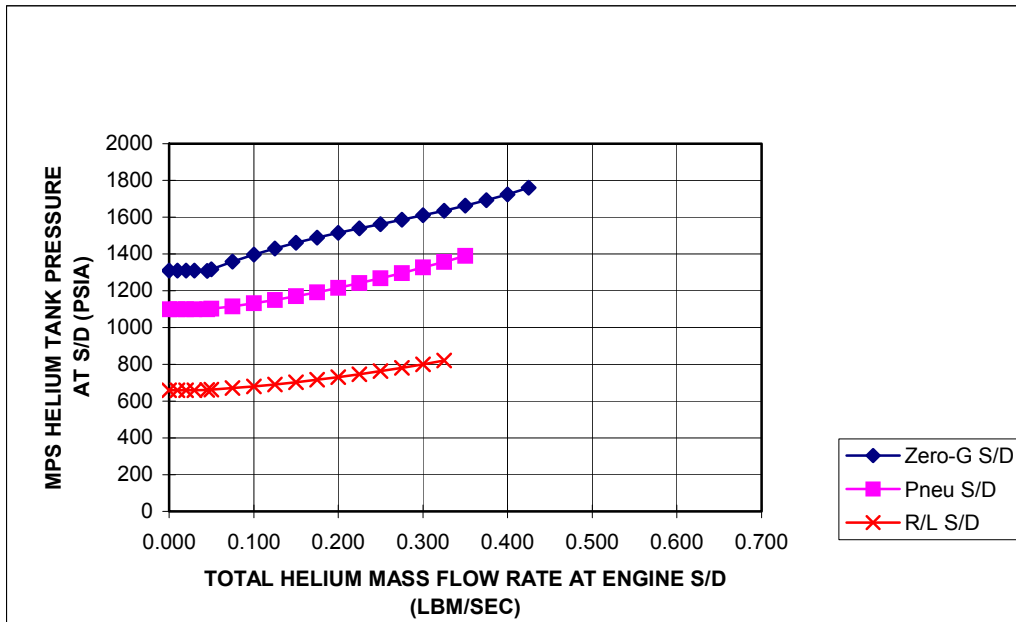

@[110900-7239] @[033105-6606A]

- ◆ ZERO G S/D, 630 PSIA AT S/D +7 SECONDS
- PNEU S/D, 529 PSIA AT S/D + 7 SECONDS
- × REDLINE S/D, 576 PSIA AT S/D

@[050495-1767B] @[020196-1812] @[121197-6472A] @[110900-7239] @[033105-6606A]

THIS RULE CONTINUED ON NEXT PAGE

FLIGHT RULES

A5-153

PRE-MECO SHUT DOWN OF ENGINES DUE TO MPS HELIUM LEAKS [HC] (CONTINUED)

An MPS upper system helium leak is a leak upstream of the system regulators. The resulting leak rate should decay over time (unless the leak rate increases). Upper system leaks are isolatable only when they occur between the helium isolation valve and the downstream regulator. ©[033105-6606A]

The zero-g line represents the minimum supply pressure to support a hydraulic or pneumatic shutdown at MECO (zero-g) with two system regulators, with or without an upper system leak. This requirement is the ICD value of 630 psia interface pressure at shutdown plus 7 seconds (ref. SSME-to-Orbiter ICD 13M15000). The pneumatic shutdown line represents the minimum supply pressure to support a pre-MECO pneumatic shut down with two system regulators, with or without an upper system leak. This requirement is based on an analytical value of 529 psia interface pressure at shutdown plus 7 seconds. The redline shutdown curve is the minimum supply pressure at which the HPOTP IMSL purge redline will be violated with one or two system regulators, with or without an upper system leak. This value is 576 psia interface pressure at shutdown and is based on SSME test 901-835 (reference SODB data request R1-1640). The minimum pressure which will support the expected shutdown mode and mass flow rate should always be protected. These curves include 20 psia instrumentation error. ©[050495-1767B] ©[121197-6472A] ©[110900-7239]

3. IF THE ENGINE CAN SHUT DOWN HYDRAULICALLY BUT HPOTP IMSL REDLINE SHUT DOWN CAPABILITY IS LOST FOR ANY REASON, A MANUAL SHUTDOWN MUST PROTECT THE MINIMUM INTERFACE PRESSURES FOR A PRE-MECO HYDRAULIC SHUT DOWN AS SHOWN IN PARAGRAPH E. ©[090894-1676A] ©[032807-8396A]

If both HPOTP IMSL purge pressure transducers have failed or the redline limit software is not available for any reason, a redline engine shutdown will never occur. Manual action must be taken above the minimum hydraulic shutdown interface pressure.

4. IF A PNEUMATIC SHUT DOWN IS REQUIRED FOR ANY REASON, A MANUAL SHUT DOWN MUST PROTECT THE MINIMUM INTERFACE PRESSURES FOR A PRE-MECO PNEUMATIC SHUTDOWN PER PARAGRAPH E.

It takes significantly more helium to support a pre-MECO pneumatic shutdown than it does to support a pre-MECO hydraulic shutdown. Consequently, pre-MECO pneumatic shutdown capability must be manually protected for all cases where hydraulic engine function has been lost or for which a pneumatic shutdown will occur. ©[050495-1767B] ©[121197-6472A] ©[033105-6606A]

THIS RULE CONTINUED ON NEXT PAGE

FLIGHT RULES

A5-153

**PRE-MECO SHUT DOWN OF ENGINES DUE TO MPS HELIUM
LEAKS [HC] (CONTINUED)**

5. IF THE PNEUMATIC SYSTEM ALONE WILL BE USED TO SUPPORT THE SHUTDOWN HELIUM REQUIREMENT OF AN ENGINE, AND THE ENGINE SYSTEM HAS TWO OPERATIONAL REGULATORS AND NO DOWNSTREAM HELIUM LEAK, THE FOLLOWING NUMBERS MUST BE PROTECTED:
- | | | |
|----|--------------------|--|
| a. | ZERO-G | - 2800 (2830) PSIA
(3 ENG S/D) @[110900-7239] |
| | | - 2357 (2387) PSIA
(1 ENG S/D) |
| b. | PRE-MECO PNEUMATIC | - 2036 (2066) PSIA |
| c. | PRE-MECO HYDRAULIC | 639 (669) PSIA |

@[050495-1767B] @[020196-1812] @[121197-6472A] @[110900-7239] @[033105-6606A]

If the MPS supply system has an upper system leak, and three engines are running, the pneumatic system will be interconnected to the engine as late in the flight as is practical, but above the minimum tank pressure required to support engine shut down. After the interconnect is performed a determination is made as to whether or not the leak is an upper system leak or a tank leak. If the leak is found to be a tank leak, the pneumatic tank only numbers must be protected. The leak in the tank may deplete all of the engine system helium before the pneumatic tank and engine tank equalize in pressure. If this is the case, the pneumatic tank alone must support engine shutdown. @[090894-1676A]

The zero-g pressure requirement for three engines assumes interconnect in-open on all three engines with one engine requiring a pneumatic only shutdown. This number would be used when the pneumatic helium system has been either manually interconnected to multiple engines, or will be automatically interconnected at MECO because those engines have a tank pressure that is below 2000 psia or is commfaulted. The zero-g pressure requirement for one engine assumes interconnect in-open on only the engine requiring a pneumatic shutdown (the more likely situation).

With calibration curve coefficients unique to each helium tank pressure transducer, the accuracy of each reading is 0.15 percent. An accuracy of 0.15 percent over the 5000 psi transducer range equates to an error of 7.5 psi. To account for any potential degradation in accuracy (e.g., transducer replacements where the new transducer is less accurate or calibration equipment changes), one PCM count (20 psi) was added to the 7.5 psi error. This new instrumentation error of 27.5 psi was then rounded to 30 psi instrumentation error used by the MCC and incorporated into crew actions. @[033105-6606A]

THIS RULE CONTINUED ON NEXT PAGE

FLIGHT RULES

A5-153

PRE-MECO SHUT DOWN OF ENGINES DUE TO MPS HELIUM LEAKS [HC] (CONTINUED)

6. WHEN AN MPS HELIUM SUPPLY OPERATION OCCURS THROUGH A SINGLE REGULATOR BECAUSE OF AN ISOLATED LEAK OR SYSTEM FAILURE, SINGLE REGULATOR SHUTDOWN REQUIREMENTS MUST BE PROTECTED. THE MINIMUM ENGINE SYSTEM HELIUM TANK PRESSURE REQUIREMENTS FOR SINGLE REGULATOR SHUTDOWN WITHOUT A HELIUM LEAK ARE: ©[090894-1676A]
- | | | |
|----|--------------------|-----------------------------------|
| a. | ZERO-G | - 1963 (1983) PSIA ©[110900-7239] |
| b. | PRE-MECO PNEUMATIC | - 1457 (1477) PSIA |
| c. | PRE-MECO HYDRAULIC | 679 (699) PSIA |

©[050495-1767B] ©[020196-1812] ©[121197-6472A] ©[110900-7239] ©[033105-6606A]

The requirements for engine shutdown in the single regulator mode are represented by three distinct pressures. The single regulator must now flow two times nominal mass in order to meet shutdown requirements. A higher initial helium tank pressure is needed to meet this demand. Note that shutdown requirements for a single regulator plus a leak have not been determined since this is two failures deep. ©[050495-1767B] ©[ED] ©[100997-6298] ©[032807-8396A]

Hazard Reports ORBI-108, Overpressurization of the Orbiter Aft Fuselage Caused by the Failure of an MPS Helium Regulator or Relief Valve; IMPS-16, Loss of MPS Helium Supply; and IMPS-17, Inadvertent SSME Shutdown, are controlled by this rule. ©[033105-6606A] ©[032807-8396A]

Rules {A5-5}, SUSPECT ENGINE [HC]; {A5-102}, AUTO/MANUAL SHUTDOWN [HC]; {A5-103}, LIMIT SHUTDOWN CONTROL [HC]; and {A5-152}, PRE-MECO MPS HELIUM SYSTEM INTERCONNECTS [CIL] [HC], reference this rule. ©[121197-6482B] ©[111298-6785A] ©[102506-7856] ©[102506-7858B] ©[102506-7859]

FLIGHT RULES

A5-154

LH₂ TANK PRESSURIZATION [CIL] [HC] @[022405-6600C]

THE ET LH₂ TANK ULLAGE PRESSURE WILL BE MANUALLY CONTROLLED USING THE LH₂ ULLAGE PRESSURE SWITCH WHEN THE LH₂ ULLAGE PRESSURE IS < 27.7 (28.0) PSIA. THE PRESSURIZATION WILL BE CONTROLLED SO THAT THE ULLAGE PRESSURE DOES NOT EXCEED 34.3 (33.0) PSIA TO AVOID THE LOW CRACKING PRESSURE OF THE TANK VENT/RELIEF VALVE. @[101096-4474A]

The pressurization flow control system consists of three tank ullage pressure sensors, signal conditioners for the orbiter flow control valve electronics, and three gaseous hydrogen flow control valves. Each ullage pressure sensor is wired to a signal conditioner which in turn controls the GH₂ pressurant flow from its respective engine. Each control system is single string; i.e., ullage pressure no. 1 feeds only the electronics for the center SSME, no. 2 to the left SSME, and no. 3 to the right SSME. The flow control valves are used to maintain the LH₂ tank ullage pressure between 32 and 34 psia. The signal conditioners use 33.0 psia as the set point for the ullage pressure. Failure of one flow control valve to the closed position (low flow) does not cause the ullage pressure to drop below 28.0 psia or violate the SSME NPSP ICD. However, the pressure cannot be maintained above 28.0 psia when two flow control valves fail closed. Additionally, failure of one flow control valve to the open position (high flow) does not cause the ullage pressure to rise to the LH₂ tank vent valve relief setting of 34.3 psig (reference December 22, 1995 PSIG and Rockwell action item 951208-02). When vibrational and thermal effects are taken into account, 34.3 psig is the minimum pressure at which venting of the LH₂ tank could occur (reference January 30, 2004 PSIG and Lockheed Martin agenda item 040128-D03). @[021199-6791A]

There are several failure modes associated with the LH₂ tank pressurization flow control system. This flight rule addresses the case of two ullage pressure sensors failed high (i.e., above the ullage pressure where the flow control valve is commanded closed) which will cause their respective flow control valves to remain closed. The remaining flow control system will not maintain the tank pressure. When the true tank pressure decays to 28.0 psia on the remaining good sensor, a class 3 BFS alert will be set. (The 28.0 psia value was reviewed and approved as DCR 3581A and DCR 3586 at the July 11, 1996 SASCB.) An LH₂ ullage pressure of 28.0 psia is the value at which manual action will be taken. This pressure includes crew response time and one sigma dispersions of the instrumentation error: 0.21 psia (reference Booster SCP 2.2.1). Additionally, this lower value of 28.0 psia protects the minimum ullage pressure to support the NPSP requirement of 27.7 (reference December 22, 1995 PSIG and Rockwell action item 951208-02, chart 1-18). In response to the alert, the crew will use the LH₂ ullage pressure switch to open the flow control valves by overriding the electronics on all flow control valves. The tank pressure should then increase. However, the pressure could go through the control band and reach the tank vent valve relief setting of 34.3 psig. The value of 33.0 psia was chosen as the value at which the crew would close the flow control valves before venting could occur. The value of 33.0 was arrived at by subtracting 1 psia for crew response time, subtracting 0.21 psia for instrumentation error from the vent relief setting of 34.3 psig, and then rounding down to the nearest 0.1 psia (reference December 1, 2004 PSIG action item 040922-01). If venting occurs while the vehicle is in first stage, a fire could propagate along the side of the external tank (reference PRCB presentation February 10, 1987 and the 32nd PSIG). The high flow setting of the -1301 FCV's (70 percent instead of 100 percent used with the -0361) allows for manual action to be taken prior to staging. For this failure case, venting GH₂ is not a concern due to a gradual pressure recovery when the switch is placed in the high flow position during first stage (reference May 8, 1996 PSIG and action item-941005-03 Rev 3). @[101096-4474A] @[021199-6791A] @[022405-6600C]

FLIGHT RULES

THIS RULE CONTINUED ON NEXT PAGE

FLIGHT RULES**A5-154 LH2 TANK PRESSURIZATION [CIL] [HC] (CONTINUED)**

Other failure modes of the GH₂ pressurization system include: a mechanical failure of two flow control valves, a flow restriction in either an SSME GH₂ repressurization path or in the main pressurization line, a hole in the side of the LH₂ tank or a vent valve not closed. However, the LH₂ ullage pressure switch cannot correct conditions caused by these failure modes. For these cases, all three ullage pressures could decay below 28.0 psia since the sensors are accurately reading the decaying tank pressure. If the pressure decay continues, the minimum NPSP of the engines will be violated. ©[101096-4474A] ©[021199-6791A]

Hazard Report IMPS 05 is controlled by this rule. ©[022405-6600C]

Rules {A4-56H}, PERFORMANCE BOUNDARIES, and {A5-156}, ABORT PREFERENCE FOR SYSTEMS FAILURES [HC], reference this rule. ©[071494-1646A] ©[ED] ©[032807-8395B]

**A5-155 LIMIT SHUTDOWN CONTROL, MANUAL THROTTLING, AND
MANUAL SHUTDOWN FOR LOW LH2 NPSP [CIL] [HC]**
©[040899-6818A] ©[032807-8399B]

- A. UPON RECOGNITION OF EITHER AN LH₂ ULLAGE LEAK OR FOR ANY ORBITER GH₂ PRESSURIZATION SYSTEM ANOMALY, EXCEPT ONE GH₂ FLOW CONTROL VALVE FAILED CLOSED, THE MAIN ENGINE LIMIT SHUTDOWN SOFTWARE WILL BE MANUALLY ENABLED BY PLACING THE MAIN ENGINE LIMIT SHUTDOWN SWITCH TO "INHIBIT" AND THEN "ENABLE" IN ORDER TO DISABLE THE SINGLE COMMAND CHANNEL SHUTDOWN LOGIC AND ENSURE THAT THE LIMITS REMAIN ENABLED FOR POSSIBLE ENGINE FAILURES.
- B. MAIN ENGINES SHALL NOT BE ALLOWED TO RUN BELOW A MINIMUM NPSP OF 3.0. THE MAIN ENGINES WILL BE THROTTLED DOWN OR SHUT DOWN TO AVOID RUNNING BELOW THE MINIMUM ALLOWABLE NPSP. IF 3.0 NPSP IS PREDICTED TO OCCUR AFTER THE NOMINAL PRE-MECO SHUTDOWN VELOCITY CUE, BUT PRIOR TO MECO, THE ENGINE SHALL BE SHUT DOWN AT THE NOMINAL PRE-MECO SHUTDOWN VELOCITY CUE.

NOTE: WHEN AN ENGINE SHUTDOWN IS REQUIRED, THE ENGINE WITH THE LOWEST NPSP SHALL BE SHUT DOWN, TAKING INTO ACCOUNT WHICH ENGINE IS PROVIDING REPRESSURIZATION. WHEN APPROPRIATE, AN ENGINE PROVIDING THE LEAST AMOUNT OF EXTERNAL TANK REPRESSURIZATION SHALL BE SELECTED FOR SHUTDOWN. ©[032807-8399B]

THIS RULE CONTINUED ON NEXT PAGE

FLIGHT RULES

A5-155

**LIMIT SHUTDOWN CONTROL, MANUAL THROTTLING, AND
MANUAL SHUTDOWN FOR LOW LH2 NPSP [CIL] [HC]
(CONTINUED)**

If the LH₂ pressure at the inlet of the SSME falls below ICD values, the low pressure fuel pump (LPFP) and high pressure fuel pump (HPFP) in the SSME will eventually cavitate and overspeed, potentially causing catastrophic damage to the SSME. In the Block II SSME, the LPFP typically cavitates earlier than the HPFP, resulting in critical low pressure fuel turbopump (LPFT) speeds prior to the high pressure fuel turbopump (HPFT) turbine discharge temperature (TDT) redline exceedance (based on analysis of Block II engine tests 904-317 and 904-321). It was determined at the A/EFTP #220, May 19, 2006, that the HPFT TDT redline does not provide adequate protection for the Block II SSME from low LH₂ inlet pressure. To prevent a catastrophic failure, A/EFTP recommended that the SSME's be prevented from running to a low NPSP value by manually throttling down the SSME to recover NPSP and/or by shutting down the SSME's. The minimum acceptable NPSP value is slightly lower than the minimum ICD NPSP value. SSME test 902-871 on August 22, 2006, demonstrated NPSP margin below the ICD value, but cannot be used to derive a universally acceptable minimum NPSP limit due to unknown pump to pump variations in response to low NPSP. Based on this engine test and others in the program history, the SSME project and P&W Rocketdyne agreed on a new minimum value of 3.0 NPSP in the Chief Engineering Telecon, January 2007. @[032807-8399B]

In the scenario where the NPSP is predicted to fall below 3.0 after the nominal pre-MECO velocity cue for the ascent or abort profile being flown, but prior to MECO, the engine should be shut down at the nominal pre-MECO velocity cue to avoid last minute surges of crew activity.

Although the HPFT TDT redline may not provide protection to the SSME from low LH₂ NPSP, the main engine limit shutdown switch will be taken to "ENABLE" in this case to ensure the SSME limits are in the best configuration to handle low LH₂ inlet pressure.

C. ORBITER GH₂ PRESSURIZATION SYSTEM ANOMALY

IF ULLAGE PRESSURE IS STEADILY DECAYING BELOW THE CONTROL BAND AND IS NOT THE RESULT OF AN ULLAGE LEAK (PER RULE {A5-9}, LH₂ ULLAGE LEAK [HC]), THE ENGINES WILL BE MANUALLY THROTTLED PER THE STEPS GIVEN BELOW. THE MANUAL THROTTLE STEPS WILL BE BASED ON THE SETTINGS LISTED IN THE TABLE BELOW WHEN THE LH₂ NPSP DROPS BELOW 3.0 PSI OR THE HPFTP TDT'S INCREASE TO WITHIN 75 DEG R OF THEIR REDLINES. TO PREVENT THE VEHICLE ACCELERATION FROM EXCEEDING 3.0 G'S AFTER MANUAL THROTTLING IS INVOKED, THE CREW WILL MANUALLY THROTTLE BACK TO MAINTAIN 3.0 G'S. @[ED] @[040899-6818A] @[031500-7181A] @ [ED] @[042706-7349] @[032807-8399B]

<u>STEP</u>	<u>THROTTLE SETTING (PERCENT)</u>
1	95
2	80
3	67

THIS RULE CONTINUED ON NEXT PAGE

FLIGHT RULES

A5-155

**LIMIT SHUTDOWN CONTROL, MANUAL THROTTLING, AND
MANUAL SHUTDOWN FOR LOW LH₂ NPSP [CIL] [HC]
(CONTINUED)**

ONCE INITIATED, MANUAL THROTTLES WILL BE MAINTAINED UNTIL MECO. A MANUAL MECO WILL BE REQUIRED.

A GH₂ pressurization system anomaly could be caused by either multiple flow control valves failed closed or a plugged GH₂ pressurization leg. Coverage of the highly unlikely GH₂ plugged pressurization leg failure mode is a result of PRCB Directive S050270DP, "Main Propulsion System (MPS) Critical Items List (CIL) Submittal Waiver Request," November 9, 1998. ©[040899-6818A]

The underspeeds resulting from three GH₂ flow control valves failed closed or a plugged GH₂ pressurization leg may result in loss of crew and vehicle due to black zones resulting from early engine shutdowns due to LH₂ NPSP or due to ET structural failure. Boeing/MPS analysis of the two GH₂ flow control valves failed at liftoff indicates that manual throttle steps and an engine shutdown 21 seconds to MECO will be required to protect the LH₂ NPSP limit, as presented at the PSIG, November 29, 2006. For this two flow control valves failed case, a MECO underspeed may result, depending on actual SRB/SSME performance and the actual launch time. Manually throttling to a lower throttle setting increases the supplied NPSP by lowering LH₂ pressure losses across the LH₂ manifolds and lines and also reduces the SSME NPSP requirement for engine operation. The combination of higher supplied NPSP and reduced NPSP requirement enables continued engine operation. Once initiated, manual throttles are maintained until MECO in order to prevent the auto throttle up to the mission power level that would occur following an SSME failure. Since the NPSP drops with this throttle up, maintaining manual throttles protects against the potential loss of additional SSME(s). ©[051500-7181A] ©[032807-8399B]

The severity of the LH₂ NPSP loss is not only dependent upon the GH₂ pressurization system failure mode but also upon the engine configuration and power level for a particular mission. Analysis shows that two GH₂ flow control valves failed closed on a nominal, ATO, or AOA mission using three Block II SSME's may require manual throttling to increase engine operation time. Additionally, manual throttling may also be required if one of the SSME's pressurization legs becomes plugged such that there is 0 percent flow from that leg (reference PSIG, February 19, 1997, Action Item 970205-01). ©[032807-8399B]

A GH₂ pressurization leg refers to the series of hardware in the GH₂ pressurization line that carries flow from each SSME's LPFTP turbine outlet to the 2-inch pressurization line that provides ullage pressure to the ET LH₂ tank. Each engine contains a check valve, a filter, and a flow control valve (reference SSSH 10-12). The hardware in these lines could potentially fail closed or, in the most extreme case, become plugged by contamination. ©[040899-6818A]

THIS RULE CONTINUED ON NEXT PAGE

FLIGHT RULES

A5-155

**LIMIT SHUTDOWN CONTROL, MANUAL THROTTLING, AND
MANUAL SHUTDOWN FOR LOW LH₂ NPSP [CIL] [HC]
(CONTINUED)**

There are three possible scenarios resulting in a plugged GH₂ pressurization system leg. The first scenario involves the filter upstream of the flow control valve becoming plugged, resulting in 0 percent flow to the associated valve. The second and third scenarios are an obstruction, or mechanical failure, of the check valve upstream of the flow control valve or an obstruction of the flow control valve itself. This would result in 0 percent flow being provided from that engine to the 2-inch pressurization line. Since flow from all three pressurization legs is required to maintain ullage pressure above 32.6 psia, all three flow control valves will be commanded open as the system attempts to maintain pressure in the ET LH₂ tank. However, since flow in a single leg is obstructed, ullage pressure will steadily decay below the control band as the fuel volume in the ET LH₂ tank decreases. ©[040899-6818A]

The throttling cue of 3.0 psi for the LH₂ NPSP was chosen as high enough to be the primary cue to avoid LH₂ NPSP regions where severe cavitation occurs and HPFTP turbine temperatures increase exponentially, but low enough to minimize the underspeed for the two flow control valves failed closed at liftoff scenario. A given HPFTP may run at an NPSP value of less than 3.0, but this is unquantified for all HPFTP/LPFTP combinations and, if the pumps begin to cavitate, it is believed that the HPFTP redline will not shut down the SSME in time to prevent damage. The ground LH₂ NPSP computation assumes a 3 sigma worst case LH₂ inlet temperature of 37.2 deg R from liftoff until MECO. The use of this constant value provides approximately 0.5 psi NPSP conservatism to the calculated NPSP early in flight, but due to temperature stratification effects in the LH₂ tank, this conservatism can be as low as -0.7 psi at MECO. The conservatism is zero psi at approximately 5 percent remaining in the LH₂ tank. Other ground computation uncertainties are a result of measurement inaccuracies in ullage pressure, head pressure, frictional losses, and vapor pressure used in the derivation of NPSP. For the first approximately 80 percent of the LH₂ used from the external tank, the actual vehicle NPSP will be 0.8 psi higher than the NPSP value displayed by the MCC ground computation. After that point, the temperature stratification in the LH₂ tank reduces that conservatism to a negative value by MECO. ©[032807-8399B]

HPFTP TDT's were selected as a backup cue in case an HPFTP starts to severely cavitate at a higher LH₂ NPSP value than expected. Both temperature limits (channels A and B) are calculated by subtracting 75 deg R from the redline values. Larger margins from the redline may overlap the nominal operating temperature range and provide false cues for action (ref. PSIG Flight Rule Reviews on February 25, 1988; March 23, 1988; and November 17, 1993). ©[071494-1646A] ©[032807-8399B]

The cue of 3.0 g's of acceleration was selected to ensure protection of vehicle acceleration limits (3.0 g). Various vehicle configurations or GH₂ pressurization system failure modes may or may not result in exceedance of vehicle acceleration limits. However, if a 3.0 g acceleration limit is used as an auto or manual throttling cue for all cases, vehicle structural limits are protected at all times. Reference Rule {A2-61}, Q-BAR/G-CONTROL. Three-g is not used as a cue for the first manual throttle step since leaving throttles in auto will throttle at 3.0 g's. Once manual throttles are taken for an NPSP or HPFTP TDT cue, throttles will remain in manual and 3.0 g's will be protected in addition to the NPSP and HPFTP TDT cues. The shuttle crews are trained that after selecting manual throttles, if the vehicle acceleration exceeds 3.0 g's, they will need to manually throttle to maintain 3.0 g's. ©[031500-7181A]

THIS RULE CONTINUED ON NEXT PAGE

FLIGHT RULES

A5-155

LIMIT SHUTDOWN CONTROL, MANUAL THROTTLING, AND
MANUAL SHUTDOWN FOR LOW LH2 NPSP [CIL] [HC]
(CONTINUED)

Throttling in three steps was selected to minimize crew/MCC impact and workload. The steps approximately divide the action equally into thirds. The first step, 95 percent, was originally chosen to avoid the Rocketdyne HPFTP impeller resonance region (i.e., 88 to 92 percent). This is no longer a concern as a result of a redesign of the impeller. The throttle setting of 95 percent was retained for training simplicity. The second step, 80 percent, is midway between the first step and the minimum power level. The last step, 67 percent, is the minimum power level and further commanded power reduction is not possible. ©[040899-6818A]

D. LH₂ ULLAGE LEAK ©[040899-6818A] ©[032807-8399B]

A DELAYED TAL ABORT WILL BE PERFORMED (REF. RULE {A2-70}, DELAYED TRANSATLANTIC LANDING (TAL) ABORT). PRIOR TO TAL SELECTION, MANUAL THROTTLES WILL BE SELECTED. AFTER TAL SELECTION, THE THROTTLES WILL BE RETURNED TO AUTO.

ENGINES SHALL NOT BE THROTTLED TO 109 PERCENT.

Throttling for low LH₂ NPSP due to an LH₂ ullage leak (reference Rule {A5-9}, LH₂ ULLAGE LEAK [HC]), or an open LH₂ vent/relief valve, delivers less ullage pressurization gas causing LH₂ NPSP to decay faster than keeping the engines at 104 percent. ©[ED] ©[042706-7349]

Throttling the engines to 109 percent to achieve an abort boundary shall not be attempted because the repress rate and NPSP requirement does not support the ullage pressure decay rate, and will make the ullage situation worse when compounded with a leak condition.

Since the leak rate could increase at any time, it is important to reach multiple engine-out capability and an acceptable MECO as soon as possible. Performing a delayed TAL maintains East Coast Abort Landing (ECAL) opportunities and improves bailout survival/recovery probabilities, while maintaining intact TAL performance margins to no less than a 3-sigma confidence level (reference Rule {A2-70}, DELAYED TRANSATLANTIC LANDING (TAL) ABORT).

GPC software automatically throttles the engines down if TAL is selected above an I-loaded inertial velocity. To prevent the software from throttling the engines down when there is an LH₂ ullage leak, manual throttles are selected prior to selecting TAL. Once TAL is selected, the throttles will be returned to AUTO where they will stay at 104 percent until 3 g's are reached. Three-g throttling may exacerbate the NPSP decay necessitating earlier engine shutdowns, but this is an accepted risk to avoid vehicle structural damage. ©[071494-1646A] ©[032807-8399B]

THIS RULE CONTINUED ON NEXT PAGE

FLIGHT RULES

A5-155

LIMIT SHUTDOWN CONTROL, MANUAL THROTTLING, AND
MANUAL SHUTDOWN FOR LOW LH2 NPSP [CIL] [HC]
(CONTINUED)

The main engine limit shutdown software will be manually enabled upon recognition of this failure to protect against multiple engine shutdowns without limits enabled. ©[032807-8399B]

Reference Hazard Report IMPS-06, Underpressurization of the Integrated MPS H2 System.

©[032807-8399B]

Rules {A2-64}, MANUAL THROTTLE CRITERIA; {A4-59}, MANUAL THROTTLE SELECTION; {A5-5}, SUSPECT ENGINE [HC]; {A5-9}, LH2 ULLAGE LEAK [HC]; {A5-103}, LIMIT SHUTDOWN CONTROL; and {A5-156}, ABORT PREFERENCE FOR SYSTEMS FAILURES [HC], reference this rule. ©[092195-1770A] ©[040899-6818A] ©[ED] ©[042706-7349] ©[102506-7856] ©[ED] ©[032807-8395B]

FLIGHT RULES

A5-156

ABORT PREFERENCE FOR SYSTEMS FAILURES [HC]

©[032807-8395B]

A. LH₂ ULLAGE LEAK ©[040899-6818A]

IF LOW LH₂ NPSP OCCURS DUE TO AN EXTERNAL TANK LH₂ ULLAGE LEAK, A DELAYED TAL ABORT WILL BE PERFORMED TO PROVIDE THE EARLIEST MULTIPLE ENGINE-OUT CAPABILITY. REFERENCE RULE {A2-70}, DELAYED TRANSATLANTIC LANDING (TAL) ABORT. ©[ED]
©[102506-7861B]

B. GH₂ PRESSURIZATION SYSTEM ANOMALIES

IF THE LOW LH₂ NPSP OCCURS DUE TO THREE GH₂ FLOW CONTROL VALVES FAILED CLOSED, A DELAYED TAL ABORT WILL BE PERFORMED TO PROVIDE THE EARLIEST MULTIPLE ENGINE-OUT CAPABILITY. THIS IS THE ONLY GH₂ PRESSURIZATION SYSTEM ANOMALY FOR WHICH AN ABORT WILL BE PERFORMED. REFERENCE RULES {A5-155}, LIMIT SHUTDOWN CONTROL, MANUAL THROTTLING, AND MANUAL SHUTDOWN FOR LOW LH₂ NPSP [CIL] [HC], AND {A2-70}, DELAYED TRANSATLANTIC LANDING (TAL) ABORT. ©[032807-8399B]

A TAL abort is preferred over RTLS because TAL MECO conditions are satisfied sooner than RTLS MECO conditions. If an LH₂ ullage leak occurs, throttling will not be performed for low LH₂ NPSP (see rationale for Rule {A5-155}, LIMIT SHUTDOWN CONTROL, MANUAL THROTTLING, AND MANUAL SHUTDOWN FOR LOW LH₂ NPSP [CIL] [HC]). Once an ullage leak occurs, it is possible for the leak to worsen. In this case, the NPSP may deteriorate much faster than the failed closed flow control valve case. For ullage leaks, the time of each engine shutdown may be determined by predicting when the engines will reach the minimum allowable NPSP value. Since the leak rate could increase at any time, it is important to reach multiple engine-out capability and MECO conditions as soon as possible. Performing a Delayed TAL maintains East Coast Abort Landing (ECAL) opportunities and improves bailout survival/recovery probabilities, while maintaining intact TAL performance margins to no less than a 3 sigma confidence level (reference Rule {A2-70}, DELAYED TRANSATLANTIC LANDING (TAL) ABORT). ©[021199-6791A] ©[032807-8395B]

THIS RULE CONTINUED ON NEXT PAGE

FLIGHT RULES

A5-156

ABORT PREFERENCE FOR SYSTEMS FAILURES [HC] (CONTINUED)

An abort will not be performed for two flow control valves failed closed or for a plugged GH₂ pressurization system leg. The flow control valves are normally open valves (must be powered closed). The close power will cycle the valves as required to satisfy the ullage pressure control band (reference Rule {A5-154}, LH₂ TANK PRESSURIZATION [CIL] [HC]). It is assumed that the failure will occur during power cycling. With two valves failed closed, the third valve will not be power-cycled. Therefore, the third valve will remain open (unpowered) and nominal MECO conditions may be achieved by implementing Rule {A5-155}, LIMIT SHUTDOWN CONTROL, MANUAL THROTTLING, AND MANUAL SHUTDOWN FOR LOW LH₂ NPSP [CIL] [HC]. For a plugged GH₂ pressurization leg, the other two flow control valves will operate and nominal MECO conditions may be achieved by implementing Rule {A5-155}, LIMIT SHUTDOWN CONTROL, MANUAL THROTTLING, AND MANUAL SHUTDOWN FOR LOW LH₂ NPSP [CIL] [HC]. If three flow control valves are failed closed, a Delayed TAL abort will be performed. ©[040899-6818A] ©[102506-7861B] ©[032807-8399B] ©[032807-8395B]

C. ENGINE-TO-ENGINE HELIUM INTERCONNECT WITH TWO ENGINES OPERATING

A TAL ABORT TO EITHER A TAL OR AUGMENTED CONTINGENCY LANDING SITE (ACLS), BASED ON WHICHEVER PROVIDES THE EARLIEST MULTIPLE ENGINE-OUT CAPABILITY, WILL BE PERFORMED IF THE HELIUM SYSTEM FROM A RUNNING ENGINE IS INTERCONNECTED TO A LEAKING ENGINE HELIUM SUPPLY IN ORDER TO ACHIEVE INTACT ABORT CAPABILITY (REF. RULE {A5-152B}, PRE-MECO MPS HELIUM SYSTEM INTERCONNECTS [CIL] [HC]) ©[090894-1676A] ©[102506-7861B] ©[032807-8398]

Because of the severity of the helium leak which requires the implementation of Rule {A5-152B}, PRE-MECO MPS HELIUM SYSTEM INTERCONNECTS [CIL] [HC], adequate helium may not be available to support a nominal MECO. In this case, it is possible that a non-leaking engine as well as the leaking engine could shut down due to inadequate helium. Therefore, it is important to reach multiple engine-out capability and MECO conditions as soon as possible. This will be accomplished by performing a TAL abort or an abort to an ACLS. ©[090894-1676A] ©[021199-6791A]

Reference Hazard Report IMPS-06, Underpressurization of the Integrated MPS H₂ System. ©[102506-7861B]

Reference Ascent/Entry Flight Techniques #220, May 19, 2006, and A/EFTP #227, February 16, 2007. ©[032807-8395B]

Rules {A5-5}, SUSPECT ENGINE [HC]; and {A5-9}, LH₂ ULLAGE LEAK, reference this rule. ©[040899-6818A] ©[ED] ©[102506-7856]

FLIGHT RULES

A5-157

MPS LOW LEVEL CUTOFF SENSORS FAILED DRY [HC]

©[102506-7354A]

DURING POWERED FLIGHT, IF THREE OR MORE MPS PROPELLANT LOW LEVEL CUTOFF SENSORS OF THE SAME PROPELLANT HAVE FAILED TO THE DRY STATE: ©[021397-4824]

- A. BASED ON A PRE-MISSION UNDERSPEED ANALYSIS, IF A PREMATURE MECO AT THE EXTERNAL TANK ARMING MASS I-LOAD ALLOWS FOR AN ACCEPTABLE INTACT UPHILL ABORT (AOA STEEP, ATO, NOMINAL) PER RULE {A4-56}, PERFORMANCE BOUNDARIES, THEN NO PRE-MECO ABORT IS REQUIRED.
- B. IF UPHILL ABORT CAPABILITY DOES NOT EXIST, PER PARAGRAPH A, THEN A TAL ABORT TO A TAL OR ACLS LANDING SITE WILL BE PERFORMED IN ORDER TO AVOID AN ELS/CONTINGENCY ABORT BASED ON A PREMATURE MECO AT THE ARMING MASS I-LOAD.

NOTE: THREE OR MORE "DRY" INDICATIONS WILL CAUSE PREMATURE MECO IF THE LOW LEVEL ARM COMMAND IS PRESENT PRIOR TO REACHING THE REQUIRED MECO TARGET. TWO SENSORS INDICATING "DRY" WILL NOT REQUIRE AN ABORT.

Propellant low level shutdown software is provided to protect the vehicle from an uncontained engine failure caused by the depletion of either LO₂ or LH₂ propellant on a running engine. The software logic requires two qualified sensors to indicate dry after the low level cutoff (LLCO) ARM flag is set in order to start the low level timer and issue the MECO command. This flag can be set by reaching a flight specific arming mass or by the loss of two main engines. On the first pass after the ARM flag is set, the software will disable one dry low level sensor and will command MECO if two other low level sensors on the same propellant are failed dry. Therefore, three sensors indicating dry when the ARM flag is set will result in an early MECO which may require a high energy TAL or a downrange abort to an ELS. The failure of two sensors will not cause a premature MECO when the ARM flag is set, since one will be disabled. If three low level sensors fail dry, the crew will be required to abort TAL (or ACLS if no TAL site is available) on most performance-critical missions (as determined by flight design) to prevent a MECO from occurring in a region where no intact abort capability exists.

©[021397-4824]

Hazard Report IMPS-17, Inadvertent SSME Shutdown, is controlled by this rule. ©[102506-7354A]

Rule {A2-301}, Note 31, CONTINGENCY ACTION SUMMARY [HC], references this rule. ©[032807-8400]

A5-158 THROUGH A5-199 RULES ARE RESERVED

FLIGHT RULES

MPS MANAGEMENT: POST-MECO

A5-200

MPS PROPELLANT DUMP/ET SEPARATION MANAGEMENT [HC]

FOR NOMINAL/ATO MISSIONS, THE MPS PROPELLANT DUMP AND ET SEPARATION WILL BE MANAGED AS FOLLOWS: @[112304-6444A]

- A. IF THE MPS PROPELLANT DUMP BEGINS PRIOR TO ET-ORBITER SEPARATION, SEPARATION WILL BE MANUALLY DELAYED UNTIL AFTER THE MPS DUMP IS COMPLETE.
- B. IF THE MPS PROPELLANT DUMP IS MANUALLY DELAYED UNTIL AFTER SEPARATION, THE MPS DUMP WILL BE STARTED NO EARLIER THAN THE COMPLETION OF THE ORBITER -Z TRANSLATION.

There are failure scenarios that require the crew to manually delay either the beginning of the post-MECO MPS propellant dump or to delay ET-orbiter separation. Analysis performed by Boeing in July 1999 indicated potential ET-orbiter recontact issues when the MPS propellant dump is initiated immediately before or immediately after separation (reference PSIG telecon July 29, 1999). Therefore, it is prudent to either complete the MPS dump prior to ET separation or to initiate the MPS dump after the completion of the orbiter -Z translation away from the External Tank.

Initiating separation while the MPS dump is in progress may also cause the loss of the digital orbiter umbilical camera function. Digital umbilical camera power is removed at the completion of the MPS dump as long as ET separation has occurred. If the MPS dump is completed shortly after ET separation, the digital umbilical cameras may not have had enough time to complete taking all of the necessary photographs of the external tank. For this case, completing the MPS dump before ET separation ensures that the digital umbilical camera power will not be removed early.

Due to the time critical nature of ET separation during RTLS/TAL aborts, this rule does not apply to those trajectories.

Hazard Report INTG 010 is controlled by this Rule. @[112304-6444A]

FLIGHT RULES

A5-201

MPS DUMP INHIBIT [CIL] [HC] @[020196-1813A] @[022405-6578A]

A. INSIGHT INTO ENGINE INLET CONDITIONS AVAILABLE:

IF A PROPELLANT LEAK IS DETECTED PRE-MECO ON ANY ENGINE WHICH SHUTS DOWN PRIOR TO MECO, IT WILL BE ISOLATED FROM DUMPING. THIS DUMP INHIBIT DECISION WILL BE BASED ON THE FOLLOWING:
@[032807-8397A]

1. LO₂ INLET PRESSURE < 40 PSIA

DUMP INHIBIT STEPS ARE PERFORMED IMMEDIATELY FOLLOWING MECO.

FOR A DUMP INHIBIT OF THE LO₂ SYSTEM, AN EARLY APU SHUTDOWN WILL BE REQUIRED POSTLANDING FOR TAL AND RTLS ABORTS (REFERENCE RULE {A16-205A}, EARLY APU SHUTDOWN [HC]). @[020196-1813A] @[022405-6578A]

2. LH₂ INLET PRESSURE < 30 PSIA

THE LPFTP DISCHARGE PRESSURE CAN BE USED AS A BACKUP CUE TO ASSESS LH₂ INLET CONDITIONS IF THE INLET PRESSURE IS UNAVAILABLE.

- a. IF THE LH₂ 4-INCH RECIRCULATION DISCONNECT CLOSES AS COMMANDED AFTER THE ENGINE FAILURE, THEN DUMP INHIBIT STEPS WILL BE PERFORMED IMMEDIATELY POST MECO.
- b. IF THE LH₂ 4-INCH RECIRCULATION DISCONNECT DOES NOT CLOSE AFTER THE ENGINE FAILURE OR INSIGHT INTO THE RECIRC DISCONNECT IS LOST, THEN THE CONTROLLERS OF THE AFFECTED SSME WILL BE POWERED OFF IMMEDIATELY AND THE REMAINING DUMP INHIBIT STEP(S) WILL BE PERFORMED IMMEDIATELY POST MECO. @[032807-8397A]

FOR A DUMP INHIBIT OF THE LH₂ SYSTEM, AN EMERGENCY POWERDOWN/MODE V EGRESS WILL BE REQUIRED FOR TAL AND RTLS ABORTS (REFERENCE RULE {A16-12B}.2, EMERGENCY POWERDOWN). AN EARLY APU SHUTDOWN WILL OCCUR AS A RESULT OF THE EMERGENCY POWERDOWN. @[020196-1813A]

THIS RULE CONTINUED ON NEXT PAGE

FLIGHT RULES

A5-201

MPS DUMP INHIBIT [CIL] [HC] (CONTINUED)

For nominal, RTLS, TAL, ATO, and AOA missions, the dump inhibit will be performed immediately post-MECO on the affected SSME if insight into the engine inlet conditions is available and the above criteria are met. The dump inhibit is performed by manually closing the associated prevalve and powering down that engine's controller. To minimize dump and vacuum inert impacts, only the associated prevalve will be closed on the side which was determined to be leaking. The engine controller is powered off to close the bleed and hydraulic valves. These actions will prevent excessive leakage of propellant into the aft compartment during the MPS propellant dump, thereby minimizing a potentially hazardous condition in the aft compartment (reference the PSIG Flight Rule Review of February 25, 1988). Causes for early shutdown include redline limit shutdown, multiple loss of controller avionics, and manual shutdown for a MPS helium leak, a hydraulic or electrical lockup, or a command path failure. Since flight data indicates that the pump inlet pressures drop below the above limits after MECO, an engine propellant leak cannot be detected post-MECO. The low pressure fuel pump discharge pressure can be used as a backup to the LH₂ inlet pressure and would also use 30 psia as the dump inhibit criterion. ©[032807-8397A]

If an LH₂ propellant leak on a failed SSME is detected pre-MECO and the LH₂ 4 inch Recirculation Disconnect does not close as commanded, the associated SSME controllers are powered off as soon as possible to close the LH₂ bleed valve and help prevent continuing leakage of LH₂ into the aft compartment (reference Corrective Action Record #109RF03). The remaining dump inhibit step for closing the associated LH₂ prevalve can wait until post-MECO because the prevalve is closed by the automated SSME safing function and does not open again until MPS dump start. ©[032807-8397A]

If a breach of one or more of the LH₂ propellant lines has occurred, the possibility exists of uncontained/uncontrolled LH₂ propellant in the aft, which constitutes a flammability and explosion hazard on a RTLS or TAL abort. This condition requires the most expeditious powerdown of the vehicle (emergency powerdown) and crew egress (Mode V) possible. An LO₂ leak is not considered as hazardous as an LH₂ leak and therefore does not require an emergency powerdown and Mode V egress. However, both kinds of leaks do warrant an early APU shutdown after an RTLS or TAL abort in order to eliminate an ignition source in a hydrogen or oxygen enriched environment. These postlanding actions are not required after a nominal, ATO, or AOA mission since no uncontained residuals will remain in the aft compartment at the time of landing.

THIS RULE CONTINUED ON NEXT PAGE

FLIGHT RULES

A5-201

MPS DUMP INHIBIT [CIL] [HC] (CONTINUED)

B. INSIGHT INTO ENGINE INLET PRESSURE CONDITIONS UNAVAILABLE:
@[032807-8397A]

1. NOM/ATO/AOA

FOR ANY ENGINE WHICH SHUTS DOWN PRIOR TO MECO EITHER MANUALLY OR AUTOMATICALLY, THE MPS DUMP INHIBIT WILL BE PERFORMED ON THE PROPELLANT SYSTEM(S) ON WHICH PRESSURE INSIGHT HAD BEEN LOST. THESE ACTIONS WILL BE TAKEN ON A TIME PERMITTING BASIS TO MINIMIZE POTENTIAL LEAKAGE. THE LPFTP DISCHARGE PRESSURE CAN BE USED AS A BACKUP CUE TO ASSESS LH₂ INLET PRESSURE CONDITIONS.

IF INSIGHT INTO THE LO₂ SYSTEM PRESSURE IS LOST, THEN THE DUMP INHIBIT STEPS FOR LO₂ ARE PERFORMED IMMEDIATELY POST MECO.

IF INSIGHT INTO THE LH₂ SYSTEM PRESSURE IS LOST AND THE LH₂ 4-INCH RECIRCULATION DISCONNECT DOES NOT CLOSE AFTER A PREMATURE ENGINE SHUTDOWN, THEN THE CONTROLLERS OF THE AFFECTED SSME WILL BE POWERED OFF IMMEDIATELY AND THE REMAINING DUMP INHIBIT STEPS ARE PERFORMED IMMEDIATELY POST MECO. OTHERWISE, WITH THE RECIRCULATION DISCONNECT CLOSED, THE DUMP INHIBIT STEPS FOR LH₂ WILL BE PERFORMED IMMEDIATELY POST-MECO.

Loss of insight into the inlet pressures and the LH₂ LPFTP discharge pressure results in the inability to assess the engine inlet conditions; therefore, the dump will be inhibited for any engine that shuts down prior to MECO for the nominal, ATO, or AOA if the inlet condition(s) cannot be assessed at the time of shutdown since a contained shutdown cannot be guaranteed. Additionally, if the inlet conditions are unavailable, and the LH₂ 4 inch Recirculation Disconnect did not close after the engine shut down pre-MECO, then the controllers are powered off immediately in order to prevent leakage of LH₂ into the aft compartment through the LH₂ bleed valves. In the case where there was no leakage, any residuals trapped in the engine by the dump inhibit procedure will have time to bleed out prior to landing.

@[032807-8397A]

THIS RULE CONTINUED ON NEXT PAGE

FLIGHT RULES

A5-201 MPS DUMP INHIBIT [CIL] [HC] (CONTINUED)

2. TAL/RTLS

THE MPS DUMP INHIBIT WILL NOT BE PERFORMED.

Due to the extremely low probability of a non-catastrophic, uncontained shutdown, and the additional failure required to lose insight into the inlet conditions, the cases of survivable shutdowns with leakage hidden due to loss of insight on a TAL and RTLS will not be covered. If the MPS dump is inhibited for the RTLS and TAL cases due to loss of insight and no leakage existed, it would induce an unnecessary risk of trapped LH₂ residuals (approximately 26 lbs. LH₂ on a RTLS and approximately 8 lb LH₂ on a TAL abort, at touchdown). These amounts of LH₂ are enough to cause a venting concern for the convoy and preclude normal convoy operations and would require as a minimum an expedited powerdown and Mode V egress per Rule {A16-11F}, EXPEDITED POWERDOWN [HC]. However, if leakage was assumed, an emergency powerdown and Mode V egress would be performed per paragraph A of this rule. ©[020196-1813A] ©[022405-6578A] ©[032807-8397A]

Hazard Report ORBI 306, Fire/Explosion in the Orbiter Aft Compartment Caused by MPS Propellant Leakage/Component Rupture is controlled by this rule.

Hazard Reports ORBI 338, GO2 External Tank Pressurization Line as MPS/APU Ignition Source; ORBI 035, Hydrogen Accumulation in the Orbiter Compartments During RTLS or TAL Abort; and IMEO-01, Hazardous Environment in the Aft Compartment reference this rule.

Rules {A16-12B}.2, EMERGENCY POWERDOWN, and {A16-205A}.1, EARLY APU SHUTDOWN [HC], reference this rule. ©[032807-8397A]

FLIGHT RULES**A5-202****ET SEPARATION INHIBIT FOR 17-INCH DISCONNECT FAILURE [CIL]**

A. NOMINAL/ATO/AOA @[102506-7355A]

1. IF AN ET/ORBITER 17-INCH DISCONNECT VALVE IS NOT AUTOMATICALLY VERIFIED CLOSED BY GPC SOFTWARE:
 - a. ET SEPARATION WILL BE DELAYED UNTIL MECO PLUS 6 MINUTES TO ALLOW THRUST DECAY FROM THE OPEN VALVE AND THUS PREVENT RECONTACT BETWEEN THE ET AND ORBITER. THE MPS PROPELLANT DUMP WILL BE AUTOMATICALLY PERFORMED DURING THE WAIT PERIOD.
 - b. FOR AN UNDERSPEED AT MECO WHICH REQUIRES THE OMS-1 BURN TO BE PERFORMED PRIOR TO MECO PLUS 6 MINUTES, ET SEPARATION WILL BE PERFORMED AT OMS-1 TIG MINUS 1 MINUTE 30 SECONDS OR IMMEDIATELY IF REQUIRED, AND THE MPS DUMP WILL BE MANUALLY DELAYED UNTIL AFTER SEPARATION. @[030994-1618B]
2. FOR AN LH₂ DISCONNECT FAILURE, TIME PERMITTING, THE AUTOMATIC LH₂ MANIFOLD REPRESS WILL BE INHIBITED BY TAKING THE LH₂ MANF PRESS SWITCH TO CLOSE PRIOR TO MM106 AND THEN BACK TO GPC AFTER MM106 +3 MINUTES.
3. FOR NOMINAL/ATO, BOTTOM-SUN WILL BE REQUIRED FOR THERMAL CONDITIONING (REFERENCE RULE {A10-243}, ET UMBILICAL DOOR CLOSURE DELAY FOR DISCONNECT VALVE FAILURE [CIL]). @[021199-6795A] @[102506-7355A]

B. RTLS/TAL

ET SEPARATION IS AUTOMATIC FOR 17-INCH DISCONNECT VALVE FAILURE.

The ET separation sequence software in the GPC's will inhibit ET separation automatically if it does not receive at least one of the two close position indications from each of the orbiter 17-inch disconnect valves. The closed position indicators may not show closed for real valve failures or loss of insight. This prevents a recontact problem which could occur between the ET and the orbiter after separation due to the large venting force (>10,000 lbf) of the open 17-inch valve (reference SODB, volume 1, section 3.4.3.1).

THIS RULE CONTINUED ON NEXT PAGE

FLIGHT RULES

A5-202

ET SEPARATION INHIBIT FOR 17-INCH DISCONNECT FAILURE [CIL] (CONTINUED)

The crew will perform a manual separation 6 minutes after the nominal separation time. This waiting period allows the tank and the Orbiter manifold to vent to a level where the venting force < 1800 lbf, which is considered safe for separation (reference SODB, volume 1, section 3.4.3.1). ©[102506-7355A]

For underspeeds at MECO, which require an OMS-1 to be performed prior to MECO plus 6 minutes, ET separation has to be performed 1 minute 30 seconds prior to OMS-1 ignition. The 1 minute 30 second time was selected to ensure that the crew had sufficient time to prepare for the OMS-1 ignition (reference SODB, volume 1, section 3.4.3.1). The MPS dump will be manually delayed by placing the MPS Propellant Dump Sequence Switch in the STOP position if the separation time would occur during the scheduled MPS dump. The switch is taken back to the GPC position after the ET SEP -Z translation to allow the automated MPS dump to commence. The MPS dump is delayed since performing the MPS dump during ET separation is not a certified separation mode.

Time criticality during an RTLS and TAL aborts necessitates an automatic ET separation for OI-22 and subsequent software. The RTLS ET separation software allows 6 seconds of venting. Recontact damage will be risked on an RTLS to avoid rapid degradation of ET separation conditions and possible loss of control. The TAL ET separation software allows 15 seconds of venting to avoid recontact while minimizing the time to OPS 3 transition. TAL aborts incorporate an I-loaded software timer expiration (MSID V97U9717C) to sequence automatic ET separation while RTLS aborts use a hardcoded software constant for separation.

The LO₂ MPS manifold repressurization valves are not commanded open after a 17-inch LO₂ disconnect failure to prevent excessive loss of helium during the MPS dump. The LH₂ MPS manifold repressurization valves are not opened during this timeframe but are automatically opened at MM106 +2:10 for the LH₂ manifold pressurization checkout. For a disconnect that fails to close, the repress is inhibited by taking the LH₂ manifold press switch to CLOSE in order to override the GPC command and prevent wasting helium through the open disconnect valve.

Rule {A2-204}, MANUALLY DELAYED MPS DUMP, references this rule. ©[021199-6795A] ©[102506-7355A]

FLIGHT RULES

A5-203

MPS PROPELLANT MANIFOLD OVERPRESSURE [CIL] [HC]
@[102506-7356A]

A. AN MPS PROPELLANT MANIFOLD OVERPRESSURE CONDITION (> 312 (249) PSIA FOR LO_2 OR > 66 (60) PSIA FOR LH_2) WILL BE RELIEVED BY THE FOLLOWING METHODS:

1. PRE-MPS DUMP (NOM/ATO/AOA)

THE MPS DUMP WILL AUTOMATICALLY BE STARTED IMMEDIATELY IF THE LH_2 MANIFOLD PRESSURE IS BETWEEN 60 AND 90 PSIA AND NOT COMMFAULTED. @[092701-4867A]

2. POST-MPS DUMP (NOM/ATO/AOA), PRE-FIRST AUTOMATED VACUUM INERT

THE LH_2 OUTBOARD FILL/DRAIN AND TOPPING VALVES WILL AUTOMATICALLY OPEN IF THE LH_2 MANIFOLD PRESSURE IS BETWEEN 60 AND 90 PSIA AND NOT COMMFAULTED.

THE LH_2 OUTBOARD FILL/DRAIN AND TOPPING VALVES WILL AUTOMATICALLY CLOSE AT MPS DUMP START + 19 MINUTES (APPROXIMATELY MECO + 21 MINUTES). IF THE OUTBOARD FILL/DRAIN DOES NOT CLOSE, THE SOFTWARE WILL COMMAND THE LH_2 INBOARD FILL/DRAIN VALVE CLOSED. @[111094-1730A] @[021199-6792B]

3. POST-FIRST AUTOMATED VACUUM INERT (NOM/ATO/AOA)
@[092701-4867A]

THE AFFECTED LO_2 OR LH_2 OUTBOARD FILL/DRAIN VALVE WILL BE MANUALLY OPENED IMMEDIATELY. THIS VALVE WILL BE CLOSED AFTER THE SYSTEM HAS BEEN INERTED.

4. RTLS/TAL

NO CHANGE TO THE AUTOMATIC ENTRY DUMP SEQUENCE. THE LO_2 VACUUM INERT WILL BE AUTOMATICALLY INHIBITED ON A TAL IF THE PRESSURE IS GREATER THAN 30 PSI AND NOT COMMFAULTED.
@[102506-7356A]

THIS RULE CONTINUED ON NEXT PAGE

FLIGHT RULES

A5-203

MPS PROPELLANT MANIFOLD OVERPRESSURE [CIL] [HC] (CONTINUED)

Because of the characteristics of the LO₂ system, it is highly unlikely that a real overpressure condition will occur without multiple (> 2) system failures prior to the start of the MPS dump (nominally at MECO + 2 minutes). Therefore, no crew action is taken for LO₂ manifold pressure above C&W (249 psia). Heat soak back will vaporize any fluid propellants, increasing the pressure in the lines. On the LO₂ side, the pressure can be relieved by either the MPS dump or vacuum inerting. ©[102506-7356A]

On the LH₂ side, the pressure can be relieved by MPS dump, vacuum inerting, or opening the LH₂ backup dump valves in OPS 1. An automatic MPS dump will be performed to avoid reaching proof pressure (66 psig) if the software limit (greater than 60 psia and less than 90 psia) is reached before the scheduled MPS dump occurs. If the LH₂ manifold pressure C&W limit of 65 psia is reached, the crew will open the LH₂ backup dump valves and both LH₂ inboard and outboard fill/drain valves per the Ascent Pocket Checklist procedure. If the LH₂ manifold pressure is between 60 and 90 psia after the MPS dump terminates but prior to the first automated vacuum inert start (dump start + 17 minutes, approximately MECO + 19 minutes), an automated contingency LH₂ vacuum inert will be started by the software and relieve the pressure. This contingency inert will be performed by opening the LH₂ topping and LH₂ outboard fill/drain valves (the LH₂ inboard fill/drain valve remains open following the MPS dump). If the LH₂ manifold pressure is between 60 and 90 psia after the MPS dump terminates but prior to the first automated vacuum inert start and the LH₂ backup dump valves switch on panel R2 was taken to OPEN, an automated contingency LH₂ vacuum inert will not be started by the software because manual action has already been taken. ©[092701-4867A]

If either the LO₂ or LH₂ C&W limit is reached after the first automated vacuum inert, the affected LO₂ or LH₂ outboard fill/drain valve will be opened manually to relieve the pressure. Only the outboards are opened since the inboards should already be open. This is only performed for true high pressure in the affected manifold and not for instrumentation failures. Procedures in the Orbit Pocket Checklist have the crew open all the fill/drain valves since the crew does not have time to determine which system has the overpressure condition. The LO₂ manifold pressure C&W limit (249 psia) is approximately midway between the relief (190 psig) and proof (312 psig) pressures (ref. SODB, volume I, section 4.3). The LH₂ manifold pressure C&W limit (65 psia) is set to avoid having system delays in starting the MPS dump allow the LH₂ manifold pressure to exceed the C&W limit. Rule {A5-205C}, NOMINAL, AOA, AND ATO MPS DUMP FAILURES, references this rule. ©[111094-1730A] ©[021199-6792B] ©[092701-4867A] ©[ED]

For RTLS/TAL there is no change to the automatic dump sequence since the dump and inert sequences are initiated upon transition to MM 602 for RTLS and OPS 304 for TAL and the sequences will protect for over pressurization conditions. Any excessive pressure in the LH₂ system is relieved through the nominal dump and inert sequences and will automatically prevent over pressurization of the manifold if the pressure is between 60 and 90 psi. Vacuum inerting of the LH₂ system continues down to Vrel 5300 for a TAL and 3800 for an RTLS. For the LO₂ system, the vacuum inert will be automatically inhibited on a TAL if the manifold pressure is greater than or equal to 30 psi in order to prevent control transients due to high pressure venting through the LO₂ fill/drain valves. On an RTLS, the LO₂ dump and inert continues down to Vrel 3800, and over pressurization of the manifold is not a concern since it would take multiple system failures to interfere with the dump and the LO₂ to vaporize to a high pressure due to heat soak back. ©[102506-7356A]

FLIGHT RULES

THIS RULE CONTINUED ON NEXT PAGE

FLIGHT RULES

A5-203

**MPS PROPELLANT MANIFOLD OVERPRESSURE [CIL] [HC]
(CONTINUED)**

- B. IF THE LH₂ RELIEF ISOLATION VALVE FAILS CLOSED POST-MECO AND ANY OMS BURN TIG IS PRIOR TO THE START OF THE FIRST AUTOMATED VACUUM INERT AT MPS DUMP START + 17 MINUTES (APPROXIMATELY MECO + 19 MINUTES) : @[021199-6792B] @[090999-7035] @[092701-4867A]
1. THE LH₂ BACKUP DUMP VALVES WILL BE MANUALLY OPENED PRIOR TO THE OMS BURN. THE LH₂ BACKUP DUMP VALVES WILL AUTOMATICALLY CLOSE AT THE COMPLETION OF THE FIRST AUTOMATED VACUUM INERT AT MPS DUMP START + 19 MINUTES (APPROXIMATELY MECO + 21 MINUTES) .
 2. THE AUTOMATED LH₂ MANIFOLD REPRESSURIZATION FOLLOWING THE SECOND AUTOMATED VACUUM INERT WILL BE MANUALLY INHIBITED BY TAKING THE LH₂ MANIFOLD PRESS SWITCH TO CLOSE PRIOR TO THE MM 106 TRANSITION. THE LH₂ MANIFOLD PRESS SWITCH WILL BE TAKEN TO GPC AFTER THE MM 106 TRANSITION + 3 MINUTES .

If the LH₂ relief isolation valve does not open, the LH₂ manifold cannot be relieved through the relief valve. The nominal pressure buildup post-MECO is not expected to reach the manifold relief setting with a nominal MPS dump and nominal vacuum inerts. If the manifold pressure builds up greater than 60 psia, the software will automatically start the MPS dump or an automated contingency LH₂ vacuum inert (through the LH₂ fill/drain valves) to relieve the pressure. The LH₂ backup dump valves will be manually opened if an OMS burn is expected to occur prior to the nominal first automated vacuum inert start time of MPS dump start + 17 minutes (approximately MECO + 19 minutes). The OMS burn will increase the sublimation of the LH₂ residuals, resulting in a pressure buildup that may reach the relief setting. @[102506-7356A]

Although the software will automatically provide pressure relief if needed, the LH₂ backup dump valves are opened to prevent the pressure rise from nearing the proof pressure of the manifold (66 psig). The valves will be left open until the end of the first automated vacuum inert when they will automatically close. The second automated vacuum inert will be allowed to proceed normally. The LH₂ manifold repressurization will be manually inhibited. The repressurization is manually inhibited by taking the LH₂ manifold press switch to close because there is no manifold relief capability. This will be performed prior to the MM 106 transition because the second automated vacuum inert and subsequent manifold repressurization will initiate at the MM 106 transition. The LH₂ manifold press switch will be taken to GPC after the MM 106 transition + 3 minutes (corresponding to the completion of the second automated vacuum inert and subsequent manifold repressurization) in order to avoid powering the valve until it is nominally checked in the Deorbit Prep timeframe. @[092701-4867A] @[102506-7356A]

THIS RULE CONTINUED ON NEXT PAGE

FLIGHT RULES**A5-203****MPS PROPELLANT MANIFOLD OVERPRESSURE [CIL] [HC]
(CONTINUED)**

- C. IF AUTOMATIC LH₂ VENT, DUMP, AND RELIEF CAPABILITY IS LOST AS A RESULT OF DUAL GPC/FA MDM FAILURES (GPC'S/FA MDM'S 1 AND 3, 1 AND 4, OR 3 AND 4), THE CREW WILL MANUALLY OPEN THE LH₂ FEEDLINE RELIEF ISOLATION VALVE IMMEDIATELY POST-MECO. ©[090999-7035]

Certain dual GPC/FA MDM failure combinations occurring during ascent will prevent the LH₂ relief isolation valve as well as the LH₂ backup dump valves and LH₂ fill/drain valves from opening after MECO. Without a relief path, the LH₂ manifold pressure will rapidly rise to a dangerous pressure level in seconds. During the STS-1 flight, where the LH₂ backup dump valves were not commanded open at 11.4 seconds after MECO as they are now, the LH₂ manifold pressure went from 34 psia before 17-inch disconnect closure to 50 psia within 15 seconds and subsequently relieved until the start of the MPS dump. The LH₂ manifold burst pressure is 83 psig. The crew can manually open the LH₂ feedline relief isolation valve with a single switch throw on panel R4. Pressure rise on the LO₂ side is not a major concern as a result of the slower pressure rise rate, higher manifold burst pressure, and the available leak path through the SSME oxidizer pump seal packages. For any dual GPC/FA MDM failures, the onboard procedure has the crew take both the LO₂ and LH₂ feedline relief isolation valve switches to open for procedural simplicity. ©[030994-1618B] ©[021199-6792B] ©[092701-4867A]

Hazard Reports ORBI 035, Hydrogen Accumulation in the Orbiter Compartments During RTLS or TAL Abort; ORBI 278, Loss of Structural Integrity Due to Overpressurization of the Mid and/or Aft Fuselage; ORBI 306, Fire/Explosion in the Orbiter Aft Compartment Caused by MPS Propellant Leakage/Component Rupture; and IMPS-05, Overpressurization of the Integrated Main Propulsion System H2 System, are controlled by this rule. ©[102506-7356A]

FLIGHT RULES

A5-204**MANUALLY DELAYED MPS DUMP** ©[092701-4867A] ©[022405-6546]

FOR NOMINAL/ATO/AOA TRAJECTORIES, THE MPS DUMP WILL BE MANUALLY DELAYED BY TAKING THE MPS PRPLT DUMP SEQUENCE SWITCH TO "STOP" UNTIL AFTER ET SEPARATION FOR THE FOLLOWING FAILURE CASES IN ORDER TO AVOID PERFORMING THE MPS DUMP DURING ET SEPARATION:

- A. AFT RCS LEAK
- B. FORWARD RCS LEAK
- C. MPS FEEDLINE DISCONNECT FAILURE WITH AN OMS-1 TIG PRIOR TO MECO + 6 MINUTES ©[090999-7035]
- D. ET SEP INHIBIT DUE TO HIGH RATES

To prevent orbiter recontact with the ET, the MPS dump is delayed until after ET separation for an RCS leak, feedline disconnect failure, or an ET sep inhibit due to high rates.

With an RCS leak, the potential exists for the MPS dump forces to overwhelm the reduced RCS control authority during ET separation; therefore, the MPS dump is delayed until after ET separation by taking the MPS PRPLT DUMP SEQUENCE switch to STOP. For an RTLS or TAL abort, the MPS dump sequence is skipped and the MPS entry dump sequence will not start until MM 602 or MM 304, respectively, so recontact due to dump and vent forces is not a concern in these cases. Procedurally, the crew will take the MPS PRPLT DUMP SEQUENCE switch to STOP for an RCS leak on a TAL trajectory, but since the switch position is not monitored for the TAL dump in MM 304, the dump will still start automatically. ©[090999-7035] ©[092701-4867A] ©[ED]

With a feedline disconnect failure and an OMS-1 TIG prior to MECO + 6 minutes, the MPS dump is delayed per Rule {A5-202}, ET SEPARATION INHIBIT FOR 17-INCH DISCONNECT FAILURE [CIL], to prevent dump forces from interfering with the separation (dump and vent forces could cause recontact). For the feedline disconnect fail case during RTLS or TAL, ET separation is time critical and will happen automatically after an additional delay (6 seconds for RTLS and 15 seconds for TAL) as long as the ET SEPARATION switch is in AUTO.

For a sep inhibit due to rates greater than 0.7 degrees per second in any axis after MECO on a NOM/ATO/AOA trajectory, the crew may not get the rates under control in time to separate off the tank before the MPS dump automatically starts at MECO confirmed + 122 seconds. In this situation (if the MPS dump were not manually delayed), it would be possible for the crew to initiate a manual separation from the External Tank just before or during the MPS dump and risk recontacting the External Tank. For a TAL, ET separation will be automatically inhibited until the rates are under control (and then occur automatically with no delay as long as the ET SEPARATION switch is in AUTO) but there is no risk of a dump occurring during this time frame (the MPS entry dump sequence will not start until MM 304). For an RTLS, ET separation will occur automatically after a 6-second delay as long as the ET SEPARATION switch is in AUTO. ©[022405-6546]

THIS RULE CONTINUED ON NEXT PAGE

FLIGHT RULES

A5-204 MANUALLY DELAYED MPS DUMP (CONTINUED)

Analysis certifying the MPS dump during ET separation (SSEIG minutes, April 26, 1999) is not valid in these cases because the analysis assumed 1) the only RCS jets that are failed are those affected by a GPC 4 failure, and 2) the MPS dump can occur no earlier than 1.4 seconds after ET structural separation. ©[022405-6546]

Taking the MPS PRPLT DUMP SEQUENCE switch to STOP for an ET SEPARATION toggle switch failure along with an LH₂ manifold pressure transducer bias between 60 and 90 psia is not covered per the direction of the PRCB (PRCBD # S050270EF) on July 1, 1999. Since the most likely time that the ET SEPARATION toggle switch failure (FMEA/CIL's 05-6-2237-02 and 05-6-2237-03) can occur is post MECO, the crew would not have time to inhibit the MPS dump prior to MECO + 22 seconds (dump start time for the LH₂ transducer failure). The PRCB also considered the combination of these two failures to be too unlikely to be specifically covered by crew procedures or by the Flight Rules.

Rule {A5-205}, NOMINAL, AOA, AND ATO MPS DUMP FAILURES [HC], references this rule. ©[090999-7035] ©[092701-4867A] ©[ED] ©[022405-6546] ©[102506-7357]

A5-205 NOMINAL, AOA, AND ATO MPS DUMP FAILURES [HC]
 ©[092701-4867A] ©[ED] ©[102506-7357]

A. MPS DUMP SWITCH FAILURE - IF THE MPS DUMP SEQUENCE SWITCH IS NEEDED TO DELAY THE MPS DUMP AND IS INOPERATIVE DUE TO A CONTROL BUS OR SWITCH CONTACT FAILURE, THE AFFECTED CONTACT WILL BE COMM FAULTED BY POWER CYCLING THE APPROPRIATE MDM PER THE TABLE BELOW. ©[021397-4825]

<u>SW CONTACT</u>	<u>CONTROL BUS</u>	<u>MDM</u>
A	AB3	FF1
B	BC3	FF2

If contact failures or control bus failures cause redundancy management to declare the STOP position of the MPS Dump switch in dilemma, then the switch can no longer be used to control the dump. The MPS dump sequence switch is only used to delay the automated MPS dump until after ET separation for an aft RCS leak, a forward RCS leak, or an ET separation inhibit due to feedline disconnect failures with an OMS-1 TIG prior to MECO + 6 minutes, or SEP INH due to high rates per Rule {A5-204}, MANUALLY DELAYED MPS DUMP. If the MPS dump sequence switch is needed to delay the MPS dump and one of the contacts is failed or is lost due to loss of either control bus AB3 or BC3, the affected contact will be comm faulted in the switch RM logic by power cycling either MDM FF1 or FF2. ©[111094-1720B] ©[021397-4825] ©[092701-4867A] ©[ED] ©[102506-7357]

THIS RULE CONTINUED ON NEXT PAGE

FLIGHT RULES

A5-205

NOMINAL, AOA, AND ATO MPS DUMP FAILURES [HC]
(CONTINUED)

B. MPS PRPLT DUMP BACKUP LH₂ VLV SWITCH FAILURE - IF THE BACKUP DUMP VALVE SWITCH IS NEEDED TO OPEN THE BACKUP LH₂ VALVES, BUT THE SWITCH IS INOPERATIVE DUE TO A CONTROL BUS OR SWITCH CONTACT FAILURE, THE AFFECTED CONTACT WILL BE COMM FAULTED BY POWER CYCLING THE APPROPRIATE MDM PER THE TABLE BELOW. @[102506-7357]

<u>SW CONTACT</u>	<u>CONTROL BUS</u>	<u>MDM</u>
A	AB2	FF3
B	BC2	FF4

If the backup dump valve switch fails redundancy management, it cannot be used to manually open the valves. The switch is used to open the backup dump valves manually in the event of failures that will result in off nominal LH₂ dump residuals or as a means of relieving pressure in the event of a relief isolation or relief valve failure. If the switch is needed to open the valves and one of the contacts is failed or is lost due to loss of either control bus AB2 or BC2, the affected contact will be taken out of the switch RM logic by power cycling either MDM FF3 or FF4.

C. LH₂ DUMP FAILURES - AN LH₂ DUMP WILL BE PERFORMED BY MANUALLY OPENING THE LH₂ BACKUP DUMP VALVES PRIOR TO THE END OF THE MPS DUMP FOR THE FAILURE TO OPEN EITHER THE LH₂ INBOARD OR OUTBOARD FILL/DRAIN VALVE. THE LH₂ BACKUP DUMP VALVES WILL BE MANUALLY CLOSED BETWEEN DUMP START + 5 MINUTES AND DUMP START + 8 MINUTES BY TAKING THE LH₂ BACKUP DUMP VALVE SWITCH TO CLOSE THEN GPC. OTHERWISE, THE LH₂ MANIFOLD REPRESSURIZATION FOLLOWING THE SECOND AUTOMATED VACUUM INERT WILL BE MANUALLY INHIBITED BY TAKING THE LH₂ MANIFOLD PRESS SWITCH TO CLOSE PRIOR TO THE MM 106 TRANSITION. THE LH₂ MANIFOLD PRESS SWITCH WILL BE TAKEN TO GPC AFTER THE MM 106 TRANSITION + 3 MINUTES. @[092701-4867A]

The LH₂ portion of the MPS dump is a 120-second unpressurized dump through the LH₂ fill/drain valves, the LH₂ topping valve, and the LH₂ backup dump valves. If the LH₂ outboard fill/drain valve fails closed prior to the start of the MPS dump, approximately 55.7 lbm of hydrogen will remain at the end of the MPS dump. If the LH₂ inboard valve fails closed, approximately 3.43 lbm of hydrogen will remain. For these cases, the LH₂ backup dump valves will be taken to the open position prior to the end of the MPS dump. This will allow all but approximately .55 lbm (outboard failed) or .47 lbm (inboard failed) of hydrogen to be vented off by the time the LH₂ backup dump valves are manually closed and the first automated vacuum inert is completed at dump start + 19 minutes. @[102506-7357]

THIS RULE CONTINUED ON NEXT PAGE

FLIGHT RULES

A5-205

NOMINAL, AOA, AND ATO MPS DUMP FAILURES [HC]
(CONTINUED)

If no other crew action is taken after opening the backup dump valves, the LH₂ backup dump valves will remain open until the termination of the first automated vacuum inert at dump start + 19 minutes (approximately MECO + 21 minutes). At the termination of the first automated vacuum inert, the LH₂ backup dump valves will automatically close until the start of the second automated vacuum inert at the MM 106 transition. At the termination of the second automated vacuum inert, all but 0.24 lbm of hydrogen will be vented. This amount of hydrogen residual is sufficiently high to cause concern regarding the automatic manifold press checkout because the manifold pressure is expected to reach approximately 41 psia which is high enough to open the LH₂ feedline relief valve. In order to avoid opening the LH₂ feedline relief valve (the vent port is located near the vertical stabilizer), the automatic manifold press checkout will be manually inhibited by taking the LH₂ manifold press switch to close. This will be performed prior to the MM 106 transition because the second automated vacuum inert and subsequent manifold repressurization will initiate at the MM 106 transition. The LH₂ manifold press switch will be taken to GPC after the MM 106 transition + 3 minutes (corresponding to the completion of the second automated vacuum inert and subsequent manifold repressurization) in order to avoid powering the valve until it is nominally checked in the Deorbit Prep timeframe. ©[092701-4867A] ©[102506-7357]

If the crew closes the LH₂ backup dump valves between dump start + 4 minutes, 40 seconds and dump start + 8 minutes, the hydrogen residuals following the second automated vacuum inert will be between 0.09 lbm and 0.10 lbm (inboard and outboard failed, respectively). For simplicity, the crew action to take the LH₂ backup dump valve switch to close then GPC will be performed between dump start + 5 minutes and dump start + 8 minutes (approximately MECO + 7 to MECO + 10). It is believed that these residuals are insufficient to cause hydrogen to relieve on orbit. All residuals are based on Boeing IL SHA0-01-014 / SI-01-044 dated February 19, 2001. ©[092701-4867A] ©[102506-7357]

Manual control of the LH₂ backup dump valves is only available in OPS 1. If the hydrogen residuals were not properly inerted in OPS 1, the manifold pressure may rise above the 83 psig burst pressure of the manifold. This scenario would require the crew to pro to OPS 303 (via OPS 301) in order for the software to automatically open the LH₂ backup dump valves. Once the manifold pressure returns to normal, the vehicle may be transitioned back to OPS 2. For this reason, the hydrogen residuals are managed in OPS 1 via the LH₂ backup dump valve switch.

Currently, no ops code exists to open the LH₂ backup dump valves via real-time command (RTC), and due to the fact that the pressure will rise from the max relief setting to the burst pressure in a relatively short amount of time (approximately 1.0 hour), the decision was made not to pursue a GPC memory read/write (GMEM). In the case of an AOA, the manifold pressure should not reach burst pressure prior to the OPS 303 transition. ©[111094-1720B]

THIS RULE CONTINUED ON NEXT PAGE

FLIGHT RULES

A5-205

NOMINAL, AOA, AND ATO MPS DUMP FAILURES [HC]
(CONTINUED)

- D. LO₂ DUMP FAILURES - AN INCOMPLETE LO₂ DUMP MAY REQUIRE A MANUAL LO₂ VACUUM INERT TO BE PERFORMED PER RULE {A5-206}, MANUAL VACUUM INERTING REQUIREMENTS (NOMINAL, ATO, AOA) [HC].
@[111094-1730A] @[021397-4825] @[102506-7357] @[102506-7358]

The LO₂ is dumped through the SSME main oxidizer valves. There is no secondary dump path available during the MPS dump. However, after MPS dump termination, residuals will vent through the engine high pressure oxidizer pump seals, and the relief system will protect the manifold from overpressurization. @[092701-4867A]

Hazard Reports ORBI 035, Hydrogen Accumulation in the Orbiter Compartments During RTLS or TAL Abort; ORBI 278, Loss of Structural Integrity Due to Overpressurization of the Mid and/or Aft Fuselage; ORBI 306, Fire/Explosion in the Orbiter Aft Compartment Caused by MPS Propellant Leakage/Component Rupture; and IMPS-05, Overpressurization of the Integrated Main Propulsion System H2 System, are controlled by this rule. @[102506-7357]

FLIGHT RULES

A5-206

MANUAL VACUUM INERTING REQUIREMENTS (NOMINAL, ATO, AOA) [HC] @[102506-7358]

- A. FOR NOMINAL/ATO MISSIONS, A MANUAL LO₂ VACUUM INERTING MAY BE PERFORMED BY THE CREW IF THE LO₂ MANIFOLD PRESSURE IS GREATER THAN 30 PSIA AFTER THE SCHEDULED TERMINATION OF THE FIRST AUTOMATED VACUUM INERT. MANUAL LO₂ VACUUM INERTING WILL NOT BE PERFORMED UNTIL THE LO₂ MANIFOLD PRESSURE VENTS BELOW 30 PSIA. @[111094-1718A] @[092701-4867A]

LO₂ vacuum inerting can be delayed because the LO₂ prevalues remain open after the MPS dump which allows the pressure to vent through the engine high-pressure oxidizer pump seals. After the pressure decays below 30 psia, the software or crew can then perform vacuum inerting without any vehicle control problems. The software can only perform the automated LO₂ vacuum inert between MPS dump start +17 minutes (approximately MECO + 19 minutes) and MPS dump start + 19 minutes (approximately MECO + 21 minutes).

For a nominal and ATO mission, there should be sufficient time to allow the pressure to decay and then perform the LO₂ vacuum inert if required. The manual vacuum inert may not be necessary depending on the effectiveness of the pressure relief through the engine high-pressure oxidizer pump seals. On an AOA, there may not be sufficient time to vent below 30 psia, however, no action would be required because the LO₂ manifold will be inerted automatically in MM 304 by the MPS entry dump sequence.

LO₂ manifold pressure will be less than 30 psia if the MPS dump was performed successfully. However, if two or three engine main oxidizer valves were not able to open for the MPS dump, the residual oxidizer could result in a manifold pressure greater than 30 psia. Opening the LO₂ fill/drain valves when the manifold pressure is greater than 30 psia will cause the vehicle to roll significantly as was experienced during an MPS dump detailed test objective on STS 51-D. The roll was due to the oxidizer flow force at the LO₂ outboard fill/drain valve and flow impingement on the wing.

- B. FOR A BCE STRING 2C FAILURE OR AN LO₂ MANIFOLD PRESSURE SENSOR BIASED OR FAILED HIGH, A MANUAL LO₂ VACUUM INERT WILL BE PERFORMED AFTER MPS DUMP START + 22 MINUTES (APPROXIMATELY MECO + 24 MINUTES) IF THE LO₂ MANIFOLD PRESSURE IS CONFIRMED TO BE LESS THAN 30 PSIA.

The loss of BCE STRING 2C commfaults the LO₂ manifold pressure sensor. The MPS dump sequence will not perform the LO₂ portion of the first automated vacuum inert if the manifold pressure sensor is commfaulted or indicating 30 psi or greater. Any LO₂ inlet pressure sensor can be used by the MCC as a backup to the LO₂ manifold pressure if the corresponding LO₂ prevalue is open. The crew's LO₂ manifold pressure meter should also be available to determine the LO₂ manifold pressure in the event that the sensor is commfaulted. The BCE STRING X procedure in the Ascent Pocket Checklist directs the crew to perform the MPS vacuum inert procedure for the STRING 2C failure. @[092701-4867A] @[102506-7358]

THIS RULE CONTINUED ON NEXT PAGE

FLIGHT RULES

A5-206

MANUAL VACUUM INERTING REQUIREMENTS (NOMINAL, ATO, AOA) [HC] (CONTINUED)

- C. ON AN AOA, A MANUAL LO₂ AND LH₂ VACUUM INERT MAY BE REQUIRED IF OPS 3 IS ENTERED PRIOR TO INITIATION OF THE FIRST AUTOMATED VACUUM INERT. @[092701-4867A] @[102506-7358]

On an AOA, there may not be sufficient time for the software to initiate the first automated vacuum inert and the crew must manually perform the vacuum inert to insure no residuals, since no entry dump/inert will be performed. @[102506-7358]

- D. MANUAL LH₂ VACUUM INERTING WILL BE PERFORMED BY MANUALLY OPENING THE LH₂ INBOARD AND OUTBOARD FILL/DRAIN VALVES FOR THE FAILURE TO OPEN THE LH₂ BACKUP DUMP VALVES. THE FIRST MANUAL VACUUM INERT WILL BE PERFORMED AS CLOSE TO THE AUTOMATIC SEQUENCE AS POSSIBLE, BETWEEN MPS DUMP START + 17 MINUTES (APPROXIMATELY MECO + 19 MINUTES) AND MPS DUMP START + 19 MINUTES (APPROXIMATELY MECO + 21 MINUTES). THE SECOND MANUAL VACUUM INERT WILL BE PERFORMED POST OMS-2 AND PRIOR TO THE MM 106 TRANSITION. @[092195-1791]

If either of the LH₂ backup dump valves do not open during the MPS dump or automated vacuum inert(s), the system will be manually inerted using the LH₂ fill/drain valves in order to minimize residuals in the LH₂ manifold. The first manual vacuum inert will be performed as close to the automatic sequence timing as possible (to minimize hydrogen residuals). The second manual vacuum inert will be performed prior to the MM 106 transition in order to allow the automatic manifold press checkout and to minimize hydrogen residuals. By performing the manual vacuum inert(s), the hydrogen residuals will be sufficiently low to allow for the automatic manifold press checkout. The MCC will direct the crew to perform the manual vacuum inerting procedure in the Ascent Pocket Checklist for both vacuum inerts. @[ED] @[092701-4867A]

THIS RULE CONTINUED ON NEXT PAGE

FLIGHT RULES

A5-206 MANUAL VACUUM INERTING REQUIREMENTS (NOMINAL, ATO, AOA) [HC] (CONTINUED)

E. IF A MANUAL VACUUM INERTING IS REQUIRED, THE MCC WILL REQUEST, WHENEVER POSSIBLE, THAT THE CREW PERFORM THE PROCEDURE ON THE AFFECTED SYSTEM(S) ONLY LO₂/LH₂. IF POSSIBLE, THE MER MPS ENGINEER WILL BE CONSULTED PRIOR TO SCHEDULING A MANUAL VACUUM INERT. ©[111094-1718A] ©[092701-4867A]

Although several crew LO₂/LH₂ vacuum inerting procedures are integrated in order to cover single failure cases which affects both systems, it is preferable that the procedures be performed on only the affected system(s) whenever possible. Performing the manual vacuum inert for only the affected system will minimize cycling of the MPS fill/drain valves and should, consequently, maximize the useful life of the MPS hardware. ©[111094-1718A] ©[ED]

Vacuum inerting will be repeated if propellants are believed to remain in the manifolds. Because there are several potential causes for propellant residuals, because of the significant technical resources available to the MER MPS engineer, and because it is likely that there will be a significant period of time to discuss the situation, the Booster Flight Control Team will consult with the MER MPS engineer if at all possible. Based on reviews of Boeing IL SHA0-01-014 / SI-01-044 dated February 19, 2001, LH₂ manifold pressures above 40 psia will be considered high enough to perform a manual vacuum inert of the LH₂ manifold. ©[092701-4867A]

Hazard Reports ORBI 306, Fire/Explosion in the Orbiter Aft Compartment Caused by MPS Propellant Leakage/Component Rupture, and IMPS-05, Overpressurization of the Integrated Main Propulsion System H2 System, are controlled by this rule.

Rules {A5-13}, MPS DUMPS AND VACUUM INERTING DEFINITIONS [HC], and {A5-205}, NOMINAL, AOA, AND ATO MPS DUMP FAILURES [HC], reference this rule. ©[102506-7358]

A5-207 LH₂ PRESSURIZATION VENT CONTROL

AFTER THE ET/ORBITER UMBILICAL DOOR IS CLOSED, THE LH₂ PRESSURIZATION LINE VENT WILL NOT BE OPENED TO AVOID VENTING LH₂ INTO THE UMBILICAL CAVITY. ©[021199-6793]

Damage to the door or cavity may occur if the LH₂ pressurization line vent is opened while line pressure is high and the vent door is closed (ref. SODB, volume I, section 3.4.3.1-6).

FLIGHT RULES

A5-208**POST-MECO AND ENTRY HELIUM ISOLATION [HC]** @[ED]
@[033006-7013C]

- A. MPS ENGINE OR PNEUMATIC HELIUM REGULATOR PRESSURE < 715 (679)
OR > 800 (810) PSIA AND THE: @[021199-6787B]
1. VENT DOORS CLOSED: CLOSE THE ASSOCIATED MPS HELIUM ISOLATION VALVE ASAP.
 2. VENT DOORS OPEN: CLOSE THE ASSOCIATED MPS HELIUM ISOLATION VALVE AS TIME PERMITS.

Currently, the fleet uses both MC284-0398-0005 and -0006 helium relief valves, which have minimum pilot stage cracking pressures of 790 and 800 psig, respectively. Both configurations are designed to achieve full flow (> 1 lbm/sec) through the main stage at a maximum inlet pressure of 860 psig. The crew caution and warning upper limit is set to 810 psia, which was established prior to the -0006 relief valve going into service and was intended to provide margin against false trips while still accounting for transducer accuracy effects. The worst-case scenario would be a failed-open regulator, causing the relief valve pilot stage to crack, followed immediately by main stage actuation and full flow. In that case, the caution and warning upper limit would be rapidly exceeded, thus alerting the crew to close the associated isolation valve. There is also the potential for a drifting regulator, which could cause the relief valve pilot stage to crack but not actuate the main stage. This condition will be undetectable by caution and warning but would not cause a problem due to the low flow rate of the relief valve pilot stage, which is several orders of magnitude lower than main stage flow. If the relief valve main stage fails open with a fully functional upstream regulator, the caution and warning lower limit of 679 psia would be exceeded as the regulator attempts to satisfy the increased flow demand, thus alerting the crew to close the associated isolation valve. If the relief valve pilot stage fails open, the same benign condition discussed above for a drifting regulator would result. Note that, in the above discussion, the units of pressure (psig and psia) are essentially equivalent in the post-MECO/entry timeframe and can be used interchangeably. @[033006-7013C]

THIS RULE CONTINUED ON NEXT PAGE

FLIGHT RULES

A5-208

POST-MECO AND ENTRY HELIUM ISOLATION [HC] (CONTINUED)

With the vent doors open, no action is required. The vent doors close on a TAL at ET SEP command. During an RTLS, the vent doors close at the MM 602 transition. During the nominal or ATO entry, the vent doors close at the transition to MM 304. During an AOA, the vent doors are manually closed just prior to the MM 304 transition. For all of these entry profiles, the vent doors open at Mach 2.4.

Entry MPS helium regulator shifts are most likely to occur during periods of high flow demand such as when the MPS helium isolation valves open at the transition to MM 303 or when the MPS helium blowdown valves open at Mach 5.3. For simplicity, the crew procedure for MPS helium regulator shifts call for the immediate isolation of the associated MPS helium isolation valve(s) on entry prior to Mach 2.4. After Mach 2.4, MCC may direct the crew to close the associated MPS helium regulator valves, time permitting. ©[021199-6787B] ©[033006-7013C]

Training in the nominal helium leak isolation procedure will allow the crew to react to the caution and warning system in less than 15 seconds. Previous analysis predicted no loss of crew and vehicle but did predict a factor of safety (FOS) violation of 1.31 on the 1307 bulkhead within 17 seconds (reference Rockwell International/Tibor Lak presentation PCIN R76186, July 15, 1988). This FOS violation would require the orbiter to be taken out of service for thorough inspections and refurbishment as necessary. However, certain assumptions in that analysis cannot be confirmed, making the analysis results suspect. As a result, no accurate aft compartment overpress analysis currently exists for large helium leaks. Therefore, there is no guarantee that the current crew procedures will be able to prevent a catastrophic overpress condition. This increase in risk was accepted by the Orbiter Configuration Control Board (OCCB) on June 20, 2005, as an update to Hazard Report ORBI 108, and approved out of board by the Program Requirements Control Board. The Mission Operations Directorate (MOD) concurs with the opinion of the MPS technical community that the robust design and flight history of the MPS helium system justifies Program acceptance of the increased risk. ©[033006-7013C]

Hazard Reports ORBI 108, Overpressurization of the Orbiter Aft Fuselage Caused by the Failure of an MPS Helium Regulator or Relief Valve, and ORBI 278, Loss of Structural Integrity Due to Overpressurization of the Mid and/or Aft Fuselage, are controlled by this rule.

References: FMEA/CIL 03-1-0205-02, SSME Gaseous Helium (GHe) Supply 750 psig Regulator, and FMEA CIL 03-1-0206-01, SSME GHe Supply 850 psig Relief Valve. ©[033006-7013C]

THIS RULE CONTINUED ON NEXT PAGE

FLIGHT RULES

A5-208

POST-MECO AND ENTRY HELIUM ISOLATION [HC] (CONTINUED)

- B. FOR ALL OTHER POST-MECO AND ENTRY HELIUM OR PNEUMATIC SYSTEM LEAKS, THE SYSTEM WILL BE ISOLATED AS TIME PERMITS. POST-ISOLATION, AN ATTEMPT WILL BE MADE TO MANUALLY RECONFIGURE THE MPS HELIUM SYSTEM TO SUPPORT THE ENTRY PURGE IF TIME PERMITS. @[021199-6787B]

If a leak occurs on an engine or pneumatic helium system, the affected system will be isolated as time permits. Helium is required for manifold pressurization during the MPS dump and entry, for valve actuation, and for the entry aft compartment purge. Since the crew has no insight into the configuration of the MPS helium system interconnect valves, it is likely that the crew will need assistance from MCC in order to isolate any post-MECO helium leak. These procedures may be complicated and will be performed as time permits.

For nominal missions, if a leak occurs prior to the MPS dump, the leak may be isolated and the helium system subsequently reconfigured to support the MPS dump. On entry, if time permits after the leak is isolated, the helium system may be manually reconfigured to support the entry purge. The entry purge is highly desirable for the nominal end of mission but is considered mandatory during aborts. If a hazardous gas leak is evident in the aft compartment or OMS pods, the entry purge will be required. Also, contamination may be ingested into the evacuated MPS manifolds if the helium pressurization is not performed. The contamination in the lines would require cleaning before the next flight which would increase the vehicle's turnaround time.

During an RTLS abort, post-MECO isolation may not be performed. Because of the limited flight duration and the crew workload, there may not be adequate time to reconfigure the MPS helium system to support the entry purge.

THIS RULE CONTINUED ON NEXT PAGE

FLIGHT RULES

A5-208

POST-MECO AND ENTRY HELIUM ISOLATION [HC] (CONTINUED)

- C. IF ALL CAUTION AND WARNING IS LOST FOR ANY MPS HELIUM REGULATOR PRESSURE TRANSDUCER(S) :
1. NOMINAL/ATO:
 - a. PRIOR TO MACH 2.4: MCC WILL HAVE THE CREW CLOSE THE ASSOCIATED MPS HELIUM ISOLATION VALVE(S) .
 - b. AFTER MACH 2.4: NO ACTION REQUIRED. @[021199-6787B]
 2. AOA/TAL/RTLs: NO ACTION REQUIRED. @[021199-6787B]

Without hardware or software caution and warning, it is unlikely that MCC could diagnose an MPS helium regulator failed open and tell the crew to close the associated MPS helium isolation valve before the aft compartment is overpressurized. For a nominal or ATO entry, if hardware and software caution and warning is unavailable, the crew will preemptively close the associated MPS helium isolation valve(s). Caution and warning may be lost due to the loss (or bias) of the MPS helium regulator pressure transducer, loss of the associated OI DSC or OI MDM, or loss of the BFS. @[033006-7013C]

After the vent doors open at Mach 2.4, the overpressurization of the aft compartment is no longer a concern and preemptively closing the MPS helium isolation valve(s) to protect for a potential MPS helium regulator failed open is not required. Preemptive helium isolation is also not required on the AOA, TAL, or RTLs entry. Protecting for the additional, unrelated failure of an MPS helium regulator following the loss of caution and warning will not be performed because of the relatively short exposure period and high crew workload during aborts.

Preemptive closure of MPS helium isolation valves for the loss of caution and warning will require an MCC call except for a failure of the BFS GPC. The BFS FAIL crew procedure in the Entry Pocket Checklist and Ascent/Entry Systems Procedures directs the crew to close the MPS helium B isolation valves and the pneumatic helium isolation valves since caution and warning for these pressure transducers is only available in the BFS. This procedure does not differentiate between a nominal and abort entry profiles. @[021199-6787B]

Hazard Report ORBI 038, Loss of Vehicle Due to Failure of Multiplexer-Demultiplexer (MDM) or Enhanced Multiplexer-Demultiplexer (EMDM), is controlled by this rule. @[033006-7013C]

Rule {A10-261}, VENT DOOR MANAGEMENT [HC], references this rule. @[102506-7825A]

FLIGHT RULES

A5-209

ENTRY MPS HELIUM PURGE/MANIFOLD PRESSURIZATION

@[022802-5080] @[ED]

THE ENTRY MPS HELIUM PURGE AND MANIFOLD PRESSURIZATION FUNCTIONS ARE HIGHLY DESIRABLE TO PURGE THE AFT COMPARTMENT OF ANY HAZARDOUS FLUID BUILDUP AND TO PREVENT AIR INGESTION INTO THE MPS LO₂ AND LH₂ MANIFOLDS. IF THIS FUNCTION IS LOST, THEN THE FOLLOWING ATTEMPTS WILL BE MADE, TIME PERMITTING, TO RECOVER THEM:

A. NOMINAL/AOA:

EFFORTS TO RECOVER THE ENTRY MPS HELIUM PURGE AND LO₂ AND LH₂ MANIFOLD PRESSURIZATION WILL ONLY BE ATTEMPTED IF IT WILL NOT IMPACT CRITICAL CAPABILITY IN OTHER ORBITER SYSTEMS. FOR CRITICAL POWER/COOLING CASES (I.E., LOSS OF TWO FUEL CELLS OR TWO FREON LOOPS), THE ENTRY PURGE AND MANIFOLD PRESSURIZATION WILL BE INHIBITED PER CREW PROCEDURES.

B. RTLS/TAL:

1. FOR THE ENTRY MPS HELIUM PURGE, RECOVERY EFFORTS WILL ONLY BE ATTEMPTED IF IT WILL NOT IMPACT CRITICAL CAPABILITY IN OTHER ORBITER SYSTEMS.
2. FOR THE MPS LH₂ MANIFOLD PRESSURIZATION, IF THE SITUATION PERMITS, THE FUNCTION WILL BE RECOVERED (BY A SWITCH THROW, PORT MODE, OR RESTRING) IN ORDER TO AVOID INGESTION OF AIR INTO THE LH₂ MANIFOLD.

NOTE: FAILURE TO PRESSURIZE THE LH₂ MANIFOLD WITH MPS HELIUM REQUIRES AN EXPEDITED POWERDOWN AND MODE V EGRESS PER RULE {A16-11F}, EXPEDITED POWERDOWN.
@[022802-5080]

THIS RULE CONTINUED ON NEXT PAGE

FLIGHT RULES

A5-209

ENTRY MPS HELIUM PURGE/MANIFOLD PRESSURIZATION (CONTINUED)

The MPS entry helium purge is used to purge the aft compartment of hazardous fluids (e.g., LH₂, LO₂, N₂H₄, NH₃, or hydraulic oil) during entry. For nominal and AOA entries, hazardous MPS propellants will have had time to be fully inerted as part of the MPS dump sequence; and therefore, the importance of the purge is low. On RTLS and TAL entries, residual MPS propellants may be present, thereby increasing the importance of the purge. If the presence of hazardous fluids is suspected due to system leaks or failures, the purge may help to reduce the potential for combustion by reducing the hazardous fluid concentrations in the aft compartment. The effectiveness of the MPS entry purge is unknown; therefore, critical capability in other Shuttle systems should not be traded off to regain the purge. At the Ascent Entry Flight Techniques Panel Meeting (A/EFTP #168 on October 27, 2000), it was decided that if it was deemed appropriate by the flight control team to regain the purge, a temporary port mode (to latch the purge valve commands) could be attempted, but a restring was determined to not be warranted due to the unknown effectiveness of the purge. The decision to port mode will depend upon the specific flight phase and failure scenario present in the orbiter as established in Rule {A2-5}, PORT MODING/RESTRINGING GUIDELINES. ©[022802-5080]

It is desirable to pressurize the MPS propellant manifold during entry because failure to do so will result in the ingestion of air into the MPS propellant lines requiring additional turnaround time to clean the contaminated manifolds. Also, loss of the LH₂ manifold pressurization on RTLS and TAL aborts will result in the creation of an explosive mixture in the LH₂ manifold as air is ingested and mixes with the hydrogen residuals. This scenario will require an expedited powerdown per Flight Rule {A16-11}, EXPEDITED POWERDOWN. At the AEFTP Meeting (A/EFTP #168 on October 27, 2000), it was decided that the recovery technique for the loss of LH₂ manifold pressurization could be a switch throw, temporary port mode (to latch the LH₂ manifold pressurization commands), or restring. In general, a switch throw will be attempted before a port mode, which will be attempted before a restring; however, the recovery technique used will depend upon the specific flight phase and failure scenario present in the orbiter as established in Flight Rule {A2-5}, PORT MODING/RESTRINGING GUIDELINES. The importance of the LO₂ manifold pressurization function is insufficient to justify recovery actions during an RTLS or TAL entry (contamination/reflight issue).

To accomplish a safe entry on a nominal or AOA entry with the loss of two Freon loops or the loss of two fuel cells, critical power and cooling capability must be conserved via power reductions in all orbiter systems. MPS valves that are normally closed valves will be positioned to the CLOSE position in order to conserve power (as documented in the Orbit Pocket Checklist, Entry Pocket Checklist, Contingency Deorbit Prep, and Systems AOA Procedures Flight Data File). This reconfiguration will save approximately 218.4 watts. ©[022802-5080]

FLIGHT RULES**A5-210****ENTRY MPS PROPELLANT DUMP FAILURES [CIL] [HC]**

@[020196-1813A] @[052704-6255B]

A. NOMINAL/ATO: @[110900-7240]

NO ACTION IS REQUIRED.

During nominal/ATO missions, automatic software or crew procedures will ensure dumping and/or inerting of the LO₂ and LH₂ residuals prior to entry. A complete LH₂ dump can be done if either the LH₂ backup dump valves or LH₂ fill/drain valves are open. A complete LO₂ dump can be done if two or three SSME's perform LO₂ dumps, or if the LO₂ fill/drain valves are both open (reference Rockwell Internal Letter no. 287-104-87-004, dated January 8, 1987). The LH₂ backup dump valves are the only dump path opened during the nominal/ATO entry MPS dump sequence, and no action is required in the event that these valves do not open. @[042403-5896A]

B. AOA/TAL/RTLs:

IN CASE OF A NEGATIVE INERT, AN EXPEDITED POWERDOWN WITH EARLY APU SHUTDOWN AND MODE V EGRESS WILL BE REQUIRED (REFERENCE RULES {A16-11F}, EXPEDITED POWERDOWN [HC], AND {A16-205A}.1, EARLY APU SHUTDOWN [HC]). @[022405-6578A]

Failures in the MPS LH₂ system during the MPS dump and inert will result in off-nominal residuals (negative inert) on TAL and RTLs aborts. Analysis (reference Boeing Internal Letter SHA0-01-043 dated April 26, 2001) predicts the MPS LH₂ manifold pressure will exceed the relief setting and vent hydrogen residuals as early as 10.8 minutes after touchdown, creating a concern for crew and convoy safety (reference Rule {A16-11F}, EXPEDITED POWERDOWN [HC]). Even when manual actions are taken to inert the LH₂ manifold, the residual will be greater than nominal due to timing constraints. Therefore, any MPS dump and inert requiring manual actions will be considered a negative inert for TAL/RTLs. Failure of all LH₂ dump paths will be considered a negative inert for AOA.

Early APU shutdown is required for possible hydrogen concentrations building in the aft compartment due to residuals higher than nominal and positive pressure in the propellant manifold.

Hazard reports ORBI 035, Hydrogen Accumulation in the Orbiter Compartments During RTLs/TAL Aborts; ORBI 338, GO₂ External Tank Pressurization Line as MPS/APU Ignition Source; INTG 016, Ignition Sources Igniting Flammable Fluids in the Aft Compartment; INTG 020, Hydrogen Accumulation in the Aft Compartment During Ascent; and INTG 112, H₂/O₂ Component Leakage During Ascent, reference this rule. @[052704-6255B] @[022405-6578A]

THIS RULE CONTINUED ON NEXT PAGE

FLIGHT RULES

A5-210

ENTRY MPS PROPELLANT DUMP FAILURES [CIL] [HC]
(CONTINUED)

1. AOA/TAL @[042403-5896A]

IN MM 304, IF GPC/MDM FAILURES CAUSE ALL LH₂ DUMP PATHS TO BE LOST (INCLUDING THE LH₂ BACKUP DUMP VALVES), THE AFFECTED LH₂ FILL/DRAIN VALVE(S) WILL BE MANUALLY OPENED. IF THE SOFTWARE CANNOT CLOSE THE LH₂ OUTBOARD FILL/DRAIN OR THE LH₂ INBOARD FILL/DRAIN AND TOPPING VALVES, THE LH₂ OUTBOARD FILL/DRAIN VALVE WILL BE MANUALLY CLOSED AT A RELATIVE VELOCITY (V_{REL}) OF 5300 FT/SEC.

In the LH₂ system, there are single GPC/MDM failures which result in the loss of GPC control of the LH₂ fill/drain valves and the LH₂ topping valve. In these cases, the affected LH₂ fill/drain valve(s) will be manually opened on an AOA/TAL only if the LH₂ backup dump valves are not open. Sufficient time exists to dump LH₂ residuals through the backup LH₂ valves for AOA or TAL aborts, leaving approximately 3 lbs of hydrogen residuals (reference Boeing Internal Letter SHA0-01-043 dated April 26, 2001). There are also combinations of GPC/MDM failures which result in the loss of all LH₂ dump paths. On an AOA/TAL abort, the crew will manually open the affected LH₂ fill/drain valve(s). The LH₂ backup dump valves cannot be manually opened in these cases because the switch is software driven and only read in OPS 1. The LH₂ outboard fill/drain valve will be closed in order to preserve helium for the aft compartment purge and to prevent the combination of atmospheric O₂ with the residual LH₂ in the manifold. The velocity cue used to close the LH₂ outboard fill/drain valve represents the nominal closing time and corresponds to an altitude at which possible ignition of residual LH₂ can occur. @[111094-1730A] @[110900-7240] @[042403-5896A]

2. RTLS: @[110900-7240]

IN MM 602, IF GPC/MDM FAILURES CAUSE THE LH₂ OUTBOARD FILL/DRAIN DUMP PATH TO BE LOST (DUE TO A FAILURE OF THE LH₂ OUTBOARD FILL/DRAIN, OR THE LH₂ INBOARD FILL/DRAIN AND TOPPING VALVES), THE AFFECTED LH₂ FILL/DRAIN VALVE(S) WILL BE MANUALLY OPENED. IF THE SOFTWARE CANNOT CLOSE EITHER THE LH₂ OUTBOARD FILL/DRAIN VALVE OR THE LH₂ INBOARD FILL/DRAIN AND TOPPING VALVES, THE LH₂ OUTBOARD FILL/DRAIN VALVE WILL BE CLOSED AT A V_{REL} OF 3800 FT/SEC.

THIS RULE CONTINUED ON NEXT PAGE

FLIGHT RULES

A5-210

ENTRY MPS PROPELLANT DUMP FAILURES [CIL] [HC]
(CONTINUED)

In the LH₂ system, there are GPC/MDM failures which result in the loss of GPC control of the LH₂ fill/drain valves and the LH₂ topping valve. The failure of the LH₂ outboard fill/drain valve will result in an incomplete LH₂ dump on RTLS aborts. Analysis has shown that approximately 40.8 pounds of LH₂ residuals will remain in the MPS LH₂ manifold if the only LH₂ dump path is through the backup LH₂ valves (reference Boeing Internal Letter SHA0-01-043 dated April 26, 2001). Venting H₂ residuals will preclude normal convoy operations (reference Rule {A16-11F}, EXPEDITED POWERDOWN [HC]). In order to minimize this ground hazard, the affected LH₂ fill/drain valve(s) will be opened. The LH₂ outboard fill/drain valve will be closed in order to preserve helium for the aft compartment purge and to prevent the combination of atmospheric O₂ with the residual LH₂ in the manifold. The velocity cue used to close the LH₂ outboard fill/drain valve represents the nominal closing time and corresponds to an altitude at which possible ignition of residual H₂ can occur. ©[111094-1730A] ©[110900-7240] ©[042403-5896A] ©[022405-6578A]

FLIGHT RULES

SECTION 6 - PROPULSION

FAILURE DEFINITIONS

A6-1	OMS/RCS HELIUM TANK.....	6-1
A6-2	OMS PROPELLANT TANK (OXIDIZER OR FUEL).....	6-1
A6-3	OMS ENGINE.....	6-5
A6-4	OMS N2 TANK.....	6-10
A6-5	OMS N2 ACCUMULATOR.....	6-10
A6-6	OMS/RCS CROSSFEED LINE.....	6-11
A6-7	RCS PROPELLANT TANK (OXIDIZER OR FUEL).....	6-12
A6-8	RCS THRUSTER.....	6-14
A6-9	RCS JET HEATER.....	6-15
A6-10	THROUGH A6-50 RULES ARE RESERVED.....	6-16

OMS/RCS MANAGEMENT

A6-51	OMS FAILURE MANAGEMENT [CIL] [HC].....	6-17
A6-52	RCS FAILURE MANAGEMENT.....	6-51
A6-53	OMS HELIUM INGESTION.....	6-61
A6-54	OMS PROPELLANT FAIL FEED CONSTRAINTS [CIL]....	6-62
A6-55	OMS N2 TANK FAILURE MANAGEMENT.....	6-63
A6-56	OMS N2 REGULATOR FAILURE MANAGEMENT.....	6-64
A6-57	AFT RCS PROPELLANT TANK FAIL/HELIUM INGESTION	6-65
A6-58	RCS REGULATOR FAILURE TROUBLESHOOTING.....	6-66
A6-59	LOSS OF AFT RCS LEAK DETECTION.....	6-67
A6-60	RCS MANIFOLD CLOSURE CRITERIA [HC].....	6-68
A6-61	RCS MANIFOLD/OMS CROSSFEED LINE REPRESSURIZATION [CIL].....	6-71
A6-62	OMS/RCS CONTINUOUS VALVE POWER MANAGEMENT.....	6-76
A6-63	RCS BFS PVT INIT PRELAUNCH CRITERIA.....	6-77
A6-64	THROUGH A6-100 RULES ARE RESERVED.....	6-77

FLIGHT RULES

OMS ENGINE MANAGEMENT

A6-101	OMS ENGINE BELL MOVEMENT DURING ASCENT.....	6-78
A6-102	OMS PROPELLANT SETTLING REQUIREMENT.....	6-79
A6-103	OMS BURN DOWNLIST REQUIREMENT.....	6-79
A6-104	OMS ENGINE INSTRUMENTATION REQUIREMENT.....	6-80
A6-105	OMS BURN MINIMUM PRESSURE REQUIREMENTS.....	6-83
A6-106	OMS ENGINE BURN TO DEPLETION.....	6-84
A6-107	OMS ENGINE FAILURE MANAGEMENT.....	6-85
A6-108	OMS BALL VALVE FAILURE MANAGEMENT.....	6-86
A6-109	THROUGH A6-150 RULES ARE RESERVED.....	6-86

RCS THRUSTER MANAGEMENT

A6-151	RCS JET DRIVER MANAGEMENT [CIL].....	6-87
A6-152	RCS ENTRY HOTFIRE CHECK.....	6-87
A6-153	RCS JET MAXIMUM BURN TIME.....	6-88
A6-154	RCS VERNIER OPERATION TERMINATION.....	6-89
A6-155	SUSPECT RCS JET REPRIORITIZATION CRITERIA.....	6-90
A6-156	RCS RM LOSS MANAGEMENT [HC].....	6-91
A6-157	RCS JET FAILED OFF HOTFIRE TEST.....	6-96
A6-158	RCS LEAKING JET MANAGEMENT.....	6-97
A6-159	FAILED PRCS JET RESELECTION PRIORITY.....	6-99
A6-160	RCS AUTO MANIFOLD CLOSE [HC].....	6-100
A6-161	THROUGH A6-200 RULES ARE RESERVED.....	6-102

OMS/RCS LEAK MANAGEMENT

A6-201	OMS/RCS LEAKING HE TANK BURN.....	6-103
A6-202	OMS LEAKING HE SYSTEM BURN.....	6-103
A6-203	OMS LEAKING INLET LINE PERIGEE ADJUST BURN...	6-104
A6-204	OMS GN2 ACCUMULATOR LEAK DETERMINATION.....	6-104
A6-205	RCS LEAKING PROPELLANT TANK BURN.....	6-105
A6-206	RCS MANIFOLD/LEG LEAK REPRESSURIZATION.....	6-105
A6-207	THROUGH A6-250 RULES ARE RESERVED.....	6-105

FLIGHT RULES

THERMAL REDLINES AND MANAGEMENT

A6-251	GENERAL.....	6-106
A6-252	OMS/RCS POD HEATER.....	6-108
A6-253	FORWARD RCS MODULE TEMPERATURE MANAGEMENT....	6-108
A6-254	OMS/RCS PODS TEMPERATURE MANAGEMENT.....	6-109
A6-255	OMS/RCS CROSSFEED LINES TEMPERATURE MANAGEMENT.....	6-110
A6-256	OMS/RCS HEATER PERFORMANCE MONITORING.....	6-111
A6-257	RCS JET TEMPERATURE MANAGEMENT.....	6-117
A6-258	ARCS BULK PROPELLANT TEMPERATURE MANAGEMENT..	6-121
A6-259 THROUGH A6-300	RULES ARE RESERVED.....	6-122

CONSUMABLES DEFINITIONS AND REDLINES

A6-301	OMS USABLE PROPELLANT.....	6-123
A6-302	RCS USABLE PROPELLANT.....	6-125
A6-303	OMS REDLINES [CIL].....	6-126
A6-304	FORWARD RCS REDLINES.....	6-132
A6-305	AFT RCS REDLINES [HC].....	6-138
A6-306 THROUGH A6-350	RULES ARE RESERVED.....	6-151

CONSUMABLES MANAGEMENT

A6-351	OMS PROPELLANT MANAGEMENT MATRIX.....	6-152
A6-352	OMS PROPELLANT BUDGET GROUND RULES.....	6-153
A6-353	CG MANAGEMENT.....	6-155
A6-354	RCS ENTRY REDLINE PROTECTION.....	6-156
A6-355	OMS PROPELLANT DEFICIENCY FOR DEORBIT.....	6-156
A6-356	DEORBIT PLANNING CRITERIA.....	6-157
A6-357	FORWARD RCS CONTINGENCY PROPELLANT AVAILABLE..	6-157
A6-358	VIOLATION OF MISSION COMPLETION REDLINES MATRIX.....	6-158
A6-359	RCS PROPELLANT CONSERVATION PRIORITIES.....	6-160
A6-360 THROUGH A6-400	RULES ARE RESERVED.....	6-160

FLIGHT RULES

OMS/RCS GO/NO-GO CRITERIA

A6-1001	OMS/RCS GO/NO-GO CRITERIA [CIL].....	6-161
---------	--------------------------------------	-------

FLIGHT RULES

SECTION 6 - PROPULSION

FAILURE DEFINITIONS

A6-1 **OMS/RCS HELIUM TANK**

AN OMS AND/OR HELIUM TANK IS CONSIDERED LOST IF:

- A. OMS PRESSURE < 390 (640) PSIA, RCS PRESSURE < 400 (456) PSIA.

The fail limit is defined as a low helium tank pressure such that the regulated outlet pressure is insufficient to maintain the propellant tank pressure within normal operating range.

The OMS fail limit is 390 psia. At that helium pressure a single engine flow rate will result in lower than nominal propellant tank pressures (below 250 psia). Off-nominal testing has shown that under a single engine flow rate the helium tank pressure decreased to 180 psia before a chamber pressure of 80 percent was reached. However, the 390 psia limit guarantees nominal regulator performance (390 psia corresponds to the regulator spec inlet pressure). Reference SODB constraint 4.3.3.2.1.e.1 for the 390 psia limit.

The RCS fail limit is 400 psia. At this helium pressure a four-jet flow rate will result in lower than nominal propellant tank pressures (below 245 psia). Reference SODB constraint 4.3.2.3.3-f.2 for the 400 psia limit.

- B. ALL PRESSURIZATION PATHS CLOSED.

If both valves or regulators are failed closed, no passageway exists for He to pressurize the propellant tank. Therefore, the He tank is effectively lost.

A6-2 **OMS PROPELLANT TANK (OXIDIZER OR FUEL)**

AN OMS PROPELLANT TANK IS CONSIDERED LOST IF:

- A. PREBURN - FUEL INLET PRESSURE < 208 (216) OR OXIDIZER INLET PRESSURE < 143 (151) OR BOTH FUEL AND OXIDIZER INLET PRESSURE < 158 (166) PSIA OR PROPELLANT QUANTITY ≤ 3 PERCENT.

A low fuel inlet pressure (< 208) preburn will result in reduced fuel flow at the OMS engine during the burn. The fuel is used as a coolant for the engine combustion chamber, and with reduced flow, the cooling jacket temperature will increase. At ignition, a low fuel inlet pressure (208 psia) will result in the violation of the onboard OMS fuel injector temperature fault detection annunciation (FDA) limit (260 deg F). Within approximately 10 to 20 seconds, the injector temperatures will increase to a dangerous level causing possible chamber wall burn through. Consequently, for confirmed low fuel inlet pressure as defined in the Flight Rules, the affected propellant feed system will be considered failed.

THIS RULE CONTINUED ON NEXT PAGE

FLIGHT RULES

A6-2

OMS PROPELLANT TANK (OXIDIZER OR FUEL) (CONTINUED)

A low oxidizer pressure less than normal but > 143 psia preburn will cause the engine to burn cooler than normal (fuel rich mixture ratio results in a cooler burn). However, with oxidizer inlet pressure < 143 psia, the chamber pressure violates the FDA limit of 80 percent and may cause unstable combustion and chamber wall hot spots. Therefore, this engine should not be started to prevent possible chamber wall burn through.

When both of the oxidizer and fuel inlet pressures are low (i.e., operating in a blowdown condition), the OMS engines can be burned until the inlet pressures reach 158 psia because the mixture ratio remains fairly constant. Although the chamber FDA limit is violated, the engine can be safely operated until both the oxidizer and fuel inlet pressures decrease below the 158 psia value, the chamber pressure decreases below 72 percent, or the fuel injector temperature reaches 260 deg F.

The OMS propellant tank is also considered failed (unusable) when propellant quantities are < 3 percent. This is to prevent the propellant tank from reaching depletion levels during a burn and ingesting helium into the OMS engine. The ingestion of helium into the OMS engine could result in unstable operation. For a propellant-critical situation, the engine can be operated until tank depletion without risk of uncontained engine damage. The 3 percent quantity is derived as follows: 2.3 percent trapped propellant in the tank plus > 0.7 percent gauge error (0.7 percent gauge error only applies for total quantities less than 5.0 percent). The 3 percent value should be utilized only during the burn while monitoring the OMS hardware quantity gauging system.

B. ALL ASSOCIATED TANK ISOLATION VALVES FAILED CLOSED.

Restriction of a propellant path from the propellant tanks to the OMS engine is an effective loss of the propellant tank.

C. PROPELLANT TEMPERATURE < 40 DEG (44 DEG) F OR > 100 DEG (96 DEG) F.

The engine design specification is 40 deg to 100 deg F propellant. These temperatures define an envelope for which it is known to be safe to start and operate the OMS engine. Engine testing has been limited to this temperature range and engine performance is unknown beyond this range. High propellant (fuel) temperature may result in propellant boiling in the cooling jacket causing unknown performance. It is also believed that low propellant temperatures could cause large Pc spikes at engine start. (Reference SODB, volume I, paragraph 4.3.3.D.)

THIS RULE CONTINUED ON NEXT PAGE

FLIGHT RULES

A6-2

OMS PROPELLANT TANK (OXIDIZER OR FUEL)
(CONTINUED)

D. RESTRICTION IN OXIDIZER FEED SYSTEM: PC < 76 (80) PERCENT, OMS RM ENGINE SELECT DOWN ARROW ("↓") ON MANEUVER EXECUTE DISPLAY (POST-MECO ONLY), AND OXIDIZER INLET PRESSURE < 128 (136) PSIA.

An oxidizer restriction may cause Pc and total vehicle acceleration to decrease below the OMS RM limit triggering the down arrow. The oxidizer feed restriction can be confirmed, during the burn, with a low oxidizer inlet pressure which corresponds to the Pc limit of 80 percent. (Reference SODB paragraph 3.4.3.3-11a for minimum Pc, and SODB request response R921 for inlet pressure verification.)

E. RESTRICTION IN FUEL FEED SYSTEM: OMS FUEL INJECTOR TEMPERATURE > 260 DEG (260 DEG) F* AND FUEL INLET PRESSURE LESS THAN OR EQUAL TO THE LOWER FAIL LIMIT.

* NORMAL OPERATING TEMPERATURE PLUS INSTRUMENTATION ACCURACY WILL NOT MEET FAILURE LIMIT.

ENGINE SERIAL #	FU IN P LOWER FAIL LIMIT (PSI)
101	199 (207)
105	201 (209)
106	196 (204)
107	193 (201)
108	206 (214)
109	204 (212)
110	199 (207)
111	201 (209)
113	200 (208)
114	192 (200)
115	197 (205)
116	203 (211)
117	193 (201)

©[110900-7250]

The fuel flow through the engine cooling jacket may be reduced by a fuel restriction, causing hot spots in the combustion chamber. Without proper engine cooling, the probability exists for an engine burn through, creating a hazard to the surrounding structure and pod. In addition, a restriction in the fuel feed line system would result in an oxidizer rich mixture ratio with a higher combustion temperature. SODB data indicates a need for engine specific fuel inlet pressures as cues for OMS propellant tank failures. Instrumentation inaccuracy of 8 psi must be protected to adequately protect the OMS engine. SODB, volume III (CAUTION: SODB, volume III, contains engineering estimates for non-nominal performance evaluation. Data may not be supported by test.), table 4.3.3 contains engine-specific data and should be used to determine tank failure limits.

THIS RULE CONTINUED ON NEXT PAGE

FLIGHT RULES

A6-2

OMS PROPELLANT TANK (OXIDIZER OR FUEL) (CONTINUED)

A 260 deg F fuel injector temperature at the cooling jacket outlet clearly identifies an off-nominal situation, yet is sufficiently removed from the failure limit to allow time for crew action. The low fuel inlet pressure indicates that the restriction is upstream of the transducer. A restriction large enough to result in a decreased fuel inlet pressure and high fuel injector temperature beyond the defined limits results in the failure of the propellant tank to support further OMS/RCS activities.

Rule {A6-256}, OMS/RCS HEATER PERFORMANCE MONITORING, references this rule.

F. OXIDIZER AND FUEL BOTH IN BLOWDOWN (LOSS OF HE TANK), OMS RM ENGINE SELECT DOWN ARROW ("↓") ON MANEUVER EXECUTE DISPLAY AND PC < 68 (72) PERCENT.

Test results have determined that with both the oxidizer and fuel tanks in blowdown, the OMS engines can be safely operated below the 80 percent Pc alarm with an acceptable propellant mixture ratio. When Pc drops below 68 percent, unstable combustion occurs. (Reference SODB, paragraph 3.4.3.3-11b.)

G. PROPELLANT LEAK UPSTREAM OF BALL VALVES, PC < 76 (80) PERCENT AND OMS RM ENGINE SELECT DOWN ARROW ("↓") ON MANEUVER EXECUTE DISPLAY.

A propellant leak large enough to cause low Pc and decayed acceleration during an OMS engine burn, as indicated by a down arrow, identifies an OMS propellant system failure. Even though the leak may be isolated, the engine and associated propellant system cannot be used since the leak would affect crossfeed (ref. SODB, paragraph 3.4.3.3-11a).

FLIGHT RULES

A6-3

OMS ENGINE

AN OMS ENGINE IS CONSIDERED LOST IF:

- A. AN ENGINE BALL VALVE POSITION < 47 (70) PERCENT THAT RESULTS IN AN ENGINE PC < 76 (80) PERCENT AND AN OMS DOWN ARROW ("↓") ON THE MANEUVER EXECUTE DISPLAY.

OMS engine Pc must be > 76 (80) percent (100 psia) when not in ullage blowdown (reference SODB, volume I, paragraph 3.4.3.3) or Pc must be > 68 (72) percent (90 psia) in ullage blowdown (reference SODB, volume I, paragraph 3.4.3.3) to ensure safe engine operation. A ball valve position of 47 percent causes sufficient blockage of propellant flow to result in an engine Pc = 76 percent (100 psia). Although ball valve position > 47 percent results in safe engine operation, a conservative 70 percent (ref. SODB, volume I, paragraph 3.4.3.3) is required to clearly identify ball valves not in a normal position. This ball valve failure confirms that the problem is an engine failure and not a propellant tank failure.

- B. OMS ENGINE FEEDLINE TEMPERATURE < 30 DEG (38 DEG) F OR > 125 DEG (117 DEG) F.

Test data have demonstrated that engine starts are acceptable with propellant temperatures at these limits as long as the bulk propellant tank temperature is within limits. Operation with bulk propellant outside of these limits is untested and uncertified. Problems that would probably be encountered are rough combustion, insufficient cooling, and excessive high chamber pressure which could overstress the engine chamber. (Reference SODB, paragraph 4.3.3.4.)

THIS RULE CONTINUED ON NEXT PAGE

FLIGHT RULES

A6-3 OMS ENGINE (CONTINUED)

C. FUEL RESTRICTION: OMS FUEL INJECTOR TEMPERATURE > 260 DEG (260 DEG) F* AND FUEL INLET PRESSURE GREATER THAN OR EQUAL TO THE UPPER FAIL LIMIT.

* NORMAL OPERATING TEMPERATURE PLUS INSTRUMENTATION ACCURACY WILL NOT MEET FAILURE LIMIT.

ENGINE SERIAL #	FU IN P UPPER FAIL LIMIT (PSI)
101	230 (222)
105	235 (227)
106	228 (220)
107	227 (219)
108	238 (230)
109	238 (230)
110	234 (226)
111	232 (224)
113	228 (220)
114	229 (221)
115	233 (225)
116	233 (225)
117	225 (217)

©[110900-7251]

Fuel is used to cool the OMS engine combustion chamber. The fuel injector temperature is measured after the fuel has passed through the regenerative cooling jacket. Normally this temperature is 220 deg F during a burn. The 260 deg limit was selected to positively identify that the engine was operating in an anomalous manner. At all temperatures below 260 deg F, engine operation is safe. However, as the fuel injector temperature exceeds this limit, combustion chamber wall burn through becomes increasingly likely. Since chamber pressure is largely unaffected by the loss of cooling, only fuel inlet pressure can confirm that a fuel restriction exists. A higher-than-normal fuel inlet pressure is indicative of a restriction in the fuel flow downstream of the engine ball valves. SODB data indicates a need for engine-specific fuel inlet pressures as a secondary cue for OMS engine failure. Instrumentation inaccuracy of 8 psi must be protected to prevent the crew concluding fuel injector temperature transducer failure when an OMS engine failure has occurred.

SODB, volume III, table 4.3.3 (CAUTION: SODB volume III contains engineering estimates for non-nominal performance evaluation. Data may not be supported by test.) contains engine-specific data and should be used to determine engine failure limits.

THIS RULE CONTINUED ON NEXT PAGE

FLIGHT RULES**A6-3 OMS ENGINE (CONTINUED)**

- D. PROPELLANT LEAK DOWNSTREAM OF BALL VALVES, PC < 76 (80) PERCENT, AND OMS RM ENGINE SELECT DOWN ARROW ("↓") ON MANEUVER EXECUTE DISPLAY OR FUEL INJECTION TEMP > 260 DEG F.

A propellant leak large enough to cause low Pc and decayed acceleration, as indicated by the down arrow or fuel injector temperature high, during a burn results in the loss of the affected engine. (Reference SODB, volume I, paragraphs 3.4.3.3 and 3.4.4.3.)

- E. PREVIOUS FUEL OR OXIDIZER DEPLETION CUTOFF.

Although WSTF tests with a fuel depletion cutoff did not damage an OMS engine, there is significant risk that engine damage may occur during shutdown. This is due to the loss of engine cooling when fuel no longer passes through the cooling jacket around the combustion chamber. Uncontained damage did not occur during WSTF tests but zero-g effects are unknown.

It is not desirable to reuse an OMS engine following an oxidizer depletion cutoff. A period of time is required for oxidizer from a different propellant source to reach the engine during the first engine start following oxidizer depletion cutoff. During this time, unburned fuel accumulates in the combustion chamber because of the very low vapor pressure of monomethylhydrazine. When the oxidizer reaches the injector, extremely rough combustion will result. Uncontained engine damage could result.

There have not been any tests to verify reuse of an engine which has experienced a previous oxidizer or fuel depletion cutoff.

Reference: SODB 3.4.3.3.

Rule {A6-106}, OMS ENGINE BURN TO DEPLETION, references this rule.

- F. PRE-MECO PC ≤ 76 (80) PERCENT CONFIRMED BY ENGINE BALL VALVE POSITION < 47 (70) PERCENT OR OXIDIZER INLET PRESSURE > 235 (227) PSIA.

The crew will get a class 2 alarm at Pc < 76 (80) percent, but there is no MNVR EXEC display or ENG SEL down arrow pre-MECO to indicate loss of acceleration. Therefore, oxidizer inlet pressure or ball valve position is checked for an additional indication of an engine failure. The rationale used for paragraphs A and C (CAUTION: SODB, volume III, contains engineering estimates for non-nominal evaluation. Data may not be supported by test.) applies here also. (Reference SODB, volume I, 3.4.3.3, table 3.4.3.3 and SODB request response R921.)

THIS RULE CONTINUED ON NEXT PAGE

FLIGHT RULES

A6-3 OMS ENGINE (CONTINUED)

G. OXIDIZER RESTRICTION: PC < 76 (80) PERCENT, OMS RM ENGINE SELECT DOWN ARROW ("↓") ON MANEUVER EXEC DISPLAY, AND OXIDIZER INLET PRESSURE > 235 (227) PSIA.

The engine can also fail if the oxidizer injector is restricted, which causes the upstream oxidizer inlet pressure to increase. Operating at this low oxidizer inlet pressure will result in an engine failure indicated by low Pc and acceleration. (Reference SODB, volume I, paragraph 3.4.3.3. A request has been submitted for inlet pressure verification.)

H. OMS BALL VALVE POSITION > 0 PERCENT (FAILED OPEN RANGE LOWER LIMIT) AND < 47 (70) PERCENT POSTBURN AND INSTRUMENTATION FAILURE CANNOT BE POSITIVELY IDENTIFIED.

ENGINE SERIAL #	OMS BALL VALVE FAILED OPEN RANGE LOWER LIMIT	
	BV1 %	BV2 %
101	6	5
105	3	5
106	4	6
107	6	6
108	4	5
109	4	6
110	3	4
111	6	3
113	4	4
114	5	3
115	3	3
116	2	4
117	5	4

@[110900-7251] @[ED]

For failure definition purposes, the OMS ball valves are considered a functionally integral part of the OMS engine. OMS ball valve position indicators are single-point instrumentation on the series ball valves. To distinguish an instrumentation failure from a hardware failure, it is necessary to examine the time-ordered history of the anomaly.

The normal position of the ball valves when not operating is 0 percent open (decimals of percent open are rounded). If the ball valves are failed to < 47 percent, the affected OMS Pc will be < 80 percent which is the level at which the engine is considered failed. (Refer to rationale of Rule {A6-108}, OMS BALL VALVE FAILURE MANAGEMENT.) The position indicators have an instrumentation accuracy of 5 percent.

THIS RULE CONTINUED ON NEXT PAGE

FLIGHT RULES

A6-3

OMS ENGINE (CONTINUED)

In order to avoid declaring an engine failed due to instrumentation accuracy effects, the ball valve will be considered closed if the indicated position is less than or equal to 5 percent. The failed open range lower limits listed in the above table are based on this value of 5 percent, plus an engine-specific error. This additional error is caused by the generic scale and generic bias factor used to convert the voltage measured by the hardware to a percent open. These generic factors are used for all engines and vary slightly from the individual scale and bias factors associated with each engine. For example, the value of 4 percent shown for ball valve 1 of engine 109 is the result of adding the scale and bias factor error of -1 percent to the instrumentation error of 5 percent. When that ball valve is closed, it should indicate within the range of -6 to 4 percent.

Note that flow through the valve begins at 10 percent. If the failed open range lower limit is exceeded, then the valve is failed open and a flow path through that valve may exist. Since there are two ball valves in series, should any single ball valve be open > 10 percent postburn, the other ball valve in that series will prevent propellant leakage into the engine proper.

If an instrumentation failure cannot be positively identified, the engine is considered failed. The affected engine will be used for deorbit only, and then, only if the other engine is failed. If the ball valve position is more than 47 percent open, an acceptable OMS Pc will be obtained during any subsequent engine operation. (Reference SODB, volume I, paragraph 3.4.3.3-17, and Rules {A6-3A}, OMS ENGINE, and {A6-108}, OMS BALL VALVE FAILURE MANAGEMENT.)

- I. OMS GN₂ SYSTEM FAILURE (REF. RULE {A6-5}, OMS N₂ ACCUMULATOR) .

Reference Rule {A6-5}, OMS N₂ ACCUMULATOR, for rationale. Rules {A6-106}, OMS ENGINE BURN TO DEPLETION; and {A6-108}, OMS BALL VALVE FAILURE MANAGEMENT, reference this rule.

FLIGHT RULES

A6-4

OMS N₂ TANK

AN OMS N₂ TANK IS CONSIDERED LOST IF:

- A. PRESSURE < 309 (469) PSIA (NO PURGE AVAILABLE).

An OMS N₂ tank failure is defined as insufficient GN₂ pressure to allow a nominal engine start with no purge and a subsequent accumulator only start with the GN₂ tank isolation valve closed. A GN₂ tank pressure of 309 psia (283 psi for an accumulator start and 26 psi for a nominal no purge start) will provide sufficient pressure to accomplish this requirement with a 100 percent ball valve opening on both burns. (Reference SODB, volume I, paragraph 3.4.3.3.14.)

- B. REGULATOR FAILED CLOSED.
 C. FAILED CLOSED CHECK VALVES.
 D. OMS ENGINE PRESSURE VALVE FAILED CLOSED.

Any one of these conditions has isolated the tank from the ball valve rack assembly, effectively failing the tank.

Rule {A6-55}, OMS N₂ TANK FAILURE MANAGEMENT, references this rule.

A6-5

OMS N₂ ACCUMULATOR

THE OMS N₂ SYSTEM IS CONSIDERED LOST IF:

INSUFFICIENT N₂ REGULATOR PRESSURE TO OPERATE ENGINE BALL VALVES:

- A. N₂ REGULATOR PRESSURE < 283 (299) PSIA WITH ENGINE PRESSURE VALVE CLOSED.
 B. N₂ REGULATOR PRESSURE < 244 (260) PSIA WITH ENGINE PRESSURE VALVE OPEN (ASSUMES N₂ TANK PRESSURE EQUAL TO N₂ REGULATOR PRESSURE)

An OME is considered failed if ball valves cannot be guaranteed to fully open. The engine can be used in a contingency if ball valves can be guaranteed to open > 90 percent. With the engine pressurization valve closed, the pressure below the valve must be above 283 psia to move the ball valve rack assembly. With the pressurization valve open, allowing the large tank volume to pressurize the accumulator, the ball valve rack will only require 244 psi. (Both the regulator pressure and tank pressure must be above 244 psia.) Performance drops off drastically at lower N₂ or accumulator pressures. Instrumentation accuracy is 16 psi on the accumulator pressure. (Reference SODB, volume I, table 4.3.3-3.)

Rules {A6-3I}, OMS ENGINE; {A6-51}, OMS FAILURE MANAGEMENT [CIL]; {A6-55}, OMS N₂ TANK FAILURE MANAGEMENT; and {A6-56}, OMS N₂ REGULATOR FAILURE MANAGEMENT, reference this rule.

FLIGHT RULES

A6-6

OMS/RCS CROSSFEED LINE

THE OMS/RCS CROSSFEED LINE IS CONSIDERED LOST IF:

- A. OMS/RCS CROSSFEED TEMPERATURE < 40 DEG (48 DEG) F OR > 125 DEG (117 DEG) F.

It takes approximately 10 seconds from ignition to reach thermal equilibrium in an OMS engine and regenerative cooling jacket. A crossfed OME will use the propellant from the feedlines and all of the propellant in the crossfeed lines during this thermal startup phase. It takes approximately 6 seconds to burn the feedline and crossfeed line propellant through an OME. ©[092701-4850]

The OME starts with propellant below 30 deg F or OME steady state operation with propellant below 40 deg F may result in rough combustion and excessive high chamber pressure which could overstress the engine chamber. Propellant temperatures below 40 deg F may also affect structural components such as service couplings and transducer fittings. Below 30 deg F, there is a concern that the oxidizer may freeze, rupturing or blocking propellant lines. RCS jet operation with propellant below 40 deg F may result in rough combustion. For RCS crossfeed during entry, the lower limit is 68 deg (70 deg) F to protect against ZOT's (refer to Rule {A6-258}, ARCS BULK PROPELLANT TEMPERATURE MANAGEMENT).

OME startup with propellant above 125 deg F reduces engine cooling effectiveness, resulting in violation of injector temperature limits. Localized "hot spots" of propellant may develop in stagnant crossfeed lines. This is caused by non-uniformity's in line heater installation coupled with non-synchronous heater cycling. Hot spots can be tracked and confirmed during periods of interconnect. Hot spots less than 125 deg F are acceptable for OME and RCS steady state operation. Refer to SODB table 3.4.3.3.

- B. NO FLOW PATH EXISTS.

The OMS/RCS crossfeed lines are considered failed when no flow path exists. Dual valve failure or a line leak could result in a flow path loss.

- C. CROSSFEED LINE PRESSURE IS < 15 (49) PSI OXIDIZER OR < 1 (35) PSIA FUEL (AS INDICATED BY RCS MANIFOLD PRESSURES) AS A RESULT OF PROPELLANT LEAKAGE.

Pressure less than 49 psia oxidizer or 35 psia fuel as a result of propellant leakage is cause to declare the crossfeed line failed. A known leaking line resulting in violation of the above limits will not be repressed unless staged repress techniques increase pressures to within acceptable limits. The OMS crossfeed line pressure will be checked via RCS manifold pressures until additional pressure transducers are installed. Any attempt to repressurize the leaking line risks structural damage as a result of excessive surge pressures.

For a crossfeed pressure less than the above limit as a result of thermal affects, the crossfeed line may be repressed according to the Flight Rules restrictions.

FLIGHT RULES

A6-7

RCS PROPELLANT TANK (OXIDIZER OR FUEL)

AN RCS PROPELLANT TANK IS CONSIDERED LOST IF:

A. PRESSURE IS < 185 (190) PSIA.

To maintain primary jet inlet pressures greater than 175 psia, the tank pressure must remain above 185 psia. With lower than normal inlet pressures (< 175), the chamber pressure during a firing becomes significantly higher than the inlet pressure. This results in a high frequency "chug" or combustion instability which causes hot spots on the chamber wall and in extreme cases may cause the chamber wall to fail. Reference SODB 3.4.3.2.10.a.

The vernier jets have a lower but undefined operational limit where the lower pressure can lead to the accumulation of carbon deposits in the chamber pressure tube. Blockage of the Pc tube may result in false fail-off jet indications.

B. ARCS:

1. ARCS (ENTRY ONLY) AND FRCS: PROPELLANT QUANTITY ≤ 0 PERCENT.

Propellant gauge quantity reflects usable propellant. Trapped propellant and gauge error are not included in the gauge quantity. For the FRCS, the gauge error propellant is available for contingency operations to 1.5 percent below a gauge reading of 0 percent (ref. Rule {A6-357}, FORWARD RCS CONTINGENCY PROPELLANT AVAILABLE).

2. ARCS ON ORBIT: PROPELLANT QUANTITY ≤ 20 PERCENT.

The on-orbit aft RCS tank failure limit is based upon the on-orbit expulsion efficiency of the RCS tank (78 percent of the design tank volume; ref. SODB 4.3.2.2.1.f.2). The on-orbit expulsion efficiency of the RCS is significantly less than the entry expulsion efficiency because the aft RCS tanks were designed to operate most efficiently during entry g-loading. Propellant can be expelled on orbit to 16 percent PVT gauge quantity (provided PVT gauging is perfectly accurate). Protecting for gauge error (50 lbs OX, 34 lbs FU), the minimum quantity on orbit becomes 20 percent. The 20 percent of propellant will be available for control during entry (post EI: $g > 0.05$), since expulsion efficiency during this period increases to 96.5 percent of the design tank volume.

C. ASSOCIATED TANK ISOLATION VALVES FAILED CLOSED.

No passageway exists for propellant to flow from the tank to the jets, effectively failing the tank.

THIS RULE CONTINUED ON NEXT PAGE

FLIGHT RULES

A6-7

RCS PROPELLANT TANK (OXIDIZER OR FUEL)
(CONTINUED)

- D. ARCS PROPELLANT TEMPERATURE IS < 50 DEG (52 DEG) F OR > 100 DEG (98 DEG) F.

The concern with violating the upper limit is that the oxidizer viscosity and adhesion to the acquisition screens allows a lower pressure to pull helium into the lower compartment and then to the jets. Violating the lower limit increases the restriction of fuel flow in the channels. During high flow demands, the large delta pressure across the screens occurs near the tank outlet. This large delta pressure breaks down the screen and pulls helium into the lower compartment. (Reference SODB, volume I, table 3.4.3.2.)

- E. FRCS PROPELLANT TEMPERATURE < 40 DEG (42 DEG) F OR > 100 DEG (98 DEG) F.

Tank certification constraint (reference SODB, volume I, table 3.4.3.2).

- F. PROPELLANT ACQUISITION DEVICE BREAKDOWN.

Confirmed evidence of propellant acquisition device breakdown will be cause to declare that RCS tank failed. Multiple jet fail-offs on the same feed system (e.g., multiple LRCS jet fail-offs while feeding from the LRCS) are the indication that a breakdown has occurred in either the screens or bulkhead of the RCS tank. Helium ingestion resulting from the tank failure may be cleared using propellant from either the good RCS feed system or the OMS. The tank will not be used except as a last resort during entry.

Rules {A4-202}, DEORBIT BURN COMPLETION [HC], and {A6-305}, AFT RCS REDLINES [HC], reference this rule. [ED] [042706-7370D]

FLIGHT RULES

A6-8

RCS THRUSTER

AN RCS THRUSTER IS CONSIDERED LOST IF:

A. FAILED ON - FIRES IN ABSENCE OF GPC "ON" COMMAND.

A thruster is "failed-on" when it fires in the absence of an "ON" command from the GPC. This failure will occur if the injector valve power (driver output) from the RJD fails high or if both the oxidizer and fuel thruster valves fail open. The failure is detected by RCS RM when an RJD output discrete is present with the absence of the GPC jet command B for three consecutive cycles. The failure is confirmed on the ground via the analog chamber pressure (Pc) and/or vehicle rates, and propellant consumption.

The BFS fail-on jet is detected by RM when the affected jet Pc discrete is present (> 36 psia) with no GPC command B for three consecutive cycles and fuel manifold valve open discrete indicates true.

B. FAILED OFF - DOES NOT FIRE IN PRESENCE OF GPC "ON" COMMAND.

A thruster is "failed-off" when the jet does not fire in the presence of an "ON" command from the GPC. This failure will occur when the RJD output discrete fails low (which can be caused by any of a number of upstream failures) or one of the thruster valves fails closed. The failure is detected by RCS RM when the Pc discrete is zero (indicating Pc < 26 psia as sensed by the RJD electronics) in the presence of a GPC command B for three consecutive cycles. The failure is confirmed on the ground via analog Pc, RJD output discrete, jet injector temperature, or vehicle rates.

C. FAILED LEAK - LOSS OF PROPELLANT THROUGH THRUSTER VALVE AS CONFIRMED BY PRIMARY OXIDIZER INJECTOR TEMPERATURE < 30 DEG F OR FUEL INJECTOR TEMPERATURE < 20 DEG F; OPS 2 VERNIER INJECTOR TEMPERATURE (OXIDIZER OR FUEL) < 130 DEG F.

A jet is "failed-leak" if either injector valve (oxidizer or fuel) fails to close completely or if propellant leaks through a deformed or damaged thruster valve seal. Seal leakage is the most common form of jet leak. The failure is detected both on the ground and by RCS RM when either injector temperature falls below RCS RM limits for three consecutive cycles. The RM limits are established as specified in the SODB. The failure is confirmed on the ground via the injector temperature signature or RCS quantity telemetry. The vernier injector temperatures are assumed to track together; therefore, action will be taken when the first of either fuel or oxidizer is < 130 deg F.

During entry, residual fuel may be held against the injector on the primary upfiring jets by gravity. This is why the fuel limit is lower than the oxidizer limit. Vernier jet injector temperature sensors are located on a large mass of metal which acts as a heat source. Because of the location, these sensors respond more slowly to leaks than do the primary jet sensors. The vernier leak limit is set to accommodate these conditions.

FLIGHT RULES

A6-9

RCS JET HEATER

AN RCS JET HEATER IS CONSIDERED LOST IF:

- A. PRIMARY THRUSTER - BOTH OXIDIZER AND FUEL INJECTOR TEMPERATURES DECREASE TOGETHER TO BELOW 50 DEG (55 DEG) F.

Normal heater operations will keep the jets above 60 deg F. In the event of a jet heater failure, the colder temperatures may result in shrinkage of the injector valve seats causing jet leakage. To prevent seat shrinkage, the jet should be kept above 50 deg F; and to prevent RM from deselection the jet, the temperatures should be kept above the thermal leak limit (fuel > 20 deg F, oxidizer > 30 deg F). The jets may be warmed by hot-firing the jets for at least 2 seconds (firing a cold jet less than 2 seconds may cause the jet to leak). Reference SODB, volume I, paragraph 3.4.3.2.13.a.

B. VERNIER THRUSTERS:

1. INADEQUATE JET HEATER OPERATION - THRUSTER HAS NOT BEEN FIRED IN AT LEAST 1.5 HOURS AND BOTH OXIDIZER AND FUEL INJECTOR TEMPERATURES DROP BELOW 130 DEG F AND DECREASE FROM 130 DEG TO 90 DEG F AT A RATE OF LESS THAN 15 DEG F PER HOUR WITH NO INCREASE IN THE JET CHAMBER PRESSURE.
2. HEATER FAILED OFF - BOTH OXIDIZER AND FUEL INJECTOR TEMPERATURES DROP BELOW 130 DEG F AND DECREASE FROM 130 DEG TO 90 DEG F AT A RATE OF LESS THAN 2 DEG F PER MINUTE WITH NO INCREASE IN THE JET CHAMBER PRESSURE.

Normal operating temperatures for vernier jets are above 140 deg F. However, some attitudes (e.g., gravity gradient) which do not require vernier jet firings may allow a vernier jet to cool to below 130 deg F, even without a heater failure, because the heaters are undersized. For inadequate jet heater operation or a failed vernier heater, the vernier minimum injector temperature can be reduced from 130 deg to 90 deg F if the conditions set forth in this rule are met. Failure to meet these conditions indicates a vernier jet leak. Cooler temperatures are less likely to cause the verniers to leak than the primaries because of the conical valve seat design. The 90 deg F coldsoak limit will prevent seal shrinkage which would result in propellant leakage. It is possible that a slow temperature decay rate is due to a leak that is contained within the vernier thrust chamber. If the chamber pressure increases, it is probable that the vernier has leaked, the jet throat has frozen closed, and the leak has continued. In this case, firing the affected thruster may cause damage in the pod.

THIS RULE CONTINUED ON NEXT PAGE

FLIGHT RULES

A6-9**RCS JET HEATER (CONTINUED)**

Vernier jet injector temperatures less than 130 deg F indicate either inadequate heater operation, a heater failure, or an injector leak. Inadequate heater operation or a heater failure will allow both fuel and oxidizer temperatures to decay together. Jet injector leaks will cause the injector temps to decay much faster than for a heater failure. Also, the leaking injector temperature (oxidizer or fuel) will decay further than the nonleaking injector temperature. However, an instrumentation contact resistance may cause false readings greater than 15 deg F delta oxidizer and fuel temperatures masking any 5 deg F or greater delta created by a leak. Therefore, delta temperature cannot be used to distinguish leaks from heater failures. Reference Rule {A6-158}, RCS LEAKING JET MANAGEMENT; and SODB, volume I, paragraph 3.4.3.2.13.b.

A6-10 THROUGH A6-50 RULES ARE RESERVED

FLIGHT RULES

OMS/RCS MANAGEMENT

A6-51

OMS FAILURE MANAGEMENT [CIL] [HC] @[121604-6531A]

(ASSUMES NOMINAL MECO)

FAILURE MATRIX	L/O TO OMS-2	OMS-2 TO DEORBIT
1 OMS HE TANK LEAK	A	B
1 OMS HE TANK FAIL	C	D
2 OMS HE TANK LEAK/FAIL	E	F
1 OMS HE LEG LEAK	G	G
2 OMS HE LEG LEAK	H	H
1 OMS GN2 TANK LEAK/FAIL	I	I
2 OMS GN2 TANK LEAK/FAIL	J	J
1 OMS GN2 ACCUMULATOR LEAK	K	K
2 OMS GN2 ACCUMULATOR LEAK	L	L
1 OMS PROP TANK LEAK	M	N
1 OMS PROP TANK FAIL	M	O
2 OMS PROP TANK LEAK/FAIL	P	P
1 OMS INLET LINE LEAK	Q	R
2 OMS INLET LINE LEAK	S	S
1 OMS ENGINE FAIL	T	T
2 OMS ENGINE FAIL	U	U

NOTES:

- [1] USE OMS ENGINE IN BLOWDOWN UNTIL OMS CHAMBER PRESSURE < 72 PERCENT ON ENGINE BEING SUPPLIED BY LEAKING POD, THEN SEGP.
- [2] REPRESSURIZE LEAKING TANK. BURN IF FUEL INLET PRESSURE > 216 PSIA, OXIDIZER PRESSURE > 151 PSIA.
- [3] ENTER FIRST DAY PLS.
- [4] ENTER NEXT PLS.
- [5] CUTOFF AT MINIMUM HP WHICH REQUIRES THE LEAST TOTAL DELTA V FOR THE INSERTION AND DEORBIT BURNS AND ENSURES ORBITAL LIFETIME AT LEAST TWO ORBITS BEYOND THE FIRST DAY PLS. (REF. ANNEX FLIGHT RULE, TRAJECTORY AND GUIDANCE PARAMETERS.) @[ED]
- [6] IF TANK IS FAILED, PERFORM ALL BURNS SEGP.

OMS CONFIGURATION	DEORBIT	OPTIMUM DUMP
TEGP - TWO ENGINES GOOD POD	NOMINAL DEORBIT: NOMINAL (STEEP) TARGETS	OPTIMUM POSIGRADE DUMP: FULL DUMP DELTA V CAN BE BURNED POSIGRADE WITHOUT RADIAL DELTA V LOSS
TETP - TWO ENGINES TWO PODS (NORMAL CONFIGURATION)		
TELP - TWO ENGINES LEAKING POD		
SETP - SINGLE ENGINE TWO PODS (CROSSFEED IN BURN)		
SESP - SINGLE ENGINE SINGLE POD (MAY BE CROSSFEED)		
SELP - SINGLE ENGINE LEAKING POD		
SEGP - SINGLE ENGINE GOOD POD		

@[121604-6531A]

THIS RULE CONTINUED ON NEXT PAGE

FLIGHT RULES

A6-51

OMS FAILURE MANAGEMENT [CIL] [HC] (CONTINUED)

FAILURE DEFINITION

OMS HE TANK LEAK/FAIL:

- HE TANK LEAK IF PRESSURE > 640 PSI AND DECREASING WHEN NOT BURNING AND HE PRESS/VAPOR ISOLATION VALVE CLOSED. @[121604-6531A]
- HE TANK FAIL IF PRESSURE < 640 PSI.
- MAXIMUM BLOWDOWN IF PROPELLANT TANK QUANTITY EQUAL TO 39 PERCENT (GENERIC QUANTITY).
- FULL BLOWDOWN IF PROPELLANT TANK QUANTITY ≤ ENGINE SPECIFIC MAXIMUM BLOWDOWN QUANTITY. @[072398-6518A]
- OMS PROPELLANT TANK LANDING WEIGHT CONSTRAINT IS APPROXIMATELY 21 PERCENT PER POD. @[121604-6531A]

THIS RULE CONTINUED ON NEXT PAGE

FLIGHT RULES

A6-51

OMS FAILURE MANAGEMENT [CIL] [HC] (CONTINUED)

ACTION SUMMARY

A. ONE OMS HE TANK LEAK PRIOR TO OMS-2:

1. IF HE TANK LEAK RATE WILL SUPPORT POST-MECO BURN TELP AT 20 MINUTES MET TO A QUANTITY SUFFICIENT TO PROTECT THE OMS PROPELLANT TANK LANDING WEIGHT CONSTRAINT: @[072398-6518A] @[121604-6531A]
 - a. PERFORM ASSIST TETP. IF HE TANK LEAK RATE WILL NOT SUPPORT A POST-MECO BURN TELP TO MAX BLOWDOWN AT THE OPTIMUM POSIGRADE BURN TIG, REQUEST ASSIST TIMER REDUCTION.
 - b. PERFORM ATO OMS DUMP TETP.
 - c. PERFORM POST-MECO BURN TELP AT 20 MIN MET UNTIL AFFECTED POD REACHES FULL BLOWDOWN OR HE TANK FAIL.
 - d. THE POST-MECO BURN MAY BE PERFORMED AT A LATER TIG TO OPTIMIZE DELTA V CAPABILITY IF HE LEAK RATE WILL SUPPORT.
 - e. IF AN OMS-1 BURN IS REQUIRED PRIOR TO 20 MIN MET, PERFORM OMS-1 TELP TO TARGET, HE TANK FAIL, OR QUANTITY EQUAL TO 5 PERCENT. CONTINUE BURN TEGP IF REQUIRED. @[022405-6619]
 - f. RAISE ORBIT WITHIN REDLINES. @[121604-6531A]

THIS RULE CONTINUED ON NEXT PAGE

FLIGHT RULES

A6-51

OMS FAILURE MANAGEMENT [CIL] [HC] (CONTINUED)

2. IF HE TANK LEAK RATE WILL NOT SUPPORT POST-MECO BURN TELP AT 20 MIN MET TO A QUANTITY SUFFICIENT TO PROTECT THE OMS PROPELLANT TANK LANDING WEIGHT CONSTRAINT: @[121604-6531A]
 - a. PERFORM ASSIST SELP.
 - b. PERFORM PRE-MECO OMS DUMP SELP UNTIL AFFECTED POD REACHES MAXIMUM BLOWDOWN OR HE TANK FAIL. CONTINUE PRE-MECO OMS DUMP SELP BELOW MAXIMUM BLOWDOWN IF DUMPING FOR ATO ABORT.
 - c. IF REQUIRED PER FDO REQUEST, PERFORM PRE-MECO OMS DUMP TETP AND/OR ENABLE INTERCONNECT.
 - d. IF NO PRE-MECO OMS DUMP OR DUMP NOT COMPLETE AND HE PRESSURE > 640 PSI, PERFORM OUT-OF-PLANE DUMP TELP ASAP POST-MECO UNTIL AFFECTED POD REACHES MAXIMUM BLOWDOWN OR HE TANK FAIL.
 - e. PERFORM OMS-2 TEGP. RAISE ORBIT WITHIN REDLINES.
3. DEORBIT TETP [1]. @[121604-6531A]

THIS RULE CONTINUED ON NEXT PAGE

FLIGHT RULES

A6-51 **OMS FAILURE MANAGEMENT [CIL] [HC] (CONTINUED)**

- B. ONE OMS HE TANK LEAK POST OMS-2: @[121604-6531A]
1. USE OMS ACTIVITIES TO MAXIMIZE BLOWDOWN IF HE TANK LEAK RATE WILL SUPPORT. CONTINUE OMS ACTIVITIES WITHIN REDLINES.
 2. IF HE TANK LEAK RATE WILL NOT SUPPORT UPCOMING OMS ACTIVITIES, THEN PERFORM AN OMS BURN TO MAXIMUM BLOWDOWN OR HE TANK FAIL. CONTINUE OMS ACTIVITIES WITHIN REDLINES.
 3. DEORBIT TETP [1]. @[072398-6518A]
- C. ONE OMS HE TANK FAILURE PRIOR TO OMS-2: @[072398-6518A]
1. CANCEL ASSIST/ATO OMS DUMP.
 2. PERFORM ATO OMS DUMP SEGP, IF REQUIRED PER FDO REQUEST.
 3. PERFORM OMS-2 TEGP, CUTOFF AT MIN HP [5].
 4. RAISE ORBIT WITHIN REDLINES.
 5. DEORBIT TETP [1].
- D. ONE OMS HE TANK FAILURE POST OMS-2: @[121604-6531A]
1. CONTINUE OMS ACTIVITIES WITHIN REDLINES.
 2. DEORBIT TETP [1]. @[072398-6518A]

THIS RULE CONTINUED ON NEXT PAGE

FLIGHT RULES

A6-51**OMS FAILURE MANAGEMENT [CIL] [HC] (CONTINUED)**

- E. TWO OMS HE TANKS LEAKING/FAILED PRIOR TO OMS-2: @[072398-6518A]
@[121604-6531A]
1. CONTINUE ASSIST/ATO OMS DUMP IF HE PRESSURE > 640. IF HE TANK FAIL, AFFECTED OMS ENGINE OFF.
 2. PERFORM PRE-MECO OMS DUMP TETP, IF HE PRESSURE > 640. IF MAXIMUM BLOWDOWN REACHED OR HE TANK FAIL, AFFECTED OMS ENGINE OFF.
 3. IF PRE-MECO DUMP NOT COMPLETE OR POST-MECO AND HE PRESSURE > 640 PSI, PERFORM POST-MECO DUMP. IF MAXIMUM BLOWDOWN REACHED OR HE TANK FAIL, AFFECTED OMS ENGINE OFF. @[072398-6518A]
 4. IF PRE-MECO AND INSUFFICIENT DELTA V IS AVAILABLE TO ACHIEVE AOA STEEP OR REV 3 SHALLOW DEORBIT, THEN ABORT TAL TO A TAL/ACLS. IF POST-MECO, DETERMINE ABORT OR DEORBIT CAPABILITY BASED ON DELTA V AVAILABLE. @[072398-6518A]
 5. IF AT OMS-2 TIG:
 - BOTH HE TANK PRESSURE \geq 640, TETP
 - EITHER HE TANK PRESSURE \geq 640, SINGLE ENGINE, NON-FAILED POD
 - BOTH HE TANK PRESSURE \leq 640, SESP
 - CUT OFF AT HP \geq MINIMUM HP [5].
 6. RAISE ORBIT WITHIN REDLINES.
 7. DEORBIT TETP [1] IF AVAILABLE. @[121604-6531A]

THIS RULE CONTINUED ON NEXT PAGE

FLIGHT RULES

A6-51 **OMS FAILURE MANAGEMENT [CIL] [HC] (CONTINUED)**

F. TWO OMS HE TANKS LEAKING/FAILED POST OMS-2: @[121604-6531A]

1. CONTINUE OMS ACTIVITIES WITHIN REDLINES.
2. DEORBIT TETP [1]. @[072398-6518A]

FAILURE DEFINITION

OMS HE LEG LEAK:

HE TANK PRESSURE DECREASING ONLY WHEN HE PRESS/VAPOR ISOLATION VALVE OPEN AND NOT BURNING.

ACTION SUMMARY

G. ONE OMS HE LEG LEAK: @[072398-6518A]

1. CONTINUE ASSIST/ATO OMS DUMP TETP.
2. PERFORM OMS-2 TELP UNTIL AFFECTED POD REACHES MAXIMUM BLOWDOWN OR OMS HE TANK FAIL. @[121604-6531A]
3. USE ON-ORBIT ACTIVITIES TO MAXIMIZE BLOWDOWN.
4. CONTINUE OMS ACTIVITIES WITHIN REDLINES. ONLY BLOWDOWN CAPABILITY IN AFFECTED POD WILL BE CONSIDERED IN REDLINE DETERMINATION.
5. DEORBIT TETP [1].

THIS RULE CONTINUED ON NEXT PAGE

FLIGHT RULES

A6-51 **OMS FAILURE MANAGEMENT [CIL] [HC] (CONTINUED)**

- H. TWO OMS HE LEG LEAKS: @[121604-6531A]
1. CONTINUE ASSIST/ATO OMS DUMP TETP.
 2. PERFORM OMS-2 TETP.
 3. USE ON-ORBIT ACTIVITIES TO MAXIMIZE BLOWDOWN.
 4. CONTINUE OMS ACTIVITIES WITHIN REDLINES. ONLY BLOWDOWN CAPABILITY WILL BE CONSIDERED IN REDLINE DETERMINATION.
 5. DEORBIT TETP [1]. @[072398-6518A]

FAILURE DEFINITION

OMS GN₂ TANK LEAK/FAIL:

- GN₂ TANK LEAK IF PRESSURE DECREASING WHEN GN₂ PRESS VALVE CLOSED. @[072398-6518A]
- GN₂ TANK FAIL IF PRESSURE < 470 PSI.

ACTION SUMMARY

- I. ONE OMS GN₂ TANK LEAKING/FAILED:
1. PERFORM ASSIST/ATO OMS DUMP SEGP IF AFFECTED GN₂ TANK FAILED AT TIG. OTHERWISE, PERFORM ALL PRE-MECO DUMPS TETP.
 2. PERFORM OMS-1, OMS-2, AND ON-ORBIT BURNS:
 - a. TETP IF AFFECTED GN₂ PRESSURE > 470 PSI AT TIG.
 - b. SESP (GOOD ENGINE) IF AFFECTED GN₂ TANK FAILED AT TIG, CROSSFEED AS REQUIRED. @[121604-6531A]
 3. DEORBIT TETP.

THIS RULE CONTINUED ON NEXT PAGE

FLIGHT RULES

A6-51 **OMS FAILURE MANAGEMENT [CIL] [HC] (CONTINUED)**

- J. TWO OMS GN₂ TANKS LEAKING/FAILED: @[121604-6531A]
1. CANCEL ASSIST/ATO OMS DUMP IF BOTH TANKS FAILED. FOR OTHER PRE-MECO ABORT DUMPS, TETP. @[072398-6518A]
 2. IF LEAK RATE INDICATES EITHER GN₂ PRESSURE > 470 PSI AT TIG, TREAT AS SINGLE LEAK/FAIL. (SEE PARAGRAPH I.)
 3. IF BOTH GN₂ TANKS FAILED AT TIG, PERFORM OMS-2 SINGLE ENGINE, CUT OFF AT MIN HP [5] (OMS ENG - ARM POST IGN). RAISE ORBIT WITHIN REDLINES. DEORBIT TETP IF BOTH GN₂ REG PRESSURES > 299 PSIA; OTHERWISE, SESP. @[121604-6531A]

THIS RULE CONTINUED ON NEXT PAGE

FLIGHT RULES

A6-51

OMS FAILURE MANAGEMENT [CIL] [HC] (CONTINUED)

FAILURE DEFINITION

OMS GN2 ACCUMULATOR LEAK

OMS GN₂ ACCUMULATOR PRESSURE DECREASING.

ACTION SUMMARY

K. ONE OMS GN₂ ACCUMULATOR LEAK: @[121604-6531A]

1. IF LEAK RATE IS CONFIRMED TO BE ≤ 14 PSIA/SEC WITH ENGINE PRESS VALVE CLOSED (≤ 5 PSIA/SEC WITH P VALVE OPEN) AND N₂ ACCUMULATOR PRESSURE ≥ 260 PSIA PREBURN (P VALVE OPEN): @[ED]

a. PERFORM OMS-1 TETP. OMS-2 AND CRITICAL ON-ORBIT BURNS MAY BE PERFORMED TETP PROVIDED THE REQUIREMENTS OF PARAGRAPH 1.c ARE NOT COMPROMISED. USE CROSSFEED AS REQUIRED. @[121604-6442A]

b. PERFORM NON-CRITICAL OMS BURNS SESP (GOOD ENGINE), WITHIN REDLINES. @[072398-6518A]

c. RCS STEEP DEORBIT MUST BE REDLINED IF THE LEAK RATE WILL NOT SUPPORT THE ENTIRE DEORBIT BURN (PLUS REPRESS) SINGLE (LEAKING) ENGINE OR IF THE LEAK RATE IS INCREASING SUCH THAT THE ENGINE MAY NOT BE A VALID DEORBIT METHOD. @[072398-6518A] @[121604-6442A]

d. THE LEAKING ENGINE MAY BE USED FOR THE DEORBIT BURN IF THE LEAK RATE WILL SUPPORT SINGLE (LEAKING) ENGINE COMPLETION FROM AN HP \geq SAFE HP (IF THE GOOD ENGINE FAILS

ABOVE THIS HP, TERMINATE AND REPLAN THE BURN). OTHERWISE, DEORBIT GOOD ENGINE WITH RCS STEEP AS THE DOWNMODE.

THIS RULE CONTINUED ON NEXT PAGE

FLIGHT RULES

A6-51

OMS FAILURE MANAGEMENT [CIL] [HC] (CONTINUED)

2. IF LEAK RATE IS UNKNOWN OR IS > 14 PSIA/SEC WITH ENGINE PRESS VALVE CLOSED (> 5 PSIA/SEC WITH P VALVE OPEN) OR GN₂ ACCUMULATOR PRESSURE < 260 PSIA PREBURN (P VALVE OPEN): @ED]

AFFECTED OMS ENGINE IS CONSIDERED FAILED (SEE PARAGRAPH T). @[121604-6531A]

L. TWO OMS GN₂ ACCUMULATOR LEAKS:

1. IF BOTH LEAK RATES ARE CONFIRMED TO BE ≤ 14 PSIA/SEC WITH ENGINE PRESS VALVE CLOSED (≤ 5 PSIA/SEC WITH P VALVE OPEN) AND N₂ ACCUMULATOR PRESSURE ≥ 260 PSIA PREBURN (P VALVE OPEN): @ED]
- a. PERFORM OMS-1/2 SELP IF EITHER LEAK RATE WILL SUPPORT THE ENTIRE BURN. OTHERWISE, INTERCONNECT OMS TO RCS +X. @[121604-6442A]
- b. BOTH ENGINES MAY BE USED FOR OMS-1/2 AND CRITICAL ON-ORBIT BURNS PROVIDED THE DEORBIT REQUIREMENTS OUTLINED IN PARAGRAPH 1.c ARE NOT COMPROMISED.
- c. RCS STEEP DEORBIT MUST BE REDLINED IF BOTH ENGINES CANNOT SUPPORT THE ENTIRE DEORBIT BURN SINGLE ENGINE, OR IF EITHER LEAK RATE IS INCREASING SUCH THAT THE ENGINE MAY NOT BE A VALID DEORBIT METHOD. PERFORM ON-ORBIT BURNS RCS AS REQUIRED. RAISE ORBIT WITHIN REDLINES.
- d. EVEN WHEN THE LEAK RATE IS SUCH THAT BOTH ENGINES WILL SUPPORT ALL PLANNED OPERATIONS AND SINGLE ENGINE DEORBIT, CONSIDERATION MAY BE GIVEN TO REDLINING RCS STEEP DUE TO THE INCREASED POSSIBILITY OF LOSING ONE OR BOTH OMS ENGINES.
- e. BOTH ENGINES MAY BE USED FOR THE DEORBIT BURN IF THE LEAK RATES WILL SUPPORT SINGLE ENGINE COMPLETION FROM AN HP \geq SAFE HP (IF AN ENGINE FAILS ABOVE THIS HP, TERMINATE AND REPLAN THE BURN). OTHERWISE, DEORBIT SINGLE ENGINE (AS AVAILABLE) WITH RCS STEEP AS THE DOWNMODE. @[072398-6518A] @[121604-6442A]

THIS RULE CONTINUED ON NEXT PAGE

FLIGHT RULES**A6-51 OMS FAILURE MANAGEMENT [CIL] [HC] (CONTINUED)**

2. IF EITHER LEAK RATE IS UNKNOWN OR IS > 14 PSIA/SEC WITH ENGINE PRESS VALVE CLOSED (> 5 PSIA/SEC WITH P VALVE OPEN) OR GN₂ ACCUMULATOR PRESSURE < 260 PSIA PREBURN (P VALVE OPEN): @[ED]

AFFECTED OMS ENGINE IS CONSIDERED FAILED (SEE PARAGRAPHS T AND U). @[121604-6531A]

FAILURE DEFINITIONOMS PROPELLANT TANK LEAK/FAIL:

- PROPELLANT TANK LEAK IF FUEL INLET PRESSURE ≥ 216, OXIDIZER INLET PRESSURE ≥ 151 AND DECREASING.
- PROPELLANT TANK FAILED IF FUEL INLET PRESSURE < 216 OXIDIZER INLET PRESSURE < 151 AND WILL NOT REPRESS OR QUANTITY ≤ 3 PERCENT.

ACTION SUMMARY

- M. ONE OMS PROPELLANT TANK LEAK/FAIL PRIOR TO END OF OMS-2 [CIL]: @[072398-6518A]
1. CONTINUE ASSIST/ATO OMS DUMP SELP. IF TANK FAILED, CANCEL DUMP. @[072398-6518A] @[121505-7210A]
 2. EXTEND ASSIST/ATO OMS DUMP OR PERFORM/PRE-MECO OMS DUMP SELP TO DEPLETION. IF TANK FAILED, CANCEL DUMP.
 3. IF REQUIRED TO PROTECT DESIGN UNDERSPEED PER FDO REQUEST, PERFORM PRE-MECO OMS DUMP TETP AND/OR ENABLE INTERCONNECT.
 4. IF NO PRE-MECO OMS DUMP OR DUMP NOT COMPLETE AND SIGNIFICANT PROPELLANT QUANTITY REMAINS, PERFORM POST-MECO DUMP SELP [2] TO DEPLETION.
 5. PERFORM OMS-2 SEGP, CUT OFF AT MIN HP [5].
 6. DEORBIT [3] SEGP OR MIXED CROSSFEED IF REQUIRED AND AVAILABLE. @[121604-6531A] @[121505-7210A]

THIS RULE CONTINUED ON NEXT PAGE

FLIGHT RULES

A6-51 OMS FAILURE MANAGEMENT [CIL] [HC] (CONTINUED)

- N. ONE OMS PROPELLANT TANK LEAK POST-OMS-2: @[121604-6531A]
1. CANCEL ON-ORBIT BURNS.
 2. PERFORM OMS BURN TO DEPLETION AT NEXT OPPORTUNITY, SELP [2], IN ACCORDANCE WITH RULE {A4-104}, OMS LEAK/PERIGEE ADJUST.
 3. DEORBIT [3] SEGP OR MIXED CROSSFEED IF REQUIRED AND AVAILABLE.
- O. ONE OMS PROPELLANT TANK FAIL POST OMS-2 [CIL]:
1. DURING DEORBIT, CUTOFF BURN IF $HP \geq$ PROPELLANT FAIL HP.
 2. DEORBIT [4], SEGP OR MIXED CROSSFEED IF REQUIRED AND AVAILABLE. @[072398-6518A] @[121604-6531A]

THIS RULE CONTINUED ON NEXT PAGE

FLIGHT RULES

A6-51

OMS FAILURE MANAGEMENT [CIL] [HC] (CONTINUED)

- P. TWO OMS PROPELLANT TANKS LEAKING/FAILED [2]: @[072398-6518A]
@[121604-6531A]
1. SAME SIDE, TREAT AS SINGLE LEAK/FAIL (SEE PARAGRAPHS M, N, AND O).
 2. DIFFERENT SIDES:
 - a. ABORT TAL IF PRIOR TO LAST TAL BOUNDARY; AFTER TAL BOUNDARY AND PRE-MECO, ABORT TAL TO AN ACLS. @[072398-6518A]
 - b. IF POST-MECO, PERFORM AOA OMS-2 (MIXED CROSSFEED IF AVAILABLE; COMPLETE WITH RCS IF NECESSARY).
@[121604-6531A]

THIS RULE CONTINUED ON NEXT PAGE

FLIGHT RULES

A6-51 **OMS FAILURE MANAGEMENT [CIL] [HC] (CONTINUED)**

FAILURE DEFINITION

OMS INLET LINE LEAK:

INLET LINE LEAK IF INLET PRESSURE DECREASING OR ZERO WITH TANK ISOLATION AND CROSSFEED VALVES CLOSED (SYSTEM SECURE IS ASSUMED).
@[072398-6518A]

ACTION SUMMARY

Q. ONE OMS INLET LINE LEAK PRIOR TO OMS-2: @[121604-6531A]

1. SECURE POST-MECO.
2. PERFORM OMS-2 SEGP, CUT OFF AT MIN HP [5].
3. POST OMS-2, PERFORM DUMP SELP [2] IF REQUIRED TO SATISFY CG ENVELOPE OR OMS TANK LANDING WEIGHT CONSTRAINT.
4. DEORBIT [3] SEGP OR MIXED CROSSFEED IF REQUIRED AND AVAILABLE. @[072398-6518A]

R. ONE OMS INLET LINE LEAK POST OMS-2: @[072398-6518A]

1. PERFORM PERIGEE ADJUST OR OUT-OF-PLANE (OOP) BURN SELP [2]. IF PROPELLANT REMAINS POST PERIGEE ADJUST BURN, PERFORM OOP DUMP SELP [2] IF REQUIRED TO SATISFY CG ENVELOPE OR OMS TANK LANDING WEIGHT CONSTRAINT (REF. RULE {A6-203}, OMS LEAKING INLET LINE PERIGEE ADJUST BURN).
2. DEORBIT [4] SEGP OR MIXED CROSSFEED IF REQUIRED AND AVAILABLE. @[121604-6531A]

THIS RULE CONTINUED ON NEXT PAGE

FLIGHT RULES

A6-51 **OMS FAILURE MANAGEMENT [CIL] [HC] (CONTINUED)**

- S. TWO OMS INLET LINES LEAKING: @[121604-6531A]
1. SAME SIDE, DIFFERENT PROPELLANT:
 - a. TREAT AS SINGLE LEAK (SEE PARAGRAPHS Q AND R).
 - b. PERFORM UPHILL BURNS SEGP, DO NOT REPRESS. @[072398-6518A]
 2. DIFFERENT SIDES, SAME PROPELLANT:
 - a. IF PRE-MECO, SAME AS TWO TANK LEAKS (SEE PARAGRAPH P).
 - b. IF POST-MECO, SECURE. PERFORM AOA OMS-2 TETP [2] (COMPLETE WITH RCS IF NECESSARY).
 3. DIFFERENT SIDES, DIFFERENT PROPELLANT:
 - a. IF PRE-MECO, SAME AS TWO TANK LEAKS (SEE PARAGRAPH P).
 - b. IF POST-MECO, SECURE. PERFORM OMS-2 TETP [2] CUTOFF AT MIN HP [5]. DEORBIT [3] MIXED CROSSFEED 4+X (COMPLETE WITH RCS IF NECESSARY). @[121604-6531A]

THIS RULE CONTINUED ON NEXT PAGE

FLIGHT RULES

A6-51

OMS FAILURE MANAGEMENT [CIL] [HC] (CONTINUED)

FAILURE DEFINITION

OMS ENGINE FAIL:

ACTION SUMMARY

- T. ONE OMS ENGINE FAILURE: @[072398-6518A] @[121604-6531A]
1. PERFORM ASSIST DUMP SINGLE ENGINE.
 2. IF ATO, PERFORM OMS DUMP SINGLE ENGINE. ENABLE INTERCONNECT IF REQUIRED.
 3. PERFORM OMS-1 SINGLE ENGINE, CROSSFEED AS REQUIRED.
 4. PERFORM OMS-2 AND ON-ORBIT OMS BURNS WITHIN REDLINES (RCS STEEP DEORBIT MUST BE REDLINED). @[121604-6531A]

THIS RULE CONTINUED ON NEXT PAGE

FLIGHT RULES

A6-51 **OMS FAILURE MANAGEMENT [CIL] [HC] (CONTINUED)**

U. TWO OMS ENGINES FAILED: @[072398-6518A] @[121604-6531A]

1. CANCEL ASSIST DUMP.
2. USE OMS INTERCONNECT TO RCS JETS FOR ABORT DUMPS.
3. USE OMS INTERCONNECT TO RCS +X JETS FOR OMS-1 AND OMS-2.
4. IF PRIOR TO OMS-2, CUT OFF OMS-2 AT MIN HP [5].
5. DEORBIT [3]. @[121604-6531A]

THIS RULE CONTINUED ON NEXT PAGE

FLIGHT RULES

A6-51

OMS FAILURE MANAGEMENT [CIL] [HC] (CONTINUED)OMS HELIUM TANK LEAK/FAIL @[072398-6518A] @[121604-6531A]

A. ONE OMS HELIUM TANK LEAK PRIOR TO OMS-2:

Protecting the OMS tank landing weight constraint implies the leak rate should support a burn to an engine specific quantity (approximately 49 percent) such that the remaining ullage is sufficient to support a subsequent burn in blowdown to approximately 21 percent.

A helium leak rate that supports a post-MECO burn with a TIG of 20 minutes MET to a quantity sufficient to protect the OMS tank landing weight constraint also guarantees that there will be sufficient delta V to support any uphill scenario while protecting design underspeed. Full OMS delta V capability can be assumed since, if required, a subsequent ATO dump will either get the affected tank below maximum blowdown or the resulting underspeed will not require full OMS capability.

If the helium leak rate will support a post-MECO burn, continue OMS assist or an ATO dump to reduce or prevent an underspeed while simultaneously increasing blowdown. Both engines will be burned for ATO to protect ET IP constraints (ref. Rule {A2-62}, ET FOOTPRINT CRITERIA).

Post-MECO, Flight Dynamics Officer (FDO) will target a posigrade burn at or after 20 minutes MET, based on the leak rate supportability, that will achieve OMS-1 targets, if required, and reach tank fail or maximum blowdown. Twenty minutes MET is the earliest FDO can generate targets real time for a posigrade burn. However, the burn will be performed as late as possible in order to minimize delta V loss and may be delayed until the nominal OMS-2 TIG if the leak rate will support. Preflight, FDO Support determines a post-MECO optimum posigrade dump TIG that results in no mission capability loss. This TIG is a function of rendezvous altitude and required burn delta V and may be earlier or later than 20 minutes MET. If the leak rate will not support this optimum burn TIG to maximum blowdown such that there will be an overall mission delta V loss, then an attempt will be made to reduce the OMS assist timer in order to maximize the post-MECO OMS delta V.

If an OMS-1 burn is required prior to 20 minutes MET due to multiple SSME failures, as much of the affected pod's propellant will be burned as possible in order to minimize the impacts and the difficulty in planning subsequent burns with a system in blowdown. For instance, multiple OMS starts will most likely not be available due to OMS engine start box constraints (ref SODB, Volume I, Paragraph 4.3.3.4-4a). If the delta V requirement for OMS-1 is greater than the capability in the affected pod, a tank switch from TELP to TEGP will be performed when 5 percent is reached in the affected pod. This quantity maximizes the propellant used from the affected pod and provides a sufficient indication for the reconfiguration to be completed so that propellant depletion and potential engine damage do not occur.
@[121604-6531A] @[022405-6619]

THIS RULE CONTINUED ON NEXT PAGE

FLIGHT RULES**A6-51****OMS FAILURE MANAGEMENT [CIL] [HC] (CONTINUED)**

If the helium leak rate will not support a post-MECO burn, then OMS assist will be extended or a pre-MECO dump will be started to increase the OMS blowdown capability prior to helium tank fail, thus resulting in a net increase in delta V available. If the pre-MECO dump is being performed for an ATO abort, continue the dump SELP even if the affected system will be below maximum blowdown at dump cutoff. Performing the pre-MECO dump SELP will preserve full delta V capability in the good pod while increasing the blowdown capability in the affected pod. However, if a pre-MECO dump of the affected system is insufficient to protect design underspeed, FDO may request dumping the good system and/or enabling the interconnect. ©[121604-6531A]

Reference: Hazard Reports ORBI 111, "Structural/TPS Damage from Overpressurization due to Rupture/Leakage of OMS/RCS He and/or GN2 Pressurization Systems;" ORBI 120, "Orbital Maneuvering Subsystem (OMS) Engine Burnthrough;" ORBI 165, "Inability to Deplete OMS Propellant Prior to Landing Can Result in Structural Damage;" and ORBI 183, "Loss of Vehicle Control Due to Exceeding CG Limits as a Result of Propellant Management Failures."

B. ONE OMS HELIUM TANK LEAK POST-OMS-2:

Full blowdown may exist post OMS-2. If full blowdown does not exist, nominal orbit activities and/or an OMS burn may be used to maximize blowdown (ref. Rule {A6-201}, OMS/RCS LEAKING HE TANK BURN).

Reference: Hazard Reports ORBI 111, 120, 165, and 183. ©[121604-6531A]

Rule {A4-63}, OMS SYSTEM FAILURES DURING ASCENT, references this rule. ©[ED]

THIS RULE CONTINUED ON NEXT PAGE

FLIGHT RULES

A6-51 **OMS FAILURE MANAGEMENT [CIL] [HC] (CONTINUED)**

C. *ONE OMS HELIUM TANK FAILURE PRIOR TO OMS-2:* ©[121604-6531A]

If an OMS assist or ATO OMS dump is in progress and an OMS He tank failure has occurred, the OMS assist or ATO OMS dump must be terminated. If the dump is completed, the Y CG may considerably exceed the limit. However, should FDO determine that performing an ATO dump and/or freezing the plane would provide uphill capability or ET footprint protection, an ATO abort may be declared. The FDO will determine the ATO dump duration while protecting both Y CG ballast and post-MECO delta V requirements.

If a He tank fail occurs prior to OMS-2, blowdown delta V is available in that system (approximately 15 fps for a full OMS load assuming no OMS assist). Pre-flight analysis, based on OMS load and mass properties, determines the resulting abort mode capability on a flight specific basis.

Reference: Hazard Reports ORBI 111, 120, 165, and 183.

D. *ONE OMS HELIUM TANK FAILURE POST OMS-2:*

Full blowdown may exist post-OMS-2. OMS redlines must be assessed to determine whether all orbit activities can be accomplished.

Reference: Hazard Reports ORBI 111, 120, 165, and 183. ©[121604-6531A]

THIS RULE CONTINUED ON NEXT PAGE

FLIGHT RULES

A6-51 OMS FAILURE MANAGEMENT [CIL] [HC] (CONTINUED)

E. *TWO OMS HELIUM TANKS LEAKING/FAILED PRIOR TO OMS-2:* @[121604-6531A]

For OMS assist and ATO dumps, when the He tank pressure < 640 psi, the dump will be reconfigured to SEGP until the remaining system reaches a He tank pressure < 640 psi. The ATO OMS dump will be continued to a quantity below maximum blowdown if required to provide uphill capability and if the He tank pressure supports. If a pre-MECO OMS dump is required, the dump will be performed TETP. The affected OMS engine will be turned off or a Dump Stop will be executed during a pre-MECO dump when the propellant quantity reaches maximum blowdown or the He tank pressure < 640 psi. @[121604-6531A]

If both OMS He tanks are leaking, the abort dump software will be utilized to increase the OMS blowdown prior to He tank fail. MCC is prime to recommend the pre-MECO dump based on an evaluation of both the leak rate and time to MECO. Performing the pre-MECO dump may result in the capability to achieve an ATO orbit with steep deorbit and nominal CG's versus aborting pre-MECO.

THIS RULE CONTINUED ON NEXT PAGE

FLIGHT RULES

A6-51**OMS FAILURE MANAGEMENT [CIL] [HC] (CONTINUED)**

If either He tank fails or a partial dump is performed, insufficient delta V may exist to achieve an AOA steep or Rev 3 shallow deorbit. In this case, an abort will be performed according to the abort priorities (reference Rule {A2-52A}, ASCENT MODE PRIORITIES FOR PERFORMANCE CASES). Abort TAL, if prior to last TAL boundary. After TAL boundary and pre-MECO, Abort TAL to an ALCS. Post-MECO, a determination will be made on whether available delta V results in an abort or in the mission being extended to a later deorbit opportunity. AOA-shallow can be performed if sufficient delta V is available using OMS blowdown delta V with aft RCS supplement to AFT PRESS QTY. If insufficient delta V is available for an AOA shallow, a TAL abort to an ACLS/ELS may be performed. ©[121604-6531A]

If uphill capability available (due to OMS load or pre-MECO dump) and either He tank pressure will be < 640 psi post-OMS-2, perform OMS-2 SESP. This will preserve the remaining system for deorbit. Determination of which system to use for OMS-2 is situation dependent. In general, if one He system will support through OMS-2, that system should be used. This will preserve the engine for a second start without violating OMS engine start box constraints (ref SODB Vol III, Para. 4.3.3.14). Target consideration for OMS-2 should include post-burn start box, CG and tank landing weight constraints.

If both He leak rates will support OMS-2, nominal OMS-2 will be performed TETP. Note: Nominally, maximum blowdown will not exist post-OMS-2, thus an additional dump may be required post-OMS 2. ©[072398-6518A]

Reference: Hazard Reports ORBI 111, 120, 165, and 183. ©[121604-6531A]

THIS RULE CONTINUED ON NEXT PAGE

FLIGHT RULES

A6-51 **OMS FAILURE MANAGEMENT [CIL] [HC] (CONTINUED)**

F. *TWO OMS HELIUM TANKS LEAKING/FAILED POST-OMS-2:* @[121604-6531A]

If maximum blowdown exists post-OMS-2, some portion of the mission may be supported. If maximum blowdown does not exist, shallow deorbit may be required with RCS supplement. OMS redlines must be assessed to determine whether orbit activities can be accomplished.

Reference: Hazard Reports ORBI 111, 120, 165, and 183.

OMS HELIUM LEG LEAK

G. *ONE OMS HELIUM LEG LEAK:*

The intent of this rule is to maximize the blowdown available in the affected system with as few represses as possible. Each time the helium isolation valves are opened to repress the leaking leg, there is a possibility that the sudden increase in pressure in that leg will completely fracture the helium line, causing total loss of that helium tank. After OMS-1 and/or -2, the affected system should be at or below maximum blowdown. If the leak occurs on orbit, orbit activities would be used to bring the remaining propellant quantity down to maximum blowdown. However, if interconnect operations are used towards this end, only that blowdown capability predicted to be available at the next PLS TIG can be included in the planning for that deorbit. This is to avoid relying on a repressurization from the leaking helium leg to meet the deorbit redlines.

Reference: Hazard Reports ORBI 111, 120, 165, and 183. @[121604-6531A]

THIS RULE CONTINUED ON NEXT PAGE

FLIGHT RULES

A6-51 **OMS FAILURE MANAGEMENT [CIL] [HC] (CONTINUED)**

H. *TWO OMS HELIUM LEG LEAKS:* @[072398-6518A] @[121604-6531A]

Same as single leak rationale.

Reference: Hazard Reports ORBI 111, 120, 165, and 183.

OMS GN₂ TANK -LEAK/FAIL @[072398-6518A]

I. *ONE OMS GN₂ TANK LEAK/FAIL:*

As long as the GN₂ tank can support an engine burn without affecting the accumulator pressure and subsequent one start capability, the affected OMS engine is available. GN₂ tank failures do not impact pre-MECO abort dumps since only one start is required for the OMS dump. If the GN₂ tank has failed, the OMS assist or ATO dump should be performed SEGP to save the last start for OMS or deorbit.

Reference: Hazard Reports ORBI 111, 165, and 183. @[121604-6531A]

THIS RULE CONTINUED ON NEXT PAGE

FLIGHT RULES

A6-51 OMS FAILURE MANAGEMENT [CIL] [HC] (CONTINUED)

J. *TWO OMS GN₂ TANK LEAKING/FAILED:* @[121604-6531A]

GN₂ tank failures do not impact pre-MECO abort dumps since only one start is required for the OMS dump. An OMS assist or ATO dump is canceled to reserve the OMS starts for OMS-1 and deorbit.

@[072398-6518A]

As long as the GN₂ tank can support an engine burn without affecting the accumulator pressure and subsequent one start capability, the affected OMS engine is available. If both OMS GN₂ tanks are failed prior to the scheduled burn, use one of the remaining OMS starts for OMS-1 and save the other start for the deorbit burn. After a safe orbit has been achieved, a tail-Sun attitude may be selected to warm up the OMS accumulator in an attempt to gain another OMS start (N₂ REG P > 299 is sufficient N₂ to operate engine ball valves).

Previous rules specified performing OMS-1 4+X for this case. The rule was changed to perform OMS-1 using one of the two remaining starts for the following reasons:

- a. *Provides redundancy (downmode from OMS to 4+X). If burn initially performed 4+X and a +X jet failure occurs, the remaining jets may not have the capability to perform uphill OMS-1 due to lack of thrust.*
- b. *Depending on the OMS-1 delta V, 4+X thrust may be insufficient to accomplish the burn (large underspeed cases).*
- c. *Saves propellant.*
- d. *Have the capability to change attitude while on orbit to warm up OMS GN₂ accumulator and increase the pressure to greater than 299 psi (299 allows one additional start).*

Reference: Hazard Reports ORBI 111, 165, and 183. @[121604-6531A]

THIS RULE CONTINUED ON NEXT PAGE

FLIGHT RULES**A6-51 OMS FAILURE MANAGEMENT [CIL] [HC] (CONTINUED)****OMS GN₂ ACCUMULATOR LEAK** @[072398-6518A]

K. **ONE OMS GN₂ ACCUMULATOR LEAK:** @[121604-6531A]

WSTF testing has shown that, if a GN₂ leak occurs through the purge valves at a rate of ≤ 14 psia/sec with the engine press valve closed (≤ 5 psia/sec with P valve open), sufficient cooling will be provided to the affected OMS engine and chamber wall burn through will not occur. As a result, the affected OMS engine can be used, but only for critical burns. In addition, the GN₂ accumulator pressure must be > 260 psia preburn (ref. {A6-5}, OMS N₂ ACCUMULATOR). @[ED] @[ED] @[121604-6442A]

Note that the WSTF data indicated a leak rate of 14 psia/sec through the purge valves will not significantly affect engine startup, operation, or shutdown. However, leak rates > 14 psia/sec were not tested due to concerns that the GN₂ tank did contain enough supply to support larger leak rates for an appreciable (deorbit-sized) OMS burn. There are also concerns of engine cooling at higher leak rates; however, no data or analysis exists to validate these concerns.

If the GN₂ leak rate is small enough such that sufficient GN₂ will be preserved to allow the leaking engine to support the entire deorbit burn single engine from the leaking side including repress, then using the engine for critical burns may be considered. While the possibility exists that repeated use of the engine may increase the leak rate rendering the engine unusable for deorbit, having redundancy for OMS-2 and critical on-orbit burns may outweigh this concern, particularly for small leak rates.

If the engine will not support the entire deorbit burn SETP, then it is not considered a valid deorbit downmode (ref Annex Flight Rule, OMS/RCS DOWNMODING CRITERIA) and RCS steep deorbit must be redlined. Otherwise, if RCS steep deorbit is not redlined and the good OMS engine fails during the deorbit burn, the burn cannot be completed SETP and RCS 4+X steep deorbit capability would not exist. In addition, if the leak rate increases such that the ability of that engine to support the entire burn is in doubt, RCS steep deorbit must be redlined since there is no way to guarantee that the rate will not increase again and either exceed the 14 psia/sec limit or render the engine incapable of supporting the entire burn. @[ED]

If RCS steep deorbit must be redlined, OMS-2 will be performed only if sufficient OMS and RCS propellant margin is available to cover RCS deorbit from the nominal orbit. Propellant trade-offs as defined in Rule {A2-108}, CONSUMABLES MANAGEMENT, must also be considered when calculating the redline. If sufficient margin does not exist to cover RCS deorbit to steep targets, perform OMS-2 to Min Hp and raise orbit within redlines. These calculations are performed preflight and are based on nominal MECO delta V's obtained from FDO's prior to flight. @[072398-6518A] @[121604-6531A] @[121604-6442A]

THIS RULE CONTINUED ON NEXT PAGE

FLIGHT RULES**A6-51****OMS FAILURE MANAGEMENT [CIL] [HC] (CONTINUED)**

If the leak rate cannot support the deorbit burn leaking engine, two pods from an $HP \geq$ safe HP, then a two OMS engines to one OMS engine downmode will not be available to complete the burn should the good engine fail. For this case, the leaking engine will experience a GN_2 depletion shutdown, and a subsequent downmode to RCS will be required. To avoid a GN_2 depletion shutdown (which carries a risk of unstable combustion), it is prudent in this case to not use the leaking engine for deorbit but instead to plan the burn SETP using the non-leaking engine. This not only provides a valid downmode to RCS for a subsequent engine failure but allows the use of existing procedures (one OME burn card, etc.). Attempting TETP downmode to RCS is not recommended due to the complications associated with real-time modification of procedures and downmode cues. ©[072398-6518A]

If the leak rate will support SETP from greater than safe Hp, then the engine may be used for deorbit with the condition that if the good engine fails above safe Hp but prior to having SETP completion, the burn must be stopped. ©[072398-6518A]

(Ref. SODB, Volume I, Paragraph 3.4.3.3-15. Ref. Hazard Reports ORBI-111, 165, and 183.) ©[ED 1] ©[121604-6442A]

L. TWO OMS GN_2 ACCUMULATOR LEAKS: ©[121604-6531A]

Analysis shows that for GN_2 leak rates that are less than the engine fail limit, sufficient Arm/Press time should be available to support most OMS-1/2 burn delta Vs. It is prudent to use some of this GN_2 capability for insertion burns rather than preserving it all for deorbit.

Minimum altitude targets are chosen for two GN_2 accumulator leaks that will not each support single engine deorbit in order to preserve the necessary GN_2 for the deorbit burn. The orbit may be raised using RCS jets within redlines. Sufficient GN_2 to complete the deorbit burn single engine must be available in each OMS pod in order to raise the orbit. ©[121604-6531A]

If both accumulators are leaking GN_2 , the concern is of a common cause failure mechanism that has led to the two leaks and could render both engines inoperable with little or no warning. For this reason redlining RCS steep propellant requirements should be considered even if the calculations show that both engines will satisfy the necessary deorbit requirements. In the event that one of the engines does subsequently fail due to an increased leak rate, then consideration should be given to declaring a next PLS deorbit as the same failure mechanism could be pending for the remaining OMS engine.

(Ref. SODB, Volume I, Paragraph 3.4.3.3-15. Ref. Hazard Reports ORBI-111, 165, and 183.) ©[ED 1] ©[072398-6518A] ©[121604-6442A]

THIS RULE CONTINUED ON NEXT PAGE

FLIGHT RULES

A6-51

OMS FAILURE MANAGEMENT [CIL] [HC] (CONTINUED)OMS PROPELLANT TANK LEAK/FAIL @[072398-6518A]

M. ONE OMS PROPELLANT TANK LEAK/FAIL PRIOR TO END OF OMS-2: @[121604-6531A]

Dumping leaking propellant pre-MECO decreases the possibility of ascent performance losses since the desired amount of propellant for OMS Assist is likely to be dumped. A pre-MECO dump also contributes toward reducing an underspeed which may result from an SSME failure or having one SSME stuck in the bucket. Capability from the leaking system is more assured during powered flight which reduces the risk of losing all capability in the leaking system post-MECO due to pod freeze-up or loss of tank ullage. A pre-MECO dump mitigates the need for a mixed crossfeed configuration to satisfy Tank Landing Weight Constraints (TLC) and/or Y center-of-gravity constraints since less propellant will be trapped and more ullage will be present in the non-leaking tank of the affected system. Additionally, a pre-MECO dump lessens the amount of leaked propellant which will help minimize secondary effects of uncontained propellant on the pod environment, such as freezing of propellant lines or damaging wires and/or wire insulation. (Ref. Ascent/Entry Flight Techniques Panel #212, June 14, 2005.) @[121505-7210A]

For an OMS propellant leak detected and confirmed prior to assist, the good engine will be turned off and assist will be performed with only the leaking system. An Item 9, equivalent to the manual dump timer, will be executed to extend assist in an attempt to dump the leaking system to depletion. The dump will either be canceled when the leaking propellant tank fails/depletes or be terminated by MECO Prep. If a propellant leak is detected after assist completes, the good engine will be turned off and an Item 9 dump of the leaking system will be initiated as soon as the leak is confirmed.

FDO may declare an ATO abort to freeze the plane and/or provide uphill capability or ET footprint protection. The ATO dump will be performed SELP to avoid a TAL abort and/or to reduce the underspeed. Once the ATO abort is onboard, the dump of the leaking system will be shortened, or could be terminated, when the dump time becomes equivalent to the ATO dump timer. An Item 9, equivalent to the manual dump timer, will be re-executed so that the leaking system will be dumped to depletion or as close to depletion as possible. The extended dump further reduces the underspeed while also reducing the risk of losing all capability in the leaking system post-MECO due to pod freeze-up or loss of ullage. If an AOA or ATO abort cannot be achieved as determined by FDO, a TAL abort must be performed. For no-comm cases, the crew procedure will extend the dump unless no-comm flight rules require a TAL abort for a single OMS tank leak. @[121604-6531A]

If the pre-MECO dump of the leaking system is insufficient to protect design underspeed, FDO may request dumping the good system and/or enabling the interconnect. The run time for the good system will be based on a specific amount of propellant that needs to be dumped as provided by FDO. Additionally, the interconnect may be manually enabled if necessary to provide uphill capability. However, the interconnect will not be enabled if the Prop Officer deems that there is any possibility of propellant depletion occurring while interconnected. This decision will be a function of the leak rate and the amount of dump that has already been performed. @[121505-7210A]

THIS RULE CONTINUED ON NEXT PAGE

FLIGHT RULES**A6-51****OMS FAILURE MANAGEMENT [CIL] [HC] (CONTINUED)**

For cases where the amount of OMS delta V available from the non-leaking side, supplemented with RCS delta V above the Aft Press Quantity, is insufficient to protect a Press-to-Orbit (ref. Rule {A2-52}, ASCENT MODE PRIORITIES FOR PERFORMANCE CASES) which includes AOA Steep and ATO to Min Hp with First PLS or FD2 deorbit to shallow targets (ref. Rule {A4-56}, PERFORMANCE BOUNDARIES), a TAL abort must be declared. This case will typically occur for those missions that have the combination of a small OMS load, large ballast requirements, and large delta V requirements for the described scenario. Analysis must be performed post dump to determine whether the trapped propellant on the leaking side might be able to offset any aft RCS ballast requirements. Ballast cannot be shifted from the aft RCS prior to the dump since the leak may be of ullage gas only, resulting in a complete dump of both propellants. ©[121505-7210A]

Direct insertion ascent implies that an OMS-1 burn is nominally not performed. Since OMS-2 is not performed until approximately 38 minutes into the flight, the leaking propellant will be burned post MECO either out-of-plane (OOP) or posigrade. If desired, a posigrade burn would preserve an option to rendezvous and would be performed at the earliest MET that can be supported by the crew and MCC. However, if the amount of propellant predicted to leak between MECO and burn TIG results in an unacceptable amount of uncontained propellant in the pod and/or an insufficient amount of propellant to provide a beneficial posigrade burn, an OOP burn will be performed as soon as possible. A posigrade burn will not be performed if the resulting deorbit delta V requirement cannot be satisfied with capability remaining post-burn. This capability assessment will be made prior to deciding on a burn type. For no comm situations, an OOP burn will be performed. Burning the propellant prevents the weight of the propellant from being trapped onboard. As a result, all of the propellant in the good pod can be used without a Y CG impact. In addition, burning the propellant reduces the likelihood of freezing the entire pod. ©[121505-7210A]

Since no propellant will be available for use in the leaking pod, OMS-2 will be performed SEGP. Cut off at minimum Hp which requires the least total delta V for the insertion and deorbit burns and ensures orbital lifetime at least two orbits beyond the first day PLS (ref. Annex Flight Rule, TRAJECTORY AND GUIDANCE PARAMETERS). Deorbit first day PLS if the leaking pod thermal environment allows. If pod thermal indicates that an orbit 3 deorbit is not feasible, consideration should be given to raising the orbit above minimum Hp if system capability can support larger delta V requirements and the pod thermal environment can be improved with additional time. ©[ED] ©[121604-6531A]

If tank fail occurs prior to the post-MECO dump or at OMS-2 ignition (all propellant trapped onboard), steep day 2 deorbit targets may be accomplished with RCS supplement and Y CG within limits.

Note that consideration may be given to executing the deorbit burn using mixed crossfeed if doing so will optimize overall performance and vehicle health (CG impacts, tank landing constraints, etc.).

©[072398-6518A]

Reference: Hazard Reports ORBI 120, 165, 183, ORBI 203, "Degradation of the RCS/OMS Oxidizer System due to Metallic Nitrate Contamination," and ORBI 501, "Flammable/Explosive Atmosphere Created by External Leakage of Hypergolic Fluids in Reaction Control Subsystem (RCS) and/or Orbital Maneuvering System (OMS)." ©[121604-6531A]

THIS RULE CONTINUED ON NEXT PAGE

FLIGHT RULES

A6-51 OMS FAILURE MANAGEMENT [CIL] [HC] (CONTINUED)

N. ONE OMS PROPELLANT TANK LEAK POST-OMS-2: @[072398-6518A] @[121604-6531A]

A perigee adjust or out-of-plane burn is performed immediately in accordance with Rule {A4-104}, OMS LEAK/PERIGEE ADJUST. Propellant should be dumped to depletion (↓ on crew display) in order to reduce the amount of propellant leaked into the pod and to minimize the amount of propellant that is trapped onboard.

Reference: Hazard Reports ORBI 120, 165, 183, and 501.

O. ONE OMS PROPELLANT TANK FAIL POST OMS-2:

For a propellant tank failure during the deorbit burn, the deorbit burn must be terminated if the perigee is above a value calculated by FDO that will allow completion of the OMS burn. If above this PRPLT FAIL Hp, insufficient delta V remains in the OMS and RCS to complete the planned deorbit burn.

Reference: Hazard Reports ORBI 120, 165, 183, 203, and 501.

P. TWO OMS PROPELLANT TANKS LEAKING/FAILED:

For two OMS leaks in the same pod, treat as a single leak/fail realizing mixed crossfeed is not an option, see paragraphs M, N, and O rationale.

For two OMS leaks on different sides, abort according to the abort priorities (reference Rule {A2-52A}, ASCENT MODE PRIORITIES FOR PERFORMANCE CASES). Abort TAL, if prior to last TAL boundary. After TAL boundary and pre-MECO, abort TAL to an ACLS. If the leaks occur post-MECO, an AOA must be performed. AOA delta V costs vary according to MECO Ha and AOA site. As a result, RCS supplement may or may not be required. Again, mixed crossfeed will be used if required and available in order to maintain Y CG within limits. @[072398-6518A]

An ATO will not be considered for the two leak case. With two OMS leaks, insufficient blowdown delta V exists post-OMS-2 for a shallow deorbit.

Reference: Hazard Reports ORBI 120, 165, 183, 203, and 501. @[121604-6531A]

THIS RULE CONTINUED ON NEXT PAGE

FLIGHT RULES

A6-51 OMS FAILURE MANAGEMENT [CIL] [HC] (CONTINUED)**OMS INLET LINE LEAK**

Q. **ONE OMS INLET LINE LEAK PRIOR TO OMS-2:** @[072398-6518A] @[121604-6531A]

If the delta V available supports continuing to MECO, Post-MECO, the leak will be secured to minimize propellant leakage into the pod. Direct insertion implies that an OMS-1 is nominally not performed. To avoid a repress of the inlet line, OMS-2 is performed SEGP cutoff at minimum Hp. As in the OMS 1/2 case, a dump will be performed only if necessary to satisfy the Orbiter CG envelope or the OMS tank landing weight constraint. Deorbit using mixed crossfeed if required with forward and aft RCS supplement.

Note that consideration may be given to executing the deorbit burn using mixed crossfeed if doing so will optimize overall performance and vehicle health (CG impacts, tank landing constraints, etc.).

If the inlet line repress fails, propellant tank fail rules apply (see paragraphs M and O). @[072398-6518A]

Reference: Hazard Reports ORBI 120, 165, 183, and 501.

R. **ONE OMS INLET LINE LEAK POST OMS-2:** @[072398-6518A]

A perigee adjust burn is performed at the next opportunity to lower Orbiter altitude using the leaking propellant. Rule {A6-203}, OMS LEAKING INLET LINE PERIGEE ADJUST BURN, provides additional guidelines on the scheduling of the perigee adjust burn. If propellant remains after the perigee adjust burn, an out-of-plane dump may be performed if required to satisfy the Orbiter CG envelope or the OMS tank landing weight constraint.

Reference: Hazard Reports ORBI 120, 165, 183, and 501. @[121604-6531A]

THIS RULE CONTINUED ON NEXT PAGE

FLIGHT RULES

A6-51 OMS FAILURE MANAGEMENT [CIL] [HC] (CONTINUED)

S. *TWO OMS INLET LINES LEAKING:* ©[121604-6531A]

For two OMS inlet line leaks in the same pod, treat as a single leak. Mixed crossfeed is not an option (see paragraphs O and R). Any attempt to dump the propellant could lead to an explosive situation as the two leaking propellants mix in the pod. For this reason, if the Y CG and TLC conditions are deemed acceptable, then no repressurization and dump should be attempted.

For two OMS inlet line leaks, different sides, same propellant, the leaks will be treated as tank leaks pre-MECO and an abort according to the abort priorities (reference Rule {A2-52A}, ASCENT MODE PRIORITIES FOR PERFORMANCE CASES) will be performed. If post-MECO, the leaks will be secured to minimize leakage into the pod and an AOA OMS-2 TETP will be attempted with RCS supplement if required.

For two OMS inlet line leaks, different sides, different propellant, the leaks will be treated as tank leaks pre-MECO and an abort according to the abort priorities (reference Rule {A2-52A}, ASCENT MODE PRIORITIES FOR PERFORMANCE CASES) will be performed. An ATO can be attempted since 4+X mixed crossfeed is available. The leaks will be secured post-MECO to minimize leakage into the pod and an OMS-2 cutoff at minimum Hp will be performed. Deorbit 4+X mixed crossfeed with RCS supplement if required. ©[072398-6518A]

Reference: Hazard Reports ORBI 120, 165, 183, and 501. ©[121604-6531A]

THIS RULE CONTINUED ON NEXT PAGE

FLIGHT RULES

A6-51

OMS FAILURE MANAGEMENT [CIL] [HC] (CONTINUED)

OMS ENGINE FAILURE:

T. ONE OMS ENGINE FAILURE: @[072398-6518A] @[121604-6531A]

OMS assist will be performed single engine to reduce the eventual underspeed if an SSME has failed. An ATO dump should be performed single engine, or with interconnect enabled (per FDO's request), also to reduce the underspeed. Not performing an ATO dump will result in an increased underspeed with a corresponding increase in the post-MECO delta V requirement. If the underspeed is severe enough, a non-optimally targeted OMS-1 can result, with a considerably higher delta V for the one OMS engine case than for the designed two OMS engine case. This can result in the failure to achieve the necessary target. Performing the ATO dump using the good engine reduces the underspeed, avoiding a non-optimum OMS-1 burn. For this case, FDO will make a Press-to-ATO (PTA) call, but may base the call on different criteria than the normal PTA call since protecting ET IP is not required after an OMS engine failure (ref. Rule {A2-62}, ET FOOTPRINT CRITERIA).

If sufficient OMS and RCS propellant margin is available to redline RCS steep deorbit from the nominal orbit, then nominal OMS-1 and OMS-2 will be performed. Propellant trade-offs as defined in Rule {A2-108}, CONSUMABLES MANAGEMENT, must also be considered when calculating the redline. If OMS-1 is required and sufficient margin does not exist to cover RCS deorbit to steep targets, perform ATO OMS-1 and OMS-2. If the failure occurs during OMS-1, nominal OMS-1 must be completed. Perform OMS-2 within redlines, otherwise cutoff at minimum Hp.

These calculations are performed preflight and based on nominal MECO delta V's obtained from FDO's prior to flight.

Reference: Hazard Reports ORBI 165,183, and 203.

U. TWO OMS ENGINES FAILED:

RCS +X is the last option for translation after both OMS engines have failed. RCS 4+X uses more OMS propellant than the OMS engines for an equivalent delta V due to Isp differences. Therefore, an ATO to minimum Hp is performed to minimize the delta V requirements. Deorbit is scheduled first day or next PLS opportunity because the next failure results in the loss of deorbit capability. @[072398-6518A]

Reference: Hazard Reports ORBI 165,183, and 203. @[121604-6531A]

Rules {A6-204}, OMS GN2 ACCUMULATOR LEAK DETERMINATION, and {A4-63}, OMS/RCS SYSTEM FAILURES DURING ASCENT, reference this rule. @[ED]

FLIGHT RULES

A6-52

RCS FAILURE MANAGEMENT

<u>FAILURE MATRIX</u>	L/O TO OMS-1	OMS-1 TO OMS-2	OMS-2 TO DEORBIT
1 OR 2 FRCS HE TANK LEAK.....	A	A	B
1 OR 2 FRCS HE TANK FAIL.....	C	C	D
1 OR 2 FRCS PROP TANK LEAK....	E	E	E
1 OR 2 FRCS PROP TANK FAIL.....	F	F	F
1 ARCS HE TANK LEAK/FAIL.....	G	G	H
2 ARCS HE TANK LEAK/FAIL.....	I	I	I
1 ARCS PROP TANK LEAK/FAIL.....	J	J	J
2 ARCS PROP TANK LEAK/FAIL.....	K	K	K

NOTES:

- [1] WITH FRCS SECURED, LOSE VERNIER CONTROL.
- [2] ENTER FIRST DAY PLS.
- [3] ENTER NEXT PLS.
- [4] CUT OFF AT MINIMUM HP WHICH REQUIRES THE LEAST TOTAL DELTA V FOR THE INSERTION AND DEORBIT BURNS AND ENSURES ORBITAL LIFETIME AT LEAST TWO ORBITS BEYOND THE FIRST DAY PLS.

THIS RULE CONTINUED ON NEXT PAGE

FLIGHT RULES

A6-52

RCS FAILURE MANAGEMENT (CONTINUED)

FAILURE DEFINITION

FRCS HE TANK LEAK/FAIL:

- HE TANK LEAK IF PRESSURE > 456 PSI AND DECREASING ABNORMALLY.
- HE TANK FAIL IF PRESSURE < 456 PSI.
- FULL BLOWDOWN IF PROPELLANT TANK QUANTITY < 23 PERCENT.

ACTION SUMMARY

- A. ONE OR TWO HE SYSTEM LEAK PRIOR TO OMS-2:
1. PRE-MECO SECURE, RATE DAMP WITH ARCS.
 2. USE FRCS FOR ET SEPARATION, CANCEL +X TRANSLATION.
 3. USE UNTIL HE FAILED, THEN SECURE FRCS [1].
 4. USE RCS PROPELLANT CONSERVATION TECHNIQUES.
- B. ONE OR TWO LEAK POST-OMS-2:
1. PERFORM -X TRANSLATION OR FRCS DUMP TO ACHIEVE MAXIMUM BLOWDOWN UNTIL HE TANK FAIL.
 2. DESELECT FRCS JETS [1] UNLESS REQUIRED FOR HIGH PRIORITY ACTIVITIES.
 3. USE RCS PROPELLANT CONSERVATION TECHNIQUES.
 4. RESELECT FRCS JETS PRIOR TO DEORBIT.
 5. SECURE FRCS WHEN PROPELLANT TANK PRESSURE \leq 190 PSI.

THIS RULE CONTINUED ON NEXT PAGE

FLIGHT RULES

A6-52**RCS FAILURE MANAGEMENT (CONTINUED)**

- C. ONE OR TWO FAIL PRIOR TO OMS-2:
1. PRE-MECO SECURE, RATE DAMP WITH ARCS.
 2. USE FRCS FOR ET SEPARATION, CANCEL +X TRANSLATION.
 3. POST-ET SEPARATION, SECURE FRCS [1]
 4. USE RCS PROPELLANT CONSERVATION TECHNIQUES.
- D. ONE OR TWO FAIL POST-OMS-2:
1. DESELECT FRCS JETS [1] UNLESS REQUIRED FOR HIGH PRIORITY ACTIVITIES.
 2. USE RCS PROPELLANT CONSERVATION TECHNIQUES.
 3. RESELECT FRCS JETS PRIOR TO DEORBIT.
 4. SECURE FRCS WHEN PROPELLANT TANK PRESSURE \leq 190 PSI.

FRCS is critical for ET separation. Since very little blowdown capability exists at launch, the mated coast rate damping is performed using the ARCS maximizing the FRCS capability for ET separation. The MCC can determine if the helium tank will support a nominal mated coast/ET separation and will advise crew to open FRCS pre-MECO (maximizing blowdown) if the capability exists; otherwise the crew will perform mated coast with the ARCS. Once the helium tank has failed, the FRCS capability is drastically reduced. Therefore, propellant conservation techniques must be utilized to stretch mission duration. Sufficient blowdown capability is available to perform a successful ET separation.

Post-OMS-2, time is available to attempt a maximum blowdown burn to maximize FRCS capability for high priority on-orbit activities which require FRCS, in the entry preparation and deorbit burn timeframes.

The full blowdown quantity of 23 percent assumes use of the propellant tank to a pressure of 190 psi. (Reference SODB 4.3.2.1.)

THIS RULE CONTINUED ON NEXT PAGE

FLIGHT RULES

A6-52

RCS FAILURE MANAGEMENT (CONTINUED)FAILURE DEFINITIONFRCS PROPELLANT TANK LEAK/FAIL:

- PROPELLANT TANK LEAK IF QUANTITY DECREASE ABNORMAL.
- PROPELLANT TANK FAIL IF QUANTITY \leq 0 PERCENT OR PRESSURE \leq 190 PSI.

ACTION SUMMARY

E. ONE OR TWO LEAK:

1. SECURE, IF LEAK RATE CAN SUPPORT MATED COAST/ET SEPARATION, USE FRCS FOR MATED COAST AND ET SEPARATION. OTHERWISE, RATE DAMP WITH ARCS.
2. USE FRCS FOR ET SEPARATION. CANCEL +X TRANSLATION.
3. PERFORM FRCS DUMP TO DEPLETION, THEN SECURE FRCS [1].
4. USE RCS PROPELLANT CONSERVATION TECHNIQUES.

NOTE: IF THE LEAK RATE RESULTS IN A QTY < 52 PERCENT AT MECO, AND MECO CONDITIONS EXIST WHICH PROVIDE A DELAYED ET SEP CAPABILITY WITHOUT IMPACTING ORBITER PERFORMANCE (N/A RTLS, TAL), PERFORM DELAYED ET SEP (MECO + 6 MINUTES).

This rule allows using the FRCS to 0 percent versus performing a NO FRCS ET SEP by optimizing FRCS capability for ET SEP. The A/E FTP #48, 9/9/88, judged the risk of using the FRCS for ET SEP (when the computed quantity at MECO is < 52 percent) to be lower than the uncertified NO FRCS ET SEP procedure. Delaying ET SEP (MECO + 6 minutes) provides additional time to allow possible FRCS screen rewetting to occur. Rewetting the screens may prevent jet fail off's due to helium ingestion. If an RTLS, TAL, or underspeed conditions exist at MECO, an on-time ET SEP will be performed.

Same as paragraph A except apply propellant tank and perform FRCS dump to depletion. Dumping propellant overboard versus allowing propellant to leak into the FRCS module minimizes on-orbit cool down or postlanding fire hazard.

THIS RULE CONTINUED ON NEXT PAGE

FLIGHT RULES

A6-52 RCS FAILURE MANAGEMENT (CONTINUED)

F. ONE OR TWO FAIL:

1. SECURE [1], RATE DAMP WITH ARCS.
2. PERFORM NO JET ET SEPARATION, CANCEL +X TRANSLATION.
3. USE RCS PROPELLANT CONSERVATION TECHNIQUES.

Loss of the FRCS for ET separation requires the use of a special technique to separate from the external tank.

FAILURE DEFINITION

ARCS HE TANK LEAK/FAIL:

- HE TANK LEAK IF PRESSURE > 456 PSI AND DECREASING ABNORMALLY.
- HE TANK FAIL IF PRESSURE < 456 PSI.
- FULL BLOWDOWN IF PROPELLANT TANK QUANTITY < 24 PERCENT.
- SINGLE POD QUANTITY REDLINE NOT VIOLATED IF PROPELLANT TANK QUANTITY ≥ 32.3 PERCENT AND USABLE PROPELLANT AVAILABLE IN BLOWDOWN ≥ 15.9 PERCENT. @[042507-8466B]

ACTION SUMMARY

G. ONE LEAK/FAIL PRIOR TO OMS-2:

1. RATE DAMP AND ET SEPARATION IN NORMAL CONFIGURATION, CANCEL +X TRANSLATION.
2. WHEN HE TANK PRESSURE > 456 PSI, PERFORM AN RCS BURN TO 34 PERCENT OR HE TANK FAIL. CONTINUE RCS ACTIVITIES WITHIN REDLINES.
3. WHEN HE TANK PRESSURE < 456 PSI OR PROPELLANT TANK QUANTITY AT 34 PERCENT, CROSSFEED FROM GOOD SIDE. POST-OMS-1, INTERCONNECT FROM OMS.
4. IF USABLE QUANTITY IN BLOWDOWN < 15.9 PERCENT AND HE TANK FAIL, DEORBIT NEXT PLS [2]. CROSSFEED FROM GOOD SIDE FOR ENTRY. @[042507-8466B]

THIS RULE CONTINUED ON NEXT PAGE

FLIGHT RULES**A6-52****RCS FAILURE MANAGEMENT (CONTINUED)**

The full blowdown quantity of 24 percent assumes use of the propellant tank to a pressure of 190 psi. (Reference SODB 4.3.2.1.)

The Single Pod Quantity Redline is not violated if the propellant tank quantity is greater than 32.3 percent with a usable quantity of 15.9 percent (348 lbs) (ref. Rule {A6-305D}, AFT RCS REDLINES [HC]). ©[042507-8466B]

Use mated coast/ET separation to increase the blowdown capability if the helium tank has not yet failed. If helium tank has failed, good pod RCS can be used for ET separation. Cancel the +X translation to save propellant in the non-leaking RCS system. Perform an RCS burn to 34 percent unless the leak rate is slow enough to allow other activities (including an unplanned, dedicated burn if required) to achieve a quantity of 34 percent. If the He tank fails prior to an OMS-1 burn, crossfeed from the good RCS to save OMS propellant for OMS-1. Post-OMS-1 or if OMS-1 is not required, interconnect from the OMS after He tank fail or a quantity of 34 percent is achieved. Once the He tank fails, evaluate the current blowdown capability to determine if the Single Pod Quantity Redline has been violated. If not, continue nominal mission activities within redlines; otherwise, deorbit Next PLS.

Reference Hazard Report ORBI-129, Loss of Capability to Safely Separate Orbiter from External Tank (ET) Caused by Loss of Pressurized Propellant Supply to the FRCS and/or ARCS Thrusters.

H. ONE LEAK/FAIL POST-OMS-2:

1. FOR FAIL: INTERCONNECT FROM OMS.
FOR LEAK: CROSSFEED FROM LEAKING RCS.
2. USE RCS ACTIVITIES TO REACH A QUANTITY OF 34 PERCENT IF THE LEAK RATE WILL SUPPORT. CONTINUE RCS ACTIVITIES WITHIN REDLINES.
3. IF LEAK RATE WILL NOT SUPPORT UPCOMING RCS ACTIVITIES TO REACH A QUANTITY OF 34 PERCENT, THEN PERFORM AN RCS BURN TO 34 PERCENT OR HE TANK FAIL. CONTINUE RCS ACTIVITIES WITHIN REDLINES.
4. IF USABLE QUANTITY AVAILABLE IN BLOWDOWN < 15.9 PERCENT AND HE TANK FAIL, DEORBIT NEXT PLS [2] [3]. CROSSFEED FROM GOOD SIDE FOR ENTRY. ©[042507-8466B]

THIS RULE CONTINUED ON NEXT PAGE

FLIGHT RULES

A6-52

RCS FAILURE MANAGEMENT (CONTINUED)

If the He tank is failed, an interconnect to the OMS may be required to conserve RCS propellant. If necessary, interconnect to OMS or go free drift to enable MCC to establish a reliable leak rate. Once the leak rate is determined, then the decision to use nominally planned on-orbit activities or a dedicated RCS burn to reach a quantity of 34 percent can be made. Save affected pod blowdown for deorbit and entry. If the blowdown system has a quantity greater than or equal to 32.3 percent with 15.9 percent (348 lbs) usable in blowdown, then enough propellant is available to protect the Single Pod Quantity Redline (ref. Rule {A6-305D}, AFT RCS REDLINES). The 34 percent target was agreed to at Ascent/Entry Flight Techniques Panel #215, October 28, 2005, because it protects for dispersions in burn usage (if a dedicated RCS burn is required) and allows an extra percent of propellant above the on-orbit tank fail quantity for the regime from deorbit to 0.05g. If a quantity of 32.3 percent with 15.9 percent usable in blowdown cannot be protected, then Next PLS must be invoked. Blowdown capability must be assessed real time since it is dependent on current pressure and temperature. ©[042507-8466B]

Reference Hazard Reports ORBI-129, Loss of Capability to Safely Separate Orbiter from External Tank (ET) Caused by Loss of Pressurized Propellant Supply to the FRCS and/or ARCS Thrusters, and ORBI 111, Structural/TPS Damage from Overpressurization Due to Rupture/Leakage of OMS/RCS He and/or GN2 Pressurization Systems. ©[042507-8466B]

I. TWO LEAK/FAIL:

1. IF ON SAME SIDE, TREAT AS SINGLE LEAK/FAIL. SEE PARAGRAPHS G AND H.
2. IF LEAKING, CONTINUE TO USE TO MAXIMIZE ULLAGE UNTIL HE TANK FAILED.
3. IF SAME PROPELLANT, UPHILL ABORT [4].
4. IF DIFFERENT PROPELLANT, INTERCONNECT FROM OMS TO SAVE RCS ULLAGE. NOMINAL DEORBIT [2] [3], USE MIXED CROSSFEED FOR ENTRY.

Same as paragraph H. If same propellant in different pods, mixed crossfeed cannot be utilized to support entry.

With the OI-8 NO YAW JET software, a certified entry from a Q-bar = 20 to touchdown is now available. With this capability, previous abort calls for dual RCS He/propellant tank fail/leak can be avoided if control can be guaranteed through a Q-bar = 20. OMS interconnect is utilized from MECO until prior to EI for attitude control to minimize RCS propellant requirements.

THIS RULE CONTINUED ON NEXT PAGE

FLIGHT RULES

A6-52

RCS FAILURE MANAGEMENT (CONTINUED)

The two He tank fail same propellant TAL abort case was eliminated. Sufficient blowdown is available to supply propellant requirements for EI to a $Q\text{-bar} = 20$ (available blowdown = 160 lb; required from EI to $Q\text{-bar} = 20$ nearly equal to 127 lb (based on review of GNC entry data)). An uphill abort cutting off at minimum H_p , which requires the least delta V for the insertion and deorbit burns and ensures orbital lifetime at least two orbits beyond the first day PLS, is selected to maximize the amount of OMS remaining to protect for interconnect operations post-deorbit burn. OMS remaining post-deorbit burn must be ≥ 10.3 percent (SODB 3.4.3.3.7.C) plus any expected usage.

The action is the same for one or both helium tanks leaking as for two He tanks failed. The rationale deals with the time to maximize blowdown in the leaking system(s). The time from MECO until a $Q\text{-bar} = 20$ on a TAL is 374 seconds (6.25 minutes) where if applied to a normal ascent would allow time to increase blowdown capability.

Two propellant tanks failed same propellant does not allow any type of certified entry. Since no control can be guaranteed, the most prudent action is the one that allows the most time and the most benign environment. By pressing uphill, time is gained to allow complex procedure and/or software changes to take place to help provide control until a $Q\text{-bar} = 20$ (i.e., DAP or procedure changes that will allow forward RCS control in pitch and yaw). A delayed ATO is selected to maximize the amount of OMS remaining to protect for interconnect operations post-deorbit burn.

For the cases of one propellant tank fail and the other leaking or both leaking same propellant yields a more complex case. If one pod contains 75 percent or more, ET separation can be performed in a timely and safe manner. The leak rate after ET separation must still support $Q\text{-bar} = 20$ to guarantee control until NO YAW JET can be engaged. If the leak rate supports TAL, the proper course of action is to abort TAL. If the leak rate does not support TAL, this case becomes the same as two propellant tanks failed.

THIS RULE CONTINUED ON NEXT PAGE

FLIGHT RULES

A6-52

RCS FAILURE MANAGEMENT (CONTINUED)

FAILURE DEFINITION

ARCS PROPELLANT TANK LEAK/FAIL:

- PROPELLANT TANK LEAK IF QUANTITY DECREASE ABNORMAL.
- PROPELLANT TANK FAILURE IF QUANTITY < 0 PERCENT OR PRESSURE < 190 PSI.
- NOMINAL OR ABORT ET SEPARATION: PROPELLANT TANK FAILURE IF QUANTITY < 75 PERCENT.

ACTION SUMMARY

J. ONE LEAK/FAIL:

1. PRE/DURING OMS-1, IF FAILED, CROSSFEED FROM GOOD RCS FOR ET SEP, CANCEL +X TRANSLATION.
2. POST-OMS-1, IF FAILED, INTERCONNECT FROM OMS.
3. PERFORM NOMINAL OMS-1 AND OMS-2.
4. PERFORM PERIGEE ADJUST OR OUT-OF-PLANE BURN IMMEDIATELY.
5. NOMINAL DEORBIT [2] [3].
6. IF FAILED, PRE-EI, CROSSFEED FROM GOOD RCS.

Crossfeed from good RCS to guarantee ET separation is accomplished. Then interconnect from OMS to conserve good pod RCS propellants. There is no reduction in the OMS delta V capability so a nominal ascent can be completed. However, deorbit will occur at the next PLS opportunity due to the violation of the RCS entry redline.

THIS RULE CONTINUED ON NEXT PAGE

FLIGHT RULES

A6-52

RCS FAILURE MANAGEMENT (CONTINUED)

K. TWO LEAK/FAIL:

1. IF ON SAME SIDE, TREAT AS SINGLE FAILURE, SEE PARAGRAPH J.
2. INTERCONNECT FROM OMS, CANCEL +X TRANSLATION. POST-EI, FEED FROM RCS.
3. IF SAME PROPELLANT, SELECT RETURN, PRIORITY:
 - TAL/LATE TAL (IF LEAK RATE SUPPORTS ET SEPARATION AND ENTRY TO A Q-BAR = 20).
 - AOA (IF POST-MECO AND LEAK RATE SUPPORTS AN ENTRY TO A Q-BAR = 20).
 - ELS (IF LEAK RATE SUPPORTS AN ENTRY TO A Q-BAR = 20 CONSISTENT WITH RULE {A2-205}, EMERGENCY DEORBIT).
 - UPHILL ABORT [4].
4. IF DIFFERENT PROPELLANT, INTERCONNECT FROM OMS TO RCS TO SAVE RCS PROPELLANT. NOMINAL ENTRY [3]. USE MIXED CROSSFEED FOR ENTRY.

The rationale is the same as that for paragraphs I and J.

FLIGHT RULES

A6-53

OMS HELIUM INGESTION

FOR HELIUM INGESTION INTO THE OMS PROPELLANT TANK AFT COMPARTMENT AS REFLECTED IN AN OMS PROPELLANT TANK AFT QUANTITY DECREASE OF > 1.0 PERCENT FOR ANY SINGLE BURN WHEN OMS TANK QUANTITY > 45 PERCENT, OMS/RCS INTERCONNECT FROM THAT POD WILL NOT BE PERFORMED EXCEPT FOR DEORBIT.

The OMS bulkhead screen should not allow more than 1 percent of helium gas to enter the aft compartment for a single OMS burn. Experience to date has shown little or no gas transfer. A decrease in the aft quantity gauge > 1 percent during a burn when the propellant level covers the bulkhead screen indicates screen breakdown has occurred and further use of that tank without propellant settling burns is prohibited.

OMS tank propellant quantity less than 45 percent, RCS interconnect propellant usage may result in a decrease in OMS aft quantity (the forward compartment propellant may not be in contact with the bulkhead screen). With OMS propellant quantity less than 30 percent, there is no propellant remaining in the forward compartment and all usage will come from the aft compartment. In these cases, a decrease in the aft compartment quantity is not indicative of a screen failure. (Reference SODB, volume I, paragraph 3.4.3.3.)

FLIGHT RULES

A6-54

OMS PROPELLANT FAIL FEED CONSTRAINTS [CIL]

THE OMS CROSSFEED OR INTERCONNECT MODE WILL NOT BE USED TO FEED FROM A FAILED OR A SUSPECTED FAILED OMS PROPELLANT TANK AS LONG AS SHALLOW TARGETS, TANK LANDING WEIGHT CONSTRAINTS, AND CG LIMITS ARE PRESERVED. IF ANY OF THE ABOVE CONSTRAINTS ARE VIOLATED, THE INTERCONNECT MODE MAY BE USED TO ATTEMPT AN RCS +X PERIGEE ADJUST.

- A. ABOVE MINIMUM SAFE PERIGEE (SAFE HP), THE INTERCONNECT MODE MAY BE USED TO ATTEMPT AN RCS +X PERIGEE ADJUST. @[072398-6692A]

The only case of propellant blockage to date (STS-1) demonstrated that the screens present in the system are adequate to prevent migration of contaminants. STS-1 data showed that 50 percent of the OMS oxidizer inlet filter was blocked by contaminants with small traces downstream. The blockage may allow flow rate sufficient to support a +X translation while not supporting an OMS flow rate (+X OX=3.9 lb/sec and FU=2.4 lb/sec compared to OMS OX=12 lb/sec and FU=7.2 lb/sec, reference SODB tables 4.3.2-1 and 4.3.3-1 for flow rates). Troubleshooting can be performed by interconnecting to the L(R) RCS 1/2 leg. The OMS propellant might be able to support an RCS flow rate, thus avoiding an undesirable entry, (OMS propellant fail is not protected and can mean a shallow deorbit and no-yaw jet entry). For propellant contamination in the OMS to reach the RCS jets, it must pass through seven screens (two on each ac-motor valve and one at the inlet to the jet). This rule will allow determination of a leak downstream of the ball valves that would appear as a propellant fail.

CIL retention rationale (FMEA 03-3-4002-1) addresses the case of propellant filter screens blocked by contamination. However, the conclusion of the March 9, 1995, PRCB was that by the time of the deorbit burn, the system has proved itself free of contaminants. Even so, propellant lines may be frozen by a small, undetected leak (ref. AEFTP #141, August 15, 1997), resulting in a propellant fail condition. For any OMS propellant fail (actual or suspected) above minimum safe perigee (safe hp), the CIL requirement is to stop the burn and troubleshoot the problem via interconnect.
@[072398-6692A]

THIS RULE CONTINUED ON NEXT PAGE

FLIGHT RULES

A6-54

OMS PROPELLANT FAIL FEED CONSTRAINTS [CIL] (CONTINUED)

- B. BELOW MINIMUM SAFE PERIGEE (SAFE HP), OMS CROSSFEED MAY BE ATTEMPTED FROM THE FAILED SYSTEM AFTER THE GOOD SYSTEM USABLE PROPELLANT HAS BEEN USED. @[072398-6692A]

Once below safe Hp, the deorbit burn must be completed. The best immediate response is to terminate propellant wasting, ensuring the delta V from the remaining OMS is utilized efficiently. Still, because OMS propellant fail is not protected (Ref. Rule {A6-303B}, OMS REDLINES [CIL]), attempting completion of the deorbit burn using only the remaining systems (Good OMS + Aft RCS + Fwd RCS) will most likely violate one or more of the constraints listed above. It is prudent, therefore, to attempt a crossfeed from the failed system but only when the good system is nearly empty (i.e., 4 percent quantity remaining.) In that way, if the crossfeed is unsuccessful, almost no delta V has been lost in the attempt. However, if the failure proves not to have been a propellant failure, or if the blockage is below the crossfeed tee, the crossfeed will be successful and the deorbit burn can be completed normally. RCS interconnect to the failed system below minimum safe perigee should not be attempted since, should the interconnect not succeed, there is not sufficient time available to execute the necessary recovery procedures (staged manifold repress, failed jet recovery, etc.). @[072398-6692A]

A6-55

OMS N₂ TANK FAILURE MANAGEMENT

FOR A FAILED OMS N₂ TANK, THE ASSOCIATED ENGINE WILL NOT BE USED UNTIL THE DEORBIT BURN IN ORDER TO CONSERVE THE FINAL ENGINE RESTART. IF N₂ REGULATOR PRESSURE > 366 (382) PSIA, TWO STARTS ARE POSSIBLE.

With an N₂ tank failure, a minimum of one OMS start remains in the accumulator. This start will be saved for the final engine burn in order to maintain OMS engine redundancy while on orbit. If the accumulator pressure is sufficient to support two OMS burns (N₂ regulator pressure > 366 (382) psi, 83 psi for the first start (no purge), and 283 psi for the last start and 16 psi instrumentation), the engine may be burned if subsequent failures dictate. A pressure of 366 (382) assumes that sufficient time is allowed between burns to allow the N₂ tank to return to equilibrium. Both burns will be 100 percent ball valves open. (Ref. Rules {A6-4}, OMS N₂ TANK; {A6-5}, OMS N₂ ACCUMULATOR; and {A6-56}, OMS N₂ REGULATOR FAILURE MANAGEMENT.) (Reference SODB, volume I, paragraph 3.4.3.3.15 and 4.3.3.1.d.)

FLIGHT RULES

A6-56**OMS N2 REGULATOR FAILURE MANAGEMENT**

AN OMS ENGINE WITH INSUFFICIENT OMS N₂ ACCUMULATOR PRESSURE (N₂ REG PRESS < 283 (299) PSIA) TO OPEN BOTH BALL VALVES FULLY WILL NOT BE USED UNLESS THE OTHER ENGINE HAS FAILED AND THEN ONLY FOR THE DEORBIT BURN. IF THE OTHER OMS ENGINE HAS FAILED, N₂ ACCUMULATOR PRESSURE ON THE REMAINING OME MUST SUPPORT 90 PERCENT BALL VALVE OPENING (N₂ REG PRESS > 270 (270) PSIA).

Lower than 100 percent ball valve opening will result in off-nominal start characteristics. The risk of using an engine with < 100 percent ball valve opening is only acceptable if it is the last OME available for the deorbit burn. If an OMS engine has failed and the other will support 90 percent opening (N₂ Reg P > 270 (270) psia), then the risk versus risk tradeoff is between 90 percent OME ball valve opening (no regulator pressure instrumentation) and RCS deorbit. The 90 percent OME is preferable in this case. If the last remaining OME can only support < 90 percent, then an RCS deorbit must be performed since performance drops off drastically at lower N₂ or accumulator pressures. At 228 psia with pressurization valves open (246 psia if closed), the ball valves only open to 70 percent with greater than 1/2 second transition time. Engine starting characteristics are unacceptable with this slow opening time. Reference Rules {A6-5}, OMS N2 ACCUMULATOR; and {A6-55}, OMS N₂ TANK FAILURE MANAGEMENT. (Reference SODB, volume I, 3.4.3.3.14, and volume III, table 4.3.3.)

FLIGHT RULES

A6-57

AFT RCS PROPELLANT TANK FAIL/HELIUM INGESTION

A. MATRIX:

PRE-MECO TANK QUANTITY (PERCENT)	RTL5	ASCENT	ORBIT	ENTRY
QTY >75	<ul style="list-style-type: none"> NOM ET SEP 	<ul style="list-style-type: none"> NOM ET SEP 	<ul style="list-style-type: none"> NOM ORBIT OPS 	<ul style="list-style-type: none"> NOM ENTRY
QTY <75	<ul style="list-style-type: none"> XFEED FROM GOOD RCS FOR ET SEP AFFECTED POD AVAIL FOR GRTL5 IF REQ'D 	<ul style="list-style-type: none"> XFEED FROM GOOD RCS FOR ET SEP POST-OMS-1 INTERCONNECT FROM OMS 	<ul style="list-style-type: none"> PRIMARY JETS: INTERCONNECT FROM OMS OR XFEED FROM GOOD RCS VERNIER JETS: NOM ORBIT OPS 	<ul style="list-style-type: none"> AFFECTED POD AVAIL POST-EI

B. RULES:

1. AN RCS TANK WILL BE CONSIDERED FAILED FOR ET SEPARATION IF PRE-MECO TANK QUANTITY < 75 PERCENT. ET SEPARATION WILL BE PERFORMED IN CROSSFEED FROM GOOD RCS.

An analysis has been completed based upon the RCS tank redesign (addition of abort helium diffusers and deletion of abort ducts) and recertification of the ARCS tanks. The analysis has shown that a gauge quantity of less than 75 percent prior to MECO results in a gas "short" to the lower compartment (L/C) and large quantities of gas will transfer to the L/C prior to the start of mated coast external tank separation (MC/ET SEP). Usage from tanks in this condition should be avoided during MC/ET SEP by crossfeeding from the good side to prevent possible jet fail because of helium ingestions. Reference SODB, volume I, paragraph 3.4.3.2-14.c.

2. AN RCS TANK SUSPECTED TO HAVE INGESTED HE:
 - a. CAN BE USED DURING ENTRY (POST-EI) WITH NO RESTRICTIONS OTHER THAN TO ACCOUNT FOR INCREASED TANK RESIDUALS (LOSS OF PROPELLANT PRIOR TO MECO WILL INCREASE TANK RESIDUALS BY 11 PERCENT).

The additional gas that transfers to the L/C will impact the tank entry expulsion efficiency by as much as 11 percent. However, during entry the gravitational force will hold the propellant over the tank outlet preventing helium ingestion and allowing use of the tank.

THIS RULE CONTINUED ON NEXT PAGE

FLIGHT RULES

A6-57

AFT RCS PROPELLANT TANK FAIL/HELIUM INGESTION
(CONTINUED)

- b. CAN BE USED FOR VERNIER JET OPERATIONS.
- c. WILL NOT BE USED FOR PRIMARY JET ORBIT OPERATIONS.

Since the vernier jets do not result in an excessive delta pressure across the RCS bulkhead screens to cause screen breakdown, verniers may be used for on-orbit operations.

Rule {A2-54}, RTL, TAL, AND AOA ABORTS FOR SYSTEM FAILURES [CIL], references this rule.

A6-58

RCS REGULATOR FAILURE TROUBLESHOOTING

THE FORWARD AND AFT RCS WILL NOT BE OPERATED IN BLOWDOWN MODE TO TROUBLESHOOT A REGULATOR PATH IF A REDUNDANT PRESSURE PATH EXISTS.

There will be no troubleshooting for an RCS regulator flow path unless additional failures restrict the remaining flow path. Crew actions and flight impact are independent of the failure mode determined by troubleshooting the system. It is not prudent to expose the system to off-nominal operating conditions during troubleshooting when no real procedural advantage can be realized.

FLIGHT RULES

A6-59

LOSS OF AFT RCS LEAK DETECTION

RCS CROSSFEED OR OMS/RCS INTERCONNECT WILL BE UTILIZED DURING CREW SLEEP PERIODS FOR THE LOSS OF SINGLE ARCS POD LEAK DETECTION CAPABILITY.

During crew sleep periods, by crossfeeding or interconnecting to a good system (RCS or OMS respectively), use of the system with no leak detection capability available can be avoided and the feeding system leak detection capability can be utilized.

Because of SMS limitations and inability to model thermal effects, training in propellant leak detection has typically been limited to annunciation of pressure decays with no associated temperature decrease. For small leaks, we feel that temperature will be our only indication. For large leaks, cooling will certainly accompany the pressure decay. Therefore, with the existing temperature sensors and associated FDA, we believe the primary means for leak detection will be thermal monitoring.

The philosophy to terminate interconnect prior to crew sleep was changed prior to STS 41-B because of newly identified crossfeed line surge pressure concerns and the desire to minimize the number of times the interconnect mode was established. In addition, a better understanding of the pod thermal effects as a result of propellant leakage resulted in an increased confidence that small leaks would be more readily detectable through thermal indications rather than the standard pressure decay (reference APU HYDRAZINE LEAK ON STS 41-A). Consequently, we feel that maintaining interconnect operations during sleep periods can be accomplished safely while at the same time maintaining an adequate leak detection capability with associated crew FDA.

During crew-awake periods, the RCS propellant tank pressure FDA may be used to provide leak detection by isolating the helium tank and forcing the RCS to operate in a blowdown mode. This allows propellant to be used from the degraded system while still providing leak detection capability. Also, because the RCS has much less ullage than the OMS, less propellant would be leaked prior to annunciation when operating with the RCS in blowdown than when interconnected from the OMS.

FLIGHT RULES

A6-60

RCS MANIFOLD CLOSURE CRITERIA [HC] ©[022405-6621B]

RCS MANIFOLDS MAY BE CLOSED FOR THE FOLLOWING CONDITIONS :

RCS manifolds are nominally open. Manifolds that have been closed may cause complications if they are reopened after the manifold pressure significantly decreases due to a temperature change or a leak. A high pressure spike will be transmitted through the manifold when the manifold valve is reopened. If the pressure spikes are large enough, thruster valve bounce may occur resulting in propellant leakage.

Therefore, the manifolds are only cycled for the following identified cases.

* Note: *There is no concern with vernier manifold pressure spikes and no concern with rupturing the primary manifold bellows. (Some test data indicate primary thruster valves may only bounce if helium gas is in the injector valve.)*

A. SYSTEM LEAK TROUBLESHOOTING.

Current leak isolation procedures require manifold isolation valves to be closed. In the event of a manifold leak, the manifold valve must be closed to prevent any further leakage. If the leak was not in the manifold, the manifold valve can be reopened with no damage to the failed system.

B. ISOLATION OF RM INDICATED FAILED-ON JET (FOR VERIFIED FAILED ON JET, MANIFOLD WILL NOT BE OPENED) .

For an RCS jet failed on, the associated manifold valve must be closed to prevent excessive propellant usage and attitude control problems either manually in any OPS or by the auto manifold close function in RCS Fail On RM during OPS 2 and 8.

For false fail-on indications, the manifold can be reopened. If the indication is not intermittent, during OPS 2 and 8 the switch should be placed in the GPC position to allow for auto manifold closure if another jet on that manifold were to fail on. If the indication is intermittent, the switch may be placed in the open position, rendering the Auto Manifold Close inactive, to preclude repeated actions to recover the manifold of jets. MCC should then consult Rules {A6-156}, RCS RM LOSS MANAGEMENT, and {A6-160}, RCS AUTO MANIFOLD CLOSE.

For real fail-on jets the manifold will be evacuated when closed. If the failure has been cleared and the affected manifold is required to be GO for on-orbit operations, a GMEM procedure is available to repressurize the evacuated manifold. Consult Rule {A6-61}, RCS MANIFOLD/OMS CROSSFEED LINE REPRESSURIZATION [CIL].

References: Hazard Report ORBI-055, "Inadvertent Firing of a Forward/Aft Reaction Control Subsystem Jet Results in Death or Injury to Ground Personnel and/or Loss of Orbiter Crew and Vehicle" and Rule {A6-160}, RCS AUTO MANIFOLD CLOSE. ©[022405-6621B]

THIS RULE CONTINUED ON NEXT PAGE

FLIGHT RULES**A6-60 RCS MANIFOLD CLOSURE CRITERIA [HC] (CONTINUED)**

- C. ISOLATION OF RM INDICATED LEAKING JET.
1. IF DIVERGENCE OCCURS BETWEEN OXIDIZER AND FUEL QUANTITIES.
 2. IF CORRESPONDING NONLEAKING INJECTOR TEMPERATURE DROPS BELOW 40 DEG F.
 3. IF INJECTOR TEMPERATURES AND CHAMBER PRESSURE SIGNATURES INDICATE BOTH INJECTOR VALVES ARE LEAKING.
 4. IF LEAK RATE IS OF THE MAGNITUDE THAT RESULTS IN PLUGGING OF THE CHAMBER THROAT AS INDICATED BY CHAMBER PRESSURE AND INJECTOR TEMPERATURES.

Normally no action is taken if a jet should fail leak. The injector valves are pressure assisted by design. Maintaining system pressure on the valve provides the best seal possible at the injector valve seat which may help seal the leak. Also, it is undesirable to close the manifold isolation valve because of the loss of additional RCS jets on that manifold (RCS RM declares the jets unavailable if manifold isolation valves are closed). If the manifold isolation valve were to be closed, the isolated manifold pressure would quickly decrease because of the leak.

The manifold isolation valve shall be closed if any of the following conditions are met:

1. *To isolate the leaking jet from the system should a divergence be detected between the oxidizer and fuel quantities. ©[022405-6621B]*
2. *To prevent ZOTS from occurring if both injector valves should start leaking. Due to the evaporative cooling effect of the initial propellant leak, the temperature of the nonleaking engine valve will tend to decrease. Should the second propellant valve begin to leak due to cold temperature, the resulting dual propellant leak can have very undesirable effects, such as valve ZOT. The minimum temperature reached by the nonleaking valve is primarily a function of the leak rate of the leaking valve. Thus, for a leaking jet, the nonleaking valve/injector temperature differential cannot be determined. The 40 deg F limit represents best engineering judgment for the minimum acceptable injector temperature for the nonleaking valve. ©[091098-6708]*
3. *To prevent off-nominal combustion in the chamber due to both valves leaking, as evidenced by injector temperature and chamber pressure. ©[091098-6708]*
4. *To prevent second valve leakage due to initial valve leakage causing blockage of the chamber throat. Blockage of the chamber throat will cause pressure to build up on the outside portion of the seal of the nonleaking valve, thus reducing its sealing force. ©[022405-6621B]*

THIS RULE CONTINUED ON NEXT PAGE

FLIGHT RULES

A6-60

RCS MANIFOLD CLOSURE CRITERIA [HC] (CONTINUED)

References: Hazard Reports ORBI-056, "RCS Thruster Valve Leakage Leads to Explosion in Thruster;" ORBI-167, "Explosive Loss of ARCS Primary Thrusters During Entry;" and ORBI-501, "Flammable / Explosive Atmosphere Created by External Leakage of Hypergolic Fluids in Reaction Control Subsystem (RCS) and/or in Orbital Maneuvering System (OMS)." ©[022405-6621B]

D. SYSTEM SECURING AS A RESULT OF POWERDOWNS.

Orbiter failures resulting in powerdown of electrical buses may cause the loss of RCS jet heaters and/or jet injector temperatures. Loss of the jet heaters will allow the jets to cool and the injector valve Teflon seals to shrink. When injector temperatures reach approximately 47 deg F, leakage may occur preventing future use of the jet (ref. Rule {A6-257}, RCS JET TEMPERATURE MANAGEMENT). Special hot fire procedures could be utilized to warm the jets but may be impractical because of the numerous jets affected. The manifold valves can be closed reducing propellant leakage into the jet. ©[091098-6708]

E. UNRECOVERABLE LOSS OF:

1. COMMAND PATH TO ALL JETS ON A MANIFOLD.
2. ELECTRICAL POWER (BOTH REDUNDANT SOURCES) TO A REACTION JET DRIVER (RJD).
3. RJD FUNCTION TO ALL ITS ASSOCIATED JETS.

For these three cases, all jets on a single manifold are lost. No additional jets can be lost because of the manifold valve closure. Even though no additional capability is lost, the manifold valve is not normally closed since jet leaks can occur as a result of closing the manifold. The injector valves are pressure assisted by design. Maintaining system pressure on the valve provides the best seal possible at the injector valve seat. ©[022405-6621B]

FLIGHT RULES

A6-61

RCS MANIFOLD/OMS CROSSFEED LINE REPRESSURIZATION [CIL]

A. RCS MANIFOLD REPRESSURIZATION MANAGEMENT:

1. GENERAL:

- a. MANIFOLDS WILL BE REPRESSURIZED DIRECTLY FROM THE TANK VOLUME USING THE MANIFOLD ISOLATION VALVE ANYTIME BOTH THE MANIFOLD PRESSURES > 130 PSIA.

Tests conducted at WSTF revealed that when repressurization of a manifold was attempted with an initial manifold pressure < 50 psia and the tank pressure approximately 245 psia, the thruster valves bounced, leaking propellant into the combustion chamber. The uncontrolled leaking of oxidizer or fuel into the chamber can lead to oxidizer/fuel detonation in the injector passage (ZOT's). The concern is that the fuel will stay in the oxidizer injector passages and will not vaporize prior to the oxidizer reaching the jet (vapor pressure: oxidizer = 15 psi; fuel = 0 psi). Consequently, combustion will take place in the injector instead of the chamber, leading to thruster valve damage and propellant leaks. Based on these concerns and the test results, it was agreed in flight techniques to use special procedures (stage repress) if time permits for repressurization of manifolds where both the oxidizer and fuel manifold pressure < 130 psia (130 = 50 pressure + 50 pad + 30 instrumentation). Repress via the manifold isolation valve will be performed only if mandatory for attitude control during time-critical phases. There is no restriction against repressing manifolds if the manifold pressure > 130 psia.

- b. SIMULTANEOUS REPRESSURIZATION OF MORE THAN ONE SET (OXIDIZER AND FUEL) OF EVACUATED MANIFOLDS FROM AN RCS TANK IS NOT ALLOWED.

Simultaneous repressurization of evacuated manifolds is not allowed. Two evacuated manifolds repressed at WSTF resulted in an RCS tank bulkhead delta pressure > 7.0 psid (spec limit = 3.7 psid). This could result in damage to the bulkhead, resulting in broken screens, helium gas ingestion into the jets, jet failure, and subsequent loss of the tank.

- c. VERNIER MANIFOLDS WILL BE REPRESSURIZED USING THE MANIFOLD ISOLATION VALVE IF THE VERNIER JETS ARE OTHERWISE AVAILABLE FOR NORMAL ON-ORBIT OPERATIONS.

There is no constraint against repressing a vernier manifold. The vernier thruster valves are solenoid, not pilot operated, and do not bounce when subjected to large pressure spikes. The vernier alignment bellows spec limit was exceeded during repress tests at WSTF, but resulted in no damage. As long as the vernier jet capability is not precluded by another system failure, vernier manifolds will be repressed as required.

THIS RULE CONTINUED ON NEXT PAGE

FLIGHT RULES

A6-61

RCS MANIFOLD/OMS CROSSFEED LINE REPRESSURIZATION [CIL] (CONTINUED)

- d. LEAKING LINES WILL NOT BE REPRESSURIZED UNLESS MANDATORY FOR VEHICLE CONTROL.

The risks associated with leaking propellant into an OMS pod or forward RCS module do not warrant feeding a leak if the flow path is not mandatory to maintain vehicle control. Leaking lines should not be repressed to gain redundancy. The corrosive effects of oxidizer (N₂O₄), along with structural integrity (bulkhead delta P) concerns and toxicity, make it undesirable to feed an OX leak unless mandatory. The fire, explosive, and toxicity hazards of the fuel (mmH) make it undesirable to feed a fuel leak unless mandatory. Leakage of either propellant in a vacuum environment may cause freezing of other pod components resulting in loss of additional propulsion capability.

2. INDIVIDUAL OXIDIZER OR FUEL MANIFOLD PRESSURE < 130 PSIA:

MANIFOLDS WILL BE REPRESSURIZED DIRECTLY FROM THE TANK USING THE MANIFOLD ISOLATION VALVE EXCEPT IF CAUSED BY A JET FAIL LEAK OR PROPELLANT LEAK. MANIFOLD(S) WILL BE REPRESSURIZED IF REQUIRED FOR ET SEPARATION OR ENTRY CONTROL.

ANYTIME IF MANDATORY TO MAINTAIN ATTITUDE CONTROL.

Repressing a manifold where an individual oxidizer or fuel manifold pressure < 130 psia and the other pressure > 130 psia is allowed using the manifold isolation valve. For this case, the expected valve bounce will only occur on the affected propellant manifold, leaking only oxidizer or fuel into the chamber. The presence of one propellant does not represent a ZOT risk if the propellant sublimates and clears the chamber before further jet use. Oxidizer will clear the chamber in approximately 10 seconds while fuel takes 1 to 2 minutes.

Manifolds will not be repressed on orbit if the manifold pressure decay was caused by a propellant leak. Repressing the manifold may increase the leak rate. For jet leaks, manifolds may be repressed in an attempt to put pressure on the injector valve, possibly sealing the leak. These manifolds can be repressed during entry if mandatory for control.

3. BOTH OXIDIZER AND FUEL MANIFOLD PRESSURE < 130 PSIA:

- a. AN EVACUATED MANIFOLD CAUSED BY A JET FAIL-ON WILL NOT BE REPRESSURIZED UNLESS THE FAILURE HAS BEEN CLEARED.

THIS RULE CONTINUED ON NEXT PAGE

FLIGHT RULES

A6-61

RCS MANIFOLD/OMS CROSSFEED LINE REPRESSURIZATION
[CIL] (CONTINUED)

- b. MANIFOLDS WILL BE REPRESSURIZED DIRECTLY FROM THE TANK USING THE MANIFOLD ISOLATION VALVE:
- (1) ANYTIME IF MANDATORY TO MAINTAIN ATTITUDE CONTROL.
 - (2) DURING NOMINAL/RTLS ASCENT IF REQUIRED FOR ET SEPARATION. (SEE RULE {A8-55}, ASCENT/ENTRY RCS CONTROL REQUIREMENTS [HC].) @ED]
- NOTE: MANIFOLDS WILL NOT BE REPRESSED TO REGAIN REDUNDANCY. MULTIPLE MANIFOLDS WILL BE REPRESSED IF REQUIRED FOR ET SEPARATION OR ENTRY CONTROL.
- c. INADVERTENT EVACUATED MANIFOLDS WILL BE REPRESSURIZED ON ORBIT USING A READ/WRITE PROCEDURE IF REQUIRED TO BE GO TO STAY ON ORBIT.
- d. A STAGED REPRESSURIZATION PROCEDURE WILL BE USED ON ORBIT TO REPRESSURIZE MANIFOLDS AT VAPOR PRESSURE (LIQUID IN LINES).

A staged repressurization or read/write procedure will be used on orbit to repressurize desired manifolds where both the oxidizer and fuel manifold pressures are < 130 psia. The staged repressurization procedure is only effective if liquid exists in the lines and will not work for an evacuated manifold. The manifold is repressurized using the line volume between the tank isolation valves and the manifold isolation valves until a manifold pressure > 130 psia is achieved. (If the manifold pressure is not above vapor pressure after the first cycle of the staged repressurization procedure, the manifold may be partially evacuated and the staged repressurization procedure will not work.) Repressurization directly from the tank is acceptable after manifold pressures are > 130 psia. The read/write procedure allows the inadvertent evacuated manifold to be repressurized on orbit without the risk of a ZOT occurring. The GMEM procedure consists of opening the oxidizer tank isolation valve prior to the fuel isolation valve, allowing the oxidizer to sublime before the fuel arrives at the jet. These procedures will not be attempted in time-critical phases. Deorbit preparation OPS 3 transition has been baselined as the point at which these special procedures will no longer be utilized. The manifold isolation valve will be used to repressurize a manifold directly from the tank volume during time-critical phases. Confirmed jet fail-on evacuated manifolds will not be repressurized due to excessive propellant consumption and the possibility of further jet and RCS propellant tank damage. However, jet fail-on evacuated manifolds will be repressurized if the failures have been cleared (no driver out command with the RJD power on). The inadvertent evacuated manifold repressurized actions should be used in this case.

THIS RULE CONTINUED ON NEXT PAGE

FLIGHT RULES

A6-61

RCS MANIFOLD/OMS CROSSFEED LINE REPRESSURIZATION
[CIL] (CONTINUED)

B. OMS/RCS CROSSFEED LINE REPRESSURIZATION MANAGEMENT [CIL]:

	FUEL PRESSURE					
	> 130 PSIA		< 130 PSIA AND > 35 PSIA		< 35 PSIA	
OXID PRESSURE > 130 PSIA	[1]	[1]	[3]	[4]		
OXID PRESSURE < 130 PSIA AND > 49 PSIA	[1]	[2]	[5]	[4]	[6]	
OXID PRESSURE < 49 PSIA	[3]	[4]	[4]	[6]	[4]	[6]

NOTES:

- [1] NOMINAL OPERATIONS ALLOWED.
- [2] CROSSFEED LINE AVAILABLE FOR INTERCONNECT/CROSSFEED OPERATIONS SUBJECT TO RCS MANIFOLD REPRESS CONSTRAINTS.
- [3] REPRESSURIZATION OF RCS MANIFOLDS ALLOWED FROM THE RCS USING THE MANIFOLD ISOLATION VALVES ONE MANIFOLD AT A TIME. (REF. PARAGRAPH A.)
- [4] REPRESSURIZATION OF CROSSFEED NOT ALLOWED UNLESS CRITICAL FOR CREW SAFETY.
- [5] REPRESSURIZATION OF RCS MANIFOLDS ALLOWED USING RCS OR OMS STAGED REPRESSURIZATION PROCEDURE. (REF. PARAGRAPH A.)
- [6] REPRESSURIZATION OF RCS MANIFOLDS ALLOWED USING RCS STAGED REPRESSURIZATION PROCEDURES ONLY. (REF. PARAGRAPH A.)

1. RCS MANIFOLD PRESSURES WILL BE USED ON ORBIT TO DETERMINE THE GO/NO-GO STATUS OF THE CROSSFEED LINE PRIOR TO REPRESSURIZATION DIRECTLY FROM THE PROPELLANT TANK.

All 10 manifolds are used because analysis indicates if the crossfeed pressure were at a minimum because of thermal cycles, the pressure contained in the volume of 10 manifolds is sufficient to bring the crossfeed pressure up to within acceptable limits without a special staged repressurization procedure. There are pressure transducers on the crossfeed lines; however, when the lines are isolated, thermal cycles cause the pressures of the hydraulically locked-up lines to cycle significantly. The crossfeed line pressure transducers have a large instrumentation error (34 psia); and, when the lines are isolated, the fuel line pressure frequently indicates below the sum of the vapor pressure (1 psia) and the instrumentation error. The RCS manifold pressures are, therefore, used as a pressure check at the time of interconnect or crossfeed. Note that when the RCS manifolds are opened to the crossfeed lines, the RCS tank isolation and OMS crossfeed valves are closed, alleviating the concern of a pressure surge from a large pressurant source and ullage. An average pressure of all oxidizer manifolds will be used as the oxidizer crossfeed line pressure for evaluation. An average will also be used for the fuel crossfeed line pressure. Instrumentation bias must also be considered prior to averaging the pressures.

THIS RULE CONTINUED ON NEXT PAGE

FLIGHT RULES

A6-61

RCS MANIFOLD/OMS CROSSFEED LINE REPRESSURIZATION [CIL] (CONTINUED)

- a. OXIDIZER OR FUEL MANIFOLD PRESSURES < 15 (49) PSIA OXIDIZER OR < 1 (35) PSIA FUEL. THE CROSSFEED LINE WILL BE CONSIDERED FAILED FOR FURTHER ON-ORBIT OPERATIONS UNLESS CRITICAL FOR CREW SAFETY. DEORBIT WILL BE SCHEDULED AT THE NEXT PLS.

If the oxidizer pressure is < 49 psia and/or the fuel pressures < 35 psia, repress of the OMS crossfeed line from a high pressure tank is not allowed. A staged repressurization may be attempted to increase the crossfeed pressures to within acceptable limits. If the staged repressurization is unsuccessful, the crossfeed line will be declared failed. The pressure limits are based on an instrumentation error of 34 psia and vapor pressure of 15 psia for the oxidizer and one for the fuel. WSTF tests have verified that repressurizing a crossfeed line at pressures less than propellant vapor pressure is known to create unacceptable large surge pressures and must be avoided if possible. (Reference SODB 3.4.3.3.17.)

Flight Rules require two methods of deorbit capability to be go past the next PLS. Because of the crossfeed line failure, there will be no downmode capability for an OMS engine failure during the deorbit burn. (Reference Rule {A6-358}, VIOLATION OF MISSION COMPLETION REDLINES MATRIX.)

- b. OXIDIZER AND FUEL MANIFOLD PRESSURES > 15 (49) PSIA OXIDIZER OR > 1 (35) PSIA FUEL. THE CROSSFEED LINE IS AVAILABLE FOR INTERCONNECT/CROSSFEED OPERATIONS SUBJECT TO RCS MANIFOLD REPRESSURIZATION CONSTRAINTS. (REF. PARAGRAPH A.)

For crossfeed pressures > 49 psia oxidizer or > 35 psia fuel, there are no crossfeed line constraints. However, the RCS manifolds require a staged repressurization when both propellants are < 130 psia. The staged repressurization procedure will prevent surge pressures from bouncing the jet injector valves and causing a ZOT. An OMS staged repressurization procedure exists that allows the repressurization of all 10 RCS manifolds simultaneously rather than one at a time. (Ref. paragraph A.)

2. THE OMS CROSSFEED LINE WILL BE USED INDEPENDENT OF THE CROSSFEED LINE PRESSURE FOR MANEUVERS CRITICAL FOR CREW SAFETY, ABORT PROPELLANT DUMPS, OR IF REQUIRED, TO MAINTAIN ATTITUDE CONTROL.

Any interconnect or crossfeed required for crew safety will be executed without regard to the crossfeed line pressure.

THIS RULE CONTINUED ON NEXT PAGE

FLIGHT RULES

A6-61 RCS MANIFOLD/OMS CROSSFEED LINE REPRESSURIZATION [CIL] (CONTINUED)

3. THE OMS CROSSFEED LINE WILL NOT BE USED TO SUPPORT MISSION SUCCESS ACTIVITIES (CROSSFEED/INTERCONNECT) UNTIL AN ACCEPTABLE CROSSFEED LINE PRESSURE HAS BEEN VERIFIED.

The OMS crossfeed line will not be used to support mission success activities (crossfeed/interconnect) until a satisfactory pressure check has been performed. This includes on-orbit crossfeed burns (planned or as a result of an engine failure). The risk of structural damage as a result of excessive surge pressures (i.e., no crossfeed pressure check) will only be accepted if the crossfeed is required to maintain crew safety.

Rules {A2-54B.3}, RTL5, TAL, AND AOA ABORTS FOR SYSTEMS FAILURES [CIL]; and {A6-60}, RCS MANIFOLD CLOSURE CRITERIA, reference this rule.

A6-62 OMS/RCS CONTINUOUS VALVE POWER MANAGEMENT

WHEN DETECTED, CONTINUOUS POWER TO AN OMS/RCS AC MOTOR VALVE WILL BE REMOVED ACCORDING TO THE FOLLOWING GUIDELINES:

- A. BY PLACING THE APPROPRIATE SWITCH IN GPC, OR
- B. IF "A" IS UNSUCCESSFUL AND CONTINUOUS POWER OCCURRED DURING A NONCRITICAL RECONFIGURATION PERIOD, BY PULLING THE APPROPRIATE AMC POD BUS CIRCUIT BREAKERS.

CIRCUIT BREAKERS PULLED UNDER "B":

1. WILL BE RESET DURING CRITICAL RECONFIGURATION PERIODS.
2. MAY BE RESET IF VALVE MOVEMENT IS REQUIRED.

A CRITICAL RECONFIGURATION PERIOD IS DEFINED AS MM 102 TO 105, MM 302 THROUGH THE OPS 9 TRANSITION, RENDEZVOUS, OR ORBIT BURNS REQUIRING A NON-STRAIGHTFEED DOWNMODE.

Continuous power is detectable only through ground monitoring of MCA logic status discretes. A reading of "0" for an unexpected length of time indicates the presence of a continuous power situation. Analysis indicates that continuous power on a valve in conjunction with a fuel leak through the valve bellows may result in auto-decomposition of mmH. Since bellows leaks are not detectable in flight, removing power minimizes the potential hazard. Tests to date have not yet resulted in auto-decomposition of mmH. Therefore, during critical reconfiguration periods where immediate OMS/ RCS valve movement is required, the circuit breakers will be reset. Use of the switch to remove power is preferred over pulling the circuit breakers, since it affects only a single valve. Pulling of the AMC pod bus circuit breakers affects only OMS/RCS valve functions.

FLIGHT RULES

A6-63**RCS BFS PVT INIT PRELAUNCH CRITERIA**

RCS PVT INIT TMBU WILL BE UPLINKED PREFLIGHT IF THE I-LOADED WEIGHT OF HE INITIAL (WHI) RCS QUANTITIES DIFFER FROM THE ACTUAL LOADED RCS QUANTITIES BY GREATER THAN 3 PERCENT (HIGHER OR LOWER). ALL RCS QUANTITIES WILL BE CORRECTED WHEN AN UPLINK IS REQUIRED FOR ONE OR MORE QUANTITIES OUT OF LIMITS.

I-loaded WHI's, which are used to calculate the RCS usable quantities, are based on standard temperatures, pressures, and propellant loadings. Changes in temperatures, pressures, forward RCS propellant off-loading, off-nominal helium loads (still within LCC limits), and transducer biases or failures can affect the quantity readings. With these conditions present, it is possible to get false leak messages or degraded leak detection due to incorrect quantity readings. Preflight RCS PVT INIT TMBU's are sent to the BFS computer to update the BFS quantity gauging WHI constants. The updated constants reflect the actual temperatures, pressures, and propellant loadings in the RCS systems and adjust and finely tune the RCS quantity readings. The 3 percent uplink criteria was developed to minimize preflight uplinks (PVT INIT) and still provide reasonable leak detection protection. Currently, leak alarms are annunciated when the delta between the oxidizer and fuel quantities is 9.5 percent. With the 3 percent criteria a leak alarm will not be annunciated until a 12.5 percent oxidizer/fuel delta (169 lb oxidizer or 106 lb fuel). On orbit both the PASS (OPS 2) and BFS (OPS 3) RCS WHI constants will be updated via TMBU/UPLINK to reflect the actual usable RCS quantities remaining.

If an uplink is required prelaunch to correct quantities that differ from actual by 3 percent, WHI's will be uplinked to correct all RCS quantities. Once a prelaunch TMBU is required, the risk of building and sending the TMBU is not dependent on the number of constants being updated.

A6-64 THROUGH A6-100 RULES ARE RESERVED

FLIGHT RULES

OMS ENGINE MANAGEMENT

A6-101

OMS ENGINE BELL MOVEMENT DURING ASCENT

- A. FOR OMS TVC MOVEMENT CONFIRMED BY TWO SOURCES DURING THE HIGH QBAR REGION (REF. RULE {A8-53C}, OMS TVC LOSS), THE AFFECTED OMS ENGINE WILL BE CONSIDERED FAILED FOR ALL PURPOSES INCLUDING ABORT PROPELLANT DUMPS. THE OMS ENGINE SWITCH WILL BE IMMEDIATELY MODDED TO THE "OFF" POSITION TO PRECLUDE ANY SUBSEQUENT FIRING. @[111298-6733]
- B. FOR TVC MOVEMENT SUSPECTED DURING THE HIGH Q-BAR REGION BUT NOT CONFIRMED DUE TO MOVEMENT INDICATED BY ONLY ONE SOURCE, THE AFFECTED OMS ENGINE WILL BE CONSIDERED FAILED FOR ATO, OMS ASSIST, AND ON-ORBIT BURNS PENDING FURTHER TROUBLESHOOTING. THE OMS ENGINE SWITCH WILL BE PLACED IN THE "OFF" POSITION PRIOR TO OMS ASSIST OR FOLLOWING MECO.

PRE-MECO, THE ENGINE WILL BE USED FOR RTLS, TAL, AND CONTINGENCY DUMPS. POST-MECO, THE ENGINE WILL ONLY BE USED IN CONTINGENCY CASES IF REQUIRED FOR ORBITER OR CREW SAFETY, NOT FOR MISSION SUCCESS. @[111298-6733]

The consequences of using an OMS engine which has suffered engine bell damage due to aerodynamic forces can be severe (reference System Briefs "OMS Gimbal Position Constraints During Ascent Max G"). Clearly, such an engine should be disabled ASAP. Further note that since some abort propellant dumps and OMS Assist start both OMS engines immediately, the OMS engine switch must be in the OFF position prior to abort selection to prevent the engine from firing. Therefore, for confirmed thrust vector control (TVC) movement during the high Q-bar region of ascent, the engine will be considered failed (including OMS Assist, OMS-1, OMS-2, and abort dumps). @[111298-6733]

However, the consequences of performing an abort dump without using an OMS engine are not risk free. During RTLS, TAL, and contingency aborts, the resultant vehicle CG (both X and Y) may be unacceptable for flight control, the total vehicle weight may be significantly above the design factor of safety for g forces around the HAC or for touchdown, and the OMS propellant tank may be significantly above the constraint for both the g forces around the HAC and landing. For all these cases possible loss of vehicle could occur.

THIS RULE CONTINUED ON NEXT PAGE

FLIGHT RULES

A6-101 **OMS ENGINE BELL MOVEMENT DURING ASCENT (CONTINUED)** ®[ED]

Additionally, there are other cases, extreme MECO underspeeds or loss of other OMS engine and RCS capability, where the results would be catastrophic if the affected engine were not used.

Therefore, if the TVC movement during the high Q-bar region cannot be confirmed with two sources, the engine bell will be considered failed for OMS Assist, ATO, and On-orbit burns only. The engine bell will be used for RTLs, TAL, and contingency aborts where maximum dumping is required to avoid violating constraints which may result in loss of vehicle. ATO dumps are designed to protect ET impact constraints and will not be performed (ref. Rule {A2-62E}, ET FOOTPRINT CRITERIA). ®[11298-6733]

During orbit, the suspect engine bell will not be used if other methods of propulsion are available.

Rule {A8-53}, OMS TVC LOSS, references this rule.

A6-102 **OMS PROPELLANT SETTLING REQUIREMENT**

AN RCS SETTLING BURN (15 SECONDS 2 +X JETS) IS REQUIRED PRIOR TO EACH OMS ENGINE RESTART IF THE OMS PROPELLANT TANK (OXIDIZER OR FUEL) AFT QUANTITY < 11 PERCENT.

If the OMS aft quantity is less than 11 percent, bulkhead screens have been uncovered allowing helium to enter into the tanks aft compartment. The next OMS burn could pull this helium into the OMS engine unless a 15-second RCS +X burn is performed prior to the OMS burn. The RCS +X burn forces the propellant over the outlet tube of the tank, preventing helium ingestion and improper mixture ratio shifts.

A6-103 **OMS BURN DOWNLIST REQUIREMENT**

DURING OMS BURNS IN OPS 2 AND 3, 44.8 KBPS HIGH RATE GNC DOWNLIST DATA IS REQUIRED (EITHER REAL-TIME OR RECORDED AND DUMPED) EVEN IF THIS CAUSES TEMPORARY LOSS OF PAYLOAD DATA OR REAL-TIME LOW DATA RATE DOWNLINK.

There are parameters (e.g., OMS Pc, inlet pressure, etc.) that are not available in LDR OPS 2 and 3 GNC downlist that are mandatory to determine failure modes in the OMS system. If these data are not available either real time or in postburn dumps, relatively minor anomalies may result in severe mission action being required to cover the worst case failure mode since the exact mode cannot be determined. For example, in certain circumstances, the difference between an OMS engine failure and an OMS propellant system failure cannot be determined. The consequences of an OMS engine failure are loss of redundancy and possible mission termination; the consequences of an OMS propellant system failure include very shallow deorbit burns with RCS completions to the minimum requirements for entry control, plus Y CG offsets that may be unacceptable from the flight control standpoint. The inconvenience of not having a short period of real-time data or payload data (less than 2 minutes) is greatly outweighed by the consequences of not having OMS data to resolve anomalies during burns.

Rule {A2-129}, ORBITER ON-ORBIT HIGH DATA RATE REQUIREMENTS, references this rule.

FLIGHT RULES

A6-104

OMS ENGINE INSTRUMENTATION REQUIREMENT

- A. LOSS OF OMS ENGINE FUEL INJECTOR TEMPERATURE INDICATION (MDM FAIL, TRANSDUCER FAIL, ETC.) WILL BE CAUSE TO NO-GO FURTHER USE OF THE AFFECTED ENGINE FOR NONCRITICAL OMS BURNS IF THE OTHER OMS ENGINE IS STILL AVAILABLE. THE AFFECTED ENGINE WILL BE USED FOR CRITICAL BURNS TO MEET DOWNMODING CRITERIA PROVIDED ALL OTHER ENGINE PARAMETERS REMAIN WITHIN NORMAL OPERATING LIMITS. @[091098-6366]

The fuel injector temperature is a primary cue for monitoring engine health and analyzing engine failure. During normal engine operation, the nominal fuel inlet pressure often exceeds the documented engine fail limit. Without the fuel injector temperature, the crew monitoring capability is severely degraded and an engine failure may be impossible to distinguish from nominal engine operation.

For critical crew safety burns, such as OMS-1, -2, and deorbit, the affected engine will be used with the remaining good engine (two-engine burn) to provide a downmode capability. For safety critical on-orbit burns, such as an inertial upper stage (IUS) separation, the good engine should be used with downmode to RCS. If there is no remaining good engine, the FRCS -X jets can be used. For mission critical on-orbit burns that are too large for an RCS downmode, both engines can be used.

Other engine parameters also include Pc, oxidizer and fuel inlet pressures.

- B. THE FOLLOWING CRITERIA WILL BE USED TO DETERMINE SYSTEM STATUS FOR LOSS OF OMS INLET PRESSURE INSIGHT (MDM FAIL, TRANSDUCER FAIL, ETC.) IN COMBINATION WITH A FUEL INJECTOR TEMP HIGH ANNUNCIATION OR A PC LOW ANNUNCIATION (CONFIRMED BY DOWN ARROW OR GIMBAL MOVEMENT; NO CONFIRMATION IS AVAILABLE DURING PRE-MECO DUMPS).

AN ENGINE FAILURE WILL BE ASSUMED IF ALL OF THE FOLLOWING CONDITIONS ARE MET:

1. FAILURE OCCURS DURING POWERED FLIGHT.
2. PROPELLANT SYSTEM AND ENGINE PERFORMED NOMINALLY ON THE PREVIOUS FLIGHT.
3. NO INTRUSION WAS MADE INTO THE OMS FEEDLINES DURING VEHICLE TURNAROUND. @[091098-6366]

THIS RULE CONTINUED ON NEXT PAGE

FLIGHT RULES

A6-104

OMS ENGINE INSTRUMENTATION REQUIREMENT (CONTINUED)

OTHERWISE, A PROPELLANT FAILURE WILL BE ASSUMED UNTIL DATA REVIEW CAN CONCLUSIVELY DIAGNOSE THE FAILURE. ©[091098-6366]

This flight rule documents the decisions made at the March 9, 1995, PRCB stemming from the ROMS Oxidizer Inlet pressure bias observed prior to the liftoff of STS-66 (PCIN S062105).

Thirty hours before the scheduled liftoff of STS-66, the ROMS OX inlet pressure biased up approximately 6 psia. However, per Launch Commit Criteria (LCC), this is a NO-GO condition until the transducer is replaced. The OMS inlet pressure is the primary cue to determine and confirm engine fail, propellant fail, or instrumentation fail for FUEL INJECTOR TEMP HIGH and PC LOW FDA. Without this insight, the proper system diagnosis cannot be performed and the worst case, propellant fail, is assumed. Because of the launch impact of replacing the OMS Inlet Pressure transducers on the pad, the decision was made by the PRCB to waive the LCC. The decision was based on 1) the affected pod had considerable flight time without incident, 2) previous flight data indicated no problems, and 3) the propellant tank and feedline plumbing had not been breached during vehicle turnaround. The procedures were updated so that any ROMS PC annunciation during pre-MECO dumps would be assumed an engine failure. Post-MECO, any ROMS PC annunciation in combination with a failed acceleration check would be assumed to be a propellant failure to allow time for evaluation.

After STS-66, the PRCB elected to permanently change the LCC based on the rationale above. The PRCB discussions centered on internal contamination that could cause a blockage of the system resulting in a propellant failure. However, there are external conditions that can induce a blockage within the system. For example, if a propellant line has a small leak, the leaked propellant could freeze the OME inlet line. Engineering analysis shows that less than 1 pound of fuel can freeze a 3foot length of oxidizer feedline. A leak could develop that would be small enough that it would go undetected in tank pressure decay for some time and yet be sufficient to freeze the feedline. This condition is not applicable to powered flight because any leaked propellant would pool at the bottom of the pod and not affect the feedlines. If a detectable amount of propellant is leaked, it is understood that the pod could be adversely affected and a real-time evaluation of the situation would be required.

It should be noted that there are cases where, if an engine fail was assumed when an actual propellant fail has occurred, the loss of vehicle and crew would result. ©[091098-6366]

THIS RULE CONTINUED ON NEXT PAGE

FLIGHT RULES

A6-104

OMS ENGINE INSTRUMENTATION REQUIREMENT (CONTINUED)

- C. FOR LOSS OF AN OMS ENGINE PRESSURIZATION VALVE POSITION INDICATION, THE AFFECTED ENGINE WILL BE USED ONLY FOR OMS-1 AND DEORBIT UNLESS USE OF THE ENGINE IS REQUIRED TO MEET OMS/RCS DOWNMODING CRITERIA, OR IF PROPER ENGINE PRESSURIZATION VALVE OPERATION CAN BE VERIFIED BY AN INCREASE IN THE OMS GN₂ REGULATOR PRESSURE AND/OR DECREASE IN THE GN₂ TANK PRESSURE PRIOR TO IGNITION.

For OMS burns, proper pressurization valve operation is required in order to ensure one start capability for the affected engine is retained for the deorbit burn. For OMS-1 the valve is assumed to be open for confirmed instrumentation losses because redundant hardwired command paths are used. The risk of using the last start if the valve is actually closed (dual failure) is accepted since the burn is critical for orbit insertion.

For burns other than OMS-1 and deorbit, it is prudent not to use the affected engine if the burn can be accomplished without it. The engine may be used, however, if proper valve operation can be verified, or if required to meet OMS/RCS downmoding requirements as defined by Rule {A2-114}, OMS/RCS MANEUVER CRITICALITY. For instance, the engine may be used for OMS-2 if proper valve operation has been verified prior to insight being lost as a result of an MDM FA3 or FA4 failure since a subsequent MDM FA1 or FA2 power failure would fail the other OME and four +X capability. If the OMS engine pressurization valve is actually failed closed, two OMS starts may still be available due to the initial, higher than normal regulator pressure available prelaunch, assuming the ARM/PRESS switch is taken to ARM before the purge. @[091098-6366]

FLIGHT RULES

A6-105

OMS BURN MINIMUM PRESSURE REQUIREMENTS

AN OMS ENGINE WILL NOT BE USED FOR NONCRITICAL ON-ORBIT BURNS IF THE FUEL INLET PRESSURE < 244 PSIA OR OXIDIZER INLET PRESSURE < 244 PSIA OR N₂ TANK PRESSURE < 563 PSIA.

The OMS engine inlet pressure requirements preserve blowdown capability in an OMS system that has incurred a previously undetected failure of the pressurization system. The engine inlet pressure limits represent the bottom of the regulator band (252 psia) minus 2 percent instrumentation error (8 psia). If either inlet pressure cannot be repressed to above 244 psia, the system can be operated further in blowdown. However, the blowdown capability should be preserved for critical burns.

The nominal start envelope limits are 239 and 238 psia for the fuel and oxidizer inlet pressures, respectively (reference SODB, volume I, figure 4.3.3). The N₂ criteria represents the following:

(1)	Engine start	26 psia	(ref. SODB, volume I, fig. 4.3.3)
(2)	Purge	94 psia	
(3)	Accumulator start at 100 percent ball valve opening	283 psia	(ref. SODB, volume I, table 3.4.3.3)
(4)	Instrumentation error	<u>160 psia</u>	
	Total =	563 psia	

The limits defined in this rule are used in the FDF for noncritical on-orbit OMS burns.

FLIGHT RULES

A6-106**OMS ENGINE BURN TO DEPLETION**

FOR A LEAKING PROPELLANT PERIGEE ADJUST BURN OR FOR A DEORBIT BURN, AN OMS ENGINE MAY BE BURNED TO DEPLETION (PC = 80 PERCENT). THE ENGINE WOULD BE USED SUBSEQUENTLY ONLY IF IT IS THE ONLY DEORBIT METHOD AVAILABLE. (REF. RULE {A6-3E}, OMS ENGINE.)

Critical OMS burns (leaking OMS perigee adjust and deorbit) may be continued to a depletion level (defined as an 80 percent chamber pressure and an OMS engine “↓” on the MNVR EXECUTE display) to maximize delta V and minimize the residuals in the leaking tank. OMS propellant gage quantity will not be used as a cutoff cue since the hardware readings are unreliable. Consequently, no effort will be made to stop the burn prior to exhausting the propellant in the lines.

During depletion, the Pc decreases. The presence of a single propellant mixing with helium pressurant in the chamber prevents the Pc from reading zero. However, the Pc will fall below the fault detection threshold (80 percent) resulting in an alert. During WSTF tests to depletion in a one-g environment, engine damage did not occur. There are substantial unknowns regarding zero-g operations and crew response time to the failure to minimize damage. If engine damage occurs during the depletion cutoff, off-nominal mixture ratios may cause uncontained engine damage when the engine is restarted. Because of this potential for engine damage an engine which has failed due to depletion of either propellant (OX or FU) will not be reused unless mandatory and then only for the deorbit burn.

(Reference SODB, 3.4.3.3.)

FLIGHT RULES

A6-107

OMS ENGINE FAILURE MANAGEMENT

FOR THE LOSS OF ONE OMS ENGINE:

- A. THE REMAINING GOOD OMS WILL BE USED FOR ON-ORBIT BURNS ONLY IF THE FIRST FAILURE CAN BE IDENTIFIED AS AN ENGINE FAILURE AND IS UNDERSTOOD.

As long as the first failure is confirmed to be an engine failure, the affected pod's propellant will be available for use through the remaining good engine via crossfeed operation. Engine versus propellant failures must be determined prior to future crossfeed operations to protect against contamination affecting the remaining good OMS engine.

- B. RCS 4 +X JETS WILL BE HOT-FIRED PRIOR TO COMMITTING TO CONTINUE TO NOMINAL EOM UNLESS THE JETS HAVE PREVIOUSLY FIRED.

For the loss of an OMS engine, the good OMS engine and the RCS 4 +X jets are considered the remaining two deorbit methods (sufficient propellant to redline RCS steep deorbit must be available). If either of the remaining deorbit methods is lost, a next PLS must be invoked since zero fault tolerance exists (ref. Rule {A2-201}, DEORBIT GUIDELINES). If the 4 +X RCS jets have not fired previously, the health of the jets is unknown. As a result, if the jets have not fired, in order to gain confidence in the +X jets, the jets should be hot-fired. Since these jets are hot-fired the day before entry in the normal hot-fire procedure, the normal hot-fire procedure should be rescheduled to an earlier time.

FLIGHT RULES

A6-108**OMS BALL VALVE FAILURE MANAGEMENT**

AN OMS ENGINE WITH A FAILED OPEN BALL VALVE INDICATING GREATER THAN THE FAILED OPEN RANGE LOWER LIMIT (RULE {A6-3H}, OMS ENGINE) BUT < 47 (70) PERCENT POSTBURN WILL NOT BE USED UNLESS THE OTHER ENGINE HAS FAILED, AND THEN ONLY FOR THE DEORBIT BURN. HOWEVER, IF THE FAILED OPEN BALL VALVE INDICATES > 47 (70) PERCENT, THE ENGINE IS NOT CONSIDERED FAILED BUT WILL BE USED ONLY FOR THE DEORBIT BURN.

Each OMS engine has two ball valves in series (V1 and V2) for both the oxidizer and fuel lines. Instrumentation for V1 on both the oxidizer and fuel is measured by one potentiometer while both V2 valves are measured by another. Either V1 or V2 failed closed will prevent propellant from feeding the engines.

If postburn and either ball valve indicates open (after a nominal OMS burn cutoff), either the instrumentation has shifted high or the valve has failed partially open. There are no problems with burning an engine with failed instrumentation since the valves function properly. The lower limit of the failed open range is engine specific and is listed in Rule {A6-3H}, OMS ENGINE. If the ball valve position is between the lower limit and 70 percent there is no guarantee that the affected ball valve will open properly. The possibility of engine hard start or combustion instability then exists, with the result of structural failure and/or chamber burn through.

If the other engine is failed, it is preferable to attempt to burn the engine with the failed ball valves, relying on them to open greater than 70 percent, rather than to attempt a 4 +X deorbit. Should the ball valves fail to open sufficiently, the 4 +X deorbit downmode is still available. With the 4 +X deorbit there is no downmode.

In any case, whenever a burn is attempted using an engine with failed open ball valves, the crew should be prepared to cut off the burn by closing the appropriate tank isolation valves if a generic problem keeps both sets of ball valves from closing.

If the ball valve indicates > 70 percent open, even a real valve problem will support a nominal engine flow rate. Consequently, the engine can be used for the deorbit burn. (Reference SODB, volume I, paragraph 3.4.3.3-17.)

Rule {A6-3}, OMS ENGINE, references this rule.

A6-109 THROUGH A6-150 RULES ARE RESERVED

FLIGHT RULES

RCS THRUSTER MANAGEMENT

A6-151 RCS JET DRIVER MANAGEMENT [CIL]

- A. THE PRIMARY JET RJD CONFIGURATION WILL BE ALL ON DURING CREW AWAKE PERIODS INCLUDING PROXIMITY OPERATIONS, PAYLOAD DEPLOYMENT, AND RENDEZVOUS MANEUVERS. THE PRIMARY RJD'S WILL BE POWERED OFF DURING CREW SLEEP PERIODS AND EVA OUTSIDE THE PAYLOAD BAY.
- B. IF VERNIER JET CAPABILITY IS LOST, CREW SLEEP PERIODS WILL BE FLOWN PRCS, TAIL ONLY OPTION PRIMARY CONTROL WITH ALL RJD'S POWERED ON.
- C. IF A FAILURE IS DETECTED IN THE RJD LOGIC POWER CIRCUIT VIA MCC TELEMETRY, THE AFFECTED RJD POWER WILL REMAIN POWERED ON FOR CREW SLEEP PERIODS.

RJD system testing has resulted in a failure rate of one failure every 10 billion hours. With the possibility of failure so low, the RJD configuration will be all on during crew awake periods. If a failure were to occur, crew accessibility would allow prompt corrective action. During sleep periods, the RJD's will be powered off because of the crew response time to failures while sleeping in the middeck. For extravehicular activities (EVA's) outside the payload bay, plume impingement activities are the concern.

Failure of the RJD logic power circuit as detected by RJD logic switch telemetry has no immediate effect on the operation of the affected jets. However, if RJD power is removed per the normal presleep procedure, the jets will be permanently lost. In this instance, the risk of a failure causing an RCS jet to fail on is considered more acceptable than a definite loss of two manifolds of RCS jets. It is considered prudent to sleep in tail-only PRCS control.

Rule {A15-22}, RCS/APU THRUSTER PLUME AVOIDANCE, references this rule.

A6-152 RCS ENTRY HOTFIRE CHECK

ALL ENTRY-CRITICAL JETS (OTHER THAN FIRST PRIORITY ON-ORBIT JETS) WILL BE HOT-FIRED ONCE DURING THE MISSION.

The hot-fire test is performed to verify that all primary jets needed for deorbit or entry are operating properly. The number one priority orbit DAP jets are fired during normal orbit ops and will not need to be fired again during the hot-fire test.

A special hot-fire test will be required for the first flight of a new vehicle to test all jets including the forward up-firing jets since these jets are not normally fired and need to be tested.

FLIGHT RULES

A6-153

RCS JET MAXIMUM BURN TIME

- A. THE OPERATIONAL LIMIT FOR CONTINUOUSLY FIRING PRCS JETS IS 150 SECONDS. THE CONTINUOUS FIRING LIMIT FOR VERNIER RCS JETS IS 500 SECONDS. THE VERNIER JETS ALSO HAVE A SEPARATE CONSTRAINT OF NO MORE THAN 1000 "ON" COMMANDS PER THRUSTER IN A 1-HOUR PERIOD. @[072398-6690] @[110900-7249] @[012303-5887A]

The limiting component of the primary thrusters is the titanium canister because it is heat-load sensitive. Exceeding temperature limits could damage adjacent components. On-orbit, the limiting component for the vernier thrusters is the Teflon valve seat that can be deformed by valve actuation when above 200 degrees F; during entry, the limiting VRCS component is the aluminum structure since it too is heat-load sensitive. The 1000 "ON" commands limitation is driven by the PC transducer which could fail due to overheating leading to a false failoff. The 150-second firing limit is driven by a qualification limit and not by any data that shows damage occurs at these durations. (Ref. SODB, volume I, paragraph 3.4.3.2). Additional analysis data shows that the PRCS thrusters could be fired for 250 seconds without violating thermal limits even with entry heating immediately following the firing. WSTF testing, in support of ISS reboost, was used to validate a Boeing Thermal Math Model (TMM) of the VRCS thrusters. A TMM Analysis and WSTF test firings have both demonstrated that 500-second VRCS firings do not violate any vernier jet thermal constraints (ref. SODB, volume I, paragraph 3.4.3.2). There is no minimum cooldown period required between 500-second VRCS firings. For on-orbit conditions where an extended cooldown period is available, consideration may be given to raising the limits to 400/710 seconds for primary and vernier jets respectively, with associated cooldowns of 2100/1400 seconds (35 minutes/23 minutes 20 seconds) prior to entry interface. (Ref. SODB, Volume III, Paragraph 4.3.2.9. (Caution: SODB, Volume III contains engineering estimates for non-nominal performance evaluation. Data may not be supported by test.)) @[110900-7249] @[012303-5887A]

- B. A SINGLE MISSION CONTINGENCY FIRING OF 800 SECONDS FOR ARCS (+X) THRUSTERS AND 300 SECONDS FOR FRCS (-X) THRUSTERS IS PERMISSIBLE.

The 800/300-second constraints represent the maximum +X/-X burn time that can be used in a contingency without resulting in structural damage due to overheating. (Ref. SODB, Volume I, Paragraph 3.4.3.2). Additional thermal analysis shows that a 1050-second (17 minutes 30 seconds) ARCS and 400-second FRCS thruster firing may be permissible. For these durations, the limiting component for the ARCS thrusters is the Kapton wire insulation. If the temperature limit is exceeded, it could jeopardize the capability to refire the jet if a 3500-second (58 minute 20 second) cooldown period is not allowed. The limiting component for the FRCS thrusters is the Inconel thermal barrier spring. If the limit is exceeded, the elasticity of the spring will be degraded and its life span shortened. (Ref. SODB, Volume III, Paragraph 4.3.3.2.9. (Caution: SODB, Volume III contains engineering estimates for non-nominal performance evaluation. Data may not be supported by test.)) @[072398-6690]

FLIGHT RULES

A6-154**RCS VERNIER OPERATION TERMINATION**

RCS VERNIER THRUSTER OPERATION SHALL BE TERMINATED AND SYSTEM OPERATION PERFORMED ON PRIMARY THRUSTERS WHENEVER:

- A. THE RCS FUEL TANK PRESSURE IS 20 (20)* PSID GREATER THAN THE OXIDIZER TANK PRESSURE. VERNIER OPERATION MAY BE RESUMED WHEN FUEL/OXIDIZER TANK PRESSURE DELTA < 20 (20) PSID.

NOTE: *ZERO INSTRUMENTATION ERROR IS USED SINCE SECONDARY REGULATOR OPERATION PLUS INSTRUMENTATION INACCURACY COULD EXCEED CONSTRAINTS.

Vernier thruster test data have demonstrated that low oxidizer/fuel mixture ratio (less than 1.6) shifts the main combustion from the center to near the wall of the chamber which results in high combustion chamber temperatures. Tests conducted at an oxidizer/fuel mixture ratio of 1.3 resulted in severe damage to the vernier thruster chamber protective coating. The test duration was equivalent to approximately one mission day. Continued operation at this mixture ratio would have resulted in chamber burnthrough. By limiting the differential of the oxidizer and fuel propellant tank pressures to 20 psid, the mixture ratio for the vernier thruster will not be less than 1.5. Tests were conducted at a mixture ratio of 1.5 for an equivalent of approximately 3 mission days with no detectable coating damage. Also, 20 psid allows vernier operation when the He system is operating on the secondary regulator (including system tolerances 2-sigma).

- B. THE HIGH-LOAD FLASH EVAPORATOR IS OPERATING FOR MORE THAN 20 MINUTES.

On STS-2, overtemperatures in the VRCS thrusters occurred during lengthy operation of the flash evaporator. The propulsive vent holds the DAP to one side of the deadband. The DAP continues to cycle the same jets at such a frequency that the thrusters do not have an opportunity to cool down. The best way to protect the vernier thrusters from overheating is to configure the DAP to the PRCS when the high load evaporator will be run for more than 20 or 30 minutes. Reference STS-3 Orbit Flight Techniques meeting number 14, March 30, 1982.

- C. THE VRCS DAP MODE IS LOST.

Reference Rule {A8-60}, LOSS OF VERNIER RCS DAP MODE, to determine the status of the VRCS DAP mode following the loss of the six VRCS jets.

FLIGHT RULES

A6-155

SUSPECT RCS JET REPRIORITIZATION CRITERIA

- A. A SUSPECT PRIMARY JET WILL BE CHANGED TO LAST PRIORITY FOR THE FOLLOWING CONDITIONS:
1. CONFIRMATION OF OFF-NOMINAL OPERATING CONDITIONS (LOW PC, THRUST) .
 2. SUSPECT INSTRUMENTATION (OXIDIZER/FUEL INJECTOR TEMPERATURE DELTA > 25 DEG LOW, BIASED PC WITH DELTA > 25 PSIA FROM NOMINAL) .
- B. A VERNIER JET WITH SUSPECT INSTRUMENTATION (LOW PC) MAY BE DESELECTED DURING CREW SLEEP PERIODS TO AVOID NUISANCE ALARMS .

Low Pc confirmed with low rates (indicating low-thrust) identifies a real jet problem. Further use of the affected jet could create hot spots along the thruster wall damaging the jet.

Injector temperatures and Pc are used for determining jet leaks and jet fail-offs. Biased instrumentation could mask a real problem and, if the jet is fired, create a large jet leak or unstable combustion.

A jet placed in last priority will not be called on to fire unless the DAP determines it to be necessary due to additional jet failures in the associated direction. If the crew deselects the jet, it becomes one additional action required by the crew if the jet is later required. For entry, a yaw jet will be deselected because the DAP will command all available yaw jets to fire during roll reversals.

With either case, it is prudent to discontinue use of the jet when other jets are available. The affected jet will be placed in last priority so that if it is needed for achieving mission objectives, it can be used.

Vernier jets with suspect instrumentation may be deselected for sleep to avoid possible fail-off nuisance alarms. The affected jet must be hot fired to determine whether it is a real problem or instrumentation problem. For real problems, the jet will only be used for mission success. For instrumentation problems the jet will be used except for sleep.

FLIGHT RULES

A6-156

RCS RM LOSS MANAGEMENT [HC] ©[022405-6622B]

RCS RM LOSS	VERNIER JETS	PRIMARY JETS	
	ORBIT DAP	ORBIT/TRANS DAP	AEROJET/GRTLS DAP
FAIL OFF DETECTION	RESELECT IF AUTO DESELECTED CONTINUE TO USE WITHOUT "FAIL OFF" DETECTION	CHANGE AFFECTED JET TO LAST PRIORITY RESELECT IF AUTO DESELECTED AT SEAT INGRESS: IF YAW JET DESELECT	CHANGE AFFECTED JET TO LAST PRIORITY IF YAW JET DESELECT [2] OTHERWISE RESELECT
FAIL LEAK DETECTION	IF L5L AND/OR R5R DESELECT AFFECTED JET CONTINUE TO USE VRCS IF DOWNFIRING VRCS JET, SELECT PRCS, CLOSE AFFECTED VRCS MANIFOLD	CHANGE AFFECTED JET TO LAST PRIORITY RESELECT IF AUTO DESELECTED AT SEAT INGRESS: IF YAW JET DESELECT	CHANGE AFFECTED JET TO LAST PRIORITY IF YAW JET DESELECT [2] OTHERWISE RESELECT
FAIL ON DETECTION	CONTINUE TO USE DURING CREW AWAKE PERIODS SELECT PRCS TAIL ONLY FOR CREW SLEEP AND VERNIER RJD-OFF	CHANGE AFFECTED JET TO LAST PRIORITY SET MANIFOLD STATUS TO "CLOSED" IF FAIL-SAFE REDUNDANCY EXISTS AFFECTED RJD-OFF [1] AT SEAT INGRESS: AFFECTED RJD-ON SET MANIFOLD STATUS TO "OPEN" IF YAW JET DESELECT	CHANGE AFFECTED JET TO LAST PRIORITY IF YAW JET DESELECT [2]
TOTAL RM (MDM INPUT OR BCE BYPASS)	SELECT PRIMARY JETS CLOSE AFFECTED VRCS MANIFOLDS VERNIER RJD-OFF	CHANGE AFFECTED JET TO LAST PRIORITY LEAVE MANIFOLD STATUS "CLOSED" IF FAIL-SAFE REDUNDANCY EXISTS AFFECTED RJD-OFF [1] FOR OMS-1,2 OR DEORBIT SET MANIFOLD STATUS TO "OPEN" AND AFFECTED RJD-ON TO REGAIN ANY AFFECTED ± JETS AT SEAT INGRESS: AFFECTED RJD-ON	CHANGE AFFECTED JET TO LAST PRIORITY LEAVE MANIFOLD STATUS "CLOSED" IF FAIL-SAFE REDUNDANCY EXISTS

NOTES:

- [1] JETS MAY BE MADE AVAILABLE FOR HIGH PRIORITY ACTIVITIES REQUIRING MULTIPLE JETS AND/OR REDUNDANCY.
- [2] JETS MAY BE RESELECTED TO MAINTAIN FAIL-SAFE REDUNDANCY.

THIS RULE CONTINUED ON NEXT PAGE

FLIGHT RULES

A6-156

RCS RM LOSS MANAGEMENT [HC] (CONTINUED)

A. VERNIER JETS

I. ORBIT DAP:

a. FAIL OFF

The vernier jets will continue to be used after the loss of fail-off protection. In the event of an undetected fail off of a vernier jet, drifting attitude control problems may result, but there are no system problems associated with additional firing on a vernier fail-off jet.

b. FAIL LEAK

WSTF testing has demonstrated that propellant leakage into the chamber may freeze and block the small vernier chamber. If the failure went undetected and the jet were allowed to fire, the blockage could cause severe damage. Therefore, for loss of failed leak protection, the jet will be deselected. If the remaining vernier jets have good RM and are adequate to maintain attitude control, vernier control may be selected; otherwise, primary jets must be selected.

c. FAIL ON

During active attitude hold, a vernier jet failed on would force the orbiter outside the DAP deadbands. Opposing jets would then fire to correct the attitude until the failed-on jet was stopped (i.e., manifold closure or RJD driver poweroff) or the propellant was depleted. Normally, the RCS RM would annunciate the failure but with loss of RM there would be no alarm. During crew awake periods, numerous jet firings would alert the crew to take corrective action before significant propellant loss occurs. However, during crew sleep, the failure could go undetected for several hours depleting the RCS tanks. Therefore, during crew sleep the vernier jets would not be used for loss of fail-on RM. Primary jets will be selected in the tail-only control mode to eliminate cabin noise associated with the firing of the FRCS thrusters.

During OPS 2 and 8, a detected fail on thruster will cause the associated RCS manifold isolation valve to be commanded closed. Auto manifold close is dependent on good GPC command paths to the RCS manifold isolation valves and valve functionality. For loss of GPC command capability or valve close capability, nominal operations will continue unaffected due to the low probability of a vernier thruster failing on. A fail on thruster will require the crew to manually close the affected RCS manifold isolation valve or RCS tank isolation valves. ©[022405-6622B]

THIS RULE CONTINUED ON NEXT PAGE

FLIGHT RULES

A6-156

RCS RM LOSS MANAGEMENT [HC] (CONTINUED)*d. TOTAL RM*

An MDM comm fault or BCE bypass would cause loss of total RM on a pair of vernier jets (e.g., L5L and L5D). This would be at least equivalent to the worst case of loss of fail leak RM and therefore cause the loss of verniers and selection of primary jets.

B. PRIMARY JETS

For any loss of RM protection during any DAP phase the affected jet will be changed to the lowest priority. The lowest priority jet will not fire during normal orbit/trans DAP operations. Jet availability (reselect/deselect) will be managed to minimize the use of the jet. For orbit/trans DAP, the affected jet (all axes) will remain available (reselected) to provide system redundancy should multiple failures (additional jet loss) occur. This allows the jet to be available without requiring crew actions during a time-critical phase.

For Aerojet/GRTLS DAP, only an affected yaw jet will be deselected. This prevents the affected yaw jet from being fired during roll reversals. The DAP commands all available yaw jets to provide attitude control. All other jet axes will remain available to provide system redundancy, since these jets will not fire while in lowest priority during normal operations of the Aerojet/GRTLS DAP.

RCS manifolds will not be closed due to the loss of RM protection on primary jets. Complications that may result from manifold closure are more probable than the failures due to loss of RM, such as manifold pressure decay resulting in jet leaks or possible staged repress procedures.

Firing jets with loss of fail leak or fail off detection may result in zots, valve damage, or contamination. This minimal risk is accepted to provide vehicle control capability should multiple failures occur.

References: Hazard Reports ORBI-055, "Inadvertent Firing of a Forward/Aft Reaction Control Subsystem Jet Results in Death or Injury to Ground Personnel and/or Loss of Orbiter Crew and Vehicle" and ORBI-056, "RCS Thruster Valve Leakage Leads to Explosion in Thruster" and Rules {A6-60}, RCS MANIFOLD CLOSURE CRITERIA, and {A6-160}, RCS AUTO MANIFOLD CLOSE. ©[022405-6622B]

1. ORBIT/TRANS DAP:

The orbit and trans DAP require one jet/direction/pod to maintain attitude control. Fail-safe redundancy (two jets/direction/pod) is required for time and safety critical events (RNDZ, deploy).

Action for loss of fail off, leak, on, or total RM will usually be delayed until after ET SEP or OMS-1 in order to minimize crew activity during the ascent phase.

THIS RULE CONTINUED ON NEXT PAGE

FLIGHT RULES

A6-156

RCS RM LOSS MANAGEMENT [HC] (CONTINUED)a. *FAIL OFF/LEAK*

The affected jet will remain available and be put into last priority. The orbit and trans DAP will only fire one jet/direction/pod for rotational control. For translation the DAP may fire more than one jet/direction/pod. Multiple failures may require the use of the affected jet to maintain fail safe redundancy for time/safety critical events. The jet will be available without further crew action.

b. *FAIL ON*

The affected manifold status will be set to "closed" and the RJD powered off. This will eliminate any chance of an undetected fail-on jet.

For high priority events which require the affected jet, such as -X jets for low-Z translations, the affected jet can be reselected and RJD power turned on. The risk of a jet fail-on is considered acceptable to achieve mission success activities.

While in the trans DAP for entry, manifold status actions may be performed to prepare for Aerojet DAP and deorbit burn.

During OPS 2 and 8, a detected fail on thruster will cause the associated RCS manifold isolation valve to be commanded closed. Auto manifold close is dependent on good GPC command paths to the RCS manifold isolation valves and valve functionality. For loss of GPC command capability or valve close capability, nominal operations will continue due to the low probability of a primary thruster failing on. A fail on thruster will require the crew to manually close the affected RCS manifold isolation valve or RCS tank isolation valve(s). ©[022405-6622B]

c. *TOTAL RM*

The affected manifold status will be left "closed" and the RJD powered off. This will eliminate any possible chance of an undetected fail-on jet.

With an MDM comm fault or BCE bypass, the manifold status will be set to "closed" automatically. For OMS-1, -2 or deorbit any affected manifold with $\pm X$ jets will be set to "open" and associated RJD powered on. The risk of an undetected jet failure will be accepted to ensure RCS X jets are available for OMS-1, -2 or deorbit.

While in the trans DAP for entry, RJD actions may be performed to prepare for aerojet DAP and deorbit burn.

THIS RULE CONTINUED ON NEXT PAGE

FLIGHT RULES

A6-156

RCS RM LOSS MANAGEMENT [HC] (CONTINUED)2. *AEROJET/GRTLS DAP:*

Entry requires three yaw jets/pod and two pitch jets/direction/pod for the aft RCS to maintain fail-safe redundancy.

a. *FAIL OFF/LEAK/ON*

The Aerojet/GRTLS DAP will fire four yaw jets if available during roll reversals. Therefore a yaw jet with loss of fail off, leak or on detection will be deselected and placed in last priority. For subsequent/multiple failures the jet may be reselected per the reselection priority table (Rule {A6-159}, FAILED PRCS JET RESELECTION PRIORITY).

The possibility of firing three pitch jets in the Aerojet/GRTLS DAP exists; however, the probability of firing the last priority jet is small enough that it is an accepted risk not to deselect a pitch jet that has lost RM detection. Therefore, the pitch jet will be placed in last priority and reselected if it was autodeselected.

The affected jet may remain available if it is not a yaw jet. Multiple failures may require the use of the jet to maintain fail-safe redundancy. The jet will be available without further crew actions.

b. *TOTAL RM*

The affected manifold status will be set to "closed" and the RJD powered off. These actions provide a conservative approach to compensate for the loss of all three detection methods. Jets may be reselected, if necessary, depending on the cause of the failure and based on the criteria in Rule {A6-159}, FAILED PRCS JET RESELECTION PRIORITY.

FLIGHT RULES

A6-157

RCS JET FAILED OFF HOTFIRE TEST

FOR RM FAIL-OFF, VERNIER THRUSTERS WILL BE TESTED AFTER THE FIRST FAILURE. PRIMARY THRUSTERS, FOR UNKNOWN FAILURES, WILL BE TESTED IN ORDER TO MAINTAIN FAIL-SAFE REDUNDANCY.

Vernier thrusters will be hot fired for failures where the cause is unknown in an attempt to regain vernier control. Vernier jets are required for propellant conservation such that mission objectives can be completed and mission success achieved. Primary jets will not be hot fired after the first failure because of redundant jet availability and to avoid any unnecessary risks associated with the hot fire. If multiple failures make troubleshooting desirable because of loss of fail-safe redundancy, the primary jets may be hot fired, depending on the suspected failure. For example, if it is suspected that hot firing might result in loss of the entire manifold of jets, the test will not be performed. For suspected instrumentation failures, the jet may be hot fired after the first failure. The risk is low if the data indicate an instrumentation problem, plus accomplishing the hot fire may reduce vehicle turnaround time postlanding.

For real fail leak jets, the affected jet will not be hot fired because of possible ice in the chamber and injector plate. Reference Rule {A6-158}, RCS LEAKING JET MANAGEMENT.

FLIGHT RULES

A6-158

RCS LEAKING JET MANAGEMENT

A. PRIMARY JETS:

1. A LEAKING JET WILL NOT BE DESELECTED UNLESS THE INJECTOR TEMPERATURE VIOLATES THE RCS RM LIMIT OR PROPELLANT LEAKAGE IMPACTS CONTAMINATION SENSITIVE ORBIT ACTIVITIES.
2. FOR A LEAKING JET THAT HAS BEEN DESELECTED BY RCS RM, THE JET CAN BE RESELECTED AND USED ON A NONINTERFERENCE BASIS (NO IMPACT TO MISSION EVENTS) ONCE THE OXIDIZER AND FUEL INJECTOR TEMPERATURES WARM UP > 65 DEG F.
3. A LEAKING JET THAT HAS BEEN ANNUNCIATED "FAIL LEAK" ON TWO SEPARATE OCCASIONS WILL BE CHANGED TO THE LOWEST JET PRIORITY AND REMAIN DESELECTED UNLESS REQUIRED TO MAINTAIN ATTITUDE CONTROL. DURING ENTRY IF BOTH OF THE INJECTOR TEMPERATURES > 65 DEG F, THE JET WILL BE RESELECTED AS REQUIRED TO MAINTAIN FAIL-SAFE REDUNDANCY.

In three different leak cases (FIL on STS-4, R4U and L2D on STS-6), the leak always started coincident with the jet being fired. A sharp decay in the injector temperature occurs until thermal equilibrium is obtained or until the leak has stopped. Subsequent firing of the affected jet after the leak has stopped and warmed up to normal temperatures does not necessarily restart the leak as evidenced with FIL and R4U. These two cases showed no further leakage even after repeated jet use. Data have indicated that the leak will eventually stop and the temperatures warm up without firing the jet, i.e., applying pressure to jet injector valve may result in leak stoppage due to valve seat design and compression of valve into Teflon seat. The leaks that we have seen to date have been very small, on the order of 0.1 to 0.3 lb/hr or less than 100 cc/hr propellant leakage. It is felt that these sizes of leaks do not represent any impact to mission operations. However, the system will be configured to minimize any jet leakage that may occur by taking advantage of redundant jets and preclude further firing of the affected jet. Firing a leaking primary jet (RCS RM declared failed leak) presents no hardware concerns if the injector temperatures > 65 deg F. WSTF tests showed that with the injector temperatures < 65 deg F (ref. SODB, volume I, paragraph 3.4.3.2-12a), ZOT's could occur that may increase the jet leak and require a manifold be closed. However, if the primary jet is required for control during entry, the risk of further damage to the jet is low compared to the crew risk if not reselected.

THIS RULE CONTINUED ON NEXT PAGE

FLIGHT RULES

A6-158

RCS LEAKING JET MANAGEMENT (CONTINUED)

B. VERNIER JETS:

LEAKING VERNIER JETS WILL CONTINUE TO BE USED UNLESS DESELECTED BY RCS RM. SUBSEQUENT RESELECTION AND USE IS ONLY ALLOWED IF THE INJECTOR TEMPERATURES HAVE BEEN GREATER THAN THE RM LIMIT FOR 3 HOURS VERIFYING THAT NO ICE REMAINS IN THE INJECTOR. ©[091098-6708]

A vernier jet known to be leaking will be used until the injector temperatures violate the RCS RM leak limit and is automatically deselected. Until this limit is violated, there are no risks associated with firing the jet. Conversely, after the RM limit has been violated, the leak freezes and plugs the small chamber quickly. Subsequent jet firings may result in possible uncontained damage.

Reference SODB Volume 1, Paragraphs 3.4.3.2.12.b and 3.4.3.2.13.b.

Rules {A6-9B}, RCS JET HEATER; {A6-157}, RCS JET FAILED OFF HOTFIRE TEST; and {A6-159}, FAILED PRCS JET RESELECTION PRIORITY, reference this rule. ©[091098-6708]

FLIGHT RULES

A6-159

FAILED PRCS JET RESELECTION PRIORITY

FOR MULTIPLE PRIMARY JET/RM FAILURES RESULTING IN JET DESELECTION AND PRIORITY CHANGES, JET WILL BE RESELECTED, AS REQUIRED, TO PROVIDE ATTITUDE CONTROL OR FAIL-SAFE REDUNDANCY IN THE FOLLOWING ORDER (HIGHEST RESELECT FIRST) :

- A. JET WHICH HAS BEEN ANNUNCIATED FAIL LEAK, AND BOTH INJECTOR TEMPERATURES > 65 DEG F.
- B. JET WITH DEGRADED INSTRUMENTATION.
- C. JET WITHOUT FAIL-ON RM.
- D. JET WITH DEGRADED OR LOSS OF FAIL-OFF RM.
- E. JET WITH DEGRADED OR LOSS OF FAIL LEAK RM.
- F. JET WITH LOSS OF TOTAL RM.
- G. JET WHICH HAS BEEN ANNUNCIATED FAIL LEAK TWICE AND BOTH INJECTOR TEMPERATURES > 65 DEG F.
- H. JET WHICH HAS BEEN ANNUNCIATED FAIL-OFF.
- I. JET WHICH HAS BEEN ANNUNCIATED FAIL LEAK AND INJECTOR TEMPERATURES < 65 DEG F (POSSIBLY STILL LEAKING).

The redundancy in primary jets allows a single jet failure to be deselected with little or no impact to the vehicle capability. If no capability is lost, it would be desirable to deselect the jet since subsequent failures may go undetected. For the second jet failure, fail-safe redundancy can be lost since two pitch jets and three yaw jets are required and only three pitch and four yaw jets are available. To maintain fail-safe redundancy, it may be worth the risk to reselect the jet and be exposed to a subsequent failure going undetected. After all, the jet with failed instrumentation or the jet that has stopped leaking are healthy and if used will be exposed to the same failures as a jet with no problem.

The priority for choosing which jet to reselect is provided in this rule starting with a jet with good RM and only slightly degraded instrumentation. Jets with no fail on RM will be reselected next since the chances of a failed-on jet are minimal compared to fail-off jets. Loss of leak RM would create more of a problem since a leaking jet undetected could cause the leak to increase. Loss of total RM (ON, OFF, LEAK) increases the chances of a failed jet being undetected.

THIS RULE CONTINUED ON NEXT PAGE

FLIGHT RULES

A6-159**FAILED PRCS JET RESELECTION PRIORITY (CONTINUED)**

Jets which have leaked once, but stopped as indicated by injector temperatures > 65 deg F, may be reselected and used on a noninterference basis (reference SODB, volume I, paragraph 3.4.3.2-12a). (See Rule {A6-158}, RCS LEAKING JET MANAGEMENT.) Jets which have leaked twice, but stopped as indicated by injector temperatures > 65 deg F, may be reselected according to the priority listing above. For a jet that has failed leak, experience has shown that there are no means for determining whether the jet will leak again and be declared fail leak by RM. These jets will be selected before a jet that has failed off since these jets are known to be healthy. Since the failed-off jet status has not changed, the failed-off jet will most likely fail off. ®[042904-6239A]

Jets that have been annunciated fail off will have RM toggled so that it may be declared fail off again, if the failure is still present. Reselecting the jet would not be a safety hazard.

Jets which have been annunciated fail leak and may be still leaking will not be reselected except to maintain attitude control since firing a leaking jet may cause injector seal leakage to increase.

Rules {A6-156}, RCS RM LOSS MANAGEMENT, and {A8-55}, ASCENT/ENTRY RCS CONTROL REQUIREMENTS [HC], reference this rule. ®[042904-6239A]

Reference Ascent/Entry Flight Techniques Panel #196, December 17, 2003. ®[042904-6239A]

FLIGHT RULES

A6-160

RCS AUTO MANIFOLD CLOSE [HC]

- A. RCS AUTO MANIFOLD CLOSE CAPABILITY IS AVAILABLE IN OPS 2 AND 8 AND WILL BE ENABLED TO MITIGATE THE EFFECTS OF A FAILED ON THRUSTER. @[022405-6620B]
- B. RCS AUTO MANIFOLD CLOSE MAY BE DISABLED FOR FALSE FAIL ON INDICATIONS THAT ARE INTERMITTENT, EITHER BY PLACING THE MANIFOLD ISOLATION VALVE SWITCH IN THE OPEN POSITION OR VIA ITEM ENTRY.
- C. IF AUTO MANIFOLD CLOSE CAPABILITY IS LOST, RCS MANIFOLD ISOLATION VALVES WILL NOT BE CLOSED PREEMPTIVELY TO PROVIDE PROTECTION FOR A FAILED ON THRUSTER.

LOSS OF RCS AUTO MANIFOLD CLOSE IS DEFINED AS THE INABILITY FOR RCS RM TO SUCCESSFULLY CLOSE RCS MANIFOLD ISOLATION VALVES IN RESPONSE TO A DETECTED FAILED ON THRUSTER. THIS CAPABILITY MAY BE LOST DUE TO LOSS OF MANIFOLD VALVE FUNCTIONALITY, LOSS OF VALVE COMMAND CAPABILITY, OR LOSS OF RCS FAIL ON RM.

The auto manifold close software was added to RCS RM in OI-30 in order to mitigate the potential catastrophic effects of a failed on thruster while docked to ISS and to mitigate the effects of a failed on thruster during shuttle-only operations. Once a thruster is detected to be failed on by RCS RM in Ops 2 and 8, the associated manifold isolation valves will be commanded closed in less than 1.5 seconds, which will reduce the impact of the failed-on thruster. The DAP will also mode to free drift in order to prevent subsequent attitude control during RMS operations, ISS mated operations, or any other operation when the control accel is non-zero. @[022405-6620B]

THIS RULE CONTINUED ON NEXT PAGE

FLIGHT RULES

A6-160**RCS AUTO MANIFOLD CLOSE [HC] (CONTINUED)**

If the capability to close the manifold isolation valve associated with a failed on thruster is lost, the failed on thruster firing can no longer be limited to less than 1.5 seconds. This capability may be lost due to loss of manifold valve functionality, loss of valve command capability, or loss of RCS fail ON RM.
©[022405-6620B]

For either loss of valve commanding or Fail ON RM, the only preventative action would be to manually close the associated RCS manifold isolation valve and place the RCS manifold in hydraulic lockup. In this condition, the manifold may require numerous manual represses by the crew to maintain acceptable manifold pressures which is not operationally feasible. Additionally, if electrical power was lost while the RCS manifold isolation valves were closed, the manifolds could not be reopened and multiple manifolds of thrusters could be lost. Additionally, if the pressure relief device in the manifold isolation valve fails closed, the RCS manifold may overpressurize and potentially rupture.

Due to the low probability of a failed on thruster, RCS manifold isolation valves will not be closed for the loss of Auto Manifold Close functionality as agreed to by the JPRCB on November 8, 2004.

For false fail on indications, the manifold can be reopened. If the indication is not intermittent, the switch should be placed in the GPC position to allow for auto manifold closure if another jet on that manifold were to fail on. If the indication is intermittent, the switch may be placed in the open position or the software inhibited via item entry to preclude repeated actions to recover the manifold of jets.

References: Hazard Report ORBI 055, "Inadvertent Firing of a Forward/Aft Reaction Control Subsystem Jet Results in Death or Injury to Ground Personnel and/or Loss of Orbiter Crew and Vehicle;" Rule {A6-60}, RCS MANIFOLD CLOSURE CRITERIA; and Rule {A6-156}, RCS RM LOSS MANAGEMENT. ©[022405-6620B]

A6-161 THROUGH A6-200 RULES ARE RESERVED

FLIGHT RULES

OMS/RCS LEAK MANAGEMENT

A6-201

OMS/RCS LEAKING HE TANK BURN

FOR A LEAKING OMS/RCS HELIUM TANK, A BURN MAY BE SCHEDULED TO INCREASE THE PROPELLANT ULLAGE VOLUME.

It is important to increase the ullage volume for He tank leaks so that the delta velocity (V) lost with a He tank failure is minimized. ©[042507-8466B]

If OMS propellant tank quantities are below 39 percent, the OMS tanks can be used in the blowdown mode (no He tank support) with little or no loss of capability. Ascent procedures for OMS He tank leaks have been developed to maximize blowdown capability by performing a pre-MECO dump or a post-MECO burn using the leaking OMS propellant system that has the helium leak. If post-OMS 2 quantities are above 39 percent when a leak occurs, a maximum blowdown burn should be performed. The on-orbit maximum blowdown procedures for use on orbit are documented in the Orbit Pocket, "Leaking OMS PRPLT/He Burn."

For an Aft RCS He tank leak, perform a burn to a quantity of 34 percent rather than to maximum blowdown since maximum blowdown would result in a Next PLS requirement for violation of the Single Pod Quantity Redline (ref. Rules {A6-52H}, RCS FAILURE MANAGEMENT, and {A6-305D}, AFT RCS REDLINES). For a Forward RCS He tank leak, perform a burn to maximum blowdown (27 percent OX and 26 percent FU). On-orbit procedures for burning to either 34 percent for the ARCS or maximum blowdown for the FRCS are documented in the MALF PROC RCS SSR-5, "Leaking RCS PRPLT/He Burn."

Next PLS may be required if propellant margins dictate.

Reference Hazard Reports ORBI-129, Loss of Capability to Safely Separate Orbiter from External Tank (ET) Caused by Loss of Pressurized Propellant Supply to the FRCS and/or ARCS Thrusters, and ORBI 111, Structural/TPS Damage from Overpressurization Due to Rupture/Leakage of OMS/RCS He and/or GN2 Pressurization Systems.

Rule {A6-51B}, OMS FAILURE MANAGEMENT [CIL] [HC], references this rule. ©[042507-8466B]

A6-202

OMS LEAKING HE SYSTEM BURN

DURING OMS BURNS, A LEAKING HELIUM SYSTEM MAY BE USED TO FEED BOTH ENGINES TO INCREASE PROPELLANT ULLAGE VOLUME.

As long as the helium tank pressure supports a nominal propellant tank pressure, a leaking helium tank can be used to feed both OMS engines. This configuration attempts to maximize the blowdown delta V capability in the affected OMS system prior to the helium tank being declared failed. No risk of damage to the OMS engines exists because a good propellant feed source is always used. Starting two OMS engines from one pod is acceptable.

FLIGHT RULES

A6-203**OMS LEAKING INLET LINE PERIGEE ADJUST BURN**

FOR AN OMS INLET LINE LEAK WHICH HAS BEEN ISOLATED ON ORBIT, A PERIGEE ADJUST OR OUT-OF-PLANE BURN WILL BE PERFORMED AS SOON AS PRACTICAL TO ASSURE TIME FOR POSTBURN PROPELLANT SUBLIMATION. MISSION-CRITICAL EVENTS MAY BE COMPLETED PRIOR TO THE PERIGEE ADJUST BURN ONLY IF THE EVENT CANNOT BE COMPLETED AFTER THE PERIGEE ADJUST BURN AND IF THE EVENT DOES NOT RESULT IN A NET LOSS OF DELTA V CAPABILITY.

OMS inlet line leaks which have been isolated must be repressurized prior to performing a burn. The repressurization will create a surge which could cause the leak to increase, and as a result, it is unknown how much delta V may be available from the leaking system. Therefore, the remaining RCS and good OMS propellant must be conserved until after the burn. Also, the earlier the burn, the more time for propellant sublimation

Rule {A6-51T}, OMS FAILURE MANAGEMENT [CIL], references this rule.

A6-204**OMS GN₂ ACCUMULATOR LEAK DETERMINATION**

A LEAKING OMS GN₂ ACCUMULATOR MAY BE REPRESSURIZED TO DETERMINE THE LEAK RATE.

Since the leak rate is so critical in determining health of the OMS engine, the accumulator may be repressurized to determine the leak rate. If a leak occurs through the purge valves, each time the purge valves are used this leak rate may increase. Since the affected OMS engine may be used for OMS-1 and a purge will occur at OMS-1 cutoff, the leak rate should be checked before the deorbit burn to ensure the rate has not increased to beyond acceptable limits.

(Reference Rule {A6-51M}, OMS FAILURE MANAGEMENT [CIL]), ©[ED]

FLIGHT RULES

A6-205

RCS LEAKING PROPELLANT TANK BURN

FOR RCS PROPELLANT TANK LEAKS, A PERIGEE ADJUST OR OUT-OF-PLANE MANEUVER WILL BE EXECUTED IMMEDIATELY. PROPELLANT MAY BE DUMPED TO DEPLETION.

Thermal effects of a propellant leak and propellant sublimation rates vary as a function of which propellant is leaking, the location of the leak, the distribution of the propellant within the pod, and the thermal environment. As a result, to preclude propellant feedlines from freezing thus rendering the entire pod unusable, the propellant will be dumped immediately. If the tank is dumped to depletion, MALF RCS SSR-7 will be used to clear the helium from the propellant lines. (OMS tank leaks are handled in a similar manner.) This leak philosophy was agreed upon at the July 13, 1987, Flight Rules PRCB.

A6-206

RCS MANIFOLD/LEG LEAK REPRESSURIZATION

RCS LINE LEAKS WILL NOT BE REPRESSURIZED IN MM 602, 304 (POST Q-BAR = 20), AND 305 TO RECOVER RCS YAW JETS IF NO YAW JET DAP MODE IS AVAILABLE. RCS LINE LEAKS WILL BE REPRESSURIZED TO RECOVER FAIL CRITICAL JET REQUIREMENTS FOR ET SEPARATION AND PRIOR TO Q-BAR = 20 AFTER ALL OTHER OPTIONS HAVE BEEN ATTEMPTED (E.G., RESTRING, PORTMODE, ETC.)

GNC Rules {A8-19}, YAW JET DOWNMODE, and {A8-55}, ASCENT/ENTRY RCS CONTROL REQUIREMENTS [HC], address entry yaw jet downmode for multiple failures. This rule prescribes No Yaw Jet selection if all four jets are failed on either side. No yaw jet DAP mode is a certified flight control mode, and without numerous failures further downmode will not be required. Leaking oxidizer (N_2O_4) or fuel (MMH) may create a greater flammability hazard due to the operation of the APU's. Fuel (MMH) has demonstrated a fire potential when leaked onto the internal thermal blankets. The vent doors must be opened for a nonisolated N_2O_4 leak during entry which will result in major vehicle damage and subsequent extended downtime for repairs. Additionally, leaking oxidizer (N_2O_4) will cause corrosion of internal components, potentially requiring replacement. Rules {A16-204}, WINDWARD APU OPERATION CONSTRAINT, (oxidizer) and {A16-11}, EXPEDITED POWERDOWN, (fuel) address the off nominal postlanding impacts for leaking propellants into the pods. Due to the nature of the propellants and the uncertainty of a successful repressurization, all other options should be pursued prior to attempting repressurization of a leaking line. If no other option exists, then the line will be repressed and the leak supported to a Q-bar = 20. At Q-bar = 20 no yaw jet DAP mode will be selected and the leaking RCS isolated. ©[021998-6485B] ©[042904-6239A]

Reference Ascent/Entry Flight Techniques Panel #196, December 17, 2003. ©[042904-6239A]

A6-207 THROUGH A6-250 RULES ARE RESERVED

FLIGHT RULES

THERMAL REDLINES AND MANAGEMENT

A6-251

GENERAL

- A. IF INSTRUMENTATION IS LOST FOR VERIFICATION OF HEATER OPERATION, THE REDUNDANT SET (A OR B) WILL NOT BE BROUGHT ONLINE WITH THE EXCEPTION OF THE OMS/RCS CROSSFEED HEATERS.

The loss of insight into the heater operations does not make the heater suspect. The heater in use has been proven functional and there is no reason to switch to the redundant heater set with unknown operation.

The pod heaters are designed differently than the crossfeed heaters. If both sets of pod heaters are powered on possible heater patch delamination could occur since the patches (A and B) are laid on top of each other. The crossfeed line heaters are wrapped around the line, with A and B circuits wrapped together in a single "rope" heater. Consequently, both heaters can be powered on simultaneously to protect for failed-off heaters without risking damage to heater elements. The crossfeed line heaters also have series redundant thermostats for overtemperature protection.

- B. THE HEATERS WILL BE CYCLED TO THE REDUNDANT SET (A OR B) AT LEAST ONCE DURING THE MISSION.

Ensures two functioning heater systems.

- C. RCS PRIMARY THRUSTERS HEATERS WILL BE OFF FOR ASCENT, UNLESS THE AMBIENT TEMPERATURE AT THE LAUNCH SITE IS < 50 DEG F. THE HEATERS WILL BE ENABLED FOR ALL OTHER FLIGHT PHASES OF THE MISSION. VERNIER THRUSTER HEATERS WILL BE ENABLED PRIOR TO LAUNCH AND TURNED OFF FOR ENTRY.

Primary jet heaters are powered off for ascent to provide additional power savings.

For cold launch conditions where the ambient temperature at the launch site is < 50 deg F (reference OMRSD, general requirements, 9.2.5), the primary heaters may be powered on during ascent to preclude launch commit criteria (LCC) violations (injector temperature ≤ 64 deg F) (reference LCC page 6.3-28). The LCC limits preclude jet valve seat shrinkage and subsequent jet leakage during ascent.

Primary heaters can only be turned on if the ascent electrical load for the particular mission is small enough to allow the additional power consumption. However, if power requirements do not permit, heaters should be left on until T-20 minutes.

THIS RULE CONTINUED ON NEXT PAGE

FLIGHT RULES

A6-251

GENERAL (CONTINUED)

Vernier jet heaters are on prelaunch through ascent to ensure proper operating temperature for on-orbit operations. They are turned off for entry since the jets are not used, and to prevent overtemping.

Jet heaters may be turned off in flight for contingency powerdowns.

- D. IN THE EVENT THAT ONE SET OF HEATERS IS NOT OPERATING IN ITS HEATER CONTROL RANGE AND THE THERMAL ENVIRONMENT CONDITIONS ARE NOT A FACTOR, THAT SET WILL BE TURNED OFF AND THE OTHER SET TURNED ON. IF THE APPROPRIATE TEMPERATURE INDICATES THAT THE HEATER IS THEN OPERATING WITHIN ITS HEATER CONTROL RANGE, THEN THE FIRST SET OF HEATERS WILL BE DECLARED FAILED.

After switching to another heater set which controls the thermal environment within normal limits, the first set of heaters is declared failed because no other factors were involved.

- E. ANY HEATER SET (A OR B) THAT IS FAILED ON WILL BE CONTROLLED BY MANUAL OPERATION AND STILL BE CONSIDERED OPERATIONAL IF THE OTHER SET FAILS.

Failed-on heaters are not considered failed because they can manually be controlled by cycling power on and off

Rule {A6-256}, OMS/RCS HEATER PERFORMANCE MONITORING, references this rule.

FLIGHT RULES

A6-252

OMS/RCS POD HEATER

LOSS OF REDUNDANT CRITICAL HEATER CIRCUITS IN THE OMS POD NECESSARY TO MAINTAIN CG CONTROL, PROPELLANT REDLINES, AND RCS ATTITUDE CONTROL FOR ENTRY IS CAUSE FOR ENTRY AT THE NEXT PLS IF THE ENVIRONMENT CANNOT MAINTAIN THERMAL REDLINES:

CRITICAL HEATER LOCATION	EQUIPMENT
A. KEEL WEB, INNER "Y" WEB	OMS/RCS TANKS, RCS HE LINES
B. RCS HOUSING HEATERS	RCS PROPELLANT LINES
C. (2 OF 3) - UPPER "Y" WEB, OUTBOARD "Y" WEB, GSE SERVICE PANEL	RCS MANIFOLD LINES
D. OME COVER	OME PROPELLANT FEEDLINES
E. OME COMPARTMENT	OME PROPELLANT FEEDLINES GN ₂ TANK AND ACCUMULATOR

All critical OMS/RCS heater circuits are redundant. For the loss of both A and B heaters, vehicle attitude may be used to maintain an acceptable thermal environment. The heater circuitry protects all equipment that contains propellant. The propellant temperatures must be maintained for each piece of equipment according to the Flight Rules. Violation of the thermal redlines will be cause for deorbit at the next PLS.

* Part C says "(2 of 3)" because all three heaters provide heating for the same vicinity.

A6-253

FORWARD RCS MODULE TEMPERATURE MANAGEMENT

WHEN NO SM MACHINE IS RUNNING, FRCS HEATERS WILL BE OFF. MANUAL CYCLING OF HEATER SWITCHES WILL BE MCC CALL.

The forward pod will stay within acceptable limits for a sufficient period of time without the heaters being powered on. The concern is that a failed-on heater will result in overtemping manifold lines without being annunciated by SM.

FLIGHT RULES

A6-254

OMS/RCS PODS TEMPERATURE MANAGEMENT

- A. ONE OF THE REDUNDANT SETS OF POD HEATERS WILL BE USED TO MAINTAIN ACCEPTABLE THERMAL CONDITIONS IN THE PODS. BOTH SETS OF HEATERS WILL NOT BE USED SIMULTANEOUSLY.

The OMS pod heaters are operated only one circuit at a time. The concern is that the heater patches will overtemperature and debond from the structure if both sets of heaters are operated concurrently. This would result in heater circuit failures in both circuits since both circuits are contained in each heater patch and the patches must be on the structure to work properly.

- B. DURING OPS 1, ALL POD HEATERS WILL BE TURNED OFF. MANUAL CYCLING OF HEATER SWITCHES WILL BE ON MCC CALL.

The OMS pods are warmed by hot GN₂ prelaunch. The heaters are off during ascent phase to reduce the power level in the event a power failure would occur during launch. Further, since the switches are not accessible during ascent, corrective action could not be taken for a heater failed on.

- C. ALL POD HEATERS WILL BE TURNED OFF AT CREW SEAT INGRESS FOR ENTRY AND WILL REMAIN OFF THROUGH ENTRY.

The OMS pods heaters are not required during entry due to aero heating. Also, the heaters are off during entry to reduce the power level in the event a power failure would occur during entry.

- D. WHEN THERE IS NO ONBOARD THERMAL VISIBILITY INTO THE PODS (NO SM AND NO BFS), ALL POD HEATERS WILL BE OFF. MANUAL CYCLING OF HEATER SWITCHES WILL BE ON MCC CALL.

An undetected fail-on heater may damage pod components. The ground will monitor the pod temperatures and cycle the heaters as required to maintain temperatures within limits.

FLIGHT RULES

A6-255

OMS/RCS CROSSFEED LINES TEMPERATURE MANAGEMENT

- A. DURING ASCENT, FROM LIFT-OFF UNTIL POST OMS-2, BOTH (A AND B) SETS OF HEATERS WILL BE ON.

The crossfeed line heaters are wrapped around the line, with A and B circuits wrapped together in a single "rope" heater. Consequently, both heaters can be powered on simultaneously to protect for failed-off heaters without risking damage to heater elements. The crossfeed line heaters also have series redundant thermostats for overtemp protection.

- B. DURING ON-ORBIT PERIODS, ONE OF THE REDUNDANT HEATERS (A OR B) WILL BE ON.

Heaters are required to maintain the crossfeed line thermal conditions within acceptable limits for interconnect and crossfeed operations.

- C. BOTH (A AND B) SETS OF HEATERS WILL BE TURNED ON AT CREW SEAT INGRESS FOR ENTRY AND WILL REMAIN ON THROUGH ENTRY.

The crossfeed line heaters are wrapped around the line, with A and B circuits wrapped together in a single "rope" heater. Consequently, both heaters can be powered on simultaneously to protect for failed-off heaters without risking damage to heater elements. The crossfeed line heaters also have series redundant thermostats for overtemp protection.

- D. WHEN THERE IS NO ONBOARD THERMAL VISIBILITY INTO THE CROSSFEED LINES (NO SM AND NO BFS), BOTH (A AND B) SETS OF HEATERS WILL BE TURNED ON.

The heater operation cannot be verified without instrumentation. Therefore both A and B heaters are turned on to provide fail-safe protection.

FLIGHT RULES

A6-256

OMS/RCS HEATER PERFORMANCE MONITORING

THE PARAMETERS MARKED IN THE TABLES WITH SINGLE ASTERISKS ARE LOCATED NEAR HEATER THERMOSTATS, AND ARE USED TO MONITOR HEATER OPERATION. THE NOMINAL TEMPERATURE RANGE FOR EACH HEATER IS VEHICLE/POD SPECIFIC. THE RANGE DEPENDS ON THE TESTED SET POINTS OF THE CONTROLLING THERMOSTATS, AS DOCUMENTED IN THE SPACE SHUTTLE SYSTEMS HANDBOOK DRAWINGS 11.7 THROUGH 11.9. THE TEMPERATURE INDICATED BY THE OI PARAMETER NEAR THE HEATER THERMOSTAT MAY VARY SLIGHTLY OUTSIDE THE SET POINT RANGE DUE TO THE DIFFERENCE IN LOCATION BETWEEN THE OI PARAMETER AND THE THERMOSTAT, AND DUE TO THE EFFECT OF VEHICLE ATTITUDE.

THE PARAMETERS USED TO MONITOR COMPONENT TEMPERATURES SHOULD NOMINALLY REMAIN WITHIN THE SYSTEM REDLINES:

FWD RCS HEATERS

HEATER/COMPONENT	OI PRIMARY PARAMETER	OI BACKUP PARAMETER	SYSTEM REDLINE (°F)	RESPONSE/NOTE
FU FWD RCS	V42T1306A*	V42T1308A	40- 150 **	
FU FILL LN	V42T1304A		-30-150	
FU TK T	V42T1300C		40-150 ***	
FU HE TK	V42T1104C		-160-125 -160-150	PROP QTY >85% PROP QTY ≤85%
OX FWD RCS	V42T1206A*	V42T1208A	40-150 **	
OX FILL LN	V42T1204A		20-150	
OX TK T	V42T1200C		40-150 ***	
OX HE TK	V42T1100C		-160-125 -160-150	PROP QTY >85% PROP QTY ≤85%

NOTE: A OR B HTRS ONLY, NOT BOTH.

- * CONTROL PARAMETER NEAREST THERMOSTAT. SPEC HTR THERMOSTAT RANGE 55 DEG-70 DEG F (MINIMUM 6 DEG F DB).
- ** THESE ARE ON-SERVICE LINES WHICH HAVE AN UPPER LIMIT OF 150 DEG F. HOWEVER, THEY ARE USED TO MONITOR MANIFOLD LINES WHICH HAVE AN UPPER LIMIT OF 100 DEG F NOMINALLY AND 150 DEG F FOR A 5-SECOND TRANSIENT. @[062801-4341A]
- *** 100 DEG F UPPER LIMIT FOR BULK PROPELLANT TEMPERATURE. TEMPERATURE SENSOR IS ON TANK SKIN WHICH HAS UPPER LIMIT OF 150 DEG F FOR LOCALIZED REGIONS.

THIS RULE CONTINUED ON NEXT PAGE

FLIGHT RULES

A6-256

OMS/RCS HEATER PERFORMANCE MONITORING (CONTINUED)

RIGHT/LEFT OMS/RCS POD HEATERS

HEATER COMPONENT	OI PRIMARY PARAMETER	OI BACKUP PARAMETER	SYSTEM REDLINE (°F)	RESPONSE/NOTE
'Y' WEB OME COMPARTMENT HTRS				
UPPER Y WEB	V43T5703A * (4703A)		**	
OUTBOARD Y WEB	V43T5702A * (4702A)		**	
INBOARD Y WEB ***	V43T5704A * (4704A)	V43T5705A * (4705A)	20-150	
ENG SERV PNL OME COMPARTMENT HTRS	V43T5707A* (4707A)		20-150	[1]
OME COVER	V43T5720A * (4720A)	V43T5216A (4216A)	**	
OX INLT T	V43T5216A (4216A)		30-125	
FU FDLN T	V43T5642A (4642A)		30-125	
OX BPV T	V43T5641A (4641A)		30-125	
FU INJ T	V43T5643A (4643A)		NA-260	

@[062801-4341A]

NOTE: BOTH A AND B POD HTRS SHOULD NOT BE USED SIMULTANEOUSLY.

* CONTROL PARAMETER NEAREST THERMOSTAT. SPEC HTR THERMOSTAT RANGE 55 DEG - 75 DEG F (MIN 6 DEG DB).

** PARAMETER MEASURES STRUCTURE TEMPERATURE ONLY, AND IS USED TO VERIFY HEATER PERFORMANCE. THE TEMPERATURE OF COMPONENTS AND FLUID WARMED BY HEATERS MAY VARY FROM SENSED TEMPERATURE

*** INCLUDES OX DRAIN PANEL.

[1] THERMAL ANALYSIS IS REQUIRED FOR THE LOSS OF INSIGHT IN THIS REGION DUE TO THE LACK OF REDUNDANT PARAMETERS AND DUE TO THE POTENTIAL CONSEQUENCES OF A HEATER FAILED ON OR OFF. @[062801-4341A]

THIS RULE CONTINUED ON NEXT PAGE

FLIGHT RULES

A6-256

OMS/RCS HEATER PERFORMANCE MONITORING (CONTINUED)

RIGHT/LEFT OMS/RCS POD HEATERS

HEATER/COMPONENT	OI PRIMARY PARAMETER	OI BACKUP PARAMETER	SYSTEM REDLINE (°F)	RESPONSE/NOTE
OMS HE TK	V43T5111C (4111C)		-160-200	
RCS OX HE	V42T3100C (2100C)	V42T3104C (FU) (2104C)	-160-125 -160-150	PROP QTY >85% PROP QTY ≤85%
RCS FU HE	V42T3104C (2104C)	V42T3100C (OX) (2100C)	-160-125 -160-150	PROP QTY >85% PROP QTY ≤85%
GSE SERV PNL	V43T5706A* (4706A)		20-150	[1]
RCS HOUSING HEATERS				
DRAIN PNL	V42T3304A * (2304A)	V42T3305A * (2305A)	**	
VERNIER PNL	V43T5701A * (4701A)	V43T5711A * (4711A)	**	
OX MANF1 TEMP	V42T3204A (2204A)		40-150 ***	
VERN OX FDLN	V42T3560A (2560A)		40-200	

@[062801-4341A]

NOTES:

- * CONTROL PARAMETER NEAREST THERMOSTAT. SPEC HTR THERMOSTAT RANGE 55 DEG - 75 DEG F (MIN 6 DEG DB).
- ** PARAMETER MEASURES STRUCTURE TEMPERATURE ONLY, AND IS USED TO VERIFY HEATER PERFORMANCE. THE TEMPERATURE OF COMPONENTS AND FLUID WARMED BY HEATERS MAY VARY FROM SENSED TEMPERATURE.
- *** 70 DEG F LOWER LIMIT DURING ENTRY FOR ZOT PREVENTION. UPPER LIMIT IS 100 DEG F NOMINALLY, AND 150 DEG F FOR A 5-SECOND TRANSIENT.
- [1] THERMAL ANALYSIS IS REQUIRED FOR THE LOSS OF INSIGHT IN THIS REGION DUE TO THE LACK OF REDUNDANT PARAMETERS AND DUE TO THE POTENTIAL CONSEQUENCES OF A HEATER FAILED ON OR OFF. @[062801-4341A]

THIS RULE CONTINUED ON NEXT PAGE

FLIGHT RULES

A6-256

OMS/RCS HEATER PERFORMANCE MONITORING (CONTINUED)

RIGHT/LEFT OMS/RCS POD HEATERS

HEATER/COMPONENT	OI PRIMARY PARAMETER	OI BACKUP PARAMETER	SYSTEM REDLINE (°F)	RESPONSE/NOTE
KEEL WEB HTRS				
RCS OX PRESS PNL	V43T5700A* (4700A)	V43T5710A* (4710A)	20-150	
OX/HE TEST PNL	V43T5708A (4708A)	V43T5718A (4718A)	20-150	
RCS OX TK	V42T3200C (2200C)	V42T3300C (2300C)	50 **-150 ***	
RCS FU TK	V42T3300C (2300C)	V42T3200C (2200C)	50 **-150 ***	
OMS OX TK	V43T5215A (4215A)	V43T5315A (4315A)	40-150 ****	
OMX FU TK	V43T5315A (4315A)	V43T5215A (4215A)	40-150 ****	

@[062801-4341A]

NOTE: BOTH A AND B POD HTRS SHOULD NOT BE USED SIMULTANEOUSLY.

- * CONTROL PARAMETER NEAREST THERMOSTAT. SPEC HTR THERMOSTAT RANGE, A HTRS 55 DEG - 75 DEG F, B HTRS 70 DEG - 90 DEG F (MIN 6 DEG DB).
- ** 70 DEG F LOWER LIMIT DURING ENTRY FOR ZOT PREVENTION.
- *** 100 DEG F UPPER LIMIT FOR BULK PROPELLANT, BASED ON EXPULSION EFFICIENCY. TEMPERATURE SENSOR IS LOCATED ON TANK SKIN WHICH HAS UPPER LIMIT OF 150 DEG F FOR LOCALIZED REGIONS.
- **** 100 DEG F UPPER LIMIT FOR BULK PROPELLANT. TEMPERATURE SENSOR IS LOCATED ON TANK SKIN WHICH HAS AN UPPER LIMIT OF 150 DEG F.

THIS RULE CONTINUED ON NEXT PAGE

FLIGHT RULES

A6-256

OMS/RCS HEATER PERFORMANCE MONITORING (CONTINUED)

AFT FUSELAGE HEATERS

HEATER/COMPONENT	OI PRIMARY PARAMETER	OI BACKUP PARAMETER	SYSTEM REDLINE (°F)	RESPONSE/NOTE
XFD FLOW LINES				
OX XFD LN C **	V43T6242A *		40-125	
OX XFD LN L **	V43T6243A *		40-125	
OX XFD LN R **	V43T6244A *		40-125	
AFT XFD L TEMP **	V43T6218A *		40-125	
AFT XFD R TEMP **	V43T6219A *		40-125	
DRAIN LINES				
LH OX LP DL HTRS **	V43T6236A *		20-150	
RH OX LP DL HTRS **	V43T6237A *		20-150	

@[062801-4341A]

NOTE: BOTH A AND B XFD HTRS CAN BE USED SIMULTANEOUSLY.

* CONTROL PARAMETER NEAREST CONTROL THERMOSTAT, SPEC HTR THERMOSTAT RANGE 55 DEG - 75 DEG F. EACH HEATER CIRCUIT ALSO HAS AN OVERTEMP THERMOSTAT, RANGE 70 DEG - 90 DEG F.

** TEMPERATURE SENSOR IS ON OX LINE, BUT THERMOSTAT CONTROLS BOTH OX AND FU HEATERS.
@[062801-4341A]

The heater matrix allows a determination to be made on the health of the OMS/RCS heater system. The different heater systems are shown down to the heater/component level. The instrumentation used to verify the operation of each heater is defined.

Operating outside of the nominal temperature range (vehicle/pod and attitude-dependent) may identify a heater failure condition (refer to Rule {A6-251D}, GENERAL (thermal management)). The thermostat set points SSSH drawings are supplied by the Operational Space Shuttle Orbiter Heater Systems Book, JSC-18549, which is maintained by the JSC/ES311 Thermal Branch.

Several of the parameters in the tables monitor heater operation by close proximity to the heater thermostat. If the indicated temperature of such a parameter exceeds the thermostat set point range by 5 deg F or more, then this must be explained by the influence of sensor location with respect to the thermostat and/or by the vehicle attitude, else the heater will be declared failed.

The OMS and RCS thermal redlines are defined in the SODB tables 3.4.3.2-1 and 3.4.3-1. If a parameter directly measures the temperature of a component that has SODB constraints, then these constraints are listed in this rule under SYSTEM REDLINE. In several cases (as noted with asterisks in the SYSTEM REDLINE column), the parameter is mounted on the pod structure and is used to monitor heater performance only. These structure temperatures do not necessarily reflect the temperature of components that are warmed by the monitored heaters.

THIS RULE CONTINUED ON NEXT PAGE

FLIGHT RULES

A6-256

OMS/RCS HEATER PERFORMANCE MONITORING (CONTINUED)

Thermal analysis (reference Data Request - RI-1512A) has shown that for the loss of temperature parameters listed as requiring thermal analysis it may be possible to tolerate a heater failing on or off. A thermal analysis for the specific planned attitude timeline will be required if loss of insight occurs to determine if vehicle attitude management and/or manual cycling of heaters will be required to protect SODB redlines. ©[062801-4341A]

The crossfeed flow lines and drain/bleed lines are all wrapped with rope-type heaters. The thermal status of each section of crossfeed line is monitored by the temperature parameters near the thermostat for that section of line. Although these parameters measure the line temperatures directly, the configuration of the rope heaters may allow warm spots to develop in the line away from any temperature parameter. For this reason, the fault detection annunciation (FDA) limits for these temperature parameters are well within the system redlines, allowing action to be taken before the redlines are violated anywhere in the lines. These FDA limits are documented in SSSH drawing 11.9, HTR AFT OMS/RCS.

Rule {A18-451}, ORBITER THERMAL CONSTRAINTS AND ATTITUDE MANAGEMENT [CIL], references this rule. ©[062801-4341A]

FLIGHT RULES

A6-257**RCS JET TEMPERATURE MANAGEMENT**

A. PRIMARY JETS: @[091098-6708]

1. IN THE EVENT OF A FAILED-OFF PRIMARY RCS JET HEATER, THE AFFECTED THRUSTER MAY BE FIRED MANUALLY OR CHANGED TO FIRST PRIORITY, OR ORBITER ATTITUDE MAY BE CHANGED TO MAINTAIN INJECTOR TEMPERATURES > 42 (47) DEG F (50 DEG AT VALVE SEAT) .

The 50 deg F limit (ref. Shuttle Operational Data Book (SODB) volume I, table 3.4.3.2-1, note L) protects against increased risk of valve leakage. The corresponding injector temperature limit is derived from thermal math model analysis data for the case of a heater failed off and exposure to deep space. If the jet is exposed to some solar heating (but not enough to alleviate the leakage concern), then the injector/valve temperature differential may diminish slightly; however, since the rule assumes worst-case instrumentation error (5 deg F), the 50 deg valve limit is reasonably protected.

Note that a primary RCS jet heater is considered failed when the injector temperatures reach 55 deg F (ref. Rule {A6-9}, RCS JET HEATER). Firing the jet periodically will maintain the injector within operating limits. (Testing has shown that a 2-second firing will increase the jet injector temperature approximately 16 deg F.) If planned orbit activities would result in single minimum duration pulse firings, hot-fire the jet for a minimum of 2 seconds prior to changing the jet to first priority. A minimum duration pulse firing with the injector temperatures ≤ 55 deg F can cause a jet leak due to cold Teflon valve seats not seating properly. (Ref. SODB, volume I, paragraph 3.4.3.2.13).

2. PRCS JETS MAY NOT BE FIRED IF INJECTOR TEMPERATURES EXCEED 162 (157) DEG F (150 DEG F AT VALVE SEAT) FOR A SUSTAINED PERIOD (EXCEPT AS DEFINED IN PARAGRAPH A.3 OF THIS RULE). TO STAY BELOW THIS OPERATIONAL THERMAL LIMIT:
 - a. ORBITER ATTITUDE MAY BE CHANGED
 - b. THE AFFECTED JET(S) MAY BE PLACED IN LAST PRIORITY
 - c. A FAILED-ON HEATER MAY BE SWITCHED OFF @[091098-6708]

THIS RULE CONTINUED ON NEXT PAGE

FLIGHT RULES

A6-257

RCS JET TEMPERATURE MANAGEMENT (CONTINUED)

The 150 deg F limit (ref. SODB volume I, table 3.4.3.2-1, note L) protects against permanent deformation and damage to the Teflon valve seat due to the combined effects of high closing seat loads and degraded Teflon strength at the higher temperature. In turn, this protects against resulting valve leakage and reduced valve lifetime. The 157 deg F injector temperature limit is derived from the 150 deg F valve limit +12 deg F injector/valve differential (based on Rockwell-Downey thermal analysis) - 5 deg F instrumentation error. Unrestricted thruster firings with valve seat temperatures above 150 deg F are not permitted. In this case, any DAP/RM configuration that could result in the firing of the affected primary thrusters is forbidden. Depending on the heat source (Sun, heat of combustion, or failed heater), a variety of actions may be performed, as appropriate, to keep a thruster operational. Note that the crew does not have insight into jet injector temperatures on board, so these actions must be initiated by the ground. Every reasonable effort will be made to do this in a timely manner such that jet firings above the operational limit may be avoided. ©[091098-6708]

3. PRCS JETS MAY BE FIRED IF INJECTOR TEMPERATURES HAVE EXCEEDED 162 (157) DEG F, BUT ONLY IF:
 - a. ALL JETS IN THE GROUP (SAME POD AND DIRECTION) HAVE EXCEEDED THIS OPERATIONAL LIMIT.
 - b. THE DAP IS CONFIGURED TO ENSURE A MINIMUM FIRING DURATION OF 400 MSEC.

The main concern with thruster operation above 157 deg F is the load imparted on the valve seat as the poppet closes. Since the real concern is at valve closing, increasing the minimum "on time" reduces the valve seat temperature to an acceptable level at shutdown. However, immediately following the firing, the temperatures will rise quickly back up due to thermal soak back effects. If a thruster needs to be fired, a minimum "on time" of 400 msec may be used to preclude valve seat degradation (ref. SODB volume III, paragraph 4.3.2.7. Note that SODB volume III contains engineering data which may not be supported by test.).

A thruster which has exceeded the operational limit of 157 deg F due to a high duty cycle will be placed in last priority in favor of a colder, redundant jet in the same group. If all jets in a group exceed the operational limit and use of the jet group is still required, then the DAP will be configured accordingly. This approach, documented in CHIT 013, was successfully utilized during STS-77 rendezvous activities. One re-prioritization was required for both of the first priority +X jets, but the redundant +X jets did not reach their operational limit for the remainder of the rendezvous and no further actions were required.

THIS RULE CONTINUED ON NEXT PAGE

FLIGHT RULES**A6-257****RCS JET TEMPERATURE MANAGEMENT (CONTINUED)**

4. ONE OF THE FOLLOWING ACTIONS WILL BE TAKEN TO PREVENT INJECTOR TEMPERATURES FROM EXCEEDING 187 (182) DEG F (175 DEG F AT VALVE SEAT) : @[091098-6708]
 - a. ORBITER ATTITUDE WILL BE CHANGED. IF DOING SO WILL VIOLATE MISSION REQUIREMENTS, THEN RCS JET INJECTORS MAY BE EXPOSED TO TEMPERATURES UP TO 207 (202) DEG F (195 DEG F AT VALVE SEAT) FOR UP TO 12 HOURS PER SHUTTLE MISSION. @[091098-6708]
 - b. A FAILED-ON HEATER WILL BE SWITCHED OFF.

The 175 deg F limit (ref. SODB volume I, table 3.4.3.2-1, note L) protects against permanent deformation and damage (cold flow) to the Teflon seat from extended exposure to high temperatures and seal loads at system pressure. The 182 deg F injector temperature limit is derived from the 175 deg F valve limit +12 deg F injector/valve differential (based on Rockwell-Downey thermal analysis) -5 deg F instrumentation error.

The 195 deg F limit (ref. SODB volume I, table 3.4.3.2-1, note L) is a contingency value intended to accommodate predicted peak temperatures during continuous exposure to solar radiation. The 12-hour constraint is a cumulative total and is not "reset" if the thruster injector temperatures decrease to below the limit for any amount of time.

B. VERNIER JETS :

1. IN THE EVENT OF A FAILED-OFF VERNIER RCS JET HEATER OR INADEQUATE DUTY CYCLES, THE FOLLOWING STEPS MAY BE TAKEN TO INCREASE FIRING FREQUENCY AND DURATION, IF REQUIRED TO PREVENT A FALSE RM FAIL LEAK ANNUNCIATION:
 - a. BIAS THE ATTITUDE.
 - b. DESELECT AFT YAW VERNIERS.
 - c. TIGHTEN THE DEADBAND.

These methods have been employed on many previous flights. However, it has been shown that biasing the attitude (and taking advantage of gravity gradient torque) and deselecting the aft yaw verniers are better long-term methods of raising jet temperatures (as determined from STS-62 and STS-94) because both methods cause certain targeted jets to fire more frequently while allowing others to fire less frequently. Tightening the deadband increases jet firing frequency (which is undesirable for microgravity payloads) and unless the deadband is severely tightened may not solve the problem. Ref. Rule {A6-9B}, RCS JET HEATER, for relevant failed-heater definitions. @[091098-6708]

THIS RULE CONTINUED ON NEXT PAGE

FLIGHT RULES

A6-257

RCS JET TEMPERATURE MANAGEMENT (CONTINUED)

2. A VERNIER JET THAT HAS INCURRED A FALSE RM FAIL LEAK ANNUNCIATION DUE TO A FAILED-OFF JET HEATER OR INADEQUATE DUTY CYCLES MAY BE USED WITHOUT ONBOARD LEAK RM UNDER THE FOLLOWING CONDITIONS: ©[091098-6708]
 - a. JET IS USED DURING AOS PERIODS ONLY.
 - b. THE JET INJECTOR TEMPERATURES ARE > 90 DEG F AND < 140 DEG F.
 - c. THE JET INJECTOR TEMPERATURES HAVE NOT DECREASED > 20 DEG F PER MINUTE AT ANY TIME IN THE PAST HOUR.

Due to inadequate or failed heater operations, the forward vernier jets may cool during extended periods of low activity resulting in a violation of the 130 deg F RCS RM leak detection limit and a false leak annunciation. False annunciation can be distinguished from an actual leak based on ground data evaluation. The 130 deg F limit protects against leaking propellant freezing and plugging the combustion chamber and is not applicable if there is no leak; therefore, once it has been determined that a deselected jet is not leaking, it may be used without onboard RM as long as the injector temperatures remain above 90 deg F, which protects against seal shrinkage and propellant leakage (ref. Rule {A6-9B}, RCS JET HEATER).

Use of the jet must be confined to AOS periods since the MCC is now prime for leak detection, and the crew does not have onboard insight into jet injector temperatures. If/when the injector temperatures recover and are sufficiently above the RM limit (upon reaching 140 deg F), RM must be toggled for the jet so as to re-enable automatic onboard leak detection. For vernier operation below the RM limit, engineering analysis (ref. Marquardt Report No. TM05-V009, June 1980) has determined that a leak will be indicated by an injector temperature drop of more than 20 deg F per minute. In this case, the MCC will immediately instruct the crew to cease use of the jet (via jet deselection or DAP configuration).

Note that a 10-second steady-state firing will warm a vernier jet injector from 90 deg F to above the 130 deg F RM limit (ref. SODB volume 1, paragraph 3.4.3.2.13). Such a firing is particularly advisable after vernier injector temperatures have dropped significantly below 130 deg F (for example, when a deorbit backout and 24-hour waiveoff are declared and verniers are reactivated hours after their heaters have been turned off), and it is desired to immediately re-enable RCS RM. ©[091098-6708]

FLIGHT RULES

A6-258**ARCS BULK PROPELLANT TEMPERATURE MANAGEMENT**

VEHICLE ATTITUDE WILL BE CHANGED ON A NONINTERFERENCE BASIS TO PROVIDE ARCS BULK PROPELLANT TANK TEMPERATURE THERMAL CONDITIONING WHENEVER THE ARCS TANK TEMPERATURE IS < 68 DEG (70 DEG) F. IF AN ATTITUDE CHANGE IMPACTS HIGH PRIORITY FLIGHT OBJECTIVES, THE ARCS TANK TEMPERATURE LIMIT MAY BE REDUCED TO 65 DEG (67 DEG) F BEFORE ACTION IS REQUIRED. THE FOLLOWING ATTITUDES ARE DESIRABLE TO PROVIDE THERMAL CONDITIONING TO INCREASE PROPELLANT TEMPERATURES:

- A. NOSE SUN 10 DEGREES PITCHUP.
- B. NOSE SUN.
- C. TAIL SUN.
- D. BOTTOM SUN.

FOR HIGH BETA ANGLE (> 60 DEGREES) BOTTOM SUN WOULD BE PREFERRED OVER TAIL SUN TO AVOID ORBITER MANEUVERING ENGINE (OME) LINE TEMPERATURE CONSTRAINTS.

Rules {A6-6A}, OMS/RCS CROSSFEED LINE; and {A18-451}, ORBITER THERMAL CONSTRAINTS AND ATTITUDE MANAGEMENT [CIL], reference this rule.

Propellant temperatures must be maintained above the 70 deg F limit to avoid possible ZOT's during entry jet firings below 70,000 feet. WSTF testing has shown that 65 deg F propellant temperatures caused minor ZOT's without creating jet leaks. Similar tests with propellant temperatures at 60 deg F have caused several ZOT's which resulted in liquid leakage at the jet.

Because of the entry ZOT concern, the 70 deg F bulk propellant constraint will be protected if it can be done without violating mission objectives. If the mission objectives prevent the proper vehicle attitude required to maintain the 70 deg F limit, the bulk propellant constraint will be reduced to 67 deg F (65 deg plus 2 deg F instrumentation accuracy) with the understanding that an increased risk of ZOT's exists during entry. The decision to reduce the bulk propellant constraint will be a real-time call and will not be used as a premission planning tool. Because the 67 deg F limit resides in SODB, volume 3, the engineering community (MER) will be notified of the plan to reduce the bulk propellant temperature constraint and given the associated rationale.

THIS RULE CONTINUED ON NEXT PAGE

FLIGHT RULES

A6-258

ARCS BULK PROPELLANT TEMPERATURE MANAGEMENT (CONTINUED)

To prevent cold tank temperatures, the vehicle can be oriented (OMS pods are in the shade) causing the heater to cycle on. Top to Sun and side to Sun attitudes prevent heater cycles and result in a decay in tank temperature. Changing attitudes will not result in immediate heater activation since heater thermostats are located on the warm pod deck (4 to 6 hours for first cycle). The following table was generated from flight data and will help determine which attitude provides the required response.

<i>Attitude</i>	<i>Equil. Temp (°F)</i>	<i>Rise rate (°F/day)</i>
<i>Nose Sun 10° Up</i>	<i>74</i>	<i>5</i>
<i>Nose Sun</i>	<i>74</i>	<i>No data</i>
<i>Tail Sun *</i>	<i>75</i>	<i>>1</i>
<i>Bottom Sun *</i>	<i>75</i>	<i>>1</i>

**High beta angles will cause bondline temperature limit concerns.*

A6-259 THROUGH A6-300 RULES ARE RESERVED

FLIGHT RULES

CONSUMABLES DEFINITIONS AND REDLINES

A6-301 OMS USABLE PROPELLANT

A. OMS GAGED PROPELLANT IS DEFINED AS THE AMOUNT OF OMS PROPELLANT LOADED PER POD MINUS THE LINE TRAPPED:

LINE TRAPPED: $\frac{OX}{50.5}$ $\frac{FU}{26.5}$

@[092701-4850]

B. OMS USABLE PROPELLANT IS DEFINED AS THE OMS GAGED PROPELLANT MINUS THE FOLLOWING RESIDUALS:

TANK TRAPPED: $\frac{OX}{212}$ $\frac{FU}{110}$
 DISPERSIONS: (REF. PARAGRAPH C) (REF. PARAGRAPH C)

C. OMS DISPERSIONS ARE DEFINED AS THE RSS OF (1) FLOW RATE AND MIXTURE RATIO ERROR BASED ON NOMINAL LOAD WITH 2 PERCENT ERROR AND (2) LOADING UNCERTAINTY. DISPERSIONS ARE CALCULATED AS FOLLOWS:

1. a = FLOW RATE AND MIXTURE RATIO ERROR.
 a = 0.02 (OX (FU) GAGED LBS PROPELLANT - OX (FU) TANK TRAPPED) .
2. b = LOADING UNCERTAINTY:

BENCHMARK	RESIDUALS	WSP AVAIL	LOADING UNCERTAINTY
GOOD	N/A	N/A	40 LB OX, 24 LB FU
OUT-OF-SPEC	N/A	N/A	81 LB OX, 49 LB FU
NO	N/A	YES	81 LB OX, 49 LB FU
NO	AFT GAGE	NO	1.5 PERCENT, PROP LOADED PLUS 40 LB OX, 24 LB FU
NO	CALCULATED	NO	1.5 PERCENT PROP LOADED

THIS RULE CONTINUED ON NEXT PAGE

FLIGHT RULES**A6-301****OMS USABLE PROPELLANT (CONTINUED)**RESIDUALS

IF | AFT GAGE RESIDUALS - CALCULATED RESIDUALS | < 1 PERCENT
THEN USE,

RESIDUALS = AFT GAGE RESIDUALS

OTHERWISE USE,

RESIDUALS = CALCULATED RESIDUALS

$$\text{DISPERSION (OX (FU) PER POD)} = (a^2 + b^2)^{\frac{1}{2}}.$$

Since the OMS tank and line-trapped propellant cannot be burned, it must be accounted for when calculating usable propellant. Since OMS dispersions may or may not be in the tank, this propellant must also be accounted for when calculating usable propellant. The OMS tank and line-trapped quantities are documented in SODB, volume II, section 4.1.

The calculation for loading uncertainty is based on whether KSC gets a "benchmark" while loading. The "benchmark" is defined as the point at which the total quantity updates after the forward probe gets wet. A "good benchmark" is a benchmark that occurs at 45 ± 0.5 percent (quantity of propellant in tank is determined by a flowmeter). A "benchmark out-of-spec" is a benchmark that occurs greater than 45.5 percent or less than 44.5 percent. "No benchmark" is when the forward probe does not give a quantity reading.

The primary loading method uses the onboard OMS gages. Only for the no-benchmark loading cases are the wet sense point (WSP) and residuals considered. The WSP is the first edge of the forward probe which senses propellant. There is a delay between the forward probe getting wet and the total quantity gage update. The update is not triggered until a voltage threshold in the totalizer electronics is met. Normally this delay is not important, but for a no-benchmark case, the WSP is determined by interpreting graphical data of total quantity gage output versus time. These graphs show a distinct change in voltage which correlates to wetting of the forward probe.

The loading uncertainty for the good benchmark is defined as 40 lb OX and 24 lb FU equal to 0.5 percent of a full load. This 0.5 percent is the advertised accuracy of the onboard OMS gages. The out-of-spec benchmark adds an additional 0.5 percent for a total uncertainty of 81 lb and 49 lb. For the first of the three no-benchmark loading cases, the WSP is known. The confidence in loading with the WSP is considered equal to that of the out-of-spec case; therefore, the loading uncertainty is 81 lb OX and/or 49 lb FU.

THIS RULE CONTINUED ON NEXT PAGE

FLIGHT RULES

A6-301

OMS USABLE PROPELLANT (CONTINUED)

For the next two no-benchmark cases, the WSP could not be determined, so a residuals check is made. The residuals check determines the confidence in the aft gages. If the absolute difference between the calculated residuals and aft gage residuals is less than 1 percent, then there is confidence in the aft gages (i.e., the aft gage and onboard totalizer is tracking the GSE). The problem; therefore, lies in the forward probe. Subsequently, the loading uncertainty retains the initial 40 lb and 24 lb, then adds 1.5 percent more loading uncertainty; that is, 1.5 percent of the remaining propellant to be loaded using the GSE flowmeters. This 1.5 percent additional loading uncertainty is the advertised accuracy of the GSE gages. The tanks are not drained and refilled because of the amount of work involved, the aft gages are working, and the 1.5 percent additional propellant is conservative.

In the final no-benchmark cases, the WSP is unknown and the absolute difference of the residuals is greater than 1 percent (i.e., the aft gage and onboard totalizer are not tracking the GSE). The problem lies in the totalizer, or both the aft and forward probes. In this case, the tanks are drained and the loading is restarted with zero percent residuals.

Rules {A4-153K.1}, CG PLANNING; and {A6-303}, OMS REDLINES [CIL], reference this rule.

A6-302

RCS USABLE PROPELLANT

RCS USABLE PROPELLANT IS DEFINED AS THE AMOUNT OF RCS PROPELLANT LOADED MINUS THE FOLLOWING RESIDUALS:

ARCS	<u>OX</u>	<u>FU</u>
TANK TRAPPED	58	33
GAGE ERROR	50	34
LINE TRAPPED	<u>59</u>	<u>39</u>
LBS/POD	167	106
FRCS	<u>OX</u>	<u>FU</u>
TANK TRAPPED	139	84
GAGE ERROR	50	34
LINE TRAPPED	<u>38</u>	<u>21</u>
LBS/POD	227	139

Since the propellant trapped in the tank and lines cannot be burned, this propellant must be accounted for when calculating RCS usable propellant. Since the gage error may or may not be in the tank, this propellant must also be accounted for when calculating RCS usable propellant. (Reference SODB, volume II, table 4.2.)

FLIGHT RULES**A6-303****OMS REDLINES [CIL]**

A. OMS DEORBIT REDLINE: @[091098-6711B]

OMS DEORBIT REDLINE RESERVES PROPELLANT FOR: @[092800-7247A]

TANK TRAPPED	644
DISPERSIONS AND UNCERTAINTIES	<u>TBD</u>
OMS STEEP DELTA V	<u>TBD</u>
NOMINAL DEORBIT PREP	<u>TBD</u>
DEORBIT WAVE-OFF EXTENSION DAY [1]	156
OMS ENGINE FAIL	106
WEATHER WAVE-OFF EXTENSION DAY [1]	<u>TBD</u>
ADDITIONAL DEORBIT OPPORTUNITIES	<u>TBD</u>
CG BALLAST (IF REQUIRED)	<u>TBD</u>

DISPERSIONS AND UNCERTAINTIES ARE THE RSS OF LOADING UNCERTAINTY AND DISPERSIONS IN OMS ENGINE FLOWRATE AND MIXTURE RATIO. THE OMS STEEP DELTA V MUST PROTECT THE PLANNED EOM OPPORTUNITY AND A BACKUP PLS OPPORTUNITY (IF AVAILABLE) ONE REV LATER. FOR EACH EXTENSION DAY (EOM+1 AND EOM+2), THE CHEAPEST COMBINATION OF A PLS OPPORTUNITY WITH A ONE REV LATE BACKUP SLS OPPORTUNITY MUST BE PROTECTED. IF ADDITIONAL DEORBIT ATTEMPTS ARE PROTECTED, AS DOCUMENTED IN THE FLIGHT RULE ANNEX, THEN OMS STEEP DELTA V MUST ALSO PROTECT THESE ADDITIONAL OPPORTUNITIES. OMS STEEP DELTA V WILL BE COMPUTED WITH 3-SIGMA N-CYCLE PROTECTION. EXTENSION DAYS, NOMINAL DEORBIT PREPARATION, AND ADDITIONAL DEORBIT ATTEMPTS MUST BE PROTECTED IN THE AFT RCS IF NOT PROTECTED IN THE OMS. THE WEATHER WAVE-OFF EXTENSION DAY MAY BE DELETED IN FAVOR OF CRITICAL PAYLOAD ACTIVITIES AS DOCUMENTED IN RULE {A2-108}, CONSUMABLES MANAGEMENT, AND THE FLIGHT RULE ANNEX. OMS ENGINE FAILURE FOR THE DEORBIT WAVE-OFF EXTENSION DAY MAY BE GIVEN UP IN ORDER TO ACCOMPLISH HIGHER PRIORITY ACTIVITIES AS DOCUMENTED IN THE FLIGHT RULE ANNEX. IF OMS ENGINE FAILURE IS PROTECTED, THE ADDITIONAL SINGLE ENGINE RESIDUALS (77 LBS) ARE ACCOUNTABLE AS BALLAST. VIOLATION OF THE OMS DEORBIT REDLINE IS CAUSE FOR DEORBIT AT NEXT PLS IF NO FURTHER PROPELLANT TRADE-OFFS CAN BE ACCOMPLISHED AS LISTED IN RULE {A2-108}, CONSUMABLES MANAGEMENT. @[091098-6711B] @[092800-7247A]

THIS RULE CONTINUED ON NEXT PAGE

FLIGHT RULES

A6-303

OMS REDLINES [CIL] (CONTINUED)

NOTE: [1] ASSUMES ATTITUDE CONTROL IN -ZLV -XVV PER RULE {A2-108}, CONSUMABLES MANAGEMENT. IF THERMAL CONDITIONING IS REQUIRED, UTILIZE ATTITUDE PROFILE PER RULE {A2-110}, STRUCTURES THERMAL CONDITIONING, OR AS SPECIFIED IN THE FLIGHT RULES ANNEX. @[092800-7247A]

- 644 - *Propellant which cannot be extracted by the propellant acquisition system.*
@[091098-6711B]
- TBD** *Dispersions* - *Dispersions for flow rate, mixture ratio, and loading errors must be taken into account (ref. Rule {A6-301}, OMS USABLE PROPELLANT).*
- TBD** *OMS Steep* - *OMS steep delta V will be based on targeting constraints which require enough N-cycles (guidance cycles from closed-loop guidance initiation to the first non-zero roll command (ref. Rule {A4-152}, DEORBIT BURN TARGETING PRIORITIES) to protect 3-sigma entry dispersions. Note that real-time planning may reflect a delta V which protects more N-cycles, if propellant is available. In order to guarantee that there is sufficient propellant to perform an OMS steep deorbit, standard redlines must protect a delta V sufficient to deorbit at nominal end of mission, EOM plus 1 day, and EOM plus 2 days (ref. Rule {A2-103}, EXTENSION DAY REQUIREMENTS.) Standard redlines protect four attempts over 3 days; thus, the OMS steep delta V must cover the planned EOM opportunity, a one orbit late backup to the PLS, and the cheapest combination of a PLS opportunity with a one rev backup SLS opportunity for EOM +1 and +2. This level of protection is referred to as 2-1-1 deorbit opportunities. The specific opportunities protected may need to be modified in real time to account for trajectory variations, weather conditions, non-propulsive consumables margins, etc. If greater than 2-1-1 deorbit attempts are protected, OMS steep delta V may need to be increased.*
- TBD** *Nom D/O Prep* - *It is not operationally desirable to protect any part of the nominal deorbit prep in the OMS. However, if for any reason it cannot be protected in the Aft RCS, then it must be protected in the OMS.*

THIS RULE CONTINUED ON NEXT PAGE

FLIGHT RULES

A6-303

OMS REDLINES [CIL] (CONTINUED)

156

- *Standard redlines protect as much of the deorbit wave-off extension day propellant as is operationally convenient in the OMS. This helps to assure that the aft RCS deorbit redline is protected at a higher priority than OMS steep deorbit propellant, because any excess usage during these extension days will come from the OMS. However, any or all of this propellant can be protected in the aft RCS in order to maximize capability and/or minimize crew workload. The extension day portion of the deorbit wave-off extension day protects 56 lb and is based on using Nose/Tail ALT control. An additional 100 lb of propellant are normally redlined in the OMS to perform a partial deorbit preparation after the extension day. This propellant covers the period from the start of deorbit preparation activities at TIG-4:40 to TIG-0:30 minutes. The remainder of this deorbit prep is normally redlined in the aft RCS. The 156 lb must be increased to 321 lb if Tail-Only control is required. The deorbit (systems) wave-off extension day propellant cannot be traded against other orbit activities. Per Rule {A2-108}, CONSUMABLES MANAGEMENT, the deorbit wave-off extension day must be protected using the primary jets since many of the orbiter contingencies which require such a wave-off also fail the vernier jets. Note also that the deorbit wave-off extension day assumes a specific attitude profile: -ZLV -XVV is the default attitude and was chosen to provide the minimum propellant consumption with maximum debris protection, and because it is relatively insensitive to altitude, thus providing the best protection for off-nominal (abort) orbits. However, if a different attitude profile is required for deorbit thermal conditioning, this must be protected. Ref. Rule {A2-110}, STRUCTURES THERMAL CONDITIONING, and the Flight Rule Annex. The deorbit wave-off extension day requires 382 lb Nose/Tail ALT or 533 lb Tail-Only ALT with 10 hours of Tail-Only ALT 5 degrees PTC protected per Rule {A2-110}, STRUCTURES THERMAL CONDITIONING. According to an email dated June 5, 2000, from ES/Y. Chang, up to a 10-degree deadband for PTC is thermally acceptable. @[091098-6711B] @[092800-7247A]*

THIS RULE CONTINUED ON NEXT PAGE

FLIGHT RULES

A6-303

OMS REDLINES [CIL] (CONTINUED)

106

- *Reference Rockwell International Internal Letter IL P&AS-DLJ-77-032, the OMS portion of OMS engine failure protection consists of out-of-plane thrusting during gimbal retrim (15 lb per pod) and increased tank residuals due to less favorable orientation of the propellant with respect to the acquisition screens (38.4 lb per pod). These increased tank residuals must be protected, especially after the loss of one OMS engine. However, because the residual propellant (77 lb) remains in the tank, it may be counted toward the CG ballast requirement. The original OMS engine failure requirement, as documented in the letter referenced above, also protected 14 lb of fuel per pod to account for the OMS crossfeed mixture ratio shift. This protection is no longer required since current propellant management procedures account for actual engine performance including crossfeed. Because the deorbit wave-off extension day is reserved specifically for orbiter contingencies (ref Rule {A2-103}, EXTENSION DAY REQUIREMENTS), the risk of having a major orbiter systems failure followed by an OMS engine fail is small. On a flight specific basis, it may be worth accepting that risk in order to accomplish high priority objectives, as documented in the Flight Rule Annex. If OMS engine fail protection is given up, then the deorbit wave-off extension day propellant should be distributed in the OMS and aft RCS to cover the equivalent of OMS engine failure propellant in each system at the nominal EOM deorbit burn. This implicit protection will be lost if the extension day propellant is used. Once an OMS engine failure occurs, then explicit OMS engine failure protection is mandatory. @[091098-6711B]*

THIS RULE CONTINUED ON NEXT PAGE

FLIGHT RULES

A6-303

OMS REDLINES [CIL] (CONTINUED)

TBD Wx W/O Day - *In order to protect against unforeseen weather that results in unacceptable deorbit/landing conditions, Rule {A2-108}, CONSUMABLES MANAGEMENT, provides a weather wave-off extension day. Although it would normally be desirable to protect the extension portion of the weather wave-off extension day in the OMS, a single maneuver and 19 hours of vernier attitude hold is only 23 lb which would require first establishing interconnect, performing a 15-minute maneuver, and then immediately performing an OMS tank switch, which is not practical. Thus, the propellant required to extend 24 hours on the vernier jets (or N/T ALT) is normally redlined in the Aft RCS. However, if failures or other considerations require an increase in the amount of propellant protected for the 24-hour extension, then it may become practical to protect the extension day propellant in the OMS. For example, if T/O ALT attitude hold (89 lb) is required for the extension day, it would normally be preferable to protect it in the OMS. Unlike the propellant redlined for the deorbit wave-off extension day, the weather wave-off extension day is tradable against critical on-orbit activities per the established priorities detailed in Rule {A2-108}, CONSUMABLES MANAGEMENT, and Rule {A6-358}, VIOLATION OF MISSION COMPLETION REDLINES MATRIX. Note that the weather wave-off extension day assumes a specific attitude profile: -ZLV -XVV is the default attitude and was chosen to provide the minimum propellant consumption with maximum debris protection, and because it is relatively insensitive to altitude, thus providing the best protection for off-nominal (abort) orbits. However, if a different attitude profile is required for deorbit thermal conditioning, this must be protected. Ref. Rule {A2-110}, STRUCTURES THERMAL CONDITIONING, and the Flight Rule Annex. The weather wave-off extension day requires 98 lb of OMS with 10 hours of vernier 1 deg PTC protected (250 lb Nose/Tail ALT or 301 lb Tail-Only ALT, both with 10 hours of 5 deg Tail-Only PTC) per Rule {A2-110}, STRUCTURES THERMAL CONDITIONING. According to an email dated June 5, 2000 from ES/Y. Chang, up to a 10-deg deadband for PTC is thermally acceptable. ©[091098 6711B] ©[092800-7247A]*

THIS RULE CONTINUED ON NEXT PAGE

FLIGHT RULES

A6-303

OMS REDLINES [CIL] (CONTINUED)

TBD *D/O Attempts* - Propellant for additional deorbit attempts, such as extra orbits of attitude hold in the deorbit burn configuration, may be protected on a flight specific basis as documented in the Flight Rule Annex. Propellant for extra deorbit attempts is typically reserved in the Aft RCS, but may be protected in the OMS, Aft RCS, or both. ©[091098-6711B] ©[092800-7247A]

TBD *CG Ballast* - Propellant may be redlined to act as ballast to maintain the X and Y CG within limits. The amount of propellant required for CG ballast (ref. Rule {A4-153}, CG PLANNING) is determined during preflight analysis and updated in real time. Ballast will be protected in the OMS, the Aft RCS, or both. Care must be taken in apportioning ballast because OMS and ARCS propellant are not equivalent for ballast purposes. CG ballast cannot be traded against other orbit activities. CG ballast can be traded against other redline items only if the ballast requirement changes for extension day deorbit opportunities.

B. OMS TANK FAIL:

OMS TANK FAIL IS NOT PROTECTED.

There is no requirement to protect for an OMS tank failure.

C. OMS REDLINE FOR RCS DEORBIT [CIL]:

AFTER THE LOSS OF ONE OMS ENGINE, ADDITIONAL OMS PROPELLANT WILL BE REDLINED TO PROTECT 4+X RCS DEORBIT TO STEEP TARGETS. IF INSUFFICIENT OMS PROPELLANT IS AVAILABLE, ADDITIONAL RCS PROPELLANT MUST BE REDLINED. IF INSUFFICIENT OMS AND RCS PROPELLANT IS AVAILABLE TO PROTECT 4+X RCS DEORBIT TO STEEP TARGETS, DEORBIT WILL BE PLANNED FOR THE NEXT PLS OPPORTUNITY.

If RCS propellant must be used to supplement OMS propellant during a deorbit burn, a two-stage deorbit burn is preferred in order to simplify execution of the actual deorbit burn. ©[091098-6711B]

THIS RULE CONTINUED ON NEXT PAGE

FLIGHT RULES

A6-303 **OMS REDLINES [CIL] (CONTINUED)**

D. OMS MISSION COMPLETION REDLINE: @[091098-6711B]

THE OMS MISSION COMPLETION REDLINE IS DEFINED AS THE OMS DEORBIT REDLINE PLUS THE REMAINING FLIGHT PLAN ACTIVITIES. REFERENCE RULE {A6-358}, VIOLATION OF MISSION COMPLETION REDLINES MATRIX, FOR ACTIONS REQUIRED FOR VIOLATION OF THE OMS MISSION COMPLETION REDLINE.

Self-explanatory.

E. OMS ENTRY REDLINE:

THERE IS NO OMS REQUIREMENT FOR ENTRY.

The OMS tanks cannot be used during entry because of the tank design constraints.

Rules {A2-108A.11} and {A2-108C}, CONSUMABLES MANAGEMENT; {A2-121A.1}, RNDZ/PROX OPS PROPULSION SYSTEMS MANAGEMENT; {A4-1B}, PERFORMANCE ANALYSES; {A6-351}, OMS PROPELLANT MANAGEMENT MATRIX; and {A6-1001}, OMS/RCS GO/NO-GO CRITERIA [CIL]; reference this rule. @[091098-6711B] @[092800-7247A]

A6-304 **FORWARD RCS REDLINES**

A. FORWARD RCS DEORBIT REDLINE

THE FRCS DEORBIT REDLINE RESERVES FOR: @[091098-6711B] 092800-7247A

NOMINAL DEORBIT PREPARATION	57
OMS ENGINE FAIL ATTITUDE CONTROL	12
DEORBIT WAVE-OFF EXTENSION DAY [1]	110
WEATHER WAVE-OFF EXTENSION DAY	
EXTENSION DAY	85
1 REV DEORBIT DELAY	17
ADDITIONAL DEORBIT OPPORTUNITIES	<u>TBD</u>
DEORBIT SUPPLEMENT (IF REQUIRED)	<u>TBD</u>
CG BALLAST (IF REQUIRED)	<u>TBD</u>

@[091098-6711B] @[092800-7247A]

THIS RULE CONTINUED ON NEXT PAGE

FLIGHT RULES

A6-304

FORWARD RCS REDLINES (CONTINUED)

THE WEATHER WAVE-OFF ACTIVITIES MAY BE DELETED IN FAVOR OF CRITICAL PAYLOAD ACTIVITIES AS DOCUMENTED IN RULE {A2-108}, CONSUMABLES MANAGEMENT, AND THE FLIGHT RULE ANNEX. OMS ENGINE FAILURE FOR THE DEORBIT WAVE-OFF EXTENSION DAY MAY BE DELETED FOR HIGHER PRIORITY ACTIVITIES AS DOCUMENTED IN THE FLIGHT RULE ANNEX. ADDITIONAL DEORBIT ATTEMPTS MAY BE PROTECTED AS DOCUMENTED IN THE FLIGHT RULE ANNEX. VIOLATION OF THE FRCS DEORBIT REDLINE IS CAUSE FOR DEORBIT AT NEXT PLS IF INSUFFICIENT PROPELLANT IS AVAILABLE TO PROTECT THE OMS AND ARCS DEORBIT REDLINES USING TAIL-ONLY CONTROL. @[091098-6711B] @[092800-7247A]

NOTE: [1] ASSUMES ATTITUDE CONTROL IN -ZLV -XVV PER RULE {A2-108}, CONSUMABLES MANAGEMENT. IF THERMAL CONDITIONING IS REQUIRED, UTILIZE ATTITUDE PROFILE PER RULE {A2-110}, STRUCTURES THERMAL CONDITIONING, OR AS SPECIFIED IN THE FLIGHT RULES ANNEX. @[092800-7247A]

- 57 - *Reserved for nominal deorbit prep.*
- 12 - *If an OMS engine fails during the deorbit burn, the FRCS will control the attitude excursions that will occur while the OMS engine gimbals to realign the thrust vector through the CG. Propellant is normally redlined to protect for this contingency. FRCS is not necessarily required if sufficient aft propellant is redlined to control the attitude excursion using tail only control. The requirement for OMS engine fail protection after a deorbit wave-off extension may be deleted in order to accomplish higher priority activities as documented in the Flight Rule Annex. If so, engine fail protection should still be provided at nominal end of mission using the deorbit wave-off extension allotment or the FRCS contingency propellant (ref. Rule {A6-357}, FORWARD RCS CONTINGENCY PROPELLANT AVAILABLE).*

THIS RULE CONTINUED ON NEXT PAGE

FLIGHT RULES

A6-304

FORWARD RCS REDLINES (CONTINUED)

- 110 - *The deorbit wave-off extension day consists of 66 lb for a deorbit prep plus 11 lb for the waveoff, which will sustain nose-tail control for 1 hour until vernier control can be established, plus 33 lb for the extra day Nose/Tail ALT. Note that Nose/Tail ALT is assumed because many failures which require a deorbit wave-off extension day also fail the vernier jets, reference Rule {A2-108}, CONSUMABLES MANAGEMENT. Nose/Tail ALT control is normally protected instead of Tail-Only ALT control because it requires less propellant overall and also provides sufficient propellant to utilize the vernier jets if they actually are available. Note also that the deorbit wave-off extension day assumes a specific attitude profile: -ZLV -XVV is the default attitude and was chosen to provide the minimum propellant consumption with maximum debris protection, and because it is relatively insensitive to altitude, thus providing the best protection for off-nominal (abort) orbits. However, if a different attitude profile is required for deorbit thermal conditioning, this must be protected. Ref. Rule {A2-110}, STRUCTURES THERMAL CONDITIONING, and the Flight Rule Annex. The deorbit wave-off extension day requires 92 lb for Nose-Tail ALT with 10 hours of Tail-Only 5 deg PTC protected per Rule {A2-110}, STRUCTURES THERMAL CONDITIONING. According to an email dated June 5, 2000, from ES/Y. Chang, up to a 10 deg deadband for PTC is thermally acceptable. ©[092800-7247A]*
- 85 - *As part of the weather wave-off extension day, propellant is provided to perform a wave-off/backout (11 lb), a vernier extension day (17 lb), and an additional nominal deorbit prep (57 lb). This item requires 107 lb if protected Nose/Tail ALT. Propellant budgeted for the weather wave-off extension day may be traded for critical on-orbit activities as defined in Rule {A2-108}, CONSUMABLES MANAGEMENT, and the Flight Rule Annex. Note that the extension day portion of the weather wave-off extension day assumes a specific attitude profile: -ZLV -XVV is the default attitude and was chosen to provide the minimum propellant consumption with maximum debris protection, and because it is relatively insensitive to altitude, thus providing the best protection for off-nominal (abort) orbits. However, if a different attitude profile is required for deorbit thermal conditioning, this must be protected. Ref. Rule {A2-110}, STRUCTURES THERMAL CONDITIONING, and the Flight Rule Annex. The weather wave-off extension day requires 134 lb with 10 hours of vernier 1 deg PTC protected (115 lb for Nose-Tail ALT with 10 hours of 5 deg Tail-Only PTC) per Rule {A2-110}, STRUCTURES THERMAL CONDITIONING. According to an email dated June 5, 2000, from ES/Y. Chang, up to a 10-deg deadband for PTC is thermally acceptable. ©[092800-7247A]*

THIS RULE CONTINUED ON NEXT PAGE

FLIGHT RULES

A6-304

FORWARD RCS REDLINES (CONTINUED)

- 17 - *As part of the weather wave-off extension day, propellant to perform one rev of attitude hold on the TRANS DAP is provided to ensure 2 consecutive deorbit attempts on one of the three deorbit days. Propellant budgeted for the weather wave-off extension day may be traded for critical on-orbit activities as defined Rule {A2-108}, CONSUMABLES MANAGEMENT, and the Flight Rule Annex. ©[092800-7247A]*
- TBD** D/O Attempts - *Propellant for additional deorbit attempts, such as extra orbits of attitude hold in the deorbit burn configuration, may be protected as specified in the Flight Rule Annex. One orbit of Nose/Tail Trans DAP with FES will cost 17 lb Fwd RCS. ©[091098-6711B]*
- TBD** D/O Supplement- *If Forward RCS propellant is required to supplement the OMS deorbit steep propellant, either for +X translation, +Z translation, or for attitude hold during aft RCS +X translation, then this propellant, as well as any associated maneuvers, must be protected. ©[091098-6711B]*
- TBD** CG Ballast - *Propellant may be redlined to act as ballast to maintain the X and Y CG within limits. The amount of propellant required for CG ballast (ref. Rule {A4-153}, CG PLANNING) is determined during preflight analysis and updated in real time. CG ballast cannot be traded against other orbit activities. CG ballast can be traded against other redlined items only if the ballast requirement changes for extension day deorbit opportunities.*

B. FORWARD RCS REDLINE FOR OMS TANK FAIL

FORWARD RCS DELTA V IS NOT CONSIDERED WHEN DETERMINING OMS TANK FAIL CAPABILITY. IF FORWARD RCS PROPELLANT IS TO BE USED FOR A PERIGEE ADJUST AFTER AN OMS TANK FAIL, SUFFICIENT AFT RCS PROPELLANT MUST BE REDLINED TO ACCOUNT FOR ATTITUDE CONTROL DURING THE -X TRANSLATION (**TBD**), PLUS TWO VERNIER MANEUVERS (6 LB FORWARD RCS, 19 LB AFT). ©[092800-7247A]

Forward RCS cannot be committed to the deorbit burn when computing OMS tank fail capability, e.g., steep vs. shallow, in-plane vs. out-of-plane dump, etc. (ref. Rule {A4-104}, OMS LEAK/PERIGEE ADJUST). However, Forward RCS delta V is available for a -X perigee adjust if required to supplement the Aft RCS/OMS. OPS 2 2-X with forward pitch control requires 2.5 lb of Aft RCS attitude hold per fps.

THIS RULE CONTINUED ON NEXT PAGE

FLIGHT RULES

A6-304

FORWARD RCS REDLINES (CONTINUED)

C. FORWARD RCS MISSION COMPLETION REDLINE

THE FORWARD RCS MISSION COMPLETION REDLINE IS DEFINED AS THE FORWARD RCS DEORBIT REDLINE PLUS THE REMAINING FLIGHT PLAN ACTIVITIES. SEE RULE {A6-354}, RCS ENTRY REDLINE PROTECTION, FOR ACTIONS REQUIRED AS A RESULT OF VIOLATION OF THE FORWARD RCS MISSION COMPLETION REDLINE. @[091098-6711B] @[092800-7247A]

D. FLIGHT DAY 2 FORWARD RCS PRESS QUANTITY @[012402-5112B]

THE FD2 FORWARD RCS PRESS QUANTITY IS THE AMOUNT OF FORWARD RCS PROPELLANT FOR ATTITUDE HOLD AND MANEUVERS THAT MUST BE PROTECTED IN ORDER TO SUPPORT A FD2 DEORBIT. FORWARD RCS USABLE PROPELLANT IN EXCESS OF THE FORWARD RCS PRESS QUANTITY CAN BE USED FOR ORBIT ADJUST BURNS TO PROVIDE FD2 ORBIT LIFETIME. THE FORWARD RCS PRESS QUANTITY FOR FD2 IS DEFINED AS:

OMS ENGINE FAIL ATTITUDE CONTROL	12
USAGE MECO TO DEORBIT	267
MNVRS TO SUPPORT OPS2 FORWARD RCS BURNS	12
ATTITUDE HOLD FOR +X TRANSLATION	<u>TBD</u>

@[012402-5112B]

THIS RULE CONTINUED ON NEXT PAGE

FLIGHT RULES

A6-304

FORWARD RCS REDLINES (CONTINUED)

- 12 - For a press case, the OMS engines are deliberately burned to depletion. The OMS engine fail propellant will be used to control the attitude transients resulting from sequential OME shutdown during the depletion sequence. This quantity cannot not be traded against any other events or activities (reference All Flights Rule {A6-352}, OMS PROPELLANT BUDGET GROUND RULES). ©[012402-5112B]
- 267 - Forward RCS usage required for window protect through the maneuver to the deorbit burn. Usage from launch to deorbit for the ATO case is dependent on when the FD2 deorbit opportunity occurs. FD2 assumes OPS 2 and vernier jets.
- 12 - The Forward RCS will be utilized in OPS 2 to raise or lower the orbit as needed. Four vernier maneuvers will be protected to support two Forward RCS burns.
- TBD** Attitude Hold - The amount of propellant required to control the vehicle during a +X translation is a function of the Aft RCS propellant available above the Aft RCS press quantity, which is defined by Rule {A6-305G}, AFT RCS REDLINES [HC]. ©[042706-7370D]

The addition of the FD2 Forward RCS Press Quantity is a result of decisions made at the A/E Flight Techniques #178, which allows the Forward RCS Delta V capability to be considered for OPS 2 burns in support of a FD2 PLS (reference Rule {A2-53}, FORWARD RCS USAGE GUIDELINES). ©[012402-5112B]

Rules {A2-108C}, CONSUMABLES MANAGEMENT; {A2-121A.1}, RNDZ/PROX OPS PROPULSION SYSTEMS MANAGEMENT; {A4-1B}, PERFORMANCE ANALYSES; {A4-153I}, CG PLANNING; {A6-305}, AFT RCS REDLINES [HC]; and {A6-351}, OMS PROPELLANT MANAGEMENT MATRIX; reference this rule. ©[092800-7247A] ©[042706-7370D]

FLIGHT RULES

A6-305

AFT RCS REDLINES [HC] @[042706-7370D]

A. AFT RCS DEORBIT REDLINE: @[091098-6711B]

THE TOTAL AFT RCS REQUIRED FOR DEORBIT IS DEPENDENT UPON ORBITER X CG LOCATION. THE AFT RCS DEORBIT REDLINE RESERVES PROPELLANT FOR: @[092800-7247A]

	ORBITER X CG (IN)	
	≤ 1095	> 1095
NOMINAL DEORBIT PREP	162	162
USAGE DEORBIT TO EI	160	160
99.5 PERCENT USAGE EI TO MACH 1	1175	1375
OMS ENGINE FAIL	70	70
DEORBIT WAVE-OFF AND MIN ENTRY PREP	81	81
WEATHER WAVE-OFF EXTENSION DAY		
EXTENSION DAY [1]	228	228
1 REV DEORBIT DELAY	65	65
DEORBIT SUPPLEMENT (IF REQUIRED)	<u>TBD</u>	<u>TBD</u>
ADDITIONAL DEORBIT ATTEMPTS	<u>TBD</u>	<u>TBD</u>
CG BALLAST (IF REQUIRED)	<u>TBD</u>	<u>TBD</u>
PREBANK (IF REQUIRED)	150	150

NOMINAL DEORBIT PREP, DEORBIT WAVE-OFF AND MIN ENTRY PREP, WEATHER WAVE-OFF ACTIVITIES, AND ADDITIONAL DEORBIT ATTEMPTS MUST BE PROTECTED IN THE OMS IF NOT PROTECTED IN THE ARCS. WEATHER WAVE-OFF ACTIVITIES MAY BE DELETED IN FAVOR OF CRITICAL ON-ORBIT ACTIVITIES PER RULE {A2-108}, CONSUMABLES MANAGEMENT, AND THE FLIGHT RULE ANNEX. OMS ENGINE FAILURE MAY BE DELETED FOR THE DEORBIT WAVE-OFF EXTENSION DAY IN ORDER TO ACCOMPLISH HIGHER PRIORITY ACTIVITIES AS DOCUMENTED IN THE FLIGHT RULE ANNEX. VIOLATION OF THE AFT RCS DEORBIT REDLINE IS CAUSE TO DEORBIT AT NEXT PLS IF NO FURTHER PROPELLANT TRADE-OFFS CAN BE ACCOMPLISHED AS LISTED IN RULE {A2-108}, CONSUMABLES MANAGEMENT.

NOTE: [1] ASSUMES ATTITUDE CONTROL IN -ZLV -XVW PER RULE {A2-108}, CONSUMABLES MANAGEMENT. IF THERMAL CONDITIONING IS REQUIRED, UTILIZE ATTITUDE PROFILE PER RULE {A2-110}, STRUCTURES THERMAL CONDITIONING, OR AS SPECIFIED IN THE FLIGHT RULES ANNEX. @[092800-7247A]

THIS RULE CONTINUED ON NEXT PAGE

FLIGHT RULES

A6-305

AFT RCS REDLINES [HC] (CONTINUED)

- 162 - *Aft portion of nominal, vernier deorbit prep. Tail-Only control requires 298 lb.* ©[092800-7247A]
- 160 - *Required to support attitude control from the deorbit burn to entry interface. This is mean usage and is confirmed by actual flight data.* ©[091098-6711B]
- 1175/1375 - *The amount of Aft RCS required to perform an entry from EI to Mach 1 given a specific orbiter X CG location, reference Ascent/Entry Flight Techniques #150. The X CG constraint applies throughout the entry profile (ref. Rule {A4-153}, CG PLANNING), but because the X CG moves forward from EI to Mach 1, the X CG at EI is used to determine the redline. These numbers were chosen to provide 99.5 percent WRAP DAP protection based on Weissman's estimator for non-normal distributions. The Monte Carlo data were generated with STS-1 through STS-89 (less STS-4) reconstructed flight atmospheres using both SES and SDAP simulators.* ©[091098-6711B]

In early 2006, additional entry Monte Carlo analysis was performed to determine if the aft RCS entry redline provided adequate protection for an early onset of Asymmetric Boundary Layer Transition (ABLT) above Mach 19 due to concerns of gap filler protrusions on the forward part of the vehicle. A small subset of the 1998 Monte Carlo analysis was repeated using the same methodology and with the Boundary Layer Transition (BLT) aerodynamic model extrapolated from its previous limit of Mach 19 to Mach 25. The BLT model is documented in the Orbiter Aerodynamic Data Book and varies the BLT onset Mach number as well as the probability that asymmetry will be encountered. The analysis examined the EI to Mach 1 usage exclusively for orbiter X cg's that fell under the '≤ 1095' column above. The analysis showed that the current 1175 lb EI to Mach 1 generic redline does not need to be changed for ABLT onset up to Mach 25 and that the flight control system has sufficient authority to handle ABLT. The analysis was reviewed at A/EFTP #218, March 31, 2006, and at several Entry GNC Panels. ©[042706-7370D]

Reference Ascent/Entry Flight Techniques Panel #218, March 31, 2006, and Boeing IL FSSE-OFSDA-06-015. ©[042706-7370D]

THIS RULE CONTINUED ON NEXT PAGE

FLIGHT RULES

A6-305

AFT RCS REDLINES [HC] (CONTINUED)

- 70 - *If an OMS engine failure should occur during the deorbit burn, 70 lb of Aft RCS usage are required to perform single OMS engine attitude control (reference STSOC Transmittal Form No. 330-320-352). This number should be increased to 82 lb if Tail-Only control is required. OMS engine fail protection may be given up for the deorbit wave-off extension day in order to accomplish high priority mission success activities as documented in the Flight Rule Annex. If OMS engine fail protection is given up, then the deorbit wave-off extension day propellant should be redistributed in the OMS and Aft RCS in order to retain the equivalent of the OMS engine failure propellant in each system at nominal end of mission. This implicit protection will be lost if the deorbit wave-off extension day is used. If an OMS engine has previously failed, then this allotment must be redlined in the Aft RCS or OMS to provide roll control during the deorbit burn. ©[091098-6711B]*
- 81 - *Normally, as part of the deorbit wave-off extension day, the propellant required for a deorbit prep backout and the last 30 minutes of a subsequent deorbit preparation is protected in the Aft RCS deorbit redline. This consists of 43 lb that is budgeted to support PRCS attitude control for 1 hour until the RCS system can be interconnected to the OMS, and 38 lb to perform the last 30 minutes of deorbit preparation. This propellant can be protected in the OMS if required. The equivalent quantity for Tail-Only control is 147 lb. ©[091098-6711B] ©[092800-7247A]*

THIS RULE CONTINUED ON NEXT PAGE

FLIGHT RULES

A6-305

AFT RCS REDLINES [HC] (CONTINUED)

- 228 - *Propellant reserved as part of the weather wave-off extension day to back out of the deorbit burn config (43 lb), extend one day (23 lb), and then complete a second nominal deorbit prep (162 lb). The extension day propellant is protected in the Aft RCS because it is such a small amount of propellant that it is not operationally convenient to protect it in the OMS. Similarly, Nose/Tail ALT control requires 43 lb for the backout, 53 lb for the extension day, and 137 lb for the deorbit prep, total 233 lb. Note that if the propellant required for the extension day increases, such as for Tail-Only ALT control (as mentioned below), or because an alternate attitude profile is required for structural thermal conditioning, the extension day may be protected either in the OMS or the Aft RCS. Tail-Only ALT control requires 75 lb for the deorbit backout and 298 lb for the deorbit prep, total 373 lb, with the extension day propellant (89 lb) normally protected in the OMS. Note also that the weather wave-off extension day assumes a specific attitude profile: -ZLV -XVV is the default attitude and was chosen to provide the minimum propellant consumption with maximum debris protection, and because it is relatively insensitive to altitude, thus providing the best protection for off-nominal (abort) orbits. However, if a different attitude profile is required for deorbit thermal conditioning, this must be protected. Ref. Rule {A2-110}, STRUCTURES THERMAL CONDITIONING, and the Flight Rule Annex. The weather wave-off extension day requires 205 lb of aft RCS with 10 hours of vernier 1 deg PTC protected (180 lb Nose/Tail ALT, 373 lb Tail-Only ALT, both with 10 hours of 5 deg Tail-Only PTC) per Rule {A2-110}, STRUCTURES THERMAL CONDITIONING, with the remainder of the extension day propellant protected in the OMS. According to an email dated June 5, 2000, from ES/Y. Chang, up to a 10-deg deadband for PTC is thermally acceptable. All propellant budgeted for the weather wave-off extension day may be traded for critical on-orbit activities as defined in Rule {A2-108}, CONSUMABLES MANAGEMENT, and the Flight Rule Annex. ©[092800-7247A]*
- 65 - *Also as part of the weather wave-off extension day, propellant is provided to perform one rev of attitude hold on the TRANS DAP to ensure two consecutive deorbit attempts on one of the three days. All propellant budgeted for the weather wave-off extension day may be traded for critical on-orbit activities as defined in Rule {A2-108}, CONSUMABLES MANAGEMENT, and the Flight Rule Annex. One orbit of Nose/Tail Trans DAP with FES will cost 65 lb aft (113 lb Tail-Only control). This propellant may be protected in the OMS if required. ©[092800-7247A]*
- TBD** *D/O Supplement - If Aft RCS propellant is required to supplement the OMS deorbit steep propellant, either for +X translation, +Z translation, or for attitude hold during FRCS -X translation, this propellant, plus any associated maneuvers, must be protected.*

THIS RULE CONTINUED ON NEXT PAGE

FLIGHT RULES

A6-305

AFT RCS REDLINES [HC] (CONTINUED)

- TBD** *D/O Attempts* - Propellant for additional deorbit opportunities, such as extra orbits of attitude hold in the deorbit burn configuration, may be protected on a flight specific basis as documented in the Flight Rule Annex. One orbit of Nose Tail Trans DAP with FES will cost 65 lb aft (113 lb Tail-Only control). This propellant may be protected in the OMS if required. ©[092800-7247A]
- TBD** *CG Ballast* - Propellant may be redlined to act as ballast to maintain the X and Y CG within limits. The amount of propellant required for CG ballast (ref. Rule {A4-153}, CG PLANNING) is determined during preflight analysis and updated in real time. Ballast will be protected in the OMS, the Aft RCS, or both. Note that OMS and ARCS propellant cannot be traded 1:1 for ballast purposes. CG ballast cannot be traded against other orbit activities. CG ballast can be traded against other redlined items if the ballast requirement changes for extension day deorbit opportunities.
- 150 - If the OMS targets are shallowed, an extra 150 lb of Aft RCS propellant must be redlined to perform the prebank maneuvers. The size of the prebank maneuver is not a factor; a 1-degree prebank maneuver is estimated to use as much propellant as a 90-degree prebank. A shallow deorbit causes the vehicle to enter the atmosphere at a shallower angle than usual and is more prone to “skip” off the atmosphere back into orbit. To avoid skipping off the atmosphere, the vehicle is rolled (“banked”) so that the lift from the orbiter wings is minimized. This increases the sink rate and decreases the possibility of skipping back out of the atmosphere. The consequences of skipping back out are likely to be catastrophic - at the very least, the planned landing site would be missed. ©[091098-6711B] ©[092800-7247A]

B. MISSION COMPLETION REDLINE ©[091098-6711B]

THE AFT RCS MISSION COMPLETION REDLINE IS DEFINED AS THE NOMINAL AFT RCS DEORBIT REDLINE PLUS ENOUGH PROPELLANT TO EXECUTE THE REMAINING FLIGHT PLAN ACTIVITIES. ©[092800-7247A]

The mission completion redline is the amount of RCS propellant required to perform the flight plan activities, PTI's, DTO's, while still protecting the deorbit redline requirements.

C. AEROCAPTURE AFT RCS REDLINE:

THE TOTAL AFT RCS REQUIRED FOR AEROCAPTURE ENTRY IS 460 LBS. THIS INCLUDES DEORBIT TO EI USAGE (160 LB) AND MEAN SHALLOW EI TO QBAR 20 USAGE (300 LB).

THIS RULE CONTINUED ON NEXT PAGE

FLIGHT RULES

A6-305

AFT RCS REDLINES [HC] (CONTINUED)

The aerocapture RCS redline defines a theoretical minimum amount of Aft RCS propellant required to control the vehicle from deorbit to the point at which NO YAW JET option can be selected (Qbar = 20 psf; ref. Rule {A4-207C}, ENTRY LIMITS). 300 lb protects mean RCS usage for a shallow entry from EI to Qbar = 20 based on data supplied by DM after AEFTP #150. The propellant protected by this redline is used (see Aft RCS Quantity 2 below) to define the maximum propellant that may be used for the deorbit burn in an emergency and still have some chance for a successful entry. @[092800-7247A]

D. ON ORBIT AFT RCS SINGLE POD QUANTITY REDLINE:

ARCS ON ORBIT TANK FAIL	440	440
MEAN USAGE DEORBIT TO EI	160	160
MEAN USAGE STEEP EI TO 0.05G	96	(109) *
TOTAL	696	(709)

@[042507-8466B]

USABLE PROPELLANT REQUIRED FOR A NO YAW JET ENTRY:

MEAN USAGE DEORBIT TO EI	160	160
MEAN USAGE STEEP EI TO 0.05G	96	(109)
MEAN USAGE STEEP 0.05G TO QBAR=20	69	(79)
TOTAL	325	(348)

* () REFLECTS USAGE NUMBERS FOR THE CASE WHERE THE PROPELLANT WILL BE USED IN BLOWDOWN

THE ON-ORBIT AFT RCS SINGLE POD QUANTITY REDLINE IS THE MINIMUM QUANTITY ALLOWED IN EACH AFT RCS SYSTEM DURING ORBIT OPERATIONS. LEFT AND RIGHT RCS PROPELLANT WILL BE MANAGED TO ENSURE THIS QUANTITY AND THE USABLE PROPELLANT REQUIRED FOR A NO YAW JET ENTRY ARE NOT VIOLATED PRIOR TO NOMINAL EOM. VIOLATION OF THIS REDLINE IS CAUSE FOR DEORBIT AT NEXT PLS.

System failures could result in an imbalance between left and right RCS usable quantities (i.e., maximum blowdown burn after a helium tank leak) while the total ARCS usable is greater than the nominal RCS Deorbit Redlines. However, if either RCS system cannot individually protect sufficient propellant to maintain control during a NO YAW JET entry redline, a PLS must be executed. RCS tank fail protection is required in order to stay on orbit. @[091098-6711B] @[042507-8466B]

THIS RULE CONTINUED ON NEXT PAGE

FLIGHT RULES**A6-305****AFT RCS REDLINES [HC] (CONTINUED)**

The ON-ORBIT AFT RCS SINGLE POD QUANTITY REDLINE represents the minimum quantity required per side to protect for an RCS tank failure and still guarantee a no yaw jet entry. This quantity assumes that OMS propellant will not be available after the deorbit burn for OMS to RCS interconnect (quantity < 11 percent per pod, ref. SODB 3.4.3.3.16a). Deorbit to EI (160 lb), EI to 0.05g (96 lb), and 0.05g to $Q_{bar}=20$ psf (69 lb) propellant usages must come out of the remaining RCS system. From deorbit to 0.05g (256 lb), since there is no appreciable acceleration on the vehicle, the AFT RCS ON-ORBIT TANK FAIL limit (ref. Rule {A6-7}, RCS PROPELLANT TANK (OXIDIZER OR FUEL)) applies. The 440 lb of trapped propellant will become available once the entry g-load on the vehicle increases to the 0.05g level. Of this 440 lb (20 percent), only 69 lb is needed to maintain control from 0.05g to $Q_{bar}=20$. At $Q_{bar} = 20$, NO YAW JET may be selected and RCS propellant is no longer required. ©[091098-6711B] ©[042507-8466B]

For the case where the propellant will be used in blowdown, the usage numbers increase since the thrust from the jets will be less than nominal (up to approximately 18 percent less) because of the lower propellant tank pressures and the crossfeed configuration. With reduced thrust, the usage from EI to 0.05g is 109 lb and the usage from 0.05g to $Q_{bar}=20$ is 79 lb. Therefore, for an ARCS He tank leak, a quantity of 32.3 percent (709 lb vs 696 lb) must be in the tank and of that amount, 15.9 percent (348 lb vs 325 lb) must be usable. For a helium tank leak, nominal RCS activities or a dedicated RCS burn should be performed to reach a quantity of 34 percent (reference Ascent/Entry Flight Techniques Panel #215, October 28, 2005). Circumstances may not allow reaching 34 percent; in that case, there is an upper quantity limit that still protects the required usable propellant in blowdown. At tank pressures of 245 psi, tank temperatures of 70 degrees F, and tank quantities of 54 percent, enough usable propellant is available in blowdown to guarantee a no yaw jet entry. Real-time data must be used to evaluate blowdown capability since this quantity can vary based on tank pressure and temperature. ©[091098-6711B]

Reference Hazard Reports ORBI-129, Loss of Capability to Safely Separate Orbiter from External Tank (ET) Caused by Loss of Pressurized Propellant Supply to the FRCS and/or ARCS Thrusters, and ORBI 183, Loss of Vehicle Control Due to Exceeding cg Limits as a Result of Propellant Management Failures. ©[042507-8466B]

E. AFT RCS QUANTITY 1 IS DEFINED AS SUFFICIENT AFT RCS PROPELLANT TO GUARANTEE 1134 LB AT EI AND PROVIDES 97.5 PERCENT CONFIDENCE FOR SHALLOW EI TO 0.05G USAGE ABOVE ARCS ON ORBIT TANK FAIL. AFT RCS PROPELLANT ABOVE AFT RCS QUANTITY 1 WILL BE USED DURING THE DEORBIT BURN FOR DELTA-V PURPOSES PRIOR TO USE OF FWD RCS PROPELLANT, REDESIGNATION, OR PREBANK. AFT RCS QUANTITY 1 IS DEFINED AS:

THIS RULE CONTINUED ON NEXT PAGE

FLIGHT RULES**A6-305****AFT RCS REDLINES [HC] (CONTINUED)**

ARCS ON ORBIT TANK FAIL	880
97.5 PERCENT SHALLOW USAGE FROM EI TO NZ 0.05G	254
PREBANK	150
USAGE DEORBIT TO EI	160
ATTITUDE HOLD FOR FRCS (-X) TRANS	<u>TBD</u>
FAST FLIP	100
CG BALLAST (IF REQUIRED)	<u>TBD</u>

If OMS propellant is depleted during the deorbit burn prior to the completion of the targeted delta V, the crew will use the Aft RCS propellant through the +X jets until either the desired targets are achieved, or until the Aft RCS propellant quantity decreases to "Aft RCS Quantity 1." If deorbit targets still have not been achieved, the crew will utilize the aft Hp, target Hp, flip Hp, and Capture Hp cues (calculated by MCC) to determine the actions required to complete the deorbit burn. These actions may include requiring prebank, utilizing the FRCS -X jets which requires a fast flip maneuver and attitude hold propellant, and/or redesignation. Since these tools will not be used until after the +X translation, their propellant requirement is included in the definition of "Aft RCS Quantity 1." The propellant required to control the vehicle during the FRCS -X translation is a function of FRCS propellant available and is calculated by the PROP console prior to deorbit. The amount of propellant required for CG ballast (if any) to protect the nominal CG box (ref. Rule {A4-153}, CG PLANNING) will be determined during preflight analysis for AOA/Orbit 3 scenarios. Preflight analysis will also determine nominal end-of-mission ballast requirements, which may be updated during real-time operations. Ballast will normally be protected in the RCS for AOA/Orbit 3, and in the OMS for EOM, but may be protected in the OMS, or RCS, or divided between the two systems. ®[901-98-6711B] ®[042706-7370D]

Per A/E Flight Techniques Meeting #150, lowering the EI to Mach 1 usage protection to 97.5 percent confidence is preferred over fast flip, redesignation, or prebank. Even so, a steep entry cannot be guaranteed in a case where AQ1 is applied, and a shallow entry uses more propellant in the EI to Nz=0.05g region. To provide 97.5 percent protection from EI to Nz=0.05g for a shallow entry requires 254 lb over and above the 880 lb AFT RCS ON-ORBIT TANK FAIL quantity (ref. Rule {A6-7}, RCS PROPELLANT TANK (OXIDIZER OR FUEL)). The total EI to Mach 1 requirement is 1134 lb. and may be reduced to 1028 lb if steep targets are achieved (see section H, Aft Hp Quantity). Note that this may provide slightly less than the 97.5 percent EI to Mach 1 usage and so may require the use of NO YAW JETS if worst case entry conditions are encountered. ®[091098-6711B] ®[092800-7247A]

The Ascent/Entry Flight Techniques Community also determined that Aft RCS Quantity 1 provided adequate propellant coverage with "mean" usages for the contingency Capture Hp procedures. The Capture Hp procedures expose the orbiter to extended flight durations from deorbit burn cutoff to EI, and again from EI to Nz=0.05g. For this case, 97.5 percent confidence will be sacrificed to provide the highest possible Hp at which the crew might achieve aerocapture to a downrange ELS when there has been a serious delta V shortfall in completing the deorbit burn. A limited number of runs performed in the SES showed that Aft Quantity 1 will provide adequate protection at the highest possible, and therefore worst case, Capture Hp, and for this contingency scenario this level of protection was deemed sufficient. ®[042706-7370D]

THIS RULE CONTINUED ON NEXT PAGE

FLIGHT RULES**A6-305****AFT RCS REDLINES [HC] (CONTINUED)**

F. AFT RCS QUANTITY 2 IS DEFINED AS SUFFICIENT AFT RCS PROPELLANT TO PROTECT AEROCAPTURE REQUIREMENTS. AFT RCS PROPELLANT AVAILABLE ABOVE AFT RCS QUANTITY 2 WILL BE USED FOR DELTA V PURPOSES ONLY IF FORWARD RCS PROPELLANT, REDESIGNATION, AND PREBANK ARE NOT SUFFICIENT. AFT RCS WILL BE USED NO LOWER THAN AFT RCS QUANTITY 2 TO SUPPORT DEORBIT. AFT RCS QUANTITY 2 DOES NOT GUARANTEE A SUCCESSFUL ENTRY. AFT RCS QUANTITY 2 IS DEFINED AS:

DEORBIT TO EI	160
EI TO QBAR \geq 20	300
PREBANK	150
ATT HOLD FOR FRCS TRANS	<u>TBD</u>
FAST FLIP	100
©[091098-6711B]	

If, using all the Aft RCS available above Aft RCS Quantity 1, all the Forward RCS available, redesignation (if available), and prebank to 90 degrees, insufficient delta V is available to complete the deorbit burn, additional Aft RCS must be used. However, to run completely out of Aft RCS during the deorbit burn is also catastrophic. Some minimum amount of Aft RCS must be protected to maintain vehicle control until the aerosurfaces have some chance of maintaining control. When completing a deorbit burn, if the Aft RCS propellant available decreases to Aft RCS Quantity 1, and the other resources cannot meet the target (as calculated by the MCC and provided in the form of aft Hp, target Hp, flip Hp, and Capture Hp), rather than flip, crew procedures will continue to use Aft RCS through the +X jets. Note that time is not available to flip to use Forward RCS to depletion and then flip back to complete with Aft RCS, even though this is probably the optimum use of the propellant. Crew procedures continue to use Aft RCS until the delta V requirement decreases to the point that the other tools (Forward RCS, redesignation, and prebank) can meet the target. At that time (or when Aft RCS propellant decreases to Aft RCS Quantity 2), the procedures execute the other options; first flip to use Forward RCS to depletion, then redesignation and prebank. All three options will be fully utilized; therefore, the Aft RCS propellant requirements for these additional options must be protected. As in the case of Aft RCS Quantity 1, the Forward RCS attitude control propellant is calculated in the MCC prior to deorbit. No ballast is protected in Aft RCS Quantity 2 because a propellant failure is the most likely reason for using Aft RCS below Aft RCS Quantity 1, in which case the propellant trapped in the failed tank can serve as ballast. Further, completion of the deorbit burn is a higher priority than any ballast requirement.

©[091098-6711B] ©[042706-7370D]

Aft Quantity 2 does not protect the AFT RCS ON ORBIT TANK FAIL limit (ref. Rule {A6-7}, RCS PROPELLANT TANK (OXIDIZER OR FUEL)). Below 20 percent remaining, with Nz < 0.05g, the Aft RCS tanks may not be able to supply propellant to the RCS jets. ©[092800-7247A]

THIS RULE CONTINUED ON NEXT PAGE

FLIGHT RULES**A6-305****AFT RCS REDLINES [HC] (CONTINUED)**

G. THE AFT RCS PRESS QUANTITY IS THE AMOUNT OF AFT RCS PROPELLANT THAT MUST BE PROTECTED IN ORDER TO PROVIDE 97.5 PERCENT ENTRY CONFIDENCE FOR AN AOA OR ATO. AFT RCS USABLE PROPELLANT IN EXCESS OF THE AFT RCS PRESS QUANTITY IS COMMITTED TO THE PRESS TO ATO CALL. THE AFT RCS PRESS QUANTITY IS DEFINED AS: @[012402-5112B]

ARCS ON ORBIT TANK FAIL	880
USAGE EI TO NZ 0.05G SHALLOW/STEEP PREBANK (IF REQUIRED)	254/148 150
USAGE DEORBIT TO EI	160
OMS ENGINE FAIL ATTITUDE CONTROL	70
USAGE MECO TO DEORBIT AOA/ORBIT 3/ORBIT 7/FD2 MNVRS TO SUPPORT OPS 2 FRCS BURNS (FD2 ONLY)	259/427/495/525 38
ATTITUDE HOLD FOR OPS 2 FRCS BURNS (FD2 ONLY)	<u>TBD</u>
CG BALLAST (IF REQUIRED)	<u>TBD</u>

@[092800-7247A] @[012402-5112B]

- 880 - *At Nz=0.05g, the AFT RCS ON-ORBIT TANK FAIL constraint (ref. Rule {A6-7}, RCS PROPELLANT TANK (OXIDIZER OR FUEL)) is released and 880 lb of additional Aft RCS becomes available to support entry usage. @[091098-6711B]*
- 254/148 - *Data presented at A/E Flight Techniques #150 showed 254 lb required for shallow EI to Nz=0.05g usage with 97.5 percent protection. For a steep entry, 148 lb of EI to Nz=0.05g usage provides the same level of protection. @[091098-6711B]*
- 150 - *For an AOA or ATO shallow, prebank must be protected. Prebank is not required for a steep entry.*
- 160 - *Required to support attitude control from the deorbit burn to entry interface.*
- 70 - *For a press case, the OMS engines are deliberately burned to depletion. The OMS engine fail propellant will be used to control the attitude transients resulting from sequential OME shutdown during the depletion sequence. This quantity cannot be traded against any other events or activities (ref. Rule {A6-352}, OMS PROPELLANT BUDGET GROUND RULES).*
- 259/427/495/525 - *Aft RCS usage required for mated coast/ET SEP through the maneuver to the deorbit burn. Usage from MECO to deorbit for the ATO case is dependent on when the FD1 or FD2 deorbit opportunity occurs. FD2 assumes OPS 2 and vernier jets.*

THIS RULE CONTINUED ON NEXT PAGE

FLIGHT RULES

A6-305

AFT RCS REDLINES [HC] (CONTINUED)

38 - *The Forward RCS will be utilized in OPS 2 to raise or lower the orbit as needed in support of a FD2 PLS. Four vernier maneuvers will be protected to support two Forward RCS burns. This applies to the FD2 Aft RCS press quantity only.* ©[012402-5112B]

TBD *Attitude Hold* - *The amount of propellant required to control the vehicle during the OPS 2 Forward RCS -X burns is a function of Forward RCS propellant available above the FD2 Forward RCS press quantity, which is defined by Rule {A6-304D}, FORWARD RCS REDLINES. This applies to the FD2 Aft RCS press quantity only.* ©[012402-5112B]

CG Ballast - *The amount of CG ballast required will be determined during preflight analysis. This ballast will nominally be protected in the RCS. The nominal CG box (ref. Rule {A4-153}, CG PLANNING) is used for AOA steep ballast determination and the contingency CG box is used for AOA shallow.*

H. AFT HP QUANTITY

AFT HP QUANTITY IS DEFINED AS THE AMOUNT OF PROPELLANT RESERVED IN AFT QUANTITY 1 FOR FAST FLIP, AFT ATT HOLD FOR FORWARD RCS (-X) TRANSLATION, PREBANK, AND EXTRA USAGE DURING A SHALLOW ENTRY. THIS PROPELLANT CAN BE USED TO COMPLETE THE DEORBIT BURN IF IT IS SUFFICIENT TO COMPLETE THE STEEP TARGET REQUIREMENT. AFT HP QUANTITY IS COMPUTED AS FOLLOWS: ©[092800-7247A]

FAST FLIP	100
AFT ATT HOLD FOR FRCS (-X) TRANSLATION	<u>TBD</u>
EI TO 0.05G REDUCTION FOR STEEP ENTRY	106
PREBANK	150

Fast flip and shallow targets are less desirable than steep targets. If burning the aft propellant reserved for these activities will allow the steep target to be met that is the preferred action. 97.5 percent protection for shallow EI to Nz=0.05g requires 254 lb while equivalent protection for a steep entry only requires 148 lb. The difference is 106 lb. ©[091098-6711B]

THIS RULE CONTINUED ON NEXT PAGE

FLIGHT RULES

A6-305

AFT RCS REDLINES [HC] (CONTINUED)

I. ENGAGE NO YAW JET QUANTITY @[091098-6711B]

DURING ENTRY, BETWEEN QBAR=20 AND MACH 6, WHEN THE TOTAL AMOUNT OF AFT RCS USABLE PROPELLANT FALLS BELOW 10 PERCENT (220 LBS), NO YAW JET WILL BE ENGAGED. BELOW MACH 6, NO YAW JET WILL BE DISENGAGED. NO YAW JET WILL NOT BE RE-ENGAGED BELOW MACH 6 UNLESS MULTIPLE RCS JETS FAIL OFF (PROPELLANT DEPLETION).

According to study results presented at the A/E Flight Techniques #150, less than 132 lb (6 percent) is required for the Mach 6 to Mach 1 regime. To reduce the likelihood of a time critical RCS crossfeed being required, the number actually protected is 10 percent or 220 lb. Above Mach 6, once 10 percent total (L+R) quantity is reached, NO YAW JET will be selected, preserving the 220 lb for any control problems which might be encountered in NO YAW JET. Once Mach 6 is reached, the 220 lb remaining should be more than adequate to complete a normal entry, so AUTO will be selected to lower the crew workload.

J. AFT RCS OMS TANK FAIL QUANTITY

THE AFT RCS OMS TANK FAIL QUANTITY IS DEFINED AS THE AMOUNT OF AFT RCS PROPELLANT THAT MUST BE RESERVED FOR OMS TANK FAIL DETERMINATION. ONLY AFT RCS USABLE PROPELLANT IN EXCESS OF THE AFT RCS OMS TANK FAIL QUANTITY CAN BE COMMITTED TO DEORBIT DELTA V. THE AFT RCS OMS TANK FAIL QUANTITY IS DEFINED AS:

ARCS ON ORBIT TANK FAIL	880
97.5 PERCENT SHALLOW USAGE EI TO NZ	254
0.05G	
PREBANK	150
DEORBIT TO EI	160
ENGINE FAIL	70
NOMINAL (VERNIER) DEORBIT PREPARATION	162
USAGE TO DEORBIT TIG - 5 HOURS	<u>TBD</u>
VRCS EXTENSION DAY	64
ATTITUDE HOLD FOR FRCS TRANS	<u>TBD</u>
MANEUVERS TO FRCS BURN ATTITUDE	<u>TBD</u>
TWO ULLAGE BURNS	188
MANEUVERS TO OMS BURN ATTITUDE	39
CG BALLAST (IF REQUIRED)	<u>TBD</u>

@[092800-7247A]

The Aft RCS OMS Tank Fail Quantity is used to determine whether a leaking OMS propellant burn will be done retrograde or out-of-plane (ref. Rule {A4-104}, OMS LEAK/PERIGEE ADJUST). @[091098-6711B]

THIS RULE CONTINUED ON NEXT PAGE

FLIGHT RULES

A6-305

AFT RCS REDLINES [HC] (CONTINUED)

- 880 - *The AFT RCS ON-ORBIT TANK FAIL limit applies until the G-load on the vehicle reaches 0.05G. This propellant is then available for entry control (ref. Rule {A6-7}, RCS PROPELLANT TANK (OXIDIZER OR FUEL)). All Aft RCS propellant available above this quantity will be committed to OMS tank fail protection. By not protecting the full EI to Mach 1 propellant requirements, it is possible that NO YAW JET will have to be engaged if worst case entry conditions are present (bent airframe, wind and turbulence, and aero variations). However, the RCS propellant gained to commit to OMS tank fail may prevent a southern hemisphere ELS after an OMS propellant tank leak. ©[091098-6711B] ©[092800-7247A]*
- 254 - *The EI to Nz of 0.05G usage must be protected above the AFT RCS ON-ORBIT TANK FAIL limit to ensure attitude hold propellant is available until 0.05G when the propellant trapped on orbit becomes usable; 254 lb provides 97.5 percent protection for a shallow entry.*
- 150 - *A prebank maneuver will be performed in an OMS tank fail case since the determination of OMS tank fail capability is based on shallow deorbit.*
- 160 - *Required to support attitude control from the deorbit burn to entry interface.*
- 70 - *Since one engine will have failed at the end of the leaking OMS depletion burn, the ensuing deorbit burn will generally be performed with a single engine; accordingly, propellant for roll control must be protected. Furthermore, if RCS completion is required during the deorbit burn, propellant is needed for the maneuver to RCS 4+X attitude. The 70 lb protects both of these requirements.*
- 162 - *Protects a nominal deorbit prep with no additional thermal conditioning.*
- *USAGE TO DEORBIT TIG-5 HOURS - Determined real time based on the actual NPLS TIG.*
- 64 - *A vernier extension day is protected to allow for propellant sublimation prior to deorbit. ©[092800-7247A]*
- *ATTITUDE HOLD FOR FRCS TRANS - Determined real time based on the amount of FRCS propellant available. This will not be the standard 1:3 since fast flip is not to be used during the deorbit burn. Instead, the FRCS will be used for a perigee adjust burn prior to deorbit (ref. Rule {A4-104}, OMS LEAK/PERIGEE ADJUST). This will require 2.5 lb Aft RCS per fps.*
- *MANEUVERS TO FRCS BURN ATTITUDE - If an FRCS -X perigee adjust is to be performed after an OMS tank fail, two vernier maneuvers (19 lb) are required to maneuver to and from the -X burn attitude. ©[091098-6711B]*

THIS RULE CONTINUED ON NEXT PAGE

FLIGHT RULES

A6-305**AFT RCS REDLINES [HC] (CONTINUED)**

- 188 - Two 15-second ullage burns are protected. The first ullage burn is required for either the perigee adjust or the dump out of plane. The second ullage burn is required if the leaking propellant tank is not depleted during a perigee adjust burn. ©[091098-6711B] ©[092800-7247A]
- 39 - MANEUVERS TO BURN ATTITUDE (two primary maneuvers) are required for the leaking OMS perigee adjust burn and the subsequent out-of-plane burn to depletion. ©[091098-6711B] ©[092800-7247A]
- TBD** CG Ballast - The amount of propellant, if any, to protect the contingency CG box (ref. Rule {A4-153}, CG PLANNING) required for CG ballast will be determined real time, based on the next PLS deorbit TIG. Ballast will be protected in the OMS or the RCS, or divided between the two systems.

Reference Hazard Report ORBI 183, Loss of Vehicle Control Due to Exceeding C.G. Limits as a Result of Propellant Management Failures. ©[042706-7370D]

Rules {A2-121A}.1, RNDZ/PROX OPS PROPULSION SYSTEMS MANAGEMENT; {A4-1B}, PERFORMANCE ANALYSES; {A4-2}, LANDING SITE CONDITIONS; {A4-55}, DESIGN AND CRITICAL MECO UNDERSPEED DEFINITIONS; {A4-153C}.10, {A4-153D}.4, {A4-153I}, {A4-153K}.1.b, and {A4-153K}.2.b, CG PLANNING; {A4-202}, DEORBIT BURN COMPLETION [HC]; {A6-304}, FORWARD RCS REDLINES; {A6-351}(Note 10), OMS PROPELLANT MANAGEMENT MATRIX; and {A8-19}, YAW JET DOWNMODE, reference this rule. ©[092800-7247A] ©[042706-7370D]

A6-306 THROUGH A6-350 RULES ARE RESERVED

FLIGHT RULES

CONSUMABLES MANAGEMENT

A6-351

OMS PROPELLANT MANAGEMENT MATRIX

ITEM TO BE PROTECTED	NOMINAL AME [1]	ATO		PLS DAILY GO/NO-GO	PROP REQUIREMENTS [10]		
		AME [1]	RAISE ORB		LEFT	RIGHT	TOTAL
1. DISPERSIONS [8]	√	√	√	√	[8]	[8]	[8]
2. ENG OUT	√	√	√	√	62	62	124
3. TRAPPED [9]	√	√	√	√	399.5	399.5	799
4. DEORBIT WAVE-OFF	√ [2]		√ [2]	√ [2]	110	110	220
5. Y CG	√		√ [4]	√ [4]		TBD IN REAL TIME	
6. X CG	√		√ [3]	√ [3]			
7. OMS 1	√	√					
8. OMS 2	√	√					
9. OMS 3, ATO			√				
10. OMS 4, ATO			√				
11. PYLD SEP	√		√				
12. DEORBIT TARGET	STEEP	SHALLOW	STEEP [5]	STEEP [5]			
13. DOWNMODE [6]	ONE ONLY [7]	NONE	ONE ONLY [7]	ONE ONLY [7]			
14. TIG SLIP	1-RCS		1-RCS	1-RCS			
RESULT IF NOT PROTECTED	ATO	AOA	105 CIRC	DEORBIT PLS			

@[051194-1612A] @[092701-4850]

- | | |
|---|---|
| [1] OMS 1/2 EXECUTION. | [6] ONE DOWNMODE IS 2-1 OR 1-RCS. |
| [2] OMS PORTION OF THE DEORBIT WAVE-OFF EXTENSION DAY MUST BE PROTECTED IN THE ARCS IF OMS NOT AVAILABLE. | [7] 1-RCS TIG SLIP PROTECTED ONLY AFTER OMS ENGINE FAILURE |
| [3] FORWARD RCS DUMP MAY BE USED TO OPTIMIZE CG. | [8] OMS DISPERSIONS ARE DEFINED AS THE RSS OF (A) FLOW RATE AND MR ERROR, AND (B) LOADING ERROR. (REF. RULE {A6-301}, OMS USABLE PROPELLANT.) |
| [4] SEE RULE {A6-353B}, CG MANAGEMENT. | [9] TRAPPED RESIDUALS INCLUDE LINE AND TANK TRAPPED. |
| [5] SEE RULE {A2-108}, CONSUMABLES MANAGEMENT, FOR PROPELLANT VS FLIGHT ACTIVITY TRADEOFF. | [10] REF. RULES {A6-303}, OMS REDLINES [CIL]; {A6-304}, FORWARD RCS REDLINES; AND {A6-305}, AFT RCS REDLINES [HC]. |

NOTE: CHECKMARKS CANNOT BE "ADDED" TO COMPUTE TOTAL BUDGET FOR ANY GIVEN MISSION MODE. √ = ITEM MUST BE PROTECTED TO EXECUTE STATED MODE. IF IT IS NOT, DOWNMODE IS IN "RESULT" ROW.

@[051194-1612A] @[092701-4850] @[042706-7370D]

The OMS propellant matrix details the propellant required to be protected in order to fly to nominal, ATO, or AOA targets as well as the daily PLS GO/NO-GO. These requirements are protected by the abort maneuver evaluator (AME) during ascent and by the OMS propellant redlines during orbit. The ground rules are documented in Rule {A6-352}, OMS PROPELLANT BUDGET GROUND RULES.

FLIGHT RULES

A6-352

OMS PROPELLANT BUDGET GROUND RULES

- A. COMMITTING TO A NOMINAL ASCENT WILL BE CONSERVATIVE WITH REGARD TO OMS PROPELLANT EXPENDED. DISPERSIONS IN OMS ENGINES FOR FLOW RATE, MIXTURE RATIO, OMS TRAPPED, ONE ENGINE FAILURE, AND GAGING ERROR WILL BE ACCOMMODATED WHILE MAINTAINING NOMINAL ENTRY X AND Y CG, PAYLOAD SEPARATION REQUIREMENTS, AND OMS STEEP DEORBIT TARGETS, WITH PARTIAL PROPULSION DOWNMODING CAPABILITY (2-1 OMS).

Ascent to nominal targets will occur only if propellant is available for the above items. For cases where insufficient propellant exists to continue to nominal targets, ATO/AOA capability will be evaluated. Because an ATO orbit can be reevaluated and subsequently raised to an orbit on a future revolution depending upon the OMS propellant available, the requirements are conservative towards the nominal targets.

- B. ALL OMS PROPELLANT WILL BE USED TO AVOID AN AOA EXCEPT THE PROPELLANT BUDGETED FOR OMS SHALLOW TARGETS (INCLUDES 90 DEGREES PREBANK), OMS TRAPPED, DISPERSIONS, AND OMS ENGINE FAIL.

Since an AOA is not desirable due to increased trajectory dispersion sensitivity, high crew work load, and assured loss of mission, an AOA will be avoided if at all possible. In order to avoid an AOA, more OMS propellant is committed to achieve an ATO. OMS shallow deorbit, OMS dispersions, and OMS engine fail will be protected in the AME. Since aft RCS to RCS PRESS QTY is committed to achieve an AOA or ATO, during propellant critical situations it is expected that OMS depletion will occur during the deorbit burn and four +X RCS will be used to complete the burn. As a result, OMS engine fail propellant must be protected to protect this sequential shutdown during the deorbit burn. If propellant is not available to protect the above items, an AOA will be selected by the AME.

- C. OMS TANK FAILURE PROTECTION IS NOT REQUIRED TO CONTINUE THE NOMINAL ASCENT, TO CONTINUE PAST THE FIRST DAY PLS OR WHEN RAISING AN ATO ORBIT. OTHERWISE, ALL THE PROPELLANT CONSERVATISM INVOLVED IN COMMITTING TO THE NOMINAL ORBIT WILL BE OBSERVED PLUS CG MANAGEMENT AT EI/MACH 3.5, WHILE MAINTAINING OMS STEEP DEORBIT TARGETS WITH PARTIAL PROPULSION DOWNMODING CAPABILITY (2-1 OMS).

Decision was made to delete the tank fail requirement because of the low probability of occurrence and because the large tank fail redline did not provide sufficient propellant margins for on-orbit activities.

Although tank fail redlines can be protected during the early part of a flight, there is not sufficient propellant during the latter part. The Flight Director will be advised of the tank fail status but there has been no requirement to protect a tank failure since STS-3.

THIS RULE CONTINUED ON NEXT PAGE

FLIGHT RULES

A6-352

OMS PROPELLANT BUDGET GROUND RULES (CONTINUED)

In the event of an OMS tank leak, a perigee adjust burn will be performed ASAP to make use of the leaking propellant.

- D. OMS PROPELLANT PREVIOUSLY ALLOCATED FOR A DEORBIT WAVEOFF EXTENSION DAY MAY BE COMMITTED TO SUPPORT THE DEORBIT BURN. ©[051194-1612A]

The probability of a failure occurring that requires the deorbit burn to be terminated above safe H_p is low. The failures identified are redundant set fail, GPC splits, two main buses, IMU dilemma, and an OMS propellant tank fail. Because of this low probability, the propellant allocated for the deorbit wave-off extension day may be used in calculating deorbit burn targets. If the deorbit burn should be terminated above the safe H_p , the deorbit wave-off extension day propellant requirements could be obtained from the margins in the ARCS (if any margins are available) or by using OMS propellant below the 5 percent remaining (Rule {A6-356}, DEORBIT PLANNING CRITERIA) to the redlined OMS trapped/dispersion value. If the deorbit waveoff extension day capability cannot be obtained from these sources, the propellant allocated for the deorbit burn must be used to provide the deorbit waveoff extension day capability (results in shallow deorbit targets). ©[051194-1612A]

- E. NOMINALLY, OMS AND RCS PROPELLANT WILL BE BUDGETED FOR A DEORBIT WAVE-OFF EXTENSION DAY. IF OMS PROPELLANT IS NOT AVAILABLE, AFT RCS PROPELLANT WILL BE BUDGETED FOR THE DEORBIT WAVE-OFF EXTENSION DAY. ©[051194-1612A]

The OMS will be interconnected to the RCS jets to provide the extension day using tail-only ALT control and deorbit preparation using nose-tail control. RCS is budgeted for wave-off, until interconnect is established, and entry preparation (TIG - 30 minutes). ©[051194-1612A]

Rules {A6-305}, AFT RCS REDLINES [HC], and {A6-351}, OMS PROPELLANT MANAGEMENT MATRIX, reference this rule. ©[042706-7370D]

FLIGHT RULES

A6-353

CG MANAGEMENT

- A. OMS BALLAST FOR X CG MANAGEMENT IS NOT REQUIRED TO CONTINUE PAST THE FIRST DAY PLS IF FORWARD RCS PROPELLANT IS AVAILABLE TO DUMP POST-DEORBIT BURN.

The CG can be moved aft by two methods: (1) allocating OMS propellant for CG management versus delta V ("liquid ballast"), or (2) performing an FRCS dump after the deorbit burn. Either method can improve the CG for entry aerodynamics but the latter is preferred because it does not require additional propellant to be saved to EOM.

- B. OMS PROPELLANT WILL BE MANAGED IN AN ATTEMPT TO ACHIEVE A ZERO Y CG OFFSET. CHANGES IN THE NOMINAL INTERCONNECT SCHEDULE MAY BE MADE IN ORDER TO IMPROVE THE Y CG PRIOR TO DEORBIT.

The OMS propellant will be budgeted such that the left and right pod imbalance will achieve the desired Y CG. This may be achieved by feeding from either OMS system during on-orbit RCS activities or during OMS burns.

The left and right pod interconnect schedule will be modified to achieve the desired imbalance for CG management.

- C. THE PROJECTION OF PROPELLANT USAGE RESULTING IN VIOLATION OF THE CG ENVELOPE (REF. RULE {A4-153}, CG PLANNING) AT THE NEXT PLS WILL BE CAUSE FOR ENTRY AT THE NEXT PLS OPPORTUNITY.

If propellant usage cannot be budgeted to assure a satisfactory CG at the next PLS, entry will be performed at the next PLS prior to violating the CG envelope.

Rule {A6-351}, OMS PROPELLANT MANAGEMENT MATRIX, references this rule.

FLIGHT RULES

A6-354

RCS ENTRY REDLINE PROTECTION

THE OMS/RCS INTERCONNECT WILL BE USED TO PROTECT THE RCS ENTRY REDLINES EVEN AT THE EXPENSE OF STEEP DEORBIT PROTECTION.

OMS tank fail protection is not required to continue to the nominal end of mission. However, if tank fail protection is available, it will be traded off to protect the RCS entry redlines.

The OMS propellant is not available to feed the RCS jets during entry due to tank feed limitations (location of propellant). The RCS can be used to supply deorbit delta V and entry attitude control. Therefore, the OMS is used on-orbit in an OMS/RCS interconnect mode to protect RCS redlines realizing that the RCS can be used to supplement the deorbit delta V required. The deorbit targets are shallowed to 45 deg prebank to achieve the priority mission or to 90 deg prebank to protect the RCS entry requirements. This can be seen in the Propellant Consumables Management Table (ref. Rule {A2-108}, CONSUMABLES MANAGEMENT).

Rule {A6-304C}, FORWARD RCS REDLINES, references this rule.

A6-355

OMS PROPELLANT DEFICIENCY FOR DEORBIT

IF INSUFFICIENT PROPELLANT EXISTS IN THE OMS TO MEET THE REQUIRED DEORBIT TARGETS, IT IS ACCEPTABLE TO REDLINE PROPELLANT IN THE RCS TO PERFORM A TWO-STAGE DEORBIT TO THE REQUIRED TARGETS ONLY IF THERE IS FAIL-SAFE JET REDUNDANCY FOR TRANSLATION IN THE AFFECTED RCS.

Additional propellant can be redlined in the RCS in the event of an OMS/RCS problem (i.e., isolatable propellant or helium leak or high usage) resulting in insufficient OMS propellant to achieve the steep deorbit targets. Rather than performing a single stage burn such that the crew must downmode to RCS in a time-critical period, a two-stage deorbit is preferred. This provides steep deorbit capability while maintaining at least four revs between burns for guidance and crew planning. However, this is acceptable only if fail-safe redundancy exists in the RCS jets which means 4+X or 3-X jets are required prior to the first stage of the deorbit. If a two-stage deorbit is required, RCS propellant will be redlined to protect 2 + X for the RCS perigee adjust. This provides downmode capability from 4+X to 2 +X to protect for a +X jet failure during the burn. 2 +X is protected since this capability is cheaper than 3 +X. (Ref. Rule {A2-108}, CONSUMABLES MANAGEMENT, for propellant trade-offs.)

Rules {A2-201B}.4, DEORBIT GUIDELINES; and {A6-303C}, OMS REDLINES [CIL];, reference this rule.

FLIGHT RULES

A6-356

DEORBIT PLANNING CRITERIA

FOR DEORBIT PLANNING PURPOSES, OMS PROPELLANT CAN BE USED TO SUPPORT RCS DOWNMODE CAPABILITY AND/OR PROTECT VEHICLE CG/LANDING WEIGHT CONSTRAINTS PROVIDED THAT THE OMS REMAINING POST-DEORBIT BURN (NO FAILURES) IS GREATER THAN 5 PERCENT PER POD.

RCS downmode protection is not required as long as two OMS engines are available. If OMS propellant margin is available to support RCS downmode, deorbit planning will protect RCS downmode capability subject to the constraints identified in this rule. To provide for TIG SLIP, RCS downmode capabilities and to protect vehicle CG and downweight constraints, additional OMS propellant (above the OMS deorbit optimal requirements) may be required. Backing up TIG requires additional delta V to satisfy deorbit targets. The 5 percent propellant remaining constraint in each OMS tank (403 lb oxidizer, 245 lb fuel) provides optimum delta V capability while protecting the worst case OMS dispersions which could occur in either the straight feed or crossfeed OMS burn configurations. The 5 percent remaining constraint also prevents inadvertent engine depletion. Engine depletion during zero gravity (either oxidizer or fuel) is undesirable during nominal deorbit conditions because it may result in damage to the OMS engines. This damage to the OMS engine is contained damage and will not damage the orbiter. OMS engine replacement will be required.

Rules {A4-153C}.3, CG PLANNING; and {A6-352}, OMS PROPELLANT BUDGET GROUND RULES, reference this rule.

A6-357

FORWARD RCS CONTINGENCY PROPELLANT AVAILABLE

DURING CONTINGENCY OPERATION INCLUDING OMS ENGINE FAILURE, OMS TANK FAILURE AND RENDEZVOUS BREAKOUT MANEUVER, THE FRCS MAY BE USED TO 1.5 PERCENT BELOW THE ONBOARD GAGE READING OF ZERO PERCENT.

SODB paragraph 4.3.2.3 (III) (CAUTION: SODB, volume III, contains engineering estimates for non-nominal performance evaluation. Data may not be supported by test.) indicates that a gauge reading of 1.5 percent below zero assures gas free propellant (no helium ingestion) flow to thrusters with reasonable risk. This assumes a factor of safety of 1.0 on tank expulsion performance and actual worst case gauging error (based on WSTF test data).

Rule {A6-7}, RCS PROPELLANT TANK (OXIDIZER OR FUEL), references this rule.

FLIGHT RULES

A6-358

VIOLATION OF MISSION COMPLETION REDLINES MATRIX

MISSION COMPLETION REDLINE VIOLATED	ACTION
LEFT OR RIGHT OMS	<ol style="list-style-type: none"> 1. PERFORM FLIGHT PLAN INTERCONNECTED FROM GOOD OMS TO THE TOTAL OMS MISSION COMPLETION REDLINE. 2. PERFORM RCS FLIGHT PLAN ACTIVITIES NORMALLY SCHEDULED FOR INTERCONNECT WITH RCS PROPELLANTS IF AVAILABLE ABOVE THE MISSION COMPLETION REDLINE. 3. DELETE FLIGHT PLAN ACTIVITIES AS DEFINED IN RULE {A6-359}, RCS PROPELLANT CONSERVATION PRIORITIES.
LEFT OR RIGHT AFT RCS	<ol style="list-style-type: none"> 1. INTERCONNECT TO OMS MISSION COMPLETION REDLINE. 2. CROSSFEED FROM OTHER RCS UNTIL TOTAL RCS (LEFT AND RIGHT) MISSION COMPLETION REDLINE. 3. DELETE FLIGHT PLAN ACTIVITIES AS DEFINED IN RULE {A6-359}, RCS PROPELLANT CONSERVATION PRIORITIES.
FORWARD RCS	<ol style="list-style-type: none"> 1. DECREASE FRCS SUPPLEMENT TO OMS/RCS DEORBIT REDLINE IF PROPELLANT AVAILABLE ABOVE OMS/RCS MISSION COMPLETION REDLINE. 2. DELETE FLIGHT PLAN ACTIVITIES AS DEFINED IN RULE {A6-359}, RCS PROPELLANT CONSERVATION PRIORITIES.

The table describes what action can be taken when the mission completion redline (MCR) has been violated. These actions attempt to regain propellant margins required to continue to the nominal end of mission.

LEFT OR RIGHT OMS MCR:

The first action to maintain positive propellant margins would be to crossfeed to the OMS pod with margin to protect the total OMS MCR (left and right)

The second is to cancel planned interconnects. This requires the interconnect propellant to be budgeted in the RCS, increasing the RCS MCR and reducing the OMS MCR. Again the total OMS MCR is protected.

The third action to take is to minimize RCS usage as described in Rule {A6-359}, RCS PROPELLANT CONSERVATION PRIORITIES.

LEFT OR RIGHT AFT RCS MCR:

The first action required to lower the RCS MCR can be to interconnect to an OMS pod with margin above the MCR. Secondly, if one pod has more propellant than the other the lower RCS pod can be fed from the higher RCS pod. This protects the total (left and right) MCR. Thirdly, the mission extension propellant budget can be reduced according to Rule {A2-108}, CONSUMABLES MANAGEMENT. Fourthly, implement minimized techniques in Rule {A6-359}, RCS PROPELLANT CONSERVATION PRIORITIES, and if needed delete flight plan activities according to the Propellant Usage versus Flight Activity table.

THIS RULE CONTINUED ON NEXT PAGE

FLIGHT RULES

A6-358

VIOLATION OF MISSION COMPLETION REDLINES MATRIX (CONTINUED)

FORWARD RCS MCR:

The first action when the forward RCS MCR has been violated will be to reduce the supplement to the OMS/RCS deorbit redline. The OMS supplement was used for tank fail protection in earlier flights (tank fail requirements have since been eliminated) and is now used only after failures dictate. During an RCS deorbit, selecting tail-only control during the 4 +X deorbit eliminates the need for forward RCS propellant thus reduces the FRCS deorbit redline while increasing the OMS/RCS deorbit redline due to the lower ISP associated with the 4 +X deorbit. The second action will be to minimize RCS usage as defined in Rule {A6-359}, RCS PROPELLANT CONSERVATION PRIORITIES.

Rules {A6-61}, RCS MANIFOLD/OMS CROSSFEED LINE REPRESSURIZATION [CIL]; and {A6-303D}, OMS REDLINES [CIL]; reference this rule.

FLIGHT RULES

A6-359

RCS PROPELLANT CONSERVATION PRIORITIES

RCS minimization techniques will be utilized after redline margins have been exhausted in each of the five OMS/RCS systems (FRCS, LRCS, RRCS, LOMS, ROMS). Redlines are protected by redlining additional propellant in the remaining tanks if margins exist.

A. UTILIZE NOSE-ONLY/TAIL-ONLY CONTROL MODES.

If margins exist in either the forward or aft tanks, attitude control can be performed using either the nose-only or tail-only control technique. This reduces propellant usage in either the aft or forward RCS to protect the deorbit redline. Nose-only control mode requires aft RCS for roll control.

B. VERNIER OR PRIMARY CONTROL WIDE DEADBANDS.

Widening deadbands during periods of attitude hold will reduce total propellant consumption. Care must be taken not to impact specific mission objectives requiring tight deadbands.

C. DELETE MISSION ACTIVITIES AS REQUIRED (REF. FLIGHT RULE ANNEX FOR PRIORITIES).

If further propellant consumption is required, DTO's will be deleted from the Flight Plan starting with the lowest priority defined in the Flight Rule Annex.

D. GRAVITY GRADIENT/FREE DRIFT DURING CREW AWAKE PERIODS.

In an attempt to remain on orbit for the priority flight, gravity gradient or free drift will be selected during crew awake periods.

E. MINIMIZE ENTRY PREPARATION.

Entry preparation is a relatively high usage phase 4 hours prior to deorbit. Releasing pre-entry checkout requirements would be the last resort to protect propellant for the entry or deorbit phase.

Rule {A6-358}, VIOLATION OF MISSION COMPLETION REDLINES MATRIX, references this rule.

A6-360 THROUGH A6-400 RULES ARE RESERVED

FLIGHT RULES

OMS/RCS GO/NO-GO CRITERIA

A6-1001

OMS/RCS GO/NO-GO CRITERIA [CIL]

<u>FAILURE</u>	CONTINUE NOMINAL ASCENT IF:	INVOKE MDF IF:	ENTER NEXT PLS IF:
A. <u>OMS</u>			
....1. HE TANK (2).....[4] [1]	0 ↓		
2. PROP TANK (4).....	0 ↓		1 ↓
3. N2 TANK (2).....	1 ↓		
4. ENGINE (2).....	1 ↓		2 ↓ [6]
5. CRITICAL OMS POD HEATERS		[5]	[5]
6. OMS INLET LINE.....	0 ↓		1 ↓
B. <u>RCS</u>			
1. HE TANK			
a. FWD (FU & OX TANKS).....		[2] [3]	[2] [3]
b. AFT (FU & OX TANKS, 1 POD) (2)	2 ↓		[8]
2. PROP TANK.....			
a. FWD (FU & OX TANKS).....		[2] [3]	[2] [3]
b. AFT (FU & OX TANKS, 1 POD) (2)	2 ↓		1 ↓
3. RCS MANIFOLD.....			
a. FWD (PRIMARY).....	[3]	[3]	[3]
b. AFT PRIMARY (4).....			2 ↓
4. +X JETS (PRIMARY).....			[6]
C. <u>CROSSFEED</u>			
OMS/RCS CROSSFEED.....			
2 FLOW PATHS (2).....		1 ↓ [7]	2 ↓

LEGEND:

	NO REQUIREMENT
	REQUIRED
()	QUANTITY
[]	NOTE REFERENCE

NOTES:

- [1] FOR LOSS OF HE TK, USE ENGINE IN BLOWDOWN UNTIL PC = 68 (72 PERCENT).
- [2] FWD RCS NOT REQUIRED IF AFT POD HAS FULL CAPABILITY FOR RCS DEORBIT.
- [3] MAINTAIN CG CONTROL WITH AFT PODS.

THIS RULE CONTINUED ON NEXT PAGE

FLIGHT RULES**A6-1001 OMS/RCS GO/NO-GO CRITERIA [CIL] (CONTINUED)**

- [4] OMS HE TANKS NOT REQUIRED IF BLOWDOWN GREATER THAN TANK FAIL LIMIT.
 [5] ENTRY REQUIRED PRIOR TO PREDICTED VIOLATION OF THERMAL LIMITS.
 [6] LOSS OF 1 OMS ENGINE AND 1 +X PRCS JET OR 1 OMS ENGINE AND LESS THAN RCS STEEP CAPABILITY IS CAUSE FOR A NEXT PLS ENTRY [CIL].
 [7] ONLY IF PROCEDURAL WORKAROUNDS ARE NOT AVAILABLE TO PROTECT THE REMAINING FLOW PATHS [CIL].
 [8] RCS HE TANK NOT REQUIRED IF THE ARCS SINGLE POD QUANTITY REDLINE IS NOT VIOLATED. @[042507-8466B]

Rule {A8-1001}, GNC GO/NO-GO CRITERIA, references this rule.

The rationale for this matrix is explained in three categories as follows:

- a. Continue nominal ascent if:*
- b. Invoke MDF if:*
- c. Enter next PLS if:*

CONTINUE NOMINAL ASCENT IF:

- **1 OMS ENGINE LOST:**
 - *Nominal ascent can be continued with the remaining engine; there has been no loss of delta V capability.*
- **1 OMS N₂ TANK LOST:**
 - *Nominal ascent can be continued on the remaining engine; there has been no loss of delta V capability.*
- **2 AFT RCS He OR PROP TANK LEAK:**
 - *Leaves only the good system for entry control and ET separation; loss of the good system means no control during early entry.*

INVOKE MDF IF:

- **1 OMS/RCS FLOW PATH (XFD) LOST:**
 - *An MDF is required only if procedural workarounds are not available to guarantee the remaining flow path (i.e., open the remaining crossfeed valve to guarantee crossfeed capability). If no workaround is available, then single fault tolerance remains to protect against engine/RCS propellant failures that require crossfeed.*

THIS RULE CONTINUED ON NEXT PAGE

FLIGHT RULES

A6-1001 OMS/RCS GO/NO-GO CRITERIA [CIL] (CONTINUED)

ENTER NEXT PLS IF:

- 2 OMS ENGINES LOST:
 - Only deorbit method is RCS, next failure means loss of deorbit capability (fail critical for deorbit).
- 1 OMS PROP TANK LEAK:
 - OMS tank failure no longer covered through end of mission. Failure means loss of deorbit capability (fail critical for deorbit).

Propellant budgeting for any flight is such that the loss of an OMS propellant tank early in flight (post-OMS-2) may not leave sufficient propellant between the good OMS, FRCS, and ARCS (above the entry redline) to achieve the shallow target line deorbit. Similarly, for the loss of both OMS engines plus one or more +X jets, there may be enough propellant to achieve the steep deorbit targets.

- 1 OMS INLET LINE LEAK:
 - Due to high pressure surges during repress of the OMS inlet line, it may not be possible to use the propellant for deorbit. In this case, the inlet line leak will be treated as an OMS propellant tank fail. The only guaranteed deorbit method is the good OMS engine supplemented by the FRCS and aft RCS.
- 1 AFT RCS He OR PROP TANK LEAK:
 - Leaves only the good system for entry control; loss of the good system means no control during early entry (fail critical for entry control).
- 1 AFT RCS He TANK FAIL and < ARCS Single Pod Quantity Redline Requirements:

@[042507-8466B]

 - If an ARCS He tank fails and the amount of propellant available in blowdown does not meet the ARCS Single Pod Quantity Redline requirements, then only the good system is capable of providing entry control; loss of the good system means no control during early entry (fail critical for entry control).

Reference Hazard Report ORBI-129, Loss of Capability to Safely Separate Orbiter from External Tank (ET) Caused by Loss of Pressurized Propellant Supply to the FRCS and/or ARCS Thrusters. @[042507-8466B]

THIS RULE CONTINUED ON NEXT PAGE

FLIGHT RULES

A6-1001 OMS/RCS GO/NO-GO CRITERIA [CIL] (CONTINUED)

- *2 AFT RCS MANIFOLD LOST - SAME SIDE:*
 - *Next RCS jet lost could result in no control for entry/no RCS downmode for deorbit (fail critical for entry control/fail safe for deorbit since propellant not available for 2 +X deorbit).*
- *2 OMS/RCS FLOW PATH (XFD) LOST:*
 - *Failure of OMS engine is same as OMS tank failure which is loss of deorbit capability (fail critical for deorbit).*
 - *Failure of RCS prop tank or He tank is loss of RCS jets on same side, which is no control for entry (fail critical for entry).*
- *1 OMS ENGINE AND 1 +X RCS JET LOST:*
 - *Only the remaining OMS engine and three +X jets are available to provide deorbit capability. Flight rules define four +X jets to steep targets as the only acceptable RCS deorbit method. Three +X jets can provide a deorbit capability if sufficient propellant is available. Because flight rules do not recognize three -X jets as a deorbit option; loss of one +X jet and one OMS engine require a deorbit at the next PLS, because only one deorbit method remains (fail critical).*
- *1 OMS ENGINE AND < RCS STEEP DEORBIT PROPELLANT REQUIREMENTS:*
 - *RCS steep propellant is redlined for the loss of one OMS engine per Rule {A6-303}, OMS REDLINES [CIL]. Unavailability of the propellant necessary for an RCS steep deorbit in conjunction with the loss of one OMS engine leaves only one safe deorbit method and results in a next PLS deorbit (loss of deorbit redundancy). RCS shallow targets may be acceptable on a flight-specific basis if defined in the Flight Rule Annex Priority Table.*
- *2 OMS/RCS FLOW PATH (CROSSFEED) LOST:*
 - *Failure of OMS engine is same as OMS tank failure which is loss of deorbit capability (fail critical for deorbit). Failure of RCS propellant tank or He tank is loss of RCS jets on same side, which is no control for entry (fail critical for entry).*

FLIGHT RULES

SECTION 7 - DATA SYSTEMS

GPC & DATA PATH MANAGEMENT

A7-1	PASS DPS FAILURE.....	7-1
A7-2	UNRECOVERABLE GPC.....	7-4
A7-3	GPC FAILURE.....	7-5
A7-4	TRANSIENT GPC.....	7-6
A7-5	PASS GPC BCE FAILURE MANAGEMENT.....	7-7
A7-6	DATA PATH FAILURE.....	7-9
A7-7	POWERED OFF GPC ACTION (101S).....	7-10
A7-8	REDUNDANT SET FAILURE.....	7-10
A7-9	REDUNDANT SET SPLIT.....	7-11
A7-10	GNC GPC REACTIVATION PRIORITY.....	7-13
A7-11	GNC GPC REDUNDANCY REQUIREMENTS.....	7-14
A7-12	PASS/BFS REDUNDANCY.....	7-14
A7-13	GPC MAJOR FUNCTION CONFIGURATION.....	7-15
A7-14	GNC 3 ARCHIVE MANAGEMENT.....	7-19
A7-15	SM OPS 4 TRANSITION REQUIREMENTS.....	7-20
A7-16	GPC MEMORY WRITE CRITERIA [CIL].....	7-21
A7-17	GPC MEMORY DUMP CRITERIA.....	7-24
A7-18	THROUGH A7-50 RULES ARE RESERVED.....	7-24

BFS SYSTEMS MANAGEMENT

A7-51	BFS DPS FAILURE.....	7-25
A7-52	ASCENT/ENTRY BFS MANAGEMENT GUIDELINES.....	7-28
A7-53	ON-ORBIT BFS MANAGEMENT GUIDELINES [HC].....	7-30
A7-54	BFS MANAGEMENT WHEN ONE FAILURE AWAY FROM SELF ENGAGE.....	7-30b
A7-55	THROUGH A7-100 RULES ARE RESERVED.....	7-31

FLIGHT RULES

OTHER DPS SYSTEMS MANAGEMENT

A7-101	POWER CYCLING/MANAGEMENT.....	7-32
A7-102	PASS DATA BUS ASSIGNMENT CRITERIA [HC].....	7-32
A7-103	I/O RESET.....	7-37
A7-104	NONUNIVERSAL I/O ERROR ACTION.....	7-38
A7-105	MDM PORT MODING.....	7-39
A7-106	MMU OPERATIONS.....	7-41
A7-107	TIME MANAGEMENT.....	7-42
A7-108	DEU EQUIVALENT CRITERIA.....	7-44
A7-109	IN-FLIGHT MAINTENANCE (IFM).....	7-46
A7-110 THROUGH A7-150	RULES ARE RESERVED.....	7-48

PAYLOAD-SPECIFIC DPS SYSTEMS MANAGEMENT

A7-151	CONSTRAINTS ON PORT MODING OR I/O RESETS.....	7-49
A7-152 THROUGH A7-200	RULES ARE RESERVED.....	7-49

DPS EOM REQUIREMENTS/DEFINITIONS

A7-201	DPS REDUNDANCY REQUIREMENTS.....	7-50
A7-202 THROUGH A7-1000	RULES ARE RESERVED.....	7-51

DPS GO/NO-GO MATRIX

A7-1001	DPS GO/NO-GO MATRIX.....	7-52
---------	--------------------------	------

FLIGHT RULES

SECTION 7 - DATA SYSTEMS

GPC & DATA PATH MANAGEMENT

A7-1 PASS DPS FAILURE

PASS DPS FAILURES ARE DECLARED BY THE FOLLOWING GUIDELINES USING ONBOARD AND GROUND MONITORING:

A. REDUNDANT SET (RS) FAILURE - DURING ASCENT OR ENTRY, AN RS FAILURE IS DEFINED AS FOLLOWS:

1. ALL PASS GPC'S QUIT OR HALT (POSSIBLE ANNUNCIATION OF THREE OR FOUR COMPUTER ANNUNCIATION MATRIX (CAM) DIAGONALS).

A QUIT or HALT state means that no software is being executed.

2. RS BREAKUP TO ALL SIMPLEX (THREE OR FOUR DIAGONALS).

An RS breakup can be induced by a GPC software or hardware problem. When an RS breakup occurs, each simplex GPC uses only the response data from its assigned string; it no longer incorporates response data from LRU's/BTU's controlled by the other GPC's. The PASS set is no longer operating on the same information and individual GPC's may send conflicting commands to subsystems.

B. AN RS SPLIT IS DEFINED AS FOLLOWS:

1. DURING ASCENT OR ENTRY, THE ORIGINAL SET OF FOUR PASS GPC'S SPLIT INTO TWO SETS OF TWO GPC'S (CALLED A TWO-ON-TWO) WITH EACH SET OF GPC'S VOTING AGAINST THE OTHER, OR TWO GPC'S EACH SPLIT FROM THE REMAINING SET OF TWO GPC'S, RESULTING IN A 2-1-1 SPLIT.

A GPC software or hardware failure can induce an RS split. With this type of failure, each set of two GPC's continues to process as if that set were the only one running. Although information is no longer exchanged between the two sets, both GPC's within each set maintain coordination. Unlike the redundant set breakup to all simplex, incorporation of flight-critical MDM response data is maintained within each set. In this configuration, the sets may send conflicting commands to subsystems. Additionally, it is possible for two GPC's to each split from the remaining redundant set of two GPC's. The result is three separate groups of GPC's that may each be issuing commands to subsystems that could be conflicting.

2. ON ORBIT, WHEN RS GNC GPC'S DO NOT MAINTAIN RS SYNC BUT DO MAINTAIN COMMON SET (CS) SYNC WITH EACH OTHER.

THIS RULE CONTINUED ON NEXT PAGE

FLIGHT RULES

A7-1 PASS DPS FAILURE (CONTINUED)

A GPC software or hardware problem can induce an RS split. With this type of failure, the GNC GPC uses only response data from its assigned strings; it no longer incorporates response data from LRU's/BTU's controlled by the other GNC GPC. The GNC GPC's do maintain common set coordination with each other and other GPC(s) in the common set. In this configuration, the sets may send conflicting commands to subsystems.

C. A GPC FAILURE IS DEFINED AS FOLLOWS:

1. A GPC FAILS OUT OF CS OPERATIONS OR ANNUNCIATES MULTIPLE "GPC BITE" FAULT MESSAGES.

GPC BITE fault messages indicate GPC software or hardware problems exist. A GPC BITE fault message annunciated multiple times by a single GPC implies that the GPC has ceased running a software module for multiple cycles. This cessation is considered an abnormal early termination of software capability and the GPC is considered failed. However, a GPC which only experiences a single GPC BITE and still maintains common set synchronization implies that no critical processes have been affected by the one-time early termination and that no immediate action is required.

2. A SINGLE GPC ANNUNCIATES A "SUMWORD ICC X" FAULT MESSAGE WHILE OPERATING IN THE CS WITH OTHER GPC'S IN MM 105, MM 106, OPS 2, MM 301, MM 302, OR MM 303.

A SUMWORD ICC X fault message notifies the crew of data mismatches between the CS GPC's on specific parameters being passed via ICC buses. To avoid possible use of incorrect GPC data that may cause subsequent OPS transition failures, this single GPC is treated as failed.

3. DURING ASCENT (MM 102 TO MM 104) OR ENTRY (MM 304, MM 305, MM 601 TO MM 603), A GPC ANNUNCIATING A "SUMWORD ICC X" FAULT MESSAGE AND NOT FAILED-TO-SYNC WILL BE ALLOWED TO CONTINUE OPERATING IN THE REDUNDANT SET AND DECLARED FAILED FOR THE NEXT OPS TRANSITION. MANAGEMENT OF THE GPC SHALL BE PER FIGHT RULE {A7-3A}, GPC FAILURE.

THIS RULE CONTINUED ON NEXT PAGE

FLIGHT RULES

A7-1 PASS DPS FAILURE (CONTINUED)

A SUMWORD ICC X message is not indicative of a GPC's ability to command a FC bus. If the GPC remains in the RS after the message is annunciated, it is expected that the set will remain intact until the next OPS transition when the GPC should be moded to HALT. If the GPC remains in the set, control redundancy is not affected and action to remove the GPC from the set is not warranted since the worst-case result would be a forced FTS. The GPC is expected to FTS at the OPS transition and should be removed prior to attempting the transition.

The response to this condition is divided into two groupings because of the opportunities to respond to the condition. During ascent through MM 104, GPC MODE/POWER switches are considered to be inaccessible. Therefore, a non-FTS GPC cannot be taken to HALT. The dynamic part of entry starts with MM 304. Although GPC MODE switches are accessible, DPS system reconfiguration is not allowed except for certain failure conditions as stated in All Flights Rule {A2-254C}, ENTRY STRING REASSIGNMENT. Therefore, removing an annunciating GPC would reduce system redundancy. Prior to MM 304, an annunciating GPC still in the RS can be HALTED and the DPS system reconfigured to maintain redundancy (Rule {A2-254A}, ENTRY STRING REASSIGNMENT).

This rule is referenced by Rule {A7-3A}, GPC FAILURE.

D. A DATA PATH FAILURE IS DEFINED AS THE LOSS OF CORRECT COMMUNICATION BETWEEN A GPC AND A BTU OR LRU (I.E., MDM, MMU, DEU, IMU, HUD, ETC.). @[040899-2459B]

A data path failure is manifested when problems occur at the GPC, BTU, or LRU. Loss of information to/from a GPC may be indicated by an INPUT/OUTPUT (I/O) ERROR fault message, BCE STRING fault message, BCE BYPASS fault message, or MDM OUTPUT fault message. However, failures exist (i.e., GPC to BTU/LRU output failures) where no message is annunciated. Failures where no message is annunciated may be detected by the flight control community and/or by crewmembers using subsystems performance or onboard indications.

Rules {A2-59}, BFS ENGAGE CRITERIA, {A2-258A}, BFS ENGAGE, and {A7-4}, TRANSIENT GPC, reference this rule.

FLIGHT RULES

A7-2

UNRECOVERABLE GPC

AN UNRECOVERABLE GPC IS DEFINED AS FOLLOWS:

An unrecoverable GPC will not be used for PASS redundant/common set operations, or as a BFS GPC.

A. THE GPC FAILS AND WILL NOT RESPOND TO AN IPL.

A GPC that does not respond to an IPL after experiencing a failure is indicative of a hardware problem. The GPC is considered failed and cannot be used.

B. THE GPC FAILS FOR UNKNOWN CAUSES MORE THAN ONCE EVEN THOUGH IT RESPONDS TO AN IPL.

A GPC that responds to an IPL even after it has failed more than once does not ensure the GPC is healthy. IPL'ing a computer more than once for unexplained failures points to an unreliable GPC.

C. THE GPC HAS ONE OR MORE FAILED INPUT/OUTPUT PROCESSOR (IOP) RECEIVER ON BUS CONTROL ELEMENT (BCE) FC 1, 2, 3, 4, 5, 6, 7, 8 OR ANY ICC BCE (EXCEPT AS NOTED IN RULE {A7-5}, PASS GPC BCE FAILURE MANAGEMENT) .

A PASS GPC with an ICC receiver failure prevents that GPC from operating in a redundant or common set. A PASS GPC with a flight-critical receiver failure prevents that GPC from operating in a redundant set. Although a PASS GPC with a flight-critical receiver failure could operate in the common set, that GPC could not operate in the redundant set for entry. Hence, it is declared unrecoverable. @[101096-4516]

The exception as noted in Rule {A7-5}, PASS GPC BCE FAILURE MANAGEMENT, is for BCE FC4 (primary ports) or FC8 (secondary ports) receiver failures where FF4 MDM is bypassed. For this case, turning off MDM FF4 allows the GPC with the receiver failure to be assigned any string and operated in the redundant set to allow us to retain GPC redundancy. @[101096-4516]

FLIGHT RULES

A7-3

GPC FAILURE

- A. DURING ASCENT (MM 102 TO 104) OR ENTRY (MM 304, 305, 601 TO 603), MODE A FAILED GPC TO "HALT" ASAP. POST-MM 104 OR PRE-MM 304, POWER OFF A FAILED GPC ASAP.

A GPC that experiences a fail-to-sync can send erroneous commands to the orbiter subsystems. To prevent a failed GPC from sending erroneous commands, the GPC is moded from RUN to STANDBY then HALT when the power switch is not accessible, otherwise GPC power is removed to preserve data for analysis.

In general, reach and visibility constraints do not allow the crew to reach the GPC mode switches until post-MECO. The exception to the MECO cutoff point is the SSME command path recovery restring done post-SRB SEP when the g-forces have decreased and the crew can reach the switches. The failed GPC will have to be moded to HALT prior to the restring to avoid dual commands. This rule is referenced by Rule {A7-1C}, PASS DPS FAILURE.

- B. ON ORBIT, POWER OFF FAILED GPC, CONFIGURE DPS PER RULES {A7-13}, GPC MAJOR FUNCTION CONFIGURATION, AND {A7-102}, PASS DATA BUS ASSIGNMENT CRITERIA [HC], AND ATTEMPT TO RECOVER FAILED GPC. @[042507-8489A]

A GPC failure will create a loss of GPC redundancy. Depending on the flight requirements, different GPC configurations may be required. Until GPC recovery can be performed, the referenced rules can be used as a guideline for reconfiguring the DPS system following GPC failures.

FLIGHT RULES

A7-4**TRANSIENT GPC**

A TRANSIENT GPC IS DEFINED AS:

- A. A GPC WHICH HAS FAILED ONLY ONCE, BUT HAS SUCCESSFULLY RESPONDED TO AN IPL.

A GPC failure is generally thought to be caused by hardware failures more than software problems. Even if the failed GPC recovers by doing an IPL, there is concern that the GPC will fail again. If dump analysis can confirm a software-induced failure, the GPC will be considered recovered. ©[092195-1798] ©[101096-4516]

- B. A GPC (101S) WHICH EXPERIENCES SOFT ERRORS AGAINST THE LOWER PAGE FOR A PASS OR BFS, OR UPPER PAGE FOR A PASS GPC, OF MEMORY AT A CONSTANT RATE OR EXPERIENCES A SOFT ERROR COUNT OF 7F. ©[101096-4477]

Random single-memory hits are expected to occur at a rate of several per day or in single bursts of several errors. A constant incrementing of the error count is indicative of a hard-memory failure. Although a single hard bit error in a GPC memory location is corrected by the error detection and correction code, an additional error in this memory location cannot be corrected, and if accessed by the computer would cause the GPC to fail. Errors in the upper page of memory are not reflective of errors in the lower page of memory. ©[101096-4477]

The upper page of memory in PASS GPC's is used for G3 archive. Starting with OI-25, the upper page of PASS GPC's is also used to store certain software library routines. Therefore, a hard memory error in the upper memory of a PASS GPC becomes significant to normal operation in addition to the concern for the G3 archive software. G3 archive concerns with soft errors against the upper page of memory are addressed in Rule {A7-14}, GNC 3 ARCHIVE MANAGEMENT. Upper memory in a BFS GPC is currently not utilized. ©[101096-4477]

- C. A GPC WHICH ANNUNCIATES A SINGLE "GPC BITE" FAULT MESSAGE.

A GPC BITE fault message indicates that a GPC software or hardware problem exists and the GPC has ceased running a software module for at least one cycle. This cessation is considered an abnormal early termination of software capability. If only a single BITE condition is annunciated, then the cause of the problem is considered transient and the GPC should be treated as such under Rule {A7-13C}, GPC MAJOR FUNCTION CONFIGURATION. If the GPC fails-to-sync, then the GPC is declared failed per Rule {A7-1C}.1, PASS DPS FAILURE.

FLIGHT RULES

A7-5

PASS GPC BCE FAILURE MANAGEMENT

PASS GNC 3 GPC'S THAT INCUR BCE FAILURES WILL BE CONFIGURED ACCORDING TO THE FOLLOWING GUIDELINES:

- A. PRE-DEORBIT BURN: FOR BCE FAILURES AFFECTING STRINGS 1, 2, OR 3, RESTRINGING WILL BE PERFORMED WITH STRINGS ASSIGNED PER RULE {A7-102}, PASS DATA BUS ASSIGNMENT CRITERIA [HC]. FOR STRING 4 FAILURES, PORT MODING WILL BE DONE TO RECOVER FA4. ©[042507-8489A]
- B. POST-DEORBIT BURN: PORT MODING WILL BE DONE FOR BCE FAILURES IN ORDER TO RECOVER THE CAPABILITY OF FF1, 2, OR 3, AND FA4. FA1, 2, OR 3 WILL BE GIVEN UP IN FAVOR OF FF1, 2, OR 3, AND FF4 WILL BE GIVEN UP IN FAVOR OF FA4.

GPC's incurring FC BCE failures will be reconfigured by port moding or restringing to obtain the most optimum flight-critical capabilities depending on flight phase. Pre-deorbit burn restringing will be done to regain the full capability of strings 1, 2, and 3. Restringing will not be performed for string 4 BCE failures due to its lack of sensor authority with respect to strings 1 to 3. String 4 will be port moded to recover FA4 to obtain FCS channel capability. Post-deorbit burn, port moding will be done to recover the capability of FF1, 2, or 3 and FA 4. Post-deorbit burn restringing will not be performed for FC BCE failures due to concerns for the hazards of dynamic restringing. Port moding recovers nearly the same capability as restringing, while avoiding a restring.

- C. FOR HARD OR TRANSIENT PASS GPC BCE RECEIVER FAILURES THE GNC OPS 3 SET WILL BE CONFIGURED USING THE FOLLOWING CRITERIA FOR SYSTEM RECONFIGURATION:
 - 1. FOR BCE RECEIVER FAILURES AFFECTING STRINGS 1, 2, OR 3 THE GPC WILL BE GIVEN UP IN FAVOR OF THE MDM WITH STRINGS ASSIGNED PER RULE {A7-102}, PASS DATA BUS ASSIGNMENT CRITERIA [HC]. ©[042507-8489A]
 - 2. FOR FC4 (FF4) RECEIVER FAILURES, MDM FF4 MAY BE POWERED OFF TO RETAIN GPC REDUNDANCY.

THIS RULE CONTINUED ON NEXT PAGE

FLIGHT RULES

A7-5

PASS GPC BCE FAILURE MANAGEMENT (CONTINUED)

3. FOR FC8 (FA4) RECEIVER FAILURES, STRING 4 MAY BE MODED TO SECONDARY PORTS AND MDM FF4 MAY BE POWERED OFF TO RETAIN GPC REDUNDANCY.

GPC's that experience flight-critical BCE receiver failures will force fail to sync due to nonuniversal I/O errors that result from RS GPC's disagreeing on the occurrence of the error. In the deorbit preparation timeframe, IFM's are not routinely done (ref. Rule {A2-105}, IN-FLIGHT MAINTENANCE (IFM) [HC]), so reconfiguration can be done to optimize GPC or LRU redundancy for entry. A GPC with a receiver failure affecting strings 1, 2, or 3 will be given up in favor of recovering full LRU redundancy. For string 4 failures, FF4 may be given up in order to maintain GPC redundancy, since FF4 is the "least critical" FC MDM. @[101096-4516] @[ED]

If the failure is FC4 (FF4), MDM FF4 may be powered off prior to adding the previously failed GPC back into the GNC 3 set. This causes all GPC's to see I/O errors against FF4, therefore FF4 is bypassed and the recovered GPC does not fail to sync.

If the failure is FC8 (FA4), port moding string 4 will cause the failed BCE (FC8) to attempt to communicate with FF4's secondary port. FF4 can then be powered off and the failed GPC can be recovered.

- D. WHEN A CHOICE EXISTS BETWEEN LOSS OF A PASS GPC AND A DEU, THE DEU WILL NOT BE USED WITH PASS GPC'S AND WILL BE ASSIGNED TO THE BFS FOR ENTRY. FOR MEDS CONFIGURED VEHICLES, AN IDP MAY STILL BE USED IN A NON-DPS MODE ONCE IT HAS BEEN DEASSIGNED FROM ALL PASS GPC'S. @[040899-2459B]

Each GPC in a redundant set listens to all data to and from the DEU's assigned to the RS. Should a single RS GPC have a receiver failure on a DK data bus, that GPC will fail to sync with the rest of the redundant set. The GPC can be recovered by assigning the DEU that caused the problem to the BFS because the RS will stop listening to the data from that DEU. IDP's which are not assigned to a PASS computer may still be used with a PASS GPC in a non-DPS mode since only the DPS mode requires the DK data bus interface. @[040899-2459B]

Rules {A2-5}, PORT MODING/RESTRINGING GUIDELINES; {A7-2}, UNRECOVERABLE GPC; and {A7-6}, DATA PATH FAILURE, reference this rule.

FLIGHT RULES

A7-6

DATA PATH FAILURE

- A. DURING ASCENT OR ENTRY, DPS RECONFIGURATION MAY BE PERFORMED PER RULES {A2-63}, ASCENT STRING REASSIGNMENT; {A2-254}, ENTRY STRING REASSIGNMENT; {A7-102C}, PASS DATA BUS ASSIGNMENT CRITERIA [HC]; OR {A7-5}, PASS GPC BCE FAILURE MANAGEMENT, TO RECOVER DATA PATHS LOST DUE TO GPC FAILURES. ©[042507-8489A]

Data-path loss due to GPC failures results in a bypass of an entire or half-string. Although the string is downmoded, the attached peripheral devices are healthy. Communication may be reestablished with the string by reassigning the bypassed string(s) to a good GPC.

For failure of a PASS GPC BCE transmitter and/or receiver, communications may be reestablished by reassigning the entire string to another GPC with a good BCE, or port moding will regain the bypassed MDM at the expense of the alternate MDM on the same string.

For string reassignment criteria, refer to Rules {A2-63}, ASCENT STRING REASSIGNMENT; {A2-254}, ENTRY STRING REASSIGNMENT; and {A7-102C}, PASS DATA BUS ASSIGNMENT CRITERIA [HC]. For PASS GPC BCE failure management, refer to Rule {A7-5}, PASS GPC BCE FAILURE MANAGEMENT.

- B. ON ORBIT, RECONFIGURE PER RULES {A7-13}, GPC MAJOR FUNCTION CONFIGURATION; {A7-102}, PASS DATA BUS ASSIGNMENT CRITERIA [HC]; AND {A7-105}, MDM PORT MODING. ©[ED] ©[042507-8489A]

Data path lost because of GPC failures implies communication with the affected string is lost temporarily, but the attached LRU's are healthy. Communications may be reestablished by reassigning the affected string to a good GPC. This rule identifies the legal reassignment phases.

- C. ON ORBIT, A BTU OR LRU MAY BE DEACTIVATED TO PRECLUDE RECURRING NUISANCE FAULT MESSAGES.

A recurring fault message may become a nuisance to the crew. If the cause of the annunciation can be isolated to a BTU or LRU, consideration will be given to deactivating the erring unit. This will eliminate the repeat generations of the fault message. Deactivation may take the form of MCDS entered item entries which reconfigure the subsystem, or the unit may be powered off.

FLIGHT RULES

A7-7 **POWERED OFF GPC ACTION (101S)**

A GPC (101S) THAT HAS HAD POWER REMOVED SHOULD BE RE-IPL'D BEFORE USE, TIME PERMITTING.

The GPC (101S) battery maintains memory during GPC poweroff but does not support memory error correction. This allows memory errors to accumulate. If this results in a double-bit error, the GPC will fail when the location is accessed. Re-IPL'ing the GPC will remove all soft errors and reestablish memory integrity.

Re-IPL'ing a GPC may not, however, be the best action in all cases because the GPC can require multiple uplinks before it can be used. Therefore, for time-critical cases where the IPL/uplink recovery sequence takes too much time, it may be desirable to accept the risk of a double-bit error. This risk is not constant and is directly related to the amount of time the GPC is powered off. As that time is reduced, the risk decreases.

A7-8 **REDUNDANT SET FAILURE**

FOR AN RS FAILURE DURING ASCENT AND ENTRY DYNAMIC PHASES, ENGAGE BFS.

This rule calls for a BFS engage to regain vehicle control due to a redundant set failure.

FLIGHT RULES

A7-9

REDUNDANT SET SPLIT

A. ASCENT:

1. ASCENT, PRE-MECO, FOR MULTIPLE, NEAR SIMULTANEOUS GPC FAILURES WHERE AT LEAST ONE IS FAIL-TO-SYNC (INCLUDING 2-ON-2 SPLITS), ENGAGE BFS (REF. RULE {A2-59}, BFS ENGAGE CRITERIA). IF THE BFS IS TRACKING AND BOTH OF THE FOLLOWING ARE TRUE, THEN THE PASS SET WILL BE RECONFIGURED RATHER THAN BFS ENGAGE:
 - a. RECONFIGURATION CAN BE COMPLETED PRE-MECO (E.G., CREW CAN REACH THE AFFECTED GPC SWITCHES AND SUFFICIENT TIME IS AVAILABLE TO COMPLETE THE PROCEDURE).
 - b. NO ADDITIONAL COMPLICATING FAILURES ARE PRESENT.
2. IF PASS SET RECONFIGURATION IS TO BE PERFORMED, MCC WILL COORDINATE WITH THE CREW THE FOLLOWING STEPS PRE-MECO:
 - a. HALT SIMPLEX (OR NONPREFERRED PAIR) GPC'S.
 - b. MANUALLY SHUT DOWN THE ENGINE(S) WITH COMMAND PATH FAILURES PER RULE {A5-106}, MANUAL SHUTDOWN FOR COMMAND/DATA PATH FAILURES [HC]. ©[102506-7352]
 - c. RESTRING ONLY IN ACCORDANCE WITH RULE {A2-63}, ASCENT STRING REASSIGNMENT.

If the BFS is standalone at the set split during powered flight, then its navigation state will quickly diverge, which eliminates the BFS engage option (ref. Rule {A7-51B}.1, BFS DPS FAILURE). In this case immediate engagement is the only acceptable action. Even if the BFS is tracking, BFS engagement is the quickest and simplest option to regain full vehicle control and LRU redundancy (except for GPC redundancy, of course). As long as the BFS continues to track the PASS following a set split, then reconfiguration of the PASS set is a viable option. However, adequate time must be available to complete the procedures before MECO; the crew must be physically capable of reaching the required switches under g-loads; and the overall crew/MCC work load due to additional complicating factors is not excessive.

THIS RULE CONTINUED ON NEXT PAGE

FLIGHT RULES

A7-9

REDUNDANT SET SPLIT (CONTINUED)

Due to the extremely low probability of this failure case, no additional procedures will be documented nor valuable integrated simulation time expended. Any crew training will be limited and will emphasize the BFS engage procedure as this is the preferred option and will safely allow recovery from this failure scenario.

The PASS GPC fail procedure in the ascent cue cards is considered to be sufficient to specify those crew actions essential to immediately safing the vehicle in the event of a set split. Also, additional failures (at least two) in the communications system that preclude MCC instructions to the crew in this situation is not considered credible. Therefore, all remaining actions will be by MCC call.

In a two-on-two set split, the flight control team will identify the GPC's with the best remaining capability; the nonpreferred set will be moded to halt pre-MECO to avoid erroneous outputs from those GPC's.

The major reason for requiring pre-MECO crew action is to avoid a catastrophic SSME shutdown. For the 2-1-1 case, two or three engines could have command path failures at MECO with possible loss of crew and vehicle.

A manual shutdown of all three engines will not work because of LO₂ NPSP problems caused by a zero-g shutdown. Manual shutdown for the case of two command path failures could result in loss of vehicle control because guidance may not recognize all engines that are shutdown. Single Engine Roll Control (SERC) will activate immediately after the second engine failure, due to the sensed loss of vehicle acceleration; however, degraded control will result if guidance does not recognize the second engine out failure flag to properly establish ascent DAP flight control gains. To preclude these problems, the simplex GPC's must be prevented from commanding engines. This can be done by taking the simplex GPC's to HALT, if the crew can reach the MODE switches. This may cause one engine to have a command path failure, but this is less severe than two or three engines with a command path failure. If only one GPC is halted, then two engines could still have command path failures. After the GPC(s) are moded to HALT, there will be no more than one engine with a command path failure that will need to be shut down manually. If the simplex GPC's cannot be halted, then engaging the BFS is the only other method to ensure a safe MECO. After the second SSME failure, BFS engage is no longer an option since the BFS does not support SERC and a loss of control will likely occur on the BFS. (Ref. A/E FTP #74 Minutes of 1/18/91.) ©[022802-5250]

B. DURING ASCENT OR ENTRY, FOR LOSS OF CONTROL, ENGAGE BFS.

This rule calls for a BFS engage to regain vehicle control for the case where a redundant set split causes a loss of control situation.

THIS RULE CONTINUED ON NEXT PAGE

FLIGHT RULES

A7-9 **REDUNDANT SET SPLIT (CONTINUED)**

- C. ON ORBIT, A SELECTION MAY BE PERFORMED BY IDENTIFYING THE GPC THAT IS COMMANDING TWO OF THREE IMU'S. THE OTHER GPC WILL BE POWERED OFF AND A RESTRING WILL BE PERFORMED TO RECOVER ALL STRINGS.

An initial selection of the GPC commanding two of three IMU's will provide IMU redundancy. The remaining GPC will be powered off to cease software execution and allow for a restring to be performed. If the GPC is not powered off and a restring is performed, dual commands will result.

Rule {A2-59}, BFS ENGAGE CRITERIA, references this rule.

A7-10 **GNC GPC REACTIVATION PRIORITY**

THE ORDER OF PREFERENCE FOR REGAINING VEHICLE CONTROL FOR LOSS OF ALL OPERATING GNC GPC(S) ON ORBIT IS:

- A. FREEZE-DRY GNC 2.
- B. FREEZE-DRY GNC 3 (IF AVAILABLE).
- C. BFS.

Activation of the G2FD GPC would recover full vehicle control with minimal impact to nominal-orbit configuration. Activation of the G3FD GPC requires activation of special LRU's needed by the OPS 3 software. A G3FD GPC will only be available if G3 archive capability has been lost and a G3FD has been established. In addition, the crew procedures for recovering and/or reconfiguring the PASS are simplified if the BFS has not been engaged. Ref. Rule {A7-14}, GNC 3 ARCHIVE MANAGEMENT.

FLIGHT RULES

A7-11

GNC GPC REDUNDANCY REQUIREMENTS

REDUNDANT GNC GPC'S ARE REQUIRED FOR THE FOLLOWING ORBIT OPERATIONS:

- A. RNDZ/PROX OPS.
- B. PAYLOAD RETRIEVAL.
- C. EVA OPERATIONS WITH MANNED FREE FLYER OPS. ©[090894-1667]
- D. OMS/RCS BURNS WHICH ARE CRITICAL FOR CREW SAFETY AND/OR WHICH ARE CLASSIFIED AS FLIGHT SUCCESS DELTA V MANEUVERS.

Redundant GNC GPC's meet the fail-safe capability that is required for these operations. Rendezvous requires redundancy at the point in the profile where on-time execution of delta V maneuvers becomes critical to mission success and when a breakout capability is required. For crew safety, proximity operations and payload retrieval operations require +Z redundancy for translation separation maneuvers. For EVA operations involving an untethered crewmember, vehicle control is required in order to rescue a crewmember for certain free flyer apparatus (i.e., SAFER) failures. OMS burns require a downmode capability for delta V maneuvers which are critical for crew safety (such as some postdeployment separation burns) and flight success. RCS burns require +Z redundancy for translation separation maneuvers that are critical for crew safety (such as IPS, RMS, or KU jettison). With redundant GPC's, uninterrupted vehicle control would be provided even if one GNC GPC fails.

Rule {A7-13A}, GPC MAJOR FUNCTION CONFIGURATION, references this rule.

In general, reference rules {A2-114}, OMS/RCS MANEUVER CRITICALITY, and {A2-120}, RNDZ/PROX OPS DPS SYSTEMS MANAGEMENT, for related requirements. ©[090894-1667]

A7-12

PASS/BFS REDUNDANCY

THE BFS IS NOT CONSIDERED IN THE PASS DPS REDUNDANCY REQUIREMENTS.

The BFS software was not designed with the requirement to accomplish on-orbit operations. It was designed to assume control of the vehicle in the event the PASS can no longer control the vehicle during dynamic flight regimes. Unlike the PASS, the BFS cannot perform IMU alignments or MDM port moding; and it does not have any time management controls. The system management (SM) function is limited in the sense that all PASS SM capabilities are not available in the BFS. With this in mind, the BFS cannot be considered as being interchangeable or redundant to the PASS GPC's.

FLIGHT RULES

A7-13

GPC MAJOR FUNCTION CONFIGURATION

GPC MAJOR FUNCTION CONFIGURATION WILL BE PERFORMED PER THE FOLLOWING GUIDELINES:

A. ORBIT CONFIGURATION @ [082593-1538]

1. NOMINAL ON-ORBIT GPC DISTRIBUTION BY MAJOR FUNCTION WILL BE AS FOLLOWS:

GPC 1 - GNC 2

GPC 2 - GNC 2 (FREEZE-DRY, IF REQUIRED FOR POWER SAVINGS)

GPC 3 - GNC 2 FREEZE-DRY (GNC 3 FREEZE-DRY)

GPC 4 - SM 2

GPC 5 - BFS

Two GNC GPC's are required to satisfy Rule {A7-11}, GNC GPC REDUNDANCY REQUIREMENTS. One GPC is required to accomplish the systems management functions. The BFS is always loaded in a GPC to gain vehicle control, if lost, from the PASS GPC's. The last GPC is loaded with G3 software to protect against mass memory failures if no G3 archive is resident in a nonfailed GNC major function GPC, otherwise G2 software will be loaded into this GPC.

2. DURING RENDEZVOUS/PROX OPS, A REDUNDANT SET (RS) OF THREE GPC'S MAY BE UTILIZED.

Three GNC GPC's are preferred for rendezvous/prox ops to simplify recovery procedures if a GNC GPC fails during the period when rendezvous nav is enabled. Only two GPC's are actually required (ref. Rule {A7-11}, GNC GPC REDUNDANCY REQUIREMENTS). If a GNC GPC fails, a restring to the remaining two GPC's recovers all LRU redundancy, still meets rendezvous GPC requirements and does not affect rendezvous nav functions as long as the target set is not changed. Since all PASS GPC's have G3 software stored in high memory, there is not a concern with giving up the G3 FD GPC prior to rendezvous to form a three GPC set. @ [082593- 1538]

THIS RULE CONTINUED ON NEXT PAGE

FLIGHT RULES

A7-13

GPC MAJOR FUNCTION CONFIGURATION (CONTINUED)

- B. A REDUNDANT GNC GPC MAY BE CONFIGURED TO PL9 FOR THE FOLLOWING:

Using a redundant set GPC would not give up existing capability, only redundancy.

1. A PASS DEU IPL

A DEU can only be IPL'ed from PL9, SM OPS 2/4, a post-IPL OPS 0 GPC, or the BFS. If available, an SM 2/4 DEU IPL is preferred over a PL9 DEU IPL in order to preserve GNC GPC redundancy. A PL9, SM OPS 2/4, or post-IPL OPS 0 GPC provides full PASS DEU IPL capability. PASS critical formats will not be available after loading a DEU from the BFS, so it is preferable not to perform a BFS DEU IPL on a DEU which is to be driven by the PASS when one of the other viable alternatives exists.

2. A MASS MEMORY DUMP/PATCH

SM will normally be used for an MMU dump or patch as long as the MMU load block is less than or equal to 2,048 halfwords. PL9 has capability to accommodate an MMU dump or patch involving large MMU load blocks up to 16,384 halfwords.

- C. A TRANSIENT GPC WILL BE MADE THE REDUNDANT GNC GPC ON ORBIT, EXCEPT FOR SAFETY-CRITICAL OPERATIONS. A TRANSIENT GPC MAY BE MADE THE FREEZE-DRY GNC 2 IF REQUIRED FOR POWER SAVING ON ORBIT. IF USED FOR ENTRY, A TRANSIENT GPC WILL BE ASSIGNED STRING 4.

A transient GPC may fail again and, therefore, will not be used for orbit periods of safety-critical operations such as proximity operations where continuous and complete vehicle control is required to preclude collisions. For other periods, running the transient GPC in a redundant set may provide more data relating to the original failure. The use of a transient GPC for entry will generally be avoided, but if conditions cause a transient to be used for entry, then it will be assigned string 4 because string 4 interfaces with fewer LRU's and loss of this string is less significant than loss of any other string during the entry timeframe.

THIS RULE CONTINUED ON NEXT PAGE

FLIGHT RULES

A7-13

GPC MAJOR FUNCTION CONFIGURATION (CONTINUED)

- D. FOR TWO PASS GPC'S FAILED DURING ASCENT, ATTEMPTS TO RECOVER THE GPC'S WILL BEGIN FOLLOWING THE FIRST DPS TRANSITION. THE CONFIGURATION DURING THIS PERIOD WILL BE ONE GNC 2 GPC, ONE SM GPC, AND THE BFS (EXCEPT AS NOTED IN PARAGRAPH E).

Recovery will be attempted as soon as possible after the data processing system is configured for orbit. One GNC GPC, one SM GPC, and one BFS provide the best configuration to continue with a minimum duration mission and accomplish mission objectives (i.e., one GNC GPC for vehicle control, one SM GPC for system management, and the BFS for backup in case a PASS failure occurs).

The exception reference refers to those operations that require redundant GNC GPC's. Orbit operations that require redundant GNC GPC's should be delayed, if possible, until GPC recovery is complete. The SM GPC would be given up to provide a redundant GNC GPC and the BFS should be activated to provide systems monitoring if a redundant GNC GPC is required for crew safety or total loss of major mission objectives. The BFS should not be given up to allow the SM GPC to support payload operations.

- E. FOR A GENERAL PURPOSE COMPUTER (GPC) FAILURE ON ORBIT:
 @[011295-1746]

1. A BFS WILL BE MAINTAINED AS LONG AS AT LEAST TWO GPC'S ARE OPERABLE.

The BFS can perform limited systems management and it is preferred over the PASS SM when only two GPC's are available because of its entry capability.

2. RECONFIGURATION WILL BE BASED ON GPC AVAILABILITY PER THE FOLLOWING PRIORITIES:
 - a. IF A G2FD (FREEZE DRY) IS AVAILABLE, THIS GPC MAY BE RECONFIGURED AS A GNC, SM, OR BFS GPC.
 - b. IF A G3FD IS CONFIGURED (DUE TO A LOSS OF G3 ARCHIVE) :
 - (1) THE G3FD GPC MAY BE RECONFIGURED AS A GNC, SM, OR BFS GPC IF BOTH MASS MEMORY UNITS (MMU'S) ARE OPERATIONAL.

THIS RULE CONTINUED ON NEXT PAGE

FLIGHT RULES

A7-13

GPC MAJOR FUNCTION CONFIGURATION (CONTINUED)

(2) IF AN MMU IS FAILED, THE G3FD WILL NOT BE SACRIFICED.

- c. IF THE ORIGINAL CONFIGURATION WAS MULTIPLE G2, RECONFIGURATION WILL BE PERFORMED AS NEEDED TO MAINTAIN DUAL G2 IF REQUIRED PER THE FLIGHT RULE ANNEX (I.E., SACRIFICE THE SM IF NECESSARY). IF NO REQUIREMENT EXISTS FOR DUAL G2'S, THEN A SINGLE GNC GPC WILL BE MAINTAINED.

For normal DPS orbit operations, there will be either one or two G2FD GPC's since nominally three sources of entry software will exist onboard (two MMU's and G3 archive present in all PASS GPC's). A G2FD will be given up for any GPC failure. If G3 archive is lost in all GNC major function base GPC's, a G3FD will be established. The G3FD will only be given up as long as both MMU's are operational.

If dual G2 is required and only 3 GPC's are available, the SM GPC will be sacrificed as opposed to the BFS because of the rationale provided in paragraph 1 above.

Reference {A7-3B}, GPC FAILURE; {A7-14A}, GNC 3 ARCHIVE MANAGEMENT; and {A7-201C} and D, DPS REDUNDANCY REQUIREMENTS. @[011295-1746]

- f. IF BOTH MMU'S HAVE FAILED PRIOR TO SUCCESSFUL COMPLETION OF THE GNC OPS 3 TRANSITION, THE SM GPC WILL BE RETAINED UNTIL TIG-50 MINUTES.

The SM software is only available from an MMU. In this case, where both MMU's are failed, once the SM function is given up to build another G3 GPC, it is not possible to reestablish an SM GPC if deorbit is waived off and a return to orbit ops is desired. An SM machine offers advantages over a BFS for use in systems monitoring and provides for the use of the Ku-band system, which the BFS GPC cannot provide. TIG-50 minutes is chosen as a convenient point to finally give up the SM machine and configure to a full up G3 set of GPC's before stowing all the orbit FDF and going to the Entry Checklist at TIG-50 minutes.

- g. IF PASS GPC'S INCUR HARD IP BCE FAILURES, DPS RECONFIGURATION, IF POSSIBLE, WILL BE PERFORMED TO REGAIN A MAJOR FUNCTION'S DOWNLIST.

Each GPC has a single IP bus to transmit data to the PCMMU for downlist. The redundant set designates a single GPC as the prime downlist GPC. Therefore, if a downlisting GPC can be recovered by simply redesignating the downlist GPC via item number on SPEC 0, it will be done. If the GPC with the IP bus failure is the SM GPC, the downlist can be recovered by placing SM in one of the redundant GNC GPC's and putting GNC back into the GPC previously loaded with SM.

Rules {A7-3B}, GPC FAILURE; and {A7-6B}, DATA PATH FAILURE, reference this rule.

FLIGHT RULES

A7-14

GNC 3 ARCHIVE MANAGEMENT

- A. A GNC 3 FREEZE-DRIED GPC WILL NOT BE ESTABLISHED IF A COPY OF GNC 3 ARCHIVED SOFTWARE IS RESIDENT IN A NONFAILED GNC MAJOR FUNCTION GPC. IF NO GNC MAJOR FUNCTION GPC'S HAVE A COPY OF GNC 3 ARCHIVE RESIDENT IN UPPER MEMORY, A GNC 3 FREEZE-DRIED GPC WILL BE ESTABLISHED AS SOON AS PRACTICAL.

As long as a GNC major function GPC that has not failed or been re-IPL 'ed on orbit has a copy of G3 archive software, it will be considered a redundant source of G3 software. If no such GPC exists, a G3FD GPC will be loaded to provide an additional onboard G3 software source.

Reference Rule {A7-13E}, GPC MAJOR FUNCTION CONFIGURATION. ©[011295-1746]

- B. A GPC CONTAINING ARCHIVED GNC 3 SOFTWARE, WHICH EXPERIENCES AN UPPER MEMORY SOFT ERROR COUNT OF 7F, OR A CONSTANTLY INCREMENTING COUNT WILL NOT BE USED AS A SOURCE OF ENTRY SOFTWARE FOR NON-TAL OPS 3 TRANSITIONS. FOR TAL TRANSITIONS, THE GPC WILL BE USED.

A soft error counter increment is indicative of a single location memory error that was successfully corrected by the memory scrub circuitry. Random single-memory hits are expected to occur at a rate of several per day or in single bursts of several errors. A constant incrementing of the error count is indicative of a hard-memory failure.

All targeted G3 GPC's with G3 archive resident in upper memory will transfer the OPS 3 overlay to lower memory at initiation of OPS 3 when archive retrieve is enabled. Any targeted GPC's without G3 archive resident in upper memory will then receive the overlay from the lowest ID GPC that has the overlay in lower memory. If the archive retrieve is disabled, then the OPS 3 transition will utilize the mass memory units (MMU's) as the source for the G3 software. If one memory location in upper memory has two hard errors and the location is used to store the G3 software, then the GPC will fail-to-halt at the transition. If the location is not used to store G3 software, then the GPC will continue to operate without failing. If there exists only a single error in any upper memory location, then the error correction code will correct the data before it is moved into lower memory and the subsequent execution of G3 from lower memory is not impacted.

THIS RULE CONTINUED ON NEXT PAGE

FLIGHT RULES

A7-14**GNC 3 ARCHIVE MANAGEMENT (CONTINUED)**

For non-TAL G3 transitions, there is no time criticality, and therefore certain actions can be taken to eliminate the chance of having a GPC fail because of upper memory errors. The easiest action for the crew is to simply disable the archive retrieve by entering a single item entry before execution of the OPS transition. The rest of their procedures can then be run without changes.

Due to the highly dynamic and time critical nature of TAL transitions, time delays in entering OPS 3 are critical. Therefore, disabling the archive retrieve and going to the MMU's introduces delays that should be avoided. The chance of having two errors in a single memory location is considered to be very slight, and therefore accepting the possibility of a single GPC fail versus delaying the entry into OPS 3 by using the MMU's is reasonable.

Errors in the upper page of memory are not reflective of problems with the lower page of memory. Rule {A7-10}, GNC GPC REACTIVATION PRIORITY, references this rule.

A7-15**SM OPS 4 TRANSITION REQUIREMENTS**

FOR FLIGHTS WHERE SM OPS 4 IS NOT SUPPORTED IN THE FLIGHT SOFTWARE TESTING CYCLE, A TRANSITION TO SM OPS 4 WILL NOT BE PERFORMED.

In order to reduce FEID and testing times for flight software loads, missions that require SM OPS 2 only will not have a requirement for SM OPS 4 S/W testing and verification. Therefore, for flights where SM OPS 4 S/W has not been tested, an SM OPS 4 transition will not be performed. Beginning with OI-20, a transition to SM OPS 4 will be prohibited by the flight S/W (by generating an ILLEGAL ENTRY message on the scratch pad line (SPL)) when SM OPS 4 S/W testing is not supported or required for the flight.

FLIGHT RULES

A7-16

GPC MEMORY WRITE CRITERIA [CIL]

THE USE OF GPC MEMORY WRITE PROCEDURES ARE SUBJECT TO THE FOLLOWING GUIDELINES:

- A. ONLY THOSE WRITE PROCEDURES WHICH HAVE COMPLETED SOFTWARE DEVELOPMENT LEVEL VERIFICATION, CREW PROCEDURAL VERIFICATION, AND HAVE BEEN DOCUMENTED IN A CONTROLLED MANNER WILL BE CONSIDERED FOR USE.

Changing GPC memory contents in an uncontrolled manner can lead to catastrophic results. Therefore, this rule is designed to prevent real-time write procedures from being used before they have been evaluated and tested.

- B. GPC MEMORY PROCEDURES THAT MODIFY PERFORMANCE RELATED PARAMETERS WILL BE VERIFIED AND APPROVED IN REAL TIME PRIOR TO THEIR EXECUTION.

This rule documents an agreement that Systems Division made with the Orbiter Project Office.

- C. ONLY PREFLIGHT APPROVED AND VERIFIED (PREAUTHORIZED) GMEM WRITE PROCEDURES NEEDED IN TIME-CRITICAL SITUATIONS WILL BE USED WITHOUT FURTHER VERIFICATION. WHEN TIME PERMITS, THEY WILL BE REVERIFIED BEFORE USE. IF REVERIFICATION IS NOT COMPLETE BEFORE THE LAST IMPLEMENTATION OPPORTUNITY FOR A PREAUTHORIZED GMEM WRITE PROCEDURE, IT WILL BE IMPLEMENTED. ALL GMEM WRITE PROCEDURES THAT ARE NOT PREAUTHORIZED MUST UNDERGO FULL VERIFICATION BEFORE USE.

Certain GMEM's were approved with the understanding that they might be executed in time-critical situations. These GMEM's have been extensively verified by testing prior to release and can be used without further verification when required. An informational SPAN/MER chit should be initiated following such use. Good practice and NSTS policy require any countdown or in-flight GMEM to be verified to the greatest possible extent in real-time before being implemented. Therefore, when time permits, a SPAN/MER chit should be initiated requesting reverification of any preauthorized GMEM before its use. Waiting for that reverification to be completed, however, is not grounds to delay implementing a preauthorized GMEM beyond when it is needed. For GMEM's that have not been preauthorized, a chit requesting verification must be submitted, and the verification must be completed before the GMEM is authorized for use. The specific conditions, including major mode restrictions governing their use, are contained in the PASS Release Authorization Documents (RAD's) and the BFS Engineering Orders (EO's) that authorize their use. The authorizing document of the preflight approved GMEM's is the Release Authorization for Shuttle Software (RASS).

THIS RULE CONTINUED ON NEXT PAGE

FLIGHT RULES

A7-16

GPC MEMORY WRITE CRITERIA [CIL] (CONTINUED)

- D. UPLINK COMMAND LOADS WILL BE USED WHERE PRACTICAL FOR INCORPORATION OF GPC MEMORY WRITE PROCEDURES. PARAGRAPH G LISTS APPROVED AND DOCUMENTED GENERAL MEMORY WRITE PROCEDURES. WRITE PROCEDURES THAT WILL NOT BE PERFORMED BY UPLINK ARE SO NOTED.

Uplink command loads from the ground offer more flexibility and assurance of the accuracy of the GPC memory procedure. This procedure also allows a change of a larger set of GPC memory addresses as opposed to only six at a time via the GPC memory SPEC. Additionally, it allows real-time review by the MCC personnel before its use (more eyes to detect errors).

- E. GPC MEMORY WRITE PROCEDURES WILL BE IMPLEMENTED AS PATCHES TO GPC RESIDENT SOFTWARE ONLY, AND WILL NOT BE IMPLEMENTED AS PATCHES TO THE MMU'S.

The MMU's are loaded prelaunch with all three areas the same or with approved and verified changes. The intent here is to not pollute the MMU contents in real time because of lack of appropriate time to permit verification and testing.

- F. FOLLOWING THE IMPLEMENTATION OF THE FIRST IN-FLIGHT GPC MEMORY WRITE PROCEDURE, ADDITIONAL PREFLIGHT APPROVED GMEM WRITES WILL NOT BE USED UNTIL REVERIFICATION BY THE APPROPRIATE SOFTWARE DEVELOPER IS PERFORMED, UNLESS AUTHORIZED FOR CONCURRENT USE.

Once a GPC write procedure has been implemented, it is necessary to ensure that subsequent use of GMEM's do not induce failures in the system. Unless authorized for concurrent use while maintaining approved configuration, reverification is required to confirm that the next GMEM considered for use can be used in conjunction with at most one other GMEM in the system without any impact to the system. The appropriate PASS or BFS software developer is responsible for reverifying all subsequent GPC write procedures prior to their use. For GMEM write procedure(s) which can be used concurrently, refer to the authorizing document.

THIS RULE CONTINUED ON NEXT PAGE

FLIGHT RULES

A7-16

GPC MEMORY WRITE CRITERIA [CIL] (CONTINUED)

G. GPC MEMORY WRITE CRITERIA: PREFLIGHT APPROVED AND VERIFIED GENERAL MEMORY WRITE PROCEDURES. EXCEPT AS NOTED, THESE GMEM'S WILL NORMALLY BE IMPLEMENTED VIA UPLINK:

<u>TITLE</u>	<u>APPROVED IMPLEMENTATION</u>
OMS MIXED CROSSFEED (PASS) (CR 89577B) *	U/L AND KYBD [1]
* PLANNED FOR EXECUTION IN A CRITICAL PHASE	

NOTE: THE GMEM WRITE UPLINK OPERATION CODES ARE NOT LEGAL IN PASS OPS 1 AND 3. THE DEU EQUIVALENT UPLINK IS THE ONLY OPTION. DUE TO THE RELATIVELY LONG UPLINK TIME OF A DEU EQUIVALENT AND THE POSSIBILITY OF DATA DROPOUTS, THE CREW KEYBOARD IMPLEMENTATION IS PREFERRED OVER THE DEU EQUIVALENT UPLINK OPTION IF THIS GMEM WRITE IS IMPLEMENTED DURING TIME-CRITICAL ASCENT OR DEORBIT OPERATIONS. THIS GMEM WRITE WILL BE IMPLEMENTED VIA UPLINK IF REQUIRED FOR A NONTIME-CRITICAL DEORBIT. @[111094-1731]

Reapplication of a previously applied GMEM write is permitted and is not considered a second GMEM write application.

The list of GPC memory read/write procedures contained in paragraph G is considered critical enough to the crew and/or orbiter safety that preflight approval and verification for their use is obtained prior to the flight. Reverification is required unless specific authorization provides for procedures used in conjunction with another GPC memory altering procedure.

Rule {A2-111}, DPS COMMAND CRITERIA, references this rule.

H. GPC MEMORY WRITE CRITERIA: PREFLIGHT APPROVED, UNVERIFIED GENERAL MEMORY WRITE PROCEDURES:

<u>TITLE</u>	<u>IMPLEMENTATION</u>
NONE CURRENTLY DEFINED	N/A

Rule {A2-111}, DPS COMMAND CRITERIA, references this rule.

I. FOR PASS REDUNDANT SET GMEM'S APPLIED TO PERMANENTLY RESIDENT SYSTEM SOFTWARE, GMEM'S WILL BE APPLIED TO A RE-IPL'ED GPC BEFORE THE GPC IS ADDED TO THE REDUNDANT SET.

The PASS software is required to be functionally identical in each GPC of the redundant set. A re-IPL'ed GPC would not have GMEM's installed, so reapplying active GMEM's would be necessary for the redundant system software to be identical. This rule is limited to the system software because GMEM's in the ops application software would be loaded from the PASS prime GPC during the ops transition. @[030994-1611]

FLIGHT RULES

A7-17

GPC MEMORY DUMP CRITERIA

GPC MEMORY DUMPS, ASSOCIATED PROCESSING, AND ANALYSIS WILL BE ACCOMPLISHED USING THE FOLLOWING GUIDELINES:

- A. IF THE BFS IS RECALLED FROM MASS MEMORY, THE ENTIRE INVARIANT MEMORY CONTENTS OF THE RELOADED GPC WILL BE VERIFIED, TIME PERMITTING.

If a PASS RS GPC is re-IPL'ed, the verification of a good IPL is essentially provided by its ability to run in a redundant set. Since the BFS is used alone, the dump and compare is the only complete verification process available to ensure the validity of the reload software.

- B. IN GENERAL, FOR FAILED GPC'S, A HARDWARE-INITIATED DUMP WILL BE PERFORMED, TIME PERMITTING, TO SUPPORT GROUND ANALYSIS. WHEN POSSIBLE, A SOFTWARE DUMP OF A LIKE MEMORY CONFIGURATION GPC WILL BE OBTAINED.

A hardware dump of a failed GPC (PASS or BFS) is taken because it does not require a good software load to obtain the dump. A software dump of a nonfailed, like-configuration GPC is done because a software dump can be done without affecting the ability of a GPC to continue its operation after the dump. The two dumps can then be compared to help find where the problem that caused the GPC failure occurred. Although during entry there will probably not be enough time to complete the dump analysis prior to landing, collecting the data at the time of the failure and prior to any GPC reconfiguration allows the greatest probability of being able to determine the cause of the GPC failure. Also, in the event of a day(s) waveoff, the dumps can be analyzed to determine possible impacts to the subsequent entry attempt. These impacts may include, but are not limited to, GPC reconfigurations and/or GPC memory read/writes. If the dumps are not performed and the problem cannot be recreated during postflight analysis, the failure would be treated as an unexplained anomaly. With TDRS coverage for entry, downlist interruption by a GPC dump is no longer a concern as it once was with STDN only coverage. (Ref. Rule {A2-203E}, DEORBIT DELAY GUIDELINES.) @[121593-1585A]

- C. INABILITY TO OBTAIN, PROCESS, OR COMPLETE GROUND ANALYSIS OF MEMORY DUMP DATA IS NOT CAUSE TO DELAY RECOVERY OF A FAILED GPC.

Recovery procedures should not be dependent upon the results of ground-based memory dump processing since ground-based processing can be delayed by numerous external factors.

@[121593-1585A]

A7-18 THROUGH A7-50 RULES ARE RESERVED

FLIGHT RULES

BFS SYSTEMS MANAGEMENT

A7-51

BFS DPS FAILURE

BFS DPS FAILURES ARE DECLARED BY THE FOLLOWING GUIDELINES:

- A. THE BFS WILL BE DECLARED FAILED IF NO FORWARD DEU INTERFACE EXISTS (POSSIBLY CONCURRENT WITH "SELF FAIL" COMPUTER ANNUNCIATION MATRIX (CAM) LIGHT). [ED] [040899-2459B]

If no forward DEU interface exists, the crew has no insight or interface with the BFS. The CAM light may blink for some BFS GPC hardware failures where the BFS is restarting on multiple major cycles. One point worth noting is that the CAM light will not illuminate for the total GPC power loss failure. Reference Rule {A7-52A}, ASCENT/ENTRY BFS MANAGEMENT GUIDELINES. [040899-2459B]

- B. THE BFS WILL BE "NO-GO FOR ENGAGEMENT" FOR THE FOLLOWING:

BFS is no-go if it cannot be relied upon to back up the PASS because it either (1) cannot be engaged or (2) the hardware/software of the BFS GPC cannot control the vehicle subsequent to engage.

1. BFS HAS OPERATED IN STANDALONE MODE (WILL NOT TRACK PASS) IN:
 - a. MM 102, 103, AND 601 FOR 10 SECONDS.
 - b. MM 304, 305, 602, AND 603 FOR 45 SECONDS.

The BFS is NO-GO when sensor data are lost due to not listening to any PASS-initiated input transactions because the BFS has lost the ability to accurately update the vehicle's state vector. GNC degradation rate is not exactly known; however, 10 seconds in ascent powered flight and 45 seconds in entry dynamic flight were estimated pre-ST5-1. Reference Rule {A7-52B}, ASCENT/ENTRY BFS MANAGEMENT GUIDELINES.

2. CONTROL CA1 BUS FAILED.

If CNTL CA1 is lost and BFS resides in GPC's 3 or 5, the BFS will not receive engage discretetes. (For BFS in GPC's 1, 2, or 4, failure of CNTL AB3 bus will cause the loss of engage discretetes.) It is important to note, if the engage is attempted, BFS will not recognize the engage and part of the PASS set will go to software halt. Reference Rule {A7-52C}, ASCENT/ENTRY BFS MANAGEMENT GUIDELINES.

3. LOSS OF ESS 3AB.

For loss of ESS 3AB power, the BFS select capability is lost and no GPC's can be selected as the BFS. If an engage is attempted, BFS will not recognize the engage, and all of the PASS set will go to software halt. Reference Rule {A7-52C}, ASCENT/ENTRY BFS MANAGEMENT GUIDELINES.

THIS RULE CONTINUED ON NEXT PAGE

FLIGHT RULES**A7-51****BFS DPS FAILURE (CONTINUED)**

4. IF THE BFS I/O TERM B FAILS HIGH.

If the BFS I/O TERM B is failed high, then the BFS cannot be engaged since this input must be low for the BFS to recognize an engage. If an engage is attempted with the BFS I/O TERM B failed high, the BFS will not recognize the engage and PASS will go to software halt. Since the I/O TERM B is normally high for the BFS pre-engage, this failure will probably not be recognized unless the BFS internal receiver 2 of hybrid receiver 4 failed. The "half-hybrid" failure will cause the BFS I/O TERM A to go high since the I/O TERM B and I/O TERM A are paired together on internal receiver 2 of hybrid 4 (ref. paragraph C7 and Rule {A7-52D}, ASCENT/ENTRY BFS MANAGEMENT GUIDELINES).

5. BOTH BFS BFC CRT SEL DISCRETES AND THE BFS I/O TERM B DISCRETE FAIL LOW SIMULTANEOUSLY.

The simultaneous failure of both the BFS BFC CRT SEL discrettes and the BFS I/O TERM B discrete is indicative of a 5 volt power supply failure in the BFS BFC module. The BFS BFC module will not respond to the engage with the 5-volt power supply failed, and the BFS will not engage. PASS will recognize the engage and go to software halt.

- C. THE BFS WILL BE DECLARED "SUSPECT" FOR THE FOLLOWING:

An operating BFS (GNC and SM) is considered suspect when its ability to respond to an engage or to control the vehicle subsequent to engage is in doubt due to a hardware/software failure.

1. BFS HAS EVER ENTERED THE HALT STATE WITHOUT FIRST EXECUTING AN OPS 000 PRO AND HAS SUBSEQUENTLY BEEN RETURNED TO STANDBY OR RUN.

The BFS performs a cleanup when an OPS 000 PRO is performed. Without proper cleanup, the BFS may not be initialized correctly when placing the mode switch back to standby (User Note B04524C). This same situation can occur after the BFS experiences a transient halt state and subsequently returns to standby or run.

2. BFS HAS BEEN RE-IPL'D DURING ASCENT PER RULE {A7-52E}, ASCENT/ENTRY BFS MANAGEMENT GUIDELINES. A BFS RE-IPL'D DURING ASCENT WILL NOT BE USED FOR GNC PURPOSES.
@[071494-1641]

A BFS which failed and was re-IPL'd during ascent should not be used for GNC purposes. Since the GPC has failed once, the hardware and software integrity of the BFS cannot be assured. Therefore, a BFS so 'recovered' should only be used for systems monitoring and should not be engaged except as a last resort in the event of loss of vehicle control.

THIS RULE CONTINUED ON NEXT PAGE

FLIGHT RULES

A7-51

BFS DPS FAILURE (CONTINUED)

3. BFS HAS EXPERIENCED SOFT ERRORS AGAINST THE LOWER PAGE OF MEMORY AT A CONSTANT RATE OR EXPERIENCED AN INSTANTANEOUS SOFT ERROR COUNT OF 7F. @[041896 1872]

Random single-memory hits are expected to occur at a rate of several per day or in single bursts of several errors. A constant incrementing of the error count is indicative of a hard-memory failure. Errors in the upper page of memory are not reflective of errors in the lower page of memory. Currently, the upper page of memory is not used for BFS and; therefore, soft errors in this portion of memory will have no impact to the operating ability of the BFS. @[041196 1872]

4. UNEXPLAINED "GPC BITE" FAULT MESSAGE.

The BFS generates a GPC BITE fault message when it encounters a condition requiring a software restart for error recovery. This could also point to a software or hardware problem. The BFS may not function properly in the event that a BFS engage is required.

5. UNEXPLAINED "GPC PWR" FAULT MESSAGE.

A GPC PWR fault message is an indication that the BFS GPC has experienced a power transient. The BFS may not function properly in the event that a BFS engage is required. Rules {A7-53}, ON-ORBIT BFS MANAGEMENT GUIDELINES, and {A7-9}, REDUNDANT SET SPLIT, reference this rule.

6. IF THE BFS I/O TERM B FAILS LOW.

The I/O TERM B and the engage discrete inputs to the BFS are generated by logic contained within the BFC. The BFC depends on power to and the configuration of the GPC OUTPUT switches on panel 06. If the fuse leading to the output switches fails or if the BFC experiences an internal power failure, the I/O TERM B will go low at the BFS. While the lack of an I/O TERM B discrete input to the BFS will not prevent the BFS from recognizing an engage, it does cast doubt on the inputs to the BFC and/or its ability to properly process the engage discretely and I/O TERM B. If the problem is within the BFC module serving the BFS or the inputs to this module, then the PASS set will go to software halt upon engage and the BFS may not engage. Since the source of the problem cannot be determined, the BFS should be declared suspect.

7. IF THE BFS I/O TERM A FAILS HIGH.

The I/O TERM A and the I/O TERM B share a common internal receiver in GPC hybrid receiver 4. An I/O TERM A failure could be indicative of a single discrete failure on hybrid receiver 4 or could indicate the loss of both the I/O TERM A and I/O TERM B if the common internal receiver has failed. Since the pre-engage state of the BFS I/O TERM B is high, it is not possible to determine the health of the I/O TERM B discrete without moding the BFS OUTPUT switch to NORMAL. If the common receiver has failed high, then the BFS cannot be engaged since the I/O TERM B must be low for the BFS to recognize the engage. If an engage is attempted with the common receiver failed high, the BFS will not recognize the engage and PASS will go to software halt. The BFS should be declared suspect until the status of the I/O TERM B can be verified (ref. paragraph B,4).

FLIGHT RULES

A7-52

ASCENT/ENTRY BFS MANAGEMENT GUIDELINES

DURING ASCENT (POST-MECO) AND ENTRY (POST-TIG), THE FOLLOWING GUIDELINES WILL BE FOLLOWED:

- A. FOR LOSS OF FORWARD DEU INTERFACE, MODE THE BFS GPC TO "HALT" AND PLACE THE OUTPUT SWITCH IN "TERMINATE". ©[040899-2459B]

If no forward DEU interface exists after the crew performs BFS/DEU recovery procedures, they will have no interface with the BFS; hence, the BFS is unusable. As a cleanup item, the BFS GPC will be moded to HALT to cease software execution, and the output switch will be placed in the TERMINATE position to protect the PASS from going to software halt in the event of an inadvertent engage. The TERMINATE position will be used instead of NORMAL for consistency with BFS standalone actions (ref. paragraph B). ©[040899-2459B]

- B. FOR BFS STANDALONE MODE, MODE THE BFS GPC TO "STANDBY", AND PLACE THE BFS OUTPUT SWITCH IN "TERMINATE".

If the BFS continues in a standalone mode after the crew performs BFS recovery procedures, the BFS will be unable to perform SM antenna management. In addition, the ground will be unable to command via the payload buses. Moding the mode switch to STANDBY causes the BFS to relinquish the PL buses to the PASS. In the STANDBY position, the BFS can continue to perform FDA processing on orbiter OI subsystems. The output switch in the TERMINATE position will protect the PASS from going to software halt in the event of an inadvertent engage. The switch is placed in TERMINATE rather than NORMAL to keep the I/O TERM B discrete input high at the BFS, thus preventing a single-point BFS GPC failure (either full or half hybrid receiver 10 failing high) from causing the BFS to self-engage.

- C. FOR LOSS OF CONTROL CA1 (AB3) OR ESSENTIAL 3AB BUS, PLACE THE BFS OUTPUT SWITCH IN "TERMINATE".

The loss of control CA1 prevents the BFS from processing engage discrettes for GPC's 3 and 5. If the BFS is in one of these GPC's, then it cannot be engaged and it is necessary to protect the PASS from going to software halt in the event of an inadvertent engage. This is accomplished by placing the BFS output switch in TERMINATE. The switch is placed in TERMINATE rather than NORMAL to keep the I/O TERM B discrete input high at the BFS, thus preventing a single-point BFS GPC failure (either full or half hybrid receiver 10 failing high) from causing the BFS to self-engage. The same rationale can be applied to the loss of control AB3 if the BFS is in GPC 1, 2, or 4.

The loss of essential 3AB prevents any GPC from properly processing the engage discrettes as a BFS (ref. Rule {A7-51B}.3, BFS DPS FAILURE). This also places the BFS one failure away from self-engage by removing the I/O TERM B input to the BFS GPC. If the BFS is in GPC 1, 2, 4, or 5, the I/O TERM B can be reapplied by placing the BFS output switch in TERMINATE since this position is powered by a different bus. The I/O TERM B cannot be recovered if the BFS is in GPC 3 since the TERMINATE position is also powered by ESS3AB. However, placing the switch in TERMINATE for this case will maintain procedural consistency without placing the BFS or PASS in a worse configuration.

THIS RULE CONTINUED ON NEXT PAGE

FLIGHT RULES

A7-52

ASCENT/ENTRY BFS MANAGEMENT GUIDELINES (CONTINUED)

- D. FOR BFS GPC I/O TERM B FAIL HIGH, PLACE THE BFS OUTPUT SWITCH IN "TERMINATE".

If the BFS/I/O TERM B is failed high, then the BFS cannot recognize an engage and it is necessary to protect the PASS from going to software halt in the event of an inadvertent engage. This is accomplished by placing the BFS output switch in TERMINATE. The switch is placed in TERMINATE rather than NORMAL for consistency with other BFS NO-GO actions.

- E. FOR BFS GPC FAIL DURING ASCENT, A BFS IPL MAY BE ATTEMPTED IN GPC 5 POST ET SEP.

BFS IPL during ascent is an MCC call to regain crew insight into critical systems.

BFS IPL will only be requested when there is adequate time to complete the procedure before the OMS-2 burn, and it would not interfere with other activities. A GPC 5 hardware dump will normally be performed before IPL'ing.

The BFS IPL is performed only on GPC 5 because we are unwilling to give up a good PASS GPC during ascent.

DPS will not recommend a BFS IPL in GPC 5 if GPC 5 has exhibited symptoms of erroneous output or degraded IOP functions.

Even if GPC 5 recovers via IPL, the BFS will be moved on orbit per Rule {A7-53}, ON-ORBIT BFS MANAGEMENT GUIDELINES.

- F. IF DECLARED "SUSPECT", THE BFS WILL BE CONSIDERED "NOT AVAILABLE" FOR ASCENT/ENTRY RESTRING PURPOSES (RULE {A2-63}, ASCENT STRING REASSIGNMENT, AND RULE {A2-254}, ENTRY STRING REASSIGNMENT) AND WILL ONLY BE ENGAGED AS A LAST RESORT.

The difference between a "NO-GO for engagement" call and a "suspect" call is that in "NO-GO for engagement" the BFS will not fly the vehicle. In the "suspect" case, the BFS may fly the vehicle but it cannot be guaranteed.

Rule {A7-51}, BFS DPS FAILURE, references this rule.

FLIGHT RULES

A7-53

ON-ORBIT BFS MANAGEMENT GUIDELINES [HC]

ON ORBIT (POST-OPS 2 THROUGH PRE-TIG), THE FOLLOWING GUIDELINES WILL BE FOLLOWED: @[042403-5930B]

- A. FOR ANY BFS INDICATION DETERMINED TO BE A FAULT CONDITION INCLUDING THOSE LISTED BELOW, THE BFS WILL BE RELOADED INTO A GPC THAT HAS NOT EXPERIENCED ANY FAILURES. @[101096-4516]

A reload of the BFS (into a PASS GPC) regains the BFS function and provides a backup means during entry to assume control of the vehicle in the event the PASS set can no longer maintain vehicle control. Reassignment of the BFS should be performed as soon as practical to protect for contingency deorbit.

The BFS GPC is the last means of recovery for loss of the PASS set and is therefore critical to vehicle safety if it is engaged. The BFS will always be maintained in a GPC without any previous failures. @[101096-4516]

1. BFS GPC HAS BEEN DECLARED FAILED.
2. BFS HAS BEEN DECLARED NO-GO FOR ENGAGEMENT DUE TO LOSS OF CONTROL CA1 BUS.

For loss of control CA1 bus, the BFS engage capability can be regained by reloading the BFS into another GPC except GPC 3 (or 5).

3. THE BFS HAS BEEN DECLARED SUSPECT.

BFS "suspect" is defined in Rule {A7-51}, BFS DPS FAILURE.

4. BFS GPC HAS AN INSTRUMENTATION PCMMU (IP) BUS CONTROL ELEMENT (BCE) FAILURE (LOSS OF DOWNLIST), TIME PERMITTING.

An IP BCE failure results in a loss of downlist and results in loss of OI data to the crew. With this type of failure, the MCC has no insight into orbiter systems performance. In addition, insight on two-stage command feedback is not available. It is highly desirable to have insight into the BFS; hence, the BFS will be reloaded time permitting. @[101096-4516]

5. BFS GPC HAS A PL1 OR PL2 BCE FAILURE, TIME PERMITTING. @[042403-5930B]

A loss of a PL1 or PL2 BCE failure results in a loss of redundancy for antenna management. It is preferred to have redundancy for SM antenna management; hence, the BFS will be reloaded into another GPC.

THIS RULE CONTINUED ON NEXT PAGE

FLIGHT RULES

A7-53

ON-ORBIT BFS MANAGEMENT GUIDELINES [HC] (CONTINUED)

6. BFS GPC HAS ONE OR MORE FC BCE RECEIVER FAILURES, TIME PERMITTING. @[042403-5930B]

Loss of one flight-critical BCE receiver results in loss of data from the associated MDM/BTU's to the BFS. Upon a BFS engage, the BFS would start without a full flight-critical redundancy. It is desirable to have the BFS track all PASS strings upon an engage; consequently, the BFS will be reloaded into another GPC time permitting. @[032807-8400]

- B. FOR A BFS ENGAGE, IF A SUBSEQUENT DISENGAGE IS PERFORMED, THE BFS WILL BE RE-IPLD.

A re-IPL of the BFS assures subsequent BFS Engage capability, since the BFS Software is designed for a one-time-only Engage. The BFS will not be considered acceptable for Engage until a re-IPL is performed. The BFS Engage transition dispatches many unique one-time jobs which have no requirements to provide for a resetting of the Engage transition upon Disengage (prior to a subsequent re-engage). Several critical software modules, procedures, and tasks are attached upon Engage and are not detached upon a Disengage. This puts the BFS software in a state that is not certified by BFS Software developers to control the vehicle upon another Engage. A re-IPL of the BFS is required to return the BFS software to a certified configuration prior to Entry.

An engageable BFS will be maintained as long as one PASS GPC can be maintained. A re-IPL of the BFS provides a backup means during entry to assume control of the vehicle in the event the PASS set can no longer maintain vehicle control. Re-IPL of the BFS should be performed as soon as practical to protect for contingency deorbit. It is not necessary to move the BFS function to another GPC. The same GPC is preferred for IPL to keep a nominal configuration.

Reference Hazard Report OrBI 334, Loss of Vehicle Control Due to Loss of Ability to Engage or Late Engagement of the Backup Flight System (BFS). @[042403-5930B]

Rules {A2-301}.Note 71, CONTINGENCY ACTION SUMMARY [HC], and {A7-52}, ASCENT/ENTRY BFS MANAGEMENT GUIDELINES, reference this rule. @[032807-8400]

FLIGHT RULES

A7-54

BFS MANAGEMENT WHEN ONE FAILURE AWAY FROM SELF ENGAGE

BFS MANAGEMENT WHEN THE BFS IS ONE FAILURE AWAY FROM SELF ENGAGE WILL BE AS FOLLOWS: ©[121505-7211A]

- A. IF ITS I/O TERM B HAS FAILED TO THE LOW STATE, THE BFS WILL BE LEFT IN RUN AND NO ACTION WILL BE TAKEN. THE BFS WILL BE SUSPECT PER RULE {A7-51C}, BFS DPS FAILURE.
- B. IF TWO OF THREE OF ITS ENGAGE DISCRETES ARE FAILED HIGH, THE BFS WILL BE TAKEN TO HALT AS SOON AS POSSIBLE.

NOTE: FOR UPHILL TRAJECTORIES POST MECO, THE BFS MAY BE RETAINED OR RESTORED IF REQUIRED FOR CRITICAL SYSTEMS MONITORING.

There are two requirements that must be met for the BFS to recognize an engage. The first is that the BFS I/O TERM B must be low, and the second is that two of the three BFS engage discretets must be high. If one of these conditions is met due to a failure condition, the BFS is said to be one failure away from a self engage. If both conditions are met due to failure conditions, a BFS self engage is said to have occurred.

During a BFS self engage, the crew has not pressed the engage pushbutton. As a result, the PASS is unaware that the BFS is engaged and is actively attempting to command the vehicle through the flight critical data busses. During this period of time, dual commanders exist on the flight critical data busses as PASS and BFS each independently issue commands and request data. In concert with this activity, the crew will have dual commanders on CRT displays given by the current position of the BFC/CRT display switch, which will look like a garbled display. From the PASS point of view, the BFS is injecting noise on these busses. Likewise, from the BFS point of view, PASS is injecting noise on these busses. Because of this, it is highly likely that PASS will begin to bypass flight critical MDM's and have GPC's fail to sync due to non-universal I/O errors. During the same time period, the BFS will begin to bypass flight critical MDM's. This dual commander situation may not be survivable. ©[121505-7211A]

THIS RULE CONTINUED ON NEXT PAGE

FLIGHT RULES

A7-54

BFS MANAGEMENT WHEN ONE FAILURE AWAY FROM SELF ENGAGE (CONTINUED)

The issue of how to best configure the DPS when the BFS is one failure away from a self engage was discussed at the Ascent/Entry Flight Techniques Panel #212 on June 14, 2005. During the meeting, it was noted that the BFS provides a great many benefits to the crew such as Fault Detection and Annunciation (FDA), trajectory monitoring, auto antenna management, and providing an engageable backup in the event of a PASS failure. These benefits were weighed against the potential loss of crew and vehicle should the next worse failure occur and cause a BFS self engage. ®[121505-7211A]

The only known failure mode that can cause two of three engage discretely to fail high simultaneously is the failure of the half-hybrid input receiver 10A (containing discretely 36 and 37) at the GPC. The JSC Safety and Mission Assurance (S&MA) organization provided the theoretical probability of a half-hybrid failure as 1 in 132,000 ascent/entry periods. In this context, an ascent/entry period is defined as 2 hours. The AP-101S hybrid input receiver has never failed in the shuttle program. In order to arrive at an estimated failure rate, the JSC S&MA organization surveyed the failure rate of similarly designed hybrid input receivers in aerospace applications.

There are many failure modes that can cause the I/O TERM B signal to fail low at the BFS. Examples include the GPC 5 OUTPUT switch, ESS 3AB, the ESS3AB fuse in panel O6, orbiter wiring problems, GPC discrete input receiver failure, and numerous failures in the BFC module. The JSC S&MA organization calculated a theoretical probability of failure of the BFS I/O TERM B signal to be 1 in 5,700 ascent/entry periods. This probability was calculated using the failure data of the individual components that can cause the BFS I/O TERM B to fail low.

A central point of discussion with regard to the I/O TERM B failure rate is the observation that the BFS I/O TERM B signal has failed in flight twice. On STS-32 (1990), the BFS I/O TERM B toggled 42 times from the high to the low state. On STS-78, the BFS I/O TERM B toggled seven times from high to low. These failures occurred on the same vehicle (OV-102), and there were several flights of this vehicle between STS-32 and STS-78 with no I/O TERM B anomalies. The most probable cause was identified to be a wiring problem in a connector that carries the I/O TERM B signal. ®[121505-7211A]

THIS RULE CONTINUED ON NEXT PAGE

FLIGHT RULES

A7-54

BFS MANAGEMENT WHEN ONE FAILURE AWAY FROM SELF ENGAGE (CONTINUED)

The A/EFTP discussion also centered around the probability of a PASS crit 1 software failure that would cause the loss of vehicle and crew. As of April, 2005, USA Flight Software calculates the probability of encountering a crit 1 software DR as 1 in 3,400 ascent/entry periods. This probability was obtained by examining the historical DR rate over the life of the STS program taking into consideration the DR severity and frequency of occurrence. Should a crit 1 DR be encountered by the PASS, a BFS engage would be the most likely means to attempt recovery. ©[121505-7211A]

If the BFS is one failure away from a self engage because its I/O TERM B has failed low, no action will be taken because the probability of the next worse failure that would cause a self engage (the half-hybrid receiver) is much less than the probability of the PASS encountering a crit 1 software DR requiring an engage of the BFS. Note that the BFS is suspect in this case and a successful engage is not guaranteed. However, if the PASS fails, the BFS is the best chance of crew survival.

If the BFS is one failure away from a self engage because two of three of its engage discrettes are failed high (half-hybrid failure), the BFS will be taken to halt as soon as possible. Although the theoretical probability of the next worse failure (I/O TERM B failing low) is of the same order of magnitude of the PASS encountering a crit 1 software DR (which would necessitate an engage of the BFS), emphasis is placed on the flight history of the I/O TERM B failures. Because the BFS I/O TERM B has failed to the low state in flight before, the BFS will be taken down in these cases. No attempt will be made to PRO the BFS to OPS 0 prior to taking it to halt. This is because PROing the BFS to OPS 0 from some major modes is not legal, and procedural simplicity is desired. ©[121505-7211A]

THIS RULE CONTINUED ON NEXT PAGE

FLIGHT RULES

A7-54

BFS MANAGEMENT WHEN ONE FAILURE AWAY FROM SELF ENGAGE (CONTINUED)

Note that the crew does not have insight into the I/O TERM B failure or the half-hybrid receiver failure. Because of this, MCC will be responsible for informing the crew of the state of the BFS and any crew actions that are required. Additionally, the rule intent is to perform the BFS securing actions as soon as possible during dynamic flight phases (powered flight; TAL, RTLS, ECAL, aborts; and post deorbit burn). For uphill trajectories, the BFS securing actions are not as time critical in the post MECO timeframe since the consequences of dual commanders is not an immediate loss of control issue. If the BFS was taken down during powered flight, it may be reactivated post MECO if required for critical systems monitoring and insight. Similarly, the BFS may be retained during the post MECO timeframe for the same reasons. @[121505-7211A]

A7-55 THROUGH A7-100 RULES ARE RESERVED

FLIGHT RULES

OTHER DPS SYSTEMS MANAGEMENT

A7-101 POWER CYCLING/MANAGEMENT

A. FAILURES

GPC'S, MMU'S, DEU/DU'S, AND MDM'S WILL BE POWERED OFF IF THEY INCUR HARD FAILURES. MDM'S WILL BE CYCLED "OFF" THEN "ON" TO RESET OUTPUTS FOLLOWING A DATA PATH FAILURE. MDM'S MAY BE CYCLED "OFF" THEN "ON" FOR GPC FAILURES. ©[040899-2459B]

LRU's experiencing hard failures may be powered off to save power if they are nonfunctional.

B. POWER MANAGEMENT

MMU'S, DEU/DU'S, AND MDM'S MAY BE POWERED OFF FOR POWER MANAGEMENT. GPC'S (101S) WILL NOT NORMALLY BE POWERED OFF FOR POWER MANAGEMENT. ©[040899-2459B]

LRU's, except for the new GPC's (101S), may be powered off for power management. Mission extensions or unique flights may require minimization of power consumption. The 101S GPC's power consumption in the sleep mode is 56 watts, less than one tenth of its operating power consumption. Since removing power from the 101S GPC causes loss of memory integrity, a 101S GPC will only be powered off under extreme powerdown conditions. ©[092701-4872]

A7-102 PASS DATA BUS ASSIGNMENT CRITERIA [HC] ©[042507-8489A]

PASS GPC DATA BUSES WILL BE ASSIGNED USING THE FOLLOWING GUIDELINES:

A. DISPLAY/KEYBOARD (DK) BUSES:

1. FOR RS OPERATION, THE CDR'S (PLT'S) DEU AND DDU WILL NOT BE ASSIGNED TO THE SAME GPC. DISTRIBUTION OF THE DEU'S AND DDU'S PREVENTS LOSS OF CDR'S (PLT'S) INSTRUMENTATION AND DEU DISPLAYED DATA FOR A SINGLE GPC FAILURE (N/A FOR MEDS VEHICLES). ©[040899-2459B]

Three DEU's and two DDU's are available during RS operation. The DEU's are nominally assigned to different GPC's (ref. paragraph A.2). The DDU's are driven from a flight-critical bus as selected by the data bus switches on panels F6 and F8. By proper data bus selection, the CDR's (PLT's) DEU and flight instruments can be driven by different GPC's providing protection against total data loss for a single GPC failure.

THIS RULE CONTINUED ON NEXT PAGE

FLIGHT RULES

A7-102

PASS DATA BUS ASSIGNMENT CRITERIA [HC]
(CONTINUED)

2. FOR RS OPERATION IN A MEDS ENVIRONMENT, ALL OF THE CDR'S (PLT'S) DISPLAYS WILL NOT BE DRIVEN BY THE SAME GPC.

The DPS displays are driven via the DK buses that are nominally assigned to different GPC's. The flight instrument displays are driven from flight critical buses selected by the edge keys. By proper data bus selection, the CDR's (PLT's) DPS displays and flight instrument displays can be driven by different GPC's and IDP's providing protection against total data loss for a single GPC or IDP failure.

3. ALL DEU'S IN A PASS COMMON SET WILL NOT BE ASSIGNED VIA MAJOR FUNCTION SWITCH OR GPC/CRT KEY TO ANY ONE GPC.

If all DEU's were assigned to a single GPC, and this GPC failed, the crew would lose insight into healthy GPC's and would be unable to communicate with the GPC's. @[040899-2459B]

- B. MMU BUSES WILL BE ASSIGNED TO DIFFERENT GPC'S FOR RS OPERATION.

The MMU buses will be distributed via NBAT assignment to different redundant set GPC's to provide different commanding GPC's on each MMU bus. This provides redundant GPC-to-MMU data paths.

- C. FLIGHT CRITICAL (FC) BUSES:

1. ALL STRINGS WILL BE USED BY THE RS REGARDLESS OF THE NUMBER OF GPC'S IN THE SET.

All strings will be used by the redundant set to maintain full flight-critical systems redundancy except for cases of non-universal I/O errors (ref. Rule {A7-104}, NONUNIVERSAL I/O ERROR ACTION).

2. ORBIT STRINGING @[082593-1538]
 - a. NORMAL STRINGING FOR ORBIT OPERATIONS WHEN THERE ARE TWO GNC GPC'S WILL BE STRINGS 1 AND 3 ASSIGNED TO ONE GPC AND STRINGS 2 AND 4 ASSIGNED TO THE OTHER.

This stringing provides optimal redundancy; it will provide continuous uninterrupted vehicle control (assuming no other failures) even if one GNC GPC fails. This string combination will provide jet redundancy for translation and LO Z rotation.

THIS RULE CONTINUED ON NEXT PAGE

FLIGHT RULES

A7-102

PASS DATA BUS ASSIGNMENT CRITERIA [HC]
(CONTINUED)

- b. NORMAL STRINGING FOR ORBIT OPERATIONS WHEN THERE ARE THREE GNC GPC'S WILL BE STRING 1 TO ONE GPC, STRING 2 TO ANOTHER GPC, AND STRINGS 3 AND 4 TO THE THIRD GPC.

For a rendezvous/prox ops with three GPC's, pairing strings 3 and 4 together provides the best jet authority protection against a GPC failure. If a GPC fails, there is no jet authority requirement that forces an immediate restrung. There is no other LRU failure that will force a restrung. This is true whether norm-Z or low-Z is being used. This stringing also keeps the three IMU's separated. ©[082593-1538]

3. FOR HARD OR TRANSIENT FLIGHT-CRITICAL (FC) BCE TRANSMITTER-ONLY FAILURES IN GPC'S, STRING REASSIGNMENT MAY BE UTILIZED TO REGAIN THE DATA PATH.

A GPC BCE transmitter-only failure results in a data path loss; reassigning the bypassed BTU's/ LRU's to a GPC with a healthy transmitter will restore communications with the bypassed BTU's/ LRU's. Because the GPC with the BCE transmitter-only failure will continue to operate in the redundant set and is capable of commanding a different string, it will be assigned a different string and full flight-critical systems redundancy is maintained.

4. DURING ASCENT, STRING REASSIGNMENT WILL BE PERFORMED PER RULE {A2-63}, ASCENT STRING REASSIGNMENT.

Reference Rule {A2-63}, ASCENT STRING REASSIGNMENT.

5. DURING ENTRY, STRING REASSIGNMENT WILL BE PERFORMED PER RULE {A2-254}, ENTRY STRING REASSIGNMENT. ©[042507-8489A]

Reference Rule {A2-254}, ENTRY STRING REASSIGNMENT.

6. FOLLOWING GPC FAILURES, THE CRITERIA FOR ASCENT STRING ASSIGNMENTS IN ORDER OF PRIORITY ARE (ASSUMES NO LRU FAILURES) : ©[042507-8489A]

To maintain a fail-safe operational configuration, a set of priorities was established for string assignments.

- a. STRINGS 1, 2, AND 3 WILL NOT BE ASSIGNED TO THE SAME GPC TO PROTECT IMU REDUNDANCY.

Self-explanatory.

THIS RULE CONTINUED ON NEXT PAGE

FLIGHT RULES

A7-102

PASS DATA BUS ASSIGNMENT CRITERIA [HC]
(CONTINUED)

- b. STRINGS 1 AND 3 WILL NOT BE ASSIGNED TO THE SAME GPC TO PROTECT NSP REDUNDANCY.

Assigning strings 1 and 3 together causes a potential for loss of command and communication with the crew if the commanding GPC failed.

7. FOR A PASS SET OF FOUR GPC'S, A TRANSIENT GPC WILL BE ASSIGNED STRING 4 DURING ENTRY. @[101096-4516] @[042507-8489A]

A transient GPC may fail again during entry. Because string 4 has fewer LRU's, loss of string 4 is of less significance than loss of other strings. @[101096-4516]

8. FOR DEORBIT BURN AND ENTRY, IF LESS THAN FOUR PASS GPC'S ARE AVAILABLE, THE STRINGS WILL BE DISTRIBUTED TO MINIMIZE THE LOSS OF CRITICAL FUNCTIONS FOR A SUBSEQUENT GPC FAILURE. THE PRIORITIZED LIST OF FUNCTIONS TO BE PROTECTED BY SELECTING THE STRING ASSIGNMENTS IS SHOWN BELOW, STARTING WITH THE HIGHEST PRIORITY. STRING ASSIGNMENTS WILL BE BASED ON DISTRIBUTION CONSIDERATIONS FIRST (DISTRIBUTING STRINGS AS EVENLY AS POSSIBLE OR AVOIDING CERTAIN STRING COMBINATIONS). AFTER DISTRIBUTION CONCERNS ARE MET, FINAL STRING ASSIGNMENT SELECTION WILL BE BASED ON AVOIDING ASSIGNMENT TO ANY TRANSIENT GPC'S, IF POSSIBLE. @[042507-8489A]

- a. ONE IMU (TRANSIENT GPC CONCERN ONLY)
b. TWO ASA'S
c. TWO RGA'S
d. TWO AA'S

THIS RULE CONTINUED ON NEXT PAGE

FLIGHT RULES

A7-102

PASS DATA BUS ASSIGNMENT CRITERIA [HC]
(CONTINUED)

- e. TWO IMU'S
- f. TWO YAW JETS
- g. PITCH JETS (ONE FAULT TOLERANT)
- h. RHC CONTACTS (ONE FAULT TOLERANT)
- i. THREE ASA'S
- j. VENT DOORS @[071494-1638]
- k. NWS (FOR RTLS/TAL/AOA (KSC) OR ANY SITE WITH KNOWN DIRECTION CONTROL PROBLEMS) [1]
- l. THREE RGA'S
- m. THREE AA'S
- n. FOUR ASA'S (FCS CRITERIA) (REF. RULE {A8-107}, FCS CHANNEL MANAGEMENT) AVOID ASSIGNING STRINGS 1 AND 2, 1 AND 3, OR 2 AND 3 TOGETHER
- o. THREE YAW JETS
- p. THREE ADTA'S (ONE FAULT TOLERANT)
- q. RHC CONTACTS (TWO FAULT TOLERANT)
- r. THREE IMU'S
- s. L RHC CONTACTS
- t. NWS FOR EOM LANDING
- u. L OMS IGNITION (ONE FAULT TOLERANT) (DEORBIT BURN CONSIDERATION ONLY)
- v. R OMS IGNITION (ONE FAULT TOLERANT) (DEORBIT BURN CONSIDERATION ONLY)
- w. OMS TVC (DEORBIT BURN CONSIDERATION ONLY)

THIS RULE CONTINUED ON NEXT PAGE

FLIGHT RULES

A7-102

PASS DATA BUS ASSIGNMENT CRITERIA [HC]
(CONTINUED)

- x. FOUR AFT FIRING PRIMARY RCS JETS (DEORBIT BURN CONSIDERATION ONLY)
- y. ONE OR TWO NSP'S

NOTE:

[1] CURRENT CHANNELIZATION FOR NWS IS THE SAME AS FOR VENT DOOR FUNCTION, I.E., PROTECTING ONE COVERS BOTH.

Rationale TBS.

- 9. IF THERE ARE MULTIPLE STRINGING COMBINATIONS WHICH SATISFY THE ABOVE CRITERIA, THE COMBINATION CLOSEST TO NOMINAL WILL BE SELECTED.

It is preferred to stay close to nominal because it reduces the risk of inducing errors when the crew responds to subsequent failures.

Reference Hazard Report ORBI 068, Keyboard Failures, IDP Erroneous Output or IDP/CRT Select Switch Failures Could Cause Loss of Crew/Vehicle. ©[042507-8489A]

*Rules {A2-120}, RNDZ/PROX OPS DPS SYSTEMS MANAGEMENT; {A7-3B}, GPC FAILURE; {A7-6B}, DATA PATH FAILURE; {A7-5A and B}, PASS GPC BCE FAILURE MANAGEMENT; and {A8-55}, ASCENT/ENTRY RCS CONTROL REQUIREMENTS [HC], reference this rule. ©[042904-6239A]
©[ED]*

A7-103

I/O RESET

I/O RESET KEY MAY BE USED ANYTIME IN PASS AND BFS TO ATTEMPT RESTORATION OF NOMINAL I/O, EXCEPT FOR CASES OF NONUNIVERSAL I/O ERROR. (REF. RULE {A7-104}, NONUNIVERSAL I/O ERROR ACTION.)

An I/O reset provides resetting of hardware electronics that reinitiates I/O and may clear transient I/O functions. Reinitiating I/O if a nonuniversal I/O error condition has occurred could cause a FTS or set split. Reference Rule {A7-104}, NONUNIVERSAL I/O ERROR ACTION (ref. FRCB meeting #49 held on January 23, 1991).

FLIGHT RULES

A7-104

NONUNIVERSAL I/O ERROR ACTION

RESTRINGING OR I/O RESETS WILL NOT BE PERFORMED FOR RECOVERY OF A BCE ELEMENT BYPASS NOR WILL AN OPS TRANSITION BE PERFORMED IF A NON-UNIVERSAL I/O ERROR CONDITION HAS OCCURRED ON ANY BUS UNLESS CRITICAL CAPABILITY RECOVERY IS BEING ATTEMPTED, OR UNTIL THE STRING ASSOCIATED WITH THE NON-UNIVERSAL CONDITION HAS BEEN SAFED. PORT MODING WILL NOT BE ATTEMPTED ON A STRING WITH A NON-UNIVERSAL I/O ERROR UNLESS THE BUS WITH THE ERROR HAS BEEN SAFED OR CRITICAL RECOVERY IS BEING ATTEMPTED. @[121296-4564A]

When an element bypass occurs, if the I/O error condition is not logged equally in the I/O error logs by each GPC in the RS, then a nonuniversal I/O error has occurred. This could be caused by a GPC problem, an unterminated data bus, or a loquacious BTU. If only a single GPC in an RS logs an error associated with this condition, then that GPC will fail-to-sync. If more than one GPC, but not all GPC's log an error, then the condition is more properly called a nonuniversally detected error condition (as defined by the software developers). Upmoding of a bypassed element under conditions of nonuniversal I/O error by the use of port moding, restringing or I/O resets, can result in an FTS or in a redundant set split. Therefore, these actions should be avoided (user note 101757) until the string associated with the nonuniversal I/O error has been safed, unless critical capability recovery is being attempted. @[121296-4564A]

Safing of a string associated with a non-universal I/O error condition is guaranteed by deassigning the string from the NBAT and performing an OPS mode recall or OPS transition. Also, a string may be safed by ensuring that all LRU's (except GPC's) capable of transmitting on the affected bus are powered off. If this can be done, then the nonuniversal I/O error condition becomes a universally detected error since there is no longer any LRU remaining that can respond to a request from the GPC for data. For the entry phase of flight, the only active LRU's on the flight critical buses are the FF and FA MDM's. The MEC's and EIU's are also connected to flight critical buses, but these LRU's are powered off during entry. If the MDM associated with the bus having the nonuniversal I/O error condition is powered off, the error is made universal, and the bus has been safed. During ascent, the MEC's and EIU's are powered on. Since the MEC's and EIU's cannot be powered off during OPS 1 or 6, the only viable method of safing flight critical buses five through eight is to deassign the affected string. Flight critical buses one through four (used by FF MDM's while on primary ports) only have the FF MDM's (or FA MDM if port moded to secondary ports) that can transmit on the bus. Therefore, for ascent, only buses one through four could be safed by powering off the associated MDM. @[121296-4564A]

If fault messages indicate that not all GPC's are annunciating the error, then a nonuniversal I/O error has occurred and the crew will be aware of the condition. If the fault messages indicate universal annunciation of the error, there still may be a nonuniversal error condition, but the crew will not be able to detect it since the I/O error logs are the only absolute indicator of the condition.

Given no evidence of nonuniversal I/O errors or no advice from flight controllers, the crew will follow normal procedures which use I/O reset, port moding, and in some cases, restring, as part of the recovery attempts for bypasses.

THIS RULE CONTINUED ON NEXT PAGE

FLIGHT RULES

A7-104 NONUNIVERSAL I/O ERROR ACTION (CONTINUED)

Because the port moding operation only upmodes the string being port moded, a port mode can be done to recover a bypassed element under nonuniversal I/O error conditions if the nonuniversal error is associated with a different string than the one being port moded.

If recovery of critical capability is needed, then I/O reset, port mode and restringing may be attempted even if nonuniversal error conditions exist in an attempt to recover the bypassed element with the knowledge that a FTS or set split may occur.

For cases where a nonuniversal I/O error condition exists prior to execution of an OPS transition, the string with the nonuniversal I/O error condition should not be assigned in the NBAT for the OPS being entered unless the string has been safed. ®[121296-4564A]

Rules {A7-102C}.1, PASS DATA BUS ASSIGNMENT CRITERIA [HC]; {A7-103}, I/O RESET; and {A7-105}, MDM PORT MODING, reference this rule. ®[042507-8489A]

A7-105 MDM PORT MODING

MDM PORT MODING WILL BE PERFORMED ACCORDING TO THE FOLLOWING GUIDELINES:

- A. MM 102 - PORT MODING OF FLIGHT-CRITICAL OR PAYLOAD MDM'S WILL NOT BE ATTEMPTED UNLESS IT IS NECESSARY TO REGAIN CRITICAL SYSTEM CAPABILITY.

For port dependent MDM failures, port moding may be attempted to regain the required MDM redundancy by giving up port redundancy in the bypassed MDM. During MM 102, system reconfiguration is not routinely done due to the dynamic nature of this flight phase. For multiple failures that impact critical systems capability, port moding may be done.

- B. POST-MM 102 TO PRE-MECO - PORT MODING OF FLIGHT-CRITICAL AND PAYLOAD MDM'S MAY BE PERFORMED TO REGAIN CRITICAL SYSTEM CAPABILITY OR AFTER ANY SECOND FAILURE. NONCRITICAL RECOVERY WILL NOT BE ATTEMPTED FOR CASES OF NONUNIVERSAL I/O ERROR (REF. RULE {A7-104}, NONUNIVERSAL I/O ERROR ACTION).

For noncritical recovery, port moding is not performed until another failure has occurred. The other failure is any other failure and does not have to be avionics related, but a failure that sufficiently adds complexity to the overall vehicle system to warrant taking action.

THIS RULE CONTINUED ON NEXT PAGE

FLIGHT RULES

A7-105

MDM PORT MODING (CONTINUED)

- C. POST-MECO, FOR FLIGHT-CRITICAL OR PAYLOAD MDM FAILURES, RECOVERY ATTEMPTS BY PORT MODING MAY BE PERFORMED IN ANY MAJOR MODE OF ANY VALID OPS VIA DISPLAY ITEM ENTRIES ON THE DPS UTILITY DISPLAY EXCEPT FOR CASES OF NONUNIVERSAL I/O ERROR (REF. RULE {A7-104}, NONUNIVERSAL I/O ERROR ACTION).

FC or PL MDM's communicate on one of two redundant ports that are selectable via software. If an MDM is bypassed due to a port failure, communication on the redundant port may be attempted via an item entry to the available user SPEC to attempt recovery of the MDM.

- D. WHEN A CHOICE EXISTS BETWEEN THE LOSS OF AN FF OR FA MDM AND NO OTHER CRITICAL SYSTEM FAILURES EXIST, FA1, 2, OR 3 WILL BE GIVEN UP IN FAVOR OF FF1, 2, OR 3. FF4 WILL BE GIVEN UP IN FAVOR OF FA4.

For certain multiple MDM failure scenarios (i.e., FFX primary port failure and FAX secondary port failure) only one FC MDM per string can be selected at any given time. Using the port mode capability, system optimization can be achieved with respect to protecting for the next failure. FF1, 2, and 3 are selected for IMU capability. FA4 is desired for insight into OMS system/FCS channel capability, since giving up FF4 costs a minimum of capability. FA3 is given up even though it provides insight into the left OMS. It is believed that losing an IMU is more probable and critical than the loss of insight into an OMS system.

Rule {A2-5}, PORT MODING/RESTRINGING GUIDELINES, references this rule.

FLIGHT RULES

A7-106**MMU OPERATIONS**

MMU OPERATIONS WILL BE ACCOMPLISHED USING THE FOLLOWING GUIDELINES:

- A. SM CHECKPOINTS WILL BE MAINTAINED ON ALL OPERATIONAL TAPE-DRIVEN MASS MEMORY UNITS AND SOLID STATE MASS MEMORY (SSMM) UNITS. ©[012402-5017]
- B. IF ONE SSMM HAS FAILED, OPERATIONS ON THE REMAINING SSMM WILL NOT BE RESTRICTED.

The Modular Memory Unit (MMU) houses both the SSMM and the Solid State Recorders (SSR). The SSMM is a replacement for the tape-driven Mass Memory Unit. The SSR is a replacement for the Payload Recorder and OPS Recorders. This rule is only applicable to the SSMM portion of the Modular Memory Unit.

SSMM units are initially loaded with exactly the same data, and, procedurally, this redundancy is maintained throughout a flight. Since SSMM's are not mechanical devices, failure susceptibility of the remaining SSMM does not significantly increase when that SSMM is utilized for nominal shuttle operations. Therefore, if one SSMM fails or is inaccessible, the remaining SSMM will still have a complete copy of all data. A single failed or inaccessible MMU should not impact the utilization of the remaining SSMM.

- C. IF ONE MMU HAS FAILED, OPERATIONS ON THE REMAINING MMU WILL PRECLUDE ROUTINE SM CHECKPOINTS. IN ADDITION, USE OF SM ROLL-IN DISPLAYS AND TFL/DFL OPTIONS WILL BE MINIMIZED (NOT APPLICABLE FOR VEHICLES WITH SSMM'S).

If one tape-driven MMU fails or is inaccessible, the remaining MMU will still have a complete copy of all data. However, tape-driven MMU's (because of their mechanical nature and tape wear) are more susceptible to a subsequent failure of the remaining unit. Therefore, use of the remaining tape-driven MMU will preclude routine SM checkpoints and all other MMU transactions will be strictly minimized to help protect against the subsequent loss of the remaining MMU. Reducing MMU access will help to minimize the possibility of a subsequent loss of the remaining MMU. ©[012402-5017]

FLIGHT RULES

A7-107**TIME MANAGEMENT**

ONBOARD TIME MANAGEMENT WILL BE ACCOMPLISHED USING THE FOLLOWING GUIDELINES:

- A. MTU/GPC GMT ERROR WILL BE MAINTAINED AT OR BELOW 100 MS WHEN SPEC 2 "TIME" IS AVAILABLE. A 15-MS UPDATE WILL BE PERFORMED ANYTIME THE ERROR EXCEEDS THAT THRESHOLD.

The MTU provides a stable frequency output that, over the course of a 7-day mission, should never be in error more than 100 milliseconds. However, due to an MTU failure, GMT may be in error. A greater variance in GMT may impact navigation, thus the GMT will be maintained within ± 100 milliseconds of true GMT. Since the onboard computers are processing in a redundant and/or common set, a software limitation of a maximum of 15 milliseconds per update precludes a GPC failure caused by a time change. A time update can only be performed using the SPEC 2 "time" display. SPEC 2 is not available in the BFS or during PASS GNC OPS 1/6/3.

- B. THE ONBOARD TIME MANAGEMENT SYSTEM (MTU/GPC) WILL NOT BE UPDATED IN-FLIGHT TO INCORPORATE ADJUSTMENTS TO THE WORLD WIDE TIME BASE REFLECTED BY WWV.

Because of variations in the Earth's orbit, leap seconds are incorporated into true GMT. Leap seconds are added or subtracted from GMT and are reflected in WWV GMT. Since the vehicle is not connected to WWV GMT, the crew would have to make multiple 15-millisecond updates to correct onboard time. (Note: It takes 1 to 2 minutes for one update.) Therefore, orbiter GMT will not be updated for leap seconds.

- C. FOR YEAR END ROLLOVER OF MTU GMT, THE MTU WILL BE REINITIALIZED WITH GPC GMT.

The onboard GPC's do not roll over (reset to GMT day 1) at year-end; the MTU does. For the GPC's to accept the MTU time, they must be taken to STBY and reinitialized. This results in a period of no vehicle control, no navigation updates, and no payload support. Since this is unacceptable, the MTU is forced to accept GPC time. When this is done, the orbiter no longer reflects true GMT as reflected by WWV.

THIS RULE CONTINUED ON NEXT PAGE

FLIGHT RULES

A7-107

TIME MANAGEMENT (CONTINUED)

- D. A MANUAL MTU OSCILLATOR SWITCH WILL BE PERFORMED POST-MECO UP UNTIL HAC INTERCEPT FOR EITHER OF THE FOLLOWING CONDITIONS:
1. THE MTU BITE BIT 4 (OSCILLATOR 1/2 FREQ DIFFERENCE) IS SET AND THE MCC OBSERVES STEADILY INCREASING MTU DELTA TIMES.
 2. IF THE BFS LOSES TRACK WITHIN 1 MINUTE OF THE MTU BITE BIT 4 BEING SET AND BFS I/O RESETS ARE UNSUCCESSFUL IN RECOVERING THE BFS.

If the MTU BITE bit 4 is set, this indicates a frequency difference between the two oscillators; this bit does not tell which oscillator is malfunctioning and is, therefore, not used by the auto switch logic. Therefore, the MCC must use the MTU 1 and MTU 2 delta times (the difference between the onboard MTU referenced GMT and the ground GMT) and/or the state of the BFS to determine if a manual oscillator switch needs to be made.

The BFS will lose track if the HFE listen command is late by more than 180 microseconds for 24 consecutive minor cycles. Because of perturbations in the HFE listen cycle, the engineering community feels the BFS may not lose track immediately. However, best engineering judgment dictates that the BFS will lose track within 1 minute. Therefore, if the BFS loses track of the PASS when the MTU BITE bit 4 is set, it is a good indication that the selected oscillator is drifting and is the cause of the BITE indication.

In the event of launch with the BITE bit indicator already set (either because of a false BITE indication due to a BITE circuitry failure or because of a failed oscillator), consideration should be given to performing a manual oscillator switch after BFS loses track before declaring the BFS failed and performing a BFS IPL.

If a manual oscillator switch is made to the bad oscillator, the worst outcome would be that the PASS would fault down to internal time (which testing has verified causes no serious degradation of performance). If this happened, the PASS could not be switched back to MTU time until SPEC 2 is available.

In general, reach and visibility constraints do not allow the crew to reach the MTU oscillator select switch until post-MECO. There is a time shortly after SRB SEP, however, when the G-forces have decreased enough for the crew to reach the switch. Therefore, a manual MTU oscillator switch post-SRB SEP could be attempted and will be a real-time call. Ref. Ascent/Entry Flight Techniques Panel #69 (7/20/90) minutes, and the 5/15/90 and 6/21/90 SARS minutes.

FLIGHT RULES

A7-108

DEU EQUIVALENT CRITERIA

(REFERENCE RULE {A2-111}, DPS COMMAND CRITERIA.) @[072595-1775A]

- A. ALL DEU EQUIVALENT LOADS SHOULD BE COORDINATED WITH THE CREW. DEU EQUIVALENT LOADS DURING CREW SLEEP MUST BE COORDINATED WITH THE CREW PRIOR TO THE START OF THE SLEEP SHIFT UNLESS THE LOADS ARE REQUIRED TO AVOID POTENTIAL NUISANCE ALARMS.

In order for the crew to maintain situational awareness of all orbiter activities, they need to be informed of all planned DEU equivalent loads. As long as the crew has been informed of a general plan prior to going to sleep, it is acceptable to alter the specifics of the plan without notifying the crew of the changes. If the need arises for a DEU equivalent load after the crew has gone to sleep, it will not be uplinked unless it is required to prevent waking up the crew.

- B. OPS TRANSITIONS, MAJOR MODE TRANSITIONS, AND OPS MODE RECALLS WILL NOT BE PERFORMED VIA DEU EQUIVALENT LOADS. THE ONLY EXCEPTION TO THIS IS FOR THE G1 TO G9 OPS TRANSITION DURING PAD ABORTS/HOLDS TO PROVIDE A BACKUP TO THE CREW OR KSC LDB COMMANDING. @[042502-5317B]

Although OPS transitions, major mode transitions, and OPS mode recalls can be performed via a DEU equivalent load, a program level decision was made to avoid such commands based on the high level of risk associated with them. Due to the complexity of performing these types of software operations, there exists the possibility of annunciating fault messages or, worse case, not successfully completing the transition. For pad aborts/holds, the LPS safing/recovery procedure allows the MCC to control the transition from G1 to G9 in the event KSC and the crew are both unable to perform the transition. Allowing MCC to perform this transition in the event of an LPS loss will potentially minimize vehicle turn-around time and risks from unexpected command outputs and/or system failures. @[072795-1775A] @[042502-5317B]

- C. DEU EQUIVALENT LOADS WILL NOT BE CHAINED. @[072595-1775A]

DEU equivalent loads will not be chained because the successful execution of one load cannot be verified before subsequent commands are executed. Although not necessarily recommended, it is acceptable to link multiple item entries on a specific page together via separator keys as long as a separate command is required to invoke the loaded data (i.e., arm and fire).

THIS RULE CONTINUED ON NEXT PAGE

FLIGHT RULES

A7-108

DEU EQUIVALENT CRITERIA (CONTINUED)

- D. IF A SPEC OTHER THAN THE OPS DISPLAY IS REQUIRED FOR DEU EQUIVALENT LOADS, IT WILL NOT BE CALLED UP UNTIL REQUIRED. THE SPEC WILL THEN BE RESUMED AS SOON AS PRACTICAL.

In order to avoid the possibility of accidentally trapping a SPEC due to certain GPC and CRT failures, it is best to always RESUME SPEC's when not in use. The crew is trained to place the CRT's in a specific configuration prior to sleep, and they expect them to be in this same configuration when they wake up. Therefore, leaving the OPS display up on all CRT's will coincide with what the crew expects.

- E. DUE TO GROUND LIMITATIONS, THE FOLLOWING KEYSTROKES CANNOT BE USED IN ANY DEU EQUIVALENT LOAD.

1. FAULT SUMM
2. SYS SUMM
3. GPC/CRT
4. MSG RESET
5. CLEAR
6. ACK @[072795-1775A]

Although the onboard software allows the above keystrokes, the ground command processing software prohibits DEU equivalent loads from containing them. Since the FAULT SUMM and SYS SUMM displays do not contain any ITEM entries, the MCC does not benefit from uplinking these keystrokes. The other four keystrokes can interfere with the crew's CRT configuration or fault message recognition. Therefore, it was decided prior to STS-1 to prohibit the ground from uplinking these specific keystrokes.
@[072795-1775A]

FLIGHT RULES

A7-109

IN-FLIGHT MAINTENANCE (IFM)

IN-FLIGHT REPLACEMENT OF LRU'S WILL BE PERFORMED FOR THE FOLLOWING EQUIPMENT FAILURE DEFINITIONS:

In-flight replacement (IFM) will be done to regain LRU redundancy and/or lost capabilities.

- A. IF A KEYBOARD FAILURE CAN BE ISOLATED TO A SPECIFIC KEY, THE KEY WILL BE REPLACED WITH THE AFT KEYBOARD "ACK" KEY; OTHERWISE, A FAILED FORWARD KEYBOARD WILL BE REPLACED BY THE AFT KEYBOARD.

Keyboard failures can occur on specific keys or the entire keyboard. IFM on such failures associated with the forward keyboard will be to replace it with the aft keyboard, since it is not used during entry.

- B. ANY FORWARD CRT MAY BE REPLACED BY CRT 4 IF THE SCREEN BLANKS OR IS UNREADABLE AND THE GROUND VERIFIES THE CRT IS THE FAILED ELEMENT VIA DISPLAY UNIT BITE (N/A FOR MEDS VEHICLES).
 @[021397-4763] @[040899-2459B]

CRT 4 has been selected as a replacement CRT for any forward CRT because it is not used during entry.

- C. ANY FAILED MDU MAY BE REPLACED BY ANOTHER MDU. AT LEAST ONE CDR MDU AND ONE PLT MDU MUST BE MAINTAINED FOR ENTRY. AN MDU IS CONSIDERED FAILED IF IT HAS A BLANK DISPLAY, AN INOPERATIVE 1553 DATA PORT, OR AN INTERNAL PROBLEM THAT PREVENTS THE MDU FROM BEING USEFUL AS A DISPLAY DEVICE. @[111501-4949]

- a. *Failed forward MDU* @[031500-7172D]

An IFM to replace any failed forward MDU with an aft MDU will regain full redundancy for entry. When replacing a forward MDU with an aft MDU, AFD1 MDU is the preferred MDU since CRT4 MDU is used during entry.

- b. *Failed AFT MDU*

If it is desired to replace a failed aft MDU with a forward MDU, MFD2 MDU is the preferred MDU. MFD2 MDU is preferred based on the following: CRT MDU's should be left in place, CDR2 and PLT1 MDU's are used for the primary flight instrument displays, and removing CDR1 or PLT2 MDU's would make their respective side of the cockpit vulnerable to single-point electrical bus failures. Because of the large number of MDU's (11) and the simple and low risk MDU IFM (45 minutes), an IFM to replace a failed aft MDU with a forward MDU could aid the crew in critical aft station operations (RNDZ, dock/undock) without losing any capability in the forward cockpit. In addition, the MDU can be reinstalled in the forward cockpit after the critical aft operations are complete. @[031500-7172D]

THIS RULE CONTINUED ON NEXT PAGE

FLIGHT RULES**A7-109****IN-FLIGHT MAINTENANCE (IFM) (CONTINUED)**c. *MDU failures* @[111501-4949]

There are multiple failures that may cause an MDU to be declared failed. The most obvious is a blank or unusable display. Loss of one of the two 1553 data ports by itself is not a problem for non-CRT MDU's since switching to the alternate port provides full functionality. CRT MDU's have only one 1553 data bus connected. Therefore, loss of that data port to a CRT MDU renders it useless. Combinations of failures may cause a non-CRT MDU with a single failed port to be declared failed such as the case of a failed IDP on the other port. Other internal failures may still prevent the MDU from being a useful display device. A failed edge key could preclude the ability to navigate to the desired display. @[111501-4949]

D. DEU 1, 2, 3 MAY BE REPLACED WITH DEU 4 IF THE DEU FAILS TO FUNCTION FOLLOWING AN IPL AND THE GROUND VERIFIES THE DEU IS THE FAILED ELEMENT VIA DEU BITE (N/A FOR MEDS VEHICLES).
@[040899-2459B]

DEU's 1, 2, 3 will be replaced with DEU 4 because DEU 4 is not used during entry.

E. IDP 1, 2, 3 MAY BE REPLACED WITH IDP 4 IF THE IDP FAILS TO FUNCTION.

IDP's 1, 2, 3 will be replaced with IDP 4 because sacrificing IDP4 to regain IDP1, 2, or 3 regains full capability for the forward flight stations. If an IDP only loses interface to the flight critical buses, an IFM is not required due to IDP redundancy. @[040899-2459B]

F. A PL MDM WILL BE SWAPPED WITH THE OTHER PL MDM ONLY AFTER POWER CYCLING AND PORT MODING FAILS TO CLEAR A NON-GPC CAUSED "I/O ERROR PL" AND THERE HAS BEEN A FAILURE OF ANY PLBD MCA (EXCEPT MCA 2) CONTROLLED BY THE GOOD MDM. @[040899-2459B]

Payload MDM will be swapped to allow payload bay door closure. MCA 2 is an exception because swapping PL MDM will not recover all the necessary functions, and pin kit IFM procedures would still be required to close and latch the doors. For this case, Rule {A2-105C}.16, IN-FLIGHT MAINTENANCE (IFM) [HC], will be implemented. @[ED]

THIS RULE CONTINUED ON NEXT PAGE

FLIGHT RULES

A7-109

IN-FLIGHT MAINTENANCE (IFM) (CONTINUED)

- G. AN FF MDM 1, 2, OR 3 MAY BE REPLACED BY FF4 ONLY AFTER POWER CYCLING AND PORT MODING FAILS TO CLEAR A NON-GPC CAUSED "I/O ERROR FFX" OR TOTAL OUTPUT CARD FAILURE AND IT RESULTS IN THE LOSS OF:
1. A SECOND IMU
 2. A SECOND AA (AA4 MUST BE FAILED)

Where previous LRU failures would cause a loss of at least fail-safe redundancy in an entry-critical system, it is considered viable to replace FF1, 2, or 3 with FF4. This operation would be accomplished to recover an IMU for redundancy in onboard navigation for entry. The same is true for an AA to regain redundancy for entry control.

- H. AN MMU CONTINGENCY POWERUP MAY BE PERFORMED TO RECOVER AN MMU THAT IS DOWN DUE TO POWER LOSS. @[101096-4516]

The IFM may be performed at a convenient time when it will not interfere with higher priority mission operations or crew activities. If the remaining MMU fails, this IFM will be performed ASAP. A successful IFM will return power to the MMU that in turn can be used for GNC/SM transitions, and GPC/DEU reload capabilities.

Rules {A2-301}, CONTINGENCY ACTION SUMMARY [HC], and {A2-333}, LOSS OF PAYLOAD MDM DURING SPACEHAB ACT/ENTRY PREP, reference this rule. @[040899-2459B] @[032807-8400] @[ED]

A7-110 THROUGH A7-150 RULES ARE RESERVED

FLIGHT RULES

PAYLOAD-SPECIFIC DPS SYSTEMS MANAGEMENT

A7-151 CONSTRAINTS ON PORT MODING OR I/O RESETS

THERE ARE NO SPACEHAB-RELATED CONSTRAINTS ON PAYLOAD MDM PORT MODING OR SM I/O RESETS. @[092701-4872]

Both port moding and I/O resets are transparent to Spacehab. @[ED] @[092701-4872]

A7-152 THROUGH A7-200 RULES ARE RESERVED

FLIGHT RULES

DPS EOM REQUIREMENTS/DEFINITIONS

A7-201

DPS REDUNDANCY REQUIREMENTS

THE MINIMUM DPS REDUNDANCY REQUIREMENTS TO CONTINUE TO EOM ARE:

This rule provides a guideline for continuing nominal mission activities with less than a fullup complement of DPS resources, equipment, and capabilities. The objective is to maintain sufficient resources such that one additional failure can be sustained without jeopardizing vehicle safety, while protecting against a generic failure in both the primary and redundant systems (either hardware or software).

A. NO MORE THAN ONE GPC HAS BEEN DECLARED UNRECOVERABLE. @[101096-4516]

If one GPC fails, the DPS system is still fail-operational. With one GPC failed, there is no reason to believe the failure is more than an isolated incident; there is no increased risk to the orbiter or crew safety associated with staying to the nominal end of mission. @[092195-1798] @[101096-4516]

A second GPC failure may indicate a generic problem with an increase in risk to orbiter and crew safety. For this reason, a second GPC failure is reason for not going to nominal end of mission even though the orbiter would still be fail-operational for entry. @[092195-1798] @[101096-4516]

B. DATA PATHS NECESSARY TO SUPPORT REQUIRED LRU AND DISPLAY REDUNDANCY.

Each discipline has LRU and display redundancy requirements for continuing nominal mission activities; consequently, this was written to provide data bus capability if they require it to maintain critical systems redundancy.

C. TWO INDEPENDENT SOURCES OF DEORBIT PASS SOFTWARE ARE REQUIRED AND ARE DEFINED AS ONE OF THE FOLLOWING:

1. TWO MASS MEMORY UNITS (MMU'S)
2. ONE GNC MAJOR FUNCTION GNC 3 ARCHIVE GPC (FREEZE DRIED GNC-3 GPC) AND ONE MMU

The PASS deorbit software (GNC OPS 3) is available from the following sources: MMU 1, MMU 2, a previously G3 archived GPC, or a freeze-dried GNC 3 GPC on orbit. The allowable combinations of sources always include one MMU.

Rules {A2-120B}, RNDZ/PROX OPS DPS SYSTEMS MANAGEMENT; and {A7-13E}.1.d, GPC MAJOR FUNCTION CONFIGURATION, reference this rule.

THIS RULE CONTINUED ON NEXT PAGE

FLIGHT RULES

A7-201

DPS REDUNDANCY REQUIREMENTS (CONTINUED)

- D. AT LEAST ONE MMU TO PROVIDE GPC INITIAL PROGRAM LOAD (IPL) AND DEU LOAD CAPABILITY.

This rule provides software reload capability for maintaining GPC and DEU redundancy, and recovery for failed GPC's.

A7-202 THROUGH A7-1000 RULES ARE RESERVED

FLIGHT RULES

DPS GO/NO-GO MATRIX

A7-1001

DPS GO/NO-GO MATRIX

<u>DPS SYSTEMS</u>	CONTINUE NOMINAL ASCENT IF:	INVOKE MDF IF:	ENTER NEXT PLS IF
A. GPC'S: (5)		2 ↓ [4]	3 ↓
B. MDM'S:			
[1] FF1-4 (4)			2 ↓
[2] FA1-4 (4)			2 ↓
[3] PF1-2 (2)			2 ↓ [5]
C. MCDS:			
[1] DEU/CRT (4)		2 ↓ [7]	2 FWD ↓ [3][7]
[2] FWD KEYBOARD (2)			1 ↓ [3]
[3] AFT KEYBOARD (1)			
D. MEDS			
[1] IDP (4) DPS FUNCTION		2 ↓ [8][9]	2 FWD ↓ [3][8][9]
[2] IDP (4) FLIGHT INSTRUMENT FUNCTION			2 FWD ↓ [3][8][9]
[3] MDU (11) [6]			
[4] ADC (4)			
E. MMU 1-2: (2) [1]		2 ↓	
F. COMPUTER STATUS/COMPUTER C&W: (2)			
G. TIMING:			
[1] MTU (1) [2]			
[2] EVENT TIMER			
[3] MISSION TIMER			

@[101096-4516] @[121296-4595C] @[040899-2459B] @[031500-7172D]

LEGEND:

NO REQUIREMENT

REQUIRED

()

QUANTITY

[]

NOTE REFERENCE

THIS RULE CONTINUED ON NEXT PAGE

FLIGHT RULES

A7-1001

DPS GO/NO-GO MATRIX (CONTINUED)

NOTES:

- [1] ASSUMES G3 ARCHIVE OR G3 FREEZE-DRY CAPABILITY IS AVAILABLE.
- [2] LOSS OF MTU PRECLUDES BFS MET/GMT INITIALIZATION CAPABILITY.
- [3] SWAP OUT MAY BE USED TO SATISFY THE MINIMUM REQUIREMENTS.
- [4] ASSUMES TWO OPERATIONAL MMU'S OR ONE MMU AND GNC 3 ARCHIVE CAPABILITY IS AVAILABLE.
- [5] ASSUMES IFM CAPABILITY FOR PAYLOAD BAY DOOR CLOSURE.
- [6] BECAUSE OF THE LARGE NUMBER OF MDU'S AND SYSTEM FLEXIBILITY, THE MINIMUM DURATION REQUIREMENTS ARE COVERED IN RULE {A2-102}, MISSION DURATION REQUIREMENTS, WHICH ADDRESSES GENERIC FAILURES. @[040899-2459B]
- [7] IF TWO FORWARD CRT'S, PERFORM IFM ASAP.
- [8] IF TWO FORWARD IDP'S, PERFORM IFM ASAP. @[04082459A]
- [9] LOSS OF EITHER FUNCTION, DPS OR FLIGHT INSTRUMENT, IN ANY 3 SEPARATE IDP'S IS PLS. @[031500-7172D]

The DPS GO/NO-GO CRITERIA matrix reflects the MDF/PLS criteria (ref. Rules {A2-102B}.2, MISSION DURATION REQUIREMENTS, and {A2-1001}, ORBITER SYSTEMS GO/NO-GO).

MDF - Multiple failures in an avionics system, even though it remains single-fault tolerant, may be indicative of a generic failure; consequently, an MDF is invoked for loss of two GPC's, loss of two DEU/CRT's, or for MEDS flights, two IDP's. @[040899-2459B]

Although a nominal end of mission can be accomplished with no accessible mass memory units (MMU's), the loss of two MMU's would result in the inability to recover subsequent GPC and/or DEU failures, loss of TFL's and DFL's, and loss of system management (SM) roll-in displays. Loss of SM roll-in displays contributes to a loss of additional insight into systems status in the event of a significant failure. Therefore, because of the loss of the above capability, an MDF is invoked for failure of two MMU's.

Loss of flight-critical and payload MDM's is an exception to the single-fault tolerant rule because loss of a single MDM reduces redundancy in multiple systems increasing the risk that a single LRU failure in any one of several systems could put the orbiter at a zero-fault tolerant level.

A risk assessment presented at the AEFTP #131 concluded that the combination of LRU's lost with FF4 does not warrant early mission termination. There is no systems requirement for an MDF after the loss of FF4. In addition, mission length for the loss of FF1, 2, 3 and FA MDM's should correspond to the IMU and FCS mission length, respectively. Mission length for the first IMU and FCS failure was changed to NEOM. The probability of losing a second PL MDM, thereby requiring an IFM to close the PLBD's and latch gangs, is extremely low. Therefore, NEOM is acceptable after the loss of one PL MDM. @[121296-4595C]

PLS - A next PLS deorbit will be executed at the earliest practical time for failures which place the orbiter system at the zero-fault tolerant level or results in a condition where one more failure causes a severe orbiter configuration management condition.

THIS RULE CONTINUED ON NEXT PAGE

FLIGHT RULES

A7-1001

DPS GO/NO-GO MATRIX (CONTINUED)

Loss of three GPC's may be indicative of a generic problem. If another GPC failure occurred, this would result in entry on a single PASS GPC. Therefore, a next PLS is invoked.

If two CRT's are lost in the forward station, for non-MEDS vehicles, a next PLS will be invoked because it will place the orbiter in a fail-critical situation for entry. The aft CRT may be used as a replacement CRT for the forward station. ®[121296-4595C] ®[040899-2459B]

One remaining keyboard (following an IFM) will place the orbiter in a zero-fault tolerant situation.

If two IDP's are lost in the forward station, a next PLS will be invoked because it will place the orbiter in a fail critical situation for entry. The aft IDP may be used as a replacement IDP for the forward station.

If two forward MDU's are failed, they can be replaced with the two aft MDU's. If additional MDU's fail, display flexibility allows the other MDU's to support DPS displays, Flight Instrument displays, and Subsystem Status displays. The loss of eight MDU's places the orbiter in a zero-fault tolerant entry configuration: one MDU for PASS software control, one for BFS insight, and one for ADI/AMI/AVVI/HSI capability. ®[040899-2459B] ®[031500-7172D]

®[092701-4872]

FLIGHT RULES

SECTION 8 - GUIDANCE, NAVIGATION, AND CONTROL (GN&C)

GENERAL

A8-1	FCS DOWNMODE.....	8-1
A8-2	SSME THRUST VECTOR CONTROL (TVC) HARDOVER.....	8-3
A8-3	LOSS OF GNC SYSTEM.....	8-4
A8-4	FAULT TOLERANCE PHILOSOPHY.....	8-5
A8-5	ACCELEROMETER ASSEMBLIES (AA) FAULT TOLERANCE	8-6
A8-6	CONTROLLERS/FCS SWITCHING FAULT TOLERANCE.....	8-6b
A8-7	ENTRY SYSTEMS SINGLE-FAULT TOLERANCE VERIFICATION.....	8-7
A8-8	ENTRY SYSTEMS RM DILEMMA.....	8-7
A8-9	AFT STATION GNC REDUNDANCY.....	8-8
A8-10	POWER/DATA PATH REDUNDANCY.....	8-8
A8-11	LOSS OF BFS.....	8-8
A8-12	HEAD UP DISPLAY (HUD) AND CREW OPTICAL ALIGNMENT SIGHT (COAS) ALIGNMENT.....	8-9
A8-13	RTLS ET SEPARATION.....	8-10
A8-14	POWER MANAGEMENT.....	8-11
A8-15	GNC PARAMETERS/LRU FAILURES.....	8-11
A8-16	GNC SYSTEMS FAILURES.....	8-11
A8-17	EQUIPMENT REQUIRED FOR EMERGENCY AUTOLAND.....	8-12
A8-18	LANDING SYSTEMS REQUIREMENTS.....	8-12
A8-19	YAW JET DOWNMODE.....	8-15
A8-20	ENTRY ELEVON SCHEDULE SELECTION CRITERIA.....	8-16
A8-21	THROUGH A8-50 RULES ARE RESERVED.....	8-16

FLIGHT RULES

FAILURE DEFINITIONS

A8-51	PHILOSOPHY.....	8-17
A8-52	SENSOR FAILURES [CIL] [HC].....	8-17
A8-53	OMS TVC LOSS.....	8-19
A8-54	FIRST STAGE LOSS OF CONTROL DEFINITION.....	8-22
A8-55	ASCENT/ENTRY RCS CONTROL REQUIREMENTS [HC]....	8-23
A8-56	BFS LRU REQUIREMENTS.....	8-30
A8-57	PRELAUNCH IMU HOLD.....	8-32
A8-58	ADI LOSS.....	8-38
A8-59	IMU BITE FAILURE DEFINITION.....	8-39
A8-60	LOSS OF VERNIER RCS DAP MODE.....	8-40
A8-61	SSME SHUTDOWN DUE TO HYDRAULIC SYSTEM FAILURES [HC].....	8-42
A8-62	THROUGH A8-100 RULES ARE RESERVED.....	8-45

MANAGEMENT

A8-101	BEEP TRIM DEROTATION.....	8-46
A8-102	RGA SYSTEM MANAGEMENT [CIL].....	8-47
A8-103	PRIORITY RATE LIMITING (PRL) SYSTEMS MANAGEMENT.....	8-48
A8-104	FCS CHECKOUT [CIL] [HC].....	8-49
A8-105	CONTROLLERS.....	8-51
A8-106	TVC-SSME STOW/ACTUATOR FLUID FILL (REPRESSURIZATION).....	8-52
A8-107	FCS CHANNEL MANAGEMENT.....	8-54
A8-108	HUD/COAS SYSTEM MANAGEMENT.....	8-57
A8-109	STAR TRACKER SYSTEM MANAGEMENT [CIL].....	8-58
A8-110	IMU SYSTEM MANAGEMENT.....	8-59
A8-111	GNC AIR DATA SYSTEM MANAGEMENT [CIL].....	8-63

FLIGHT RULES

A8-112	AEROSURFACE ACTUATOR PROTECTION.....	8-65
A8-113	OMS TVC SYSTEM MANAGEMENT.....	8-65
A8-114	ENTRY BODY BENDING FILTER SELECTION.....	8-67
A8-115	GPS SYSTEM MANAGEMENT [HC].....	8-68
A8-116	AEROJET DAP SYSTEMS MANAGEMENT [CIL] [HC].....	8-69
A8-117 THROUGH A8-150	RULES ARE RESERVED.....	8-71

GNC GO/NO-GO CRITERIA

A8-1001	GNC GO/NO-GO CRITERIA [HC].....	8-72
---------	---------------------------------	------

FLIGHT RULES

THIS PAGE INTENTIONALLY BLANK

FLIGHT RULES

SECTION 8 - GUIDANCE, NAVIGATION, AND CONTROL (GN&C)

GENERAL

A8-1

FCS DOWNMODE

- A. FOR CONTROL PROBLEMS, FCS DOWNMODE (CSS AND BFS ENGAGE) IS AN ONBOARD DECISION AND MAY RESULT FOR ANY OF THE FOLLOWING:
1. IMPENDING LOSS OF CONTROL (LOC).
 2. NO VEHICLE RESPONSE TO EXPECTED MANEUVERS.
 3. ANY UNEXPLAINED ATTITUDE/RATE EXCURSIONS OR UNDAMPED OSCILLATORY MOTIONS. WITH THIS IN MIND, THE FOLLOWING GUIDELINES ARE PROVIDED:
 - a. ASCENT - FIRST STAGE: ANY UNEXPLAINED VEHICLE RATE OR UNDAMPED OSCILLATION GREATER THAN 3 DEG/SEC.
 - b. ASCENT - SECOND STAGE: ATTITUDE ERRORS (3 DEGREES IN PITCH OR YAW; OR 10 DEGREES IN ROLL) WITHOUT CONVERGING RATES OR RATES GREATER THAN 3 DEG/SEC WITHOUT CORRESPONDING ATTITUDE ERRORS.
- B. CREW DOWNMODING PROCEDURE FOR LOSS OF CONTROL IN FIRST STAGE THROUGH LOAD RELIEF (90 SECONDS MET) SHOULD BE TO ENGAGE THE BFS. POST LOAD RELIEF AND THROUGHOUT SECOND STAGE, THE DOWNMODING SEQUENCE SHOULD BE, CONDITIONS PERMITTING, TO FLY CSS CONTROL FOLLOWED, IF NECESSARY, BY BFS ENGAGE.

FCS downmoding (CSS and BFS engagement) is an onboard decision. The crew is ultimately responsible for the safety of the vehicle and onboard personnel. The types of situations requiring downmode action include impending loss of control, lack of vehicle response to expected maneuvers or trajectory changes, or any unexplained vehicle attitude/rate excursions or undamped oscillations.

THIS RULE CONTINUED ON NEXT PAGE

FLIGHT RULES

A8-1

FCS DOWNMODE (CONTINUED)

Guideline limits are given which reflect our flight experience and simulation data base or, in the case of second stage, bound vehicle behavior such that an acceptable MECO target is achieved. The following sources were used to develop these criteria:

- a. R&E ascent flight control system certification tests show vehicle rates no greater than 2 to 3 deg/sec.
- b. Flight Design and Dynamics Division range safety simulation cases of flight control disturbances (stuck SRB actuators, etc.) show, for survivable cases, that vehicle rates and oscillations typically did not exceed 3 deg/sec. In addition, these oscillations had periods on the order of 6 to 10 seconds and were fairly well damped.
- c. Rockwell simulations cases (refer to RI Internal Letter FSD&P/IGN&C87, November 25, 1987) with an attitude error bias in the digital autopilot concluded that proper MECO targets could be met and good flight control maintained when a 3-degree attitude error in any axis was applied and when a 10-degree attitude error in roll was applied. These runs included RTLS, TAL, and ATO abort scenarios.

As a result, downmoding action is warranted when vehicle response is outside this flight envelope.

For violation of any of the criteria in paragraph A, the downmoding action is dependent upon the phase of flight. During first stage, loss of control may occur rapidly due to the control authority of the SRB's. In addition, the crew cannot adequately control the vehicle in CSS during load relief. Moding to the BFS in this timeframe changes the entire flight software which may recover control of the vehicle. (Note, auto flight control is the only mode available during powered flight in the BFS.) Post load relief, dynamic pressure is diminished (and in second stage control authority is decreased) which allows the crew to attempt CSS control for unusual vehicle behavior and then engage the BFS if necessary. Typically, CSS provides greater rate command authority than auto. In any phase of flight, however, conditions may be such (e.g., rapid LOC) to preclude the use of CSS prior to BFS engage. Note, for vehicle rate excursions or oscillations, CSS without RHC inputs will command attitude hold (zero rate command with attitude error command coming from integrated RGA data) and eliminate guidance, auto steering (and effectively IMU data) from the command loop. Vehicle displays, however, will reflect guidance parameters.

Rule {A2-301}, CONTINGENCY ACTION SUMMARY [HC], references this rule. ©[032807-8400]

FLIGHT RULES

A8-2

SSME THRUST VECTOR CONTROL (TVC) HARDOVER

AN SSME WITH A CONFIRMED, UNCOMMANDED HARDOVER TVC ACTUATOR WILL BE MANUALLY SHUT DOWN IN ACCORDANCE WITH THE FOLLOWING TABLE:

ACTUATOR, DIRECTION	FAILURE OCCURS:	
	FIRST STAGE	SECOND STAGE
LEFT -YAW, RIGHT +YAW * CENTER + PITCH * CENTER ±YAW LEFT & RIGHT ±PITCH	PRIOR TO 1:40	N/A
LEFT +YAW, RIGHT -YAW	PRIOR TO 1:40	SINGLE ENG PRESS
CENTER -PITCH	PRIOR TO 7:00	PRIOR TO 7:00

* BELL COLLISION CONCERN

“Confirmed” hardovers imply that multiple independent sources of information indicate that an actuator is stuck hardover. These sources include OI position indications for all actuators, multiple FCS channel bypasses (same actuator), and vehicle control problems. Only the MCC can confirm that an actuator is hardover, and the MCC will inform the crew immediately upon recognition of the failure.

Failure of the lower engines hardover inboard in yaw (left -Y, right +Y) result in immediate bell collision in first or second stage. The MCC will attempt to recommend shutdown of the affected engine prior to MET 1:40 after which SRB thrust tailoff would further increase the amount of bell collision. In second stage, the MCC will not offer a recommended action (listed as N/A) because of the expected immediate bell collision.

Failure of the center engine hardover in positive pitch (toward lower engines) in first stage results in bell collision during SRB tailoff. Engine shutdown prior to MET 1:40 will prevent collision. In second stage, the case is listed as N/A because of the expected immediate bell collision.

Hardovers of the center engine ± yaw and lower engines ± pitch are controllable in first stage until SRB thrust tailoff. Shutdown of the affected engine prior to MET 1:40 will prevent LOC. These same failures in second stage cause vehicle control to be lost immediately. These cases are listed as N/A because of the expected immediate LOC.

THIS RULE CONTINUED ON NEXT PAGE

FLIGHT RULES

A8-2

SSME THRUST VECTOR CONTROL (TVC) HARDOVER (CONTINUED)

Failures of the lower engines outboard in yaw (left +Y, right -Y) during first stage result in vehicle sideslip (beta) angles of more than 25 degrees as SRB thrust tails off. This is well above the limits established to protect external tank (ET) heating constraints. Maximum ET heating occurs in the MET 100- to 120-second timeframe. The hardover engine should be shut down no later than MET 1:40 to allow control transients (specifically beta) to damp so as to not violate ET heating constraints. The same hardovers during second stage result in control transients (expected to be recoverable) at the time of the hardover. Depending on the time of the second stage failure, less than desirable MECO conditions can result if the affected engine is allowed to run until MECO. This occurs because control perturbations caused by failures later in second stage may not have sufficient time to damp out. Thus, the recommended action is to shut down the affected engine at single engine press to MECO.

Failure of the center engine hardover in negative pitch (bell up away from the lower engines) is controllable until late in ascent. As the vehicle center of gravity changes, the good actuators gimbal to maintain a trimmed vehicle. By approximately MET 7:00, the good actuators reach their software command limits and loss of control follows.

The actions presented in this rule summarize the results of SMS runs and an ascent thrust vector control hardover failure study using the Space Shuttle Functional Simulator. The study was performed using the STS-26 mission design. The recommended shutdown actions apply to all flights. (Ref. Lockheed Correspondence No. 46-88, 04/11/88, and Ascent Flight Techniques Panel Meeting #44, 05/17/88.)

Rule {A2-301}, CONTINGENCY ACTION SUMMARY [HC], references this rule. ©[032807-8400]

A8-3

LOSS OF GNC SYSTEM

REGARDLESS OF GNC SYSTEMS PROBLEMS DURING ASCENT, THE MOST DESIRABLE ACTION IS TO CONTINUE TO ORBIT. FOR CONFIRMED, PERMANENT LOSS OF ALL FAULT TOLERANCE IN ANY ENTRY-CRITICAL GNC SYSTEM, A FIRST DAY PLS RETURN WILL BE INVOKED.

Failures in an entry-critical GNC system will not cause aborts (RTLS, TAL, ATO, AOA) during the ascent phase. However, for the confirmed loss of all fault tolerance in an entry-critical system during ascent, a first day PLS should be performed to reduce the time available for any subsequent system failures which may affect deorbit/entry. Continuing the mission with no system redundancy constitutes unreasonable risk and deorbit should be performed.

Rule {A8-1001}, GNC GO/NO-GO CRITERIA, references this rule.

FLIGHT RULES

A8-4

FAULT TOLERANCE PHILOSOPHY

- A. EARLY MISSION TERMINATION WILL BE SCHEDULED AT THE NEXT PLS OPPORTUNITY IF ANY ENTRY-CRITICAL GNC SYSTEM HAS LOST ALL FAULT TOLERANCE.

Continuing the mission with no fault tolerance in a critical system would result in unreasonable risk. By performing a next PLS deorbit, we reduce the exposure to a subsequent failure which would preclude a safe deorbit/entry (ref. Rule {A8-1001}, GNC GO/NO-GO CRITERIA).

Several GNC systems have zero-fault tolerance during entry with two LRU's remaining. The system can still support entry if one of these LRU's fails on orbit. For these systems, remaining on orbit is acceptable, since the next on-orbit failure does not preclude a safe entry. Reference EFTP #45, 06/17/88.

- B. THE FLIGHT WILL CONTINUE TO NOMINAL END OF MISSION FOR THE FIRST FAILURE WHICH IMPACTS AN ENTRY-CRITICAL SYSTEM. IF THE SYSTEM IS NO LONGER SINGLE-FAULT TOLERANT (FAIL-SAFE), A REVIEW OF THE FAILURE MODE AND REMAINING SYSTEMS CAPABILITY WILL BE CONDUCTED TO DETERMINE WHETHER NEOM IS APPROPRIATE. ©[121296-4610]

REFERENCE RULES {A8-1001}, GNC GO/NO-GO CRITERIA, AND {A2-102}, MISSION DURATION REQUIREMENTS.

In general, it is an acceptable configuration to continue to nominal EOM after a single failure in an avionics system which leaves that system with single-fault tolerance. The systems which fall into this category are the four-LRU systems (i.e., AA's, RGA's, and FCS channel position feedbacks). The risk of staying on orbit until nominal EOM is acceptable after one failure because these systems, after the second failure regardless of the cause for the failure (i.e., LRU, MDM, or GPC), are only vulnerable to the next LRU failure (third failure overall) while in MM 304 to 305. Prior to entry, a failure in the AA's, RGA's, or position feedbacks can be deselected via SPEC 53, ENTRY CONTROLS display.

The Flight Control System (FCS) command channels and the IMU system are single-fault tolerant (fail-safe) after the first failure, with the exception of certain "smart failures" during specific windows of deorbit and entry. Neither the IMU system nor the FCS command channels can sustain greater than two failures and still be able to fly entry. However, a risk assessment completed by the AEFTP in 1996 (Ref. AEFTP #131 and 6/96 AEFTP Splinter Meeting) concluded that the relative risk of remaining on-orbit to NEOM rather than returning at the minimum duration flight (MDF) point after the first failure (in the FCS or IMU system) is an order of magnitude less than the launch risks and orbital debris risks. For an IMU or FCS command channel failure, the risk will be re-assessed in real time based on the latest run-time and failure history. ©[121296-4610]

In addition (per Rule {A2-102}, MISSION DURATION REQUIREMENTS), for multiple failures in an entry-critical system which results in loss of two-fault tolerance but still retains single-fault tolerance, an MDF will be declared. The MDF is performed due to the loss of confidence in the integrity of the system (ref. Rule {A2-102}, MISSION DURATION REQUIREMENTS).

FLIGHT RULES

A8-5

ACCELEROMETER ASSEMBLIES (AA) FAULT TOLERANCE

AT THE TWO-LEVEL FOR NORMAL AA'S, PITCH CSS WILL BE SELECTED FOR TAEM (MM 305 AND 603). PITCH AUTO MAY BE USED AT CDR DISCRETION BASED ON CREW WORKLOAD. FOR NZ HOLD PHASE (MM 602), PITCH WILL REMAIN IN AUTO UNLESS AA'S ARE SUSPECT. FOR THIS CASE, PITCH CSS WILL BE SELECTED. MCC CALL MAY BE REQUIRED. @[121505-7212A]

Fail-safe redundancy of normal accelerometers is required to engage the pitch axis auto mode in MM 305, and MM 603. MCC call may be required since RM terminates after first failure. @[121505-7212A]

The flight control auto pitch channel receives normal acceleration commands from guidance in MM 305, MM 602, and MM 603. If two normal accelerometers have failed, then the AA selection filter will be midvalue selecting bad Nz data if a third normal axis accelerometer fails. If the first two accelerometer failures are due to commfaults, the selection filter will average the remaining two.

The pitch channel uses Nz feedback to close the auto flight control loop and, if bad data concerning vehicle response is fed back, loss of control can occur. CSS removes Nz feedback from the flight control loop.

THIS RULE CONTINUED ON NEXT PAGE

FLIGHT RULES

A8-5

ACCELEROMETER ASSEMBLIES (AA) FAULT TOLERANCE (CONTINUED)

During the Nz hold phase of MM 602, the pitch channel uses Nz feedback to drive the pitch error needles and vehicle acceleration meter. Bad Nz data will result in erroneous needles. With the deletion of the mechanical g-meter in the MEDS cockpit, there are no practical piloting cues available to ensure successful completion of the Nz hold phase after a third AA failure (unlike TAEM where the VERT SIT EAS can be used). Given the scenario of two AA's failed on an RTLS, the alternatives are to pre-emptively select pitch CSS and fly manually to provide a filter (the pilot) between an erroneous AA input and the FCS or to accept the risk of the next AA failure and remain in AUTO. Selecting CSS pre-emptively introduces the risk that if the pilot does not adequately follow guidance, it may not be possible to reach the target runway. Furthermore, there exist other fail-critical system configurations (e.g., single IMU or two-level RGA's) that are not protected by selecting CSS and, in light of the deletion of the mechanical g-meter, protecting for the Normal AA failure case becomes inconsistent with risk management of those scenarios. Unless there is reason to suspect the remaining AA's, the course of action providing the best chance of success is to remain in AUTO and continue to follow established FDF procedures. If there is reason to suspect AA's, then flying pitch CSS would be the prudent course of action. For this reason, it is important that the FCT and crew maintain situational awareness of AA status prior to entering Nz hold. A technique using a manual pitch down procedure was performed successfully in the SMS; however, the task was determined to be impractical as an established FDF procedure. Therefore, it was decided that, given the depth of the failure case (third AA failure on an RTLS) in combination with the risks involved in flying CSS, pitch CSS would not be used to protect for a third AA failure during Nz hold. Reference Ascent/Entry Flight Techniques Meeting #213, August 26, 2005. ©[121505-7212A]

In some circumstances, the additional burden of manual flying may incur greater risk than allowing automated pitch control (e.g., other critical system management required for a safe landing). For these cases, it is acceptable to remain in AUTO pitch control and accept the risk of a third AA failure until crew workload permits protecting for that additional failure.

The determination of suspect AA's must be made in real time. However, examples of conditions that result in suspect AA's would be generic failure modes (common cause conditions), and for one of two remaining AA's: impending loss or suspect electrical bus, transient AA power supply/circuit breaker/RPC, or suspect FF MDM card 14 (common inputs with NWS, RHC, RPTA, and SBTC). ©[121505-7212A]

Rule {A2-261}, ENTRY DTO/AUTO MODE/CROSSWIND DTO GO/NO-GO, references this rule.

FLIGHT RULES

A8-6

CONTROLLERS/FCS SWITCHING FAULT TOLERANCE

EXCEPT FOR RHC'S, REQUIRED FAILURE TOLERANCE FOR ALL CONTROLLERS OR FCS SWITCHING FUNCTIONS CAN BE SATISFIED FROM EITHER SIDE OR BOTH SIDES OF THE COCKPIT. RECONFIGURATION IN GNC 8 IS ALLOWED TO MEET CONTROLLER AND SWITCH REDUNDANCY REQUIREMENTS.

Existence of station processing and system redundancy ensures availability of functions from either side of the cockpit. However, because of their use during entry (especially the CDR's RHC), RHC's require a higher priority for system reconfiguration which can be done in OPS 2 or 8.

Rule {A8-1001}, GNC GO/NO-GO CRITERIA, references this rule.

FLIGHT RULES

A8-7 **ENTRY SYSTEMS SINGLE-FAULT TOLERANCE VERIFICATION**

- A. A FAILURE IN ANY ENTRY-CRITICAL SYSTEM THAT WILL PRECLUDE SINGLE-FAULT TOLERANCE DURING ENTRY WILL BE VERIFIED PRIOR TO DEORBIT BURN. IF THE FAILURE IS RECOVERABLE (TRANSIENT), ENTRY WILL BE DELAYED ONE ORBIT, IF AVAILABLE, TO ALLOW RECONFIGURATION.

A one-orbit deorbit delay will be called to allow system failure compensation/reconfiguration to be performed since most can be handled in one orbit. Delaying an entire extra day unnecessarily increases the exposure to further system failures.

- B. THE DEORBIT BURN WILL BE DELAYED UP TO 1 DAY TO ALLOW RECONFIGURATION TO RECOVER THE FUNCTION OF EITHER RHC.

Due to the RHC requirements during entry, a 1-day delay will be performed if multiple failures cause the loss of function of one RHC. The 1-day delay will allow the implementation of an RHC/DDU IFM (ref. Rule {A2-105C}.7, IN-FLIGHT MAINTENANCE (IFM) [HC]) in order to recover the RHC capability. The 1-day delay is needed due to the amount of time required to perform the RHC or DDU IFM. Both hardware changes take at least 3 hours to perform. ©[ED]

Rules {A2-301}, CONTINGENCY ACTION SUMMARY [HC]; and {A8-8}, ENTRY SYSTEMS RM DILEMMA, reference this rule. ©[032807-8400]

A8-8 **ENTRY SYSTEMS RM DILEMMA**

FOR FAILURES RESULTING IN LOSS OF AN ENTRY-CRITICAL FUNCTION DUE TO RM DILEMMA, ENTRY WILL BE DELAYED TO ALLOW THE SINGLE REMAINING SYSTEM TO BE PRIME SELECTED.

If an entry-critical function has been lost due to an RM dilemma, delaying entry allows the crew to perform any recovery procedures necessary to recover the function by prime-selecting the single remaining system. The systems which could announce a dilemma prior to deorbit burn are the hand controllers and IMU's. However, of the hand controllers, only the RHC would cause a deorbit delay to recover the function of the RHC (ref. Rule {A8-7B} ENTRY SYSTEMS SINGLE-FAULT TOLERANCE VERIFICATION). For most of the systems, prime selection can be done in OPS 2 or 3.

Rule {A2-301}, CONTINGENCY ACTION SUMMARY [HC], references this rule. ©[032807-8400]

FLIGHT RULES

A8-9 **AFT STATION GNC REDUNDANCY**

LOSS OF AFT STATION GNC SYSTEMS SHALL NOT BE A CAUSE FOR EARLY FLIGHT TERMINATION. NO IFM WILL BE DONE TO REPLACE AN AFT GNC SYSTEM WITH A FORWARD SYSTEM.

Aft station systems are not required for safe entry. There are no on-orbit activities that would require risking the loss of an entry-critical forward system.

Rule {A8-1001E}, GNC GO/NO-GO CRITERIA, references this rule.

A8-10 **POWER/DATA PATH REDUNDANCY**

LOSS OF POWER REDUNDANCY OR DATA PATH REDUNDANCY TO A GNC LRU IS NOT CONSIDERED LOSS OF THE LRU REDUNDANCY.

Loss of power or data path redundancy to an LRU does not indicate a generic systems failure. A single external failure should not imply impending LRU-related failures. The LRU should be considered operational as long as power and a communications path exist to the LRU.

A8-11 **LOSS OF BFS**

LOSS OF BFS BECAUSE OF LOSS OF GNC SYSTEMS WILL NOT BE CAUSE TO TERMINATE THE FLIGHT EARLY.

The role of the BFS GNC software is a protection against generic errors in the prime GNC software. The level of BFS GNC fault-tolerance is not considered a requirement for on-orbit stay time. Given the present early termination rules for GNC systems loss, only the loss of the BFS engage switches would invoke this rule. If the BFS GNC is lost by BFS hardware or software problems, then the generic protection is already lost and no extra risk is involved in staying on orbit until nominal end-of-flight.

Rule {A8-1001}, GNC GO/NO-GO CRITERIA, references this rule.

FLIGHT RULES

A8-12**HEAD UP DISPLAY (HUD) AND CREW OPTICAL ALIGNMENT
SIGHT (COAS) ALIGNMENT**

A CALIBRATED HUD/-Z COAS IS AN ADEQUATE BACKUP TO THE STAR TRACKERS FOR ENTRY IMU ALIGNMENT. ©[111094-1723A]

A 3-sigma COAS IMU alignment and a HAINS IMU drifting at 1 sigma in all axes result in a total platform misalignment of 0.25 degrees at EI which meets the navigation requirement of no more than 0.5 degrees (ref. Rule {A4-151}, IMU ALIGNMENT). The KT-70 IMU represents the worse case, since the HAINS IMU 1 sigma drift rate is significantly low. The 0.25 degree misalignment is based on SODB data (SODB para. 4.5.1.2.3.e.3.d) for a COAS calibrated immediately following a star tracker IMU alignment and an entry alignment that is done 2.5 hours prior to the deorbit burn with a time of approximately 30 minutes from burn to EI. Based on flight calibration data, it is assumed that a HUD IMU alignment will be as good as, if not better than, a COAS IMU alignment. As backups to the star trackers for IMU alignments, the CDR HUD is the primary station and the PLT HUD/-Z COAS is the secondary station. The +X COAS performance during flights has not been adequate to support an entry IMU alignment and should not be used as a backup to the star trackers (ref. On-Orbit FTP meeting #133, October 9, 1992, HUD/COAS CALIBRATION, and On-Orbit FTP meeting #148, September 9, 1994, HUD/COAS CALIBRATION STATUS). ©[111094-1723A]

Rule {A8-108}, HUD/COAS SYSTEM MANAGEMENT, references this rule.

FLIGHT RULES

A8-13**RTL5 ET SEPARATION**

FOR RTL5 ET SEPARATION, CREW ACTION SHALL BE AS FOLLOWS:

- A. DURING MATED COAST, COMMAND A FAST SEPARATION IF ALPHA $\neq -4 \pm 2$ DEGREES AND DIVERGING OR BETA $\neq 0 \pm 2$ DEGREES AND DIVERGING.

During RTL5 mated coast, MM 601, G/C steer is commanding attitude hold in all axes in either CSS (while the RHC is in detent) or auto flight control mode. Due to the time limitations of performing RTL5 ET separation, a fast separation should be commanded anytime the vehicle attitude is diverging from the RTL5 ET separation structural release constraints. All of the RTL5 ET separation design staging conditions are documented in NSTS-07700, volume X, figure 3.2.1.1.10.4. ©[ED]

- B. DURING -Z TRANSLATION, SELECT CSS IF ALPHA DECREASING OR ANY RATE > 2 DEG/SEC WITH DIVERGING ATTITUDE ERRORS. THE CREW SHOULD DELAY 1 SECOND AFTER SEPARATION PRIOR TO DOWNMODING TO ENSURE ADEQUATE ORBITER/ET CLEARANCE.

During -Z translation, decreasing alpha may cause recontact with the ET. Rates greater than 2 deg/sec with a diverging attitude indicate a control problem in the auto mode which may lead to loss of control during recovery phase and entry. When performing an auto separation, the DAP will inhibit automatic rotational control for 1 second. CSS rotational commands are allowed anytime but should be avoided until adequate orbiter/ET clearance exists. One second was established as the optimum time to prevent propagation of initial disturbances resulting in loss of control but yet allow sufficient clearance from the ET (ref. Rockwell ET SEP Panel meeting, December 2, 1982).

FLIGHT RULES

A8-14 **POWER MANAGEMENT**

- A. SYSTEMS REQUIRED FOR GNC 6 OR GNC 3 WILL BE ON FOR ASCENT AND LEFT ON UNTIL THE END OF AOA OPPORTUNITY.

Should an AOA be necessary, the crew will be busy preparing for the maneuver and should not be burdened with a requirement to power up equipment in this time-critical phase.

The MLS is the only GNC system not powered for the launch. However, the MLS will be powered for the abort (entry) per the FDF checklist.

- B. DURING ENTRY DAY, THE OPS 3 CRITICAL LRU'S (RGA'S, AA'S, AND ASA'S) WILL BE POWERED PRIOR TO MCC GO/NO-GO FOR OPS 3 TRANSITION. MCC TELEMETRY VERIFICATION IS HIGHLY DESIRABLE.

Additional time could be required for adequate MCC telemetry verification since it will not be obvious to the crew that all LRU's have been powered. The RGA's are powered prior to the OPS-3 transition in order to provide vehicle rate feedback to flight control (TRANS DAP). The ASA's are powered prior to the OPS-3 transition to preclude possible damage to the rudder/speed brake power drive unit (PDU) at APU start. The AA's are powered prior to the OPS-3 transition because of the proximity of these switches to the other LRU switches.

A8-15 **GNC PARAMETERS/LRU FAILURES**

GNC PARAMETERS/LRU'S THAT PERMANENTLY FAIL RM LIMITS OR GNC 8 SELF-TEST WILL BE INHIBITED FROM FURTHER USE.

Once an LRU has been identified as faulty by self-test or RM, it is no longer considered reliable.

A8-16 **GNC SYSTEMS FAILURES**

GNC SYSTEMS DECLARED FAILED BY RM WILL BE CONSIDERED FAILED UNLESS SUBSEQUENT VERIFICATION INDICATES THAT THE SYSTEM IS RECOVERABLE. WHEN TIME PERMITS, RECOVERY WILL BE ATTEMPTED FOR ANY GNC SYSTEMS TRANSIENT FAILURE.

FOR SOME SYSTEMS, THE CREW HAS VERY LITTLE VISIBILITY INTO THE REASON FOR RM DECLARED FAILURES. IN MOST CASES, THE FAILURES ARE CAUSED BY SYSTEM DEGRADATION WHICH CAN BE COMPENSATED BY THE MCC, THEREBY RECOVERING THE FUNCTION OF THAT LRU.

FLIGHT RULES

A8-17 **EQUIPMENT REQUIRED FOR EMERGENCY AUTOLAND**

THE FOLLOWING EQUIPMENT IS REQUIRED TO ALLOW USE OF AUTOLAND CAPABILITY TO TOUCHDOWN IN EMERGENCY SITUATIONS:

- A. ONE - NORMAL AA.
- B. ONE - MSBLS.
- C. ONE - ADTA.

Situations that may require emergency autoland include crew incapacitation, window contamination, or any contingency landing below weather minimums.

Normal axis accelerometer data is required for the Aerojet DAP auto mode in MM 305.

MLS is the only navigation LRU with sufficient accuracy to guide the orbiter to a precision runway landing in the auto mode. Autoland cannot be flown on default air data. The availability of these systems should not be considered as part of GO/NO-GO for deorbit.

Rule {A8-1001}, GNC GO/NO-GO CRITERIA, references this rule.

A8-18 **LANDING SYSTEMS REQUIREMENTS**

- A. FOR THE GIVEN CONDITIONS AND LANDING SITES, THE FOLLOWING ARE THE NUMBER OF ONBOARD MSBLS REQUIRED:

	LAKEBED	CONCRETE RUNWAY
DAYLIGHT LANDING:		
CEILINGS > 10K FEET	0	0
CEILINGS < 10K FEET	1	2
NIGHT LANDING:		
CEILINGS > 15K FEET	1	2
CEILINGS < 15K FEET	2	2

For lower ceilings (8,000 to 10,000 feet) or night operations, redundant MSBLS (single-fault tolerance) is required for landing on a concrete runway. This is due to the fact that longitudinal and lateral concrete runway environments are limited and less forgiving of navigation errors when adequate visual cues are not available (i.e., lower ceilings or night landings). MSBLS provides accurate azimuth, elevation, and range information that allow a precise approach to the runway.

MSBLS is also mandatory for daylight landings on the lakebed with reduced ceilings but is not required to be redundant due to the increased margin for error on the lakebed.

THIS RULE CONTINUED ON NEXT PAGE

FLIGHT RULES**A8-18****LANDING SYSTEMS REQUIREMENTS (CONTINUED)**

For a night landing and the loss of redundant MSBLS, a lakebed runway is required. In addition, ceilings must be greater than 15,000 feet for a night landing to a lakebed runway without redundant MSBLS to allow early acquisition of PAPI lights and aimpoint should a single point failure causing loss of MSBLS occur. This increased ceiling requirement allows more time for glide slope and runway centerline corrections. The 15,000 feet altitude is based on extensive analysis conducted in the Shuttle Mission Simulator (SMS) and Shuttle Training Aircraft (STA) by Flight Design and Dynamics personnel and crew representatives (ref. Rule {A2-6}, LANDING SITE WEATHER CRITERIA [HC]). ©[111094-1622B]

MSBLS redundancy is maintained with two onboard MSBLS remaining (one MSBLS failed) assuming the MCC is available to solve dilemmas. A dilemma occurs for an erroneous output failure of one of the remaining two units. The only information used to solve the dilemma (outside of MCC assistance) is built-in test equipment (BITE), which is limited in its ability to detect failures. The MCC requires ground radar along with telemetry data to isolate the bad MSBLS in the event of a dilemma.

Rule {A2-6}, LANDING SITE WEATHER CRITERIA [HC], references this rule. ©[111094-1622B]

B. A DAYLIGHT LANDING WILL BE REQUIRED, IF AVAILABLE, FOR LOSS OF ANY OF THE FOLLOWING:

1. THREE MSBLS.
2. TWO FORWARD ADI'S (N/A FOR MEDS VEHICLES). ©[040899-2459B]

MSBLS is required at night to maintain an accurate approach path to a lower altitude before transitioning to visual cues (PAPI's, ball bar, and runway markings). For the loss of all three onboard MSBLS, enter to a daylight landing, if available.

One ADI is required to commit to a night landing in order to fly bank angle around the HAC in the event of guidance problems.

A requirement for the HSI was considered for night landings due to the need for accurate heading and course information; however, such a requirement was not levied since MSBLS and the HUD were required and should supply sufficient information during the approach phase.

C. FOR LOSS OF THE LEFT HUD, A DAYLIGHT LANDING IS HIGHLY DESIRABLE.

The left HUD is highly desirable for night landings in order to reduce approach and landing workload, monitor touchdown critical parameters, and offset the loss of outside visual references. Therefore, the left HUD is desired to commit to a night landing, situation permitting (e.g., weather, etc.). Reference Memorandum CB-89-265, and Rule {A2-105}, IN-FLIGHT MAINTENANCE (IFM) [HC]. ©[072398-6646]

©[ED]

THIS RULE CONTINUED ON NEXT PAGE

FLIGHT RULES

A8-18

LANDING SYSTEMS REQUIREMENTS (CONTINUED)

D. RA ALTITUDE DATA IS HIGHLY DESIRABLE FOR NIGHT LANDINGS.
©[072398-6646]

Due to the lack of visual depth perception during night landings, the RA's and ball bar become the primary source for altitude and altitude rate information from approximately 50 feet until main gear touchdown. If RA data is not available, the ball bar is considered sufficient under normal circumstances to allow the pilot to achieve acceptable touchdown conditions. In the event of an RA failure(s), consideration should be given to landing site conditions (e.g., winds, turbulence, ceiling, lighting conditions, visibility, landing ground speed, vehicle mass properties, touchdown point, runway lighting, mission duration, etc.) as they relate to pilot workload and usefulness of the ball bar. Of particular concern are conditions, which if combined with no RA data, will increase the probability of exceeding landing gear/tire limits. Consideration should be given to selecting the landing site that offers the more benign landing conditions. This consideration should focus on which of the sites' landing conditions would result in minimum pilot workload and/or impact to the usefulness of the ball bar. ©[072398-6646]

Rules {A8-58}, ADI LOSS; and {A8-1001}, GNC GO/NO-GO CRITERIA, reference this rule.

FLIGHT RULES

A8-19

YAW JET DOWNMODE

- A. IF NO YAW JETS ARE AVAILABLE ON EITHER LEFT OR RIGHT SIDE, THE NO-YAW-JET DAP MODE WILL BE SELECTED IF MACH > 1.
 @[082604-6360]

The no-yaw-jet mode for emergencies is a certified flight control mode from Q -bar = 20 psf through landing. This mode should be selected between Q -bar = 20 psf and Mach 1 (yaw jets inhibited) if no-yaw-jets are available on a side. In the low Q -bar regime (Q -bar < 20), vehicle response will be sluggish and pilot workload increased, but control will be better than with the baseline DAP. Once selected, it is not necessary to deselect the no-yaw-jet mode. Rule {A6-305}, AFT RCS REDLINES [HC], defines when to engage no-yaw-jet based on aft RCS quantity. Reference DA8-88-20 (FT), Entry Flight Techniques Meeting #41. @[042706-7370D]

- B. IN OPS 3, IF ADDITIONAL LATERAL CONTROL MARGIN IS REQUIRED, THE WRAPAROUND DAP MODE WILL BE ENABLED IF MACH > 1. @[021998-6485B]

The aerojet DAP wraparound mode is normally enabled for EOM, AOA/ATO, and contingency payload return entry but is not enabled for TAL abort entries due to lack of certification for TAL aborts. The wraparound DAP is not available in OPS 6. If lateral control margin is reduced due to three yaw jets failed on one side, aileron trim saturation (trim greater than 3.0 degrees on Baseline DAP or 5.0 degrees on Wrap-DAP), aileron trim rate saturation (trim rate greater than 1.05 deg/min on Baseline DAP or 4.2 deg/min on Wrap-DAP), or a failed/stuck elevon or BF actuator (reference Rule {A8-116}, AEROJET DAP SYSTEMS MANAGEMENT [CIL] [HC]), a loss of control may occur. In addition, if LVAR 9 aerodynamic uncertainties are experienced (a low-probability potential below Mach 6), excessive jet firings and high RCS propellant usage may result. Enabling wraparound mode eliminates these problems by providing increased aileron authority, and more efficiently uses the available entry RCS propellant. Reference DA8-88-20 (FT), Entry Flight Techniques #41, Ascent/Entry Flight Techniques Panel #141, and Ascent/Entry Flight Techniques Panel #200 minutes. @[021998-6485B]

Rules {A6-206}, RCS MANIFOLD/LEG LEAK REPRESSURIZATION; {A8-116}, AEROJET DAP SYSTEMS MANAGEMENT [CIL] [HC]; {A8-55}, ASCENT/ENTRY RCS CONTROL REQUIREMENTS [HC]; and {A8-1001}, GNC GO/NO-GO CRITERIA, reference this rule. @[ED] @[042904-6239A]

Reference Ascent/Entry Flight Techniques Panel #196, December 17, 2003. @[042904-6239A]

Reference Rules {A4-153}, CG PLANNING; {A8-20}, ENTRY ELEVON SCHEDULE SELECTION CRITERIA; and {A8-116}, AEROJET DAP SYSTEMS MANAGEMENT [CIL] [HC]. @[082604-6360]

FLIGHT RULES

A8-20**ENTRY ELEVON SCHEDULE SELECTION CRITERIA**

THE AUTO ELEVON SCHEDULE WILL NOMINALLY BE SELECTED INDEPENDENT OF X-AXIS CENTER-OF-GRAVITY (X CG) LOCATION WITH THE FOLLOWING EXCEPTIONS:

- A. THE FIXED ELEVON SCHEDULE WILL BE SELECTED AS REQUIRED ON A FLIGHT-SPECIFIC BASIS IN ORDER TO SUPPORT AERODYNAMIC PTI'S. IF AERO PTI'S ARE SCHEDULED AND IT IS SUBSEQUENTLY DECIDED NOT TO EXECUTE THEM, THEN THE AUTO SCHEDULE WILL BE SELECTED.
- B. IF THE NO-YAW-JET MODE OF THE AEROJET DAP IS REQUIRED DURING ENTRY, THE FIXED SCHEDULE WILL BE SELECTED IF IT IS I-LOADED WITH THE AFT SCHEDULE. IF EITHER THE FORWARD OR MID SCHEDULE IS LOADED, THE AUTO SCHEDULE WILL BE SELECTED.

The smart body flap logic incorporated with OI-20 software eliminates the need for selecting elevon schedules based on the X CG for entry. The smart body flap is enabled anytime the auto schedule is selected and will maintain the elevons on a schedule that is similar to the previous mid-CG schedule but will allow the elevons to move off-schedule, within limits, in order to thermally protect the body flap and main engines.

The fixed elevon schedule maintains the body flap logic used prior to OI-20 and allows one of the three previously used schedules (fwd, mid or aft) to be loaded into this slot. It is planned to use this schedule to support aero PTI's as required on a flight-specific basis.

Low RCS propellant quantity or loss of yaw jets may require that the no-yaw-jet mode of the Aerojet DAP be selected during entry. Selecting a schedule with more positive elevon deflection (down) increases the control authority of the elevons by moving them into the airstream. For flights in which aero PTI's are not planned, the aft schedule will be loaded into the fixed slot and this schedule will be selected if the no-yaw-jet mode is required even though this may thermally impact the main engine nozzles (turnaround issue). The auto elevon schedule is certified for use with the no-yaw-jet mode; however, the aft schedule provides better control authority (ref. Ascent/Entry Flight Techniques Panel #76, held March 15, 1991). The fwd schedule is not certified for use with the no-yaw-jet mode. The RCS critical entry cue card contains the procedural callout for selecting the correct schedule to be used with the no-yaw-jet mode. ®[042904-6239A]

Rule {A8-55}, ASCENT/ENTRY RCS CONTROL REQUIREMENTS [HC], references this rule. ®[042904-6239A].

A8-21 THROUGH A8-50 RULES ARE RESERVED

FLIGHT RULES

FAILURE DEFINITIONS

A8-51 PHILOSOPHY

A GNC PARAMETER WILL BE CONSIDERED FAILED WHEN IT DIFFERS WITH COMMON REDUNDANT OUTPUTS BY A VALUE GREATER THAN THE I-LOADED RM TRACKING TEST LIMITS. IF AN LRU DOES NOT PROVIDE REDUNDANT OUTPUTS (IMU, TACAN, MSBLS, ETC.), PARAMETER LOSS WILL CONSTITUTE LRU LOSS. FOR THOSE LRU'S WITH REDUNDANT OUTPUTS, (RHC, RPTA, SBTC, SWITCHES, ETC.), THE LRU WILL NOT BE CONSIDERED FAILED UNTIL MULTIPLE FAILURES HAVE CAUSED THE SELECTION FILTER TO OUTPUT BAD DATA. REDUNDANT LRU'S MAY BE REGAINED BY RECONFIGURING RM TO "PRIME SELECT" A SINGLE OUTPUT PARAMETER. SUBSEQUENT FAILURE OF THE PRIME SELECT PARAMETER WILL CONSTITUTE LOSS OF THE LRU.

An LRU with redundant outputs may still be usable as long as the SF outputs good data. Deselection of failed parameters, allowing the SF to prime select the good parameter, regains use of that LRU. When this final good parameter fails, the LRU is, therefore, unusable.

A8-52 SENSOR FAILURES [CIL] [HC] @[032807-8373A]

SENSOR FAILURES DETECTED BY COMPARISON WITH GROUND RADAR DATA:

- A. IMU - AFTER ONBOARD RM HAS DECLARED A DILEMMA, THE FAULT IS ISOLATED TO THE LRU WITH THE MOST NON-ZERO SLOPE ON THE RADAR/IMU VELOCITY PLOTS.
- B. TACAN @[032807-8373A]
 1. AFTER ONBOARD RM HAS DECLARED A DILEMMA, THE FAULT IS ISOLATED TO THE LRU WHOSE RANGE OR BEARING EXHIBITS THE LARGEST DELTA FROM GROUND RADAR.
 2. IF THE GROUND RADAR/TACAN COMPARISON INDICATES A SIMILAR ERROR ON ALL LRU'S GREATER THAN 0.3 NM (RANGE) OR 1.0 DEGREE (BEARING), THEN THE ALTERNATE TACAN GROUND STATION WILL BE SELECTED (IF AVAILABLE).
 3. AT THE TACAN 2-LRU LEVEL, IF THE AVERAGE GROUND RADAR/TACAN DELTA IS GREATER THAN 0.3 NM (RANGE) OR 1.0 DEGREE (BEARING), THEN THE LRU WITH THE LARGER ERROR WILL BE DESELECTED.

THIS RULE CONTINUED ON NEXT PAGE

FLIGHT RULES

A8-52 SENSOR FAILURES [CIL] [HC] (CONTINUED)

- C. ADTA - AFTER ONBOARD RM HAS DECLARED A DILEMMA, THE FAULT IS ISOLATED TO THE LRU WHOSE ALTITUDE IS FURTHEST FROM THE RADAR-COMPUTED ALTITUDE ON THE RADAR/ADTA PLOTS.
- D. MLS - AFTER ONBOARD RM HAS DECLARED A DILEMMA, THE FAULT IS ISOLATED TO THE LRU WHOSE RANGE/AZIMUTH/ELEVATION EXHIBITS THE LARGEST DELTA WITH RESPECT TO RADAR-COMPUTED VALUES ON THE MCC MLS PLOTS.
- E. GPS - AFTER A QA4 DILEMMA HAS BEEN ANNUNCIATED, THE FAULT IS ISOLATED TO THE LRU WHOSE STATE VECTOR EXHIBITS THE LARGEST DELTA FROM GROUND RADAR. @[032807-8373A]

This rule applies to ascent/entry only.

A dilemma occurs at the two-level when a disagreement greater than the RM threshold occurs. Onboard RM may not be able to correctly isolate a dilemma. The ground can determine more readily and accurately which unit should be deselected by comparing the orbiter parameters to the ground radar. The crew has no insight into radar data.

- a. *For the IMU, the onboard state vector (PASS and BFS) may be compared to ground vector to resolve the dilemma. Onboard velocity data is a function of platform alignment as well as accelerometer accuracy. When accelerations are large (i.e., during powered flight or entry), the onboard velocity data is compared with radar data to determine which unit is providing the most accurate data, thus breaking the dilemma. During orbit operations, accelerometer output is read directly to reveal the IMU with incorrect velocity output.*
- b. *A TACAN dilemma will occur for a range disagreement of 3000 feet or for a bearing disagreement of 6 degrees. Analysis shows that in the absence of GPS, selected TACAN errors greater than 0.3 nm in range or 1.0 degree in bearing can result in violation of position delta state limits. Rule {A4-206}, NAVIGATION FILTER MANAGEMENT AUTO/INHIBIT/FORCE (AIF), references this rule. (Ref. Rule {A4-203}, ENTRY DELTA STATE UPDATE PHILOSOPHY [HC], and Ascent/Entry Flight Techniques #80.) @[032807-8373A]*
- c. *At the four-level, a side-to-side dilemma can occur if there is a data miscompare between the two sides.*

THIS RULE CONTINUED ON NEXT PAGE

FLIGHT RULES

A8-52**SENSOR FAILURES [CIL] [HC] (CONTINUED)**

- d. For the MLS, the data good flag will be reset for a disagreement of 0.329 nm in range, 0.5 degree azimuth, or 0.4 degree elevation. In this case, navigation will resume processing of TACAN, GPS, and ADTA data, if available. For an azimuth or range dilemma, MLS data will not be processed. For an elevation dilemma, elevation data will not be processed, but azimuth or range data will be processed. Processing of bad MLS data can be terminated by powering off the appropriate LRU, by changing the channel thumbwheel selection, by forcing TACAN data, by forcing GPS to G&C, or by inhibiting MLS on a 3-string GPS vehicle. ©[032807-8373A]
- e. A QA4 dilemma will be annunciated when the computed state vector solutions of two GPS units disagree by 500 feet in position or 5.0 feet/second in velocity. The QA override function cannot be used to clear a QA4 miscompare at the 2-level. Consequently, the GPS unit with the largest delta from ground RADAR must be deselected to allow GPS processing.

Reference GPS Three String FMEA/CIL 05-2P-300RCV-02, MSBLS FMEA/CIL 05-2F-22400-02, TACAN FMEA/CIL 05-2C-22200-02.

Rule {A4-206A}, NAVIGATION FILTER MANAGEMENT AUTO/INHIBIT/FORCE (AIF), references this rule.

Hazard report ORBI 211 references this rule

Modifications for 3-String GPS were reviewed and approved at AEFTP #217 on January 27, 2006.
©[032807-8373A]

FLIGHT RULES

THIS PAGE INTENTIONALLY BLANK

FLIGHT RULES

A8-53

OMS TVC LOSS

- A. AN OMS ENGINE IS CONSIDERED FAILED IF TVC CAPABILITY (BOTH PRIMARY AND SECONDARY) IS LOST IN EITHER AXIS AND THE ENGINE DOES NOT MEET THE REQUIREMENT AS SPECIFIED IN PARAGRAPH D.

TVC capability is required in both axes of the OMS gimbal for proper vehicle control. It is possible to burn an engine with TVC power off if the position mistrim with respect to the vehicle CG is acceptable. RCS usage will increase in proportion to the magnitude of the mistrim. The maximum amount of mistrim acceptable (determined by RCS constraints) is documented in paragraph D.

- B. THE PRIMARY OR SECONDARY OMS TVC IS CONSIDERED FAILED IF THE GIMBAL DRIVE CHECK INDICATES A DRIVE RATE OF LESS THAN 2.9 DEG/SEC BETWEEN A GIMBAL POSITION OF ± 3 DEGREES.

The limit of 2.9 deg/sec is sufficient to provide adequate vehicle control, but this rate is well below average rate of all actuators in the field. The spec (Aerojet Rocket Company ALRC 42483-J) is 2.9 deg/sec and thus the lower limit for drive rate was established in accordance with the spec.

- C. ENGINE BELL MOVEMENT DURING ASCENT:

1. AN OMS ENGINE WILL NOT BE FIRED IF IT HAS BEEN CONFIRMED, BY BOTH THE PRIMARY AND SECONDARY POSITION TRANSDUCERS, THAT THE ENGINE BELL MOVED INBOARD OR UP MORE THAN 1.5 DEGREES IN EITHER AXIS FROM THE PRELAUNCH NORMAL ENGINE STOW POSITION (ENGINE BELL DOWN AND OUTBOARD) DURING THE TIME BETWEEN LIFTOFF +40 TO 70 SECONDS.

During the time between liftoff plus 40 to 70 seconds, the vehicle experiences maximum dynamic pressure. Movement of the OMS engine into the airstream during this region of ascent could expose the engine to windstream pressures great enough to cause damage to the nozzle/throat. Both the primary and secondary position transducers must confirm that the engine moved 1.5 degrees in either axis into the airstream. If such movement occurs, the nozzle may be deformed and/or the throat may be cracked. Firing an engine in this condition is potentially catastrophic. The constraints in this rule apply to both the thin- and thick-walled engine bells. (Ref. SODB, volume III, paragraph 4.3.3.6, CA8-82-05 (FT), EH12-81-99, and EH12-82-030.)

2. FOR SUSPECTED MOVEMENT (ONE OF TWO TRANSDUCERS) INBOARD OR UP MORE THAN 1.5 DEGREES IN EITHER AXIS, THE ENGINE WILL ONLY BE FIRED DURING ABORT DUMPS IN ACCORDANCE WITH RULE {A6-101}, OMS ENGINE BELL MOVEMENT DURING ASCENT.

Suspected movement is movement indicated by only one transducer. PROP Rule {A6-101}, OMS ENGINE BELL MOVEMENT DURING ASCENT, explains the risks incurred by not firing an engine during ascent abort dumps.

THIS RULE CONTINUED ON NEXT PAGE

FLIGHT RULES**A8-53****OMS TVC LOSS (CONTINUED)**

- D. AN OMS ENGINE MAY BE USED FOR OMS BURNS WITH TVC POWER OFF IF THE NO-BACK DEVICE HELD POSITION, ± 0.2 DEGREES, FOR THE ASCENT PHASE OF FLIGHT AND ALL SUBSEQUENT OMS BURNS WITH THE TVC POWER OFF. THE PROPELLANT COST (ADDITIONAL POUNDS OF RCS PROPELLANT PER SECOND OF COMPUTED BURN TIME) FOR BURNING ENGINES WITH THE TVC POWER OFF (FIXED TVC) IS AS FOLLOWS:
1. FOR A TWO-ENGINE OMS BURN, ONE ENGINE FIXED TVC, A PROPELLANT COST OF 0.9 LB/SEC (100 PERCENT ARCS) WILL PROTECT FOR AN ENGINE TRIMMED THROUGH THE CG WITHIN 1.0 DEGREE IN PITCH AND WITHIN 0.5 DEGREES IN YAW.
 2. FOR A SINGLE ENGINE OMS BURN WITH FIXED TVC, THE PROPELLANT COST WILL BE (72 PERCENT ARCS, 28 PERCENT FRCS):
 - a. 1.5 LB/SEC, FOR TOTAL MISTRIM ($|P| + |Y|$) ≤ 2.0 DEGREES
 - b. 0.75 LB/SEC PER DEGREE MISTRIM, FOR TOTAL MISTRIM > 2.0 DEGREES

SODB paragraph 4.3.3.4.6.1.2e specifies that the minimum operating life of a no-back device is unknown. It further specifies, however, that if the no-back device holds ± 0.2 degrees for the boost phase of flight, it will hold an engine in position for subsequent OMS burns for the remainder of that mission and is acceptable for a subsequent mission.

The propellant cost figures for fixed TVC burns are taken from studies in which data from Trans DAP OMS TVC burns was gathered/generated and analyzed from the following sources: SSFS (1983), SAIL (1984, 1985), and Draper SLS Simulator (1987, 1988). The data was analyzed separately for the two-engine burns (one fixed TVC) and for the single-engine fixed TVC burns.

For the two-engine cases, the pre-deorbit burn mass properties were used from STS 61-C; delta-V total = 227.7 ft/sec and vehicle weight = 216,520 lb (ref. SODB, volume II). These cases involved combinations of cg mistrims on the fixed TVC of pitch = -1.0, 0.0, +1.0 and yaw = -0.5, 0.0, +0.5. It should be noted that uncertainties in the cg estimate contribute to the expected total mistrim error (RSS of 3-sigma mistrim estimates) of approximately 0.6 degrees (ref. Charles Stark Draper Laboratory, Inc. memo no. SSV-88-50). The data indicated that a propellant cost of 0.9 lb/sec of computed burn time would protect for all combinations of P and Y mistrims as stated above.

THIS RULE CONTINUED ON NEXT PAGE

FLIGHT RULES

A8-53

OMS TVC LOSS (CONTINUED)

For the single-engine cases, the pre-deorbit burn mass properties were used from STS-6, STS 41-D, and STS 61-C. The delta-V total ranged from 227.7 to 284.7 ft/sec, and the vehicle weight ranged from 197,500 to 216,520 lb (ref. SODB, volume II.). Other pertinent assumptions include the trimming of residuals and data normalization. In all cases, if the X and Z residuals were more than 2.0 ft/sec, the propellant cost to trim them to less than 2.0 ft/sec [+X (25 lb/fps), -X (30 lb/fps), +Z (24 lb/fps), -Z (35 lb/fps)] was included in the total propellant cost figure. In order to account for the differences in mass properties and delta V of the burns, the data was normalized using computed burn time.

The propellant cost for total mistrims ($|P| + |Y|$) less than or equal to 2.0 degrees is 1.5 lb/sec of computed burn time. However, even in this range where the cost is a constant, one can expect that the lower the total mistrim, the lower the propellant cost, especially for single axis mistrims. Therefore, mistrim should still be minimized. The data is noisy in this regime and it was necessary to assume a cost of 1.5 lb/sec for all cases less than 2.0 degrees in order to safely blanket all data points.

The cost for a total mistrim of greater than 2.0 degrees was determined to be 0.75 lb/sec of computed burn time, per degree of total mistrim. This is the linear function that safely covers all data points for total mistrims greater than 2.0 degrees. The 0.75 lb/sec per degree of mistrim is conservative and the actual amount of mistrim in each axis (and the direction of the mistrim) determines the more exact propellant cost. Due to the general dependence on the given combination of pitch and yaw mistrims and the differences in mass properties and burn delta V, it is recommended that, time permitting, the actual case is simulated to supplement the results shown here. This data and all other data from the mentioned studies is documented (ref. Lockheed Engineering and Management Services Co. memo LEMSCO-19176; Charles Stark Draper Laboratory, Inc., memos SSV-87-10, SSV-87-18, and SSV-88-14; and G&C Systems Briefs 12.0, OMS TVC).

Rules {A6-101A}, OMS ENGINE BELL MOVEMENT DURING ASCENT; {A8-113A.4, A.5 and B}, OMS TVC SYSTEM MANAGEMENT; and {A8-1001}, GNC GO/NO-GO CRITERIA, reference this rule.

FLIGHT RULES

A8-54

FIRST STAGE LOSS OF CONTROL DEFINITION

FOR THE PURPOSES OF RANGE SAFETY DECISIONS, LOSS OF VEHICLE CONTROL DURING FIRST STAGE POWERED FLIGHT IS DEFINED AS PITCH OR YAW RATES GREATER THAN 5 DEG/SEC SUSTAINED FOR MORE THAN 5 SECONDS.

This rule defines vehicle loss of control during first stage, for the purposes of range safety, as sustained rates in pitch or yaw of larger than 5 deg/sec. For large oscillations where the rates are returning to less than 5 deg/sec (within 5 seconds), the vehicle will not be defined as out of control in order to allow the flight control system the opportunity to arrest the perturbations.

Flight control system certification tests showed pitch and yaw rates no greater than 2 to 3 deg/sec. An additional limited set of simulation runs by FDDD of stuck SRB actuators showed that, for the cases where intact abort capability and vehicle structural integrity were maintained, the vehicle pitch and yaw rates did not exceed 3 deg/sec (ref. Range Safety Panel Minutes from August 27, 1987). Typical periods of these oscillations were on the order of 6 to 10 seconds. (In other words, the flight control system responded in only a few seconds.)

It is postulated that a disturbance resulting in vehicle rate oscillations of greater than 5 deg/sec may be arrested by the flight control system. Hence, the flight control system should be given the opportunity (up to 5 seconds) to arrest such a disturbance (ref. Rule {A4-256D}, CONTROLLABILITY, and Ascent Flight Techniques, April 24, 1987).

Rule {A2-301}, CONTINGENCY ACTION SUMMARY [HC], references this rule. ®[032807-8400]

FLIGHT RULES

A8-55

ASCENT/ENTRY RCS CONTROL REQUIREMENTS [HC]

@[042904-6239A]

THE FOLLOWING RCS JETS ARE REQUIRED, AS A MINIMUM, TO MAINTAIN VEHICLE CONTROL. IF AT ANY TIME THE MINIMUM RCS REQUIREMENTS ARE NOT MET, THEN SYSTEMS RECONFIGURATION WILL BE PERFORMED TO PRECLUDE A LOSS OF CONTROL DURING:

A. ET SEPARATION:

REQUIRED JETS (GROUPS)	NOMINAL/AOA/ATO	TAL	RTL/CONTINGENCY [1]
FORWARD LEFT (GROUP 2)	NONE	NONE [2]	1 OF 2
FORWARD RIGHT (GROUP 3)	NONE	NONE [2]	1 OF 2
FORWARD DOWN (GROUPS 5&6)	1 OF 4	2 OF 4 [2]	3 OF 4
AFT LEFT (GROUP 9)	1 OF 4	1 OF 4	3 OF 4
AFT RIGHT (GROUP 10)	1 OF 4	1 OF 4	3 OF 4
AFT LEFT UP (GROUP 11)	1 OF 3	1 OF 3	2 OF 3
AFT RIGHT UP (GROUP 12)	1 OF 3	1 OF 3	2 OF 3
AFT LEFT DOWN (GROUP 13)	1 OF 3	1 OF 3	2 OF 3
AFT RIGHT DOWN (GROUP 14)	1 OF 3	1 OF 3	2 OF 3

- [1] PROVIDES ONLY 1 SIGMA PROTECTION FOR AERODYNAMIC UNCERTAINTIES. TO OBTAIN MAXIMUM AERODYNAMIC UNCERTAINTY PROTECTION (2.5 SIGMA MAXIMUM), FULL RCS JET CAPABILITY MUST EXIST IN ALL JET GROUPS LISTED. REFER TO RULES {A2-63}, ASCENT STRING REASSIGNMENT; {A2-69}, REGAIN RCS JETS FOR RTL ET SEPARATION; {A6-159}, FAILED PRCS JET RESELECTION PRIORITY; AND {A6-206}, RCS MANIFOLD/LEG LEAK REPRESSURIZATION, FOR RECOVERY OPTIONS IF LESS THAN FULL JET CAPABILITY EXISTS.
- [2] IN ORDER TO HAVE A SYMMETRIC ET SEP, ONE FORWARD DOWN-FIRING JET FROM BOTH GROUPS 5 AND 6 ARE REQUIRED. IF NO FORWARD DOWN JETS ARE AVAILABLE FOR EITHER GROUP 5 OR 6, THEN ONE FORWARD YAW JET FROM EITHER GROUP 2 OR 3, RESPECTIVELY, IS REQUIRED TO ENSURE STABLE CONTROL DURING THE ET SEP SEQUENCE.

The requirements represent the minimum number of jets necessary to maintain vehicle control during mated coast (rate damping and attitude hold), to achieve the desired Delta-V during the automatic -Z translation command, and to prevent recontact between the ET and the orbiter during the automatic -Z translation. Nominal, AOA, and ATO ET separations occur at a lower dynamic pressure and Delta-V, so fewer jets are required to achieve satisfactory separation. The requirements listed above protect for aerodynamic uncertainties, atmospheric dispersions, and center of gravity (cg) offsets within the certified cg envelope. @[042904-6239A]

THIS RULE CONTINUED ON NEXT PAGE

FLIGHT RULES

A8-55

ASCENT/ENTRY RCS CONTROL REQUIREMENTS [HC] (CONTINUED)

Nominal, AOA, ATO, and RTLIS requirements are based on the SODB, Volume I, paragraph 4.5.1.1.6.1 (Avionics Subsystems, Flight Control Subsystem, Separation Operations, ET Separation). TAL and contingency abort ET separation requirements are not formally documented, and are based on simulation experience and engineering judgment. Simulation data from the SMS shows that the required numbers of ET SEP jets during a contingency abort are the same as the RTLIS ET SEP requirements. NSTS-07700, Volume X requirements do not require formal testing and certification for the TAL and contingency abort cases because they are at least three failures deep. ©[042904-6239A]

Simulation data from the SMS shows that ET separation on a TAL with no forward down or yaw jets on either side (i.e., either groups 2 and 6 or 3 and 5 failed) results in a significant roll rate. The roll rate may result in ET recontact and the inability to achieve the required Delta-V. Three contributors generate the roll rate. First, the functioning forward down-firing jets produce both yaw and roll components. Second, without a down or yaw-firing jet on the opposing side of the forward module, the aft yaw jets must be used to arrest the yaw rate. The aft yaw jets also have a roll component, which also contributes to the roll rate. Third, the up-firing jets are inhibited during the ET separation sequence, further limiting the control authority of the roll axis. Reference Ascent/Entry Flight Techniques Panel #50, November 2, 1988, and Ascent/Entry Flight Techniques Panel #196, December 17, 2003.

If no forward down-firing jets are available prior to the ET separation sequence, then the auto -Z translation sequence must be inhibited or it will result in ET recontact. In order to safely separate from the ET with no forward RCS, a specific sequence of timed manual rotation and translation commands must be performed. The no forward-RCS ET separation procedure is only available for a nominal, ATO, or AOA ET separation. The procedure is not available for TAL, RTLIS, or contingency abort ET separation due to the dynamic flight conditions, and the requirement to quickly transition to the glided entry flight phase to provide proper clearance distance from the ET debris field.

If no forward down jets are available during the ET separation sequence (due to the last down jet failing during the -Z translation, GPC or MDM failures, etc.), then the ET separation sequence must be manually interrupted or ET recontact may result. To interrupt the auto -Z translation sequence, the THC may be manually deflected in any axis.

Reference Rules {A2-63}, ASCENT STRING REASSIGNMENT; {A2-69}, REGAIN RCS JETS FOR RTLIS ET SEPARATION; {A2-254}, ENTRY STRING REASSIGNMENT; {A6-159}, FAILED PRCS JET RESELECTION PRIORITY; {A6-206}, RCS MANIFOLD/LEG LEAK REPRESSURIZATION; {A7-102C}.4, PASS DATA BUS ASSIGNMENT CRITERIA [HC], and Ascent/Entry Flight Techniques Panel #196, December 17, 2003. ©[042507-8489A]

Rules {A2-69}, REGAIN RCS JETS FOR RTLIS ET SEPARATION, and {A6-61A}.3, RCS MANIFOLD/OMS CROSSFEED LINE REPRESSURIZATION [CIL], reference this rule. ©[042904-6239A]

THIS RULE CONTINUED ON NEXT PAGE

FLIGHT RULES

A8-55

ASCENT/ENTRY RCS CONTROL REQUIREMENTS [HC] (CONTINUED)

B. SINGLE-ENGINE ROLL CONTROL (SERC) : @[042904-6239A]

REQUIRED JETS (GROUPS)	NOMINAL, AOA, ATO, TAL AND POST-SRB SEP	RTLs, CONTINGENCY AND SRB SEP
FORWARD LEFT (GROUP 2)	6 OF 12 JETS (+ ROLL)	12 OF 12 JETS (+ ROLL)
AFT LEFT (GROUP 9)		
AFT LEFT DOWN (GROUP 13)		
AFT RIGHT UP (GROUP 12)		
FORWARD RIGHT (GROUP 3)	6 OF 12 JETS (-ROLL)	12 OF 12 JETS (- ROLL)
AFT RIGHT (GROUP 10)		
AFT RIGHT DOWN (GROUP 14)		
AFT LEFT UP (GROUP 11)		

The requirements documented above are based on the SODB, Volume I, paragraph 4.5.1.1.3.f (Avionics Subsystems, Ascent Flight Control Subsystem Subphases, Vehicle Control Requirements, Single-Engine Roll Control). The jet requirements must be met prior to SERC activation, or loss of control may result.

SERC is activated if either (1) two SSME fail flags are set by guidance, or (2) the total axial vehicle acceleration as sensed by the IMU's is less than 1 and 1/2 equivalent SSME's thrust, or (3) the crew performs an Item 6 on the TRAJ display. Once SERC is automatically activated, SERC cannot be turned off via Item Entry. The BFS does not support SERC.

If two SSME's are failed prior to SRB separation, then full up SERC jet control authority is necessary (12 of 12 jets in each direction) to ensure satisfactory rate conditions at SRB separation. The SRB TVC's are commanded to their null positions just prior to SRB separation. During this time, the SSME's are used to control roll, pitch, and yaw of the stack. If less than full RCS jet capability is available, then adequate roll control authority may not exist to ensure proper SRB clearance during staging. @[042904-6239A]

THIS RULE CONTINUED ON NEXT PAGE

FLIGHT RULES

A8-55

ASCENT/ENTRY RCS CONTROL REQUIREMENTS [HC]
(CONTINUED)

C. TRANS DAP (MM104-106, 301-303) ©[042904-6239A]

1. ROTATION AND ATTITUDE HOLD:

ROTATION AXIS:	REQUIRED NUMBER OF JETS (APPLICABLE JET GROUP(S))
+ROLL [3]	ONE AFT RIGHT UP (GROUP 12) AND ONE AFT LEFT DOWN (GROUP 13)
-ROLL [3]	ONE AFT RIGHT DOWN (GROUP 14) AND ONE AFT LEFT UP (GROUP 11)
+PITCH [3]	ONE FORWARD DOWN (GROUP 5 OR 6) AND ONE AFT UP PER POD (GROUPS 11 AND 12)
-PITCH [3]	ONE FORWARD UP (GROUP 4) AND ONE AFT DOWN PER POD (GROUPS 13 AND 14)
+YAW [3]	ONE FORWARD LEFT (GROUP 2) AND ONE AFT RIGHT (GROUP 10)
-YAW [3]	ONE FORWARD RIGHT (GROUP 3) AND ONE AFT LEFT (GROUP 9)

[3] ALL ROTATIONS MAY BE PERFORMED IN A TAIL-ONLY CONFIGURATION WITHOUT AN IMPACT TO CONTROL. IN A CONTINGENCY, ALL ROTATIONS MAY BE PERFORMED WITH ONLY TWO OF THREE RCS PODS AVAILABLE (I.E., FORWARD RCS AND LEFT OR RIGHT RCS) WITH SOME CONTROL DEGRADATION.

Rotation and attitude hold jets requirements apply to all rotation axes for manual and automatic maneuvers, rate damping (except post-MECO mated coast), and attitude hold. Refer to paragraph A of this rule for post-MECO mated coast attitude hold and rate damping requirements.

Nominally, rotation and attitude hold are performed using all three RCS pods (i.e., Forward, Left, and Right). Tail-only maneuvers and attitude hold are acceptable with no control impacts. Use of the tail-only configuration occurs on a flight specific basis in OPS 1 (Post ET Sep) for forward RCS propellant savings, and in OPS 3 for missions with low forward RCS quantities. Tail-only control is automatically selected by the TRANS DAP jet selection logic for the loss of an entire forward RCS jet group. This automatic downmode occurs on an individual rotation-axis-by-rotation-axis basis (i.e., roll, pitch, and/or yaw).

In a contingency, rotations and attitude hold may be performed using only two of three RCS pods (i.e., Forward and Left-RCS only, or Forward and Right-RCS only). The Forward and Left, or Forward and Right TRANS DAP control mode is uncertified. Limited simulation data and engineering judgment show this 2two of 3three RCS pod control mode to be degraded such that higher than normal RCS use results, but control is considered acceptable. ©[042904-6239A]

THIS RULE CONTINUED ON NEXT PAGE

FLIGHT RULES

A8-55

ASCENT/ENTRY RCS CONTROL REQUIREMENTS [HC]
(CONTINUED)

2. TRANSLATION ONLY: @[042904-6239A]

TRANSLATION AXIS:	REQUIRED NUMBER OF JETS (APPLICABLE JET GROUP(S))
+X [4]	ONE +X JET IN EACH AFT POD (GROUPS 7 & 8)
-X	ONE FORWARD FORWARD (GROUP 1)
+Y	ONE FORWARD LEFT (GROUP 2) AND ONE AFT LEFT (GROUP 9)
-Y	ONE FORWARD RIGHT (GROUP 3) AND ONE AFT RIGHT (GROUP 10)
+Z	ONE FORWARD UP (GROUP 4) AND ONE AFT UP PER POD (GROUPS 11 AND 12)
-Z (N/A FOR ET SEP) [5]	ONE FORWARD DOWN (GROUPS 5 AND 6) AND ONE AFT DOWN PER POD (GROUPS 13 AND 14)

- [4] USE OF +X TRANSLATION AS A DEORBIT METHOD REQUIRES 4 OF 4 JETS PER RULE {A2-201}, DEORBIT GUIDELINES.
- [5] IF NO FORWARD DOWN-FIRING JETS ARE AVAILABLE IN EITHER GROUP (5 OR 6), THEN A FORWARD SIDE-FIRING JET (IN GROUP 2 OR 3, RESPECTIVELY) MUST BE AVAILABLE FOR ATTITUDE HOLD TO PRECLUDE LOSS OF CONTROL DURING THE -Z TRANSLATION COMMAND.

Translation requirements assume adequate attitude hold and rate damping are available as discussed in paragraph C.1. of this rule. The -Z translation requirements documented in paragraph C of this rule do not apply to the automatic -Z translation performed at ET separation. For ET separation requirements, refer to paragraph A of this rule. The translation requirements noted above are based on the flight software requirements documented in STS 83-0008, Volume 2, Table 4.4.4.2.2.1-1, TRANS DAP Jet Selection Logic.

Reference Rules {A2-201}, DEORBIT GUIDELINES; {A2-301}, CONTINGENCY ACTION SUMMARY [HC]; and {A4-153}, CG PLANNING; and Ascent/Entry Flight Techniques Panel #196, December 17, 2003. @[042904-6239A] @[032807-8400]

THIS RULE CONTINUED ON NEXT PAGE

FLIGHT RULES

A8-55

ASCENT/ENTRY RCS CONTROL REQUIREMENTS [HC]
(CONTINUED)

D. AEROJET DAP (MM 304/602, AND 305/603 UNTIL MACH = 1) :
 ©[042904-6239A]

RCS JET REQUIREMENTS (WRAP OR BASELINE DAP)	PRIOR TO QBAR = 10	PRIOR TO QBAR = 20	PRIOR TO QBAR = 40	PRIOR TO MACH = 1
AFT ROLL JETS (LEFT UP, RIGHT UP, LEFT DOWN, RIGHT DOWN)	1 PER JET GROUP	NONE	NONE	NONE
AFT PITCH JETS (LEFT UP, RIGHT UP, LEFT DOWN, RIGHT DOWN)	1 PER JET GROUP	1 PER JET GROUP	1 JET PER GROUP	NONE
AFT YAW JETS (AFT LEFT, AFT RIGHT) [6]	2 PER JET GROUP	2 PER JET GROUP	2 PER JET GROUP	2 PER JET GROUP

[6] IF NO-YAW JET (NYJ) IS ENGAGED, THEN NO AFT SIDE-FIRING JETS ARE REQUIRED AFTER QBAR = 20.

The requirements documented in the table above reflect the minimum RCS jets necessary to meet the integrated GN&C system certification requirements to protect for aerodynamic uncertainties, atmospheric dispersions, and the certified center of gravity (cg) envelope. Wrap-DAP and the Baseline DAP are fully certified for use with two or more yaw jets available per side.

Aerojet DAP (Wrap and Baseline) does not require use of the forward RCS (groups 1 through 6) and the +X jets (groups 7 and 8). In general, the Wrap-DAP flight control submode provides more lateral directional control authority than the Baseline DAP (Wrap-DAP provides 5 degrees of aileron trim, vice 3 degrees provided by the Baseline DAP).

In a contingency, single yaw jet Wrap-DAP control is acceptable for all Mach regimes, and is preferred over No-Yaw-Jet (NYJ). Specifically, the order of preference is (1) single yaw jet Wrap-DAP in CSS, (2) single yaw jet Wrap-DAP in AUTO, (3) then No-Yaw-Jet (NYJ) Mode (which forces R/Y CSS mode). Although the Wrap-DAP and NYJ gains are the same, single yaw jet Wrap DAP control is preferred over NYJ because it has better overall control margin than NYJ. Flying single yaw jet Wrap DAP in CSS is preferred over single yaw jet Wrap DAP in AUTO, because the AUTO system has known lag which causes flight control system to not follow guidance within the required guidance constraints. By selecting CSS, the pilot is able to account for this lag and lead the guidance commands as necessary (with the assistance of the ground). Selecting CSS effectively reduces the single yaw jet control system lag and its effect on guidance. If crew workload is an issue, then single yaw jet Wrap DAP is acceptable in AUTO. The conclusion that single yaw jet Wrap-DAP is preferred over NYJ is based on limited engineering analysis, integrated training simulation data, and engineering judgment. No flight data (i.e., PTI's) exist to verify that single yaw jet Wrap-DAP is better than NYJ. ©[042904-6239A]

THIS RULE CONTINUED ON NEXT PAGE

FLIGHT RULES

A8-55

ASCENT/ENTRY RCS CONTROL REQUIREMENTS [HC] (CONTINUED)

The No-Yaw Jet (NYJ) submode is certified in a contingency from $Q_{bar} = 20$ until Mach = 1. The NYJ contingency certification is from a flight control stability standpoint only. Limited simulation data shows that if no aft RCS remains, selecting NYJ as early as $Q_{bar} = 10$ may provide adequate (but degraded) control authority. If aft RCS propellant remains, NYJ should not be engaged above $Q_{bar} = 10$ because the roll jets are still active, and use of the NYJ gains with roll jets active may result in a loss of control. Even with NYJ selected, the pitch jets will remain active and fire as necessary until $Q_{bar} = 40$. ©[042904-6239A]

In the event of a contingency (i.e., expedited aft RCS leak isolation) or excessive crew workload, Wrap-DAP may be flown in AUTO below $M = 5$ with no yaw jets available. If Wrap-DAP is used in AUTO without yaw jets between $M = 5$ and $M = 1$, the crew and ground should monitor the ADI needles for the presence of low frequency guidance oscillations about the roll axis. If the roll oscillations continue or increase in magnitude, then NYJ should be engaged to prevent the AUTO system from getting into an unstable guidance oscillation that results in significant vehicle energy loss. Selecting NYJ forces Roll/Yaw CSS in the DAP, opens the guidance loop to prevent the roll oscillations from increasing with time, but requires additional workload to manually fly the roll reversals. The ability to fly Wrap-DAP in AUTO from $M = 5$ to $M = 1$ is based on limited engineering simulation data completed during the NYJ development and contingency certification testing, limited SES tests conducted in September 2003, flight data, and engineering judgment. The engineering judgment is based on the fact that the flight control gains for NYJ and the Baseline DAP start to converge at $M = 5$, the fact that the rudder activates at $M = 5$ giving additional lateral directional control authority, and limited simulator data. Flight data from the STS-85 through STS-111 timeframe indicates that the last time yaw jets are nominally fired during entry (EOM) occurs around TAEM interface (all flights last used yaw jets between $M = 2.3$ to $M = 2.6$).

Reference Rules {A8-19}, YAW JET DOWNMODE, and {A8-20}, ENTRY ELEVON SCHEDULE SELECTION CRITERIA; and Entry Flight Techniques Panel #41, March 1, 1988; Ascent/Entry Flight Techniques Panel #141, August 15, 1997; and Ascent/Entry Flight Techniques Panel #196, December 17, 2003.

*Rules {A2-63}, ASCENT STRING REASSIGNMENT, {A6-206}, RCS MANIFOLD/LEG LEAK REPRESSURIZATION, and {A8-1001}, GNC GO/NO-GO CRITERIA, reference this rule.
©[042904-6239A]*

FLIGHT RULES

A8-56

BFS LRU REQUIREMENTS

THE FOLLOWING DOUBLE LRU FAILURES (ERROR > PASS RM LIMIT) WHICH COULD RESULT IN LOSS OF CONTROL WILL CAUSE THE BFS TO BE NO-GO UNTIL THE LRU'S ARE DESELECTED BY THE CREW. DUAL NULL FAILURES ARE ACCEPTABLE FOR ALL LRU'S EXCEPT SRB RGA'S.

There is no FDI in the BFS. To determine if the LRU is failed in the BFS, the same criteria that is used by FDI in the PASS to declare an RM failure must be applied.

Interchangeable-mid-value-select (IMVS) is used for all AA's and RGA's, the same as in the PASS. The aerosurface feedback selection scheme utilizes IMVS that functions like quad-mid-value-select (QMVS) due to an I-load which is unique to the BFS. QMVS and IMVS protect against dual null failures, but neither protect against dual null failures greater than RM. In either case, the crew will deselect the failed LRU's in the BFS in order to maintain an engageable BFS. The BFS has the same manual deselect capability as the PASS for AA's, RGA's, and aerosurface feedbacks. There is no automatic downmoding for comm faults, so deselection is also needed for these cases. The SRB RGA selection filter uses a mid-value-select (MVS) scheme for LRU's 1, 2, and 3 only, with no deselect capability.

A. OPS 1:

1. ANY TWO LATERAL AA'S PRIOR TO THE END OF FIRST STAGE (LATERAL AA'S NOT USED IN OPS 1 POST-MM 102).
2. ANY TWO NORMAL AA'S PRIOR TO END OF LOAD RELIEF (90 SECONDS MET).

The lateral axis feedback is used in first stage from load relief through SRB tailoff, but the normal axis feedback is not used in OPS 1 after load relief is complete. The normal axis feedback is gained to zero at $V_{rel} = 2628$ fps, which correlates to approximately 90 seconds MET. Double failures of AA feedback in the same axis would cause the BFS selection filter to output bad data.

3. ANY TWO ORBITER RGA'S, SAME AXIS.
4. ANY TWO OF SRB RGA'S 1, 2, OR 3, SAME AXIS (MM 102 ONLY).

The RGA's are used all through ascent to provide vehicle rate data to guidance and flight control. Like the AA's, a double failure in RGA feedback in the same axis could cause the BFS selection filter to provide bad data to flight control. The SRB RGA selection filter uses a MVS scheme for LRU's 1, 2, and 3 only, with no deselect capability.

THIS RULE CONTINUED ON NEXT PAGE

FLIGHT RULES

A8-56 BFS LRU REQUIREMENTS (CONTINUED)

B. OPS 3 OR 6:

1. ANY TWO LATERAL AA'S.
2. ANY TWO ELEVON OR BODY FLAP POSITION FEEDBACKS, SAME SURFACE.
3. ANY TWO RGA'S, SAME AXIS.

In general, it is assumed that the crew will not engage the BFS unless absolutely required. The philosophy is that, if it is considered usable, the BFS is GO for engage after committing to entry, even though it may require off-nominal crew procedures.

Double failures of RGA, lateral AA, body flap, or elevon position feedbacks could cause the BFS selection filter to provide bad data to flight control. This may result in loss of vehicle control.

AA lateral (Ny) feedback was originally added to the flight control system to control beta (sideslip) dispersions as a result of alpha errors. A post-ST5-4 R&E study (which assumed no Ny feedback, LVAR 20 elliptical uncertainties, FAD 4 aero, and only two RCS yaw jets available per pod) concluded that alpha errors (as a result of IMU errors and winds) resulted in a beta buildup and subsequent reduction of stability margins.

Sensitivity to alpha errors was especially noted during bank maneuvers since these maneuvers are performed about the vehicle stability axis (alpha is used in flight control to determine the stability axis).

A reduction in both the aerodynamic variations and in the severity of wind environment since the ST5-1 development program increase the capability of the flight control system with Ny feedback failed to null. A quick look R&E study performed in 1987 using the ST5-26 conditions and nominal aero revealed that with Ny feedback failed to null, alpha errors up to 4 degrees were acceptable assuming all RCS yaw jets were available. As a result, the EFTP concluded that the BFS flight control system should be considered GO with null Ny feedback.

It is also important to note that the incorporation of air data into GNC essentially eliminates alpha error and reduces the requirement for Ny feedback. Reference EFTP #39, 12/11/87.

AA normal (Nz) feedback is not as critical in the BFS. It is removed from the command loop in CSS (BFS is CSS only). However, with bad Nz feedback, the crew displayed ADI pitch error will be erroneous. This presents an increased flying challenge since the crew is not well trained to fly in this configuration.

For body flap (BF) feedback failures, loss of control is a concern if the failures cause the BF to drive full DOWN and stay there. The elevons will be driven up to maintain pitch axis trim. This causes a degradation of aileron control authority which significantly impacts lateral/directional vehicle control. SES studies (September 4, 1990) showed that loss of control can occur with the BF stuck full DOWN. A full UP BF does not create flight control problems, but this may have significant thermal impacts.

Rule {A2-59B}, BFS ENGAGE CRITERIA, references this rule.

FLIGHT RULES

A8-57

PRELAUNCH IMU HOLD

PRELAUNCH IMU HOLD DOES NOT APPLY PRIOR TO T MINUS 4 MINUTES (EVENT 11 TIME) WHEN CONTINUOUS IMU ALIGNMENT IS COMPLETE AND THE IMU'S GO INERTIAL. AFTER T MINUS 4 MINUTES, THE FOLLOWING CRITERIA APPLY:

- A. THE JSC MISSION EVALUATION ROOM (MER) WILL PROVIDE THE IMU INERTIAL REFERENCE MISALIGNMENT LAUNCH GO/NO-GO RECOMMENDATION TO THE JSC FLIGHT CONTROL TEAM. KSC WILL SERVE AS A BACKUP TO THE MER.

The inertial reference alignment monitor system (IRAMS) is required to monitor individual IMU prelaunch misalignment. IRAMS is available at the JSC MER and at KSC. All MER calls relating to the IMU system will be coordinated with the GNC officer. The MER is responsible for coordination with all elements (KSC, RI, etc.) (ref. AFTP #40).

- B. THE LAUNCH WILL BE NO-GO FOR THE FOLLOWING:

1. THE INERTIAL REFERENCE MISALIGNMENT OF ANY IMU AXIS, AS MEASURED BY THE IRAMS, EXCEEDS THE APPLICABLE REDLINE AS SHOWN BELOW:

The redlines have been developed as limits on the IMU inertial reference misalignment as measured by IRAMS. Redlines are applicable for standard and direct insertion flights (ref. AFTP #40).

- a. FOR A 28.5-DEGREE INCLINATION (DUE EAST) LAUNCH, THE GENERIC REDLINES FOR A SAFE AOA TO EDWARDS ARE:
©[011295-1752A]

$$-243 \text{ ARC SECONDS} \leq \theta_N \leq 330 \text{ ARC SECONDS}$$

$$| 0.43\theta_W + \theta_U | \leq 821 \text{ ARC SECONDS}$$

- b. FOR A 28.5-DEGREE INCLINATION (DUE EAST) LAUNCH, THE GENERIC REDLINES FOR A SAFE AOA TO NORTHROP ARE:
©[011295-1752A]

$$-203 \text{ ARC SECONDS} \leq \theta_N \leq 279 \text{ ARC SECONDS}$$

$$| 0.43\theta_W + \theta_U | \leq 841 \text{ ARC SECONDS}$$

THIS RULE CONTINUED ON NEXT PAGE

FLIGHT RULES

A8-57

PRELAUNCH IMU HOLD (CONTINUED)

- c. FOR A 39-DEGREE INCLINATION LAUNCH, THE GENERIC REDLINES FOR A SAFE AOA TO EDWARDS ARE:

$$-251 \text{ ARC SECONDS} \leq \theta N + 0.513\theta W + 0.102\theta U \leq 334 \text{ ARC SECONDS}$$

$$828 \text{ ARC SECONDS} \geq | -0.206\theta N + 0.348\theta W + \theta U |$$

- d. FOR A 39-DEGREE INCLINATION LAUNCH, THE GENERIC REDLINES FOR A SAFE AOA TO NORTHRUP ARE:

$$-232 \text{ ARC SECONDS} \leq \theta N + 0.516\theta W + 0.098\theta U \leq 310 \text{ ARC SECONDS}$$

$$853 \text{ ARC SECONDS} \geq | -0.201\theta N + 0.338\theta W + \theta U |$$

- e. FOR A 51.6-DEGREE INCLINATION (MIR RENDEZVOUS) LAUNCH, THE GENERIC REDLINES ARE:

$$-287 \text{ ARC SECONDS} \leq \theta N + 0.992\theta W - 0.184\theta U$$

$$373 \text{ ARC SECONDS} \geq \theta N + 0.992\theta W - 0.184\theta U$$

$$855 \text{ ARC SECONDS} \geq | -0.307\theta N + 0.262\theta W + \theta U | \quad \text{@[011295-1752A]}$$

- f. FOR A 57-DEGREE INCLINATION LAUNCH, THE GENERIC REDLINES ARE:

$$-266 \text{ ARC SECONDS} \leq 0.82\theta N + \theta W - 0.18\theta U$$

$$322 \text{ ARC SECONDS} \geq 0.73\theta N + \theta W - 0.04\theta U$$

$$847 \text{ ARC SECONDS} \geq | -0.33\theta N + 0.23\theta W + \theta U |$$

THIS RULE CONTINUED ON NEXT PAGE

FLIGHT RULES**A8-57****PRELAUNCH IMU HOLD (CONTINUED)**

- g. FOR RENDEZVOUS MISSIONS (EXCEPT FOR MIR RENDEZVOUS), REDLINES ARE SPECIFIED IN THE FLIGHT-SPECIFIC ANNEX WHEN REQUIRED: @[011295-1752A]

WHERE:

 θ_n = MISALIGNMENT ABOUT THE NORTH AXIS

 θ_w = MISALIGNMENT ABOUT THE WEST AXIS

 θ_u = MISALIGNMENT ABOUT THE UP AXIS

NOTE: REF. FLIGHT RULES ANNEX FOR FLIGHT-SPECIFIC MISALIGNMENT REDLINES.

The OI-22 software upgrades added the capability to continuously align IMU's in OPS 1, up to T-4 minutes. With this change, the probability of violating the above redlines is extremely low. The scenario to invoke this part of the rule would generally involve counting down past T-4 minutes, where the OPS 1 continuous align software is terminated, and then recycling back for a later launch attempt while remaining in OPS 1. (Note: at least 1 hour of holdtime is required for ET propellant conditioning and APU cooldown.) If the recycle requires returning to G9, then the IMU preflight alignment will have to be reaccomplished (time permitting, ref. paragraph E.1.a of this rule) and the likelihood of violating this part of the rule will be negligible. For 51.6-degree inclination missions (Mir and Station flights), the extremely small launch window makes the probability of violating the redlines (without failing an IMU) negligible. @[011295-1752A]

Historically, the redlines were written to protect for a safe launch and abort (RTLS, TAL, ATO, AOA) (ref. AFTP's #35, #37, #39, #40, and #44). The constraining case is the AOA. With the OPS 1 continuous IMU alignment, it is very unlikely that the redlines could be violated. Effectively, this rule now protects for an IMU failure occurring after T-4 minutes (no BITE or RM FL annunciated) and thus precludes launching into an early mission termination. @[011295-1752A]

THIS RULE CONTINUED ON NEXT PAGE

FLIGHT RULES

A8-57

PRELAUNCH IMU HOLD (CONTINUED)

The redlines protect for 99.74 percent (3 sigma) probability for a safe AOA based on the following assumptions and groundrules:

- a. A single IMU was assumed as the baseline configuration in redline determination.
- b. A 3-sigma IMU postlaunch performance based on previous flight experience is equal to 2/3 of the 3-sigma IMU specification.
- c. OPS 1/3 transition will be accomplished per procedure at least 10 minutes before OMS-2 ignition.
- d. An AOA requires EI-5 downtrack navigation to protect the following constraints:
 1. 375 psf Q -bar vehicle structural limit with worst case aerodynamics at TACAN update (constraint drives the negative north tilt misalignment redline for a 28.5-degree inclination launch and contributes to the redlines for a 57-degree inclination launch).
 2. TACAN low energy stretch maneuver capability assuming TACAN is forced at 130k feet altitude (constraint drives the positive north tilt misalignment redline for a 28.5-degree inclination launch; not a driver for 57-degree inclination launch redlines).
 3. Leading edge temperature limit of 3100° F with no heat rate limit (constraint contributes to 57-degree inclination launch redlines; not a driver for 28.5-degree inclination launch redlines).
- e. A ground state vector uplink or GCA is not required.
- f. Launch is from KSC.
- g. AOA landing site is Edwards or Northrup for 28.5-degree or 39-degree inclination launch and Northrup for 57-degree inclination launch (ref. CSDL Memo Shuttle - 90-035). The AOA landing site is 51.6-degree inclination launch (ref. CSDL MEMO Shuttle-94-025). ©[011295-1752A]
- h. KT-70 IMU.
- i. 245 fps maximum MECO underspeed.
- j. Prelaunch and postlaunch IMU performance are independent.
- k. Maximum EI minus 5 crosstrack dispersion 16.7 nm to protect trajectory control and autoland transition criteria (constraint drives the west and up misalignment redlines for a 28.5-degree inclination launch; not a driver for 57.0-degree inclination launch redlines). ©[011295-1752A]
- l. The Onboard Navigation Systems Characteristics (ONSC) model was used in developing the redlines.

THIS RULE CONTINUED ON NEXT PAGE

FLIGHT RULES

A8-57

PRELAUNCH IMU HOLD (CONTINUED)

- m. IRAMS 1-sigma azimuth measurement error is 40 arc seconds.
 - n. Worst case vehicle AOA mass properties of heavyweight and forward CG (240k lb, 1080 inches).
2. IF THE IRAMS MISALIGNMENT COMPUTATION IS NOT AVAILABLE AT EITHER JSC OR KSC, THE LAUNCH GO/NO-GO CALL WILL BE MADE BASED ON THE FOLLOWING GUIDELINES:

LAUNCH WILL BE NO-GO IF MCC IMU RELATIVE DRIFT COMPUTATIONS INDICATE THAT ANY IMU CLUSTER AXIS IS DRIFTING AT A RATE > 0.05 DEG/HR. IMU PREFLIGHT CALIBRATION AND ALIGNMENT WILL BE REQUIRED BEFORE A SUBSEQUENT LAUNCH ATTEMPT. ©[011295-1752A]

Individual IMU misalignment cannot be observed if IRAMS is unavailable at both KSC and JSC. MCC relative drift computations (between IMU's) provide the only remaining method of monitoring IMU prelaunch drift. Since relative drift only indicates the rate at which IMU's are drifting apart and does not indicate individual IMU performance, it can only serve as a rough health check of the IMU's. An IMU axis drift rate greater than 0.05 deg/hr (HAINS) in the IMU cluster reference frame (ref. SODB 4.5.1.2.3.p.2) indicates an anomalous condition. Interpretation of relative drift data and implementation of this rule is dependent on engineering judgment. A preflight calibration is required before a subsequent launch attempt to calculate gyro drift compensation terms and correct excessive drift, or verify an IMU failure. This will require a minimum of approximately 3.6 hours and exceed the 3-hour crew hold-time limit (ref. Rule {A2-4A}, LAUNCH DAY CREW TIME CONSTRAINTS), causing the launch to be scrubbed. The limit serves only as a health check of the IMU (ref. AFTP #40). Derivation of the limit follows:

	<u>HAINS</u>
a. 1-Sigma Acceleration Sensitive Drift Specification At 1g	0.015 Deg/Hr
b. 1-Sigma Bias Drift Specification (Up To 17 Hours From Start Of Preflight Calibration)	0.006 Deg/Hr
c. 1-Sigma Total Prelaunch Drift (RSS Of Above)	0.016 Deg/Hr
d. 3-Sigma Total Prelaunch Drift	0.05 Deg/Hr

©[011295-1752A]

THIS RULE CONTINUED ON NEXT PAGE

FLIGHT RULES

A8-57**PRELAUNCH IMU HOLD (CONTINUED)**

- C. A PERIOD OF 30 MINUTES AFTER THE IMU'S GO INERTIAL (T MINUS 4 MINUTES) IS REQUIRED PRIOR TO USING THE IRAMS LAUNCH HOLD PREDICTION CAPABILITY.

IRAMS requires 30 minutes to generate an accurate hold time. The time required for an accurate hold time prediction is dependent on actual IMU performance and may vary, but 30 minutes is used as a guideline. If a prediction is required before 30 minutes, it will be accompanied by an estimated accuracy of the prediction. In this case, the predicted hold time and the estimated accuracy of that prediction are heavily dependent on engineering judgment (ref. AFTP #40).

- D. THE IMU'S MAY BE REALIGNED IF EITHER OF THE FOLLOWING WILL OCCUR PRIOR TO T-0 (THE NEW T-0 FOR UNPLANNED HOLDS), OR PRIOR TO THE END OF THE LAUNCH WINDOW IF A NEW T-0 IS UNCERTAIN:
1. IMU RELATIVE DATA INDICATES THREE-SIGMA OR GREATER DRIFT RATES.
 2. IRAMS HOLD PREDICTION PROGRAM DETERMINES THAT A MISALIGNMENT REDLINE WILL BE VIOLATED.

NOTE: REFERENCE PARAGRAPHS B.1, B.2, AND E OF THIS RULE.

If it is predicted that the IMU relative drift will exceed three sigma or if the IRAMS prediction program indicates that a violation will occur, then the IMU's should be realigned, time permitting, to attempt a launch within the window. If the IMU's are not realigned and a redline violation occurs without sufficient time for realignment, then the launch may be scrubbed unnecessarily.

- E. PRELAUNCH IMU REALIGNMENT MAY BE ACCOMPLISHED BY THE FOLLOWING METHODS:
1. G9 IMU PREFLIGHT ALIGNMENT MAY BE USED SUBJECT TO THE FOLLOWING CONSTRAINTS:
 - a. THE LAUNCH WINDOW MUST SUPPORT THE 90 MINUTES REQUIRED TO RECYCLE TO G9 FOR IMU REALIGNMENT AND COUNTDOWN TO T-0.

After a recycle to G9, the IMU alignment and nominal G1 prelaunch timeline requires 90 minutes. Some additional time may be required in G1 prior to transition to G9.

THIS RULE CONTINUED ON NEXT PAGE

FLIGHT RULES

A8-57

PRELAUNCH IMU HOLD (CONTINUED)

2. G1 GYRO BIAS UPLINK MAY BE USED FOR IMU REALIGNMENT SUBJECT TO THE FOLLOWING CONSTRAINTS:
 - a. IRAMS IS REQUIRED TO CALCULATE GYRO BIAS UPLINK TERMS.

IRAMS is required to monitor individual IMU prelaunch misalignment and calculate gyro bias uplink values to correct the misalignment.

- b. THE LAUNCH WINDOW MUST SUPPORT THE 15 MINUTES REQUIRED TO GENERATE AND VERIFY THE GYRO BIAS UPLINK. THE GYRO BIAS TERMS (AS COMPUTED BY THE IMU PREFLIGHT CALIBRATION) WILL BE ON-BOARD, AND THE PERFORMANCE WILL BE VERIFIED PRIOR TO LIFT-OFF. IT IS HIGHLY DESIRABLE TO VERIFY THE PERFORMANCE PRIOR TO RESUMING THE COUNT AT T MINUS 5 MINUTES.

Five minutes is required for the uplink decision and implementation process. This process consists of the MER/MCC decision that an uplink is required; coordination of required compensation values between MER and MCC; uplink load generation; uplink load verification; coordination between MER, MCC and KSC prior to uplink execution; uplink execution; and 1 minute for torquing out IMU misalignment. An additional 10-minute monitoring/verification period is required after the realignment is complete prior to committing to launch.

A8-58

ADI LOSS

AN ADI IS CONSIDERED FAILED ONLY IF THE ATTITUDE BALL IS FAILED (N/A FOR MEDS VEHICLES) . @[040899-2459B]

The entry-critical parameters required by the crew can be monitored using the attitude ball (or sphere). While rate and error needles are desirable (especially for monitoring vehicle control), the attitude ball is sufficient in providing the required information. As a result, an ADI will be considered failed only if the attitude sphere is not providing accurate or stable attitude reference. This rule is needed for making decisions regarding early flight termination, night landings, and IFM. (Ref. Rules {A8-1001E}, GNC GO/NO-GO CRITERIA, for dedicated displays and {A8-18}, LANDING SYSTEMS REQUIREMENTS.) (Ref. Entry Flight Tech. Panel #34, 8/21/87.)

FLIGHT RULES

A8-59

IMU BITE FAILURE DEFINITION

FOR PURPOSES OF EARLY MISSION TERMINATION AND LANDING SITE DOWNMODING, AN IMU WITH A BITE SHOULD BE CONSIDERED FAILED WITH THE FOLLOWING EXCEPTIONS:

- A. TRANSMISSION WORD 2 BITE
- B. TRANSMISSION WORD 1 BITE
- C. TEMPERATURE SAFE BITE
- D. TEMPERATURE READY BITE @[011295-1752A]

IF REAL-TIME ASSESSMENT DETERMINES THE BITE TO BE FALSE OR NO IMPACT, THEN THE IMU WILL NO LONGER BE CONSIDERED FAILED.

At the three-level, redundancy management (RM) will not downmode an IMU with a BITE because there is no risk of incorporating bad data. At the two-level, RM will downmode the IMU with the BITE should the attitude or velocity disagree by more than the RM threshold.

A BITE is an indication that the IMU has experienced a failure and may be operating outside of spec. BITE will almost always indicate an actual problem with the IMU. In most cases, data can be used to determine whether or not the BITE is real. There is, however, the possibility of a failure in the BITE circuitry itself - termed false BITE. Also, it cannot necessarily be determined whether or not an IMU will continue to operate in a consistent manner while outside of spec. For several BITE's, performance will remain unknown until data is observed during entry. It is logical, therefore, to assume that the BITE logic has correctly identified a real failure and to consider the unit failed. Since RM provides for BITE's, there is no requirement for manual deselection of the affected IMU.

A next PLS should be declared after the second BITE (or the first BITE at the two-level) to reduce the risk of losing the last IMU. Reference Rule {A2-207}, LANDING SITE SELECTION, for runway priorities. @[102402-5804C]

The Transmission Word 2 Fail BITE (loss of slew) only impacts the IMU if an IMU/IMU alignment is required. Even if an IMU/IMU is required, other options exist to fully recover the IMU.

THIS RULE CONTINUED ON NEXT PAGE

FLIGHT RULES

A8-59

IMU BITE FAILURE DEFINITION (CONTINUED)

A Transmission Word 1 Fail BITE (loss of pulse torquing) indicates that the IMU has detected an error in the GPC transmitted pulse torquing commands. The IMU will not use these commands and will drift at its uncompensated rate. Since, the internal compensations of the HAINS are not updated on a flight-to-flight basis, the uncompensated drift rates can vary. For a real Transmission Word 1 BITE, real-time assessment will be required to determine if drifts are within acceptable limits to support entry. Matrix alignments can be performed to keep the IMU aligned and not appreciably alter the relative skew between the IMU platforms. ©[011295-1752A]

A false BITE has no impact to IMU performance except in the case of a false Transmission Word 1 BITE. If the Transmission Word 1 Fail BITE is false, the GPC will overtorque the IMU. The impact of this false BITE can be minimized by zeroing the uplinked gyro drift compensation command, moding the IMU to standby and back to operate, and then performing a matrix alignment. ©[011295-1752A]

The Temperature Safe and Temperature Ready BITE's do not indicate temperature problems, but rather power supply failures. These discrettes are driven directly by the +5 V dc isolated power supply on the input power conditioner (IPC) card and are used only to maintain transparency between the current HAINS and the previous KT-70 IMU's. If only one of these BITE's is annunciated, it is probably a false indication. If both BITE's are set together, then the +5 V dc isolated power supply is suspect. Failure of this power supply would also result in Platform Temperature Safe, Platform Temperature Ready, and Communication Good BITE's. The In-operate Mode and Operate command would also be set false, resulting in the IMU moding to standby. ©[011295-1752A]

A8-60

LOSS OF VERNIER RCS DAP MODE

THE VERNIER RCS DAP MODE IS CONSIDERED LOST IF:

A. ANY SINGLE DOWN-FIRING VRCS JET (F5L, F5R, L5D, R5D) IS LOST.

For the loss of a down-firing VRCS jet, closed-loop (i.e., AUTO, INRTL-DISC, LVLH-DISC) DAP stability and controllability usually cannot be maintained, and the VRCS system will not be used in this mode. The DAP will downmode to free drift when any VRCS jet is lost, but the software will not prevent reselection of a VRCS closed-loop mode, even though this mode could result in an unstable DAP configuration. Open-loop VRCS control (INRTL-PULSE, FREE) will also be significantly degraded, and the use of this mode should be assessed on a case by case basis. ©[110900-7259]

THIS RULE CONTINUED ON NEXT PAGE

FLIGHT RULES

A8-60

LOSS OF VERNIER RCS DAP MODE (CONTINUED)

- B. EITHER SIDE-FIRING VRCS JET (R5R, L5L) IS LOST WHILE A PAYLOAD IS ATTACHED TO THE ORBITER IN ANY NON-ENTRY CONFIGURATION.

EXCEPTIONS IN WHICH DAP PERFORMANCE IS KNOWN TO BE ACCEPTABLE FOR THE LOSS OF EITHER SIDE-FIRING JET INCLUDE:

1. ALL SPACELAB MISSIONS IN WHICH LOADED RMS OPERATIONS ARE NOT BEING PERFORMED.
2. ALL CONFIGURATIONS FOR INERTIAL UPPER STAGE (IUS) DEPLOYS.
3. THE PORTIONS OF THE HUBBLE SPACE TELESCOPE (HST) REVISITS IN WHICH THE PAYLOAD IS ATTACHED DIRECTLY TO THE PAYLOAD BAY.
4. ALL FLIGHTS FOR WHICH MISSION-SPECIFIC DAP STABILITY ANALYSES HAVE FOUND DAP PERFORMANCE TO BE ACCEPTABLE FOR THIS CONFIGURATION.

Stable VRCS DAP performance has been verified for the loss of L5L or R5R with either an empty payload bay or payloads berthed in the bay. The DAP will still downmode to free drift when any VRCS jet is lost, but the software will not prevent reselection of a VRCS closed-loop mode, even though this mode could result in an unstable DAP configuration. If payloads are attached to the orbiter in a non-entry configuration (e.g., on the remote manipulator system (RMS) or deployed on the stabilized payload deployment system (SPDS)), the stability and controllability of the orbiter/payload system must be uniquely verified for each payload position and each combination of operable VRCS jets. This type of study is necessitated by the influence on DAP performance of both payload CG offsets and the flexibility of the attached mechanisms. ©[110900-7259]

A study has already been performed on several payloads which are commonly flown (Spacelab and all payloads deployed using an IUS), as well as the portions of the HST maintenance missions in which HST is attached directly to the payload bay. It was found during the study that DAP stability will be adequate with these payloads in these configurations (ref. Draper Memo SSV-90-027, Controllability of Orbiter With Vernier Jet Failures During Attached Payload Operations). For any other non-entry orbiter/payload configuration, the loss of a side-firing vernier should be cause to NO-GO the VRCS DAP mode unless an applicable study has been performed which indicates that the given configuration will result in adequate DAP performance. If such a study is performed, it will be documented in Section A3.12 of the mission-specific Flight Rules Annex (NSTS-18308). Rule {A6-154}, RCS VERNIER OPERATION TERMINATION, references this rule. ©[ED]

FLIGHT RULES

A8-61

SSME SHUTDOWN DUE TO HYDRAULIC SYSTEM FAILURES

[HC] @[121505-7209A]

THE FAILURE OF TWO HYDRAULIC SYSTEMS DURING ASCENT WILL RESULT IN THE LOSS OF TVC ON ONE SSME AND THE LOSS OF THROTTLE CAPABILITY ON TWO SSME'S. IF TWO HYDRAULIC SYSTEMS FAIL, THE FOLLOWING ACTION WILL BE TAKEN:

- A. WITH TWO ENGINES RUNNING (NOM/ATO/TAL/RTL), ONE OF THEM NONGIMBALLING, SINGLE ENGINE ROLL CONTROL (SERC) WILL BE INVOKED IMMEDIATELY BY THE CREW. THE NONGIMBALLING ENGINE WILL BE SHUT DOWN WHEN SINGLE-ENGINE PRESS CAPABILITY FOR THE CURRENT TRAJECTORY IS ACHIEVED, BASED ON THE THROTTLE LEVEL OF THE GIMBALLING ENGINE AND WITHOUT ABORT GAP CLOSURE TECHNIQUES APPLIED.

Simulator testing has verified that a loss of control is almost certain to occur, usually very quickly, when one of the two remaining engines has lost gimbal capability and SERC is not active. Even if SERC is invoked (TRAJ display, Item 6), a loss of vehicle control is still possible, especially during very dynamic vehicle maneuvers such as powered pitcharound (PPA) on an RTL. However, if SERC is invoked within a few seconds of the failure that results in this configuration, it will often provide good vehicle control until SSME gimbal saturation occurs. Gimbal saturation generally does not occur prior to single-engine capability, but will usually occur prior to MECO, resulting in rapid degradation of vehicle control. Shutting down the nongimballing engine at single-engine press eliminates the possibility of gimbal saturation occurring after that point. Single-engine capability calls ("single-engine press," "single-engine TAL," etc. depending on current trajectory) should be based on the throttle level of the gimballing engine with no abort gap closure techniques applied (ref. Rule {A4-56I}, PERFORMANCE BOUNDARIES). The risk of a few more seconds of exposure to potential gimbal saturation is considered small compared to the risks of flying gap closure techniques. If single-engine capability has already been achieved when this failure scenario occurs, the nongimballing engine should be shut down immediately. @[082593-1464C]

- B. THREE ENGINES RUNNING:

1. NOMINAL/ATO - THE NONGIMBALLING ENGINE WILL BE SHUT DOWN AT SINGLE-ENGINE PRESS TO MECO.

SES testing has verified that vehicle control is acceptable with three engines running and one nongimballing (two-engine control laws are utilized). To minimize the time to single-engine press, the nongimballing engine will be allowed to continue to run. The risk incurred in this period is that a gimballing engine will shut down and immediate action (invoking SERC, ref. Paragraph A above) will be required to maintain vehicle control. @[082593-1464C]

THIS RULE CONTINUED ON NEXT PAGE

FLIGHT RULES

A8-61

SSME SHUTDOWN DUE TO HYDRAULIC SYSTEM FAILURES [HC] (CONTINUED)

After single-engine capability is achieved, the performance risk incurred due to a good engine failing following shutdown of the nongimballing engine is minimized. At the same time, the loss of control risk associated with allowing the nongimballing engine to continue to run remains. Therefore, the non-gimballing engine should be shut down at single-engine press to minimize the next failure impact.

If two engine throttles are stuck at a high power level, 3.5g may be exceeded near MECO. Shutting an engine down at an operationally convenient point such as single-engine press will eliminate this problem.

2. TAL - THE NONGIMBALLING ENGINE WILL BE SHUT DOWN AT SINGLE-ENGINE TAL. MANUAL THROTTLES WILL BE ENABLED PRIOR TO ABORT SELECTION IN ORDER TO MAINTAIN THE THROTTLES AT THE NOMINAL POWER LEVEL. @[082593-1464C]

For a three-engine TAL, the same rationale as paragraph 1 above applies for engine shutdown. There are several reasons why it is undesirable to throttle down the good engine: It may result in guidance transients, flight control would not be as good during the roll to heads up (although it would still be acceptable), little time would be gained to perform the abort dump, and the time to single-engine press would be increased. Therefore, manual throttles will be selected to prevent an automatic throttle down when TAL is declared. This action is not required if TAL is declared early enough that automatic throttling will not occur at abort selection. However, since there is no disadvantage to selecting manual throttles for this short period of time, manual throttles will always be selected, for consistency. AUTO throttle will be reselected after TAL is declared. @[082593-1464C]

3. RTLS:
 - a. IF ONE OR BOTH OF THE ENGINES WITH STUCK THROTTLES ARE AT 85 PERCENT OR LESS, THEN THE NONGIMBALLING ENGINE WILL BE ALLOWED TO RUN TO MECO.
 - b. IF BOTH ENGINES WITH STUCK THROTTLES ARE AT MORE THAN 85 PERCENT, THEN THE NONGIMBALLING ENGINE WILL BE SHUT DOWN 2 MINUTES PRIOR TO MECO.

NOTE: BEFORE SELECTING RTLS, MANUAL THROTTLES WILL BE ENABLED AND MINIMUM THROTTLES SELECTED. AT LEAST 10 SECONDS OF MINIMUM THROTTLE LEVEL IS DESIRED PRIOR TO RTLS SELECTION. AUTO THROTTLES WILL BE RESELECTED ANYTIME PRIOR TO PPA. @[082593-1464C]

THIS RULE CONTINUED ON NEXT PAGE

FLIGHT RULES

A8-61

SSME SHUTDOWN DUE TO HYDRAULIC SYSTEM FAILURES [HC] (CONTINUED)

IF BOTH ENGINES WITH STUCK THROTTLES ARE AT
NOMINAL POWER LEVEL (104.5 PERCENT), THEN MANUAL
THROTTLE ACTIONS ARE NOT REQUIRED PRIOR TO ABORT
SELECTION @[121505-7209A]

As with the NOM/ATO/TAL cases, it is preferable to leave the nongimballing engine running through single-engine press to MECO and accept the risk of the loss of a gimballing engine to this point. Due to the possibility of SSME failures resulting from valve drift on the engines in hydraulic lockup, the time to single-engine press should be minimized, since engine failures prior to this point can result in loss of vehicle and crew bailout. Unfortunately, shutting an engine down at single-engine press on an RTLS with two stuck throttles can lead to undesirable results.

For the contingency case in which two hydraulic system failures, in addition to another independent failure, result in a three-engine RTLS with two SSME throttles stuck high, it is possible for g forces to get as high as 3.9g. Therefore, if both stuck throttles are above 85 percent, an engine must be shut down before MECO-20 seconds in order to avoid the possibility of exceeding 3.5g. However, analysis has shown that shutting down the nongimballer with 85 seconds of MECO in this scenario leaves more than 2 percent propellant remaining in the ET at MECO, resulting in orbiter/ET recontact after ET SEP. Therefore, MECO-2 minutes was selected as an operationally convenient shutdown cue that would eliminate both the recontact and the g-load concerns. One drawback to shutting down at this point (or any later point) is that guidance commands a large pitch-up. Although the vehicle adequately follows the guidance commands, this pitch transient causes the dedicated displays to pass through the singularity point, degrading the crew's capability to monitor vehicle control. The only way to avoid this pitch transient would be to shut the engine down just after powered pitcharound (PPA), which would extend the time to single-engine press by more than 1 minute, compared to shutting down at MECO-2 minutes. Since the pitch transient is due to a guidance command and not a control problem and since the risk of engine failure due to valve drift was considered to be a greater concern than the momentary loss of crew monitoring capability, it was decided that MECO-2 minutes is the optimal shutdown time. (Reference Ascent/Entry Flight Techniques Panel #105, 10/22/93.)

For the case in which at least one throttle is stuck at or below 85 percent, there is no threat of exceeding 3.5g. Depending on the throttle levels of the stuck engines, it also may not be acceptable, from a performance standpoint, to shut down the nongimballing engine before single-engine press. Since shutting down after single-engine press can result in an undesirable pitch transient and is not required to protect for excessive g-loads, it is preferable to leave all three engines running to MECO for this case. The only risk incurred with this philosophy is that the window of exposure to the failure of a gimballing engine remains open until MECO for this case.

THIS RULE CONTINUED ON NEXT PAGE

FLIGHT RULES

A8-61

SSME SHUTDOWN DUE TO HYDRAULIC SYSTEM FAILURES
[HC] (CONTINUED)

The 85-percent throttle level provides an operationally convenient breakpoint which ensures that a shutdown will never be performed if the engine is needed to achieve the desired MECO targets, while also ensuring that an engine will always be shut down if any threat of exceeding 3.5g exists. For scenarios in which engines are stuck at intermediate throttle settings, acceptable results can sometimes be obtained regardless of whether or not an engine is shut down.

For RTLS cases with two stuck throttles, minimum throttles will be selected prior to abort selection for any engine stuck at a power level below the nominal 104.5 percent. Doing so will allow guidance to converge on the correct average thrust level and will reduce the probability of a early PPA. For guidance to have enough time to converge, minimum throttle levels must be achieved at least 10 seconds prior to RTLS selection. If not, an early PPA may occur, resulting in MECO conditions that are not optimized since additional propellant above the 2 percent target may remain in the ET at MECO. AUTO throttles should be reselected immediately after minimum throttles is selected. Doing so ensures that RTLS guidance fine mass control is maintained. If manual throttles is active at PPA or enabled anytime after PPA, then the guidance fine mass control is disabled. ©[082593-1464C] ©[121505-7209A]

If both stuck engines are at the nominal power level (104.5 percent) these steps are unnecessary since the chances of an early PPA are eliminated and a late PPA is possible, since the guidance turnaround velocity limit (VLATE) is being approached and the man/min/auto throttle steps could cause the crew to exceed this velocity limit prior to aborting RTLS. (Reference Ascent/Entry Flight Techniques Panel #215, October 28, 2005.)

C. SHUTDOWN MATRIX:

FAILED HYDRAULIC SYSTEM	NONGIMBALLING ENGINE	ENGINES WITH STUCK THROTTLES
1 AND 3	CENTER	CENTER AND RIGHT
1 AND 2	LEFT	CENTER AND LEFT
2 AND 3	RIGHT	LEFT AND RIGHT

The failure of two hydraulic systems will cause two engines to lock up hydraulically and eliminate TVC capability on one of these two engines. The engine shutdown matrix identifies which engines have lost TVC and/or throttle capability.

Hazard Reports ORBI 099, Failure of Elevon or SSME TVC Actuator Check Valve Could Cause Loss of Flight Control, and IVLD-01, Exposure to Induced Environment Exceed Structural Capability of SSV, are controlled by this rule. Hazard Report IMIPS-17, Inadvertent SSME Shutdown, references this rule.

Rules {A4-59}, MANUAL THROTTLE SELECTION [HC]; {A5-109}, MANUAL SHUTDOWN FOR TWO STUCK THROTTLES (NOT DUAL APU FAILURES) [HC]; {A5-103}, LIMIT SHUTDOWN CONTROL; and {A2-301}, CONTINGENCY ACTION SUMMARY [HC], reference this rule. ©[092195-1770A] ©[ED] ©[121505-7209A] ©[032807-8400]

A8-62 THROUGH A8-100 RULES ARE RESERVED

FLIGHT RULES

MANAGEMENT

A8-101**BEEP TRIM DEROTATION**

- A. THE RHC BEEP TRIM SWITCH WILL NOMINALLY BE USED TO PERFORM ORBITER DEROTATION. THE RHC WILL BE USED AS A BACKUP IF THE BEEP TRIM IS INOPERABLE. @[120894-1722A] @[110900-3780]

The RHC beep trim switch provides a smooth and predictable orbiter pitch derotation rate. Use of this switch eliminates the derotation rate dispersions introduced during the initiation of derotation when using the RHC. The improved derotation characteristics provided by the beep trim switch reduces tire and main landing gear peak loads. This in turn allows derotation to be performed at higher airspeeds than it can be performed using the RHC. Derotating at higher airspeeds reduces the time in the two-point attitude where less lateral control authority is available.

Beginning with OI-28, PASS software was modified to provide effectively two-fault tolerance to an uncommanded rate input by using WOW and EAS as the enable function for the Beep Trim derotation (beep trim is a two-contact switch). This eliminated a requirement to reconfigure the PANEL power and RHC/PANEL enable switches at M 2.7, and closes a window of exposure where a failed contact/commfault combination resulted in an undesired rate command. On the first pass after WOW is set, the software polls the left and right beep trim contacts, and no-ops contacts indicating "1" (vote to initiate a negative pitch rate) by latching the failed high contacts to "0". If both contacts on one RHC indicate "1" during the first pass, only one contact is set to "0". Additionally, a commfaulted contact is considered to be "0" by the logic. Post WOW, while greater than 195 KEAS (I-load), both contacts of either the left or right beep trim are required to indicate "1" prior to a derotation command being honored. Less than or equal to 195 KEAS, only one contact is required to initiate a derotation. If both contacts are failed open or commfaulted, or if one contact is failed high prior to WOW and the other contact commfaulted, a manual derotation using the RHC is required. There are specific failures which will result in an auto-derotation anytime the orbiter airspeed is less than or equal to 195 KEAS. These are 1) failure of a single contact high after WOW, and 2) two contacts failed high pre-WOW.

- B. IF THE BFS IS ENGAGED, THE CDR'S PANEL TRIM POWER WILL BE TURNED OFF AND THE RHC/PNL TRIM INHIBIT/ENABLE SWITCH WILL BE PLACED IN ENABLE TO PROVIDE BEEP TRIM DEROTATION CAPABILITY.

This action will provide beep trim derotation capability for the CDR only; there is no PLT capability in the BFS. @[110900-3780]

FLIGHT RULES

A8-102

RGA SYSTEM MANAGEMENT [CIL]

IF FOUR ORBITER RGA'S ARE AVAILABLE AND A KNOWN FAILURE CONDITION EXISTS WHERE ONE ADDITIONAL FAILURE WOULD CAUSE TWO ORBITER RGA'S TO SIMULTANEOUSLY LOSE POWER, ONE OF THE AFFECTED RGA'S WILL BE DESELECTED IN THE BFS [CIL].

Test data indicates that when power is removed from an orbiter RGA or SRB RGA the RGA output electronics generate a false rate approximately equal to 18 deg/sec in roll and 10 deg/sec in pitch and yaw. This false rate signature decreases linearly to zero approximately 10 seconds after the power is removed from the RGA. Since interchangeable midvalue selection (IMVS) is used for the RGA selection filter in the BFS when four RGA's are available, a simultaneous power fail of two RGA's would feed the bad rate signature directly into BFS flight control. This is not a concern in the PASS, since PASS redundancy management automatically deselects power failed RGA's. The effect of this transient and subsequent bad rate feedback on flight control may be catastrophic during any dynamic flight phase. (Ref. Configuration Control Board, January 22, 1991, Power Loss Characteristics for FCS RGA's.)

If it is known that one electrical bus failure will remove power simultaneously from two RGA's (requires previous failure), one of those RGA's can be deselected in the BFS to protect for that bus failure. Deselecting an RGA will downmode the selection filter to a MVS scheme and thus regain full single-fault tolerance.

If less than four RGA's are available, deselecting an RGA to protect for the next bus failure would leave the system at risk to any RGA LRU or power failure (while averaging or prime selecting), so no action will be taken.

FLIGHT RULES

A8-103

PRIORITY RATE LIMITING (PRL) SYSTEMS MANAGEMENT

- A. MANUAL SYSTEMS MANAGEMENT WILL BE REQUIRED ANY TIME THE PRL SOFTWARE DOES NOT REFLECT THE CURRENT STATUS OF THE HYDRAULIC SYSTEMS.

Self-explanatory.

- B. DURING ENTRY, SINGLE APU PRL RATES ARE REQUIRED WHEN ONE HYDRAULIC SYSTEM IS DRIVING THREE OR MORE ELEVONS.

One hydraulic system cannot support the flow rate required to move three elevons at the maximum commanded rate of 30 degrees per second (ref. SODB 4.2.7.1.1). Short term pressure degradations (due to the high hydraulic fluid flow rate) would have an adverse effect on vehicle flight control due to sluggish or stalled elevon movement.

There are no concerns with the hydraulic flow required to support single APU rates with two hydraulic systems, regardless of how many elevons are being driven by one of the two systems.

The areas of concern for vehicle flight control are during the final flare maneuver and vehicle derotation, when actuator rates are at the highest. The risks associated with single APU drive rates during this timeframe are less than those associated with unequal elevon movement. Ascent load relief and entry prior to Mach 0.6 are not of concern for this case, since the nominal actuator rates are not high enough to cause significant pressure degradation. (Ref. A/E Flight Techniques Panel #69, July 20, 1990.)

FLIGHT RULES

A8-104

FCS CHECKOUT [CIL] [HC] @[121604-6534B]

FCS CHECKOUT PART 1 (SECONDARY ACTUATOR CHECK) AND PART 2 (SENSOR AND CONTROLLER TEST) SHALL BE PERFORMED IN OPS 8 PRIOR TO THE DEORBIT BURN (NORMALLY SCHEDULED THE DAY PRIOR TO NOMINAL EOM). IN THE EVENT OF HYDRAULIC SYSTEM FAILURES, OR OFF-NOMINAL, TIME CRITICAL SCENARIOS THAT DO NOT ALLOW TIME TO COMPLETE FCS CHECKOUT, PART 1 WILL BE COMPLETED ACCORDING TO THE FOLLOWING PRIORITY:

- A. UTILIZING AN APU PREBURN
- B. UTILIZING A CIRCULATION PUMP PREBURN
- C. UTILIZING AN APU POSTBURN

The purpose of the FCS checkout procedure is to verify the functionality of redundant entry critical systems prior to use during entry. Should failures be detected, the entry critical systems may be reconfigured and/or additional troubleshooting performed to optimize the entry configuration to protect for additional failures. The primary purpose of Part 1 of FCS checkout (secondary actuator check) is to test the aerosurface servo amplifiers (ASA's) for null driver failures. Two undetected null failures on an elevon could cause loss of vehicle control because the two good channels could be bypassed during a request for high surface rate (CIL 02-2C-C01-SV-B-01). Additionally, Part 1 provides a functional check of all aerosurfaces by driving them through a range of motion, and the capability to test the secondary pressure transducers and the fault-detection circuitry in the ASA that issues channel bypass commands. (This test requires hydraulic system pressure greater than 2025 psi to be completely accomplished.)

@[ED]

It is preferable to perform the complete FCS checkout one day prior to nominal EOM to allow time to fully troubleshoot any flight control system failures. An early FCS checkout (or partial FCS checkout) should be performed if an entry critical system is considered suspect due to an unexpected or off-nominal signature during ascent or any failure in an entry critical system, if it is deemed necessary to ensure redundancy for continuing the mission. An early FCS checkout does not preclude the need to do a complete FCS checkout the day before nominal EOM.

The first priority when performing the secondary actuator check is to use an APU. Rule {A10-29}, FCS CHECKOUT APU OPERATIONS, will be used to determine if it is appropriate to use an APU for the secondary actuator check. If an APU cannot be used, then a hydraulic system circulation pump will be used, if possible, to perform the secondary actuator check preburn. @[121604-6534B]

THIS RULE CONTINUED ON NEXT PAGE

FLIGHT RULES**A8-104****FCS CHECKOUT [CIL] [HC] (CONTINUED)**

When using an APU, the checkout procedure has the crew bypass any port that does not automatically bypass when the stimulus is applied. A port may not automatically bypass because of either a null driver failure (1R/2) or a fault detection circuit failure (1R/3). Without insight into secondary delta pressures, the crew must assume the worst case driver failure and manually bypass the port. Given time to review the data (i.e., for checks done preburn), the MCC can confirm which failure exists. For a fault-detection circuitry failure, the channel is considered to be good and the port will be reset. ©[121604-6534B]

When using a circulation pump, several things are given up because the hydraulic system pressure is not great enough. The rudder and speedbrake drivers cannot be checked by the crew because brakes will not allow these surfaces to move, the fault-detection circuitry for all surfaces cannot be tested, and the rudder/speedbrake and bodyflap cannot be functionally checked via surface drive. Even with the lost capability, it is still preferable to accomplish the circulation pump check for null elevon drivers before committing to entry rather than to wait until after the deorbit burn to accomplish a more complete check.

If the situation does not permit the secondary actuator check to be accomplished with either an APU or circulation pump prior to the burn, the check will be performed in MM 303 if it is possible to do so. An APU will be used with its hydraulic pump in normal pressure even if only one APU is available for entry.

One polarity stimulus is sufficient to test for null failures; both polarity stimuli are required to fully test the fault-detection circuitry. If the secondary actuator check is done using a circulation pump or if it is done postburn, it will be abbreviated in that only one stimulus will be used. The abbreviated check is appropriate postburn because it minimizes the time required to perform the check.

The priorities for the secondary actuator check are the same for early mission termination scenarios (AOA, next PLS, MDF) with or without APU/hydraulic systems failures. Considerations of whether to perform any part of FCS checkout when entering early include crew workload, other systems failures, and APU hot restart constraints.

Reference Rules {A10-21}, LOSS OF APU/HYDRAULIC SYSTEM(S) ACTIONS; {A10-29}, FCS CHECKOUT APU OPERATIONS; and Ascent/Entry Flight Techniques Panel Meetings #47, Continuation, August 29, 1988 and #204, September 15, 2004.

Rules {A10-21}, LOSS OF APU/HYDRAULIC SYSTEM(S) ACTIONS, and {A10-29}, FCS CHECKOUT APU OPERATIONS, reference this rule.

Reference elevon FMEA/CIL 02-2C-C01-SV-B-01.

Reference Hazard Controls ORBI-003 "Loss of Flight Control due to Loss of Elevon Function;" ORBI-023 "Loss of Control During Entry due to Failure of the Rudder/Speedbrake System;" ORBI-025 "Loss of Control During Entry due to Failure of the Body Flap Mechanism;" ORBI-38 "Loss of Vehicle due to Failure of Multiplexer-Demultiplexer (MDM);" ORBI-052 "Loss of Flight Control Caused by Failure of ASA/ATVC, Servo Valve or Power Switch;" and ORBI-152 "Manual Controller Failure Can Result in Loss of Flight Control." ©[121604-6534B]

FLIGHT RULES

A8-105**CONTROLLERS**

IF TWO CHANNEL FAILURES OCCUR ON AN RHC, THE REMAINING TRANSDUCER WILL BE PRIME SELECTED, IF POSSIBLE, TO REGAIN THE CONTROLLER FUNCTION AND THE RHC WILL THEN BE POWERED OFF. THE RHC MAY BE POWERED AT ANY TIME IF REQUIRED FOR VEHICLE CONTROL. IF THE FAILED RHC IS ON THE CDR'S SIDE, THE CDR WILL FLY THE VEHICLE DURING APPROACH AND LANDING AS LONG AS THERE HAS BEEN NO MORE THAN ONE TRANSDUCER FAILURE.

If two channels of an RHC fail, prime-selecting the one remaining transducer permits use of that RHC. The RHC is powered off to preclude a failure of the remaining good transducer which could cause inadvertent jet firings, incorrect aerosurface commands, or loss of vehicle control. This implies that if the left (CDR) RHC is failed, then the vehicle must be flown using the right (PLT) RHC, either by the PLT or by the CDR after changing seats. Since the CDR and PLT are most proficient in systems knowledge and operation on their respective sides of the cockpit and the CDR is more highly trained to fly the vehicle, it is strongly desired that the CDR fly the vehicle whenever possible and only from the left seat. The only danger in using the remaining channel (pitch and roll transducer) is if it should fail when the orbiter is extremely close to the ground. This would be a third failure and would have to be a smart failure as well, since it would have to occur in a very narrow bandwidth of time after having successfully functioned for most of the approach. Since each member of the crew is highly trained to perform specific functions during the approach and landing, there is a much greater risk involved with altering these functions just to protect for a highly unlikely smart, third failure. If there is no reason to suspect the reliability of the remaining channel (pitch and roll transducer), i.e., its outputs are normal and both previous failures were not due to transducer problems, then there is an acceptable risk in using that RHC (two transducer failures could indicate a possible generic problem). Therefore, as long as the last remaining channel (pitch and roll transducer) on the CDR's RHC has good outputs and is believed to be reliable, the CDR will fly the vehicle during approach and landing.

Rules {A2-261}, ENTRY DTO/AUTO MODE/CROSSWIND DTO GO/NO-GO, and {A8-1001}, GNC GO/NO-GO CRITERIA, reference this rule.

FLIGHT RULES

A8-106

TVC-SSME STOW/ACTUATOR FLUID FILL (REPRESSURIZATION)

- A. IF SSME STOW PROBLEMS OCCUR AT THE END OF ASCENT, THE APU'S WILL BE SHUT DOWN ON TIME AND THE STOW OPERATION WILL BE COMPLETED ON ENTRY DAY.

It is possible, under certain conditions, to not achieve SSME stow during ascent. Because the last commands issued are carried across OPS transitions, if the stow commands are not sent before the stow sequence is halted in OPS 1, the SSME's will not be commanded to stow in OPS 3. Thus, a transition to OPS 8 is required since the stow commands are issued upon transition. If the stow commands are sent before the sequence is halted, the stow commands will carry over across the OPS 3 transition.

- B. SSME ACTUATOR FLUID FILL USING FULL HYDRAULIC PRESSURE WILL BE PERFORMED ON ENTRY DAY ON ALL ACTUATORS OF ALL THREE ENGINES EXCEPT FOR THE FOLLOWING CONDITIONS:
1. THE DIFFERENCE BETWEEN ANY COMMAND (AVERAGE OF THE ACTIVE ATVC DRIVER OUTPUTS) AND THE INDICATED POSITION IS GREATER THAN 2 DEGREES. FOR ACTUATORS THAT ARE SUSPECTED TO HAVE A BIASED POSITION TRANSDUCER (SINGLE STRING), DATA FROM PAST FLIGHTS OF THAT ACTUATOR WILL BE USED TO ASSESS THE LIKELIHOOD OF ACTUALLY MOVING THE ACTUATOR MORE THAN 2 DEGREES.
 2. MAIN ENGINE POSITION DATA IS NOT AVAILABLE AND DATA BEFORE THE LOSS INDICATES THAT A STEP OF 2 DEGREES OR MORE IS POSSIBLE.

EVERY ATTEMPT WILL BE MADE TO AVOID VIOLATING THE 2-DEGREE STEP CONSTRAINT, INCLUDING STARTING AN APU ON ORBIT TO PERFORM SSME FLUID FILL.

Fluid fill and engine repositioning is required due to hydraulic fluid shrinkage after cooling down which may result in engine movement of 2 to 3 degrees in each axis. A 2- to 3-degree movement from the stow position would result in exceeding the design nozzle temperature limits (aerodynamic heating) on engines 2 and 3 (left and right ME's). Two APU's will repressurize all three engines. One APU will repressurize two ME's (ref. Rule {A10-21B}, LOSS OF APU/HYDRAULIC SYSTEM (S) ACTIONS).

THIS RULE CONTINUED ON NEXT PAGE

FLIGHT RULES

A8-106

TVC-SSME STOW/ACTUATOR FLUID FILL (REPRESSURIZATION) (CONTINUED)

SSME steps greater than 2 degrees (indicated) under full hydraulic pressure risk damage (possible rupture) to the hydraulic lines and subsequent loss of that hydraulic system. The average of the active ATV driver outputs are used in the differencing scheme (as opposed to the software command) to eliminate the uncertainties in the command path. The 2-degree constraint takes into account the transducer uncertainty (ref. SODB 3.4.5.1h.1). Since some SSME TVC actuator position transducers have shown biases and scale factors in the position output, a false indication of the command/position delta could lead to multiple APU starts and SSME represses. For a suspected bias in the transducer (single transducer through MDM OA1), data from the post-MECO stow position and past hydraulic represses of that actuator will be used to assess the likelihood of actually moving the actuator more than 2 degrees. The flight history data will be obtained from the SSME actuator and hydraulics subsystem managers through a SPAN-MER chit.

Main engine position data are used by the MCC to ensure the 2-degree constraint will not be violated. If position data is lost, an attempt will be made to determine if a 2-degree step is likely. The command/position delta at the time of loss of data, the drift rate at the time of loss of data, and previous flight history are factors that will be used to aid in this determination.

Wind tunnel testing indicates that movement of a main engine nozzle from its stow position during entry increases aerodynamic heating on that nozzle. Not performing SSME fluid fill increases the possibility that nozzle damage will occur during entry.

This rule is referenced by Rule {A8-107}, FCS CHANNEL MANAGEMENT.

FLIGHT RULES

A8-107

FCS CHANNEL MANAGEMENT

- A. FOR RESTRING CASES DUE TO GPC FAILURES, ASA AVAILABILITY (VIA FCS CHANNEL SWITCHES) WILL BE MANAGED SO THAT EACH GPC IN THE REDUNDANT SET WILL BE ASSIGNED AN EQUAL NUMBER OF ASA'S. WITH NO ADDITIONAL FAILURES, THE GPC/FCS CHANNEL ASSIGNMENTS WILL BE:

FOUR GPC'S - FOUR CHANNELS IN AUTO, ONE CHANNEL PER GPC.

THREE GPC'S - THREE CHANNELS IN AUTO, ONE CHANNEL PER GPC, ONE CHANNEL OFF.

TWO GPC'S - FOUR CHANNELS IN OVERRIDE, TWO CHANNELS PER GPC.

ONE GPC - FOUR CHANNELS IN AUTO.

If each GPC does not control an equal number of FCS channels, subsequent failure of the GPC that has the larger number of channels could cause good ports to be bypassed resulting in a loss of vehicle control. Ports are taken offline by taking the FCS channel power to OFF.

To equalize channels for the three GPC-four FCS channel case, one FCS channel must be turned off. It is desirable to turn off FCS channel 4 since both the bodyflap and the BFS use channels 1-3. On OV-102, this will result in the loss of high rate ACIP data, but low rate data is considered acceptable. For the two-GPC case, having all channels in override will prevent loss of good ports for the next GPC failure. In this case, rapid crew action will still be required to turn off the channels on the failed GPC, but this is the safest configuration of all of the options. With one GPC, the next GPC failure cannot be accepted, but the auto system will operate properly for FCS channel problems.

- B. FOR AN FA MDM OR GPC FAILURE DURING ASCENT OR ENTRY, THE CORRESPONDING FCS CHANNEL WILL BE TURNED OFF.

When an FA MDM fails or a GPC fails to halt or sync, its actuator commands are no longer valid. The FCS channel, if left powered, would cause a force fight with the other good channels. It is appropriate to turn the FCS channel OFF, which will bypass that channel. It will also eliminate the possibility of a subsequent failure causing a two-on-two force fight.

THIS RULE CONTINUED ON NEXT PAGE

FLIGHT RULES

A8-107

FCS CHANNEL MANAGEMENT (CONTINUED)

- C. DURING OPS 1, 3, OR 6 IF ANY OF THE FIRST THREE FCS CHANNELS ARE TURNED OFF, THE CORRESPONDING POSITION FEEDBACKS WILL BE DESELECTED. IF FCS CHANNEL 4 IS TURNED OFF, THE CORRESPONDING FEEDBACKS WILL NOT BE DESELECTED UNLESS THERE IS A POSITION FEEDBACK FAILURE ON ONE OF THE FIRST THREE FCS CHANNELS.

Deselection of feedbacks is performed on CONTROLS SPEC 53, which is available in OPS 1, 3, and 6. Crew item deselection removes all feedbacks on the associated FCS channel. For the first three FCS channels, feedbacks should be deselected any time the channel is turned off. This action allows FCS channel 4 feedbacks to be used and protects against failing the position feedbacks on the unpowered channel if the failure that caused the channel to be turned off is subsequently recovered. If there are no other FCS channel position feedback problems, position feedbacks should not be deselected on FCS channel 4 when it is turned off. This action will allow FDIR to isolate a problem on FCS channels 1, 2, or 3 without requiring the position feedbacks to be deselected on all aerosurfaces of the affected channel. It is not critical to protect the rudder or speedbrake position feedbacks. The rudder feedback is only used for crew display on the surface position indicator (SPI). The speedbrake position is used to set a pitch trim rate gain in the AEROJET DAP and for crew display on the SPI. Since the bodyflap uses a QMVS selection filter, no action is required for the bodyflap position feedbacks. Feedbacks are deselected in OPS 1 to ensure a good feedback configuration is available should an abort be required.

- D. IF A SINGLE CHANNEL IS FAILED BUT NOT BYPASSED, THE REMAINING CHANNELS WILL BE PLACED IN "OVERRIDE".

This action protects for the next GPC/MDM/LRU failure. If the channels are left in auto, the next failure could cause both good channels to be bypassed resulting in loss of vehicle control. By placing the remaining channels in override, we inhibit port popping of the good channels. The FCS system must now be managed manually, using ground calls. Reference RI-Downey Internal Letter 283-430-81-075.

- E. WHEN ONLY TWO GOOD FCS CHANNELS REMAIN ON A SINGLE ACTUATOR, BOTH WILL BE PLACED IN "OVERRIDE".

This action protects for the next GPC/MDM/LRU failure. If the channels are left in AUTO, the next failure could cause the good channel to be bypassed resulting in loss of vehicle control. In override, the next failure will result in a one-on-one force fight which is preferred because it may allow the crew time to secure the bad channel and engage BFS to recover good channels. One channel control is not certified. The FCS channels in override must be managed manually. Reference RI-Downey Internal Letter 283-430-81-075.

THIS RULE CONTINUED ON NEXT PAGE

FLIGHT RULES

A8-107

FCS CHANNEL MANAGEMENT (CONTINUED)

- F. WHEN MOVING MULTIPLE FCS CHANNEL SWITCHES FROM "AUTO" TO "OVERRIDE" OR "OVERRIDE" TO "AUTO", A 2-SECOND DELAY BETWEEN INDIVIDUAL SWITCH ACTUATIONS WILL BE MAINTAINED.

The FCS switches are of the break-before-make type. When moved from one position to another, power to the FCS channel is temporarily interrupted. When power is interrupted, logic inside the ASA causes power to remain off for at least 510 msec and for as long as 1370 msec regardless of how fast the FCS switch is moved (ref. RI-Downey Internal Letter 283-220-86-009). The affected channel is bypassed during the time that the ASA power is off. If multiple channel switches are actuated at the same time, an aerosurface may have no active ports controlling it because all ports have been bypassed due to previous failures and/or switch actuations. This could cause the surface to go hardover which would cause a transient in the flight control system.

- G. IN OPS 3 OR 6, AN AEROSURFACE PORT WILL BE MANUALLY BYPASSED IF IT IS FORCE FIGHTING OTHER CHANNELS WITH A SECONDARY DELTA PRESSURE OF 1400 PSI OR GREATER.

The ASA hardware has built-in fault detection that will bypass a port if its secondary delta pressure is greater than 2025 psi. This limit is a compromise; it is high enough to avoid transient failures of good channels yet low enough that a bad channel will likely be isolated. Also, the ASA has a redundant channel equalization function designed to compensate for variation of hardware tolerances. By design, equalization should prevent a port with no hardware failure from being bypassed. The effect of equalization is fully realized when the secondary delta pressure for the affected port has reached about 1400 psi (ref. SODB volume III, par. 4.5.1.1.1).

The intent of this rule is to allow for manual isolation of a port that has a failure below the hardware fault detection limit of 2025 psi, but above equalization (1400 psi). This action protects for the next worst failure which could result in a two-on-two force fight. A two-on-two is an uncertified FCS configuration and could cause bypass of the two good FCS channels resulting in loss of control during entry. No action is required in OPS 1 because aerosurfaces are not used for control. (The capability to manually bypass a port exists in OPS 1, 3, 6, and 8.)

- H. DURING OPS 3, FCS CHANNEL MANAGEMENT TO REGAIN ATVC REDUNDANCY WILL NOT BE PERFORMED IF IT RESULTS IN A LOSS OF ASA SINGLE FAULT TOLERANCE.

FCS channel management to optimize ATVC's in OPS 3 would only be performed to provide fault tolerance for drag chute repositioning. Aerosurface control redundancy will not be jeopardized to reposition SSME bells for drag chute deployment since the drag chute can be deployed, if required, without SSME repositioning. Reference Ascent/Entry Flight Techniques Panel meeting #84, November 15, 1991, DRAG CHUTE IMPACTS.

©[041196 1883]

Reference Rule {A8-106B}, TVC-SSME STOW/ACTUATOR FLUID FILL (REPRESSURIZATION).

FLIGHT RULES

A8-108**HUD/COAS SYSTEM MANAGEMENT**

- A. IF EITHER STAR TRACKER IS SUSPECTED OF BEING FAILED, THE CALIBRATION PROCEDURE FOR THE CDR HUD WILL BE PERFORMED WITHIN 24 HOURS. IF AN UPDATE IS REQUIRED, THE PROCEDURE WILL BE RUN AGAIN WITHIN 24 HOURS TO VERIFY THE CALIBRATION. ©[111094-1723A]

If a star tracker is lost and the CDR HUD is not calibrated, the capability to perform an entry alignment is zero-fault tolerant. The calibration procedure should be run for the CDR HUD to ensure the SODB specified COAS IMU alignment accuracy for entry is met. During the procedure, if the delta bias is large enough that an update is required, the procedure should be run again within 24 hours to verify the accuracy of the calibration. Although the HUD flight data has shown no significant in-flight line-of-sight (LOS) shifts, it is prudent to ensure it will provide the best possible IMU alignment capability if required. (Ref. Rule {A8-12}, HEAD UP DISPLAY (HUD) AND CREW OPTICAL ALIGNMENT SIGHT (COAS) ALIGNMENT). (Ref. On-Orbit FTP meeting #133, October 9, 1992, HUD/COAS CALIBRATION and On-Orbit FTP meeting #148, September 9, 1994, HUD/COAS CALIBRATION STATUS.)

- B. THE SECONDARY STATION CALIBRATION WILL BE PERFORMED AS SOON AS PRACTICAL UPON LOSS OF THE PRIMARY STATION IF A STAR TRACKER IS FAILED.

A calibrated device at one station is required. If it has been determined that the calibrated device has been lost (e.g., loss of power or an obstructed window), the other station will be calibrated to meet the requirements in paragraph A of this rule. As backups to the star trackers for IMU alignments, the CDR HUD is the primary station and the PLT HUD/-Z COAS is the secondary station. (Ref. On-Orbit FTP meeting #148, September 9, 1994, HUD/COAS CALIBRATION STATUS.)

- C. THE SECONDARY STATION WILL BE CALIBRATED IF THE CABIN IS AT A PRESSURE DIFFERENT FROM THE PRIMARY STATION CALIBRATION AND A STAR TRACKER IS FAILED.

There is insufficient data to state that a decrease in cabin pressure to 10.2 psi will or will not cause a HUD/COAS line-of-sight shift large enough to violate the 0.5 degree EI IMU alignment accuracy requirement for entry (ref. Rule {A4-151}, IMU ALIGNMENT). Therefore, if a star tracker is lost, a HUD/-Z COAS calibration is required for fail-safe redundancy to perform an entry IMU alignment. Using the CDR or PLT HUD and the alternate software location for the calibrated vector is acceptable to meet the intent of this rule which is to provide a calibrated device at both cabin pressures. ©[111094-1723A]

THIS RULE CONTINUED ON NEXT PAGE

FLIGHT RULES

A8-108 HUD/COAS SYSTEM MANAGEMENT (CONTINUED)

- D. IT IS HIGHLY DESIRABLE THAT HUD/COAS CALIBRATIONS BE IMMEDIATELY PRECEDED BY A STAR TRACKER IMU ALIGNMENT.
@[111094-1723A]

HUD/COAS calibration accuracy is directly dependent on IMU misalignment. This is a controllable error source and should be minimized.

- E. IF BOTH STAR TRACKERS ARE SUSPECTED OF BEING FAILED, THE SECONDARY STATION WILL BE CALIBRATED AS SOON AS POSSIBLE.

If both star trackers are failed, the CDR HUD will be the primary device for performing IMU alignments. Since the HUD is zero fault tolerant (e.g., power failure), a PLT HUD/-Z COAS calibration is required for fail-safe redundancy to perform an entry IMU alignment. The PLT HUD/-Z COAS calibration should be performed as soon as possible to minimize IMU misalignment error and improve the accuracy of the calibration. @[111094-1723A]

A8-109 STAR TRACKER SYSTEM MANAGEMENT [CIL]

- A. BOTH STAR TRACKERS WILL BE CONTINUOUSLY POWERED FOR THE ON-ORBIT PORTION OF THE FLIGHT TO OBTAIN STAR-OF-OPPORTUNITY DATA. TRACKERS MAY BE POWERED OFF IF A PARTICULAR LONG DURATION ATTITUDE PRECLUDES GATHERING STAR-OF-OPPORTUNITY DATA.
- B. ONE STAR TRACKER DOOR WILL BE CLOSED IF A KNOWN FAILURE CONDITION EXISTS WHERE ONE ADDITIONAL FAILURE WOULD CAUSE BOTH DOORS TO BE FAILED OPEN. [CIL]

Star-of-opportunity alignments can decrease or eliminate the need to repeatedly perform maneuvers for IMU alignment, saving crew effort, time, and propulsion consumables.

Rockwell thermal studies (ref. SAS-TA-TPS-87-238, IL 294-400-87-071, and IL SAS-TA-RCC-78-160) have shown that entry with one star tracker door open results only in minor local damage due to stagnation conditions in a single opening cavity. In the absence of further studies showing that a two-door-open entry is also safe, conservative engineering judgment must assume that a plasma flow between the two doors could cause potentially catastrophic damage to the airframe, crew cabin, and/or navigation base.

Therefore, if the next electrical failure results in the loss of the last motor function on both doors, one door will be closed immediately to eliminate the potential for a two-door-open entry. Additionally, if one door is already stuck open, the other door will be closed immediately (even if redundant motor capability is available) in order to protect for a mechanical failure (e.g., door jam) that could result in a two-door-open entry (ref. CIL 02-4F-032001-1).

FLIGHT RULES

A8-110

IMU SYSTEM MANAGEMENT

- A. A PRE-DEORBIT IMU-TO-IMU ALIGNMENT WILL BE PERFORMED AT DEORBIT TIG - 70 MINUTES TO RESET THE IMU RM THRESHOLDS.

The pre-deorbit IMU/IMU alignment is required to reset the IMU RM thresholds. If the thresholds are not reset, then the IMU RM two-level attitude failure coverage during entry is drastically reduced. For no pre-deorbit IMU/IMU alignment, the probability of isolation for XY plane IMU errors at the two-level is 64 percent to 46 percent (decreasing with time) between EI and touchdown. The probability of isolation for Z-axis IMU errors (corresponds to critical orbiter vertical and down-range position and velocity errors) is 0 percent between EI and touchdown. In contrast, having performed the pre-deorbit IMU/IMU alignment, the probability of isolation for XY plane IMU errors at the two level is approximately 68 percent (reaching a max of 70 percent) between EI and touchdown. The probability of isolation for Z-axis (critical) IMU errors is 100 percent between EI and touchdown.

For deorbit wave-off cases, the pre-deorbit IMU/IMU alignment can be waved and performed one time only at the TIG - 70-minute point of the actual deorbit. For a wave-off declared after the IMU/IMU alignment has been performed, the alignment will be performed again at the next TIG - 70-minute point.

- B. THE PRE-DEORBIT STAR ALIGNMENT ON ENTRY DAY IS DEFINED AS CRITICAL.

IMU accuracy needs to be determined during the entry alignment and verification to assure that the IMU's will be within 0.5 degrees of desired attitude (RSS at EI) in order to protect the vehicle and crew during the entry phase (ref. Rule {A4-151}, IMU ALIGNMENT). The pre-deorbit alignment is currently the only identified critical alignment.

- C. ONBOARD ALIGNMENT VERIFICATION IS REQUIRED FOLLOWING ANY CRITICAL ALIGNMENT. DEORBIT WILL BE DELAYED ONE ORBIT, IF AVAILABLE, TO ALLOW THE OPS 3 STAR ALIGNMENT VERIFICATION TO BE COMPLETED.

The time element here is crucial. Any noncritical alignment results can be observed over some extended time period and verified by the MCC. Any problems discovered can then be corrected. However, a critical alignment must be as accurate as possible at that point in time, as the future provides little or no opportunity for correction.

- D. ONBOARD VERIFICATION IS NOT REQUIRED FOLLOWING NONCRITICAL ALIGNMENTS. VERIFICATION WILL BE ACCOMPLISHED BY THE MCC USING TELEMETERED STAR-OF-OPPORTUNITY AND RELATIVE MISALIGNMENT DATA.

Rationale same as for paragraph C.

THIS RULE CONTINUED ON NEXT PAGE

FLIGHT RULES

A8-110

IMU SYSTEM MANAGEMENT (CONTINUED)

- E. IMU GYRO DRIFT TERMS WILL BE UPDATED WHEN THE DRIFT EXCEEDS 3 SIGMA IN ANY AXIS. COMPENSATIONS LESS THAN 3 SIGMA WILL BE DONE AS REQUIRED TO MINIMIZE LONG TERM, STABLE DRIFT.

Correcting large (3 sigma) gyro drift errors will maintain the IMU's in the best possible position to support contingency deorbit and orbiter and payload operations. An IMU drifting at 3 sigma (0.02 deg/hr) will not jeopardize the 0.5 degree entry misalignment constraint for over 25 hours but does indicate significant out-of-spec performance, which should be corrected. Gyro drifts of this magnitude need not be compensated immediately but should wait for reliable drift measurements. Gyro drifts of less than 3 sigma, but which are stable and of long duration (typically 8 hours or more), should be corrected to place the IMU's in the best possible configuration to support orbiter and payload activities, sleep periods, IMU align wave-offs, entry, and any contingencies. The 1-sigma drift value is 0.006 deg/hr (ref. SODB 4.5.1.2.3.q.2.a-2). ©[011291752A] ©[081497-4060A]

- F. IMU ACCELEROMETER BIAS TERMS WILL BE UPDATED WHEN THE ERROR EXCEEDS 3 SIGMA IN ANY AXIS. COMPENSATIONS LESS THAN 3 SIGMA WILL BE DONE AS REQUIRED TO MINIMIZE LONG TERM, STABLE ERRORS.

Correcting large (3 sigma) accelerometer errors will maintain the IMU's in the best possible position to support orbiter and payload activities and entry. A 3-sigma error indicates significant out-of-spec performance which should be corrected when a reliable error measurement is available. Accelerometer errors of less than 3 sigma, but which are stable and of long duration (typically 4 hours or more), should be corrected to place the IMU in the best possible position to support entry as well as to provide an extra margin of safety on orbit. The 1-sigma value is 50µG's (ref. SODB 4.5.1.2.3.q.1-b). ©[011295-1752A] ©[081497-4060A]

- G. THE IMU'S NEED NOT BE REALIGNED WITH STAR DATA TO SUPPORT A DEORBIT ON ORBITS 2 OR 3.

A worse case IMU (3 sigma in all axes) results in a total platform misalignment of 0.125 degrees (RSS) at EI for an orbit 3 deorbit which meets navigation's requirement of 0.5 degrees (RSS) (ref. Rule {A4-151}, IMU ALIGNMENT). An orbit 2 or 3 deorbit would be an emergency action, and an IMU alignment using stars would impact the crew timeline. This rule does not preclude the use of an IMU/IMU alignment to regain a failed IMU.

THIS RULE CONTINUED ON NEXT PAGE

FLIGHT RULES

A8-110 IMU SYSTEM MANAGEMENT (CONTINUED)

H. IMU ALIGNMENTS WILL BE PERFORMED FOR LAUNCH DAY DEORBITS AFTER ORBIT 3 TO OPTIMIZE ENTRY NAVIGATION.

A 3-sigma HAINS IMU drift (in all axes) results in a total platform misalignment of 0.312 degrees (RSS) at EI for orbit 7 deorbit. This meets navigation's requirement of 0.5 degree (RSS) but is worse than the desired 0.25 deg at EI (ref. Rule {A4-151}, IMU ALIGNMENT). Using the scheduled alignment for these deorbit opportunities has no impact on the crew timeline workload and the align will be performed as required to optimize entry navigation. ©[011295-1752A]

I. THE CRITICAL ENTRY IMU STAR ALIGNMENT WILL BE REACCOMPLISHED AS REQUIRED IN ORDER TO PROTECT THE 0.5 DEGREE (RSS) ATTITUDE ERROR LIMIT (REF. RULE {A4-151}, IMU ALIGNMENT). IF A "NO-GO" FOR DEORBIT IS GIVEN PRIOR TO THE IMU ALIGNMENT, THEN, TIMELINE PERMITTING, THE ALIGNMENT WILL SLIP TO THE SAME RELATIVE PLACE AS NOMINAL WITH RESPECT TO THE NEW BACKUP DEORBIT OPPORTUNITY.

From the time of critical alignment for entry to the one orbit late backup orbit deorbit time, the IMU drift is still within requirements to support an entry without a realignment. If a NO-GO for deorbit is called prior to the entry alignment, it is best to move the alignment to the nominal pre-entry time to maximize IMU accuracy for entry (ref. A/E Flight Techniques #5, Sept. 9, 1983). ©[011295-1752A]

J. IMU STAR ALIGNMENTS WILL BE PERFORMED AS REQUIRED TO MAINTAIN THE ENTRY INTERFACE (EI) IMU ALIGNMENT CRITERIA. STAR ALIGNMENTS WILL BE SCHEDULED APPROXIMATELY ONCE PER FLIGHT DAY. ©[011295-1752A]

IMU star alignments will be performed periodically on orbit to ensure that the 0.5 degree (RSS) EI IMU alignment criteria is satisfied for contingency situations (ref. Rule {A4-151}, IMU ALIGNMENT). For nominal circumstances, the desired 0.25 degree alignment criteria will be maintained to ensure the best possible navigation performance during entry. IMU star alignments will be performed using either star-of-opportunity (SOO) data or star data acquired from dedicated orbiter maneuvers.

Scheduling star alignments once per flight day accounts for the expected IMU performance to ensure that the EI criteria is satisfied, while minimizing crew time and RCS propellant usage for alignments. ©[011295-1752A]

THIS RULE CONTINUED ON NEXT PAGE

FLIGHT RULES

A8-110

IMU SYSTEM MANAGEMENT (CONTINUED)

- K. IMU GYRO CALIBRATION WILL BE BASED ON A SET OF TORQUING ANGLES MEASURED AT LEAST 3 HOURS FROM THE TIME THE PREVIOUS SET OF TORQUING ANGLES WAS MEASURED.

For several hours postalignment, the misalignment uncertainty is as large as the actual platform misalignment. Therefore, reliable drift rates cannot be computed from torquing angles generated shortly after an alignment. As IMU misalignment grows with time, one can more accurately determine the true drift rate of the platform.

- L. CALIBRATION DATA WILL BE UPLINKED TO THE BFS, IF REQUIRED, AS SOON AS PRACTICAL ON ENTRY DAY. @[011295-1752A]

As the BFS has not been running on orbit, the gyro drift and accelerometer changes have only been made in the PASS. Thus, the BFS machine needs to be brought up to date with the PASS machine bias alterations by uplink as soon as practical on entry day.

- M. G-SENSITIVE TERMS WILL BE UPDATED IN-FLIGHT VIA UPLINK, BASED ON ANALYSES OF ASCENT PERFORMANCE AND PREDICTED CHANGES AS REQUIRED TO MAINTAIN 3 SIGMA LRU PERFORMANCE. @[011295-1752A]

Analysis of ascent data may indicate a scale factor problem (G-sensitive term) in an IMU. An uplink will be done to maximize performance. Due to the granularity of MCC programs, it will not be possible to guarantee any level of LRU performance.

@[111501-4906]

FLIGHT RULES

A8-111

GNC AIR DATA SYSTEM MANAGEMENT [CIL]

- A. AIR DATA WILL BE INCORPORATED INTO G&C BASED ON A REASONABLENESS ASSESSMENT OF h , M , AND ALPHA ONBOARD, AND A REASONABLENESS ASSESSMENT OF THE ALTITUDE (H-GROUND COMPUTED) AND RAW PRESSURES ON THE GROUND.

The crew is able to read h , M , and alpha onboard on their override SPEC. They can compare this to navigation data as we can on the ground. If the data agrees, within reason (reasonableness assessment), then the crew will pass the air data information into the flight control system. This assessment opportunity is used in solving dilemmas as well.

- B. IF ONLY ONE GOOD ADTA REMAINS, AIR DATA INPUT TO G&C WILL BE INHIBITED AND VEHICLE WILL BE FLOWN WITH "DEFAULT/NAVDAD" AIR DATA EXCEPT FOR THE FOLLOWING CONDITIONS WHEN A SINGLE GOOD ADTA WILL BE INCORPORATED INTO G&C:
1. BFS ENGAGE.
 2. BAD NAV STATE.
 3. HIGH WINDS ON THE HAC (≥ 80 KNOTS).
 4. ANYTIME THE ADDITIONAL BURDEN OF FLYING THETA LIMITS PRESENTS AN UNSATISFACTORY RISK OF LOSING CONTROL OR THE ABILITY TO MAINTAIN A SATISFACTORY GROUNDTRACK (CDR'S DISCRETION).

Incorporating air data (AD) to G&C when only a single ADTA remains may result in loss of vehicle control if that last remaining ADTA should fail. Numerous AD parameters (dynamic press, TAS, EAS, M , and alpha) are being used by the flight control system. Should the last remaining ADTA fail, no fault detection exists to identify or isolate this bad ADTA and loss of vehicle control could result before the crew or MCC can react. While a high piloting task, use of default AD/NAVDAD (flying "theta limits") is considered an acceptable flight control mode and should be used when only a single good ADTA remains.

The BFS, however, does not have default AD and, thus, resorts to NAVDAD alone for no AD. Also, the BFS itself is only single string. Therefore, when the BFS is engaged, incorporating the last ADTA into G&C is preferred.

In the event of a bad navigational state, air data incorporation would be required to G&C. Since NAVDAD/default air data utilizes navigation parameters (V_{rel} , altitude, drag decel, alpha, and vehicle mass), a bad navigation state, and in particular a bad V_{rel} , would be reason to incorporate AD to G&C when only a single ADTA remains.

THIS RULE CONTINUED ON NEXT PAGE

FLIGHT RULES

A8-111

GNC AIR DATA SYSTEM MANAGEMENT [CIL] (CONTINUED)

High winds on the HAC would be another circumstance for which air data will be incorporated into G&C. For winds on the HAC ≥ 80 knots, the risk of LOC or excessive loss of energy due to the difficulty of the theta limits task exceeds the risk of utilizing the last remaining ADTA.

A single ADTA will be incorporated into G&C, at the CDR's discretion, in the event conditions arise which would significantly increase the possibility of loss of vehicle control or result in an unsatisfactory groundtrack if theta limits were flown. The crew task of flying "theta limits" should be avoided when circumstances arise such that the crew is not able to devote the attention required for this task. These circumstances include, but are not limited to, numerous other systems failures, health problems, etc. As a result, under these conditions, the risk associated with using a single ADTA will be accepted.

Reference Entry Flight Techniques Panel meetings #39 and #43.

C. IF AIR DATA IS BEING INPUT TO G&C BELOW TAEM INTERFACE (< MACH 2.5), THE PITCH AXIS "CSS" MODE WILL BE SELECTED. "AUTO" MAY BE RESELECTED FOLLOWING INCORPORATION.

Dynamic pressure (Q-bar) and dynamic pressure rate (Q-bar dot) are currently not reinitialized for all ADTA SOP dynamic pressure source selection changes. Large, falsely derived Q-bar dot rates can occur during NAVDAD-to-air-data mode changes. In TAEM ($M < 2.5$), an increase in Q-bar of the order that can occur during the NAVDAD-to-air-data mode change will result in a step in the normal acceleration command (Nzc). Pitch axis CSS mode will prevent the step Nzc change.

D. WHEN ALL AIR DATA IS LOST OR NOT INCORPORATED INTO FLIGHT CONTROL, THETA LIMITS WILL BE ENFORCED. [CIL] ©[041196 1870A]

If air data is not incorporated into G&C, flight control defaults to use a fixed value of alpha (7.5 degrees). Q-bar is derived from an I-loaded table as a function of navigation ground relative velocity (V_{rel}). Since guidance no longer limits alpha by protecting the low Q-bar boundary, it is necessary for the crew to follow theta limits on the vertical situation display. In this situation, the displayed alpha is not reliable. Keeping theta between the NOSE HI and NOSE LO region will ensure that the vehicle alpha is within acceptable limits. Allowing theta to exceed NOSE HI increases the chances of stall while allowing theta to fall below NOSE LO could cause Q-bar to increase to unacceptable limits. Keeping theta within limits also reduces energy dispersions. Although the speedbrake setting during Approach and Landing is affected by the lack of air data to G & C, off-line simulations have shown that when the speedbrake is left in auto, performance is generally better than when it is set to a predetermined position (reference AEFTP #128, 12/8/95). Therefore, the speedbrake will be left in auto and the setting evaluated for reasonableness. If the speedbrake setting is unreasonable, the crew may select manual speedbrake and set it as necessary. ©[041196 1870A]

THIS RULE CONTINUED ON NEXT PAGE

FLIGHT RULES

A8-111 GNC AIR DATA SYSTEM MANAGEMENT [CIL] (CONTINUED)

- E. DEPLOY/HEAT WILL BE SELECTED AFTER MACH 2.4 FOR ELS/ECAL LANDINGS OR IF PRECIPITATION IS PRESENT OR FORECAST PRIOR TO TOUCHDOWN. ©[033006-7279A]

Although initial probe temperatures at deploy typically are on the order of 300 degrees F, convective cooling will typically cool the probes to below freezing (32 degrees F) around the M=1 timeframe. Analysis and flight history have shown there is no risk of air data probe icing without precipitation present, and current weather flight rules adequately protect for probe icing conditions during nominal, RTL5, and TAL entries (reference Rule {A2-6}, LANDING SITE WEATHER CRITERIA [HC]). However, there are no constraints to protect for ECAL or emergency deorbit cases, and there is risk of encountering icing conditions. To protect for probe icing, and subsequent loss of air data or an air data dilemma, the probe heaters should be activated after Mach 2.4 when precipitation is likely. Mach 2.4 was chosen to reduce electrical bus loading during vent door operation.

Reference Ascent/Entry Flight Techniques Panel #212, June 14, 2005; Thermal Mathematical Model for Model 874AU Air Data Probe Subsystem Deployment, RMT Report 117424, Rev A., January 17, 1975; minutes from April 25, 1980 telecon between RI (M. Stiles) and Rosemount (T. Stickney) on Space Shuttle Air Data Probe Heat Transfer; and NASA Memorandum ES3-79-111M, Early ADS (Air Data System) Probe Deployment, September 7, 1979.

- F. IF POWERDOWN CONSIDERATIONS ONLY ALLOW ONE SET OF HEATERS TO BE USED, ONLY ONE PROBE WILL BE DEPLOYED, AND THAT PROBE WILL USE DEPLOY/HEAT.

Icing of one probe with two probes deployed almost guarantees an air data dilemma condition. For cases when heaters are required, but powerdown considerations (e.g., loss of two Freon loops) require that only one set of heaters be used; then the preferred technique will be to deploy only one probe with the heaters on. Flight software will compensate for the single probe configuration, with system accuracy slightly degraded from 6 percent with two probes to 7.3 percent with one probe (Ascent/Entry Flight Techniques Panel #112, June 14, 2005). Requirements are for accuracy at TAEM to be within 10 percent. Heater power requirements are 925 W for each probe. ©[033006-7279A]

Rules {A2-207}, LANDING SITE SELECTION [HC]; {A2-261}, ENTRY DTO/AUTO MODE/CROSSWIND DTO GO/NO-GO; and {A2-301}, CONTINGENCY ACTION SUMMARY [HC], reference this rule. ©[ED] ©[032807-8400]

FLIGHT RULES

THIS PAGE INTENTIONALLY BLANK

FLIGHT RULES

A8-112**AEROSURFACE ACTUATOR PROTECTION**

TO PRECLUDE DAMAGE TO AEROSURFACE ACTUATORS, APU'S WILL NOT BE STARTED IN OPS 2. ALSO, ALL AVAILABLE AEROSURFACE AMPLIFIERS MUST BE "ON" PRIOR TO APU START (REF. RULE {A10-22G}, APU START/RESTART LIMITS).

By turning the APU's on while in OPS 2, we run the risk of damaging the aerosurface actuators by applying hydraulic pressure to the systems. Since OPS 1, the aerosurfaces may have drifted from their last commanded position such that, if the position delta is great enough at APU start, it could be possible to generate such a command force on the actuator that damage may occur. If the APU's have to be started on orbit, it is prudent to turn the ASA's on prior to transition to OPS 8 and APU start. The OPS 8 software for aerosurface control will be active so that at transition to OPS 8 the aerosurface commands will be made equal to their present position.

Rule {A10-22G}, APU START/RESTART LIMITS, references this rule.

A8-113**OMS TVC SYSTEM MANAGEMENT**

A. FOR LOSS OF AN OMS TVC:

1. DURING PERIODS OF INACTIVITY, THAT OMS ENGINE WILL BE PARKED THROUGH THE NOMINAL EOM DEORBIT BURN CG AND THE TVC WILL BE POWERED OFF AS SOON AS PRACTICAL.

Parking the affected OMS engine through the cg and powering off the TVC protects against loss of that OMS engine for numerous single-point failures in the OMS TVC, failure of an FA MDM, or power failure. (Note: Loss of an FA MDM can result in loss of the remaining TVC on that engine, ignition redundancy on the other engine, and two +X RCS jets.) Given that the other OMS engine is usable, the procedure for parking that engine should be performed when practical.

2. OMS-1, OMS-2, AND THE DEORBIT BURN WILL BE PERFORMED TWO-ENGINE WITH TVC ACTIVE ON BOTH ENGINES.

As long as the other OMS engine is usable, sufficient redundancy exists to permit use of the remaining TVC for OMS burns. This is especially true for OMS-1, OMS-2, and the deorbit burn due to the criticality and time constraints of these burns.

3. IT IS PREFERABLE TO PERFORM ALL ON-ORBIT BURNS SINGLE ENGINE, USING THE OMS ENGINE WITH REDUNDANT TVC.

Given that OMS TVC redundancy is lost on one engine, it is preferable to perform all on-orbit burns single engine, using the OMS engine with redundant TVC. It is desired to leave the OMS engine with only a single TVC parked and powered off as much as possible to preserve it as a safe deorbit capability.

THIS RULE CONTINUED ON NEXT PAGE

FLIGHT RULES**A8-113****OMS TVC SYSTEM MANAGEMENT (CONTINUED)**

4. IF THE REMAINING TVC ON THE OMS ENGINE WITH THE FAILED TVC IS SUSPECT, POST-OMS-2 THAT OMS ENGINE WILL BE PARKED THROUGH THE NOMINAL EOM DEORBIT BURN CG ASAP AND POWERED OFF UNTIL AFTER THE DEORBIT BURN.

The purpose of this rule is to preserve the engine as a safe deorbit method. The engine should remain parked and powered off through the deorbit burn. The deorbit burn will be accomplished with that engine parked through the CG and TVC powered off. Post-deorbit burn, the engine should be powered on and driven to the entry stow position. (Ref. Rule {A8-53}, OMS TVC LOSS.)

5. IF THE AFFECTED OMS ENGINE IS THE LAST REMAINING OMS ENGINE:
 - a. OMS-1 WILL BE PERFORMED SINGLE ENGINE WITH TVC ACTIVE.
 - b. POST-OMS-1 THE OMS ENGINE WILL BE PARKED THROUGH THE CG ASAP AND POWERED OFF. OMS-2 AND ALL SUBSEQUENT OMS BURNS WILL BE PERFORMED SINGLE ENGINE, TRIMMED THROUGH THE CG WITH TVC OFF.

If the last OMS engine has only one TVC remaining, that engine should be parked through the CG and powered off as soon as possible to preserve it as a safe deorbit method. The first opportunity to park the engine is post-OMS-1 due to the time constraints and criticality of that burn. Since that engine is the last remaining engine, all OMS burns post-OMS-1 should be performed with the engine parked through the CG and TVC powered off. Even if RCS deorbit capability exists, parking the engine protects against the requirement for a next PLS entry for failure of the TVC. (Ref. Rule {A8-53}, OMS TVC LOSS.)

- B. FOR TWO-ENGINE BURNS WHERE ONE ENGINE IS TO BE BURNED WITH THE TVC POWER OFF, THE BURN WILL BE PERFORMED USING CG TRIMS.

For two-engine burns where one engine is to be burned with TVC power off, CG trims are required to protect for the loss of the engine with TVC on. Using CG trims places the OMS engine without TVC through the CG and enables the use of that engine if the engine with active TVC fails during the burn. (Ref. Rule {A8-53}, OMS TVC LOSS.)

THIS RULE CONTINUED ON NEXT PAGE

FLIGHT RULES

A8-113 OMS TVC SYSTEM MANAGEMENT (CONTINUED)

C. OMS TVC GIMBAL CHECKS

1. THE NOMINAL OMS GIMBAL CHECK PLAN IN OPS 1 AND OPS 3 WILL CONSIST OF PERFORMING ONE GIMBAL CHECK OF BOTH PRIMARY AND SECONDARY SYSTEMS POST-OMS-2 AND IN MM 301 (PRE DEORBIT BURN) .

IN OPS 2, POSTBURN GIMBAL CHECKS WILL BE PERFORMED ON THE GIMBALS THAT ARE PLANNED TO BE USED DURING THE NEXT BURN. ONLY GIMBALS THAT WILL BE USED FOR TWO-ENGINE CRITICAL BURNS OR ANY SINGLE-ENGINE BURN NEED BE CHECKED.

A full system gimbal check performed post-OMS-2 and prior to deorbit burn will always be performed in order to assess the status of the TVC system. The gimbals, nominally, will not be checked prior to OMS-2 due to the time constraints and ground coverage available.

It is desirable to minimize gimbal checks on orbit to increase the lifetime of the TVC's. Hence, for any single-engine or two-engine critical burn, only the system(s) that have not been checked since their last active use will be checked. During single-engine burns, the nonburning engine TVC is still active (unless powered off) and being driven and so must be checked before subsequent selection as an engine to be burned, per the criteria above (two-engine critical or single-engine burn). Checking the gimbals immediately after the previous burn provides the maximum amount of time to troubleshoot any problem uncovered during the check.

2. UNSCHEDULED GIMBAL CHECKS WILL BE PERFORMED AS REQUIRED BY MCC FOR SYSTEM ANALYSIS TO TROUBLESHOOT ANY INDICATED OMS SYSTEMS ANOMALIES.

Gimbal checks will be performed on a system anytime the MCC believes there may be a problem with a gimbal system.

A8-114 ENTRY BODY BENDING FILTER SELECTION

THE PAYLOAD BODY BENDING FILTER WILL BE SELECTED FOR RETURNING PAYLOADS GREATER THAN 10,000 LB.

Selection of the payload body bending filter for returning payloads greater than 10,000 lb precludes the flex body high frequency oscillations which creates greater elevon deflections and increased APU fuel consumption. The 10,000-lb weight is representative of the weight for primary payloads (i.e., PAM's, IUS, Syncom, etc.).

FLIGHT RULES

A8-115 GPS SYSTEM MANAGEMENT [HC] @[032807-8382]

- A. A GPS LRU WILL BE CONSIDERED TO BE FUNCTIONING PROPERLY GIVEN THE FOLLOWING CRITERIA: @[092602-5643]
1. NO COMMFAULT, HARDWARE, OR POWER FAILURES
 2. NO EXTENDED PERIODS OF HIGH FOM
 - a. ORBIT FOM LIMITS - CAN BE > 175 FT (FOM > 2) FOR NO MORE THAN 5 MIN.
 - b. ENTRY FOM LIMITS - CAN BE > 650 FT (FOM > 5) FOR NO MORE THAN 3 MIN.
 3. PERIODS OF TRACKING LESS THAN FOUR SATELLITES LIMITED TO NO MORE THAN 5 MIN.

The orbiter's GPS system (1-string and 3-string) is certified to be used for both on orbit and entry operations (as a TACAN replacement) with the consideration given to the above criteria for evaluating the status and availability of GPS. The above limits for FOM and periods of tracking less than four satellites were established to meet the requirements for on-orbit state vector maintenance as well as loss of service requirements for entry certification. Antenna pointing, structural blockage, and other constellation and environmental surroundings should be considered as having a possible impact on the GPS's ability to track satellites and maintain low FOM conditions. A receiver experiencing extended periods of high FOM during the entry plasma region or unavailable for use due to environmental, constellation, or signal blockage issues should not be considered failed per this rule. These specifications will be used to consider mission duration impacts, single-fault tolerance, and zero-fault tolerance for orbit and entry operations. (Ref. AEFTP #176 July 27, 2001, #185 June 28, 2002) @[092602-5643]

- B. ALL GPS LRU'S WILL BE POWERED ON PRIOR TO MIDNIGHT GMT -2.5 HOURS ON THE DAY PRIOR TO LANDING, AND WILL REMAIN POWERED ON THROUGH POST LANDING (INCLUDING ANY EXTENSION DAYS) .

An issue with the MAGR-S/3S GPS receiver can prevent verification of the current daily encryption key if the MAGR has been powered off for an extended period of time. The cause of this issue is unknown and it can occur even though the MAGR has a valid GUK key loaded. The issue has been observed to clear at the beginning of the next GPS day (midnight GMT) when the MAGR is able to successfully use the next day's daily key. The reasoning for the midnight GMT -2.5 hour requirement is to ensure that the MAGR has 30 minutes on time prior to midnight GMT -2 hours, which is when the next day's key broadcast begins.

The results of not following this rule are possible SPS (Standard Positioning Service) operation for receivers which have been powered off during the mission. In SPS mode, the affected receivers will only be capable of tracking satellites using C/A (coarse/acquisition) code on the L1 frequency. Operation in SPS mode is certified, however, will result in elevated FOM and reduced accuracy in the GPS state vector, as well as expose the receiver to increased risk of possible adverse effects of signal multipath. (Ref. MAGR-S/3S OPS NOTE, MAGR DR 110645 "PPS Anomaly")

Hazard report ORBI 211 references this rule. @[032807-8382]

FLIGHT RULES

A8-116

AEROJET DAP SYSTEMS MANAGEMENT [CIL] [HC]

TO MAXIMIZE THE PROBABILITY OF SAFE ENTRY, THE FOLLOWING ACTIONS ARE REQUIRED IN OPS 304/305: ©[082604-6360]

- A. FOR A STUCK/FAILED ELEVON OR BODYFLAP ACTUATOR, SELECT THE WRAP-DAP.

Limited engineering simulation data shows that use of the Wrap-DAP for a single stuck elevon actuator positioned within 10 degrees of trail, or a bodyflap actuator that is stuck at less than 70 percent deflection (+12 degrees) may be survivable. For a single stuck elevon position greater than 10 degrees from trail, or the bodyflap stuck at more than 70 percent deflection, a loss of control will likely result. The actual control margin available is dependant on the Cg location.

- B. THE LIMITED ENGINEERING DATA USED TO STUDY THE STUCK ELEVON ACTUATOR CASES ASSUMED NEOM STS-114 MISSION MASS PROPERTIES, WITH NO AERODYNAMIC OR ATMOSPHERIC DISPERSIONS IN THE SES. THE DATA USED TO STUDY THE STUCK BODYFLAP ACTUATOR CASES USED BOTH THE STS-107 AND STS-114 NEOM MASS PROPERTIES, WITH NO AERODYNAMIC OR ATMOSPHERIC DISPERSIONS IN THE BOEING-HOUSTON SDAP SIMULATOR, THE BOEING-HOUSTON FDAX ANALYSIS TOOL, AND IN THE SHUTTLE ENGINEERING SIMULATOR (SES). FOR A STUCK/FAILED RUDDER/SPEEDBRAKE ACTUATOR (RSBA):
1. SELECT BASELINE DAP PRIOR TO M=5 (SELECT BASELINE DAP IMMEDIATELY IF BETWEEN M=5 AND M=1).
 2. UTILIZE STUCK SPEEDBRAKE CONTINGENCY ENERGY MANAGEMENT PROCEDURES.

The purpose of using the Baseline DAP during entry for a stuck rudder/speedbrake actuator is to minimize the probability of loss of control in the Mach 5 to 1 region. The Baseline DAP is able to maintain control with a stuck rudder actuator, because the Baseline DAP utilizes tighter yaw jet deadbands, vice the wider yaw jet deadbands used by the Wrap-DAP. The wider yaw jet deadbands used by the Wrap-DAP were intentionally designed that way to reduce the RCS propellant consumption required during entry, but also allow a larger beta angle to build up. The larger beta angle in combination with the reduced lateral directional control margin in the M=5 to M=1 region lead to conditions that overcome the yaw jet control authority, and loss of control likely results on the Wrap-DAP. The Baseline DAP's use of tighter yaw jet deadbands reduces the beta angle, and as such, a positive control margin is maintained in the M=5 to 1 region. ©[082604-6360]

THIS RULE CONTINUED ON NEXT PAGE

FLIGHT RULES

A8-116

AEROJET DAP SYSTEMS MANAGEMENT [CIL] [HC]
(CONTINUED)

Limited engineering simulation data shows that use of the Baseline DAP for a failed rudder actuator stuck at trail, with the speedbrake at any position (0 percent to 100 percent), is most likely survivable. The limited engineering data used to study the stuck RSBA cases assumed STS-114 NEOM mass properties with no aerodynamic or atmospheric dispersions in the SES. A stuck RSBA where the rudder is stuck at a non-zero deflection may be controllable up to a rudder deflection of 5 degrees, but only in CSS. Stuck rudder deflections of greater than 5 degrees will likely result in a loss of control even under the best conditions, since significant amounts of entry RCS propellant are required to maintain control (greater than the protected entry RCS redlines). Below M=5, the aft RCS propellant is required because the yaw jets are the only other control effectors available to perform the rudder function. ©[082604-6360]

For a loss of rudder/speedbrake function, contingency energy management procedures are also required. The energy management procedures ensure that the vehicle has enough energy to make the runway and is able to touch down at a safe airspeed. The contingency energy management procedures are manual actions that are performed while on the HAC, and final approach to modulate vehicle energy, since the speedbrake is not available to perform that function. Energy management steps may include flying inside or outside the HAC, early gear deploy (below M=1), and/or selection of Close-In Aimpoint. Typically for a rudder at trail and a speedbrake stuck less than 40 percent, the vehicle will be high on energy; typically for a speedbrake stuck at more than 40 percent, the vehicle will be low on energy. For cases where the rudder has a non-zero deflection, the drag on the vehicle will be increased and the vehicle will typically be low on energy. The actions necessary to manage the vehicle energy are a function of the position of the stuck rudder/speedbrake position, and are not as time critical as the selection of Baseline DAP. As a result, the contingency energy management procedural actions are not available onboard the vehicle, and must be called up from the ground in real time once the stuck rudder/speedbrake position is identified.

The limited engineering analysis used to build this flight rule was completed in the September 2002 to April 2004 timeframe in response to the body flap and rudder/speedbrake actuator corrosion studies. A summary of the engineering tests and analysis was presented to A/E FTP #200 on April 23, 2004, and assessed the controllability of stuck FCS actuators from EI to touchdown. The study analyzed BF, RSB, and LOB elevon actuators stuck at various positions from EI to touchdown using STS-114 entry mass properties with nominal aerodynamic and atmospheric conditions. The BF study also utilized STS-107 NEOM mass properties. The study was not a full up Monte Carlo analysis. The stuck entry FCS actuator study only assessed controllability of the vehicle throughout the entry profile, and as such did not assess other concerns such as aerothermal effects on the aerosurfaces or elevon cove areas, structural loads associated with aerosurface hinge moments, tail-scrape concerns at touchdown, nose gear slap-down moments/loads, and vehicle energy loss in TAEM. ©[082604-6360]

THIS RULE CONTINUED ON NEXT PAGE

FLIGHT RULES

A8-116

AEROJET DAP SYSTEMS MANAGEMENT [CIL] [HC] (CONTINUED)

Probable Risk Assessment (PRA) work lists the entry FCS actuator mechanical failure modes near the top of all failure modes that could lead to a loss of control during entry. The PRA models predict that the most probable entry FCS actuator failure modes will occur about once in every 106,975 flights, and are due to mechanical failure in the Rudder/Speedbrake and Bodyflap gear box drive mechanisms. Many other FCS actuator failure modes were listed in the PRA study, including loss of mechanical actuator, jams due to foreign object debris (FOD), structural failure of the actuator, and a jammed power valve; but were considered lower probability than the mechanical gearbox failure modes. Reference the Probable Risk Assessment (PRA) Data Summit results, conducted by the Safety and Mission Assurance (S&MA) Directorate in the September 2003 timeframe. ©[082604-6360]

Reference elevon FMEA/CIL's 02-2C-C01-CR-A01; 02-2C-C01-CV-C08; 02-2C-C01-CV-C09; 02-2C-C01-ES-C06; 02-2C-C01-FE-B08; 02-2C-C01-PP-A06; 02-2C-C01-PP-A07; 02-2C-C01-PV-B05; 02-2C-C01-SP-01; 02-2C-C01-ST-A02; 02-2C-C01-SV-B01; 02-2C-C01-SW-C02; and 02-2C-C01-SW-C03. Reference rudder/speedbrake FMEA/CIL's 02-2A-011-10001; 02-2A-011-10003; 02-2A-011-10101; 02-2A-011-10102; 02-2A-011-10202; 02-2A-011-10401; 02-2A-011-10601; 02-2A-011-10802; 02-2A-011-11001; 02-2A-011-11002; 02-2A-011-11003; 02-2A-011-11201; 02-2A-011-11202; 02-2A-011-11205; 02-2A-011-11402; 02-2A-011-20001; and 02-2A-011-30001. Reference bodyflap FMEA/CIL's 02-2A-021-10001; 02-2A-021-10401; 02-2A-021-10502; 02-2A-021-10902; 02-2A-021-11001; 02-2A-021-11002; 02-2A-021-11003; 02-2A-021-11101; 02-2A-021-11102; 02-2A-021-11105; 02-2A-021-11302; 02-2A-021-11402; 02-2A-021-11601; 02-2A-021-20001; and 02-2A-021-30001.

Reference Hazard Controls ORBI-003 "Loss of Flight Control due to Loss of Elevon Function," ORBI-023 "Loss of Control During Entry due to Failure of the Rudder/Speedbrake System," and ORBI-025 "Loss of Control During Entry due to Failure of the Body Flap Mechanism."

Reference Rules {A8-19}, YAW JET DOWNMODE, and {A8-20}, ENTRY ELEVON SCHEDULE SELECTION CRITERIA.

Reference Shuttle Operations Data Book (SODB), Volume 1, Section 3.4.1.3.8 Thermal Protection Subsystem, Elevon/Bodyflap Limits.

Reference JSC-12843, Guidance & Control Systems Console Handbook, SCP 5.8 "ENTRY FCS ACTUATOR FAILURE RESPONSE (RSB, BF, ELEVON)" Revision J, PCN-8, dated October 4, 2002; and JSC-23254, Ascent/Entry GPO Console Handbook, SCP 2.8.21 "Stuck Speedbrake," Volume 1, Rev B, dated February 2002. ©[082604-6360]

Rule {A10-33}, APU DEFINITIONS, references this rule. ©[121505-7143B]

A8-117 THROUGH A8-150 RULES ARE RESERVED

FLIGHT RULES

GNC GO/NO-GO CRITERIA

A8-1001

GNC GO/NO-GO CRITERIA [HC] ©[032807-8383A]

SYSTEMS	INVOKE MDF IF:	ENTER NEXT PLS IF:	ENTER FIRST DAY PLS IF:
A. CONTROLLER AND SWITCHES:			
1. LH RHC (3).....	[2] 2 ↓ SAME SIDE [5]	[16] [2] 5 ↓ [5]	
2. RH RHC (3).....			
3. AFT RHC (3).....			
4. LH THC (3).....		[3] 3 ↓ [2]	
5. AFT THC (3).....			
6. LH RPTA (3).....			
7. RH RPTA (3).....			
8. LH SBTC (3).....	3 ↓ SAME SIDE		
9. RH SBTC (3).....	1 ↓ OTHER SIDE		
10. LH BF UP & DN SW (2).....			
11. RH BF UP & DN SW (2).....			
12. LH & RH RHC TRIM SW (2).....			
13. LH PANEL TRIM SW (2).....			
14. RH PANEL TRIM SW (2).....			
15. LH & RH BFS ENG SW (3).....			
16. LH FCS MODE AUTO SW (3).....		[4]	
17. RH FCS MODE AUTO SW (3).....			
18. LH & RH FCS MODE CSS SW (3).....			
19. LH FCS MODE BF A/M SW (3).....	2 ↓	[4]	
20. RH FCS MODE BF A/M SW (3).....			
21. LH & RH FCS MODE SB A/M (3).....			
22. LH SBTC TAKEOVER SW (3).....	3 ↓ SAME SIDE		
23. RH SBTC TAKEOVER SW (3).....	1 ↓ OTHER SIDE		
24. ENTRY MODE (4).....			
25. ABORT MODE SW (3).....			
26. ORBIT DAP PBI'S (2).....	[6]	[6]	

©[102402-5804C]

THIS RULE CONTINUED ON NEXT PAGE

FLIGHT RULES

A8-1001

GNC GO/NO-GO CRITERIA [HC] (CONTINUED)

<u>SYSTEMS</u>	INVOKE MDF IF:	ENTER NEXT PLS IF:	ENTER FIRST DAY PLS IF:
B. <u>TVC AND DRIVERS:</u>			
1. SSME ACT CHNL (4)			
2. SSME SEC ΔP (4)			
3. SRB ACT CHNL (4)			
4. SRB SEC ΔP (4)			
5. L OMS PITCH TVC (2)		[7] [8]	[7] [8]
6. L OMS YAW TVC (2)		[7] [8]	[7] [8]
7. R OMS PITCH TVC (2)		[7] [8]	[7] [8]
8. R OMS YAW TVC (2)		[7] [8]	[7] [8]
9. FORWARD RCS JETS (16)			
10. LEFT RCS JETS LEFT (4)		2 ↓ [11]	
11. RIGHT RCS JETS RIGHT (4)		2 ↓ [11]	
12. L/R RCS JETS VERNIER (4)			
13. LEFT RCS JETS UP (3)		2 ↓	2 ↓
14. LEFT RCS JETS DOWN (3)		2 ↓	2 ↓
15. RIGHT RCS JETS UP (3)		2 ↓	2 ↓
16. RIGHT RCS JETS DOWN (3)		2 ↓	2 ↓
17. LEFT RCS JETS AFT (2)		[8]	[8]
18. RIGHT RCS JETS AFT (2)		[8]	[8]

THIS RULE CONTINUED ON NEXT PAGE

FLIGHT RULES

A8-1001

GNC GO/NO-GO CRITERIA [HC] (CONTINUED)

<u>SYSTEMS</u>	INVOKE MDF IF:	ENTER NEXT PLS IF:	ENTER FIRST DAY PLS IF:
C. <u>AEROSURFACES:</u>			
1. FCS CHNL (4)		[16] 2 ↓ [9]	[16] 2 ↓ [9]
2. BF ACT CHNL (3).....		[16] 2 ↓	
3. ELEVON/BF POS FDBK (4).....	[12] 2 ↓ [9]	[12] 3 ↓ [9]	[12] 3 ↓ [9]
4. RUDDER POS FDBK (4).....		[12]	[12]
5. SPDBK POS FDBK (4).....		[12]	[12]
6. ELEVON PRI ΔP (4).....	2 ↓ [9]	3 ↓ [9]	
7. SEC ΔP (4).....			
D. <u>SENSORS</u>			
1. AA (LATERAL) (4).....	[16] 2 ↓	[16] 3 ↓	[16] 3 ↓
2. AA (NORMAL) (4).....			
3. RGA - ORB (4).....	[16] 2 ↓	[16] 3 ↓	[16] 3 ↓
4. RGA - SRB (4).....			
5. IMU (3).....		[16] 2 ↓	[16] 2 ↓
6. STAR TRACKER (2) & HUD (2).....	[6] 4 ↓ [19]	[6] 3 ↓ [19]	
7. -Z COAS (1).....		AND 1 ↓	
8. ATT REF PB (3).....	[10]	[10] 2 ↓	
9. TACAN (3) & SINGLE STRING GPS (1).....	[14] 3 ↓ [20]	[15] 4 ↓ [20]	
10. TACAN MODE SW (3).....			
11. TACAN ANT SEL (3).....			
12. TACAN CHNL SEL (3).....			
13. ADTA (4).....	[16] 2 ↓	[16] 3 ↓	[16] 3 ↓
14. MSBLS (3).....			
15. RA (2).....			

©[121296-4610] ©[ED] ©[111298-6750] ©[092602-5718] ©[032807-8383A]

THIS RULE CONTINUED ON NEXT PAGE

FLIGHT RULES

A8-1001

GNC GO/NO-GO CRITERIA [HC] (CONTINUED)

<u>SYSTEMS</u>	INVOKE MDF IF:	ENTER NEXT PLS IF:	ENTER FIRST DAY PLS IF:
E. DEDICATED DISPLAYS: 1. HUD (2)			

@[040899-2459B] @[032807-8383A]

- LEGEND:
- NO REQUIREMENT
 - REQUIRED
 - QUANTITY ()
 - NOTE REFERENCE []

THIS RULE CONTINUED ON NEXT PAGE

FLIGHT RULES**A8-1001 GNC GO/NO-GO CRITERIA [HC] (CONTINUED)**

NOTES:

- [1] RESERVED
- [2] THE AVAILABILITY OF A GOOD REPLACEMENT UNIT MAY BE USED TO SATISFY THE MINIMUM REQUIREMENTS FOR NEXT PLS OPPORTUNITY. (REPLACEMENT MAY OCCUR SUBSEQUENT TO NEXT PLS DECISION POINT.)
- [3] + X ONLY. REQUIRED ONLY IF RCS DEORBIT REQUIRED.
- [4] EITHER TWO OF THREE PER SIDE OR THREE OF THREE ON EITHER SIDE IS REQUIRED.
- [5] FOR FOUR OR MORE CHANNELS DOWN, REQUIRE ALL SYSTEMS NEEDED FOR AN EMERGENCY AUTOLAND (ADTA, MLS, AA-N₂). REF. RULE {A8-17}, EQUIPMENT REQUIRED FOR EMERGENCY AUTOLAND.
- [6] ROTATIONAL PULSE OR DISC RATE DAP MODE IS REQUIRED IN APPROPRIATE AXES FOR -Z COAS (PITCH AND ROLL) AND HUDS (PITCH AND YAW). Ⓜ[111298-6750]
- [7] ENGINE IS NO-GO IF TVC CAPABILITY IS LOST AS DEFINED IN RULE {A8-53}, OMS TVC LOSS.
- [8] REF. RULES {A6-1001}, OMS/RCS GO/NO-GO CRITERIA [CIL], FOR MDF AND NEXT PLS; {A2-301}, CONTINGENCY ACTION SUMMARY [HC], FOR FIRST DAY PLS; AND {A8-55}, ASCENT/ENTRY RCS CONTROL REQUIREMENTS [HC]. Ⓜ[042904-6239A] Ⓜ[032807-8400]
- [9] SAME SURFACE.
- [10] REQUIRED ONLY IF COAS AND/OR HUD IS REQUIRED. ANY LOCATION ACCEPTABLE.
- [11] ONE FAILED YAW JET AND ORBITER CG OUTSIDE NOMINAL EOM BOUNDARY IS CAUSE FOR NEXT PLS ENTRY PROVIDED THAT THE CG CANNOT BE RESTORED BY RECONFIGURATION, PAYLOAD DEPLOYMENT, ETC.
- [12] ENTER PLS IF POSITION FEEDBACK FAILURE(S) RESULTS IN TWO FCS CHNLS FAILED. Ⓜ[102402-5804C]
- [13] RESERVED
- [14] MDF IF SINGLE-FAULT TOLERANCE CAPABILITY EXISTS WITH THE REMAINING ENTRY NAVAIDS (TACAN OR SINGLE STRING GPS) AND COMMAND DELTA STATE CAPABILITY. IF HIGH-SPEED C-BAND RADAR IS NOT AVAILABLE FOR ENTRY (REF. RULE {A3-3}, HIGH SPEED TRACKING LAUNCH AND LANDING REQUIREMENTS) THEN DEORBIT NEXT PLS. Ⓜ[041196-1914] Ⓜ[092602-5718] Ⓜ[032807-8383A]
- [15] ENTER NEXT PLS (NOT FIRST DAY PLS) IF ALL FOUR ENTRY NAVAIDS (THREE TACANS AND SINGLE STRING GPS) ARE FAILED AND COMMAND DELTA STATE CAPABILITY EXISTS.
- [16] REFERENCE RULE {A2-207}, LANDING SITE SELECTION, FOR RUNWAY PRIORITIES.
- [17] RESERVED
- [18] RESERVED Ⓜ[102402-5804C]
- [19] THIS ASSUMES MANUAL CALIBRATION INSTRUMENTS ARE CALIBRATED AND VERIFIED. ANY UNCALIBRATED/UNVERIFIED INSTRUMENT SHOULD BE CONSIDERED FAILED FOR MISSION DURATION DETERMINATION. Ⓜ[111298-6750]
- [20] RESERVED Ⓜ[040899-2459B]
- [21] REFERENCE RULE {A8-115}, GPS SYSTEM MANAGEMENT. Ⓜ[092602-5718] Ⓜ[032807-8383A]

Reference Rule {A2-102}, MISSION DURATION REQUIREMENTS.

Rules {A8-4}, FAULT TOLERANCE PHILOSOPHY; {A2-301}, CONTINGENCY ACTION SUMMARY [HC]; and {A8-58}, ADI LOSS, reference this rule. Ⓜ[032807-8400]

When failure(s) require a next PLS entry but do not require a first day PLS entry, the rationale is that the risks associated with performing a first day PLS entry are greater than those associated with remaining on orbit until the next PLS opportunity.

THIS RULE CONTINUED ON NEXT PAGE

FLIGHT RULES**A8-1001 GNC GO/NO-GO CRITERIA [HC] (CONTINUED)****A. *CONTROLLERS and SWITCHES***

If necessary or desirable, most entry-critical controllers and switches can be reconfigured in OPS 8 and/or OPS 2 (ref. Rule {A8-6} CONTROLLERS/FCS SWITCHING FAULT TOLERANCE).

LH, RH RHC

For the loss of two RHC channels on the same controller, MDF is required. Subsequent failures can be tolerated on orbit, either by RM or by channel reconfiguration. For four or more RHC channels failed, the next failure results in the loss of at least one RHC, and possibly both. For five channels failed, a next PLS is required since the RHC's are zero-fault tolerant for manual flight of the vehicle. There are no first day PLS requirements for RHC channel failures, since an IFM will be done to recover the failed RHC.

LH THC

There are no first day PLS requirements for the left THC since an IFM will be performed to regain RCS deorbit capability, if required.

AFT RHC, THC

Loss of aft station capability does not require early mission termination since these systems are not available for entry (ref. Rule {A8-9}, AFT STATION GNC REDUNDANCY).

LH, RH RPTA

There are no mission duration impacts. Although manual control capability is desirable, RPTA control is not required for a safe entry.

LH, RH SBTC

For three SBTC channels failed on one side (loss of that SBTC) and one failed on the other side, MDF is required. The next failure, unless a commfault, will result in the loss of manual speedbrake operations. Reference A/E FTP #128, 12/8/95. ©[102402-5804C]

LH, RH BF UP and DN SW

There are no mission duration impacts since the body flap can be manually driven UP for any number of body flap UP/DOWN switch failures. Manual control is only required for off-nominal CG or aero conditions, to use the body flap as a trim device and allow better elevon control authority.

THIS RULE CONTINUED ON NEXT PAGE

FLIGHT RULES

A8-1001 GNC GO/NO-GO CRITERIA [HC] (CONTINUED)LH, RH PANEL and RHC TRIM SW

These switches are not considered critical for entry and do not impact mission duration.

LH, RH BFS ENGAGE SW

Failures associated with the BFS engage switches do not require early mission termination (ref. Rule {A8-11}, LOSS OF BFS).

LH, RH FCS MODE AUTO SWITCH

For three or more FCS MODE AUTO switch (PITCH and ROLL/YAW) contacts failed (at least two failed one side, one failed other side), a next PLS is required. The system is zero-fault tolerant since the next failure results in no capability to mode the flight control system to AUTO.

LH, RH FCS MODE CSS SW

Failures in these switches are not considered critical and do not require early mission termination. RHC hot stick (to manual control) is available any time in OPS 3.

LH, RH FCS MODE BF A/M SW

The body flap will be in AUTO under most flight conditions, but manual (MAN) may be required (off-nominal CG or aero conditions). For two BF AUTO/MAN (A/M) switch contacts failed, changing the body flap flight control mode is single-fault tolerant, and MDF is required. For three or more contacts failed (at least two failed one side, one failed other side), a next PLS is required. At least two contacts on each side, or all three contacts on one side, are required to maintain single-fault tolerance on these switches.

LH, RH FCS MODE SB A/M SW

The SB A/M switch is used to mode the speedbrake from MAN to AUTO only, since MAN is achieved with the SBTC takeover switch. If the crew is required to take over MAN speedbrake and subsequent failures result in the loss of capability to mode back to AUTO, the crew can remain in manual with no added workload.

LH, RH SBTC TAKEOVER SW

Reference rationale for LH, RH SBTC rationale.

THIS RULE CONTINUED ON NEXT PAGE

FLIGHT RULES

A8-1001 GNC GO/NO-GO CRITERIA [HC] (CONTINUED)

ENTRY MODE

This switch is not considered critical for entry. For a failure of the switch during entry (LO GAIN or NO-YAW-JET), the AUTO position can be selected on SPEC 51, OVERRIDE, in MM 304/305.

ABORT MODE SW

This switch is used to select the bailout function and early mission termination is not required.

ORBIT DAP PBI's

If the COAS is required for entry IMU alignment, then MDF is required by definition of COAS/STAR TRACKER requirements. If any of the required switches is zero-fault tolerant (and the COAS is required for entry IMU alignment), then a next PLS will be declared.

B. TVC and DRIVERS

SSME ACT CHNL and SSME SEC DELTA P

These systems are not required for performing a safe entry (impacts to postlanding configuration and turnaround activities only).

SRB ACT CHNL and SRB SEC DELTA P

These systems are not used for entry, and mission duration impacts do not apply.

L, R OMS PITCH and YAW TVC

The two OMS engines and the four +X RCS jets constitute three means of deorbit capability. If failures of the left and/or right OMS TVC in combination with failures of the +X RCS jets result in the loss of two out of three deorbit methods, then a next PLS (or first day PLS) is required (ref. Rule {A6-1001}, OMS/RCS GO/NO-GO CRITERIA [CIL], and Rule {A8-3}, LOSS OF GNC SYSTEM).

FORWARD RCS JETS

The forward RCS jets are not considered critical for entry. Reduction of mission duration is not required for failures of these jets.

THIS RULE CONTINUED ON NEXT PAGE

FLIGHT RULES

A8-1001 GNC GO/NO-GO CRITERIA [HC] (CONTINUED)

L, R RCS JETS LEFT and RIGHT (YAW JETS)

For one yaw jet failed and the orbiter CG outside of the nominal EOM boundary (ref. Rule {A4-153}, CG PLANNING), a next PLS is required due to the potential for elevon saturation. A full complement of yaw jets is required to ensure vehicle control within the contingency CG envelope. The loss of three yaw jets on the same side results in significantly degraded flight control in the low Q -bar regime (Q -bar < 20 psf). Therefore, a next PLS is required after two yaw jet failures, without regard to vehicle CG. There are no first day PLS requirements for the loss of these jets because the no-yaw-jet mode is certified (Q -bar > 20 psf) for flight control (ref. Rule {A6-1001}, OMS/RCS GO/NO-GO CRITERIA [CIL]; Rule {A8-19}, YAW JET DOWNMODE; Rule {A8-55}, ASCENT/ENTRY RCS CONTROL REQUIREMENTS [HC]; Entry Flight Techniques Panel, January 15, 1988; and Ascent/Entry Flight Techniques Panel #196, December 17, 2003). ©[042904-6239A]

L, R RCS VERNIER JETS

The loss of these jets has no impact on mission duration.

L, R RCS JETS UP and DOWN

For the loss of any two jets on the same side that fire in the same direction (two LEFT UP firing, for example), a next PLS (or first day PLS) is required. These jets are critical for vehicle pitch and roll control during entry, and entering next PLS reduces the risk for the next failure which could impact vehicle control (ref. Rule {A6-1001}, OMS/RCS GO/NO-GO CRITERIA [CIL]; Rule {A8-55}, ASCENT/ENTRY RCS CONTROL REQUIREMENTS [HC]; and Ascent/Entry Flight Techniques Panel #196, December 17, 2003).

L, R RCS JETS AFT (+X JETS)

If failures of the left and/or right OMS TVC in combination with failures of +X RCS jets result in the loss of two out of three deorbit methods, then a next PLS (or first day PLS) is required. There are no mission duration requirements for loss of these jets alone (ref. Rule {A6-1001}, OMS/RCS GO/NO-GO CRITERIA [CIL]; Rule {A8-55}, ASCENT/ENTRY RCS CONTROL REQUIREMENTS [HC]; and Ascent/Entry Flight Techniques Panel #196, December 17, 2003). ©[042904-6239A]

THIS RULE CONTINUED ON NEXT PAGE

FLIGHT RULES

A8-1001 **GNC GO/NO-GO CRITERIA [HC] (CONTINUED)**

C. AEROSURFACES

FCS CHANNELS

For one channel failed (any surface) the FCS is single-fault tolerant, with the exception of certain “smart failures” during specific windows of entry, and there are no mission duration impacts (ref. Rule {A8-4}, FAULT TOLERANCE PHILOSOPHY). The risk of sustaining a second failure in the FCS affecting the same aerosurface (ASA, MDM, or actuator) while on-orbit for the remainder of the mission (NEOM) will be assessed in real time as required per Rule {A2-102}, MISSION DURATION REQUIREMENTS. After the first failure, there are certain failures in the FCS command channels (ASA, servo valve, actuator) which could reduce flight control margins (2-on-1 force fight) for short periods during entry until the MCC and crew can isolate the bad channel. However, the risk of sustaining one of these failures at the three-level on the FCS command channels during entry is the same regardless of when entry occurs (i.e., the window-of-exposure is the same regardless of flight duration). For two channels failed on the same aerosurface, a next PLS (or first day PLS) will be declared. PLS landing site selection will be determined per Rule {A2-207}, LANDING SITE SELECTION. Loss of three command channels on any aerosurface is an uncertified flight mode. ©[121296-4610] ©[102402-5804C]

BF ACT CHNL

For one of three bodyflap (BF) channels failed, BF control is single-fault tolerant, and there are no mission duration impacts (ref. Rule {A8-4}, FAULT TOLERANCE PHILOSOPHY). The risk of sustaining a second BF channel failure while on-orbit for the remainder of the mission (NEOM) will be assessed in real time as required per Rule {A2-102}, MISSION DURATION REQUIREMENTS. For two channels failed, next PLS is required since BF control is zero-fault tolerant. It is required to maintain control of the BF in order to avoid off-nominal flying configurations and to prevent damage to the main engine bells and/or the body flap itself. There are no first day PLS requirements for BF channel failures. ©[121296-4610]

ELEVON/BF POS FDBK

For two elevon or body flap position feedbacks failed on the same surface, MDF is required since the system is single-fault tolerant. For three feedbacks failed on the same surface, the system is fail critical and a next PLS (or first day PLS) is required. However, if the affected port is bypassed, then the FCS channel loss criteria will apply (ref. Ascent/Entry Flight Techniques Panel #45, June 17, 1988). ©[ED] ©[042904-6239A]

RUDDER and SPDBK POS FDBK

The position feedbacks for these surfaces are not used in the aerojet DAP but are used for surface position indications on the SPI. Although desirable, these indications are not considered critical for entry and there are no mission duration impacts associated with them. However, if the affected port is bypassed, then the FCS channel loss criteria will apply (ref. Ascent/Entry Flight Techniques Panel #45, June 17, 1988). ©[ED] ©[042904-6239A]

THIS RULE CONTINUED ON NEXT PAGE

FLIGHT RULES

A8-1001 GNC GO/NO-GO CRITERIA [HC] (CONTINUED)

ELEVON PRI DELTA P

For two elevon primary delta pressure indications failed on the same surface, MDF is required since the system is single-fault tolerant. For three failed, a next PLS is required because the system is zero-fault tolerant. The effector system requires at least one primary pressure feedback loop in an actuator since the ASA relies on these pressure indications to provide command stability (ref. SODB, volume I, paragraph 3.4.5.1-4).

SECONDARY DELTA P

The aerosurface and SSME/SRB actuator secondary delta pressure transducers provide fault detection (RM) in the ASA's and ATVC's, respectively. If RM is lost, the system can still be managed (MCC required) and any failed channels can be manually bypassed if required. FCS channel loss criteria will apply for transducer failures that degrade the FCS performance/redundancy.

D. SENSORS

LATERAL AA

For two lateral axis AA's failed, an MDF is required and, for three failed, a next PLS (or first day PLS), is required. Landing site selection will be determined per Rule {A2-207}, LANDING SITE SELECTION. The lateral axis AA feedback is used in the aerojet DAP for turn coordination by preventing rolloff during bank maneuvers. The lateral feedback is also used for NWS control during rollout (ref. Ascent/Entry Flight Techniques Panel #45, June 17, 1988). ©[102402-5804C] ©[ED]

NORMAL AA

The normal AA feedback is used for ADI pitch error and alpha error indications only prior to MM 305. In MM 305, the normal AA feedback is used by guidance to provide Nz commands to the flight control system. However, failures in these feedbacks do not require reduction in mission duration because the crew can fly CSS in the pitch axis in MM 305, thereby removing the normal feedback from the command loop.

ORBITER RGA

For two orbiter RGA's failed, MDF is required because the system is single-fault tolerant on orbit. For three failed, a next PLS (or first day PLS) is required because the system is zero-fault tolerant on orbit. Landing site selection will be determined per Rule {A2-207}, LANDING SITE SELECTION. (ref. Ascent/Entry Flight Techniques Panel #45, June 17, 1988). ©[102402-5804C] ©[ED]

SRB RGA

These systems are not used for entry, and mission duration impacts do not apply.

THIS RULE CONTINUED ON NEXT PAGE

FLIGHT RULES**A8-1001****GNC GO/NO-GO CRITERIA [HC] (CONTINUED)**IMU

For the loss of one IMU, the system is single-fault tolerant, with the exception of certain “smart failures” during specific windows of deorbit and entry, and there are no mission duration impacts (ref. Rule {A8-4}, FAULT TOLERANCE PHILOSOPHY). The risk of sustaining a second IMU failure while on-orbit for the remainder of the mission (NEOM) will be assessed in real time as required per Rule {A2-102}, MISSION DURATION REQUIREMENTS. There are single-point failures that can result in either an unresolvable dilemma at the two-level, or bad selected data due to a transient output which is not present long enough for IMU RM to operate and declare a failure. For these cases, the onboard state vector and/or vehicle flight control could be significantly impacted during critical deorbit or entry phases. However, the risk of sustaining one of these failures at the two-level during entry is the same regardless of when entry occurs (i.e., the window-of-exposure is the same regardless of flight duration). Additionally, it is expected that the IMU entry two-level redundancy management (RM), including the use of BITE, will correctly isolate and reconfigure the system (prime selecting the good IMU) for at least 98 percent of all failures. For two IMU’s failed, a next PLS (or first day PLS) is required. The system is zero-fault tolerant because navigation and flight control require one IMU for entry. Landing site selection will be determined per Rule {A2-207}, LANDING SITE SELECTION. ©[041196-1914] ©[121296-4610] ©[ED] ©[102402-5804C] ©[032807-8383A]

STAR TRACKER/COAS/HUD ©[111298-6750]

If only one instrument for aligning the IMU’s remains, enter next PLS. It is important to note that in considering the availability of manual alignment instruments, an instrument can only be considered available if it has been calibrated and verified. An instrument that is not calibrated and verified should not be used to perform IMU alignments. Only the CDR HUD is considered calibrated at launch (except on OV-104). This calibration should be verified before using the HUD to perform IMU alignments. Refer to Rule {A8-108}, HUD/COAS SYSTEM MANAGEMENT.

The only exception to the PLS rule is the case where the -Z COAS is the only instrument remaining for performing IMU alignments. Since the probability of a COAS failure is considered extremely remote (COAS is a simple mechanical apparatus), the mission can be extended beyond next PLS to MDF.

If a manual alignment instrument is required, it is necessary to have the appropriate digital auto pilot (DAP) modes available. The DAP modes are required to allow the crew to mark accurately on a star. ©[111298-6750]

THIS RULE CONTINUED ON NEXT PAGE

FLIGHT RULES

A8-1001 **GNC GO/NO-GO CRITERIA [HC] (CONTINUED)**

ATT REF PB

The ATT REF PB is required for IMU alignments using the COAS or HUD. If the COAS and/or HUD is required for the entry and only a single ATT REF PB remains, a next PLS is required. It should be noted that only the forward station ATT REF PB's are supported in OPS 3; and, if only the aft PB remains, the alignment will have to be performed in OPS 2. ©[111298-6750]

TACAN AND SINGLE STRING GPS

For three of four Entry Nav aids (TACAN's and/or Single String GPS) failed, the system is single-fault tolerant (assuming command delta state capability exists), and MDF is required. For three of four LRU's failed, enter next PLS if high-speed C-band radar is not available for entry (ref. Rule {A3-3}, HIGH SPEED TRACKING LAUNCH AND LANDING REQUIREMENTS). For all four Entry Nav aids failed, a next PLS is required to protect for the loss of CONUS site capability. Entry with no TACAN's or GPS could require a GCA and/or a command delta state uplink to correct navigation errors, and declaring next PLS minimizes exposure to landings that do not have these options. Consideration must be given to Data and Power Bus configurations to ensure that fault tolerance exists for remaining TACAN and GPS LRU's. If fault tolerance does not exist, then a PLS landing is required (ref. Entry Flight Techniques Panels #28, #29, #30, #176, #185). ©[041196-1914] ©[092602-5718] ©[ED] ©[032807-8383A]

TACAN MODE SW, ANT SEL, CHNL SEL

The TACAN mode switch, antenna select, and channel select are not critical for entry. If the switch failures render the TACAN(s) unusable, then the TACAN loss criteria will apply.

THIS RULE CONTINUED ON NEXT PAGE

FLIGHT RULES

A8-1001

GNC GO/NO-GO CRITERIA [HC] (CONTINUED)ADTA

For two ADTA's failed, the system is zero-fault tolerant and MDF is required. With the next failure (three ADTA's failed), air data (AD) will not be incorporated into G&C except for specific off-nominal circumstances, and a next PLS (or first day PLS) is required. Landing site selection will be determined per Rule {A2-207}, LANDING SITE SELECTION. The incorporation of AD to G&C is required for auto flight control and very desirable for manual. It is highly desirable to protect against the last ADTA failure so that it can be used if necessary. Without AD, the crew will fly theta limits for pitch control (ref. Ascent/Entry Flight Techniques Panel #45, June 17, 1988, Entry Flight Techniques Panel #34, August 21, 1987, and Ascent/Entry Flight Techniques Panel #187, September 20, 2002). [102402-5894C] [102402-5804C] [102402-5804C] [ED]

MSBLS

There are no requirements for early mission termination for MLS failures, since in most cases a safe landing can be performed without the use of MLS (ref. Rule {A8-18}, LANDING SYSTEMS REQUIREMENTS). [041196-1914] [ED] [032807-8383A]

RA

The radar altimeters are used for altitude source from 5k feet to the ground and are highly desirable for night landings and/or low ceilings. However, there are no mission duration impacts for RA failures. (Ref. Rule {A8-18}, LANDING SYSTEMS REQUIREMENTS.) [072398-6646]

THIS RULE CONTINUED ON NEXT PAGE

FLIGHT RULES

A8-1001 **GNC GO/NO-GO CRITERIA [HC] (CONTINUED)**

E. *DEDICATED DISPLAYS* @[032807-8383A]

HUD

The HUD is highly desirable but not mandatory for night landings; therefore, an MDF is not required.
@[111298-6750]

Hazard Reports ORBI 051, 052, 061, 152, and 211 reference this rule. @[032807-8383A]

FLIGHT RULES

SECTION 9 - ELECTRICAL

LOSS/FAILURE DEFINITIONS

A9-1	FUEL CELL (FC) LOSS [CIL] [HC].....	9-1
A9-2	FC ALTERNATE H2O SYSTEM LOSS.....	9-6
A9-3	ELECTRICAL POWER DISTRIBUTION AND CONTROL (EPDC) SYSTEM [CIL].....	9-7
A9-4	CAUTION AND WARNING (C&W).....	9-9
A9-5	THROUGH A9-50 RULES ARE RESERVED.....	9-9

FUEL CELL SYSTEMS MANAGEMENT

A9-51	FC POWER LEVEL CONSTRAINTS [HC].....	9-10
A9-52	FC PURGE [HC].....	9-11
A9-53	FC H2O SYSTEM HEATERS.....	9-14
A9-54	FC STANDBY DEFINITION.....	9-14
A9-55	FC SHUTDOWN DEFINITION [CIL] [HC].....	9-15
A9-56	FC SAFING [HC].....	9-16
A9-57	REUSABLE FC [HC].....	9-18
A9-58	FC HEATER MANAGEMENT [HC].....	9-20
A9-59	FC - CELL PERFORMANCE MONITOR [CIL].....	9-23
A9-60	FC COOLANT PUMP/H2 PUMP/H2O SEPARATOR FAILURE MANAGEMENT [CIL] [HC].....	9-24
A9-61	ACTIONS FOR FUEL CELL PH INDICATIONS.....	9-26
A9-62	FUEL CELL MONITORING SYSTEM DATA TAKE.....	9-28
A9-63	THROUGH A9-100 RULES ARE RESERVED.....	9-28

FLIGHT RULES

DC POWER DISTRIBUTION AND CONTROL SYSTEMS MANAGEMENT

A9-101	DC BUS VOLTAGE LIMITS [HC].....	9-29
A9-102	ESSENTIAL BUS.....	9-29
A9-103	POWER REDUCTION GUIDELINES.....	9-29
A9-104	MAIN BUS SHORT [HC].....	9-30
A9-105	CB/RPC RESET.....	9-32
A9-106	CONTROL BUS [HC].....	9-33
A9-107	MAIN BUS TIE [CIL] [HC].....	9-36
A9-108	CRITICAL PHASE BUS MANAGEMENT.....	9-38
A9-109	PRIMARY PAYLOAD BUS MANAGEMENT.....	9-39
A9-110	PREFLIGHT TEST BUS MANAGEMENT.....	9-40
A9-111	SHORTED BUS/EQUIPMENT.....	9-44
A9-112 THROUGH A9-150	RULES ARE RESERVED.....	9-44

AC POWER DISTRIBUTION AND CONTROL SYSTEMS MANAGEMENT

A9-151	AC INVERTER MANAGEMENT.....	9-45
A9-152	AC BUS SENSORS SWITCH MANAGEMENT.....	9-45
A9-153	AC BUS LOADING.....	9-45
A9-154	AC LOAD MANAGEMENT DURING ASCENT [HC].....	9-46
A9-155	AC INVERTER OPERATIONAL LIMITS.....	9-49
A9-156	LOSS OF SINGLE-PHASE AC.....	9-52
A9-157	LOSS OF TWO-PHASE AC.....	9-53
A9-158	AC POWER TRANSFER CABLE.....	9-53
A9-159	MOTOR CONTROL ASSEMBLY (MCA).....	9-54
A9-160	CAUTION AND WARNING (C&W) [CIL].....	9-54
A9-161	HYDRAULIC CIRCULATION PUMP OPERATION.....	9-55
A9-162 THROUGH A9-200	RULES ARE RESERVED.....	9-55

FLIGHT RULES

CRYOGENIC LOSS/FAILURE DEFINITIONS

A9-201	O2 (H2) MANIFOLD.....	9-56
A9-202	CRYO TANK.....	9-57
A9-203	CRYO TANK ANNULUS VACUUM.....	9-58
A9-204	CRYO HEATER [CIL] [HC].....	9-59
A9-205	O2 DELTA CURRENT SENSOR.....	9-60
A9-206	THROUGH A9-250 RULES ARE RESERVED.....	9-60

CRYOGENIC SYSTEMS MANAGEMENT

A9-251	CRYO HEATER MANAGEMENT FOR ASCENT.....	9-61
A9-252	CRYO HEATER MANAGEMENT FOR ORBIT [CIL].....	9-62
A9-253	CRYO TANK HEATER TEMPERATURE MANAGEMENT.....	9-66
A9-254	CRYO HEATERS DEACTIVATION.....	9-66
A9-255	O2 DELTA CURRENT SENSOR.....	9-67
A9-256	CRYO O2/H2 TANK QUANTITY BALANCING.....	9-68
A9-257	POWER REACTANT STORAGE AND DISTRIBUTION (PRSD) H2 AND O2 REDLINE DETERMINATION.....	9-70
A9-258	CRYO O2 AND H2 PRESSURE MANAGEMENT.....	9-71
A9-259	CRYO O2/H2 MANIFOLD VALVES.....	9-73
A9-260	CRYO SYSTEM LEAKS [CIL].....	9-75
A9-261	IMPENDING LOSS OF ALL CRYO.....	9-78
A9-262	EDO PALLET MANAGEMENT.....	9-79
A9-263	CRYO O2 MANAGEMENT FOR EVA SUPPORT.....	9-79
A9-264	THROUGH A9-300 RULES ARE RESERVED.....	9-79

SPACEHAB SUPPORT

A9-301	SPACEHAB DC BUSES.....	9-80
A9-302	SPACEHAB AC INVERTER.....	9-80
A9-303	THROUGH A9-350 RULES ARE RESERVED.....	9-80

FLIGHT RULES

SPACEHAB ELECTRICAL POWER SUBSYSTEM (EPS) MANAGEMENT

A9-351	ELECTRICAL POWER SUBSYSTEM (EPS) CONSTRAINTS..	9-81
A9-352	SPACEHAB MAIN BUS MANAGEMENT.....	9-82
A9-353	SPACEHAB EMERGENCY BUS LOSS.....	9-83
A9-354	SPACEHAB AC MANAGEMENT.....	9-84
A9-355	FUSE/CIRCUIT BREAKER MANAGEMENT.....	9-88
A9-356	FUEL CELL FAILURE MANAGEMENT.....	9-89
A9-357	SPACEHAB SURVIVAL POWER CONFIGURATION.....	9-89
A9-358	CAUTION AND WARNING (C&W).....	9-89
A9-359 THROUGH A9-400	RULES ARE RESERVED.....	9-89

STATION TO SHUTTLE POWER TRANSFER SYSTEM (SSPTS) LOSS/FAILURE DEFINITIONS

A9-401	SSPTS ORBITER POWER CONVERSION UNIT (OPCU)....	9-90
A9-402	SSPTS ASSEMBLY POWER CONVERSION UNIT (APCU)...	9-91
A9-403 THROUGH A9-450	RULES ARE RESERVED.....	9-91

SSPTS SYSTEM MANAGEMENT

A9-451	SSPTS ORBITER POWER CONVERSION UNIT (OPCU) MANAGEMENT.....	9-92
A9-452	SSPTS OPCU FAILURE MANAGEMENT.....	9-92
A9-453 THROUGH A9-460	RULES ARE RESERVED.....	9-94

SSPTS APCU MANAGEMENT

A9-461	SSPTS APCU INPUT POWER MANAGEMENT.....	9-95
A9-462	SSPTS APCU OUTPUT RELAY MANAGEMENT.....	9-95
A9-463	SSPTS APCU OUTPUT POWER CONSTRAINTS.....	9-96
A9-464	SSPTS APCU FAILURE MANAGEMENT.....	9-96
A9-465 THROUGH A9-470	RULES ARE RESERVED.....	9-97
A9-471	SSPTS PTU ASCENT AND ENTRY MANAGEMENT.....	9-98

FLIGHT RULES

ELECTRICAL GO/NO-GO CRITERIA

A9-1001 ELECTRICAL GO/NO-GO CRITERIA [HC]9-99

FLIGHT RULES

THIS PAGE INTENTIONALLY BLANK

FLIGHT RULES

SECTION 9 - ELECTRICAL

LOSS/FAILURE DEFINITIONS

A9-1 FUEL CELL (FC) LOSS [CIL] [HC] @[033006-7297A]

A FUEL CELL (FC) IS CONSIDERED LOST IF:

- A. AN ABNORMAL OR UNEXPLAINED VOLTAGE VERSUS CURRENT PERFORMANCE LOSS OF ≥ 0.5 VOLT FOR A SINGLE FC BASED ON PREDICTED PERFORMANCE DATA. @[ED]

For a three substack FC, the loss of 1 of 96 cells will result in a performance drop of approximately 0.5 volt. This assumes the FC is thermally stable with no internal heaters on. For each flight, predicted nominal performance curves are provided for each FC by Rockwell International Corp. via R&E subsystem manager. In-flight nominal performance is defined by the cue card curve selected after the first purge (reference back of the FC cue card).

DOCUMENTATION: SODB 3.4.4.1.6.b.

- B. THE COOLANT PUMP OR H₂ PUMP/H₂O SEPARATOR IS LOST. [CIL]

Loss of coolant pump results in loss of FC cooling and cryogenic O₂/H₂ preheating capability. With ascent electrical loads, excessive heating of the FC power section can occur within 9 minutes of pump failure. Excessive heating of the FC results in loosening of the stack due to loss of tie-rod tension resulting in the uncontrolled mixing of O₂ and H₂ that is a catastrophic failure. Since the FC coolant loop is no longer circulating, the cryogenic preheaters are no longer warming the cold reactants. This results in excessive cooling of the dual-gas regulator and possible loss of pressure regulation. Loss of H₂ pump results in loss of water removal capability from the FC. A FC without water removal capability has a predicted lifetime of about 110 amp-hrs. (See paragraph E for 110 amp-hr explanation.) @[ED]

DOCUMENTATION: SODB, 3.4.4.1.15.

Rules {A9-1001}, ELECTRICAL GO/NO GO CRITERIA [HC], and {A9-160}, CAUTION AND WARNING (C&W) [CIL], reference this rule. @[ED] @[ED]

THIS RULE CONTINUED ON NEXT PAGE

FLIGHT RULES**A9-1 FUEL CELL (FC) LOSS [CIL] [HC] (CONTINUED)**

- C. THE FC STACK COOLANT TEMPERATURE IS > 250 DEG (242.5 DEG) F OR < 175 DEG (182.5 DEG) F. @[ED]

At a stack temp > 250 deg F, FC tie-rods lose tension causing loosening of the FC stack and seat/seal softening occurs allowing direct O₂/H₂ reactant mixing, or possible FC failure due to reactant gas crossover through a dry electrolyte matrix resulting from excessive water removal. At a stack temp < 175 deg F, water removal capability is degraded sufficiently to allow FC failure due to dilution of KOH electrolyte to the point where it will no longer support adequate reaction within the cell. This flooding is caused by the reduced vapor pressure of H₂O at lower temperatures. Normally the water is removed from the power section as a vapor. It cannot be removed as a liquid. @[ED]

DOCUMENTATION: SODB, 3.4.4.1.11. @[ED]

- D. THE COOLANT PRESSURE IS > 75 (71.4) PSIA AND INCREASING. @[ED]

Normal coolant pressure range is 55 to 70 psia. All insight into coolant pressure is lost at 100 psia. No real constraint at up to 100 psia has been identified. The upper limit comes from O₂/H₂ dual-gas regulator relief valve crack pressures plus instrumentation error. Likely causes of increased coolant pressure are preheater leak which would probably be confirmed by coolant pump cavitation causing delta P to fluctuate and eventually remain low, O₂/H₂ dual-gas regulator shift high, regulator stage failed open, or thermal expansion of an overfilled coolant loop (STS 61-A).

DOCUMENTATION: SODB, 4.4.1.6.i.

- E. THE FC IS UNABLE TO DISCHARGE WATER. [CIL]

Inability to relieve product water from a FC results in loss of the FC due to flooding within approximately 110 amp-hr. The 110 amp-hr figure assumes a healthy FC with a KOH concentration of 32 percent at the time water removal capability is lost. With a water production rate of 0.02371 lb H₂O/amp-hr, the KOH concentration falls to 26 percent (flooded condition) within approximately 110 amp-hrs. Actual FC lifetime after loss of water removal capability depends on KOH concentration at the time of the failure. Even temporary water line blockage can result in an H₂ pump/water separator motor stall due to water buildup. Once stalled, the motor may not restart even if the blockage is removed. In a flooded cell, water electrolysis and O₂ generation in the H₂ system can occur. Therefore, a flooded fuel cell must be shut down and/or safed. @[ED] @[033006-7297A]

THIS RULE CONTINUED ON NEXT PAGE

FLIGHT RULES**A9-1****FUEL CELL (FC) LOSS [CIL] [HC] (CONTINUED)**

Analysis has indicated that if a FC is shut down on orbit, the product H₂O line could freeze in some attitudes. The location of the heater thermostat may result in the inability of the H₂O line heaters to cycle with sufficient duty cycle to maintain the product H₂O line above 32 deg F. Due to lack of direct insight into the product H₂O line temperature, analysis will need to be performed to predict how much time is available before the line freezes. Restart of a fuel cell that is considered reusable must be performed prior to exceeding the "time to freeze" analysis prior to continuing past MDF. (Reference Rules {A9-55}, FC SHUTDOWN DEFINITION [CIL] [HC], and {A9-57}, REUSABLE FC [HC].) With no direct insight into the product H₂O line temperatures, it may be unknown if the line has frozen and the integrity of the H₂O line has been compromised. A frozen product H₂O line may cause fuel cell flooding. Confirming cues for FC flooding may be seen in FC performance degradation, FC temperatures, H₂ pump status and associated AC currents, the delta amps when FC is bus tied, substack delta volts, and the Fuel Cell Monitoring System (FCMS). The fuel cell H₂O production rate into the supply H₂O tanks may also be useful in determining H₂O line blockage or rupture. Restart of a fuel cell with a product H₂O line that has ruptured may result in free water in the payload bay. If any confirming cues exist to indicate the fuel cell is flooding or the product H₂O line integrity is in question, the fuel cell will be shut down and considered lost for the remainder of the mission. ©[033006-7297A]

Reference Hazard Report ORBI 253, Loss of Electrical Power Due to FCP Flooding.

DOCUMENTATION: SODB, 4.4.15, and Orbit Flight Techniques Panel #223, February 10, 2006. ©[033006-7297A]

F. LOCAL KOH CONCENTRATION IS > 48 PERCENT (45 PERCENT) DRY OR < 24 PERCENT (29 PERCENT) WET AS INDICATED BY FC STACK TEMPERATURE, CONDENSER EXIT TEMPERATURE, AND CURRENT RELATIONSHIP. ©[ED]

A KOH concentration > 48 percent indicates that a FC is drying out. This condition can lead to uncontrolled mixing of O₂ and H₂ (crossover) through a dry electrolyte matrix, which is a hazardous situation. A KOH concentration < 24 percent indicates a wet FC which leads to a flooded condition; i.e., fluid covering the O₂ and H₂ reaction sites to the point that it will no longer support adequate reaction within the FC. If the H₂/H₂O separator is running, flooding a FC can lead to the leaching of KOH from the FC matrix and expulsion into the FC manifold and the orbiter potable H₂O supply. This contaminated H₂O is unsuitable for crew consumption and FES usage. KOH in the FC manifold is a possibly catastrophic situation inside the FC since the disassociation of H₂O could occur, generating O₂ in the H₂ manifold. ©[ED]

DOCUMENTATION: SODB, 3.4.4.1.8.a.

THIS RULE CONTINUED ON NEXT PAGE

FLIGHT RULES

A9-1 FUEL CELL (FC) LOSS [CIL] [HC] (CONTINUED)

G. A FC REACTANT VALVE FAILS CLOSED. [ED]

FC is unable to produce electricity without reactants.

H. THE FC CANNOT BE CONNECTED TO A MAIN BUS. [CIL]

An FC capable of producing power cannot be utilized if it cannot be connected to main bus A, B, or C.

I. CONFIRMED PRESENCE OF KOH IN THE FC PRODUCT WATER DOES NOT CLEAR IN 1 HOUR. [070899-6892A]

KOH in the fuel cell product water is a hazardous situation. KOH can be transported to the H₂ manifold in the humidified H₂ stream that can create a conductive path providing a mechanism for the disassociation of H₂O into O₂ and H₂ through electrolysis, producing a potentially explosive environment in the fuel cell. KOH is a highly corrosive material, exposure of the FES to KOH can lead to FES core damage resulting in leakage and/or blockage. Purging a FC in which this leaching has occurred can deposit KOH into the common H₂ purge line causing possible clogging of the line and preventing over pressure relief and H₂ purge capability from all three fuel cells. A FC should be safed for this failure. [070899-6892A] [ED]

The 1-hour limit is based on flight experience and engineering judgment. Flight experience has shown that, on occasion, some fuel cells have residual KOH (either from a new stack build or from being in storage for extended periods of time) that is expelled into the product water. Small amounts of residual KOH in FC product water will not lead to a hazardous O₂ concentration in the H₂ manifold; therefore, the 1-hour time will allow for the intermittent pH condition to clear. During STS-79, KOH was expelled from a fuel cell (new stack build) for a period lasting approximately 20 minutes. In addition, STS-2 flight experience and vendor tests have shown that if hazardous amounts of KOH are being expelled from the FC, other signs of degradation will be present. [070899-6892A]

Methods of confirming KOH in the product water after an initial fuel cell pH indication include: an indication from the pH sensor in the common product H₂O line, litmus test of the product water confirming pH>9, unexplained FC performance degradation, or by FC flooding. Confirming cues for FC flooding may be seen in FC performance degradation, FC temperatures, H₂ pump status and associated AC currents, and the Delta Amps when FC is bus tied. Substack delta volts and the Fuel Cell Monitoring System (FCMS) may also be useful in confirming flooding or performance degradation in a fuel cell.

DOCUMENTATION: SODB, 3.4.4.1.13., STS-2 flight experience, STS-79 flight experience, engineering judgment, and vendor testing. [070899-6892A] [ED]

THIS RULE CONTINUED ON NEXT PAGE

FLIGHT RULES

A9-1 FUEL CELL (FC) LOSS [CIL] [HC] (CONTINUED)

J. THE FC SUBSTACK DELTA VOLTS CHANGES BY 150 MV FROM THE BASELINE PREFLIGHT VALUE, IS INCREASING, AND MEASUREMENT OF SINGLE CELL VOLTAGES HAS NOT BEEN PERFORMED. [CIL] ©[070899-6893A]

The failure that the cell performance monitor (CPM) is designed to detect; i.e., reactant crossover, can be hazardous if allowed to progress uncontrolled. If time permits, the FCMS will be activated, data recorded, downlinked, and analyzed to verify FC health. If health cannot be verified before a change of 150 mv has occurred, the FC will be safed. If single cell voltages clearly show that crossover is not present (i.e., small degradation in multiple cells or CPM malfunction) fuel cell operation can continue. Since the FCMS requires use of Portable General Support Computers (PGSC's), it will not be available during Ascent/Entry and may not be available during other mission critical timeframes. Baseline prelaunch values are obtained once the fuel cells have been started, reached thermal equilibrium, and are operating at the nominal prelaunch load of 150 amps. ©[070899-6893A]

DOCUMENTATION: SODB, 3.4.4.1.6.a.

K. ITS VOLTAGE CANNOT BE MAINTAINED ≥ 27.5 VOLTS. ©[ED]

This voltage is required to assure that orbiter equipment requiring dc power is maintained at a voltage no lower than 24 volts. Below 27.5 volts, the capability to maintain voltage at all equipment above 24 volts is not possible due to line losses.

DOCUMENTATION: SODB, 3.4.5.6.2.

L. ANY SINGLE CELL OPEN CIRCUIT VOLTAGE IS BELOW 1100 MV.
©[070899-6893A]

It is the engineering judgment of the FC vendor and has been confirmed through testing that individual cells with voltages below 1100 mv at open circuit are most probably experiencing reactant crossover. It should be kept in mind that CPM readings are not valid for fuel cells that are at open circuit. There are single point wiring failures that could affect both the CPM and FCMS measurements. Single cell voltages < 1100 mv may be measured on cells whose voltage measurement pin connection has high resistance. High resistance in a cell pin connection manifests itself as a low voltage reading on a single cell and a high voltage reading on an adjacent cell. Verification of the health of cells with high resistance in the pin connection may not be possible.

DOCUMENTATION: Engineering judgment and Fuel Cell Lifetime Testing (serial # 122) at International Fuel Cells. ©[070899-6893A]

M. THE STARTUP HEATER IS FAILED ON. ©[102506-7765B]

THIS RULE CONTINUED ON NEXT PAGE

FLIGHT RULES

A9-1 FUEL CELL (FC) LOSS [CIL] [HC] (CONTINUED)

Thermal analysis by United Technologies Company (UTC) Fuel Cells indicates that a failed-on startup heater would result in marginal operation for a FC with a nominal on-orbit load of 5kW. Thermal equilibrium should be reached in approximately 15 minutes. The stack inlet temperature will rise from 182 to 212 degrees F, and the stack outlet temperature will rise from 204 to 228 degrees F. This results in calculated electrolyte concentrations of 47.6, 42.0, and 44.8 percent for the inlet, exit, and average cell conditions respectively. Operating the FC at higher power levels will drive the electrolyte concentration even higher and raise stack temperatures close to loss limits. The FC will not be useable as a single FC for entry and will be marginal or out of limits operating as a second FC, even after the loss of one FC powerdown steps are performed. Taking further powerdown steps to keep the FC operating as a second FC will result in reducing the vehicle's fault tolerance, possibly taking it to the loss of second FC powerdown fault tolerance level. ©[102506-7765B]

DOCUMENTATION: SODB 4.4.1.1.1

If a FC startup heater can be disabled by taking the FC Controller power to off, a FC which has been shut down in this manner may be reusable for a short period of time as a contingency only.

DOCUMENTATION: Engineering judgment ©[102506-7765B]

Rules {A9-52}, FC PURGE [HC]; {A9-55}, FC SHUTDOWN DEFINITION [CIL] [HC]; {A9-57}, REUSABLE FC [HC]; {A9-58}, FC HEATER MANAGEMENT [HC]; {A9-60}, FC COOLANT PUMP/H₂ PUMP/H₂O SEPARATOR FAILURE MANAGEMENT [CIL] [HC]; {A9-61}, ACTIONS FOR FUEL CELL PH INDICATIONS; {A9-160}, CAUTION AND WARNING (C&W) [CIL]; AND {A9-1001}, ELECTRICAL GO/NO-GO CRITERIA [HC], reference this rule. ©[ED] ©[102506-7766B] ©[ED]

A9-2 FC ALTERNATE H₂O SYSTEM LOSS

THE FC ALTERNATE H₂O SYSTEM IS CONSIDERED LOST IF:

- A. BOTH SYSTEM A AND B HEATER SYSTEMS ON THE FC ALTERNATE H₂O SYSTEM ARE LOST.

Loss of both heater systems will allow the stagnant H₂O in the alternate H₂O lines to freeze, resulting in a disabled alternate system.

- B. TWO OR MORE FC'S RELIEVING OVERBOARD.

Any FC relieving H₂O overboard indicates either a possible alternate and primary H₂O system failure or an overboard relief valve failed open. More than one FC relieving H₂O overboard indicates a probable generic FC H₂O system problem.

- C. ALTERNATE H₂O SYSTEM PRESSURE NOT TRACKING THE EVCSS (EMU WATER SUPPLY PRESSURE) H₂O SUPPLY PRESSURE (WHILE TANK B INLET AND OUTLET VALVES ARE OPEN) .

Normal on-orbit alternate H₂O pressure will track the EVCSS H₂O supply pressure. Alternate H₂O pressure not tracking indicates a probable alternate common path failure.

FLIGHT RULES

A9-3 ELECTRICAL POWER DISTRIBUTION AND CONTROL (EPDC) SYSTEM [CIL]

A. MAIN BUS IS CONSIDERED LOST IF THE BUS VOLTAGE CANNOT BE MAINTAINED > 27.0 (27.2) V DC AND < 32.0 (31.8) V DC. [CIL].
 ©[ED]

NOTE: WHEN THE OPCU IS PROVIDING POWER TO THE MAIN BUS, THE UPPER LIMIT INSTRUMENTATION ERROR CAN BE EXCEEDED IF NO OTHER BUS VOLTAGES ARE $>$ THAN 32.0 (31.8) V. ©[042507-8408F]

The OPCU voltage can be adjusted up to 31.8 ± 0.04 V dc; therefore, with SSPTS providing power to the main bus, the upper instrumentation limit could be violated. However, SSPTS is two fault tolerant to failures which would cause an output overvoltage at the main bus. The functionality of the over voltage protection circuits (the two overvoltage protections circuits and the fault isolator circuit) is checked out on the ground between every flight.

DOCUMENTATION: MC409-0547, PTU Spec, paragraph 3.2.1.2.2.1.2, OPCU Output Voltage Adjust Range; paragraph 3.2.1.2.9.1.2, OPCU Output Voltage Protection - Slow; paragraph 3.2.1.2.9.1.4, Fault Isolator; and paragraph 3.3.8.2, OPCU OOV (Output Over Voltage) Fault Tolerance; SODB 4.5.6.3.3.3 PTU OPCU Voltage; and engineering judgment.

B. FORWARD PCA BUS IS CONSIDERED LOST IF THE BUS VOLTAGE CANNOT BE MAINTAINED > 26.2 (26.4) V DC AND < 32.0 (31.8) V DC.
 ©[ED]

C. AFT PCA BUS IS CONSIDERED LOST IF THE BUS VOLTAGE CANNOT BE MAINTAINED > 26.1 (26.3) V DC AND < 32.0 (31.8) V DC. ©[ED]

D. CONTROL BUS IS CONSIDERED LOST IF THE BUS VOLTAGE CANNOT BE MAINTAINED > 24.8 (25.0) V DC AND < 32.0 (31.8) V DC, OR THE CONTROL BUS IS DETERMINED TO HAVE A SHORT BY THE MCC. ©[ED]

E. ESSENTIAL BUS IS CONSIDERED LOST IF THE BUS VOLTAGE CANNOT BE MAINTAINED > 25.5 (25.7) V DC AND < 38.0 (37.8) V DC. ©[ED]

Orbiter equipment is qualified to operate at 23 V dc for intermittent loads and at 24 V dc for continuous loads. Considering line losses from the orbiter buses to the user equipment, the lower voltage limits for the buses listed above guarantee 24 V dc at the equipment interface. The upper voltage for most orbiter equipment is 32 V dc; however, the equipment on the essential buses is qualified to 38 V dc due to the requirement to operate at near FC open circuit voltage. If a control bus is shorted, it will be unpowered even though its voltage measurement may be > 24.8 V dc. ©[ED]

Rule {A9-101}, DC BUS VOLTAGE LIMITS [HC], references this rule. ©[042507-8408F]

Reference Rule {A9-106}, CONTROL BUS, for additional control bus loss rationale. ©[ED]

THIS RULE CONTINUED ON NEXT PAGE

FLIGHT RULES

A9-3 ELECTRICAL POWER DISTRIBUTION AND CONTROL (EPDC) SYSTEM [CIL] (CONTINUED)

DOCUMENTATION: SODB, 3.4.5.6.2; Lockheed memo #EP5-M10-215, Shuttle Control Bus Kapton Wire Arc Tracking Test Summary, 10-12-90; and LEMSCO-25658, Summary of the Control Bus Re-power Test, May 1988.

F. AN AC SINGLE-PHASE BUS IS CONSIDERED LOST IF:

1. THE BUS VOLTAGE IS < 110 (110.7) V AC OR > 120 (119.3) V AC. ©[ED]

Orbiter ac equipment was designed to operate between 110 and 120 V ac.

DOCUMENTATION: SODB, 3.4.5.6.3.a.

2. THE POWERED SINGLE-PHASE BUS CURRENT EXCEEDS:
 - a. 14.4 (13.4) AMPS - (GROUND CALL ONLY) LAUNCH THROUGH MPS POWERDOWN .
 - b. 7.7 (6.7) AMPS - CONTINUOUS LOAD FROM MPS POWERDOWN PROJECTED THROUGH ENTRY.

NOTE: AC BUS CURRENT VALUES BASED ON BUS LOAD POWER FACTOR OF 0.8 LAGGING.

These numbers represent the output power capability of the inverter under both a continuous normal 100 percent load, 7.7 amps, and at 200 percent rated load for 2 minutes, 14.4 amps with cooling. An inverter operated above these limits could fail due to overheating.

DOCUMENTATION: SODB, 4.5.6.3.1.8.

G. AN AC THREE-PHASE BUS IS CONSIDERED FAILED IF THE BUS CANNOT SATISFY USER REQUIREMENTS.

Self-explanatory.

H. MCA THREE-PHASE AC BUS IS CONSIDERED LOST IF ANY TWO PHASES ARE FAILED, OR IF ANY SINGLE AC PHASE IS SHORTED.

MCA buses power three-phase motors that cannot operate with two phases lost. Also, the MCA three-phase buses use "ganged" circuit breakers, so all three phases are lost when the single cb is opened to isolate a short circuit.

Rules {A9-101}, DC BUS VOLTAGE LIMITS [HC]; {A9-401}, SSPTS ORBITER POWER CONVERSION UNIT (OPCU); and {A9-452}, SSPTS OPCU FAILURE MANAGEMENT, reference this rule. ©[042507-8408F]

FLIGHT RULES

A9-4 CAUTION AND WARNING (C&W)

- A. ALL C&W LIGHTS AND TONES ARE CONSIDERED LOST (PRIMARY, BACKUP, AND SM) IF POWER SUPPLIES A AND B ARE LOST.

Without power, the hardwire C&W, C&W tones, and SM tones are inoperable.

- B. PRIMARY C&W IS CONSIDERED LOST IF:
1. POWER SUPPLY A IS LOST.
 2. FAILS SELF-TEST.
 3. FALSE ALARMS ARE GENERATED TO EXTENT IT IS UNUSABLE.
 4. NEITHER LIGHT NOR TONE WILL ANNUNCIATE.

For any of the above failure modes, the system is either totally inoperable or suspect to the point of being unreliable.

- C. BACKUP C&W IS CONSIDERED LOST IF:
1. NEITHER LIGHT NOR TONE WILL ANNUNCIATE.
 2. FALSE ALARMS ARE GENERATED TO EXTENT IT IS UNUSABLE.

For any of the above failure modes, the system is either totally inoperable or suspect to the point of being unreliable.

A9-5 THROUGH A9-50 RULES ARE RESERVED

FLIGHT RULES

FUEL CELL SYSTEMS MANAGEMENT

A9-51

FC POWER LEVEL CONSTRAINTS [HC] [042507-8478A]

- A. THE FC'S CAN BE OPERATED AT ANY POWER LEVEL LESS THAN 12 KW CONSISTENT WITH SATISFACTORY DC BUS VOLTAGE AND FC TEMPERATURE MAINTENANCE. TO SATISFY MISSION OBJECTIVES AND FC LIFETIME CONSTRAINTS, FC POWER LEVELS SHOULD BE MANAGED AS FOLLOWS:
1. < 2 KW - CONTINUOUSLY, ONLY WHEN SHARING ORBITER BUS LOAD WITH THE SSPTS OPCU
 2. 2-10 KW - CONTINUOUSLY
 3. 10-12 KW - NOT MORE THAN 15 MINUTES EVERY 3 HOURS
- B. IN THE EVENT OF A FC FAILURE, FC LOADING IMBALANCE BECAUSE OF UNEVEN FC PERFORMANCE CHARACTERISTICS, OR OTHER SYSTEM FAILURE, THE REMAINING FC'S MAY BE OPERATED AT: [ED]
1. < 2 KW - CONTINUOUSLY, ONLY WHEN SHARING ORBITER BUS LOAD WITH THE SSPTS OPCU
 2. 2-12 KW - CONTINUOUSLY
 3. 12-13 KW - FOR LESS THAN 4 HOURS
 4. UP TO 16 KW FOR 10 MINUTES CONSISTENT WITH SATISFACTORY BUS VOLTAGE AND FC TEMPERATURES

At < 2 kW the FC voltage may exceed 32 volts. Most orbiter equipment is only certified to 32 volts. When SSPTS OPCU is sharing the orbiter bus load with the FC, the SSPTS OPCU will maintain the main bus voltage < 32 volts; therefore, there is not a restriction on operating the FC below 2 kW. At > 12 kW, the FC thermal control system capability may become unable to maintain the FC at safe operating temperatures. Due to lifetime considerations, FC power should be limited to less than 8 kW for normal operations. However, continuous operation between 8 and 10 kW is allowable as long as accelerated lifetime decay is accepted. When operating a FC continuously below 2 kW, the sustaining heater will cycle in order to maintain FC stack temperature within operational limits; however, sustaining heater cycles might start to occur when operating below 3 kW. [ED] [042507-8478A]

THIS RULE CONTINUED ON NEXT PAGE

FLIGHT RULES

A9-51 FC POWER LEVEL CONSTRAINTS [HC] (CONTINUED)

Reference Hazard Reports ORIB 090, Undetected Interloop Leakage of FC-40 Between Two FC Heat Exchanger Coolant Loops That May Cause Loss of 2 FC, and IEPD 01, Inability to Power Critical Functions. ©[042507-8478A]

DOCUMENTATION: SODB, Volume I, 3.4.4.1.2, and Volume III, 4.4.1.1.15. ©[ED]

Rule {A9-107}, MAIN BUS TIE [CIL] [HC], references this rule. ©[042507-8478A]

A9-52 FC PURGE [HC] ©[033006-7297A]

- A. THE FC'S WILL BE PURGED SEQUENTIALLY WITH O₂ AND H₂ ON A SCHEDULED BASIS NOT TO EXCEED 96 HOURS BETWEEN PURGES. THE FREQUENCY OF PURGES WILL BE BASED UPON FC PERFORMANCE LOSS OF 0.2 VOLTS BETWEEN EACH PURGE. FC LOAD SHOULD NOT EXCEED 10 KW OR 350 AMPS DURING PURGES. HOWEVER, FOR CONTINGENCY CASES, A NORMAL 2-MINUTE PURGE CAN BE DONE AT 12 KW OR 430 AMPS. ©[090894-1681]

Both the O₂ and H₂ paths through an FC must be purged to rid the FC of inerts that dilute reactant, thereby reducing FC performance. Fuel cell degradation of 0.2 volts is based on engineering judgment as the minimum performance change that can be accurately assessed in real time. The 96-hour duration is based upon flight experience of the average maximum time before fuel cell degradation reaches 0.2 volts. Should the onboard cryogenic O₂ and H₂ contain excessive inerts, faster than normal voltage degradation would occur necessitating more frequent purges. ©[090894-1681]

During a purge, the preheater capability to warm the cryogenic reactants coming into the dual-gas regulator is marginal. Regulator freeze-up and subsequent lockup of the regulator is possible if purged too long at > 350 amps (430 amps for contingency operations provided purge is continuous for only 2 minutes). ©[ED]

DOCUMENTATION: SODB, 3.4.4.1.4.c. ©[080894-1681]

- B. FC'S WILL NOMINALLY BE PURGED USING THE AUTOMATIC SEQUENCE (SM OPS 2). THE MANUAL SEQUENCE WILL BE USED AS A BACKUP. ONE MANUAL PURGE WILL BE PERFORMED PER FLIGHT. AUTO PURGES WILL NORMALLY BE INITIATED BY MCC TMBU. ©[050400-7188A]

MCC initiation of purges via TMBU allows real-time detailed analysis of fuel cell purge data by the MCC while relieving the flightcrew from housekeeping duties. The manual purge will normally be performed early in the flight to verify operational backup capability and to satisfy ground turnaround activities. ©[050400-7188A]

THIS RULE CONTINUED ON NEXT PAGE

FLIGHT RULES**A9-52****FC PURGE [HC] (CONTINUED)**

- C. A FC THAT HAS LOST O₂ PURGE CAPABILITY AND ITS PREDICTED PERFORMANCE WILL NOT SUPPORT NOMINAL EOM PLUS 2 DAYS WILL BE BUS TIED TO A HEALTHY FC, AND THEN EITHER PLACED IN STANDBY OR SHUTDOWN IN ORDER TO SUPPORT NOMINAL EOM PLUS 2 DAYS. THE DECISION TO PLACE THE FC IN STANDBY OR SHUTDOWN WILL DEPEND ON LIFETIME PREDICTIONS BASED ON DEGRADATION TO THAT POINT AND THE RESULTING FC TERMINAL VOLTAGE. IF THE FC IS SHUT DOWN, RESTART CAPABILITY MUST BE DEMONSTRATED TO CONTINUE PAST MDF. ©[ED]

Except during purge operations the FC O₂ system is not a flowthrough design. O₂ gas flows directly to the reaction sites where it is consumed. Contained within the O₂ reactant gas are minute quantities of other gases which accumulate in the reaction chambers. With time, inerts begin to dilute the O₂ gas, effectively reducing the partial pressure of O₂ in the area of the electrolyte/catalyst reaction sites. As FC performance is a direct function of reactant partial pressure, FC output decays as inert content builds. The O₂ system is more sensitive to performance loss than the H₂ system since the H₂ system has a large volume circulating loop to distribute the inerts. Remaining lifetime depends upon gas purity, FC load, and initial FC performance.

Taking the fuel cell to standby or offloading the fuel cell will slow fuel cell performance degradation by decreasing the buildup of inerts on the cell plates. The decision to place a fuel cell in standby or to shut it down will depend on predicted fuel cell voltage based on performance degradation rates and number of FC restarts. The amount of attitude management required to keep the FC product water line from freezing will also be a factor in this decision (reference Rule {A9-1E}, FUEL CELL (FC) LOSS [CIL] [HC]). ©[033006-7297A]

DOCUMENTATION: SODB, 4.4.1.3r., 4.4.1.4.o, and flight data.

- D. FOR THE LOSS OF THE CAPABILITY TO PURGE EITHER THE O₂ OR H₂ REACTION CHAMBERS FOR ALL THREE FC'S, A NEXT PLS IS REQUIRED.

The single-point failure causing the loss of all O₂ or all H₂ purge capability from all FC's is a blockage in the common purge vent line. With the blockage in the common purge ventline, all FC's are no longer fail-safe (see paragraph E rationale). In addition, all FC's have no means to recover from performance degradation, so their useful lifetime remaining is limited; therefore, the prudent action is to prepare for a PLS at the next opportunity.

DOCUMENTATION: SODB, 4.4.1.3r, 4.4.1.4.o, and flight data.

THIS RULE CONTINUED ON NEXT PAGE

FLIGHT RULES

A9-52

FC PURGE [HC] (CONTINUED)

- E. A FC THAT HAS LOST EITHER O₂ OR H₂ PURGE CAPABILITY DUE TO A SUSPECTED BLOCKED VENT/PURGE LINE WILL NOT BE SHUTDOWN UNLESS DICTATED BY PERFORMANCE DEGRADATION (REF. PARAGRAPH C).

Ⓢ[ED]

With a blocked vent/purge line the dual-gas regulator in the fuel cell can no longer vent overboard should a failure occur in the regulator. This can result in overpressurization of the fuel cell. The worst-case scenario, undetected rapid pressure increase, could cause fuel cell rupture. For vent/purge line blockage, shutting down the fuel cell would appear to be the appropriate action. However, this would result in a two-FC entry which exposes the program to potentially greater risks; therefore, the rule is to leave the fuel cell running. These risk trades were made when arriving at this decision:

- a. *Evaluation of regulator failure history for 18 units with a total of 30,000 hours of operation (through STS 51-L) have indicated that the only failures involving internal leakage/pressurization were seal or seat leakage at a rate well below normal flow (consumption).*
- b. *Seal leakage would not be significant during normal operation because the reactant being leaked is consumed as part of the normal flow.*
- c. *Shutting down the fuel cell for seal leakage could result in a pressure increase as the consumption goes to zero, assuming the upstream reactant valve also leaks when closed. For this case continued operation of the fuel cell would be the proper action.*
- d. *Postulating a significant decrease in fuel cell load (50 amps) with a regulator that sticks at the higher demand setting, a pressure increase of approximately 20 psi/min could result. For this case the crew would have greater than 5 minutes to respond to the COOL P alert and shut down the fuel cell. Ⓢ[033006-7297A]*
- e. *Shutting down a fuel cell for a blocked vent line and flying a two-fuel cell entry exposes the program to any number of failures during entry on either of the remaining fuel cells that could result in a single fuel cell operation.*

Reference Hazard Report ORBI 285, Overpressurization of Fuel Cell Powerplant. Ⓢ[033006-7297A]

Rules {A9-57}, REUSABLE FC [HC], and {A9-1001}, ELECTRICAL GO/NO-GO CRITERIA [HC], reference this rule. Ⓢ[ED]

FLIGHT RULES

A9-53

FC H₂O SYSTEM HEATERS

ONE SET OF FC H₂O RELIEF SYSTEM HEATERS AND WATER LINE HEATERS WILL BE ENABLED AT ALL TIMES.

Capability to dump FC product water overboard must be immediately available in the event the FC can no longer deliver product water into the potable water tanks. Without this backup H₂O removal capability, the FC's will be lost due to flooding. To preclude any blockage in the nonredundant dump line due to freezing, thermal control of this dump line and nozzle is required continuously. Similarly, the FC alternate water lines are normally nonflowing and require thermal control to preclude freezing and line blockage.

DOCUMENTATION: SODB, 3.4.4.1.9.a. Also see System Thermal Control Design and Analysis (RI), SD 77-SH-0284, Dec. 1977, and Electrical Power Generation Water Relief Nozzle Development Test Final Report (RI) EPST-03, 6 Oct. 1976.

Rule {A18-301A}, TCS HEATER CONFIGURATION, references this rule.

A9-54

FC STANDBY DEFINITION

FC IN STANDBY IS DEFINED AS DISCONNECTION FROM ITS MAIN AND ESSENTIAL BUSES. THE ELECTRONIC CONTROL UNIT (ECU) REMAINS POWERED AND THE REACTANT VALVES REMAIN OPEN.

With the FC in standby, the disconnection of the FC from the buses removes all external load from the FC. By leaving the ECU powered and the reactant valves open, the FC remains thermally controlled by the internal sustaining heater and the coolant loop, which maintains it for immediate use.

FLIGHT RULES

A9-55

FC SHUTDOWN DEFINITION [CIL] [HC] ©[033006-7297A]

- A. FC SHUTDOWN IS DEFINED AS DISCONNECTION FROM BUSES, FC TO "STOP", AND REACTANT VALVES CLOSED. IF THE FC IS STILL CONSIDERED USABLE IN-FLIGHT, THE REACTANT VALVES NEED NOT BE CLOSED AFTER THE FC IS STOPPED.

In the shutdown procedure, disconnection of the FC from the buses removes all external electrical load from the FC. FC to STOP removes any normal load on the FC caused by the thermostatically-controlled FC heaters and unpowers the coolant and H₂ pumps. Closing the reactant valves precludes the possibility of providing the reactants in a possible crossover, internal short, or failed-on heater situation.

- B. ANY FC THAT IS SHUT DOWN, BUT CONSIDERED AVAILABLE FOR REUSE, WILL BE CONSIDERED GO FOR MISSION PLANNING PURPOSE IF THE FC AND ASSOCIATED H₂O LINES CAN BE MAINTAINED ABOVE FREEZING. FC RESTART CAPABILITY MUST BE DEMONSTRATED TO CONTINUE PAST MDF. FC WILL BE PERIODICALLY RESTARTED TO PREVENT FREEZING OF PRODUCT WATER LINES (REF RULE {A9-1E}, FUEL CELL (FC) LOSS [CIL] [HC]). ©[071494-1659]

On-orbit restart capability of the FC's was a design consideration; however, this capability has not been verified at thermal equilibrium. Therefore, in order to confirm this capability, it is necessary to attempt a restart during which the FC will be put through as realistic of a thermal transient as it will see when it is called upon later in the flight to support entry. For planning purposes, the FC will be considered GO if the fuel cell and its associated H₂O lines can be maintained above freezing and restart capability can be verified.

The original thermal analysis was based on FC shutdown data from STS-2, STS-54, and STS-51 (all -ZLV attitude) and an estimated duration of 48 hours was expected before restart was required. On STS-2, FC1 was shut down due to internal flooding and not restarted. The cooling characteristics of the STS-2 fuel cell was different than the existing 3-substack fuel cells because it had only 2 substacks and less thermal blanketing. On STS-54, FC2 was shut down for 9 hours and then successfully restarted (DTO). The thermal data is based on accessory section of the FC since no direct power section insight exists.

Reference Hazard Report ORBI 253, Loss of Electrical Power Due to FCP Flooding. ©[033006-7297A]

DOCUMENTATION: JSC-26545, FC ON-ORBIT SHUTDOWN/RESTART DTO. ©[071494-1659]

Rules {A9-1}, FUEL CELL (FC) LOSS [CIL] [HC], and {A9-57}, REUSABLE FC [HC], reference this rule. ©[ED]

FLIGHT RULES

A9-56

FC SAFING [HC] @[012407-7823A]

FC SAFING WILL BE PERFORMED UNDER THE FOLLOWING CIRCUMSTANCES:

- A. CONFIRMED PRESENCE OF KOH IN FC PRODUCT WATER THAT DOES NOT CLEAR IN 1 HOUR. @[070899-6891A]
- B. CROSSOVER OF REACTANTS WITHIN THE FC
- C. A SHORT CIRCUIT WITHIN THE FC
- D. CONFIRMED COOLANT PRESSURE > 75 (71.4) PSIA
- E. A FC WITH A FAILED ON HEATER (START UP OR SUSTAINING) THAT MUST BE SHUTDOWN @[012407-7823A]

FC SAFING IS DEFINED AS EVACUATION OF THE FC REACTANT CHAMBERS BY OPERATING THE FC WHILE ITS REACTANT VALVES ARE CLOSED. FC SAFING IS COMPLETE WHEN THE FC COOLANT PRESSURE IS < 15 PSI. ONCE SAFING IS COMPLETE, THE FC WILL BE DISCONNECTED FROM THE ASSOCIATED ESSENTIAL AND MAIN BUSES AND THEN TAKEN TO STOP. IF THE FC CURRENT EQUALS 0 AMPS BEFORE THE COOLANT PRESSURE IS < 15 PSI, THE FC WILL BE DISCONNECTED FROM THE ASSOCIATED ESSENTIAL AND MAIN BUSES TO ALLOW THE SUSTAINING HEATERS TO COMPLETE FC SAFING.

THIS RULE CONTINUED ON NEXT PAGE

FLIGHT RULES**A9-56****FC SAFING [HC] (CONTINUED)**

The onboard FC safing procedures close the reactant valves, and for all cases except a short within the FC, use the Main Bus loads to rapidly consume the reactants. This shortens the time a crossover situation or a FC internal short could sustain itself. Also, for the case of KOH in the manifold (pH high), safing evacuates the manifold of reactants to prevent electrolysis due to thin films of KOH across two or more cells. With KOH and water in the reactant chamber, electrolysis can occur that would disassociate H₂O into H₂ and O₂, allowing for recombination and resultant heat. At < 15 psi, the density of the reactants is so small that a catastrophic event is unlikely. Getting much below 15 psi may be difficult due to the continuing outgassing of reactants and H₂O vapor pressure. Also, the dual-gas regulator is designed such that the O₂ side always remains 5 psi above the H₂ side. In case of high coolant pressure, FC safing will relieve the FC stack overpressure. For a failed on heater (Start up or Sustaining) followed by a loss of cooling, safing will prevent excessive localized heating, damage to the heater element, thermal breakdown of the FC coolant, FC stack over-pressurization, and ultimately over-heating of the stack (Reference Rule {A9-58}, FC HEATER MANAGEMENT [HC]). During on-orbit safing scenarios, it is unlikely, but possible, that FC current will reach 0 amps before the coolant pressure reaches 15 psi. At a FC current telemetry output of 0 amps, the healthy fuel cell, in parallel with the failed fuel cell, could drive cells in the failed fuel cell in the negative direction, resulting in the evolution of free O₂ and H₂ molecules. These free O₂ and H₂ molecules could end up on either the O₂ or H₂ side of the cell resulting in extra heat and H₂O production. Therefore, when FC safing is complete, the fuel cell will be disconnected from the associated essential and main buses and then taken to stop. ©[ED] ©[012407-7823A]

Documentation: STS-2 and STS-83 flight experience, vendor electrochemical analysis, and engineering judgment. ©[070899-6891A]

Reference Hazard Reports ORBI 090, Undetected Interloop Leakage of FC-40 (Fluorinert) Coolant Between Two Fuel Cell Heat Exchanger Coolant Loops May Cause Loss of Two Fuel Cells; ORBI 253, Loss of Electrical Power Due to FCP Flooding; ORBI 278, Loss of Structural Integrity Due to Overpressurization of the Mid and/or Aft Fuselage; ORBI 282, Internal Mixing of Reactants in Fuel Cell Power Section; and ORBI 284, Overheating of the Fuel Cell Power Section. ©[012407-7823A] ©[ED]

Rules {A9-58}, FC HEATER MANAGEMENT [HC], and {A9-60}, FC COOLANT PUMP/H₂ PUMP/H₂O SEPARATOR FAILURE MANAGEMENT [CIL] [HC], reference this rule. ©[102506-7766B] ©[102506-7767A] ©[ED]

FLIGHT RULES

A9-57

REUSABLE FC [HC] @[033006-7297A]

A FC WILL BE SHUT DOWN OR PLACED IN STANDBY AND WILL BE CONSIDERED REUSABLE FOR THE FOLLOWING CASES: @[ED]

- A. INABILITY TO MAINTAIN BUS VOLTAGE <32 VOLTS. CONSIDERATION WILL BE GIVEN TO REPOWERING EQUIPMENT IN ORDER TO REDUCE FUEL CELL OUTPUT VOLTAGE. IF MISSION OBJECTIVES PREVENT REPOWERING OF EQUIPMENT, CONSIDERATION WILL BE GIVEN TO TAKING THE AFFECTED FC TO STANDBY (REF RULE {A9-1E}, FUEL CELL (FC) LOSS [CIL] [HC]).

All orbiter equipment requiring DC power is qualified to a maximum of 32 volts. A main bus voltage is > 32 only when the FC is lightly loaded (i.e., due to a powerdown). The FC is reusable when it is sufficiently loaded to drop its voltage below 32 V DC. @[ED]

DOCUMENTATION: SODB, 3.4.5.6.2.b.

- B. ANY FC WITH A COOLANT PRESSURE THAT IS NOT AT LEAST 10 PSIA ABOVE THE SUPPLY H₂O TANK PRESSURE WILL BE SHUT DOWN IMMEDIATELY. THE FC MAY BE RESTARTED AFTER H₂O TANK A HAS BEEN VENTED PROVIDED THE COOLANT PRESSURE IS AT LEAST 6 PSIA ABOVE THE SUPPLY H₂O TANK PRESSURE IF ONLY TANK A VENTED, OR 10 PSIA ABOVE THE SUPPLY H₂O TANK PRESSURE IF ALL TANKS VENTED, AND ULLAGE EXISTS IN THE VENTED TANK(S). @[090894-1680]

A FC with a low coolant pressure that is not at least 10 psia above the supply H₂O tank pressure cannot be guaranteed to have its product H₂O removed. Without the H₂O removal capability, the FC H₂ pump will be irrecoverably lost within a few minutes resulting in FC flooding. If the FC is shut down quickly, it may be used after supply water tank A has been vented to allow the FC coolant pressure to be at least 6 psia greater than supply H₂O pressure if tank A is the only tank vented, or at least 10 psia greater than supply H₂O pressure if all tanks are vented. The 10 psia differential pressure requirement is due to the measurement error of the pressure transducer (3.6 psia) plus worst case tolerances on three check valves between the FC's and the ECLSS supply H₂O tanks (2 psia each). With supply H₂O tank A vented, all three FC's will be filling tank A since it has the lowest tank pressure. Therefore, tank A ullage must be managed. If H₂O tank venting and FC restart cannot occur prior to the predicted time to product water line freeze, the FC will be considered lost until restart capability can be proven. (Reference Rules {A9-1E}, FUEL CELL (FC) LOSS [CIL] [HC], and {A9-55}, FC SHUTDOWN DEFINITION [CIL] [HC]). @[090894-1680] @[ED]
@[033006-7297A]

THIS RULE CONTINUED ON NEXT PAGE

FLIGHT RULES

A9-57

REUSABLE FC [HC] (CONTINUED)

- C. UNABLE TO PURGE O₂ OR H₂ REACTANT SYSTEM AND PREDICTED FC PERFORMANCE WOULD NOT BE ABOVE THE LAUNCH COMMIT V-I CURVE AT NOMINAL EOM (REF RULE {A9-52C}, FC PURGE [HC]). @[033006-7297A]

It is advisable to save the FC for critical mission phases such as entry. Taking the fuel cell to standby or offloading the fuel cell will slow fuel cell performance degradation by decreasing the amount of cryo ingested in the fuel cell, therefore decreasing the buildup of inerts on the cell plates, which results in voltage degradation of the cells over time.

- D. LOSS OF FC PUMP PACKAGE THAT IS RECOVERABLE BY AN IFM REQUIRING CONTINUOUS POWER FROM AN ASSOCIATED PREFLIGHT TEST BUS. IN ADDITION TO THE PREFLIGHT TEST BUS CONSTRAINTS (REF. RULE {A9-110}, PREFLIGHT TEST BUS MANAGEMENT), THE FOLLOWING CONSTRAINTS WILL BE USED FOR THE IFM IMPLEMENTATION:
1. THIS IFM IS NOT CONSIDERED FEASIBLE FOR LOSS OF THE MAIN DISTRIBUTION BOX ESSENTIAL BUS.
 2. ORBIT - USE TO RECOVER FC ON FIRST FAILURE AND KEEP THE FC THERMALLY CONDITIONED. THE FC WILL BE CONSIDERED LOST FOR GO/NO-GO PURPOSES AND WILL BE POWERED DOWN FOR ENTRY UNLESS REQUIRED TO PROVIDE SFT. MISSION IMPACT - MDF.
 3. IFM USED ONLY TO RESTORE ENTRY SFT (TWO FC ENTRY).

The IFM procedure to restore power to the FC pump package takes a minimum of 1.5 to 2 hours to perform, depending on which fuel cell will be recovered. The FC can be operated a maximum of 9 minutes without the coolant pump; therefore, the FC must be shut down while the IFM procedure is performed. Each essential bus has three power sources. The single failure that would cause loss of a main distribution box essential bus is a bus short. Since the preflight test bus powers the essential bus, the short would probably cause the preflight test bus fuse to open. On orbit, the IFM will be performed for the first FC failure, since single failures associated with powering the preflight test bus are recoverable without placing the crew/vehicle in a critical situation. To be consistent with the preflight test bus Rule {A9-110}, PREFLIGHT TEST BUS MANAGEMENT, concerning entry operations, only SFT entry critical functions are recovered, since use of the preflight test bus may expose the crew to problems not as easily recoverable as during orbit operations. The mission impact for first FC failure will be MDF since the FC will not be used for entry. While on orbit, the preflight test bus will be continuously powered in order to allow the fuel cell pumps to operate and allow the fuel cell to be thermally conditioned, thus avoiding freezing the fuel cell product H₂O line. @[ED]

THIS RULE CONTINUED ON NEXT PAGE

FLIGHT RULES

A9-57 REUSABLE FC [HC] (CONTINUED)

Reference Rules {A9-110}, PREFLIGHT TEST BUS MANAGEMENT, and {A9-1E}, FUEL CELL (FC) LOSS [CIL] [HC], for additional rationale. ©[ED]

Reference Hazard Report ORBI 253, Loss of Electrical Power Due to FCP Flooding. ©[033006-7297A]

Rules {A2-1001}, ORBITER SYSTEMS GO/NO-GO [HC]; {A9-1}, FUEL CELL (FC) LOSS [CIL] [HC]; and {A9-110}, PREFLIGHT TEST BUS MANAGEMENT, reference this rule. ©[ED]

A9-58 FC HEATER MANAGEMENT [HC] ©[102506-7766B]

- A. OPERATION OF A FC WITH A FAILED-ON HEATER IS PERMISSIBLE PROVIDED KOH CONCENTRATION AND FC STACK TEMPERATURES ARE WITHIN OPERATIONAL LIMITS.

Thermal analysis by United Technologies Company (UTC) Fuel Cells indicates that a failed-on sustaining heater does not overheat a FC and that the FC would be usable for external loads up to 12 kW continuously. Operating a FC with a failed-on sustaining heater will result in a minimum impact of 870 watts to mission cryo margins.

Thermal analysis by UTC Fuel Cells indicates that a failed-on startup heater would result in marginal operation for a FC with a nominal on-orbit load of 5kW. Thermal equilibrium should be reached in approximately 15 minutes. The stack inlet temperature will rise from 182 to 212 degrees F, and the stack outlet temperature will rise from 204 to 228 degrees F. This results in calculated electrolyte concentrations of 47.6, 42.0, and 44.8 percent for the inlet, exit, and average cell conditions respectively. Maintaining external loads below 5kW may not be possible for all flight phases. Operating a FC with a failed-on startup heater will result in a minimum impact of 1740 watts to mission cryo margins.

Subsequent failure of the fuel cell coolant pump will require fuel cell safing actions be performed as soon as possible to prevent localized heating, heater element damage, breakdown of the fuel cell coolant, FC stack overpressurization, and potentially catastrophic overheating of the stack (Ref. Rule {A9-60}, FC COOLANT PUMP/H2 PUMP/H2O SEPARATOR FAILURE MANAGEMENT [CIL] [HC]: shutdown within 9 minutes.)

DOCUMENTATION: SODB 4.4.1.1.1

- B. IF A FC HAS A FAILED ON STARTUP HEATER, THE STARTUP HEATER LOGIC WILL BE INHIBITED.

If failed electronics have caused the heater to fail on, inhibiting the heater logic will disable the electronics.

DOCUMENTATION: Engineering judgment

THIS RULE CONTINUED ON NEXT PAGE

FLIGHT RULES

A9-58

FC HEATER MANAGEMENT [HC] (CONTINUED)

- C. ADDITIONAL TROUBLESHOOTING WILL BE PERFORMED FOR THE FOLLOWING:
1. A FC WITH A FAILED ON STARTUP HEATER AND TAKING THE HEATER LOGIC TO INHIBIT HAS NO EFFECT.
 2. OPERATING A FC WITH A FAILED ON HEATER WILL RESULT IN SHORTENING THE MISSION DUE TO INSUFFICIENT CRYO MARGINS.
 3. A FC WITH A FAILED ON HEATER MUST BE SHUT DOWN FOR OTHER REASONS (LOSS OF COOLING, ETC.). @[102506-7766B]

Additional troubleshooting involves a FC shutdown, and should only be performed when specific conditions require doing so. For a failed-on startup heater, the FC is considered lost (Ref. Rule {A9-1}, FUEL CELL (FC) LOSS [CIL] [HC]), so if taking the heater logic to inhibit fails, additional troubleshooting could recover nominal FC operations. For a failed-on sustaining heater and cryo margins will not support through NEOM, additional troubleshooting could prevent shortening the mission. If a failed-on heater cannot be disabled and a FC must be shut down, FC safing is required (Ref. Rule {A9-56}, FC SAFING) and additional troubleshooting could prevent FC safing and in some cases the FC would be reusable. @[102506-7766B]

DOCUMENTATION: Engineering judgment

- D. ADDITIONAL TROUBLESHOOTING STEPS ARE THE FOLLOWING, IN PRIORITY ORDER:
1. TAKE THE FC TO STANDBY, THEN TAKE THE FC CONTROLLER POWER OFF THEN BACK ON IN AN ATTEMPT TO REMOVE POWER FROM THE HEATER. IF THIS DISABLES THE HEATER, THE FC MAY BE RESTARTED OR IF FC SHUTDOWN IS REQUIRED, THE SHUTDOWN WILL BE COMPLETED BY CLOSING THE REACTANT VALVES.
 2. IF THE FC HEATER IS FAILED ON ONLY WHEN THE FC CONTROLLER POWER IS ON, THE FC SHUTDOWN WILL BE COMPLETED BY TAKING THE FC CONTROLLER POWER TO OFF AND CLOSING THE REACTANT VALVES.
 3. IF THE HEATER CANNOT BE DISABLED, THE FC WILL BE SAFED BY TAKING THE FC TO START AND CLOSING THE REACTANT VALVES.

THIS RULE CONTINUED ON NEXT PAGE

FLIGHT RULES

A9-58**FC HEATER MANAGEMENT [HC] (CONTINUED)**

All reasonable attempts to disable heaters should be performed to preserve consumables margins, lower FC operating temperatures to nominal, and preserve FC lifetime. Disabling the heater by taking the FC Controller power off will prevent having to safe an otherwise good FC. If all attempts to disable the heater are unsuccessful, but the fuel cell is able to continue operation without violating temperature or KOH limits, the fuel cell may be left running to provide redundancy and to allow more time to gather data.

If the FC must be shut down and the failed-on heater cannot be disabled, the reactants will be depleted ASAP to prevent excessive localized heating, damage to the heater element, thermal breakdown of the FC coolant, FC stack overpressurization, and ultimately overheating of the stack. With the increased heating associated with a failed-on heater, FC cooling problems, or high power levels, the time-to-effect for overheating and potential overpressure will be reduced, and a more timely response is required. (Ref. Rule {A9-60}, FC COOLANT PUMP/H2 PUMP/H2O SEPARATOR FAILURE MANAGEMENT [CIL] [HC]: shutdown within 9 minutes.)

DOCUMENTATION: Engineering judgment, SODB 4.4.1.1.1 ©[102506-7766B]

Rules {A9-56}, FC SAFING [HC], and {A9-60}, FC COOLANT PUMP/H2 PUMP/H2O SEPARATOR FAILURE MANAGEMENT [CIL] [HC], reference this rule. ©[102506-7767A] ©[ED]

FLIGHT RULES

A9-59

FC - CELL PERFORMANCE MONITOR [CIL]

FOR PROBLEMS RELATED TO THE CELL PERFORMANCE MONITOR (CPM), THE FOLLOWING ACTIONS WILL BE TAKEN: @[070899-6893A] @[111705-7127B]

- A. FOR A FC THAT HAS ANY SUSPECT OR FAILED CPM TELEMETRY, THE AFFECTED FC WILL BE TIED TO ANOTHER FC.
- B. FOR A FC THAT HAS EXPERIENCED A CPM CHANGE OF GREATER THAN 50 MV FROM THE BASELINE PRELAUNCH VALUE, THE AFFECTED FC WILL BE TIED TO ANOTHER FC.
- C. SINGLE CELL VOLTAGES WILL BE RECORDED, DOWNLINKED, AND ANALYZED AT LEAST ONCE PER DAY. IF ANY INDIVIDUAL CELL VOLTAGE IS LESS THAN 910 MV WITH FC LOAD BETWEEN 4 AND 8 KW, THE FUEL CELL WILL BE TAKEN OPEN CIRCUIT, AND SINGLE CELL VOLTAGES WILL BE RECORDED, DOWNLINKED, AND ANALYZED. FOR AN OPEN CIRCUIT SINGLE CELL READING OF LESS THAN 1100 MV, THE FC WILL BE SAFED. @[070899-6893A] @[111705-7127B]
- D. WITH LOSS OF CPM INSIGHT, A FC WILL BE SAFED FOR A PERFORMANCE SHIFT SUFFICIENT TO CAUSE A DELTA AMPS CHANGE OF > 12 AMPS AND DIVERGING BETWEEN TIED MAIN BUSES THAT IS NOT RELATED TO REACTANT PRESSURE CHANGE, THERMAL CONTROL, INERTS, OR NORMAL V-I PERFORMANCE DIFFERENCES, UNLESS THE FC'S HEALTH CAN BE VERIFIED. @[111705-7127B]

For loss of CPM telemetry, a viable procedure to regain insight into possible crossover in a FC is to tie the affected FC to an adequately instrumented healthy FC and note any change in the delta amps between the FC's once an equilibrium delta amp has been identified. A performance shift of 12 amps is equivalent to an approximate 300 mV degradation in one of the 96 cells of the FC. It is the engineering judgment of the FC vendor that this degree of performance change might indicate an internal cell problem and, if allowed to continue, could lead to a crossover condition. Critical flight phases are considered short enough not to require the insight afforded by the bus tie. Also, it is advisable to isolate the three main buses whenever possible for EPDC redundancy. @[ED]

THIS RULE CONTINUED ON NEXT PAGE

FLIGHT RULES**A9-59 FC - CELL PERFORMANCE MONITOR [CIL] (CONTINUED)**

Using the FCMS provides insight into individual cell voltages. Testing at International Fuel Cells on FC serial number 122 showed that during the beginning stages of crossover, changes to individual cell voltages will be small and may be difficult to detect while the fuel cell is under load. During testing, cells known to have crossover were consistently below 910 mv while under load. When taken to open circuit, the voltage degradation due to crossover was clearly evident and the cell voltages were consistently below 1100 mv. A change of 50 mv from the established baseline prelaunch value indicates that something off-nominal may be occurring in the fuel cell and the FCMS will be utilized to ensure safety of the crew and vehicle. In addition, the FCMS may provide additional insight whenever the health of the fuel cell is in question. There are single point wiring failures which could affect both the CPM and FCMS measurements. Single cell voltages < 1100 mv may be measured on cells whose voltage measurement pin connection has high resistance. High resistance in a cell pin connection (pin sharing) manifests itself as a low voltage reading on a single cell and a high voltage reading on an adjacent cell. Verification of the health of cells with high resistance in the pin connection may not be possible. ©[070899-6893A]

DOCUMENTATION: Rule {A9-107}, MAIN BUS TIE [CIL] [HC], references this rule. ©[070899-6893A] ©[111705-7127B]

A9-60 FC COOLANT PUMP/H2 PUMP/H2O SEPARATOR FAILURE MANAGEMENT [CIL] [HC] ©[033006-7297A]

- A. THE FC MUST BE SHUT DOWN WITHIN 9 MINUTES (AT 7 KW) FOR LOSS OF COOLING. FC SAFING IS NOT REQUIRED.

After the loss of cooling, the FC must be shut down to preclude catastrophic failure due to overheating. Overheating will result in expansion of the stack, leaking of reactants into the PBD, and uncontrolled mixing of O₂ and H₂, resulting in potential explosion. Testing and analysis indicate that the FC will reach the redline stack temperature of 250 deg F in approximately 9 minutes at 7 kW.

DOCUMENTATION: SODB, 3.4.4.1.15.

- B. FUEL CELL OPERATION WITHOUT COOLING MAY BE EXTENDED BEYOND 9 MINUTES IF THE MCC CALCULATED FC STACK TEMPERATURE IS PREDICTED TO BE LESS THAN 250 DEG F. FC OPERATIONS BEYOND 9 MINUTES WILL ONLY BE ALLOWED DURING CRITICAL MISSION PHASES TO:
1. MAINTAIN TWO FUEL CELLS, OR
 2. MAINTAIN THREE MAIN BUSES (I.E., BUS TIE CAPABILITY LOST)

THIS RULE CONTINUED ON NEXT PAGE

FLIGHT RULES

A9-60

FC COOLANT PUMP/H2 PUMP/H2O SEPARATOR FAILURE MANAGEMENT [CIL] [HC] (CONTINUED)

At the FC power load of 7 kW, a FC can be operated for 9 minutes before the FC stack temperature reaches 250 deg F. However, if the power level can be reduced quickly after the loss of FC cooling, FC operation may be extended beyond 9 minutes, since a lower power level lowers the heating rate. FC operations would be extended when absolutely necessary to maintain two FC's or three main buses to allow critical equipment to remain powered, provide extra time to reconfigure safely, or to get past a critical event (i.e., ascent/entry). The 250 deg F limit of the FC stack temperature is required to maintain integrity of the FC power stack. Based on analysis and testing conducted by IFC and JSC E&D, the predicted FC stack temperature can be calculated from the FC stack temperature at the time of the failure and the affected FC subsequent power levels. (Reliable FC stack temperature measurement is lost following the loss of coolant flow.)

DOCUMENTATION: RI Internal Letter, 287-EPS-88-074, FC Operating Time Following Loss of Coolant, May 24, 1988; JSC-23091, Internal Note for FC X708 Thermal System Off-Limits Test, November 25, 1988; and SODB, 3.4.4.1.15.

C. THE FUEL CELL MUST BE SHUT DOWN IF UNABLE TO DISCHARGE H₂O.

A FC without water removal capability has a predicted lifetime of about 110 amp-hrs. (Reference Rule {A9-1E}, FUEL CELL (FC) LOSS [CIL] [HC].)

DOCUMENTATION: SODB, 4.4.1.3. and Hazard Reports ORBI-253, Loss of Electrical Power Due to FCP Flooding; ORBI 282, Internal Mixing of Reactants in Fuel Cell Power Section; and ORBI 284, Overheating of the Fuel Cell Power Section. ©[033006-7297A]

With the increased heating associated with a failed-on heater, FC cooling problems, or high power levels, the time-to-effect for overheating and potential overpressure will be reduced, and a more timely response is required. ©[102506-7767A]

DOCUMENTATION: RI Internal Letter, 287-EPS-88-074, FC Operating Time Following Loss of Coolant, May 24, 1988; JSC-23091, Internal Note for FC X708 Thermal System Off-Limits Test, November 25, 1988; and SODB, 3.4.4.1.15.

If the affected FC has previously experienced a failed-on heater that cannot be disabled, the reactants will be depleted to preclude potential catastrophic failure due to overheating. (Reference Rules {A9-58}, FC HEATER MANAGEMENT [HC], and {A9-56}, FC SAFING). ©[102506-7767A]

Rule {A9-58}, FC HEATER MANAGEMENT [HC], references this rule. ©[102506-7766B]

FLIGHT RULES

A9-61

ACTIONS FOR FUEL CELL PH INDICATIONS @[121296-4737B]

A FUEL CELL THAT HAS RECEIVED A "PH" INDICATION WILL BE HANDLED IN THE FOLLOWING MANNER:

- A. THE FUEL CELL'S ASSOCIATED MAIN BUS WILL BE BUS TIED TO A GOOD FUEL CELL'S MAIN BUS. THE SUPPLY H₂O TANKS WILL BE MANAGED TO ISOLATE KOH FROM UNDESIRE TANKS. IF CONFIRMING INDICATIONS OF FUEL CELL FLOODING OR CROSSOVER ARE RECEIVED AT ANY TIME, THE FUEL CELL WILL BE SAFED AND CONSIDERED LOST.
@[070899-6892A]

Reception of a fuel cell pH indication can be the result of a new stack build or from being in storage for extended periods, flooding, crossover, or other mechanisms that cause the KOH to escape from a fuel cell. If KOH is escaping, fuel cell failure may occur. The bus tie is performed to protect the fuel cell's associated main bus should the fuel cell completely fail and also to monitor the fuel cell's performance. Aside from a new stack build, fuel cell flooding is the most probable cause of KOH in the product water. Flooding may be the result of improper condenser temperature maintenance, coolant pressure imbalance, or degraded or failed water removal system. Confirming cues for FC flooding may be seen in FC performance degradation, FC temperatures, H₂ pump status and associated AC currents, and the Delta Amps when the FC is bus tied. Confirming indications of crossover may be changing substack delta volts or unexplained performance degradation. The Fuel Cell Monitoring System (FCMS) may also be useful in confirming crossover, flooding, or performance degradation in a fuel cell.

H₂O tank management should consider effects of KOH on crew drinking supply, FES usage, water transfers, and any other potential uses of the fuel cell product water.

DOCUMENTATION: SODB Volume 1, Section 3.4.4.1 (13), STS-2 and STS-79 flight experience.
@[ED]

- B. FOR RECEPTION OF THE FUEL CELL AND/OR COMMON H₂O LINE PH INDICATION, A LITMUS TEST OF THE FUEL CELL PRODUCT WATER WILL BE PERFORMED WITHIN 1 HOUR TO VERIFY THE PRESENCE OF KOH.

It is imperative that the litmus test be expedited. Continued operation of a fuel cell with KOH discharge could result in a hazardous condition. The fuel cell pH and common H₂O line pH sensors measure conductivity of the fuel cell product water and are not specifically measurements of KOH content. A litmus test of the water must be performed to conclusively determine if KOH is present. As much as 20 minutes transport time from the affected fuel cell to the galley QD may be required (8-9 minutes between the affected fuel cell pH indication and the common H₂O line indication). @[070899-6892A]

THIS RULE CONTINUED ON NEXT PAGE

FLIGHT RULES

A9-61

ACTIONS FOR FUEL CELL PH INDICATIONS (CONTINUED)

1. IF BOTH FUEL CELL AND COMMON H₂O LINE PH INDICATIONS ARE PRESENT AND THE LITMUS TEST CANNOT BE PERFORMED WITHIN 1 HOUR, THE FUEL CELL WILL BE SAFED AND CONSIDERED LOST.
@[070899-6892A]

With both FC and common pH sensors indicating a high pH, the likelihood that the fuel cell is releasing KOH is high. Continued operation of a fuel cell with a KOH discharge could result in a hazardous condition. The 1-hour operational constraint is based upon engineering judgment. It was chosen to allow the pH indications (from residual KOH) to clear, thus preventing premature fuel cell safing (fuel cell historical flight data STS-79 FC2 pH indication only lasted about 20 minutes). Sustained pH indications for 1 hour would represent a continuing problem and an eminently hazardous condition requiring the FC to be safed.

2. FUEL CELL OPERATION FOR CONFIRMED KOH RELEASE PH > 9 (BY A LITMUS TEST) WITHOUT SIGNS OF FLOODING OR CROSSOVER IS ALLOWABLE FOR 1 HOUR. IF THE INDICATIONS ARE SUSTAINED FOR GREATER THAN 1 HOUR, THE FUEL CELL WILL BE SAFED AND CONSIDERED LOST.

The 1-hour limit is based on flight experience and engineering judgment. Flight experience has shown that, on occasion, some fuel cells have residual KOH (either from a new stack build or from being in storage for extended periods of time) that is expelled into the product water. Small amounts of residual KOH in FC product water will not lead to a hazardous O₂ concentration in the H₂ manifold; therefore, the 1-hour time will allow for the intermittent pH condition to clear.

3. FUEL CELL OPERATION MAY CONTINUE WITH BOTH SENSORS ON IF PH < 9 (BASED UPON A LITMUS TEST) AND THERE ARE NO INDICATIONS OF FLOODING OR CROSSOVER. THE BUS TIE WILL BE MAINTAINED TO MONITOR FUEL CELL PERFORMANCE. THE BUS TIE WILL BE BROKEN FOR ENTRY. AN FCMS DATA TAKE AND AN H₂O LITMUS TEST WILL BE PERFORMED DAILY.

A fuel cell whose pH sensors continue to indicate a high pH but whose product water is verified to have a pH level < 9 and whose performance is nominal, will be allowed to continue operation. Flight experience has shown that some fuel cells may have residual KOH, either from a new stack build or from being in storage that is intermittently expelled into the product water. The sensor indications are possibly due to very minute amounts of KOH that the litmus test cannot verify. Because this is still an off-nominal situation, the bus tie will be maintained so that fuel cell performance can be monitored. If performance degradation or indications of flooding are received, the fuel cell will be safed. An FCMS data take and an H₂O litmus test will be performed daily to verify FC health.

THIS RULE CONTINUED ON NEXT PAGE

FLIGHT RULES

A9-61 ACTIONS FOR FUEL CELL PH INDICATIONS (CONTINUED)

DOCUMENTATION: SODB Volume 1, Section 3.4.4.1 (13) and STS-79 flight experience. Rule {A9-1}, FUEL CELL (FC) LOSS [CIL], references this rule. ©[121296-4737B] ©[070899-6892A]

- C. A FUEL CELL PURGE WILL NOT BE PERFORMED WHEN EITHER A FUEL CELL INDIVIDUAL OR COMMON H₂O LINE PH INDICATION IS PRESENT, UNLESS FUEL CELL PRODUCT WATER PH IS CONFIRMED < 9.0 USING A LITMUS TEST. ©[070899-6892A]

Purging a FC that is expelling KOH can result in KOH being deposited in the common H₂ purge line causing possible clogging of this line and preventing over-pressure relief of all three fuel cells. With the common H₂ purge line plugged, the H₂ purge capability from all three fuel cells is also lost.

DOCUMENTATION: SODB Volume 1, Section 3.4.4.1 (13).

Rule {A9-1}, FUEL CELL (FC) LOSS [CIL] [HC], references this rule. ©[070899-6892A] ©[ED] ©[033006-7297A]

A9-62 FUEL CELL MONITORING SYSTEM DATA TAKE

A MINIMUM OF ONE FCMS DATA TAKE WILL BE PERFORMED EACH FLIGHT. ©[070899-6893A]

The FCMS data take will nominally be scheduled as early as is practical in the mission timeline to establish a fully operational on orbit baseline and to verify system capability. Performing a data take each flight adds to the historical data base of inflight single cell voltages. In the event of a fuel cell problem, this data base will be used to help evaluate fuel cell health. The only time to verify operation of the entire FCMS, including data interfaces, onboard PGSC's, and downlink capability, is during flight. Since the PGSC configurations are constantly being upgraded, it becomes imperative to do a data take every flight to ensure FCMS capability is available when required. ©[070899-6893A]

A9-63 THROUGH A9-100 RULES ARE RESERVED

FLIGHT RULES

DC POWER DISTRIBUTION AND CONTROL SYSTEMS MANAGEMENT

A9-101 DC BUS VOLTAGE LIMITS [HC] ©[042507-8408F]

DC BUS VOLTAGE WILL BE MAINTAINED AS FOLLOWS:

A. MAIN BUS VOLTS > 27.0 (27.2) V DC AND \leq 32.0 (31.8) V DC.

NOTE: WHEN THE OPCU IS PROVIDING POWER TO THE MAIN BUS, THE UPPER LIMIT INSTRUMENTATION ERROR CAN BE EXCEEDED IF NO OTHER BUS VOLTAGES ARE > THAN 32.0 (31.8)V.

B. CONTROL BUS VOLTS > 24.8 (25.0) V DC AND < 32.0 (31.8) V DC.

C. ESSENTIAL BUS VOLTS > 25.5 (25.7) V DC AND < 38.0 (37.8) V DC.

D. FORWARD PCA VOLTS > 26.2 (26.4) V DC AND < 32.0 (31.8) V DC.

E. AFT PCA VOLTS > 26.1 (26.3) V DC AND < 32.0 (31.8) V DC.

Rationale same as for Rule {A9-3A-E}, ELECTRICAL POWER DISTRIBUTION AND CONTROL (EPDC) SYSTEM [CIL].

Reference Hazard Reports IEPD 01, Inability to Power Critical Functions, and ORBI 205, Opening of FC3 Structural Ground Contact can Cause Over Voltage or Lead to Fire/Explosion. ©[042507-8408F]

A9-102 ESSENTIAL BUS

EACH ESSENTIAL BUS WILL BE CONNECTED TO ALL THREE OF ITS POWER SOURCES.

The highest level of power redundancy will be maintained to the essential buses. They power orbiter critical equipment such as GPC's.

A9-103 POWER REDUCTION GUIDELINES

IF AN ELECTRICAL POWER SYSTEM PROBLEM REQUIRES AN IMMEDIATE POWER REDUCTION, POWER TO MADS AND/OR PAYLOAD EQUIPMENT MAY BE TERMINATED.

Those electrical loads not required for orbiter systems operations while in a situation requiring immediate reduction in electrical load to prevent FC overloading and/or equipment undervoltage will be terminated.

FLIGHT RULES

A9-104**MAIN BUS SHORT [HC]** @[121604-6524B]

FOR A CONFIRMED MAIN BUS SHORT THAT DOES NOT CLEAR AUTOMATICALLY:

- A. PRE-MECO, THE MAIN BUS WILL REMAIN POWERED AS LONG AS THE ASSOCIATED AC BUS VOLTAGE IS > 95 V AC OR UNTIL MCC CONFIRMS SSME CONTROLLER SWITCHOVER HAS OCCURRED.

The orbiter EPDC system is designed for self-isolation of shorted circuitry. In reality, a sustained short of this magnitude is highly unlikely. Should it occur, however, main engine controller power requirements will not be jeopardized. The crew has no insight into SSME controller switchover. Once the ground confirms switchover or MECO has occurred, the uncleared short will be isolated. As long as the ac voltage remains above 95 volts, controller switchover will not take place.

- B. DURING OMS MANEUVERS CRITICAL FOR CREW SAFETY, DEORBIT BURN, AND TAEM, THE MAIN BUS WILL REMAIN POWERED AS LONG AS BUS VOLTAGE DOES NOT DROP BELOW 26.4 (26.6) V DC.

During OMS maneuvers critical for crew safety (as defined in the Flight Rule Annex), deorbit burn, and TAEM, it is highly desirable that the maximum level of electrical power redundancy to orbiter equipment be maintained and that single power source equipment not be lost. The crew should take action at the C&W limit of 26.4 V dc.

- C. ALL OTHER TIMES, THE MAIN BUS WILL BE UNPOWERED AS SOON AS POSSIBLE BY DISCONNECTING THE BUS FROM THE TIE BUS, THE PRI PL BUS, THE PTU, AND ITS ASSOCIATED FUEL CELL UNLESS DOING SO WILL RESULT IN THE LOSS OF CRITICAL CAPABILITY. @[042507-8408F]

The FC/MN bus connection was purposely designed to preclude automated isolation. In the event of a short on the Main Bus, the crew will need to take actions to isolate the short. These bus isolation steps must be performed to confirm the location of the short. For the case where the short is isolated to a FC, the FC must be safed, and the Main Bus can be recovered.

The bus will be unpowered as soon as practical. In some cases such as in high speed flight phases (powered flight, immediately post-MECO, deorbit, and entry) this will mean that the action will not occur until the flight regime is less dynamic and/or until the crew reach and visibility improves enough to allow for the action to be completed safely without compromising other critical equipment. For cases where multiple failures have occurred, action may be delayed while the MCC determines if critical capability will be affected when unpowering the bus/equipment.

THIS RULE CONTINUED ON NEXT PAGE

FLIGHT RULES

A9-104

MAIN BUS SHORT [HC] (CONTINUED)

Loss of critical capability includes any failure that results in loss of crew and/or vehicle, and also includes the loss of any function that significantly decreases safety margins (e.g., loss of a Main Engine resulting in an abort being required, or a more severe abort).

DOCUMENTATION: A/EFTP's #205, September 17, 2004, and #206, October 22, 2004, and Hazard Reports ORBI 310, Inadvertent Function of Critical Hardware or Loss of Critical Function Due to Orbiter Interconnecting Hardware Fault, and ORBI 127, AC Bus Failure During RTLS With OMS/RCS Interconnect for Depletion Burn. ©[121604-6524B] ©[042507-8408F]

Rule {A9-155}, AC INVERTER OPERATIONAL LIMITS, references this rule. ©[ED]

FLIGHT RULES

A9-105

CB/RPC RESET

- A. A CB OR RPC WILL NOT BE RESET IMMEDIATELY UNLESS THE FUNCTION OR SYSTEM LOST IS REQUIRED TO RESTORE CRITICAL CAPABILITY. THE MCC WILL REVIEW ASSOCIATED DATA FOR CAUSE OF THE OPEN CIRCUIT. @[121604-6524B]
1. IF A SHORT OR OVERLOAD CAUSED THE TRIP, IT WILL NOT BE RESET UNLESS THE AFFECTED LRU(S) WOULD BE REQUIRED FOR CRITICAL CAPABILITY. IT WILL NOT BE RESET TO REGAIN REDUNDANCY FOR A CRITICAL FUNCTION OR TO REGAIN MISSION SUCCESS ITEMS. @[121604-6524B]
 2. IF THERE IS CONCLUSIVE EVIDENCE THAT NO SHORT/OVERLOAD EXISTS, IT CAN BE RESET (DURING MCC COVERAGE). RESET SHOULD ONLY BE PERFORMED IF THE LRU IS NEEDED. CONCLUSIVE EVIDENCE IS TELEMETRY INDICATING THE EXACT TIME OF POWER LOSS AND ADEQUATE RESOLUTION AND SAMPLE RATE FOR THE BUS CURRENTS AT THAT TIME. IF THE LRU IS REGAINED DURING A CB RESET AND NO SHORT IS SEEN, BUT THE CB FAILS TO HOLD, THE IFM CB RETENTION DEVICE CAN BE INSTALLED IMMEDIATELY FOR CREW SAFETY ISSUES ONLY. INSTALLATION OF THE RETENTION DEVICE FOR MISSION SUCCESS SHOULD BE AVOIDED, BUT INDIVIDUAL CASES WILL BE CONSIDERED BASED UPON IMPACT OF LRU LOSS, LENGTH OF TIME THAT RETENTION DEVICE IS NEEDED, MOST PROBABLE FAILURE MODE, ETC.
 3. IF DATA IS INCONCLUSIVE (E.G., INADEQUATE RESOLUTION OR TIME NOT KNOWN) CB/RPC RESET WILL BE BASED UPON IMPACT OF LRU LOSS, WIRE TYPE (KAPTON TWISTED PAIR IS HIGHEST RISK), DEGREE OF UNCERTAINTY IN DATA ANALYSIS, ETC.

Laboratory tests on Kapton wiring indicate that "arc tracking" can cause extensive damage to wire harnesses. Loss of a wire harness in itself could be catastrophic. Reset of the circuit protection in many cases caused more damage than the original occurrence. However, if it is known that the open circuit was not caused by a short, the cause is most likely mechanical failure or the control was inadvertently bumped. Installation of the cb retention device should be avoided since there have been instances where the cb is damaged in such a manner that it will not latch, nor would it be able to trip if held closed. Under some circumstances, it will be impossible to verify that no short occurred. Examples include: loss of data, circuit protection trip characteristics in noise level of bus currents, low data sample rates, unable to determine exact time of event, etc. Since these present varying degrees of uncertainty and since wire type plays an important role in the risk of reset, cases falling into this category will be addressed based on real-time conditions.

THIS RULE CONTINUED ON NEXT PAGE

FLIGHT RULES

A9-105 CB/RPC RESET (CONTINUED)

DOCUMENTATION: Testing performed at KSC Malfunction Analysis Laboratory and at the JSC EPDC Laboratory. Also CAR # AC1737-010.

- B. A CIRCUIT OR LRU WHICH IS PROTECTED BY A CB (NOT TRIPPED) AND WHICH HAS FAILED TO FUNCTION FOR AN UNDETERMINED REASON, MAY HAVE ITS CB CYCLED ONCE. IF NO SHORT IS SEEN, IT MAY BE CYCLED FIVE TIMES.

Corrosion can form on the contacts of cb's. Troubleshooting experience has shown that this corrosion can be removed by cycling the cb while under load. Five cycles have been sufficient. In case the cb has popped internally due to a short, MCC must review data after the first cycle.

DOCUMENTATION: CF NOI53 (STS-3 and subs), CF7/82-19, Orbiter Circuit Breaker Contact Oxidation.

Rule {A9-204}, CRYO HEATER [CIL] [HC], references this rule. ©[ED]

A9-106 CONTROL BUS [HC] ©[121604-6524B]

- A. A CONTROL BUS THAT IS DETERMINED TO HAVE A SHORT BY THE MCC WILL BE UNPOWERED AS SOON AS POSSIBLE, UNLESS DOING SO WILL RESULT IN THE LOSS OF CRITICAL CAPABILITY. POWER WILL BE REMOVED USING THE FOLLOWING GUIDELINES:
1. IF A SHORT CAUSES THE LOSS OF A CONTROL BUS RPC, THE CONTROL BUS CENTER POWER SOURCE CIRCUIT BREAKER (ON PANEL R14) WILL BE OPENED AND THE REMAINING RPC WILL BE DISABLED BY CONTINUOUSLY HOLDING THE CONTROL BUS RPC RESET SWITCH (ON PANEL R1) IN THE RESET POSITION UNTIL AN IFM IS PERFORMED TO UNPOWER THE DESIRED RPC.
 2. IF A SHORT DOES NOT CAUSE LOSS OF ANY CONTROL BUS RPC'S, BOTH OF THE ASSOCIATED CONTROL BUS RPC RESET SWITCHES WILL BE ACTUATED CONTINUOUSLY TO DISABLE BOTH CONTROL BUS RPC'S UNTIL AN IFM IS PERFORMED TO UNPOWER THE DESIRED RPC'S. IF AFTER DISABLING BOTH RPC'S A PORTION OF THE BUS IS DETERMINED TO STILL BE POWERED, THE R14 CENTER SOURCE CB WILL BE PULLED. THIS WILL DISABLE THREE CONTROL BUSES (E.G., CNTL AB1/2/3) UNTIL THE IFM CAN BE PERFORMED. ©[121604-6524B]

THIS RULE CONTINUED ON NEXT PAGE

FLIGHT RULES**A9-106 CONTROL BUS [HC] (CONTINUED)**

- B. A CONTROL BUS WHICH HAS FAILED DUE TO A SHORT MAY HAVE ONE OF ITS RPC'S RESET (DURING GROUND COVERAGE ON MCC REQUEST) TO ATTEMPT TO REGAIN A CRITICAL CAPABILITY. @[121604-6524B]
- C. ON-ORBIT, IF A CONTROL BUS HAS BEEN UNPOWERED WITH USE OF ONE OR MORE SWITCH RETENTION DEVICES TO CONTINUOUSLY RESET THE RPC(S), AN IFM PROCEDURE WILL BE PERFORMED TO SELECTIVELY UNPOWER THE DESIRED RPC AND ALLOW REDUNDANT POWER TO BE REAPPLIED TO THE REMAINING ASSOCIATED CONTROL BUSES.

*Breadboard testing in May 1988 determined that a control bus short would not open all three circuit protection devices due to bus wire size and length. The result would be a partial control bus loss with the short still being supplied power. (The maximum power possible from a 5-amp RPC source is $7.5A * 30V = 225$ watts).*

A control bus short is confirmed by any two or more of the following which are determined to be concurrent events associated with the same control bus: RPC OFF indication, RPC trip signature observed in the FPC and/or FC currents, a drop in Control Bus Volts, a "short" signature in the FC amps that can be associated with the center feed fuse opening, fire/smoke, "arcing" signatures observed in the FPC and/or FC currents, and reports of failed equipment. Reports of failed equipment must also be associated by location by either being located near an opened fuse or RPC, or collocated with other failed equipment.

If a control bus is determined to have a short, it will be unpowered as soon as practical to prevent further damage due to localized heating and/or possible arc tracking. Kapton wire arc-tracking tests performed in 1990 indicate that initiation of arc tracking on a single conductor wire (as used for control buses) is unlikely. However, if it did occur, testing indicates that the entire bundle/ harness could be damaged. Since control bus wires are routed in bundles and harnesses containing other control buses and critical functions, damage affecting multiple wires could be catastrophic. @[121604-6524B]

The bus will be unpowered as soon as practical. In some cases such as in high speed flight phases (powered flight, immediately post-MECO, deorbit and entry) this will mean that the action will not occur until the flight regime is less dynamic and/or until the crew reach and visibility improves enough to allow for the action to be completed safely without compromising other critical equipment. For cases where multiple failures have occurred, action may be delayed while the MCC determines if critical capability will be affected when unpowering the bus/equipment. @[121604-6524B]

Loss of critical capability includes any failure that results in loss of crew and/or vehicle, and also includes the loss of any function that significantly decreases safety margins (e.g., loss of a Main Engine resulting in an abort being required, or a more severe abort).

Documentation: A/EFTP #205 and #206, and Hazard Report ORBI 292, Loss of Normal Isolation Between Two Control Buses.

THIS RULE CONTINUED ON NEXT PAGE

FLIGHT RULES

A9-106

CONTROL BUS [HC] (CONTINUED)

If a control bus is shorted, one of the power sources will most likely be lost.

- a. *If a control bus RPC is lost due to a short, the quickest way to remove the other two power sources is to use the RPC reset switch and open the center source circuit breaker. This action will cause four other control buses to lose one of three power sources, and two other control buses to lose two of three power sources. After the IFM is performed to unpower the "reset RPC," two RPC's will be regained by releasing the RPC reset switch. This will result in one control bus (the one with the short) with no power sources, four control buses with two of three power sources, and all others with all three power sources.*
- b. *If a control bus short does not cause the loss of an RPC, the center source 5-amp fuse (downstream of the 10-amp cb) is probably open. The only quick method of removing the other two power sources is to use the two associated RPC reset switches. This action will cause six other control buses to lose one of three power sources, and two other control buses to lose two of three power sources. After the IFM is performed to unpower the associated "reset RPC's," four RPC's will be regained by releasing the RPC reset switches. This results in one control bus (the one with the short) with no power sources, two control buses with two of three power sources, and all others with all three power sources. Continued arcing and smoke may require the center feed cb to be pulled to ensure no power is available to the shorted bus.*

The IFM unpowers individual RPC's using the appropriate LF MDM cable pins. The IFM does not power the LF MDM or the preflight test bus.

With respect to resetting a control bus RPC to attempt positioning of valves or relays, depending on the location and magnitude of the short, tests have indicated that it may be possible to power momentary (2 to 3 seconds) loads by resetting one of the control bus RPC's.

DOCUMENTATION: SODB 3.4.5.6.2; Lockheed memo #EP5-M10-215, Shuttle Control Bus Kapton Wire Arc Tracking Test Summary, 10-12-90; and LEMSCO-25658, Summary of the Control Bus Repower Test, May 1988. Orbiter Kapton™ Insulated Wire Arc Track Investigation Report number: N200316JU01, July 2001. AEFTP #205 and #206. ©[121604-6524B]

Rule {A9-3}, ELECTRICAL POWER DISTRIBUTION AND CONTROL (EPDC) SYSTEM [CIL], references this rule. ©[ED]

FLIGHT RULES

A9-107

MAIN BUS TIE [CIL] [HC] @[121604-6523B]

- A. NORMALLY THE MAIN BUSES WILL BE ISOLATED FROM EACH OTHER. TWO OR THREE MAIN BUSES WILL BE TIED AS FOLLOWS: @[111705-7127B]
1. TWO BUSES WILL BE TIED TO GAIN INSIGHT INTO FC PERFORMANCE DUE TO SUSPECT OR FAILED INSTRUMENTATION; BUSES WILL NOT BE TIED PRIOR TO MECO AND WILL BE UNTIED PRIOR TO DEORBIT TIG. BUSES WILL BE UNTIED FOR SEPARATION OF CRITICAL REDUNDANCY (I.E., CRITICAL BURN, RENDEZVOUS/PROX OPS, PAYLOAD DEPLOYS).

It has been determined that a viable alternative to adequate FC instrumentation is to tie the FC to a healthy, adequately instrumented FC. For critical flight phases, buses will be untied to provide greater system redundancy in the event of a main bus short. In order to preserve redundancy through separation of the main buses, no more than two buses will be tied solely to gain insight into a fuel cell. Buses may be untied for short periods when separation of critical system redundancy is deemed a higher priority than FC monitoring. In situations where three buses would have to be tied to gain insight into one or more FC's, maintaining three healthy main buses and separation of function take precedence over gaining insight into a fuel cell. While tied for a CPM failure, FC's will be managed in accordance with Rule {A9-59}, FC - CELL PERFORMANCE MONITOR [CIL].

DOCUMENTATION: SODB, 4.4.1.1.1.

2. TWO OR THREE MAIN BUSES WILL BE TIED AS REQUIRED TO MAINTAIN THREE POWERED MAIN BUSES IN THE EVENT OF FC FAILURE(S) OR DEGRADATION SUCH THAT THE FC'S CAPABILITY TO SUPPORT ITS MAIN BUS IS SUSPECT.

It is highly desirable to always maintain the highest level of power redundancy to all orbiter equipment. Fuel Cells are rated to produce 12 kW for sustained periods of time. A FC can support approximately 13 kW for up to 4 hours or approximately 16 kW for up to 10 minutes if required for contingency situations.

3. TWO OR THREE MAIN BUSES MAY BE TIED TO MINIMIZE LOAD TRANSIENTS ON THE FC'S. @[111705-7127B]

It is highly desirable that no FC be stressed unnecessarily by excessive loading. Therefore, for total vehicle electrical loads of >18 kW, all three buses will be tied during periods of troubleshooting. The FC malfunction procedures reflect this philosophy.

DOCUMENTATION: SODB, 3.4.4.1.2.

THIS RULE CONTINUED ON NEXT PAGE

FLIGHT RULES

A9-107

MAIN BUS TIE [CIL] [HC] (CONTINUED)

4. NOMINALLY, TWO MAIN BUSES WILL BE TIED FOR EXTENDED ON-ORBIT OPERATION OF PAYLOADS REQUIRING > 4 KW. @[111705-7127B]

A bus tie is used to preclude one FC from being overstressed by excessive electrical load caused from supporting a main bus and the high power requirement of the payload. @[092701-4872]

After a powerdown of orbiter equipment to accommodate payload power requirements, the orbiter will still require approximately 4 kW power per FC. FC lifetime is directly proportional to the cumulative load on the FC throughout its life. A standard FC lifetime of 2600 hours is based on an average load of 4.5 kW. At power levels greater than 4.5 kW, FC performance degradation rates increase exponentially. To keep a single FC's load under 8 kW continuous, two buses will be tied for a payload requiring > 4 kW to allow the additional load to be shared between two FC's. This will decrease any single FC's degradation rate and maximize its useful lifetime.

Reference Rule {A9-51}, FC POWER LEVEL CONSTRAINTS [HC]. @[111705-7127B] @[042507-8478A]

DOCUMENTATION: SODB, 3.4.4.1.2 and engineering judgment.

5. TWO MAIN BUSES MAY BE TIED IN ORDER TO MAXIMIZE SSPTS OPCU POWER TRANSFER FROM ISS. @[042507-8408F]

When both OPCU converters are operating in a PTU, the full power transfer from those OPCU's might not be able to be transferred due to orbiter bus loading. Bus tying a main bus will allow the OPCU's more loads to power. When choosing which two buses to tie together, consideration should be given to each fuel cell's performance curve and the resistance between the different bus ties.

DOCUMENTATION: Engineering judgment. @[042507-8408F]

- B. BUS TYING DURING ASCENT/ENTRY WILL ONLY BE PERFORMED IF THE TOTAL FC ELECTRICAL LOAD IS \leq 27 KW OR 930 AMPS AND THE REMAINING FC PERFORMANCE (V-I) HAS BEEN NOMINAL.

A bus tie to a decaying FC during powered flight is acceptable provided the remaining FC's have adequate performance margins available to support two buses.

THIS RULE CONTINUED ON NEXT PAGE

FLIGHT RULES

A9-107 MAIN BUS TIE [CIL] [HC] (CONTINUED)

C. DURING ASCENT, A BUS WILL NOT BE TIED TO A DEAD BUS (I.E., BUS VOLTS < 20 V DC) PRIOR TO SRB SEPARATION. AFTER SRB SEPARATION AND PRIOR TO MECO, A BUS TIE WILL ONLY BE PERFORMED TO REGAIN CRITICAL CAPABILITY. ©[121604-6523B]

The voltage transient on a good bus while tying to an unpowered bus may cause an undervoltage condition on the SRB buses resulting in the loss of two of three power sources to the SRB's. All critical equipment will remain powered with loss of one main bus (volts < 20). Therefore, only the switching absolutely necessary should be performed pre-SRB separation, and the bus tie steps when main volts are < 20 Vdc should not be performed.

Loss of a main bus during powered flight results in the loss of one power source to two main engine controllers. Bus tying to a dead bus may cause a large enough voltage transient on the good bus to result in the total loss of power to a main engine controller. This will cause the loss of a main engine and could result in an abort. Therefore, a bus tie may only be performed in second stage of powered-flight if it is required to regain critical capability taking into account the associated risk of losing a single SSME. A bus tie will not be performed pre-MECO to regain redundancy. ©[121604-6523B]

Reference: Ascent/Entry Flight Techniques Panel #207, November 12, 2004, and Hazard Reports ORBI 090, Undetected Interloop Leakage of FC-40 Between Fuel Cell Coolant Loops; ORBI 094, Loss of Reactant Supply for Fuel Cell Powerplant (FCP) Operation; ORBI 205, Opening of Orbiter Fuel Cell 3 Structural Ground Contact Can Cause Overvoltage Condition or Lead to Fire/Explosion; ORBI 287, Inability to Safely an Overheated Fuel Cell Can Cause Fire and/or Explosion; ORBI 127, AC Bus Failure During RTLS with OMS/RCS Interconnect for Depletion Burn; ORBI 243, Possible ET Recontact Due to Inability to Reconfigure RCS Isolation Valves Following Valve Closure to Isolate a Leak; ORBI 38, Loss of Vehicle Due to Failure MDM's or EMDM; and IEPD 01, Inability to Power Critical Functions. ©[121604-6523B] ©[ED] ©[042507-8408F]

A9-108 CRITICAL PHASE BUS MANAGEMENT

ELECTRICAL BUSES NOT REQUIRED FOR ASCENT AND/OR ENTRY (E.G., PAYLOAD BUSES NOT REQUIRED FOR THESE PHASES) WILL NORMALLY BE POWERED OFF PRIOR TO THE CRITICAL PHASE.

Unpowered circuitry cannot provide a site for a short. This affords more protection to the orbiter during critical mission phases.

Rules {A9-257}, POWER REACTANT STORAGE AND DISTRIBUTION (PRSD) H2 AND O2 REDLINE DETERMINATION; {A9-262}, EDO PALLET MANAGEMENT; and {A9-471}, SSPTS PTU ASCENT AND ENTRY MANAGEMENT, reference this rule. ©[ED]

FLIGHT RULES

A9-109**PRIMARY PAYLOAD BUS MANAGEMENT**

ELECTRICAL POWER TO MAJOR PAYLOADS IN THE ORBITER PLB IS PROVIDED VIA THE ORBITER PRIMARY PAYLOAD BUS. THE PRIMARY PAYLOAD POWER SOURCES TO THE ORBITER PLB WILL BE MANAGED AS FOLLOWS:

- A. PRIMARY PAYLOAD MNC - 8 KW CONTINUOUS, 12 KW PEAK FOR 15 MINUTES EVERY 3 HOURS.
- B. PRIMARY PAYLOAD FC3 - 8 KW CONTINUOUS, 12 KW PEAK FOR 15 MINUTES EVERY 3 HOURS.
- C. PRIMARY PAYLOAD MNB - 7 KW CONTINUOUS, AND PEAK @[071494-1658A]

By design, the power level constraints noted above must be observed. The orbiter MNC bus feed is the normal source of power to the primary payload bus to maximize the amount of power delivered to a payload. Although the FC3 feed has the same power constraints as the orbiter MNC bus feed, it has always been the philosophy to feed the payloads from orbiter buses rather than directly from the FC, when possible. The MNC and FC3 feeder constraint is based upon FC power limitations. The existing fuel cells cannot supply the full power capabilities of the four feeders (each with 200 amp fuses) without violating the FC power constraints. The orbiter MNB feed does not have the power capabilities of the other feeds due to the fuse sizing between the orbiter MNB bus and the primary payload bus. The MNB feeder constraint was based on a detailed analysis completed by the subsystems managers. It was determined for a worst case of 26.8 volts and a 10 percent difference between the two feeders, that 7 kW continuous and peak was to be the highest level that the MNB bus should operate at and still maintain the integrity of the feeder and provide a slight margin of safety. Payload power includes all ac and dc power provided to the payload. Primary payload power is measured at the FC output terminals. @[071494-1658A]

DOCUMENTATION: SODB 4.5.6.8.1.

Rule {A9-352}, SPACEHAB EMERGENCY BUS LOSS, references this rule. @[ED]

FLIGHT RULES

A9-110

PREFLIGHT TEST BUS MANAGEMENT

IF NECESSARY TO REGAIN A CRITICAL FUNCTION, THE PREFLIGHT TEST BUS MAY BE POWERED MOMENTARILY OR CONTINUOUSLY FOR ORBIT OR ENTRY. THE PRELAUNCH MDM'S WILL NOT BE POWERED. SPECIFIC LRU'S OR SITUATIONS THAT USE THE PREFLIGHT TEST BUS WILL BE IDENTIFIED IN THE RULES SECTION FOR EACH DISCIPLINE.

- A. USAGE OF THE PREFLIGHT TEST BUS WILL BE CONSTRAINED AS FOLLOWS:
1. ORBIT - RESTORE CRITICAL EQUIPMENT AFTER FIRST FAILURE.
 2. ENTRY - RESTORE CRITICAL EQUIPMENT FOR ENTRY SINGLE-FAULT TOLERANCE (SFT).
- B. THE FOLLOWING CONSTRAINTS MUST BE FOLLOWED IF THE PREFLIGHT TEST BUS IS POWERED CONTINUOUSLY.
1. ORBIT - A MAIN BUS TIE WILL BE PERFORMED TO PROTECT AGAINST AN INADVERTENT MAIN BUS DISCONNECT PRIOR TO PREFLIGHT TEST BUS POWERUP:
 - a. FOR PREFLIGHT BUS 1 USAGE - BUS TIE MNA TO MNB.
 - b. FOR PREFLIGHT BUS 2 USAGE TO RECOVER FC3 - TO PRECLUDE POSSIBLE LOSS OF TWO MAIN BUSES, BUS TIE MNA TO MNC WHILE THE PREFLIGHT BUS IS POWERED AND FC3 IS NOT YET RECOVERED. ONCE FC3 IS RECOVERED, RECONFIGURE THE BUS TIE MNB TO MNC AND CONNECT FC3 AND MNC TO THE PRIMARY PAYLOAD BUS.
 - c. FOR PREFLIGHT BUS 2 USAGE IN ALL OTHER CASES - BUS TIE MNB TO MNC AND CONNECT FC3 AND MNC TO THE PRIMARY PAYLOAD BUS.

THIS RULE CONTINUED ON NEXT PAGE

FLIGHT RULES

A9-110

PREFLIGHT TEST BUS MANAGEMENT (CONTINUED)

2. ENTRY - FOR FUEL CELL (ECU) RECOVERY, THE PREFLIGHT TEST BUS WILL BE USED TO PROVIDE A TWO FC ENTRY (REF. RULE {A9-57D}, REUSABLE FC). TO PRECLUDE POSSIBLE LOSS OF TWO MAIN BUSES DUE TO A PREFLIGHT TEST BUS DRIVER FAILURE, THE FOLLOWING MAIN BUS TIE/PRIMARY PAYLOAD BUS CONFIGURATION SCHEDULE WILL BE IMPLEMENTED:
 - a. FC1 RECOVERED, FC2(3) FAILED: BUS TIE MNB TO MNC
 - b. FC2 RECOVERED, FC1 FAILED: BUS TIE MNC TO MNA
CONNECT FC3 TO PRI PL BUS
CONNECT MNC TO PRI PL BUS
 - c. FC2 RECOVERED, FC3 FAILED: BUS TIE MNC TO MNA
 - d. FC3 RECOVERED, FC1(2) FAILED: BUS TIE MNA TO MNC (MNB)
CONNECT FC3 TO PRI PL BUS
CONNECT MNC TO PRI PL BUS

FOR ALL OTHER USES, FOLLOW THE MAIN BUS TIE GUIDELINES IN PARAGRAPH B.1.

NOTE: A CREWMEMBER MUST BE ABLE TO UNPOWER THE PREFLIGHT TEST BUS WHILE SECURED IN SEAT.

THIS RULE CONTINUED ON NEXT PAGE

FLIGHT RULES

A9-110

PREFLIGHT TEST BUS MANAGEMENT (CONTINUED)

C. MOMENTARY USE OF THE PREFLIGHT TEST BUS CONSTRAINTS ARE AS FOLLOWS :

IF MOMENTARY USE IS POSSIBLE DURING ENTRY, ON-ORBIT PREFLIGHT TEST BUS POWERUP IS REQUIRED TO VERIFY NO DRIVER FAILURES. IF POSSIBLE, THE MOMENTARY FUNCTION WILL BE EXERCISED ON ORBIT.

Powering the preflight test bus enables circuits that use the single-string launch MDM's and data bus system to operate most orbiter systems equipment during ground turnaround. Due to the design, a single driver failure could cause equipment to be inadvertently commanded whenever the preflight test bus is powered. A study prepared by the Electrical Systems Section, Systems Division, Mission Operations Directorate, showed that the results of each driver failure is recoverable and would not place the orbiter or crew in a critical situation. Therefore, while on orbit, the preflight test bus may be used to restore critical redundancy beyond SFT. Due to entry being a critical phase of flight, use of the preflight test bus is limited to restore only single-fault tolerance to entry-critical systems. Note that at no time would the prelaunch MDM's be powered during a mission since a single card failure could send multiple, conflicting commands to orbiter systems and alter vehicle configuration severely (e.g., simultaneous FC/main bus disconnect/connect, etc.). The three most significant single driver failures that were noted were the FC/main bus disconnect, three-phase ac inverter and bus disconnect, and APU fuel valve closure.

During the orbit phase, if the preflight bus is to be powered continuously, a bus tie is performed to prevent loss of a main bus due to an inadvertent disconnect caused by a preflight test bus driver failure. For the recovery of FC3, total prevention of the loss of a main bus cannot be met. However, to avoid losing two main buses, the bus tie configuration is modified so MNC is tied to MNA during the relatively brief time when the preflight test bus is powered, but FC3 is not yet recovered. This configuration covers the case for the untied FC2/MNB bus system having a failed driver when the preflight test bus is first powered which results in the temporary loss of MNB. The prevention of the loss of a main bus can be met once FC3 is recovered and connected to its main bus by reconfiguring the bus tie between MNB and MNC. In addition, while FC3 is operating, the primary payload bus can be used to provide a redundant electrical path between FC3 and MNC which will prevent FC3 from inadvertently disconnecting from its main bus.

During entry, the bus tie configuration depends upon the reason the preflight test bus is being used. For the case where it is used to recover a FC, the bus tie configuration depends upon which FC is recovered and which FC has failed. The reason for this is to protect the electrical system from losing more than one main bus due to a driver failure. Again, the primary payload bus can be used to provide a redundant electrical path between FC3 and MNC which will prevent FC3 from inadvertently disconnecting from its main bus.

THIS RULE CONTINUED ON NEXT PAGE

FLIGHT RULES

A9-110

PREFLIGHT TEST BUS MANAGEMENT (CONTINUED)

A disconnect of either ac inverter power or ac buses can be corrected during either orbit or entry phase of flight by unpowering the preflight bus and using the panel switches to restore the affected ac system. Unpowering the preflight test bus will result in the loss of the system it recovered.

Since avionics bay fire suppression can be inhibited by an undetectable DISCHARGE CMD driver failure (one driver per avionics bay), as well as other undesirable driver failures affecting vehicle configuration, the crew must be able to unpower the preflight test bus while seated for entry. If fire suppression is required for an avionics bay while on orbit, either the preflight test bus can be unpowered momentarily to recover the AV bay built-in system or a handheld bottle can be discharged. Preflight test bus 1 can affect avionics bay 3 fire suppression, and preflight test bus 2 can affect avionics bays 1 and 2 fire suppression.

Momentary use of the preflight test bus would require only a few seconds of operations (<5 seconds) to accomplish most switching or reconfiguration tasks, so exposure to driver failures is limited. The only constraint is that on-orbit verification of preflight test bus capability be performed which will ensure the integrity of the test bus and the IFM procedure prior to its use during entry.

DOCUMENTATION: On-Orbit/Entry Usages of Preflight Test Bus, Electrical Systems Section - Mission Operations Directorate. Presented to Orbit Flight Techniques on November 18, 1988.

Rule {A9-57D}, REUSABLE FC, references this rule.

FLIGHT RULES

A9-111

SHORTED BUS/EQUIPMENT

ANY BUS OR PIECE OF EQUIPMENT THAT IS DETERMINED TO HAVE A SHORT THAT DOES NOT CLEAR AUTOMATICALLY WILL BE UNPOWERED AS SOON AS POSSIBLE UNLESS DOING SO WILL RESULT IN THE LOSS OF CRITICAL CAPABILITY. ACTIONS FOR SPECIFIC BUSES/EQUIPMENT ARE IDENTIFIED SEPARATELY. ©[121604-6524B]

A shorted bus or piece of equipment that does not automatically clear presents several concerns for causing additional damage/equipment failures. They include but are not limited to: localized heating, fire/smoke/toxic gases, arcing, arc-tracking and flashover, and loss of wiring integrity.

The bus or affected equipment will be unpowered as soon as practical. In some cases such as in high speed flight phases (powered flight, immediately post-MECO, deorbit, and entry) this will mean that the action will not occur until the flight regime is less dynamic and/or until the crew reach and visibility improves enough to allow for the action to be completed safely without compromising other critical equipment. For cases where multiple failures have occurred, action may be delayed while the MCC determines if critical capability will be affected when unpowering the bus/equipment.

Loss of critical capability includes any failure that results in loss of crew and/or vehicle, and also includes the loss of any function that significantly decreases safety margins (e.g., loss of a Main Engine resulting in an abort being required, or a more severe abort)

Documentation: AEFTP #205 and #206. ©[121604-6524B]

A9-112 THROUGH A9-150 RULES ARE RESERVED

FLIGHT RULES

AC POWER DISTRIBUTION AND CONTROL SYSTEMS MANAGEMENT

A9-151 AC INVERTER MANAGEMENT

NORMALLY, ALL AC INVERTERS AND BUSES WILL BE POWERED DURING FLIGHT. IF AN INVERTER FAILS, IT WILL BE DISCONNECTED FROM BOTH THE AC AND DC BUSES.

All nine ac inverters are utilized by orbiter equipment. The dc power to a failed inverter will be disconnected since the inverter could act as a load. Also, the output capacitor acts as a load of 2.95 amps on the other two phases of the ac bus supplying power to coupled three-phase loads (ac motors).

A9-152 AC BUS SENSORS SWITCH MANAGEMENT

TO PRECLUDE INADVERTENT AC BUS DISCONNECT, THE AC BUS SENSORS WILL BE PLACED IN THE "MONITOR" POSITION DURING ASCENT (UNTIL MM 105). ALSO, DURING ASCENT PRIOR TO MECO, IF ANY AC PHASE BUS FAILS, OR IF A MAIN ENGINE SHUTS DOWN, OR IF AN SSME CONTROLLER LOSES REDUNDANCY, THEN ALL THREE AC BUS SENSOR SWITCHES WILL BE PLACED TO "OFF". POST OMS-1, THE AC BUS SENSORS WILL NOMINALLY BE PLACED IN "AUTO TRIP" AND REMAIN IN THAT POSITION FOR THE REMAINDER OF THE FLIGHT (THROUGH WHEEL STOP). @[110900-3510]

AC sensors are put to MONITOR during powered flight to prevent an inadvertent tripoff that would cause SSME controller auto switchover from the affected bus to a secondary SSME controller on another ac bus. If a main engine shuts down, or SSME controller redundancy is lost, or a failure occurs in the AC system, the ac sensor switches will be put to OFF so that no failure in the ac bus sensor could cause further complications. If a failure occurs in an AC system during the entry timeframe, the affected AC bus sensor can be taken "OFF" to protect for critical equipment redundancy. @[110900-3510]

Rules {A5-111A}, AC BUS SENSOR ELECTRONICS CONTROL [CIL], and {A9-1001}, ELECTRICAL GO/NO-GO CRITERIA [HC], reference this rule. @[ED]

A9-153 AC BUS LOADING

WHEN POSSIBLE, AC BUS LOADING WILL BE SELECTED TO PROVIDE SEPARATE POWER SOURCES TO REDUNDANT EQUIPMENT AND TO BALANCE BUS LOADS.

The highest level of power redundancy should be maintained. It is advisable to maintain near equal loading on all buses in the event that, if a single FC powers two main buses, it will not be overstressed.

FLIGHT RULES

A9-154

AC LOAD MANAGEMENT DURING ASCENT [HC] @[121604-6523B]

- A. ONLY THE FOLLOWING AC SWITCHABLE LOADS, WHOSE RECOVERY CANNOT BE DELAYED UNTIL POST-MECO, MAY BE RECONFIGURED PRE-MECO:

Under normal circumstances, the startup transients of three-phase motors will not introduce a voltage transient on an ac bus that would affect a Space Shuttle Main Engine Controller (SSMEC). However, switching such equipment increases the risk of causing severe voltage transients since an unknown short circuit may be present on the previously unpowered circuitry. By limiting the reconfiguration of ac loads to those absolutely required, this risk can be minimized.

1. FREON PUMPS (IF ONLY ONE FREON LOOP AFFECTED, SWITCH POST-MECO; IF BOTH FREON LOOPS AFFECTED, SWITCH ONE ASAP).

With only one Freon loop active, corrective actions can be delayed on the inactive loop for 1 hour (at ascent power loads) without any violation of any orbiter thermal limits (ref. Analysis TS-TM-04-007, March 23, 2004). However, if both Freon loops are affected, troubleshooting of the Freon loops will occur ASAP, since they provide vehicle cooling. The loss of both Freon loops is an RTLS/TAL abort.

2. RAD BYPASS VALVES (ONLY FOR LOSS OF FES OR FREON LOOP(S) AFFECTED)

Radiator bypass valve motors may be moved to obtain radiator flow for cooling if total FES fails or to determine if there is blockage in the bypass leg of the Freon loop when Freon flow is low.

3. RAD ISOLATION VALVES (FOR AN UNEXPLAINED LEAKING LOOP, ATTEMPT ISOLATION ASAP; IF LEAK RATE CAN SUPPORT MECO AND AC CRITICAL, DELAY ACTION UNTIL POST-MECO) @[040899-2568A]

Moving the Rad bypass valves or Rad isolation valves may be required to determine the status of the Freon loops before an abort call can be made. Additionally, a Freon loop leak that is observable during ascent is a large leak and will require first day PLS if no action is taken. The radiator isolation valve may isolate the leak and allow mission extension to PLS.

4. AVIONICS BAY FANS (SWITCH WITHIN 3 MINUTES IF A POWERED GOULD TACAN IS LOCATED IN AFFECTED AVIONICS BAY. IF AV BAY 3A UPGRADED FOR ENHANCED COOLING, THE FAN WILL NOT BE SWITCHED.)

Swapping of the Av Bay Fan pre-MECO to restore cooling for TACAN's is no longer a concern with Collin's TACAN's since they are free air cooled and will not exceed temperature limitations prior to MECO. (Boeing MOA 04-xxx Comm and Track, February 11, 2004). @[121604-6523B]

THIS RULE CONTINUED ON NEXT PAGE

FLIGHT RULES**A9-154 AC LOAD MANAGEMENT DURING ASCENT [HC] (CONTINUED)**

The Enhanced Middeck Cooling modification will place cabin fans in Av Bay 3A vice the normal avionics fans. Because of the large startup ac transient associated with this type of fan, the Av Bay 3 fan will not be switched, in powered flight, if the modification is in place. Vehicles with cabin fans installed in Av Bay 3A will have Collin's TACAN's which are free air cooled. Switching fans pre-MECO will not be necessary. @[121604-6523B]

5. H₂O LOOP PUMP (FOR LOSS OF THE INACTIVE LOOP ACCUMULATOR N₂ CHARGE)

Loss of the N₂ charge on the inactive H₂O loop will lead to loss of the loop and a Next PLS unless the pump is activated prior to the loss of the N₂ charge. Consideration may be given to activating the H₂O Loop Pump for this case if no other failures exist that would put the SSMEC's at risk.

Should real-time data indicate that temperatures are out of limits, then action will be considered in order to preserve the necessary equipment prior to MECO. (SODB Vol III, Table 4.5.0-1 TIME/LIMITATIONS FOR OPERATION OF AVIONICS LRU'S WITHOUT COOLING)

6. OMS/RCS VALVES

OMS/RCS valves may be required in malfunction cases, leak isolation, or propellant dump operations.

7. APU/HYD WSB CONTROLLER (ONLY AFTER HIGH TEMP FDA ALERT)

APU/HYD WSB controller, reconfiguration can wait until post-MECO without great risk to the equipment. Should real-time data indicate that the temperature is out of limits, then action will be considered in order to preserve the necessary equipment prior to MECO.

8. CREW SEAT OPERATIONS (ONLY IF CONSIDERED MANDATORY BY THE CREW) @[040899-2568A]

The crew seat motors may be needed due to reach or visual problems. @[121604-6523B]

- B. AC CIRCUIT BREAKERS WHICH HAVE OPENED WILL NOT BE RESET PRE-MECO UNLESS THE FUNCTION IS CRITICAL AND:

1. THE MCC HAS CONFIRMED THAT THE CB(S) DID NOT OPEN BECAUSE OF A SHORT, OR:
2. THE MCC CONFIRMS THAT BOTH SSME CONTROLLERS ON THE AFFECTED BUS HAVE BEEN LOST, OR:

THIS RULE CONTINUED ON NEXT PAGE

FLIGHT RULES

A9-154 AC LOAD MANAGEMENT DURING ASCENT [HC] (CONTINUED)

3. LOSS OF THE FUNCTION IS CONSIDERED TO BE A GREATER RISK THAN LOSS OF THE TWO AFFECTED SSME CONTROLLERS.

If a circuit breaker (cb) has opened, it could very well be due to a short circuit. If both SSME controllers have been lost, or if a short was not the problem, then the cb(s) may be reset if needed to regain a critical function. Resetting a cb that has opened due to a short will expose SSME controllers to a voltage transient, potentially resulting in the loss of the controllers, while the chance of a successful reset of the cb(s) is minimal. ©[121604-6523B]

- C. ANY AC LRU THAT IS DETERMINED TO HAVE A SHORT OR STALL CONDITION THAT DOES NOT CLEAR AUTOMATICALLY WILL BE UNPOWERED AS SOON AS POSSIBLE.

A shorted or stalled LRU can cause a voltage transient large enough to cause the loss of an SSMEC. AC LRU's with alternate power sources should not be reconfigured since the electrical short in the LRU will be transferred to another ac bus. During ascent, this could result in the loss of one SSME and loss of redundancy for the two remaining SSME's.

- D. IF PRE-MECO AND A SSME HAS LOST SSMEC REDUNDANCY, SWITCHING OF REDUNDANT HARDWARE ON TO A CRITICAL AC BUS WILL BE DELAYED AS LONG AS POSSIBLE.

In the unlikely event the alternate fan or pump is stalled or shorted and causes a transient on a critical bus, by delaying switching to after "Press to MECO" or "Single Engine Press," the orbiter could still make it to orbit with the loss of a SSME.

- E. IF NEEDED, ANY UNSHORTED EQUIPMENT THAT HAS BECOME UNPOWERED MAY BE REPOWERED PRE-MECO.

If an LRU is not shorted and was operating nominally, but somehow became deactivated, then it can be repowered pre-MECO, if it is required since the shutdown and startup of the LRU would be on the same ac bus.

Reconfiguring affected ac equipment prior to MECO may be attempted in order to reduce the risk of further problems. For a nominal ascent, temperature violations are not expected pre-MECO. Cabin fan, IMU fan, Freon Pump, Av Bay fan, H₂O Loop pump, and humidity separator reconfiguration is not required until post-MECO.

DOCUMENTATION: SODB 3.4.5.2-1, and Hazard Reports ORBI 127, AC Bus Failure During RTLs with OMS/RCS Interconnect for Depletion Burn; ORBI 243, Possible ET Recontact Due to Inability to Reconfigure RCS Isolation Valves Following Valve Closure to Isolate a Leak; and ORBI 275, Loss of Freon Coolant Loops.

Reference Ascent/Entry Flight Techniques Panel #207, November 12, 2004. ©[121604-6523B]

FLIGHT RULES

A9-155**AC INVERTER OPERATIONAL LIMITS** @[121604-6522]

- A. THE INVERTER/AC BUS WILL BE DISCONNECTED IMMEDIATELY IF:
1. THE AC VOLTAGE IS CONFIRMED > 130 , OR
 2. THE AC VOLTAGE IS < 95 AS CAUSED BY A SHORT/OVERLOAD, OR
 3. BOTH MAIN ENGINE CONTROLLERS POWERED BY THAT BUS ARE NONFUNCTIONAL (POST-MECO OR MCC VERIFIED FAILED PRE-MECO) AND:
 - a. THE AC VOLTAGE IS CONFIRMED < 108 , OR
 - b. THE AC VOLTAGE IS CONFIRMED > 123 , OR
 - c. A SHORT/OVERLOAD CONDITION EXISTS.

AC equipment is only guaranteed to operate from 110 to 120 volts. If the voltage is > 123 (C&W high limit), the potential exists to damage LRU's on the bus. If the voltage is < 108 (C&W low limit), leaving the inverter connected to the bus can result in a load on the remaining two phases, or maintaining power to a short circuit if an overload exists. These risks will be accepted for a short duration of time (until MECO) providing that at least one of the affected main engine controllers is still functioning. Only the MCC can verify controller operation. If the voltage is > 130 , then the main engine controllers should not be functional and damage could occur to other equipment on the bus. If the voltage is < 95 and caused by a short/overload condition, then the engine controllers will probably not be functional, and leaving the inverter on line and feeding the short creates a fire hazard. This rule is consistent with the philosophy expressed in Rule {A9-104A}, MAIN BUS SHORT.

DOCUMENTATION: SODB 4.5.6.2.a, ICD-13MI5000, engineering judgment.

THIS RULE CONTINUED ON NEXT PAGE

FLIGHT RULES

A9-155

AC INVERTER OPERATIONAL LIMITS (CONTINUED)

- B. POWERDOWN WILL BE PERFORMED AS REQUIRED TO MEET THE FOLLOWING LOADING CRITERIA: @[121604-6522]
1. 6.41 (6.12) AMPS 750 VA CONTINUOUS, 0.7 LAGGING TO 0.9 LEADING PF
 2. 9.62 (9.32) AMPS 1125 VA (150 PERCENT), > 0.8 PF LAGGING 8 HOURS
 3. 9.62 (9.32) AMPS 1125 VA (150 PERCENT), > 0.7 PF LAGGING 30 MINUTES
 4. 12.8 (12.50) AMPS (200 PERCENT) 2 MINUTES

AC bus current limits are based on thermal limitations of the electronic components internal to the inverter. Inverter temperature evaluation testing indicates that when operated at 150 percent of rated load, maximum derated temperature limits of inverter internal components are not violated. The elevated temperatures resulting from operation of the inverter above the continuous limits result in an increased degradation rate on component lifetime. Inverter procurement specification requires a minimum useful life of 40,000 hours; some inverters have already exceeded this life limit.

A total instrumentation error of 1.52 percent (0.304 amps) is assumed; this is based on a sensor accuracy of 1.32 percent and an OI downlink error of 0.2 percent. The current sensor accuracy is temperature dependent with a range of $\pm 1-4$ percent. AC current sensors are located in the avionics bays; assuming a maximum nominal AV Bay temperature of 90 degrees F, accuracy is 1.32 percent of full scale value. Worst case instrumentation error is 4.3 percent of full scale value (0.86 amps), assuming 200 degree F.

The power factor is the composite power factor of all loads on the bus and must be determined analytically. Analytical summations of all of the bus loads may also be used to verify current sensor accuracy.

During ascent, if operation of the inverter above these limits is unavoidable due to a bus short, the risks associated with operation of the inverter outside these limits will be accepted, as long as at least one of the associated main engine controllers is still functioning.

DOCUMENTATION: SODB 4.5.6.3.1.8, Temperature Evaluation Report LMSO EP5-5F1-094, A9-104. @[121604-6522]

THIS RULE CONTINUED ON NEXT PAGE

FLIGHT RULES

A9-155

AC INVERTER OPERATIONAL LIMITS (CONTINUED)

C. WITHOUT COOLING:

1. 3.2 (2.3) AMPS (60 PERCENT) CONTINUOUS
2. 5.1 (4.2) AMPS (70 PERCENT) 5 HOURS
3. 6.4 (5.5) AMPS (85 PERCENT) 1.5 HOURS
4. 8.3 (7.4) AMPS (115 PERCENT) 30 MINUTES

These values represent the output power capability of the inverters under various load conditions without cooling (extrapolated from test data); assuming a bus load power factor of 0.85 lagging. With the loss of cooling, a worst case instrumentation error of 0.86 amps is assumed to provide margin above the extrapolated data. @[121604-6522]

DOCUMENTATION: Westinghouse Elec. Corp., Aerospace Elec. Div., Lima, Ohio, Engineering Development Lab, Report No. LY21018, April, 1980, Test Report on 150 percent Overload and no Coolant Tests, Space Shuttle 750 VA Power Static Inverter. @[121604-6522]

Rule {A9-354}, SPACEHAB AC MANAGEMENT, references this rule. @[ED]

FLIGHT RULES

A9-156

LOSS OF SINGLE-PHASE AC

- A. IF ANY SINGLE-PHASE BUS IS SHORTED, IT WILL BE ISOLATED FROM BOTH THE INVERTER AND ITS THREE-PHASE AC LOADS. THE AFFECTED THREE-PHASE "GANGED" CB'S WILL BE OPENED TO ISOLATE THESE LOADS FROM THE SHORTED BUS. THE SUB-BUSES POWERED BY THESE CB'S WILL BE CONSIDERED LOST.

Single-phase shorts will be isolated from the three-phase loads so that the remaining two phases will not be loaded by the short by motor transformer coupling.

- B. IF ANY SINGLE-PHASE BUS IS LOST, BUT NOT SHORTED, ONLY THE AFFECTED SINGLE-PHASE LOADS WILL BE ISOLATED FROM THE BUS. ALL THREE-PHASE LOAD CB'S WILL REMAIN CLOSED.

Single-phase loads will be isolated from the lost ac bus so that the remaining two phases will not be loaded by motor transformer coupling.

- C. IF A SINGLE-PHASE BUS IS LOST FROM AC2 OR AC3 AND A DEACTIVATED CABIN FAN IS AFFECTED, THEN IT MUST BE DEMONSTRATED ON THE AFFECTED CABIN FAN THAT IT CAN SUCCESSFULLY START ON THE REMAINING TWO PHASES IN ORDER TO CONTINUE TO NOMINAL EOM. OTHERWISE, THE CABIN FAN IS CONSIDERED TO BE LOST.

Ground tests of the start capability of the cabin fan on two phases was marginal. Therefore, start capability on two phases should be demonstrated on orbit before continuing to nominal EOM.

- D. AFTER ALL REQUIRED BUS ISOLATION HAS BEEN PERFORMED, THREE-PHASE EQUIPMENT WILL BE ALLOWED TO OPERATE ON THE TWO REMAINING PHASES, WITH THE EXCEPTION OF THE H₂O AND FREON PUMPS WHICH WILL BE SWITCHED TO AN ALTERNATE POWER SOURCE OR PUMP.

The two-phase operation of the Freon and H₂O pumps results in loss of flow capability that is significant enough to warrant switching pumps or power sources. All other motors are capable of operating on two phases.

Rule {A9-1001}, ELECTRICAL GO/NO-GO CRITERIA [HC], references this rule. ©[ED]

FLIGHT RULES

A9-157 LOSS OF TWO-PHASE AC

IF TWO PHASES OF A THREE-PHASE ARRAY ARE LOST, MULTIPLE PHASE AC LOADS WILL BE DISCONNECTED SO THAT THE REMAINING SINGLE AC PHASE CAN REMAIN POWERED.

Attempted operation of three-phase equipment with only one good phase results in stall currents on the good remaining phase. The multiphase loads will be removed so that normal operation of single-phase loads can be resumed.

A9-158 AC POWER TRANSFER CABLE

- A. THE AC POWER TRANSFER CABLE WILL BE USED TO REPOWER A THREE-PHASE BUS WHEN TWO OR MORE OF ITS INVERTERS ARE FAILED. ALL INVERTERS WILL BE DISCONNECTED FROM THE FAILED THREE-PHASE BUS BEFORE CONNECTING THE CABLE. CRITICAL EQUIPMENT WILL BE POWERED THROUGH THE CABLE; HOWEVER, AC CURRENT PER PHASE WILL BE LIMITED TO 3 AMPS. A THREE-PHASE AC BUS REGAINED BY USE OF THIS CABLE WILL BE CONSIDERED ACCEPTABLE FOR MDF PROVIDED CRITICAL LRU'S CAN BE POWERED.

The IFM procedure describes the concept of using an "extension cord" from a reliable ac bus utility outlet to power another ac bus through its utility outlet. A maximum of 3 amps per phase is due to the size of the utility outlet circuit breakers. This load will always include the FC pumps (coolant and H₂) and may include any other required equipment as long as the total continuous load does not exceed 3 amps. An MDF will be declared for this failure since the next worst failure (loss of the FPC bus powering the inverters used to recover the lost ac system) would result in the loss of two ac systems and the associated fuel cells. (The ac power transfer cable would be used to regain one ac system, if the second failure occurred on orbit.)

- B. FOR LOSS OF TWO OF THREE PHASES ON AN AC BUS (UNSHORTED), A ONE ORBIT DELAY PRIOR TO A DEORBIT BURN WILL BE INVOKED, IF NECESSARY, TO INSTALL THE AC TRANSFER CABLE, REGAINING THE AC BUS. A 1-DAY DELAY IS ACCEPTABLE IF INSTALLATION OF THE AC TRANSFER CABLE IS REQUIRED TO MAINTAIN TWO-FC ENTRY CAPABILITY.

Loss of the ac bus causes loss of a fuel cell and some critical ac loads. It is preferable to delay to install the cable and regain the fuel cell and critical ac loads.

DOCUMENTATION: FDF, IFM Checklist, All Vehicle, AC Power Transfer Cable Installation, pg. A-3. Also, a list of possible loads to repower is in the FPC bus loss SSR's in the Orbiter Malfunction Procedures Book.

Rules {A2-301}, CONTINGENCY ACTION SUMMARY [HC], and {A9-1001}, ELECTRICAL GO/NO-GO CRITERIA [HC], reference this rule. ©[ED] ©[032807-8400]

FLIGHT RULES

A9-159

MOTOR CONTROL ASSEMBLY (MCA)

INDIVIDUAL MCA BUS POWER MAY BE CYCLED AS REQUIRED TO PROTECT A BUS FROM SHORTED MOTOR LOADS OR TO REMOVE A "FAILED ON" MOTOR LOAD FROM A BUS.

Shorts will always be isolated from the rest of the electrical power and distribution system. It also may be necessary to remove power to a failed-on motor to protect the motor for future use during the flight.

A9-160

CAUTION AND WARNING (C&W) [CIL]

- A. PRIMARY C&W SYSTEM PARAMETERS THAT ARE NOT OPERATIONALLY FUNCTIONING WILL BE INHIBITED TO EXTINGUISH ANNUNCIATION LIGHTS.

Primary C&W system parameters that are not operationally functioning will be inhibited to extinguish annunciation lights so that they will not mask other parameters using the same light for alarm annunciation or interfere with recognition of new malfunctions.

- B. BACKUP C&W PARAMETERS THAT GENERATE NUISANCE ALARMS WILL BE INHIBITED.

Backup C&W parameters that generate nuisance alarms will be inhibited because by definition the nuisance alarms provide no new information for system operations and distract the flight crew from other activities.

- C. THE PRIMARY AND BACKUP C&W LIMIT VALUES WILL BE MAINTAINED THE SAME.

The primary C&W limits and backup C&W limits will be the same to ensure fail-safe operations in alerting the flight crew to perform necessary safing reconfiguration.

- D. A FAILED PRIMARY C&W SYSTEM MAY REMAIN POWERED AND ENABLED TO RETAIN TONE CAPABILITY PROVIDED NO NUISANCE ALARMS ARE GENERATED.

A failed primary C&W system may remain powered and enabled to retain tone capability if no nuisance alarms are generated in order to provide redundancy in audio tones for the backup C&W system. Redundant alarm tones are not required when they are a nuisance and distract the flight crew from other activities.

THIS RULE CONTINUED ON NEXT PAGE

FLIGHT RULES**A9-160 CAUTION AND WARNING (C&W) [CIL] (CONTINUED)**

- E. FOLLOWING THE LOSS OF C&W POWER SUPPLY A OR B, ONE OF THE FOLLOWING ACTIONS WILL BE PERFORMED:
1. REDUNDANTLY POWER THE REMAINING C&W POWER SUPPLY SO THAT LOSS OF ANY ESSENTIAL BUS WILL TRIGGER AN AUDIBLE ALARM.
 2. DEDICATE A CREWMEMBER TO CONTINUOUSLY MONITOR CRT MESSAGES FOR LOSS OF ESS2CA DA2 AFTER LOSS OF C&W SYSTEM A OR ESS1BC DA1 AFTER LOSS OF C&W SYSTEM B (NO AUDIBLE ALARMS) .
 3. PLACE AFFECTED FC IN STANDBY AFTER LOSS OF C&W SYSTEM A (FC 2) OR AFTER LOSS OF C&W SYSTEM B (FC 1) .

Failure of ESS1BC DA1 (ESS2CA DA2) after loss of C&W power supply B(A) will not be aurally annunciated. The FC 1(2) coolant pump will stop, and the flight crew must, within a few minutes, shut down the fuel cell to prevent a catastrophic failure due to overheating. The flight crew must continuously monitor displays so that a failure will be detected and appropriate actions to safe the orbiter can be taken. Restoration of power to a lost C&W power supply or establishment of redundant power to the remaining power supply may be accomplished by performing C&W ELECTRONICS UNIT CONTINGENCY POWER IFM procedure and will allow audible alarms if an essential bus is lost. Standby operation of the associated FC will preclude the time-critical ESS bus/coolant pump failure mode. (Ref. Rules {A9-1B}, FUEL CELL (FC) LOSS [CIL] [HC]; {A2-104A}.5.b and {A2-104A}.6, SYSTEMS REDUNDANCY REQUIREMENTS.) [ED] [033006-7297A]

A9-161 HYDRAULIC CIRCULATION PUMP OPERATION

NORMALLY, A HYDRAULIC CIRC PUMP WILL NOT BE STARTED ON A MAIN BUS THAT POWERS THE PRIMARY PAYLOAD BUS WHILE SPACEHAB IS ACTIVATED. AN EXCEPTION WOULD BE IF REACTION TO PREVENT LOSS OF A HYDRAULIC SYSTEM DID NOT PERMIT TIME FOR POWER RECONFIGURATION, IF REQUIRED. [092701-4872]

The voltage ripple caused by the startup of a hydraulic circ pump is greater than the Spacehab interface control document (ICD) requirements. Critical orbiter systems take precedence over payload systems if those orbiter systems are in jeopardy.

Reference: Spacehab PIP. [ED] [092701-4872]

A9-162 THROUGH A9-200 RULES ARE RESERVED

FLIGHT RULES

CRYOGENIC LOSS/FAILURE DEFINITIONS

A9-201

O₂ (H₂) MANIFOLD

AN O₂ (H₂) MANIFOLD IS CONSIDERED LOST IF UNABLE TO ISOLATE A PRSD SYSTEM LEAK OF > 10 LB/HR (O₂) OR 1 LB/HR (H₂) TO THE MANIFOLD ASSOCIATED TANK(S), FUEL CELL, OR PCS SYSTEM.

The O₂ manifold leak rate at which the manifold would be considered failed was derived to cover the worst case in which a tank near residual quantities of approximately 10 percent could be required to supply the leak and two fuel cells at entry power levels. Entry power levels will require about 5 lb/hr per fuel cell or 10 lb/hr total. The flow capacity of an O₂ tank (with single heater) near 10 percent quantity is approximately 20 lb/hr. Therefore the maximum leak rate that can be tolerated on top of the required fuel cell flow is 10 lb/hr.

DOCUMENTATION: SODB figure 4.4.2-16 and engineering judgment.

The H₂ manifold leak rate at which the manifold would be considered failed was derived from a study which concluded that the isolation or reduction of an H₂ leak to less than 2 lb/hr before entry is mandatory to eliminate a possible hazardous concentration during entry/landing. Additionally, H₂ leaks less than 1 lb/hr result in nonflammable H₂ concentrations throughout entry. Therefore, 1 lb/hr leak rate was chosen to provide a margin of safety.

DOCUMENTATION: Engineering judgment.

FLIGHT RULES

A9-202

CRYO TANK

A CRYO TANK IS CONSIDERED LOST IF:

A. ALL CRYO HEATERS IN THE AFFECTED TANK ARE DEFINED AS LOST.

The addition of heat into the cryogenic reactant is the method used to extract fluid from the tank. With the loss of tank heaters, the only flow available from a tank is that corresponding to tank heat leak which is negligible compared to normal requirements. Therefore, the tank is considered lost for all practical purposes.

DOCUMENTATION: SODB, H₂ figure 4.4.1-6, 4.4.2-9 and O₂ figure 4.4.1-11, 4.4.2-17.

B. ELECTRICAL POWER DEMAND CANNOT BE SUPPORTED BY THE TANK.

If the cryo tank cannot be depended on to support normal electrical power levels, declaring it lost guards against the next tank failure for GO/NO-GO rule implementation purposes. The management philosophy that consumables will determine mission duration for a single tank loss still applies; therefore, the tank can be used to extend the mission as long as practical, but a subsequent tank failure would be considered two tanks lost for entering the GO/NO-GO matrix to determine the appropriate action. This rule is intended to cover the blocked filter and the failed closed check valve scenarios.

DOCUMENTATION: Engineering judgment.

C. CRYO TANK PRESSURE CANNOT BE MAINTAINED ABOVE THE TWO-PHASE SATURATION PRESSURE OF THE FLUID.

If the pressure goes significantly below the saturation pressure, there is a possibility that the fluid would go two-phase (under normal operating pressures the fluid is always single phase). The tank can be repressurized with the tank heaters; however, the danger is that, if the fluid is two-phase, some areas of the heater surface may be in the gaseous region and localized overtemperatures could occur that would not necessarily be indicated by the heater surface temperature. Overtemperature in the O₂ tank could result in ignition of Teflon in the tank. Overtemperature in the H₂ tank could result in damage to the tank structure.

DOCUMENTATION: SODB, paragraph 3.4.4.2, and EGIL Console Handbook, SCP 2.8.6. [ED]

FLIGHT RULES

A9-203

CRYO TANK ANNULUS VACUUM

A CRYO TANK ANNULUS VACUUM IS CONSIDERED LOST IF:

A. A TANK LEAK OF ANY SIZE HAS BEEN IDENTIFIED.

Leakage from the pressure vessel into the annulus vacuum will cause the burst disk to open on the girth ring of the tank assembly when the pressure difference exceeds 60 ± 25 psid. Very small leaks into the annulus resulting in total gas in the annulus of as little as 0.1 lbm H_2 or 0.7 lbm O_2 (at gas temperature of 70 deg F) will result in this pressure differential. Since the exact location of a pressure vessel leak cannot be identified, it must be assumed for worst-case purposes that the leak is from the pressure vessel into the annulus.

DOCUMENTATION: Engineering judgment.

B. EXCESSIVE HEAT LEAK INTO THE TANK HAS BEEN IDENTIFIED WHEN THE HEATERS ARE UNPOWERED.

In atmospheric flight, air entering the annulus will increase the heat transfer into the tank. In orbit, small pressure vessel leaks into the annulus, prior to the burst disk opening, will result in increased heat leak into the tank from the outer shell because of conduction through the gas in the annulus. This heat leak into the tanks may not always be readily detectable.

DOCUMENTATION: Orbiter Hazard Reassessment ORBI 281, Qualification Test Report for PRSD Vacuum Lost Test, Ball Aerospace Division (TM06,BR16425), and engineering judgment.

Rule {A9-252G}, CRYO HEATER MANAGEMENT FOR ORBIT [CIL], references this rule.

FLIGHT RULES

A9-204

CRYO HEATER [CIL] [HC] @[033006-6608A]

A CRYO HEATER IS CONSIDERED LOST IF:

- A. O₂/H₂ CRYO HEATER TEMPERATURE CANNOT BE MAINTAINED BELOW 350 DEG/200 DEG F (INSTRUMENTATION ERROR INCLUDED).

The O₂ heater temperature was set on the basis of the auto ignition temperature of Teflon (700 deg F) contained in the quantity probe. The 350 deg includes a 200 deg F margin and takes into account sensor lag (50 deg F), analytical and instrumentation error (50 deg F), and the delta T between the temperature sensor and the maximum point (50 deg F). The H₂ tank maximum heater temperature is 200 deg F to prevent potential damage to the tank structure. @[ED]

DOCUMENTATION: SODB, paragraph 3.4.4.2; and NASA memo, Oxygen tank heater temperature limit, February 4, 1971. CIL: M4-1BG-HE010-03. Hazard Report ORBI 089, Rupture of H2 or O2 Tank, cause E.

- B. AN O₂ DELTA CURRENT SENSOR TRANSITIONS TO "TRIP" WHILE ITS HEATER IS RECEIVING POWER. @[ED]

If a delta current sensor trips while a heater is receiving power, it is considered highly possible that a short had developed in the heater. The consequences of repowering a shorted heater element are so grave that it would not be considered for mission success.

DOCUMENTATION: Flight experience, Apollo 13, and engineering judgment. CIL: M4-1BG-HE010-03. Hazard Report ORBI 089, Rupture of H2 or O2 Tank, cause E.

- C. BOTH O₂ DELTA CURRENT SENSORS TO THE HEATER ARE LOST.

Without a delta current sensor, a heater short would be a single point catastrophic failure. This is not an acceptable risk to accomplish mission objectives.

DOCUMENTATION: Flight experience, Apollo 13, and engineering judgment. CIL: M4-1BG-HE010-03. Hazard Report ORBI 089, Rupture of H2 or O2 Tank, cause E.

- D. AN ELEMENT OF THE HEATER FAILS TO FUNCTION.

A heater with a failed element will be considered lost to avoid repowering failed circuitry.

Reference Rules {A9-105}, CB/PC RESET, and {A9-252}, CRYO HEATER MANAGEMENT FOR ORBIT [CIL].

DOCUMENTATION: Engineering judgment. @[033006-6608A]

Rule {A9-252F}, CRYO HEATER MANAGEMENT FOR ORBIT [CIL], references this rule. @[ED]

FLIGHT RULES

A9-205

O2 DELTA CURRENT SENSOR

AN O₂ DELTA CURRENT SENSOR IS CONSIDERED LOST IF:

- A. THE O₂ DELTA CURRENT SENSOR DOES NOT INHIBIT THE A OR B HEATER WHEN TESTED.

If a sensor test does not inhibit the heater when tested, it is assumed that the sensor would not function if an actual heater short were to occur. @[061297-6005]

DOCUMENTATION: Engineering judgment.

- B. THE O₂ DELTA CURRENT SENSOR TRANSITIONS TO "TRIP" WHEN NO POWER IS BEING APPLIED TO THE HEATER ELEMENT, AND A RESET DOES NOT REMOVE THE "TRIP" STATUS.

A "trip" due to an actual heater short cannot occur unless a heater is being powered. The inability to reset the "trip" status indicates a failed sensor.

DOCUMENTATION: Engineering judgment.

- C. THE O₂ DELTA CURRENT SENSOR LATCHING LOGIC WILL NOT REMAIN TRIPPED ONCE THE SENSOR HAS TRANSITIONED TO "TRIP".

The delta current sensor will automatically shut down the defective heater circuit in less than 5 milliseconds if a differential current of greater than 0.91 ampere is sensed, but once the sensor has tripped, the short has been removed and the sensor will allow heater reactivation. The function of the latching logic is to ensure that the heater remains disabled after it has been shut down or tripped offline. A heater element with a short that could not be automatically shut down would be a single point catastrophic failure. This is not an acceptable risk to accomplish mission objectives.

DOCUMENTATION: Engineering judgment.

A9-206 THROUGH A9-250 RULES ARE RESERVED

FLIGHT RULES

CRYOGENIC SYSTEMS MANAGEMENT

A9-251

CRYO HEATER MANAGEMENT FOR ASCENT

- A. THE A HEATERS IN CRYO TANKS 1 AND 2 WILL BE ENABLED FOR LIFT-OFF. THE B HEATERS IN CRYO TANKS 1 AND 2 WILL BE ENABLED POST-OMS-1.

Tank heaters will be enabled for launch in an attempt to maintain system pressurization. Only one heater per tank is used to minimize power load transients. In the event of a fuel cell/main bus loss during ascent, electrical power usage is critical. Since cryo heaters are normally not required, it is desirable to lose as many cryo heaters as possible with loss of a fuel cell or main bus during ascent. Since the A heaters are more susceptible to bus failures (loss of either of two main buses causes loss of heater) than the B heaters (requires loss of particular main bus to lose heater), the A heaters will be used for launch.

DOCUMENTATION: Engineering judgment.

- B. SHOULD AN RTLS BE REQUIRED FOR A CABIN LEAK, BOTH HEATERS IN CRYO O₂ TANKS 1 AND 2 SHOULD BE ACTIVATED.

In an RTLS case, the O₂ tanks have to supply flow to both the ACES and fuel cell demand. Since the ACES's are used through touchdown, all heaters in O₂ tanks 1 and 2 are activated to assure adequate flow capability in this circumstance. (Refer to Rule {A17-201A}, CABIN PRESSURE INTEGRITY [HC].)
©[062305-6653] ©[ED]

FLIGHT RULES

A9-252

CRYO HEATER MANAGEMENT FOR ORBIT [CIL]

- A. CRYO HEATER AND CONTROLLER OPERATION, IN ALL TANKS, WILL BE VERIFIED AS SOON AS PRACTICAL, BASED UPON BALLAST/CG REQUIREMENTS AND STANDARD CRYOGENIC MANAGEMENT PLAN.
@[071494-1653A]

A system health check on all tanks is required to determine flight duration and to formulate any off-nominal cryo management plan. Should a cryo controller be discovered to be failed, and AUTO cryo heater control capability be lost in a tank, MANUAL heater operations would be required. This may place constraints on crew activities. Therefore, it is desirable to discover controller failures early in the mission when latitude is available for timeline replanning. There is no safety of flight requirement to check out cryo controllers. Normally, Orbiter Tank Sets 1 - 5 will be checked out during the first 24 hours of the flight. Heaters in the EDO Tank Sets will be enabled per the cryo management plan.
@[071494-1653A]

DOCUMENTATION: Engineering judgment and flight data.

- B. A DELTA CURRENT SENSOR CHECK WILL BE PERFORMED ONCE PER FLIGHT EXCEPT IN A TANK WHERE A REAL CURRENT SENSOR TRIP (HEATER SHORT) HAD OCCURRED. IF A SENSOR FAILS, A SENSOR CHECK WILL BE PERFORMED ON THE REDUNDANT SENSOR EACH DAY THAT THE AFFECTED HEATERS ARE USED. @[061297-6005]

The purpose of the delta current sensors is to protect against heater shorts internal to the tank. The delta current sensors are tested to ensure that a trip and heater inhibit will occur if a heater is shorted. If the sensors fail the test, the affected heater(s) will not be used. @[061297-6005]

Rule {A9-255A}, O2 DELTA CURRENT SENSOR, states that a delta current sensor that had transitioned to "trip" while its associated heater is receiving power will not be reset, ensuring that the heater will not be operated. If the remaining heater in that tank is required for use, it will not be possible to test and reset the delta current sensor in the operating heater without also resetting the tripped sensor (one switch tests and resets all delta current sensors in a tank). Therefore, no current sensor tests will be conducted in that tank.

DOCUMENTATION: Engineering judgment.

- C. IF AUTO CRYO HEATER CONTROL IS LOST, THE HEATERS IN THE AFFECTED TANK OR TANK SET WILL BE MANUALLY CYCLED DURING CREW AWAKE PERIODS. TANK QUANTITY BALANCING WILL BE MAINTAINED.

THIS RULE CONTINUED ON NEXT PAGE

FLIGHT RULES

A9-252

CRYO HEATER MANAGEMENT FOR ORBIT [CIL]
(CONTINUED)

If auto heater control is lost, the crew must manually cycle the heaters in order to use the tank. The management plan is followed in order to balance quantities in the tanks and to minimize the impact of a single failure on consumables and mission duration.

DOCUMENTATION: Engineering judgment.

D. A CRYO HEATER THAT IS DEFINED AS LOST WILL BE DEACTIVATED BY PLACING ITS CORRESPONDING SWITCH IN THE "OFF" POSITION. IF POSSIBLE, CRYO MANAGEMENT WILL BE MODIFIED TO EXPEDITE DEPLETION OF THE AFFECTED TANK. THE EXPEDITED TANK DEPLETION WILL BE TERMINATED WHEN THE NOMINAL MISSION DURATION PLUS TWO EXTENSION DAYS CAN BE ACCOMPLISHED IF THE REMAINING HEATER FAILS (LOSS OF TANK). IN ANY CASE, THE TANK WILL NOT BE DEPLETED PAST THE FOLLOWING POINTS:

1. FOR TANK 1 AND 2: MINIMUM QUANTITY TO GUARANTEE USAGE TO SUPPORT ITS ASSOCIATED FC/MN BUS FOR A NEXT PLS IN THE EVENT THAT ITS MANIFOLD BECOMES ISOLATED.
2. MINIMUM QUANTITY WHICH WILL ALLOW CLOSURE OF ONE MANIFOLD VALVE FOR EACH SLEEP PERIOD FOR THE NOMINAL MISSION DURATION PLUS TWO EXTENSION DAYS, IF REQUIRED. IF TANK 1 OR 2 IS THE AFFECTED TANK, ITS ASSOCIATED MANIFOLD VALVE WILL NOT BE CLOSED FOR SLEEP PERIODS, IF POSSIBLE, TO PROTECT AGAINST A FAILED MANIFOLD VALVE.

The reference to the switch position is made so an O₂ delta current sensor "trip" will not be considered as a way of heater deactivation without further action. If the failure occurs in tank 1 or 2, the affected tank will be used until the total quantity remaining in the unaffected tanks will support the nominal mission duration plus two extension days. However, tank 1 or 2 will not be depleted because the next worst failure (center manifold leak) could result in loss of two fuel cells. If the failure occurs in any one of tanks 3 through 9, the same next failure would result in loss of one fuel cell. If the failure occurs in tanks 3 through 9, the affected tank will be immediately depleted. Also, sufficient quantity must remain in the tank so that a manifold valve may be closed during crew sleep. However, if other tanks can be used (e.g., modified cryo management), then the sufficient quantity requirement is met by the other tanks.

THIS RULE CONTINUED ON NEXT PAGE

FLIGHT RULES

A9-252

CRYO HEATER MANAGEMENT FOR ORBIT [CIL]
(CONTINUED)

E. AN O₂ CRYO HEATER WITH ONE OF TWO DELTA CURRENT SENSORS LOST WILL BE DEACTIVATED BY PLACING ITS CORRESPONDING SWITCH IN THE "OFF" POSITION, UNLESS DOING SO WOULD RESULT IN LOSS OF THE TANK.

If mission success can be performed without the use of the affected heater, then it is an unnecessary risk to continue to operate that heater with loss of the current sensor redundancy. With loss of a current sensor on each string in a tank (failure of the cb powering both current sensors), normal operation will continue since there is one current sensor left on each string and this sensor will be verified operational at least once a day (ref. paragraph B). The old ideology of depleting the tank is considered to be an unnecessary increase of risk, due to operation of the heaters more often than normal.

F. A CRYO HEATER THAT CONTINUES TO BE POWERED AFTER PLACING ITS CORRESPONDING SWITCH IN THE "OFF" POSITION WILL BE DEACTIVATED BY PERFORMING THE FOLLOWING: [CIL] ©[ED]

1. AN ATTEMPT WILL BE MADE TO DEACTIVATE AN O₂ HEATER BY PERFORMING A CURRENT LEVEL DETECTOR TEST. IF REQUIRED, THE HEATER CAN STILL BE USED MANUALLY BY OPERATION OF THE CURRENT LEVEL DETECTOR SWITCH (TEST/RESET FOR HEATER OFF/ON) .

An O₂ heater that fails on for more than 9 hours after depletion of the tank to residual levels will risk exceeding the thermal limits of the tank. Prior to this though, the heater surface temperature will exceed the flight rule limit of 350 deg F for O₂ (ref. Rule {A9-204A}, CRYO HEATER [CIL] [HC]).

©[033006-6608A]

DOCUMENTATION: FMEA/CIL No. M5-6MB-2029M1-2.

2. IF REQUIRED, AN H₂ HEATER OR AN O₂ HEATER WILL BE DEACTIVATED BY DROPPING THE MAIN BUS THAT POWERS THE HEATER. THE MAIN BUS MAY BE BROUGHT UP FOR ENTRY IF THE TANK QUANTITY ALLOWS CONTINUOUS HEATER OPERATION WITHOUT VIOLATING HEATER TEMPERATURE LIMITS.

If the use of the current level detector function for O₂ or any potential IFM for either O₂ or H₂ is not successful, dropping a main bus is the only option.

THIS RULE CONTINUED ON NEXT PAGE

FLIGHT RULES

A9-252

CRYO HEATER MANAGEMENT FOR ORBIT [CIL] (CONTINUED)

An H₂ heater that fails on for more than 35 hours after depletion of the tank to residual levels will risk exceeding the thermal limits of the tank. Prior to this, however, the heater surface temperature will exceed the flight rule limits of 350 deg/200 deg F for O₂/H₂ (ref. Rule {A9-204A}, CRYO HEATER [CIL] [HC]). Based on quantity and fuel cell flowrate, the heater could pressurize the tank and manifold until relieved by the overboard relief valve. Cracking of the relief valve could cause ingestion of cryo into the midbody, which is a hazardous condition. However, the alternative is performing entry with two main buses that could put the orbiter/crew at greater risk. ©[033006-6608A]

DOCUMENTATION: Engineering judgment, FMEA/CIL No. M5-6MB-2027MI-2, and SODB paragraph 4.4.2.6.2/4.4.2.7.2.

G. AN O₂ (H₂) TANK THAT HAS LOST ITS ANNULUS VACUUM WILL BE DEPLETED PRIOR TO ENTRY.

Loss of annulus vacuum in a PRSD O₂ (H₂) (ref. Rule {A9-203}, CRYO TANK ANNULUS VACUUM) tank would result in overboard venting of O₂ (H₂) through the relief ports near compartment vent doors. In atmospheric flight, atmosphere will enter the annulus and increase the heat transfer to the tank. An uncontrollable pressure rise would result until the overboard relief opens. Ingestion of vented H₂ through open vent doors may result in the accumulation of a flammable/explosive environment in orbiter compartments during entry. The possible H₂ flowrates, as determined by testing, vary from 120 lb/hr (100 percent quantity) to 240 lb/hr (40 percent quantity) to 2.5 lb/hr (10 percent quantity). Depletion of the affected H₂ tank will reduce the H₂ available to be vented and minimize venting flowrates. If the relief valve is opened during entry due to an O₂ tank vacuum loss, verification of that valve will have to be performed during ground turnaround. Depletion of the affected O₂ tank prior to entry will reduce the chance of opening the relief valve.

DOCUMENTATION: Orbiter Hazard Reassessment ORBI 281, Qualification Test Report for PRSD Vacuum Lost Test, Ball Aerospace Systems Division (TM06, BR16425), FMEA/CIL No. 04-1B-TK010-2, 04-1B-TK0 30-2.

Rules {A9-204}, CRYO HEATER [CIL] [HC]; {A9-255}, 02 DELTA CURRENT SENSOR; and {A9-256}, CRYO O₂/H₂ TANK QUANTITY BALANCING, reference this rule. ©[ED]

FLIGHT RULES

A9-253

CRYO TANK HEATER TEMPERATURE MANAGEMENT

CRYO HEATERS WILL BE MANAGED TO PRECLUDE HEATER TEMPERATURES EXCEEDING 350 DEG FOR O₂ (INSTRUMENTATION ERROR INCLUDED) AND 200 DEG F FOR H₂. O₂/H₂ FLUID TEMPERATURES WILL BE MANAGED TO PRECLUDE EXCEEDING 160 DEG. @[052401-4643]

The O₂ heater temperature was set on the basis of the auto ignition temperature of Teflon (700 deg F) (in the quantity gauging probe). The 350 deg includes a 200 deg F margin and takes into account sensor lag (50 deg F), analytical and instrumentation error (50 deg F), and the delta T between the temperature sensor and the maximum point (50 deg F). The H₂ tank maximum heater temperature is 200 deg F to prevent potential damage to the tank structure.

DOCUMENTATION: SODB, paragraph 3.4.4.2, and NASA memo, Oxygen Tank Heater Temperature Limit, February 4, 1971.

A9-254

CRYO HEATERS DEACTIVATION

AT APPROXIMATELY 50 (53) PERCENT QUANTITY, ONE SET OF O₂ CRYO HEATERS WILL BE DEACTIVATED IN THE AFFECTED TANK.

With both heater sets activated in an O₂ tank, the heater surface temperature will begin to increase exponentially at lower quantities and could exceed 350 deg F. Therefore, below about 50 percent quantity, one-half of the heaters in each tank are disabled to minimize heater temperature.

DOCUMENTATION: SODB, 3.1.4.2-7, and flight data.

FLIGHT RULES

A9-255

O2 DELTA CURRENT SENSOR

- A. IF AN O₂ DELTA CURRENT SENSOR TRANSITIONS TO "TRIP" WHILE ITS HEATER IS RECEIVING POWER, IT WILL NOT BE RESET AND THE HEATER WILL NOT BE USED UNLESS REQUIRED FOR PREVENTION OF LOSS OF CREW AND VEHICLE.

THE REDUNDANT HEATER IN THE TANK WILL BE UNPOWERED AND USED ONLY TO: COMPLETE THE NOMINAL MISSION DURATION, PROVIDE AUTO HEATER CONTROL WHEN THE MANIFOLD VALVE(S) CLOSES, OR ALLOW USE OF TANKS 1 AND 2 FOR ENTRY.

The purpose of the heater delta current sensors is to provide automatic protection against O₂ tank internal electrical shorts that could cause explosions. In the event of a sensor trip, a reset of the sensor will not be attempted and the heater will be deactivated for safety. A reset and heater use would be allowed if the vehicle encountered extreme circumstances.

The unaffected heater in the tank will be unpowered because, although it is not considered likely, a short on one of two heater elements in an O₂ heater assembly could potentially damage an adjacent heater. It is prudent to unpower all heaters which could be affected if loss of the tank does not impact the mission duration. The unaffected heater may also be used to allow manifold valves to be closed during crew sleep and for entry, if required.

DOCUMENTATION: Flight experience and Apollo 13.

- B. RESET OF A TRIPPED DELTA CURRENT SENSOR ON AN UNPOWERED CIRCUIT CAN BE PERFORMED. THE ASSOCIATED HEATER WILL BE LEFT OFF UNLESS REQUIRED TO PREVENT LOSS OF THE TANK. IF THE HEATER MUST BE POWERED, THE SUSPECT SENSOR WILL BE UNPOWERED.

Two reasons exist for the reset: to allow determination of failure status (hard fail or inadvertent trip); and performing the daily sensor test (no reset would lock out rest of tank). It is undesirable to use a heater string with a failed sensor (see Rule {A9-252E}, CRYO HEATER MANAGEMENT FOR ORBIT [CIL]). Loss of the tank is considered to be a greater impact than operation of a heater string with only one delta current sensor.

DOCUMENTATION: Engineering judgment.

Rule {A9-252}, CRYO HEATER MANAGEMENT FOR ORBIT [CIL], references this rule. ©[ED]

FLIGHT RULES

A9-256

CRYO O2/H2 TANK QUANTITY BALANCING

TANK MANAGEMENT WILL BE PERFORMED IN A MANNER WHICH WOULD MINIMIZE THE IMPACT OF A TANK OR MANIFOLD LOSS.

- A. FOR THREE TANK SET MISSIONS, TANK HEATERS AND MANIFOLD VALVES WILL BE CONFIGURED DURING THE PRE/POSTSLEEP PERIODS TO MAINTAIN QUANTITY BALANCE AMONG ALL TANKS. @[082593-1532]
- B. FOR MISSIONS WITH FOUR OR MORE TANK SETS, ONE TANK IN THE CENTER MANIFOLD (PREFERABLY TANK 3) WILL BE HELD IN RESERVE, AND THE ADDITIONAL CENTER MANIFOLD TANKS (TANKS 4, 5, AND 6-9) WILL BE DEPLETED AS SOON AS PRACTICAL.

THE ADDITIONAL CENTER MANIFOLD TANKS WILL BE MANAGED TO PROVIDE QUANTITY BALANCING AMONG THEMSELVES AS THEY ARE DEPLETED. @[022604-6184]

- C. FOR FORWARD CG PROBLEMS PREDICTED DURING NEOM OR EARLY ENTRY, CONSIDERATION WILL BE GIVEN TO THE FOLLOWING:
 - 1. FOR MISSIONS WITH ADDITIONAL MARGIN, CONSIDERATION WILL BE GIVEN TO LEAVING CRYO IN THE CENTER MANIFOLD TANKS (4-9) AS OPPOSED TO DEPLETING THE TANKS. THE AMOUNT AVAILABLE TO REMAIN IN THE TANKS (4-9) IS THE DIFFERENCE BETWEEN THE CURRENT TOTAL QUANTITY MINUS THE MISSION REQUIREMENTS AND REDLINE QUANTITIES. THIS DIFFERENCE SHOULD BE THE CURRENT MARGIN AVAILABLE.

THIS RULE CONTINUED ON NEXT PAGE

FLIGHT RULES

A9-256

CRYO O2/H2 TANK QUANTITY BALANCING (CONTINUED)

2. FOR MISSIONS WITHOUT MARGIN, TANKS 1, 2, AND 3 WILL BE USED AS NECESSARY, EARLIER THAN NORMALLY PLANNED, IN COMBINATION WITH THE CENTER MANIFOLD TANKS TO MAINTAIN THE REQUIRED CG. MINIMUM TANK QUANTITY AS DEFINED IN RULE {A9-252D}.1, 2, CRYO HEATER MANAGEMENT FOR ORBIT [CIL], WILL NOT BE VIOLATED.

When flying with four or more tank sets, a manifold leak could cause loss of all tanks in the center manifold (as many as seven tanks). Depletion of these tanks first minimizes the time exposure where a large number of tanks could be lost. While depleting these tanks, their quantity will be balanced to minimize the impact of a single tank loss. Tank 3 is the preferred center manifold tank to hold in reserve since its switches are accessible during entry. ®[022604-6184]

For the forward CG missions, the mission margin may be used to adjust the CG. This will be accomplished by leaving the margin in the center manifold tanks, which are normally depleted. Tanks 1 and 2 will be held in reserve for entry. For extension requirements, if the margin is required, the quantity reserved in the center tanks will be used and the tanks will be depleted. A cryo management plan that allows quantity balancing between the forward cryo tanks and the center manifold tanks will alleviate the necessity to carry additional ballast to control forward CG.

DOCUMENTATION: Engineering judgment.

*Rules {A4-153}, CG PLANNING, and {A9-262}, EDO PALLET MANAGEMENT, reference this rule.
®[ED]*

FLIGHT RULES

A9-257

POWER REACTANT STORAGE AND DISTRIBUTION (PRSD) H2 AND O2 REDLINE DETERMINATION

THE REDLINE (AMOUNT CONSIDERED UNAVAILABLE FOR NORMAL MISSION OPERATIONS) CONSISTS OF:

- A. TANK RESIDUALS ($H_2 = 4$ PERCENT IN EACH OF TWO TANKS, 2.5 PERCENT IN REMAINING H_2 TANKS, $O_2 = 6.5$ PERCENT IN ALL TANKS).
- B. MEASUREMENT ERROR RSS'ED FOR THE NUMBER OF TANKS. INDIVIDUAL TANK ERROR IS 2.6 PERCENT.
- C. A 2-DAY MISSION EXTENSION PAST THE PLANNED LANDING. THE ON-ORBIT POWER LEVEL DURING THESE 2 DAYS WILL BE BASED ON A PRIORITY POWERDOWN GROUP C CONFIGURATION (REF. RULE {A2-108}, CONSUMABLES MANAGEMENT), PLUS ANY PAYLOAD SURVIVAL POWER. TWO DEORBIT OPPORTUNITIES ON EACH EXTENSION DAY (IN ADDITION TO THE TWO NORMAL EOM DEORBIT OPPORTUNITIES) WILL BE BUDGETED DURING THESE 2 DAYS.
@[092800-7247A] @[012303-5856]

The 2.5 percent and 6.5 percent numbers are the minimum quantities guaranteed to be obtainable prior to reaching maximum tank heater temperature limits. The 4 percent requirement in two H_2 tanks protect for entry fuel cell flow demands. This assumes dual heaters in each of two tanks (400 watts total) which yields a flow capacity of $400 \times 3.41/750 = 1.8$ lb/hr, or approximately 20 kW. 750 is the approximate dQ/dM for the 4 percent density fluid at 200 psia.

DOCUMENTATION: Flight Design Level B Groundrules and Constraints (NSTS 21075); S0DB 3.4.4.2, 4.4.2, Table 4.4.2-6; Rockwell Internal Letter #287-100-91-MMS-019; and NBS Technical Note 617.

FLIGHT RULES

A9-258

CRYO O₂ AND H₂ PRESSURE MANAGEMENT

CRYO O₂ AND H₂ PRESSURES WILL BE MANAGED ACCORDING TO THE FOLLOWING CONSTRAINTS:

- A. MANIFOLD PRESSURE UPPER LIMIT OF 950 (890) PSIA FOR O₂ AND 270 (250) PSIA FOR H₂.

Maximum absolute pressure should be such that the manifold relief valves do not crack. If the manifold relief valves open in flight, a retest is required before the next flight. This is not normally a planned test. Crack pressures are 975 psig for oxygen and 290 psig for hydrogen. The recommended maximum operating pressures are chosen to allow some margin for pressure overshoot and transducer error.

DOCUMENTATION: Engineering judgment and SODB 4.4.2.

- B. PEAK-TO-PEAK PRESSURE EXCURSIONS SHALL NOT EXCEED 375 PSI FOR OXYGEN AND 150 PSI FOR HYDROGEN.

Pressure excursions of greater than these values represent a structural pressure cycle on the tank. The tanks are designed to accommodate a lifetime total of 300 such pressure cycles. With a total lifetime requirement of 100 flights, only three structural cycles can be experienced per flight. One cycle is used during initial loading and pressurization. The other two cycles per flight are intended for any required ground testing or checkout.

DOCUMENTATION: SODB 3.4.4.2.9.

- C. OPERATION OF THE CRYO TANK HEATERS IN A TWO-PHASE FLUID WILL BE AVOIDED.

1. FOR MANUAL HEATER OPERATIONS, THE TANK PRESSURE WILL BE MAINTAINED ABOVE THE O₂/H₂ CRITICAL PRESSURES OF 731.4/187.5 PSIA.

Flight data from STS-51D shows that a two-phase condition existed in a tank during manual operation of the heaters. The expected condition of the fluid in the tank, based on quantity and pressure measurements, indicated a single-phase condition. This situation possibly existed because the heaters boiled the liquid around the elements faster than the pressure rise could keep the fluid liquefied. The danger of this is that some areas of the heater surface may be in the gaseous region and localized overtemperature could occur that would not necessarily be indicated by the heater temperature transducer. For this reason, operating heaters in this condition for long periods of time is unacceptable. Overtemperature in the O₂ tank could result in ignition of Teflon in the tank. Overtemperature in the H₂ tank could result in structural tank damage. Maintaining super-critical pressurization ensures that the fluid is single-phase at any temperature or density.

DOCUMENTATION: SODB, paragraph 3.4.4.2, and flight data.

THIS RULE CONTINUED ON NEXT PAGE

FLIGHT RULES

A9-258

CRYO O2 AND H2 PRESSURE MANAGEMENT (CONTINUED)

2. FOR SITUATIONS IN WHICH THE TANK PRESSURE GOES BELOW THE CRITICAL PRESSURE BUT IS STILL ABOVE THE TWO-PHASE SATURATION PRESSURE, HEATERS MAY BE USED (DUAL HEATERS ARE PREFERRED) TO RAISE THE PRESSURE BACK ABOVE THE CRITICAL PRESSURE.

A two-phase condition may still exist depending on the degree of stratification in the tank. Dual heater operation will increase the pressure of the tank at a faster rate and lessen the possibility of creating a two-phase condition. This was evident from the flight data of STS-51D. Initially, when operating manual heaters, dual heaters were used and no phase change was observed. Later in the flight, single heaters were used and the pressure plateaued at the critical pressure of the fluid. Once the phase change was complete, the pressure continued to rise at a slower rate than before.

DOCUMENTATION: Engineering judgment and flight data.

3. IF THE TANK PRESSURE FALLS BELOW THE TWO-PHASE SATURATION PRESSURE, THE HEATERS WILL BE DISABLED UNTIL NORMAL HEAT TRANSFER INTO THE TANK RAISES THE PRESSURE ABOVE THE TWO-PHASE SATURATION PRESSURE. THE HEATERS MAY BE OPERATED ONLY IN A CONTINGENCY SITUATION.

When the pressure falls below the two-phase saturation pressure, two-phase fluid is located throughout the tank. The amount could be considerably more than the situation created in paragraph 2. The reason for the deactivation is the same as paragraph 2, except that greater risk is thought to be involved.

DOCUMENTATION: Engineering judgment.

FLIGHT RULES

A9-259

CRYO O2/H2 MANIFOLD VALVES

MANIFOLD VALVE CONFIGURATION WILL BE MANAGED AS FOLLOWS:

- A. AT LEAST ONE MANIFOLD VALVE (PER SYSTEM) WILL REMAIN OPEN, EXCEPT DURING ISOLATION PROCEDURES FOR LEAKS EXCEEDING THE CURRENTLY CONFIGURED TANK HEATER FLOW CAPACITY. FOR THESE MAJOR LEAKS, BOTH MANIFOLD VALVES WILL BE CLOSED. IF NECESSARY, THE REACTANT VALVES ON THE AFFECTED FUEL CELL WILL BE CLOSED TO TROUBLESHOOT THE LEAK. A MANIFOLD VALVE WILL BE REOPENED AS SOON AS POSSIBLE ONCE MANIFOLD INTEGRITY IS RESTORED OR VERIFIED.

The PRSD system was designed without a relief valve in the crossover manifold. Closure of both manifold valves induces a potential hazard if reactant flow to fuel cell 3 is stopped (e.g., reactant valve fails closed). This is due to pressure buildup from environmental heat flow into a dense fluid contained within a fixed volume. An open manifold valve will provide relief through its associated hardware.

It is not considered acceptable to induce this potential hazard with a normal manifold valve configuration. However, in the event of a major system leak, it is desirable to isolate as many fuel cells from the leak as quickly as possible. If the leak is in manifold 1 or 2, no risk is induced by closure of the associated fuel cell reactant valves. If the leak is in the crossover manifold, then closure of the fuel cell 3 reactant valves for a short time period is considered to be a smaller risk than exposing a second fuel cell to the leak, or performing an unorthodox fuel cell shutdown procedure. Analytical and test data indicate that more than 1 minute could elapse before the pressure in the closed manifold reaches the advertised PRSD component burst pressure. Manifold valve testing at JSC indicated that the valves do relieve overpressures. However, relief pressure was in excess of the advertised manifold valve and check valve burst.

THIS RULE CONTINUED ON NEXT PAGE

FLIGHT RULES

A9-259

CRYO O2/H2 MANIFOLD VALVES (CONTINUED)

B. ASCENT/ENTRY: ALL MANIFOLD VALVES WILL NORMALLY BE OPEN.

The risk of pressure buildup is not considered to be an acceptable trade-off for protecting (by closing both manifold valves) against a major PRSD system leak. The crew response time to the leak is considered to be roughly the same as the response time required for the overpressure concern (30 to 60 seconds). Since closure of any manifold valve can result in loss of a fuel cell due to a tank leak, both valves open is considered to be the best configuration.

C. ORBIT: ONE MANIFOLD VALVE PER SYSTEM WILL NORMALLY BE CLOSED FOR CREW SLEEP PERIODS (SINGLE SHIFT OPS).

During sleep, a major PRSD system leak could cause loss of fuel cell pressurization before the crew could respond. Closure of one valve will protect at least one fuel cell, while not inducing a safety hazard. The vehicle can be safed and reconfigured on orbit starting with a single main bus.

DOCUMENTATION: Rockwell informal desktop analysis on tank pressure blowdown, SODB volume I, tables 4.4.1-2, 4.4.1-3, and 4.4.1-5; and engineering judgment.

FLIGHT RULES

A9-260

CRYO SYSTEM LEAKS [CIL]

THE PRSD SYSTEM WILL BE MANAGED AS FOLLOWS FOR SYSTEM LEAKS:

A. ASCENT (PRE-MECO) - ISOLATION PROCEDURES WILL BE INITIATED IF A LEAK CAUSES THE PRESSURE TO DECAY BELOW THE HEATER CONTROL RANGE. THE PRSD SYSTEM WILL BE CONFIGURED TO MAINTAIN FULL CELL POWER OUTPUT BY:

1. CLOSING BOTH MANIFOLD VALVES.
2. ACTIVATING ALL TANK HEATERS IN THE LEAKING LEG.
3. CLOSING THE AFFECTED PCS O₂ SUPPLY VALVE (IF AN O₂ LEAK).

By the time that leak isolation procedures could be accomplished, the vehicle is no longer in atmospheric flight. Therefore, feeding the leak only amounts to a loss of consumables and is not a flammability concern. The above actions are considered to be the best compromise to prevent loss of pressurization to two fuel cells, while still trying to maintain pressure to the fuel cell in the leaking leg.

B. ENTRY (POST-DEORBIT TIG) - ISOLATION PROCEDURES WILL BE INITIATED IF A LEAK CAUSES THE PRESSURE TO DECAY BELOW THE HEATER CONTROL RANGE. FOR H₂ LEAKS WHERE NO FUEL CELLS HAVE PREVIOUSLY FAILED, THE PRSD SYSTEM WILL BE CONFIGURED TO ISOLATE OR REDUCE THE LEAK RATE BY:

1. CLOSING BOTH MANIFOLD VALVES.
2. USING ONLY THE STANDARD HEATER CONFIGURATION IN THE LEAKING LEG TO MAINTAIN PRESSURE.
3. SHUTTING DOWN THE AFFECTED FUEL CELL.

FOR O₂ LEAKS OR FOR H₂ LEAKS WHERE ONE FUEL CELL HAS PREVIOUSLY FAILED, THE PRSD SYSTEM WILL BE CONFIGURED TO MAINTAIN FUEL CELL POWER OUTPUT IN ACCORDANCE WITH THE ASCENT GROUNDRULES.

Since a hydrogen leak during entry can result in fire or explosion, it is considered less of a risk to shut down the first fuel cell than to attempt hydrogen leak isolation. Consequently, extra heat will not be used in the leaking leg (as done for ascent) to overpower the leak. However, after TIG, if isolation of the leak requires a fuel cell shutdown leaving the orbiter with only one fuel cell, then the leak will be allowed to continue and extra heaters activated. This is because the risk of recovering from the loss of one main bus and further powerdown (for loss of the second fuel cell) is considered greater than the chance of fire or explosion in the midbody.

THIS RULE CONTINUED ON NEXT PAGE

FLIGHT RULES

A9-260

CRYO SYSTEM LEAKS [CIL] (CONTINUED)

Increased oxygen concentrations from leaks are not considered a significant enough risk to warrant fuel cell shutdown to attempt leak isolation.

DOCUMENTATION: Engineering judgment and FMEA/CIL 04-1B-A01FSH-1/FSO-1.

C. ORBIT (MECO TO DEORBIT TIG) :

1. TANK LEAKS - CONSUMPTION OUT OF THE LEAKING TANK WILL BE MAXIMIZED. THE CONFIGURATION OPTIONS ARE CONTINGENT ON HEATER FLOW CAPACITY (FUNCTION OF TANK QUANTITY) AND THE SIZE OF THE LEAK. IN ORDER OF PREFERENCE, THEY ARE:
 - a. DEACTIVATE ALL OTHER TANK HEATERS (LEAVE TANKS 1 AND 2 ACTIVE IF LEAK IS IN TANK 3/4/5) AND FEED ALL FUEL CELLS FROM THE LEAKING TANK. IF NECESSARY, DEORBIT WILL BE DELAYED IN ORDER TO DEplete A LEAKING H₂ TANK (FOR ANY SIZE LEAK). MANUAL HEATERS CAN BE USED TO CRACK THE TANK RELIEF VALVE IF NECESSARY TO EXPEDITE DEPLETION FOR A DEORBIT OPPORTUNITY.
 - b. FOR A TANK 1 OR 2 LEAK, IF SUPERCRITICAL PRESSURE CANNOT BE MAINTAINED WITH OPTION A, ISOLATE TANK TO ITS MANIFOLD AND FEED ITS ASSOCIATED FUEL CELL.
 - c. IF SUPERCRITICAL PRESSURE CANNOT BE MAINTAINED WITH OPTIONS A OR B, DEACTIVATE THE TANK HEATERS AND ALLOW THE PRESSURE TO BLEED DOWN. THIS MUST BE PERFORMED PRIOR TO ENTRY. IF INSUFFICIENT TIME EXISTS PRIOR TO DEORBIT TIG TO REDUCE AN H₂ LEAK TO < 1 LB/HR, THEN ENTRY WILL BE DELAYED IF ADEQUATE CONSUMABLES ARE AVAILABLE.

Maximizing consumption from the leaking tank will minimize the amount of consumables lost due to the leak. H₂ leaks > 1 lb/hr create flammable concentrations in the midbody during portions of entry and are considered to be of more risk than delaying entry. Depleting the tank and allowing its pressure to bleed down can aid in minimizing the leak rate and flammability concern during entry. If the leak rate/heater flow capacity will allow depletion, then deorbit can be waived off, if required, for any size leak. This is because the smallest of leaks can fill the vacuum annulus, pop the burst disk, and allow convective heat transfer during entry to cause extremely high venting overboard (200-300 lb). It is possible that the vented H₂ could be ingested into the midbody through the vents, creating a flammable condition.

THIS RULE CONTINUED ON NEXT PAGE

FLIGHT RULES

A9-260

CRYO SYSTEM LEAKS [CIL] (CONTINUED)

DOCUMENTATION: Engineering judgment, FMEA/CIL 04-1B-A01FSH-1/FSO-1, and JSC Structures and Mechanics Division informal analysis.

Rule {A2-301}, CONTINGENCY ACTION SUMMARY, references this rule.

2. MANIFOLD OR FUEL CELL LEAKS:

- a. ORBIT RECONFIGURATION - AT LEAST ONE GOOD MANIFOLD/FUEL CELL WILL BE PROTECTED FROM THE LEAK BY CLOSURE OF A MANIFOLD VALVE OR THE LEAKING FUEL CELL REACTANT VALVES. FOR MANIFOLD LEAKS, THE ASSOCIATED TANK(S) WILL BE DEPLETED AS SOON AS PRACTICAL. IF ADEQUATE CONSUMABLES ARE NOT AVAILABLE TO FEED THE LEAK FOR AN MDF + 24 HOURS (PLS + 24 HOURS IF ONE FUEL CELL HAS PREVIOUSLY FAILED), OR IF SUPER-CRITICAL PRESSURIZATION CANNOT BE MAINTAINED, THEN THE LEAK WILL BE ISOLATED (REQUIRING FUEL CELL SHUTDOWN).
- b. ENTRY RECONFIGURATION - SEVERAL OPTIONS ARE AVAILABLE, BASED ON THE SIZE OF THE LEAK AND WHICH SYSTEM (O₂ OR H₂) IS AFFECTED:

FOR AN H₂ LEAK < 1 LB/HR OR O₂ LEAK OF ANY SIZE, ENTRY WILL BE PERFORMED WHILE FEEDING THE LEAK, PROVIDING THAT SUPER-CRITICAL PRESSURIZATION CAN BE MAINTAINED USING NORMAL HEATER MANAGEMENT. AT LEAST ONE GOOD MANIFOLD/FUEL CELL WILL BE PROTECTED FROM THE LEAK BY CLOSURE OF A MANIFOLD VALVE.

FOR AN H₂ LEAK > 1 LB/HR WHERE NO FUEL CELL HAS PREVIOUSLY FAILED, THE LEAK WILL BE ISOLATED (REQUIRING FUEL CELL SHUTDOWN) AND ENTRY PERFORMED ON TWO FUEL CELLS. IF INSUFFICIENT TIME EXISTS PRIOR TO DEORBIT TIG TO REDUCE THE LEAK RATE TO <1 LB/HR, THEN ENTRY WILL BE DELAYED IF ADEQUATE CONSUMABLES ARE AVAILABLE.

FOR AN H₂ LEAK > 1 LB/HR WHERE ONE FUEL CELL HAS PREVIOUSLY FAILED, THE LEAK WILL BE ISOLATED (AND FUEL CELL SHUT DOWN) ONLY IF SUPER-CRITICAL PRESSURIZATION CANNOT BE MAINTAINED. THE REMAINING FUEL CELL WILL BE PROTECTED FROM THE LEAK BY CLOSURE OF A MANIFOLD VALVE.

THIS RULE CONTINUED ON NEXT PAGE

FLIGHT RULES

A9-260 CRYO SYSTEM LEAKS [CIL] (CONTINUED)

Since the plumbing in the affected manifold or fuel cell is no longer reliable, it must be isolated from the other manifolds and fuel cells to protect against rapid loss of pressurization affecting all fuel cells. Since the tanks themselves do not have isolation valves, then the only method of stopping or minimizing a manifold leak is to isolate it by closing one or both manifold valves, and then depleting its associated tank(s). After this is done, the manifold can be repressurized/isolated by opening/closing a manifold valve.

Since shutdown of a fuel cell requires the mission to be shortened to an MDF (PLS for loss of the second fuel cell), and if consumables will support the abbreviated mission plus a 24-hour extension while feeding the leak, then no gain is achieved by shutting down the fuel cell while on orbit.

Hydrogen leaks of > 1 lb/hr create flammable concentrations during portions of entry and are considered to be a greater risk than loss of the first fuel cell, but not the second.

DOCUMENTATION: Engineering judgment, FMEA/CIL 04-1B-A01FSH-1/FS0-1, and JSC Structures and Mechanics Division informal analysis.

Rule {A2-301}, CONTINGENCY ACTION SUMMARY [HC], references this rule. ©[032807-8400]

A9-261 IMPENDING LOSS OF ALL CRYO

IN THE EVENT THAT ALL RECONFIGURATION PROCEDURES HAVE BEEN PERFORMED FOR CRYOGENIC SYSTEMS FAILURES AND THAT A CONDITION STILL EXISTS WHERE ALL TANK AND MANIFOLD PRESSURES ARE DECREASING, THE EARLIEST ASCENT ABORT MODE AVAILABLE WILL BE SELECTED (REF. RULE {A2-54}, RTLS, TAL, AND AOA ABORTS FOR SYSTEMS FAILURES [CIL]).

If the pressure cannot be maintained in at least one cryo tank and manifold, the fuel cells will eventually stop producing electrical power, no matter what the quantity is in the cryo tanks. Since the amount of time available before "blowdown" of the tanks is dependent on a large number of variables, specific numbers cannot be defined for the purpose of selecting the most preferred abort mode. Therefore, this condition warrants the selection of the earliest abort opportunity.

DOCUMENTATION: Engineering judgment.

Rule {A2-54A}.4, RTLS, TAL, AND AOA ABORTS FOR SYSTEMS FAILURES [CIL], references this rule. ©[ED]

FLIGHT RULES

A9-262

EDO PALLET MANAGEMENT

- A. ACTIVATION/DEACTIVATION - THE MAIN DC POWER TO THE PALLET WILL BE ACTIVATED SHORTLY AFTER POST INSERTION AND DEACTIVATED IN DEORBIT PREP. INSTRUMENTATION POWER WILL BE ACTIVE FOR LAUNCH AND ENTRY FOR THE PURPOSES OF TANK QUANTITY GAUGING AND LEAK DETECTION.

Since the pallet tanks are not required for ascent/entry, the main power will be removed to eliminate an unnecessary path for an electrical short. Reference rule {A9-108}, CRITICAL PHASE BUS MANAGEMENT. The pressure and quantity instrumentation was intentionally placed on a separate power source to allow quantity gauging and leak detection.

- B. TANK HEATER MANAGEMENT - TANK QUANTITY BALANCING WILL BE PERFORMED PER RULE {A9-256}, CRYO O₂/H₂ TANK QUANTITY BALANCING. IF THE SPARE MDCA-1 (100-AMP FUSE SIZE) IS USED, NORMALLY ONLY ONE SET OF HEATERS WILL BE ACTIVATED WHEN USING A TANK.

The original design modification to MDCA-1 included a 100-amp fuse to the EDO bus A power feed. A subsequent design change was performed which made it possible to exceed 100 amps if all the tank heaters were activated simultaneously. The second of two units built has a 200-amp fuse to correct this problem. The first unit (used as a spare) will retain the 100-amp fuse until the unit requires further modification. Single-string tank heaters will be used to provide a margin of safety if that box is ever flown.

A9-263

CRYO O₂ MANAGEMENT FOR EVA SUPPORT

NORMALLY, CRYO O₂ TANKS WILL BE CONFIGURED TO PROVIDE HIGHER PRESSURE TANK CONTROLLERS DURING EVA ACTIVITIES. @[033006-7285A]

Providing a higher supply pressure for shuttle-supported EVA activities provides several benefits for EVA operations and increases the likelihood of a successful EVA. During EMU purging operations (denitrogenation or contingency vacuum purges), maximizing the O₂ supply pressure will mitigate the risk of having insufficient EMU suit pressures, requiring denitrogenation purge time extensions or activation of the EMU Secondary Oxygen Pack (SOP). During EVA prebreathe activities, the flow capability of the system is affected by supply pressure; a higher supply pressure mitigates the risk of violating O₂ flow requirements and prebreathe times are not affected. During EMU recharge activities, the use of a higher O₂ supply pressure maximizes the amount of the recharge, resulting in a longer EVA capability. @[033006-7285A]

A9-264 THROUGH A9-300 RULES ARE RESERVED @[033006-7285A]

FLIGHT RULES

SPACEHAB SUPPORT

A9-301 **SPACEHAB DC BUSES** ©[111501-4986A]

LOST IF:

VOLTAGE CANNOT BE MAINTAINED ≥ 24 AND ≤ 32 VOLTS DC. ©[111699-7113]

Spacehab DC equipment was designed to operate within these values. Spacehab DC buses include Main, Emergency, Subsystem, and Inverter DC. ©[111501-4986A]

A9-302 **SPACEHAB AC INVERTER** ©[111501-4986A]

LOST IF:

OUTPUT VOLTAGES CANNOT BE MAINTAINED ≥ 105 AND ≤ 125 VOLTS AC.

Spacehab AC equipment was designed to operate within these values. ©[111501-4986A] ©[111705-7064]

A9-303 THROUGH A9-350 RULES ARE RESERVED ©[111501-4986A]

FLIGHT RULES

SPACEHAB ELECTRICAL POWER SUBSYSTEM (EPS) MANAGEMENT

A9-351

ELECTRICAL POWER SUBSYSTEM (EPS) CONSTRAINTS

- A. POWER MANAGEMENT - ON-ORBIT SPACEHAB POWER LEVELS WILL BE MANAGED BY THE SPACEHAB OPERATIONS DIRECTOR (SHOD) AND WILL BE MAINTAINED WITHIN PREFLIGHT ALLOCATED QUANTITIES. ©[111501-4975A]

Spacehab is allotted a specific quantity of energy preflight in the Carrier Integration Plan (CIP) and may use this energy as long as the Spacehab operations do not compromise normal orbiter operations.

- B. WHEN SPACEHAB IS REQUIRED TO BE POWERED DURING ASCENT/ENTRY, THE ASCENT/ENTRY ORBITER CONFIGURATION WILL INCLUDE:
1. FUEL CELLS CONNECTED TO THEIR RESPECTIVE BUSES
 2. PRIMARY PAYLOAD POWER - ON (PROVIDING POWER TO SPACEHAB)
 3. PAYLOAD AUX A - ON AND PAYLOAD AFT MN B - ON (PROVIDING EMERGENCY POWER IN THE SPACEHAB FOR SMOKE DETECTION/SUPPRESSION)
 4. PAYLOAD CABIN - MN A (B) (PROVIDING POWER TO THE STANDARD SWITCH PANEL (SSP))

Payload Primary provides power to the Spacehab power subsystem; this subsystem then provides power to subsystems and experiments requiring power on ascent/entry as negotiated in the CIP. The Payload AUX A and Payload AFT MN B orbiter buses provide redundant power to Spacehab's emergency buses. The emergency buses are required on ascent/entry for fire/smoke detection, fire suppression, and the Caution and Warning (C&W) system. ©[111501-4975A]

- C. THE ON-ORBIT ORBITER CONFIGURATION FOR THE ORBITER TO SPACEHAB WILL BE: ©[111501-4975A]
1. FUEL CELLS CONNECTED TO THEIR RESPECTIVE BUSES
 2. PAYLOAD PRIMARY POWER - ON (PROVIDING POWER TO SPACEHAB)
 3. AUX A AND PAYLOAD AFT MN B - ON (PROVIDING EMERGENCY POWER IN THE SPACEHAB FOR SMOKE DETECTION/FIRE SUPPRESSION)

THIS RULE CONTINUED ON NEXT PAGE

FLIGHT RULES

A9-351 **ELECTRICAL POWER SUBSYSTEM (EPS) CONSTRAINTS** **(CONTINUED)**

4. PAYLOAD CABIN - MN A (B) (PROVIDING POWER TO THE SSP)
5. PAYLOAD AC 3 POWER - ON (PROVIDING POWER TO SPACEHAB)

Payload Primary provides power to the Spacehab power subsystem; this subsystem then provides DC power to subsystems and experiments. The payload AUX A and payload AFT MN B orbiter buses provide redundant power for fire/smoke detection, C&W sensors, and fire suppression. @[111501-4975A] @[111705-7065]

A9-352 **SPACEHAB MAIN BUS MANAGEMENT** @[111501-4986A]

ELECTRICAL POWER TO THE SPACEHAB MAIN BUS IS PROVIDED VIA THE PRIMARY PAYLOAD BUS. THE LOADS ON THE PRIMARY PAYLOAD BUS MUST BE MANAGED TO KEEP TOTAL POWER WITHIN THE CONSTRAINTS SPECIFIED IN RULE {A9-109}, PRIMARY PAYLOAD BUS MANAGEMENT. @[111705-7066]

Total payload bus power limitations are due to the Fuel Cell limitations and not on the individual SMCH fuse and wire ratings. The ICD specifies a power limit on each SCMCH feed to 2 kW continuous and allow a 3 kW peak for 15 minutes every 3 hours (a total excess energy of 0.25 kWh). The ICD is written to ensure that total payload power constraints are not violated on a mission where there are four independent payloads, each using its own dedicated SCMCH feed. Manifested payloads generally meet the ICD requirement. This drives the operational constraint to be based on the total payload power and not on the physical wire and fuse ratings of the individual SMCH feed. In the case where multiple SMCH feeds fail, the power on each SMCH will be managed to stay within its physical wire and fuse ratings.

*Reference: Rule {A9-109}, PRIMARY PAYLOAD BUS MANAGEMENT, and ICD-A-21095.
@[111501-4986A] @[111705-7066]*

FLIGHT RULES

A9-353

SPACEHAB EMERGENCY BUS LOSS ©[111501-4986A]

- A. IF EITHER ORBITER DC SOURCE, PL AUX A OR PL AFT B, SUPPLYING POWER TO THE SPACEHAB EMERGENCY BUS IS LOST, SPACEHAB ACTIVITIES WILL CONTINUE.

PL AUX A and PL AFT B provide redundant power to the Spacehab emergency bus. The emergency bus sources are cross-strapped and the Spacehab emergency bus is still powered.

- B. IF THE SPACEHAB EMERGENCY BUS IS LOST, THE SPACEHAB WILL BE DEACTIVATED AND ALL POWER REMOVED.

All fire detection/suppression capability has been lost as well as power to the water line heaters. Therefore, orbiter attitude control will be required to prevent water line freezing.

Reference Rule {A18-555}, WATER LINE HEATER MANAGEMENT. ©[111501-4986A]

FLIGHT RULES

A9-354**SPACEHAB AC MANAGEMENT** @[111501-4986A]

- A. THE SPACEHAB INVERTER WILL BE THE MODULE'S NOMINAL AC POWER SOURCE DURING ASCENT AND ENTRY.

Orbiter AC power is not available to payloads during the ascent mission phase in order to protect critical orbiter systems (i.e., Space Shuttle Main Engine Controllers). Orbiter AC may be used during entry for a Spacehab AC system failure provided the total AC load (Orbiter + Spacehab) can be managed to stay within limits specified in Rule {A9-155}, AC INVERTER THERMAL LIFE.

- B. FOR LOSS OF SPACEHAB INVERTER(S), AC EQUIPMENT SHALL BE MANAGED AS FOLLOWS:

1. ASCENT

- a. AC EQUIPMENT POWERED BY THE FAILED INVERTER(S) WILL BE POWERED OFF VIA INCO COMMAND POST MECO.
- b. AC EQUIPMENT WILL BE CONFIGURED TO ORBITER POWER AND REPOWERED AS SOON AS PRACTICAL POST MECO PROVIDED THE TOTAL AC LOAD (ORBITER + SPACEHAB) CAN BE MANAGED TO STAY WITHIN LIMITS SPECIFIED IN RULE {A9-155}, AC INVERTER THERMAL LIFE.

If the Spacehab inverter fails during ascent, module heat rejection and smoke detection are lost. To protect critical orbiter systems (i.e., Space Shuttle Main Engine Controllers) during ascent, orbiter AC power is not available to payloads prior to MECO (AC PL 3 phase circuit breaker(s) open). Therefore, orbiter AC power cannot be applied to Spacehab until the crew closes the AC PL 3 phase circuit breaker and the SM GPC is available to change the power source from Spacehab inverter to orbiter AC (the exception is the Spacehab subsystem water pump 2 which does have contingency commands to change the power source and therefore, does not require the SM GPC). If telemetry indicates thermal limits will be violated before power can be restored post MECO, consideration will be given to issuing the Main Power Kill command by arming the FSS. This will remove all power to the Spacehab, except PL AFT MN B, which is required to power the Spacehab water line heaters. @[111501-4986A]

THIS RULE CONTINUED ON NEXT PAGE

FLIGHT RULES

A9-354

SPACEHAB AC MANAGEMENT (CONTINUED)

2. ON-ORBIT @[111501-4986A]

AC EQUIPMENT POWERED BY THE FAILED INVERTER(S) WILL BE POWERED OFF, RECONFIGURED TO ORBITER POWER, AND REPOWERED AS SOON AS PRACTICAL PROVIDED THE TOTAL AC LOAD (ORBITER + SPACEHAB) CAN BE MANAGED TO STAY WITHIN LIMITS SPECIFIED IN RULE {A9-155}, AC INVERTER THERMAL LIFE.

Orbiter AC power can be utilized if the Spacehab inverter(s) fail as long as AC loads can be managed within orbiter power capabilities.

3. ENTRY

- a. AC EQUIPMENT POWERED BY THE FAILED INVERTER(S) WILL BE POWERED OFF VIA INCO COMMAND.
- b. BACKUP AC EQUIPMENT CONFIGURED TO ORBITER POWER WILL BE POWERED AS SOON AS PRACTICAL PROVIDED THE TOTAL AC LOAD (ORBITER + SPACEHAB) CAN BE MANAGED TO STAY WITHIN LIMITS SPECIFIED IN RULE {A9-155}, AC INVERTER THERMAL LIFE.

During entry, if there is a failure in the Spacehab AC system that precludes its use, orbiter AC may be used provided the total AC load can be managed within limits, the AC PL 3 phase circuit breaker is closed, and backup subsystem equipment (pump or fan) was configured to orbiter AC during Spacehab Entry Prep (the exception is the Spacehab subsystem water pump 2 which does not need to be pre-configured to orbiter AC since contingency commands are available to change the power source). A contingency command can then be sent by INCO to reconfigure and activate the backup fan or pump on orbiter AC power. If telemetry indicates thermal limits will be violated before power can be restored during entry when the crew is unable to respond to the failure, the Main Power Kill command will be issued by arming the FSS to remove all power to the Spacehab, except PL AFT MN B, which is required to power the Spacehab water line heaters. @[111501-4986A]

THIS RULE CONTINUED ON NEXT PAGE

FLIGHT RULES

A9-354

SPACEHAB AC MANAGEMENT (CONTINUED)

- C. IF ORBITER AC POWER IS THE NOMINAL POWER SOURCE AND BECOMES UNAVAILABLE, AFFECTED SPACEHAB AC EQUIPMENT WILL BE POWERED OFF AND RECONFIGURED TO SPACEHAB INVERTER POWER IF SPACEHAB AC LOADS PERMIT. @[111501-4986A]

On orbit, both the Spacehab inverter and orbiter AC power are used.

- D. SUBSYSTEM AC EQUIPMENT WHICH CAN BE SWITCHED BETWEEN SPACEHAB INVERTER AND ORBITER AC POWER SOURCES WILL NORMALLY BE DEACTIVATED BEFORE SWITCHING SOURCES.

Hot switching equipment will lead, over time, to degraded relay contacts in the Power Distribution Unit (PDU); however, in an off-nominal condition, hot switching can be performed without significantly damaging Spacehab hardware. @[111705-7068]

- E. APPLYING POWER TO UNPOWERED SPACEHAB SUBSYSTEM AC EQUIPMENT CONFIGURED ON, BUT NOT OPERATING, IS ACCEPTABLE, PROVIDED NO MORE THAN A SINGLE SUBSYSTEM COMPONENT IS CONFIGURED TO DRAW ORBITER AC POWER AT INITIAL BUS ACTIVATION.

In order to protect for failures (i.e., SM GPC not available for commanding) that could delay or inhibit Spacehab Activation or crew initial ingress into the module, some Spacehab subsystem components can be configured to turn ON when the orbiter AC PL 3 Φ circuit breaker is closed. This configuration is normally used when Spacehab is unpowered for ascent. Having only one subsystem component activated at a time minimizes start-up transients that could exceed orbiter inverter capabilities. @[111705-7068]

- F. WHEN POWER IS INTERRUPTED TO SUBSYSTEM AC EQUIPMENT, THE EQUIPMENT WILL BE DEACTIVATED BEFORE POWER IS REAPPLIED.

If Spacehab subsystem AC equipment using orbiter or Spacehab AC power are not deactivated after losing power, the orbiter's or Spacehab's inverter capabilities may be exceeded if power is reapplied simultaneously to all of the previously operating AC equipment. @[092800-7114] @[111501-4986A]

THIS RULE CONTINUED ON NEXT PAGE

FLIGHT RULES

A9-354

SPACEHAB AC MANAGEMENT (CONTINUED)

- G. IN ORDER TO PREVENT EXCEEDANCE OF THE SPACEHAB INVERTER'S CAPABILITIES: @[111501-4986A]
1. NO LOADS SHALL BE APPLIED UNTIL THE INVERTER HAS BEEN VERIFIED OPERATIONAL.
 2. TURN ON FANS BEFORE THE WATER PUMP IF TWO FANS ARE TO BE POWERED BY INVERTER AC.
 3. MCC APPROVAL MUST BE OBTAINED BEFORE USING THE AC VACUUM CLEANER. @[092800-7114]

Verifying that the Spacehab inverter is operational before applying AC loads minimizes possible failure of the inverter or damage to Spacehab hardware.

Turning two fans on before the pump avoids potential in-rush problems, since the fans have a higher in-rush current. The Spacehab inverters are capable of providing power to the ARS fan, cabin fan, and Subsystem Water Pump. @[111501-4986A] @[111705-7068]

The orbiter vacuum cleaner has a high in-rush current of 4.5 amps/phase. Due to the mission unique experiment configuration and other ac power concerns that are timeline dependent, the MCC must be contacted to perform an ac analysis to ensure inverter capability.

Rules {A17-706}, SPACEHAB FAN CONFIGURATIONS, and {A18-553}, SPACEHAB SUBSYSTEM PUMP OPERATIONS, reference this rule. @[ED]

FLIGHT RULES

A9-355

FUSE/CIRCUIT BREAKER MANAGEMENT

- A. APPLICABLE EXPERIMENTS AND SUBSYSTEM EQUIPMENT WILL BE DEACTIVATED PRIOR TO REPLACING A FUSE OR RESETTING A CIRCUIT BREAKER.

This action is required to prevent in-rush current or the original cause of the failure from opening the fuse or tripping the breaker again during the reset/replacement activity.

- B. A CIRCUIT BREAKER SHALL ONLY BE RESET OR FUSE REPLACED AFTER MCC REVIEW OF THE ASSOCIATED DATA. IT IS MANDATORY TO HAVE MCC REAL-TIME COVERAGE WHEN A CIRCUIT BREAKER RESET ATTEMPT OR FUSE REPLACEMENT IS MADE. REPEATED CIRCUIT BREAKER RESETS OR FUSE REPLACEMENTS WILL NOT BE ALLOWED.

A known short will not be repowered due to safety concerns. Real-time coverage is required in order to provide systems experts the opportunity to monitor the action and the associated response. Repeated circuit breaker trips or fuse failures indicate a hardware problem and for safety reasons, the repeated actions will not be allowed.

- C. A CIRCUIT BREAKER MAY BE RESET, IN ACCORDANCE WITH PARAGRAPH B, TO REGAIN SUBSYSTEM OR EXPERIMENT EQUIPMENT FUNCTIONS AFTER REMOVING UNNECESSARY LOADS AND THE EQUIPMENT CAUSING THE FAILURES. @[111501-4986A]

Circuit breakers often feed more than one piece of equipment; therefore, if unnecessary loads or troublesome equipment is removed, the circuit breaker may be successfully reset and the remaining loads used.

- D. NO CIRCUIT BREAKER RETENTION DEVICE SHALL BE USED IN THE SPACEHAB ELECTRICAL SUBSYSTEM.

The circuit breaker retention device is only used to recover emergency or crew safety related items. Mission success does not justify use of the retention device. Failure modes exist where the retention device can override circuit protection.

Reference: NASA/DF Note Of Interest, DF7/83-45, June 14, 1983.

Rule {A2-312}, REAL-TIME SAFETY COORDINATION, references this rule. @[ED]

FLIGHT RULES

A9-356

FUEL CELL FAILURE MANAGEMENT

- A. FOR THOSE MISSIONS REQUIRING A POWERED SPACEHAB MODULE DURING ASCENT/ENTRY, IF A FUEL CELL FAILS DURING ASCENT, THE SPACEHAB WILL NOT REMAIN POWERED EXCEPT PL AFT MN B. ©[111501-4986A]

There is not adequate power margin for Spacehab operations with only two orbiter fuel cells available during ascent. During orbit and entry, power margins may potentially allow payload power. PL AFT MN B provides power to Spacehab water line heaters.

- B. FOR A FUEL CELL FAILURE ON ORBIT, THE SPACEHAB POWER WILL BE MANAGED WITHIN THE 18 KW LIMIT FOR TOTAL ORBITER POWER.

In the event of a fuel cell failure, the 18 kW limit prevents overloading of the last remaining fuel cell. ©[111501-4986A]

A9-357

SPACEHAB SURVIVAL POWER CONFIGURATION ©[111501-4986A]

SPACEHAB SURVIVAL POWER IS DEFINED AS THE POWER LEVEL REQUIRED TO MAINTAIN THE SPACEHAB IN A CONFIGURATION THAT ENSURES CREW SAFETY, INTEGRITY OF SCIENCE RESULTS/SAMPLES ALREADY OBTAINED, AND PROTECTION OF HARDWARE. REFERENCE FLIGHT SPECIFIC ANNEX FOR SURVIVAL POWER REQUIREMENT.

A known minimum power level is required to provide for a case in which the crew's full attention would have to be turned to an orbiter problem. The Spacehab/experiments would need to be placed in a condition which would draw the least amount of both crew time and orbiter resources. The survival configuration for the Spacehab/experiments needs to be clearly defined pre-mission so that this configuration can be achieved quickly and without ambiguity. ©[111501-4986A]

Rule {A2-330}, EXTENSION DAY GROUND RULES, references this rule. ©[ED]

A9-358

CAUTION AND WARNING (C&W)

CAUTION AND WARNING SYSTEM AND SYSTEM MANAGEMENT PARAMETERS WHICH GENERATE FALSE OR NUISANCE ALARMS WILL BE INHIBITED.

Inhibiting the alarms prevents reaction/response to nuisance and/or erroneous failure indications. ©[092701-4872]

A9-359 THROUGH A9-400 RULES ARE RESERVED

FLIGHT RULES

STATION TO SHUTTLE POWER TRANSFER SYSTEM (SSPTS) LOSS/FAILURE DEFINITIONS

A9-401 SSPTS ORBITER POWER CONVERSION UNIT (OPCU)

THE OPCU WILL BE DEACTIVATED IF: @[042507-8408F]

- A. IT CANNOT MAINTAIN MAIN BUS VOLTAGE \leq 32 VOLTS WHEN CONNECTED TO THE MAIN BUS.

Most orbiter electrical equipment was designed and certified to an upper voltage limit of 32 V dc. Operation of orbiter hardware above 32 V could lead to hardware failure. Reference Rule {A9-3}, ELECTRICAL POWER DISTRIBUTION AND CONTROL (EPDC) SYSTEM [CIL].

DOCUMENTATION: MF0004-002 Electrical design Requirements paragraph 3.2, SODB 3.4.5.6 DC Voltage Limits.

- B. OPCU TEMPERATURE CANNOT BE MAINTAINED $<$ 205 (200) DEGREES F.

If the temperature exceeds 205 degrees F, this could lead to premature failure of internal components, causing undesirable output voltage levels, distorted waveforms, or a short circuit. To prevent possible damage to the PTU, the OPCU will be shut down and/or loads managed until nominal operating temperatures are reestablished.

DOCUMENTATION: SODB Table 3.4.5.6-1, Electrical Power Distribution Subsystem Components Temp Limits, qualification testing, and engineering judgment.

- C. THE OPCU EXPERIENCES AN UNRECOVERABLE AUTO TRIP SHUTDOWN.

The OPCU was designed to automatically shut down for a failure that would lead to an output overvolt, input undervolt, input overcurrent, or a transformer primary to secondary short. If the protection circuitry inadvertently trips, it still may be possible to reset the protection circuit and continue safe operation. Reference Rule {A9-452}, SSPTS OPCU FAILURE MANAGEMENT.

DOCUMENTATION: MC409-0547 PTU Spec paragraph 3.2.1.2.9 OPCU Fault Protection and engineering judgment. @[042507-8408F]

FLIGHT RULES

A9-402

SSPTS ASSEMBLY POWER CONVERSION UNIT (APCU)

THE APCU WILL BE DEACTIVATED IF: @[042507-8408F]

- A. THE APCU CANNOT MAINTAIN ITS OUTPUT VOLTAGE BETWEEN 123 AND 126 VDC.

If the APCU voltage is outside of its normal range, it may be possible that the voltage at the LRU is still within permissible operational ranges as determined by payload customer or other user. Instrumentation error for the APCU voltage sensor is 1.0 percent of full scale value or 1.5 volts. If the indicated APCU voltage is outside the 123- to 126-volt range, but still within the instrumentation error, the 116 to 126 voltage requirement at the payload (interface B) may still be satisfied after line loss is taken into account.

DOCUMENTATION: SSP 30482 Electrical Power Specification and Standards, Volume 1, paragraphs 3.1.2.1 and 3.1.3.1.1, and SODB paragraph 4.5.6.3.3.1, PTU APCU Voltage.

- B. APCU TEMPERATURE CANNOT BE MAINTAINED < 195 (190) DEGREES F.

If the temperature cannot be maintained below 195 degrees F, continued operations at elevated temperatures can lead to premature failure of internal components, possibly causing undesirable output voltage levels, distorted waveforms, or a short circuit. To prevent possible damage to payload equipment or the OBSS, the APCU will be shut down until nominal operating temperatures are reestablished.

DOCUMENTATION: SODB Table 3.4.5.6-1, Electrical Power Distribution Subsystem Components Temp Limits, qualification testing, and engineering judgment.

- C. THE APCU EXPERIENCES AN UNRECOVERABLE AUTO TRIP SHUTDOWN CONDITION.

The APCU is designed to automatically shut down for a failure that leads to an input undervolt, output undervolt, output overvolt, or output overcurrent condition. If the protection circuit inadvertently trips, it may be possible to reset the logic and continue safe operation. Reference Rule {A9-464}, SSPTS APCU FAILURE MANAGEMENT.

DOCUMENTATION: MC409-0547 PTU Spec paragraph 3.2.1.3.9 APCU Fault Protection and engineering judgment. @[042507-8408F]

A9-403 THROUGH A9-450 RULES ARE RESERVED

FLIGHT RULES

SSPTS SYSTEM MANAGEMENT

A9-451

SSPTS ORBITER POWER CONVERSION UNIT (OPCU) MANAGEMENT

DURING OPCU OPERATION, THE MAIN BUS CONNECTED TO THE OPCU WILL BE CONNECTED TO A FUEL CELL EITHER DIRECTLY OR VIA A BUS TIE.
@[042507-8408F]

There is a potential for bus loading to be greater than OPCU output power capability, resulting in less than desirable voltage at main bus LRU's. Additionally, OPCU output response to large transient loads may result in LRU exposure to undesirable voltage transients. The SSPTS design does not preclude the OPCU from solely powering a main bus as long as the main bus loads are managed to be within the OPCU output power capabilities and main bus voltages are kept within limits.

DOCUMENTATION: Engineering judgment.

A9-452

SSPTS OPCU FAILURE MANAGEMENT

- A. FOR AN OPCU CONVERTER THAT HAS AN UNRECOVERABLE OUTPUT UNDERVOLT TRIP, THE REMAINING OPCU CONVERTER IN THE AFFECTED PTU WILL BE USED ONLY TO COMPLETE THE NOMINAL MISSION DURATION.

An OPCU converter that has experienced an output undervolt trip that cannot be reset is indicative of the loss of one of the PTU box's remote sense lines. The other OPCU converter in the affected PTU will be operated only to complete NEOM. With the loss of one of the two remote sense lines, one of the three layers of protection against the OPCU overvolting the main bus is lost.

If the nominal mission duration can be obtained without using the other OPCU converter in the affected PTU, then the converter should be deactivated. Consideration should be given to ISS power balancing when determining if an alternate OPCU converter can be used to achieve the nominal mission duration.

DOCUMENTATION: MC409-0547 PTU Spec paragraph 3.2.1.2.9.1.3 Loss of Main Bus Remotes Sense Signal and engineering judgment. @[042507-8408F]

THIS RULE CONTINUED ON NEXT PAGE

FLIGHT RULES

A9-452

SSPTS OPCU FAILURE MANAGEMENT (CONTINUED)

- B. THERE ARE NO CONSTRAINTS AGAINST USING AN OPCU THAT DOES NOT OPERATE IN REMOTE SENSE WHEN CONNECTED TO THE MAIN BUS.
@[042507-8408F]

The OPCU has two voltage regulation modes: remote sense (sensing the voltage at the main bus - nominal state when PTU is connected to the main bus) and local sense (sensing the voltage at its output terminals - nominal state when PTU is not connected to the main bus). If the OPCU has lost the capability to regulate the voltage remotely, it can still be operated in local sense when connected to the main bus. Operating the OPCU in local sense results in degraded power transfer since the voltage at the main bus is lower than the setpoint voltage due to line losses.

DOCUMENTATION: MC409-0547 PTU Spec paragraph 3.2.1.2.2.1 OPCU Voltage Control and engineering judgment.

- C. IF AN OPCU EXPERIENCES AN AUTO SHUTDOWN, IT WILL BE DISCONNECTED FROM ITS MAIN BUS BEFORE THE FOLLOWING TROUBLESHOOTING CAN BE PERFORMED:

Disconnecting the OPCU from the main bus during troubleshooting will isolate the equipment on the main bus, protecting it from a potentially malfunctioning OPCU. It may not be possible to determine the exact failure mode that caused the shutdown since protection circuit trip times are significantly faster than orbiter data rates and direct insight into OPCU input current is not available.

With the main bus isolated, there is minimal risk in attempting a reset (cycling the OPCU Converter switch or turning the ISS RPC's off, then on) due to the limited amount of energy that can be delivered before protection circuits disable power conversion circuitry. Operation of an OPCU with protection circuits that continually trip may result in equipment being exposed to unsafe operating conditions (out of spec voltage). Reference Rule {A9-3}, ELECTRICAL POWER DISTRIBUTION AND CONTROL (EPDC) SYSTEM [CIL].

DOCUMENTATION: MC409-0547 PTU Spec paragraph 3.2.1.9.2 OPCU, Fault Protection; MF0004-002 Electrical design Requirements, paragraph 3.2; SODB 3.4.5.6, DC Voltage Limits; and engineering judgment. @[042507-8408F]

THIS RULE CONTINUED ON NEXT PAGE

FLIGHT RULES

A9-452

SSPTS OPCU FAILURE MANAGEMENT (CONTINUED)

1. AN OPCU THAT EXPERIENCES AN INPUT OVERCURRENT TRIP, OUTPUT UNDERVOLT TRIP, OR A FAULT ISOLATOR TRIP WILL NOT BE RESET UNTIL AN MCC DATA REVIEW IS PERFORMED. IF THE OPCU CONVERTER IS REQUIRED TO COMPLETE THE NOMINAL MISSION DURATION AND THERE IS NO EVIDENCE OF A SHORT, A RESET MAY BE PERFORMED IN AN ATTEMPT TO RECOVER. ©[042507-8408F]

If the nominal mission duration can be obtained without using the affected OPCU converter, then the converter should be deactivated. Consideration should be given to ISS power balancing when determining if an alternate OPCU converter can be used to achieve the nominal mission duration. A fault isolator trip can only be reset by cycling input power (ISS RPC) to the OPCU.

2. AN OPCU THAT EXPERIENCES AN OUTPUT OVERVOLT TRIP MAY BE RESET IF THE OPCU CONVERTER IS REQUIRED TO COMPLETE THE NOMINAL MISSION DURATION. THE OPCU RESET MAY BE PERFORMED IN ORDER TO DETERMINE WHICH CONVERTER CAUSED THE TRIP OR IN AN ATTEMPT TO RECOVER.

If the nominal mission duration can be obtained without using the affected OPCU converter, then the converter should be deactivated. Consideration should be given to ISS power balancing when determining if an alternate OPCU converter can be used to achieve the nominal mission duration.

3. AN OPCU THAT EXPERIENCES AN INPUT UNDERVOLT TRIP MAY BE RESET IN AN ATTEMPT TO RECOVER.

An OPCU input undervolt trip is indicative of a problem upstream of the OPCU or of a protection circuit problem. Resetting the OPCU will not adversely affect the upstream conditions.

*Rule {A9-401}, SSPTS ORBITER POWER CONVERSION UNIT (OPCU), references this rule.
©[042507-8408F]*

A9-453 THROUGH A9-460 RULES ARE RESERVED

FLIGHT RULES

SSPTS APCU MANAGEMENT

A9-461

SSPTS APCU INPUT POWER MANAGEMENT

- A. NOMINALLY, THE APCU WILL BE CONNECTED TO ITS RESPECTIVE MAIN BUS WHEN OPERATING. @[042507-8408F]
- B. THE APCU CAN OPERATE RECEIVING INPUT POWER SOLELY FROM ITS RESPECTIVE OPCU(S).

The APCU was designed to operate at an input voltage range of 23 to 36 volts, the full output voltage range of the OPCU. When the PTU is not connected to the main bus, the OPCU will not shut itself down for an output overvolt failure condition; however, the APCU input circuits were designed with enough margin that they will operate under all possible OPCU output voltages.

If the APCU is receiving its input power solely from the OPCU, both OPCU converters in the respective PTU may need to be activated in order for the APCU to provide its maximum output capability.

DOCUMENTATION: MC409-0547 PTU Spec paragraph 3.1.2.1.3, APCU Input Power Interface; 3.2.1.3.9, APCU Fault Protection; 3.2.1.2.9 OPCU, Fault Protection; and engineering judgment.

A9-462

SSPTS APCU OUTPUT RELAY MANAGEMENT

- A. NOMINALLY, THE APCU OUTPUT RELAY WILL NOT BE OPENED OR CLOSED WITH A LOAD OF GREATER THAN 1 AMP.

The output relay was not certified to open or close under a load greater than 1 amp. Manufacture specification for CII Technologies AP44P KILOVAC relay indicates a minimum cycle life of 5,000 cycles at rated load (15 amps at 270 V dc); however, this rating is for a resistive type load. Loading on the APCU is expected to have both capacitive and inductive characteristics. Relay wear for opening and closing under this type of loading has not been evaluated as part of the SSPTS project. Relay operational life will be extended if loading is limited to minimal values when cycled.

DOCUMENTATION: AP44P Product specification and engineering judgment.

- B. IN AN OFF-NOMINAL SITUATION, OPENING OR CLOSING THE APCU OUTPUT RELAY WITH A LOAD OF GREATER THAN 1 AMP IS PERMISSIBLE.

In a contingency or off-nominal situation, there is high confidence the relay will open or close, and the potential impact to relay lifetime is acceptable.

DOCUMENTATION: AP44P Product specification and engineering judgment. @[042507-8408F]

THIS RULE CONTINUED ON NEXT PAGE

FLIGHT RULES

A9-462 **SSPTS APCU OUTPUT RELAY MANAGEMENT (CONTINUED)**

- C. THE APCU OUTPUT RELAY AND CONVERTER WILL BE MANAGED TO ENSURE THAT THERE IS NEVER AN EXPOSED POWERED CONNECTOR DURING CONNECTOR MATE/DEMATE OR CLOSE PROXIMITY EVA OPERATIONS. ©[042507-8408F]

Unpowering exposed APCU power connectors during connector mate/demate operations (for example EVA ROEU mate/demate) will preclude connector arcing and short circuits during mate/demate operations. In addition, unpowering any exposed APCU power connectors during EVA operations will minimize the hot molten metal debris hazard to suits that could result from connector arcing or short circuits. APCU converter and output relay 'OFF' indications provide two verifiable inhibits for electrical hazards.

DOCUMENTATION: MA2-99-170 , NSTS 08080-1 Standard 69, and engineering judgment.

A9-463 **SSPTS APCU OUTPUT POWER CONSTRAINTS**

APCU (S) AND/OR DOWNSTREAM LOADS WILL BE MANAGED TO KEEP EACH APCU OUTPUT CURRENT BELOW 14.7 AMPS.

Each APCU is rated for a maximum continuous output of 14.7 amps.

DOCUMENTATION: MC409-0547 PTU Spec paragraph 3.2.1.3.2.5 APCU Output Current and SODB 4.5.6.3.3.2 PTU APCU Current.

Rule {A9-464}, SSPTS APCU FAILURE MANAGEMENT, references this rule.

A9-464 **SSPTS APCU FAILURE MANAGEMENT**

- A. IF TWO APCU'S ARE CONNECTED IN PARALLEL AND ONE APCU FAILS, OPERATION OF THE REMAINING APCU MAY CONTINUE AS LONG AS THE LOADS ARE MANAGED TO STAY WITHIN THE OUTPUT POWER CONSTRAINTS OF THE REMAINING APCU. ©[042507-8408F]

Two APCU's may be flown in a parallel configuration to meet flight specific payload requirements. Continued operations may be possible after a single APCU failure. The loads need to be managed to stay below the output power constraints of the remaining APCU. Reference Rule {A9-463}, SSPTS APCU OUTPUT POWER CONSTRAINTS, for details on APCU output power constraints. Under certain failure scenarios, such as a short circuit, single APCU operation may not be possible.

DOCUMENTATION: MC409-0547 PTU Spec 3.21.3.2.5 APCU Output Current and engineering judgment. ©[042507-8408F]

THIS RULE CONTINUED ON NEXT PAGE

FLIGHT RULES

A9-464**SSPTS APCU FAILURE MANAGEMENT (CONTINUED)**

- B. IF AN APCU EXPERIENCES AN AUTO SHUTDOWN, ITS OUTPUT RELAY (AND THE OUTPUT RELAY OF THE OTHER APCU IF CONNECTED IN PARALLEL) WILL BE OPENED BEFORE THE FOLLOWING TROUBLESHOOTING CAN BE PERFORMED: ©[042507-8408F]

Opening the APCU's output relay will isolate the equipment from a potentially malfunctioning APCU. Opening the output relay does not, however, preclude a short being reenergized if the short was on the interconnect cable. If the protection circuitry inadvertently trips, it still may be possible to reset the protection circuit and continue safe operation. It may not be possible to determine the exact failure mode since trip times are significantly faster than data rates. With the output isolated, there is minimal risk in attempting a reset due to the limited amount of energy that can be delivered before protection circuits disable power conversion circuitry. Operating the APCU with a protection circuit that continually trips may result in equipment being exposed to unsafe operating conditions (out of spec voltage).

DOCUMENTATION: MC409-0547 PTU Spec paragraph 3.2.1.3.9 APCU Fault Protection and engineering judgment.

1. AN APCU THAT EXPERIENCES AN OUTPUT OVERCURRENT TRIP, OUTPUT OVERVOLT TRIP, OR OUTPUT UNDERVOLT TRIP WILL NOT BE RESET UNTIL AN MCC DATA REVIEW IS PERFORMED. IF THE APCU CONVERTER IS REQUIRED TO COMPLETE MISSION OBJECTIVES, AN APCU RESET MAY BE PERFORMED IF THERE IS NO EVIDENCE OF A SHORT IN AN ATTEMPT TO RECOVER.

If mission objectives can be obtained without using the affected APCU converter, then the converter should be deactivated.

2. AN APCU THAT EXPERIENCES AN INPUT UNDERVOLT TRIP MAY BE RESET IN AN ATTEMPT TO RECOVER.

An APCU input undervolt trip is indicative of a problem upstream of the APCU or of a protection circuit problem. Resetting the APCU will not adversely affect the upstream conditions.

*Rule {A9-402}, SSPTS ASSEMBLY POWER CONVERSION UNIT (APCU), references this rule.
©[042507-8408F]*

A9-465 THROUGH A9-470 RULES ARE RESERVED

FLIGHT RULES

A9-471

SSPTS PTU ASCENT AND ENTRY MANAGEMENT

- A. THE APCU CONVERTERS WILL BE UNPOWERED DURING THE ASCENT AND ENTRY TIMEFRAMES. @[042507-8408F]

Operating the APCU's during the ascent and entry flight phases is not a specific requirement and, therefore, the APCU's are not certified to operate during these timeframes. However, APCU qualification testing was performed to demonstrate operation in a decreasing pressure environment. Results indicate the design will not preclude APCU operations during ascent/entry. Application of input power to the APCU is not a concern for corona arching.

DOCUMENTATION: MC409-0547 PTU Spec paragraph 3.3.3.2

- B. THE PTU(S) WILL NOMINALLY BE DISCONNECTED FROM ITS MAIN BUS DURING THE ASCENT AND ENTRY TIMEFRAMES.

The PTU is only required to be operational during the on-orbit phase of missions and through ground-induced operations, but not during ascent or entry. Since the PTU is not required for ascent/entry, the PTU will be disconnected from its main bus to eliminate it as a potential short circuit source during critical flight phases. Reference Rule {A9-108}, CRITICAL PHASE BUS MANAGEMENT. However, there are no corona arching concerns during ascent or entry if the PTU is connected to the main bus.
@[042507-8408F]

FLIGHT RULES

ELECTRICAL GO/NO-GO CRITERIA

A9-1001

ELECTRICAL GO/NO-GO CRITERIA [HC]

®[052704-6257A]

SYSTEM/COMPONENTS/FUNCTIONS	CONTINUE NOMINAL ASCENT IF:	INVOKE MDF IF:	ENTER NEXT PLS IF:
A. <u>CRYO:</u>			
1. O2 TANKS (3/4/5)	2/3/4 ↓	[2]	[1] [2]
2. H2 TANKS (3/4/5)	2/3/4 ↓	[2]	[1] [2]
3. O2, H2 MANIFOLDS (6)		1 ↓ [3]	2 ↓ [3]
B. <u>FUEL CELLS:</u>			
FUEL CELLS (3)	2 ↓	1 ↓ [4]	2 ↓ [5]
FC PRIMARY H2O FLOW TO ECLSS (3)		2 ↓ [6]	3 ↓ [6]
FC OVERBOARD RELIEF SYSTEM			
FC ALTERNATE H2O SYSTEM			
FC VENT LINE BLOCKAGE (O2 OR H2)			[7]
FC O2 PURGE		[8]	[8]
FC H2 PURGE			
FC STARTUP HEATER - FAILED ON		[41]	[42]
FC SUSTAINING HEATER - FAILED ON			[43]
C. <u>ELECTRICAL PWR DIST & CNTL:</u>			
1. MAIN DC BUSES			
a. <u>MNA</u>			
DA1			[9]
FPC1		[10] [11]	[10] [22]
FLC1			
FMC1			
MPC1		[13]	[22]
MMC1		[15]	[22]

®[032802-4814A] ®[052704-6257A] ®[033105-6658A] ®[102506-7768A]

FLIGHT RULES

THIS RULE CONTINUED ON NEXT PAGE

FLIGHT RULES

A9-1001

ELECTRICAL GO/NO-GO CRITERIA [HC] (CONTINUED)

SYSTEM/COMPONENTS/FUNCTIONS	CONTINUE NOMINAL ASCENT IF:	INVOKE MDF IF:	ENTER NEXT PLS IF:
C. <u>ELECTRICAL PWR DIST & CNTL: (CONT)</u>			
1. MAIN DC BUSES			
a. <u>MNA (CONT)</u>			
MMC3			[22]
APC4			[17]
APC1			
ALC1			[17]
AMC1			
014		[38]	
R15			
014 & A8			
R1A1			
A6 & A14			
ML86B			
A11EDO			
A15EDO			
PPC1			
b. <u>MNB</u>			[18]
DA2			
FPC2		[10] [19]	[10] [22]
FLC2		[20]	
FMC2			
MPC2		[21]	[22]
MMC1			
MMC2		[15]	[22]

©[050400-7189] ©[032802-4814A] ©[092503-5546B]

THIS RULE CONTINUED ON NEXT PAGE

FLIGHT RULES

A9-1001

ELECTRICAL GO/NO-GO CRITERIA [HC] (CONTINUED)

SYSTEM/COMPONENTS/FUNCTIONS	CONTINUE NOMINAL ASCENT IF:	INVOKE MDF IF:	ENTER NEXT PLS IF:
C. <u>ELECTRICAL PWR DIST & CNTL: (CONT)</u>			
1. MAIN DC BUSES			
b. <u>MNB (CONT)</u>			
MMC3			
MMC4		[15]	[22]
APC5			[40]
APC2			
ALC2			[40]
AMC2			
R15			
015 & A8			
015		[39]	
R1A1			
A6 & A14			
ML86B			
A11EDO			
A15EDO			
PPC2			
c. <u>MNC</u>			
DA3			[23]
FPC3		[10] [24]	[10] [22]
FLC3		[25]	
FMC3			
MPC3		[26]	[22]
MMC2			[22]
MMC4		[15]	[22]

©[050400-7189] ©[032802-4814A] ©[092503-5546B]

THIS RULE CONTINUED ON NEXT PAGE

FLIGHT RULES

A9-1001

ELECTRICAL GO/NO-GO CRITERIA [HC] (CONTINUED)

SYSTEM/COMPONENTS/FUNCTIONS	CONTINUE NOMINAL ASCENT IF:	INVOKE MDF IF:	ENTER NEXT PLS IF:
C. <u>ELECTRICAL PWR DIST & CNTL</u> : (CONT)			
1. MAIN DC BUSES			
c. <u>MNC</u> (CONT)			
APC6			
APC3			
ALC3			
AMC3			
R15			
016RJD			
016		[27]	
R1A1			
A6 & A14			
ML86B			
2. CONTROL BUSES			
a. <u>CNTL</u>			
CNTLAB1		[14]	[12] [16] [17]
CNTLAB2			[12] [17] [40]
CNTLAB3		[15]	[22]
CNTLBC1		[14] [28]	[12] [17]
CNTLBC2		[14] [25]	[12] [17]
CNTLBC3		[15]	[22]
CNTLCA1			[12] [17]
CNTLCA2		[14]	[12] [17]
CNTLCA3		[15]	[22]

©[011801-3851] ©[032802-4814A]

THIS RULE CONTINUED ON NEXT PAGE

FLIGHT RULES

A9-1001

ELECTRICAL GO/NO-GO CRITERIA [HC] (CONTINUED)

SYSTEM/COMPONENTS/FUNCTIONS	CONTINUE NOMINAL ASCENT IF:	INVOKE MDF IF:	ENTER NEXT PLS IF:
C. <u>ELECTRICAL PWR DIST & CNTL: (CONT)</u>			
3. ESSENTIAL BUSES			
a. <u>ESS1BC</u>		[29]	
DA1			
FP & LC1			
MPC1		[29]	
ALC1			
APC4			
FD		[29]	
013 & R15			
ML86B			
b. <u>ESS2CA</u>		[30]	
DA2			
FP & LC2			
MPC2		[30]	
AP & LC2			
APC5			
FD		[30]	
013 & R15			
ML86B			
c. <u>ESS3AB</u>		[31]	
DA3			
FP & LC3			
MPC3		[31]	
AP & LC3			
APC6			
FD		[31]	
013			
ML86B			

THIS RULE CONTINUED ON NEXT PAGE

FLIGHT RULES

A9-1001

ELECTRICAL GO/NO-GO CRITERIA [HC] (CONTINUED)

SYSTEM/COMPONENTS/FUNCTIONS	CONTINUE NOMINAL ASCENT IF:	INVOKE MDF IF:	ENTER NEXT PLS IF:
C. <u>ELECTRICAL PWR DIST & CNTL: (CONT)</u>			
4. AC BUSES			
a. <u>AC INVERTERS</u>			
AC1 INVERTERS ↓ (3)		2 ↓ [10] [11]	2 ↓ [10] [22]
AC2 INVERTERS ↓ (3)		2 ↓ [10] [32]	2 ↓ [10] [5] [22]
AC3 INVERTERS ↓ (3)		2 ↓ [10] [33]	2 ↓ [10] [22]
b. <u>AC1</u>			
AC1(3Φ)		[11]	[22]
AC1ΦA		[34]	[34]
AC1ΦB		[34]	[34]
AC1ΦC		[34]	[34]
AC1 FMC1			
AC1 MMC1		[15]	[22]
AC1 MMC3			[22]
AC1 AMC1			
c. <u>AC2</u>		[32]	[22]
AC2(3Φ)			
AC2ΦA		[34] [35]	[34]
AC2ΦB		[34] [35]	[34]
AC2ΦC		[34] [35]	[34]
AC2 FMC2			
AC2 MMC1			
AC2 MMC2		[15]	[22]
AC2 MMC3			
AC2 MMC4		[15]	[22]
AC2 AMC2			

@[032802-4814A]

THIS RULE CONTINUED ON NEXT PAGE

FLIGHT RULES

A9-1001

ELECTRICAL GO/NO-GO CRITERIA [HC] (CONTINUED)

SYSTEM/COMPONENTS/FUNCTIONS	CONTINUE NOMINAL ASCENT IF:	INVOKE MDF IF:	ENTER NEXT PLS IF:
C. <u>ELECTRICAL PWR DIST & CNTL: (CONT)</u>			
4. AC BUSES (CONT)			
d. <u>AC3</u>			
AC3(3Φ)		[33]	[22]
AC3ΦA		[34] [36]	[34]
AC3ΦB		[34] [36]	[34]
AC3ΦC		[34] [36]	[34]
AC3 FMC3			
AC3 MMC2			[22]
AMC MMC4		[15]	[22]
AC3 AMC3			
D. <u>CAUTION AND WARNING:</u>			
C&W - PRIMARY AND BACKUP (2).....			2 ↓ [37]

Ⓢ[032802-4814A]

LEGEND: NO REQUIREMENT () QUANTITY

REQUIRED [] NOTE REFERENCE

- [1] LOSE ALL TANKS ASSOCIATED WITH TWO MANIFOLDS, REF. RULE {A2-102C}.1, MISSION DURATION REQUIREMENTS. Ⓢ[052704-6257A] Ⓢ[033105-6658A]
- [2] FOR TANK FAILURES, CONSUMABLES DETERMINE FLIGHT DURATION. IF A GENERIC FAILURE CAUSES LOSS OF MULTIPLE TANKS, REF. RULE {A2-104A}.3, SYSTEMS REDUNDANCY REQUIREMENTS.
- [3] IF CRYO LEAK CAUSED LOSS OF THE MANIFOLD(S), FUEL CELL SHUTDOWN MAY BE REQUIRED PRIOR TO ENTRY. Ⓢ[052704-6257A]
- [4] SINGLE FAULT TOLERANT. REF. RULE {A2-102B}, MISSION DURATION REQUIREMENTS. Ⓢ[101796-4561A]
- [5] ZERO FAULT TOLERANT. REF. RULE {A2-102C}, MISSION DURATION REQUIREMENTS.
- [6] LOSS OF PRIMARY SYSTEM FOR MULTIPLE FC'S MAY HAVE RESULTED FROM FREEZING OF H2O RELIEF PANEL WHICH COULD ALSO CAUSE LOSS OF OVERBOARD RELIEF AND LEAVE ONLY THE ALTERNATE SYSTEM FOR H2O REMOVAL. REF. RULE {A2-102C}, MISSION DURATION REQUIREMENTS. Ⓢ[101796-4561A]
- [7] LOSS OF PURGE CAPABILITY ON ALL THREE FC'S. ALSO, ALL THREE FC'S UNABLE TO VENT O2 (H2) FOR A DUAL GAS REGULATOR FAILURE. ALL THREE FC'S NO LONGER FAIL-SAFE. REF. RULES {A9-1J}, FUEL CELL (FC) LOSS [CIL] [HC]; AND {A9-52C} D AND E, FC PURGE, [HC]. Ⓢ[033006-7297A]

THIS RULE CONTINUED ON NEXT PAGE

FLIGHT RULES**A9-1001 ELECTRICAL GO/NO-GO CRITERIA [HC] (CONTINUED)**

- [8] FUEL CELL PREDICTED PERFORMANCE DETERMINES MISSION DURATION.
- [9] LOSE ALL MNA SUB-BUSES AND ASSOCIATED EQUIPMENT.
- [10] IF AC BUS NOT SHORTED, AN MDF MAY BE COMPLETED BY THE USE OF THE AC POWER TRANSFER CABLE TO REGAIN CRITICAL AC LRU'S. NEXT PLS REQUIRED IF AC BUS NOT REGAINED. REF. RULE {A9-158}, AC POWER TRANSFER CABLE. @[ED]
- [11] LOSE PLBD CLOSE FUNCTION MOTOR REDUNDANCY, FUEL CELL 1 PUMPS. REF. RULES {A9-1B}, FUEL CELL (FC) LOSS [CIL] [HC], AND {A10-209H}, PLBD RULE REFERENCE MATRIX. @[033006-7297A]
- [12] LOSE ONE MOTOR IN MULTIPLE PLBD CENTERLINE/BULKHEAD LATCH GANGS. REDUNDANCY MAY BE REGAINED BY PERFORMING THE PLBD SYS ENABLE RECOVERY IFM. REF. RULE {A10-209}, PLBD RULE REFERENCE MATRIX. @[011801-3851] @[032802-4814A]
- [13] LOSE PLBD CLOSE FUNCTION MOTOR REDUNDANCY, FUEL CELL 1 PURGE VALVES. REF. RULES {A9-52C} AND D, FC PURGE [HC], AND {A10-209H}, PLBD RULE REFERENCE MATRIX.
- [14] LOSE PLBD CLOSE FUNCTION MOTOR REDUNDANCY. REDUNDANCY MAY BE REGAINED BY PERFORMING THE PLBD SYS ENABLE RECOVERY IFM, ASSUMING THERE ARE NO OTHER SYSTEMS GO/NO-GO CRITERIA VIOLATED. REF. RULE {A10-209}, PLBD RULE REFERENCE MATRIX.
- [15] LOSE PLBD CLOSE FUNCTION MOTOR REDUNDANCY. REF. RULE {A10-209}, PLBD RULE REFERENCE MATRIX.
- [16] LOSE OMS X-FEED AND REPRESS CAPABILITY. A G-MEM CAN BE SENT TO RECOVER THESE FUNCTIONS.
- [17] FAILURE OF ANOTHER BUS RESULTS IN LOSS OF CAPABILITY TO OPEN FUEL TANK VALVES ON AN APU AND CAPABILITY TO DEPRESS ANOTHER HYD SYSTEM AND/OR LOSS OF WSB CONTROLLERS ON ANOTHER APU/HYD SYSTEM. REF. RULE {A10-21A}, LOSS OF APU/HYDRAULIC SYSTEM(S) ACTIONS. @[082593-1530] @[032802-4814A] @[092503-5546B]
- [18] LOSE ALL MNB SUB-BUSES AND ASSOCIATED EQUIPMENT.
- [19] LOSE FUEL CELL 2 PUMPS, PLBD CLOSE FUNCTION MOTOR REDUNDANCY, S-BAND SYSTEM 1 (INCLUDES NSP 1), CABIN FAN B. REF. RULES {A9-1B}, FUEL CELL (FC) LOSS [CIL] [HC]; {A9-1001}, ELECTRICAL GO/NO-GO CRITERIA [HC]; {A10-209H}, PLBD RULE REFERENCE MATRIX; AND {A11-1001}, COMMUNICATIONS GO/NO-GO CRITERIA. @[ED] @[ED]
- [20] LOSE S-BAND SYSTEM 1 (INCLUDES NSP 1). REF. RULE {A11-1001}, COMMUNICATIONS GO/NO-GO CRITERIA.
- [21] LOSE PLBD CLOSE FUNCTION MOTOR REDUNDANCY, FUEL CELL 2 PURGE VALVES. REF. RULES {A9-52C} AND D, FC PURGE [HC], AND {A10-209H}, PLBD RULE REFERENCE MATRIX.
- [22] LOSE ONE MOTOR IN MULTIPLE PLBD CENTERLINE/BULKHEAD LATCH GANGS. REF. RULE {A10-209}, PLBD RULE REFERENCE MATRIX. @[011801-3851]
- [23] LOSE ALL MNC SUB-BUSES AND ASSOCIATED EQUIPMENT.
- [24] LOSE FUEL CELL 3 PUMPS, PLBD CLOSE FUNCTION MOTOR REDUNDANCY, S-BAND SYSTEM 2 (INCLUDES NSP 2), CABIN FAN A. REF. RULES {A9-1B}, FUEL CELL (FC) LOSS [CIL] [HC]; {A9-1001}, ELECTRICAL GO/NO-GO CRITERIA [HC]; {A10-209H}, PLBD RULE REFERENCE MATRIX; AND {A11-1001}, COMMUNICATIONS GO/NO-GO CRITERIA. @[ED]
- [25] LOSE S-BAND SYSTEM 2 (INCLUDES NSP 2). REF. RULE {A11-1001}, COMMUNICATIONS GO/NO-GO CRITERIA. @[ED]
- [26] LOSE PLBD CLOSE FUNCTION MOTOR REDUNDANCY, FUEL CELL 3 PURGE VALVES, RGA 3. REF. RULES {A8-1001D}, GNC GO/NO-GO CRITERIA; {A9-52C} AND D, FC PURGE [HC]; AND {A10-209H}, PLBD RULE REFERENCE MATRIX. @[ED]
- [27] LOSE ADTA 3 AND 4. REF. RULE {A8-1001D}, GNC GO/NO-GO CRITERIA.
- [28] LOSE S-BAND SYSTEM 1 (INCLUDES NSP 1). RGA 2. REF. RULES {A11-1001}, COMMUNICATIONS GO/NO-GO CRITERIA; AND {A8-1001D}, GNC GO/NO-GO CRITERIA. @[ED]
- [29] LOSE FUEL CELL 1 ECU PUMP PRIMARY RELAYS. REF. RULE {A9-1B}, FUEL CELL (FC) LOSS [CIL] [HC].
- [30] LOSE FUEL CELL 2 ECU PUMP PRIMARY RELAYS. REF. RULE {A9-1B}, FUEL CELL (FC) LOSS [CIL] [HC].
- [31] LOSE FUEL CELL 3 ECU PUMP PRIMARY RELAYS. REF. RULE {A9-1B}, FUEL CELL (FC) LOSS [CIL] [HC]. @[033006-7297A]

THIS RULE CONTINUED ON NEXT PAGE

FLIGHT RULES

A9-1001 ELECTRICAL GO/NO-GO CRITERIA [HC] (CONTINUED)

- [32] LOSE PLBD CLOSE FUNCTION MOTOR REDUNDANCY, FUEL CELL 2 PUMPS, CABIN FAN B. REF. RULES {A9-1B}, FUEL CELL (FC) LOSS [CIL] [HC]; SECTION B; AND {A10-209H}, PLBD RULE REFERENCE MATRIX. @[033006-7297A]
- [33] LOSE PLBD CLOSE FUNCTION MOTOR REDUNDANCY, FUEL CELL 3 PUMPS, CABIN FAN A. REF. RULES {A9-1B}, FUEL CELL (FC) LOSS [CIL] [HC]; SECTION B; AND 1 {A10-209H}, PLBD RULE REFERENCE MATRIX. @[033006-7297A]
- [34] IF BUS SHORT-CIRCUITED, INVOKE CRITERIA FOR FMC, MMC, AMC SUB-BUSES, UNLESS SHORTED PHASE CAN BE ISOLATED FROM GANGED CB ASSEMBLY. REF. RULE {A9-156}, LOSS OF SINGLE-PHASE AC. @[ED]
- [35] LOSE 1 AC ϕ OF CABIN FAN B. CONTINUE IF DEMONSTRATED IN FLIGHT THAT CABIN FAN CAN BE STARTED ON TWO REMAINING AC ϕ 'S.
- [36] LOSE 1 AC ϕ OF CABIN FAN A. CONTINUE IF DEMONSTRATED IN FLIGHT THAT CABIN FAN CAN BE STARTED ON TWO REMAINING AC ϕ 'S.
- [37] LOSS OF ALL C&W ALARM TONES AND LIGHTS. FLIGHT CREW MUST MONITOR CRT MESSAGES FOR CRITICAL SYSTEM FAULT ANNUNCIATION. REF. RULES {A2-102C}, MISSION DURATION REQUIREMENTS; AND {A2-104A}.6, SYSTEMS REDUNDANCY REQUIREMENTS. @[101796-4561A]
- [38] LOSE POWER TO PCS O2 CROSSOVER VALVE 1 MDF UNTIL IFM TO RESTORE FULL MANIFOLD CAPABILITY IS INSTALLED OR UNTIL REAL-TIME TEST VERIFIES ADEQUATE O2 SUPPLY TO CREW. REF. RULE {A17-1001D}, LIFE SUPPORT GO/NO-GO CRITERIA. @[050400-7189]
- [39] LOSE POWER TO PCS O2 CROSSOVER VALVE 2 MDF UNTIL IFM TO RESTORE FULL MANIFOLD CAPABILITY IS INSTALLED OR UNTIL REAL-TIME TEST VERIFIES ADEQUATE O2 SUPPLY TO CREW. REF. RULE {A17-1001D}, LIFE SUPPORT GO/NO-GO CRITERIA. @[050400-7189]
- [40] NEXT WORST FAILURE (CNTLAB2 AND ALC2 COMBINATION) RESULTS IN LOSS OF CAPABILITY TO OPEN THE TANK VALVES ON APU 2 AND LOSS OF BOTH WSB 1 CONTROLLERS. REF. RULE {A10-21A}, LOSS OF APU/HYDRAULIC SYSTEM(S) ACTIONS. @[032802-4814A] @[092503-5546B]
- [41] WITH A FAILED-ON STARTUP HEATER, VI PERFORMANCE IS NOT EXPECTED TO MEET MINIMUM REQUIRED PERFORMANCE LEVEL FOR ENTRY AND WOULD NOT BE ACCEPTABLE AS A SECOND FUEL CELL. MARGINAL OR INADEQUATE ABILITY TO SUPPORT BUS VOLTAGE REQUIREMENTS FOR CONTINGENCY OPERATIONS (LOSS OF ONE FUEL CELL). MARGINAL OR INADEQUATE ABILITY TO MAINTAIN TEMPERATURE OR KOH CONCENTRATIONS WITHIN ACCEPTABLE LIMITS FOR HIGH POWER LEVEL OPERATIONS (ENTRY, LOSS OF ONE FC). CONSUMABLES IMPACT MAY DRIVE EARLIER MISSION TERMINATION IF FUEL CELL IS ALLOWED TO CONTINUE TO OPERATE. @[102506-7768A]
- [42] WITH A FAILED-ON STARTUP HEATER AND ANOTHER FUEL CELL FAILED, ENTER NEXT PLS. WITH A FAILED-ON STARTUP HEATER, VI PERFORMANCE IS NOT EXPECTED TO MEET MINIMUM REQUIRED PERFORMANCE LEVEL FOR ENTRY AND WOULD NOT BE ACCEPTABLE AS A SECOND OR LAST FUEL CELL. MARGINAL OR INADEQUATE ABILITY TO SUPPORT BUS VOLTAGE REQUIREMENTS FOR CONTINGENCY OPERATIONS (LOSS OF TWO FUEL CELLS). MARGINAL OR INADEQUATE ABILITY TO MAINTAIN TEMPERATURE OR KOH CONCENTRATION WITHIN ACCEPTABLE LIMITS FOR HIGH POWER LEVEL OPERATIONS (LOSS OF TWO FUEL CELLS). RA-05 FAILURE MODES AND EFFECTS ANALYSIS, SEPTEMBER 30, 1983, AND SHUTTLE INFORMATION MEMORANDUM (SIM) # 33B JUNE 13, 1990.
- [43] WITH A FAILED-ON SUSTAINING HEATER AND ANOTHER FUEL CELL FAILED, ENTER NEXT PLS. VI PERFORMANCE IS NOT EXPECTED TO MEET MINIMUM ACCEPTABLE PERFORMANCE LEVEL FOR ENTRY IF USED AS A LAST FUEL CELL. CONSUMABLES IMPACT MAY DRIVE EARLIER MISSION TERMINATION IF FUEL CELL IS ALLOWED TO CONTINUE TO OPERATE. RA-05 FAILURE MODES AND EFFECTS ANALYSIS, SEPTEMBER 30, 1983, AND SHUTTLE INFORMATION MEMORANDUM (SIM) # 33B, JUNE 13, 1990. @[102506-7768A]

THIS RULE CONTINUED ON NEXT PAGE

FLIGHT RULES

A9-1001 ELECTRICAL GO/NO-GO CRITERIA [HC] (CONTINUED)

CRYO

a. Continue Nominal Ascent

If all but one of the cryo tanks fails during ascent, an abort is not required because the remaining tank will support a first day PLS entry.

b. Invoke Minimum Duration Flight

If a single tank fails, the amount of consumables will determine the length of the mission. After a single tank failure, at least two more failures are required before loss of crew/ vehicle.

c. Enter Next PLS

If multiple tanks fail, a PLS is called because the risk has increased that similar failures will occur in the remaining tanks. Loss of cryo is loss of crew/vehicle. ©[052704-6257A]

Reference Hazard Reports ORBI 094, Loss of Reactant Supply for Fuel Cell Powerplant (FCP) Operation; ORBI 090, Undetected Interloop Leakage of FD-40 Between Fuel Coolant Loops; ORBI 253, Loss of Electrical Power Due to FCP Flooding; and ORBI 285, Overpressurization of Fuel Cell Powerplant. ©[052704-6257A] ©[033105-6658A]

Rules {A2-301}, CONTINGENCY ACTION SUMMARY [HC]; {A2-1001}, ORBITER SYSTEMS GO/NO-GO [HC]; and {A9-1001}, ELECTRICAL GO/NO-GO CRITERIA [HC], reference this rule. ©[032807-8400] ©[ED]

FLIGHT RULES

SECTION 10 - MECHANICAL

AUXILIARY POWER UNIT (APU) LOSS FAILURE/DEFINITION

A10-1	APU LOSS DEFINITIONS [HC].....	10-1
A10-2	THROUGH A10-20 RULES ARE RESERVED.....	10-7

APU SYSTEMS MANAGEMENT

A10-21	LOSS OF APU/HYDRAULIC SYSTEM(S) ACTIONS.....	10-8
A10-22	APU START/RESTART LIMITS [HC].....	10-11
A10-23	APU ENTRY START TIME [HC].....	10-17
A10-24	APU OIL/GEARBOX TEMPERATURE/PRESSURE.....	10-22
A10-25	APU HIGH SPEED SELECTION/SHIFT.....	10-24
A10-26	APU AUTO SHUTDOWN INHIBIT MANAGEMENT [HC]....	10-26
A10-27	APU FUEL LEAKS [CIL].....	10-35
A10-28	AOA APU/HYDRAULIC SYSTEM OPERATIONS.....	10-39
A10-29	FCS CHECKOUT APU OPERATIONS [HC].....	10-40
A10-30	LOSS OF APU HEATERS/INSTRUMENTATION [CIL]....	10-42
A10-31	APU FREEZE/THAW.....	10-44
A10-32	APU/HYD CONSUMABLES.....	10-46
A10-33	APU DEFINITIONS.....	10-49
A10-34	THROUGH A10-50 RULES ARE RESERVED.....	10-52

HYDRAULIC SYSTEMS LOSS/FAILURE DEFINITIONS

A10-51	HYDRAULIC LOSS DEFINITIONS.....	10-53
A10-52	THROUGH A10-70 RULES ARE RESERVED.....	10-55

FLIGHT RULES

HYDRAULIC SYSTEMS MANAGEMENT

A10-71	HYDRAULIC SYSTEMS CONFIGURATION [HC].....	10-56
A10-72	HYDRAULIC LEAKS.....	10-60
A10-73	HYDRAULIC SYSTEMS PRESSURE/TEMPERATURE [CIL].	10-63
A10-74	HYDRAULIC CIRCULATION PUMP OPERATION [CIL]...	10-66
A10-75 THROUGH A10-100	RULES ARE RESERVED.....	10-70

WATER SPRAY BOILER (WSB) LOSS/FAILURE DEFINITIONS

A10-101	WSB LOSS DEFINITIONS.....	10-71
A10-102 THROUGH A10-120	RULES ARE RESERVED.....	10-71

WSB SYSTEMS MANAGEMENT

A10-121	WSB CONFIGURATION.....	10-72
A10-122	LOSS OF WSB(S) ACTIONS.....	10-72
A10-123 THROUGH A10-140	RULES ARE RESERVED.....	10-73

LANDING/DECEL SYSTEMS MANAGEMENT

A10-141	NOSE WHEEL STEERING (NWS) [HC].....	10-74
A10-142	TIRE PRESSURE [CIL] [HC].....	10-78
A10-143	DRAG CHUTE DEPLOY TECHNIQUES [HC].....	10-89
A10-144	DRAG CHUTE DEPLOY CONSTRAINTS [HC].....	10-94
A10-145	UNCOMMANDED BRAKE PRESSURE [CIL].....	10-96
A10-146	BRAKING.....	10-97
A10-147 THROUGH A10-160	RULES ARE RESERVED.....	10-98

MECHANICAL SYSTEMS LOSS/FAILURE DEFINITIONS

A10-161	DRIVE MECHANISMS LOSS DEFINITIONS.....	10-99
A10-162 THROUGH A10-180	RULES ARE RESERVED.....	10-100

FLIGHT RULES

GENERAL MECHANISMS SYSTEMS MANAGEMENT

A10-181	DRIVE MECHANISMS.....	10-101
A10-182	THROUGH A10-200 RULES ARE RESERVED.....	10-101

PAYLOAD DOOR (PLBD) SYSTEMS MANAGEMENT

A10-201	PLBD GENERAL.....	10-102
A10-202	PLBD VISUAL CUES.....	10-104
A10-203	PLBD CRITICAL LATCHES.....	10-105
A10-204	FAILED PLBD GPC SEQUENCE.....	10-106
A10-205	PLBD CLEARANCE CONSTRAINTS.....	10-106
A10-206	PLBD CLOSE GO/NO-GO.....	10-107
A10-207	PLBD OVERLAP.....	10-112
A10-208	CONTINGENCY PLBD CLOSURE.....	10-113
A10-209	PLBD RULE REFERENCE MATRIX.....	10-114
A10-210	THROUGH A10-220 RULES ARE RESERVED.....	10-119

RADIATOR SYSTEMS MANAGEMENT

A10-221	RADIATOR MECHANICAL.....	10-120
A10-222	RADIATOR VISUAL CUES.....	10-122
A10-223	THROUGH A10-240 RULES ARE RESERVED.....	10-122

ET UMBILICAL DOORS SYSTEMS MANAGEMENT

A10-241	ET UMBILICAL DOOR KEYBOARD ENTRY.....	10-123
A10-242	ET UMBILICAL DOORS ON ORBIT.....	10-123
A10-243	ET UMBILICAL DOOR CLOSURE DELAY FOR DISCONNECT VALVE FAILURE [CIL].....	10-124
A10-244	THROUGH A10-260 RULES ARE RESERVED.....	10-124

FLIGHT RULES

VENT DOOR SYSTEMS MANAGEMENT

A10-261	VENT DOOR MANAGEMENT [HC].....	10-125
A10-262	THROUGH A10-280 RULES ARE RESERVED.....	10-130

PAYLOAD RETENTION LATCHES (PRLA) SYSTEMS MANAGEMENT

A10-281	PRLA'S/AKA'S.....	10-130b
A10-282	THROUGH A10-300 RULES ARE RESERVED.....	10-133

KU-BAND ANTENNA DEPLOY MECHANISM SYSTEMS MANAGEMENT

A10-301	ANTENNA STOW REQUIREMENT [HC] [CIL].....	10-134
A10-302	DAP CONFIGURATION FOR ANTENNA STOW.....	10-135
A10-303	ANTENNA CONTINGENCY PROCEDURES.....	10-136
A10-304	KU-BAND ANTENNA/OBSS CLEARANCE CONSTRAINTS [HC].....	10-136a
A10-305	THROUGH A10-320 RULES ARE RESERVED.....	10-136a

REMOTELY OPERATED ELECTRICAL/FLUID UMBILICAL (ROEU/ROFU) SYSTEMS MANAGEMENT

A10-321	ROEU/ROFU OPERATIONS.....	10-137
A10-322	THROUGH A10-340 RULES ARE RESERVED.....	10-138

ANDROGYNOUS PERIPHERAL DOCKING SYSTEM (APDS) SYSTEMS MANAGEMENT

A10-341	APDS CONFIGURATION.....	10-139
A10-342	APDS PRESSURE/TEMPERATURE.....	10-140
A10-343	APDS MECHANISM END OF TRAVEL INDICATIONS....	10-142
A10-344	APDS DOCKING SEQUENCE OPERATIONS.....	10-144
A10-345	APDS RECONFIGURATION AFTER FAILED DOCKING...	10-148
A10-346	APDS REDUNDANCY REQUIREMENTS.....	10-148
A10-347	THROUGH A10-360 RULES ARE RESERVED.....	10-148

FLIGHT RULES

VIEWPORT SYSTEMS MANAGEMENT

A10-361	VIEWPORT (VP)	10-149
A10-362	CRACKED VIEWPORT.....	10-151
A10-363	VIEWPORT CONFIGURATION FOR CLOSED SPACEHAB HATCH.....	10-152
A10-364	LOSS OF VP PRESSURE INTEGRITY.....	10-152
A10-365	EVA REQUIREMENTS FOR FAILED VP OUTER COVER..	10-152
A10-366	THROUGH A10-380 RULES ARE RESERVED.....	10-152

STRUCTURAL MANAGEMENT

A10-381	THERMAL WINDOWPANE FAILURE [CIL].....	10-153
A10-382	PRESSURE/REDUNDANT WINDOWPANE FAILURE [HC]..	10-154
A10-383	BAILOUT/POSTLANDING EMERGENCY EGRESS PYROTECHNICS MANAGEMENT.....	10-156
A10-384	RESERVED.....	10-157
A10-385	FILLED CWC STOWAGE MANAGEMENT.....	10-157
A10-386	THROUGH A10-400 RULES ARE RESERVED.....	10-160

CREW ESCAPE SYSTEM

A10-401	PRE-LAUNCH CREW ESCAPE EQUIPMENT REQUIREMENTS	10-161
A10-402	THROUGH A10-450 ARE RESERVED.....	10-162

MMACS GO/NO-GO

A10-1001	MMACS GO/NO-GO CRITERIA [HC].....	10-163
----------	-----------------------------------	--------

FLIGHT RULES

THIS PAGE INTENTIONALLY BLANK

FLIGHT RULES**SECTION 10 - MECHANICAL****AUXILIARY POWER UNIT (APU) LOSS FAILURE/DEFINITION** @[ED]**A10-1** **APU LOSS DEFINITIONS [HC]** @[082604-6318A]

- A. AN APU IS CONSIDERED LOST IF:
1. THERE IS A CONFIRMED OR SUSPECTED HYDRAZINE LEAK. LEAKS MUST BE CONFIRMED BY THE GROUND. HYDRAZINE LEAKS CAN BE DETECTED BY ANY OF THE FOLLOWING:
 - a. UNEXPLAINED DECAY IN FUEL TANK OR FUEL FEED LINE PRESSURE. @[040899-6824]
 - b. UNEXPLAINED COOLING OF HYDRAZINE TANKS, LINES, AND VALVES, OR ON-ORBIT HEATER DUTY CYCLES.
 - c. WHILE THE FUEL ISOLATION VALVES ARE OPEN, A PUMP SEAL CAVITY PRESSURE INCREASE TO ABOVE 40 PSIA FOLLOWED BY A DROP IN PRESSURE (INDICATING THAT THE BURST DISK HAS RUPTURED) AND EITHER:
 - (1) REPEATED PUMP SEAL CAVITY EXCURSIONS TO THE RELIEF VALVE CRACKING PRESSURE OF APPROXIMATELY 28 TO 42 PSIA, OR
 - (2) SUSTAINED FUEL PUMP SEAL CAVITY PRESSURE ABOVE THE VALVE RESEAT PRESSURE OF 16.8 TO 25.2 PSIA.
 - d. UNEXPLAINED DECAY IN SEAL CAVITY DRAIN LINE PRESSURE WHEN FUEL PUMP SEAL LEAKAGE HAS BEEN DETECTED.

A hydrazine leak into the aft compartment is a fire and corrosion hazard that could lead to loss of crew/vehicle.

There are cases where a hydrazine leak cannot be confirmed. For example, a decay in fuel tank pressure could be the result of a GN₂ leak. The only way to distinguish between a fuel leak and a GN₂ leak (without other confirming cues) is to run the APU until the fuel is depleted. The fuel tank pressure will stabilize around 80 psia for a hydrazine leak (the GN₂ precharge pressure) and 0 psia for a GN₂ leak. The flight rules assume the worst case scenario of a fuel leak. @[040899-6824]

THIS RULE CONTINUED ON NEXT PAGE

FLIGHT RULES

A10-1

APU LOSS DEFINITIONS [HC] (CONTINUED)

Due to a combination of transducer placement and the large thermal mass of the tank and fuel, a fuel tank heater cycle causes the tank temperature to rise much faster than the corresponding rise in tank pressure. Before equilibrium is established, the onboard and ground fuel quantity computations show a decrease in quantity similar to a leak, followed by a rise in quantity to the original pre-heater cycle value. Since the crew cannot always distinguish between an actual leak and a heater cycle or transducer failure, the ground must confirm whether or not a leak exists. ©[040899-6824]

A cooling effect may be seen if fuel is leaking near a temperature transducer. During STS-9 entry, an APU injector stem leak was indicated by a 20 degree F drop in GGVM temperature. However, a drop in GGVM temperature shortly after liftoff can be the result of normal H₂O condensation in the aft compartment (the temperature decrease will be present for only about 1 minute; this signature was seen on STS 41-C).

An increased heater duty cycle could result from the cooling effect of leaking fuel or the loss in fuel line thermal mass caused by the vacated fuel. However, attitude effects and thermostat debonding can show a similar signature.

An internal hydrazine leak occurs when the fuel pump seal degrades and hydrazine leaks into the fuel pump seal cavity drain system. This is indicated by an increase in drain line pressure. With continuing leakage, the pressure will increase to the point that the burst disk ruptures (at 45 +5 psid) and the relief valve opens (at 28 to 42 psia), causing hydrazine to be spilled overboard. A leak of this type occurred on an ALT flight (without the burst disk; this modification first flew on STS-88). The relief valve will remain open until the reseal pressure of 16.8 to 25.2 psia is reached (the relief valve will not reseal for high enough leak rates).

Fuel pump seal leakage can be detected by an increase in drain line pressure (not due to heater cycles) while the APU is running (dynamic leak), or by a decrease in feed line pressure with a corresponding increase in drain line pressure while the APU is not running (static leak). However, fuel pump seal leakage by itself is not sufficient reason to declare an APU lost because the hydrazine is contained within the drain system. For the case of a decay in both feed line and drain line pressures, or a decay in drain line pressure following a dynamic leak, a small amount of hydrazine (up to 1.4 lbs, from between the fuel isolation valves and the shutoff valve, for the static leak case; reference SODB, vol. I, 4.4.3.2.d.3) has leaked into the aft compartment and the APU should be considered lost.

Hydrazine may also leak past multiple seals into the APU gearbox. This would be detected as an increase in both gearbox and drain line pressures since, in order to leak in to the gearbox, the fuel has to first leak into the seal cavity. No leakage of this type has been seen since the dual lip seals were incorporated as part of the IAPU design (first flight STS-45). ©[040899-6824]

Reference Rule {A10-27B}, APU FUEL LEAKS [CIL], and SODB, vol. I, 4.4.3.6.

THIS RULE CONTINUED ON NEXT PAGE

FLIGHT RULES**A10-1 APU LOSS DEFINITIONS [HC] (CONTINUED)**

2. UNABLE TO MAINTAIN TURBINE SPEED BETWEEN 95 (95) PERCENT AND 121 (121) PERCENT WHILE THE APU IS RUNNING.

The primary fuel valve controls turbine speed at 103 ± 8 percent (95 to 111 percent) and is the one normally in control. If HI SPEED is selected, the secondary valve will control turbine speed at 113 ± 8 percent (105 to 121 percent).

If turbine speed cannot be maintained > 95 percent, the capability of that APU to support high demand is questionable and is considered lost.

If turbine speed cannot be maintained < 121 percent, then the normal speed control circuit has failed and an automatic shutdown for overspeed is likely. Since the length of time the APU will run is unknown, the APU is considered lost for mission rule purposes.

3. THE LUBRICATION OIL OUTLET PRESSURE IS > 150 (143) PSIA WHILE THE APU IS RUNNING. @[032802-5345A]

A high lubrication oil outlet pressure is indicative of severely restricted lube oil flow. The oil pump and associated plumbing are not qualified for pressures above 150 psia, so component rupture is a concern. Also, since oil flow is restricted, little or no cooling of the gearbox will take place, resulting in bearing overheat and possible failure. Reference SODB, Vol. I, 3.4.4.3.

Reference Rule{A10-24D}, APU OIL/GEARBOX TEMPERATURE/PRESSURE.

4. THE DELTA PRESSURE BETWEEN THE GEARBOX GN₂ PRESSURE AND THE LUBRICATION OIL OUTLET PRESSURE IS < 20 PSID WHILE THE APU IS RUNNING.

A low delta P across the gearbox is indicative of a severely degraded oil pump. If the delta P is less than 20 psid, then not enough oil is flowing to provide adequate lubrication/cooling to the gearbox. If allowed to continue, the gearbox will overheat, resulting in possible bearing failure. Reference SODB, Vol. I, 3.4.4.3. @[032802-5345A]

Reference Rule{A10-24C}, APU OIL/GEARBOX TEMPERATURE/PRESSURE.

THIS RULE CONTINUED ON NEXT PAGE

FLIGHT RULES**A10-1 APU LOSS DEFINITIONS [HC] (CONTINUED)**

5. GEARBOX PRESSURE < 2.0 (3.1) PSIA PRIOR TO APU START.
 @[032802-5345A]

If the gearbox pressure is less than 2 psia, the oil pump may cavitate at APU startup. The low pressure may be caused by a GN₂ leak or an oil leak in the gearbox, which are indistinguishable prior to APU start. If the low pressure is due to a GN₂ leak, starting the APU will repressurize the gearbox from the GN₂ bottle, thus preventing pump cavitation. Once the APU is running, this GN₂ will also begin to leak from the gearbox, and volumetric inefficiency with resulting degradation in lubrication can result. However, an APU start attempt is safe as long as the oil pressure is carefully monitored during startup so the unit can be shut down if there is no oil pressure. The APU should be considered lost in the meantime. Reference SODB, Vol. I, 3.4.4.3.

Reference Rules {A10-23B}.5, APU ENTRY START TIME [HC], and {A10-24C}, APU OIL/GEARBOX TEMPERATURE/PRESSURE. @[ED]

6. THE LUBRICATION OIL OUTLET TEMPERATURE > 425 (418) DEG F
 OR GEARBOX BEARING TEMPERATURE > 450 (439) DEG F WHILE APU
 IS RUNNING.

At high lube oil and bearing temperatures, the oil begins to break down (low viscosity) resulting in degraded lubrication/heat transfer capability, with high bearing and gear wear. Once all lubrication is lost, the bearings will seize and the APU will experience an underspeed shutdown. Although a start on an APU that has previously exceeded these limits may be attempted on entry, its condition is suspect and should be considered lost for planning purposes. Reference Ascent/Entry Flight Techniques #50, October 20, 1988.

Rule {A10-24A}, APU OIL/GEARBOX TEMPERATURE/PRESSURE, references this rule.

7. UNABLE TO MAINTAIN THE FOLLOWING APU TEMPERATURES WITHIN
 LIMITS:
- a. FUEL TANK > 35 (38) DEG F
 - b. FUEL LINES > 35 (40 DEG, GGVM SUPPLY LN 45, BYPASS LN
 49) DEG F
 - c. FUEL PUMP > 35 (41) DEG F
 - d. LUBRICATION OIL > 0 (INLET TEMPERATURE 10 DEG, OUTLET
 TEMPERATURE 7) DEG F @[011295-1736C] @[ED]
 - e. GGVM > 35 (41) DEG F @[011295-1736C] @[ED] @[032802-5345A]

THIS RULE CONTINUED ON NEXT PAGE

FLIGHT RULES**A10-1 APU LOSS DEFINITIONS [HC] (CONTINUED)**

Hydrazine freezes at 35 deg F (ref. SODB, Vol. I, tables 3.4.4.3-1 and 4.4.3-4). If the fuel is frozen, then obviously the APU will not operate. If the fuel cannot be thawed, the APU will be considered lost. As hydrazine freezes, it contracts; when it thaws, it expands. Analysis has not been performed for APU components subjected to freeze/thaw cycles. Because of the possibility that a fuel system component could rupture, the APU is considered lost if any of the fuel system drops below 35 deg F. Below 0 deg F the lube oil will have such a high viscosity that it cannot adequately lubricate the gearbox. If the APU is started, gear bearing temperature will rise much faster than the oil temperature, and bearing or gear damage may occur before the oil can reach temperature for proper lubrication. Since the APU may be very limited in run time, it is considered lost for mission rule purposes. ®[011295-1736C] ®[032802-5345A]

Because the GGVM temperature and GGVM supply line temperature instrumentation errors are so large, the temperatures should be compared to other transducers in the area.

Reference Rule {A10-31}, APU FREEZE/THAW.

8. AN APU FUEL LINE HAS SUSTAINED TWO OR MORE FREEZE/THAW CYCLES.

McDonnell Douglas and JSC have performed analyses that indicate that a fuel line may rupture if it sustains as few as 3 freeze/thaw cycles (McDonnell Douglas Report TM-950002-02, December 23, 1994). The theoretical analysis addressed a straight section of 1/2 inch diameter fuel line that has yielded as a result of the freeze/thaw cycle. The fuel line radius has permanently expanded due to the yield. The line freezes again, and during thaw the resulting pressures further yield the line. This process continues until the ultimate strain of the line has been exceeded resulting in rupture. RI/Downey performed an analysis on fuel line bends that coupled TTA test data with a theoretical analysis. The engineering community decided, after a review of the analysis, that the fuel line bends could withstand two freeze/thaw cycles. A qualitative review of the fuel line welds and T's found them to be less critical for freeze/thaw than the tube bend section. The pressures resulting from thaw are directly related to the density of the frozen hydrazine. As hydrazine freezes the density increases linearly as a function of temperature decrease. The analysis assumed a worst case temperature of the solid hydrazine at -45 Deg F which then warms up to 70 Deg F. ®[032802-5345A]

Reference Rule{A10-31}, APU FREEZE/THAW.

THIS RULE CONTINUED ON NEXT PAGE

FLIGHT RULES**A10-1 APU LOSS DEFINITIONS [HC] (CONTINUED)**

9. FUEL TANK PRESSURE < 90 (99) PSIA PRIOR TO ON-ORBIT START. @[011295-1736C] @[032802-5345A]

APU startup time is a function of tank pressure. In order for the turbine speed to reach 80 percent in 10.5 seconds (to avoid an underspeed shutdown), the fuel tank pressure must be at least 90 psia. If INHIBIT is used to defeat the 10.5-second timer, the APU may start at a lower tank pressure, and a start attempt may be made unless the pressure is < 70 psi. Below 70 psia, start attempts become dangerous. However, as far as the flight rules are concerned, the APU must be considered lost because it may not start if the pressure is less than 90 psia. Reference SODB, Vol. I, 3.4.4.3 and figure 4.4.3.

Rules {A10-22D}, APU START/RESTART LIMITS [HC]; {A10-24C}, APU OIL/GEARBOX TEMPERATURE/ PRESSURE; and {A10-30A}, LOSS OF APU HEATERS/INSTRUMENTATION [CIL], reference this rule. @[ED]

10. THE FUEL PUMP INLET PRESSURE IS < 15 (34) PSIA PRIOR TO OPENING THE FUEL ISOLATION VALVES. LOSS OF INSTRUMENTATION WILL NOT BE CAUSE FOR DECLARING AN APU LOST. @[021998-6491A]

If a large delta pressure exists across the FIV's, a surge pressure could result when the valves are opened. Under normal conditions, residual hydrazine in the fuel lines provides a damping force that reduces this surge pressure. At low pressures, the rapid compression results in frothing which may significantly reduce this damping force. When the pressure in the fuel lines is less than 15 psia prior to opening the FIV's, surge pressures over 2500 psia could result (WSTF Report 96-30335, 11/14/96). White Sands straight tube and U-tube testing showed that hydrazine becomes unstable above 2500 psia and Adiabatic Bubble Compression Detonation (ABCD) could occur (RD-WSTF-0002, 2/20/90). Reference SODB, Vol. I, 3.4.4.3, and Rule {A10-22}, APU START/RESTART LIMITS [HC]. @[032802-5345A] @[ED]

Loss of the FPIP transducer results in loss of pressure monitoring of the portion of fuel line between the FIV's and the SOV. Loss of instrumentation alone is insufficient cause to declare an APU lost, but other factors (rising drain line pressure, history of leakage, leakage trend prior to transducer loss, etc.) in conjunction with loss of instrumentation may be enough to declare loss of a system.

The 34 psia limit accounts for transducer inaccuracies. Actual transducer biases are given for each mission based on data from KSC and should be taken into account for each system. @[021998-6491A]

THIS RULE CONTINUED ON NEXT PAGE

FLIGHT RULES

A10-1 APU LOSS DEFINITIONS [HC] (CONTINUED)

11. THE APU HAS SHUT DOWN DUE TO MPU AND/OR CONTROLLER FAILURES. @[082604-6318A]

An APU that has shut down due to speed control-related failures is unlikely to be operable; this is true for the multiple MPU failure case. The APU is considered lost for the case where multiple failures have occurred in the underspeed or overspeed detection logic, leading to a controller-commanded shutdown, even if the APU can be regained by inhibiting the auto shutdown function. Though the APU may be operable (and possibly be operated if the APU met the flight rule inhibit criteria), the controller, having sustained multiple failures, is considered suspect in this case; the failure may indicate generic controller component problems, for example.

Hazard reports ORBI 030, Potential Loss of Orbiter Caused by Vehicle Handling Qualities; ORBI 045, Ignition of Orbiter Fluids Entrapped in the TCS Materials; ORBI 047, Structural Overheating Caused by Loss of TPS Tile from Leakage of Orbiter Fluids; ORBI 106, APU Gas Generator Leakage; and ORBI 250, External Leakage from the APU Fuel Supply System, reference this rule. @[082604-6318A]

- B. GG INJECTOR COOLING CAPABILITY IS CONSIDERED LOST IF GG INJECTOR COOLING WATER TANK PRESSURE IS < 55 (62) PSIA AT 70 DEG F (GROUND DETECTION ONLY) OR TANK OR LINE TEMPERATURES ARE < 32 (38) DEG F. @[ED] @[032802-5345A]

As long as at least one restart capability remains, injector cooling is still usable. From the SODB curve, with one restart remaining (five used already) and using worst case temperature of 70 deg F, the minimum pressure is 55 psia. Below this pressure, no hot restarts remain and injector cooling is considered lost. Reference SODB, Vol. I, 4.4.3.5. @[032802-5345A]

A10-2 THROUGH A10-20 RULES ARE RESERVED

FLIGHT RULES

APU SYSTEMS MANAGEMENT

A10-21 LOSS OF APU/HYDRAULIC SYSTEM(S) ACTIONS

A. EARLY MISSION TERMINATION FOR APU/HYDRAULIC SYSTEM LOSS (ES) WILL BE AS FOLLOWS:

1. FOR LOSS OF A SINGLE APU/HYDRAULIC SYSTEM, FLIGHT WILL CONTINUE TO NOMINAL EOM UNLESS A REVIEW OF THE FAILURE MODE AND THE REMAINING APU/HYDRAULIC SYSTEMS' CAPABILITY DETERMINES EARLY MISSION TERMINATION IS APPROPRIATE.
@[041097-4611B]

The APU/hydraulic systems are essentially quiescent while on-orbit. Because a subsequent failure of another APU/hydraulic system will likely only occur when these systems are operated for entry, there are no significant risks to continuing the flight until nominal EOM. A review of the failure mode and the remaining APU/hydraulic systems capability is required to determine that there are no generic or other failure concerns.

Rules {A2-102B}, MISSION DURATION REQUIREMENTS; and {A2-301}, CONTINGENCY ACTION SUMMARY, reference this rule.

2. FOR LOSS OF REDUNDANCY IN THE APU/HYDRAULIC/WSB SYSTEMS WHERE THE NEXT FAILURE RESULTS IN SINGLE APU/HYDRAULIC SYSTEM OPERATION AT ANY POINT FROM EI TO WHEELSTOP, A NEXT PLS WILL BE PERFORMED.

It is prudent to shorten the mission to minimize the time of exposure to any additional on-orbit failure that would result in a single APU entry. Only detectable on-orbit failures, including electrical bus failures, which may be affected by increased time on orbit will be considered as basis for early mission termination. Examples of redundancy for APU/hydraulic/WSB systems include, but are not limited to, the following:

<i>APU</i>	<i>Controller RPC, MPU, fuel tank isolation valve, fuel line heaters</i>
<i>HYD</i>	<i>Accumulator (leak), circ pump, main pump depress RPC</i>
<i>WSB</i>	<i>Controller, steam vent heater</i>

Each of the above components has experienced failure at least once during the history of the program.
@[041097-4611B] @[ED]

THIS RULE CONTINUED ON NEXT PAGE

FLIGHT RULES

A10-21

LOSS OF APU/HYDRAULIC SYSTEM(S) ACTIONS (CONTINUED)

3. FOR LOSS OF TWO APU/HYDRAULIC SYSTEMS, ENTRY WILL BE PERFORMED AT THE NEXT PLS OPPORTUNITY THAT ALLOWS FOR EXPEDITED PAYLOAD DEPLOY/JETTISON. FOR NONDEPLOY FLIGHTS, ENTRY WILL BE PERFORMED AT THE NEXT PLS OPPORTUNITY (FIRST DAY PLS IF APPLICABLE). @[041097-4611B]

The loss of two APU/hydraulic systems results in a situation where a single APU entry has to be made. It is desirable to stay on orbit in order to deploy payloads because this will improve the vehicle capability to maneuver and land safely. Jettison of deployable payloads that for some reason cannot be deployed should be considered and used as a means of last resort to improve the vehicle entry and landing capability. Once attempts have been made to deploy the payloads, the mission should not be extended beyond the next PLS opportunity. Staying on orbit increases the vehicle exposure time to the loss of the last APU. For flights where nondeployable payloads are onboard, the risk of staying on orbit outweighs the gain of continuing the flight; therefore, the mission should be terminated.

The PLS opportunity should be selected which provides the best possible conditions (i.e., trajectory, landing site, crew and vehicle health, weather conditions, etc.) for a single APU entry. Reference WX placards in Rule {A10-23A}, APU ENTRY START TIME [HC]. @[ED]

4. FOR IMPENDING LOSS OF ALL APU/HYDRAULIC SYSTEM CAPABILITY, AN ABORT AT THE EARLIEST OPPORTUNITY WILL BE PERFORMED. THE PREFERRED ABORT MODE PRIORITY IS RTLS, TAL, AOA, FIRST DAY PLS, PLS, AND ELS. @[041097-4611B] @[040899-6857]

Since at least one operating APU/hydraulic system is required for entry, a landing as soon as possible is required if all APU/hydraulic system capability is failing. If this failure situation develops during ascent, an abort mode should be selected that minimizes entry time. This rule assumes that at least one APU/hydraulic system will be operating at any point throughout entry to wheelstop. @[040899-6857]

Rules {A2-54A}.1, RTLS, TAL, AND AOA ABORTS FOR SYSTEMS FAILURES [CIL], and {A2-205A}.2.c, EMERGENCY DEORBIT, reference this rule.

THIS RULE CONTINUED ON NEXT PAGE

FLIGHT RULES

A10-21

LOSS OF APU/HYDRAULIC SYSTEM(S) ACTIONS (CONTINUED)

- B. DURING ENTRY, IF ONLY ONE GOOD APU/HYDRAULIC SYSTEM IS AVAILABLE THE APU WILL NOT BE SHUT DOWN IF RUNNING AND ITS HYDRAULIC PUMP WILL BE IN "LOW PRESS" UNTIL MM 304. IF NOT RUNNING, THE APU WILL BE STARTED AT TIG MINUS 5 MINUTES. AN ABBREVIATED ACTUATOR CHECK MAY BE PERFORMED IF REQUIRED. NO HYDRAULIC THERMAL CONDITIONING OR SSME REPRESSURIZATION WILL BE PERFORMED. IF THE APU/HYDRAULIC SYSTEM IS NOT NOMINAL, IT WILL BE SHUT DOWN AND RESTARTED, IF REQUIRED, TO MAINTAIN THE SYSTEM FROM MM 304 THROUGH WHEELSTOP. ©[021199-6814]

If an APU is shut down, there is always the risk that it may not restart. This risk, however small, is simply not warranted in light of the criticality of the single APU that remains. The hydraulic pump is depressurized not only to save fuel, but also to put minimum stress on the system until absolutely required (MM 304-EI). However, if an abbreviated secondary actuator check is to be performed, the system will be taken to normal pressure in MM 303 post-deorbit burn just prior to the start of the check. If the APU is not already running (other two APU's known to be failed prior to TIG minus 5 minutes), it will be started at TIG minus 5 minutes. This ensures the APU will be fully operational before committing to the deorbit burn.

Reference Rules {A8-104}, FCS CHECKOUT, and {A10-1}, APU LOSS DEFINITIONS [HC]. ©[ED]

Rules {A2-54A}.1, RTLS, TAL, AND AOA ABORTS FOR SYSTEMS FAILURES [CIL]; {A2-102}, MISSION DURATION REQUIREMENTS; {A2-205A}.2.c, EMERGENCY DEORBIT; {A2-301}, CONTINGENCY ACTION SUMMARY [HC]; {A2-1001}, ORBITER SYSTEMS GO/NO-GO [HC]; {A8-104}, FCS CHECKOUT [CIL] [HC]; {A8-106}, TBC-SSME STOW/ACTUATOR FLUID FILL (REPRESSURIZATION); {A9-1001}, ELECTRICAL GO/NO-GO CRITERIA [HC]; and {A10-29}, FCS CHECKOUT APU OPERATIONS [HC], reference this rule. ©[ED] ©[032807-8400]

FLIGHT RULES

A10-22

APU START/RESTART LIMITS [HC] @[082604-6318A]

- A. BRANCH PASSAGE TEMPERATURE CONSTRAINTS AT INITIATION OF APU OPERATION ARE AS FOLLOWS: @[072398-6685A] @[022405-6425D]
1. APU START:
 - a. GG BED TEMPERATURE < 470 (456) DEG F, AND GG INJECTOR TUBE TEMPERATURE < 470 (437) DEG F, WITHOUT ACTIVE GG INJECTOR COOLING IF HIGH TEMPERATURE IS DUE TO BED HEATER CYCLING.
 - b. GG BED TEMPERATURE < 415 (401) DEG F, AND GG INJECTOR TUBE TEMPERATURE < 415 (382) DEG F, WITHOUT ACTIVE GG INJECTOR COOLING IF HIGH TEMPERATURE IS DUE TO HEAT SOAKBACK FROM APU OPERATION.
 2. APU RESTART: TEMPERATURE IS WITHIN ACCEPTABLE LIMITS ONLY IF NO MORE THAN 1 SECOND HAS ELAPSED AFTER TERMINATION OF A MINIMUM OF 209 SECONDS OF CONTINUOUS ACTIVE GG INJECTOR COOLING.
 3. APU HOT RESTART: MAY BE ATTEMPTED AT ANY TEMPERATURE, BUT ONLY IF THE APU IS NEEDED AS A LAST APU. EFFORTS WILL BE MADE TO COMPLETE AS MUCH OF A 209-SECOND COOLDOWN AS PRACTICAL. @[022405-6425D]

THIS RULE CONTINUED ON NEXT PAGE

FLIGHT RULES**A10-22****APU START/RESTART LIMITS [HC] (CONTINUED)**

The A and B GG bed heaters are located on opposite sides of the bed and wrap 143 degrees around the bed. The GG bed temperature transducer is located near the B heater. If the supplied heat comes from either heater, Hamilton Sundstrand thermal analysis has shown that the temperature of the branch passages will remain well below that indicated by the bed temperature transducer provided the heater is operating within specified limits. A GG bed temperature or injector temperature limit of 470 deg F has been shown by Hamilton Sundstrand analysis to protect for the GG bed apex temperature limit of 444 deg F during A or B heater operation. However, if the supplied heat is from soakback due to APU operation, there are parts of the bed that will be much hotter than the transducer and the measured temperature will not be the maximum. Branch passage temperature must be below 450 deg F for a safe (re)start when high temperature in the GG bed is due to APU operation (heat soakback). This temperature is not necessarily reflected by the GG injector and bed instrumentation; therefore, the only reliable method to ensure a safe limit is to cool the injector for 209 seconds or to verify the temperature, as measured by instrumentation at the injector is below 415 deg F, which will ensure that the branch passages are also below the limit. Once cooling has been terminated, the branch passage temperature will rise rapidly with the GG injector temperature, violating restart limits and causing the APU to require additional cooling. See the SODB, vol. I, figure 4.4.3-55 for test data. If the GG bed temperature is above specified limits and a start attempt is made, the hydrazine fuel will begin decomposing before reaching the bed. The result will be extreme GG pressure spikes and possibly an uncontained APU GG explosion. The danger of explosion increases with GG temperature at the time of restart. On a test stand at Hamilton Sundstrand, an APU was successfully restarted with sea-level pressure and a hot bed 19 times. It exploded during the 20th try. Later, with near space pressure in a chamber at JSC (TTA), an APU exploded during the first hot restart attempt. Despite this test information, it is not possible to make a correlation between altitude and the probability of an explosion for a hot restart attempt (reference SODB, vol. I, 3.4.4.3.5). ©[022405-6425D]

Rules {A10-23B}, APU ENTRY START TIME [HC], and {A10-33}, APU DEFINITIONS, reference this rule. ©[072398-6685A] ©[ED]

Hazard Report ORBI 265, Fire/Explosion Due to Inadvertent Failures in APU Controller or Associated Electrical Distribution System after APU Shutdown, references this rule. ©[022405-6425D]

THIS RULE CONTINUED ON NEXT PAGE

FLIGHT RULES

A10-22 APU START/RESTART LIMITS [HC] (CONTINUED)

- B. AN APU CAN BE RESTARTED PROVIDED THE FUEL PUMP TEMPERATURE IS < 210 (204) DEG F, AND THE VALVE MODULE TEMPERATURE IS < 200 (194) DEG F. ©[032802-5345A]

Large bubbles may form in the valve module or in the fuel pump due to decomposition. When the APU is started, the bubbles will collect in the filter downstream of the pump or in the valve, and the pump output pressure will increase as the pump comes up to speed when the APU is started. Adiabatic compression of the bubbles will increase their temperature and could cause the hydrazine to detonate. If allowed to cool, the bubbles that may have formed are much less likely to cause problems when the APU is started. During tests, an APU fuel system has detonated on a start attempt with fuel pump temperature above 240 deg F and GGVM temperature above 200 deg F. None have detonated during starts below 210 deg F on the pump and 200 deg on the valve, even if the temperature had been higher previous to the start attempt. While the high temperatures were not absolutely determined to have caused the APU detonations, they are still considered to be the most likely reason for the failures. Reference RI internal letter no. SSD-287-400-92-050, dated January 16, 1992.

Reference Rule {A10-33}, APU DEFINITIONS. ©[022405-6425D]

Rule {A10-23B}.4, APU ENTRY START TIME [HC], references this rule. ©[ED]

Hazard Report ORBI 121, Hydrazine (N₂H₄) Detonation an Bubble Compression in the APU, references this rule. ©[022405-6425D]

THIS RULE CONTINUED ON NEXT PAGE

FLIGHT RULES

A10-22

APU START/RESTART LIMITS [HC] (CONTINUED)

C. AN APU WILL NOT BE STARTED/RESTARTED THAT HAS BEEN SHUT DOWN DUE TO CONFIRMED OVERSPEED. @[022405-6425D]

An APU overspeed is an extremely hazardous situation as the turbine could disintegrate, producing shrapnel, and if uncontained, could damage other equipment in the aft fuselage. Once safed, either by manual or automatic shutdown, the affected APU should never be restarted.

Hazard Report ORBI 031, Inability of the APU Turbine Housing to Contain a Disintegrating Turbine Wheel Due to Hub Failure or an Overspeed Condition, references this rule. @[022405-6425D]

D. RESTART WILL NOT BE PERFORMED ON AN APU WITH THE FUEL TANK PRESSURE < 100 (109) PSIA. @[032802-5345A] @[082604-6318A]

Restarts at low fuel pressures can result in uncontrolled hydrazine decomposition in the APU bed, causing a detonation.

THIS RULE CONTINUED ON NEXT PAGE

FLIGHT RULES**A10-22 APU START/RESTART LIMITS [HC] (CONTINUED)**

- E. AN APU WILL NOT BE STARTED WITH THE GAS GENERATOR BED TEMPERATURE < 70 (84) DEG F, UNLESS REQUIRED. @[072398-6685A] @[032802-5345A]

Should both GG bed heaters fail on orbit, this rule allows the affected APU to be restarted as long as the bed temperature remains above 70 deg (84 deg) F. Testing at the component GG level showed that peak chamber pressures and catalyst ignition time delays were affected more by bed temperature than catalyst poisoning and both began increasing below a temperature of 100 deg F. Below 70 deg F, the peak chamber pressures and ignition time delays increased exponentially, indicating a potential for detonation at APU start.

Operationally, the risk of APU detonation as a result of low GG bed temperatures is judged to be less than the risks associated with entry on only one APU. An APU with both GG bed heaters failed off will not be considered lost for mission planning purposes since it may be used when absolutely necessary.

Documentation: SODB, Vol. I, sec. 3.4.4.3 and Figure 4.4.3-20, and ORBITER APU REVIEW, Sundstrand, June 28, 1990, p. 22-25.

Reference Rules {A10-30A}, LOSS OF APU HEATERS/INSTRUMENTATION [CIL], and {A10-33}, APU DEFINITIONS.

- F. DURING ASCENT, IF AN APU LUBE OIL OUTLET TEMPERATURE EXCEEDS 375 (368) DEG F OR GEARBOX BEARING TEMPERATURE EXCEEDS 400 (389) DEG F, THE AFFECTED APU WILL NOT BE STARTED FOR ENTRY UNLESS REQUIRED.

Above these limits, lubrication is degraded, and gear/bearing/APU damage will eventually occur. Engineering tests have not been performed to determine APU life with temperatures above these limits. However, based on engineering judgment, the APU should be able to support entry, although seal and/or lube oil degradation and increased APU temperatures may result. In addition, consideration can be given to starting the APU at TAEM to provide three APU's if a real-time evaluation of the ascent temperature signature indicates that the oil/bearing heat up rate will be slow enough to prevent overheating from TAEM through wheel stop. Reference SODB, Vol. I, sec. 3.4.4.3. @[032802-5345A]

Rule {A10-23B}, APU ENTRY START TIME [HC] references this rule. Reference Rule {A10-33}, APU DEFINITIONS. @[072398-6685A] @[ED]

THIS RULE CONTINUED ON NEXT PAGE

FLIGHT RULES**A10-22****APU START/RESTART LIMITS [HC] (CONTINUED)**

- G. ON ORBIT, AN APU CAN ONLY BE STARTED IN OPS 8 OR OPS 3. ALL AEROSURFACE AMPLIFIERS MUST BE ON TO PRECLUDE DAMAGE TO THE AEROSURFACE ACTUATORS.

With the APU's and aerosurface amplifiers (ASA's) off (normal on-orbit conditions), the aerosurfaces, over a period of days, tend to "drift" from their original positions. This is due to a combination of gravity torques and circulation pump operations. If an APU is then started with the ASA's off and full hydraulic pressure applied, the actuator will try to drive the aerosurface to its hardstop, possibly causing damage. With the ASA's on and the software in OPS 3 or OPS 8, new commands are issued which cause little or no surface motion. Without OPS 3 or OPS 8, the surfaces will drive at high rate to the last commanded position. Once an APU has been started in OPS 3 or OPS 8, transition back to OPS 2 can be accomplished without fear of damage to an actuator.

Reference Rule {A8-112}, AEROSURFACE ACTUATOR PROTECTION.

- H. THE FUEL ISOLATION VALVES WILL NOT BE OPENED ON AN APU WITH A FUEL PUMP INLET PRESSURE < 15 (34) PSIA, UNLESS THE APU IS REQUIRED. THE FUEL ISOLATION VALVES MAY BE CYCLED OPEN ONCE TO REPRESSURIZE THE FUEL LINE PRIOR TO REACHING THE LOWER LIMIT. ©[021998-6491A] ©[072398-6685A]

Starting an APU with a low FPIP may result in high surge pressures and introduces the possibility of Adiabatic Bubble Compression Detonation (ABCD). Reference SODB, vol. I, 3.4.4.3, and Rules {A10-1}, APU LOSS DEFINITIONS, and {A10-33}, APU DEFINITIONS. ©[072398-6685A]

If a corresponding increase in drain line pressure is noted, , the fuel isolation valves may be opened to repressurize the fuel line to prevent reaching the loss limit. The pressure in the drain line and the fuel feed line should equalize to a value greater than 16.8 psia (the reseal pressure of the drain line overboard relief valve) if leakage continues. This should not be done more than once, since continued leakage below the limit indicates a possible external leak.

The 34 psia limit accounts for transducer inaccuracies. Actual transducer biases are given for each mission based on data from KSC and should be taken into account for each system. ©[021998-6491A]

Hazard reports ORBI 031, Inability of the APU Turbine Housing to Contain a Disintegrating Turbine Wheel due to Hub Failure or an Overspeed Condition, and ORBI 250, External Leakage from the APU Fuel Supply System, reference this rule. ©[082604-6318A]

Rule {A10-23}, APU ENTRY START TIME [HC], references this rule. ©[ED]

FLIGHT RULES

A10-23

APU ENTRY START TIME [HC] @[082604-6318A]

- A. AT LEAST ONE APU/HYDRAULIC SYSTEM MUST BE OPERATING PRIOR TO EXECUTING THE DEORBIT BURN.
1. PRIOR TO THE DEORBIT BURN, IF AN APU/HYDRAULIC SYSTEM FAILS OR ITS CAPABILITY TO SUPPORT TAEM THROUGH WHEELSTOP IS SUSPECT, ANOTHER APU WILL BE STARTED IF THE FOLLOWING WEATHER PLACARDS ARE MET FOR THE TARGETED LANDING SITE:
@[021199-6814]
 - a. CEILING \geq 10K FEET
 - b. VISIBILITY \geq 7 STATUTE MILES
 - c. CROSSWIND \leq 10 KNOTS (PEAK)
 - d. NO GREATER THAN LIGHT TURBULENCE
 - e. ACCEPTABLE ROLLOUT MARGIN/BRAKE ENERGY ON HALF BRAKES WITHOUT NWS (DIFFERENTIAL BRAKING)

OTHERWISE, THE DEORBIT BURN WILL NOT BE EXECUTED.

2. IF AN APU/HYDRAULIC SYSTEM IS NOT OPERATING NOMINALLY PRIOR TO THE DEORBIT BURN, BUT IS NOT CONSIDERED FAILED, AND ITS CAPABILITY TO SUPPORT TAEM THROUGH WHEELSTOP IS NOT SUSPECT, THE DEORBIT BURN WILL BE EXECUTED. IF NECESSARY, ANOTHER APU WILL BE STARTED AND THE FIRST APU SHUT DOWN. @[021199-6814]

THIS RULE CONTINUED ON NEXT PAGE

FLIGHT RULES**A10-23****APU ENTRY START TIME [HC] (CONTINUED)**

Starting an APU prior to the deorbit burn gives a measure of confidence that at least one APU will support entry. Nominally, more than one APU is not started prior to the deorbit burn in order to preserve consumables for dynamic flight where operating APU/hydraulic systems are required. The loss of a second APU can be sustained as long as the weather placards are observed. Actual runway priority depends on weight and C.G. (reference Rule {A2-207}, LANDING SITE SELECTION). Once the deorbit burn begins, no action will be taken to terminate above safe Hp for APU/hydraulic system failures.

An APU that is not operating nominally, yet not considered failed (e.g., shift to high speed), can still be operated during the critical portions of entry, though it may be preferable to shut it down until it is needed. If there is a situation where it is prudent to shut down the off-nominal APU, the plan is to start another APU prior to the deorbit burn and shut down the off-nominal APU/hydraulic system. If there is not time to start a second APU, the deorbit burn will proceed, and appropriate action will be taken during deorbit coast. In this situation, starting a second APU is acceptable even though, in some cases, if the APU had actually been failed, a second APU would not have been started. However, if the failure mode is not understood, then that APU capability to support TAEM through wheelstop will be considered suspect. ©[021199-6814]

Reference Rules {A2-6}, LANDING SITE WEATHER CRITERIA [HC], and {A4-108}, TIRE SPEED, BRAKING, AND ROLLOUT REQUIREMENTS [HC]. ©[111094-1622B] ©[042706-7363A]

Rules {A2-6}, LANDING SITE WEATHER CRITERIA [HC]; {A2-102B}, MISSION DURATION REQUIREMENTS; {A2-207}, LANDING SITE SELECTION; {A2-301}, CONTINGENCY ACTION SUMMARY [HC]; and, {A10-21}, LOSS OF APU/HYDRAULIC SYSTEM(S) ACTIONS; {A10-22}, APU START/RESTART LIMITS [HC]; {A10-24}, APU OIL/GEARBOX TEMPERATURE/PRESSURE; {A10-26}, APU AUTO SHUTDOWN INHIBIT MANAGEMENT [HC]; {A10-73}, HYDRAULIC SYSTEMS PRESSURE/TEMPERATURE [CIL]; {A10-101}, WSB LOSS DEFINITIONS; and {A10-122}, LOSS OF WSB(S) ACTION, reference this rule. ©[111094-1622B] ©[032807-8400] ©[ED]

THIS RULE CONTINUED ON NEXT PAGE

FLIGHT RULES

A10-23

APU ENTRY START TIME [HC] (CONTINUED)

B. AN APU WILL HAVE ITS ENTRY START TIME DELAYED FOR THE FOLLOWING:

FAILURE/CONSTRAINT	START TIME
1. LOSS OF WSB COOLING CAPABILITY	TAEM
2. APU LUBE OIL OUTLET OR GEARBOX BEARING TEMPERATURES EXCEEDED LIMITS SPECIFIED IN RULE {A10-22F}, APU START/RESTART LIMITS [HC], DURING ASCENT	NO EARLIER THAN TAEM (IF NEEDED TO MAINTAIN TWO SYSTEMS)
3. APU WILL ONLY OPERATE WITH THE AUTO SHUTDOWN FUNCTION INHIBITED AND APU MEETS CRITERIA IN RULE {A10-26}, APU AUTO SHUTDOWN INHIBIT MANAGEMENT [HC]	NO EARLIER THAN TAEM (NO EARLIER THAN EI-13 IF NEEDED TO MAINTAIN TWO SYSTEMS)
4. APU DOES NOT HAVE GG INJECTOR COOLING (IF APPLICABLE TO SINGLE APU ONLY)	EI-13
5. GEARBOX OR GN ₂ REPRESS BOTTLE HAS KNOWN EXTERNAL LEAK WHICH WILL NOT SUPPORT ENTIRE ENTRY OR GN ₂ REPRESS VALVE IS FAILED CLOSED	NO LATER THAN MACH 1.0
6. HYDRAULIC SYSTEM LEAK	NO EARLIER THAN TAEM BASED ON LEAK RATE
7. FREON LEAK INTO A HYDRAULIC SYSTEM	TAEM
8. HYDRAULIC SYSTEM RESERVOIR PRESSURE LOST	AFTER OTHER APU'S RUNNING AT NORMAL PRESSURE
9. HYDRAULIC SYSTEM RESERVOIR TEMPERATURE > 162° (154°) F PRIOR TO DEORBIT APU START.	TAEM

@[051194-1619B] @[ED] @[ED] @[082604-6318A] @[ED]

1, 2. *The loss of lube oil cooling will limit APU run time to approximately 11 minutes, based on data from previous flights. The time period from TAEM through landing is more critical for APU/hydraulic system availability since the system will be needed for heavy aerosurface activity, landing gear deployment, and braking during that period.*

If WSB cooling was lost for the hydraulic fluid (due to a failure of the bypass valve), the impact to the system is not so much overheating of the hydraulic system, but rather possible premature depletion of the water supply for the water boiler, resulting in the loss of APU cooling. Bypass valve failures during entry on STS-7 and STS 61-C caused significant depletion in the water supply. The hydraulic fluid temperature sensors demanded spraying, but the bypass valve failure did not allow the fluid to receive any cooling and spraying continued. The APU start time should be delayed to move the time at which the hydraulic fluid temperatures will demand spraying to as close to TAEM as possible.

Reference Rule {A10-22F}, APU START/RESTART LIMITS [HC]. @[ED]

THIS RULE CONTINUED ON NEXT PAGE

FLIGHT RULES

A10-23

APU ENTRY START TIME [HC] (CONTINUED)

3. *Since inhibiting the auto shutdown logic removes underspeed/overspeed protection, starting the APU at TAEM or later reduces the amount of time the APU is operated without this protection. However, if another APU/hydraulic system is failed or failing, this APU may be started earlier than TAEM to prevent operating in the uncertified mode of only a single operating hydraulic system. In this case, it would not be necessary to start the APU any earlier than EI minus 13 minutes. ©[082604-6318A]*

Reference Rule {A10-26}, APU INHIBIT MANAGEMENT [HC].

4. *If an APU is started at TIG minus 5 minutes and then a one-orbit waveoff is declared, the APU will have to be shut down. Without injector cooling, this APU could not be restarted to support entry as it would not have had time to cool (reference Rule {A10-22A}, APU START/RESTART LIMITS [HC]). For this case, the APU should be started after the deorbit burn as a waveoff is no longer a possibility. ©[ED 1]*
5. *If gearbox GN₂ leakage occurs, the GN₂ repressurization bottle will repressurize the gearbox at APU start. GN₂ will leak, requiring further represses and eventually depleting the bottle. By delaying the start of the APU until Mach 1.0, atmospheric pressure would prevent further leakage from the gearbox while the APU is running and actually would tend to back pressurize the gearbox. It is not possible to distinguish between an oil leak and a GN₂ leak when the APU is not running. If the drop in pressure is due to oil leakage, low oil pressure will be seen at startup, bearing temperatures will rise rapidly, and the APU will have to be shut down.*

If the GN₂ bottle develops a leak or the repress valve fails closed, typical GN₂ leakage from the gearbox may not support the entire entry. In this case, delay the start of the APU until it will support through wheelstop or Mach 1.0, where atmospheric pressure will prevent GN₂ leakage from the gearbox. With an evacuated repress bottle, if a gearbox repress is required, the valve will come open and the oil/GN₂ from the gearbox will flow into the bottle. The pressure would equalize at a lower value, the valve will remain open, and the oil/GN₂ will continue to leak. Below Mach 1, the repress valve most likely will not be activated. If it is, there will be some atmospheric pressure in the bottle that will reduce the amount of flow from the gearbox. ©[021199-6814]

Reference Rules {A10-1A}.5, APU LOSS DEFINITIONS [HC], and {A10-24C}, APU OIL/GEARBOX TEMPERATURE/PRESSURE. ©[ED 1]

6. *See Rule {A10-72}, HYDRAULIC LEAKS, for rationale.*

THIS RULE CONTINUED ON NEXT PAGE

FLIGHT RULES**A10-23****APU ENTRY START TIME [HC] (CONTINUED)**

7. *Analysis by RI/Downey has determined that when Freon and hydraulic fluid are mixed, the bulk modulus of the hydraulic fluid is maintained within an acceptable range as long as fluid temperatures are limited to below 150 deg F. To prevent excessive temperature buildup in a hydraulic system with a Freon leak into it, the associated APU start should be delayed until no earlier than TAEM. The temperature rise from TAEM to wheelstop is not expected to exceed 100 deg F. ©[021199-6814]*
8. *Loss of bootstrap pressure may result in cavitation of the hydraulic pump when a start attempt is made. Rockwell/Downey studies have shown that start capability is questionable when reservoir pressure is below 15 psia. If bootstrap pressure is lost and cannot be maintained by the circulation pump, the start attempt should be delayed until the most favorable conditions exist. Intersystem leakage from two other hydraulic systems operating at full pressure will provide some head pressure. Additional head pressure may be obtained by starting the APU at a lower altitude, when atmospheric pressure and gravity will be acting on the hydraulic system. Once the APU has started, the main pump should be run in NORM pressure. ©[082604-6318A]*

Reference Rule {A10-51A}.5, HYDRAULIC LOSS DEFINITIONS; RIC IL 288-503-81-055, November 10, 1981; and STS-7 SPAN/MER Action Request 041, June 21, 1983.

9. *Hydraulic system temperatures greater than 162 deg F at APU start will lead to early water spray boiler spraying. The early spraying coupled with cool lube oil temperatures could lead to a water spray boiler freeze up and loss of the associated APU lube oil cooling. Loss of lube oil cooling would require an APU shutdown. The APU could not be restarted until Mach 1 to support through wheelstop (reference Rule {A10-24B}, APU OIL/GEARBOX TEMPERATURE/PRESSURE). To avoid this situation, starting an APU/hydraulic system with reservoir temperature greater than 162 (154) deg F should be delayed until TAEM. At reservoir temperatures below 162 (154) deg F the APU lube oil will require cooling prior to hydraulic spraying. The heat load from the APU will prevent a water spray boiler freezeup. ©[021199-6814]*

Hazard reports ORBI 030, Potential Loss of Orbiter Caused by Vehicle Handling Qualities, and ORBI 326, Loss of Flight Control During Entry/Landing due to Single APU Operation Resulting in Priority Rate Limiting of the Aero Surfaces, reference this rule. ©[082604-6318A]

Rules {A10-24C}, APU OIL/GEARBOX TEMPERATURE/PRESSURE; {A10-122B}, LOSS OF WSB(S) ACTIONS; {A10-22}, APU START/RESTART LIMITS [HC]; and {A10-73E}, HYDRAULIC SYSTEMS PRESSURE/TEMPERATURE [CIL], reference this rule. ©[051194-1619B] ©[ED]

FLIGHT RULES

A10-24

APU OIL/GEARBOX TEMPERATURE/PRESSURE

- A. POST-MECO, AN APU WILL BE SHUT DOWN IF THE LUBE OIL OUTLET TEMPERATURE EXCEEDS 325 (318) DEG F OR IF THE GEARBOX BEARING TEMPERATURE EXCEEDS 350 (339) DEG F (MCC CALL) . @[032802-5345A]

The APU should be shut down after MECO is obtained, since the consequences are no longer severe. This is done to protect the APU for use during entry and landing. At or below these temperatures, APU reuse is guaranteed.

Reference Rule {A10-1A}.6, APU LOSS DEFINITIONS [HC], and SODB, vol. I, 3.4.4.3. @[ED]

- B. DURING ENTRY/ABORTS, FOR CONFIRMED LOSS OF APU LUBE OIL COOLING CAPABILITY, IF POST-MECO AND MACH > 1.0, THE AFFECTED APU WILL BE SHUT DOWN ASAP IF AT LEAST ONE OTHER GOOD APU/HYDRAULIC SYSTEM REMAINS. A RESTART WILL BE PERFORMED NO EARLIER THAN MACH 1.0, IF THE APU IS REQUIRED. FOR MACH < 1.0, AN APU WILL NOT BE SHUT DOWN FOR LOSS OF LUBE OIL COOLING UNTIL POST-WHEELSTOP. @[072398-6685A] @[ED]

If all lube oil cooling capability has been lost due to water spray boiler failure(s), the affected APU will have only a limited operational lifetime. APU lube oil and bearing temperature rise rates without sufficient cooling may be higher than during previous operation. This is due to a continuous breakdown of lube oil viscosity at elevated temperatures as well as the high workload of the APU in the latter portions of approach and landing.

If cooling capability is lost after the normal cooling control point is reached (250 deg F), the available APU run time is estimated to be no more than a few minutes before gearbox seals are lost and/or bearing seizure occurs. For this reason, the APU should be shut down and the remaining run time saved if needed to provide a second system operating during final approach and landing.

Once a velocity of Mach 1 (approximately 4 minutes to touchdown) is reached, an APU that loses its lube oil cooling capability should be left running through wheelstop. This is because below Mach 1, there may not be sufficient time to perform shutdown, cooldown, and restart before touchdown. Though continued operation through wheelstop may be questionable, it is preferable to have the APU operating as long as possible. @[021199-6814] @[ED]

Rules {A10-23B}.9, APU ENTRY START TIME [HC], and {A10-33}, APU DEFINITIONS, reference this rule. @[051194-1619B] @[072398-6685A] @[ED]

THIS RULE CONTINUED ON NEXT PAGE

FLIGHT RULES**A10-24 APU OIL/GEARBOX TEMPERATURE/PRESSURE (CONTINUED)**

- C. AN APU WITH GEARBOX PRESSURE < 2.0 (3.1) PSIA WILL ONLY BE USED FOR ENTRY. FOLLOWING APU START, IF THE OIL OUTLET PRESSURE IS NOT > 20 (27) PSIA AFTER 30 SECONDS AND OIL OUTLET TEMPERATURE IS NOT INCREASING, THE APU WILL BE SHUT DOWN AND NOT RESTARTED. @[032802-5345A]

If the APU gearbox pressure is < 2 psia, a leak is present in the gearbox or associated plumbing and some amount of lube oil/GN₂ has been lost. Starting the APU will repressurize the gearbox from the GN₂ bottle, but it may only be able to do this once (GN₂ bottle may be dumped into the gearbox) and this will also begin to leak from the gearbox. Because of this one-shot potential, the APU should only be started to support entry. Once the APU is started, if the oil pressure is greater than 20 psia, then the gearbox has been successfully repressurized and sufficient lube oil is still present to allow the APU to operate.

- D. DURING ENTRY/ABORTS, AN APU WILL BE SHUT DOWN POST-MECO IF THE OIL OUTLET PRESSURE IS > 150 (143) PSIA.

Structural damage could result if the APU is run with an oil pressure > 150 psia. Reference SODB, Vol. I, 3.4.4.3. @[072398-6685A]

Rules {A10-1A}.4, 5, and 8, APU LOSS DEFINITIONS [HC], and {A10-23B}.5, APU ENTRY START TIME [HC], reference this rule. @[ED]

- E. POST-MECO AND MACH > 1.0, AN APU THAT IS RUNNING WITH A GEARBOX PRESSURE OF < 2.0 (3.1) PSIA WILL BE SHUT DOWN ASAP IF AT LEAST ONE OTHER GOOD APU/HYDRAULIC SYSTEM REMAINS. A RESTART WILL BE PERFORMED, NO EARLIER THAN MACH = 1.0, IF THE APU IS REQUIRED. FOR MACH < 1.0, AN APU WILL NOT BE SHUT DOWN FOR LOSS OF GEARBOX PRESSURE UNTIL POST-WHEELSTOP. @[ED] @[032802-5345A]

If an APU is running with its gearbox pressure < 2 psia, a leak is present in the gearbox or associated plumbing that can no longer be supported by repressurizations from the GN₂ bottle. It is not possible to distinguish between a lube oil or GN₂ leak. However, if the leak is mostly GN₂, shutting down the APU at this point will prevent it from seizing due to loss of lubrication. The APU can then be restarted, if required, at Mach 1.0 since the atmospheric pressure would prevent further leakage from the gearbox while the APU is running and actually would tend to back pressurize the gearbox. If a significant amount of oil is also being lost, the bearing temperatures will eventually began to rise, indicating the loss of lubrication and imminent bearing seizure. In this case, the APU would be shut down based on temperature rise and would be nonrecoverable.

Rule {A10-33}, APU DEFINITIONS, references this rule. @[072398-6685A]

FLIGHT RULES

A10-25

APU HIGH SPEED SELECTION/SHIFT

- A. THE REMAINING APU(S) WILL BE RUN AT HIGH SPEED IF ONE OR MORE APU/HYDRAULIC SYSTEMS ARE LOST DURING ASCENT OR RTLS.

In order to minimize the performance degradation resulting from APU/hydraulic system loss(es), the remaining APU(s) are taken to high speed as soon as a system is declared lost.

- B. DURING ENTRY/ABORTS (EXCEPT RTLS), HIGH SPEED WILL BE SELECTED:
1. AT MM 304 IF ONLY A SINGLE GOOD APU/HYDRAULIC SYSTEM IS OPERATING.

If two APU's have been lost, then there is degradation in aerosurface movement rate capability. The remaining APU must be in high speed in order to obtain maximum horsepower to minimize this degradation. Also, it is absolutely essential that the APU be operating at maximum rpm when the vehicle first enters the Earth's atmosphere (MM 304-EI) to provide the best chance of landing the orbiter on one APU.

2. AT TAEM, IF ONLY TWO GOOD APU/HYDRAULIC SYSTEMS ARE OPERATING.

If one APU is lost, the two remaining APU's can still meet all aerosurface rate demands with no loss of performance even if they are running at normal speed. They are taken to high speed at TAEM as a precautionary measure in the event one of the remaining APU's fails during the critical final landing maneuvers.

Rule {A10-72}, HYDRAULIC LEAKS, references this rule.

- C. AN APU WILL NOT BE SHUT DOWN PRIOR TO MECO, EXCEPT FOR CONFIRMED OVERSPEED > 129 (129) PERCENT.

Shutting down an APU in powered flight will result in the associated main engine going into hydraulic lockup. Test data on SSME valve drift is very limited while in the hydraulic lockup condition. Excessive SSME valve drift can severely impact ascent performance to the point of risking loss of orbit capability. For this reason, it is highly desirable to avoid hydraulic lockup even at the expense of possible loss of an APU.

In addition to valve drift concerns, the failure of an SSME bypass valve prior to STS-26 has also contributed to the desire to avoid the SSME hydraulic lockup condition. Failure of the bypass valve in combination with hydraulic lockup (i.e., APU shutdown) can result in loss of hydraulic and pneumatic engine shutdown capability. A catastrophic engine shutdown will result. Because the bypass valve failure is not detectable (transparent to crew and MCC), manual shutdown of an APU in response to any failure except a confirmed overspeed during powered flight is not allowed. Reference Ascent/Entry Flight Techniques #50, October 20, 1988.

THIS RULE CONTINUED ON NEXT PAGE

FLIGHT RULES

A10-25

APU HIGH SPEED SELECTION/SHIFT (CONTINUED)

- D. DURING ASCENT, AN APU WHICH SHIFTS TO HIGH SPEED WITH NORMAL SPEED SELECTED WILL BE SHUT DOWN ASAP POST-MECO.

An APU that shifts to high speed (due to a failure of the pulse control valve to regulate speed) is a single failure (failed open secondary valve) from a possible uncontained overspeed. The risk of a second failure in that APU is accepted in powered flight in order to retain SSME throttling capability and SSME hydraulic valve control. (Shutting down one APU results in hydraulic lockup of one main engine.) Risk of operating the APU after MECO is not warranted, and the APU will be shut down.

Though it has experienced a shift to high speed, the APU will not be considered lost for planning purposes since it may be used when absolutely necessary.

- E. DURING ENTRY/ABORTS, IF AN APU SHIFTS TO HIGH SPEED WITH NORMAL SPEED SELECTED AND TWO GOOD APU/HYDRAULIC SYSTEMS REMAINING, THE APU WILL BE SHUT DOWN ASAP POST-MECO. A RESTART WILL BE PERFORMED IF THE APU IS REQUIRED (SHUTDOWN WILL NOT BE PERFORMED FOR THESE CASES IF INSUFFICIENT TIME IS AVAILABLE TO RESTART THE AFFECTED APU). @[072398-6685A]

If the other APU's are functioning properly, the affected APU will be shut down to protect against a possible uncontained overspeed. That APU may be considered available for restart after completion of injector cooling should a second APU be required.

If only one other APU is functioning properly, the affected APU will be left operating in order to provide dual APU flight control authority throughout entry.

APU operations after an uncommanded shift to high speed shall be performed with the APU SPEED SELECT switch in high in order to prevent nuisance alarms. This will also enable the 115 percent comparator, which will provide backup speed control in the case that the initial failure was in the 103 percent comparator. In addition, auto shutdown shall remain enabled as long as one other good APU remains.

Reference Rules {A2-254C}, ENTRY STRING REASSIGNMENT; {A10-26}, APU AUTO SHUTDOWN INHIBIT MANAGEMENT [HC]; and {A10-33}, APU DEFINITIONS. @[072398-6685A] @[ED]

FLIGHT RULES

A10-26

APU AUTO SHUTDOWN INHIBIT MANAGEMENT [HC]
@[082604-6318A]

- A. AN OPERATING APU WILL HAVE ITS AUTO SHUTDOWN FUNCTION INHIBITED IF:
1. DURING ASCENT, ANOTHER APU/HYDRAULIC SYSTEM IS LOST OR FAILING SUCH THAT SUPPORT THROUGH MECO IS SUSPECT.
 2. DURING ENTRY/ABORTS:
 - a. THE OTHER TWO APU/HYDRAULIC SYSTEMS ARE LOST OR FAILING SUCH THAT SUPPORT THROUGH WHEELSTOP IS SUSPECT, @[021199-6814]
 - b. THE APU IS NEEDED AS A LAST APU, @[072398-6685A]
 - c. THE APU IS NEEDED TO PROVIDE NWS IF THERE IS A KNOWN DIRECTIONAL CONTROL PROBLEM (I.E., FAILED NLG OR MLG TIRE, UNCOMMANDED BRAKE PRESSURE, OR PEAK CROSSWINDS ABOVE THE SURFACE WIND LIMIT), OR
 - d. THE APU IS REQUIRED, WILL CONTINUE TO RUN ONLY IF AUTO SHUTDOWN IS INHIBITED, AND A DUAL MPU FAILURE IS NOT SUSPECTED.
- B. THE AUTO SHUTDOWN FUNCTION WILL BE (RE)ENABLED FOR AN APU WHEN:
1. THE APU IS NOT NEEDED AS A LAST APU AND: @[121505-7135A]
 - a. THE APU TURBINE SPEED HAS SHIFTED TO THE HIGH SPEED BAND, IS ERRATIC, OR IS LOST DUE TO A SUSPECTED MPU FAILURE, OR
 - b. THE APU IS RUNNING WITH A KNOWN OR SUSPECTED ISOLATABLE FUEL LEAK INTO THE AFT COMPARTMENT.
 2. THE APU NO LONGER MEETS THE CRITERIA FOR OPERATION WITH ITS AUTO SHUTDOWN FUNCTION INHIBITED. @[082604-6318A]

THIS RULE CONTINUED ON NEXT PAGE

FLIGHT RULES

A10-26

APU AUTO SHUTDOWN INHIBIT MANAGEMENT [HC]
(CONTINUED)

- C. AN APU MAY BE (RE)STARTED WITH ITS AUTO SHUTDOWN FUNCTION INHIBITED IF: @[082604-6318A]
1. THE AUTO SHUTDOWN SWITCH IS FAILED IN INHIBIT, AND THE APU HAS NO KNOWN OR SUSPECTED SPEED CONTROL FAILURES,
 2. THE APU IS REQUIRED, WILL START OR RUN ONLY IF AUTO SHUTDOWN IS INHIBITED, AND A DUAL MPU FAILURE IS NOT SUSPECTED,
 3. THE APU IS NEEDED AS A LAST APU, OR
 4. FUEL TANK PRESSURE < 90 (99) PSIA.

The purpose of the auto shutdown function is to quickly and automatically secure an APU in the event of a failure that causes turbine speed to fall outside acceptable, safe limits. These limits, built into the APU controller, are turbine speed < 80 percent (underspeed) and > 129 percent (overspeed). The auto shutdown logic secures the APU by disabling the shutoff valve (SOV) commands and removing power from the fuel tank isolation valves (causing these valves to close). Underspeeds can be caused by numerous failure conditions: loss of power to the normally closed shutoff valve, erroneous pulse control valve (PCV) or SOV commands, insufficient fuel flow, excessive gearbox loads, etc. An overspeed is caused when both the PCV and SOV fail open, due to mechanical failures or erroneous commanding, permitting unrestricted fuel flow to the gas generator. Since the auto shutdown logic closes the fuel tank isolation valves, the maximum amount of fuel available (assuming the SOV cannot close) is restricted to that within the fuel line, so the turbine will not reach disintegration speed (this is called a "contained overspeed"). @[082604-6318A]

THIS RULE CONTINUED ON NEXT PAGE

FLIGHT RULES

A10-26**APU AUTO SHUTDOWN INHIBIT MANAGEMENT [HC]**
(CONTINUED)

The APU's are nominally operated with auto shutdown enabled in order to have underspeed/overspeed protection. The auto shutdown function can be inhibited to protect against an inadvertent shutdown of an APU - that caused by multiple failures in the controller's speed protection logic, or conditions that cause speed to go outside the shutdown limits but for which the APU is still providing adequate output (multiple failures in the controller's speed control logic, restricted fuel flow, high gearbox loads, GG bed poisoning, etc.). For the latter conditions, the ability of the affected APU/hydraulic system to provide useful support is highly questionable. With the redundancy inherent in the controller, an inadvertent APU shutdown due to speed protection logic failures is highly unlikely. At least two controller component failures are necessary to cause such a shutdown after the first 10.5 seconds of operation. Loss of two magnetic pickup units (MPU's) with auto shutdown enabled is detected by the controller as an underspeed condition. However, in inhibit, the loss of two MPU's results in the controller commanding the turbine speed to continue increasing (this is called an "uncontained overspeed"). The turbine will eventually disintegrate, producing shrapnel which can damage other equipment in the aft and lead to loss of the crew and vehicle. Due to their design, location, and failure history, the probability of two MPU failures, though small, is considered much greater than that of two controller failures (the MPU's have been redesigned to use thicker wire with fewer turns to minimize their failure potential, but are still more likely to fail than the controller components). In order of decreasing likelihood, shutdown can occur for single mechanical failures (valve failed closed, fuel blockage, etc.), dual MPU failures, and dual controller failures. Use of inhibit will likely provide no benefit for mechanical failures, will result in a potentially catastrophic condition for dual MPU failures, or will potentially regain APU operation for dual controller failures. Therefore, even though the increased risk associated with running an APU in inhibit is relatively small, the potential consequences do not warrant accepting the risk, except for those cases where inadvertent shutdown of the APU would lead to loss of critical function or redundancy.

©[082604-6318A]

THIS RULE CONTINUED ON NEXT PAGE

FLIGHT RULES

A10-26

APU AUTO SHUTDOWN INHIBIT MANAGEMENT [HC] (CONTINUED)

Note that with the failure of one of the two controller power supplies (e.g., a controller RPC failure), which will leave only two of the four speed control channels operable, the APU is only one failure away from an inadvertent underspeed shutdown (controller or MPU failure); however, it would take at least two controller or MPU failures to produce an uncontained overspeed. Since multiple levels of redundancy still exist before the catastrophic case can occur (uncontained overspeed), use of inhibit is not prohibited due solely to loss of a controller power supply. ©[082604-6318A]

- A.1 *For loss of a single APU during powered flight, the risk of operating in inhibit is deemed acceptable due to controllability concerns associated with the loss of a second APU.*
- A.2 *During entry/aborts, inhibit is used in those cases where the affected APU is needed to provide a critical function. For maintaining redundancy for a critical function, the auto shutdown function is inhibited only if needed to overcome failures in the overspeed/underspeed circuitry (with these failures alone, the APU will run safely with auto shutdown inhibited, though at some additional risk). The APU is considered lost for the case where multiple failures have occurred in the underspeed or overspeed detection logic, leading to a controller-commanded shutdown, even if the APU can be regained by inhibiting the auto shutdown function. Though the APU may be operable (and possibly be operated if the APU met the flight rule inhibit criteria), the controller, having sustained multiple failures, is considered suspect in this case; the failure may indicate generic controller component problems, for example. Reference Rule {A10-1A}.11, APU LOSS DEFINITIONS [HC]. For example, inhibit will be used to circumvent failures in an APU's auto shutdown logic in order to restore gear deploy redundancy. However, auto shutdown will not be selected on a good APU merely because that APU provides gear deploy redundancy. In the former case, gear deploy redundancy will not exist unless inhibit is used to regain the affected APU, so its use is justified since the next failure (resulting in loss of gear deploy capability) is catastrophic. In the latter case, gear deploy redundancy exists without the use of inhibit and the next failure (e.g., loss of the APU) still leaves a method of gear deploy. ©[082604-6318A] ©[121505-7135A]*

THIS RULE CONTINUED ON NEXT PAGE

FLIGHT RULES

A10-26

APU AUTO SHUTDOWN INHIBIT MANAGEMENT [HC] (CONTINUED)

- B.1 Auto shutdown should be (re)enabled in situations where there is a known, high potential for an uncontrolled shutdown which could cause damage to other equipment in the aft compartment. If the turbine speed is erratic in either NORM or HIGH speed, or if turbine speed has shifted to the high speed band, the APU has lost speed control redundancy and is one failure away from an overspeed condition. Similarly, the loss of an MPU (i.e., loss of turbine speed not explainable by an MDM/DSC or other telemetry-related failure), with the auto shutdown function inhibited, places the APU one failure away from an uncontained overspeed condition. A fuel leak can lead to a fire and an explosive shutdown such as occurred on STS-9. The auto shutdown logic is beneficial in this case because it automatically closes the fuel tank isolation valves upon shutting down the APU. This may isolate the leak, thus minimizing the risk due to hydrazine in the aft compartment. In these cases, the outcome of an uncontrolled shutdown is considered more dangerous than an inadvertent shutdown causing single APU operations. The APU auto shutdown function should only be left inhibited if the APU is needed to provide critical support (i.e., needed as a last APU). ©[082604-6318A] ©[121505-7135A]*
- B.2 If conditions change such that the rationale for operating an APU with auto shutdown inhibited no longer applies (e.g., another system is recovered), then auto shutdown will be reenabled. This is done in order to limit exposure to the risks associated with running while in inhibit. Enable will be reselected even if doing so will result in the APU shutting down.*
- C.1 In the event that an APU's auto shutdown switch has failed in the INHIBIT position and the APU has no speed control-related failures (MPU, PCV, or SOV failure), the APU may be operated as a third system. An uncontained overspeed would still require at least two controller or MPU failures to occur. However, since a level of protection has been removed, start time should be delayed per Rule {A10-23B}.3, APU ENTRY START TIME [HC], in order to minimize operation in this configuration. ©[082604-6318A]*

THIS RULE CONTINUED ON NEXT PAGE

FLIGHT RULES

A10-26

APU AUTO SHUTDOWN INHIBIT MANAGEMENT [HC] (CONTINUED)

- C.2 *If the APU has sustained failures such that it will start and run only if auto shutdown is inhibited (e.g., multiple failures in the speed protection logic), then the APU may be started in inhibit. However, the risk of operating an APU in inhibit with known failures is justified only if the APU is required to perform a critical function or redundancy, and then only if the dual MPU failure case is not present (to preclude an uncontained overspeed).* @[082604-6318A]
- C.3 *If an APU/hydraulic system is needed to provide critical support (i.e., “needed as a last APU”), then auto shutdown can be inhibited in order to increase the chance of a successful (re)start. In this case, the risk associated with (re)starting in inhibit is accepted, since not regaining the system would lead to loss of crew and vehicle.*
- C.4 *Low tank pressures will cause a slower than normal turbine spinup which can lead to violating the 10.5-second startup criteria, resulting in the controller commanding an underspeed shutdown. Therefore, the auto shutdown function should be inhibited in the event a low pressure (re)start is necessary.*

Reference SODB, Vol. I, 3.4.4.3, and Rule {A10-1A}.8, APU LOSS DEFINITIONS [HC].

- D. DURING ENTRY/ABORT, FOR AN APU THAT HAS SHUT DOWN DUE TO AN UNEXPLAINED UNDERSPEED WITH THE AUTO SHUTDOWN FUNCTION ENABLED: @[062797-4889]
1. THE APU WILL BE RESTARTED WITH AUTO SHUTDOWN ENABLED AND NORM SPEED SELECTED ONLY IF TIME IS AVAILABLE TO PERFORM TWO APU RESTARTS (T/D > APPROX 10 MIN) AND ANY OF THE FOLLOWING ARE TRUE:
 - a. ANOTHER APU/HYDRAULIC SYSTEM IS FAILED OR SUSPECT. @[082604-6318A]
 - b. THE APU IS REQUIRED. @[072398-6685A]
 - c. SINGLE APU WX PLACARDS ARE EXCEEDED.
 - d. THE APU IS NEEDED FOR BODYFLAP REDUNDANCY. @[121505-7143B]

THIS RULE CONTINUED ON NEXT PAGE

FLIGHT RULES

A10-26

APU AUTO SHUTDOWN INHIBIT MANAGEMENT [HC]
(CONTINUED)

2. IF A RESTART IS ATTEMPTED AND THE APU:
 - a. STARTS AND RUNS, THE APU WILL CONTINUE TO OPERATE WITH AUTO SHUTDOWN ENABLED. THE APU WILL BE CONSIDERED SUSPECT.
 - b. DOES NOT START OR SUSTAINS AN UNDERSPEED SHUTDOWN WITHIN THE FIRST 10.5 SECONDS OF OPERATION, THE APU WILL BE RESTARTED AND OPERATED WITH AUTO SHUTDOWN INHIBITED IF IT IS REQUIRED. @[072398-6685A] @[082604-6318A]
 - c. SUSTAINS AN UNDERSPEED SHUTDOWN AFTER 10.5 SECONDS, ANOTHER RESTART OF THE APU MAY BE ATTEMPTED IF TIME PERMITS. THE APU WILL BE OPERATED WITH AUTO SHUTDOWN ENABLED.
 - d. SUSTAINS AN OVERSPEED SHUTDOWN, THE APU WILL BE SHUT DOWN AND NO FURTHER TROUBLESHOOTING WILL BE ATTEMPTED. @[061297-4889]
3. IF TIME IS NOT AVAILABLE TO ATTEMPT TWO RESTARTS, AN APU COOLDOWN WILL BE PERFORMED AT MACH 7. THE APU WILL BE RESTARTED, WITH AUTO SHUTDOWN INHIBITED, IF IT IS NEEDED AS A LAST APU. @[061297-4889] @[082604-6318A]

THIS RULE CONTINUED ON NEXT PAGE

FLIGHT RULES

A10-26**APU AUTO SHUTDOWN INHIBIT MANAGEMENT [HC]**
(CONTINUED)

An APU has sustained an “unexplained” underspeed shutdown if a dual magnetic pickup unit (MPU) failure cannot be ruled out as the cause of the shutdown (other than by attempting a restart of the APU; examples of explainable underspeed shutdowns include failures within the underspeed or overspeed slow latch circuits). Analysis performed by JSC SR&QA indicates that the most probable APU electrical failure is an MPU. The APU has three MPU’s which provide APU turbine speed data to the APU controller - dual MPU failures result in APU shutdown. The signature for a dual MPU failure case is closure of the fuel tank isolation valves (FIV), illumination of the F7 APU underspeed light, and closure of the shutoff valve (SOV) while the APU is running in NORM or HIGH speed. This occurs because three of the four speed control channels indicate zero speed due to the failed MPU’s which results in the logic on these three channels voting for underspeed. The same signature can result with two intermittent MPU’s. Another signature is also possible for the case of two intermittent MPU’s. The signature for this scenario is the APU spinning down from NORM or HIGH speed, and at a turbine speed of 80 percent, the FIV’s close and the F7 APU underspeed light is illuminated. The signature for two intermittent MPU’s is dependent on which of the three MPU’s have failed. Therefore, there is not a specific shutdown signature for all MPU failure cases. ©[082604-6318A]

During APU start, the controller locks out the underspeed shutdown logic for 10.5 seconds to allow the APU adequate time to spin up. The overspeed shutdown logic is not affected during this 10.5 second period. Since the dual MPU failure is interpreted as a zero turbine speed by the APU controller on three of the four speed control channels, the controller does not sense the APU spinning up. As a result, the APU continues to increase in RPM until the remaining MPU senses that the speed has reached 129 percent, which triggers the overspeed shutdown logic and shuts down the APU if auto shutdown is enabled. If auto shutdown was inhibited, the APU would experience an uncontained overspeed - the turbine could disintegrate, producing shrapnel that could damage other equipment in the aft compartment. ©[082604-6318A]

To determine if the underspeed was due to a dual MPU failure, the APU is restarted with auto shutdown enabled. If the APU overspeeds and automatically shuts down, then the dual MPU failure case is confirmed - the APU will be safed and should never be restarted. If the APU does not start or experiences an underspeed shutdown within the first 10.5 seconds of operation, a dual MPU failure is not the cause of the shutdown (dual failures may be in the APU or the controller). If the APU restarts and operates but subsequently fails after 10.5 seconds, the failure is transient (e.g., a single failed MPU coupled with an intermittent MPU) - the APU would experience an uncontained overspeed if the transient MPU recurred with auto shutdown inhibited, so the APU will only be restarted and run with auto shutdown enabled. ©[061297-4889]

THIS RULE CONTINUED ON NEXT PAGE

FLIGHT RULES

A10-26

APU AUTO SHUTDOWN INHIBIT MANAGEMENT [HC] (CONTINUED)

Touchdown minus 10 minutes is the minimum amount of time needed to accomplish two APU cooldowns in order to support APU operations no later than approach and landing. Since hardware damage to the affected APU may result if an overspeed condition occurs, troubleshooting for an unexplained underspeed should only be performed if critical redundancy is lost. @[121505-7143B]

For the case of bodyflap redundancy, the diagnostic restart is performed even if the APU is not required for bodyflap control. If the last method of bodyflap control is lost, there is some time to recover another channel (approximately 30-45 seconds, worst case based on failures leading to a stuck bodyflap only). If the diagnostic restart indicates that the APU can be started in INH, then a cooldown will be initiated at M=7 and the APU will be restarted for the bodyflap only if the last method of control is lost. If the diagnostic restart had not been performed and bodyflap control is lost, significant risk would be incurred since the APU would have to be started immediately, in INH, with a potential dual MPU failure.

If there is insufficient time to perform two cooldowns and the APU is needed to provide a critical landing capability, a start attempt will be made with auto shutdown inhibited to provide the best chance of regaining the APU. @[061297-4889]

Reference Rule {A10-33}, APU DEFINITIONS. @[061297-4889] @[072398-6685A]

Hazard Reports ORBI 030, Potential Loss of Orbiter Caused by Vehicle Handling Qualities; ORBI 031, Inability of the APU Turbine Housing to Contain a Disintegrating Turbine Wheel Resulting in Loss of Crew/Vehicle; ORBI 040, Premature Shutdown of Second APU Due to Electrical Circuit, Lube Oil, or Fuel System Functional Failures After One APU Lost; ORBI 106, APU Gas Generator Injector External Leakage of Hydrazine; and ORBI 250, Hydrazine Leakage from the APU System Results in Catastrophic Loss, reference this rule. @[082604-6318A] @[121505-7135A] @[121505-7143B]

Rules {A10-25}, APU HIGH SPEED SELECTION/SHIFT, and {A10-23}, APU ENTRY START TIME [HC], reference this rule. @[082604-6318A] @[ED]

FLIGHT RULES

A10-27

APU FUEL LEAKS [CIL]

- A. DURING ASCENT, IF AN APU DEVELOPS A FUEL LEAK, IT WILL BE SHUT DOWN ASAP POST-MECO.

If the leak is upstream of the tank valves, then the leak is not isolatable and fuel will continue to leak into the orbiter aft compartment even with the APU shut down. A significant amount of free hydrazine in the aft compartments presents a severe safety hazard during entry. To avoid this, the APU should be restarted and allowed to run until its fuel is depleted. This will ensure that most of the hydrazine is burned and exhausted overboard and will minimize the amount of hydrazine that leaks into the aft bay. The restart should only be performed if fuel tank pressure is > 100 (107) psi.

If the fuel leak is downstream of the tank valves, the leak will be isolated when the APU is shut down. The APU is still considered lost, however, and should not be started unless one of the two remaining APU's fails (not available for entry).

Reference Rule {A10-1A}.1.b, APU LOSS DEFINITIONS [HC]. [ED]

- B. ON ORBIT POST-MECO, AN APU WILL BE OPERATED FOR THE PURPOSE OF BURNING ITS FUEL IF THERE IS A SUSPECTED OR CONFIRMED NONISOLATABLE HYDRAZINE LEAK. [CIL]
1. WITH TWO OTHER GOOD APU/HYDRAULIC SYSTEMS, THIS TECHNIQUE WILL APPLY WITHOUT CONSIDERING LANDING OPPORTUNITIES.

THIS RULE CONTINUED ON NEXT PAGE

FLIGHT RULES

A10-27

APU FUEL LEAKS [CIL] (CONTINUED)

2. WITH ONLY ONE OTHER GOOD APU/HYDRAULIC SYSTEM REMAINING, THIS WILL APPLY IF THE LEAK RATE DOES NOT SUPPORT THE NEXT PLS ASSUMING THE AFFECTED APU IS STARTED AT TAEM.

If the leak is upstream of the fuel tank isolation valves, then the leak is not isolatable and fuel will continue to leak into the orbiter aft compartment even with the APU shut down. A significant amount of free hydrazine in the aft compartment presents a severe safety hazard during entry. If two fully operational APU's remain, the leaking APU will be started and its fuel burned off in order to minimize the amount of free hydrazine that is left to leak in the aft compartment. If one APU has already failed, however, the leak rate will be assessed to see if fuel will support a next PLS entry. If the leak rate is slow enough that the APU would be able to support a next PLS entry, then the APU will not be started to burn off its fuel. Performing a single APU entry is more hazardous than having free hydrazine in the aft bay. Start of the APU will be delayed until TAEM to reduce entry usage requirements and optimize the remaining capability to support the leak rate. If the leak rate will not support the next PLS, then the APU will be started and the fuel burned off since it would not be available for entry whether the APU was started or not.

- C. DURING ENTRY/ABORTS, FOR A FUEL LEAK, ACTION WILL BE TAKEN IN ORDER TO PROVIDE AT LEAST TWO APU/HYDRAULIC SYSTEMS FROM TAEM THROUGH WHEELSTOP. @[021199-6814]

1. IF ONLY ONE OTHER GOOD APU/HYDRAULIC SYSTEM REMAINS AND THE LEAK SUPPORTS CONTINUED OPERATION THROUGH WHEELSTOP, THE APU WILL BE ALLOWED TO RUN. IF THE LEAK WILL NOT SUPPORT CONTINUED OPERATION THROUGH WHEELSTOP OR IF TWO OTHER GOOD APU/HYDRAULIC SYSTEMS REMAIN, THE AFFECTED APU WILL BE SHUT DOWN IF IT IS DETERMINED THAT THE FUEL TANK PRESSURE WILL NOT FALL BELOW 100 (109) PSIA BEFORE AN APU RESTART COULD BE PERFORMED. [CIL] @[032802-5345A]
 - a. IF THE LEAK IS ISOLATED, THE AFFECTED APU WILL BE RESTARTED IF NEEDED TO MAINTAIN TWO APU/HYDRAULIC SYSTEMS FROM TAEM THROUGH WHEELSTOP, A LAST METHOD OF GEAR DEPLOY, OR DIRECTIONAL CONTROL [CIL]. @[072398-6685A] @[021199-6814]

THIS RULE CONTINUED ON NEXT PAGE

FLIGHT RULES

A10-27

APU FUEL LEAKS [CIL] (CONTINUED)

- b. IF THE LEAK IS NOT ISOLATED AND THE LEAK RATE WILL NOT SUPPORT APU OPERATIONS FROM TAEM THROUGH WHEELSTOP, THE AFFECTED APU WILL BE RESTARTED ASAP. OTHERWISE, THE AFFECTED APU WILL BE RESTARTED WHEN ABLE TO SUPPORT APU OPERATIONS THROUGH WHEELSTOP (NO LATER THAN TAEM). [CIL] ©[021199-6814]

There are two important goals to achieve when troubleshooting a leaking APU: maintaining two good APU's for flight control and minimizing fuel leakage into the aft compartment, which can lead to fire. This rule will minimize free hydrazine in the aft compartment and reduce the risk of a fire that could potentially cause the loss of a second APU. The risk of fire damaging remaining APU's is considered greater than APU detonation concerns as a result of APU shutdown and subsequent heat soakback. Restarting a leaking APU risks a large fuel leak and potential detonation of the GGVM, but this risk is considered acceptable when considering the inability of the vehicle to land on a single APU. ©[032802-5345A]

We are forced to accept the risk of an aft compartment fire in order to provide two APU's for flight control. If only two APU's are operating, we do not want to risk shutting one down to try and isolate the leak, since it may not restart when required at TAEM. If the leaking APU will not support through wheelstop in its present condition, it is acceptable to shut it down and try to isolate the leak. If the leak is isolatable, this may allow a restart at TAEM to provide two APU's for landing.

If the leak rate is large enough that the fuel tank pressure would fall below 100 psia before an APU restart could be performed (in the event shutting the APU down does not isolate the leak), it should be assumed that the leak is nonisolatable; thus, the APU should be allowed to run to continue burning off fuel. Simulation experience shows that it takes approximately 5 minutes for the crew to shut down and then immediately restart an APU; this 5 minute time should be used when determining if the tank pressure will fall below 100 psia.

Reference Rule {A10-22A}, APU START/RESTART LIMITS [HC], and SODB, Vol. I, 3.4.4.3. ©[ED]

2. PRIOR TO TAEM, AN APU WITH A SUSTAINED OVERBOARD FUEL PUMP SEAL CAVITY DRAIN SYSTEM LEAK WILL BE SHUT DOWN ASAP IF TWO OTHER GOOD APU/HYDRAULIC SYSTEMS REMAIN AND THE LEAKING APU FUEL TANK PRESSURE IS > 100 (109) PSIA. THE APU WILL BE RESTARTED IF NEEDED TO MAINTAIN TWO APU/HYDRAULIC SYSTEMS FROM TAEM THROUGH WHEELSTOP, A LAST METHOD OF GEAR DEPLOY, OR DIRECTIONAL CONTROL. ©[072398-6685A] ©[040899-6824] ©[032802-5345A]

THIS RULE CONTINUED ON NEXT PAGE

FLIGHT RULES

A10-27

APU FUEL LEAKS [CIL] (CONTINUED)

This rule accepts the risk of aft compartment fire damage after TAEM caused by ingestion, through the aft vent doors, of the fuel leaking overboard. A fuel pump seal leak may be detected by repeated excursions in drain line pressure to the relief valve cracking pressure (28 to 42 psia) or sustained drain line pressure above the relief valve reseal pressure (16.8 to 25.2 psia). A fuel pump seal leak will, by nature, be small; combined with the low probability of ingestion, chances of catastrophic damage from such a leak are small. There is insufficient time post-TAEM for a cooldown and restart of the affected APU, if required. Therefore, it is better to allow the APU to continue running so it will be available to support operations through wheelstop in the event another APU is lost. If the fuel tank pressure has already fallen below 100 psia, the APU should not be restarted if it is shut down.

@[021199-6814] @[040899-6824] @[032802-5345A]

Reference Rule {A10-22A}, APU START/RESTART LIMITS [HC], and SODB, Vol. I, 3.4.4.3.

@[032802-5345A] @[ED]

FLIGHT RULES

A10-28

AOA APU/HYDRAULIC SYSTEM OPERATIONS

- A. IF ORBIT CAPABILITY IS QUESTIONABLE, THE APU'S WILL REMAIN RUNNING UNTIL THE DECISION IS MADE TO CONTINUE TO ORBIT. THE HYDRAULIC MAIN PUMPS WILL BE TAKEN TO "LOW PRESS" FOLLOWING MPS DUMP COMPLETION.

If an AOA has been declared, or is even a strong possibility, the APU's should continue operating to preclude the need for a later restart of all three APU's in order to support the AOA. Performing a restart on an APU is not something to be done without good reason and should be avoided if at all possible. A single failure in the injector cool system could cause the loss of all restart capability. The hydraulic main pumps will be depressurized to minimize fuel usage as well as WSB H₂O usage.

Reference SODB, vol. I, 3.4.4.3.5a

Rule {A2-66}, APU SHUTDOWN DELAY CRITERIA, references this rule.

- B. DURING AN AOA, THE APU'S WILL REMAIN RUNNING WITH HYDRAULIC PUMPS IN "LOW PRESS" UNTIL MM 304. AN APU WILL BE SHUT DOWN, IF REQUIRED, TO MAINTAIN THE APU FOR ENTRY REGARDLESS OF OTHER APU/HYDRAULIC SYSTEMS STATUS.

APU consumables are loaded to account for continuous APU operation throughout an AOA. However, the margins are very small. Any off-nominal APU or WSB operation could result in exceeding these margins. Failure modes, such as a MPS/TVC ISOL valve failing to fully close (STS 51-J), result in additional loads and increased fuel and water usage on the APU which are not accounted for in the consumable analyses. When required, an APU should be shut down if this will allow it to be available throughout entry and landing.

FLIGHT RULES

A10-29

FCS CHECKOUT APU OPERATIONS [HC] @[022405-6569B]

- A. APU SELECTION FOR FCS CHECKOUT WILL BE DONE REAL TIME BASED ON APU/HYDRAULIC SYSTEMS STATUS. CONSIDERATION WILL NOT BE GIVEN TO LANDING GEAR REDUNDANCY OR SWITCHING VALVE CYCLING.

The overriding consideration for APU system management decisions during the orbit/FCS checkout flight phase is the upcoming entry. The APU's must be in the best possible condition for entry. Therefore, the APU selected for FCS checkout must have had no potentially serious anomalies during ascent, consumables must be adequate to meet redline criteria, and there must be no major loss in performance monitoring instrumentation.

If APU 1 is selected for FCS checkout and should fail as a result of being selected, landing gear deploy redundancy would be lost. However, if APU 1 ran only long enough for FCS checkout, then it probably would not have supported the entire entry anyway. Thus, landing gear redundancy will not be considered when selecting an APU.

Certain hydraulic switching valves will change state during FCS checkout depending on which APU is selected. Should they fail in that state, hydraulic redundancy would be lost. But some switching valves must change state no matter which APU is selected; so switching valve cycling is not good criteria for selecting an APU.

- B. FCS CHECKOUT WITH AN APU WILL BE PERFORMED ONLY IF IT IS DETERMINED THAT TWO OF THREE APU/HYDRAULIC SYSTEMS WILL HAVE AT LEAST 192 LBS APU FUEL AND 54 LBS WSB H₂O (79 LBS H₂O/PGME) FOLLOWING FCS CHECKOUT. @[012694-1596]

Reference Rule {A10-32B}.1, APU/HYD CONSUMABLES, for the derivation of these values.

Hazard Reports ORBI 003, Loss of Flight Control Due to Loss of Elevon Function; ORBI 023, Loss of Control During Entry Due to Failure of the Rudder/Speedbrake System; ORBI 025, Loss of Control During Entry Due to Failure of the Body Flap Mechanism; and ORBI 344, Water Spray Boiler (WSB) System Failures Could Cause Loss of Two (2) Auxiliary Power Unit (APU)/Hydraulic (HYD) Systems, reference this rule. @[022405-6569B]

THIS RULE CONTINUED ON NEXT PAGE

FLIGHT RULES

A10-29 FCS CHECKOUT APU OPERATIONS [HC] (CONTINUED)

- C. IF THE STATUS OF AN APU/HYDRAULIC SYSTEM IS QUESTIONABLE TO SUPPORT ENTRY, ATTEMPTS MAY BE MADE TO START AND OPERATE THAT SYSTEM FOR FCS CHECKOUT IN ORDER TO VERIFY ENTRY CAPABILITY PROVIDED THAT THE SYSTEM CAN BE OPERATED SAFELY (MCC CALL).

If only one or two APU's are nominally operable, it is unwise to activate either, except to support entry. If the orbit FCS checkout part 1 (secondary actuator check) were to be performed, one of the two remaining nominal APU's (or the last operational APU for the single remaining APU case) would have to be activated twice, increasing the risk of loss. Under these conditions, if an APU/hydraulic system has experienced suspect operation such that its capability to support entry is questionable, its entry status can be verified, if determined safe to operate, by attempting to use the system for FCS checkout.

- D. IF CONDITIONS PRECLUDE OPERATION OF ANY ONE OF THE THREE APU/HYDRAULIC SYSTEMS, THE HYDRAULIC CIRCULATION PUMP ON A FAILED SYSTEM MAY BE ACTIVATED IN ORDER TO PERFORM AN ABBREVIATED SECONDARY ACTUATOR CHECK. IF CONDITIONS ALSO PRECLUDE USE OF A CIRCULATION PUMP ON A FAILED SYSTEM, A CIRCULATION PUMP ON A NOMINAL HYDRAULIC SYSTEM MAY BE USED TO PERFORM THE CHECK.

If only one or two APU's are nominally operable or if it could be determined that operating an APU would be unsafe (isolated fuel leak, etc.), an abbreviated actuator check could be performed utilizing the system circulation pump. If it would also be unwise to activate the hydraulic system utilizing the circulation pump, a circulation pump on a nominal system could then be used to perform the abbreviated actuator check.

Reference Rule {10-74E}, HYDRAULIC CIRCULATION PUMP OPERATION. ©[072398-6686B]

- E. IF MISSION CONSTRAINTS PRECLUDE ACCOMPLISHING EITHER THE FULL OR ABBREVIATED ACTUATOR CHECK ON ORBIT, THE NOMINAL APU/HYDRAULIC SYSTEM WHICH IS STARTED AT TIG MINUS 5 MINUTES MAY BE OPERATED WITH THE HYDRAULIC MAIN PUMP IN "NORM PRESS" IN ORDER TO SUPPORT AN ABBREVIATED ACTUATOR CHECK IN MM 303.

Self-explanatory

Reference Rules {A8-104}, FCS CHECKOUT, and {A10-21B}, LOSS OF APU/HYDRAULIC SYSTEM(S) ACTIONS.

FLIGHT RULES

A10-30 LOSS OF APU HEATERS/INSTRUMENTATION [CIL]

- A. AN APU WILL BE STARTED PERIODICALLY OR THE ORBITER ATTITUDE ADJUSTED, IF REQUIRED TO MAINTAIN ACCEPTABLE APU SYSTEM TEMPERATURES. [CIL]

If there is a dual heater failure in an APU subsystem, orbiter attitude adjustment will be considered to prevent component freeze-up. If this is not practical, this rule allows an APU to be started to generate heat in the system and, using the heat soakback, to warm the surrounding components.

Reference Rules {A10-1A}.8, APU LOSS DEFINITIONS [HC], and {A18-451}, ORBITER THERMAL CONSTRAINTS AND ATTITUDE MANAGEMENT [CIL]. ©[ED]

Rules {A8-104}, FCS CHECKOUT; {A8-112}, AEROSURFACE ACTUATOR PROTECTION; {A10-1A}.1, APU LOSS DEFINITIONS [HC]; {A10-21B}, LOSS OF APU/HYDRAULIC SYSTEMS(S) ACTIONS; and {A10-22}, APU START/RESTART LIMITS [HC], reference this rule.

©[ED]

- B. THE FOLLOWING ACTIONS WILL BE TAKEN FOR AN APU WITH BOTH FUEL LINE TEMPERATURE TRANSDUCERS T1 AND T2 LOST:
1. SIDE/TOP SUN SOLAR INERTIAL ATTITUDE WILL BE ESTABLISHED ASAP AND MAINTAINED SUBJECT TO HIGH PRIORITY PAYLOAD REQUIREMENTS (⊙S90 ØS45 FOR APU 3; ⊙S90 ØS315 FOR APU 1, 2).
 2. WHEN NOT IN SIDE/TOP SUN ATTITUDE OR PRIOR TO THERMAL STABILIZATION AFTER SIDE/TOP SUN ATTITUDE HAS BEEN ESTABLISHED, MANUAL HEATER MANAGEMENT WILL BE PERFORMED BY CYCLING APU HEATERS TANK FUEL LINE/H₂O SYSTEMS A AND B SIMULTANEOUSLY TO "AUTO" FOR 18 MINUTES THEN "OFF" FOR 42 MINUTES. THE HEATERS WILL BE TURNED "OFF" DURING ON-ORBIT OPERATIONS WHEN MANUAL HEATER MANAGEMENT IS NOT REQUIRED AND DURING ENTRY. ©[ED]
 - a. FOR SIDE/TOP SUN ATTITUDE ESTABLISHED BEFORE MET = 35 HOURS, MANUAL HEATER MANAGEMENT IS REQUIRED UNTIL MET = 40 HOURS.

THIS RULE CONTINUED ON NEXT PAGE

FLIGHT RULES

A10-30

LOSS OF APU HEATERS/INSTRUMENTATION [CIL] (CONTINUED)

- b. FOR SIDE/TOP SUN ATTITUDE ESTABLISHED AFTER MET = 35 HOURS, MANUAL HEATER MANAGEMENT IS REQUIRED FOR 5 HOURS AFTER SIDE/TOP SUN HAS BEEN ESTABLISHED.

Because APU fuel line heater operation cannot be verified, steps must be taken to ensure that a failed-on heater does not detonate the fuel line, while also ensuring the fuel line does not freeze. Going to a side/top Sun attitude will eventually provide a warm enough environment for the fuel line that the heaters can be turned off. After an MET of 40 hours, going to side/top Sun will provide a stable environment within about 5 hours, but before 40 hours, the MPS cryogenic chilldown in the aft compartment hinders the warming process. For the period prior to the establishment of side/top Sun and thermal stabilization, manual heater cycling must be conducted to try to prevent the fuel from freezing. Both heaters are cycled on simultaneously to preclude a failed-off heater from allowing fuel line freezing, and a manual off cycle is required to prevent a failed-on heater from detonating the line. Once the affected APU is started, heater management is no longer required and the heaters can be powered off for entry.

Analysis by Rockwell-Downey has determined that as long as the manual heater cycling is done when the aft compartment is not warm enough to keep the heater off, the affected APU can be considered good and usable for entry. The APU will be started prior to the deorbit burn to preclude heater management postburn.

Reference Rockwell IL SETO TCS-87-134, Heater Duty Cycles for Low/Intermediate Angle Top LV & GG Attitudes, and SODB submittal R1-1371, December 11, 1987.

3. IF THE INSTRUMENTATION IS LOST BEFORE DEORBIT TIG - 5 MINUTES, THE AFFECTED APU WILL BE STARTED AT TIG - 5 MINUTES.

Because a failed fuel line heater has little or no impact upon an APU that is running, it is best to start this APU at the "single APU start" time in order to protect against subsequent heater failures and to have this APU for entry operations.

4. IF THE INSTRUMENTATION IS LOST AFTER DEORBIT TIG - 5 MINUTES, THE AFFECTED APU WILL BE STARTED ASAP.

As stated above, fuel line heater failures are not a concern when the APU is running. Because there are sufficient consumables margins in all APU's to run for the entire entry, the affected APU can be immediately started.

FLIGHT RULES

A10-31

APU FREEZE/THAW

- A. FOR AN APU THAT HAS SUSTAINED ONE OR MORE FUEL LINE FREEZES THE FOLLOWING ACTIONS WILL BE TAKEN (UNLESS THE FREEZE IS SUSPECTED TO BE THE RESULT OF THE APU LEAKING FUEL) :
 ©[011295-1736C]
1. POWER BOTH 'A' AND 'B' FUEL LINE HEATERS SIMULTANEOUSLY.
 ©[011295-1736C]
 2. ESTABLISH A SIDE/TOP SUN SOLAR INERTIAL ATTITUDE AS LONG AS NECESSARY TO THAW THE FROZEN FUEL LINE SEGMENT (THETA S90 PHI S45 FOR APU 3; THETA S90 PHI S315 FOR APU 1,2) .
- B. FOR AN APU THAT HAS SUSTAINED MULTIPLE FUEL LINE FREEZE/THAW CYCLES AND NO FUEL LEAKAGE IS SUSPECTED, THE APU WILL NOT BE STARTED UNLESS REQUIRED. ©[072398-6685A]

APU data from STS-62, TTA , and McDonnell Douglas indicate that the APU fuel lines can sustain a single freeze/thaw cycle without rupture. The STS-62 fuel line freeze was a result of aft water intrusion that pooled between the fuel line insulation and the fuel line. The sublimation of the water provided enough heat transfer from the hydrazine to overcome the effect of the fuel line heater resulting in a line freeze during the post insertion time frame. The frozen fuel line segment was located near the fuel tank isolation valves downstream of where the test line attaches to the fuel line. This prevented pressure relief back into the APU fuel tank during soakback and resulted in fuel line pressures of around 800 psia. The location of the frozen segment was determined by the effect of the fuel line and test line heaters on the fuel pump inlet pressure trace.

Although difficult to determine, the time frame in which line freezing occurs may help to indicate what type of mechanism is causing the freeze. STS-62 data indicates that the water intrusion failure mode should occur relatively shortly after post insertion.

During STS-62 the engineering community (JSC engineering, RI/Downey, Sundstrand and SR&QA) concluded that there were no constraints with APU operation due to the single freeze/thaw cycle. The APU was started at TAEM due to the slight possibility the fuel line freeze may have been caused by an external fuel leak. Although inconclusive on the exact cause of the failure, post landing examination of the affected area did not reveal any fuel leaks or line bulges.

THIS RULE CONTINUED ON NEXT PAGE

FLIGHT RULES

A10-31

APU FREEZE/THAW (CONTINUED)

The published freezing point of N_2H_4 is 35 Deg F. As N_2H_4 freezes the density increases resulting in a decreased volume. Superpacking results when a line full of liquid transforms into a line full of solid. As N_2H_4 expands during the thaw process line yield may result if the pressures can not be relieved. For this to occur the thaw would have to occur in a trapped volume or from the middle outward in a frozen line segment.

TTA tests performed in 1988 (JSC-22912) used a 3/8 inch diameter APU fuel line to study the effects of frozen N_2H_4 in a superpacked state. The results indicate that line yield occurred in both tests, with a maximum line pressure of 6300 psia. ©[011295-1736C]

A separate theoretical analysis was performed by McDonnell Douglas and JSC which indicate that a fuel line may rupture if it sustains as few as 3 freeze/thaw cycles (McDonnell Douglas Report TM-950002-02, December 23, 1994). The analysis addressed a straight 1/2 inch diameter fuel line that has yielded as a result of the freeze/thaw cycle. The fuel line radius has permanently expanded due to the yield. The line freezes again, and during thaw the resulting pressures further yield the line. This process continues until the ultimate strain of the line has been exceeded which results in rupture. The engineering community feels that this analysis, due to the level of detail, is more representative of the freeze/thaw event as compared with analysis performed during STS-62. RI/Downey performed an analysis on fuel line bends that coupled TTA test data with a theoretical analysis. The engineering community decided, after a review of the analysis, that the fuel line bends could withstand two freeze/thaw cycles. A qualitative review of the fuel line welds and T's found them to be less critical for freeze/thaw than the tube bend section. The McDonnell Douglas analysis also concluded that a straight section of yielded fuel line has infinite fatigue life due to fuel pump pressure cycles and vibration.

Establishing a vehicle attitude will warm the affected APU fuel lines which will accelerate the sublimation of the frozen fluid that may be causing the line freeze.

*Reference Rules {A10-1A}.8, APU LOSS DEFINITIONS [HC], and {A10-33}, APU DEFINITIONS.
©[011295-1736C] ©[072398-6685A] ©[ED]*

FLIGHT RULES

A10-32

APU/HYD CONSUMABLES

A. THE FOLLOWING MATRIX DEPICTS THE BASIS FOR DEFINING APU AND WSB CONSUMABLES REDLINES.

	NOMINAL			AOA		
	APU FUEL (LBS)	WSB		APU FUEL (LBS)	WSB	
		H ₂ O (LBS)	H ₂ O/PGM E (LBS)		H ₂ O (LBS)	H ₂ O/PGME (LBS)
TOTAL AVAILABLE PER SYSTEM	332.0	146.3	144.0	332.0	146.3	144.0
CORE (WSB ONLY)	N/A	3.5	5.0	N/A	3.5	5.0
TANK QUANTITY AVAILABLE	332.0	142.8	139.0	332.0	142.8	139.0
QUANTITY (NORMAL LOAD)	332.0	121.8	139.0	332.0	121.8	139.0
RESIDUALS	5.4	2.8	2.8	5.4	2.8	2.8
LOADING UNCERTAINTY	8.0	1.0	1.0	8.0	1.0	1.0
THERMAL OFF-LOAD (FULL LOAD ONLY)			1.7			1.7
USABLE QTY (QA)	318.6	118.0	133.5	318.6	118.0	133.5
MISSION REQUIREMENTS (MR)	198.1	40.0	60.0	221.6	67.0	101.0
MISSION MARGIN (MM) MM = QA - MR	120.5	78.0	73.5	97.0	51.0	32.5
RESERVES AND ALLOWANCES (RA)	53.4	16.0	24.0	30.3	18.0	27.0
KSC RESERVES PER SYSTEM (KR)	65.7	3.0	5.0	65.7	3.0	5.0
FLIGHT PLANNING MARGIN (FPM) FPM = MM - RA - KR	1.4	59.0	44.5	1.0	30.0	0.5
ESTIMATED USAGE RATE ASC/ORBIT/ENTRY	2.0 -3.5 LBS/MIN	0.15 - 0.8 LBS/MIN	0.2 - 1.2 LBS/MIN	2.0 -3.5 LBS/MIN	0.15 - 0.8 LBS/MIN	0.2 - 1.2 LBS/MIN

@[022405-6569B]

THE CONSUMABLES REDLINE DATA INCLUDE ALLOWANCES FOR:

- [1] WHEELSTOP, LANDING AT KSC @[ED]
- [2] ONE APU FAILURE DURING NOMINAL ENTRY CASE, DURING ASCENT FOR AOA CASE
- [3] 19-MINUTE PRELAUNCH RUN TIME (5-MINUTE LAUNCH RECYCLE, TWO 7-MINUTE LAUNCH HOLDS) @[022405-6569B]

THIS RULE CONTINUED ON NEXT PAGE

FLIGHT RULES**A10-32****APU/HYD CONSUMABLES (CONTINUED)**

The APU fuel values are based upon consumables budgets developed by the generic STS redline analysis performed using composite APU and hydraulic data and generic trajectory tapes. A detailed explanation of all above data is located in the Level B Groundrules and Constraints document (NSTS-21075). The SODB (vol. I, sec. 4.4) also documents the above data. The loading uncertainty is consistent with that of the KSC APU "1317" Fuel Loading Cart. ©[012694-1596] ©[022405-6569B]

The values for the Water Spray Boiler water quantities are based on a review of actual flight data from 63 missions which includes all flights from STS-47 to STS-113 where only the improved APU's were used. The values for the mixture of water and propylene glycol monomethyl ether (PGME) were derived using the data for the water and scaling based on the difference in thermal capacities of water and the water/PGME mixture. This data was presented at A/EFTP #205, September 17, 2004.

- B. MINIMUM PRE-DEORBIT APU FUEL AND WSB H₂O QUANTITY REQUIREMENTS ARE AS FOLLOWS (THESE ASSUME A SINGLE APU/HYDRAULIC SYSTEM STARTED PRIOR TO EXECUTING THE DEORBIT BURN AND APU SHUTDOWN AT WHEELSTOP) :
1. WITH TWO OR THREE APU/HYDRAULIC SYSTEMS OPERATIONAL, 192 LBS APU FUEL AND 54 LBS H₂O (79 LBS H₂O/PGME) ARE REQUIRED. ©[012694-1596] ©[ED]

The APU fuel, WSB H₂O, and H₂O/PGME quantities above are based on the following:

	APU FUEL	WSB (H ₂ O)	WSB (H ₂ O/PGME)
FCS CHECKOUT	14.7	0.0	0.0
DEORBIT COAST	27.1	14.2	21.4
ENTRY	98.0	19.5	29.4
RESIDUALS	5.4	2.8	2.8
LOADING UNCERTAINTY	8.0	1.0	1.0
RESERVES AND ALLOWANCES	53.4	16.0	24.2
TOTALS	206.6 LBS	53.5 LBS	78.8 LBS
TOTAL WITHOUT FCS CHECKOUT	191.9 LBS	53.5 LBS	78.8 LBS

©[012694-1596] ©[022405-6569B]

THIS RULE CONTINUED ON NEXT PAGE

FLIGHT RULES

A10-32

APU/HYD CONSUMABLES (CONTINUED)

2. WITH ONE APU/HYDRAULIC SYSTEM OPERATIONAL, 203 LBS APU FUEL AND 57 LBS H₂O (84 LBS H₂O/PGME) ARE REQUIRED. @[022405-6569B]

The APU fuel, WSB H₂O, and H₂O/PGME quantities above are based on the following:

	APU FUEL	WSB (H ₂ O)	WSB (H ₂ O/PGME)
DEORBIT COAST ENTRY	27.1 108.9	13.2 23.4	19.9 35.3
RESIDUALS LOADING UNCERTAINTY	5.4 8.0	2.8 1.0	2.8 1.0
RESERVES AND ALLOWANCES	53.4	16.0	24.2
TOTALS @[012694-1596]	202.8 LBS	56.4 LBS	83.2 LBS

Rule {A10-29}, FCS CHECKOUT APU OPERATIONS [HC], references this rule. @[022405-6569B]

FLIGHT RULES

A10-33

APU DEFINITIONS

- A. FOR ENTRY/ABORTS AND PLANNING PURPOSES, AN APU IS DEFINED AS "REQUIRED" IF IT IS NEEDED TO PROVIDE THE FOLLOWING: ©[072398-6685A]
1. A SECOND APU/HYDRAULIC SYSTEM FOR ELEVON OR RUDDER/SPEEDBRAKE CONTROL, ©[082604-6318A] ©[121505-7143B]
 2. A SINGLE APU/HYDRAULIC SYSTEM FOR BODYFLAP CONTROL, IF PRIOR TO APPROACH AND LAND INTERFACE,
 3. LANDING GEAR DEPLOY REDUNDANCY,
 4. NWS (IF REQUIRED), OR
 5. BRAKING REDUNDANCY FOR MAINTAINING HALF BRAKES CAPABILITY.

Single APU/hydraulic system operation for the period between EI and wheelstop is uncertified. This is based on the possibility of hydraulic pump overdemand that can occur due to elevon and rudder/speedbrake movement. However, a single APU/hydraulic system is sufficient to control the bodyflap. At approach and land interface (starting at approximately 10,000 ft altitude), the bodyflap is commanded to trail and remains there until it is repositioned post-landing. The critical need for gear deploy necessitates having deploy redundancy when possible. NWS requirements are defined in Rule {A10-141A}, NOSE WHEEL STEERING (NWS) [HC]. Braking redundancy is satisfied if the next failure (following recovery of the "required" APU) results in at least single string, 50 percent braking. ©[082604-6318A] ©[ED]

- B. FOR ENTRY/ABORTS AND PLANNING PURPOSES, AN APU IS DEFINED AS BEING "NEEDED AS A LAST APU" IF IT IS NEEDED TO PROVIDE THE FOLLOWING: ©[082604-6318A]
1. THE LAST METHOD OF CONTROL FOR AN ELEVON OR THE RUDDER/SPEEDBRAKE, ©[121505-7143B]

THIS RULE CONTINUED ON NEXT PAGE

FLIGHT RULES

A10-33

APU DEFINITIONS (CONTINUED)

2. THE LAST METHOD OF CONTROL FOR THE BODYFLAP, IF PRIOR TO APPROACH AND LAND INTERFACE AND ANOTHER BODYFLAP CONTROL COMBINATION CANNOT BE RECOVERED, @[121505-7143B]
3. THE LAST METHOD OF GEAR DEPLOY, OR
4. THE LAST METHOD OF BRAKING.

This definition applies to those cases where operation of the affected system, even if it entails considerable risk, is necessary to prevent a catastrophic condition.

The elevons and rudder/speedbrake are required to maintain vehicle control, so at least one APU/hydraulic system must be operating for these surfaces from EI through wheelstop.

The bodyflap is driven as a function of the auto elevon schedule to mitigate and balance a variety of factors during a shuttle entry. Early in the entry profile, the elevon schedule keeps the bodyflap and elevons from experiencing excessive heating while allowing the surfaces to respond to and trim out pitch moments. Early entry elevon schedule also takes into account thermal concerns on the SSME's and the orbiter itself. As the peak heating loads subside, the focus of the elevon schedule shifts to ensure that the elevons have sufficient effectivity to provide lateral vehicle control. During STS-31, a bodyflap "pulse" was performed by the crew to aid in defining the aero uncertainties of the vehicle. Just above Mach 9, the bodyflap was driven down momentarily, causing the elevons to drive up to compensate. As a result, lateral stability control was momentarily lost, causing a 5 deg/sec roll excursion. Control settled out once the bodyflap was driven back in place. A study performed in 2003 using engineering simulators showed similar results (LOC at approximately Mach 8) with the bodyflap stuck below 70 percent. It should be noted that mass properties as well as other variables can significantly impact the vehicle's ability to maintain lateral control stability. The study mentioned used the STS-107 mass properties. A comprehensive study to evaluate the impact of having a failed bodyflap on vehicle control has never been performed.

There are portions of the entry profile (around Mach 1) where dynamic bodyflap control is critical. As the transonic region approaches and the rudder takes over some of the lateral control requirements, the elevon schedule focuses on elevon hinge moments. In the transonic region, shock patterns can drastically alter aero-surface forces. This flight regime incurs the most dynamic bodyflap motion in an effort to reduce elevon hinge moments. @[121505-7143B]

THIS RULE CONTINUED ON NEXT PAGE

FLIGHT RULES

A10-33**APU DEFINITIONS (CONTINUED)**

There are three bodyflap control channels, each tied to a specific FA MDM. Each channel in turn is matched to a specific APU/hydraulic system so that the control combinations are FA1 and APU/HYD 1, FA2 and APU/HYD 2, and FA3 and APU/HYD 3. At a minimum, one of these combinations is needed to control the bodyflap. Loss of bodyflap control does not lead to immediate loss of vehicle control - there is time to take action to regain another control channel and APU/hydraulic system combination if such a recovery option is available. If recovery is not possible, then the APU providing bodyflap control meets the criteria of being "needed as a last." However, as long as the option exists to quickly (within approximately 30-45 seconds, worst case based on failures leading to a stuck bodyflap only) recover another combination (by restarting a shut down, but operable APU; restringing to regain an FA MDM; etc.), then the APU providing bodyflap control does not meet the criteria of being "needed as a last." ©[121505-7143B]

At approach and land interface (starting at approximately 10,000 ft altitude), the bodyflap is commanded to trail and remains there until it is repositioned post-landing, so protecting for bodyflap control is no longer necessary.

Regaining NWS, even for cases where a known directional control problem exists, is not considered sufficient reason to accept the risk of operating a severely impaired system. Landing with an excessive crosswind is avoided procedurally; however, if a crosswind above the surface wind limit develops after the deorbit burn, steering authority should be acceptable using differential braking. Uncommanded brake pressure is unlikely since hydraulic pressure is unavailable to the brakes until post-MGTD. For a failed MLG tire, the tire failure mitigation techniques, tested in the Ames VMS in 2003 and accepted at A/EFTP #194, October 31, 2003, can be used to reduce the possibility of failing the remaining tire on the affected strut. If the remaining tire does not fail, steering can be accomplished using differential braking if NWS is unavailable.

Reference Rule {A8-116}, AEROJET DAP SYSTEMS MANAGEMENT. ©[121505-7143B]

- C. AN APU "START" IS DEFINED AS INITIATING APU OPERATION WHILE BRANCH PASSAGE TEMPERATURE IS WITHIN ACCEPTABLE LIMITS WITHOUT REQUIRING ACTIVE GG INJECTOR COOLING. ©[082604-6318A]
- D. AN APU "RESTART" IS DEFINED AS INITIATING APU OPERATION WHEN ACTIVE GG INJECTOR COOLING WAS REQUIRED TO ENSURE ACCEPTABLE BRANCH PASSAGE TEMPERATURE.

THIS RULE CONTINUED ON NEXT PAGE

FLIGHT RULES

A10-33**APU DEFINITIONS (CONTINUED)**

E. AN APU "HOT RESTART" IS DEFINED AS INITIATING APU OPERATION WHILE BRANCH PASSAGE TEMPERATURE IS ABOVE ACCEPTABLE LIMITS.

These are the definitions for "START," "RESTART," and "HOT RESTART" used by other flight rules. Branch passage temperatures must be below 450 deg F for a safe (re)start. There is no direct measurement for injector branch passage temperature; gas generator (GG) injector and bed temperature measurements are used to infer acceptable branch passage temperature for APU start conditions. For restarts, testing has shown that the branch passage will be at an acceptable temperature immediately following a nominal 209-second cooldown by the GG injector cooling system, regardless of the initial and final GG injector and bed temperatures. Initiation of APU operation with the GG injector and bed temperatures above the start limits and without an immediate, complete cooldown results in a hot restart.

©[082604-6318A]

Reference Rule {A10-22A}, APU START/RESTART LIMITS [HC]. ©[072398-6685A] ©[ED]

Hazard Reports ORBI 121, Hydrazine (N₂H₄) Adiabatic Bubble Compression Detonation (ABCD) in the APU System; ORBI 250, Hydrazine Leakage from the APU System Results in Catastrophic Loss; and ORBI 265, Overheating of Hydrazine in the APU Due to Controller or Injector Cooling Failures Could Result in Fire/Explosion, reference this rule. ©[121505-7143B]

Rules {A10-22E}, F, H, APU START/RESTART LIMITS [HC]; {A10-24B}, D, E, APU OIL/GEARBOX TEMPERATURE/PRESSURE; {A10-25E}, APU HIGH SPEED SELECTION/SHIFT; {A10-26}, APU AUTO SHUTDOWN INHIBIT MANAGEMENT [HC]; {A10-31B}, APU FREEZE/THAW; and {A10-72E}, HYDRAULIC LEAKS, reference this rule. ©[082604-6318A] ©[ED]

A10-34 THROUGH A10-50 RULES ARE RESERVED

FLIGHT RULES

HYDRAULIC SYSTEMS LOSS/FAILURE DEFINITIONS [ED]

A10-51 HYDRAULIC LOSS DEFINITIONS

A. A HYDRAULIC SYSTEM IS CONSIDERED LOST IF:

1. IT IS UNABLE TO PROVIDE HYDRAULIC PUMP PRESSURE OF 2760-3500 (2860-3400) PSIA AT DEMANDED FLOW WITH THE APU RUNNING AND THE MAIN PUMP PRESSURIZED.

Operation of the hydraulic actuators requires a minimum pressure of 2700 psi. A 60 psi safety margin is given. Maximum hydraulic pressure is 3500 psia (reference SODB, vol. I, 3.4.3.1-12 and 4.2.4.8.1.).

2. THE SYSTEM HAS A CONFIRMED NONISOLATABLE HYDRAULIC LEAK: [022201-3989]
 - a. DURING ASCENT/ORBIT, THE SYSTEM WILL BE CONSIDERED LOST FOR PLANNING PURPOSES.

For planning purposes, a system with a nonisolatable leak should be considered lost since its capability to support entry from EI through wheelstop in NORM PRESS is suspect. [ED]

- b. DURING ENTRY/ABORTS, THE SYSTEM WILL BE CONSIDERED FAILED IF THE ASSOCIATED RESERVOIR QUANTITY IS LESS THAN 20 (25) PERCENT FOR SYSTEM 1, OR 5 (10) PERCENT FOR SYSTEMS 2 AND 3.

A reservoir quantity of 20 percent is required for system 1 due to the drop in quantity typically seen at landing gear deploy; this quantity drop is typically 12 to 16 percent. Failure to maintain 20 percent for landing gear deploy may lead to pump cavitation and the loss of that system. Since systems 2 and 3 are prime for elevon operation, a reservoir quantity of 5 percent is required to protect control system operations during approach and landing (reference SODB, vol. I, 3.4.2.4.4.). [022201-3989] [062603-6039]

3. HYDRAULIC FLUID TEMPERATURES CANNOT BE MAINTAINED ABOVE - 40 DEGREES F.

At -40 deg F, the hydraulic fluid viscosity will have increased to a point where it is no longer possible for the hydraulic main pump to push the fluid through the system. Other hydraulic system components may be damaged if their temperatures are less than -65 deg F (reference SODB, vol. I, table 3.4.2.4-1.).

THIS RULE CONTINUED ON NEXT PAGE

FLIGHT RULES**A10-51****HYDRAULIC LOSS DEFINITIONS (CONTINUED)**

4. A SWITCHING VALVE WILL NOT SELECT A HYDRAULIC SYSTEM TO AN ACTUATOR (DUE TO A FAILURE IN THE SWITCHING VALVE). (FAILURE OF PRIMARY/STANDBY 1 VALVE TO STANDBY 1 POSITION IS LOSS OF ONE SYSTEM. FAILURE OF STANDBY 2 VALVE TO STANDBY 2 POSITION IS LOSS OF TWO SYSTEMS.)

Switching valves are two-position valves which compare pressure between two of the redundant hydraulic systems assigned to a control element to ensure that the actuator receives flow from a hydraulic system with adequate pressure. Redundant hydraulic systems are designated as primary, standby 1, and standby 2 systems.

An actuator having three redundant hydraulic systems assigned to it will have two switching valves, a primary/standby 1 valve and a standby 1/standby 2 valve. A switching valve failure to one position will only allow pressure from the hydraulic systems assigned to that position to operate the actuator. The hydraulic system assigned to the other position is essentially lost insofar as the actuator is concerned.

A failure in the primary/standby 1 valve to either position results in the loss of one of the hydraulic systems to the actuator. A failure in the standby 1/standby 2 valve to the standby 1 position results in the loss of one system, the standby 2 system. Both the primary and standby 1 systems may still operate the actuator through the standby 1 port.

A failure of the standby 1/standby 2 valve to the standby 2 position will allow only the standby 2 system to operate the control element, resulting in the loss of the primary and standby 1 systems.

5. UNABLE TO MAINTAIN RESERVOIR PRESSURE GREATER THAN 15 (28) PSIA WITH THE APU NOT RUNNING. ©[ED]

Hydraulic pumps may cavitate with insufficient head pressure at startup. Main pumps require a minimum 15 psia positive pressure to start. Reference SODB, vol. I, 3.4.2.4-7.

Rules {A10-23}, APU ENTRY START TIME [HC]; {A10-73E}, HYDRAULIC SYSTEMS PRESSURE/TEMPERATURE [CIL]; and {A10-74A}.1, HYDRAULIC CIRCULATION PUMP OPERATION [CIL], reference this rule. ©[051194-1619B] ©[070899-6879A] ©[ED]

THIS RULE CONTINUED ON NEXT PAGE

FLIGHT RULES

A10-51 HYDRAULIC LOSS DEFINITIONS (CONTINUED)

- B. A HYDRAULIC CIRCULATION PUMP WILL BE CONSIDERED LOST IF THE CIRCULATION PUMP BODY TEMPERATURE IS > 230 (222) DEG F, OR RESERVOIR TEMPERATURE > 230 (222) DEG F WHILE THE CIRCULATION PUMP IS RUNNING. ©[091098-6554B]

Operating a circulation pump above 230 deg F exceeds the circulation pump electronics temperature limit. (ref SODB, vol. I, table 3.4.2.4-1). Testing has shown that operating a circulation pump above this limits significantly reduces the pump electronics lifetime. The loss of a circulation pump alone is not considered loss of a hydraulic system. If the circulation pump is running to maintain accumulator pressure fore a leaking accumulator, it is possible that the accumulator may lock up (as it did on STS-50). Therefore, the loss of a circulation pump does not require loss of a hydraulic system actions. ©[051194-1619B]

Rule {A10-73E}, HYDRAULIC SYSTEMS PRESSURE/TEMPERATURE [CIL], references this rule.

©[051194-1619B] ©[091098-6554B] ©[ED]

A10-52 THROUGH A10-70 RULES ARE RESERVED

FLIGHT RULES

HYDRAULIC SYSTEMS MANAGEMENT [ED]

A10-71 HYDRAULIC SYSTEMS CONFIGURATION [HC] [ED] [031705-6668A]

- A. THE LANDING GEAR EXTEND ISOLATION VALVE WILL REMAIN CLOSED EXCEPT WHEN OPENED DURING ENTRY/ABORTS.

Landing gear extend isolation valve remains closed to safeguard the hydraulic system from attempting to deploy the landing gear at any time other than landing. The landing gear cannot be retracted during flight once it has been deployed. Landing gear extend isolation valve is opened when the vehicle reaches V_{rel} of 800 fps to set up gear deployment.

Hazard reports ORBI 182, Premature Landing Gear Deployment; ORBI 184, Loss of Directional Control Due to Failed Nosewheel Steering; and ORBI 188, Lack of or Incomplete Landing Gear Deployment, reference this rule. [031705-6668A]

- B. THE BRAKE ISOLATION VALVES WILL REMAIN CLOSED UNTIL OPENED DURING ENTRY/ABORTS UNLESS REQUIRED FOR ON ORBIT THERMAL CONDITIONING.

Brake isolation valves 1, 2, and 3 remain closed when the landing gear systems are not in use to protect the hydraulic systems in the event of a leak downstream of one of the isolation valves. All brake isolation valves open automatically at main gear touchdown.

- C. DURING ENTRY/ABORTS, IF AUTOMATIC CAPABILITY TO OPEN A BRAKE ISOLATION VALVE AT WOW IS LOST, THE VALVE WILL BE OPENED MANUALLY AFTER $M=8$ TO PROVIDE NWS (IF REQUIRED) OR FULL BRAKING. BRAKE ISOLATION VALVE 2 WILL BE OPENED BETWEEN $M=8$ AND LANDING GEAR DEPLOY IF REQUIRED TO PROVIDE REDUNDANT NLG DEPLOY.

To protect against uncommanded brake pressure, brake isolation valves will only be opened manually for the cases listed. It is desirable to open the valves during wings-level flight periods to reduce the risk of vertigo in the PLT. Manual valve opening will be delayed until after $M=8$ to reduce the opportunity for silting of the brake system (can lead to uncommanded brake pressure). Brake silting is a function of the time the isolation valve is open with the hydraulic system in NORM PRESS. Reference Ascent/Entry Flight Techniques Panel #45 minutes, June 23, 1988.

The risk of uncommanded brake pressure is acceptable to gain redundant nose landing gear deploy capability.

THIS RULE CONTINUED ON NEXT PAGE

FLIGHT RULES

A10-71 HYDRAULIC SYSTEMS CONFIGURATION [HC] (CONTINUED)

Opening brake isolation valves after WOW for braking and nosewheel steering retains protection against uncommanded brake pressure, which is no longer catastrophic after wheel spinup. However, manual valve opening prior to landing is acceptable, if automatic capability is lost, due to the high crew workload after touchdown and the risk of inducing vertigo. Allowing the isolation valves to open automatically is considered acceptable due to the inherent reliability of the redundant WOW cue. Brake energy and rollout margin calculations do not protect for the loss of half brakes (reference Rule {A4-108}, TIRE SPEED, BRAKING, AND ROLLOUT REQUIREMENTS [HC]). Half brakes are adequate for any directional control requirements between MGTD and NGTD. For uncommanded brake pressure actions, reference Rule {A10-145}, UNCOMMANDED BRAKE PRESSURE [CIL]. For nosewheel steering requirements, reference Rule 777

A}, NOSE WHEEL STEERING (NWS). ©[042706-7363A]

Hazard reports ORBI 182, Premature Landing Gear Deployment; ORBI 184, Loss of Directional Control Due to Failed Nosewheel Steering; and ORBI 188, Lack of or Incomplete Landing Gear Deployment, reference this rule. ©[031705-6668A]

D. THE MPS/TVC ISOLATION VALVES WILL BE CLOSED ON ORBIT AND WILL REMAIN CLOSED EXCEPT FOR SSME HYDRAULIC REPRESSURIZATION AND SSME REPOSITIONING.

The TVC isolation valves are pressure-actuated valves requiring a minimum of 100 psid positive pressure to close. This pressure may be supplied by the APU or the hydraulic circulation pump.

Closing the MPS/TVC isolation valve during powered flight will cause the hydraulically actuated main engine valves to lock up, so the MPS/TVC isolation valve is left open past MECO.

The MPS/TVC isolation valves are normally closed after SSME stowage on orbit is complete.

Two isolation valves are normally opened for 10 seconds each prior to EI to repressurize the hydraulic fluid in the TVC actuators (SSME HYD REPRESS). This is done to eliminate any voids which may be formed in the actuators due to hydraulic fluid contraction as a result of orbit cooling. Eliminating the voids ensures that the actuators will hold the engine bells in place when subjected to aerodynamic loads during entry.

The isolation valves will be cycled in order to reposition the main engines to preclude contact with the drag chute during deploy and post-rollout for rain drain.

THIS RULE CONTINUED ON NEXT PAGE

FLIGHT RULES

A10-71 HYDRAULIC SYSTEMS CONFIGURATION [HC] (CONTINUED)

- E. THE HYDRAULIC MAIN PUMP WILL BE RUN IN "NORM PRESS" AFTER APU START ON A HYDRAULIC SYSTEM WITH AN ACCUMULATOR LEAK.

Accumulator pressure is used to charge the hydraulic reservoir and maintain the required inlet pressure for the main pump to operate without cavitation. The main pump must provide its own inlet pressure through a bootstrap system when the accumulator has lost its charge. Operating the main pump at low pressure (800 psi) may not provide sufficient head pressure at the pump inlet (reference RIC IL 288-503-81-055, November 10, 1981). The main pump is nominally run in low pressure after APU start on an APU started prior to the deorbit burn.

- F. THE FOLLOWING ACTIONS WILL BE PERFORMED TO STOP BACKDRIVING ON A SPEEDBRAKE HYDRAULIC MOTOR: ©[031705-6668A]
1. IN OPS 1 (POST-MECO), OR IN MM304 PRIOR TO MACH 10, CLOSE OR CYCLE (OPEN, THEN CLOSE) THE ASSOCIATED HYDRAULIC SYSTEM'S MPS/TVC ISOLATION VALVE.
 2. IN OPS 1 (POST-MECO AND PRIOR TO COMPLETION OF THE MPS DUMP), TAKE ONE OF THE TWO REMAINING HYDRAULIC SYSTEMS TO "LOW PRESS."
 3. IN OPS 1 (FOLLOWING COMPLETION OF THE MPS DUMP), TAKE THE REMAINING HYDRAULIC SYSTEM(S) TO "LOW PRESS."

Backdriving is a condition where a speedbrake hydraulic motor is driven in the opposite direction of its normal operation by other speedbrake motors. This situation can occur when the speedbrake is commanded to overclose (-10 degrees) and a speedbrake motor output torque is reduced (through a loss of associated normal hydraulic pressure). This scenario allows the other motor(s) to overcome the diminished output torque, causing the affected motor to drive in the opposite direction. With sufficient pressure remaining in the hydraulic system, the spring-loaded, hydraulically-released motor brake does not engage. Damage to the speedbrake gears, in the form of gear scuffing, can result from backdriving. Gear scuffing caused by backdriving can lead to failure of the rudder/speedbrake gearbox, which is a critical failure. ©[031705-6668A]

THIS RULE CONTINUED ON NEXT PAGE

FLIGHT RULES

A10-71

HYDRAULIC SYSTEMS CONFIGURATION [HC] (CONTINUED)

A backdriving speedbrake hydraulic motor is operating in an out-of-design condition; therefore, it is prudent to minimize the time the motor is operating in this fashion. These actions cannot prevent backdriving or the associated damage, but may mitigate the damage by stopping the backdriving once it has started. Closing the MPS/TVC ISOL VLV that is associated with the backdriving motor will cause a pressure spike to travel through the hydraulic system, thus giving the motor brakes a chance to engage and stop the backdrive. Placing the remaining hydraulic main pumps in "Low Press" will also stop the backdriving due to the loss of input torque from the associated motor(s). This is only an option when normal hydraulic pressure is no longer required (i.e., post-MPS DUMP through EI-5). Between MECO and the completion of the MPS dump, one hydraulic system must remain in "Norm Press." Therefore, taking a system to "Low Press" to stop the backdrive is performed during this timeframe only as long as the third system is operating in "Norm Press." ©[031705-6668A]

The speedbrake hydraulic motors are only susceptible to backdriving when the overclose command is present. This condition and resulting window of exposure occurs throughout all of OPS 1 and from MM304 to Mach 10. The overclose command of -10 degrees is required to protect the rudder/speedbrake system from an FCS channel hardover failure in the open direction, which would cause the speedbrake panels to open momentarily and then slam closed. While this overclose command is present, any loss of normal hydraulic pressure in any system (either from an APU/hydraulic failure or from taking a hydraulic system to "Low Press") will place the speedbrake hydraulic motor system into a situation where backdriving is possible.

Reference Ascent/Entry Flight Techniques Panels #200, April 23, 2004, and #209A, January 21, 2005.

Reference FMEA #02-2A-011112-X, Rudder Speed Brake, Power Drive Unit Gearbox: failure modes - 01, -02, -03. ©[031705-6668A]

FLIGHT RULES

A10-72

HYDRAULIC LEAKS

FOR A HYDRAULIC FLUID LEAK, THE FOLLOWING ACTIONS WILL BE TAKEN:

- A. DURING ASCENT, NO ACTION WILL BE TAKEN UNTIL POST-MECO. IF THE APU/HYDRAULIC SYSTEM IS STILL OPERATING POST-MECO, THE APPROPRIATE MPS/TVC ISOLATION VALVE WILL BE CLOSED. IF THE LEAK IS NOT SUBSEQUENTLY ISOLATED, THE SYSTEM(S) WILL BE TAKEN TO "LOW PRESS" AND/OR SHUT DOWN AS REQUIRED IN ORDER TO EVALUATE AND MAINTAIN REMAINING CAPABILITY. ©[072398-6686B]

The MPS/TVC isolation valve is closed in an attempt to isolate the leak if the leak is downstream of the isolation valve. Closing the MPS/TVC isolation valve before MECO would cause the main engine hydraulically actuated valves to lock up, resulting in a loss of throttle control and TVC redundancy.

If the leak is not isolated by closing the MPS/TVC valve, the leaking hydraulic system should be taken to low pressure to reduce the stress on the system while allowing continued evaluation of the leak. Efforts within system limitations will be made to verify that the location of leakage does not exist downstream of an actuator switching valve where it could potentially cause imminent loss of all three hydraulic systems. Additionally, the leak could be due to intersystem leakage. It may become necessary to depressurize additional hydraulic systems to try to pinpoint the source of the leak. If the leak is determined to be downstream of an actuator switching valve, a mission abort will be required.

After all pertinent troubleshooting has been completed, the APU should be shut down as soon as practical to further reduce the pressure on the system thereby reducing the leak.

Rule {A2-54}, RTLS, TAL, AND AOA ABORTS FOR SYSTEMS FAILURES [CIL], references this rule. ©[072398-6686B]

- B. ON ORBIT, IF A LEAK IS DETECTED AND THE ASSOCIATED HYDRAULIC SYSTEM BRAKE ISOLATION VALVE IS OPEN, THE VALVE WILL BE CLOSED ASAP.

Closing the brake isolation valve may isolate the leak. If the leak is isolated, then the valve will remain closed to protect the system and to limit the amount of hydraulic fluid leaked into the wheel well. This reduces the chance of a fire at wheelstop due to hydraulic fluid on hot brakes. ©[ED]

THIS RULE CONTINUED ON NEXT PAGE

FLIGHT RULES**A10-72****HYDRAULIC LEAKS (CONTINUED)**

- C. DURING ENTRY/ABORTS, IF A LEAK IS DETECTED PRIOR TO TOUCHDOWN AND THE ASSOCIATED SYSTEM BRAKE ISOLATION VALVE IS OPEN AND THE LEAK WILL NOT SUPPORT OPERATIONS THROUGH WHEELSTOP, THE VALVE WILL BE CLOSED ASAP. THE VALVE MAY BE OPENED AT TOUCHDOWN TO PROVIDE BRAKING AND WILL BE CLOSED ASAP POST-WHEELSTOP. ©[ED]

The brake isolation valve will be allowed to open automatically at main gear touchdown to provide braking capability but must be closed ASAP post-wheelstop to reduce the amount of hydraulic fluid leaked into the fuselage or wheel well. This will reduce the chance of a tire fire due to hydraulic fluid on hot brakes if the leak is in the wheel well. ©[ED]

- D. DURING ENTRY/ABORTS, IF A LEAK IS DETECTED AND THE LANDING GEAR EXTEND ISOLATION VALVE IS OPEN AND THE LEAK WILL NOT SUPPORT OPERATIONS THROUGH WHEELSTOP, THE VALVE WILL BE CLOSED ASAP. THE VALVE WILL BE REOPENED ONLY TO GAIN NWS OR REDUNDANT LANDING GEAR DEPLOY. THE VALVE WILL BE CLOSED ASAP POST-WHEELSTOP. ©[ED]

Closing the landing gear extend isolation valve may isolate the leak, and hydraulics for NWS and two methods of gear deploy remain. If the leak is isolated, the valve will remain closed to preserve the system unless NWS or a redundant landing gear deploy method is required. In these cases, the valve will be opened near the ground and closed post-wheelstop to minimize the amount of hydraulic fluid leaked. This reduces the chance of a fire due to hydraulic fluid on hot brakes if the leak is in the wheel well. ©[ED]

- E. DURING ENTRY/ABORTS, A SYSTEM WITH A NONISOLATABLE HYDRAULIC LEAK WILL HAVE ITS MAIN PUMP TAKEN TO "LOW PRESS". IF THE LEAK RATE IS SUCH THAT, WITH "NORM PRESS" SELECTED AT HAC INTERCEPT, THE SYSTEM WILL: ©[072398-6686B]

Taking the main hydraulic pump to "low press" will likely slow the leak by reducing pressure in the system. Even if the leak rate as detected in "norm press" will support to wheelstop, there is a possibility that the leak will become larger, so the system should be depressurized to improve its chances of supporting the later phase of entry. To protect for a subsequent failure of one of the good systems, the leaking system should be allowed to operate in "low press" to be ready to provide two APU/Hydraulic systems during entry should another APU/Hydraulic system fail.

THIS RULE CONTINUED ON NEXT PAGE

FLIGHT RULES

A10-72

HYDRAULIC LEAKS (CONTINUED)

1. SUPPORT TO WHEELSTOP, THE SYSTEM, IF REQUIRED, WILL BE TAKEN BACK TO "NORM PRESS" AS SOON AS THE CAPABILITY TO SUPPORT TO WHEELSTOP IS ACHIEVED (NO EARLIER THAN TAEM).
2. NOT SUPPORT TO WHEELSTOP, THE APU WILL BE SHUTDOWN. THE APU WILL BE RESTARTED (TIME PERMITTING), IF REQUIRED, WHEN THE LEAKING SYSTEM WILL SUPPORT TO WHEELSTOP.

If the leaking hydraulic system will not support entry at its present leak rate, then the APU should be shut down to minimize fluid leakage. It will be restarted later to support the final phase of entry if there is enough time to perform a cooldown and restart. ©[072398-6686B]

During STS-76, when a known hydraulic leak existed, the APU was started at TAEM with the hydraulic system kept in "low press" for the remainder of the entry. Remaining in "low press" affords support in a standby mode while minimizing fluid leakage. Additionally, remaining in "low press" allows the other two good hydraulic systems to be in control of all the aerosurface actuators. In the event that the leaking system fails at a critical time while close to the ground, the aerosurface switching valves will already be set up to use the good system(s) and will not enter into a "chattering" mode whereby control could be jeopardized. ©[072398-6686B]

Reference Rule {A10-33}, APU DEFINITIONS. ©[072398-6686B]

FLIGHT RULES

A10-73

HYDRAULIC SYSTEMS PRESSURE/TEMPERATURE [CIL] ©[ED]

- A. A HYDRAULIC SYSTEM THAT CANNOT MAINTAIN > 200 (300) PSIA WILL HAVE ITS APU SHUT DOWN. DURING ASCENT, THE APU WILL BE SHUT DOWN POST-MECO.

Running the main pump at less than 200 psi does not support actuator performance and may result in cavitation and/or overheating of the main pump due to insufficient hydraulic fluid flow.

- B. A HYDRAULIC SYSTEM WILL BE TAKEN TO "LOW PRESS" OR ITS APU SHUT DOWN (DURING ASCENT, THE APU WILL BE SHUTDOWN POST-MECO), IF PUMP PRESSURE FLUCTUATIONS OCCUR SUCH THAT PUMP OUTLET PRESSURE REPEATEDLY FALLS BELOW 1500 (1600) PSI. [CIL]

Pressure fluctuations below 1500 psi are indicative of a malfunction in the main pump compensator system. This type of failure will not allow the pump to maintain system pressure on demand.

The pump supply pressure will decrease in response to the demand from an actuator supplied by the pump. The actuator will not respond until the failed system pressure falls below the switching valve pressure (1500 psi). At that pressure, the standby hydraulic system cycles the switching valve and takes over control of the actuator. With the standby system controlling the actuator and the demand gone, the failed hydraulic pump pressure will recover and eventually the switching valve will cycle back to the failed system. The switching valve will cycle in this manner each time the actuator is commanded.

The switching valve cycling will cause the actuator response to be slower due to the time required for the switching valve to transfer. Additionally, continued operation of the actuator could cause switching valve cycling to occur at a rapid rate, which could cause damage to the valve or create undesirable vibration frequencies due to pressure fluctuations.

Depressurizing the failed pump will drop its output pressure to 800 to 1000 psi, which will allow the standby hydraulic systems to cycle the switching valves and take control of the actuators. If the main pump cannot be depressurized, the APU will have to be shut down.

THIS RULE CONTINUED ON NEXT PAGE

FLIGHT RULES

A10-73

HYDRAULIC SYSTEMS PRESSURE/TEMPERATURE [CIL]
(CONTINUED) @[ED]

- C. DURING ASCENT, NO ACTION WILL BE TAKEN FOR A HIGH HYDRAULIC RESERVOIR TEMPERATURE UNTIL AFTER MECO. DURING ENTRY/ABORTS, THE FOLLOWING ACTIONS WILL BE TAKEN:
1. THE HYDRAULIC MAIN PUMP WILL BE TAKEN TO "LOW PRESS" IF THE RESERVOIR TEMPERATURE EXCEEDS 250 DEG (**TBD**) F.
 2. THE APU WILL BE SHUT DOWN IF THE RESERVOIR TEMPERATURE EXCEED 275 DEG (268 DEG) F.

The hydraulic reservoir temperature increases based on the amount of APU run time and the load on the system. Flight data has shown that ascent conditions typically cause the hydraulic reservoir temperatures to increase to 150 deg to 175 deg F at APU shutdown (approximately 4 to 8 minutes after MECO). For this reason, the reservoir temperature is very unlikely to demand action prior to MECO, except in the case of a pump compensator failure. This failure results in high output pressure and flow through the relief valve and is considered unlikely. The hydraulic system design is, therefore, considered to be protection against exceeding the SSME interface temperature requirements (reference SODB, vol. I, 3.4.2.4-12.).

Hydraulic fluid temperatures in excess of 275 deg F can cause degradation of the hydraulic seals which could ultimately lead to leakage (ref. SODB, vol. I, 3.4.2.4.1.d). Depressurizing the main pump reduces the heat input into the hydraulic system and should allow the APU to continue operating. If depressurizing the main pump fails to maintain the reservoir temperature below 275 deg F, the APU will have to be shut down.

- D. DURING DEORBIT, HYDRAULIC THERMAL CONDITIONING WILL BE PERFORMED IF THE ACTIVE HYDRAULIC SYSTEM FLUID LINE TEMPERATURES ARE PREDICTED TO BE < 35 DEG F, OR THE FIRST STANDBY SYSTEM FLUID LINE TEMPERATURES ARE PREDICTED TO BE < 0 DEG F AT EI.

The active hydraulic system fluid line temperatures are required to be > 35 deg F since this is the minimum hydraulic fluid temperature where optimum system performance can be expected. Standby system temperatures need to be above 0 deg F (per Rockwell/Downey thermal analysis) by EI so they may be quickly warmed up to the full performance temperature if required. Preentry hydraulic thermal conditioning involves cycling the aerosurfaces with all three APU's running before EI (reference SODB, vol. I, table 3.4.2.4.1.).

THIS RULE CONTINUED ON NEXT PAGE

FLIGHT RULES

A10-73

HYDRAULIC SYSTEMS PRESSURE/TEMPERATURE [CIL]
(CONTINUED) @[ED]

- E. ON ORBIT, ATTEMPTS WILL BE MADE TO MAINTAIN HYDRAULIC RESERVOIR TEMPERATURE < 162 (154) DEG F PRIOR TO APU START. THE FOLLOWING ARE ACCEPTABLE METHODS TO ATTEMPT TO MAINTAIN RESERVOIR TEMPERATURES < 162 (154) DEG F.
1. MINIMIZE CIRC PUMP RUN TIME WHILE MAINTAINING RSVR p > 15 (28) PSIA. @[ED]
 2. POWER DOWN ORBITER/SPACELAB EQUIPMENT OR RECONFIGURE THE ORBITER ACTIVE THERMAL COOLING SYSTEM (ATCS) TO LOWER FREON TEMPERATURES AT THE FREON/HYDRAULIC HEAT EXCHANGER TO < 95 DEG F AS INDICATED BY THE FREON COOLANT RAD IN TEMP (V63T1209A AND V63T1409A).

During STS-50, hydraulic system 2 circulation pump was run for extended periods due to an accumulator GN2 leak. The hydraulic system fluid temperature continued to increase during this time. Post flight data revealed the increase was due to high Freon temperatures (Freon temperatures greater than 95 deg F at the Freon/hydraulic heat exchanger). As the hydraulic fluid temperature increased, the Freon/hydraulic heat exchanger bypass valve cycled causing the hydraulic fluid to bypass the heat exchanger. Heat from the hydraulic circ pump caused the hydraulic fluid temperature to continue to increase until the circulation pump was taken off. Flight data indicates that maintaining Freon temperatures below 95 deg F allows the hydraulic fluid to reject heat to the Freon loops and prevents the bypass valve from bypassing the Freon/hydraulic heat exchanger (the bypass valve cycles when the hydraulic fluid reaches 115 deg F). Once the heat exchanger is bypassed, the hydraulic fluid will continue to heat up as long as the circulation pump continues to run.

Minimizing circulation pump run time will minimize the heat added to the hydraulic system. The reservoir pressure however should not be allowed to drop below 15 (24) psia (reference Rule {A10-51A}.5, HYDRAULIC LOSS DEFINITION).

Powering down orbiter and Spacelab equipment, deploying the radiators, or activating the FES can lower the Freon/hydraulic heat exchanger temperature. Radiator deployment will not affect the Freon/hydraulic heat exchanger temperature.

Excessively high hydraulic systems temperatures can lead to a delayed APU start for entry and loss of the hydraulic circulation pump (reference Rules {A10-23B}, APU ENTRY START TIME [HC], and {A10-51B}, HYDRAULIC LOSS DEFINITIONS). @[051194-1619B] @[ED]

FLIGHT RULES

A10-74

HYDRAULIC CIRCULATION PUMP OPERATION [CIL]

A. HYDRAULIC CIRCULATION PUMPS WILL BE USED AS REQUIRED: [CIL]

1. TO MAINTAIN BOOTSTRAP ACCUMULATOR PRESSURE ABOVE THE 1715 (1835) PSIA PREFLIGHT CHARGE PRESSURE. [CIL] @[042904-6247]

The hydraulic main pump requires a minimum positive inlet pressure of 15 psia to avoid cavitation during on-orbit zero-gravity starts. This pressure is provided by the bootstrap accumulator acting on the hydraulic reservoir. @[070899-6879A]

The preflight charge pressure is the GN₂ pressure with the bellows bottomed out at the fluid end of the cylinder (equivalent to the maximum GN₂ volume and hence the minimum GN₂ pressure possible, assuming no GN₂ has leaked). If fluid pressure falls below this value (and no GN₂ has leaked), the GN₂ pressure is no longer able to push against the hydraulic fluid, and bootstrap pressure is lost. Repressurization with the circulation pump is required to prevent the bellows from bottoming out in this manner (reference SODB, vol. I, 4.2.4.4.c).

The design of the bellows accumulator makes a GN₂ leak unlikely, so a leak is always assumed to be on the fluid side. If, however, a GN₂ leak does occur, the resulting pressure decay will be indistinguishable from that caused by an internal fluid leak. Until all of the GN₂ leaks and the bellows fully extends to the GN₂ end of the cylinder, represses will continue to reach the expected > 2500 psia. At the point where no GN₂ remains, if the circulation pump turns off, the fluid pressure will drop to zero, and bootstrap pressure will be lost. @[070899-6879A] @[042904-6247]

THIS RULE CONTINUED ON NEXT PAGE

FLIGHT RULES

A10-74

HYDRAULIC CIRCULATION PUMP OPERATION [CIL]
(CONTINUED)

2. FOR SUPPLEMENTARY FREON LOOP COOLING FOR FES FAILURES.

The circulation pump can be used to circulate hydraulic fluid through the hydraulic heat exchanger to remove heat from the orbiter Freon loops.

3. TO PROVIDE WARMING FOR HYDRAULIC FLUID, IF REQUIRED, SHOULD APU START BE DELAYED PAST EI MINUS 13 MINUTES.

The hydraulic fluid is warmed before entry to the minimum fluid temperature for system full performance, which is 35 deg F. This is normally done by the APU at nominal startup time. If APU startup is delayed, the circulation pump may be used to warm the hydraulic fluid until APU start. This is done to assure that the hydraulic fluid will be warmed to 35 deg F in time for hydraulic system performance (reference SODB, vol. I, table 3.4.2.4-1.).

4. TO MAINTAIN HYDRAULIC SYSTEM COMPONENT AND LINE TEMPERATURES WITHIN THE FOLLOWING LIMITS: @[121296-4173B]

<u>COMPONENTS AND LINES</u>	<u>TEMPERATURE LIMIT</u>
DOWNSTREAM OF BRAKE ISOLATION VALVES	ABOVE -20 DEG F PRIOR TO LANDING
ELEVON, BODYFLAP, AND RUDDER/SPEEDBRAKE	- 40 DEG F
DOWNSTREAM OF LANDING GEAR EXTEND ISOLATION VALVE	NOT APPLICABLE
ALL OTHERS	ABOVE -4 DEG F

Hydraulic fluid viscosity increases at low temperatures. Maintaining the fluid above -4 degrees F where practical will keep fluid viscosity at a level where the hydraulic pumps will have no problem pumping the fluid. Reference: SODB, vol. I, 3.4.2.4-8. @[121296-4173B]

Starting the circulation pump at low fluid temperatures will result in a longer period of time for the pump to reach operating speed and may adversely affect the lifetime of a pump. @[091098-6554B]

The components and line temperatures downstream of all the brake isolation valves should be above -20 degrees F prior to landing due to brake system limitations. The -20 degrees F is the lower limit for the brakes for degraded performance and exceeding that may result in a delayed release from a brake lockup condition. Reference: SODB, vol. I, 3.4.2.4-8. @[121296-4173B]

THIS RULE CONTINUED ON NEXT PAGE

FLIGHT RULES

A10-74

HYDRAULIC CIRCULATION PUMP OPERATION [CIL]
(CONTINUED)

The elevon bodyflap and rudder/speedbrake components typically get very cold on orbit due to the shading effects of the vertical tail. These components experience highly localized temperature excursions and recover immediately as soon as fluid is circulated. There are no adverse effects to the circulation pump start-up due to these particular cold temperatures so these components have lower allowable temperatures. @[121296-4173B]

Hydraulic system 1 landing gear extend isolation valve is closed during all flight phases (except entry) to protect against deploying the landing gear inadvertently. Therefore, system 1 hydraulic components downstream of the landing gear extend isolation valve cannot be warmed by the circulation pump on orbit and have lower allowable temperatures. @[ED]

5. TO CYCLE MPS/TVC ISOLATION VALVES OR BRAKE ISOLATION VALVES WHILE THE APU IS NOT RUNNING.

The valves are pressure-actuated, requiring a minimum of 100 psid positive pressure to operate. Therefore, the circulation pump is required to supply adequate hydraulic pressure to operate the valves when the APU's are not running.

6. TO MAINTAIN CIRCULATION PUMP BODY AND INLET TEMPERATURE ABOVE 20 (20) DEG F (EXCEPT IN POWER-CRITICAL SITUATIONS). @[091098-6554B] @[062801-4522]

Hydraulic circulation pump starts with the pump body temperature between 240 and -20 deg F were performed during testing. Longer than nominal starts (>1 second to attain stable operating speed) occurred at 0 deg F, and nominal starts occurred at 20 deg F. No further testing was performed between these two temperatures, so the 20 deg F limit was conservatively chosen as the lower limit. Longer starts produce high stress on the circulation pump inverter/motor transistors and possibly limit the lifetime of the pump (reference SODB, vol I, 3.4.2.4.8b and table 3.4.2.4-1, JSC-14860 Internal. Note: Hydraulic Circulation Pump Test, July 1979). There was a concern that in certain attitudes the minimum 20 deg F temperature at the inlet could be violated while the thermal control temperatures remained above the pump 'on' limits. Due to this concern and the inability to predict temperatures in that region, circ pump inlet temperature measurements were added (reference CCB, September 9, 1997). @[062801-4522]

The value used in this rule does not take into account transducer error. The circ pump body temperature transducer has proven reliable in accuracy, and the hydraulic community has signed up to not protecting for transducer error. @[091098-6554B]

7. TO GENERATE WATER FOR ACTIVE THERMAL CONTROL SYSTEM USE.

The circulation pumps may be used to generate water through consumption of fuel cell cryogenic fuel. This was done successfully during STS 61-C.

THIS RULE CONTINUED ON NEXT PAGE

FLIGHT RULES

A10-74

HYDRAULIC CIRCULATION PUMP OPERATION [CIL]
(CONTINUED)

- B. CIRCULATION PUMPS WILL NOT BE ALLOWED TO CYCLE DURING PAYLOAD DEPLOYMENT WHEN THE DEPLOYMENT MECHANISM INVOLVES PYROTECHNICS WHICH ARE POWERED BY THE ORBITER. FOR CONDITION REQUIRING CONTINUOUS CIRCULATION PUMP OPERATION, THE PUMPS WILL BE PLACED IN THE "ON" POSITION VICE "GPC" (REFERENCE THE FLIGHT RULES ANNEX FOR OPERATING CONSTRAINTS DURING PAYLOAD ACTIVITIES).

The startup transient of a circulation pump has a high inrush current, a bus voltage drop of 4 to 5 volts, and considerable EMI. This transient is only present for less than 1 second, but the concern is that the bus voltage spikes or EMI could trigger any armed pyrotechnics in the vicinity. There is no concern with a circulation pump that is already running at the start of these types of payload operations - only the startup transient causes problems. Since in GPC mode the pump could be commanded on at an inopportune time caused by the failure of control transducers or their respective MDM's or DSC's, the GPC position will not be allowed during these operations.

- C. A CIRCULATION PUMP WILL NOT BE STARTED ON A MAIN BUS THAT POWERS THE PRIMARY PAYLOAD BUS WHILE A PAYLOAD IS ACTIVATED AND SENSITIVE TO CIRCULATION PUMP ACTIVATION, EXCEPT TO PREVENT LOSS OF AN APU/HYDRAULIC SYSTEM IF REACTION TIME DID NOT PERMIT FOR POWER SOURCE RECONFIGURATION.

The voltage ripple caused by the startup of a hydraulic circulation pump may be greater than the payload ICD requirements. Critical orbiter systems take precedence over payload systems if those orbiter systems are in jeopardy.

DOCUMENTATION: ICD2-19001, NSTS 07700, Volume XIV, Attachment 1.

THIS RULE CONTINUED ON NEXT PAGE

FLIGHT RULES

A10-74 HYDRAULIC CIRCULATION PUMP OPERATION [CIL]
(CONTINUED)

D. HYDRAULIC THERMAL CONDITIONING SOFTWARE WILL NOT BE REQUIRED FOR CONTINUING ANY FLIGHT PHASE.

For loss of software control of the hydraulic circulation pumps, the ground controllers will be responsible for tracking the relevant temperatures. The crew will then control the circulation pumps per ground instruction. Since these actions can be performed manually, there will be no constraints to continuing any flight phase.

E. A CIRCULATION PUMP ON A HYDRAULIC SYSTEM WITH A NON-ISOLATABLE LEAK WILL ONLY BE USED FOR HYDRAULIC ACCUMULATOR/RESERVOIR PRESSURE MANAGEMENT AND TO MAINTAIN SYSTEM COMPONENTS AND LINES ABOVE THEIR MINIMUM OPERATING TEMPERATURES. THE CIRCULATION PUMP WILL NOT BE USED FOR FCS CHECKOUT. ©[072398-6686B]

Circulation pump cycles on a hydraulic system with a non-isolatable leak may potentially degrade that system or possibly decrease the available run time for entry. Therefore, the use of this circ pump should be minimized. It is acceptable to run circ pumps for accumulator/reservoir pressure management to preclude the loss of that hydraulic system. Additionally, thermally conditioning this particular system in order to protect for optimal hydraulic performance is not warranted. However, a better trade-off can be made by keeping the system only minimally conditioned so as to only protect for minimum performance.

(Reference SODB, vol. I, table 3.4.2.4-1)

Rule {A10-29}, FCS CHECKOUT APU OPERATIONS references this rule. ©[072398-6686B]

A10-75 THROUGH A10-100 RULES ARE RESERVED

FLIGHT RULES

WATER SPRAY BOILER (WSB) LOSS/FAILURE DEFINITIONS

A10-101 WSB LOSS DEFINITIONS

A WSB IS CONSIDERED LOST IF:

- A. AN N₂ OR H₂O LEAK IS VIOLATING CONSUMABLES REDLINES OR N₂ REGULATOR PRESSURE < 19.0 (21.6) PSIG WITH THE N₂ SUPPLY VALVE OPEN.

If consumables (water or GN₂) are below the redline, there is insufficient water supply for the WSB to provide adequate cooling for the APU or hydraulic fluid. The water spray bar will not operate properly at pressures < 19 psig; thus, there will be inadequate cooling (reference SODB, vol. I, 3.4.2.4.11b.).

- B. UNABLE TO MAINTAIN APU LUBRICATION OIL RETURN TEMPERATURE < 325 DEG (310 DEG) F OR HYDRAULIC RESERVOIR TEMPERATURE < 230 DEG (222 DEG) F WITH CONTROLLER A OR B.

These temperatures are the SODB (vol. I, 3.4.2.4.1d and table 3.4.4.3-1) limits on these fluids. At 325 deg F, lubrication oil breakdown occurs and its viscosity becomes unacceptable. At 275 deg F, the seals in the hydraulic system become degraded which could result in leaks. Since the WSB primary purpose is to maintain these temperatures within limits, its failure to do so using both controllers constitute its loss.

- C. UNABLE TO MAINTAIN H₂O TANK TEMPERATURES < 125 DEG (118 DEG) F OR > 32 DEG (39 DEG) F.

The WSB controllers are mounted on the water tank which serves as the heat sink for the controllers. Temperatures > 125 deg F may cause excessive controller temperatures which could cause controller failure (reference SODB, vol. I, table 3.4.2.4-1). Temperatures below 32 deg F will allow the water to freeze.

- D. BOTH STEAM VENT HEATERS ARE LOST.

A steam vent heater is required prior to deorbit APU start to ensure that ice does not plug or restrict the steam vent orifice. A restricted steam vent orifice causes excessive boiler core pressure and may result in a steam vent duct rupture. The rupture (large orifice) may lead to a boiler spray bar freeze up and loss of lube oil cooling. This would require the APU to be shut down prior to Mach 1. A TAEM start of the associated APU ensures that cooling is not required and the system is available from TAEM to wheelstop.
 ©[021199-6814]

Reference Rules {A10-23}, APU ENTRY START TIME, and {A10-24}, APU OIL/GEARBOX TEMPERATURE/ PRESSURE.

NOTE: LOSS OF WSB RESULTS IN EVENTUAL LOSS OF ITS ASSOCIATED APU/HYDRAULIC SYSTEM.

A10-102 THROUGH A10-120 RULES ARE RESERVED

FLIGHT RULES

WSB SYSTEMS MANAGEMENT ©[ED]

A10-121 WSB CONFIGURATION

THE WSB N₂ SUPPLY VALVE WILL BE CLOSED EXCEPT IN PREPARATION FOR AND DURING APU OPERATIONS.

The valve provides isolation of the GN₂ tank. If a leak develops downstream of the valve, keeping it closed will preserve the GN₂ until needed for WSB operation.

A10-122 LOSS OF WSB(S) ACTIONS

A. FOR THE LOSS OF A SINGLE WSB, FLIGHT WILL CONTINUE TO NOMINAL EOM. ©[041097-4611B]

The WSB's are essentially quiescent while on orbit. Because a subsequent failure of another APU/hydraulic/WSB system will likely only occur when these systems are operated for entry, there are no significant risks to continuing the flight until nominal EOM.

The loss of a WSB system does not indicate the immediate loss of an APU/hydraulic system, though the APU can only run for about 11 minutes before reaching an overtemperature condition. The APU associated with the lost WSB will be started late during entry to support landing (reference Rule {A10-23}, APU ENTRY START TIME). Assuming the other two APU/hydraulic/WSB systems are good, three APU/hydraulic systems will be available to support the latter part of entry and landing. ©[041097-4611B]

B. FOR THE LOSS OF TWO WSB'S, A NEXT PLS ENTRY WILL BE PERFORMED. IF THE FAILURE OCCURS ON LAUNCH DAY:

1. FOR NONDEPLOYABLE PAYLOAD FLIGHTS, A FIRST DAY PLS ENTRY WILL BE PERFORMED.

THIS RULE CONTINUED ON NEXT PAGE

FLIGHT RULES

A10-122 LOSS OF WSB(S) ACTIONS (CONTINUED)

2. FOR DEPLOYABLE PAYLOAD FLIGHTS, PAYLOAD DEPLOY AND/OR JETTISON WILL BE SCHEDULED TO ALLOW FOR DEORBIT ON DAY 2.

The loss of a WSB system does not indicate the immediate loss of an APU/hydraulic system, though the APU can only run about 11 minutes before reaching temperature limits. The APU associated with the lost WSB will be started late during entry to support landing (reference Rule {A10-23}, APU ENTRY START TIME). Assuming the other APU/hydraulic/WSB systems are good, three APU/hydraulic systems will be available to support the latter part of entry and landing.

For the loss of two WSB's, entry should be made at the next PLS opportunity after deployable payloads have been deployed. It is desirable to deploy the payloads since this will improve the vehicle capability to maneuver and land safely if an APU or hydraulic system fails during entry. Jettison of deployable payloads that, for some reason, cannot be deployed should be considered as a means of last resort to improve the vehicle entry and landing capability.

If the APU/hydraulic system not associated with the lost WSB's fails or if the remaining WSB fails, one of the APU/hydraulic systems with limited run time must be started. Starts and restarts of both limited lifetime APU/hydraulic systems must be managed to allow for at least one system running at all times. Accomplishing this may be an impossible task if the good APU/hydraulic system fails at the worst possible time, i.e., prior to the deorbit burn. A next PLS entry should be performed for the loss of two WSB's in order to minimize the amount of time the vehicle is exposed to the next failure that would result in the orbiter being down an APU/hydraulic system and two water spray boilers.

Rule {A2-301}, CONTINGENCY ACTION SUMMARY [HC], references this rule. ©[032807-8400]

A10-123 THROUGH A10-140 RULES ARE RESERVED

FLIGHT RULES

LANDING/DECEL SYSTEMS MANAGEMENT

A10-141 **NOSE WHEEL STEERING (NWS) [HC]** @[121604-6254C] @[121505-6726C]

A. NWS IS DEFINED AS "REQUIRED" IF IT IS NEEDED TO MAINTAIN DIRECTIONAL CONTROL DURING ROLLOUT: @[102402-5804C]

1. FOR INTACT ABORT (RTLS, TAL, OR KSC/EDW AOA OR ECAL/ELS LANDINGS, OR
2. AT ANY LANDING SITE IF THERE ARE KNOWN DIRECTIONAL CONTROL PROBLEMS (MLG OR NLG TIRE PREDICTED TO BE FAILED PRIOR TO WHEELSTOP, UNCOMMANDED BRAKE PRESSURE, OR PEAK CROSSWINDS ABOVE THE SURFACE WIND LIMITS)

EFFORTS WILL BE TAKEN TO REGAIN NWS AS SPECIFIED IN THE REFERENCED FLIGHT RULES.

NWS provides the most effective means of preventing runway departure at any site where lateral margins are very limited, especially if a subsequent directional control problem develops. Ames VMS testing (July/August 1988, May/June 1989) demonstrated that differential braking and rudder inputs may not always provide adequate directional control capability when directional control problems are known to exist, even for runways with wide lateral margins. The forward position of the nose wheel provides a long moment arm (relative to the vehicle c.g.) for very effective vehicle steering. Therefore, NWS can overcome high frictional forces that may develop between a failed tire and a runway surface and also overcome the high frictional forces caused by uncommanded brake pressure. Moreover, excessive energy dissipated through differential braking can lead to subsequent loss of tire pressure (overtemperature of fuse plugs, post wheelstop). In all cases, NWS is much more effective for directional control than differential braking. @[102402-5804C]

Hazard Reports ORBI 021 and ORBI 184 reference this rule. @[121604-6254C]

B. NWS WILL BE USED AS THE PRIMARY MEANS OF DIRECTIONAL CONTROL. NWS 1 IS PREFERRED OVER NWS 2. @[102402-5804C]

Although both NWS 1 and NWS 2 modes of nosewheel steering provide identical functions and capabilities, NWS 1 provides more downlisted system status parameters; NWS 1 is, therefore, preferred over NWS 2. @[102402-5804C]

If NWS 1 is determined to be failed during the OPS 8 checkout or anytime prior to nose gear touchdown (ground speed enable flag set true), selecting NWS 2 will provide the best alternative for rollout directional control. Ames VMS testing (July/August 1988) demonstrated that switching NWS modes during rollout was an effective procedure, particularly for MDM hardover failure cases. @[121505-6726C]

THIS RULE CONTINUED ON NEXT PAGE

FLIGHT RULES**A10-141 NOSE WHEEL STEERING (NWS) [HC] (CONTINUED)**

However, SAIL testing (April 1991) demonstrated that for certain scenarios where the NWS 1 channel downmoded to free castor (post-NGTD), the NWS system did not recover after selecting NWS 2. In these cases, the NWS 2 channel was selected coincident with a large rudder pedal command (DR 100737 and 106206). The NWS system was never perceived to have recovered as it downmoded to castor unnoticeably 240 milliseconds after selection. Although the NWS software may not recover if the alternate NWS channel is selected on rollout, NWS 2 can still be safely selected post-NGTD and is likely to regain control if a large rudder pedal input is not present at selection. @[102402-5804C] @[121505-6726C]

- C. NWS WILL BE TURNED OFF WHEN THE EXISTING FAILURES, OR NEXT FAILURE, RESULT IN AN UNCOMMANDED STEERING INPUT. SPECIFIC CASES WHERE NWS WILL BE TURNED OFF INCLUDE LOSS OF MORE THAN ONE: @[102402-5804C]
1. LATERAL AA,
 2. LEFT RPTA CHANNEL (UNLESS THE ENTIRE LEFT SIDE IS DESELECTED),
 3. RIGHT RPTA CHANNEL (UNLESS THE ENTIRE RIGHT SIDE IS DESELECTED),
 4. RIGHT DDU POWER SUPPLY , OR
 5. STEERING POSITION TRANSDUCER/AMPLIFIER. AN SPT/SPA IS CONSIDERED LOST IF IT DOES NOT INDICATE -0.42 ± 0.31 VOLTS (GROUND) OR 0.0 ± 0.75 DEGREES (ONBOARD). @[102402-5804C]
- D. NWS, IF REQUIRED, MAY BE (RE)ENABLED IF (RE)ENABLING WILL NOT RESULT IN AN UNDESIRED STEERING INPUT. SPECIFIC CASES WHERE NWS MAY BE (RE)ENABLED INCLUDE FAILURES LEAVING AT LEAST ONE GOOD:
1. LATERAL AA,
 2. LEFT OR RIGHT RPTA CHANNEL,
 3. RIGHT DDU POWER SUPPLY, AND
 4. STEERING POSITION TRANSDUCER/AMPLIFIER @[121505-6726C]

THIS RULE CONTINUED ON NEXT PAGE

FLIGHT RULES

A10-141

NOSE WHEEL STEERING (NWS) [HC] (CONTINUED)

If failures exist in the NWS system such that it will not function during rollout, then it should be turned off. Certain failure combinations will cause NWS to simply downmode to castor; though this does not result in a rollout control problem, there is no need to keep the system active. Other failure modes will cause a lateral excursion which could lead to loss of control or runway departure, in which case turning NWS off is critical. ©[121505-6726C]

The benefits of NWS (improved control, reduced tire wear) must be balanced against the potential for uncommanded steering inputs resulting from failures in the system. For cases when NWS is one failure away from an uncommanded steering input, the system is still functional but there is a possibility of the next failure occurring, causing a lateral excursion. If no directional control problem exists, then differential braking provides adequate steering authority during rollout. Therefore, NWS should be turned off to preclude exposure to the next failure. However, if NWS meets the "required" criteria (a directional control problem is already extant, or for abort landing sites without wide lateral margins), it can remain enabled with only zero fault tolerance. In this case, mitigating the known effect of the directional control problem outweighs protecting against the potential for a subsequent failure in the NWS system.

AA and RPTA Failures:

Once two lateral AA's or RPTA's have failed, there are potential vehicle control risks if NWS is enabled. A hardover or bias of one of these remaining components could result in loss of vehicle control since, with RM no longer possible with only a single input, this erroneous component's output would be incorporated into the NWS software.

The NWS software uses the greater of the left or right RPTA RM selected inputs, so NWS should be turned off when RM has only a single RPTA channel on a side - the next failure could result in a bad RPTA value being selected. However, if RM has deselected the affected side entirely, NWS may remain enabled, as no inputs from that side will be processed.

Results of a NWS test matrix performed using the NASA Ames VMS in May/June 1991 indicate that vehicle control can be difficult to nonrecoverable after a third AA or RPTA hardover failure has occurred (Cooper/Harper ratings from 5 to 10). The matrix also demonstrated that, although landing with a known directional control problem (failed tire) without NWS is unsatisfactory (Cooper/Harper ratings between 5 and 8), this condition is sometimes controllable. However, reducing the possibility of runway departure due to a known directional control problem by (re)enabling NWS is more prudent than turning off NWS in order to protect against the potential for a third AA or RPTA failure during rollout. ©[102402-5804C] ©[121505-6726C]

THIS RULE CONTINUED ON NEXT PAGE

FLIGHT RULES**A10-141****NOSE WHEEL STEERING (NWS) [HC] (CONTINUED)***SPT/SPA/DDU Failures:* @[121505-6726C]

Each of the three nosewheel position outputs is produced by a steering position transducer (SPT) and a steering position amplifier (SPA) powered by a right DDU power supply. The NWS system requires at least two good nosewheel position outputs for reliable nosewheel position SOP operation. The SPT/A values are used primarily to provide wraparound position error detection separate from the GPC commands. Additionally, these values are used to provide the initial nosewheel position command at NGTD. If none of the steering position transducers have been comm faulted (all three inputs available), the nosewheel position SOP will midvalue select from the three position transducer values, regardless of how well the values match. If one transducer is failed or biased, one of the two good transducers will always yield the midvalue of the three, and the SOP will always select a good value. If two transducers are failed or biased, one of these two may yield the midvalue, and the SOP would then select an erroneous value. Ames VMS data (July/August 1988) confirmed that, for the two failed/biased transducer scenario, the selected value can exceed the nosewheel position comparison limits when compared against the DAP-commanded nosewheel position and rate. The nosewheel position SOP will then generate a nosewheel position error and downmode to castor.

SES testing in 2004 post A/EFTP #202 explored the condition of biased/failed SPT/A's inducing an uncommanded steering input at NGTD. This testing showed that two nosewheel positions failed OSH, which causes the maximum possible induced lateral acceleration due to SPT/A failures, produced a transient of approximately 0.2g (NWS downmoded to castor after 0.75 seconds). This is of an equivalent magnitude to the actuator hardover cases currently trained at Ames VMS sessions, which are controllable. SES test cases with two or three SPA's failed to null proved benign; lateral acceleration transients at NGTD were much lower than in the worst case scenario (i.e., multiple OSH nosewheel position outputs), and the position difference did not exceed 2 degrees, so NWS remained active throughout rollout (though this result is dependent on the magnitude of the crew's steering inputs; a downmode to castor is possible).

Reference Hazard Reports ORBI 184, Loss of Directional Control Due to Failed Nosewheel Steering, and ORBI 021, Structural Failure and/or Loss of Vehicle Control From Failure of Wheel/Tire and/or Landing Gear. @[121505-6726C]

Rules {A2-254C}.1, ENTRY STRING REASSIGNMENT; {A2-261}, ENTRY DTO/AUTO MODE/CROSSWIND DTO GO/NO GO; {A10-33}, APU DEFINITIONS; and {A10-71}, HYDRAULIC SYSTEM CONFIGURATION, reference this rule. @[111094-1622B] @[121604-6254C] @[ED]

FLIGHT RULES

THIS PAGE INTENTIONALLY BLANK

FLIGHT RULES**A10-142** **TIRE PRESSURE [CIL] [HC]** ©[121604-6254C]

A. THERMAL EFFECTS:

THE ORBITER ATTITUDE WILL BE MANAGED TO THERMALLY CONDITION THE TIRES TO MAINTAIN ACCEPTABLE PRESSURES AND TEMPERATURES FOR LANDING. THE FOLLOWING CONSTRAINTS APPLY: ©[041097-4009E]

1. FOR NEOM LANDING AND EXTENSION DAYS, MAIN LANDING GEAR TIRE PRESSURE WILL BE MAINTAINED ABOVE THE MINIMUM PRESSURE DERIVED FROM THE NEOM/EXTENSION DAY PLOTS (+2 PSI UNCERTAINTY) .
2. DURING THE FLIGHT, WHEN PAYLOAD ACTIVITIES ALLOW, MAIN LANDING GEAR TIRE PRESSURE WILL BE MAINTAINED ABOVE THE MINIMUM TIRE PRESSURE DERIVED FROM THE NEOM/EXTENSION DAY PLOTS (+2 PSI UNCERTAINTY) (OR AS HIGH AS PRACTICAL IF THE LIMIT CANNOT BE MET) .
3. AT ALL TIMES DURING THE FLIGHT, MAIN LANDING GEAR TIRE PRESSURE WILL BE MAINTAINED ABOVE THE MINIMUM PRESSURE DERIVED FROM THE ANYTIME DEORBIT CONCRETE (+2 PSI UNCERTAINTY) PLOTS. EXCEPTIONS TO THIS RULE WILL BE DOCUMENTED IN THE FLIGHT-SPECIFIC ANNEX.
4. FOR A DEORBIT PRIOR TO NEOM, ALL REASONABLE EFFORTS WILL BE MADE TO SATISFY THE EOM REQUIREMENT. IN THE EVENT THE NEOM MINIMUM TIRE PRESSURE CANNOT BE MET (I.E., EMERGENCY DEORBIT), THEN DRAG CHUTE DEPLOY MAY BE USED TO REDUCE TIRE LOADS. ©[050495-1771B]
5. TIRE TEMPERATURE WILL BE MAINTAINED ABOVE THE MINIMUM OPERATIONAL TEMPERATURE OF -45 (-43) DEG F. ©[111298-6764A]

Depending on the orbiter attitude, main gear tire temperatures are typically between 0 to 30 deg F while on orbit (some flights have seen temperatures as low as -25 deg F). Since the tires are very good insulators and require significant time to warm up, there is no significant change in tire pressure from TIG to landing. The nose gear tires have never required thermal conditioning. ©[111298-6764A]

Michelin Aircraft Tire Corporation completed a Delta Certification for the Space Shuttle Orbiter Main Landing Gear Tire on August 20, 1998 (reference CR # 26-194-0007-0005B), verifying that the tire is capable of operating at a temperature of -45 deg F (previous certification limit was -35 deg F). The tire demonstrated the ability to maintain air retention after being subjected to four landing load tests at -45 deg F. ©[111298-6764A]

THIS RULE CONTINUED ON NEXT PAGE

FLIGHT RULES

A10-142**TIRE PRESSURE [CIL] [HC] (CONTINUED)**

During the development of the Improved Main Landing Gear (IMLG) tires, the -45 deg F thermal limit specified for the old tire design was carried over as part of the new tire's design requirements. Load handling capability was verified through mission cycle and wear tests while at the -45 deg F thermal limit between January and March of 2004 (reference CR # 26-194-0007-0005D). ®[042507-8472A]

Past flight experience and thermal analysis show that, due to thermal inertia, after going to a bottom sun attitude, it is typically 4 to 5 hours before any temperature increase is seen in the wheel wells. Once this occurs, the temperature typically goes up 1 deg per hour. (Reference AEFTP #91, July 17, 1992.) ®[041097-4009E]

Protecting the -45 deg F thermal limit is required in order to ensure emergency deorbit capability, since there would be no time to thermally condition the tires in an emergency deorbit timeline. (Reference SODB, vol. I, table 3.4.2.1-1.) ®[050495-1771B] ®[041097-4009E] ®[111298-6764A]

A tire's load handling capability is determined by its internal pressure and maximum allowable deflection while under load. In order to not exceed the maximum allowable deflection (66 percent for the IMLG tires), a tire's load handling capability decreases as its pressure decreases. The relationship between orbiter weight, X-cg, and minimum tire pressure was portrayed in the carpet plots for the previous generation orbiter main landing gear tires. For a known landing weight and X-cg, the minimum pressure needed to support landing loads was first determined from the plots. Using the known correlation between the tire's pressure and temperature, a minimum allowable temperature corresponding to the minimum pressure was derived. If the calculated temperature was above the -45 deg F tire material limit, then the tire was thermally conditioned, as needed, to stay above the minimum temperature. If the calculated temperature was lower, then the -45 deg F material limit was protected. ®[041097-4009E]

New carpet plots were not stipulated in the design requirements of the IMLG tires. Michelin provided two reports (No. FDAD-93-001 for the previous generation tire and AVTAN-05-03 for the IMLG tires) that correlate peak landing load with the required minimum tire inflation pressure.

The original carpet plots were derived directly off of FDAD-93-001. From the similarity of these two reports, NASA, United Space Alliance, and Boeing engineering issued an official memo (06BB123, Use of Current Carpet Plots for the Improved Main Landing Gear Tires, June 2, 2006) stating that the existing carpet plots could be used to determine the minimum pressure for the IMLG tires.

The carpet plots will continue to be used to verify whether the tire will be operationally constrained by minimum temperature or pressure. In the majority of cases defined by these plots, temperature will be the limiting factor. The few remaining points that necessitate maintaining a minimum pressure opposed to temperature are for extreme heavyweight vehicles and/or very forward cg's. These cases are not likely to be experienced in actual flight. ®[042507-8472A]

THIS RULE CONTINUED ON NEXT PAGE

FLIGHT RULES

A10-142

TIRE PRESSURE [CIL] [HC] (CONTINUED)

In order to avoid significant payload impact, the limits for anytime deorbit which do not include the undispersed limit (nominal load for given mass properties without RSS'd performance dispersions added) will be used. This is acceptable due to the unlikely event of an anytime deorbit, the availability of drag chute deploy, and the additional capability of the tire/strut shown in off-nominal testing. In the event of deorbit earlier than NEOM, all reasonable attempts will be made to meet the dispersed limits (i.e., MDF or next PLS with deorbit the following day should allow sufficient time to condition the tires). ©[050495-1771B]

Tire load capability depends greatly on the maximum load conditions that the tires may encounter. The maximum load is a function of several parameters primarily associated with the initiation of the derotation maneuver post-main gear touchdown. Orbiter mass properties (total weight and X center of gravity) are significant factors in the maximum tire loading. The other factors which significantly affect tire loading are controlled by crew procedures which affect the derotation maneuver, especially in the first second or two of the initiation of derotation. These procedures are documented in the Flight Procedures Handbook; Approach, Landing, and Rollout, JSC-23266, Section 5.3.6.7, and were not changed as a result of the upgrade to the new IMLG tire/wheel. ©[042507-8472A]

Among these crew procedure controlled parameters are the indicated airspeed at which derotation is initiated. This is a significant factor in the maximum load that the tires will experience. Crew technique to initiate derotation is to wait for an indicated 185 KEAS and perform a beep trim derotation. Errors in display plus some allowance for human factors lead to a maximum dispersion on the high side of 195 KEAS actual for a dispersed initiation of derotation. Lower airspeeds lead to significantly lower main gear loads but increase the nose gear load at slapdown. Lakebed runways have significantly higher loads on the nose gear. The same 10-KEAS error applies to lakebed runway derotation as well as to concrete runway derotation.

The second parameter affecting main gear maximum loads that is controlled by crew procedure is the derotation rate that is established by the crew in the initial part of the derotation for a manual derotation. This should not be confused with the overall or average derotation rate for the entire maneuver since quite high rates can be achieved after $\theta = 0$ degree. Nor should this rate be confused with the actual rate the vehicle achieves in the initial few seconds of derotation. Ames VMS sims (and flight data) have consistently shown that the average rate achieved in the initial derotation is on the order of 0.7 to 0.8 deg/sec. For simplicity, the analysis assumes the derotation rate of 1.0 deg/sec and includes dispersions to 1.5 deg/sec.

The third important parameter affected by crew procedural control is the speed with which the derotation rate is achieved. A rapid or jerky rate can lead to tire "bounce" with greatly increased (though oscillating) loads. Crew procedures specifically call for the rate to be put in smoothly over a 1- to 2-second interval. Ames VMS studies (and flight data) show that the average time for rate buildup is 1 second with the most dispersed times being 0.5 second. ©[042507/8472A]

THIS RULE CONTINUED ON NEXT PAGE

FLIGHT RULES

A10-142

TIRE PRESSURE [CIL] [HC] (CONTINUED)

When initial studies were done with the maximum dispersions (185 KEAS derotation, 2.0 deg/sec, 0.5 second ramp input time), the loads exceed the tire capability at nominal (launch) pressures. Further examination of the Ames VMS data (and flight data) shows that the combination of high rate (over 1 deg/sec) and short input time (less than 1 second) never occurs. The 1 deg/sec with 0.5 second input time represents a worst case combination from the load standpoint. Therefore, this was chosen as the dispersed case (the other option, 2 deg/sec with 1 second ramp time yielded significantly lower loads). This is why the table in this rule shows the command initiation time to be 1.0 second with -0.5 second dispersion. Other combinations of dispersions may be postulated, but all real-world possible combinations result in lower main gear loads. ©[050495-1771B] ©[042507-8472A]

Interpolation for different orbiter weights on the tire plots is allowed between 185,000 pounds and 248,000 pounds. Extrapolation below 185,000 pounds on the tire plots is not allowed. If vehicle landing weight is less than 185,000 pounds, either mission-specific analysis is required or use the 185,000 pound line at the proper CG. If vehicle mass properties are otherwise off the chart (landing weight above 248,000 pounds, CG forward of 1076 or aft of 1111.0 - which is a contingency case), specific analysis is required. The forward CG limit of 1075.2 inches is for Mach 3.5 and not touchdown. Gear deploy causes the CG to shift AFT and therefore the carpet plots were only derived to 1076 inches. ©[050495-1771B] ©[091098-6713]

All plots use the following nominal and dispersed pitchover command parameters for main gear rollout assessments shown below and are taken from the SODB (reference SODB, vol. V, sec. 4.3 and Rule {A2-206}, DEROTATION SPEED.) Current derotation is at 185 KEAS using beep trim. The minimum loads and tire pressures for 185 KEAS beep trim and 175 KEAS manual derotation are protected by the 185 manual derotation plots. The 185 KEAS beep trim and 175 KEAS manual derotation plots are not shown here but are in SODB, vol V., sec. 4.3.3. ©[050495-1771B]

Parameter	Value	
	Nominal	Dispersion
Derotation speed		
• Concrete	185 KEAS	+10 KEAS
• Lakebed	185 KEAS	+10 KEAS
Command initiation time	1.0 sec	-0.5 sec
Pitch command rate *	-1.0 deg/sec	-0.5 deg/sec
Crosswind	15 knots	+5 knots

©[050495-1771B]

- This is RHC commanded rate being fed into the system. Since derotation rate increases during derotation, actual pitch rate at slapdown would be of a high magnitude.

THIS RULE CONTINUED ON NEXT PAGE

FLIGHT RULES

A10-142

TIRE PRESSURE [CIL] [HC] (CONTINUED)

OI-26 Nominal Orbiter Main Gear Tire Pressures
 Contingency De-Orbit Mission Planning Assessments - Concrete Runways
 Contingency Abort & Emergency Landings (Nominal Vderotate @ 185 keas)
 Orbiter X-c.g. With Gear Deployed

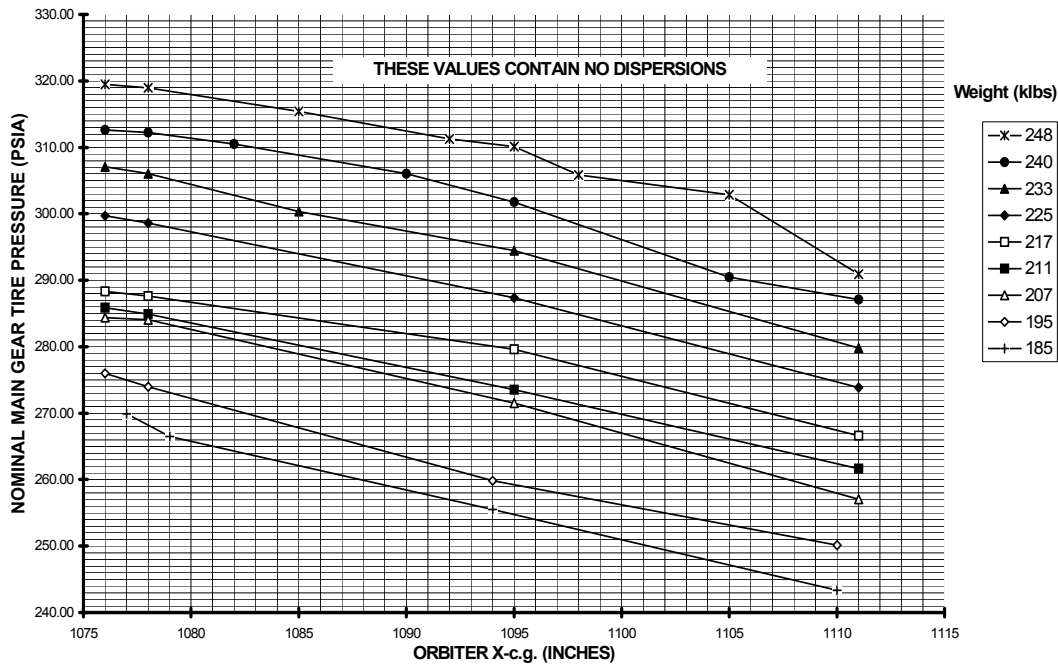

®[091098-6713]

Contingency Minimum Orbiter Main Gear Tire Pressure - Concrete - Derotation Initiation at 185 KEAS

FIGURE A10-142-I - ANYTIME DEORBIT (CONCRETE RUNWAY)

THIS RULE CONTINUED ON NEXT PAGE

FLIGHT RULES

A10-142

TIRE PRESSURE [CIL] [HC] (CONTINUED)

OI-26 Nominal Orbiter Main Gear Tire Pressures
 Contingency De-Orbit Mission Planning Assessments - Lakebed Runways
 Contingency Abort & Emergency Landings (Nominal Vderotate @ 185 keas)
 Orbiter X-cg With Gear Deployed

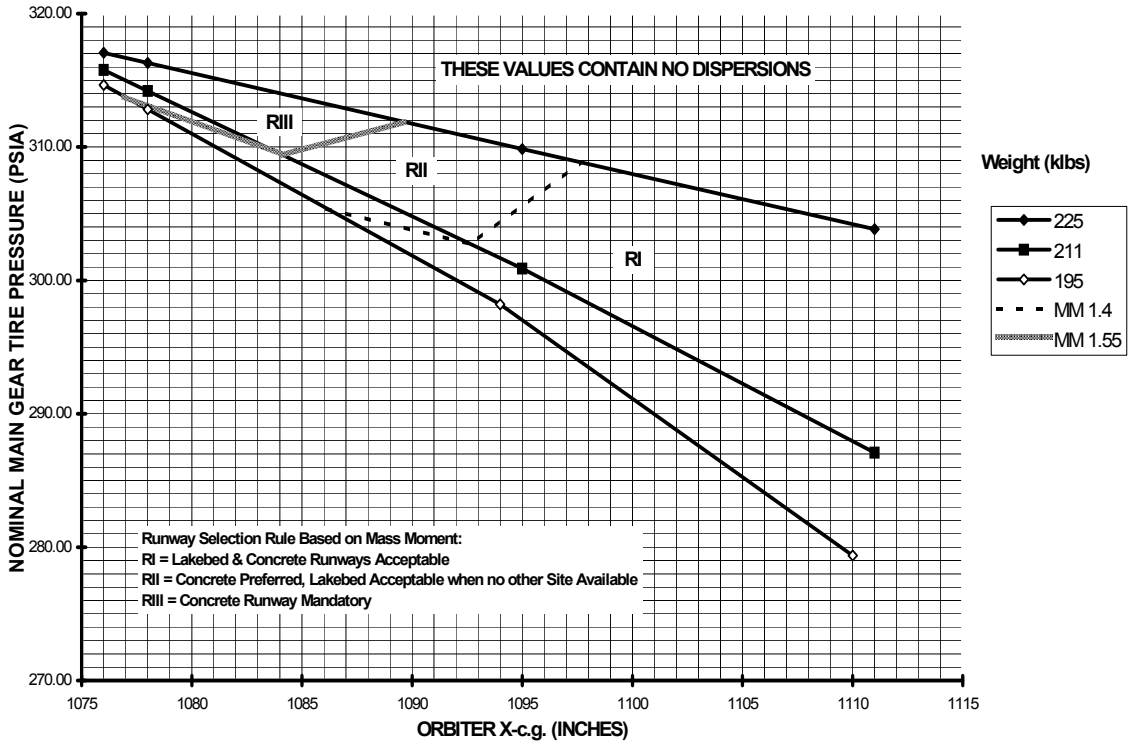

©[091098-6713]

Contingency Minimum Orbiter Main Gear Tire Pressure - Lakebed - Derotation Initiation at 185 KEAS

Orbiter Landing Weights Greater Than 225 KLBS Require Separate Evaluation

FIGURE A10-142-II - ANYTIME DEORBIT (LAKEBED RUNWAY)

THIS RULE CONTINUED ON NEXT PAGE

FLIGHT RULES

A10-142

TIRE PRESSURE [CIL] [HC] (CONTINUED)

OI-26 Minimum Orbiter Main Gear Tire Pressure
 Mission Planning Assessments - Concrete Runways
 All Normal & Intact Abort Landings (Nominal Vderotate @ 185 keas)
 Orbiter X-c.g. With Gear Deployed

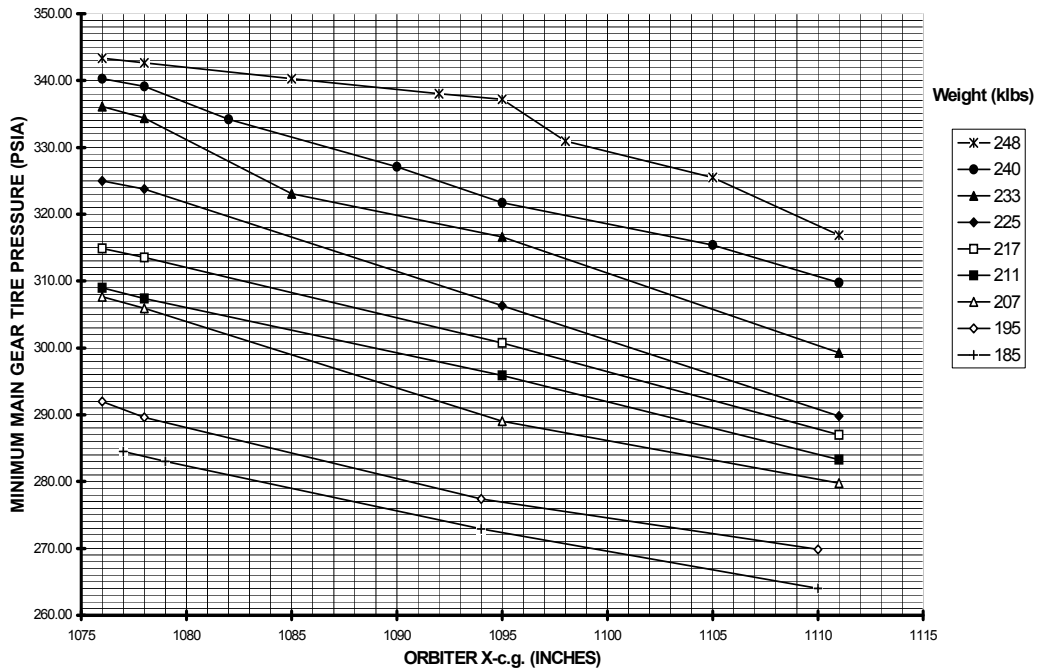

©[091098-6713]

Minimum Orbiter Main Gear Tire Pressure - Concrete - Derotation Initiation at 185 KEAS

FIGURE A10-142-III - NOMINAL/EXTENSION DAY (CONCRETE RUNWAY)

THIS RULE CONTINUED ON NEXT PAGE

FLIGHT RULES

A10-142

TIRE PRESSURE [CIL] [HC] (CONTINUED)

**OI-26 Minimum Orbiter Main Gear Tire Pressure
Mission Planning Assessments - Lakebed Runways
All Normal & Intact Abort Landings (Nominal Vderotate @ 185 keas)
Orbiter X-cg With Gear Deployed**

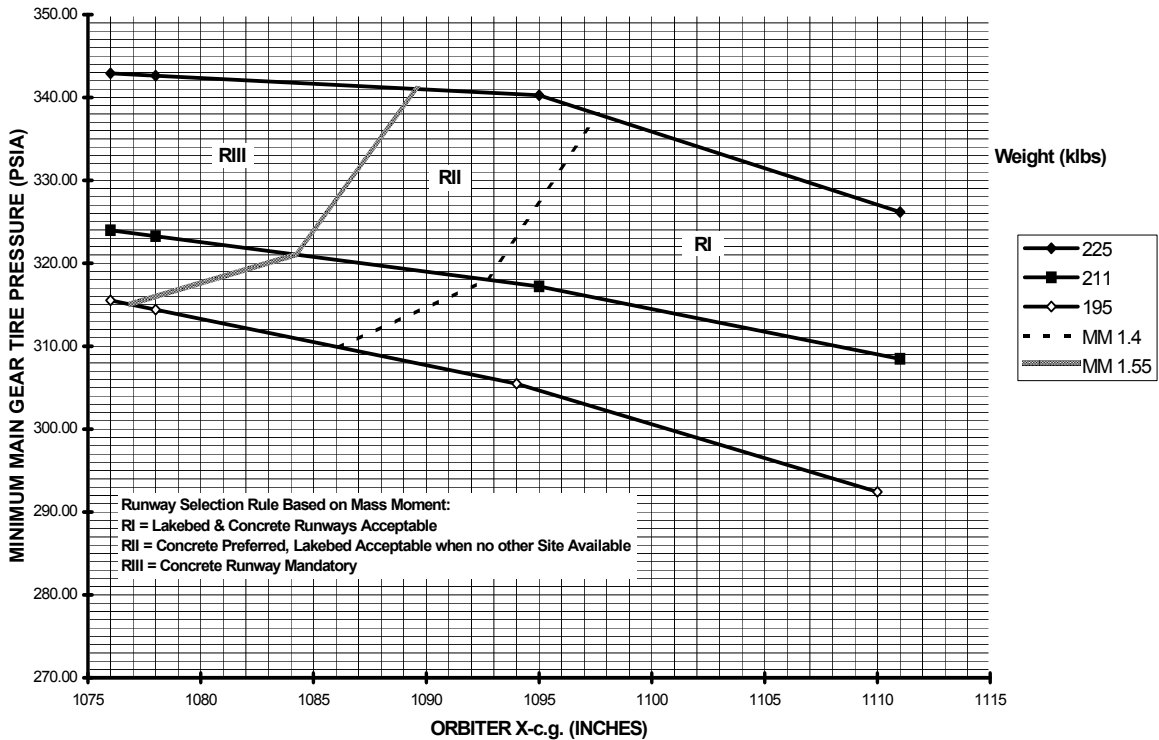

©[091098-6713]

Minimum Orbiter Main Gear Tire Pressure - Lakebed - Derotation Initiation at 185 KEAS

Orbiter Landing Weights Greater Than 225 KLBS Require Separate Evaluation

FIGURE A10-142-IV - NOMINAL/EXTENSION DAY (LAKEBED RUNWAY)

THIS RULE CONTINUED ON NEXT PAGE

FLIGHT RULES

A10-142

TIRE PRESSURE [CIL] [HC] (CONTINUED)

B. LEAKING/FAILED TIRE: @[121604-6254C]

1. A TIRE LEAK IS DEFINED AS A DECREASE IN A TIRE'S PRESSURE MEASUREMENTS THAT IS INCONSISTENT WITH CHANGES IN PRESSURE OF THE OTHER TIRES AND CANNOT BE EXPLAINED BY INSTRUMENTATION INACCURACY/FAILURE OR VARIATIONS IN TEMPERATURE. @[041097-4009E]
2. A TIRE WITH A PRESSURE OF LESS THAN 260 (262) PSIG/275 (277) PSIA IS CONSIDERED FAILED.
3. LOSS OF TIRE PRESSURE INSTRUMENTATION WILL NOT BE CAUSE FOR EARLY MISSION TERMINATION.
4. PAYLOADS MAY BE DEPLOYED/JETTISONED PRIOR TO ENTRY IN ORDER TO DECREASE TIRE LOADS.
5. FOR A LEAKING TIRE:
 - a. IF THE AFFECTED TIRE PRESSURE CAN BE MAINTAINED ABOVE THE FAIL LIMIT AT THE LANDING TIME FOR THE NEXT PLS PLUS 2 EXTENSION DAYS, PLANNED ON-ORBIT ACTIVITIES MAY CONTINUE. OTHERWISE, DEORBIT WILL BE SCHEDULED AT THE NEXT PLS OPPORTUNITY.
 - b. A LANDING WITH A CROSSWIND FROM THE SIDE OF THE LEAKING TIRE, WHILE MINIMIZING GROUNDSPED, IS HIGHLY DESIRABLE (MAIN GEAR TIRE ONLY).
6. FOR A FAILED MAIN GEAR TIRE, THE FOLLOWING ACTIONS WILL BE TAKEN TO PROTECT AGAINST FAILING THE ADJACENT TIRE DURING DEROTATION AND ROLLOUT:
 - a. LAND WITH CROSSWIND FROM THE SIDE OF THE FAILED TIRE WHILE MINIMIZING GROUNDSPED.
 - b. POST-MGTD, SELECT PITCH - AUTO FOR DEROTATION. IF AUTO-DEROTATION IS UNAVAILABLE, NOMINAL BEEP TRIM DEROTATION WILL BE DELAYED TO NO SLOWER THAN 165 KEAS TO ACHIEVE A 10 KT DELTA FROM THE DRAG CHUTE DEPLOY AIRSPEED. @[121604-6254C]

THIS RULE CONTINUED ON NEXT PAGE

FLIGHT RULES**A10-142****TIRE PRESSURE [CIL] [HC] (CONTINUED)**

- c. DEPLOY THE DRAG CHUTE AT 185 KEAS. IF AUTO-
DEROTATION IS UNAVAILABLE, A NOMINAL DRAG CHUTE
DEPLOY WILL BE PERFORMED. @[121604-6254C]
- d. AT NGTD, INPUT AN IMMEDIATE FULL DEFLECTION LATERAL
ROLL AWAY FROM THE FAILED TIRE AND MAINTAIN UNTIL
WHEELSTOP.

Since tire pressure is greatly dependent upon temperature, a leak cannot be confirmed unless there is a sustained unexpected decay in both the actual and temperature-corrected pressure measurements on a tire. The loss of both pressure measurements will not be cause to declare a leaking/failed tire. The 2 psi transducer error is based on the ability to compare the TPDMS system to KSC mechanical gauge readings (0.1 percent accuracy) prelaunch and to eliminate the measurement scatter. The remaining 2 psi error includes the KSC mechanical gauge error and scatter seen prelaunch in the TPDMS pressure readings due to variations in temperature.

If a leaking condition is confirmed in a main or nose gear tire, the load-carrying capability of that tire is reduced. The main gear and nose gear values were derived from Convair 990 low pressure testing which simulated a 248K vehicle landing at 225 knots in a 15 knot crosswind for the mains (20 knot crosswind for the nose tires) and showed a low pressure tire could sustain a heavy load. Neither main nor nose gear tire failed at the lowest pressures tested on Convair. The failed tire limit was derived from this lowest pressure tested (235 psig/250 psia) with 10 percent added for safety. The good main gear tire, 355 psia, received 62 percent of the strut load (162.5K peak vert. load) while the failed tire, 250 psia, received 48 percent (123.5K) of the load (Convair flight tests 121/122). The 161.5K peak load tested exceeds the tire certification of 142.5 klbs. The CV-990 test demonstrated additional vertical load capability by reducing the crosswind to 15 knots. The good nose gear tire, 325 psia, received 61 percent of the strut load (55.0K peak vert. load) while the failed nose tire, 250 psia, received 49 percent (46.3 percent of the load). (Convair flight tests 145/150). (Ref. Dryden Test Report, August 1995: Landing System Research Aircraft Low Pressure Stress Test Flights.) Reference SODB, vol. I, 3.4.2.1. @[041097-4009E] @[111094-1690B]

Requiring the tire pressure to support 2 additional days maintains tire capability should a deorbit waveoff or bad weather occur to prevent landing on the desired PLS opportunity (protects for one additional PLS landing opportunity). Because load-carrying capability of the tire is reduced if tire pressure is degraded, deploy or jettison of the payload is desired, if accomplishable, so that orbiter landing weight and tire loading may be reduced, increasing the possibility of tire survival. The one additional PLS landing opportunity should not be sacrificed in order to avoid an early payload deploy or jettison, if applicable. @[121604-6254C]

THIS RULE CONTINUED ON NEXT PAGE

FLIGHT RULES

A10-142**TIRE PRESSURE [CIL] [HC] (CONTINUED)**

Landing with a crosswind from the side of the failed main gear tire, while minimizing groundspeed, is required in order to decrease the possibility of failing the adjacent tire on the same strut. If the affected tire is leaking, but predicted to remain above the fail limit through wheelstop, this technique is still highly desirable and will decrease the possibility of failing the leaking tire. Landing and rollout loads are less on the upwind tires and strut than those encountered on the downwind side of the vehicle. Minimizing the groundspeed on the tire adjacent to a leaking or failed tire during the high strut load region of rollout (approximately NGTD through wheelstop) is critical since tire damage in these cases is correlated with groundspeed. Lower groundspeeds during rollout reduce the number of revolutions the tire is subjected to, thereby lowering the damage incurred through repeated cycling of the tire carcass. Ames VMS testing in 2003 using the updated "load persistence" MLG tire model shows that minimizing both crosswind and groundspeed is crucial to reducing the possibility of failure of the adjacent tire. The data captured during this limited study was inadequate for defining quantitative limits or trade-offs between these two parameters, so real-time decisions affecting crosswind and groundspeed, such as runway selection, speedbrake option, and forecast uncertainty, should give equal weight to both variables. ©[041097-4009E] ©[121604-6254C]

Options to reduce touchdown groundspeed include landing in a headwind, selecting short field speedbrake, or reducing targeted touchdown airspeed by 10 KEAS. The only effective method to reduce groundspeed during rollout is to change the airspeed to groundspeed relationship by selecting a headwind. Reducing the targeted touchdown airspeed (by landing slow and/or selecting shortfield speedbrake) only reduces the groundspeed during the low strut loading region between MGTD and NGTD; it does not reduce groundspeed during rollout since auto will derotate the vehicle at the same airspeed for all vehicles. While reducing the targeted touchdown airspeed should help the remaining good tire by reducing total cycles and heating, there is no model data to quantify the reduction.

Ames VMS testing in 2003, incorporating the updated "load persistence" tire model, indicates that the main landing gear tire load profile generated by an auto-derotation when the drag chute is deployed at 185 KEAS is less severe than with a beep trim derotation. The testing indicated that landing with the lowest groundspeed (e.g., landing in a headwind) and with a crosswind from the side of the failed tire, initiating auto-derotation (which automatically starts at 180 KEAS and yields lower MLG peak loads due to higher target derotation rates), deploying the drag chute at 185 KEAS, and inputting an immediate full lateral flight control input (RHC roll) in the direction opposite the failed tire at NGTD all contributed to maximizing the probability of survival for the remaining tire on the same strut as the failed tire. Simulations using this technique for typical ISS EOM weights showed a high likelihood of saving the second tire, while heavier abort weights usually showed loss of the second tire on the same strut regardless of the technique applied. A model audit performed in 2004 in support of nose gear tire certification activities resulted in changes that increased tire damage trends from the load persistence model when compared to the version used for the 2003 study. Although the tire failure mitigation procedure is less effective than indicated by the results of the 2003 study, preliminary Ames VMS training session data suggest the procedure still increases the probability of saving the second tire on the same strut for lightweight vehicles. Additional strength is expected with the new main gear tires, which will further increase the probability of saving the second tire. ©[121604-6254C]

THIS RULE CONTINUED ON NEXT PAGE

FLIGHT RULES

A10-142 TIRE PRESSURE [CIL] [HC] (CONTINUED)

Note that if the BFS has been engaged, auto-derotation is not available. In this case, a nominal drag chute deploy (at 195 KEAS) will be performed and a beep trim derotation will be delayed to achieve a 10 kt delta from the drag chute deploy airspeed (reference AEFTP #194, October 2003). With the BFS engaged, beep trim derotation is available only via the CDR's RHC. The intent of a nominal drag chute deploy is to achieve disreef just prior to NGTD (reference Ascent/Entry Flight Techniques Panel #104, September 1993). Ames VMS data (6/93) indicates that main landing gear loads are minimized (decreased by up to 17 percent) by obtaining disreef just before NGTD. Flight data and testing at Ames (1/96) show that to ensure disreef prior to NGTD, the chute should be deployed 10 knots prior to derotation. Chute deploy will be performed regardless of the status of SSME repositioning (reference Rule {A10-143}, DRAG CHUTE DEPLOY TECHNIQUES [HC]). ©[121604-6254C]

Hazard report ORBI 021 references this rule. ©[121604-6254C]

Rules {A2-6}, LANDING SITE WEATHER CRITERIA [HC]; {A2-206}, DEROTATION SPEED [HC]; {A2-207}, LANDING SITE SELECTION [HC]; {A2-261}, ENTRY DTO/AUTO MODE/CROSSWIND DTO GO/NO-GO; {A2-301}, CONTINGENCY ACTION SUMMARY [HC]; and {A10-143}, DRAG CHUTE DEPLOY TECHNIQUES [HC], reference this rule. ©[022604-6218]
 ©[ED] ©[032807-8400]

FLIGHT RULES

A10-143

DRAG CHUTE DEPLOY TECHNIQUES [HC] @[032504-6223B]

- A. NOMINAL DEPLOY: DRAG CHUTE DEPLOY WILL BE PERFORMED POST MGTD AT 195 KEAS. THE FOLLOWING EXCEPTIONS APPLY: @[121604-6254C]

The intent of a nominal drag chute deploy is to achieve disreef just prior to NGTD. Flight data and testing at Ames (1/96 and 7/96) show that, to ensure disreef prior to NGTD, the chute should be deployed 10 knots prior to derotation. Results from DTO 521 (Drag Chute System) show that a chute deploy after the derotation rate is established results in a disreef immediately after NGTD. Ames (2/93) data shows that the vehicle sensitivity to lateral excursions is a function of how long the orbiter's nose is in the air after chute disreef, due to the limited ability of the rudder to compensate for large yawing moments. STS-47 chute disreef occurred approximately 2 seconds prior to NGTD, which resulted in a 40 ft lateral excursion off the runway centerline and subsequent redesign of the drag chute (5 ribbons were removed to improve chute stability). Ames (1/96, 7/96, and 1/97) data shows that deploying the chute 10 knots prior to the initiation of derotation is a safe technique for all vehicle mass moment cases with regard to nose gear touchdown limits and lateral excursions. The delta between chute deploy speed and the speed at the initiation of derotation should be no greater than 10 knots to prevent lateral control position and rate saturation from occurring, particularly with crosswinds > 10 knots with a lightweight vehicle. A nominal deploy alleviates the concern of objectionable vehicle performance which may occur if disreef occurs significantly prior to NGTD (ref. Ascent/Entry Flight Techniques Panel #97, #104). Flight experience) supports these conclusions. @[041097-4890A] @[121604-6254C]

1. EARLY DEPLOY: DRAG CHUTE DEPLOY MAY BE PERFORMED BETWEEN MGTD AND THE NOMINAL DEPLOY TIME ONLY FOR INSUFFICIENT ROLLOUT MARGIN (ECAL, ELS, AND BERMUDA RUNWAYS ARE CONSIDERED TO MEET THIS CRITERIA). @[041097-4890A] @[032504-6223B]

Maximum deceleration benefits from the drag chute are obtained when the drag chute is deployed as early as possible. A chute deploy at MGTD provides approximately an additional 1000 ft of rollout margin over a nominal deploy (ref. Ames Pilot Report dated 4/93).

THIS RULE CONTINUED ON NEXT PAGE

FLIGHT RULES**A10-143****DRAG CHUTE DEPLOY TECHNIQUES [HC] (CONTINUED)**

Adequate braking capability is determined based on brake energy predictions, rollout margin, and landing conditions of the day (reference Rule {A4-108}, TIRE SPEED, BRAKING, AND ROLLOUT REQUIREMENTS [HC]). An analysis performed by Flight Design & Dynamics (10/92) indicated that for adequate control and stopping distance, ≥ 37.5 percent brakes are required without NWS, and that ≥ 25 percent brakes are required with NWS (for all landing sites). This analysis assumed 15 kt crosswinds and no drag chute, and looked at brake torque only. The rollout margin predictions made from real-time trajectory simulations must satisfy flight Rule {A4-108}, TIRE SPEED, BRAKING, AND ROLLOUT REQUIREMENTS [HC], specified minimums to make a runway GO. These simulations do not include the effects of the drag chute. After committing to a landing site, if a braking/deceleration system partially or totally fails or touchdown energy is unexpectedly high, an early drag chute deploy is allowed to provide additional rollout margin protection. ©[121604-6254C] ©[042706-7363A]

Ames VMS data (February 1994) indicates that early deploys with vehicle mass moments $> 1.80 \times 10^6$ ft-lb may violate NLG touchdown limits (6 percent of the VMS runs). Ames testing performed in 1993, 1994, and 1997 shows that strut loads and handling qualities are acceptable with all vehicle mass moments. ©[041097-4890A]

Because of the lack of availability of weather balloons at ECAL, ELS, or Bermuda landing sites, energy predictions are not calculated for these sites. In order to stop the vehicle on a minimum length runway in a high energy approach, early chute deploy along with special speedbrake, derotation, and braking procedures are required. Reference A/EFTP's #165, June 16, 2000; #182, February 15, 2002; #183, March 22, 2002; #184, May 17, 2002; and #186, August 16, 2002. Reference Rule {A4-110}, AIMPOINT, SPEEDBRAKE RETRACT OPTION, AND EVALUATION TOUCHDOWN VELOCITY SELECTION [HC]. ©[032504-6223B]

2. LATE DEPLOY: DRAG CHUTE DEPLOY WILL BE PERFORMED AFTER NGTD FOR A LOW ENERGY LANDING OR IN SUPPORT OF THE CROSSWIND LANDING DTO. ©[111094-1690B]

Ames VMS data (July 1992) shows a late deploy is required because, after drag chute deployment during a low energy landing, deceleration happens so quickly that trailing edge "up" saturation occurs, and it is difficult to control derotation precisely. These factors cause high pitchdown rates and excessive NLG strut loads. Late deployment of the chute still allows some of the benefits of the chute to be retained. ©[121604-6254C]

THIS RULE CONTINUED ON NEXT PAGE

FLIGHT RULES**A10-143****DRAG CHUTE DEPLOY TECHNIQUES [HC] (CONTINUED)**

DTO 805, Crosswind Landing Performance, calls for orbiter landings in the presence of a 10-15 kt crosswind. The DTO was written prior to implementation of the drag chute, and the DTO text was not amended to reflect the change. However, deploying the drag chute prior to NGTD will complicate extracting the effect of the crosswind on the vehicle systems; therefore, drag chute deploy is delayed until post-NGTD if the crosswind and vehicle status support the DTO condition (reference NSTS 17625, Flight Test and Supplementary Objectives Document, and Rule {A2-261}, ENTRY DTO/AUTO MODE/CROSSWIND DTO GO/NO-GO). ©[121604-6254C]

3. DRAG CHUTE DEPLOY WILL BE PERFORMED POST MGTD AT 185 KEAS FOR LANDINGS WITH A FAILED TIRE WHEN USING AUTO-DEROTATION.

Ames VMS testing in 2003, incorporating the updated "load persistence" tire model, indicates that the main landing gear tire load profile generated by an auto-derotation when the drag chute is deployed at 185 KEAS is less severe than with a beep trim derotation. The testing indicated that landing with the lowest groundspeed (e.g., landing in a headwind) and with a crosswind from the side of the failed tire, initiating auto-derotation (which automatically starts at 180 KEAS and yields lower MLG peak loads due to higher target derotation rates), deploying the drag chute at 185 KEAS, and inputting an immediate full lateral flight control input (RHC roll) in the direction opposite the failed tire at NGTD all contributed to maximizing the probability of survival for the remaining tire on the same strut as the failed tire. Simulations using this technique for typical ISS EOM weights showed a high likelihood of saving the second tire, while heavier abort weights usually showed loss of the second tire on the same strut regardless of the technique applied. A model audit performed in 2004 in support of nose gear tire certification activities resulted in changes that increased tire damage trends from the load persistence model when compared to the version used for the 2003 study. Although the tire failure mitigation procedure is less effective than indicated by the results of the 2003 study, preliminary Ames VMS training session data suggest the procedure still increases the probability of saving the second tire on the same strut for lightweight vehicles. Additional strength is expected with the new main gear tires, which will further increase the probability of saving the second tire. Note that if the BFS has been engaged, auto-derotation is not available. In this case, a nominal drag chute deploy (at 195 KEAS) will be performed and a beep trim derotation will be delayed to achieve a 10 kt delta from the drag chute deploy airspeed (reference AEFTP #194, October 2003). With the BFS engaged, beep trim derotation is available only via the CDR's RHC.

Rules {A2-206}, DEROTATION SPEED [HC]; {A2-261}, ENTRY DTO/AUTO MODE/CROSSWIND DTO GO/NO-GO; and {A10-142}, TIRE PRESSURE [CIL] [HC], reference this rule. ©[121604-6254C]

THIS RULE CONTINUED ON NEXT PAGE

FLIGHT RULES

A10-143 DRAG CHUTE DEPLOY TECHNIQUES [HC] (CONTINUED)

- B. EMERGENCY DEPLOY: DRAG CHUTE DEPLOY WITH SSME REPOSITIONING INCOMPLETE WILL ONLY BE PERFORMED FOR A TAL/ELS, LEAKING/FAILED TIRE, INSUFFICIENT ROLLOUT MARGIN, LOSS OF BRAKING CAPABILITY, OR A SINGLE APU LANDING. ©[111094-1690B] ©[121604-6254C]

If SSME repositioning is not complete, the drag chute will not be deployed unless one or more of the above conditions are present. If none of the above conditions are present, the call to the crew should be "Go for emergency chute deploy only", indicating to the crew to not deploy the drag chute unless they feel that the drag chute could provide some additional benefit. If SSME repositioning did not occur and one or more of the above conditions are present, the call to the crew will be the type of deploy to be performed (e.g. Go for nominal deploy, early deploy, or late deploy).

Deploying the drag chute without SSME repositioning risks damage to engine bells. Rockwell analysis (1/91) shows that the most likely contact point would be between the top edge of the center main engine bell and the risers, when the risers are at full line stretch (twang). For certain cases, the benefits of the drag chute outweigh the risk of potential damage to the SSME bells.

The drag chute minimizes MLG loads if disreef occurs prior to NGTD. The additional loads margin of a nominal chute deploy and the margin the chute provides for the uncertainties of a short, narrow runway outweigh the risk of engine bell damage in the event of a TAL or ELS landing. During an RTLS, the engine bells are moved to the RTLS stow position which is the same as the drag chute stow position. Due to the length and width of the KSC runway, RTLS is not a sufficient reason to deploy if failures prevent the center main engine from reaching the stow position.

In the event of a leaking/failed tire, by minimizing MLG loads there is a possibility that the good tire on that strut will not fail. Main landing gear loads are minimized (decreased by up to 17 percent) by obtaining disreef just before NGTD (reference Rule {A10-142}, TIRE PRESSURE [CIL] [HC], and Ascent/Entry Flight Techniques Panel #104, September 17, 1993). ©[121604-6254C]

THIS RULE CONTINUED ON NEXT PAGE

FLIGHT RULES

A10-143

DRAG CHUTE DEPLOY TECHNIQUES [HC] (CONTINUED)

Adequate rollout margin is determined based on brake energy predictions and landing conditions of the day (reference Rule {A4-108}, TIRE SPEED, BRAKING, AND ROLLOUT REQUIREMENTS AND ROLLOUT REQUIREMENTS [HC]). An analysis performed by Flight Design & Dynamics (10/92) indicated that for adequate control and stopping distance, ≥ 37.5 percent brakes are required without NWS, and that ≥ 25 percent brakes are required with NWS (for all landing sites). This analysis assumed 15 kt crosswinds and no drag chute, and looked at brake torque only. ©[121604-6254C] ©[042706-7363A]

For a single APU landing, the drag chute provides rollout margin in the event the last APU fails during rollout. Ames '91 testing shows no noticeable changes in drag chute handling qualities due to a single APU landing.

Rules {A2-262}, LANDING DTO'S, and {A10-142}, TIRE PRESSURE [CIL] [HC], reference this rule. ©[111094-1690B]

Hazard reports ORBI 030, ORBI 180, and ORBI 342 reference this rule. ©[121604-6254C]

FLIGHT RULES

A10-144 **DRAG CHUTE DEPLOY CONSTRAINTS [HC]** ©[121604-6254C]

THE DRAG CHUTE WILL BE DEPLOYED FOR ALL LANDINGS SUBJECT TO THE FOLLOWING: ©[111094-1690B]

The drag chute adds margin to the landing and rollout capabilities of the shuttle by reducing main gear strut loads (possibly preventing a second blown tire at NGTD in the event of a leaking/failed tire), increasing directional stability (especially with directional control problems), and reducing rollout distance. Ames (6/93) data indicates that main gear load savings are maximized (loads decreased up to 17 percent) by obtaining disreef just before NGTD (ref. Ascent/Entry Flight Techniques Panel #104, September 17, 1993).

Hazard reports ORBI 030 and ORBI 342 reference this rule. ©[121604-6254C]

- A. THE DRAG CHUTE WILL NOT BE DEPLOYED IF CROSSWIND > 15 KNOTS PEAK.

The crosswind limit is for peak winds, in accordance with Rule {A2-6}, LANDING SITE WEATHER CRITERIA [HC]. Ames 1991 data shows that deploying the chute in high crosswinds will increase the vertical loads on the downwind tires and may also cause reduced pilot handling qualities. Handling qualities ratings (HQR's) degrade as the crosswinds approach 15 kts, but are still typically within acceptable limits (level 1-2 Cooper Harper ratings). A few level 3 HQR's occurred during 6/93 VMS runs with crosswinds of 15 and 20 kts (ref Ascent/Entry Flight Techniques Panel #104, September 17, 1993).

- B. THE DRAG CHUTE WILL NOT BE DEPLOYED PRIOR TO MGTD.

Before MGTD, the crew may not have time to jettison the chute nor will there be sufficient force to cause the pivot pin (105k - 125k lb shear pin) to disengage and release the chute (Ames 1990).

THIS RULE CONTINUED ON NEXT PAGE

FLIGHT RULES

A10-144 DRAG CHUTE DEPLOY CONSTRAINTS [HC] (CONTINUED)

- C. THE DRAG CHUTE WILL NOT BE DEPLOYED AT SPEEDS > 230 KEAS OR < 80 KGS. @[111094-1690B]

The pivot pin in the attach/jettison mechanism is designed to disengage and release the chute for forces between 105k lbs and 125k lbs, preventing structural damage. Above 230 KEAS, the loads are expected to exceed the pivot pin disengage limits. If these limits are exceeded, the pivot pin will most likely release the chute during disreef, the period of maximum loading. If this occurs, the elevons may not have enough time to react to the sudden change in moment of the orbiter, and derotation could increase to a rate which would result in exceeding NLG slapdown loads. @[111094-1690B]

If the drag chute is deployed at speeds < 80 KGS, only the pilot chute will deploy (ref. Rockwell Downey 1992 Computer Simulations). Analytical data shows there should be no contact between the risers and the center main engine bell at speeds as low as 75 KGS. Flight data shows that 75 KGS may be conservative, as the chute is riding higher than anticipated.

- D. THE DRAG CHUTE WILL BE ARMED AND DEPLOYED SIMULTANEOUSLY.

When the chute is armed, an inadvertent deploy can result from additional failures in a deploy switch and/or electrical components within the drag chute avionics. An inadvertent deploy of the chute can result in excessive sink rates, which can be catastrophic.

- E. FOLLOWING DEPLOY, THE CHUTE WILL BE JETTISONED AT A SPEED OF 60 ± 20 KGS. THE CHUTE WILL NOT BE JETTISONED BELOW 40 KGS.

Ames (1/93) data has shown that jettison of the chute prior to NGTD can result in poor handling qualities, and can increase the nose gear slapdown loads above allowable structural limits.

If the chute is jettisoned below 20 KEAS, there is an increased probability that the drag chute risers will contact and possibly damage the engine bells (Rockwell engineering analysis). All crew procedures after nose gear touchdown that are cued to velocity must use ground speed because the HUD display changes from airspeed to ground speed at WONG. The 40 KGS minimum jettison cue is 20 kt faster than the 20 KEAS constraint to account for wind and atmospheric effects, instrumentation error, and system lag.

Rules {A2-6}, LANDING SITE WEATHER CRITERIA [HC], and {A2-262}, LANDING DTO's, reference this rule. @[111094-1690B]

FLIGHT RULES

A10-145

UNCOMMANDED BRAKE PRESSURE [CIL]

- A. BRAKE ISOLATION VALVE (S) WILL BE CLOSED IF NECESSARY TO PREVENT LANDING WITH UNCOMMANDED BRAKE PRESSURE > 180 (180) PSI IN ONE OR MORE BRAKE/SKID CONTROL VALVES. THE ASSOCIATED BRAKE ISOLATION VALVE (S) WILL BE OPENED AFTER NOSE GEAR TOUCHDOWN TO PROVIDE FULL BRAKING.

Brake application is possible at pressures ≥ 180 psi. If brake pressure increases above 180 psi at main gear touchdown, the tire(s) will "skid" until tire failure. The tire adjacent to the failed tire may fail at nose gear touchdown, resulting in severe lateral-directional control problems during rollout. The high friction forces of a locked wheel may also result in nose gear loads in excess of structural limits.

Closing the affected isolation valve(s) isolates the brakes from the high pressure flow, and the pressure should decrease to nominal levels through the return pressure lines. This covers the most credible failure modes (brake servovalve problems due to contamination and silting or an antiskid card failure).

- B. IF CLOSING THE BRAKE ISOLATION VALVE(S) FAILS TO RELIEVE THE BRAKE PRESSURE, AN APU WILL BE SHUT DOWN TO PREVENT LANDING WITH BRAKE PRESSURE > 180 (180) PSI IN A SINGLE BRAKE/SKID CONTROL VALVE IF TWO OTHER GOOD APU/HYDRAULIC SYSTEMS REMAIN. TWO APU'S WILL BE SHUT DOWN IF NECESSARY TO RELIEVE UNCOMMANDED BRAKE PRESSURE IN MULTIPLE BRAKE/SKID CONTROL VALVES. THE ASSOCIATED BRAKE ISOLATION VALVE(S) WILL BE OPENED PRIOR TO APU SHUTDOWN.

If uncommanded brake pressure is not relieved when the isolation valve(s) is closed, the selector valve is stuck such that it is blocking both the primary and secondary return lines. The primary system brake isolation valve(s) will be reopened to allow a return path for the hydraulic fluid, and the primary APU (1 or 2) will be shut down. If high brake pressure is detected in only one brake/skid control module, a second APU will NOT be shut down because of the possibility that the failure is a transducer failure.

The 180-psi value used in this rule does not take into account the ± 100 psi transducer error. If transducer error was considered, the value at which to take action would be well within the nominal system operating range. The transducers have proven to be reliable in their accuracy.

With OI-21 software and the major modification hydraulic changes, the brake isolation valves will remain closed until MGTD. Therefore, it would take at least two failures to implement this rule.

Reference SODB, vol. I, sec. 3.4.2.1, and Mechanical Systems Console Handbook, volume II, section 2.5.9.

Rule {A10-71}, HYDRAULIC SYSTEMS CONFIGURATION, references this rule.

FLIGHT RULES

A10-146

BRAKING

A. DEFINITIONS:

1. NOMINAL BRAKING PROFILE - THE NOMINAL BRAKING PROFILE CONSISTS OF APPLYING THE BRAKES WHEN THE VEHICLE HAS REACHED A SPEED OF 140 KNOTS GROUND SPEED (GS). ONCE BRAKES ARE APPLIED, A DECELERATION RATE OF 8 FPS² SHOULD BE MAINTAINED UNTIL A SPEED OF 40 KNOTS GS IS REACHED, WHEN THE DECELERATION RATE SHOULD BE REDUCED TO LESS THAN 6 FPS².

The 140 knots GS was chosen as the nominal brake-on speed because it is the maximum speed that can be used with this deceleration rate and not exceed the reuse energy limit of the brakes. This was determined by landing and rollout analysis programs discussed at Flight Techniques meetings and verified in the SMS and Ames VMS. Applications of brakes before 140 knots will lead to brake energies above the allowable limits before wheelstop occurs. Applying brakes below this speed will lengthen rollout distances from the predicted values. An additional consideration with regards to brake-on speed is that the hydroplaning speed for the orbiter tire pressure is approximately 140 knots, and skidding could occur above this speed if brakes are applied. The deceleration rate was chosen to provide the most efficient stop versus total brake energy and takes into consideration the following design characteristic of the brakes: working best under moderately high torque values. (Because of heat buildup and transfer throughout the brake, it is desirable to stop quickly, before thermal damage can occur - yet not so quickly that total energy exceeds limits.) Finally, brake torque increases at lower speeds, and it is therefore desirable to let off on the deceleration rate below 40 knots GS to prevent brake structural failure and subsequent lockup of the wheel. ©[ED]

2. MAXIMUM BRAKING PROFILE - THE MAXIMUM BRAKING PROFILE CONSISTS OF APPLYING MAXIMUM BRAKE PRESSURE TO ACHIEVE THE HIGHEST POSSIBLE DECELERATION RATE. MAXIMUM DECELERATION RATE SHOULD BE ACHIEVED IN NOT < 2 SECONDS FROM BRAKE APPLICATION. WHEN THE VEHICLE REACHES 40 KNOTS GS, IF SUFFICIENT RUNWAY REMAINS, THE DECELERATION RATE SHOULD BE DECREASED TO < 6 FPS² UNTIL WHEELSTOP. ©[ED]

Since the maximum braking profile is to be used only when there is a danger of the vehicle running off the end of the runway, no regard is given to using up the brake hardware by exceeding energy limits; therefore, the maximum amount of torque available should be used. A smooth rather than sudden application is preferred to prevent possible high-speed failure of the brake stack. Also, if sufficient runway remains after the high-speed part of the stop, it is desirable to release the brakes below 40 knots GS to prevent low-speed lockup of the wheel, since brake torque increases at lower speeds.

THIS RULE CONTINUED ON NEXT PAGE

FLIGHT RULES

A10-146 BRAKING (CONTINUED)

B. BRAKING PROFILE SELECTION - THE FOLLOWING CRITERIA DETERMINE THE SELECTION OF THE BRAKING PROFILE TO BE USED:

1. NO BRAKING BEFORE MIDFIELD.

All shuttle runways are at least 11,000 feet long to ensure that midfield will always provide a minimum distance (5,500 feet) to the end of the runway. Landing analysis shows that stopping distance requirements can always be met in this distance; therefore, there is no requirement to apply the brakes before midfield, thus preserving the brakes and reducing the risk of failures.

2. AFTER MIDFIELD, BUT BEFORE THE 5,000-FOOT REMAINING POINT, THE NOMINAL BRAKING PROFILE WILL BE USED WHEN A SPEED OF 140 KNOTS GS IS REACHED. (BRAKES WILL NOT BE APPLIED IN THIS REGION UNTIL THE 140 KNOTS GS SPEED IS REACHED.)

Landing and deceleration analysis has shown that the nominal braking profile can stop the vehicle with sufficient margin when used before the 5,000-foot remaining point when brakes are applied at 140 knots GS. There is no requirement to apply the brakes before the 140 knots GS speed in this region thus preventing damage from high-energy stops.

3. WHEN THE VEHICLE PASSES THE 5,000-FOOT REMAINING POINT AND IF THE GROUND SPEED IS < 140 KNOTS, THE NOMINAL BRAKING PROFILE WILL BE OBSERVED. IF THE GROUND SPEED IS > 140 KNOTS, THE MAXIMUM BRAKING PROFILE WILL BE OBSERVED.

If the vehicle is still going faster than 140 knots GS when it passes the 5,000-foot remaining point, maximum braking will be required to stop before the end of the runway with adequate margins. Maximum braking effort is reserved for this extreme case, since it will lead to extensive brake damage, possibly before wheelstop, and creates a potential for a post-stop brake fire. If the vehicle has already slowed to less than 140 knots GS at the 5,000-foot remaining point, the vehicle can be stopped using the nominal braking profile. ®[ED]

A10-147 THROUGH A10-160 RULES ARE RESERVED

FLIGHT RULES

MECHANICAL SYSTEMS LOSS/FAILURE DEFINITIONS

A10-161 DRIVE MECHANISMS LOSS DEFINITIONS

DRIVE MECHANISMS ASSOCIATED WITH VENT DOORS, PLBD'S, RADIATORS, ET UMBILICAL DOORS, PAYLOAD RETENTION LATCHES, ACTIVE KEEL LATCHES, KU-BAND, AND ROEU/ROFU ARE CONSIDERED FAILED IF: @[062801-4355A]

- A. THE DRIVE TIME EXCEEDS SINGLE MOTOR DRIVE TIME (EXCEPT IN THOSE CASES WHERE VISUAL INDICATIONS ARE AVAILABLE) .

The drive mechanisms mentioned above each possess two motors for redundancy purposes. A single motor can drive the mechanism; however, dual motor drive will actuate the mechanism in half the time (dual motor drive is nominally used for the mechanisms above). Therefore, if the drive time (for open/close, latch/unlatch, etc.) associated with the mechanism exceeds that for single-motor drive (the maximum it would take if either motor drove), then it is assumed that the mechanism has failed to reach the desired position. If visual cues are available to ascertain the mechanism's position and it is determined that the desired position has been reached, the mechanism is not considered failed.

- B. THE DRIVE MECHANISM CAN BE OBSERVED AND IS NOT MOVING IN RESPONSE TO THE COMMAND.

Assuming the proper switch and circuit breaker configuration and that the mechanism has not already attained the commanded position, movement should be seen; otherwise, the mechanism has failed.

- C. THE DRIVE MECHANISM CANNOT BE OBSERVED AND THERE IS NEITHER OPEN NOR CLOSED POSITION INDICATIONS AND DRIVE TIME EXCEEDS SINGLE-MOTOR DRIVE TIME.

If sufficient time has elapsed for the mechanism to have reached the desired state for only one motor driving and no indications of it reaching the commanded position are seen, then the mechanism is considered to have failed in transit. This applies only to that mechanism's position. This is based on the low probability of transducer failures for the end-of-travel indications that would imply that the mechanism had failed coupled with the assumption that it is safer to consider the mechanism failed.

THIS RULE CONTINUED ON NEXT PAGE

FLIGHT RULES

A10-161 DRIVE MECHANISMS LOSS DEFINITIONS (CONTINUED)

APPROXIMATE SINGLE MOTOR DRIVE TIMES ARE:

PLBD CENTERLINE LATCHES (*OPEN ONLY)	40 SECONDS
PLBD BULKHEAD LATCHES*	60 SECONDS
PLBD DRIVE*	126 SECONDS
RADIATOR LATCHES	60 SECONDS
RADIATOR STOW/DEPLOY DRIVE*	100 SECONDS
ET DOOR CENTERLINE LATCHES	12 SECONDS
ET DOOR DRIVE	48 SECONDS
ET DOOR UPLOCK LATCHES	12 SECONDS
VENT DOOR DRIVE	10 SECONDS
PAYLOAD RETENTION LATCHES	60 SECONDS
KU-BAND DRIVE*	46 SECONDS
ROEU/ROFU DRIVE*	60 SECONDS
ROEU/ROFU LATCH	40 SECONDS
ROEU/ROFU RELAX	24 SECONDS

*VISUAL CUE AVAILABLE @[062801-4355A]

The table above gives the design specification time required for the indicated drive mechanism to reach the full open/close/etc. position. These times can vary somewhat and are usually less than that shown. The dual motor drive time can be determined by dividing the single-motor drive time by two.

Visual cues are provided by bulkhead camera views and/or by looking out the payload bay windows. For the centerline latches only, the open position can be observed. When partially or fully closed, the latch hook is hidden behind the extended guide roller and the latch hook roller brackets. It is not possible to visually determine if the latches are closed far enough.

A10-162 THROUGH A10-180 RULES ARE RESERVED

FLIGHT RULES

GENERAL MECHANISMS SYSTEMS MANAGEMENT

A10-181 DRIVE MECHANISMS

- A. IF VISUAL CUES ARE NOT AVAILABLE, A DRIVE MECHANISM WILL BE CONSIDERED TO HAVE ATTAINED ITS COMMANDED POSITION, OPEN/CLOSED/STOWED/DEPLOYED/LATCHED/RELEASED, IF AT LEAST ONE INDICATION OF THAT STATE OCCURS WITHIN SINGLE-MOTOR OPERATING TIME.

Redundant indications are provided for the drive mechanisms for the open/closed/stowed/deployed/latched/released positions. If, during a drive sequence for any of the above mechanisms that does not have means of visual verification, any of the end-of-travel indications are present within the single-motor drive envelope, the mechanism will be considered to be in the desired position. This is based on the low probability of a transducer failing within the time that the indication was expected thereby giving a false verification of position.

- B. DRIVE MECHANISM COMMANDS WILL BE TERMINATED IF THE MECHANISM CAN BE OBSERVED AND IS NOT MOVING IN RESPONSE TO THE COMMAND.

To prevent damage to motors (burnout), drive mechanism commands will be terminated if no mechanism movement is observed for those mechanisms which can be visually verified.

- C. DRIVE MECHANISMS WHICH CANNOT BE OBSERVED WILL BE ALLOWED TO DRIVE TO THE SINGLE-MOTOR DRIVE TIME. COMMANDS WILL BE TERMINATED AFTER SINGLE-MOTOR TIME OR AFTER RECEIPT OF ONE TERMINAL POSITION INDICATION IN THE DIRECTION OF TRAVEL.

If one motor fails, the time required for the mechanism to change state will be twice the normal dual motor time. If the mechanism cannot be observed, it is safe to send drive commands for the single-motor drive time which will be adequate even if one motor has failed. Commands should be terminated after single-motor time even if no terminal indication is received because (the mechanism may have a more serious failure, possible jam) continuing the command could possibly damage the motor(s) or clutch(es).

- D. DRIVE MECHANISMS WHICH CAN BE OBSERVED WILL BE ALLOWED TO DRIVE IN EXCESS OF SINGLE-MOTOR DRIVE TIME WHEN DRIVING IN THE CLOSED/LATCHED DIRECTION WITH DETECTABLE MOTION.

Allowing a mechanism to drive beyond single-motor drive time, as long as the mechanism can be observed, can possibly place that mechanism in a fail-safe configuration (closed/latch direction is fail-safe and desirable).

A10-182 THROUGH A10-200 RULES ARE RESERVED

FLIGHT RULES

PAYLOAD DOOR (PLBD) SYSTEMS MANAGEMENT

A10-201

PLBD GENERAL

A. LAUNCH DAY LANDING PLBD OPERATIONS:

1. IF A LANDING IS REQUIRED AND SUPPLY/WASTE WATER WILL SUPPORT FES OPERATIONS UNTIL ENTRY, NO ATTEMPT WILL BE MADE TO OPEN ONE OR BOTH THE PLBD'S. @[020196-1804A]

For launch day landings at the first available PLS, the supply and waste water tanks are loaded such that there is sufficient water for FES operations; therefore, there is no requirement to incur the risks associated with opening the PLBD's, thus eliminating an increase in the crew workload during this timeframe.

2. IF A LANDING IS REQUIRED AFTER PREDICTED EXHAUSTION OF SUPPLY AND WASTE WATER FOR THE FES, THE PLBD'S MAY BE OPENED.

For launch day landings after the first PLS opportunity, insufficient supply/waste water may have been loaded to support FES operations to entry. If the first PLS opportunity is no-go or likely to be no-go, then PLBD opening will be required. This situation may result in having to open the PLBD without close redundancy. @[020196-1804A]

3. FOR PROBLEMS PROHIBITING NECESSARY HEAT REJECTION, THE PLBD'S MAY BE OPENED (TIME PERMITTING) WITHOUT REGARD TO CLOSE-MOTOR REDUNDANCY, FES WATER SUPPLY AVAILABILITY, OR MET OF LANDING. @[020196-1804A]

For cases where there are cooling problems and opening the PLBD's is required to alleviate heating of critical equipment needed for entry, the PLBD's should be opened to provide the increased cooling capability. This may be necessary even though redundant PLBD closure does not exist and the timeline/workload would be increased.

- B. IF A LATCH GANG FAILS TO FULLY OPEN BUT CAN BE VERIFIED TO CLEAR THE ROLLERS BY VISUAL OBSERVATION/TV, IT WILL NOT BE CYCLED CLOSED.

In order to provide a maximum chance to at least complete an MDF, a failed in-transit latch gang that can be observed to be open will not be cycled closed. Some risk is associated with cycling the latch gang closed. It may fail close or nearly closed prohibiting PLBD opening operations. There is no real advantage in cycling the latch gang closed when the problem is first discovered over closing it in preparation for entry.

THIS RULE CONTINUED ON NEXT PAGE

FLIGHT RULES

A10-201 **PLBD GENERAL (CONTINUED)**

- C. PLBD LATCHES WILL NOT BE CYCLED CLOSED WHILE THE PLBD'S ARE OPEN.

To preclude system failures (mechanical, structural, software) that may occur while the latch gang is being closed or is closed, the most conservative thing to do is not close the latch gang while the PLBD's are opened. There is no EVA capability to open a failed closed latch gang. A failure where the latch gang remains closed would prohibit complete PLBD closure and latching for entry. Cycling of a latch gang while the PLBD's are open will not be done for troubleshooting purposes.

- D. THE STARBOARD PLBD WILL NOT BE CLOSED WITH THE PORT PLBD OPEN.

Structural interference between the centerline latch hangers (port PLBD) and the bell-crank/hook bracket assembly (starboard PLBD) prevents complete PLBD closure and latching. Also, if the starboard PLBD drive mechanism fails (PLBD jams closed) while the port PLBD is open, the orbiter is in an unflyable system configuration.

- E. PLBD WILL NOT BE REOPENED ONCE IT HAS BEEN CLOSED DURING AN EVA.

If an EVA had to be performed in order to put the vehicle in a fail-critical configuration, reopening a failed latch and/or PLBD in any case is not a prudent thing to do. Entry should be made at the next PLS opportunity after the EVA is completed.

FLIGHT RULES

A10-202

PLBD VISUAL CUES

THE PLBD'S AND PLBD LATCHES ARE CONSIDERED OPEN OR CLOSED IF THEY CAN BE VISUALLY VERIFIED VIA THE FOLLOWING CRITERIA:

- A. PLBD'S OPEN - THE SIX PUSH RODS SHOULD HAVE 10 STRIPES IN THE FIELD OF VIEW ABOVE THE LONGERON SILL.

Opening and closing of the PLBD's is accomplished by actuators acting through pushrods and bell cranks and thus on the PLBD's themselves. The actuators are hidden beneath the payload bay liner. Each pushrod has 10 stripes; the first, eighth, and ninth (counting from the top) are gold with the other seven being silver. When the PLBD's are closed, the pushrods retract behind the liner and only the uppermost stripe may be visible on any of the six pushrods for that door. For the fully open position, the pushrods must extend far enough that all 10 stripes can be seen. The other stripes indicate intermediate door positions.

- B. CENTERLINE LATCHES CLEAR OF ROLLERS (DESIGN OVERLAP CASE) - THE TIP OF THE LATCH SHOULD BE POINTING ABOUT 30 DEGREES DOWN FROM THE Y-AXIS WITH THE TIP APPROXIMATELY 1 INCH FROM THE ROLLER.

When the centerline latches are in the open position, the tip of the latch is pointing about 30 degrees down from the horizontal (see SSSH drawing 14.1,2). If this can be visually confirmed, then the latches are clear of the rollers. Due to the position of the latches when partially to fully closed, it is not possible to determine if the latches are closed far enough. Binoculars are available, but no markings are provided.

FLIGHT RULES

A10-203

PLBD CRITICAL LATCHES

- A. FOR FAILURE OF ANY TWO PLBD LATCH GANGS TO FULLY ENGAGE (CENTERLINE OR BULKHEAD), AN EVA WILL BE PERFORMED TO INSTALL MANUAL LATCH TOOLS ON AT LEAST ONE OF THE FAILED LATCH GANGS.
- B. FOR FAILURE OF ANY SINGLE OR MULTIPLE PLBD LATCH GANGS TO FULLY ENGAGE (CENTERLINE OR BULKHEAD), ENTRY LOADS WILL BE MINIMIZED PER THE FOLLOWING:
 1. ENTRY TEST MANEUVERS WILL NOT BE PERFORMED, AND ANY PROGRAMMED TEST INPUTS (PTI'S) WILL BE INHIBITED.
 2. CONSIDERATION WILL BE GIVEN TO TARGETING A RUNWAY/HAC APPROACH AT THE PLS OR SLS TO MINIMIZE TAILWIND AT HAC INITIATION AND TURBULENCE/SURFACE WINDS.

There is no analysis which indicates that entry with multiple latch gang failures is an acceptable condition. Although the latch tools have not been proven to provide the same structural integrity as a nominal latch gang, performing an EVA to install these latch tools provides a workaround to recover at least some load-carrying capability. Two latch tools are required to secure a single failed latch gang; however, only two centerline and two bulkhead latch tools are flown. When two of the same type gangs have failed, only one gang can be secured, as both available tools are required to secure one of these latch gangs.

A 1991 Rockwell assessment (which refined analyses performed in 1981 and 1987/1988) for a PLBD single latch-out (centerline or bulkhead) certified a nominal entry trajectory in AUTO flight control by exhibiting structural, thermal, and aerodynamic margins above the required 1.4 safety factor. This analysis shows that steps and gaps may occur as a result of the payload bay-to-ambient delta pressure and latch disengagement. Temperature exceedances may occur at these steps and gaps, but the resulting thermal damage poses no flight safety concerns. The extent of the postflight repairs can be limited by minimizing side slip and steady pitch-up maneuvers, according to the 1991 analysis. (Reference Structural Assessment of Shuttle Payload Bay Doors for Entry with a Latch Gang Out, SSD91D0276, May 1991, and A/E FTP #96, 12/18/92.)

Although entry test maneuvers and PTI's should not expose the vehicle to conditions outside of its certification limits, flying a nominal entry trajectory minimizes adverse mechanical, thermal, and aerodynamic loads. Vehicle accelerations, heating, and compartment-to-ambient pressure differentials can be limited by avoiding these maneuvers. Selecting a runway/HAC that minimizes HAC winds (most importantly, tailwind at HAC initiation) will help to minimize normal loads, and selecting a landing site with benign turbulence and surface wind conditions reduces the need for any abrupt directional control maneuvers.

Rules {A2-260}, ENTRY LOAD MINIMIZATION, and {A10-209}, PLBD RULE REFERENCE MATRIX, reference this rule.

FLIGHT RULES

A10-204 FAILED PLBD GPC SEQUENCE

IF THE GPC CONTROLLING THE PLBD SEQUENCE FAILS DURING PLBD OPERATIONS, THE PAYLOAD MDM'S WILL BE CYCLED OFF, THEN ON, TO TERMINATE EXISTING PLBD COMMANDS UNTIL THE SOFTWARE FUNCTION CAN BE REESTABLISHED.

Cycling the MDM's will clear the commands.

A10-205 PLBD CLEARANCE CONSTRAINTS

- A. THE KU-BAND ANTENNA CAN BE DEPLOYED ONLY IF THE STARBOARD PAYLOAD BAY DOOR IS FULLY OPEN.

The starboard PLBD must be fully open (reference Rule {A10-202A}.1, PLBD VISUAL CUES) in order to allow the antenna to rotate freely without any interference with orbiter hardware. If the starboard PLBD is open to 160 degrees, interference will occur between the PLBD bellcrank/pushrod assembly and the Ku-band antenna deployed electronics assembly (DEA). Each pushrod has 10 stripes; nine visible stripes indicate that the door is only 140 degrees open and 10 visible stripes confirm a full-open position of 175 degrees. Intermediate PLBD positions (e.g., 160 degrees) between 140 degrees and 175 degrees cannot be accurately determined. Therefore, the open microswitch indications and/or the tenth pushrod stripe must be visible prior to performing any Ku-band deploy/stow operation. (Reference SODB, vol. I, 3.4.5.2-25.)

- B. THE MANIPULATOR POSITIONING MECHANISMS (MPM) CAN BE DEPLOYED ONLY IF THE PORT PLBD PUSHRODS HAVE AT LEAST SIX STRIPES VISIBLE. IF THE RMS IS INSTALLED, NINE STRIPES MUST BE VISIBLE.

The port PLBD must be open greater than 69 degrees in order to allow the MPM's to be deployed without any interference with the PLBD structure. If the port PLBD is open less than 69 degrees, the bottom of the RMS shoulder pedestal will interfere or drive against the bottom of the PLBD. Each PLBD pushrod has 10 stripes; six stripes indicate that the door is at a minimum angle of 84 degrees. A PLBD position of 69 degrees is indicated on the fifth silver stripe. Intermediate positions prior to the sixth stripe cannot be accurately measured for adequate clearance margins. Therefore, in order to provide acceptable clearance capability prior to performing any MPM deploy operations, six PLBD pushrod stripes must be visible.

The port PLBD must be open greater than 130 degrees in order to allow MPM's to deploy a cradled RMS. If the port PLBD is open less than 130 degrees, interference will occur between the RMS wrist yaw joint and the EVA slidewire mount. Each PLBD pushrod has 10 stripes; nine visible stripes indicate that the door is at a minimum angle of 137 degrees. Eight pushrod stripes correspond to a maximum PLBD angle of 125 degrees. Intermediate PLBD positions (e.g., 130) cannot be accurately determined; therefore, the ninth pushrod stripe must be visible prior to performing any MPM deploy operations.

THIS RULE CONTINUED ON NEXT PAGE

FLIGHT RULES

A10-205

PLBD CLEARANCE CONSTRAINTS (CONTINUED)

- C. THE OBSS MANIPULATOR POSITIONING MECHANISMS (MPM'S) CAN BE DEPLOYED ONLY IF THE STBD PLBD PUSHRODS HAVE AT LEAST SIX STRIPES VISIBLE. @[102506-7826]

The starboard PLBD must be open greater than 75 degrees in order to allow the MPM's to be deployed without any interference with the PLBD structure. If the starboard PLBD is open less than 75 degrees, the bottom of the forward OBSS MPM pedestal will interfere or drive against a PLBD avionics bracket. Each PLBD pushrod has 10 stripes; six stripes indicate that the door is at a minimum angle of 84 degrees. A PLBD position of 75 degrees is indicated between the fifth and sixth stripes. Intermediate positions prior to the sixth stripe cannot be accurately measured for adequate clearance margins. Therefore, in order to provide acceptable clearance capability prior to performing any OBSS MPM deploy operations, six PLBD pushrod stripes must be visible.

The starboard EVA slidewire is not manifested and is, therefore, not an interference concern with the OBSS. The six-stripe requirement is valid as long as the OBSS MPM's are flown, whether the OBSS is present or not.

Reference STS-115 PLBD Flight Rule with OBSS, Boeing CATIA Kinematic Analysis, Hai Pham & Ed Zadorozny, February 24, 2005; and UCN/MCR: 19755, PCIN: S164599D, RHFA of Retention Pedestal Mechanism Assembly Used for OBSS Modal Survey Testing, October 1, 2004. @[102506-7826]

FLIGHT RULES

THIS PAGE INTENTIONALLY BLANK

FLIGHT RULES

A10-206

PLBD CLOSE GO/NO-GO

A. THERMAL CONSTRAINTS:

1. ON ORBIT, PLBD CLOSURES WILL NOT BE PERFORMED FOR THE FOLLOWING THERMAL CONDITIONS:
 - a. PORT DOOR - IF V34T1126A IS \leq -100 DEG (-87 DEG) F. FOR FAILURE OF V34T1126A, V34T1128A IS AN ALTERNATE.
 - b. STARBOARD - IF V34T1130A IS \leq -100 DEG (-87 DEG) F. FOR FAILURE OF V34T1130A, V34T1132A IS AN ALTERNATE.

The PORT RDY-TO-LATCH switch module failed on STS-3. The failure of this module to switch state after PLBD opening (during cold case testing) determined these low temperature operational limits (ref. paragraph B).

2. FOR NOMINAL END OF MISSION PLBD CLOSURE, THE BENDING EFFECT TEMPERATURE MUST BE LESS THAN 160 DEG F. THE BENDING EFFECT TEMPERATURE IS DEFINED AS THE DIFFERENCE BETWEEN AVERAGE LOWER BONDLINE AND AVERAGE SILL LONGERON TEMPERATURES ADDED TO THE DIFFERENCE BETWEEN 70 DEG F AND THE AVERAGE SILL LONGERON TEMPERATURES. (LOWER BONDLINE TEMPERATURES - V09T1016A, V34T1110A, V34T1112A; PORT LONGERON TEMPERATURES - V34T1114A, V34T1116A, V34T1118A; AND STBD LONGERON TEMPERATURES - V34T1120A, V34T1122A, V34T1124A USE THE AVERAGE OF THE COLDER SIDE LONGERON TEMPERATURES.)

Bending effect temperature (BET) = (lower bondline avg. T - sill longeron avg. T) + (70 deg F - sill longeron avg. T). This equation uses both the delta between top and bottom on the orbiter and a comparison between a standard ground temperature of 70 deg F and average sill longeron temperatures to predict door closure constraints caused by thermal deflections. The worst case thermal conditions for PLBD closure were seen on STS-3. During the first attempt to close the doors, door closure was prevented by structural interference between the port PLBD and the aft bulkhead. This occurred because of the extremely cold overall temperatures and the high thermal delta between the top and bottom, resulting in a "banana effect" which expanded the bottom and shrunk the top to make the gap between the door and the aft bulkhead too small to allow proper door closure. After thermal conditioning, the doors closed properly with a delta between lower bondline and sill longerons of approximately 52 deg F and an average sill longeron temperature of -41 deg F. For this case: $BET = 52 \text{ deg F} + (70 \text{ deg} - 41 \text{ deg F}) = 163 \text{ deg F}$. From this, 160 deg F was selected as the limit. This constraint is for all planned PLBD operations.

THIS RULE CONTINUED ON NEXT PAGE

FLIGHT RULES

A10-206

PLBD CLOSE GO/NO-GO (CONTINUED)

3. THERMAL ATTITUDE WILL BE MANAGED TO MAINTAIN THE BET BELOW 200 DEG F TO FACILITATE CONTINGENCY PLBD CLOSURE. THERMAL CONDITIONING WILL BE PERFORMED FOR AS LONG AS PRACTICAL TO ATTEMPT TO GET WITHIN THE CONSTRAINTS DEFINED IN PARAGRAPH B. FLIGHT SPECIFIC EXCEPTIONS FOR HIGH PRIORITY FLIGHT OPERATIONS WILL BE IDENTIFIED IN THE FLIGHT RULES ANNEX. FOR ANY MISSION NOMINALLY EXCEEDING THE CONTINGENCY LIMITS, THE EXCEPTION WILL BE TAKEN TO THE PRCB FOR INFORMATION.

After STS-3, the hardware was modified by shaving 0.39 inch off the aft lug to allow for additional door gap clearance between the doors and aft bulkhead. This additional clearance would have allowed the doors to close, even for the worst-case thermal conditions seen during the unsuccessful door closing attempt on STS-3. (BET = 74 deg F + (+7 deg minus -64 deg F) = 208 deg F. A limit of 200 deg F was selected to allow for uncertainties in the analysis. This constraint is for contingency deorbit/PLBD closure anytime during the mission.

Reference Rockwell Document, Effect of On-Orbit Temperature on Shuttle Payload Bay Door Closure, STS90D0172, March 1990, for temperature effect and bulkhead modification descriptions.

Rules {A2-106}, PBD OPERATIONS [CIL], and {A2-129}, ORBITER ON-ORBIT HIGH DATA RATE REQUIREMENTS, reference this rule.

B. PLBD CENTERLINE LATCH EXTENDED GUIDE ROLLER TRAJECTORY:

THE GO/NO-GO CRITERIA FOR PLBD CLOSE IS PER RULE {A10-205}, PLBD CLEARANCE CONSTRAINTS. THE PORT PLBD WILL BE CLOSED AND LATCHED, AND THE STARBOARD PLBD WILL BE CLOSED TO THE POINT THAT THE CLOSEST EXTENDED GUIDE ROLLER (STARBOARD DOOR) IS AS NEAR AS FEASIBLE TO ITS STRIKER PLATE (PORT PLBD) WITHOUT IMPACTING IT. THE VISUAL PROJECTION OF THE EXTENDED GUIDE ROLLER TRAJECTORY MUST NOT EXCEED THE BOUNDARIES IDENTIFIED IN THE PLBD CENTERLINE LATCH EXTENDED GUIDE ROLLER TRAJECTORY DIAGRAM BELOW.

The crew will utilize the PLBD CENTERLINE LATCH EXTENDED GUIDE ROLLER TRAJECTORY (diagram) as GO/NO-GO criteria to latch the centerline latches on entry day. In addition, this diagram is used to satisfy the "PLBD FIT TEST" DTO requirement to continue the mission on launch day for the first flight of a new vehicle.

THIS RULE CONTINUED ON NEXT PAGE

FLIGHT RULES

A10-206

PLBD CLOSE GO/NO-GO (CONTINUED)

PLBD CENTERLINE LATCH EXTENDED GUIDE ROLLER TRAJECTORY (DIAGRAM):

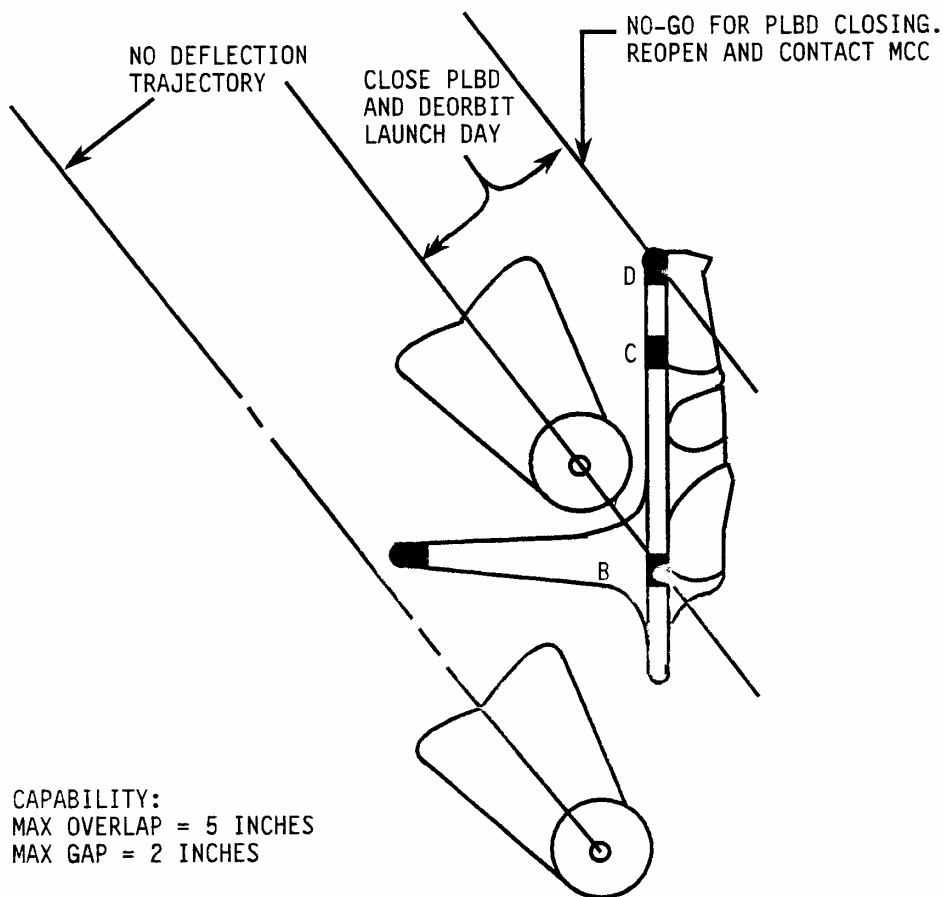

THIS RULE CONTINUED ON NEXT PAGE

FLIGHT RULES

A10-206

PLBD CLOSE GO/NO-GO (CONTINUED)

C. PORT AFT BULKHEAD LATCH GO/NO-GO CRITERIA:

PLBD'S CLOSED SUFFICIENT FOR BULKHEAD LATCHING - THE PORT PLBD SCALLOP MUST BE ON OR BELOW THE TOP OF TARGET STRIPE (AFT BULKHEAD) OR THE PORT AFT PLBD CLOSE INDICATION MUST BE PRESENT AS SHOWN IN THE PORT AFT BULKHEAD LATCH GO/NO-GO DIAGRAM ON THE FOLLOWING PAGE.

The PORT AFT BULKHEAD LATCH GO/NO-GO CRITERIA was developed to aid in bulkhead latching subsequent to the jamming of the port PLBD edge of the aft bulkhead seal bracket on STS-4. If the port PLBD close indications are present, then the PLBD is sufficiently closed to permit bulkhead latching. Without these indications, visual verification can be made by observing if the port PLBD scallop (the leading edge of the PLBD/latch mechanism at the extreme aft portion of the PLBD) is on or below the top of the black stripe (1 inch wide) painted on the aft bulkhead. If so, the PLBD is closed far enough for the latches to engage.

THIS RULE CONTINUED ON NEXT PAGE

FLIGHT RULES

A10-206

PLBD CLOSE GO/NO-GO (CONTINUED)

PORT AFT BULKHEAD LATCH GO/NO-GO (DIAGRAM)

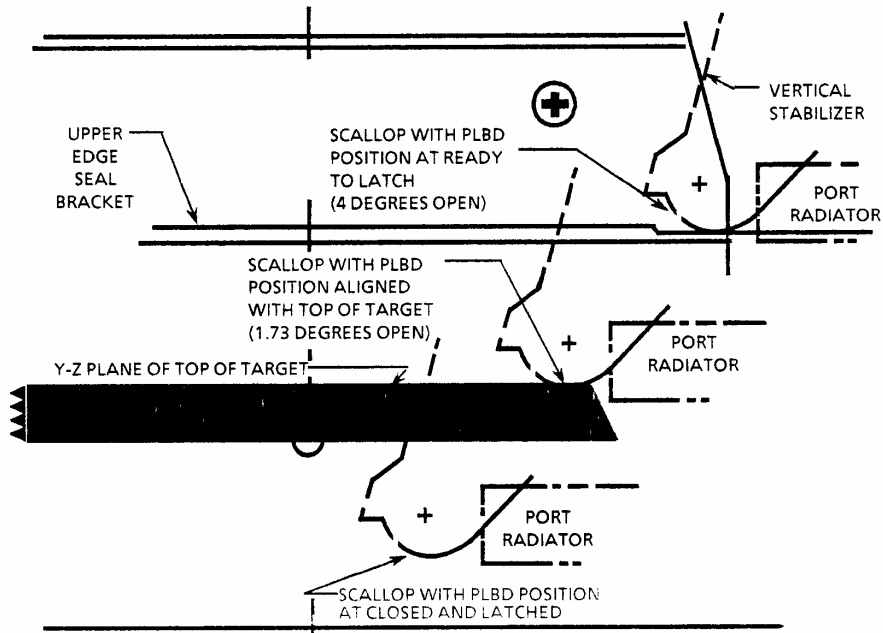

PORT AFT LATCH
GO/NO-GO CRITERIA

- GO - IF SCALLOP IS ON OR BELOW TOP OF TARGET PLANE OR IF PORT AFT PLBD CLOSE INDICATION IS PRESENT.
- NO-GO - IF SCALLOP IS ABOVE TOP OF TARGET PLANE AND PORT AFT PLBD CLOSE INDICATION IS NOT PRESENT.

FLIGHT RULES

A10-207

PLBD OVERLAP

IF A PLBD OVERLAP CONDITION EXISTS AT EOM DOOR CLOSURE SUCH THAT THE PLBD'S CANNOT BE CLOSED, ENTRY WILL BE DELAYED 24 HOURS ALLOWING PLBD THERMAL CONDITIONING TO REGAIN NORMAL CLOSING CONDITIONS. IF ENTRY-CRITICAL SYSTEMS ARE NOT SINGLE-FAULT TOLERANT OR A 1-DAY WAVE-OFF CAPABILITY IS NOT AVAILABLE, THEN TOP SUN PLBD CONDITIONING WILL BE DONE FOR AS LONG AS PRACTICAL. IF ADVERSE OVERLAP CONDITIONS STILL EXIST AFTER TOP SUN, THE SIMULTANEOUS PLBD CLOSING PROCEDURE WILL BE USED.

Steps will be undertaken to thermal condition the PLBD's for entry when nominal preentry conditioning does not adequately allow for PLBD centerline latching. The simultaneous PLBD closing procedure is the last means by which the centerline can be latched and is used as a contingency means to latch the PLBD's.

Rules {A2-301}, CONTINGENCY ACTION SUMMARY [HC], and {A18-451}, ORBITER THERMAL CONSTRAINTS AND ATTITUDE MANAGEMENT [CIL], reference this rule. @[032807-8400] @[ED]

FLIGHT RULES

A10-208**CONTINGENCY PLBD CLOSURE**

FOR PLBD JAM CASES, WHICH RESULT IN THE INABILITY TO NOMINALLY LATCH THE AFT BULKHEAD LATCHES, THE FOLLOWING CONTINGENCY PLBD CLOSE PROCEDURES WILL BE IMPLEMENTED IN LISTED ORDER UNTIL ONE METHOD IS SUCCESSFUL.

A. NOMINAL EOM PLBD CLOSE PROBLEMS:

1. CYCLE PLBD.
2. ONE ORBIT TOP SUN THERMAL CONDITIONING - REPEAT PLBD CYCLE.
3. DRIVE AFT LATCHES AND PLBD PART WAY.
4. WAVE OFF (THERMAL CONDITION IN TOP SUN - CHECK CLOSE BEFORE SLEEP).
5. PERFORM EVA.

B. EMERGENCY DEORBIT PLBD CLOSE PROBLEMS:

1. CYCLE PLBD.
2. TOP SUN THERMAL CONDITIONING (IF TIME PERMITS) - REPEAT PLBD CYCLE.
3. DRIVE AFT LATCHES AND PLBD PART WAY.
4. DRIVE AFT LATCHES AND PLBD TO STALL.
5. CLOSE BOTH PLBD'S AND FORWARD BULKHEAD LATCHES, THEN CLOSE CENTERLINE LATCHES IN FORWARD TO AFT ORDER, THEN CLOSE AFT BULKHEAD LATCHES.

PLBD contingency PLBD closure procedures were developed as a result of the PLBD closure problems experienced on STS-3 and STS-4 during thermal testing of the orbiter. Postmission investigations resulted in the conclusion that midfuselage structure thermal distortion caused by the extreme thermal attitudes had closed the gap between the PLBD and the X=1307 bulkhead. These attitudes were (1) at the end of tail Sun, top to space, orbital late roll attitude and (2) at the end of bottom solar inertial attitude. In response to these problems, PLBD and latch modifications were made to the orbiters. The solution basically allowed the PLBD lug to be moved forward to increase the gap. Flight verification of this fix has not been done; however, analysis has indicated that a positive gap will exist at more severe temperature gradients than was experienced on STS-3 and STS-4; i.e., PLBD closure should not be a problem after experiencing the same attitude profiles.

The procedures listed above start with the most benign steps and progress to the more severe action to be taken for each case.

FLIGHT RULES

A10-209

PLBD RULE REFERENCE MATRIX

FAILURE MODE	FLIGHT RULE	
	DAY 1/ON ORBIT	ENTRY DAY
	DOOR RULES	
A. LATCH GANG DOES NOT HAVE TWO MOTORS FOR CLOSE	<ul style="list-style-type: none"> CONTINUE FLIGHT AS PLANNED 	<ul style="list-style-type: none"> CONTINUE FLIGHT AS PLANNED
B. ONE MOTOR IN EACH OF TWO SEPARATE LATCH GANGS FAILED DUE TO A MECHANICAL, ELECTRICAL, OR PL MDM FAILURE, AND NEXT FAILURE WILL RESULT IN MULTIPLE LATCH GANGS OUT, WHERE MOTOR FUNCTION IS: 1. NOT RECOVERABLE BY IFM 2. RECOVERABLE BY IFM	<ul style="list-style-type: none"> ENTER FIRST DAY PLS/NEXT PLS CONTINUE FLIGHT AS PLANNED 	<ul style="list-style-type: none"> ENTER FIRST DAY PLS/NEXT PLS CONTINUE FLIGHT AS PLANNED
C. C/L LATCH GANG FAILS CLOSED OR IN TRANSIT AND CANNOT BE VISUALLY VERIFIED TO BE CLEAR OF THE ROLLERS	<ul style="list-style-type: none"> DO NOT OPEN PLBD'S ENTER FIRST DAY PLS/NEXT PLS [1] [2] 	<ul style="list-style-type: none"> ENTER NEXT PLS [1] [2]
D. STARBOARD BULKHEAD LATCH GANG FAILS CLOSED OR IN TRANSIT AND CANNOT BE VISUALLY VERIFIED TO BE CLEAR OF THE ROLLERS	<ul style="list-style-type: none"> DO NOT OPEN PLBD'S ENTER FIRST DAY PLS/NEXT PLS [1] [2] 	<ul style="list-style-type: none"> ENTER NEXT PLS [1] [2]
E. PORT BULKHEAD LATCH GANG FAILS CLOSED OR IN TRANSIT AND CANNOT BE VISUALLY VERIFIED TO BE CLEAR OF THE ROLLERS	<ul style="list-style-type: none"> CANNOT OPEN PORT PLBD LEAVE STBD DOOR OPEN IF ADEQUATE COOLING EXISTS, INVOKE MDF (IF NOT, NEXT PLS) POWER DOWN, IF NEEDED [1] [2] 	<ul style="list-style-type: none"> CONTINUE FLIGHT AS PLANNED CANNOT OPEN PORT PLBD [1] [2]
F. C/L LATCH GANG FAILS OPEN OR IN TRANSIT AND CAN BE VERIFIED CLEAR OF THE ROLLERS	<ul style="list-style-type: none"> OPEN PLBD'S IN MANUAL MODE CONTINUE FLIGHT AS PLANNED [1] [2] 	<ul style="list-style-type: none"> CONTINUE FLIGHT AS PLANNED [1] [2]
G. BULKHEAD LATCH GANG FAILS OPEN OR IN TRANSIT AND CAN BE VERIFIED CLEAR OF ROLLERS	<ul style="list-style-type: none"> OPEN PLBD'S IN MANUAL MODE CONTINUE FLIGHT AS PLANNED [1] [2] 	<ul style="list-style-type: none"> CONTINUE FLIGHT AS PLANNED [1] [2]
H. PLBD DOES NOT HAVE CLOSE REDUNDANCY DUE TO A MECHANICAL, ELECTRICAL, OR PL MDM FAILURE, WHERE MOTOR FUNCTION IS: 1. NOT RECOVERABLE BY IFM 2. RECOVERABLE BY IFM	<ul style="list-style-type: none"> MDF CONTINUE FLIGHT AS PLANNED 	<ul style="list-style-type: none"> MDF CONTINUE FLIGHT AS PLANNED
I. STBD DOOR FAILED CLOSED	<ul style="list-style-type: none"> ENTER FIRST DAY PLS/NEXT PLS 	<ul style="list-style-type: none"> ENTER NEXT PLS

@[121296-3194B] @[022201-3996]

[1] ACCEPTABLE TO ENTER WITH ONE LATCH GANG UNLATCHED.

[2] MINIMIZE ENTRY LOADS PER RULE {A10-203B}, PLBD CRITICAL LATCHES.

THIS RULE CONTINUED ON NEXT PAGE

FLIGHT RULES

A10-209

PLBD RULE REFERENCE MATRIX (CONTINUED)

FAILURE MODE	FLIGHT RULE	
	DAY 1/ON ORBIT	ENTRY DAY
	DOOR RULES	
<p>J. STBD PLBD FAILED OPEN OR IN TRANSIT:</p> <p>1. READY-TO-LATCH INDICATIONS PRESENT</p> <p>2. READY-TO-LATCH INDICATIONS NOT PRESENT:</p> <p style="padding-left: 20px;">a. ADEQUATE CLEARANCE TO OPEN PORT DOOR</p> <p style="padding-left: 20px;">b. NOT ENOUGH CLEARANCE TO OPEN PORT DOOR</p>	<ul style="list-style-type: none"> • LATCH STBD BULKHEAD/C/L LATCHES • ENTER FIRST DAY PLS/NEXT PLS • OPEN PORT DOOR AND LEAVE OPEN UNTIL CLOSED FOR D/O • PREPARE FOR EVA [3] (POWER DOWN, IF NECESSARY) • INVOKE MDF IF COOLING ALLOWS (IF NOT, PLS) • IF ADEQUATE COOLING, PORT DOOR CLEARANCE, AND PAYLOAD CLEARANCE EXISTS, A 5-SEC DRIVE TEST CAN BE PERFORMED • DO NOT OPEN PORT DOOR • IF FAILED OPEN, TRY TO CLOSE STBD DOOR • EVA TO CLOSE STBD DOOR [3] • ENTER FIRST DAY PLS/NEXT PLS 	<ul style="list-style-type: none"> • LATCH STBD BULKHEAD/C/L LATCHES • ENTER NEXT PLS • OPEN PORT PLBD • 24-HOUR DELAY (POWER DOWN, IF NECESSARY) • EVA TO CLOSE DOOR [3] • DO NOT OPEN PORT DOOR • EVA TO CLOSE STBD DOOR [3]
<p>K. PORT PLBD FAILED CLOSED</p>	<ul style="list-style-type: none"> • STBD DOOR WILL REMAIN OPEN UNTIL D/O • POWER DOWN, IF NEEDED • INVOKE MDF IF COOLING ALLOWS (IF NOT, PLS) 	<ul style="list-style-type: none"> • STBD DOOR WILL REMAIN OPEN UNTIL D/O • POWER DOWN, IF NEEDED
<p>L. PORT PLBD FAILED OPEN OR IN TRANSIT</p>	<ul style="list-style-type: none"> • STBD PLBD WILL REMAIN OPEN UNTIL D/O • PREPARE FOR EVA (POWER DOWN, IF NECESSARY) [3] • INVOKE MDF IF COOLING ALLOWS (IF NOT, PLS) • IF ADEQUATE COOLING AND PAYLOAD CLEARANCE IS AVAILABLE A 5-SEC DRIVE TEST CAN BE PERFORMED 	<ul style="list-style-type: none"> • STBD PLBD WILL BE OPENED OR REMAIN OPEN • 24-HOUR DELAY (POWERDOWN, IF NECESSARY) • EVA TO CLOSE PLBD [3]

[3] ENTRY IS REQUIRED AT NEXT PLS AFTER EVA IS COMPLETE. @[ED] @[022201-3996]

THIS RULE CONTINUED ON NEXT PAGE

FLIGHT RULES

A10-209

PLBD RULE REFERENCE MATRIX (CONTINUED)A. *LATCH GANG DOES NOT HAVE TWO MOTORS FOR CLOSE.*

The vehicle is in a fail-safe condition where the redundant motor remains to close the latch gang. Loss of the redundant motor will still allow safe entry. Rockwell's 1991 latch-out analysis has shown that an entry can be performed with a single bulkhead or centerline latch gang out. Adequate structural, thermal, and stability margins exist above the required 1.4 factor of safety for all tested flight conditions. (Ref. Structural Assessment of Shuttle Orbiter Payload Bay Door for Entry with a Latch Gang Out, SSD91D0276, May 1991; and SODB, vol. I, 3.4.2.3.)

B. *ONE MOTOR IN EACH OF TWO SEPARATE LATCH GANGS FAILED DUE TO A MECHANICAL, ELECTRICAL, OR PL MDM FAILURE, AND NEXT FAILURE WILL RESULT IN MULTIPLE LATCH GANGS OUT, WHERE MOTOR FUNCTION IS: @[022201-3996]*1. *NOT RECOVERABLE BY IFM.*

Entry should be made at the next PLS opportunity in order to minimize exposure time to the next failure which could result in multiple latch gangs out. There is no analysis to indicate that entry with multiple latch gangs out is an acceptable condition or that the manual latch tools provide the same structural integrity as a latch gang. (Reference Rule {A10-203}, PLBD CRITICAL LATCHES, and Structural Assessment of Shuttle Orbiter Payload Bay Door for Entry with a Latch Gang Out, SSD91D0276, May 1991.) @[121296-3194B]

2. *RECOVERABLE BY IFM. @[ED]*

PLBD IFM procedures exist that allow for closing a PLBD latch group(s) and/or the PLBD's if one or both payload MDM's (or associated cards) is lost or if control busses AB1, AB2, BC1, BC2, CA1, or CA2 are failed. These IFM procedures are considered a level of redundancy for PLBD and latch gang closure. Therefore, after the loss of one PL MDM or one of the aforementioned control busses, single-fault tolerance to close the PLBD's and latch gangs exists. Since single-fault tolerance exists and since the probability of requiring the IFM is extremely low, NEOM is acceptable after the loss of one PL MDM or applicable control bus. (Reference AEFTP #131 and #164 minutes, and 6/96 MDF splinter AEFTP.) @[ED]

THIS RULE CONTINUED ON NEXT PAGE

FLIGHT RULES

A10-209

PLBD RULE REFERENCE MATRIX (CONTINUED)

- C. *CENTERLINE (C/L) LATCH GANG FAILS CLOSED OR IN TRANSIT AND CANNOT BE VISUALLY VERIFIED TO BE CLEAR OF THE ROLLERS.*

If the C/L latch gang fails closed or in transit without visual verification that it is clear of the rollers, the PLBD's should remain closed and entry should be done at the next PLS opportunity. For the C/L latch gang failed in transit where the latches cannot be verified clear of the rollers, opening the PLBD's with no positive cues that the C/L latch gangs are completely open could lead to structural damage to the PLBD and/or latches (reference Rule {A10-202A}.2, PLBD VISUAL CUES). Additionally, full PLBD closure and/or C/L latching may be inhibited. ©[022201-3996]

Entry should be performed as early as possible, and entry loads should be minimized (reference Rule {A10-203B}, PLBD CRITICAL LATCHES).

- D. *STARBOARD BULKHEAD LATCH GANG FAILS CLOSED OR IN TRANSIT AND CANNOT BE VISUALLY VERIFIED CLEAR OF THE ROLLERS.*

If a starboard bulkhead latch gang fails closed or in transit and cannot be visually verified to be clear of the rollers, the PLBD's cannot be opened and entry should be done at the next PLS opportunity. For a starboard bulkhead latch failed in transit where it cannot be visually verified clear of the rollers, opening the starboard PLBD without positive cues that the latches are clear of the rollers could also lead to structural damage of the PLBD and/or bulkhead latches. PLBD closing could be inhibited. Entry loads should be minimized (reference Rule {A10-203B}, PLBD CRITICAL LATCHES).

- E. *PORT BULKHEAD LATCH GANG FAILS CLOSED OR IN TRANSIT AND CANNOT BE VISUALLY VERIFIED TO BE CLEAR OF THE ROLLERS.*

For a port bulkhead latch failed closed or in transit with no visual verification that it is clear of the rollers, the starboard door should remain open to provide cooling. The port door cannot be opened, and a MDF should be invoked. If a port bulkhead latch gang is partially open, but not clear of the rollers, any attempt to open the door could cause structural damage to the door and/or latches, and PLBD closure could be inhibited. An MDF should be considered, if adequate cooling allows, otherwise, entry must be done next PLS. Entry loads should be minimized (reference Rule {A10-203B}, PLBD CRITICAL LATCHES).

THIS RULE CONTINUED ON NEXT PAGE

FLIGHT RULES

A10-209

PLBD RULE REFERENCE MATRIX (CONTINUED)

F./G. CENTERLINE/BULKHEAD LATCH GANG FAILS OPEN OR IN TRANSIT AND CAN BE VERIFIED CLEAR OF THE ROLLERS.

If a centerline or bulkhead latch gang fails open or in transit and can be verified clear of the rollers the flight can continue as planned since entry with a single bulkhead latch gang out has been deemed acceptable (SODB, vol. 1, 3.4.2.3 and Rockwell Latch Out Analysis, 1991). Auto PLBD software will terminate PLBD operations if single motor drive time is exceeded and manual mode will have to be used. The only single-point failure that will result in multiple latch gang failure is a mechanical jam during PLBD closure. Since the doors are already open, the risk associated with another mechanical jam is incurred only when the doors are closed. Terminating the mission early does not reduce the risk of the next failure. Consequently, the mission can continue as planned. EVA is not required for a single latch gang out, but entry loads should be minimized if a gang is unlatched (reference Rule {A10-203}, PLBD CRITICAL LATCHES).

H. PLBD DOES NOT HAVE CLOSE REDUNDANCY DUE TO MECHANICAL, ELECTRICAL, OR PL MDM FAILURE, WHERE MOTOR FUNCTION IS: @[022201-3996]

1. NOT RECOVERABLE BY IFM.

For loss of door closure redundancy due to an electrical or mechanical failure, an MDF must be declared to minimize exposure to the next failure that would prevent the payload bay doors from closing without an EVA.

2. RECOVERABLE BY IFM. @[022201-3996]

Reference B2 rationale. @[121296-3194B] @[ED]

Reference Rules {A2-104A}.1.b, SYSTEMS REDUNDANCY REQUIREMENTS, and {A17-1001}, LIFE SUPPORT GO/NO-GO CRITERIA. @[ED]

I. STARBOARD DOOR FAILED CLOSED.

For the starboard door failed closed, entry must be done at the next PLS opportunity. The failed starboard door prevents either door from opening, and results in lack of radiator cooling.

THIS RULE CONTINUED ON NEXT PAGE

FLIGHT RULES

A10-209

PLBD RULE REFERENCE MATRIX (CONTINUED)**J. STARBOARD PLBD FAILED OPEN OR IN TRANSIT.**

If the ready-to-latch indications are present, the starboard door is within 4 degrees of being fully closed. The bulkhead latches can be used to help “pull” the PLBD closed, since this position is within the bulkhead latch reach capability. Entry should be made at the next PLS since the PLBD’s cannot be opened and limited vehicle cooling exists.

If the ready-to-latch indications are not present, the starboard door is partially or fully opened. The starboard door is opened greater than two stripes on the pushrods, there is sufficient clearance for the port door to open without interference. The port door should be opened and remain open to allow some radiator cooling since an EVA will have to be performed to close the starboard door. An MDF will be done, if adequate cooling allows, to limit exposure to the next failure that might affect EVA capability or cooling. If the door is jammed while opening, a 5-second drive test can be done to troubleshoot the problem as long as closing the door will not threaten cooling margins, port door closure, or the payload deploy envelope.

If the failure occurs on entry day, a 24-hour waveoff will be required to prepare for and complete the EVA. A next PLS entry will be required after the EVA is complete. If the starboard door is not open far enough (two pushrod stripes) to allow the port door to open, an entry must be done at the next PLS opportunity, since neither door can be opened for radiator cooling. If the door will drive closed, close it; if jammed in the open direction, perform an EVA to close the door.

K. PORT PLBD FAILED CLOSED.

If the port door fails closed, the starboard door should remain open to provide radiator cooling. An MDF should be considered if adequate cooling is available, otherwise enter next PLS.

L. PORT PLBD FAILED OPEN OR IN TRANSIT.

For a port door failed open or in transit, an MDF can be considered, but whether it can be accomplished depends on how far the failed PLBD is open for radiator cooling. Even if there is no cooling constraint, an MDF must be invoked to limit exposure to the next failure that will affect EVA capability. The starboard door should remain open. An EVA should be planned. If the door jammed while opening, a 5-second drive test may be performed to troubleshoot the problem as long as closing the door will not threaten cooling margins or the payload deploy envelope.

For a failure on entry day, a 24-hour waveoff should be done to prepare for and complete the EVA. Landing at the next PLS will be required upon completion of the EVA.

*Rules {A2-104}, SYSTEMS REDUNDANCY REQUIREMENTS; {A2-301}, CONTINGENCY ACTION SUMMARY [HC]; and {A9-1001}, ELECTRICAL GO/NO-GO CRITERIA [HC], reference this rule.
 @[ED] @[032807-8400] @[ED]*

A10-210 THROUGH A10-220 RULES ARE RESERVED

FLIGHT RULES

RADIATOR SYSTEMS MANAGEMENT

A10-221

RADIATOR MECHANICAL

- A. PORT OR STARBOARD RADIATOR PANELS WILL BE STOWED AND LATCHED WHEN ONLY SINGLE-MOTOR CAPABILITY REMAINS TO STOW OR LATCH THAT SIDE.

Failure of one radiator stow or latch motor places the vehicle one failure away from loss of stow/latch capability. Losing the stow function on a deployed radiator will require an EVA to stow that radiator prior to payload bay door closure. An unlatched radiator may cause the loss of the associated Freon loop due to entry loads and vibrations which would place the vehicle one failure away from possible loss of crew/vehicle (loss of remaining Freon loop). It is not known if the stowed, unlatched radiator could come into contact with items in the payload bay during entry. While EVA backup exists for stowing the radiators, it does not exist for latching them.

- B. THE FLIGHT WILL CONTINUE, WATER CONSUMABLES PERMITTING, WITH THE FOLLOWING FAILURES:
1. RADIATOR LATCHES FAILED CLOSED OR OPEN.
 2. RADIATOR PANELS FAILED STOWED OR DEPLOYED.

The radiators were designed to operate in either the deployed or stowed position. This rule was written to document to the community that, regardless of the radiator position or latch status, the mission may continue.

- C. AN EVA WILL BE REQUIRED TO STOW A FAILED DEPLOYED RADIATOR PANEL.

The PLBD's cannot be closed with a failed, deployed radiator due to possible interference with the opposite door, radiator, or payload. EVA is the only means available if the deploy/stow mechanism has failed. No EVA capability is available for a failed radiator latch.

THIS RULE CONTINUED ON NEXT PAGE

FLIGHT RULES

A10-221 RADIATOR MECHANICAL (CONTINUED)

D. OPERATIONS WHILE THE RMS IS UNCRADLED:

1. RADIATOR DEPLOY OPERATIONS:

IF PRACTICAL, RADIATOR DEPLOY OPERATIONS WILL BE DELAYED UNTIL AFTER RMS OPERATIONS ARE COMPLETE OR THE RMS WILL BE CRADLED DURING DEPLOY OPERATIONS. IF IT IS NOT PRACTICAL TO CRADLE THE RMS, RADIATOR DEPLOY OPERATIONS WILL BE PERFORMED WITH THE CIRCUIT BREAKERS OPEN FOR MPM SYSTEM SAFING (SOME ACTUATORS WILL OPERATE SINGLE MOTOR).

2. RADIATOR STOW OPERATIONS MAY BE PERFORMED WHILE THE RMS IS UNCRADLED (SOME ACTUATORS WILL OPERATE SINGLE MOTOR).

In order to prevent the uncradled RMS from being one failure away from inadvertent MPM stow (possible loss of crew/vehicle), the following cb's are opened to remove power to the MPM system:

MA73C: C cb MCA PWR AC 2 3Ø MID 2
D cb MCA PWR AC 3 3Ø MID 4

These also affect radiator motors, but allow at least single-motor operations in all actuators. Stow operations may occur anytime since it is not necessary to verify dual-motor operations. During deploy operations, dual-motor operations must be verified so that the radiators and latches will not be one failure away from loss of latch/stow capability due to an undetected failure (i.e., it is not known if the powered-off motor is functional). Losing the latch or stow function on a radiator may cause the loss of the associated Freon loop due to entry loads and vibrations which would put the vehicle one failure away from the possible loss of crew/vehicle. It is not known if the unsecured radiator could come into contact with a returned payload; this should be considered, if applicable. Therefore, to ensure dual-motor radiator operations, deploy should wait until after RMS nominal operations are completed and the RMS can be safely cradled (payload berthed or released, etc.). If radiator deploy is time critical, the RMS will be cradled if present operations permit; otherwise, the radiators will be deployed single motor. It is highly desirable that dual-motor operations be verified ASAP after the RMS is cradled. This is especially critical for latching, because there is no known EVA backup to provide this function as there is for stowing.

Rule {A12-74}, INADVERTENT MPM CYCLING PROTECTION [CIL] [HC], references this rule.

©[ED]

FLIGHT RULES

A10-222

RADIATOR VISUAL CUES

- A. RADIATOR DEPLOYED - A SUSPECT RADIATOR IS CONSIDERED DEPLOYED IF IT APPEARS TO BE IN THE SAME RELATIVE POSITION AS THE OTHER RADIATOR WHEN IT IS DEPLOYED.
- B. RADIATOR STOWED - A SUSPECT RADIATOR CANNOT BE EVALUATED FOR THE STOWED POSITION (IF CLOSE TO IT) UNTIL THE PLBD IS PARTIALLY CLOSED (90 DEGREES). FOR SAFE LATCHING THE POSITIONS OF THE FIXED AND DEPLOYED PANELS ON THE SAME SIDE SHOULD BE ALIGNED WITH EACH OTHER.

If the radiator is thought to have not deployed fully (e.g., failure to receive the deploy indications), then the only visual means of determining if it reached the commanded position is to compare it to the other (fully deployed) radiator.

If a radiator is suspected to have not reached the stowed position (e.g., failure to receive the stow indications), then it can be checked in the following manner. The PLBD to which it is attached must be closed 90 degrees (about halfway) so that the radiator can be easily seen. On each PLBD, there are four radiator panels, two deployable (forward) and two fixed (aft). When the deployable panels are stowed, the seam between them and the fixed set should match up. If so, the radiator can be safely latched.

A10-223 THROUGH A10-240 RULES ARE RESERVED

FLIGHT RULES

ET UMBILICAL DOORS SYSTEMS MANAGEMENT

A10-241 ET UMBILICAL DOOR KEYBOARD ENTRY

THE ET DOOR CLOSE KEYBOARD ITEM ENTRY WILL ONLY BE USED IF MANUAL ET UMBILICAL DOOR CLOSE OPERATIONS ARE UNSUCCESSFUL AND:
@[022802-5110]

- A. THE CENTERLINE LATCHES ARE STOWED AND BOTH ET DOORS ARE CONFIRMED READY-TO-LATCH, OR
- B. AN AOA IS BEING PERFORMED.

With the exception of an RTLS or a TAL, the software sequence is not nominally used, and the ET umbilical doors are closed manually. After ET separation, but while still in OPS 1 (MM 104, 105, 106), the software sequence may be initiated by an item entry on SPEC 51. This software issues commands based on single motor drive times and does not check (or stop) for anomalous operation. The potential exists to drive the doors against the centerline latches (if they do not stow nominally), damaging the drive mechanism and preventing proper door closure.

Crew initiation of the software sequence is possible only in OPS 1 via the SPEC 51 item entry. Therefore, for an AOA, the ET umbilical doors will be closed prior to transitioning out of OPS 1 in order to maintain redundancy in the event of an ET umbilical door switch failure. Following nominal ascent or an ATO, door closure can be delayed until OPS 2 since real-time commands (RTC's) can be used to close and latch the doors in the event of a switch failure. In cases where there is no potential for driving the doors against the centerline latches or latching the uplock latches before the doors are closed, the OPS 1 SPEC 51 item entry may be used instead of sending ground commands. Closure during an RTLS/TAL is automatic, using the software sequence. In all other situations, the MCC will be contacted to determine the method of door closure. @[022802-5110]

A10-242 ET UMBILICAL DOORS ON ORBIT

THE ET DOORS WILL NORMALLY BE CLOSED AFTER THE H₂ PRESSURIZATION LINE VENTING IS COMPLETED. BOTH ET DOORS MUST BE CLOSED AND LATCHED BEFORE DEORBIT.

H₂ pressurization line venting should be completed before ET door closure to ensure that any residual H₂ in the line can dissipate into space. If the doors are closed, H₂ can be trapped in the ET door cavity and will take a much longer time to vent through the aft compartment. The doors should be closed and latched before entry to avoid structural damage because of protruding surfaces during reentry heating and to provide a smooth undersurface for stable aerodynamic control.

FLIGHT RULES

A10-243**ET UMBILICAL DOOR CLOSURE DELAY FOR DISCONNECT VALVE FAILURE [CIL]**

FOR FAILURE OF THE LO₂ AND/OR LH₂ 17-INCH DISCONNECT VALVE(S) TO CLOSE, ET UMBILICAL DOOR CLOSURE: ©[022802-5110]

- A. FOLLOWING NOMINAL ASCENT OR AN ATO, WILL BE DELAYED IN ORDER TO OBTAIN A MINIMUM OF 40 CONTINUOUS MINUTES OF BOTTOM-SUN EXPOSURE IMMEDIATELY PRIOR TO ATTEMPTING CLOSURE.
- B. DURING AN AOA, WILL BE DELAYED AS LONG AS POSSIBLE, WITH BOTTOM-SUN EXPOSURE IF FEASIBLE, BUT WILL BE PERFORMED PRIOR TO TRANSITIONING FROM OPS 1.
- C. DURING A TAL OR RTLS, WILL NOT BE DELAYED.

When possible, ET umbilical door closure will be delayed following failure of the LO₂ or LH₂ disconnect valves to close in order to allow for venting of residual cryogenic propellants and thermal conditioning of the ET door pressure seal and thermal barrier. This will allow proper door closure/sealing, prevent pressurization of the ET umbilical compartment, and prevent residuals from entering the aft compartment. A bottom-sun attitude speeds this conditioning/venting. For most orbits (160 nm, 28.5-degree inclination), a maximum of 55 minutes of sun exposure can be obtained. For ATO orbits (106 nm altitude), only 40 minutes of sun exposure can be obtained. Higher inclination orbits provide longer sun exposure. A minimum of 40 continuous minutes with the orbiter in a bottom-sun attitude will ensure adequate conditioning/venting. Reference SODB submittal P1-1577 for thermal analysis.

Crew initiation of the software sequence is possible in OPS 1 only (MM 104, 105, 106), via the SPEC 51 item entry. Therefore, for an AOA, the ET umbilical doors will be closed prior to transitioning out of OPS 1 in order to maintain redundancy in the event of an ET umbilical door switch failure. For nominal ascent/ATO, door close redundancy exists in OPS 2 via ground-issued RTC's. Closure during an RTLS/TAL is automatic; also, the time criticality of door closure precludes additional venting or conditioning. ©[022802-5110]

A10-244 THROUGH A10-260 RULES ARE RESERVED

FLIGHT RULES

VENT DOOR SYSTEMS MANAGEMENT @[ED]

A10-261 VENT DOOR MANAGEMENT [HC] @[032504-6224B]

- A. ON ORBIT, ALL VENTS WILL NOMINALLY BE OPEN EXCEPT FOR THE FOLLOWING: @[102506-7825A]
1. IF REDUNDANT CLOSE CAPABILITY IS LOST, THE AFFECTED VENT(S) WILL BE CLOSED ASAP. IF BOTH FORWARD OR AFT COMPARTMENT VENTS HAVE LOST CLOSE REDUNDANCY, ONE VENT MAY REMAIN OPEN: @[032504-6224B]
 - a. IF IFM CAPABILITY EXISTS TO RESTORE CLOSE REDUNDANCY, OR
 - b. FOR A KNOWN OR SUSPECTED NON-ISOLATED RCS OXIDIZER, OMS OXIDIZER, OR OMS HE LEAK.

For loss of close redundancy, the affected door is closed to limit the exposure to the next failure that would leave the door failed open. Data presented at the Ascent/Entry Flight Techniques Panel (A/E FTP) #218, March 31, 2006, showed that vent box 3, if left open, is predicted to reach a temperature of 1100 deg F during the entry profile. Since the melting point of 2024 aluminum is 935 deg F, a breach of the box is expected to occur, possibly resulting in loss of crew and vehicle. Because the new thermal analysis data shows temperatures very similar to the old thermal analysis, the previous temperature predictions for vent doors 1/2, 5, 6, and 8/9 will be used until the new thermal analysis is complete. Currently, if left open during entry, vent box 1/2 is expected to reach a temperature of 1200 deg F, vent box 5 and 6 will experience 600 to 700 deg F heating, and vent box 8/9 will experience up to 550 deg F heating. Based on these temperatures, vent box 1/2 will surpass the melting point of 2024 aluminum and would result in a breach and possible loss of crew and vehicle. The reusability temperature limit of 2024 aluminum is 350 deg F and soon after reaching this temperature, the aluminum starts to lose structural integrity (around 400 deg F). Therefore, 400 deg F was chosen as the temperature limit for which to protect the vent doors. Even though vent doors 5, 6, and 8/9 do not reach the melting point of 2024 aluminum, they do exceed the structural integrity limit if left open during entry. Additionally, it is important that these doors are closed during entry heating above 400 deg F to protect various components in close proximity to the vent openings from failing, such as electrical wires, freon lines, hydraulic lines, and APU hydrazine lines. @[102506-7825A]

THIS RULE CONTINUED ON NEXT PAGE

FLIGHT RULES

A10-261

VENT DOOR MANAGEMENT [HC] (CONTINUED)

If redundancy is lost on both left and right vents 1/2 (8/9), closing both doors to protect against the next failure will leave the forward (aft) compartment unvented. If an RCS oxidizer, OMS oxidizer, or OMS helium leak subsequently develops, the affected compartment can overpressurize. If IFM capability can restore close redundancy to at least one of the compartment vents, that vent may remain open. If IFM capability does not exist, it is acceptable to close off the forward (aft) compartment because the probability of an RCS oxidizer, OMS oxidizer, or OMS helium leak is substantially less than that for a failure that affects vent door drive. However, one vent from the forward (aft) compartment will be opened, regardless of IFM capability, in order to vent the forward or aft compartment due to a known or suspected RCS oxidizer, OMS oxidizer, or OMS helium leak. If the vents are not opened, the compartment could overpressurize, causing structural damage that would lead to loss of crew and vehicle during entry. Unless the IFM close capability criteria is met, if the leak is subsequently isolated the vent will be closed. ©[102506-7825A]

2. VENTS MAY BE CLOSED/OPENED IN ORDER TO TROUBLESHOOT ELECTRICAL OR COMMAND PATH PROBLEMS. THE AFFECTED VENT(S) MAY BE LEFT IN THE POST-TEST CONFIGURATION UNLESS REPOSITIONING IS NECESSARY TO SATISFY PARAGRAPH A.1 OF THIS RULE.

Sending real-time commands to drive vent doors can be used to determine the status of a suspect AC bus, to verify the state of a motor control assembly relay, or to verify proper GPC-FF/FA MDM function. There is no requirement to reposition a vent door to its previous configuration following the test unless the flight rules dictate a different configuration due to failures. ©[072398-6686B] ©[032504-6224B]

- B. ENTRY WILL BE PERFORMED AT THE NEXT PLS OPPORTUNITY FOR LOSS OF VENT DOOR REDUNDANCY WHERE THE NEXT FAILURE RESULTS IN INABILITY TO MEET ENTRY VENT OPERATION CONSTRAINTS, UNLESS IFM CAPABILITY EXISTS TO RESTORE REDUNDANCY.

“Entry vent operation constraints” refers to paragraph E of this rule.

Data presented at the A/E FTP #218, March 31, 2006, showed that adequate venting margins could be maintained if at least one side of the forward compartment, one side of the aft compartment, and any four midbody vent doors are opened by 70,000 ft. If only three midbody vents are open by 70,000 ft, adequate venting margins can be maintained if at least one of the midbody vents open is left or right vent 3. Failures resulting in loss of open capability on both sides of the forward or aft compartments would result in structural failure and loss of crew and vehicle. Additionally, failures resulting in more than three midbody vent doors failed closed would also result in structural failure and loss of crew and vehicle. It is prudent to shorten the mission to minimize the time of exposure to any additional on-orbit failure that would result in insufficient venting. ©[102506-7825A]

THIS RULE CONTINUED ON NEXT PAGE

FLIGHT RULES**A10-261****VENT DOOR MANAGEMENT [HC] (CONTINUED)**

If failure(s) requires both left and right vents 1/2 (8/9) to be closed, closing the vents will remove the potential for a single failure causing a vent to be failed open, and it will take two additional failures to cause loss of venting capability. However, with both vents closed the forward (aft) compartment is subject to catastrophic failure if an RCS oxidizer, OMS oxidizer (aft only), or OMS helium (aft only) leak occurs. Such a leak is considered to have a remote probability of occurrence, especially when compared to the probability of failures affecting vent door drive capability. ©[102506-7825A]

C. IF IFM CAPABILITY EXISTS AND IS NEEDED TO MEET ENTRY VENT OPERATION CONSTRAINTS:

“Entry vent operation constraints” refers to paragraph E of this rule.

1. TO REGAIN REDUNDANCY FOR ZERO FAULT TOLERANCE, CONSIDERATION WILL BE GIVEN TO PERFORMING THE IFM IF THE FAILURE OCCURS ANY TIME PRIOR TO THE DEORBIT BURN.

Consideration will be given to performing an IFM to regain vent door redundancy when zero fault tolerant to the next worse failure. However, increasing this fault tolerance will be weighed against deorbit consumables (i.e., propellant, water, O₂, and N₂), available deorbit opportunities, and landing site weather. After the deorbit burn has been initiated, it is not warranted to stop the burn to regain fault tolerance.

2. TO REGAIN CAPABILITY, THE IFM WILL BE PERFORMED IF THE FAILURE OCCURS AT ANY TIME PRIOR TO ACHIEVING SAFE HP.

The deorbit burn will be terminated if necessary to regain critical capability.

D. FOR ENTRY, LEFT VENTS 1/2 AND 8/9 WILL NOMINALLY REMAIN OPEN UNTIL THE MM 304 TRANSITION AND ALL OTHER VENTS WILL BE CLOSED PRIOR TO THE DEORBIT BURN. IF CLOSE REDUNDANCY IS LOST ON LEFT VENT 1/2 OR 8/9, THE AFFECTED VENT WILL BE CLOSED ASAP (PRIOR TO THE DEORBIT BURN, IF APPLICABLE).

No vents will remain open to protect against the next worst failure.

Leaving the forward and aft compartments vented until MM 304 minimizes exposure to an OMS/RCS oxidizer or OMS helium leak, which can lead to overpressurization. However, this means committing to the deorbit burn with a forward vent open - if it cannot be closed then burn-through will occur. Since it takes two failures for the vent door to fail open and only one for the leak, it is important to protect for the leak when able. ©[102506-7825A]

THIS RULE CONTINUED ON NEXT PAGE

FLIGHT RULES

A10-261

VENT DOOR MANAGEMENT [HC] (CONTINUED)

With redundancy lost on left vent 1/2 or 8/9, the vehicle is one failure away from either burn-through (if the vent fails open) or overpressurization (if the vent fails closed). This assumes protecting against burn-through since one failure has already occurred to the vent and a similar one will lose capability.
@[102506-7825A]

E. DURING ENTRY/ABORTS, THE FOLLOWING CONSTRAINTS FOR VENT OPERATIONS APPLY POST MECO:

1. ALL VENTS MUST BE CLOSED BETWEEN MACH 24 AND MACH 3.5.

For loss of close redundancy, the affected door is closed to limit the exposure to the next failure that would leave the door failed open. Data presented at the A/E FTP #218, March 31, 2006, showed that vent box 3, if left open, is predicted to reach a temperature of 1100 deg F during the entry profile. Since the melting point of 2024 aluminum is 935 deg F, a breach of the box is expected to occur, possibly resulting in loss of crew and vehicle. Because the new thermal analysis data shows temperatures very similar to the old thermal analysis, the previous temperature predictions for vent doors 1/2, 5, 6, and 8/9 will be used until the new thermal analysis is complete. Currently, if left open during entry, vent box 1/2 is expected to reach a temperature of 1200 deg F, vent box 5 and 6 will experience 600 to 700 deg F heating, and vent box 8/9 will experience up to 550 deg F heating. Based on these temperatures, vent box 1/2 will surpass the melting point of 2024 aluminum and would result in a breach and possible loss of crew and vehicle. The reusability temperature limit of 2024 aluminum is 350 deg F and soon after reaching this temperature, the aluminum starts to lose structural integrity (around 400 deg F). Therefore, 400 deg F was chosen as the temperature limit for which to protect the vent doors. Even though vent doors 5, 6, and 8/9 do not reach the melting point of 2024 aluminum, they do exceed the structural integrity limit if left open during entry. Additionally, it is important that these doors are closed during entry heating above 400 deg F to protect various components in close proximity to the vent openings from failing, such as electrical wires, freon lines, hydraulic lines, and APU hydrazine lines. The Mach number limits are based on the thermal analysis for vent door 3; between Mach 24 (approximately 7.5 min after EI) and Mach 3.5 (approximately 24 min after EI, or approximately 1 min prior to Vrel = 2400) the vent temperature is predicted to exceed 400 deg F.

2. PRIOR TO REACHING AN ALTITUDE OF 70,000 FT, THE MINIMUM NUMBER OF VENTS THAT MUST BE OPEN ARE AS FOLLOWS:
 - a. FORWARD AND AFT COMPARTMENTS: THE LEFT OR RIGHT SIDE VENTS (SINGLE SIDE) FOR EACH COMPARTMENT, AND
 - b. MIDBODY: ANY FOUR VENTS, OR ANY THREE VENTS IF AT LEAST ONE OF THESE IS LEFT OR RIGHT VENT 3.
@[102506-7825A]

THIS RULE CONTINUED ON NEXT PAGE

FLIGHT RULES

A10-261

VENT DOOR MANAGEMENT [HC] (CONTINUED)

Data presented at the A/E FTP #218, March 31, 2006, showed that adequate venting margins could be maintained if at least one side of the forward compartment, one side of the aft compartment, and any four midbody vent doors are opened by 70,000 ft. If only three midbody vents are open by 70,000 ft, adequate venting margins can be maintained if at least one of the midbody vents open is left or right vent 3. Failures resulting in loss of open capability on both sides of the forward compartment would result in significantly exceeding Performance Enhancement (PE) certification limits for compartment pressures and structural loading resulting in loss of crew and vehicle. Failures resulting in loss of open capability on both sides of the aft compartment would result in compartment pressures very close to the PE certification limits. Therefore, entry with all aft vent doors closed depends on all other vents to open nominally and on the 1307 bulkhead check valve to repressurize the aft compartment. As a result, it is not recommended to enter with all aft vent doors closed due to venting tolerances. Additionally, failures resulting in more than three midbody vent doors failed closed would also result in structural failure and loss of crew and vehicle. ©[102506-7825A]

3. FOR A NON-ISOLATED OMS OXIDIZER, RCS OXIDIZER, OR OMS HELIUM LEAK, LEFT VENTS 1/2 AND 8/9 WILL BE OPENED IF PRIOR TO MACH 24 OR AFTER MACH 3.5. BETWEEN MACH 24 AND MACH 3.5, LEFT VENT 1/2 AND 8/9 MUST BE CLOSED.

Left vents 1/2 and 8/9 will be opened if prior to Mach 24 or after Mach 3.5 in order to vent the forward and aft compartments due to an OMS/RCS oxidizer or OMS helium leak. If the vents are not opened, the compartment could overpressurize and cause a loss of crew and vehicle. Per Hazard Reports ORBI-178, Loss of Vent Door Operation Decreases Structural Safety Margin, and ORBI-278, Loss of Structural Integrity Due to Overpressurization of the Mid and/or Aft Fuselage, MPS helium, RCS helium, and OMS nitrogen can also cause overpressurization leading to possible LOCV. For an MPS helium leak, procedures are in place to isolate the leak; therefore, no vent door action is required. Reference Rule {A5-208}, POST-MECO AND ENTRY HELIUM ISOLATION [HC]. Additionally, no vent door action is required for an RCS helium or OMS nitrogen leak because a massive leak rate is required to overpress the compartment and this is considered unlikely. Left vent 1/2 and 8/9 must be closed between Mach 24 and Mach 3.5 to protect for burn-through, which would lead to a loss of crew and vehicle. The onboard software does not allow driving left vents 1/2 and 8/9 separately; however, if time and access allow, the crew can take steps to allow only the affected compartment to be vented if prior to Mach 24 or after Mach 3.5.

4. FOR A MIDBODY H₂ LEAK > 1.0 LB/HR, ALL VENTS WILL REMAIN OPEN UNTIL THE MM 304 TRANSITION UNLESS CLOSE REDUNDANCY IS LOST ON ANY VENT DOOR. FOR LOSS OF CLOSE REDUNDANCY AND IF TIME PERMITS, ACTION WILL BE TAKEN TO LEAVE OPEN, UNTIL THE MM 304 TRANSITION, AS MANY MIDBODY VENTS AS PRACTICAL THAT STILL HAVE CLOSE REDUNDANCY. ©[102506-7825A]

THIS RULE CONTINUED ON NEXT PAGE

FLIGHT RULES

A10-261 VENT DOOR MANAGEMENT [HC] (CONTINUED)

Leaks of H₂ greater than 1 lb/hr can lead to H₂ concentrations in the midfuselage that exceed the H₂ flammability limit during entry (ref. informal note, DF7/84-126, dated June 20, 1984). Delaying the closure of the vent doors until the MM 304 transition will reduce the amount of time that is available for H₂ to build up within the midfuselage while providing the maximum amount of time prior to the high heating phase of entry that H₂ has the opportunity to escape. If close redundancy is lost on any vent door, the affected vent must be closed regardless of hydrogen build-up concerns to protect for the next failure that would leave the vent door failed open and result in loss of crew and vehicle. ©[102506-7825A]

The current vent door software will automatically close any vent doors at the MM 304 transition that might have been left open prior to that time. Additionally, the capability does not exist in the current software to open any midbody vent door prior to the MM 305 transition, which occurs well below the 100,000 foot altitude. Therefore, the latest the midbody vent doors can be left open for H₂ venting is MM 304, and the earliest the doors can be opened is MM 305 (Mach 2.4).

Rules {A2-105}, IN-FLIGHT MAINTENANCE 9IFM) [HC], and {A2-254}, ENTRY STRING REASSIGNMENT, reference this rule. ©[102506-7825A]

A10-262 THROUGH A10-280 RULES ARE RESERVED

FLIGHT RULES

THIS PAGE INTENTIONALLY BLANK

FLIGHT RULES

PAYLOAD RETENTION LATCHES (PRLA) SYSTEMS MANAGEMENT

A10-281

PRLA'S/AKA'S

A. PRLA/AKA MANAGEMENT:

1. FOR A DEPLOYABLE PAYLOAD (WITH RETURN CAPABILITY), THE ASSOCIATED PRLA'S/AKA'S WILL NOT BE CLOSED UNTIL PAYLOAD RETURN CAPABILITY IS NO LONGER AN OPTION. [ED]
2. FOR A PAYLOAD RETRIEVAL MISSION, THE ASSOCIATED PRLA'S/AKA'S WILL NOT BE CLOSED ON ORBIT UNTIL THE PAYLOAD IS BERTHED.

Because of inherent single-point failures in the payload retention system, the PRLA's and AKA's will remain open to avoid a failure that could preclude returning a payload.

3. AN EVA WILL BE CONSIDERED TO OPEN OR CLOSE ANY TYPE PRLA THAT HAS FAILED TO RELEASE OR LATCH. AKA'S ARE EXCLUDED FROM CONSIDERATION. [011801-3849]

The standard weight longeron latch, super middleweight longeron latch (SMWLL), middleweight longeron latch (MWLL), modified middleweight longeron latch (MMWLL), and lightweight longeron latch (LWLL) types have EVA release/latch drive mechanisms incorporated into their designs. EVA should be considered in lieu of discontinuing payload operations or payload jettison in order to preserve mission success. The standard weight and lightweight AKA types have neither EVA drive capability nor physical access. [011801-3849]

B. PRLA/AKA REQUIREMENTS FOR NOMINAL PAYLOAD BERTHING OPERATIONS:

1. CONFIRMING VISUAL CUES AND/OR AT LEAST ONE OF TWO RELEASE INDICATIONS ON ALL PRLA'S/AKA'S MUST BE PRESENT BEFORE MANEUVERING THE PAYLOAD INTO THE PRLA V-GUIDES.

During berthing operations, PRLA's/AKA's must be verified released in order to preclude possible structural damage to the payload and orbiter.

THIS RULE CONTINUED ON NEXT PAGE

FLIGHT RULES

A10-281

PRLA' S/ AKA' S (CONTINUED)

2. CONFIRMING VISUAL CUES AND/OR AT LEAST ONE OF TWO READY-FOR-LATCH MICROSWITCH INDICATIONS MUST BE PRESENT ON ALL PRLA' S BEFORE CONTINUING NOMINAL PRLA/ AKA CLOSE PROCEDURES.

The absence of both PRLA R-F-L indications represents a condition where a payload trunnion may be outside the 2-inch PRLA latch envelope. Continuation of PRLA ops without further evaluation could allow the payload operator to drive this latch against the trunnion, causing the PRLA motors to stall.

For contingency IUS reberthing operations, R-F-L indications are not required, since the IUS keel kick-off spring will nominally prevent the IUS trunnions from contacting the R-F-L microswitch lever arms. The AFTA, however, will maintain the trunnions within the PRLA latch envelope once the IUS is returned to the PRLA release position.

When latching an AKA, the R-F-L indication is not expected until the latch is almost completely closed. The indication actually serves as a trunnion-in-place indication instead of a R-F-L cue.

3. WHEN NOMINALLY BERTHING A PAYLOAD WITH MULTIPLE PRLA' S AND ONE OR MORE AKA' S, THE AKA(S) MUST BE LATCHED FIRST BEFORE CLOSING THE PRLA' S. (REFER TO SPACE SHUTTLE OPERATIONAL FLIGHT RULES ANNEX FOR EXCEPTIONS.)

During berthing operations, the AKA(s) provides the necessary force required to center the payload within the payload bay. The AKA has a limited capability in the Y-direction (2,500 lb with less than a 0.25-inch payload offset, 1,000 lb with a greater than 0.25-inch offset), which may be insufficient to overcome the longeron latch resistance once the PRLA's are latched. Therefore, the AKA(s) must be closed prior to the PRLA's to preclude an AKA from stalling. Reference RI STS84-0190A, Payload Retention System Latches Safety Assessment Report, July 1984; and Shuttle Flight Operations Manual (SFOM), Volume 16, Payload Deployment and Retrieval System, Final, June 1, 1981.

C. PRLA/ AKA REQUIREMENTS FOR PAYLOAD DEPLOY

CONFIRMING VISUAL CUES AND/OR AT LEAST ONE OF TWO RELEASE INDICATIONS ON ALL PRLA' s/ AKA' S MUST BE PRESENT BEFORE CONTINUING NOMINAL PAYLOAD DEPLOY OPERATIONS.

During deploy operations, PRLA' s/ AKA' s must be verified released in order to preclude possible structural damage to the payload and orbiter.

THIS RULE CONTINUED ON NEXT PAGE

FLIGHT RULES

A10-281 **PRLA' S/ AKA' S** **(CONTINUED)**

D. PRLA/ AKA LATCHED DEFINITION

FOR PAYLOAD RETURN OR ON-ORBIT MANEUVERS AND TRANSLATIONS, A PRLA/ AKA WILL NOT BE CONSIDERED LATCHED WITHOUT THE COMBINATION OF AT LEAST ONE OF TWO LATCH MICROSWITCH INDICATIONS, AND AT LEAST ONE OF TWO RFL MICROSWITCH INDICATIONS (VISUAL CUES ACCEPTABLE FOR R-F-L INDICATIONS).

PRLA's/ AKA's must be verified latched in order to preclude possible structural damage to the payload and orbiter. Failure of any PRLA/ AKA to indicate a latched configuration will be evaluated on a flight-specific basis regarding subsequent on-orbit maneuvers, orbiter attitude control, and return to Earth capabilities.

E. PAYLOAD RETENTION PAYLOAD SELECT ROTARY SWITCH OPERATIONS:

1. FOR MISSIONS WHERE NOMINALLY ONLY A SINGLE PAYLOAD SELECT POSITION WILL BE UTILIZED, THE PAYLOAD RETENTION PAYLOAD SELECT ROTARY SWITCH WILL BE CONFIGURED TO THAT POSITION FOR LAUNCH AND WILL REMAIN IN THAT POSITION FOR THE DURATION OF THE FLIGHT.
2. FOR ALL OTHER MISSIONS, THE ROTARY SWITCH WILL BE LAUNCHED IN THE MONITOR POSITION AND WILL BE OPERATED AS REQUIRED TO BEST SUPPORT THE MISSION.

Operation of the rotary switch for single payload select missions is not necessary; and because of inherent single-point failures within the payload select rotary switch, use of this switch for this type mission is avoided to preclude the potential of mission failure. The payload retention system maintains fail op/ fail safe redundancy against inadvertent operation when launched and flown in any position.

For missions using multiple payload select positions, use of the rotary switch is usually required. The monitor position allows a complete systems status verification for launch commit criteria purposes and for orbit operations.

F. PRLA/ AKA CONFIGURATION FOR ASCENT/ ENTRY ©[072398-6687] ©[011801-3849]

1. WITH NO PAYLOAD
 - a. PRLA' S: LATCHED
 - b. FLOATING AKA' S: RELEASED ©[011801-3849]

THIS RULE CONTINUED ON NEXT PAGE

FLIGHT RULES

A10-281

PRLA' S/ AKA' S (CONTINUED)

- c. FIXED AKA' S: LATCHED OR RELEASED (REFER TO SPACE SHUTTLE OPERATIONAL FLIGHT RULES ANNEX FOR EXCEPTIONS.) ©[011801-3849]

All PRLA certification testing for dynamic flight was done using hardware in the latched configuration. Because of the inherent latch mechanism free-play when not latched overcenter, the loads and vibration levels associated with dynamic flight may cause internal PRLA damage and accelerate mechanism wear. Without a payload trunnion present, a floating AKA in its latched position is free to move along its bridge fitting approximately 9 inches in the x-axis. Therefore, the AKA can impact its end stops, resulting in AKA and/or orbiter payload bay hardware damage. In addition, extensive ground turnaround testing/repair would be required. When released, however, a floating AKA opens up to completely fill the gap between its end stops, and movement along its bridge fitting cannot occur. A fixed AKA is installed with a center stop which prevents the AKA from sliding when fully latched. The bridge fitting end stops prevent movement when the AKA is released.

Reference SODB, vol. I, 3.4.2.5-14 and table 3.4.2.5-5 (Active Keel Latch Ascent and Entry Constraints). ©[072398-6687]

2. WITH PAYLOAD (REFER TO SPACE SHUTTLE OPERATIONAL FLIGHT RULES ANNEX FOR EXCEPTIONS)
- a. PRLA' S: LATCHED
- b. FLOATING AKA' S: LATCHED
- c. FIXED AKA' S: LATCHED

The payload must be constrained during ascent/entry to prevent movement that could lead to damage of the orbiter or payload, or loss of crew/vehicle. This constraint may be relaxed for entry based on loads analysis for the specific payload; the annex documents any such analysis. ©[011801-3849]

A10-282 THROUGH A10-300 RULES ARE RESERVED

FLIGHT RULES

KU-BAND ANTENNA DEPLOY MECHANISM SYSTEMS MANAGEMENT

A10-301 ANTENNA STOW REQUIREMENT [HC] [CIL] ©[042904-6240A]

- A. FOR LOSS OF REDUNDANT KU-BAND ANTENNA STOW CAPABILITY, THE DEPLOYED ASSEMBLY WILL BE STOWED AS SOON AS PRACTICAL UNLESS REQUIRED TO SUPPORT RENDEZVOUS, DOCKING, PLANNED EVA, OR OTHER OPERATIONS STATED IN THE FLIGHT SPECIFIC ANNEX. FOR THESE CASES: [CIL] ©[090999-6930]
1. THE DEPLOYED ASSEMBLY WILL BE DEPLOYED AND REMAIN DEPLOYED TO SUPPORT THE OPERATION.
 2. THE DEPLOYED ASSEMBLY WILL BE STOWED AS SOON AS PRACTICAL AFTER COMPLETION OF THE OPERATION(S) BUT NO LATER THAN THE BEGINNING OF THE DAY PRIOR TO ENTRY.

IF THE LAST OPERATION IS A PLANNED EVA, THE DEPLOYED ASSEMBLY WILL BE STOWED PRIOR TO THE END OF THE EVA.

Without redundant stow capability, the antenna could not be stowed normally if a single additional failure occurred. If stow capability could not be regained by one of the methods given in Rule {A10-303}, ANTENNA CONTINGENCY PROCEDURES, the antenna would be costly in terms of mission success (cases stated above or in the annex), the antenna will be stowed when redundancy is lost. For the loss of redundancy case, the antenna should be stowed prior to the end of the last planned EVA in the event that EVA assistance is needed to complete the stow operation.

Rule {A2-103C}, EXTENSION DAY REQUIREMENTS, references this rule. ©[090894-1670B]

- B. FOR FAILURES AFFECTING KU-BAND ANTENNA TEMPERATURES AND TEMPERATURE MONITORING, THE ANTENNA WILL BE STOWED AS REQUIRED BY RULES {A11-56}, LOSS OF KU-BAND TEMPERATURE CONTROL [CIL], AND {A11-57}, LOSS OF KU-BAND TEMPERATURE MONITORING CAPABILITY [CIL]. ©[090999-6930] ©[042904-6240A]

THIS RULE CONTINUED ON NEXT PAGE

FLIGHT RULES

A10-301 ANTENNA STOW REQUIREMENT [HC] [CIL] (CONTINUED)

Reference Rules {A10-303C}, ANTENNA CONTINGENCY PROCEDURES; {A11-56}, LOSS OF KU-BAND TEMPERATURE CONTROL [CIL]; {A11-57}, LOSS OF KU-BAND TEMPERATURE MONITORING CAPABILITY [CIL]; and {A11-77}, LOSS OF ANY OI DSC. ©[090999-6930]

Rule {A2-103}, EXTENSION DAY REQUIREMENTS, references this rule.

Reference Hazard Report ORBI 305, Inability to Close and Latch Payload Bay Doors (PLBD). ©[042904-6240A]

- C. THE KU-BAND ANTENNA WILL NOT BE REDEPLOYED FOR MISSION EXTENSION DAYS.

Reference Rule {A2-103C}, EXTENSION DAY REQUIREMENTS.

- D. FOLLOWING UNSUCCESSFUL ATTEMPTS TO FULLY DEPLOY THE KU-BAND ANTENNA, THE ANTENNA WILL BE DRIVEN BACK TO THE STOWED POSITION.

If the antenna cannot be successfully deployed, there is a good possibility of a mechanism problem that could also affect the stow capability. It is important to stow the antenna early in the flight so IFM or EVA contingency procedures can be planned per Rule {A10-303}, ANTENNA CONTINGENCY PROCEDURES, if required. Also, the antenna is no use if not fully deployed and there is a potential for an additional failure to make antenna stowage impossible as the flight progresses. ©[090999-6930]

A10-302 DAP CONFIGURATION FOR ANTENNA STOW

THE DAP WILL BE CONFIGURED TO "VERN" OR "FREE DRIFT" DURING KU-BAND DEPLOY ASSEMBLY STOWING.

Reference SODB, vol. I, 3.4.5.2.10. In order to ensure proper gimbal locking during the antenna automatic stow sequence, the primary RCS jets cannot be selected. Damage to the gimbal locking mechanism may be caused by orbiter accelerations greater than 0.5 deg/sec² and orbiter rates greater than 5 deg/sec during the stow sequence. Either "vern" or "free drift" is acceptable.

FLIGHT RULES

A10-303

ANTENNA CONTINGENCY PROCEDURES

- A. IF THE KU-BAND ANTENNA GIMBALS CANNOT BE LOCKED FOR KU-BAND STOW, CONSIDERATION WILL BE GIVEN TO PERFORMING AN EVA TO LOCK THE GIMBALS IF A DEORBIT DAY PLUS 1-DAY WAVEOFF IS AVAILABLE AFTER EVA DAY.

For this case, an EVA is considered an option if it can be performed and consumables will support a deorbit day plus 1 day waveoff after EVA day.

- B. IF THE KU-BAND ANTENNA CANNOT BE STOWED OR THE GIMBALS CANNOT BE LOCKED BUT THE FAILURE OCCURS SUCH THAT AN EVA CANNOT BE PERFORMED, CONSIDERATION WILL BE GIVEN TO A 1-ORBIT WAVEOFF OR A 1-DAY EXTENSION IN ORDER TO PERFORM ANY OF THE FOLLOWING CONTINGENCY PROCEDURES IF A DEORBIT DAY PLUS 1-DAY WAVEOFF DAY IS MAINTAINED:
1. KU-BAND ANTENNA - FAILED DEPLOY/STOW SWITCH (IFM) .
 2. KU-BAND ANTENNA - GIMBALS CAN BE LOCKED (IFM) .
 3. USE OF THE KU-BAND ANTENNA DIRECT STOW SWITCH.
 4. KU-BAND ANTENNA JETTISON (IF FAILURE PREVENTS PLBD CLOSURE) .

The rule assumes that, for whatever reason, performing an EVA has not been an option. It also assumes that on entry day we are unable to stow the antenna or lock the gimbals.

There are a few contingency procedures that do not involve an EVA, but might require a one-orbit waveoff or a 1-day extension to perform. Depending on the failure, they could result in saving the antenna and still enter with at least a 1-day backup.

The contingency procedure required to be used is dependent on the actual failure condition; however, if the failure can be corrected via IFM, the IFM procedure should have priority over the others. The IFM procedures allow for normal antenna stow procedures to be used once the gimbals are locked.

Rule {A10-301B and C}, ANTENNA STOW REQUIREMENT [HC] [CIL], references this rule. ©[042904-6240A]

- C. THE KU-BAND WILL BE JETTISONED IF THE GIMBALS CANNOT BE LOCKED FOR ENTRY.

With the Ku-band mechanism stowed and the antenna gimbals unlocked, the antenna disk is free to move about its gimbal axes and cause radiator damage when subjected to entry and landing loads. Loss of the ability to lock the antenna gimbals and secure the disk for entry is considered a criticality 1 failure.

Reference JSC VNS-87-26, Ku-Band Comm/Radar FMEA/CIL, Level III CCB minutes, December 10, 1986.

FLIGHT RULES

A10-304**KU-BAND ANTENNA/OBSS CLEARANCE CONSTRAINTS [HC]**

IN ORDER TO PRECLUDE CONTACT BETWEEN THE KU-BAND ANTENNA AND THE OBSS, THE FOLLOWING CONSTRAINTS APPLY TO KU ANTENNA DEPLOY AND STOW OPERATIONS: @[102506-7824A]

- A. WITH THE OBSS CRADLED, THE OBSS MPM'S MUST BE IN THE STOWED POSITION PRIOR TO KU ANTENNA DEPLOY OR STOW.
- B. WITH THE OBSS UNCRADLED, STOWING OR DEPLOYING OF THE KU ANTENNA CAN BE PERFORMED, AS NEEDED, REGARDLESS OF OBSS MPM POSITION.

With the OBSS cradled, contact between the Ku-band antenna and the OBSS can occur during antenna deploy or stow operations, depending on the OBSS MPM position. Approximately 2.6 inches of clearance exists with the antenna stowed and the OBSS cradled and stowed, so no concern exists for this configuration (including during launch and entry). However, this clearance decreases as the antenna moves past the OBSS during Ku stow and deploy operations. KSC testing showed that, with the OBSS MPM's in the deployed position, contact will occur. With the MPM's stowed, clearance exists, but is very small (minimum clearance was measured at 0.688 inches on OV-103, and 0.469 inches on OV-104; the point of contact is between the antenna dish and an OBSS thermal blanket). Thermal effects (material expansion, contraction, bending, and rotation) and OBSS positioning in the MPM's can decrease this clearance by 0.371 inches (reference Boeing technical memorandum TM-SJ00-SJC0D-2005-014, Maximum Thermal Deflections Between Ku-band Antenna and OBSS, April 19, 2005). Imagery, Science, and Analysis Group performed a photogrammetric analysis during STS-114 (STS-114 Ku Deployment - Measured Linear Clearance Between the Edge of Ku Dish and Forward Edge of the OBSS, D. Liddle/D. Bretz, August 3, 2005), which indicated a positive clearance of 0.8 ± 0.1 inches between the Ku dish and the OBSS (MPM's stowed). All the analysis and photogrammetry was validated with a successful Ku stow on STS-114. For STS-121, both the Ku Deploy (FD1) and Ku Stow were performed with the OBSS cradled and MPM's stowed.

Reference ORBI 348, Catastrophic Damage to Orbiter Resulting from SRMS/OBSS TPS Inspection/Repair Activities. @[102506-7824A]

A10-305 THROUGH A10-320 RULES ARE RESERVED

FLIGHT RULES

THIS PAGE INTENTIONALLY BLANK

FLIGHT RULES

**REMOTELY OPERATED ELECTRICAL/FLUID UMBILICAL (ROEU/ROFU) SYSTEMS
MANAGEMENT** ©[062801-4355A]

A10-321 **ROEU/ROFU OPERATIONS**

- A. THE ROEU/ROFU WILL BE DEMATED FROM THE PAYLOAD PRIOR TO UNLATCHING THE PRLA(S) OR AKA(S) .

The ROEU/ROFU was not designed to withstand the loads that may be caused by a payload that is not fully constrained in the payload bay. This will preclude possible damage to the ROEU/ROFU, which may lead to binding during unberthing of the payload.

- B. THE ROEU/ROFU WILL NOT BE MATED TO THE PAYLOAD UNTIL AND UNLESS THE PRLA(S) AND AKA(S) REQUIRED FOR ENTRY ARE CONFIRMED LATCHED.

The ROEU/ROFU was not designed to withstand the loads that may be caused by a payload that is not fully constrained in the payload bay. This will preclude possible damage to the ROEU/ROFU which may lead to binding should a contingency unberthing of the payload be required.

- C. THE PAYLOAD WILL NOT BE UNBERTHED UNTIL CONFIRMATION THAT THE ROEU/ROFU IS DEMATED AND OVERCENTER LOCKED OR VISUAL VERIFICATION OF CLEARANCE IS OBTAINED.

The separation distance between the payload and the orbiter disconnect assembly (ODA) is critical during berth and unberth. If the distance is less than the specified 3.2 inches, contact may occur between the ODA and the payload. If not overcenter locked, the orbiter arm drive mechanism (ODM) may be free to backdrive such that the clearance is less than 3.2 inches and potentially cause contact during berth or unberth. During unberthing, without confirmation of overcenter lock, the crew will have to visually verify the clearances to avoid ODA-to-payload contact. ©[062801-4355A]

THIS RULE CONTINUED ON NEXT PAGE

FLIGHT RULES

A10-321 ROEU/ROFU OPERATIONS (CONTINUED)

- D. IF A POSITIVE LATCH INDICATION IS NOT RECEIVED AFTER ROEU/ROFU LATCH HAS BEEN ATTEMPTED, THE ROEU/ROFU WILL BE UNLATCHED AND DEMATED PRIOR TO ENTRY. @[062801-4355A]

Without at least one microswitch confirming that the ODA hooks are overcenter locked, possible damage to the ROEU/ROFU may occur during entry due to separation of the ODA and the payload disconnect assembly (PDA). The overcenter demated position is safe for entry.

- E. IF THE ROEU/ROFU FAILS TO DEMATE, AN UNSCHEDULED EVA WILL BE CONSIDERED TO DEMATE THE ROEU/ROFU.

The ROEU/ROFU ODA Hooks and ODM Arm have EVA drive capability. Demating the ROEU/ROFU via EVA should be considered in lieu of discontinuing payload operations in order to preserve mission success.

- F. IF THE ROEU/ROFU CANNOT BE REMATED WITH THE PAYLOAD, AN UNSCHEDULED EVA WILL BE CONSIDERED TO REMATE THE ROEU/ROFU.

The ROEU/ROFU ODA Hooks and ODM Arm have EVA drive capability. Remating the ROEU/ROFU via EVA should be considered to avoid damage to the payload resulting from loss of functions provided by the ROEU/ROFU. @[062801-4355A]

A10-322 THROUGH A10-340 RULES ARE RESERVED

FLIGHT RULES

ANDROGYNOUS PERIPHERAL DOCKING SYSTEM (APDS) SYSTEMS MANAGEMENT

A10-341

APDS CONFIGURATION

- A. THE DOCKING RING MUST BE AT THE INITIAL POSITION AND THE RING ALIGNED BEFORE ATTEMPTING TO DOCK. @[021199-6816]

With the ring aligned at the initial position, each ballscrew/nut assembly has its maximum stroke available to react to and attenuate the docking loads. If the ring is not aligned, or if it is extended beyond or below the initial position, the available stroke decreases, thus decreasing attenuation capability. This would also increase the probability of bottoming out the mechanism, which could result in excessive loads and damage to the mechanism or the vehicles. In addition, if the ring is not aligned, the probability of achieving capture is reduced, since the mechanism must then overcome misalignments in the ring as well as piloting misalignments in order to engage all three capture latches.

- B. THE INNER HATCH WILL BE CLOSED AND LATCHED PRIOR TO ANY ATTEMPT TO DOCK WITH ISS. IF AN IFM IS REQUIRED TO COMPLETE DOCKING, THE IFM WILL BE SET UP PRIOR TO THE DOCKING ATTEMPT. THE INNER HATCH WILL BE OPENED AFTER CAPTURE IS OBTAINED TO DRIVE THE APPROPRIATE APDS MOTOR TO COMPLETE THE SEQUENCE.

Closing the inner hatch isolates the crew cabin from the ODS volume should the APDS hatch or ODS structure be breached during a docking attempt.

- C. THE DOCKING RING WILL NOMINALLY BE RETRACTED TO ITS FINAL POSITION PRIOR TO CLOSING THE PLBD'S. IF THE RING CANNOT BE RETRACTED, THE SYSTEM IS STILL IN A SAFE CONFIGURATION FOR ENTRY.

The active docking ring will nominally be retracted during the docking sequence and will not be re-extended. If the docking sequence is not completed, the ring should be retracted before attempting to close the payload bay doors. Analysis has not been done to show that damage to the ring or ballscrew mechanism will not occur if the ring is extended during entry. However, the ring does not interfere with the payload bay door envelope even at its fully extended position. If the capability does not exist to retract the ring, there are no safety concerns with the ring being extended during entry. Reference Rockwell-Downey Internal Letter ODS-36.11-94-142. @[021199-6816]

- D. THE APDS HOOKS WILL NOT BE CLOSED BEFORE THE MATING INTERFACES REACH THE READY-TO-HOOK POSITION DURING DOCKING. @[032504-6208A]

Prior to reaching the ready-to-hook position, driving the hooks closed for troubleshooting exposes the system to the next failure (hooks failed closed) which would prevent docking. Closing of the hooks will only be performed after the actual docking event and the ready-to-hook indication is achieved. At this time, the interface is close enough for the shuttle hooks to engage the PMA passive hooks. @[032504-6208A]

FLIGHT RULES

A10-342

APDS PRESSURE/TEMPERATURE

- A. THE DMCU, DSCU, LACU, PACU, AND PSU AVIONICS BOXES WILL NOT BE OPERATED IF THE EXTERNAL AIRLOCK PRESSURE IS LESS THAN 8.0 PSIA. ©[021199-6816]

To ensure adequate heat dissipation, the atmospheric pressure within the DMCU, DSCU, LACU, and PACU avionics boxes (which is represented by the external airlock pressure) must be greater than 8.0 psia. If the airlock pressure falls below 8.0 psia and is subsequently repressurized to > 8.0 psia, operation of these boxes is acceptable (assuming paragraph D of this rule has not been violated). Reference APDS Multi-Mir Critical Design Review, February 1995.

- B. THE PFCU IS DESIGNED AS A ONE-TIME USE BOX AND MAY BE OPERATED IN A VACUUM IF REQUIRED.

There are no relays within the PFCU that are continuously energized as in the other boxes. Since it takes less than a second to activate the necessary relays to fire the hook 6, there is no issue with overheating and premature failure of the components due to lack of atmosphere in the box. In addition, the PFCU is designed to be used only once. This is due to the degradation of the fusistors as they are heated by the current flow and the probability of the KQ relay contacts welding closed. Reference APDS Multi-Mir Critical Design Review Protocol, February 23, 1995.

- C. THE DCU'S ARE SEALED BOXES AND MAY BE OPERATED AS REQUIRED IN A VACUUM.

There are no heat rejection concerns with the DCU's because the DCU's do not use the same heat-generation relays that the other boxes have. Since these boxes are also hermetically sealed, there is no constraint to operation in a vacuum.

- D. THE DMCU, DSCU, LACU, PACU, AND PFCU AVIONICS BOXES HAVE A MAXIMUM CUMULATIVE NON-OPERATING VACUUM EXPOSURE LIMIT OF 200 HOURS.

The DMCU, DSCU, LACU, PACU and PFCU avionics boxes are not sealed; therefore, exposing these boxes to a vacuum will expose the internal electronics to a vacuum. Due to concerns about the effect of vacuum exposure on the electronics, these boxes have a maximum cumulative nonoperation vacuum exposure limit of 200 hours. Reference: Procurement Specification for the Androgynous Peripheral Docking System for the ISS Missions (JSC-26938, Rev C). ©[021199-6816]

THIS RULE CONTINUED ON NEXT PAGE

FLIGHT RULES

A10-342

APDS PRESSURE/TEMPERATURE (CONTINUED)

E. DOCKING SYSTEM TEMPERATURES, AS INDICATED BY THE DOCKING BASE, CAPTURE LATCH, BALL DRIVE, RING DRIVE, AND HOOK DRIVE TEMPERATURES, MUST BE MAINTAINED WITHIN THE LIMITS LISTED BELOW. ORBITER ATTITUDE WILL BE MANAGED, OR THE DOCKING RING EXTENDED OR RETRACTED, TO MAINTAIN THESE LIMITS. @[021199-6816]

MISSION PHASE		LIMITS
OPERATING	[1]	-22°F/-30°C (-13°F/-25°C) < T < 122°F/50°C (113°F/45°C)
NON-OPERATING	[2]	-67°F/-55°C (-58°F/-50°C) < T < 167°F/75°C (158°F/70°C)

@[121902-5838]

- [1] OPERATING LIMITS SHALL APPLY DURING RING EXTENSION/RETRACTION AND DURING THE ENTIRETY OF THE DOCKED MISSION FROM CONTACT THROUGH HOOKS OPEN.
- [2] NON-OPERATING LIMITS SHALL APPLY WHEN NOT DOCKED AND NO APDS MECHANISMS ARE DRIVING.

A 9 deg F (5 deg C) margin was used to protect worst-case component temperatures, which may not be reflected in the transducer measurements due to location differences. Operating limits protect APDS hardware during periods of mechanism movement and when the seals are compressed. Non-operating limits apply at all other times regardless of the avionics power status. Reference: Procurement Specification for the Androgynous Peripheral Docking System for the ISS Missions (JSC-26938, Rev C).
@[121902-5838]

F. THE DMCU, DSCU, LACU, PACU, AND PSU AVIONICS BOXES WILL NOT REMAIN POWERED ON FOR LONGER THAN 2 HOURS. THE AVIONICS MUST THEN BE POWERED OFF FOR A MINIMUM OF 30 MINUTES PRIOR TO THE NEXT POWERUP.

To avoid excessive heat buildup, the docking system avionics boxes have a maximum power on time constraint of 2 hours. Following powerup, the boxes must be powered down for a minimum of 30 minutes to allow for adequate heat dissipation.

G. THE DCU BOXES DO NOT HAVE A POWER ON TIME CONSTRAINT.

The electronics within the data collection units have negligible heat buildup characteristics even though the box is sealed. Therefore, the DCU's are capable of remaining powered indefinitely. Reference APDS Multi-Mir Critical Design Review, February 23, 1995.

H. THE DAMPERS WILL NOT REMAIN POWERED ON FOR MORE THAN 5 MINUTES OF CONTINUOUS OPERATION.

RSC-Energia has constrained damper operation to a maximum of 5 minutes in order to preclude excessive heat buildup and potential hardware degradation. Note that once the dampers are powered off, they cannot be re-enabled during the same docking attempt. Reference Technical Interface Meeting, June 1998. @[021199-6816]

FLIGHT RULES

A10-343

APDS MECHANISM END OF TRAVEL INDICATIONS

- A. THE ACTIVE DOCKING RING WILL BE CONSIDERED TO HAVE ATTAINED ITS COMMANDED POSITION, FINAL/INITIAL/FORWARD, IF AT LEAST ONE OF THE FOLLOWING INDICATIONS OCCURS WITHIN SINGLE-MOTOR DRIVE TIME: @[021199-6816]
1. THE ASSOCIATED APDS CONTROL PANEL STATUS LIGHT OR THE ASSOCIATED DISCRETE TELEMETRY DATA INDICATES FINAL/INITIAL/FORWARD.
 2. THE ASSOCIATED ANALOG POTENTIOMETER MEASUREMENT IS AT 5 PERCENT (± 3 PERCENT) FOR FINAL POSITION, 76 PERCENT (± 3 PERCENT) FOR INITIAL POSITION, OR 98 PERCENT (± 2 PERCENT) FOR FORWARD POSITION.

Redundant indications are provided for the ring drive mechanisms for the final/initial/forward and analog position indications. During ring operations, if any of the proper end-of-travel indications are obtained within the single-motor drive envelope, the ring will be considered to be in the desired position. This is based on the low probability of a sensor failing within the time that the indication was expected, thereby giving a false verification of position. Reference January 1998, APDS ISS Brassboard Functional Testing.

- B. THE ACTIVE DOCKING RING WILL BE CONSIDERED PROPERLY ALIGNED IF AT LEAST ONE OF THE FOLLOWING INDICATIONS IS OBTAINED:
1. THE ASSOCIATED APDS CONTROL PANEL STATUS LIGHT OR DISCRETE TELEMETRY DATA INDICATES RING ALIGNED.
 2. THE ASSOCIATED ANALOG POTENTIOMETER MEASUREMENTS ON THE RING ARE AT 50 PERCENT (± 1 PERCENT) AND THOSE ON THE BASE ARE WITHIN 1 PERCENT OF EACH OTHER.

The docking ring is aligned when all six ballscrews are extended the same length. For the ring to be aligned in pitch, roll, and z, the base potentiometer measurements should be within 1 percent of each other. Alignment in the yaw, x, and y axes is confirmed by the ring potentiometer measurements being centered at 50 percent ± 1 percent.

- C. THE CAPTURE LATCHES WILL BE CONSIDERED OPEN IF AT LEAST ONE OF THE FOLLOWING INDICATIONS CAN BE VERIFIED:
1. THE ASSOCIATED APDS CONTROL PANEL STATUS LIGHT OR THE ASSOCIATED DISCRETE TELEMETRY DATA INDICATES OPEN WITHIN THE MOTOR DRIVE TIME. @[021199-6816]

THIS RULE CONTINUED ON NEXT PAGE

FLIGHT RULES

A10-343

APDS MECHANISM END OF TRAVEL INDICATIONS (CONTINUED)

2. THE LATCHES CAN BE VERIFIED OPEN AS INDICATED BY A FULLY RETRACTED RING POST-HARD-DOCK. @[021199-6816]

The capture latches indicate open when all three latches are open (i.e., the redundant contacts of each sensor are wired in series). During latch operations, if the open indications are obtained within the expected drive time of 3-4 seconds, the latches will be considered to be in the desired position. This is based on the low probability of a sensor failing within the time that the indication was expected, thereby giving a false verification of position. Also, if the ring can be retracted to the final position as indicated by ring position or verified visually, all three latches are known to be open.

- D. THE CAPTURE LATCHES WILL BE CONSIDERED CLOSED IF THE ASSOCIATED APDS CONTROL PANEL STATUS LIGHT OR THE ASSOCIATED DISCRETE TELEMETRY DATA INDICATES CLOSED WITHIN THE MOTOR DRIVE TIME.

The capture latches indicate closed when all three latches are closed (i.e., the redundant contacts of each sensor are wired in series). During latch operations, if the closed indications are obtained within the expected drive time of 3-4 seconds, the latches will be considered to be in the desired position. This is based on the low probability of a sensor failing within the time that the indication was expected, thereby giving a false verification of position. Also, if the ring cannot be retracted to the final position post-hard-dock, at least one capture latch should be considered closed.

- E. EACH GANG OF APDS HOOKS WILL BE CONSIDERED OPEN/CLOSED IF AT LEAST ONE OF THE FOLLOWING INDICATIONS OCCURS WITHIN SINGLE-MOTOR DRIVE TIME:

1. THE ASSOCIATED APDS CONTROL PANEL STATUS LIGHT OR THE ASSOCIATED DISCRETE TELEMETRY DATA INDICATES OPEN/CLOSED.
2. THE ASSOCIATED ANALOG POTENTIOMETER MEASUREMENT IS AT 5 PERCENT (± 3 PERCENT) FOR HOOKS OPEN OR 92 PERCENT (± 3 PERCENT) FOR HOOKS CLOSED.

Redundant indications are provided for the hook drive mechanisms for the open/close and analog position indications. During hook operations, if any of the end-of-travel indications are obtained within the single-motor drive envelope, the hooks will be considered to be in the desired position. This is based on the low probability of a sensor failing within the time that the indication was expected, thereby giving a false verification of position. In addition to the indications above, the APDS hooks have close microswitches on each of the individual hooks (except for hooks 6 and 7, which are driven directly by the hook power drive units). These sensors indicate the individual hooks are closed when the hook potentiometer indicates approximately 80 percent. The PMA 2/3 hooks have close microswitches similar to the PMA-1 hooks; however, the PMA 2/3 sensors are wired in series, in groups of three. @[021199-6816]

FLIGHT RULES

A10-344

APDS DOCKING SEQUENCE OPERATIONS

- A. IF ANY APDS CONTROL PANEL STATUS LIGHT INADVERTENTLY ACTIVATES OR FAILS TO ACTIVATE: ©[021199-6816]
1. PRIOR TO DOCKING, IF THE FAILURE IS DETERMINED TO BE IN A SINGLE SENSOR CONTACT, DOCKING MAY PROCEED AS PLANNED. IF MULTIPLE FAILURES EXIST, DOCKING WILL BE DELAYED AS REQUIRED TO ALLOW TROUBLESHOOTING.
 2. DURING DOCKING, THE APDS DOCKING SEQUENCE WILL BE STOPPED VIA A POWER CYCLE. IF THE FAILURE IS DETERMINED TO BE IN A SINGLE SENSOR CONTACT, DOCKING MAY BE COMPLETED. IF MULTIPLE FAILURES EXIST, COMPLETION OF THE DOCKING SEQUENCE WILL BE DELAYED AS REQUIRED TO ALLOW TROUBLESHOOTING.

The design philosophy within the APDS avionics utilizes three separate electrical paths; two of the three are required to activate any particular function. For feedback from sensors external to the avionics boxes, the three paths are typically combined into two paths to the sensors, with the APDS A logic bus feeding both paths (i.e., A and B paths completed through one sensor contact, A and C through the other). In this way, with any two busses powered, the system can complete its function. Conversely, however, if any one contact or associated wiring shorts to ground or fails closed, two of the three paths associated with that sensor will be activated, possibly disrupting the system operation. This is the basis for all of the avionics single-point failures.

Due to the avionics design, workarounds are available to bypass any single contact failure (e.g., by removing one source of power to the contact). Removing one power source also provides a means of determining if a single-point failure exists, or if multiple failures have caused the erroneous indication. Since the single failure scenarios are already accounted for in the docking sequence cue cards, if there is a contact short, the docking may proceed using the appropriate workarounds. If multiple failures exist, further troubleshooting must be done to determine the source of the failures and any possible workarounds.
©[021199-6816]

THIS RULE CONTINUED ON NEXT PAGE

FLIGHT RULES**A10-344****APDS DOCKING SEQUENCE OPERATIONS (CONTINUED)**

- B. POST-CONTACT, ALL RELATIVE ANGULAR MOTION BETWEEN THE ORBITER AND ISS MATED STACK WILL BE ALLOWED TO DAMP OUT PRIOR TO ATTEMPTS TO DRIVE THE DOCKING RING. DURING RING RETRACTION: ©[021199-6816] ©[022604-6210]
1. IF RING ALIGNMENT IS LOST AND ANY BASE POTENTIOMETER MEASUREMENT IS > 20 PERCENT, RING DRIVE WILL BE PAUSED TO ALLOW RING ALIGNMENT TO BE REGAINED.
 2. IF RING ALIGNMENT IS LOST DURING RING RETRACTION AND ALL BASE POTENTIOMETER MEASUREMENTS ARE ≤ 20 PERCENT, RING RETRACTION WILL BE ALLOWED TO CONTINUE.

Post-contact, a pendulum motion occurs, causing the entire stack to rotate about the combined c.g. This pendulum motion is due to two causes. The first is that the docking interface is not on the line joining the c.g. of the orbiter and the c.g. of ISS - this force is imparted once, at contact. The second is the gravity gradient (GG) effect, which is due to gravitational acceleration decreasing with increasing distance from the earth's c.g. An orbiting body is a three-dimensional object, so portions of it are closer to (and further from) the earth's c.g., and are thus under different gravitational accelerations. These differences in acceleration on the distribution of the body's mass produce uneven torques, causing the body to rotate. There is a stable attitude wherein these forces attain equilibrium - this is known as the gravity gradient attitude. Since the combined stack at contact is not at this equilibrium attitude, and the contact constraints mandate the vehicles remain in free drift until hard mate is achieved, the stack will rotate under the GG effect. The stable attitude is closer to that of an orbiter Rbar docking, and the GG effect counteracts the rotation produced by the contact conditions, so the severity of the rotation is much less than with a Vbar docking. For a Vbar docking, the two rotation effects are additive, and the stack is accelerated towards the GG attitude. Momentum carries it past this point, after which the GG effect counters the rotation. The stack will then reverse rotation and momentum will again swing it past the GG attitude; this pendulum motion will continue until either the motion is naturally damped out and the GG attitude is attained, or until attitude control (RCS, CMG, etc.) is reestablished. As the stack approaches the GG attitude, the centripetal force exerted builds. Due to the docking interface not lying along the line between the stack's rotation point and the orbiter's c.g., a torque is produced on the interface. This torque can become strong enough to overcome the docking system's centering springs and cause the ring to become misaligned. As the stack swings past the GG attitude and the acceleration lessens, the torque on the APDS is reduced and the springs will realign the ring. The realignment should occur within 30 minutes from loss of alignment due to the GG effect. If the ring has not realigned within 30 minutes, then the ring should be driven to the forward position to force alignment. Below 20 percent it is not necessary to pause and wait for ring alignment because the 60mm long alignment pins will already have engaged the alignment sockets. Reference Orbit Flight Techniques Panel #204, August 23, 2002. ©[022604-6210]

THIS RULE CONTINUED ON NEXT PAGE

FLIGHT RULES**A10-344 APDS DOCKING SEQUENCE OPERATIONS (CONTINUED)**

MCC-H is usually prime for determining when relative motion has damped completely, and when the ring has been aligned sufficiently to allow ring extension/retraction. However, in a loss of communications scenario, the crew has sufficient indications/verifications in order to continue the docking sequence without ground concurrence. ©[022604-6210]

- C. THE DOCKING SEQUENCE CAN BE PAUSED OR STOPPED AT ANY TIME AFTER CAPTURE, IN ORDER TO TROUBLESHOOT ERRONEOUS APDS OPERATION OR TO PERFORM A BACKAWAY.

Five seconds after capture, the high energy and low energy electromagnetic dampers are activated to null the relative motion between the vehicles. These dampers remain active until the crew performs a PWR ON reset or a power cycle of the avionics. If a backaway needs to be performed, the successful completion of damping becomes irrelevant, and the sequence may be stopped as required. ©[021199-6816]

- D. IF RING EXTENSION TO THE FORWARD POSITION IS REQUIRED IN ORDER TO FORCE ALIGNMENT AND THE DAMPERS ARE DE-ENERGIZED, THE RING WILL BE PAUSED JUST PRIOR TO REACHING THE FORWARD POSITION. WHEN ANY RELATIVE ANGULAR MOTION HAS STOPPED, THE RING DRIVE TO THE FORWARD POSITION WILL BE RESTARTED. ©[021199-6816]

By stopping the ring drive just prior to the Forward position and allowing all relative motion to damp out, excessive loads against the mechanism hard stops can be avoided. Loads against the hard stops will be minimized when the ring drive is restarted. ©[022604-6210]

- E. FOLLOWING CONTACT, IF CAPTURE CANNOT BE CONFIRMED, BUT SEPARATION DOES NOT OCCUR, THE DOCKING SEQUENCE SHALL CONTINUE AFTER PASSIVE DAMPING IS COMPLETED PROVIDED: ©[052302-5111A]
1. NO VISIBLE GAPPING BETWEEN THE ACTIVE AND PASSIVE RINGS EXISTS, AND
 2. THE HOOKS DRIVE AUTOMATICALLY UPON RING RETRACTION.

CAPTURE CAN BE CONFIRMED BY EITHER ILLUMINATION OF THE CAPTURE LIGHT OR INITIATION OF ACTIVE DAMPING. ©[052302-5111A]

THIS RULE CONTINUED ON NEXT PAGE

FLIGHT RULES

A10-344

APDS DOCKING SEQUENCE OPERATIONS (CONTINUED)

If the interfaces do not separate post-contact, physical capture has most likely occurred. A single failed capture sensor could cause the capture latching logic to remain unlatched. This would result in no CAPTURE light and no active damping. Continuing the docking sequence is safe in this case provided any relative motion is allowed to damp passively. The "manual" steps in the docking sequence must be performed since the auto-sequence will not have initiated. ®[052302-5111A]

Analysis indicates that if one capture latch failed to engage the passive latch, separation would not likely occur. (Ref Mir FTP #12, November 18, 1994.) Prior to retracting the ring to the Ready-to-Hook position during the docking sequence, this case would not be distinguishable from the loss of a capture sensor unless visible gapping is noted between the active and passive rings at one or more petals. If the docking sequence were to continue, it may be possible to determine if all three latches are engaged when retracting the active ring to the Ready-to-Hook position. At the Ready-to-Hook position, four spring pushers (two on each mechanism) positioned around the structural ring will exert a separating force on the interface, which may result in the inability to compress one or more of the four Ready-to-Hook sensors. If two such sensors are not depressed far enough to make contact, the Ready-to-Hook light will not be illuminated and automatic hooks closure will not occur. Attempting to close the hooks manually in this case may result in binding and damage to the structural hook mechanisms. Under these circumstances the ring should be driven out to the Initial Position and the Failed Capture procedure executed to undock.

The likelihood of a failed capture sensor is considered much higher than the likelihood of a structural or mechanical failure of a capture latch. The three capture latches are configured to the closed (ready to dock) position at KSC before launch and are not driven open until structural mate is complete during the docking sequence. The LATCHES CLOSED light and accompanying telemetry can be used to confirm that all three capture latches are closed. ®[052302-5111A]

FLIGHT RULES

A10-345

APDS RECONFIGURATION AFTER FAILED DOCKING

- A. IN THE EVENT OF A FAILED CAPTURE, THE DOCKING RING WILL BE EXTENDED TO THE FORWARD POSITION (IF REQUIRED TO REALIGN THE RING), FULLY RETRACTED, AND THEN RE-EXTENDED TO THE INITIAL POSITION PRIOR TO A SECOND DOCKING ATTEMPT. THE AVIONICS WILL ALSO BE REINITIALIZED BY MEANS OF A POWER CYCLE.

To ensure the APDS mechanism did not experience excessive loads during a failed capture that could damage mechanism components and to ensure all active dampers have disengaged, the ring will be extended with the fixers off to the forward position (in order to force alignment), then retracted and re-extended. This allows a review of the drive system characteristics (drive time, currents) as an indicator of system health. The ring also needs to be realigned to be in the proper position for the next docking attempt. The avionics will also be reinitialized to ensure that its logic is in the proper state for another docking attempt.

- B. AFTER AN UNSUCCESSFUL DOCKING ATTEMPT DURING WHICH THE APDS ACTIVE DAMPING WAS COMMANDED ON, A SECOND DOCKING ATTEMPT WILL NOT BE ATTEMPTED UNTIL THE DAMPING MECHANISM IS CONFIRMED TO BE DISENGAGED.

During 6 degree-of-freedom docking loads testing in Moscow, an instance occurred during which the damping mechanism did not disengage after the damping commands were removed. During the next test, loads in excess of the acceptable docking loads were noted. Upon investigation of the high loads, it was determined that the damping mechanisms clutch had not disengaged. Therefore, to ensure that a similar problem does not occur during the Shuttle/ISS docking missions, a second docking attempt, following an attempt that failed after the dampers were commanded ON, should not be performed until the dampers can positively be verified disengaged. @[021199-6816]

A10-346

APDS REDUNDANCY REQUIREMENTS

IN SUPPORT OF ALL FLIGHTS RULE {A2-104}, SYSTEMS REDUNDANCY REQUIREMENTS, EXTRAVEHICULAR ACTIVITY (EVA) WILL BE CONSIDERED AS A LEVEL OF REDUNDANCY IN ORDER TO ACCOMPLISH SHUTTLE/ISS UNDOCKING. EVA WILL BE USED AS THE THIRD METHOD TO ACHIEVE SEPARATION. @[021199-6816]

The shuttle docking system has two sets of six hooks; each set is opened and closed by dual-motor electro-mechanical actuators and a pulley/cable drive system. Additionally, there are independent pyro systems that can remotely release the active and/or passive hooks. The active hooks pyro system releases all 12 shuttle hooks, and the passive hooks system releases all 12 passive hooks. In the event that either hooks drive system fails, and discharging either or both pyro systems is unsuccessful, the 96-Bolt EVA will be executed in order to separate the shuttle. @[021199-6816]

A10-347 THROUGH A10-360 RULES ARE RESERVED

FLIGHT RULES

VIEWPORT SYSTEMS MANAGEMENT

A10-361

VIEWPORT (VP)

- A. WHEN THE VP IS NOT IN USE, THE OUTER COVER WILL REMAIN CLOSED. @[051194-1637]

Limiting VP use to experiment operations and earth/space observations minimizes the risk of mechanism damage (from landing loads) should the outer cover fail in the OPEN position. The outer cover provides mechanical and thermal protection when it is closed; however, it does not provide a redundant pressure seal.

- B. THE VP OUTER COVER MUST BE CLOSED WITHIN 35 MINUTES OF VP WINDOW EXPOSURE TO THE SUN IN FIELD OF VIEW (FOV) OR 2 HOURS OF VP WINDOW EXPOSURE TO DEEP SPACE (VP HEATER ACTIVATED AND FUNCTIONAL) .

The sun exposure constraint precludes the VP internal surfaces from exceeding the maximum allowable touch temperature of 45 deg C (113 deg F). The deep space constraint precludes the formation of condensation on the actuator mechanism and VP glass (a free fluid, ice formation, and hardware degradation concern), and ensures VP seal integrity. The VP lower thermal qualification limit is -10 deg C (14 deg F). @[111501-4966A]

The sun is in FOV of the VP whenever it is within a 60 deg half-cone angle about the VP normal vector. The VP is exposed to deep space whenever the sun and the entire earth are outside an 80 deg half-cone angle about the VP normal vector. (The VP normal vector is in the orbiter -Z body axis.)

Reference: JSC-16744, Spacelab Operational Data Book (SLODB) 3.5.1, Constraints/Contingency Operations; TR-OK-0008, Thermal Vacuum Test Results: Viewport; TN-ER-36-061-77, VP/Viewport Adapter Assembly (VAA) Thermal Analysis, 5/30/78; and MDC-93-W-5652, 5/93. @[051194-1637]

THIS RULE CONTINUED ON NEXT PAGE

FLIGHT RULES

A10-361**VIEWPORT (VP) (CONTINUED)**

- C. THE INNER SAFETY COVER SHOULD REMAIN INSTALLED ON THE VP AT ALL TIMES, UNLESS ITS REMOVAL IS REQUIRED FOR PAYLOAD ACCOMMODATIONS OR PHOTOGRAPHY. THE INNER SAFETY COVER MUST BE INSTALLED PRIOR TO MODULE EGRESS. (INSTALLATION IS REQUIRED WHEN EGRESSING FOR MODULE DEACTIVATION, ENTRY PREP, OR EVA PREPARATIONS; INSTALLATION IS NOT REQUIRED WHEN EGRESSING FOR EMERGENCY DEACTIVATION.) AN INNER SCREEN OTHER THAN THE INNER SAFETY COVER WILL NOT BE INSTALLED ON THE VP. ©[051194-1637] ©[111501-4966A]

The VP glass assembly contains three laminated panes of Triplex "10-20" glass (26mm total thickness). Because these panes are laminated, the assembly cannot be considered fail-safe. However, the inner safety cover (a safety pane of polycarbonate plastic) provides a structural seal over the VP aperture that allows sufficient time to complete a contingency Spacehab deactivation/evacuation of the module in the event of a total glass failure. (A small port in the inner safety cover allows for venting/air circulation/pressure equalization between both sides of the cover.) The inner safety cover also protects the VP glass against impact from inside the module. However, safe return of the crew is not compromised if the inner safety cover is not installed for a Spacehab emergency deactivation. To preclude the scenario where an EVA is required during the mission, and subsequent module ingress is not possible, the inner safety cover must be installed to properly restrain it for entry. An installed inner screen (other than the inner safety cover) can cause a potential "greenhouse" effect from solar radiation whenever the outer cover is open, or from a failed on VP heater whenever the outer cover is closed. Either case can cause VP glass degradation. The inner safety cover provides similar optical qualities (transmissivity) as the VP glass assembly.

Reference: TN-ER-36-061-77, VP/Viewport Adapter Assembly (VAA) Thermal Analysis, 5/30/78.

- D. THE VP HEATER MUST BE ACTIVATED WHENEVER THE VP WINDOW IS EXPOSED TO DEEP SPACE, OR AT ANY TIME CONDENSATION FORMS ON THE VP GLASS OR ACTUATOR MECHANISM. THE VP HEATER MAY REMAIN POWERED FOR NO LONGER THAN 20 MINUTES WHEN THE SUN IS IN FOV OF THE VP GLASS.

The VP heater is only required when the VP window is exposed to deep space to prevent condensation from forming on the VP glass and/or to extend the time until condensation forms on the VP actuator. The seals will remain above the lower thermal qualification limit of -10 deg C (14 deg F) if the deep space exposure time limits are not exceeded, and/or the heater is active. The VP inner surface may exceed the maximum allowable touch temperature of 45 deg C (113 deg F) if the heater is activated with the outer cover closed, if the VP glass is not exposed to deep space, or if the VP heater is powered for more than 20 minutes with the sun in FOV of the VP glass.

Reference: TR-OK-0008, Thermal Vacuum Test Results: Viewport; and MDC-93-W-5652, 5/93.
©[051194-1637]

THIS RULE CONTINUED ON NEXT PAGE

FLIGHT RULES

A10-361 VIEWPORT (VP) (CONTINUED)

- E. ORBITER ATTITUDE ADJUSTMENTS MAY BE MADE TO MAINTAIN THE VP TEMPERATURE WITHIN OPERATIONAL LIMITS IF HIGH PRIORITY MISSION OBJECTIVES ARE NOT JEOPARDIZED. @[051194-1637]

If required to work around an outer cover and/or heater failure, adjusting the attitude timeline is an acceptable option for maintaining the VP temperature within operational limits as long as high priority mission objectives are not significantly affected. The VP lower thermal qualification limit is -10 deg C (14 deg F); the upper limit is 60 deg C (140 deg F).

- F. ON-ORBIT VP ATTITUDE TIMELINE MANAGEMENT TO ENSURE COMPLIANCE WITH VP OPERATIONAL FLIGHT RULES/TEMPERATURE LIMITS IS THE RESPONSIBILITY OF MISSION CONTROL CENTER-HOUSTON (MCC-H).

Due to the dynamic nature of orbiter flight attitude timeline changes, MCC-H management of on-orbit VP operations will be required to ensure VP FOV constraints and operational temperature limits are not exceeded.

A10-362 CRACKED VIEWPORT

FOR A CRACKED VP WINDOW, THE INNER SAFETY COVER WILL BE INSTALLED, AND THE OUTER COVER WILL BE CLOSED AND REMAIN CLOSED. SPACEHAB OPS WILL BE ALLOWED TO CONTINUE IF THE VP WINDOW CAN MAINTAIN PRESSURE INTEGRITY.

The VP glass assembly contains three laminated panes of Triplex "10-20" glass (26 mm total thickness), each of which is capable of maintaining pressure. However, the VP inner safety cover (a safety pane of polycarbonate plastic) provides a structural seal over the VP aperture that allows sufficient time to complete a contingency Spacehab deactivation/evacuation of the module in the event of a total glass failure (A small port in the inner safety cover allows for venting/air circulation/pressure equalization between both sides of the cover.) VP operations should be terminated in order to minimize thermal stresses on a cracked VP window. Installing the inner safety cover and closing the outer cover ensures containment of any loose glass debris. Installing the VP inner safety cover also ensures safe continuation of Spacehab operations by providing cabin pressure redundancy (as long as the VP window is maintaining pressure). @[051194-1637]

FLIGHT RULES

A10-363 **VIEWPORT CONFIGURATION FOR CLOSED SPACEHAB HATCH**

FOR SPACEHAB OPERATIONS WITH THE SPACEHAB HATCH CLOSED, THE VP OUTER COVER WILL BE CLOSED AND THE INNER SAFETY COVER WILL BE INSTALLED. ©[051194-1637] ©[021600-7101]

Failure conditions exist which would prevent re-entry into the module (e.g., after an EVA) to secure the viewport. If orbiter entry is performed with the external cover open, damage to the cover/viewport is likely to occur.

A10-364 **LOSS OF VP PRESSURE INTEGRITY**

FOR LOSS OF VP PRESSURE INTEGRITY, THE INNER SAFETY COVER WILL BE INSTALLED, AND THE OUTER COVER WILL BE CLOSED AND REMAIN CLOSED. SPACEHAB OPERATIONS WILL BE TERMINATED.

The VP inner safety cover provides a structural seal over the VP aperture that allows sufficient time to complete a contingency Spacehab deactivation/evacuation of the module when VP pressure integrity has been lost. (A small port in the inner safety cover allows for venting/air circulation/pressure equalization between both sides of the cover.)

A10-365 **EVA REQUIREMENTS FOR FAILED VP OUTER COVER**

AN EVA IS NOT REQUIRED TO STOW OR SECURE A FAILED OPEN VP OUTER COVER.

When open, the VP outer cover does not infringe upon the PLBD dynamic envelope. Although there is a potential for VP mechanism damage from landing loads, the risk of an EVA to stow the outer cover is not warranted. ©[051194-1637]

©[021998-6492] ©[121400-3850]

A10-366 THROUGH A10-380 RULES ARE RESERVED

FLIGHT RULES

STRUCTURAL MANAGEMENT

A10-381 THERMAL WINDOWPANE FAILURE [CIL]

A THERMAL WINDOWPANE IS CONSIDERED FAILED IF PIECES OF THE PANE ARE MISSING. A CRACKED THERMAL WINDOWPANE IS NOT CONSIDERED FAILED WHILE THE PANE REMAINS INTACT.

NOTE: THE PROBABILITY OF A CRACKED PANE FAILING IS HIGHEST DURING THE MAXIMUM DYNAMIC PRESSURE PHASE (MAX Q) (T=40 TO T=60).

FOR A FAILED FORWARD WINDSHIELD OR SIDE HATCH THERMAL WINDOWPANE PRIOR TO THE RTLS BOUNDARY, ABORT RTLS, OTHERWISE CONTINUE EOM. FOR A FAILED OVERHEAD THERMAL WINDOWPANE, CONTINUE EOM.

A thermal windowpane could fail due to flaws caused by ice or other debris impacting it during ascent. A cracked thermal windowpane is more likely to fail during MAX Q phase. An RTLS abort should be performed if possible to minimize thermal effects on the remaining windowpanes and structure, as the RTLS abort has the most benign reentry thermal environment of all entry modes. The nominal and the thermally similar AOA impose the most heating on the panes.

TAL aborts have a slightly more benign thermal environment with respect to the windowpanes and surrounding structure than the nominal EOM. However, the risk of a TAL abort outweighs the benefit of slightly less heating on the windows. Therefore, post-RTLS, no other abort should be initiated. The overhead windows are not considered for an RTLS abort since the thermal environment for these windows during a nominal EOM entry is relatively benign (ref. A/E FTP #68, June 29, 1990).

A side hatch thermal pane failure may be undetectable during ascent because of crew visibility. For a failed side hatch thermal pane or forward windshield past the RTLS boundary, thermal conditioning of the affected window may be required prior to deorbit, based on real-time thermal analysis.

Rule {A2-54A}.2, RTLS, TAL. AND AOA ABORTS FOR SYSTEMS FAILURES [CIL], references this rule. ©[021998-6493]

FLIGHT RULES

A10-382

PRESSURE/REDUNDANT WINDOWPANE FAILURE [HC] ©[033105-6599B]

FOR A FAILURE OF EITHER A PRESSURE PANE (I.E., UNIFORM SHATTERING OF AN INNER PANEL INTO SMALL PIECES) OR A REDUNDANT PANE (I.E., CRACKED OR SHATTERED PANE WITH FRAGMENTS AROUND RETAINER FRAME), CABIN PRESSURE WILL BE REDUCED ASAP. THE CABIN PRESSURE WILL NOT BE REDUCED PRIOR TO MECO OR AFTER SEAT INGRESS FOR ENTRY.

CABIN PRESSURE WILL BE REDUCED TO:

- A. 10.2 PSIA IF THERE ARE NO GLASS FRAGMENTS IN THE CABIN, OR IF FRAGMENTS ARE PRESENT IN THE CABIN AND THE CREW IS ON GOGGLES AND SURGICAL MASKS, OR
- B. 8 PSIA IF THERE ARE GLASS FRAGMENTS IN THE CABIN AND THE CREW IS ON VISORS OR QDM'S.

THE MISSION WILL BE TERMINATED NEXT PLS (FIRST DAY PLS IF APPLICABLE).

The pressure panes are composed of high strength tempered aluminosilicate glass - when tempered glass fails it breaks into small, uniform pieces, rather than simply cracking or breaking into sharp shards. The redundant panes are composed of annealed fused silica glass - failure of annealed glass can result in cracks only, or can produce shards of glass in varying sizes. A severe impact may break a pressure or redundant pane (the pressure pane is exposed to direct impact from objects within the crew compartment; the redundant pane is protected from direct impact by the thermal pane on the exterior side and the pressure pane on the interior side - a debris hit could shatter both the thermal and redundant panes, leaving only the pressure pane intact). Failure of the pressure pane can cause failure of the redundant pane due to the sudden pressure loading on the redundant pane (since the volume between the pressure and redundant panes is vented to vacuum) in addition to impact loads from the pressure pane fragments (reference Stress Analysis of Orbiter Window Redundant Panes Subjected to Loads Resulting from Pressure Pane Breakage, May 29, 2001, revised October 30, 2001, Boeing/Mike Koharchik). If a failure of one of these panes has occurred for an unknown reason, the remaining windows may be threatened. Pressure redundancy is required in the orbiter window system (the thermal panel does not provide cabin pressure redundancy). The pressure redundancy requirement is violated with a failure of any one of the pressure panes or redundant panes (windshields, overhead windows, rear viewing windows, or side hatch window). Loss of both the pressure pane and the redundant pane in a window results in loss of the crew and vehicle.

The timeframe restrictions for depressurization are due to the inaccessibility of the valves used for depress by the crew while seated. ©[033105-6599B]

THIS RULE CONTINUED ON NEXT PAGE

FLIGHT RULES

A10-382

PRESSURE/REDUNDANT WINDOWPANE FAILURE [HC] (CONTINUED)

The level to which the cabin is depressurized is based on the need to control O₂ concentration (reference Rule {A17-254}, CABIN O₂ CONCENTRATION). A cabin total pressure of 10.2 psia is chosen if there are no glass fragments in the cabin, or if fragments are present but the crew is protected by goggles and surgical masks, since the procedure to reduce pressure to this level is well documented and no powerdowns are required on orbit. Use of the ACES helmets or QDM's (for protection against glass fragments) results in continued O₂ flow into the cabin. A cabin total pressure of 8 psia is required in this case - contingency O₂ concentration control is easier to manage at a lower total pressure, since higher O₂ concentrations are allowed. ©[033105-6599B]

Flight techniques discussions have resulted in the choice of a first day PLS deorbit as the best choice to minimize exposure time to a zero fault tolerant window pane situation without the risks entailed in more rapid abort situations. A reduced cabin pressure is desired due to the time-at-stress nature of window pane failures.

Flight techniques discussions determined that wearing the ACES helmet for the duration of an orbit 3 deorbit case is acceptable. Keeping the visor closed on the ACES helmet after a pressure pane failure reduces the possibility of exposing a crewmember to shattered glass particles. If deorbit will occur after orbit 3, then anti-contamination goggles and quick-don masks will be donned until donning the ACES helmet for entry. Reference Rule {A13-155}, ORBITER HAZARDOUS SUBSTANCE SPILL RESPONSE [HC].

Reference Ascent Flight Techniques Panel meetings #33 and #36, August 28 and October 15, 1987.

Reference Hazard Controls ORBI-009 "LOSS OF CREW AND VEHICLE DUE TO WINDOW FAILURE," and ORBI-279 "FLIGHT AND GROUND GENERATED DEBRIS/SHATTERABLE GLASS IN CREW CABIN CAUSING CREW INJURY." ©[033105-6599B]

FLIGHT RULES

A10-383

BAILOUT/POSTLANDING EMERGENCY EGRESS PYROTECHNICS MANAGEMENT

- A. THE SAFING PIN FOR THE T-HANDLE BOX COVER WILL BE REMOVED AND STOWED PRELAUNCH, REINSTALLED DURING POST INSERTION, REMOVED AND STOWED DURING DEORBIT PREP, AND REINSTALLED POSTLANDING.

This procedure improves access to the pyro vent valve and side hatch jettison T-handles during an ascent, entry, or postlanding emergency, and ensures that the handles are less accessible at other times.

- B. THE SAFING PINS FOR THE PYRO VENT VALVE AND SIDE HATCH JETTISON T-HANDLES WILL NOT BE REMOVED UNLESS REQUIRED FOR ORBITER BAILOUT OF EMERGENCY GROUND EGRESS.

The purpose of this rule is to prevent accidental activation of the handles. Removal of the safing pins requires less than 1 second for each handle; therefore, an insignificant time delay is imposed during an emergency.

- C. THE PYRO VENT VALVE WILL ONLY BE ACTIVATED:
1. DURING AN IN-FLIGHT BAILOUT, PRIOR TO JETTISONING THE SIDE HATCH.
 2. DURING A POSTLANDING EMERGENCY EGRESS, IF NECESSARY.

The purpose of the pyro vent valve is to equalize the difference in pressure between the crew compartment and the outside atmosphere. If the side hatch is jettisoned during an in-flight bailout before the pressure is equalized, the large delta P will probably cause the floor of the middeck to buckle, leading to extensive damage within the vehicle. The postlanding delta P is much smaller and will not buckle the middeck floor. Because the pyro vent valve is an ignition source in the payload bay, it should not be activated postlanding unless a side hatch emergency egress is impossible and the overhead escape panel (W8) will not open due to the delta P.

- D. THE SIDE HATCH WILL ONLY BE JETTISONED:
1. DURING AN IN-FLIGHT BAILOUT.
 2. DURING A POSTLANDING EMERGENCY WHERE THE SIDE HATCH CANNOT BE OPENED NORMALLY AND RAPID EGRESS OF THE CREW IS NECESSARY IN ORDER TO PREVENT LOSS OF LIFE. IN THIS CASE, THE CREW SHALL MAKE EVERY EFFORT TO VERIFY THAT ALL FIRE/RESCUE PERSONNEL ARE CLEAR OF THE SIDE HATCH BEFORE IT IS JETTISONED.

This rule prevents unnecessary damage to the orbiter and minimizes the risk that side hatch jettison poses to fire/rescue personnel.

FLIGHT RULES

A10-384 **RESERVED** @[072398-6621] @[062603-6039]

A10-385 **FILLED CWC STOWAGE MANAGEMENT**

A. FILLED CONTINGENCY WATER CONTAINERS (CWC'S) THAT MUST BE RETURNED IN THE ORBITER WILL BE DISPOSED OF WITH THE FOLLOWING PRIORITY, TIME AND AVAILABILITY PERMITTING:
@[100997-6345A] @[032802-5305]

1. OVERBOARD NOZZLE DUMP @[032802-5305]

A filled CWC represents a considerable mass that must be properly restrained to insure structural loads will not be violated in an emergency landing. CWC's can be used to transfer water from the orbiter to ISS. Stowage of filled CWC's will be required if water transfer cannot be accomplished. For ISS water transfer, CWC's are normally filled to approximately 100 lbs. This weight is assumed below, unless otherwise stated. Reference SODB, vol. I, 3.4.1. To avoid the stowage and structural limits concern, it is most desirable to dump the water from the CWC's overboard and then stow the empty CWC's. Filled CWC's can also represent considerable mass stowed far forward of the orbiter CG. An overboard CWC dump prior to deorbit may relax propellant margins if ballasting would otherwise be increased. However, there must be adequate time to dump water from filled CWC's overboard prior to deorbit prep. Flight data from STS-60 shows that it takes approximately 1 hour to dump a single CWC (the rate is 1.56 lbm/min). Certain stowage locations can accept loads imposed by a filled CWC during landing and will be utilized if dump capability is not available. In cases where propellant margins are tight, stowage locations minimizing ballast requirements are preferred. @[100997-6345A] @[092701-4840]

THIS RULE CONTINUED ON NEXT PAGE

FLIGHT RULES

A10-385

FILLED CWC STOWAGE MANAGEMENT (CONTINUED)

2. STOWAGE IN THE FOLLOWING STRUCTURALLY CERTIFIED LOCATIONS
 (SEE FLIGHT SPECIFIC RULES ANNEX FOR ADDITIONS) : @[100997-6345A]
 @[032802-5305]

LOCATION	MAXIMUM WEIGHT (LBS)	ORBITER COORDINATES			MAX. VOL. (CU. FT.)	MAX. # CWC'S
		X _o	Y _o	Z _o		
EXTERNAL AIRLOCK STOWAGE BAG [2]	206	649 (BAY2) 731 (BAY3)	0	333	9.7	2 [1]
MIDDECK BAG [3]	206	545	±24 (STBD/PORT)	333 (FLOOR) 382 (CEILING)	9.7	2 [1]
VOLUME F	240	491	33	315	8	2 [1]
VOLUME H	95	525	-42	317	3.33	1 [1]
VOLUME G [8]	95	525	42	317	3.33	1 [1]
VOLUME D	271	439	0	314	9.06	2 [4] [10]
SEAT 6 STOWAGE BAG	204	492	-12	325	N/A	2 [1] [6]
SEAT 7 STOWAGE BAG	204	492	12	325	N/A	2 [1] [6]

@[100997-6345A] @[072398-6621] @[022201-3987] @[092701-4840] @[032802-5305] @[062603-6039]

Reference SODB, Vol. I, paragraph 3.4.1. These locations would be available (provided soft stowage can be removed and stowed in alternate locations) for return of fully filled CWC's (95 lbs). Stowage of partially filled CWC's will be addressed in real time based on approximate mass and available stowage locations. @[032802-5305]

THIS RULE CONTINUED ON NEXT PAGE

FLIGHT RULES

A10-385

FILLED CWC STOWAGE MANAGEMENT (CONTINUED)

- [1] ANY VOIDS SURROUNDING A CWC MUST BE FILLED WITH SOFT GOODS SUCH AS CLOTHING TO ENSURE THAT THE CWC IS SUPPORTED ON ALL SIX SIDES. @[032802-5305]
- [2] 206 LBS IS MAX WEIGHT OF EXTERNAL AIRLOCK BAG. EXT A/L IS LIMITED TO 990 LBS MINUS THE WEIGHT OF EMU'S (TWO @ 330 LBS EACH). 649 IN. IS X-CG FOR BAY 2 EXTERNAL AIRLOCK LOCATION. 731 IS X-CG FOR BAY 3 EXTERNAL AIRLOCK LOCATION (FORWARD TUNNEL ADAPTER).
- [3] THE LIMITS ARE VALID FOR THE SMALL AND LARGE VERSIONS OF THE MIDDECK BAG. @[072398-6621]
- [4] 95 LBS EACH.
- [5] RESERVED @[092701-4840]
- [6] CWC'S STANDING ON END, SIDE-BY-SIDE
- [7] RESERVED @[062603-6039]
- [8] LOCKER REMOVAL REQUIRED TO ALLOW ACCESS TO VOLUME G. @[100997-6345A]
- [9] RESERVED @[022201-3987] @[062603-6039]
- [10] VOLUME NOT AVAILABLE ON OV-103

3. DUMP INTO WCS. @[032802-5305]

This option would only apply if the nozzle dump was unavailable, no certified stowage was available, and adequate time existed. There is only limited ullage in the waste tank, and it is time consuming for the crew to do this. @[100997-6345A] @[062603-6039]

THIS RULE CONTINUED ON NEXT PAGE

FLIGHT RULES

A10-385

FILLED CWC STOWAGE MANAGEMENT (CONTINUED)

4. STOWED AND RESTRAINED IN THE FOLLOWING UNCERTIFIED LOCATIONS: @[032802-5305]

LOCATION	MAXIMUM WEIGHT (LBS.)	ORBITER COORDINATES			MAX. # CWC'S
		X _o	Y _o	Z _o	
EXTERNAL AIRLOCK FLOOR	300 (MINUS WEIGHT OF OTHER FLOOR STOWAGE)	649 (BAY 2) 731 (BAY 3)	0	333	2
FORWARD TUNNEL ADAPTER FLOOR	<u>TBD</u>	582	0	333	2

@[100997-6345A] @[062603-6039]

These locations have not been certified, due to possible inability to fully restrain CWC's. These locations should only be used when necessitated by lack of certified stowage and the time criticality of entry. The priority reflects the desire to remove the CWC's as far as possible from the cabin, due to the possibility of hatch penetration by the CWC as a projectile during hard landing. Leakage or failure of a CWC carries the risk of damaging electronic equipment stowed in these locations. All stowage in these locations should be restrained on the floor in such a manner that it does not interfere with, or damage existing, certified equipment stowed nearby during landing settling. Gray tape and bungies are suggested (although uncertified) methods of restraint. @[100997-6345A]

- B. THE NUMBER OF FILLED CWC'S IN THE ORBITER WILL NOT EXCEED THE NUMBER OF CERTIFIED STOWAGE LOCATIONS AVAILABLE FOR LANDING. THE MAXIMUM NUMBER OF FILLED CWC'S THAT MAY BE RETURNED IN THE ORBITER IS FOUR. EXCEPTIONS/ADDITIONS TO THIS LIMIT WILL BE ADDRESSED IN THE FLIGHT-SPECIFIC ANNEX.

Preflight planned stowage has been reviewed and the number of certified stowage locations is limited to this amount. The available CWC stowage locations are Vol H (1), Vol G (1), and Vol F (2). Changes to this limit based on planned stowage will be addressed on a flight-by-flight basis in the Flight-Specific Annex.

Analysis of the number of CWC's is performed by DX33/Crew Systems (OFTP #161, February 14, 1997). @[032802-5305] @[121902-5803] @[062603-6039]

A10-386 THROUGH A10-400 RULES ARE RESERVED

FLIGHT RULES

CREW ESCAPE SYSTEM

A10-401 PRE-LAUNCH CREW ESCAPE EQUIPMENT REQUIREMENTS

- A. THE FOLLOWING CREW ESCAPE EQUIPMENT IS MANDATORY FOR ALL CREWMEMBERS : @[033006-7190D]
1. SUIT INTEGRITY/PRESSURIZATION
 2. SUIT O₂
 3. EMERGENCY OXYGEN SYSTEM (EOS)
 4. PARACHUTE
 5. LIFE PRESERVER UNIT (LPU)
 6. LIFE RAFT
 7. SEARCH AND RESCUE SATELLITE AIDED TRACKING (SARSAT) BEACON
8. CREW-WORN COMMUNICATION EQUIPMENT
- B. DUE TO THE CRITICALITY OF THIS EQUIPMENT, ANY UNRESOLVED PRELAUNCH LOSS OF FUNCTION FOR THIS EQUIPMENT WILL RESULT IN A LAUNCH HOLD.

This rule defines the minimum complement of crew escape equipment required to satisfy the IAW JSC-23003, Rev G, Specification Assembly Drawing Part II for the Crew Escape Equipment, December 8, 2000, Section 1.0, Shuttle CEE SAD requirements for protective survival equipment if a pre-flight, in-flight, and/or post-flight emergency occurs requiring environmental protection (e.g., a bailout). These requirements include protection below 100,000 feet altitude, as well as for 24 hours after a water landing.

The Advanced Crew Escape Suit (ACES) is designed to provide protection to each crewmember for loss of cabin pressure, environmental extremes, effects of prolonged micro-gravity, and contaminated atmosphere. Additionally, the parachute, LPU, life raft, and SARSAT beacon are required in the event of an over-water bailout. Loss of any of this equipment will compromise the ability to survive a bailout.
@[033006-7190D]

THIS RULE CONTINUED ON NEXT PAGE

FLIGHT RULES

A10-401**PRE-LAUNCH CREW ESCAPE EQUIPMENT REQUIREMENTS
(CONTINUED)**

The ACES is a full pressure suit that applies static pressure evenly to the entire body surface. ACES pressurization and O₂ are required to provide a safe environment for crew egress and a safe breathing environment in the event of cabin leak or contaminated atmosphere. Inability to pressurize or loss of ACES integrity may result in crewmember inability to survive an emergency egress. ©[033006-7190D]

The Emergency Oxygen System (EOS) is required for crew breathing during emergency egress conditions where the suit is no longer supported by orbiter oxygen.

The crew worn communication equipment includes the ACES helmet, Communications Carrier Assembly (CCA), Headset Interface Unit (HIU), comm cable, and Multiple Headset Adapter (MHA). All crewmembers must be able to communicate with each other and the MCC to coordinate normal or off-nominal operations.

There are documented workarounds for failures of the above equipment if time permits. These are documented on a crew cue card and in USA004803, Escape Console Handbook, and would be implemented by JSC MOD via the Flight Director and the NASA Test Director if required. The crew-worn communication equipment preplanned contingency procedures are documented in NSTS-16007, Launch Commit Criteria.

Since the crew escape equipment is checked multiple times prior to crew ingress, the probability of a crew escape equipment failure late in the launch countdown is low. However, because of the criticality of this equipment for crew survival in the event of a pre-flight, in-flight, and/or post-flight emergency, a launch hold will be required to resolve any loss of equipment function as long as the hold occurs prior to T-31 seconds and counting. Reference Rule {A2-3}, LAUNCH HOLD.

Reference Ascent/Entry Flight Techniques Panel #204, August 27, 2004. ©[033006-7190D]

A10-402 THROUGH A10-450 ARE RESERVED

FLIGHT RULES

MMACS GO/NO-GO @ [062801-4355A]

A10-1001

MMACS GO/NO-GO CRITERIA [HC]

@ [021199-6816] @ [121604-6254C]

SYSTEMS/COMPONENTS/FUNCTIONS	CONTINUE NOMINAL ASCENT IF:	INVOKE MDF IF:	ENTER NEXT PLS IF:
A. APU/HYD:.....	2↓ [2]		1↓ [10] [11]
B. WSB:..... [1]			1↓ [10] [11]
C. LANDING GEAR:.....			
1. HYD OR PYRO DEPLOYMENT SYSTEMS..... [3]			2 ↓
2. DIRECTIONAL CONTROL (BRAKES, NWS).....			ZERO FAULT TOLERANT
3. TIRES (LEAKING/FAILED).....			[13]
D. MECHANICAL SYSTEMS:.....			
1. PLBD DRIVE MOTORS (2/DOOR)		1 CLS ↓	2 ↓ [8]
2. PLBD LATCH DRIVE MOTORS (2/GANG).....			2 ↓ [6]
3. RAD DEPLOYMENT SYSTEMS			
4. VENT DOOR DRIVE SYSTEMS			
5. ET UMB DOOR CLOSURE (NOT RECOVERABLE)..... [4]	[14]		
6. KU-BAND ANT STOW MECHANISM..... [9]			
7. ROEU/ROFU MECHANISM			
8. WINDOWS			
PRESSURE (OR REDUNDANT) PANE.....			1 ↓
THERMAL PANE (FORWARD OR SIDE HATCH).	[12]		
THERMAL PANE (OVERHEAD)			
E. CREW ESCAPE SYSTEMS..... [7]			

@ [041097-4611B] @ [062801-4355A] @ [121604-6254C] @ [ED] @ [102506-7435]

LEGEND:



NO REQUIREMENT

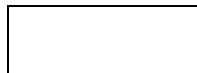

REQUIRED

[] NOTE REFERENCE

THIS RULE CONTINUED ON NEXT PAGE

FLIGHT RULES

A10-1001 MMACS GO/NO-GO CRITERIA [HC] (CONTINUED)

The table above gives the action taken for specific MMACS hardware losses. The decision to invoke MDF or to enter next PLS is based on redundancy and safety requirements. Refer to the MMACS systems loss/failure definitions for what constitutes a "down" system.

NOTES:

- [1] LOSS OF A WSB COULD RESULT IN EVENTUAL LOSS OF ITS ASSOCIATED APU AND HYDRAULIC SYSTEM.
- [2] IF TWO APU'S ARE SHUT DOWN DURING ASCENT, AND THE THIRD APU/HYDRAULIC/WSB SYSTEM PERFORMANCE IS NOMINAL, THE THIRD ONE WILL BE SHUT DOWN AND LATER RESTARTED TO SUPPORT A DAY 1 PLS. THE THIRD APU/HYDRAULIC/WSB WILL NOT BE SHUT DOWN FOR AN AOA, TAL, OR RTLS ABORT. IF THE THIRD APU/HYDRAULIC/WSB SYSTEM IS NOT NOMINAL, IT WILL BE SHUT DOWN AND RESTARTED AS REQUIRED TO SUPPORT ANY ABORT OR ENTRY.
- [3] HYDRAULIC SYSTEM 1 PLUS 2 PYROS.
- [4] MUST BE CLOSED PRIOR TO ENTRY.
- [5] FAILURE TO DEPLOY ONE RADIATOR PANEL WILL RESULT IN A 20 TO 30 PERCENT LOSS OF HEAT REJECTION IN THAT FCL/RAD. ORBIT LIFETIME WILL BE DEPENDENT ON ORBITER THERMAL HEAT REJECTION REQUIREMENTS.
- [6] NEXT PLS IF IN SEPARATE LATCH GANGS AND NEXT FAILURE RESULTS IN MULTIPLE LATCH GANG FAILURES, OR IN SAME LATCH GANG AND CANNOT BE VISUALLY VERIFIED CLEAR OF ROLLERS. NOMINAL EOM IF IN SAME LATCH GANG AND CAN BE VISUALLY VERIFIED CLEAR OF ROLLERS.
- [7] LAUNCH WILL BE HELD TO RESOLVE FAILURES. @[033006-7190D]
- [8] SAME DOOR. IF DOOR OPEN AND OPEN CAPABILITY LOST, INVOKE MDF. ENTRY IS REQUIRED AT NEXT PLS AFTER EVA TO CLOSE DOORS IS COMPLETED.
- [9] KU-BAND ANTENNA WILL BE STOWED FOR LOSS OF REDUNDANT STOW CAPABILITY.
- [10] ENTER NEXT PLS IF ONE APU/HYD/WSB FAILED AND THE NEXT FAILURE RESULTS IN A SINGLE APU ENTRY.
- [11] ENTER NEXT PLS AFTER EXPEDITED PAYLOAD DEPLOY, IF APPLICABLE.
- [12] IF PIECES ARE NOTED MISSING PRIOR TO THE RTLS BOUNDARY, AN RTLS ABORT WILL BE PERFORMED. OTHERWISE, CONTINUE NEOM.
- [13] ENTER NEXT PLS IF TIRE PRESSURE WILL BE BELOW THE FAIL LIMIT AT NEXT PLS LANDING OPPORTUNITY PLUS 2 DAYS. @[121604-6254C]
- [14] IF CAPABILITY TO CLOSE ET DOORS IS LOST PRIOR TO RTLS BOUNDARY AND CAPABILITY IS NOT RECOVERABLE, PERFORM AN RTLS. @[041097-4611B] @[102506-7435]

Hazard Report ORBI 302, Inability to Close Orbiter/External Tank Doors Results in Structural Damage During Entry, references this rule. @[121604-6254C] @[ED]

FLIGHT RULES

SECTION 11 - COMMUNICATIONS

SYSTEM MANAGEMENT RULES

A11-1	COMMUNICATIONS DURING ASCENT.....	11-1
A11-2	S-BAND/UHF LAUNCH REQUIREMENT.....	11-1
A11-3	UPLINK HANDOVER DURING ASCENT FROM KSC.....	11-2
A11-4	ORBITER DATA PRIORITY DURING ASCENT/ENTRY.....	11-2
A11-5	POSTLANDING S-BAND ANTENNA SELECTION.....	11-3
A11-6	MINIMUM COMMUNICATIONS REQUIREMENTS FOR SCHEDULED EVA.....	11-3
A11-7	KU-BAND OPERATIONS DURING EVA.....	11-4
A11-8	ORBITER S-BAND OPERATIONS DURING EVA.....	11-6
A11-9	RECORDER USAGE.....	11-7
A11-10	UHF USAGE.....	11-8
A11-11	S-BAND FM USAGE.....	11-9
A11-12	S-BAND PM USAGE.....	11-10
A11-13	S-BAND PAYLOAD USAGE.....	11-11
A11-14	CREW ALERT SPC'S.....	11-12
A11-15	ELBOW CAMERA/PAYLOAD INTERFERENCE [CIL].....	11-12
A11-16	KU-BAND MANAGEMENT [HC].....	11-13
A11-17	PI CHANNELS AND S-BD FREQUENCIES COMPATIBILITIES.....	11-14
A11-18	COMSEC USAGE.....	11-14
A11-19	UPLINK BLOCK.....	11-15
A11-20	UPLINK COMMANDING DURING OPS TRANSITIONS.....	11-15
A11-21	CRITICAL UPLINK COMMAND POLICY.....	11-16
A11-22	TWO-STAGE COMMAND BUFFER TLM REJECT.....	11-16
A11-23	KU BAND TRANSMITTER INHIBITED DURING ACQUISITION OF TDRS INSIDE THE RF PROTECT BOX	11-16
A11-24	ORBITER S-BAND LOW FREQUENCY FOR ASCENT.....	11-17
A11-25	THROUGH A11-50 RULES ARE RESERVED.....	11-17

FLIGHT RULES

SYSTEM FAILURE RULES

A11-51	LOSS OF TWO-WAY VOICE.....	11-18
A11-52	LOSS OF BOTH VOICE AND COMMAND.....	11-19
A11-53	LOSS OF COMMAND.....	11-22
A11-54	LOSS OF TELEMETRY.....	11-22
A11-55	LOSS OF KU-BAND.....	11-23
A11-56	LOSS OF KU-BAND TEMPERATURE CONTROL [CIL]....	11-23
A11-57	LOSS OF KU-BAND TEMPERATURE MONITORING CAPABILITY [CIL].....	11-24
A11-58	LOSS OF TRANSPONDERS.....	11-25
A11-59	FM SYSTEM IFM GROUND RULE.....	11-26
A11-60	LOSS OF TDRS TRACKING CAPABILITY.....	11-26
A11-61	LOSS OF S-BAND PREAMPS AND POWER AMPS.....	11-27
A11-62	LOSS OF ANTENNA ELECTRONICS.....	11-27
A11-63	LOSS OF NSP'S.....	11-28
A11-64	LOSS OF COMMUNICATIONS SECURITY (COMSEC)....	11-29
A11-65	AUDIO CENTRAL CONTROL UNIT (ACCU).....	11-30
A11-66	LOSS OF ACCU'S.....	11-31
A11-67	LOSS OF THE PLT AND MS ATU'S.....	11-32
A11-68	LOSS OF INTERCOM.....	11-32
A11-69	LOSS OF UHF.....	11-33
A11-70	LOSS OF GCIL.....	11-33
A11-71	LOSS OF RECORDERS.....	11-34
A11-72	LOSS OF TV.....	11-36
A11-73	LOSS OF OCA.....	11-36
A11-74	PCM MASTER UNIT (PCMMU).....	11-36
A11-75	LOSS OF PCMMU'S.....	11-37
A11-76	LOSS OF OI MDM.....	11-37
A11-77	LOSS OF ANY OI DSC.....	11-37
A11-78	LOSS OF EXTERNAL TANK FEEDLINE CAMERA REAL- TIME DOWNLINK.....	11-38
A11-79	LOSS OF OBSS ITVC.....	11-38
A11-80	LOSS OF LCS.....	11-38

FLIGHT RULES

A11-81	LOSS OF IDC.....	11-38
A11-82	LOSS OF RSC.....	11-39
A11-83	LOSS OF LDRI.....	11-39
A11-84 THROUGH A11-100	RULES ARE RESERVED.....	11-39

GO/NO-GO CRITERIA

A11-1001	COMMUNICATIONS GO/NO-GO CRITERIA.....	11-40
----------	---------------------------------------	-------

FLIGHT RULES

THIS PAGE INTENTIONALLY BLANK

FLIGHT RULES

SECTION 11 - COMMUNICATIONS

SYSTEM MANAGEMENT RULES

A11-1 **COMMUNICATIONS DURING ASCENT**

THERE ARE NO COMMUNICATIONS FAILURES FOR WHICH THE ASCENT PHASE WILL BE TERMINATED.

Termination of the ascent phase implies an immediate return; i.e., an RTLS, AOA, or TAL/TPL. Continuing to orbit is the most benign environment for the orbiter and crew. In addition, there is a high probability of restoring at least one communications link once on orbit; and, if communication is not restored, the orbiter is capable of a safe day 1 return without any further contact with the MCC.

A11-2 **S-BAND/UHF LAUNCH REQUIREMENT**

S-BAND PM VOICE WILL BE PRIME FOR LAUNCH. THE UHF SYSTEM WILL BE CONFIGURED IN TRANSMIT/RECEIVE MODE AS BACKUP TO THE S-BAND PM SYSTEM.

The S-band PM system is the only system available for launch that can provide redundant real-time telemetry, command, ranging, and duplex voice required for ascent phase support. SSME engine interface unit (EIU) data uses the S-band FM system and is redundantly recorded on solid state recorder 2. C-band skin tracking provides a redundant tracking source, and the UHF system provides an additional simplex voice source. ®[121505-7133B]

FLIGHT RULES

A11-3

UPLINK HANDOVER DURING ASCENT FROM KSC

UPLINK HANDOVER FROM MIL TO PDL WILL OCCUR BEFORE THE LINE-OF-SIGHT FROM THE ORBITER TO MIL INTERSECTS THE SRB PLUME. THE CARRIER WILL REMAIN ON PDL UNTIL POST-SRB STAGING. AT THAT TIME IT WILL BE HANDED BACK TO MIL TO REGAIN S-BAND TRACKING.

During ascent it is highly desirable to provide S-band ranging data to the MCC as an additional tracking source for trajectory evaluation. S-band ranging is available from MIL/MILX but not PDL. Ascents from KSC necessarily result in the line-of-site from the orbiter to MIL/MILX intersecting the SRB plume. The SRB plume characteristics are such that severe S-band attenuation (approaching 60 dB) and erratic phase shifts will adversely affect the S-band PM link, resulting in poor uplink lock conditions and intermittent downlink data. To avoid the plume, the orbiter antennas are optimized for PDL from lift-off and the uplink is handed to PDL just before plume intersection until after SRB staging. This loss of S-band ranging and somewhat weaker signal margin during this time period is considered preferable to intermittent S-band uplink and downlink lock conditions, since downlink vectors and C-band tracking are still available for trajectory monitoring. ©[092602-5734]

A11-4

ORBITER DATA PRIORITY DURING ASCENT/ENTRY

ORBITER DATA WILL TAKE PRIORITY OVER PAYLOAD DATA DURING ASCENT/ENTRY. PCMMU SWITCHES FOR THE PURPOSE OF RECOVERING ORBITER DATA WILL BE PERFORMED AT THE EXPENSE OF PDI PAYLOAD DATA.

OI MDM port failures and internal PCMMU failures affecting downlink or crew display of orbiter data can be recovered by power cycling the active PCMMU or by switching to the alternate PCMMU. During ascent/entry phases, when the SM major function for PCMMU reloading is unavailable, the PDI data downlinked to the MCC would be lost as the PCMMU defaults to Format 129 upon powerup and this format allocates no bandwidth to PDI data. The intent of this rule is to document that monitoring of orbiter data during ascent/entry takes precedence over remoting payload data to remote POCC's. PDI data displayed to the crew will not be affected.

FLIGHT RULES

A11-5

POSTLANDING S-BAND ANTENNA SELECTION

MCC WILL INSURE THAT THE UPPER ANTENNAS ARE SELECTED FOR POSTLANDING COMMUNICATIONS SUPPORT.

- A. MCC WILL NOMINALLY INHIBIT BFS ANTENNA POINTING AND SELECT UPPER ANTENNAS VIA COMMAND POST WHEELSTOP.
- B. FOR LOSS OF MCC COMMAND THE CREW WILL BE INSTRUCTED TO MANUALLY SELECT THE PROPER UPPER ANTENNAS AFTER WHEELSTOP.

Upper antennas are required to protect the convoy personnel from RF radiation. BFS automatic antenna pointing is required to be inhibited due to nominal postlanding nav state "drift". This drift in orbiter position could cause an inadvertent antenna selection which could result in a loss of comm or a hazard to the convoy personnel. If command is not available the crew will be instructed to manually select the proper upper antennas which overrides the BFS automatic pointing capability. This task will be performed for both GSTDN and TDRS landings.

A11-6

MINIMUM COMMUNICATIONS REQUIREMENTS FOR SCHEDULED EVA

IN ORDER TO COMMIT TO OR CONTINUE A SCHEDULED EVA, EACH EVA CREWMEMBER MUST HAVE TWO-WAY COMMUNICATIONS WITH THE ORBITER, EITHER DIRECTLY OR VIA THE OTHER EVA CREWMEMBER.

All scheduled EVA's are planned for two crewmembers who are trained to coordinate their activities and accomplish their task within a limited time. EVA activities often result in encountering unforeseen problems which must be solved by the EVA crewmember on the scene as the orbiter and MCC are in a poor position for offering assistance. Additionally, the EVA crewmembers must always be prepared to assist each other in case of emergency. As long as the EVA is scheduled and not required for contingency reasons (e.g., failure of the payload bay doors to close), it is not prudent to attempt an EVA without adequate means of crew coordination, even if some mission objectives cannot be accomplished.

Rule {A15-7}, MINIMUM RF COMMUNICATIONS DEFINITION, references this rule.

FLIGHT RULES

A11-7

KU-BAND OPERATIONS DURING EVA

- A. FOR EVA ACTIVITIES CONDUCTED WITHIN THE AREAS PROTECTED BY THE KU-BAND BETA MASK OR ORBITER STRUCTURAL BLOCKAGE, THE KU-BAND MAY BE OPERATED WITHOUT POINTING CONSTRAINTS DURING AOS AND WILL BE PLACED IN STANDBY DURING LOS.

When EVA activities are conducted within the areas protected by the microprocessor mask (including the Beta function in the communication mode) or orbiter structural blockage, the Ku-band transmitter is automatically turned off protecting the crew. The radiation exposure levels will remain below 20 volts/meter which is the limit exposed by the EMU specification. Although a single-point failure which could allow the transmitter to radiate into the normally protected region exists, the risk is considered acceptable because the MCC will monitor the automatic cutoff function during AOS and because a redundant cutoff function (standby mode) will be commanded by MCC to be effective during LOS periods. No permanent damage is expected at levels exceeding 20 volts/meter although this has not been confirmed by tests. Human exposure limits have been defined as 137 volts/meter. ©[ED]

1. A BETA MASK OF 0 DEGREES BETA ONLY WILL BE USED TO PROTECT EVA CREWMEMBERS OPERATING WITHIN THE GENERIC PAYLOAD BAY ENVELOPE. REFERENCE RULE {A15-24}, EVA OPERATIONS IN THE GENERIC PAYLOAD BAY ENVELOPE. ©[ED]
2. A BETA MASK OF 21 DEGREES BETA + MASK WILL BE USED TO PROTECT EVA CREWMEMBERS OPERATING ENTIRELY WITHIN THE CONFINES OF THE PAYLOAD BAY MOLDLINE.

Analysis presented at EVA Flight Techniques #16 in January 1992 revealed that a Beta Mask of 0 degrees Beta Only will protect any EVA crewmember confined to operating within the limits of the generic payload bay envelope as defined in Rule {A15-24}, EVA OPERATIONS IN THE GENERIC PAYLOAD BAY ENVELOPE. The SM default value of 21 degrees Beta + Mask is known to protect the Orbiter payload bay moldline boundary. ©[ED]

THIS RULE CONTINUED ON NEXT PAGE

FLIGHT RULES

A11-7

KU-BAND OPERATIONS DURING EVA (CONTINUED)

- B. FOR EVA ACTIVITIES WHICH MAY BE CONDUCTED EXTERNAL TO THE KU-BAND PROTECTIVE BETA MASK OR ORBITER STRUCTURAL BLOCKAGE, THE KU-BAND SYSTEM/ORBITER ATTITUDE WILL BE MANAGED TO PRECLUDE RADIATING THE EVA CREWMEMBER WITH AN EXPOSURE OF > 20 VOLT/METER OR EXPOSURE IN THE MAIN BEAM AT A RANGE < 125 METERS FROM THE ANTENNA FACE. DURING AOS PERIODS, THE CREW AND THE MCC WILL BOTH BE PREPARED TO TAKE THE KU-BAND SYSTEM TO STANDBY IN THE EVENT THAT THE LINE OF SIGHT CROSSES INTO THE PROTECTED HEMISPHERE. DURING PREDICTED LOS PERIODS, THE MCC WILL COMMAND THE KU-BAND SYSTEM TO STANDBY. @[021998-6515A]

When EVA activities are conducted outside the areas protected by the microprocessor mask or orbiter structural blockage, the Ku-band transmitter is not automatically turned off to protect the crew. In this case it is acceptable to manage the orbiter attitude so that Ku-band pointing will be restricted to the + Z hemisphere (below the X-Y plane) while EVA activities will be conducted in the opposite hemisphere. The crew and the MCC will both be prepared to take the Ku-band to STANDBY in the event that the line of sight crosses into the protected hemisphere. This will be based upon predicted times and will be backed up with real-time monitoring of antenna position. During predicted LOS periods, the MCC will command the Ku-band to STANDBY to positively preclude any possibility of radiation. The maximum exposure levels are defined in the rule for reference. @[021998-6515A]

- C. IF THE MMU IS FLOWN OUTSIDE THE PAYLOAD BAY AND SIMULTANEOUS KU-BAND TRANSMISSION IS REQUIRED, THEN MMU FLIGHT WILL BE RESTRICTED TO THE ORBITER - Z HEMISPHERE AND THE KU-BAND ANTENNA POINTING WILL BE RESTRICTED TO THE + Z HEMISPHERE.

The rationale for this rule applying to MMU operations is same as rationale for paragraph B.

- D. USE OF THE KU-BAND IN THE LOW POWER RADAR MODE DURING EVA OPERATIONS IS UNRESTRICTED.

When the Ku-band system is in the radar mode with low power selected, analysis has shown that the crewmember radiation limits will not be exceeded at any range or look angle. Therefore, EVA operations may be freely conducted without any special monitoring or procedure for the purposes of avoiding excessive radiation levels of exposure.

Rule {A15-24}, EVA OPERATIONS IN THE GENERIC PAYLOAD BAY ENVELOPE, references this rule.

FLIGHT RULES

A11-8

ORBITER S-BAND OPERATIONS DURING EVA

- A. ALL ORBITER S-BAND SYSTEMS MAY BE OPERATED WITHOUT RESTRICTION DURING EVA OPERATIONS CONDUCTED WITHIN THE GENERIC PAYLOAD BAY ENVELOPE.

The generic payload bay EVA envelope was developed assuming the use of simple avoidance to control S-band radiation to less than 120 V/M (ref. Rule {A15-24}, EVA OPERATIONS IN THE GENERIC PAYLOAD BAY ENVELOPE).

- B. ALL ORBITER S-BAND SYSTEMS MAY BE OPERATED WITHOUT RESTRICTION DURING EVA OPERATIONS OUTSIDE THE GENERIC PAYLOAD BAY ENVELOPE AS LONG AS THE EVA CREWMEMBER REMAINS AT LEAST 1 METER AWAY FROM ANY RADIATING OR POTENTIALLY RADIATING ANTENNA.

An S-band dipole antenna "near field" is generally considered to extend approximately 1 meter from the antenna in all directions. Within this near field region, exact field intensities cannot be computed, and as such, could exceed the acceptable level for the EMU (120 V/M). If an antenna is totally inhibited (e.g., PI turned OFF or S-band FM forced to the lower antenna by crew switch) then the EVA crewmember is not at risk in approaching these antennas. Since an S-band PM antenna under GPC control could begin radiating without warning, the crewmember must stay 1 meter away to ensure his/her safety.

- C. FOR EVA OPERATIONS WHICH MUST BE CONDUCTED LESS THAN 1 METER AWAY FROM AN ORBITER S-BAND ANTENNA, STEPS MUST BE TAKEN TO ENSURE THAT THE ANTENNA WILL NOT RADIATE WHILE THE CREWMEMBER IS WITHIN 1 METER.

An S-band dipole antenna's "near field" is generally considered to extend approximately 1 meter from the antenna in all directions. Within this near field region, exact field intensities cannot be computed, and as such, could exceed the certification level for the EMU (120 V/M). If an antenna is totally inhibited (e.g., PI turned OFF or S-band FM forced to the lower antenna by crew switch) then the EVA crewmember is not at risk in approaching these antennas. Since an S-band PM antenna under GPC control could begin radiating without warning, the crewmember must stay 1 meter away to ensure his/her safety.

Reference Documentation: United Technology/Hamilton Standard Engineering Memorandum EMUM-604, April 30, 1992.

Rule {A15-24}, EVA OPERATIONS IN THE GENERIC PAYLOAD BAY ENVELOPE, references this rule.

FLIGHT RULES

A11-9

RECORDER USAGE

- A. THE SOLID STATE RECORDERS (SSR) WILL BE MANAGED FROM THE GROUND SUCH THAT ONE RECORDER WILL ALWAYS BE RECORDING HIGH DATA RATE (HDR) TELEMETRY (128 KBPS). ©[092701-4847] ©[121505-7133B] ©[012407-7870]

Because of the unpredictable nature of communications, data must be recorded all the time so that any missed data can be played back after communications is restored. The retrieved data is used to analyze events and anomalous conditions that occur during LOS periods. Only one recorder is powered on during most of a mission. The other recorder is powered off to save cryo. The crew does not have an interface to operate the SSR's so they must be managed from the MCC. ©[092701-4847]

- B. CREW VOICE RECORDING ON THE SSR SHALL ONLY OCCUR DURING ASCENT AND ENTRY PHASES.

Crew voice recording is still required for ascent and entry phases so that in the event of a major malfunction the crew's communications may be recovered to support anomaly resolution. ©[121505-7133B]

- C. COMMUNICATIONS ASSETS SHALL BE SCHEDULED TO PROVIDE RECORDER PLAYBACK CAPABILITY AT LEAST ONCE EVERY 7 HOURS.

A recorder can hold a total of 7 hours and 26 minutes of HDR data or 4 hours and 57 minutes of HDR data plus voice. The limiting factor for data recovery is that there are only 15 queues available to protect LOS data. Since there will be approximately 3 queues used per orbit, there is approximately 5 orbits of queues available. Five orbits is approximately 7.5 hours, therefore, to prevent the loss of LOS data, a playback of the stored queues is required at least every 7 hours. It is desired that the data be played back from the recorder more often than every 7 hours; therefore, the MCC will request playback support at least every 4 hours to support data mining needs of the flight control team and the MER.

- D. PLAYBACK AFTER LANDING WILL ONLY OCCUR FOR LANDINGS AT THE KENNEDY SPACE CENTER (KSC) OR EDWARDS AIR FORCE BASE (EDW).

Of the three primary landing sites, KSC and EDW have ground stations which can process a post landing playback. White Sands Space Harbor (WSSH) cannot support post landing playbacks. The data will be retrieved from the recorder after the orbiter has returned to KSC for a WSSH landing. ©[012407-7870]

FLIGHT RULES

A11-10

UHF USAGE

THE UHF TRANSCEIVER WILL BE NOMINALLY CONFIGURED IN SIMPLEX 259.7 MHZ. @[111705-6555]

The UHF system provides a completely independent source of air/ground voice to the S-band system. The UHF system is simplex for air/ground use (one direction at a time) and can be configured to any one of three frequencies: 296.8, 259.7 and 243.0 MHz. The 243.0 MHz frequency is reserved as a guard channel (for contingency communications with air traffic control facilities only) and is not normally used on orbit. Either 296.8 MHz or 259.7 MHz can be used on orbit (not TDRS). The 259.7 MHz channel is preferred as it has the better circuit margins. Should ground interference disturb the crew, the UHF system is often turned off. It is generally turned off during DOD flights on orbit as UHF voice is not encrypted. @[111705-6555]

FLIGHT RULES

A11-11

S-BAND FM USAGE

- A. THE S-BAND SYSTEM SHALL BE REQUIRED TO TRANSMIT MAIN ENGINE DATA DURING ASCENT PHASE.

The S-band FM system provides the only real-time source of main engine interface unit (EIU) high rate data. It is sufficiently important enough to require downlinking in real time as well as being redundantly recorded onboard.

- B. FOR THE REMAINDER OF THE FLIGHT, THE S-BAND FM SYSTEM WILL BE USED FOR TV, SOLID STATE RECORDERS DUMPS, AND REAL-TIME PAYLOAD DATA. @[102402-5735] @[121505-7133B]

The S-band FM system provides a wideband downlink to ground sites (not for TDRS) which can be configured for any one of several inputs (e.g., solid state recorder dumps, TV, and real-time analog, or digital payload data). Individual mission requirements will dictate when these inputs will be required to use the FM system for a particular flight and what the time-sharing plan will be.
@[102402-5735] @[121505-7133B]

FLIGHT RULES

A11-12

S-BAND PM USAGE

- A. THE S-BAND PM SYSTEM 2 LRU'S WILL NOMINALLY BE SELECTED VIA COMMAND FOR THE ENTIRE FLIGHT. ONBOARD SWITCHES WILL BE IN THE SYSTEM 1 LRU CONFIGURATION.

Since the S-band system is the prime orbiter communications system, it is desirable that switchover capability to the redundant system be reachable from the CDR or PLT seats during ascent/entry and other high activity phases. The design of panel and command hybrid driver logic within the GCIL allows the entire S-band PM system (NSP, XPNDR, antenna electronics, Power Amp, Pre Amp) to be switched to the redundant string with a single switch on panel C3. The redundant string is selectable via the panel C3 switch (nominally string 1). The choice of system 1 or 2 is arbitrary; however, the Flight Data File has long been written assuming this configuration.

- B. THE GROUND WILL BE PRIME FOR OPERATION OF THE S-BAND PM SYSTEM.

The orbiter S-band PM system must be configured differently for TDRS, GSTDN or SGLS modes continuously as required during the flight. This is a routine, repetitive task necessary during both crew awake and crew sleep periods in order to maximize data retrieval and is best done by MCC to free the flightcrew for more mission-unique tasks. Additionally, through telemetry indications from the orbiter and using voice reports and other indications from TDRS, GSTDN, and SGLS sites, the MCC has better overall visibility into the total air/ground communications network and is better suited for operating the total system, especially during non-nominal conditions.

- C. S-BAND PM ANTENNA MANAGEMENT WILL BE VIA GPC AUTOMATIC ANTENNA SELECTION.

S-band PM antenna management can be done either manually by the crew or ground or via GPC automatic selection. As long as the GPC's knowledge of attitude and position is accurate, it is less error prone to enable automatic selection. This has the added benefit of greatly reducing crew or ground workload for what is largely a routine function.

FLIGHT RULES

A11-13

S-BAND PAYLOAD USAGE

- A. THE S-BAND PAYLOAD SYSTEM 1 LRU'S WILL NORMALLY BE USED TO SUPPORT PAYLOAD OPERATIONS. ONBOARD SWITCHES WILL MATCH THE DESIRED CONFIGURATION.

The S-band payload system consists of redundant PI/PSP strings. Although there are exceptions on some flights, the flightcrew is typically much more involved with the usage of this system than in the S-band PM system, the management of which is primarily a ground function. The switch setup for S-band PM is unmatched from that commanded so that the crew need throw a minimum number of switches to restore communications in the event of onboard failure. In the case of the S-band payload system, it is preferable to have the switches match the commanded configuration so that the crew can easily track the current status since they are the prime system operators.

- B. THE S-BAND PAYLOAD INTERROGATOR (PI) CHANNEL SELECT THUMBWHEELS WILL BE CONFIGURED SO THAT INADVERTENT PI ACTIVATION WILL NOT INTERFERE WITH THE S-BAND PM SYSTEM. THE STANDARD SETTING FOR ASCENT/ENTRY SHALL BE CHANNEL 910. ®[102402-5737]

Although the PI may be unpowered, a single-point failure exists that can inadvertently result in PI activation. Should this occur when the selected channel is one that interferes with the S-band PM uplink or downlink, a loss of uplink or downlink PM lock may occur disrupting the prime mode of communications. The cause of this unexpected disruption would be difficult to detect, result in confusion, and the workaround would not be obvious even if the alternate UHF link were available. Therefore, it should be avoided. Channel 910 is safe for ascent/entry since it cannot cause any interference. ®[102402-5737]

FLIGHT RULES

A11-14

CREW ALERT SPC'S

DURING TIME PERIODS WHEN ALL CREWMEMBERS SLEEP SIMULTANEOUSLY, A CREW ALERT SPC WILL BE ROUTINELY USED TO ALERT THE CREW TO COMMUNICATIONS SYSTEMS PROBLEMS. THE SPC WILL TIME OUT APPROXIMATELY HALFWAY THROUGH THE SLEEP PERIOD IN THE EVENT OF A LOSS OF UPLINK COMMAND.

The crew alert commands result in an onboard class 3 alarm. When loaded into the SM SPC buffer during time periods when all crewmembers are sleeping, it can be used to alert the crew that uplink S-band command and probably voice capability has been lost. The crew alert commands are uplinked at the beginning of a sleep period and timetagged to execute midway through the sleep period. Should no loss of command occur, these commands are cleared from the SPC buffer before execution. If uplink command is lost, it is possible that uplink voice or even downlink voice and telemetry may be lost as well since common components are used. Single-point failures in the S-band PM system exist making this possible. UHF provides a redundant voice source but is often deactivated during crew sleep periods due to ground interference. Therefore, the crew alert commands are used to warn the crew of a possible loss of all monitoring capability and all communications capability. This is considered serious enough to wake the crew.

A11-15

ELBOW CAMERA/PAYLOAD INTERFERENCE [CIL]

FOR THOSE MISSIONS WHERE AN ELBOW CAMERA/PAYLOAD INTERFERENCE PROBLEM EXISTS, THE ELBOW CAMERA WILL NOT BE ACTIVATED UNLESS THE INTERFERENCE PROBLEM IS ELIMINATED. THIS APPLIES EVEN IF THE RMS IS DEPLOYED.

FLIGHT-SPECIFIC EXCEPTIONS FOR HIGH PRIORITY OPERATIONS WILL BE IDENTIFIED IN THE FLIGHT RULES ANNEX.

Due to the geometry of the elbow camera 25-degree mounting wedge when the MPM is stowed, the maneuvering envelope of the camera intrudes upon the maximum payload envelope. A potential interference problem exists with a payload manifested at the same X location as the elbow camera. The interference could prevent stowing the MPM's and require an RMS jettison or EVA to close PLBD's.

FLIGHT RULES

A11-16

KU-BAND MANAGEMENT [HC] [032807-8281B]

THE ORBITER KU-BAND SYSTEM WILL BE OPERATED IN THE "BETA PLUS MASK" MODE WITH A LIMIT OF 21 DEGREES UNLESS A PAYLOAD EXTENDS BEYOND THE PAYLOAD BAY DOOR ENVELOPE. [ED] [102402-5742]

The Ku-band masking is used to protect a payload in the payload bay from the Ku main beam RF radiation. A limit of 21 degrees in the "Beta Plus Mask" mode will protect the entire bay up to the payload bay door moldline and prevent any part of the bay being exposed to a level greater than 10 volts per meter (the ICD limit). This masking mode also provides the maximum comm coverage while still providing the required protection. [102402-5742]

If a payload instrument is present which extends beyond the payload bay door moldline, then this masking may not protect the payload from levels higher than the ICD level. The required mode and beta limit is then dependent on the location of the payload in the bay and on the dimensions of the payload. Thus, the limit must be calculated for the specific mission case. [102402-5742]

Note that the beta mask function does not apply to Ku radar operation. The radar mode uses the old microprocessor mask which is equivalent to beta plus mask with a limit of -90 degrees. This is more restrictive (i.e., more protection) than 21 degrees. [ED]

Rule {A2-118}, RNDZ/PROX OPS COMMUNICATION SYSTEMS MANAGEMENT, references this rule. [061396-1961]

- B. ALL ORBITER STRUCTURE INSIDE OF THE PAYLOAD BAY ENVELOPE FROM THE INTERSECTION OF THE WINDOW 3 AND WINDOW 4 FRAME ON THE CREW CABIN TO THE 1307 INCH PAYLOAD BAY BULKHEAD MUST BE PROTECTED FROM KU-BAND COMM RADIATION. ADDITIONAL ORBITER STRUCTURE THAT MUST BE PROTECTED INCLUDES THE APDS AND THE SRMS.

The orbiter Ku-band antenna system utilizes an obscuration mask, a beta mask, and RF protect boxes to prevent radiation above the exposure limits. Reflections off of orbiter structure or other vehicles could damage the orbiter Ku-band antenna or exceed the exposure limits of the orbiter components (ICD-2-19001) (ICOM-01).

- C. AREAS THAT MAY BE EXPOSED TO KU-BAND COMM RADIATION ARE THE ORBITER WINGS, PAYLOAD BAY DOORS, RADIATORS, VERTICAL TAIL, THE OMS PODS, AND NOSE FORWARD OF THE INTERSECTION OF WINDOW 3 AND WINDOW 4. [032807-8281B]

FLIGHT RULES

A11-17

PI CHANNELS AND S-BD FREQUENCIES COMPATIBILITIES

IN ORDER TO PREVENT MUTUAL INTERFERENCE BETWEEN THE PAYLOAD INTERROGATOR (PI) AND THE S-BAND PM SYSTEM, THE FOLLOWING PI CHANNELS AND S-BAND PM FREQUENCIES COMPATIBILITY TABLE WILL BE FOLLOWED FOR ALL PI OPERATIONS: ©[090894-1648B]

COMPATIBLE PI CHANNELS AND S-BAND PM FREQUENCIES	
WHEN USING PI CHANNEL	USE S-BAND PM FREQUENCY
001-407	HIGH
408-433	NOT COMPATIBLE WITH LOW OR HIGH *
434-883	LOW
899-909	HIGH
910-920	LOW

* PI INTERFERENCE WITH SSA FORWARD LINK TEST SHOWS THAT THERE IS A POTENTIAL FOR DEGRADED SSA FORWARD LINK ACQUISITION AND; THEREFORE, THIS PI/S-BD PM COMBINATION (408-420/421-433) WILL NOT BE USED. EXCEPTIONS MAY BE MADE ON A FLIGHT SPECIFIC BASIS BY DETAILED ANALYSIS.

The S-Band PM system and Payload Interrogator selectable frequencies overlap and if not properly selected could interfere with each other. The consequence of selecting channels other than those noted in the table above are unknown and potentially compromise S-Band PM communications and/or communications with a detached payload. Reference ESTL report EE7-93-214. ©[090894-1648B]

A11-18

COMSEC USAGE

IN ORDER TO PROTECT THE ORBITER FROM UNAUTHORIZED COMMANDS, THE S-BAND SYSTEM UPLINK WILL NORMALLY BE ENCRYPTED FOR ALL FLIGHTS.

Configuring the S-band uplink for encryption protects against unauthorized commands being received via both the S-band and Ku-band systems as the COMSEC equipment interfaces with the NSP which is common to both systems. Uplinks bypassing the NSP can still be received via the alternate (216 kbps) Ku-band channel, but this channel (intended for OCA and high rate payload data) does not interface with the GPC's or other critical orbiter systems. ©[111298-6778] ©[012402-5068]

FLIGHT RULES

A11-19

UPLINK BLOCK

- A. WHEN SM IS UNAVAILABLE AND THE UPLINK IS NOT ENCRYPTED, COMMANDS WILL BE BLOCKED VIA "UPLINK" SWITCH WHEN COMMAND ACTIVITY IS NOT REQUIRED. LOSS OF THE BLOCK FUNCTION, HOWEVER, IS NOT A CONSTRAINT TO CONTINUING TO NOMINAL EOM.

National Security Decision Directive 145 (NSDD 145) and NASA policy dictates that the uplink command path be blocked or encrypted to prohibit unauthorized command sources from reaching the orbiter. This is necessary to preclude any possibility of unwanted GMEM's, DEU equivalents, etc., from disrupting or endangering flight operations. When SM and encryption are both unavailable, the crew is required to manually enable or block the uplink using the UPLINK switch in panel C3 since no automatic function exists.

- B. WHEN SM IS AVAILABLE, UPLINK COMMANDS WILL BE AUTOMATICALLY BLOCKED BY THE SM SOFTWARE WHENEVER THE SITE-IN-VIEW FLAG IS NOT PRESENT AND THE UPLINK WILL NORMALLY BE ENCRYPTED. REFERENCE RULE {A11-64}, LOSS OF COMMUNICATION SECURITY (COMSEC) .

SM software and the use of encryption provide uplink protection during on-orbit periods. Rule {A11-64}, LOSS OF COMMUNICATION SECURITY (COMSEC), addresses cases when COMSEC is failed.

A11-20

UPLINK COMMANDING DURING OPS TRANSITIONS

NORMALLY, UPLINK COMMANDING TO THE ORBITER WILL BE PROHIBITED DURING OPS MODE TRANSITIONS.

Because of software cleanup operations during an OPS transition, there is a short (1 second) window of vulnerability where a redundant set split, fail-to-sync, or erroneous command may occur if an uplink command is received. This could be hazardous during time-critical operations or could cause serious delays to mission completion operations.

FLIGHT RULES

A11-21 **CRITICAL UPLINK COMMAND POLICY**

CRITICAL COMMANDS SHALL NOT BE UPLINKED WITHIN 10 MINUTES OF LOS OR DURING PERIODS OF PREDICTED POOR COMMUNICATIONS UNLESS THOSE COMMANDS ARE TIME CRITICAL TO OPERATIONS.

During periods of marginal communications, error rates increase and uplinks have a higher probability of dropouts. Commands which are critical, such as GMEM's, state vectors, etc., but not time critical, should only be uplinked when sufficient time remains to assess the success of those commands on the onboard systems.

A11-22 **TWO-STAGE COMMAND BUFFER TLM REJECT**

NO TWO-STAGE COMMANDS SHALL BE EXECUTED WHEN THE TWO-STAGE COMMAND BUFFER IS NOT AVAILABLE VIA TELEMETRY TO VERIFY SUCCESSFUL UPLINK, WITHOUT THE APPROVAL OF THE FLIGHT DIRECTOR.

Without telemetry, the ground cannot verify that the uplinked command has correctly been received onboard. However, for cases where not executing a command may have worse consequences than the possible consequences of an erroneous command, the Flight Director may elect to approve execution of the command. @[060800-7213]

A11-23 **KU BAND TRANSMITTER INHIBITED DURING ACQUISITION OF TDRS INSIDE THE RF PROTECT BOX**

THE KU BAND SYSTEM SHALL BE INHIBITED FROM RADIATING, DURING ACQUISITION OF THE TDRS SATELLITE, WHEN IT IS PREDICTED TO BE POINTING INSIDE THE KU BAND RF PROTECT BOX. @[110900-7263]

A race condition was discovered in the antenna management flight software that allows radiation to occur while the Ku Band system is slewing to the designated pointing angles inside the RF protect box. To prevent inadvertent radiation of protected regions, the ground will inhibit the Ku Band from radiating prior to the acquisition of TDRS inside the RF protect box. This condition only occurs when the Ku Band is performing a fast slew to angles which are inside the RF protect box but outside the beta masking. @[110900-7263]

FLIGHT RULES

A11-24

ORBITER S-BAND LOW FREQUENCY FOR ASCENT

- A. THE ORBITER WILL BE OPERATED IN LOW FREQUENCY DURING ENHANCED LAUNCH VEHICLE IMAGING SYSTEM (ELVIS) EXTERNAL TANK (ET) CAMERA OPERATIONS TO PREVENT ADVERSELY EFFECTING THE REAL-TIME DOWNLINK VIDEO. ©[042706-7325A]

The ELVIS component located on the ET, which downlinks real-time images of the underside of the orbiter and the ET, operates from about L-2 minutes to shortly after ET separation at about MET 9:00 minutes. This system operates at 2272.5 MHz. The orbiter S-band high frequency at 2287.5 MHz will degrade the image quality from the ET real-time camera downlink, so the orbiter should operate in low frequency (2217.5 MHz) to prevent this problem. Reference EV7-04-3065, Radio Frequency Interference from the Space Shuttle Orbiter S-band High Frequency Link to the External Tank Camera System Downlink.

- B. THE ORBITER MAY USE S-BAND HIGH FREQUENCY FOR ASCENT IF LOW FREQUENCY IS FAILED.

ET real-time video downlink is considered crit 3. Orbiter S-band is a crit 1 system so, if S-band low frequency is lost, the orbiter may use S-band high frequency to recover this crit 1 capability. ET real-time video will be degraded in this case. ©[042706-7325A]

A11-25 THROUGH A11-50 RULES ARE RESERVED ©[042706-7325A]

FLIGHT RULES

SYSTEM FAILURE RULES

A11-51 **LOSS OF TWO-WAY VOICE**

IF ONLY A SINGLE SOURCE OF ENTRY TWO-WAY VOICE COMMUNICATIONS REMAINS (COMMAND OK), THE FLIGHT WILL BE TERMINATED AT THE NEXT PLS. IF THIS OCCURS ON FD 1 HOWEVER, DELAY ENTRY UNTIL FD 2. THIS COULD RESULT FROM THE FOLLOWING FAILURES:

- A. TWO NSP'S (UPLINK OR DOWNLINK) .
- B. TWO XPNDRS (UPLINK OR DOWNLINK WITH UNSUCCESSFUL IFM) .
- C. UHF AND ONE NSP OR XPNDR .

Voice communications is the most valuable communications mode of all due to its flexibility. In contingency cases when command or telemetry is lost, voice can be used as a substitute although it is a slower means of conveying this type of information. It is the only satisfactory means of crew/MCC coordination during high activity phases. The only available voice sources during entry are the two S-band channels (A/G 1 and 2) and UHF. A/G 1 and 2 are redundant and UHF is partially redundant. Should a combination of failures result in being a single failure away from loss of all entry two-way voice, it is best to be prudent and terminate the mission while overall systems and landing site status are known and understood. This is more prudent than risking future occurrences which could result in a crew or vehicle safety hazard due to the absence of a satisfactory means of crew/MCC coordination. In the event these multiple voice failures occur on FD 1, it is better to stay on orbit until the next day and deliberately plan on the possibility of a no-voice entry rather than rush through deorbit activities while adapting to the zero g environment.

Rules {A11-63A}, C, and D, LOSS OF NSP's; {A11-58B}, LOSS OF TRANSPONDERS; and {A11-1001}, COMMUNICATIONS GO/NO-GO CRITERIA, reference this rule.

FLIGHT RULES

A11-52

LOSS OF BOTH VOICE AND COMMAND

A. DURING ASCENT - CONTINUE TO ORBIT: @[092701-4816]

1. IF GPS IS NOT VERIFIED TO BE FUNCTIONING PROPERLY, DEORBIT ON ORBIT 2.
2. IF GPS IS VERIFIED TO BE FUNCTIONING PROPERLY, DEORBIT ON PREFERRED FIRST DAY PLS OPPORTUNITY.

Continuing to orbit is the most benign action. If GPS is not verified to be functioning properly (hardware problems or commfaults, extended periods of high FOM, extended periods of less than 4 satellite tracking), deorbit on orbit 2 is recommended since this allows sufficient time to perform the loss of command and voice procedures while minimizing the degradation of the onboard state vector. Deorbit on orbit 3 would probably not be useful from a systems recovery standpoint and only causes further degradation of the state vector.

GPS will provide an adequate source for orbit navigation and the deorbit state vector as long as it is verified to be functioning properly (no hardware problems or commfaults, no extended periods of high FOM, no extended periods of less than 4 satellite tracking). Caution should be taken when using GPS state vectors with FOM's > 5 (650 feet position error one sigma), since the estimated position error increases rapidly with higher FOM values. A later first day PLS deorbit may be preferred over an orbit 2 deorbit after a loss of both voice and command. Deorbit capability, weather forecasts, and lighting conditions will be considered for the landing site selection.

THIS RULE CONTINUED ON NEXT PAGE

FLIGHT RULES

A11-52

LOSS OF BOTH VOICE AND COMMAND (CONTINUED)

- B. ON-ORBIT - DEORBIT TO THE PLS AT THE TIG OF THE SLEEP VECTOR TARGET SET. IF THIS TIG IS IN THE PAST OR A SLEEP VECTOR IS NOT ONBOARD, THEN:
1. IF GPS IS NOT VERIFIED TO BE FUNCTIONING PROPERLY AND NO ALTERNATE VOICE OR FILE TRANSFER PATH EXISTS TO UPDATE THE ONBOARD STATE VECTOR, DEORBIT WITHIN THE NEXT 13 HOURS IF PERIGEE IS GREATER THAN OR EQUAL TO 120 NM; OR THE NEXT 9 HOURS IF PERIGEE IS GREATER THAN 105 NM, BUT LESS THAN 120 NM; OR FROM LOSS OF VOICE AND COMMAND ACCORDING TO THE FOLLOWING PRIORITIES:
 - a. THE NEXT LIGHTED CONUS OPPORTUNITY.
 - b. THE NEXT CONUS OPPORTUNITY.
 - c. THE NEXT LIGHTED ELS OPPORTUNITY. @[092701-4816]
 2. IF GPS IS VERIFIED TO BE FUNCTIONING PROPERLY OR AN ALTERNATE VOICE OR FILE TRANSFER PATH EXISTS, DEORBIT NEXT PLS, PREFERABLY TO A LIGHTED OPPORTUNITY. @[092701-4816]

A study was presented to Orbit Flight Techniques Panel #86, June 1, 1988, which shows, for a general case, an onboard state vector will remain within tolerances per Rule {A4-154}, DOWNTRACK ERROR, for 13 hours if perigee is greater than 120 nm. A subsequent study showed that the vector will remain within tolerances for 9 hours if perigee is greater than 105 nm. This assumes a 1-sigma case with a semi-major axis error of 1000 feet and a downtrack error of 20,000 feet at loss of communication (the crew will be informed if the ground is unable to maintain the vector to this accuracy.) This was approximately the average quality of the onboard state vector before a new one was uplinked based on previous flight data. This was selected to reduce the chance of committing to an ELS landing. It is therefore best to deorbit within the specified time limits unless the state vector is confirmed for a future landing opportunity or GPS is verified to be functioning properly (no hardware problems or commfaults, no extended periods of high FOM, no extended periods of less than 4 satellite tracking) to maintain state vector accuracy. State Vector confirmation can come as a sleep vector (zero delta-V command load with the TIG of the deorbit burn to the PLS) or by voice at the time the state vector was uplinked.

THIS RULE CONTINUED ON NEXT PAGE

FLIGHT RULES

A11-52

LOSS OF BOTH VOICE AND COMMAND (CONTINUED)

If the onboard state vector has been confirmed for a deorbit to the next PLS, it is best to plan for that.

The case where the confirmation has not been received and GPS is not verified to be functioning properly (hardware problems or comm faults, extended periods of high FOM, extended periods of less than 4 satellite tracking) is more difficult. It is clearly more desirable to land at a CONUS landing site containing a full complement of landing aids. It is also more desirable to land during the day. Therefore, the next two priorities are a lighted CONUS landing, then a dark one.

If no CONUS opportunity exists within the specified times, it is best to deorbit as soon as possible to the next lighted ELS. There will always be a lighted ELS opportunity within the next 9 hours at any time during the mission, so a dark ELS landing is not addressed.

GPS will provide an adequate source for orbit navigation and the deorbit state vector as long as it is verified to be functioning properly. Caution should be taken when using GPS state vectors with FOM's > 5 (650 feet position error one sigma), since the estimated position error increases rapidly with higher FOM values. Orbit stay periods of up to 24 hours or longer may be performed to avoid ELS landings if GPS is used to maintain the onboard state vector. Deorbit capability, weather forecasts, and lighting conditions will be considered for the landing site selection.

If the Ku-band and Orbital Communications Adapter (OCA) systems are operational or a comm link via ISS is available, a delta state update can be performed. The orbiter state vector can be downlinked to the MCC via OCA file transfer or read down by the crew via OCA videoconference or ISS assets if GNC downlist telemetry is not available. Once the ground has computed the delta state, it can be uplinked to the orbiter via OCA file transfer or read up via OCA videoconference or ISS assets. The crew can then manually enter the delta state into the GPC in GNC OPS 3. The generation of the orbit delta state by the ground is no longer trained and will require a thorough procedure review prior to implementation. Orbit stay periods can be extended to next PLS to avoid an ELS landing if GPS or delta states are available to keep the state vector within limits. ©[021998-6516] ©[092701-4816]

Rules {A2-301}, CONTINGENCY ACTION SUMMARY [HC]; {A4-107}, PLS/EOM LANDING OPPORTUNITY REQUIREMENTS [HC]; and {A11-1001}, COMMUNICATIONS GO/NO-GO CRITERIA, reference this rule. ©[032807-8400] ©[ED]

FLIGHT RULES

A11-53

LOSS OF COMMAND

IF ALL COMMAND CAPABILITY IS LOST BUT AT LEAST TWO SOURCES OF ENTRY VOICE ARE STILL AVAILABLE, AN MDF WILL BE PERFORMED.

Loss of all command capability implies redundant failures and would impose a significant increase in workload to the crew as state vectors, gyro biases, target loads, etc., would have to be relayed to the crew by voice or OCA and entered into the computers manually, in many cases, by GMEM Read/Write. Recorder dumps and communications configurations would also have to be done manually and, for some flights, payload operations would be adversely affected as control is only from the POCC. Therefore, the potential for introducing errors into computer updates is increased. ©[021998-6516] ©[012402-5068]

Rules {A11-58B}, LOSS OF TRANSPONDERS; {A11-63A}, LOSS OF NSP's; and {A11-1001}, COMMUNICATIONS GO/NO-GO CRITERIA, reference this rule.

A11-54

LOSS OF TELEMETRY

IF ALL SOURCES OF TELEMETRY TO MCC ARE LOST THE FLIGHT WILL TERMINATE AT THE NEXT PLS. THIS COULD RESULT FROM:

- A. LOSS OF DOWNLINK FROM BOTH NSP'S.
- B. LOSS OF BOTH PCMMU'S.
- C. LOSS OF BOTH TRANSPONDERS FOLLOWED BY AN UNSUCCESSFUL IFM.
(REF. RULE {A11-58C}, LOSS OF TRANSPONDERS.)

The MCC has a much greater systems monitoring capability than available onboard and most crew procedures and training are based on the availability of having telemetry data in the MCC or POCC monitored by systems experts. Without telemetry, computer loads could not be verified before execution. Some future system failures could remain undetected (such as those requiring trend monitoring) or the extent of the failure unappreciated (e.g., bus transients). Also, for many missions, payload data is only retrievable via telemetry. If telemetry during the entry phase is known to be unavailable (even though onboard data may be unaffected), then it is safest to terminate the mission while overall systems status is known and understood by all rather than risk adverse future occurrences which could result in a crew or vehicle safety hazard due to the loss of insight normally provided by the MCC.

Rules {A11-63}, LOSS OF NSP's; and {A11-1001}, COMMUNICATIONS GO/NO-GO CRITERIA, reference this rule.

FLIGHT RULES

A11-55 **LOSS OF KU-BAND**

LOSS OF KU-BAND WILL RESULT IN THE FLIGHT CONTINUING TO NOMINAL EOM. IF THE MISSION-SPECIFIC CAPABILITY JUSTIFIES THE REQUIREMENT FOR THE KU-BAND, PERFORM AN MDF.

Refer also to mission-specific rules that may be documented in Flight Rules Annexes.

Ku-band communication is provided primarily to support payloads. It is used to provide supplemental capabilities unavailable via the prime S-band communications system such as TDRS television, TDRS recorder dumps, OCA, and high rate payload data. Generally speaking, other useful mission objectives can be accomplished even with the loss of these capabilities and, therefore, early mission termination is not justified. The Ku-band system also provides the only source of rendezvous radar capability, but alternate onboard and ground capabilities allow rendezvous to continue in the event of radar failure. Specific mission objectives that cannot be accomplished with a loss of Ku-band are identified in the Flight Rules Annex. ©[021998-6516] ©[012402-5068]

Rule {A11-1001}, COMMUNICATIONS GO/NO-GO CRITERIA, references this rule.

A11-56 **LOSS OF KU-BAND TEMPERATURE CONTROL [CIL]**

INABILITY TO MAINTAIN KU-BAND TEMPERATURES WITHIN THEIR SODB LIMITS (DEFINED AS ABOVE MINIMUM TURN-ON AND BELOW MAXIMUM SURVIVAL) WILL RESULT IN KU-BAND DEACTIVATION AND STOWAGE.

If temperature control of the Ku-band gyro or either alpha or beta gimbal cannot be maintained within SODB limits, the subsequent potential of degradation could result in inability to properly stow the deployed assembly since fairly precise positioning is required for the antenna to lock. Stowing the deployed assembly with an unlocked antenna could result in damage to the antenna or the adjacent radiator panel during entry. Temperature control of the antenna feed, the transmitter, and the receiver is also required to prohibit damage to these components. For any of these cases the system should be deactivated and stowed as a precaution.

Rules {A10-301B}, ANTENNA STOW REQUIREMENT [HC] [CIL], and {A11-57}, LOSS OF KU-BAND TEMPERATURE MONITORING CAPABILITY [CIL], reference this rule. ©[042904-6240A]

FLIGHT RULES

A11-57

LOSS OF KU-BAND TEMPERATURE MONITORING CAPABILITY
[CIL]

LOSS OF THE CAPABILITY TO MONITOR THE KU-BAND GYRO, ALPHA GIMBAL, OR BETA GIMBAL TEMPERATURES WILL RESULT IN DEACTIVATION AND STOWAGE EXCEPT FOR THOSE CASES DOCUMENTED IN THE JOINT SHUTTLE-ISS OPERATIONAL FLIGHT RULES OR THE FLIGHT RULES ANNEX. ©[012407-7903A]

EXCEPTIONS FOR HIGH PRIORITY OPERATIONS WILL BE IDENTIFIED IN THE JOINT SHUTTLE-ISS OPERATIONAL FLIGHT RULES VOLUME C (REF RULE {C11-9}, LOSS OF SHUTTLE KU-BAND TEMPERATURE MONITORING) OR IN THE FLIGHT RULES ANNEX. ©[012407-7903A]

Ku-band temperature control is necessary to ensure that component damage will not occur and to ensure that the antenna can be properly locked and stowed for entry (ref. Rule {A11-56}, LOSS OF KU-BAND TEMPERATURE CONTROL [CIL]). A failed transducer would result in the inability to detect a heater that is failed ON or failed OFF. Since heater monitoring locations are relatively insulated, attempting to extrapolate remaining measurements to determine an out-of-limits condition for the gyro or either gimbal is unreliable.

Rule {A10-301B}, ANTENNA STOW REQUIREMENT [HC] [CIL], references this rule. ©[042904-6240A]

FLIGHT RULES

A11-58

LOSS OF TRANSPONDERS

- A. LOSS OF ONE TRANSPONDER (UPLINK OR DOWNLINK) WILL RESULT IN CONTINUING TO NOMINAL EOM.

Loss of one transponder is still one failure away from any condition resulting in either a minimum duration flight or a next PLS landing.

- B. LOSS OF UPLINK CAPABILITY FROM BOTH TRANSPONDERS WILL RESULT IN A NEXT PLS LANDING.

Refer to Rule {A11-51}, LOSS OF TWO-WAY VOICE; and Rule {A11-53}, LOSS OF COMMAND. This failure results in the loss of all S-band voice and command.

- C. IF ALL S-BAND PM DOWNLINK TO MCC IS LOST RESULTING FROM A FAILURE OF BOTH TRANSPONDERS AND THE IFM TO USE THE S-BAND FM IS SUCCESSFUL, AN MDF WILL BE COMPLETED. IF THE IFM IS UNSUCCESSFUL THEN THE FLIGHT WILL TERMINATE AT THE NEXT PLS.

Loss of telemetry and downlink voice from two transponders leaves only Ku-band as a telemetry source and UHF and Ku-band for voice. An IFM is available to restore real-time S-band telemetry and downlink S-band voice in the event of a dual transponder failure using the S-band FM transmitters. This coverage is unavailable via TDRS and would result in limited ground coverage from DOD and NASA stations which would have to be called up for support. However, it still would provide a source for entry telemetry. This failure leaves recorded telemetry still available. Therefore, sufficient systems insight remains to complete a minimum duration flight. An unsuccessful IFM would result in no telemetry and only UHF voice following Ku-band stowage. To avoid the possibility of a no-telemetry entry with an orbiter degraded by a subsequent systems failure, a next PLS landing is justified as being the conservative approach.

Rules {A11-54}, LOSS OF TELEMETRY; and {A11-1001}, COMMUNICATIONS GO/NO-GO CRITERIA, reference this rule.

FLIGHT RULES

A11-59

FM SYSTEM IFM GROUND RULE

FOLLOWING A CONFIRMED LOSS OF DOWNLINK IN ONE S-BAND TRANSPONDER, CONSIDERATION WILL BE GIVEN TO IMPLEMENTING AN IFM PROCEDURE TO ALLOW THE USE OF THE FM SYSTEM AS A REDUNDANT TELEMETRY SOURCE FOR ENTRY.

Following a transponder loss, no redundancy remains for downlink telemetry. The IFM regains this redundancy using the FM system, and implementation of the IFM should be considered prior to entry. The IFM procedure to allow the use of the S-band FM system for downlink voice and telemetry results in disconnecting flight cables and terminating the use of one of the solid state recorders. This is compatible only with ground stations, not TDRS. For these reasons it is desirable to troubleshoot the transponders to determine alternate capabilities before considering the IFM which nominally requires about 2-1/2 hours of crew time. As transponder troubleshooting necessarily requires a ground station or TDRS to confirm status, the ground should direct the procedure rather than the crew if the remaining capability makes this feasible. The ground is required because compatible configurations are necessary onboard and at the ground stations to ensure valid checks. @[121505-7133B]

A11-60

LOSS OF TDRS TRACKING CAPABILITY

LOSS OF TDRS TRACKING CAPABILITY WILL RESULT IN CONTINUING TO NOMINAL EOM.

Loss of TDRS tracking would require call up of contingency use S-band tracking stations that are obligated to provide support in the event of such an orbiter or ground system failure. These stations, supplemented as required by C-band radars, can provide satisfactory support to continue nominal orbital operations and entry preparations.

Rule {A11-1001}, COMMUNICATIONS GO/NO-GO CRITERIA, references this rule.

FLIGHT RULES

A11-61

LOSS OF S-BAND PREAMPS AND POWER AMPS

LOSS OF BOTH S-BAND PREAMPLIFIERS AND/OR BOTH POWER AMPLIFIERS WILL RESULT IN CONTINUING TO NOMINAL EOM.

Loss of either both preamps or both power amps results in loss of all TDRS S-band capability. Ku-band still remains but does not provide a tracking source and is unavailable following antenna stowage during deorbit prep. A total loss of TDRS S-band would require call up of the contingency ground stations that are obligated to provide support in the event of such an orbiter failure. These stations would be a combination of the NASA Spacecraft Tracking and Data Network (STDN), DOD remote tracking stations (RTS), and C-band radars. These stations can provide satisfactory support to continue nominal orbital operations and nominal entry preparations. ©[102402-5741]

Rule {A11-1001}, COMMUNICATIONS GO/NO-GO CRITERIA, references this rule.

A11-62

LOSS OF ANTENNA ELECTRONICS

THE FLIGHT WILL BE CONTINUED FOR LOSS OF THE S-BAND ANTENNA ELECTRONICS.

Loss of both S-band antenna electronics results in the inability to select S-band antennas (i.e., only one antenna could be used). All communications functions would remain, but severe attitude constraints would have to be imposed to maintain TDRS S-band. TDRS Ku-band would be unaffected, and ground station (GSTDN) S-band would be slightly degraded due to reduced (but still acceptable) circuit margins. Since the attitude timeline would be affected, it is reasonable to assume that mission activities would be impacted. As long as productive mission objectives can still be accomplished, the mission need not be shortened. Rule {A11-1001}, COMMUNICATIONS GO/NO-GO CRITERIA, references this rule.

FLIGHT RULES

A11-63

LOSS OF NSP'S

- A. LOSS OF UPLINK CAPABILITY FROM ONE NSP WILL RESULT IN CONTINUING TO NOMINAL EOM.

Loss of uplink from one NSP is still one failure away from any condition resulting in either a minimum duration flight or a next PLS landing. Refer to Rules {A11-51}, LOSS OF TWO-WAY VOICE; and {A11-53}, LOSS OF COMMAND.

- B. LOSS OF ALL DOWNLINK REAL TIME AND ALL RECORDED DATA OUTPUTS FROM ONE NSP WILL RESULT IN AN MDF.

The NSP's are required to provide all telemetry, recorded telemetry and voice, all command and all S-band voice. UHF voice may still remain, but the limited ground coverage (essentially Continental U.S.) is insufficient to satisfy orbital requirements. Ku-band OCA and downlink TV capabilities may also remain during the period that the Ku-band is deployed. Although two-way voice and video capability with OCA may be available, flight experience has demonstrated that this capability is not robust. Considering the impact of losing all NSP capability in the event of a second failure versus the small gain in mission achievement that may be possible, redundant NSP's should be required to extend the flight beyond minimum duration. @[021998-6516] @[012402-5068]

- C. LOSS OF UPLINK CAPABILITY FROM BOTH NSP'S WILL RESULT IN A NEXT PLS LANDING.

Refer to the rationale for Rule {A11-51}, LOSS OF TWO-WAY VOICE. Loss of both NSP uplinks would result in only UHF availability for two-way voice.

- D. LOSS OF ALL DOWNLINK REAL TIME AND ALL RECORDED DATA OUTPUTS FROM BOTH NSP'S WILL RESULT IN A NEXT PLS LANDING.

Refer to the rationale for Rules {A11-51}, LOSS OF TWO-WAY VOICE; and {A11-54}, LOSS OF TELEMETRY. Loss of all downlink capability from both NSP's would result in only UHF availability for two-way voice and no telemetry to MCC.

Rule {A11-1001}, COMMUNICATIONS GO/NO-GO CRITERIA, references this rule.

FLIGHT RULES

A11-64

LOSS OF COMMUNICATIONS SECURITY (COMSEC)

- A. LOSS OF COMSEC WILL RESULT IN THE FLIGHT CONTINUING TO NOMINAL EOM.

Refer also to mission-specific rules that may be documented in Flight Rules Annexes.

Current agency policy with a fully operational TDRSS is to encrypt command/control uplinks or data as appropriate to protect sensitive government data and provide protection from unauthorized commands. When all data is unclassified, as it is for NASA flights, this policy would be waived (as it has been in the past) in order to complete the mission. In the event of total COMSEC failure, uplink protection will be provided by use of the uplink block protection. When data is classified, as for DOD flights, COMSEC rules will be defined in the Flight Rules Annex.

- B. FOR LOSS OF A SINGLE COMSEC (UPLINK AND/OR DOWNLINK), ORBIT OPERATIONS WILL CONTINUE TO BE ENCRYPTED. FOR ASCENT AND ENTRY, REDUNDANCY WILL BE PROVIDED BY GOING TO CLEAR. IF UPLINK ENCRYPTION IS DESELECTED, THE UPLINK BLOCK SWITCH WILL BE USED BY THE CREW TO PROTECT COMMAND UPLINK WHEN COMMAND ACTIVITY IS NOT REQUIRED.

ENCRYPTION LOST	CONFIGURATION FOR ASCENT/ENTRY
BOTH UPLINK AND DOWNLINK	CLEAR UPLINK AND DOWNLINK (CREW USES BLOCK SWITCH)
UPLINK ONLY	CLEAR UPLINK AND DOWNLINK (CREW USES BLOCK SWITCH)
DOWNLINK ONLY	ENCRYPTED UPLINK, CLEAR DOWNLINK

Loss of a single COMSEC (uplink and/or downlink) does not prevent protection of that link with the remaining COMSEC system. Subsequent COMSEC failures can be resolved by deselecting encryption. For ascent and entry, the encryption will be deselected (uplink and/or downlink) to recover redundancy for command and S-band voice (the encryption switches are not accessible from the crew seats). When data are classified, as for DOD flights, COMSEC rules will be defined in the Flight Rules Annex.

Rule {A11-1001}, COMMUNICATIONS GO/NO-GO CRITERIA, references this rule.

FLIGHT RULES

A11-65

AUDIO CENTRAL CONTROL UNIT (ACCU)

THE ACCU IS CONSIDERED LOST IF TWO-WAY VOICE ON THE FOLLOWING LOOPS IS INOPERABLE:

- A. AIR/GROUND 1.
- B. AIR/GROUND 2.
- C. AIR/AIR.

These are the only loops that interface with the communications equipment (both air/ground and EVA). Only Intercom and Page loops remain. Therefore, a subsequent failure in the alternate ACCU would result in the loss of all orbiter communications. One-half of the ACCU BYPASS IFM (J4) should be performed as described in Rule {A11-66}, LOSS OF ACCU's.

Rule {A11-66}, LOSS OF ACCU's, references this rule.

FLIGHT RULES

A11-66

LOSS OF ACCU'S

- A. FOR THE LOSS OF ONE ACCU, ONE-HALF OF THE ACCU BYPASS IFM (J4) WILL BE PERFORMED AS SOON AS PRACTICAL AND THE NOMINAL FLIGHT COMPLETED. IF UNSUCCESSFUL A NEXT PLS LANDING WILL BE PERFORMED.

Refer to Rule {A11-65}, AUDIO CENTRAL CONTROL UNIT (ACCU).

- B. FOR THE LOSS OF BOTH ACCU'S, THE IFM WILL BE COMPLETED AND AN MDF WILL BE PERFORMED.

The primary difference between A and B above is that loss of an ACCU is only loss of one source of redundancy while loss of total IFM is loss of two sources.

Loss of one ACCU is one failure away from loss of all air/ground voice. The IFM, when installed, provides two sources of air/ground voice. Implementing the J4 half of the IFM allows normal use of the remaining ACCU but with the following lost capabilities:

1. PS, OS, and AIRLOCK ATU's.
2. TACAN 3 tones.
3. C&W B tones via ACCU (Middeck Speaker Unit). @[102402-5743]
4. NSP 2 voice record channel 1.
5. NSP 1 voice record channel 2.
6. NSP 1 Air/Ground 2 loop.
7. PLT ATU is limited to only the Air/Ground 1 loop in NSP 2 and only in hot mike mode.

The extent of these lost capabilities is of minor mission impact and does not constitute grounds for shortening the mission. For vehicles 103 and 104 only one crewmember in the airlock will have hardline communications which has a minor procedural impact. Should the remaining ACCU fail after the J4 IFM, the CDR and PLT ATU's (only) will still retain an S-band communications capability although it will be nonredundant. The IFM should then be completed restoring dual S-band communications redundancy. Since redundancy is available, an immediate (next PLS) landing is not necessary, but the dwindling communication capabilities justify that the flight be continued only until MDF.

Rule {A11-65}, AUDIO CENTRAL CONTROL UNIT (ACCU), references this rule.

FLIGHT RULES

A11-67

LOSS OF THE PLT AND MS ATU'S

LOSS OF BOTH THE PLT AND MS ATU'S WILL RESULT IN THE FLIGHT CONTINUING TO NOMINAL EOM.

These two ATU's are necessary to process audio system configuration data for external interfaces such as the NSP's, recorders, UHF, etc. In the event of a subsequent ACCU switch failure, these external configurations would come up in a random state. However, testing and analysis have shown that the probability of regaining a working Air/Ground loop on each switch attempt (A/G 1, 2, or UHF) exceeds 90 percent. Therefore, shortening the mission for these failures is not justified. @[092701-4872]

Rule {A11-1001}, COMMUNICATIONS GO/NO-GO CRITERIA, references this rule.

A11-68

LOSS OF INTERCOM

THE FLIGHT WILL BE CONTINUED FOR THE LOSS OF ALL INTERCOM.

Intercom is desirable but not mandatory for crew coordination. When seated for entry, the CDR and PLT can easily communicate without the intercom. Communications with MS1 and MS2 can be done using the Air/Ground or Air/Air loops if necessary, although simultaneous transmissions to the STDN in these cases would occur. It would also be necessary to use the Air/Ground or Air/Air loops to record voice on the solid state recorders. These conditions may be undesirable but not considered serious enough to shorten the mission @[121505-7133B]

Rule {A11-1001}, COMMUNICATIONS GO/NO-GO CRITERIA, references this rule.

FLIGHT RULES

A11-69

LOSS OF UHF

LOSS OF UHF WILL RESULT IN THE FLIGHT CONTINUING TO NOMINAL EOM.

UHF voice is used as the sole source of EVA communications, as the source of communication on the universal guard channel (243.0 MHz), and as an alternate source of communication during ascents and entries. Failures of UHF affecting air/ground communications should not result in an early mission termination as long as S-band redundancy exists for entry.

Rule {A11-1001}, COMMUNICATIONS GO/NO-GO CRITERIA, references this rule.

A11-70

LOSS OF GCIL

LOSS OF GCIL WILL RESULT IN THE FLIGHT CONTINUING TO NOMINAL EOM.

Loss of GCIL capability implies loss of command capability to most of the communications systems, loss of a quick way to switch S-band strings (the "Panel/Command" capability) and loss of some unique functions that require a GCIL; e.g., frequency selection. Workarounds exist in all cases although the crew would have to assume some additional workload. The resulting loss of efficiency does not justify shortening the mission.

Rule {A11-1001}, COMMUNICATIONS GO/NO-GO CRITERIA, references this rule.

FLIGHT RULES

A11-71

LOSS OF RECORDERS

- A. THE FLIGHT WILL BE CONTINUED FOR A LOSS OF ALL SOLID STATE AND MADS RECORDERS. @[092701-4848A] @[121505-7133B]

In order to justify a mission termination, either an actual or potential crew safety hazard must exist, all planned mission objectives must have been achieved, or no further useful mission objectives can be achieved on this flight for whatever reason. It is extremely unlikely that failure of any or all of these recorders would result in one of these three conditions. Recorders are generally used to document a complete mission history and to backup or supplement analog or digital data that is acquired by other means, e.g., real time. When this is not the case, the data is rarely critical to total mission success as a backup was apparently not justifiable. The MADS recorder is a sole source of orbiter supplemental data; but, since this data is usually for entry performance evaluation, a MADS recorder failure does not justify an early reentry as the data is lost regardless. Recorder criticality, if any, would be defined in the Flight Rules Annex. @[092701-4848A] @[121505-7133B]

THIS RULE CONTINUED ON NEXT PAGE

FLIGHT RULES

A11-71 **LOSS OF RECORDERS (CONTINUED)**

- B. IF SSR 2 FAILS DURING ASCENT ON A MISSION IN WHICH SSR 1 IS RECORDING PAYLOAD DATA INSTEAD OF OPS DATA, SSR 1 WILL BE RECONFIGURED TO RECORD OI DATA. @[092701-4848A] @[121505-7133B]
- C. AN SSR IS CONSIDERED FAILED WHEN ANY OF THE FOLLOWING OCCUR:
@[121505-7133B]
1. RECORDER BITE INDICATION PRESENT.
 2. RECORD POSITION DOES NOT INCREASE.

SSR 2 normally records Main Engine and OPS data during ascent; SSR 1 normally records OPS data also, but is available for use as a payload recorder if required. Should SSR 2 fail during ascent, SSR 1 is required to record OPS data. @[092701-4848A]

Rule {A11-1001}, COMMUNICATIONS GO/NO-GO CRITERIA, references this rule.

FLIGHT RULES

A11-72 LOSS OF TV

THE FLIGHT WILL BE CONTINUED FOR LOSS OF ALL OR PART OF THE TV SYSTEM.

The TV system has never been identified as being essential for crew safety purposes. It is usually used for real-time or near real-time public information purposes and for mission documentation of payload bay activities. It has also proven useful as a close-in ranging aid, as an RMS grapple aid, for monitoring PAM PKM burns, and miscellaneous, often unforeseen, mission activities such as water dump nozzle survey. None of these uses are considered a realistic justification for an early flight termination. It is conceivable however, that some mission objectives may not be satisfied for a total TV system loss. These will be identified in the Flight Rule Annex.

Rule {A11-1001}, COMMUNICATIONS GO/NO-GO CRITERIA, references this rule.

A11-73 LOSS OF OCA @[012402-5068]

LOSS OF OCA WILL RESULT IN THE FLIGHT CONTINUING TO NOMINAL EOM.

OCA is a major convenience for passing information to the crew. If OCA capability were lost, the same information would be passed via voice. @[021998-6516] @[012402-5068]

A11-74 PCM MASTER UNIT (PCMMU)

A PCMMU IS CONSIDERED FAILED IF ANY ONE OF THE FOLLOWING CONDITIONS EXISTS: @[012407-7383A]

- A. IT CANNOT SEND OPERATIONAL INSTRUMENTATION (OI) DATA TO ANY GPC.
- B. IT CANNOT DOWNLIST ANY GNC DATA.
- C. IT CANNOT SEND HIGH DATA RATE TELEMETRY TO EITHER NSP.

A PCMMU is considered failed for the loss of its ability to send OI data to any GPC because the resident flight software in the GPC's require insight into systems which only pass their data to the GPC's via the PCMMU. A PCMMU is considered failed for loss of its ability to process GNC data from any GPC because this is the only means by which the MCC can monitor the status of the orbiters guidance systems and orbiter attitude. Loss of SM and BFS data is not considered in this rule since their loss is only considered to be an issue for systems management tasks or backup guidance information being monitored in the MCC. The crew continues to have SM and BFS data on their displays. A PCMMU is considered failed for the loss of its ability to send high data rate telemetry (128 KBPS) to either NSP because high data rate to the MCC as well as the crew is required to be able to support normal crew operations during certain phases of the mission. Loss of the low data rate (64 KBPS) was not considered in this rule because its loss does not impact MCC or crew operations.

Reference Rules {A2-129}, ORBITER ON-ORBIT HIGH DATA RATE REQUIREMENTS [HC] and {A6-103}, OMS BURN DOWNLIST REQUIREMENT. @[012407-7383A]

FLIGHT RULES

A11-75 **LOSS OF PCMMU'S**

A. LOSS OF ONE PCMMU WILL RESULT IN AN MDF.

The PCMMU's are required to provide all real-time and recorded telemetry to MCC and much onboard systems data to the SM or BFS GPC's for crew display and class 3 alerts. There are no available workarounds for a PCMMU failure. Considering the impact of losing such extensive insight into the onboard systems in the event of a second failure versus the small gain in mission achievement that may be possible, redundant PCMMU's should be required to extend the flight beyond minimum duration.

B. LOSS OF TWO PCMMU'S WILL RESULT IN A NEXT PLS LANDING.

This failure results in a significant loss of telemetry or onboard monitoring capability.

Rule {A11-1001}, COMMUNICATIONS GO/NO-GO CRITERIA, references this rule.

A11-76 **LOSS OF OI MDM**

LOSS OF ANY OI MDM WILL RESULT IN THE FLIGHT CONTINUING TO NOMINAL EOM.

The impacts of losing any single OI multiplexer/demultiplexer have been analyzed with the results documented in JSC-16983, OI MDM/DSC Failure Impacts. The analysis reveals that adequate instrumentation remains for making mission-critical decisions using other sources. Flight Data File procedures exist that reference any configurations that are necessary following the loss of the LRU.

A11-77 **LOSS OF ANY OI DSC**

LOSS OF ANY OI DSC WILL RESULT IN THE FLIGHT CONTINUING TO NOMINAL EOM.

The impacts of losing any single OI Dedicated Signal Conditioner have been analyzed with the results documented in JSC-16983, OI MDM/DSC Failure Impacts. The analysis reveals that adequate instrumentation remains for making mission critical decisions using other sources. Flight Data File procedures exist that reference any reconfigurations that are necessary following the loss of the LRU.

FLIGHT RULES

A11-78 **LOSS OF EXTERNAL TANK FEEDLINE CAMERA REAL-TIME DOWNLINK**

NO ACTION WILL BE TAKEN FOR THE LOSS OF REAL-TIME DOWNLINK FROM THE EXTERNAL TANK CAMERA SYSTEM. ©[042706-7326A]

ET camera downlink is considered a crit 3 function and by design the MCC has limited insight and control over this system. ©[042706-7326A]

A11-79 **LOSS OF OBSS ITVC**

OBSS INTENSIFIED TELEVISION CAMERA (ITVC) IS CONSIDERED FAILED WHEN IMAGES FROM THE CAMERA ARE NOT RECEIVED AT THE CCTV SYSTEM. ©[062206-7329A]

The Orbiter Boom Sensor System (OBSS) ITVC is used for situational awareness and as backup to the Laser Dynamic Range Imager (LDRI) imaging. It decodes and forwards the commands that move the Pan and Tilt Unit (PTU). If flown, the Integrated Sensor Inspection System (ISIS) Digital Camera (IDC) is a backup to OBSS ITVC 2-Dimensional images. ©[062206-7329A]

A11-80 **LOSS OF LCS**

THE LASER CAMERA SYSTEM (LCS) IS CONSIDERED FAILED WHEN COMMUNICATION BETWEEN THE LASER CAMERA HEAD (LCH) AND THE LASER CAMERA CONTROLLER (LCC) IS PERMANENTLY LOST. ©[062206-7330]

The LCS requires communications between its components. The LCH is the sensor located at the end of the OBSS. If the LCH cannot communicate across the ethernet link to the LCC located in a laptop computer on the flight deck of the orbiter, it will not be able to scan because the laser will turn off. ©[062206-7330]

A11-81 **LOSS OF IDC**

THE INTEGRATED SENSOR INSPECTION SYSTEM (ISIS) DIGITAL CAMERA (IDC) IS CONSIDERED FAILED WHEN COMMUNICATION BETWEEN THE CAMERA HEAD AND THE DIGITAL CAMERA CONTROL SOFTWARE (DCCS) OPERATING ON A LAPTOP COMPUTER IS PERMANENTLY LOST. ©[062206-7344A]

The IDC requires communications between its components. The IDC is the sensor located at the end of the OBSS. If the IDC cannot communicate across the ethernet link to the DCCS located in a laptop computer on the flight deck of the orbiter, it will not be able to operate. ©[062206-7344A]

FLIGHT RULES

A11-82

LOSS OF RSC

THE REMOTE MANIPULATOR SYSTEM (RMS) SIDE-VIEW CAMERA (RSC) IS CONSIDERED FAILED WHEN IMAGES FROM THE CAMERA ARE NO LONGER AVAILABLE TO THE CCTV MONITORS. LOSS OF THE RSC WILL REQUIRE MORE TIME FOR OBSS SURVEYS AND POSSIBLY RESULT IN TERMINATION OF OBSS SURVEYS IF SUPPLEMENTAL VIEWS ARE NOT AVAILABLE (I.E., ISS CAMERAS) . @[062206-7332A]

Without the RSC, the crew will not have a critical view of the position of the OBSS relative to the area of Thermal Protection System (TPS) that is being surveyed. The time to complete the survey will increase due to the fact that other views, if available, will have to be used to supplement the loss of the RSC. If other views are not available, it may not be possible to safely position the OBSS for surveys. @[062206-7332A]

A11-83

LOSS OF LDRI

LASER DYNAMIC RANGE IMAGER (LDRI) IS CONSIDERED FAILED WHEN IMAGES FROM THE CAMERA ARE NOT RECEIVED AT THE CCTV SYSTEM. @[052006-7328]

LDRI has a single failure which could cause the images from the camera to not be transmitted to the CCTV system. If flown, the Laser Camera System (LCS) is a backup to LDRI. @[052006-7328]

A11-84 THROUGH A11-100 RULES ARE RESERVED @[062206-7326A] @[062206-7329A]
@[062206-7330] @[062206-7344A] @[062206-7332A] @[052006-7328]

FLIGHT RULES

GO/NO-GO CRITERIA

A11-1001

COMMUNICATIONS GO/NO-GO CRITERIA

FAILURE	INVOKE MDF IF:	ENTER NEXT PLS IF:	RULE REF.
A. COMMUNICATIONS			
(1) 2-WAY VOICE (3) (A/G, 1, 2, UHF)		2 ↓	{A11-51}
(2) COMMAND (S-BD 1, 2)	2 ↓		{A11-53}
(3) 2-WAY VOICE + COMMAND		ALL ↓ [4]	{A11-52}
(4) TELEMETRY		ALL ↓	{A11-54}
(5) TDRS TRACKING			{A11-60}
(6) NSP UPLINK (2)		2 ↓ [8]	{A11-63A},C
(7) NSP DOWNLINK (2)	1 ↓	2 ↓ [9]	{A11-63B},D
(8) XPNDR UPLINK (2)		2 ↓ [8]	{A11-58A},B
(9) XPNDR DOWNLINK (2) (I)	2 ↓	2 ↓ I ↓ [7]	{A11-58A},C
(10) ACCU (2) (I)	2 ↓ [5] I ↑	1 ↓ I ↓ [6]	{A11-65}
(11) COMSEC (2) [1]			{A11-64}
(12) KU-BAND [1]			{A11-55}
(13) UHF			{A11-69}
(14) ATU (PLT & MS)			{A11-67}
(15) TV			{A11-72}
(16) OCA			{A11-73}
(17) INTERCOM			{A11-68}
(18) PI (2) [1]			ANNEX
(19) PSP (2) [1]			ANNEX
(20) S-BD PREAMP (2) [10]			{A11-61}
(21) S-BD PWR AMP (2) [10]			{A11-61}
(22) GCIL			{A11-70}
(23) ANTENNA ELECTRONICS			{A11-62}
B. INSTRUMENTATION			
(1) PCMMU (2)	1 ↓	2 ↓	{A11-75}
(2) OI MDM'S (7)			{A11-76}
(3) OI DSC'S (14) [11]			{A11-77}
(4) PDI [1]			ANNEX
(5) MADS/OEX			{A11-71A}
(6) OPS RCDR (2)			{A11-71A}
(7) PL RCDR [1]			{A11-71A} OR ANNEX

LEGEND:

	NO REQUIREMENT
	REQUIRED

- () QUANTITY
- [] NOTE REFERENCE
- I ↑ IFM SUCCESSFUL

Rule {A17-1001}, LIFE SUPPORT GO/NO-GO CRITERIA, references this rule.

THIS RULE CONTINUED ON NEXT PAGE

FLIGHT RULES

A11-1001

COMMUNICATIONS GO/NO-GO CRITERIA (CONTINUED)

NOTES:

- [1] REFER ALSO TO ANY MISSION-SPECIFIC RULES DOCUMENTED IN FLIGHT RULES ANNEXES.
- [2] RESERVED
- [3] RESERVED
- [4] IF NO VOICE AND NO COMMAND AND PAST LAST PLS OPPORTUNITY, THEN DEORBIT PER CRITERIA AND PRIORITIES LISTED IN RULE {A11-52}, LOSS OF BOTH VOICE AND COMMAND. @[012402-5069]
- [5] IFM REMAINS WHICH BYPASSES THE ACCU'S AND RESTORES DUAL AIR/GROUND VOICE SOURCES.
- [6] LOSS OF ONE ACCU AND AN UNSUCCESSFUL IFM RESULTS IN BEING ONE FAILURE AWAY FROM LOSS OF ALL VOICE. LOSS OF BOTH ACCU'S AND AN UNSUCCESSFUL IFM RESULTS IN LOSS OF ALL VOICE.
- [7] IFM ALLOWS REGAIN OF DOWNLINK (NOT TO TDRS) TO GROUND STATIONS. RULE IS BASED UPON LOSS OF ALL ENTRY TELEMETRY AND ONLY A SINGLE VOICE SOURCE (UHF) REMAINING FOR ENTRY.
- [8] RULE IS BASED ON ONLY A SINGLE VOICE SOURCE (UHF) REMAINING FOR ENTRY.
- [9] RULE IS BASED UPON LOSS OF TELEMETRY AND ONLY A SINGLE VOICE SOURCE (UHF) REMAINING FOR ENTRY.
- [10] IMPLIES LOSS OF TDRS TELEMETRY.
- [11] ADDITIONAL DCS'S ARE INSTALLED FOR EDO PALLET FLIGHTS. @[092701-4872]

FLIGHT RULES

THIS PAGE INTENTIONALLY BLANK

FLIGHT RULES

SECTION 12 - ROBOTICS

GENERAL

A12-1	EVA FOR RMS OPERATIONS.....	12-1
A12-2	UNATTENDED RMS CONSTRAINTS.....	12-3
A12-3	TEMPERATURE CONSTRAINTS [CIL].....	12-6
A12-4	RMS ACTIVITY TERMINATION.....	12-8
A12-5	ORBITER AVOIDANCE MANEUVERS CONSTRAINT [CIL]..	12-8
A12-6	OMS/RCS CONSTRAINTS.....	12-9
A12-7	RMS IFM D&C KIT.....	12-15
A12-8	RMS OPCODE UPLINKS.....	12-18
A12-9	RMS MCIU BITE OVERRIDES [CIL].....	12-19
A12-10	SPARE MANIPULATOR CONTROL INTERFACE UNIT (MCIU).....	12-20
A12-11	ORBITER BOOM SENSOR SYSTEM (OBSS) THERMAL CONSTRAINTS.....	12-21
A12-12	ORBITER BOOM SENSOR SYSTEM (OBSS) POWER CONSTRAINTS.....	12-24
A12-13	THROUGH A12-50 RULES ARE RESERVED.....	12-24

MPM/MRL LOSS/FAILURE DEFINITIONS

A12-51	MPM/MRL POSITIONING.....	12-25
A12-52	MPM FAILED IN TRANSIT.....	12-25
A12-53	MRL FAILED IN TRANSIT.....	12-26
A12-54	THROUGH A12-70 RULES ARE RESERVED.....	12-26

FLIGHT RULES

MPM/MRL SYSTEMS MANAGEMENT

A12-71	MPM/MRL CYCLING.....	12-27
A12-72	MPM DEPLOY/STOW CONSTRAINTS.....	12-28
A12-73	MRL CONSTRAINTS.....	12-30
A12-74	INADVERTENT MPM CYCLING PROTECTION [CIL] [HC]	12-32
A12-75 THROUGH A12-90	RULES ARE RESERVED.....	12-32

RMS PREOPERATION SYSTEM MANAGEMENT

A12-91	SHOULDER BRACE OPERATION.....	12-33
A12-92	RMS CHECKOUT.....	12-34
A12-93 THROUGH A12-110	RULES ARE RESERVED.....	12-34

RMS DRIVE SYSTEM MANAGEMENT

A12-111	MODE AVAILABILITY DRIVE CONSTRAINT.....	12-35
A12-112	FIELD OF VIEW CONSTRAINT [CIL].....	12-35
A12-113	AUTO MODE ENTRY CONSTRAINT [CIL].....	12-36
A12-114	ORBITER PROXIMITY CONSTRAINTS [CIL].....	12-37
A12-115	INOPERATIVE BRAKE CONSTRAINT [CIL].....	12-39
A12-116	AUTO BRAKES CONSTRAINT [CIL].....	12-39
A12-117	CONTINGENCY STOP [CIL] [HC].....	12-40
A12-118	POHS AND LEFT-HANDED COORDINATE SYSTEMS [HC].	12-41
A12-119 THROUGH A12-140	RULES ARE RESERVED.....	12-41

END EFFECTOR (EE) LOSS/FAILURE DEFINITIONS

A12-141	EE BACKUP RELEASE.....	12-42
A12-142	EE CAPTURE/RIGIDIZE.....	12-42
A12-143	EE RELEASE/DERIGIDIZE.....	12-42
A12-144 THROUGH A12-160	RULES ARE RESERVED.....	12-42

FLIGHT RULES

END EFFECTOR SYSTEM MANAGEMENT

A12-161	PAYLOAD GRAPPLE CONSTRAINTS.....	12-43
A12-162	EE MODE SWITCH CONSTRAINTS [CIL].....	12-45
A12-163	CAPTURE AND RELEASE PROXIMITY CONSTRAINT [CIL].....	12-46
A12-164	PAYLOAD RELEASE DURING BERTHING.....	12-46
A12-165	THROUGH A12-180 RULES ARE RESERVED.....	12-46

RMS JETTISON SYSTEM MANAGEMENT

A12-181	JETTISON SYSTEM CONSTRAINT.....	12-47
A12-182	RMS/PAYLOAD JETTISON.....	12-48
A12-183	THROUGH A12-200 RULES ARE RESERVED.....	12-48

GO/NO-GO CRITERIA

A12-1001	RMS GO/NO-GO CRITERIA.....	12-49
----------	----------------------------	-------

FLIGHT RULES

THIS PAGE INTENTIONALLY BLANK

FLIGHT RULES

SECTION 12 - ROBOTICS

GENERAL

A12-1 **EVA FOR RMS OPERATIONS**

- A. FOR RMS FAILURES THAT ARE KNOWN PRIOR TO THE START OF RMS OPERATIONS:

AN UNSCHEDULED EVA TO CONFIGURE THE RMS FOR OPERATIONS (E.G., SHOULDER BRACE RELEASE, MPM DEPLOY) MAY BE CONSIDERED ONLY IF A SECOND EVA WILL NOT BE REQUIRED TO MAKE THE ORBITER SAFE FOR ENTRY.

FOR THE COMPLETE LOSS OF MPM MOTOR DRIVE CAPABILITY, AN EVA TO DEPLOY AND/OR STOW THE MPM'S WILL BE PERFORMED TO PERMIT HIGH PRIORITY LOADED RMS OPERATIONS. @[092503-6085A]

EVA techniques are available to release the shoulder brace and to deploy the arm which will place the RMS into an operational configuration. The shoulder brace is only required for ascent loads; so, once it is released, an additional EVA will not be required to reattach it. Subsequent to MPM deploy, there could be occasions where the EVA crewmember would wait for the accomplishment of the mission objective and stow the MPM within the same EVA. However, if the arm is deployed EVA, it is very likely a second EVA would be required to stow it. If a second EVA is not available due to an emergency deorbit or for protecting contingency EVA consumables, the arm would have to be jettisoned to make the payload bay safe for entry.

The MPM must be deployed to achieve mission success for high priority RMS operations. Due to the priority of the mission objectives, EVA support for these contingencies has been preflight planned.
@[092503-6085A]

THIS RULE CONTINUED ON NEXT PAGE

FLIGHT RULES

A12-1

EVA FOR RMS OPERATIONS (CONTINUED)

B. FOR RMS FAILURES THAT OCCUR OR ARE DISCOVERED AFTER RMS OPERATIONS HAVE COMMENCED:

IF CONDITIONS PERMIT, AND AFTER ALL OTHER METHODS HAVE FAILED, AN UNSCHEDULED EVA MAY BE CONSIDERED FOR THE FOLLOWING TASKS TO PRECLUDE HAVING TO JETTISON THE RMS, PAYLOAD, AND/OR MPM:

1. END EFFECTOR (EE) RELEASE.
2. RMS JOINT ALIGN.
3. RMS TIEDOWN.
4. MPM STOW.
5. PAYLOAD BERTHING.

Once RMS operations have commenced, there are additional EVA techniques available for various failures in the end effector, joint motors, MRL, and MPM which will make the RMS safe for entry and preclude jettison of the arm, payload, and/or MPM. For certain payloads, the crew may also be trained to berth the payload manually using EVA techniques.

Rule {A2-112A}, PDRS, references this rule. ©[ED 1

FLIGHT RULES

A12-2

UNATTENDED RMS CONSTRAINTS

- A. DURING CREW AWAKE PERIODS, THE UNCRADLED RMS (LOADED OR UNLOADED) MAY BE LEFT UNATTENDED IF ALL OF THE FOLLOWING CONDITIONS ARE MET:
1. THE ARM IS SELECTED.
 2. THE BRAKES ARE ON.
 3. THE MODE SWITCH IS NOT IN DIRECT.
 4. THE JOINT SWITCH IS IN THE CRITICAL TEMPERATURE POSITION.
 5. THE MANIPULATOR CONTROLLER INTERFACE UNIT (MCIU) MAINTAINS I/O WITH THE GPC. @[ED]
 6. THE FLIGHT-SPECIFIC ANNEX RULES ARE MET.
 7. RMS/PAYLOAD CLEARANCE OF AT LEAST 1.5 METERS (5 FEET) FROM STRUCTURE, AS DEFINED BELOW BY THE RMS BOOM ENVELOPE, IS MAINTAINED. @[062603-6028]

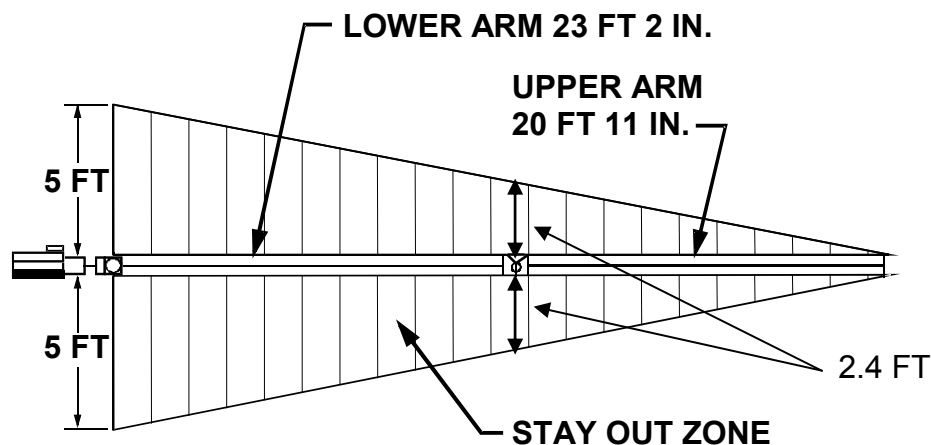

@[062603-6028]

THIS RULE CONTINUED ON NEXT PAGE

FLIGHT RULES

A12-2

UNATTENDED RMS CONSTRAINTS (CONTINUED)

With the arm selected, I/O established with the MCIU, and the brakes on, the RMS software is in the idle mode with all six joints held by the mechanical brakes. Idle mode is required to determine the health of the arm. The RMS mode switch should be left in any position except DIRECT so that the joint slip algorithm will operate. The joint switch should be in the CRIT TEMP position so that a failure of the SINGLE/DIRECT DR switch will not lead to a single-joint runaway. Meeting the flight-specific annex rules is required to ensure that specific DAP configuration and RMS position/clearance constraints are met to prevent orbiter/RMS/payload contact (PDRS Working Panel 16-4 baselined this criteria).

- B. NOMINALLY, DURING CREW SLEEP PERIODS AND DURING EXTENDED PERIODS OF NON-RMS OPERATIONS, THE RMS SHALL BE CRADLED, LATCHED, AND THE SYSTEM LEFT IN THE TEMPERATURE MONITOR MODE. HOWEVER, PREFLIGHT PLANNED OVERNIGHT PARKING IS ACCEPTABLE IF THE RMS IS UNGRAPPLED AND THE CONDITIONS IN PARAGRAPH A ARE SATISFIED. FLIGHT-SPECIFIC EXCEPTIONS FOR HIGH PRIORITY PAYLOADS ARE IDENTIFIED IN THE FLIGHT RULES ANNEX. THE RMS CONFIGURATION FOR THE EXCEPTIONS IS DEFINED IN PARAGRAPH A.

The cradled and latched configuration of the RMS protects against RMS and MRL failures causing a delay should an emergency deorbit be required. Preflight planned parking of the ungrappled RMS is acceptable to accommodate specific customer requirements such as witness plates and other data gathering that cannot be accomplished in 1 crew day. No flight-specific analysis needs be done for the ungrappled RMS.

- C. FOR A CONTINGENCY REQUIRING OVERNIGHT PARK, THE UNCRADLED RMS (LOADED OR UNLOADED) MAY BE LEFT UNATTENDED PROVIDED ALL CONDITIONS IN PARAGRAPH A ARE SATISFIED.

The crew response time to an RMS alert is longer when the crew is asleep. The additional risk imposed by a longer response time is considered small and preferable to RMS/payload jettison. The arm shall be left configured per paragraph A for the same reasons as above. On-Orbit Flight Techniques Panel #130 baselined acceptability of this RMS configuration for contingency overnight parking.

THIS RULE CONTINUED ON NEXT PAGE

FLIGHT RULES

A12-2

UNATTENDED RMS CONSTRAINTS (CONTINUED)

- D. FOR RMS/ORBITER CONTINGENCIES WHERE THE CONDITIONS OF PARAGRAPH A CANNOT BE MET, UNLOADED, UNATTENDED OVERNIGHT PARK IS ACCEPTABLE WITH THE ARM UNPOWERED.

FLIGHT-SPECIFIC EXCEPTIONS FOR LOADED CASES WILL BE IDENTIFIED IN THE FLIGHT RULES ANNEX.

Certain RMS anomalies (e.g., loss of health monitoring insight or loss of one electrical inhibit) combined with mission situations may require the RMS to be deselected and/or power removed. An unpowered arm prevents subsequent electrical failures from causing a possible unannounced or unprotected hazard. Deselecting the arm is the preferred method of removing power to allow temperature, MCIU, and D&C health monitoring. RMS power may also be removed via the RMS power switch. RMS temperature control and/or monitoring should be considered prior to removing RMS power. Real-time insight and annunciation as to the status of the RMS will be affected when removing RMS power.

FLIGHT RULES

A12-3

TEMPERATURE CONSTRAINTS [CIL]

- A. BOTH RMS HEATERS SHALL BE ACTIVATED AT LEAST 1 HOUR PRIOR TO RMS OPERATIONS. IF EVENTS REQUIRE THE RMS TO BE USED BEFORE THE 1 HOUR REQUIREMENT HAS BEEN MET, BOTH HEATER SYSTEMS SHOULD BE ACTIVATED AND THE LIGHT EMITTING DIODE (LED) AND THE ARM BASED ELECTRONICS (ABE) TEMPERATURES MUST BE AT LEAST 10 DEG (21 DEG) F.

SPAR Aerospace recommended, during the FMEA/CIL activities, that both RMS heater buses be turned on at least 1 hour before arm operations to guarantee that thermal gradients across the joints do not cause joint problems in the event of a heater failure. SPAR also confirmed that RMS operations may proceed immediately without any risk of uncommanded motion if the temperatures as reported by the thermistors are within the nominal range (at least 21 deg F). (SPAR Aerospace Response to NASA-VP-87-020.)

- B. RMS OPERATIONS WILL BE TERMINATED AND THE ARM CRADLED AND LATCHED WITHIN 25 MINUTES IF THE LOW TEMPERATURE ALARM LIMIT (LED -20 DEG (0 DEG) F, ABE -20 DEG (0 DEG) F) IS REACHED, AND TROUBLE-SHOOTING DOES NOT ALLEVIATE THE PROBLEM. IF THE LOW TEMPERATURE QUALIFICATION LIMIT (LED -42 DEG (-10 DEG) F, ABE -33 DEG (-10 DEG) F) IS REACHED, FURTHER RMS OPERATIONS WILL NOT BE PERFORMED UNTIL THE TEMPERATURES RETURN WITHIN THE ALARM LIMITS. A JOINT DRIVE TEST IN DIRECT WILL BE PERFORMED TO VERIFY HEALTH PRIOR TO ANY FURTHER OPERATIONS.

There is an SODB requirement that heater power must be restored within 25 minutes of receipt of the low temperature alarm. If troubleshooting does not alleviate the low temperature problem, the arm must be placed in a safe configuration (meaning cradled and latched) within 25 minutes to prevent any degraded performance due to the low temperature. If the low temperature qualification limits are reached, arm performance may be unreliable; so, further RMS operations will not be performed until temperatures return within the alarm limits. Once within limits, a joint drive test in direct will be performed to ascertain joint health. Numbers in parentheses assume a 1-3/4 count potential error in the thermistor readings.

THIS RULE CONTINUED ON NEXT PAGE

FLIGHT RULES

A12-3

TEMPERATURE CONSTRAINTS [CIL] (CONTINUED)

- C. RMS OPERATIONS WILL BE TERMINATED AND THE ARM CRADLED AND LATCHED WITHIN 15 MINUTES IF THE HIGH TEMPERATURE ALARM LIMIT (LED 176 DEG (172 DEG) F, ABE (EE) 147 DEG (144 DEG) F, ABE (SPA) 110 DEG (106 DEG) F) IS REACHED, AND TROUBLESHOOTING DOES NOT ALLEVIATE THE PROBLEM. THE ARM MUST BE CRADLED AND LATCHED BEFORE THE TEMPERATURE REACHES THE ACCEPTANCE TEMPERATURE LIMIT (LED 186 DEG (181 DEG) F, ABE (EE) 157 DEG (154 DEG) F, ABE (SPA) 120 DEG (117 DEG) F). IF THE ARM REACHES THE ACCEPTANCE TEMPERATURE LIMIT, POWER WILL BE REMOVED. IF THE HIGH TEMPERATURE QUALIFICATION LIMIT (LED 205 DEG (202 DEG) F, ABE (EE) 178 DEG (176 DEG) F, ABE (SPA) 140 DEG (136 DEG) F) IS REACHED, FURTHER RMS OPERATIONS WILL NOT BE PERFORMED UNTIL THE TEMPERATURES RETURN WITHIN THE ALARM LIMITS. A JOINT DRIVE TEST IN DIRECT WILL BE PERFORMED TO VERIFY HEALTH PRIOR TO ANY FURTHER OPERATIONS. ©[ED]
 @[111298-6744]

There is an SODB requirement that continued operation of the RMS is limited to 15 minutes if the high temperature alarm limit has been reached. In addition, all power will be removed from the arm if the high temperature acceptance test limits are reached. If troubleshooting does not alleviate the problem, the arm must be placed in a safe configuration (meaning cradled and latched) as soon as possible to prevent any degraded performance due to the high temperature. If the high temperature qualification limits are reached, arm performance may be unreliable so the arm should not be uncradled again until temperatures return within the alarm limits. Once within limits, a joint drive test in direct will be performed to ascertain joint health prior to any further arm operations. Numbers in parentheses assume a 1-3/4 count potential error in the thermistor readings. Spar Aerospace Memo PMO/97-017, dated June 25, 1997, updated the upper limit ABE numbers based on the redesigned SPA lower acceptance and qualification limits. @[111298-6744]

Rules {A18-451}, ORBITER THERMAL CONSTRAINTS AND ATTITUDE MANAGEMENT [CIL], and {A12-1001V}, RMS GO/NO-GO CRITERIA, reference this rule. ©[ED]

FLIGHT RULES

A12-4 **RMS ACTIVITY TERMINATION**

- A. FOR MPM AND MRL EOM CONSTRAINTS, REFERENCE RULE {A2-103C} AND D, EXTENSION DAY REQUIREMENTS. @[090894-1670B] @[113095-1809A]
- B. DECLARATION OF A NEXT PLS DEORBIT IS CAUSE TO TERMINATE RMS ACTIVITIES IMMEDIATELY. FLIGHT-SPECIFIC EXCEPTIONS FOR HIGH-PRIORITY OPERATIONS WILL BE IDENTIFIED IN THE FLIGHT-SPECIFIC ANNEX.

In the event of a next PLS situation, the orbiter must be in a safe configuration as soon as possible. This requires that the RMS be cradled, latched, and stowed prior to payload bay door closure. If important arm operations are being performed, such as berthing a payload, the situation may allow for those operations to be completed depending on the time left before deorbit.

A12-5 **ORBITER AVOIDANCE MANEUVERS CONSTRAINT [CIL]**

A PILOT SHALL ALWAYS BE AVAILABLE TO PERFORM A COLLISION AVOIDANCE MANEUVER DURING ALL LOADED RMS OPERATIONS IN THE EVENT OF A PAYLOAD UNCOMMANDED RELEASE.

Since there are failure modes that result in an uncommanded release of a payload that is attached to the arm, it may be necessary to maneuver the orbiter in a short period of time to avoid collision with the free-flying payload.

FLIGHT RULES

A12-6

OMS/RCS CONSTRAINTS

A. VRCS @[113095-1809A]

1. VRCS CONTROL IS NOT PERMITTED WHEN THE RMS IS:
 - a. IN TEST MODE AND GRAPPLED TO A NON-CONSTRAINED PAYLOAD.
 - b. PERFORMING FREE-FLYING PAYLOAD END EFFECTOR OPERATIONS.
 - c. IN MOTION WITH A PAYLOAD OVER 3640 KG (8000 LBS).
(NOTE: THIS CONSTRAINT APPLIES TO DAP AUTO CONTROL ONLY; DAP MANUAL MODE IS ALLOWED.)
2. FOR OTHER VRCS CONSTRAINTS DURING LOADED RMS OPERATIONS (DUE TO DAP STABILITY PROBLEMS, PAYLOAD CLEARANCE CONCERNS, PAYLOAD LOADS SENSITIVITY CONCERNS, OR OTHER PAYLOAD CONSTRAINTS), REFERENCE THE FLIGHT RULES ANNEX.

When in test mode, unexpected arm motion due to payload inertia may result from VRCS firings since all joints are at maximum current attenuation and are essentially free to rotate when external forces are applied (except for internal gearbox friction). No free-flying EE operations should be performed with VRCS because jet firings may cause unexpected motion of the EE when the arm is limped for capture or rigidize sequences or tipoff rates may occur at release. Volume XIV, Appendix 8 states that prior to the grapple sequence, the orbiter RCS will be configured to free drift. It also specifies an orbiter DAP free drift period prior to release between 15 and 120 seconds to allow RMS oscillation damping.

Both SPAR and MPAD have performed analyses which show there is no chance of exceeding RMS or longeron loads for any combination of VRCS firings with a loaded RMS. However, there can be stability problems associated with manipulation of high mass payloads due to the change in the composite cg of the orbiter/payload. Volume XIV, Appendix 8 states that for payloads weighing over 8000 pounds, DAP free drift is required while the RMS is maneuvering the payload. @[113095-1809A]

THIS RULE CONTINUED ON NEXT PAGE

FLIGHT RULES

A12-6

OMS/RCS CONSTRAINTS (CONTINUED)

B. PRCS ATTITUDE CONTROL @[113095-1809A]

1. PRCS PRI DAP ATTITUDE CONTROL IS NOT PERMITTED WHEN THE RMS IS:
 - a. IN A SINGULARITY.
 - b. AT A REACH LIMIT.
 - c. IN TEST MODE UNLESS GRAPPLED TO A CONSTRAINED PAYLOAD.
 - d. PERFORMING END EFFECTOR OPERATIONS.
 - e. MANEUVERING A PAYLOAD OVER APPROXIMATELY 450 KG (1000 LBS).
 - f. CLOSER THAN APPROXIMATELY 1.5M (5 FT) FROM ORBITER STRUCTURE, OTHER PAYLOADS, OR EVA CREWMEMBER.
2. FOR ADDITIONAL LOADED RMS PRCS CONSTRAINTS, REFERENCE THE FLIGHT RULES ANNEX.

Both SPAR and MPAD have performed analyses that show there is no constraint to an unloaded arm for PRCS firing as long as the arm is not positioned near a reach limit or singularity. At these positions, a degree of freedom is lost and the arm cannot relieve loads through backdriving. When in test mode, unexpected arm motion may result from PRCS firings since all joints are at maximum current attenuation and are essentially free to rotate when external forces are applied (except for internal gearbox friction). No EE operations should be performed with PRCS because jet firings may cause unexpected motion of the EE when the arm is limped for capture or rigidize sequences or tipoff rates may occur at release. Volume XIV, Appendix 8 states that prior to the grapple sequence, the orbiter RCS will be configured to free drift. It also specifies an orbiter DAP free drift period prior to release between 15 and 120 seconds to allow RMS oscillation damping.

The ICD specifically prohibits RMS from maneuvering a payload greater than 450 kg (1000 lbs) unless PRCS is inhibited.

Level B Groundrules and Constraints defines minimum clearance of 1.5 M (5 ft) to protect for induced motion resulting from PRCS auto hold and PRCS auto maneuver. @[113095-1809A]

THIS RULE CONTINUED ON NEXT PAGE

FLIGHT RULES

A12-6

OMS/RCS CONSTRAINTS (CONTINUED)

C. PRCs TRANSLATIONS @[113095-1809A]

1. PRCs TRANSLATIONS ARE NOT PERMITTED EXCEPT WHEN THE RMS IS:
 - a. UNLOADED PROVIDED CLEARANCE OF APPROXIMATELY 1.5M (5 FT) OR GREATER IS MAINTAINED BETWEEN THE RMS AND OTHER ORBITER STRUCTURE.
 - b. GRAPPLED TO A SIX-DOF CONSTRAINED PAYLOAD IN CONTINGENCY SITUATIONS THAT REQUIRE TRANSLATIONS.
2. REFERENCE THE FLIGHT RULES ANNEX FOR EXCEPTIONS FOR PAYLOADS REQUIRING TRANSLATIONS.

The loaded RMS has not been certified to withstand the motion or loads associated with PRCs translations, and a flight-specific analysis will need to be done for each specific case.

D. OMS USAGE: @[113095-1809A]

1. OMS BURNS WILL NOT BE PERFORMED WITH AN UNCONSTRAINED LOADED RMS.
2. PLANNED OMS BURNS (DUAL OR SINGLE ENGINE) ARE PERMITTED PROVIDED THE RMS IS CRADLED WITH AT LEAST TWO OF THREE MRL'S LATCHED OR THE UNLOADED RMS IS IN THE PRECRADLE POSITION (SY = 0, SP = 25, EP = -25, WP = 5, WY = 0, WR = 0).
3. IN CONTINGENCY SITUATIONS THAT REQUIRE OMS BURNS (I.E., OMS LEAK), OMS USAGE IS PERMITTED WITH THE UNLOADED RMS UNCRADLED AND NOT IN THE PRECRADLE POSITION (ASSUMES BEST EFFORT TO POSITION THE RMS AS CLOSE TO THE PRECRADLE POSITION AS POSSIBLE). OMS BURNS ARE ALSO PERMITTED IF THE RMS IS GRAPPLED TO A SIX-DOF CONSTRAINED PAYLOAD.

THIS RULE CONTINUED ON NEXT PAGE

FLIGHT RULES

A12-6

OMS/RCS CONSTRAINTS (CONTINUED)

Rockwell Space Operations Company (RSOC) analysis has determined that loads from OMS burns are well below the flight planning load limits, and no joint slippage occurs when the RMS is in the precradle position during an OMS burn. The analysis investigated single, double, and worst case failure conditions as well and determined all loads and motion were acceptable. Other positions analyzed showed several inches to several feet of motion for worst case OMS failures. OMS burns with a loaded RMS showed unacceptable motion and loads and could result in payload-to-orbiter contact. If a contingency OMS burn is required and the RMS cannot be maneuvered to the precradle position, a best effort to maneuver to the precradle is required to minimize the potential motion. Refer to STSOC transmittal Form, RSOC-635/250-91-066, October 4, 1991.

- E. EXCEPT FOR TRANSITORY MOTION, NO PART OF THE RMS SHALL BE MANEUVERED OR PARKED WITHIN THE FOLLOWING DISTANCES OF AN RCS JET CONTINUOUS FIRING RATE STAY-OUT ZONE, AS DEFINED BELOW, UNLESS THE JET IS DESELECTED. @[113095-1809A]

- F. FLIGHT-SPECIFIC EXCEPTIONS FOR THE LOWER RATE STAYOUT ZONES MAY BE IDENTIFIED IN THE FLIGHT-SPECIFIC ANNEX. @[113095-1809A]

- 1. PRCS:

FIRING RATE	STAY-OUT ZONES*							
CONTINUOUS	X=0	R=200	X=425	R=150	X=500	R=100	X=600	R=0
6 SECONDS	X=0	R=200	X=200	R=100	X=340	R=0		
80 MSEC	X=0	R=40	X=130	R=40	X=160	R=30	X=180	R=0

- 2. VRCS:

FIRING RATE	STAY-OUT ZONES*							
CONTINUOUS	X=0	R=18	X=50	R=18	X=70	R=10	X=80	R=0
80 MSEC	X=0	R=5	X=30	R=0				

*X = DISTANCE IN INCHES FROM THRUSTER IN DIRECTION OF THRUSTER PLUME

R = LATERAL DISTANCE IN INCHES FROM CENTER OF THRUSTER

THIS RULE CONTINUED ON NEXT PAGE

FLIGHT RULES

A12-6

OMS/RCS CONSTRAINTS (CONTINUED)

Based on data presented by SPAR at the STS-2 Orbit Flight Techniques Meeting #19 on August 28, 1981, the above clearances are required to prevent damage to the RMS thermal protection system. This is the minimum required separation in direct line with the center axis of the thruster. Based on Orbit Flight Techniques Meeting #149 on December 16, 1994, the decision was made to deselect the affected jets for long-term parking of the RMS in a jet stay-out zone to preclude the inadvertent pluming of the RMS. Additionally, PDRS Ops Checklist Unloaded Survey procedures have been updated to deselect jets for those surveys that violate RCS stay-out zones. @[113095-1809A]

- G. IN UNPLANNED CONTINGENCY SITUATIONS, WHEN THE STATIONARY RMS IS LOADED, CLOSED-LOOP VRCS ATTITUDE CONTROL (I.E., DAP AUTO, INRTL-DISC, LVLH-DISC) IS PERMITTED FOR ARM CONFIGURATIONS THAT HAVE NOT BEEN ANALYZED FOR DAP STABILITY PREFLIGHT IF THE FOLLOWING CRITERIA ARE MET: @[113095-1809A]
1. THE PAYLOAD WEIGHT IS LESS THAN 35K LB.
 2. THE RMS IS NOT IN A REACH LIMIT OR SINGULARITY.
 3. CLEARANCE BETWEEN THE PAYLOAD AND ORBITER IS AT LEAST 10 FEET.
 4. THE PAYLOAD IS NOT LOAD SENSITIVE.
 5. THE CREW MONITORS THE RMS AND ORBITER FOR SIGNS OF DAP INSTABILITY.
 6. THE FLIGHT CONTROL TEAM MONITORS FOR SIGNS OF DAP INSTABILITY.
 7. TIGHT RATE AND ATTITUDE DEADBANDS, SUCH AS THOSE USED FOR PAYLOAD RELEASE, ARE NOT USED.
 8. CLOSED-LOOP ATTITUDE HOLD WILL NOT BE INITIATED DURING LOS.
 9. CLOSED-LOOP ATTITUDE MANEUVERS WILL NOT BE INITIATED OR TERMINATED DURING LOS.
 10. THE BEST AVAILABLE DAP I-LOAD SET (CNTL ACCEL) FOR THE RMS/PL CONFIGURATION IS USED.

THIS RULE CONTINUED ON NEXT PAGE

FLIGHT RULES

A12-6

OMS/RCS CONSTRAINTS (CONTINUED)

IF AN INSTABILITY IS DETECTED, THE ORBITER DAP SHOULD BE DOWNMODED TO FREE DRIFT AND MANUAL CONTROL USED FOR ATTITUDE HOLD AND MANEUVERS.

IN ORDER TO REGAIN CLOSED-LOOP DAP CAPABILITY AFTER AN INSTABILITY HAS OCCURRED, THE RMS AND/OR DAP SHOULD BE RECONFIGURED BEFORE REINITIATING AUTO CONTROL.

A limited analysis of the effects of an unstable VRCS DAP on the loaded RMS (22k PL) has shown loads to be below the flight planning load limit and motion of the payload at a rate less than 2 in/min with the RMS brakes on and insignificant when the RMS was in position hold (Orbit Flight Techniques Panel Meeting #101). Discussion at Orbit Flight Techniques Panel meeting #105 concluded that the magnitude of the uncommanded motion of the RMS/PL is more than an order of magnitude below any unacceptable limit and that the RMS joints will backdrive to relieve loads as long as the RMS is not in a singularity or reach limit. Additionally, flight controllers can monitor phase plane activity and jet firing patterns to determine whether or not the DAP is unstable if the crew cannot detect the instability (ref. Draper memo SSV-88-49, Identification of RMS/FCS Instability During Payload Extended Operations, 10/21/88). Tight deadbands should not be used at nonanalyzed configurations because they have a high probability of causing an instability. Draper Lab recommends widening the deadbands to a rate limit of 0.1 deg/sec and an attitude deadband of 2.0 degrees. Instability during attitude maneuvers is less likely to occur by using a maneuver rate less than or equal to the rate limit. The most likely time for an instability to occur is when closed-loop control is first initiated or when an auto maneuver is started or terminated. Because the crew cannot easily detect an instability, it is preferable to initiate closed-loop control during a period of AOS to allow the flight control team to assess the DAP's performance. Auto maneuvers should be scheduled to begin and end during an AOS period, also. Before initiating closed-loop attitude control, the DAP I-load set (CNTL ACCEL on SPEC 20) that best matches the RMS/PL configuration should be selected. In determining the best CNTL ACCEL, the payload Z position is the most important parameter. An improper CNTL ACCEL can lead to inefficient jet selection and possible loss of attitude control.

If an instability occurs, the crew should downmode to free drift and use manual control. Reconfiguring the RMS and/or DAP before reinitiating auto control may result in a stable DAP.

FLIGHT RULES

A12-7

RMS IFM D&C KIT

- A. FOR RMS A8 D&C PANEL FAILURES, IF THE MISSION TIMELINE CAN ACCOMMODATE THE INSTALLATION AND REMOVAL TIME OF THE RMS D&C KIT, FOR GO/NO-GO DECISIONS, ITS PRESENCE CAN BE ASSUMED WHETHER IT IS CURRENTLY INSTALLED OR NOT. CONVERSELY, WHEN THE KIT IS INSTALLED, PANEL A8 CONTROLLED FUNCTIONS WHICH ARE DISABLED BY KIT INSTALLATION (AUTO/MAN EE DRIVE AND DIRECT DRIVE) WILL NOT BE CONSIDERED PERMANENTLY LOST FOR GO/NO-GO DECISIONS.

Approximately 1 hour is required to install the RMS D&C kit and an additional hour is required for removal. If sufficient time exists for installation and removal, the system configuration (and capabilities) will be modified by the kit; hence, its functions should be used in the decision-making process.

Since the kit will only be installed if sufficient time exists for its removal, the system configuration will be returned to nominal, and those functions disabled by kit presence should not be considered permanently lost in the decision-making process.

- B. WHEN THE RMS D&C KIT IS INSTALLED, THE APPLICABLE AC/DC SWITCH POWERING THE KIT WILL REMAIN OFF UNTIL IMMEDIATELY PRIOR TO THE REQUIRED OPERATION AND WILL BE RETURNED TO OFF IMMEDIATELY AFTER THE OPERATION IS COMPLETED. THE KIT WILL BE REMOVED AS SOON AS PRACTICAL AFTER THE REQUIRED FUNCTION IS COMPLETED.

The RMS D&C kit utilizes separate cabling for ac and dc controlled functions. Since the kit design does not include an enable switch for the joint drive or end effector functions, failures of these switches with the kit installed will potentially produce CRIT 1 situations. For this reason, the switch powering the kit will be used as an enable/inhibit switch, and power will only be applied during the actual operation which caused installation of the kit. ©[111298-6744]

- C. USE OF ANY APPROVED DC POWER KIT FUNCTIONS EXCEPT EE OPERATIONS IN SUPPORT OF PAYLOAD RELEASE MUST BE PRECEDED BY A KIT VERIFICATION. PRIOR TO APPLICATION OF DC POWER TO THE KIT, THE FOLLOWING CONDITIONS MUST BE MET:
1. THE RMS/PL MUST BE POSITIONED WELL CLEAR OF (> APPROXIMATELY 5 FEET) STRUCTURE.
 2. THE KIT JOINT SELECT SWITCH MUST BE POSITIONED TO A JOINT WHICH WILL PRODUCE BENIGN MOTION IF UNCOMMANDED DIRECT DRIVE OCCURS.

THIS RULE CONTINUED ON NEXT PAGE

FLIGHT RULES

A12-7

RMS IFM D&C KIT (CONTINUED)

3. IF LOADED, THE RMS MUST BE POSITIONED SUCH THAT PAYLOAD ROTATIONS DUE TO UNCOMMANDED DERIGID WILL NOT CAUSE CONTACT, AN ORBITER PILOT MUST BE AVAILABLE TO PERFORM AN IMMEDIATE SEPARATION SHOULD AN UNCOMMANDED RELEASE OCCUR, AND DOWNLINK MUST BE AVAILABLE TO CONFIRM LACK OF EE STALL CURRENTS.

When dc power is applied to the kit, the direct drive and EE drive switches are all enabled and failures within these switches could command those functions. Failures within the kit direct drive switch will override all commands (even if brakes on and RMS stationary) and result in uncommanded drive of the joint selected on the kit. The best method to halt this motion is to remove primary power from the RMS (application of brakes will be ineffective). Also, when dc power is applied to the kit, EE functions are enabled, and subsequent failure of those switches could result in uncommanded payload derigid, release, or EE burnout. @[111298-6744] @[062603-6028]

It should be determined that the selected joint does not drive in the presence of no command and that multiple joints do not drive when a command is issued. The kit joint select switch should be prepositioned to the joint which would produce the most benign motion should uncommanded joint drive occur when power is applied to the kit. Application of dc power to support EE functions is short term and hence an acceptable risk.

For application of the 5 ft rule, reference the RMS boom envelope figure in Rule {A12-2}, UNATTENDED RMS CONSTRAINTS. @[062603-6028]

- D. USE OF THE RMS D&C KIT IS APPROVED FOR THE FOLLOWING FUNCTIONS:
1. RMS SHOULDER BRACE RELEASE
 2. EE OPERATIONS

THIS RULE CONTINUED ON NEXT PAGE

FLIGHT RULES

A12-7

RMS IFM D&C KIT (CONTINUED)

3. DIRECT DRIVE (LOADED OR UNLOADED) @[111298-6744]

RMS shoulder brace release utilizes ac power. There are no other ac kit functions hence no risk associated with use of this function.

*When dc power is applied to the kit, the direct drive and EE drive switches are all enabled and failures within these switches could command those functions. However, health status of the kit is verified prior to its operational use (except for PL release) and; hence, the period of vulnerability to subsequent failure is limited to the timeframe that dc power is actually applied to the kit. Other flight rules constrain power application times to the minimum required to perform the desired function with the kit. @[111298-6744]
@[062603-6028]*

EE operations utilize dc power. EE drive times are procedurally limited to under 30 seconds; hence, this is deemed to be an acceptable risk (to failures within the direct drive switch).

Direct drive operations utilize dc power. Direct drive may require extensive time periods for maneuvering; however, the potential benefits to loaded RMS mission success outweigh the risk of uncommanded EE operations if a successful kit verification has been completed as required.

*The redesign of the Servo Power Amplifiers has obviated the need for a safing inhibit function.
@[111298-6744]*

FLIGHT RULES

A12-8

RMS OPCODE UPLINKS

- A. RMS OPCODE UPLINKS ARE NOT PERFORMED ON A NOMINAL BASIS. UPLINKS MAY BE PERFORMED FOR THE FOLLOWING CASES.

RMS level C data is nominally defined during the flight cycle of the flight software (FSW) build.

1. IDENTIFICATION OF LEVEL C REQUIREMENTS LATE IN THE PROGRAM FLOW.

FLIGHT-SPECIFIC REQUIREMENTS WILL BE IDENTIFIED IN THE FLIGHT-SPECIFIC ANNEX.

Previously, payload or program requirements identified after the nominal flight cycle deadlines could only be accommodated by a costly software patch. The uplink capability provides a cost-efficient alternative to meeting these requirements.

2. PAYLOAD OR PROGRAM REQUIRES MORE LEVEL C DATA THAN FSW LIMITATIONS CAN SUPPORT.

FLIGHT-SPECIFIC REQUIREMENTS WILL BE IDENTIFIED IN THE FLIGHT-SPECIFIC ANNEX.

Current manifest projections and increased payload complexities may require more EEID's, PLID's, or autosequences than FSW can support. The opcode uplink enables RMS to have the capability to support these situations without requiring a GMEM read/write.

3. CONTINGENCY RMS OPCODE UPLINKS DESIGNED AND SUBMITTED DURING A MISSION.

Situations unanticipated preflight could arise where the opcode unlink capability is useful to successfully meet mission objectives.

- B. CONTINGENCY OPCODE UPLINK DATA WILL BE DEVELOPED AND TESTED WITH THE RMS PLANNING SYSTEM (RPS) TOOL AND VALIDATION WILL CONSIST OF THE FOLLOWING:

RPS is a configuration controlled (MOD Software Management Plan for Workstation Applications) RMS tool used to design, develop, and test nominal level C data and RMS procedures. An application exists on RPS to build and test data files for uplink applications.

THIS RULE CONTINUED ON NEXT PAGE

FLIGHT RULES

A12-8

RMS OPCODE UPLINKS (CONTINUED)

1. RPS TESTING FOR LEVEL C GENERATION, RANGE LIMIT CHECKING, AND RMS FUNCTIONAL TESTS. ANY RANGE LIMIT EXCEEDANCES WILL BE DOCUMENTED IN A MER CHIT, RESOLVED WITH THE MER, AND BROUGHT TO THE FD'S ATTENTION PRIOR TO UPLINK.

Data range limits defined in STS-97-0017 (RMS Level C Functional Subsystem Software Requirements document) are based on formulas developed to ensure RMS integrity given payload-specific mass property data. Level C data must be within these specified ranges else it will be rejected by the SM preprocessor and the opcode program. Situations arise where these limits can safely be exceeded. Range limit exceedances announced to the RPS or workstation user will be evaluated on a case-by-case basis to determine if the uplink should be performed.

RPS and the opcode uplink program software are designed to perform testing and procedure verification comparable to the Shuttle Avionics Integration Laboratory (SAIL), RSOC Level 8, IBM Software Development Facility (SDF), and SM preprocessor. Therefore, no additional testing is required.

2. MER CONCURRENCE ON THE UPLINK AND RPS VALIDATION VIA MER CHIT.

The MER chit ensures the RMS community concurs the data is valid and will not compromise the RMS.

- C. THE RMS MUST HAVE THE BRAKES ON WHEN THE OPCODE UPLINK IS PERFORMED.

This ensures a runaway due to the uplinked data will not occur. Additionally, the FSW will reject the uplink if the RMS is not in the suspend, idle, or temperature monitor mode.

A12-9

RMS MCIU BITE OVERRIDES [CIL]

MCIU OVERRIDES (SM 95, ITEMS 36, 37, OR 38) WILL NOT BE PERFORMED WITHOUT MCC CONCURRENCE. ©[071494-1644]

With BITE overrides enabled, the failed joint is one failure away from a crit 1 situation for which the autobrakes are designed to catch. With a joint BITE failure overridden, autobrakes and fault annunciation are disabled for a subsequent failure of that same joint. Requiring the MCC to concur with performing BITE overrides ensures that the risks are assessed and precautions taken to mitigate the effects of subsequent failures. ©[071494-1644]

FLIGHT RULES

A12-10 **SPARE MANIPULATOR CONTROL INTERFACE UNIT (MCIU)**

FOR A MANIPULATOR CONTROLLER INTERFACE UNIT (MCIU) FAILURE, THE SPARE MCIU WILL BE INSTALLED AS TIME PERMITS. ©[102506-7585A]

Computer-supported modes (Single, Auto, and manual-augmented) are preferred to ease operations. For a failed MCIU, direct and backup are the remaining methods of driving the RMS. Replacing the MCIU will regain computer-supported modes and considerably simplify operations. The typical time allocated to attain operational status of the replacement MCIU and stow the failed MCIU is 2.5 hours. Pending crew availability and aft flight deck (AFD) activity, a trade must be made real time as to whether sufficient time exists to replace the MCIU and proceed with nominal RMS operations (versus proceeding with available modes, which will take longer and may be more complex) and still retain the ability to meet the mission objectives. Deferring the stowing of the failed MCIU may be considered to resume RMS operations sooner.

During the time that the MCIU is disconnected, only backup mode is available (end effector release only, no Special Purpose End Effector (SPEE) power). ©[102506-7585A]

FLIGHT RULES

A12-11

ORBITER BOOM SENSOR SYSTEM (OBSS) THERMAL CONSTRAINTS

- A. BOTH STBD RMS HEATERS SHALL BE ACTIVATED AS EARLY AS PRACTICAL AFTER ASCENT. @[102506-7830]

While berthed in the MPM, the OBSS heaters are powered using STBD RMS assets. Activating both heater strings provides system redundancy from the power source to the base of the OBSS.

- B. BOTH STBD RMS HEATERS SHALL BE DEACTIVATED DURING DEORBIT PREP.

Thermal analysis shows that the OBSS can survive with the heaters unpowered for 2 hours. Currently, the STBD RMS heaters are scheduled to be activated at Launch +2:30 and deactivated at Landing -3:51. These specific cases have been determined to be acceptable times to power and unpower the heaters.

If a landing attempt is waved off after the deactivation of the OBSS heaters, the STBD RMS heaters shall be reactivated during DEORBIT PREP BACKOUT.

- C. WHILE THE OBSS IS BERTHED, SENSOR TEMPERATURES WILL BE MANAGED TO STAY WITHIN OPERATING LIMITS AS DEFINED IN THE FOLLOWING TABLE:

SENSOR	OPERATING LIMITS (°F)	
	LOW	HI
AVIONICS BOX 1 & 2	-31° (-10°)	131° (128°)
LCS	32° (15°)	122° (119°)
LDRI	32° (39°)	158° (156°)
ITVC	-4° (8°)	140° (138°)
PTU	-4° (-10°)	140° (138°)
IDC	32° (14°)	131° (122°)

The OBSS thermal limits are defined at the component level for each sensor. The sensor limits in the table are defined by the component limit that bounds the sum of all the components. @[102506-7830]

THIS RULE CONTINUED ON NEXT PAGE

FLIGHT RULES**A12-11****ORBITER BOOM SENSOR SYSTEM (OBSS) THERMAL
CONSTRAINTS (CONTINUED)**

Reference LDRI Orbiter Inspection System Critical Design Review Presentation, Thermal Design & Analysis, June 7, 2004; NDG006275, Rev. 1, Laser Camera Head Thermal Analysis, July 23, 2004; MDR-RMS-R.7684, Rev. 2.0, IBA Thermal Analysis Report, March 2, 2004; Addendum for IBA Thermal Report Post CDR, SRMS.71465, Two Sensor Design Thermal Report, October 20, 2004; ITVC Critical Design Review Presentation, May 19, 1992; MSAD-04-0197, Integrated Sensor Inspection System (ISIS) String 1 Thermal Analysis, May 25, 2004; TH-95-162, Rev. A, ITVC Camera Thermal Balance Report, October 14, 1995; MS-410-2 A-18, Revised ITVC Thermal Analysis, June 16, 1992; and Jacobs Sverdrup memo ESCG-4470-06-TEAN-DOC-0028, Updated Thermal Analysis of ISIS (Integrated Shuttle Inspection System) Digital Camera (IDC), March 8, 2006. ©[102506-7830]

With the exception of the Laser Camera System (LCS), ISIS Digital Camera (IDC), and the Pan Tilt Unit (PTU) low limits, the numbers in parentheses reflect the limit set in software, assuming a 1-3/4 count potential error in the thermistor readings. The LCS and PTU low limits are set to protect against false alarms due to thermal gradients between the heater and thermistor locations. The IDC Temperature thresholds are as set in the DCCS.ini file for caution and warning.

- D. THE OBSS SHALL REMAIN BERTHED IF THE SENSOR TEMPERATURES ARE NOT WITHIN OPERATING LIMITS.

When the OBSS is unberthed, insight into the sensor temperatures is not readily available. Therefore, the temperatures must be verified to be within the acceptable operating limits prior to unberth. For any violation of the operating limits, the SSP MER must provide concurrence prior to continuing OBSS operations.

- E. SENSOR SURVIVAL TIME

1. SENSOR PACKAGE 1 (ITVC, LDRI, AND PTU) SHALL NOT BE LEFT WITHOUT POWER FOR LONGER THAN 90 MINUTES AND SENSOR PACKAGE 2 (LCS, IDC) SHALL NOT BE LEFT WITHOUT POWER FOR LONGER THAN 105 MINUTES.

Periods longer than 90 minutes without power will result in certain Sensor Package 1 components falling below non-operational limits. The most sensitive component is the pan motor which is used to point the ITVC/LDRI for scanning. Reference ES3-95-007, Integrated Sensor Inspection System Sensor Package 1 (SP1) Handover Capabilities memorandum, April 14, 2005. Periods longer than 105 minutes without power will result in certain Sensor Package 2 components falling below non-operational limits. The most sensitive component is the Y-axis galvanometer which is used to direct the laser during scanning operations. Reference Laser Camera Head Thermal Analysis, NDG006275 Rev. May 4, 2005. ©[102506-7830]

THIS RULE CONTINUED ON NEXT PAGE

FLIGHT RULES

A12-11

ORBITER BOOM SENSOR SYSTEM (OBSS) THERMAL CONSTRAINTS (CONTINUED)

2. IN THE EVENT THAT SENSOR PACKAGE 1 IS LEFT WITHOUT POWER FOR LONGER THAN 90 MINUTES AND/OR SENSOR PACKAGE 2 IS LEFT WITHOUT POWER FOR LONGER THAN 105 MINUTES, REAL-TIME ANALYSIS SHALL BE PERFORMED TO DETERMINE WARM-UP TIME(S) REQUIRED TO RETURN THE COMPONENT(S) TO OPERATIONAL TEMPERATURES SO THAT THEIR HEALTH CAN BE VERIFIED. @[102506-7830]

The thermal analysis performed pre-flight covered a range of betas and various attitudes. The 90-minute and 105-minute survival times are based on the worst of the cases run for the limiting components. Thermal analysis done with the actual on-orbit conditions during the period the OBSS is without power can determine the time required to return the component(s) to operational temperatures. Once the warm-up times have elapsed, the health of the component(s) can be verified.

F. SENSOR WARM-UP TIMES

1. AFTER SRMS OBSS UNBERTH, THE LDRI SHALL HAVE POWER APPLIED FOR 15 MINUTES PRIOR TO BEING MODED TO MODES 3, 4, 5, OR 6, AND THE LCS SHALL HAVE POWER APPLIED FOR 15 MINUTES PRIOR TO ANY SCANNING ACTIVITY. THE IDC SHALL HAVE (HEATER OR CAMERA) POWER APPLIED FOR 15 MINUTES PRIOR TO PHOTOGRAPHIC ACTIVITIES.
2. AFTER OBSS HANDOFF TO THE SRMS, THE LDRI SHALL HAVE POWER APPLIED FOR 2 HOURS PRIOR TO BEING MODED TO MODES 3, 4, 5, OR 6, AND THE LCS SHALL HAVE POWER APPLIED FOR 30 MINUTES PRIOR TO ANY SCANNING ACTIVITY. THE IDC SHALL HAVE (HEATER OR CAMERA) POWER APPLIED FOR 90 MINUTES PRIOR TO PHOTOGRAPHIC ACTIVITIES.

Since insight into the LDRI, LCS, and IDC temperatures is not readily available once the OBSS is unberthed or handed off, power must be applied for a certain period of time before applying operational power to the electronics. LDRI modes 1 and 2 are acceptable modes without any warm-up time.
@[102506-7830]

FLIGHT RULES

A12-12

ORBITER BOOM SENSOR SYSTEM (OBSS) POWER CONSTRAINTS

- A. KEEP-ALIVE POWER THROUGH THE STARBOARD FORWARD MANIPULATOR POSITIONING MECHANISM (MPM) WILL BE REMOVED PRIOR TO UNBERTH UNTIL AFTER REBERTH OF THE ORBITER BOOM SENSOR SYSTEM (OBSS). ©[102506-7864A]

The OBSS avionics and sensors receive keep-alive heater power through contacts on the forward end of the OBSS and the starboard forward MPM. Removing power through the starboard forward MPM during unberth and reberth will prevent arcing and sparking through the contacts. Keeping the power removed while the OBSS is unberthed from the starboard MPM's will prevent shorts due to debris and prevent the starboard forward MPM contacts from being an EVA hazard.

- B. SPECIAL PURPOSE END EFFECTOR (SPEE) CONNECTOR POWER WILL BE REMOVED PRIOR TO GRAPPLING THE OBSS ELECTRICAL FLIGHT-RELEASABLE GRAPPLE FIXTURE (EFGF), DURING UNBERTH OF THE OBSS, PRIOR TO BERTH IN THE STARBOARD MPM'S, AND DURING UNGRAPPLE OF THE OBSS EFGF.

The OBSS sensors receive operational and heater power through the interface of the SPEE connector on the SRMS EE and the ERGF. Removing SPEE connector power will prevent arcing and sparking during grapple and ungrapple, and prevent power from flowing into the starboard forward MPM contacts during unberth and berth. Grapple and ungrapple includes during handoff from/to the SSRMS. ©[102506-7864A]

A12-13 THROUGH A12-50 RULES ARE RESERVED

FLIGHT RULES

MPM/MRL LOSS/FAILURE DEFINITIONS

A12-51 MPM/MRL POSITIONING

AN MPM OR MRL MECHANISM SHALL BE CONSIDERED TO HAVE ATTAINED ITS COMMANDED POSITION IF AT LEAST ONE INDICATION OF THAT STATE OCCURS WITHIN THE SINGLE MOTOR DRIVE TIME.

If a microswitch changes to reflect what is believed to be the true state of the hardware at the exact time the hardware is supposed to achieve that state, it is extremely probable that the hardware is indeed at the indicated state even if the redundant microswitch does not verify the condition.

While operating the MPM or MRL, flight experience has demonstrated that there are normal drive times associated with failure free conditions. Anything other than those times achieved during operation would be grounds to suspect an anomalous condition. However, if the drive time is within the single motor specification time and other cues (visual and/or duration of current signatures) corroborate the single microswitch indication, it is assumed that the mechanism is actually at the indicated state.

A12-52 MPM FAILED IN TRANSIT

WHEN COMMANDING THE MPM, IF NEITHER THE SHOULDER DEPLOYED (ONE OF TWO) NOR STOWED (ONE OF TWO) POSITIONS ARE INDICATED AFTER THE SINGLE MOTOR DRIVE TIME HAS ELAPSED, IT SHALL BE ASSUMED THAT THE MPM HAS FAILED IN TRANSIT.

Without a deploy or stow indication of the MPM, the system is considered in transit and unlocked. The rule is only applicable when the MPM is being driven. Once the MPM has reached the stowed or deployed position, it is assumed that it remains there, even if the microswitches change state, unless there is a drive command present.

In fact, this has occurred during flight on several occasions. While the arm was being driven, the MPM deploy microswitches cycled to the "not deploy" state. The community has concluded that this phenomenon is associated with arm operational stresses applied to the base of the MPM and the relatively sensitive nature of the microswitch rigging calibration.

FLIGHT RULES

A12-53

MRL FAILED IN TRANSIT

WHEN COMMANDING THE MRL'S, IF AN MRL DOES NOT INDICATE THE LATCHED (ONE OF TWO) OR RELEASED (ONE OF TWO) POSITION AFTER THE SINGLE MOTOR DRIVE TIME HAS ELAPSED, IT SHALL BE ASSUMED THAT THE MRL HAS FAILED IN TRANSIT.

Without the proper latched or released indications, the latch position is indeterminate.

A12-54 THROUGH A12-70 RULES ARE RESERVED

FLIGHT RULES

MPM/MRL SYSTEMS MANAGEMENT

A12-71

MPM/MRL CYCLING

- A. CYCLING OF THE PORT MPM OR MRL SHALL ONLY BE PERFORMED WHILE THE RMS IS CRADLED. @[102506-7539A]

There are two intentions for this rule. The first is to prevent MPM motion with the arm uncradled since the system was not designed for that capability. The other is to prevent the latches from failing closed when the RMS is uncradled. If this occurred, the RMS could not be cradled. Therefore, adequate clearance would not exist between the arm and radiators with the doors shut, and the arm would have to be jettisoned.

- B. CYCLING OF THE STARBOARD MPM OR MRL SHALL ONLY BE PERFORMED WHILE THE OBSS IS BERTHED.

There are two intentions for this rule. The first is to prevent MPM motion with the OBSS unberthed since there are clearance issues while berthing the OBSS with the starboard MPM's stowed. In particular, while a large volume payload (e.g., MPLM or truss segments) is berthed in the payload bay, it is not possible to berth the OBSS with the starboard MPM's stowed. The other is to prevent the latches from failing closed when the OBSS is unberthed. If this occurred, the OBSS could not be berthed with three of three latches, and would have to be jettisoned or left on ISS. @[102506-7539A]

FLIGHT RULES

A12-72

MPM DEPLOY/STOW CONSTRAINTS

- A. THE MPM'S SHALL BE STOWED AS SOON AS PRACTICAL IF ONLY SINGLE MOTOR DRIVE IS AVAILABLE.

The MPM's are all driven by a single torque tube from two separate motors. The MPM shall be stowed if a single motor is lost since a subsequent failure of the other motor would require an EVA or jettison of the arm and MPM's. During normal operations of the arm, it is unacceptable to continue if the system is one failure from having to jettison or perform an EVA. EVA tools and procedures are available to deploy or stow the MPM that has stopped because of an electrical failure but not for a mechanical jam.

@[110900-7257]

Rule {A2-103E}, EXTENSION DAY REQUIREMENTS, references this rule. @[090894-1670B]

- B. FOR LOSS OF MPM STOW REDUNDANCY DURING HIGH PRIORITY OPERATIONS, THE MPM'S WILL REMAIN DEPLOYED UNTIL OPERATIONS ARE COMPLETE. IF FAILURE OF THE REMAINING MPM STOW SYSTEM OCCURS WHILE DEPLOYED, OPERATIONS WILL CONTINUE UNTIL AN EVA CAN BE PERFORMED OR JETTISON IS REQUIRED.

The MPM must be deployed to achieve mission success for high priority RMS operations. Termination of loaded activities due to loss of stow capability during loaded operations will be of no benefit. A subsequent failure of the second MPM drive system would require an EVA to roll in the MPM or jettison of the RMS/MPM. EVA may be viable for electrical failures only (mechanical jam may result in jettison). Due to the priority of the mission objectives, the risk is acceptable.

Rule {A12-1001}, RMS GO/NO-GO CRITERIA, references this rule. @[110900-7257]

- C. FOR THE COMPLETE LOSS OF MPM MOTOR DRIVE CAPABILITY, AN EVA TO DEPLOY AND/OR STOW THE MPM'S WILL BE PERFORMED TO PERMIT HIGH PRIORITY LOADED RMS OR OBSS OPERATIONS. @[110900-7257] @[102506-7540]

The MPM must be deployed to achieve mission success for high priority RMS operations. Electrical failures which prevent driving the MPM can be worked around via IFM or EVA; mechanical failures cannot. Due to the priority of the mission objectives, EVA support for these contingencies has been preflight planned.

THIS RULE CONTINUED ON NEXT PAGE

FLIGHT RULES

A12-72

MPM DEPLOY/STOW CONSTRAINTS (CONTINUED)

- D. THE MPM MUST BE POSITIONED AS FOLLOWS DURING OPS: @[102506-7540]
1. UNLOADED RMS - THE PORT MPM MUST BE EITHER FULLY DEPLOYED OR FULLY STOWED. IF STOWED, DAP FREE DRIFT, VRCS, OR ALT MODE ATTITUDE CONTROL IS REQUIRED. IF ALT MODE IS USED, ONE OR TWO JET CONTROL WITH JET ON TIME OF 0.08 SECONDS MUST BE USED. ANY DELAY TIME IS ACCEPTABLE. @[071494-1662A] @[042403-5599A]
 2. LOADED RMS - THE PORT MPM MUST BE FULLY DEPLOYED. FLIGHT-SPECIFIC EXCEPTIONS FOR HIGH PRIORITY OPERATIONS WILL BE IDENTIFIED IN THE FLIGHT-SPECIFIC ANNEX.

Without deployed or stowed indications, the MPM's are considered in transit and unlocked with only the stiffness of the torque tube present to maintain a firm shoulder position. This is not a sufficient load path to support any arm operations without possible structural failure. In the fully deployed or stowed positions, loads are distributed to the sill longeron by overcenter locked structural links plus, if fully deployed, a load-bearing J-hook. Supplemental Rockwell-Downey analyses (280-STSD-106-89-027) have shown that for an unloaded RMS, positive MPM structural margins exist during nominal RMS maneuvering or RMS runaway failures at various worst case (bounding) RMS orientations with the shoulder MPM in the stowed position. Previous analyses have concluded that runaway loads bound VRCS induced loads but do not always bound Pri DAP induced loads. RSOC Analysis (RSOC-635/250-94-009) also shows that longeron loads induced by reasonable worst case PRCS alt mode jet firings are bounded by the previous runaway loads, hence, the free drift, VRCS, or alt mode constraint. For purposes of the analysis, worst case delay times of between 0 and 5 seconds were used. These times bound the system fundamental frequency and, since the analysis was deemed acceptable at these worst case frequencies, any delay time may be used. @[071494-1662A] @[113095-1809A] @[042403-5599A]

3. THE PORT AND STARBOARD MPM MUST BE FULLY DEPLOYED FOR OBSS UNBERTH/BERTH AND PAYLOAD UNBERTH/BERTH OPERATIONS.

There are clearance concerns with OBSS grapple and unberth/berth with the starboard MPM's stowed. There are also clearance concerns during payload unberth/berth with the starboard MPM's stowed even if the OBSS is unberthed. @[102506-7540]

- E. ONCE THE MPM'S ARE DEPLOYED, THEY MAY REMAIN DEPLOYED UNTIL RMS MISSION OPERATIONS ARE COMPLETED. REFERENCE PARAGRAPHS A, B, AND C FOR THE LOSS OF DUAL-MOTOR STOW CAPABILITY.

With two-motor stow capability, there is no problem with leaving the MPM's deployed. Paragraphs A, B, and C of this rule address the loss of dual-motor stow capability. The intent of this rule is to not require stowing the MPM's at the end of each day if RMS operations are planned on subsequent days.

Rule {A12-1001}, RMS GO/NO-GO CRITERIA, references this rule. @[110900-7257]

FLIGHT RULES

A12-73

MRL CONSTRAINTS

- A. THE RMS SHALL BE CRADLED AND LATCHED AS SOON AS PRACTICAL IF THE MRL'S ARE ONE FAILURE AWAY FROM BEING UNABLE TO LATCH AT LEAST TWO OF THREE PEDESTALS.

There are failures that result in the loss of two or three MRL latch motors. If the configuration of the MRL is such that the next failure can result in the inability to latch at least two MRL's, the arm shall be cradled ASAP since there is no analysis that indicates that it is safe to return the orbiter with the RMS unlatched (ref. paragraph C). ©[110900-7257]

Rule {A2-103E}, EXTENSION DAY REQUIREMENTS, references this rule. ©[090894-1670B]

- B. FOR HIGH PRIORITY MISSION OBJECTIVES, IF FAILURES CAUSE THE MRL'S TO BE ONE FAILURE AWAY FROM THE LOSS OF ABILITY TO LATCH TWO PEDESTALS, RMS OPERATIONS WILL BE ALLOWED TO CONTINUE. THE RMS SHALL BE CRADLED AND LATCHED AS SOON AS PRACTICAL AFTER ALL RMS SUPPORTED HIGH PRIORITY MISSION OBJECTIVES ARE COMPLETED.

At least two of three MRL's are required to be latched to allow the orbiter to enter with the RMS. Due to the importance of the mission objectives, operations will be permitted to continue if the MRL's are one failure away from the loss of ability to latch two or three MRL's. Either EVA tiedown or RMS jettison is available as an alternative means to safe the RMS or orbiter for entry.

Rule {A12-1001}, RMS GO/NO-GO CRITERIA, references this rule.

- C. THE RMS MUST HAVE TWO OF THREE MRL'S SECURED FOR ENTRY.

Each of the three MRL's have two independent drive motors, and either a mechanical jam would have to occur or both drive systems would have to fail to cause loss of latch capability for an MRL pedestal. Flight Techniques analysis has indicated that two of three MRL's must be secured for entry (via MRL latch or EVA technique) to prevent RMS/radiator contact. This capability is protected by staying at least two failures away from not being able to latch two of three MRL's.

Rules {A12-1001}, RMS GO/NO-GO CRITERIA, and {A2-103E}, EXTENSION DAY REQUIREMENTS, reference this rule. ©[090894-1670B] ©[110900-7257]

THIS RULE CONTINUED ON NEXT PAGE

FLIGHT RULES

A12-73

MRL CONSTRAINTS (CONTINUED)

- D. OBSS OPERATIONS WILL BE ALLOWED TO CONTINUE WITH A COMPLETE LOSS OF STARBOARD MRL LATCH CAPABILITY. @[102506-7834]

Two of three MRL's are required to be latched to allow the orbiter to dock and undock with the OBSS berthed. Three of three MRL's are required to be latched to allow the orbiter to enter with the OBSS berthed. Due to the importance of the OBSS operations, operations will be permitted to continue if the ability to latch three of three MRL's has been lost. The OBSS can be left on the SRMS for undocking. The OBSS may be able to be left on the ISS or OBSS jettison is available as an alternative means to safe the orbiter for entry.

Rule {A12-1001}, RMS GO/NO-GO CRITERIA, references this rule.

- E. THE OBSS MUST HAVE TWO OF THREE MRL'S SECURED FOR DOCKING AND UNDOCKING AND OMS BURNS.

- F. THE OBSS MUST HAVE THREE OF THREE MRL'S SECURED FOR ENTRY.

Each of the three MRL's have two independent drive motors, and either a mechanical jam would have to occur or both drive systems would have to fail to cause loss of latch capability for an MRL pedestal. IBA Strength Assessment: two of three MRL's latched + OMS Burn Condition (SRMS 83258) has shown that any two of three MRL's are acceptable for OMS burns, docking and undocking with no safety or loads concerns. OBSS Loads Analysis Report (NS04HB00) has shown that three of three MRL's must be secured during entry to prevent OBSS/radiator contact. @[102506-7834]

FLIGHT RULES

A12-74

INADVERTENT MPM CYCLING PROTECTION [CIL] [HC]
 ©[022306-6923B]

- A. WHILE THE RMS IS UNCRADLED OR DURING OBSS UNBERTHING/BERTHING OPERATIONS, THE FOLLOWING CIRCUIT BREAKERS WILL BE OPENED TO PREVENT INADVERTENT CYCLING OF THE PORT OR STARBOARD MPM SYSTEM:

MA73C:C cb MCA PWR AC2 3Φ MID 2

MA73C:D cb MCA PWR AC3 3Φ MID 4

FMEA's exist for the port and starboard MPM DPLY/STOW switches and hybrid relay failures that result in uncommanded motion of the MPM. The orbiter/SRMS/SSRMS/payload may be damaged if the MPM stows during RMS operations or while the OBSS is being unberthed or berthed. Opening these circuit breakers removes AC power from both port and both stbd MPM motors. This provides protection while the payload bay mechanical power switches are on. These cb's must be closed for vent and payload bay door operations, neither of which are normally done during RMS operations. For radiator stow/deploy, see Rule {A10-221D}, RADIATOR MECHANICAL.

- B. EITHER OR BOTH CIRCUIT BREAKERS LISTED IN PARAGRAPH A MAY BE TEMPORARILY CLOSED IN ORDER TO FULLY LATCH OR RELEASE THE OBSS IN THE CASE OF AN INABILITY TO DRIVE STBD FWD MRL MOTOR 2 AND/OR STBD AFT MRL MOTOR 1.

With the cb's MCA PWR AC2 3Φ MID 2 and MCA PWR AC3 3Φ MID 4 open, stbd fwd motor 1 and stbd aft motor 2 will not operate. If the motor planned for nominal use were to fail (stbd fwd motor 2 or stbd aft motor 1), the affected MRL would not be able to be latched or released unless the cb providing power to its other motor was closed. In doing this, the MPM's would be exposed to the risk of inadvertent cycling for a minimum of 18 seconds (MRL single motor drive time per the SODB).

For the case of the inability to drive either stbd fwd motor 2 or stbd aft motor 1, an alternative to closing the required cb would be to only latch the remaining MRL's, assuming three Ready-For-Latch indications have been acquired. Then, after the arm ungrappled the OBSS and maneuvered to a safe position (SRMS cradled and latched or SSRMS clear of orbiter), the required cb would be closed and the remaining MRL latched. This option, however, exposes the OBSS/orbiter/ISS to the risk of inadvertent OBSS jettison if the stbd Retention Latch switch were to be thrown in the wrong direction (release instead of latch) while the OBSS was not grappled by either manipulator.

Reference Hazard Report ORBI 313, Loss of Control to RMS May Result in Catastrophic Damage to the Orbiter. ©[022306-6923B]

A12-75 THROUGH A12-90 RULES ARE RESERVED

FLIGHT RULES

RMS PREOPERATION SYSTEM MANAGEMENT

A12-91

SHOULDER BRACE OPERATION

THE SHOULDER BRACE SHOULD BE RELEASED AS EARLY AS PRACTICAL AFTER PLBD OPENING.

There are failure modes which may prohibit the operation of the shoulder brace release mechanism. Orbit thermal effects could also prevent release. Therefore, it is prudent to release the brace as soon as practical since its only function is to support ascent loads.

Rule {A12-1001A}, RMS GO/NO-GO CRITERIA, references this rule.

FLIGHT RULES

A12-92

RMS CHECKOUT

- A. THE RMS FLIGHT DATA FILE CHECKOUT PROCEDURES SHALL BE PERFORMED ONCE PER MISSION, AS EARLY AS PRACTICAL, PRIOR TO ANY NOMINAL RMS OPERATIONS.

There are several failure modes that can be detected during the RMS checkout. Early detection of a failure may provide adequate time to troubleshoot the problem and develop workaround procedures.

- B. FOR OFF-NOMINAL SITUATIONS WHERE A RAPID RMS RESPONSE IS DESIRED, COMPLETION OF THE CHECKOUT PROCEDURES FOR BACKUP AND DIRECT DRIVE MODE SHALL BE ACCOMPLISHED AS A MINIMUM.

This will ensure that the arm is not a single failure away from having to be jettisoned or stowed EVA. One of these modes is required to cradle the arm. Approximately 5 to 10 minutes are required to complete these tests. A test of direct drive gives valuable insight into any possible joint degradation while testing single may not indicate the problem. The PDRS checklist has been modified to give the crew a success criteria for direct drive.

- C. THE EE CHECKOUT WILL BE PERFORMED ONCE PER MISSION PRIOR TO ANY EE OPERATIONS.

It is important to understand if there are any failures resident in the EE prior to operations to prohibit unsafe use of the system. This rule also implies that the EE does not have to be checked if there are no EE operations for the flight.

- D. RESERVED

- E. THE DIRECT DRIVE TEST SHALL BE PERFORMED ON EACH JOINT WITH A MINIMUM CONTINUOUS DRIVE IN EACH DIRECTION FOR 12 SECONDS.

RMS checkout operations on orbit are the only tests of the RMS in which the results are not affected by gravity and the inadequacies of the test equipment. Parametric studies by SPAR Aerospace Limited have concluded that the direct drive mode tests, if properly run, will supply the necessary data for trend analysis of the individual RMS joints. To make this data meaningful, each joint must be driven continually in each direction for 12 seconds to guarantee that the motor has stabilized at the maximum rate.

A12-93 THROUGH A12-110 RULES ARE RESERVED

FLIGHT RULES

RMS DRIVE SYSTEM MANAGEMENT

A12-111 **MODE AVAILABILITY DRIVE CONSTRAINT**

- A. RMS OPERATIONS SHALL CEASE AND THE RMS SHALL BE CRADLED AND LATCHED IF BACKUP PLUS ONE OTHER PRIMARY SINGLE JOINT MODE IS NOT AVAILABLE TO DRIVE EACH JOINT. @[110900-7257]

Backup mode is electrically independent from all other modes; therefore, requiring this mode in addition to one other single joint mode to begin or continue normal RMS operations ensures that, after a single point failure, the arm can still be cradled. It has not been demonstrated that the arm can be cradled in any mode other than one utilizing a single joint drive method. In addition, the only way that loss of backup can be determined is during the RMS checkout or by the loss of main bus B.

Rule {A12-1001}, RMS GO/NO-GO CRITERIA, references this rule.

- B. RMS OPERATIONS IN SUPPORT OF HIGH PRIORITY TASKS CAN BE PERFORMED WITH ONLY ONE MODE OF OPERATING THE RMS AVAILABLE.

The RMS utilizes two power sources, primary and backup, and has multiple modes for driving the arm on primary power. The priority of operations is such that operations will continue with only one mode available to drive the RMS. EVA and jettison can be considered as redundancy for cradling the RMS or safing the payload bay.

Rule {A12-1001}, RMS GO/NO-GO CRITERIA, references this rule. @[110900-7257]

A12-112 **FIELD OF VIEW CONSTRAINT [CIL]**

THE RMS SHALL NOT BE DRIVEN UNLESS THE CREW IS OBSERVING THE EXPECTED MOTION OF THE RMS/PAYLOAD STRUCTURE VIA WINDOW AND/OR CCTV VIEWS.

There are a considerable number of failure modes identified in the FMEA which can result in unannounced, uncommanded motion (e.g., two joints drive, wrong joint drives, hand controller fails at 56 percent of max command, etc.). If the operator is driving the arm in a configuration where the occurrence of one of these failure modes could not be observed, then the operator may not react to the failure by stopping the arm with the brakes (or whatever means are available) to avoid a collision with the orbiter/payload/EVA crewmember.

FLIGHT RULES

A12-113

AUTO MODE ENTRY CONSTRAINT [CIL]

AUTO MODES SHALL NOT BE ENTERED UNLESS THE PAYLOAD BAY AND PAYLOAD STRUCTURES ARE IN A CONFIGURATION FOR WHICH THE SEQUENCES HAVE BEEN VERIFIED. THE OPERATOR SHALL ONLY ENTER AN AUTO MODE IMMEDIATELY PRIOR TO SELECTION OF "PROCEED".

The first part of the rule requires that the payload bay be configured the way it was when the sequence was validated. This is simply to ensure that no appendages or other objects have been placed in the path of the sequence. Validation of the preflight designed auto sequences is accomplished by performing them on several of the available simulators and during crew training. Most of the operator-commanded auto sequences (OCAS) are also verified preflight in this way. However, in some cases, the crew may opt to develop a new OCAS real time. This OCAS can be verified by the ground flight controllers on their simulator or by the crew if the geometry is simple enough that they are confident that the procedure will run safely.

There are failure modes which can cause an auto sequence to begin prematurely (once the mode is entered), not stop at pause points, or not stop when "stop" is selected. By following this procedural rule, these failures will not place the crew in a hazardous condition. For operator-commanded auto sequences, care should be exercised in entering the desired position and attitude parameters because the sequence could begin with no operator command.

Rule {A12-114}, ORBITER PROXIMITY CONSTRAINTS [CIL], references this rule.

FLIGHT RULES

A12-114

ORBITER PROXIMITY CONSTRAINTS [CIL]

- A. IF THE MANIPULATOR CONTROLLER INTERFACE UNIT (MCIU) SAFING FUNCTION IS LOST, COMPUTER-SUPPORTED MODES SHALL NOT BE USED CLOSE TO (WITHIN APPROXIMATELY 5 FEET) STRUCTURE/PAYLOAD/EVA CREWMEMBER. WHILE BERTHING A PAYLOAD, ALL MODES CAN BE USED ONCE THE TRUNNIONS HAVE ENTERED THE V-GUIDES.

With this class of failure mode, MCIU safing will not automatically stop the arm if I/O with the GPC is erratic or interrupted while the arm is operating in a computer-supported mode. It is prudent to use only direct when close to any obstacles when MCIU safing is lost since direct is unaffected by these failure modes. Approximately 5 feet is considered sufficient since the runaway will be at the last commanded rate unlike other runaways which can result in maximum torque and joint rates. Once within the V-guides, any uncommanded motion is constrained by the physical guide. When the arm is not close to obstacles, all modes can be used since there is sufficient time for the operator to detect any uncommanded motion and apply the brakes.

For application of the 5 ft rule, reference the RMS boom envelope figure in Rule {A12-2}, UNATTENDED RMS CONSTRAINTS. @[062603-6028]

- B. OPERATE AT/OR LESS THAN VERNIER RATES WHEN THE ARM/PAYLOAD IS CLOSE TO (WITHIN APPROXIMATELY 10 FEET) STRUCTURE/PAYLOAD/EVA CREWMEMBER. THE OPERATOR MUST CYCLE THE APPROPRIATE PANEL SWITCH WHEN DRIVING IN DIRECT OR BACKUP TO APPROXIMATELY MAINTAIN RATES AT OR LESS THAN VERNIER RATES.

There are many failure modes which result in uncommanded, unannounced motion (e.g., hand controller fails, wrong joint drives, wrong joint direction, two joints drive, sluggish, or stalled joint, etc.) which the operator must detect and stop by applying the brakes. Many of these failure modes will run away at the last commanded rate or are joint rate limited so operating in vernier will limit the ultimate rates the failure can produce. The rest of the failure modes result in unexpected motion, uncommanded release, or derigidize. The detection and arresting of this motion or maneuvering the orbiter clear of a released payload will be less hazardous (i.e., give the crew more time to react) if the arm is operating at a slow rate.

- C. RATE HOLD SHALL NOT BE USED WHEN THE RMS/PAYLOAD IS CLOSE TO (WITHIN APPROXIMATELY 10 FEET) AND IS MOVING TOWARDS STRUCTURE/PAYLOAD/EVA CREWMEMBER EXCEPT WHEN CAPTURING A FREE FLYING PAYLOAD.

There are failure modes which result in the inability to cancel rate hold. If this occurs close to an obstacle, a collision could occur before the operator has enough time to detect and apply the brakes. Therefore, it is prudent not to use rate hold close to any obstacles. Rate hold may be used when capturing a free-flying payload since the payload/arm combination will be far from the orbiter.

THIS RULE CONTINUED ON NEXT PAGE

FLIGHT RULES

A12-114 ORBITER PROXIMITY CONSTRAINTS [CIL] (CONTINUED)

- D. AUTO TRAJECTORIES SHALL BE DESIGNED SUCH THAT THE ARM/PAYLOAD DOES NOT PASS CLOSE TO (WITHIN APPROXIMATELY 5 FEET) STRUCTURE/PAYLOAD/EVA CREWMEMBER. @[111298-6744]

There are failure modes (e.g., sluggish and stalled joints) which result in undetected deviations from the intended auto trajectory. This requirement will allow the operator time to detect the failure and apply brakes. There is another rule (Rule {A12-113}, AUTO MODE ENTRY CONSTRAINT [CIL]) which governs use of auto mode (vice design). That rule prohibits using auto for unverified trajectories.

For application of the 5 ft rule, reference the RMS boom envelope figure in Rule {A12-2}, UNATTENDED RMS CONSTRAINTS. @[062603-6028]

- E. THE RMS/PAYLOAD SHALL NOT BE MANEUVERED OR PARKED IN REGIONS WHERE IT CANNOT BE MANEUVERED TO A SAFE JETTISON POSITION WITH THE LOSS OF ANY SINGLE JOINT. @[111298-6744]

There are single point failure modes which result in the inability to drive an arm joint in either primary or backup modes. If any of these failures occurs and an EVA cannot be performed, the arm must be jettisoned prior to closing the PLBD. Therefore, since a joint failure may restrict arm mobility, the arm shall never be in a position where it cannot be maneuvered to a safe jettison position using only five of six joints.

The only single point failure modes which can result in the inability to drive all joints are in the power and arm select switches. These failure modes can be worked around by using an IFM pin kit. @[062603-6028]

- F. EXCEPT FOR TRANSITORY MOTION (I.E., BERTHING/UNBERTHING, CRADLING/UNCRADLING, PAYLOAD DOCKING/UNDOCKING, OR PAYLOAD CAPTURE/RELEASE), THE RMS/PAYLOAD SHALL NOT BE MANEUVERED OR PARKED (CREW AWAKE) CLOSER THAN 60 CM (2 FT) FROM ORBITER STRUCTURE OR OTHER PAYLOADS. FOR APPLICATION OF THIS RULE, EVA CREWMAN IS NOT CONSIDERED ORBITER STRUCTURE OR PAYLOAD.

FLIGHT SPECIFIC EXCEPTIONS FOR HIGH PRIORITY OPERATIONS WILL BE IDENTIFIED IN THE FLIGHT SPECIFIC ANNEX.

Crew comfort, RMS and payload visibility, VRCS and ALT mode induced motion, RMS failures, and lack of task specific crew training become overriding concerns when maneuvering payloads in close proximity to orbiter structure. In cases where missions cannot be completed without violating this rule, the program incurs greater risk. As such, task specific assessment is required to document the risk and proposed methods, if any, to control it.

THIS RULE CONTINUED ON NEXT PAGE

FLIGHT RULES

A12-114 ORBITER PROXIMITY CONSTRAINTS [CIL] (CONTINUED)

G. DURING SRMS MANEUVERS OF THE ORBITER BOOM SENSOR SYSTEM (OBSS) USING THE PAYLOAD ID'S DESIGNED FOR SENSOR SCANS, COARSE RATE SELECTION IS PERMITTED EVEN WITHIN 10 FEET OF STRUCTURE. @[102506-7836]

These rates are set based on sensor specifications, not through the typical implementation of the Marks formula for a payload with the mass of the OBSS. Rates calculated using the Marks formula would be higher. @[102506-7836]

A12-115 INOPERATIVE BRAKE CONSTRAINT [CIL]

IF A BRAKE IS INOPERATIVE DUE TO A MECHANICAL FAILURE, THE RMS SHALL BE CRADLED IN SINGLE MODE AND LATCHED AS SOON AS POSSIBLE. IF THE WRIST ROLL BRAKE IS INOPERATIVE, UNLOADED RMS OPERATIONS MAY CONTINUE. PAYLOAD OPERATIONS WILL NOT CONTINUE WITH THE EXCEPTION OF COMPLETION OF BERTHING OPERATIONS IF THE PAYLOAD IS ALREADY WITHIN THE BERTHING GUIDES.

A failure mode exists which results in a brake pad mechanically not engaging. The motor drive amplifier (MDA) will still be inhibited when the brakes are electrically commanded on, so the failed joint will be free in both primary and backup modes. Single mode must be used to cradle the arm since it is the only remaining single joint mode that is still operative (uses position hold instead of brakes to maintain arm position). During unloaded operations, operations may continue with a known wrist roll brake problem since runaways on the wrist roll cannot result in any uncommanded translations of the arm.

Rule {A12-1001O} and P, RMS GO/NO-GO CRITERIA, reference this rule.

A12-116 AUTO BRAKES CONSTRAINT [CIL]

COMPUTER-SUPPORTED MODES SHALL NOT BE USED IF THE AUTO BRAKES FUNCTION HAS FAILED.

There are many failure modes which result in runaways (six or single joint) which are detected and automatically stopped by the auto brakes function. SPAR SIMFAC simulations have demonstrated that without these automatic checks a runaway in a computer-supported mode could travel as far as 18 feet before a crewmember could stop it by applying the brakes. Therefore, computer-supported modes should not be used after loss of this function.

Rule {A12-1001Q}, RMS GO/NO-GO CRITERIA, references this rule.

FLIGHT RULES

A12-117

CONTINGENCY STOP [CIL] [HC] @[082505-6872B]

THE BRAKES SHALL ALWAYS BE THE METHOD USED TO STOP THE RMS IF UNCOMMANDED MOTION OR UNUSUAL RMS BEHAVIOR OCCURS (INSTEAD OF SAFING, AUTO STOP SWITCH, OR RELEASING THE COMMAND). IF THE BRAKES ARE INOPERATIVE VIA THE PANEL SWITCH, THEY SHALL BE APPLIED BY DESELECTING THE PORT ARM. @[082505-6872B]

Use of the brakes is the most positive method of stopping the arm in emergency situations. It is preferred over safing since it inhibits the MDA at the joints which will stop a runaway joint caused by the servo or MDA (safing would not in many cases). It is also preferred over the stop switch during auto sequences since there are D&C failures which could prohibit the stop switch from operating.

DN 34801 documents a sneak circuit which can result in power continuing to be applied to the port arm if primary power is terminated without deselecting the port arm and the brakes switch is ON. Therefore, in a contingency stop situation, to guarantee that power is removed from the arm, the port arm should be deselected rather than termination of primary power. @[082505-6872B]

This rule is referenced as a control for Hazard Reports ORBI 313, Loss of Control to RMS May Result in Catastrophic Damage to the Orbiter; RMS 01000, Loss of Orbiter Due to Inability to Close Payload Bay Doors; RMS 02000, Loss of Orbiter or Damage to Equipment Due to Impact/Collision; and RMS 03000, Personnel Injury. @[082505-6872B]

FLIGHT RULES

A12-118

POHS AND LEFT-HANDED COORDINATE SYSTEMS [HC]

@[022405-6479A]

- A. RMS POSITION AND ORIENTATION HOLD SELECT (POHS) MUST BE DISABLED FOR USE OF RMS PAYLOAD ID'S THAT ARE DEFINED USING A LEFT-HANDED PAYLOAD OPERATING COORDINATE FRAME. @[071494-1644]

POHS is a right-handed algorithm. It generates arm drive commands that are normal to the desired path which attempt to reduce off-axis deviations. Attempts to use it with left-handed defined payload operating systems results in unexpected motion by generating commands which are in a direction away from the desired trajectory. @[071494-1644]

- B. SM94 POHS CNTL INH - ITEM 29 MUST NOT BE EXECUTED UNLESS BRAKES ARE APPLIED TO THE RMS.

DR 121214 documents a software condition whereby the RMS is put in an uncontrolled state if POHS is disabled while in an auto mode (either preprogrammed or operator commanded) without a "READY" AND "IN PROG" light being illuminated. Thus, external forces that move the arm will not be corrected by the software. Although this is more restrictive than required, having the BRAKES applied is prudent to ensure this undesired software condition is avoided. If the RMS is in the middle of a pre-programmed auto sequence, the auto sequence may be paused and the READY light verified illuminated prior to disabling POHS. This allows the auto sequence to resume in an efficient manner avoiding the initial tolerance criteria.

Reference Hazard Report ORBI 313. @[022405-6479A]

A12-119 THROUGH A12-140 RULES ARE RESERVED

FLIGHT RULES

END EFFECTOR (EE) LOSS/FAILURE DEFINITIONS

A12-141 **EE BACKUP RELEASE**

EE BACKUP RELEASE IS CONSIDERED LOST IF SNARES DO NOT OPERATE SMOOTHLY TO THE FULLY OPEN POSITION.

Data from SPAR indicates that temperature has a significant effect on the time for the snares to open during the backup release check. Times on the order of minutes were seen at the lowest qualification test temperatures. With no grapple pin in the EE, the snares open quickly for the first 70-80 percent of travel then slow down at the end of travel. At the coldest flight conditions, during the on-orbit backup release check, the snares should fully open within 2 minutes, although 20-25 seconds has been typical. If the snares do not open smoothly and completely, there is a mechanical problem and backup release would be considered lost.

A12-142 **EE CAPTURE/RIGIDIZE**

EE CAPTURE OR RIGIDIZE FUNCTIONS ARE CONSIDERED LOST FOR AUTO AND/OR MANUAL IF THE CAPTURE TIME EXCEEDS 3 SECONDS OR THE RIGIDIZE TIME EXCEEDS 25 SECONDS.

The maximum capture specification time is 3 seconds and the maximum rigidize specification time is 25 seconds. Failure to meet these time constraints is indicative of binding in the drive mechanism or loss of one mode due to an electrical failure.

Rule {A2-112}, PDRS, references this rule.

A12-143 **EE RELEASE/DERIGIDIZE**

EE RELEASE OR DERIGIDIZE FUNCTIONS ARE CONSIDERED LOST FOR AUTO AND/OR MANUAL IF THE RELEASE TIME EXCEEDS 3 SECONDS OR THE DERIGIDIZE TIME EXCEEDS 25 SECONDS.

The maximum release specification is 3 seconds and the maximum derigidize specification time is 25 seconds. Failure to meet these constraints is indicative of binding in the drive mechanism or loss of one mode due to an electrical failure.

A12-144 THROUGH A12-160 RULES ARE RESERVED

FLIGHT RULES

END EFFECTOR SYSTEM MANAGEMENT

A12-161

PAYLOAD GRAPPLE CONSTRAINTS

- A. PAYLOADS SHALL NOT BE GRAPPLED AND UNBERTHED UNLESS BACKUP RELEASE AND ONE OF TWO METHODS TO CAPTURE AND RIGIDIZE (AUTO OR MANUAL) AND ONE OF TWO METHODS TO DERIGIDIZE AND RELEASE (AUTO OR MANUAL) ARE AVAILABLE.

The EE system is designed such that a single failure can result in the loss of both the auto and manual release capability. The backup release capability can also be lost with a single failure, but it is electrically isolated from auto and manual. As a rule, backup as well as one other release mode is required so that more than one failure has to occur before the arm must be jettisoned or the payload released via EVA. ©[110900-7257]

- B. LOADED OPERATIONS WILL CEASE AS SOON AS PRACTICAL IF BACKUP AND ONE OF TWO METHODS TO RELEASE (AUTO OR MANUAL) ARE NOT AVAILABLE.

If backup or both primary methods of releasing a payload are lost, then the RMS is one failure from being unable to release the payload. In a worst case situation this would lead to arm/payload jettison. It is unacceptable to continue operations when the system is one failure away from jettison.

Mission activities such as final release or berth may be completed under certain conditions with this failure.

- C. RMS OPERATIONS IN SUPPORT OF HIGH PRIORITY ACTIVITIES CAN BE PERFORMED WITH A SUSPECTED LOSS OF BACKUP RELEASE CAPABILITY.

There are three methods for opening the EE to release a payload (auto, manual, and backup). Without backup release capability, the EE is one failure away from the inability to release the payload. The priority of this mission is such that operations are allowed to continue with loss of two of the methods. ©[110900-7257]

THIS RULE CONTINUED ON NEXT PAGE

FLIGHT RULES

A12-161 **PAYLOAD GRAPPLE CONSTRAINTS (CONTINUED)**

- D. RMS OPERATIONS IN SUPPORT OF HIGH PRIORITY ACTIVITIES CAN BE COMPLETED WITH A SUSPECTED LOSS OF END EFFECTOR (EE) DERIGIDIZE CAPABILITY. @[110900-7257]

Loss of derigidize capability does not preclude releasing of the grapple fixture; however, if the snares are opened without derigidizing, potential exists that tip-off rates may be induced. Additionally, without the capability to derigidize/extend the snare carriage, future capture capability is lost.

One alternative which may or may not be available is to install the RMS IFM Display and Control (D&C) kit to work around a D&C panel failure.

- E. A CAPTURE SHALL NOT BE ATTEMPTED WHILE IN A REACH LIMIT OR SINGULARITY. @[110900-7257]

The RMS does not respond normally to commands while in a reach limit or singularity. Also, excessive arm loads may result when a capture is attempted in a reach limit or singularity since one or more degrees of freedom are lost. With this loss the arm may not be able to conform to the payload if there are any EE/payload grapple fixture misalignments. If the arm cannot conform, significant forces may be applied to the EE/RMS structure.

Rules {A12-1001S}, T and U, RMS GO/NO-GO CRITERIA, reference this rule.

FLIGHT RULES

A12-162

EE MODE SWITCH CONSTRAINTS [CIL]

- A. THE EE MODE SWITCH SHALL ONLY BE TAKEN OUT OF THE "OFF" POSITION:
1. FOR FREE-FLYING PAYLOADS (I.E., PAYLOADS NOT ATTACHED TO THE RMS OR ANY ORBITER STRUCTURE) WHEN THE EE IS IN THE:
 - a. PRECAPTURE POSITION (I.E., THE POSITION THE RMS MAINTAINS ABOVE THE PLB DURING THE RENDEZVOUS PROCESS) JUST PRIOR TO CAPTURE,
 - OR
 - b. RELEASE POSITION.
 2. FOR BERTHED PAYLOADS WHEN THE EE IS IN THE:
 - a. CAPTURE ENVELOPE,
 - OR
 - b. RELEASE POSITION.
 3. DURING RMS CHECKOUT.

There are many failure modes that can cause the arm to limp unexpectedly or produce an uncommanded release or derigidize when the EE mode switch is in the manual or auto position. Therefore, the EE mode switch should only be taken out of the OFF position when it is safe to do so (i.e., when the arm is not moving and is far from obstacles or is in the process of moving the last few feet during the capture process of a free-flying payload).

- B. THE EE MODE SWITCH SHALL ALWAYS BE PLACED BACK IN THE "OFF" POSITION IMMEDIATELY AFTER THE NOMINAL CAPTURE/RIGIDIZE AND RELEASE/DERIGIDIZE TIMES HAVE ELAPSED.

There are many failure modes which can result in a continuously limped arm (e.g., incomplete rigidize sequence) or stalled EE drive motor (e.g., motor reversals, rigid microswitch fails low, etc., which lead to motor burnout in approximately 2 minutes) so that the microswitches never attain the proper state to complete an automatic EE capture or release. The effect of these failure modes can be nullified simply by turning the EE mode switch to off.

FLIGHT RULES

A12-163 CAPTURE AND RELEASE PROXIMITY CONSTRAINT [CIL]

DURING A CAPTURE OR RELEASE OF A FREE-FLYING PAYLOAD, THE EE SHALL BE FAR ENOUGH AWAY FROM ORBITER STRUCTURE/OTHER PAYLOADS/EVA CREWMEMBER THAT NO CONTACT COULD OCCUR REGARDLESS OF PAYLOAD ROTATIONS.

FLIGHT-SPECIFIC EXCEPTIONS FOR LARGE PAYLOADS OR TO MEET DAP STABILITY CONSTRAINTS WILL BE IDENTIFIED IN THE FLIGHT-SPECIFIC ANNEX.

There are many failure modes which result in a payload being snared but only partially rigidized. When capturing a rotating payload, the payload could continue to rotate around the EE. If this occurs during release, gravity gradient and LVLH effects could result in payload rotation. This rule would procedurally prohibit any contact (other than the arm) for these failure scenarios. For payloads that cannot be positioned far enough from orbiter structure due to size or DAP constraints, an exception shall be identified in the flight-specific annex.

A12-164 PAYLOAD RELEASE DURING BERTHING

DURING BERTHING, A NOMINAL RELEASE OF A PAYLOAD WILL NOT BE PERFORMED UNTIL THE PAYLOAD IS VERIFIED BERTHED AND LATCHED.

If the payload was released without being latched, orbiter recontact could occur. The payload would have to be jettisoned per procedure unless EVA straps are available to strap a payload down for entry. Minimum payload latch configuration must be examined from a structural standpoint and may be different for on-orbit and entry/landing requirements. Reference flight-specific annex rules for the definition of the minimum payload latch configuration.

A12-165 THROUGH A12-180 RULES ARE RESERVED

FLIGHT RULES

RMS JETTISON SYSTEM MANAGEMENT

A12-181**JETTISON SYSTEM CONSTRAINT**

- A. RMS OPERATIONS SHALL BE ALLOWED TO CONTINUE IF EITHER OF THE JETTISON SYSTEM BUSES MNB ML86B OR MNC ML86B IS LOST PROVIDED RMS DRIVE MODE REDUNDANCY, END EFFECTOR RELEASE MODE REDUNDANCY, AND MPM AND MRL STOW AND LATCH REDUNDANCY EXISTS. @[113095-1809A]
- B. OBSS OPERATIONS SHALL BE ALLOWED TO CONTINUE IF EITHER OF THE JETTISON SYSTEM BUSES MNA ML86B OR MNC ML86B IS LOST PROVIDED STARBOARD MPM STOW REDUNDANCY EXISTS. @[102506-7831C]
- C. AN IFM WILL BE PERFORMED TO REGAIN A LOST JETTISON SYSTEM BUS WHEN CONVENIENT. THE IFM ONLY NEEDS TO BE PERFORMED UP TO THE POINT OF BEING INVASIVE TO THE ORBITER PANELS AND OTHER ORBITER SYSTEMS (I.E., RCS HEATERS).

With an RMS or MPM system redundancy failure and loss of a jettison system, the system is two failures away from a catastrophic situation in the event of an emergency deorbit. However, there is no means of verifying the current health of the alternate pyro system even though load and resistance tests were performed on turnaround. Therefore, if the Flight Specific Annex allows operations to continue in this posture, as much of the IFM should be performed as possible without impacting RCS heaters and by removing all but two of the panel A14 fasteners. With loss of RCS heaters, hotfiring of the affected RCS jets is the primary method to maintain thermal conditioning. A PRCS hotfire, if required, would be at odds with RMS operations. An additional 5 minutes will be required to complete the IFM should jettison subsequently be required. @[113095-1809A] @[110900-7257]

Rule {A12-1001}, RMS GO/NO-GO CRITERIA, references this rule.

- D. IF PORT OR STBD RMS JETTISON SYSTEM BUS IS LOST PRIOR TO COMPLETION OF HIGH PRIORITY MISSION OBJECTIVES, OPERATIONS WILL CONTINUE WITHOUT JETTISON SYSTEM REDUNDANCY. @[102506-7831C]

Operations may continue with the loss of a jettison system due to mission objective priorities. An IFM is available to restore a failed (short or open) jettison bus. This IFM will restore the jettison capability for any detected loss, but will impact other orbiter systems.

Rule {A12-1001}, RMS GO/NO-GO CRITERIA, references this rule. @[110900-7257]

FLIGHT RULES

A12-182

RMS/PAYLOAD JETTISON

IF AN RMS/PAYLOAD COMBINATION MUST BE JETTISONED, THE RMS AND PAYLOAD SHALL BE JETTISONED AS A SINGLE UNIT, IF AT ALL POSSIBLE.

It is desirable to limit the number of free objects in space to avoid recontact problems by jettisoning the arm and payload as one unit.

A12-183 THROUGH A12-200 RULES ARE RESERVED

FLIGHT RULES

GO/NO-GO CRITERIA

A12-1001

RMS GO/NO-GO CRITERIA

CONTINUE OPERATIONS IF:							
	RMS UNCRADLE	CONTINUE UNLOADED	GRAPPLE UNBERTH	CONTINUE LOADED	HIGH PRIORITY	ENTRY	FLIGHT RULES REF.
A. SHOULDER BRACE REL (1)	0 ↓ [6]						{A12-91}
B. JETTISON SYSTEM (2)	1 ↓ [4]	1 ↓ [4]	1 ↓ [4]	1 ↓ [4]	1 ↓		{A12-181}
C. MPM STOW MOTORS (2)	0 ↓ [6]	0 ↓ [6]	0 ↓ [6]	0 ↓ [6]	2 ↓ [6]		{A12-72}
D. MRL LAT CAP (3)	[1]	[1]	[1]	[1]	[5]		{A12-73}
E. PORT MPM (4) STOWED INDICATIONS (8)						[2]	{A12-72}
F. STBD MPM (3) STOWED INDICATIONS (6)						[8]	{A12-72}
G. PORT MPM (4) DEP INDICATIONS (8)	SHOULDER 1 ↓	SHOULDER 1 ↓	SHOULDER 1 ↓	SHOULDER 1 ↓	SHOULDER 1 ↓		{A12-72}
H. STBD MPM (3) DEP INDICATIONS (6)	FORWARD 1 ↓	FORWARD 1 ↓	FORWARD 1 ↓	FORWARD 1 ↓	FORWARD 1 ↓		{A12-72}
I. PORT MRL'S LATCHED (3)						1 ↓	{A12-73}
J. STBD MRL'S LATCHED (3)						0 ↓	{A12-73}
K. AUTO MODE							
L. MANUAL AUG MODE (1)					4 ↓ [7]		{A12-111}
M. DIRECT MODE (1)	1 ↓	1 ↓	1 ↓	1 ↓			{A12-111}
N. SINGLE MODE (1)							
O. BACKUP MODE (1)	0 ↓	0 ↓	0 ↓	0 ↓			{A12-111}
P. BRAKES (6)	WRIST ROLL ↓	WRIST ROLL ↓	0 ↓	0 ↓	0 ↓		{A12-115}
Q. AUTO BRAKES (1)	0 ↓ [3]	0 ↓ [3]	0 ↓ [3]	0 ↓ [3]	0 ↓ [3]		{A12-116}
R. CAPTURE & RIGIDIZE (2)			1 ↓		1 ↓		{A12-161}
S. DERIGIDIZE (2)			1 ↓	1 ↓	2 ↓		{A12-161}
T. RELEASE (2)			1 ↓ [6]	1 ↓ [6]	2 ↓ [6]		{A12-161}
U. BACKUP, RELEASE (1)			0 ↓ [6]	0 ↓ [6]			{A12-161}
V. RMS AND OBSS THERMAL	REQUIRED	REQUIRED	REQUIRED	REQUIRED	REQUIRED		{A12-3} {A12-11}

@[113095-1809A] @[111298-6744] @[110900-7257] @[102506-7835B] @[ED]

THIS RULE CONTINUED ON NEXT PAGE

FLIGHT RULES

A12-1001

RMS GO/NO-GO CRITERIA (CONTINUED)

NOTES:

- [1] CONTINUE OPERATIONS IF ONE FAILURE WILL NOT RESULT IN THE INABILITY TO LATCH AT LEAST TWO MRL'S.
- [2] ONE AT THE SHOULDER AND ONE AT EITHER THE MID OR AFT PEDESTAL IS REQUIRED.
- [3] OPERATIONS IN DIRECT AND BACKUP CAN CONTINUE WITH THE LOSS OF AUTOBRAKES.
- [4] RMS SYSTEM REDUNDANCY OR JETT REDUNDANCY IFM REQUIRED. @[113095-1809A]
- [5] CONTINUE OPERATIONS EVEN IF ONE FAILURE WILL RESULT IN THE INABILITY TO LATCH AT LEAST TWO MRL'S (ASSUMES CURRENTLY HAVE TWO-LATCH CAPABILITY). EVA CAPABILITY REQUIRED. @[110900-7257]
- [6] EVA CAPABILITY EXISTS FOR THE FOLLOWING CONTINGENCIES:
 - SHOULDER BRACE RELEASE
 - MPM DEPLOY/STOW
 - RMS STRAPDOWN
 - GRAPPLE FIXTURE (GF) RELEASE
- [7] ONE OF SINGLE, DIRECT, OR BACKUP REQUIRED FOR UNCRADLING, DAMAGE ASSESSMENT/REPAIR, AND JETTISON. @[110900-7257] @[102506-7535B]
- [8] ONE AT THE FORWARD AND ONE AT EITHER THE MID OR AFT PEDESTAL IS REQUIRED. @[102506-7835B]

FLIGHT RULES

SECTION 13 - AEROMEDICAL

ASCENT

A13-1	ASCENT ABORT.....	13-1
A13-2	SPACEHAB SAFE ATMOSPHERE REQUIREMENTS - UNPOWERED ASCENT.....	13-1
A13-3 THROUGH A13-20	RULES ARE RESERVED.....	13-1

ON-ORBIT

A13-21	EARLY FLIGHT TERMINATION.....	13-2
A13-22	ONBOARD MEDICAL KIT.....	13-2
A13-23	PRIVATE MEDICAL COMMUNICATION (PMC).....	13-3
A13-24	CPHS PROTOCOLS.....	13-5
A13-25	CREW AWAKE TIME CONSTRAINT.....	13-5
A13-26	ACCELERATION RESTRICTIONS ON MEDICAL PROCEDURES.....	13-6
A13-27	RESERVED.....	13-6
A13-28	RESERVED.....	13-6
A13-29	NOISE LEVEL CONSTRAINTS.....	13-7
A13-30	IODINE REMOVAL REQUIREMENT [HC].....	13-10
A13-31	CREW CABIN TEMPERATURE LIMITS.....	13-12
A13-32	EXPERIMENTAL/DSO INTENSE EXERCISE PROTOCOLS..	13-15
A13-33	EXERCISE REQUIREMENTS [HC].....	13-17
A13-34	TANK B WATER CONTINGENCY USE [HC].....	13-20
A13-35 THROUGH A13-50	RULES ARE RESERVED.....	13-20

FLIGHT RULES

ATMOSPHERE

A13-51	CABIN PRESSURE [HC].....	13-21
	TABLE A13-51-I - 8000 FOOT AIR EQUIVALENT ISOPLETHS ($P_{A_{O_2}} = 69$ MMHG).....	13-23
A13-52	PPCO2 CONSTRAINT (TWO GAS) [HC].....	13-28
A13-53	MINIMUM PPO2 CONSTRAINTS [HC].....	13-30
A13-54	100 PERCENT OXYGEN USE CONSTRAINT [HC].....	13-35
A13-55 THROUGH A13-100	RULES ARE RESERVED.....	13-36

EVA OPERATIONS

A13-101	SCHEDULED AND UNSCHEDULED EVA CONSTRAINTS [HC].....	13-37
A13-102	MAXIMUM EVA DURATION CONSTRAINTS.....	13-38
A13-103	EVA PREBREATHE PROTOCOL [HC].....	13-39
A13-104	DECOMPRESSION SICKNESS SYMPTOMS AND CREW DISPOSITION.....	13-44
A13-105	DECOMPRESSION SICKNESS RESPONSE AND TREATMENT	13-47
A13-106	MINIMUM PPO2 CONSTRAINTS.....	13-51
A13-107	PPCO2 CONSTRAINT (ONE GAS).....	13-52
A13-108 THROUGH A13-150	RULES ARE RESERVED.....	13-53

HAZARD MANAGEMENT

A13-151	HOT CABIN ATMOSPHERE [HC].....	13-54
	TABLE A13-151-I - LOSS OF EVAPORATION CAPABILITY IN A HOT CABIN ATMOSPHERE.....	13-58
	TABLE A13-151-II - CORE TEMPERATURE RANGE LIMITS AND ASSOCIATED PERFORMANCE DECREMENTS.....	13-59
	TABLE A13-151-III - COGNITIVE DEFICIT ONSET AND METABOLIC RATE LIMITS VS CABIN TEMP WITH ACES ON/OFF AND NOMINAL ICU FUNCTION.....	13-60
A13-152	RESERVED.....	13-63
A13-153	BROKEN GLASS/HAZARDOUS SUBSTANCE CONSTRAINT [HC].....	13-63
A13-154	HAZARDOUS SPILL LEVEL DEFINITIONS [HC].....	13-64

FLIGHT RULES

A13-155	ORBITER HAZARDOUS SUBSTANCE SPILL RESPONSE [HC].....	13-66
A13-156	SPACEHAB HAZARDOUS SUBSTANCE SPILL RESPONSE..	13-70
A13-157	CABIN ATMOSPHERE CONTAMINATION FIRE/SMOKE....	13-76
	TABLE A13-157-I - CSA-CP READINGS EQUIVALENT TO 24-HOUR SMAC LIMITS (MASKING LEVELS).....	13-78
	TABLE A13-157-II - 1-HOUR, 24-HOUR, AND 7-DAY SMAC LIMITS.....	13-79
A13-158	CABIN ATMOSPHERE CONTAMINATION - HALON 1301 [HC].....	13-81
A13-159	CABIN ATMOSPHERE CONTAMINATION - FREON 21 [HC].....	13-85
A13-160	THROUGH A13-200 RULES ARE RESERVED.....	13-86

ENTRY

A13-201	ANTI-G SUIT PROTOCOL (ANTI-ORTHOSTATIC COUNTERMEASURE) [HC].....	13-87
A13-202	FLUID LOADING [HC].....	13-88
A13-203	RESERVED.....	13-89

FLIGHT RULES

THIS PAGE INTENTIONALLY BLANK

FLIGHT RULES

SECTION 13 - AEROMEDICAL

ASCENT

A13-1 ASCENT ABORT

THERE ARE NO MEDICAL REASONS FOR ABORTING DURING THE ASCENT PHASE.

The powered flight phase is too short to allow an adequate evaluation of any medical problem that may develop and to call an abort would impose unacceptable risks on the remainder of the crew.

A13-2 SPACEHAB SAFE ATMOSPHERE REQUIREMENTS - UNPOWERED ASCENT

THE ATMOSPHERE FOR AN UNPOWERED SPACEHAB ON ASCENT IS CERTIFIED SAFE PREFLIGHT AND FOR INITIAL CREW ENTRY FOR 36 DAYS FROM THE TIME GROUND VENTILATION IS REMOVED IN THE ABSENCE OF PAYLOADS WITH HIGH OFFGASSING CHARACTERISTICS (T-VALUE > 0.2). SPACEHAB PAYLOADS WITH HIGH OFFGASSING CHARACTERISTICS SUCH THAT THE SAFE ENTRY TIME IS REDUCED WILL BE LISTED IN THE FLIGHT SPECIFIC ANNEX. @[111501-4964A]

High offgassing characteristics are defined as any hardware with an index of toxicity (T-value) greater than 0.2. Off-gassing analyses by JSC Toxicology have shown that the atmosphere of a closed, unpowered Spacehab module develops unacceptably high levels of toxic gases after 36 days and may not be certified for crew ingress after 36 days. For missions that the Spacehab module is unpowered, the module is enclosed without ventilation or circulation from the time that ground ventilation is removed through launch, allowing a potential buildup of toxic offgas products. The level of these products remains below the maximum allowable for 36 days; therefore, there is no constraint to accessing the module on FDI prior to crew sleep. There is no constraint for a powered Spacehab module on ascent because air circulation remains active.

Reference: Toxicology Group Memo 375, Safe Entry Into the Double and Single Spacehab Modules, dated February 25, 1998 and the Special Daily PRCB Presentation, Item No. 1 Spacehab Module Purge Evaluation (STS-101), dated May 11, 2000. @[111501-4964A]

A13-3 THROUGH A13-20 RULES ARE RESERVED

FLIGHT RULES

ON-ORBIT

A13-21 EARLY FLIGHT TERMINATION

ANY FLIGHT TERMINATION DECISION RELATED TO CREW HEALTH WILL BE A REAL-TIME CALL AND WILL ONLY BE CONSIDERED IF ACCEPTABLE ON-ORBIT TREATMENT IS NOT AVAILABLE.

Early flight termination may be required for the onset of any condition that adversely affects crew safety or health and performance. ©[ED]

A13-22 ONBOARD MEDICAL KIT

THOSE ITEMS IN THE SHUTTLE MEDICAL CHECKLIST LABELED WITH AN "*" ARE TO BE USED ONLY AFTER SURGEON APPROVAL OR AS DIRECTED IN THE CHECKLIST. A COMPLETE LISTING OF ALL ONBOARD MEDICATIONS AND THEIR SIDE EFFECTS CAN BE FOUND IN THE MEDICAL CHECKLIST APPENDIX. ALL ITEMS USED FROM MEDICAL KITS AND CREW CARRY ON ITEMS WILL BE LOGGED IN FLIGHT ON INDIVIDUAL CARDS LOCATED IN THE SOMS KIT AND REPORTED TO THE SURGEON DURING THE POSTFLIGHT DEBRIEF. ©[022604-6183] ©[082604-6349A]

Prescription drugs must be controlled by a physician during flight in the same manner that they are controlled on the ground. Some drugs in the Shuttle Orbiter Medical System (SOMS) require physician approval before use and others do not. Drug control protects the crew by preventing inappropriate use of medications and unexpected side effects that could affect performance. Records of usage are required for accounting of controlled substances, reconstructing medical history, and developing and maintaining SOMS kits for subsequent flights. ©[082604-6349A]

DOCUMENTATION: Medical Operations Requirements Document for Space Shuttle, April 2003, JSC-13956; Code of Federal Regulations (CFR, title 21, section 1306.03), April 1, 2003; Federal Food, Drug and Cosmetic Act, Section 503(b)(1), March 6, 1999; and Texas Dangerous Drug Act, chapter 483, subchapter A, section 483.001. ©[022604-6183]

FLIGHT RULES

A13-23

PRIVATE MEDICAL COMMUNICATION (PMC)

- A. A PMC MAY BE REQUESTED AS NEEDED BY THE CDR, ANY CREWMEMBER, FCR SURGEON, OR FLIGHT DIRECTOR. @[092204-6386A]

This rule reflects NASA Policy and Privacy Act of 1974 considerations regarding the privileged nature of doctor-patient communications.

- B. SCHEDULED PMC'S WILL BE CONDUCTED AS FOLLOWS:
1. A PMC WILL BE SCHEDULED ON ALL FLIGHT DAYS. IT WILL USUALLY BE SCHEDULED DURING THE PRESLEEP PERIOD EXCEPT ON LANDING DAY WHEN IT WILL BE SCHEDULED PRIOR TO DEORBIT PREP, PREFERABLY IN THE POST SLEEP PERIOD.
 2. FOR DUAL-SHIFT MISSIONS, PMC'S WILL BE SCHEDULED WHEN BOTH TEAMS ARE AWAKE, IF POSSIBLE.
 3. A PMC WILL BE SCHEDULED PRIOR TO LANDING EXCEPT WHEN LANDING ON LAUNCH DAY.
 4. A PMC WILL BE SCHEDULED PRIOR TO ANY EVA.

This rule provides the opportunity for the surgeon and the crew to discuss health-related concerns, operational medical issues, and treatment of medical problems.

Scheduling PMC's on dual-shift missions when both teams are awake allows access to the entire crew and minimizes impacts to crew sleep.

Early deorbit/landing or scheduled and unscheduled EVA's may be considered during flight. A PMC is necessary to accurately assess crew health, particularly during the first 72 hours MET, when symptoms of motion sickness are greatest.

Reference Rule {A13-101B} and C, SCHEDULED AND UNSCHEDULED EVA CONSTRAINTS [HC], and rationale. @[092204-6386A] @[ED]

THIS RULE CONTINUED ON NEXT PAGE

FLIGHT RULES

A13-23

PRIVATE MEDICAL COMMUNICATION (PMC) (CONTINUED)

- C. ALL PMC'S WILL BE CATEGORIZED AND COMMUNICATED TO THE FLIGHT DIRECTOR IN ONE OF THE FOLLOWING WAYS: @[092204-6386A]
1. NO MISSION IMPACT
 2. POSSIBLE MISSION IMPACT - REQUIRES ADDITIONAL COMMUNICATION FROM SURGEON TO FLIGHT DIRECTOR AND OTHER FCR OPERATORS AS REQUIRED
 3. MISSION IMPACT - REQUIRES CDR SUMMARY OF MISSION IMPACT ON OPEN AIR-TO-GROUND

In the event a PMC does not disclose information that will have a mission impact, the content of the PMC will not be released to the public. A flight note will be sent to the Flight Director that a PMC was conducted but there was no impact to scheduled mission objectives.

In the event that a PMC discloses information for which mission impact is uncertain, the surgeon will communicate his/her assessment to the Flight Director; other Flight Control Room Operators; Manager, Medical Operations; and Chief, Space Medicine and Health Care Systems, in sufficient detail to permit a proper mission impact assessment. This information will not be released to the public.

If the Crew Commander and/or Flight Director have determined a mission impact, then the Surgeon, with the Manager, Medical Operations and Chief, Space Medicine and Health Care Systems, will prepare a summary statement for public release. The summary will identify the crewmember(s) and will provide sufficient information for a clear understanding of the nature, gravity, and prognosis of the crew health situation as it relates to mission impact. It is the responsibility of the Mission Commander to report on the open air-to-ground link, in at least a summary form, any crew health situation which will have mission impact.

- D. MEDICAL TREATMENT IN RESPONSE TO CREW REQUESTS MAY BE PRESCRIBED DURING NONPRIVATE COMMUNICATION PERIODS AT THE DISCRETION OF THE CDR AND THE FCR SURGEON.

The crew may discuss medical concerns and treatment over nonprivate air-to-ground loops if they choose to waive the privacy accorded them by the Privacy Act of 1974.

DOCUMENTATION: Medical Operations Requirements Document for Space Shuttle, April 2003, JSC-13956. @[ED]

Reference JPD 8610.3C. @[092204-6386A]

FLIGHT RULES

A13-24

CPHS PROTOCOLS

ALL LIFE SCIENCES EXPERIMENTS USING THE CREW AS TEST SUBJECTS WILL BE CONDUCTED ACCORDING TO PROTOCOLS APPROVED BY THE JSC COMMITTEE FOR THE PROTECTION OF HUMAN SUBJECTS (CPHS) AND OTHER PARTICIPATING MEDICAL BOARDS. SUBSTANTIVE DEVIATIONS IN FLIGHT TO THESE PROTOCOLS REQUIRE THE CONCURRENCE OF THE FCR SURGEON, THE CPHS, AND THE PRINCIPAL INVESTIGATOR (PI). ANY NON-SUBSTANTIVE DEVIATIONS, SAFETY RELATED ISSUES, OR PROCEDURES ARE THE FINAL RESPONSIBILITY OF FCR SURGEON. ©[092195-1797] ©[022604-6195]

Life sciences experiments often involve hardware that requires detailed procedures, safety devices, and restraints to minimize the risk of injury to the participating crewmember(s). Data collection is not allowed until the JSC CPHS is satisfied that the experiment has been designed to minimize the risk of injury or illness for the crewmember. Therefore, substantive deviations (e.g., switching a non-max exercise test to a max exercise test) from approved protocols and procedures may compromise the safety of an experiment and expose the crewmember to an unacceptable level of risk for injury. Non-substantive changes (e.g., change of timing of a blood draw or other data collection) do not require real-time concurrence, but the PI still needs to be informed as time and the situation permit. ©[092195-1797] ©[ED]

DOCUMENTATION: PROTECTION OF HUMAN RESEARCH SUBJECTS, NASA Procedures and Guidelines, March 28, 2003, NPG 7100.1. ©[022604-6195] ©[ED]

A13-25

CREW AWAKE TIME CONSTRAINT

- A. ON ORBIT - THE MAXIMUM ON-ORBIT CREW AWAKE TIME IS 18 HOURS.
- B. LANDING DAY - THE MAXIMUM CREW AWAKE TIME ON LANDING DAY IS 18 HOURS FROM CREW WAKE-UP ON ORBIT TO THE SLEEP PERIOD AFTER LANDING, INCLUSIVE OF ALL POSTLANDING ACTIVITIES.

Fatigue represents a blend of factors resulting in a state of decreased ability. It has been shown to negatively impact both mental and physical performance, and fatigue-induced changes increase after 18 hours awake time. The strong relationship between sleep loss and the development of fatigue is well known.

For landing day, the post landing activities are described in the Crew Scheduling Constraints Document, Section 4.0 (NSTS-37326). Post landing activities may be scheduled up to a maximum crew awake time of 18 hours inclusive of the presleep period. ©[022405-6590A]

DOCUMENTATION: Dinges DF. An overview of sleepiness and accidents. J Sleep Research, 4 (2): 414, 1995. ©[022405-6590A]

FLIGHT RULES

A13-26 ACCELERATION RESTRICTIONS ON MEDICAL PROCEDURES

- A. THE FOLLOWING TYPES OF MEDICAL EXPERIMENTS WILL NOT BE PERFORMED DURING PRCS ATTITUDE HOLD, TRANSLATIONS, OR OMS FIRINGS: @[111094-1714A]
1. INVASIVE EXPERIMENTS THAT REQUIRE A DEVICE TO PENETRATE THE SKIN OF THE SUBJECT CREWMEMBER
 2. APPLICATION OF ANY DEVICE TO THE SURFACE OF THE EYE
 3. EXPERIMENTS THAT REQUIRE THE INSERTION OF ANY DEVICE INTO THE EAR, NOSE, OR MOUTH
 4. EXPERIMENTS THAT REQUIRE THE USE OF A SYRINGE OR ANY SHARP-EDGED DEVICE

Relative motion between an operator and subject will occur during OMS or RCS firings. This motion could lead to injury.

- B. THE CREW WILL INFORM THE ORBITER COMMANDER OR PILOT PRIOR TO PERFORMING DELICATE/INVASIVE MEDICAL OPERATIONS.

Delicate or invasive operations require that acceleration levels do not exceed those produced by the VRCS. In the case of the loss of VRCS, the crew needs to coordinate with the CDR or PLT to ensure that the orbiter is in free drift until the operation has been completed. This will prevent injury to the crew. @[111094-1714A] @[ED]

Rules {B13-151}, ACCELERATION RESTRICTIONS ON MEDICAL PROCEDURES [RC] [E], and {C2-15}, SHUTTLE RCS THRUSTER USAGE CONSTRAINTS WHILE CONDUCTING EXPERIMENTS [RC] [E], reference this rule. @[ED]

A13-27 RESERVED @[022604-6196]

A13-28 RESERVED @[022604-6197]

FLIGHT RULES

A13-29

NOISE LEVEL CONSTRAINTS

A. IF, AT ANY TIME, THE NOISE LEVELS ARE SUCH THAT THE CREW BECOMES UNCOMFORTABLE OR IS UNABLE TO COMMUNICATE WITH EACH OTHER OR THE GROUND ADEQUATELY, TAKE THE FOLLOWING ACTIONS:
@[072795-1785A] @[092204-6381]

1. DON HEARING PROTECTION. @[ED]
2. USE THE AUDIO DOSIMETER TO DETERMINE SOUND LEVELS IN ANY HABITABLE VOLUME (INCLUDING ORBITER FLIGHT DECK, MIDDECK, SPACEHAB).
 - a. IF THE AUDIO DOSIMETER REVEALS, WHEN USED IN SOUND LEVEL METER (SLM) MODE, THAT THE FOLLOWING SOUND PRESSURE LEVELS ARE MEASURED, ONE OR MORE OF THE ACTIONS LISTED IN PARAGRAPH B WILL BE IMPLEMENTED.

EXPOSURES (SOUND LEVEL AND DURATION) :

(1) 76-80 DBA FOR 5 MINUTES

(2) 81-85 DBA FOR 1 MINUTE

(3) \geq 86 DBA FOR ANY TIME IS NOT ALLOWED.

- b. IF THE AUDIO DOSIMETER REVEALS, WHEN USED IN LAVG/LEQ DOSIMETER MODE, THAT THE 24-HOUR AVERAGE NOISE LEVEL (LEQ) IS GREATER THAN OR EQUAL TO 74 DBA, ONE OR MORE OF THE ACTIONS LISTED IN PARAGRAPH B WILL BE IMPLEMENTED. @[092204-6381]

THIS RULE CONTINUED ON NEXT PAGE

FLIGHT RULES

A13-29

NOISE LEVEL CONSTRAINTS (CONTINUED)

B. CREWMEMBER RESPONSES TO HIGH NOISE EXPOSURES: @[092204-6381]

1. POWER OFF THE GREATEST NOISE PRODUCER(S). THE POCC/MCC WILL DECIDE ANY PRIORITIES IN THE POWERDOWN IF THERE IS MORE THAN ONE LOUD NOISE SOURCE.
2. RESCHEDULE THE TIMELINE SO THAT ESPECIALLY NOISY EXPERIMENTS DO NOT OCCUR ON THE SAME DAY.
3. WEAR HEARING PROTECTION DURING SLEEP TO ALLOW A RECOVERY PERIOD FROM THE NOISE.
4. WEAR HEARING PROTECTION DURING THE DAY, IF DESIRED.
@[072795-1785A]

In the sound level meter mode, the Audio Dosimeter reports instantaneous noise levels at the time of measurement. In the Lavg/Leq dosimeter mode, the Audio Dosimeter reports the average noise exposure, integrated over a measured time period.

Exposure to noise levels of 74-76 dBA for 10 days has been seen to cause fatigue, headaches, ringing in the ears and temporary threshold shifts of up to 20-25 dB. Exposure to these levels for even 24 hours led to complaints of the irritating effect of the noise. Each payload has been required to meet certain noise constraints. A number of payloads have not met those constraints and have been granted waivers. Any individual payload is not likely to cause difficulty but, in combination, may produce unacceptable noise levels. Powering off the loudest noise producers or rescheduling the time so that several loud experiments do not occur on the same day should lower the 24-hour noise exposure to an acceptable level. @[072795-1785A] @[092204-6381]

THIS RULE CONTINUED ON NEXT PAGE

FLIGHT RULES

A13-29

NOISE LEVEL CONSTRAINTS (CONTINUED)

Wearing hearing protection (e.g., foam ear plugs) during sleep provides a period of time to recover from the temporary threshold shift in hearing. The noise level during the day may still be irritating and fatiguing and may cause difficulty with communication. Wearing hearing protection during the day should eliminate the irritation and fatigue from the noise; however, communication among the crew, with the ground, and the ability to hear alert tones may be impacted.

At noise levels greater than 85 dBA, adequate communication with the ground would be extremely difficult, if not impossible, representing a potentially unsafe situation if urgent calls to the crew cannot be heard. Noise levels in the range from 76-85 dBA will make communication difficult both among the crew and between the crew and the ground. These time limits have been recommended by the former Spacelab Payloads Acoustic Working Group and the JSC Occupational Health Human Test Support Office (Audiology and Hearing Conservation) were approved by the Shuttle Program as a maximum time that this level of communication interference by an individual payload should be allowed.

@[092204-6381]

C. IF THE AUDIO DOSIMETER IS INOPERATIVE OR NOT AVAILABLE, IMPLEMENT THE SAME CORRECTIVE ACTIONS LISTED IN PARAGRAPH B. @[092204-6381]

D. NOISE LEVEL READINGS CAN BE TAKEN AT ANY TIME BY THE CREW, OR MAY BE REQUESTED BY THE FLIGHT DIRECTOR OR FCR SURGEON, IF PREFLIGHT OR INFIGHT CONCERN OVER NOISE LEVEL EXISTS. @[092204-6381]

Noise levels in paragraphs A & B are established as mandatory levels; however, the crew may experience fatigue, headaches, or other symptoms at lower noise levels or may encounter problems in communication with each other or the ground. The crew has the authority to make such judgment calls and use the above corrective actions and priorities to achieve a workable environment to complete the mission safely and successfully. @[012694-1601] @[ED]

Documentation: Occupational Noise Exposure, OSHA Hearing Conservation Amendment – CFR-1910.95, 1983

NASA Flight Crew Hearing Conservation Program, JSC-28927, April 2000.

Medical Operations Requirements Document (MORD) for Space Shuttle, JSC-13956, Section 3.2.7.1, Revision H, April 2003.

Shuttle Audio Dosimeter procedures, Orbit Operations Checklist, All Flights, Generic, Rev. J. @[092204-6381]

FLIGHT RULES

A13-30

IODINE REMOVAL REQUIREMENT [HC] @[012705-6529B]

THE TOTAL IODINE AND IODIDE INGESTED BY CREWMEMBERS SHOULD BE LIMITED TO 1.0 MG/DAY FOR EACH CREWMEMBER ON ALL SPACE SHUTTLE FLIGHTS. THIS LIMIT INCLUDES IODINE FROM ALL SOURCES INCLUDING DIETARY INTAKE AND POTABLE WATER CONSUMPTION. @[090999-6996]

Medical Operations and a medical expert review panel agree that ingesting 1.0 mg iodine/day is relatively safe; however, excess iodine causes adverse effects in people who are susceptible to thyroid disorders. The shuttle supply water system is designed to add 3-4 mg/L iodine to the drinking water for disinfection. With an average daily consumption of 2L water, this would equate to ingestion of 6-8 mg of iodine/day. Because ingestion of 2 mg iodine/day decreases thyroid hormone synthesis, a Galley Iodine Reduction Assembly (GIRA) is required. The GIRA removes all iodine from the cold water line and leaves approximately 1.4 mg/L iodine in the hot water line. Each crewmember should ingest no more than 16 oz (0.5 L) of hot water per day from the shuttle supply (0.7 mg/day iodine). Cold water consumption is not restricted. Hot water consumption from the ISS water system has no restrictions as iodine is not used for disinfection on ISS. Food contributes approximately 0.3 mg of iodine per day.
@[090999-6996] @[012705-6529B]

THIS RULE CONTINUED ON NEXT PAGE

FLIGHT RULES

A13-30

IODINE REMOVAL REQUIREMENT [HC] (CONTINUED)

Prior to the GIRA being flown, thyroid stimulating hormone (TSH) levels were significantly increased in astronauts ingesting iodinated water during shuttle flights. It was suggested that the large doses of iodine ingested by astronauts transiently decreased thyroid function, as reflected by elevated serum TSH values. Beginning with STS-87, the GIRA was installed on each shuttle flight to remove iodine from the potable cold water. The average hot water consumption is 17 oz/crewmember/day (range is 10-30 oz/crewmember/day) based on data from 25 shuttle flights since the GIRA has been manifested (STS-87 through STS-113). Thyroid function was evaluated on all shuttle crews from STS-87 to STS-110, and no post-flight increase in TSH was detected. The results suggest the GIRA and pre-flight training limit total iodine intake to 1.0 mg/day, preserve normal thyroid function in shuttle crewmembers, and is effective in protecting crewmembers from iodine excess. ©[012705-6529B]

Reference Rule {A17-551}, IODINE REMOVAL IMPLEMENTATION [HC].

Rule {A17-551}, IODINE REMOVAL IMPLEMENTATION [HC], references this rule.

DOCUMENTATION: Medical Effects of Iodine: Proceedings of NASA/JSC Conference, March 1998, JSC 28379.

NSTS 07700, Vol X – Book 1, Para 3.3.1.2.4.9, defines the total iodine consumption per day/crewperson.

Policy on Iodine Consumption During Space Flight, memorandum SD2-98-852, April 17, 1998.

Institute of Medicine. 2001. Iodine. In: Dietary Reference Intakes. Washington, D.C.: National Academy Press. pp8-1 to 8-27.

McMonigal KA, Sauer RL, Smith SM, et al. Physiological Effects of Iodinated Water on Thyroid Function. In: Lane HW, ed. Isolation: NASA Experiments in Closed-Environment Living. American Astronautical Society, Univelt, Incorporated. 2002, Chapter 5.5, pp 369-395.

Hazard Report ORBI-323, Contamination of Potable Water ©[012705-6529B]

FLIGHT RULES

A13-31

CREW CABIN TEMPERATURE LIMITS

TO MAXIMIZE CREW COMFORT AND PERFORMANCE, MISSION THERMAL ANALYSIS AND PLANNING SHALL KEEP THE CABIN TEMPERATURE AT OR BELOW THE FOLLOWING LIMITS: @[022201-7095A]

- A. PRE-LAUNCH: ≤ 80 DEGREES F
- B. ON-ORBIT: ≤ 80 DEGREES F
- C. ENTRY/LANDING: ≤ 75 DEGREES F

IF ATTEMPTING TO MEET THE ENTRY/LANDING CONSTRAINT OF 75 DEG RESULTS IN UNACCEPTABLY COLD TEMPERATURES DURING CREW SLEEP, THE 75 DEG LIMIT CAN BE INCREASED WITH CDR AND SURGEON CONCURRENCE. @[092701-4860]

Excessive thermal stress can have a negative effect on crew health, safety, and performance. Exceeding these limits would be expected to result in an increased incidence of orthostatic intolerance, and an increased awareness and reporting of thermal discomfort by the crew. Liquid cooling for the LES partial-pressure suit was developed in response to crew complaints of thermal discomfort during mission activities. Post-flight medical data shows the incidence of orthostatic intolerance has been reduced since liquid cooling was made available to crews starting with STS-62, March 1994. Orthostatic intolerance is mainly a concern during the entry/landing phase. Excessive heat load exacerbates orthostatic intolerance by increasing vasodilatation and sweating. Therefore, the recommended temperature limits are more restrictive during entry. @[033105-6638A]

The individual cooling units (ICU's) used during ascent/entry starting with STS-88, December 1998 were designed to remove 340 BTU's/hr at an ambient temperature of 75 deg F and 50 percent RH. Metabolic heat load produced by a resting, minimally active crewmember is approximately 450 BTU/hr. The remaining 110 BTU/hr is assumed lost through passive diffusion, respiratory evaporation, and radiation.

Operational experience has shown that a 75 deg F entry temperature is acceptable at low metabolic rates. According to data provided by EC5; however, the ICU's are expected to degrade at ambient temperatures above 75 deg F. An engineering evaluation of ICU's at higher ambient temperatures has not been performed to date. At higher metabolic rates and higher cabin temperatures, ICU performance may not be adequate and may lead to insufficient cooling resulting in Cognitive Deficit Onset (CDO) or Loss of Tracking Skills (LOTS). The predicted metabolic rate at which this can happen is shown in Table 3, reference Rule {A13-151}, HOT CABIN ATMOSPHERE [HC]. @[033105-6638A]

THIS RULE CONTINUED ON NEXT PAGE

FLIGHT RULES**A13-31****CREW CABIN TEMPERATURE LIMITS (CONTINUED)**

A single cabin temperature sensor is located on the flight deck. Data points from STS-43 shows 5 deg F higher on FD than MDDK and 11 deg F higher on FD than airlock. On-orbit experience from DTO-664 showed that cabin temperatures vary 20-30 deg F throughout the cabin during missions. Sleep station air outlet temperature may be 15-20 deg F colder than other cabin temperatures, compromising crew tolerance for thorough cold soak prior to de-orbit. Therefore, single data points representing either a measured value or an averaged value are inadequate to predict with confidence temperatures in the microclimate of crewmembers in microgravity because of the absence of air convection and widely disparate forced air circulation. Un-stirred air in the vicinity of crewmembers can result in temperature and humidity levels that can be seriously underestimated and be worse than expected by assumptions of homogeneity of cabin air. Additionally, orbiter orientation with respect to the sun, payload bay heat sources, and middeck payloads affect the temperature gradients between middeck and flight deck and the effectiveness of cabin thermal control. ©[033105-6638A]

If CDR/Surgeon determines that the temperature control measures to attain an entry/landing temperature of 75 deg F would compromise crew sleep by being too cold, then the cabin temperature controller will be adjusted to ensure a comfortable sleep environment. A thermal assessment of the projected wake-up and entry landing target temperatures will be provided by EECOM to the Surgeon to assist in making this decision. The data will be provided prior to the PMC the evening before landing. ©[092701-4860]

Measures to achieve the crew cabin temperature limits listed above are documented in Rule {A17-152}, CABIN TEMPERATURE CONTROL AND MANAGEMENT.

References: "Revised Cabin Temperature Requirements," SD-99-005, March 23, 1999

Summary Chart: "Liquid Cooling in the LES Phase I Test Results," Medical Sciences Division/James M. Waligora, 1993

Environmental Guidelines for Aerobic and Resistive Exercise Activities, Tables 1 & 2, Medical Operations Bone/Muscle/Exercise IPT, Medical Operations Branch, Jeff Jones, M.D.

Graph of ICU Performance vs Cabin Temperature, EC5/Stephanie Walker; Figure 5.8.2.2-1, Environmental Requirements, NASA MSIS-131 Rev. A

Minutes of Medical Operations EVA IPT, Cabin Temperature Recommendations, SD26/Joseph P. Dervay, M. D., November 17, 1998

"Use of liquid cooling in the launch and entry suit," NASA Technical Report, May 12, 1993

"Use of Liquid Cooling in the Launch and Entry Suit - Phase II," NASA Technical Report, February 17, 1994 ©[033105-6638A]

THIS RULE CONTINUED ON NEXT PAGE

FLIGHT RULES

A13-31

CREW CABIN TEMPERATURE LIMITS (CONTINUED)

“Temperature Control as a Countermeasure to Post-Flight Orthostatic Intolerance,” NASA Technical Presentation, April 11, 1996. ©[022201-7095A] ©[033105-6638A]

Kuznetz, L. The effect of compromised cabin thermal control on crew performance during entry, August 2004.

Lee, S., McDaniel, A., Jacobs, T., and Schneider, S. (2004). Performance of the Liquid-Cooling Garment With the Advanced Crew Escape Suit in Elevated Cabin Temperatures. NASA/TP-2004-212074.

DTO-664 Cabin Temperature Survey results evaluation

STS-43 Orbiter Cabin Temperature Survey in conjunction with the Bioserve-Instrumentation Technology Associates Materials Dispersion Apparatus (BIMDA) ©[033105-6638A]

*Rule {A17-152}, CABIN TEMPERATURE CONTROL AND MANAGEMENT, references this rule.
©[ED]*

FLIGHT RULES

A13-32

EXPERIMENTAL/DSO INTENSE EXERCISE PROTOCOLS

@[052605-6601A]

THIS RULE APPLIES TO EXPERIMENTAL/DSO EXERCISE PROTOCOLS, WHEN REQUIRED BY THE COMMITTEE FOR THE PROTECTION OF HUMAN SUBJECTS (CPHS), AND DOES NOT APPLY TO CREW OPTIONAL EXERCISE.

A. A/G VOICE AND TELEMETRY REQUIREMENTS

WHEN FLOWN, EXPERIMENTAL/DSO INTENSE EXERCISE REQUIRES ELECTROCARDIOGRAM (ECG) TELEMETRY AND CONTINUOUS A/G VOICE COMMUNICATIONS DURING PORTIONS OF THE CYCLE TEST (I.E., AT LEVELS > 80 PERCENT PREFLIGHT MAXIMUM HEART RATE) AND CONTINUING THROUGH THE RECOVERY PERIOD. THE RECOVERY PERIOD SHALL LAST A MINIMUM OF 5 MINUTES AND MAY BE EXTENDED AT THE FLIGHT SURGEON'S DISCRETION. THE CREWMEMBER MONITORING THE EXERCISE SHALL CONTACT FLIGHT SURGEON IMMEDIATELY PRIOR TO BEGINNING THE EXERCISE PROTOCOL AND AGAIN IMMEDIATELY BEFORE PERFORMING EACH WORKLOAD INCREASE THAT EXCEEDS 80 PERCENT IN ORDER TO CONFIRM NO ORBITER LOSS OF SIGNAL (LOS).

B. ON FLIGHTS WITHOUT AN ADVANCED CARDIAC LIFE SUPPORT (ACLS) TRAINED PHYSICIAN ASTRONAUT OR ONBOARD ECG MONITORING CAPABILITY, LOSS OF ECG/COMM WILL NECESSITATE LIMITING EXERCISE TO 80 PERCENT WORKLOAD OR REDUCING EXERCISE TO 80 PERCENT IF ALREADY ABOVE IT. @[072893-1517A]

C. IF ECG CAN BE MONITORED ONBOARD AND AN ACLS TRAINED PHYSICIAN ASTRONAUT IS AVAILABLE, THE A/G VOICE AND TELEMETRY REQUIREMENTS IN PARAGRAPHS A AND B ABOVE DO NOT APPLY. THE PHYSICIAN ASTRONAUT MUST CONTINUOUSLY MONITOR THE ECG DURING EXERCISE ABOVE THE 80-PERCENT WORKLOAD. THE PHYSICIAN ASTRONAUT MAY NOT PERFORM OTHER EXPERIMENTS AT THIS TIME AND MUST BE ABLE TO SEE THE ECG DATA.

The physician astronaut will be able to detect significant dysrhythmias since ECG is available onboard. The physician astronaut should be certified in advanced cardiac life support to assure capability in dysrhythmia recognition and intervention. If downlink is available, the flight surgeon in the MCC will monitor the ECG data.

D. TEST TERMINATION CRITERIA @[072893-1517A]

EXPERIMENTAL/DSO INTENSE EXERCISE OPERATIONS ON A SUBJECT WILL BE TERMINATED FOR ANY ONE OF THE CRITERIA LISTED BELOW: @[052605-6601A]

THIS RULE CONTINUED ON NEXT PAGE

FLIGHT RULES

A13-32

EXPERIMENTAL/DSO INTENSE EXERCISE PROTOCOLS
(CONTINUED)

G - GROUND PERSONNEL CAN MAKE CALL

S - CREWMEMBER IN SPACE CAN MAKE CALL

G S 1. THE CARDIAC RHYTHM DISTURBANCES, LISTED BELOW, OCCUR:
SUSTAINED ABNORMAL SUPRAVENTRICULAR TACHYCARDIA (I.E.,
PAROXYSMAL ATRIAL TACHYCARDIA, ATRIAL FIBRILLATION,
ATRIAL FLUTTER, OR OTHER SUPRAVENTRICULAR TACHYCARDIA
OF UNIDENTIFIED ETIOLOGY LASTING MORE THAN 10 SECONDS)
@[052605-6601A]

- a. VENTRICULAR TACHYCARDIA
- b. EXERCISE INDUCED BUNDLE BRANCH BLOCK
- c. R-ON-T PVC'S
- d. UNEXPLAINED INAPPROPRIATE BRADYCARDIA
- e. MULTIFOCAL PVC'S
- f. ONSET OF SECOND OR THIRD DEGREE HEART BLOCK
- g. INCREASING VENTRICULAR ECTOPY (> 30 PERCENT OF
TOTAL BEATS UNIFOCAL PVC'S DEFINED AS ABNORMAL)

G S 2. A MAXIMUM HEART RATE VALUE GREATER THAN THAT
EXPLAINABLE BY THE EXERCISE STIMULUS AND NORMAL
PHYSIOLOGICAL VARIABILITY OCCURS. (IF THIS OCCURS AT
LOW LEVELS, WITH NO SIGNS OF INTOLERANCE, CREWMEMBER
SHOULD CHECK HEART WATCH AND CONFIRM HEART RATE WITH
GROUND) .

S 3. SUBJECT EXPERIENCES CHEST PAIN, DIZZINESS, OR OTHER
INAPPROPRIATE SYMPTOMS.

S 4. SUBJECT REQUESTS TO STOP. @[ED]

DOCUMENTATION: ACSM's Guidelines for Exercise Testing and Prescription (6th Edition, p. 80)
(2000). Philadelphia: Lippincott Williams & Wilkins. @[052605-6601A]

FLIGHT RULES

A13-33

EXERCISE REQUIREMENTS [HC] @[042904-6249A]

- A. EXERCISE WILL BE SCHEDULED ON A DAILY BASIS FOR ALL CREW MEMBERS STARTING ON FD3 THROUGH EOM-1. IT IS ACCEPTABLE NOT TO SCHEDULE EXERCISE FOR THE FOLLOWING: @[022802-4887C]
1. RENDEZVOUS FOR CDR AND PLT
 2. EVA DAY FOR EV AND IV CREW MEMBERS
 3. INTENSE ROBOTIC DAYS FOR PRIME ARM OPERATORS @[022405-6577A]
 4. MANDATORY MICROGRAVITY ENVIRONMENT FOR EXTENDED PERIOD OF TIME
 5. DSO REQUIREMENT

IN THESE SITUATIONS, THE FOLLOWING EXERCISE REQUIREMENT MUST BE MET: AT A MINIMUM, PRESCRIBED EXERCISE SHALL BE SCHEDULED STARTING NO LATER THAN FD4 AND EXTENDING THROUGH EOM-1 AT LEAST EVERY OTHER DAY FOR THE CDR, PLT, AND MS2 AND AT LEAST EVERY 3 DAYS FOR ALL OTHER CREWMEMBERS.

Properly performed exercise results in improved condition of the crew on return to a 1-G environment. The parameters defining the specific components of the exercise prescription are based upon the findings of the Extended Duration Orbiter Medical Project and from evaluation of crews on Mir during Phase 1.

All shuttle crewmembers need to be capable of emergency egress, if required, and should possess the level of physical conditioning required to assist in the egress of returning long-duration crewmembers. The CDR, PLT, and MS2 must be capable of performing the necessary piloting tasks of a nominal landing, and therefore have priority in the scheduling of exercise. Some exceptions (i.e., entry day, launch day, prime arm operator for intense robotic days, and IV and EV crewmembers on EVA day) are allowed due to lack of time on these days to schedule the exercise periods. The experiment exception permits approved biomedical testing in microgravity. Only the flight surgeons have the authority to determine whether a PL activity is an acceptable substitute for exercise. Exercise will be scheduled daily according to the Shuttle Crew Scheduling Constraints (SCSC) (NSTS-37326) and Medical Operations Requirements Document for Space Shuttle (JSC-13956). @[022405-6577A]

THIS RULE CONTINUED ON NEXT PAGE

FLIGHT RULES

A13-33

EXERCISE REQUIREMENTS [HC] (CONTINUED)

Prescribed aerobic exercise can be performed on the cycle ergometer, treadmill, or rowing device. Treadmill exercise shall not be scheduled during sleep periods since the treadmill is loud when it is operating. ©[042904-6249A].

Specific components of the aerobic/anaerobic exercise protocol shall at a minimum include: exercise duration (exclusive of warm-up) ≥ 20 minutes; exercise frequency \geq three times/seven flight days; and exercise intensity performed at a level eliciting ≥ 70 percent of the individual crewmember's age-predicted maximum heart rate.

Aerobic/anaerobic exercise performed at an intensity, duration, or frequency lower than that listed above will result in insufficient training for maintenance of exercise capacity.

Strength training with resistive exercise hardware is also encouraged every 3 days, especially for CDR, PLT, and MS2.

Shuttle exercise will be briefed to the crew by the shuttle crew surgeon, prior to flight, and will be discussed when necessary via Private Medical Conference. ©[022802-4887C]

B. THE STANDARD EXERCISE DURATION IS 1.5 HOURS (THE MINIMUM IS 1 HOUR). EXERCISE PERIODS MAY OVERLAP BY 30 MINUTES. ©[042904-6249A]

Exercise periods may overlap, if necessary, since the exercise period includes prep and cleanup of the exercise equipment.

C. FAILURE OF EXERCISE EQUIPMENT ALONE WILL NOT BE CAUSE TO SHORTEN THE FLIGHT. ©[022802-4887C]

If exercise hardware fails, exercise will be performed according to a workaround/contingency prescription from the surgeon.

D. EXERCISE REQUIREMENTS FOR ISS CREWMEMBERS RETURNING ON SHUTTLE ARE DOCUMENTED IN RULE {C13-101}, EXERCISE REQUIREMENTS FOR ISS CREWMEMBERS DURING UNDOCKED OPERATIONS (ON SHUTTLE HARDWARE) [RI] [E].

THIS RULE CONTINUED ON NEXT PAGE

FLIGHT RULES

A13-33

EXERCISE REQUIREMENTS [HC] (CONTINUED)

DOCUMENTATION:

Johnston, S. L., Wear, M. L., and Hamm, P. B. Incidence of Herniated Nucleus Pulposus Among Astronauts and Other Selected Populations. Presented at 69th meeting of the Aerospace Medical Association, May 1998.

Jones, Jeffrey A. Effects of Sustained Microgravity on the Musculoskeletal System and Joint Countermeasures for ISS Crews. August 2000.

Shackelford, L. C., et al. Countermeasures against Disuse Bone Loss. Life Science Research Laboratories, NASA/JSC, Houston, TX; Baylor College of Medicine, Houston, TX.

Watenpaugh, DE, RE Ballard, M Aratow, AR Hargens, DF Schwandt, SE Parazynski, SM Fortney. Exercise technology for space and earth. Abstract in AIAA Conference in Houston, March 5-7, 1996. ©[022802-4887C]

Extended Duration Orbiter Medical Project. Final Report 1989-1995. Section 1: Cardiovascular Deconditioning and Section 3: Functional Performance Evaluation. NASA-SP-1999-534

Reference: Hazard Report ORBI 322.

Rules {C13-101}, EXERCISE REQUIREMENTS FOR ISS CREWMEMBERS DURING UNDOCKED OPERATIONS (ON SHUTTLE HARDWARE) [RI] [E], and {C13-102}, EXERCISE REQUIREMENTS FOR CREWMEMBERS DURING DOCKED OPERATIONS (ON ISS HARDWARE) [RC], reference this rule. ©[042904-6249A] ©[ED]

FLIGHT RULES

A13-34**TANK B WATER CONTINGENCY USE [HC]**

TANK B WATER SHOULD ONLY BE USED AS A POTABLE WATER SOURCE IN A CONTINGENCY. IF IT BECOMES NECESSARY FOR CREWMEMBERS TO CONSUME TANK B WATER, DIRECT FLOW OF TANK B WATER THROUGH THE AUXILIARY WATER PORT MICROBIAL CHECK VALVE (MCV) AND WAIT 10 MINUTES TO ALLOW THE IODINE SUFFICIENT TIME TO KILL THE BACTERIA. TANK B WATER MUST NOT BE MIXED WITH ANY FLAVORING ADDITIVES DURING THE 10-MINUTE PERIOD. ©[022604-6230B]

Tank B water is unsafe for crew consumption without additional preparation. Although it is iodinated prior to launch, it is nominally utilized for FES operations soon after orbital insertion. Tank B subsequently receives water directly from the fuel cell without being iodinated by an MCV. Therefore, while on orbit, tank B water is subject to bacterial growth and should be considered contaminated. In order to ensure the crew does not drink contaminated water, tank B water should be iodinated for an appropriate period of time prior to consumption. An IFM procedure will be utilized to divert flow of tank B water through the auxiliary water port MCV. The water must not be consumed for 10 minutes after passing through the MCV, allowing the iodine sufficient time to kill bacteria. In addition, water flavoring additives (lemonade, tea, etc.) should not be added to the recently iodinated tank B water. These additives will bind with iodine and prevent its antibacterial activity.

DOCUMENTATION: Atwater, J.E., Sauer, R.L., and Schultz, J.R., Numerical Simulation of Iodine Speciation in Relation to Water Disinfection Aboard Manned Spacecraft I. Equilibria, J. Environ. Sci. Health, A31, 1965-1979, 1996. ©[022604-6230B]

A13-35 THROUGH A13-50 RULES ARE RESERVED

FLIGHT RULES

ATMOSPHERE

A13-51 CABIN PRESSURE [HC] @[112304-6463C]

A. MINIMUM CABIN PRESSURE:

1. IF THE PRESSURE CONTROL SYSTEM (PCS) IS UNABLE TO MAINTAIN THE CABIN PRESSURE AT OR ABOVE 8.0 PSIA (15,775 FEET), THE FLIGHT WILL BE TERMINATED AT THE NEXT PLS OR ELS AS DICTATED BY AVAILABLE CONSUMABLES. THE CREW WILL BE REQUIRED TO WEAR THE QUICK DON MASK (QDM) OR ACES.

The risk of decompression sickness is reduced if the magnitude of the depressurization is limited, the time after the depressurization is limited, or if some oxygen prebreathing is provided prior to the depressurization. Based on empirical data and various interpolations from models about decompression sickness, the risk of any symptoms for an unlimited exposure at 8.0 psi is less than 8 percent, and less than 2 percent for symptoms that could impact the crew's ability to initiate corrective actions. The minimum cabin pressure of 8 psia (15,775 feet) is specified to provide adequate protection from decompression sickness (bends) for continued on-orbit operations. Additionally, shuttle avionics are certified to go to a total pressure of no less than 8.0 psia for a maximum duration of 165 min. A decompression from 14.7 to 8 psia would produce an R value of 1.50. (The R-value is a measure of risk for developing decompression sickness and is the ratio of tissue nitrogen pressure prior to decompression to the final ambient pressure.) This level is more conservative than the EVA rule (ref. Rule {A13-103}, EVA PREBREATHE PROTOCOL [HC]) because the crew could be exposed for many hours, and the cabin could not be repressurized above 8 psia should symptoms of bends develop. @[ED]

Rule {A17-258}, LOSS OF CABIN INTEGRITY TMAX DEFINITION AND TIG SELECTION, references this rule. @[042594-ED]

2. MINIMUM PRESSURES BELOW 8 PSI: FOR CONTINGENCY PLANNING, PRESSURE REDUCTIONS BELOW 8 PSI WILL NOT EXCEED THE SPECIFIED LIMITS SHOWN BELOW. THE CREW WILL BE REQUIRED TO WEAR THE QDM OR ACES.
 - a. 6.5 PSI (20,775 FEET) FOR NO MORE THAN 90 MINUTES.
 - b. 3.5 PSI (34,775 FEET) FOR NO MORE THAN 30 MINUTES.
@[112304-6463C]

THIS RULE CONTINUED ON NEXT PAGE

FLIGHT RULES

A13-51**CABIN PRESSURE [HC] (CONTINUED)**

If cabin pressure is predicted/expected to drop below 8.0 psia, the crew should immediately begin donning ACES in an effort to maximize crew survivability. This will allow to maintain 3.5 psia internal suit pressure should cabin pressure continue to drop inadvertently. This is consistent with "flight termination" called out in paragraph A.1 and places the crew in the best survivability posture. Based on limited empirical data and various extrapolations from models about decompression sickness, the risk of any symptoms for a 90-minute exposure to 6.5 psi is less than 8 percent, and less than 1 percent for symptoms that could impact the crew's ability to initiate corrective actions. Due to the limited 30-minute exposure to 3.5 psi, the risk of symptoms is expected to be similar to that for exposures to 8.0 psi and 6.5 psi. The risk of symptoms is further reduced at 6.5 psi and 3.5 psi by limiting the exposure time as much as possible and by providing as much oxygen prebreathe time as possible prior to the depressurization. There is considerable uncertainty about the risk of symptoms that could impact the crew's ability to initiate corrective actions given a 30-minute exposure to 3.5 psi without significant prebreathe time. The contingency limits on cabin pressure specified provide adequate protection from decompression sickness to allow safe return of crew to preferred recovery sites. Risk of decompression sickness is a complex function of many factors, including amount of pressure reduction, exposure time, and activity of the crewmembers. @[112304-6463C]

- B. ANY UNPLANNED REDUCTION OF CABIN PRESSURE LEVEL BELOW 10.2 PSIA (9,775 FEET) WILL REQUIRE ALL CREWMEMBERS TO DON THE QDM UNLESS THE CABIN PRESSURE-PPO₂ COMBINATIONS CAN BE RELIABLY PREDICTED TO PROVIDE THE EQUIVALENT OF AN 8,000-FOOT CABIN PRESSURE ALTITUDE (PPO₂ ≥ 2.29 PSIA). @[112304-6463C]

THIS RULE CONTINUED ON NEXT PAGE

FLIGHT RULES

A13-51

CABIN PRESSURE [HC] (CONTINUED)

TABLE A13-51-I - 8000 FOOT AIR EQUIVALENT ISOPLETHS
($P_{A}O_2 = 69$ MMHG) ©[112304-6463C]

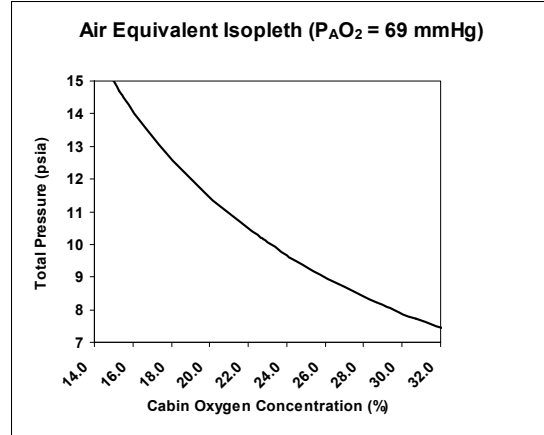
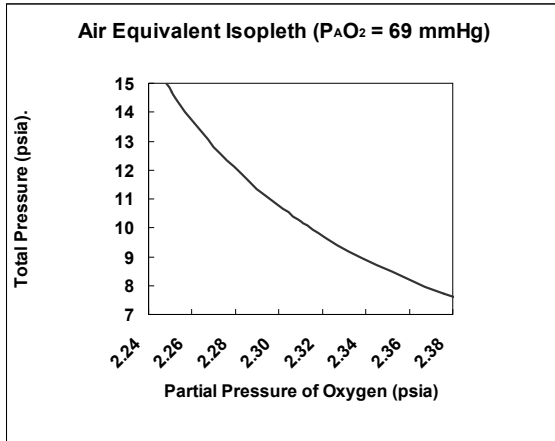

The atmosphere must be maintained on or above these curves. These curves show combinations of cabin pressures and partial pressures of oxygen and cabin O₂ concentrations that produce an acute 8000-foot equivalent air exposure. The alveolar O₂ partial pressure all along the curve is 69 mmHg, and this is an 8000-foot equivalent isopleth where $P_{A}O_2 = 69$ mmHg. The table below shows eleven combinations of cabin pressure and cabin O₂ concentration that produce $P_{A}O_2 = 69$ mmHg given 36 mmHg for $P_{A}CO_2$ and 0.88 for RQ.

DETAILS ABOUT THE CURVES:

Combinations of cabin pressure and cabin O₂ concentration that produce an acute 8000-foot equivalent air exposure with $P_{A}O_2 = 69$ mmHg are found by iterating the Alveolar Oxygen Equation:

$$P_{A}O_2 = F_{I}O_2 * (PB - 47) - P_{A}CO_2 * [F_{I}O_2 + ((1 - F_{I}O_2) / RQ)],$$

where $P_{A}O_2$ is alveolar oxygen partial pressure (mmHg), $F_{I}O_2$ is inspired oxygen fraction (decimal percent), PB is ambient pressure (mmHg), $P_{A}CO_2$ is alveolar carbon dioxide partial pressure, and RQ is Respiratory Quotient (unitless).

At 8000 feet altitude, there is initially a mild hyperventilation in response to a mild hypoxia. This hyperventilation slightly reduces alveolar carbon dioxide partial pressure from 40 to 36 mmHg and slightly increases the respiratory coefficient from 0.85 to 0.88 as a response to the mild hypoxia. Using these values and a range of inspired oxygen fraction, the ambient pressures were computed that provided a $P_{A}O_2$ of 69 mmHg, the alveolar oxygen partial pressure measured at 8000 feet altitude. ©[112304-6463C]

THIS RULE CONTINUED ON NEXT PAGE

FLIGHT RULES

A13-51

CABIN PRESSURE [HC] (CONTINUED)

CABIN PRESSURE (PSIA) (MMHG)	OXYGEN CONCENTRATION (%)	CABIN PPO ₂ (PSIA)	COMPUTED P _A O ₂ (MMHG) 8000-FOOT AIR EQUIVALENT
14.70 760.0	15.3	2.25	69
13.30 690.0	17.0	2.26	69
11.95 618.0	19.1	2.28	69
10.92 564.0	21.0	2.29	69
10.20 527.0	22.6	2.31	69
9.96 515.0	23.3	2.32	69
9.50 491.0	24.5	2.33	69
9.28 480.0	25.1	2.33	69
8.31 430.0	28.3	2.35	69
8.00 414.0	29.6	2.37	69
7.93 410.0	29.9	2.37	69

@[112304-6463C]

The crew can also follow those actions listed in the Orbit Pocket Checklist (Reference: OPCL/ALL/O2/N2 FLOW HIGH/CAB P/dP/dt) that define a rapid depress to maintain the integrity of the cabin atmosphere for mask donning.

All crewmembers should don their QDM when the pressure is below 10.2 psia or the cabin pressure altitude is greater than 8000 feet (PPO₂ < 2.29 psia) to protect themselves from hypoxia, acute mountain sickness, and decompression sickness.

When the QDM is donned to maintain an arterial O₂ saturation of 88 percent or greater, this will enhance crew performance during critical operations, preventing hypoxia and acute mountain sickness, and reducing the formation of microemboli in the blood to diminish the likelihood of decompression sickness.

Crew should start preparing ACES for donning early in the evolution of a possible contingency landing event. Due to the unknown time constraints and vehicle PPO₂ posture, crew should start preparing ACES for donning to maximize contingency readiness and crew survivability. Cooling performance of the LCG at pressures below 14.7 psia is unknown.

C. CREWMEMBERS MAY DISCONTINUE (DOFF) THE QDM: @[112304-6463C]

WHEN THE FINAL, STABILIZED CABIN PRESSURE AND PPO₂ LEVELS/OXYGEN CONCENTRATION LEVELS ARE AT OR ABOVE THE FOLLOWING INDICATED MINIMUM VALUES: @[112304-6463C] @[ED]

THIS RULE CONTINUED ON NEXT PAGE

FLIGHT RULES

A13-51 CABIN PRESSURE [HC] (CONTINUED)

FOR TEMPERATURES WITHIN 70 DEG F TO 85 DEG F, USE THE IN-RANGE INDICATED VALUE. FOR TEMPERATURES LESS THAN 70 DEG F OR GREATER THAN 85 DEG F, USE THE OUT-OF-RANGE INDICATED VALUE. THE RATIONALE OF RULE {A13-53A}.1, MINIMUM PPO₂ CONSTRAINTS [HC], APPLIES. ©[112304-6463C] ©[112304-6462B] ©[ED]

CABIN PRESSURE (PSIA)	IN-RANGE INDICATED (70-85 DEG F)		OUT-OF-RANGE INDICATED (< 70 DEG F OR > 85 DEG F)	
	PPO ₂ (PSIA)	OXYGEN CONCENTRATION (PERCENT)	PPO ₂ (PSIA)	OXYGEN CONCENTRATION (PERCENT)
14.7	2.33	15.9	2.40	16.3
10.2	2.39	23.4	2.46	24.2
8.0	2.45	30.6	2.52	31.6

The crew will respond in doffing the QDM to the displayed, indicated values as shown above. All of the cabin pressure-PPO₂ combinations provide the equivalent of an 8000-foot pressure altitude breathing air.

The final, stabilized cabin pressure will determine the need for continued use of the QDM. The increasing cabin O₂ concentrations for 10.2 psia and 8.0 psia operations will also need to be discussed real time and factored into a minimum risk management decision.

Rule {A17-258}, LOSS OF CABIN INTEGRITY TMAX DEFINITION AND TIG SELECTION, references this rule. ©[ED]

For temperatures of 70 deg F to 85 deg F, the maximum PPO₂ sensor error is ± 0.08 psia. This error is added to the minimum acceptable true PPO₂ (8000 feet altitude equivalent) to arrive at the minimum acceptable PPO₂ sensor reading (e.g., 2.29 + 0.08 = 2.37). For temperatures outside this range, the PPO₂ error is ± 0.15 psia, and this error must be adjusted accordingly per OMRSD V61AJ0.141. ©[ED]

Therefore, the true value is based on sensor error for the PPO₂ and oxygen concentration transducers and could yield the worse-case true, physiological values shown below:

THIS RULE CONTINUED ON NEXT PAGE

FLIGHT RULES

A13-51

CABIN PRESSURE [HC] (CONTINUED)

CABIN PRESSURE (PSIA)	PPO ₂ (PSIA)	OXYGEN CONCENTRATION (PERCENT)
	TRUE VALUE	TRUE VALUE
14.7	2.25	15.3
10.2	2.31	22.6
8.0	2.37	29.6

©[112304-6463C] ©[ED]

- D. FOLLOWING ANY UNPLANNED REDUCTION IN CABIN PRESSURE BELOW THE LIMITS SPECIFIED IN THIS RULE, THE FCR SURGEON SHOULD BE CONSULTED FOR PLANNING OF ALL SUBSEQUENT CREW ACTIVITIES. ©[112304-6463C]

With a rapid loss of pressure, an understanding of the resulting cabin environment and the restrictions it may impose must be evaluated by the Surgeon for recommendations of crew actions.

Rule {A13-53}, MINIMUM PP02 CONSTRAINTS [HC], references this rationale. ©[112304-6462B]

If an EVA is anticipated during an unplanned reduction in cabin pressure, then those crewmembers who are assigned to go EVA will have their final EVA prebreathe protocol calculated real time with the Surgeon and the EVA IPT. If time does not permit, Rule {A13-103B}, EVA PREBREATHE PROTOCOL [HC], applies. ©[ED]

DOCUMENTATION: NASA memo from James M. Waligora/SD5 - July 14, 1986, EVA Prebreathe N2 vs Decompression Sickness Risk Table, engineering judgment, and KSC 8-psia reg OMRSD ground checkout testing.

Pickard, Jeb., Chapter 2, "Atmosphere and Respiration" in Fundamentals of Aerospace Medicine, Editor Roy L. DeHart 3rd Edition, 2002 p. 19-38.

Locke, James P., Chapter 9, "Space Environments" in Fundamentals of Aerospace Medicine, Editor Roy L. DeHart 3rd Edition, 2002, p. 245-270. ©[112304-6463C]

Fitzpatrick, Dan and Conkin, John, et al, EVA IPT Review of Rationale for Physiologic Pressure Limits for DCS Risk Evaluation, April 30 and November 26, 2003 ©[112304-6463C].

Cable, Gordon G., In-Flight Hypoxia Incidents in Military Aircraft: Causes and Implications for Training; Aviation Space Environmental Medicine 2003; 74:169-72.

THIS RULE CONTINUED ON NEXT PAGE

FLIGHT RULES

A13-51

CABIN PRESSURE [HC] (CONTINUED)

National Transportation Safety Board, Aircraft Accident Brief (NTSB/AAB-00/01) and Safety Recommendation in reference to Accident No: DCA00MA005, December 20, 2000.

Loeppky, Jack A. and Riedesel, Marvin L. in Oxygen Transport to Human Tissues, Elsevier North Holland, 1982.

OPCL/ALL/ O2/N2 FLOW HIGH/CAB P/dP/dt

Hazard Report ORBI-270, Inability to Supply Oxygen to Cabin/Crew.

Hazard Report ORBI-071, Inadequate Nitrogen Supply to Maintain Total Cabin Pressure.
©[112304-6463C]

FLIGHT RULES

A13-52

PPCO₂ CONSTRAINT (TWO GAS) [HC] @[101305-6655A]

TWO-GAS ENVIRONMENT (CABIN) :

- A. WHEN NOT DOCKED TO ISS, IF THE SHUTTLE ATMOSPHERIC REVITALIZATION SYSTEM (ARS) IS UNABLE TO MAINTAIN THE PPCO₂ IN THE ORBITER CREW COMPARTMENT BELOW 15 MMHG INDICATED AND HIGH CO₂ LEVELS ARE CONFIRMED, THE MISSION WILL BE TERMINATED AT THE NEXT PLS. THE CREW WILL DON THE QUICK DON MASK (QDM) TO ALLEVIATE CO₂ SYMPTOMS OR AT THE DIRECTION OF THE FLIGHT CONTROL ROOM SURGEON. @[062206-7271A]

When not docked to ISS, if the ARS is unable to maintain PPCO₂ levels below 15 mmHg, the mission must be terminated as the cabin atmosphere is unsafe for routine crew activities without supplementary oxygen. Length of time to PLS can be as long as 20 hours from the time of failure of the ARS to remove CO₂. With seven crewmembers on the orbiter and no CO₂ removal capability, the PPCO₂ will rise 1 mmHg every 30 minutes. Deleterious physiological changes can be expected at PPCO₂ levels of 15 mmHg and above. The OSHA standard for an 8-hour workplace exposure is 3.8 mmHg. The most common sign of CO₂ exposure is an increased breathing rate that will occur at CO₂ levels of 7.6 to 15 mmHg. The pulse rate will increase at CO₂ levels of 22 to 38 mmHg. Other symptoms experienced by the crewmembers can be headache, dizziness, drowsiness, muscular weakness, etc. These symptoms will be alleviated by using the QDM and breathing 100 percent O₂. The Flight Control Room Surgeon may request an unplanned PMC to discuss crew CO₂ symptoms and possible use of the QDM. However, as a result of a mission impact classification, this discussion may be conducted via open air-to-ground communication. @[032807-8309B]

In order to avoid unnecessary QDM donning and early mission termination due to a faulty PPCO₂ transducer, a confirming cue will be required before action is taken. The following will be considered in determining if high CO₂ levels exist in the cabin: Crew reports of symptoms indicating hypercapnia, number of crew experiencing symptoms, Carbon Dioxide Monitor (CDM) readings, PC-LiOH CO₂ removal model predictions, and indications of faulty Air Revitalization System (ARS) airflow. The Flight Surgeon will assist in periodically monitoring the crew's physiological conditions. Corrective actions may include an early LiOH canister changeout, performing LiOH changeouts at lower indicated PPCO₂ levels, and having affected crewmembers don QDM's. @[062206-7271A] @[032807-8309B]

Prolonged use of the QDM has constraints. Oxygen toxicity must be avoided with the prolonged exposure to 100 percent O₂ while using the QDM (ref. Rule {A13-54}, 100 PERCENT OXYGEN USE CONSTRAINT [HC]). Use of QDM may be limited by O₂ supply or cabin O₂ concentration constraints. (Ref. rule {A17-254}, CABIN O₂ CONCENTRATION). Due to O₂ concentration limits, three crewmembers can breathe 100 percent O₂ for 1 hour, or seven crewmembers can breathe 100 percent O₂ for 30 minutes (ref. Rule {A13-158}, CABIN ATMOSPHERE CONTAMINATION – HALON 1301 [HC]). The CDR, PLT, and MS2 - Flight Engineer may be required to close and lock visors on the ACES and breathe 100 percent oxygen beginning at TIG through landing rollout.

THIS RULE CONTINUED ON NEXT PAGE

FLIGHT RULES

A13-52

PPCO2 CONSTRAINT (TWO GAS) [HC] (CONTINUED)

- B. FOR PPCO₂ LEVELS BETWEEN 7.6 MMHG AND 15 MMHG, PLANNING FOR ALL CREW ACTIVITIES WILL REQUIRE EVALUATION BY THE FCR SURGEON.

A PPCO₂ of 7.6 mmHg is the maximum level that can be tolerated by the crew for long periods on space shuttle flights. The NASA SMAC is 13 percent at 14.7 psia, equivalent to a partial pressure of 10 mmHg (1 and 24-hour exposure). The NASA long-term SMAC is a time weighted average and equates to a level of 5.3 mmHg (7, 30, and 180-day exposure). Above 7.6 mmHg, physiological changes may occur that are unacceptable for crew safety, health, and performance. The duration of exposure to levels above 7.6 mmHg and planned crew activities will need to be reviewed by the FCR surgeon for consideration of physiological and performance effects. @[121197-6456A] @[101305-6655A] @[032807-8309B]

- C. IF THE CREW EXPERIENCES CO₂-RELATED SYMPTOMS, CORRECTIVE ACTION MUST BE TAKEN TO REDUCE CO₂ LEVELS. CREW ACTIONS MAY INCLUDE:
1. CARBON DIOXIDE MONITOR (CDM) READINGS TO DETECT LOCALIZED HIGH CO₂ LEVELS.
 2. IF CDM CO₂ LEVELS ARE ELEVATED ABOVE THE AMBIENT CO₂ SENSOR LEVELS, THE FOLLOWING ACTIONS WILL BE CONSIDERED:
 - a. CHECK FOR AIRFLOW OBSTRUCTIONS
 - b. REDIRECT DUFFY DUCTS TO IMPROVE AIR CIRCULATION
 - c. PERFORM UNSCHEDULED LIOH CHANGEOUTS
 - d. ACTIVATE THE BOOSTER FAN(S)
 - e. INSPECT AIR FILTERS AND PERFORM FILTER CLEANING AS REQUIRED
 - f. IF DOCKED TO ISS, COORDINATE WITH ECLSS TO SEE IF THE ISS CO₂ REMOVAL SYSTEMS CAN LOWER THE STACK PPCO₂. @[032807-8309B]

THIS RULE CONTINUED ON NEXT PAGE

FLIGHT RULES

A13-52

PPCO2 CONSTRAINT (TWO GAS) [HC] (CONTINUED)

Based on experience from past flights, it has been shown that some crewmembers are more sensitive and can experience CO₂ related symptoms at levels as low as 4.5mmHg. ©[032807-8309B]

Symptoms of elevated CO₂ exposure include the following: headaches, lethargy, mental slowness, emotional irritation, and disrupted sleep. The Flight Surgeon will assess the reported symptoms and provide a recommendation as to whether they are CO₂ related.

ARS modeling performed by Boeing ECLSS engineering has shown the cabin air is not well-stirred for even distribution of CO₂ levels throughout the flight deck and middeck. A single shuttle crew cabin CO₂ sensor is located below the middeck floor, sampling ARS duct air flow. Reduced forced air circulation velocities or inhomogeneous cabin air flow paths in the middeck can result in localized pockets of elevated CO₂ in the vicinity of crewmembers. The crewmembers are the generators of CO₂ in the cabin. The normal level (partial pressure) of CO₂ exhaled by each crewmember is 40mmHg. Elevated levels will follow the crewmembers if they are working in an area of the cabin where air is not well-circulated.

The CDM is class III hardware used to detect localized accumulations of CO₂. For readings above ambient, the crew will need to improve air circulation in the cabin. This can be accomplished by looking for obstructions to airflow, ducts, and passages. Temporary stowage of transfer items may also be a cause of poor air circulation.

Unscheduled LiOH changeouts are effective for reducing overall, ambient CO₂ levels. They do not effectively reduce localized accumulations of CO₂. Unscheduled LiOH changeouts will be coordinated with EECOM.

The shuttle booster fan(s) is located in the shuttle airlock and may be activated to increase the air circulation between the ISS and shuttle. Because the booster fan is a powered device, it will consume cryo when activated. The activation of this fan will need to be coordinated with EECOM, ECLSS, and EGIL.

Air filter inspection and cleaning are scheduled to be performed during the mission. Additional filter inspection and cleaning may provide increased air circulation and improve atmospheric conditions.

The ISS has standalone ppCO₂ removal capability. The ISS CO₂ removal systems together with increased air circulation between the shuttle and ISS may be able to lower the stack ppCO₂ levels for certain scenarios. ©[032807-8309B]

THIS RULE CONTINUED ON NEXT PAGE

FLIGHT RULES

A13-52

PPCO2 CONSTRAINT (TWO GAS) [HC] (CONTINUED)

Documentation: @[101305-6655A]

Space Shuttle Hot Cabin Emergency Responses, D. Gillis, P. Stepaniak, L. Kuznetz, D.R. Hamilton, R. Effenhauser, and R. A. McCluskey, AsMA 76th Annual Scientific Meeting Program and Abstract Issue, 2005 76(3):207. @[032807-8309B]

Assessment of Crew Reports on ISS Carbon Dioxide Symptoms, DF83/P. Felker, March 18, 2003

Carbon Dioxide Toxicity on an Orbital Space Station: A Case Report, Julie Ho, M.D., April 25, 2003

Impact of Moderate Elevations in CO₂ on Astronauts During Long-Duration Spaceflight on the International Space Station, Christopher E. Carr, M.Sc., undated

Threshold Limit Values and Biological Exposure Indices for Chemical Substances and Physical Agents, ACHIH Worldwide, Cincinnati, OH, 2002

Carr, Christopher E., "Impact of Moderate Elevations in CO₂ On Astronauts During Long-Duration Spaceflight On The International Space Station," Harvard-MIT Division of Health Sciences and Technology and MIT Department of Aeronautics and Astronautics.

Wong, K. L., Carbon Dioxide in Spacecraft Maximum Allowable Concentrations for Selected Airborne Contaminants, Vol. II, pp. 105-187, National Academy Press, Washington D.C.

Hazard Report ORBI 073, Contamination of the Crew Compartment by Carbon Monoxide (CO) and Carbon Dioxide (CO₂), ORBI 044 Unknown Gaseous Contamination Levels in the Cabin Causing Crew Illness/Incapacitation. @[032807-8309B]

Reference Rules {A13-54}, 100 PERCENT OXYGEN USE CONSTRAINT [HC]; {A13-158}, CABIN ATMOSPHERE CONTAMINATION – HALON 1301 [HC]; and {A17-254}, CABIN O₂ CONCENTRATION.

Rules {A13-54}, 100 PERCENT OXYGEN USE CONSTRAINT [HC]; {A15-102H}, EMU GO/NO-GO CRITERIA; {A17-102}, CABIN ATMOSPHERIC CONTROL; {A17-106}, REGENERATIVE CO₂ REMOVAL SYSTEM (RCRS) LOSS DEFINITION; {A17-157}, LIOH REDLINE DETERMINATION [HC]; and {A17-701}, MODULE ATMOSPHERIC CONTROL, reference this rule. @[ED] @[101305-6655A]

FLIGHT RULES

A13-53

MINIMUM PPO₂ CONSTRAINTS [HC] @[112304-6462B]

TWO-GAS ENVIRONMENT (CABIN) :

A. THE PRESSURE CONTROL SYSTEM (PCS) SHOULD MAINTAIN THE INDICATED PPO₂/OXYGEN CONCENTRATIONS AT OR ABOVE THE FOLLOWING SPECIFIED CABIN PRESSURES:

1. FOR TEMPERATURES WITHIN 70 DEG F TO 85 DEG F, USE THE IN-RANGE INDICATED VALUE. FOR TEMPERATURES LESS THAN 70 DEG F OR GREATER THAN 85 DEG F, USE THE OUT-OF-RANGE INDICATED VALUE. @[ED]

CABIN PRESSURE (PSIA)	IN-RANGE INDICATED (70-85 DEG F)		OUT-OF-RANGE INDICATED (< 70 DEG F OR > 85 DEG F)	
	PPO ₂ (PSIA)	OXYGEN CONCENTRATION (PERCENT)	PPO ₂ (PSIA)	OXYGEN CONCENTRATION (PERCENT)
14.7	2.33	15.9	2.40	16.3
10.2	2.39	23.4	2.46	24.2
8.0	2.45	30.6	2.52	31.6

2. IF THE LEVEL OF INDICATED PPO₂/OXYGEN CONCENTRATIONS CANNOT BE MAINTAINED AT THE ABOVE LEVELS, THE MISSION WILL BE TERMINATED AT THE NEXT PLS.

The PPO₂ minimum acceptable limits defined in the table are established to ensure adequate delivery of oxygen to the pulmonary alveoli. These limits represent the minimum PPO₂ required to maintain the alveolar pressure of oxygen equivalent to that of breathing air at an 8000-foot pressure altitude. Due to the saturation of breathing gases with water, PPO₂ limits must increase as cabin pressure decreases to maintain the same alveolar partial pressure of oxygen. For temperatures of 70 deg to 85 deg F, the maximum PPO₂ sensor error is ± 0.08 psia. This error is added to the minimum acceptable true PPO₂ (8,000 feet altitude equivalent) to arrive at the minimum acceptable PPO₂ sensor reading (e.g., 2.29 + 0.08 = 2.37). For temperatures outside this range, the PPO₂ error is ± 0.15 psia, and this error must be adjusted accordingly per OMRSD V61AJ0.141. @[112304-6462B]

THIS RULE CONTINUED ON NEXT PAGE

FLIGHT RULES

A13-53

MINIMUM PPO₂ CONSTRAINTS [HC] (CONTINUED)

Therefore, the true value is based on sensor error for the PPO₂ and oxygen concentration transducers and could yield the worse-case true, physiological values shown below: ©[112304-6462B]

CABIN PRESSURE (PSIA)	PPO ₂ (PSIA)	OXYGEN CONCENTRATION (PERCENT)
	TRUE VALUE	TRUE VALUE
14.7	2.25	15.3
10.2	2.31	22.6
8.0	2.37	29.6

Above a pressure altitude of 8,000 feet, deleterious changes in crew performance can occur from hypoxia and altitude sickness. Symptoms of altitude sickness can develop over several hours consisting of headache, lethargy, and reduced appetite in 15 to 20 percent of crewmembers. More serious symptoms of confusion, loss of coordination, and difficulty in breathing may occur. These more serious symptoms must be treated with oxygen and an immediate increase in ambient pressure. (Ref. Rule {A13-54}, 100 PERCENT OXYGEN USE CONSTRAINT [HC].) ©[ED]

Rule {A17-1001}, LIFE SUPPORT GO/NO-GO CRITERIA, references this rule. ©[ED]

B. FOR NEXT PLS LANDING, THE INDICATED PPO₂/OXYGEN CONCENTRATIONS MAY BE ALLOWED TO DECREASE TO THE FOLLOWING LEVELS FOR NO MORE THAN 24 HOURS. CREW SHOULD BE COMPLETE WITH ADVANCED CREW ESCAPE SUIT (ACES) DONNING 1 HOUR PRIOR TO LANDING WITH VISORS DOWN/LOCK. ©[112304-6462B]

THIS RULE CONTINUED ON NEXT PAGE

FLIGHT RULES

A13-53 MINIMUM PPO2 CONSTRAINTS [HC] (CONTINUED)

FOR TEMPERATURES WITHIN 70 DEG F TO 85 DEG F, USE THE IN-RANGE INDICATED VALUE. FOR TEMPERATURES LESS THAN 70 DEG F OR GREATER THAN 85 DEG F, USE THE OUT-OF-RANGE INDICATED VALUE. [112304-6462B] [ED]

CABIN PRESSURE (PSIA)	IN-RANGE INDICATED (70-85 DEG F)		OUT-OF-RANGE INDICATED (< 70 DEG F OR > 85 DEG F)	
	PPO ₂ (PSIA)	OXYGEN CONCENTRATION (PERCENT)	PPO ₂ (PSIA)	OXYGEN CONCENTRATION (PERCENT)
14.7	2.17	14.8	2.23	15.2
10.2	2.22	21.8	2.30	22.5
8.0	2.28	28.5	2.35	29.4

Therefore, the true value is based on sensor error for the PPO₂ and oxygen concentration transducers and could yield the worse-case true, physiological values shown below:

CABIN PRESSURE (PSIA)	PPO ₂ (PSIA)	OXYGEN CONCENTRATION (PERCENT)
	TRUE VALUE	TRUE VALUE
14.7	2.09	14.2
10.2	2.14	21.0
8.0	2.20	27.5

These PPO₂ levels represent a pressure altitude, breathing air of 10,000 feet. Rapid ascents to 10,000 feet cause a mild altitude sickness incidence of 20 to 40 percent. The risk of altitude sickness is increased principally from the reduced alveolar oxygen tension and to a lesser degree from the decrease in the ambient air pressure. High altitude pulmonary edema has been noted in the 15 to 25 percent of those exposed to a 14,000-foot pressure altitude for 24 hours and has occurred as low as 9,000 feet. Death from high altitude cerebral edema has been reported at 10,000 feet. The risk of altitude sickness at certain cabin pressures and PPO₂ levels must be balanced against system anomalies and difficulties generated from landing at a non-PLS site. Wearing the ACES and breathing 100 percent oxygen 1 hour prior to landing will eliminate the subtle performance decrements that occur with hypoxia (ref. Rule {A13-54}, 100 PERCENT OXYGEN USE CONSTRAINT [HC]). [112304-6462B] [ED]

THIS RULE CONTINUED ON NEXT PAGE

FLIGHT RULES

A13-53

MINIMUM PPO₂ CONSTRAINTS [HC] (CONTINUED)

C. FOR CONTINGENCY LANDING PURPOSES, IN A SITUATION WHERE THE INDICATED PPO₂/OXYGEN CONCENTRATIONS CANNOT BE MAINTAINED AT THE LEVELS IN PARAGRAPH A.2, THE QDM SHALL BE DONNED. THE FINAL DETERMINATION OF QDM USE AND ACES DONNING WILL DEPEND ON FINAL STABLE CABIN PRESSURE, PPO₂, OXYGEN CONCENTRATION, AND TIG. @[112304-6462B] @[ED]

If the cabin cannot be maintained at the PPO₂ levels delineated in paragraph A.2, use of the QDM is necessary to prevent hypoxia and altitude sickness. Providing supplementary oxygen with the QDM or ACES can prevent deleterious changes in crew performance from both hypoxia and altitude sickness.

Crew should start preparing ACES for donning early in the evolution of a contingency landing event. Due to the unknown time constraints and vehicle PPO₂ posture, crew should start preparing ACES for donning to maximize contingency readiness and crew survivability.

D. CONSULT THE FCR SURGEON FOR THE TOTAL LENGTH OF TIME THAT THE CREW MAY WEAR THE QDM OR ACES.

The next PLS opportunity may not occur for several hours. Some crewmembers may be able to remove their QDM or ACES for brief periods of time during low activity and/or sleep periods. This removal will provide for greater crew comfort, increased mobility, and will prevent possible oxygen toxicity from breathing 100 percent oxygen (ref. Rule {A13-54}, 100 PERCENT OXYGEN USE CONSTRAINT [HC]). The FCR surgeon can estimate the pressure altitude, breathing air from the known cabin pressure and PPO₂, and can estimate the length of time that the crew may safely remove their QDM or ACES. @[050400-7197A] @[112304-6462B] @[ED]

THIS RULE CONTINUED ON NEXT PAGE

FLIGHT RULES

A13-53

MINIMUM PPO2 CONSTRAINTS [HC] (CONTINUED)

Documentation: @[112304-6462B]

“Atmosphere” in Bioastronautics Data Book, Editors James F. Parker, Jr., and Vita R. West, 2nd Edition, 1973.

Hackett, Peter H. and Robert C. Roach, “High-Altitude Medicine” in Wilderness Medicine, 4th Edition, Mosby, Inc., St. Louis, MO, 2001.

Pickard, JS 2002 Chapter 2: The Atmosphere and Respiration in Fundamentals of Aerospace Medicine eds. DeHart R. and Davis, J. Lippincott, Williams and Wilkins, Philadelphia, PA pp. 19-38.

Hazard Report ORB-270, Inability to Supply Oxygen to Cabin/Crew.

Hazard Report ORB-299, Cabin Flammability Threat due to Oxygen Leakage.

Hazard Report ORBI-406, Loss of Habitable Environment in the Crew Cabin/ODS Habitable Volume due to Flooding of the Volume with Gaseous Nitrogen. @[112304-6462B]

Rules {A2-301}, CONTINGENCY ACTION SUMMARY [HC]; {A13-51}, CABIN PRESSURE [HC]; {A17-254}, CABIN O2 CONCENTRATION; {A17-258}, LOSS OF CABIN INTEGRITY TMAX DEFINITION AND TIG SELECTION; {A17-301}, CABIN ATMOSPHERE MANAGEMENT; {A17-701}, MODULE ATMOSPHERIC CONTROL; and {A17-1001}, LIFE SUPPORT GO/NO-GO CRITERIA, reference this rule. @[ED] @[032807-8400]

FLIGHT RULES

A13-54

100 PERCENT OXYGEN USE CONSTRAINT [HC] @[012705-6567]

- A. THE MAXIMUM AMOUNT OF TIME A CREWMEMBER MAY BREATHE 100 PERCENT OXYGEN BY WEARING THE QDM OR ACES AT VARIOUS CABIN PRESSURES IS:

CABIN PRESSURE	MAXIMUM QDM OR ACES HELMET TIME
12-14.7 PSI	6 HOURS
10.2-12 PSI	12 HOURS
<10.2 PSI	INDEFINITELY

Breathing 100 percent oxygen at sea level pressure will result in physiologic changes due to oxygen toxicity after 6 hours minimum. Since oxygen toxicity is proportional to the oxygen partial pressure and not the percent gas, longer exposures of 100 percent oxygen can be tolerated at lower pressures. For 100 percent oxygen at sea level, physiologic changes begin as mild (2 to 5 percent) asymptomatic decreases in vital capacity (the largest volume of air which can be exhaled voluntarily) beginning with fully inflated lungs. After 12 hours, coughing, sore throat, and substernal soreness are usually seen, and after 24 hours, atelectasis, pulmonary edema, broncho-pneumonia, and further decrements in vital capacity may develop. Intermittent air breaks or lowering pressure may avoid such effects.

- B. CONTINGENCIES SUCH AS FIRE OR SMOKE IN THE CABIN, HALON 1301 OR OTHER TOXIC COMPOUNDS SPILED IN THE CABIN, MAY REQUIRE EXTENDED USE OF THE QDM OR ACES BEYOND THE LIMITS STATED IN PARAGRAPH A. THE FCR SURGEON SHOULD BE CONSULTED FOR THE MAXIMUM LENGTH OF TIME THE QDM OR ACES MUST BE WORN (REF. RULE {A13-52}, PPCO2 CONSTRAINT (TWO GAS) [HC]).
 @[012705-6567] @[101305-6655A]

After exposure of the shuttle cabin atmosphere to a toxic substance and subsequent cleanup, the atmosphere may need to be purged of residual toxic contamination based on the type of substance, amount released, relative toxic potential, and the ability of ARS to remove the substance.

The atmosphere is considered purged of residual toxic material that can be removed by the ARS after a six-fold cycle through the ARS.

Oxygen toxicity changes are usually mild at onset and may be considered less limiting than other considerations, including PLS availability and deorbit time requirements. Individual determination by the crew surgeon is required to balance cost/benefits for specific cases.

THIS RULE CONTINUED ON NEXT PAGE

FLIGHT RULES

A13-54

100 PERCENT OXYGEN USE CONSTRAINT [HC]
(CONTINUED)

References: ©[012705-6567]

Stein TP, Leskiw, MJ (2000). Oxidant damage during and after spaceflight. Am J Physiol Endocrinol Metab 278:E375-82.

Mensack, S & Murtaugh, R Dept. of Clinical Science, Tufts University School of Veterinary Medicine, North Grafton, MA; Oxygen Toxicity Compend Contin Educ Pract Vet 21[4]:341-351 Apr'99 Review Article 67 website: <http://www.vspn.net/vspnsearch/aow/oxygentoxicity.htm>

United States Naval Flight Surgeon's Manual: Third Edition 1991: Chapter 1: Physiology of Flight Oxygen Toxicity

Hazard Reports ORBI 073, Contamination of the Crew Compartment by Carbon Monoxide (CO) and Carbon Dioxide (CO2), and ORBI 044, Unknown Gaseous Contamination Levels in the Cabin Causing Crew Illness/Incapacitation.

Rules {A13-52A.1}, PPCO2 CONSTRAINT;{A13-53}, MINIMUM PPO2 CONSTRAINTS [HC]; {A13-155}, ORBITER HAZARDOUS SUBSTANCE SPILL RESPONSE [HC]; and {A17-1001}, LIFE SUPPORT GO/NO-GO CRITERIA, reference this rule. ©[012705-6567] ©[ED]

A13-55 THROUGH A13-100 RULES ARE RESERVED

FLIGHT RULES

EVA OPERATIONS

A13-101 **SCHEDULED AND UNSCHEDULED EVA CONSTRAINTS [HC]**
@[062305-6636A]

- A. NO SCHEDULED OR UNSCHEDULED EVA SHALL OCCUR PRIOR TO APPROXIMATELY 24 HOURS MET OF FLIGHT.
- B. NO SCHEDULED EVA SHALL OCCUR PRIOR TO APPROXIMATELY 72 HOURS MET UNLESS AN ASSESSMENT OF CREW HEALTH HAS BEEN ACCOMPLISHED BY THE FCR SURGEON DURING A PMC.

Symptoms of motion sickness are experienced by 79 percent of crewmembers on their first shuttle flight. Thirteen percent of them will have a severe case characterized by drowsiness, inability to concentrate, severe nausea and vomiting, and little or no food or water intake over 24 to 48 hours. The majority of susceptible crewmembers develop symptoms in the first 6 hours of flight, and all crewmembers graded as moderate or severe had symptom onset in the first 6 hours. Symptoms peak over 24 to 48 hours MET and resolve over 48 to 72 hours MET. During adaptation to zero-g, movement (especially head movement) may provoke nausea and vomiting in susceptible crewmembers and potentially endanger the safety of the crewmember by decreased concentration, lethargy, or vomitus in the helmet.

- C. NO UNSCHEDULED EVA SHALL OCCUR PRIOR TO APPROXIMATELY 48 HOURS MET UNLESS AN ASSESSMENT OF CREW HEALTH HAS BEEN ACCOMPLISHED BY THE FCR SURGEON DURING A PMC.

An unscheduled EVA for mission success is a high priority EVA and may be performed after approximately 48 hours MET as many crewmembers will have resolving symptoms of motion sickness and will be less susceptible to provocative motion stimuli after 48 hours MET. The reduced risk of motion sickness is balanced against the prospective gain of a successful mission. The limitations elaborated in the Shuttle Crew Scheduling Constraints, NSTS-37326, Appendix K, recognize that the EVA may not be performed due to crew health concerns.

Reference Rules {A15-14}, SCHEDULED AND UNSCHEDULED EVA CONSTRAINTS, and {A15-18}, PAYLOAD OPERATION/DEPLOY GUIDELINE.

Reference Hazard Report ORBI 322, Adverse Effects of Zero-G on Crew Functions.

Documentation: Inflight Medical Events, LSAH Program, STS-1 through STS-108, M. Wear.
@[062305-6636A]

Rules {A2-102}, MISSION DURATION REQUIREMENTS, and {A13-23}, PRIVATE MEDICAL COMMUNICATION (PMC), reference this rule. @[ED]

FLIGHT RULES

A13-102

MAXIMUM EVA DURATION CONSTRAINTS

EXTENSION OF ANY EVA BEYOND AN EVA PET 6.5 HOURS REQUIRES FLIGHT SURGEON APPROVAL BASED ON OBJECTIVE AND/OR SUBJECTIVE PHYSIOLOGICAL DATA AND PARAMETERS FOR EACH EV CREWMEMBER.
@[050400-7193A]

The energy level of the EV crewmember may be diminished after 6.5 hours. The average metabolic rate of an EV crewmember is approximately 800 BTU/hr (200 kcal/hr), with peak rates during heavy work periods of 1600 to 2000 BTU/hr (400 to 500 kcal/hr). While in the EMU, crewmembers do not have access to food. An increase in EVA duration could result in energy deficiency that begins to affect performance. Higher than average workloads will also affect the EV crewmember. Wearing the EMU suit and performing special EVA tasks could cause local fatigue in the hands, arms, and upper body. Free floating also requires more energy and produces greater cumulative fatigue than tasks utilizing foot restraints.

The body loses 6 to 8 ounces of water per hour during the EVA. This could cause an EV crewmember with a 32-ounce drink bag to be 1 percent dehydrated (thirsty) at the end of an 8-hour EVA. If the crewmember begins the EVA already at a 1 percent dehydration level, performance will be affected in the 6.5 to 8-hour period of the EVA.

Other factors that could lead to limiting EVA extension include, but are not limited to, residual Space Adaptation Sickness, uncertain hydration, nutrition, inadequate sleep/rest, poor thermal control of the Liquid Cooling Garment (leading to a hot crewmember losing excessive water), higher than normal metabolic rates, abnormal biomedical signs, and performance decrement.

DOCUMENTATION: Kumar, K.V and Waligora, J.M. Energy Utilization Rates During Shuttle Extravehicular Activities. Elsevier Science Ltd. Vol 36, Nos 8-12, pp.595-599. 1995.

DOCUMENTATION: Pepper, Larry J. and Waligora, James M. Physiological Experience During Shuttle EVA. SAE Technical Paper Series: 951592. July 10-13, 1995. @[050400-7193A]

FLIGHT RULES

A13-103

EVA PREBREATHE PROTOCOL [HC] @[111705-6690D]

A. THE 10.2 PSI STAGED DECOMPRESSION PROTOCOL (DEFINED IN PARAGRAPH A.1) AND THE 4-HOUR IN-SUIT PREBREATHE PROTOCOL (DEFINED IN PARAGRAPH A.2) ARE BOTH ACCEPTABLE FOR USE ON SHUTTLE WITH VARYING DEGREES OF DCS RISK UNCERTAINTY. THE SELECTION OF A PREBREATHE PROTOCOL FOR A GIVEN EVA WILL DEPEND ON THE INTEGRATED MISSION OBJECTIVES, DECOMPRESSION SICKNESS (DCS) RISK, CREW TIMELINE, AND OVERALL OPERATIONAL RISKS.

The PB protocol selected for a given EVA event should consider all the factors affecting risk to the crew and mission. Predicted risk of DCS, procedural risk due to timeline complexity or fatigue, and criticality of completing the EVA tasks within a specified timeframe are all factors that must be weighed. Other approved prebreathe protocols, such as the ISS EVA Exercise PB Protocol (reference Rule {B13-107}, EVA PREBREATHE PROTOCOL [RC] [E]), apply only to ISS-based EVA's from the Joint Airlock, and are not included in this flight rule.

The PB protocols are ranked according to their pedigree based on laboratory testing, on-orbit and suited vacuum chamber experience, and model predictions.

- a. *10.2 psi Staged Decompression Protocol: The 10.2 staged decompression protocol has extensive ground-based testing, has been used in over 140 operational EVA's without a DCS incident, and minimizes fatigue and discomfort associated with long stays in the EMU.*
- b. *4-hr In-Suit PB Protocol: The 4-hr in-suit PB protocol has been extensively used on ground suited vacuum chamber exposures (> 300 exposures) with acceptable DCS risk (< 1.5 percent total DCS observed, no Type II). This protocol is particularly useful when a specific flight carries equipment that cannot be exposed to a 10.2 psia indicated atmosphere and must continue to operate throughout the EVA.*

1. 10.2 PSI STAGED DECOMPRESSION OPTIONS:

- a. EVA SCHEDULED WITHIN 36 HOURS OF CABIN DEPRESS TO 10.2 PSI INDICATED: @[111705-6690D]

INITIAL PREBREATHE	TIME AT 10.2 PSI	FINAL PREBREATHE
60 MINUTES	24 HOURS	40 MINUTES
60 MINUTES	20 HOURS	50 MINUTES
60 MINUTES	16 HOURS	60 MINUTES
60 MINUTES	12 HOURS	75 MINUTES

THIS RULE CONTINUED ON NEXT PAGE

FLIGHT RULES

A13-103

EVA PREBREATHE PROTOCOL [HC] (CONTINUED)

The final prebreathe duration will always be the more conservative time if intermediate exposures at 10.2 psi indicated are encountered. @[111705-6690D]

- (1) THE INITIAL PREBREATHE MUST BE AN UNBROKEN PREBREATHE WITH > 95 PERCENT O₂, AT LEAST 45 MINUTES OF WHICH MUST BE ACCOMPLISHED PRIOR TO DEPRESSURIZATION BELOW 12.5 PSI INDICATED. THE PREBREATHE WILL NOT BE TERMINATED UNTIL THE CABIN PRESSURE REACHES 10.2 PSI INDICATED.
- (2) THE FINAL PREBREATHE MUST BE AN UNBROKEN PREBREATHE IN THE SUIT OF 40 MINUTES (24-HOUR PROTOCOL) OR 75 MINUTES (12-HOUR PROTOCOL) IMMEDIATELY PRIOR TO EVA. THE FINAL PREBREATHE MAY BE GRADUALLY REDUCED FOR 10.2 PSI INDICATED EXPOSURES LONGER THAN 12 HOURS BUT LESS THAN 24 HOURS. CONSULT THE FCR SURGEON FOR THE TOTAL TIME REQUIRED FOR THE FINAL PREBREATHE.

b. EVA SCHEDULED FOR LATER THAN 36 HOURS AT 10.2 PSI INDICATED:

- (1) IF THE EVA IS SCHEDULED FOR LATER THAN 36 HOURS AFTER CABIN DEPRESS TO 10.2 PSI INDICATED, THE INITIAL PREBREATHE MAY BE ELIMINATED. THE FINAL PREBREATHE WILL BE 40 MINUTES.
- (2) IF THE INITIAL PREBREATHE IS ELIMINATED, BUT THE EVA OCCURS PRIOR TO 36 HOURS AT 10.2 PSI INDICATED, THEN 60 MINUTES WILL BE ADDED TO THE FINAL PREBREATHE.

2. IN-SUIT OPTION:

A MINIMUM OF 4 HOURS UNBROKEN PREBREATHE WITH > 95 PERCENT O₂ IS REQUIRED AT A CABIN PRESSURE ABOVE 12.5 PSI INDICATED PRIOR TO ANY CABIN OR AIRLOCK DEPRESSURIZATION BELOW 8 PSI INDICATED. @[032395-1761] @[111705-6690D]

THIS RULE CONTINUED ON NEXT PAGE

FLIGHT RULES

A13-103

EVA PREBREATHE PROTOCOL [HC] (CONTINUED)

When an EVA is scheduled after 36 hours at 10.2, it is unlikely that any dispersed gas bubbles formed by the depressurization to 10.2 would remain beyond 36 hours. If the initial prebreathe was not performed, but an EVA becomes necessary prior to 36 hours, then the calculated final prebreathe will be extended by 60 minutes. It is estimated that the extra 60 minutes of final prebreathe would offset the reduced nitrogen washout capability that small persistent bubbles would cause. @[111705-6690D]

- B. FOR ANY CONTINGENCY EVA, PREBREATHING WILL BE ACCOMPLISHED AS FOLLOWS:
1. IF SUFFICIENT CREW TIME IS AVAILABLE DURING PREPARATION FOR A CONTINGENCY EVA, THE PREBREATHE PROTOCOLS OF PARAGRAPHS A.1 OR A.2 SHALL APPLY.
 2. IF EVA PREPARATION TIME IS CRITICAL TO CREW SAFETY, A MINIMUM OF 2.5 HOURS UNBROKEN PREBREATHE WITH > 95 PERCENT O₂ IS RECOMMENDED AT A CABIN PRESSURE ABOVE 12.5 PSI INDICATED PRIOR TO ANY CABIN OR AIRLOCK PRESSURE BELOW 8 PSI INDICATED. THE FCR SURGEON SHALL BE CONSULTED FOR A RECOMMENDED PREBREATHE PROTOCOL FOR ANY CONTINGENCY EVA.

A minimum prebreathe of 2.5 hours will reduce the estimated risk of incapacitating bends to < 20 percent for an EVA up to 6 hours in duration. This recommended prebreathe time should be extended if possible. A prebreathe < 2.5 hours would exceed a 20 percent risk of incapacitating bends, and the risk of serious decompression sickness would increase as the prebreathe was progressively shortened.

- C. INTERRUPTION OF THE PREBREATHE PROTOCOL:
1. 10.2 STAGED DECOMPRESSION OPTION:
 - a. NO MODIFICATION OF THE 10.2 PSI STAGED DECOMPRESSION PREBREATHE PROTOCOL IS REQUIRED IF THE CABIN PRESSURE IS MAINTAINED BELOW THE MAXIMUM LIMIT OF 10.6 PSI INDICATED.

When the cabin pressure indication is 10.6 psi, the worst case atmospheric value could be 10.84 psi based on a sensor bias of ±0.24 psi. @[111705-6690D]

- b. IF THE CABIN PRESSURE EXCEEDS 10.6 PSI INDICATED, THE EVA CREWMEMBERS WILL DON THE QDM IMMEDIATELY. CONSULT THE FCR SURGEON FOR THE REQUIRED MODIFICATION TO THE PREBREATHE PROTOCOL.

THIS RULE CONTINUED ON NEXT PAGE

FLIGHT RULES

A13-103

EVA PREBREATHE PROTOCOL [HC] (CONTINUED)

An increase in the cabin pressure that exceeds 10.6 psi indicated will cause the tissues and blood to reabsorb nitrogen. At an indicated cabin pressure of 10.6 psi, the true cabin pressure may be 10.84 psi. The indicated PPO₂ caution and warning limit of 2.43, 2.35 psi true, produces a worst case PPN₂ of 8.49 (10.84 - 2.35) psi. This maximum PPN₂ of 8.49 psi is acceptable for continued prebreathe without modification. For pressures that exceed 10.6 psi indicated, wearing the QDM and breathing 100 percent oxygen can prevent renitrogenation and preserve the prebreathe protocol. (Ref. Rule {A17-301}, CABIN ATMOSPHERE MANAGEMENT.) @[11705-6690D]

2. QDM/EMU OPERATIONS (100 PERCENT O₂ PREBREATHE)

- a. ANY INTERRUPTION OF THE PREBREATHE PROTOCOL WHICH OCCURS WHILE THE CREW IS WEARING THE QDM OR IS IN THE EMU WILL REQUIRE AN INCREASE IN THE TIME ON 100 PERCENT O₂ AT A RATIO OF 2 ADDITIONAL MINUTES FOR EACH 1 MINUTE INTERRUPTION OF PREBREATHE. @[021199-6806A]
- b. IF THE EMU IN-SUIT PREBREATHE IS INTERRUPTED AFTER COMPLETION OF THE SUIT PURGE, THE INTERRUPTION DURATION IS DEFINED AS THE TIME BREATHING CABIN ATMOSPHERE PLUS THE TIME BREATHING SUIT ATMOSPHERE PRIOR TO REINITIATION OF A SUBSEQUENT SUIT PURGE. THE SUBSEQUENT SUIT PURGE DURATION DOES NOT COUNT AS EITHER THE INTERRUPTION TIME OR THE ADDITIONAL PREBREATHE TIME.
- c. THE RESULTING PREBREATHE TIME (ADDITIONAL PREBREATHE PLUS REMAINDER OF ORIGINAL PREBREATHE) WILL NOT EXCEED THE ORIGINAL PREBREATHE TIME PER PARAGRAPH A.1 OR A.2. CONSULT THE FCR SURGEON FOR THE REQUIRED INCREASE IN LENGTH OF THE PREBREATHE PERIOD. @[021199-6806A]

Breathing nitrogen after the prebreathe has begun allows the tissues and blood to reabsorb nitrogen. Renitrogenation may occur at a faster rate than denitrogenation, especially if the astronaut is physically active during the break in prebreathe. Therefore, a break in the prebreathe will require extra prebreathe time to be added to the protocol.

D. FOR MULTIPLE EVA'S:

1. IF THE PROTOCOLS OUTLINED IN PARAGRAPH A.1 ARE USED AND THE CABIN PRESSURE IS MAINTAINED AT 10.2 PSI INDICATED UNTIL COMPLETION OF THE FINAL EVA, EACH SUBSEQUENT EVA MUST HAVE AN UNBROKEN PREBREATHE OF AT LEAST 40 MINUTES IN THE SUIT IMMEDIATELY PRIOR TO EVA. @[11705-6690D]

THIS RULE CONTINUED ON NEXT PAGE

FLIGHT RULES

A13-103

EVA PREBREATHE PROTOCOL [HC] (CONTINUED)

2. IF THE IN-SUIT PREBREATHE OPTION IS USED, EACH EVA WILL FOLLOW THE PROTOCOL OUTLINED IN PARAGRAPH A.2.

Documentation: ©[111705-6690D]

GFE Hazard Report, EMU014, Pathological/Physiological: Illness: Loss of Crewman

NASA Technical Memorandum 58259, Verification of an Altitude Decompression Sickness Prevention Protocol for Shuttle Operations Utilizing a 10.2-psi Pressure Stage, June 1984. (Empirical data that is the basis for the 4-hour and 10.2 stage decompression protocols)

Minutes of the second meeting of the Environmental Science Review Committee, December 2-3 1986. (Part of post-Challenger safety review – contains additional empirical data and model-based consolidation of data presented to the committee, the committee deliberations, and recommendations, including recommendations for prebreathe protocols and for prebreathe make-up time.)

Memorandum SD-5 87-161, Actions Related to Altitude Decompression Sickness Protection to be Taken Relating to the Review of Our Pre-EVA Procedures by the Environmental Science Review Committee, April 28, 1987. (The Environmental Science Committee recommended that it was appropriate to negotiate some specific details of the prebreathe protocols with the flight crew office. This memo reflects the protocols recommended by the Environmental Science Review Committee as modified by our discussions with flight crew representatives. These are substantially the current shuttle flight protocols.)

Chronology of Events and Documentation Relating to the Risk of Decompression Sickness in the Shuttle and Space Station Programs, prepared by James Waligora, July 17, 2000, (provides additional rationale for prebreathe flight rules and rationale for a few minor additions since 1986).

Conkin J, BF Edwards, JM Waligora, J Stanford, Jr., JH Gilbert, III, DJ Horrigan, Jr. Updating empirical models that predict the incidence of aviator decompression sickness and venous gas emboli for shuttle and space station extravehicular operations. NASA Technical Memorandum 100456 Update, Johnson Space Center, Houston, Tx. October 1990.

Van Liew HD, Burkard ME, Conkin J. Testing of hypotheses about altitude decompression sickness by statistical analyses. Undersea Hyperbaric Med. 1996; 23:225-33.

Rules {A2-107C}, EVA GUIDELINES; {A13-51}, CABIN PRESSURE [HC]; {A15-151}, DENITROGENATION; {A17-301}, CABIN ATMOSPHERE MANAGEMENT; and {A17-309}, CABIN PRESSURE TIME AT 10.2 PSIA, reference this rule. ©[012694-1600] ©[111705-6690D]

FLIGHT RULES

A13-104

DECOMPRESSION SICKNESS SYMPTOMS AND CREW DISPOSITION

A. CUFF CLASS 1: @[040899-6836A]

1. SYMPTOMS: MILD PAIN AT SINGLE OR MULTIPLE SITES AND/OR SINGLE EXTREMITY PARASTHESIA. SYMPTOMS THAT ARE DIFFICULT TO DISTINGUISH FROM SUIT PRESSURE POINTS. SYMPTOMS DO NOT INTERFERE WITH PERFORMANCE.
2. RESPONSE: CONTINUE EVA AND REPORT IN POST-EVA PMC.
3. NO IMPACT ON FUTURE EVA PLANS FOR THE AFFECTED CREWMEMBER OR ON MISSION DURATION.

The EMU can cause pressure points and pains that could be confused with DCS symptoms. However, the risk of mild pain of this nature progressing to a serious symptom is low. Because there is low concern with injury and the symptoms are expected to resolve during repress if they are DCS related, it is acceptable to continue the EVA and report the symptoms later in a PMC. It is specifically mentioned in the rule that there is no impact to future EVA to encourage cuff class 1 symptom reporting. This reporting is required to verify total DCS risk over time.

B. CUFF CLASS 2:

1. SYMPTOMS: MODERATE CUFF CLASS 1 SYMPTOMS THAT INTERFERE WITH PERFORMANCE.
2. RESPONSE: TERMINATE EVA FOR AFFECTED CREWMEMBER. UNAFFECTED CREWMEMBER TERMINATES EVA AFTER COMPLETING WORK SITE CLEANUP AND PAYLOAD BAY SAFING. REPRESS AIRLOCK AS SOON AS PAYLOAD BAY SAFING IS COMPLETE. CONDUCT PMC AFTER REPRESS.
3. NO IMPACT ON MISSION DURATION IF SYMPTOMS RESOLVE. SURGEON WILL DETERMINE CONSTRAINTS ON FUTURE EVA FOR AFFECTED CREWMEMBER CONSISTENT WITH NASA JSC DECOMPRESSION SICKNESS PROCEDURAL REQUIREMENTS JPR 1800.3. @[040899-6836A] @[033105-6637B]

THIS RULE CONTINUED ON NEXT PAGE

FLIGHT RULES

A13-104

DECOMPRESSION SICKNESS SYMPTOMS AND CREW DISPOSITION (CONTINUED)

This level of symptoms is distinguishable from EMU pressure points by a trained EVA astronaut. Because it represents confirmed DCS symptoms and pressure is one of the most effective treatments, the affected crewmember should be repressed as soon as practical. The overall risk is low enough to warrant work site cleanup and payload bay safing before repressing but not additional mission success tasks. The affected crewmember's activity should be minimized because continued joint loads can aggravate the symptoms. During the post-repress PMC, the Surgeon will determine specific treatment required. NASA JSC Decompression Sickness Procedural Requirements JPR 1800.3 documents the approved limits for return-to-duty and return-to-delta pressure operations. The JPR was developed by critical review and analysis of U.S. Navy, U.S. Air Force, and Commercial hypobaric and hyperbaric literature and policies concerning return to duty. The responses in these flight rules are consistent with this document. ©[040899-6836A] ©[033105-6637B]

C. CUFF CLASS 3:

1. SYMPTOMS: SEVERE CUFF CLASS 1 SYMPTOMS OR MIGRATORY, TRUNKAL OR MULTIPLE SITE PARESTHESIA, OR SEVERE OR UNUSUAL HEADACHE.
2. RESPONSE: TERMINATE EVA FOR BOTH CREWMEMBERS. UNAFFECTED CREWMEMBER WILL ASSIST AFFECTED CREWMEMBER TO AIRLOCK, THEN PERFORM PAYLOAD BAY SAFING. REPRESS AIRLOCK AS SOON AS PAYLOAD BAY SAFING IS COMPLETE. CONDUCT PMC AFTER REPRESS.
3. NO IMPACT ON MISSION DURATION IF SYMPTOMS RESOLVE. SURGEON WILL DETERMINE CONSTRAINTS ON FUTURE EVA FOR AFFECTED CREWMEMBER CONSISTENT WITH NASA JSC DECOMPRESSION SICKNESS PROCEDURAL REQUIREMENTS JPR 1800.3.

These symptoms are more severe than cuff class 2 because they are a more generalized level of DCS and there is a higher risk of symptom progression. Because continued joint loads can aggravate the symptoms, the affected crewmember's activity should be restricted to airlock ingress and should be assisted as much as possible. Further, work site and payload bay cleanup should be limited to only those required to safe the payload bay for an expedited deorbit. The overall risk is low enough to warrant delaying repress until both crewmembers are in the airlock. During the post-repress PMC, the Surgeon will determine specific treatment required. NASA JSC Decompression Sickness Procedural Requirements JPR 1800.3 documents the approved limits for return-to-duty and return-to-delta pressure operations. The responses in these flight rules are consistent with this document. ©[040899-6836A] ©[033105-6637B]

THIS RULE CONTINUED ON NEXT PAGE

FLIGHT RULES

A13-104

DECOMPRESSION SICKNESS SYMPTOMS AND CREW DISPOSITION (CONTINUED)

D. CUFF CLASS 4: @[040899-6836A]

1. SYMPTOMS: CENTRAL NEUROLOGICAL OR CARDIOPULMONARY
2. RESPONSE: ABORT EVA. UNAFFECTED CREWMEMBER WILL ASSIST AFFECTED CREWMEMBER TO AIRLOCK. AFFECTED CREWMEMBER WILL BE RERESSED IMMEDIATELY, WITH THE UNAFFECTED CREWMEMBER PERFORMING PAYLOAD BAY SAFING AND REPRESSING SEPARATELY, IF REQUIRED. CONDUCT PMC AFTER REPRESSING THE AFFECTED CREWMEMBER.
3. SURGEON WILL DETERMINE CONSTRAINTS ON FUTURE EVA FOR AFFECTED CREWMEMBER CONSISTENT WITH NASA JSC DECOMPRESSION SICKNESS PROCEDURAL REQUIREMENTS JPR 1800.3. @[033105-6637B]

The absolute minimum time to repress the affected crewmember is essential because these symptoms pose a serious health risk and increase the probability of an emergency deorbit. Therefore, it is acceptable to repress the affected crewmember separately while the other crewmember safes the payload bay for an expedited deorbit. At this level, it is likely the affected crewmember will require assistance due to impairment, and continued joint loads can aggravate the symptoms. During the post-repress PMC, the Surgeon will determine specific treatment required. NASA JSC Decompression Sickness Procedural Requirements JPR 1800.3 documents the approved limits for return-to-duty and return-to-delta pressure operations. The responses in these flight rules are consistent with this document.

DOCUMENTATION: DCS Risk Definition and Contingency Plan Review, April 1998.

NASA JSC Decompression Sickness Procedural Requirements JPR 1800.3B, 2004.

EVA Console Handbook, EMU Operations, Volume IV, JSC-20597. @[033105-6637B]

*Reference Rule {A13-105}, DECOMPRESSION SICKNESS RESPONSE AND TREATMENT.
@[040899-6836A]*

Rule {A13-105}, DECOMPRESSION SICKNESS RESPONSE AND TREATMENT, references this rule. @[ED]

FLIGHT RULES

A13-105

DECOMPRESSION SICKNESS RESPONSE AND TREATMENT

A. DEORBIT REQUIREMENTS: @[040899-6835B]

1. ANY EARLY MISSION TERMINATION AND DEORBIT FOR DCS PURPOSES WILL ONLY BE CONSIDERED TO A SITE DESIGNATED AS A PRIMARY HYPERBARIC CARE SITE.

Deorbit timeframe will be based on deorbit opportunities and Surgeon's evaluation of the severity of the specific symptoms. The additional risk of landing at an ELS will only be considered if the site has hyperbaric treatment capability since the most important treatment for DCS is increased pressure. The landing site list maintained by Flight Surgeon is annotated to show sites that medical operations has classified as primary hyperbaric care sites. This designation reflects the time to transport the injured crewmember to the chamber and the level of support available at the chamber.

2. FOR ALL LEVELS OF DCS THAT RESOLVE WITH TREATMENT, THERE IS NO REQUIREMENT FOR EMERGENCY DEORBIT.

If symptoms resolve with treatment, there is a low risk of recurring symptoms and injury to the crewmember. Therefore, the risk of an emergency deorbit is not warranted. However, based on specific symptoms and response to treatment, Surgeon may request the affected crewmember be returned to Earth before the nominal end of mission.

3. FOR ALL CUFF CLASS 1 SYMPTOMS, OR CUFF CLASS 2 AND 3 SYMPTOMS WHICH RESOLVE WITH TREATMENT, THERE IS NO REQUIREMENT FOR ANY EARLY MISSION TERMINATION.
4. EARLY DEORBIT WILL GENERALLY NOT BE CONSIDERED FOR UNRESOLVED NON-CUFF CLASS 4 SYMPTOMS UNLESS MEDICAL JUDGMENT DEEMS THE SYMPTOMS ARE PROGRESSING AND/OR ENDANGER CREW HEALTH AND SAFETY.

In a study of altitude decompression sickness, human subjects reporting DCS symptoms were immediately recompressed to ground level. Of the 749 subjects who received 2 hours of ground level oxygen, 739 (98.7 percent) resolved completely and required no further treatment. Therefore, concerning those with non-cuff class 4 symptoms, despite the fact that there is a delay in reaching the original cabin pressure, it could be expected that crewmembers' symptoms would resolve with on-orbit treatment. Additionally, we have data and experience that clearly suggests the suit creates residual symptoms, pain and paresthesia, that are consistent with non-Cuff Class 4 DCS. Also, data indicates there is no long-term injury associated with unresolved non-Cuff Class 4 symptoms. @[101305-6735]

THIS RULE CONTINUED ON NEXT PAGE

FLIGHT RULES

A13-105

DECOMPRESSION SICKNESS RESPONSE AND TREATMENT (CONTINUED)

5. FOR UNRESOLVED CUFF CLASS 4 SYMPTOMS, DEORBIT TO THE NEXT PRIMARY LANDING SITE OR WITHIN THE SCOPE OF NORMAL NPLS DEORBIT TIMING TO A LANDING SITE DESIGNATED AS A PRIMARY HYPERBARIC CARE SITE. BASED ON THE SPECIFIC MEDICAL SITUATION, DEORBIT WILL BE CONSIDERED TO THESE SITES AS EARLY AS 10 HOURS AFTER THE ONSET OF CUFF 4 SYMPTOMS. @[040899-6835B]

After the full treatment flow, persistent Cuff Class 4 symptoms are life threatening. Even in this case, the additional risk of landing at an ELS will only be considered if the site has hyperbaric treatment capability since the most important treatment for DCS is increased pressure. Long-term risk to an affected crewmember is reduced if treatment is initiated within approximately 12 hours. Depending on the severity of the specific Cuff 4 symptoms, Surgeon may request an expedited deorbit. Considering the treatment available simply from cabin pressure and when the risk to the affected crewmember is weighed against the risk to the full crew and spacecraft, it was concluded that landing in less than 10 hours is not justified. @[040899-6835B]

- B. THE CAPABILITY OF THE AFFECTED CREWMEMBER TO RETURN TO DUTY AND TO EVA AFTER TREATMENT WILL BE DETERMINED BY THE SURGEON CONSISTENT WITH NASA JSC DECOMPRESSION SICKNESS PROCEDURAL REQUIREMENTS JPR 1800.3. @[101305-6735]

The JPR was developed by critical review and analysis of U.S. Navy, U.S. Air Force, and commercial hypobaric and hyperbaric literature and policies concerning return to duty. @[101305-6735]

- C. THE SUIT WILL REMAIN IN THE PRESS MODE OR AT BTA TREATMENT PRESSURE AS SUPPORTED BY SUIT CONSUMABLES. THE BTA CAN BE INSTALLED TO PROVIDE THE MAXIMUM PRESSURE IN THE SUIT FOR TREATMENT. @[071001-4742]

The BTA can now be installed without depressurizing the suit. The use of the BTA will pressurize the affected crewmember to 6 or 8 psi above ambient. Using the BTA to press the suit to 8 psi over ambient, renders the suit unusable for subsequent EVAs due to a need for re-certification of the suit seals. @[071001-4742]

- D. CABIN PRESSURE WILL BE MANAGED AS FOLLOWS:

1. FOR CUFF CLASS 2 OR 3 SYMPTOMS THAT DO NOT RESOLVE WITHIN 20 MINUTES OF AIRLOCK REPRESS, THE CABIN WILL BE REPRESSURIZED TO 14.7 PSI. FOR CASES THAT DO NOT RESOLVE WITH 14.7 TREATMENT, THE CABIN WILL BE FURTHER PRESSURIZED TO THE HIGHEST PRESSURE SUPPORTABLE BY CONSUMABLES AND OXYGEN CONSTRAINTS UP TO 15.56 PSI.

THIS RULE CONTINUED ON NEXT PAGE

FLIGHT RULES

A13-105

DECOMPRESSION SICKNESS RESPONSE AND TREATMENT (CONTINUED)

2. FOR CUFF CLASS 4 SYMPTOMS, THE CABIN WILL BE REPRESSURIZED TO 14.7 PSI BEFORE OR DURING AIRLOCK REPRESS. FOLLOWING CABIN/AIRLOCK REPRESS, THE CABIN WILL BE FURTHER PRESSURIZED TO THE HIGHEST PRESSURE SUPPORTABLE BY CONSUMABLES AND OXYGEN CONSTRAINTS UP TO 15.56 PSI. @[040899-6835B]
3. FOR CUFF CLASS 2, 3 AND 4 SYMPTOMS, THE AFFECTED CREWMEMBER WILL NOT BE EXPOSED TO A REDUCED CABIN PRESSURE FOR AT LEAST 72 HOURS AFTER DCS TREATMENT UNLESS REQUIRED FOR DEORBIT, CONSUMABLES MANAGEMENT, OR OXYGEN CONSTRAINTS. FOR CASES WITH THE CABIN PRESSURE RAISED ABOVE 14.7 PSIA, THE CABIN PRESSURE WILL BE ALLOWED TO BLEED DOWN TO 14.7 PSIA. @[040899-6835B]

In all cases, the most effective immediate treatment is repressurization. The total pressure reached at cabin pressure with the suit in PRESS mode suffices for cuff class 2 and 3 symptoms. If the symptoms resolve, there is no need to increase the cabin pressure above the pressure at ingress. However, if Cuff Class 2 and 3 symptoms do not resolve with the initial treatment in a 10.2-psi cabin, the additional 4.5 psi is the most effective next step and the cabin will be repressed to 14.7 psi.

Due to the severity of cuff class 4 symptoms, the cabin will immediately be repressed to at least 14.7 psi to maximize the initial treatment pressure. Total pressure will be raised as high as 15.56 psi if supported by consumables and oxygen constraints. This pressure provides 0.24-psi margin (cabin pressure sensor measurement error) below the positive pressure relief valve (PPRV) cracking pressure based on a relief pressure of 15.8 psi for OV-105. 15.8 psia is the lowest PPRV cracking pressure of the fleet. The other vehicle's PPRV cracking pressures are as follows: OV-103 - 15.9 psia, OV-104 - 15.95 psia. @[072403-6070]

To prevent recurring symptoms, the affected crewmember will not be exposed to cabin pressure reductions for at least 72 hours. Surgeon may require a longer period based on specific symptoms and response to treatment.

The cabin pressure may be raised to 15.56 psia while treating severe symptoms. However, at the end of the treatment, the crewmember will be removed from the EMU that is providing the majority of the additional pressure during the treatment. Therefore, it is acceptable to allow the cabin pressure to bleed down over time to 14.7 psia in order to return to automatic atmosphere maintenance using the O₂/N₂ cabin regulators.

THIS RULE CONTINUED ON NEXT PAGE

FLIGHT RULES

A13-105

DECOMPRESSION SICKNESS RESPONSE AND TREATMENT
(CONTINUED)

DOCUMENTATION: @[101305-6735]

NSTS 16007 LCC Rev G (ECL-05)

OMI V1217 Test Data

Krause KM and Pilmanis AA. *The effectiveness of ground level oxygen treatment for altitude decompression sickness in human research subjects. Aviat Space Environ Med 2000 Feb; 71(2):115-118.*

Rudge FW. *The role of ground level oxygen in the treatment of altitude chamber decompression sickness. Aviat Space Environ Med 1992 Dec; 63(12):1102-5*

DCS Risk Definition and Contingency Plan Review, April 1998

NASA JSC Decompression Sickness Procedural Requirements, JPR 1800.3B, 2004

OMI V1217 Test Data @[101305-6735]

Arthur DC and Margulies RA. *The pathophysiology, presentation, and triage of altitude-related decompression sickness associated with hyperbaric chamber operation. Aviat Space Environ Med 48:489-494, May 1982. @[071001-4742]*

Wade Frost presented to the Systems Safety Review Panel, Review of the revised on-orbit bends treatment procedure, May 23, 2001.

Conkin, J. *EVA-IPT response to ACTION about barotrauma risk with rapid decompression of EMU with BTA attached. February 2, 2001. @[071001-4742]*

Reference Rules {A13-104}, DECOMPRESSION SICKNESS SYMPTOMS AND CREW DISPOSITION, and {A17-254}, CABIN O2 CONCENTRATION. @[040899-6835B]

Rule {A13-104}, DECOMPRESSION SICKNESS SYMPTOMS AND CREW DISPOSITION, references this rule. @[ED]

FLIGHT RULES

A13-106

MINIMUM PPO2 CONSTRAINTS

ONE-GAS ENVIRONMENT (EMU) - IF THE PRESSURE IN THE SUIT FALLS BELOW 3.15 (3.3) PSI, THE EVA CREWMEMBER WILL ABORT THE EVA. ©[112304-6462B]

At 92 percent O₂, 3.15 (3.3) psia corresponds to a pressure altitude of 8000 feet and the rationale of Rule {A13-53A}, MINIMUM PPO2 CONSTRAINTS [HC], applies. Exhaled nitrogen from the crewmember dilutes the oxygen atmosphere in the suit to 92 percent. ©[112304-6462B] ©[ED]

FLIGHT RULES

A13-107

PPCO₂ CONSTRAINT (ONE GAS)

ONE-GAS ENVIRONMENT (EMU) : @[101305-6655A]

1. FOR PPCO₂ LEVELS BETWEEN 3 AND 8 MMHG WITH SYMPTOMS INDICATIVE OF CO₂ EXPOSURE, THE CREWMEMBER WILL TERMINATE THE EVA, PROCEED TO THE AIRLOCK, AND CONNECT TO THE SERVICE AND COOLING UMBILICAL (SCU).
2. FOR PPCO₂ LEVELS GREATER THAN 8 MMHG DURING EVA, IF IT CANNOT BE CONFIRMED THAT THE ELEVATED LEVELS ARE DUE TO A SENSOR ERROR, THE EVA CREWMEMBER WILL TERMINATE THE EVA, PROCEED TO THE AIRLOCK, AND CONNECT TO THE SCU.
@[121197-6456A]
3. FOR LOSS OF PPCO₂ SENSOR, THE FLIGHT SURGEON MAY REQUEST PHYSIOLOGICAL STATUS CHECKS TO EVALUATE THE CREWMEMBER FOR SYMPTOMS OF HYPERCAPNIA. IF SYMPTOMS ARE DETECTED, THE EVA WILL BE TERMINATED. @[121197-6456A]

For a PPCO₂ indication of 3 to 8 mmHg, the actual level in the helmet can be 11 to 15 mmHg due to the slow sensor system response and location of the sensor. The sensor draws samples from the ventilation loop upstream of the helmet, not from the actual helmet environment. An additional compounding factor is that the indicated PPCO₂ readings vary with absolute pressure in the EMU. Actual PPCO₂ levels may reach 19 to 23 mmHg, depending on the metabolic rate. If symptoms are associated with indicated values of 3 to 8 mmHg, this indicates a high level of CO₂ in the helmet, and the EVA should be terminated.

In order to avoid unnecessary termination of an EVA due to faulty high PPCO₂ readings, an evaluation of the PPCO₂ sensor should be performed if the indicated level is greater than 8 mmHg. The EVA cuff checklist outlines the procedure to be followed by the crewmember. Additional evaluation can be performed by ground personnel to determine the status of the sensor. If the indicated PPCO₂ level is greater than 8 mmHg, due to a confirmed sensor error, the crewmember may continue the EVA; but crewmember symptoms should be evaluated periodically. If symptoms are noted, the EVA should be terminated and the crewmember should proceed to the airlock and connect to the SCU. When the crewmember is connected to the SCU with the helmet purge valve open, the resultant O₂ flow alleviates danger of high PPCO₂ levels. @[101305-6655A]

THIS RULE CONTINUED ON NEXT PAGE

FLIGHT RULES

A13-107**PPCO2 CONSTRAINT (ONE GAS) (CONTINUED)**

For CO₂ transducer loss, the ability to detect a high CO₂ level relies primarily on the crewmember's ability to detect physiological symptoms. Since one of the symptoms of hypercapnia is impaired judgment, the unaffected EVA crewmember, IV crewmember, and Flight Surgeon will assist in periodically monitoring the affected crewmember's physiological condition. The most common sign of CO₂ exposure is an increased breathing rate that will occur at 1 to 2 percent (7.6 to 15 mmHg). The pulse rate will increase at 3 to 5 percent (22 to 38 mmHg). Nonspecific symptoms experienced by the crewmember can be headache, dizziness, drowsiness, muscular weakness, etc. Note that the OSHA standard for an 8-hour workplace exposure is 0.5 percent (3.8 mmHg). The Flight Surgeon will continually monitor the downlinked ECG and metabolic data as well as the voice communications and breathing rate, and may request physiological status checks be performed with the crewmember as necessary. The other EVA crewmember and the IV crewmember will monitor the affected crewmember's task performance and voice communications, and should perform status checks every 30-60 minutes or as requested by the Flight Surgeon. If symptoms are detected, the EVA should be terminated. Thirty minutes was determined to be the minimum time it would take for the PPCO₂ levels to increase from 3 mmHg to 8 mmHg due to a LiOH breakthrough. ©[121197-6456A] ©[101305-6655A]

Reference: Email from DX3/D. Brashinger, 22 Nov 2004, EMU PPCO2 Sensor. ©[101305-6655A]

Rule {A13-103}, EVA PREBREATHE PROTOCOL [HC], references this rule. ©[ED]

A13-108 THROUGH A13-150 RULES ARE RESERVED ©[101305-6655A]

FLIGHT RULES

HAZARD MANAGEMENT

A13-151 **HOT CABIN ATMOSPHERE [HC]** ©[022405-6611A]

IN THE EVENT OF LOSS OF CABIN COOLING CAPABILITY, THE FOLLOWING MEASURES SHALL BE TAKEN:

- A. DEORBIT TO AN EMERGENCY LANDING SITE (ELS) MAY BE REQUIRED PRIOR TO PRIMARY LANDING SITE (PLS).
- B. MONITOR AND RECORD CREW SYMPTOMS, CABIN TEMPERATURE, AND HUMIDITY CHANGES USING AVAILABLE SENSORS INCLUDING MEDICAL KIT THERMOMETERS. REPORT DATA TO MCC AT EVERY AVAILABLE COMMUNICATION OR DATA PASS.
- C. BEGIN IMMEDIATE FLUID LOADING, WITH 8 OUNCES OF WATER EVERY 15 MINUTES AND ONE SALT TABLET EVERY 30 MINUTES OR 12 OUNCES OF ASTROADE/CONSUMME EVERY 15 MINUTES.
- D. AT CREWMEMBER DISCOMFORT, DON QUICK DON MASK (QDM). CONTINUE WEAR UNTIL RESOLUTION OF THE COOLING PROBLEM.
- E. IN THE EVENT OF A HOT CABIN ATMOSPHERE, ACES ARE NOT REQUIRED FOR ENTRY. WEARING THE ACES WILL ACCELERATE THERMAL LOADING AND COGNITIVE DETERIORATION AT TEMPERATURES GREATER THAN 90 DEG F AND HUMIDITY > 50 PERCENT.

The need for an emergency landing will be a real-time call depending on the situation due to the numerous factors involved. An emergency landing may be required to prevent crew incapacitation. Accurate trending of cabin conditions and preparations for landing must begin well in advance of TIG. A hot cabin may quickly reach crew tolerance limits and impair crew performance and health prior to ELS/PLS opportunities, and monitoring of the cabin and crew may be very limited due to associated powerdowns. ©[022405-6611A]

THIS RULE CONTINUED ON NEXT PAGE

FLIGHT RULES

A13-151

HOT CABIN ATMOSPHERE [HC] (CONTINUED)

The worst case is a loss of cabin cooling resulting from a loss of two water loops; loss of two Freon coolant loops, which critically limits orbiter life; or loss of two cabin fans, which critically limits crew tolerance and cognitive performance. Each situation will require immediate actions for landing. Orbiter life is approximately 2 hours until wheelstop following a loss of two Freon loops, assuming all three fuel cells remain operational. The loss of two water loops is 8 hours to the ground and loss of two cabin fans is 4 hours to the ground. Crew tolerance will be less than 2 hours in a loss of two cabin fans or two water loops scenario. Other losses, such as ACES or two fuel cells, do not affect the deorbit timeline to the same extent. Suit donning, if performed at temperatures less than 90 deg F and relative humidity less than 50 percent, takes approximately 10 minutes/crewmember and seat installation is 10 minutes/seat. @[022405-6611A]

Powerdowns associated with loss of cabin cooling include both galley hardware and environmental sensors. Temperature and humidity sensors will be lost early in the evolution of the event and will interfere with acquiring data for trending of temperature and humidity. The only cabin temperature sensor is located on the flight deck. Data points from STS-43 in evaluating cabin temperatures in conjunction with the Bioserve-Instrumentation Technology Associates Materials Dispersion Apparatus (BIMDA) shows temperatures 5 deg F higher on flightdeck than middeck and 11 deg F higher on flightdeck than in the airlock. Secondly, DTO-664 showed the cabin temperatures typically vary 20-30 deg F throughout the cabin during missions. Therefore, single datapoints representing either a measured value or an averaged value are inadequate to predict with confidence temperatures in the microclimate of crewmembers in microgravity because of the absence of air convection and widely disparate forced air circulation. Unstirred air in the vicinity of crewmembers can result in temperature and humidity levels that can be seriously underestimated and be worse than expected by assumptions of homogeneity of cabin air. Additionally, orbiter orientation with respect to the sun, payload bay heat sources, and middeck payloads also affect the temperature gradients between middeck and flightdeck and the effectiveness of cabin thermal control.

Cabin purges and depress/repress cycles may interfere with trending of the cabin environment and result in a slightly cooler cabin than predicted. If Loss of two Water Loops procedure is executed, telemetry will be lost within approximately 5 minutes. If Loss of Two Cabin Fans procedure is executed, telemetry will be lost within approximately 10 minutes. To regain telemetry, the powerup takes 5 minutes of crew time, but telemetry downlink is restricted by groundsite availability. Alternate sources of environmental data include medical thermometers and Fluke meter. Medical kit thermometers can measure skin temperatures ranging from 85-105 deg F (Shuttle Orbiter Medical System (SOMS) contains 15 thermometers) and air temperatures between 58-120 deg F (SOMS contains two). @[022405-6611A]

THIS RULE CONTINUED ON NEXT PAGE

FLIGHT RULES

A13-151**HOT CABIN ATMOSPHERE [HC] (CONTINUED)**

Stepwise preventive measures are necessary to provide protection from the hot environment. Dehydration impairs heat dissipation, cognitive function, short-term memory, and cardiovascular/orthostatic function. Some of these effects are synergistic with the direct effects of heat stress. The primary means of removing heat from the body are convection, conduction (LCVG), radiation, and evaporation. As cabin temperature increases, convection, conduction (LCVG), and radiation become ineffective. Evaporation, i.e., perspiration, becomes ineffective as cabin atmosphere approaches 33 mmHg water vapor pressure (see Table A13-151-I - LOSS OF EVAPORATION CAPABILITY IN A HOT CABIN ATMOSPHERE). Above 90-95 deg F and a humid environment greater than 50 percent, heat removal from the body is drastically reduced or almost absent. In a loss of two water loop failure, it would take approximately 45 minutes to reach 95 deg F and 50 percent humidity in the crew cabin. In a loss of two cabin fans failure, it would take slightly greater than 90 minutes to reach 90 deg F and 100 percent humidity in the crew cabin. For a loss of one Freon loop or ACES, powerdowns occur and the result is that no real cabin temperature or humidity violations would occur. ©[022405-6611A]

Crew impairment begins when skin temperature increases greater than 2.5 deg F (1 deg F core) or if pulse is greater than 140 bpm. Precise prediction of crew tolerances and time constraints for entry are not possible. However, minimizing unnecessary crew activity will help mitigate the situation. Table A13-151-II - CORE TEMPERATURE RANGE LIMITS AND ASSOCIATED PERFORMANCE DECREMENTS, identifies core temperature range limits and associated performance decrements.

In a nonacclimatized individual, water loss is approximately 1 L (32 oz)/hour and salt loss is approximately 2-3 grams/hour. In microgravity and elevated humidity, sweat forms an insulating layer over the body. Drink bags must be filled as soon as possible after loss of cabin cooling. It takes approximately 20 seconds to fill one 8oz drink bag. In addition, there may be operational constraints on performing the standard fluid loading protocols for landing. Despite the powerdowns, the galley can be activated and provide enough potable water for crew consumption. Thirst is an unreliable indicator of dehydration, so proactive water and salt loading are essential to prevent dehydration. Each salt tablet is 1 gram and there are two fluid loading kits onboard. Each kit supports the fluid loading requirements of the crew for a full prescription plus an additional half prescription.

Quick-don masks provide dry, cool oxygen. While gaseous oxygen does not have a high heat capacity, it may provide some limited cooling in addition to increased subjective comfort due to ventilating the face with cool, dry air. Military experience indicates that cool dry breathing gas may account for as much as 10 percent of total body heat exchange. Use of QDM may be limited by O₂ supply or cabin O₂ concentration constraints. ©[022405-6611A]

THIS RULE CONTINUED ON NEXT PAGE

FLIGHT RULES

A13-151**HOT CABIN ATMOSPHERE [HC] (CONTINUED)**

The advantages of wearing the ACES are the Liquid Cooled Garment (LCG) conductive cooling provided by the ICU, integrated G-suit portion, crash protection and toxic exposure (Modes V-VII), bailout capability (Mode VIII), and integrated communication. The disadvantage of the ACES is the increased thermal loading and cognitive impairments caused by the failure of LCG/ICU cooling system in a hot cabin environment. The priority is to maintain the health of the crew for landing support with the understanding that the contingency modes will not be protected. The ambient temperature in the smaller microclimate of the ACES is a function of the microenvironment volume, metabolic rate, flow rate, and time. The smaller ACES volume will increase in temperature faster than the larger cabin volume. In addition, the thermopiles (ICU) used to cool the ACES are only 18 percent efficient; for every BTU they extract from the crewmember, they dump 6 BTU's into the cabin. The net result is to increase the cabin temperature at a greater rate. Furthermore, G-suit protection is compromised by dehydration, heat-induced peripheral vasodilation, and orthostatic dysfunction. The G-suit and bailout equipment cannot be worn separately from the ACES. In addition, the G-suit is impermeable and prevents evaporation of sweat for up to 40 percent of the body area. Experimental data with human test subjects relating body temperature and ambient atmosphere above 90 deg F and 50 percent relative humidity while wearing ACES is not available. However, JSC thermoregulatory models (Wissler & 41-node man) simulating hot cabin entries wearing entry suits with the properties of the ACES (thickness, conductance, wickability, emmissivity) predicted loss of all body cooling mechanisms. Therefore, wearing ACES will be detrimental. Finally, supporting data from military aircrew protective ensembles suggests body temperature may increase more rapidly over time in ACES, compared to a shirt-sleeve environment. The JSC thermal model predictions described above are shown in Table A13-151-III - COGNITIVE DEFICIT ONSET AND METABOLIC RATE LIMITS VS CABIN TEMP WITH ACES ON/OFF AND NOMINAL ICU FUNCTION, and identify cognitive deficit onset time limits and metabolic rate limits versus cabin temperature. ©[022405-6611A]

THIS RULE CONTINUED ON NEXT PAGE

FLIGHT RULES

A13-151 HOT CABIN ATMOSPHERE [HC] (CONTINUED)

**TABLE A13-151-I - LOSS OF EVAPORATION CAPABILITY IN A
HOT CABIN ATMOSPHERE**

TEMPERATURE °F	RELATIVE HUMIDITY %	WATER VAPOR PRESSURE MMHG
87	100	33
90	90	33
95	79	33
100	67	33
105	59	33
110	50	33
115	44	33

PROVIDED BY J. WALIGORA, MAY 2000

@[022405-6611A]

THIS RULE CONTINUED ON NEXT PAGE

FLIGHT RULES

A13-151

HOT CABIN ATMOSPHERE [HC] (CONTINUED)

TABLE A13-151-II - CORE TEMPERATURE RANGE LIMITS AND ASSOCIATED PERFORMANCE DECREMENTS

CORE TEMPERATURE (°F)	EQUIVALENT HEAT STORAGE (BTU)	MEDICAL CONDITION
99.9-100.8	300-400	COGNITIVE TASK DECREMENT ONSET DECREASING MANUAL DEXTERITY DISCOMFORT HYPERTHERMIA/HEAT STRESS
100.8-102.6	400-600	SLOWED COGNITIVE FUNCTION INCREASED ERRORS IN JUDGMENT LOSS OF TRACKING SKILLS 25% RISK OF HEAT CASUALTIES POSSIBLE HEAT EXHAUSTION
102.6-103.3	600-800	FUNCTIONAL LIMIT OF PHYSICAL TASKS 50% RISK OF HEAT CASUALTIES PROBABLE HEAT EXHAUSTION POSSIBLE HEAT STROKE
> 104	> 800	100% RISK OF HEAT CASUALTIES PROBABLY HEAT STROKE

@[022405-6611A]

THIS RULE CONTINUED ON NEXT PAGE

FLIGHT RULES

A13-151

HOT CABIN ATMOSPHERE [HC] (CONTINUED)

**TABLE A13-151-III - COGNITIVE DEFICIT ONSET AND
METABOLIC RATE LIMITS VS CABIN TEMP WITH ACES
ON/OFF AND NOMINAL ICU FUNCTION**

COGNITIVE DECREMENT ONSET (CDO) LIMITS	CABIN TEMP = 70	CABIN TEMP = 80	CABIN TEMP = 90	CABIN TEMP = 95	CABIN TEMP = 100
LIMIT RANGE = 99.9 – 100.8 °F	RH = 50% MET = 772 BTU/HR	RH = 50% MET = 772 BTU/HR	RH = 50% MET = 772 BTU/HR	RH = 50% MET = 772 BTU/HR	RH = 50% MET = 772 BTU/HR
TIME TO CDO ACES OFF	3+ HRS	3+ HRS	3.25 HRS EXTRAPOL	2.45 HRS EST	1.66 HRS EXTRAPOL
TIME TO CDO ACES ON	3+ HRS	3+ HRS	1.25 HRS EXTRAPOL	0.75 HRS EST	0.25 HRS
MAX METABOLIC RATE TO STAY BELOW LOSS OF TRACKING SKILLS (LOTS) WITH ACES ON. LIMIT RANGE = 100.8 – 102.6 °F	~2000 BTU/HR (~10MIN/ MILE)	~1400 BTU/HR (~FIGHTER PILOT)	~825 BTU/HR (~SUIT DONNING, ASSISTED)	~550 BTU/HR (~QUIET SITTING)	~400 BTU/HR (AT REST)

©[022405-6611A]

THIS RULE CONTINUED ON NEXT PAGE

FLIGHT RULES

A13-151 HOT CABIN ATMOSPHERE [HC] (CONTINUED)

References: ®[022405-6611A]

"Thermal Stressor;" in: *Textbook of Clinical, Occupational, and Environmental Medicine*; pp658-665; ed: L. Rosenstock, M. Cullen; W. B. Saunders Company, 1994.

"Thermal Problems: Prevention and Treatment;" in: *The Physiology and Medicine of Diving*; pp306; ed: P. Bennett, D. Elliott; W.B. Saunders Company, 1993.

Effects of wearing aircrew protective clothing on physiological and cognitive response under various ambient conditions; H Faerevik, R Reinertsen; *Ergonomics* 46(8):780-99; 2003.

Effects of heat stress on baroreflex function in humans; C Crandall, J Cui, T Wilson; *ACTA Physiologica Scandinavica* 177(3):321-8; 2003.

Microenvironment changes inside impermeable protective clothing during a continuous work exposure; I Muir, P Bishop, J Kozusko *Ergonomics* 44(11): 953-61; 2001.

Cardiovascular reflexes during rest and exercise modified by gravitational stresses; F Bonde-Petersen; *ACTA Astronautica* 8(9-10):951-8; 1981.

Impact of fluid replacement on heat storage while wearing protective clothing; T McLellan, S Cheung *Ergonomics* 43(12):2020-30; 2000.

Human tolerance to heat strain during exercise: influence of hydration; M Sawka, et al, *Journal of Applied Physiology* 73(1):368-75; 1992.

M.W. Bungo, J.B. Charles, and P.C. Johnson, *Cardiovascular Deconditioning During Space Flight and the Use of Saline as a Countermeasure to Orthostatic Intolerance*, *Aviation Space Environment Medicine*, 56 (10): 985-990, 1985.

Levine et al, *Heat Strain Evaluation of Chemical Protective Garments*, *Aviation Space Environ Med*, 2001; 72:329-35.

McLellan et al, *Effects of Metabolic Rate and Ambient Vapour Pressure on Heat Strain in Protective Clothing*, *Eur J Appl Physiol*, 1996; 74:518-527.

Reardon et al, *Flight Performance Effects of Thermal Stress and Two Aviator Uniforms in a UH-60 Helicopter Simulator*, *Aviation Space Environ Med*, 1998; 69:569-576.

Cheung et al, *Heat Acclimation, aerobic fitness, and hydration effects on tolerance during uncompensable heat stress*, 1998; 84(5): 1731-1739. ®[022405-6611A]

THIS RULE CONTINUED ON NEXT PAGE

FLIGHT RULES

A13-151 **HOT CABIN ATMOSPHERE [HC] (CONTINUED)**

Textbook of Medical Physiology, 9th Ed., Guyton, A.C. and Hall, J.E., pp 911-922, W. B. Saunders Co., Philadelphia PA. ©[022405-6611A]

The Physiological Basis for Spacecraft Environmental Limits, J. M. Waligora, NASA Reference Publication 1045, November, 1979.

Human tolerance to heat strain during exercise: influence of hydration, M.N. Sawka, A.J. Young, W.A. Latzka, et. Al., J. Appl. Physiol 73(1):368-375, 1992.

Crew Tolerance Times (Wearing the LES) in Selected Hot Cabin Conditions, Rockwell International, Space Transportation Systems Division, no date, not otherwise identified chart.

Heat Strain Evaluation of Chemical Protective Garments, L. Levine, R.F. Johnson, WB Teal, D. J. Merullo, et al, Aviation, Space, and Environmental Medicine 72(4):329-355, April 2001.

BioAstronautics Data Book, 2nd Edition, 1973, Parker, JF, West, VR, Editors, BioTechnology, Inc., Scientific & Technical Information Office, NAS.

Kuznetz, L. The effect of compromised cabin thermal control on crew performance during entry, August 2004.

Control of Human Thermal Comfort with a Liquid Cooled Garment, Based on a Mathematical Model of the Human Thermoregulatory System, Ph.D. Thesis, UC Berkeley and NASA- TMX-581190, 1977.

Anecdotal information from STS-101 CDR during launch abort (S. Horowitz).

Briefing by R. McCluskey to the A/E FTP #205 on September 17, 2004.

STS-43 Orbiter Cabin Temperature Survey in conjunction with with the Bioserve-Instrumentation Technology Associates Materials Dispersion Apparatus (BIMDA).

DTO-664 Cabin Temperature Survey results evaluation.

Reference procedures: OPCL/ALL/GEN K/LOSS OF 2 CAB FANS, OPCL/ALL/LOSS OF 2 H2O LOOPS, and IFM/ALL/IFM TOOL LOCKER: TRAY 1 – DIGITAL MULTIMETER.

Reference Rule {A2-205}, EMERGENCY DEORBIT. ©[012204-6182]

Hazard Control ORBI-321, Crew Incapacitation from Heat Strain. ©[022405-6611A]

Rule {A13-31}, CREW CABIN TEMPERATURE LIMITS, references this rule. ©[ED 1]

FLIGHT RULES

A13-152 RESERVED @[090894-1682A] @[021600-7170] @[ED] @[090894 1673A]
 @[101305-6739B] @[101305-6740C] @[101305-6741A]

A13-153 BROKEN GLASS/HAZARDOUS SUBSTANCE CONSTRAINT [HC]
 @[022405-6587]

- A. IF BROKEN GLASS OR A HAZARDOUS SUBSTANCE SPILLS INTO A CLOSED VOLUME AREA, THAT VOLUME AREA WILL NOT BE OPENED TO THE HABITABLE ENVIRONMENT. FLIGHT-SPECIFIC EXCEPTIONS WILL BE LISTED IN THE FLIGHT-SPECIFIC ANNEX.

This will prevent the introduction of the hazardous substance into the crew's environment.

- B. RELEASE OF BROKEN GLASS IN THE CABIN ENVIRONMENT IS A LEVEL 2 HAZARDOUS SPILL. REFERENCE RULE {A13-155C}, ORBITER HAZARDOUS SUBSTANCE SPILL RESPONSE [HC], FOR CREW ACTIONS.
 @[ED]

Free-floating glass particles represent a hazard to the eyes and respiratory tract. Cleanup may be attempted with the crew wearing protective equipment as noted for a level 2 hazardous spill.

Hazard Report, ORBI 220, Presence of Mercury in the Crew Module.

Hazard Report, ORBI 279, Flight and Ground Generated Debris/Shatterable Glass in Crew Cabin Causing Crew Injury. @[022405-6587]

FLIGHT RULES

A13-154

HAZARDOUS SPILL LEVEL DEFINITIONS [HC] ©[033006-7274A]

HAZARDOUS SPILL LEVELS ARE DEFINED BY THE FOLLOWING HAZARDOUS SPILL LEVEL DEFINITION TABLE.

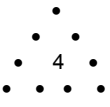
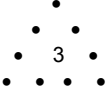
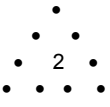
COLOR/ LEVEL	STATE	FLAMMABILITY	SYSTEMIC/ INTERNAL DAMAGE	IRRITANCY	CRIT	SUMMARY OF HAZARD LEVEL
<p>RED</p> 	GAS, VOLATILE LIQUID, OR FUMES THAT ARE NOT CONTAINABLE BY A CLEANUP CREW.	MAY BE CAPABLE OF PRODUCING FLAMMABLE VAPORS OR FINE MIST IN SUFFICIENT QUANTITY TO PRODUCE A HAZARD.	APPRECIABLE EFFECTS ON COORDINATION, PERCEPTION, MEMORY, ETC., OR POTENTIAL FOR LONG TERM (DELAYED) SERIOUS INJURY (E.G., CANCER) OR MAY RESULT IN INTERNAL TISSUE DAMAGE.	<p>MODERATE TO SEVERE IRRITATION THAT HAS THE POTENTIAL FOR LONG-TERM CREW PERFORMANCE DECREMENT (FOR EYE-ONLY HAZARDS, THERE MUST BE A RISK OF PERMANENT EYE DAMAGE).</p> <p>NOTE: WILL REQUIRE THERAPY IF CREW IS EXPOSED.</p>	[1]	<p>IT IS A CATASTROPHIC HAZARD (CAPABLE OF CAUSING DISABLING INJURY) THAT IS NOT CONTAINABLE BY A CLEANUP CREW AND HAS THE POTENTIAL FOR SYSTEMIC TOXICITY, MODERATE-TO-SEVERE IRRITANT, TISSUE DAMAGE, OR CAN PRODUCE FLAMMABLE VAPORS. NO PROVISION HAS BEEN MADE FOR SEVERE SKIN IRRITATION OR ABSORPTION.</p> <p>EXAMPLE: METAL VAPOR LIKE MERCURIC IODIDE.</p>
<p>ORANGE</p> 	EITHER A SOLID OR NONVOLATILE LIQUID. CAN BE CONTAINED BY A CLEANUP CREW AND DISPOSED OF IN THE WET TRASH.	MAY BE CAPABLE OF PRODUCING FLAMMABLE VAPORS OR FINE MIST IN SUFFICIENT QUANTITY TO PRODUCE A HAZARD.	APPRECIABLE EFFECTS ON COORDINATION, PERCEPTION, MEMORY, ETC., OR THE POTENTIAL FOR LONG-TERM (DELAYED) SERIOUS INJURY (E.G., CANCER) OR MAY RESULT IN INTERNAL TISSUE DAMAGE.	<p>THERE MAY BE IRRITATION THAT ACCOMPANIES THE SYSTEMIC TOXICITY CONCERNS; HOWEVER, IRRITANCY ALONE WOULD NOT DRIVE YOU TO A LEVEL 3.</p> <p>NOTE: WILL REQUIRE THERAPY IF CREW IS EXPOSED.</p>	[1]	<p>IT IS A CATASTROPHIC HAZARD (CAPABLE OF CAUSING DISABLING INJURY) THAT IS CONTAINABLE BY A CLEANUP CREW AND HAS THE POTENTIAL FOR SYSTEMIC TOXICITY, OR IS CAPABLE OF PRODUCING FLAMMABLE VAPORS, OR COULD CAUSE INTERNAL TISSUE DAMAGE.</p> <p>EXAMPLE: ACETONITRILE.</p>
<p>YELLOW</p> 	EITHER A SOLID OR NONVOLATILE LIQUID. CAN BE CONTAINED BY A CLEANUP CREW AND DISPOSED OF IN THE WET TRASH.	MAY BE CAPABLE OF PRODUCING FLAMMABLE SOLIDS OR LIQUIDS BUT NOT VAPORS IN SUFFICIENT QUANTITY TO PRODUCE A HAZARD.	NONE	<p>MODERATE-TO-SEVERE IRRITATION THAT HAS THE POTENTIAL FOR LONG-TERM CREW PERFORMANCE DECREMENT (FOR EYE-ONLY HAZARDS, THERE MAY BE A RISK OF PERMANENT EYE DAMAGE).</p> <p>NOTE: WILL REQUIRE THERAPY IF CREW IS EXPOSED.</p>	[1]	<p>IT IS A CATASTROPHIC HAZARD (CAPABLE OF CAUSING DISABLING INJURY) THAT IS CONTAINABLE BY A CLEANUP CREW. SINCE THERE ARE NO SYSTEMIC TOXICITY CONCERNS OR TISSUE DAMAGE (OTHER THAN EYE), NO RESPONSE HAS BEEN MADE FOR SEVERE SKIN IRRITATION OR ABSORPTION. IT IS EXPECTED THAT SKIN IRRITATION WILL BE LESS SEVERE THAN EYE IRRITATION.</p> <p>EXAMPLE: SODIUM HYDROXIDE WITH VERY HIGH PH (> 12)</p>

©[033006-7274A]

KEY:

[1] - CATASTROPHIC

[2] - CRITICAL

[3] - NONE

THIS RULE CONTINUED ON NEXT PAGE

FLIGHT RULES

A13-154

HAZARDOUS SPILL LEVEL DEFINITIONS [HC]
(CONTINUED)

COLOR/ LEVEL	STATE	FLAMMABILITY	SYSTEMIC/ INTERNAL DAMAGE	IRRITANCY	CRIT	SUMMARY OF HAZARD LEVEL
BLUE • • • • 1 • • • • •	GAS, SOLID, OR LIQUID MAY OR MAY NOT BE CONTAINABLE.	VERY LOW FLAMMABILITY POTENTIAL. THE SUBSTANCE HAS A HIGH FLASH POINT AND A LOW VAPOR PRESSURE.	MINIMAL EFFECTS. NO POTENTIAL FOR LASTING INTERNAL TISSUE DAMAGE.	SLIGHT-TO-MODERATE IRRITATION THAT LASTS > 30 MINUTES. IF AN EYE-ONLY HAZARD, CAN AFFECT VISUAL ACUITY > 30 MINUTES. NOTE: WILL REQUIRE THERAPY IF CREW IS EXPOSED.	[2]	IT IS A CRITICAL HAZARD (CAPABLE OF CAUSING NONDISABLING INJURY) AND MAY OR MAY NOT BE CONTAINABLE BY A CLEANUP CREW. EXAMPLE: SOLUTIONS LIKE 15% SODIUM CHLORIDE.
GREEN • • • • 0 • • • • •	GAS, SOLID, OR LIQUID MAY OR MAY NOT BE CONTAINABLE.	NONE	NONE	SLIGHT IRRITATION THAT LASTS < 30 MINUTES AND WILL NOT REQUIRE THERAPY. ALL EFFECTS WILL BE RESOLVED WITHIN 30 MINUTES WITHOUT THERAPY.	[3]	IT IS NOT A HEALTH OR FIRE HAZARD. MAY OR MAY NOT BE CONTAINABLE. IF NOT, REPORT TO MCC. EXAMPLE: SILICON OIL OR WEAK HYPERTONIC SOLUTIONS.

@[033006-7274A]

KEY:

[1] - CATASTROPHIC [2] - CRITICAL [3] - NONE

DOCUMENTATION: Probabilistic Risk Assessment Procedures Guide for NASA Managers and Practitioners, Version 1.1, August 2002; JSC-26895 - Guidelines for Assessing the Toxic Hazard of Spacecraft Chemicals and Test Materials, October 1997; and SSP 50481, Management Plan for Waste Collection and Disposal, Section 8.3.4 - Chemical Waste Handling, and Section 8.5.3 - Haz Waste Labeling.

Reference Hazard Reports ORBI 044, Unknown Gaseous Contamination Levels in the Cabin Causing Crew Illness/Incapacitation, and ORBI 279, Flight and Ground Generated Debris/Shatterable Glass in Crew Cabin Causing Crew Injury. @[033006-7274A]

Rules {A13-155}, ORBITER HAZARDOUS SUBSTANCE SPILL RESPONSE [HC], and {A13-156}, SPACEHAB HAZARDOUS SUBSTANCE SPILL RESPONSE, reference this rule. @[ED]

FLIGHT RULES

A13-155

ORBITER HAZARDOUS SUBSTANCE SPILL RESPONSE [HC]

@[033105-6599B]

THE FOLLOWING ACTIONS WILL BE TAKEN IN THE EVENT THAT A HAZARDOUS SUBSTANCE IS RELEASED INTO THE ORBITER ATMOSPHERE. HAZARDOUS SPILL LEVEL DEFINITIONS ARE REFERENCED AND DEFINED IN RULE {A13-154}, HAZARDOUS SPILL LEVEL DEFINITIONS [HC]. HAZMAT WILL LIST ALL FLIGHT SPECIFIC LEVEL 4 THROUGH LEVEL 0 PAYLOAD HAZARDOUS SUBSTANCES. @[033006-7274A] @[042706-7275A]

A. LEVEL 4

1. ALL CREWMEMBERS WILL DON AND ACTIVATE QUICK DON MASKS (QDM'S).
2. THE CLEANUP CREW WILL TAKE THE FOLLOWING ACTIONS:
 - a. SET CABIN TEMPERATURE CONTROLLER TO FULL COOL.
 - b. TURN ON THE WASTE COLLECTION SYSTEM.
 - c. TURN OFF THE REGENERATIVE CO₂ REMOVAL SYSTEM (RCRS) (IF APPLICABLE).
3. THE CREW SHALL PERFORM A CABIN DEPRESS TO 8 PSI AND A CONTINUOUS CABIN PURGE AT 8 PSI IF REQUIRED TO CONTROL PPO₂. (REFERENCE RULE {A17-254}, CABIN O₂ CONCENTRATION). @[090894-1673A]
4. THE FLIGHT CONTROL ROOM SURGEON SHOULD BE CONSULTED FOR THE MAXIMUM LENGTH OF TIME THE QUICK DON MASKS CAN BE WORN. (REFERENCE RULE {A13-54}, 100 PERCENT OXYGEN USE CONSTRAINT [HC].) @[ED]

All crewmembers will follow certain protocols for hazardous substances released into the cabin based on their toxic level.

Definitions of these toxic substances and their hazard levels, catastrophic nature, criticality, and systemic and local effects are explained in Rule {A13-154}, HAZARDOUS SPILL LEVEL DEFINITIONS [HC]. @[042706-7275A]

THIS RULE CONTINUED ON NEXT PAGE

FLIGHT RULES

A13-155**ORBITER HAZARDOUS SUBSTANCE SPILL RESPONSE [HC]**
(CONTINUED)

Hazmat data will contain all hazardous substances. Hazmat can be accessed by selected users in MCC on the JSC-MAS workstations. This information is not always available in suitable time before launch to include all hazards in the flight specific annex. Level 4 substances will be documented in the flight specific annex, section 19 (Payloads), PAYLOAD HAZARDOUS MATERIALS. ©[042706-7275A]

A level 4 hazardous substance is defined as either a gas, a volatile liquid, or fumes that are not containable by the crew. Crew exposure could result in systemic toxicity, severe irritation, and/or tissue damage. The driving factor that distinguishes a level 4 substance from a level 3 substance is noncontainability. Slow cleanup of some level 4 substances (e.g., thionyl chloride) by the Atmospheric Revitalization System (ARS) in the timeframe of hours to days may be possible.

The immediate priorities for a level 4 spill are to prevent crew exposure to the substance and to configure the ARS to scrub the environment. All crewmembers will don and activate QDM's to avoid any debilitating effects.

The ARS configuration steps were determined to provide maximum decontamination. Setting the cabin temperature to full cool will provide maximum removal of water soluble or particulate hazardous substances through the humidity separator as condensate. Other atmospheric scrubbing can be accomplished with the use of the odor/bacterial filter of the WCS and the LiOH and/or charcoal canisters that are already installed. The most recently installed LiOH canisters may have exhausted CO₂ removal capability; however, the LiOH/CO₂ product, Li₂CO₃, and existing charcoal still have scrubbing potential. For flights that use the RCRS, the RCRS must be unpowered to prevent contamination of the solid amine.

A cabin depress to 8 psi and continuous purge at 8 psi will manage O₂ concentrations below maximum levels as well as decrease the concentration of the level 4 substance. This action could extend the time on orbit so as to avoid an ELS entry. ©[090894-1673A]

Breathing 100 percent oxygen for extended periods of time can cause deleterious effects to the respiratory system. The FCR Surgeon and EECOM will determine the length of time the crew can continue to breathe 100 percent oxygen. Reference Rules {A13-54}, 100 PERCENT OXYGEN USE CONSTRAINT [HC], and {A17-254}, CABIN O₂ CONCENTRATION. ©[042706-7275A]

THIS RULE CONTINUED ON NEXT PAGE

FLIGHT RULES

A13-155

ORBITER HAZARDOUS SUBSTANCE SPILL RESPONSE [HC]
(CONTINUED)

B. LEVEL 3

1. ALL CREWMEMBERS WILL DON AND ACTIVATE QUICK DON MASKS.
@[042706-7275A]
2. THE CLEANUP CREW WILL TAKE THE FOLLOWING ACTIONS:
 - a. TURN OFF THE CABIN, AIRLOCK, AND IMU FANS.
 - b. TURN OFF THE ORBITER CABIN AIR CLEANER (OCAC).
 - c. DON SILVER SHIELD GLOVES.
 - d. ONE CREWMEMBER WILL CONTINUOUSLY MONITOR THE SPILL.
 - e. CLEAN UP THE SPILL; BAG, LABEL, AND STOW WASTES IN WET TRASH.

A level 3 hazardous substance is defined as a solid or low volatility liquid that is catastrophic, but containable by the crew during cleanup. It is this containability that separates a level 3 substance from a level 4, which cannot be contained during cleanup.

Crew exposure to a level 3 substance could result in catastrophic systemic toxicity (lasting and serious injury; i.e., cancer) and/or tissue damage. All crewmembers must wear QDM's and the cleanup crew will don silver shield gloves for protection during cleanup.

During the cleanup, all airflow is halted by deactivating the cabin, airlock, and IMU fans, and the OCAC to prevent dispersion of the spilled substance. The maximum time that a cabin fan can be deactivated in an off-nominal situation is 30 minutes. The maximum time that an IMU fan can be deactivated in an off-nominal situation is 90 minutes. Reference Rule {A18-501}, MAXIMUM OFF TIME FOR COOLING EQUIPMENT [HC]. @[042706-7275A]

THIS RULE CONTINUED ON NEXT PAGE

FLIGHT RULES

A13-155

ORBITER HAZARDOUS SUBSTANCE SPILL RESPONSE [HC]
(CONTINUED)

C. LEVEL 2

1. CREWMEMBERS MAY DON GOGGLES, AND PARTICLE FILTER MASKS, IF NEEDED. [ED] [042706-7275A]
2. THE CLEANUP CREW WILL TAKE THE FOLLOWING ACTIONS:
 - a. TURN OFF THE CABIN, AIRLOCK, AND IMU FANS.
 - b. TURN OFF THE OCAC.
 - c. DON GOGGLES, PARTICLE FILTER MASKS, AND GLOVES (CHECK MCC FOR SILVER SHIELD OR LATEX).
 - d. CLEAN UP THE SPILL; BAG, LABEL, AND STOW WASTES IN WET TRASH.

A level 2 substance is either a solid or a nonvolatile liquid that is catastrophic, but containable by the cleanup crew. Crew exposure could result in moderate to severe irritation that has the potential for long-term crew performance decrement. Crewmembers will be adequately protected by the 0.3-micron particle filter masks and goggles. If in a no-comm situation, per training, crew will use silver shield gloves. The FCR Surgeon should be consulted to determine appropriate gloves for cleanup crew protection. For example, during LiOH dust cleanup, latex gloves are appropriate.

During the cleanup, all airflow is halted by deactivating the cabin, airlock, and IMU fans, and the OCAC to prevent dispersion of the spilled substance. The maximum time that a cabin fan can be deactivated in an off-nominal situation is 30 minutes. The maximum time that an IMU fan can be deactivated in an off-nominal situation is 90 minutes. Reference Rule {A18-501}, MAXIMUM OFF TIME FOR COOLING EQUIPMENT [HC]. [033105-6599B] [042706-7275A]

THIS RULE CONTINUED ON NEXT PAGE

FLIGHT RULES

A13-155

ORBITER HAZARDOUS SUBSTANCE SPILL RESPONSE [HC]
(CONTINUED)

D. LEVEL 1

1. CREWMEMBERS MAY DON GOGGLES AND PARTICLE FILTER MASKS, IF NEEDED. ©[042706-7275A]
2. THE CLEANUP CREW WILL TAKE THE FOLLOWING ACTIONS:
 - a. TURN OFF THE CABIN AND IMU FANS.
 - b. DON GOGGLES, PARTICLE FILTER MASKS, AND LATEX GLOVES.
 - c. ATTEMPT TO CLEAN UP THE SPILL; BAG, LABEL, AND STOW WASTES IN WET TRASH.

A level 1 hazardous substance may or may not be containable by the crew. Crew exposure will result only in slight to moderate irritation and/or systemic effects that will last longer than 30 minutes. A level 1 compound can cause several kinds of injury, including systemic injury. The effect is serious, but not lasting. This is a critical injury. Crewmembers will be protected by goggles, particle filter masks, and gloves.

During the cleanup, all airflow is halted by deactivating the cabin and IMU fans to prevent dispersion of the spilled substance. The maximum time that a cabin fan can be deactivated in an off-nominal situation is 30 minutes. The maximum time that an IMU fan can be deactivated in an off-nominal situation is 90 minutes (reference Rule {A18-501}, MAXIMUM OFF TIME FOR COOLING EQUIPMENT [HC]). ©[042706-7275A]

If the spill is not containable by the crew, the MCC will determine other procedures for containment or for a workaround.

THIS RULE CONTINUED ON NEXT PAGE

FLIGHT RULES

A13-155

ORBITER HAZARDOUS SUBSTANCE SPILL RESPONSE [HC]
(CONTINUED)

E. LEVEL 0

1. NO PERSONAL PROTECTIVE EQUIPMENT IS REQUIRED FOR ANY CREWMEMBERS. ©[042706-7275A]
2. THE CLEANUP CREW WILL ATTEMPT TO CLEAN UP THE SPILL AND BAG, LABEL, AND STOW WASTES IN WET TRASH.

A level 0 substance may or may not be containable by the crew. Crew exposure would result in only slight transient (less than 30 minutes) irritation.

No protective gear is required.

If the spill is not containable by the crew, the MCC will determine other procedures for containment or for a workaround.

Level 0 substances do not require the crew to turn off cabin or IMU fans due to the benign nature of the released substance and the complications of monitoring other orbiter systems while fans are turned off.

All payload substances are reviewed by the Payload Safety Review Panel; those not listed as level 4 through 1 are considered nonhazardous (level 0).

DOCUMENTATION: Hazard Reports ORBI 044, Unknown Gaseous Contamination Levels in the Cabin Causing Crew Illness/Incapacitation; ORBI 220, Presence of Mercury in the Crew Module; and ORBI 279, Flight and Ground Generated Debris/Shatterable Glass in Crew Cabin Causing Crew Injury; 3M Health Care Particulate Respirator and Surgical Mask product information guide, July 2003; SSP 50481, Management Plan for Waste Collection and Disposal, Section 8.3.4 Chemical Waste Handling, and Section 8.5.3 Haz Waste Labeling; JSC-62964, Risk Assessment Executive Summary Report for the Government Furnished Equipment Containment Clean-up Kit (CCK); and Fibre Glast Developments Corporation, latex gloves information, company website.

Rules {A2-105}, IN-FLIGHT MAINTENANCE (IFM) [HC]; {A10-382}, PRESSURE/REDUNDANT WINDOW PANE FAILURE [HC]; {A13-153}, BROKEN GLASS/HAZARDOUS SUBSTANCE CONSTRAINT [HC]; {A13-156}, SPACEHAB HAZARDOUS SPILL RESPONSE; and {A17-255}, 8 PSIA EMERGENCY CABIN CONFIGURATION, reference this rule. ©[ED] ©[042706-7275A] ©[102506-7825A]

FLIGHT RULES

A13-156

SPACEHAB HAZARDOUS SUBSTANCE SPILL RESPONSE

@[092701-4872]

THE FLIGHT-SPECIFIC ANNEX WILL LIST ALL EXPERIMENT/SAMPLES CONTAINING LEVEL 4 THROUGH LEVEL 1 PAYLOAD HAZARDOUS SUBSTANCES. REFERENCE RULE {A13-154}, HAZARDOUS SPILL LEVEL DEFINITIONS [HC]. THE FOLLOWING ACTIONS WILL BE TAKEN IN THE EVENT THAT A HAZARDOUS SUBSTANCE IS RELEASED INTO THE SPACEHAB/ORBITER ATMOSPHERE: @[111501-4971] @[033006-7274A]

A. LEVEL 4

1. ORBITER

REFERENCE RULE {A13-155A}, ORBITER HAZARDOUS SUBSTANCE SPILL RESPONSE [HC]. THE CREW SHALL SAFE AND ISOLATE THE SPACEHAB MODULE PER RULE {A2-329}, SPACEHAB DEACTIVATION/ENTRY PREP. @[ED] @[ED]

A level 4 hazardous substance is defined as either a gas, a volatile liquid, or fumes that are not containable by the crew. Crew exposure could result in a systemic toxicity, severe irritation, and/or tissue damage. The driving factor that distinguishes a level 4 substance from a level 3 substance is noncontainability.

The immediate priorities for a level 4 spill in the orbiter are prevention of crew exposure to the substance and configuration of the atmospheric revitalization system (ARS) for environmental scrubbing. All crewmembers will don and activate Quick Don Masks to avoid any detrimental effects.

The Spacehab module cannot be used as a safe haven for the crew because the module ARS is incapable of controlling humidity, O₂, N₂, and CO₂ concentrations.

2. SPACEHAB MODULE

IF HAZARDOUS SPILL OCCURS IN THE SPACEHAB MODULE, EVACUATE ALL CREWMEMBERS TO THE ORBITER EXCEPT THE SAFING CREW. THE FLIGHTDECK CREW WILL TURN OFF ALL SPACEHAB FANS. THE EVACUATING CREW WILL CLOSE THE MAN PL ISOL VLV. THE SAFING CREW WILL PERFORM THE FOLLOWING ACTIONS: @[021600-7102A]

- a. DON/ACTIVATE SEBS.
- b. OPEN CABIN DEPRESS VALVE (CDV).
- c. EVACUATE THE MODULE.
- d. CLOSE THE SPACEHAB HATCH.

THIS RULE CONTINUED ON NEXT PAGE

FLIGHT RULES

A13-156

SPACEHAB HAZARDOUS SUBSTANCE SPILL RESPONSE (CONTINUED)

e. CLOSE AND CAP EQUALIZATION VALVES. @[111501-4971]

NOTE: MODULE ISOLATION IS NECESSARY BECAUSE THE MODULE ARS DOES NOT HAVE THE CAPABILITY TO SCRUB THE CONTAMINATED AIR. ALL EXPERIMENTS/SAMPLES CONTAINING LEVEL 4 PAYLOAD HAZARDOUS SUBSTANCES ARE LISTED IN THE FLIGHT SPECIFIC ANNEX. @[021600-7102A] @[111501-4971]

Reference the rationale for paragraph 1 for a definition of level 4 hazardous substances.

The immediate priorities for a level 4 spill in the module are crew evacuation to the orbiter and isolating Spacehab. Nonessential crew will evacuate to the orbiter to limit crew exposure to the hazardous substance. The ARS and cabin/HFA fans are temporarily deactivated by the flightdeck crew to halt air exchange within the transfer tunnel while the Spacehab hatch is still open. The MAN PL ISOL VLV is closed to stop air exchange between Spacehab and the orbiter through the transfer tunnel ducting. Since the Spacehab will remain powered, the CDV is being opened to protect the option to depress the module in case of a fire or to reduce the level of the hazardous spill concentration. @[021600-7102A]

The safing crew will don and activate SEBS to avoid systemic effects while they secure the module.

B. LEVEL 3

1. ORBITER:

REFERENCE RULE {A13-155B}, ORBITER HAZARDOUS SUBSTANCE SPILL RESPONSE [HC]. THE FLIGHTDECK CREW WILL DEACTIVATE THE SPACEHAB ARS FAN. @[ED]

A level 3 hazardous substance is defined as a solid or nonvolatile liquid that is containable by the cleanup crew. It is this containability that separates a level 3 substance from a level 4.

Crew exposure to a level 3 substance could result in systemic toxicity, severe irritation, and/or tissue damage. It is this severity of effects on exposure that separates a level 3 substance from the level 2, 1, and 0 substances. Since O₂/N₂, CO₂, and humidity control are not available in the module for an orbiter spill, all crewmembers must don and activate Quick Don Masks and don chemically resistant silver shield gloves.

During the cleanup, all airflow in the spill area is halted to prevent dispersion of the spilled substance. For an orbiter spill, this requires deactivating the cabin and IMU fans and turning off the Spacehab ARS fan, which will halt air exchange between the orbiter and Spacehab. If the hazardous spill is such that total isolation of the Spacehab module is required, the MAN PL ISOL VLV and the Spacehab hatch will be closed. @[111501-4971]

THIS RULE CONTINUED ON NEXT PAGE

FLIGHT RULES

A13-156

SPACEHAB HAZARDOUS SUBSTANCE SPILL RESPONSE
(CONTINUED)

2. SPACEHAB MODULE:

ALL CREWMEMBERS EXCEPT THE CLEANUP CREW WILL EVACUATE THE MODULE. THE FLIGHTDECK CREW WILL DEACTIVATE THE SPACEHAB ARS AND CABIN/HFA FANS. THE EVACUATING CREW WILL CLOSE THE MAN PL ISOL VLV. THE CLEANUP CREW WILL TAKE THE FOLLOWING ACTIONS: @[111501-4971]

- a. DON/ACTIVATE SEBS AND SILVER SHIELD GLOVES.
- b. DEACTIVATE AFT MODULE FAN (LDM ONLY) . @[021600-7102A]
- c. ATTEMPT TO CLEAN UP THE SPILL.
- d. BAG, LABEL, AND STOW IN WET TRASH.

NOTE: IF CLEANUP FAILS, THIS SPILL WILL BE UPGRADED TO A LEVEL 4. ALL EXPERIMENTS/SAMPLES CONTAINING LEVEL 3 PAYLOAD TOXIC MATERIALS ARE LISTED IN THE FLIGHT SPECIFIC ANNEX.

See rationale from paragraph 1 for a definition of a level 3 hazardous spill.

The cleanup crew must use SEBS along with chemically resistant silver shield gloves to protect themselves while they perform the cleanup.

During the cleanup, all airflow in the spill area is halted by closing the MAN PL ISOL VLV and by deactivating all Spacehab subsystem fans. Unlike for a level 4 spill, the aft module fan is deactivated from inside the module by the cleanup crew because an item entry by the flightdeck crew would turn off the aft module lights, reducing module illumination for the cleanup crew. @[021600-7102A]

If the initial module PPCO₂ level is 7.15 mmHg at the time the SH ARS fan is deactivated, it will take 23.7 minutes to reach a level of 7.6 mmHg and 378 minutes to reach 15 mmHg (reference TM-SPACEHAB-91003, April 1991) in a Spacehab single module configuration. Times will be greater for Spacehab double module (LDM/RDM) configurations.

By definition, a level 3 hazardous spill is catastrophic and containable. If the level 3 cleanup fails, this spill will be upgraded to a level 4, and level 4 cleanup actions will be implemented. @[111501-4971]

THIS RULE CONTINUED ON NEXT PAGE

FLIGHT RULES

A13-156

SPACEHAB HAZARDOUS SUBSTANCE SPILL RESPONSE
(CONTINUED)

C. LEVEL 2 @[111501-4971]

1. ORBITER:

REFERENCE RULE {A13-155C}, ORBITER HAZARDOUS SUBSTANCE SPILL RESPONSE [HC]. THE FLIGHTDECK CREW WILL DEACTIVATE THE SPACEHAB ARS FAN. @[ED]

2. SPACEHAB MODULE:

ALL CREWMEMBERS EXCEPT THE CLEANUP CREW WILL EVACUATE THE MODULE. THE FLIGHTDECK CREW WILL DEACTIVATE THE SPACEHAB ARS AND CABIN/HFA FANS. THE EVACUATING CREW WILL CLOSE THE MAN PL ISOL VLV. THE CLEANUP CREW WILL TAKE THE FOLLOWING ACTIONS:

- a. DON SURGICAL MASKS, GOGGLES, AND SILVER SHIELD GLOVES.
- b. DEACTIVATE AFT MODULE FAN (LDM ONLY).
- c. ATTEMPT TO CLEAN UP THE SPILL.
- d. BAG, LABEL, AND STOW IN WET TRASH.

NOTE: IF CLEANUP FAILS, THIS SPILL WILL BE UPGRADED TO A LEVEL 4. ALL EXPERIMENTS CONTAINING LEVEL 2 PAYLOAD TOXIC MATERIALS ARE LISTED IN THE FLIGHT SPECIFIC ANNEX.

A level 2 hazardous substance is either a solid or a nonvolatile liquid that is containable by the cleanup crew. Crew exposure could result in moderate-to-severe irritation that has the potential for long-term crew performance decrement. All crewmembers will be adequately protected by the 5-micron surgical masks, goggles, and silver shield gloves.

Reference paragraph B, level 3 rationale for the reason for stopping airflow in the spill area.

Even though a level 2 substance causes less severe effects than a level 3 substance, a level 2 hazardous spill is defined as catastrophic and containable. If the level 2 cleanup fails, this spill will be upgraded to a level 4, and level 4 cleanup actions shall be implemented. @[111501-4971]

THIS RULE CONTINUED ON NEXT PAGE

FLIGHT RULES

A13-156

SPACEHAB HAZARDOUS SUBSTANCE SPILL RESPONSE
(CONTINUED)

D. LEVEL 1 @[111501-4971]

1. ORBITER:

REFERENCE RULE {A13-155D}, ORBITER HAZARDOUS SUBSTANCE SPILL RESPONSE [HC]. THE FLIGHTDECK CREW WILL DEACTIVATE THE SPACEHAB ARS FAN. @[ED]

2. SPACEHAB MODULE:

ALL CREWMEMBERS EXCEPT THE CLEANUP CREW WILL EVACUATE THE MODULE. THE FLIGHTDECK CREW WILL DEACTIVATE THE SPACEHAB ARS AND CABIN/HFA FANS. THE EVACUATING CREW WILL CLOSE THE MAN PL ISOL VLV. THE CLEANUP CREW WILL TAKE THE FOLLOWING ACTIONS:

- a. DON GOGGLES AND SURGICAL MASKS AND GLOVES.
- b. DEACTIVATE AFT MODULE FAN (LDM ONLY).
- c. ATTEMPT TO CLEAN UP THE SPILL.
- d. BAG, LABEL, AND STOW IN WET TRASH.

A level 1 hazardous substance may or may not be containable by the crew. Crew exposure could result only in slight-to-moderate irritation. All crewmembers will be protected by surgical masks and goggles. Also, the cleanup crew will need to use surgical gloves. @[111501-4971]

Reference paragraph B, level 3 rationale for the reason for stopping the airflow in the vicinity of the spill. Reference Rule {A13-154}, HAZARDOUS SPILL LEVEL DEFINITIONS [HC]. @[033006-7274A]

THIS RULE CONTINUED ON NEXT PAGE

FLIGHT RULES

A13-156

SPACEHAB HAZARDOUS SUBSTANCE SPILL RESPONSE
(CONTINUED)

E. LEVEL 0 @[111501-4971]

1. ORBITER:

REFERENCE RULE {A13-155E}, ORBITER HAZARDOUS SUBSTANCE SPILL RESPONSE [HC]. NO SPACEHAB ACTIONS ARE REQUIRED.
@[ED]

2. SPACEHAB MODULE:

THE FLIGHTDECK CREW WILL DEACTIVATE THE SPACEHAB ARS AND CABIN/HFA FANS. THE CLEANUP CREW WILL TAKE THE FOLLOWING ACTIONS:

- a. DEACTIVATE AFT MODULE FAN (LDM ONLY).
- b. ATTEMPT TO CLEAN UP THE SPILL.
- c. BAG, LABEL, AND STOW IN WET TRASH.

A level 0 substance is assumed to be containable by the crew. Crew exposure would result in only slight transient (less than 30 minutes) irritation. No protective gear is required. Reference paragraph B, level 3 rationale for the reason for stopping the airflow in the vicinity of the spill.

All payload substances are reviewed by the Payload Safety Review Panel; those not listed as level 4 through 1 are considered non-hazardous (level 0). @[111501-4971]

Rules {A2-325}, IFM PROCEDURES ON EXPERIMENTS WITH TOXIC HAZARDS, and {A17-753}, CABIN DEPRESS VALVE (CDV), reference this rule. @[ED]

FLIGHT RULES**A13-157****CABIN ATMOSPHERE CONTAMINATION FIRE/SMOKE**

SMOKE OR FIRE DETECTED AND CONFIRMED VIA VISUAL OBSERVATION, TWO SMOKE DETECTORS, OR CREW SYMPTOMS: @[101305-6739B]

- A. IMMEDIATELY DON THE QDM'S AND INITIATE O₂ FLOW.
- B. INSTALL TWO FRESH LIOH CANISTERS IN THE ATMOSPHERIC REVITALIZATION SYSTEM (ARS). @[032807-8374B]
- C. TURN CABIN TEMPERATURE CONTROLLER TO FULL COOL.
- D. ACTIVATE THE WASTE COLLECTION SYSTEM (WCS) FAN SEPARATOR.
- E. UNSTOW CSA-CP AND TAKE READINGS IN VICINITY OF THE FIRE.
- F. WHEN HCL < 5 PPM OR TIG < 3 HOURS, REPLACE ONE LIOH CANISTER WITH THE AMBIENT TEMPERATURE CATALYTIC OXIDIZER (ATCO) CANISTER.

To protect crewmembers from toxicological injury, noncontaminated breathing gases must be provided immediately following a fire since even small concentrations of some combustion products can be lethal. Combustion products of Halon, polyvinyl chloride, Teflon, and Kapton can include hydrogen fluoride (HF), hydrogen chloride (HCl), hydrogen cyanide (HCN), hydrogen bromide (HBr), carbonyl fluoride (COF₂), and carbon monoxide (CO).

HF, HCl, and HBr act instantaneously on the mucous membrane of the eye and respiratory tract causing temporary blindness, coughing, and wheezing. Bronchitis and pneumonitis can develop hours later. High levels of HCN and CO may become an immediate danger to life and health.

Protection of the eyes and respiratory tract is achieved by donning the QDM. The QDM is recommended over the ACES since the QDM can be donned more quickly. Donning the full ACES will be considered later. Since the O₂ concentration will increase due to the O₂ put into the cabin by the QDM or ACES, the cabin may need to be depressed and N₂ introduced into the cabin to prevent the O₂ concentration from rising above the maximum allowable limit; reference Rule {A17-254}, CABIN O₂ CONCENTRATION. The mission would need to be terminated prior to N₂ depletion. The rate of N₂ depletion is based upon the number of crewmembers and the total usable N₂ available. For the worst-case redline value of 80 lb usable N₂ and a crew of seven breathing 3 lb/hr of O₂, the time to N₂ depletion would be approximately 5 hours and 40 minutes. @[101305-6739B] @[032807-8374B]

THIS RULE CONTINUED ON NEXT PAGE

FLIGHT RULES

A13-157

CABIN ATMOSPHERE CONTAMINATION FIRE/SMOKE
(CONTINUED)

HF, HBr, and HCl are absorbed by the LiOH canisters. The CO is removed only by the ATCO canister. HCN is only effectively removed by the activated charcoal in the LiOH canister, the WCS Odor Bacteria Filter, or the ATCO canister. ©[101305-6739B] ©[032807-8374B]

Two fresh LiOH canisters are immediately installed to remove the acid gases (primarily HCl) that can degrade the platinum catalyst in the ATCO canister and, therefore, inhibit the effect of CO and HCN removal. Only one ATCO canister is nominally manifested. When HCl concentration drops below 5 ppm, the ATCO canister can be installed without significant risk of degradation. Five ppm is based upon engineering judgment. At tested HCl levels of 500 ppm, the ATCO canister was completely degraded and, conversely, HCl levels of 1 ppm resulted in no measurable degradation. In the interest of beginning CO scrubbing as quickly as possible, a level of 5 ppm was determined to pose no significant risk of degradation and allowed the ATCO to be installed earlier by several hours as compared to 1 ppm HCl. If TIG < 3 hrs, the ATCO should be installed regardless of the detected HCl levels. By analysis, the worst case CO levels will be scrubbed out of the cabin atmosphere in approximately 4 hrs; therefore, the ATCO is installed to provide the maximum CO scrubbing capability prior to touchdown.

One LiOH canister should be changed out every 15 minutes for HCN scrubbing. Since there is only 1/4 lb of charcoal in the LiOH canister, its capability to scrub HCN is limited to approximately 15 minutes. LiOH canister changeouts should continue until the HCN concentration reaches acceptable levels or stabilizes, at which time the preflight changeout schedule can be reimplemented. ©[090894-1673A] ©[021600-7170]

Turning the cabin temperature controller to the full-cool mode will maximize the airflow rate through the cabin heat exchanger and, therefore, increase the amount of contaminants removed by the humidity separator.

The WCS air scrubber contains activated charcoal and can assist in the removal of acid gases due to its high flow rate and large capacity. ©[032807-8374B]

The Compound Specific Analyzer-Combustion Products (CSA-CP) should be used to measure the levels of the toxic target compounds (CO, HCN, HCl) in the crew cabin and to follow trends in these levels as cleanup efforts continue. ©[021600-7170]

Documentation: Combustion Product Removal From Cabin Air (OFTP #109 minutes, dated August 1990); Phase I Combustion Products Test Results (OFTP # 113 minutes, dated January 9, 1991); Phase II Combustion Products Test Results (OFTP #120 minutes, dated August 21, 1991); and LESC memo 053-52-BR1, Suggested Flight Procedures in Response to an Accidental Burning of Wire in the Orbiter, dated September 12, 1990. ©[090894-1673A] ©[101305-6739B]

THIS RULE CONTINUED ON NEXT PAGE

FLIGHT RULES

A13-157

CABIN ATMOSPHERE CONTAMINATION FIRE/SMOKE
(CONTINUED)

G. THE MCC WILL ASSIST IN EVALUATING THE CABIN CONCENTRATION OF THE COMBUSTION PRODUCTS. THE CREW WILL SEQUENTIALLY REMOVE QDM'S ONLY ON MCC CALL. THE DOFFING SEQUENCE WILL BE DETERMINED BY THE CDR. THIS DECISION WILL BE BASED UPON THE FOLLOWING: @[090894-1682A] @[101305-6739B]

1. CREW SYMPTOMS
2. SMOKE DETECTOR RESPONSE @[032807-8374B]
3. ALL CSA-CP READINGS BELOW 24-HOUR SPACECRAFT MAXIMUM ALLOWABLE CONCENTRATION (SMAC) @[021600-7170]

WHENEVER THE CSA-CP IS BEING USED, COMPARE THE INDICATED CSA-CP VALUES DIRECTLY WITH THE VALUES IN TABLE A13-157-I:

TABLE A13-157-I - CSA-CP READINGS EQUIVALENT TO 24-HOUR SMAC LIMITS (MASKING LEVELS)

CABIN PRESSURE (PSIA)	HCN (PPM)	CO (PPM)	HCL (PPM)
16.00 - 14.00	4.0	20	2.0
13.99 - 12.00	3.0	19	1.5*
11.99 - 10.0	2.4	19	1.2*
9.99 - 8.00	2.1	18	1.0*

* PRESSURE-CORRECTED VALUES FOR HCL ARE ONLY ESTIMATES. THEY WERE DEVELOPED USING AN INDIRECT METHOD OF ANALYSIS DUE TO THE REACTIVITY OF THE COMPOUND DURING CHAMBER TESTS.

THE VALUES LISTED IN TABLE A13-157-I ARE THE FIRE/SMOKE QDM MASKING LEVELS WHICH HAVE BEEN CORRECTED FOR VARIOUS CABIN PRESSURES. NO CORRECTION FACTOR NEEDS TO BE APPLIED TO THE INDICATED CSA-CP VALUES WHEN USING THE VALUES IN TABLE A13-157-I.

4. CREW INPUT ON AMOUNT AND TYPE OF MATERIAL BURNED @[090894-1992A]
5. MATHEMATICAL MODELING OF COMBUSTION BYPRODUCT REMOVAL @[090894-1682A] @[032807-8374B]

THIS RULE CONTINUED ON NEXT PAGE

FLIGHT RULES

A13-157

**CABIN ATMOSPHERE CONTAMINATION FIRE/SMOKE
(CONTINUED)**

Collectively, these will provide only an estimate of the total toxicity hazard in the cabin. If crew symptoms like temporary blindness, coughing, and wheezing are noted, QDM's should remain donned. Crew will remove QDM's based on coordinated communication with the Flight Director, Surgeon, and EECOM. Doffing QDM's sequentially will reduce the possibility that the entire crew will be simultaneously affected by unexpected contaminants. QDM's will be donned if any symptoms are incurred. QDM's can stay doffed if all crewmembers remain symptom-free for greater than 10 minutes. Cabin clean-up may be discontinued when the atmospheric contaminants are below 7-day SMAC.

TABLE A13-157-II - 1-HOUR, 24-HOUR, AND 7-DAY SMAC LIMITS

	1-HOUR (PPM)	24-HOUR (PPM)	7-DAY (PPM)
CO	55	20	10
HCN	8	4	1
HCL	5	2	1

Medical Operations recommends crewmembers continue breathing 100 percent oxygen until there is satisfactory evidence that the cabin concentration of combustion products is within safe limits. However, the risk of breathing contaminated gases must be weighed against the risks of an ELS or exceeding cabin O₂ limits. These risks were assessed by the community and have been considered in paragraphs H, I, and J of this rule. ©[101305-6739B] ©[032807-8374B]

Provided sufficient airflow exists, smoke detector readings will be evaluated by EECOM to determine if a fire/smoke event is still occurring. The Shuttle Smoke Detectors are designed to detect only particles smaller than 2.0 microns; thus, any detected particles would be in the respirable range and could pose a threat to crew health. QDM's should remain donned if visible indication of smoke remains in the cabin. ©[101305-6739B]

Mathematical modeling of toxic compound removal will be conducted to predict the rate of decrease in cabin concentrations. These predictions will be correlated with real-time CSA-CP data. EECOM and the MER Life Support will make this determination. Crew input on the amount and type of materials burned may determine the potential thermal degradation and/or toxic byproducts. ES4/Materials and Processing will assist in this assessment with real-time support coordinated through the MER manager. ©[032807-8374B]

THIS RULE CONTINUED ON NEXT PAGE

FLIGHT RULES**A13-157****CABIN ATMOSPHERE CONTAMINATION FIRE/SMOKE**
(CONTINUED)

A real-time decision-making process, using the CSA-CP, will be based upon the initial post-fire readings compared with the decreasing trend in contaminant concentrations measured by the CSA-CP. Sampling locations will be determined real time based on event location and will be coordinated between EECOM, Surgeon, and Toxicology Group. These baseline readings will be compared with the following contaminant levels (assuming the readings were taken at a pressure between 14.0 and 16.0 psia; otherwise the CSA-CP readings need to first be corrected per the methodology below): CO < 55 ppm (1-hour SMAC); HCN < 8 ppm (1-hour SMAC); HCl < 5 ppm (1-hour SMAC). Depending on the profile of changing contaminant concentrations, the following 24-hour SMAC may be used as guidelines: CO < 20 ppm; HCN < 4 ppm; HCl < 2 ppm. The criteria for determining a safe cabin or removing QDM's will not be based solely on CSA-CP readings. ©[021600-7170] ©[032807-8374B]

CSA-CP unit testing indicated the hydrogen cyanide (HCN), carbon monoxide (CO), and hydrogen chloride (HCl) sensors of the CSA-CP are biased low at lower pressures. Therefore, the actual constituent levels in the cabin could be higher than the CSA-CP unit readings.

The values in Table A13-157-I represent indicated CSA-CP values at various cabin pressures. If appropriate pressure corrections are applied, the values listed in the table would equal the 24-hour SMAC. Using the equivalent 24-hour SMAC limits provides a conservative approach to the biased readings that the CSA-CP provides.

The true atmospheric contaminant concentrations at reduced pressure must be obtained by the flight control team by correcting the CSA-CP display value using the following equations:

$$C_t = D * CF$$

Where

C_t = True atmospheric contaminant Concentration (ppm)

D = CSA-CP Displayed value called down by the crew (ppm)

CF = CSA-CP Correction factor for that contaminant at that atmospheric pressure (unitless)

and the correction factors for carbon monoxide and hydrogen cyanide are given by:

Carbon Monoxide: CF = -0.2366LN(P) + 1.6448

Hydrogen Cyanide: CF = 0.001222P⁴ - 0.05565P³ + 0.92815P² - 6.8577P + 20.9885

Where

P = Absolute pressure at the time of the CSA-CP display call-down (psia)

LN = Natural log ©[032807-8374B]

THIS RULE CONTINUED ON NEXT PAGE

FLIGHT RULES

A13-157

CABIN ATMOSPHERE CONTAMINATION FIRE/SMOKE
(CONTINUED)

A correction formula for HCl is not provided because HCl is too reactive a gas to be able to perform reduced pressure testing in the laboratory. However, based on data using an indirect method, HCl responses can be estimated (greater degree of uncertainty) at reduced pressures. A correction multiplier of 2.2 provides a good approximation of the actual exposure concentration at 8 psia with linear extrapolation between 15 (multiplier of 1) and 8 psia. Moreover, the probability of a combustion event that does not produce CO is remote; hence, the progress of post-fire cabin cleanup can be monitored by measurement of CO and HCN, both of which are more difficult to remove than HCl.
@[032807-8374B]

The shuttle CSA-CP design is certified with an operational pressure range of 7.8 psia to 16.0 psia for the CO and HCN sensors. The CSA-CP is certified to accurately display CO concentrations from 3 to 500 ppm, HCN concentrations from 0.4 to 30 ppm, and HCl concentrations from 0.4 to 30 ppm. The CSA-CP will display concentrations outside of these ranges, but the readings may be grossly inaccurate.

Grab Sample Container will be utilized as practical with real-time CSA-CP. @[032807-8374B]

H. IF EVALUATION SHOWS THE CABIN ATMOSPHERE PRESENTS A HAZARD THAT CANNOT BE MITIGATED:

1. AN ELS OR NEXT PLS LANDING WILL BE PERFORMED BASED ON N₂ CONSUMABLES AND THE TIME TO THE NEXT PLS. @[090894-1682A]
2. ALL CREWMEMBERS WILL REMAIN ON QDM'S UNTIL ACES ARE DONNED FOR ENTRY. THE QDM'S MAY BE REMOVED, IF REQUIRED, TO PREVENT EXHAUSTING ALL N₂ PRIOR TO THE NEXT PLS LANDING. IF POSSIBLE, CDR, PLT, AND MS2 WILL REMAIN ON QDM'S OR ACES. @[090894-1682A]
3. IF, AFTER DOFFING QDM'S, THE CABIN ATMOSPHERE IS CONFIRMED TO BE HAZARDOUS, QDM'S WILL BE RE-DONNED BY ALL CREWMEMBERS.
4. ACES WILL BE USED WITH VISORS DOWN AND LOCKED FOR ENTRY AND ORBITER EGRESS. @[090894-1682A] @[101305-6739B]

If the cabin atmosphere is clearly hazardous, there is no choice but to protect the crew by wearing the QDM's and ACES. An ELS may be required. @[101305-6739B]

THIS RULE CONTINUED ON NEXT PAGE

FLIGHT RULES**A13-157****CABIN ATMOSPHERE CONTAMINATION FIRE/SMOKE
(CONTINUED)**

If the assessment of the inhalation hazard of combustion products is inconclusive or the range of uncertainty in the assessment is such that some risk still exists that the atmosphere may be hazardous, the risk to the crew is real and a next PLS or CONUS landing is justified. Although the potential risk to crew health with the QDM's removed is recognized, in the assessment of the overall community, there is a greater risk associated with an ELS landing or exceeding cabin O₂ concentration limits (fire risk). If it becomes necessary to remove the QDM's to minimize N₂ consumption, ensuring a PLS or CONUS landing, the CDR, PLT, and MS2 should remain on oxygen to assure their peak performance throughout entry and landing. ®[090894-1682A]

- I. IF EVALUATION SHOWS THE CABIN ATMOSPHERE IS CLEARLY SAFE, THE SOURCE OF THE FIRE CAN BE LOCATED AND SAFED (I.E., A SHORT THAT CAN BE UNPOWERED), AND A HALON BOTTLE HAS NOT BEEN DISCHARGED: ®[090894-1682A]
1. MISSION DURATION WILL BE DETERMINED BY THE CRITERIA DEFINED IN RULE {A17-1001}, LIFE SUPPORT GO/NO-GO CRITERIA.
 2. QDM'S WILL BE REMOVED.
- J. IF A HALON BOTTLE HAS BEEN DISCHARGED, RULE {A13-158}, CABIN ATMOSPHERE CONTAMINATION - HALON 1301 [HC], WILL APPLY.

If the cabin atmosphere can be shown to be safe, there is no reason to shorten the flight.

Documentation: Spacecraft Maximum Allowable Concentrations for Selected Airborne Contaminants, Vol. 1-4 (2000).

ECLS FRP-2/MAL/GEN F/POST FIRE CABIN CLEANUP/OPCL/GEN ®[101305-6739B]

Orbit Flight Techniques Panel #220, May 9, 2005 ®[032807-8374B]

SF23-07-071, Pressure Corrections of the Hydrogen Cyanide (HCN), Carbon Monoxide (CO), and Hydrogen Chloride (HCL) Sensors in the Shuttle Compound Specific Analyzer for Combustion Products (CSA-CP, SED46115801-306), February 2007

Government Certification Acceptance Request (GCAR) -G5510

Judgment of the NASA Chief Toxicologist ®[032807-8374B]

Rules {A2-301}, CONTINGENCY ACTION SUMMARY [HC]; {A2-1001}, ORBITER SYSTEMS GO/NO-GO [HC]; {A17-1}, AVIONICS BAY FIRE DEFINITIONS AND ACTIONS [HC]; {A17-2}, CABIN FIRE DEFINITION AND ACTIONS [HC]; {A17-4}, SMOKE EVENT DEFINITION AND ACTIONS [HC]; {A17-603}, SPACEHAB FIRE/SMOKE MANAGEMENT; and {A17-1001}, LIFE SUPPORT GO/NO-GO CRITERIA, reference this rule. ®[ED] ®[032807-8400]

FLIGHT RULES**A13-158****CABIN ATMOSPHERE CONTAMINATION - HALON 1301 [HC]**

- A. PLANNED OR ACCIDENTAL DISCHARGE OF ONE OR MORE FIXED AVIONICS BAY FIRE EXTINGUISHERS OR PORTABLE FIRE EXTINGUISHERS INTO AN AVIONICS BAY WITH NO SMOKE/FIRE DETECTED: @[090894-1682A] @[101305-6740C]
1. THE CREW MAY BE EXPOSED TO THE CABIN ATMOSPHERE FOR UP TO 100 HOURS FROM THE TIME OF DISCHARGE WITHOUT IMPACT. @[032807-8310]
 2. THE CREW WILL CONTACT MCC TO DETERMINE THE MAXIMUM ALLOWABLE EXPOSURE TIME ON-ORBIT. THE SURGEON WILL MAKE A DECISION AS TO WHEN THE CREW MAY DON THE QDM'S OR ACES AND BREATHE 100 PERCENT OXYGEN TO INCREASE MISSION DURATION.
 3. REAL-TIME DISCUSSION OF MISSION DURATION OR EXTENSION WILL BE DEPENDENT UPON SUCH FACTORS AS CREW SYMPTOMS, PERFORMANCE, AND INITIATION OF A DEDICATED AVIONICS BAY PURGE. THE CDR, PLT, AND MS2 - FLIGHT ENGINEER MAY BE REQUIRED TO CLOSE VISORS ON THE ACES AND BREATHE 100 PERCENT OXYGEN BEGINNING AT TIG THROUGH LANDING ROLLOUT.

The above criterion was established based upon information from NASA's Halon 1301 Human Inhalation Study (reference JSC-23845, August 1989), the National Research Council (NRC), and JSC Toxicology Group. The human study involved exposing eight volunteers to Halon 1301 for a period of 24 hours at a concentration of 1.0 percent (10,000 ppm). The effects on both physiology and performance were studied using a computerized battery of tests on reaction time, decision-making, etc. No significant changes in any physiological parameters were noted. There were no alterations of any blood counts or chemistries, no pulmonary function changes, no cardiac dysrhythmias, and no mental status changes. There were no significant decrements in performance recorded from the pre-exposure baselines. Based on this study, exposure of crewmembers to Halon concentration levels is limited to 1.0 percent. @[021600-7170]

As a result of research done in the "Documentation of the Spacecraft Maximal Allowable Concentration Values on Bromotrifluoromethane" (White Paper), the NRC approved revised SMAC levels for Halon 1301 on November 18, 1993. These guidelines state that for a 24-hour exposure, the SMAC level is 0.35 percent (3500 parts per million), and for a 7-day exposure, the SMAC level is 0.18 percent (1800 ppm). The JSC Toxicology Group sponsored the mentioned study and proposed SMAC levels to the NRC. @[101305-6740C]

THIS RULE CONTINUED ON NEXT PAGE

FLIGHT RULES**A13-158****CABIN ATMOSPHERE CONTAMINATION - HALON 1301 [HC]**
(CONTINUED)

The 24-hour SMAC of 0.35 percent was derived from the findings of no cardiac effects in six human test subjects exposed to 7 percent of Halon 1301 for 3 hours. For assessing the effects in a general (large) population (approximately 100) from the results of a test on a small number ($n = 6$) of subjects, an adjustment factor of $\sqrt{(6/100)}$ is incorporated (according to a National Research Council's guideline). Due to uncertainties of physiologic effects of Halon in microgravity, an additional safety factor of 5 was incorporated. Thus 0.35 percent is obtained by $7\% \times \sqrt{(6/100)} \div 5$. The SMAC of 0.18 percent for longer exposure duration (>1 day) was derived from the findings of no CNS effects in six subjects exposed to 7 percent and seven subjects exposed to 1 percent ($n = 6 + 7$). To calculate the SMAC, an adjustment factor of $\sqrt{(13/100)}$ is incorporated. Thus 0.18 percent is obtained by $1\% \times \sqrt{(13/100)}$. ©[101305-6740C]

Approximately 50 percent of Halon 1301 discharged from a fire extinguisher into the avionics bay will diffuse into the cabin atmosphere within 50 hours, and 100 percent of it will diffuse in 100 hours. Halon 1301 is poorly absorbed by the charcoal in the LiOH canisters as well as the Ambient Temperature Catalytic Oxidizer (ATCO) canister. Thus, it cannot be effectively removed from the cabin atmosphere. ©[090894-1682A]

Each fixed extinguisher contains 3.06-3.80 pounds of Halon. Each portable extinguisher contains 2.7 lbs. of Halon. Discharge of one portable fire extinguisher into an avionics bay would produce a Halon 1301 concentration of approximately 0.3 percent (3000 ppm) at equilibrium. Discharge of one fixed avionics bay fire extinguisher would produce a concentration of approximately 0.4 percent (4000 ppm) at equilibrium. These concentrations were calculated on the assumption that complete equilibration of Halon 1301 with the cabin atmosphere occurs after 100 hours. In a worst-case scenario, if all Halon bottles are discharged (three portable and three fixed avionics bay), the total concentration at equilibrium is 2.1 percent. For Halon released into an avionics bay, the affected avionics bay would be purged for 7 hours and, at the expected flow rate, the air volume of the bay (approximately 100 ft³) would be turned over three times. ©[090894-1682A] ©[021600-7170]

Provided sufficient consumables are available, the mission duration may be extended by having the crew don the QDM's or ACES and breathe 100 percent oxygen for up to 6 hours at 12.0-14.7 psia without risk of oxygen toxicity (reference Rule {A13-54}, 100 PERCENT OXYGEN USE CONSTRAINT [HC]). The Surgeon and EECOM shall coordinate their efforts to derive a plan that can increase mission duration after the crew has been exposed to Halon 1301.

Data shows that the half-life of Halon 1301 in non-fatty tissues (primarily blood) is 5 minutes; whereas, the half-life of Halon 1301 is approximately 200 minutes in fat (Halon is lipid soluble). Breathing 100 percent oxygen prior to landing should significantly reduce the blood and brain levels of Halon 1301 and further protect crew performance during critical performance periods (i.e., deorbit preparation, landing, and landing rollout). Due to O₂ concentration limits, three crewmembers can breathe 100 percent O₂ for 1 hour, or seven crewmembers can breathe 100 percent O₂ for 30 minutes. ©[101305-6740C]

THIS RULE CONTINUED ON NEXT PAGE

FLIGHT RULES

A13-158

CABIN ATMOSPHERE CONTAMINATION - HALON 1301 [HC]
(CONTINUED)

A real-time decision is to be made by the Flight Director, Surgeon, EECOM, IFM, and any other disciplines involved with the decision-making process to perform a landing after the crew has been exposed to Halon 1301. The range of up to 100 hours is to be used as a guideline. The actual mission duration or extension is dependent upon such factors as crew symptoms, performance, and initiation of a dedicated avionics bay purge. @[101305-6740C] @[032807-8310]

- B. PLANNED OR ACCIDENTAL DISCHARGE OF ONE OR MORE PORTABLE FIRE EXTINGUISHERS INTO A PANEL OR INTO THE OPEN CABIN ATMOSPHERE, OR DETECTION OF A LEAKING PORTABLE FIRE EXTINGUISHER, WITH NO SMOKE/FIRE DETECTED:
1. THE CREW MAY BE EXPOSED TO THE CABIN ATMOSPHERE FOR UP TO 48 HOURS FROM THE TIME OF DISCHARGE OR DETECTION OF A LEAKING BOTTLE WITHOUT IMPACT.
 2. THE CREW WILL CONTACT MCC TO DETERMINE THE MAXIMUM ALLOWABLE EXPOSURE TIME ON ORBIT. THE SURGEON WILL MAKE A DECISION AS TO WHEN THE CREW MAY DON THE QDM'S OR ACES AND BREATHE 100 PERCENT OXYGEN TO INCREASE MISSION DURATION. @[090894-1682A]
 3. REAL-TIME DISCUSSION OF MISSION DURATION OR EXTENSION WILL BE DEPENDENT UPON SUCH FACTORS AS CREW SYMPTOMS, PERFORMANCE, AND INITIATION OF A CABIN PURGE. THE CDR, PLT, AND FLIGHT ENGINEER MAY BE REQUIRED TO CLOSE AND LOCK VISORS ON THE ACES AND BREATHE 100 PERCENT OXYGEN BEGINNING AT TIG THROUGH LANDING ROLLOUT.

Discharge of a single fire extinguisher into a panel or into the open cabin will produce a rapid equilibration with the cabin atmosphere. A Halon 1301 level of approximately 0.3 percent (3000 ppm) will be rapidly achieved, and the maximum allowable crewmember exposure time at this level is in the range of up to 48 hours based on the SMAC levels for Halon 1301 in paragraph A's rationale. In a worst-case scenario of three portable fire extinguishers into a panel or the open atmosphere, the Halon 1301 will be approximately 0.9 percent (9000 ppm) at equilibrium. For Halon released into the open atmosphere, a depress/repress cycle can be considered to lower the concentration of Halon in the atmosphere based on available N₂ consumables. @[101305-6740C] @[032807-8310]

THIS RULE CONTINUED ON NEXT PAGE

FLIGHT RULES

A13-158

CABIN ATMOSPHERE CONTAMINATION - HALON 1301 [HC] (CONTINUED)

Provided sufficient consumables are available, the mission duration may be extended by having the crew don the QDM's or ACES and breathe 100 percent oxygen for up to 6 hours at 12.0-14.7 psia without risk of oxygen toxicity (reference Rule {A13-54}, 100 PERCENT OXYGEN USE CONSTRAINT [HC]). The Surgeon and EECOM shall coordinate their efforts to derive a plan that can increase mission duration after the crew has been exposed to Halon 1301. ©[101305-6740C]

Breathing 100 percent oxygen prior to landing should significantly reduce the blood and brain levels of Halon 1301 and further protect crew performance during critical performance periods (i.e., de-orbit preparation, landing, and landing rollout). Due to O₂ concentration limits, three crewmembers can breathe 100 percent O₂ for 1 hour, or seven crewmembers can breathe 100 percent O₂ for 30 minutes.

A real-time decision is to be made by the Flight Director, Surgeon, EECOM, and any other disciplines involved with the decision-making process to perform a landing after the crew has been exposed to Halon 1301. The range of up to 48 hours is to be used as a guideline. The actual mission duration or extension is dependent upon such factors as crew symptoms, performance, and determination of the amount of Halon leaked/discharged into the cabin. Reference Rule {A17-54}, MANAGEMENT FOLLOWING HALON DISCHARGE WITHOUT FIRE CONFIRMATION. ©[090894-1682A] ©[ED] ©[032807-8310]

DOCUMENTATION:

Lam, C.W., Bromotrifluoromethane (Halon 1301) in Spacecraft Maximum Allowable Concentrations for Selected Airborne Contaminants, Vol. 3, pp 21-52 (2000).

Hazard Reports, ORBI 044, Unknown Gaseous Contamination Levels in the Cabin Causing Crew Illness/Incapacitation.

Hazard Report, ORBI 259, Material Flammability Threat in the Cabin and Orbiter Docking System (ODS). ©[101305-6740C]

Rules {A2-301}, CONTINGENCY ACTION SUMMARY [HC]; {A2-1001}, ORBITER SYSTEMS GO/NO-GO [HC]; {A13-157}, CABIN ATMOSPHERE CONTAMINATION - FIRE/SMOKE [HC]; {A17-1}, AVIONICS BAY FIRE DEFINITIONS AND ACTIONS [HC]; {A17-2}, CABIN FIRE DEFINITION AND ACTIONS [HC]; {A17-51}, MANAGEMENT FOLLOWING LOSS OF SMOKE DETECTION; {A17-54}, MANAGEMENT FOLLOWING HALON DISCHARGE WITHOUT FIRE CONFIRMATION; {A17-603}, SPACEHAB FIRE/SMOKE MANAGEMENT; and {A17-1001}, LIFE SUPPORT GO/NO-GO CRITERIA, reference this rule. ©[032807-8310] ©[032807-8400] ©[ED]

FLIGHT RULES

A13-159

CABIN ATMOSPHERE CONTAMINATION - FREON 21 [HC]

IF A FREON-TO-WATER-LOOP LEAK OCCURS IN THE HEAT EXCHANGER AND, SUBSEQUENTLY, A WATER LOOP LEAK INTO THE CABIN DEVELOPS:
@[101305-6741A]

- A. QDM'S WILL BE DONNED BY ALL CREWMEMBERS.
- B. CABIN ATMOSPHERE CONTAMINATION BY FREON 21 WILL REQUIRE MISSION TERMINATION AT THE NEXT PLS OR ELS.
- C. ACES WILL BE USED WITH VISORS DOWN AND LOCKED FOR ENTRY AND ORBITER EGRESS.

Freon in the compromised water loop will leak into the cabin upon degradation of viton seals used in the water loop plumbing. Testing has shown that with 100 percent freon on one side of the viton seal, this degradation will begin approximately 54 hours later. Freon entering the lower pressure cabin environment begins to "flash." This "flashing" (a rapid expansion of the freon due to moving from a higher pressure to a lower pressure) would be seen as an increase in cabin pressure.

Prolonged use of the QDM may exceed the max O₂ concentration limit of 25.9 percent, resulting in contingency O₂ control procedures.

A next PLS landing will be called for to prevent staying on orbit long enough to allow seal degradation.

Freon 21 detection and concentration determination will be difficult on orbit and require conservative management. It is a colorless compound with a slight ether-like odor. Although SMAC limits at various time intervals have been established for Freon 21, accurate in-flight measurement of concentrations is not possible at present. Release into the 65 m³ cabin of the nearly 272 kg of Freon 21 onboard the orbiter could theoretically replace 100 percent of the cabin atmosphere (1,000,000 ppm Freon 21), requiring donning of QDM's to prevent asphyxiation. Exposure to 10 percent (100,000 ppm) Freon 21 killed rats and guinea pigs in 1 hour, while 5 percent (50,000 ppm) killed rats in 4 hours. Cardiac arrhythmias have been reported in monkeys and dogs at 2.5 percent (25,000 ppm) and in mice at 1 percent (10,000 ppm) during acute exposures (less than 5 minutes). The risk of cardiac arrhythmias is progressively worsened at higher levels and is potentiated by increased epinephrine levels. In chronic exposures and low concentrations (500 ppm for the equivalent of 9 days), Freon 21 can cause cirrhosis of the liver similar to that seen with chloroform. For each 0.45 kg. of charcoal in the ARS LiOH canisters, Freon 21 concentration will only be lowered approximately 12.5 ppm.

*Rule {A18-1001}, THERMAL GO-NO GO CRITERIA [HC], references this rule. @[101305-6741A]
@[ED]*

THIS RULE CONTINUED ON NEXT PAGE

FLIGHT RULES

A13-159

CABIN ATMOSPHERE CONTAMINATION - FREON 21 [HC]
(CONTINUED)

DOCUMENTATION: Garcia, H. D., Dichlorofluoromethane (Freon 21) in Spacecraft Maximum Allowable Concentrations for Selected Airborne Contaminants, Vol. 4, pp 175-189 (2000).

@[101305-6741A]

SODB, Volume III, November 1985, section 4.6.1.2.1.2, Change in the FCL Accumulator Quantity.

SODB, Vol I, TABLE 3.4.6.1- 2 - RECOMMENDED EMERGENCY EXPOSURE LIMITS FOR FREON 21 [(DICHLOROMONOFUOROMETHANE (CHCL2F)].

SODB, Vol I, Section 3.4.6.1, Atmospheric Revitalization Subsystem.

SODB, Vol. I, Section 3.4, Paragraph 5., Toxic Exposure Limits in the Shuttle Cabin Breathing Atmosphere.

Hazard Report: ORBI 241, FREON LEAKAGE INTO THE WATER COOLANT LOOP/CABIN.

@[101305-6741A]

A13-160 THROUGH A13-200 RULES ARE RESERVED @[022802-4887C] @[101305-6739B]

@[101305-6740C] @[101305-6741A] @[102506-7828A] @[032807-8375]

FLIGHT RULES

ENTRY

A13-201

ANTI-G SUIT PROTOCOL (ANTI-ORTHOSTATIC
COUNTERMEASURE) [HC] ©[ED] ©[102501-4885] ©[022405-6589A]

- A. WHEN PREPARING FOR ENTRY, EACH CREWMEMBER WILL DON THE ACES. IF THE CREWMEMBER ELECTS TO INFLATE THE ANTI-G BLADDERS, THE BLADDERS WILL REMAIN INFLATED UNTIL LANDING. IF THE CREWMEMBER ELECTS TO DEFLATE THE ANTI-G BLADDERS PRIOR TO EGRESS, DEFLATION WILL BE ACCOMPLISHED PROGRESSIVELY OVER AT LEAST A 10-MINUTE PERIOD. ©[ED]

Normal adaptation to zero-g results in a condition equivalent to a 12-percent loss of plasma volume. During entry (re-exposure to gravity), blood tends to pool in the lower extremities and a "light headedness" or visual symptoms may result. Inflation of the anti-G bladders prevents blood pooling and increases blood return to the heart. Gradual deflation of the bladders after landing minimizes symptoms by reducing blood pooling.

- B. FOR FLIGHTS GREATER THAN 11 DAYS (COMMANDER FLIGHT DAYS) OF PLANNED MISSION LENGTH, ANTI-G SUITS MUST BE INFLATED TO 0.5 PSI AFTER ENTRY INTERFACE AND TO AT LEAST 1.0 PSI AT 1 G. THE ANTI-G SUITS MUST REMAIN INFLATED UNTIL AT LEAST WHEEL-STOP.

Anti-G suit inflation needs to occur prior to occurrence of symptoms. This will be especially important to help prevent orthostatic problems after longer duration flights. ©[102501-4885]

DOCUMENTATION: M.W. Bungo, J.B. Charles, and P.C. Johnson, Cardiovascular Deconditioning During Space Flight and the Use of Saline as a Countermeasure to Orthostatic Intolerance, Aviation Space Environment Medicine, 56 (10): 985-990, 1985.

Duration Orbiter Medical Project. Final Report 1989-1995. Section 1: Cardiovascular Deconditioning and Section 3: Functional Performance Evaluation. NASA-SP-1999-534.

Hazard Report, ORBI 211, Landings Which Exceed Design Limits Can Result in Loss of Crew and Vehicle.

Hazard Report, ORBI 322, Adverse Effects of Zero-G on Crew Functions. ©[022405-6589A]

FLIGHT RULES

A13-202

FLUID LOADING [HC] @[022405-6588A]

- A. FLUID LOADING IS REQUIRED BY ALL CREWMEMBERS PRIOR TO DEORBIT. CREWMEMBERS WILL INITIATE FLUID LOADING 1 HOUR BEFORE DEORBIT TIG AND SHOULD BE COMPLETED BY EI. EACH CREWMEMBER WILL CONSUME 8 OUNCES OF WATER AND TWO SALT TABLETS OR 8 OUNCES OF OTHER APPROVED SOLUTION EVERY 15 MINUTES, ACCORDING TO THE FOLLOWING TABLE:
@[030994-1608] @[011801-7187A]

FLUID LOADING AMOUNTS FOR ENTRY BASED ON BODY MASS:

PREFLIGHT CREWMEMBER MASS	NUMBER OF 8 OZ DRINK CONTAINERS	AND	NUMBER OF SALT TABLETS	OR	APPROVED SOLN (OZ)
< 120 LBS	3		6		24
120-155	4		8		32
156-190	5		10		40
> 190 LBS	6		12		48

@[050400-7187]

THE CREWMEMBERS WILL BE INSTRUCTED ON THE PROPER AMOUNTS PRIOR TO LAUNCH. REMINDERS CAN BE GIVEN DURING THE ENTRY DAY PMC, IF NECESSARY.

- B. IF THERE IS A ONE ORBIT WAVEOFF AND THE FLUID-LOADING PROTOCOL DESCRIBED IN PARAGRAPH A WAS COMPLETED, THE PROTOCOL SHOULD BE REPEATED TO A TOTAL OF ONE-HALF OF THE PRESCRIBED AMOUNT DETERMINED IN PARAGRAPH A, TO BE COMPLETED BY EI. IF THERE IS A GREATER THAN ONE ORBIT WAVEOFF OR A PARTIAL FLUID LOAD WAS COMPLETED ON THE PREVIOUS DEORBIT ATTEMPT, THE ENTIRE PROTOCOL DESCRIBED IN PARAGRAPH A SHOULD BE REPEATED. @[011801-7187A]
- C. IF A CREWMEMBER IS PARTICIPATING IN A FLUID-LOADING DSO, THE PROTOCOL AND ITS METHOD OF IMPLEMENTATION WILL BE DETAILED PREFLIGHT BY THE INVESTIGATOR AND THE CREW SURGEON. THE PROTOCOL WILL ALSO BE DOCUMENTED IN THE MISSION-SPECIFIC FLIGHT RULES ANNEX.

During spaceflight, it has been shown that crewmembers lose approximately 12 percent of their total plasma volume and this equates to 1-2 percent of total body water. @[022405-6588A]

THIS RULE CONTINUED ON NEXT PAGE

FLIGHT RULES

A13-202

FLUID LOADING [HC] (CONTINUED)

Oral fluid loading with a salt/water mixture similar to body fluids has been shown to significantly reduce detrimental heart rate and blood pressure changes during orthostatic stress post flight. Basing the amount of salt and water (in a proper ratio) or other approved solution on the crewmember's body mass helps to assure the fluid loading is adequate for larger crewmembers and possibly not too much for smaller crewmembers. ASTROADE® and other tested isotonic solutions provide plasma volume expansion similar to salt tablets/water and may be easier for some crewmembers to ingest. Flight Surgeons must approve these alternate solutions for individual use prior to flight. ©[030994-1608]

The basis for initiating fluid loading 1 hour prior to TIG includes the amount of time it takes for fluid to leave the stomach, enter the intestine, and be absorbed to affect the plasma volume. A plot for gastric emptying (i.e., the time to leave the stomach and enter the intestine) showed that it takes approximately 60 minutes for nearly all of an isotonic solution consumed to enter the intestine (approximately 20 minutes for 80 percent, approximately 40 minutes for 95 percent, approximately 60 minutes for 98 percent, and approximately 80 minutes for 100 percent). Furthermore, it takes approximately 2 hours from initiation of fluid loading for the change in plasma volume to plateau (at approximately 5 percent). Since landing occurs 1 hour after TIG, change in plasma volume will peak at landing if fluid loading is initiated 1 hour prior to TIG.

From a waveoff perspective, the desire is to delay fluid loading as close to TIG as possible since weather waveoffs often occur just minutes prior to TIG. However, consuming too much too fast can cause gastric discomfort and vomiting.

If fluid loading is initiated 1 hour prior to TIG but deorbit is subsequently delayed, the impact is crew discomfort and increased WCS usage. Although this is undesirable, it is not a safety issue. However, if fluid loading is delayed and the reduction in the change in plasma volume at landing is significant, then crewmembers may feel faint or dizzy upon return to 1g and may not be able to egress unassisted. This can be a safety concern for crewmembers involved with landing the vehicle and for all crewmembers in an emergency egress scenario. ©[011801-7187A]

DOCUMENTATION: M.W. Bungo, J.B. Charles, and P.C. Johnson, Cardiovascular Deconditioning During Space Flight and the Use of Saline as a Countermeasure to Orthostatic Intoleranc, Aviation Space Environment Medicine, 56 (10): 985-990, 1985. ©[011801-7187A]

DOCUMENTATION: F. Brouns, Gastric Emptying as a Regulatory Factor in Fluid Uptake. International Journal Sports Medicine, 19(1998) S125-S128, George Thieme Verlag Stuttgart, New York. ©[011801-7187A]

Hazard Report, ORBI 211, Landings Which Exceed Design Limits Can Result in Loss of Crew and Vehicle. ©[022405-6588A]

Hazard Report, ORBI 322, Adverse Effects of Zero-G on Crew Functions. ©[022405-6588A]

A13-203

RESERVED ©[022604-6230B]

FLIGHT RULES

THIS PAGE INTENTIONALLY BLANK

FLIGHT RULES

SECTION 14 - SPACE ENVIRONMENT

DEFINITIONS

A14-1	UNCONFIRMED ARTIFICIAL EVENT DEFINITION.....	14-1
A14-2	CONFIRMED ARTIFICIAL EVENT DEFINITION.....	14-1
A14-3	SOLAR PARTICLE EVENT WARNING DEFINITION.....	14-2
A14-4	SOLAR PARTICLE EVENT DEFINITION.....	14-2
A14-5	GEOMAGNETIC STORM DEFINITION.....	14-3
A14-6	OTHER RADIATION EVENT DEFINITION.....	14-3
A14-7	RADIATION ENVIRONMENT CONDITION DEFINITION....	14-4
A14-8	PROJECTED OPERATIONAL DOSE LIMIT VIOLATION DEFINITION.....	14-5
A14-9	ALARA DEFINITION.....	14-5
A14-10	LEGAL EXPOSURE LIMITS [HC].....	14-6
	TABLE A14-10-I - EXPOSURE LIMITS (REM (SIEVERT)).....	14-6
A14-11	SHUTTLE ADMINISTRATIVE LIMIT [HC].....	14-6
A14-12	HIGH DOSE RATE LIMITS [HC].....	14-7
A14-13	THROUGH A14-50 RULES ARE RESERVED.....	14-7

MANAGEMENT

A14-51	CREW RADIATION EXPOSURE LIMITS [HC].....	14-8
A14-52	ACTIONS REQUIRED FOR RADIATION ENVIRONMENT CONDITIONS - PRELAUNCH.....	14-9
A14-53	ACTIONS REQUIRED FOR RADIATION ENVIRONMENT CONDITIONS - ON ORBIT [HC].....	14-10
A14-54	GO/NO-GO CRITERIA FOR EVA BASED ON RADIATION EXPOSURE [HC].....	14-12
A14-55	DOWNGRADING TO NOMINAL FROM ALERT OR CONTINGENCY.....	14-15
A14-56	THROUGH A14-100 RULES ARE RESERVED.....	14-16

FLIGHT RULES

SPACE ENVIRONMENT GO/NO-GO CRITERIA

A14-1001 SPACE ENVIRONMENT GO/NO-GO CRITERIA [HC]14-17

FLIGHT RULES

SECTION 14 - SPACE ENVIRONMENT

The Flight Rules of the Space Environment Section deal specifically with ionizing radiation and are intended to provide assurance that crew radiation exposure during Space Shuttle operations will be maintained as low as reasonably achievable (ALARA), as required by the Code of Federal Regulations for Safety and Health.. In this context, Space Shuttle operations include crew activities for EVA and IVA for the orbiter and any habitable payload (Spacelab, Spacehab, etc.). JSC Space and Life Sciences personnel (Flight Surgeon, Radiological Health Officer, and the Space Radiation Analysis Group) are responsible for prelaunch, orbit, and postflight assessment of all shuttle mission crew radiation hazard/health issues. ©[ED]

DEFINITIONS

A14-1 **UNCONFIRMED ARTIFICIAL EVENT DEFINITION**

AN UNCONFIRMED ARTIFICIAL EVENT IS DEFINED AS AN ARTIFICIAL EVENT NOT CONFIRMED BY THE PROPER SUPPORT DATA SOURCE.

This definition is self-explanatory. It is included to minimize the influence on space shuttle operations of rumor or speculation from unofficial sources.

Reference Rule {B14-1}, UNCONFIRMED ARTIFICIAL EVENT DEFINITION [RC] [E]. ©[032901-7266A] ©[ED]

Rules {A14-7}, RADIATION ENVIRONMENT CONDITION DEFINITION; {A14-55}, DOWNGRADING TO NOMINAL FROM ALERT OR CONTINGENCY; and {B14-1}, UNCONFIRMED ARTIFICIAL EVENT DEFINITION [RC] [E], reference this rule.

A14-2 **CONFIRMED ARTIFICIAL EVENT DEFINITION**

A CONFIRMED ARTIFICIAL EVENT IS DEFINED AS AN ARTIFICIAL EVENT THAT IS REPORTED BY THE PROPER SUPPORT DATA SOURCE.

Reference Rule {B14-2}, CONFIRMED ARTIFICIAL EVENT DEFINITION [RC] [E]. ©[032901-7266A]

Rules {A14-7}, RADIATION ENVIRONMENT CONDITION DEFINITION; {A14-55}, DOWNGRADING TO NOMINAL FROM ALERT OR CONTINGENCY; and {B14-2}, CONFIRMED ARTIFICIAL EVENT DEFINITION [RC] [E], reference this rule. ©[ED]

FLIGHT RULES

A14-3

SOLAR PARTICLE EVENT WARNING DEFINITION ©[032901-7265] ©[032901-7271A]

A SOLAR PARTICLE EVENT (SPE) WARNING IS DEFINED AS AN SPE WARNING GENERATED BY NOAA. NOAA WILL GENERATE THIS WARNING BASED ON THEIR PROJECTIONS THAT CURRENT CONDITIONS ARE SUCH THAT THERE IS A HIGH PROBABILITY THAT AN SPE (10 PROTONS (>10 MEV)/CM²-S-STER AT GEOSYNCHRONOUS ALTITUDE) IS LIKELY.

NOAA solar models take into account many different factors to determine that a solar particle event is likely. NOAA will also provide a window of time that the onset of the SPE may be observed. This warning replaces the previous alert criterion based on X-ray events, magnitude >M5, as an indicator that an SPE is possible. This will help reduce the number of alerts.

Reference Rule {B14-3}, SOLAR PARTICLE EVENT WARNING DEFINITION [RC] [E]. ©[032901-7271A] ©[ED]

Rules {A14-7}, RADIATION ENVIRONMENT CONDITION DEFINITION and {B14-3}, SOLAR PARTICLE EVENT WARNING DEFINITION [RC] [E], reference this rule.

A14-4

SOLAR PARTICLE EVENT DEFINITION

A SOLAR PARTICLE EVENT IS DEFINED AS AN INCREASE IN THE NEAR-EARTH PROTON RADIATION ENVIRONMENT RESULTING FROM SOLAR FLARE ACTIVITY. THRESHOLD LEVEL IS 10 PROTONS (>10 MEV)/CM²-S-STER AT GEOSYNCHRONOUS ALTITUDE. THRESHOLD LEVEL FOR AN ENERGETIC SPE IS 1 PROTON (>100 MEV)/CM²-S-STER AT GEOSYNCHRONOUS ALTITUDE. ©[032901-7267A]

A distinction is made between "ordinary" SPE's and energetic SPE's. Ordinary SPE's are mostly a concern for EVA astronauts. Energetic SPE's include particles with sufficient energy to penetrate the shuttle and thus is a concern for both IVA and EVA crewmembers.

Reference Rule {B14-4}, SOLAR PARTICLE EVENT (SPE) DEFINITION [RC] [E]. ©[032901-7267A]

Rules {A14-7}, RADIATION ENVIRONMENT CONDITION DEFINITION; {A14-55}, DOWNGRADING TO NOMINAL FROM ALERT OR CONTINGENCY; and {B14-4}, SOLAR PARTICLE EVENT (SPE) DEFINITION [RC] [E], reference this rule. ©[ED]

FLIGHT RULES

A14-5 GEOMAGNETIC STORM DEFINITION ©[032901-7272A]

A GEOMAGNETIC STORM IS DEFINED AS A CHANGE FROM NORMAL LEVELS IN THE HORIZONTAL COMPONENT OF THE MAGNETIC FIELD AT THE SURFACE OF THE EARTH AS MEASURED BY MAGNETOMETERS AT BOULDER, CO. MAJOR GEOMAGNETIC STORM THRESHOLD IS $A_B = 50-99$ OR $K_B = 6$. SEVERE GEOMAGNETIC STORM THRESHOLD IS $A_B \geq 100$ OR $K_B \geq 7$.

Reference Rule {B14-5}, GEOMAGNETIC STORM DEFINITION [RC] [E]. ©[032901-7272A] ©[ED]

Rules {A14-7}, RADIATION ENVIRONMENT CONDITION DEFINITION, and {A14-55}, DOWNGRADING TO NOMINAL FROM ALERT OR CONTINGENCY, reference this rule.

A14-6 OTHER RADIATION EVENT DEFINITION ©[032901-7268A]

OTHER RADIATION EVENT IS DEFINED AS INCREASED RADIATION RATES PRODUCED BY ANY SOURCE OTHER THAN SOLAR, GEOMAGNETIC OR ARTIFICIAL EVENT ACTIVITY. THRESHOLD LEVEL IS ANY INCREASE ABOVE THE NOMINAL MISSION RATE PROJECTIONS.

This definition is included to cover any natural or manmade exposure enhancement from radiation sources not listed in the definitions above. For example, geomagnetic storms can inject or accelerate particles in the Earth's trapped charged particle belts resulting in an increased ambient radiation environment surrounding the shuttle. These enhancements can last from days to weeks. Occasionally, during severe geomagnetic activity, new radiation belts that may persist for lengthy periods can be formed apart from the existing belts, and may increase shuttle crew exposure, particularly during EVA's.

Reference Rule {B14-6}, RADIATION BELT ENHANCEMENT DEFINITION [RC] [E]. ©[032901-7268A]

Rules {A14-7}, RADIATION ENVIRONMENT CONDITION DEFINITION, and {A14-55}, DOWNGRADING TO NOMINAL FROM ALERT OR CONTINGENCY, reference this rule. ©[ED]

FLIGHT RULES

A14-7

RADIATION ENVIRONMENT CONDITION DEFINITION

CONDITION	DEFINITION
NOMINAL	NO ADVERSE ENVIRONMENTAL CONDITION EXISTS.
ALERT	A CONDITION WHERE AN IMMINENT INCREASE IN CREW RADIATION EXPOSURES IS POSSIBLE. A RADIATION ALERT IS INITIATED WHEN ANY OF THE FOLLOWING EVENTS OCCUR: 1. UNCONFIRMED ARTIFICIAL EVENT (REF. RULES {A14-1}, UNCONFIRMED ARTIFICIAL EVENT DEFINITION); 2. SOLAR PARTICLE EVENT WARNING (REF. RULE {A14-3}, SOLAR PARTICLE EVENT WARNING DEFINITION); 3. SOLAR PARTICLE EVENT (REF. RULE {A14-4}, SOLAR PARTICLE EVENT DEFINITION); 4. GEOMAGNETIC STORM (REF. RULE {A14-5}, GEOMAGNETIC STORM DEFINITION); OR 5. OTHER RADIATION EVENT (REF. RULE {A14-6}, OTHER RADIATION EVENT DEFINITION);
CONTINGENCY	A CONFIRMED INCREASE IN RADIATION EXPOSURE LEVELS TO THE CREW THAT MAY REQUIRE ACTIVE INTERVENTION TO MINIMIZE THE EFFECTS FROM THE ENHANCED ENVIRONMENT. 1. FOR >45-DEGREE INCLINATION FLIGHTS, >100 PFU (>100 MEV PROTONS) AS MEASURED FROM GOES; 2. FOR >45-DEGREE INCLINATION FLIGHTS AND IF SIGNIFICANT MISSION OBJECTIVES ARE TO BE PERFORMED EVA, IF $K_B > 8$ OR A SIGNIFICANT SHIFT IN THE ELECTRON BELTS HAS OCCURRED; 3. IF IN THE JUDGMENT OF THE RADIATION CONSOLE OPERATOR, ENVIRONMENTAL CONDITIONS WILL PRODUCE LOCAL DOSE RATES > 5 MRADS/MIN; 4. A CONFIRMED ARTIFICIAL EVENT (REF. RULE {A14-2}, CONFIRMED ARTIFICIAL EVENT DEFINITION);

©[032901-7273A] ©[ED]

Space weather events may trigger substantial changes in the near-Earth radiation environment. Close monitoring of the radiation environment is required to detect trends that could lead to unacceptable increases in crew radiation exposure. Radiation environment enhancements may become significant enough to warrant actions by the crew to reduce radiation exposures in order to remain within crew exposure limits (ref. Rule {A14-11}, SHUTTLE ADMINISTRATIVE LIMIT [HC]) and/or comply with ALARA (ref. Rule {A14-9}, ALARA DEFINITION).

Reference Rule {B14-7}, RADIATION ENVIRONMENT CONDITIONS DEFINITION [RC][E].

©[032901-7273A] ©[ED]

FLIGHT RULES

A14-8

PROJECTED OPERATIONAL DOSE LIMIT VIOLATION

DEFINITION ©[032901-7268A]

PROJECTED OPERATIONAL DOSE LIMIT VIOLATION IS DEFINED AS A DOSE EXTRAPOLATION THAT VIOLATES AN OPERATIONAL LIMIT (RULE {A14-51}, CREW RADIATION EXPOSURE LIMITS [HC]) BASED UPON ANALYTICAL PROJECTIONS WITH ACCUMULATION RATES CONFIRMED BY ONBOARD DOSIMETRY READOUT.

This definition is self-explanatory. ©[032901-7268A]

Rules {A14-10}, LEGAL EXPOSURE LIMITS [HC], and {A14-53}, ACTIONS REQUIRED FOR RADIATION ENVIRONMENT CONDITIONS - ON ORBIT [HC], reference this rule. ©[ED]

A14-9

ALARA DEFINITION

ALARA, AS LOW AS REASONABLY ACHIEVABLE, REFERS TO A RADIATION PROTECTION PRINCIPLE THAT REQUIRES ANY ADDITIONAL RADIATION EXPOSURE BE SUBJECT TO A RISK-VERSUS-GAIN ANALYSIS REGARDLESS OF THE MAGNITUDE OF ADDITIONAL EXPOSURE. THE MAXIMUM PERMISSIBLE LEVELS, OR LIMITS, ARE NOT TO BE CONSIDERED AS "ACCEPTABLE," BUT INSTEAD, THEY REPRESENT THE LEVELS THAT SHOULD NOT BE EXCEEDED. ©[032901-7275A]

NASA is required by the Occupational Safety and Health Administration (OSHA) to maintain a risk-limitation system for all activities that involve radiation exposure. This risk-limitation system includes the need to minimize cumulative radiation exposures for all crewmembers. Since OSHA classifies crewmembers as radiation workers, these federally mandated rules apply.

Reference Rule {B14-8}, ALARA DEFINITION [RC] [E]. ©[032901-7275A]

Rules {A14-7}, RADIATION ENVIRONMENT CONDITION DEFINITION; {A14-10}, LEGAL EXPOSURE LIMITS [HC]; {A14-51}, CREW RADIATION EXPOSURE LIMITS [HC]; {A14-52}, ACTIONS REQUIRED FOR RADIATION ENVIRONMENT CONDITIONS - PRELAUNCH, {A14-53}, ACTIONS REQUIRED FOR RADIATION ENVIRONMENT CONDITIONS - ON ORBIT [HC], and {A14-54}, GO/NO-GO CRITERIA FOR EVA BASED ON RADIATION EXPOSURE [HC], reference this rule. ©[ED]

FLIGHT RULES

A14-10 LEGAL EXPOSURE LIMITS [HC]

THE FOLLOWING OPERATIONAL CREW IONIZING RADIATION EXPOSURE LIMITS SHALL BE ADHERED TO: @[032901-7274B]

TABLE A14-10-I - EXPOSURE LIMITS (REM (SIEVERT))

EXPOSURE PERIOD	BLOOD FORMING ORGAN (BFO)	EYE	SKIN
30 DAYS	25 (0.25)	100 (1.00)	150 (1.50)
ANNUAL	50 (0.50)	200 (2.00)	300 (3.00)

Space shuttle crew radiation exposure limits recommended to NASA by the National Council on Radiation Protection and Measurements, "Guidance on Radiation Received in Space Activities," NCRP Report No. 98, July 31, 1989, have been legally adopted as the agency's supplementary standard in accordance with 29 CFR 1960.18. Space shuttle flights are nominally constrained to the 30-day exposure limits that are conservatively set to minimize mission impact (ref. Rule {A14-8}, PROJECTED OPERATIONAL DOSE LIMIT VIOLATION DEFINITION). The practice of ALARA is part of NASA's legal requirement to regulate crew exposures just as much as the maximum exposure limits.

Reference Rule {B14-9}, JOINT EXPOSURE LIMITS [RC] [E]. @[032901-7274B] @[ED]

Rules {A14-51}, CREW RADIATION EXPOSURE LIMITS [HC]; {A14-54}, GO/NO-GO CRITERIA FOR EVA BASED ON RADIATION EXPOSURE [HC]; and {B14-9}, JOINT EXPOSURE LIMITS [RC] [E], reference this rule.

A14-11 SHUTTLE ADMINISTRATIVE LIMIT [HC]

THE SHUTTLE ADMINISTRATIVE LIMIT IS 0.5 RAD (SKIN) ABOVE THE PREFLIGHT MISSION EXPOSURE LEVELS. @[032901-7276B]

This rule is applied by the EVA go/no-go rule to establish a threshold when EVA's are required to be rescheduled to reduce exposure. Below this threshold, normal ALARA practices govern EVA exposure control. The administrative limit includes all additional exposures (IVA and EVA) resulting from the enhanced radiation environment, from the beginning of the mission projected through the next EVA.

Reference Rule {B14-11}, CREW EXPOSURE ADMINISTRATIVE LIMITS [RC] [E] (TBR FOR RUSSIAN CONCURRENCE). @[032901-7276B]

Rules {A14-7}, RADIATION ENVIRONMENT CONDITION DEFINITION; {A14-53}, ACTIONS REQUIRED FOR RADIATION ENVIRONMENT CONDITIONS - ON ORBIT [HC]; and {A14-54}, GO/NO-GO CRITERIA FOR EVA BASED ON RADIATION EXPOSURE [HC], reference this rule. @[ED]

FLIGHT RULES

A14-12 **HIGH DOSE RATE LIMITS [HC]**

A HIGH DOSE RATE CONDITION IS DEFINED AS A DOSE PROJECTED FOR 1 DAY THAT EQUALS OR EXCEEDS ONE OF THE FOLLOWING: ©[032901-7277B]

- A. 2.5 RAD BFO/DAY (0.025 GRAY)
- B. 10 RAD EYE/DAY (0.10 GRAY)
- C. 15 RAD SKIN/DAY (0.15 GRAY)

The National Council on Radiation Protection, in making their recommendation for the legal radiation exposure limits, defines 5 rem BFO in 1 day as the threshold for acute exposure. For uniformity, the "rem" values are converted to "rad" using an assumed quality factor of 2.0. This quality factor is an estimate of the expected value during a large solar proton event. Dose rates above this threshold will result in additional risk compared to a similar exposure delivered over a longer period of time (e.g., protracted/chronic exposure). Eye and skin values are extrapolated from the legal limits based on the BFO exposure.

Reference Rule {B14-12}, HIGH DOSE RATE LIMITS [RC] [E]. ©[032901-7277B] ©[ED]

Rule {A14-54}, GO/NO-GO CRITERIA FOR EVA BASED ON RADIATION EXPOSURE [HC], references this rule.

A14-13 THROUGH A14-50 RULES ARE RESERVED

FLIGHT RULES

MANAGEMENT

A14-51 **CREW RADIATION EXPOSURE LIMITS [HC]** ©[032901-7269B]

THE FOLLOWING OPERATIONAL CREW IONIZING RADIATION EXPOSURE LIMITS SHALL BE ADHERED TO:

- A. LEGAL EXPOSURE LIMITS (REF. RULE {A14-10}, LEGAL EXPOSURE LIMITS [HC])

- B. ALARA: FLIGHT MANAGEMENT SHALL EXERCISE REASONABLE EFFORTS TO MAINTAIN CREW EXPOSURES AS LOW AS REASONABLE ACHIEVABLY (REF. RULE {A14-9} ALARA DEFINITION).

Space shuttle crew radiation exposure limits recommended to NASA by the National Council on Radiation Protection and Measurements, "Guidance on Radiation Received in Space Activities," NCRP Report No. 98, July 31, 1989, have been legally adopted as the Agency's Supplementary Standard in accordance with 29 CFR 1960.18. Space shuttle flights are nominally constrained to the 30-day exposure limits that are conservatively set to minimize mission impact. The practice of ALARA is part of NASA's legal requirement to regulate crew exposures. ©[032901-7269B]

Rules {A14-51}, CREW RADIATION EXPOSURE LIMITS [HC], and {A14-52}, ACTIONS REQUIRED FOR RADIATION ENVIRONMENT CONDITIONS - PRELAUNCH, reference this rule. ©[ED]

FLIGHT RULES

A14-52

ACTIONS REQUIRED FOR RADIATION ENVIRONMENT CONDITIONS - PRELAUNCH @[032901-7265] @[032901-7278A]

- A. NOMINAL OR ALERT - GO FOR LAUNCH
- B. CONTINGENCY -
 - 1. CONSIDERATION SHALL BE MADE TO DEFER THE FLIGHT UNTIL RADIATION LEVELS HAVE DECLINED.
 - 2. CONFIRMED ARTIFICIAL EVENT (ONLY) :
 - a. PRIOR TO L-31 SECONDS, THE FLIGHT DIRECTOR WILL REQUEST A LAUNCH HOLD.
 - b. AFTER L-31 SECONDS, GO FOR LAUNCH. FURTHER ACTION WILL BE GOVERNED BY ON-ORBIT (REF. RULE {A14-53}, ACTIONS REQUIRED FOR RADIATION ENVIRONMENT CONDITIONS - ON ORBIT) [HC].
 - 3. OTHERWISE, GO FOR LAUNCH.

During alert or contingency conditions, substantial changes in the near-Earth radiation environment may be initiated. Close monitoring of the radiation environment is required to detect trends that could lead to unacceptable increases in crew radiation exposure. Radiation environment enhancements may become significant enough to warrant actions by the crew to reduce radiation exposures in order to remain within crew exposure limits (ref. Rule {A14-51}, CREW RADIATION EXPOSURE LIMITS [HC] and/or comply with ALARA (ref. Rule {A14-9}, ALARA DEFINITION).

For Artificial events: If prior to L-31 seconds, it is better to hold/terminate than to risk exposing the crew to a potentially hazardous radiation environment. After L-31 seconds, it is safer to continue a nominal ascent and subsequently order deorbit if required. After achieving orbit, further action will be governed by orbit flight phase rules. Dosimeter readings are needed to confirm exposure and rate of exposure so that valid projections can be determined. This rule will minimize crew exposure from the potentially very high dose rates that can be produced before stabilization of the enhanced trapped electron belts.

Reference Rule {B14-103}, ACTIONS REQUIRED FOR RADIATION ENVIRONMENT CONDITIONS [RC] [E] (TBR FOR RUSSIAN CONCURRENCE). @[032901-7278A] @[ED]

FLIGHT RULES

A14-53

ACTIONS REQUIRED FOR RADIATION ENVIRONMENT

CONDITIONS - ON ORBIT [HC] @[032901-7265] @[032901-7279B]

A. ALERT

1. ENSURE SHUTTLE TEPc IS OPERATING.
 - a. OBTAIN A BASELINE TEPc CALLDOWN IF NOT OBTAINED IN LAST 24 HRS.
 - b. IF THE TEPc IS INOPERABLE, OBTAIN BASELINE MEASUREMENTS FROM THE RADIATION DOSIMETER ASSEMBLY.
2. PERFORM SHUTTLE TEPc DISPLAY CALL-DOWNS DAILY.

B. CONTINGENCY

1. ENSURE SHUTTLE TEPc IS OPERATING.
 - a. OBTAIN A BASELINE TEPc CALLDOWN IF NOT OBTAINED IN LAST 24 HRS.
 - b. IF THE TEPc IS INOPERABLE, OBTAIN BASELINE MEASUREMENTS FROM THE RADIATION DOSIMETER ASSEMBLY.
2. PERFORM SHUTTLE TEPc DISPLAY CALLDOWNS AT LEAST TWICE DAILY.
3. INFORM CREW. RECOMMEND REMAINING IN THE AIRLOCK DURING INTERVALS OF HIGH RISK ORBITAL ALIGNMENTS.
4. CONFIRMED ARTIFICIAL EVENT (ONLY):
 - a. THE FLIGHT DIRECTOR WILL NOTIFY THE CREW AND REQUEST THE CREW TO TAKE AND REPORT DOSIMETER READINGS AT SPECIFIED INTERVALS.
 - b. EVA CREWMEMBER WILL RETURN TO THE AIRLOCK ASAP. GO/NO-GO FOR CONTINUATION OF EVA WILL BE BASED ON PROJECTED RADIATION EXPOSURE LEVELS. @[032901-7279B]

THIS RULE CONTINUED ON NEXT PAGE

FLIGHT RULES

A14-53

ACTIONS REQUIRED FOR RADIATION ENVIRONMENT CONDITIONS - ON ORBIT [HC] (CONTINUED)

5. IF AN OPERATIONAL DOSE LIMIT VIOLATION HAS BEEN PROJECTED (REF. RULE {A14-8}, PROJECTED OPERATIONAL DOSE LIMIT VIOLATION DEFINITION), THE FLIGHT DIRECTOR WILL BE NOTIFIED. @[032901-7279B]
- a. THE FLIGHT DIRECTOR WILL NOTIFY THE CREW OF THE PROJECTED DOSE LIMIT VIOLATION.
- b. BASED ON THE PROJECTED RADIATION EXPOSURE LEVELS AND TIME REMAINING TO REACH THE DOSE LIMIT, CONSIDERATION WILL BE GIVEN TO:
- (1) RESTRICT CREW LOCATION WITHIN THE ORBITER.
 - (2) CHANGE ORBITER ALTITUDE/ATTITUDE IF IT DECREASES CREW EXPOSURES.
 - (3) DEORBIT NEXT PLS.
 - (4) DEORBIT NEXT DAY PLS.

During alert or contingency conditions, substantial changes in the near-Earth radiation environment may be initiated. Close monitoring of the radiation environment is required to detect trends that could lead to unacceptable increases in crew radiation exposure. Radiation environment enhancements may become significant enough to warrant actions by the crew to reduce radiation exposures in order to remain within crew exposure limits (ref. Rule {A14-11}, SHUTTLE ADMINISTRATIVE LIMIT [HC]) and/or comply with ALARA (ref. Rule {A14-9}, ALARA DEFINITION). Higher shielded locations are based on analysis conducted by SRAG. Unplanned exposures will be evaluated in real time by the surgeon to determine risk of medical implications and weighed against other mission risks prior to making recommendations on crew actions. Communications with the Flight Director concerning crew actions will be coordinated with the surgeon.

Reference Rule {B14-103}, ACTIONS REQUIRED FOR RADIATION ENVIRONMENT CONDITIONS [RC] [E] (TBR FOR RUSSIAN CONCURRENCE). @[032901-7279B] @[ED]

Rule {A14-52}, ACTIONS REQUIRED FOR RADIATION ENVIRONMENT CONDITIONS - PRELAUNCH, references this rule. @[ED]

FLIGHT RULES

A14-54

GO/NO-GO CRITERIA FOR EVA BASED ON RADIATION EXPOSURE [HC] ©[032901-7265] ©[032901-7280B]

THE FOLLOWING WILL BE DONE ONLY TO REDUCE CREW EVA EXPOSURES:

- A. FOR PREDICTED EVA EXPOSURE LESS THAN SHUTTLE ADMINISTRATIVE LIMIT (REF. RULE {A14-11}, SHUTTLE ADMINISTRATIVE LIMIT [HC]):
1. CONSIDER DELAYING OR ACCELERATING EGRESS 1-2 REVS IF THIS WILL REDUCE THE EXPOSURE WHILE ACCOMPLISHING MISSION OBJECTIVES CONSISTENT WITH NORMAL CREW GROUND RULES AND CONSTRAINTS, AND TIMELINE CHANGES ARE LIMITED TO A SINGLE FLIGHT DAY.
 2. AN EVA IN PROGRESS WILL CONTINUE. CONSIDER NOT ADDING UNSCHEDULED ITEMS TO EXISTING TIMELINE IF THIS RESULTS IN ADDITIONAL EVA CREW EXPOSURE.

While performing EVA's, crewmembers have reduced levels of shielding against radiation environments compared with IVA operations. The reduced shielding can result in significantly higher exposures to the radiation sensitive organs of EVA crewmembers compared with the IVA crew. Avoiding EVA's or rescheduling EVA's when possible during enhanced radiation environment conditions is in compliance with the federally mandated ALARA principle. To meet mission objectives, complete avoidance of radiation exposure may not be possible. Actions are based on combining the best estimate on the current mission dose with the projected EVA dose and comparing that value against the administrative limit for that time in the mission.

Even for crew exposures below the admin limit, the flight control team will consider rescheduling airlock egress in order to shift out of high radiation areas, if this can be done while still accomplishing all mission objectives. Based on the levels of exposure below the admin limit, this replanning is limited to a 1-2 rev change in egress time in order to preclude significant subsequent replanning, crew scheduling groundrule violations, etc. Unscheduled tasks will not be added for the next EVA if they will result in additional elevated exposures. ©[032901-7280B]

The risk from additional radiation exposures below the admin limit compared with the risk incurred by going EVA is low enough to support continuing an EVA already in progress. Unscheduled tasks added at the end of the EVA will be evaluated against additional exposures. Due to the structure of the radiation environment, certain geographic regions may produce significant fractions of the total exposure. In most cases, the phasing will be such that little additional risk is added from performing extra tasks and, therefore, the tasks could be added. Potentially, a significant exposure could be phased at the end of the EVA that would merit avoiding the unscheduled task in lieu of continuing. (Ref. Rule {A14-9}, ALARA DEFINITION.) ©[032901-7280B]

THIS RULE CONTINUED ON NEXT PAGE

FLIGHT RULES

A14-54

GO/NO-GO CRITERIA FOR EVA BASED ON RADIATION EXPOSURE [HC] (CONTINUED)

The admin limit is in place to regulate mission actions to minimize risk. The mortality risk associated with this limit is comparable to the risk of EMU suit penetration/depressurization. It is also comparable to the average total radiation risk for shuttle flights. The maximum mission exposure for the shuttle remains at the 30-day legal limit values (e.g., 25 rem BFO, etc.).

- B. PREDICTED CREW MISSION EXPOSURE GREATER THAN SHUTTLE ADMINISTRATIVE LIMIT AT THE END OF THE EVA (REF. RULE {A14-11}, SHUTTLE ADMINISTRATIVE LIMIT [HC]):
1. DELAY OR ACCELERATE EGRESS 1-2 REVS TO REDUCE EXPOSURES OR DELAY 1 DAY TO RESCHEDULE IN A LOWER EXPOSURE EVA PATH.
 2. IF AN ISS MISSION, CONSIDER TRANSFERRING TASKS TO A STATION-BASED EVA TO BE PERFORMED AT A LATER DATE.
 3. AN EVA IN PROGRESS WILL CONTINUE. CONSIDER EXPEDITING TASKS NOT REQUIRED FOR PRIMARY MISSION OBJECTIVES.

For crew mission exposures above the admin limit, replanning will be more aggressive, including accepting more downstream timeline impacts, crew scheduling groundrule violations, etc. Since shuttle operations are typically time constrained, the first option is to delay or accelerate by 1-2 revs to shift out of the enhanced radiation areas. The EVA may also be conducted with a lower exposure by delaying the EVA up to 1 day to allow the increased radiation environment to decay or to select a trajectory that has shifted out of the high radiation areas. ©[032901-7280B]

The risk from this level of radiation exposure/risk compared to the risk incurred by going EVA is low enough to support continuing an EVA already in progress. However, consideration of expediting or deleting tasks shall be made to aid in minimizing the radiation risk consistent with mission objectives and the associated risk of being EVA. If an ISS mission, consider transferring tasks to a station-based EVA. A later station based EVA may result in completing the task with a lower exposure. ©[032901-7280B]

THIS RULE CONTINUED ON NEXT PAGE

FLIGHT RULES

A14-54

GO/NO-GO CRITERIA FOR EVA BASED ON RADIATION EXPOSURE [HC] (CONTINUED)

- C. PREDICTED CREW EXPOSURE GREATER THAN THE HIGH DOSE RATE LIMITS (REF. RULE {A14-12}, HIGH DOSE RATE LIMITS [HC]):
1. A PLANNED EVA SHALL BE RESCHEDULED AS REQUIRED TO REDUCE THE EXPOSURE TO BELOW THE HIGH DOSE RATE LIMIT.
 2. AN EVA IN PROGRESS SHALL CONTINUE ONLY IF NO INCREASED ADDITIONAL DOSE IS PROJECTED FOR THE REMAINDER OF THE EVA. OTHERWISE, EXPEDITE THE EVA BY DELETING TASKS NOT REQUIRED FOR PRIMARY MISSION OBJECTIVES.

The high dose rate limits are daily exposure limits that meet the bounding assumptions used as a basis for the U.S. legal limits and, therefore, require replanning using similar options described in paragraph B. This replanning will ensure the predicted exposure is below the high dose rate limit and that the crewmember's mission exposure is below the legal exposure limit, if possible, or as low as practical above the admin limit if exposure history is currently in the restricted range, to preclude additional replanning.

The risk of this level of radiation warrants ending the EVA early. Since some risk has already been incurred by going EVA, an EVA in progress will be expedited by completing only the tasks required for minimum mission success. Remaining tasks will be replanned for a subsequent EVA. @[032901-7280B]

- D. PREDICTED CREW EXPOSURE GREATER THAN THE LEGAL EXPOSURE LIMITS (REF. RULE {A14-10}, LEGAL EXPOSURE LIMITS [HC]): @[032901-7280B]
1. A PLANNED EVA SHALL BE RESCHEDULED AS REQUIRED TO REDUCE THE CREWMEMBER'S MISSION EXPOSURE TO BELOW THE LEGAL EXPOSURE LIMIT.
 2. AN EVA IN PROGRESS SHALL BE TERMINATED.

The short-term and long-term health risks incurred with exposures above the legal exposure limits require replanning the EVA to reduce the radiation exposure, despite any long-term planning impacts that result. Replanning will be done in a manner that ensures the predicted EVA exposure is as low as possible to preclude additional replanning.

The risk of this level of radiation warrants terminating an EVA in progress as early as safely possible. Only tasks required for crew and vehicle safety will be performed.

Reference Rule {B14-106}, GO/NO-GO CRITERIA FOR EVA BASED ON RADIATION EXPOSURE [HC] [RC] [E]. @[032901-7280B] @[ED]

FLIGHT RULES

A14-55

DOWNGRADING TO NOMINAL FROM ALERT OR CONTINGENCY

A. AN ALERT IS CANCELED WHEN: @[042601-7281A]

1. SPE WARNING: THE TIME PROJECTED BY NOAA HAS EXPIRED.
2. SPE: FLUX LEVELS HAVE BEEN REDUCED BELOW EVENT THRESHOLD CRITERIA FOR THREE CONSECUTIVE READINGS AND SHOW A CLEAR TREND DOWN. SUBSEQUENT MINOR FLUCTUATIONS WILL NOT CONSTITUTE A NEW ALERT UNLESS LEVELS INCREASE OVER DEFINED SPE THRESHOLDS FOR THREE CONSECUTIVE READINGS (REF. RULE {A14-4}, SOLAR PARTICLE EVENT DEFINITION).
@[ED]
3. GEOMAGNETIC STORM: GEOMAGNETIC K_B OR A_B LEVELS ARE REDUCED BELOW EVENT THRESHOLD LEVELS (REF. RULE {A14-5}, GEOMAGNETIC STORM DEFINITION).
4. OTHER RADIATION EVENT: REGRESSION TO NOMINAL ENVIRONMENTAL CONDITIONS IS AT THE DISCRETION OF THE RADIATION CONSOLE OPERATOR (REF. RULE {A14-6}, OTHER RADIATION EVENT DEFINITION).
5. UNCONFIRMED ARTIFICIAL EVENT: WILL BE EVALUATED ON A CASE BY CASE BASIS FOR DOWNGRADING (REF. RULE {A14-1}, UNCONFIRMED ARTIFICIAL EVENT DEFINITION).
@[042601-7281A]

THIS RULE CONTINUED ON NEXT PAGE

FLIGHT RULES

A14-55

**DOWNGRADING TO NOMINAL FROM ALERT OR CONTINGENCY
(CONTINUED)**

- B. A CONTINGENCY IS DOWNGRADED TO NOMINAL WHEN: @[042601-7281A]
1. SPE: FLUX LEVELS HAVE BEEN REDUCED BELOW EVENT THRESHOLD CRITERIA FOR THREE CONSECUTIVE READINGS AND SHOW A CLEAR TREND DOWN. SUBSEQUENT MINOR FLUCTUATIONS WILL NOT CONSTITUTE A NEW ALERT UNLESS LEVELS INCREASE OVER DEFINED SPE THRESHOLDS FOR THREE CONSECUTIVE READINGS (REF. RULE {A14-4}, SOLAR PARTICLE EVENT DEFINITION).
@[ED]
 2. GEOMAGNETIC STORM (FOR EVA CONSIDERATION): GEOMAGNETIC K_B OR A_B LEVELS ARE REDUCED BELOW EVENT THRESHOLD LEVELS AND TRAPPED ELECTRONS ARE NOT AT ELEVATED LEVELS (REF. RULE {A14-5}, GEOMAGNETIC STORM DEFINITION).
 3. OTHER RADIATION EVENT: REGRESSION TO NOMINAL ENVIRONMENTAL CONDITIONS IS AT THE DISCRETION OF THE RADIATION CONSOLE OPERATOR (REF. RULE {A14-6}, OTHER RADIATION EVENT DEFINITION).
 4. CONFIRMED ARTIFICIAL EVENT: WILL BE EVALUATED ON A CASE BY CASE BASIS FOR DOWNGRADING (REF. RULE {A14-2}, CONFIRMED ARTIFICIAL EVENT DEFINITION).

An alert indicates a change in the environment that threatens to increase crew exposures. This rule provides guidelines when conditions are no longer indicative of escalating environmental conditions (SPE/Geomagnetic Storm/Artificial Event) or an assessment of re-planning (belt enhancement). Likewise, contingency conditions will also be downgraded. During big events, downgrading may only be temporary due to re-initiation of activity of events.

Reference Rule {B14-109}, DOWNGRADING TO NOMINAL FROM ALERT OR CONTINGENCY [RC] [E]. @[032901-7265] @[042601-7281A] @[ED]

A14-56 THROUGH A14-100 RULES ARE RESERVED

FLIGHT RULES

SPACE ENVIRONMENT GO/NO-GO CRITERIA

A14-1001

SPACE ENVIRONMENT GO/NO-GO CRITERIA [HC] ©[032901-7270B]

RADIATION CONDITION	FLIGHT PHASE		
	PRELAUNCH	ORBIT	EVA
UNCONFIRMED ARTIFICIAL EVENT	[1]	[1]	[1]
CONFIRMED ARTIFICIAL EVENT	[2] [4] [5]	[4] [5]	[3] [4] [5]
SOLAR PARTICLE EVENT WARNING	[1]	[1]	[1]
SOLAR PARTICLE EVENT	[4]	[4]	[4]
GEOMAGNETIC STORM	[1] [4]	[1] [4]	[1] [4]
OTHER RADIATION EVENT	[4]	[4]	[4]
PROJECTED OPERATIONAL DOSE LIMIT VIOLATION	[2] [4] [5]	[5]	[3] [5]

©[032901-7270B]

- NOTES:
- [1] PURSUE CONFIRMATION FROM ALL DATA SOURCES.
 - [2] HOLD LAUNCH IF PRIOR TO L-31 SECONDS.
 - [3] EVA CREW TO AIRLOCK (MAY REQUIRE RISK VERSUS GAIN ASSESSMENT). (TEMPORARY ACTION. GO/NO-GO FOR CONTINUATION OF EVA DETERMINED THROUGH IMPLEMENTATION OF NOTES 4 AND 5, IF NECESSARY.)
 - [4] PURSUE MAXIMUM DATA RECOVERY FROM STS RADIATION SUPPORT DATA SOURCES AND/OR SPACECRAFT DOSIMETRY FOR RISK ASSESSMENT. (ONBOARD DOSIMETRY READOUT WILL BE REQUESTED IF PROJECTED EXPOSURES REACH LEVELS OF CONCERN OR IF DATA ASSESSMENT INDICATES HIGH EXPOSURES HAVE BEEN RECEIVED. RESULTS OF DATA ASSESSMENT WILL DETERMINE THE NECESSITY FOR NOTE 5 IMPLEMENTATION.)
 - [5] CONSIDER MISSION CHANGE TO LOWER DOSE WITHOUT INCREASING TOTAL RISK TO CREW. NASA MANAGEMENT RISK VERSUS GAIN DECISION REQUIRED. (CONSIDERATIONS ARE RADIATION SOURCE AND EXPOSURE LEVEL DEPENDENT, AND INCLUDE: LOWERING ALTITUDE, CHANGING ORBITER ATTITUDE, RESTRICTING CREW LOCATION, EVA CREW TO AIRLOCK AT SPECIFIED TIMES, TERMINATE EVA, DEORBIT AT A SPECIFIED PLS, DEORBIT NEXT PLS, DEORBIT NEXT DAY PLS, ETC.)

The criteria table provides a logical sequence for operational decisions to maximize crew safety: (1) identifies the radiation source, (2) confirms the enhanced radiation condition, (3) projects the anticipated exposure level, and (4) provides information pertinent to risk versus gain assessment.

Rule {B14-106}, GO/NO-GO CRITERIA FOR EVA BASED ON RADIATION EXPOSURE [HC] [RC] [E], references this rule. ©[ED]

FLIGHT RULES

THIS PAGE INTENTIONALLY BLANK

FLIGHT RULES

SECTION 15 - EXTRAVEHICULAR ACTIVITY (EVA)

GENERAL

A15-1	EVA TIME DEFINITION.....	15-1
A15-2	TERMINATE EVA DEFINITION.....	15-1
A15-3	ABORT EVA DEFINITION.....	15-2
A15-4	SCHEDULED EVA DEFINITION.....	15-2
A15-5	UNSCHEDULED EVA DEFINITION.....	15-2
A15-6	CONTINGENCY EVA DEFINITION.....	15-2
A15-7	MINIMUM RF COMMUNICATIONS DEFINITION.....	15-2
A15-8	OPERATIONAL CAUTION AND WARNING SYSTEM (CWS) DEFINITION.....	15-3
A15-9	TWO/ONE-CREWMEMBER EVA GUIDELINES.....	15-3
A15-10	EVA CREWMEMBER(S) SUPPORT.....	15-3
A15-11	SAFETY TETHER REQUIREMENTS.....	15-4
A15-12	RESERVED.....	15-4
A15-13	AIRLOCK CONFIGURATION.....	15-4
A15-14	SCHEDULED AND UNSCHEDULED EVA CONSTRAINTS.....	15-5
A15-15	CONTINGENCY EVA PROTECTION.....	15-6
A15-16	EVA TERMINATION FOR CABIN LEAK.....	15-6
A15-17	PAYLOAD BAY CONFIGURATION POST-EVA.....	15-6
A15-18	PAYLOAD OPERATION/DEPLOY GUIDELINE.....	15-7
A15-19	UNSCHEDULED EVA PREPARATION.....	15-7
A15-20	ECG TELEMETRY CHECKOUT.....	15-7
A15-21	LEAKING RCS THRUSTER/APU AVOIDANCE.....	15-8
A15-22	RCS/APU THRUSTER PLUME AVOIDANCE.....	15-8
A15-23	EV CREW IN VICINITY OF ACTIVE PAYLOAD RETENTION LATCH ASSEMBLIES.....	15-8
A15-24	EVA OPERATIONS IN THE GENERIC PAYLOAD BAY ENVELOPE.....	15-9
A15-25	ORBITER EVA OPERATIONS NEAR S-BAND ANTENNAS..	15-10

FLIGHT RULES

A15-26	KEEPOUT ZONE FOR EVA OPERATIONS NEAR THE ORBITER UHF PAYLOAD BAY ANTENNA.....	15-11
A15-27	GO/NO-GO FOR SAFER TPS INSPECTION.....	15-12
A15-28	KEEP-OUT ZONE FOR EVA OPERATIONS NEAR THE LDRI OR LCS [HC].....	15-18
	FIGURE A15-28-I - LCS NOMINAL AND MAX FOV ILLUSTRATION	15-18b
A15-29	THROUGH A15-100 RULES ARE RESERVED.....	15-18b

LOSS/FAILURE DEFINITIONS

A15-101	EVA CAPABILITY.....	15-19
A15-102	EMU GO/NO-GO CRITERIA.....	15-19
A15-103	THROUGH A15-150 RULES ARE RESERVED.....	15-29

SYSTEMS MANAGEMENT

A15-151	DENITROGENATION.....	15-30
A15-152	RESERVED.....	15-30
A15-153	RESERVED.....	15-30
A15-154	RESERVED.....	15-30
A15-155	MANIPULATOR FOOT RESTRAINT (MFR) AND PFR ATTACHMENT DEVICE (PAD) GUIDELINES.....	15-30
A15-156	RESERVED.....	15-30
A15-157	EMU CONSUMABLES FOR SHUTTLE.....	15-31
A15-158	THROUGH A15-200 RULES ARE RESERVED.....	15-34b

EXTERNAL AIRLOCK

A15-201	EXTERNAL AIRLOCK HATCH THERMAL COVER.....	15-35
A15-202	EXTERNAL AIRLOCK LCG PRESSURE AND TEMPERATURE MANAGEMENT USING THE EMU.....	15-36
A15-203	CABIN ATMOSPHERE DECONTAMINATION FOLLOWING EVA.....	15-38
A15-204	EXTERNAL AIRLOCK EMU SERVICING CONSTRAINTS...	15-42
A15-205	EMU DECONTAMINATION DURING EVA.....	15-45

FLIGHT RULES

SECTION 15 - EXTRAVEHICULAR ACTIVITY (EVA)

GENERAL

A15-1 **EVA TIME DEFINITION**

A. EMU TIME

EMU TIME STARTS WHEN THE EMU IS SWITCHED TO INTERNAL POWER, ENDS WHEN THE EMU IS SWITCHED TO ORBITER POWER.

EMU time represents the time that the EMU is operating on internal power. The EMU primary life support subsystem (PLSS) provides consumables for a duration of 7 hours. In order to provide a 30-minute reserve of primary consumables, EVA operations should be scheduled to be completed within a phase elapse time (PET) of 6 hours 30 minutes. This time includes all overhead activities (such as airlock egress/ingress and payload bay setup/cleanup) in addition to the EVA task itself.

B. EVA PHASE ELAPSE TIME

EVA PET STARTS WHEN THE EMU IS SWITCHED TO INTERNAL POWER, ENDS WHEN AIRLOCK REPRESSURIZATION IS INITIATED.

EVA PET represents the time that the EMU is exposed to vacuum. Some EVA scenarios require the EVA crew to return to the airlock and wait for some other operation to be completed (e.g., a payload deployment) before resuming EVA tasks or before initiating airlock repressurization. Since the EMU is operating on orbiter power during this time, EVA PET may be significantly longer than EMU time. EVA PET will be used when tabulating historical mission data.

A15-2 **TERMINATE EVA DEFINITION**

TERMINATE EVA MEANS TO CEASE EVA ACTIVITIES, CLOSE OUT PAYLOAD BAY, TRANSFER TO ORBITER AIRLOCK, INGRESS, AND REPRESSURIZE AIRLOCK.

NOTE: IF EMU PROBLEM CAN BE STABILIZED/CORRECTED BY USING SERVICE AND COOLING UMBILICAL (SCU), CREWMEMBER WITH PROBLEM MAY REMAIN ON SCU AT VACUUM FOR POSSIBLE RESCUE/ASSIST, WHILE OTHER CREWMEMBER COMPLETES EVA.

FLIGHT RULES

A15-3 **ABORT EVA DEFINITION**

ABORT EVA MEANS TO IMMEDIATELY TRANSFER TO ORBITER AIRLOCK, INGRESS, AND REPRESSURIZE AIRLOCK.

A15-4 **SCHEDULED EVA DEFINITION**

A SCHEDULED EVA IS DEFINED AS ANY EVA INCORPORATED INTO THE NOMINAL FLIGHT PLAN. @[041896-1868]

A15-5 **UNSCHEDULED EVA DEFINITION**

AN UNSCHEDULED EVA IS USED TO ACHIEVE/ENHANCE THE MISSION OBJECTIVES OF THE ORBITER OR ITS PAYLOADS. IT IS NOT PART OF THE FLIGHT PLAN. @[041896-1869]

A15-6 **CONTINGENCY EVA DEFINITION**

A CONTINGENCY EVA IS DEFINED AS AN EVA REQUIRED TO EFFECT THE SAFE RETURN OF THE CREW AND THE ORBITER.

A15-7 **MINIMUM RF COMMUNICATIONS DEFINITION**

IN ORDER TO COMMIT TO OR CONTINUE A SCHEDULED OR UNSCHEDULED EVA, EACH EVA CREWMEMBER MUST HAVE TWO-WAY COMMUNICATIONS WITH THE ORBITER, EITHER DIRECTLY OR VIA THE OTHER EVA CREWMEMBER (REF. RULE {A11-6}, MINIMUM COMMUNICATIONS REQUIREMENTS FOR SCHEDULED EVA). @[ED]

Rules {A15-102E}, EMU GO/NO-GO CRITERIA; and {A15-155}, MANIPULATOR FOOT RESTRAINT (MFR) AND PFR ATTACHMENT DEVICE (PAD) GUIDELINES, reference this rule. @[090894-1669A]
@[ED]

FLIGHT RULES

A15-8 **OPERATIONAL CAUTION AND WARNING SYSTEM (CWS) DEFINITION**

THE EMU CWS IS DETERMINED TO BE OPERATIONAL IF EITHER OF THE FOLLOWING TWO CONDITIONS ARE SATISFIED: ©[090894-1668]

- A. THE ABILITY TO MONITOR THE OPERATIONAL INTEGRITY OF THE EMU (AT LEAST STATUS LIST) BY THE EVA CREW
- B. THE ABILITY FOR MCC TO MONITOR THE EMU STATUS WITH THE EVA CREW MONITORING CWS ALERT TONES AND THE DISPLAYS AND CONTROL MODULE (DCM) SUIT PRESSURE GAUGE

The EMU CWS is operational if the EVA crew can monitor at least the DCM status list to determine EMU failures. If the crew cannot monitor the DCM status list, then MCC will have to monitor EMU status while the EVA crew monitors the CWS alert tones and the DCM suit pressure gauge. If a CWS alert tone was to occur with a non-functional DCM display, the EVA crew would check the suit pressure gauge and check with MCC to determine the type of failure and action.

Reference Rule {A15-102K}.2, EMU GO/NO-GO CRITERIA. ©[090894-1668] ©[ED]

A15-9 **TWO/ONE-CREWMEMBER EVA GUIDELINES**

REFERENCE RULE {A2-107}, EVA GUIDELINES.

A15-10 **EVA CREWMEMBER(S) SUPPORT**

AT ALL TIMES DURING EVA, AT LEAST ONE INTRAVEHICULAR (IV) CREWMEMBER WILL BE DEDICATED TO SUPPORTING THE EVA CREWMEMBERS. ©[021199-6747B]

IV crewmember is responsible for recording EMU status, monitoring the timeline, and providing orbiter support.

FLIGHT RULES

A15-11 **SAFETY TETHER REQUIREMENTS**

- A. AT ALL TIMES DURING EVA, EXCEPT WHEN INSIDE A CLOSED AIRLOCK, EACH EVA CREWMEMBER WILL BE ATTACHED TO THE ORBITER VIA A SAFETY TETHER. FLIGHT-SPECIFIC EXCEPTIONS TO TETHERING TO THE ORBITER WILL BE IDENTIFIED IN THE FLIGHT-SPECIFIC ANNEX. ©[021199-6747B]

Prevent loss of crewmember and resulting rescue scenarios. For some missions, it may be desirable for the crewmember to be attached (to a certified tether point) to the payload secured in the payload bay rather than the orbiter.

- B. EVA TOOLS WILL BE TETHERED TO THE CREWMEMBER AT ALL TIMES DURING THEIR USE.

Prevents loss of tools. Free-floating tools could impact orbiter causing orbiter damage.

A15-12 **RESERVED** ©[102506-7818]

A15-13 **AIRLOCK CONFIGURATION**

AN EVA CREWMEMBER SHALL NOT BE LOCKED OUT OF A PRESSURIZED AIRLOCK EXCEPT IN THE CASE OF AN "ABORT EVA" WHERE THE EV CREWMEMBERS ARE SIGNIFICANTLY SEPARATED AND REPRESSURIZATION TIME IS CRITICAL. ©[021199-6747B]

In the case of a serious EMU failure (i.e., loss of suit pressure), the EV crewmember must have immediate access to the airlock. This includes an abort scenario where the other EV crewmember is significantly separated from the airlock. In this case, the separated crewmember still has the capability to depressurize the airlock for ingress via the outer hatch equalization valves. ©[021199-6747B]

FLIGHT RULES

A15-14

SCHEDULED AND UNSCHEDULED EVA CONSTRAINTS

A. NO SCHEDULED EVA WILL BE PERFORMED PRIOR TO MET 72 HOURS.

During adaptation to zero-g conditions, moving about may provoke symptoms of illness. The activity associated with putting on a suit would increase the chance of an EVA crewmember being ill and potentially endanger the crewmember with vomitus in the suit.

B. UNSCHEDULED EVA'S :

1. NO UNSCHEDULED EVA SHALL OCCUR DURING THE FIRST 24 HOURS OF FLIGHT.
2. AN UNSCHEDULED EVA MAY BE PERFORMED PRIOR TO MET 72 HOURS ONLY IF AN ASSESSMENT OF CREW HEALTH HAS BEEN ACCOMPLISHED BY THE FCR SURGEON AND APPROVED BY THE FLIGHT DIRECTOR.

Asymptomatic crewmembers may be able to safely perform an unscheduled EVA before MET 72 hours. An accurate assessment of the health status of the EVA crew can be made by the FCR surgeon during a private medical conference.

C. NO SCHEDULED OR UNSCHEDULED EVA SHALL BE PERFORMED ON ENTRY DAY.

1. FOR A FLIGHT USING A SINGLE CREW SHIFT, A SCHEDULED OR UNSCHEDULED EVA MAY BE PERFORMED ON THE DAY BEFORE ENTRY ONLY IF AIRLOCK INGRESS IS COMPLETED NOT LATER THAN CREW SLEEP MINUS 7 HOURS.
2. FOR A FLIGHT USING DUAL SHIFT OPERATIONS, A SCHEDULED OR UNSCHEDULED EVA MAY BE PERFORMED ON THE DAY BEFORE ENTRY ONLY IF AIRLOCK INGRESS IS COMPLETED NOT LATER THAN CREW SLEEP (NONENTRY TEAM) MINUS 4.5 HOURS.

An EVA may be done on the day before entry if there is adequate time post-EVA to perform required activities. These activities include airlock repress, post-EVA, EMU maintenance recharge, post-EVA entry prep, cabin stow, and presleep. Seven hours is considered the minimum amount of time to accomplish these activities for a single shift flight. FCS C/O, RCS hot fire, and cabin repress activities must also be performed but can be overlapped with post-EVA and cabin stow activities. For an unscheduled EVA on the day before entry, it will be necessary to perform this EVA as a "quick response" EVA (i.e., the EMU C/O and cabin depress will need to be done on the day prior to the EVA). For a dual shift flight, 4.5 hours is considered the minimum due to cabin stow occurring on entry day for the nonentry team.

Rule {A13-101}, SCHEDULED AND UNSCHEDULED EVA CONSTRAINTS [HC], references this rule.

®[ED]

FLIGHT RULES

A15-15 **CONTINGENCY EVA PROTECTION**

A SCHEDULED OR UNSCHEDULED EVA WILL NOT BE CONDUCTED IF IT JEOPARDIZES FUTURE CONTINGENCY EVA CAPABILITY (E.G., INSUFFICIENT CONSUMABLES FOR RECHARGE) .

Must always preserve the capability to perform a contingency EVA to bring the orbiter home safely. Reference Rule {A2-107A}, EVA GUIDELINES.

A15-16 **EVA TERMINATION FOR CABIN LEAK**

A SCHEDULED OR UNSCHEDULED EVA WILL BE TERMINATED FOR A CABIN LEAK WHICH CAUSES LOSS OF HIGHER PRIORITY FLIGHT OBJECTIVES OR COMPROMISES SAFE ENTRY .

This rule assumes that the leak is in the inner hatch and became evident after the start of the EVA.

A15-17 **PAYLOAD BAY CONFIGURATION POST-EVA**

AT THE END OF AN EVA, THE PAYLOAD BAY WILL BE LEFT IN A CONFIGURATION WHICH DOES NOT REQUIRE A SUBSEQUENT EVA FOR DEORBIT. EXCEPTIONS :

- A. ABORT THE EVA .
- B. A SPECIFIC PAYLOAD HAS THE CAPABILITY TO BE JETTISONED OR STOWED BY REMOTE ACTION .

It can never be assumed that there will be the time or consumables available for a subsequent EVA to clean up the payload bay:

- a. The first exception is the case when an EVA must be aborted because an EV crewmember's life might be in jeopardy. In that case, repressurization of the airlock is the immediate priority.*
- b. The second exception is allowed since the payload in question has the capability to be jettisoned or stowed remotely (e.g., cabin switch or ground command) if a subsequent orbiter condition would preclude a second EVA for entry safing.*

FLIGHT RULES

A15-18 **PAYLOAD OPERATION/DEPLOY GUIDELINE**

PAYLOADS OPERATIONS THAT REQUIRE AN UNSCHEDULED EVA AS A THIRD LEVEL OF REDUNDANCY MAY OPERATE PRIOR TO 48 HOURS ASSUMING THE UNSCHEDULED EVA CAN BE DELAYED UNTIL AFTER 48 HOURS. PREFLIGHT-IDENTIFIED EXCEPTIONS WILL BE DOCUMENTED IN THE FLIGHT SPECIFIC FLIGHT RULES, SECTION 2.

Due to the possibility that the crew may be disabled by SAS, payload operations which would require a quick mandatory response EVA should not be started prior to 48 hours. Unscheduled EVA's will be defined preflight as to the nature of the response time required. Certain payloads may require an unscheduled EVA earlier than 48 hours. These payloads will have processed exemptions to the generic EVA rules and each will have a rule in the Flight Specific Annex to govern the conduct of unscheduled EVA.

Rule (A13-101), SCHEDULED AND UNSCHEDULED EVA CONSTRAINTS [HC], references this rule.
@[ED]

A15-19 **UNSCHEDULED EVA PREPARATION**

IF A FAILURE HAS OCCURRED IN A PAYLOAD THAT WOULD PLACE CONTINUED OPERATION/DEPLOYMENT ONE FAILURE AWAY FROM AN UNSCHEDULED EVA, THE FLIGHT DIRECTOR MAY DELAY PAYLOAD OPERATIONS UNTIL EMU CHECKOUT AND THE 10.2 EVA PREBREATHE PROTOCOL ARE COMPLETED TO SET UP FOR THE POTENTIAL UNSCHEDULED EVA. CASES IDENTIFIED PREFLIGHT WILL BE DOCUMENTED IN THE FLIGHT SPECIFIC FLIGHT RULES, SECTION 2.

Based on the nature of the payload failure and the current condition of orbiter systems, it may be appropriate to delay payload operations or a deployment until preparations can be completed to accomplish an unscheduled EVA. Certain payload operations are allowed to continue even though we may be one failure away from an EVA. This is due to: (1) confidence in the remaining system, (2) the payload may be jettisonable, (3) there is already a scheduled EVA available, or (4) continuing to deploy is safer than waiting (e.g., TDRS).

A15-20 **ECG TELEMETRY CHECKOUT**

IF POSSIBLE, ECG TELEMETRY SIGNAL QUALITY WILL BE CHECKED PRIOR TO EVA.

The rule allows for troubleshooting of hardware or adjusting of sensors prior to EVA if no signal is received. Biomed is not a requirement for any EVA.

Rule {A15-102N}, EMU GO/NO-GO CRITERIA, references this rule. @[090894-1669A] @[ED]

FLIGHT RULES

A15-21 **LEAKING RCS THRUSTER/APU AVOIDANCE**

AN EVA CAN BE PERFORMED DURING A KNOWN RCS JET OR APU LEAK. THE EVA CREWMEMBER WILL AVOID THE IMMEDIATE VICINITY OF THE LEAKING JET OR APU.

For RCS or APU leaks, the propellant tends to sublime very quickly and is not considered to be a threat to the crewmember as long as he stays out of the vicinity. The propellant has no effect on the EMU in small quantities.

A15-22 **RCS/APU THRUSTER PLUME AVOIDANCE**

AN EVA CREWMEMBER SHALL NOT BE POSITIONED WITHIN THE FOLLOWING DISTANCES OF AN RCS THRUSTER WITH DRIVER POWER ON OR THE EXHAUST PORT OF AN OPERATING APU (ALONG PRIMARY AXIS) . ©[021199-6747B]

PRCS - 27 FEET

VRCS - 3 FEET

APU - 3 FEET

These distances are conservative estimates based on the thermal effects of the jets on the EMU, particularly the visor, which is most sensitive to thermal extremes. These numbers were generated from analytical tests which modeled the heat flux from the respective jets and the thermal characteristics of the visor. Crew injury/EMU damage may result from hydrazine brought into the cabin after being picked up from an operating APU. Rule {A6-151A}, RCS JET DRIVER MANAGEMENT [CIL], requires primary RJD's to be powered off while the crew is outside the payload bay envelope. The EVA checklist "CONTINGENCY DAP/JET CONFIG" directs the crew as to which jets to inhibit or power off based on EVA crew location.

A15-23 **EV CREW IN VICINITY OF ACTIVE PAYLOAD RETENTION LATCH ASSEMBLIES**

WHEN PAYLOAD RETENTION LATCH ASSEMBLIES MUST BE OPERATED AND EV CREWMEMBERS MAY BE WITHIN REACH, THEN THE EV CREW SHALL STAY CLEAR OF THE LATCHES AT THE TIME OF ACTUATION AND THE EV CREWMEMBERS SHALL GIVE THE GO FOR LATCH OPERATION.

Latch actuation without regard for EVA crewmembers constitutes a potential pinch hazard. The path traced by the motion of a latch is sufficiently localized for EV crewmembers to avoid when they are warned and properly positioned during the actuation.

FLIGHT RULES

A15-24

EVA OPERATIONS IN THE GENERIC PAYLOAD BAY ENVELOPE

EVA OPERATIONS MAY BE CONDUCTED IN ANY REGION OF THE GENERIC PAYLOAD BAY ENVELOPE. THE GENERIC PAYLOAD BAY ENVELOPE IS DEFINED AS THOSE REGIONS OF THE PAYLOAD BAY ACCESSIBLE TO THE UNAIDED EVA CREWMEMBER (E.G., NOT ATTACHED TO THE RMS, ETC.) WITH THE FOLLOWING EXCEPTIONS: ©[021199-6747B]

- A. FOR $X_0 = 576$ TO $X_0 = 596$, THE CREWMEMBER MUST REMAIN BELOW THE LEVEL OF THE PAYLOAD BAY DOOR MOLD LINE.
- B. FOR $X_0 = 576$ TO $X_0 = 815$, THE CREWMEMBER MUST REMAIN ON THE INBOARD SIDE OF THE STARBOARD EVA SLIDEWIRE.

THIS AREA WILL BE PROTECTED FROM S-BAND PER RULE {A11-8}, ORBITER S-BAND OPERATIONS DURING EVA, AND KU-BAND PER RULE {A11-7}, KU-BAND OPERATIONS DURING EVA. ©[ED]

EVA operations for the unaided crewmember in the payload bay are constrained by potential RF radiation exposure from only two sources. Those sources are represented by the restrictions in paragraphs A and B.

S-band radiation from the orbiter S-band PM antennas creates the restriction in paragraph A. This limit means that the crewmember must stay below the mold line for the first 20 inches aft of the 576 bulkhead. This requirement is based upon the need to remain 1 meter away from all S-band antennas.

Paragraph B is created by the need to maintain a reasonable level of Ku-band communications while not overly restricting EVA mobility. This limit implies that the crewmember must stay on the inboard side of the starboard slidewire for the first 20 feet of its length. This limitation will allow the use of a 0-degree Beta mask and a Beta-only operating mode for the Ku-band system. It should be understood that this rule does not require the use of any specific Beta mask, only that the volume was designed with Beta = 0 degree as an acceptable value. This requirement is based on the need to prevent Ku-band exposures for the EVA crewmember from exceeding the 20 V/M certification limit for the EMU at Ku-band. If there are no planned EVA operations outboard of the starboard slidewire, then the normal Ku-band operating mode of Beta + mask with Beta = 21 degrees may be used. ©[ED]

FLIGHT RULES

A15-25

ORBITER EVA OPERATIONS NEAR S-BAND ANTENNAS

EVA OPERATIONS MAY NOT BE CONDUCTED WITHIN 1 METER OF ANY ORBITER S-BAND ANTENNA UNLESS STEPS HAVE BEEN TAKEN TO PREVENT THAT ANTENNA FROM RADIATING.

An S-band dipole antenna's "near field" is generally considered to extend approximately 1 meter from the antenna in all directions. Within this near field, exact field intensities cannot be computed and as such could exceed the acceptable level for the EMU (120 V/M). If an antenna is totally inhibited (e.g., PI turned OFF or S-band FM forced to the lower antenna by crew switch), then the EVA crewmember is not at risk in approaching these antennas. Since an S-band PM antenna could begin radiating without warning, the crewmember must stay 1 meter away to ensure his/her safety

Reference Documentation: United Technology/Hamilton Standard Engineering Memorandum EMUM-604, April 30, 1992.

FLIGHT RULES

A15-26

KEEPOUT ZONE FOR EVA OPERATIONS NEAR THE ORBITER UHF PAYLOAD BAY ANTENNA

- A. WHEN THE SPACE-TO-SPACE ORBITER RADIO (SSOR) IS IN HIGH POWER MODE, THE EVA KEEPOUT ZONE IS 0.3 METER (1.0 FT) OVERHEAD AND FROM THE SIDE OF THE UHF PLB ANTENNA RADOME SURFACE. @[040899-6873A] @[121400-3856B]
- B. WHEN THE SSOR IS IN LOW POWER MODE, THE EVA KEEPOUT ZONE IS 0.1 METER (0.33 FT) OVERHEAD AND FROM SIDE OF THE UHF PLB ANTENNA RADOME SURFACE.

The SSOR and UHF PLB antenna are required for EVA communications with the crew, and the EV crew will nominally translate in close proximity to the UHF PLB antenna. During EVA, the SSOR nominally operates in low power mode (UHF PWR AMP off) and a smaller keepout zone precludes exposure of the EMU to excessive RF radiation (recommended exposure limit of 60 V/m rms which includes 6dB of safety margin). If the SSOR operates in high power mode (UHF PWR AMP on), the keepout zone increases. If the EV crew violates the keepout zone in low power mode, a potential exists to temporarily bias the EMU SOP transducer high and cause RF interference to the SSER (momentary ratty or broken comm). If the KOZ is violated in high power, potential exists to cause the EMU CWS to malfunction, trip EMU current limiters, damage the SSER, and exceed the physiological limit (102 V/m).

The SSOR operating frequency also affects the EMU. If the SSOR is in 414.2 MHz (nominal frequency) and inadvertently switches from low to high power mode while the crew maintains the low power keepout zone, sufficient margin still remains to protect the crewmember and EMU from harm. In 417.1 MHz, the EMU margin is still sufficient but is reduced, resulting in greater susceptibility to CWS and EMU current limiter malfunctions.

Provided that the crew maintains the specified keepout zones, the physiological limit (72 V/m) will not be exceeded. The analysis showed that no physiological impacts would be incurred when at the physiological limit (72 V/m). In low power mode, the physiological limits are reached at the radome top surface and at 0.0766 meter (3 inches) from the side. In high power, the limits are reached at 0.2 meter (9 inches) from the radome top surface and 0.19 meter (7.5 inches) from the side. These values are based on a 60 V/m output and are therefore conservative for an actual 72 V/m keepout zone.

The following telemetry will be used to determine whether the SSOR is in high or low power mode before the EV crew approaches the UHF PLB antenna: UHF POWER AMP (V74S2016E), SSOR POWER LEVEL (V74E2045A), and SSOR POWER STATUS (V74C2047A). @[121400-3856B]

THIS RULE CONTINUED ON NEXT PAGE

FLIGHT RULES

**A15-26 KEEPOUT ZONE FOR EVA OPERATIONS NEAR THE ORBITER
UHF PAYLOAD BAY ANTENNA (CONTINUED)**

DOCUMENTATION: Orbit Flight Techniques Panel #171, EVA Space-to-Space Communications UHF PLB Antenna Keep-Out Zones, NASA Extravehicular Mobility Unit (EMU) with ISS EMU Umbilical Electromagnetic Compatibility Certification Test Report for the International Space Station/Orbiter Requirements (Hamilton-Standard EMU 1-13-025), EMUM1-0463 STS-106, ISS Mission 2A2.B and STS-92, ISS Mission 3A, EVA Keep Out Recommendations For EMU w/SSEER Radio For U.S. and Russian Segment Antennas, NASA Report, EV4-00-039, April 2000, "ISS USOS and SSO Antenna RF Exposure Keep Out Zone Data Book," and IEEE Standards for Safety Levels with Respect to Human Exposure to Radio Frequency Electromagnetic Fields, 3 kHz to 300 GHz (IEEE C95.1-1991). @[121400-3856B]

A15-27 GO/NO-GO FOR SAFER TPS INSPECTION

A. SIMPLIFIED AID FOR EVA RESCUE (SAFER) WILL NOT BE USED FOR LARGE AREA, THERMAL PROTECTION SYSTEM (TPS) MAPPING WITH A HAND HELD OR OTHER MANUALLY OPERATED CAMERA. @[102506-7796]

Due to the mental workload during SAFER inspection flights, the crew must be able to focus on flight control while in motion. Any inspection activities should be reserved for periods of flight that have little relative motion with respect to the vehicle. This limits SAFER to point inspection only and precludes TPS mapping tasks.

Reference GFE Hazard Report US-SAFER-02, Impact/Collision with Structure During TPS Inspection.

B. SUFFICIENT SAFER CONSUMABLES MUST BE RESERVED FOR THE DIFFERENT PHASES OF A TPS INSPECTION FLIGHT. THE FOLLOWING TABLE DEFINES THE CONSUMABLE REDLINES FOR POWERON TIME, GN2, AND POWER:

	MAX POWERON TIME PER EVA (MINUTES) [11]	GN2% [7]	PWR% [10]
GO FOR SINGLE/SUBSEQUENT DAMAGE INSPECTION	23	45	38
TERMINATE INSPECTION	32	30	34
FLIGHT PLANNING	32 - N*9	30 + N*15	34 + N*4
SAFER UNUSABLE	45	0	28

N = NUMBER OF PLANNED INSPECTION SITES DURING FLIGHT @[102506-7796]

THIS RULE CONTINUED ON NEXT PAGE

FLIGHT RULES

A15-27

GO/NO-GO FOR SAFER TPS INSPECTION (CONTINUED)

- C. A SINGLE SAFER UNIT CAN BE USED ON MULTIPLE INSPECTION FLIGHTS DURING THE SAME EVA. TOTAL ALLOWABLE HAND CONTROLLER MODULE (HCM) DEPLOYED TIME IS 1:15 (POWERED OR UNPOWERED). THEREFORE, THE HCM MUST BE POWERED OFF AND STOWED IN THE PROPULSION MODULE, WHILE NOT IN USE, TO PREVENT THERMAL DAMAGE. @[102506-7796]

During TPS inspection EVA's, it may be desirable to relocate the arm closer to specific damage sites between SAFER flights. See GO/NO-GO matrix for details of power-on time limitations.

- D. A SAFER CHECKOUT MUST BE PERFORMED WITHIN 24 HOURS OF THE INSPECTION EVA. IN ADDITION, A SAFER SELF-TEST MUST BE PERFORMED AT VACUUM IMMEDIATELY PRIOR TO INITIATION OF THE INSPECTION FLIGHT. THE FOLLOWING MATRIX AND NOTES DISCUSS THE CRITERIA THAT DETERMINE THE GO/NO-GO TO BEGIN A SAFER TPS INSPECTION FLIGHT. IF ANY OF THESE NO-GO CONDITIONS OCCUR DURING THE SAFER FLIGHT, THE CREW MUST TERMINATE THE INSPECTION AND RETURN TO STRUCTURE. @[102506-7796]

THIS RULE CONTINUED ON NEXT PAGE

FLIGHT RULES

A15-27

GO/NO-GO FOR SAFER TPS INSPECTION (CONTINUED)

FOR LOSS OF:	EVA STATUS
THRUSTERS:	
ANY NUMBER FAILED ON [1]	NO-GO
SINGLE FAILED OFF [2]	-
MULTIPLE FAILED OFF [3]	NO-GO
AAH:	
SINGLE AXIS [4]	NO-GO
RATE SENSOR DATA [5]	NO-GO
PROPULSION:	
PROPULSION SYSTEM PRESSURE INTEGRITY [6]	NO-GO
MINIMUM TANK GN2 PERCENT [7]	NO-GO
PYRO VALVE CONTROL (NSI) [8]	NO-GO
PYRO VALVE UNINTENTIONAL FIRE DURING IV CHECKOUT [8]	GO
POWER:	
MINIMUM BATTERY VOLTAGE DURING IV CHECKOUT [9]	NO-GO
MINIMUM PWR PERCENT [10]	NO-GO
ALLOWABLE POWER ON TIME [11]	NO-GO
PREVIOUS EVA BATTERY USAGE [12]	NO-GO
CONTROLS:	
ANY ROTATIONAL OR TRANSLATIONAL HAND CONTROLLER AXIS [13]	NO-GO
MODE SWITCH (TRANS MODE) [14]	NO-GO
MODE SWITCH (ROT MODE) [15]	NO-GO
STATUS SWITCH [16]	NO-GO
MANUAL ISOLATION VALVE OPEN [17]	NO-GO
MANUAL ISOLATION VALVE CLOSED [18]	NO-GO
INSTRUMENTATION:	
TANK PRESSURE XDUCER [19]	NO-GO
TANK TEMPERATURE XDUCER [19]	NO-GO
BATTERY CAPACITY GAUGE [20]	NO-GO
HCM DISPLAY [21]	NO-GO
THRUSTER LED [22]	GO
AAH LED [22]	GO
OTHER:	
1 YEAR ON-ORBIT LIFE [23]	NO-GO
DIGITAL EVA CAMERA [24]	NO-GO
BRT/MUT [25]	NO-GO
SAFER HARD MOUNT [25]	NO-GO
ORBIT DAY FOR DURATION OF PLANNED INSPECTION [26]	NO-GO
2ND DEDICATED EV CREW FOR GCA AND TETHER MANAGEMENT [27]	NO-GO
DIRECT SAFER TO IV COMMUNICATION [28]	GO

@[102506-7796]

GO = GO FOR TPS INSPECTION FLIGHT

NO-GO = NO-GO FOR TPS INSPECTION @[102506-7796]

THIS RULE CONTINUED ON NEXT PAGE

FLIGHT RULES**A15-27****GO/NO-GO FOR SAFER TPS INSPECTION (CONTINUED)**

NOTES: @[102506-7796]

- [1] SAFER IS NO-GO FOR INSPECTION FOR ANY NUMBER OF FAILED-ON THRUSTERS. A FAILED-ON THRUSTER CAUSES UNCOMMANDED MOTION AND RAPIDLY DEPLETES SAFER GN₂. FOR A SINGLE FAILED ON THRUSTER, A FULL GN₂ TANK WOULD BE DEPLETED IN ABOUT 240 SECONDS.
- [2] ALL SAFER TRANSLATION/ROTATION COMMANDS ARE STILL AVAILABLE WITH ONLY A SINGLE FAILED-OFF THRUSTER. THE SAFER IS GO IF THE INSPECTION ONLY INVOLVES PHOTOGRAPHY FROM A MINIMUM DISTANCE OF 5 FEET. AN ALTERNATE SAFER OR ROBOTIC BASED INSPECTION SHOULD BE USED IF AVAILABLE. SOME MINOR CROSS-COUPPLING WILL OCCUR IN THE COMMANDS THAT UTILIZE THE FAILED THRUSTER. SIMULATIONS HAVE SHOWN THAT THIS EFFECT DOES NOT SERIOUSLY HINDER SAFER MANEUVERABILITY, BUT MAY SLIGHTLY INCREASE PROPELLANT USAGE.
- [3] MULTIPLE FAILED-OFF THRUSTERS DEGRADE SAFER PERFORMANCE AND HINDER THE ABILITY FOR PRECISION FLYING, WHICH IS REQUIRED FOR TPS INSPECTION.
- [4] ALTHOUGH IT MAY BE POSSIBLE FOR AN EVA CREWMEMBER TO MANUALLY NULLIFY RATES IN THE LOST AXIS, SAFER IS NO-GO DUE TO THE ADDED FLIGHT COMPLEXITY, PROP INEFFICIENCY, AND DEGRADED PRECISION.
- [5] SAFER CONTAINS A RATE SENSOR TO SENSE ANGULAR RATES IN ROLL, PITCH, AND YAW ROTATION AXES. THESE RATES ARE NEEDED TO PROVIDE PROPER AUTOMATIC ATTITUDE HOLD (AAH). IF SENSOR OUTPUT IS LOST DUE TO A SENSOR FAILURE, THE SOFTWARE IS UNABLE TO DETERMINE WHEN RATES ARE NULLED. THIS RESULTS IN UNCONTROLLED ROTATIONAL ACCELERATIONS WHEN AAH IS ACTIVATED.
- [6] THE SAFER AVIONICS PROVIDE A LEAK DETECTION ALGORITHM (WHEN IN OPERATIONAL MODE) THAT RUNS CONTINUALLY IN THE BACKGROUND WHEN THRUSTERS ARE NOT BEING FIRED. IF THIS ALGORITHM DETERMINES THAT THERE HAS BEEN MORE THAN A 0.3 PERCENT DECREASE IN GN₂ MASS DURING THREE OF FOUR CONSECUTIVE 1-SECOND PERIODS, AN "EXCESSIVE LEAK" MESSAGE IS AUTOMATICALLY DISPLAYED ON THE HAND CONTROLLER MODULE (HCM) DISPLAY. THIS NET LEAK RATE IS EQUIVALENT TO THAT OF A SINGLE FAILED-ON THRUSTER. AT THIS RATE, A FULL GN₂ TANK WOULD BE DEPLETED IN ABOUT 240 SECONDS. BECAUSE GN₂ MASS IS CALCULATED BASED ON GN₂ PRESSURE AND TEMPERATURE, A SPORADIC TRANSDUCER MAY RESULT IN A FALSE LEAK INDICATION. LOSS OF TRANSDUCERS IS ALSO NO-GO AS ADDRESSED UNDER LOSS OF INSTRUMENTATION.
- [7] EXTENSIVE TESTING OF TPS SAFER INSPECTION FLIGHTS WAS PERFORMED USING VIRTUAL REALITY (VR) TO DETERMINE THE MINIMUM GN₂ REQUIREMENTS. IF MULTIPLE SAFERS ARE CONSIDERED GO, THE UNIT WITH THE MOST GN₂ SHOULD BE USED TO FURTHER INCREASE MARGIN. THE MINIMUM GN₂ REQUIRED TO INITIATE AN INSPECTION FLIGHT IS 45 PERCENT WHICH IS SUFFICIENT TO PHOTOGRAPH ONE DAMAGE SITE. FIFTEEN PERCENT SHOULD BE ADDED FOR EACH ADDITIONAL INSPECTION LOCATION PLANNED. IF REMAINING GN₂ EVER REACHES 30 PERCENT, THE INSPECTION SHALL BE IMMEDIATELY TERMINATED WITH RETURN FLIGHT TO STRUCTURE. IF MULTIPLE LOCATIONS ARE TO BE INSPECTED, THE SAFER IS GO TO PROCEED TO SUBSEQUENT DAMAGE SITES IF 45 PERCENT GN₂ REMAINS. THIS SHOULD BE SUFFICIENT TO COMPLETE THE INSPECTION PRIOR TO REACHING THE 30 PERCENT TERMINATE REDLINE. @[102506-7796]

THIS RULE CONTINUED ON NEXT PAGE

FLIGHT RULES**A15-27****GO/NO-GO FOR SAFER TPS INSPECTION (CONTINUED)**

- [8] THE PYRO VALVE IS A SINGLE-USE COMPONENT WHICH AUTOMATICALLY FIRES WHEN SAFER IS POWERED UP UNLESS AN INHIBITOR IS INSTALLED. IF THE PYRO FIRES UNINTENTIONALLY DURING IV CHECKOUT, SAFER IS CONSIDERED GO FOR INSPECTION AS LONG AS IT HAS THE MINIMUM GN₂ PERCENT. @[102506-7796]
DURING EVA, THE PYRO VALVE WILL FIRE WHEN SAFER IS POWERED ON. DURING THE SUBSEQUENT SELF TEST, AN "NSI CIRCUIT OPEN" AND "FAILED TEST" MESSAGE SHOULD BE DISPLAYED ON THE HCM. PRIOR TO OBSERVING SAFER THRUST, IT IS IMPOSSIBLE TO DETERMINE IF THESE MESSAGES ARE DUE TO THE NSI CONTROL SIGNAL NOT BEING RECEIVED, OR A NOMINAL PYRO FIRE. THEREFORE, THE SAFER EV SHALL FLY OUT OF THE SECOND EV'S GRASP RATHER THAN BEING PUSHED TOWARDS THE DAMAGE.
- [9] THE MINIMUM SAFER BATTERY VOLTAGE REQUIRED IS 35 VOLTS AS DETERMINED DURING CHECKOUT WITHIN 24 HOURS OF EVA. THIS IS ONLY APPLICABLE WHEN CHECKED AT IV AMBIENT TEMPERATURES, AS EXTREME COLD WILL LOWER THE VOLTAGE BELOW 35 VOLTS.
- [10] FORTY-FIVE MINUTES OF OPERATION IS POSSIBLE WITH 45 PERCENT POWER REMAINING AS SHOWN ON THE HCM DISPLAY. SAFER IS NOT FUNCTIONAL WHEN THE DISPLAY INDICATES 28 PERCENT POWER REMAINING. THE MINIMUM POWER REQUIRED TO INITIATE AN INSPECTION FLIGHT IS 38 PERCENT, WHICH IS SUFFICIENT TO PHOTOGRAPH ONE INSPECTION SITE. FOUR PERCENT SHOULD BE ADDED FOR EACH ADDITIONAL INSPECTION LOCATION PLANNED. POWER MUST BE RESERVED TO PROVIDE ENOUGH OPERATIONAL TIME FOR THE VARIOUS PHASES OF TPS INSPECTION FLIGHT. VR TESTING CONCLUDED WITH HIGH CONFIDENCE THAT 13 MINUTES IS SUFFICIENT TO RETURN TO STRUCTURE FROM ANY INSPECTION SITE. ACCORDINGLY, IF THE REMAINING POWER EVER REACHES 34 PERCENT, THE INSPECTION SHALL BE IMMEDIATELY TERMINATED WITH RETURN FLIGHT TO STRUCTURE. IF MULTIPLE LOCATIONS ARE TO BE INSPECTED DURING THE SAME FLIGHT, THE SAFER IS GO TO PROCEED TO SUBSEQUENT DAMAGE SITES IF 38 PERCENT POWER REMAINS. THIS WILL PROVIDE 9 ADDITIONAL MINUTES TO COMPLETE THE INSPECTION PRIOR TO REACHING THE 34 PERCENT TERMINATE REDLINE. THESE POWER LIMITS ARE CONSERVATIVE BECAUSE THEY ASSUME WORST CASE COLD, AND THAT ONE OF THREE PARALLEL BATTERY STRINGS HAS FAILED. BATTERY STRING FAILURE IS ONE OF THE MOST LIKELY ANOMALIES TO CAUSE LOSS OF FLIGHT CONTROL AND THERE IS NO EARLY CREW INDICATION OF THE PROBLEM. BATTERY DISCHARGE TESTS HAVE SHOWN THAT 100 MINUTES OF SAFER OPERATION CAN BE SUPPORTED IN WORST CASE COLD ENVIRONMENTS WITH 45 PERCENT INITIAL CAPACITY IF ALL THREE STRINGS ARE FUNCTIONING. IN THIS CASE, THE SAFER BECOMES UNUSABLE AT 5 PERCENT POWER. ALTHOUGH TWO STRINGS ALONE WILL NOT MEET THE CERTIFICATION REQUIREMENTS, THERMAL TESTS OF BATTERY CELL BUNDLES FROM THE SAME LOT AS THOSE LAUNCHED ON STS-114 ACHIEVED 43-46 MINUTES OF SAFER RUN TIME UNDER WORST-CASE TPS INSPECTION THERMAL CONDITIONS WITH ONLY TWO HEALTHY STRINGS.
- [11] THE MAXIMUM ALLOWABLE TIME THAT A SAFER CAN BE POWERED ON DURING A SINGLE EVA IS 45 MINUTES. THE INERTIAL RATE UNIT (IRU), WHICH IS CRITICAL FOR AAH FUNCTIONALITY, MAY REACH ITS MAXIMUM THERMAL LIMIT AFTER THIS TIME. TEMPERATURE INCREASE IS A FUNCTION OF INTERNAL HEAT GENERATION AND THE IRU LOCATION IS WELL INSULATED, WHICH PREVENTS SIGNIFICANT HEAT DISSIPATION. THEREFORE, NEGLIGIBLE TIME IS GAINED IN A COLD ENVIRONMENT. VR TESTING CONCLUDED WITH HIGH CONFIDENCE THAT 13 MINUTES IS SUFFICIENT TO RETURN TO STRUCTURE FROM ANY INSPECTION SITE. THEREFORE, IF THE POWER-ON TIME EVER REACHES 32 MINUTES, THE INSPECTION SHALL BE IMMEDIATELY TERMINATED WITH RETURN FLIGHT TO STRUCTURE. IF MULTIPLE LOCATIONS ARE TO BE INSPECTED DURING THE SAME FLIGHT, THE SAFER IS GO TO PROCEED TO SUBSEQUENT DAMAGE SITES IF POWER ON TIME IS LESS THAN 23 MINUTES. IF POWER ON TIME IS GREATER, THERE IS LESS CONFIDENCE THAT A SUCCESSFUL INSPECTION CAN BE COMPLETED PRIOR TO MEETING THE 32-MINUTE REDLINE AND; THEREFORE, THE SUBSEQUENT INSPECTION SHOULD NOT BE ATTEMPTED.
- [12] THE SAFER BATTERY IS ONLY CERTIFIED FOR ONE EVA USE. AFTER A BATTERY IS DISCHARGED IN A COLD ENVIRONMENT, ITS CAPACITY DECREASE CANNOT BE MEASURED ACCURATELY IN WARMER ENVIRONMENTS, SO THE PWR PERCENTAGE READING (AS DISPLAYED ON THE SAFER HCM) IS NOT VALID ON SUBSEQUENT EVA'S. THEREFORE, THE BATTERY IS NO-GO FOR INSPECTION CAPABILITY EVEN IF THE PWR PERCENTAGE READS GREATER THAN 45. THE SAFER CAN BE USED AGAIN IF A BATTERY CHANGEOUT IS PERFORMED.
- [13] SAFER TPS INSPECTION FLIGHT REQUIRES 6-DEGREE-OF-FREEDOM FLIGHT CONTROL. @[102506-7796]

THIS RULE CONTINUED ON NEXT PAGE

FLIGHT RULES**A15-27****GO/NO-GO FOR SAFER TPS INSPECTION (CONTINUED)**

- [14] FOR FUNCTIONAL LOSS OF THE TRANS POSITION OF THE MODE SWITCH, TRANSLATION CONTROL IS LOST IN THE Y AND Z AXES. SAFER TPS INSPECTION FLIGHT REQUIRES 6-DEGREE-OF-FREEDOM FLIGHT CONTROL.
@[102506-7796]
- [15] FOR FUNCTIONAL LOSS OF THE ROT POSITION OF THE MODE SWITCH, ROTATION CONTROL IS LOST IN THE ROLL AND YAW AXES. SAFER TPS INSPECTION FLIGHT REQUIRES 6-DEGREE-OF-FREEDOM FLIGHT CONTROL.
- [16] THE SAFER IS NO-GO FOR TPS INSPECTION IF THE STATUS SWITCH IS FAILED IN BOTH DIRECTIONS BECAUSE THE SELF TEST AT VACUUM WILL NOT BE ABLE TO PROCEED BEYOND THE "NSI CIRCUIT OPEN" MESSAGE.
- [17] FOR A FAILED-CLOSED MANUAL ISOLATION VALVE, SAFER IS NO-GO FOR EVA BECAUSE IT CANNOT DELIVER GN₂ TO THE THRUSTER MANIFOLDS.
- [18] FOR A FAILED-OPEN MANUAL ISOLATION VALVE, SAFER IS NO-GO FOR EVA BECAUSE GN₂ TANK/THRUSTER ISOLATION IS LOST. GN₂ TANK/THRUSTER ISOLATION IS REQUIRED TO RECOVER FROM SAFER FAILURES THAT LEAD TO UNCOMMANDED MOTION (E.G., A THRUSTER MECHANICALLY FAILED-OPEN WHEN SAFER IS NOT IN USE).
- [19] FOR LOSS OF THE TANK PRESSURE OR TEMPERATURE TRANSDUCER, SAFER IS NO-GO FOR INSPECTION BECAUSE THESE READINGS ARE USED TOGETHER TO CALCULATE THE GN₂ MASS. THE CAPABILITY TO CONTINUOUSLY MONITOR GN₂ IS REQUIRED TO ENSURE AVAILABILITY FOR RETURN FLIGHT TO STRUCTURE.
- [20] FOR LOSS OF THE BATTERY CAPACITY GAUGE, SAFER IS NO-GO FOR INSPECTION. THE BATTERY CAPACITY GAUGE, LOCATED ON THE BATTERY PACK, IS REQUIRED TO ENSURE POWER AVAILABILITY FOR RETURN FLIGHT TO STRUCTURE. MONITORING CAPABILITY CAN BE RESTORED BY IV REPLACEMENT OF THE BATTERY PACK IF A SPARE BATTERY IS AVAILABLE.
- [21] MONITORING CAPABILITY OF GN₂ PERCENT, PWR PERCENT, AND "EXCESSIVE LEAK" MESSAGES MUST BE AVAILABLE SO THAT FLIGHT TERMINATION CAN BE PERFORMED IF REQUIRED.
- [22] THRUSTER AND AAH LED'S ARE NOT REQUIRED FOR TPS INSPECTION FLIGHTS BECAUSE THE PILOT WILL HAVE VERIFICATION OF PROPER AAH AND THRUSTER PERFORMANCE THROUGH FLIGHT CONTROL RESPONSE. IF THE LED FAILURE IS PRESENT DURING THE SELF TEST AT VACUUM, THE CREW WILL BE SENSITIVE TO RELY ON FLIGHT CONTROL RESPONSE RATHER THAN LED'S.
- [23] SAFER COMPONENTS ARE CERTIFIED FOR 1 YEAR ON-ORBIT LIFE. IF THIS DURATION IS EXCEEDED, SAFER IS CONSIDERED NO-GO FOR EVA.
- [24] THE DIGITAL EVA CAMERA IS REQUIRED FOR 2-D INSPECTION OF RCC AND 3-D INSPECTION OF TILE DAMAGE. RELIABLE VEHICLE RE-ENTRY ANALYSIS CANNOT BE PERFORMED BASED ON VOICE CALLS DURING A CREW VISUAL INSPECTION. THEREFORE, THE RISK OF SAFER FLIGHT IS NOT RECOMMENDED IN THIS CASE. A REAL-TIME RISK TRADE WOULD BE REQUIRED IF THE MECHANICAL CONTOUR GAUGE WERE TO BE USED IN THE ABSENCE OF A DIGITAL CAMERA. HOWEVER, IT IS EXPECTED THAT THIS WOULD ONLY PROVIDE THE DEPTH OF THE DEEPEST POINT WITH LARGE MARGINS OF ERROR. FOR POST REPAIR INSPECTIONS, THE BENEFIT OF HAVING ONLY A DUROMETER WILL NEED TO BE BALANCED AGAINST THE RISK OF USING SAFER.
- [25] DUE TO THE CLOSE PROXIMITY TO ORBITER TPS, THE EV CREW MUST BE ABLE TO MAKE FLIGHT ADJUSTMENTS AT ANY TIME. ONE-HANDED OPERATION OF THE HCM AND INSPECTION TOOLS IS REQUIRED. THE BODY RESTRAINT TETHER (BRT) OR MULTI-USE TETHER (MUT) IS REQUIRED FOR ONE-HANDED OPERATION OF THE DIGITAL CAMERA.
- [26] PLANNED SAFER FLIGHT IS NO-GO DURING ORBIT NIGHT BECAUSE THE HCM DISPLAY MAY NOT THERMALLY SURVIVE THE REQUIRED 45 MINUTES WITH MORE THAN 5 MINUTES OF NIGHT EXPOSURE. THE HCM SHALL NOT BE DEPLOYED MORE THAN 5 MINUTES PRIOR TO SUNRISE. ADDITIONALLY, SAFETY TETHER SLACK MANAGEMENT REQUIRES THE ABILITY TO SEE THE TETHER CABLE. PHOTOGRAMMETRIC 3-D ANALYSIS OF TILE DAMAGE IS ONLY POSSIBLE WITH IMAGES CAPTURED DURING ORBIT DAY (NIGHT IMAGES WITH FLASH ARE UNACCEPTABLE).
@[102506-7796]

THIS RULE CONTINUED ON NEXT PAGE

FLIGHT RULES**A15-27 GO/NO-GO FOR SAFER TPS INSPECTION (CONTINUED)**

- [27] A SECOND EV CREWMEMBER MUST BE AVAILABLE AND HAVE A DIRECT LINE OF SIGHT TO THE SAFER CREW THROUGHOUT THE ENTIRE INSPECTION. SIMULATIONS HAVE SHOWN THAT THE GCA PROVIDED BY THIS SECOND EV CREW GREATLY INCREASES FLIGHT EFFICIENCY, REDUCES PILOT ERRORS, AND ASSISTS IN RAPID MALFUNCTION DETECTION. THIS CREWMEMBER IS ALSO REQUIRED TO MANAGE SAFETY TETHER SLACK SO THAT CABLE TENSION DOES NOT IMPART LOADS INTO THE SAFER. IN THE EVENT OF A SAFER MALFUNCTION THAT CAUSES LOSS OF FLIGHT CONTROL, TETHER MANAGEMENT IS ESSENTIAL TO REDUCE THE POTENTIAL FOR CATASTROPHIC DAMAGE TO THE ORBITER OR EMU. @[102506-7796]
- [28] ONLY RELAY COMMUNICATION CAPABILITY IS REQUIRED FOR SAFER INSPECTION. THE SECOND EV CREWMEMBER, THEREFORE, MUST HAVE DIRECT COMMUNICATION WITH IV. @[102506-7796]

A15-28 KEEP-OUT ZONE FOR EVA OPERATIONS NEAR THE LDRI OR LCS [HC]

- A. WHEN THE LASER DYNAMIC RANGE IMAGER (LDRI) IS ENABLED (MODES 2-6), THE EVA KEEP-OUT ZONE (KOZ) IS 2.74 METERS (9.0 FEET) FROM THE RADIATING SOURCE AT THE FRONT OF THE LDRI. THERE IS NO KOZ FOR AN LDRI CONFIRMED TO BE IN MODE 1 OR POWERED OFF. @[042507-8047]

The LDRI has two KOZ's, one for the diffuse light generated by the LDRI diffuser window, and a second zone for beams escaping through voids or defects in the diffuser. This second KOZ is narrower and significantly longer than the zone for the nominal diffuse light. The KOZ for diffuse light hazards is a hemisphere resting on the surface of the diffuser window, with a radius of 0.61 meters (2 feet). The KOZ for escaping beams is a trapezoidal volume created by taking a 3 x 1.5 inch (7.6 x 3.8 cm) rectangle corresponding to the diffuser window area, and expanding it outwards at an angle of 10 deg from a line perpendicular to the window, to a distance of 2.74 meters (9 feet) from the window.

If the EV crew must enter the LDRI keep-out zone, the LDRI will be placed into Mode 1 (confirmed by using a camera view of the diffuser window to observe the laser turn off), and the command path removed for switching modes (VIDEO IN - not MIDDECK). In addition, the PTU/LDRI will be pointed away from the crewmember and subsequent PTU motion inhibited with ITVC ENA - OFF. The LDRI can survive thermally for the entire EVA in Mode 1, which provides it with heater power.

The LDRI uses a modulated laser to create range and video imagery during Reinforced Carbon-Carbon (RCC) and tile inspection for depth defect and surface area analysis. At a lesser distance than the specified keep-out zones, ocular exposure to this laser directly hitting the eyes could result in serious injury of the retina. This keep-out zone assumes no attenuation of the beam strength by the EMU visor. Additional details on the LDRI are provided in the Flight Specific Annex (KEEP-OUT ZONE (KOZ) FOR IVA CREWMEMBERS DURING LASER DYNAMIC RANGE IMAGER (LDRI) OPERATIONS [HC]). @[042507-8047]

THIS RULE CONTINUED ON NEXT PAGE

FLIGHT RULES**A15-28****KEEP-OUT ZONE FOR EVA OPERATIONS NEAR THE LDRI OR
LCS [HC] (CONTINUED)**

- B. WHEN THE LASER CAMERA SYSTEM (LCS) IS SCANNING, THE EVA KEEP-OUT ZONE IS 14.4 METERS (47.2 FEET) FROM THE RADIATING SOURCE AT THE TOP OF THE LCS, WITH A MAXIMUM FIELD OF VIEW (FOV).
@[042507-8047]
- C. WHEN THE LCS IS IN HEATER-ONLY MODE (LCC DEACTIVATION COMPLETE), OR POWERED OFF, THERE IS NO KEEP-OUT ZONE.

The worst-case EVA KOZ for a scanning LCS is based on a specific two-failure case in which first the scan database on the Laser Camera Head (LCH) becomes corrupted such that the beam is allowed to travel to the maximum possible FOV, followed by a failure of the Complex Programmable Logic Device (CPLD), which causes the beam to remain stationary. These two failures must occur in this order to generate this KOZ. If the CPLD failure occurs first, the associated KOZ would be 14.4 meters with a nominal FOV and the crew would be notified of the failure, allowing them to take action prior to a second failure. In addition, a failed CPLD will not respond to software, so the database error would have no additional effect. All the other possible LCS one- and two-failure scenarios lead to KOZ's smaller than 14.4 meters with max FOV. The Hazard Report OBSS LCS 001 lists a 19.1 meter KOZ, but it is based on a two-failure case in which the first failure would lead to a worst-case KOZ of 14.4 meters with nominal FOV and the crew receives notification of that failure, so they can take action prior to a second failure that would lead to the 19.1 meter KOZ. In evaluating the KOZ's, two-failure tolerance is maintained in that a third failure would have to occur, i.e., the crewmember entering the KOZ, before injury could be caused. No attenuation of the beam strength by the EMU visor is assumed.

Nominal FOV is defined as a square pyramid with sides that angle outward at ± 15 deg from the central perpendicular ray. Max FOV is an irregular rectangular pyramid. Along the LCS Y axis (which is parallel with the OBSS long axis), the sides of the pyramid are limited by the edge of the aperture window and angle outward from the central perpendicular ray at ± 37 degrees. Along the LCS +X axis (which points toward the LCS/orbiter inboard when OBSS is berthed in the MPM's), the side of the pyramid is also limited by the edge of the aperture window and angles outward at 18 deg from the central perpendicular ray. Along the LCS -X axis, the FOV is limited by the angle at which the beam misses the Y-galvanometer mirror that would direct it out of the window and is, instead, trapped inside the box. This side of the pyramid angles outward at 22 deg from the central perpendicular ray. Note that the aperture window (15.2 x 5.8 cm = 6.0 x 2.3 inches) is sized to allow light reflected from the scanned surface to enter the window and reach the sensors. The laser does not shine out through all parts of the window.

Once the LCC DEACTIVATION procedure has been performed (placing the LCS in heater-only mode), there is no credible failure mode that would cause the laser to be activated.

The LCS uses a continuous laser to create range data during RCC and tile inspections. Ocular exposure to this laser directly hitting the eyes could result in serious injury to the cornea. Additional details on the LCS are provided in the Flight Specific Annex (KEEP-OUT ZONE (KOZ) FOR IVA CREWMEMBERS DURING LASER CAMERA SYSTEM (LCS) OPERATIONS [HC]). @[042507-8047]

THIS RULE CONTINUED ON NEXT PAGE

FLIGHT RULES

A15-28

KEEP-OUT ZONE FOR EVA OPERATIONS NEAR THE LDRI OR LCS [HC] (CONTINUED)

DOCUMENTATION: *EV Memo, Normal Hazard Zone for Laser Dynamic Range Imager, March 11, 2005; NDG007332, Laser Safety Analysis for the OBSS LCS, Rev B, June 2006; and Hazard Reports LDRI-5, Pathological/Physiological/Psychological; and OBSS LCS 001 Rev F, Crew Eye or Skin Injury as a Result of Exposure to Laser Radiation, July 13, 2006.* ©[042507-8047]

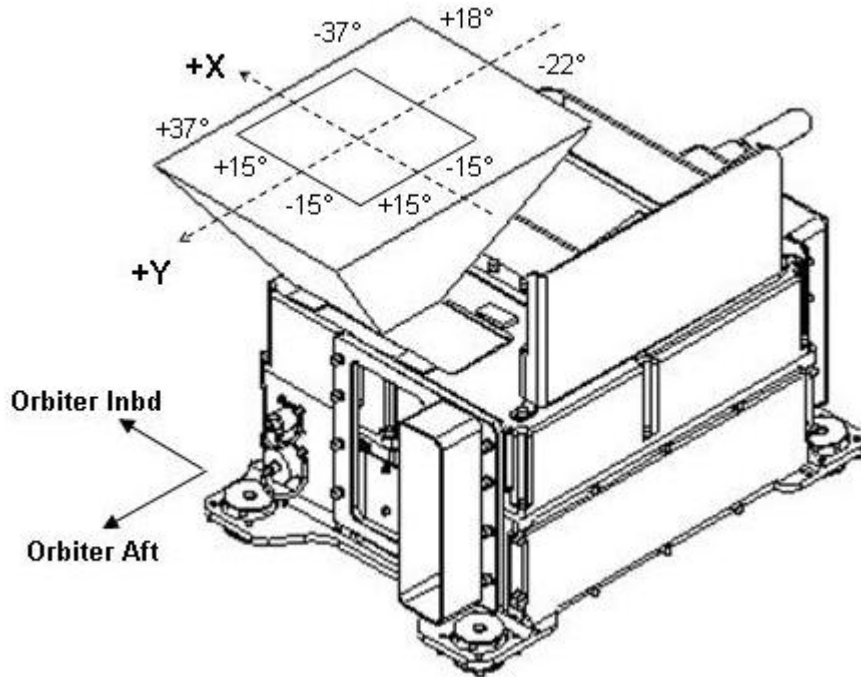

FIGURE A15-28-I - LCS NOMINAL AND MAX FOV ILLUSTRATION ©[042507-8047]

A15-29 THROUGH A15-100 RULES ARE RESERVED ©[102506-7796] ©[042507-8047]

FLIGHT RULES

LOSS/FAILURE DEFINITIONS

A15-101 **EVA CAPABILITY**

EVA CAPABILITY IS CONSIDERED LOST IF UNABLE TO DEPRESSURIZE/REPRESSURIZE THE AIRLOCK WHILE MAINTAINING CABIN INTEGRITY.

The inability to depressurize/repressurize the airlock while maintaining cabin integrity resolves to a leaking airlock hatch. If either hatch leaks at greater than 0.2 psi/min airlock pressure decay rate, the EVA capability is lost.

A15-102 **EMU GO/NO-GO CRITERIA**

THE EMU CAPABILITIES LISTED IN THE EMU GO/NO-GO MATRIX ARE CONSIDERED LOST IF ONE OF THE FOLLOWING CONDITIONS ARE MET:
@[090894-1669A] @[102506-7805]

- A. SUIT PRESSURE INTEGRITY - EMU PRESSURE DECAY > 0.3 PSI/MIN DURING INTEGRITY CHECK

A leak > 0.3 psi/min can no longer be considered a worst case for EMU specification leakage (i.e., seal leaks and metabolic use). At greater than 0.3 psi/min, there is some other leak that could possibly propagate.

The automated leak check will report failure when the pressure drop is ≥ 0.3 psi over 1 minute for a manned suit or 2 minutes for an unmanned suit. A manual leak check can be performed where failure is determined by a pressure drop of ≥ 0.3 psi over 1 minute for a manned suit or 2 minutes for an unmanned suit.

For loss of suit pressure integrity, if the failure occurs prior to EVA, the EMU is considered to be non-fail-safe and is therefore NO-GO for EVA. If the failure occurs during EVA, the SCU may provide a safe configuration if the leak (minor leak) does not allow the suit pressure to drop below the caution and warning SUIT P LOW limit (4.05 psid). If this is the case, then a TERMINATE EVA (i.e., enter airlock, connect SCU) is required for the affected crewmember. If the suit leak allows the suit pressure to drop below the CWS limit (major leak), an ABORT EVA (i.e., both crewmembers enter airlock and perform emergency repress) is required. @[102506-7805]

THIS RULE CONTINUED ON NEXT PAGE

FLIGHT RULES**A15-102****EMU GO/NO-GO CRITERIA (CONTINUED)**

- B. PRIMARY O₂ TANK PRESSURE INTEGRITY - PRIMARY O₂ PRESSURE DECAYS AT A RATE > 110 PSI/24 HRS FROM A FULLY CHARGED STATE, AND LEAK RATE IS SUCH THAT IT WILL PRECLUDE SAFE COMPLETION OF THE INTENDED EVA TASK. @[102506-7805]

The primary O₂ tanks are considered fully charged when they are pressurized > 850 psi. Leak rates > 110 psi/24 hrs are indicative of a significant primary tank leak. An excessive external leak of the primary O₂ tanks will cause the primary O₂ supply to be depleted at a higher than normal rate. However, in the case where an excessive external leak is detected, real-time analysis may indicate that the leak will not preclude an EVA for the intended tasks. Further testing may determine that the leak is internal to the suit volume, which may not impact the O₂ use rate during EVA.

The EMU is considered NO-GO for EVA for a major leak. A major leak is a leak rate that is too high to support on the SCU (i.e., requires more O₂ than can be provided by the orbiter, case specific). If a major leak happens during EVA, then an ABORT EVA is required, since the EMU is no longer capable of remaining at vacuum. A minor leak is a leak rate that can be supported on the SCU. The EMU is considered GO for EVA if the leak is minor and if periodic recharges do not interfere with completing the EVA tasks. The EMU is considered GO to remain on the SCU if the leak is a minor leak and if frequent recharges interfere with completing the EVA tasks. If this happens during EVA, then a TERMINATE EVA is required for the affected crewmember. Leak propagation is not a concern with primary O₂ tank leaks because the seals in this system are hard/static seals.

- C. PRESSURE REGULATION - SUIT PRESSURE CANNOT BE MAINTAINED IN A RANGE ABOVE THE SOP REGULATION PRESSURE AND BELOW THE POSITIVE PRESSURE RELIEF VALVE (PPRV) CRACKING PRESSURE.

If the primary suit regulator cannot maintain suit pressure above SOP regulation pressure, the SOP will flow during the EVA and the emergency oxygen supply will be consumed, eventually making the SOP incapable of supporting 30 minutes of DCM purge flow. If the primary suit regulator cannot regulate below the positive pressure relief valve (PPRV) cracking pressure, the PPRV will open during the EVA and primary oxygen will be depleted more rapidly than normal.

The operational specification for the primary regulator with the O₂ actuator in PRESS or EVA is 4.2 to 4.4 psid. Checkout values outside of this range warrant further investigation to ensure that the requirements of this rule will be met. If the primary regulator is determined to be stable between 4.05 - 4.55 psid, then SOP flow and PPRV cracking should not be a concern since the specifications of the SOP regulator and PPRV will not overlap this range. If the primary regulation pressure is outside of the 4.05 to 4.55 psid range, real-time analysis considering the preflight performance of the specific EMU will be required. @[102506-7805]

THIS RULE CONTINUED ON NEXT PAGE

FLIGHT RULES**A15-102****EMU GO/NO-GO CRITERIA (CONTINUED)**

The specification for SOP regulation is 3.33 to 3.9 psid (dependent on flow rate). The specification for the minimum cracking pressure for the PPRV is 4.7 psid. A "SUIT P LOW" message occurs when sensed suit pressure is less than 4.05 psid. A "SUIT P EMERG" message occurs when sensed suit pressure is less than 3.10. A "SUIT P HIGH" message will occur when sensed suit pressure is 4.55 psid or greater. ©[102506-7805]

For scheduled or unscheduled EVA's, the EMU is considered to be non-fail-safe and is therefore NO-GO. For contingency EVA's, the EMU is considered GO for SCU ops to be available for rescue/assist scenarios. For either types of EVA's, if a pressure regulation failure happens during EVA, a TERMINATE EVA is required for the affected crewmember.

D. OPERATIONAL SECONDARY OXYGEN PACK (SOP) : ©[033105-6679B]

1. SOP BOTTLE PRESSURE (AT IV AMBIENT TEMPERATURES) < 5410 PSI.

The SOP must be capable of supporting (with DCM purge valve open) a minimum of 30 minutes. The design specification for the EMU SOP bottle pressure is ≥ 5410 psig (at ambient IV temperatures) which guarantees a minimum of 30 minutes secondary O₂.

For scheduled or unscheduled EVA's, the EMU is considered to be non-fail-safe and is therefore NO-GO. For contingency EVA's, the EMU is considered GO for SCU ops to be available for rescue/assist scenarios.

Reference: EMU On-Orbit Operation, Maintenance, Testing, Storage, and Tracking Requirements and Constraints - FEMU-R-003, JSC #60417, Rev. B, Change 1. Requirement 7.1.3.4 - #3.

2. SOP REGULATOR IS NOT CAPABLE OF MAINTAINING SUIT PRESSURE ABOVE 3.33 PSI AND BELOW PRIMARY O₂ REGULATION PRESSURE FOR 30 MINUTES DURING EMERGENCY DCM PURGE.

The operational specification for the SOP regulator is 3.33 to 3.9 (dependent on flow rate). SOP checkout values outside of this range warrant further investigation to ensure that the requirements of this rule will be met. Emergency DCM purge is representative of the worst case oxygen demand that could occur during an EVA. The SOP must be capable of maintaining suit pressure at a safe level (> 3.33 psi) during an emergency purge configuration (DCM purge valve open). An SOP that is regulating above the specification limit of 3.9 is satisfactory as long as it is regulating below the regulation pressure of the primary regulator. If the SOP regulates above the primary regulator pressure, the SOP oxygen will be consumed instead of primary oxygen. If this occurs during EVA, a TERMINATE EVA is required for the affected crewmember.

For scheduled or unscheduled EVA's, the EMU is considered to be non-fail-safe and is therefore NO-GO. For contingency EVA's, the EMU is considered GO for SCU ops to be available for rescue/assist scenarios. ©[102506-7805]

THIS RULE CONTINUED ON NEXT PAGE

FLIGHT RULES

A15-102

EMU GO/NO-GO CRITERIA (CONTINUED)

3. SOP FIRST STAGE REGULATION PRESSURE CANNOT BE MAINTAINED BELOW 600 PSIG AS MEASURED BY THE INTERSTAGE GAUGE DURING SOP CHECKOUT. @[102506-7805]

The primary intent of the interstage gauge (located between the first- and second-stage pressure regulators) is to detect excessive leakage or failed open conditions related to the SOP first-stage regulator. Preflight processing also uses this gauge as a reference point for first-stage regulation. The 600 psig value is based on nominal first-stage regulation of 200 psig added to the +400 psig gauge tolerance. Due to the inaccuracy of the gauge at the low end (+400/-200 psig), detection of regulator shifts is difficult. However, gauge readings are worthwhile for comparison with pre-flight data. If the SOP interstage gauge fails on orbit, it is impossible to verify that the first-stage regulator was unaffected by the damaging event. A failed SOP first-stage regulator followed by a failed SOP second-stage regulator will result in rapid suit overpressurization and rupture.

For scheduled or unscheduled EVA's, the EMU is considered to be non-fail-safe and is therefore NO-GO. For contingency EVA's, the EMU is considered GO for SCU ops to be available for rescue/assist scenarios.

- E. MINIMUM RF COMMUNICATIONS (REF. RULE {A15-7}, MINIMUM RF COMMUNICATIONS DEFINITION)

For crew safety, two-way voice (including relay) communication must be available. Crewmembers must preserve the availability to vocally communicate in case assistance or aid is necessary in areas where the crewmember might not be able to maintain visual contact.

For scheduled or unscheduled EVA's, the EMU is considered to be non-fail-safe and is therefore NO-GO. For contingency EVA's, the EMU is considered GO for SCU ops to be available for rescue scenarios. For either types of EVA's, if the failure happens during EVA, a TERMINATE EVA is required for the affected crewmember.

- F. POSITIVE PRESSURE RELIEF VALVE - FAILS CLOSED DURING DEPRESS

This failure is only detected during depressurization. The EMU is considered NO-GO for EVA if the valve cannot be opened, because the EMU is not fail-safe for overpressurization. @[102506-7805]

THIS RULE CONTINUED ON NEXT PAGE

FLIGHT RULES

A15-102 EMU GO/NO-GO CRITERIA (CONTINUED)

- G. VENTILATION FLOW - INSUFFICIENT FLOW (< 4.0 ACFM) TO PROVIDE CO₂ REMOVAL FROM THE HELMET OR DEFOGGING CAPABILITY. @[102506-7805]

The vent flow sensor detects low flow at less than 4.0 acfm, and the CWS message (NO VENT FLOW) is triggered when vent flow drops below this level. This is the minimum flow required to adequately remove CO₂ from the helmet. CO₂ buildup in the helmet will lead to hypercapnia (excess CO₂ in the blood stream) which increases heart and respiration rate and can impair a crewmember's judgment and ability to perform the EVA task. Hypercapnia will eventually lead to an unconscious crewmember. Normal ventilation flow is 6 to 8 acfm. Helmet purge valve may be used to provide alternate vent flow if EMU consumables can be managed to support this.

Insufficient ventilation flow will also increase the fogging of the visor. This will hinder the crewmember's vision and will impair their ability to perform the EVA task. Under this condition while EVA, the crewmember is in a safe configuration while attached to the SCU. The EMU is somewhat degraded, but operational, for a possible crewmember assist/rescue scenario.

- H. CO₂ CONTROL - PRESSURE COMPENSATED PPCO₂ LEVEL CANNOT BE MAINTAINED BELOW 12.4 MMHG (8.0 MMHG UNCOMPENSATED) .

With a PPCO₂ indication of 12.4 mmHg (8.0 mmHg uncompensated) by the ECWS, the actual CO₂ level in the EMU could be as high as 15 mmHg with sensor and calculation error. This PPCO₂ level can cause physiological changes (hypercapnia) that can impair the crewmember's judgment and ability to perform the EVA task. Reference Rule {A13-107}, PPCO₂ CONSTRAINT (ONE GAS).

Under this condition, the crewmember is in a safe condition while attached to the SCU with the helmet purge valve open. The EMU is somewhat degraded, but operational, for a possible crewmember assist/rescue scenario.

- I. BATTERY POWER - EMU BATTERY IS NOT CAPABLE OF PROVIDING POWER.

The EMU battery provides power for all EMU systems once off of the SCU. At cabin pressure, the battery may be replaced by a spare and the EMU is GO-For-EVA. If a spare is unavailable, the EMU will be able to remain on the SCU for a possible crewmember assist/rescue scenario. @[102506-7805]

THIS RULE CONTINUED ON NEXT PAGE

FLIGHT RULES

A15-102

EMU GO/NO-GO CRITERIA (CONTINUED)

- J. THERMAL CONTROL - THERMAL CONTROL CANNOT BE MAINTAINED IN A TOLERABLE RANGE THROUGHOUT ALL SUITED OPERATIONS WHILE STILL PROVIDING AN ADEQUATE LEVEL OF WATER VAPOR REMOVAL. ©[102506-7805]

Thermal control must be maintained throughout all EMU suited operations. If water vapor produced by the crewmember and as a byproduct of the chemical reaction of CO₂ with LiOH is not removed, excessive water vapor levels in the EMU will cause fogging of the visor, degrading crewmember visibility. If cooling control is lost, it may be possible, if the crewmember is too cold, for the crewmember to manage cooling by periodically opening and closing the feedwater shutoff valve. Another option, if the crewmember is too hot, involves opening one of the two available purge valves on the suit. The feasibility of utilizing these options is case dependent.

If thermal control is lost via the SCU, the EMU is considered GO for EVA, since cooling will be restored once at vacuum when the sublimator is activated. If this is the case, when not on the sublimator, cooling must be provided through the DCM purge valve, assuming that the SCU can support the purge flow for the required time or by swapping SCU's if possible. If the failure happens during EVA, the EMU is considered GO to continue EVA. If thermal control is lost via the EMU (i.e., failure in either sublimator or LCVG), the EMU is considered GO to remain on the SCU, since cooling will be provided via the SCU (for sublimator failure) or will be provided with the DCM purge valve (for LCVG failure), assuming the SCU can support the purge flow for the required time. If the failure happens during EVA, a TERMINATE EVA is required for the affected crewmember.

- K. CRITICAL INSTRUMENTATION:

1. LOSS OF EVA CREW'S CAPABILITY TO MONITOR BOTH SUIT PRESSURE SENSOR AND DISPLAY AND CONTROL MODULE (DCM) SUIT PRESSURE GAUGE

The capability must exist to monitor suit pressure via either the pneumatic gauge or the pressure transducer at all times during the EVA

With the loss of both suit pressure transducer and gauge, there is no indication to the crewmember of suit pressure. For a scheduled or unscheduled EVA, the EMU is considered NO-GO. Since a third failure has to occur before the crewmember's life is in danger, the EMU is considered GO for SCU ops for a contingency EVA so that the crewmember is available for rescue ops. ©[102506-7805]

THIS RULE CONTINUED ON NEXT PAGE

FLIGHT RULES

A15-102 **EMU GO/NO-GO CRITERIA (CONTINUED)**

2. LOSS OF OPERATIONAL CWS : @[102506-7805]

Reference Rule {A15-8}, OPERATIONAL CAUTION AND WARNING SYSTEM (CWS) DEFINITION.

- a. BITE LIGHT ILLUMINATED

The built-in test equipment (BITE) light is illuminated when the BITE circuitry has detected either a hardware or software problem within the CWS. The EMU should be considered NO-GO in this condition, unless the status list can be verified to be functioning accurately.

- b. CREWMEMBER OR MCC DETERMINES INSUFFICIENT RELIABLE DATA AVAILABLE.

For the loss of operational CWS, the crewmember is in a safe condition while attached to the SCU. The EMU is somewhat degraded, but operational, for a possible crewmember assist/rescue scenario.

3. DCM DISPLAY - CREWMEMBER IS UNABLE TO READ DCM DISPLAY AND MCC CANNOT MONITOR EMU DATA VIA REAL-TIME DATA DOWNLINK.

EMU is considered GO (fail-ops) if MCC is capable of monitoring EMU status via the EMU Real-Time Data System (RTDS). EMU is considered GO to remain on the SCU if MCC monitoring capability is not available. If the failure happens during EVA, EMU is considered GO to continue EVA, unless MCC monitoring capability of EMU data is lost. If MCC monitoring capability is lost, then a TERMINATE EVA is required by the affected crewmember. @[102506-7805]

THIS RULE CONTINUED ON NEXT PAGE

FLIGHT RULES**A15-102****EMU GO/NO-GO CRITERIA (CONTINUED)**

- L. SINGLE COMPONENT INSTRUMENTATION - LOSS OF ONE OF THE FOLLOWING SENSORS: @[102506-7805]

SUIT PRESSURE XDUCER	SUBLIMATOR PRESSURE XDUCER
	SOP PRESSURE XDUCER
VENT FLOW SENSOR	H ₂ O GAS PRESSURE XDUCER
CO ₂ XDUCER	H ₂ O WATER PRESSURE XDUCER
BATTERY VDC XDUCER	H ₂ O TEMPERATURE XDUCER
BATTERY AMP XDUCER	
O ₂ PRESSURE XDUCER	

EMU is considered GO (fail-ops). For the loss of any one sensor or transducer, the integrity of the system monitored by the failed sensor can be monitored via other sensors. A failure in that system will be manifested by a warning message from another sensor or by some other noticeable indication. For CO₂ transducer loss, the ability to detect a high CO₂ level relies entirely on the crewmember's ability to detect physiological symptoms and take appropriate action as required, such as purge valve activation (Rule {A13-52B}, PPCO₂ CONSTRAINT (TWO GAS) [HC], rationale indicates symptoms of CO₂ exposure). For SOP interstage gauge loss, there is no other instrumentation device available in flight to verify SOP first-stage regulation. For any single sensor loss, consider using EMU 3 (if available) to regain full operational capability, depending on the extent of resizing necessary to accommodate the affected crewmember. If the first-stage regulator function cannot be verified, the EMU could be one failure away (second-stage regulator failing open) from a catastrophic hazard, with a time of effect of seconds.

- M. SCU POWER - NO POWER PROVIDED TO EMU THROUGH SERVICE AND COOLING UMBILICAL

The EMU is considered fully operational on battery power. Battery may need to be changed out prior to depressurization to preserve full EVA time capability. EMU is considered GO-for-EVA under this condition.

- N. ECG TELEMETRY - NO ECG TELEMETRY IS PROVIDED TO MCC.

The EMU is considered fully operational. Reference Rule {A15-20}, ECG TELEMETRY CHECKOUT. @[102506-7805]

THIS RULE CONTINUED ON NEXT PAGE

FLIGHT RULES

A15-102

EMU GO/NO-GO CRITERIA (CONTINUED)

- O. LOSS OF OPERATIONAL EMU HEATED GLOVE(S) IS NOT A CONSTRAINT TO PERFORMING AN EVA. @[111298-6755A] @[102506-7805]
1. FOR A FAILURE OF HEATED GLOVES PRE-EVA AND THERMAL ANALYSIS INDICATING SKIN TEMPERATURE VIOLATIONS WITHOUT USE OF HEATED GLOVES BY THE CREW, ACTION WILL BE TAKEN TO RESTORE HEATED GLOVE POTENTIAL OR ESTABLISH CREW LIMITS WITHIN MISSION CAPABILITIES.

The actions for a failure are: EVA flights fly backup heated gloves for EV crewmembers which should be used for a heater element failure; replacement of batteries; identify to the crew potential keep-out areas or limit handling of items for durations as specified in the EMU Glove Palm Certification Curves if capability is not restored (i.e., scheduled use of items listed in paragraph 2 of rule); swapping to backup EMU components (i.e., PLSS/HUT or arm segments) for a harness failure. The last action may place an EV crewmember in a non-optimum sized EMU and is the least preferred action and will be decided real time.

The EMU is considered GO for a failure of EMU heated glove(s) before the EVA. Reasonable effort will be made to restore the capability so that heated gloves will be available to the EV crewmember if preflight thermal analysis deems likely the use of heated gloves. Need for heated gloves depends on mission attitude, timelines, locations of EVA tasks, and initial hand temperatures. The heated glove system for the EMU is a simple wire harness connecting a battery to the heater elements in the glove fingertips through connectors and toggle switches routed along the outside of the PLSS and arms. For the 3-volt system, a single failure will result in the loss of only one heated glove because each has a separate wire harness and battery.

Reference Documentation: JSC-39116 (CTSD-SS-1621) EMU Phase VI Glove Thermal Vacuum Test and Analysis Final Report, "Glove Palm Certification Limits" graphs, August 20, 1998. @[102506-7805]

THIS RULE CONTINUED ON NEXT PAGE

FLIGHT RULES

A15-102

EMU GO/NO-GO CRITERIA (CONTINUED)

2. FOR LOSS OF OPERATIONAL HEATED GLOVE DURING THE EVA, THE FOLLOWING OPTIONS, LISTED IN PRIORITY, ARE AVAILABLE TO THE EV CREW: @[102506-7805]
 - a. NOTIFICATION TO CREW OF POTENTIAL COLD AREAS TO AVOID, IF POSSIBLE, BASED ON THERMAL ANALYSIS.
 - b. FOR SINGLE GLOVE FAILURE, USE OF NON-AFFECTED HAND FOR GRASPING AND HANDLING COLD OBJECTS.
 - c. USE OF BRT (OR OTHER RESTRAINT DEVICE) TO ALLOW HANDS-FREE OPERATION.
 - d. USE OF ADJUSTABLE THERMAL MITTENS.
 - e. USE OF OTHER EV CREWMEMBER FOR OPERATIONS THAT ARE DEEMED TOO COLD BY THE AFFECTED EV CREW OR LIMIT HAND CONTACT DURATION.
 - f. USE OF EMU LCVG BYPASS.
 - g. CREW WOULD NOT WORK DURING NIGHT PASSES.
 - h. EV CREW MAY MOVE TO SUN SIDE TO WARM HANDS AFTER TASK.

For a failure of the EMU heated gloves during the EVA, the EMU is GO to continue. The loss may require the affected EV crewmember to modify his/her operations as deemed necessary by that crewmember. For the 3-volt system, a single failure will result in the loss of only one heated glove because each has a separate wire harness and battery.

Restraint devices can be used to hold ORU's or restrain crewmembers to handrails. Thermal mittens may be used as an added layer to the EMU gloves but will reduce dexterity of the hands. The other EV crewmember may be used for cold tasks. Least preferred options include; EMU LCVG bypass may be used in an attempt to warm the crewmember's core temperature in an effort to warm the arms and hands, not working during night passes, or having the affected crewmember warm hands on the sun side as required.

The crewmember shall be reminded to preclude affected hand(s) from becoming too cold in the first place. Once the hands are cold, it will invalidate the crewmember's sense of temperature and lower their "threshold" of comfort. The affect is that the crewmember's hand does not need to warm as much to give the sensation of being comfortable; therefore, the hand will start at a colder initial temperature the next time it is exposed. Iterations of this process over the EVA duration could lead to tissue damage without the crewmember being aware.

Reference Documentation: JSC-39116 (CTSD-SS-1621), EMU Phase VI Glove Thermal Vacuum Test and Analysis Final Report, "Glove Palm Certification Limits" graphs, August 20, 1998. @[102506-7805]

THIS RULE CONTINUED ON NEXT PAGE

FLIGHT RULES

A15-102

EMU GO/NO-GO CRITERIA (CONTINUED)

	LOSS OF:	PRE EVA			EVA			COMMENTS (FOR EVA CASE)
		NO GO	GO FOR SCU	GO FOR EVA	ABORT	TERMINATE	CONTINUE	
A	SUIT PRESSURE INTEGRITY MAJOR LEAK MINOR LEAK	X X			X	X		SUIT P LOW & O ₂ USE HIGH MSGS DISPLAYED ONLY O ₂ USE HIGH MSG DISPLAYED
B	PRIMARY O ₂ TANK P INTEGRITY MAJOR LEAK MINOR LEAK PERIODIC RECHARGE ACCEPTABLE PERIODIC RECHARGE <u>NOT</u> ACCEPTABLE	X		X	X		X	LEAK RATE TOO HIGH TO SUPPORT ON SCU RECHARGE ON SCU AS REQUIRED REMAIN ON SCU IF RECHARGE FREQUENCY TOO HIGH TO SUPPORT EVA TASKS
C	PRESSURE REGULATION HIGH LOW	X X	C C		X X			ASSUMES SCU CAN SUPPORT PPRV FLOW ASSUMES SOP OPERATIONAL
D	OPERATIONAL SOP	X	C		X			
E	MINIMUM RF COMMUNICATIONS	X	C		X			
F	POS PRESS RELIEF VALVE FAILS CLOSED	X						ONLY DETERMINED DURING DEPRESS
G	VENTILATION FLOW		X		X			ASSUMES SCU CAN SUPPORT PURGE FLOW
H	CO ₂ CONTROL		X		X			ASSUMES SCU CAN SUPPORT PURGE FLOW
I	BATTERY POWER		X		X			EMU WILL NOT HAVE POWER WHEN OFF SCU
J	THERMAL CONTROL SCU EMU		X	X		X		ASSUMES SCU CAN SUPPORT PURGE FLOW ASSUMES SCU CAN SUPPORT PURGE FLOW
K	CRITICAL INSTRUMENTATION: SUIT P XDUCER & GAUGE CWS	X	C X		X X			
	DCM DISPLAY WITH MCC MONITOR WITHOUT MCC MONITOR		X	X	X			TERMINATE EVA IF MCC MONITORING LOST
L	SINGLE COMPONENT INSTRUMENTATION: SUIT P XDUCER GAUGE VENT FLOW SENSOR CO ₂ XDUCER BATTERY VDC XDUCER BATTERY AMPS XDUCER O ₂ P XDUCER SUBLIMATOR XDUCER SOP P XDUCER SOP INTERSTAGE GAUGE H ₂ O GAS P XDUCER H ₂ O WATER P XDUCER H ₂ O TEMP XDUCER			X X X X X X X X X X X C X X X X X		X X X X X X X X X X X X X X X		
M	SCU POWER			X		X		MAY REQUIRE BATTERY CHANGEOUT
N	ECG TELEMETRY			X		X		
O	HEATED GLOVE(S)			X		X		WORKAROUNDS NOTED IN FLIGHT RULE

@[102506-7805]

NOTE: C = CONTINGENCY EVA ONLY @[102506-7805]

A15-103 THROUGH A15-150 RULES ARE RESERVED

FLIGHT RULES

SYSTEMS MANAGEMENT

A15-151 DENITROGENATION

DENITROGENATION OF THE EVA CREWMEMBER WILL BE ACCOMPLISHED IN ACCORDANCE WITH AEROMED RULE {A13-103}, EVA PREBREATHE PROTOCOL [HC]. ©[ED]

Proper denitrogenation is required to prevent bends in the EV crewmember.

A15-152 RESERVED ©[050400-7199A] ©[032807-8253]

A15-153 RESERVED ©[032807-8253]

A15-154 RESERVED ©[032807-8253]

A15-155 MANIPULATOR FOOT RESTRAINT (MFR) AND PFR ATTACHMENT DEVICE (PAD) GUIDELINES

- A. ONLY MINIMUM COMMUNICATIONS FOR EVA BETWEEN THE RMS OPERATOR AND THE MFR/PAD OPERATOR ARE REQUIRED. (REF. RULE {A15-7}, MINIMUM RF COMMUNICATIONS DEFINITION.)

The EVA crewmember on the MFR/PAD has the best vantage point from which to direct the operator of the RMS to and about the worksite. Communications between the RMS operator and the MFR/PAD operator will maximize safety. Minimum communication is two-way communication with the orbiter even if relayed through the other EVA person.

- B. VISUAL VERIFICATION OF MFR/PAD POSITION/CLEARANCE IS REQUIRED.

This is to preclude contact and possible damage to payloads and structures in the payload bay imparted by the RMS and MFR/PAD.

- C. MFR/PAD WILL BE OPERATED ONLY IN THOSE AREAS WHERE THE RMS CANNOT IMPART EXCESSIVE LOADS TO THE EMU.

In certain configurations, the arm can impart excessive loads to the EMU and the EVA crewmember. The PLSS (the part of the EMU least tolerant to impact forces) is certified for a maximum 400-lb impact force on a 2-inch diameter sphere at a 2 ft/sec velocity before impact. The RMS will be kept out of regimes where impact loads of this type are possible to minimize the possibility of damage to the EMU.

A15-156 RESERVED ©[032807-8253]

FLIGHT RULES

A15-157

EMU CONSUMABLES FOR SHUTTLE

A. EMU CONSUMABLES PRE-EVA @[032807-8253] @[ED]

SUFFICIENT CONSUMABLES MUST BE AVAILABLE TO SUPPORT THE COMPLETE EVA TIMELINE PLUS 15 MINUTES OF EVA EGRESS ACTIVITIES, 15 MINUTES OF INGRESS ACTIVITIES, AND A 30-MINUTE RESERVE.

This rule is provided as an operational guide in planning EVA timelines based on consumable constraints. For purposes of EMU certification, this rule assumes 6 hours of EVA operations with 5 minutes for post depress, 10 minutes for egress, 10 minutes for ingress, 5 minutes of pre-repress, and 30 minutes of reserve to make a total of 7 hours EVA time. In addition, a 30-minute emergency oxygen supply is provided.

B. EMU CONSUMABLES WITH REAL-TIME EMU DATA DOWNLINK

EVA CREWMEMBERS MUST BE COMPLETE WITH AIRLOCK INGRESS AND CONNECTED TO THE SERVICE AND COOLING UMBILICAL (SCU) WHEN 30 MINUTES REMAIN OF ANY EMU CONSUMABLE AS DETERMINED BY MCC.
@[032807-8253]

THIS RULE CONTINUED ON NEXT PAGE

FLIGHT RULES**A15-157****EMU CONSUMABLES FOR SHUTTLE (CONTINUED)**

Thirty minutes is considered the redline for primary consumables (O₂, power, LiOH, and water). This 30-minute reserve is necessary to prevent bringing the non-replenishable redundant oxygen system (SOP) on-line. If real-time data capability with MCC is available, the flight control team can use this information to determine which consumable will reach the 30-minute limit first. MCC consumables calculations can be more realistic due to the use of flight specific initial loading data rather than the standard minimum required values used by the EMU Caution and Warning System (CWS). A/G voice must be available for MCC to alert crew when they are approaching the 30-minute limit. If A/G voice capability is available, but is interrupted by periods of LOS, MCC can confirm consumables status with the crew prior to LOS. The affected crewmember(s) must be complete with airlock ingress and pre-repress when 30 minutes remain of any consumable. If consumables allow, the other crewmember will continue with remaining EVA tasks and will complete sortie cleanup. Timeline management will ensure that the EVA sortie cleanup, airlock ingress, and pre-repress are completed prior to the last crewmember reaching the 30-minute redline. Translation time back to the airlock will be determined by either Neutral Buoyancy Laboratory (NBL) or Virtual Reality (VR) Laboratory crew training. EVA tasks will be modified or deleted real time to ensure that the EV crewmember is connected to the SCU within the timeframe necessary to maintain the 30-minute reserve. Connection to the SCU is considered a safe configuration because the SCU can support the loss of any EMU consumable. Battery and LiOH have a finite capacity; however, opening the helmet purge valve while on the SCU compensates for the loss of LiOH, and configuring the EMU to accept airlock power compensates for the loss of battery. In the event that airlock power is not available, opening the helmet purge valve while on the SCU can compensate for the loss of the battery. Oxygen and water are rechargeable at vacuum. If the 30-minute consumable is oxygen, the crewmembers can connect to the SCU, recharge the oxygen, and return to EVA tasks. If the 30-minute consumable is water, a vacuum water recharge can be performed, but only for a contingency EVA. This rule is considered an operational constraint. ©[032807-8253]

DOCUMENTATION: Hamilton Sundstrand Engineering Memorandum EMUM1-0404, Consumable Tracking During EVA, March 15, 2000, and engineering judgment.

C. EMU CONSUMABLES WITHOUT REAL-TIME EMU DATA DOWNLINK

1. IF NO A/G VOICE CAPABILITY, AN EVA CREWMEMBER WILL TERMINATE THE EVA WHEN THE CAUTION AND WARNING SYSTEM (CWS) ISSUES A 30-MINUTE ALERT FOR ANY EMU CONSUMABLE.

If A/G voice and real-time EMU data capability with MCC are not available, the EMU CWS will be used to determine which consumable will reach the 30-minute limit first. If the EV crewmember has no ability to communicate with MCC, the only insight into the EMU consumables is via the CWS. The EV crewmember will rely on the CWS to display a message when 30 minutes remain of any EMU consumable. Oxygen and water are rechargeable at vacuum. If the 30-minute consumable is oxygen, the crewmembers can connect to the SCU, recharge the oxygen, and return to EVA tasks. If the 30-minute consumable is water, a vacuum water recharge can be performed, but only for a contingency EVA. This rule is considered an operational constraint. ©[032807-8253]

THIS RULE CONTINUED ON NEXT PAGE

FLIGHT RULES

A15-157

EMU CONSUMABLES FOR SHUTTLE (CONTINUED)

2. IF A/G VOICE CAPABILITY, AN EVA CREWMEMBER WILL TERMINATE THE EVA WHEN THE CAUTION AND WARNING SYSTEM (CWS) ISSUES A 30-MINUTE ALERT FOR OXYGEN, LIOH, OR WATER CONSUMABLES. THE EVA CREWMEMBER MUST BE COMPLETE WITH AIRLOCK INGRESS AND CONNECTED TO THE SERVICE AND COOLING UMBILICAL (SCU) WHEN 30 MINUTES OF POWER REMAIN AS DETERMINED BY MCC THROUGH PERIODIC REPORTS OF EMU STATUS. @[032807-8253]

If A/G voice is available but real-time EMU data is not available, the EMU CWS will be used to determine which consumable (oxygen, LiOH, or water) will reach the 30-minute limit first. However, battery power can be tracked on the ground with a periodic status, because the power usage is relatively constant during the EVA as compared with other consumables. The EV crew will give an hourly EMU status for the first 6.5 hours followed by an increase in status calls to every 10 minutes so that MCC can track more closely the battery performance towards the lower end of its capacity. Oxygen, LiOH, and water calculations depend on crewmember metabolic rate, requiring more frequent status checks to get an accurate estimate of use rate. The battery 30-minute limit will be calculated by the ground using the periodic status checks. Oxygen and water are rechargeable at vacuum. If the 30-minute consumable is oxygen, the crewmembers can connect to the SCU, recharge the oxygen, and return to EVA tasks. If the 30-minute consumable is water, a vacuum water recharge can be performed, but only for a contingency EVA. This rule is considered an operational constraint.

DOCUMENTATION: Hamilton Sundstrand Engineering Memorandum EMUMI-0404, Consumable Tracking During EVA, March 15, 2000, and engineering judgment.

D. EMU CONSUMABLES REDLINES

THE FOLLOWING TABLE IDENTIFIES EMU CONSUMABLES REDLINES. THE REDLINES WILL:

1. PROTECT THE REQUIRED 30-MINUTE RESERVE (REF PARAGRAPHS A-C ABOVE) .
2. LIMIT WITH EMU DATA TO MCC - REQUIRE THE EV CREW TO BE CONNECTED TO THE UMBILICAL (SCU) BY THE TIME THESE LIMITS ARE REACHED. @[032807-8253]

THIS RULE CONTINUED ON NEXT PAGE

FLIGHT RULES

A15-157

EMU CONSUMABLES FOR SHUTTLE (CONTINUED)

3. LIMIT WITHOUT EMU DATA TO MCC - REQUIRE THE EV CREW TO TERMINATE THE EVA WHEN THESE LIMITS ARE REACHED. NOTE THAT THIS COLUMN IN THE CHART BELOW ASSUMES THE WORST CASE - NO DATA AND NO VOICE TO GROUND. IN THE MORE LIKELY CASE WHERE VOICE COMMUNICATION WITH THE CREW IS AVAILABLE, TRENDING OF THE O₂ PRESSURE/USE RATE WILL BE PERFORMED FROM THE HOURLY CREW SHORT STATUS CALL DOWNS. THIS TRENDING IS NOT GUARANTEED TO HAVE THE CREW BACK ON SCU WITH 150 PSIA O₂ REMAINING, BUT WILL GIVE A BEST ESTIMATE TO GET AS CLOSE AS POSSIBLE. @[032807-8253]

	PRIMARY O ₂	WATER	POWER	LIOH	METAL OXIDE
LIMIT WITH EMU DATA TO MCC	150 PSIA	CWS MESSAGE RESERVE WATER ON / TIME LF = 0:30 [4] [5]	MCC FLIGHT SPECIFIC AMP-HR CALCULATION [1] OR CWS MESSAGE PWR TIME LEFT= 0:30 [4] OR 16.5 VOLTS (BATT VDC LOW CWS MESSAGE)	CO2 = 2.75 MMHG AND INCREASING (PRESSURE COMPENSATED) [2] OR MCC FLIGHT SPECIFIC BTU CALCULATION [2]	CO2 = 3.2 MMHG AND INCREASING (PRESSURE COMPENSATED) [3] OR MCC 7400 BTU CALCULATION [3]
LIMIT WITHOUT EMU DATA TO MCC	CWS MESSAGE O2 TIME LEFT = 0:30 [4]	CWS MESSAGE RESERVE WATER ON / TIME LF = 0:30 [4]	MCC FLIGHT SPECIFIC AMP-HR CALCULATION [1] OR CWS MESSAGE PWR TIME LEFT= 0:30 [4] OR 16.5 VOLTS (BATT VDC LOW CWS MESSAGE)	CWS MESSAGE MONITOR CO2 = 8.0 MMHG (PRESSURE COMPENSATED) OR 3.0 MMHG (UNCOMPENSATED)	CWS MESSAGE MONITOR CO2 = 8.0 MMHG (PRESSURE COMPENSATED) OR 3.0 MMHG (UNCOMPENSATED)

@[032807-8253]

THIS RULE CONTINUED ON NEXT PAGE

FLIGHT RULES

A15-157

EMU CONSUMABLES FOR SHUTTLE (CONTINUED)

NOTES: @[032807-8253]

- [1] FIRST OF EITHER LIMIT REACHED (VOLTS OR AMP-HR LEFT CALCULATION). MCC WILL HAVE THE PRE-EVA AMP-HR CHARGE CAPACITY OF THE EMU BATTERY. GROUND CALCULATION OF THE AMP-HRS USED DURING THE EVA WILL BE SUBTRACTED FROM THE PRE-EVA CAPACITY TO DETERMINE AMP-HR LEFT IN BATTERY. IF USING THE AMP-HR CALCULATION ON THE GROUND, THE CREW WILL BE ON THE SCU PRIOR TO REACHING THE 30 MINUTES LEFT INDICATION. OTHERWISE, THE CWS MESSAGES (PERCENT PWR LEFT AND BATT VDC LOW) WILL ALERT THE CREW TO TERMINATE WHEN 30 MINUTES OF BATTERY POWER REMAIN.
- [2] FIRST OF EITHER LIMIT REACHED (MMHG OR BTU LEFT CALCULATION). MCC WILL HAVE PRE-EVA LIOH CANISTER BTU CAPACITY. PER AGREED 30-MINUTE RESERVE OF 1500 BTU, GROUND CALCULATION OF THE BTU'S USED DURING THE EVA WILL BE SUBTRACTED FROM THE BTU CAPACITY TO DETERMINE BTU'S LEFT IN THE CANISTER. FOR LIOH, THE CO₂ VALUE OF 2.75 MMHG AND INCREASING (I.E., TRENDING CURVE NOT JUST ONE TIME VALUE INCREASE FROM HIGH MET RATE) IS WHEN THE EV CREW WILL TERMINATE THE EVA. MONITORING OF CO₂ TRENDING SHOULD BEGIN AT 2.4 MMHG. THESE VALUES ASSUME PRESSURE COMPENSATION OF THE CO₂ SENSOR READINGS. IF PRESSURE COMPENSATION IS LOST, THE EVA WILL BE TERMINATED AT A CO₂ VALUE OF 1.7 MMHG AND INCREASING.
- [3] FIRST OF EITHER LIMIT REACHED (MMHG OR BTU LEFT CALCULATION). METOX CANISTERS WILL HAVE A MAXIMUM 8000-BTU CAPACITY. PER AGREED 30-MINUTE RESERVE OF 600 BTU, A TOTAL OF 7400 BTU'S IS AVAILABLE FOR EVA TIME. GROUND CALCULATION OF THE BTU'S USED DURING THE EVA WILL BE SUBTRACTED FROM THE BTU CAPACITY TO DETERMINE BTU'S LEFT IN THE CANISTER. DUE TO THE DIFFERENCE IN COMPOSITION AND OPERATION OF METOX AS COMPARED TO LIOH, THE CO₂ VALUE OF 3.2 MMHG AND INCREASING (I.E., TRENDING CURVE NOT JUST ONE TIME VALUE INCREASE FROM HIGH MET RATE) IS WHEN THE EV CREW WILL TERMINATE THE EVA. MONITORING OF CO₂ TRENDING SHOULD BEGIN AT 2.9 MMHG. THESE VALUES ASSUME PRESSURE COMPENSATION OF THE CO₂ SENSOR READINGS. IF PRESSURE COMPENSATION IS LOST, THE EVA WILL BE TERMINATED AT A CO₂ VALUE OF 2.0 MMHG AND INCREASING.
- [4] THE EMU C&W SYSTEM PROVIDES 30-MINUTE LIMITING CONSUMABLE MESSAGES FOR:

- a. OXYGEN: WHEN O₂ TIME LEFT = $\frac{O_2 P - 75}{O_2 \text{ USE RATE}}$ = 30 MINUTES.
- b. WATER: WHEN H₂O GAS PRESS - H₂O WATER PRESS > 2.1 PSID.
- c. POWER: WHEN PWR TIME LEFT = $\frac{\text{INITIAL CAPACITY - AMP HR USED}}{\text{PWR USE RATE}}$ = 30 MINUTES.

THE PERCENTAGE OF O₂ AND POWER REMAINING IS DISPLAYED TO THE CREWMEMBER. THE LIMITING CONSUMABLE AND THE TIME LEFT IN THE EVA IS ALSO DISPLAYED. THE CALCULATION IN PART C IS BASED ON THE CREWMEMBER INPUT INITIAL CAPACITY OF THE BATTERY PER MCC-H DIRECTION. THE CWS ASSUMES A DEFAULT OF 32 AMP-HRS IF THE CREWMEMBER MAKES NO INITIAL SELECTION.

- [5] SINCE THERE IS NO INSIGHT INTO WATER USE RATE OR ACTUAL TANK CAPACITY, THE CREW WILL TERMINATE WHEN THE RESERVE H₂O ON MESSAGE IS RECEIVED. FOR THIS CONSUMABLE WE CANNOT GUARANTEE THAT THE CREW WILL BE CONNECTED TO THE SCU WITH 30 MINUTES REMAINING; HOWEVER, FROM PAST FLIGHT DATA OF POST EVA EMU WATER RECHARGES, WATER HAS NOT BEEN OUR LIMITING CONSUMABLE. @[032807-8253]

THIS RULE CONTINUED ON NEXT PAGE

FLIGHT RULES

A15-157

EMU CONSUMABLES FOR SHUTTLE (CONTINUED)

DOCUMENTATION: Hamilton Sundstrand Engineering Memorandum EMUM1-0404, Consumable Tracking During EVA, March 15, 2000; Hamilton Sundstrand Engineering Memorandum EMUM1-0598; Hamilton Sundstrand Engineering Memorandum EVAM-0215, IRCO2 Sensor Pressure Compensation with ECWS, February 22, 2006; and engineering judgment. ©[032807-8253]

A15-158 THROUGH A15-200 RULES ARE RESERVED ©[101305-6698A] ©[032807-8253]

FLIGHT RULES

EXTERNAL AIRLOCK

A15-201

EXTERNAL AIRLOCK HATCH THERMAL COVER

DURING EVA, THE EXTERNAL AIRLOCK HATCH THERMAL COVERS FOR THE UPPER AND AFT HATCHES SHOULD REMAIN CLOSED. IF EITHER COVER OPENS DURING EVA, AN EVA CREWMEMBER WILL RETURN TO THE AIRLOCK TO CLOSE IT AT THE NEXT CONVENIENT OPPORTUNITY. ©[061297-4904]

This rule is constrained by the orbiter cold case attitude (+XSI, PLB to space, beta = 90, or -XLV, PLB north, beta = -75). Design analysis that considered a closed hatch and thermal cover indicated that the water lines will approach freezing temperatures during the EVA period, even with the heaters enabled (for the analysis, the EVA period was defined as 10 hours with the airlock depressurized).

The airlock internal water lines are thermally insulated from the airlock structure by fiberglass standoffs. The segments of the internal water lines that have a direct view of deep space when both hatch and thermal cover are opened, will decrease more rapidly than the airlock structure. Therefore, there is a potential of the internal water lines freezing if the hatch thermal cover remains open during the EVA period.

Analysis indicates that when the airlock is pressurized, there is no concern for water line freezing regardless of the position of the hatch thermal cover.

DOCUMENTATION: Rockwell OER Presentation Charts September 18, 1996, and November 6, 1996, Rockwell IL 270-200-97-007, engineering judgment. ©[061297-4904]

FLIGHT RULES

A15-202

EXTERNAL AIRLOCK LCG PRESSURE AND TEMPERATURE MANAGEMENT USING THE EMU

IN THE EVENT THE EXTERNAL AIRLOCK LIQUID COOLING GARMENT (LCG) FLUID LINES EXPERIENCE AN UNEXPECTED PRESSURE OR TEMPERATURE INCREASE (REF RULE {A18-62}, EXTERNAL AIRLOCK WATER LINE OVERPRESSURE/TEMPERATURE MANAGEMENT), THE FOLLOWING CONSTRAINTS AND ACTIONS APPLY: @[070899-6889A]

- A. IF THE SERVICE AND COOLING UMBILICAL (SCU) IS DISCONNECTED FROM THE EMU:

WITH THE EMU O₂ VALVES CLOSED AND THE TCV IN MAX "C," THE SCU CAN BE CONNECTED TO THE EMU AND THE EMU FAN/PUMP TURNED ON FOR A MAXIMUM OF 2 MINUTES, IF THE EMU WATER TANKS CONTAIN THE NOMINAL ULLAGE AND BEFORE THE LCG WATER LINE TEMPERATURES IN EITHER ZONE EXCEED 92 DEGREES F.

The external airlock EMU Liquid Cooling Garment (LCG) lines are routed externally to the airlock/orbiter and are susceptible to pressure (MSID V64P0170A {EV1}) and V64P0171A {EV2}) and temperature (MSID V64T0182A {ZNI} and V64T0185A {ZN2}) increases due to a "hot" orbiter attitude or failed on line heaters. There are no accumulators, shutoff valves, or regulators in the LCG loops, which are in a hydraulic lockup condition when disconnected from the EMU. In the EMU, the LCG loop is connected to the water tanks through the bypass of the EMU Coolant Isolation Valve. The EMU water tanks, with nominal 1 pound ullage, will act as an accumulator for the LCG lines through the bypass of the EMU Coolant Isolation Valve.

The O₂ valves must remain closed because the maximum thermal limit for O₂ supplied to the EMU is 90 deg F. LCG2 water line temperatures ≤ 92 deg F in both zones ensure that all sections of the LCG water lines are below the EMU thermal limit of 100 deg F. The maximum limit for the EMU water line vent tube assembly (WLVTA) is 100 deg F. Anytime the EMU TCV is out of the max "H" position, water will flow through the WLVTA.

Although not designed for this purpose, the EMU can be used as a contingency device for lowering the pressure (and temperature) in the LCG lines by using the EMU fan/pump to circulate the LCG water to the orbiter LCG HX for cooling. The EMU fan/pump should not be on for longer than 2 minutes without O₂ pressurization of the EMU water tanks due to potential cavitation and damage of the pump. Calculations show the LCG supply "hot" water flows through the LCVG water loop in 45 seconds with the TCV in max "C." Two minutes will ensure that the water can pass through the LCG HX at least twice for cooling.

THIS RULE CONTINUED ON NEXT PAGE

FLIGHT RULES

A15-202

EXTERNAL AIRLOCK LCG PRESSURE AND TEMPERATURE MANAGEMENT USING THE EMU (CONTINUED)

It is preferable to change orbiter attitude if possible to lower the pressure (temperature) of the LCG fluid lines. ©[070899-6889A]

DOCUMENTATION: Hamilton Standard Engineering Memorandums EMUM1-0085 and EMUM1-0195, "STS-88 Hot External Airlock Return Temperatures & Revisions," and engineering judgment. ©[070899-6889A]

- B. IF THE SERVICE AND COOLING UMBILICAL (SCU) IS CONNECTED TO THE EMU:
1. THE EMU FAN/PUMP WILL BE TURNED ON FOR A MAXIMUM OF 2 MINUTES BEFORE THE LCG LINE PRESSURE REACHES 18 (16.6) PSIG FOR UNEXPECTED AND INCREASING PRESSURE.
 2. A NOMINAL EMU WATER TANK ULLAGE DUMP MUST BE PERFORMED AFTER AN UNEXPECTED PRESSURE INCREASE OR IF THE LCG PRESSURE DID NOT DECREASE AFTER SCU CONNECTION.

A steady pressure increase in either of the LCG lines (MSID V64P0170A {EV1} or V64P0171A{EV2}) with the SCU connected, EMU fan/pump and O₂ actuator off, indicates the EMU water tanks no longer contain any nominal ullage and are no longer acting as an accumulator for the LCG lines. In the EMU, the LCG loop is connected to the water tanks through the bypass of the EMU Coolant Isolation Valve. At 19.0 ±1.0 psig, the EMU Feedwater Relief Valve will open and vent water from the EMU water tanks into the airlock (ref Rule {A18-61}, EXTERNAL AIRLOCK LCG FLUID LINE LOSS DEFINITION).

Although not designed for this purpose, the EMU can be used as a contingency device for lowering the pressure (and temperature) in the LCG lines by using the EMU fan/pump to circulate the LCG water to the orbiter LCG HX for cooling. Therefore, the EMU pump will be turned on prior to reaching 18 psig (16.6 psig indicated) which will prevent the LCG loop pressure from reaching the Feedwater Relief Valve lower regulation of 18 psig. The EMU fan/pump should not be on for longer than 2 minutes without O₂ pressurization of the EMU water tanks due to potential cavitation and damage of the pump.

If the LCG line water has been cooled using the EMU fan/pump to stop a pressure increase, or if the pressure did not decrease after SCU connection, approximately 1 pound of water must be dumped from the EMU water tanks before reaching the Feedwater Relief Valve lower regulation of 18 psig to restore the capability for the EMU to act as an accumulator for the LCG lines through the bypass of the EMU Coolant Isolation Valve. In place of using the EMU, it is preferable to change orbiter attitude if possible.

DOCUMENTATION: Reference Hamilton Standard, EMUM-1337; Hamilton Standard Engineering Memorandums EMUM1-0085 and EMUM1-0195, "STS-88 Hot External Airlock Return Temperatures & Revisions;" and engineering judgment. ©[070899-6889A]

FLIGHT RULES

A15-203

CABIN ATMOSPHERE DECONTAMINATION FOLLOWING EVA

@[021199-6821A]

- A. FOLLOWING A NEGATIVE DRAGER TUBE READING, THE CABIN AIR WILL BE TREATED UNDER THE ASSUMPTION THAT THE AIRLOCK VOLUME IS CONTAMINATED TO THE MINIMUM SENSITIVITY LEVEL FOR THE SPECIFIC DRAGER TUBE (250 PPB FOR HYDRAZINES AND AMMONIA, AND 500 PPB FOR NO₂) . @[021199-6821A]

This rule assumes that contamination of the EMU was either suspected or confirmed and action was taken to eliminate the contaminants from the affected EVA crewmember (such as bakeout) prior to performing airlock repress. Under these conditions, a Drager tube reading is required.

Because the Drager tubes are not sensitive enough to detect acceptable SMAC levels, lack of a reading does not verify that the contamination level is below the 7-day SMAC. The assumed contamination level is the minimum sensitivity of the specific Drager tube. The minimum sensitivities of the hydrazine/ammonia and nitrogen dioxide tubes are 250 ppb and 500 ppb, respectively.

DOCUMENTATION: Drager-Tube Handbook, 1994.

- B. THE FOLLOWING ACTIONS WILL BE TAKEN IN AN ATTEMPT TO REDUCE THE ASSUMED CONTAMINANT CONCENTRATION BELOW THE DESIGNATED 7-DAY SMAC LEVELS AND TO PROTECT THE CREW DURING ATMOSPHERE SCRUBBING:
1. IMMEDIATELY PRIOR TO AIRLOCK HATCH OPENING, THE IV CREW WILL DON QDM'S AND BREATHE O₂. THE IV CREW WILL REMAIN ON THE QDM'S FOR 20 MINUTES FOLLOWING HATCH OPENING.
 2. PRIOR TO AIRLOCK HATCH OPENING, PERFORM THE FOLLOWING ACTIONS AND CONTINUE FOR 3 HOURS AFTER AIRLOCK HATCH OPENING:
 - a. INSTALL TWO ATCO CANISTERS TO SCRUB HYDRAZINES AND AMMONIA FROM THE CABIN ATMOSPHERE.
 - b. PLACE CABIN TEMP CONTROLLER IN THE "FULL COOL" POSITION.
 - c. INITIATE AIR FLOW THROUGH WCS ODOR/BACTERIA FILTER.
 - d. IV CREW WILL DON LONG SLEEVES, LONG PANTS, AND GLOVES AS PRACTICAL. @[021199-6821A]

THIS RULE CONTINUED ON NEXT PAGE

FLIGHT RULES

A15-203

**CABIN ATMOSPHERE DECONTAMINATION FOLLOWING EVA
(CONTINUED)**

3. FOLLOWING AIRLOCK HATCH OPENING: ©[021199-6821A]
- a. EV CREW WILL REMAIN IN EMU'S FOR 20 MINUTES FOLLOWING AIRLOCK HATCH OPENING.
 - b. WIPE EMU'S AND AIRLOCK WALLS WITH WET TOWELS.
 - c. INSTALL/ACTIVATE BOOSTER FAN AND ASSOCIATED DUCTWORK AS SOON AS POSSIBLE.
- C. FOLLOWING A NEGATIVE READING AND COMPLETION OF THE ATMOSPHERE SCRUBBING ACTIVITIES (REF PARAGRAPH B), THERE ARE NO MISSION DURATION CONSTRAINTS.

Following EVA, the Drager test is performed with the airlock pressure at 5 psia. Repressurizing the airlock to 10.2 psia will reduce the contaminant concentration by a factor of 2 in the airlock (2.9 by repressurizing to 14.7 psia). This will bring the concentration below the 24-hour SMAC for all cases except MMH.

After airlock hatch opening and the atmospheres have mixed, the concentration will be further reduced by a factor of 7 (tunnel adapter) and 12 (airlock only) depending upon the specific volume configuration. This will bring the concentration below the 7-day SMAC for all cases except MMH.

The expected contamination level following dilution by volume equalization, assuming good atmospheric mixing, will be approximately 11 ppb (approximately 18 ppb with a tunnel adapter) for a 10.2 psia cabin. For a 14.7 psia cabin following equalization, the expected contamination level will be approximately 7 ppb (approx 12 ppb with a tunnel adapter).

The IV crew must remain on the QDM's and the EV crew must remain in the EMU for at least 20 minutes following hatch opening to allow time for the two atmospheres to mix and to allow any localized pockets of contaminants to dissipate. Twenty minutes was chosen as a time to allow effective mixing without requiring further action to control the O₂ concentration in the cabin. Donning long sleeves, long pants and gloves will minimize the amount of exposed skin and further protect the IV crewmembers from exposure to the toxic products following airlock hatch opening. This is listed as "as practical" because there is currently no requirement for crewmembers to select long pants and long-sleeved shirts as part of their in-flight wardrobe.
©[021199-6821A]

THIS RULE CONTINUED ON NEXT PAGE

FLIGHT RULES

A15-203

**CABIN ATMOSPHERE DECONTAMINATION FOLLOWING EVA
(CONTINUED)**

Two ambient temperature catalytic oxidizer (ATCO) canisters are installed to remove additional hydrazine, MMH, UDMH, and ammonia from the cabin atmosphere. In 2 to 3, hours it is expected that the cabin POCO₂ levels will increase enough to require replacement of one of the ATCO canisters with a fresh LiOH canister. The other ATCO canister should remain in place as long as practical. The ATCO canister is 100 percent effective at neutralizing the contaminants from the air that passes through it. Based upon nominal cabin fan airflow, each ATCO canister will scrub the volume equivalent of the cabin atmosphere every 90 minutes. It is assumed that for each volume equivalent cycle through an ATCO can, approximately 63 percent of the remaining contaminants have been neutralized. Therefore, in 3 hours, assuming one ATCO is replaced with a LiOH after 2 hours, the entire cabin atmosphere will have passed through an ATCO canister at least three times and the concentration will be reduced to < 10 percent of the initial concentration. The 63 percent contamination reduction number is based upon analysis that shows for each complete volume equivalent cycle through a LiOH canister slot, because the atmospheric mixing is not ideal, only 63 percent vs 100 percent of the molecules of air in the cabin will actually flow across the catalyst bed in the ATCO canister. For all of the contamination compounds, including MMH, final concentration will be below the 7-day SMAC within 3 hours of airlock hatch opening and initial ATCO scrubbing. ©[021199-6821A]

Because hydrazines are water soluble, wiping the EMU's with wet towels will dilute the contaminant and transfer the contaminant to the towels and prevent additional off-gassing from the EMU. The contaminated towels can be placed in Ziplock bags. Also, due to the solubility of hydrazines, contaminants can be condensed out of the atmosphere and sent in solution to the waste water system. Therefore, the IV crew will place the cabin temp controller to the "FULL COOL" position thus maximizing airflow across the ARS condensing heat exchanger.

The WCS odor/bacteria filter is designed to remove ammonia (NH₃) from the airflow through the WCS. Activation of the WCS commode will initiate the maximum airflow through the odor/bacteria filter and aid in scrubbing ammonia from the cabin atmosphere. The volume equivalent of the cabin atmosphere will flow through the WCS odor/bacteria filter approximately every 60 minutes.

The booster fan is reinstalled and activated, with associated ductwork connected, as soon as possible to circulate the contaminated atmosphere from the airlock to the cabin in an attempt to dilute the overall concentration through mixing of the atmospheres and to send the contaminated atmosphere through the ARS as quickly as possible. ©[021199-6821A]

THIS RULE CONTINUED ON NEXT PAGE

FLIGHT RULES

A15-203

**CABIN ATMOSPHERE DECONTAMINATION FOLLOWING EVA
(CONTINUED)**

In all cases, the procedure governed by this rule meets the criteria listed in the following table with the exception of the 24-hour SMAC for MMH. Orbit Flight Techniques (November 12, 1998) deemed this acceptable based upon the ability to meet the 24-hour and the 7-day SMAC within 3 hours of cabin contamination. Additionally, White Sands personnel have been previously exposed to MMH at levels several orders of magnitude higher than the 24-hour SMAC with no deleterious effects. ©[021199-6821A]

The table below lists the SMAC levels informally proposed by the JSC Toxicology group.

TABLE A15-203-I - SMAC LEVELS (PPB)

CHEMICAL	DRAGER DETECTION LEVEL	1-HOUR	24-HOURS	7-DAYS
N ₂ H ₄	250	4,000	300	40
MMH	250	2	2	2
UDMH	250	NOT SET	NOT SET	100
N ₂ O ₄ (NO ₂)	500	NOT SET	NOT SET	500
NH ₃	250	30,000 (30 PPM)	20,000 (20 PPM)	10,000 (10 PPM)

DOCUMENTATION: EVA Console Handbook, Sec. 6.5 N2H4 Contamination (EVA/JSC-20597), engineering judgment. ©[021199-6821A]

FLIGHT RULES

A15-204

EXTERNAL AIRLOCK EMU SERVICING CONSTRAINTS

EMU SERVICING AND OPERATION IS CONSTRAINED BY THE FOLLOWING THERMAL LIMITS: @[070899-6890A]

- A. O₂ SERVICING MAY BE PERFORMED WHEN EITHER OF THE FOLLOWING TWO CONDITIONS ARE SATISFIED:
1. THE O₂ SUPPLY TEMPERATURE IS \leq 80 DEG F (INDICATED). @[121400-3862A]
 2. THE O₂ SUPPLY LINE TEMPERATURE SENSOR IS FAILED AND:
 - a. THE EXTERNAL AIRLOCK FLUID LINE HEATERS ARE CYCLING IN BOTH ZONES.
- OR
- b. THE EXTERNAL AIRLOCK FLUID LINE HEATERS ARE NOT CYCLING AND THE LCG SUPPLY AND POTABLE SUPPLY TEMPERATURES ARE $<$ 72 DEG F (INDICATED).

O₂ servicing is defined as the period of time when the SCU is mated to the EMU and the airlock O₂ valves are open. Flow analyses were performed to ensure that all O₂ delivered to the airlock is less than 90 deg F since temperature gradients can exist between the sensor location and the rest of the line. Based on the analyses, an O₂ supply line temperature (MSID V64T0183A through STS-98; the MSID will be V64T0186A starting with STS-102) less than or equal to 80 deg F ensures the O₂ flow into the EMU is less than 90 deg F. If the O₂ supply temperature sensor fails, then heater cycling (MNA, MNB, or MNC heaters) on the fluid lines indicates a payload bay environment below 70 deg F and, therefore, environmental heating above the O₂ limit is not possible. Also, for a failed O₂ sensor, maintaining a supply water (MSID V64T0181A {ZN1} and V64T0184A {ZN2}) and LCG supply (MSID V64T0182A {ZN1} and V64T0185A {ZN2}) line temperature in both zones below 72 deg F with no heater cycling (implying that the 72 deg F is due to environmental heating and not heater operations) ensures that the O₂ line temperature is below 90 deg F. The O₂ limit of 90 deg F was chosen because all EMU safety analysis was performed with this limit. Impacts from exceeding this limit are unknown. There is also a 90 deg F maximum inlet temperature to the helmet that EMU must meet. There is currently no active method of cooling the O₂ line. @[121400-3862A]

Indicated values are used since the analyses have conservative assumptions that cover the instrumentation error. Applying instrumentation error to the conservative analysis values may unnecessarily constrain operations. @[121400-3862A]

THIS RULE CONTINUED ON NEXT PAGE

FLIGHT RULES

A15-204

EXTERNAL AIRLOCK EMU SERVICING CONSTRAINTS
(CONTINUED)

- B. LCG WATER MAY BE CIRCULATED THROUGH A MANNED SUIT IF THE EXTERNAL AIRLOCK LCG2 WATER LINE TEMPERATURE IN BOTH ZONES IS ≤ 92 DEG F.

LCG2 water line temperatures ≤ 92 deg F in both zones (MSID V64T0182A {ZN1} and V64T0185A {ZN2}) ensure that the all sections of the LCG water lines are below the EMU thermal limit of 100 deg F. The 100 deg F thermal limit for water circulated through a manned suit is defined by Hamilton Sundstrand to ensure crew comfort.

- C. LCG WATER MAY BE CIRCULATED THROUGH AN UNMANNED SUIT IF EXTERNAL AIRLOCK LCG2 WATER LINE TEMPERATURE IN BOTH ZONES IS ≤ 110 DEG F.

FOR AN UNMANNED EMU, IF THE EXTERNAL AIRLOCK LCG LINE TEMPERATURE IN EITHER ZONE IS < 110 DEG F BUT > 92 DEG F, THE EMU TCV MUST BE PLACED IN THE MAX "H" POSITION PRIOR TO INITIATING WATER CIRCULATION. @[070899-6890A]

LCG2 water line temperatures ≤ 110 deg F in both zones (MSID V64T0182A {ZN1} and V64T0185A {ZN2}) ensure that all sections of the LCG water lines are below the EMU thermal limit of 120 deg F. For an unmanned suit, the limit of 120 deg F comes from the EMU certification limit. The tubing in the HUT is molded at 120 deg F and may deform when exposed to this limit. Placing the TCV in MAX "H" (LCVG bypass) minimizes the EMU exposure to hot water. @[070899-6890A]

- D. WATER RECHARGE MAY BE PERFORMED IF THE EXTERNAL AIRLOCK SUPPLY WATER LINE TEMPERATURE IN BOTH ZONES IS ≤ 95 DEG F. @[121400-3862A]

Supply water line temperatures ≤ 95 deg F in both zones (MSID V64T0181A {ZN1} and V64T0184A {ZN2}) ensure that all sections of the supply water line are below the EMU thermal limit of 100 deg F. The thermal limit of 100 deg F for water recharge protects the life of the SCU bacteria filter cartridge and minimizes the risk of having a high concentration of iodine in the feedwater bladders.

THIS RULE CONTINUED ON NEXT PAGE

FLIGHT RULES

A15-204

EXTERNAL AIRLOCK EMU SERVICING CONSTRAINTS
(CONTINUED)

- E. BATTERY RECHARGE IS NOT CONSTRAINED BY EXTERNAL AIRLOCK LINE THERMAL LIMITS.

Battery recharge has no thermal constraints because the airlock O₂ valves are closed to isolate O₂ flow, and no water is supplied to or circulated through the EMU.

- F. EMU O₂ SERVICING SHALL BE AVAILABLE FOR THE DURATION OF AN EVA PER CONSTRAINTS IN PARAGRAPH A. EMU LCG COOLING SHALL BE AVAILABLE FOR THE DURATION OF AN EVA PER CONSTRAINTS IN PARAGRAPH B.

To protect for early termination of an EVA due to EMU failures, and provide vehicle consumables, the EMU O₂ supply must be available at all times during an EVA to provide immediate O₂ resupply/flow through the Service and Cooling Umbilical (SCU). The LCG supply line temperatures must be maintained ≤ 92 deg F in both zones (MSID V64T0182A {ZNI} and V64T0185A {ZN2}) during the EVA in order to provide cooling to the EV crew in the case of an EMU cooling failure.

DOCUMENTATION: Hamilton Standard Engineering Memorandums, EMUM1-0085 and EMUM1-0195, "STS-88 Hot External Airlock Return Temperatures & Revisions," EMUM1-0248, "EMU Requirements for External Airlock," EMUM1-0268, "Additional Limits on Airlock Interface Temperatures," and engineering judgment. ©[070899-6890A] ©[121400-3862A]

FLIGHT RULES

A15-205

EMU DECONTAMINATION DURING EVA

- A. IF CHEMICAL CONTAMINATION OF THE EMU IS CONFIRMED BY VISUAL OBSERVATION OR CHEMICAL DETECTION EQUIPMENT, THEN THE HYDRAZINE DECONTAMINATION PROCEDURE WILL BE EXECUTED. @[070899-6869A]

For confirmed contamination, the decontamination procedure is designed to reduce the hydrazine, ammonia, or oxidizer levels to safe values based on analysis.

Use of consumables and impact to the crew timeline for airlock depress and bakeout are significant mission impacts and will not be performed unless contamination of the EMU is confirmed by visual inspection or chemical detection equipment.

- B. DRAGER TUBES WILL ONLY BE UTILIZED WHEN EMU CONTAMINATION IS SUSPECTED.

EMU CONTAMINATION IS SUSPECTED WHEN THE EMU WAS IN THE VICINITY OF A THRUSTER OR AMMONIA SYSTEM COMPONENT WITH A VISUALLY OR TELEMETRY DETECTED LEAK.

Because there is a limited supply of drager tubes on board, they will only be used if contamination is suspected.

Suspected EMU contamination must be investigated further with the hydrazine detection equipment to either confirm or disprove the suspected contamination before it presents a hazard to the IV crew.

Reference Rule {A15-203}, CABIN ATMOSPHERE DECONTAMINATION FOLLOWING EVA. @[070899-6869A]

FLIGHT RULES

THIS PAGE INTENTIONALLY LEFT BLANK

FLIGHT RULES

SECTION 16 - POSTLANDING

GENERAL

A16-1	CONVOY POSITIONING.....	16-1
A16-2	VEHICLE SYSTEM RECONFIGURATION CONSTRAINT.....	16-1
A16-3	PRECREW EGRESS TROUBLESHOOTING CONSTRAINT.....	16-1
A16-4	VEHICLE SYSTEM MODING CONSTRAINT.....	16-1
A16-5	MEMORY RECONFIGURATION CONSTRAINT.....	16-1
A16-6	RECORDER DUMP.....	16-2
A16-7	GOM HANDOVER.....	16-2
A16-8	CREW EGRESS METHOD DETERMINATION (FOR MODE V EGRESS).....	16-3
A16-9	SSME REPOSITIONING CONSTRAINT.....	16-4
A16-10	NORMAL POSTLANDING OPERATIONS.....	16-6
A16-11	EXPEDITED POWERDOWN [HC].....	16-7
A16-12	EMERGENCY POWERDOWN.....	16-10
A16-13	SIDE HATCH OPENING CONSTRAINT.....	16-12
A16-14	THROUGH A16-50 RULES ARE RESERVED.....	16-12

COOLING

A16-51	NO GROUND COOLING/EARLY VEHICLE POWER TERMINATION.....	16-13
A16-52	EXTENDED COOLING.....	16-15
A16-53	FREON LOOP CONFIGURATION.....	16-15
A16-54	AMMONIA BOILER MANAGEMENT.....	16-16
A16-55	THROUGH A16-100 RULES ARE RESERVED.....	16-16

ET UMBILICAL DOOR

A16-101	ET UMBILICAL DOOR POSITIONING.....	16-17
A16-102	THROUGH A16-200 RULES ARE RESERVED.....	16-17

FLIGHT RULES

VENT DOORS

A16-151	VENT DOOR POSITIONING.....	16-18
A16-152	THROUGH A16-200 RULES ARE RESERVED.....	16-18

APU/HYDRAULIC

A16-201	HYDRAULIC CIRCULATION PUMP OPERATION.....	16-19
A16-202	APU REQUIREMENTS.....	16-20
A16-203	APU/HYDRAULIC LOAD TEST TERMINATION.....	16-20
A16-204	WINDWARD APU OPERATION CONSTRAINT.....	16-21
A16-205	EARLY APU SHUTDOWN [HC].....	16-22
A16-206	THROUGH A16-250 RULES ARE RESERVED.....	16-23

FUEL CELLS

A16-251	FUEL CELL LIFETIME.....	16-24
A16-252	THROUGH A16-300 RULES ARE RESERVED.....	16-24

CONTAMINATION/FLAMMABILITY

A16-301	CONTAMINATION/FLAMMABILITY/TOXICITY.....	16-25
A16-302	EMERGENCY OXYGEN SYSTEM REQUIREMENTS.....	16-25

FLIGHT RULES

SECTION 16 - POSTLANDING

GENERAL

A16-1 **CONVOY POSITIONING**

CONVOY POSITIONING WILL NOT BE CAUSE TO CONSTRAIN RUNWAY SELECTION.

A16-2 **VEHICLE SYSTEM RECONFIGURATION CONSTRAINT**

SYSTEM RECONFIGURATION WHICH WOULD RESULT IN DESTROYING VEHICLE TURNAROUND PROBLEM ANALYSIS WILL BE AVOIDED WHERE POSSIBLE.

A16-3 **PRECREW EGRESS TROUBLESHOOTING CONSTRAINT**

PRECREW EGRESS TROUBLESHOOTING WILL BE LIMITED TO REGAINING A CAPABILITY REQUIRED FOR POSTLANDING ACTIVITIES.

Emphasis will be on configuring the Orbiter in a safe configuration for crew egress. Activities that can be accomplished by the exchange crew will be delayed until crew egress in order to expedite the crew egress timeline.

A16-4 **VEHICLE SYSTEM MODING CONSTRAINT**

IF AN EMERGENCY POWERDOWN IS REQUIRED, NO VEHICLE SYSTEM MODING WILL BE ACCOMPLISHED TO PROTECT VEHICLE SYSTEMS DATA.

Emergency powerdown and crew safety have priority over vehicle systems data.

A16-5 **MEMORY RECONFIGURATION CONSTRAINT**

IF THE BFS IS ENGAGED PRIOR TO THE POSTLANDING G3-TO-G9 TRANSITION, GNC RECONFIGURATION TO A SIMPLEX PASS GNC 9 MEMORY CONFIGURATION WILL NOT BE ATTEMPTED.

Cause for the BFS engage is most likely a combination of LRU failures and GPC failures. No attempt at establishing a PASS computer will be performed in order to preserve data for failure reconstruction purposes. SSME repositioning will not be attempted since the capability is not supported in the BFS.

Rule {A16-9}, SSME REPOSITIONING CONSTRAINT, references this rule.

FLIGHT RULES

A16-6 RECORDER DUMP

POSTLANDING RECORDER DUMPS WILL BE ACCOMPLISHED BY MCC SO AS NOT TO CONSTRAIN THE CREW EGRESS TIMELINE.

This rule clarifies that MCC is prime for recorder dumps and crew participation will be minimal. Should there be an unexpected need for onboard assistance, the dump will be delayed until the astronaut support crew is available.

A16-7 GOM HANDOVER

- A. NOMINAL HANDOVER TO THE GOM WILL OCCUR AT CREW EGRESS OR GSE COOLING ACTIVATION, WHICHEVER OCCURS LATER.
- B. FOR LOSS OF MCC VOICE AND TELEMETRY, OR IF A MODE V OR VI EMERGENCY CONDITION IS DECLARED, HANDOVER TO THE GOM WILL BE ACCOMPLISHED ASAP; IF TOTAL LCC CAPABILITY IS LOST, NO CHANGE TO POSTLANDING ACTIVITIES WILL OCCUR, BUT HANDOVER TO THE GOM WILL BE DELAYED UNTIL THE CAPABILITY IS REGAINED OR THE ORBITER IS POWERED DOWN.
- C. HANDOVER TO THE GOM WILL OCCUR AT WHEELS STOP FOR LOSS OF MCC COMMUNICATIONS WITH THE VEHICLE.

LCC data monitoring is available to the Ground Operations Manager if loss of MCC systems insight and communication capability occurs. Handover will occur ASAP in order for normal postlanding operations to continue. If LCC monitoring capability is lost, systems monitoring will continue to be supported by the MCC until no longer needed (vehicle powerdown or restoration of LCC capability).

FLIGHT RULES

A16-8

CREW EGRESS METHOD DETERMINATION (FOR MODE V EGRESS)

THE CREW WILL DETERMINE WHICH OF THE FOLLOWING MODE V EGRESS METHODS WILL BE USED: @[041196-1881A]

- A. HATCH ON MODE V - CREW MANUALLY OPENS SIDE HATCH. WHENEVER POSSIBLE, THE CREW WILL USE THIS TECHNIQUE.
- B. HATCH JETTISON MODE V - CREW PYROTECHNICALLY JETTISONS THE SIDE HATCH. A CREW WILL USE THIS TECHNIQUE ONLY UNDER THE FOLLOWING CONDITIONS:
 1. INTOLERABLE CABIN CONDITIONS DUE TO FIRE, SMOKE, TOXIC GASSES, OR HIGH TEMPERATURES PRESENT IN THE CREW CABIN AND NOT READILY ELIMINATED BY OTHER ACTIONS.
 2. IMMINENT THREAT TO LIFE AND SAFETY OF THE CREW AS DETERMINED BY THE CDR.
- C. ESCAPE PANEL MODE V - CREW PYROTECHNICALLY JETTISONS THE WINDOW 8 ESCAPE PANEL. THIS TECHNIQUE WILL BE USED ONLY UNDER THE CIRCUMSTANCES LISTED FOR HATCH JETTISON IN PARAGRAPH B ABOVE, AND THEN HATCH JETTISON IS PREFERRED. ESCAPE PANEL MODE V WILL BE PERFORMED ONLY IF SITUATIONS REQUIRING IMMEDIATE EGRESS WHEN THE SIDE HATCH IS (1) BLOCKED, (2) JAMMED, (3) STRUCTURALLY DEFORMED, (4) OTHERWISE SUSPECTED OF BEING UNABLE TO BE JETTISONED, OR (5) WHEN GROUND PERSONNEL ARE IN THE HAZARD ZONE AROUND THE SIDE HATCH.

PYROTECHNIC JETTISON WILL NOT BE UTILIZED WHEN AN EXPLOSIVE/FLAMMABLE ATMOSPHERE IS PRESENT. THE CREW SHOULD MAKE EVERY POSSIBLE ATTEMPT TO COORDINATE WITH GROUND PERSONNEL BEFORE PYROTECHNIC JETTISON.

The crew is in the best position to determine the safest egress mode. If time allows, it is preferable to reposition the egress slide on the side hatch and then open the hatch normally and inflate the slide. This prevents further damage to the vehicle. If the crew is in immediate danger, the side hatch may be jettisoned. In the case of a slide failure, the crew can still egress out the side hatch using the sky genie descent devices.. An egress through the overhead escape panel (window W8) is slower and more inherently dangerous and, therefore, should not be performed unless egress through the side hatch is impossible.

The crew should attempt to notify the crash/rescue crew of their intentions either by orbiter A/G, PRC-112 survival radio (Channel A), or light signals per the Entry Checklist. @[041196-1881A]

FLIGHT RULES

A16-9

SSME REPOSITIONING CONSTRAINT

A. SSME REPOSITIONING WILL NOT BE ATTEMPTED UNDER ANY OF THE FOLLOWING CONDITIONS: @[031500-7180]

1. OI MDM OA1, DSC OA1, OR BOTH PCMMU'S FAILED.

The GPC's depend on SSME actuator position feedback information transmitted through OI MDM OA1 and the PCMMU's to properly reposition the SSME's. The SSME actuator position feedback transducers receive power through DSC OA1.

2. MULTIPLE AEROSURFACE POSITION FEEDBACK FAILURES RESULTING IN ERRONEOUS OPS-9 SELECTED POSITION. REPOSITIONING CAN BE PERFORMED IF COMMFAULTING ONE OF THE FAILED FEEDBACKS WILL PROVIDE A GOOD SELECTED POSITION.

The OPS 9 aerosurface position feedback selection filter utilizes a mid-value selection scheme among the first three feedbacks, and only downmodes to use the channel 4 feedback when one of the first three is commfaulted by powering off the associated FA MDM (further commfaults would result in averaging the two available feedbacks or using the one available feedback). Feedbacks failed by OPS 3 or 6 RM, or deselected manually by the crew, are still considered available. If two of the feedbacks among channels 1, 2, and 3 are failed, a bad feedback will be selected and the subsequent AI Model command will set the commands equal to this erroneous value causing a large step input to the actuator command. By commfaulting one of these failed feedbacks, the selection filter will use the channel 4 feedback and output a good selected feedback. Nominal repositioning can continue with this FA MDM and associated FCS channel off. (The performance of OPS 9 repositioning software with commfaulted FA MDM's was verified in formal SAIL testing on September 28-30, 1998. This testing confirmed that the repositioning software will function properly with up to three FA MDM's commfaulted.)

3. TWO APU'S/HYDRAULICS SYSTEMS UNAVAILABLE.

The loss of two APU's/hydraulic systems (due to system failures or failed-closed MPS/TVC isolation valves) will keep one of the SSME's from being repositioned since each engine only has two hydraulic systems available as shown below:

Center engine: Hydraulic systems 1 and 3.

Right engine: Hydraulic systems 2 and 3.

Left engine: Hydraulic systems 1 and 2.

The inability to reposition one engine will cause the repositioning sequence to fail. @[031500-7180]

THIS RULE CONTINUED ON NEXT PAGE

FLIGHT RULES

A16-9

SSME REPOSITIONING CONSTRAINT (CONTINUED)

4. BODY FLAP ANOMALY ("HOLD, CYCLE, FAIL") THAT CANNOT BE ISOLATED. @[031500-7180]

The failure of the body flap to move as commanded during entry, which causes the messages of HOLD, CYCLE, or FAIL to occur, signifies a problem in the body flap drive system (messages due to FCS channel reconfigurations do not apply). In cases where the body flap happens to be in the up position, a recontact of the body flap with the SSME's may occur when the repositioning sequence is activated. If the condition is due to a failed command channel, the bad channel can be isolated by turning off the corresponding FCS channel for a failed ASA command, or by shutting down the corresponding APU for a failed pilot valve.

5. THE DIFFERENCE BETWEEN ANY SSME ACTUATOR COMMAND (AVERAGE OF THE ACTIVE ATVC DRIVER OUTPUTS) AND THE INDICATED POSITION IS GREATER THAN 2.0 DEGREES.

Application of full hydraulic pressure to ATVC's, with a command-actual position difference of greater than 2 degrees, risks damage (possible rupture) to the hydraulic lines and subsequent loss of that hydraulic system. The average of the active ATVC driver outputs are used in the differencing scheme (as opposed to the software command) to eliminate the uncertainties in the command path. The 2.0-degree constraint takes into account the transducer uncertainty (ref. SODB 3.4.5.1.h.1).

When the post-landing repositioning sequence is started, the MDM commands are first set equal to the indicated position feedbacks (AI mode 1). If an engine actuator position measurement is in error, the resulting Mode 1 command will likewise be in error by the same amount, resulting in a step change in position if the isolation valves are open. Should this step exceed 2.0 degrees, the possibility of rupturing hydraulic lines exists. Even if the hydraulic lines are not ruptured, the command/position delta (if caused by transducer failure) may result in an error code 103 being generated and displayed on SPEC 105 which in turn will prevent any further repositioning of the SSME's.

6. BFS ENGAGED

The BFS cannot perform SSME repositioning (ref. Rule {A16-5}, MEMORY RECONFIGURATION CONSTRAINT).

THIS RULE CONTINUED ON NEXT PAGE

FLIGHT RULES

A16-9 SSME REPOSITIONING CONSTRAINT (CONTINUED)

- B. IF SSME REPOSITIONING CANNOT BE PERFORMED, THE SPEEDBRAKE AND BODY FLAP WILL BE REPOSITIONED PROVIDED THE LANDING IS AT KSC AND THE SSME'S ARE IN THE CHUTE STOW POSITION.

The primary benefit of SSME repositioning is that it allows GSE access for the main engine turbopump bearing purges. To prevent a significant turnaround impact, these purges must begin within 48 hours of landing. Provided the landing is at KSC and the SSME's are in the drag chute stow position, adequate access for the purges is achieved by positioning only the body flap and speedbrake. In this case, the body flap is manually positioned full down, prior to the OPS 9 transition. For OI-28 and subsequent flights, fully closing (position of 15 percent) the speedbrake prior to the OPS 9 transition will provide adequate clearance for GSE in the OPF. For OI-27, a software K-load will not allow the speedbrake to be sufficiently closed prior to OPS 9. Therefore, the speedbrake must be closed using OPS 9 software and SPEC 113. If the landing is at a site other than KSC, or the SSME's are not in the drag chute stow position at touchdown, then full SSME repositioning is required to gain access for the turbopump purges.
 ©[031500-7180]

A16-10 NORMAL POSTLANDING OPERATIONS

NORMAL POSTLANDING OPERATIONS WILL BE CONTINUED EXCEPT FOR THE FOLLOWING CONDITIONS:

- A. LIGHTNING WITHIN 5 MILES.

The KSC Ground Operations Safety Plan (GP-1098E) requires that all operations be terminated for lightning within 5 miles. However, if orbiter tow operations are underway, towing may continue if all personnel on foot enter a covered vehicle.

- B. LIQUID LEAKS, HYPERGOLIC VENTING, OR HAZARDOUS MATERIALS TOXICITY ABOVE ALLOWABLE LIMITS (REF. RULE {A16-301}, CONTAMINATION/FLAMMABILITY/TOXICITY).
- C. MMH, N₂O₄, OR HYDRAZINE CONCENTRATIONS WITHIN THE POD/AFT COMPARTMENT. (FOR MMH OR HYDRAZINE, REF. RULE {A16-11C}, EXPEDITED POWERDOWN.) (FOR N₂O₄, REF. RULE {A16-204}, WINDWARD APU OPERATION CONSTRAINT.)
- D. LOSS OF COMMUNICATION/SYSTEMS MONITORING CAPABILITY (REF. RULE {A16-11}, EXPEDITED POWERDOWN).
- E. ORBITER CONDITIONS REQUIRING EXPEDITED/EMERGENCY POWERDOWN (REF. RULE {A16-12}, EMERGENCY POWERDOWN).

FLIGHT RULES

A16-11

EXPEDITED POWERDOWN [HC] ©[022405-6578A]

AN EXPEDITED POWERDOWN IS DEFINED TO ALLOW ACCOMPLISHMENT OF ET DOOR OPENING (RTLIS/TAL ONLY), OMS/RCS-SAFING, NOMINAL GPC POWERDOWN FOLLOWED IMMEDIATELY BY AN EMERGENCY POWERDOWN. ©[012402-5079]

AN EXPEDITED POWERDOWN AND MODE V CREW EGRESS WILL BE ACCOMPLISHED FOR:

- A. LOSS OF ALL COMMUNICATIONS (INCLUDING VISUAL SIGNALS AND MCC RELAY) BETWEEN CREW AND CONVOY ELEMENTS.

NOTE: RULE {A16-8}, CREW EGRESS METHOD DETERMINATION (FOR MODE V EGRESS) GOVERNS THE MODE V EGRESS METHOD THE CREW WILL USE. ©[041196-1881A]

Crew safety could be compromised with the loss of communication between the crew and convoy personnel. Possible orbiter problems that occur during landing and rollout not reflected in orbiter systems would not be available to the crew (i.e., tire fire, explosive/flammable conditions, etc.).

- B. LOSS OF ALL TELEMETRY (MCC AND LCC) AND ONBOARD SYSTEMS MONITORING (BFS, C&W PANEL, AND FDA) VISIBILITY. IF COMM IS AVAILABLE TO CREW, MCC WILL DETERMINE IF MODE V IS REQUIRED.

As long as insight into critical vehicle systems and communication with the crew are maintained, normal postlanding operations can continue. Critical systems information is available at KSC (LCC) that allows the LCC to be an acceptable source for orbiter systems monitoring.

- C. A NONISOLATABLE OMS, RCS, OR APU FUEL LEAK OR FOR AN ISOLATED LEAK WHEN THERE HAS BEEN INSUFFICIENT TIME FOR FUEL SUBLIMATION (RTLIS, TAL, AOA, OR POST-DEORBIT IGNITION). FOR THESE CASES, A MODE V CREW EGRESS WILL BE IMPLEMENTED. RCS JET LEAKS AND APU SEAL CAVITY DRAIN LEAKS ARE EXEMPTED FROM THIS CATEGORY.

Leaking OMS, RCS, or APU fuel poses a toxicity and fire hazard. An expedited powerdown should be performed in order to minimize the danger to the flightcrew and ground operations personnel. If a fuel leak occurs and is isolated during an RTLIS, TAL, AOA, or post-deorbit ignition, there is insufficient time for the fuel to sublimate, and an expedited powerdown is prudent.

THIS RULE CONTINUED ON NEXT PAGE

FLIGHT RULES

A16-11

EXPEDITED POWERDOWN [HC] (CONTINUED)

An isolated RCS jet leak does not pose a risk to the orbiter/crew with continued postlanding operations. In the event of an APU fuel pump seal failure, the APU seal cavity drain dumps hydrazine overboard. Once the APU is shut down, the leak is isolated.

Rules {A16-10C} and D, NORMAL POSTLANDING OPERATIONS, and {A6-206}, RCS MANIFOLD/LEG LEAK PRESSURIZATION, reference this rule. [ED]

D. A CONFIRMED OR SUSPECTED FIRE FOR WHICH A FIRE SUPPRESSION BOTTLE HAS BEEN DISCHARGED DURING ENTRY.

Vehicle damage can pose hazards to crew safety after a fire is extinguished, especially if its location is unknown. Wires melted together could cause any number of hazards (e.g., inadvertent GPC commanding causing fuel valves to open, etc.). In addition, if the fire occurred in an avionics bay several hours (minutes for a cabin fire) before landing, the crew should exit the vehicle to avoid breathing Halon and toxic combustion byproducts which slowly leak out of the avionics bay and panels.

E. A NON-ISOLATABLE H₂ LEAK GREATER THAN 6.5 LB/HR (5.5 LB/HR FOR SPACELAB/PAYLOAD RETURN) .

Leaking H₂ poses a possible fire hazard in the midbody. An H₂ concentration of 4 percent represents the lower ignitable limit of H₂ (deflagrates or burns rapidly).

Rule {A16-205A}.4, EARLY APU SHUTDOWN [HC], references this rule. [072398-6577] [022405-6578A]

Normally, KSC is prime for recommending an expedited powerdown/crew egress based on detected H₂ concentrations. For known H₂ leaks prior to touchdown, this rule identifies the H₂ leak rate criteria to be used by MCC in determining whether an expedited powerdown/crew egress should be performed prior to KSC assessment (i.e., for large leaks). These leak rates are based on a 4 percent concentration 35 minutes after wheels stop.

For leak rates below 6.5 (5.5) lb/hr, KSC is prime for determining whether or not an expedited powerdown is required, based on actual detection of H₂. The MCC H₂ leak rate prediction is based on the initial size of the leak once detected, a homogenous mixing in the midbody, and no consideration for venting or leakage of H₂ from the midbody at wheel stop.

DOCUMENTATION: ECLS Console Handbook, SCP 4.6.2, and KSC OMI S0026, Revision L.

Hazard report ORBI 035, Hydrogen Accumulation in the Orbiter Compartments During RTLS/TAL Aborts, references this rule. [022405-6578A]

THIS RULE CONTINUED ON NEXT PAGE

FLIGHT RULES

A16-11

EXPEDITED POWERDOWN [HC] (CONTINUED)

F. AN INCOMPLETE MPS LH₂ DUMP (NEGATIVE INERT) OR FAILURE TO PRESSURIZE THE MPS LH₂ MANIFOLD ABOVE ATMOSPHERIC PRESSURE ON AN RTLS OR TAL ABORT. ©[012402-5079]

Failure(s) in the MPS LH₂ system during the MPS dump and inert will result in an incomplete LH₂ dump (negative inert) on RTLS and TAL aborts. Analysis (reference Rockwell Internal Letter no. 287-100-94-186 dated October 12, 1994) has shown that the loss of a dump path or the loss of helium pressurization (during the MPS dump) will trap between approximately 0.8 to 40.3 pounds of LH₂ residuals in the MPS LH₂ manifold depending on the specific scenario. Loss of a dump path may be caused by failure of one of the following LH₂ valves: outboard or inboard fill/drain valve, backup dump valves, topping valve, prevalve, or SSME fuel bleed valve. Loss of helium pressurization may be caused by numerous reasons such as: relief isolation valve fails closed, relief valve fails open, inboard fill/drain fails open, clogged orifice, etc. Failure of all dump paths on an AOA abort will lead to residuals similar to the TAL case. In these failure cases, concern exists for crew and convoy safety because analysis (reference Boeing Internal Letter SHA0-01-043 dated April 26, 2001) predicts the MPS LH₂ manifold will exceed its relief setting and venting of hydrogen residuals (potentially explosive mixture) will occur as early as 10.8 minutes after touchdown. In addition, nominal leakage in the MPS system could lead to the buildup of an explosive mixture of hydrogen in or around the aft compartment. ©[012402-5079] ©[042403-5896A] ©[052704-6255B]

After discussion at the Ascent/Entry Flight Techniques Panel (AEFTP #168 on October 27, 2000) and subsequent discussions with KSC ground operations and KSC safety, it was decided that the appropriate action for MPS dump failures on RTLS and TAL aborts is to perform an expedited powerdown. Rationale for this decision is based on the potential hazard to the flight crew and ground personnel due to uncertainties in the hazards of the trapped hydrogen residuals. Although residuals due to a failure in the MPS system on a TAL abort can be lower than the residuals on a nominal RTLS abort, an expedited powerdown will still be performed on the TAL because of the limited ground operations equipment available to assess and manage the situation at the TAL site. Failure of all dump paths on an AOA abort is a negative inert case. Expedited powerdown actions are not required for nominal missions because sufficient time exists on orbit to fully inert the MPS LH₂ manifold of all LH₂ residuals. ©[012402-5079]

After discussion at the AEFTP Meeting (AEFTP #168 on October 27, 2000) and subsequent discussions with KSC ground operations and KSC safety, it was also decided that the failure to pressurize the MPS LH₂ manifold above atmospheric pressure on RTLS and TAL aborts would result in the ingestion of air into the LH₂ manifold resulting in the creation of an explosive mixture (reference Boeing Internal Letter SHA0-01-043 dated April 26, 2001). The hazards of an explosive mixture in the MPS manifold that the flight crew and ground operations personnel would be exposed to are difficult to quantify. However, these hazards represent an unnecessary risk, and, therefore, this scenario warrants an expedited powerdown.

Rules {A5-13}, MPS PROPELLANT DUMPS AND INERTING DEFINITIONS; {A5-210}, ENTRY MPS PROPELLANT DUMP FAILURES [CIL] [HC]; and {A5-209}, ENTRY MPS HELIUM PURGE/MANIFOLD PRESSURIZATION, reference this rule. ©[030994-1604B] ©[030994-1617] ©[090894-1730A] ©[012402-5079] ©[ED] ©[052704-6255B]

FLIGHT RULES

A16-12**EMERGENCY POWERDOWN**

AN EMERGENCY POWERDOWN WILL BE IMPLEMENTED POST-ROLLOUT FOR THE FOLLOWING CONDITIONS OR AS REQUESTED BY THE FLIGHT DIRECTOR OR CONVOY COMMANDER:

An emergency powerdown will be performed if Orbiter systems cannot support continued operations or if orbiter conditions compromise crew safety. The normal egress mode is preferred if allowed by system conditions. Loss of cooling will allow an orderly egress to continue.

If conditions exist that compromise crew safety (fire, smoke, explosive conditions, etc.), a MODE V egress is warranted. Based on knowledge of Orbiter conditions and systems indications, the Flight Director and Convoy Commander are able to recognize problems and recommend the appropriate action/egress mode.

A. NORMAL EGRESS (SIDE HATCH, CONVOY CREW ASSIST):

1. LOSS OF BOTH FREON COOLANT LOOPS.

If both loops are lost, the emergency powerdown is required because there is absolutely no cooling of the vehicle. The fuel cell stack temperature will reach the specification limit of 250 degrees F within approximately 50 minutes. In addition, the electrolyte concentration will reach the 25 percent operational limit in approximately 75 minutes. At this point, continued operation of the fuel cells is questionable. This assumes a simultaneous purge of all three fuel cells and a 12.54 kWH (4.18 kWH/fuel cell) power level. If the failure occurred on orbit, the situation would be time-critical postlanding. Purging H2 into the atmosphere should be avoided if at all possible (ref. Rule {A16-301}, CONTAMINATION/ FLAMMABILITY/TOXICITY). Without the purge, the fuel cells will flood in approximately 18 minutes based on an 8.0 kWH (2.67 kWH/fuel cell) power level (ref. Rules {A2-54}, RTLS, TAL, AND AOA ABORTS FOR SYSTEMS FAILURES [CIL]; and {A2-205}, EMERGENCY DEORBIT). Upon completion of the emergency powerdown, a normal crew egress can be performed.

DOCUMENTATION: Dual Freon Loop Failure Entry Analysis, Rockwell International IL 388-301-79-018, and SODB table 3.4.4.1-1.

2. LOSS OF BOTH H₂O COOLANT LOOPS.

If both loops are lost, the emergency powerdown is required because there is no cooling to water and air cooled equipment in the cabin. If the failure occurred on orbit, avionics equipment and GPC's would be cycled to their thermal limits in order to maintain as much redundancy as possible during critical mission phases. Since this failure scenario does not contain any hazard to the crew, an orderly, normal egress can be accomplished.

DOCUMENTATION: MDTSCO analysis 1.1-ECLSS-09, Dual Water Coolant Loop Failed Entry Contingency.

THIS RULE CONTINUED ON NEXT PAGE

FLIGHT RULES

A16-12

EMERGENCY POWERDOWN (CONTINUED)

3. LOSS OF BOTH NH₃ SYSTEMS WHEN CRITICAL TEMPERATURES ARE (RULE {A16-51}, NO GROUND COOLING/EARLY VEHICLE POWER TERMINATION) EXCEEDED.

Postlanding, orbiter cooling is provided by the heat sink capacity remaining from the on-orbit radiator coldsoak, the NH₃ system, and the ground-cooling cart. In the event that the ground-cooling cart is not available, NH₃ must supply the cooling once the radiator coldsoak has been used. Therefore, subsequent loss of both NH₃ systems will eventually lead to loss of all vehicle cooling, and loss of all vehicle cooling has the same result as described in the loss of both Freon loops in paragraph A.1.

DOCUMENTATION: Engineering judgment.

B. MODE V EGRESS:

1. WHEEL WELL FIRE OR BRAKE FIRE THAT POTENTIALLY WILL PROPAGATE TO THE WHEEL WELL. EGRESS WILL BE BASED ON CONVOY COMMANDER RECOMMENDATION.
2. EXPLOSIVE/FLAMMABLE CONDITIONS (REF. RULE {A16-301}, CONTAMINATION/FLAMMABILITY/TOXICITY).
3. SMOKE, FIRE, OR OBVIOUS STRUCTURAL DAMAGE.
4. INTOLERABLE CABIN CONDITIONS.

NOTE: RULE {A16-8}, CREW EGRESS METHOD DETERMINATION (FOR MODE V EGRESS) GOVERNS THE MODE V EGRESS METHOD THE CREW WILL USE. @[041196-1881A]

It is preferable to perform a normal egress. However, if cabin conditions warrant, a MODE V egress may be performed. An emergency powerdown should be implemented for the conditions listed in paragraph B1, 2, 3 above in order to eliminate electrical ignition/isolate volatile propellant sources that could make the vehicle anomalous condition worse. A confirmed MPS LH₂ leak is considered to be an explosive/flammable condition (ref. rule {A5-201}, MPS DUMP INHIBIT [CIL]). @[030994-1604B]
@[ED]

DOCUMENTATION: Engineering judgment.

Rules {A5-201}, MPS DUMP INHIBIT [CIL], and {A16-10E}, NORMAL POSTLANDING OPERATIONS, reference this rule. @[052704-6255B]

FLIGHT RULES

A16-13

SIDE HATCH OPENING CONSTRAINT

IF CABIN PRESSURE EXCEEDS LANDING SITE ATMOSPHERIC PRESSURE BY MORE THAN 3.2 PSID, THEN THE CABIN VENT VALVES WILL BE USED TO DEPRESSURIZE THE CABIN TO BRING THE PRESSURE DIFFERENTIAL BELOW 3.2 PSID BEFORE ATTEMPTING TO OPEN THE SIDE HATCH.

An unisolatable leak into the cabin could result in cabin pressure being as much as 16 psid greater than landing site atmosphere pressure (the cabin relief valves relieve at 16 psid). Rockwell International has verified side hatch structural capability to vent excess cabin pressure postlanding only as high as 3.2 psid. The 3.2 psid pressure differential was selected for verification because it is the maximum expected to be encountered at the highest altitude landing site (White Sands) under normal cabin pressure conditions.

DOCUMENTATION: Side Hatch Structural Capability to Release Cabin Pressure Following Rollout, Rockwell International Internal Letter No. 280-106-82-016, May 7, 1983.

A16-14 THROUGH A16-50 RULES ARE RESERVED

FLIGHT RULES

COOLING

A16-51 **NO GROUND COOLING/EARLY VEHICLE POWER TERMINATION**

POSTLANDING LOSS OF COOLING WILL BE DEFINED AS FOLLOWS: @[012694-1599]

- A. IF MCC VOICE AND TELEMETRY ARE AVAILABLE, COOLING WILL BE DECLARED LOST AND AN EMERGENCY POWERDOWN PERFORMED WHEN ANY OF THE FOLLOWING CONDITIONS OCCUR:
1. FUEL CELL COOLANT RETURN TEMP > 140 DEGREES (135 DEGREES) F OR LOCAL FUEL CELL KOH < 24 PERCENT (29 PERCENT)
 2. AVIONICS BAY AIR OUTLET TEMP EXCEEDS THE FOLLOWING LIMITS PRIOR TO ENT C/L "LRU DEACT":
 - a. AVIONICS BAY 1 OR 2 AIR OUTLET TEMP > 133 DEGREES (128 DEGREES) F
 - b. AVIONICS BAY 3 AIR OUTLET TEMP > 117 DEGREES (112 DEGREES) F
 3. AVIONICS BAY AIR OUTLET TEMP EXCEEDS THE FOLLOWING LIMITS POST ENT C/L "LRU DEACT":
 - a. AVIONICS BAY 1 OR 2 AIR OUTLET TEMP > 113 DEGREES (108 DEGREES) F
 - b. AVIONICS BAY 3 AIR OUTLET TEMP > 107 DEGREES (102 DEGREES) F
 4. CABIN TEMPERATURE > 95 DEGREES (90 DEGREES) F
 5. MIDBODY COLDPLATE OUTLET TEMP > 115 DEGREES (110 DEGREES) F
 6. AFT COLDPLATE OUTLET TEMP > 112 DEGREES (107 DEGREES) F

THIS RULE CONTINUED ON NEXT PAGE

FLIGHT RULES

A16-51

NO GROUND COOLING/EARLY VEHICLE POWER TERMINATION (CONTINUED)

The FCP coolant return temp is a direct indication of the status of the FCP cooling capability. Inadequate cooling of the fuel cell may result in fuel cell KOH concentrations < 24 percent, which indicate a wet fuel cell and impending fuel cell flooding.

Avionics bay temperatures above the listed limits indicate LRU outlet temperature > 130 degrees F limit. Cabin temperatures above 95 degrees F will cause overtemp conditions for flight deck avionics. The limits listed above will not result in hardware damage or certification violation if an emergency powerdown is executed when the limit is reached. @[012694-1599]

- B. FOR LOSS OF MCC VOICE OR TELEMETRY, AN EMERGENCY POWERDOWN PERFORMED WHEN ANY OF THE FOLLOWING CONDITIONS OCCUR: @[012694-1599]
1. FUEL CELL CONDENSER EXIT TEMP > 164 DEGREES F
 2. AVIONICS BAY AIR OUTLET TEMP EXCEEDS THE FOLLOWING LIMITS PRIOR TO ENT C/L "LRU DEACT":
 - a. AVIONICS BAY 1 OR 2 AIR OUTLET TEMP > 133 DEGREES (128 DEGREES) F
 - b. AVIONICS BAY 3 AIR OUTLET TEMP > 117 DEGREES (112 DEGREES) F
 3. AVIONICS BAY AIR OUTLET TEMP EXCEEDS THE FOLLOWING LIMITS POST ENT C/L "LRU DEACT":
 - a. AVIONICS BAY 1 OR 2 AIR OUTLET TEMP > 113 DEGREES (108 DEGREES) F
 - b. AVIONICS BAY 3 AIR OUTLET TEMP > 107 DEGREES (102 DEGREES) F

Postlanding cooling tests performed after STS-58 indicate that loss of the 508 GSE cooling cart will not result in violations of the above limits if the radiators are flowing, and PLB purge air is available. The purge air for this test was controlled to approximately 45 degrees F. If PLB purge is not available, or is insufficient, an emergency powerdown should be implemented when the appropriate thermal limit is violated.

DOCUMENTATION: MACDAC 1.1 ECLSS 122 and SODB 3.4.4.1.11, page 3.4.4.1-3, engineering judgment, and STS-58 Post Mission report.

Rule {A16-12A}.3, EMERGENCY POWERDOWN, references this rule. @[012694-1599]

FLIGHT RULES

A16-52 **EXTENDED COOLING**

ORBITER COOLING MAY BE EXTENDED AS FOLLOWS:

- A. MAINTAIN RADIATOR FLOW.
- B. POWERDOWN AS QUICKLY AS POSSIBLE PER THE NORMAL POST-ROLLOUT PROCEDURES (DEPENDING ON LANDING SITE AND OTHER FAILURE SITUATIONS).

It is highly desirable to hand over the vehicle in a powered condition in order to expedite turnaround operations. Crew requirements or vehicle systems management may dictate a need to operate the vehicle for a greater than normal amount of time without ground cooling.

DOCUMENTATION: Engineering judgment.

A16-53 **FREON LOOP CONFIGURATION**

THE FPV IN BOTH FREON LOOPS WILL BE PLACED TO THE "ICH" POSITION IF BOTH THE EVAPORATOR OUTLET TEMPERATURES ARE LESS THAN 32 DEGREES (34.4 DEGREES) F. IF THE PAYLOAD LOOP DOES NOT CONTAIN WATER, A REAL-TIME CALL WILL BE MADE TO PLACE BOTH FPV'S TO THE "P/L" POSITION.

Provided that both orbiter water loops and a payload water loop (if installed) are flowing, the ICH position provides orbiter water loop freeze protection for Freon temperatures as low as 6 degrees F and payload water loop protection for Freon temperatures as low as -30 degrees F (extrapolated). If left in the P/L position, the payload water loop would freeze at a Freon temperature of 32 degrees F and the orbiter water loops at -30 degrees F (extrapolated) Freon temperature. For payload flow rates < 150 lb/hr, the P/L water loop will freeze eventually, but is delayed if the FPV is placed in the ICH position.

DOCUMENTATION: Lockheed analysis, LEMSCO 19630.

FLIGHT RULES

A16-54

AMMONIA BOILER MANAGEMENT

THE AMMONIA BOILER WILL BE ACTIVATED WHEN THE FLASH EVAPORATOR OUTLET TEMPERATURE > 55 DEGREES F.

The standard orbiter entry cooling configuration is to utilize radiator heat sink capacity (cold soak) from 160k feet altitude until depletion. Normally this occurs post-rollout. At that time the ammonia boiler is activated to maintain thermal control. Upon ammonia activation, specification leakage past the primary control valves will result in ammonia boiler outlet temperatures dropping 17 degrees F. Delaying ammonia activation until flash evaporator outlet temperatures are greater than 55 degrees F protects downstream H₂O loop components from freezing.

DOCUMENTATION: Engineering judgment. SODB, volume 1, 4.6.3.11.2.b.6 and c.3

A16-55 THROUGH A16-100 RULES ARE RESERVED

FLIGHT RULES

ET UMBILICAL DOOR

A16-101 **ET UMBILICAL DOOR POSITIONING**

- A. FAILURE TO OPEN THE ET UMBILICAL DOOR WILL REQUIRE NO CHANGE TO NORMAL POSTLANDING PROCEDURES.

For normal postlanding, the ET doors are opened by the flightcrew to facilitate ground handling at KSC, EAFB, and NOR. If the doors cannot be opened by the crew, ground turnaround time of the vehicle will be extended somewhat. There are no safety concerns if this cannot be done.

- B. THE ET DOORS MUST BE OPENED ASAP POSTLANDING FOR TAL OR RTLS. FOR NORMAL EOM, AOA, OR CLS, THEY MUST BE OPENED ASAP IF THERE IS EVIDENCE OF POTENTIAL FOR H₂ BUILDUP.

Hydrogen poses an explosion hazard. Opening the ET doors as soon as possible after wheel stop will help to vent the trapped hydrogen into the atmosphere.

- C. WHEN OPENING IS REQUIRED, THE ET DOORS WILL BE DRIVEN TO THE POSTLANDING POSITION OF 110 ± 30 DEGREES. THERE IS NO CONSTRAINT ON OPENING THE ET DOORS POSTLANDING FOR BLOWING DUST OR SAND. [ED]

The postlanding ET door position of 110 ± 30 degrees takes into consideration allowable tolerances for wind loads on door mechanism (stationary vehicle or while being towed) and tolerances on clearance for mounting the GSE jacks when used to prepare the vehicle for transport on the Shuttle carrier aircraft. It has been established that the doors can be opened regardless of blowing sand or dust (ref. Ascent/Entry Flight Techniques #5, 7/27/83).

A16-102 THROUGH A16-200 RULES ARE RESERVED

FLIGHT RULES

VENT DOORS

A16-151 **VENT DOOR POSITIONING**

A. VENT DOOR POSITIONING IS NOT A CONSTRAINT TO NORMAL POSTLANDING OPERATIONS (REGARDLESS OF BLOWING SAND OR DUST).

KSC prefers to have the vent doors configured to the purge position (midbody vents closed; forward and aft vents in purge) in order to expedite vehicle turnaround time. However, if this cannot be accomplished, having the doors open, as is the case when the vehicle lands, all doors open is considered to be a safe configuration (hazardous gas buildup prevention). Hazardous gas protection is of higher priority than blowing sand or dust protection. Other normal crew-initiated postlanding procedures can continue since the procedures are unaffected by the position of the vent doors.

B. IF PURGING CAN BE ACCOMPLISHED, THE VENT DOORS WILL BE CONFIGURED AS FOLLOWS:

1. ALL MIDBODY VENT DOORS CLOSED.
2. ALL FORWARD AND AFT VENT DOORS IN THE PURGE POSITION.

These are the desired positions of the vent doors for vehicle purging.

C. IF PURGING CANNOT BE ACCOMPLISHED OR IS LOST AFTER INITIATION, THE PREFERRED VENT DOOR POSITION IS OPEN (REGARDLESS OF BLOWING SAND OR DUST).

Reference rule rationale for paragraph A.

A16-152 THROUGH A16-200 RULES ARE RESERVED

FLIGHT RULES

APU/HYDRAULIC

A16-201

HYDRAULIC CIRCULATION PUMP OPERATION

- A. FOLLOWING APU SHUTDOWN, HYDRAULIC CIRCULATION PUMPS WILL BE OPERATED IF ANY OF THE FOLLOWING BONDLINE TEMPERATURES EXCEED 245 DEGREES F UNTIL THE HYDRAULIC RETURN LINE TEMPERATURES HAVE PEAKED AND BEGUN TO DECREASE. LOSS OF ONE OR MORE OF THESE PUMPS WILL NOT CONSTRAIN NORMAL POSTLANDING OPERATIONS. SHOULD POWER PROBLEMS DICTATE, CIRCULATION PUMPS MAY BE OPERATED ONE AT A TIME IN 5-MINUTE INTERVALS; OTHERWISE, ALL THREE WILL BE OPERATED SIMULTANEOUSLY (MCC CALL):

V09T1006A LIB ELVN LWR BL Y-235 T (OV-102 ONLY).

V09T1026A BODY FLAP LWR CL BL T (OV-102 ONLY).

V09T1002A LWR L WING BL X 1278, Y-240 T.

V09T1702A AFT FUS LWR CL BL T.

V09T1004A TOP R WING BL X 1278, Y 240 T.

V09T1624A CAB CL BL LWR X 560 T.

When vehicle bondline temperatures have exceeded 245 degrees F, heat soakback would cause temperatures to rise in the hydraulic fluid to the point where seals would degrade resulting in fluid leakage. Turning on the circulation pumps will help transport hotter fluid to cooler areas, thus reducing the chances of seal degradation.

If bus power problems arise such that it is desirable not to run all three circulation pumps at once, then each pump can be run at 5-minute intervals.

- B. MPS HELIUM WILL BE PROVIDED TO AN ENGINE PRIOR TO HYDRAULIC CIRCULATION PUMP OPERATION POSTLANDING IF THE ASSOCIATED MPS/TVC ISOLATION VALVE IS OPEN.

Maintaining helium pressure on the closed side of the engine valves will insure that the valves do not drift open when hydraulic circulation pump pressure is applied to the TVC actuators. Keeping the engine valves closed prevents engine contamination and reduces the number of helium regulator cycles.

©[072795-1786]

FLIGHT RULES

A16-202**APU REQUIREMENTS**

POSTLANDING ACTIVITIES WITH APU'S OPERATING, IN ORDER OF PRIORITY, ARE:

- A. BODY FLAP REPOSITIONING (OPS 3) . @[012402-5090A]
- B. SSME REPOSITIONING (OPS 9, PASS) .
- C. SPEED BRAKE REPOSITIONING (OPS 9, PASS) .
- D. HYDRAULIC LOAD TEST (OPS 3) .

Body flap repositioning (full down) must be performed, in OPS 3, in preparation for a potential SSME repositioning failure. Even if SSME repositioning is NO-GO, this measure can help reduce the cost of turnaround operations and is desirable. SSME repositioning, available in PASS OPS 9, is required every flight to position the engines for ferry operations (Edwards/ Northrup) and to prevent rain from entering into the nozzle, possibly damaging engine components. In the event SSME repositioning is not accomplished and landing occurred at KSC, the speedbrake must be repositioned (in PASS OPS 9) in order to expedite and reduce the cost of turnaround operations. The hydraulic load test is performed in OPS 3 to test the capability of the APU's after the fifth flight of a particular APU. However, the load test can be rescheduled to another flight and is not critical to postlanding operations. @[012402-5090A]

A16-203**APU/HYDRAULIC LOAD TEST TERMINATION**

AN APU/HYDRAULIC LOAD TEST WILL BE TERMINATED FOR ANY OF THE FOLLOWING:

- A. ANY PROBLEM REQUIRING AN EXPEDITED OR EMERGENCY POWERDOWN.
- B. INSUFFICIENT CONSUMABLES.
- C. INABILITY TO OBTAIN DATA (REAL TIME OR RECORDED) .
- D. LESS THAN TWO GOOD APU/HYDRAULIC SYSTEMS.

The APU/hydraulic load test is conducted to gather data on APU catalyst bed roughness; i.e., the efficiency of fuel decomposition and hydraulic system main pump performance degradation. The test entails manually cycling the elevons, rudder, and body flap with hydraulic system 1 depressed and then system 2 depressed. The duration of motion is about 80 seconds. For the cases listed above, the load test should be terminated since the data being obtained is not critical and can be obtained during postlanding of a later flight.

FLIGHT RULES

A16-204

WINDWARD APU OPERATION CONSTRAINT

TO AVOID EXCEEDING VERTICAL TAIL STRUCTURAL TEMPERATURE LIMITS, THE WINDWARD APU(S) WILL NOT BE OPERATED LONGER THAN THE ALLOWABLE POSTLANDING APU RUN TIME, OBTAINED FROM THE POSTLANDING OPERATIONS PLOT.

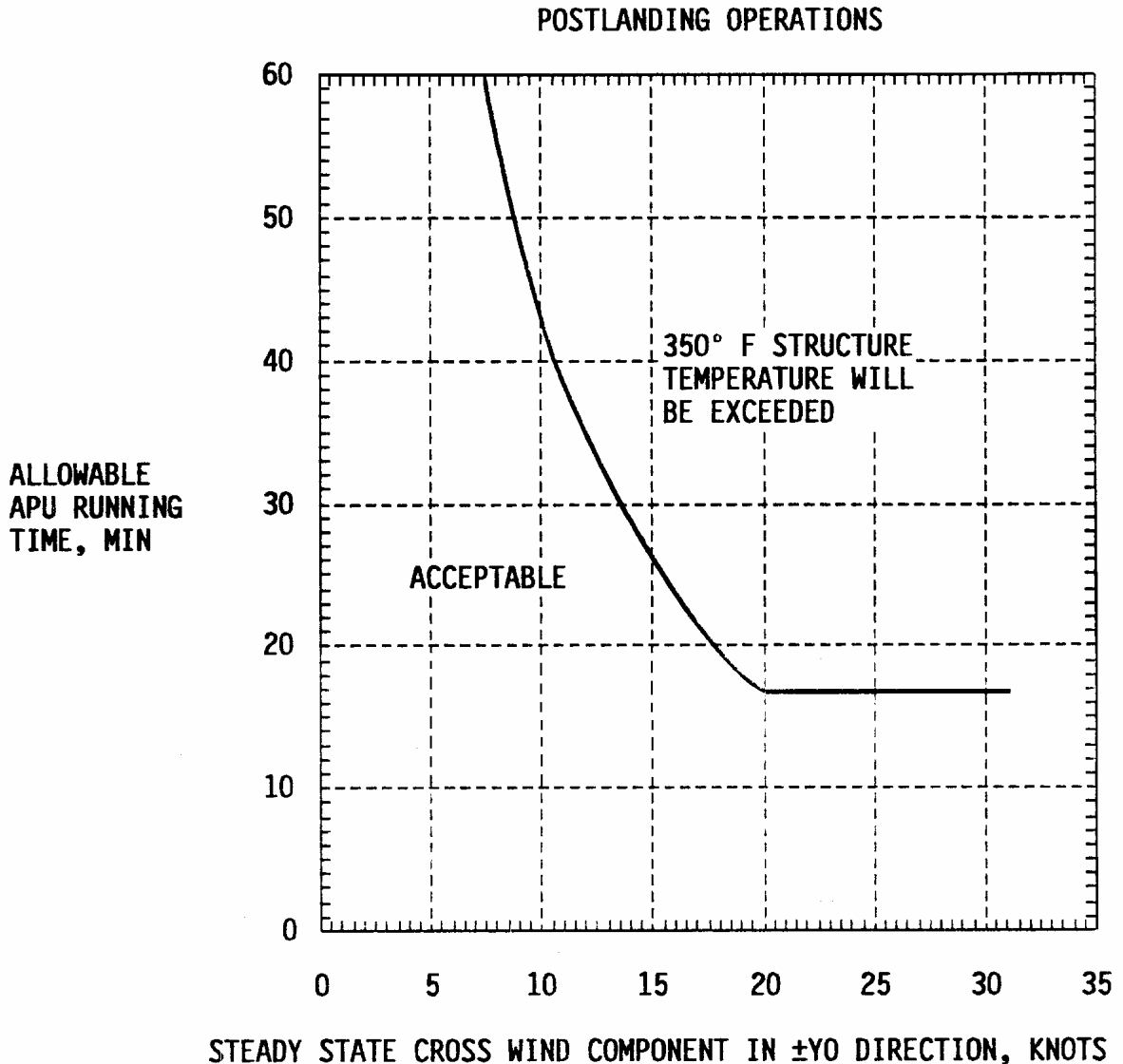

If the postlanding run time exceeds the allowable run time, vertical tail overtemperature and subsequent structural damage can occur if the APU plume has ignited. There are no constraints to run time if the APU plume has not ignited; however, due to the difficulty in visually determining whether the plume is burning or not, the worst case is assumed.

Reference SPDB 3.2.1.1.

FLIGHT RULES

A16-205 EARLY APU SHUTDOWN [HC] ©[052704-6255B]

A. ALL APU'S WILL BE SHUT DOWN ASAP POST-WHEEL STOP: ©[022405-6578A]

1. IF A FUEL OR OXIDIZER LEAK IS SUSPECTED OR DETECTED IN THE MPS, OMS, RCS, OR ANY APU, EVEN IF THE LEAKS HAVE BEEN ISOLATED (DOES NOT APPLY FOR RCS JET LEAKS) ©[030994-1604B]

The requirements for APU operations postlanding (SSME repositioning, speedbrake repositioning, and hydraulic load test) are not considered mandatory. In cases where fuel or oxidizer leaks are suspected or detected, the APU's should be shut down ASAP to reduce chances of the leak developing into a greater flammability hazard, brought on by the operation of hot, rotating machinery. Note that an APU fuel tank N₂ leak is considered a fuel leak.

MPS cases include a known oxidizer (LO₂) leak associated with a MPS LO₂ Dump Inhibit, and a fuel (LH₂) "Negative Inert."

Reference Rules {A5-201}, MPS DUMP INHIBIT [CIL] [HC]; {A5-210}, ENTRY MPS PROPELLANT DUMP FAILURES [CIL] [HC]; and {A5-13G}, MPS DUMPS AND VACUUM INERTING DEFINITIONS [HC].

Hazard report ORBI 250, External Leakage from the APU Fuel Supply System, references this rule.

APU's will not be shut down early for RCS jet leaks since these types of leaks are isolated and external to the orbiter. No flammability hazard exists for continued APU operations with known RCS jet leaks.

*Rule {A5-201}, MPS DUMP INHIBIT [CIL] [HC], references this rule. ©[030994-1604B] ©[ED]
©[052704-6255B]*

2. FOR A WSB WATER/PGME COOLANT LEAK

The water spray boiler coolant mixture of water and propylene glycol monomethyl ether (PGME) is combustible, with a fire point of approximately 148 deg F and, in the presence of an ignition source, will sustain a fire. Since the APU's provide possible ignition sources (hot spots and exhaust plume), it is prudent to shut down all operating APU's as soon as practical postlanding. Leaks covered by this rule include liquid or vapor coolant leakage into the aft compartment, and overfilling the boiler core (e.g., from leakage past a spray valve) leading to liquid spillage from the steam vent opening.

3. IF A FIRE IS OBSERVED IN A WHEEL WELL OR TIRE/BRAKE AREA, THE HYDRAULIC LANDING GEAR EXTEND AND BRAKE ISOLATION VALVES WILL BE CLOSED PRIOR TO SHUTTING DOWN THE APU'S.

A fire in the wheel well or landing gear area could involve hydraulic fluid. Closing the landing gear extend and brake isolation valves will isolate the fluid from the gear area, thus preventing any further feeding of the fire. The APU's should be shut down in an effort to reduce high-pressure flow of hydraulic fluid to the gear area should an isolation valve fail to close. ©[022405-6578A]

THIS RULE CONTINUED ON NEXT PAGE

FLIGHT RULES

A16-205

EARLY APU SHUTDOWN [HC] (CONTINUED)

4. FOR A NON-ISOLATABLE H₂ LEAK GREATER THAN 6.5 LB/HR (5.5 LB/HR FOR SPACEHAB/PAYLOAD RETURN) @[022405-6578A]

Leaking H₂ poses a possible fire hazard in the orbiter midbody. The leaking H₂ is lighter than air and may escape from the payload bay at the payload bay door (PLBD) aft bulkhead interface and from where payload bay doors interface along the centerline. Pressure seals are located at the PLBD/bulkhead interface as well as along the PLBD centerline. However, the integrity of the pressure seals to contain H₂ is unknown. The APU exhaust ducts are located at the base of the vertical tail and are in close proximity to the aft bulkhead/PLBD interface. The APU exhaust plume is assumed to be ignited, which could provide an ignition source for the H₂ in the payload bay.

Reference Rule {A16-11E}, EXPEDITED POWERDOWN [HC].

B. THE AFFECTED APU WILL BE SHUT DOWN ASAP POST-WHEEL STOP:

1. IF THERE IS A NON-ISOLATABLE LEAK IN ITS ASSOCIATED HYDRAULIC SYSTEM

The APU should be shut down postlanding to minimize hydraulic leakage into the aft compartment. Postlanding operations requiring hydraulic power are not mandatory and can be performed if there are two remaining good systems.

2. IF THE APU TURBINE SPEED HAS SHIFTED TO THE HIGH SPEED BAND, IS ERRATIC, OR IS LOST DUE TO A SUSPECTED MPU FAILURE @[082604-6318A]

The APU should be shut down postlanding to protect against a possible uncontained overspeed. Postlanding operations requiring the APU's are not mandatory and can be performed if there are two remaining good systems.

3. FOR INSUFFICIENT LUBE OIL OR HYDRAULIC COOLING

The APU should be shut down postlanding to minimize bearing and gear wear due to degraded lubrication capability. Postlanding operations requiring the APU's are not mandatory and can be performed if there are two remaining good systems. @[072398-6577] @[032504-6234]

Hazard reports ORBI 035, Hydrogen Accumulation in the Orbiter Compartments During RTLS/TAL Aborts; ORBI 036, The APU is an Ignition Source; ORBI 050, Fire/Explosion Caused by Orbiter's Hot Brakes; and ORBI 176, Reingestion of Vented Hydrazine, reference this rule. @[082604-6318A] @[022405-6578A]

A16-206 THROUGH A16-250 RULES ARE RESERVED

FLIGHT RULES

FUEL CELLS

A16-251

FUEL CELL LIFETIME

FUEL CELL LIFETIME CONSIDERATION WILL NOT BE A CONSTRAINT DURING POSTLANDING OPERATIONS THROUGH CREW EGRESS.

Fuel cell lifetime concerns will not preclude normal postlanding operations through crew egress because of the desire to perform nominal postlanding procedures. The additional time impact to fuel cell lifetime from touchdown through crew egress is insignificant.

A16-252 THROUGH A16-300 RULES ARE RESERVED

FLIGHT RULES

CONTAMINATION/FLAMMABILITY

A16-301 **CONTAMINATION/FLAMMABILITY/TOXICITY**

- A. THE CONVOY COMMANDER WILL NOTIFY THE FLIGHT DIRECTOR OF ANY EXPLOSIVE, FLAMMABLE, AND/OR TOXIC CONDITIONS THAT EXIST THAT PRECLUDE/DELAY NORMAL CREW EGRESS OPERATIONS.

- B. FOR EXTERNAL LEAKS OR HYPERGOLIC VENTING WHERE CONTAMINATION IS SUSPECT BUT BELOW MAXIMUM ALLOWABLE LIMITS, NORMAL POSTLANDING/CREW EGRESS OPERATIONS WILL BE CONTINUED.

Reference the postlanding Operational Maintenance Instructions (OMI) for contamination/flammability/toxicity limits. Convoy personnel are primarily responsible for the detection of hazardous substances that may preclude normal crew egress operations. Notification of explosive/ toxic limit violation is consistent with the Flight Director's responsibility to ensure adequate vehicle safing and allow normal crew egress. Postlanding operations will continue as long as hazardous substance concentrations are within acceptable limits (i.e., below established explosive/toxic limit criteria).

Contamination, flammability, and toxic limits have been identified in the KSC Ground Operations Safety Plan and are consistent with the most stringent OSHA/NIOSH standards.

Rules {A16-10B}, NORMAL POSTLANDING OPERATIONS; and {A16-12A}.1, and B.2, EMERGENCY POWERDOWN, reference this rule.

A16-302 **EMERGENCY OXYGEN SYSTEM REQUIREMENTS**

- A. THE CREW WILL ACTIVATE THE EMERGENCY OXYGEN SYSTEM FOR ANY UNAIDED EMERGENCY EGRESS.

For an unaided egress, the KSC Safety Assessment Team will not be available to test for the hazardous materials toxicity limits so the emergency oxygen system will be activated to protect against unknown contamination.

DOCUMENTATION: Engineering judgment.

- B. THE CREW WILL ACTIVATE EMERGENCY OXYGEN SYSTEM FOR ANY NONEMERGENCY EGRESS WHERE THE CABIN OR EXTERNAL ATMOSPHERE IS EITHER CONTAMINATED OR UNKNOWN.

This rule protects the crew from the hazards of toxic materials.

DOCUMENTATION: Engineering judgment.

FLIGHT RULES

THIS PAGE INTENTIONALLY BLANK

FLIGHT RULES

SECTION 17 - LIFE SUPPORT

SMOKE DETECTION/FIRE SUPPRESSION DEFINITIONS/MANAGEMENT

A17-1	AVIONICS BAY FIRE DEFINITIONS AND ACTIONS [HC].....	17-1
A17-2	CABIN FIRE DEFINITION AND ACTIONS [HC].....	17-9
A17-3	FORWARD AVIONICS BAY FIRE SUPPRESSION.....	17-12
A17-4	SMOKE EVENT DEFINITION AND ACTIONS [HC].....	17-13
A17-5	SMOKE DETECTION LOSS DEFINITION [HC].....	17-20
A17-6 THROUGH A17-50	RULES ARE RESERVED.....	17-21

SMOKE DETECTION/FIRE SUPPRESSION MANAGEMENT

A17-51	MANAGEMENT FOLLOWING LOSS OF SMOKE DETECTION.....	17-22
A17-52	MANAGEMENT FOLLOWING LOSS OF FIRE SUPPRESSION IN AN AVIONICS BAY.....	17-25
A17-53	RESERVED.....	17-25
A17-54	MANAGEMENT FOLLOWING HALON DISCHARGE WITHOUT FIRE CONFIRMATION.....	17-26
A17-55 THROUGH 17-100	RULES ARE RESERVED.....	17-26

ATMOSPHERE REVITALIZATION SYSTEM (ARS) AIR LOSS DEFINITIONS

A17-101	CABIN FAN.....	17-27
A17-102	CABIN ATMOSPHERIC CONTROL.....	17-28
A17-103	LOSS OF AVIONICS BAY FAN.....	17-29
A17-104	IMU FAN.....	17-31
A17-105	AVIONICS BAY COOLING.....	17-32
A17-106	REGENERATIVE CO2 REMOVAL SYSTEM (RCRS) LOSS DEFINITION.....	17-35
A17-107 THROUGH A17-150	RULES ARE RESERVED.....	17-35

FLIGHT RULES

ARS AIR SYSTEM MANAGEMENT

A17-151	CABIN ATMOSPHERE CONTROL.....	17-36
A17-152	CABIN TEMPERATURE CONTROL AND MANAGEMENT.....	17-38
A17-153	CABIN/AVIONICS BAY FAN MANAGEMENT [HC].....	17-45
A17-154	MANAGEMENT OF DEGRADED ROTATING EQUIPMENT [HC].....	17-46
A17-155	REGENERATIVE CO2 REMOVAL SYSTEM (RCRS) MANAGEMENT.....	17-48
A17-156	RCRS MANUAL SHUTDOWN CRITERIA.....	17-50
A17-157	LIOH REDLINE DETERMINATION [HC].....	17-50
A17-158	MANAGEMENT OF LIOH CANS FOR ADDITIONAL DAYS..	17-51
A17-159	THROUGH A17-200 RULES ARE RESERVED.....	17-52

PRESSURE CONTROL SYSTEMS (PCS) LOSS DEFINITIONS

A17-201	CABIN PRESSURE INTEGRITY [HC].....	17-53
A17-202	8 PSIA CABIN CONTINGENCY 165-MINUTE RETURN CAPABILITY.....	17-55
A17-203	PPO2 CONTROL.....	17-59
A17-204	N2 SUPPLY.....	17-60
A17-205	PPO2 SENSOR LOSS DEFINITION.....	17-60
A17-206	LES O2 SUPPLY SYSTEM LOSS DEFINITION.....	17-61
A17-207	THROUGH A17-250 RULES ARE RESERVED.....	17-61

PCS SYSTEMS MANAGEMENT

A17-251	NORMAL PCS CONFIGURATION.....	17-62
A17-252	CABIN PRESSURE RELIEF VALVES.....	17-64
A17-253	CABIN VENT VALVES.....	17-64
A17-254	CABIN O2 CONCENTRATION.....	17-65
A17-255	8 PSIA EMERGENCY CABIN CONFIGURATION.....	17-68
A17-256	O2 BLEED ORIFICE MANAGEMENT.....	17-69
A17-257	N2 SYSTEM MANAGEMENT.....	17-69

FLIGHT RULES

A17-258 LOSS OF CABIN INTEGRITY TMAX DEFINITION AND TIG SELECTION.....17-70

A17-259 LES O2 SUPPLY SYSTEM LOSS MANAGEMENT [HC]....17-71

A17-260 PCS O2/N2 CONTROLLER CHECKOUT.....17-73

A17-261 THROUGH A17-300 RULES ARE RESERVED.....17-74

10.2 PSIA CABIN ATMOSPHERE OPERATION

A17-301 CABIN ATMOSPHERE MANAGEMENT.....17-75

A17-302 10.2 PSIA CABIN DEPRESSURIZATION CONSTRAINTS.17-75

A17-303 CABIN REPRESSURIZATION MANAGEMENT.....17-79

A17-304 RESERVED.....17-79

A17-305 RESERVED.....17-80

A17-306 RESERVED.....17-80

A17-307 PAYLOAD 10.2 PSIA CABIN OPERATIONS.....17-80

A17-308 ATCS (10.2 PSIA CABIN) CONFIGURATION.....17-81

A17-309 CABIN PRESSURE TIME AT 10.2 PSIA.....17-81

A17-310 THROUGH A17-350 RULES ARE RESERVED.....17-81

WASTE COLLECTION SYSTEM (WCS) / VACUUM VENT LOSS DEFINITIONS

A17-351 WCS SEPARATOR.....17-82

A17-352 WCS URINE COLLECTION.....17-82

A17-353 WCS COMMODE.....17-83

A17-354 VACUUM VENT LOSS DEFINITION [HC].....17-84

A17-355 THROUGH A17-400 RULES ARE RESERVED.....17-84

WCS/VACUUM VENT MANAGEMENT

A17-401 WCS USAGE CONSTRAINT.....17-85

A17-402 LEAKING WCS WATER LINES.....17-85

A17-403 ALTERNATE FECAL COLLECTION.....17-85

A17-404 ALTERNATE URINE COLLECTION [HC].....17-86

A17-405 VACUUM VENT SYSTEMS MANAGEMENT [CIL] [HC]....17-86

A17-406 THROUGH A17-450 RULES ARE RESERVED.....17-87

FLIGHT RULES

WASTE WATER LOSS DEFINITIONS

A17-451	WASTE WATER TANK.....	17-88
A17-452	WASTE WATER DUMP CAPABILITY.....	17-89
A17-453	THROUGH A17-500 RULES ARE RESERVED.....	17-90

WASTE WATER MANAGEMENT

A17-501	ALTERNATE PRESSURE VALVE MANAGEMENT.....	17-91
A17-502	WASTE DUMP NOZZLE ICE FORMATION.....	17-91
A17-503	WASTE WATER MANAGEMENT [HC].....	17-92
A17-504	RESERVED.....	17-93
A17-505	WASTE WATER DUMP NOZZLE TEMPERATURE CONSTRAINTS.....	17-94
A17-506	WASTE WATER SYSTEM LEAK MANAGEMENT.....	17-96
A17-507	OMS & PRCS BURNS WITH FREE H2O IN THE CABIN..	17-98
A17-508	WASTE TANK QUANTITY MANAGEMENT [HC].....	17-99
A17-509	THROUGH A17-550 RULES ARE RESERVED.....	17-99

GALLEY MANAGEMENT LIFE SUPPORT

A17-551	IODINE REMOVAL IMPLEMENTATION [HC].....	17-100
A17-552	THROUGH A17-600 RULES ARE RESERVED.....	17-103

SPACEHAB FIRE/SMOKE

A17-601	SPACEHAB FIRE/SMOKE DETECTION LOSS.....	17-104
A17-602	SPACEHAB FIRE/SMOKE CONFIRMATION.....	17-107
A17-603	SPACEHAB FIRE/SMOKE MANAGEMENT.....	17-108
A17-604	THROUGH A17-650 RULES ARE RESERVED.....	17-113

SPACEHAB ECS MANAGEMENT

A17-651	SPACEHAB ENVIRONMENTAL CONTROL AND LIFE SUPPORT (ECLS) REQUIREMENTS.....	17-114
A17-652	SPACEHAB SUBSYSTEM FANS/AIR LOOP.....	17-115
A17-653	THROUGH A17-700 RULES ARE RESERVED.....	17-115

FLIGHT RULES

MODULE ATMOSPHERE MANAGEMENT

A17-701	MODULE ATMOSPHERIC CONTROL.....	17-116
A17-702	PARTIAL PRESSURE OF OXYGEN (PPO2) SENSORS...	17-117
A17-703	PARTIAL PRESSURE OF CARBON DIOXIDE (PPCO2) SENSORS.....	17-117
A17-704	CABIN/HFA FAN.....	17-118
A17-705	ATMOSPHERE REVITALIZATION SYSTEM (ARS) FAN..	17-120
A17-706	SPACEHAB FAN CONFIGURATIONS.....	17-121
A17-707	THROUGH A17-750 RULES ARE RESERVED.....	17-125

ATMOSPHERE INTEGRITY

A17-751	MODULE PRESSURE INTEGRITY.....	17-126
A17-752	NEGATIVE PRESSURE RELIEF VALVE COVERS.....	17-126
A17-753	CABIN DEPRESS VALVE (CDV).....	17-127
A17-754	EXPERIMENT VENT VALVE.....	17-127
A17-755	PPRV MANAGEMENT.....	17-128
A17-756	SM/LDM ASCENT/DESCENT INLET STUB.....	17-129
A17-757	RESERVED.....	17-130
A17-758	RESERVED.....	17-130
A17-759	THROUGH A17-800 RULES ARE RESERVED.....	17-130

LIFE SUPPORT GO/NO-GO CRITERIA

A17-1001	LIFE SUPPORT GO/NO-GO CRITERIA.....	17-131
----------	-------------------------------------	--------

FLIGHT RULES

THIS PAGE INTENTIONALLY BLANK

FLIGHT RULES

SECTION 17 - LIFE SUPPORT

SMOKE DETECTION/FIRE SUPPRESSION DEFINITIONS/MANAGEMENT

@[022306-6754C]

A17-1 AVIONICS BAY FIRE DEFINITIONS AND ACTIONS [HC]

- A. AN AVIONICS BAY FIRE SHALL BE DEFINED AS ONE OR MORE OF THE FOLLOWING:
1. CREW OBSERVANCE OF SUSTAINED FLAME OR SMOKE
 2. ANY ONE OF THE FOLLOWING: @[090894-1674]
 - a. TWO SMOKE DETECTOR CONCENTRATION LEVELS OVER 2000 UG/M**3 IN THE SAME COMPARTMENT
 - b. ONE CONCENTRATION LEVEL 2000 UG/M**3 AND INCREASING, AND THE ALTERNATE DETECTOR HAS FAILED SELF TEST
 - c. ONE CONCENTRATION LEVEL 2000 UG/M**3 AND INCREASING, AND CONFIRMATION BY ELECTRICAL DATA OF A SUSTAINED SHORT OR EQUIPMENT MALFUNCTION

*A confirmation is required to accurately detect a fire condition; this confirmation can be via a separate smoke detector indicating a concentration level over 2000 ug/m**3, equipment problems, or crew observations. In the event the alternate smoke detector fails a self-test in an avionics bay, a fire condition will be assumed. Any indications of a sustained short in the affected avionics bay will also be considered as confirmation of a fire. @[090894-1674] @[022306-6754C]*

THIS RULE CONTINUED ON NEXT PAGE

FLIGHT RULES

A17-1 **AVIONICS BAY FIRE DEFINITIONS AND ACTIONS [HC]**
(CONTINUED)

B. ON-ORBIT AVIONICS BAY FIRE ACTIONS ©[022306-6754C]

IF A FIRE CONDITION IS DETECTED IN THE AVIONICS BAY DURING ANY PHASE OF FLIGHT, THE FOLLOWING ACTIONS WILL BE ACCOMPLISHED AS SOON AS POSSIBLE:

1. THE CREW WILL DON THE QDM'S/ACES HELMETS WITH VISORS DOWN.
2. A HALON BOTTLE WILL BE DISCHARGED IN THE AFFECTED AVIONICS BAY.
3. THE AVIONICS BAY FAN WILL BE TURNED OFF. ©[090894-1674]

The QDM's/ACES helmets protect the crew from breathing potentially toxic gases; donning of the ACES will be considered later if appropriate. A Halon discharge should safe the avionics bay from any further combustion except for arc tracking, upon which Halon has no effect. Also, the avionics fan produces convection air currents that will feed oxidizer to a fire. Without convection currents, a fire should extinguish itself due to a lack of oxidizer and also localize toxins in the vicinity of combustion until the crew has donned protective gear. ©[090894-1674]

Reference Rules {A13-157}, CABIN ATMOSPHERE CONTAMINATION FIRE/SMOKE, and {A13-158}, CABIN ATMOSPHERE CONTAMINATION - HALON 1301 [HC].

DOCUMENTATION: NASA SP-443 Materials Processing in Space: Early Experiments by Robert J. Naumann and Harvey W. Herring, January 1, 1980. ©[022306-6754C]

DOCUMENTATION: SODB 4.6.5.1.e; engineering judgment; and materials branch discussions.

THIS RULE CONTINUED ON NEXT PAGE

FLIGHT RULES

A17-1 **AVIONICS BAY FIRE DEFINITIONS AND ACTIONS [HC]**
(CONTINUED)

C. ON-ORBIT AVIONICS BAY POST-FIRE ACTIONS ©[022306-6754C]

FOLLOWING A FIRE CONDITION FOR WHICH A HALON BOTTLE HAS BEEN DISCHARGED INTO AN AVIONICS BAY, THE FOLLOWING WILL BE PERFORMED:

1. CSA-CP READINGS WILL BE TAKEN IN THE CABIN AND NEAR THE AVIONICS BAY FIRE PORT. IF REQUIRED, POST-FIRE CABIN CLEANUP PROCEDURES WILL BE INITIATED PER RULE {A13-157}, CABIN ATMOSPHERE CONTAMINATION FIRE/SMOKE.

The Compound Specific Analyzer - Combustion Products (CSA-CP) will be used to take readings of acidic gas levels both in the general cabin area and near the fire port of the affected avionics bay to determine if the atmosphere was contaminated with toxic gases. If SMAC levels are exceeded, the crew will scrub toxins from the cabin atmosphere per existing procedures.

2. AN AV BAY PURGE WILL BE INITIATED IN THE AFFECTED AV BAY.

Purging the avionics bay atmosphere overboard will remove the Halon and toxins from the atmosphere and help preclude contaminants from diffusing into the cabin. An avionics bay purge of approximately 7 hours should reduce the Halon concentration from approximately 10 percent to approximately 1 percent in the affected bay.

3. CABIN O₂ CONCENTRATION CONTROL
 - a. CONTINGENCY CABIN O₂ CONTROL PROCEDURES WILL BE INITIATED IF REQUIRED TO CONTROL CABIN O₂ CONCENTRATION.
 - b. THE AV BAY PURGE MUST BE STARTED PRIOR TO ANY CABIN DEPRESS REQUIRED TO CONTROL O₂ CONCENTRATIONS.
©[022306-6754C]

THIS RULE CONTINUED ON NEXT PAGE

FLIGHT RULES

A17-1

AVIONICS BAY FIRE DEFINITIONS AND ACTIONS [HC] (CONTINUED)

4. THE CREW WILL DOFF QDM'S/ACES HELMETS ACCORDING TO THE CRITERIA OUTLINED IN RULE {A13-157}, CABIN ATMOSPHERE CONTAMINATION FIRE/SMOKE. ©[022306-6754C]

Post-fire, a cabin depress to 8 psi and continuous purge at 8 psi will manage O₂ concentrations below maximum levels (ref Rule {A17-254}, CABIN O₂ CONCENTRATION) as well as decrease the concentration of discharged Halon and any toxic gases that were produced by a fire. This action will extend the time on orbit so as to potentially avoid an ELS entry by effectively reducing the amount of N₂ needed to control O₂ concentrations. Following a fire condition, the health of the systems and/or crew cannot be guaranteed; therefore, following a cabin atmosphere evaluation, entry may be necessary. Since in an 8 psi cabin condition the O₂ concentration is allowed to reach 40 percent, which increases the flammability potential, the crew should make sure that the fire has been fully extinguished before initiating the depress to prevent flares. If sufficient N₂ is available to reach a PLS, it is not necessary to go to 8 psi.

A cabin depress without first purging the affected avionics bay directly overboard would create a negative pressure differential between the cabin and avionics bay that would draw any Halon and/or toxic combustion products from the avionics bay into the cabin. Therefore, the 50-hour (28-hour if Av Bay 3A with enhanced cooling) period between the Halon discharge in an avionics bay and the diffusion of a potentially hazardous level of Halon into the cabin (ref Rule {A13-158}, CABIN ATMOSPHERE CONTAMINATION - HALON 1301 [HC]) could not be guaranteed following a cabin depress without first initiating an avionics bay purge. A dedicated avionics bay purge of at least 3 lb/hr directly overboard will maintain a positive delta pressure on the avionics bay with respect to the cabin during a controlled cabin depress to 8 psi, thus ensuring that any Halon and/or combustion products would not be drawn into the cabin. In order to maintain the positive delta pressure on the affected avionics bay, the cabin EQ dP/dT must be controlled to below a maximum of -0.1 psi/min during the transition from the current cabin pressure to 8 psi.

In the case of a fire following the depletion of all available Halon, lowering of the O₂ concentrations to 15 percent could be used as an alternative means of fire suppression. ©[090894-1673A]

Note: A safe level of toxicity in the cabin cannot be guaranteed following a fire condition, but a cabin depress without initiating a dedicated avionics bay purge would quicken the diffusion rate of toxins into the cabin. ©[090894-1673A]

DOCUMENTATION: SODB 4.6.5.2.a.2.r; engineering judgment; and Halon 1301 Fire Extinguishment in Avionics Bays, M. Pedley, May 30, 1989. ©[022306-6754C]

THIS RULE CONTINUED ON NEXT PAGE

FLIGHT RULES**A17-1 AVIONICS BAY FIRE DEFINITIONS AND ACTIONS [HC]
(CONTINUED)**

5. AV BAY POWERDOWN @[022306-6754C]
- a. ANY FAILING OR FAILED EQUIPMENT WILL BE POWERED OFF IMMEDIATELY AND CONSIDERED LOST PER THE GO/NO-GO CRITERIA. THIS EQUIPMENT WILL NOT BE REPOWERED.

Failed or malfunctioning equipment was either responsible for or was damaged by the fire. In either case, the equipment will be unpowered and remain so to preclude further damage to the avionics bay. A shorted bus or piece of equipment that continues to be powered presents several concerns for causing additional damage/equipment failures. They include but are not limited to: Localized heating, fire/smoke/toxic gases, arcing, arc-tracking and flashover, and loss of wiring integrity. Laboratory tests on Kapton wiring indicate that arc-tracking can cause extensive damage to wire harnesses. Loss of a wire harness in itself could be catastrophic.

DOCUMENTATION: Testing performed at KSC Malfunction Analysis Laboratory and at the JSC EPDC Laboratory. Also CAR # AC1737-010.

- b. A POWERDOWN OF ALL ADDITIONAL EQUIPMENT IN THE AFFECTED AVIONICS BAY SHALL BE ACCOMPLISHED AS SOON AS POSSIBLE, EXCEPT FOR THE FOLLOWING:
- (1) IMU FANS
 - (2) INSTRUMENTATION REQUIRED FOR THE CREW AND MCC TO ASSESS POST-FIRE SAFETY STATUS
 - (3) COMMUNICATIONS EQUIPMENT
 - (4) ANY EQUIPMENT REQUIRED TO MAINTAIN CRITICAL CAPABILITY

Powering down all equipment in the affected avionics bay will minimize electrical and frictional ignition sources. For avionics bay 1, IMU fans (located in the avionics bay) must remain operating since the IMU's (not located in avionics bays) cannot operate for more than 90 minutes (180 minutes) if operating (if in standby) without cooling (ref Rule {A18-501}, MAXIMUM OFF TIME FOR COOLING EQUIPMENT [HC]). If a fan has failed, a redundant fan will be activated immediately. For avionics bay 3, communication is considered too important during the entry phase of flight to allow it to become unpowered without a confirmed failure. For all three avionics bays, in order to maintain insight into the health of the remaining systems and to implement the post-fire cabin depress and purge at 8 psi, the instrumentation equipment is required. Instrumentation is required in order to properly limit the rate of the cabin depress such that a positive delta pressure is maintained on the avionics bay while a dedicated avionics bay purge is in place. The positive delta pressure on the avionics bay will ensure that the toxic combustion products from the fire are not forced into the cabin. @[022306-6754C]

THIS RULE CONTINUED ON NEXT PAGE

FLIGHT RULES

A17-1

AVIONICS BAY FIRE DEFINITIONS AND ACTIONS [HC]
(CONTINUED)

Equipment required for critical capability will remain powered until it is no longer required. Equipment in this category includes avionics and/or other LRU's that, if unpowered, would result in loss of crew and/or vehicle, or would significantly decrease safety margins (e.g., loss of an OMS engine that is required for OMS-1, OMS-2, or other burn that is critical for crew safety). ©[022306-6754C]

- c. IF A FIRE EVENT OCCURS DURING ISS RENDEZVOUS/PROXIMITY OPERATIONS AND A SINGLE LRU IS MOST LIKELY THE CAUSE OF THE FIRE, THE FOLLOWING SHALL APPLY:
- (1) IF SUFFICIENT PROPELLANT MARGIN ALLOWS A DELAY IN DOCKING, DOCKING MAY BE DELAYED TO PERFORM DATA ANALYSIS AND INSPECT THE AFFECTED AVIONICS BAY. ©[ED]
 - (2) IF PROPELLANT MARGIN WILL NOT ALLOW A 24-HOUR DELAY, ESSENTIAL EQUIPMENT (FF MDM'S, REACTION JET DRIVERS FORWARD (RJDF'S)) MAY REMAIN POWERED FOR THE DURATION REQUIRED FOR DOCKING. IN THIS CASE, AN AVIONICS BAY FAN WILL REMAIN POWERED TO MAINTAIN FIRE/SMOKE DETECTION.

In most cases, all unnecessary equipment in the affected avionics bay will be powered down. After the Halon concentration drops below 4 percent, having the avionics bay fan remain unpowered is the primary means for precluding a fire/smoke flare-up by reducing the O₂ provided to the event. With the avionics bay fan unpowered, all forced air-cooled equipment should be powered down unless considered essential for crew safety. In certain circumstances, it may be prudent to delay powering down equipment required for docking and undocking. If sufficient propellant is available, rendezvous operations may be delayed 24 hours to permit an overboard purge of contaminants, a detailed investigation of the data, and a visual inspection of the avionics bay. However, if propellant margin is insufficient to delay docking and confidence is high that a single LRU is affected, equipment considered essential for a safe docking may remain powered. Once the equipment is no longer needed, it will be immediately unpowered. Since smoke concentration readings are only valid if an avionics bay fan is running, an avionics bay fan will be turned on to monitor the conditions in the affected avionics bay when additional equipment remains powered. The Halon should still assist in suppressing the fire event and the insight in smoke concentrations will allow a rapid response in the timeframe where there is significant risk to both the shuttle and ISS. The fan will be deactivated when the docking equipment is unpowered to reduce oxygen supplied to a potential flare-up. ©[022306-6754C] ©[ED]

THIS RULE CONTINUED ON NEXT PAGE

FLIGHT RULES

A17-1

AVIONICS BAY FIRE DEFINITIONS AND ACTIONS [HC] (CONTINUED)

- d. EQUIPMENT WHICH WAS EITHER POWERED DOWN OR WAS UNPOWERED AT THE TIME OF THE FIRE EVENT WILL BE DECLARED LOST UNTIL PROVEN GO FOR GO/NO-GO CRITERIA. ©[022306-6754C]

Without direct insight into the affected bay, the damage to the equipment is unknown. Some of the equipment may not have been in use during the fire or may have suffered failures not immediately detectable; therefore, the equipment must be considered suspect for all GO/NO-GO purposes.

- e. THE ONLY EQUIPMENT TO BE CONSIDERED FOR REACTIVATION WILL BE EQUIPMENT REQUIRED TO RESTORE SINGLE-FAULT TOLERANCE FOR CRITICAL OPERATIONS AND/OR ENTRY. IF POSSIBLE, REACTIVATION WILL ONLY OCCUR WHEN MCC IS AVAILABLE TO ASSESS. PRIOR TO POWERING UP EQUIPMENT, A PORTABLE HALON BOTTLE WILL BE HELD NEARBY, READY FOR DISCHARGE. ©[090894-1673A]

Repowered equipment in the affected avionics bay should be restricted to that required to achieve single-fault tolerance to entry or during critical operations to minimize the risk of reigniting the fire. To additionally minimize risk, the equipment will only be powered during times when its operation is needed. The health of the systems and/or crew cannot be guaranteed following a fire; therefore, entry may be necessary following avionics bay evaluation. To prove equipment is GO per GO/NO-GO criteria, required equipment may be powered up to an extent necessary to determine its functionality and then unpowered until needed. Reference Rule {A13-158}, CABIN ATMOSPHERE CONTAMINATION - HALON 1301 [HC].

6. TO ASSIST IN DETERMINING THE EXTENT OF DAMAGE IN THE AFFECTED AVIONICS BAY, AN INSPECTION WILL BE PERFORMED IF TIME PERMITS.

To assist in determining the extent of the collateral damage and the remaining vehicle capability in the affected avionics bay, a visual inspection of the bay is highly desired. To minimize the health risks to the crew, the inspection will not occur until the avionics bay purge is complete and the initial visual assessment will be done via boroscope. If equipment or wire bundles are seen to be damaged, then that equipment is considered lost and will not be repowered. However, visual inspection alone will not exonerate any equipment. If there is insufficient time to inspect the avionics bay or no damage is seen, critical equipment may be powered up one piece at a time when (if possible) MCC is available to assess equipment health. ©[022306-6754C]

THIS RULE CONTINUED ON NEXT PAGE

FLIGHT RULES

A17-1

AVIONICS BAY FIRE DEFINITIONS AND ACTIONS [HC]
(CONTINUED)

7. THE REGENERATIVE CARBON DIOXIDE REMOVAL SYSTEM (RCRS) WILL BE MANUALLY SHUT DOWN FOLLOWING AN ORBITER AVIONICS BAY FIRE. ®[022306-6754C]

See Rule {A17-156}, RCRS MANUAL SHUTDOWN CRITERIA, for rationale.

DOCUMENTATION: Engineering judgment.

Hazard Reports ORBI 044, Unknown Gaseous Contamination Levels in the Cabin Causing Crew Illness/Incapacitation; ORBI 259, Material Flammability Threat in the Cabin and Orbiter Docking System; and ORBI 301, Electrical Short Causing Fire in the Cabin, are controlled by this flight rule.

Reference Orbit Flight Techniques Panel meetings #210 on January 30, 2004, and #215 on October 15, 2004, for detailed discussion. ®[022306-6754C]

FLIGHT RULES

A17-2

CABIN FIRE DEFINITION AND ACTIONS [HC]

- A. A CABIN FIRE SHALL BE DEFINED AS ONE OR MORE OF THE FOLLOWING: @[022306-6754C]
1. CREW OBSERVANCE OF SUSTAINED FLAME OR SMOKE
 2. ANY ONE OF THE FOLLOWING: @[090894-1674]
 - a. TWO CABIN SMOKE DETECTOR (RIGHT AND LEFT FLIGHT DECK AND CABIN RETURN AIR DETECTOR) CONCENTRATION LEVELS EXCEEDING 2000 UG/M**3
 - b. ONE CABIN SMOKE CONCENTRATION LEVEL EXCEEDING 2000 UG/M**3, AND CONFIRMATION OF A SUSTAINED SHORT OR EQUIPMENT MALFUNCTION

*A confirmation is required to accurately detect a fire condition; this confirmation can be via a separate smoke detector indicating a concentration level over 2000 ug/m**3, or crew observations. Any indications of a sustained short will also be considered as confirmation of a fire.*

In the event of a cabin fire, the crew will most likely react to olfactory sensing prior to the annunciation of a smoke detector(s), since the human nose is significantly more sensitive. Also, visual cues will most likely be used as confirmation of a fire condition rather than relying solely upon smoke detector indications. @[090894-1674]

B. CREW CABIN FIRE ACTIONS

IF A FIRE CONDITION IS DETECTED IN THE CABIN DURING ANY PHASE OF FLIGHT, THE FOLLOWING ACTIONS SHALL BE ACCOMPLISHED AS SOON AS POSSIBLE:

1. THE CREW SHALL DON QDM'S/ACES HELMETS WITH VISORS DOWN.
2. THE CABIN FAN WILL BE TURNED OFF.
3. THE CREW WILL POWER DOWN SUSPECT EQUIPMENT.
4. THE CREW SHALL DISCHARGE THE HANDHELD HALON BOTTLE IN THE APPROPRIATE FIRE PORT. @[022306-6754C]

THIS RULE CONTINUED ON NEXT PAGE

FLIGHT RULES

A17-2

CABIN FIRE DEFINITION AND ACTIONS [HC] (CONTINUED)

The QDM's/ACES helmets protect the crew from breathing potentially toxic gases; donning of the ACES will be considered later if appropriate. Also, the cabin fan produces convection air currents that will feed oxidizer to a fire. Without convection currents, a fire should extinguish itself due to a lack of oxidizer and also localize toxins in the vicinity of combustion until the crew has donned protective gear. A Halon discharge should save the equipment from any further combustion except for arc tracking, upon which Halon has no effect. It may not be possible to determine the exact location of the fire. In that case, discharging a Halon bottle would not aid in suppressing the fire and would needlessly expose the crew to Halon. The crew should power down suspect equipment because the equipment health cannot be guaranteed and is a potential ignition source. ©[022306-6754C]

Reference Rules {A13-157}, CABIN ATMOSPHERE CONTAMINATION FIRE/SMOKE, and {A13-158}, CABIN ATMOSPHERE CONTAMINATION - HALON 1301 [HC].

DOCUMENTATION: NASA SP-443 Materials Processing in Space: Early Experiments by Robert J. Naumann and Harvey W. Herring, January 1, 1980.

C. CREW CABIN POST-FIRE ACTIONS

POST-FIRE, THE FOLLOWING ACTIONS SHALL BE ACCOMPLISHED:

1. POST-FIRE CABIN CLEANUP ACTIONS WILL BE INITIATED PER RULE {A13-157}, CABIN ATMOSPHERE CONTAMINATION FIRE/SMOKE.
2. IF COMBUSTION PRODUCTS ARE DETECTED IN THE CABIN, THE CREW WILL REMAIN ON THE QDM'S/ACES HELMETS. THE CREW SHALL PERFORM A CABIN DEPRESS TO 8 PSI AND A CONTINUOUS PURGE AT 8 PSI WILL BE PERFORMED. THE PURGE MAY BE TERMINATED AND THE CREW ALLOWED TO BREATHE CABIN AIR ACCORDING TO THE CRITERIA OUTLINED IN RULE {A13-157}, CABIN ATMOSPHERE CONTAMINATION FIRE/SMOKE. ©[090894-1673A] ©[022306-6754C]

THIS RULE CONTINUED ON NEXT PAGE

FLIGHT RULES

A17-2

CABIN FIRE DEFINITION AND ACTIONS [HC] (CONTINUED)

Post-fire, a cabin depress to 8 psi and continuous purge at 8 psi will manage O₂ concentrations below maximum levels (ref Rule {A17-254}, CABIN O₂ CONCENTRATION) as well as decrease the concentration of discharged Halon and any toxic gases that were produced by a fire. This action will extend the time on orbit so as to potentially avoid an ELS entry by effectively reducing the amount of N₂ needed to control O₂ concentrations. Following a fire condition, the health of the systems and/or crew cannot be guaranteed; therefore, following a cabin atmosphere evaluation, entry may be necessary. Since in an 8 psi cabin condition, the O₂ concentration is allowed to reach 40 percent, which increases the flammability potential, the crew should make sure that the fire has been fully extinguished before initiating the depress to prevent flares. If sufficient N₂ is available to reach a PLS, it is not necessary to go to 8 psi. ©[022306-6754C]

Note: In the case of a fire following the depletion of all available Halon, lowering of the O₂ concentrations to 15 percent could be used as an alternative means of fire suppression. ©[090894-1673A]

DOCUMENTATION: SODB 4.6.5.2.a.2.r; engineering judgment; and Halon 1301 Fire Extinguishment in Avionics Bays, M. Pedley.

3. THE CREW SHALL PERFORM A FLIGHT DECK AVIONICS CHECKOUT FOR SUSPECT EQUIPMENT AND/OR EQUIPMENT REQUIRED FOR ENTRY.

If required for entry, the equipment should be checked out before use.

4. THE RCRS WILL BE MANUALLY SHUT DOWN FOLLOWING AN ORBITER CABIN FIRE.

See Rule {A17-156}, RCRS MANUAL SHUTDOWN CRITERIA, for rationale.

DOCUMENTATION: Engineering judgment.

Hazard Reports ORBI 044, Unknown Gaseous Contamination Levels in the Cabin Causing Crew Illness/Incapacitation; ORBI 259, Material Flammability Threat in the Cabin and Orbiter Docking System; and ORBI 301, Electrical Short Causing Fire in the Cabin, are controlled by this flight rule.

Reference OFTP meeting #210 minutes, January 30, 2004 for detailed discussion. ©[022306-6754C]

Rules {A17-254}, CABIN O₂ CONCENTRATION, and {A17-255}, 8 PSIA EMERGENCY CABIN CONFIGURATION, reference this rule. ©[ED]

FLIGHT RULES

A17-3

FORWARD AVIONICS BAY FIRE SUPPRESSION

FORWARD AVIONICS BAY FIRE SUPPRESSION IS CONSIDERED LOST IF:

- A. THE "AGENT DISCHARGE" PBI IS ILLUMINATED WITH NO CONCURRENT AURAL CUE.

The system is suspect to the point of being unreliable. An AGENT DISCHARGE light indicates an "empty" bottle. Without an aural cue, it would not be known when or how fast the agent discharged.

- B. 50 HOURS HAS ELAPSED AFTER THE "AGENT DISCHARGE" PBI IS ILLUMINATED AND WITH A CONCURRENT AURAL CUE.

The avionics bays are not airtight and will allow the Halon 1301 fire suppressant to dissipate into the cabin over a period of time. However, the resultant concentration of Halon 1301 in an avionics bay from a fully charged bottle will stay above the required 4 percent needed to extinguish a fire for 50 hours.

DOCUMENTATION: SODB 4.6.5.2.A.2.R.

- C. FOR AV BAY 3A WITH ENHANCED MIDDECK COOLING AND ACTIVELY COOLED PAYLOADS: 28 HOURS HAS ELAPSED AFTER THE "AGENT DISCHARGE" PBI IS ILLUMINATED WITH A CONCURRENT AURAL CUE.
@[040899-2497]

Avionics bays that have been modified for enhanced middeck cooling, and have actively cooled payloads stowed in the bay, have a higher leakage rate than avionics bays that have not been modified. As such, Halon 1301 fire suppressant will dissipate into the cabin faster from the enhanced avionics bays. The resultant concentration of Halon 1301 in an enhanced avionics bay from a fully charged bottle will stay above the required 4 percent needed to extinguish a fire for 28 hours. If the av bay has enhanced cooling capability; however, no actively cooled payloads have been manifested, then paragraph B applies because the payload ducts have been capped.

DOCUMENTATION: BNA 287-200-098-017, Middeck Bay 3A Leakage Analysis. @[040899-2497]

Rule {A17-1001}, LIFE SUPPORT GO/NO-GO CRITERIA, references this rule.

FLIGHT RULES

A17-4

SMOKE EVENT DEFINITION AND ACTIONS [HC]

- A. A SMOKE EVENT WILL BE DEFINED AS AN OFF-NOMINAL SMOKE CONCENTRATION EVENT WHICH DOES NOT MEET THE DEFINITION OF A FIRE PER RULES {A17-1}, AVIONICS BAY FIRE DEFINITION AND ACTIONS [HC], AND {A17-2}, CABIN FIRE DEFINITION AND ACTIONS [HC]. @[022306-6754C]

THE FOLLOWING WILL BE CONSIDERED IN DETERMINING A SMOKE EVENT:

1. CREW REPORT OF TRANSIENT SMOKE OR FLAME
2. OFF-NOMINAL SMOKE DETECTOR INDICATIONS AND ANY OF THE FOLLOWING:
 - a. DATA INDICATING AN ELECTRICAL SHORT
 - b. EQUIPMENT DEGRADATION OR FAILURE

The above lists the data that will be used in determining a smoke event and not telemetry or sensor failure. The primary indications will be crew report and smoke detector indications. Electrical data and equipment degradation/failure will be considered as supporting data in the determination of a smoke event.

Two flights have had transient fire or smoke events clearly isolatable to single pieces of equipment in the cabin. On STS-28, the teleprinter cable shorted and the crew reported embers that burned for only a few seconds. On STS-35, two payload Display Electronics Unites (DEU's) failed and the crew reported a burnt plastic smell that went away after the suspect DEU's were unpowered. In both cases, the equipment was quickly unpowered and the cabin atmosphere contamination was minimal, with no early mission termination.

- B. FOLLOWING A SMOKE EVENT, THE FOLLOWING ACTIONS SHALL BE ACCOMPLISHED AS SOON AS POSSIBLE:
1. THE CREW WILL DON QDM'S/ACES HELMETS WITH VISORS DOWN.
 2. THE CREW WILL POWER DOWN SUSPECT EQUIPMENT.
 3. CSA-CP READINGS WILL BE TAKEN IN THE VICINITY OF THE EVENT. IF COMBUSTION PRODUCTS LEVELS VIOLATE RULE {A13-157}, CABIN ATMOSPHERE CONTAMINATION FIRE/SMOKE, THE FOLLOWING WILL APPLY: @[022306-6754C]

THIS RULE CONTINUED ON NEXT PAGE

FLIGHT RULES

A17-4

SMOKE EVENT DEFINITION AND ACTIONS [HC] (CONTINUED)

- a. ATMOSPHERE CLEANUP WILL BE PERFORMED PER RULE {A13-157}, CABIN ATMOSPHERE CONTAMINATION FIRE/SMOKE. ®[022306-6754C]
- b. IF THE CREW MUST REMAIN ON QDM'S/VISORS AND THE RULE {A17-254}, CABIN O₂ CONCENTRATION, UPPER LIMIT IS VIOLATED, A CABIN DEPRESS TO 8 PSI FOLLOWED BY A CONTINUOUS CABIN PURGE AT 8 PSI WILL BE PERFORMED. THE PURGE WILL BE TERMINATED AND THE CREW ALLOWED TO BREATHE CABIN AIR ACCORDING TO THE CRITERIA OUTLINED IN RULE {A13-157}, CABIN ATMOSPHERE CONTAMINATION FIRE/SMOKE.

It is prudent to protect the crew from contaminants until the atmosphere is shown to be breathable. This includes the case of an avionics bay smoke event, where combustion products are not expected to dissipate into the cabin environment in a short period of time. Since the CSA-CP is quickly available to monitor the cabin atmosphere on orbit, the crew will be able to determine if the atmosphere contains combustion products prior to exceeding either the percent O₂ flammability limits or overpressurization constraints (above positive pressure relief valve limits). If combustion products are detected at unsafe levels, the crew will remain on QDM's/visors until the air is scrubbed per Rule {A13-157}, CABIN ATMOSPHERE CONTAMINATION FIRE/SMOKE. If the O₂ concentration will violate flammability constraints, the cabin will be depressed to 8 psia per Rule {A17-254}, CABIN O₂ CONCENTRATION. The intent of making the initial actions for a smoke event and fire identical is to protect the crew and ensure an immediate and consistent response (don QDM's/visors and take CSA-CP readings).

A cabin depress to 8 psia and continuous purge at 8 psia will manage O₂ concentrations below maximum levels as well as decrease the concentration of any toxic gases that were produced by the event. This action will extend the time on orbit so as to potentially avoid an ELS entry by effectively reducing the amount of N₂ needed to control O₂ concentrations. If sufficient N₂ is available to reach a PLS, it is not necessary to go to 8 psi.

4. IN THE EVENT OF AN AVIONICS BAY SMOKE EVENT, THE FOLLOWING SHALL ALSO APPLY:
 - a. AN OVERBOARD PURGE OF THE AFFECTED AVIONICS BAY WILL BE INITIATED ASAP AND PRIOR TO ANY CABIN DEPRESS. ®[022306-6754C]

THIS RULE CONTINUED ON NEXT PAGE

FLIGHT RULES

A17-4

SMOKE EVENT DEFINITION AND ACTIONS [HC] (CONTINUED)

Purging the avionics bay atmosphere overboard will remove any toxins from the atmosphere and help preclude contaminants from diffusing into the cabin. A cabin depress without first initiating a purge of the affected avionics bay directly overboard would create a negative pressure differential between the cabin and avionics bay that would draw any toxic combustion products from the avionics bay into the cabin. A dedicated avionics bay purge of at least 3 lb/hr directly overboard will maintain a positive delta pressure on the avionics bay with respect to the cabin during a controlled cabin depress to 8 psi, thus ensuring that any combustion products would not be drawn into the cabin. In order to maintain the positive delta pressure on the affected avionics bay, the cabin EQ dP/dT must be controlled to below a maximum of -0.1 psi/min during the transition from the current cabin pressure to 8 psi. ©[022306-6754C]

b. AVIONICS BAY POWERDOWN

- (1) ANY FAILING OR FAILED EQUIPMENT WILL BE POWERED OFF IMMEDIATELY AND CONSIDERED LOST PER THE GO/NO-GO CRITERIA. THIS EQUIPMENT WILL NOT BE REPOWERED.

Failed or malfunctioning equipment was either responsible for or was damaged by the smoke event. In either case, the equipment will be unpowered and remain so to preclude further damage to the avionics bay. A shorted bus or piece of equipment that continues to be powered presents several concerns for causing additional damage/equipment failures. They include but are not limited to: Localized heating, fire/smoke/toxic gases, arcing, arc-tracking and flashover, and loss of wiring integrity. Laboratory tests on Kapton wiring indicate that arc-tracking can cause extensive damage to wire harnesses. Loss of a wire harness in itself could be catastrophic.

DOCUMENTATION: Testing performed at KSC Malfunction Analysis Laboratory and at the JSC EPDC Laboratory. Also CAR # AC1737-010.

- (2) A POWERDOWN OF ALL ADDITIONAL EQUIPMENT IN THE AFFECTED AVIONICS BAY SHALL BE ACCOMPLISHED AS SOON AS POSSIBLE, EXCEPT FOR THE FOLLOWING:
 - (a) IMU FANS
 - (b) INSTRUMENTATION REQUIRED FOR THE CREW AND MCC TO ASSESS POST-SMOKE SAFETY STATUS ©[022306-6754C]

THIS RULE CONTINUED ON NEXT PAGE

FLIGHT RULES

A17-4

SMOKE EVENT DEFINITION AND ACTIONS [HC]
(CONTINUED)

- (c) COMMUNICATIONS EQUIPMENT @[022306-6754C]
- (d) ANY EQUIPMENT REQUIRED TO MAINTAIN CRITICAL CAPABILITY

Powering down all equipment in the affected avionics bay will minimize electrical and frictional ignition sources. For avionics bay 1, IMU fans (located in the avionics bay) must remain operating since the IMU's (not located in avionics bays) cannot operate for more than 90 minutes (180 minutes) if operating (if in standby) without cooling (ref Rule {A18-501}, MAXIMUM OFF TIME FOR COOLING EQUIPMENT [HC]. If an IMU fan has failed, a redundant fan will be activated immediately. For avionics bay 3, communication is considered too important during the entry phase of flight to allow it to become unpowered without a confirmed failure. For all three avionics bays, in order to maintain insight into the health of the remaining systems and to implement the post-fire cabin depress and purge at 8 psi, the instrumentation equipment is required. Instrumentation is required in order to properly limit the rate of the cabin depress such that a positive delta pressure is maintained on the avionics bay while a dedicated avionics bay purge is in place. The positive delta pressure on the avionics bay will ensure that the toxic combustion products from the smoke event are not forced into the cabin.

Equipment required for critical capability will remain powered until it is no longer required. Equipment in this category includes avionics and/or other LRU's that, if unpowered, would result in loss of crew and/or vehicle, or would significantly decrease safety margins (e.g., loss of an OMS engine that is required for OMS-1, OMS-2, or other burn that is critical for crew safety).

- (3) IF A SMOKE EVENT OCCURS DURING ISS RENDEZVOUS/PROXIMITY OPERATIONS AND A SINGLE LRU IS MOST LIKELY THE CAUSE, THE FOLLOWING SHALL APPLY:
 - (a) IF SUFFICIENT PROPELLANT MARGIN ALLOWS A DELAY IN DOCKING, DOCKING MAY BE DELAYED TO PERFORM DATA ANALYSIS AND INSPECT THE AFFECTED AVIONICS BAY. @[ED]
 - (b) IF PROPELLANT MARGIN WILL NOT ALLOW A 24-HOUR DELAY, ESSENTIAL EQUIPMENT (FF MDM'S, RJDF'S) MAY REMAIN POWERED FOR THE DURATION REQUIRED FOR DOCKING. IN THIS CASE, AN AVIONICS BAY FAN WILL REMAIN POWERED TO MAINTAIN FIRE/SMOKE DETECTION. @[022306-6754C]

THIS RULE CONTINUED ON NEXT PAGE

FLIGHT RULES

A17-4

SMOKE EVENT DEFINITION AND ACTIONS [HC] (CONTINUED)

In most cases, all unnecessary equipment in the affected avionics bay will be powered down. Having the avionics bay fan remain unpowered is the primary means for precluding a fire/smoke flare-up by reducing the O₂ provided to the event. With the avionics bay fan unpowered, all forced air-cooled equipment should be powered down unless considered essential for crew safety. In certain circumstances, it may be prudent to delay powering down equipment required for docking and undocking. If sufficient propellant is available, rendezvous operations may be delayed 24 hours to permit an overboard purge of contaminants, a detailed investigation of the data, and a visual inspection of the avionics bay. However, if propellant margin is insufficient to delay docking and confidence is high that a single LRU is affected, equipment considered essential for a safe docking may remain powered. Once the equipment is no longer needed, it will be immediately unpowered. Since smoke concentration readings are only valid if an avionics bay fan is running, an avionics bay fan will be turned on to monitor the conditions in the affected avionics bay when additional equipment remains powered. The fan will be deactivated when the docking equipment is unpowered to reduce oxygen supplied to a potential flare-up.

©[022306-6754C] ©[ED]

- (4) EQUIPMENT WHICH WAS EITHER POWERED DOWN OR WAS UNPOWERED AT THE TIME OF THE SMOKE EVENT WILL BE DECLARED LOST UNTIL PROVEN GO FOR GO/NO-GO CRITERIA.

Without direct insight into the affected bay, the damage to the equipment is unknown. Some of the equipment may not have been in use during the smoke event or may have suffered failures not immediately detectable; therefore, the equipment must be considered suspect for all GO/NO-GO purposes.

- (5) THE ONLY EQUIPMENT TO BE CONSIDERED FOR REACTIVATION WILL BE EQUIPMENT REQUIRED TO RESTORE SINGLE-FAULT TOLERANCE FOR CRITICAL OPERATIONS AND/OR ENTRY. IF POSSIBLE, REACTIVATION WILL ONLY OCCUR WHEN MCC IS AVAILABLE TO ASSESS. PRIOR TO POWERING UP EQUIPMENT, A PORTABLE HALON BOTTLE WILL BE HELD NEARBY, READY FOR DISCHARGE.

Repowered equipment in the affected avionics bay should be restricted to that required to achieve single-fault tolerance to entry or during critical operations to minimize the risk of reigniting the smoke event source. To additionally minimize risk, the equipment will only be powered during times when its operation is needed. The health of the systems and/or crew cannot be guaranteed following a smoke event; therefore, entry may be necessary following cabin or avionics bay evaluation. To prove equipment is GO per GO/NO-GO criteria, required equipment may be powered up to an extent necessary to determine its functionality and then unpowered until needed. ©[022306-6754C]

THIS RULE CONTINUED ON NEXT PAGE

FLIGHT RULES

A17-4

SMOKE EVENT DEFINITION AND ACTIONS [HC] (CONTINUED)

- (6) TO ASSIST IN DETERMINING THE EXTENT OF DAMAGE IN THE AFFECTED AVIONICS BAY, AN INSPECTION WILL BE PERFORMED IF TIME PERMITS. ©[022306-6754C]

To assist in determining the extent of the collateral damage and the remaining vehicle capability in the affected avionics bay, a visual inspection of the bay is highly desired. To minimize the health risks to the crew, the inspection will not occur until the avionics bay purge is complete and the initial visual assessment will be done via boroscope. If equipment or wire bundles are seen to be damaged, then that equipment is considered lost and will not be repowered. However, visual inspection alone will not exonerate any equipment. If there is insufficient time to inspect the avionics bay or no damage is seen, critical equipment may be powered up one piece at a time when (if possible) MCC is available to assess equipment health.

5. IN THE EVENT OF AN AVIONICS BAY SMOKE EVENT AFTER THE DEORBIT BURN IS COMPLETE, THE FOLLOWING ACTIONS WILL BE TAKEN:
- a. THE CREW WILL DON QDM' S/ACES HELMETS WITH VISORS DOWN.
 - b. THE CREW WILL POWER DOWN SUSPECT EQUIPMENT.
 - c. A HALON BOTTLE WILL BE DISCHARGED INTO THE AFFECTED AVIONICS BAY.

A/E FTP #214 (September 30, 2005) reviewed a proposal to always discharge a Halon bottle into an avionics bay for a smoke event that occurs after the deorbit burn is complete. The benefit of always discharging a bottle is to prevent an isolated event from becoming a more pervasive or extensive fire during the critical entry timeframe. Additionally, there are no risks to the crew or to the existing avionics or LRU's associated with the discharge. The only negative aspect of discharging the bottle is a turnaround issue since extensive intrusion into the Av bay is required to recharge the Halon bottle. Since a significant Av bay inspection will be required during turnaround to locate the source of the smoke event and to locate damage associated with the smoke event, the A/E FTP determined that the prudent course of action is to always discharge the Halon bottle for an avionics bay smoke event.

6. THE RCRS WILL BE MANUALLY SHUT DOWN FOLLOWING AN ORBITER SMOKE EVENT.

See Rule {A17-156}, RCRS MANUAL SHUTDOWN CRITERIA, for rationale. ©[022306-6754C]

THIS RULE CONTINUED ON NEXT PAGE

FLIGHT RULES

A17-4

SMOKE EVENT DEFINITION AND ACTIONS [HC]
(CONTINUED)

DOCUMENTATION: Engineering judgment. ®[022306-6754C]

Hazard Reports ORBI 044, Unknown Gaseous Contamination Levels in the Cabin Causing Crew Illness/Incapacitation; ORBI 259, Material Flammability Threat in the Cabin and Orbiter Docking System; and ORBI 301, Electrical Short Causing Fire in the Cabin, are controlled by this flight rule.

Reference Orbit Flight Techniques Panel meetings #210 on January 30, 2004 and #215 on October 15, 2004, for detailed discussion. ®[022306-6754C]

FLIGHT RULES

A17-5

SMOKE DETECTION LOSS DEFINITION [HC]

- A. AVIONICS BAY SMOKE DETECTION SHALL BE CONSIDERED LOST FOR ANY ONE OF THE FOLLOWING REASONS: ©[022306-6754C]
1. ONE SMOKE DETECTOR FAILS BOTH PORTIONS OF THE CIRCUIT TEST AND THE OTHER SMOKE DETECTOR FAILS EITHER PORTION OF THE CIRCUIT TEST.
 2. NEITHER OF THE DETECTORS IN THAT AVIONICS BAY CAN BE POWERED.
 3. LOSS OF AIR CIRCULATION (BOTH AVIONICS BAY FANS FAILED) IN THE BAY
- B. CREW CABIN SMOKE DETECTION SHALL BE CONSIDERED LOST FOR ANY ONE OF THE FOLLOWING REASONS:
1. ALL THREE DETECTORS FAIL BOTH PORTIONS OF THE CIRCUIT TEST.
 2. NONE OF THE THREE CABIN DETECTORS CAN BE POWERED.
 3. LOSS OF AIR CIRCULATION (BOTH CABIN FANS FAILED) IN THE CREW CABIN

Each smoke detector outputs two smoke detection indications (an alarm indication and a concentration measurement), and these two measurements are independent of one another except for a smoke detector hardware failure. Alarm indications include siren, L1 and F7 lights, and downlisted telemetry, any of which can satisfy smoke detection requirements for a given detector. The only hardware failure that can be detected by the circuit test is an air pump failure which would force the detector to fail both portions of the circuit test. If the smoke detector passes either portion of the circuit test, the air pump is then verified as operative, and the concentration readout sent to the GPC for FDA limit sensing is considered a valid indication.

Power is required for the smoke detectors to operate. Loss of air circulation prevents particulates from reaching the smoke detector in a timely manner if the combustion is not close to the smoke detector. If only one indication is left in an avionics bay, the system is considered suspect to the point of being unreliable.

DOCUMENTATION: R.I. Vendor drawings VS70-620109 and V070-623420. Rewording was approved at OFTP #210, January 30, 2004. ©[022306-6754C]

THIS RULE CONTINUED ON NEXT PAGE

FLIGHT RULES

A17-5 **SMOKE DETECTION LOSS DEFINITION [HC] (CONTINUED)**

Rule {A17-1001}, LIFE SUPPORT GO/NO-GO CRITERIA, references this rule. ©[022306-6754C]

Hazard Reports ORBI 259, Material Flammability Threat in the Cabin and Orbiter Docking System, and ORBI 301, Electrical Short Causing Fire in the Cabin, are controlled by this flight rule. ©[022306-6754C]

A17-6 THROUGH A17-50 RULES ARE RESERVED ©[022306-6754C]

FLIGHT RULES

SMOKE DETECTION/FIRE SUPPRESSION MANAGEMENT

A17-51

MANAGEMENT FOLLOWING LOSS OF SMOKE DETECTION

A. AVIONICS BAY:

1. HALON DISCHARGE CRITERIA

DURING ANY PHASE OF FLIGHT, A HALON BOTTLE WILL BE DISCHARGED IF THERE IS EQUIPMENT FAILURE IN THAT AVIONICS BAY AND THE FAILURE IS ATTRIBUTED TO A SUSTAINED SHORT. IF THE MCC IS NOT AVAILABLE TO DETERMINE IF A SHORT WAS PRESENT, THE REMAINING EQUIPMENT IN THE BAY WILL BE POWERED DOWN UNTIL THE ASSESSMENT CAN BE MADE. A HALON BOTTLE WILL BE DISCHARGED IF SECONDARY CUES ARE PRESENT.
@[090894-1674]

An equipment failure due to a sustained short could provide an ignition source for a fire and should be considered a fire condition. A short that has cleared has effectively eliminated the ignition source and should not be considered a fire condition. If the MCC is not available when a piece of equipment fails, powerdown of the bay is considered the best compromise to safe the bay while not prematurely discharging Halon. If the crew confirms a fire condition with secondary cues such as simultaneous or subsequent equipment failure or crew observance of smoke, a Halon bottle will be discharged.

2. POWERDOWN MANAGEMENT FOR AVIONICS BAYS 1 AND 2

- a. FOR AVIONICS BAYS 1 AND 2, A POST-OMS-2 POWERDOWN OF ALL AIR-COOLED EQUIPMENT AND THE AVIONICS BAY FAN IN THE AFFECTED AVIONICS BAY SHALL BE ACCOMPLISHED. ALL THIS EQUIPMENT MAY BE POWERED UP FOR ENTRY.

Air-cooled equipment and avionics bay fan will be powered down to (1) prevent the propagation of any fire by removing the convection currents that would feed O₂ to the fire and (2) eliminate friction generated by the fan as a potential ignition source. This action safes the avionics bay from any combustion except for arc tracking during the critical time of powering up equipment required for entry.

THIS RULE CONTINUED ON NEXT PAGE

FLIGHT RULES

A17-51

MANAGEMENT FOLLOWING LOSS OF SMOKE DETECTION
(CONTINUED)

- b. PRIOR TO POWERUP OF EQUIPMENT IN THE AFFECTED AVIONICS BAY FOR ENTRY, A HANDHELD HALON BOTTLE WILL BE DISCHARGED IN THAT BAY.

The affected avionics bay will be safed by Halon discharge because the possibility exists that a fire condition could occur without proper and timely fire suppression since smoke detection is lost. Firing of a handheld bottle is preferred since it allows the crew the option of firing the remotely controlled Halon bottle during entry, if it becomes necessary and the remote bottle is still available. ©[090894-1674]

3. AVIONICS BAY 3 MANAGEMENT:

- a. FOR AVIONICS BAY 3, A POST-OMS-2 POWERDOWN OF ALL AIR-COOLED EQUIPMENT (EXCEPT COMMUNICATIONS EQUIPMENT, CAUTION AND WARNING EQUIPMENT, AND THE AVIONICS BAY FAN) SHALL BE ACCOMPLISHED. ALL OF THIS EQUIPMENT MAY BE POWERED UP FOR ENTRY. A LOCKER IN FRONT OF AVIONICS BAY 3 WILL BE REMOVED TO EXPOSE THE BAY TO THE CABIN ENVIRONMENT FOR SMOKE DETECTION. ©[090894-1674]

The communication and caution and warning equipment (air-cooled equipment) in avionics bay 3 is required for flight and cannot be unpowered. This precludes fire suppression by lack of convection currents because the fan is still running. Removal of a locker in front of avionics bay 3 will expose the bay to the cabin environment, thus allowing the cabin smoke detectors and the crew to monitor the powered equipment for evidence of a fire. The alternative would be to leave the locker in place and discharge a handheld Halon bottle to safe the bay since air-cooled equipment remains powered up. This action would cause possible early mission termination due to Halon discharge constraints (ref. Rule {A13-158}, CABIN ATMOSPHERE CONTAMINATION - HALON 1301 [HC]). ©[ED]

- b. PRIOR TO POWERUP OF EQUIPMENT IN AVIONICS BAY 3 FOR ENTRY, ANY PREVIOUSLY REMOVED LOCKERS WILL BE REINSTALLED AND A HANDHELD HALON BOTTLE WILL BE DISCHARGED IN THE BAY.

The avionics bay 3 will be safed by Halon discharge prior to entry because the possibility exists that a fire condition could occur without proper and timely fire suppression since smoke detection is lost. Firing of a handheld bottle is preferred since it allows the crew the option of firing the remotely controlled Halon bottle during entry, if it becomes necessary, and the remote bottle is still available. ©[090894-1674]

THIS RULE CONTINUED ON NEXT PAGE

FLIGHT RULES

A17-51

MANAGEMENT FOLLOWING LOSS OF SMOKE DETECTION
(CONTINUED)

B. CREW CABIN

A CREWMEMBER MUST REMAIN AWAKE AT ALL TIMES FOLLOWING LOSS OF SMOKE DETECTION IN THE CREW CABIN TO MONITOR FOR SMOKE/FIRE.

A crewmember must be available for monitoring the cabin since a sleeping crew may not be awakened by a smoke/fire condition.

C. MINIMAL SMOKE DETECTION MANAGEMENT

IF ONLY TWO SMOKE DETECTION INDICATIONS REMAIN IN THE CABIN OR AVIONICS BAY, THE CIRCUIT TEST SHALL BE PERFORMED EVERY DAY UNTIL EOM.

Each smoke detector has two separate indications (hardware alarm and GPC concentration readout). Thus, nominally, the cabin has six indications, and each avionics bay has four indications. If only two of these indications are available in an area, the circuit test should be performed every day to verify that the minimum requirement is still met.

Note: The risk of an avionics bay fire is extremely low due to the design of the vehicle. The design limits ignition sources and provides little fuel for a fire. Any ignition that did occur would most likely be due to wire bundle arc tracking on which Halon has no effect.

Note: The powerdown of the air-cooled equipment causes little procedural impact on orbit but is a severe impact during dynamic flight phases (ascent through OMS-2, deorbit prep through landings).

Note: The discharge of a handheld Halon bottle in the avionics bay has little postlanding turnaround impact.

DOCUMENTATION: Engineering judgment; Flammability Requirements, NHB 8060.1b, p. 1-1; and Halon 1301 Fire Extinguishment in Avionics Bays, M. Pedley.

Rule {A17-1001}, LIFE SUPPORT GO/NO-GO CRITERIA, references this rule.

FLIGHT RULES

A17-52

MANAGEMENT FOLLOWING LOSS OF FIRE SUPPRESSION IN AN AVIONICS BAY

FOR LOSS OF FIRE SUPPRESSION IN AN AVIONICS BAY, NO ACTION WILL BE TAKEN UNLESS THE SMOKE DETECTORS IN THE AFFECTED AVIONICS BAY INDICATE A FIRE CONDITION. AT THAT TIME A HANDHELD HALON BOTTLE WILL BE DISCHARGED INTO THE AVIONICS BAY.

A HANDHELD HALON BOTTLE WILL BE DISCHARGED INTO THE AFFECTED AVIONICS BAY PRIOR TO SEAT INGRESS IF ONE HAS NOT BEEN PREVIOUSLY DISCHARGED INTO THE AVIONICS BAY.

If a fire condition exists in an avionics bay, then the handheld Halon bottles will be used to suppress the fire. During deorbit, however, the crew may not be able to reach the affected bay to discharge a handheld Halon bottle to suppress a fire; therefore, it is prudent to discharge a handheld Halon bottle in the avionics bay prior to seat ingress to prevent the ignition and/or propagation of a fire. This action has no adverse turnaround impacts.

DOCUMENTATION: Engineering judgment.

Rule {A17-1001}, LIFE SUPPORT GO/NO-GO CRITERIA, references this rule.

A17-53

RESERVED ®[022306-6754C]

FLIGHT RULES

A17-54**MANAGEMENT FOLLOWING HALON DISCHARGE WITHOUT FIRE CONFIRMATION**

A. AVIONICS BAY: @[090894-1673A]

FOLLOWING A BOTTLE EMPTY INDICATION, AN AVIONICS BAY PURGE WILL BE PERFORMED. IF THE TIME OF DISCHARGE CAN BE ACCURATELY DETERMINED, EARLY MISSION TERMINATION CRITERIA AS SPECIFIED IN RULE {A13-158A}, CABIN ATMOSPHERE CONTAMINATION - HALON 1301 [HC], MAY BE WAIVED ON MCC CALL. IF THE TIME OF DISCHARGE OF THE HALON BOTTLE CANNOT BE DETERMINED, A WORSE CASE TIME OF DISCHARGE AT LIFT-OFF WILL BE APPLIED. @[ED]

A dedicated overboard purge of the affected avionics bay will begin to decrease the concentration of Halon in the bay and ensure that it does not migrate into the cabin. The purge should be initiated as soon as possible in order to avoid potential mission termination due to toxic concentrations of Halon in the cabin. If the time of discharge cannot be accurately determined, it must be assumed that the bottle began leaking at the worst case time of lift-off. The MCC indication of an empty bottle provides no insight into the start of a potential leak or the time of discharge. A 140 db audible cue and a rapid rise in smoke concentrations are the only indications to determine time of discharge and this only applies to a bottle discharging all of its contents within a matter of seconds. Reference Rule {A13-158}, CABIN ATMOSPHERE CONTAMINATION - HALON 1301 [HC], for EOM determination due to Halon concentrations from an avionics bay Halon bottle.

B. CABIN:

IF THE START OF A LEAK FROM A HANDHELD BOTTLE CAN BE ACCURATELY DETERMINED, THE REMAINING CONTENTS OF THE BOTTLE WILL BE DISCHARGED OVERBOARD THROUGH THE AIRLOCK DEPRESS VALVE.

Discharge of the remaining contents of a handheld Halon bottle directly overboard will reduce the concentration of Halon in the cabin and potentially minimize the EOM impacts. The time of the start of the leak is critical because, coupled with the discharge duration through the depress valve, there is no other way to effectively determine how much Halon has leaked into the cabin. The nominal discharge time for a handheld Halon bottle is 15 - 19 seconds. Neither the crew nor the MCC have insight into an empty or leaking handheld bottle unless the crew can audibly detect a leak. Reference rule {A13-158B}, CABIN ATMOSPHERE CONTAMINATION - HALON 1301 [HC], for EOM determination due to Halon concentrations from a handheld Halon bottle. @[ED]

Another option for disposal of a leaking handheld bottle is to place it in the airlock and expose it to vacuum. However, since there is no effective way to determine the leak rate of the bottle, it is not possible to determine how much Halon has leaked into the cabin or how long the bottle must be exposed to vacuum before it is completely empty. @[090894-1673A]

A17-55 THROUGH 17-100 RULES ARE RESERVED

FLIGHT RULES

ATMOSPHERE REVITALIZATION SYSTEM (ARS) AIR LOSS DEFINITIONS

A17-101

CABIN FAN

A CABIN FAN IS CONSIDERED LOST IF THE FAN DELTA PRESSURE IS <4.20 (4.49) INCHES H₂O OR >6.80 (6.51) INCHES H₂O AND CREW DETECTS LOSS OF AIR FLOW.

With a delta P of 4.2 inches H₂O (low on the portion of performance band) the flow is approximately 1575 lb/hr. This is considered to be the maximum flow available with low delta P with intact systems (no leakage; therefore, proper cooling to all areas).

The minimum required flowrate for proper cooling is 1400 lb/hr (at the high portion of the performance band); the delta P required to maintain the flow is 6.8 inches H₂O. A delta P higher than this will not meet the required minimum cooling.

Measurement accuracy is ± 3.6 percent of full scale (0.036 x 8 inches H₂O = 0.288).

FLIGHT RULES

A17-102

CABIN ATMOSPHERIC CONTROL

CABIN ATMOSPHERIC CONTROL IS CONSIDERED LOST IF:

- A. UNABLE TO MAINTAIN CABIN TEMPERATURE CONTROL AT <95 DEG (90 DEG) F.

Temperatures above 95 deg F would cause an overtemperature condition in the avionics on the flight deck. The lower limit for the flight deck avionics is 40 deg F which cannot be achieved if the vehicle is in the full, on-orbit avionics configuration. From analysis and flight experience, the water pump outlet temperature will run 8 deg to 10 deg F below cabin temperature; therefore, a 39 deg F cabin temperature would result in a water pump outlet temperature below the freezing point of water.

DOCUMENTATION: SODB 4.6.1.3.4-I.1, 1.1-ECLSS-122

- B. UNABLE TO SATISFY BIOMED CONSTRAINTS ON PPCO₂ (REF. RULE {A13-52}, PPCO₂ CONSTRAINT (TWO GAS) [HC]). @[101305-6655A]

See Rule {A13-52}, PPCO₂ CONSTRAINT (TWO GAS) [HC], rationale. @[101305-6655A]

DOCUMENTATION: SODB 3.4.6.1 and SODB 4.6.1.3.1-C.

- C. HUMIDITY CONTROL

1. UNEXPLAINED DECREASE IN THE WASTE WATER TANK FILL RATE (NORMALLY 6 ±1 LB/DAY-CREWMEMBER) .

The increase in waste tank quantity is used in determining status of humidity control instead of change in the humidity level. On STS-5 when fan separator B became degraded due to blockage at the separator inlet, the humidity level did not change. The failure was detected by the flight controllers when the waste quantity increase became a slower rate. From past flights, the combined waste water quantity fill rate from metabolic production and the LiOH-CO₂ reaction has been about 0.25 lb/hr-crewmember (6 lb/day-crewmember). If the waste quantity is increasing only from the crew's use of the WCS (3.49 lb/day-crewmember), the crew will inspect the crew module for condensation.

DOCUMENTATION: SODB 4.6.2.2.4, 1.3-TM-DF86T50-54.

2. VISUAL CONDENSATION ON THE STRUCTURE OR THE EQUIPMENT .

If humidity control fails, moisture in the air will condense on equipment and/or parts of the vehicle structure with a corresponding temperature below the dewpoint.

DOCUMENTATION: Flight experience and SEH-SETO-87-014.

FLIGHT RULES

A17-103

LOSS OF AVIONICS BAY FAN

AV BAY COOLING @[040899-2498A] @[022405-6256B]

AVIONICS BAY FAN SHALL BE CONSIDERED LOST IF THE FAN DELTA PRESSURE IS GREATER THAN THE UPPER LIMITS OR LESS THAN THE LOWER LIMITS AS DEFINED IN THE FOLLOWING TABLE:

VEHICLE		CABIN P = 14.5 - 14.9 PSI		CABIN P = 10.0 - 10.6 PSI	
		LOWER LIMIT (IN. H ₂ O)	UPPER LIMIT (IN. H ₂ O)	LOWER LIMIT (IN. H ₂ O)	UPPER LIMIT (IN. H ₂ O)
OV103	AV BAY 1	3.00	4.90	2.29	3.82
	AV BAY 2	2.50	4.50	1.91	3.51
	AV BAY 3 (STD FAN)	2.90	5.10	2.21	3.98
	AV BAY 3 (CAB FAN)	4.50	7.80	3.43	6.08
OV104	AV BAY 1	2.50	4.50	1.91	3.51
	AV BAY 2	2.50	4.50	1.91	3.51
	AV BAY 3 (STD FAN)	2.90	5.10	2.21	3.98
	AV BAY 3 (CAB FAN)	4.50	7.80	3.43	6.08
OV105	AV BAY 1	3.00	4.90	2.29	3.82
	AV BAY 2	2.50	4.50	1.91	3.51
	AV BAY 3 (STD FAN)	2.90	5.10	2.21	3.98
	AV BAY 3 (CAB FAN)	4.50	7.80	3.43	6.08

@[102506-7722]

The minimum value corresponds to the estimated fan delta pressure of two-phase fan operation. This delta pressure should also provide adequate cooling flow in the case of duct leakage or degraded fan performance.

The maximum delta pressure/minimum airflow is based on a temperature violation of the GPC's. A delta pressure > the specified upper limit for the respective vehicle and av bay will not meet the required minimum flowrate for adequate cooling. A delta pressure exceeding this value would be indicative of possible duct blockage or filter blockage. @[022405-6256B]

THIS RULE CONTINUED ON NEXT PAGE

FLIGHT RULES

A17-103

LOSS OF AVIONICS BAY FAN (CONTINUED)

The minimum and maximum delta pressure values are in general agreement with current LCC and OMRSD limits which are based on analytical predictions of flowrates as described in reference documentation.

Fan delta pressure is a coarse representation of avionics bay cooling performance. Other indicators to determine the effectiveness of the cooling are avionics bay air outlet, active water coolant loop heat exchanger inlet and outlet temperatures, and H₂O flowrate. Therefore, measurement error for delta pressure will not be used to determine the loss of an avionics bay fan.

Fan delta pressure limits at a cabin pressure range of 14.5 to 14.9 psi were determined by analysis using the Thermal Hydraulic Analyzer Program (THAP). ©[102506-7722]

Fan delta pressure limits at a cabin pressure range of 10.0 to 10.6 psi were provided by Boeing in the Boeing Technical Memorandum No. TS-TM-06-005 dated March 28, 2006. The avionics bay fan delta pressure limits at a cabin pressure range of 10.0 to 10.6 psi were determined by fitting a curve to actual flight data from STS-114, 109, 104, 100, and 102. This equation is as follows and is valid for cabin pressures ranging from 9.55 to 15.12 psia:

$$\Delta p_{\text{new_lower_limit}} = \Delta p_{14.5} \{P_{\text{new}} \div 14.5\}^{0.73} \{T_{14.5} \div T_{\text{new}}\}$$

$$\Delta p_{\text{new_upper_limit}} = \Delta p_{14.9} \{P_{\text{new}} \div 14.9\}^{0.73} \{T_{14.9} \div T_{\text{new}}\}$$

A cabin temperature of 70 deg F was assumed because this is normally the coldest cabin temperature experienced. The lower temperature leads to the most dense air and the highest fan delta pressure. This assumption is consistent with previous engineering analyses. A cabin pressure of 10.0 psi was used because this is the lower pressure of the operational control range when performing 10.2 EVA operations.

DOCUMENTATION: Boeing Technical Memorandum No. TS-TM-06-005, Avionics Fan Performance as a Function of Cabin Pressure; RI-D IL-287-203-91-003, IL-287-203-90-86, Update to Avionics Bay Changes for Installation of new GPC's and TACAN's; BNA Memo No. SJ00-SJCOD-2004-029, Avionics Bay Cooling Limits; BNA Memo No. 287-200-098-019, Bay 3A Enhanced Avionics Fan Delta Pressure Limit, and engineering judgment. ©[040899-2498A] ©[022405-6256B] ©[102506-7722]

FLIGHT RULES

A17-104

IMU FAN

AN IMU FAN IS CONSIDERED LOST IF:

- A. FAN DELTA PRESSURE IS < 3.70 (3.94) OR > 4.95 (4.71) INCHES H_2O .

The minimum required flowrate for proper cooling is 144 lb/hr which is supplied by a maximum delta P of 4.95 inches H_2O (temperature dependent value). A delta P any higher than this would not be able to supply the air flowrate required for proper cooling.

A delta P of 3.7 inches H_2O produces a flow of approximately 185 lb/hr. This is considered to be the maximum fan flow available for an intact system. Therefore, any lower delta P would have to be produced by a system with questionable integrity (leakage). Measurement accuracy is ± 3.4 percent of full scale (0.034×7 inches $H_2O = 0.238$).

- B. IMU FAN SPEED INDICATES ABNORMAL WHEN FAN IS SELECTED.

IMU fan speed range for normal speed indication is $10,000 \pm 240$ to $12,720 \pm 700$ rpm. Fan speeds outside this range indicate degraded fan operations not producing the necessary flow for cooling or a breach of system integrity.

DOCUMENTATION: Hamilton Standard Component Data Handbook SP01T80, Specification Number SVHS 6416.

FLIGHT RULES

A17-105

AVIONICS BAY COOLING

AVIONICS BAY COOLING IS LOST IF:

A. ASCENT/ENTRY:

UNABLE TO MAINTAIN AVIONICS BAY AIR OUTLET TEMPERATURE <
130 DEG (125 DEG) F.

For a fully powered avionics bay, air outlet temperatures above 130 deg F would result in an overtemperature condition of the avionics in that avionics bay. @[030994-1609]

DOCUMENTATION: SODB 3.4.6.1.1.

B. ON-ORBIT:

1. FOR A 14.7 PSI CABIN, UNABLE TO MAINTAIN AVIONICS BAY AIR OUTLET TEMPERATURE BELOW: @[090894-1673A]
 - a. 120 DEG (115 DEG) F, IF TWO GPC'S IN RUN.
 - b. 108 DEG (103 DEG) F, IF ONLY ONE GPC IN RUN.
 - c. 100 DEG (95 DEG) F, IF NO GPC'S IN RUN.
2. FOR A 10.2 PSI CABIN, UNABLE TO MAINTAIN AVIONICS BAY AIR OUTLET TEMPERATURE BELOW:
 - a. 117 DEG (112 DEG) F, IF TWO GPC'S IN RUN.
 - b. 101 DEG (96 DEG) F, IF ONLY ONE GPC IN RUN.
 - c. 89 DEG (84 DEG) F, IF NO GPC'S IN RUN.
3. FOR AN 8 PSI CABIN, UNABLE TO MAINTAIN AVIONICS BAY AIR OUTLET TEMPERATURE BELOW:
 - a. 127 DEG (122 DEG) F, IF TWO GPC'S IN RUN (AV BAY 1, WITH COLLINS TACAN, ONLY).

122 DEG (117 DEG) F, IF TWO GPC'S IN RUN (AV BAY 1, WITH GOULD TACAN, ONLY).

119 DEG (114 DEG) F, IF TWO GPC'S IN RUN (AV BAY 2 ONLY).

THIS RULE CONTINUED ON NEXT PAGE

FLIGHT RULES**A17-105****AVIONICS BAY COOLING (CONTINUED)**

- b. 109 DEG (104 DEG) F, IF ONLY ONE GPC IN RUN (AV BAY 1, WITH COLLINS TACAN, ONLY).
- 105 DEG (100 DEG) F, IF ONLY ONE GPC IN RUN (AV BAY 1, WITH GOULD TACAN, ONLY).
- 101 DEG (96 DEG) F, IF ONLY ONE GPC IN RUN (AV BAYS 2 & 3). @[090894-1673A]
- c. 87 DEG (82 DEG) F, IF NO GPC'S IN RUN (AV BAY 1 ONLY). @[090894-1673A]
- 83 DEG (78 DEG) F, IF NO GPC'S IN RUN (AV BAYS 2 & 3).

The airflow in each of the avionics bays is distributed such that each LRU has enough airflow to remain under its maximum operational temperature limit based upon a design requirement of 95 degrees F maximum avionics bay inlet temperature. Since the inlet temperature is not a measured parameter, the air outlet temperature sensor must be used to determine if adequate cooling is available to the individual LRU's. The measured avionics bay air outlet temperature is a mixed air temperature for all LRU's (active & inactive) in the respective bay and is therefore an indication of the average heat load. When an LRU is powered off, its relatively cooler airflow will mix with the warmer air from the active LRU's, resulting in a mixed air temperature, in most cases, lower than that of an active LRU. For example, with a single active GPC, a mixed air outlet temperature of 130 degrees F would result in a GPC operating above its maximum operational limit of 130 degrees F. Consequently, a measured avionics bay air outlet temperature which corresponds to a maximum inlet temperature of 95 degrees F will be LRU configuration dependent. When set up for on-orbit operations (assuming nominal on-orbit configuration: TACAN, MLS, etc., are unpowered), the GPC is the largest heat load and each GPC affects approximately one-third of the airflow in that bay. Therefore, the configuration dependent air outlet temperature limit for on-orbit is driven primarily by the individual avionics bay's GPC configuration. The derived outlet temperature limits assume no airflow blockage within the avionics bay/LRU ducting.

Three different analyses were performed for cabin pressures of 14.7, 10.2, and 8.0 psia. The 14.7 psia case protects against the design requirement of 95 degrees F maximum avionics bay inlet temperature. Based upon the airflow distribution unique to each avionics bay, the individual GPC operating temperatures were derived to be 122 and 126 degrees F for avionics bays #1 and #2 respectively. The resulting mixed air temperatures (avionics bay air outlet temperature) are listed in section 1 of the rule since it is the monitored parameter. Consequently, there is between 4 and 8 degrees F margin depending on the specifics of the avionics bay.

THIS RULE CONTINUED ON NEXT PAGE

FLIGHT RULES

A17-105

AVIONICS BAY COOLING (CONTINUED)

Since there are no design requirements for the 10.2 and 8.0 psia cases, the analyses were performed as follows:

In order to be consistent between the two nominal cases (10.2 and 14.7 psia), the 10.2 analysis protected the same individual GPC box outlet temperatures as the 14.7 psia case, and backed out an air inlet temperature of approximately 80 degrees F. From these two parameters, the mixed air outlet temperature was calculated and listed in section 2 of the rule. The analysis was performed taking into account the decrease in air flow due to the lower cabin pressure. The expected decrease in airflow at 10.2 psia is based upon a linear function of the airflow at 14.7 psia and the lower cabin pressure. ©[090894-1673A]

Since the 8.0 psia case is a contingency scenario, the analysis protected against the maximum GPC operating temperature of 130 degrees as opposed to the derived design limit used for the 14.7 and the 10.2 psia cases. Therefore, based upon a GPC operating temperature of 130 degrees F, the analysis calculated the mixed air outlet temperatures listed in section 3 of the rule. The 8.0 psi case has limits which are specific to the avionics bays as compared to the 10.2 and 14.7 psi cases. This is due to the fact that the lower pressure of 8.0 psi magnifies the impacts of the different avionics bay airflow configurations (including whether Gould or Collins TACAN's are installed in the avionics bay). For the higher pressure cases, the airflow differences did not cause a divergence in results significant enough to be considered separately. ©[090894-1673A]

Avionics bay airflow reconfigurations due to the installation of the new Collins TACAN's has no impact on the avionics bay air outlet temperature limits at either 8, 10.2 or 14.7 psi cabin pressures. ©[030994-1609]

DOCUMENTATION: Memo DF7-93-46, Avionics Bay Temperature Limits Analyses for On-Orbit and Post-Landing; Memo DF7-94-36, , Avionics Bay Temperature Limits Analyses for On-Orbit and Post-Landing Addendum, SODB 3.4.5.3, 3.4.5.4, 4.6.1.4.2, and 4.6.1-41; IBM 855440-010, Flight GPC Thermal Analysis Report; and RI Memo 287-203-90-086, Update To Avionics Bay Changes For Installation of New GPC's and New TACAN's. ©[090894-1673A]

C. BOTH FANS ARE LOST. ©[030994-1609]

If unable to get the required air flow, the avionics bay is considered lost.

DOCUMENTATION: Engineering judgment.

FLIGHT RULES

A17-106

REGENERATIVE CO₂ REMOVAL SYSTEM (RCRS) LOSS DEFINITION

THE RCRS IS CONSIDERED LOST IF:

A. UNABLE TO MAINTAIN PPCO₂ BELOW 7.6 MM HG.

RCRS CO₂ removal capability will not be effective if the vacuum vent line isol valve closes the vacuum vent duct blocks, or for ARS duct leakage occurs.

RCRS operations are not possible if both controller A and B have failed since the RCRS requires an automatic controller (no manual RCRS override capability).

RCRS auto shutdown logic will shut down the RCRS if bed pressures, bed delta pressures, or compressor RPM and valve position indications are not acceptable.

Reference Rule {A13-52A}.2, PPCO₂ CONSTRAINT (TWO GAS) [HC], rationale. ©[101305-6655A]

DOCUMENTATION: RCRS Critical Design Review, March 15-17, 1990.

B. UNABLE TO MAINTAIN PPCO₂ INSIGHT.

See Rule {A17-155B}.4, REGENERATION CO₂ REMOVAL SYSTEM (RCRS) MANAGEMENT, for rationale.

DOCUMENTATION: Engineering judgment.

A17-107 THROUGH A17-150 RULES ARE RESERVED

FLIGHT RULES

ARS AIR SYSTEM MANAGEMENT

A17-151 CABIN ATMOSPHERE CONTROL

- A. THE CABIN TEMPERATURE CONTROL BYPASS VALVE WILL BE AUTOMATICALLY DRIVEN TO THE "FULL COOL" POSITION FOR ASCENT AND ENTRY.

The heat load in the cabin is large enough to require full cool during these phases. Having the valve in full cool is SOP. This is done to protect against the high heat loads in the cabin during an 8 psi ascent or entry situation.

DOCUMENTATION: SEH-ITA-80-245.

- B. WHEN TIME PERMITS THE LIOH CANISTERS WILL BE REMOVED FOR AN 8 PSI ENTRY.

The canister removal increases the fan efficiency for cooling which is critical at a reduced pressure. One fan increases in flow from 820 lb/hr (with LiOH in) to 870 lb/hr (with LiOH out). This rule also assumes the crew is wearing launch/entry suit (ACES) helmets or that the PPCO₂ level is under control before removing the canisters. ©[062305-6653]

DOCUMENTATION: 1.2-TM-B1709-24.

- C. LIOH CANISTER(S) WILL NORMALLY BE REPLACED PRESLEEP AND POSTSLEEP OR WHEN PPCO₂ IS VERIFIED TO BE ≥ 7.6 (6.1) MMHG.

Changeouts are scheduled so normal housekeeping activities will not interfere with mission or payload operations. Single or dual canister changeouts are based on an analysis to maximize LiOH utilization as a function of crew size. Additionally, the rule specifies that a changeout will occur when PPCO₂ increases above 7.6 mmHG which is the level we will manage PPCO₂ to prevent possible physiological changes to the crew.

DOCUMENTATION: SEH-ITA-85-145, SODB 3.4.6.1, SODB 4.6.1.3.1-C.

- D. WINDOW SHADES MAY BE USED TO MINIMIZE LOCAL CABIN TEMPERATURE GRADIENTS.

The effects of solar heat loads transmitted through the windows to the cabin and flight deck can essentially be negated by installing the shades.

DOCUMENTATION: SEH-ITA-82-028T.

THIS RULE CONTINUED ON NEXT PAGE

FLIGHT RULES

A17-151

CABIN ATMOSPHERE CONTROL (CONTINUED)

E. CABIN FANS WILL NOT BE CYCLED PRE-MECO. @[040899-2570]

The cabin fan large ac loads during the first stage are nearly at their maximum level. Cycling fans (8.0 amps startup) could create a voltage transient to the main engine controllers jeopardizing engine performance.

F. UPGRADED AVIONICS BAY FANS WILL NOT BE CYCLED PRE-MECO.

Upgraded avionics fans have been installed in OV-104 and will later be installed in OV-103 and OV-105 to provide additional cooling to middeck payloads. The startup transient currents associated with these fans are significantly larger than the older avionics fans (7.4 amps/phase vs 2.0 amps/phase). Cycling fans could create a voltage transient to the main engine controllers, jeopardizing engine performance.
@[040899-2570]

FLIGHT RULES

A17-152

CABIN TEMPERATURE CONTROL AND MANAGEMENT

CREW CABIN TEMPERATURE WILL BE MANAGED IN THE FOLLOWING MANNER:
@[022201-4146]

A. ASCENT:

THE CABIN TEMPERATURE CONTROL BYPASS VALVE WILL BE AUTOMATICALLY DRIVEN TO THE "FULL COOL" POSITION FOR ASCENT.

The heat load in the cabin is large enough to require full cool during this phase. Having the valve in full cool is SOP. This is done to protect against the high heat loads in the cabin during an 8 psi ascent situation.

DOCUMENTATION: SEH-ITA-80-245.

B. ON-ORBIT:

THE CREW MAY ADJUST THE CABIN TEMPERATURE CONTROLLER TO ANY DESIRED POSITION TO SATISFY CREW COMFORT, REGARDLESS OF THE TEMPERATURE INDICATED ON THE CABIN TEMPERATURE SENSOR. ONE EXCEPTION TO THIS IS THAT IF LOWERING THE CABIN TEMPERATURE IS REQUIRED TO MAINTAIN ACCEPTABLE ISS DEWPOINT LEVELS DURING DOCKED OPS, THIS WILL HAVE PRIORITY OVER CREW COMFORT. OTHER EXCEPTIONS TO THIS RULE WILL BE DOCUMENTED IN THE FLIGHT-SPECIFIC ANNEX. @[022201-4146]

1. THE FOLLOWING SENSORS MAY BE USED TO MEASURE CABIN TEMPERATURE: @[022201-4146]

INSTRUMENT
CABIN TEMP DUCER
MICRO-WIS
MULTIMETER

THIS RULE CONTINUED ON NEXT PAGE

FLIGHT RULES

A17-152

CABIN TEMPERATURE CONTROL AND MANAGEMENT (CONTINUED)

The cabin temperature transducer is normally used to measure cabin temperature. However, the cabin temperature transducer can be affected by ambient conditions immediately surrounding the transducer. In order to lessen the effects, the box surrounding the transducer is normally taped to minimize this influence, but STS-103 data indicated that this transducer could still be affected by other heat loads in the near vicinity. Furthermore, DTO 664, performed on STS-60, STS-62, STS-59, STS-64, and STS-66, showed that the cabin temperature could vary significantly throughout the cabin. For example, on STS-103, the cabin temperature transducer reading was approximately 7-11 deg F higher than multimeter readings taken at various locations. These data indicate that a difference between the cabin temperature transducer and the actual cabin temperature should not be discounted during flight. Therefore, if a more accurate temperature reading at the avionics inlet is required, other sources can be used.

2. IF THE CABIN TEMPERATURE IS TOO COLD, THE FOLLOWING ACTIONS WILL BE PERFORMED IN ORDER OF PRIORITY:
 - a. MANUALLY PIN CABIN HEAT EXCHANGER BYPASS VALVE IN THE REQUIRED POSITION.
 - b. POWERUP PANEL AND FLOOD LIGHTS.
 - c. POWERUP AIR COOLED EQUIPMENT.
 - d. OPERATE BOTH WATER LOOPS WITH FULL INTERCHANGER FLOW.
 - e. DEACTIVATE THE FES. @[022201-4146]
 - f. OPERATE THE RADIATOR CONTROLLER OUTLET TEMPERATURE IN "HI" (57 DEG ± 2 DEG F). @[022201-4146]

Each action will decrease the amount of heat rejected from the cabin or increase the cabin heat load, thus allowing an incremental temperature increase.

DOCUMENTATION: RI IL 287-203-91-025, SODB RI-1344.

THIS RULE CONTINUED ON NEXT PAGE

FLIGHT RULES

A17-152

CABIN TEMPERATURE CONTROL AND MANAGEMENT
(CONTINUED)

3. IF PRE-FLIGHT OR REAL-TIME ANALYSIS PREDICTS A VIOLATION OF THE UPPER CABIN TEMPERATURE LIMIT DEFINED IN {A13-31}, CREW CABIN TEMPERATURE LIMITS, THE CABIN TEMP CNTLR BYP VLV WILL BE AUTOMATICALLY DRIVEN TO THE "FULL COOL" POSITION POSTSLEEP ON THE DAY OF THE EVENT. IF THE CREW THEN BECOMES UNCOMFORTABLE DUE TO THIS CONFIGURATION, THEY MAY ADJUST THE CABIN TEMPERATURE CONTROLLER TO ANY DESIRED POSITION TO SATISFY CREW COMFORT.

For each flight, BNA produces a Thermal Verification Analysis at the L-5 Month and L-1 Month time periods. An overall ATCS analysis, the Thermal Verification Analysis, provides the predicted cabin temperatures for each flight analyzed. Using this analysis, extensive preflight coordination is performed by EECOM and BNA to ensure the cabin temperature constraint is not violated. As part of this coordination, paragraph a will be used to provide a "cabin coldsoak" prior to any event that is foreseen as possibly causing the crew to be uncomfortably warm. Events that may require a cabin coldsoak include rendezvous, 10.2 psi operations, ISS ingress/egress operations, or other operations during which the ARS cannot react quickly enough to protect the upper limits. For most cases, ensuring the orbiter ATCS configuration is in the 10.2 Psi cabin configuration, in addition to paragraph a above, will ensure that the cabin temperature does not exceed the upper limit. @[022201-4146]

4. IF THE INDICATED CABIN TEMPERATURE EXCEEDS: @[022201-4146]

CABIN PRESSURE (PSIA)	HARDWARE UPPER LIMIT (DEG F)
14.7	95
10.2	85
INTERMEDIATE PRESSURE	85 + (CABIN P - 10.2) X 2.22

THEN THE MCC MAY REQUEST THAT THE CREW OBTAIN ADDITIONAL TEMPERATURE DATA ON SPECIFIC AVIONICS BOXES TO CHARACTERIZE ANY POSSIBLE EFFECTS ON AVIONICS LIFETIME.

THIS RULE CONTINUED ON NEXT PAGE

FLIGHT RULES

A17-152

CABIN TEMPERATURE CONTROL AND MANAGEMENT (CONTINUED)

The upper temperature limit for the avionics hardware is based on protecting the maximum air outlet temperature of 130 deg F for all flight deck avionics. Since outlet temperature cannot be measured directly, an inlet temperature limit is used to protect the outlet temperature constraint. At 14.7 psi, the SODB inlet temperature limit is 95 deg F. To derive the upper cabin temperature limit at lower cabin pressures, the 95 deg limit was scaled to account for the air density reduction and still protect the 130 deg outlet temperature limit. Since the previous limit (80 deg F) at 10.2 had been violated on occasion and the limit waived real time, a higher upper hardware limit was recommended (85 deg F). An analysis was performed by Boeing to assess the impact to the avionics lifetime of increasing the limit by 5 deg F. Per the aforementioned analysis, there is negligible impact to the reliability/lifetime of the avionics equipment so the hardware limit was changed to 85 deg F.

DOCUMENTATION: SODB 4.6.1.3.4-d, 4.6.1.4.3-a, and SD2-99-005, "Revised Cabin Temperature Requirements," OFTP#182. @[022201-4146]

5. IF, FOLLOWING AN AVIONICS TEMPERATURE CHARACTERIZATION, IT IS FOUND THAT THE AVIONICS LIMITS ARE BEING VIOLATED, THE FOLLOWING ACTIONS WILL BE CONSIDERED: @[022201-4146]
 - a. INCREASE AIRFLOW TO THE AVIONICS BY OPENING ACCESS DOORS IF INLET TEMPERATURES ARE WARMER THAN THE CABIN ENVIRONMENT.

Previous flight data have shown that the temperatures behind the panels can be higher than the cabin environment. Opening the access doors to the avionics is an easy way to improve mixing of the cooler cabin air with the air behind the panels and possibly reduce the inlet temperatures below the limit.

- b. USE WINDOW SHADES TO MINIMIZE LOCAL CABIN TEMPERATURE GRADIENTS.

Installing the shades can essentially negate the effects of solar heat loads transmitted through the windows to the cabin and flight deck. This action may be taken any time the crew desires to minimize temperature gradients.

DOCUMENTATION: SEH-ITA-82-028T. @[022201-4146]

- c. POWER DOWN SELECTED EQUIPMENT FROM THE FOLLOWING MATRIX. THE PRIORITY AND DEPTH OF POWERDOWN WILL DEPEND ON MISSION ACTIVITIES AND THE TRENDS IN CABIN TEMPERATURE. @[022201-4146]

THIS RULE CONTINUED ON NEXT PAGE

FLIGHT RULES

A17-152

CABIN TEMPERATURE CONTROL AND MANAGEMENT (CONTINUED)

EQUIPMENT	ELECTRICAL LOAD (WATTS)	IMPACT OF POWERDOWN (RNDZ, EVA)
LIGHTS	0-300	MINIMAL
GALLEY WATER HTR	500	MINIMAL - NO HOT WATER
GALLEY OVEN HTR	196	MINIMAL - CREW WATER DISPENSER DISABLED
GALLEY OVEN FAN	31.7	MINIMAL - FOOD TAKES LONGER TO HEAT
COLOR PRINTER	23.6	MINIMAL - PRINTER CAN BE PWRD UP FOR MSG PRINTING AND PWRD DOWN WHEN COMPLETE.
TV MONITOR COLOR	56 (NOM) 86 (MAX)	MAJOR - DURING RNDZ REQD TO VIEW CENTERLINE CAMERA, EXTERNAL IMAGES AND SVS MAJOR - DURING EVA REQD TO VIEW CREW IN OBSTRUCTED WORK AREAS
VCU	46	MAJOR - DURING RNDZ CANNOT VIEW, RECORD, AND DOWNLINK VIDEO. NO INCO OR CREW TV OPERATIONS POSSIBLE, EXCEPT IN-CABIN CAMCORDER RECORDING.
8MM VTR (TEAC)	10	MINIMAL - NO VIDEO RECORDING
CAMCORDER	10	MINIMAL - NO VIDEO IMAGING AND RECORDING IN CABIN
MEDS MDU (IF FLOWN)	66	MINIMAL - ONLY 4 MDU'S REQD FOR RNDZ 2 MDU'S REQD FOR EVA
MEDS IDP (IF FLOWN)	55	MINIMAL - 2 IDP'S REQD FOR REDUNDANCY FOR RNDZ & EVA
MCDS CRT (IF FLOWN)	101.7	MINIMAL - ONLY 2 CRTS REQD FOR RNDZ AND CRT4 MUST BE ONE 1 CRT REQD FOR EVA
MCDS DEU (IF FLOWN)	183.7	MINIMAL - 2 DEU'S REQD FOR RNDZ AND CRT4 MUST BE ONE 1 DEU REQD FOR EVA
MIDDECK CCU AUD PWR	4 (STBY/RCV) 12 (XMIT)	IF NO M/D AUDIO REQUIREMENTS, NO IMPACT
DDU	111.7	MAJOR DURING RNDZ - 2 DDU'S REQD FOR MANUAL FIT CNTL MINIMAL DURING EVA
OIU	12	MAJOR - OIU USED NORMALLY FOR ISS TELEMETRY/CMD. ECOM POSSIBLE BACKUP.
OTHER EQUIPMENT		WILL BE DETERMINED REAL TIME

@[022201-4146]

NOTES:

IMPACT SEVERITY IF LRU UNPOWERED DURING RNDZ/EVA @[022201-4146]

MINIMAL - IMPACT TO OPERATIONS NOT SEVERELY HAMPERED

MARGINAL - WILL REQUIRE CREW ACTION FOR SOME SITUATIONS

MAJOR - NOT DESIRED, FLIGHT SAFETY COMPROMISED

THIS RULE CONTINUED ON NEXT PAGE

FLIGHT RULES

A17-152

CABIN TEMPERATURE CONTROL AND MANAGEMENT (CONTINUED)

The matrix above lists selected equipment that will be powered off and includes the electrical load and the impact of powerdown. The priority of the equipment in the matrix depends on mission activities.

C. ENTRY:

CABIN TEMPERATURE WILL BE MANAGED AS FOLLOWS TO ENSURE ADEQUATE ENTRY TEMPERATURES IN ACCORDANCE TO RULE {A13-31}, CREW CABIN TEMPERATURE LIMITS:

1. PRE-SLEEP OF EOM-1, THE CABIN TEMP CONTROLLER WILL BE AUTOMATICALLY DRIVEN TO A POSITION TO ACHIEVE A CABIN TEMP OF 70 DEG F AT CREW WAKE ON ENTRY DAY.
2. PRE-SLEEP OF EOM-1, IF SLEEP TEMPERATURES WILL BE UNACCEPTABLY COLD, PER CDR AND SURGEON AGREEMENT, THE CABIN TEMP CONTROLLER POSITION CAN BE CONFIGURED TO PROVIDE A COMFORTABLE SLEEP ENVIRONMENT WHILE STILL STRIVING TO ACHIEVE THE OPTIMAL COLDSOAK. @[092701-4860]
3. THE CABIN TEMPERATURE CONTROLLER BYPASS VLV WILL BE AUTOMATICALLY DRIVEN TO THE "FULL COOL" POSITION, POST SLEEP OF ENTRY DAY.
4. ACTION WILL NOT BE TAKEN TO REDUCE CABIN TEMPERATURE IF THE D/O PREP TIMELINE HAS BEEN ENTERED.
5. FOR WAVEOFF DAYS, PREFLIGHT ANALYSIS WILL DICTATE THE LEVEL OF ACCEPTABLE POWER (EITHER GROUP B OR C POWERDOWN) TO OBTAIN CABIN TEMPERATURE CONCERNS. @[092701-4860]

Per Rule {A13-31}, CREW CABIN TEMPERATURE LIMITS, the Individual Cooling Units (ICU's), used during ascent/entry since STS-88, were designed to remove 340 BTU's/hr at an ambient temperature of 75 deg F, which is the metabolic heat load produced by a resting, minimally active crewmember. The actions above seek to ensure that the temperatures documented in the Section 13 rule are met and still provide comfortable temperatures for the crewmembers during the sleep period prior to entry day.
@[022201-4146]

THIS RULE CONTINUED ON NEXT PAGE

FLIGHT RULES

A17-152

CABIN TEMPERATURE CONTROL AND MANAGEMENT (CONTINUED)

Flight data from several flights indicated that achieving a cabin temperature of 70 deg F, at crew wake on entry day, would satisfy the defined limits and still provide comfortable temperatures for the crewmembers during the sleep period prior to entry day. At the OFTP #176 in August 1999, the recommended position for the Cabin Temp Selector to achieve this temperature was approximately the 10 o'clock position. Flight demands may necessitate a different position for future flights. If other temperature data indicate that the cabin temperature transducer has a significant bias, the position of the cabin temperature controller selector can also be biased to target an actual temperature of 70 deg F, rather than a cabin temperature transducer indicated temperature of 70 deg F. ©[022201-4146]

Pre-sleep of EOM-1, if sleep temperatures will be unacceptably cold, per CDR and surgeon agreement, the cabin temp controller position can be configured to provide a comfortable sleep environment while still striving to achieve the optimal coldsoak. ©[092701-4860]

The Cabin Temperature Controller Bypass Valve will be driven to the "Full Cool" position, post-sleep, to continue the cabin coldsoak for entry.

Analyses produced by Boeing North America at the L-5 month and L-1 month milestones provide feedback to MOD on whether or not these temperature limits are met during the flight planning process. Predicted violations will be worked on a flight-by-flight basis, if required.

If a limit is violated during the Deorbit Prep/Entry timeframe, there are no easy actions remaining to reduce the cabin heat load. Powerdowns of orbiter or payload equipment would be necessary but are not desirable during this time period. The risks introduced by turning off entry-related equipment outweigh the slight increased risks to crew health that temps above 75 deg F may cause.

In order to produce water for additional entry attempts (for weather wave-off days, etc.), the Flash Evaporator is normally deactivated for weather extension days. This configuration, in conjunction with the nominal debris protect attitude of -ZLV -XVV, caused concerns that the entry cabin temperature constraints could not be met. BNA produced an analysis (November 3, 1999), in this configuration, with a Group B powerdown. Temperatures were found to be acceptable for an extension day with only a Group B powerdown in place. Temperatures were elevated for the actively cooled payload case, with a 3000 W payload allocation. Flights with actively cooled payloads will require additional analyses to ensure adherence to the entry cabin temperature limit. Because of this, the rule allows for either a Group B or C powerdown to be performed, dependent on the flight manifest.

DOCUMENTATION: OFTP #176 Meeting Minutes, August 1999; engineering judgment; flight data; "Revised Cabin Temperature Requirements," SD2-99-005. ©[022201-4146]

FLIGHT RULES

A17-153

CABIN/AVIONICS BAY FAN MANAGEMENT [HC] ©[052704-6261C]

- A. THE LOSS OF AN AVIONICS BAY FAN DELTA PRESSURE TRANSDUCER WILL BE MANAGED AS FOLLOWS:
1. IF THE GROUND HAS INSIGHT INTO THE AC CURRENTS FOR BOTH FANS IN THE AFFECTED BAY, THE SECOND FAN WILL BE TURNED ON AND LEFT ON UNTIL EOM FOR REDUNDANCY AS LONG AS THE IMPACTS TO CONSUMABLES DO NOT AFFECT MISSION OBJECTIVES (REF. MISSION SPECIFIC ON-ORBIT PRIORITIES RULE) AND VEHICLE POWER LOADING LIMITS ARE NOT EXCEEDED (REF. RULE {A9-155}, AC INVERTER OPERATIONAL LIMITS). ©[042507-7258B]

Since the crew and the ground operator have lost primary insight into fan performance with the loss of a fan delta pressure transducer, two fans will be turned on for redundancy. This rule still applies for upgraded avionics fans (cabin fans) installed in av bay 3A. Even though the fans are larger than regular avionics fans, the crew may not be able to detect a fan loss by sound as mentioned in paragraph B of this rule. The gain in redundancy is not worth affecting mission objectives or exceeding any power loading limits. Since there is some insight into fan health with AC currents and H₂O loop parameters, the second fan should be left off if these are affected. ©[040899-2499B]

2. IF THE GROUND HAS LOST INSIGHT INTO THE AC CURRENTS FOR ONE OF THE FANS IN THE AFFECTED BAY, ONLY THE FAN WITH THE AC CURRENT INSIGHT WILL BE ON.

Secondary insights into fan performance are the AC currents. For the cases where the fan delta pressure transducer is lost and there is no AC current insight for one of the fans, such as due to the loss of an MDM, only the fan with the AC current insight will be on. This may require a swap to the redundant fan. Activation of an av bay fan without AC current insight would only occur if it were the last remaining option. Running only the fan with the AC current insight will protect against a failure such as a degraded fan going undetected and potentially causing a fire.

DOCUMENTATION: Hazard Report ORBI 088. Engineering judgment.

- B. FOR LOSS OF THE CABIN FAN DELTA PRESSURE TRANSDUCER, BOTH CABIN FANS WILL BE TURNED ON DURING SLEEP PERIODS FOR REDUNDANCY AS LONG AS THE IMPACTS TO CONSUMABLES DO NOT AFFECT MISSION OBJECTIVES (REF. MISSION SPECIFIC ON-ORBIT PRIORITIES RULE) AND VEHICLE POWER LOADING LIMITS ARE NOT EXCEEDED (REF. RULE {A9-155}, AC INVERTER OPERATIONAL LIMITS). ©[042507-7258B]

THIS RULE CONTINUED ON NEXT PAGE

FLIGHT RULES

A17-153

CABIN/AVIONICS BAY FAN MANAGEMENT [HC]
(CONTINUED)

Primary insight into fan performance is the cabin fan delta pressure transducer, while secondary insight includes the AC currents. Unlike with an av bay fan, the AC current insight into both cabin fans will remain, even with the loss of the MDM associated with the cabin fan delta pressure transducer (MDM OF1). This insight precludes the risk of a fan degrade going undetected and potentially causing a fire. ©[040899-2499B]

During crew wake periods, the crew can detect cabin fan loss (sound and airflow). Therefore, both fans are turned on for redundancy due to the loss of primary insight only during crew sleep. This precludes having to wake the crew in the event of a complete fan failure where the circuit breakers have opened and safed the situation.

The gain in redundancy is not worth affecting mission objectives or exceeding any power loading limits. Since there is some insight into fan health with AC currents and H₂O loop parameters, the second fan should be left off if these are affected. ©[042507-7258B]

DOCUMENTATION: Hazard Report ORBI 321, Crew Incapacitation from Heat Strain. Engineering judgment. ©[052704-6261C] ©[042507-7258B]

A17-154

MANAGEMENT OF DEGRADED ROTATING EQUIPMENT [HC]
©[121604-6456A]

- A. ANY ROTATING EQUIPMENT (EXCEPT THE CABIN FAN) THAT LOSES A SINGLE PHASE WILL BE SWITCHED TO THE ALTERNATE EQUIPMENT.
©[032395-1752A]

All equipment with the exception of the cabin fan and the upgraded avionics fan can be restarted on two phases. ©[040899-2500]

Since the lifetime of two-phase operations is confirmed to 168 hours (for new equipment) and the two-phase equipment operates below normal performance, it is prudent to switch from the two-phase equipment.

The JSC test and OV-101 fan test at Rockwell-Downey showed that when a cabin fan was started on two phases that it popped the 3 AMP cb's powering the fans.

THIS RULE CONTINUED ON NEXT PAGE

FLIGHT RULES

A17-154

MANAGEMENT OF DEGRADED ROTATING EQUIPMENT [HC] (CONTINUED)

If a cabin fan loses a phase, it is prudent to continue operating the two phase cabin fan since it may not be possible to restart that fan if it is turned off and loss of one cabin fan results in an MDF (reference Rule {A17-1001}, LIFE SUPPORT GO/NO-GO CRITERIA). In the case of an upgraded avionics fan, which is the same as a cabin fan, it is not necessary to continue operating an upgraded av bay fan on two phases since the loss of one av fan has no mission duration impacts. Further, it is not recommended to continue operating the fan on two phases since two phase operation is below nominal performance and could cause damage to the fan. Should a second failure occur which causes loss of the remaining fan, there is an IFM to swap power supplies assuming the second failure is not a power supply failure.
 @[040899-2500]

- B. FOR ROTATING EQUIPMENT THAT IS DEGRADED FROM NORMAL OPERATING LEVELS, BUT ABOVE LOSS DEFINITIONS FOR REASONS OTHER THAN LOSS OF A PHASE, THE FOLLOWING MANAGEMENT WILL BE APPLIED:
1. FOR EQUIPMENT THAT WOULD CAUSE EARLY MISSION TERMINATION IF THE EQUIPMENT COULD NOT BE RESTARTED, THE DEGRADED EQUIPMENT WILL CONTINUE TO BE OPERATED, PROVIDED NO SAFETY HAZARD EXISTS.

If equipment is degrading for reasons other than loss of a phase (bearing seizure, material failure, etc.) then restarting that piece of equipment could not be guaranteed (static friction being greater than dynamic friction). If the equipment is required GO for GO/NO-GO purposes, then it would have to be shown that it would restart once it was deactivated. This could cause early mission termination. Therefore, it would be prudent to remain on the degraded equipment until the performance violates its loss definition, provided no safety hazard exists. Note that the cabin fan and H₂O pump loop 2 are the only pieces of equipment that would cause early mission termination if deactivated. @[032894-1751A]
 @[121604-6456A]

2. FOR EQUIPMENT THAT WOULD NOT CAUSE EARLY MISSION TERMINATION IF IT COULD NOT BE RESTARTED, THE DEGRADED EQUIPMENT WILL BE SWITCHED TO THE ALTERNATE EQUIPMENT.
 @[032894-1751A]

Since the equipment is not required GO for GO-NO/GO purposes, it would be prudent to switch from the degraded equipment. This would eliminate the risk/probability of a safety hazard while having no EOM impacts.

Documentation: SODB Vol. IV 4.1.6.3, 4.1.6.4, Hamilton Standard, SP 01TB0 [Item SV 6405 (Avionics Fans), SV 6470 (Humidity Separator), SV 6416 (IMU fans)], MCR 6159 (Rockwell's pitch to the CCB on 10/12/79 about starting fans on two phases). Engineering judgment ORBI-275 (Loss of Freon Coolant Loops). @[032395-1751A] @[121604-6456A]

FLIGHT RULES

A17-155

REGENERATIVE CO₂ REMOVAL SYSTEM (RCRS) MANAGEMENT

A. ASCENT/ENTRY OPERATIONS

THE RCRS WILL BE DEACTIVATED FOR ASCENT AND ENTRY.

The RCRS requires a vacuum source to operate properly. Since a vacuum source is not available during ascent and entry, the unit is deactivated. LiOH canisters provide PPCO₂ control during these periods. If the RCRS remains activated through entry, the loss of vacuum source will cause the RCRS to shut down and will not damage the RCRS.

DOCUMENTATION: Engineering judgment.

B. ORBIT OPERATIONS

1. ACTIVATION/DEACTIVATION

THE RCRS WILL BE ACTIVATED AS SOON AS PRACTICAL ONCE ON ORBIT POST-OMS 2 AND DEACTIVATED AS LATE AS PRACTICAL PRE-DEORBIT BURN.

The RCRS serves a highly critical PPCO₂ removal function. Without a successful RCRS activation, mission duration is limited by the number of LiOH canisters flown. Early on-orbit RCRS activation allows immediate determination of whether the unit is operating properly allowing the crew maximum utility of the remaining LiOH canisters for entry planning. Troubleshooting and failure impact can then begin as soon as this information is known.

Deactivating the RCRS late in the deorbit timeframe minimizes usage of the manifested LiOH canisters in the event the mission is waved off for weather or system failures. When the RCRS is deactivated, a fresh LiOH canister will have been installed to control CO₂ levels through the remainder of deorbit prep and through entry.

DOCUMENTATION: Engineering judgment.

2. REACTIVATION

IF THE RCRS HAS BEEN DEACTIVATED FOR DEORBIT PREP, THE RCRS WILL NOT BE REACTIVATED FOR WAVE-OFF ORBITS, BUT WILL BE REACTIVATED FOR A WAVE-OFF DAY IF CONSUMABLES PERMIT.

THIS RULE CONTINUED ON NEXT PAGE

FLIGHT RULES

A17-155

REGENERATIVE CO2 REMOVAL SYSTEM (RCRS) MANAGEMENT (CONTINUED)

For wave-off orbits, the RCRS is not reactivated since RCRS activation coupled with LiOH canister removal during the busy deorbit prep period creates an unacceptably high crew workload.

For wave-off days, the RCRS is reactivated to save LiOH but only if cryogenic consumables permit the additional power consumption. Generally, sufficient stowed LiOH cans will permit at least two days of mission extension. The LiOH canister installed for RCRS deactivation will be removed for later use.

DOCUMENTATION: Engineering judgment.

3. CABIN AND AIRLOCK DEPRESS

THE RCRS WILL BE DEACTIVATED DURING A CABIN DEPRESS OR AN AIRLOCK DEPRESS.

The RCRS controller logic will shut down during cabin depresses or during an airlock depress since the failure logic criteria will be satisfied due to vacuum vent line or cabin pressure inputs. When the unit shuts down, a fault summary message (S66 CO₂ RL SYS MALF) will be generated and a fault light (panel M051F) lit. Once shutdown has occurred, the unit must be powered down and repowered in an orderly fashion to regain RCRS operations. Due to the high probability of this shutdown occurring during a critical time period, it is preferred to manually shut down the unit during these events. After these time periods, the RCRS will be reactivated.

CO₂ removal during this period is of little concern since the deactivation duration is short (~20 minutes) and since the partial pressure of CO₂ will decrease simply from the reduction of cabin or airlock pressure.

4. FOR LOSS OF THE RCRS, LIOH CANS WILL BE INSTALLED AND WILL DETERMINE EOM.

When the RCRS is lost (loss of PPCO₂ insight or total functional loss (ref. Rule {A17-106}, REGENERATIVE CO₂ REMOVAL SYSTEM (RCRS) LOSS DEFINITION)), either proper evaluation of the RCRS CO₂ removal capability is not possible or CO₂ control is lost. Without PPCO₂ insight, the proper action is to install and remove LiOH cans on a regular basis to ensure adequate CO₂ control.

Similarly, installation of LiOH cans subsequent to a total RCRS functional loss is required to regain proper CO₂ control.

Due to the limited number of cans stowed, their number will determine EOM.

FLIGHT RULES

A17-156

RCRS MANUAL SHUTDOWN CRITERIA

THE RCRS WILL BE MANUALLY SHUT DOWN FOLLOWING EITHER A CABIN OR AN AVIONICS BAY FIRE.

In the event of either an orbiter cabin or avionics bay fire, preserving the RCRS CO₂ removal capability is of primary importance due to the limited number of LiOH canisters flown. Fire/smoke contaminants will be removed from the orbiter atmosphere with either fresh or used LiOH/charcoal and ATCO canisters. Exposure of the RCRS solid amine beds to fire contaminants causes irreversible damage to the RCRS CO₂ removal capability. Of the most probable orbiter fire combustion products (CO₂, CO, COF₂, HF, HCL, HCN, SO₂, NO_x, CF₃Br), the HCL, HF, and HCN react irreversibly with solid amine. Once absorbed, these gases will not be removed on exposure to vacuum through normal operation but will remain on the surface adsorption sites, degrading RCRS CO₂ removal capability. Additionally, RCRS post-fire contaminant removal is inefficient due to the limited RCRS airflow. After the contaminants have been removed from the air environment via LiOH/ATCO canisters, the RCRS will be reactivated to continue CO₂ removal operations. Reference Rule {A17-2C}.4, CABIN FIRE DEFINITION AND ACTIONS [HC]. ©[ED 1]

DOCUMENTATION: Engineering judgment.

A17-157

LiOH REDLINE DETERMINATION [HC] ©[082604-6282E]

A MINIMUM OF 2 DAYS OF UNUSED LiOH CANS MUST BE HELD IN RESERVE FOR CONTINGENCY USE THROUGH PLANNED NOMINAL END OF MISSION. A MAXIMUM PPCO₂ OF 7.6 MMHG WILL BE PROTECTED, UNLESS MISSION-SPECIFIC PAYLOAD CONSTRAINTS (REFERENCE PAYLOAD ANNEX FOR THAT MISSION) DICTATE MORE RESTRICTIVE LIMITS. ©[032395-1749]

Since the capability of a used (bagged) can is assessed only through analysis and cannot be guaranteed, only unused LiOH cans will be counted towards the redline. Enough unused standard LiOH canisters should be held in reserve to allow a minimum of 2 days of CONUS landing site opportunities in the event the prime form of CO₂ removal is lost (i.e., CO₂ removal system, LiOH cans in excess of redline, ISS CO₂ removal system while docked). If a repair cannot be completed before using LiOH from the 2-day reserve, a next PLS should be declared. The only form of CO₂ removal after all LiOH is depleted would be to perform cabin air overboard purges which will support as little as 2 hours of CO₂ control (assumes seven crewmembers, start and maintain 7.6 mmHg CO₂, N₂ consumables at redline). As a guideline, the number of LiOH canisters required for 2 days at 7.6 mmHg equals the number of crewmembers on board (a LiOH canister provides CO₂ removal for approximately 48 man-hours). Real-time or mission-specific assessments may override this guideline. ©[032395-1749]

Reference Rule {A13-52A}.2, PPCO₂ CONSTRAINT (TWO GAS) [HC]. ©[101305-6655A]

Hazard Reports ORBI 044, Unknown Gaseous Contamination Levels in the Cabin Causing Crew Illness/Incapacitation, and ORBI 073, Contamination of the Crew Compartment by Carbon Monoxide (CO) and Carbon Dioxide (CO₂).

Documentation: SODB 4.6.1.3.1.A, Engineering judgment based on STS-97 flight data. ©[082604-6282E]

FLIGHT RULES

A17-158

MANAGEMENT OF LIOH CANS FOR ADDITIONAL DAYS

- A. WHEN ADDITIONAL MISSION DAYS ARE DESIRED, A CHANGEOUT PLAN UTILIZING A PPCO₂ LEVEL OF 7.6 MMHG MAY BE USED IF NEEDED TO CREATE LIOH MARGIN. IN ORDER TO ACHIEVE MAXIMUM MISSION DURATION AND TO MINIMIZE BAGGING AND REUSE OF CANS, 7.6 CHANGEOUT SCHEDULES SHOULD BE IMPLEMENTED AS SOON AS POSSIBLE. MISSION-SPECIFIC PAYLOAD CONSTRAINTS MAY DICTATE WHETHER THIS MAXIMUM PPCO₂ LEVEL (AND THEREFORE THE MISSION EXTENSION) CAN BE SUPPORTED. FLIGHT SPECIFIC EXCEPTIONS WILL BE DOCUMENTED IN THE ANNEX. ©[032395-1748A]
- B. WHEN EXTENSION OF MISSION DURATION REQUIRES USED (BAGGED) LIOH CANS, THE FOLLOWING GUIDELINES WILL APPLY:
1. NO BAGGED CAN WITH LESS THAN 1 LBM OF LIOH REMAINING WILL BE CONSIDERED.
 2. BAGGED CANS WILL BE USED AS EARLY AS POSSIBLE.
 3. ONE USED CAN WILL BE UTILIZED IN COMBINATION WITH ONE FRESH CAN.
 4. THE PPCO₂ WILL BE NORMALLY MANAGED BELOW 7.6 MMHG. ADDITIONAL PAYLOAD CONSTRAINTS MAY REQUIRE LOWER PPCO₂ LEVELS; HOWEVER, THESE LOWER LEVELS WILL MAKE RE-USE OF CANS LESS EFFECTIVE.

When mission days are added to a flight after pre-flight planning has already dictated the use of a "standard" LiOH changeout schedule (cue card), a "7.6 Changeout Schedule" is the preferred way to ensure desired mission extension. Utilizing fresh LiOH until a PPCO₂ level of 7.6 mmHg is reached maximizes the efficiency of each can. Analysis and implementation of such a plan is straightforward, since the amount of LiOH in each fresh (unused) can is always known. The amount of LiOH in previously used cans is not known. This amount is arrived at by analysis only and is subject to variables such as actual crew metabolic rates, exactly when a can has been changed out, and how well it has been sealed.

Whenever a 7.6 plan is being considered, it should always be implemented as soon as possible. The longer a decision is delayed about the use of a 7.6 plan, the greater the uncertainty (amount of LiOH in bagged cans). ©[032395-1748A]

THIS RULE CONTINUED ON NEXT PAGE

FLIGHT RULES

A17-158

MANAGEMENT OF LIOH CANS FOR ADDITIONAL DAYS
(CONTINUED)

Circumstances may be such that mission duration extension can only be achieved through the use of previously used LiOH cans. However, cans with less than 1 lbm of usable LiOH remaining do not have sufficient CO₂ removal capability to be of practical use. ©[032395-1748A]

Since the amount of LiOH in used cans is estimated, they should be used as much as possible before the end of the mission. Further, since CO₂ removal rate degrades substantially as the quantity of LiOH remaining decreases, it is not always possible to maintain acceptable CO₂ rates, even though LiOH is being consumed out of the can. Installing a used can with a fresh can allows the used can to completely deplete while the fresh can maintains control over CO₂ levels.

DOCUMENTATION: Engineering judgment. ©[032395-1748A]

A17-159 THROUGH A17-200 RULES ARE RESERVED

FLIGHT RULES

PRESSURE CONTROL SYSTEMS (PCS) LOSS DEFINITIONS

A17-201 CABIN PRESSURE INTEGRITY [HC] @[082604-6305A]

CABIN PRESSURE INTEGRITY IS CONSIDERED LOST IF:

A. ASCENT:

1. A NONISOLATABLE LEAK > 0.15 PSIA/MIN WILL RESULT IN THE INTACT ABORT THAT WILL PROVIDE THE EARLIEST AVAILABLE RETURN AND LANDING TIME.
2. A NONISOLATABLE LEAK > 0.02 PSIA/MIN, AND ≤ 0.15 PSIA/MIN, WILL RESULT IN AN AOA ABORT (GROUND CALL).
3. FOR A NONISOLATABLE LEAK \leq TO 0.02 PSIA/MIN, OR ANY LEAK WHICH OCCURS AFTER THE CLOSE OF THE AOA WINDOW, PARAGRAPH B WILL DETERMINE EOM.

NOTE: ALL DP/DT VALUES REFERENCED IN THIS RULE ARE ASSUMED TO BE AN EQUIVALENT DP/DT AT 14.7 PSI CABIN PRESSURE AND NEGATIVE IN SIGN.

The rationale for selecting one dp/dt on which to call an immediate abort comes from the assumption that any penetration through the cabin wall always has the possibility of propagating, thereby increasing the leak rate. The numbers contained in this rule and rationale are leak rates which confirm a cabin leak during the different phases of ascent. Additionally, the numbers include a margin to protect for an increase in the leak rate. The leak rate of 0.15 psia/min is the dp/dt limit for an orbit 3 deorbit opportunity which protects for an 8 psi cabin to the ground. In order to provide margin against an increase in the leak rate, the intact abort that results in the quickest return and landing will be selected for any cabin leak rate that remains above 0.15 psia/min (both on-orbit and ground call). @[120894-1740]

The highest probability of the leak occurring is during the first few minutes of flight when the drop in atmospheric pressure creates a large delta in pressure across the cabin wall. However, during the first 2 minutes of flight, cabin stretch (by approx 0.07 psia/min) and LES flow (by approx +0.02 psia/min) will bias any dp/dt that is associated with a true leak. By selecting a leak rate of 0.15 psia/min as the immediate abort call, a dp/dt of this size will provide positive indication of a cabin leak at any point during ascent. @[120894-1740] @[082604-6305A]

THIS RULE CONTINUED ON NEXT PAGE

FLIGHT RULES**A17-201 CABIN PRESSURE INTEGRITY [HC] (CONTINUED)**

A leak rate in the range $0.02 < dp/dt \leq 0.15$ will allow continuing to orbit and then performing leak isolation procedures to determine whether the leak can be stopped. A leak rate of 0.02 would allow a landing at the next PLS. However, an AOA will be performed to provide additional margin should the leak rate increase. This leak rate, which assumes no ACES flow, is small enough to allow conservatism, but also large enough to not be masked by the post-MECO transient (approx 0.02) so that a NO-GO call for APU shutdown can be made for a real leak. @[120894-1740] @[ED] @[082604-6305A] @[062305-6653]

The onboard AOA call will be 0.08 psia/min which will be used for crew loss of communication procedures. This leak rate trips the class 1 Klaxon alarm and, therefore, cues the crew to a possible cabin leak and to cross check with a cabin pressure decrease. The C&W dp/dt limit is set at 0.08 psia/min to prevent nuisance alarms during the period from lift off to MECO when cabin pressure is transient due to ACES helmet flow, thermal and external pressure drop effects. @[062305-6653]

Hazard Reports ORBI-051 Loss or Erroneous IMU Output can Cause Loss of Flight Control, ORBI-071 Inadequate Nitrogen Supply to Maintain Total Cabin Pressure, and ORBI-511 External Leakage of the Crew Module/ODS Resulting in Loss of Habitable Environment

DOCUMENTATION: Engineering judgment. @[120894-1740] @[ED]

B. ON-ORBIT:

A NONISOLATABLE LEAK SUCH THAT O₂/N₂ CONSUMABLES CAPABILITY WILL NOT ALLOW A NEXT PLS ENTRY AT 14.7 PSIA (10.2 IF ALREADY IN 10.2 OPS) PLUS THE GREATER CONSUMABLE REQUIREMENT OF THE FOLLOWING:

1. A 48-HOUR FLIGHT EXTENSION AT 14.7 PSIA (10.2 IF ALREADY IN 10.2 OPS) BEYOND THE NEXT PLS OPPORTUNITY, OR
2. THE PLANNED CONSUMABLES FOR THE 165-MINUTE, 8 PSIA CONTINGENCY RETURN REQUIREMENT

Cabin pressure integrity for on-orbit operations is defined to be lost at the point where normal operations can no longer take place (i.e., 14.7 psia (10.2 if already in 10.2 ops) cabin plus all reserves remaining intact). The two reserves which must be included to define loss of cabin pressure integrity are: (1) The required consumables to maintain 14.7 psia (10.2 if already in 10.2 ops) for two mission extension days, or (2) loss of the 165-minute, 8 psia contingency reserve which would not allow an emergency deorbit should one become necessary. Allowing for all three of the above named consumable requirements does not leave sufficient margin between loaded quantities and what is required for contingency. Therefore, only the greater of the two reserves is required in addition to the 14.7 psia (10.2 if already in 10.2 ops) cabin maintenance to the next PLS. @[082604-6305A]

THIS RULE CONTINUED ON NEXT PAGE

FLIGHT RULES

A17-201 CABIN PRESSURE INTEGRITY [HC] (CONTINUED)

Hazard Reports ORBI-051 Loss or Erroneous IMU Output can Cause Loss of Flight Control, ORBI-071 Inadequate Nitrogen Supply to Maintain Total Cabin Pressure, and ORBI-511 External Leakage of the Crew Module/ODS Resulting in Loss of Habitable Environment ©[082604-6305A]

DOCUMENTATION: Engineering judgment. ©[082604-6305A]

Rules {A2-54}, RTLS, TAL, AND AOA ABORTS FOR SYSTEMS FAILURES [CIL]; {A2-301}, CONTINGENCY ACTION SUMMARY [HC]; {A9-251}, CRYO HEATER MANAGEMENT FOR ASCENT; {A17-303}, CABIN REPRESSURIZATION MANAGEMENT; and {A17-1001}, LIFE SUPPORT GO/NO-GO CRITERIA, reference this rule. ©[ED] ©[082604-6356] ©[ED] ©[032807-8400]

A17-202 8 PSIA CABIN CONTINGENCY 165-MINUTE RETURN CAPABILITY

THE 8 PSIA CABIN CONTINGENCY (165 MINUTES) RETURN CAPABILITY IS CONSIDERED LOST IF:

- A. AT LEAST 2.5 LB O₂/HR/CREWMEMBER CANNOT BE SUPPLIED TO THE ACES HELMETS. ©[062305-6653]

The 8 psia cabin may present an unacceptable atmosphere for normal breathing (PPO₂ can drop below 2.5 psia), in which case the ACES helmets must be worn. A 20 lb/hr flowrate to the LES helmet manifold is necessary to provide eight ACES helmets with 2.5 lb/hr O₂ (11.0 liters/minute). This means sufficient upstream pressure must be supplied from the cryo tanks to accommodate ACES helmet flowrates during ACES helmet operations. The 2.5 lb/hr can supply enough O₂ to allow regular breathing both at rest and during a state of excitement in a resting position. ©[062305-6653]

DOCUMENTATION: (TWO-WAY MEMO RECEIVED FROM J. WALIGORA/SD5 DATED 2/2/87).

- B. TOTAL N₂ QUANTITY IS LESS THAN THE N₂ REDLINE. ©[050400-7196]

The N₂ Redline (also defined as the 8 psia cabin contingency 165-minute return capability requirement) is determined by the summation of N₂ tank measurement error and residuals (MER) and the N₂ required to support the 8 psia cabin pressure maintenance duration following a bleed down to 8 psia.

1. FOR AN INITIAL CABIN PRESSURE OF 14.7 PSIA, THE N₂ REDLINE IS THE VOLUME-DEPENDENT AMOUNT SHOWN IN THE FOLLOWING TABLE. ©[050400-7196]

THIS RULE CONTINUED ON NEXT PAGE

FLIGHT RULES

A17-202

8 PSIA CABIN CONTINGENCY 165-MINUTE RETURN CAPABILITY (CONTINUED)

VEHICLE CONFIGURATION	N2 REDLINE (LBM N2)						
	2 TKS	3 TKS	4 TKS	5 TKS	6 TKS	7 TKS	8 TKS
	103.9	111.7	119.3	126.8	134.1	141.4	148.7
ORB + INT ARLK + TNL ADPTR	101.0	108.8	116.4	123.9	131.2	138.5	145.8
ORB + INT ARLK + TNL ADPTR + SHORT TNL + SINGLE HAB	76.7	84.5	92.1	99.6	106.9	114.2	121.5
ORB + INT ARLK + TNL ADPTR + SHORT TNL + DOUBLE HAB	53.0	60.8	68.4	75.9	83.2	90.5	97.8
ORB + INT ARLK + TNL ADPTR + LONG TNL + SINGLE HAB	72.5	80.3	87.9	95.4	102.7	110.0	117.3
ORB + INT ARLK + TNL ADPTR + LONG TNL + DOUBLE HAB	48.2	56.0	63.6	71.1	78.4	85.7	93.0
ORB + EXT ARLK	99.1	106.9	114.5	122.0	129.3	136.6	143.9
ORB + EXT ARLK + TNL ADPTR	95.8	103.6	111.2	118.7	126.0	133.3	140.6
ORB + EXT ARLK + TNL ADPTR + SHORT TNL + SINGLE HAB	71.6	79.4	87.0	94.5	101.8	109.1	116.4
ORB + EXT ARLK + TNL ADPTR + SHORT TNL + DOUBLE HAB	48.3	56.1	63.7	71.2	78.5	85.8	93.1
ORB + EXT ARLK + TNL ADPTR + LONG TNL + SINGLE HAB	67.8	75.6	83.2	90.7	98.0	105.3	112.6

@[050400-7196]

The 8 psia cabin pressure maintenance duration requirement is based on the amount of N₂ required to support a cabin leak caused by a 0.45-inch diameter hole and a landing 165 minutes later. The 165 minutes consists of two distinct durations: 1) The volume-dependent time required for the cabin pressure to “bleed down” from an initial cabin pressure to 8 psia during which no N₂ is used, and 2) The duration at 8 psia where the emergency 8 psia cabin regulators flow N₂ (and O₂) to make up for the cabin air loss and to maintain the cabin pressure at 8 psia. The entire orbiter volume, including modules, will be used to support the cabin leak. Larger volumes allow for a longer bleed down time to 8 psia, and N₂ will not be used until the cabin pressure reaches 8 psia; as the total usable volume increases, the amount of N₂ required to make the balance of the 165-minute duration decreases. @[050400-7196]

THIS RULE CONTINUED ON NEXT PAGE

FLIGHT RULES

A17-202

8 PSIA CABIN CONTINGENCY 165-MINUTE RETURN CAPABILITY (CONTINUED)

The 165-minute contingency return requirement assumes an intermittent flow of 17 lbm/hr O₂ from the direct O₂ orifice and an intermittent flow of 23 lbm/hr O₂ from the cabin pressure regulator to manage O₂ levels in the cabin environment. It also assumes a starting cabin pressure of 14.7 psia, PPO₂ of 3.20 psia, and temperature of 70 deg F. The actual amount of N₂ required to support the 8 psia cabin maintenance duration is shown in the table below. ©[050400-7196]

VEHICLE CONFIGURATION	VOLUME (ft ³)	8 PSIA MAINTENANCE REQ'T (LBM N ₂)
Orb + Int Arlk	2475	85.2
Orb + Int Arlk + Tnl Adptr	2605	82.3
Orb + Int Arlk + Tnl Adptr + Short Tnl + Single Hab	3718	58.0
Orb + Int Arlk + Tnl Adptr + Short Tnl + Double Hab	4824	34.3
Orb + Int ArLk + Tnl Adptr + Long Tnl + Single Hab	3921	53.8
Orb + Int Arlk + Tnl Adptr + Long Tnl + Double Hab	5027	29.5
Orb + Ext Arlk	2703	80.4
Orb + Ext Arlk + Tnl Adptr	2833	77.1
Orb + Ext Arlk + Tnl Adptr + Short Tnl + Single Hab	3946	52.9
Orb + Ext Arlk + Tnl Adptr + Short Tnl + Double Hab	5052	29.6
Orb + Ext ArLk + Tnl Adptr + Long Tnl + Single Hab	4149	49.1
Orb + Ext Arlk + Tnl Adptr + Long Tnl + Double Hab	5255	24.2

N₂ tank measurement error (4.05 lbm/tank RSS'd) and residuals (6.5 lbm/tank) are shown in the table below. Nominal management of the N₂ systems (ref Rule {A17-257}, N₂ SYSTEM MANAGEMENT) has both N₂ systems being used as one system. Therefore, MER determination should be based on all N₂ tanks being used to supply N₂ to the cabin.

	N ₂ (LBM)						
	2 TKS	3 TKS	4 TKS	5 TKS	6 TKS	7 TKS	8 TKS
Measurement Error	5.7	7.0	8.1	9.1	9.9	10.7	11.5
Residuals	13.0	19.5	26.0	32.5	39.0	45.5	52.0
MER (TOTAL)	18.7	26.5	34.1	41.6	48.9	56.2	63.5

©[050400-7196]

THIS RULE CONTINUED ON NEXT PAGE

FLIGHT RULES

A17-202

8 PSIA CABIN CONTINGENCY 165-MINUTE RETURN CAPABILITY (CONTINUED)

2. FOR AN INITIAL CABIN PRESSURE OF 10.2 PSIA, ADD THE FOLLOWING N₂ QUANTITY TO THE 14.7 PSIA REQUIREMENT IN PARAGRAPH 1 TO GET THE N₂ REDLINE (165-MIN CONTINGENCY RETURN CAPABILITY REQUIREMENT) . @[050400-7196]

IF THE FOLLOWING VOLUME IS AT 10.2	ADD THIS QUANTITY TO THE 14.7 PSIA REDLINE (LBM N ₂)
ORB + INT ARLK	40.8
ORB + INT ARLK + TNL ADPTR	42.6
ORB + INT ARLK + TNL ADPTR + SHORT TNL + SINGLE HAB	56.7
ORB + INT ARLK + TNL ADPTR + SHORT TNL + DOUBLE HAB	69.7
ORB + INT ARLK + TNL ADPTR + LONG TNL + SINGLE HAB	59.5
ORB + INT ARLK + TNL ADPTR + LONG TNL + DOUBLE HAB	73.9
ORB + EXT ARLK	43.9
ORB + EXT ARLK + TNL ADPTR	46.3
ORB + EXT ARLK + TNL ADPTR + SHORT TNL + SINGLE HAB	59.1
ORB + EXT ARLK + TNL ADPTR + SHORT TNL + DOUBLE HAB	71.9
ORB + EXT ARLK + TNL ADPTR + LONG TNL + SINGLE HAB	62.6
ORB + EXT ARLK + TNL ADPTR + LONG TNL + DOUBLE HAB	76.2

If the orbiter volume is at 10.2 psia, the additional N₂ is the amount required to give the same 165-min return capability for a cabin leak at an initial cabin pressure of 10.2 psia as exists with an initial cabin pressure of 14.7 psia. Because the bleed down duration from 10.2 to 8 psia is shorter than the bleed down time from 14.7 to 8 psia, the 8 psia cabin pressure maintenance duration is longer; therefore, more N₂ is required. To determine the total 8 psia maintenance duration requirement for an initial pressure of 10.2 psia, the N₂ quantity from the table above should be added to the 8 psia maintenance N₂ requirement from the table in the Paragraph B.1 rationale.

DOCUMENTATION: DF7/93-39, Cabin Leak Analysis (0.45 in Hole in Cabin, 165-Minute Return Capability), 11/16/93; and Level B Groundrules and Constraints. @[121593-1597]

Rules {A2-54D}.6, RTL, TAL, AND AOA ABORTS FOR SYSTEMS FAILURES [CIL]; {A17-302C}, 10.2 PSIA CABIN DEPRESSURIZATION CONSTRAINTS; and {A17-1001D}, LIFE SUPPORT GO/NO-GO CRITERIA, reference this rule. @[050400-7196]

FLIGHT RULES

A17-203

PPO₂ CONTROL

PPO₂ CONTROL IS CONSIDERED LOST WHEN BOTH AUTOMATIC AND MANUAL METHODS OF CONTROLLING PCS OXYGEN SUPPLY CAN NO LONGER CONTROL THE AMOUNT OF OXYGEN FLOWING INTO THE CABIN.

The ability to control PPO₂ inside the crew module is dependent on the integrity of the oxygen supply lines, valves, sensors, and automatic controllers. Control is considered lost on the low side when oxygen can no longer be fed to the cabin. This will eventually result in the PPO₂ level inside the cabin dropping to unsafe limits due to crew metabolic consumption of oxygen and cabin leakage.

PPO₂ control is considered lost on the high side when an unisolatable oxygen leak occurs or the crew is required to wear their launch/entry suit helmets for a period of time which causes the percent oxygen level in the cabin to exceed the GO/NO-GO criteria for a PLS (ref. Rule {A17-1001D}.3, LIFE SUPPORT GO/NO-GO CRITERIA). Depending on the leak rate, early termination will probably be necessary due to high oxygen concentration within the cabin.

DOCUMENTATION: Engineering judgment.

Rules {A17-301}, CABIN ATMOSPHERE MANAGEMENT; and {A17-1001D}, LIFE SUPPORT GO/NO-GO CRITERIA, reference this rule.

FLIGHT RULES

A17-204

N2 SUPPLY

THE PCS N2 SUPPLY IS CONSIDERED LOST IF THE N2 TANK PRESSURE IS < 200 (375) PSIA. [ED] [052704-6304A]

The N₂ regulators control the N₂ pressure to the cabin regulators to 200 ± 15 psig. If the N₂ tank pressure is < 200 psia, the N₂ regulator loses control and regulator flow may not be adequate to meet the demand of the 14.7 psi cabin regulator. Below 200 psia, the N₂ supply is, for all practical purposes, lost.

DOCUMENTATION: SODB 4.6.1.1.4.A.3. [ED] [052704-6304A]

A17-205

PPO₂ SENSOR LOSS DEFINITION

A SINGLE PPO₂ SENSOR WILL BE CONSIDERED LOST IF IT DEVIATES MORE THAN 0.15 PSI FROM THE NEAREST READING OF THE TWO SENSORS THAT ARE WITHIN 0.15 PSI OF EACH OTHER.

A SUBSEQUENT SENSOR FAILURE WILL BE DETERMINED BY ANALYSIS USING PREVIOUS SIGNATURES AND O₂ FLOWRATES.

The initial failure of a PPO₂ sensor will be determined by comparison with the readings of the other two sensors. The sensors that are reading within 0.15 psi (±3.0 percent full scale) of each other are assumed to be nominal and the deviant sensor (>0.15 psi from the nearest PPO₂ reading) will be considered failed based on this assumption.

Because there are only two remaining sensors, no “voting out” capability exists; so, subsequent PPO₂ sensor failures will have to be determined through the analysis of previous PPO₂ signatures from both the current and past flight data, by the frequency of O₂/N₂ controller cycles, and by O₂ flow rates.

Note that the PPO₂ sensors have different accuracy specifications based on ambient temperature. Between 70 deg and 85 deg F, the sensor accuracy is ±1.5 percent of full scale; outside this band the accuracy drops to ±3.0 percent of full scale. The greater error is assumed for this rule.

DOCUMENTATION: Engineering judgment and MCR 16202.

FLIGHT RULES

A17-206**LES O₂ SUPPLY SYSTEM LOSS DEFINITION**

ONE (OF TWO) LES O₂ SUPPLY SYSTEMS IS LOST IF THE ASSOCIATED O₂ CROSSOVER VALVE OR ECLSS O₂ SUPPLY VALVE CANNOT BE OPENED, OR FOR ANY OTHER BLOCKAGE IN THAT LEG OF THE SYSTEM (E.G., CHECK VALVE FAILED CLOSED) . ©[050495-1756B]

The LES manifold is required to support procedures for a fire or toxic spill case. For these cases, the crew immediately dons the ACES helmet/QDM. At 14.7 (10.2) psia, the maximum crew breathing rate is 5.5 (3.8) lbm/hr/crewman. If this rate cannot be met then on the ACES helmet, the anti-suffocation device will open allowing ambient air to be ingested, possibly subjecting the crew to harmful gases/combustion products. When the crew is on the QDM's, they may be starved of O₂, possibly forcing them to remove the masks. For a 5 to 8 man crew at 14.7 psia, this rate cannot be met by a single O₂ supply system (24 lbm/hr). For a 5 or 6 man crew at 10.2 psia, the safety tolerance is marginal. ©[062305-6653]

For the cabin leak case, the crew dons the ACES helmets/QDM's at a pressure below 10.2 psia; therefore, the breathing requirement is lowered (2.7 lb/hr/crewman) and one O₂ system can supply enough O₂ for this contingency. Also, it would be acceptable for the anti-suffocation valves to periodically open since there is not a contamination concern. ©[050495-1756B]

The 8 psia cabin may present an unacceptable atmosphere for normal breathing (PPO₂ can drop below 2.7 psia), in which case the ACES helmets/QDM's must be worn. A 21.6 lb/hr flowrate to the LES helmet manifold is necessary to provide eight ACES helmets/QDM's with 2.7 lb/hr O₂ (11.8 liters/minute). This means sufficient upstream pressure must be supplied from the cryo tanks to accommodate ACES helmet/QDM flowrates during ACES helmet/QDM operations. The 2.7 lb/hr can supply enough O₂ to allow regular breathing both at rest and during a state of excitement in a resting position. ©[050495-1756B] ©[062305-6653]

The O₂ supply system can be obstructed by the O₂ XOVR valve, ECLSS O₂ SUPPLY valve, or CHECK valve failing closed, as well as a blockage.

DOCUMENTATION: Two-way memo received from J. Waligora/SD5, dated February 2, 1987. ©[050495-1756B]

A17-207 THROUGH A17-250 RULES ARE RESERVED

FLIGHT RULES

PCS SYSTEMS MANAGEMENT

A17-251 NORMAL PCS CONFIGURATION

NORMAL PCS COMPONENT CONFIGURATION WILL BE AS FOLLOWS:

- A. PCS 1 WILL BE OPERATED FROM LIFT-OFF TO MISSION MIDPOINT.
PCS 2 WILL BE OPERATED FROM MISSION MIDPOINT TO EOM.

As part of the redundant component checkout that is normally performed midway through the mission, the PCS system will be reconfigured to the alternate PCS system to verify system health and maximize total operating lifetime. Additionally, PCS 2 will be selected since it is impractical for KSC to perform a redundant component checkout during ground turnaround.

DOCUMENTATION: Engineering judgment.

- B. NORMAL PCS VALVE CONFIGURATION:

1. ASCENT/ENTRY:
 - a. BOTH PCS 1 AND 2 14.7 PSIA CABIN REGULATOR INLET VALVES - CLOSED.
 - b. PCS 1 O₂/N₂ CONTROL VALVE - OPEN.
 - c. PCS 2 O₂/N₂ CONTROL VALVE - CLOSED.
 - d. O₂ REGULATOR INLET VALVES - CLOSED.

(NOTE: 8.0 PSIA EMERGENCY REGULATORS CANNOT BE DISABLED.)

2. ORBIT:
 - a. PCS 1(2) 14.7 PSIA CABIN REGULATOR INLET VALVES - OP;
PCS 2(1) 14.7 CABIN REGULATOR INLET VALVES - CLOSED.

THIS RULE CONTINUED ON NEXT PAGE

FLIGHT RULES

A17-251 NORMAL PCS CONFIGURATION (CONTINUED)

- b. PCS 1 (2) O₂/N₂ CONTROL VALVE - AUTO;
PCS 2 (1) O₂/N₂ CONTROL VALVE - CLOSED.
- c. O₂ REGULATOR INLET VALVE 1 (2) - OPEN;
O₂ REGULATOR INLET VALVE 2 (1) - CLOSED.

The above ascent/entry configuration is the desirable switch setup in the event of a cabin leak during these flight phases. This configuration and associated rationale is different from the orbit configuration for a cabin leak, since the crew, on orbit, has more time to react to the leak and they are able to move about and reach the necessary switches.

For ascent/entry, the cabin regulator inlet valves must be configured prior to entering these flight phases due to the crew not being able to reach these switches once in their seats. The configuration of the O₂/N₂ control valves allows for one PCS system to be active to respond to a cabin leak once cabin pressure reaches 8.0 psia. For large leaks (meaning a leak where the stabilization pressure is below 6.5 psia with only one system active), the crew will procedurally activate PCS system 2 upon reaching 6.5 psia cabin pressure, to gain a minimum of 75 lb/hr additional N₂ flow. For the smaller leaks (<75 lb/hr), only one PCS system active is the preferred configuration. The O₂ regulator inlet valves are closed to supply all O₂ flow to the crew and any extra O₂ will flow to the cabin, during a cabin leak, via the direct O₂ valve.

For orbit operations, paragraph A of this rule defines PCS system configuration for the mission. This determines which cabin regulator inlet valves and O₂/N₂ control valves apply in the orbit portion of this rule. Normally, while on orbit, only one PCS system is used to automatically control cabin atmosphere. Therefore, the active PCS system will have the 14.7 psia cabin regulator open to maintain a 14.7 psia cabin, the O₂/N₂ control valve in auto to automatically regulate oxygen/nitrogen partial pressure, and the O₂ regulator inlet valve open to allow O₂ flow during O₂ cycles.

DOCUMENTATION: Engineering judgment.

FLIGHT RULES

A17-252

CABIN PRESSURE RELIEF VALVES

BOTH CABIN POSITIVE PRESSURE RELIEF VALVES WILL BE ENABLED DURING ALL FLIGHT PHASES.

The failure of a pressure relief valve to open will not be detected until an overpressure condition exists. Because of the potential for an overpressure condition with possible catastrophic results, the redundant pressure relief function is enabled at all times.

DOCUMENTATION: Engineering judgment.

DOCUMENTATION: Engineering judgment.

A17-253

CABIN VENT VALVES

THE CABIN VENT VALVES WILL BE CLOSED PRELAUNCH AND THE CB'S OPENED AFTER ASCENT. THE CB'S WILL REMAIN OPEN FOR THE REMAINDER OF THE FLIGHT THROUGH POSTLANDING HANDOVER.

The cabin vent valves are opened to vent the cabin after the prelaunch cabin leak check at T minus 30 minutes and closed at T minus 20 minutes. After ascent the circuit breakers are opened to prevent accidental opening of the valves. Circuit breaker opening is postponed until after ascent because they cannot be reached by the crew prior to lift-off or during powered flight.

FLIGHT RULES

A17-254

CABIN O₂ CONCENTRATION

CABIN O₂ CONCENTRATION WILL BE MAINTAINED WITHIN THE SPECIFIED LIMITS FOR THE FOLLOWING CABIN PRESSURES:

- A. FOR 14.7 PSIA OPERATIONS, THE CABIN O₂ CONCENTRATION LEVEL WILL BE MAINTAINED BELOW 25.9 PERCENT.

Orbiter cabin materials and all middeck payload/experiments are required to be compatible (non-fire-propagating) with 25.9 percent O₂ concentration and have been qualified by test. Any materials or payloads flown which do not meet O₂ concentration requirements as stated in the Shuttle/Payload Middeck Accommodations document must have a waiver from the program office prior to flight.

Instrumentation error for percent O₂ is derived by dividing worst case (high) PPO₂ plus instrumentation error (0.075) by worst case (low) cabin pressure minus instrumentation error (0.24) and equating this value to 25.9 percent. Then the indicated values, without the instrumentation error, are divided to arrive at the percent O₂ error.

DOCUMENTATION: NHB 8060.1B and NSTS 21000-IDD-MDK.

- B. FOR 10.2 PSIA OPERATIONS, THE CABIN O₂ CONCENTRATION LEVEL WILL BE MAINTAINED BELOW 30.0 PERCENT.

Testing on orbiter cabin materials has demonstrated that orbiter materials are non-fire-propagating at O₂ concentrations up to 30 percent. Middeck payloads/experiments are required to be compatible with a 30 percent O₂ atmosphere at a cabin pressure of 10.2 psi. Currently, all planned scheduled/unscheduled and contingency EVA's will be performed at 10.2 psi, if possible. However, until the vehicle is certified for 10.2 psi operations, a waiver is required to allow O₂ concentrations up to 30 percent.

DOCUMENTATION: MCR 11891 and NSTS 21000-IDD-MDK.

THIS RULE CONTINUED ON NEXT PAGE

FLIGHT RULES**A17-254****CABIN O₂ CONCENTRATION (CONTINUED)**

- C. FOR 8.0 PSIA OPERATIONS, THE CABIN O₂ CONCENTRATION LEVEL WILL BE MAINTAINED BELOW 40 PERCENT IF REMAINING CONSUMABLES ALLOW LESS THAN 36 HOURS TO ACCOMPLISH A LANDING. IF GREATER THAN 36 HOURS EXISTS, 35 PERCENT WILL BE THE UPPER LIMIT WHILE AT 8.0 PSIA. ©[090894-1673A]
1. FOR CABIN LEAK SCENARIOS, OR SITUATIONS WHERE IT IS POSSIBLE, AN UPPER LIMIT OF 30 PERCENT WILL APPLY TO THE TRANSITION FROM 14.7 PSIA OPERATIONS TO 8.0 PSIA OPERATIONS.
 2. WHEN A DEPRESS TO 8 PSI IS USED AS A METHOD TO CONTROL RISING O₂ CONCENTRATIONS, AN UPPER LIMIT OF 40 PERCENT WILL APPLY TO THE TRANSITION FROM 14.7 PSIA OPERATIONS TO 8.0 PSIA OPERATIONS.

The 8.0 psia cabin operations is a contingency situation only requiring a landing no further than the next PLS. The 30 percent limit during the transition represents an O₂ concentration which is considered acceptable at all operating cabin pressures (14.7, 10.2, 8.0) for contingency situations. However, for scenarios where the depress to 8 psi is required as a method for controlling rising O₂ concentrations below the maximum limits (such as when the crew is required to remain on the QDM's/ACES for extended periods of time or during an unisolatable O₂ leak into the cabin), it is not possible or practical to maintain the O₂ concentration below 30 percent. Therefore, in these cases, the 8.0 psia upper limit of 40 percent will apply. For example, in an avionics bay fire case, a depress rate great enough to maintain 30 percent maximum O₂ concentrations will also result in a negative differential pressure on the avionics bay, with respect to the cabin, causing the Halon and toxic combustion products to be drawn into the cabin (reference the rationale for Rule {A17-2C}.2, CABIN FIRE DEFINITION AND ACTIONS [HC]). For these cases, it is considered less risk to manage the O₂ concentration between 30 and 40 percent in order to extend on-orbit time and avoid exposing the crew to toxic gasses. The decision to manage oxygen concentration up to 40 percent while at 8.0 psia is based on several factors. First, Rule {A13-53A}.2, MINIMUM PPO₂ CONSTRAINTS [HC], requires the minimum acceptable PPO₂ level for 8.0 psia operations to be 2.35 psi in order for the crew to remain off the Advanced Crew Escape Suit (ACES) helmets/Quick Don Masks (QDM's) in a contingency situation. This is equivalent to a 30 percent O₂ level which is equivalent to the limit to which cabin materials have been tested. If the crew were to don the ACES helmets once PPO₂ dropped below 2.35 psi, the resulting excess flow of oxygen would not allow maintaining the O₂ concentration below 30 percent. Therefore, it is not possible to both maintain percent O₂ under acceptable limits (30 percent) and maintain an acceptable breathing atmosphere for the crew, without helmets, at 8.0 psia. Secondly, Halon 1301 effectively is degraded at O₂ percentages higher than 40 percent; however, test data shows it can extinguish a fire in 8.0 psia/40 percent O₂ concentration. Finally, 40 percent allows the crew more on-orbit stay time and less crew involvement with the direct O₂ valve than an upper limit less than 40 percent. ©[090894-1673A] ©[062305-6653] ©[ED]

THIS RULE CONTINUED ON NEXT PAGE

FLIGHT RULES

A17-254

CABIN O2 CONCENTRATION (CONTINUED)

The 36-hour decision point for which upper limit to apply to oxygen concentration at 8.0 psi is arbitrary. A reason for having two upper limits while at 8.0 psi is to avoid extended operations at high O₂ concentration levels. Leak rates which allow less than 36 hours will be large enough to keep the oxygen concentration from remaining above 35 percent for long periods of time. (Ref. Rule {A13-53A}.2, MINIMUM PPO2 CONSTRAINTS [HC].) ©[090894-1673A] ©[ED]

Documentation: PRCB PCIN 41004, NASA TR-255-001.

Rules {A2-301}, CONTINGENCY ACTION SUMMARY [HC]; {A10-382}, PRESSURE/REDUNDANT WINDOW PANE FAILURE [HC]; {A13-52}, PPCO2 CONSTRAINT (TWO GAS) [HC]; {A13-105}, DECOMPRESSION SICKNESS RESPONSE AND TREATMENT; {A13-155}, ORBITER HAZARDOUS SUBSTANCE SPILL RESPONSE [HC]; {A13-157}, CABIN ATMOSPHERE CONTAMINATION FIRE/SMOKE; {A17-1}, AVIONICS BAY FIRE DEFINITIONS AND ACTIONS [HC]; {A17-2}, CABIN FIRE DEFINITION AND ACTIONS [HC]; {A17-4}, SMOKE EVENT DEFINITION AND ACTIONS [HC]; {A17-258}, LOSS OF CABIN INTEGRITY TMAX DEFINITION AND TIG SELECTION; and {A17-1001}, LIFE SUPPORT GO/NO-GO CRITERIA, reference this rule. ©[ED] ©[033105-6599B] ©[101305-6655A] ©[ED] ©[042706-7275A] ©[032807-8400] ©[ED]

FLIGHT RULES

A17-255

8 PSIA EMERGENCY CABIN CONFIGURATION

THE 14.7 PSIA CABIN REGULATOR INLET VALVES WILL BE CLOSED AND THE CABIN WILL BE ALLOWED TO BLEED TO 8 PSIA ONLY IF: @[090894-1673A]

- A. CABIN LEAK: O₂/N₂ CONSUMABLES ARE INSUFFICIENT TO ALLOW THE ORBITER TO EFFECT A NEXT PLS ENTRY AT 14.7 (10.2 IF ALREADY IN 10.2 PSIA OPS) PSIA CABIN PRESSURE PLUS A 24-HOUR FLIGHT EXTENSION AT 8 PSIA.

Operation at 14.7 psia is preferred because, at 8 psia, a powerdown is required and the crew must wear the ACES helmet. However, if inadequate consumables exist to allow both a 14.7 (10.2 if already in 10.2 PSIA ops) psia cabin pressure to the next PLS opportunity and 1 extension day at 8 psia, the cabin will be immediately reconfigured to the 8 psia emergency configuration (i.e., 14.7 cabin regulators closed and associated powerdowns performed). @[062305-6653]

If it is determined that enough consumables exist to allow the 14.7 (10.2 if already in 10.2 PSIA ops) psia cabin pressure to the next PLS plus the 24-hour extension day at 8 psia, then the 14.7 (10.2 if already in 10.2 PSIA ops) psia cabin will be maintained to the next PLS opportunity to attempt a normal entry. If entry cannot be performed at the PLS opportunity, then the cabin must be reconfigured to the 8 psia emergency configuration for the remainder of the mission and an entry performed prior to consumables depletion @[090894-1673A]

DOCUMENTATION: Engineering judgment.

- B. CABIN/AV BAY FIRE OR LEVEL 4 HAZARDOUS SPILL: THE CREW IS REQUIRED TO WEAR THE ACES/QDM, FOR AN EXTENDED PERIOD OF TIME TO PROTECT THEMSELVES AGAINST A CONTAMINATED CABIN ATMOSPHERE. @[090894-1673A] @[062305-6653] @[ED]

A cabin depress to 8 psi and continuous purge at 8 psi will manage O₂ concentration below maximum levels as well as decrease the concentration of discharged Halon and any potentially toxic gases that were produced by a fire or hazardous elements that were spilled into the cabin atmosphere. This action could extend the time on orbit so as to avoid an ELS entry (ref. Rule {A17-2}, CABIN FIRE DEFINITION AND ACTIONS [HC], and {A13-155}, ORBITER HAZARDOUS SUBSTANCE SPILL RESPONSE [HC]). @[ED] @[ED]

DOCUMENTATION: Engineering judgment @[090894-1673A] @[ED]

FLIGHT RULES

A17-256**O₂ BLEED ORIFICE MANAGEMENT**

THE O₂ BLEED ORIFICE WILL BE INSTALLED IN AN LEH VALVE QUICK DISCONNECT (QD), PRESLEEP ON FLIGHT DAY 1, IF PPO₂ LEVELS ARE BELOW 3.20 PSIA. THE O₂ BLEED ORIFICE WILL BE REMOVED DURING DEORBIT PREPARATION ACTIVITIES ON ENTRY DAY. FOR WAVEOFF DAYS, THE BLEED ORIFICE WILL BE REINSTALLED AS REQUIRED. @[042403-5957A]

The O₂ bleed orifice, sized specifically for metabolic consumption of O₂ based on crew size, is installed to keep the 14.7 cabin regulator inlets in the low flow region of the regulator. This eliminates nuisance O₂/N₂ FLOW HIGH alarms caused by WCS cycles and O₂/N₂ flow switchovers. Normally, the bleed orifice is installed presleep on flight day 1, if PPO₂ levels permit. Due to oxygen introduced into the cabin via LES flow during ascent, however, the PPO₂ may be elevated to such a degree that bleed orifice installation is not necessary until postsleep on flight day 2. Delaying the installation will allow metabolic consumption to lower PPO₂ to nominal levels.

The bleed orifice is not used during ascent/entry since the PCS system is deactivated and there is no concern of generating nuisance flow alarms.

DOCUMENTATION: Flight data.

A17-257**N₂ SYSTEM MANAGEMENT**

BOTH N₂ SYSTEMS WILL NORMALLY BE OPERATED AS ONE SYSTEM.

Nominal operations for N₂ systems 1 and 2 has both systems fully open (i.e., supply valves, regulator inlet valves, etc.) so N₂ will be depleted simultaneously from all tanks. One of the drawbacks of operating both nitrogen systems as a single system is the possibility of losing more than one system's nitrogen quantity in the event of a massive tank leak. However, by operating both systems fully open, the risk is removed of a supply valve failing closed and cutting off one N₂ system for the remainder of the mission. The likelihood of a supply valve failing closed is considered greater than the possibility of a massive tank leak, and therefore the system is operated to protect against failure of one, or both, of the N₂ supply valves failing closed. Also, by depleting nitrogen equally from both systems, the quantity of N₂ remaining in a good system is maximized.

DOCUMENTATION: Engineering judgment.

Rule {A17-202B}, 8 PSIA CABIN CONTINGENCY 165-MINUTE RETURN CAPABILITY, references this rule.

FLIGHT RULES

A17-258

LOSS OF CABIN INTEGRITY TMAX DEFINITION AND TIG SELECTION

- A. T_{MAX} IS DEFINED AS THE LATEST DEORBIT TIG THAT WILL ALLOW A LANDING BEFORE THE DEPLETION OF N_2 CONSUMABLES. IF CONSUMABLES WILL BE DEPLETED BEFORE A PLS LANDING, AN ELS LANDING WILL BE EFFECTED.
- B. THE MINIMUM ACCEPTABLE CABIN PRESSURE PRIOR TO ATMOSPHERIC REPRESSURIZATION IS 8 PSIA. THE PCS SHALL BE CONFIGURED TO MAINTAIN 8 PSIA. NOTE: EXTENDED TIME ON ORBIT AT A LOWER CABIN PRESSURE WILL BE SACRIFICED TO MAINTAIN A CABIN PRESSURE OF 8 PSIA.
- C. A DEORBIT TIG FOR LOSS OF CABIN PRESSURE INTEGRITY SHALL OCCUR AT OR BEFORE T_{MAX} .

T_{max} is defined as the deorbit TIG that synchronizes touchdown with the depletion of N_2 consumables. Note that T_{max} is independent of landing site availability and does not account for cooling certification violations due to loss of cabin pressure.

The T_{max} prediction is based on an assumed 8-psia emergency regulator maximum flowrate of 125 lb/hr of N_2 each (while the spec max flow is 75 lb/hr, OMRSD testing shows that the actual average max flow is about 125 lb/hr). It also assumes that the time from TIG to touchdown is 60 minutes and that O_2 is managed between 2.2 and 3.0 psia (ref. Rules {A17-254}, CABIN O_2 CONCENTRATION, and {A13-53}, MINIMUM PPO2 CONSTRAINTS [HC]). N_2 depletion is defined in Rule {A17-204}, N_2 SUPPLY, as tank pressure below 200 (375) psia. ©[ED] ©[ED]

The vehicle avionics are not certified to withstand cabin pressures below 8 psia due to cooling requirements. Also, a cabin pressure of 8 psia is the minimum pressure which will allow the crew to function normally for any length of time without a prebreathe. Reference Rule {A13-51A}, CABIN PRESSURE [HC]. For these reasons, maintaining 8 psia (if possible) is mandatory. ©[ED]

In maintaining 8 psia, N_2 supplies will be exhausted as necessary. No N_2 conservation steps that involve lowering the cabin stabilization pressure below 8 psia will be attempted. Therefore, the time on orbit that could be achieved if the cabin was allowed to stabilize at a lower pressure will be sacrificed to maintain 8 psia.

THIS RULE CONTINUED ON NEXT PAGE

FLIGHT RULES

A17-258 LOSS OF CABIN INTEGRITY T_{MAX} DEFINITION AND TIG SELECTION (CONTINUED)

Actual TIG determination will be based on T_{max} and not the cabin stabilization pressure. Obviously, TIG must occur at or before T_{max} so that N_2 consumables do not deplete before touchdown, thereby allowing the cabin to drop to near zero pressure.

If a PLS site is available at 8 psia, it would be the most desirable landing site. Landing site options at cabin pressures lower than 8 psia will be very limited (probably one, if any) due to the rapid depletion of N_2 (a leak would have to be over 250 lb/hr for cabin pressure to stabilize below 8 psia). Therefore, landing site selection at cabin stabilization pressures lower than 8 psia need not be addressed.

All other rules regarding acceptable PPO₂ levels for breathing and O₂ concentration levels in the cabin must be upheld during a cabin leak in order to effect a safe entry.

DOCUMENTATION: NASA memo from James M. Waligora/SD5 - 7/14/86, EVA Prebreathe N_2 vs. Decompression Sickness Risk Table, engineering judgment, and KSC 8-psia reg OMRSD ground checkout testing. @[050400-7196]

A17-259 LES O2 SUPPLY SYSTEM LOSS MANAGEMENT [HC] @[102506-6388A]

- A. IF AN O₂ SYSTEM IS LOST DUE TO AN O₂ XOVR VALVE FAILURE, CHECK VALVE FAILURE, OR BLOCKAGE, AN IFM TO RESTORE FLOW WILL BE PERFORMED. @[050495-1756B]

If an O₂ XOVR valve or check valve is failed closed, the ability to protect the crew from a contaminated cabin is probably lost. For the blockage case, the IFM will be performed if the blockage is in such a place that allows the IFM to be viable. The IFM will restore full functionality to the LES MANIFOLD.

- B. UNTIL THE IFM IS COMPLETE, MIDDECK EXPERIMENTS INVOLVING LEVEL 3 OR 4 TOXIC MATERIALS THAT HAVE FEWER THAN THE SAFETY PANEL APPROVED NUMBER OF LEVELS OF CONTAINMENT SHOULD NOT BE PERFORMED, UNLESS DOING SO CLEARLY DOES NOT INCREASE THE RISK FOR A SPILL.

Experiments involving Level 3 or 4 toxic materials that have fewer than the Safety Panel approved number of levels of containment have lost a level of containment. Performing these experiments while an LES O₂ SUPPLY SYSTEM is lost may subject the crew to unnecessary risk. Experiments in isolatable volumes (Spacehab, etc.) are not affected by this rule. @[050495-1756B] @[092701-4872]

THIS RULE CONTINUED ON NEXT PAGE

FLIGHT RULES

A17-259

LES O2 SUPPLY SYSTEM LOSS MANAGEMENT [HC] (CONTINUED)

C. CONSIDERATION WILL BE GIVEN TO PERFORMING A REAL-TIME TEST OF THE LES MANIFOLD CAPABILITIES.

1. IF THE SINGLE O₂ SYSTEM SUPPLIES ENOUGH O₂ WHILE ALL CREWMEMBERS ARE BREATHING RAPIDLY, THEN THE LES O₂ SUPPLY SYSTEM WILL BE CONSIDERED GO. @[050495-1756B] @[102506-6388A]
2. IF THE REAL-TIME TEST FAILS AT 14.7 PSIA, CONSIDERATION WILL BE GIVEN TO LOWERING THE CABIN PRESSURE TO SUCH THAT A SINGLE SYSTEM COULD SUPPLY SUFFICIENT O₂. @[050495-1756B]

It is generally believed that each crewmember consumes approximately 5.5 lbm/hr of O₂ at 14.7 psia while breathing on ACES or QDM's, which exceeds the capacity of a single O₂ supply system. A single system can provide approximately 25 lbm/hr. However, usage varies with each crew, so it is possible that a single system could supply sufficient O₂. The 5.5 lbm/hr of O₂ at 14.7 psia is equivalent to a volumetric breathing rate of 31.5 L/m which is assumed constant regardless of the ambient pressure. Therefore, reducing the cabin pressure will decrease the lbm/hr flow demand, while maintaining the required volumetric flow rate. If the real-time test fails at 14.7 psia, consideration will be given to lowering the cabin pressure to such that a single system could supply sufficient O₂. (For example, at 9.4 psia, a crewmember with a sustained worst-case respiratory rate of 31.5 L/m (equivalent to 5.5 lbm/hr at 14.7 psia) will consume approximately 3.4 lbm/hr of O₂, sufficient to support seven crewmembers with one O₂ system). @[062305-6653]

Documentation: STS-26 flight data, engineering judgment.

Reference Rule {A17-206}, LES O2 SUPPLY SYSTEM LOSS DEFINITION. @[050495-1756B]

Hazard Report ORBI-270 Inability to Supply Oxygen to Cabin/Crew @[102506-6388A]

FLIGHT RULES

A17-260

PCS O₂/N₂ CONTROLLER CHECKOUT

- A. THE IN-FLIGHT CHECKOUT OF THE PCS O₂/N₂ CONTROLLERS REQUIRES A SWITCHOVER IN EACH DIRECTION WHILE OPERATING AT A CABIN PRESSURE OF 14.7 PSIA WITH THE O₂/N₂ CONTROLLER SWITCH IN THE "AUTO" POSITION. ALTHOUGH NOT REQUIRED, CHECKOUT OF BOTH SYSTEMS IS DESIRABLE AND WILL BE ACCOMPLISHED ON A NON-INTERFERENCE BASIS WITH MISSION OBJECTIVES. ©[032901-4188] ©[ED]

Checkout of the PCS O₂/N₂ Controllers is performed in-flight due to impacts associated with performing the checkout during ground processing. Switchover is based on the change in sensed ppO₂ across the upper and lower set points of the controller. Observing switchovers from both O₂ to N₂ and from N₂ to O₂ verify that the O₂/N₂ Controller is operating properly in its control range. Both switchovers must be observed during the same flight in order to complete a controller checkout. Full vehicle checkout requires four switchovers: one in each direction, and on each controller while operating at a cabin pressure of 14.7 psia. The Space Shuttle Master Verification Plan (MVP) requires at least one PCS system performance to be verified each flight. The PCS is normally reconfigured mid-flight to provide checkout time on both systems. However, mission events may require reconfiguration to be delayed to obtain a full checkout on one controller.

DOCUMENTATION: OMRS File IX, DV611FC.030 and ARPCS Performance Verification.

- B. IF A "NATURAL" SWITCHOVER DURING AUTOMATIC 14.7 PSI OPERATIONS DOES NOT OCCUR, THE FOLLOWING STEPS WILL BE EXECUTED, IN PRIORITY ORDER, TO INDUCE A SWITCHOVER AND ENSURE THE CHECKOUT OF AT LEAST ONE CONTROLLER:
1. TERMINATE FLOW TO THE O₂ BLEED ORIFICE.
 2. PLACE THE O₂/N₂ CONTROLLER SWITCH IN THE "CLOSED" POSITION (O₂) DURING CREW SLEEP.

Nominally, during 14.7 psi operations, the O₂/N₂ Controller switch is in "AUTO" while the crew is awake and "OPEN" (N₂) during sleep (to preclude switchover from O₂ to N₂ which can cause an N₂ Flow Hi alarm). Some missions do not provide enough time in auto mode to satisfy a complete checkout of both controllers due to 10.2 psi operations, pressures above 14.7 psi due to ISS repress, etc. In addition, some crews' metabolic O₂ use is well matched to the makeup flow from the O₂ Bleed Orifice and therefore ppO₂ does not change enough to drive a switchover. Auto switchovers cannot be predicted preflight; predictions require trend data for the specific crew during several wake and sleep periods.

©[032901-4188]

THIS RULE CONTINUED ON NEXT PAGE

FLIGHT RULES

A17-260

PCS O₂/N₂ CONTROLLER CHECKOUT (CONTINUED)

Terminating O₂ Bleed Orifice flow will cause ppO₂ to decrease more rapidly, increasing the likelihood of a switchover from N₂ to O₂. Similarly, configuring the O₂/N₂ control valve to flow O₂ during crew sleep will slow the decrease of PPO₂ and possibly cause PPO₂ to rise overnight. This action will expedite a switchover from O₂ to N₂ once the O₂/N₂ controller is configured back to "AUTO" during crew wake. In this case, O₂ will be managed prior to sleep to prevent alarms during sleep. These methods require ground analysis for prediction and additional crew switch throws. ©[032901-4188]

Switchovers observed during represses do not satisfy the PCS checkout requirement because the data gathered could be lower fidelity due to the transient PPO₂ levels and short time between switchovers during the variable pressure environment of a repress. Therefore, switchovers observed during represses will only be used for PCS checkout verification in the event that a 'natural' or 'induced' switchover has not been observed due to unexpected events.

If a complete in-flight PCS checkout of at least one O₂/N₂ Controller cannot be accomplished on a mission, then additional ground testing is required prior to the next flight of that vehicle. If a full in-flight checkout is not accomplished, ground personnel will document the specific switchovers that did not occur and will ensure that the PCS is placed in the appropriate configuration to achieve the required switchovers during the next flight of the vehicle.

DOCUMENTATION: Engineering judgment and In-flight Checkout of the Orbiter Pressure Control System, EC3-00-011 ©[032901-4188]

A17-261 THROUGH A17-300 RULES ARE RESERVED

FLIGHT RULES

10.2 PSIA CABIN ATMOSPHERE OPERATION

A17-301 CABIN ATMOSPHERE MANAGEMENT

THE CABIN ATMOSPHERE WILL BE MANUALLY MANAGED TO MAINTAIN THE CABIN PRESSURE BETWEEN 10.0 AND 10.4 PSIA AND THE CABIN PPO₂ BETWEEN 2.55 AND 2.80 PSIA, INDICATED.

Operation at these conditions satisfies the 10.2 EVA protocol for bends prevention, provides adequate PPO₂, and maintains an acceptable O₂ concentration below 30 percent. The 10.0 psia cabin pressure minimum avoids a powerdown due to cooling requirements. The 10.4 psia cabin pressure avoids C&W alarms from being tripped. The C&W upper limit is set at 10.6 to avoid breaking the 8.44 PPN₂ limit for EVA prebreathe. A PPO₂ of 2.55 psia prevents the crew from having to don ACES helmets for 2.50 psia minimum metabolic PPO₂ at a 10.2 psia cabin pressure. 2.80 psia PPO₂ is within the 30 percent O₂ concentration flammability limit during 10.2 psia operations (ref. Rule {A13-53A}.1, MINIMUM PPO₂ CONSTRAINTS [HC]). ©[062305-6653] ©[ED]

Rule {A13-103C}.1, EVA PREBREATHE PROTOCOL [HC], references this rule. ©[ED]

A17-302 10.2 PSIA CABIN DEPRESSURIZATION CONSTRAINTS

CABIN DEPRESSURIZATION WILL NOT BE PERFORMED IF ANY OF THE FOLLOWING CONDITIONS EXIST:

- A. CABIN PRESSURE TRANSDUCER HAS FAILED, OR THE CABIN PRESSURE TRANSDUCER HAS DRIFTED BEYOND ±1.2 PERCENT FULL-SCALE AND NEITHER OF THE FOLLOWING IS AVAILABLE:
 1. UPLINK OF A PASS SM CABIN PRESSURE CALIBRATION COEFFICIENT REAL-TIME COMMANDER OR,
 2. AN EMU FEEDWATER PRESSURE SENSOR THAT CAN BE VERIFIED AS ACCURATE TO WITHIN ±0.24 PSIA FOR USE AS AN ALTERNATE CABIN PRESSURE TRANSDUCER. ©[111094-1687]

The available OI backup measurements to determine cabin pressure, airlock/overboard delta P, and the delta P between supply H₂O inlet P and H₂O regulator P are not accurate enough to keep the cabin within specified pressure and PPO₂ limits. The airlock/overboard delta P transducer can give as much as ±2.0 psi inaccuracy on the true cabin pressure. Using the H₂O regulator inlet pressure transducers and the H₂O supply inlet pressure can give as much as ±2.8 psi inaccuracy. Therefore, the depressurization should not be performed using only these since these transducers do not provide accurate means of determining cabin pressure and O₂ concentration. ©[111094-1687]

THIS RULE CONTINUED ON NEXT PAGE

FLIGHT RULES

A17-302

10.2 PSIA CABIN DEPRESSURIZATION CONSTRAINTS (CONTINUED)

One of the requirements for the 10.2 psi certification (PCIN 60154) was to ensure the cabin pressure transducer would be within ± 1.2 percent full-scale (± 0.24 psi) accuracy prior to launch. The OMRSD requires the transducer to be within ± 1.0 percent prior to the vehicle leaving the OPF. This allows for some drift to occur between OPF processing and launch. A single point check is then performed during PPO₂ sensor calibration approximately 2 weeks prior to launch. If the transducer is determined to have drifted beyond ± 1.2 percent during the single point check, then a SCALING COEFFICIENT SET UPDATE (OI-21 and subs) will be required for any 10.2 psi operations using the last seven-point calibration verification for that vehicle. ©[111094-1687]

The EMU feedwater pressure sensor is certified as Crit 1 flight instrumentation. The spec accuracy of the EMU feedwater pressure sensor is ± 0.4 psia (± 2.5 percent full-scale); however, actual performance of the sensor far exceeds the specifications during vacuum chamber testing. The actual sensor performance varies with each EMU and is calibrated prior to each mission. If the orbiter cabin pressure sensor were to fail, an EMU would be unstowed, powered up, and a reading made of the feedwater pressure (AIRLK P XX.X on the EMU DCM) with the feedwater shutoff valve closed (WATER - OFF). The downlinked value of feedwater pressure sensor is given to two decimal places; however, it requires that the EMU UHF comm be active. The reading should be taken as soon as possible (within 1/2 hour is preferred) after the failure of the cabin pressure sensor is detected. The reported EMU reading will be compared to the last valid reading of the orbiter cabin pressure sensor and the vacuum chamber feedwater pressure sensor calibration data to verify that ± 0.24 psia accuracy (the 10.2 certification requirement) can be met. ©[050400-7196]

Use of the EMU for monitoring cabin pressure will only be required during the depress to 10.2 psi and the 10.2 psi maintenance activities. It is not necessary for the EMU to remain powered continuously. This will not pose a constraint to missions where only two EMU's are manifested since the cabin atmosphere will be managed to preclude the need for a 10.2 psi maintenance during the EVA when no EMU's are available in the orbiter. If there are no other EVA's scheduled, the cabin can be repressed to 14.7 psi during the EVA. ©[050400-7196]

Additional methods are available to perform coarse checks of the EMU feedwater pressure reading without the orbiter cabin pressure sensor. These methods include comparisons of the airlock/overboard (cabin/airlock) delta pressures and the delta pressure between the supply H₂O inlet pressure and H₂O regulator pressure, and Fluke MultiCal Pressure Sensor. The CSA-CP reads O₂ percent; therefore, if PPO₂ is known, the cabin pressure can be estimated as another means of comparison. The Fluke MultiCal Pressure Sensor and CSA-CP are currently not certified as Crit 1 hardware and are, therefore, not available for use as an alternate means of monitoring for 10.2 psi operations. ©[121604-6458A]

If 10.2 EVA protocol cannot be utilized, the EVA crew will be required to prebreathe for 4 hours (14.7 EVA protocol) prior to each EVA. The 10.2 EVA protocol requires only a 40-minute prebreathe. ©[111094-1687]

THIS RULE CONTINUED ON NEXT PAGE

FLIGHT RULES

A17-302

10.2 PSIA CABIN DEPRESSURIZATION CONSTRAINTS
(CONTINUED)

DOCUMENTATION:	PCN 60154	-	10.2 PSI CERTIFICATION WAIVER/QSA.
	MCR 11891	-	ESTABLISHMENT AND CERTIFICATION OF ORBITER FOR EVA OPERATIONAL ENVIRONMENTS.
	SS-P-0002-1400	-	CPDS SS DOWNLIST/UPLINK SOFTWARE REQUIREMENTS.
	SCR 90173A	-	ADD CABIN P TO SCALING COEFF U/L CMD.
	SV799100/S	-	PLSS S/A D (PORTABLE LIFE SUPPORT SYSTEM SPECIFICATIONS AND DRAWINGS)
			BOEING FEPC EMU FLIGHT DATA BOOK
			JSC EMU CHAMBER TESTING, AND ENGINEERING JUDGMENT

@[111094-1687]

B. TWO OF THE THREE PPO₂ SENSORS ARE FAILED. @[090894-1455]

During the depress to 10.2 psia and while at 10.2 psia, the cabin atmosphere is maintained manually, using PPO₂ as one of the determining parameters. Because the PPO₂ transducers have a history of drifting and PPO₂ must be maintained within tight limits, one sensor is not sufficient to guarantee that PPO₂ will be maintained within limits; therefore, there needs to be at least one confirming sensor to insure an accurate PPO₂ and O₂ concentration reading. @[121604-6458A]

If C&W/FDA limits cannot be annunciated for PPO₂, the crew will have to closely monitor it to maintain the proper atmosphere. @[090894-1455]

DOCUMENTATION: *Engineering judgment.*C. TOTAL N₂ QUANTITY IS LESS THAN: @[050400-7196]

1. THE NOMINAL MISSION REQUIREMENT, PLUS
2. THE N₂ REDLINE REQUIREMENT (FROM THE TABLE IN PARAGRAPH B.1 OF RULE {A17-202}, 8 PSIA CABIN CONTINGENCY 165-MINUTE RETURN CAPABILITY), PLUS
3. IF NOT INCLUDED IN THE NOMINAL MISSION REQUIREMENT, THE VOLUME-DEPENDENT AMOUNT REQUIRED TO REPRESS THE CABIN FROM 10.2 TO 14.7 PSIA, PER THE FOLLOWING TABLE. (NOTE: ONLY THE VOLUME THAT IS ACTUALLY BEING RERESSED SHOULD BE USED.) @[050400-7196]

THIS RULE CONTINUED ON NEXT PAGE

FLIGHT RULES

A17-302

10.2 PSIA CABIN DEPRESSURIZATION CONSTRAINTS (CONTINUED)

CONFIG (VOLUMES TO BE DEPRESSED)	VOLUME (FT ³)	REPRESS REQ'T (LBM)
ORB + EXT ARLK	2703	59.9
ORB + EXT ARLK + TNL ADPTR	2833	62.8
ORB + EXT ARLK + TNL ADPTR + SHORT TNL + SINGLE HAB	3946	87.4
ORB + EXT ARLK + TNL ADPTR + SHORT TNL + DOUBLE HAB	5052	111.9
ORB + EXT ARLK + TNL ADPTR + LONG TNL + SINGLE HAB	4149	91.9
ORB + EXT ARLK + TNL ADPTR + LONG TNL + DOUBLE HAB	5255	116.4

@[050400-7196] @[121604-6458A]

If the 10.2 depress had been scheduled preflight, the amount of N₂ required to repress the cabin would be contained in the Nominal Mission Requirement.

The repress requirement listed in the above table assumes a cabin temp of 70 deg F and a repress of N₂ only, which is conceivable though conservative.

Some volumes may have requirements against operating at 10.2 psia. It may also be advantageous to preserve N₂ by isolating volumes prior to depressing to 10.2 psia. Only the volumes to be repressed from 10.2 psia should be used.

DOCUMENTATION: Engineering judgment. @[050400-7196]

FLIGHT RULES

A17-303 **CABIN REPRESSURIZATION MANAGEMENT** ©[082604-6356]

PRIOR TO PERFORMING DEORBIT PREP, THE CABIN WILL BE REPRESSURIZED BACK TO 14.7 PSIA UNLESS A CABIN LEAK OF UNKNOWN ORIGIN OCCURS WHILE THE CABIN PRESSURE IS BEING MANAGED AT 10.2 PSIA.

An entry at a cabin pressure less than 14.7 psia is undesirable due to reduced cooling efficiency of the avionics and cabin atmosphere. Concern exists about the integrity of powered avionics exposed to higher heat loads at cabin pressures less than 14.7 psi during entry power levels. These components would require a postflight analysis to determine if they should be replaced prior to the next flight, resulting in extended postflight turnaround time.

By repressurizing the cabin with a declared unknown leak in the pressurized module, a structural pressure increase will be imparted on the cabin which could cause the size of the leak to increase. If the leak is of known origin and the source of the leak ensures the hole will not become larger by repressing the cabin to 14.7 psia, then a cabin repressurization may be performed if it can be done within the consumables guidelines of Rule {A17-201B}, CABIN PRESSURE INTEGRITY [HC].

DOCUMENTATION: Engineering judgment and Minutes of Initial 10.2 psia Certification meeting, August 18, 1986, Document # TM3-86-039. ©[082604-6356]

A17-304 **RESERVED** ©[112304-6468]

FLIGHT RULES

A17-305 RESERVED ®[082604-6356]

A17-306 RESERVED ®[042403-5900]

A17-307 PAYLOAD 10.2 PSIA CABIN OPERATIONS

PAYLOADS WITHIN THE CREW MODULE THAT HAVE NOT BEEN CERTIFIED TO OPERATE IN A 30 PERCENT O₂ ENVIRONMENT WILL BE POWERED OFF DURING 10.2 PSIA CABIN OPERATIONS.

The Orbiter Middeck/Payload Standard Interface Control Document (ICD) gives a requirement that payloads must be compatible with a 31 percent O₂ environment at 10.2 psia cabin pressure. This avoids creating an ignition source in a high oxygen concentrated environment. This rule applies to payloads which may have a waiver or some other reason for being manifested on a flight with a scheduled cabin depress.

DOCUMENTATION: Orbiter Middeck/Payload Standard ICD, ICD 2-1 M001, March 1984.

FLIGHT RULES

A17-308 ATCS (10.2 PSIA CABIN) CONFIGURATION

ATCS CONFIGURATION WILL BE AS FOLLOWS:

- A. WITH ONLY ONE FLOW PROPORTIONING VALVE (FPV) IN THE INTERCHANGER (ICH) POSITION, A FES PRIMARY CONTROLLER MUST BE ACTIVATED. ©[ED]

With only one FPV in the ICH position, the FES is required to maintain cabin temperature < 80 deg F and the avionics bay air outlet temperatures < 130 deg F. ©[ED]

- B. WITH BOTH FPV'S IN THE ICH POSITION, THE FES MAY BE DEACTIVATED IF ORBITER ATTITUDES ALLOW THE RADIATORS TO CONTROL THE EVAP OUT T < 52 DEG F. ©[ED]

This should maintain cabin temperature < 80 deg F and the avionics bay air outlet temperatures < 130 deg F. However, the FES is normally activated during 10.2 psia operations to minimize fluctuations in cabin temperature and cabin pressure. ©[ED]

During periods when the orbiter attitude allows sunlight into the orbiter windows, the cabin temperature may experience fluctuations that exceed 80 deg F. For those cases, the window sunshades should be installed on the affected windows to minimize the thermal impact.

DOCUMENTATION: SEH-ITA-83-179T; flight data (STS-7, STS-41D, STS-31).

A17-309 CABIN PRESSURE TIME AT 10.2 PSIA

TIME AT 10.2 PSIA WILL BE MINIMIZED AS MUCH AS PRACTICAL.

Operations at 10.2 psia run closer to the flammability and cooling limits (than at 14.7 psia) as well as putting the orbiter in an off-nominal configuration for emergency deorbit. For these reasons, time at 10.2 psia should be minimized. However, the prebreathe protocol that requires the crew to be at 10.2 psia for 36 hours prior to an EVA should have priority over these concerns. The 36-hour period is required to avoid the initial 1-hour prebreathe prior to/during cabin depress.

Documentation: SEH-ITA-83-179T, Minutes of Initial 10.2 psia Certification meeting, August 18, 1986.

Reference Rule {A13-103}, EVA PREBREATHE PROTOCOL [HC]. ©[012694-1600] ©[ED]

A17-310 THROUGH A17-350 RULES ARE RESERVED

FLIGHT RULES

WASTE COLLECTION SYSTEM (WCS) / VACUUM VENT LOSS DEFINITIONS

A17-351 **WCS SEPARATOR**

THE WCS SEPARATOR IS CONSIDERED LOST IF:

- A. UNABLE TO ESTABLISH DC OR AC POWER TO THE WCS SEPARATOR.
- B. THE SEPARATOR IS FLOODED AND CANNOT BE CLEARED.

The primary function of the WCS separator is to separate waste water from the cabin atmosphere. If the separator is flooded and cannot be cleared, or it will not start because it is unpowered, it is considered lost.

DOCUMENTATION: Engineering judgment.

A17-352 **WCS URINE COLLECTION**

WCS URINE COLLECTION CAPABILITY IS CONSIDERED LOST IF UNABLE TO TRANSPORT URINE TO THE WASTE WATER SYSTEM THROUGH EITHER PATH IN THE WCS.

The primary function of the WCS urine collection system is to transport liquid waste water to the waste water tank. If the line is blocked, leaking, or both separators are lost or any combination of failures which prevents the WCS from transporting urine to the waste water system, the urine collection mode is considered lost.

DOCUMENTATION: Engineering judgment and schematic.

FLIGHT RULES

A17-353

WCS COMMODE

THE WCS COMMODE IS CONSIDERED LOST AND SHOULD NO LONGER BE OPERATED IF:

- A. UNABLE TO OPEN THE SLIDE VALVE.
- B. THE COMMODE IS FULL AND CANNOT BE EMPTIED.
- C. UNABLE TO ESTABLISH SUFFICIENT AIRFLOW THROUGH COMMODE OUTLET TO CONTAIN FECAL MATTER WHEN THE SLIDE VALVE IS OPEN.
- D. VACUUM VENT CANNOT BE REMOVED FROM COMMODE FOR WCS USAGE.
- E. THE FECAL STORAGE TANK IS RUPTURED.

The commode must be able to collect and retain fecal matter. Operation of the WCS with any of the above conditions (except paragraph D) results in potential fecal matter in the cabin environment, which is unacceptable for reason of crew health.

For conditions A, B, C, and E, lengthy IFM procedures may have to be executed. If the WCS cannot be repaired, the mission may be terminated early because only a finite number of bags are carried on the orbiter.

If the vacuum vent (ref. paragraph D) cannot be removed from the commode during WCS usage, the WCS is at least partially open to vacuum. Furthermore, operation of the WCS under this condition could damage the slide valve and/or its seals. Several EECOM/IFM methods exist to remove the vacuum vent from the commode (e.g., STS-33 in-flight anomaly), but the intent of this rule is to cease WCS operations while the WCS is being evaluated and repaired.

DOCUMENTATION: Engineering judgment and schematic.

FLIGHT RULES

A17-354 VACUUM VENT LOSS DEFINITION [HC] @[102506-7367]

VACUUM VENT CAPABILITY IS LOST IF THE WCS WASTE COLLECTOR PRESSURE EXCEEDS 0.5 PSIA (ABOVE ANY BIAS ON WCS COLLECTOR PRESSURE TRANSDUCER) WITH THE COMMODE NOT IN USE. THE IFM FLUKE METER WILL BE USED TO EXONERATE A FAILED WCS WASTE COLLECTOR PRESSURE TRANSDUCER.

The primary function of the vacuum vent is to vent gaseous waste, particularly H₂ gas extracted from fuel cell product water (approximately 9.75 × E-5 lb/hr, approximately 10 sccm). The vacuum vent isolation valve is constructed such that an orifice in the valve plate allows a flow of approximately 3 lb/hr (at 14.7 psia cabin conditions) even with the valve fully closed. Assuming the commode is not in use, an increasing WCS waste collector pressure would indicate an obstruction somewhere in the vacuum vent line. This pressure increase will continue due to the buildup of hydrogen from the hydrogen separators, and cabin air from the WCS wet trash vents as the line attempts to equalize to cabin pressure. The WCS Waste Collector Pressure transducer exhibits a range of 0.0 to 2.0 psia with flight data showing a nominal pressure reading of 0.0 psia when the WCS is not in use. A pressure reading of 0.5 psia above any transducer bias on the WCS Waste Collector Pressure transducer is therefore an indicator of a pressure increase in the Vacuum Vent line. An unexplained pressure increase is an indicator of blockage and a failure of the Vacuum Vent System to effectively vent hydrogen and wet trash air.

Based upon analysis, this mixture of hydrogen and oxygen (from the air) could produce a potentially flammable mixture within 4 hours of the failure, requiring an alternate means to vent this mixture overboard. To exonerate a failed WCS Collector Pressure transducer, the IFM Fluke meter will be connected to the vacuum vent line via the vacuum vent QD. @[ED 1]

DOCUMENTATION: NASA Hydrogen Safety Standard (NSS 1740.16, SAFETY STANDARD FOR HYDROGEN AND HYDROGEN SYSTEMS, 1997), RD-WSTF-0001, Ignition and Thermal Hazards of Selected Aerospace Fluids (1988), Hazard Report ORBI-240D, Vacuum Vent Line Blockage Hydrogen Combustion Hazard Analysis, Document #WSTF-H2HAZ/FAIL.0001 (February 28, 2005), engineering judgment, STS-114 flight data, and schematic.

*Rule {A17-405}, VACUUM VENT SYSTEMS MANAGEMENT [CIL] [HC], references this rule.
@[102506-7367]*

A17-355 THROUGH A17-400 RULES ARE RESERVED

FLIGHT RULES

WCS/VACUUM VENT MANAGEMENT

A17-401 WCS USAGE CONSTRAINT

THE WCS WILL NOT BE USED IF:

A. THE CABIN IS BEING REPRESSURIZED.

Possible low O₂ concentrations resulting from high N₂ flow during cabin repressurization could cause possible acute hypoxia of the crewmember using the WCS. Due to the small area that the WCS is in and due to the location of the WCS in relation to the PCS panel, M010W, exposure to the WCS area should be minimized.

DOCUMENTATION: CSD-SH-194.

B. AN EMU IS BEING DRAINED.

The WCS fan separator maximum waste water flowrate is 0.09 lbm/sec. With a crewmember using the WCS at a flowrate of 0.088 lbm/sec, the separator will flood when the EMU waste water is also drained through the WCS.

DOCUMENTATION: SODB 4.6.2.2.1.a.1.a and 4.6.2.2.3.b.2.b.

A17-402 LEAKING WCS WATER LINES

FOR AN UNREPAIRABLE LEAK IN THE WCS URINE LINE FROM THE INLINE FILTER TO THE WCS/WASTE WATER INTERFACE QUICK DISCONNECT, NO LIQUIDS WILL BE TRANSPORTED THROUGH THE WCS.

This is to prevent water from flowing into the cabin. Free water in the cabin could cause crew exposure to bacteria and toxins contained in waste water or the possibility of an electrical circuit malfunction.

DOCUMENTATION: Engineering judgment and schematic.

A17-403 ALTERNATE FECAL COLLECTION

IF THE WCS COMMODE IS LOST, THE CREW WILL USE THE APOLLO FECAL BAG TO COLLECT FECAL MATTER.

Waste bags are the alternate method of collecting waste. The standard manifest provides 40 bags to accommodate at least a PLS plus 2 days (3 days).

DOCUMENTATION: Engineering judgment and Crew Compartment Configuration Drawings, drawing SED-32101800-306.

FLIGHT RULES

A17-404 **ALTERNATE URINE COLLECTION [HC]** @[082604-6310A]

IF THE WCS URINE COLLECTION CAPABILITY IS LOST, THE CREW WILL USE THE APPROPRIATE CONTINGENCY OPTIONS:

- A. THE MALE URINE COLLECTION DEVICE (UCD) OR ADULT PANTS (FEMALE) .
- B. IFM TO PROVIDE OVERBOARD URINATION CAPABILITY.

UCD's and adult pants are alternate measures for collecting urine. The standard manifest provides UCD's (four are dedicated to the EMU's) and adult pants to accommodate at least a PLS plus 2 days (3 days). An IFM exists to provide urination capability using the overboard waste dump line via the contingency cross-tie.

DOCUMENTATION: Engineering judgment and Crew Compartment Configuration Drawing, "Volume G, contingency UCD's/Waste Management," SED-32101800. Hazard Control Reference: "Crew Illness Due to Cabin Contamination by Free Waste Water or Solid Waste," ORBI-254. @[082604-6310A]

A17-405 **VACUUM VENT SYSTEMS MANAGEMENT [CIL] [HC]**
@[102506-7367]

SHOULD THE VACUUM VENT ISOLATION VALVE FAIL CLOSED OR VACUUM VENT CAPABILITY BE DETERMINED LOST, THE FOLLOWING ACTIONS WILL BE TAKEN: @[042507-7366]

- A. OPERATION OF THE COMMODE WILL BE TERMINATED UNTIL VACUUM VENT CAPABILITY IS RESTORED.
- B. THE WCS VACUUM VALVE MUST REMAIN OPEN AND THE WCS WASTE COLLECTOR PRESSURE TRANSDUCER UTILIZED TO MONITOR PROPER VENTING OF GASEOUS WASTE OVERBOARD.
- C. THE "CONTINGENCY VACUUM VENT OPERATION" IFM WILL BE ACCOMPLISHED AS SOON AS PRACTICAL TO PROVIDE VACUUM VENT REDUNDANCY, AND WILL REMAIN INSTALLED THROUGH ENTRY.
- D. THE IFM HOSE WILL BE DISCONNECTED AT THE CONTINGENCY WATER CROSSTIE WASTE QD DURING WASTE WATER DUMPS. @[042507-7366]

THIS RULE CONTINUED ON NEXT PAGE

FLIGHT RULES

A17-405

VACUUM VENT SYSTEMS MANAGEMENT [CIL] [HC] (CONTINUED)

The vacuum vent isolation valve is constructed such that an orifice in the valve plate allows a flow of approximately 3 lbm/hr (at 14.7 psia cabin conditions) even with the valve fully closed. If the vacuum vent isolation valve were to fail in the closed position, the next worst failure (blockage of the valve's orifice) would prevent H₂ from the fuel cells and air from the wet trash from being vented overboard. Monitoring the WCS waste collector pressure will provide insight to ensure that H₂ and air are being vented overboard through the vacuum vent isolation valve orifice. An increase in the WCS collector pressure not related to a WCS commode repress (ref. Rule {A17-354}, VACUUM VENT LOSS DEFINITION [HC]) would be indicative of a blockage in the vacuum vent orifice. The WCS vacuum valve must remain open, as closing the valve would allow the H₂ concentration to more rapidly approach flammability limits due to the decreased volume. This action would also take away insight of vacuum vent system pressure by isolating the WCS collector pressure transducer. ©[102506-7367] ©[042507-7366]

The primary concern with a blockage of the vacuum vent line is the buildup of a flammable/detonable H₂-air mixture. H₂ is being introduced into the system at approximately 10 sccm (approximately 9.75 x 10⁻⁵ lbm/hr) from the hydrogen separators while moist air from the wet trash is entering the system at about 6 lbm/day. Mixing of the air and hydrogen prevent the lower flammability limit from being reached for approximately 4 hours. H₂ is flammable/detonable in air between concentrations of 4 percent and 75 percent. As time from the initial blockage increases, the H₂ concentration increases, reaching 8 percent (deflagration likely if ignited) within 9.5 hours and 20 percent (detonation possible if ignited) within about 25 hours. While there are no known ignition sources within the system, the conservative approach is to assume one is present. A non-uniform mixture may form as H₂ and air continue to enter the system and could create the hazard of a small flash fire before 4 hours has elapsed. Such an event would have insufficient energy to cause significant damage; however, action will be taken as soon as possible. An IFM allowing venting of the vacuum vent line through the waste dump line path will be conducted upon failure of the vacuum vent isolation valve or upon indication of a blockage in the vacuum vent line. Operation of the commode will be terminated until the IFM has restored vacuum vent capability so as to prevent the hydrogen-air mixture from entering the cabin during commode operations.

The IFM will be temporarily disconnected during waste dumps to prevent waste water from entering the vacuum vent system and possibly the cabin. Should the WCS collector pressure transducer indicate that both venting routes have been blocked, the IFM will then be moved to the supply water dump line.

DOCUMENTATION: NASA Hydrogen Safety Standard (NSS 1740.16, Safety Standard for Hydrogen and Hydrogen Systems, 1997); RD-WSTF-0001, Ignition and Thermal Hazards of Selected Aerospace Fluids, 1988; Hazard Report ORBI-240, Rev D, Vacuum Vent Line Blockage Hydrogen Combustion Hazard Analysis; Document WSTF-H2HAZ/FAIL.0001, February 28, 2005; engineering judgment; and schematic. ©[042507-7366]

A17-406 THROUGH A17-450 RULES ARE RESERVED

FLIGHT RULES

WASTE WATER LOSS DEFINITIONS

A17-451 WASTE WATER TANK

THE WASTE WATER TANK IS CONSIDERED LOST IF:

- A. UNABLE TO FILL THE TANK.
- B. THE TANK OR INLET MANIFOLD HAS AN IRREPARABLE LEAK.
- C. THE WASTE TANK QUANTITY IS AT 98 (93) PERCENT AND WASTE DUMP CAPABILITY IS LOST.
- D. THE WASTE TANK HAS A BELLOWS LEAK AND THE WASTE LIQUID PRESSURE IS ≥ 5 PSID ABOVE THE H₂O N₂ REGULATOR INLET PRESSURE. [ED]

The primary purpose of the waste tank is to collect and store waste water. If the line to the waste tank is blocked or has an irreparable leak, or if the waste water tank is full and cannot be dumped, the waste tank is considered lost. For an irreparable leak, the waste tank will be unable to store waste water. For a bellows leak, there is no way to determine the quantity in the waste water tank. The waste liquid pressure normally reads approximately the same as H₂O N₂ regulator inlet pressure. If the waste liquid pressure is ≥ 5 psid, then the waste water tank is full and will not be allowed to store any more water, because then water will transfer into the N₂ system by passing through the hydrophobic filter.

DOCUMENTATION: Engineering judgment and SODB, 4.6.2.2.4.c.2.

FLIGHT RULES

A17-452

WASTE WATER DUMP CAPABILITY

THE WASTE WATER DUMP CAPABILITY IS CONSIDERED LOST IF:

- A. THE WASTE WATER DUMPLINE TEMPERATURE CANNOT BE MAINTAINED > 32 DEG (37 DEG) F.

This is the minimum temperature at which a successful dump may be accomplished to prevent any ice from forming on the nozzle and to prevent the water in the dumpline from freezing.

The contingency crosstie will not be used because it is downstream of the dump isolation valve. This is to prevent the stagnant water in the waste water dumpline from forming into ice, while the waste water is being dumped through the supply water nozzle.

DOCUMENTATION: SEH-TCH-85-036.

- B. THE WASTE WATER DUMPLINE IS BLOCKED AND THE CREW IS UNABLE TO USE THE CONTINGENCY CROSSTIE.

If the dumpline is blocked, the primary path to dump waste water is unusable. If the crew cannot use the contingency crosstie to dump waste water through the supply water nozzle (see Rule {A18-52}, SUPPLY/WASTE WATER CROSSCONNECT), the only other method to dump waste water has been lost.

DOCUMENTATION: Engineering judgment.

- C. AN IRREPARABLE LEAK IN THE LINE EXISTS PAST THE WASTE DUMP ISOLATION VALVE.

This is to prevent free water in the cabin if the leak is inside the crew module. If the leak is outside the 576 bulkhead, it is to prevent ice from forming under the payload bay liner causing damage to the equipment that is located under the liner.

DOCUMENTATION: Engineering judgment and schematic.

THIS RULE CONTINUED ON NEXT PAGE

FLIGHT RULES

A17-452 WASTE WATER DUMP CAPABILITY (CONTINUED)

- D. BOTH WASTE NOZZLE TEMPERATURE TRANSDUCERS ARE FAILED, THE RMS IS UNAVAILABLE TO OBSERVE A WASTE WATER DUMP, AND THE CREW IS UNABLE TO USE THE CONTINGENCY CROSSTIE.

With no insight into the nozzle temperatures, waste water dumps will not be permitted (without the RMS observing) to prevent forming an icicle on the nozzle due to an undetectable heater failure. If available, the RMS must be used to observe all subsequent dumps. Once ice growth outward from the nozzle is visually observed, the dump shall be terminated (see Rule {A17-505C}, WASTE WATER DUMP NOZZLE TEMPERATURE CONSTRAINTS). If the crew cannot use the contingency crosstie to dump waste water through the supply water nozzle (see Rule {A18-52}, SUPPLY/WASTE WATER CROSSCONNECT), the only remaining method to dump waste water has been lost.

DOCUMENTATION: Engineering judgment.

- E. THE NOZZLE TEMPERATURE CRITERIA FOR DUMPING WASTE WATER CANNOT BE MET AND THE CREW IS UNABLE TO USE THE CONTINGENCY CROSSTIE.

If the nozzle temperature criteria cannot be met, the primary path to dump waste water is unusable (ref. Rule {A17-505}, WASTE WATER DUMP NOZZLE TEMPERATURE CONSTRAINTS). If the crew cannot use the contingency crosstie to dump waste water through the supply water nozzle (ref. Rule {A18-52}, SUPPLY/WASTE WATER CROSSCONNECT), the only other method to dump waste water has been lost.

DOCUMENTATION: Engineering judgment.

A17-453 THROUGH A17-500 RULES ARE RESERVED

FLIGHT RULES

WASTE WATER MANAGEMENT

A17-501 ALTERNATE PRESSURE VALVE MANAGEMENT

THE ALTERNATE PRESSURE VALVE WILL NORMALLY BE CLOSED THROUGHOUT THE FLIGHT.

The alternate pressure valve is a backup means of supplying pressure (cabin pressure) to the water system. Normal water system pressurization utilizes the gaseous nitrogen system. Activation of this valve only lowers available water system pressure to cabin pressure and should be used in a contingency mode only.

DOCUMENTATION: Engineering judgment, SODB 4.6.1.1.1 r, SODB figures 4.6.1-3 and 4.6.1-4.

A17-502 WASTE DUMP NOZZLE ICE FORMATION

- A. IF ICE IS DETECTED ON THE WASTE DUMP NOZZLE, ALL FURTHER DUMPS FROM EITHER NOZZLE WILL BE DISCONTINUED UNTIL SUCH TIME AS THE ABSENCE OF THE ICE CAN BE VERIFIED. @[061396-1878C]
- B. ONCE THE ABSENCE OF ICE CAN BE VERIFIED VISUALLY OR BY THE OBSERVATION OF NOMINAL NOZZLE HEATER CYCLES, DUMPS FROM THE SUPPLY NOZZLE MAY BE PERFORMED.
- C. SUBSEQUENT WASTE DUMPS MAY BE CONSIDERED IF SUFFICIENT ULLAGE (WASTE TANK + CWCS) IS NOT AVAILABLE TO MAKE NOMINAL EOM, AND A METHOD TO VISUALLY OBSERVE THE NOZZLE IS AVAILABLE. @[061396-1878C]

Detectable ice buildup on the waste dump nozzle has been known to compound the ice formation on the supply nozzle due to the close proximity of the nozzles to each other (approximately 6.5 to 7.0 inches). Frost has not been a problem. If the ice can be procedurally removed, supply dumping can be resumed because the mechanism aiding in the supply nozzle ice growth no longer exists. The original problem causing the waste nozzle to ice is probably still present so the risk of creating more ice is reduced by not allowing any more waste dumps. When a method is available to visually observe the nozzle for ice formation, the dump can be stopped when it is observed that the ice is starting to grow outward from the nozzle and before the ice becomes a problem. @[061396-1878C]

DOCUMENTATION: Engineering judgment; CSD-SH-291; flight data STS-8, STS 41-B, STS 41-D and STS-65. @[061396-1878C]

Rule {A17-505}, WASTE WATER DUMP NOZZLE TEMPERATURE CONSTRAINTS, references this rule. @[061396-1878C]

FLIGHT RULES

A17-503 **WASTE WATER MANAGEMENT [HC]** ©[052704-6267B] ©[ED]

THE FOLLOWING TECHNIQUES WILL BE USED, IN ORDER OF PRIORITY, TO MANAGE WASTE WATER:

The priorities for management of liquid waste are necessary to provide for protection of the crew's health while maintaining ability to complete certain mission objectives.

- A. STORE WASTE WATER IN THE WASTE WATER TANK AND DUMP THROUGH THE WASTE DUMPLINE. ©[042502-5329B]

Storing waste water in the waste tank and dumping it through the waste dumpline is the most acceptable way to manage the waste water system because it provides for protection of the crew's health by isolating the waste water from the crew compartment and supply water system.

- B. UTILIZE THE CONTINGENCY WATER COLLECTION BAG (CWC).

Although storing waste water in a CWC also protects crew health, it raises significant operational concerns, including crew time for unstowing, using and restowing contingency equipment, temporary stowage of the CWC in the middeck, planning for CWC dump and/or stowage for landing (ref Rule {A10-385}, FILLED CWC STOWAGE MANAGEMENT), and the possibility of a leak and/or odor from the CWC (unlikely due to CWC redesign). ©[042502-5329B]

- C. UTILIZE THE URINE COLLECTION DEVICE (UCD).

- D. OVERBOARD URINATION VIA CONTINGENCY CROSSTIE AND WASTE DUMPLINE.

- E. USE THE CONTINGENCY WATER CROSSTIE TO DUMP WASTE WATER THROUGH THE SUPPLY WATER DUMP NOZZLE.

Use of the contingency water crosstie and the supply water dumpline limits the amount of line that has to be replaced during ground turnaround (potable water is protected from contamination by the dump isolation and tank A outlet valves).

- F. TERMINATE THE FLIGHT EARLY.

- G. CONFIGURE SUPPLY WATER TANK B AS A SPARE WASTE TANK AFTER THE LAST EMU RECHARGE FOR ALL PLANNED EVA'S. ©[052704-6267B]

THIS RULE CONTINUED ON NEXT PAGE

FLIGHT RULES

A17-503

WASTE WATER MANAGEMENT [HC] (CONTINUED)

Use of supply water Tank B as a spare/contingency waste water tank will result in contamination of supply water Tank B, FES Feedline A, and the EMU supply water line. Use of FES Feedline A (waste water for FES cooling) could result in a FES shutdown and loss of one or both FES cores. Due to the risk to FES redundancy and the major impacts to ground turnaround at KSC (to clean or replace contaminated components), this option should be considered a last resort for remaining on-orbit to accomplish major mission objectives. ©[052704-6267B]

DOCUMENTATION: Hazard Report ORBI-254, Crew Illness Due To Cabin Contamination By Free Waste Water or Solid Waste, April 29, 1988; engineering judgment. ©[052704-6267B]

A17-504

RESERVED ©[052704-6267B]

FLIGHT RULES

A17-505

WASTE WATER DUMP NOZZLE TEMPERATURE CONSTRAINTS

- A. THE WASTE DUMP NOZZLE TEMPERATURE SHOULD NOT EXCEED 350 DEG F WHILE THE NOZZLE HEATERS ARE ACTIVATED.

The maximum design operating temperature of the waste water dump nozzle is 350 deg F. External tiles surrounding the nozzle are likely to debond if this temperature is exceeded.

- B. NORMALLY, WASTE WATER DUMPS WILL BE INITIATED WHEN THE NOZZLE TEMPERATURES ARE GREATER THAN 150 DEG F.

This is the minimum temperature (on STS-35) at which waste water dumps have been accomplished).

DOCUMENTATION: STS-35 flight data and STS-35 SPAN-MER CHIT 037.

- C. IF THE RMS IS USED TO OBSERVE A WASTE H₂O DUMP, THE DUMP WILL BE TERMINATED IF EITHER:

1. THE WASTE WATER DUMP NOZZLE TEMPERATURE IS < 45 DEG F. THE NOZZLE MAY BE REHEATED FOR ANOTHER DUMP ATTEMPT;

OR

2. ICE GROWTH OUTWARD FROM THE NOZZLE IS VISUALLY OBSERVED. ANOTHER DUMP WILL NOT BE ATTEMPTED UNTIL THE ICE FORMATION IS MELTED. NOZZLE GLAZING OR FROSTING IS NOT CAUSE TO TERMINATE THE DUMP.

The minimum temperature limit prevents ice from forming on the nozzle. Instrumentation error is not considered when the RMS is available to monitor for ice formation. The dump can be stopped when it is observed that the ice is starting to grow outward from the nozzle and before it becomes a problem.

DOCUMENTATION: SODB 3.4.6.2, table 3.4.6.2.1, and flight data.

THIS RULE CONTINUED ON NEXT PAGE

FLIGHT RULES

A17-505

WASTE WATER DUMP NOZZLE TEMPERATURE CONSTRAINTS
(CONTINUED)

- D. IF THE RMS IS NOT OBSERVING THE WASTE WATER DUMP, THE DUMP WILL BE TERMINATED IF THE WASTE DUMP NOZZLE TEMPERATURE IS < 50 DEG F. THE NOZZLE MAY BE REHEATED FOR ANOTHER DUMP ATTEMPT.

This is the minimum temperature used in past missions at which successful waste water dumps have been accomplished. Another dump attempt will be done only if the slope of the dump nozzle temperature indicates a normal profile (to prevent the formation of ice on the nozzle).

DOCUMENTATION: STS-49 and STS-46 flight data.

- E. IF PLATEAUIING IS OBSERVED ANYTIME IN THE NOZZLE TEMPERATURE WARM-UP PROFILE, NO FURTHER WASTE H₂O DUMPS WILL BE PERFORMED.

The plateauiing effect, indicating that ice has formed on the nozzle, has been observed on past flights. To prevent more ice from forming on the nozzle, no dumps will be performed until Rule {A17-502}, WASTE DUMP NOZZLE ICE FORMATION, is satisfied.

DOCUMENTATION: SEH-ITA-84-134 and flight data.

Rule {A17-452}, WASTE WATER DUMP CAPABILITY, references this rule.

FLIGHT RULES

A17-506

WASTE WATER SYSTEM LEAK MANAGEMENT

FOR WASTE WATER SYSTEM LEAKS, THE FOLLOWING GUIDELINES WILL PERTAIN:

- A. IF FREE WASTE WATER IS IN THE CABIN, THE "FREE FLUID DISPOSAL" IFM PROCEDURE WILL BE PERFORMED IMMEDIATELY. IF PRACTICAL, THE WASTE WATER TANK WILL BE DUMPED TO 5 PERCENT PRIOR TO INITIALLY PERFORMING THE "FREE FLUID DISPOSAL" IFM PROCEDURE.

Immediate removal of free waste water is necessary to protect the crew from the bacteria and toxins in the waste water. Free fluid in the cabin is an unacceptable condition because of LRU exposure to the free liquid causing an electric circuit malfunction and possible subsequent LRU failures.

Dumping the waste water tank creates additional ullage so that, if the IFM procedure causes a blockage in the waste water dump line, waste water will continue to collect to maximize the on-orbit stay period. STS-32 experienced free water in the lower equipment bay due to degraded humidity separator collection. The FREE FLUID DISPOSAL IFM was employed to dump the water overboard via the waste water dump nozzle. However, while employing the IFM procedure on the third occasion during the mission on FD 10, the waste water dump line became blocked by matter collected using the free fluid nozzle (wand). The mission was then limited by the remaining ullage in the waste water tank and the CWC volume.

For the STS-36 humidity separator failure, the waste water tank was dumped prior to using the FREE FLUID DISPOSAL IFM. Even though no blockage occurred in the waste water dump line, the mission on-orbit stay was maximized by having additional ullage created by the dump.

DOCUMENTATION: Ref. STS-32 MER Anomaly #21, January 19, 1990; STS-32 CAR No. 32RF21; STS-36 MER Anomaly #11, April 3, 1990; STS-36 CAR No. 36RF13; and engineering judgment.

- B. IF THE WASTE TANK HAS AN IRREPARABLE EXTERNAL LEAK, THE TANK WILL BE VENTED TO CABIN PRESSURE AND DUMPED OVERBOARD (IF POSSIBLE). PROVISIONS WILL BE MADE FOR COLLECTION OF LIQUID WASTE USING CWC. IF POSSIBLE, NO FURTHER WASTE WATER WILL BE ALLOWED TO ACCUMULATE IN THE WASTE TANK. ©[090894-1665A]

THIS RULE CONTINUED ON NEXT PAGE

FLIGHT RULES

A17-506

WASTE WATER SYSTEM LEAK MANAGEMENT (CONTINUED)

Venting a leaking waste tank equalizes the pressure to that of the cabin, which serves to reduce the outflow of waste water into the cabin. Dumping the waste tank is necessary to further prevent waste water flow into the cabin and should be done unless otherwise prevented from doing so. Since the orbiter has only one waste tank, the CWC is used to collect liquid waste from the Humidity and WCS Fan Separators. The CWC is then dumped periodically, based on the actual flight waste production rate. Each flight typically carries two CWC's, rated at 95 lbm H₂O. For a typical 7-person crew, this is about 45 hours capability per CWC based on 0.3 lb/hr per crewmember. @[090894-1665A] @[041196-1874A]

- C. IF AN UNISOLABLE N₂ LEAK INVOLVING THE WASTE TANK IS PRESENT, THE N₂ SUPPLY TO THE WATER PRESSURIZATION SYSTEM WILL BE SHUT OFF. LEAK LOCATION PERMITTING, AN IFM TO ISOLATE THE WASTE TANK FROM THE REST OF THE WATER PRESSURIZATION SYSTEM WILL BE PERFORMED. THE REMAINING PARTS OF THE WATER SYSTEM WILL BE RETURNED TO NORMAL PRESSURE ONCE THAT IFM IS COMPLETE (LEAK LOCATION PERMITTING) .

For an unisolable N₂ leak, the N₂ pressurant supply to the water pressurization manifold is temporarily shut off to prevent continuous N₂ flow into the cabin. Returning to normal water system pressurization is highly desirable, since the FES is sometimes adversely affected by lower system pressures (depending on orbiter power level and cooling needs).

DOCUMENTATION: STS-55 flight experience and engineering judgment.

FLIGHT RULES

A17-507

OMS & PRCS BURNS WITH FREE H₂O IN THE CABIN

CONSIDERATION WILL BE GIVEN TO DELAYING NON-CRITICAL OMS AND PRCS BURNS WHEN THE PRESENCE OF FREE H₂O IN THE CREW CABIN IS CONFIRMED. @[051195-1755]

In microgravity, the surface tension of water tends to force free water to collect in globules. OMS and PRCS burns have the potential to disperse free H₂O throughout the Cabin/LEB, possibly being dislodged to the surfaces of electrically powered LRU's/wire bundles, thus providing the potential for an electrical short.

Several flights have had instances where large amounts of H₂O was present in the LEB. During STS-27 and STS-32, approximately 2 gallons of free H₂O was found present in the lower equipment bay. This water was found to be dispersed and present on the surfaces of several pieces of equipment in the LEB. On STS-27, some of this water seeped through two middeck panels.

The amount of H₂O present, its location and adherence to equipment or structure, and the criticality of the burn will determine if delaying of the burn will be necessary.

DOCUMENTATION: Engineering judgment. @[051195-1755]

FLIGHT RULES

A17-508

WASTE TANK QUANTITY MANAGEMENT [HC]

THE WASTE TANK QUANTITY WILL BE MANAGED AS FOLLOWS : @[052704-6267B]

- A. ON ORBIT, THE WASTE TANK WILL NOT BE ALLOWED TO EXCEED 98 (93) PERCENT. A WASTE TANK DUMP WILL BE PLANNED SUCH THAT DUMP INITIATION OCCURS PRIOR TO THE WASTE QUANTITY EXCEEDING 95 (90) PERCENT.

Exceeding 98 (93) percent could lead to backflow of waste water into the cabin, and/or possible waste tank bellows damage. The waste tank should be managed such that there is sufficient time for the ground and crew to react to problems with dump execution (ice, blockage, crew or attitude availability, etc.). Since waste dumps must be planned many hours in advance, 3 percent is held in reserve for variables such as higher than predicted waste production rates, mission activities, and contingency operations that may prevent the crew from initiating the dump on time, or being able to start an IFM if there are dump problems. If the waste tank is allowed to fill to 98 (93) percent prior to dump initiation, measures such as constraining WCS ops or offloading waste water into a CWC should be made available for immediate implementation should dump capability be lost.

DOCUMENTATION: 12A JOP#3/13A JOP#4 (October 7, 2003) and JOP #174 (October 9, 2003) minutes.

- B. FOR ENTRY DAY, THE WASTE TANK QUANTITY SHOULD NOT EXCEED 93 (88) PERCENT 2 HOURS AFTER TOUCHDOWN FOR THE LAST OPPORTUNITY OF THE DAY.

Protecting for 93 (88) percent tank quantity 2 hours after the last landing (TD) opportunity provides adequate ullage for postlanding waste (condensate) generation prior to vehicle powerdown, as well as expansion of gas in the waste water tank when the water tanks are "unpressurized" to perform vacuum vent inerting.

- C. WASTE DUMP TERMINATION SHOULD OCCUR PRIOR TO THE WASTE TANK QUANTITY REACHING 0 (5) PERCENT.

Terminating a waste dump prior to the tank reaching 0 (5) percent precludes the metal bellows from being subjected to stress when it hits the hard stop. If the waste tank is at 0 percent, a vacuum will exist on both the waste dumphine and the water side of the waste tank bellows. Subsequently, a cabin leak will occur when the WCS and the humidity separator liquid check valves crack. If the pressure on the water side decreases too much, the bellows will exceed its maximum operational pressure of 28 psid or its maximum structural pressure of 32 psid.

DOCUMENTATION: SODB 4.6.2.2.4.e, Hazard Report ORBI-254, Crew Illness Due To Cabin Contamination By Free Waste Water or Solid Waste, April 29, 1988, engineering judgment. @[052704-6267B]

A17-509 THROUGH A17-550 RULES ARE RESERVED

FLIGHT RULES

GALLEY MANAGEMENT LIFE SUPPORT @[021600-7139A]

A17-551 **IODINE REMOVAL IMPLEMENTATION [HC]** @[082604-6299B]

A. HARDWARE INSTALLATION AND REMOVAL

1. THE GALLEY IODINE REMOVAL ASSEMBLY (GIRA) SHALL BE INSTALLED ON FLIGHT DAY 1.
2. ON ENTRY DAY, THE GIRA SHALL BE REMOVED AND STOWED AFTER THE CREW HAS DRAWN WATER IN PREPARATION FOR FLUID LOADING.
3. IF A 1-DAY DEORBIT WAVEOFF IS DECLARED, THE GIRA NEED NOT BE REINSTALLED AFTER DEORBIT PREP BACKOUT UNLESS REQUIRED BY SURGEON AND/OR DESIRED BY THE CREW.

The Galley Iodine Removal Assembly (GIRA) consists of a microbial check valve, microbial filter, and an ACTivated carbon/ion EXchange (ACTEX) cartridge. The GIRA eliminates iodine from the chilled galley water and reduces the concentration to about 1.5 ppm in galley ambient/hot water. The hardware assembly is installed as soon as practical to maintain the crew iodine consumption to less than 1 mg/day/crewmember. GIRA hardware is nominally removed after crew fluid loading prep is complete. During the time period of a 1-day waveoff, the crew will not consume enough iodine to be a health risk. Therefore, reinstallation is not required unless Surgeon deems it necessary for crew health (flight specific basis). The crew also has the option of reinstalling the GIRA hardware if they prefer it.

Reference Rule {A13-30}, IODINE REMOVAL REQUIREMENT [HC]. @[ED 1]

DOCUMENTATION: NSTS 07700, Vol X – Book 1, Para 3.3.1.2.4.9, defines the total iodine consumption per day/crewperson.

4. FOR THE FAILURE OF GIRA, THE HARDWARE ASSEMBLY WILL BE REMOVED AND THE MISSION WILL CONTINUE TO COMPLETION.

The requirement is to minimize the amount of iodine consumed by the crew. This will be accomplished within the capacity of the galley hardware without compromising primary mission objectives. @[021600-7139A]

DOCUMENTATION: ORBI-323; Safety Assessment Report (SAR) for the International Space Station (ISS) Water Transfer System (WTS), JSC-39244A (April 2001); Safety Assessment Report (SAR) for the Activated Carbon/Ion Exchange (ACTEX) unit, JSC-39134, Revision A (February 1999). @[082604-6299B]

THIS RULE CONTINUED ON NEXT PAGE

FLIGHT RULES**A17-551 IODINE REMOVAL IMPLEMENTATION [HC] (CONTINUED)****B. GALLEY CONFIGURATION ©[021600-7139A] ©[082604-6299B]**

1. THE CHILLED SUPPLY LINE WILL BE DISCONNECTED FROM THE GIRA HARDWARE AND CONNECTED TO THE SUPPLY TEE AT THE CHILLED LINE QD PRIOR TO CREW SLEEP ("OVERNIGHT CONFIG"). IODINATED CHILLED WATER WILL BE CIRCULATED BY CYCLING THE GALLEY/RHS SWITCH. THERE ARE NO RESTRICTIONS ON DRINKING GALLEY SUPPLIED WATER WHILE IN THE OVERNIGHT CONFIG.
2. THE GIRA CHILLED WATER CONNECTION WILL BE RESTORED IN POSTSLEEP ("MORNING CONFIG"). UNIODINATED CHILLED WATER WILL BE CIRCULATED BY CYCLING THE GALLEY/RHS SWITCH.

The overnight configuration will bypass the GIRA during chilled water recirculations and leave iodinated water in the galley overnight to inhibit microbial growth. The crew is not restricted from drinking while the galley is in the overnight configuration, since the amount of iodine so consumed is limited. In the morning, uniodinated water will be restored to the chilled lines for crew consumption by returning the GIRA to its original configuration. ©[021600-7139A]

3. FOR DUAL SHIFT FLIGHTS, IN EACH 24-HOUR PERIOD, THE GALLEY WILL BE PLACED IN THE OVERNIGHT CONFIGURATION FOR AN ABSOLUTE MINIMUM OF 1 CONTINUOUS HOUR. IT IS HIGHLY DESIRED TO HAVE THE GALLEY IN THE OVERNIGHT CONFIGURATION FOR A TOTAL OF 4 HOURS IN A 24-HOUR PERIOD. ©[021600-7139A]

In order to provide microbial control in the chilled water side of the galley during dual shift flights, it is recommended that the ACTEX cartridge and microbe filter be bypassed for a minimum of 1 hour during each 24-hour period (4 hours is highly desired). This is done by placing the GIRA hardware in the overnight configuration described in B.1 above. The chilled water loop volume is approximately 4 ounces or 120 ml. The recirculation pump operates at a rate of 1 L/min for 20-seconds every 8 minutes causing about 2.4 L iodinated water/hour to circulate through the system. The resulting iodinated water dwell time is sufficient to inhibit microbial growth.

C. FOR EACH EVA, EMU DISPOSABLE IN-SUIT DRINK BAGS (DIDB) SHALL BE FILLED AS FOLLOWS:

1. NOMINAL FILL (UNIODINATED): USING THE GALLEY REHYDRATION STATION (RHS) IN COMBINATION WITH THE ANGLED FILL ADAPTER TOOL (AFAT). THE WATER MUST BE CONSUMED WITHIN 24 HOURS OF BAG FILLING. ©[082604-6299B]

THIS RULE CONTINUED ON NEXT PAGE

FLIGHT RULES**A17-551 IODINE REMOVAL IMPLEMENTATION [HC] (CONTINUED)**

2. ALTERNATE FILL (IODINATED): USING WATER DISPENSED THROUGH THE GALLEY AUX PORT THROUGH A COMBINATION OF THE IDB FILL TOOL AND SPARE RHS SIDE-DISCHARGING NEEDLE IN COMBINATION WITH THE AFAT ©[082604-6299B]
3. EACH DIDB WILL BE DISCARDED IN WET TRASH AFTER A SINGLE USE. ©[021600-7139A]

EMU Disposable In-suit Drink Bags (DIDB) are only certified for a single use. They are nominally filled with non-iodinated water (via the Galley RHS using the AFAT) to minimize crew consumption of iodine. If timeline constraints prevent filling a DIDB within 24 hours of an EVA, iodinated water may be used with prior concurrence from the Flight Surgeon based on preflight testing of crew TSH levels. If iodinated water is used, the side-discharging RHS needle [part of the Contingency Water Dispenser (CWD)] must be used to ensure a proper fit into the AFAT.

Reference Rule {A13-30}, IODINE REMOVAL REQUIREMENT [HC]. ©[ED 1

- D. ALTERNATIVELY, IF THE RE-USABLE EMU IN-SUIT DRINK BAGS (IDB) ARE MANIFESTED, THEY SHALL BE FILLED AS FOLLOWS:
 1. NOMINAL FILL (IODINATED): USING THE IDB FILL TOOL TO DISPENSE IODINATED WATER FROM THE GALLEY AUX PORT
 2. ALTERNATE FILL (UNIIODINATED): USING WATER DISPENSED DIRECTLY DOWNSTREAM OF THE GIRA HARDWARE. THE WATER MUST BE CONSUMED WITHIN 24 HOURS OF BAG FILLING. AFTER THE EVA, THE BAG MUST BE FILLED WITH IODINATED WATER FROM THE GALLEY AUX PORT. THE AMOUNT OF WATER ADDED WILL BE AT LEAST EQUAL TO ONE HALF THE TOTAL VOLUME OF THE BAG. THIS IODINATED WATER MUST BE DRAWN INTO THE IDB DRINK VALVE. THE BAG WILL SIT UNTIL THE NEXT EVA OR POST EVA ENTRY PREP OR NO LESS THAN 1 HOUR.

EMU In-suit Drink Bags (IDB) will be filled from the Aux port unless prohibited by crew specific pre-flight tests of Thyroid Stimulating Hormone (TSH) levels. The amount of iodine consumed from an EMU drink bag filled in this manner will not be detrimental to crewmembers with low TSH levels. ©[082604-6299B]

THIS RULE CONTINUED ON NEXT PAGE

FLIGHT RULES

A17-551 IODINE REMOVAL IMPLEMENTATION [HC] (CONTINUED)

If preflight tests indicate crew TSH levels are high, the IDB will be filled with uniodinated (GIRA) water for each EVA. The iodine concentration of the water used to fill the bags is not sufficient to inhibit microbial growth in the drink bag for greater than 24 hours. If the GIRA is installed, the bag must be filled from the chilled side. After an EVA, the bags will be filled with partially iodinated water from the Galley Auxiliary port to combat any microbial growth in-between EVA's or until the bags are drained in the Post EVA Entry Prep. This sit time must be no less than 1 hour. When filled with iodinated water, water must be drawn into the IDB's drink valve to ensure that this area is also flushed with iodinated water. Iodinated water must be added at a ratio of 1 to 2 (with respect to total volume) in order to achieve a minimum iodine concentration to combat microbial growth (i.e., add a minimum 16 oz iodinated water to a 32 oz bag). ©[082604-6299B]

Reference Rule {A13-30}, IODINE REMOVAL REQUIREMENT [HC]. ©[021600-7139A] ©[ED]

Rule {A13-30}, IODINE REMOVAL REQUIREMENT [HC], references this rule. ©[012704-6529B] ©[ED]

A17-552 THROUGH A17-600 RULES ARE RESERVED

FLIGHT RULES

SPACEHAB FIRE/SMOKE @[111501-4992]

A17-601

SPACEHAB FIRE/SMOKE DETECTION LOSS

A. SPACEHAB SMOKE DETECTION SHALL BE CONSIDERED LOST FOR ANY ONE OF THE FOLLOWING REASONS:

1. ONE SMOKE DETECTOR FAILS BOTH PORTIONS OF THE CIRCUIT TEST AND THE OTHER SMOKE DETECTOR FAILS EITHER PORTION OF THE CIRCUIT TEST (LOSS OF THREE OF THE FOUR SMOKE INDICATIONS) .

Each smoke detector electronics assembly provides a frequency output for continuous monitoring, rate and concentration alarm signals, reset capability to recycle the alarm signal for hazard evaluation, and a built-in self test circuit to verify the status of the smoke sensor. If either the concentration of particles (from potential fire and smoke sources) or the rate of concentration increase measured by the sensor becomes larger than defined values, a continuous alarm signal is generated. To obtain a rate alarm, the sensor output frequency must change at a rate of 4.0 Hz/sec for eight consecutive time intervals of 2.5 seconds each. The concentration alarm is obtained whenever the sensor output frequency exceeds 820 ± 36 Hz (approximately 2000 to 2500 $\mu\text{g}/\text{m}^3$) for two consecutive time intervals of 2.5 seconds each. Energizing the self-test circuit generates an internal signal, which examines the sensor electronics and produces an alarm signal to signify a properly functioning unit. This sequence verifies sensor signal circuit continuity from the sensor since a circuit failure would prevent obtaining an alarm signal. The only hardware failure that can be detected by the circuit test is an air pump failure, which would force the detector to fail both portions of the circuit test. If the smoke detector passes either portion of the circuit test, the air pump is then verified as operative, and the concentration readout sent to the GPC for FDA limit sensing (Class 0 only, does not produce alarm) is considered a valid indication. If only one indication is left in the Spacehab, the system is considered suspect to the point of being unreliable.

2. POWER TO THE DETECTORS CANNOT BE MAINTAINED.

Power is required for the smoke detectors to operate. @[111501-4992]

THIS RULE CONTINUED ON NEXT PAGE

FLIGHT RULES**A17-601****SPACEHAB FIRE/SMOKE DETECTION LOSS (CONTINUED)**

3. LOSS OF AIR CIRCULATION DEFINED PER THE FOLLOWING: @[111501-4992]
 - a. (SM/LDM) ONLY) LOSS OF ATMOSPHERIC REVITALIZATION SYSTEM (ARS) FAN AND CABIN FAN @[ED]
 - b. (RDM) ONLY) LOSS OF BOTH HFA FANS

Loss of air circulation prevents particulates from reaching the smoke detector in a timely manner if the combustion is not close to the smoke detector. In the SM/Logistics Double Module (LDM) configuration, either the ARS or cabin fan provides sufficient airflow for smoke detection.

For the RDM, any single fan provides airflow to the smoke sensors. Analysis to ensure adequate air circulation with the habitable volume of the Research Double Module (RDM) for crew comfort and to preclude areas of stagnation, has been performed with at least one HFA fan operating nominally. When all three fans are operating nominally, the airflow is approximately 680 cfm, which results in the module air volume being recirculated approximately every 3.5 minutes. For loss of either a single HFA fan or the ARS fan, the airflow is reduced to approximately 460 cfm, which results in the module air volume being recirculated approximately every 5 minutes such that smoke detection may only be slightly delayed. For loss of the ARS fan and a single HFA fan, the airflow is approximately 270 cfm, which results in the module air volume being recirculated approximately every 9 minutes such that delay in smoke detection is still not considered significant enough to be considered lost. The stated times are average times for each case and actual times for smoke detection is dependent on location and severity of the fire. Note that without the ARS fan operating, the mixing box cap must be removed for adequate smoke detection in the forward module subfloor volume (reference Rule {A17-757}, RDM MIXING BOX CAP). With only the ARS fan operating and neither HFA fan operating, the airflow within the aft module subfloor volume may not be sufficient to provide timely movement of smoke particles from this location to the smoke sensors. Since no analysis has been performed for this fan configuration, smoke detection is considered lost in this case. If both HFA fans are failed, opening panel(s) above the aft subfloor volume may improve air circulation in this region until an IFM can be performed to recover an HFA fan. Reference: Boeing MEMO 2C-SPACEHAB-01044 and A90-SPACEHAB-2000192. @[111501-4992] @[ED]

THIS RULE CONTINUED ON NEXT PAGE

FLIGHT RULES

A17-601 **SPACEHAB FIRE/SMOKE DETECTION LOSS (CONTINUED)**

- B. FOR LOSS OF ONE OF THE FOUR SMOKE INDICATIONS, NOMINAL SPACEHAB OPERATIONS MAY CONTINUE. @[111501-4992]

Three smoke indications remain that can be used to provide monitoring capability and fire confirmation, half of one smoke detector and a second/redundant smoke detector.

- C. FOR LOSS OF TWO OF THE FOUR SMOKE INDICATIONS, SPACEHAB OPERATIONS MAY CONTINUE; HOWEVER, A SMOKE SENSOR TEST IS REQUIRED EVERY 24 HOURS.

Two of four smoke indications are lost when one smoke sensor fails both portions of the circuit test or both smoke sensors fail either portion of the circuit test. A smoke sensor test is required every 24 hours to verify that the remaining two smoke detection indications are valid.

- D. FOR LOSS OF SMOKE DETECTION, SPACEHAB OPERATIONS MAY CONTINUE IF A CREWMEMBER IS AWAKE IN THE MODULE AT ALL TIMES TO MONITOR FOR SMOKE/FIRE. IF AN AWAKE CREWMEMBER WILL NOT BE IN THE MODULE, THE MODULE WILL BE DEACTIVATED (EXCEPT FOR PL AFT MN B) AND CONFIGURED FOR SAFE ENTRY AND THE HATCH CLOSED UNTIL THE CREW RETURNS.

An awake crewmember must be available for monitoring the module for smoke/fire. If an awake crewmember is not inside the module, the Spacehab must be configured for a safe entry. This configuration will force the deactivation of certain experiments.

PL AFT MN B remains powered because it is the only source of power to the Spacehab water line heaters that protect the Spacehab water line from freezing. @[111501-4992]

FLIGHT RULES

A17-602

SPACEHAB FIRE/SMOKE CONFIRMATION

- A. CONFIRMATION OF A FIRE WILL BE ANY ONE OR MORE OF THE FOLLOWING: @[111501-4992]
1. CREW OBSERVANCE OF SMOKE OR FLAME
 2. FOR A SPACEHAB MODULE WITH A CLOSED HATCH, ANY ONE OF THE FOLLOWING:
 - a. BOTH SMOKE DETECTOR CONCENTRATION LEVELS OVER 2000 $\mu\text{G}/\text{M}^{**3}$
 - b. ONE CONCENTRATION LEVEL 2000 $\mu\text{G}/\text{M}^{**3}$ AND INCREASING (SUBSEQUENT TO A SENSOR TEST, WHEN POSSIBLE), AND THE ALTERNATE DETECTOR HAS FAILED CIRCUIT TEST
 - c. ONE CONCENTRATION LEVEL 2000 $\mu\text{G}/\text{M}^{**3}$ AND INCREASING, AND CONFIRMATION BY ELECTRICAL DATA OF A SUSTAINED SHORT

*A confirmation is required to accurately detect a fire condition; this confirmation can be via a separate smoke detector indicating a concentration level over 2000 $\mu\text{g}/\text{m}^{**3}$ or crew observations. In the event the alternate smoke detector fails both portions of the circuit test, per Rule {A17-601}, SPACEHAB FIRE/SMOKE DETECTION LOSS, the functional detector must be tested successfully every 24 hours. A sensor test is not possible during ascent/entry since the crew does not have access to the SSP. Any indications of a sustained short in the module with a concentration above 2000 $\mu\text{g}/\text{m}^{**3}$ will also be considered as confirmation of fire.*

- B. CONFIRMATION OF SMOKE DETECTION, AS DEFINED IN PARAGRAPH A, IS REQUIRED PRIOR TO FIRE SUPPRESSION SYSTEM (FSS) OR PORTABLE FIRE EXTINGUISHER(S) DISCHARGE.

A secondary cue is mandatory for FSS or portable extinguisher discharge. Paragraph A defines the cues required to confirm fire/smoke and ensures that action is not taken for a failed sensor.

- C. VISIBLE SMOKE AND/OR FIRE IS A CONFIRMED EMERGENCY WITH OR WITHOUT SMOKE DETECTOR WARNING.

Self-explanatory. @[111501-4992]

FLIGHT RULES

A17-603

SPACEHAB FIRE/SMOKE MANAGEMENT

A. ASCENT/ENTRY @[111501-4992]

FOR A CONFIRMED SPACEHAB FIRE (SEE RULE {A17-602A}, SPACEHAB FIRE/SMOKE CONFIRMATION, FOR CONFIRMATION CUES), THE FSS WILL BE ARMED AND DISCHARGED.

The Payload Safety Review Panel approved SH HR F-1, which states that the module material selection and design practices should prevent initiation and/or propagation of a fire. Based on this, the most likely cause of smoke in the module would be from a transient electrical short.

The STS-60 Flight Techniques Panel concluded on November 23, 1993, that, for a confirmed fire during ascent, the FSS should be discharged. This panel consisted of representatives of Crew Safety, Emergency, Environmental and Consumables Management (EECOM), STS-60 CDR, Safety, Flight Surgeon, and Spacehab. Flight experiences (STS-6, STS-28, and STS-35) indicate that short-term electrical transients do not typically produce enough smoke to exceed smoke sensor noise levels, which is far below alarm thresholds. Once the fire confirmation criteria outlined in Rule {A17-602}, SPACEHAB FIRE/SMOKE CONFIRMATION, has been satisfied, it can be inferred that the cause of smoke in this case would not be self-safing and that crew action must be taken. Based on proper material selection and stowage, removal of power from the module should be adequate to safe the situation. However, if removal of main power to the module was required, it would not be advisable to subsequently repower the module (removal of power was the only corrective action taken to safe the situation). Additionally, the sustained burning described could have released highly toxic combustion products into the module atmosphere, and it should remain isolated from the orbiter. Since module ingress after an event of this magnitude is unlikely, and since removal of power removes insight into fire propagation (smoke concentration readings), it is considered prudent to maximize protection by discharging Halon from the FSS.

Documentation: SH HR F-1, STS-60 OFTP Minutes (November 23, 1993), STS-6, STS-28, STS-35 flight experience, and engineering judgment.

B. ON-ORBIT

1. FLIGHT CREW RESPONSIBILITIES

THE COMMANDER (CDR) AND PILOT (PLT) WILL EXIT THE SPACEHAB MODULE AT THE INITIAL SMOKE DETECTOR WARNING OR OBSERVANCE OF SMOKE/FLAME.

Should smoke incapacitate a portion of the crew (i.e., the Spacehab crewmember(s)), evacuating the CDR and PLT will guarantee the availability of healthy crewmembers to accomplish entry and landing.
@[111501-4992]

THIS RULE CONTINUED ON NEXT PAGE

FLIGHT RULES**A17-603****SPACEHAB FIRE/SMOKE MANAGEMENT (CONTINUED)**

2. SPACELAB EMERGENCY BREATHING SYSTEM (SEBS) @[111501-4992]
@[ED]
- a. SEBS WILL BE PARTIALLY DONNED AT THE INITIAL WARNING.
 - b. THE SEBS WILL BE DONNED AND ACTIVATED ONLY IF THE FIRE/SMOKE IS CONFIRMED AS DEFINED IN RULE {A17-602}, SPACEHAB FIRE/SMOKE CONFIRMATION.
 - c. SEBS WILL BE UTILIZED BY THE CREWMEMBER(S) UNTIL THEY EXIT FROM THE SPACEHAB MODULE AND HAVE CLOSED AND LATCHED THE SPACEHAB HATCH.

Partially donned means that the SEBS shall be unstowed and be readied for use without actually putting on the facemask. Hydrogen cyanide (HCN), hydrogen fluoride (HF), hydrogen bromide (Hbr), and carbon monoxide (CO) are four potentially toxic thermal degradation products of Halon 1301, insulation, and paint. Levels exceeding the spacecraft maximum allowable concentration criteria (SMAC) could be produced from discharging a single fire suppression system (FSS) bottle on a fire. Reference Rules {A13-157}, CABIN ATMOSPHERE CONTAMINATION FIRE/SMOKE, and {A13-158B}, CABIN ATMOSPHERE CONTAMINATION - HALON 1301 [HC]. @[ED]

3. AT THE FIRST INDICATION OF FIRE/SMOKE, THE ATMOSPHERE REVITALIZATION SUBSYSTEM (ARS) FAN WILL BE DEACTIVATED AND PL ISO VLV WILL BE CLOSED, EXCEPT WHEN OPERATING IN THE LDM REDUCED POWER MODE WHERE THE ARS FAN WILL BE DEACTIVATED AND THE PL ISO VLV CLOSED UPON CONFIRMATION OF A FIRE.

Removal of power to the ARS fan and closing the PL ISO VLV is necessary to determine smoke source (Spacehab or orbiter), will reduce the chance of a fire spreading, and will reduce the circulation of fumes and smoke into the orbiter. A Spacelab analysis showed that crew movement had a negligible effect on overall cabin atmosphere with the fans off. By analogy, toxic gases, fumes, etc., in the Spacehab module will likely only propagate by diffusion. In the LDM reduced power mode, the Spacehab ARS fan will not be deactivated until a fire has been confirmed because the cabin fan is not operating to provide continued smoke detection. @[111501-4992]

THIS RULE CONTINUED ON NEXT PAGE

FLIGHT RULES

A17-603

SPACEHAB FIRE/SMOKE MANAGEMENT (CONTINUED)

4. FOR A CONFIRMED SPACEHAB FIRE, THE FOLLOWING ACTIONS WILL BE USED IN PRIORITY AS REQUIRED TO SUPPRESS THE FIRE:
@[111501-4992]
 - a. REMOVE INDIVIDUAL LINE REPLACEABLE UNIT (LRU) POWER (IF CREW CAN DETERMINE SOURCE OF SMOKE), FOLLOWED BY CREW EVALUATION.
 - b. IF POSSIBLE, USE PORTABLE FIRE EXTINGUISHER ON INDIVIDUAL LRU, FOLLOWED BY CREW EVALUATION.
 - c. PERFORM MAIN POWER KILL BY ARMING THE FSS, FOLLOWED BY CREW EVALUATION.
 - d. SECURE MODULE FOR ENTRY AND LANDING, OPEN MANUAL CABIN DEPRESS VALVE (CDV), EGRESS MODULE, CLOSE HATCH, AND DISCHARGE THE FSS.
 - e. DEPRESS THE SPACEHAB MODULE USING THE CDV IF SIGNS OF FIRE PERSISTS AFTER FSS DISCHARGE.

The crew will attempt to remove power from the fire source (if the source can be determined). If that does not work and the crew can identify the individual LRU, the crew can use the Portable Fire Extinguisher to try to put out the fire. This is to limit the exposure to Halon 1301 to the crewmembers that are in the Spacehab module yet provide adequate fire suppression in the affected area. If the individual LRU cannot be identified or individual LRU powerdown does not stop the fire, then the crew will arm the FSS to issue a MAIN POWER KILL, which eliminates the most likely source of the ignition/fire and stops the circulation of air/oxygen to the fire. The crew will then monitor conditions to determine if the fire has been safed. If the fire has been extinguished, but the module atmosphere contaminated, cleanup procedures must be initiated and the module isolated from the orbiter, until the cleanup is complete.

If the fire is not safed, the module must be secured for entry and prepared for Halon discharge. Spacehab securing/stowing will be limited to that which is required for a safe orbiter entry and landing configuration. Required stow items will be listed on the Spacehab Fire/Smoke cue card. Isolating the module will provide protection of the crew from the fire, smoke, and impending Halon release. This isolation will also increase the effectiveness of the fire suppression system by constraining the volume. The manual cabin depress valve must be opened prior to module egress to allow for remote depressurization of the Spacehab module if signs of a fire (temperature/pressure increasing, PPO₂ decreasing) continue after FSS discharge or failure. @[111501-4992]

THIS RULE CONTINUED ON NEXT PAGE

FLIGHT RULES

A17-603

SPACEHAB FIRE/SMOKE MANAGEMENT (CONTINUED)

5. SPACEHAB REPOWERING/REVISIT @[111501-4992]

a. AFTER FSS DISCHARGE:

- (1) SPACEHAB WILL REMAIN UNPOWERED (EXCEPT FOR THE AFT PL MN B BUS) FOR THE REMAINDER OF THE FLIGHT.

After Spacehab FSS discharge, fire suppression capability is limited to the orbiter hand-held fire extinguishers (if not previously used) or depressurization of the module, which does not require main power. The AFT PL MN B bus provides power to the H₂O loop line heaters to prevent freezing.

- (2) SPACEHAB WILL NOT BE REVISITED.

If the FSS is used, the Spacehab environment has been compromised. The unknown combustion byproducts concentration resulting from a fire requiring the FSS discharge as well as the resultant Halon concentration precludes revisiting the module for any reason.

b. AFTER PORTABLE FIRE EXTINGUISHER DISCHARGE FOR A CONFIRMED FIRE

- (1) THE MODULE MAY REMAIN POWERED, UNLESS THE PORTABLE FIRE EXTINGUISHER WAS UNSUCCESSFUL OR THERE IS AN INDICATION OF A FIRE STILL IN PROGRESS.
- (2) THE SPACEHAB MODULE WILL NOT BE REVISITED, UNLESS THE ATMOSPHERE CAN BE DEEMED SAFE. @[111501-4992]
@[ED]

THIS RULE CONTINUED ON NEXT PAGE

FLIGHT RULES

A17-603

SPACEHAB FIRE/SMOKE MANAGEMENT (CONTINUED)

- c. FOR AN ACCIDENTAL DISCHARGE OF A SINGLE PORTABLE FIRE EXTINGUISHER ANYWHERE IN THE SPACEHAB MODULE OR FOR A SINGLE FIXED LEAKING PORTABLE FIRE EXTINGUISHER OR FSS BOTTLE WITH NO SMOKE/FIRE CONFIRMATION, THE CREW MAY BE EXPOSED TO THE HABITABLE ENVIRONMENT FOR 72-100 HOURS FOR A SPACEHAB SINGLE MODULE CONFIGURATION AND THE ENTIRE MISSION FOR DOUBLE MODULE CONFIGURATIONS. REAL-TIME DISCUSSION OF MISSION EXTENSION WILL BE DEPENDENT UPON SUCH FACTORS AS CREW SYMPTOMS AND/OR PERFORMANCE. @[111501-4992]

The above criterion was established based upon information from NASA's Halon 1301 Human Inhalation Study (reference JSC 23845, August 1989), the National Research Council (NRC), and JSC Toxicology Group. The human study involved exposing eight volunteers to Halon 1301 for a period of 24 hours at a concentration of 1 percent (10,000 ppm). The effects on both physiology and performance were studied using a computerized battery of tests on reaction time, decision-making, etc. No significant changes in any physiological parameters were noted. There were no alterations of any blood counts or chemistries, no pulmonary function changes, no cardiac dysrhythmias, and no mental status changes. There were no significant biological decrements in performance recorded from the pre-exposure baselines. Based on this study, exposure of crewmembers to Halon concentration levels above 1 percent is not recommended.

As a result of recommendations published in the "Documentation of the Spacecraft Maximal Allowable Concentration Values on Bromotrifluoromethane" (White Paper; JSC Toxicology Group), the NRC approved revised SMAC levels for Halon 1301 on November 18, 1993. These guidelines state that for 24-hour exposure, the SMAC level is 0.35 percent (3500 parts per million), and for 7 or 30-day exposure, the SMAC level is 0.18 percent (1800 ppm). The JSC Toxicology Group sponsored the mentioned study and established SMAC levels with approval from the NRC.

Discharge of a portable fire extinguisher and/or a single fixed leaking fire extinguisher into the open Spacehab module will produce an equilibration with the habitable environment. Habitable environment is defined as the orbiter crew cabin volume plus the Spacehab module volume. A Halon 1301 level of approximately 0.20 percent to 0.26 percent (2000 ppm to 2600 ppm) will be achieved in the Spacehab single module, and based on the SMAC values mentioned above, the crewmembers can be exposed to this environment for 72-100 hours. In the Spacehab double module (LDM/RDM), the Halon 1301 level will remain below the 30 day SMAC value due to the added volume. The crew can be exposed to this environment for the entire mission. @[111501-4992]

THIS RULE CONTINUED ON NEXT PAGE

FLIGHT RULES

A17-603

SPACEHAB FIRE/SMOKE MANAGEMENT (CONTINUED)

A real-time decision to possibly land earlier than nominal EOM will be made by MCC after the crew has been exposed to Halon 1301. Although a concentration of 0.20 percent is less than the 24-hour SMAC value but slightly greater than the 7 or 30-day SMAC value for exposure to Halon 1301, the actual mission duration or extension is dependent upon such factors as crew symptoms and/or performance.
@[111501-4992]

Reference Rule {A13-158B}, CABIN ATMOSPHERE CONTAMINATION - HALON 1301 [HC].
@[ED]

d. AFTER DEPRESSURIZATION:

- (1) SPACEHAB WILL REMAIN UNPOWERED FOR THE REMAINDER OF THE FLIGHT (EXCEPT FOR AFT PL MN B BUS).
- (2) SPACEHAB AND ORBITER WATER LINE HEATERS OR ORBITER ATTITUDE CONTROL FOR THERMAL MANAGEMENT TO AVOID FREEZING AND OVERPRESSURIZING THE PAYLOAD HEAT EXCHANGER WILL BE REQUIRED.
- (3) SPACEHAB WILL NOT BE REPRESSURIZED.

After depressurization, the state and operational capability of the avionics is unknown. The AFT PL MN B bus provides power to the H₂O loop line heaters to prevent freezing.

C. LOSS OF BOTH THE SPACEHAB FSS BOTTLE DISCHARGE CAPABILITIES; MONITOR AND CONTROL PANEL (MCP) AND FIRE SUPPRESSION CONTROL UNIT (FSCU); AND LOSS OF SPACEHAB DEPRESSURIZATION CAPABILITY WILL REQUIRE THE MODULE TO BE DEACTIVATED AND UNPOWERED.

Loss of both fire suppression methods and loss of depressurization capability in Spacehab would make the module zero fault tolerant to a fire. @[111501-4992]

A17-604 THROUGH A17-650 RULES ARE RESERVED

FLIGHT RULES

SPACEHAB ECS MANAGEMENT @[111501-5010A]

A17-651

SPACEHAB ENVIRONMENTAL CONTROL AND LIFE SUPPORT
(ECLS) REQUIREMENTS @[111501-4993]

- A. THE ANNEX WILL USE THE FOLLOWING FORMAT TO ENSURE ORBITER COMPATIBILITY:

DURING OPERATIONS OF SPACEHAB ACTIVELY COOLED EXPERIMENTS, THE ORBITER CABIN ATMOSPHERE MUST BE MAINTAINED WITHIN THESE SPECIFIED LIMITS:

(PAYLOAD 1)	OPERATING RANGE
PPCO ₂	<u>TBD</u> < MMHG < <u>TBD</u>
TEMPERATURE	<u>TBD</u> < T < <u>TBD</u>
TOTAL PRESS, PPO ₂ , ETC	<u>TBD</u>

- B. PAYLOADS WHICH REQUIRE SPECIFIC ENVIRONMENTAL CONTROLS IN EXCESS OF NORMAL SUBSYSTEM REQUIREMENTS ARE DOCUMENTED IN THE FLIGHT-SPECIFIC ANNEX.

Documenting payload cooling limits in this rule in the annex ensures that the proper orbiter cooling configuration will be established for the flight. The operating range indicates absolute minimum and maximum acceptable temperatures of the payload coolant as it exits the payload heat exchanger. Analysis of heat exchanger performance will use payload heat load data as supplied in PIP annex 2 paragraph 1. The stability requirement dictates special payload limits to minimize oscillations within the operating range. The stability values reflected here are those introduced by changes in the orbiter Freon inlet temperature and do not account for perturbations due to changes in payload heat load.

Certain middeck and/or Spacehab payloads may require unique atmosphere conditions that are outside of the normal range of operations of the ARS. Documentation of the payload constraints in this rule ensures that the atmosphere is managed within the specified limits.

- C. EXPERIMENTS THAT WILL NORMALLY RELEASE GASES INTO THE CABIN ARE DOCUMENTED IN THE FLIGHT-SPECIFIC ANNEX. @[111501-4993]

FLIGHT RULES

A17-652 **SPACEHAB SUBSYSTEM FANS/AIR LOOP** ©[111501-5010A]

SPACEHAB ARS, CABIN, OR HFA FAN SHALL BE CONSIDERED LOST IF ITS RESPECTIVE FAN DELTA PRESSURE IS ≤ 0.2 INCHES H₂O.

The accuracy of the delta pressure sensor measurement is ± 0.1 inches H₂O. Each fan has two redundant sensors. The RDM HFA fan pair share the same two delta pressure sensors. ©[111501-5010A]

A17-653 THROUGH A17-700 RULES ARE RESERVED

FLIGHT RULES

MODULE ATMOSPHERE MANAGEMENT

A17-701 MODULE ATMOSPHERIC CONTROL @[111501-5010A]

THE ORBITER ENVIRONMENT WILL BE MANAGED TO ALLOW THE MODULE TO OPERATE WITHIN THE FOLLOWING GUIDELINES:

A. MODULE PRESSURE BETWEEN 10.0 AND 15.95 PSI @[021600-7104]

Spacehab systems are certified to operate above a cabin pressure greater than or equal to 10 psia. The positive pressure relief valves are designed to maintain Spacehab pressure below its maximum design pressure (MDP) of 15.95 psia.

B. MODULE PPO₂ PER RULE {A13-53A}, MINIMUM PPO₂ CONSTRAINTS [HC] @[ED]

The orbiter ECLSS is designed to maintain these levels. The most likely cause of low PPO₂ in the Spacehab module would be inadequate air exchange with the orbiter or an orbiter malfunction.

C. MODULE PPCO₂ PER RULE {A13-52A}, PPCO₂ CONSTRAINT (TWO GAS) [HC] @[101305-6655A]

The orbiter ECLSS is designed to maintain these levels. The most likely cause of low PPCO₂ in the Spacehab module would be inadequate air exchange with the orbiter or an orbiter malfunction.

D. MODULE TEMPERATURE BETWEEN 65 AND 80 DEG F @[021600-7104]

The Spacehab thermal control system is designed to maintain these levels during open hatch operations.

E. HUMIDITY

1. SM/LDM: MODULE DEWPOINT < FAN HX INLET H₂O TEMP
2. RDM: NO CONSTRAINT ON ORBITER

The Spacehab single and logistics double modules have no provision for condensate removal. Therefore, module humidity (dewpoint) must be maintained below the water loop temperature at the inlet to the air/water heat exchanger to avoid uncontained condensation. Spacehab RDM has a condensing heat exchanger; therefore, humidity control is not a concern as long as the rotary separator is functioning nominally. @[111501-5010A]

THIS RULE CONTINUED ON NEXT PAGE

FLIGHT RULES

A17-701 **MODULE ATMOSPHERIC CONTROL (CONTINUED)**

F. IF ANY OF THE ABOVE CONDITIONS CANNOT BE MAINTAINED, CONSIDERATION WILL BE GIVEN TO REDUCING THE NUMBER OF CREWMEMBERS IN THE MODULE OR DEACTIVATION OF SOME EXPERIMENTS. EXCEPTIONS WILL BE DOCUMENTED IN THE FLIGHT-SPECIFIC ANNEX. @[111501-5010A]

The module atmospheric composition is controlled during open hatch operations by the mixing of orbiter/module air flow. The orbiter and module systems must be operated to yield an environment as described in order to provide crew habitability and stay within certification limits. @[111501-5010A]

A17-702 **PARTIAL PRESSURE OF OXYGEN (PPO₂) SENSORS** @[111501-5010A]

NOMINAL SPACEHAB OPERATIONS MAY CONTINUE FOR LOSS OF BOTH SENSORS IF THE SPACEHAB ARS FAN IS OPERATIONAL. @[030994-1606A]

As long as there is air flow between the Spacehab module and the orbiter, PPO₂ parameters should be very close to orbiter readings. @[111501-5010A]

A17-703 **PARTIAL PRESSURE OF CARBON DIOXIDE (PPCO₂) SENSORS** @[111501-5010A]

NOMINAL SPACEHAB OPERATIONS MAY CONTINUE FOR LOSS OF BOTH SENSORS IF THE SPACEHAB ARS FAN IS OPERATIONAL. @[030994-1606A]

As long as there is air flow between the Spacehab module and the orbiter, PPCO₂ parameters should be very close to orbiter readings. @[111501-5010A]

FLIGHT RULES

A17-704

CABIN/HFA FAN @[111501-5010A]

- A. FOR LOSS OF A SINGLE PHASE, THE CABIN/HFA FAN MAY CONTINUE TO BE OPERATED ON TWO-PHASE POWER. @[021600-7105A]

Cabin fan and HFA fan can be used interchangeably throughout these rules, depending on the Spacehab module configuration. Both fans are used to circulate air within the Spacehab module. Cabin fan is applicable for Spacehab SM and LDM configurations. HFA fan is applicable for the Spacehab RDM configuration.

The cabin/HFA fan was operated during preflight testing on two phases. The cabin/HFA fan may be operated but not started on only two phases.

If the cabin/HFA fan is operating on the SH INV and phase A fails, the fan will stop working because phase A of the SH INV provides the sync pulse required for SH INV phases B and C to operate. However, the fan will continue to operate on the SH INV on two-phase power if phase A continues to operate with either phase B or phase C.

- B. FOR LOSS OF THE CABIN/HFA FAN, AN IFM WILL BE CONSIDERED TO CHANGE OUT THE FAN.

For loss of the cabin fan in the SM/LDM or a single HFA fan in the RDM, Spacehab has determined that the ARS fan in the SM/LDM or the ARS fan and a single HFA fan in the RDM can supply enough air flow to maintain smoke detection capability throughout the module. However, the temperature in the module may not be maintained. Based on temperature and other environmental parameters, it is possible that the IFM could be postponed or the mission continued using only the ARS fan in the SM/LDM or the ARS fan and a single HFA fan in the RDM. Smoke detection is considered lost in the aft subfloor volume of the RDM if both HFA fans are lost. Reference Rule {A17-601}, SPACEHAB FIRE/SMOKE DETECTION LOSS. @[111501-5010A]

THIS RULE CONTINUED ON NEXT PAGE

FLIGHT RULES

A17-704

CABIN/HFA FAN (CONTINUED)

C. RDM HFA FANS STARTUP @[111501-5010A]

1. BOTH HFA FANS WILL BE ACTIVATED PRIOR TO POWERING ON THE ARS FAN.
2. IF BOTH HFA FANS ARE TO BE OPERATED SIMULTANEOUSLY, THE AIR BYPASS VALVE (ABV) SHALL BE SET TO 80-210 COUNTS PRIOR TO POWERING THE SECOND HFA FAN.

Preflight testing by Boeing has shown that the HFA fans will operate in a degraded mode if the second HFA fan is activated while the ARS fan is operating and when the ABV is not positioned in an acceptable range. No immediate damage to the fans is associated with operation in this mode, only degraded system performance (> 30 percent reduction in HFA flow). During activation, it will be the MCC's responsibility to command the ABV to 80-210 counts because the crew does not have the capability to command the ABV. The crew can manually set the valve to the desired range, but this action would be very time consuming. Reference Rule {A17-705}, ATMOSPHERE REVITALIZATION SYSTEM (ARS) FAN.

DOCUMENTATION: Boeing RDM Certification Acceptance Review Presentation, October 4-5, 2000, ECS Special Topic. @[111501-5010A]

FLIGHT RULES

A17-705

ATMOSPHERE REVITALIZATION SYSTEM (ARS) FAN @[021600-7106B] @[111501-5101A]

- A. FOR LOSS OF A SINGLE PHASE, THE ARS FAN MAY CONTINUE TO BE OPERATED ON TWO-PHASE POWER.

The ARS fan was operated on two phases during preflight testing. The ARS fan may be operated but not started on only two phases. @[111501-5010A]

If the ARS fan is operating on the SH INV and phase A fails, the fan will stop working because phase A of the SH INV provides the sync pulse required for SH INV phases B and C to operate. However, the fan will continue to operate on the SH INV on two-phase power if phase A continues to operate with either phase B or phase C. @[021600-7106B]

- B. FOR LOSS OF THE ARS FAN, AN IFM WILL BE PERFORMED (BASED ON PPCO₂, ETC.) TO CHANGE OUT THE FAN. UNTIL THE IFM IS PERFORMED, ALLOWABLE CREW TIME IN THE MODULE IS LIMITED BY DEWPOINT, PPO₂, AND PPCO₂ RESTRICTIONS PER RULE {A17-701}, MODULE ATMOSPHERIC CONTROL. @[101096-4494]

Without the ARS fan, air exchange with the orbiter is degraded. In the Spacehab RDM, smoke detection in the forward subfloor volume is considered lost when the ARS fan is not operating with the mixing box cap installed. As long as one HFA fan is operating, smoke detection capability can be regained throughout the RDM by removing the mixing box cap. Reference Rule {A17-757}, RDM MIXING BOX CAP.

- C. (SM/LDM ONLY) THE ARS FAN SHALL NOT BE OPERATED WITH THE PL ISO VALVE CLOSED UNLESS THE ASCENT/DESCENT INLET STUB IS OPEN OR THE FLEX DUCT IS REMOVED. @[021600-7106B]

Operation of the ARS fan with the PL ISO valve closed and flex duct connected in the Spacehab single or logistics double module configurations may cause failure of the ARS fan. Reference Rule {A17-756}, SM/LDM ASCENT/DESCENT INLET STUB. @[021600-7106B]

- D. (RDM ONLY) THE ARS FAN SHALL BE DEACTIVATED PRIOR TO POWERING ON A SECOND HFA FAN.

Preflight testing by Boeing has shown that the HFA fans will operate in a degraded mode if a second HFA fan is powered up while the ARS fan is operating. Reference Rule {A17-704}, CABIN/HFA FAN. No immediate damage to the fans is associated with operation in this mode, only degraded system performance (> 30 percent reduction in HFA flow).

DOCUMENTATION: Boeing RDM Certification Acceptance Review Presentation, October 4-5, 2000, ECS Special Topic. @[111501-5010A]

FLIGHT RULES

A17-706

SPACEHAB FAN CONFIGURATIONS

THE FOLLOWING FAN CONFIGURATION WILL BE USED FOR NOMINAL SPACEHAB SM/LDM OR RDM OPERATIONS FOR ASCENT, ON-ORBIT, AND ENTRY: @[111501-5000]

A. ASCENT

1. SM/LDM:

a. UNPOWERED SPACEHAB MODULE

- (1) ARS FAN - ON, CONFIGURED TO SPACEHAB INVERTER POWER, BUT NOT OPERATIONAL SINCE THE SPACEHAB INVERTER IS UNPOWERED
- (2) CABIN FAN - OFF, CONFIGURED TO SPACEHAB INVERTER POWER
- (3) AFT MODULE FAN - OFF (LDM ONLY)

When the Spacehab module is unpowered for ascent, all subsystem equipment is OFF. Although the ARS fan is configured ON, it is not operational because its power source is configured to an unpowered Spacehab inverter. This configuration simply allows the ARS fan to be activated by commanding its power source from Spacehab inverter to orbiter AC.

b. POWERED SPACEHAB MODULE

- (1) ARS FAN - ON, USING SPACEHAB INVERTER POWER
- (2) CABIN FAN - OFF, BUT CONFIGURED TO SPACEHAB INVERTER POWER
- (3) AFT MODULE FAN - OFF (LDM ONLY)

IF THE ARS FAN FAILS, IT WILL BE COMMANDED OFF AND THE CABIN FAN COMMANDED ON ASAP POST MAIN ENGINE CUTOFF (MECO). FOR FAILURE OF THE SPACEHAB INVERTER, REFERENCE RULE {A9-354}, SPACEHAB AC MANAGEMENT.
@[ED] @[ED]

THIS RULE CONTINUED ON NEXT PAGE

FLIGHT RULES**A17-706****SPACEHAB FAN CONFIGURATIONS (CONTINUED)**

The ARS or cabin fan is required to maintain airflow for heat rejection and fire/smoke detection in the module. The cabin fan is unpowered, but configured to inverter power to allow it to serve as a backup in case the ARS fan fails. Without switching fans, all fire/smoke detection capability is lost. Since no on-board command capability exists in OPS 1 (SM GPC not available), the fans will be reconfigured via ground command post MECO. The aft module fan uses Spacehab DC power and is not powered for ascent. @[111501-5000]

2. RDM: @[111501-5000]
 - a. HFA FAN 1 - ON, USING SPACEHAB INVERTER POWER
 - b. HFA FAN 2 - OFF, CONFIGURED TO SPACEHAB INVERTER POWER
 - c. ARS FAN - ON, CONFIGURED TO ORBITER AC, BUT NOT OPERATIONAL SINCE ORBITER AC IS NOT AVAILABLE TO PAYLOADS FOR ASCENT

IF HFA FAN 1 FAILS, IT WILL BE COMMANDED OFF AND HFA FAN 2 COMMANDED ON ASAP POST MAIN ENGINE CUTOFF (MECO). FOR FAILURE OF THE SPACEHAB INVERTER, REFERENCE RULE {A9-354}, SPACEHAB AC MANAGEMENT. @[ED] @[ED]

The Spacehab RDM is always powered for ascent. An HFA fan is required to maintain airflow for heat rejection and fire/smoke detection in the module. HFA fan 1 is preferred over HFA fan 2 because contingency commanding is only available to turn HFA fan 1 OFF and HFA fan 2 ON. HFA fan 2 is unpowered but configured to inverter power to allow it to serve as a backup in case HFA fan 1 fails. Without switching fans, all fire/smoke detection capability is lost. Since no on-board command capability exists in OPS 1 (SM GPC not available), the fans will be reconfigured via ground command post MECO. The ARS fan is not operational during ascent; however, it is configured ON, but to orbiter AC power which is not available during ascent. In this configuration, the ARS fan can be activated whenever power is applied to the payload AC 2 bus in the event of a failure that prevents Spacehab commanding.

THIS RULE CONTINUED ON NEXT PAGE

FLIGHT RULES**A17-706 SPACEHAB FAN CONFIGURATIONS (CONTINUED)**

B. ON-ORBIT

1. SM/LDM:

- a. ARS FAN - ON, USING ORBITER AC POWER
- b. CABIN FAN - ON, USING ORBITER AC POWER
- c. AFT MODULE FAN - ON, USING SPACEHAB DC POWER (LDM ONLY)

IF ORBITER AC POWER IS UNAVAILABLE, REFERENCE RULE {A9-354}, SPACEHAB AC MANAGEMENT. @[111501-5000] @[ED]
@[ED]

2. RDM: @[111501-5000]

- a. ARS FAN - ON, USING ORBITER AC3 POWER
- b. HFA FAN 1 - ON, USING SPACEHAB INVERTER POWER
- c. HFA FAN 2 - ON, USING ORBITER AC2 POWER

FOR FAILURE OF THE SPACEHAB INVERTER OR ORBITER AC, REFERENCE RULE {A9-354}, SPACEHAB AC MANAGEMENT. @[ED]
@[ED]

All subsystem fans for Spacehab SM/LDM or RDM are nominally operating on-orbit to obtain the best air circulation throughout the module. It is highly desired to power the ARS fan from orbiter AC in order to maintain fan operation in case of an inadvertent loss of the Spacehab inverter. Powering any of the fans via the Spacehab inverter(s) or orbiter AC is acceptable and is preferred over not running the fans. In the RDM, HFA fan 1 is powered by the Spacehab inverters and HFA fan 2 is powered by orbiter AC to maintain airflow in case of a failure of either power source, as well as to off load orbiter AC 2. Operation of both HFA fans from the same power source is acceptable, but will impact troubleshooting in the case of a failed fan.

THIS RULE CONTINUED ON NEXT PAGE

FLIGHT RULES

A17-706

SPACEHAB FAN CONFIGURATIONS (CONTINUED)

C. ENTRY

1. SM/LDM:

- a. ARS FAN - ON, USING SPACEHAB INVERTER POWER
- b. CABIN FAN - OFF, CONFIGURED TO ORBITER AC
- c. AFT MODULE FAN - OFF (LDM ONLY)

IF THE ARS FAN FAILS, IT WILL BE COMMANDED OFF AND THE CABIN FAN COMMANDED ON USING ORBITER AC POWER ASAP PROVIDED THE TOTAL AC LOAD (ORBITER + SPACEHAB) CAN BE MANAGED TO STAY WITHIN LIMITS SPECIFIED IN RULE {A9-155}, AC INVERTER THERMAL LIFE. FOR FAILURE OF THE SPACEHAB INVERTER, REFERENCE RULE {A9-354}, SPACEHAB AC MANAGEMENT. ©[ED] ©[ED]

The ARS or cabin fan is required to maintain airflow for heat rejection and fire/smoke detection in the module. The cabin fan is unpowered but configured to orbiter AC power to allow it to serve as a backup in case the ARS fan or Spacehab inverter fails. Without switching fans, all fire/smoke detection capability is lost. Since no on-board command capability exists in OPS 3 (SM GPC not available), the fans will be reconfigured via ground command. The aft module fan uses Spacehab DC power and is not powered for entry. ©[111501-5000]

THIS RULE CONTINUED ON NEXT PAGE

FLIGHT RULES

A17-706 SPACEHAB FAN CONFIGURATIONS (CONTINUED)

2. RDM: @[111501-5000]
- a. HFA FAN 1 - ON, USING INVERTER POWER
 - b. HFA FAN 2 - OFF, CONFIGURED TO ORBITER AC
 - c. ARS FAN - OFF

IF HFA FAN 1 FAILS, IT WILL BE COMMANDED OFF AND HFA FAN 2 COMMANDED ON USING ORBITER AC POWER ASAP PROVIDED THE TOTAL AC LOAD (ORBITER + SPACEHAB) CAN BE MANAGED TO STAY WITHIN LIMITS SPECIFIED IN RULE {A9-155}, AC INVERTER THERMAL LIFE. FOR FAILURE OF THE SPACEHAB INVERTER, REFERENCE RULE {A9-354}, SPACEHAB AC MANAGEMENT. @[ED]
@[ED]

An HFA fan is required to maintain airflow for heat rejection and fire/smoke detection in the module. HFA fan 1 is preferred over HFA fan 2 because contingency commanding is only available to turn HFA fan 1 OFF and HFA fan 2 ON. HFA fan 2 is unpowered, but configured to orbiter AC to allow it to serve as a backup in case HFA fan 1 or the Spacehab inverter fails. Without switching fans, all fire/smoke detection capability is lost. Since no on-board command capability exists in OPS 3 (SM GPC not available), the fans will be reconfigured via ground command. The ARS fan is OFF during entry and is not considered a viable option to regain smoke detection should both HFA fans fail (reference Rule {A17-601}, SPACEHAB FIRE/SMOKE DETECTION LOSS). @[111501-5000]

A17-707 THROUGH A17-750 RULES ARE RESERVED

FLIGHT RULES

ATMOSPHERE INTEGRITY

A17-751 **MODULE PRESSURE INTEGRITY** @[111501-5010A]

FOR A NON-ISOLATABLE MODULE PRESSURE LEAK, THE MODULE WILL BE MANAGED AS FOLLOWS:

- A. IF PRIOR TO THE MISSION MDF, THE MODULE WILL BE ISOLATED FROM THE ORBITER AS REQUIRED TO PRESERVE AN MDF +2 DAYS WITHOUT VIOLATION OF ORBITER N₂ REDLINES.
- B. IF AFTER THE MISSION MDF, THE MODULE WILL BE ISOLATED FROM THE ORBITER AS REQUIRED TO PRESERVE LANDING AT THE NEXT PLS +2 DAYS WITHOUT VIOLATION OF ORBITER N₂ REDLINES.
- C. FOR CASES WHERE ORBITER REDLINES FOR THE PLANNED EOM +2-DAY DURATION CANNOT BE PROTECTED WHILE FEEDING A MODULE LEAK, THE DECISION TO SHORTEN THE MISSION OR ISOLATE THE MODULE WILL BE BASED ON MISSION PRIORITIES AND LANDING SITE AVAILABILITY.
- D. ALL POWER, EXCEPT FOR PL AFT MNB, WILL BE REMOVED FROM THE MODULE IF THE PRESSURE DROPS BELOW 10.0 PSIA.

Mission success items such as module operations cannot be allowed to impact the ability of the orbiter to reach an MDF or PLS. Adequate protection (+2 days) must always be available in the event of unforeseen circumstances such as weather or systems problems preventing deorbit. For cases where orbiter and crew safety are not in jeopardy, mission priorities (balanced with other factors) will be used to determine proper tradeoffs. Also, Spacehab equipment is not certified for operations below 10.0 psia; however, Spacehab accepts all risks associated with operating sensors below spec value. PL AFT MN B must remain powered because it is the only source of power to the SH waterline heaters that protect the waterline from freezing. @[111501-5010A]

A17-752 **NEGATIVE PRESSURE RELIEF VALVE COVERS** @[111501-5010A]

THE MODULE'S NEGATIVE PRESSURE RELIEF VALVE COVERS WILL BE OUT AND LOCKED OPEN DURING ASCENT. THE COVERS WILL BE CLOSED ON ORBIT AND REMAIN CLOSED DURING ENTRY.

This action prevents chatter damage to valve seats during periods of ascent vibration. @[111501-5010A]

FLIGHT RULES

A17-753 **CABIN DEPRESS VALVE (CDV)** ©[111501-5010A]

- A. THE MANUAL CABIN DEPRESS VALVE LOCATED IN THE SPACEHAB MODULE WILL BE LEFT CLOSED AT ALL TIMES UNLESS OPENED BY THE CREW DURING A FIRE/SMOKE ALARM OR HAZARDOUS SPILL INITIATED MODULE EGRESS.

Leaving the CDV nominally closed eliminates a potential leak source. The CDV assembly consists of a 28-volt dc motor driven butterfly valve in series with a manually operated butterfly valve.

- B. IN THE EVENT THE FIRE SUPPRESSION SYSTEM (FSS) FAILS, THE MODULE WILL BE DEPRESSURIZED USING THE REMOTELY ACCESSED MOTORIZED CABIN DEPRESS VALVE.

Depressurization is the final method to eliminate a fire or reduce hazardous spill concentration. Reference Rule {A13-156}, SPACEHAB HAZARDOUS SUBSTANCE SPILL RESPONSE, and Rule {A17-603}, SPACEHAB FIRE/SMOKE MANAGEMENT. ©[111501-5010A]

A17-754 **EXPERIMENT VENT VALVE** ©[111501-4995] ©[111501-5010A]

- A. IF THE EXPERIMENT VENT VALVE IS NOT IN USE, THE VALVE WILL BE CLOSED.
- B. THE EXPERIMENT VENT VALVE WILL ALWAYS BE CLOSED WHEN ALL THE CREW IS ASLEEP UNLESS REQUIRED FOR EXPERIMENT OPERATION AS DEFINED IN THE FLIGHT-SPECIFIC ANNEX. ©[111501-5010A]

Closing the valve will significantly reduce the likelihood of a slow leak or of an inadvertent opening of the vent. For certain experiment complements, a vent line is attached and flown on the experiment vent valve. When this is the case, only the vent valve is closed.

FLIGHT RULES

A17-755

PPRV MANAGEMENT @[111501-5010A]

THE TWO SPACEHAB PPRV'S WILL BE CLOSED PRIOR TO ANY PLANNED INCREASE OF CABIN PRESSURE GREATER THAN 15.35 (15.00) PSIA. WHEN THE CABIN PRESSURE RETURNS TO BELOW 15.35 (15.00) PSIA OR WHEN THE SPACEHAB MODULE IS ISOLATED, THE SPACEHAB PPRV'S WILL BE REOPENED.

The Spacehab module has a maximum design pressure (MDP) of 15.95 psia, which shall not be exceeded. Based on the lower limit of the Spacehab PPRV crack pressure acceptance specification (15.35 psia), the Spacehab PPRV's will be closed prior to any planned pressure increase above the crack pressure to preserve consumables (0.35 psia is allowed for sensor and pressure control band uncertainty). Orbiter PPRV's will provide redundancy for pressure relief for the module as long as the Spacehab hatch remains open. The Spacehab PPRV's will be reopened after the pressure has decreased below the crack value or when the module is isolated in order to re-enable this design safety feature. @[111501-5010A]

FLIGHT RULES

A17-756

SM/LDM ASCENT/DESCENT INLET STUB @[111501-5010A]

THE ASCENT/DESCENT INLET STUB WILL REMAIN CLOSED DURING OPEN HATCH OPERATIONS. IF THE SPACEHAB HATCH IS CLOSED WITHOUT DISCONNECTING THE DUCTWORK BETWEEN THE SPACEHAB TUNNEL AND THE ORBITER PL ISOLATION VALVE, THE ASCENT/DESCENT INLET STUB WILL BE OPENED BEFORE MODULE EGRESS EXCEPT IN AN EMERGENCY.

The Spacehab SM/LDM is launched with the flex duct between the Spacehab tunnel and the orbiter PL isolation valve disconnected and the ascent/descent inlet stub closed. During Spacehab activation, the crew connects this flex duct to provide air exchange from the orbiter to the Spacehab. The Ascent/Descent inlet stub remains closed so that Spacehab air is not drawn into the Ascent/Descent inlet stub to ensure good air exchange with the orbiter.

Opening the Ascent/Descent inlet stub prior to module egress or disconnecting the PL ISO Valve flex duct prior to hatch closure allows the ARS fan to operate and draw air from these openings. Nominally, the crew will disconnect the flex duct between the Spacehab tunnel and the PL isolation valve prior to closing the Spacehab hatch and leave the Ascent/Descent inlet stub closed. The option exists to leave the flex duct connected for closed hatch operations (e.g., Spacehab closeout for EVA or docking), but since the time savings is minimal, the flex duct is normally disconnected before closing the hatch. However, if the ductwork is left connected, the Ascent/Descent inlet stub will be opened to allow the ARS fan to serve as backup to the cabin fan. If the cabin fan fails, the ARS fan is required to provide air flow for smoke detectors and equipment cooling. If the module is egressed due to an emergency (e.g., cabin leak, toxic spill, fire), the ductwork and ascent/descent inlet stub will not be reconfigured prior to the emergency egress.

Reference Rule {A17-705}, ATMOSPHERE REVITALIZATION SYSTEM (ARS) FAN. @[111501-5010A]

FLIGHT RULES

A17-757 **RESERVED** ©[111501-5000] ©[032807-7136]

A17-758 **RESERVED** ©[111501-5000] ©[032807-7136]

A17-759 THROUGH A17-800 RULES ARE RESERVED

FLIGHT RULES

LIFE SUPPORT GO/NO-GO CRITERIA

A17-1001

LIFE SUPPORT GO/NO-GO CRITERIA

SYSTEM/COMPONENTS/FUNCTIONS	ASCENT ABORT IF:	INVOKE MDF IF:	ENTER NEXT PLS IF:
A. <u>FIRE PROTECTION:</u>	04/28/94 FINAL, PCN-20		
1. AV BAY SMOKE DETECTION SYS (2 PER BAY) [1]			
2. CABIN, SMOKE DETECTION SYS			3 ↓ [3]
3. FIRE SUPPRESSION SYS (1 BOTTLE PER BAY)			
4. FIRE DETECTED/SUPPRESSED [16]			[2]
5. HALON DISCHARGE, CABIN OR AV BAY (W/O FIRE CONFIRMATION) [16]			
B. <u>ARS AIR:</u>			
1. CABIN FANS (2)		1 ↓	2 ↓ [20]
2. AV BAY COOLING			
a. AV BAY 1 [4]		[6]	[7]
b. AV BAY 2 [4]		[6]	[7]
c. AV BAY 3 [4]		[8]	[9] [7]
3. IMU FANS (3) [5]			2 ↓
C. <u>CABIN ATMOSPHERE:</u>			[10]
1. CO2 CONTROL			
2. CABIN TEMP CONTROL			
3. HUMIDITY CONTROL			[10]
4. RCRS		[11]	[11]
D. <u>PCS:</u> [19]			
1. CABIN PRESS INTEGRITY			
2. 165-MIN 8-PSI CONTINGENCY RETURN			
3. PPO2			[12]
4. LES O2 SUPPLY SYSTEM (2)		1 ↓ [17]	2 ↓ [18]

@[050495-1756B] @[020196-1810A] @[ED]

THIS RULE CONTINUED ON NEXT PAGE

FLIGHT RULES

A17-1001

LIFE SUPPORT GO/NO-GO CRITERIA (CONTINUED)

SYSTEM/COMPONENTS/FUNCTIONS	ASCENT ABORT IF:	INVOKE MDF IF:	ENTER NEXT PLS IF:
E. <u>WASTE COLLECTION:</u>			
1. FECAL COLLECTION (WCS/APOLLO BAGS)		[13]	[13]
2. URINE COLLECTION (WCS/URINE BAGS)		[13]	[13]
F. <u>WASTE H2O:</u>			
1. WASTE H ₂ O TANK (1) [14]			
2. DUMP CAPABILITY		[15]	[15]

©[121593-1589] ©[020196-1810A]

LEGEND: NO REQUIREMENT () QUANTITY

REQUIRED [] NOTE REFERENCE

THIS RULE CONTINUED ON NEXT PAGE

FLIGHT RULES**A17-1001****LIFE SUPPORT GO/NO-GO CRITERIA (CONTINUED)**

NOTES:

- [1] ALL AIR-COOLED EQUIPMENT INCLUDING THE FAN WILL BE UNPOWERED (EXCEPT FOR THE COMMUNICATIONS EQUIPMENT, CAUTION & WARNING EQUIPMENT, AND FAN IN AV BAY 3A). ALL EQUIPMENT MAY BE REPOWERED FOR ENTRY IF SAFED WITH A HALON BOTTLE. REFERENCE RULE {A17-51A}, 2 & 3, MANAGEMENT FOLLOWING LOSS OF SMOKE DETECTION. @[090894-1675] @[ED]
- [2] IF TOXIC COMBUSTION PRODUCTS CANNOT BE SATISFACTORILY REMOVED FROM THE CABIN ATMOSPHERE, THE CREW WILL REMAIN ON THE QDM/ACES BREATHING 100 PERCENT O₂ UNTIL ORBITER EGRESS. AN ELS OR PLS LANDING IS REQUIRED BASED UPON AVAILABLE N₂ CONSUMABLES FOR MAINTAINING THE O₂ CONCENTRATION WITHIN ACCEPTABLE LIMITS. REFERENCE RULES {A13-157}, CABIN ATMOSPHERE CONTAMINATION FIRE/SMOKE, AND {A17-254}, CABIN O₂ CONCENTRATION. @[070201-4726A] @[062305-6653] @[ED]
- IF THE EXTENT OF THE DAMAGE TO THE EQUIPMENT AND WIRE BUNDLES IS UNKNOWN, EVEN IF THE ATMOSPHERE HAS BEEN CLEANED UP. A NEXT PLS LANDING WILL BE PERFORMED TO MINIMIZE THE RISK OF THE OCCURRENCE OF AN ADDITIONAL FIRE OR ARC TRACKING. @[090894-1675] @[070201-4726A]
- [3] UNLESS CREW PERSON REMAINS AWAKE DURING SLEEP PERIODS TO MONITOR FOR SMOKE CONDITIONS. REF. RULE {A17-5}, SMOKE DETECTION LOSS DEFINITION [HC] @[ED]
- [4] LOSS OF BOTH FANS IN ANY ONE BAY IS A GO-TO-ORBIT CASE. THE AVIONICS BAY WILL BE RECONFIGURED POST-MECO (TACAN'S AND MLS ONLY) AND POST-OMS-1 (ALL AIR-COOLED EQUIPMENT).
- [5] LOSS OF THREE IMU FANS IS A GO-TO-ORBIT CASE WITH IMU CYCLING. VACUUM CLEANER FAN WILL BE INSTALLED ON ORBIT. ENTER FIRST DAY PLS. @[020196-1810A]
- [6] MDF FOR LOSS OF COOLING TO TWO GPC'S (DUE TO UNACCEPTABLE TEMPERATURE).
- [7] ENTER NEXT PLS IF A SINGLE ELECTRICAL FAILURE (AC BUS) COULD CAUSE THE LOSS OF AIR COOLING TO TWO AV BAYS.
- [8] MDF FOR LOSS OF SMOKE DETECTION (LOSS OF AIR FLOW ONLY).
- [9] PLS FOR LOSS OF COOLING TO THE C&W.
- [10] AN ALTERNATE MODE OF CO₂/HUMIDITY CONTROL WOULD BE TO PERFORM CABIN PURGES (OR PARTIAL DUMPS) VIA THE AIRLOCK DEPRESSURIZATION VALVE.
- [11] QUANTITY OF LIOH CANISTERS AND CREW SIZE WILL DETERMINE EOM.
- [12] PLS REQUIRED IF AUTO/MANUAL PPO₂ CONTROL CANNOT MAINTAIN AEROMED MINIMUM (REF. RULE {A13-53A}, 1, MINIMUM PPO₂ CONSTRAINTS [HC]) AND LESS THAN 30 PERCENT O₂ AT TOUCHDOWN. ELS REQUIRED IF 40 PERCENT O₂ IS EXPECTED TO BE EXCEEDED PRIOR TO NEXT PLS TOUCHDOWN. @[ED]
- [13] WITHOUT THE WCS, THE CREW REQUIRES SUFFICIENT BAGS FOR AT LEAST A PLS PLUS 2 DAYS (3 DAYS). EOM IS DEPENDENT ON DEFECATION/URINATION RATE, NUMBER/GENDER OF CREW, AND NUMBER OF ALTERNATE COLLECTION DEVICES.
- [14] CWC AND UCD ULLAGE WILL DETERMINE EOM. @[121593-1589]
- [15] ULLAGE WILL DETERMINE EOM.
- [16] FOR CONFIRMED DISCHARGE INTO AN AVIONICS BAY, AN OVERBOARD PURGE OF THE AFFECTED BAY WILL BE INITIATED AS A MEANS OF REDUCING HALON CONCENTRATIONS AND EXTENDING AVAILABLE ON-ORBIT TIME. FOR A LEAKING HANDHELD HALON BOTTLE IN THE CABIN, THE BOTTLE WILL BE DISCHARGED OVERBOARD THROUGH THE AIRLOCK DEPRESS VALVE. REFERENCE THE AEROMED RULE {A13-158}, CABIN ATMOSPHERE CONTAMINATION - HALON 1301 [HC], FOR EOM DETERMINATION DUE TO HALON TOXICITY CONCERNS. REFERENCE AEROMED RULE {A13-54}, 100 PERCENT OXYGEN USE CONSTRAINT [HC], FOR MAXIMUM TIME CREW CAN REMAIN ON 100 PERCENT O₂. @[090894-1675] @[ED] @[ED]
- [17] MDF DUE TO INABILITY TO SUPPORT ACES/QDM FLOW TO ENTIRE CREW IN THE EVENT OF A CONTAMINATED CABIN (E.G., FIRE OR TOXIC SPILL). IF REAL-TIME TEST INDICATES THAT ENTIRE CREW CAN BE SUPPORTED OR AN IFM ALLEVIATES THE PROBLEM, AN MDF IS NOT REQUIRED (REF. RULE {A17-259C}, LES O₂ SUPPLY SYSTEM LOSS MANAGEMENT). @[062305-6653]
- [18] INABILITY TO SUPPORT 8 PSIA CABIN (REF. RULE {A17-203A}, PPO₂ CONTROL). @[050494-1756B]
- [19] ABORT RTLS/TAL FOR ORBITER -DP/DT > 0.15; AOA FOR ORBITER -DP/DT > 0.02.
- [20] ELS WILL PROBABLY BE REQUIRED IF THE NEXT PLS OR SLS IS GREATER THAN 8 HOURS. AS LONG AS CABIN ENVIRONMENT IS ACCEPTABLE A PLS WILL BE TARGETED. @[020196-1810A]

THIS RULE CONTINUED ON NEXT PAGE

FLIGHT RULES

A17-1001

LIFE SUPPORT GO/NO-GO CRITERIA (CONTINUED)

D. PCS

The requirement for cabin pressure integrity is dependent on the leak rate. Ascent aborts are summarized in Rule {A17-201A}, CABIN PRESSURE INTEGRITY [HC]. No requirement exists for an MDF due to the philosophy that the flight will be terminated once the integrity of the cabin has been declared lost. (Ref. Rule {A17-201}, CABIN PRESSURE INTEGRITY [HC], for rationale defining cabin pressure integrity.) ©[ED]

The 165-minute, 8-psia contingency return is defined by two requirements; the first being the N₂ required to perform the contingency return and the second being a functional launch/entry suit (ACES) helmet for each crewmember which will supply enough oxygen to allow the crewmember to breathe normally. ©[062305-6653]

The N₂ consumable is budgeted to provide enough N₂ for nominal mission requirements and remain above the N₂ redline (contingency return capability + measurement error + residuals) at EOM. If an N₂ leak develops or nominal flight activities (i.e., MMU recharges, cabin represses, etc.) cause us to break the N₂ redline prior to EOM, a next day PLS will be declared. The PLS is required due to insufficient consumables to maintain an 8-psia cabin for 165-minute contingency return in the event of a hole in the cabin equivalent to 0.45 inch.

An LEH is defined to be lost when it can no longer supply 2.5 lb/hr O₂ to the crewmember. This implies either a hardware failure or a failure in cryogenic oxygen supply which will not provide the necessary amount of O₂ to the crewmember. Since the 165-minute, 8 psia contingency return will cause cabin pressure and PPO₂ to drop below safe metabolic limits for breathing cabin atmosphere, the ACES helmet will have to be used prior to touchdown to supply enough oxygen to each crewmember. Therefore, one lost helmet is loss of the contingency return requirement. (Ref. Rule {A17-202}, 8 PSIA CABIN CONTINGENCY 165-MINUTE RETURN CAPABILITY, for loss of 165-minute, 8-psia contingency return definition.) ©[062305-6653]

If PPO₂ cannot be maintained within the specified control band (Ref. Rule {A17-203}, PPO₂ CONTROL) using either auto or manual control, a next day PLS will be declared to avoid operations with a 30 percent or greater O₂ concentration (Ref. Rule {A17-254A}, CABIN O₂ CONCENTRATION), or an oxygen deficient cabin which cannot support crew metabolic needs (Ref. Rule {A13-53 A}.1, MINIMUM PPO₂ CONSTRAINTS [HC]). ©[ED]

THIS RULE CONTINUED ON NEXT PAGE

FLIGHT RULES

A17-1001 LIFE SUPPORT GO/NO-GO CRITERIA (CONTINUED)

Memos/Documents

NSTS-07700 Vol. 10, Rev D, September 30, 1983 ©[ED]

Contract NAS9-14000 Orbiter Vehicle End Item Specification for the Space Shuttle System,
Part 1, Performance and Design Requirements, January 3, 1983

NHB 8060.1B, Flammability, Odor, and Offgassing Requirements and Test Procedures for
Materials in Environments that Support Combustion, September 1981

On-Orbit Flight Techniques #28 minutes, September 26, 1978

Master Measurement List, February 15, 1985

NASA/JSC Memo from James Waligora, EVA Prebreathe vs. Decompression Sickness Risk
Table, July 14, 1986

JSC-18504, STS Operational Flight Design - Standard Groundrules and Constraints, Level
B, September 1984

Minutes of Initial 10.2 psia Certification Meeting - August 18, 1986

JSC- 22276, STS Medical Console Handbook

Orbiter Middeck/Payload Standard Interfaces Control Document - ICD 2-1 M001, March 198.

Rockwell International Documents

Certification Approval Request - Attachment #2, May 22, 1980

Shuttle Operational Data Book - volume 1, revision D, section 4.6.1, October 1984

SEH-ITA-83-179T - ECLSS Analysis of 10.2 psia Cabin Pressure Control Demonstration,
1983

SEH-ITA-83-349T - Relative Effect of Interchanger Water Flowrates on ARS
Temperatures: October 14, 1983

E. WASTE H₂O ©[ED]

1. The waste tank is the primary means of storing waste water. Without a place to store waste water, the crew would lose humidity control, urine collection capability, and EMU drain capability. The CWC serves as a spare waste water storage container. Waste water can be drained into it from the waste tank via the Contingency Cross-tie Waste QD. Alternatively, the CWC can function as a spare waste tank, where waste water is fed directly into it (again via the Contingency Cross-tie Waste QD). In either case, the CWC would last about 47 hours (assuming seven crew members). This would require dumping the CWC when it is full or using a second one to hold more waste water. ©[121593- 1589]
2. If waste dump capability is lost, the ullage in the waste tank and the CWC will determine the end of mission. When the tank is full, the crew would lose humidity control, WCS urine collection capability, and EMU drain capability. ©[121593- 1589]

FLIGHT RULES

THIS PAGE INTENTIONALLY BLANK

FLIGHT RULES

SECTION 18 - THERMAL

SUPPLY WATER LOSS DEFINITIONS

A18-1	SUPPLY WATER TANK.....	18-1
A18-2	SUPPLY WATER DUMPLINE.....	18-2
A18-3	SUPPLY WATER DUMP CAPABILITY.....	18-3
A18-4	THROUGH A18-50 RULES ARE RESERVED.....	18-3

SUPPLY WATER MANAGEMENT - THERMAL

A18-51	IODINATED SUPPLY H2O TANK MANAGEMENT [HC].....	18-4
A18-52	SUPPLY/WASTE WATER CROSSCONNECT [HC].....	18-5
A18-53	SUPPLY WATER TANK A OUTLET VALVE MANAGEMENT...	18-5
A18-54	SUPPLY WATER TANK A BELLOWS PROTECTION.....	18-7
A18-55	SUPPLY WATER DUMP.....	18-8
A18-56	SUPPLY WATER DUMP NOZZLE TEMPERATURE CONSTRAINT.....	18-9
A18-57	ON-ORBIT SUPPLY WATER TANK MANAGEMENT [HC]...	18-10
A18-58	SUPPLY WATER SYSTEM LEAK MANAGEMENT [HC].....	18-12
A18-59	SUPPLY WATER REDLINE/MANAGEMENT.....	18-14
A18-60	EXTERNAL AIRLOCK WATER LINES.....	18-16
A18-61	EXTERNAL AIRLOCK LCG FLUID LINE LOSS DEFINITION.....	18-18
A18-62	EXTERNAL AIRLOCK WATER LINE OVERPRESSURE/TEMPERATURE MANAGEMENT.....	18-19
A18-63	THROUGH A18-100 RULES ARE RESERVED.....	18-19

FLIGHT RULES

ARS H2O LOOP LOSS DEFINITIONS

A18-101	ARS WATER LOOP [HC].....	18-20
A18-102	THROUGH A18-150 RULES ARE RESERVED.....	18-21

ARS H2O LOOP LOSS MANAGEMENT

A18-151	ARS WATER LOOP.....	18-22
A18-152	THROUGH A18-200 RULES ARE RESERVED.....	18-24

ACTIVE THERMAL CONTROL SYSTEM (ATCS) LOSS DEFINITIONS

A18-201	FREON COOLANT LOOPS (FCL) [HC].....	18-25
A18-202	TOPPING EVAPORATOR.....	18-28
A18-203	HIGH-LOAD EVAPORATOR.....	18-29
A18-204	FES PRIMARY A (B) CONTROLLER.....	18-30
A18-205	FES SECONDARY CONTROLLER.....	18-31
A18-206	FES H2O FEEDLINE.....	18-32
A18-207	AMMONIA BOILER SUBSYSTEM (ABS).....	18-33
A18-208	RADIATOR FLOW CONTROL ASSEMBLY (RFCA) [HC]...	18-33
A18-209	THROUGH A18-250 RULES ARE RESERVED.....	18-34

ATCS MANAGEMENT

A18-251	FREON COOLANT LOOPS (FCL).....	18-35
A18-252	FLASH EVAPORATOR SYSTEM (FES).....	18-39
A18-253	AMMONIA BOILER SUBSYSTEM (ABS).....	18-44
A18-254	ABS AMMONIA REDLINE.....	18-45
A18-255	RADIATOR FLOW CONTROL ASSEMBLY (RFCA) [HC]...	18-46
A18-256	RADIATOR ISOLATION VALVE MANAGEMENT [HC]....	18-50
A18-257	POSTLANDING NH3 TERMINATION.....	18-52
A18-258	THROUGH A18-300 RULES ARE RESERVED.....	18-52

FLIGHT RULES

EECOM HEATER MANAGEMENT

A18-301	TCS HEATER CONFIGURATION.....	18-53
A18-302	TCS HEATER REDUNDANCY.....	18-55
A18-303	REDUNDANT TCS HEATER VERIFICATION.....	18-55
A18-304	TCS HEATER OPERATIONS FOR LOSS OF INSTRUMENTATION.....	18-56
A18-305	LOSS OF HEATER SM CAPABILITY.....	18-57
A18-306	EXTERNAL AIRLOCK HEATER LOSS MANAGEMENT.....	18-57
A18-307	THROUGH A18 350 RULES ARE RESERVED.....	18-57

EECOM SOFTWARE REQUIREMENT

A18-351	EECOM SOFTWARE REQUIREMENT.....	18-58
A18-352	THROUGH A18-400 RULES ARE RESERVED.....	18-58

FLIGHT RULES

THIS PAGE INTENTIONALLY BLANK

FLIGHT RULES

SECTION 18 - THERMAL

SUPPLY WATER LOSS DEFINITIONS

A18-1

SUPPLY WATER TANK

THE SUPPLY WATER TANK IS CONSIDERED LOST IF:

- A. UNABLE TO EXTRACT WATER FROM OR REFILL THE TANK.
- B. THE TANK HAS AN IRREPARABLE LEAK.
- C. THE TANK HAS A BELLOWS LEAK.

The primary purpose of the supply water tanks is to store excess fuel cell water for crew consumption, EMU recharges, and for ATCS FES usage. A water tank cannot be used if unable to perform these functions. A bellows leak is loss of a tank because N₂ gas is ingested into the supply water, and it has been shown that gas adversely affects the performance of the FES by causing shutdowns.

DOCUMENTATION: Engineering judgment and flight data.

FLIGHT RULES

A18-2

SUPPLY WATER DUMPLINE

THE SUPPLY WATER DUMPLINE IS CONSIDERED LOST IF:

- A. THE DUMPLINE TEMPERATURE CANNOT BE MAINTAINED TO > 32 DEG (37 DEG) F.
- B. THE DUMPLINE IS BLOCKED.
- C. THE DUMPLINE IS RUPTURED.
- D. BOTH SUPPLY WATER NOZZLE TEMPERATURE MEASUREMENTS ARE FAILED.
- E. THE NOZZLE TEMPERATURE CRITERIA OUTLINED IN RULE {A18-56}, SUPPLY WATER DUMP NOZZLE TEMPERATURE CONSTRAINT, CANNOT BE MET. [ED]

The primary purpose of the dumpline is to provide a transport path for the supply water to the dump nozzle. If the dumpline is blocked, ruptured, frozen, or temperatures are not within an acceptable range, the transport path cannot be utilized to effectively perform this function. For the above failures, the flash evaporator is used to dump supply water before consideration is given to using the potable contingency crosstie.

DOCUMENTATION: Engineering judgment, flight data, STS-8, STS-41B, and SEH-TCS-85-036.

FLIGHT RULES

A18-3

SUPPLY WATER DUMP CAPABILITY

THE SUPPLY WATER DUMP CAPABILITY IS CONSIDERED LOST IF:

- A. THE SUPPLY WATER DUMPLINE IS LOST AND THE CREW IS UNABLE TO USE THE CONTINGENCY CROSSTIE TO DUMP SUPPLY WATER THROUGH THE WASTE WATER NOZZLE, OR INTO A CWC AND ©[071494-1647A]
- B. UNABLE TO DUMP SUPPLY WATER THROUGH THE FES.

If the dumpline is lost, the primary path to dump supply water is lost. If the crew cannot use the contingency crosstie or the FES, for any reason, the alternate methods to dump supply water have also been lost.

DOCUMENTATION: Engineering judgment.

A18-4 THROUGH A18-50 RULES ARE RESERVED

FLIGHT RULES

SUPPLY WATER MANAGEMENT - THERMAL

A18-51

IODINATED SUPPLY H₂O TANK MANAGEMENT [HC]

@[082604-6297B]

- A. FES OPERATIONS WHICH REQUIRE IODINATED H₂O WILL BE MINIMIZED, AS PRACTICAL. @[111094-1689A]

Minimizing FES operations which utilize iodinated H₂O will reduce the overall quantity of iodinated H₂O which passes through the FES core. Iodine has been found to be a cause of corrosion in the FES cores. This corrosion has caused several FES cores to develop minor Freon leaks, which is a lifetime issue for the FES. All four supply H₂O tanks are iodinated prelaunch, but tank A (and B when in the H₂O Transfer Config) remains iodinated throughout a flight.

- B. IODINATED H₂O CAN BE UTILIZED TO ACHIEVE LANDING OPPORTUNITIES.

Iodinated Supply H₂O is intended for crew consumption but can be used in the FES for contingencies and to make entry opportunities, if required.

- C. THE SUPPLY H₂O TANKS WILL BE RECONFIGURED AS SOON AS PRACTICAL TO THE NOMINAL H₂O CONFIGURATION FOLLOWING THE LAST CWC FILL.

Tank B water will be at the lowest practical quantity for reconfiguration back to a Nominal H₂O Configuration at the end of a CWC fill. This will minimize iodinated water introduced to the FES. (Reference Rule {A18-57}, ON-ORBIT SUPPLY WATER TANK MANAGEMENT.)

DOCUMENTATION: STS-65 MER-SPAN CHIT 012, Supply Tank A Dumps Using FES; Hazard Control ORBI 276, Loss of Flash Evaporator Function; and ORBI 323, Contamination of Potable Water.
@[111094-1689A] @[082604-6297B]

Rule {A18-53}, SUPPLY WATER TANK A OUTLET VALVE MANAGEMENT, references this rule.

@[ED]

FLIGHT RULES

A18-52

SUPPLY/WASTE WATER CROSSCONNECT [HC] @[032807-8252A]

THE CONTINGENCY WATER CROSSTIE CAPABILITY WILL BE USED TO:

- A. PROVIDE SUPPLY OR WASTE WATER DUMP CAPABILITY THROUGH THE ALTERNATE DUMP NOZZLE.

Provides for dumpline redundancy in the event of a dumpline failure for either system.

DOCUMENTATION: Engineering judgment.

- B. PROVIDE CONTINGENCY COOLING WATER FROM THE WASTE WATER TANK TO THE FES.

Certain launch day PLS opportunities cannot be met without increasing available supply water consumables. This is done by filling the waste tank with supply water. In the event that the PLBD's do not open, the additional supply water that was loaded in the waste tank must be used. The contingency crosstie capability allows the connection of the waste water system to the supply water system so that the supply water loaded in the waste tank is available to the FES.

DOCUMENTATION: Engineering judgment.

- C. PROVIDE CONTINGENCY WATER COLLECTION (CWC) BAG WITH FILL CAPABILITY.

A single waste tank with a maximum liquid capacity of 168 lb exists for each orbiter. Under various crew sizes and flight timelines, the amount of waste liquid generated exceeds the 168-lb storage capacity. The waste tank must be dumped under these conditions. If the waste tank cannot be dumped, additional ullage for the expected generated waste liquids must be made available. The CWC provides the additional ullage. In order for this ullage to be useful to the crew, the fill capability for the CWC must be provided via the contingency crosstie.

DOCUMENTATION: Engineering judgment.

- D. PROVIDE OVERBOARD DUMP CAPABILITY FOR CONTINGENCY WATER CONTAINERS (CWC'S) AND PAYLOAD WATER RESERVOIRS (PWR'S). SIMULTANEOUSLY DUMPING THROUGH THE CONTINGENCY WATER CROSSTIE POTABLE QD AND WASTE QD SHOULD BE AVOIDED IF POSSIBLE. @[032807-8252A]

THIS RULE CONTINUED ON NEXT PAGE

FLIGHT RULES

A18-52 **SUPPLY/WASTE WATER CROSSCONNECT [HC] (CONTINUED)**

Current ISS missions may require CWC's and PWR's to be dumped overboard. The supply and waste water crossconnect allows these bags to be dumped overboard through either dumpline. ©[032807-8252A]

Dumping CWC's and PWR's through the contingency water crosstie generates a wider spray pattern at the nozzles than a traditional water tank dump. This is due to lower back pressure on the bags when compared with pressurized orbiter water tanks. Flight data indicates that the effect of this wider spray pattern while dumping bags simultaneously through the contingency water crosstie results in increased crosstalk between the nozzles and the potential to generate ice at one or both nozzles.

DOCUMENTATION: Engineering judgment, flight data, STS-121, Hazard Control ORBI 007, Loss of Outer Moldline Due to Debris Impact; and ORBI 254, Crew Illness Due to Cabin Contamination by Free Waste Water or Solid Waste. ©[032807-8252A]

Rule {A17-452}, WASTE WATER DUMP CAPABILITY, references this rule.

A18-53 **SUPPLY WATER TANK A OUTLET VALVE MANAGEMENT**

- A. TANK A OUTLET VALVE WILL NORMALLY REMAIN CLOSED THROUGHOUT THE FLIGHT. IT WILL BE OPENED AS REQUIRED TO ENSURE SUPPLY WATER COLLECTION CAPABILITY AND THE NECESSARY ULLAGE FOR FUEL CELL WATER COLLECTION. ©[031500-7185]

Under nominal water system management and configuration, the tank A outlet valve is closed to preserve the sterility of water used for crew consumption. In the event that immediate supply water ullage is required in the supply water system (i.e., ECLSS water line blockage), water tank A outlet valve is opened to provide the necessary ullage for fuel cell water collection. Tank A outlet valve is opened because the risk of flooding three fuel cells outweighs microbial concerns affecting potable water for the crew. IFM procedures exist to guarantee potable water for crew consumption once the requirement for supply water collection capability is satisfied.

- B. FOR ISS FLIGHTS THAT REQUIRE WATER TRANSFER, THE TANK A OUTLET VALVE MAY BE OPENED TO TIE TANKS A AND B TOGETHER IN ORDER TO MAXIMIZE WATER TRANSFER CAPABILITY. TANKS A AND B WILL BE ISOLATED FROM TANKS C AND D BY CLOSING THE SUPPLY WATER CROSSOVER VALVE.

For ISS flights where the transfer of water will take place, tanks A and B will be tied together (reference Rule {A18-57A}.2, ON-ORBIT SUPPLY WATER TANK MANAGEMENT). In addition, FES PRI B will be selected to minimize the amount of iodine that would pass through the FES. Engineering has a concern that iodine in the supply water system causes corrosion in the FES core (reference Rule {A18-51}, IODINATED SUPPLY H2O TANK MANAGEMENT [HC]). ©[082604-6297B]

DOCUMENTATION: Engineering judgment. ©[031500-7185]

FLIGHT RULES

A18-54

SUPPLY WATER TANK A BELLOWS PROTECTION ©[082604-6350]

- A. FOR LAUNCH, THE SUPPLY WATER GN₂ TANK A SUPPLY AND SUPPLY WATER GN₂ TANK VENT VALVES WILL BE IN THE "CLOSED" AND "VENT" CONFIGURATION, RESPECTIVELY. THE VALVES WILL BE PLACED IN THE "OPEN" AND "PRESS" POSITIONS BEFORE WATER TANK A REACHES 98 (93) PERCENT AND PRIOR TO DEPLETION OF TANK B.

The orientation of the orbiter and the acceleration during launch both work against the flow of fuel cell product water into the supply water tanks. Without reducing the pressure of water tank A to cabin pressure, the fuel cells will vent product water through the fuel cell relief line instead of transporting the water to the water tanks. The supply water GN₂ tank A supply and supply water GN₂ tank vent valves must be placed in the CLOSED and VENT position in order to depressurize water tank A.

The valves must be placed in the OPEN and PRESS position in order to pressurize water tank A. If tank A is not pressurized prior to quantity reaching 100 percent, delta pressure across the tank bellows can exceed 15 psid resulting in serious damage to the bellows. Tank A must also be pressurized prior to the depletion of tank B to prevent the FES from shutting down.

DOCUMENTATION: Engineering judgment; flight data, 1.3 - TM - DF86050 - 013; and SODB 4.6.1.1.10 Water Tank "A" N₂ Pressure Control Valves.

- B. THE SUPPLY WATER TANK A QUANTITY WILL NOT BE ALLOWED BELOW 0 (5) PERCENT.

The Supply H₂O Tank A quantity limit prevents the metal bellows from being subjected to stress while against the hard stop.

DOCUMENTATION: SODB paragraph 4.6.2.1.1 Supply Water Storage and Control, Engineering judgment. ©[082604-6350]

FLIGHT RULES

A18-55

SUPPLY WATER DUMP

THE METHOD OF DUMPING SUPPLY WATER WILL BE AS FOLLOWS IN ORDER OF PRIORITY:

- A. IF PAYLOAD AND CREW TIMELINE CONSTRAINTS ALLOW, UTILIZE THE SUPPLY WATER DUMPLINE.
- B. UTILIZE THE FES.
- C. UTILIZE THE POTABLE H₂O CONTINGENCY CROSSTIE AND DUMP INTO A CWC.
- D. UTILIZE THE WASTE WATER DUMPLINE VIA THE WASTE WATER CONTINGENCY CROSSTIE. @[071494-1647A]

This rule outlines the desired medical and environmental systems operation priority of dumping excess supply water. Payload constraints will be considered when applicable. Utilization of the FES to dump excess supply water will be considered to minimize crew work load and propellant usage. The dumpline will remain higher priority than the FES, to minimize nozzle pulses on the FES. This priority is consistent with ensuring crew health by maintaining supply water system sterility. Dumping supply water through the supply dumpline, FES or into a CWC guarantees water system sterility. Dumping into the two CWC's onboard will create an additional 14-18 hours of ullage (depending on KW level). Connection of the supply water system to the waste dumpline increases the risk of contamination to the supply water system.
@[071494-1647A]

DOCUMENTATION: Engineering judgment.

FLIGHT RULES

A18-56

SUPPLY WATER DUMP NOZZLE TEMPERATURE CONSTRAINT

A SUPPLY WATER DUMP WILL BE TERMINATED IF BOTH OF THE SUPPLY WATER NOZZLE TEMPERATURES ARE LESS THAN 90 DEG F. NO FURTHER DUMPS WILL BE ATTEMPTED THROUGH THE SUPPLY DUMP NOZZLE. MINIMUM NOZZLE TEMPERATURE FOR SUPPLY DUMP INITIATION WILL BE 100 DEG F.

Utilizing the normal supply dump procedures, the supply water nozzle temperatures should rise and not decrease when the dump is initiated at a nozzle temperature of 100 deg F. If, instead of continuing to increase, the nozzle temperature decreases, then some problem exists with the dump nozzle which could lead to ice formation if the nozzle temperature drops below 45 deg F. The 90 deg F limit was established simply as an indication that the nozzle temperature is indeed decreasing from its original 100 deg F starting temperature and a cue that termination of the supply dump can be effected in a timely manner to prevent ice formation.

MCC GO/NO-GO requirement and visual references to frosting or glazing is not required due to the fact that ice formation, glazing, or frosting on the new supply dump nozzle does not occur until nozzle temperatures are well below 45 deg F.

The procedural act of dumping supply water calls for termination of the supply water dump if the nozzle temperatures drop below 90 deg F for no more than 4 seconds. The 90 deg F lower limit is well above the temperature at which ice, glazing, or frosting of the nozzle would occur. ®[ED]

Rule {A18-2E}, SUPPLY WATER DUMPLINE, references this rule.

FLIGHT RULES

A18-57

ON-ORBIT SUPPLY WATER TANK MANAGEMENT [HC]
@[031500-7185] @[031705-6459A]

A. ON-ORBIT SUPPLY WATER SYSTEM CONFIGURATIONS:

1. NOMINAL CONFIGURATION:

- a. TANK A INLET VALVE - OPEN;
TANK A OUTLET VALVE - CLOSED
- b. TANK B INLET, OUTLET VALVE (TWO) - OPEN;
TANK C INLET, OUTLET VALVE (TWO) - OPEN;
TANK D INLET, OUTLET VALVE (TWO) - OPEN
- c. XOVR VALVE - OPEN

2. WATER TRANSFER CONFIGURATION:

- a. TANK A INLET, OUTLET VALVE (TWO) - OPEN;
TANK B INLET VALVE - CLOSED, WITH CB PULLED;
TANK B OUTLET VALVE - OPEN
- b. TANK C INLET, OUTLET VALVE (TWO) - OPEN;
TANK D INLET, OUTLET VALVE (TWO) - OPEN
- c. XOVR VALVE - CLOSED, WITH CB PULLED @[031500-7185]

THIS RULE CONTINUED ON NEXT PAGE

FLIGHT RULES

A18-57

ON-ORBIT SUPPLY WATER TANK MANAGEMENT [HC]
(CONTINUED)

3. EVA EMU WATER RECHARGE: @[031500-7185]
 - a. NOMINAL CONFIGURATION - SUPPLY WATER TANK C INLET AND OUTLET VALVES MAY BE CLOSED TO PROTECT EVA EMU WATER RECHARGES.
 - b. WATER TRANSFER CONFIGURATION - EMU WATER RECHARGES WILL BE PERFORMED USING SUPPLY WATER TANK B. THIS CONFIGURATION POSES NO THREAT OF H₂ CONTAMINATION; THEREFORE, NO RECONFIGURATION SHOULD BE REQUIRED.

Nominal management is accomplished through water tanks B, C, and D with the crossover valve open. Tanks B, C, and D are usually tied together to provide maximum flexibility for filling and dumping. Tanks B, C, and D feed water to FES PRI A. Tank C can be isolated depending on mission requirements. Tank C is normally isolated at EOM deorbit prep to protect for waveoff opportunities.

Water Transfer management is accomplished through water tanks C and D with the crossover valve closed. Supply tanks A and B are tied and allowed to be filled to 100 percent to provide additional ullage capacity for water transfer. In this configuration, the tank B inlet valve and crossover valve circuit breakers are opened. These breakers are opened to prevent an inadvertent switch throw from contaminating tanks A and B, possibly eliminating capability to transfer water for the rest of the flight. In addition, FES PRI B will be selected, fed by tanks C and D, to minimize the amount of iodine that would pass through the FES. Engineering has a concern that iodine in the supply water system causes corrosion in the FES core (reference Rule {A18-51}, IODINATED SUPPLY H₂O TANK MANAGEMENT [HC]).

In a Nominal configuration, tank C may be isolated for EVA to protect against ingestion of hydrogen-laden fuel cell water into the EMU. In sufficient quantities, H₂ has the potential for creating a flammable condition within the EMU. On STS-82, H₂ was introduced into the supply water system through the alternate path with tanks B, C, and D tied together. Unlike the primary path, which has an H₂ Separator, the alternate path does not have H₂ separation capability. Tank C was isolated until all planned EVA's and EMU water recharges were accomplished. After the last EVA, tank C was reopened and managed with tanks B and D until EOM.

DOCUMENTATION: Engineering judgment and STS-82 chit, Hydrogen Gas Inclusion in EMU Water Tanks. @[031500-7185] @[031705-6459A]

THIS RULE CONTINUED ON NEXT PAGE

FLIGHT RULES

A18-57

ON-ORBIT SUPPLY WATER TANK MANAGEMENT [HC]
(CONTINUED)

- B. TO REFILL SUPPLY WATER TANKS C AND/OR D, FLOW THROUGH THE B/C CHECK VALVE WILL BE MINIMIZED. ©[031500-7185]

In a Nominal configuration, refilling of tanks B, C, and D will be handled by opening the crossover valve. Closing the tank B inlet and the crossover valve would result in a configuration that is one failure away (i.e., B/C check valve failed closed) from forcing the fuel cell water to relieve overboard. By opening the crossover valve instead, the fuel cell water will retain its path redundancy.

In a Water Transfer configuration, water produced by the fuel cells will enter tanks C and D through the B/C check valve once tanks A and B are full. Water planning will be utilized to minimize the amount of water that must flow through the B/C check valve. Water management must consider water transfer from tanks A and B, FES use from tanks C and D, and the supply water redlines. Tanks C and D must be refilled through the B/C check valve to maintain total water above the redlines and allow continued water transfer. After all water transfer has taken place, the supply water tanks will be reconfigured to a nominal on-orbit configuration (reference paragraph A). ©[031705-6459A]

- C. FOR REFILL, TANKS C AND D WILL NOT BE ALLOWED TO EXCEED 98 (93) PERCENT.

Tanks are fill-restricted to 98 (93) percent to prevent hardfilling the tanks which could result in venting FC water overboard. Tank A (or A and B) is not constrained because the FC water alternate path is a backup to the A/B check valve and will prevent FC water from relieving overboard. ©[031500-7185]

- D. THE AVAILABLE H₂O FOR CREW CONSUMPTION WILL BE NO LOWER THAN A QUANTITY OF 8 LBM PLUS 5 PERCENT SENSOR ERROR.

This Supply H₂O quantity along with fuel cell water generation ensures the crew has sufficient water for drinking and to prepare a meal for a crew of seven.

DOCUMENTATION: Engineering judgment and flight experience.

Hazard Report ORBI 323, Contamination of Potable Water. ©[031705-6459A]

FLIGHT RULES

A18-58

SUPPLY WATER SYSTEM LEAK MANAGEMENT [HC] @[082604-6291B]

FOR SUPPLY WATER SYSTEM LEAKS, THE FOLLOWING GUIDELINES WILL PERTAIN:

- A. IF FREE SUPPLY WATER IS IN THE CABIN, THE "FREE FLUID DISPOSAL" IFM PROCEDURE WILL BE PERFORMED IMMEDIATELY. IF PRACTICAL, THE WASTE WATER TANK WILL BE DUMPED TO 5 PERCENT PRIOR TO INITIALLY PERFORMING THE "FREE FLUID DISPOSAL" IFM PROCEDURE.

Free fluid in the cabin is an unacceptable condition because of LRU exposure to the free liquid causing an electric circuit malfunction and possible subsequent LRU failures.

Dumping the waste water tank creates additional ullage so that, if the IFM procedure causes a blockage in the waste water dump line, waste water will continue to collect to maximize the on-orbit stay period. STS-32 experienced free water in the lower equipment bay due to degraded humidity separator collection. The FREE FLUID DISPOSAL IFM was employed to dump the water overboard via the waste water dump nozzle. However, while employing the IFM procedure on the third occasion during the mission on FD 10, the waste water dump line became blocked by matter collected using the free fluid nozzle (wand). The mission was then limited by the remaining ullage in the waste water tank and the CWC volume. Note that the IFM hardware has been modified since STS-32 to mitigate the risk of waste dump line blockage.

DOCUMENTATION: Ref. STS-32 MER Anomaly #21, January 19, 1990; STS-32 CAR No. 32RF21; and engineering judgment.

- B. ANY SUPPLY WATER TANK WITH AN IRREPARABLE OR NONISOLATABLE TANK LEAK WILL BE VENTED, DUMPED, ISOLATED, AND NOT USED FOR THE REMAINDER OF THE MISSION. THE TANK WILL REMAIN DEPRESSURIZED UNTIL DUMPED. @[082604-6291B]

A leaking supply water tank cannot be pressurized without forcing water out of the tank. If the tank is dumped and isolated from further fuel cell water collection, then the remaining water tanks can be repressurized and normal operations can continue until end of mission. A tank that is depressurized is not likely to leak in a zero gravity field as no pressure differential exists to force the water out of the tank.

DOCUMENTATION: Engineering judgment.

- C. FOR A SUPPLY WATER TANK OUTLET MANIFOLD LEAK, TWO TANKS NOT SUPPLYING THE LEAK WILL BE SELECTED ALONG WITH THE PROPER FLASH EVAPORATOR SUBSYSTEM (IF REQUIRED). THE LEAKING MANIFOLD WILL BE ISOLATED FOR THE REMAINDER OF THE MISSION.

THIS RULE CONTINUED ON NEXT PAGE

FLIGHT RULES

A18-58

SUPPLY WATER SYSTEM LEAK MANAGEMENT [HC]
(CONTINUED)

Any water system manifold leak has the potential of reducing the ability of two water tanks to supply water under demand conditions. By isolating the leaking manifold, the amount of free water introduced into the cabin is minimized while maintaining water system support integrity.

DOCUMENTATION: Engineering judgment.

- D. FOR A SUPPLY WATER TANK INLET MANIFOLD LEAK THAT CANNOT BE ISOLATED, THE WATER TANKS WILL REMAIN DEPRESSURIZED. @[082604-6291B]

If the leak cannot be isolated, depressurizing the water tanks will reduce the leak rate to no greater than FC generation rate.

DOCUMENTATION: Engineering judgment.

- E. FOR A SUPPLY WATER TANK BELLOWS LEAK, THE TANK WILL BE ISOLATED AND REMAIN ISOLATED FOR THE REMAINDER OF THE MISSION. FOR CONTINGENCIES THAT REQUIRE ADDITIONAL SUPPLY WATER, CONSIDERATION WILL BE GIVEN TO USING THIS WATER.

Isolating the tank for a bellows leak will stop Nitrogen from being introduced into the supply water system. Nitrogen in the water system may cause erratic FES operation or shutdown. A Tank A bellows leak will introduce Nitrogen in the galley. The tank will not be dumped to preclude the possibility of additional tank damage.

DOCUMENTATION: Engineering judgment.

Hazard Report ORBI 276, Loss of Flash Evaporator Function. @[082604-6291B]

A18-59

SUPPLY WATER REDLINE/MANAGEMENT @[082604-6292B]

- A. TO PROTECT FOR ANYTIME DEORBIT, SUPPLY WATER WILL BE MANAGED TO ALWAYS MAINTAIN A MINIMUM QUANTITY OF 175 LBM. @[082604-6292B]

Analysis results conclude that 175 lbm of water is sufficient to supply orbiter cooling requirements for an anytime 165-minute emergency deorbit.

DOCUMENTATION: Anytime Contingency Deorbit Water Redline, STSOC Transmittal Form No. FDD-SA-88-220-082, May 25, 1988.

THIS RULE CONTINUED ON NEXT PAGE

FLIGHT RULES

A18-59

SUPPLY WATER REDLINE/MANAGEMENT (CONTINUED)

- B. IN ADDITION TO THE ANYTIME DEORBIT REQUIREMENT, SUPPLY WATER WILL BE MANAGED TO PROTECT A MINIMUM DAILY PLS REQUIREMENT OF 281 LBM THROUGH 3.5 HOURS PRIOR TO THE PLS TIG. ©[082604-6292B]

A supply water quantity of 281 lbm will support one deorbit opportunity for a nominal deorbit prep timeline. A minimum of 3.5 hours of deorbit preparation is required to perform a PLS deorbit. Supply water will be managed to satisfy the 175 lbm anytime deorbit requirement once this time has passed. Although the absolute minimum anytime deorbit requirement is 175 lbm, the requirement to maintain 281 lbm for the following day PLS typically drives supply water management planning such that water quantities are always well above the 175 lbm anytime deorbit redline.

Reference Rule {A2-102E}.4, MISSION DURATION REQUIREMENTS for the minimum deorbit preparation time of 3.5 hours. ©[082604-6292B]

- C. RETURN PAYLOAD COOLING WATER REQUIREMENTS ARE SPECIFIED IN THE APPROPRIATE FLIGHT-SPECIFIC ANNEX.

Normal orbiter configuration assumes no active payload cooling (both FCL flow proportioning valves in ICH position) and normal orbiter power levels. For active payload cooling cases, additional water is required, depending on flight-specific cooling requirements. This redline is derived as a minimum water quantity required to support a nominal deorbit timeline. Contingency return cases require less water (175 lbm) due to a shorter deorbit time. Failures requiring EVA (PLBD fail to close) would require a 1-day waveoff to accumulate extra water required to support the new deorbit and EVA timeline. The study used to define this redline uses the following major assumptions:

- a. RAD coldsoak (RADS HI, Topping FES-ON) starts at TIG minus 3:56.*
- b. RAD bypass at TIG minus 2:50.*
- c. PLBD's closed at TIG minus 2:35.*
- d. FES deactivated at TD minus 12 minutes.*
- e. Entry power level of 19 kw.*

Measurement error, crew consumption and 10 percent dispersion are included in the analysis.

DOCUMENTATION: Anytime Contingency Deorbit Water Redline, STSOC Transmittal Form No. FDD-SA-88-220-082, May 25, 1988.

FLIGHT RULES

A18-60

EXTERNAL AIRLOCK WATER LINES

THE EXTERNAL AIRLOCK WATER LINES ARE CONSIDERED LOST IF:
@[061297-4904]

- A. THE EXTERNAL AIRLOCK WATER LINE TEMPERATURES IN EITHER ZONE 1 OR ZONE 2 CANNOT BE MAINTAINED TO > 32 DEG (40 DEG) F.

The external airlock water lines consist of six different water lines broken up into two zones, routed between the Xo=576 bulkhead and the external airlock. They are:

One EMU/ISS transfer supply water line

One EMU waste water return line

Two EMU liquid cooling garment supply lines (one for each EMU)

Two EMU liquid cooling garment return lines (one for each EMU)

Each line is wrapped with triply redundant heater strings in each of the two zones. Redundant temperature transducers are available for each zone (two each for zones 1 and 2) and they are located to be representative of the temperature in all six of the lines when water is not flowing. A third transducer (V64T0185A) is available on zone 2 but, because of its location and subsequent sluggish response, it is not used for fault detection. It is mainly used to detect a short between heater segments.

Due to the location of each of the sensors, they do not indicate the exact temperature of the coldest segment of the six water lines. Per analysis, the following indicated temperatures reflect when the coldest segment of the lines has reached 32 deg. These values do not include the measurement error of the transducer. A lower limit is not assigned to the O₂ SPLY T ZN2 (V64T0186A) since analysis indicates that the coldest analyzed attitudes will not cause detrimental effects upon the O₂ lines. @[082604-6298]

H₂O SPLY T ZN1 (V64T0181A) - 34 deg F

LCG2 SPLY T ZN1 (V64T0182A) - 47 deg F

O₂ SPLY T ZN2 (V64T0186A) - N/A @[082604-6298]

H₂O SPLY T ZN2 (V64T0184A) - 36 deg F

THIS RULE CONTINUED ON NEXT PAGE

FLIGHT RULES

A18-60

EXTERNAL AIRLOCK WATER LINES (CONTINUED)

- B. THE EXTERNAL AIRLOCK STRUCTURAL TEMPERATURES CANNOT BE MAINTAINED TO > 32 DEG (40 DEG) F.

Preliminary analysis indicates that with the airlock depressed and the hatch and thermal cover open, the internal water line temperatures decrease faster than the indicated structural temperatures (reference Rule {A15-201}, EXTERNAL AIRLOCK HATCH THERMAL COVER). During EVA and while the ductwork is disconnected, the only active thermal control for the interior of the airlock is provided by the structural heaters. Based upon attitude, there is a concern for water line freezing if an active heater zone fails.

DOCUMENTATION: Engineering judgment and Rockwell I.L. 270-200-95-152, Rev 1 (December 15, 1995); Boeing TS-TC&PS-01-030 "Bay 1/2 External Airlock Fluid Line Fault Detection Annunciation"(October 29, 2001). @[061297-4904] @[082604-6298]

FLIGHT RULES

A18-61

EXTERNAL AIRLOCK LCG FLUID LINE LOSS DEFINITION

THE LCG FLUID LINES SHALL BE CONSIDERED LOST IF: @[061297-4904]

- A. WITH THE SCU DISCONNECTED FROM THE EMU, THE LCG PRESSURE CANNOT BE MAINTAINED ≤ 28.1 (26.4) PSIG.
- B. WITH THE SCU CONNECTED TO THE EMU AND THE EMU UNPOWERED, THE LCG PRESSURE CANNOT BE MAINTAINED ≤ 18 (16.6) PSIG.

The pressure in either of the LCG lines (MSID V64P0170A or V64P0171A) shall be maintained below the SCU certified maximum operating pressure of 28.1 psig, in order to protect the SCU from exposure to proof pressure cycles (SCU proof pressure is 42.2 psig, burst pressure is 56.2 psig). The SCU can be connected to the EMU to relieve the pressure in the LCG lines.

A steady pressure increase in either of the LCG lines with the SCU connected, EMU fan/pump and O₂ actuator off, indicates the EMU water tanks no longer contain any nominal ullage and are no longer acting as an accumulator for the LCG lines. In the EMU, the LCG loop is connected to the water tanks through the bypass of the EMU coolant isolation valve. At 19.0 ± 1.0 psig, the EMU feedwater relief valve will open and vent water from the EMU water tanks into the airlock.

DOCUMENTATION: Hamilton Standard EMUM-1337, S/AD SV767730/2 (Service & Cooling Umbilical Drawing), and engineering judgment. @[061297-4904]

FLIGHT RULES

A18-62

**EXTERNAL AIRLOCK WATER LINE
OVERPRESSURE/TEMPERATURE MANAGEMENT**

UNEXPECTED PRESSURE AND/OR TEMPERATURE INCREASES IN THE EXTERNAL AIRLOCK LIQUID COOLING GARMENT (LCG) FLUID LINES WILL BE MANAGED AS FOLLOWS IN ORDER OF PRIORITY: @[061297-4904]

- A. DEACTIVATION OF WATER LINE HEATERS
- B. CHANGE ORBITER ATTITUDE, IF OPERATIONAL AND PAYLOAD CONSTRAINTS ALLOW
- C. CIRCULATE THE WATER IN THE LCG LINES VIA THE EMU FAN/PUMP (REF RULE {A15-202}, EXTERNAL AIRLOCK LCG PRESSURE AND TEMPERATURE MANAGEMENT USING THE EMU) .

There is no accumulator located on the LCG fluid lines, and they are configured in a closed loop system. The only room for thermal expansion in these fluid lines is via the flexible portion of the SCU lines, when disconnected from the EMU, or the available ullage in the EMU water tanks when the SCU is connected to the EMU. It is possible, in "hot" thermal attitudes, that the available expansion in the LCG lines may not be sufficient to prevent a hydraulic lockup condition, without taking action to lower the pressure/temperature of the fluid lines.

DOCUMENTATION: Engineering judgment. @[061297-4904]

A18-63 THROUGH A18-100 RULES ARE RESERVED

FLIGHT RULES

ARS H2O LOOP LOSS DEFINITIONS

A18-101 ARS WATER LOOP [HC] ©[112304-6478A]

AN ARS WATER LOOP IS CONSIDERED LOST IF:

- A. ACCUMULATOR QUANTITY EQUALS 0 (≤ 5) PERCENT.

When the accumulator is empty, voids are created in the water loop causing pump cavitation.

DOCUMENTATION: Engineering judgment.

- B. INTERCHANGER FLOWRATE CANNOT BE MAINTAINED ≥ 600 (649) LB/HR IN THE "MIN BYP" POSITION.

At flowrate < 600 lb/hr, avionics bay 2 coldplates cannot be maintained below their 130 deg F upper limit in a normal entry (five GPC's).

DOCUMENTATION: Degraded Cabin WCL Flowrate Analysis (SEH-ECS-86-106) October 1986.

- C. ACTIVE LOOP PUMP OUTLET TEMPERATURE CANNOT BE MAINTAINED TO < 85 DEG (82.75 DEG) F AT A 14.7 PSIA CABIN PRESSURE.

The maximum air supply temperature to the avionics bays is 95 deg F at 14.7 psia cabin pressure by design specification. The air temperature leaving the avionics heat exchanger is about 10 deg F hotter than the water coolant loop pump outlet temperature. Avionics equipment may overheat if pump outlet temperature cannot be maintained to less than 85 deg F.

DOCUMENTATION: MF0004-009, REV A; Flight data (E.G. SEH-ITA-82-333).

- D. THERE IS CONFIRMED INTERLOOP LEAKAGE (WATER-TO-WATER OR FREON-TO-WATER) .

For a water-to-water loop leak, the loops are now operating as one loop. (Ref. Rule {A18-151D}, ARS WATER LOOP.) The next failure, an external leak, could result in loss of both loops. For a Freon-to-water loop leak, high pressures and material incompatibilities between Freon 21 and water loop components increase the probability of an external leak in the water loop and exposing the crew to the toxic Freon 21. To reduce such probability, the affected water loop is not to be operated unless required. (Ref. Rule {A18-151E}, ARS WATER LOOP.) ©[112304-6478A]

DOCUMENTATION: Engineering judgment; JSC-08934, vol. 3, 4.6.1.2.1.2.

THIS RULE CONTINUED ON NEXT PAGE

FLIGHT RULES

A18-101 **ARS WATER LOOP [HC] (CONTINUED)**

- E. THERE IS A CONFIRMED ACCUMULATOR BELLOWS FAILURE CAUSING GN₂ AND WATER COOLANT TO MIX SUCH THAT PUMP CAVITATION OCCURS ON EACH AVAILABLE PUMP ON THE AFFECTED LOOP.

©[112304-6478A]

For an accumulator bellows failure causing GN₂ to mix with water coolant, nitrogen bubbles will pass through the pump if the affected loop is activated. The pump would operate erratically as would be demonstrated by the pump delta P and interchanger flowrate. Since reliable continuous pump operation cannot be expected, the loop should be considered lost once the pump cavitates. If pump cavitation occurs on WCL2, no alternate pump is available. If pump cavitation occurs on WCL1, consideration will be given to activating the alternate pump on WCL1 to see if the pump cavitation is isolated to a single pump on WCL1.

DOCUMENTATION: Engineering judgment.

Hazard Reports: ORBI-117-A LOSS OF WATER COOLANT LOOPS, ORBI-241- FREON LEAKAGE INTO WATER COOLANT LOOP/CABIN, ORBI-276- LOSS OF FLASH EVAPORATOR FUNCTION, and ORBI-321- CREW INCAPACITATION FROM HEAT STRAIN. ©[112304-6478A]

A18-102 THROUGH A18-150 RULES ARE RESERVED

FLIGHT RULES

ARS H2O LOOP LOSS MANAGEMENT

A18-151

ARS WATER LOOP

A. NORMAL CONFIGURATION FOR ASCENT/ENTRY:

BYPASS VALVE CONTROL IN THE "MAN" MODE AND THE INTERCHANGER FLOW PRESET TO 950 ± 50 LB/HR ON BOTH LOOPS.

1. LOOP 1 -PUMP B WITH CONTROL "OFF".
2. LOOP 2 -PUMP CONTROL "ON".

The heat load mismatch between Freon and water loops at the interchanger causes the bypass valve controller to operate improperly at high heat loads when in the AUTO mode. Reference the Environmental Systems Console Handbook for a complete description of this mismatch. The optimum water loop flowrate for both the cabin temperatures and the avionics temperatures is determined by analysis to be 950 lb/hr for when the Freon loop FPM's are in either ICH or P/L positions. For these reasons, it is desirable to operate at this constant 950 lb/hr flowrate with the bypass valve in the MAN mode, during Ascent/Entry.

Water loop 2 is used as the active loop because of the "undetected failure" concern. Water loop 2 has one pump and water loop 1 has two pumps. If water loop 1 were to be the prime active loop, the pump in water loop 2 could fail and remain undetected until loop 1 failed and loop 2 was needed.

Water loop 1 is preset to a 950 lb/hr flowrate so that, when needed, it can be brought on line with optimum performance.

DOCUMENTATION: 1.2-TM-B1109-27; SEH-ITA-82-029.

B. CONFIGURATION FOR ON ORBIT:

1. AUTO MODE

BYPASS VALVE CONTROL IN THE AUTO MODE: LOOP 2 - PUMP CONTROL "ON", AND LOOP 1 - PUMP B WITH "GPC" CONTROL AND BYPASS VALVE IN MAN MODE.

THIS RULE CONTINUED ON NEXT PAGE

FLIGHT RULES

A18-151 ARS WATER LOOP (CONTINUED)

2. MANUAL MODE

BYPASS VALVE CONTROL IN THE MAN MODE AND THE INTERCHANGER FLOW PRESET TO 950 ± 50 LB/HR ON BOTH LOOPS: LOOP 1 - PUMP B WITH "GPC" CONTROL, AND LOOP 2 - PUMP CONTROL "ON."

Flight data has indicated that the heat load mismatch at the Freon/H₂O interchanger is not as severe as previously predicted by analysis. Water loop control temperature (PUMP OUT TEMP) is not significantly affected by the FREON/H₂O ICH heat load mismatch. During STS-44, H₂O LOOP 2 performed nominally in the AUTO mode. Postflight crew comments about cabin temperature indicate AUTO mode is also beneficial to the persistent cabin temperature problem. Reference OFTP 8-14-91, December 13, 1991.

H₂O loop 1, pump B, is in the GPC position for periodic cycling to satisfy thermal conditioning requirements. Pump A is normally operated on the ground. @[041196-1882]

DOCUMENTATION: SEH-ITA-83-151

- C. BOTH WATER LOOPS WILL BE TURNED ON IF THE EVAPORATOR OUTLET TEMPERATURES IN BOTH FREON LOOPS ARE <32 DEG (34.6 DEG) F. (REF. {A18-251E}, FREON COOLANT LOOPS (FCL).)

Turning both water loops on allows more heat to be transferred to the water loops at their coldplates and heat exchangers, which at the same time reduces the interchanger heat transfer effectiveness from water-to-Freon loops. Analysis has shown that with both water loops operating and both Freon FPM's at the ICH positions, freezing of water is prevented until the Freon inlet temperature to the interchanger drops below 6 deg F.

DOCUMENTATION: LEMSCO 19630.

- D. FOR A WATER-TO-WATER LOOP LEAK, BOTH WATER LOOPS WILL BE ACTIVATED.

Depending on the loading of the water loops, it is possible to empty the accumulator of the operating loop into the nonoperating loop in the case of an interloop leak. Operating both loops eliminates this problem.

DOCUMENTATION: Engineering judgment.

THIS RULE CONTINUED ON NEXT PAGE

FLIGHT RULES

A18-151 ARS WATER LOOP (CONTINUED)

- E. FOR A FREON-TO-WATER LOOP LEAK, THE AFFECTED WATER LOOP WILL NOT BE OPERATED UNLESS REQUIRED.

For a Freon-to-water loop leak, pressures in the water loop can get up to 135 psig (proof pressure) and higher if the affected water loop is operated. In addition, several components in the water loop are incompatible with Freon 21 and may fail to seal or function. Operating the affected water loop will circulate Freon 21 in the loop and accelerate seal degradation. The high pressures and material incompatibilities together increase the probability of an external leak in the water loop and exposing the crew to the toxic Freon 21. ©[082593-1527]

- F. FOR A WATER LOOP LEAK, THE AFFECTED LOOP WILL BE DEACTIVATED.

When there is a coolant leak into the cabin from the water loop, it becomes zero-fault tolerant to crew safety because the next failure, a Freon-to-water leak at the interchanger, will introduce toxic Freon 21 into the crew habitable area. Deactivating the leaking loop may slow the leak rate (depending on the location of the leak on the loop) and minimize the risk of transferring Freon into the cabin should an interchanger leak occur. This would allow this loop to be used in the contingency event the other water loop should fail.

DOCUMENTATION: Engineering judgment; JSC-08934, volume 3, section 4.6.1.2.1.2.

Rule {A18-101D}, ARS WATER LOOP, references this rule.

A18-152 THROUGH A18-200 RULES ARE RESERVED

FLIGHT RULES

ACTIVE THERMAL CONTROL SYSTEM (ATCS) LOSS DEFINITIONS

A18-201 **FREON COOLANT LOOPS (FCL) [HC]** ©[031705-6691D]

AN FCL IS CONSIDERED LOST IF:

A. CALCULATED FREON FLOWS, WHICH ASSUME THE RADIATORS ARE BYPASSED AND THE FLOW PROPORTIONING MODULE (FPM) IN "ICH," CANNOT BE MAINTAINED GREATER THAN:

1. INTERCHANGER FLOW EQUALS 1800 (1925) LB/HR.

The minimum interchanger flowrate required to support a one Freon loop entry (with three GPC's) is 1800 lb/hr. This flowrate is required to ensure that the fuel cell coolant return temperature is maintained below its 140 deg F limit until just before touchdown. (The exceedance is of short enough duration that no fuel cell damage will occur.)

DOCUMENTATION: G189A analysis dated August 4, 1989.

A Freon Loop with a flow proportioning valve failed in the PL position is considered lost because, with loss of the other loop, it will not provide enough cooling to the interchanger (av bays and cabin) during a one freon loop entry. Assuming one FCL powerdown and an additional two GPC's powered down (one GPC/avionics bay powered up), avionics bays 1, 2, and 3 violate mixed air outlet temperature limits. The PL position provides only 51 percent (1500 lb/hr/lp) of the total freon flow to the interchanger, while the ICH position provides 81 percent (2400 lb/hr/lp). Freon Loop total flow is not greatly affected by the FPM position and, thus, FC cooling is not a concern for this failure.
©[041097-3104B]

DOCUMENTATION: SE-TSAT-95-010. Reference SODB Volume III, par. 4.5.4.1.2; memo ED5-90-48; and IBM report 90-544-004 for GPC cooling requirements. ©[041097-3104B]

2. AFT COLDPLATE FLOW (ASSUMES THE RADIATORS ARE BYPASSED) : ©[031705-6691D]

a. ASCENT

FOR THE PURPOSE OF MAKING ASCENT ABORT CALLS (RTLs, TAL, AOA) FOR THE LOSS OF TWO FCL'S, A FCL WILL BE CONSIDERED LOST IF THE AFT COLDPLATE FLOW IS LESS THAN 193 (218) LB/HR. ©[031705-6691D]

THIS RULE CONTINUED ON NEXT PAGE

FLIGHT RULES

A18-201

FREON COOLANT LOOPS (FCL) [HC] (CONTINUED)

b. ORBIT @[031705-6691D]

AN FCL WILL BE CONSIDERED LOST IF THE AFT COLDPLATE FLOW IS LESS THAN 163 (188) LB/HR (THE SINGLE FAULT TOLERANT FIRST D/O OPPORTUNITY LIMIT).

THE FOLLOWING TABLE SHOWS THE FCL AFT COLDPLATE FLOW REQUIRED TO SUPPORT THE FIRST D/O OPPORTUNITY, AS WELL AS THE 1- AND 2-REV WAVE-OFF OPPORTUNITIES BASED ON VARIOUS FCL AFT COLDPLATE D/O PREP AND ENTRY EQUIPMENT CONFIGURATIONS.

D/O PREP & ENTRY AFT COLDPLATE CONFIG	1ST D/O OPPORTUNITY	1 REV WAVE-OFF OPPORTUNITY	2 REV WAVE-OFF OPPORTUNITY
NOMINAL	193(218) LB/HR	198(223) LB/HR	201(226) LB/HR
SFT (STS-109)	163(188) LB/HR	163(188) LB/HR	163(188) LB/HR
ABSOLUTE MIN	108(133) LB/HR	107(132) LB/HR	107(132) LB/HR

An earliest possible abort is required for the loss of two Freon Loops. The minimum aft coldplate flow required to support a one Freon loop, nominal deorbit prep and entry (radiators bypassed), is 193 lb/hr. This flowrate is required to maintain the aft avionics bay 4 coldplate outlet (RGA inlet) temperature below the 117 deg F limit. This flow limit assumes that the aft coldplate equipment is powered up for a nominal deorbit prep and entry, and no waveoffs are performed. The Nominal D/O Prep, first deorbit opportunity flow limit of 193 (218) lb/hr is chosen as the ascent abort limit because in some flow degrade cases (pump problem, blockage) there is risk for further degradation. Pressing to orbit with both Freon Loops failed (completely or partially, by FR definition) is undesirable since the loss of two FCL's could result in loss of crew and vehicle.

During STS-109, a blockage in the aft coldplate leg of FCL 1 was observed a few seconds after MECO resulting in a degraded aft coldplate flow of 200 (225) lb/hr (below the old limit of 211 (236) lb/hr). To ensure that the aft avionics bay 4 coldplate outlet temperature limit of 117 deg F would not be violated prior to EOM (wheelstop) should the good loop (FCL 2) fail, a modified deorbit prep and entry powerup plan for the equipment cooled by the aft coldplates was developed which took many of the entry critical aft coldplate LRU's to a single fault tolerant level. The aft coldplate flowrate on FCL 1 never decreased below that observed with the initial blockage and the mission was extended to the nominal duration. Postflight, the blockage was determined to be caused by a piece of brazing preform which became lodged in the FCL 1 aft coldplate flow restrictor at MECO. @[031705-6691D]

THIS RULE CONTINUED ON NEXT PAGE

FLIGHT RULES**A18-201****FREON COOLANT LOOPS (FCL) [HC] (CONTINUED)**

In an effort to bound the cooling capability of the aft coldplate flow of a single FCL (based on the STS-109 aft coldplate flow blockage experience), a set of analyses was performed to determine the minimum flow required to support various, single FCL deorbit prep and entry aft coldplate LRU configurations. FCL aft coldplate flow requirements for each deorbit prep and entry configuration are listed in the table above. Because weather plays such a critical role in the deorbit decision, minimum aft coldplate flowrates required to support a 1- and 2-rev wave-off opportunity are provided as well as the first (nominal) deorbit opportunity flowrate requirement. If landing cannot be accomplished after a single or multiple deorbit attempt(s) on the same day, the aft coldplate outlet temperature limit will not be violated during deorbit attempts on subsequent days, provided flow remains above the associated deorbit opportunity limit. Note that in the SFT and Absolute Min Configuration 1 and 2 rev waveoff cases, the flowrate required does not increase as it does in the nominal D/O Prep cases. This is because the flowrate which is gained when the radiators are bypassed is enough to remove the heat load added during deorbit prep and entry in these powerdown (modified powerup) cases, whereas in the nominal case, the flowrate gained (when the rads are bypassed) is not enough to overcome the significantly higher aft coldplate heat load. A brief summary of each configuration is given below. Details of each configuration are documented in Rule {A18-1001}, THERMAL GO/NO-GO CRITERIA [HC]. ©[031705-6691D]

The Nominal Deorbit Prep and Entry Config is the config nominally performed every mission as defined in the D/O Prep and Entry Flight Data File procedures and provides full redundancy on entry critical systems. Note: A nominal D/O Prep and entry actually requires significantly less aft coldplate flow than the nominal flowrate provided by one FCL (approximately 340 lb/hr observed).

The SFT (Single Fault Tolerant STS-109) Config is the modified FCL aft coldplate D/O Prep and Entry config developed during STS-109. This modified powerup allows for some further degradation in flow from that required to support a nominal D/O Prep and Entry while maintaining much of the critical redundancy desired for entry. The single fault tolerant first deorbit opportunity flow limit is chosen as the orbit FCL loss definition because a deorbit prep and entry with a single FCL aft coldplate flowrate below this limit would require a powerdown of some entry critical aft coldplate cooled equipment to a zero fault tolerant level which could potentially include the powerdown of aft OI MDM's and/or DSC's that provide insight into the operation and performance of many systems in the aft fuselage. In an effort to minimize the window of exposure to the next worst failure (loss of the good FCL) and the severe powerdown that would be required, the mission should be terminated NPLS if the aft coldplate flow in a single FCL degrades below this level. ©[031705-6691D]

THIS RULE CONTINUED ON NEXT PAGE

FLIGHT RULES

A18-201**FREON COOLANT LOOPS (FCL) [HC] (CONTINUED)**

The Absolute Minimum (Zero Fault Tolerant) Config takes all entry-critical aft coldplate LRU's to a zero fault tolerant level and includes the powerdown of the aft OI MDM's and DSC's that provide insight into the operation of most systems in the aft fuselage (OMS/RCS, APU/Hydraulics, FCS Channels, FCL's, FES, and Aft electrical buses). Although this configuration still provides the functionality to affect a certified entry, it is highly undesirable due to the lack of fault tolerance and insight remaining. In an effort to minimize the window of exposure to the next worst failure (loss of the good FCL), the mission should be terminated NPLS prior to the FCL aft coldplate flow degrading to this level. ©[031705-6691D]

DOCUMENTATION: SE-TSAT-93-068; SEH-ITA-84-249T; Boeing Technical Memorandum TS-TM-05-004, Minimum Aft Cold Plate Flow for Freon Coolant Loop Flow Failures with Reduced Power Levels; AE FTP #207; and Engineering judgment. ©[012694-1542A]

Hazard Control Reference: HR ORBI 0275, Loss of Freon Coolant Loops.

B. PUMP INLET PRESSURE < 33.5 (48.5) PSIA

Pump cavitation will occur for a pressure at the pump inlet below Freon vaporization point. Since there is not a measurement of pump inlet temperature, the maximum pump inlet temperature vaporization pressure is used. The FCL's were designed for a 90 deg F inlet to the midbody coldplates for one FCL operation (90 deg F pump outlet temperature). Therefore, based on design, the maximum pump inlet temperature, without exceeding the midbody coldplate outlet temperature, is 88 deg F. This corresponds to a vaporization pressure of 32 psia for Freon.

However, the location of the pressure transducer is at the upstream of the pump inlet filter, and the pressure loss through the filter must be accounted for to make sure the pump inlet pressure is above vaporization point. The maximum pressure drop of the filter is 1.5 psid; therefore, the pressure shall be no less than 33.5 psid to ensure proper pump performance. The pump cavitation will cause erratic discharge pressure and pumping flowrate.

DOCUMENTATION: SODB Figures 4.6.3-8 and 4.6.3-7. ©[031705-6691D]

THIS RULE CONTINUED ON NEXT PAGE

FLIGHT RULES

A18-201

FREON COOLANT LOOPS (FCL) [HC] (CONTINUED)

C. THERE IS A CONFIRMED INTERLOOP LEAKAGE (FREON-TO-FREON)

The FCL, as related to fluid volume, would now be acting as one FCL. One additional failure (external fluid leak) would result in loss of both FCL's. For GO/NO-GO purposes, one FCL would be considered lost in the event of interloop leakage.

DOCUMENTATION: N/A, engineering judgment.

D. ACCUMULATOR QUANTITY EQUALS 0 (3) PERCENT

When there is no freon left in the accumulator, voids are created in the FCL, causing pump cavitation.

DOCUMENTATION: N/A, engineering judgment.

E. FOR THE PURPOSES OF MAKING ASCENT ABORT CALLS, A FREON LEAK IS CONFIRMED BY AN OTHERWISE UNEXPLAINED 1.6 PERCENT DECREASE IN ACCUMULATOR QUANTITY AND A CORRESPONDING 2 PSI DROP IN PUMP IN PRESSURE FROM LIFT-OFF VALUES.

An earliest possible abort is required for loss of two Freon loops. A 1.6 percent quantity drop and 2 psi drop in PUMP IN PRESSURE is the minimum amount needed to confirm a loop leaking during ascent. Quantity and pressure always increase slightly during ascent due to the heat loads; therefore, any drop in quantity and pressure is always indicative of a leak. If, for any reason, the ascent heat loads should decrease (i.e., H₂O loop failure), this could cause a drop in pressure and quantity, and the loop would not be called lost on this criteria. Once a loop is leaking, the FCL loss is imminent and is considered failed for abort calls. Pressing to orbit with leaking loops is not desirable, since the loss of two Freon Loops during entry could result in loss of crew/vehicle.

DOCUMENTATION: Flight history and engineering judgment.

FLIGHT RULES

A18-202

TOPPING EVAPORATOR

THE TOPPING EVAPORATOR IS CONSIDERED LOST IF:

- A. BOTH PRIMARY CONTROLLERS AND THE SECONDARY CONTROLLER CANNOT MAINTAIN PROPER CONTROL, AS DEFINED IN THE CONTROLLER LOSS DEFINITION.

The topping evaporator cannot function without a controller. Reference controller loss definitions, Rules {A18-204}, FES PRIMARY A (B) CONTROLLER, and {A18-205}, FES SECONDARY CONTROLLER.

DOCUMENTATION: Hamilton Std, SEM 62408.

- B. FORWARD OR AFT TOPPING DUCTS CANNOT BE MAINTAINED ≥ 100 DEG (120 DEG) F.

This temperature ensures that, as the topping evaporator boils water, the H₂O vapor does not condense and freeze in the ducts. If freezing occurs, the back pressure in the Flash Evaporator System (FES) core increases, which raises the boiling point. This may result in an overtemp shutdown.

DOCUMENTATION: Hamilton Std, SEM 62449.

- C. BOTH A AND B FEEDLINES ARE LOST.

If both feedlines are lost, H₂O cannot be supplied to the topping evaporator. Reference Rule {A18-206}, FES H₂O FEEDLINE, loss definition.

DOCUMENTATION: N/A, system schematic analysis.

FLIGHT RULES

A18-203

HIGH-LOAD EVAPORATOR

THE HIGH-LOAD EVAPORATOR IS CONSIDERED LOST IF:

- A. BOTH PRIMARY CONTROLLERS AND THE SECONDARY CONTROLLER CANNOT MAINTAIN PROPER CONTROL, AS DEFINED IN THE CONTROLLER LOSS DEFINITION.

The high-load evaporator cannot function without a controller. Ref. Rules {A18-204}, FES PRIMARY A (B) CONTROLLER; and {A18-205}, FES SECONDARY CONTROLLER.

DOCUMENTATION: Hamilton Std, SEM 62408.

- B. INBOARD OR OUTBOARD HIGH-LOAD DUCT SECTIONS CANNOT BE MAINTAINED ≥ 150 DEG (170 DEG) F. [ED]

This temperature ensures that, as the high-load evaporator boils water, the H₂O vapor does not condense and freeze in the duct. If freezing occurs, the back pressure in the FES core increases, which raises the boiling point. This may result in an overtemp shutdown.

- C. BOTH A AND B FEEDLINES ARE LOST.

If both feedlines are lost, H₂O cannot be supplied to the high-load evaporator. Reference Rule {A18-206}, FES H₂O FEEDLINE, loss definition.

DOCUMENTATION: N/A, system schematic analysis.

FLIGHT RULES

A18-204

FES PRIMARY A (B) CONTROLLER

THE FES PRIMARY A (B) CONTROLLER IS CONSIDERED LOST IF:

- A. UNABLE TO MAINTAIN EVAPORATOR OUTLET TEMPERATURE BETWEEN 36 DEG F AND 42 DEG F WHEN THE EVAPORATOR IS ENABLED.
⑥[ED]

If the controller is controlling at temperatures outside this range, three failures have occurred in the PRI A controller (one control sensor and two shutdown sensors) and two failures have occurred in the PRI B controller (one control sensor and one shutdown sensor). Based on the number of failures, the controllers are not considered reliable and, therefore, must be considered failed. The primary controller controls between 38 deg and 40 deg F and is enabled at an inlet temperature of 41 deg F. The 36 deg F lower limit is based on the fact that the undertemperature shutdown logic on each controller will shut down the controller if the evaporator-outlet temperature remains below 37 ± 0.25 deg F for 20 seconds. The 42 deg F upper limit is based on the fact that the overtemperature shutdown logic will shut down the controller if the evaporator-outlet temperature does not decrease to less than 41.5 ± 0.25 deg F when the FES is enabled.

DOCUMENTATION: Hamilton Std, SEM 62408.

- B. AUTO SHUTDOWN CIRCUITRY WILL NOT ALLOW FES TO REMAIN ONLINE.

Auto shutdown logic will shut down the FES if temperatures and temperature decrease rates are not satisfied.

DOCUMENTATION: Hamilton Std, SEM 62408.

- C. A(B) FEEDLINE IS LOST.

If the A(B) feedline is lost, the primary A(B) controller will not operate (no H₂O).

Reference Rule {A18-206}, FES H₂O FEEDLINE, loss definition.

DOCUMENTATION: N/A, system schematic analysis.

Rules {A18-202A}, TOPPING EVAPORATOR; and {A18-203A}, HIGH-LOAD EVAPORATOR, reference this rule.

FLIGHT RULES

A18-205

FES SECONDARY CONTROLLER

THE FES SECONDARY CONTROLLER IS CONSIDERED LOST IF IT IS UNABLE TO MAINTAIN EVAPORATOR OUTLET TEMPERATURE BETWEEN > 60 DEG F AND < 65 DEG F.

The control band for the secondary controller is $62 \text{ deg} \pm 2 \text{ deg F}$. If the secondary controller is controlling below 60 deg F , a failure in the controller has occurred and it cannot be considered reliable.

The FES secondary controller does not have shutdown logic. In the event the orbiter heat load exceeds the FES capability, the evaporator outlet temperature will be maintained greater than its normal control band without shutdown.

The SODB requires the maximum temperature of air entering the avionics boxes to be less than 95 deg F and less than 130 deg F at the outlet of the boxes. At a 65 deg F evaporator outlet temperature with flow proportioning valves of both Freon loops configured to the ICH position and H_2O loop flowrate adjusted to full interchanger flow, analyses indicate that these limits will not be violated for a normal on-orbit ARS heat load (seven crewmembers, one GPC per avionics bay, etc.) in a 14.7 psia cabin environment. Powering up an additional GPC in the avionics bay will raise the measured outlet air temperature by approximately 10 deg to 15 deg F . This will cause frequent temperature excursions over the 130 deg F limit at the box outlet, leaving little or no margin for the operation of additional equipment in the same avionics bay. Since adequate thermal control cannot be maintained for a fully powered ARS when evaporator outlet temperatures are greater than 65 deg F , the FES is considered lost.

Rules {A18-202A}, TOPPING EVAPORATOR; and {A18-203A}, HIGH-LOAD EVAPORATOR, reference this rule.

DOCUMENTATION: Hamilton Std, SEM 62408; 283-440-84-005; STS85-0246; JSC 08934, 4.6.1.

FLIGHT RULES

A18-206

FES H₂O FEEDLINE

THE FES H₂O FEEDLINE IS CONSIDERED LOST IF:

A. TEMPERATURES IN ANY SECTION ARE <32 DEG (40 DEG) F.

At 32 deg F, the H₂O in the lines will freeze.

DOCUMENTATION: N/A, engineering judgment.

B. FEEDLINE ACCUMULATOR N₂ CHARGE IS LOST ("NOK" INDICATION PRESENT) .

The N₂ charge is required to prevent water hammer effect which could cause erratic FES operations.

DOCUMENTATION: N/A, engineering judgment.

C. THERE IS A CONFIRMED LEAK IN THE FEEDLINE SUCH THAT H₂O USAGE RATE WILL NOT SUPPORT NOMINAL ENTRY .

If the leak is large enough that H₂O requirements for entry cannot be met, the feedline cannot be used.

DOCUMENTATION: N/A, engineering judgment.

D. SUPPLY ISOLATION VALVE IS FAILED CLOSED (B FEEDLINE ONLY) .

If the valve is failed closed, the feedline cannot supply H₂O to the FES.

DOCUMENTATION: N/A, System schematic analysis.

Rules {A18-202C}, TOPPING EVAPORATOR; {A18-203C}, HIGH-LOAD EVAPORATOR; and {A18-204C}, FES PRIMARY A (B) CONTROLLER, reference this rule.

FLIGHT RULES

A18-207 AMMONIA BOILER SUBSYSTEM (ABS)

THE ABS SUBSYSTEM IS CONSIDERED LOST IF:

- A. UNABLE TO MAINTAIN EVAPORATOR OUTLET TEMPERATURE AT ≥ 31 DEG F AND ≤ 65 DEG F

The control point for the ammonia boiler is 34 deg \pm 3 deg F. Less than 31 deg F is unacceptable due to the potential for freezing the orbiter water loops or a payload water loop, if installed. If the EVAP OUT TEMP reaches 32 deg F, a C&W will be annunciated and the EVAP OUT TEMP LOW procedure will be worked. This will provide freeze protection for temperatures down to 6 deg F.

If the NH₃ boiler is controlling above 65 deg F, adequate thermal control of the vehicle cannot be maintained.

DOCUMENTATION: Lockheed analysis, LEMSCO 19630; 283-440-84-005; STS85-0245; JSC 08934, 4.6.1.

- B. NH₃ QUANTITY EQUALS 0 (3) LB AS DETERMINED BY P-V-T RELATIONSHIPS (GROUND ONLY)

When there is no NH₃ left, the ABS cannot cool. The NH₃ system does not have a quantity reading and, therefore, quantity must be determined by tank pressure and tank temperature. Temperature does not remain constant on orbit, and, therefore, P-V-T curves must be used to determine quantity.

DOCUMENTATION: N/A, engineering judgment.

A18-208 RADIATOR FLOW CONTROL ASSEMBLY (RFCA) [HC] @[082604-6341B]

THE RFCA IS CONSIDERED LOST IF:

- A. FAILED IN RADIATOR BYPASS POSITION OR RADIATOR ISOLATED DUE TO A FAILURE OR LEAK

The radiator, as a heat rejection source, is unusable. Therefore, the RFCA is considered lost.

DOCUMENTATION: SEH-ITA-81-416, "FCA Malfunction Analysis," Rockwell International, December 8, 1981; Engineering judgment. @[082604-6341B]

THIS RULE CONTINUED ON NEXT PAGE

FLIGHT RULES

**A18-208 RADIATOR FLOW CONTROL ASSEMBLY (RFCA) [HC]
(CONTINUED)**

- B. UNABLE TO MAINTAIN CONTROLLER OUTLET TEMPERATURE > 32 DEG (35 DEG) F

The potential exists for freezing the FES water spray valves, the ARS water coolant loops, and the payload water loop (if installed) if the RFCA cannot maintain > 32 deg F control.

DOCUMENTATION: SAE Technical Paper Series 820883, "Shuttle Orbiter Flash Evaporator Operational Flight Test Performance," Hamilton Standard/NASA JSC, July 1982; CSD-SH-123, "Orbiter Heat Rejection System Flash Evaporator Subsystem Test Plan," NASA JSC-11265, Section 2.2, January 16, 1978; SEH-ITA-81-416, "FCA Malfunction Analysis," Rockwell International, December 8, 1981; SODB, NSTS 08934, Table 3.4.6.3-1; Engineering judgment. ©[082604-6341B]

- C. CANNOT MAINTAIN EVAPORATOR OUTLET TEMPERATURE < 65 DEG F WITH THE FES DISABLED

The SODB requires the maximum temperature of air entering the avionics boxes to be less than 95 deg F and less than 130 deg F at the outlet of the boxes. At a 65 deg F evaporator outlet temperature with flow proportioning valves of both Freon loops configured to the ICH position and H₂O loop flowrate adjusted to full interchanger flow, analyses indicate that these limits will not be violated for a normal on-orbit ARS heat load (seven crewmembers, one GPC per avionics bay, etc.) in a 14.7 psia cabin environment. Powering up an additional GPC in the avionics bay will raise the measured outlet air temperature by approximately 10 deg to 15 deg F. This will cause frequent temperature excursions over the 130 deg F limit at the box outlet, leaving little or no margin for the operation of additional equipment in the same avionics bay. Since adequate thermal control cannot be maintained for a fully powered ARS when evaporator outlet temperatures are greater than 65 deg F, the RFCA is considered lost.

DOCUMENTATION: STS85-0245, "H₂O Management Plan for Galileo and Ulysses Second Day Deploy Abort with Topping FES or FCL Failure," Rockwell International, June 1985; SODB NSTS-08934, 4.6.1.3.4.

Hazard Reports ORBI 117, Loss of Water Coolant Loops; ORBI 275, Loss of Freon Coolant Loops; and ORBI 321, Crew Incapacitation from Heat Strain. ©[082604-6341B]

Rule {A18-255B}, RADIATOR FLOW CONTROL ASSEMBLY (RFCA), references this rule.

A18-209 THROUGH A18-250 RULES ARE RESERVED

FLIGHT RULES

ATCS MANAGEMENT

A18-251 FREON COOLANT LOOPS (FCL)

- A. BOTH FCL'S, WITH ONE PUMP OPERATING IN EACH FCL, ARE REQUIRED FOR NORMAL OPERATIONS.

To operate with only one FCL on orbit could require a minor powerdown (to 15 kW) and would require the use of the FES or flying in a cold attitude. If -ZLV (the most common attitude) is flown, a negative net H₂O storage rate would exist. To eliminate these types of constraints and issues, both FCL's are operated.

DOCUMENTATION: SEH-ITA-80-054T.

- B. THE FOLLOWING TEMPERATURES SHALL NOT BE EXCEEDED:
1. FOR ASCENT/ENTRY (RADIATORS BYPASSED): 140 DEG (132 DEG) F AT RADIATOR INLET.
 2. ON-ORBIT (RADIATORS IN FLOW):
 - a. 65 DEG (60 DEG) F AT EVAPORATOR OUTLET FOR NO FES OPERATIONS (BOTH LOOPS IN ICH POSITION).
 - b. 68 DEG (63 DEG) F AT RADIATOR OUTLET FOR FES OPERATIONS.

In all cases (pre-liftoff, while on orbit, and pre-deorbit) orbiter power levels are planned to ensure that these limits are not exceeded.

The maximum capability of the FES (full up mode) is 148,000 Btu/hr (test data). This is equivalent to a 140 deg F radiator inlet temperature.

The SODB requires the maximum temperature of air entering the avionics boxes to be less than 95 deg F and less than 130 deg F at the outlet of the boxes. At a 65 deg F evaporator outlet temperature with flow proportioning valves of both Freon loops configured to the ICH position and H₂O loop flowrate adjusted to full interchanger flow, analyses indicate that these limits will not be violated for a normal on-orbit ARS heat load (seven crewmembers, one GPC per avionics bay, etc.) in a 14.7 psia cabin environment. Powering up an additional GPC in the avionics bay will raise the measured outlet air temperature by approximately 10 deg to 15 deg F. This will cause frequent temperature excursions over the 130 deg F limit at the box outlet, leaving little or no margin for the operation of additional equipment in the same avionics bay.

THIS RULE CONTINUED ON NEXT PAGE

FLIGHT RULES

A18-251 **FREON COOLANT LOOPS (FCL) (CONTINUED)**

The maximum capability for the topping evaporator is 39,000 Btu/hr (SODB, based on test data). This is equivalent to a 68 deg F radiator outlet temperature.

DOCUMENTATION: SEH-ITA-81-107; 283-440-84-005; STS85-0245; JSC 08934, 4.6.1.

C. IF IT IS REQUIRED TO DEACTIVATE AN OPERATING FCL OR BYPASS A RADIATOR:

1. THE ASSOCIATED RADIATOR WILL BE STOWED.

Stowing the radiators prevents Freon freezing (except in total deep space attitudes).

*DOCUMENTATION: SODB **TBD** (request submitted).*

2. ATTITUDES THAT EXCLUDE EARTH OR SUN VIEWING (DEEP SPACE) WILL BE LIMITED TO NO MORE THAN 1 HOUR.

For an initial Freon temperature of -40 deg F, it will take approximately 1.5 hours for Freon to freeze. Since there is no insight into the actual temperature of the Freon in the radiators, a conservative limit of 1 hour was chosen.

*DOCUMENTATION: SODB **TBD** (request submitted).*

3. ORBITER ATTITUDES WILL BE MANAGED TO MAINTAIN THE ACCUMULATOR QUANTITY \geq 5 PERCENT INDICATED.

For a good FCL (not leaking), the minimum acceptable accumulator quantity is 5 percent indicated. Taking instrumentation accuracy into account, the actual quantity could be 2 percent. At 2 percent quantity, the loop can still be activated if needed in an emergency. At 0 percent quantity, thermal conditioning would be required prior to activating the FCL.

DOCUMENTATION: N/A, engineering judgment.

4. CLOSING THE AFFECTED RADIATOR'S PLBD WILL BE CONSIDERED IF ATTITUDE CONSTRAINTS CANNOT BE MET.

Closing the PLBD increases the temperature of the FCL.

DOCUMENTATION: Flight data.

THIS RULE CONTINUED ON NEXT PAGE

FLIGHT RULES**A18-251 FREON COOLANT LOOPS (FCL) (CONTINUED)**

- D. THE FLOW PROPORTIONING VALVE (FPV) IN BOTH FCL'S WILL NORMALLY BE PLACED IN THE "ICH" POSITION FOR ALL PHASES OF FLIGHT. EITHER OR BOTH FPV'S MAY BE PLACED IN "P/L" IF A PAYLOAD REQUIREMENT EXISTS.

Placing the FPV's in the ICH position maximizes the Freon flowrate to the H₂O Freon interchanger: approximately 4800 lb/hr in the ICH position vs. approximately 3000 lb/hr in the P/L HX position. This maximizes cooling to the cabin and avionics bays via the water loop. However, placing both loops in the P/L position does not increase the temperatures a significant amount (5 deg to 7 deg F).

DOCUMENTATION: Flight data.

- E. THE FPV IN BOTH FCL'S WILL BE PLACED TO THE "ICH" POSITION IF BOTH THE EVAPORATOR OUTLET TEMPERATURES ARE < 32 DEG (34.4 DEG) F. IF THE PAYLOAD LOOP DOES NOT CONTAIN WATER, A REAL-TIME CALL WILL BE MADE TO PLACE BOTH FPV'S TO THE "P/L" POSITION.

This will prevent or delay the freezing of the payload and orbiter water loops. Provided that both orbiter water loops and a 500 lb/hr flowrate payload water loop (if installed) are flowing, the ICH position provides orbiter water loop freeze protection for Freon temperatures as low as 6 deg F, and payload water loop protection for Freon temperatures as low as -30 deg F (extrapolated). If left in the P/L position, the payload water loop would freeze at Freon temps of 32 deg F and the orbiter water loops at -30 deg F (extrapolated) Freon temperatures. For payload flowrates <150 lb/hr, the payload water loop will freeze eventually, but is delayed if the FPV is placed in the ICH position.

DOCUMENTATION: Lockheed analysis, LEMSCO 19630.

- F. IF AN FCL IS DEACTIVATED, THE ASSOCIATED PRESSURE CONTROL O₂ SYSTEM (PCS) SUPPLY VALVE WILL BE CLOSED.

If the FCL is deactivated, Freon in the stagnant loop will freeze if O₂ is flowing (cryogenic O₂ temperature is -254 deg F). Since the O₂ is no longer being warmed by the Freon, the O₂ restrictor seal will leak when exposed to the cryogenic temperatures. Normal flow of O₂ is 0.5 lb/hr for crew metabolic usage. For 0.1 lb/hr O₂ flow, the stagnant FCL will freeze in 10 minutes. For a 10 lb/hr flowrate the FCL will freeze in 100 seconds. Lab test results indicate that the O₂ restrictor seal will leak when exposed to -100 deg to -240 deg F temperatures. The leak will stop when the temperature gets above -47 deg F.

DOCUMENTATION: SEH-ITA-80-236T; LTR 4309-3101.

THIS RULE CONTINUED ON NEXT PAGE

FLIGHT RULES

A18-251 FREON COOLANT LOOPS (FCL) (CONTINUED)

- G. FOR A FREON-TO-WATER LOOP LEAK, THE RADIATORS WILL NOT BE COLDSOAKED FOR ENTRY AND ATTITUDES THAT EXCLUDE EARTH OR SUN VIEWING (DEEP SPACE) WILL BE AVOIDED.

For a Freon-to-water loop leak, it is possible to get water into the Freon. Coldsoaking the Freon increases the chances of freezing this water, which may affect the performance of the Freon loop. This risk outweighs the gain of a coldsoak. It is not likely that water will be introduced into the Freon loop until the pressures in the two loops equalize; therefore if coldsoak starts before the leak occurs, it should be stopped anytime before the affected water loop's accumulator quantity reaches 100 (97) percent. The radiator controllers should be returned to the norm set point, and to avoid decreasing the Freon temperature in the radiators, deep space attitudes should be avoided.

DOCUMENTATION: N/A, engineering judgment.

- H. IF AN FCL'S RFCA IS FAILED IN BYPASS (MINIMUM RADIATOR FLOW), THE AFFECTED FCL WILL BE DEACTIVATED, AND A POWERDOWN TO AT LEAST 15 KW WILL BE PERFORMED. THE FCL WILL BE REACTIVATED FOR DEORBIT PREPARATION.

An RFCA, failed in bypass or minimum radiator flow, will result in negative H₂O production if the FES is activated, or temperature violations if the FES is deactivated. Deactivating the FCL will alleviate these problems and only requires a powerdown to 15 kW. (Also reference paragraphs C and F.)

DOCUMENTATION: SEH-ITA-80-054T; SEH-ECS-86-102T.

- I. FOR AN EXTERNAL FREON LEAK (INCLUDING FREON TO HYDRAULIC), WHICH WILL NOT SUPPORT NEXT PLS, THE AFFECTED LOOP WILL BE DEACTIVATED IN AN ATTEMPT TO SLOW THE LEAK RATE FOR USE DURING ENTRY.

Deactivating the pump decreases pressure around the loop, slowing most leaks. This is done to save the loop for deorbit/entry. Reactivating the affected Freon loop for entry would allow a full powerup and opening of the associated O₂ supply valve required to provide an adequate O₂ source for greater than four crewmembers on ACES. @[062305-6653]

DOCUMENTATION: Engineering judgment.

Rule {A18-151C}, ARS WATER LOOP, references this rule.

FLIGHT RULES

A18-252

FLASH EVAPORATOR SYSTEM (FES)

- A. NO MORE THAN ONE FES CONTROLLER SHALL BE ACTIVATED AT ANY TIME.

If two controllers are activated, both may pulse water when required thereby providing an increased rate of cooling. This will most likely result in an FES undertemperature shutdown or a freezeup of the FES core.

DOCUMENTATION: Flight data STS-51-B.

- B. FOR INITIAL TROUBLESHOOTING OF ON-ORBIT FES SHUTDOWNS, ONLY ONE RESTART ON EACH PRIMARY CONTROLLER WILL BE ATTEMPTED. DURING ASCENT OR ENTRY, THE SECONDARY CONTROLLER WILL BE ACTIVATED IF RESTARTS ON THE PRIMARY CONTROLLERS WERE UNSUCCESSFUL.

Repeated FES restarts after an unexplainable FES shutdown may add ice in the core if icing was the initial cause of the shutdown. Minimizing the number of restarts to one per controller minimizes de-icing time on orbit. During high heat load periods such as ascent or entry, every effort should be made to avoid vehicle overtemperature. Therefore, it is worth the risk to make another attempt using the secondary controller. The alternative is to open the PLBD post-OMS-1 or to establish radiator flow during entry.

DOCUMENTATION: Flight data; engineering judgment.

- C. THE HIGH-LOAD EVAPORATOR CONTROL SWITCH WILL BE PLACED IN THE "OFF" POSITION DURING ORBITAL OPERATIONS WHEN RADIATOR COOLING IS VERIFIED (CONTROLLER OUTLET TEMPERATURE < 68 DEG (62.8 DEG) F).

The high-load evaporator is unstable at low heat loads and will cause an FES shutdown under these conditions. This has been seen on several flights. The topping evaporator can maintain < 40 deg F evaporator outlet temperature for a maximum FES inlet temperature of 68 deg F (39,000 Btu/hr). Also, in disabling the high-load evaporator, the orbiter can maintain attitude control with the vernier RCS jets instead of the primary jets (minimizes propellant usage). Jet duty cycle is also a concern if VRCS is used for attitude control while in high load operations.

DOCUMENTATION: Flight data.

THIS RULE CONTINUED ON NEXT PAGE

FLIGHT RULES

A18-252 FLASH EVAPORATOR SYSTEM (FES) (CONTINUED)

D. THE TOPPING EVAPORATOR WILL BE USED WITH A PRIMARY CONTROLLER TO SUPPLEMENT RADIATOR COOLING AND MAY BE USED FOR DUMPING EXCESS FC WATER ON ORBIT.

The topping evaporator will maintain a stable evaporator outlet temperature when the radiators cannot control to < 41 deg F. The topping evaporator is used particularly when the orbiter is in a "warm" radiator attitude and the payload requires low temperatures or steady temperatures. Rule {A18-55}, SUPPLY WATER DUMP, covers dumping of FC water. The secondary controller which controls the evaporator outlet temperature of 62 deg F cannot normally be used since the radiator outlet temperatures are normally less than 62 deg F. The FES is normally on for either a payload need or for 10.2 psi cabin operations, both of which require considerably less than a 62 deg F Freon temperature.

DOCUMENTATION: N/A, engineering judgment.

E. FES DUCT TEMPERATURES MUST BE GREATER THAN THE MINIMUM VALUES LISTED BELOW PRIOR TO FES STARTUP, EXCEPT FOR TIME-CRITICAL DEORBITS:

	<u>DUCT (DEG F)</u>
1. HIGH-LOAD - INBOARD, OUTBOARD	150 (170)
2. TOPPING - FORWARD, AFT	100 (120)

These temperatures ensure that, as the FES boils water, the duct is sufficiently warm so that the water vapor does not condense and begin to freeze in any portion of the FES outlet ducting.

DOCUMENTATION: Hamilton Standard SEM #62449.

F. FES ICING @[082593-1528]

1. THE FES SHOULD NOT BE OPERATED WITH THE SUPPLY WATER TANKS VENTED UNLESS ABSOLUTELY NECESSARY TO STAY WITHIN ORBITER OR PAYLOAD CONSTRAINTS.

THIS RULE CONTINUED ON NEXT PAGE

FLIGHT RULES

A18-252

FLASH EVAPORATOR SYSTEM (FES) (CONTINUED)

2. A FES CORE FLUSH CAN BE ATTEMPTED AFTER SUSPECTED ICING. THE PREFERRED METHOD IS TO BYPASS THE RADIATORS USING THE FLOW CONTROL VALVES AND THEN USE THE SECONDARY FES CONTROLLER TO FLUSH ICE FROM THE CORE.

Vendor test results show that even at a pressure of 20 psia, ice can build up in the topping core. This was especially evident at heat loads between 23 and 32 kBtu/hr; however, even at lower heat loads, icing is possible. When the tanks are vented to cabin pressure (15.0 psia or less), there is increased risk of building ice in the topping core. During STS-55, the FES operated with the radiator set point in HI, water dump mode (24.3 kBtu/hr), successfully for 10.1 hours while the tanks were vented to 14.7 psia. It continued to operate normally in and out of standby with the radiator set point in NORM and heat loads between 0 and 17.5 Btu/hr. When a second dump was attempted, the FES overtemp shut down after 2.3 hours due to icing. Even after repressurizing the water tanks, the FES could not be restarted. It was suspected that the ice build up was gradual, interfering with the FES's capability to function and finally resulting in the shutdown.

The ice was later removed using a topping core flush procedure proven during SESL testing which had the Freon loop radiators bypassed, inducing a high heat load, and cycling the secondary FES controller. If the FES is used with the tanks vented for any reason and icing causes a FES shutdown, this flush procedure could be used at the earliest available time to flush the core and resume normal FES operations as required. If possible, the radiator set point should be left in HI to help thaw the core; however, this is not required prior to performing the flush procedure. User of the flow control valves is preferred to minimize the risk encountered during radiator bypass.

DOCUMENTATION: STS-55 mission data; Hamilton Standard SESL Test Data documented in Internal Correspondence Letter: SPACE SHUTTLE ORBITER Flash Evaporator Program, Justification for Increased Feedwater Pressure and Addition of an Accumulator to the Vehicle Feedwater System, February 15, 1978 (analysis 78-37, File 2.16.2).

- G. IF ICING IS SUSPECTED IN AN EVAPORATOR CORE DURING ASCENT, THE SECONDARY CONTROLLER WILL BE SELECTED ON BOTH CORES (AND ALTERNATE FEEDLINE, IF REQUIRED, ON THE SECONDARY HI LOAD) PRIOR TO RADIATOR ACTIVATION IN AN ATTEMPT TO FLUSH THE CORES AND PROVIDE DIAGNOSTIC INFORMATION.

THIS RULE CONTINUED ON NEXT PAGE

FLIGHT RULES**A18-252****FLASH EVAPORATOR SYSTEM (FES) (CONTINUED)**

During STS-26, FES shutdowns occurred during 38 to 55 minutes MET. Both primary controllers were selected and repeatedly shut down. The secondary topper was selected and appeared to operate nominally. A postlanding inspection indicated corrosion in the topping core surface which degraded the evaporation process and gave ice a foothold. Use of the secondary controller cleared the ice out of the topping core (secondary topper uses both A and B H₂O spray nozzles alternately, has no shutdown feature, and operates at a higher control temperature), but the high load core, which was considered suspect, was not tested until the radiator bypass FES checkout toward the end of the flight. An earlier indication of system status is preferred.

After radiator activation, the secondary controller will not operate, since radiator output temperature will be below the secondary control temperature. Flushing the core with secondary controller would require bypassing the radiators on orbit.

DOCUMENTATION: STS-26 Flight Data, engineering judgment.

- H. THE FES FEEDLINE A(B) HEATERS WILL BE DEACTIVATED IF THE HIGH-LOAD LINE TEMPERATURE EXCEEDS 250 DEG F (OSH) FOR 1 HOUR AND THE ACCUMULATOR LINE TEMPERATURE FOR FEEDLINE A(B) IS NOT CYCLING. THE ALTERNATE HEATERS MAY BE SELECTED. IF THE ACCUMULATOR LINE TEMPERATURE INDICATES THAT THE THERMOSTAT IS DITHERING, HEATER OPERATION CAN CONTINUE SO LONG AS THE ACCUMULATOR LINE TEMPERATURE IS WITHIN THE NORMAL CONTROL BAND. @[092195-1790A]

FES feedline A and B high-load line temperatures (V63T1895A and V63T1896A) have exceeded the upper limit of 250 deg F during several missions with no adverse effects. If the 250 deg F limit is exceeded for extended periods (> 1 hour), however, the water in the feedline may boil to such an extent that damage could result. This could cause a vapor barrier in the line and possible heater burnout or FES shutdown when the high-load evaporator is used for entry. Heater failure will occur at a line temperature of 400 deg F. This will be reached approximately 1 hour after exceeding 250 deg F with a failed-on heater. The accumulator line heater and the high-load line heater are controlled by the same thermostat. The accumulator line temperatures A (V63T1892A) and B (V63T1894A) indicate that the associated thermostat is operating properly. If the accumulator line temperature indicates that the thermostat is dithering, operation of the heaters can continue. Flight experience from STS-68 with a dithering thermostat showed no overheating damage after 8 hours of operation. The dithering thermostat is acceptable, provided that the thermostat is not constantly on at a temperature near the upper limit of the normal control band. @[092195-1790A]

THIS RULE CONTINUED ON NEXT PAGE

FLIGHT RULES

A18-252**FLASH EVAPORATOR SYSTEM (FES) (CONTINUED)**

DOCUMENTATION: Flight data and MER-SPAN Mission Action Requests 26 for STS 41-D and 13 for STS 61-A. document the acceptability of exceeding the 250 deg F limit for 1 hour. STS-68 PR #PV6-275540 (IFA #5, EICN ECL-5-08-0398) indicates that no damage or evidence of overheating were found during postflight inspection and replacement of dithering thermostat. ©[092195-1790A]

- I. IF A 1-DAY WAVE-OFF IS DECLARED AFTER RADIATOR BYPASS, THE TOPPING EVAPORATOR WILL BE DEACTIVATED, AS REQUIRED, DURING THE EXTENSION DAY. DISABLING THE FES WILL TAKE PRECEDENCE OVER ANY FES REQUIREMENT FOR PAYLOAD OPERATIONS BEING CONSIDERED FOR THE EXTENSION DAY. CONSIDERATION WILL BE GIVEN TO ENABLING THE FES WHEN/IF SUPPLY H₂O QUANTITIES ARE SUFFICIENT TO SUPPORT FUTURE DEORBIT OPPORTUNITIES.

After the radiators have been bypassed, the FES is the sole means of vehicle cooling. During this time, the net H₂O rate is approximately -55 lb/hr. If a wave-off is called after the radiator panels have been bypassed, supply H₂O quantities may not support multiple deorbit opportunities at a later time. Disabling the FES and allowing the radiators to maintain vehicle cooling during extension days will allow supply H₂O quantities to increase so that future deorbit opportunities may be supported. Maximizing deorbit opportunities is a high priority than conducting unplanned payload operations on extension day.

DOCUMENTATION: Engineering judgment.

FLIGHT RULES

A18-253

AMMONIA BOILER SUBSYSTEM (ABS)

- A. IF RADIATORS HAVE BEEN COLDISOAKED, BOTH NH₃ CONTROLLERS WILL REMAIN OFF, EXCEPT WHEN REQUIRED FOR ENTRY COOLING BELOW 120K FEET. WHEN RADIATOR HEAT SINK CAPACITY IS DEPLETED, ONE NH₃ CONTROLLER WILL BE ACTIVATED. THE ALTERNATE CONTROLLER WILL BE ACTIVATED WHEN THE FIRST SYSTEM IS DEPLETED.

If the radiators are coldsoaked in deorbit preparation, the radiators can provide adequate cooling from FES deactivation to touchdown. Also, since NH₃ is a consumable which can be depleted, leaving the NH₃ system off until the radiator heat sink capacity is depleted will maximize orbiter cooling capability postlanding (length of time) until GSE cooling carts can be connected to the orbiter.

- B. THE ABS MAY BE ACTIVATED POST-EI IF ADDITIONAL COOLING IS REQUIRED.

For the ABS to operate, enough gravitational force is required in the relative direction of the tank outlet to keep the NH₃ at the outlet and not allow the helium pressurant to escape first (NH₃ tanks do not have a bladder system). The vehicle orientation combined with the gravitational force is correct for ABS activation for altitudes of 400k feet (EI) or less. Therefore, if cooling is required (no radiator coldsoak, no FES, etc.), the ABS is operable post-EI and may be used.

DOCUMENTATION: SODB 3.4.6.3-2B.

- C. FOR A LOST/DEGRADED FCL:

1. IF AN FCL IS TOTALLY LOST (E.G., NO FLOW), ITS ASSOCIATED ABS CONTROLLER WILL BE DEACTIVATED AND NOT REACTIVATED. IN THE EVENT NO OTHER COOLING IS AVAILABLE DURING ENTRY, THE ABS WILL BE REACTIVATED AND MANUAL CYCLING MAY BE REQUIRED TO PREVENT WATER LOOP FREEZING.

NH₃ system A controller uses three temperature sensors on the FCL 1 outlet line while NH₃ system B controller uses three sensors on the FCL 2 outlet. If FCL 1(2) is lost and NH₃ A(B) controller is selected, the temperature at the control sensors of the lost loop will not provide proper control of the cooling. This will result in the ABS flowing NH₃ at whatever rate the inoperative sensors demand, which may result in too much cooling, thus undertemping the active loop, or too little cooling, causing an overtemperature condition. Some manual cycling of the NH₃ controller while observing the evaporator outlet temperature may be possible, but should be used only if no other cooling options exist.

DOCUMENTATION: N/A, system schematic analysis.

THIS RULE CONTINUED ON NEXT PAGE

FLIGHT RULES

A18-253**AMMONIA BOILER SUBSYSTEM (ABS) (CONTINUED)**

2. FOR A DEGRADED FCL IF THE DIFFERENCE IN TOTAL FLOW BETWEEN THE TWO FCL'S IS > 450 LB/HR, THE DEGRADED FCL'S NH₃ SYSTEM WILL BE SELECTED IF COOLING IS REQUIRED.

For a difference in total flow between the two FCL's of greater than 450 lb/hr, activating the good loop NH₃ system will result in NH₃ system outlet temperatures < 32 degrees F. This can cause freezing of low flowrate payload water loops and rupture of the payload heat exchanger.

DOCUMENTATION: SEH-ECS-85-052T.

- D. NH₃ CONTROLLERS WILL BE ALTERNATED FLIGHT TO FLIGHT FOR POSTLANDING COOLING, WHEN PRACTICAL, SO THAT EACH OF THE FOUR IS USED AT LEAST ONCE EVERY FOUR FLIGHTS (TO SATISFY STEP). ABS SECONDARY MODE OPERATION WILL BE SELECTED ONLY WHEN DATA TO THE GROUND AND VOICE COMMUNICATION ARE AVAILABLE.

NH₃ controller alternation is implemented to accomplish periodic checkout of the secondary controllers, which is a program requirement but results in an unacceptable impact to vehicle turnaround if done postflight (KSC checkout). Secondary mode operation on the ABS is attended by slightly higher risk due to the design of the undertemperature protection, such that an ABS failure causing undertemperature results in an automatic switchover from the primary to the secondary, but not from secondary to primary. For this reason, the secondary controller should be selected only when data and communication are available so that ground controllers have visibility into and can react quickly to any ABS problem that might develop.

DOCUMENTATION: MD3/84-20; DF/83-178.

A18-254**ABS AMMONIA REDLINE**

ABS AMMONIA - THERE IS NO REQUIREMENT FOR NH₃ AFTER ORBIT INSERTION.

There is no requirement for NH₃ after nominal orbit insertion. The FES and radiators are used for orbit and entry cooling. The NH₃ boiler is not required until post-rollout and an emergency powerdown can be performed if NH₃ is not available. The ammonia boiler is required for launch aborts since the radiators cannot be coldsoaked in these cases. Therefore, after nominal ascent and insertion have been completed, there is no requirement for the NH₃ boiler.

DOCUMENTATION: Flight data.

FLIGHT RULES

A18-255

RADIATOR FLOW CONTROL ASSEMBLY (RFCA) [HC]
@[082406-6262A]

A. ASCENT OPERATIONS:

1. THE RADIATORS WILL BE BYPASSED FOR ASCENT, EXCEPT IN CASE OF LOSS OF FES OPERATION.

The radiators are used as a backup heat sink in case of loss of topping, high-load, or total FES during ascent. If the radiators are not bypassed for launch, this heat sink would not be available. There are also some ground problems with launching in radiator flow. Should radiator flow be initiated with the GSE cooling system still connected (anytime the vehicle is on the pad, pre-lift-off, or during a launch hold), the GSE cannot react quickly enough to the decreased heat load. This could result in very low orbiter Freon temperatures. For these reasons radiator flow prior to lift-off is not attempted.

DOCUMENTATION: SEH-ITA-83-OI7T, "Ascent with Radiator Flow in One FCL."

2. IF THE TOTAL FES FAILS, RADIATOR FLOW WILL BE INITIATED.

During ascent, the FES is the only means of cooling the vehicle. If the total FES is lost, radiator flow is initiated for cooling. This takes advantage of any coldsoak that exists in the radiators. If only one evaporator is lost, the secondary controller can be used with the good evaporator core. Flight data from STS-26 showed that the secondary topper can handle nominal ascent loads and control to 62 deg F.

DOCUMENTATION: SEH-ITA-81-107, "OV102 ATCS Heat Sink Characteristics;" SEH-ITA-80-047T, "Ascent with Failed Topping Evaporator;" and STS-26 flight data. @[082604-6262A]

THIS RULE CONTINUED ON NEXT PAGE

FLIGHT RULES

A18-255

RADIATOR FLOW CONTROL ASSEMBLY (RFCA) [HC]
(CONTINUED)

3. MANAGEMENT OF A RADIATOR BYPASS VALVE FAILING TO ACHIEVE FULL RAD FLOW @[082604-6262A]
 - a. IF THE RADIATOR BYPASS VALVE FAILS IN BYPASS (TB-BYP) DURING RADIATOR FLOW INITIATION, THE ALTERNATE CONTROLLER WILL BE SELECTED. IF THE ALTERNATE CONTROLLER IS INOPERATIVE, ATTEMPTS WILL BE MADE TO MANUALLY POSITION THE RADIATOR BYPASS VALVE TO FULL RADIATOR FLOW.
 - b. IF THE RADIATOR BYPASS VALVE FAILS IN TRANSIT, ATTEMPTS WILL BE MADE TO POSITION IT TO FULL RADIATOR FLOW USING THE ALTERNATE RADIATOR CONTROLLER AND LEAVING THE BYPASS VALVE MODE IN MANUAL UNTIL THE BYPASS COMMAND IS TERMINATED. IF THE VALVE REMAINS IN AN INTERMEDIATE POSITION, ATTEMPTS WILL BE MADE TO MANUALLY POSITION IT TO FULL RADIATOR FLOW.
 - c. IF THE VALVE REMAINS IN AN INTERMEDIATE POSITION OR WAS MANUALLY POSITIONED TO FULL RADIATOR FLOW, THE CONTROLLER AC CB'S WILL BE OPENED AND CONSIDERATION GIVEN TO ATTITUDE CONSTRAINTS FOR UNDER TEMPERATURE PROTECTION MEASURES ON ORBIT. @[082604-6262A]

If the radiator bypass valve is in bypass after the first radiator controller is selected, changing controllers does not increase the risk of becoming stuck in bypass and may drive the bypass valve to radiator flow. After both controllers have been selected, if the valve is still stuck in bypass or an intermediate position, attempts should be made to drive the valve manually to radiator flow so that proper cooling from both FCL's is available. If the valve is manually positioned to radiator flow, opening the controller ac circuit breaker ensures that the valve will not be inadvertently driven to bypass where it might stick (possibly permanently) causing possible early mission termination. See also Rules {A18-251}, FREON COOLANT LOOPS (FCL), and {A18-1001}, THERMAL GO/NO-GO CRITERIA, (loss of an RFCA). @[082604-6262A]

DOCUMENTATION: SEH-ITA-81-416T, "FCA Malfunction Analysis." @[082604-6262A]

THIS RULE CONTINUED ON NEXT PAGE

FLIGHT RULES

A18-255 **RADIATOR FLOW CONTROL ASSEMBLY (RFCA) [HC]**
(CONTINUED)

B. ON-ORBIT OPERATIONS:

1. NORMALLY, THE RADIATORS WILL BE LEFT IN THE STOWED POSITION, BUT MAY BE DEPLOYED IF ANY OF THE FOLLOWING CONDITIONS EXIST:
 - a. IF THE AVERAGE NET WATER STORAGE RATE IS ≤ 0 AND/OR THE SUPPLY WATER QUANTITY REDLINE WILL BE VIOLATED BASED ON EXPECTED WATER STORAGE RATES
 - b. IF MINIMIZING FES OPERATION, FROM A PAYLOAD STANDPOINT, IS DESIRED
 - c. IF AN EVAPORATOR OUTLET TEMPERATURE WILL RESULT IN VIOLATION OF AN ORBITER OR PAYLOAD LIMIT WHEN THE FES CANNOT BE OPERATED

The radiators normally remain stowed. If deployed, and a failure occurs such that the radiators cannot be stowed, an EVA would be required to cut the radiator deploy/stow linkage to allow the EVA crewmember to manually stow the radiator. The PLBD will not close if the radiator is deployed. Deploying the radiators, in most attitudes, increases cooling capacity by utilizing additional surface area. Therefore, if present cooling capabilities are not adequate or if FES usage is great enough to jeopardize mission success/completion, any available cooling capacity should be used. See also the rationale for Rule {A18-208C}, RADIATOR FLOW CONTROL ASSEMBLY (RFCA) [HC]. ©[082604-6341B]

DOCUMENTATION: N/A, Engineering judgment.

THIS RULE CONTINUED ON NEXT PAGE

FLIGHT RULES

A18-255

RADIATOR FLOW CONTROL ASSEMBLY (RFCA) [HC]
(CONTINUED)

2. THE RADIATOR PANEL OUT TEMPERATURES SHOULD NOT BE ALLOWED TO DECREASE BELOW -90 DEG F (-85 DEG F) TO PROTECT AGAINST WATER CONTENT COMING OUT OF SOLUTION AND FREEZING. IF THIS VIOLATION OCCURS, ACTION WILL BE TAKEN TO INCREASE THE TEMPERATURES IN THE RADIATORS.

The SODB (volume 1, table 3.4.6.3-1) lists the minimum operating temperature for the RFCA at -85 deg F. This limit protects up to 20 ppm of water content in Freon and allows for cold spots in the radiators. The maximum allowable H₂O content in the Freon loops is 15 ppm. Data indicates that, at approximately -93 deg F, 15 ppm moisture precipitates as ice crystals. If this temperature is exceeded, ice crystals can form and damage the temperature sensor and cause flow loss by collecting on RFCA filters. The -90 deg F limit was added to protect against the maximum allowable limit of H₂O in Freon 21 (15 ppm) and to give the operations team some margin in mission planning. The -90 deg F temperature has only been exceeded once in flight (STS-35). It is believed that, since the -90 deg F protects the allowable content of H₂O from freezing and would rarely be reached, the -90 deg F limit would protect the RFCA and not impact the mission timeline. Since the radiator panel out temperatures are the inlet temperatures to the RFCA, this limit must be protected. Actions may include stowing radiators, positioning radiator controller outlet temperature to normal, and an attitude change. The -90 deg F is the limit without transducer error included. Due to the large range of the RAD PNL out temperature transducer (-250 deg to 400 deg F), a 5 percent error would make the lower limit (-53 deg F) unreasonable. Flight experience has shown that the transducer has performed better than the 5 percent error allowed; therefore, the -85 deg limit was chosen to provide operational margin. ©[082604-6262A]

DOCUMENTATION: JSC-08934 Shuttle Operations Data Book, 3.4.6.3-1. ©[082604-6262A]

THIS RULE CONTINUED ON NEXT PAGE

FLIGHT RULES

A18-255 **RADIATOR FLOW CONTROL ASSEMBLY (RFCA) [HC]**
(CONTINUED)

C. ENTRY OPERATIONS:

1. THE RADIATORS WILL NORMALLY BE COLD SOAKED 1 HOUR PRIOR TO PLBD CLOSURE BY PLACING THE RADIATOR CONTROLLER IN THE HIGH TEMPERATURE CONTROL MODE, AND THEN BYPASSING THE RADIATORS AT PLBD CLOSURE. @[082604-6262A]

This coldsoak provides heat sink capacity which may be used in a nominal entry to delay ABS activation until post-rollout. The coldsoak may also be used in the event of a FES failure to provide some cooling prior to the availability of the ABS at entry interface. The radiator controller is placed in the high temperature control mode instead of bypassing the radiators in order to conserve both supply water and propellant. Greater than 1 hour is acceptable in the normal cold soak attitude and configuration.

*DOCUMENTATION: SEH-ITA-85-001T, "Revised Deorbit Preparation Timeline Analysis."
Reference Rule {A2-110}, STRUCTURES THERMAL CONDITIONING for NEOM attitude sequence.*

2. IF THE ABILITY TO DRIVE THE RAD BYPASS VALVE TO THE "RAD FLOW" POSITION IS SUSPECT, OR IF THE BYPASS VALVE IS STUCK IN TRANSIT, ATTEMPTS WILL NOT BE MADE TO POSITION IT TO "BYPASS" AT PLBD CLOSURE TO PROTECT FOR A POSSIBLE DEORBIT PREP BACKOUT.

If positioned to "bypass," the valve could permanently stick and radiator flow could not be initiated. This assumes actions in paragraph A.3 of this rule have been performed. For loss of FES or partial loss of FES, radiator flow is required.

DOCUMENTATION: Engineering judgment. @[082604-6262A]

THIS RULE CONTINUED ON NEXT PAGE

FLIGHT RULES

A18-255

RADIATOR FLOW CONTROL ASSEMBLY (RFCA) [HC] (CONTINUED)

3. RADIATOR FLOW WILL NORMALLY BE INITIATED AT $V = 12K$ FPS (APPROXIMATELY 175K FEET) AND GREATER THAN 130K FEET TO AVOID THERMAL TRANSIENTS. RADIATOR FLOW MAY BE INITIATED EARLIER OR LATER, IF REQUIRED. ©[ED]
©[082604-6262A]

Once radiator flow is initialized, 90 seconds must pass before the valves go to the flow position and radiator cooling can be utilized. If radiator flow is initiated at 175k feet, flow will begin around 154k feet. This is prior to FES shutdown (approximately 100k to 110k feet) and eliminates thermal transients. If initiated at 130k feet, radiator flow will begin around 110k feet, or right at FES shutdown. If radiator flow is initiated below 130k feet, a thermal transient is likely before the radiator controller startup sequence is complete. Radiator flow can be initiated earlier in contingency situations.

DOCUMENTATION: Flight data.

4. IF EITHER RFCA AUTOMATICALLY BYPASSES WHEN RADIATOR FLOW IS INITIATED, THE ALTERNATE CONTROLLER WILL BE SELECTED.

The RFCA can trip to bypass due to an undertemp situation or a controller problem. Undertemps occurred on past flights where certain conditions (a warm slug of fluid immediately followed by a cold slug of fluid) caused the controller logic to bypass the radiators. Procedures were changed to mitigate this condition. Selecting the alternate controller will address both the undertemp and radiator controller problems.

DOCUMENTATION: SEH-ITA-81-416T, "FCA Malfunction Analysis;" Flight experience. Associated Hazard Controls: ORBI 117 Loss of Water Coolant Loops, ORBI 275 Loss of Freon Coolant Loops, ORBI 321 Crew Incapacitation From Heat Strain. ©[082604-6262A]

FLIGHT RULES

A18-256

RADIATOR ISOLATION VALVE MANAGEMENT [HC]

@[082604-6272B]

A. ASCENT/ENTRY OPERATIONS: @[090999-6815A]

1. THE RADIATOR ISOLATION VALVES ARE CONFIGURED TO THE RAD FLOW POSITION AND OFF.
2. DURING ASCENT, IF A LEAK IS ISOLATED TO A RADIATOR, THE AFFECTED FREON LOOP WILL BE DEACTIVATED POST MECO. A POWERDOWN TO WITHIN THE CAPABILITY OF THE OPERATING LOOP (APPROXIMATELY 14KW) AND AN EMERGENCY PAYLOAD BAY DOOR OPENING WILL BE ACCOMPLISHED AS SOON AS PRACTICAL.

The radiators are used as a backup heat sink in case of loss of topping, high-load, or total FES during ascent. To minimize operational impacts, the isolation valves are configured for radiator flow.

The cb's that provide power to the bypass valves and control electronics will be configured closed to provide the capability to manually bypass the radiators to isolate an additional portion of the affected loop, should the need arise.

If a Freon leak is isolated to the radiator during ascent, that radiator will not be usable as a cooling source once the payload bay doors are opened. If the affected Freon loop remained powered up after the PLBD's were opened, the heat load would result in a negative supply water rate due to FES usage. Therefore, the loop must be deactivated and an on-orbit powerdown to 14 kW must occur. Since radiator cooling is lost in the loop that has been isolated, Rule {A18-1001}, THERMAL GO/NO-GO CRITERIA, states that next PLS (not including 1st day PLS) will be declared if the supply water management plan will not support the next PLS with the next worst failure (loss of the good Freon loop). In the next worst-case situation (loss of the good loop), all vehicle cooling would be provided by the FES and on-orbit time would be dictated by available supply water to the FES. If the supply water management plan can support the next worst failure, then the upcoming PLS may be passed. Therefore, in an effort to avoid being next day PLS for loss of cooling in a radiator, it is prudent to open the PLBD's and power down as soon as practical post ascent to minimize supply water use.

Reference Rule {A18-1001}, THERMAL GO/NO-GO CRITERIA. @[082604-6272B]

DOCUMENTATION: Engineering judgment.

THIS RULE CONTINUED ON NEXT PAGE

FLIGHT RULES

A18-256

RADIATOR ISOLATION VALVE MANAGEMENT [HC]
(CONTINUED)

B. ON-ORBIT OPERATIONS

1. NORMALLY, AUTOMATIC RADIATOR ISOLATION CAPABILITY WILL BE CONFIGURED FOR "AUTO" OPERATIONS DURING ON-ORBIT OPERATIONS.
2. IF A RADIATOR IS ISOLATED BY THE AUTO SOFTWARE, AND GROUND DATA INDICATES NO FCL LEAK, THE AFFECTED LOOP'S ISOLATION VALVE WILL BE RECONFIGURED MANUALLY TO RADIATOR FLOW.
3. IF A LEAK IS DETECTED ON AN FCL, BEFORE AUTO ISOLATION IS INITIATED, THE AFFECTED LOOP'S RADIATOR WILL BE MANUALLY ISOLATED IN AN ATTEMPT TO STOP THE LEAK. ©[082604-6272B]
4. IF A FCL'S RADIATOR ISOLATION VALVE IS FAILED IN ISOLATE OR A LEAK HAS BEEN ISOLATED, THE AFFECTED FCL WILL BE DEACTIVATED, AND A POWERDOWN TO WITHIN THE CAPABILITY OF THE OPERATING LOOP (APPROXIMATELY 14 KW) WILL BE PERFORMED. THE FCL WILL BE REACTIVATED FOR DEORBIT PREPARATION. ©[082604-6272B]
5. IF RADIATOR ISOLATION CAPABILITY IS LOST ON EITHER OR BOTH LOOPS, THERE ARE NO MISSION DURATION CONSTRAINTS. NO ADDITIONAL ATTITUDE CONSTRAINTS FOR ORBITAL DEBRIS WILL BE LEVIED. ©[090999-6815A]

Analysis indicates that depletion of a Freon loop, due to debris puncture of a radiator tube, allows for reaction times of only seconds, even for small diameters (i.e., a 0.10 in diameter puncture will deplete the loop within 75 to 80 seconds). Due to this concern, hardware and software has been incorporated that will allow the automatic or manual isolation of a leaking radiator, based upon accumulator quantity. This "AUTO" capability will normally be activated during on-orbit operations, to ensure adequate protection of the Freon loops, for the duration of the mission. ©[090999-6815A]

Because the software is dependent upon a single accumulator quantity transducer for each loop, the capability exists to either manually position the isolation valve to the radiator flow position or the radiator isolated position. Should automatic isolation be initiated by the software, data evaluation by the MCC is required to confirm or deny a real leak (the MCC has additional insight not available to the crew, radiator leg pressures and isolation valve positions, that allow for confirmation of leaks). If no leak is detected, the valve may be moved back to radiator flow using the manual capability to prevent another inadvertent auto isolation.

THIS RULE CONTINUED ON NEXT PAGE

FLIGHT RULES

A18-256

RADIATOR ISOLATION VALVE MANAGEMENT [HC] (CONTINUED)

The software in the GPC is intended to isolate the radiator upon detection of large leaks, based solely upon the accumulator quantity ($V63Q1130A/1330A < 12$ percent). In the event that a small leak is detected, prior to detection by the software, the affected loop's radiator can be manually isolated in order to troubleshoot and possibly isolate the leak. If leak isolation is unsuccessful, radiator flow may be regained for nominal loop operations until depletion of the loop.

A radiator isolation valve failed in isolate, or is positioned in isolate due to a leak, will result in a negative H_2O storage rate if the FES is activated, or temperature violations if the FES is deactivated. Deactivating the FCL will alleviate these problems and requires a powerdown to 14 kW. (Ref Rule {A18-251C} and F, FREON COOLANT LOOPS (FCL)). ©[082604-6272B]

Radiator isolation capability does not affect the odds of debris penetration. It is assumed that attitude planning already considers debris impact odds while satisfying payload and other mission objectives.

DOCUMENTATION: MCR 92184B, "Freon Radiator Iso Valve Automation;" AEFTP #145, December 19, 1997; Radiator Shielding & Isolation CDR, October 7, 1997; SEH-ECS-86-102T; and Engineering judgment. ©[090999-6815A]

Reference Hazard Control ORBI 275 Loss of Freon Coolant Loops. ©[082604-6272B]

A18-257

POSTLANDING NH₃ TERMINATION

DURING THE POSTLANDING TIMEFRAME, THE NH₃ SYSTEM WILL BE DEACTIVATED AS SOON AS POSSIBLE FOLLOWING THE OBSERVANCE OF NH₃ SYSTEM BLOW DOWN. ©[052401-4674]

The intent of this rule is to avoid drawing ambient air into the NH₃ system. The NH₃ system is pressurized with helium gas. Once the NH₃ is depleted, the tank pressure will drop as helium quickly exits the system. The system also cools as this occurs. If the system is allowed to drop to ambient pressure and the system experiences any residual cooling, the pressure inside the tank could then drop below ambient pressure and draw air into the depleted NH₃ tank. The blow down from NH₃ depletion to ambient pressure takes approximately 3 minutes.

This is especially undesirable at KSC where the salt content in the air will cause system corrosion.

DOCUMENTATION: Flight data, Engineering judgment ©[052401-4674]

A18-258 THROUGH A18-300 RULES ARE RESERVED

FLIGHT RULES

EECOM HEATER MANAGEMENT

A18-301 TCS HEATER CONFIGURATION

A. THE FOLLOWING HEATERS WILL BE ENABLED FOR LIFT-OFF:

1. FES TOP NOZZLE (LEFT AND RIGHT) [ED]
2. FUEL CELL RELIEF LINE
3. FES TOPPING AND HIGH-LOAD DUCT
4. FUEL CELL WATER LINE

NOTE: IN ALL CASES, UNLESS THERMAL CONDITIONS REQUIRE OTHERWISE, ONLY A SINGLE HEATER SYSTEM WILL NORMALLY BE ENABLED.

FES heaters are activated prior to lift-off and remain on through lift-off to ensure that duct temperatures are high enough to prevent freezing of the water vapor in the ducts upon FES activation. Nozzle heaters are not required for nominal situations, but are desired in case of high FES carryover.

For the fuel cell relief line heater and water line heater, see Rule {A9-53}, FC H₂O SYSTEM HEATERS.

DOCUMENTATION: HAMILTON STD. SEM 62449.

B. THE FES FEEDLINE HEATERS WILL BE ENABLED POST-OMS-1:

The feedline heaters are enabled at this time to prevent freezing of the water in these lines. With PLBD's open it is estimated that in a cold attitude these lines will freeze in approximately 45 minutes and in a warm attitude in approximately 1.5 hours.

DOCUMENTATION: ES2-81-256M.

C. THE FOLLOWING HEATERS WILL BE ENABLED AFTER SEAT EGRESS:

1. VACUUM VENT NOZZLE
2. SUPPLY/WASTE/VACUUM VENT LINE

THIS RULE CONTINUED ON NEXT PAGE

FLIGHT RULES

A18-301

TCS HEATER CONFIGURATION (CONTINUED)

3. EXTERNAL AIRLOCK STRUCTURAL AND WATER LINE @[061297-4904]

Prelaunch PLB thermal conditioning maintains proper temperatures; therefore, the associated heaters are not required. As a general guideline, power not required for ascent is inhibited from use. The heaters should be enabled as soon as practical once on orbit so possible freezing water will not become a concern when the PLBD's are opened and so the WCS can be used normally, if required.

DOCUMENTATION: Rockwell I.L. 270-200-95-152, Rev 1, and engineering judgment. @[061297-4904]

D. THE FOLLOWING HEATERS WILL BE ENABLED WHEN REQUIRED:

1. SUPPLY DUMP NOZZLE
2. WASTE DUMP NOZZLE
3. FUEL CELL PURGE
4. HIGH-LOAD DUCT

The high-load evaporator and high-load duct heaters are disabled on orbit. Prior to re-enabling the high-load evaporator, the duct heaters must be reactivated to prevent freezing of the water vapor in the ducts upon high-load activation.

FC purging and water dumping are normally performed only during the presleep and post sleep periods, and thus, not continuously required. Using the heaters during the overboard venting prevents the possibility of water freezing and rendering the nozzles worthless for future mandatory dumps and purges.

DOCUMENTATION: HAMILTON STD. SEM 62449 and engineering judgment.

FLIGHT RULES

A18-302

TCS HEATER REDUNDANCY

ALL REDUNDANT HEATERS WILL NORMALLY HAVE ONLY ONE CIRCUIT ENABLED AT A TIME.

The heaters are designed so that only one circuit is necessary.

DOCUMENTATION: Engineering judgment and flight data.

A18-303

REDUNDANT TCS HEATER VERIFICATION

AT APPROXIMATELY THE MIDPOINT IN THE FLIGHT, ALL REDUNDANT HEATERS WILL BE RECONFIGURED TO THE ALTERNATE CIRCUITS TO VERIFY SYSTEM HEALTH AND MAXIMIZE TOTAL SYSTEM OPERATING LIFETIME.

The heaters will be switched to verify that the redundant heater works. This is necessary because KSC has difficulty verifying the operation of most heaters, since ambient temperatures at the Cape will prevent automatic heater operation. The heaters are designed such that both heater circuits are encased in a common insulator. For this reason, if the "a" circuit is used exclusively and fails, then both circuits, including the circuit that has never been used, would have to be replaced. By alternating their use, total system lifetime is maximized.

DOCUMENTATION: N/A; system schematic analysis.

FLIGHT RULES

A18-304

TCS HEATER OPERATIONS FOR LOSS OF INSTRUMENTATION

IF INSTRUMENTATION IS LOST ON REDUNDANT HEATER SYSTEMS OF THE FOLLOWING COMPONENTS, BOTH SYSTEMS WILL BE OPERATED SIMULTANEOUSLY FOR THE REMAINDER OF THE FLIGHT:

- A. HIGH-LOAD FES DUCT/NOZZLE (WHILE OPERATING)
- B. TOPPING FES DUCT (FORWARD OR AFT)
- C. SUPPLY AND WASTE WATER DUMP LINES
- D. EXTERNAL AIRLOCK STRUCTURAL AND WATER LINES @[061297-4904]

This is done to protect against an undetected heater failure which could cause freezing of water vapor in the duct upon FES activation and loss of FES, freezing of water in the dump lines resulting in the loss of mandatory dump capability, or freezing of water in the external airlock water lines.

The water line heaters protect against freezing of water in the externally routed airlock water lines resulting in a loss of EMU servicing and ISS water transfer. They are triply redundant; therefore, only two of the three strings are required in this scenario. Each of the two zones for the water lines have two transducers for monitoring heater performance.

The external airlock structural heaters protect against the freezing of the internally routed airlock water lines during periods when the airlock is at vacuum resulting in a loss of EMU servicing and ISS water transfer and against condensation build-up in the external airlock avionics bay where the docking avionics are installed. Each of the three structural heater zones have only one temperature transducer for the monitoring of heater performance.

DOCUMENTATION: Hamilton Standard SEM 62449; Rockwell I.L. 270-200-95-152, Rev 1, and 270-200-97-007; and engineering judgment. @[061297-4904]

FLIGHT RULES

A18-305 LOSS OF HEATER SM CAPABILITY

IF SM CAPABILITY IS LOST, BOTH SYSTEMS OF THE TOPPING FES DUCT HEATER SYSTEMS WILL BE ENABLED FOR THE REMAINDER OF THE FLIGHT.

If SM capability is lost, so is onboard alert capability for these temperatures. If a heater failed, the crew would not be alerted, causing possible loss of a critical function. Both heaters are enabled so that an undetected failure of one will not present a problem. A failed-on heater here cannot produce a high enough temperature to present a problem.

DOCUMENTATION: JSC-18549.

A18-306 EXTERNAL AIRLOCK HEATER LOSS MANAGEMENT

FOR LOSS OF THE EXTERNAL AIRLOCK WATER LINE OR STRUCTURAL HEATERS, ATTITUDE MANAGEMENT WILL BE USED TO PRECLUDE FREEZING OF THE EXTERNAL AIRLOCK INTERNAL AND EXTERNAL WATER LINES.
@[061297-4904] @[022405-6476A]

Loss of the external airlock water lines will result in the loss of EMU servicing in the orbiter.
@[022405-6476A]

DOCUMENTATION: Engineering judgment and Rockwell I.L. 270-200-95-152, Rev 1, and 270-200-97-007. @[061297-4904]

A18-307 THROUGH A18 350 RULES ARE RESERVED

FLIGHT RULES

EECOM SOFTWARE REQUIREMENT

A18-351 EECOM SOFTWARE REQUIREMENT

THE WATER LOOP GPC CYCLING MODE, FES/ABS ON-OFF COMMANDS OR ANY ECLSS COMPUTATIONS WILL NOT BE REQUIRED FOR CONTINUING ANY FLIGHT PHASE AS LONG AS MANUAL BACKUP METHODS ARE INTACT.

The GPC modes for the FES and the NH₃ boiler are used only during ascent and entry to reduce the number of switch throws required by the crew during critical phases. The inactive H₂O loop is cycled periodically on orbit via the GPC mode for thermal conditioning purposes only. If the manual modes for these systems are working, the GPC modes are not required. ©[041196-1882]

DOCUMENTATION: SEH-ITA-83-151T.

A18-352 THROUGH A18-400 RULES ARE RESERVED

FLIGHT RULES

TPS BONDLINE TEMPERATURES MANAGEMENT

A18-401	THERMAL PROTECTION SYSTEM (TPS) BONDLINE TEMPERATURES.....	18-59
A18-402 THROUGH A18-450	RULES ARE RESERVED.....	18-61

ATTITUDE MANAGEMENT FOR THERMAL CONTROL

A18-451	ORBITER THERMAL CONSTRAINTS AND ATTITUDE MANAGEMENT [CIL].....	18-62
	TABLE A18-451-I - DELTA TEMPERATURE BIAS TO BE APPLIED TO STEP PREDICTIONS TO CHECK THERMAL CONSTRAINT LIMITS.	18-76
	FIGURE A18-451-I - DELTA TEMPERATURE BIAS TO BE APPLIED TO STEP PREDICTIONS TO CHECK THERMAL CONSTRAINT LIMITS.	18-78
	FIGURE A18-451-II - OMS OXIDIZER MID HPBL HEATER SYSTEM PERFORMANCE ESTIMATE.....	18-81
	FIGURE A18-451-III - ORBITAL PERCENT SUNLIGHT AS FUNCTION OF BETA ANGLE AND ALTITUDE.....	18-82
	FIGURE A18-451-IV - PRIMARY RCS THRUSTER CONSTRAINT SCREENING GRAPH.....	18-83
A18-452 THROUGH A18-500	RULES ARE RESERVED.....	18-84

COOLING EQUIPMENT CONSTRAINTS

A18-501	MAXIMUM OFF TIME FOR COOLING EQUIPMENT [HC]..	18-85
A18-502 THROUGH A18-550	RULES ARE RESERVED.....	18-86

WATER LOOP

A18-551	SPACEHAB SUBSYSTEM WATER LOOP.....	18-87
A18-552	SPACEHAB SUBSYSTEM WATER LOOP MANAGEMENT.....	18-88
A18-553	SPACEHAB SUBSYSTEM PUMP OPERATIONS.....	18-89
A18-554	WATER LINE HEATERS.....	18-91
A18-555	WATER LINE HEATER MANAGEMENT.....	18-92
A18-556	RESERVED.....	18-95
A18-557	RESERVED.....	18-95
A18-558 THROUGH A18-600	RULES ARE RESERVED.....	18-95

FLIGHT RULES

SPACEHAB ENVIRONMENTAL CONTROL SYSTEM (ECS) MANAGEMENT

A18-601	ORBITER/SPACEHAB/EXPERIMENT THERMAL PRIORITIES.....	18-97
A18-602	ORBITER FREON FLOW PROPORTIONING VALVE (FPV) USAGE.....	18-97
A18-603	SM/LDM WATER FLOW CONTROL ELECTRONICS UNIT (WFCEU).....	18-99
A18-604	RESERVED.....	18-100
A18-605	RESERVED.....	18-100
A18-606	RESERVED.....	18-100
A18-607	THROUGH A18-650 RULES ARE RESERVED.....	18-100

THERMAL GO/NO-GO CRITERIA

A18-1001	THERMAL GO/NO-GO CRITERIA [HC]	18-105
----------	--------------------------------	--------

FLIGHT RULES

THIS PAGE INTENTIONALLY BLANK

FLIGHT RULES

TPS BONDLINE TEMPERATURES MANAGEMENT

A18-401 **THERMAL PROTECTION SYSTEM (TPS) BONDLINE TEMPERATURES**

- A. ORBITER ATTITUDE WILL BE MANAGED TO MAINTAIN BONDLINE TEMPERATURES AT GREATER THAN -170 DEG (-137.5 DEG) F AND LESS THAN THE MAXIMUM ENTRY INTERFACE TEMPERATURES, DEFINED IN PARAGRAPH B.

The minimum temperature of -170 deg F corresponds to the temperature at which glassy transition occurs on the RTV (becomes brittle). Maximum allowable entry and postlanding bondline temperatures are dependent on the type of structure underlying the TPS, and on structural thermal stress limits, as follows:

a. *Underlying Material Limits:*

- (1) ALUMINUM 350 deg F. (400 deg F or greater) is a lifetime constraint.
- (2) GRAPHITE EPOXY SKIN
 - (a) OMS POD 250 deg F (presumes water ingestion into the laminated skin)
 - (b) PLBD 350 deg F

DOCUMENTATION: SODB, Table 3.4.1.3; Shuttle Vehicle Systems Temperature Limits and STS Operational Flight Rules Review Meeting; RI IL SAS-TA-P/C/TCS-87-031; and RI IL SETO-TCS-87-066-RI, On-Orbit Thermal Constraints Summary, Revision 1.

b. *Structural Stress Limits:*

Midbody structural stress is generated by temperature gradients present in the vehicle. Bondline temperatures are used to determine the magnitude of the gradients and therefore the amount of structural stress. Limits have been established for the bondline temperatures, and exceeding these limit could result in less than 1.4 factor of safety for design entry loads. ®[030994-1598A]

THIS RULE CONTINUED ON NEXT PAGE

FLIGHT RULES**A18-401****THERMAL PROTECTION SYSTEM (TPS) BONDLINE
TEMPERATURES (CONTINUED)**

Predicted values for bondline temperatures are calculated by the Simplified Thermal Evaluation Program (STEP) analyses based on actual and predicted vehicle attitudes during the mission. Accuracy of STEP has been determined by comparing calculated temperatures to past flight data. Resulting delta-temperature biases needed to correct each bondline MSID have been tabulated. To complete a STEP analysis, the appropriate biases are added to STEP outputs to obtain the corrected prediction values. These predictions are compared to flight-specific limits similar to those shown in the table of paragraph B to verify that bondline temperatures will be acceptable at EI. The correction biases are, strictly, only applicable to attitudes, durations, sequences, and beta-angle, which duplicate flight data used to generate the biases (ref. Annex Flight Rule, THERMAL PROTECTION SYSTEM (TPS) BONDLINE TEMPERATURES, and Rule {A18-451C}, ORBITER THERMAL CONSTRAINTS AND ATTITUDE MANAGEMENT [CIL]. ©[ED]

DOCUMENTATION: STEP Accuracy Definition Document, RI IL SE-TCS-93-042, May 14, 1993, and NASA JSC Memo ES2-93-096.

Rules {A2-110}, STRUCTURES THERMAL CONDITIONING; {A2-129}, ORBITER ON-ORBIT HIGH DATA RATE REQUIREMENTS; and {A18-451B}, ORBITER THERMAL CONSTRAINTS AND ATTITUDE MANAGEMENT [CIL], reference this rule.

- B. MAXIMUM ALLOWABLE BONDLINE ENTRY INTERFACE (EI) TEMPERATURES ARE BASED ON STRUCTURAL CONSTRAINTS AND FLIGHT-SPECIFIC PARAMETERS FOR ENTRY AND VEHICLE LOADING. THE MAXIMUM GENERICALLY-ACCEPTABLE BONDLINE TEMPERATURE MEASUREMENTS ARE SHOWN BELOW. SPECIFIC MAXIMUM VALUES (RELAXED FROM THE GENERIC LIMITS) FOR EACH FLIGHT WILL BE PROVIDED IN THE FLIGHT-SPECIFIC FLIGHT RULES ANNEX. EACH FLIGHT-SPECIFIC BONDLINE LIMIT WILL REPRESENT THE WORST-CASE LIMIT FROM ANALYSIS OF ALL POSSIBLE DEORBIT OPPORTUNITIES FOR THAT FLIGHT. ©[030994-1598A]

THIS RULE CONTINUED ON NEXT PAGE

FLIGHT RULES

A18-401

**THERMAL PROTECTION SYSTEM (TPS) BONDLINE
TEMPERATURES (CONTINUED)**

DESCRIPTION	TEMPERATURE MEASUREMENT NOS.	OV-103/104/105 MAX LIMIT, DEG F	OV-102 MAX LIMIT, DEG F
PORT	V09T1012	75	52
	V09T1030 [1]	58	58
	V09T1724	29	46
	V34T1102	96	71
	V34T1106	75	120
	V43T4722	250 (237) [3]	250 (237) [3]
STBD	V09T1014	75	52
	V09T1028 [1]	58	58
	V09T1720	29	46
	V34T1104	96	71
	V34T1108	75	120
	V43T5722	250 (237) [3]	250 (237) [3]
TOP	V09T1004	81	81
	V09T1024	81	81
	V09T1524	60	61
	V09T1510	215 (198) [3]	215 (198) [3]
	V09T1514	215 (198) [3]	215 (198) [3]
	V09T1020	250 (235) [3]	250 (238) [3]
PLBD [2]	V37T1000 [1]	63	69
	V37T1002 [1]	84	88
	V37T1004 [1]	84	88
	V37T1006 [1]	63	69
BOTTOM	V09T1000	28	30
	V09T1002	28	30
	V09T1016	99	103
	V09T1022	81	91
	V09T1624	78	44
	V09T1702	47	37
	V34T1110	32	42
	V34T1112	29	38
	V09T1006		190 (177) [3]
	V09T1026		190 (177) [3]

NOTES:

- [1] GRAPHITE EPOXY SKIN.
- [2] CLOSED PLBD TEMPERATURES ARE NOT PREDICTED BY STEP.
- [3] THESE LIMITS ARE BASED MATERIAL LIMITS AS OPPOSED TO THE OTHER LOWER LIMITS BASED ON STRUCTURAL THERMAL STRESS LIMITS. THIS TPS MATERIAL IS HRSL. TEMPERATURES HIGHER THAN THOSE LISTED WOULD CAUSE VIOLATION OF THE MAXIMUM POST-ROLLOUT STRUCTURAL MATERIAL TEMPERATURES OF 250 DEGREES F FOR GRAPHITE EPOXY (OMS POD) OR 350 DEGREES F FOR ALUMINUM. THESE PREENTRY LIMITS ARE DEFINED FROM THE WORST-CASE ENTRY TRAJECTORY AVAILABLE.

DOCUMENTATION: SODB Tables 3.4.1.3-2 and 3.4.1.3-3, and SODB Vol V, Table 4.1.2-1; STEP Accuracy Definition Document, RI IL SE-TCS-93-042, May 14, 1993; and NASA, JSC Memo ES2-93-096. ©[030994-1598A]

A18-402 THROUGH A18-450 RULES ARE RESERVED

FLIGHT RULES

ATTITUDE MANAGEMENT FOR THERMAL CONTROL

A18-451 **ORBITER THERMAL CONSTRAINTS AND ATTITUDE MANAGEMENT [CIL]**

A. ORBITER ATTITUDE WILL BE MANAGED TO MAINTAIN ORBITER SYSTEMS WITHIN LIMITS LISTED IN THE FOLLOWING MATRIX: [CIL]

SYSTEM	CONCERN	LIMIT	CORRECTIVE ACTION	MISSION IMPACT IF PROBLEM NOT FIXED
PAYLOAD BAY DOOR	• EXCESSIVE OVERLAP	UL = 5 INCHES	• TOP SUN	• REF. RULES {A10-207}, PLBD OVERLAP, AND {A10-206}, PLBD CLOSE GO/NO-GO
	• EXCESSIVE GAP	UL = 2 INCHES	• TAIL SUN	
	• DOORS DO NOT FULLY CLOSE	• FOR CONT PLBD OPS, BET <200° F • FOR NOM PLBD OPS, BET <160° F	[6] • TOP SUN OR • PTC (IF TIME PERMITS)	• DOORS MAY NOT CLOSE DUE TO OBSTRUCTION • REF. RULE {A10-206}, PLBD CLOSE GO/NO-GO
PROP - FRCS	PROP LINES [1] PROP BULK	LL = + 40° F LL = + 40° F	• NOSE SUN (FWD HTR- NOT NEEDED FOR ENTRY)	• FROZEN OR HOT LINES COULD CAUSE LOSS OF COMPONENT
	BULK	UL = +100° F [2] UL = +100° F	• TAIL SUN	
ARCS	PROP BULK	LL = + 50° F [3] LL = + 70° F	• ATTITUDE CONSTRAINTS ARE NOT NORMALLY REQUIRED IF ARCS PROP "B" HEATERS ARE OPERATIONAL • IF ONLY "A" HEATERS ARE AVAILABLE, THE FOLLOWING ACTIONS APPLY - IF "A" HTRS OPERATING, TOP SUN, PITCH DWN 30 DEG, ROLL ±20 DEG - IF "A" HTRS NOT OPERATING, NOSE SUN, PITCH UP 10 DEG	• SEE OMS/RCS FLIGHT RULES FOR SPECIFIC LOSS • REF. RULE {A6-258}, ARCS BULK PROPELLANT TEMPERATURE MANAGEMENT
	PROP BULK	UL = +100° F [2]	• NOSE, SUN, PITCH UP 10 DEG	

THIS RULE CONTINUED ON NEXT PAGE

FLIGHT RULES

A18-451

ORBITER THERMAL CONSTRAINTS AND ATTITUDE MANAGEMENT [CIL] (CONTINUED)

A. ORBITER ATTITUDE VERSUS SYSTEMS LIMITS (ALL PHASES) - CONTINUED

SYSTEM	CONCERN	LIMIT	CORRECTIVE ACTION	MISSION IMPACT IF PROBLEM NOT FIXED
OMS	PROP BULK	LL = +30° F [4] LL = +40° F	<ul style="list-style-type: none"> • LINES: TAIL SUN • TANKS <ul style="list-style-type: none"> - IF HTRS OPERATING, TOP SUN, PITCH DWN 30 DEG, ROLL ±20 DEG - IF HTRS NOT OPERATING, NOSE SUN, PITCH UP 10 DEG 	
	PROP BULK	UL = +125° F [5] UL = +100° F	<ul style="list-style-type: none"> • NOSE, SUN, PITCH UP 10 DEG 	
CRSFD LNS	PROP BULK	LL = +40° F LL = N/A	<ul style="list-style-type: none"> • TOP SUN, PITCH DOWN 30 DEG 	<ul style="list-style-type: none"> • FROZEN OR HOT LINES COULD CAUSE LOSS OF COMPONENT
	PROP BULK	UL = +125° F [5] UL = N/A	<ul style="list-style-type: none"> • NOSE SUN, PITCH UP 10 DEG 	<ul style="list-style-type: none"> • SEE OMS/RCS FLIGHT RULES FOR SPECIFIC LOSS
RMS	QUALIFICATION LIMITS IF HEATERS ARE FAILED	LL = - 33° F (ABE) LL = - 42° F (LED) UL = +178° F (ABE) UL = +205° F (LED)	<ul style="list-style-type: none"> • TOP SUN • NOSE SUN OR TAIL SUN 	<ul style="list-style-type: none"> • NO RMS OPERATIONS • REF. RULE {A12-3}, TEMPERATURE CONSTRAINTS [CIL]
APU [CIL]	2 HTR FAIL, FUEL FREEZE	LL = +35° F	<p>IF PROBLEM ON:</p> <ul style="list-style-type: none"> • SERVICE LINES • FUEL FEEDLINES • TANK • SEAL CAVITY DRAIN LINES <p>APU 1, 2: PORT SIDE SUN</p> <p>APU 3: STARBOARD SIDE SUN</p> <p>IF PROBLEM ON COMPONENT ON BULKHEAD:</p> <p>APU 1, 2, 3: TOP SUN OR TAIL SUN (TOP SUN QUICKEST WARMUP)</p> <p>NOTE: DEPENDING ON PROBLEM AND PREVIOUS ATTITUDES. ATTITUDE CHANGE MAY NOT PREVENT FREEZING</p>	<ul style="list-style-type: none"> • EARLY MISSION TERMINATION (MDF)

THIS RULE CONTINUED ON NEXT PAGE

FLIGHT RULES

A18-451

ORBITER THERMAL CONSTRAINTS AND ATTITUDE MANAGEMENT [CIL] (CONTINUED)

A. ORBITER ATTITUDE VERSUS SYSTEMS LIMITS (ALL PHASES) - CONCLUDED

SYSTEM	CONCERN	LIMIT	CORRECTIVE ACTION	MISSION IMPACT IF PROBLEM NOT FIXED
BONDLINES	GLASSY TRANSITION	LL = -170° F	PTC IF TIME CRITICAL: • TOP SUN FOR UPPER SURFACE • BOTTOM SUN FOR LOWER SURFACE	• POSSIBLE TILE LOSS
	MIDBODY THERMAL STRESS DURING ENTRY	• REF. RULES {A2-110}, STRUCTURES THERMAL CONDITIONING AND {A18-401B}, TPS BONDLINE TEMPS	• REF. RULES {A2-110}, STRUCTURES THERMAL CONDITIONING AND {A18-401B}, TPS BONDLINE TEMPERATURES	• REF. RULES {A2-110}, STRUCTURES THERMAL CONDITIONING AND {A18-401B}, TPS BONDLINE TEMPERATURES
FES	2 HTR STRINGS FAIL, FEEDLINES FREEZE	LL = +32° F	• FES OPS AND/OR ATTITUDE MGMT WILL BE USED TO AVOID FREEZING	• EARLY MISSION TERMINATION
HYDRAULICS	• AFT COMPARTMENT: MAIN PUMP, RESERVOIR, SUPPLY/ RETURN LINES	LL = -40° F	• TAIL SUN	• MAIN HYD PUMP LOSS
	• BODY FLAP, PDU, RETURN LINES	LL = -40° F	• TAIL SUN	• LOSS OF BODY FLAP CONTROL
	• ELEVON RETURN LINES	LL = -40° F	• TOP SUN	• LOSS OF ELEVON CONTROL
	• MAIN LANDING GEAR	LL = -35° F	• BOTTOM SUN	• LANDING GEAR WILL NOT DEPLOY IN 10 SECONDS
	• NOSE LANDING GEAR	LL = -20° F	• BOTTOM SUN	• LANDING GEAR WILL NOT DEPLOY IN 10 SECONDS
	• NOSE LANDING GEAR STEERING	LL = -10° F	• BOTTOM SUN	• IMPACTS NWS
	• MIDBODY LINES	LL = -50° F	• BOTTOM SUN	• LOSS OF HYD CONTROL OF LG DEPLOY AND NWS
	• RSB, TVC, ISOL VLVS, COMPONENTS/LINES	LL = -40° F	• TAIL SUN	• LOSS OF RSB AND ISOL VLV CONTROL

©[030994-1598A]

THIS RULE CONTINUED ON NEXT PAGE

FLIGHT RULES

A18-451

ORBITER THERMAL CONSTRAINTS AND ATTITUDE
MANAGEMENT [CIL] (CONTINUED)

NOTES:

- [1] STAGNANT LINES FOR BOTH THE OMS AND RCS:
 - OXID LL = +20° F
 - UL = +150° F
 - FU LL = -30° F
 - UL = +150° F
- [2] +100° F UPPER LIMIT FOR BULK PROPELLANT, BASED ON EXPULSION EFFICIENCY. TEMPERATURE SENSOR IS LOCATED ON TANK SKIN WHICH HAS UPPER LIMIT OF +150° F FOR LOCALIZED REGIONS.
- [3] +70° F FOR ENTRY FOR ZOT PREVENTION. ON-ORBIT (TANK CERTIFICATION) LIMIT = +50° F. REFERENCE RULES {A6-256}, OMS/RCS HEATER PERFORMANCE MONITORING; AND {A6-258}, ARCS BULK PROPELLANT TEMPERATURE MANAGEMENT.
- [4] +30° F COLD SLUG START TRANSIENT.
- [5] +125° F HOT SLUG START TRANSIENT.
- [6] BENDING EFFECT TEMPERATURE (BET) = (LOWER BONDLINE AVG. T - SILL LONGERON AVG. T) + (70° F - SILL LONGERON AVG. T)

THIS RULE CONTINUED ON NEXT PAGE

FLIGHT RULES

A18-451

ORBITER THERMAL CONSTRAINTS AND ATTITUDE MANAGEMENT [CIL] (CONTINUED)

B. ORBITER SYSTEMS CONSTRAINTS VERSUS BETA ANGLE AND ORBITER ATTITUDE ARE LISTED IN THE FOLLOWING MATRIX. THE MATRIX SERVES AS A GUIDELINE FOR ASSESSMENT OF THERMAL ATTITUDE RESTRICTIONS WHEN A MORE DETAILED (E.G., STEP) ANALYSIS HAS NOT BEEN COMPLETED. THE TABLE DOES NOT INCLUDE POTENTIAL CONSTRAINTS FOR BET, TIRES, DRAG CHUTE, EDO PALLET, OR BONDLINES. ONLY THE MOST CONSTRAINING FACTOR IS LISTED FOR A GIVEN ATTITUDE. REFERENCE SODB, VOLUME V IF ADDITIONAL INFORMATION IS NEEDED. ©[030994-1598A]

0° TO <20° β

ORBITER ATTITUDE [1]		LIMIT [2]	CONCERN [3]	RECOVERY [4]
LVLH (EARTH INERTIAL)		NONE	NONE	NONE
SOLAR INERTIAL (THREE AXES INERTIAL)	(-X SI) TAIL TO SUN	71 HR	NLG HYDRAULIC LINES IN MID FUSELAGE LL = -50 F [5] (V58T0127,1134A)	5 HR OF PTC OR TOP SUN [7]
		72 HR	MLG HYDRAULIC COMP LL = -355 F [5] [10]	7 HR OF PTC [7]
	(±Y SI) SIDE TO SUN	110 HR	ARCS PROPELLANT [11] LL = +50° F LL = +70° F [12] (REF. RULES {A6-256}, OMS/RCS HTR PRFM MON; AND {A6-258}, ARCS BULK PROP TEMP MGT)	PREFERENCE: 20 HR NOSE SI PITCHED UP 10 DEGREES [8]
(-Z SI) TOP TO SUN	(ANY OMICRON) ALL YAW ANGLES	160 HR	ARCS PROPELLANT [11] LL = +50° F LL = +70° F [12] (REF. RULES {A6-256}, OMS/RCS HTR PRFM MON; AND {A6-258}, ARCS BULK PROP TEMP MGT)	PREFERENCE: 20 HR NOSE SI PITCHED UP 10 DEGREES [8]

THIS RULE CONTINUED ON NEXT PAGE

FLIGHT RULES

A18-451

ORBITER THERMAL CONSTRAINTS AND ATTITUDE MANAGEMENT [CIL] (CONTINUED)

B. ORBITER SYSTEMS CONSTRAINTS VERSUS BETA ANGLE - CONTINUED

20° TO <60° β

ORBITER ATTITUDE [1]		LIMIT [2]	CONCERN [3]	RECOVERY [4]	
LVLH	(-ZLV) TOP TO EARTH	(+Y VV) STBD ON V (+BETA)	13 HR	OME PROPELLANT LINE UL = +125° F (REF. RULE {A6-256}, OMS/RCS HTR PFRM MON)	30 HR PTC OR NOSE SUN
		(-Y VV) PORT ON V (-BETA)			
	(+ZLV) BOTTOM TO EARTH	(-Y VV) PORT ON V (+BETA)	13 HR	OME PROPELLANT LINE UL = +125° F (REF. RULE {A6-256}, OMS/RCS HTR PFRM MON)	30 HR PTC OR NOSE SUN
		(+YVV) STBD ON V (-BETA)			
	(-XLV) TAIL TO EARTH	(+Y VV) STBD ON V (-BETA)	100 HR	ARCS PROPELLANT [11] LL = +50° F LL = +70° F [12] (REF. RULES {A6-256}, OMS/RCS HTR PFRM MON; AND {A6-258}, ARCS BULK PROP TEMP MGT)	PREFERENCE: 20 HR NOSE SI PITCHED UP 10 DEGREES [8]
		(-Y VV) PORT ON V (+BETA)			
		(+Z VV) BOTTOM OR TOP ON V FOR BETA > 30 DEG			
	(+XLV) NOSE TO EARTH	(+Y VV) STBD ON V (+BETA)	100 HR	ARCS PROPELLANT [11] LL = +50° F LL = +70° F [12] (REF. RULES {A6-256}, OMS/RCS HTR PFRM MON; AND {A6-258}, ARCS BULK PROP TEMP MGT)	PREFERENCE: 20 HR NOSE SI PITCHED UP 10 DEGREES [8]
(-Y VV) PORT ON V (-BETA)					

©[030994-1598A]

THIS RULE CONTINUED ON NEXT PAGE

FLIGHT RULES

A18-451

**ORBITER THERMAL CONSTRAINTS AND ATTITUDE
MANAGEMENT [CIL] (CONTINUED)**

B. ORBITER SYSTEMS CONSTRAINTS VERSUS BETA ANGLE - CONTINUED

20° TO <60° β

ORBITER ATTITUDE [1]		LIMIT [2]	CONCERN [3]	RECOVERY [4]
SOLAR INERTIAL (THREE AXES INERTIAL)	(-X SI) TAIL TO SUN	(ANY OMICRON)	6 HR OMS OXIDIZER HI PT BLEED LINE QD LL = +20°F (ANALYSIS)	6 HR OF PTC
		ALL ROLL ANGLES	13 HR OME PROPELLANT LINE UL = +125°F (REF RULE {A6-256}, OMS/RCS HTR PFRM MON)	30 HR OF PTC OR NOSE SUN
	(±Y SI) SIDE TO SUN	(ANY OMICRON) ALL PITCH ANGLES	90 HR ARCS PROPELLANT [11] LL = +50° F LL = +70° [12] (REF. RULES {A6-256}, OMS/RCS HTR PFRM MON; AND {A6-258}, ARCS BULK PROP TEMP MGT)	PREFERENCE: 20 HR NOSE SI PITCHED UP 10 DEGREES [8]
	(-Z SI) TOP TO SUN	(ANY OMICRON) ALL YAW ANGLES	160 HR ARCS PROPELLANT [11] LL = +50° F LL = +70° F [12] (REF. RULES {A6-256}, OMS/RCS HTR PFRM MON; AND {A6-258}, ARCS BULK PROP TEMP MGT)	PREFERENCE: 20 HR NOSE SI PITCHED UP 10 DEGREES [8]

@[030994-1598A]

THIS RULE CONTINUED ON NEXT PAGE

FLIGHT RULES

A18-451

ORBITER THERMAL CONSTRAINTS AND ATTITUDE MANAGEMENT [CIL] (CONTINUED)

B. ORBITER SYSTEMS CONSTRAINTS VERSUS BETA ANGLE - CONTINUED

60° TO <90° β

ORBITER ATTITUDE [1]		LIMIT [2]	CONCERN [3]	RECOVERY [4]	
LVLH	(-ZLV) TOP TO EARTH	(+Y VV) STBD ON V (+BETA)	6 HR	OME PROPELLANT LINE UL = +125° F	14 HR NOSE SUN
		(-Y VV) PORT ON V (-BETA)		(REF. RULE {A6-256}, OMS/RCS HTR PFRM MON)	
		(+Y VV) STBD ON V (-BETA)	38 HR	NLG HYDRAULIC LINES IN MID FUSELAGE	6 HR OF PTC OR TOP SUN [7]
		(-Y VV) PORT ON V (+BETA)		LL = -50 F [5] (V58T0127,1134A)	
		(±X VV) NOSE OR TAIL ON V	90 HR	ARCS PROPELLANT [11] LL = +50° F [12] LL = +70° F	PREFERENCE: 20 HR NOSE SI PITCHED UP 10 DEGREES [8]
				(REF. RULES {A6-256}, OMS/RCS HTR PFRM MON; AND {A6-258}, ARCS BULK PROP TEMP MGT)	
	(+ZLV) BOTTOM TO EARTH	(±X VV) NOSE OR TAIL ON V	98 HR	MLG HYDRAULIC LL = -35° F [5] [10]	6 HR PTC [7]
		(+Y VV) STBD ON V (-BETA)	6 HR	OME PROPELLANT LINE UL = +125° F	NOSE SUN <u>TBD</u>
		(-Y VV) PORT ON V (+BETA)	6 HR	OMS OXIDIZER HI PT BLEED LINE QD LL = +20° F	6 HR OF PTC
	(-XLV) TAIL TO EARTH	(±Z VV) BOTTOM OR TOP ON V	90 HR	ARCS PROPELLANT [11] LL = +50° F [12] LL = +70° F	PREFERENCE: 20 HR NOSE SI PITCHED UP 10 DEGREES [8]
(-Y VV) PORT ON V (+BETA)			(REF. RULES {A6-256}, OMS/RCS HTR PFRM MON; AND {A6-258}, ARCS BULK PROP TEMP MGT)		
(+Y VV) STBD ON V (-BETA)					

@[030994-1598A]

THIS RULE CONTINUED ON NEXT PAGE

FLIGHT RULES

A18-451

ORBITER THERMAL CONSTRAINTS AND ATTITUDE MANAGEMENT [CIL] (CONTINUED)

B. ORBITER SYSTEMS CONSTRAINTS VERSUS BETA ANGLE - CONTINUED

60° TO <90°

ORBITER ATTITUDE [1]		LIMIT [2]	CONCERN [3]	RECOVERY [4]	
LVLH (CONCLUDED)	(+XLV) NOSE TO EARTH	(±Z VV) BOTTOM OR TOP ON V	90 HR	ARCS PROPELLANT [11] LL = +50° F LL = +70° F [12] (REF. RULES {A6-256}, OMS/RCS HTR PFRM MON; AND {A6-258}, ARCS BULK PROP TEMP MGT)	PREFERENCE: 20 HR NOSE SI PITCHED UP 10 DEGREES [8]
		(-Y VV) PORT ON V (-BETA)			
		(+Y VV) STBD ON VA (+BETA)			
	(-YLV) PORT SIDE TO EARTH	(-Z VV) TOP ON V (-BETA)	38 HR	NLG HYDRAULIC LINES IN MID FUSELAGE LL = -50° F (V58T0127,1134A) [5]	6 HR OF PTC OR TOP SUN [7]
		(+Z VV) BOTTOM ON V (+BETA)			
		(-Z VV) TOP ON V (+BETA)	6 HR	OMS OXIDIZER HI PT BLEED LINE QD LL = +20° F (BETA >80 DEG, ANALYSIS)	6 HR OF PTC
		(+Z VV) BOTTOM ON V (-BETA)		MS PROPELLANT LINE UL = + 125° F	14 HR OF NOSE SUN (REF RULE {A6-256}, OMS/RCS HTR PFRM MON)
	(+YLV) STBD SIDE TO EARTH	(-Z VV) TOP ON V (-BETA)	6 HR	OME PROPELLANT LINE UL = + 125° F (REF. RULE {A6-256}, OMS/RCS HTR PFRM MON)	14 HR NOSE SUN
		(+Z VV) BOTTOM ON V (+BETA)			
		(-Z VV) TOP ON V (+BETA)	38 HR	NLG HYDRAULIC LINES IN MID FUSELAGE LL = -50° F [5] (V58T0127,1134A)	6 HR OF PTC OR TOP SUN [7]
		(+Z VV) BOTTOM ON V (-BETA)			

@[030994-1598A]

THIS RULE CONTINUED ON NEXT PAGE

FLIGHT RULES

A18-451

ORBITER THERMAL CONSTRAINTS AND ATTITUDE MANAGEMENT [CIL] (CONTINUED)

B. ORBITER SYSTEMS CONSTRAINTS VERSUS BETA ANGLE - CONTINUED

60° TO <90° β

	ORBITER ATTITUDE [1]		LIMIT [2]	CONCERN [3]	RECOVERY [4]
SOLAR INERTIAL (THREE AXIS INERTIAL)	(-X SI) TAIL TO SUN	(ANY OMICRON) ALL ROLL ANGLES	6 HR	OME PROPELLANT LINE UL = +125° F (REF. RULE {A6-256}, OMS/RCS HTR PFRM MON)	14 HR NOSE SUN
			6 HR	OMS OXIDIZER HI PT BLEED LINE QD LL = +20° F (ANALYSIS)	6 HR OF PTC
	(+X SI) NOSE TO SUN	(ANY OMICRON) ALL ROLL ANGLES	110 HR	NLG HYDRAULIC LINES IN MID FUSELAGE LL = -50° F [5] (V58T0127,1134A)	3 HR OF PTC OR TOP SUN [7]
	(±Y SI) SIDE TO SUN	(ANY OMICRON) ALL PITCH ANGLES	90 HR	ARCS PROPELLANT [11] LL = +50° F LL = +70° F [12] (REF. RULES {A6-256}, OMS/RCS HTR PFRM MON; AND {A6-258}, ARCS BULK PROP TEMP MGT)	PREFERENCE: 20 HR NOSE SI PITCHED UP TO 10 DEGREES [8]
	(-Z SI) TOP TO SUN	(ANY OMICRON) ALL YAW ANGLES	160 HR	ARCS PROPELLANT [11] LL = +50° F LL = +70° F [12] (REF. RULES {A6-256}, OMS/RCS HTR PFRM MON; AND {A6-258}, ARCS BULK PROP TEMP MGT)	PREFERENCE: 20 HR NOSE SI PITCHED UP 10 DEGREES [8]
	(+Z SI) BOTTOM TO SUN				

@[030994-1598A]

THIS RULE CONTINUED ON NEXT PAGE

FLIGHT RULES

A18-451

ORBITER THERMAL CONSTRAINTS AND ATTITUDE MANAGEMENT [CIL] (CONTINUED)

NOTES:

- [1] DEVIATIONS FROM THE SPECIFIED ATTITUDES MAY NEED TO BE FURTHER ANALYZED.
- [2] THE ATTITUDE HOLD CONSTRAINED DURATION IS FROM PTC EQUILIBRIUM TEMPERATURES TO THE LIMIT TEMPERATURE.
- [3] ALL CONCERNS ARE SAFETY ISSUES UNLESS OTHERWISE NOTED.
- [4] UNLESS OTHERWISE NOTED, FLYING THE RECOVERY ATTITUDE ALLOWS REPETITION OF THE CONSTRAINED ATTITUDE FOR THE CONSTRAINED DURATION. ALL RECOVERY IS TO PTC EQUILIBRIUM TEMPERATURE UNLESS OTHERWISE NOTED.
- [5] SYSTEMS PERFORMANCE IS AFFECTED.
- [6] RESERVED @[030994-1598A]
- [7] RECOVERY IS TO THE MINIMUM OPERATIONAL LIMIT TEMPERATURE FROM THE MINIMUM NON-OPERATIONAL LIMIT TEMPERATURE OR ATTITUDE THERMAL EQUILIBRIUM TEMPERATURE (WHICHEVER IS WARMER).
- [8] THIS ATTITUDE RESULTS IN ONLY A MINIMAL RATE OF INCREASE ($< 2^{\circ}$ F/DAY) OF ARCS BULK PROPELLANT TEMPERATURE. THE CONSTRAINED DURATION CANNOT BE REPEATED.
- [9] RESERVED @[030994-1598A]
- [10] TCS DESIGN DATA BOOK SECTION L REFERENCE.
- [11] ATTITUDE CONSTRAINTS ARE NOT NORMALLY REQUIRED IF ARCS PROP "B" HEATERS ARE OPERATIONAL. THE ARCS CONCERN IS VALID IF ONLY THE "A" HEATERS ARE AVAILABLE.
- [12] ARCS PROP + 70° F FOR ENTRY FOR ZOT PREVENTION. ON-ORBIT (TANK CERTIFICATION) LIMIT = + 50° F.

There are six areas of concern where orbiter structure and/or systems thermal constraints can be exceeded if an unfavorable orbiter vehicle attitude is maintained for an excessive period of time. The maximum/minimum temperature, the time in the constraining attitude, and the attitude/time used to recover from a violation of the constraints are all dependent on the structure or orbiter system involved, the vehicle (OV102, 103, 104) used, Sun beta angle, and the three basic attitude control modes used; i.e., LVLH, ORB RATE (single axis), and inertial (three axis) hold. The six areas of concern, their limits (temperature or time), and the impact (lifetime (L), system performance (P), and safety of flight (S)) of violating the limits are identified below: @[030994-1598A]

THIS RULE CONTINUED ON NEXT PAGE

FLIGHT RULES

A18-451

**ORBITER THERMAL CONSTRAINTS AND ATTITUDE
MANAGEMENT [CIL] (CONTINUED)**

<u>Concern</u>	<u>Attitude/limit</u>	<u>Impact</u>
<i>OMS oxidizer hi-point bleed line, QD minimum temperature</i>	<i>6 hours, tail Sun port side or bottom to Earth/+20°F</i>	<i>Oxidizer line freeze/rupture, QD leakage (S)</i>
<i>NLG hydraulic line in mid fuselage minimum temperature</i>	<i>30-44/53-92 hours, tail or nose Sun, bottom to space/-50°/-65°F (OP/non-OP)</i>	<i>NLG deploy time > 10 seconds (P)</i>
<i>MLG hydraulic component minimum temperature</i>	<i>61-72/98-160 hours, tail or nose Sun, bottom to space/-35°/-60°F (OP/non-OP)</i>	<i>MLG deploy time > 10 seconds (P)</i>
<i>ARCS bulk propellant, minimum temperature</i>	<i>90-160 hours, top or side Sun/ 70°F (if ARCS "B" heaters are inoperative)</i>	<i>Thruster (ZOT) problem (L). Two yaw jets per side (S)</i>
<i>Bondline maximum temperature</i>	<p>(1) <i>Material Strength Limit: 1-5 hours bottom Sun/Ref. Rule {A18-401B}, THERMAL PROTECTION SYSTEM (TPS) BONDLINE TEMPERATURE</i></p> <p>(2) <i>Midbody Structural Thermal Stress: Limit is a function of Beta-angle and attitude prior to entry. (Ref. Rules {A2-110}, STRUCTURES THERMAL CONDITIONING, and {A18-401B}, TPS BONDLINE TEMPERATURES)</i></p>	<p>(1) <i>Bondline temperature may exceed maximum structural limit during entry and/or after landing. Aluminum 350°F (> 400°F) (L) graphite epoxy skin (S):</i> - OMS POD 250°F - PLBD 350°F</p> <p>(2) <i>Excessive temperature gradients can result in stresses that exceed certification limits.</i></p>
<i>OME propellant line maximum temperature</i>	<i>6-13 hours, tail Sun/125°F</i>	<i>Violates engine certification limits (S), possible engine cooling problem</i>

©[030994-1598A]

THIS RULE CONTINUED ON NEXT PAGE

FLIGHT RULES

A18-451

ORBITER THERMAL CONSTRAINTS AND ATTITUDE MANAGEMENT [CIL] (CONTINUED)

B. ORBITER SYSTEMS CONSTRAINTS VERSUS BETA ANGLE - CONCLUDED

Matrix Limitations:

This table is intended as a first iteration for attitude planning. The orbiter attitudes listed represent "pure" orientations. Flight-specific STEP analysis will confirm the acceptability of the integrated attitude timeline. The table limits, which represent the constrained attitude durations in hours, were derived from analyses initialized to PTC equilibrium temperatures. These durations define the time it takes to go from PTC equilibrium temperature to the system limit. The concern column lists the vehicle structural/system limit that constrains the attitude duration. In most cases, flying the recovery attitude provides the capability to repeat the constrained attitude for the constrained duration. Exceptions to this recovery attitude definition exist for hydraulic systems, the TPS bondline, and the ARCS propellant temperature limits. For hydraulics, the recovery attitude allows the system temperature to recover to its temperature limit (presumes that the limit can be exceeded). For the TPS bondlines, preentry thermal conditioning (in addition to the normal end of mission timeline) may be required. In the case of the ARCS propellant minimum temperatures, the recovery attitude will "maintain" the bulk propellant temperature above its limit. In all three cases, the recovery to the limiting temperatures must be accomplished prior to entry. ©[030994-1598A]

DOCUMENTATION: Space Shuttle Thermodynamics Design Data Book, TCS, SD73-SH0226, Volume 1E, Book V, 9/85; Shuttle Vehicle Systems Temperature Limits and STS Operational Flight Rules Review, RI-IL SAS-TA-P/C/TCS-87-031; On-Orbit Thermal Constraints Summary, Revision 1, RI-IL SETO-TCS-87-066-R1; and Shuttle Operational Data Book, JSC-08934, Volume V, Table 3.1-1, April 1993. ©[030994-1598A]

Rules {A10-22}, APU START/RESTART LIMITS, and {A10-30}, LOSS OF APU HEATERS/INSTRUMENTATION [CIL], reference this rule.

THIS RULE CONTINUED ON NEXT PAGE

FLIGHT RULES

A18-451

**ORBITER THERMAL CONSTRAINTS AND ATTITUDE
MANAGEMENT [CIL] (CONTINUED)**

- C. ORBITER SYSTEMS CONSTRAINTS THAT ARE APPLIED BY THE USE OF THE SIMPLIFIED THERMAL EVALUATION PROGRAM (STEP) ARE LISTED IN THE FOLLOWING TABLES. THESE CONSTRAINTS INCORPORATE STEP ACCURACY EVALUATION DATA AND REPRESENT THE WAY IN WHICH VEHICLE CONSTRAINTS ARE ANALYZED BY APPLICATION OF A BIAS AS GIVEN IN TABLE A18-451-I OR AS REFERENCED. THE LISTED BIASES ARE CONSERVATIVE ONLY FOR ATTITUDES AND TPS CONFIGURATIONS THAT HAVE BEEN PREVIOUSLY FLOWN. IT IS UNDERSTOOD THAT IF ACTUAL ATTITUDES, DURATIONS, SEQUENCES, AND BETA-ANGLES ARE BEING FLOWN FOR THE FIRST TIME, A LARGER ERROR CAN RESULT WHICH SHOULD CAUSE LIMIT VIOLATIONS AND REQUIRE REAL-TIME CORRECTIVE ACTION.

FOR THE OMS OXIDIZER HIGH-POINT BLEED QUICK DISCONNECT (QD), IF THE ENVIRONMENT CONSTRAINT CANNOT BE MET DIRECTLY, THE HEATER DUTY CYCLE WILL BE VERIFIED TO BE ACCEPTABLE USING FIGURE A18-451-II.

DETERMINATION OF WHETHER AN RCS THRUSTER CONSTRAINT MAY EXIST WILL BE DONE USING FIGURES A18-451-III AND A18-451-IV. IF A LIMIT VIOLATION IS POSSIBLE, PREFLIGHT COORDINATION WITH ENGINEERING DIRECTORATE WILL DETERMINE ACCEPTABLE ATTITUDES.

THE DRAG CHUTE WILL BE ANALYZED BY ASSUMING THAT IT IS THE SAME TEMP AS THE ENVIRONMENT OF HYDRAULIC SYSTEM 2 RSB RETURN TEMP (V58T0298) AND RSB SEAL DRAIN LINE TEMP AT LOWER AFT OF VERTICAL STABILIZER (V58T1600).

EDO CRYO PALLET CONSTRAINT ASSESSMENT WILL BE COORDINATED WITH ENGINEERING DIRECTORATE PREFLIGHT. @[030994-1598A]

THIS RULE CONTINUED ON NEXT PAGE

FLIGHT RULES

A18-451

**ORBITER THERMAL CONSTRAINTS AND ATTITUDE
MANAGEMENT [CIL] (CONTINUED)**

**TABLE A18-451-I - DELTA TEMPERATURE BIAS TO BE APPLIED TO STEP
PREDICTIONS TO CHECK THERMAL CONSTRAINT LIMITS**

GENERAL CONSTRAINTS	LIMIT -° F		
	L LOWER	DELTA TEMP [A] TO BE ADDED TO STEP	
	U UPPER	OV-103/104/105	OV-102
MLG TIRE (BRAKE LINE)	L VARIABLE	CURVE 1	CURVE 2
V58T1700/1750			
BET (PLBD CLOSURE)	U 160/200	+36° F	+36° F
OMS ENGINE OX/FUEL LINE	U 125/150	0° F	0° F
V43T4216/4642/5216/5642			
NLG HYD LINE IN MID			
V58T0127 (X=853)	L -50/-65	-13° F	-17° F
V58T1143 (X=1020)	L -50/-65	-15° F	-15° F
ZOT: V42T2200/2300/3200/3300	L 70	-7° F	-7° F
OMS OX HI POINT BLEED			
LINE QD			
ENV V34T1108	L 20	-23° F [B]	-23° F [B]
T/S V43T6235		DATA UNAVAILABLE	
RCS THRUSTERS	U 150/175	DATA UNAVAILABLE	
DRAG CHUTE	L -60	DATA UNAVAILABLE	
EDO CRYO PALLET TANKS	U 110	DATA UNAVAILABLE	

[A] CURVE NUMBERS REFER TO FIGURE A18-451.

[B] THESE DELTA TEMPERATURES ARE FOR OMS OX HPBL QD ENVIRONMENT ONLY, NOT FOR EI LIMIT.
©[030994-1598A]

THIS RULE CONTINUED ON NEXT PAGE

FLIGHT RULES

A18-451

**ORBITER THERMAL CONSTRAINTS AND ATTITUDE
MANAGEMENT [CIL] (CONTINUED)**

TABLE A18-451-I - DELTA TEMPERATURE BIAS TO BE APPLIED TO STEP PREDICTIONS TO CHECK THERMAL CONSTRAINT LIMITS (CONTINUED)

BONDLINE EI TEMPERATURES						
SENSOR	OV-103/104/105			OV-102		
	LIMIT -°F		DELTA TEMP (°F) [A]	LIMIT -°F		DELTA TEMP (°F) [A]
	MIN	MAX		MIN	MAX	
P S V09T1012	75	90	+ 12° F	52	67	+ 24° F
O I V09T1030	58	67	CURVE 3	58	67	CURVE 3
R D V09T1724	29	83	CURVE 4	46	100	CURVE 5
T E V34T1102	96	114	+ 29° F	71	89	+ 43° F
V34T1106	75	93	+ 26° F	120	138	+ 20° F
S S V09T1014	75	90	+ 10° F	52	67	+ 22° F
T I V09T1028	58	67	CURVE 3	58	67	CURVE 3
B D V09T1720	29	83	CURVE 4	46	100	CURVE 5
D E V34T1104	96	114	+ 29° F	71	89	+ 43° F
V34T1108	75	93	+ 26° F [B]	120	138	+ 20° F [B]
T V09T1004	81	100	CURVE 6	81	100	CURVE 6
O V09T1024	81	100	CURVE 6	81	100	CURVE 6
P V09T1524	60	60	+ 11° F	61	61	+ 19° F
P V37T1000	63	63	CLOSED PLBD	69	69	CLOSED PLBD
L V37T1002	84	84	TEMPS NOT	88	88	TEMPS NOT
B V37T1004	84	84	PREDICTED	88	88	PREDICTED
D V37T1006	63	63	BY STEP	69	69	BY STEP
V09T1000	28	100	CURVE 7	30	102	CURVE 8
B V09T1002	28	100	CURVE 7	30	102	CURVE 8
O V09T1016	99	158	+ 4° F	103	162	+ 4° F
T V09T1022	81	140	CURVE 9	91	150	CURVE 9
T V09T1624	78	137	CURVE 10	44	103	+ 21° F
O V09T1702	47	72	CURVE 11	37	62	CURVE 11
M V34T1110	32	91	CURVE 12	42	101	CURVE 13
V34T1112	29	88	CURVE 14	38	97	CURVE 15

[A] CURVE NUMBERS REFER TO FIGURE A18-451 -I.

[B] THESE DELTA TEMPERATURES ARE FOR IE LIMIT ONLY, NOT FOR OMS OX HPBL. @[030994-1598A]

THIS RULE CONTINUED ON NEXT PAGE

FLIGHT RULES

A18-451

ORBITER THERMAL CONSTRAINTS AND ATTITUDE MANAGEMENT [CIL] (CONTINUED)

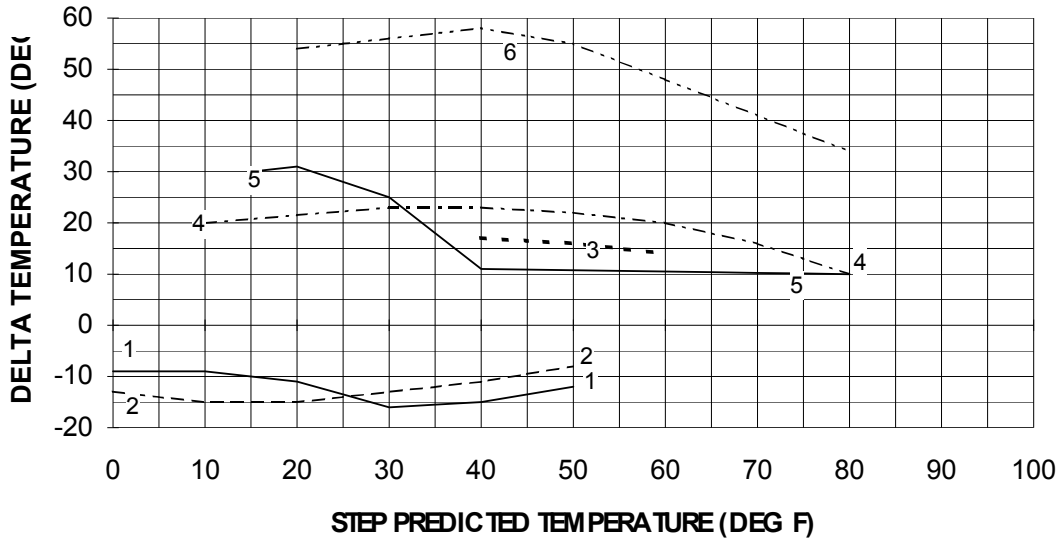

OV-103 MSID	CURVE	OV-102 MSID	CURVE
V09T1000	7	V09T1000	8
V09T1002	7	V09T1002	8
V09T1004	6	V09T1004	6
V09T1022	9	V09T1022	9
V09T1024	6	V09T1024	6
V09T1028	3	V09T1028	3
V09T1030	3	V09T1030	3
V09T1624	10	V09T1624	11
V09T1702	11	V09T1702	5
V09T1720	4	V09T1720	5
V09T1724	4	V09T1724	13
V34T1110	12	V34T1110	15
V34T1112	14	V34T1112	2
V58T1700	1	V58T1700	2
V58T1750	1	V58T1750	2

FIGURE A18-451-I - DELTA TEMPERATURE BIAS TO BE APPLIED TO STEP PREDICTIONS TO CHECK THERMAL CONSTRAINT LIMITS

THIS RULE CONTINUED ON NEXT PAGE

FLIGHT RULES

A18-451

ORBITER THERMAL CONSTRAINTS AND ATTITUDE MANAGEMENT [CIL] (CONTINUED)

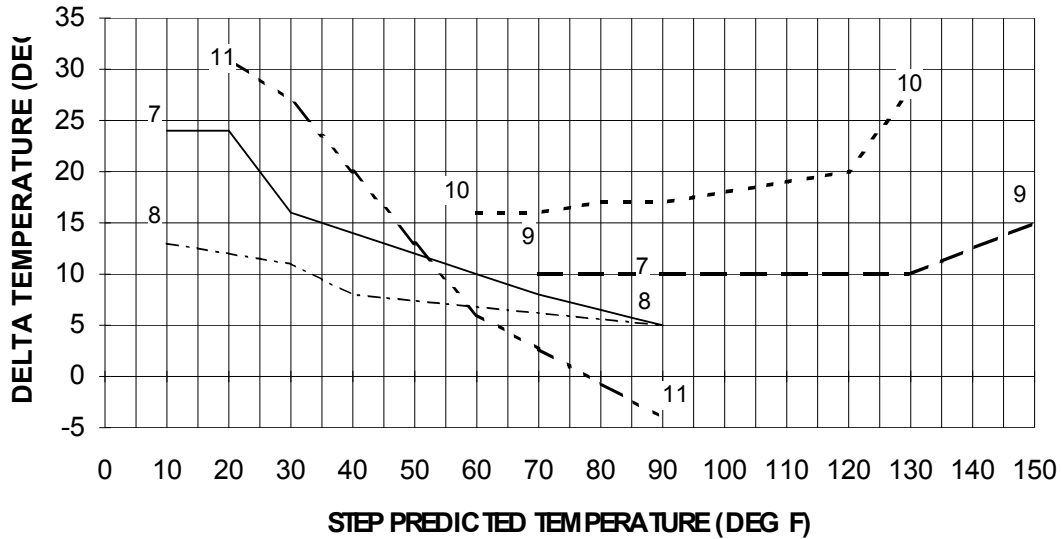

OV-103 MSID	CURVE	OV-102 MSID	CURVE
V09T1000	7	V09T1000	8
V09T1002	7	V09T1002	8
V09T1004	6	V09T1004	6
V09T1022	9	V09T1022	9
V09T1024	6	V09T1024	6
V09T1028	3	V09T1028	3
V09T1030	3	V09T1030	3
V09T1624	10	V09T1624	11
V09T1702	11	V09T1702	5
V09T1720	4	V09T1720	5
V09T1724	4	V09T1724	13
V34T1110	12	V34T1110	15
V34T1112	14	V34T1112	2
V58T1700	1	V58T1700	2
V58T1750	1	V58T1750	2

FIGURE A18-451-I - DELTA TEMPERATURE BIAS TO BE APPLIED TO STEP PREDICTIONS TO CHECK THERMAL CONSTRAINT LIMITS (CONTINUED)

THIS RULE CONTINUED ON NEXT PAGE

FLIGHT RULES

A18-451

ORBITER THERMAL CONSTRAINTS AND ATTITUDE
MANAGEMENT [CIL] (CONTINUED)

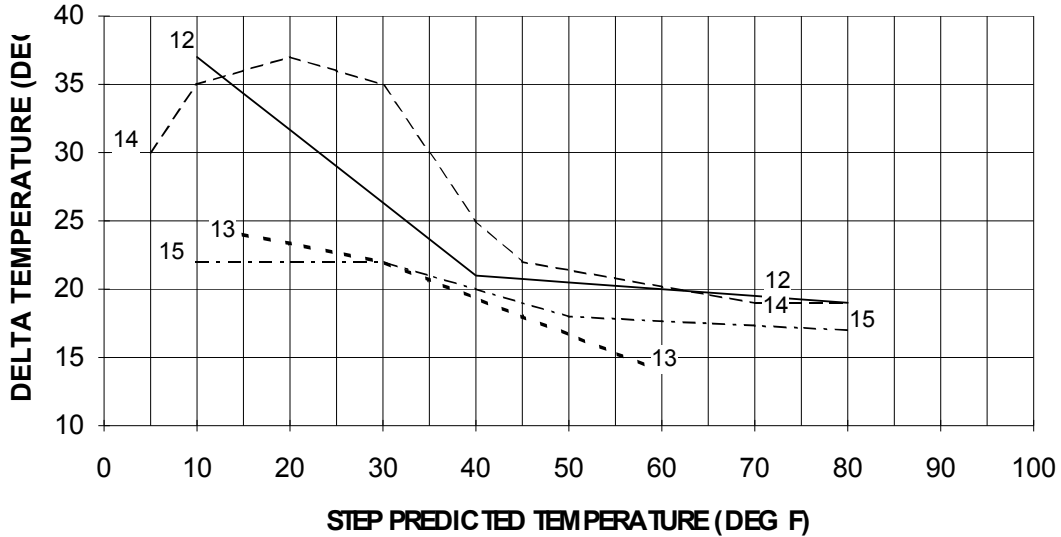

<u>OV-103</u> <u>MSID</u>	<u>CURVE</u>	<u>OV-102</u> <u>MSID</u>	<u>CURVE</u>
V09T1000	7	V09T1000	8
V09T1002	7	V09T1002	8
V09T1004	6	V09T1004	6
V09T1022	9	V09T1022	9
V09T1024	6	V09T1024	6
V09T1028	3	V09T1028	3
V09T1030	3	V09T1030	3
V09T1624	10	V09T1624	11
V09T1702	11	V09T1702	5
V09T1720	4	V09T1720	5
V09T1724	4	V09T1724	13
V34T1110	12	V34T1110	15
V34T1112	14	V34T1112	2
V58T1700	1	V58T1700	2
V58T1750	1	V58T1750	2

FIGURE A18-451-I - DELTA TEMPERATURE BIAS TO BE APPLIED TO STEP PREDICTIONS TO CHECK THERMAL CONSTRAINT LIMITS (CONTINUED)

THIS RULE CONTINUED ON NEXT PAGE

FLIGHT RULES

A18-451

ORBITER THERMAL CONSTRAINTS ATTITUDES MANAGEMENT
[CIL] (CONTINUED)

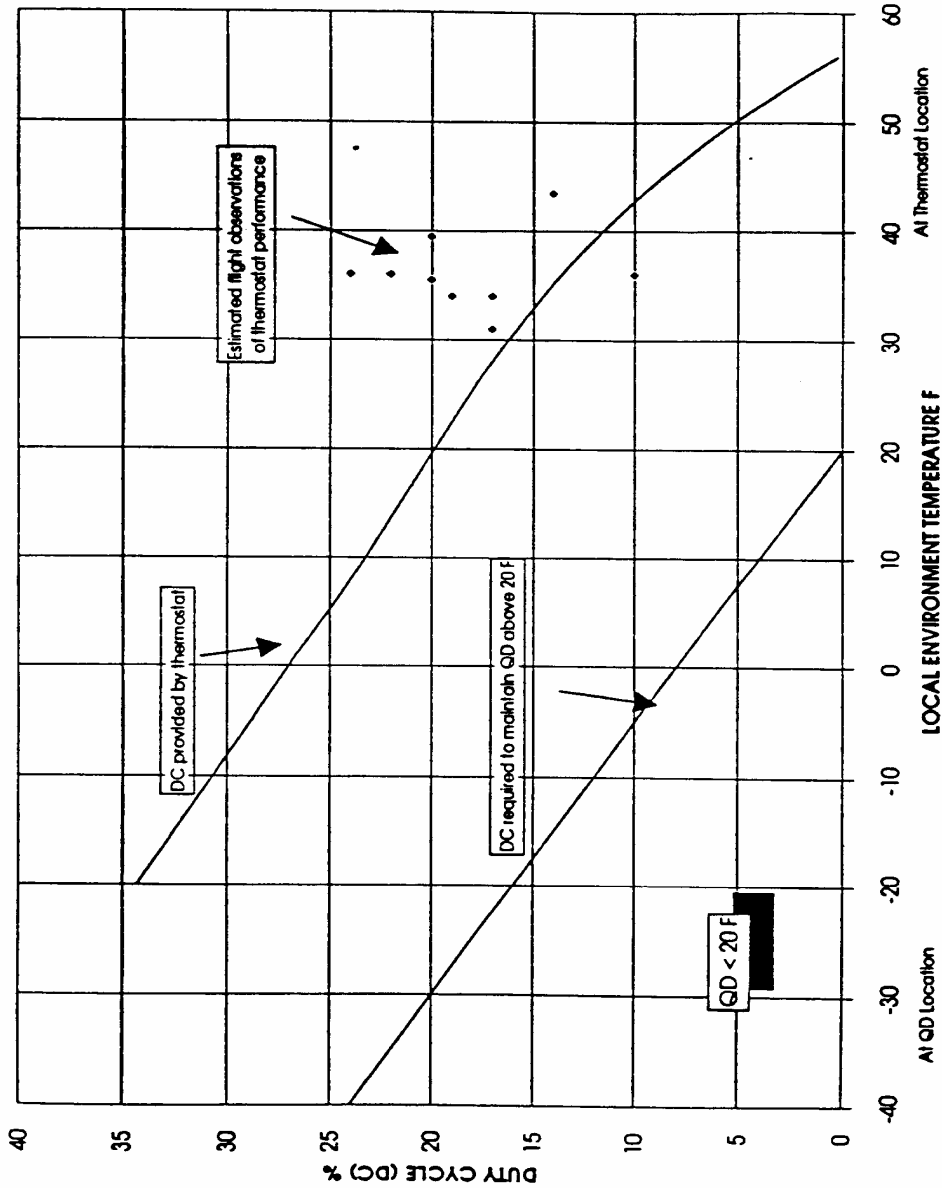

OMS Oxidizer Mid HPBL Heater System Performance Estimate

FIGURE A18-451-II - OMS OXIDIZER MID HPBL HEATER SYSTEM PERFORMANCE ESTIMATE

THIS RULE CONTINUED ON NEXT PAGE

FLIGHT RULES

A18-451

ORBITER THERMAL CONSTRAINTS AND ATTITUDE MANAGEMENT [CIL] (CONTINUED)

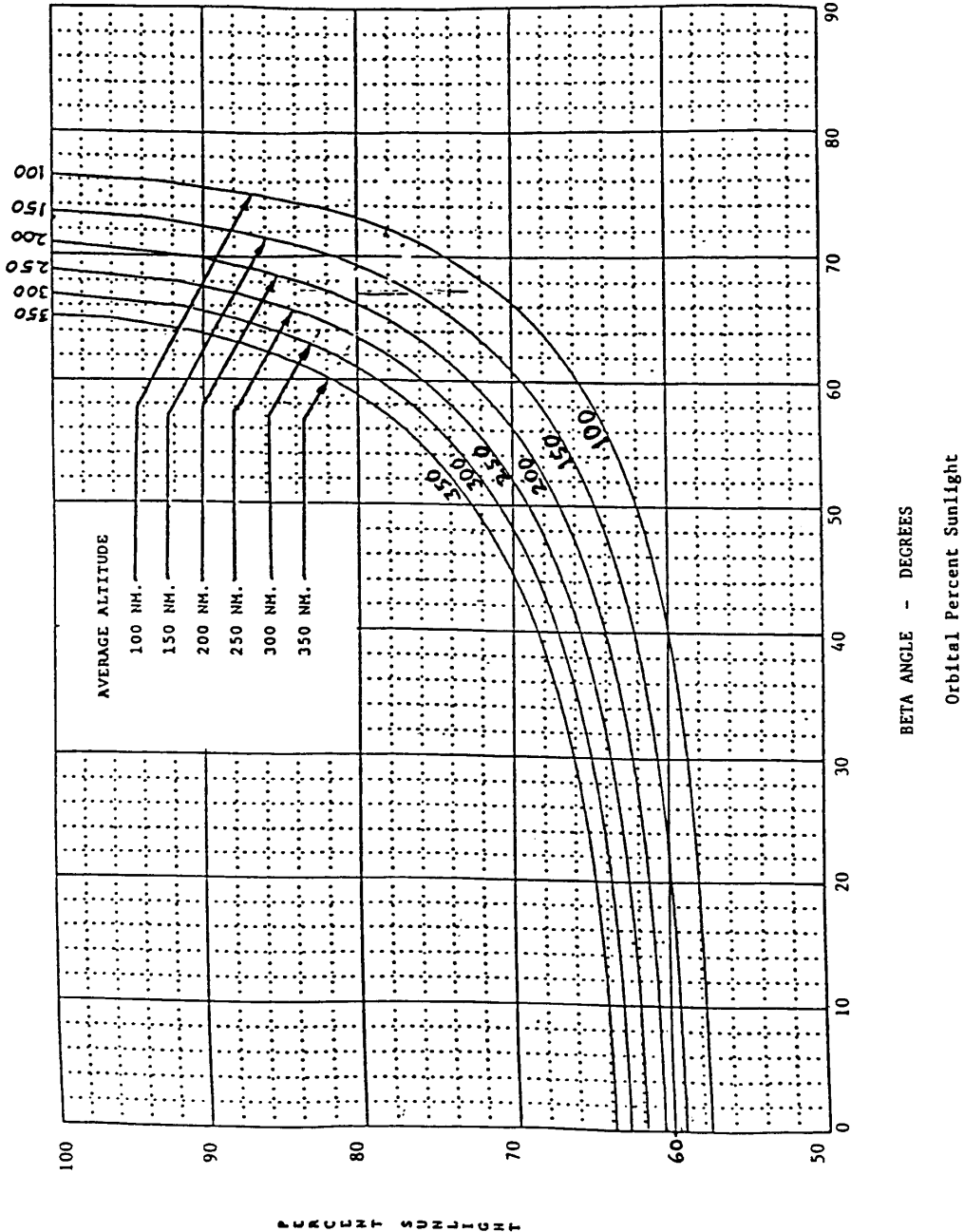

FIGURE A18-451-III - ORBITAL PERCENT SUNLIGHT AS FUNCTION OF BETA ANGLE AND ALTITUDE

THIS RULE CONTINUED ON NEXT PAGE

FLIGHT RULES

A18-451

ORBITER THERMAL CONSTRAINTS AND ATTITUDE MANAGEMENT [CIL] (CONTINUED)

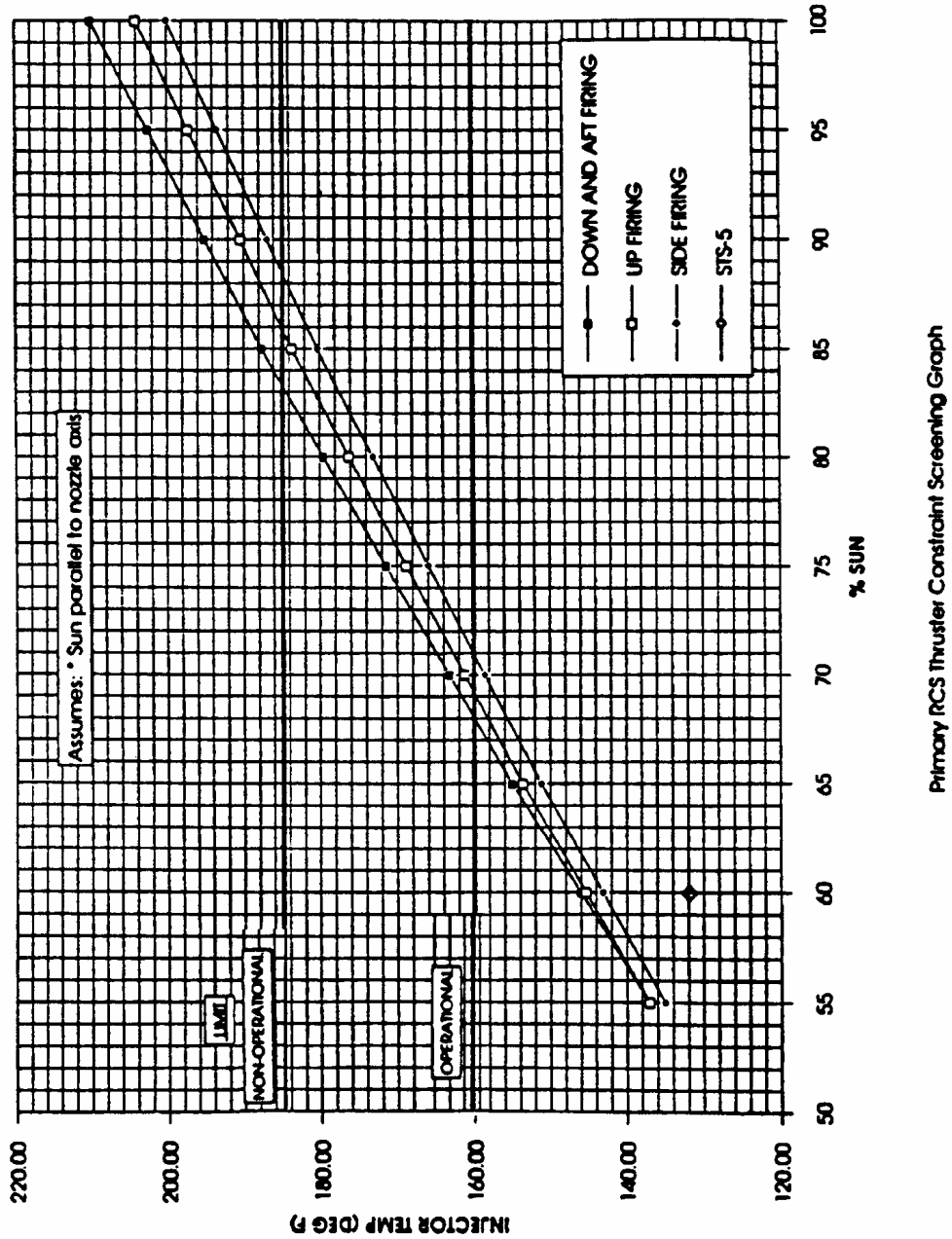

FIGURE A18-451-IV - PRIMARY RCS THRUSTER CONSTRAINT SCREENING GRAPH

THIS RULE CONTINUED ON NEXT PAGE

FLIGHT RULES

A18-451

**ORBITER THERMAL CONSTRAINTS AND ATTITUDE
MANAGEMENT [CIL] (CONTINUED)**

STEP accuracy biases were generated by evaluation of attitudes normally flown. Application to other attitudes may result in predicted temperatures that differ from actual values by additional bias uncertainty.

Documentation: STEP Accuracy Definition Document, RI IL SE-TCS-93-042, May 14, 1993; and OV-103 Orbiter On-Orbit Thermal Constraints, RI IL SE-TCS-94-004, January 17, 1994.

Rule {A18-401}, THERMAL PROTECTION SYSTEM (TPS) BONDLINE TEMPERATURES, references this rule.

A18-452 THROUGH A18-500 RULES ARE RESERVED

FLIGHT RULES

COOLING EQUIPMENT CONSTRAINTS

A18-501

MAXIMUM OFF TIME FOR COOLING EQUIPMENT [HC]

@[022405-6493]

ORBIT @[051194-1610A]

THE FOLLOWING IS A LISTING OF THE MAXIMUM TIME THAT COOLING EQUIPMENT CAN BE OFF BEFORE POWERDOWN ACTION IS REQUIRED:

- A. CABIN FANS - 30 MIN @[032802-5276C]
- B. AVIONICS FAN - 26 MIN
- C. IMU FANS

MAX TIME W/O COOLING, IMU IN "OPERATE" (MINUTES)	MAX TIME W/O COOLING, IMU IN "STANDBY" (MINUTES)
90 (75 DEG F CABIN AIR TEMP AT 14.7 PSIA)	180 (75 DEG F CABIN AIR TEMP AT 14.7 PSIA)
60 (80 DEG F CABIN AIR TEMP AT 10.2 PSIA)	180 (80 DEG F CABIN AIR TEMP AT 10.2 PSIA)

Reference SODB, para.4.5.1.2.3, Inertial Measurement Unit; and Table 4.5.1-22, HAINS IMU Operation Without Airflow.

- D. H₂O LOOPS - 10 MIN
- E. BOTH FREON LOOPS - 10 MIN

Cooling equipment off time is constrained by the requirements of the LRU's that they cool. If cooling equipment remains off for a time exceeding the LRU specific cooling limits, then a powerdown may be required due to a potential overtemp condition.

- a. *The CABIN fans can only be off for 30 minutes due to the cooling constraints of the Multifunction Display Units and the new, passively cooled Device Driver Units (DDU's). @[032802-5276C] @[022405-6493]*
- b. *The AVIONICS bay fans can only be off for 26 minutes due to the cooling constraints of the GPC's.*

THIS RULE CONTINUED ON NEXT PAGE

FLIGHT RULES

A18-501 MAXIMUM OFF TIME FOR COOLING EQUIPMENT [HC] **(CONTINUED)**

- c. *The IMU fans can only be off for 90 minutes when an IMU is in “operate,” due to the cooling constraints of the IMU’s. The maximum time without cooling for an IMU in “standby” is 180 minutes. (Ref Kearfott report test data.) At cabin air temperatures of 90 deg F, the time without cooling limit at 14.7 psia cabin conditions is 45 minutes for an IMU in operate and 180 minutes for an IMU in standby. Note that the 90 deg F limits are provided for information only. A cabin air temperature of 90 deg F is an extreme that indicates overall loss of cabin cooling has occurred.* ©[022405-6493]
- d. *The H₂O loops can only be off for 10 minutes due to the cooling constraints of the S-band power amplifier.*
- e. *Both FREON loops can only be off for 10 minutes due to the cooling constraints of the S-band power amplifier. Note that the catastrophic failure may occur as early as 50 minutes due to loss of cooling to the fuel cells.*

DOCUMENTATION: SODB Vol. III, Tables 4.5.0-1 and 4.5.1-2; Kearfott report Y257C437, December 13, 1992; and Dual Freon Loop Failure Entry Analysis, Rockwell International, IL #388-301-79-018, July 21, 1981. ©[051194-1610A]

Hazard Reports: ORBI-088, Loss of Cabin Air Circulation/Cooling; ORBI-117, Loss of Water Coolant Loops; ORBI-275, Loss of Freon Coolant Loops; and ORBI-051, Loss or Erroneous IMU Output Can Cause Loss of Flight Control. ©[022405-6493]

Rule {A13-155}, ORBITER HAZARDOUS SUBSTANCE SPILL RESPONSE [HC], references this rule. ©[042706-7275A]

A18-502 THROUGH A18-550 RULES ARE RESERVED

FLIGHT RULES

WATER LOOP

A18-551 SPACEHAB SUBSYSTEM WATER LOOP @[111501-5011A]

LOST IF:

- A. PUMP ACCUMULATOR QUANTITY IS ≤ 0 (3.4) PERCENT AND SYMPTOMS OF PUMP CAVITATION ARE PRESENT.

Spacehab has identified this percentage as an indication of accumulator failure; 3.4 percent is the range of uncertainty of the quantity sensor.

- B. FLOW CANNOT BE MAINTAINED GREATER THAN:

1. ASCENT/ENTRY: 130 POUNDS PER HOUR (LB/HR)

Analysis indicates this minimum flow is required to reject powered Spacehab ascent/entry heat loads.

2. ON-ORBIT: 140 LB/HR

For a Spacehab continuous heat load of 2 kW, this is the minimum flow which will avoid violating the maximum coolant return temperature of 104 degrees F.

- C. THERE ARE SYMPTOMS OF PUMP CAVITATION AND THE PUMP INLET PRESSURE IS LESS THAN 20 PSIA.

Pump will operate erratically and may cavitate at pressures less than specified value.

- D. FLOW TO THE PAYLOAD HEAT EXCHANGER (PLHX) CANNOT BE MAINTAINED GREATER THAN 50 (55) LB/HR. @[021600-7111A]

The water line heaters are activated to preclude water freezing in case the flow through the PLHX decreases below 50 lb/hr. The manual bypass IFM may result in flow rate to the PLHX less than 50 (55) lb/hr. The PLHX flow in the RDM configuration is measured via a flow sensor with an uncertainty of 5 lb/hr at 50 lb/hr. The PLHX flow in the Single Module/Logistics Double Module (SM/LDM) configurations is not measured directly and verification will be done analytically. In the event of water line heater failure, attitude adjustment would be necessary to prevent water freezing.

Reference: Rule {A18-555}, WATER LINE HEATER MANAGEMENT, and ICD 21095, Interface Review Notice 37. @[121593-1594] @[111501-5011A]

FLIGHT RULES

A18-552 **SPACEHAB SUBSYSTEM WATER LOOP MANAGEMENT** @[111501-5011A]

- A. THE SPACEHAB SUBSYSTEM WATER LOOP SHOULD BE OPERATING AT ALL TIMES WHEN THE MODULE IS POWERED; ONLY ONE PUMP WILL BE RUNNING AT ANY TIME.

Pump 2 can operate on orbiter or inverter power. Pump 1 can only operate on inverter power.

- B. FOR A DECLARED FAILURE OF THE SPACEHAB SUBSYSTEM WATER LOOP AS DEFINED IN RULE {A18-551}, SPACEHAB SUBSYSTEM WATER LOOP:
1. LIMITED SPACEHAB EXPERIMENT OPERATIONS MAY CONTINUE.
 2. WATER LINE HEATERS WILL BE ACTIVATED.
 3. IF THE WATER LINE HEATERS ARE LOST OR INEFFECTIVE, CONTROL THE ORBITER ATTITUDE TO PRECLUDE WATER LINE FREEZING OR PAYLOAD HEAT EXCHANGER OVER PRESSURIZATION. (REFERENCE RULE {A18-555}, WATER LINE HEATER MANAGEMENT, FOR ACCEPTABLE ATTITUDES.)

Although heat rejection via water cooling has been lost, limited heat can be rejected via air exchange with the orbiter. This would require some subsystem and experiment equipment to be powered off. This configuration is also more beneficial than total module deactivation since module temperatures are more easily controlled. The water line heaters must be activated so that the lines between the module and the orbiter's payload heat exchanger interface do not freeze. Attitude changes are the least desirable option to control water line temperatures.

- C. THE SUBSYSTEM WATER LOOP OR WATER LINE HEATERS MUST BE ACTIVE PRIOR TO PAYLOAD BAY DOOR OPENING AND MUST REMAIN ACTIVE UNTIL POST LANDING.

No analysis has been done to determine if the subsystem water loop will freeze if the water loop or water line heater is not active when the payload bay doors are closed during entry. @[111501-5011A]

FLIGHT RULES

A18-553

SPACEHAB SUBSYSTEM PUMP OPERATIONS @[111501-5012]

- A. FOR LOSS OF A SINGLE PHASE, THE SUBSYSTEM WATER PUMP MAY CONTINUE TO BE OPERATED ON TWO-PHASE POWER.

The Subsystem Water Pump was operated on two phases during preflight testing. The Subsystem Water Pump may be operated but not started on only two phases.

If the Subsystem Water Pump is operating on the Spacehab INV and phase A fails, the pump will stop working because phase A of the Spacehab INV provides the sync pulse required for Spacehab INV phases B and C to operate. However, the Subsystem Water Pump will continue to operate on the Spacehab INV on two-phase power if phase A continues to operate with either phase B or phase C.

- B. THE FOLLOWING SUBSYSTEM WATER PUMP CONFIGURATION WILL BE USED FOR NOMINAL SPACEHAB SM/LDM OR RDM OPERATIONS FOR ASCENT/ENTRY AND ON-ORBIT:

1. ASCENT/ENTRY

a. POWERED SPACEHAB MODULE

- (1) SUBSYSTEM WATER PUMP 1 - ON, USING SPACEHAB INVERTER POWER
- (2) SUBSYSTEM WATER PUMP 2 - OFF, CONFIGURED TO SPACEHAB INVERTER POWER

FOR FAILURE OF WATER PUMP 1, WATER PUMP 2 WILL BE COMMANDED ON ASAP POST-MECO OR DURING ENTRY. FOR FAILURE OF THE SPACEHAB INVERTER, REFERENCE RULE {A9-354}, SPACEHAB AC MANAGEMENT. @[ED]

Subsystem water pump 2 is configured to inverter power to allow it to serve as a backup in case pump 1 fails. Without switching pumps, module heat rejection is lost. Subsystem water pump 1 can only be powered from the Spacehab inverter. Pump 2 can be powered from Spacehab inverter or orbiter AC power. Since no on-board command capability exists in OPS 1 (Single Module General Purpose Computer (SM GPC) not available), the pumps will be reconfigured via ground command post MECO or during entry. @[111501-5012]

THIS RULE CONTINUED ON NEXT PAGE

FLIGHT RULES

A18-553

SPACEHAB SUBSYSTEM PUMP OPERATIONS (CONTINUED)

- b. UNPOWERED SPACEHAB MODULE (SM/LDM ASCENT ONLY)
@[111501-5012]

SUBSYSTEM WATER PUMP 2 IS CONFIGURED ON AND TO ORBITER POWER, BUT THE PUMP WILL NOT BE OPERATING SINCE ORBITER AC POWER IS NOT AVAILABLE TO PAYLOADS DURING ASCENT.

When the Spacehab module is unpowered for ascent, this configuration allows the Spacehab Subsystem Pump to be activated whenever power is applied to the payload AC bus in the event of a failure that prevents Spacehab commanding. Spacehab is always powered for entry.

2. ON-ORBIT

- a. SUBSYSTEM WATER PUMP 2 - ON, USING ORBITER AC
- b. SUBSYSTEM WATER PUMP 1 - OFF, CONFIGURED TO SPACEHAB INVERTER POWER

PUMP 1 WILL BE COMMANDED ON FOR FAILURE OF PUMP 2. FOR FAILURE OF THE SPACEHAB INVERTER OR ORBITER AC, REFERENCE RULE {A9-354}, SPACEHAB AC MANAGEMENT. @[ED]

A subsystem water pump is required to provide heat rejection for the module. Operation of either pump on Spacehab inverter power is acceptable, but orbiter AC power is preferred to maintain pump operation in case of a Spacehab Main Power Kill. Subsystem pump 2 is preferred because pump 1 cannot be configured to orbiter AC power. @[111501-5012]

FLIGHT RULES

A18-554 **WATER LINE HEATERS** @[111501-5011A]

WATER LINE HEATERS WILL BE CONSIDERED LOST IF ANY ONE OF THE FOLLOWING IS TRUE:

- A. SPACEHAB WATER LINE STATUS IS 0 INSTEAD OF 1 WHEN ACTIVATED.
- B. IF ORBITER WATER LINE HEATERS INSTALLED, HEATER AMPS < 1.0 WHEN ACTIVATED.

Spacehab water line heaters and orbiter water line heaters are required to protect the Spacehab water lines from freezing. The Spacehab POCC can distinguish between failures by analyzing bus currents. When the Spacehab module is directly against the 576 bulkhead, the orbiter set of heaters will not be installed. In this case, the water line heaters will be considered lost per paragraph A. If installed, orbiter water line heater amps ≥ 1.0 would indicate that the heaters are operating. @[111501-5011A] @[111705-7084]

FLIGHT RULES

A18-555

WATER LINE HEATER MANAGEMENT

A. THE WATER LINE HEATERS WILL BE ACTIVATED FOR ANY OF THE FOLLOWING CONDITIONS (WHEN THE PLBD'S ARE OPEN) : @[111501-5011A]

1. LOSS OR DEACTIVATION OF SPACEHAB WATER LOOP

Loss of water loop results in loss of flow through the PLHX.

2. PRIOR TO PERFORMING AN IFM TO ADJUST THE WFCV MANUAL BYPASS VALVES

Crew adjustment of the bypass valves may result in water flow rates to the PLHX below 50 lb/hr, leaving the water lines susceptible to freezing. Reference: ICD 21095, Interface Review Notice 37.

3. WHEN MAIN DC AND AC POWER HAVE BEEN REMOVED FROM THE SPACEHAB

If PLBD's remain open after emergency deactivation, water line heaters must be active since the pumps are no longer operational. Note that emergency power from PL AFT MN B must be supplied to the Spacehab for the water line heaters to receive power. @[111501-5011A]

4. LOSS OF THE DMU DATA STREAM TO THE PDI WHILE CONTINUING SPACEHAB OPERATIONS @[111501-5011A]

Heaters are turned on since the status of the water pumps is no longer available.

5. WHEN CONTINUING SPACEHAB OPERATIONS WITH A DEGRADED WATER LOOP, CONSIDERATION WILL BE GIVEN TO DEACTIVATING THE HEATERS IF IT CAN BE SHOWN THAT FLOW TO THE PLHX IS ≥ 50 LB/HR.

A degraded water loop could result in reduced flow to the PLHX, while providing sufficient heat rejection to continue the mission. After the heaters are activated, if power savings are required, the heaters may be deactivated if the flow through the PLHX is high enough that there is not a potential for freezing the water loop.

Reference Rule {A18-551}, SPACEHAB SUBSYSTEM WATER LOOP.

THIS RULE CONTINUED ON NEXT PAGE

FLIGHT RULES

A18-555 WATER LINE HEATER MANAGEMENT (CONTINUED)

B. THERMAL CONDITIONING BY ADJUSTING THE ORBITER ATTITUDE WILL BE USED TO PREVENT WATER LINE FREEZING IF THE WATER LINE HEATERS CANNOT BE VERIFIED ACTIVE AND THE WATER LOOP IS OFF.

In the event of a water line heater failure, no other means exists to prevent the water lines from freezing.

C. IF THE SPACEHAB WATER LINE HEATERS ARE LOST, PER RULE {A18-554}, WATER LINE HEATERS, AND WATER LOOP FLOW TO THE PLHX IS LESS THAN 50 LB/HR, A TOP SUN ATTITUDE IS REQUIRED.

ALTERNATIVE ATTITUDES OTHER THAN THE TOP SUN CAN BE ACCOMMODATED ONLY PER THE FOLLOWING TABLE. OTHER ALTERNATIVE ATTITUDES WILL ONLY BE PERFORMED AFTER THERMAL ANALYSIS CAN BE ACCOMPLISHED.

NUMBER OF ORBITS IN ALTERNATIVE ATTITUDE ALLOWED AFTER:			≈β ANGLE (DEG)	ALTERNATIVE ATTITUDE FROM -ZSI
4 ORBITS OF -ZSI	8 ORBITS OF -ZSI	12 ORBITS OF -ZSI		
5	8	NOT ANALYZED	-60<β<+60	ANY -ZLV
1	1	1	-60<β<+60	WORST CASE COLD α
2	4	6	-60<β<+60	±XLV ± ZVV
1	1	2	+β	-XLV +YVV OR +XLV -YVV
1	1	2	-β	-XLV -YVV OR +XLV +YVV

α - EXCLUDING TOP EARTH OR SUN VIEWING @[111501-5011A] @[ED]

Freezing of the water lines may result in orbiter Freon loop payload heat exchanger damage which puts both Freon loops at risk of leaking. Analysis results indicate that the onset of freezing of the water lines may occur as early as 10 minutes after this failure in an attitude which excludes Earth or Sun viewing; 12 minutes for typical ±XLV rendezvous attitudes; and 30 minutes for a -ZLV attitude. To protect against the worst case, a maneuver to a top Sun attitude should be initiated immediately. @[111501-5011A]

A nominal rendezvous lasting no more than 9 hours can be flown only if preceded by 12 or more orbits of top Sun (analyzed for Beta angles between -60 deg and +60 deg). This applies only if the rendezvous attitude is predominantly ±XLV ±ZVV.

Top Sun/alternative attitude times in table cannot be ratioed to longer durations. For example, the 4/5 -ZSI/-ZLV ratio cannot be flown as an 8/10 attitude sequence.

THIS RULE CONTINUED ON NEXT PAGE

FLIGHT RULES

A18-555

WATER LINE HEATER MANAGEMENT (CONTINUED)

For Beta angles $> \approx |60 \text{ deg}|$, the -ZSI attitudes can be biased in pitch or roll only as required to avoid upfiring RCS jet or orbiter maneuvering engine (OME) line thermal violations. However, in the event of conflicting constraints, the water loop must be considered a high priority to be protected from freezing.

Documentation: Rockwell International Internal Letter #SE-PSE-94-087, November 17, 1994, Flight Rule Revision to Payload Active Cooling Kit (PACK) Thermal Constraints.

Rule {A18-552}, SPACEHAB SUBSYSTEM WATER LOOP MANAGEMENT, references this rule.

D. EXCEPTIONS TO THIS RULE WILL BE DOCUMENTED IN THE FLIGHT SPECIFIC ANNEX. @[111501-5011A]

FLIGHT RULES

A18-556 **RESERVED** ©[111501-5013] ©[032807-7136]

A18-557 **RESERVED** ©[111501-5013] ©[032807-7136]

A18-558 THROUGH A18-600 RULES ARE RESERVED

FLIGHT RULES

THIS PAGE INTENTIONALLY BLANK

FLIGHT RULES

SPACEHAB ENVIRONMENTAL CONTROL SYSTEM (ECS) MANAGEMENT

A18-601 **ORBITER/SPACEHAB/EXPERIMENT THERMAL PRIORITIES**
@[111501-4993]

IF CONFLICTS OCCUR, ORBITER THERMAL LIMITS WILL NORMALLY BE PROTECTED AT THE EXPENSE OF SPACEHAB THERMAL LIMITS. SPACEHAB HAS PRIORITY OVER EXPERIMENTS. @[111501-4976A]

The orbiter thermal limits must always take precedence over Spacehab to ensure the capabilities of the orbiter. @[111501-4976A]

A18-602 **ORBITER FREON FLOW PROPORTIONING VALVE (FPV) USAGE**
@[111501-5011A]

THE TWO ORBITER FREON FPV'S WILL NOMINALLY BE USED ACCORDING TO THE FOLLOWING PLAN: @[111501-4976A]

- A. PRELAUNCH (POWERED ASCENT): ONE FPV IN THE INTERCHANGER (ICH) POSITION AND ONE FPV IN THE PAYLOAD HEAT EXCHANGER (PLHX) POSITION AS REQUIRED BY THE PAYLOAD UNTIL FLIGHT-SPECIFIC LAUNCH MINUS TIME SPECIFIED IN THE FLIGHT SPECIFIC ANNEX. THEN BOTH FPV'S ARE PLACED IN ICH FOR ASCENT.

Both FPV's must be in ICH for ascent. However, cold soaking the Spacehab module prelaunch via one FPV in PLHX keeps the predicted module temperatures acceptable until post insertion. Moving the FPV back to the ICH position still guarantees a nominal crew cabin temperature at ingress and during ascent.

- B. ON-ORBIT 14.7 PSI OPS: AFTER SUCCESSFULLY REACHING ORBIT, ONE FPV WILL BE PLACED IN "PLHX" POSITION UNTIL DEORBIT PREP. THE SECOND FPV WILL ONLY BE TAKEN TO "PLHX" IF REQUIRED TO SATISFY PAYLOAD THERMAL REQUIREMENTS AS DEFINED IN THE FLIGHT SPECIFIC ANNEX. AT DEORBIT PREP, BOTH FPV'S WILL BE RETURNED TO "ICH" FOR ENTRY AND LANDING. FOR EXTENSION DAYS, AN FPV IN "PLHX" IS NOT REQUIRED AS LONG AS SPACEHAB REMAINS IN THE ENTRY CONFIGURATION OR WITHIN THERMAL REQUIREMENTS.

If the cabin is at 14.7 psi, marginal cooling exists for orbiter systems if both FPV's are given to the payload. To provide sufficient cooling to the orbiter, only one FPV should be in the PLHX position unless both are required to avoid violating payload thermal limits. In the entry configuration, Spacehab thermal loads are lower such that an FPV in PLHX is not required. However, if Spacehab is reconfigured, (i.e., hatch opened), an FPV in the PLHX position may be required. @[111501-4976A]

THIS RULE CONTINUED ON NEXT PAGE

FLIGHT RULES

A18-602

ORBITER FREON FLOW PROPORTIONING VALVE (FPV) USAGE
(CONTINUED)

- C. ON-ORBIT 10.2 PSI ORBITER OPS: REFERENCE ALL FLIGHTS RULE {A17-308A}, ATCS (10.2 PSIA CABIN) CONFIGURATION. @[111501-4976A]
- D. POSTLANDING: BOTH FPV'S WILL BE IN THE "ICH" POSITION UNTIL REQUESTED FOR PAYLOAD COOLING NO EARLIER THAN CREW EGRESS. THEN ONE FPV IS PLACED INTO THE "PLHX" POSITION FOR THE DURATION OF EARLY EXPERIMENT RETRIEVAL OPERATIONS.

Moving one FPV to PLHX allows Spacehab to maintain module temperature during early experiment sample retrieval operations. Waiting until crew egress to move one FPV to PLHX maximizes orbiter cabin cooling for crew comfort until ground ventilation can be connected.

- E. EXCEPTIONS TO THIS RULE ARE DOCUMENTED IN THE FLIGHT SPECIFIC ANNEX. @[111501-4976A]

FLIGHT RULES

A18-603

SM/LDM WATER FLOW CONTROL ELECTRONICS UNIT (WFCEU)
@[111501-5011A]

- A. THE PRIORITIES, FROM HIGHEST TO LOWEST, FOR THE WFCEU CONFIGURATION ARE AS FOLLOWS: @[111501-4995]
1. MODE 2 (AUTOMATIC CONTROL OF FAN/HX INLET TEMPERATURE)
 2. MODE 1 (AUTOMATIC CONTROL OF CABIN TEMPERATURE)
 3. MODE 3 (CONTROL OF VALVE POSITION BY CABIN TEMPERATURE SET POINT KNOB)
 4. MANUAL ADJUSTMENT OF TWO WATER BYPASS VALVES (WITH WATER LINE HEATERS ON)

The WFCEU software has multiple modes to allow for multiple sensor failures. Mode 2 requires an operational fan/HX inlet temperature sensor and controls the module temperature more accurately than the other modes. Therefore, mode 2 is the preferred mode of operation. The MCC will inform the crew if an alternate operational mode is necessary and which specific commands are required. Mode 1 provides for automatic cabin temperature control by allowing the WFCEU to operate even if one of the water temperature sensors fails. Mode 3 does not require any operational temperature sensors, only the cabin temperature set point. If none of the three modes operate satisfactorily, an IFM will be necessary to reconfigure the water loop. Direction on WFCV bypass valve adjustment will be provided by the POCC. Crew adjustment of water metering valves could cause a flow rate to the PLHX less than 50 lbm/hour.

Reference: ICD 21095, Interface Review Notice 37.

- B. DURING MODE 1 OPS, IF ANY ONE OF SEVEN SENSOR INPUTS TO THE WFCEU FAIL OR GIVE ERRONEOUS DATA, A COMMAND WILL BE ISSUED FROM THE ORBITER DISPLAY SYSTEM WHICH ALLOWS THE WFCEU TO OVERRIDE THAT INPUT.

The seven inputs to the WFCEU are: dew point temperature, cabin temperature, cabin temperature setpoint, water pump inlet temperature, fan/HX inlet temperature, WFCV cold inlet temperature, and WFCV position. Any of the seven can be compensated for by the WFCEU upon commanding from the Orbiter Display System. The MCC will inform the crew which flag command should be issued.

@[111501-4995]

FLIGHT RULES

A18-604 **RESERVED** ©[111501-5013] ©[032807-7136]

A18-605 **RESERVED** ©[111501-5013] ©[032807-7136]

A18-606 **RESERVED** ©[111501-5013] ©[032807-7136]

A18-607 THROUGH A18-650 RULES ARE RESERVED

FLIGHT RULES

THIS PAGE INTENTIONALLY BLANK

FLIGHT RULES

THIS PAGE INTENTIONALLY BLANK

FLIGHT RULES

THIS PAGE INTENTIONALLY BLANK

FLIGHT RULES

THIS PAGE INTENTIONALLY BLANK

FLIGHT RULES

THERMAL GO/NO-GO CRITERIA

A18-1001

THERMAL GO/NO-GO CRITERIA [HC] @[121604-6471A]

SYSTEM/COMPONENTS/FUNCTIONS	ASCENT ABORT IF:	INVOKE MDF IF:	ENTER NEXT PLS IF
A. <u>SUPPLY H₂O</u> :			
1. SUPPLY H ₂ O TANKS (4)			2 ↓ [1]
2. DUMP CAPABILITY			
B. <u>ARS H₂O</u> :			
1. H ₂ O LOOPS (2)	[2]		1 ↓ [3]
2. H ₂ O LOOP LEAK			
C. <u>ATCS</u> :			
1. FCL (2)	2 ↓		1 ↓
2. FCL LEAK			[11]
3. FCL PMPS (4)	4 ↓		[4]
4. FES (2)	[5]	1 ↓ (TOPPING) [6] [7]	1 ↓ (HI-LOAD) [6] [7]
5. FES CONTRS (PRI A, PRI B, SEC) (3)	[5]	2 ↓ (PRIMARY)	3 ↓ [7]
6. FES FEEDLINE (2)	[5]		2 ↓ [7]
7. ABS (2)			
8. RFCA (2)			1 ↓ [8]
9. RAD ISOL			1 ↓ [8]
10. HEAT EXCHANGER LEAK		[9]	[10]

@[121593-1589] @[020196-1810A] @[061396-3104A] @[ED] @[050400-7192]

LEGEND: NO REQUIREMENT () QUANTITY
 REQUIRED [] NOTE REFERENCE

THIS RULE CONTINUED ON NEXT PAGE

FLIGHT RULES

A18-1001

THERMAL GO/NO-GO CRITERIA [HC] (CONTINUED)

NOTES:

- [1] A MINIMUM OF 300 LB OF H₂O REQUIRED TO SUPPORT CONTINGENCY EVA AND DEORBIT PREPARATION FOR A PLBD FAIL TO CLOSE CASE.
- [2] LOSS OF TWO H₂O LOOPS REQUIRES AN AOA.
- [3] IF TWO WATER LOOPS ARE LOST, A LANDING WILL BE REQUIRED WITHIN 4 HOURS OF THE FAILURE.
- [4] ENTER NEXT PLS IF FCL 1 PUMP B AND FCL 2 PUMP A FAILED.
- [5] FOR LOSS OF ALL FES COOLING, MUST PRESS TO ORBIT AND OPEN PLBD'S ASAP POST-OMS-1.
- [6] CONSIDERATION WILL BE GIVEN TO REMAINING ON ORBIT TO ATTEMPT TO THAW OUT EITHER EVAPORATOR.
- [7] REQUIRES POWERDOWN FOR ENTRY.
- [8] NEXT PLS IS REQUIRED (NOT INCLUDING FIRST DAY PLS) FOR LOSS OF RADIATOR COOLING IN ONE LOOP IF SUPPLY H₂O QUANTITIES AND MANAGEMENT PLAN WILL NOT SUPPORT THE FOLLOWING PLS WITH THE NEXT WORST FAILURE (LOSS OF GOOD FREON LOOP). ASSUMING WATER QUANTITIES WILL SUPPORT THE NEXT WORST FAILURE, THE MISSION MAY BE EXTENDED TO THE SUBSEQUENT PLS OPPORTUNITIES. @[050400-7192] @[092701-4865D] @[092701-4866B]

ELS WILL BE REQUIRED IF THE NEXT WORST FAILURE OCCURS BEFORE SUPPLY WATER QUANTITIES CAN SUPPORT NEXT PLS. @[050400-7192]
- [9] MDF IF LEAK IN HEAT EXCHANGER BETWEEN FLUID LOOPS OTHER THAN FREON LOOP TO FREON LOOP, CABIN H₂O LOOP TO CABIN H₂O LOOP, AND FREON LOOP TO CABIN H₂O LOOP. @[121604-6471A]
- [10] ENTER NEXT PLS IF LEAK BETWEEN FREON LOOP AND CABIN H₂O LOOP, FREON LOOP TO FREON LOOP, OR CABIN H₂O LOOP TO CABIN H₂O LOOP. @[020196-1810A] @[121604-6471A]
- [11] FOR A LEAKING FREON LOOP WHICH WILL SUPPORT NEXT PLS BUT NOT THE FOLLOWING PLS, A PLS WILL BE DECLARED IN ORDER TO ACHIEVE A NOMINAL D/O PREP AND ENTRY. A LOSS OF ONE FREON LOOP ENTRY REQUIRES A POWERDOWN TO 14 KW. @[061396-3104A]

THIS RULE CONTINUED ON NEXT PAGE

FLIGHT RULES

A18-1001 THERMAL GO/NO-GO CRITERIA [HC] (CONTINUED)

A. SUPPLY H₂O

1. *Supply Water - two supply water tanks are required to maintain redundancy for FC water removal capability. If only one supply water tank was maintained, one additional failure (the remaining tank) could result in loss of all three FC's.*
2. *Dump Capability - Loss of dump capability requires FC relief system activation when all water tanks are full. The FC relief system is zero fault tolerant under these conditions and failure of this relief system would cause losses of vehicle and crew.*

B. ARS H₂O

1. H₂O LOOPS

Loss of one water loop has no impact to the orbiter cooling since only one loop is normally activated. However, the failure places the orbiter in a zero-fault tolerant level. The next failure, loss of the other loop, would leave the orbiter with no control for humidity and no cooling available to the avionics inside the crew module. Effective PPCO₂ concentration control would also be lost due to restricted operations of cabin fans to avoid overheating ac inverters which are actively cooled by water loops. For loss of one water loop during ascent, nominal ascent should therefore be continued and first day PLS be executed.

An AOA, rather than an earlier ascent abort mode, is preferred for loss of both water loops during ascent because the avionics, with proper management, will not overtemp in an AOA timeframe (approximately 110 minutes). Avionics, due to the hot thermal environment encountered in the ascent phase, cannot be managed properly for the extended time required for a first day PLS to ensure a safe entry.

Thermal analysis indicates that, if two water loops are lost, cabin conditions will become intolerable within 2 hours of the failure. Cabin temperatures approach 90 deg F and relative humidity reaches 100 percent. Avionics temperatures exceed their loss of cooling operate periods and must be powered down. The cabin conditions can be relieved by performing cabin depress/repress (DEP/REP) cycles. The 4-hour time to landing is based on a crew of seven with an N₂ quantity of 262 lb. Crew exposure to the extreme cabin conditions is the primary driver for terminating the flight. The DEP/REP cycles provide relief from the high heat and humidity by dumping the excessive heat and humidity overboard and replacing the air with cool, dry N₂ and O₂.

DOCUMENTATION: Lockheed Technical Memorandum, G189A ECLSS ANALYSIS OF THE LOSS OF TWO WATER LOOPS AFO (TIG > 2.5), to be published. Document no. LESC-24843; engineering judgment; 1.1-ECLSS-09.

THIS RULE CONTINUED ON NEXT PAGE

FLIGHT RULES

A18-1001 THERMAL GO/NO-GO CRITERIA [HC] (CONTINUED)

2. *H₂O LOOP LEAK*

When there is a coolant leak into the cabin from the water loop, it becomes zero-fault tolerant to crew safety because the next failure, a Freon-to-water leak at the interchanger, will introduce toxic Freon 21 into the crew habitable area. However, based upon the confidence in the interchanger hardware integrity (stainless steel construction; no leak experience) and the desire to provide on-orbit time for crew adaption (SAS concerns), an MDF will be performed.

DOCUMENTATION: Engineering judgment; JSC-08934, volume 3, section 4.6.1.2.1.2.

C. *ATCS*

1. FCL:

Loss of one Freon loop requires a PLS because the next failure (loss of other Freon loop) could result in loss of crew/vehicle.

Nominal ascent is continued so that more time is available to reconfigure for a one Freon loop entry and also because loss of one Freon loop is not an emergency. If both loops are lost, an emergency entry (ascent abort) is required because all cooling to the vehicle is lost.

If both Freon loops are lost, an emergency entry is required because the FC stack temperatures will reach the specification operational limit of 250 deg F within approximately 50 minutes. In addition, the electrolyte will reach the 25 percent operational limit in approximately 75 minutes. At this point, continued operation of the FC's is questionable. This assumes a simultaneous purge of all three FC's and 12.54 kWh (4.18 kWh/FCP).

DOCUMENTATION: Dual Freon Loop Failure Entry Analysis, Rockwell International, IL #388-301-79-018, 7/21/81.

THIS RULE CONTINUED ON NEXT PAGE

FLIGHT RULES

A18-1001

THERMAL GO/NO-GO CRITERIA [HC] (CONTINUED)2. FCL PUMPS:

Loss of FCL 1 pump B and FCL 2 pump A requires a PLS because both remaining pumps are powered by AC1. Loss of AC1 would cause the loss of both FCLS and could result in loss of crew/vehicle.

If both Freon loops are lost, an emergency entry is required because the FC stack temperatures will reach the specification operational limit of 250 deg F within approximately 50 minutes. In addition, the electrolyte will reach the 25 percent operational limit in approximately 75 minutes. At this point, continued operation of the FC's is questionable. This assumes a simultaneous purge of all three FC's and 12.54 kWh (4.18 kWh/FCP).

DOCUMENTATION: Dual Freon Loop Failure Entry Analysis, Rockwell International, IL #388-301-79-018, 7/21/81.

3. FCL AFT COLDPLATE FLOW @[031705-6691D]

Loss of FCL Aft Coldplate Flow requires a next PLS because flow degradation beyond FR limits coupled with the next worst failure (Loss of the good FCL) would result in loss of cooling to entry critical LRU's and preclude a safe landing (loss of crew/vehicle).

The FCL aft coldplate baseplate temperature limit is 130 deg F. There is an estimated 5 deg F difference between the coldplate baseplate temperature and the Freon fluid temperature. Additionally, there is an estimated 8 deg F difference in the mixed Freon fluid temperature from the (parallel) coldplates, resulting in an aft coldplate FCL outlet temperature limit of 117 deg F. The RGA outlet (downstream of the aft coldplates) temperature limit is 150 deg F. The low heat load generated on the RGA coldplates requires much less Freon flow to maintain the RGA outlet temperature below the 150 deg F limit, making the aft coldplate outlet temperature the limiting constraint for FCL aft coldplate flow. @[031705-6691D]

THIS RULE CONTINUED ON NEXT PAGE

FLIGHT RULES

A18-1001

THERMAL GO/NO-GO CRITERIA [HC] (CONTINUED)Nominal D/O Prep and Entry Aft Coldplate Config @[031705-6691D]

The nominal deorbit prep and entry FCL aft coldplate flow limit required to protect the FCL aft coldplate temperature limit of 117 deg F is 193 (218) lb/hr. The nominal deorbit prep and entry aft coldplate config is listed below:

- a. All FA MDM's, OA MDM's, and DSC's on thru TD.
- b. All ATVC's (4) powered on at Tig-3:25 and remain on thru TD.
- c. All ASA's (4) and RGA's (4) powered on at Tig-3:15 and remain on thru TD.
- d. All RJDA's (4) powered on prior to D/O Prep (at Grp B pwrup) and remain on thru TD.
- e. All APU Cntrlrs (3) powered on at Tig-0:45 and remain on thru TD.

All FCL aft coldplate cooled equipment powered on prior to nominal Tig, remain on for a 1- and 2-rev wave-off deorbit opportunities.

Single Fault Tolerant (STS-109) D/O Prep and Entry Aft Coldplate Config

The Single Fault Tolerant (STS-109) deorbit prep and entry FCL aft coldplate is a config that was developed during STS-109 following a flow degrade (blockage) on the FCL 1 aft coldplate leg that developed at MECO. The modified deorbit prep and entry config took many of the aft coldplate leg cooled LRU's to a single fault tolerant level. The FCL aft cp flow limit required to protect the FCL aft coldplate temperature limit of 117 deg F is 163 (188) lb/hr. The single fault tolerant deorbit prep and entry aft coldplate config is listed below: @[031705-6691D]

THIS RULE CONTINUED ON NEXT PAGE

FLIGHT RULES

A18-1001

THERMAL GO/NO-GO CRITERIA [HC] (CONTINUED)

- a. *FA MDM's 1, 2, and 3 on thru TD. FA 4 powered down at loss of good FCL, then on for 15 min for D/O burn (on at Tig-0:10 then off at Tig+0:05) ©[031705-6691D]*
- b. *All OA MDM's and DSC's on thru TD.*
- c. *All ATVC's (4) powered on for 10 min at Tig+0:25 for SSME HYD Repress, then off thru TD. (TVC isols not opened at M=8; chute stow and engine repo inhibited.)*
- d. *All ASA's (4) powered on (FCS Channels 1, 2, 3 in AUTO, 4 is OFF) for 10 min for Ops 3 transition (on at Tig-2:15, off at Tig-2:05), then powered on again (same FCS Chnl config) at Tig-0:05 (for single APU start) and remain on thru TD.*
- e. *All RGA's (4) powered on nominally at Tig-3:15 and remain on thru TD.*
- f. *RJDA's 1A, 1B, 2B powered on at Tig-2:55 (just prior to Hi Load activation during Rad Byp/FES C/O) and remain on thru TD. RJDA 4 remains off thru TD (not powered on at Grp B Pwrap prior to D/O Prep).*
- e. *One APU Cntlr powered on at Tig-0:10 for single APU start; other two APU Cntlrs powered on at Tig+0:25 and remain on thru TD.*

For the 1- and 2-rev wave-off opportunities, it is assumed that the decision to waveoff is made at approx Tig-0:15 prior to single APU start and FA MDM powerup. FCL aft coldplate cooled equipment powered on prior to Tig-0:15 remain on for waveoff(s).

©[031705-6691D]

THIS RULE CONTINUED ON NEXT PAGE

FLIGHT RULES

A18-1001

THERMAL GO/NO-GO CRITERIA [HC] (CONTINUED)

Absolute Minimum D/O Prep and Entry Aft Coldplate Config ©[031705-6691D]

The Absolute Minimum deorbit prep and entry FCL aft coldplate config takes entry critical aft cold plate cooled LRU's to a zero fault tolerant level (AS'As, RJDA's, FA MDM's, APU's). In addition, APU start is delayed until post burn, and all OA MDM's and DSC's are powered down with the loss of the good FCL to ensure that the remaining FCL aft coldplate outlet temperature is as low as possible prior to deorbit prep. While a certified entry could be performed in this configuration, it is highly undesirable due to the lack of fault tolerance, insight into systems performance, and substantially increased risk that is inherent with a powerdown of this magnitude. The FCL aft cp flow limit required to protect the FCL aft coldplate temperature limit of 117 deg F is 108 (133) lb/hr. The absolute minimum deorbit prep and entry aft coldplate config is listed below:

- a. *Ops 3 Transition delayed from Tig-2:15 to Tig-1:35*
- b. *Two FA MDM's on for 10 min for Ops 3 transition (on at Tig-1:35, off at Tig-1:25), then powered on at Tig-0:05 (for single APU start) and remain on thru TD. Third FA MDM powered on for 5 min to support Vent Door closure at Tig+0:30 (just prior MM 304), then powered off thru TD.*
- c. *All OA MDM's and DSC's off from the loss of the good FCL thru entry.*
- d. *All ATVC's remain off for D/O Prep and Entry (SSME HYD Repress not performed, TVC isols not opened at M=8; chute stow and engine repo inhibited).*
- e. *All 4 ASA's powered on (2FCS Chnls - Override, 2 Chnls - OFF) for 10 min for Ops 3 transition (on at Tig-1:35, off at Tig-1:25), then powered on at Tig-0:05 (for single APU start) and remain on thru TD.*
- f. *All RGA's (4) powered on nominally at Tig-3:15 and remain on thru TD.*
- g. *One RJDA powered on at Tig-2:55 (just prior to Hi Load activation during Rad Byp/FES C/O), and remains on thru TD.*
- h. *One APU Cntlr powered on at Tig+0:30 (EI-5) for single APU start, one additional APU Cntlr powered on at TD-0:07 (TAEM) for second APU start (for maximum aerosurface loading). Both APU Cntlrs remain on thru TD once powered up. (Third APU Cntlr not powered for Entry.)* ©[031705-6691D]

THIS RULE CONTINUED ON NEXT PAGE

FLIGHT RULES

A18-1001

THERMAL GO/NO-GO CRITERIA [HC] (CONTINUED)

For the 1- and 2-rev wave-off opportunities, it is assumed that the decision to wave off is made at approx Tig-0:15 prior to single APU start and FA MDM pwrap. FCL aft coldplate cooled equipment powered on prior to Tig-0:15 remain on for waveoff(s).
@[031705-6691D]

DOCUMENTATION: SE-TSAT-93-068; SEH-ITA-84-249T; Boeing Technical Memorandum TS-TM-05-004, Minimum Aft Cold Plate Flow for Freon Coolant Loop Flow Failures with Reduced Power Levels; AE FTP #207; and Engineering judgment.

4. FES @[031705-6691D]

Total FES

Loss of total FES requires a next PLS because the next failure (loss of one Freon loop) could result in loss of the crew/vehicle.

If the failure occurs on ascent, entry is not accomplished at the first day PLS because:

The thermal condition of the vehicle would be extremely hot. Whether or not an entry could be accomplished without a massive powerdown has not been established. It is desirable to remain on orbit until the next day PLS in order to "coldsoak" the vehicle. No analysis for an orbit 3/5 loss of FES case has been run. An AOA case was run with the following assumptions and results:

- a. *PLBD open at 15 minutes.*
- b. *PLBD closed at EI-7 minutes (total time PLBD open \approx 50 minutes).*
- c. *Touchdown occurred \approx 38 minutes after doors closed.*

THIS RULE CONTINUED ON NEXT PAGE

FLIGHT RULES

A18-1001 THERMAL GO/NO-GO CRITERIA [HC] (CONTINUED)

- d. *Av bays 1 and 2 were 11 deg F above the air inlet for 27 minutes.*
- e. *Av bays 1 and 2 were 6 deg F above the air outlet for 13 minutes.*
- f. *Only two crewmembers were used.*

If the FES fails prior to TIG -45 minutes, there is sufficient time for reopening the PLBD, coldsoaking the radiators, performing the required powerdown, and reclosing the PLBD prior to TIG. No thermal violations are expected during entry. ©[020196-1810A]

If the FES fails between 45 and 15 minutes before TIG and a one rev late deorbit is available, a one rev wave off will be performed to allow time to reopen the doors, coldsoak the radiator, and perform the powerdown. No thermal violations are expected during entry if a one rev wave off is performed.

If the FES fails with the radiator coldsoaked between 45 and 15 minutes before TIG and a one rev deorbit is not available, the coldsoak will be utilized to continue with the planned TIG. Assuming the failure occurs at TIG -45 minutes, cabin temperature is expected to exceed 92 degrees F. Avionics bay supply air temperatures are expected to peak at 105 degrees (96 degrees being a violation) prior to NH3 activation. These thermal violations are limited to approximately 10 minutes, peaking at EI and returning with limits shortly after NH3 activation at EI, and will not affect crew performance. A one day wave off is not preferred since the next worst failure, loss of one Freon Loop, could cause the loss of the crew and vehicle.

If the FES fails without a radiator coldsoak between 45 and 15 minutes before TIG and a one rev deorbit is not available, a day wave off is required. There is insufficient time to reopen the PLBD and coldsoak the radiators prior to TIG. And there is not adequate thermal capacitance in the radiators to support the orbiter for up to 1.25 hours without active cooling.

THIS RULE CONTINUED ON NEXT PAGE

FLIGHT RULES

A18-1001

THERMAL GO/NO-GO CRITERIA [HC] (CONTINUED)

If the FES fails after TIG -15 minutes, powerdown will be performed and planned TIG will be executed. Without a coldsoak, avionics bay supply air temperatures are expected to peak at 105 degrees (96 degrees being a violation) prior to NH3 activation. These thermal violations are limited to approximately 20 minutes, peaking at EI and returning with limits shortly after NH3 activation at EI, and will not affect crew performance. A one day wave off is not preferred since the next worst failure, loss of one Freon Loop, could cause the loss of the crew and vehicle. However, with a coldsoak, no thermal violations are expected. ©[020196-1810A]

DOCUMENTATION: SEH-ITA-85-001T; SEH-ITA-80-206T.

5. FES CONTRS ©[031705-6691D]

Partial loss of FES/controllers

Loss of high-load evaporator is a PLS (including first day PLS) because the next failure (loss of one Freon loop) could result in loss of crew or vehicle. The capability of the topping evaporator on Freon loop one (worst case) is $\approx 24,600$ Btu/hr or 5.5 kW. The 24,600 Btu/hr is based on test data on one topping evaporator core. No specification data exists for the topping evaporator on one Freon loop. Freon loop 1 is worst case because loop 2 runs closer to the topping evaporator core and has better heat transfer than loop 1.

Loss of topping evaporator or the loss of both primary controllers requires an MDF because the next failure (loss of one Freon loop) would cause an extensive powerdown to be completed before entry; however, it is believed an entry can be performed at this power level. The capability of the high-load evaporator/secondary controller on Freon loop 2 (worst case) is $\approx 44,200$ Btu/hr or 10 kW. The 44,200 Btu/hr is based on test data on one high-load evaporator core. No specification data exists for the high-load evaporator on one Freon loop. Freon loop 2 is worst case because Freon loop 1 runs closer to the high-load evaporator core and has better heat transfer than loop 2.

THIS RULE CONTINUED ON NEXT PAGE

FLIGHT RULES

A18-1001

THERMAL GO/NO-GO CRITERIA [HC] (CONTINUED)

For loss of either the topping or high-load evaporator, due to a suspected freeze-up, consideration will be given to staying on orbit in order to attempt to thaw out the affected evaporator. It must be noted, however, that the symptoms of freeze-up are ambiguous with the instrumentation available. Further, simply flushing out the ice does not necessarily address the root cause of the problem as our flight history (below) has demonstrated. Flushing the core with the secondary controller on orbit will require elevated Freon temperatures to the FES. This can be accomplished by bypassing the radiators or by closing the doors.

Flight and Ground History. During Space Environment Simulation Laboratory (SESL) testing of the FES pre-ST5-1, there were several episodes of core freezing, all of which were successfully flushed within very short periods (hours). SESL testing was done under one g conditions, however, and the effects of that are not well known. During ST5 41-G, when the topping evaporator froze, the ice was successfully removed from the core after 28 hours with the radiators in the high set point. During ST5-26, FES shutdowns occurred between 38 and 55 minutes MET. Corrosion in the topping core surface degraded the evaporation process and gave the ice a foothold. Use of the secondary controller cleared the ice out of the topping core (secondary topper uses both A and B H₂O nozzles alternately, has no shutdown feature, and operates at a higher control temperature). On orbit, the radiator controllers were operated in the high set point to thaw out any ice that remained in the high load or topping cores.

There is a high probability that the FES core can be thawed and/or flushed while the next worst failure, loss of a Freon loop, is severe but it is a low probability. It has been decided that the risk of staying on orbit to thaw the FES is warranted.

DOCUMENTATION: SEH-ITA-081-107; SEH-ITA-83-011T; ST5 41-G and ST5-26 flight data; and engineering judgment.

THIS RULE CONTINUED ON NEXT PAGE

FLIGHT RULES

A18-1001

THERMAL GO/NO-GO CRITERIA [HC] (CONTINUED)6. FES FEEDLINES @[031705-6691D]

Loss of two feedlines is equivalent to the loss of total FES that requires a next PLS. This is because the next failure (loss of one Freon loop) could result in loss of crew or vehicle.

With the loss of one feedline, full operational capability is maintained. Although this results in a single fault tolerant situation, an MDF is not called because the Freon loops and flash evaporator system are single-fault tolerant systems from launch.

DOCUMENTATION: SEH-ITA-83-011T; SEH-ITA-81-107.

7. ABS

There is no requirement for the NH₃ after nominal orbit insertion. The FES and radiators are used for orbit and entry cooling. The NH₃ boiler is not required until post-rollout and an emergency powerdown can be performed if NH₃ is not available. The ammonia boiler is required for launch aborts since the radiators cannot be coldsoaked in these cases. Therefore, after nominal ascent and insertion have been completed, there is no requirement for the NH₃ boiler.

DOCUMENTATION: Flight data.

8. RFCA/RADIATOR ISOLATION VALVE @[050400-7192] @[031705-6691D]

An RFCA failed in min rad flow, a leak isolated to the radiators, or an isolation valve failed in the isolate position (loss of radiator) is a PLS with the following considerations:

THIS RULE CONTINUED ON NEXT PAGE

FLIGHT RULES

A18-1001

THERMAL GO/NO-GO CRITERIA [HC] (CONTINUED)

Continuing to run the loop with the failed radiator will result in high FES rates and depletion of supply H₂O. Upon the first radiator failure, the following actions are required to safe the vehicle (ref Rule {A18-251}, FREON COOLANT LOOPS (FCL)): ©[050400-7192]

- a. *Deactivate affected Freon loop and flash evaporator and power down to 14 kW.
©[050400-7192]*
- b. *Maneuver to a cold radiator attitude (e.g., GG, nose Sun).*
 - *Debris Avoidance or Docked attitudes may not be possible.*
 - *Closing the affected PLBD may be required to keep the Freon in the failed loop from freezing.*
- c. *Move the Flow Prop Valve on the good loop to the ICH position.*
- d. *Payloads that require active cooling will be terminated.*
- e. *If at 10.2 psi and cabin temps are violated, a 14.7 repress will be required.*

These actions place the orbiter in a safe configuration and allow for the filling of the supply H₂O tanks. Full Supply H₂O tanks protect the vehicle in the event of the next worst failure (loss of the good Freon loop). The next worst failure would require the following:

- a. *Power down to 7 kW immediately after the flowing loop fails.*
- b. *Power up the loop with the failed radiator with a FES controller active.*
 - *Secondary Topper or full up primary controller may be required.*
- c. *Power up to 11 kW for entry at TIG-2 hours*
- d. *If supply water quantities will not support the next PLS, an ELS will be declared. Depletion of supply H₂O would result in loss of cooling. Loss of cooling could result in loss of crew and vehicle.*

THIS RULE CONTINUED ON NEXT PAGE

FLIGHT RULES

A18-1001

THERMAL GO/NO-GO CRITERIA [HC] (CONTINUED)

Loss of both RFCA's is a PLS because the next failure (loss of FES) could result in loss of crew/vehicle.

Note that the first day PLS is passed up in order to allow the crew to recover from space adaptation sickness (SAS). This does incur some risk in that there is a window of time in which supply H₂O quantities will not support the next worst failure (loss of the good loop). The probability of this occurring is low, however, so SAS takes priority.

DOCUMENTATION: AEFTP #162, October 29, 1999. ©[050400-7192]

If an RFCA is failed in the "full open" position, several measures can be taken to ensure the evaporator outlet temperature remains above 32 deg F. This is required to prevent freezing of the H₂O loops at the interchanger. These measures include:

- a. Bypassing the good loop's radiator*
- b. Going to high control set point (57 deg F) on the good loop*
- c. Attitude constraints (-ZLV)*
- d. Closing the PLBD of the failed loop*
- e. Raise ATCS heat load.*
- f. Disable flow control valve on good loop in a hotter position.*

When deciding which measure to use, it should be taken into account that, if the good loop should suddenly fail, the evaporator outlet temperature on the failed loop should be warm enough so as not to freeze the water loops.

Since several measures can be taken to ensure the evaporator outlet temperature remains above 32 deg F, it is not necessary to shorten the mission for this failure.

THIS RULE CONTINUED ON NEXT PAGE

FLIGHT RULES

A18-1001

THERMAL GO/NO-GO CRITERIA [HC] (CONTINUED)

If both Freon loop RFCA's are failed in the full open position, the following steps can be taken to ensure the evaporator outlet temperature remains above 32 deg F:

- a. *Attitude constraints (-ZLV; bay to Earth)*
- b. *Closing the PLBD of either loop*
- c. *Raise ATCS heat load*

If one loop suddenly stops running, the evaporator outlet temperature will be above 32 deg F.

Since these measures can be taken to ensure the evaporator outlet temperature remains above 32 deg F, it is not necessary to shorten the mission for these failures.

It should be noted that, if a loop with an RFCA failed full open cannot be bypassed, either manually or automatically, it should not be deactivated if at all possible. A stagnant loop will coldsoak to temperatures below zero degrees. If the loop is deactivated, depending on the length of time deactivated, attitude, and temperature of the loop when deactivated, the loop may not be usable without freezing the interchanger.

DOCUMENTATION: SEH-ITA-81-416T

9. **HEAT EXCHANGER LEAK** @[031705-6691D]

An MDF is required for a heat exchanger leak (other than Freon to Freon, Freon to H₂O loop, and H₂O loop to H₂O loop) because the possibility exists that a generic problem, such as corrosion, exists in the heat exchanger. This type of problem could eventually result in a total loss of the heat exchanger and the vehicle. It is considered that the risk of losing the heat exchanger does not warrant a PLS, but does warrant an MDF. @[121604-6471A]

If the leak is a Freon to Freon loop leak, a PLS is required because the next worst failure is loss of both Freon loops which is possible loss of crew and vehicle. If the leak is an H₂O loop to H₂O loop leak, the next worst failure is loss of both H₂O loops which is a potential ELS. If the leak is between Freon and a cabin water loop, PLS is required because the next failure (external leak in the water loop) could result in the crew being exposed to Freon 21, which is very toxic. In addition, the water loop is considered lost because several components in the water loop are incompatible with Freon 21 and may fail to seal or function. These material incompatibilities, in addition to high pressures in the water loop (caused by the Freon loop leaking into the water loop), increase the chances of the water loop developing an external leak into the cabin and exposing the crew to Freon 21. In November of 1985, the following statement was published in the SODB, volume III concerning a Freon to water loop leak: "In the case of leakage occurring during a mission, it is mandatory to abort the mission at the earliest practical time in order to minimize the possibility for a second failure which could result in Freon leak into the cabin air." @[121604-6471A]

THIS RULE CONTINUED ON NEXT PAGE

FLIGHT RULES

A18-1001

THERMAL GO/NO-GO CRITERIA [HC] (CONTINUED)

DOCUMENTATION: Engineering judgment; SODB, volume II, section 4.6.1.2.1.2.

DOCUMENTATION for ATCS (December 8, 1986)

Hamilton Standard Memos/Analyses

SEM 62408 *Flash Evaporator Controller Operation Description, January 25, 1982*
SEM 62449 *FES Duct Heaters Launch Criteria, July 20, 1984*

JSC Memos/Documents

CSD-SH-143 *Crew Systems Division Integrated Active Thermal
(JSC-14182) Control Subsystem Test Final Report, August 24, 1979*
DF/83-178 *Orbiter Systems Redundancy Checkout, November 28, 1983*
ES2-81-256M *TCS Design & STS-1 On-Orbit Failed Heater
Summary Matrix, March 3, 1981*
JSC -08934 *Shuttle Operational Data Book*
JSC-11174 *Space Shuttle Systems Handbook*
JSC-18549 *Operational Space Shuttle Orbiter Heater Systems, October 15, 1982*
MD3/84-20 *Orbiter Systems Redundancy Checkout, May 15, 1984*

Lockheed Engineering & Management Services Co., Inc. Memos/Analyses

LEMSCO 19630 *Orbiter & P/L H₂O Coolant Loop Freezeup, August 11, 1983*

THIS RULE CONTINUED ON NEXT PAGE

FLIGHT RULES

A18-1001

THERMAL GO/NO-GO CRITERIA [HC] (CONTINUED)McDonnell Douglas Memos/Analyses

- 1.1-ECLSS-09 Dual Water Coolant Loop Failed Entry Contingency, February 7, 1983
- 1.1-ECLSS-57 One Freon Loop Failure On Orbit/Entry, December 20, 1983
- 1.1-ECLSS-122 Cabin Air Temperature Response Study, September 20, 1985
- 1.2-TM-B1109-27 Optimum Interchanger Water Flow for STS-1, October 15, 1979

Rockwell International Analyses/Tests

- SEH-ITA-80-047T STS-1 Ascent With and Evaporator Failure, March 6, 1980
- SEH-ITA-80-054T STS-1 On-orbit with a FCL Failure, March 11, 1980
- SEH-ITA-80-206T STS-11 Failed FES Abort Once Around December 9, 1980
- SEH-ITA-80-263T O₂ Restrictor Analysis, December 9, 1980
- SEH-ITA-81-107 OV102 ATCS Heat Sink Characteristics, April 8, 1981
- SEH-ITA-81-416T FCA Malfunction Analysis, December 8, 1981
- SEH-ITA-82-028 Air Cooling Perf, EVA Prep Cabin Press Study, February 1, 1982
- SEH-ITA-82-029 Optimum Interchanger Water Flow for STS-1, February 1, 1982
- SEH-ITA-82-333 STS-4 Flight Data Evaluation.
- SEH-ITA-83-011T Entry Continuation with Loss of FES, January 24, 1983
- SEH-ITA-83-017T Ascent With RAD Flow in One FCL, February 10, 1983
- SEH-ITA-83-151T OV099 Dormant Water Loop Cycle Requirements, June 9, 1983
- SEH-ITA-83-349 Relative Effect of Interchanger Water Flowrate on ARS Temperatures, October 14, 1983

THIS RULE CONTINUED ON NEXT PAGE

FLIGHT RULES

A18-1001

THERMAL GO/NO-GO CRITERIA [HC] (CONTINUED)*Rockwell International Analyses/Tests (Continued)*

<i>SEH-ITA-84-249T</i>	<i>Minimum Freon Flowrate for Aft Avionics Cooling, July 11, 1984</i>
<i>SEH-ITA-85-001T</i>	<i>Revised Deorbit Preparation Timeline Analysis, January 10, 1985.</i>
<i>SEH-ECS-85-052T</i>	<i>Ammonia Boiler Operations With Degraded Flow, April 26, 1985</i>
<i>SEH-ECS-86-102T</i>	<i>One Freon Coolant Loop Failed in Bypass, July 2, 1986</i>
<i>SEH-ECS-86-106</i>	<i>Degraded Cabin WCL Flowrate Analysis, December 1986</i>
<i>LTR 4309-3101</i>	<i>Lab Test Report - O2 Restrictor Evaluation Test, November 1984</i>
<i>MF0004-009,</i>	<i>Equip Cooling Requirements, Electrical/Electronic, Rev A August 2, 1978</i>
<i>288-503-84-010</i>	<i>Internal Letter - Freon 21 Contamination of Hydraulic Systems, February 27, 1985</i>
<i>388-301-79-018</i>	<i>Internal Letter - FCP Operation During Dual Freon/Water Coolant Loop Loss Abort and Entry, March 30, 1979</i>
<i>ORBI 045</i>	<i>Ignition of Orbiter Fluids Entrapped in the TCS Materials</i>
<i>ORBI 047</i>	<i>Structural Overheating Caused by Loss of TPS Tile from Leakage of Orbiter Fluids</i>
<i>ORBI 117</i>	<i>Loss of Water Coolant Loops</i>
<i>ORBI 208</i>	<i>Loss of Thermal Window from Pressure Loads</i>
<i>ORBI 241</i>	<i>Freon Leakage into Water Coolant Loop/Cabin</i>
<i>ORBI 275</i>	<i>Loss of Freon Coolant Loops</i>
<i>ORBI 276</i>	<i>Loss of Flash Evaporator Function</i>
©[121604-6471A]	

Reference Rule {A13-159}, CABIN ATMOSPHERE CONTAMINATION - FREON 21 [HC].

©[121604-6471A] ©[ED]

FLIGHT RULES

THIS PAGE INTENTIONALLY BLANK

FLIGHT RULES

APPENDIX A

ACRONYMS AND ABBREVIATIONS

A	SEMI-MAJOR AXIS
A&L	APPROACH AND LAND
A/D	ANALOG TO DIGITAL
A/E FTP	ASCENT/ENTRY FLIGHT TECHNIQUES PANEL
A/G	AIR-TO-GROUND (COMM)
A/L	AUTOLAND
	ASCENDING LEFT
A/M	AUTO/MANUAL
AA	ACCELEROMETER ASSEMBLY
AAH	AUTOMATIC ATTITUDE HOLD
ABE	ARM BASED ELECTRONICS
ABS	AMMONIA BOILER SUBSYSTEM
	ABSOLUTE
ABV	AIR BYPASS VALVE
AC	ALTERNATING CURRENT
ACCEL	ACCELEROMETER
ACCU	AUDIO CENTRAL CONTROL UNIT
ACCUM	ACCUMULATOR
ACES	ADVANCE CREW ESCAPE SUIT
ACFM	ACTUAL CUBIC FEET PER MINUTE
ACIP	AERODYNAMIC COEFFICIENT IDENTIFICATION PACKAGE
ACK	ACKNOWLEDGE
ACLS	AUGMENTED CONTINGENCY LANDING SITE
ACQ	ACQUISITION
ACS	AUDIO CONTROL SYSTEM
ACT	ACTUATOR
	ACTIVATION
AD	AIR DATA
ADATA	AIR DATA TRANSDUCER ASSEMBLY
ADCOM	AEROSPACE DEFENSE COMMAND
ADI	ATTITUDE DIRECTION INDICATOR
ADS	AIR DATA SYSTEM
ADTA	AIR DATA TRANSDUCER ASSEMBLY
AED	ANALOG EVENT DRIVER
AEFTP	ASCENT/ENTRY FLIGHT TECHNIQUES
AERO	AERODYNAMICS
AF	AIR FORCE
AFB	AIR FORCE BASE
AFD	AFT FLIGHT DECK
AFO	ABORT FOR ORBIT
AFFTC	AIR FORCE FLIGHT TEST CENTER
AFRCC	AIR FORCE RESCUE COORDINATION CENTER

NASA - JOHNSON SPACE CENTER

FLIGHT RULES

AFSCF	AIR FORCE SATELLITE CONTROL FACILITY
AFSCN	AIR FORCE SATELLITE CONTROL NETWORK
AFTP	ASCENT FLIGHT TECHNIQUES PANEL
AGL	ABOVE GROUND LEVEL
AGS	ANTI G-SUIT
AHMS	ADVANCED HEALTH MANAGEMENT SYSTEM
AIF	AUTO/INHIBIT/FORCE
AIL	AILERONS
AKA	ACTIVE KEEL ASSEMBLY
ALARA	AS LOW AS REASONABLY ACHIEVABLE
ALC(A)	AFT LOAD CONTROL (ASSEMBLY)
ALIGNS	ALIGNMENT(S)
ALP	APPROACH AND LANDING PLAN
ALS	AUGMENTED LANDING SITE
ALT	ALTITUDE
	APPROACH AND LANDING TESTS
AM	ACTUAL MODE
AME	ABORT MANEUVER EVALUATOR
AMI	ALPHA MACH INDICATOR
AMP	AMPERE
ANT	ANTENNA
AOA	ABORT-ONCE-AROUND
AOI	AREA OF INTREST
AOS	ACQUISITION OF SIGNAL
APC(A)	AFT POWER CONTROLLER (ASSEMBLY)
APDS	ANDROGYNOUS PERIPHERAL DOCKING SYSTEM
APDU	AFT POWER DISTRIBUTION UNIT
APU	AUXILIARY POWER UNIT
ARC	AMES RESEARCH CENTER
ARCS	AFT REACTION CONTROL SYSTEM
ARD	ABORT REGION DETERMINATION
	ABORT REGION DETERMINATOR
ARPCS	ATMOSPHERIC REVITALIZATION PRESSURE CONTROL SYSTEM
ARS	ATMOSPHERIC REVITALIZATION SYSTEM
AS	AIRSPEED
ASA	AEROSURFACE SERVO AMPLIFIER
ASAP	AS SOON AS PRACTICAL
	AS SOON AS POSSIBLE
ASC	ASCENT
ASCS	ATMOSPHERE STORAGE AND CONTROL SYSTEM
ASI	AEROSURFACE STICK INPUT
ASSY	ASSEMBLY
ATCO	AMBIENT TEMPERATURE CATALYTIC OXIDIZER
ATCS	ACTIVE THERMAL CONTROL SYSTEM
ATO	ABORT TO ORBIT
ATT	ATTITUDE

NASA - JOHNSON SPACE CENTER

FLIGHT RULES

ATU	AUDIO TERMINAL UNIT
ATVC	ASCENT THRUST VECTOR CONTROL
AUTO	AUTOMATIC
AUX	AUXILIARY
AV	AVIONICS
AVAIL	AVAILABLE
AVE	AVERAGE
AVG	AVERAGE
AVVI	ALTITUDE/VERTICAL VELOCITY INDICATOR
AZ	AZIMUTH
B/C	ELECTRICAL BUS DESIGNATORS
B/H	BULKHEAD
B/U	BACKUP
BARO	BAROMETER
BCE	BUS CONTROL ELEMENT
BD	BOARD
BD FLAP, B/F	BODY FLAP
BDA	BERMUDA ISLAND (STDN STATION)
BEN	BEN GUERIR (PRIME TAL SITE)
BET	BENDING EFFECT TEMPERATURE
	BEST ESTIMATE TRAJECTORY
BETA	VEHICLE SIDESLIP ANGLE
BF	BODY FLAP
BFS	BACKUP FLIGHT SYSTEM
BIMDA	BIOSERV-INSTRUMENTATION TECHNOLOGY ASSOCIATES MATERIALS DISPERSION APPARATUS
BITE	BUILT-IN TEST EQUIPMENT
BIU	BUS INTERFACE UNIT
BLKHD	BULKHEAD
BPM	BEATS PER MINUTE
BRT	BODY RESTRAINT TETHER
BRTS	BOOSTER REAL TIME SOFTWARE
BSR	BITE STATUS REGISTER
BSE	BOOSTER SYSTEMS ENGINEER
BT	BURN TIME
BTU	BUS TERMINAL UNIT
BUC	BACKUP COMPUTER
	BUCKHORN (STDN STATION)
BYD	BANJUL (PRIME TAL SITE)
BYP	BYPASS (ED)
C	CENTER CELSIUS

NASA - JOHNSON SPACE CENTER

FLIGHT RULES

C&W	CAUTION AND WARNING
C/A	ELECTRICAL BUS DESIGNATORS
C/A	COARSE/ACQUISITION
C/L	CENTER LINE
C/O	CHECKOUT
	CUTOFF
CA	CONTINGENCY ABORT
CA	COURSE ACQUISITION
CAB	CABIN
CAL	CALIBRATION
	CALIFORNIA
CAM	COMPUTER ANNUNCIATION MATRIX
CAP	CAPABILITY
CAR	CORRECTIVE ACTION REPORT
CAU	CHANNEL ATTACH UNIT
CB, cb	CIRCUIT BREAKER
CC	CONVOY COMMANDER
CCA	COMMUNICATIONS CARRIER ASSEMBLY
CCAFS	CAPE CANAVERAL AIR FORCE STATION
CCB	CHANGE CONTROL BOARD
	CODED CONTROL SYSTEM COMMAND BUFFER
CCC	CENTRALIZED COMPUTATION COMPLEX
CCR	CONTROL CENTER RACK
CCS	COMMAND CONTROL SYSTEM
CD	CONVERSION DEVICE
CCTV	CLOSED CIRCUIT TELEVISION
CDDS	COMMAND DATA AND DATA SUBSYSTEM
CDE	CONSOLIDATED DEVELOPMENT ENVIRONMENT
CDM	CARBON DIOXIDE MONITOR
CDMS	COMMAND AND DATA MANAGEMENT SYSTEM
CDO	COGNITIVE DEFICIT ONSET
CDR	COMMANDER
CDS	COMMAND DATA SYSTEM (SUBSYSTEM)
	CURRENT DATA SYSTEM
CDSS	CONSOLIDATED DATA SELECT SWITCH
CDV	CABIN DEPRESS VALVE
CEE	CREW ESCAPE EQUIPMENT
CEI	CERTIFIED END ITEM
CEWL	CENTRALIZED EXPERIMENT WATER LOOP
CG, cg	CENTER OF GRAVITY
CH	CHANNEL
CHIT	SHORT NOTE OR LETTER (NOT AN ACRONYM)
CI	CONE INDEX
CIC	CREW INTERFACE COORDINATOR
CIE	COMPUTER INTERFACE ELECTRONICS
CIL	CRITICAL ITEMS LIST

FLIGHT RULES

CIR, CIRC	CIRCULAR CIRCULATION
CIU	COMMUNICATIONS INTERFACE UNIT
CK	CHECK
CKT	CIRCUIT
CL, CLS	CLOSE (D)
CM	CENTIMETER CONFIGURATION MANAGEMENT
CMD, CMND	COMMAND
CMDR	COMMANDER
CME/V	COMMAND MESSAGE ENCODER/VERIFIER
CM/SEC	CENTIMETERS PER SECOND
CNTL	CONTROL
CNTRLR	CONTROLLER
CO	CARBON MONOXIDE
C/O	CHECKOUT
CO ₂	CARBON DIOXIDE
COAS	CREW OPTICAL ALIGNMENT SIGHT
COF	PATRICK AIR FORCE BASE (TACAN)
COFR	CERTIFICATE OF FLIGHT READINESS
COF ₂	CARBONYL FLUORIDE
COLA	COLLISION AVOIDANCE
COMBO	COMPUTATION OF MISSES BETWEEN ORBITS
COMM	COMMUNICATIONS
COMP	COMPUTER
COMSEC	COMMUNICATIONS SECURITY
CONF	CONFERENCE
CONFIG	CONFIGURATION
CONT	CONTINGENCY CONTINUED
CONTRS	CONTROLLERS
CONUS	CONTINENTAL UNITED STATES
CPA	COMBUSTION PRODUCTS ANALYZER CLOSEST POINT OF APPROACH
CPHS	COMMITTEE FOR THE PROTECTION OF HUMAN SUBJECTS
CPDS	COMPUTER PROGRAM DESIGN SPECIFICATION
CPM	CELL PERFORMANCE MONITOR
CPSE	COMMON PAYLOAD SUPPORT EQUIPMENT
CR	CHANGE REQUEST
CRIT	CRITICAL
CRSFD	CROSSFEED
CRT	CATHODE RAY TUBE
CRU	CONVERTER REGULATOR UNIT
CRYO	CRYOGENIC
CS	COMMON SET
CSA-CP	COMPOUND SPECIFIC ANALYZER-COMBUSTION PRODUCTS

NASA - JOHNSON SPACE CENTER

FLIGHT RULES

CSC	COMMAND SYSTEM CONTROLLER
	CONTINGENCY SUPPORT CENTER
CSCS	CONTINGENCY SHUTTLE CREW SUPPORT
CSDL	CHARLES STARK DRAPER LABORATORY
CSM	COMPUTER STATUS MATRIX
CSS	CONTROL STICK STEERING
CST	CONDENSATE STORAGE TANK
CTU	COMMAND AND TELEMETRY UNIT
CU	CONTROL UNIT
CWC	CONTINGENCY WATER COLLECTION
	CONTINGENCY WATER CONTAINER
CWEA	CAUTION AND WARNING ELECTRONIC ASSEMBLY
CWS	CAUTION AND WARNING SYSTEM

D	DAY
	DEPLOY
	DRAG
D&C	DISPLAY AND CONTROL
D/L	DOWN LINK
D/O	DEORBIT
D/Q	disqualification
DA	DISTRIBUTION ASSEMBLY
DAC	DIGITAL-TO-ANALOG CONVERTER
DACS	DATA ACQUISITION AND CONTROL SYSTEM
DAE	DOWNRANGE ABORT EVALUATOR
DAK	DAKAR (STDN SITE)
DAP	DIGITAL AUTO PILOT
DB	DEADBAND
	DECIBEL
DBZ	DECIBELS OF Z
DC, dc	DIRECT CURRENT
DCC	DATA COMPUTATION COMPLEX
DCCS	DIGITAL CAMERA CONTROL SOFTWARE
DCM	DISPLAYS AND CONTROLS MODULE
DCU	DIGITAL COMPUTER UNIT
DDF	DATA DISTRIBUTION FUNCTION
DDH	DUMP DATA HANDLER
DDS	DESCENT DESIGN SYSTEM
	DESCENT DESIGN SIMULATOR
	DATA DISPLAY SYSTEM
DDU	DISPLAY DRIVER UNIT
DEA	DEPLOYED ELECTRONICS ASSEMBLY
DEACT	DEACTIVATION
DEC	DECLINATION

NASA - JOHNSON SPACE CENTER

FLIGHT RULES

DECAT	DYNAMIC ENVIRONMENT COMMUNICATIONS ANALYSIS TESTBED
DECEL	DECELERATION
DECOM(S)	DECOMMUTATION(S)
DED	DEDICATED
DEG	DEGREE
DEG/SEC	DEGREES PER SECOND
DEL	DEORBIT/ENTRY/LANDING
DELTA T	DELTA TRACKING
DELTA V	DELTA VELOCITY (CHANGE IN VELOCITY)
DEORB	DEORBIT
DEP/REP	DEPRESS/REPRESS
DES	DESCENDING
DETECT	DETECTION
DEU	DISPLAY ELECTRONICS UNIT
DEV	DEVIATION
DFI	DEVELOPMENT FLIGHT INSTRUMENTATION
DFL	DECOM FORMAT LOAD
DFRC	DRYDEN FLIGHT RESEARCH CENTER
DFRF	DRYDEN FLIGHT RESEARCH FACILITY
DIFF	DIFFERENT
DIR	DIRECTION
DISC	DISCONNECT
DISCH	DISCHARGE
DIST	DISTRIBUTION
DK	DISPLAY/KEYBOARD
DKR	DAKAR (STDN SITE)
DMA	DIRECT MEMORY ACCESS
DMP	DUMP
DMU	DATA MANAGEMENT UNIT
DN	DISCREPANCY NOTICE
DNS	DOMAIN NAME SERVER
DOD	DEPARTMENT OF DEFENSE
DOF	DEGREE-OF-FREEDOM DIRECTION OF FLIGHT
DOL	DAY OF LAUNCH
DOLILU	DAY OF LAUNCH I-LOAD UPLINK
DOSP	DOLILU OPERATIONS SUPPORT PLAN
DPA	DATA PROCESSING ASSEMBLY
DP/DT	PRESSURE CHANGE RATE
DPLY	DEPLOY
DPS	DATA PROCESSING SYSTEM (ALSO AN MCC-H FLIGHT CONTROL POSITION)
DR	DISCREPANCY REPORT
DRK	DISPLAY REQUIREMENTS KEYBOARD
DRN	DRAIN

NASA - JOHNSON SPACE CENTER

FLIGHT RULES

DRSCS	DIGITAL RANGE SAFETY COMMAND SYSTEM
DS	DUAL STRING
DSC	DEDICATED SIGNAL CONDITIONER DYNAMIC STANDBY COMPUTER
DSMC	DATA SERVICES MANAGEMENT CENTER
DSN	DEEP SPACE NETWORK
DSO	DETAILED SUPPLEMENTARY OBJECTIVE
DT	discharge temperature
DTE	DIGITAL TELEVISION EQUIPMENT
DTO	DETAILED TEST OBJECTIVE
DU	DISPLAY UNIT
DVIS	DIGITAL VOICE INTERCOMMUNICATIONS SYSTEM
DYN	DYNAMIC
e.g.	FOR EXAMPLE
E&D	ENGINEERING AND DEVELOPMENT
EAFB	EDWARDS AIR FORCE BASE
EAS	EQUIVALENT AIR SPEED
ECAL	EAST COAST ABORT LANDING
ECAS	EXPERIMENT COMPUTER APPLICATION SOFTWARE
ECG	ELECTROCARDIOGRAM
ECIO	EXPERIMENT COMPUTER INPUT/OUTPUT
ECLS	ENVIRONMENTAL CONTROL AND LIFE SUPPORT
ECLSS	ENVIRONMENTAL CONTROL AND LIFE SUPPORT SYSTEM
ECOS	EXPERIMENT COMPUTER OPERATING SYSTEM
ECS	ENVIRONMENTAL CONTROL SYSTEM
ECU	ENVIRONMENTAL CONTROL UNIT
ED	EDITORIAL
EDO	EXTENDED DURATION ORBITER
EDOMP	EXTENDED DURATION ORBITER MEDICAL PROJECT
EDTE	EMULATED DTE
EDW	EDWARDS AIR FORCE BASE
EE	END EFFECTOR
EECOM	EMERGENCY, ENVIRONMENTAL, AND CONSUMABLES MANAGEMENT SYSTEMS - MCC-H FLIGHT CONTROL POSITION
EFGF	ELECTRICAL FLIGHT-RELEASABLE GRAPPLE FIXTURE
EFTP	ENTRY FLIGHT TECHNIQUES PANEL
EGBM	EQUILIBRIUM GLIDE BOUNDARY MARGIN
EGIL	ELECTRICAL, GENERATION, AND INTEGRATED LOADING SYSTEMS - MCC-H FLIGHT CONTROL POSITION
EGT	EXHAUST GAS TEMPERATURE
EI	ENTRY INTERFACE
EIU	ENGINE INTERFACE UNIT
ELEV	ELEVON
ELS	EMERGENCY LANDING SITE

NASA - JOHNSON SPACE CENTER

FLIGHT RULES

ELVIS	ENHANCED LAUNCH VEHICLE IMAGING SYSTEM
EM	EMERGENCY
EMCC	EMERGENCY MISSION CONTROL CENTER
EMER	EMERGENCY
EMI	ELECTROMAGNETIC INTERFERENCE
EMU	EXTRAVEHICULAR MOBILITY UNIT
EMUM	UNITED TECHNOLOGY/HAMILTON STANDARD ENGINEERING MEMORANDUM
ENA, ENBL	ENABLE (D)
ENG	ENGINE ENGAGE
ENT	ENTRY
EO	ENGINEERING ORDER
EOM	END OF MISSION
EOS	EMERGENCY OXYGEN SYSTEM
EPA	ELECTRICAL POWER SUBSYSTEM
EPBD	ELECTRICAL POWER BRANCHING DISTRIBUTOR
EPDC	ELECTRICAL POWER DISTRIBUTION AND CONTROL (SYSTEM)
EPODES	ELECTRICAL POWER DISTRIBUTION SYSTEM
EPSOM	ELECTRICAL POWER SWITCHING PANEL
EPST	ELECTRICAL POWER SYSTEM TEST
ER	EASTERN RANGE
ESCON	ENTERPRISE SYSTEM CONNECTION MANAGER
ESL	EQUIPMENT SUPPORT SECTION ESSENTIAL BUS
ESSMC	EASTERN SPACE AND MISSILE CENTER
EST	ESTIMATED
ET	EXTERNAL TANK ET CETERA
ETRO	EXPECTED TIME TO RETURN TO OPERATION
EV	EXTRAVEHICULAR
EVA	EXTRAVEHICULAR ACTIVITY
EVAC	EVACUATED
EVAP	EVAPORATOR
EVES	EXTRAVEHICULAR LIFE SUPPORT SYSTEM
EX	EXPERIMENT EXPERIMENT COMPUTER EXPERIMENT INPUT/OUTPUT
EXEC	EXECUTE
EXT	EXTENSION
F	FAHRENHEIT
F/C	FLIGHT CONTROL
FA	FLIGHT AFT
FAA	FEDERAL AVIATION AGENCY

NASA - JOHNSON SPACE CENTER

FLIGHT RULES

FAD	FLIGHT ASSESSMENT AERO DATA
FC	FLIGHT CRITICAL
	FUEL CELL
FCL	FREON COOLANT LOOP
FCMS	FUEL CELL MONITORING SYSTEM
FCO	FLIGHT CONTROL OFFICER (RANGE/KSC)
FCP	FUEL CELL PANEL
FCR	FLIGHT CONTROL ROOM
FCS	FLIGHT CONTROL SYSTEM
FCT	FLIGHT CONTROL TEAM
FD	FLIGHT DAY
	FLIGHT DECK
	FLIGHT DIRECTOR
	FREEZE DRY
FDA	FAULT DETECTION AND ANNUNCIATION
FDBK	FEEDBACK
FDDD	FLIGHT DESIGN AND DYNAMICS DIVISION
FDF	FLIGHT DATA FILE
	FLIGHT DYNAMICS FACILITY
FDI	FAILURE DETECTOR INDICATOR
	FAULT DETECTION AND IDENTIFICATION
	FAULT DETECTION AND ISOLATION
FDIR	FAULT DETECTION, IDENTIFICATION, RECONFIGURATION
FDM	FREQUENCY DIVISION MULTIPLEXER
FDO	FLIGHT DYNAMICS OFFICER
FEID	FUNCTIONAL EQUIPMENT INTERFACE DEVICE
	FUNCTIONAL ENGINEERING INTERFACE DEVICE
FEP	FRONT END PROCESSOR
FES	FLASH EVAPORATOR SYSTEM
FF	FLIGHT FORWARD
FFM	FUEL FLOWMETER
FI	ADVANCED FELT REUSABLE SURFACE INSULATION
FID	FAILURE IDENTIFIER, FAILURE IDENTIFICATION
FL	FLOW
FL'D	FAILED
FLC(A)	FORWARD LOAD CONTROL (ASSEMBLY)
FLEX	FLEXIBLE
FLMCP	FLUID LOOP MONITOR AND CONTROL PANEL
FLT	FLIGHT
FM	FREQUENCY MODULATION
FMC	FORWARD MOTOR CONTROLLER
FMEA	FAILURE MODES AND EFFECTS ANALYSIS
FO/FS	FAIL OPERATIONAL/FAIL SAFE
FOD	FLIGHT OPERATIONS DIRECTORATE
FOIO	FLIGHT OPERATIONS INTEGRATION OFFICE
FOM	FIGURE OF MERIT

NASA - JOHNSON SPACE CENTER

FLIGHT RULES

FOR	FLIGHT OPERATIONS REVIEW
FOS	FACTOR OF SAFETY
FOSA	FLIGHT OPERATIONS SUPPORT ANNEX
FOV	FIELD OF VIEW
FPC (A)	FORWARD POWER CONTROL (ASSEMBLY)
FPM	FEET PER MINUTE
	FLOW PROPORTIONING MODULE
FPOV	fuel preburner oxidizer valve
FPR	FLIGHT PROPELLANT RESERVES
FPS	FEET PER SECOND
FPV	FLOW PROPORTIONING VALVE
FRCB	FLIGHT RULES CONTROL BOARD
FRD	FLIGHT REQUIREMENTS DOCUMENT
FRCS	FORWARD REACTION CONTROL SYSTEM
FRSI	FELT REUSABLE SURFACE INSULATION
FS	FLIGHT SURGEON
FSCEU	FIRE SUPPRESSION CONTROL ELECTRONICS UNIT
FSS	FIRE SUPPRESSION SYSTEM
FSW	FLIGHT SOFTWARE
FT	FEET
	FLIGHT TECHNIQUES
	FOOT
FT/SEC	FEET PER SECOND
FTO	FLIGHT TEXT OBJECTIVE
FTP	FLIGHT TECHNIQUES PANEL
FTR	FLIGHT TEST REQUIREMENTS
FTS	FAIL TO SYNCHRONIZE
	FLIGHT TERMINATION SYSTEM
FU	FUEL
FWD	FORWARD
g or G	FORCE OF GRAVITY AT SEA LEVEL
G&C	GUIDANCE AND CONTROL (ALSO AN MCC-H FLIGHT CONTROL POSITION)
G/S	GLIDE SLOPE
GAX	GN&C/ANNUNCIATION INTERFACE
GBI	GRAND BAHAMAN ISLANDS
GCA	GROUND CONTROLLED APPROACH
GCIL	GROUND INTERFACE COMMAND LOGIC CONTROLLER
GDOP	GEOMETRIC DILUTION OF PRECISION
GDR	GENERALIZED DATA RETRIEVAL
GDS	GOLDSTONE (STDN STATION)
GFE	GOVERNMENT FURNISHED EQUIPMENT
GG	GAS GENERATOR
	GRAVITY GRADIENT

NASA - JOHNSON SPACE CENTER

FLIGHT RULES

GGVM	GAS GENERATOR VALVE MODULE
GH ₂	GASEOUS HYDROGEN
GLS	GROUND LAUNCH SEQUENCER
GMEM	GENERAL MEMORY UPDATE
	GPS MEMORY WRITE
GMT	GREENWICH MEAN TIME
GN	GROUND NETWORK
GN ₂	GASEOUS NITROGEN
GNC	GUIDANCE, NAVIGATION, AND CONTROL - MCC-H FLIGHT CONTROL POSITION
GND	GROUND
GO ₂	GASEOUS OXYGEN
GOM	GROUND OPERATIONS MANAGER
GOSR	GROUND OPERATION SUPPORT ROOM
GPC	GENERAL PURPOSE COMPUTER
GPM	GALLONS PER MINUTE
GPS	GLOBAL POSITIONING SYSTEM
GRTLS	GLIDE RETURN TO LANDING SITE
GS	GROUND SPEED
GSE	GROUND SUPPORT EQUIPMENT
GSFC	GODDARD SPACE FLIGHT CENTER
GSTDN	GROUND ELEMENTS OF SPACEFLIGHT TRACKING AND DATA NETWORK (EXCLUDES TDRSS)
GUID	GUIDANCE
GWM	GUAM (STDN STATION)
GYRO	GYROSCOPE
H	ALTITUDE
H/W	HARDWARE
H ₂	HYDROGEN
H ₂ O	WATER
H ₂ O GP	WATER GAS PRESSURE
H ₂ O WP	WATER PRESSURE
H _A	HEIGHT OF APOGEE
HAC	HEADING ALIGNMENT CIRCLE HEADING ALIGNMENT CONE
HBr	HYDROBROMIC ACID
HCl	HYDROGEN CHLORIDE
HCM	HAND CONTROLLER MODULE
HCN	HYDROGEN CYANIDE
HD	HIGHLY DESIRABLE
HDOT	RATE OF CHANGE OF ALTITUDE
HDR	HIGH DATA RATE
HDRR	HIGH DATA RATE RECORDER
HDWE	HARDWARE

FLIGHT RULES

He	HELIUM
HF	HYDROFLUORIC ACID
HFA	HAB FAN ASSEMBLY
HFE	HIGH FREQUENCY EXECUTIVE
Hg	MERCURY
HI	HIGH
HIU	HEADSET INTERFACE UNIT
HM	HINGE MOMENT
HOSC	HUNTSVILLE OPERATIONS SUPPORT CENTER
H _p	HEIGHT OF PERIGEE
HP	HIGH POWER
HPFT	HIGH PRESSURE FUEL TURBOPUMP
HPFTP	HIGH PRESSURE FUEL TURBOPUMP PRESSURE
HPG	HIGH PRESSURE GAS
HPMDE	HIGH PRIORITY MISSION OBJECTIVE EXCEPTION
HPOP	HIGH PRESSURE OXIDIZER PUMP
HPOT	HIGH PRESSURE OXIDIZER TURBOPUMP
HPOTP	HIGH PRESSURE OXIDIZER TURBOPUMP PRESSURE
HPU	HYDRAULIC POWER UNIT
HQR	HANDLING QUALITY RATING
HR	HOUR
HR(S)	HOUR(S)
HRA	HELMET RETENTION ASSEMBLY
HRDA	HIGH RATE DATA ASSEMBLY
HRDM	HIGH RATE DEMULTIPLEXER
HRM	HIGH RATE MULTIPLEXER
HRSI	HIGH TEMPERATURE REUSABLE SURFACE INSULATION
HSD	HORIZONTAL SITUATION DISPLAY
HSI	HORIZONTAL SITUATION INDICATOR
HST	HUBBLE SPACE TELESCOPE
HSTD	HIGH SPEED TRACKING DATA
HTR	HEATER
HUD	HEADS UP DISPLAY
HX	HEAT EXCHANGER
HYD	HYDRAULIC
i.e.	THAT IS
I/C, ICH	INTERCHANGER
I/C	INTERCONNECT
I/F	INTERFACE
I/O	INPUT/OUTPUT
IAW	IN ACCORDANCE WITH
IBM	INTERNATIONAL BUSINESS MACHINES
ICB	INTEGRATION CONTROL BOARD
ICC	INTERCOMPUTER COMMUNICATION

FLIGHT RULES

ICD	INTERFACE CONTROL DOCUMENT
ICH	INTERCHANGER
ICU	INDIVIDUAL COOLING UNITS
ICV	INTERCENTER VECTOR
ID	IDENTIFICATION
IDC	ISIS DIGITAL CAMERA
IE	INPUT ELECTRONICS
IECM	INDUCED ENVIRONMENT CONTAMINATION MONITOR
IFA	IN-FLIGHT ANOMALY
IFM	IN-FLIGHT MAINTENANCE
IGN	IGNITION
IGOR	INTERCEPT GROUND OPTICAL RECORDER
IIP	INSTANTANEOUS IMPACT PREDICTION (POINT)
ILL	IMPACT LIMIT LINE
IMCP	INTEGRATED MONITORING AND CONTROL PANEL
IMLG	IMPROVED MAIN LANDING GEAR
IMSL	INTERMEDIATE SEAL
IMU	INERTIAL MEASUREMENT UNIT
IMVS	INTERCHANGEABLE-MID-VALUE-SELECT
IN	INCHES
IN/HR	INCHES PER HOUR
IN/MIN	INCHES PER MINUTE
INBD	INBOARD
INCO	INTEGRATED COMMUNICATIONS OFFICER
INCORP	INCORPORATED
INH	INHIBIT
INIT	INITIATION
INSTR	INSTRUMENTATION
INTRL	INERTIAL
INV	INVERTER
INWS	IMPROVED NOSEWHEEL STEERING
IOM	INPUT/OUTPUT MODULE
IOP	INPUT/OUTPUT PROCESSOR
IOS	INDIAN OCEAN STATION (SGLS STATION)
IOU	INPUT/OUTPUT UNIT
IP	INSTRUMENTATION PCMMU IMPACT POINT
IPL	INITIAL PROGRAM LOAD
IPS	INCHES PER SECOND
IRAMS	INERTIAL REFERENCE ALIGNMENT MONITOR SYSTEM
IRD	INTEGRATED RECEIVER DECODER
IRU	INERTIAL RATE UNIT
ISIS	INTEGRATED SENSOR INSPECTION SYSTEM
ISO	ISOLATION
ISOL	ISOLATION
ISP	INTERMEDIATE SEAL PURGE

NASA - JOHNSON SPACE CENTER

FLIGHT RULES

ITVC	SPECIFIC IMPULSE
IU	INTENSIFIED TELEVISION CAMERA
IUS	INTERFACE UNIT
IV	INERTIAL UPPER STAGE
IVA	INTRAVEHICULAR
	INTRAVEHICULAR ACTIVITY
JDI	JONATHAN DICKINSON (STDN STATION)
JOIP	JOINT OPERATIONS INTERFACE PROCEDURE
JSC	JOHNSON SPACE CENTER
K	THOUSAND(S)
KB	KEYBOARD
	KILOBITS
KBPS	KILOBITS PER SECOND
KEAS	KNOTS EQUIVALENT AIR SPEED
KFT/SM	1000 FEET PER STATUTE MILE
KG	KILOGRAMS
KOH	POTASSIUM HYDROXIDE
KSC	KENNEDY SPACE CENTER
KTS	KNOTS
KVA	KILOVOLT AMPERES
KW or kW	KILOWATTS
KWH	KILOWATTS PER HOUR
L	LEFT
L/D	LIFT-TO-DRAG RATIO
L/L	LAUNCH/LANDING
L/O	LIFT-OFF
LAN	LOCAL AREA NETWORK
LAS	LAUNCH AREA STEEP
LB	POUND(S)
LB/HR	POUNDS PER HOUR
LBM	POUNDS MASS
LBMP	LOWER BODY NEGATIVE PRESSURE
LCA	LOAD CONTROL ASSEMBLY
LCC	LAUNCH COMMIT CRITERIA (DOCUMENT NSTS 16007)
	LAUNCH CONTROL CENTER
	LASER CAMERA CONTROLLER
LCH	LASER CAMERA HEAD
LCS	LASER CAMERA SYSTEM
LCU	LAUNCH CORRELATION UNIT
LCVG	LIQUID COOLING VENTING GARMENT

FLIGHT RULES

LD	LOAD
LDB	LAUNCH DATA BUS
LDO	LOADS AND DOLILU OFFICER
LDR	LOW DATA RATE
LDRI	LASER DYNAMIC RANGE IMAGER
LED	LIGHT EMITTING DIODE
LEMSCO	LOCKHEED ENGINEERING AND MANAGEMENT SERVICES COMPANY
LEQ	AVERAGE NOISE LEVEL
LES	LAUNCH/ENTRY SUIT
LF	LAUNCH FACILITY
	LAUNCH FORWARD
	LEFT FORWARD
	LOAD FACTOR
LG	LANDING GEAR
LH	LEFT HAND
LH ₂	LIQUID HYDROGEN
LIB	LEFT INBOARD
LiOH (LIOH)	LITHIUM HYDROXIDE
LK	LEAK
LL	LOW LEVEL
	LOWER LIMIT
LLCO	
LO ₂	LIQUID OXYGEN
LOB	LEFT OUTBOARD
LOC	LOSS OF CONTROL
LOS	LOSS OF SIGNAL
LOTS	LOSS OF TRACKING SKILLS
LOX	LIQUID OXYGEN
LP	LOW POWER
LPFP	LOW PRESSURE FUEL PUMP
LPFT	LOW PRESSURE FUEL TURBOPUMP
LPU	LIFE PRESERVER UNIT
LRD	LANDING AND RECOVERY DIRECTOR
LRSI	LOW TEMPERATURE REUSABLE SURFACE INSULATOR
LRU	LINE REPLACEABLE UNIT
LSEAT	LAUNCH SYSTEMS EVALUATION ADVISORY TEAM
LSO	LANDING SUPPORT OFFICER
LT	LIGHT
LUBE	LUBRICATION
LVAR	LATERAL VARIATIONS
LVL	LEVEL
LVLH	LOCAL VERTICAL LOCAL HORIZONTAL
LWKL	LIGHTWEIGHT KEEL LATCH
LWLL	LIGHTWEIGHT LONGERON LATCH

NASA - JOHNSON SPACE CENTER

FLIGHT RULES

M	MANDATORY
	MACH NUMBER
	MINUTE
MAD	MADRID (STDN STATION)
MADS	MODULAR AUXILIARY DATA SYSTEM
MAL	MALFUNCTION
MALF	MALFUNCTION
MAN	MANUAL
MANF	MANIFOLD
MAX	MAXIMUM
MAX Q	MAXIMUM DYNAMIC PRESSURE
MB	MEGABITS
MBARS	MILLIBARS
MBL	MOBILE UNIT (TACAN STATION)
MBPS	MEGABITS PER SECOND
MC	MISSION COMPLETION
MCA	MOTOR CONTROL ASSEMBLY
MCC	MISSION CONTROL CENTER
	MAIN COMBUSTION CHAMBER
MCC-H	MISSION CONTROL CENTER-HOUSTON
MCDS	MULTIFUNCTION CRT DISPLAY SYSTEM
MCF	MAJOR COMPONENT FAILURE
MCIU	MANIPULATOR CONTROLLER INTERFACE UNIT
MCP	MONITOR AND CONTROL PANEL
MCV	MICROBIAL CHECK VALVE
MD	MIDDECK
MDA	MOTOR DRIVE AMPLIFIER
MDF	MINIMUM DURATION FLIGHT
MDK	MIDDECK
MDM	MULTIPLEXER/DEMULTIPLEXER
MEC	MASTER EVENT CONTROLLER
MECO	MAIN ENGINE CUTOFF
MED	MANUAL ENTRY DEVICE
	MEDICAL
MEDS	MULTIFUNCTION ELECTRONIC DISPLAY SUBSYSTEM
MEM	MEMORY
MEP	MINIMUM ENERGY POINT
	MAIN ENGINE PROPELLANT
MER	JSC MCC-H MISSION EVALUATION ROOM
	MEASUREMENT ERROR
MET	MISSION ELAPSED TIME
METAR	SURFACE METEOROLOGICAL AIRWAYS
MEV	MILLION ELECTRON VOLTS
MF	MAJOR FUNCTION
MFR	MANIPULATOR FOOT RESTRAINT

NASA - JOHNSON SPACE CENTER

FLIGHT RULES

MGMT	MANAGEMENT
MGTD	MAIN GEAR TOUCHDOWN
MHA	MULTIPLE HEADSET ADAPTER
MHI	MCC HOST INTERFACE
MHz	MEGAHERTZ
MICB	MISSION INTEGRATION CONTROL BOARD
MIL, MILA	MERRITT ISLAND LAUNCH AREA (STDN STATION)
	MILLISECONDS
MILX	MERRITT ISLAND LAUNCH AREA (STDN STATION)
MIN	MINUTE
	MINIMUM
MKS	MARKS
MLG	MAIN LANDING GEAR
MLS	MICROWAVE LANDING SYSTEM
MM	MAJOR MODE
	MASS MOMENT
MM/HR	MILLIMETERS/HOUR
MMACS	MECHANICAL, MAINTENANCE, ARM, AND CREW SYSTEMS (MCC-H FLIGHT CONTROL POSITION)
MMC (A)	MID MOTOR CONTROL (ASSEMBLY)
MMH	MONOMETHYL HYDRAZINE
mmHG	MILLIMETERS OF MERCURY
MMT	MISSION MANAGEMENT TEAM
MMU	MANNED MANEUVERING UNIT
	MASS MEMORY UNIT
MMWL	MODIFIED MIDDLEWEIGHT LATCH
MMWLL	MODIFIED MIDDLEWEIGHT LONGERON LATCH
MN	MAIN
MNA, B, C	MAIN BUS A, B, OR C
MNVR	MANEUVER
MOA	MEMORANDUM OF AGREEMENT
MOC	MISSION OPERATIONS COMPUTER
MOCR	MISSION OPERATIONS CONTROL ROOM
MODCOMP	MISSION OPERATIONS DIRECTORATE COMPUTER
MOU	MEMORANDUM OF UNDERSTANDING
MOV	MAIN OXIDIZER VALVE
MPAD	MISSION PLANNING AND ANALYSIS DIVISION
MPCC	MULTIPURPOSE CONTROL CENTER
MPE	MISSION PECULIAR EQUIPMENT
MPL	MINIMUM POWER LEVEL
MPLM	MULTI-PURPOSE LOGISTICS MODULE
MPM	MANIPULATOR POSITIONING MECHANISM
MPS	MAIN PROPULSION SYSTEM
MPSR	MULTIPURPOSE SUPPORT ROOM
MPU	MAGNETIC PICKUP UNIT
MR	MIXTURE RATIO

NASA - JOHNSON SPACE CENTER

FLIGHT RULES

MRL	MANIPULATOR RETENTION LATCH
MRN	MORON, SPAIN (PRIME TAL SITE)
MS	MISSION SPECIALIST
MSBLS	MICROWAVE SCANNING BEAM LANDING SYSTEM
MSFC	MARSHALL SPACE FLIGHT CENTER
MSG	MESSAGE
MSID	MEASUREMENT STIMULATION IDENTIFICATION
MSK	MASK
	MANUAL SELECT KEYBOARD
MSL	MEAN SEA LEVEL
MSPC	MULTIPLE STORED PROGRAM COMMAND
MTBF	MEAN TIME BETWEEN FAILURES
MTL	MT. LEMON (USAEPG C-BAND STATION)
MTM	MOC TELEMETRY MESSAGE
MTRS	MOTORS
MTU	MASTER TIMING UNIT
MUT	MULTI-USE TETHER
MUX	MULTIPLEXER
MV	MILLIVOLT
MVS	MID-VALUE-SELECT
MW	MILLIWATT
MWLL	MIDDLEWEIGHT LONGERON LATCH
N/A	NOT APPLICABLE
N ₂	NITROGEN
N ₂ H ₄	HYDRAZINE
N ₂ O ₄	NITROGEN TETROXIDE
NASA	NATIONAL AERONAUTICS AND SPACE ADMINISTRATION
NAV	NAVIGATION
NBAT	NOMINAL BUS ASSIGNMENT TABLE
NC ₁	NOMINAL CORRECTION 1 MANEUVER
NCC	NOMINAL CORRECTION COMBINATION MANEUVER
	NETWORK CONTROL CENTER
	NASA CONVOY COMMANDER
NCRP	NATIONAL COUNCIL ON RADIATION PROTECTION
NEOM	NOMINAL END OF MISSION
NEP	NORMAL ENTRY POINT
NGTD	NOSE GEAR TOUCHDOWN
NH ₃	AMMONIA
NIS	NETWORK INFORMATION SYSTEM
NISN	NETWORK INTEGRATED SERVICES NETWORK
NLE	NO LONGER ENDANGER
NLG	NOSE LANDING GEAR
NM, nm	NAUTICAL MILES
NOK	NO OK

NASA - JOHNSON SPACE CENTER

FLIGHT RULES

NOM	NOMINAL
	NETWORK OUTPUT MULTIPLEXER
NOR	NORTHROP LAKEBED LANDING SITE
NORAD	NORTH AMERICAN AIR DEFENSE COMMAND
NORM	NORMAL
NOTAM	NOTICE TO AIRMEN
NOTMAR	NOTICE TO MARINERS
NPC	NOMINAL PLANE CHANGE
NPSP	NET POSITIVE SUCTION PRESSURE
NR	NOT REQUIRED
NRC	NATIONAL RESEARCH COUNCIL
NRS	NETWORK REGISTRATION SERVICE
NRT	NEAR REAL TIME
NSDD	NATIONAL SECURITY DECISION DIRECTIVE
NSP	NASA SUPPORT PLAN
	NETWORK SIGNAL PROCESSOR
NSR	COELIPTIC MANEUVER
NSTS	NATIONAL SPACE TRANSPORTATION SYSTEM
NTD	NASA TEST DIRECTOR
NWS	NOSE WHEEL STEERING
NWTD	NOSE WHEEL TOUCHDOWN
N _y	LATERAL ACCELERATION
N _Y J	NO YAW JET
N _z	NORMAL ACCELERATION
N _z C	NORMAL ACCELERATION COMMAND
O ₂	OXYGEN
OA	OPERATIONAL AFT
OASCB	ORBITER AVIONICS SOFTWARE CONTROL BOARD
OBS	OBSERVATION
OBSS	ORBITER BOOM SENSOR SYSTEM
OCA	ORBITER COMMUNICATIONS ADAPTOR
OCAC	ORBITER CABIN AIR CLEANER
OCAS	OPERATOR-COMMANDED AUTO SEQUENCES
OE	OUTPUT ELECTRONICS
OEX	ORBITER EXPERIMENTS
OF	OPERATIONAL FORWARD
OFT	ORBITAL FLIGHT TEST
OFTP	ORBIT FLIGHT TECHNIQUES PANEL
OI	OPERATIONAL INSTRUMENTATION
OIS	OPERATIONAL INSTRUMENTATION SYSTEM
OME	ORBITER MANEUVERING ENGINE
OMI	OPERATION AND MAINTENANCE INSTRUCTIONS
OMRS	OPERATIONAL MAINTENANCE REQUIREMENTS AND SPECIFICATION

NASA - JOHNSON SPACE CENTER

FLIGHT RULES

OMRSD	OPERATIONAL MAINTENANCE REQUIREMENTS AND SPECIFICATION DOCUMENT
OMS	ORBITAL MANEUVERING SYSTEM
ONSC	ONBOARD NAVIGATION SYSTEMS CHARACTERISTICS
OOP	OUT-OF-PLANE
OPCU	ORBITER POWER CONVERSION UNIT
OPF	ORBITER PROCESSING FACILITY
OPOV	OXIDIZER PREBURNER OXIDIZER VALVE
OPS	OPERATIONAL SEQUENCES OPERATIONS
ORB	ORBIT (AL)
ORIDE	OVERRIDE
ORR	ORRORAL VALLEY (STDN STATION)
OS	ORBIT STATION
OSH	OFF SCALE HIGH
OSHA	OCCUPATIONAL SAFETY AND HEALTH ADMINISTRATION
OST	OPERATIONS SUPPORT TEAM
OTC	ORBITER TEST CONDUCTOR
OVHD	OVERHEAD
OX	OXIDIZER
P	PRESSURE, POINTING VECTOR
P-V-T	PRESSURE-VOLUME-TEMPERATURE
P/L, PL	PAYLOAD
PA	PAYLOAD AFT
PACK	PAYLOAD ACTIVE COOLING KIT
PAD	PAYLOAD ATTACHMENT DEVICE
PADM	PORTABLE AUDIO DATA MONITOR
PAM	PAYLOAD ASSIST MODULE
PAO	PUBLIC AFFAIRS OFFICE
PAPI	PRECISION APPROACH PATH INDICATOR
PASS	PRIMARY AVIONICS SOFTWARE SYSTEM
PATC	PATRICK
PBD	PAYLOAD BAY DOOR
PB (I)	PUSHBUTTON (INDICATOR)
Pc	CHAMBER PRESSURE
PCA	POWER CONTROL ASSEMBLY
PCM	PULSE CODE MODULATION
PCMMU	PCM MASTER UNIT
PCN	PAGE CHANGE NOTICE
PCS	PRESSURE CONTROL SYSTEM
PDI	PAYLOAD DATA INTERLEAVER
PDL (S)	PONCE DE LEON (STDN STATION)
PDRS	PAYLOAD DEPLOYMENT AND RETRIEVAL SYSTEM
PDU	POWER DRIVE UNIT

NASA - JOHNSON SPACE CENTER

FLIGHT RULES

	POWER DISTRIBUTION UNIT
PEAP	PERSONAL EMERGENCY AIR PACK
PEG	POWERED EXPLICIT GUIDANCE
PF	PAYLOAD FORWARD
	PREDICTED POWER FACTOR
	PAYLOAD FLEX
PFC/ICL	POWER FACTOR CORRECTOR/INRUSH CURRENT LIMITER
PGA	PRESSURE GARMENT ASSEMBLY
PGSC	PAYLOAD GENERAL SUPPORT COMPUTER
pH	HYDROGEN-ION CONCENTRATION
PI	PAYLOAD INTERROGATOR
	PRINCIPAL INVESTIGATOR
PIBAL	PILOT BALLOON
PIC	PYROTECHNIC INITIATION CONTROLLER
PIP	PAYLOAD INTEGRATION PLAN
PIREP	PILOT REPORT
PKG	PACKAGE
PKM	PERIGEE KICK MOTOR
PL	PAYLOAD
PLB	PAYLOAD BAY
PLBD	PAYLOAD BAY DOOR(S)
PLHX	PAYLOAD HEAT EXCHANGER
PLS	PRIMARY LANDING SITE
PLSS	PRIMARY LIFE SUPPORT SYSTEM
PLOAD	PROPELLANT LOAD
PLT	PILOT
PM	PHASE MODULATION
PMC	PRIVATE MEDICAL CONFERENCE
PMD	PALMDALE
PMP	PUMP
PNL	PANEL
PNEU	PNEUMATICS
POCC	PAYLOAD OPERATIONS CONTROL CENTER
POD	PAYLOAD OPERATIONS DIRECTOR
POHS	POSITION AND ORIENTATION HOLD SELECT
POPU	PUSH OVER PULL UP
POR	POINT OF RESOLUTION
POS	PORTABLE OXYGEN SYSTEM
	POSITION
POSN	POSITION
PP	PARTIAL PRESSURE
	POWERED PITCHDOWN
	PRESENT POSITION
PPA	POWERED PITCHAROUND
PPCO ₂	PARTIAL PRESSURE OF CARBON DIOXIDE
PPD	POWERED PITCHDOWN

FLIGHT RULES

PPM	PARTS PER MILLION
PPO ₂	PARTIAL PRESSURE OF OXYGEN
PPRV	POSITIVE PRESSURE RELIEF VALVE
PRB	PROCEDURES AND REQUIREMENTS BRANCH
PRCB	PROGRAM REQUIREMENTS CONTROL BOARD
PRCS	PRIMARY REACTION CONTROL SYSTEM
PRD	PAYLOAD RETENTION DEVICE
PRECIP	PRECIPITATION
PREP	PREPARATION
PRESS	PRESSURE
PRI	PRIMARY
	PRIORITY
PRL	PRIORITY RATE LIMITING
PRLA	PAYLOAD RETENTION LATCHES
PRO	"PROCEED" - A GPC COMMAND ENTRY
PROMS	PROGRAMMABLE READ ONLY MEMORY
PROP	PROPELLANT
PROX	PROXIMITY
PROX OPS	PROXIMITY OPERATIONS (RENDEZVOUS)
PRPLT	PROPELLANT
PRSD	POWER REACTANT STORAGE AND DISTRIBUTION SYSTEM
PRTLS	POWERED RETURN TO LANDING SITE
PS	POWER SUPPLY
	PAYLOAD STATION
	PAYLOAD SPECIALIST
PSF	POUNDS PER SQUARE FOOT
PSI	POUNDS PER SQUARE INCH
PSIA	POUNDS PER SQUARE INCH ABSOLUTE
PSID	POUNDS PER SQUARE INCH DIFFERENTIAL
PSIG	POUNDS PER SQUARE INCH GAUGE
PSP	PAYLOAD SIGNAL PROCESSOR
PSS	PLATFORM SYSTEM SERVICES SOFTWARE
PTB	PAYLOAD TIMING BUFFER
PTC	PASSIVE THERMAL CONTROL
PTI	PROGRAM TEST INPUT
PTU	PAN AND TILT UNIT
PUPO	PULL UP PUSH OVER
PVT	PRIVATE
PWR	POWER
PWR	PAYLOAD WATER RESERVOIRS
PYRO	PYROTECHNIC
q	DYNAMIC PRESSURE
Q-BAR	AVERAGE DYNAMIC PRESSURE
Q-BAR DOT	RATE OF CHANGE OF DYNAMIC PRESSURE

NASA - JOHNSON SPACE CENTER

FLIGHT RULES

QD	QUICK DISCONNECT
QDM	QUICK DON MASK
QMVS	QUAD-MID-VALUE-SELECT
QSA	QUALIFICATION SITE APPROVAL
QTY	QUANTITY
R	RIGHT
R&E	RESEARCH AND ENGINEERING
R-BAR	ALONG THE RADIUS VECTOR
R-F-L	READY-FOR-LATCH
R-V	RANGE-VELOCITY
R/W	RUNWAY
RA	RADAR ALTIMETER
RAAB	REMOTE APPLICATION AND ADVISORY BOX
RAD(S)	RADIATOR(S)
	RELEASE AUTHORIZATION DOCUMENT
RASS	RELEASE AUTHORIZATION FOR SHUTTLE SOFTWARE
RAU	REMOTE ACQUISITION UNIT
RCC	RANGE CONTROL CENTER
RCCB	REMOTE CONTROL CIRCUIT BREAKER
RCDR	RECORDER
RCN	REQUIREMENTS CHANGE NOTICE
RCRS	REGENERABLE CARBON DIOXIDE REMOVAL SYSTEM
RCS	REACTION CONTROL SYSTEM
RCVR	RECEIVER
RDM	RESEARCH DOUBLE MODULE
RDY	READY
REAS	REASONABLENESS
RECAL	RECALIBRATE
REDESIG	REDESIGNATION
REDUN	REDUNDANT
REF	REFERENCE
REG(S)	REGULATOR(S)
REL	RELATIVE
RELMAT	RELATIVE MATRIX
REM	ROENTGEN-EQUIVALENT MAN
REP	REPRESS
REQ	REQUIRE
RESVR	RESERVOIR
REV	REVOLUTION
RF	RADIO FREQUENCY
RFCA	RADIATOR FLOW CONTROL ASSEMBLY
RGA	RATE GYRO ASSEMBLY
RGO	RANGE TO GO
RH	RIGHT HAND

NASA - JOHNSON SPACE CENTER

FLIGHT RULES

RHC	ROTATIONAL HAND CONTROLLER
RI	ROCKWELL INTERNATIONAL
	RECORD IDENTIFIER
RIB	RIGHT INBOARD
RIC	ROCKWELL INTERNATIONAL CORPORATION
RJD	REACTION JET DRIVER
RJDF	REACTION JET DRIVER FORWARD
RLF	RELIEF
RM	REDUNDANCY MANAGEMENT
RMS	REMOTE MANIPULATOR SYSTEM
RMU	RMS/MECHANICAL/UPPERSTAGE
RNDZ	RENDEZVOUS
ROB	RIGHT OUTBOARD
ROCC	RETRIEVAL OPERATIONS COMMUNICATIONS CENTER
	RANGE OPERATIONS CONTROL CENTER
ROLREF	ROLL REFERENCE
ROM	RETRIEVAL OPERATIONS MANAGER
ROTA	NAVAL STATION ROTA, SPAIN
RPC	REMOTE POWER CONTROLLER
RPL	RATED POWER LEVEL
RPM	REVOLUTIONS PER MINUTE
RPS	RMS PLANNING SYSTEM
RPTA	RUDDER PEDAL TRANSDUCER ASSEMBLY
RQMT	REQUIREMENT
RR	RENDEZVOUS RADAR
RRM	RUNWAY REMAINING MARKER
RS	REDUNDANT SET
	ROTARY SEPARATOR
RSB	RUDDER SPEEDBRAKE
RSC	RMS SIDE-VIEW CAMERA
RSDS	RANGE SAFETY DISPLAY SYSTEM
RSLS	REDUNDANT SET LAUNCH SEQUENCER
RSO	RANGE SAFETY OFFICER
RSOC	ROCKWELL SPACE OPERATIONS COMPANY
RSOR	RANGE SAFETY OPERATING REQUIREMENT
RSR	RANGE SAFETY REPRESENTATIVE
RSS	ROOT SUM SQUARE (D)
	RANGE SAFETY SYSTEM
RST	RESTRING
RSTDs	RANGE SAFETY TELEMETRY DISPLAY SYSTEM
RSTNG	RESTRING
RT	REAL TIME
	RIGHT
RTC	REAL-TIME COMMAND
	REAL-TIME CLOCK
RTD	RESISTIVE THERMAL DEVICE

FLIGHT RULES

RTDS	RANGE SAFETY TELEMETRY DISPLAY SYSTEM
	REAL-TIME DATA SYSTEM
RTLS	RETURN TO LAUNCH SITE
RTN	RETURN
RTS	REMOTE TRACKING STATION
RTV	PLIABLE SEALANT
RTVMS	REAL-TIME VIBRATION MONITORING SYSTEM
RUD	RUDDER
RVLC	REDLINE VOTING LOGIC CIRCUIT
S TRK	STAR TRACKER
S&MA	SAFETY AND MISSION ASSURANCE
S-BD	SIDE-BAND
S/B	STANDBY
S/C	STABILITY AND CONTROL
S/D, SHTDN	SHUTDOWN
S/W	SOFTWARE
SA	SINGLE ACCESS
SAA	SPACELAB AURAL ANNUNCIATOR
SAD	SPECIFICATION/ASSEMBLY DRAWING
SAFER	SIMPLIFIED AID FOR EVA RESCUE
SAGI	SPACEHAB AUDIO GROUND ISOLATOR
SAIL	SHUTTLE AVIONICS INTEGRATION LABORATORY
SAL	NORTHROP STRIP
SAR	SEARCH AND RESCUE
SARSAT	SEARCH AND RESCUE SATELLITE AIDED TRACKING
SAS	SPACE ADAPTATION SYNDROME
SB, SPDBK	SPEEDBRAKE
SBTA	SPEEDBRAKE TRANSDUCER ASSEMBLY
SBTC	SPEEDBRAKE/THRUST CONTROLLER
SCA	SHUTTLE CARRIER AIRCRAFT
SCAS	SUBSYSTEM COMPUTER APPLICATION SOFTWARE
SCO	SURVEILLANCE CONTROL OFFICER
SCOS	SUBSYSTEM COMPUTER OPERATING SYSTEM
SCR	STRIP CHART RECORDER
SCU	SECONDARY CONTROL UNIT
	SERVICE AND COOLING UMBILICAL
SDF	SOFTWARE DEVELOPMENT FACILITY
SDL	SOFTWARE DEVELOPMENT LAB
SDP	SHUTTLE DATA PROCESSOR
SEBS	SPACELAB EMERGENCY BREATHING SYSTEM
SEC	SECOND
	SECONDARY
SEGP	SINGLE ENGINE GOOD POD
SEII	SERVOACTUATOR ERROR INDICATION INTERRUPT

NASA - JOHNSON SPACE CENTER

FLIGHT RULES

SEL	SELECT
SELP	SINGLE ENGINE LEAKING POD
SENS	SENSOR
SEP	SEPARATION
SEPTM	SINGLE ENGINE PRESS TO MECO
SERC	SINGLE-ENGINE ROLL CONTROL
SES	SHUTTLE ENGINE SIMULATOR
SESL	SPACE ENVIRONMENTAL SIMULATION LABORATORY
SESP	SINGLE ENGINE SINGLE POD
SETP	SINGLE ENGINE TWO PODS
SFCO	SENIOR FLIGHT CONTROL OFFICER (KSC)
SFT	SINGLE FAULT TOLERANT
SGLS	SPACE/GROUND LINK SYSTEM
SHOD	SPACEHAB OPERATIONS DIRECTOR
SIG COND	SIGNAL CONDITIONER
SIMO	SIMULTANEOUS
SL	SPACELAB
SLF	SHUTTLE LANDING FACILITY
SLODB	SPACELAB OPERATIONAL DATA BOOK
SLS	SECONDARY LANDING SITE
SM	SYSTEMS MANAGEMENT
	STATUTE MILE
SM GPC	SYSTEMS MANAGEMENT GENERAL PURPOSE COMPUTER
SM/LDM	SINGLE MODULE/LOGISTICS DOUBLE MODULE
SMAC	SPACECRAFT MAXIMUM ALLOWABLE CONCENTRATION
SMCH	STANDARD MIXED CARGO HARNESS
SMG	SPACEFLIGHT METEOROLOGICAL GROUP
SMIDEX	SPACELAB MIDDECK EXPERIMENTS
SMS	SHUTTLE MISSION SIMULATOR
	SPACE MOTION SICKNESS
SMU	SPEAKER MICROPHONE UNIT
SMWLL	SUPER MIDDLEWEIGHT LONGERON LATCH
SN	SPACE NETWORK
SNSR	SENSOR
SODB	SHUTTLE OPERATIONAL DATA BOOK
SOMS	SHUTTLE OPERATIONS MEDICAL SYSTEM
	SHUTTLE ORBITER MEDICAL SYSTEM
SOO	STAR OF OPPORTUNITY
SOP	SECONDARY OXYGEN PACK
	SUBSYSTEM OPERATING PROGRAM
SOV	SHUTOFF VALVE
SPAD	SHUTTLE PERFORMANCE ASSESSMENT DATABASE
SPAH	SPACELAB PAYLOAD ACCOMMODATION HANDBOOK
SPAN	JSC MCC-H SPACECRAFT ANALYSIS ROOM
SPAR	SPAR AEROSPACE

NASA - JOHNSON SPACE CENTER

FLIGHT RULES

SPARTAN	SHUTTLE POINTED AUTONOMOUS RESEARCH TOOL FOR ASTRONOMY
SPC	STORED PROGRAM COMMAND
SPDB	SUBSYSTEM POWER DISTRIBUTION BOX
SPDS	STABILIZED PAYLOAD DEPLOYMENT SYSTEM
SPEC	SPECIALIST FUNCTION SPECIFICATION
SPEE	SPECIAL PURPOSE END EFFECTOR
SPI	SURFACE POSITION INDICATOR
SPK	SCOTT PEAK (USAEPG C-BAND STATION)
SPL	SCRATCH PAD LINE
SPLY	SUPPLY
SPOT	SPACECRAFT POSITION OPTIMAL TRACKING
SPS	STANDARD POSITIONING SERVICE
SPT	STEERING POSITION TRANSDUCER
SPW	SUPPORT WING
SRB	SOLID ROCKET BOOSTER
SRBTS	SRB RADAR BEACON TRACKING SYSTEM
SRM	SOLID ROCKET MOTOR
SRMS	SHUTTLE REMOTE MANIPULATOR SYSTEM
SRO	SUPERINTENDENT OF RANGE OPERATIONS
SS	SINGLE STRING SUBSYSTEM
SSC	SUBSYSTEM COMPUTER
SSD	SPACECRAFT SOFTWARE DIVISION
SSFS	SPACE SHUTTLE FUNCTIONAL SIMULATOR
SSIO	SUBSYSTEM INPUT/OUTPUT
SSME	SPACE SHUTTLE MAIN ENGINE
SSMEC	SPACE SHUTTLE MAIN ENGINE CONTROLLER
SSOR	SPACE-TO-SPACE ORBITER RADIO
SSP	STANDARD SWITCH PANEL SPACE SHUTTLE PROGRAM
SSPTS	STATION TO SHUTTLE POWER TRANSFER SYSTEM
SSR	SOLID STATE RECORDERS
SSR	STAFF SUPPORT ROOM
SSV	SPACE SHUTTLE VEHICLE
ST	STAR TRACKER
STA	SHUTTLE TRAINING AIRCRAFT STANDARD STANDARD OPERATING PROCEDURE
STAMPS	SPACECRAFT TRAJECTORY ANALYSIS AND MISSION PLANNING SYSTEM/SIMULATION
STBD	STARBOARD
STBY	STANDBY
STC	SATELLITE TEST CENTER (SUNNYVALE, CA)
STD	STS TEST DIRECTOR

NASA - JOHNSON SPACE CENTER

FLIGHT RULES

STDN	SPACECRAFT TRACKING AND DATA NETWORK
STEP	SHUTTLE TURNAROUND ENHANCEMENT PROGRAM
	SIMPLIFIED THERMAL EVALUATION PROGRAM
STG	STAGE
STIN	STRAIGHT-IN
STS	SPACE TRANSPORTATION SYSTEM
STSOC	SPACE TRANSPORTATION SYSTEM OPERATIONS COMPANY
STT	SPACEHAB TRANSFER TUNNEL
SUBS	SUBSEQUENT
SUPA	SHUTTLE URINE PRETREAT ASSEMBLY
SV	STATE VECTOR
SVO	SPECIAL VEHICLE OPERATIONS
S/W	SOFTWARE
SW	SPACE WING
SW(S)	SWITCH(ES)
SW VLV	SWITCHING VALVE
SYNC	SYNCHRONIZE
SYNCOM	SYNCHRONOUS COMMUNICATION SATELLITE (HUGHES)
SYS	SYSTEM
T	TEMPERATURE
	TRACKING
T/O	TAKE OVER
T/R	TRANSMIT AND RECEIVE
TACAN, TAC	TACTICAL AIR NAVIGATION
TAEM	TERMINAL AREA ENERGY MANAGEMENT
TAG	TEXT AND GRAPHICS
TAGS	TEXT AND GRAPHICS SYSTEM
TAL	TRANSOCEANIC ABORT LANDING
TAS	TRUE AIR SPEED
tb, TB	INSTRUMENT PANEL TALKBACK
TBD	TO BE DETERMINED
TBS	TO BE SUPPLIED
TC	thermocouple
TCS	THERMAL CONTROL SYSTEM
TCSS	OAKHANGER (STDN)
TD	TOUCHDOWN
TDRS	TRACKING AND DATA RELAY SATELLITE
TDRSS	TRACKING AND DATA RELAY SATELLITE SYSTEM
TDT	TURBINE DISCHARGE TEMPERATURE
TELP	TWO ENGINES LEAKING POD
TEMP	TEMPERATURE
TETP	TWO ENGINES TWO PODS
TFL	TELEMETRY FORMAT LOAD
TGO	TIME TO GO TO MECO
TGT	TARGET

NASA - JOHNSON SPACE CENTER

FLIGHT RULES

THAP	THERMAL HYDRAULIC ANALYZER PROGRAM
THC	TRANSLATIONAL HAND CONTROLLER
TI	TERMINAL PHASE INITIATION
TIG	TIME OF IGNITION
TIPS	THERMAL IMPULSE PRINTER SYSTEM
TK, TNK	TANK
TLC	TANK LANDING WEIGHT CONSTRAINTS
TLM, TM	TELEMETRY
TM	TECHNICAL MEMO
TMBU	TABLE MAINTENANCE BLOCK UPDATE
TMCC	TEMPORARY MISSION CONTROL CENTER
TP	TANGENT PLANE
TPC	TELEMETRY PREPROCESSING COMPUTER
TPF	TERMINAL PHASE FINALIZATION (BRAKING)
TPG	TOPPING
TPI	TERMINAL PHASE INITIATION
TPL	TRANSPACIFIC LANDING
TPS	THERMAL PROTECTION SYSTEM
TRAJ	TRAJECTORY
TREF	TIME REFERENCE WORD
TRK	TRACK
TRS	TRAJECTORY SERVER
TSEP	THERMAL/STRUCTURAL ENVELOPE PROGRAM
TTA	THERMAL TEST AREA
TTOL	THERMAL TRADE-OFF LINE
TTS	TITUSVILLE (TACAN STATION)
TURB	TURBINE, TURBULENCE
TV	TELEVISION
TVC	THRUST VECTOR CONTROL
U.S.	UNITED STATES
U/L	UPLINK
UAS	URINE ABSORPTION SYSTEM
UCD	URINE COLLECTION DEVICE
UHF	ULTRA HIGH FREQUENCY
UL	UPPER LIMIT
UMB	UMBILICAL
UMI	UPPER MEMORY INITIAL PROGRAM LOAD
UPP	USER PARAMETER PROCESSING
UPS	UNINTERRUPTED POWER SUPPLY
URA	USER RANGE ACCURACY
US	UNITED STATES
USAEPG	U.S. ARMY ELECTRONIC PROVING GROUND
USAF	UNITED STATES AIR FORCE
USPD	UNDERSPEED

NASA - JOHNSON SPACE CENTER

FLIGHT RULES

UTC	UNITED TECHNOLOGIES COMPANY
UTIL	UTILITIES
V	VOLTS
V, VEL	VELOCITY
V-BAR	ALONG THE VELOCITY VECTOR
VAA	VIEWPORT ADAPTER ASSEMBLY
VAB	VEHICLE ASSEMBLY BUILDING
VAC	VACUUM
	VOLTS, ALTERNATING CURRENT
VAFB	VANDENBERG AIR FORCE BASE
VAHIRR	VOLUME-AVERAGED, HEIGHT-INTEGRATED RADAR REFLECTIVITY
VARR	VOLUME-AVERAGED RADAR REFLECTIVITY
VAS	VIDEO ANALOG SWITCH
VCU	VIDEO CONTROL UNIT
VDC	VOLTS, DIRECT CURRENT
VERN	VERNIER
VGO	VELOCITY TO GO
VI, V-I	VOLTAGE - CURRENT
V_I	INERTIAL VELOCITY
VITR	VIDEO INSTRUMENTATION TAPE RECORDER
VLV(S)	VALVE(S)
VMS	VERTICAL MOTION SIMULATOR (AT NASA AMES)
VP	VERTICAL PLANE
	VIEWPORT
VR	VIRTUAL REALITY
VRCS	VERNIER REACTION CONTROL SYSTEM
VREL	RELATIVE VELOCITY
V_{rel}	RELATIVE VELOCITY
VS	VERSUS
VTR	VIDEO TAPE RECORDER
VWSS	VERTICAL WIRE SKY SCREEN
W/	WITH
W/O	WITHOUT
W	WATTS
WB	WIDE BAND
WCCU	WIRELESS CREW COMM UNIT
WCS	WASTE COLLECTION SYSTEM
WDOT	MECO CROSSTRACK VELOCITY
WFCEU	WATER FLOW CONTROL ELECTRONICS UNIT
WFCV	WATER FLOW CONTROL VALVE
WLE	WING LEADING EDGE

FLIGHT RULES

WLPS	WALLOPS
WMS	WASTE MANAGEMENT SYSTEM
WNDW	WINDOW
WONG	WEIGHT ON NOSE GEAR
WOW	WEIGHT ON WHEELS
WPA	WINDOW PROTECTION ATTITUDE
WR	WESTERN RANGE
WSA	WATER SEPARATOR ASSEMBLY
WSB	WATER SPRAY BOILER
WSGT	WHITE SANDS GROUND TERMINAL
WSMR	WHITE SANDS MISSILE RANGE
WSSH	WHITE SANDS SPACE HARBOR
WST	WASTE
WSTF	WHITE SANDS TEST FACILITY
WWV	WORLD WIDE TIME BASE
WX	WEATHER
X CG	X-AXIS CENTER OF GRAVITY
XDCR	TRANSDUCER
XDUCER	TRANSDUCER
XFEED, XFD	CROSSFEED
XFER	TRANSFER
XLV	X-AXIS LOCAL VERTICAL
XVV	X-AXIS POINTED ALONG VELOCITY VECTOR
XPNDRS	TRANSPONDERS
XPONDER	TRANSPONDER
XRANGE	CROSSRANGE
XWIND	CROSSWIND
YLV	Y-AXIS LOCAL VERTICAL
YVV	Y-AXIS POINTED ALONG VELOCITY VECTOR
ZLV	Z LOCAL VERTICAL
ZOT	THE SPONTANEOUS COMBUSTION OF A SMALL AMOUNT OF FUEL IN THE THROAT OF A THRUSTER NOZZLE
ZSI	Z-AXIS SOLAR INERTIAL
ZVV	Z-AXIS POINTED ALONG VELOCITY VECTOR
ZZA	ZARAGOZA (PRIME TAL SITE)

FLIGHT RULES

α	ALPHA - ANGLE OF ATTACK
β	BETA - SIDESLIP ANGLE
δ	DELTA - AEROSURFACE DEFLECTION ANGLE
ϕ	PHI - ROLL (BANK) ANGLE, PHASE (AC)
σ	SIGMA - STANDARD DEVIATION
θ	THETA - PITCH ANGLE
$^{\circ}\text{F}$	DEGREES FAHRENHEIT
<	LESS THAN
>	GREATER THAN
ΔP	DELTA (DIFFERENCE IN) PRESSURE
μG	MICROGRAVITY
%	PERCENT
~	APPROXIMATELY
θ_n	MISALIGNMENT ABOUT THE NORTH AXIS
θ_w	MISALIGNMENT ABOUT THE WEST AXIS
θ_u	MISALIGNMENT ABOUT THE UP AXIS
γ	GAMMA - FLIGHT PATH ANGLE

FLIGHT RULES

THIS PAGE INTENTIONALLY BLANK

FLIGHT RULES

APPENDIX B - CHANGE CONTROL

CONTENTS

1.0	<u>INTRODUCTION</u>	B-1
1.1	PURPOSE	B-1
1.2	EFFECTIVITY	B-1
1.3	WORKFLOW TOOL	B-1
1.4	WORKFLOW ENROLLMENT	B-2
1.5	FLIGHT RULES DATABASE (FRDB) ACCESS	B-2
2.0	<u>CHANGE REQUEST (CR) PROCESS</u>	B-3
2.1	CHANGES TO GENERIC FLIGHT RULES	B-4
2.1.1	CR Submittal - Generic Rules	B-4
2.1.2	CR Evaluation - Generic Rules	B-5
2.1.3	CR Approval - Generic Rules	B-6
2.2	CHANGES TO MISSION-SPECIFIC ANNEX FLIGHT RULES	B-8
2.2.1	CR Submittal - Mission-Specific Annex Rules	B-8
2.2.2	CR Evaluation - Mission-Specific Annex Rules	B-9
2.2.3	CR Approval - Mission-Specific Annex Rules	B-10
2.3	SPECIAL CONSIDERATIONS	B-11
2.3.1	Critical Items List (CIL) Identification	B-11
2.3.2	Hazard Control (HC) Identification	B-11
2.3.3	Mission-Specific Exceptions	B-12
2.4	REAL-TIME CR'S, DEVIATIONS, WAIVERS, AND VIOLATIONS	B-13
2.4.1	Real-Time Flight Rule CR's	B-13
2.4.2	Flight Rule Deviations	B-13
2.4.3	Flight Rule Waivers	B-13
2.4.4	Flight Rule Violations	B-14

FLIGHT RULES

2.5	KEY ROLES AND RESPONSIBILITIES	B-15
2.5.1	Initiator	B-15
2.5.2	Division CR Coordinator	B-15
2.5.3	DA8 Section Coordinator (Generic CR's only).....	B-15
2.5.4	DA8 Volume Coordinator (Generic CR's only)	B-16
2.5.5	Lead Flight Director (Mission-Specific Annex CR's only)	B-17
2.5.6	DA8 Flight Rules CR Coordinator (Generic CR's only)	B-17
2.5.7	FRCB Members/Other Evaluators	B-17
2.5.8	DA8 Flight Rules Book Manager	B-17
2.6	CHANGE REQUEST PROCEDURES	B-18
3.0	<u>FLIGHT RULES DOCUMENT MANAGEMENT</u>	B-19
3.1	DOCUMENT PUBLICATION	B-19
3.1.1	Generic Flight Rules Document Publication	B-19
3.1.2	Mission-Specific Annex Flight Rules Document Publication.....	B-19
3.2	DOCUMENT DISTRIBUTION	B-20
3.3	QUALITY ASSURANCE REVIEWS	B-21
3.3.1	Flight Rules Document Accuracy QA	B-21
3.3.2	Flight Rules Change Process QA	B-21
3.3.3	CR Non-Conformance Reporting.....	B-21

FLIGHT RULES

APPENDIX B

CHANGE CONTROL

1.0 INTRODUCTION

Flight rules are critical to the safe and successful conduct of human spaceflight. In order to provide the necessary rigor in developing and maintaining the associated documents, a formal change control process has been established.

This change control process document (Appendix B) is common to all generic flight rules volumes and mission-specific annexes. Note, however, that the process differs for generic rules and mission-specific annex rules. Where appropriate, separate sections are used to cover each type of rules document.

1.1 PURPOSE

This appendix describes the change process for generic and mission-specific flight rules. The process is intended to promote consistency in coordination, submittal, evaluation, and approval of change requests (CR's) to flight rules and their associated rationale.

1.2 EFFECTIVITY

This change control appendix was updated on February 28, 2007.

1.3 WORKFLOW TOOL

Workflow is a web-based database tool that is used to submit and route change requests (CR's) for all flight rules documents. The Workflow database also provides a permanent record of all change traffic. Workflow is accessed via the **Flight Rule CR System** link on the Flight Director Office's Flight Rules homepage, at <http://mod.jsc.nasa.gov/da8/Default.aspx>.

Help, Frequently Asked Questions, and a Complete User's Guide are available via the Workflow main menu.

NOTE: Workflow is simply a tool that is used to facilitate changes to flight rules. The responsibility for CR coordination lies with the individuals and organizations involved in the process, as described in the subsequent sections of this change control appendix.

FLIGHT RULES

1.4 WORKFLOW ENROLLMENT

To use Workflow, users must be “enrolled” in the database by providing their full name, mail code, domain user ID, telephone number, and e-mail address to their Division database editors (JSC Domain), trusted domain database editors (external domains), or to the Book Manager listed on the Preface page of the flight rules documents.

Enrollment is also available for users outside the JSC Domain/trusted domains, if it is required for them to support the flight rules change process. These users should contact their MOD counterparts who will sponsor them in the AutoCAR system. A short description of the AutoCAR process is as follows:

The MOD sponsor will access the AutoCAR application and select AutoCAR Access Message. They will supply the user's First Name, Last Name, e-mail address, and in the comments field, they will place a justification for access by this user to the Workflow system. The user will receive an e-mail from the AutoCAR system that includes a URL, ID, and password. The user should login and supply all information requested. If their supervisor is not already part of the AutoCAR system, they will be asked to provide contact information. The AutoCAR system will issue an e-mail requesting that supervisor's information. Once the supervisor is enrolled as a Supervisor in AutoCAR, the user can then return to AutoCAR and complete the access request form. Once complete, the request will be routed to the proper personnel who approve access to Workflow, starting with the user's supervisor. NOTE: The AutoCAR system may be used to request access to many MOD systems, but to enroll in Workflow, MOE - WORKFLOW must be selected.

1.5 FLIGHT RULES DATABASE (FRDB) ACCESS

In addition to the electronic version of the flight rules available on the Flight Director Office website at <http://mod.jsc.nasa.gov/da8/Default.aspx>, rules may also be accessed using a new tool, the Flight Rules Database (FRDB). Efforts are underway to make FRDB more widely available to users outside JSC but, at this time, only JSC personnel and those in the Mission Control Center with JSC-MAS accounts can access this tool, which is designed to allow users to search, review, generate reports, and print as required. Access to this tool may be obtained via the Flight Director Office website at http://mod.jsc.nasa.gov/Da8/rules/frdb_install.html.

FLIGHT RULES

2.0 CHANGE REQUEST (CR) PROCESS

NOTE: Successful execution of the flight rules CR process is critically dependent on each participant clearly understanding the change control process itself, as well as their specific roles and responsibilities. The Workflow system simply provides a mechanism to facilitate submittal and routing of CR's. The responsibility for timely and complete CR coordination, evaluation, and approval lies entirely with the individuals involved, as described herein.

This section details the change processes for flight rules. Due to the differences in the way that generic and mission-specific flight rule CR's are handled, separate sections are included for each.

In general, the flight rules change process starts when the need is identified (by anyone in the technical community) to change or delete an existing flight rule or to add a new rule. **The CR initiator's role is key to successful execution of the process, since it is their responsibility to ensure that the change is coordinated with all affected organizations (both internal and external to MOD).** Once initial coordination is complete, the proposed CR is routed through coordinators within the initiator's organization before being submitted to the Flight Director Office for further processing, evaluation, and approval. It is primarily during evaluation and approval that the process differs between generic and mission-specific CR's. Each step in the process is described in greater detail, below.

Also described in this section are several special considerations that need to be taken into account for certain types of rules, an outline of the process for rule changes that are identified during real-time operations, definitions of flight rule deviations, waivers, and violations (and how each are handled), and specific roles and responsibilities of key participants in the flight rules change process.

FLIGHT RULES

2.1 CHANGES TO GENERIC FLIGHT RULES

Throughout this section, key participants are denoted by all capital letters. Roles and responsibilities for each of these participants are described in section 2.5 of this document.

2.1.1 CR Submittal - Generic Rules

- A. INITIATOR prepares new or updated flight rule document using Microsoft Word:
1. NEW RULE: For new flight rule submittals, the rule and its associated rationale must be phrased exactly as it is intended to appear in the flight rules document. Thus, it is recommended that the initiator cut and paste an existing flight rule as the basis for the new rule to ensure proper document formatting. While not mandatory, this will help ensure that the rule will appear properly after approval and also assists greatly in the editing process.
 2. UPDATED RULE: For changes to existing rules, the proposed changes must be made obvious. The initiator should cut and paste the existing flight rule into a new document, accept all revisions (to provide a clean basis for the proposed changes), activate change tracking, and resave the new version in a user directory. This will ensure that the updates are captured to facilitate evaluation and approval, as well as to clearly indicate the changes when the new version of the rule is published.
 3. DELETED RULE: When deleting an entire rule, it is not necessary to attach the rule with strikethroughs shown.
- B. INITIATOR prepares a Workflow CR form for the new or updated flight rule. On the form, note that the "document date" field is automatically filled in with the last publication date of the version of the rules volume to which the change is being made. The Microsoft Word document file (produced above) containing the new or modified rule is attached to the CR form. Obviously, no file attachment is needed for rule deletions. The INITIATOR coordinates the change with all disciplines affected by the CR and then submits the CR to their organization's DIVISION CR COORDINATOR.
- C. DIVISION CR COORDINATOR reviews and approves the CR, resulting in formal submittal to the Flight Director Office. The purpose of this step is to ensure full and proper coordination within and external to the initiator's organization before the CR is formally submitted to the Flight Director Office. Each organization must establish its own process for this step, which is expected to include peer review, internal management review, and appropriate coordination with other affected disciplines, where applicable. Note that any time a CR is "approved with modification" during this step, it is the responsibility of the DIVISION CR COORDINATOR to ensure that the INITIATOR is aware of the changes made after their original submittal. This step is performed electronically via Workflow. A disposition of approve (or approve with modification) by the DIVISION CR COORDINATOR results in the CR being automatically submitted to the Flight Director Office.
- D. NOTE FOR NON-MOD ORGANIZATIONS: While organizations outside of MOD are welcome to independently submit CR's directly to the Flight Director Office, they are encouraged to submit them through the appropriate MOD division to ensure proper review and coordination with the flight control discipline responsible for that rule section.

FLIGHT RULES

2.1.2 CR Evaluation - Generic Rules

- A. DA8 FLIGHT RULES CR COORDINATOR assigns the CR to the appropriate DA8 SECTION COORDINATOR. The FD Mission Assignments document can be accessed on the DA8/Flight Director homepage at <http://mod.jsc.nasa.gov/da8/Default.aspx>.
- B. DA8 SECTION COORDINATOR reviews the CR for technical merit, clarity, and completeness. Questions and additional changes are coordinated directly with the initiator, and if necessary, additional internal peer review and evaluation may be performed. Once the DA8 SECTION COORDINATOR is satisfied that the CR is ready for evaluation by the FRCB/JFRCB (which may involve revisions to the CR), mandatory evaluators are selected, IP impacts are identified, and concurrence on the CR is provided. This concurrence automatically reassigns the CR to the DA8 FLIGHT RULES CR COORDINATOR for further processing.
- C. DA8 FLIGHT RULES CR COORDINATOR assigns the CR for approval at a future FRCB/JFRCB and sends it (via Workflow) to all board members and any other evaluators that were selected by the DA8 SECTION COORDINATOR.

NOTE: CR's must arrive at this step no later than 3 weeks prior to the next FRCB/JFRCB to be included on the agenda for that meeting. CR's submitted after the deadline may be scheduled on the agenda at the discretion of the Board Chair.

- D. FRCB/JFRCB MEMBERS/OTHER EVALUATORS review the CR and provide their evaluation/disposition via the Workflow System. Where applicable, this review must include an assessment of impact to CIL retention rationale and related Orbiter or payload hazard reports (reference section 2.3). For all proposed changes to CIL/HC-related flight rules, the rationale must be approved by the respective Program before the CR may be placed on the FRCB/JFRCB agenda.

NOTE: It is the responsibility of each FRCB/JFRCB member to coordinate their response such that their disposition accurately and completely reflects the formal position of their organization.

FLIGHT RULES

2.1.3 CR Approval - Generic Rules

- A. **GENERAL:** All generic CR's are dispositioned by the FRCB/JFRCB as approved, approved with modification, disapproved, or deferred. The FRCB/JFRCB will consider each CR based on its impact on operations, its impact on documented hazard controls or CIL retention rationale, and its technical justification. Approved or Approved with Mod CR's will be incorporated into the next page change notice (PCN) or revision to the associated rules volume. Disapproved CR's will be returned to the initiator along with the reason for disapproval, and may be appealed to the Level II Program Office, if desired. If all mandatory concurrences have not been received, or if additional data or analysis is deemed necessary by the board, then a CR will be deferred. Deferred CR's will be rescheduled for a subsequent FRCB/JFRCB meeting.
- B. Each CR will be classified in one of the following categories for FRCB processing:
1. **SIGNIFICANT CHANGES:** Whenever mandatory evaluators are selected by the DA8 Section Coordinator, the CR is automatically considered "significant" and the initiator (or designated representative) is required to present and discuss the proposed change at the FRCB meeting. These CR's are identified on the agenda with an asterisk. After the presentation, the board chair will poll the board members for approval and provide final disposition of the CR. Associated action items (if any) will be assigned at this time.
 2. **MINOR CHANGES:** For format-only changes, or when no mandatory review assignments have been made, the FRCB/JFRCB Chairman may approve the CR without formal presentation to the board as long as an approved disposition was received from all board members during the evaluation process. Each board member has the authority to disagree with this disposition, however, and the initiator (or designated representative) is expected to be present at the meeting to discuss the change in the event this occurs.
 3. **EDITORIAL CHANGES:** Editorial changes, to correct typographical errors if there are no other changes on the page concerned, do not require FRCB/JFRCB disposition.
- C. **DOCUMENTATION OF CR DISPOSITION:** FRCB/JFRCB minutes are published to document the disposition of each CR discussed at that board meeting, new action items assigned, and status of existing action items.
- D. **POST-FRCB/JFRCB PROCESSING:** CR's will be processed by the Book Manager, acting on behalf of the FRCB/JFRCB Chair, in accordance with the FRCB/JFRCB CR disposition status documented in the minutes.

FLIGHT RULES

- E. FINAL APPROVAL: CR's to generic rules volumes are collected by the Flight Director Office into either PCN's or complete revisions. The PCN or revision is then scheduled for final approval at the appropriate Program board meeting.

Five days before the respective board is convened, the DA8 Editor sends an e-mail note to a predetermined contact list that the Advance Copy, which contains the rules that will be briefed to that board, has been posted on the Flight Director Office website at <http://mod.jsc.nasa.gov/Da8/>.

At the Board meeting, the DA8 VOLUME COORDINATOR briefs the contents of the document, with emphasis on significant changes and issues that affect Program policies. The Board Chair polls the board and issues final disposition and actions, as necessary.

1. Volume A: Approved by the Chief, Flight Director Office; Director, Mission Operations; and Manager, Space Shuttle Program (PRCB).
2. Volumes B, D, E, F: Approved by the Chief, Flight Director Office; Director, Mission Operations; and Manager, Space Station Program (SSPCB).
3. Volume C: Approved by the Chief, Flight Director Office; Director, Mission Operations; Manager, Space Shuttle Program; and Manager, Space Station Program (JPRCB).

FLIGHT RULES

2.2 CHANGES TO MISSION-SPECIFIC ANNEX FLIGHT RULES

Throughout this section, key participants are denoted by all capital letters. Roles and responsibilities for each of these participants are described in section 2.5 of this document.

An initial version (called "Basic") of the mission-specific flight rules annex is prepared for each mission's Flight Operations Review (FOR) data pack and placed under configuration control (reference section 3.1.2) The FOR website can be accessed at <http://mod.jsc.nasa.gov/for/fordn/FORDNweb.html>. At FOR, changes are processed and approved via Discrepancy Notice (DN), resulting in a post-FOR "Basic, Revision" nomenclature. All subsequent changes to the annex documents are then processed via CR, as described in this section.

2.2.1 CR Submittal - Mission-Specific Annex Rules

- A. INITIATOR prepares new or updated flight rule document using Microsoft Word:
1. **NEW RULE:** For new flight rule submittals, the rule and its associated rationale must be phrased exactly as it is intended to appear in the flight rules document. Thus, it is recommended that the initiator cut and paste an existing flight rule as the basis for the new rule to ensure proper document formatting. While not mandatory, this will help ensure that the rule will appear properly after approval and also assists greatly in the editing process.
 2. **UPDATED RULE:** For changes to existing rules, the proposed changes must be made obvious. The initiator should cut and paste the existing flight rule into a new document, accept all revisions (to provide a clean basis for the proposed changes), activate change tracking, and resave the new version in a user directory. This will ensure that the updates are captured to facilitate evaluation and approval, as well as to clearly indicate the changes when the new version of the rule is published.
 3. **DELETED RULE:** When deleting an entire rule, it is not necessary to attach the rule with strikethroughs shown.
- B. INITIATOR prepares a Workflow CR form for the new or updated flight rule. On the form, note that the "document date" field is automatically filled in with the last publication date of the version of the rules annex to which the change is being made. The Microsoft Word document file (produced above) containing the new or modified rule is attached to the CR form. Obviously, no file attachment is needed for rule deletions. The INITIATOR coordinates the change with all disciplines affected by the CR and then submits the CR to their organization's DIVISION CR COORDINATOR.
- C. DIVISION CR COORDINATOR reviews and approves the CR, resulting in formal submittal to the Flight Director Office. The purpose of this step is to ensure full and proper coordination within and external to the initiator's organization before the CR is formally submitted to the Flight Director Office. Each organization must establish its own process for this step, which is expected to include peer review, internal management review, and appropriate coordination with other affected disciplines, where applicable.

FLIGHT RULES

Note that any time a CR is “approved with modification” during this step, it is the responsibility of the DIVISION CR COORDINATOR to ensure that the INITIATOR is aware of the changes made after their original submittal). This step is performed electronically via Workflow. A disposition of approve (or approve with modification) by the DIVISION CR COORDINATOR results in the CR being submitted and routed to the Lead Flight Director for that mission for disposition.

NOTE FOR NON-MOD ORGANIZATIONS: While organizations outside of MOD are welcome to independently submit CR’s directly to the Flight Director Office, they are encouraged to submit them through the appropriate MOD division to ensure proper review and coordination with the flight control discipline responsible for that rule section.

2.2.2 CR Evaluation - Mission-Specific Annex Rules

- A. The Workflow DATABASE EDITORS have assigned the LEAD FLIGHT DIRECTORS to their respective missions. Therefore, the Workflow System automatically assigns the CR to the appropriate LEAD FLIGHT DIRECTOR for that mission.

NOTE: From this point on, the mission-specific annex CR process differs greatly from the generic CR process.

- B. LEAD FD reviews the CR for technical merit, clarity, and completeness. Questions and additional changes are coordinated directly with the initiator, and if necessary, additional internal peer review and evaluation may be performed.
- C. LEAD FD then conducts a community review of the CR, with representation appropriate for the change. The LEAD FD has the responsibility and authority to select only those evaluators that they deem mandatory based on the nature of the change. The evaluation itself may be conducted by any means: verbally, e-mail, in small group meetings, or in Flight Techniques Panel/Joint Operations Panel meetings. It is the LEAD FD’s responsibility during this step to ensure that all affected organizations and IP’s are included in the evaluation, which is essentially equivalent to the entire FRCB process for generic CR’s. Once the evaluation is complete, and any identified changes have been made, the CR is ready for approval.

FLIGHT RULES

2.2.3 CR Approval - Mission-Specific Rules

- A. LEAD FD approves the CR, following the completion of the evaluation process above.
- B. FINAL ANNEX COMPILATION: After “Basic, Revision A” publication (post-FOR, reference section 3.1.2), CR’s are collected and incorporated to produce the “Final” annex book (or, as necessary, revisions to the “Final” book or PCN’s to the “Final” book). The resulting document is scheduled for final approval at the appropriate Program board: PRCB, SSPCB, or JPRCB.
 - 1. Shuttle-only annexes: Approved by the Chief, Flight Director Office; Director, Mission Operations; and Manager, Space Shuttle Program (via PRCB).
 - 2. ISS-only annexes: Approved by the Chief, Flight Director Office; Director, Mission Operations; and Manager, Space Station Program (via SSPCB).
 - 3. Joint Shuttle/ISS annexes: Approved by the Chief, Flight Director Office; Director, Mission Operations; Manager, Space Shuttle Program; and Manager, Space Station Program (via JPRCB).
- C. FINAL ANNEX APPROVAL: CR’s are collected by the Flight Director Office into either a Final revision or PCN’s. The revision or PCN is then scheduled for final approval at the appropriate Program board meeting.

An “Advance” copy of the Final document and PCN’s is provided for review, by the affected Program Board members, 5 working days prior to the scheduled Board presentation. Note that in some cases CR’s may be received and processed after Advance Copy distribution.

At the Board meeting, the LEAD FD briefs the contents of the revision or PCN, with emphasis on significant changes and mission-specific issues that affect Program policies. The Board Chair polls the board and issues final disposition and actions, as necessary.

- D. SUBSEQUENT PCN’S: L-2 weeks to L-2 days, subsequent PCN’s will be briefed to the L-2 Day MMT meeting.

FLIGHT RULES

2.3 SPECIAL CONSIDERATIONS

Several special cases of flight rules require unique considerations when processing CR's related to them. These include critical items list items, hazard controls, and mission specific exceptions.

2.3.1 Critical Items List (CIL) Identification

Some flight rules provide controls for Orbiter CIL items. The title of these rules will contain a "[CIL]" tag (including brackets) to clearly identify this relationship. The use of the "[CIL]" tag will be limited to subjects with approved CIL's in place. Additionally, the "documentation" part of the rationale will include CIL references only when the CIL is driving the core rationale for the flight rule. When a change to a CIL-related flight rule is submitted, its impact (if any) on the associated CIL retention rationale must be assessed before it can be approved. If a change to the retention rationale is required, then the change will not be incorporated until a corresponding change to the impacted CIL retention rationale is approved by the Shuttle Programs. The Space Shuttle Program Critical Items List can be accessed at <http://usa1.unitedspacealliance.com/hq/warehouse/ssp/>.

2.3.2 Hazard Control (HC) Requirements

Some flight rules provide controls for identified Orbiter or ISS hazards. These rules are identified in their titles by an "[HC]" tag and are limited to subjects with approved Operational Control Agreement Documents (OCAD's) or approved Hazard Reports (for Russian subjects) in place. HC-related flight rule rationale will be included only when an OCAD or Hazard Report is driving the core rationale for the flight rule. When a CR to an HC-designated flight rule is submitted, its impact (if any) on the associated OCAD or Hazard Report must first be assessed before the CR can be approved.

If a change to the associated OCAD or Hazard Report is required, then the flight rule CR will not be approved until the corresponding change to the impacted OCAD or Hazard Report is approved by the Shuttle or ISS Program, as appropriate. Note: Editorial changes that solely add the HC designation to a rule title, or add a Hazard Report reference to a rule rationale, will not be accepted; HC will only be added when a technical change is being made or when a new rule is being processed. The Space Shuttle Program Hazard Reports can be accessed at <http://usa1.unitedspacealliance.com/hq/warehouse/ssp/>.

NOTE: Editorial changes (via Flight Operations Review (FOR) Discrepancy Notice (DN) or CR) that solely add the [HC] designation to a rule title, or add a Hazard Report reference to a rule rationale, will not be accepted by the Flight Director Office. When a DN or CR is submitted to change an existing rule or to add a new rule, then the [HC] designation and/or hazard report references are expected as part of those change requests.

FLIGHT RULES

2.3.3 Mission-Specific Exceptions

Shuttle: Per rule A1-55, Conflicting Flight Rules, some generic Shuttle flight rules have the recurring potential for flight-specific options or exceptions. In those cases, the options or exceptions are documented in the associated mission-specific flight rules annex. Per Space Shuttle Program direction, mission-specific exceptions to any other generic Shuttle flight rules must be processed and approved as a permanent change or as a deviation to the applicable generic flight rules.

ISS: Per rule B1-54, Conflicting Flight Rules, mission/increment-specific rules in the flight rules annex that are identified as exceptions to generic rules take precedence. The ISS Program has deemed that approval of the annex rule constitutes agreement with the exception.

FLIGHT RULES

2.4 REAL-TIME CR'S, DEVIATIONS, WAIVERS, AND VIOLATIONS

Flight rules are written to establish pre-planned decisions and reduce the amount of discussion and rationalization when responding to off-nominal situations in real time. In some cases, flight rules are also used to document and provide ready reference to real-time operations policy, especially during time-critical flight phases involving multiple organizations. While every attempt is made to develop rules that are complete and accurate, there are times when flight rules must be changed in real time, deviated from, or waived. There may also be times when a published rule is violated. The purpose of this section is to define those conditions, how they will be documented, and when each applies.

2.4.1 Real-Time Flight Rule CR's

Real-time flight rule changes are those that are required while the associated vehicle is in flight, and when conditions are such that the change is needed in the short-term and cannot be processed in a timely manner using normal CR procedures. For Space Shuttle missions, this is from launch minus 2 days through landing. For continuous ISS operations, the Increment Lead Flight Director will determine whether the Real-Time process is needed, based upon when the change is needed for operational use.

Since the Real-Time Flight Rule change process is initiated by the on-console Flight Control Team, the procedures for the associated CR's may be found in the Shuttle and ISS Flight Control Operations Handbooks (FCOH), JSC-26843 and JSC-29229, respectively. These documents may be found at: <http://mod.jsc.nasa.gov/Da8/FCOH/index.htm>.

2.4.2 Flight Rule Deviations

A flight rule deviation is a special case Real-Time Flight Rule change, required when the intent of a flight rule will be met for a future, planned activity or situation, but the engineering constraint value(s) published in the associated rule will not be met for some reason. The deviation shall be documented using either the Real-Time Flight Rule CR process (reference 2.6.1, above) as a "limited use" change to the applicable flight rule, along with the appropriate rationale, or via MCC chit per ISS FCOH SOP 2.40 (Flight Note, Anomaly Report, and CHIT Communications). Note that deviations apply only in real time and are not applicable for permanent changes, since otherwise the change would simply be written via the normal CR (or Real-Time CR) process. (Forward work remains to synchronize Shuttle and ISS FCOH procedures, after which this section will be revised, as appropriate.)

2.4.3 Flight Rule Waivers

A flight rule waiver is a special case Real-Time Flight Rule change, required when a flight rule (or section of a flight rule), in its entirety, will not be enforced for a future, planned activity or situation. This differs from a deviation in that a waiver results in the rule not applying at all. The waiver shall be documented using either the Real-Time Flight Rule CR process (reference 2.6.1, above) as a "limited use" statement that the associated flight rule is not applicable for the specific situation at hand, along with the appropriate rationale, or via MCC chit per ISS FCOH SOP 2.40 (Flight Note, Anomaly Report, and CHIT Communications). Note that waivers apply only in real time and are not applicable for permanent changes, since otherwise the change would simply be written via the normal CR (or Real-Time CR) process.)Forward work remains to synchronize Shuttle and ISS FCOH procedures, after which this section will be revised, as appropriate.)

FLIGHT RULES

2.4.4 Flight Rule Violations

A flight rule violation occurs when a limit documented in a rule has been exceeded, or when it is known that an exceedance will occur in a timeframe that does not allow action to be taken to avoid it. Note that the “action to be taken” could involve either actual physical reconfiguration of the vehicle (e.g., attitude maneuver, shutdown of an affected system, activation of heaters, etc.) or processing of deviation or waiver documentation. The violation shall be documented via MCC Anomaly Report (AR) to document that the associated flight rule was not honored for the applicable situation, along with the appropriate rationale or explanation. Note that violations apply only in real time for cases where a rule limit was exceeded without prior discussion or agreement. Follow-on work after a violation has occurred may include engineering analysis/evaluation to determine the extent of vehicle damage incurred (if any) or evaluation of potential permanent changes to flight rules (if applicable). In any case, the violation must be documented and raised to Program management, such that lessons learned may be compiled and corrective or preventive actions taken to avoid similar situations in the future.

FLIGHT RULES

2.5 KEY ROLES AND RESPONSIBILITIES

As with any process, the execution is dependent on all participants understanding their roles and responsibilities. This section provides brief descriptions of those roles and responsibilities for key players that are referred to throughout this document.

2.5.1 Initiator

NOTE: The INITIATOR'S role is key to the successful execution of the entire flight rules CR process, since it is their responsibility to ensure that the change is fully coordinated with all affected organizations (both internal and external to MOD) prior to submittal.

Any individual in the technical community may initiate a Flight Rule CR. All initiators will precoordinate with the other disciplines, internal and external to MOD, affected by their CR prior to submitting it for approval. In most cases, after initial coordination is complete the CR will be submitted to a "Division CR Coordinator" who will verify that the appropriate discipline-level review has taken place before the CR is formally input to the Flight Director Office. After submittal, initiators are expected to periodically review the status of their CR to determine whether any reviewers have approved with mod or disapproved their change. The initiator must work with reviewers to attempt to come to an agreement on changes to the CR prior to the FRCB. The initiator is also responsible for coordinating with the applicable Flight Techniques Panel (FTP)/Joint Operations Panel (JOP) chair to present changes to the panel(s).

Initiators from external organizations outside of MOD are allowed to directly and independently submit CR's, but they are fully responsible for coordinating with the MOD discipline responsible for that rules section. Thus, external initiators are encouraged to submit their inputs via their MOD counterparts.

2.5.2 Division CR Coordinator

The Division CR Coordinator is the individual within each MOD Division through whom all CR's are routed. Note that each Division is responsible for determining their own internal process to accomplish this coordination. Also note that, in some cases, the Division coordinator role may be delegated to one or more coordinators at other management levels (e.g., Branch). For the purpose of this change control appendix, the term "Division CR Coordinator" is used throughout, for consistency, although it refers to whichever level has been chosen by each organization.

2.5.3 DA8 Section Coordinator (Generic CR's only)

The Flight Director Office establishes individual Flight Directors as the primary and backup DA8 points-of-contact for coordination of changes to each section within the document. The FD Mission Assignments document can be accessed on the DA8/Flight Director homepage at <http://mod.jsc.nasa.gov/da8/Default.aspx>. The following roles and responsibilities are associated with these DA8 Section Coordinators:

- A. Coordinates with applicable group lead(s) to identify the forward plan for updates, including changes required for the next flight(s)/increment(s), changes that should be "promoted" from flight specific annexes, changes for new hardware/capabilities, etc.
- B. Coordinates planned changes that have applicability to multiple sections with the DA8 Volume Coordinator (section 2.5.4) to package CR's efficiently (e.g., adding IP designator, etc.), and communicates expected change volume to the DA8 Volume Coordinator.

FLIGHT RULES

- C. Reviews CR's and verifies adequate coordination before approving or approving with modification. This includes verifying that the initiator has coordinated with other disciplines (as appropriate), verifying FTP/JOP review of philosophical changes (when applicable), and ensuring that the next several Lead Flight Directors are aware of philosophical and major changes.
- D. Dispositions CR's in their assigned section.

2.5.4 DA8 Volume Coordinator (Generic CR's only)

An individual Flight Director is named to perform overall coordination within DA8 for each generic Flight Rules volume. The FD Mission Assignments document can be accessed on the DA8/Flight Director homepage at <http://mod.jsc.nasa.gov/da8/Default.aspx>. Their roles and responsibilities are as follows:

- A. Works with DA8 Section Coordinators to develop a plan for page change notices (PCN's)/Revisions (e.g., when to publish, what content will be included, etc.).
- B. Creates presentation charts for review at the appropriate board meeting:
 - 1. Flight Operations Integrated Control Board (FOICB)/Program Requirements Control Board (PRCB) - Volume A, Space Shuttle Operational Flight Rules
 - 2. Multilateral Operations Integration Control Board (MOICB)/Space Station Program Control Board (SSPCB) - Volumes B, ISS Generic Operational Flight Rules; D, Soyuz/Progress ISS Joint Flight Rules; E, Automated Transfer Vehicle (ATV)-ISS Joint Flight Rules; or F, H-II Transfer Vehicle (HTV)-ISS Joint Flight Rulesor
 - 3. Joint Mission Integration Control Board (JMICB)/Joint Program Requirements Control Board (JPRCB) (Volume C, Joint Shuttle-ISS Operational Flight Rules).
- C. Reviews presentation charts with DA8 Assistant to the Chief for Shuttle (Volumes A, C) and DA8 Assistant to the Chief for ISS (Volumes B, C, D, E, F), provides courtesy copies to DA8 Chief, MOD Director, MOD Deputy Director, MOD Shuttle Manager (Volumes A, C), and MOD Station Manager (Volumes A, B, C, D, E, F).
- D. Coordinates with the DA8 Program Integration team to schedule Program review.
- E. Presents charts at Program review.
- F. Signs PCN's/Revisions.

FLIGHT RULES

2.5.5 Lead Flight Director (Mission-Specific Annex CR's only)

The Lead Flight Director's role is critical for mission-specific changes. Due to the sometimes rapid development of operations philosophies and techniques in the pre-mission preparation timeframe, the FRCB process is not used. The Lead Flight Director has the authority, as delegated from the Programs, to approve flight rules CR's directly. In doing so, the Lead Flight Director is therefore responsible for verifying that proper coordination has been done with all Program elements, in lieu of the FRCB. When required, this coordination may be done through mission-specific Flight Techniques Panel meetings, Joint Operations Panel Meetings, and other meetings/discussions as deemed necessary. For joint Shuttle/ISS flight rules, both the Shuttle Lead FD and the ISS Lead FD work in concert to accomplish this coordination.

2.5.6 DA8 Flight Rules CR Coordinator (Generic CR's only)

The DA8 Flight Rules CR Coordinator is responsible for facilitating all generic CR traffic in Workflow and for scheduling CR's at the FRCB/JFRCB.

2.5.7 FRCB Members/Other Evaluators

It is the responsibility of each FRCB member to coordinate their evaluation such that their disposition accurately and completely reflects the formal position of their organization. CR evaluators (FRCB member or other evaluator) will inform the CR initiator when disapproving or approving with modification so that the CR Initiator has an opportunity prior to the FRCB to resolve any issues or disagreements.

NOTE: Prior to each FRCB meeting, it is critical that each FRCB member fully understand, and have the authority to speak for, their organization's position with respect to each CR scheduled for disposition at that meeting.

2.5.8 DA8 Flight Rules Book Manager

- A. Generic CR's Only - The DA8 Generic Flight Rules Book Manager coordinates the CR's after disposition at the FRCB/JFRCB.
- B. Mission-Specific CR's Only - The DA8 Annex Flight Rules Book Manager coordinates the CR's after disposition by the Lead Flight Directors.

FLIGHT RULES

2.6 CHANGE REQUEST PROCEDURES

This appendix defines the overall process for flight rules change control, including key definitions and roles and responsibilities. The actual, mechanical procedures for operation of the Workflow system for flight rules CR's are available in Workflow itself. After logging into Workflow, they may be accessed by selecting "HELP," then "User's Guides," then the "FRCR User's Guide" link.

The FRCR User's Guide is extremely detailed and contains comprehensive, step-by-step procedures from CR submittal through approval, implementation, publication, and distribution. Specific procedures are provided for each step and for each type of user: Initiator, Reviewer, Group Lead, Branch Chief, Flight Rules Control Board (FRCB)/Joint Flight Rules Control Board (JFRCB) Representative, Flight Director, FRCR Coordinator, FRCB Chair, etc. Separate sections are provided for generic and mission-specific CR's. Mandatory inputs, optional inputs, overall responsibilities, and special points of interest are noted for each step/user.

NOTE: Any personnel involved in the Flight Rules change process must be very familiar with both the Workflow FRCR User's Guide described above and this change control appendix, especially with respect to the sections applicable to their current role(s) in the CR process.

FLIGHT RULES

3.0 FLIGHT RULES DOCUMENT MANAGEMENT

3.1 DOCUMENT PUBLICATION

3.1.1 Generic Flight Rules Document Publication

Publication of All Flights documents (Volumes A, B, C, D, E, and F) originating as either initial documents or complete revisions are scheduled periodically based on historical change traffic and to facilitate ease in document maintenance.

After initial release of generic volumes in their "Final" form, subsequent revisions will be in the form of PCN's, depending on CR traffic and mission requirements.

The current schedule for each document may be obtained from the appropriate Book Manager.

3.1.2 Mission-Specific Annex Flight Rules Document Publication

Initial publication of annexes will be in "Basic" form and provided for the Flight Operations Review (FOR) data pack distribution at approximately L-4 months for Space Shuttle only missions and at L-5 months for Joint Shuttle/ISS missions. Post-FOR, the flight rules will be published in "Basic, Revision" form and distributed in time to support flight-specific simulations. The "Final" approval process takes place at approximately L-1 month. Subsequent PCN's may be processed as long as they are initiated no later than L-2 weeks. After that point, changes will be processed real time per JSC-26843, Flight Control Operations Handbook (FCOH) Shuttle Operations, SOP 1.2.1, Real-Time Flight Rules Changes. Prior to liftoff, PCN's will be presented to the L-2 Mission Management Team (MMT) or Tanking MMT meetings instead of the Shuttle Program Board so that these changes are available in the MCC at L-1 day. After liftoff, changes will be presented at the MMT meetings. After Shuttle landing, changes will be presented to the International Space Station Mission Management (IMMT) meetings, per JSC-29279, FCOH Station Operations, SOP 2.6, Real-Time Flight Rules Changes.

The current schedule for any specific annex document may be obtained from the appropriate Book Manager or Lead Flight Director. The milestone table below is used by the DA8 Flight Rules Support Group to determine publication dates.

Shuttle and ISS Milestones for Flight Rules Publication

Milestone	Shuttle Only	Shuttle/ISS
Start Process	L - 7 months	L - 8 months
Preliminary	N/A	L - 7 months
Basic	L - 4 months	L - 5 months
FOR	L - 3 months	L - 4 months
Basic, Rev A	L - 2 months	L - 3 months
Final	L - 1 month	L - 1 month
PCN	L - 2 weeks	L - 2 weeks
Pen & Ink	L - 2 days	L - 2 days
Launch	L - 0 months	L - 0 months
Real-Time CR's	During Flight	During Increment

FLIGHT RULES

3.2 DOCUMENT DISTRIBUTION

Hard copy publications will be printed and distributed through normal administrative channels. Electronic access via the Flight Director Office web site is encouraged. All of the current Flight Rules documents are available at <http://mod.jsc.nasa.gov/da8/Default.aspx>.

WARNING

While web links to the Flight Rules web site are permissible, documents downloaded from that location are not to be placed on other systems.

The JSC Flight Director Office is the only official disseminator of these documents.

FLIGHT RULES

3.3 QUALITY ASSURANCE REVIEWS

3.3.1 Flight Rules Document Accuracy QA

All flight rules documents are reviewed for technical accuracy not less frequently than once a year. Division representatives to the FRCB/JFRCB oversee this review. Due to the high usage of flight rules during mission operations and simulations, and the resulting high volume of change traffic, additional reviews occur as a matter of ongoing business in between the formal reviews.

3.3.2 Flight Rules Change Process QA

This flight rules change control appendix is reviewed for process evaluation not less frequently than once every 2 years.

3.3.3 CR Nonconformance Reporting

If an error is discovered while reviewing an incorporated flight rule CR, the Book Manager must be notified of the nonconformance as soon as possible. The Book Manager will initiate the processing of an "errata" PCN to correct the error, and will document the nonconformance using internal DA8 and USA processes. A verified nonconformance will result in the initiation of a metric input and follow-up corrective action, as appropriate.

FLIGHT RULES

THIS PAGE INTENTIONALLY BLANK

FLIGHT RULES

APPENDIX C

INDEX OF WAIVERS

1.0	INTRODUCTION.....	C-1
1.1	PURPOSE.....	C-1
1.2	SCOPE.....	C-1
	LIST OF WAIVERS.....	C-2

FLIGHT RULES

THIS PAGE INTENTIONALLY BLANK

FLIGHT RULES

APPENDIX C

INDEX OF WAIVERS

1.0 INTRODUCTION

1.1 PURPOSE

APPENDIX C CONTAINS THE LIST OF WAIVERS TO THE NSTS 12820, SPACE SHUTTLE OPERATIONAL FLIGHT RULES ALL FLIGHTS DOCUMENT, VOLUME A.

1.2 SCOPE

EACH WAIVER IS APPROVED BY THE SPACE SHUTTLE PROGRAM REQUIREMENTS CONTROL BOARD FOR THE FLIGHT EFFECTIVITY AS SPECIFIED. WAIVERS THAT HAVE BEEN APPROVED FOR MULTIPLE FLIGHTS ARE CURRENT AND IN EFFECT UNLESS THEY ARE IDENTIFIED AS HAVING BEEN RESCINDED BY THE PROGRAM OFFICE BOARD.

THE FLIGHT OPERATIONS TEAM IS RESPONSIBLE FOR IMPLEMENTATION OF THE WAIVERS TO THE OPERATIONS FLIGHT RULES THAT HAVE BEEN APPROVED BY THE SPACE SHUTTLE REQUIREMENTS CONTROL BOARD AS SPECIFIED BY THE PRCB DIRECTIVE SIGNED BY THE CHAIR.

FLIGHT RULES**LIST OF WAIVERS**

NUMBER	TITLE	FLIGHT EFFECTIVITY	PRCB DIRECTIVE
1	WAIVER TO SPACE SHUTTLE OPERATIONAL FLIGHT RULES, ALL FLIGHTS DOCUMENT FOR STS-52	STS-52	S063689Q
2	WAIVER TO SPACE SHUTTLE OPERATIONAL FLIGHT RULES, ALL FLIGHTS DOCUMENT FOR STS-66	STS-66	S063689BQ
3	WAIVER TO SPACE SHUTTLE OPERATIONAL FLIGHT RULES, ALL FLIGHTS DOCUMENT FOR STS-71	STS-71	S063689CH
4	WAIVER TO SPACE SHUTTLE OPERATIONAL FLIGHT RULES, ALL FLIGHTS DOCUMENT FOR STS-75	STS-75	S063689CT
5	WAIVER TO SPACE SHUTTLE OPERATIONAL FLIGHT RULES, ALL FLIGHTS DOCUMENT FOR STS-76	STS-76	S063689CU
6	WAIVER TO SPACE SHUTTLE OPERATIONAL FLIGHT RULES, ALL FLIGHTS DOCUMENT FOR STS-94	STS-94	S063689DW
7	WAIVER TO SPACE SHUTTLE OPERATIONAL FLIGHT RULES, ALL FLIGHTS DOCUMENT FOR STS-95	STS-95	S063689EL
8	WAIVER TO SPACE SHUTTLE OPERATIONAL FLIGHT RULES, ALL FLIGHTS DOCUMENT FOR STS-108	STS-108	S063689FB

®[ED]

FLIGHT RULES

APPENDIX D

HAZARD REPORT/CIL CROSS-REFERENCE

1.0	INTRODUCTION.....	D-1
1.1	PURPOSE.....	D-1
1.2	GENERAL.....	D-1
2.0	UPDATE PROCEDURE.....	D-1
2.1	RESPONSIBLE PARTY.....	D-1
2.2	CURRENCY REQUIREMENT.....	D-1
3.0	USER INFORMATION.....	D-2
3.1	COLUMN IDENTIFICATION.....	D-2
3.2	LINK EXECUTION.....	D-2
4.0	FLIGHT RULE/HAZARD REPORT/CIL CROSS REFERENCE TABLE.....	D-2

FLIGHT RULES

THIS PAGE INTENTIONALLY BLANK

FLIGHT RULES

APPENDIX D

HAZARD REPORT/CIL CROSS-REFERENCE

1.0 INTRODUCTION @[012402-5144]

1.1 PURPOSE

THIS APPENDIX PROVIDES A CROSS-REFERENCE BETWEEN THE FLIGHT RULES, HAZARD REPORTS (HR'S), AND CRITICAL ITEMS LIST (CIL). THIS MATRIX FULFILLS THE REQUIREMENT DOCUMENTED IN NSTS 22206, REQUIREMENTS FOR PREPARATION AND APPROVAL OF FAILURE MODES AND EFFECTS ANALYSIS (FMEA) AND CRITICAL ITEMS LIST (CIL), FOR MISSION OPERATIONS DIRECTORATE (MOD) TO CONTROL AND MAINTAIN A DATABASE WHICH CORRELATES CIL'S WITH APPLICABLE FLIGHT RULES/CREW PROCEDURES.

1.2 GENERAL

FLIGHT RULE TITLES ARE CURRENTLY FLAGGED WITH "[HC]" AND "[CIL]" IN ORDER TO IDENTIFY THEIR RELATIONSHIP TO THE SPACE SHUTTLE PROGRAM HAZARD REPORTS (HR) AND CRITICAL ITEMS LIST (CIL). THIS APPENDIX PROVIDES THE CROSS REFERENCE FROM FLIGHT RULES TO THE ASSOCIATED HR'S AND CIL'S. NOTE: THERE IS A DIRECT ONE-TO-ONE CORRELATION BETWEEN THE FLIGHT RULE AND THE HR CAUSE. THERE IS ALSO A DIRECT CORRELATION BETWEEN THE HR CAUSE AND THE CIL'S. HOWEVER, THE CORRELATION BETWEEN THE FLIGHT RULES AND CIL'S IS NOT DIRECT. CIL EXAMINATION IS THEREFORE REQUIRED TO DETERMINE ITS APPLICABILITY TO THE FLIGHT RULE UNDER CONSIDERATION (I.E., A CIL APPLICABLE ONLY TO ASCENT/ENTRY WOULD NOT APPLY TO AN ON-ORBIT FLIGHT RULE).

2.0 UPDATE PROCEDURE

2.1 RESPONSIBLE PARTY

THIS APPENDIX WILL BE UPDATED WITH THE CHANGE REQUEST PROCEDURE THROUGH THE FLIGHT RULES CONTROL BOARD (FRCB) AS CORRECTIONS AND MODIFICATIONS ARE REQUIRED.

2.2 CURRENCY REQUIREMENT

HAZARD REPORTS AND CIL'S HAVE CURRENCY REQUIREMENTS. THIS APPENDIX IS NOT THE CONTROLLING DOCUMENT FOR HR OR CIL CURRENCY; THE USER MUST REFER TO THE APPROPRIATE PROGRAM DOCUMENTATION FOR CURRENCY OF THESE CROSS-REFERENCE ITEMS. @[012402-5144]

FLIGHT RULES

3.0 USER INFORMATION @[012402-5144]

3.1 COLUMN IDENTIFICATION

OLD FLIGHT RULE # - OLD FLIGHT RULE NUMBER

NEW FLIGHT RULE # - NEW FLIGHT RULE NUMBER

HR & CAUSE # - HAZARD REPORT NUMBER AND CAUSE NUMBER

EXAMPLE: "ORBI-086B A" STANDS FOR ORBITER HAZARD REPORT 086, REVISION B, CAUSE A. THERE IS A DIRECT CORRELATION BETWEEN THE HAZARD CAUSE AND THE FLIGHT RULE IDENTIFIED TO MITIGATE THE HAZARDOUS SITUATION.

CIL # - CRITICAL ITEMS LIST NUMBER

THIS NUMBER IS CORRELATED TO THE FLIGHT RULE BY WAY OF THE HAZARD REPORT CAUSE. THE CIL FAILURE MODE IS USUALLY (BUT NOT ALWAYS) RELATED TO THE FLIGHT RULE.

3.2 LINK EXECUTION

IF THIS DOCUMENT IS ACCESSED ON THE FLIGHT DIRECTOR OFFICE WEB SITE, ALL ASSOCIATED LINKS TO FLIGHT RULES CAN BE TRAVERSED. HOWEVER, THE LINKS TO HAZARD REPORTS OR CRITICAL ITEMS MAY NOT BE TRAVERSABLE. THOSE DOCUMENTS ARE NOT LOCATED ON THE SAME SERVER WITH THIS DOCUMENT AND ARE SUBJECT TO SECURITY RESTRICTION ON THE USA WEB SERVER.

4.0 FLIGHT RULE/HAZARD REPORT/CIL CROSS REFERENCE TABLE @[012402-5144]

VOLUME A KEY

PLEASE NOTE THAT THE NUMBERING IN SECTIONS 5, 6, 7, 10, AND 13 HAS BEEN REORDERED. ALL GO/NO-GO CRITERIA RULES ARE NUMBERED WITH THE SECTION NUMBER AND THEN RULE NUMBER 1001. EXAMPLE: A6-1001.

NEW RULE # **OLD RULE #** **RULE TITLE**

SECTION A1 - OPERATIONS POLICY, GENERAL, AND DEFINITIONS

OPERATIONS POLICY

A1-1	A1.1.1-1	FLIGHT RULE PURPOSE
A1-2	A1.1.1-2	REAL-TIME OPERATING POLICY
A1-3	A1.1.1-3	PROGRAM LIFETIME OPERATING POLICY
A1-4	A1.1.1-4	MISSION MANAGEMENT TEAM (MMT) AUTHORITY
A1-5	A1.1.1-5	FLIGHT DIRECTOR AUTHORITY
A1-6	A1.1.1-6	SHUTTLE COMMANDER AUTHORITY
A1-7	A1.1.1-7	FLIGHT CONTROL ROOM (FCR) SURGEON AUTHORITY
NONE	A1.1.1-8	RESERVED
A1-8	A1.1.1-9	WEATHER DECISION AUTHORITY
A1-9	A1.1.1-10	POSTLANDING DECISION AUTHORITY
A1-10	A1.1.1-11	POSTLANDING EMERGENCY DECLARATION
A1-11	A1.1.1-12	SEARCH AND RESCUE RESPONSIBILITY
A1-12	A1.1.1-13	ORBITER EMERGENCY LANDING SITE (ELS) AUTHORITY
A1-13	A1.1.1-14	MCC REAL-TIME COMMAND COORDINATION POLICY
		A1-14 THROUGH A1-50 RULES ARE RESERVED

GENERAL

A1-51	A1.1.2-1	VEHICLE SYSTEM LIMITS
A1-52	A1.1.2-2	INTERIM OR UNCONFIRMED LIMITS
A1-53	A1.1.2-3	MANDATORY INSTRUMENTATION REQUIREMENTS
A1-54	A1.1.2-4	FAILURE DEFINITION APPLICATION
A1-55	A1.1.2-5	CONFLICTING FLIGHT RULES
A1-56	A1.1.2-6	INSTRUMENTATION ONBOARD VS. GROUND READOUT PHILOSOPHY
A1-57	A1.1.2-7	FLIGHT-CRITICAL MODING
A1-58	A1.1.2-8	SHUTTLE OPERATIONAL DATA BOOK (SODB), VOLUME III, DATA USE
A1-59	A1.1.2-9	ACTIVITIES DURING YEAR END ROLLOVER/LEAP SECOND INCORPORATION
		A1-60 THROUGH A1-100 RULES ARE RESERVED

GENERAL DEFINITIONS

A1-101	A1.1.3-1	AS SOON AS PRACTICAL (ASAP)
A1-102	A1.1.3-2	HIGHLY DESIRABLE (HD)
A1-103	A1.1.3-3	MANDATORY (M)
A1-104	A1.1.3-4	FLIGHT PHASE
A1-105	A1.1.3-5	THROTTLE SETTINGS
A1-106	A1.1.3-6	LANDING SITES
A1-107	A1.1.3-7	LANDING OPPORTUNITIES
A1-108	A1.1.3-8	POSTLANDING CREW EGRESS/ESCAPE MODES
A1-109	A1.1.3-9	CREW MEDICAL (MED) CONDITIONS
A1-110	A1.1.3-10	REMOTE MANIPULATOR SYSTEM (RMS)
A1-111	A1.1.3-11	TIME REFERENCE DEFINITIONS
A1-112	A1.1.3-12	MULTIFUNCTION ELECTRONIC DISPLAY SUBSYSTEM

SECTION A2 - FLIGHT OPERATIONS

PRELAUNCH

A2-1	A2.1.1-1	PRELAUNCH GO/NO-GO REQUIREMENTS
A2-2	A2.1.1-2	ABORT LANDING SITE REQUIREMENTS
A2-3	A2.1.1-3	LAUNCH HOLD
A2-4	A2.1.1-4	LAUNCH DAY CREW TIME CONSTRAINTS
A2-5	A2.1.1-5	PORT MODING/RESTRINGING GUIDELINES
A2-6	A2.1.1-6	LANDING SITE WEATHER CRITERIA [HC]
A2-7	A2.1.1-7	DAY-OF-LAUNCH ET LOAD DATA
A2-8	A2.1.1-8	LAUNCH TIME SELECTION FOR GROUND-UP RENDEZVOUS
		A2-9 THROUGH A2-50 RULES ARE RESERVED

ASCENT

A2-51	A2.1.2-1	STS ABORT CRITERIA
A2-52	A2.1.2-2	ASCENT MODE PRIORITIES FOR PERFORMANCE CASES
A2-53	A2.1.2-3	FORWARD RCS USAGE GUIDELINES
A2-54	A2.1.2-4	RTLS, TAL, AND AOA ABORTS FOR SYSTEMS FAILURES [CIL]
A2-55	A2.1.2-5	USE OF LOW ENERGY GUIDANCE
A2-56	A2.1.2-6	ABORT GAP
A2-57	A2.1.2-7	CONTINGENCY ASCENTS/ABORTS
NONE	A2.1.2-8	RESERVED
A2-58	A2.1.2-9	ABORT LIGHT

VOLUME A KEY

<u>NEW RULE #</u>	<u>OLD RULE #</u>	<u>RULE TITLE</u>
A2-59	A2.1.2-10	BFS ENGAGE CRITERIA
A2-60	A2.1.2-11	NAVIGATION UPDATE CRITERIA
A2-61	A2.1.2-12	Q-BAR/G-CONTROL
A2-62	A2.1.2-13	ET FOOTPRINT CRITERIA
A2-63	A2.1.2-14	ASCENT STRING REASSIGNMENT
A2-64	A2.1.2-15	MANUAL THROTTLE CRITERIA
A2-65	A2.1.2-16	OMS-1 DELAYED TARGET CRITERIA
A2-66	A2.1.2-17	APU SHUTDOWN DELAY CRITERIA
A2-67	A2.1.2-18	ARD UPDATE CRITERIA
A2-68	A2.1.2-19	ET PHOTOGRAPHY
A2-69	A2.1.2-20	REGAIN RCS JETS FOR RTLS ET SEPARATION A2-70 THROUGH A2-100 RULES ARE RESERVED
ORBIT		
A2-101	A2.1.3-0	VEHICLE SYSTEMS REDUNDANCY DEFINITIONS
A2-102	A2.1.3-1	MISSION DURATION REQUIREMENTS
A2-103	A2.1.3-2	EXTENSION DAY REQUIREMENTS
A2-104	A2.1.3-3	SYSTEMS REDUNDANCY REQUIREMENTS
A2-105	A2.1.3-4	IN-FLIGHT MAINTENANCE (IFM)
A2-106	A2.1.3-5	PBD OPERATIONS [CIL]
A2-107	A2.1.3-6	EVA GUIDELINES
A2-108	A2.1.3-7	CONSUMABLES MANAGEMENT
A2-109	A2.1.3-8	PREFERRED ATTITUDE FOR WATER DUMPS
A2-110	A2.1.3-9	STRUCTURES THERMAL CONDITIONING
NONE	A2.1.3-10	RESERVED
NONE	A2.1.3-11	RESERVED
A2-111	A2.1.3-12	DPS COMMAND CRITERIA
A2-112	A2.1.3-13	PDRS
A2-113	A2.1.3-14	OMS/RCS DOWNMODING CRITERIA
A2-114	A2.1.3-15	OMS/RCS MANEUVER CRITICALITY
A2-115	A2.1.3-16	ENGINE SELECTION CRITERIA
A2-116	A2.1.3-17	RENDEZVOUS (RNDZ)/PROXIMITY OPERATIONS (PROX OPS) DEFINITIONS
A2-117	A2.1.3-18	RNDZ/PROX OPS GNC SYSTEMS MANAGEMENT
A2-118	A2.1.3-19	RNDZ/PROX OPS COMMUNICATION SYSTEMS MANAGEMENT
A2-119	A2.1.3-20	RNDZ/PROX OPS SENSOR REQUIREMENTS
A2-120	A2.1.3-21	RNDZ/PROX OPS DPS SYSTEMS MANAGEMENT
A2-121	A2.1.3-22	RNDZ/PROX OPS PROPULSION SYSTEMS MANAGEMENT
A2-122	A2.1.3-23	RENDEZVOUS MANEUVERS
A2-123	A2.1.3-24	RENDEZVOUS MANEUVER SOLUTION SELECTION CRITERIA
A2-124	A2.1.3-25	RENDEZVOUS MANEUVER EXECUTION
A2-125	A2.1.3-26	RNDZ OPS DELAY
A2-126	A2.1.3-27	RNDZ/PROX OPS BREAKOUT
A2-127	A2.1.3-28	RENDEZVOUS GUIDANCE
A2-128	A2.1.3-29	EMCC/TMCC ACTIVATION
A2-129	A2.1.3-30	ORBITER ON-ORBIT HIGH DATA RATE REQUIREMENTS
A2-130	A2.1.3-31	PAYLOAD OBJECTIVES VS. PAYLOAD DAMAGE POLICY
A2-131	A2.1.3-32	ATTITUDE RESTRICTIONS FOR ORBITAL DEBRIS
A2-132	A2.1.3-33	THERMAL CONDITIONING FOR FLIGHT DAY 1 LANDING
A2-133	A2.1.3-34	POCC THROUGHPUT COMMAND RATES
A2-134	A2.1.3-35	ON-ORBIT CRYO MARGIN BUYBACKS
A2-135	A2.1.3-36	COMMANDER (CDR) AND PILOT (PLT) PARTICIPATING AS TEST SUBJECTS A2-136 THROUGH A2-200 RULES ARE RESERVED
DEORBIT		
A2-201	A2.1.4-1	DEORBIT GUIDELINES
A2-202	A2.1.4-2	EXTENSION DAY GUIDELINES
A2-203	A2.1.4-3	DEORBIT DELAY GUIDELINES
A2-204	A2.1.4-4	MDF DEORBIT GUIDELINES
A2-205	A2.1.4-5	EMERGENCY DEORBIT
A2-206	A2.1.4-6	DEROTATION SPEED
A2-207	A2.1.4-7	LANDING SITE SELECTION
A2-208	A2.1.4-8	ACES PRESSURE INTEGRITY CHECK
A2-209	A2.1.4-9	LANDING SITE SELECTION FOR AN INFLIGHT EMERGENCY A2-210 THROUGH A2-250 RULES ARE RESERVED
ENTRY		
A2-251	A2.1.5-1	BAILOUT
A2-252	A2.1.5-2	GCA CRITERIA
A2-253	A2.1.5-3	ENERGY MANAGEMENT
A2-254	A2.1.5-4	ENTRY STRING REASSIGNMENT
A2-255	A2.1.5-5	CREW TAKEOVER
A2-256	A2.1.5-6	EARLY POWERDOWN
A2-257	A2.1.5-7	DEORBIT BURN TERMINATION
A2-258	A2.1.5-8	BFS ENGAGE
A2-259	A2.1.5-9	CHASE AIRCRAFT OPERATIONS
A2-260	A2.1.5-10	ENTRY LOAD MINIMIZATION
A2-261	A2.1.5-11	ENTRY DTO/AUTO MODE/CROSSWIND DTO GO/NO-GO

VOLUME A KEY

<u>NEW RULE #</u>	<u>OLD RULE #</u>	<u>RULE TITLE</u>
A2-262	A2.1.5-12	LANDING DTO'S
A2-263	A2.1.5-13	STA/WEATHER AIRCRAFT RUNWAY APPROACH OPERATIONS FOR SITES WITH ONLY ONE RUNWAY
A2-264	A2.1.5-14	EMERGENCY LANDING FACILITY CRITERIA
A2-265	A2.1.5-15	SINGLE STRING GPS OPERATIONS
		A2-266 THROUGH A2-300 RULES ARE RESERVED
		CONTINGENCY ACTION SUMMARY
A2-301	A2.1.6-1	CONTINGENCY ACTION SUMMARY
		A2-302 THROUGH A2-310 RULES ARE RESERVED
		SPACEHAB OPERATIONS MANAGEMENT
A2-311	A2.6.1-1	SPACEHAB SAFETY DEFINITION AND MANAGEMENT
A2-312	A2.6.1-2	REAL-TIME SAFETY COORDINATION
A2-313	A2.6.1-3	GROUND COMMANDING
A2-314	A2.6.1-4	SPACEHAB MINIMUM DURATION FLIGHT CRITERIA
A2-315	A2.6.1-5	POWERING OFF AND REPOWERING SPACEHAB EQUIPMENT
A2-316	A2.6.1-6	ORBITER-TO-SPACEHAB HATCH CONFIGURATION
A2-317	A2.6.1-7	EVA CONSTRAINTS
A2-318	A2.6.1-8	ORBITAL MANEUVERING SYSTEM/REACTION CONTROL SYSTEM (OMS/RCS) CONSTRAINTS
A2-319	A2.6.1-9	CONTAMINATION AND MICROGRAVITY CONSTRAINTS
A2-320	A2.6.1-10	COMMAND AND DATA SYSTEM CONSTRAINTS
A2-321	A2.6.2-5	SPACEHAB AIR-TO-GROUND (A/G) USAGE
A2-322	A2.6.1-11	SPACEHAB CAUTION AND WARNING ANNUNCIATION IN MODULE
A2-323	A2.6.1-12	COMMUNICATIONS CONSTRAINTS
A2-324	A2.6.1-13	SPACEHAB IN-FLIGHT MAINTENANCE (IFM) PROCEDURES
A2-325	A2.6.1-14	IFM PROCEDURES ON EXPERIMENTS WITH TOXIC HAZARDS
A2-326	A2.6.1-15	EQUIPMENT EXCHANGE BETWEEN ORBITER CABIN AND SPACEHAB MODULE
A2-327	A2.6.1-16	SPACEHAB MODULE/TUNNEL SLEEP CONSTRAINTS
A2-328	A2.6.1-17	CREW LIMITATIONS IN THE SPACEHAB MODULE
A2-329	A2.6.1-18	SPACEHAB DEACTIVATION/ENTRY PREP
A2-330	A2.6.1-19	EXTENSION DAY GROUND RULES
A2-331	A2.6.1-20	CONSTRAINTS ON CABLES THROUGH THE SPACEHAB HATCH AND TUNNEL
NONE	A2.6.1-21	RESERVED
NONE	A2.6.1-22	RESERVED
NONE	A2.6.1-23	RESERVED
NONE	A2.6.1-24	RESERVED
A2-332	A2.6.2-1	LOSS OF SM GPC DURING SPACEHAB ACTIVATION/ENTRY PREP
A2-333	A2.6.2-2	LOSS OF PAYLOAD MDM DURING SPACEHAB ACT/ENTRY PREP
A2-334	A2.6.2-3	LOSS OF SM MAJOR FUNCTION
A2-335	A2.6.2-4	LOSS OF ORBITER MASTER TIMING UNIT (MTU)/PAYLOAD TIMING BUFFER
NONE	A2.6.2-6	RESERVED
NONE	A2.6.2-7	RESERVED
NONE	A2.6.2-8	RESERVED
NONE	A2.6.2-9	RESERVED
		A2-336 THROUGH A2-400 RULES ARE RESERVED
		ORBITER SYSTEMS GO/NO-GO
A2-1001	A2.1.7-1	ORBITER SYSTEMS GO/NO-GO

SECTION A3 - GROUND INSTRUMENTATION REQUIREMENTS

GENERAL

A3-1	A3.1.1-1	GROUND AND NETWORK DEFINITIONS
A3-2	A3.1.1-2	GROUND AND NETWORK OVERALL PHILOSOPHY
A3-3	A3.1.1-3	GROUND AND NETWORK DETAILED REQUIREMENTS
		A3-4 THROUGH A3-50 RULES ARE RESERVED

MCC INSTRUMENTATION PRELAUNCH REQUIREMENTS

NONE	A3.1.2-1	RESERVED
NONE	A3.1.2-2	RESERVED
NONE	A3.1.2-3	RESERVED
A3-51	A3.1.2-4	TRAJECTORY PROCESSING REQUIREMENTS
A3-52	A3.1.2-5	MCC INTERNAL VOICE
NONE	A3.1.2-6	RESERVED
NONE	A3.1.2-7	RESERVED
A3-53	A3.1.2-8	MCC POWER
		A3-54 THROUGH A3-100 RULES ARE RESERVED

45 SPW/GSFC/STDN PRELAUNCH REQUIREMENTS

NONE	A3.1.3-1	RESERVED
A3-101	A3.1.3-2	GSFC
A3-102	A3.1.3-3	INTEGRATED NETWORK FAILURE DECISION MATRIX

VOLUME A KEY

<u>NEW RULE #</u>	<u>OLD RULE #</u>	<u>RULE TITLE</u>
A3-103	NONE	CRITICAL LAUNCH SYSTEM RECOVERY TIMES A3-104 THROUGH A3-150 RULES ARE RESERVED
MCC EXTERNAL INTERFACE (VOICE DATA) PRELAUNCH REQUIREMENTS		
A3-151	A3.1.4-1	MCC/KSC/45 SPW INTERFACE
A3-152	A3.1.4-2	GSFC/STDN INTERFACE
A3-153	A3.1.4-3	45 SPW/VAFB INTERFACE
A3-154	A3.1.4-4	45 SPW/WSMR INTERFACE
A3-155	A3.1.4-5	MCC/GSFC/NGT INTERFACE
A3-156	A3.1.4-6	MCC/ASCENT ABORT SITE INTERFACE A3-157 THROUGH A3-200 RULES ARE RESERVED
NAVAIDS REQUIREMENTS		
A3-201	A3.1.5-1	TACAN REDUNDANCY REQUIREMENTS AND ALTERNATE TACAN SELECTION PHILOSOPHY
A3-202	A3.1.5-2	MLS
A3-203	A3.1.5-3	LANDING AID REQUIREMENTS

SECTION A4 - TRAJECTORY AND GUIDANCE

PRELAUNCH

A4-1	A4.1.1-1	PERFORMANCE ANALYSES
A4-2	A4.1.1-2	LANDING SITE CONDITIONS
A4-3	A4.1.1-3	ORBIT CONJUNCTIONS/CONFLICTS
A4-4	A4.1.1-4	DOLILU OPERATIONS A4-5 THROUGH A4-50 RULES ARE RESERVED

ASCENT

A4-51	A4.1.2-1	KALMAN FILTER SOLUTION
A4-52	A4.1.2-2	ARD THRUST UPDATE CRITERIA AND FPR
A4-53	A4.1.2-3	USE OF MAXIMUM THROTTLES
NONE	A4.1.2-4	RESERVED
A4-54	A4.1.2-5	ABORT MODE RESPONSIBILITY
A4-55	A4.1.2-6	DESIGN AND CRITICAL MECO UNDERSPEED DEFINITIONS
A4-56	A4.1.2-7	PERFORMANCE BOUNDARIES
A4-57	A4.1.2-8	NAVIGATION UPDATES
A4-58	A4.1.2-9	AUTO GUIDANCE NO-GO
A4-59	A4.1.2-10	MANUAL THROTTLE SELECTION
NONE	A4.1.2-11	RESERVED
A4-60	A4.1.2-12	MANUAL SHUTDOWN CRITERIA
A4-61	A4.1.2-13	THRUST LIMITING, HYDRAULIC, OR ELECTRICAL LOCKUP
A4-62	A4.1.2-14	OMS-1/OMS-2 EXECUTION A4-63 THROUGH A4-100 RULES ARE RESERVED

ORBIT

A4-101	A4.1.3-1	ONBOARD NAVIGATION MAINTENANCE
A4-102	A4.1.3-2	MINIMUM ORBITAL LIFETIME
A4-103	A4.1.3-3	OFF-NOMINAL ORBITAL ALTITUDE RECOVERY PRIORITIES
A4-104	A4.1.3-4	OMS LEAK/PERIGEE ADJUST
A4-105	A4.1.3-5	MINIMUM TIME OF FREE FALL
A4-106	A4.1.3-6	DEBRIS AVOIDANCE CRITERIA FOR PREDICTED CONJUNCTIONS [HC]
A4-107	A4.1.3-7	PLS/EOM LANDING OPPORTUNITY REQUIREMENTS
A4-108	A4.1.3-8	TIRE SPEED, BRAKING, AND ROLLOUT REQUIREMENTS
A4-109	A4.1.3-9	DEORBIT PRIORITY FOR EOM WEATHER
A4-110	A4.1.3-10	AIMPOINT, EVALUATION VELOCITY, AND SHORT FIELD SELECTION
A4-111	A4.1.3-11	RUNWAY ACCEPTABILITY CONDITIONS
A4-112	A4.1.3-12	UPPER AND LOWER LEVEL MEASURED WIND AND ATMOSPHERIC DATA
A4-113	A4.1.3-13	OMS-2 TARGETING A4-114 THROUGH A4-150 RULES ARE RESERVED

ENTRY PLANNING

A4-151	A4.1.4-1	IMU ALIGNMENT
A4-152	A4.1.4-2	DEORBIT BURN TARGETING PRIORITIES
A4-153	A4.1.4-3	CG PLANNING
A4-154	A4.1.4-4	DOWNTACK ERROR
A4-155	A4.1.4-5	SUN ANGLE LIMITS AND GLARE CRITERIA FOR INNER AND OUTER GLIDE SLOPES
A4-156	A4.1.4-6	HAC SELECTION CRITERIA
A4-157	A4.1.4-7	ENERGY DOWNMODING
A4-158	A4.1.4-8	MANEUVER EXECUTION MATRIX
A4-159	A4.1.4-9	ORBITER LANDING WEIGHT A4-160 THROUGH A4-200 RULES ARE RESERVED

ENTRY

A4-201	A4.1.5-1	DELTA-T UPDATE CRITERIA
--------	----------	-------------------------

VOLUME A KEY

<u>NEW RULE #</u>	<u>OLD RULE #</u>	<u>RULE TITLE</u>
A4-202	A4.1.5-2	DEORBIT BURN COMPLETION
A4-203	A4.1.5-3	ENTRY NAVIGATION UPDATE PHILOSOPHY
A4-204	A4.1.5-4	DELTA STATE POSITION UPDATES
A4-205	A4.1.5-5	DELTA STATE VELOCITY UPDATES
A4-206	A4.1.5-6	NAVIGATION FILTER MANAGEMENT AUTO/INHIBIT/FORCE (AIF)
A4-207	A4.1.5-7	ENTRY LIMITS
A4-208	A4.1.5-8	ENTRY TAKEOVER RULES
A4-209	A4.1.5-9	AERO TEST MANEUVERS
A4-210	A4.1.5-10	EOM ENTRY DTO/RUNWAY SELECTION PRIORITIES
		A4-211 THROUGH A4-250 RULES ARE RESERVED

RANGE SAFETY FLIGHT RULES

A4-251	A4.1.6-0	SIGNATURE SECTION
A4-252	A4.1.6-1	POLICY
A4-253	A4.1.6-2	DEFINITIONS
A4-254	A4.1.6-3	FCO TO MCC WARNING NOTIFICATION
A4-255	A4.1.6-4	MCC TO FCO REPORTING
A4-256	A4.1.6-5	CONTROLLABILITY
A4-257	A4.1.6-6	FLIGHT TERMINATION/MANUAL MECO EVALUATION
A4-258	A4.1.6-7	FLIGHT TERMINATION/MANUAL MECO CRITERIA
A4-259	A4.1.6-8	FLIGHT TERMINATION/MANUAL MECO ACTION
A4-260	A4.1.6-9	RANGE SAFETY LIMIT AVOIDANCE ACTIONS

SECTION A5 - BOOSTER

FAILURE DEFINITIONS

A5-1	A5.1.1-1	LOSS OF SRB THRUST VECTOR CONTROL (TVC)
A5-2	A5.1.1-2	SPACE SHUTTLE MAIN ENGINE OUT
A5-3	A5.1.1-3	STUCK THROTTLE
A5-4	A5.1.1-4	DATA PATH FAILURE
A5-5	A5.1.1-5	SUSPECT ENGINE
A5-6	A5.1.1-6	SSME REDLINE SENSOR FAILED
A5-10	A5.1.1-7	SIGNIFICANT ENGINE HELIUM SYSTEM LEAK
A5-11	A5.1.1-8	SIGNIFICANT PNEUMATIC SYSTEM HELIUM LEAK
A5-12	A5.1.1-9	INSUFFICIENT PNEUMATIC HELIUM ACCUMULATOR PRESSURE
A5-13	A5.1.1-10	MPS DUMPS AND VACUUM INERTING DEFINITIONS
A5-7	A5.1.1-11	SSME ONE REDLINE SENSOR FAILURE AWAY FROM AN ERRONEOUS SHUTDOWN
NONE	A5.1.1-12	RESERVED
A5-8	A5.1.1-13	SPACE SHUTTLE MAIN ENGINE TYPES
A5-9	A5.1.1-14	LH2 ULLAGE LEAK
		A5-14 THROUGH A5-50 RULES ARE RESERVED

SRB SYSTEMS MANAGEMENT

A5-51	A5.1.2-1	LOSS OF SRB THRUST VECTOR CONTROL (TVC)
		A5-52 THROUGH A5-100 RULES ARE RESERVED

SSME SYSTEMS MANAGEMENT

A5-101	A5.1.3-1	ABORT CUE REQUIREMENT
A5-102	A5.1.3-2	AUTO/MANUAL SHUTDOWN
A5-103	A5.1.3-3	LIMIT SHUTDOWN CONTROL
A5-104	A5.1.3-4	DATA PATH FAIL/ENGINE-ON LIMIT SHUTDOWN CONTROL
A5-105	A5.1.3-5	DATA PATH FAIL/ENGINE-OUT ACTION
A5-106	A5.1.3-6	MANUAL SHUTDOWN FOR COMMAND/DATA PATH FAILURES
A5-108	A5.1.3-7	MANUAL SHUTDOWN FOR HYDRAULIC OR ELECTRICAL LOCKUP
A5-109	A5.1.3-8	MANUAL SHUTDOWN FOR TWO STUCK THROTTLES (NOT DUAL APU FAILURES)
A5-110	A5.1.3-9	SSME PERFORMANCE DISPERSION
A5-111	A5.1.3-10	AC BUS SENSOR ELECTRONICS CONTROL [CIL]
A5-112	A5.1.3-11	MANUAL THROTTLEDOWN FOR LO2 NPSP PROTECTION AT SHUTDOWN
A5-107	A5.1.3-12	MANUAL SHUTDOWN FOR SUSPECT COMMAND PATH FAILURES
A5-113	A5.1.3-13	MANUAL MECO/MECO CONFIRMED
A5-114	A5.1.3-14	SSME HYDRAULIC REPRESSURIZATION/POSTLANDING SSME REPOSITIONING
		A5-115 THROUGH A5-150 RULES ARE RESERVED

MPS MANAGEMENT: PRELAUNCH THROUGH MECO

A5-151	A5.1.4-1	PRE-MECO MPS HELIUM SYSTEM LEAK ISOLATION [CIL]
A5-152	A5.1.4-2	PRE-MECO MPS HELIUM SYSTEM INTERCONNECTS [CIL]
A5-153	A5.1.4-3	PRE-MECO SHUT DOWN OF ENGINES DUE TO MPS HELIUM LEAKS
A5-154	A5.1.4-4	LH2 TANK PRESSURIZATION [CIL]
A5-155	A5.1.4-5	LIMIT SHUTDOWN CONTROL AND MANUAL THROTTLING FOR LOW LH2 NPSP
A5-156	A5.1.4-6	ABORT PREFERENCE FOR SYSTEMS FAILURES
A5-157	A5.1.4-7	ET LOW LEVEL CUTOFF SENSOR FAILED DRY
		A5-158 THROUGH A5-200 RULES ARE RESERVED

VOLUME A KEY

<u>NEW RULE #</u>	<u>OLD RULE #</u>	<u>RULE TITLE</u>
MPS MANAGEMENT: POST-MECO		
A5-202	A5.1.5-1	ET SEPARATION INHIBIT FOR 17-INCH DISCONNECT FAILURE [CIL]
A5-203	A5.1.5-2	MPS PROPELLANT MANIFOLD OVERPRESSURE [CIL]
A5-208	A5.1.5-3	POST-MECO AND ENTRY HELIUM ISOLATION
A5-204	A5.1.5-4	MANUAL MPS DUMP
A5-205	A5.1.5-5	NOMINAL, AOA, AND ATO MPS DUMP FAILURES
A5-206	A5.1.5-6	MANUAL VACUUM INERTING REQUIREMENTS (NOMINAL, ATO, AOA)
A5-207	A5.1.5-7	RESERVED
A5-207	A5.1.5-8	LH2 PRESSURIZATION VENT CONTROL
A5-209	A5.1.5-9	ENTRY MPS HELIUM PURGE/MANIFOLD
A5-210	A5.1.5-10	ENTRY MPS PROPELLANT DUMP FAILURES [CIL]
A5-201	A5.1.5-11	MPS DUMP INHIBIT [CIL]

SECTION A6 - PROPULSION

FAILURE DEFINITIONS

A6-1	A6.1.1-1	OMS/RCS HELIUM TANK
A6-2	A6.1.1-2	OMS PROPELLANT TANK (OXIDIZER OR FUEL)
A6-3	A6.1.1-3	OMS ENGINE
A6-4	A6.1.1-5	OMS N2 TANK
A6-5	A6.1.1-4	OMS N2 ACCUMULATOR
A6-6	A6.1.1-8	OMS/RCS CROSSFEED LINE
A6-7	A6.1.1-7	RCS PROPELLANT TANK (OXIDIZER OR FUEL)
A6-8	A6.1.1-6	RCS THRUSTER
A6-9	A6.1.1-10	RCS JET HEATER
		A6-10 THROUGH A6-50 RULES ARE RESERVED

OMS/RCS MANAGEMENT

A6-51	A6.1.2-17	OMS FAILURE MANAGEMENT [CIL]
A6-52	A6.1.2-18	RCS FAILURE MANAGEMENT
A6-53	A6.1.2-21	OMS HELIUM INGESTION
A6-54	A6.1.2-4	OMS PROPELLANT FAIL FEED CONSTRAINTS [CIL]
A6-55	A6.1.2-1	OMS N2 TANK FAILURE MANAGEMENT
A6-56	A6.1.2-15	OMS N2 REGULATOR FAILURE MANAGEMENT
A6-57	A6.1.1-11	AFT RCS PROPELLANT TANK FAIL/HELIUM INGESTION
A6-58	A6.1.2-23	RCS REGULATOR FAILURE TROUBLESHOOTING
A6-59	A6.1.2-24	LOSS OF AFT RCS LEAK DETECTIONS
A6-60	A6.1.2-9	RCS MANIFOLD CLOSURE CRITERIA
A6-61	A6.1.2-11	RCS MANIFOLD/OMS CROSSFEED LINE REPRESSURIZATION [CIL]
A6-62	A6.1.2-14	OMS/RCS CONTINUOUS VALVE POWER MANAGEMENT
A6-63	A6.1.2-35	RCS BFS PVT INIT PRELAUNCH CRITERIA
		A6-64 THROUGH A6-100 RULES ARE RESERVED

OMS ENGINE MANAGEMENT

A6-101	A6.1.2-33	OMS ENGINE BELL MOVEMENT DURING ASCENT
A6-102	A6.1.2-5	OMS PROPELLANT SETTLING REQUIREMENT
A6-103	A6.1.2-34	OMS BURN DOWNLIST REQUIREMENT
A6-104	A6.1.2-8	OMS ENGINE INSTRUMENTATION REQUIREMENT
A6-105	A6.1.2-28	OMS BURN MINIMUM PRESSURE REQUIREMENTS
A6-106	A6.1.2-6	OMS ENGINE BURN TO DEPLETION
A6-107	A6.1.2-25	OMS ENGINE FAILURE MANAGEMENT
A6-108	A6.1.2-7	OMS BALL VALVE FAILURE MANAGEMENT
		A6-109 THROUGH A6-150 RULES ARE RESERVED

RCS THRUSTER MANAGEMENT

A6-151	A6.1.2-22	RCS JET DRIVER MANAGEMENT [CIL]
A6-152	A6.1.2-26	RCS ENTRY HOTFIRE CHECK
A6-153	A6.1.2-20	RCS JET MAXIMUM BURN TIME
A6-154	A6.1.2-27	RCS VERNIER OPERATION TERMINATION
A6-155	A6.1.2-31	SUSPECT RCS JET REPRIORITIZATION CRITERIA
A6-156	A6.1.2-19	RCS RM LOSS MANAGEMENT
A6-157	A6.1.2-12	RCS JET FAILED OFF HOTFIRE TEST
A6-158	A6.1.2-29	RCS LEAKING JET MANAGEMENT
A6-159	A6.1.2-32	FAILED PRCS JET RESELECTION PRIORITY
		A6-160 THROUGH A6-200 RULES ARE RESERVED

OMS/RCS LEAK MANAGEMENT

A6-201	A6.1.2-2	OMS/RCS LEAKING HE TANK BURN
A6-202	A6.1.2-3	OMS LEAKING HE SYSTEM BURN

VOLUME A KEY

<u>NEW RULE #</u>	<u>OLD RULE #</u>	<u>RULE TITLE</u>
A6-203	A6.1.2-30	OMS LEAKING INLET LINE PERIGEE ADJUST BURN
A6-204	A6.1.2-36	OMS GN2 ACCUMULATOR LEAK DETERMINATION
A6-205	A6.1.2-10	RCS LEAKING PROPELLANT TANK BURN
A6-206	A6.1.2-16	RCS MANIFOLD/LEG LEAK PRESSURIZATION
		A6-207 THROUGH A6-250 RULES ARE RESERVED
THERMAL REDLINES AND MANAGEMENT		
A6-251	A6.1.3-1	GENERAL
A6-252	A6.1.1-9	OMS/RCS POD HEATER
A6-253	A6.1.3-2	FORWARD RCS MODULE TEMPERATURE MANAGEMENT
A6-254	A6.1.3-3	OMS/RCS PODS TEMPERATURE MANAGEMENT
A6-255	A6.1.3-4	OMS/RCS CROSSFEED LINES TEMPERATURE MANAGEMENT
A6-256	A6.1.3-5	OMS/RCS HEATER PERFORMANCE MONITORING
A6-257	A6.1.3-6	RCS JET TEMPERATURE MANAGEMENT
A6-258	A6.1.3-7	ARCS BULK PROPELLANT TEMPERATURE MANAGEMENT
		A6-259 THROUGH A6-300 RULES ARE RESERVED
CONSUMABLES DEFINITIONS AND REDLINES		
A6-301	A6.1.5-1	OMS USABLE PROPELLANT
A6-302	A6.1.5-2	RCS USABLE PROPELLANT
A6-303	A6.1.5-3	OMS REDLINES [CIL]
A6-304	A6.1.5-4	FORWARD RCS REDLINES
A6-305	A6.1.5-5	AFT RCS REDLINES
		A6-306 THROUGH A6-350 RULES ARE RESERVED
CONSUMABLES MANAGEMENT		
A6-351	A6.1.4-1	OMS PROPELLANT MANAGEMENT MATRIX
A6-352	A6.1.4-2	OMS PROPELLANT BUDGET GROUND RULES
A6-353	A6.1.4-3	CG MANAGEMENT
A6-354	A6.1.4-4	RCS ENTRY REDLINE PROTECTION
A6-355	A6.1.4-5	OMS PROPELLANT DEFICIENCY FOR DEORBIT
A6-356	A6.1.4-6	DEORBIT PLANNING CRITERIA
A6-357	A6.1.2-13	FORWARD RCS CONTINGENCY PROPELLANT AVAILABLE
A6-358	A6.1.5-6	VIOLATION OF MISSION COMPLETION REDLINES MATRIX
A6-359	A6.1.5-7	RCS PROPELLANT CONSERVATION PRIORITIES
		A6-360 THROUGH A6-400 RULES ARE RESERVED
OMS/RCS GO/NO-GO CRITERIA		
A6-1001	A6.1.5-8	OMS/RCS GO/NO-GO CRITERIA [CIL]

SECTION A7 - DATA SYSTEMS

GPC & DATA PATH MANAGEMENT

A7-1	A7.1.2-1	PASS DPS FAILURE
A7-2	A7.1.2-3	UNRECOVERABLE GPC
A7-3	A7.1.3-3	GPC FAILURE
A7-4	A7.1.2-4	TRANSIENT GPC
A7-5	A7.1.3-10	PASS GPC BCE FAILURE MANAGEMENT
A7-6	A7.1.3-4	DATA PATH FAILURE
A7-7	A7.1.3-16	POWERED OFF GPC ACTION (101S)
A7-8	A7.1.3-1	REDUNDANT SET FAILURE
A7-9	A7.1.3-2	REDUNDANT SET SPLIT
A7-10	A7.1.1-3	GNC GPC REACTIVATION PRIORITY
A7-11	A7.1.1-4	GNC GPC REDUNDANCY REQUIREMENTS
A7-12	A7.1.1-2	PASS/BFS REDUNDANCY
A7-13	A7.1.3-5	GPC MAJOR FUNCTION CONFIGURATION
A7-14	A7.1.3-19	GNC 3 ARCHIVE MANAGEMENT
A7-15	A7.1.3-17	SM OPS 4 TRANSITION REQUIREMENTS
A7-16	A7.1.3-6	GPC MEMORY WRITE CRITERIA [CIL]
A7-17	A7.1.3-7	GPC MEMORY DUMP CRITERIA
		A7-17 THROUGH A7-50 RULES ARE RESERVED

BFS SYSTEMS MANAGEMENT

A7-51	A7.1.2-2	BFS DPS FAILURE
A7-52	A7.1.4-1	ASCENT/ENTRY BFS MANAGEMENT GUIDELINES
A7-53	A7.1.4-2	ON-ORBIT BFS MANAGEMENT GUIDELINES
		A7-54 THROUGH A7-100 RULES ARE RESERVED

OTHER DPS SYSTEMS MANAGEMENT

A7-101	A7.1.3-11	POWER CYCLING/MANAGEMENT
A7-102	A7.1.3-8	PASS DATA BUS ASSIGNMENT CRITERIA
A7-103	A7.1.3-9	I/O RESET

VOLUME A KEY

<u>NEW RULE #</u>	<u>OLD RULE #</u>	<u>RULE TITLE</u>
A7-104	A7.1.3-18	NONUNIVERSAL I/O ERROR ACTION
A7-105	A7.1.3-12	MDM PORT MODING
A7-106	A7.1.3-13	MMU OPERATIONS
A7-107	A7.1.3-14	TIME MANAGEMENT
A7-108	A7.1.3-22	DEU EQUIVALENT CRITERIA
A7-109	A7.1.3-15	IN-FLIGHT MAINTENANCE (IFM)
		A7-110 THROUGH A7-150 RULES ARE RESERVED

PAYLOAD SPECIFIC DPS SYSTEMS MANAGEMENT

A7-151	A7.1.3-21	CONSTRAINTS ON PORT MODING OR I/O RESETS A7-152 THROUGH A7-200 RULES ARE RESERVED
--------	-----------	--

DPS EOM REQUIREMENTS/DEFINITIONS

A7-201	A7.1.1-1	DPS REDUNDANCY REQUIREMENTS A7-202 THROUGH A7-200 RULES ARE RESERVED
--------	----------	---

DPS GO/NO-GO MATRIX

A7-1001	A7.1.5-1	DPS GO/NO-GO MATRIX
---------	----------	---------------------

SECTION A8 - GUIDANCE, NAVIGATION, AND CONTROL (GN&C)

GENERAL

A8-1	A8.1.1-1	FCS DOWNMODE
A8-2	A8.1.1-2	SSME THRUST VECTOR CONTROL (TVC) HARDOVER
A8-3	A8.1.1-3	LOSS OF GNC SYSTEM
A8-4	A8.1.1-4	FAULT TOLERANCE PHILOSOPHY
A8-5	A8.1.1-5	ACCELEROMETER ASSEMBLIES (AA) FAULT TOLERANCE
A8-6	A8.1.1-6	CONTROLLERS/FCS SWITCHING FAULT TOLERANCE
A8-7	A8.1.1-7	ENTRY SYSTEMS SINGLE-FAULT TOLERANCE VERIFICATION
A8-8	A8.1.1-8	ENTRY SYSTEMS RM DILEMMA
A8-9	A8.1.1-9	AFT STATION GNC REDUNDANCY
A8-10	A8.1.1-10	POWER/DATA PATH REDUNDANCY
A8-11	A8.1.1-11	LOSS OF BFS
A8-12	A8.1.1-12	HEAD UP DISPLAY (HUD) AND CREW OPTICAL ALIGNMENT SIGHT (COAS) ALIGNMENT
A8-13	A8.1.1-13	RTLs ET SEPARATION
A8-14	A8.1.1-14	POWER MANAGEMENT
A8-15	A8.1.1-15	GNC PARAMETERS/LRU FAILURES
A8-16	A8.1.1-16	GNC SYSTEMS FAILURES
A8-17	A8.1.1-17	EQUIPMENT REQUIRED FOR EMERGENCY AUTOLAND
A8-18	A8.1.1-18	LANDING SYSTEMS REQUIREMENTS
A8-19	A8.1.1-19	YAW JET DOWNMODE
A8-20	A8.1.1-20	ENTRY ELEVON SCHEDULE SELECTION CRITERIA
NONE	A8.1.1-21	RESERVED A8-21 THROUGH A8-50 RULES ARE RESERVED

FAILURE DEFINITIONS

A8-51	A8.1.2-1	PHILOSOPHY
A8-52	A8.1.2-2	SENSOR FAILURES
A8-53	A8.1.2-3	OMS TVC LOSS
A8-54	A8.1.2-4	FIRST STAGE LOSS OF CONTROL DEFINITION
A8-55	A8.1.2-5	ET SEPARATION RCS REQUIREMENTS
A8-56	A8.1.2-6	BFS LRU REQUIREMENTS
A8-57	A8.1.2-7	PRELAUNCH IMU HOLD
A8-58	A8.1.2-8	ADI LOSS
A8-59	A8.1.2-9	IMU BITE FAILURE DEFINITION
A8-60	A8.1.2-10	LOSS OF VERNIER RCS DAP MODE
A8-61	A8.1.2-11	SSME SHUTDOWN DUE TO HYDRAULIC SYSTEM FAILURES A8-62 THROUGH A8-100 RULES ARE RESERVED

MANAGEMENT

A8-101	A8.1.3-1	BEEP TRIM DEROTATION
NONE	A8.1.3-2	RESERVED
A8-102	A8.1.3-3	RGA SYSTEM MANAGEMENT [CIL]
A8-103	A8.1.3-4	PRIORITY RATE LIMITING (PRL) SYSTEMS MANAGEMENT
A8-104	A8.1.3-5	FCS CHECKOUT
A8-105	A8.1.3-6	CONTROLLERS
A8-106	A8.1.3-7	TVC-SSME STOW/ACTUATOR FLUID FILL (REPRESSURIZATION)
A8-107	A8.1.3-8	FCS CHANNEL MANAGEMENT
A8-108	A8.1.3-9	HUD/COAS SYSTEM MANAGEMENT
A8-109	A8.1.3-10	STAR TRACKER SYSTEM MANAGEMENT [CIL]
A8-110	A8.1.3-11	IMU SYSTEM MANAGEMENT

VOLUME A KEY

<u>NEW RULE #</u>	<u>OLD RULE #</u>	<u>RULE TITLE</u>
A8-111	A8.1.3-12	GNC AIR DATA SYSTEM MANAGEMENT [CIL]
A8-112	A8.1.3-13	AEROSURFACE ACTUATOR PROTECTION
A8-113	A8.1.3-14	OMS TVC SYSTEM MANAGEMENT
A8-114	A8.1.3-15	ENTRY BODY BENDING FILTER SELECTION
		A8-115 THROUGH A8-150 RULES ARE RESERVED

GNC GO/NO-GO CRITERIA

A8-1001	A8.1.6-1	GNC GO/NO-GO CRITERIA
---------	----------	-----------------------

SECTION A9 - ELECTRICAL

LOSS/FAILURE DEFINITIONS

A9-1	A9.1.1-1	FUEL CELL (FC) LOSS [CIL]
A9-2	A9.1.1-2	FC ALTERNATE H2O SYSTEM LOSS
A9-3	A9.1.1-3	ELECTRICAL POWER DISTRIBUTION AND CONTROL (EPDC) SYSTEM [CIL]
A9-4	A9.1.1-4	CAUTION AND WARNING (C&W)
		A9-5 THROUGH A9-50 RULES ARE RESERVED

FUEL CELL SYSTEMS MANAGEMENT

A9-51	A9.1.2-1	FC POWER LEVEL CONSTRAINTS
A9-52	A9.1.2-2	FC PURGE
A9-53	A9.1.2-3	FC H2O SYSTEM HEATERS
A9-54	A9.1.2-4	FC STANDBY DEFINITION
A9-55	A9.1.2-5	FC SHUTDOWN DEFINITION [CIL]
A9-56	A9.1.2-6	FC SAFING
A9-57	A9.1.2-7	REUSABLE FC
A9-58	A9.1.2-8	FC SUSTAINER HEATER
A9-59	A9.1.2-9	FC - CELL PERFORMANCE MONITOR [CIL]
A9-60	A9.1.2-10	FC COOLANT PUMP FAILURE MANAGEMENT [CIL]
A9-61	A9.1.2-11	ACTIONS FOR FUEL CELL PH INDICATIONS
A9-62	A9.1.2-12	FUEL CELL MONITORING SYSTEM DATA TAKE
		A9-63 THROUGH A9-100 RULES ARE RESERVED

DC POWER DISTRIBUTION AND CONTROL SYSTEMS MANAGEMENT

A9-101	A9.1.3-1	DC BUS VOLTAGE LIMITS
A9-102	A9.1.3-2	ESSENTIAL BUS
A9-103	A9.1.3-3	POWER REDUCTION GUIDELINES
A9-104	A9.1.3-4	MAIN BUS SHORT
A9-105	A9.1.3-5	CB/RPC RESET
A9-106	A9.1.3-6	CONTROL BUS
A9-107	A9.1.3-7	MAIN BUS TIE [CIL]
A9-108	A9.1.3-8	CRITICAL PHASE BUS MANAGEMENT
A9-109	A9.1.3-9	PRIMARY PAYLOAD BUS MANAGEMENT
A9-110	A9.1.3-10	PREFLIGHT TEST BUS MANAGEMENT
		A9-111 THROUGH A9-150 RULES ARE RESERVED

AC POWER DISTRIBUTION AND CONTROL SYSTEMS MANAGEMENT

A9-151	A9.1.4-1	AC INVERTER MANAGEMENT
A9-152	A9.1.4-2	AC BUS SENSORS SWITCH MANAGEMENT
A9-153	A9.1.4-3	AC BUS LOADING
A9-154	A9.1.4-4	AC LOAD MANAGEMENT DURING ASCENT
A9-155	A9.1.4-5	AC INVERTER THERMAL LIFE
A9-156	A9.1.4-6	LOSS OF SINGLE-PHASE AC
A9-157	A9.1.4-7	LOSS OF TWO-PHASE AC
A9-158	A9.1.4-8	AC POWER TRANSFER CABLE
A9-159	A9.1.4-9	MOTOR CONTROL ASSEMBLY (MCA)
A9-160	A9.1.4-10	CAUTION AND WARNING (C&W) [CIL]
A9-161	A9.1.4-11	HYDRAULIC CIRCULATION PUMP OPERATION
		A9-162 THROUGH A9-200 RULES ARE RESERVED

CRYOGENIC LOSS/FAILURE DEFINITIONS

A9-201	A9.1.5-1	O2 (H2) MANIFOLD
A9-202	A9.1.5-2	CRYO TANK
A9-203	A9.1.5-3	CRYO TANK ANNULUS VACUUM
A9-204	A9.1.5-4	CRYO HEATER
A9-205	A9.1.5-5	O2 DELTA CURRENT SENSOR
		A9-206 THROUGH A9-250 RULES ARE RESERVED

CRYOGENIC SYSTEMS MANAGEMENT

A9-251	A9.1.6-1	CRYO HEATER MANAGEMENT FOR ASCENT
A9-252	A9.1.6-2	CRYO HEATER MANAGEMENT FOR ORBIT [CIL]
A9-253	A9.1.6-3	CRYO TANK HEATER TEMPERATURE MANAGEMENT
A9-254	A9.1.6-4	CRYO HEATERS DEACTIVATION

VOLUME A KEY

<u>NEW RULE #</u>	<u>OLD RULE #</u>	<u>RULE TITLE</u>
A9-255	A9.1.6-5	O2 DELTA CURRENT SENSOR
A9-256	A9.1.6-6	CRYO O2/H2 TANK QUANTITY BALANCING
A9-257	A9.1.6-7	POWER REACTANT STORAGE AND DISTRIBUTION (PRSD) H2 AND O2 REDLINE DETERMINATION
A9-258	A9.1.6-8	CRYO O2 AND H2 PRESSURE MANAGEMENT
A9-259	A9.1.6-9	CRYO O2/H2 MANIFOLD VALVES
A9-260	A9.1.6-10	CRYO SYSTEM LEAKS [CIL]
A9-261	A9.1.6-11	IMPENDING LOSS OF ALL CRYO
A9-262	A9.1.6-12	EDO PALLET MANAGEMENT
		A9-263 THROUGH A9-300 RULES ARE RESERVED
		SPACEHAB SUPPORT
A9-301	A9.6.1-1	SPACEHAB DC BUSES
A9-302	A9.6.1-2	SPACEHAB AC INVERTER
		A9-303 THROUGH A9-350 RULES ARE RESERVED
		SPACEHAB ELECTRICAL POWER SUBSYSTEM (EPS) MANAGEMENT
NONE	A9.6.2-1	RESERVED
A9-351	A9.6.2-9	ELECTRICAL POWER SUBSYSTEM (EPS) CONSTRAINTS
A9-352	A9.6.2-2	SPACEHAB MAIN BUS MANAGEMENT
A9-353	A9.6.2-3	SPACEHAB EMERGENCY BUS LOSS
A9-354	A9.6.2-4	SPACEHAB AC MANAGEMENT
A9-355	A9.6.2-5	FUSE/CIRCUIT BREAKER MANAGEMENT
A9-356	A9.6.2-6	FUEL CELL FAILURE MANAGEMENT
A9-357	A9.6.2-7	SPACEHAB SURVIVAL POWER CONFIGURATION
A9-358	A9.6.2-8	CAUTION AND WARNING (C&W)
		A9-359 THROUGH A9-400 RULES ARE RESERVED
		ELECTRICAL GO/NO-GO CRITERIA
A9-1001	A9.1.7-1	ELECTRICAL GO/NO-GO CRITERIA

SECTION A10 - MECHANICAL

AUXILIARY POWER UNIT (APU) LOSS FAILURE/DEFINITION

A10-1	A10.1.1-1	APU LOSS DEFINITIONS A10-2 THROUGH A10-20 RULES ARE RESERVED
		APU SYSTEMS MANAGEMENT
A10-21	A10.1.2-1	LOSS OF APU/HYDRAULIC SYSTEM(S) ACTIONS
A10-22	A10.1.2-2	APU START/RESTART LIMITS
A10-23	A10.1.2-3	APU ENTRY START TIME
A10-24	A10.1.2-4	APU OIL/GEARBOX TEMPERATURE/PRESSURE
A10-25	A10.1.2-5	APU HIGH SPEED SELECTION/SHIFT
A10-26	A10.1.2-6	APU AUTO SHUTDOWN INHIBIT MANAGEMENT
A10-27	A10.1.2-7	APU FUEL LEAKS [CIL]
A10-28	A10.1.2-8	AOA APU/HYDRAULIC SYSTEM OPERATIONS
A10-29	A10.1.2-9	FCS CHECKOUT APU OPERATIONS
A10-30	A10.1.2-10	LOSS OF APU HEATERS/INSTRUMENTATION [CIL]
A10-31	A10.1.2-11	APU FREEZE/THAW
A10-32	A10.1.2-12	APU/HYD CONSUMABLES
A10-33	A10.1.2-13	APU DEFINITIONS A10-34 THROUGH A10-50 RULES ARE RESERVED
		HYDRAULIC SYSTEMS LOSS/FAILURE DEFINITIONS
A10-51	A10.1.3-1	HYDRAULIC LOSS DEFINITIONS A10-52 THROUGH A10-70 RULES ARE RESERVED
		HYDRAULIC SYSTEMS MANAGEMENT
A10-71	A10.1.4-1	HYDRAULIC SYSTEMS CONFIGURATION
A10-72	A10.1.4-2	HYDRAULIC LEAKS
A10-73	A10.1.4-3	HYDRAULIC SYSTEMS PRESSURE/TEMPERATURE [CIL]
A10-74	A10.1.4-4	HYDRAULIC CIRCULATION PUMP OPERATION [CIL] A10-75 THROUGH A10-100 RULES ARE RESERVED
		WATER SPRAY BOILER (WSB) LOSS/FAILURE DEFINITIONS
A10-101	A10.1.5-1	WSB LOSS DEFINITIONS A10-102 THROUGH A10-120 RULES ARE RESERVED
		WSB SYSTEMS MANAGEMENT
A10-121	A10.1.6-1	WSB CONFIGURATION
A10-122	A10.1.6-2	LOSS OF WSB(S) ACTIONS A10-123 THROUGH A10-140 RULES ARE RESERVED

VOLUME A KEY

<u>NEW RULE #</u>	<u>OLD RULE #</u>	<u>RULE TITLE</u>
LANDING/DECEL SYSTEMS MANAGEMENT		
A10-141	A10.1.7-1	NOSE WHEEL STEERING (NWS)
A10-142	A10.1.8-1	TIRE PRESSURE [CIL]
A10-143	A10.1.8-2	DRAG CHUTE DEPLOY TECHNIQUES
A10-144	A10.1.8-3	DRAG CHUTE DEPLOY CONSTRAINTS
A10-145	A10.1.8-4	UNCOMMANDED BRAKE PRESSURE [CIL]
A10-146	A10.1.8-5	BRAKING
A10-147 THROUGH A10-160 RULES ARE RESERVED		
MECHANICAL SYSTEMS LOSS/FAILURE DEFINITIONS		
A10-161	A10.1.9-1	DRIVE MECHANISMS LOSS DEFINITIONS
A10-162 THROUGH A10-180 RULES ARE RESERVED		
GENERAL MECHANISMS SYSTEMS MANAGEMENT		
A10-181	A10.1.10-1	DRIVE MECHANISMS
A10-182 THROUGH A10-200 RULES ARE RESERVED		
PAYLOAD DOOR (PLBD) SYSTEMS MANAGEMENT		
A10-201	A10.1.11-1	PLBD GENERAL
A10-202	A10.1.11-2	PLBD VISUAL CUES
A10-203	A10.1.11-3	PLBD CRITICAL LATCHES
A10-204	A10.1.11-4	FAILED PLBD GPC SEQUENCE
A10-205	A10.1.11-5	PLBD CLEARANCE CONSTRAINTS
A10-206	A10.1.11-6	PLBD CLOSE GO/NO-GO
A10-207	A10.1.11-7	PLBD OVERLAP
A10-208	A10.1.11-8	CONTINGENCY PLBD CLOSURE
A10-209	A10.1.11-9	PLBD RULE REFERENCE MATRIX
A10-210 THROUGH A10-220 RULES ARE RESERVED		
RADIATOR SYSTEMS MANAGEMENT		
A10-221	A10.1.12-1	RADIATOR MECHANICAL
A10-222	A10.1.12-2	RADIATOR VISUAL CUES
A10-223 THROUGH A10-240 RULES ARE RESERVED		
ET UMBILICAL DOORS SYSTEMS MANAGEMENT		
A10-241	A10.1.13-1	ET UMBILICAL DOOR KEYBOARD ENTRY
A10-242	A10.1.13-2	ET UMBILICAL DOORS ON ORBIT
A10-243	A10.1.13-3	ET UMBILICAL DOOR CLOSURE DELAY FOR DISCONNECT VALVE FAILURE [CIL]
A10-244 THROUGH A10-260 RULES ARE RESERVED		
VENT DOOR SYSTEMS MANAGEMENT		
A10-261	A10.1.14-1	VENT DOOR MANAGEMENT
A10-262 THROUGH A10-280 RULES ARE RESERVED		
PAYLOAD RETENTION LATCHES (PRLA) SYSTEMS MANAGEMENT		
A10-281	A10.1.15-1	PRLA'S/AKA'S
A10-282 THROUGH A10-300 RULES ARE RESERVED		
KU-BAND ANTENNA DEPLOY MECHANISM SYSTEMS MANAGEMENT		
A10-301	A10.1.16-1	ANTENNA STOW REQUIREMENT [CIL]
A10-302	A10.1.16-2	DAP CONFIGURATION FOR ANTENNA STOW
A10-303	A10.1.16-3	ANTENNA CONTINGENCY PROCEDURES
NONE	A10.1.16-4	RESERVED
A10-304 THROUGH A10-320 RULES ARE RESERVED		
REMOTELY OPERATED ELECTRICAL/FLUID UMBILICAL (ROEU/ROFU) SYSTEMS MANAGEMENT		
A10-321	A10.1.19-1	ROEU/ROFU OPERATIONS
A10-322 THROUGH A10-340 RULES ARE RESERVED		
ANDROGYNOUS PERIPHERAL DOCKING SYSTEM (APDS) SYSTEMS MANAGEMENT		
A10-341	A10.1.18-1	APDS CONFIGURATION
A10-342	A10.1.18-2	APDS PRESSURE/TEMPERATURE
A10-343	A10.1.18-3	APDS MECHANISM END OF TRAVEL INDICATIONS
A10-344	A10.1.18-4	APDS DOCKING SEQUENCE OPERATIONS
A10-345	A10.1.18-5	APDS RECONFIGURATION AFTER FAILED DOCKING
A10-346	A10.1.18-6	APDS REDUNDANCY REQUIREMENTS
A10-347 THROUGH A10-360		
VIEWPORT SYSTEMS MANAGEMENT		
A10-361	A10.6.1-1	VIEWPORT (VP)

VOLUME A KEY

<u>NEW RULE #</u>	<u>OLD RULE #</u>	<u>RULE TITLE</u>
A10-362	A10.6.1-2	CRACKED VIEWPORT
A10-363	A10.6.1-3	VIEWPORT CONFIGURATION FOR CLOSED SPACEHAB HATCH
A10-364	A10.6.1-4	LOSS OF VP PRESSURE INTEGRITY
A10-365	A10.6.1-5	EVA REQUIREMENTS FOR FAILED VP OUTER COVER A10-366 THROUGH A10-380 RULES ARE RESERVED
STRUCTURAL MANAGEMENT		
A10-381	A10.1.17-1	THERMAL WINDOWPANE FAILURE [CIL]
A10-382	A10.1.17-2	PRESSURE/REDUNDANT WINDOWPANE FAILURE
A10-383	A10.1.17-3	BAILOUT/POSTLANDING EMERGENCY EGRESS PYROTECHNICS MANAGEMENT
A10-384	A10.1.17-4	MAXIMUM NUMBER OF FILLED CWC'S
A10-385	A10.1.17-5	FILLED CWC STOWAGE MANAGEMENT A10-386 THROUGH A10-400 RULES ARE RESERVED
MMACS GO/NO-GO CRITERIA		
A10-1001	A10.1.20-1	MMACS GO/NO-GO CRITERIA

SECTION A11 - COMMUNICATIONS

SYSTEM MANAGEMENT RULES

A11-1	A11.1.1-1	COMMUNICATIONS DURING ASCENT
A11-2	A11.1.1-2	S-BAND/UHF LAUNCH REQUIREMENT
A11-3	A11.1.1-3	UPLINK HANDOVER DURING ASCENT FROM KSC
A11-4	A11.1.1-4	ORBITER DATA PRIORITY DURING ASCENT/ENTRY
A11-5	A11.1.1-5	POSTLANDING S-BAND ANTENNA SELECTION
A11-6	A11.1.1-6	MINIMUM COMMUNICATIONS REQUIREMENTS FOR SCHEDULED EVA
A11-7	A11.1.1-7	KU-BAND OPERATIONS DURING EVA
A11-8	A11.1.1-8	ORBITER S-BAND OPERATIONS DURING EVA
A11-9	A11.1.1-9	RECORDER USAGE
A11-10	A11.1.1-10	UHF USAGE
A11-11	A11.1.1-11	S-BAND FM USAGE
A11-12	A11.1.1-12	S-BAND PM USAGE
A11-13	A11.1.1-13	S-BAND PAYLOAD USAGE
A11-14	A11.1.1-14	CREW ALERT SPC'S
A11-15	A11.1.1-15	ELBOW CAMERA/PAYLOAD INTERFERENCE [CIL]
A11-16	A11.1.1-16	KU-BAND MANAGEMENT
A11-17	A11.1.1-17	PI CHANNELS AND S-BD FREQUENCIES COMPATIBILITIES
A11-18	A11.1.1-18	COMSEC USAGE
A11-19	A11.1.1-19	UPLINK BLOCK
A11-20	A11.1.1-20	UPLINK COMMANDING DURING OPS TRANSITIONS
A11-21	A11.1.1-21	CRITICAL UPLINK COMMAND POLICY
A11-22	A11.1.1-22	TWO-STAGE COMMAND BUFFER TLM REJECT
NONE	A11.1.1-23	RESERVED
A11-23	A11.1.1-24	KU BAND TRANSMITTER INHIBITED DURING ACQUISITION OF TDRS INSIDE THE RF PROTECT BOX A11-24 THROUGH A11-50 RULES ARE RESERVED

SYSTEM FAILURE RULES

A11-51	A11.1.2-1	LOSS OF TWO-WAY VOICE
A11-52	A11.1.2-2	LOSS OF BOTH VOICE AND COMMAND
A11-53	A11.1.2-3	LOSS OF COMMAND
A11-54	A11.1.2-4	LOSS OF TELEMETRY
A11-55	A11.1.2-5	LOSS OF KU-BAND
A11-56	A11.1.2-6	LOSS OF KU-BAND TEMPERATURE CONTROL [CIL]
A11-57	A11.1.2-7	LOSS OF KU-BAND TEMPERATURE MONITORING CAPABILITY [CIL]
A11-58	A11.1.2-8	LOSS OF TRANSPONDERS
A11-59	A11.1.2-9	FM SYSTEM IFM GROUND RULE
A11-60	A11.1.2-10	LOSS OF TDRS TRACKING CAPABILITY
A11-61	A11.1.2-11	LOSS OF S-BAND PREAMPS AND POWER AMPS
A11-62	A11.1.2-12	LOSS OF ANTENNA ELECTRONICS
A11-63	A11.1.2-13	LOSS OF NSP'S
A11-64	A11.1.2-14	LOSS OF COMMUNICATIONS SECURITY (COMSEC)
A11-65	A11.1.2-15	AUDIO CENTRAL CONTROL UNIT (ACCU)
A11-66	A11.1.2-16	LOSS OF ACCU'S
A11-67	A11.1.2-17	LOSS OF THE PLT AND MS ATU'S
A11-68	A11.1.2-18	LOSS OF INTERCOM
A11-69	A11.1.2-19	LOSS OF UHF
A11-70	A11.1.2-20	LOSS OF GCIL
A11-71	A11.1.2-21	LOSS OF RECORDERS
A11-72	A11.1.2-22	LOSS OF TV
A11-73	A11.1.2-23	LOSS OF OCA
A11-74	A11.1.2-24	PCM MASTER UNIT (PCMMU)
A11-75	A11.1.2-25	LOSS OF PCMMU'S
A11-76	A11.1.2-26	LOSS OF OI MDM

VOLUME A KEY

<u>NEW RULE #</u>	<u>OLD RULE #</u>	<u>RULE TITLE</u>
A11-77	A11.1.2-27	LOSS OF ANY OI DSC A11-78 THROUGH A11-100 RULES ARE RESERVED
		COMMUNICATIONS GO/NO-GO CRITERIA
A11-1001	A11.1.3-1	COMMUNICATIONS GO/NO-GO CRITERIA

SECTION A12 - ROBOTICS

GENERAL

A12-1	A12.1.1-1	EVA FOR RMS OPERATIONS
A12-2	A12.1.1-2	UNATTENDED RMS CONSTRAINTS
A12-3	A12.1.1-3	TEMPERATURE CONSTRAINTS [CIL]
A12-4	A12.1.1-4	RMS ACTIVITY TERMINATION
A12-5	A12.1.1-5	ORBITER AVOIDANCE MANEUVERS CONSTRAINT [CIL]
A12-6	A12.1.1-6	OMS/RCS CONSTRAINTS
A12-7	A12.1.1-7	RMS IFM D&C KIT
A12-8	A12.1.1-8	RMS OPCODE UPLINKS
A12-9	A12.1.1-9	RMS MCIU BITE OVERRIDES [CIL] A12-10 THROUGH A12-50 RULES ARE RESERVED

MPM/MRL LOSS/FAILURE DEFINITIONS

A12-51	A12.1.2-1	MPM/MRL POSITIONING
A12-52	A12.1.2-2	MPM FAILED IN TRANSIT
A12-53	A12.1.2-3	MRL FAILED IN TRANSIT A12-54 THROUGH A12-70 RULES ARE RESERVED

MPM/MRL SYSTEMS MANAGEMENT

A12-71	A12.1.3-1	MPM/MRL CYCLING
A12-72	A12.1.3-2	MPM DEPLOY/STOW CONSTRAINTS
A12-73	A12.1.3-3	MRL CONSTRAINTS
A12-74	A12.1.3-4	INADVERTENT MPM CYCLING PROTECTION [CIL] A12-75 THROUGH A12-90 RULES ARE RESERVED

RMS PREOPERATION SYSTEM MANAGEMENT

A12-91	A12.1.4-1	SHOULDER BRACE OPERATION
A12-92	A12.1.4-2	RMS CHECKOUT A12-93 THROUGH A12-110 RULES ARE RESERVED

RMS DRIVE SYSTEM MANAGEMENT

A12-111	A12.1.5-1	MODE AVAILABILITY DRIVE CONSTRAINT
A12-112	A12.1.5-2	FIELD OF VIEW CONSTRAINT [CIL]
A12-113	A12.1.5-3	AUTO MODE ENTRY CONSTRAINT [CIL]
A12-114	A12.1.5-4	ORBITER PROXIMITY CONSTRAINTS [CIL]
A12-115	A12.1.5-5	INOPERATIVE BRAKE CONSTRAINT [CIL]
A12-116	A12.1.5-6	AUTO BRAKES CONSTRAINT [CIL]
A12-117	A12.1.5-7	CONTINGENCY STOP [CIL]
A12-118	A12.1.5-8	POHS AND LEFT-HANDED COORDINATE SYSTEMS
NONE	A12.1.5-9	RESERVED A12-119 THROUGH A12-140 RULES ARE RESERVED

END EFFECTOR (EE) LOSS/FAILURE DEFINITIONS

A12-141	A12.1.6-1	EE BACKUP RELEASE
A12-142	A12.1.6-2	EE CAPTURE/RIGIDIZE
A12-143	A12.1.6-3	EE RELEASE/DERIGIDIZE A12-144 THROUGH A12-160 RULES ARE RESERVED

END EFFECTOR SYSTEM MANAGEMENT

A12-161	A12.1.7-1	PAYLOAD GRAPPLE CONSTRAINTS
A12-162	A12.1.7-2	EE MODE SWITCH CONSTRAINTS [CIL]
A12-163	A12.1.7-3	CAPTURE AND RELEASE PROXIMITY CONSTRAINT [CIL]
A12-164	A12.1.7-4	PAYLOAD RELEASE DURING BERTHING A12-165 THROUGH A12-180 RULES ARE RESERVED

RMS JETTISON SYSTEM MANAGEMENT

A12-181	A12.1.8-1	JETTISON SYSTEM CONSTRAINT
A12-182	A12.1.8-2	RMS/PAYLOAD JETTISON A12-183 THROUGH A12-200 RULES ARE RESERVED

RMS GO/NO-GO CRITERIA

A12-1001	A12.1.9-1	RMS GO/NO-GO CRITERIA
----------	-----------	-----------------------

VOLUME A KEY

<u>NEW RULE #</u>	<u>OLD RULE #</u>	<u>RULE TITLE</u>
SECTION A13 - AEROMED		
ASCENT		
A13-1	A13.1.1-1	ASCENT ABORT
A13-2	A13.1.1-2	SPACEHAB SAFE ATMOSPHERE REQUIREMENTS - UNPOWERED ASCENT A13-3 THROUGH A13-20 RULES ARE RESERVED
ON-ORBIT		
A13-21	A13.1.2-1	EARLY FLIGHT TERMINATION
A13-22	A13.1.2-2	ONBOARD MEDICAL KIT
A13-23	A13.1.2-9	PRIVATE MEDICAL COMMUNICATION (PMC)
A13-24	A13.1.2-10	CPHS PROTOCOLS
A13-25	A13.1.2-11	CREW AWAKE TIME CONSTRAINT
A13-26	A13.1.2-19	ACCELERATION RESTRICTIONS ON MEDICAL PROCEDURES
A13-27	A13.1.2-20	LOWER BODY NEGATIVE PRESSURE (LBNP)
A13-28	A13.1.2-21	LBNP TEST TERMINATION CRITERIA
A13-29	A13.1.2-25	NOISE LEVEL CONSTRAINTS
A13-30	A13.1.2-28	IODINE REMOVAL REQUIREMENT
A13-31	A13.1.2-30	CREW CABIN TEMPERATURE LIMITS
A13-32	A13.1.2-22	INTENSE CYCLE EXERCISE
A13-33	A13.1.2-31	EXERCISE REQUIREMENTS A13-34 THROUGH A13-50 RULES ARE RESERVED
ATMOSPHERE		
A13-51	A13.1.2-3	CABIN PRESSURE
A13-52	A13.1.2-4	PPCO2 CONSTRAINT
A13-53	A13.1.2-5	MINIMUM PPO2 CONSTRAINTS
A13-54	A13.1.2-6	100 PERCENT OXYGEN USE CONSTRAINT A13-55 THROUGH A13-100 RULES ARE RESERVED
EVA OPERATIONS		
A13-101	A13.1.2-8	SCHEDULED AND UNSCHEDULED EVA CONSTRAINTS
A13-102	A13.1.2-29	MAXIMUM EVA DURATION CONSTRAINTS
A13-103	A13.1.2-7	EVA PREBREATHE PROTOCOL
A13-104	A13.1.2-26	DECOMPRESSION SICKNESS SYMPTOMS AND CREW DISPOSITION
A13-105	A13.1.2-27	DECOMPRESSION SICKNESS RESPONSE AND TREATMENT A13-106 THROUGH A13-150 RULES ARE RESERVED
HAZARD MANAGEMENT		
A13-151	A13.1.2-12	HOT CABIN ATMOSPHERE
A13-152	A13.1.2-13	CABIN ATMOSPHERE CONTAMINATION
A13-153	A13.1.2-14	BROKEN GLASS/HAZARDOUS SUBSTANCE CONSTRAINT
A13-154	A13.1.2-17	HAZARDOUS SPILL LEVEL DEFINITIONS
A13-155	A13.1.2-15	ORBITER HAZARDOUS SUBSTANCE SPILL RESPONSE
A13-156	A13.1.2-16	SPACEHAB HAZARDOUS SUBSTANCE SPILL RESPONSE
NONE	A13.1.2-23	RESERVED
NONE	A13.1.2-24	RESERVED A13-157 THROUGH A13-200 RULES ARE RESERVED
ENTRY		
A13-201	A13.1.3-1	ANTI-G SUIT PROTOCOL (ANTI-ORTHOSTATIC COUNTERMEASURE)
A13-202	A13.1.3-2	FLUID LOADING
A13-203	A13.1.3-3	TANK B WATER CONTINGENCY USE
SECTION A14 - SPACE ENVIRONMENT		
DEFINITIONS		
A14-1	A14.1.1-1	UNCONFIRMED ARTIFICIAL EVENT DEFINITION
A14-2	A14.1.1-2	CONFIRMED ARTIFICIAL EVENT DEFINITION
A14-3	A14.1.1-3	SOLAR PARTICLE EVENT WARNING DEFINITION
A14-4	A14.1.1-4	SOLAR PARTICLE EVENT DEFINITION
A14-5	A14.1.1-5	GEOMAGNETIC STORM DEFINITION
A14-6	A14.1.1-6	OTHER RADIATION EVENT DEFINITION
A14-7	A14.1.1-7	RADIATION ENVIRONMENT CONDITION DEFINITION
A14-8	A14.1.1-8	PROJECTED OPERATIONAL DOSE LIMIT VIOLATION DEFINITION
A14-9	A14.1.1-9	ALARA DEFINITION
A14-10	A14.1.1-10	LEGAL EXPOSURE LIMITS [HC]

VOLUME A KEY

<u>NEW RULE #</u>	<u>OLD RULE #</u>	<u>RULE TITLE</u>
A14-11	A14.1.1-11	SHUTTLE ADMINISTRATIVE LIMIT [HC]
A14-12	A14.1.1-12	HIGH DOSE RATE LIMITS [HC]
		A14-13 THROUGH A14-50 RULES ARE RESERVED
		MANAGEMENT
A14-51	A14.1.2-1	CREW RADIATION EXPOSURE LIMITS [HC]
A14-52	A14.1.2-2	ACTIONS REQUIRED FOR RADIATION ENVIRONMENT CONDITIONS - PRELAUNCH
A14-53	A14.1.2-3	ACTIONS REQUIRED FOR RADIATION ENVIRONMENT CONDITIONS - ON ORBIT [HC]
A14-54	A14.1.2-4	GO/NO-GO CRITERIA FOR EVA BASED ON RADIATION EXPOSURE [HC]
NONE	A14.1.2-5	RESERVED
NONE	A14.1.2-6	RESERVED
A14-55	A14.1.2-7	DOWNGRADING TO NOMINAL FROM ALERT OR CONTINGENCY
		A14-56 THROUGH A14-100 RULES ARE RESERVED
		SPACE ENVIRONMENT GO/NO-GO CRITERIA
A14-1001	A14.1.3-1	SPACE ENVIRONMENT GO/NO-GO CRITERIA [HC]

SECTION A15 - EXTRAVEHICULAR ACTIVITY (EVA)

GENERAL

A15-1	A15.1.1-1	EVA TIME DEFINITION
A15-2	A15.1.1-2	TERMINATE EVA DEFINITION
A15-3	A15.1.1-3	ABORT EVA DEFINITION
A15-4	A15.1.1-4	SCHEDULED EVA DEFINITION
A15-5	A15.1.1-5	UNSCHEDULED EVA DEFINITION
A15-6	A15.1.1-6	CONTINGENCY EVA DEFINITION
A15-7	A15.1.1-7	MINIMUM RF COMMUNICATIONS DEFINITION
A15-8	A15.1.1-8	OPERATIONAL CAUTION AND WARNING SYSTEM (CWS) DEFINITION
A15-9	A15.1.1-9	TWO/ONE-CREWMEMBER EVA GUIDELINES
A15-10	A15.1.1-10	EVA CREWMEMBER(S) SUPPORT
A15-11	A15.1.1-11	SAFETY TETHER REQUIREMENTS
A15-12	A15.1.1-12	HAZARDOUS EQUIPMENT SAFING
A15-13	A15.1.1-13	AIRLOCK CONFIGURATION
A15-14	A15.1.1-14	SCHEDULED AND UNSCHEDULED EVA CONSTRAINTS
A15-15	A15.1.1-15	CONTINGENCY EVA PROTECTION
A15-16	A15.1.1-16	EVA TERMINATION FOR CABIN LEAK
A15-17	A15.1.1-17	PAYLOAD BAY CONFIGURATION POST-EVA
A15-18	A15.1.1-18	PAYLOAD OPERATION/DEPLOY GUIDELINE
A15-19	A15.1.1-19	UNSCHEDULED EVA PREPARATION
A15-20	A15.1.1-20	ECG TELEMETRY CHECKOUT
A15-21	A15.1.1-21	LEAKING RCS THRUSTER/APU AVOIDANCE
A15-22	A15.1.1-22	RCS/APU THRUSTER PLUME AVOIDANCE
A15-23	A15.1.1-23	EV CREW IN VICINITY OF ACTIVE PAYLOAD RETENTION LATCH ASSEMBLIES
A15-24	A15.1.1-24	EVA OPERATIONS IN THE GENERIC PAYLOAD BAY ENVELOPE
A15-25	A15.1.1-25	ORBITER EVA OPERATIONS NEAR S-BAND ANTENNAS
A15-26	A15.1.1-26	KEEPOUT ZONE FOR EVA OPERATIONS NEAR THE ORBITER UHF PAYLOAD BAY ANTENNA
		A15-27 THROUGH A15-100 RULES ARE RESERVED

LOSS/FAILURE DEFINITIONS

A15-101	A15.1.2-1	EVA CAPABILITY
A15-102	A15.1.2-2	EMU GO/NO-GO CRITERIA
NONE	A15.1.2-3	RESERVED
		A15-103 THROUGH A15-150 RULES ARE RESERVED

SYSTEMS MANAGEMENT

A15-151	A15.1.3-1	DENITROGENATION
A15-152	A15.1.3-2	EMU CONSUMABLES WITH REAL-TIME EMU DATA DOWNLINK
A15-153	A15.1.3-3	EMU CONSUMABLES WITHOUT REAL-TIME EMU DATA DOWNLINK
NONE	A15.1.3-4	RESERVED
NONE	A15.1.3-5	RESERVED
NONE	A15.1.3-6	RESERVED
NONE	A15.1.3-7	RESERVED
NONE	A15.1.3-8	RESERVED
NONE	A15.1.3-9	RESERVED
A15-154	A15.1.3-10	EMU CONSUMABLES PRE-EVA
NONE	A15.1.3-11	RESERVED
A15-155	A15.1.3-12	MANIPULATOR FOOT RESTRAINT (MFR) AND PFR ATTACHMENT DEVICE (PAD) GUIDELINES
		A15-156 THROUGH A15-200 RULES ARE RESERVED

EXTERNAL AIRLOCK

A15-201	A15.1.4-1	EXTERNAL AIRLOCK HATCH THERMAL COVER
A15-202	A15.1.4-2	EXTERNAL AIRLOCK LCG PRESSURE AND TEMPERATURE MANAGEMENT USING THE EMU

VOLUME A KEY

<u>NEW RULE #</u>	<u>OLD RULE #</u>	<u>RULE TITLE</u>
A15-203	A15.1.4-3	CABIN ATMOSPHERE DECONTAMINATION FOLLOWING EVA
A15-204	A15.1.4-4	EXTERNAL AIRLOCK EMU SERVICING CONSTRAINTS
A15-205	A15.1.4-5	EMU DECONTAMINATION DURING EVA

SECTION A16 - POSTLANDING

GENERAL

A16-1	A16.1.1-1	CONVOY POSITIONING
A16-2	A16.1.1-2	VEHICLE SYSTEM RECONFIGURATION CONSTRAINT
A16-3	A16.1.1-3	PRECREW EGRESS TROUBLESHOOTING CONSTRAINT
A16-4	A16.1.1-4	VEHICLE SYSTEM MODING CONSTRAINT
A16-5	A16.1.1-5	MEMORY RECONFIGURATION CONSTRAINT
A16-6	A16.1.1-6	RECORDER DUMP
A16-7	A16.1.1-7	GOM HANDOVER
A16-8	A16.1.1-8	CREW EGRESS METHOD DETERMINATION (FOR MODE V EGRESS)
A16-9	A16.1.1-9	SSME REPOSITIONING CONSTRAINT
A16-10	A16.1.1-10	NORMAL POSTLANDING OPERATIONS
A16-11	A16.1.1-11	EXPEDITED POWERDOWN
A16-12	A16.1.1-12	EMERGENCY POWERDOWN
A16-13	A16.1.1-13	SIDE HATCH OPENING CONSTRAINT
		A16-14 THROUGH A16-50 RULES ARE RESERVED

COOLING

A16-51	A16.1.2-1	NO GROUND COOLING/EARLY VEHICLE POWER TERMINATION
A16-52	A16.1.2-2	EXTENDED COOLING
A16-53	A16.1.2-3	FREON LOOP CONFIGURATION
A16-54	A16.1.2-4	AMMONIA BOILER MANAGEMENT
		A16-55 THROUGH A16-100 RULES ARE RESERVED

ET UMBILICAL DOOR

A16-101	A16.1.3-1	ET UMBILICAL DOOR POSITIONING
		A16-102 THROUGH A16-150 RULES ARE RESERVED

VENT DOORS

A16-151	A16.1.4-1	VENT DOOR POSITIONING
		A16-152 THROUGH A16-200 RULES ARE RESERVED

APU/HYDRAULIC

A16-201	A16.1.5-1	HYDRAULIC CIRCULATION PUMP OPERATION
A16-202	A16.1.5-2	APU REQUIREMENTS
A16-203	A16.1.5-3	APU/HYDRAULIC LOAD TEST TERMINATION
A16-204	A16.1.5-4	WINDWARD APU OPERATION CONSTRAINT
A16-205	A16.1.5-5	EARLY APU SHUTDOWN
		A16-206 THROUGH A16-250 RULES ARE RESERVED

FUEL CELLS

A16-251	A16.1.6-1	FUEL CELL LIFETIME
		A16-252 THROUGH A16-300 RULES ARE RESERVED

CONTAMINATION/FLAMMABILITY

A16-301	A16.1.7-1	CONTAMINATION/FLAMMABILITY/TOXICITY
A16-302	A16.1.7-2	EMERGENCY OXYGEN SYSTEM REQUIREMENTS

SECTION A17 - LIFE SUPPORT

SMOKE DETECTION/FIRE SUPPRESSION LOSS DEFINITIONS

A17-1	A17.1.1-1	FIRE/POST-FIRE DEFINITIONS
A17-2	A17.1.1-2	SMOKE DETECTION LOSS DEFINITION
A17-3	A17.1.1-3	FORWARD AVIONICS BAY FIRE SUPPRESSION
		A17-4 THROUGH A17-50 RULES ARE RESERVED

SMOKE DETECTION/FIRE SUPPRESSION MANAGEMENT

A17-51	A17.1.2-1	MANAGEMENT FOLLOWING LOSS OF SMOKE DETECTION
A17-52	A17.1.2-2	MANAGEMENT FOLLOWING LOSS OF FIRE SUPPRESSION IN AN AVIONICS BAY
A17-53	A17.1.2-3	FIRE AND POST-FIRE ACTIONS
A17-54	A17.1.2-4	MANAGEMENT FOLLOWING HALON DISCHARGE WITHOUT FIRE CONFIRMATION
		A17-55 THROUGH A17-100 RULES ARE RESERVED

ATMOSPHERE REVITALIZATION SYSTEM (ARS) AIR LOSS DEFINITIONS

VOLUME A KEY

<u>NEW RULE #</u>	<u>OLD RULE #</u>	<u>RULE TITLE</u>
A17-101	A17.1.3-1	CABIN FAN
A17-102	A17.1.3-2	CABIN ATMOSPHERIC CONTROL
A17-103	A17.1.3-3	LOSS OF AVIONICS BAY FAN
A17-104	A17.1.3-4	IMU FAN
A17-105	A17.1.3-5	AVIONICS BAY COOLING
A17-106	A17.1.3-6	REGENERATIVE CO2 REMOVAL SYSTEM (RCRS) LOSS DEFINITION
		A17-107 THROUGH A17-150 RULES ARE RESERVED
		ARS AIR SYSTEM MANAGEMENT
A17-151	A17.1.4-1	CABIN ATMOSPHERE CONTROL
A17-152	A17.1.4-2	CABIN TEMPERATURE CONTROL AND MANAGEMENT
A17-153	A17.1.4-3	CABIN/AVIONICS BAY FAN MANAGEMENT
A17-154	A17.1.4-4	MANAGEMENT OF DEGRADED ROTATING EQUIPMENT
A17-155	A17.1.4-5	REGENERATIVE CO2 REMOVAL SYSTEM (RCRS) MANAGEMENT
A17-156	A17.1.4-6	RCRS MANUAL SHUTDOWN CRITERIA
A17-157	A17.1.4-7	LIOH REDLINE DETERMINATION
A17-158	A17.1.4-8	MANAGEMENT OF LIOH CANS FOR ADDITIONAL DAYS
		A17-159 THROUGH A17-200 RULES ARE RESERVED
		PRESSURE CONTROL SYSTEMS (PCS) LOSS DEFINITIONS
A17-201	A17.1.5-1	CABIN PRESSURE INTEGRITY
A17-202	A17.1.5-2	8 PSIA CABIN CONTINGENCY 165-MINUTE RETURN CAPABILITY
A17-203	A17.1.5-3	PPO2 CONTROL
A17-204	A17.1.5-4	N2 SUPPLY
A17-205	A17.1.5-5	PPO2 SENSOR LOSS DEFINITION
A17-206	A17.1.5-6	LES O2 SUPPLY SYSTEM LOSS DEFINITION
		A17-207 THROUGH A17-250 RULES ARE RESERVED
		PCS SYSTEMS MANAGEMENT
A17-251	A17.1.6-1	NORMAL PCS CONFIGURATION
A17-252	A17.1.6-2	CABIN PRESSURE RELIEF VALVES
A17-253	A17.1.6-3	CABIN VENT VALVES
A17-254	A17.1.6-4	CABIN O2 CONCENTRATION
A17-255	A17.1.6-5	8 PSIA EMERGENCY CABIN CONFIGURATION
A17-256	A17.1.6-6	O2 BLEED ORIFICE MANAGEMENT
A17-257	A17.1.6-7	N2 SYSTEM MANAGEMENT
A17-258	A17.1.6-8	LOSS OF CABIN INTEGRITY TMAX DEFINITION AND TIG SELECTION
NONE	A17.1.6-9	RESERVED
A17-259	A17.1.6-10	LES O2 SUPPLY SYSTEM LOSS MANAGEMENT
A17-260	A17.1.6-11	PCS O2/N2 CONTROLLER CHECKOUT
		A17-261 THROUGH A17-300 RULES ARE RESERVED
		10.2 PSIA CABIN ATMOSPHERE OPERATION
A17-301	A17.1.7-1	CABIN ATMOSPHERE MANAGEMENT
A17-302	A17.1.7-2	10.2 PSIA CABIN DEPRESSURIZATION CONSTRAINTS
A17-303	A17.1.7-3	CABIN REPRESSURIZATION PRIOR TO DEORBIT
A17-304	A17.1.7-4	10.2 PSIA CABIN PRESSURE MANAGEMENT FOR MULTIPLE EVA'S
A17-305	A17.1.7-5	14.7 PSIA CABIN REPRESSURIZATION LIMITATION
A17-306	A17.1.7-6	10.2 PSIA CABIN TEMPERATURE CONSTRAINT
A17-307	A17.1.7-7	PAYLOAD 10.2 PSIA CABIN OPERATIONS
A17-308	A17.1.7-8	ATCS (10.2 PSIA CABIN) CONFIGURATION
A17-309	A17.1.7-9	CABIN PRESSURE TIME AT 10.2 PSIA
		A17-310 THROUGH A17-350 RULES ARE RESERVED
		WASTE COLLECTION SYSTEM (WCS)/VACUUM VENT LOSS DEFINITIONS
A17-351	A17.1.8-1	WCS SEPARATOR
A17-352	A17.1.8-2	WCS URINE COLLECTION
A17-353	A17.1.8-3	WCS COMMODE
A17-354	A17.1.8-4	VACUUM VENT LOSS DEFINITION
		A17-355 THROUGH A17-400 RULES ARE RESERVED
		WCS/VACUUM VENT MANAGEMENT
A17-401	A17.1.9-1	WCS USAGE CONSTRAINT
A17-402	A17.1.9-2	LEAKING WCS WATER LINES
A17-403	A17.1.9-3	ALTERNATE FECAL COLLECTION
A17-404	A17.1.9-4	ALTERNATE URINE COLLECTION
A17-405	A17.1.9-5	VACUUM VENT SYSTEMS MANAGEMENT [CIL]
		A17-406 THROUGH A17-450 RULES ARE RESERVED
		WASTE WATER LOSS DEFINITIONS
A17-451	A17.1.10-1	WASTE WATER TANK
A17-452	A17.1.10-2	WASTE WATER DUMP CAPABILITY
		A17-453 THROUGH A1-500 RULES ARE RESERVED

VOLUME A KEY

<u>NEW RULE #</u>	<u>OLD RULE #</u>	<u>RULE TITLE</u>
WASTE WATER MANAGEMENT		
A17-501	A17.1.11-1	ALTERNATE PRESSURE VALVE MANAGEMENT
A17-502	A17.1.11-2	WASTE DUMP NOZZLE ICE FORMATION
A17-503	A17.1.11-3	WASTE WATER STORAGE
A17-504	A17.1.11-4	MINIMUM WASTE TANK QUANTITY AFTER DUMPING
A17-505	A17.1.11-5	WASTE WATER DUMP NOZZLE TEMPERATURE CONSTRAINTS
A17-506	A17.1.11-6	WASTE WATER SYSTEM LEAK MANAGEMENT
A17-507	A17.1.11-7	OMS & PRCS BURNS WITH FREE H2O IN THE CABIN
		A17-508 THROUGH A17-550 RULES ARE RESERVED
GALLEY MANAGEMENT LIFE SUPPORT		
A17-551	A17.1.12-1	IODINE REMOVAL IMPLEMENTATION
		A17-552 THROUGH A17-600 RULES ARE RESERVED
SPACEHAB FIRE/SMOKE		
A17-601	A17.6.1-1	SPACEHAB FIRE/SMOKE DETECTION LOSS
A17-602	A17.6.1-2	SPACEHAB FIRE/SMOKE CONFIRMATION
A17-603	A17.6.1-3	SPACEHAB FIRE/SMOKE MANAGEMENT
		A17-604 THROUGH A17-650 RULES ARE RESERVED
SPACEHAB ECS MANAGEMENT		
A17-651	A17.6.2-1	SPACEHAB ENVIRONMENTAL CONTROL AND LIFE SUPPORT (ECLS) REQUIREMENTS
A17-652	A17.6.2-2	SPACEHAB SUBSYSTEM FANS/AIR LOOP
		A17-653 THROUGH A17-700 RULES ARE RESERVED
MODULE ATMOSPHERE MANAGEMENT		
A17-701	A17.6.3-1	MODULE ATMOSPHERIC CONTROL
A17-702	A17.6.3-2	PARTIAL PRESSURE OF OXYGEN (PPO2) SENSORS
A17-703	A17.6.3-3	PARTIAL PRESSURE OF CARBON DIOXIDE (PPCO2) SENSORS
A17-704	A17.6.3-4	CABIN/HFA FAN
A17-705	A17.6.3-5	ATMOSPHERE REVITALIZATION SYSTEM (ARS) FAN
A17-706	A17.6.3-6	SPACEHAB FAN CONFIGURATIONS
		A17-707 THROUGH A17-750 RULES ARE RESERVED
ATMOSPHERE INTEGRITY		
A17-751	A17.6.4-1	MODULE PRESSURE INTEGRITY
A17-752	A17.6.4-2	NEGATIVE PRESSURE RELIEF VALVE COVERS
A17-753	A17.6.4-3	CABIN DEPRESS VALVE (CDV)
A17-754	A17.6.4-4	EXPERIMENT VENT VALVE
A17-755	A17.6.4-5	PPRV MANAGEMENT
A17-756	A17.6.4-6	SM/LDM ASCENT/DESCENT INLET STUB
A17-757	A17.6.4-7	RDM MIXING BOX CAP
A17-758	A17.6.4-8	RDM LIOH CANISTER
		A17-759 THROUGH A17-800 RULES ARE RESERVED
LIFE SUPPORT GO/NO-GO CRITERIA		
A17-1001	A17.1.13-1	LIFE SUPPORT GO/NO-GO CRITERIA

SECTION A18 - THERMAL

SUPPLY WATER LOSS DEFINITIONS		
A18-1	A18.1.1-1	SUPPLY WATER TANK
A18-2	A18.1.1-2	SUPPLY WATER DUMPLINE
A18-3	A18.1.1-3	SUPPLY WATER DUMP CAPABILITY
		A18-4 THROUGH A18-50 RULES ARE RESERVED
SUPPLY WATER MANAGEMENT - THERMAL		
A18-51	A18.1.2-1	SUPPLY H2O TANK A MANAGEMENT
A18-52	A18.1.2-2	SUPPLY/WASTE WATER CROSSCONNECT
A18-53	A18.1.2-3	SUPPLY WATER TANK A OUTLET VALVE MANAGEMENT
A18-54	A18.1.2-4	SUPPLY WATER TANK A PRESSURE CONTROL MANAGEMENT
A18-55	A18.1.2-5	SUPPLY WATER DUMP
A18-56	A18.1.2-6	SUPPLY WATER DUMP NOZZLE TEMPERATURE CONSTRAINT
A18-57	A18.1.2-7	ON-ORBIT SUPPLY WATER TANK MANAGEMENT
A18-58	A18.1.2-8	SUPPLY WATER SYSTEM LEAK MANAGEMENT
A18-59	A18.1.2-9	SUPPLY WATER REDLINE
A18-60	A18.1.2-10	EXTERNAL AIRLOCK WATER LINES
A18-61	A18.1.2-11	EXTERNAL AIRLOCK LCG FLUID LINE LOSS DEFINITION
A18-62	A18.1.2-12	EXTERNAL AIRLOCK WATER LINE OVERPRESSURE/TEMPERATURE MANAGEMENT
		A18-63 THROUGH A18-100 RULES ARE RESERVED

VOLUME A KEY

<u>NEW RULE #</u>	<u>OLD RULE #</u>	<u>RULE TITLE</u>
ARS H2O LOOP LOSS DEFINITIONS		
A18-101	A18.1.3-1	ARS WATER LOOP A18-102 THROUGH A18-150 RULES ARE RESERVED
ARS H2O LOOP LOSS MANAGEMENT		
A18-151	A18.1.4-1	ARS WATER LOOP A18-152 THROUGH A18-200 RULES ARE RESERVED
ACTIVE THERMAL CONTROL SYSTEM (ATCS) LOSS DEFINITIONS		
A18-201	A18.1.5-1	FREON COOLANT LOOPS (FCL)
A18-202	A18.1.5-2	TOPPING EVAPORATOR
A18-203	A18.1.5-3	HIGH-LOAD EVAPORATOR
A18-204	A18.1.5-4	FES PRIMARY A (B) CONTROLLER
A18-205	A18.1.5-5	FES SECONDARY CONTROLLER
A18-206	A18.1.5-6	FES H2O FEEDLINE
A18-207	A18.1.5-7	AMMONIA BOILER SUBSYSTEM (ABS)
A18-208	A18.1.5-8	RADIATOR FLOW CONTROL ASSEMBLY (RFCA) A18-209 THROUGH A18-250 RULES ARE RESERVED
ATCS MANAGEMENT		
A18-251	A18.1.6-1	FREON COOLANT LOOPS (FCL)
A18-252	A18.1.6-2	FLASH EVAPORATOR SYSTEM (FES)
A18-253	A18.1.6-3	AMMONIA BOILER SUBSYSTEM (ABS)
A18-254	A18.1.6-4	ABS AMMONIA REDLINE
A18-255	A18.1.6-5	RADIATOR FLOW CONTROL ASSEMBLY (RFCA)
A18-256	A18.1.6-6	RADIATOR ISOLATION VALVE MANAGEMENT
A18-257	A18.1.6-7	POSTLANDING NH3 TERMINATION A18-258 THROUGH A18-300 RULES ARE RESERVED
EECOM HEATER MANAGEMENT		
A18-301	A18.1.7-1	TCS HEATER CONFIGURATION
A18-302	A18.1.7-2	TCS HEATER REDUNDANCY
A18-303	A18.1.7-3	REDUNDANT TCS HEATER VERIFICATION
A18-304	A18.1.7-4	TCS HEATER OPERATIONS FOR LOSS OF INSTRUMENTATION
A18-305	A18.1.7-5	LOSS OF HEATER SM CAPABILITY
A18-306	A18.1.7-6	EXTERNAL AIRLOCK HEATER LOSS MANAGEMENT A18-307 THROUGH A18-350 RULES ARE RESERVED
EECOM SOFTWARE REQUIREMENT		
A18-351	A18.1.8-1	EECOM SOFTWARE REQUIREMENT A18-352 THROUGH A18-400 RULES ARE RESERVED
TPS BONDLINE TEMPERATURES MANAGEMENT		
A18-401	A18.1.9-1	THERMAL PROTECTION SYSTEM (TPS) BONDLINE TEMPERATURES A18-402 THROUGH A18-450 RULES ARE RESERVED
ATTITUDE MANAGEMENT FOR THERMAL CONTROL		
A18-451	A18.1.10-1	ORBITER THERMAL CONSTRAINTS AND ATTITUDE MANAGEMENT [CIL] A18-452 THROUGH A18-500 RULES ARE RESERVED
COOLING EQUIPMENT CONSTRAINTS		
A18-501	A18.1.11-1	MAXIMUM OFF TIME FOR COOLING EQUIPMENT A18-502 THROUGH A18-550 RULES ARE RESERVED
WATER LOOP		
A18-551	A18.6.1-1	SPACEHAB SUBSYSTEM WATER LOOP
A18-552	A18.6.1-2	SPACEHAB SUBSYSTEM WATER LOOP MANAGEMENT
A18-553	A18.6.1-3	SPACEHAB SUBSYSTEM PUMP OPERATIONS
A18-554	A18.6.1-4	WATER LINE HEATERS
A18-555	A18.6.1-5	WATER LINE HEATER MANAGEMENT
A18-556	A18.6.1-6	RDM CENTRALIZED EXPERIMENT WATER LOOP (CEWL)
A18-557	A18.6.1-7	RDM CEWL PUMP OPERATIONS A18-558 THROUGH A18-600 RULES ARE RESERVED
SPACEHAB ENVIRONMENTAL CONTROL SYSTEM (ECS) MANAGEMENT		
A18-601	A18.6.2-1	ORBITER/SPACEHAB/EXPERIMENT THERMAL PRIORITIES
A18-602	A18.6.2-2	ORBITER FREON FLOW PROPORTIONING VALVE (FPV) USAGE
A18-603	A18.6.2-3	SM/LDM WATER FLOW CONTROL ELECTRONICS UNIT (WFCEU)
A18-604	A18.6.2-4	RDM ENVIRONMENTAL CONTROL UNIT (ECU) OPERATIONS
A18-605	A18.6.2-5	RDM ROTARY SEPARATOR (RS) OPERATIONS
A18-606	A18.6.5-6	RDM CONDENSATE STORAGE TANK (CST)/CONTINGENCY WATER CONTAINER (CWC) MANAGEMENT

VOLUME A KEY

<u>NEW RULE #</u>	<u>OLD RULE #</u>	<u>RULE TITLE</u>
		A18-607 THROUGH A18-650 RULES ARE RESERVED
		THERMAL GO/NO-GO CRITERIA
A18-1001	A18.1.12-1	THERMAL GO/NO-GO CRITERIA

VOLUME A KEY

THIS PAGE INTENTIONALLY BLANK