



International Space Station ISS/Shuttle Joint Operations Book

Mission Operations Directorate
Operations Division

28 JUN 05

This publication replaces
all previous publications.
These procedures are available
electronically on the SODF Homepage
at <http://mod.jsc.nasa.gov/do3>

National Aeronautics and
Space Administration

Lyndon B. Johnson Space Center
Houston, Texas



INTERNATIONAL SPACE STATION ISS/SHUTTLE JOINT OPERATIONS BOOK

28 JUN 05

APPROVED BY:



John J. Venditti
Book Manager



Ernest R. Edge, Jr.
Manager, Station Procedures Management

094



SODF Coordinator

ACCEPTED BY:

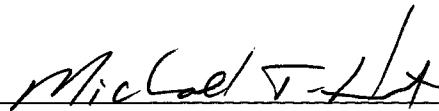

Michael T. Hurt
SODF Manager

This document is under the configuration control of the Systems Operations Data File Control Board (SODFCB).

Incorporates the following:
CR: Joint_OpsU477 Joint_OpsU480

Uplinked Messages (or Approved Flight Notes) replaced by this revision,
remove from Book:

None

**INTERNATIONAL SPACE STATION
ISS/SHUTTLE JOINT OPERATIONS BOOK**

LIST OF EFFECTIVE PAGES

28 JUN 05

Sign Off.....	* 28 JUN 05	34.....	28 JUN 05
ii.....	* 28 JUN 05	35.....	16 FEB 05
iii.....	* 28 JUN 05	36.....	16 FEB 05
iv.....	* 28 JUN 05	37.....	16 FEB 05
v.....	* 28 JUN 05	38.....	16 FEB 05
vi.....	* 28 JUN 05	39.....	16 FEB 05
vii.....	28 JUN 05	40.....	28 JUN 05
viii.....	28 JUN 05	41.....	20 OCT 04
ix.....	28 JUN 05	42.....	28 JUN 05
x.....	28 JUN 05	43.....	27 APR 05
1.....	28 JUN 05	44.....	27 APR 05
2.....	28 JUN 05	45.....	27 APR 05
3.....	11 JUL 03	46.....	27 APR 05
4.....	11 JUL 03	47.....	27 APR 05
5.....	11 JUL 03	48.....	27 APR 05
6.....	11 JUL 03	49.....	27 APR 05
7.....	08 OCT 03	50.....	27 APR 05
8.....	08 OCT 03	51.....	27 APR 05
9.....	08 OCT 03	52.....	28 JUN 05
10.....	08 OCT 03	53.....	05 FEB 02
11.....	12 JUL 04	54.....	05 FEB 02
12.....	28 JUN 05	55.....	05 FEB 02
13.....	04 APR 05	56.....	05 FEB 02
14.....	04 APR 05	57.....	16 MAY 05
15.....	04 APR 05	58.....	16 MAY 05
16.....	04 APR 05	59.....	16 MAY 05
17.....	04 APR 05	60.....	16 MAY 05
18.....	04 APR 05	61.....	16 MAY 05
19.....	04 APR 05	62.....	16 MAY 05
20.....	28 JUN 05	63.....	16 MAY 05
21.....	21 MAR 02	64.....	16 MAY 05
22.....	28 JUN 05	65.....	16 MAY 05
23.....	26 JAN 05	66.....	16 MAY 05
24.....	26 JAN 05	67.....	20 MAY 05
25.....	26 JAN 05	68.....	20 MAY 05
26.....	26 JAN 05	69.....	20 MAY 05
27.....	04 APR 05	70.....	28 JUN 05
28.....	04 APR 05	71.....	20 MAY 05
29.....	04 APR 05	72.....	20 MAY 05
30.....	28 JUN 05	73.....	20 MAY 05
31.....	28 JUN 05	74.....	28 JUN 05
32.....	28 JUN 05	75.....	28 JUN 05
33.....	29 APR 03	76.....	28 JUN 05

* - Omit from flight book

77.....	16 SEP 04	127.....	15 APR 05
78.....	16 SEP 04	128.....	15 APR 05
79.....	16 SEP 04	129.....	15 APR 05
80.....	28 JUN 05	130.....	28 JUN 05
81.....	21 MAR 05	131.....	15 FEB 05
82.....	21 MAR 05	132.....	15 FEB 05
83.....	21 MAR 05	133.....	15 FEB 05
84.....	21 MAR 05	134.....	28 JUN 05
85.....	04 APR 05	135.....	10 JAN 05
86.....	04 APR 05	136.....	10 JAN 05
87.....	04 APR 05	137.....	10 JAN 05
88.....	28 JUN 05	138.....	28 JUN 05
89.....	22 OCT 02	139.....	06 MAY 05
90.....	22 OCT 02	140.....	06 MAY 05
91.....	22 OCT 02	141.....	06 MAY 05
92.....	22 OCT 02	142.....	06 MAY 05
93.....	05 FEB 02	143.....	06 MAY 05
94.....	05 FEB 02	144.....	06 MAY 05
95.....	05 FEB 02	145.....	24 MAR 05
96.....	28 JUN 05	146.....	24 MAR 05
97.....	05 FEB 02	147.....	24 MAR 05
98.....	28 JUN 05	148.....	24 MAR 05
99.....	14 APR 05	149.....	24 MAR 05
100.....	14 APR 05	150.....	24 MAR 05
101.....	29 APR 03	151.....	24 MAR 05
102.....	29 APR 03	152.....	24 MAR 05
103.....	16 MAY 05	153.....	24 MAR 05
104.....	16 MAY 05	154.....	24 MAR 05
105.....	16 MAY 05	155.....	24 MAR 05
106.....	16 MAY 05	156.....	28 JUN 05
107.....	16 MAY 05	157.....	05 APR 05
108.....	28 JUN 05	158.....	05 APR 05
109.....	20 APR 05	159.....	05 APR 05
110.....	20 APR 05	160.....	05 APR 05
111.....	20 APR 05	161.....	05 APR 05
112.....	28 JUN 05	162.....	05 APR 05
113.....	27 APR 05	163.....	05 APR 05
114.....	27 APR 05	164.....	28 JUN 05
115.....	27 APR 05	165.....	14 APR 05
116.....	27 APR 05	166.....	14 APR 05
117.....	27 APR 05	167.....	14 APR 05
118.....	28 JUN 05	168.....	14 APR 05
119.....	27 APR 05	169.....	14 APR 05
120.....	27 APR 05	170.....	14 APR 05
121.....	27 APR 05	171.....	22 MAR 05
122.....	27 APR 05	172.....	22 MAR 05
123.....	15 APR 05	173.....	22 MAR 05
124.....	15 APR 05	174.....	22 MAR 05
125.....	15 APR 05	175.....	22 MAR 05
126.....	15 APR 05	176.....	28 JUN 05

* - Omit from flight book

177.....	24 APR 05	227.....	01 MAY 02
178.....	24 APR 05	228.....	01 MAY 02
179.....	24 APR 05	229.....	01 MAY 02
180.....	24 APR 05	230.....	01 MAY 02
181.....	24 APR 05	231.....	01 MAY 02
182.....	24 APR 05	232.....	01 MAY 02
183.....	23 APR 05	233.....	01 MAY 02
184.....	23 APR 05	234.....	28 JUN 05
185.....	23 APR 05	235.....	15 JUL 03
186.....	23 APR 05	236.....	28 JUN 05
187.....	23 APR 05	237.....	11 JUL 03
188.....	28 JUN 05	238.....	28 JUN 05
189.....	28 JUN 05	239.....	27 APR 05
190.....	28 JUN 05	240.....	27 APR 05
191.....	24 OCT 02	241.....	27 APR 05
192.....	24 OCT 02	242.....	28 JUN 05
193.....	24 OCT 02	243.....	20 APR 05
194.....	24 OCT 02	244.....	28 JUN 05
195.....	22 APR 04	245.....	14 NOV 00
196.....	22 APR 04	246.....	14 NOV 00
197.....	22 APR 04	247.....	14 NOV 00
198.....	22 APR 04	248.....	14 NOV 00
199.....	11 SEP 02	249.....	07 MAR 02
200.....	28 JUN 05	250.....	07 MAR 02
201.....	02 MAY 05	251.....	04 OCT 01
202.....	02 MAY 05	252.....	04 OCT 01
203.....	02 MAY 05	253.....	14 NOV 00
204.....	02 MAY 05	254.....	28 JUN 05
205.....	28 JUN 05	255.....	14 NOV 00
206.....	28 JUN 05	256.....	14 NOV 00
207.....	30 JAN 05	257.....	14 NOV 00
208.....	30 JAN 05	258.....	28 JUN 05
209.....	30 JAN 05	259.....	28 JUN 05
210.....	30 JAN 05	260.....	28 JUN 05
211.....	17 FEB 05	261.....	24 MAY 05
212.....	17 FEB 05	262.....	24 MAY 05
213.....	17 FEB 05	263.....	24 MAY 05
214.....	17 FEB 05	264.....	24 MAY 05
215.....	01 FEB 05	265.....	24 MAY 05
216.....	01 FEB 05	266.....	28 JUN 05
217.....	01 FEB 05	267.....	28 FEB 02
218.....	01 FEB 05	268.....	28 FEB 02
219.....	28 JUN 05	269.....	20 APR 05
220.....	28 JUN 05	270.....	20 APR 05
221.....	23 JUN 04	271.....	20 APR 05
222.....	23 JUN 04	272.....	20 APR 05
223.....	29 APR 03	273.....	20 APR 05
224.....	28 JUN 05	274.....	20 APR 05
225.....	01 MAY 02	275.....	20 APR 05
226.....	01 MAY 02	276.....	28 JUN 05

* - Omit from flight book

277.....	28 JUN 05	327.....	28 JUN 05
278.....	28 JUN 05	328.....	28 JUN 05
279.....	10 JUN 05	329.....	05 FEB 02
280.....	10 JUN 05	330.....	05 FEB 02
281.....	20 APR 05	331.....	27 APR 05
282.....	20 APR 05	332.....	27 APR 05
283.....	20 MAY 05	333.....	28 JUN 05
284.....	20 MAY 05	334.....	28 JUN 05
285.....	20 MAY 05	335.....	23 MAY 03
286.....	20 MAY 05	336.....	23 MAY 03
287.....	20 MAY 05		
288.....	20 MAY 05		
289.....	15 APR 05		
290.....	15 APR 05		
291.....	14 APR 05		
292.....	14 APR 05		
293.....	14 APR 05		
294.....	28 JUN 05		
295.....	21 JUN 05		
296.....	21 JUN 05		
297.....	21 JUN 05		
298.....	21 JUN 05		
299.....	21 JUN 05		
300.....	21 JUN 05		
301.....	16 MAY 05		
302.....	16 MAY 05		
303.....	16 MAY 05		
304.....	28 JUN 05		
305.....	16 MAY 05		
306.....	16 MAY 05		
307.....	16 MAY 05		
308.....	16 MAY 05		
309.....	04 APR 05		
310.....	04 APR 05		
311.....	28 JUN 05		
312.....	28 JUN 05		
313.....	08 JUN 04		
314.....	08 JUN 04		
315.....	08 JUN 04		
316.....	08 JUN 04		
317.....	08 JUN 04		
318.....	08 JUN 04		
319.....	08 JUN 04		
320.....	08 JUN 04		
321.....	08 JUN 04		
322.....	28 JUN 05		
323.....	05 FEB 02		
324.....	28 JUN 05		
325.....	05 FEB 02		
326.....	28 JUN 05		

* - Omit from flight book

CONTENTS

ARRIVAL	1
1.101 ISS Powerdown and Recovery - Channel 2B Only	3
1.102 ISS Powerdown and Recovery - Channel 4B Only	7
1.104 ODS Volume Preparation for Docking	11
1.106 PMA2 Pre-Arrival Configuration	13
1.107 Station-Orbiter Docking Script	21
1.108 PMA2 Arrival	23
1.109 PMA2 Post Arrival Configuration	27
INGRESS STATION	31
2.101 Post Docking Hatch Leak Check	33
2.102 Post Docking Hatch Leak Check - ISS	35
2.103 ODS Volume Preparation for Ingress	41
2.104 Hatch Opening and Shuttle/ISS Duct Installation	43
2.105 ISS Interim Ingress	53
2.106 Hatch Open and Duct Install (Bypass Config)	57
2.107 Shuttle Airlock/Tunnel Fan Activation (Bypass Duct Installed)	67
2.108 Shuttle Airlock/Tunnel Fan Deactivation (Bypass Duct Installed)	71
MATED OPERATIONS	75
3.101 Compound Specific Analyzer - Combustion Products: CSA-CP Resupply	77
3.102 Nitrogen Transfer Initiation	81
3.103 Nitrogen Transfer Termination	85
3.104 Lab FWD Hatch Thermal Cover Removal/Installation	89
3.105 O2 Repress	93
3.106 N2 Repress	95
3.107 Generic Depress	97
3.108 Genric Repress	99
3.109 Configure C&W for Ingress/Depress/Repress	101
3.110 Handover Attitude Control CMG TA to Orbiter	103
3.111 Handover Attitude Control Orbiter to CMG TA	109
3.112 VDS Shuttle Auto Route - Deroute	113
3.113 VDS Shuttle Manual Route - Deroute	119
3.115 Oxygen Transfer Setup	123
3.116 High Pressure Tank O2 Transfer	131
3.117 Low Pressure Tank O2 Transfer	135
3.118 Oxygen Transfer Teardown	139
3.119 Radiation Area Monitor Dosimeters - Installation of Dosimeters on ISS	145
3.120 Prebreathe Using Shuttle O2 Setup	157
3.121 Prebreathe Using Shuttle O2 Setup (Post O2 Transfer)	165
3.122 Prebreathe Using Shuttle O2 Teardown	171
3.123 O2 Transfer Setup (Post Prebreathe Using Shuttle O2)	177
3.124 Active and Passive CBM Inspection Criteria	183

EGRESS STATION	189
4.101 ISS Interim Egress	191
4.102 Shuttle/ISS Duct Removal and Hatch Closing	195
4.103 ODS Vestibule/PMA Depressurization and Hatch Leak Check	199
4.104 Duct Removal and Hatch Close (Bypass Config)	201
DEPARTURE	205
5.101 PMA2 Pre-Departure Configuration	207
5.102 PMA2 Departure	211
5.103 PMA2 Post Departure Configuration	215
COMM/DATA	219
6.101 Audio Loss of Docked Voice	221
6.102 Audio Configuration for Proximity Operations Voice Comm	223
6.103 Hardline Audio Configuration (ISS)	225
6.104 Hardline Audio Configuration (ISS) Backout	229
6.105 SSOR Activation	235
6.106 SSOR Deactivation	237
6.107 PCS Setup - Shuttle	239
6.108 ICOM Audio Config with Hatch Closed	243
2.302 Onboard File Transfer	245
2.303 PCS Deactivation	249
2.304 PCS Log File Save	251
2.306 PCS Reconnect	253
2.307 PCS Screen Capture	255
2.309 Transferring Log Files To Floppy Disk	257
MALFUNCTION	259
HATCH	
1.3.501 Hatch Mechanism Malfunction	261
2.305 PCS Reboot	267
3.301 Loss of PCS Telemetry	269
CONTINGENCY	277
8.101 Handover Attitude Control Orbiter to RS Thrusters	279
8.102 Handover Attitude Control RS Thrusters to Orbiter	281
8.103 PMA2 Pre-Arrival Configuration (Thrusters)	283
8.104 PMA2 Arrival (Thrusters)	289
8.105 PMA2 Post Arrival Configuration (Thrusters)	291
8.106 PMA2 Pre-Departure Configuration (Thrusters)	295
8.107 PMA2 Departure (Thrusters)	301
8.108 PMA2 Post Departure Configuration (Thrusters)	305
8.109 ORCA Safing	309
EMERGENCY RESPONSE	311
9.101 Joint Expedited Undocking and Separation	313
9.103 Utilize ISS Atmosphere	323
9.104 TMAX Determination For Utilize ISS Atmosphere	325

CUE CARD	327
10.101 Big Loop Reactivation	329
10.102 Joint Emergency Egress	331
REFERENCE DATA	333
11.103 O2 and N2 Transfer Schematic	335

This Page Intentionally Blank

ARRIVAL

This Page Intentionally Blank

1.101 ISS POWERDOWN AND RECOVERY - CHANNEL 2B ONLY

I

(JNT OPS/UF1 - ALL/FIN 3/MULTI) Page 1 of 4 pages

1. Use the POWERUP column in reverse order to back out of the powerdown.
2. The loads for the major power users are presented below.

<u>Equipment</u>	<u>dc Watts</u>
Russian Load Powerdown	Check MCC-H
Node 1 Shell Heaters String B 1 to 6	1032 W
Node 1 Shell Heaters String B 7 to 9	314 W
PMA 1 Shell Heaters String B	339 W
Power Bus Z13B Rail Heater B	56 W
LAB Shell Heaters 1 to 3	693 W
Z1 DDCU Heaters	200 W
TCCS (AR Rack)	195 W
Z1 Dome Heater	180 W
CheCS Equipment	43 W

Total (actual decrease in power draw 3052 Watts may be less than max values indicated here due to duty cycling)

1.101 ISS POWERDOWN AND RECOVERY - CHANNEL 2B ONLY

(JNT OPS/UF1 - ALL/FIN 3/MULTI) Page 2 of 4 pages

	POWERDOWN	POWERUP
PCS	<div style="border: 1px solid black; padding: 5px; margin-bottom: 10px; text-align: center;"> <p><u>NOTE</u> Depending on the load configuration, power usage may not decrease after every step.</p> </div> <ol style="list-style-type: none"> 1. <u>RS LOAD POWERDOWN</u> ARCU deactivation is requested by MCC-H and performed after MCC-M concurrence 2. <u>INHIBITING NODE 1 B HTRS (1 to 6)</u> Node 1: TCS 'Node 1' sel Htr Availability <div style="border: 1px solid black; display: inline-block; padding: 2px 10px;">Node1Htr16avail</div> 'Htr [X]B' where [X] = 1 2 3 4 5 6 'Availability' cmd Inhibit √Availability – Inh Repeat 	<p>As required</p> <p>cmd Ena Operate</p> <p>√Availability – Ena Opr</p>
PCS	<ol style="list-style-type: none"> 3. <u>INHIBITING NODE 1 B HTRS (7 to 9)</u> Node 1: TCS 'Node 1' sel Htr Availability <div style="border: 1px solid black; display: inline-block; padding: 2px 10px;">Node1Htr16avail</div> sel Node1 Htr 7 – 9 availability <div style="border: 1px solid black; display: inline-block; padding: 2px 10px;">Node1Htr79avail</div> 'Htr [X]B' where [X] = 7 8 9 'Availability' cmd Inhibit √Availability – Inh Repeat 	<p>cmd Ena Operate</p> <p>√Availability – Ena Opr</p>

1.101 ISS POWERDOWN AND RECOVERY - CHANNEL 2B ONLY

(JNT OPS/UF1 - ALL/FIN 3/MULTI) Page 3 of 4 pages

	POWERDOWN	POWERUP
PCS	<p>4. <u>INHIBITING PMA1 B SHELL HTRS</u> Node 1: TCS 'PMA1'</p> <p>sel Htr Availability</p> <div style="border: 1px solid black; display: inline-block; padding: 2px;">PMA1 HtrAvailability</div> 'Htr [X]B' where [X] = 1 2 3 5 'Availability' <p>cmd Inhibit</p> <p>√Availability – Inh</p> <p>Repeat</p>	<p>cmd Ena Operate</p> <p>√Availability – Ena Opr</p>
PCS	<p>5. <u>DISABLING Z1 RAIL HEATERS</u> Z1: EPS: Pwr Bus Z13B Rail Heaters</p> <div style="border: 1px solid black; display: inline-block; padding: 2px;">Pwr Bus Z13B Rail Htrs</div>	<p>cmd Htr B – Inhibit (√Availability – Inh)</p> <p>cmd Htr B – Ena Operate (√Availability – Ena Opr)</p>
	<p>6. <u>INHIBITING LAB SHELL HTRS</u> LAB: TCS: IATCS Details: LAB Shell Heater Control</p> <div style="border: 1px solid black; display: inline-block; padding: 2px;">LAB Shell Heater Control</div>	<p>(For Htr 1 to 3)</p> <p>cmd Override On – Ovr On</p> <p>√Heater X Cmd Status – Ovr On</p>
	<p>sel LAB Shell Htr X where X = 1 2 3</p> <div style="border: 1px solid black; display: inline-block; padding: 2px;">LAB Shell Htr X</div> 'Heater X Cmd Status' <p>cmd Override Off – Arm (√ - √) cmd Override Off – Ovr Off</p> <p>√Heater X Cmd Status – Ovr Off</p> <p>Verify RPC Posn – Op</p> <p>Repeat</p>	

1.101 ISS POWERDOWN AND RECOVERY - CHANNEL 2B ONLY

(JNT OPS/UF1 - ALL/FIN 3/MULTI) Page 4 of 4 pages

	POWERDOWN	POWERUP
	<p>7. <u>DISABLING Z1 DDCU HEATERS</u> Z1: EPS: RPCM Z13B B RPCM Z13B B</p> <p>sel RPC X where [X] = 6 11</p> <p style="padding-left: 40px;">cmd RPC Position – Open (Verify – Op)</p> <p>Repeat</p>	<p>cmd RPC Position – Close (Verify – Cl)</p>
PCS	<p>8. <u>POWERDOWN ECLSS EQUIPMENT</u> LAB: ECLSS: AR Rack LAB AR Rack Overview 'TCCS' 'Shutdown'</p> <p>cmd Shutdown Arm (√ – Armed) cmd Shutdown – Shutdown</p> <p>When TCCS Status – Shutdown Complete sel RPCM LAD62B A RPC 05</p> <p>cmd RPC Position – Open (Verify – Op)</p>	<p>'Rack Location: LAB1D6 – (Entire Rack)' √RPC Position – Closed</p> <p>To activate TCCS, perform {<u>1.301 ATMOSPHERE REVITALIZATION RACK ACTIVATION</u>}, step 8 (SODF: ECLSS: ACTIVATION AND CHECKOUT: ARS)</p>
	<p>9. <u>POWERDOWN Z1 DOME HEATERS</u> Node1: EPS: RPCM N13B B RPCM N13B B</p> <p>sel RPC 11 cmd RPC Position – Open (Verify – Op)</p>	<p>cmd RPC Position – Close (Verify – Cl)</p>
CheCS Rack	<p>10. <u>POWERDOWN CHeCS EQUIPMENT</u> Go directly to the CHeCS Rack and turn Defibrillator S1 switch to OFF.</p> <p>Go directly to the CHeCS TEPC plugged into the UOPs and turn the ON switch to OFF.</p> <p>Go directly to the CHeCS IVCPDS plugged into the UOPs and turn the ON switch to OFF.</p>	<p>S1 switch to On</p> <p>ON switch to ON</p> <p>ON switch to ON</p>

1.102 ISS POWERDOWN AND RECOVERY - CHANNEL 4B ONLY

I

(JNT OPS/UF1 - ALL/FIN 3/MULTI) Page 1 of 4 pages

1. Use the POWERUP column in reverse order to back out of the powerdown.
2. The loads for the major power users are presented below.

<u>Equipment</u>	<u>dc Watts</u>
Russian Load Powerdown	Check MCC-H
Power Bus Z14B Rail Heater B	56 W
PMA2 Shell Heaters String A	304 W
PMA2 Shell Heaters String B	302 W
LAB Shell Heaters 4 to 6	685 W
Airlock Shell Heaters	1232 W
Z1 DDCU Heaters	200 W
Z1 Dome Heater	180 W
LAB Window Heater	53 W
Node 1 Lights (3 lights)	84 W
LAB Lights (5 lights)	140 W

Total (actual decrease in power draw 3239 Watts may be less than max values indicated here due to duty cycling)

1.102 ISS POWERDOWN AND RECOVERY - CHANNEL 4B ONLY

	POWERDOWN	POWERUP
<p style="text-align: center;"><u>NOTE</u> Depending on the load configuration, power usage may not decrease after every step.</p> <p>1. <u>RS LOAD POWERDOWN</u> ARCU deactivation is requested by MCC-H and performed after MCC-M concurrence.</p> <p>2. <u>DISABLING Z1 RAIL HEATERS</u> Z1 EPS sel Pwr Bus Z14B Rail Heaters Pwr Bus Z14B Rail Htrs cmd Htr B – Inhibit (√Availability – Inh)</p> <p>3. <u>INHIBITING PMA2 A AND B SHELL HTRS</u> PMA2: TCS: PMA2 Heater Control PMA2 Heater Control cmd PMA2 Htr CLC Inhibit – Arm (√ – X) cmd PMA2 Htr CLC Inhibit – Inh Verify PMA2 Htr CLC - Inh LAB: EPS: DDCU LA1B Distribution: RPCM LA1B C RPCM LA1B C sel RPC X where [X] = 5 6 7 8 9 10 11 12 13 14 Verify RPC Position – Op Repeat</p>	<p>As required</p> <p>cmd Htr B – Ena Operate (√Availability – Ena Opr)</p> <p>PMA2 Heater Control 'CLC' cmd CLC – Ena Verify CLC – Ena</p> <p>If no shuttle present, sel PMA2 Htr X where [X] = 4 5 PMA2 Htr X For both heaters, cmd Override Off – Arm (√ - √) cmd Override Off – Ovr Off</p> <p>√PMA2 HtrXA Cmd Status – Ovr Off √PMA2 HtrXB Cmd Status – Ovr Off</p> <p>Repeat</p>	

1.102 ISS POWERDOWN AND RECOVERY - CHANNEL 4B ONLY

	POWERDOWN	POWERUP
<p>PCS</p> <p>4. <u>INHIBITING LAB SHELL HTRS</u> LAB: TCS: IATCS Details: LAB Shell Heater Control <u>LAB Shell Heater Control</u></p> <p>sel LAB Shell HtrX where X = <input type="text" value="4"/> <input type="text" value="5"/> <input type="text" value="6"/></p> <p><u>LAB Shell Htr X</u> 'Heater X Cmd Status'</p> <p>cmd Override Off – Arm (\surd – \surd) cmd Override Off – Ovrđ Off</p> <p>\surdHeater X Cmd Status – Ovrđ Off</p> <p>Verify RPC Posn – Op</p> <p>Repeat</p> <p>5. <u>DEACTIVATING SHELL HEATER CONTROL</u> Airlock: TCS : AL SHELL HEATER CONTROL <u>AL Shell Heater Control</u> 'AL Shell Heater' 'Software'</p> <p>cmd Shutdown – Arm (\surd – \surd) cmd Shutdown – Shutdown</p> <p>sel AL Shell Htr X where X = <input type="text" value="1"/> <input type="text" value="2"/> <input type="text" value="3"/> <input type="text" value="4"/> <input type="text" value="5"/></p> <p><u>AL Shell Htr X</u></p> <p>\surdCmd Status – Ovrđ Off</p> <p>Verify RPC Posn – Op</p> <p>Repeat</p>	<p>(For Htrs 4 to 6) cmd Override On – Ovrđ On</p> <p>\surdHeater X Cmd Status – Ovrđ On</p> <p>'AL Shell Heater' 'Software'</p> <p>cmd Startup – Startup</p> <p>\surdSoftware – Started \surdCLC – Ena</p>	

1.102 ISS POWERDOWN AND RECOVERY - CHANNEL 4B ONLY

(JNT OPS/UF1 - ALL/FIN 3/MULTI) Page 4 of 4 pages

	POWERDOWN	POWERUP
PCS	<p>6. DISABLING Z1 DDCU HEATERS Z1: EPS: RPCM Z14B B RPCM Z14B B</p> <p>sel RPC X where [X] = 11 16</p> <p style="padding-left: 40px;">cmd RPC Position – Open (Verify – Op)</p> <p>Repeat</p> <p>7. POWERDOWN Z1 DOME HEATERS Node1: EPS: RPCM N14B B RPCM N14B B</p> <p>sel RPC 3 cmd RPC Position – Open (Verify – Op)</p> <p>8. DEACTIVATING LAB WINDOW HEATER Lab: TCS: IATCS Details: LAB Window Heater Commands LAB Window Heater Commands 'LAB Window Heater'</p> <p>cmd CLC – Inh (√ – Inh)</p> <p>Verify Heater Status – Ovrđ Off</p> <p>9. POWERDOWN NODE LIGHTS</p> <div style="border: 1px solid black; padding: 5px; margin: 5px 0;"> <p style="text-align: center;">NOTE</p> <p>Lights should be turned off via the crew. If lights are commanded off at the RPC level, the crew will not have insight should an unknown EPS bus failure occur.</p> </div> <p>Have crew turn off three of the Node 1 lights on channel 4B via the GLA switch.</p> <p>10. POWERDOWN LAB LIGHTS</p> <div style="border: 1px solid black; padding: 5px; margin: 5px 0;"> <p style="text-align: center;">NOTE</p> <p>Lights should be turned off via the crew. If lights are commanded off at the RPC level, the crew will not have insight should an unknown EPS bus failure occur.</p> </div> <p>Have crew turn off five of the LAB lights on channel 4B via the GLA switch.</p>	<p>cmd RPC Position – Close (Verify – Cl)</p> <p>cmd RPC Position – Close (Verify – Cl)</p> <p>cmd RPC Position – Close (Verify – Cl)</p> <p>√RPCM LA1B B RPC 10 RPC Posn – Cl √Software – Started</p> <p>cmd CLC – Ena (√ – Ena) Verify Heater Status ≠ Ovrđ Off</p> <p>As required</p> <p>As required</p>

1.104 ODS VOLUME PREPARATION FOR DOCKING

(JNT OPS/7A - ALL/FIN 5) Page 1 of 1 page

- Ext A/L 1. Unstrap centerline camera diffuser flex duct from EXT A/L wall.
Attach flex duct to camera bracket to direct air flow to window.
If required, tape diffuser open.
- AW18A 2. LTG FLOOD 1(3,4) – OFF
- A6L 3. √SYS PWR SYS 1, SYS 2 (two) – ON
√cb DOCK LT (four) – cl
- 4. LT TRUSS FWD, AFT (two) – ON
- 5. LT VEST PORT, STBD (two) – ON
- MO13Q 6. AIRLK FAN A(B) – OFF
- EXT A/L 7. Disconnect airlock flex duct from booster fan muffler, rotate into middeck,
and secure.
- MO13Q 8. AIRLK FAN A(B) – ON
- 9. AIRLK 2 – OFF/ON
- 10. TNL ADAPT 1 – OFF/ON
- 11. √Airflow at muffler
- Middeck 12. Close Inner Hatch per decal.
- 13. Equal vlv (two) – OFF, install caps
- MO10W 14. 14.7 CAB REG INLET SYS 1, SYS 2 (two) – CL

This Page Intentionally Blank

1.106 PMA2 PRE-ARRIVAL CONFIGURATION

(JNT OPS/LF1 - ALL/FIN 8/MULTI) Page 1 of 7 pages

OBJECTIVE:

Perform procedure about 1 to 2 hours before the arrival of the orbiter. Configure the CCS Attitude Control System (ACS) Moding software and ensure the correct control parameters are loaded onboard.

- PCS 1. GNC COMMAND RESPONSE COUNTERS RESET
MCG: GNC Command Response Counters
GNC Command Response Counters

sel Reset

Verify the Since Reset column values are all blank.

Do not close this window until the procedure is complete.

If while executing a command, the Command Accept counter on that display does not increment

 Reselect GNC Command Response Counters to determine if a command was rejected.

√ **MCC-H**

1.106 PMA2 PRE-ARRIVAL CONFIGURATION

(JNT OPS/LF1 - ALL/FIN 8/MULTI) Page 2 of 7 pages

2. VERIFYING FLIGHT SPECIFIC PAD

MCC-H If the following information is not recorded elsewhere, record it here.

Table 1. Pre-Arrival Requirements

Required for Pre-Arrival	ADO	Pri	B/U	Ver ID	Comments
1 MASS PROPERTIES	PS21				Post Docking Mass Properties
2 CCDB SLOT 1	CA11				Failed Docking Attitude:
CCDB SLOT 1 Yaw					
CCDB SLOT 1 Pitch					
CCDB SLOT 1 Roll					
3 CCDB SLOT 2	CA12				Post Docking Attitude:
CCDB SLOT 2 Yaw					
CCDB SLOT 2 Pitch					
CCDB SLOT 2 Roll					
4 Desat Target Momentum Components				%	
				X	
				Y	
				Z	
5 Version ID for CCS PPL 180 (ACS FDIR Adaptation Data) with RS_ACS_Safing_Status set to "0" (off) to be loaded to the Backup and Standby C&C MDM.				4003	Must be built as File Uplink and uplinked to the Backup and Standby C&C.
6 Version ID for CCS PPL 181 - CCS RM PPL for GNC RM with or without Checkpointing to be loaded to all C&C MDMs.				4002	If GNC RM with checkpointing is to be inhibited for docking, uplink PPL to all C&C MDMs. Must be built as File Uplink.

3. VERIFYING INITIAL CONDITIONS

PCS

MCG

MCG Summary

'MCG Status'

1.106 PMA2 PRE-ARRIVAL CONFIGURATION

(JNT OPS/LF1 - ALL/FIN 8/MULTI) Page 3 of 7 pages

Verify US Station Mode – Prox Ops
Verify RS Station Mode – Prox Ops
Verify US GNC Mode – CMG TA
Verify RS SUDN Mode – CMG TA

'Primary GNC MDM'

Verify Frame Count – incrementing

'Backup GNC MDM'

Verify Frame Count – incrementing

- MCC-H**
4. LOADING REQUIRED PPLs TO THE PRIMARY GNC MDM
For all PPLs designated in step 2 to be loaded to the Primary GNC MDM, coordinate with ODIN.
 5. LOADING REQUIRED PPLs TO THE BACKUP GNC MDM
For all PPLs designated in step 2 to be loaded to the Backup GNC MDM, coordinate with ODIN
 6. LOADING REQUIRED PPLs TO THE C&C MDM
For all PPLs designated in step 2 to be loaded to the C&C MDMs, coordinate with ODIN
 7. CONFIGURING RUSSIAN SEGMENT FOR DOCKING

NOTE

These commands can be sent by RS any time prior to orbiter docking.

- MCC-M**
- YBL F8_10 (inf0=9, inf1=1) Inhibit the RS takeover due to Tier 1 Loss of Comm
- YBL F1_44 Update the unmated Mass Properties into the TBM buffer for Joint Expedited Undocking and Separation (JEUS)

MCC-M will uplink the cyclogram contents to channel 34 for JEUS.

MCC-M ⇒ **MCC-H**, "Step 7 complete."

1.106 PMA2 PRE-ARRIVAL CONFIGURATION

(JNT OPS/LF1 - ALL/FIN 8/MULTI) Page 4 of 7 pages

8. UPDATING CCDB COMMANDED ATTITUDE

MCG: MCS Configuration

MCS Configuration

'CCDB Slots'

For CCDB Slots 1 and 2

sel Cmd Att [X]

Cmd Att [X]

If slot [X] Yaw, Pitch, Roll does not match Yaw, Pitch, Roll in step 2

If in step 2, CCDB Slot [X] Yaw, Pitch, Roll is (0,0,0)

cmd YPR 0,0,0

If in step 2, CCDB Slot [X] Yaw, Pitch, Roll is not (0,0,0)

Input Yaw – (from step 2)

Pitch – (from step 2)

Roll – (from step 2)

cmd Set

Verify Slot [X] Yaw – (as commanded)

Pitch – (as commanded)

Roll – (as commanded)

9. SETTING MOMENTUM SERVO REFERENCE FRAME AND GNC INHIBITS

MCG: Dock and Undock: Pre-Node 2 PMA 2 Dock

Pre Node 2 PMA 2 Dock

'System Configuration'

If Cmd'd Drift Ref Frame – LVLH(Body)

cmd Inertial

Verify Cmd'd Drift Ref Frame – Inertial

If Attitude Maneuver – Inh

cmd Enable (Verify – Ena)

If Att Cntl Shutdown – Inh

cmd Enable (Verify – Ena)

If Mode Transition – Inh

cmd Enable (Verify – Ena)

If Desat Request – Inh

cmd Enable (Verify – Ena)

1.106 PMA2 PRE-ARRIVAL CONFIGURATION

(JNT OPS/LF1 - ALL/FIN 8/MULTI) Page 5 of 7 pages

10. VERIFYING STATUS OF ACS MODING SIGNALS

PCS

'Final Approach'

Verify Manual Dock Sequence Init – Not Init
Verify LA-1/LA-2 Capture – No/No
Verify Arrival Flag – No
Verify Docked Indication – NOT Docked

11. INHIBITING GNC CHECKPOINTING

If GNC Checkpointing is to be inhibited for docking, perform {2.702

12. ENABLING ARRIVAL SOFTWARE

'Pre Arrival'

sel PMA 2 Manual Arrival SW

'PMA 2'

cmd Manual Arrival SW Enable

Verify PMA 2 Docking Vehicle – Shuttle
Verify PMA 2 Manual Arrival SW – Ena

'Pre Arrival'

sel PMA 2 Automatic Arrival SW

'PMA 2'

cmd Enable

Verify PMA 2 Docking Vehicle – Shuttle
Verify PMA 2 Automatic Arrival SW – Ena

13. ENABLING APAS LEDS

'Pre-Arrival'

sel LED Control SW

1.106 PMA2 PRE-ARRIVAL CONFIGURATION

(JNT OPS/LF1 - ALL/FIN 8/MULTI) Page 6 of 7 pages

cmd Enable

Verify LED Control SW – Ena

Verify LED State – On

- MCC-H** 14. INHIBITING AUTO ATTITUDE CONTROL HANDOVER TO RS
This step should be performed at Dock - 10 minutes (this should correspond to approximately 40 ft distance).

Pre Node 2 PMA 2 Dock

'Pre Arrival'

If Auto Att Control Handover to RS – Ena

cmd Arm

cmd Inhibit

Verify Auto Att Control Handover to RS – Inh

15. PERFORMING MANUAL DESATURATION
At orbiter call, "Initiating Final Approach" or Dock - 5 minutes
(this corresponds to 30 ft distance)

Pre Node 2 PMA 2 Dock

'Pre Arrival'

Verify Thrstr Avail for CMG Desat – Yes

1.106 PMA2 PRE-ARRIVAL CONFIGURATION

(JNT OPS/LF1 - ALL/FIN 8/MULTI) Page 7 of 7 pages

If Desat Target Momentum Components in step 2 are 100 % and 0,0,0
When Desat In Progress – No
cmd Desat CMGs 100 % 0,0,0

If Desat Target Momentum Components in step 2 are not 100 % and 0,0,0

MCC-H When CMG Desat In Progress – No
If ground is performing this step
cmd <Cmd Inv: USGNC_CA_CMD_Manual_CMG_Desat_Tmplt – (LAGU96IM0137K)> using values from step 2.

PCS If crew is performing this step on PCS
Pre Node 2 PMA 2 Dock
'Related Displays'

sel Manual CMG Desat

Manual CMG Desat
'Desaturation Commands'

input Percent as recorded in step 2
X: as recorded in step 2
Y: as recorded in step 2
Z: as recorded in step 2

cmd Set

Pre Node 2 PMA 2 Dock
'Pre-Arrival'

NOTE

The desaturation will drive the On-line momentum toward the target momentum. This should happen quickly and may not be visible to the operator.

Monitor for desat complete, as follows

Verify CMG Desat In Progress – No
Verify Desat Complete – 100 %

MCC-H ⇒ orbiter, ISS, "Manual desaturation complete."

This Page Intentionally Blank

1.107 STATION-ORBITER DOCKING SCRIPT

(JNT OPS/7A - ALL/FIN 2)

Page 1 of 1 page

I

At Rendezvous 10 meters (30 ft): Blue/White FCR Flights will call "All Quiet".
All controllers will monitor Shuttle FD and A/G loops.

1. CAPTURE PHASE

Controller	Expected Call	Loop	Action
GNC	PCT ARMED	Shuttle FD	
MMACS	CONTACT	Shuttle FD	SSP GC – Start 65 second wall clock in WFCR and BFCR.
Shuttle Crew	CAPTURE CONFIRMED	A/G	ISS Crew – After 20 seconds, if software has not moded ISS to Free Drift, ISS crew will command to Free Drift.
MMACS	CAPTURE CONFIRMED	Shuttle FD	ADCO – Confirm Capture Long and Arrival Event on ISS FD.
GNC	SHUTTLE FREE DRIFT	Shuttle FD	

2. ISS FREE DRIFT

Controller	Expected Call	Loop	Action
ISS Crew,	ISS IS FREE DRIFT	A/G	ADCO – Confirm Free Drift on ISS FD
or Orbiter Crew,	ISS IS FREE DRIFT	A/G	ADCO – Confirm Free Drift on ISS FD
or ADCO	ISS IS FREE DRIFT	ISS FD	
ISS FD	STATION FLIGHT CONFIRMS FREE DRIFT	Shuttle FD	CAPCOM – table 4 block 1

3. ISS ACTIVE CONTROL - NO CHANGE AT CONTACT + 55 seconds

Controller	Expected Call	Loop	Action
ADCO	ADCO CONFIRMS ACTIVE CONTROL	ISS FD	
ISS FD	STATION FLIGHT CONFIRMS ACTIVE CONTROL	Shuttle FD	CAPCOM – Table 4, block 2

4. FINAL CALLS TO SHUTTLE CREW - NLT CONTACT + 65 seconds

	Controller	Expected Call	Loop
1	ISS FD	STATION FLIGHT CONFIRMS FREE DRIFT	Shuttle FD
	CAPCOM	STATION FREE DRIFT CONFIRMED	A/G
2	ISS FD	STATION FLIGHT CONFIRMS ACTIVE CONTROL	Shuttle FD
	CAPCOM	STATION IN ACTIVE CONTROL, PERFORM FAILED CAPTURE TO UNDOCK	A/G

This Page Intentionally Blank

1.108 PMA2 ARRIVAL

(JNT OPS/LF1 - ALL/FIN 5/MULTI/HC) Page 1 of 4 pages

OBJECTIVE:

Monitor orbiter arrival and mode ISS to Free Drift. ISS MCS is configured to allow for automatic moding to Free Drift, and then orbiter arrival is monitored. Crew will command ISS to Free Drift manually only if automatic software does not complete mode transition within 20 seconds of Capture confirmed.

NOTE

1. Perform step 1 after orbiter has begun approach (dock -15 minutes).
2. Start step 2 when orbiter starts final approach (from 30 feet). US GNC must mode to Drift within 65 seconds of orbiter call of Capture Confirmed or orbiter will perform corridor backout. ISS Crew commands Manual Dock Sequence to mode to drift after 20 seconds ONLY if automatic software is not successful.

1. VERIFYING INITIAL CONFIGURATION

PCS

MCG: Dock and Undock: Pre-Node 2 PMA 2 Dock

Pre Node 2 PMA 2 Dock

'System Configuration'

Verify US Station Mode – Prox Ops
Verify RS Station Mode – Prox Ops
Verify US GNC Mode – CMG TA
Verify RS SUDN Mode – CMG TA

Verify Attitude Maneuver – Ena
Verify Att Cntl Shutdown – Ena
Verify Mode Transition – Ena
Verify Desat Request – Ena
Verify US Drift Available – Yes

'Pre Arrival'

Verify PMA 2 Manual Arrival SW – Ena
Verify PMA 2 Automatic Arrival SW – Ena

'Final Approach'

Verify LA-1/LA-2 Capture – No/No
Verify Arrival Flag – No
Verify Docked Indication – NOT Docked

2. FINAL APPROACH AND CAPTURE

Orbiter ⇒ ISS, "Initiating final approach."

Pre Node 2 PMA 2 Dock

'Final Approach'

1.108 PMA2 ARRIVAL

(JNT OPS/LF1 - ALL/FIN 5/MULTI/HC) Page 2 of 4 pages

Orbiter ⇒ ISS, "Capture Confirmed."

Wait up to 20 seconds for the following indication.

Verify US GNC Mode – Drift

```
*****  
* When time since capture confirmed > 20 seconds  
* | If US GNC Mode – CMG TA  
* |   'Final Approach'  
* |  
* |   ✓Manual SW Enable (Verify – Ena)  
* |  
* |   cmd Manual Dock Sequence Init (Verify – Init)  
* |  
* |   Verify US GNC Mode – Drift  
* |  
* |   ISS ⇒ orbiter, "ISS is Free Drift."  
* |  
* |   'Pre Arrival'  
* |  
* |   sel PMA2 Manual Arrival SW  
* |  
* |   Manual Arrival SW  
* |   'PMA 2'  
* |  
* |   cmd Manual Arrival SW Inhibit  
* |  
* |   Verify PMA 2 Docking Vehicle – None  
* |   Verify PMA 2 Manual Arrival SW – Inhibit  
* |  
* |   Pre Node 2 PMA 2 Dock  
* |   'Final Approach'  
* |  
* |   Verify Manual Dock Sequence Init – Not Init  
*****
```

ISS ⇒ orbiter, "ISS is Free Drift."

1.108 PMA2 ARRIVAL

(JNT OPS/LF1 - ALL/FIN 5/MULTI/HC) Page 3 of 4 pages

* If at any time orbiter calls Failed Dock and proceeds to separation

* √**MCC** (if LOS, proceed)

* Pre Node 2 PMA 2 Dock

* 'System Configuration'

* √Attitude Maneuver – Ena

* √Mode Transition – Ena

* √Desat Request – Ena

* Verify US GNC Mode – Drift

* 'Final Approach'

* If Manual Dock Sequence Init – Init

* 'Pre Arrival'

* sel PMA2 Manual Arrival SW

* Manual Arrival SW

* 'PMA 2'

* **cmd** Manual Arrival SW Inhibit

* Verify PMA 2 Docking Vehicle – None

* Verify PMA 2 Manual Arrival SW – Inhibit

* Pre Node 2 PMA 2 Dock

* 'Final Approach'

* Verify Manual Dock Sequence Init – Not Init

* Pre Node 2 PMA 2 Dock

* 'Final Approach'

* If LA1/LA2 Capture – Yes/Yes

* 'Pre Arrival'

* sel PMA 2 Automatic Arrival SW

* Automatic Arrival SW

* 'PMA 2'

* **cmd** Arm

* **cmd** Inhibit

* Verify State – Disarm

* Verify PMA 2 Docking Vehicle – None

* Verify PMA 2 Automatic Arrival SW – Inhibit

* ~

1.108 PMA2 ARRIVAL

(JNT OPS/LF1 - ALL/FIN 5/MULTI/HC) Page 4 of 4 pages

```
*
*   Pre Node 2 PMA 2 Dock
*   'Failed Capture'
*
*   If Abort in Progress – Yes
*   |   cmd Clear Desat Abort
*   |
*   |   Verify Abort in Progress – No
*   |
*   If Thrstr Avail for CMG Desat – No
*   |   cmd RS Prep Thrusters for CMG Desat
*   |
*   |   Verify Thrstr Avail for CMG Desat – Yes
*
*   cmd CMG TA Slot 1
*
*   Verify Active CCDB Source Slot – 1
*
*   cmd Hold Current Attitude
*
*   'System Configuration'
*
*   Verify US GNC Mode – CMG TA
*   Verify RS SUDN Mode – CMG TA
*
*   ISS => orbiter, "ISS in Attitude Control."
```

```
*   If Failed Dock star block was performed, MCC-M will incorporate
*   unmated Mass Properties.
*
```

MCC-M

```
*   YBT F1_42 (Incorporate unmated Mass Properties)
```

3. MODING TO FREE DRIFT - HOUSTON GROUND STEP

MCC-H

```
If time since Capture Confirmed > 30 seconds and US GNC Mode is
not Drift
```

```
MCG: Dock and Undock: Pre-Node 2 PMA 2 Dock
```

```
Pre Node 2 PMA 2 Dock
```

```
'Final Approach'
```

```
√Manual SW Enable (Verify – Ena)
```

```
cmd Manual Dock Sequence Init (Verify – Init)
```

```
Verify US GNC Mode – Drift
```

```
MCC-H => orbiter, ISS, "ISS is Free Drift."
```

1.109 PMA2 POST ARRIVAL CONFIGURATION

(JNT OPS/LF1 - ALL/FIN 5/ MULTI) Page 1 of 3 pages

OBJECTIVE:

Operational sequence used to disable Arrival software.

NOTE

This procedure should be complete prior to US GNC attitude control and prior to SM attitude control if SM is using US mass properties.

- 1. GNC COMMAND RESPONSE COUNTERS RESET
 PCS MCG: GNC Command Response Counters
GNC Command Response Counters

sel Reset

Verify the Since Reset column values are all blank.

Do not close this window until the procedure is complete.

If while executing a command, the Command Accept counter on that display does not increment
 Reselect GNC Command Response Counters to determine if a command was rejected.

√MCC-H

- 2. VERIFYING FLIGHT SPECIFIC PAD
 MCC-H If the following information is not recorded elsewhere, record it here.

Table 1.- Post Arrival Requirements

Required for Post Arrival	ADO	Pri	B/U	Ver ID	Comments
Version ID for CCS PPL 181 - CCS RM PPL For GNC RM with or without Checkpointing to be loaded to all C&C MDMs.				4003	If GNC RM with Checkpointing was inhibited for docking and is now enabled, uplink PPL to all C&C MDMs. Must be built as File Uplink.

- 3. VERIFYING CORRECT CONFIGURATION
 PCS MCG: Dock and Undock: Pre-Node 2 PMA 2 Dock
Pre Node 2 PMA 2 Dock
 'System Configuration'

Verify US Station Mode – Prox Ops
 Verify RS Station Mode – Prox Ops
 Verify US GNC Mode – Drift
 Verify RS SUDN Mode – Indicator

1.109 PMA2 POST ARRIVAL CONFIGURATION

(JNT OPS/LF1 - ALL/FIN 5/ MULTI) Page 2 of 3 pages

4. LOADING REQUIRED PPLs TO THE C&C MDMs

For all PPLs designated in step 2 to be loaded to C&C MDMs, to load PPL to C&C MDMs, coordinate with ODIN.

5. ENABLING GNC CHECKPOINTING

If GNC Checkpointing is to be enabled after docking, perform {2.701 ENABLE GNC CHECKPOINTING}, all (SODF: MCS: NOMINAL: CHECKPOINTING), then:

6. DISABLING ARRIVAL SOFTWARE

NOTE

If the Manual Dock Sequence Init command was sent, the software automatically inhibits the manual software. However, to configure the Man Dock Seq Init telemetry to Not Init, the Manual Software must be commanded Inh even though its telemetry already reads Inh. After docking, if ISS attitude control is resumed while the telemetry reads Init, the ACS Moding software will automatically mode the ISS to Free Drift.

Pre Node 2 PMA 2 Dock

'Final Approach'

If Manual SW Enable – Ena, or Manual Dock Sequence Init – Init

Pre Node 2 PMA 2 Dock

'Pre Arrival'

sel PMA 2 Manual Arrival SW

Manual Arrival SW

'PMA 2'

cmd Manual Arrival SW Inhibit

Verify PMA 2 Docking Vehicle – None

Verify PMA 2 Manual Arrival SW – Inh

Pre Node 2 PMA 2 Dock

'Final Approach'

Verify Manual Dock Sequence Init – Not Init

Pre Node 2 PMA 2 Dock

'Pre Arrival'

sel PMA 2 Automatic Arrival SW

Automatic Arrival SW

'PMA 2'

cmd Arm (Verify – Arm)
cmd Inhibit

Verify PMA 2 Docking Vehicle – None
Verify PMA 2 Automatic Arrival SW – Inh

7. DISABLING LED CONTROL SOFTWARE

Pre Node 2 PMA 2 Dock
'Pre Arrival'

sel LED Control SW

LED Control SW

cmd Inhibit

Verify LED Control SW – Inh
Verify LED State – Off

8. VERIFYING APAS INDICATION OF HARD DOCK

NOTE
Perform this step after Hard Dock complete, which may take up to 17 minutes.

Pre Node 2 PMA 2 Dock
'Final Approach'

Verify LA-1/LA-2 Capture – No/No

If Docked Indication – NOT Docked

cmd Docked
 Verify Docked Indication – Docked

9. CONFIGURING US GNC MDM

Pre Node 2 PMA 2 Dock
'System Configuration'

cmd Attitude Maneuver – Inhibit (Verify – Inh)
cmd Att Cntl Shutdown – Inhibit (Verify – Inh)
cmd Mode Transition – Inhibit (Verify – Inh)
cmd Desat Request – Inhibit (Verify – Inh)
cmd Mass

Verify Active Mass Properties PPL Version ID as expected per PMA2 Pre-Arrival Configuration.

This Page Intentionally Blank

INGRESS STATION

This Page Intentionally Blank

2.101 POST DOCKING HATCH LEAK CHECK

(JNT OPS/7A - ALL/FIN 2)

Page 1 of 1 page

I

NOTE

ISS will concurrently perform a leak check of the PMA2 volume.

1. Notify **MCC** and ISS, "Beginning initial Hatch leak checks."

MO10W 2. √14.7 CAB REG INLET SYS 1, SYS 2 (two) – CL

SM 177 EXTERNAL AIRLOCK

3. Record A/L-VEST ΔP : _____ psid.
Record EXT A/L PRESS: _____ psia.
4. Wait 20 minutes.

- * If A/L-VEST $\Delta P \leq$ previously recorded - 0.16 psid
- * | Notify **MCC-H** (possible leakage through Hatches).
- * |
- * If EXT A/L Press \leq previously recorded - 0.16 psia
- * | Notify **MCC-H** (possible leakage from EXT A/L).

5. Notify **MCC** and ISS: "Initial hatch leak checks complete. Ready for vestibule pressurization."

This Page Intentionally Blank

2.102 POST DOCKING HATCH LEAK CHECK - ISS

I

(JNT OPS/LF1 - ALL/FIN 8) Page 1 of 5 pages

OBJECTIVE:

Utilize Internal Sampling Adapter (ISA), Vacuum Access Jumper (VAJ), Scopemeter, Scopemeter Pressure Probe to verify integrity of pressure in PMA2, post shuttle docking.

LOCATION:

LAB Forward Hatch

DURATION:

30 minutes

CREW:

One

MATERIALS:

9V Alkaline Battery (if Battery changeout required)

TOOLS:

Internal Sampling Adapter (ISA) P/N 97M55830-1

VAJ-78-1 P/N 683-17111-1

Scopemeter and Accessories Kit: P/N SJG33115340-301

Scopemeter P/N SEG39129678-303

Scopemeter Pressure Probe Kit: P/N SEG39130251-301

Scopemeter Pressure Probe P/N SEG39130244-301

ISS IVA Toolbox:

Drawer 3

#0 Phillips Screwdriver (if Battery changeout required)

2.102 POST DOCKING HATCH LEAK CHECK - ISS

(JNT OPS/LF1 - ALL/FIN 8) Page 2 of 5 pages

NOTE

This procedure is performed in parallel with shuttle
{2.101 POST DOCKING HATCH LEAK CHECK}
(SODF: JNT OPS: INGRESS STATION).

1. SETTING UP SCOPEMETER AND VAJ

- 1.1 Cap ←|→ VAJ-78-1 (both ends)
Inspect seals for any visible damage.

√**MCC-H** if any damage noted to seals

Refer to Figure 1.



Figure 1.- Scopemeter Pressure Probe Connected to Scopemeter.

LAB Fwd
Hatch

- 1.2 VAJ-78-1 (bent end) →|← MPEV, hand tighten.

NOTE

ISA consists of two ISA VAJ Ports. VAJ-78-1 may be connected to either ISA VAJ Port. To ensure proper leak check, remaining ISA VAJ Port must be capped.

- 1.3 Cap ←|→ ISA-VAJ Port
VAJ-78-1 (straight end) →|← ISA VAJ Port, hand tighten

- 1.4 √Cap →|← ISA VAJ Port (remaining), hand tighten

2.102 POST DOCKING HATCH LEAK CHECK - ISS

(JNT OPS/LF1 - ALL/FIN 8) Page 3 of 5 pages

1.5 ✓ISA Sample Port Valve – CLOSED

✓ISA Sample Port Capped

Refer to Figure 2.

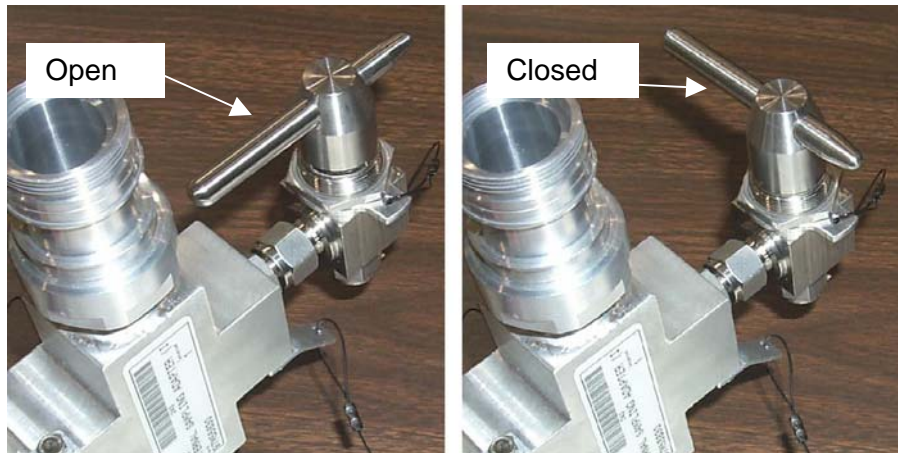

Figure 2.- ISA Sample Port Valve.

1.6 ✓Scopemeter Pressure Probe →|← ISA

NOTE

Plug marked "COM" must be inserted in COM jack on Scopemeter; plug marked "V" must be inserted in EXT mV jack. Scopemeter Pressure Probe slide switch will be facing away from user.

1.7 Scopemeter Pressure Probe COM plug →|← COM jack (black) on top of Scopemeter.

V plug of Scopemeter Pressure Probe →|← EXT mV jack of Scopemeter

Refer to Figure 1.

Scopemeter 1.8 ✓Scopemeter Pressure Probe – OFF (using slide switch)

1.9 While holding down [F5], press and release ON/OFF.
Listen for two beeps, release [F5].

1.10 Setup Scopemeter for pressure measurement.
Press [F5] (to select EXT.mV).
Press [F1] (to select CLOSE).

1.11 Verify voltage reading > 80mV DC (good Scopemeter Pressure Probe Battery indication).

If voltage reading < 80 mV DC, Scopemeter Pressure Probe Battery must be replaced.

9V Battery replaced by removing non-captive screw on back of probe (#0 Phillips Screwdriver).

2.102 POST DOCKING HATCH LEAK CHECK - ISS

(JNT OPS/LF1 - ALL/FIN 8) Page 4 of 5 pages

1.12 Select mmHg on Scopemeter Current Probe using slide switch.

2. PMA2 LEAK CHECK

2.1 MPEV → OPEN

NOTE

Scopemeter Pressure Probe displays 1 mV of output per pressure unit. Ex. 0.760 V = 760 mV = 760 mmHgA

2.2 Record Scopemeter Pressure Probe P: _____ mmHg
Record GMT ____/____:____:____ GMT

Report values to **MCC-H**.

2.3 Wait 5 minutes.

2.4 Record Scopemeter Pressure Probe P: _____ mmHg
Record GMT ____/____:____:____ GMT

Report values to **MCC-H**.

2.5 MPEV → CLOSED

* If $\Delta P > 5$ mmHg during monitoring period
* Notify **MCC-H**.
*
* ISS report to shuttle, "Abnormal leakage is being
* observed from the PMA."

3. DISASSEMBLE AND STOWING EQUIPMENT

3.1 Press ON/OFF (to power down Scopemeter).

3.2 Scopemeter Pressure Probe – OFF (using slide switch)

3.3 Scopemeter ←|→ Scopemeter Pressure Probe on ISA

3.4 VAJ-78-1 (bent end) ←|→ MPEV
VAJ-78-1 (straight end) ←|→ ISA VAJ Port
Cap →|← VAJ-78-1 (both ends)
Cap →|← ISA-VAJ Port

3.5 ISA Sample Port Valve → OPEN (for stowage).

3.6 Stow hardware
Check FOD within a 3' radius of worksite.

Inform **MCC-H** of task completion.

2.102 POST DOCKING HATCH LEAK CHECK - ISS

(JNT OPS/LF1 - ALL/FIN 8) Page 5 of 5 pages

4. INGRESSING PMA

4.1 Remove Hatch Stowage Area Closeout.
Temporarily stow.

4.2 **On MCC-H GO**, open LAB Fwd Hatch per decal.

This Page Intentionally Blank

2.103 ODS VOLUME PREPARATION FOR INGRESS

(JNT OPS/7A - ALL/FIN 5)

Page 1 of 1 page

- A6L
 - 1. LT VEST PORT, STBD (two) – OFF
 - 2. LT TRUSS FWD, AFT (two) – OFF
- Inner Hatch
 - 3. Equal vlv caps (two) – remove
 - 4. Equal vlv (two) – NORM
 - 5. $\sqrt{\text{Hatch } \Delta P < 0.2 \text{ psid}}$
 - 6. Open Hatch per decal.
 - 7. Equal vlv (two) – OFF, reinstall caps
- MO13Q
 - 8. TNL ADAPT 1 – ON/OFF
 - 9. AIRLK 2 – ON/OFF
 - 10. AIRLK FAN A(B) – OFF
- Middeck/ Ext A/L
 - 11. Rotate airlock flex duct into tunnel extension and connect to booster fan muffler inlet.
- MO13Q
 - 12. AIRLK FAN A(B) – ON
- AW18A
 - 13. As required, LTG FLOOD 1(3,4) – ON
 - 14. $\sqrt{\text{Airflow at top of external airlock halo}}$
- EXT A/L
 - 15. Unstrap centerline camera diffuser flex duct from camera bracket. Stow duct along Stbd top of EXT A/L wall (in straps).
- R12
 - 16. $\sqrt{\text{Green Jumper – PRI C/L}}$
 $\sqrt{\text{PRI C/L Cap installed}}$
 $\sqrt{\text{VPU PWR – ON}}$
- A7
 - VID OUT pb – MON 1
 $\sqrt{\text{IN pb – PL2}}$
IRIS – CLOSE
- L12 (SSP2)
 - C/L CAM PWR – OFF
Remove, stow Centerline Camera and bridge.

This Page Intentionally Blank

2.104 HATCH OPENING AND SHUTTLE/ISS DUCT INSTALLATION

(JNT OPS/X2R4 - ALL/FIN 9) Page 1 of 9 pages

OBJECTIVE:

This procedure is used to equalize pressures between ISS and shuttle post docking, as well as setting up proper IMV flow between the two vehicles.

SHUTTLE TOOLS AND EQUIPMENT REQUIRED

Towel

ISS TOOLS AND EQUIPMENT REQUIRED

Rubber Gloves

Deerskin Gloves

(NOD1 D4_G2)

10" Adjustable Wrench

(PMA)

Docking Mechanism Accessory Kit

APAS Hatch Tool

Cleaning Pads

APAS Hatch Cover

Docking Target Standoff Cross Bag

Docking Target Base Plate Cover

1-1/2" Open End Wrench

ISS IVA Tool Kit

Drawer 2:

Ratchet, 1/4" Drive

7/16" Deep Socket, 1/4" Drive

1/2" Deep Socket, 1/4" Drive

Drawer 3:

4" Common Tip Screwdriver

WARNING

PMA is unventilated at this time. Limit amount of time spent in PMA to minimum required to complete ingress tasks.

NOTE

This procedure is performed after shuttle crew performs {2.101 POST DOCKING HATCH LEAK CHECK} (SODF: JNT OPS: INGRESS STATION) and ISS crew performs {2.102 POST DOCKING HATCH LEAK CHECK - ISS} (SODF: JNT OPS: INGRESS STATION). Both procedures should be completed successfully prior to beginning this procedure.

2.104 HATCH OPENING AND SHUTTLE/ISS DUCT INSTALLATION

(JNT OPS/X2R4 - ALL/FIN 9) Page 2 of 9 pages

1. INHIBITING ISS RAPID DEPRESS SOFTWARE RESPONSE

PCS

1.1 Inhibiting Internal Systems MDM Response

Rapid Depress: Rapid Depress Response Software Control

US Rapid Depress Response Software Control

'INT MDM Rapid Depress Response'

'Inhibit'

cmd Arm ($\sqrt{\text{Arm Status - Armed}}$)

cmd Inhibit ($\sqrt{\text{Status - Inhibited}}$)

'Airlock Depress Response - INT MDM'

'Inhibit'

cmd Arm ($\sqrt{\text{Arm Status - Armed}}$)

cmd Inhibit ($\sqrt{\text{Status - Inhibited}}$)

1.2 Inhibiting C&C MDM Response

'CC MDM Rapid Depress Response'

'Inhibit'

cmd Arm ($\sqrt{\text{Arm Status - Armed}}$)

cmd Inhibit ($\sqrt{\text{Status - Inhibited}}$)

1.3 Inhibiting CCS Low Pressure Safing Response

'CCS MDM Low Cabin P Response'

'Inhibit'

cmd Arm ($\sqrt{\text{Arm Status - Armed}}$)

cmd Inhibit ($\sqrt{\text{Status - Inhibited}}$)

1.4 Inhibiting Lab & Airlock Rapid Depress C&W Messages

C&W Summ

Caution & Warning Summary

'Event Code Tools'

sel Inhibit

Inhibit an Event

input Event Code - 6 5 7 5 (RAPID DEPRESS - LAB)

cmd Arm

cmd Execute

input Event Code - 6 5 7 6 (RAPID DEPRESS - A/L)

cmd Arm

cmd Execute

1.5 $\sqrt{\text{MCC}}$ to verify Russian Segment Rapid Depress Response inhibited

2.104 HATCH OPENING AND SHUTTLE/ISS DUCT INSTALLATION

(JNT OPS/X2R4 - ALL/FIN 9) Page 3 of 9 pages

PMA

2. EQUALIZING WITH ODS VESTIBULE

2.1 APAS EQUAL VLV → OP

US Lab: ECLSS
Lab: ECLSS

2.2 When dP/dT ~0 or **On MCC GO**, proceed.

2.3 APAS EQUAL VLV → CL

2.4 ISS report to shuttle: “ODS Vestibule pressurized. GO to begin leak check.”

3. LEAK CHECKING ODS/PMA DOCKING SEAL

3.1 Wait 10 minutes for thermal stabilization.

CRT

SM 177 EXTERNAL AIRLOCK

3.2 Record A/L-VEST ΔP: _____ psid.
Wait 15 minutes.

* If A/L-VEST ΔP ≥ previously recorded + 0.16 psid,
* notify **MCC-H** (Vestibule leak).

4. Shuttle report to ISS: “ODS Vestibule leak check complete. GO for APAS Hatch opening.”

5. OPENING APAS HATCH
APAS EQUAL VLV → OP

Wipe any condensate from vestibule volume using towel.

Select ‘РАБОЧЕЕ ПОЛОЖЕНИЕ’ (Working Position) torque setting on APAS Hatch Tool.
Insert tool in Hatch socket (ensure fully seated).
Rotate tool 3 to 4 turns in direction of ‘ОТКР’ (Open) arrow until it clicks.

* If tool prematurely slips or does not engage
*
* √**MCC-H** before proceeding.
*
* Select ‘АВАРИЙНОЕ ПОЛОЖЕНИЕ’ (Emergency Position) setting on APAS Hatch Tool.
* Reattempt to open Hatch.

2.104 HATCH OPENING AND SHUTTLE/ISS DUCT INSTALLATION

(JNT OPS/X2R4 - ALL/FIN 9) Page 4 of 9 pages

Remove tool.
Allow hatch seals to relax for 5 minutes.

WARNING

Surfaces may be below freezing for a short time after initial APAS Hatch opening. Don deerskin gloves prior to touching hatch external or vestibule surfaces.

CAUTION

APAS hatch seals require 5 minutes to relax before opening Hatch.

Open Hatch.

APAS EQUAL VLV → CL

6. EQUALIZING WITH SHUTTLE

6.1 ISS report to shuttle: "PMA Hatch is opened. GO for shuttle equalization with ISS."

ODS
Hatch

6.2 Equal vlv (one) → NORM

7. REMOVING DOCKING EQUIPMENT

CAUTION

1. Docking Target Base Plate Cover should be put on the Docking Target Base Plate any time the Docking Target Standoff Cross Bag is not mounted in order to prevent scratches, surface damage.
2. Docking Target Standoff Cross should be put in its bag to protect the Docking Target Standoff Cross when not mounted to the Docking Target Base Plate. The surfaces of these items are very easily scratched.
3. When handling the Docking Target Standoff Cross or the Docking Target Base Plate, rubber gloves should be worn.

PMA
Hatch

7.1 While maintaining a ↻ torque on standoff cross threaded hexagonal cap nut, loosen jam nut on docking target base plate receptacle by applying a ↻ torque (10" Adjustable Wrench and 1-1/2" Open End Wrench).

Temporarily stow jam nut by continuing to rotate it ↻ onto smaller, non-threaded diameter of receptacle.

Loosen hexagonal cap nut by applying ↻ torque.

Continue to rotate cap nut until threaded off of receptacle.

7.2 Remove and insert Cross into Docking Target Standoff Cross Bag. Temporarily stow.

2.104 HATCH OPENING AND SHUTTLE/ISS DUCT INSTALLATION

(JNT OPS/X2R4 - ALL/FIN 9) Page 5 of 9 pages

- 7.3 Install Docking Target Base Plate Cover.
Install APAS Hatch Cover.
Secure Hatch in open position with PMA APAS Hatch Standoff.

- 7.4 Stow 10" Adjustable Wrench in NOD1D4_G2.
Stow 1-1/2" Open End Wrench in PMA.

8. OPENING ODS HATCH

CRT

SPEC 66 ENVIRONMENT

- 8.1 When Cabin dP/dT < ± 0.01, proceed.

CRT

SPEC 177 EXTERNAL AIRLOCK

- 8.2 $\sqrt{A/L} - \text{VEST } \Delta P \leq 0.5 \text{ psid}$

Open ODS Hatch per decal.
Equal vlv (one) → OFF, cap installed

9. REMOVING DOCKING EQUIPMENT

WARNING

Surfaces may be below freezing for a short time after initial ODS Hatch opening. Avoid direct contact with vestibule surfaces until SHUTTLE VESTIBULE TEMP 1,2 (two) indicate > 40° F (SM 177 EXTERNAL AIRLOCK).

ODS
Vestibule

- 9.1 For each Docking Light
Disconnect cables.
Install caps on outlet.
Remove the locking pin.
Remove Docking Light.
Reinstall locking pin.
- 9.2 Remove crosshairs.
As required, stow lights and crosshairs .
- 9.3 Wipe any condensate from vestibule volume using towel.

10. INSTALLING PMA/LAB DUCTING

PCS

- 10.1 Cycle Lab IMV Fwd Stbd Valve
US Lab: ECLSS: IMV Fwd Stbd Valve
LAB IMV Fwd Stbd Vlv

- 10.1.1 sel RPCM LA1B B RPC 16

RPCM LA1B B RPC 16

cmd Close ($\sqrt{\text{RPC Position}} - \text{CI}$)

LAB IMV Fwd Stbd Vlv

2.104 HATCH OPENING AND SHUTTLE/ISS DUCT INSTALLATION

(JNT OPS/X2R4 - ALL/FIN 9) Page 6 of 9 pages

10.1.2 'Enable'

cmd Arm (√Arm Status – Armed)

cmd Enable (√State – Enabled)

10.1.3 'Open'

cmd Arm (√Arm Status – Armed)

cmd Open

Wait 25 seconds, then:

√Position – Open

10.1.4 'Close'

cmd Arm (√Arm Status – Armed)

cmd Close

Wait 25 seconds, then:

√Position – Closed

- PMA2
- 10.2 PMA2 air duct jumper ←|→ launch restraint bracket (Use Ratchet and 7/16" Deep Socket, leave V-Band clamp on flange) Open Velcro straps securing rest of flex duct to Closeout From (two places).
- 10.3 IMV cap ←|→ Lab Fwd Stbd IMV flange (Use Ratchet and 7/16" Deep Socket, leave V-Band on flange.) Using hands and optional FDF/SODF Cover, pry the IMV cap (if required, use screwdriver). Remove face and bore O-Rings from IMV cap. Label both O-rings as "Used O-Rings. Return to Houston." Stow in "Return to Houston" Bag.
- 10.4 PMA2 air duct jumper →|← Lab Fwd Stbd IMV flange (Use V-Band clamp, Ratchet, and 7/16" Deep Socket.)
- 10.5 IMV cap →|← PMA2 launch restraint (Use V-Band clamp, Ratchet, and 7/16" Deep Socket.)

11. INSTALLING PMA/ODS DUCTING

- MO13Q 11.1 AIRLK FAN A(B) → OFF
- Ext A/L 11.2 Disconnect air inlet flex duct from external A/L duct from halo cross air duct.
- PMA 11.3 Unstow PMA/ODS Interface Duct Segment from PMA.

2.104 HATCH OPENING AND SHUTTLE/ISS DUCT INSTALLATION

(JNT OPS/X2R4 - ALL/FIN 9) Page 7 of 9 pages

Ext A/L 11.4 Connect PMA/ODS Interface Duct Segment to air inlet flex duct with T-handle clamp.

NOTE

Per SPN 26180, before Node 2 is in place at the forward end of the LAB, **MCC-H** must load patch: intr2_pat_imvn2_4_d_00001.lif; and send the enable commands for the appropriate Node 2 IMV valve. The valves (Stbd vs Port) which the INTSYS checks are switched in INTSYS R2. This means the Node 2 IMV Aft Port Valve must be open prior to commanding the Lab IMV Fwd Stbd Fan to On, and the Node 2 IMV Aft Stbd Valve open prior to commanding the Lab IMV Fwd Port Fan to On.

12. ENABLING NODE 2 IMV AFT PORT VALVE

PCS Node 2: ECLSS: IMV Aft Port Valve

Node 2 IMV Aft Port Vlv

'Enable'

cmd Arm ($\sqrt{\text{Arm Status - Armed}}$)

cmd Enable ($\sqrt{\text{State - Enable}}$)

Verify Position - Open

13. OPENING LAB IMV FWD STBD VALVE

US Lab: ECLSS: IMV Fwd Stbd Valve

LAB IMV Fwd Stbd Vlv

'Open'

cmd Arm ($\sqrt{\text{Arm Status - Armed}}$)

cmd Open

Wait 25 seconds, then:

$\sqrt{\text{Position - Open}}$

14. ACTIVATING LAB IMV FWD STBD FAN

US Lab: ECLSS: IMV Fwd Stbd Fan

LAB IMV Fwd Stbd Fan

14.1 sel RPCM LA2B B RPC 09

RPCM LA2B B RPC 09

cmd Close ($\sqrt{\text{RPC Position - Cl}}$)

Lab IMV Fwd Stbd Fan

14.2 'On'

cmd On

Wait 15 seconds.

2.104 HATCH OPENING AND SHUTTLE/ISS DUCT INSTALLATION

(JNT OPS/X2R4 - ALL/FIN 9) Page 8 of 9 pages

√State – On
√Speed, rpm: 7745 to 9278

15. INHIBIT NODE 2 IMV AFT PORT VALVE

Node 2: ECLSS: IMV Aft Port Valve

Node 2 IMV Aft Port Vlv

'Inhibit'

cmd Arm (√Arm Status – Armed)

cmd Inhibit (√State – Inhibit)

MO13Q 16. AIRLK FAN A(B) → ON

PMA2 17. √PMA2 Grille Cover – Closed

18. ENABLING ISS RAPID DEPRESS RESPONSE SOFTWARE

PCS 18.1 Enabling Internal Systems MDM Response
Rapid Depress: Rapid Depress Response Software Control
US Rapid Depress Response Software Control
'INT MDM Rapid Depress Response'
'Enable'

cmd Enable (√Status – Enabled)

'Airlock Depress Response – INT MDM'
'Enable'

cmd Enable (√Status – Enabled)

18.2 Enabling C&C MDM Response
'CC MDM Rapid Depress Response'
'Enable'

cmd Enable (√Status – Enabled)

18.3 Enabling CCS Low Pressure Safing Response
'CC MDM Low Cabin P Response'
'Enable'

cmd Enable (√Status – Enabled)

2.104 HATCH OPENING AND SHUTTLE/ISS DUCT INSTALLATION

(JNT OPS/X2R4 - ALL/FIN 9) Page 9 of 9 pages

18.4 Enabling Lab & Airlock Rapid Depress C&W Messages

If Rapid Depress C&W Messages were previously inhibited:

C&W Summ

Caution & Warning Summary

'Event Code Tools'

sel ENABLE

Enable an Event

input Event Code – 6 5 7 5 (RAPID DEPRESS – LAB)

cmd Execute

input for Event Code – 6 5 7 6 (RAPID DEPRESS – A/L)

cmd Execute

18.5 ✓ **MCC-M** to reenable Russian Segment Rapid Depress Response

This Page Intentionally Blank

SHUTTLE TOOLS AND EQUIPMENT REQUIRED

Towel

ISS TOOLS AND EQUIPMENT REQUIRED

CSA-CP Rubber Gloves

NOD1 10" Adjustable Wrench

D4_G2

PMA Docking Mechanism Accessory Kit
APAS Hatch Tool
Cleaning Pads
APAS Hatch Cover
Docking Target Standoff Cross Bag
Docking Target Base Plate Cover
1-1/2" Open End Wrench

1. INGRESSING PMA

Lab Fwd Open Lab Fwd Hatch per decal.

2. EQUALIZING ISS AND ODS VESTIBULE

PMA 2.1 APAS EQUAL VLV → OP

LAB: ECLSS

LAB: ECLSS

2.2 When dP/dT ~0 or **On MCC GO**, proceed.

3. OPENING APAS HATCH

3.1 Open APAS Hatch.

Select 'РАБОЧЕЕ ПОЛОЖЕНИЕ' (Working Position) torque setting on APAS Hatch Tool.

Insert tool in hatch socket (ensure fully seated).

Rotate tool 3 --- 4 turns in direction of 'ОТКР' (Open) arrow until it clicks.

Remove tool.

Allow Hatch Seals to relax for 5 minutes.

CAUTION

APAS Hatch Seals require 5 minutes to relax before opening Hatch.

PMA 3.2 Open Hatch.

APAS EQUAL VLV → CL

Tether hatch tool to hatch handle.

ISS report to shuttle: "PMA Hatch is opened. Go for shuttle equalization with ISS."

2.105 ISS INTERIM INGRESS

(JNT OPS/7A - ALL/FIN 3) Page 2 of 4 pages

EQUALIZING SHUTTLE AND ISS

MO10W 4. √14.7 CAB REG INLET SYS 1 vlv – CL

ODS Hatch 5. Equal vlv (one) → NORM

6. REMOVING DOCKING EQUIPMENT

CAUTION

1. The Docking Target Base Plate Cover should be put on the Docking Target Base Plate any time the Docking Target Standoff Cross Bag is not mounted in order to prevent scratches, surface damage.
2. The Docking Target Standoff Cross should be put in its bag to protect the Docking Target Standoff Cross when not mounted to the Docking Target Base Plate. The surface of these items are very easily scratched.
3. Donning of Rubber Gloves required in handling of Docking Target Standoff Cross and Docking Target Base Plate.

6.1 Don Rubber Gloves.

PMA Hatch 6.2 While maintaining a ↺ torque on standoff cross threaded hexagonal capnut, loosen jamnut on Docking Target Base Plate receptacle by applying a ↻ torque (10" Adjustable Wrench and 1-1/2" Open End Wrench).
Temporarily stow jamnut by continuing to rotate it ↻ onto smaller, non-threaded diameter of receptacle.
Loosen hexagonal capnut by applying ↺ torque.
Continue to rotate capnut until threaded off of receptacle.

6.3 Remove and insert cross into Docking Target Standoff Cross Bag. Temporarily stow.

6.4 Install Docking Target Base Plate Cover.
Install APAS Hatch Cover.
Secure Hatch in open position to PMA APAS Hatch Standoff.
Doff Rubber Gloves.

6.5 Stow 10" Adjustable Wrench in NOD1D4 G2.
Stow 1-1/2" Open End Wrench in PMA.

OPENING ODS HATCH

ODS 7. √ODS Hatch $\Delta P \leq 0.2$ psid

Open ODS Hatch per decal.
Equal vlv (one) → OFF, cap installed

8. Wipe any condensate from vestibule volume using towel.

2.105 ISS INTERIM INGRESS

(JNT OPS/7A - ALL/FIN 3) Page 3 of 4 pages

CONFIGURING IMV DUCTING

MO13Q 9. AIRLK FAN A(B) – OFF

Ext A/L 10. Disconnect air inlet flex duct from external A/L duct from halo cross air duct.

PMA 11. Unstow PMA/ODS Interface Duct Segment from PMA.

Ext A/L 12. Connect PMA/ODS Interface Duct Segment to air inlet flex duct with T-handle clamp.

13. ACTIVATING LAB IMV FWD STBD VALVE

PCS

US Lab: ECLSS: IMV Fwd Stbd Vlv

LAB IMV Fwd Stbd Valve

13.1 sel RPCM LA1B B RPC 16

'RPC Position'

cmd Close (√RPC Position – Cl)

13.2 'Enable'

cmd Arm (√Arm Status – Armed)

cmd Enable (√State – Enabled)

14. OPENING LAB IMV FWD STBD VALVE OPENING

'Open'

cmd Arm (√Arm Status – Armed)

cmd Open

√Position – In Transit

Wait 25 seconds, then:

√Position – Open

15. ACTIVATING LAB IMV FWD STBD FAN

PCS

US Lab: ECLSS: IMV Fwd Stbd Fan

LAB IMV Fwd Stbd Fan

15.1 sel RPCM LA2B B RPC 09

'RPC Position'

cmd Close (√RPC Position – Cl)

2.105 ISS INTERIM INGRESS

(JNT OPS/7A - ALL/FIN 3)

Page 4 of 4 pages

15.2 LAB IMV Fwd Stbd Fan
'On'

cmd On

√State – In Transit

Wait 15 seconds.

√State – On

√Speed, rpm: 7745 --- 9278

PMA 16. Close hard duct grille cover.

MO13Q 17. AIRLK FAN A(B) – ON

14.7 PSI REPRESSURIZATION

NOTE

Expect possible '**S66 CAB O2(N2) FLO 1**' message in next step.

MO10W 18. 14.7 CAB REG INLET SYS 1 vlv – OP

2.106 HATCH OPEN AND DUCT INSTALL (BYPASS CONFIG)

(JNT OPS/LF1 - ALL/FIN/SPN) Page 1 of 10 pages

OBJECTIVE:

This procedure is required to configure the orbiter and ISS for the booster fan bypass. This will allow deactivation of the booster fan to save Cryo O2.

SHUTTLE TOOLS AND EQUIPMENT REQUIRED

Towel

ISS TOOLS AND EQUIPMENT REQUIRED

Rubber Gloves

Deerskin Gloves

(NOD1D4_G2)

10" Adjustable Wrench

(PMA)

Docking Mechanism Accessory Kit

APAS Hatch Tool

Cleaning Pads

APAS Hatch Cover

Docking Target Standoff Cross Bag

Docking Target Base Plate Cover

1-1/2" Open End Wrench

Kapton tape

ISS IVA Tool Kit

Drawer 2:

Ratchet, 1/4" Drive

7/16" Deep Socket, 1/4" Drive

1/2" Deep Socket, 1/4" Drive

Drawer 3:

4" Common Tip Screwdriver

WARNING

The PMA is unventilated at this time. Limit the amount of time spent in the PMA to the minimum required to complete the ingress tasks.

NOTE

This procedure is performed after the shuttle crew performs {[FDF: RNDZ: POST DOCKING HATCH LEAK CHECK and AIRLOCK PREP FOR INGRESS - BYPASS CONFIG](#)} and ISS crew performs {[2.102 POST DOCKING HATCH LEAK CHECK - ISS](#)} ([SODF: JNT OPS: INGRESS STATION](#)). These procedures should be completed successfully prior to beginning this procedure.

2.106 HATCH OPEN AND DUCT INSTALL (BYPASS CONFIG)

(JNT OPS/LF1 - ALL/FIN/SPN)

Page 2 of 10 pages

PCS

1. INHIBITING ISS RAPID DEPRESS SOFTWARE RESPONSE

1.1 Inhibiting Internal Systems MDM Response

Rapid Depress

ISS Depress

sel Rapid Depress Response Software Control

US Rapid Depress Response Software Control

'INT MDM Rapid Depress Response'

'Inhibit'

cmd Arm (√Arm Status – Armed)

cmd Inhibit (√Status – Inhibited)

'Airlock Depress Response – INT MDM'

'Inhibit'

cmd Arm (√Arm Status – Armed)

cmd Inhibit (√Status – Inhibited)

1.2 Inhibiting C&C MDM Response

'CC MDM Rapid Depress Response'

'Inhibit'

cmd Arm (√Arm Status – Armed)

cmd Inhibit (√Status – Inhibited)

1.3 Inhibiting CCS Low Pressure Safing Response

'CC MDM Low Cabin P Response'

'Inhibit'

cmd Arm (√Arm Status – Armed)

cmd Inhibit (√Status – Inhibited)

1.4 Inhibiting Lab and Airlock Rapid Depress C&W Messages

C&W Summ

Caution & Warning Summary

'Event Code Tools'

sel Inhibit

Inhibit an Event

input Event Code – 6 5 7 5 (RAPID DEPRESS – LAB)

cmd Arm

cmd Execute

input Event Code – 6 5 7 6 (RAPID DEPRESS – A/L)

cmd Arm

cmd Execute

2.106 HATCH OPEN AND DUCT INSTALL (BYPASS CONFIG)

(JNT OPS/LF1 - ALL/FIN/SPN)

Page 3 of 10 pages

1.5 ✓ **MCC** to verify Russian Segment Rapid Depress Response inhibited

PMA 2. EQUALIZING WITH ODS VESTIBULE

2.1 APAS EQUAL VLV → OP

US Lab: ECLSS
Lab: ECLSS

2.2 When dP/dT ~0 or **On MCC GO**, proceed.

2.3 APAS EQUAL VLV → CL

2.4 ISS report to shuttle: “ODS Vestibule pressurized. GO to begin leak check.”

3. LEAK CHECKING ODS/PMA DOCKING SEAL

3.1 Wait 10 minutes for thermal stabilization.

CRT SM 177 EXTERNAL AIRLOCK

3.2 Record A/L-VEST ΔP: _____ psid.
Wait 15 minutes.

* If A/L-VEST ΔP ≥ previously recorded + 0.16 psid,
* notify **MCC-H** (Vestibule leak).

4. Shuttle report to ISS: “ODS Vestibule leak check complete. GO for APAS Hatch opening.”

5. OPENING APAS HATCH
APAS EQUAL VLV → OP

Wipe any condensate from vestibule volume using towel.

Select ‘РАБОЧЕЕ ПОЛОЖЕНИЕ’ (Working Position) torque setting on APAS Hatch Tool.
Insert tool in hatch socket (ensure fully seated).
Rotate tool 3 to 4 turns in direction of ‘ОТКР’ (Open) arrow until it clicks.

* If tool prematurely slips or does not engage
* | ✓ **MCC-H** before proceeding
* | Select ‘АВАРИЙНОЕ ПОЛОЖЕНИЕ’ (Emergency Position)
* | setting on APAS Hatch Tool.
* | Reattempt to open Hatch.

Remove tool.
Allow hatch seals to relax for 5 minutes.

2.106 HATCH OPEN AND DUCT INSTALL (BYPASS CONFIG)

(JNT OPS/LF1 - ALL/FIN/SPN)

Page 4 of 10 pages

WARNING

Surfaces may be below freezing for a short time after initial APAS Hatch opening. Don deerskin gloves prior to touching hatch external or vestibule surfaces.

CAUTION

APAS hatch seals require 5 minutes to relax before opening Hatch.

Open Hatch.

APAS EQUAL VLV → CL

6. EQUALIZING WITH SHUTTLE

6.1 ISS report to shuttle: "PMA Hatch is opened. GO for shuttle equalization with ISS."

Upper
Hatch

6.2 ODS Upper Hatch Equal vlv cap (one) → vent, remove

6.3 ODS Upper Hatch Equal vlv (one) → NORM

7. REMOVING DOCKING EQUIPMENT

CAUTION

1. The Docking Target Base Plate Cover should be put on the Docking Target Base Plate any time the Docking Target Standoff Cross Bag is not mounted in order to prevent scratches, surface damage.
2. The Docking Target Standoff Cross should be put in its bag to protect the Docking Target Standoff Cross when not mounted to the Docking Target Base Plate. The surfaces of these items are very easily scratched.
3. When handling the Docking Target Standoff Cross or the Docking Target Base Plate, rubber gloves should be worn.

PMA
Hatch

7.1 While maintaining a ↻ torque on standoff cross threaded hexagonal cap nut, loosen jam nut on docking target base plate receptacle by applying a ↻ torque (10" Adjustable Wrench and 1-1/2" Open End Wrench).
Temporarily stow jam nut by continuing to rotate it ↻ onto smaller, non-threaded diameter of receptacle.
Loosen hexagonal cap nut by applying ↻ torque.
Continue to rotate cap nut until threaded off of receptacle.

7.2 Remove and insert Cross into Docking Target Standoff Cross Bag. Temporarily stow.

2.106 HATCH OPEN AND DUCT INSTALL (BYPASS CONFIG)

(JNT OPS/LF1 - ALL/FIN/SPN)

Page 5 of 10 pages

- 7.3 Install Docking Target Base Plate Cover.
Install APAS Hatch Cover.
Secure Hatch in open position with PMA APAS Hatch Standoff.

- 7.4 Stow 10" Adjustable Wrench in NOD1D4_G2.
Stow 1-1/2" Open End Wrench in PMA.

8. OPENING ODS HATCH

CRT

SPEC 66 ENVIRONMENT

- 8.1 When Cabin $dP/dT < \pm 0.01$, proceed.

CRT

SPEC 177 EXTERNAL AIRLOCK

- 8.2 $\sqrt{A/L} - \text{VEST } \Delta P \leq 0.5 \text{ psid}$

Open ODS Upper Hatch per decal.

Equal vlv (one) → OFF, cap installed

9. REMOVING DOCKING EQUIPMENT

WARNING

Surfaces may be below freezing for a short time after initial ODS Hatch opening. Avoid direct contact with vestibule surfaces until SHUTTLE VESTIBULE TEMP 1,2 (two) indicate $> 40^\circ \text{ F}$ (SM 177 EXTERNAL AIRLOCK).

ODS

Vestibule

- 9.1 For each Docking Light

Disconnect cables.
Install caps on outlet.
Remove the locking pin.
Remove Docking Light.
Reinstall locking pin.

- 9.2 Remove crosshairs.

Stow lights and crosshairs as required.

- 9.3 Wipe any condensate from vestibule volume using towel.

10. INSTALLING PMA/LAB DUCTING

PCS

- 10.1 Cycle Lab IMV Fwd Stbd Valve
US Lab: ECLSS: IMV Fwd Stbd Valve
LAB IMV Fwd Stbd Vlv

10.1.1 sel RPCM LA1B B RPC 16

RPCM LA1B B RPC 16

cmd Close ($\sqrt{\text{RPC Position}} - \text{CI}$)

LAB IMV Fwd Stbd Vlv

2.106 HATCH OPEN AND DUCT INSTALL (BYPASS CONFIG)

(JNT OPS/LF1 - ALL/FIN/SPN)

Page 6 of 10 pages

10.1.2 'Enable'

cmd Arm (√Arm Status – Armed)

cmd Enable (√State – Enabled)

10.1.3 'Open'

cmd Arm (√Arm Status – Armed)

cmd Open

Wait 25 seconds.

√Position – Open

10.1.4 'Close'

cmd Arm (√Arm Status – Armed)

cmd Close

Wait 25 seconds.

√Position – Closed

- PMA2
- 10.2 PMA2 air duct jumper ←|→ launch restraint bracket (Use Ratchet and 7/16" Deep Socket, leave V-Band clamp on flange)
Open Velcro straps securing rest of flex duct to Closeout From (two places).
- 10.3 IMV cap ←|→ Lab Fwd Stbd IMV flange (Use Ratchet and 7/16" Deep Socket, leave V-Band on flange.)
Using hands and optional FDF/SODF Cover, pry the IMV cap (if required, use screwdriver).
Remove face and bore O-Rings from IMV cap.
Label both O-Rings as "Used O-Rings. Return to Houston."
Stow in "Return to Houston" Bag.
- 10.4 IMV cap →|← PMA2 launch restraint (Use V-Band clamp, Ratchet, and 7/16" Deep Socket.)
- 10.5 PMA2 air duct jumper →|← Lab Fwd Stbd IMV flange (Use V-Band clamp, Ratchet, and 7/16" Deep Socket.)

2.106 HATCH OPEN AND DUCT INSTALL (BYPASS CONFIG)

(JNT OPS/LF1 - ALL/FIN/SPN)

Page 7 of 10 pages

11. INSTALLING PMA/ODS DUCTING

- Ext A/L 11.1 Release T-handle clamp to disconnect halo inlet flex duct from halo inlet.
- PMA 11.2 Unstow PMA/ODS Interface Duct Segment from PMA.
- Ext A/L 11.3 Connect PMA/ODS Interface Duct Segment to halo inlet flex duct using T-handle clamp.
- 11.4 Disconnect bypass duct from Airlock Fan outlet.
Remove air diffuser cap from middeck floor and install on Airlock Fan outlet.
Connect bypass duct to middeck floor diffuser.
- PMA2 11.5 PMA2 Grille Cover → Partially Open (six rows of holes, using Kapton Tape per Figure 1)
Secure Velcro cover to back of duct.

Tape over remaining holes with Kapton Tape.
(Do not use Gray Tape)



Figure 1.- Grille Cover.

NOTE

Per SPN 26180, before Node 2 is in place at the forward end of the LAB, **MCC-H** must load patch: intr2_pat_imvn2_4_d_00001.lif; and send the enable commands for the appropriate Node 2 IMV valve. The valves (Stbd vs Port) which the INTSYS checks are switched in INTSYS R2. This means the Node 2 IMV Aft Port Valve must be open prior to commanding the LAB IMV Fwd Stbd Fan to On, and the Node 2 IMV Aft Stbd Valve open prior to commanding the LAB IMV Fwd Port Fan to On.

2.106 HATCH OPEN AND DUCT INSTALL (BYPASS CONFIG)

(JNT OPS/LF1 - ALL/FIN/SPN)

Page 8 of 10 pages

PCS

12. ENABLING NODE 2 AFT PORT IMV VALVE

Node 2: ECLSS: IMV Aft Port Valve

Node 2 IMV Aft Port Vlv

'Enable'

cmd Arm (√Arm Status – Armed)

cmd Enable (√State – Enabled)

Verify Position – Open

13. OPENING LAB IMV FWD STBD VALVE

US Lab: ECLSS: IMV Fwd Stbd Valve

LAB IMV Fwd Stbd Vlv

'Open'

cmd Arm (√Arm Status – Armed)

cmd Open

Wait 25 seconds.

√Position – Open

14. ACTIVATING LAB IMV FWD STBD FAN

US Lab: ECLSS: IMV Fwd Stbd Fan

LAB IMV Fwd Stbd Fan

14.1 sel RPCM LA2B B RPC 09

RPCM LA2B B RPC 09

cmd Close (√RPC Position – Cl)

Lab IMV Fwd Stbd Fan

14.2 'On'

cmd On

Wait 15 seconds.

√State – On

√Speed, rpm: 7745 to 9278

2.106 HATCH OPEN AND DUCT INSTALL (BYPASS CONFIG)

(JNT OPS/LF1 - ALL/FIN/SPN)

Page 9 of 10 pages

15. INHIBIT NODE 2 AFT PORT IMV VALVE

Node 2: ECLSS: IMV Aft Port Valve

Node 2 IMV Aft Port Vlv

'Inhibit'

cmd Arm (√Arm Status – Armed)

cmd Inhibit (√State – Inhibited)

16. ENABLING ISS RAPID DEPRESS RESPONSE SOFTWARE

PCS

16.1 Enabling Internal Systems MDM Response

Rapid Depress

ISS Depress

sel Rapid Depress Response Software Control

US Rapid Depress Response Software Control

'INT MDM Rapid Depress Response'

'Enable'

cmd Enable (√Status – Enabled)

'Airlock Depress Response – INT MDM'

'Enable'

cmd Enable (√Status – Enabled)

16.2 Enabling C&C MDM Response

'CC MDM Rapid Depress Response'

'Enable'

cmd Enable (√Status – Enabled)

16.3 Enabling CCS Low Pressure Safing Response

'CC MDM Low Cabin P Response'

'Enable'

cmd Enable (√Status – Enabled)

2.106 HATCH OPEN AND DUCT INSTALL (BYPASS CONFIG)

(JNT OPS/LF1 - ALL/FIN/SPN) Page 10 of 10 pages

16.4 Enabling Lab and Airlock Rapid Depress C&W Messages

If Rapid Depress C&W Messages were previously inhibited:

C&W Summ

Caution & Warning Summary

'Event Code Tools'

sel ENABLE

Enable an Event

input Event Code – 6 5 7 5 (RAPID DEPRESS – LAB)

cmd Execute

input for Event Code – 6 5 7 6 (RAPID DEPRESS – A/L)

cmd Execute

16.5 ✓ **MCC-M** to reenable Russian Segment Rapid Depress Response

2.107 SHUTTLE AIRLOCK/TUNNEL FAN ACTIVATION (BYPASS DUCT INSTALLED)

(JNT OPS/LF1 - ALL/FIN/SPN) Page 1 of 3 pages

OBJECTIVE:

Procedure is used if shuttle Airlock/Tunnel Fan (“booster fan”) is to be activated when starting from the “bypass duct” configuration.

- PMA2
1. Check PMA/ODS Interface Duct Segment connected between shuttle External Airlock and station PMA2
 2. PMA2 Grille Cover – Closed

WARNING

The PMA is unventilated at this time. Limit the amount of time spent in the PMA to the minimum required.

- PCS
3. DEACTIVATING LAB IMV FWD STBD FAN
LAB: ECLSS: IMV Fwd Stbd Fan
Lab IMV Fwd Stbd Fan

NOTE

Upon IMV Fan deactivation, rpm sensor register 0 volts. MDM conversion translates 0 volts (0 counts) to 7164 ± 50 rpm. Reference 2A SPN 8437.

3.1 ‘Off’

cmd Arm (\sqrt Status – Armed)
cmd Off (\sqrt State – Off)

\sqrt Speed, rpm: 7164 ± 50

3.2 sel RPCM LA2B B RPC 09

cmd Open (\sqrt RPC Position – Op)

- MDDK
4. Disconnect bypass duct from middeck floor fitting.
- EXT A/L
5. Attach bypass duct to Airlock Fan outlet.
 6. Unstow inlet duct from tunnel extension wall. Attach one end to Airlock fan muffler inlet.
- MDDK
7. Attach free-end inlet duct to cabin MDDK floor fitting.
 8. Remove mylar sleeve/tape from outer screen of Fwd Middeck Diffuser.
- MO13Q
9. ARLK FAN A(B) – ON

2.107 SHUTTLE AIRLOCK/TUNNEL FAN ACTIVATION (BYPASS DUCT INSTALLED)

(JNT OPS/LF1 - ALL/FIN/SPN)

Page 2 of 3 pages

10. VERIFYING LAB FWD STBD IMV VALVE POSITION

PCS

US Lab: ECLSS: IMV Fwd Stbd Valve

LAB IMV Fwd Stbd Vlv

√Position – Open

11. OPENING NODE 2 IMV VALVE

NOTE

Per SPN 26180, before Node 2 is in place at the forward end of the LAB, **MCC-H** must load patch intr2_pat_imvn2_4_d_00001.lif and send the enable commands for the appropriate Node 2 IMV valve. The valves (Stbd vs. Port) which the INTSYS checks are switched in INTSYS R2. This means the Node 2 IMV Aft Port Valve must be open prior to commanding the LAB IMV Fwd Stbd Fan to On, and the Node 2 IMV Aft Stbd Valve open prior to commanding the LAB IMV Fwd Port Fan to On.

PCS

Node 2: ECLSS: IMV Aft Port Valve

Node 2 IMV Aft Port Vlv

'Enable'

cmd Arm (√Arm Status – Armed)

cmd Enable (√State – Enabled)

Verify Position – Open

12. ACTIVATING LAB IMV FWD STBD FAN

PCS

US Lab: ECLSS: IMV Fwd Stbd Fan

LAB IMV Fwd Stbd Fan

12.1 sel RPCM LA2B B RPC 09

RPCM LA2B B RPC 09

cmd Close (√RPC Position – Cl)

Lab IMV Fwd Stbd Fan

12.2 'On'

cmd On

Wait 15 seconds.

√State – On

√Speed, rpm: 7745 to 9278

2.107 SHUTTLE AIRLOCK/TUNNEL FAN ACTIVATION (BYPASS DUCT INSTALLED)

(JNT OPS/LF1 - ALL/FIN/SPN) Page 3 of 3 pages

13. [INHIBITING NODE 2 IMV VALVE](#)
PCS Node 2: ECLSS: IMV Aft Port Valve
 Node 2 IMV Aft Port Vlv
'Inhibit'

cmd Arm (√Arm Status – Armed)
cmd Inhibit (√State – Inhibited)

This Page Intentionally Blank

2.108 SHUTTLE AIRLOCK/TUNNEL FAN DEACTIVATION (BYPASS DUCT INSTALLED)

(JNT OPS/LF1 - ALL/FIN/SPN) Page 1 of 3 pages

OBJECTIVE:

Procedure is used if shuttle Airlock/Tunnel Fan (“booster fan”) is to be deactivated to return to the “bypass duct” configuration.

WARNING

The PMA is unventilated at this time. Limit the amount of time spent in the PMA to the minimum required.

PMA2 1. Check PMA/ODS Interface Duct Segment connected between shuttle External Airlock and station PMA2,

PCS 2. [DEACTIVATING LAB IMV FWD STBD FAN](#)

LAB: ECLSS: IMV Fwd Stbd Fan

Lab IMV Fwd Stbd Fan

NOTE

Upon IMV Fan deactivation, rpm sensor register 0 volts. MDM conversion translates 0 volts (0 counts) to 7164 ± 50 rpm. Reference 2A SPN 8437.

2.1 ‘Off’

cmd Arm (√Status – Armed)

cmd Off (√State – Off)

√Speed, rpm: 7164 ± 50

2.2 sel RPCM LA2B B RPC 09

RPCM LA2B B RPC 09

NOTE

A “?” may temporarily appear in the RPC data field. This is due to Shuttle ODS Booster Fan generating flow through the IMV duct and causing IMV Fan rotation and back EMF.

cmd Open (√RPC Position – Op)

PMA2 3. PMA2 Grille Cover – Open

MO13Q 4. ARLK FAN A(B) – OFF

MDDK 5. Disconnect inlet duct from cabin MDDK floor fitting.

6. Disconnect other end inlet duct from Airlock Fan muffler inlet. Stow fwd flex duct on tunnel extension wall.

EXT A/L 7. Disconnect bypass duct from Airlock Fan outlet.

2.108 SHUTTLE AIRLOCK/TUNNEL FAN DEACTIVATION (BYPASS DUCT INSTALLED)

(JNT OPS/LF1 - ALL/FIN/SPN) Page 2 of 3 pages

- MDDK 8. Attach bypass duct to cabin MDDK floor fitting.
9. Replace mylar sleeve/tape onto outer screen of Fwd Middeck Diffuser.

10. VERIFYING LAB FWD STBD IMV VALVE POSITION

PCS

US Lab: ECLSS: IMV Fwd Stbd Valve

√POSITION – Open

11. OPENING NODE 2 IMV VALVE

NOTE

Per SPN 26180, before Node 2 is in place at the forward end of the LAB, **MCC-H** must load patch intr2_pat_imvn2_4_d_00001.lif and send the enable commands for the appropriate Node 2 IMV valve. The valves (Stbd vs. Port) which the INTSYS checks are switched in INTSYS R2. This means the Node 2 IMV Aft Port Valve must be open prior to commanding the LAB IMV Fwd Stbd Fan to On, and the Node 2 IMV Aft Stbd Valve open prior to commanding the LAB IMV Fwd Port Fan to On.

PCS

Node 2: ECLSS: IMV Aft Port Valve

'Enable'

cmd Arm (√Arm Status – Armed)

cmd Enable (√State – Enabled)

Verify Position – Open

12. ACTIVATING LAB IMV FWD STBD FAN

PCS

US Lab: ECLSS: IMV Fwd Stbd Fan

12.1 sel RPCM LA2B B RPC 09

cmd Close (√RPC Position – Cl)

12.2 'On'

cmd On

Wait 15 seconds.

2.108 SHUTTLE AIRLOCK/TUNNEL FAN DEACTIVATION (BYPASS DUCT INSTALLED)

(JNT OPS/LF1 - ALL/FIN/SPN)

Page 3 of 3 pages

√State – On

√Speed, rpm: 7745 to 9278

PCS

13. INHIBITING NODE 2 IMV VALVE

Node 2: ECLSS: IMV Aft Port Valve

Node 2 IMV Aft Port Vlv

'Inhibit'

cmd Arm (√Arm Status – Armed)

cmd inhibit (√State – Inhibited)

This Page Intentionally Blank

MATED OPERATIONS

**MATED
OPERATIONS**

This Page Intentionally Blank

3.101 COMPOUND SPECIFIC ANALYZER - COMBUSTION PRODUCTS: I
CSA-CP RESUPPLY

(JNT OPS/UF1 - ALL/FIN 8) Page 1 of 3 pages

OBJECTIVE:

Resupply two new CSA-CP units, ten new Battery Packs, one new Zero Filter, and two spare Pump Filters. The resupplied CSA-CP sensors (CO and HCL) may give elevated readings as a result of stowage during launch and transfer. The units should be deployed in an open environment for two to four weeks for the elevated readings to decrease to nominal levels.

NOTE

The Exp 7 primary CSA-CP (S/N 1008) should remain on board. The Exp 5 and backup Exp 7 CSA-CPs (S/N(s) 1001 and 1007) should be stowed in Resupply Kit for return.

Reference 1. Unstow CSA-CP Resupply Kit.
Transfer
List

2. Unstow Marking Pen
3. Retrieve prime CSA-CP (1008) from deployed location.

LAB01D4 4. Retrieve CSA-CP Stowage Kit and Exp 7 backup CSA-CP (1007).

5. Remove the two Exp 7 CSA-CPs (1003, 1004) from the Resupply Kit. Temporarily stow.
6. Demate (if necessary) the Exp 7 backup CSA-CP(1007) from Sampling Pump.
Unstow Exp 5 CSA-CP (1001) from NOD1D2.
Stow both in the Resupply Kit.

NOTE

1. The old and new Battery Packs have part number SED46115802-304.
2. The following Battery Pack serial numbers have been resupplied: 1012, 1027, 1076, 1077, 1078, 1079, 1080, 1082, 1084, 1085.
3. Any unused Battery Packs should remain in the Stowage Kit.
4. The new Zero Filter serial number is 1004.

7. Transfer new Battery Packs (10) from Resupply Kit to Stowage Kit.
Transfer used Battery Packs (7) from Stowage Kit to Resupply Kit.
Leave unused Battery Packs (1) in Stowage Kit.

3.101 COMPOUND SPECIFIC ANALYZER - COMBUSTION PRODUCTS: CSA-CP RESUPPLY

(JNT OPS/UF1 - ALL/FIN 8) Page 2 of 3 pages

8. Remove, exchange the following items from CSA-CP Resupply Kit with like items from CSA-CP Stowage Kit: Packet with 2 spare Pump Filters (SED46115799-601), Zero Filter (1)
9. ✓CSA-CP Resupply Kit contains the following Exp 5 and 7 items
Exp 5 CSA-CP (1001) with Battery
Backup Exp 7 CSA-CP (1007) with Battery
Used Battery Packs (8)
Zero Filter (1)
Packet with two sampling Pump Filters (1)

Reference10. Stow CSA-CP Resupply Kit for return.
Transfer
List

NOTE

Audible beeps occur when the MODE pushbutton is depressed during unit activation.

11. Activate all three CSA-CPs.
pb MODE – press, hold (until '**RELEASE**' displayed)

NOTE

Wait approximately 1 minute while unit runs self-check routine. A single beep occurs when the self-check routine is complete.

12. Wait 1 minute.

Verify display indicates readings for OXYGEN, HCN, HCL, and CO.

NOTE

1. The resupplied CSA-CP sensors (CO and HCL) may be elevated as a result of stowage for launch and transfer. The elevated readings should decrease to nominal levels after being deployed in an open environment for several days.
2. The old Exp 7 primary unit (1008) should be used until the resupplied units are operating nominally.
3. Upon activation, the new Exp 7 CSA-CPs (1003, 1004) may be in the alarm range. Readings may be required every four to seven days to determine status of elevated CO and HCL levels.

**3.101 COMPOUND SPECIFIC ANALYZER - COMBUSTION PRODUCTS:
CSA-CP RESUPPLY**

(JNT OPS/UF1 - ALL/FIN 8) Page 3 of 3 pages

13. Record sensor readings and Battery status for the old Exp 7 and new Exp 7 CSA-CPs.

After each reading recorded proceed to step 14.

Date	CSA-CP S/N	CO	HCN	HCL	O2	Batt Ticks
_____	1003	_____	_____	_____	_____	_____
	1004	_____	_____	_____	_____	_____
	1008	_____	_____	_____	_____	_____
_____	1003	_____	_____	_____	_____	_____
	1004	_____	_____	_____	_____	_____
	1008	_____	_____	_____	_____	_____
_____	1003	_____	_____	_____	_____	_____
	1004	_____	_____	_____	_____	_____
	1008	_____	_____	_____	_____	_____
_____	1003	_____	_____	_____	_____	_____
	1004	_____	_____	_____	_____	_____
	1008	_____	_____	_____	_____	_____
_____	1003	_____	_____	_____	_____	_____
	1004	_____	_____	_____	_____	_____
	1008	_____	_____	_____	_____	_____

14. Deactivate all three Exp 7 CSA-CPs.
pb MODE – press, hold (until '**RELEASE**' displayed)

√CSA-CPs – OFF

15. Deploy new Exp 7 CSA-CPs outside of the Stowage Kit in the open environment.
16. Deploy the old primary Exp 7 CSA-CP in the desired location or per **MCC-H** instruction.
17. Report sensor readings to **MCC-H** after each data logging.
18. Stow CSA-CP Stowage Kit.
19. Stow Marker

This Page Intentionally Blank

3.102 NITROGEN TRANSFER INITIATION

(JNT OPS/X2R4 - ALL/FIN 9/HC) Page 1 of 4 pages

OBJECTIVE:

Transfer nitrogen from the shuttle nitrogen tanks to the ISS Airlock nitrogen tanks via equalization.

TOOLS AND EQUIPMENT REQUIRED:

(NOD1P4_D)

GN2 Transfer Flex Hose Assy P/N V857-643003-008

Flashlight

Ear Plugs

(NOD1D4_G2)

ISS IVA Toolbox

Drawer 3:

Inspection Mirror

1. CONFIGURING ISS N2 SYSTEM

1.1 Check **MCC-H** for ISS payload nitrogen configuration.

A/L10A2 1.2 VL013 (N2) → CLOSED

PCS 1.3 Airlock: ECLSS: Nitrogen System

AL Nitrogen System

'N2 Supply Valve'

√Actual Position – Open

2. REDUCING ISS N2 SYSTEM PRESSURE TO AMBIENT

NOTE

1. Connection and disconnection of QDs requires adjoining lines to be at approximately ambient pressure on both sides of the QD, when possible.
2. As the N2 system pressure bleeds down and N2 is introduced into the cabin, the following messages may be received:
'N2 Supply Pressure Low – A/L',
'PCA N2 Line Pressure Low – A/L',
'PCA N2 Line Pressure Low – LAB'
3. The messages will return to normal as the N2 system is repressurized (step 4).

Airlock: ECLSS: Nitrogen System

AL Nitrogen System

'AL PCA N2 Intro Valve'

cmd Open (√Actual Position – Open)

Wait 5 minutes or **On MCC-H GO**, proceed.

3.102 NITROGEN TRANSFER INITIATION

(JNT OPS/X2R4 - ALL/FIN 9/HC) Page 2 of 4 pages

'AL PCA N2 Intro Valve'

cmd Close (√Actual Position – Closed)

3. CONFIGURING PMA/ODS FOR N2 TRANSFER

ODS Vest
GN2 Xfer
Panel

3.1 √FLOW – CLOSED

WARNING
Opening the ODS Vestibule Transfer Panel Vent may cause a loud hissing noise. Crew in the vicinity should don ear plugs.
Inspect GN2 Transfer Flex Hose Assy for any cracks or anomalies. If so, contact MCC-H .

3.2 Don ear plugs

3.3 VENT → OPEN

3.4 √GN2 Xfer Panel Pressure Gauge reading ~0 psi, doff ear plugs

CAUTION
Minimize the amount of time open fluid connectors are exposed to cabin air to prevent contamination. If debris is found during inspections, contact MCC-H .

<u>NOTE</u>
QDs must be closed to remove caps. As needed, refer to Figure 2 at the end of this procedure for reference information on the high pressure quick disconnects.

3.5 Inspect GN2 Transfer Flex Hose Assy for any cracks or anomalies. If so, contact **MCC-H**.

3.6 Uncap GN2 Xfer Panel QD.

3.7 Close GN2 Transfer Flex Hose Assy bent-end QD.
Remove plug.
Inspect both QDs for debris.

3.8 Install hose so that it can be routed along the ODS Flange as shown in Figure 1.

GN2 Transfer Flex Hose Assy bent-end →|← GN2 Xfer Panel QD
Hard mate/open QD.

3.102 NITROGEN TRANSFER INITIATION

(JNT OPS/X2R4 - ALL/FIN 9/HC) Page 3 of 4 pages



Figure 1.- ODS Vestibule Xfer Panel Hose Routing.

- PMA 3.9 Uncap Nitrogen Recharge QD.
- 3.10 Close GN2 Transfer Flex Hose Assy straight-end QD.
Remove plug.
Inspect both QDs for debris.
- 3.11 GN2 Transfer Flex Hose Assy straight-end →|← Nitrogen Recharge QD
Hard mate/open QD.
- PMA/ODS 3.12 Secure GN2 Transfer Flex Hose Assy to PMA/ODS Extension Duct and ODS Flange with Velcro straps.
- ODS Vest
GN2 Xfer
Panel 3.13 VENT → CLOSED
4. VERIFYING N2 TRANSFER SYSTEM PRESSURE INTEGRITY
- ML86B:D 4.1 cb MN A MMU GN2 SPLY ISOL VLV A → cl
- R13L 4.2 MMU GN2 SPLY ISOL VLV A → OP (tb-OP)
- ODS Vest
GN2 Xfer
Panel 4.3 FLOW → OPEN
- 4.4 Wait 5 minutes.
- PCS 4.5 Airlock: ECLSS: Nitrogen System
AL Nitrogen System
- Report Supply Press to **MCC-H**.

3.102 NITROGEN TRANSFER INITIATION

(JNT OPS/X2R4 - ALL/FIN 9/HC) Page 4 of 4 pages

AL ECLSS

'Equipment Lock'

Verify $dP/dt < 0.05$ mmHg/min

5. INITIATING N2 TRANSFER

A/L10A2 5.1 On MCC-H GO, VL013 (N2) → OPEN

5.2 On MCC-H GO, go to {3.103 NITROGEN TRANSFER TERMINATION} (SODF: JNT OPS: MATED OPERATIONS).

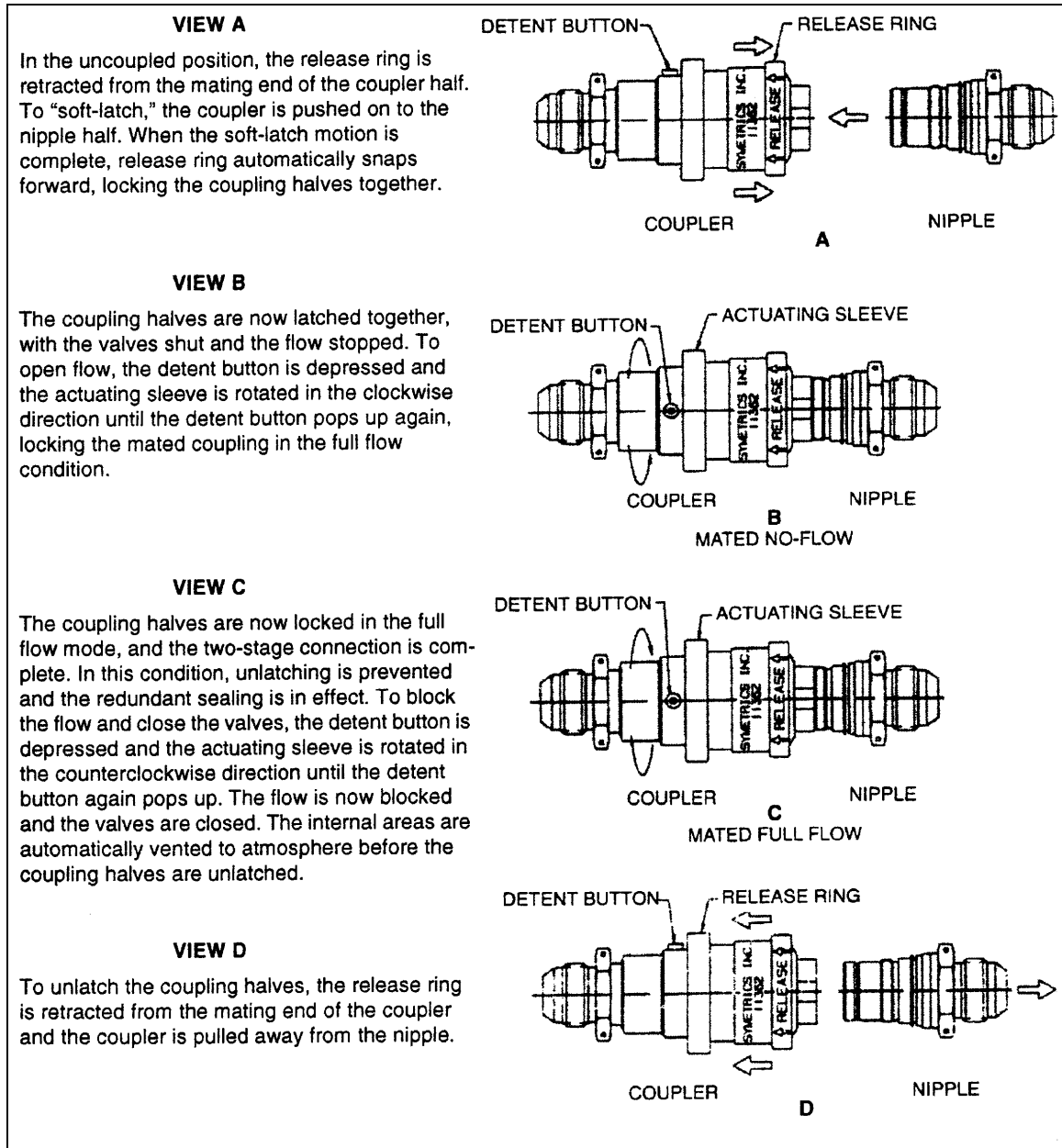

Figure 2.- Two-Stage High Pressure QDs.

3.103 NITROGEN TRANSFER TERMINATION

(JNT OPS/X2R4 - ALL/FIN 10) Page 1 of 3 pages

OBJECTIVE:

Terminate the transfer of nitrogen from the shuttle nitrogen tanks to the ISS Airlock nitrogen tanks and return both nitrogen systems to their nominal configurations.

TOOLS AND EQUIPMENT REQUIRED:

Flashlight

Ear Plugs

(NOD1D4_G2)

ISS IVA Toolbox

Drawer 3:

Inspection Mirror

1. TERMINATING N2 TRANSFER

A/L10A2

1.1 VL013 (N2) → CLOSED

PCS

1.2 Airlock: ECLSS: Nitrogen System

AL Nitrogen System

'N2 Supply Valve'

cmd Close (√Actual Position – Closed)

R13L

1.3 MMU GN2 SPLY ISOL VLV A → CL (tb-CL)

ML86B:D

1.4 cb MN A MMU GN2 SPLY ISOL VLV A → op

NOTE

1. Connection and disconnection of QDs requires adjoining lines to be at approximately ambient pressure on both sides of the QD, when possible.
2. As the N2 system pressure bleeds down and N2 is introduced into the cabin, the following messages may be received:
'N2 Supply Pressure Low – A/L'
'PCA N2 Line Pressure Low – A/L'
'PCA N2 Line Pressure Low – LAB'
3. The messages will return to normal as the N2 system is repressurized (step 3).

WARNING

Opening the ODS Vestibule Transfer Panel Vent may cause a loud hissing noise. Crew in the vicinity should don ear plugs.

1.5 Don ear plugs

ODS Vest
GN2 Xfer
Panel

1.6 VENT → OPEN

3.103 NITROGEN TRANSFER TERMINATION

(JNT OPS/X2R4 - ALL/FIN 10) Page 2 of 3 pages

1.7 Check GN2 Xfer Panel Pressure Gauge reading ~0 psi.
Doff ear plugs.

1.8 Wait 15 minutes or **On MCC-H GO**, proceed.

ODS Vest
GN2 Xfer
Panel

1.9 VENT → CLOSED

1.10 FLOW → CLOSED

2. CONFIGURING PMA/ODS FOR NOMINAL OPERATIONS

NOTE

QDs must be closed to disconnect lines.

2.1 GN2 Transfer Flex Hose Assy ←|→ GN2 Xfer Panel QD
Inspect both QDs for debris.
Install cap on GN2 Xfer Panel QD.
Install plug on GN2 Transfer Flex Hose Assy.

PMA

2.2 GN2 Transfer Flex Hose Assy ←|→ Nitrogen Recharge QD
Inspect both QDs for debris.
Install cap on Nitrogen Recharge QD.
Install plug on GN2 Transfer Flex Hose Assy.

PMA/ODS

2.3 Remove GN2 Transfer Flex Hose Assy from PMA/ODS Extension
Duct and ODS Flange.
Stow GN2 Transfer Flex Hose Assy in NOD1P4_D.

3. RETURNING ISS NITROGEN SYSTEM TO NOMINAL OPERATIONS

A/L10A2

3.1 **On MCC-H GO**, VL013 (N2) → OPEN

NOTE

The PCA Intro Valve is opened in order to avoid tripping the pressure switch in the VOA due to a regulator lockup. This trip can occur even if the VOA has been deactivated.

PCS

3.2 Airlock: ECLSS: Nitrogen System

AL Nitrogen System

'AL PCA N2 Intro Valve'

cmd Open (√Position – Open)

'N2 Supply Valve'

cmd Open (√Actual Position – Open)

Wait 2 minutes, then:

'AL PCA N2 Intro Valve'

cmd Close (√Position – Closed)

3.103 NITROGEN TRANSFER TERMINATION

(JNT OPS/X2R4 - ALL/FIN 10) Page 3 of 3 pages

Report Supply Press to **MCC-H**.

AL ECLSS

'Equipment Lock'

Verify $dP/dt < 0.05$ mmHg/min

3.3 Notify **MCC-H**, "Nitrogen Transfer Termination complete."

This Page Intentionally Blank

START_IMS

OBJECTIVE:

Remove and Install Lab Forward Hatch Thermal Cover

LOCATION:

Installed: US Lab Forward Hatch Bulkhead

DURATION:

Removal: 30 minutes

Installation: 30 minutes

PARTS:

Only required when cover not installed

Hatch Thermal Cover P/N 683-80441

TOOLS REQUIRED:

ISS IVA Toolbox:

Drawer 2:

Ratchet, 1/4" Drive

4" Ext, 1/4" Drive

3/8" Socket, 1/4" Drive

REFERENCED PROCEDURE(S):

None

NOTE

1. Hatch Thermal Cover has decal with removal steps. Decal instructions are incomplete; refer to procedure as required.
2. Hatch Thermal Cover is attached to four Corner Struts. Corner Struts are attached to Lab Fwd Hatchway. Cover Attach fasteners (four each corner) are accessed from IVA-side of Hatch. Corner Strut fasteners (two each strut) are accessed from EVA-side of Hatch. Refer to Figures 1, 2.

- * If beginning Cover removal on IVA-side of Hatch,
- * perform steps 1 to 12; else perform steps 5 to 12.

- * If installing Cover, go to step 13.

3.104 LAB FWD HATCH THERMAL COVER REMOVAL/INSTALLATION

(JNT OPS/7A - ALL/FIN 4)

Page 2 of 4 pages

REMOVING COVER FROM IVA-SIDE OF HATCH

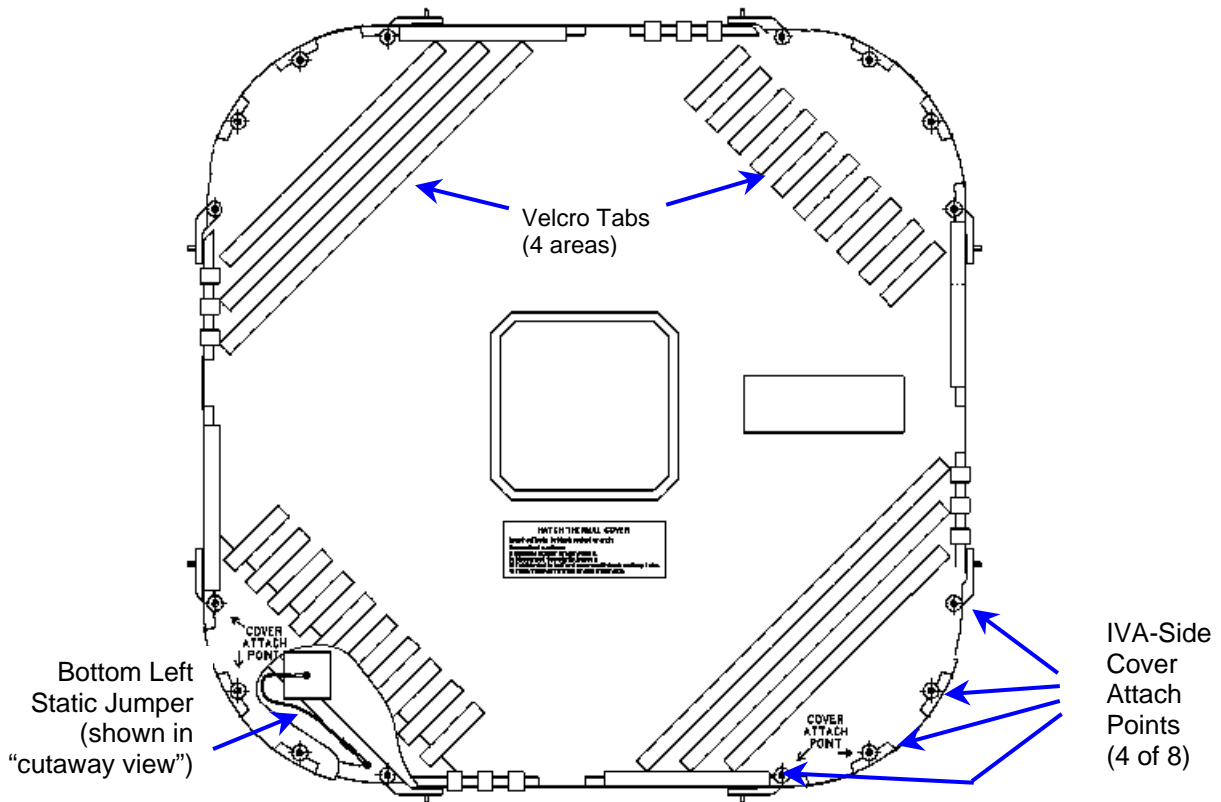

Figure 1.- IVA Side of Hatch Thermal Cover.

NOTE

There are eight IVA-side Cover Attach Point fasteners labeled "Cover Attach Point" located on deck-port, deck-starboard corners of Cover.

1. Remove deck IVA-side Cover Attach Point fasteners (eight) (Ratchet; 1/4" Drive; 4" Ext; 3/8" Socket).
Refer to Figure 1, Cover decals labeled "Cover Attach Point."

NOTE

1. Static jumpers are press-fit, no tool required.
2. There are total of four static jumpers on Cover. Only disconnect deck-port, deck-starboard static jumpers.

2. Disconnect static jumpers (two).
3. Fold blanket in half, secure with provided Velcro tabs.
4. Translate through opening to EVA-side of Hatch, continue with next section of procedure.

REMOVING COVER FROM EVA-SIDE OF HATCH

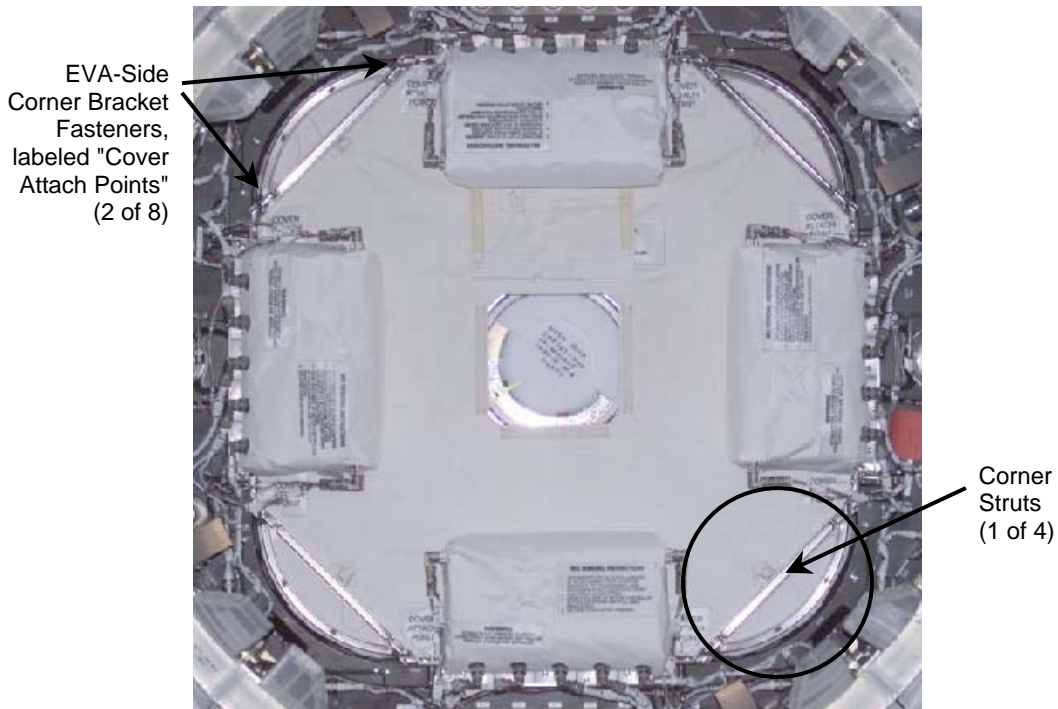

Figure 2.- EVA Side of Hatch Thermal Cover (CBM CPAs shown installed).

5. Remove EVA-Side Corner Bracket fasteners (eight) (Ratchet, 1/4 Drive; 4" Ext; 3/8" Socket).
Refer to Figure 2, Cover decals labeled "Cover Attach Point."

NOTE
Only perform steps 6 and 7 if Cover removal began on IVA-side of Hatch.

6. Reinstall deck-port, deck-starboard Corner Struts (two) onto Cover, fasteners (eight) (Ratchet, 1/4 Drive; 4" Ext; 3/8" Socket).
7. Reconnect static jumpers (two).
8. Fold four struts toward center of cover.
9. Secure edges of blanket with Velcro tabs.
10. Fold blanket diagonally.
11. Inform **MCC-H** of task completion.
12. Stow tools, equipment.

3.104 LAB FWD HATCH THERMAL COVER REMOVAL/INSTALLATION

(JNT OPS/7A - ALL/FIN 4)

Page 4 of 4 pages

HATCH THERMAL COVER INSTALLATION

13. Unfold blanket, detach center Velcro tabs, continue unfolding until blanket folded in half.

Orient Cover such that Corner Brackets visible on EVA-side of Hatch, removal decal right-side up with respect to lab.

Refer to Figure 2.

* If crewmember needs to be on EVA-side of Hatch
* after cover installation, only perform step 16.

*

* If crewmember needs to be on IVA-side of Hatch

* after cover installation, perform all steps.

14. Remove deck-port, deck-starboard Corner Struts (two) from Hatch Thermal Cover, fasteners (eight) (Ratchet, 1/4 Drive; 4" Ext; 3/8" Socket).

These two Corner Struts will be reattached to lab hatchway in step 16.

Refer to Figure 2.

NOTE

1. Static jumpers are press-fit, no tool required.
2. There are total of four static jumpers on cover. Only disconnect deck-port, deck-starboard static jumpers.

15. Disconnect static jumpers (two).
16. Snug EVA-Side Corner Bracket fasteners (eight) (Ratchet, 1/4 Drive; 4" Ext; 3/8" Socket).
Refer to Figure 2, Cover decals labeled "Cover Attach Point."
17. Translate through Cover opening to IVA-side of Hatch.
18. Reconnect static jumpers (two).
19. Snug IVA-side Cover Attach Point fasteners (eight) (Ratchet, 1/4 Drive; 4" Ext; 3/8" Socket).
Refer to Figure 1, Cover decals labeled "Cover Attach Point."
20. Inform **MCC-H** of task completion.
21. Stow tools, equipment.

3.105 O2 REPRESS

(JNT OPS/7A - ALL/FIN 2)

I

- | <u>NOTE</u> | |
|-------------|---|
| 1. | Purpose is to pressurize stack to 14.90 psia from 14.7 psia using orbiter O2 while maintaining ISS O2 concentration below US Segment limit of 24.1 %. |
| 2. | O2 repress will be repeated as required to allow adequate mixing and to avoid higher than acceptable O2 concentration in orbiter cabin. |

FDA, C/W LIMITS RESET

- | <u>NOTE</u> | |
|-------------|---|
| 1. | CABIN PRESS H/W C/W upper limit is not changed because it is adequate for the target pressures. |
| 2. | PPO2 limits are inhibited to avoid nuisance alarms. |
| 3. | O2 is limit-sensed by O2 concentration. |

- Contact **MCC-H** for uplink of B/U C/W and SM ALERT limit resets via TMBU, if desired.

SM ALERT	PARAM ID	LO EU
H2O LOOP ICH OUT T 1	0612744	33.0
	2 0612724	33.0

<u>B/U C&W</u>	<u>PARAM ID</u>	<u>ENA/INH</u>	<u>HI EU</u>
CABIN PRESS	0612405		14.90
PPO2 A	0612511	INH	
PPO2 B	0612513	INH	

<u>H/W C&W</u>	<u>CHANNEL</u>	<u>ENA/INH</u>
PPO2 A	34	INH
PPO2 B	44	INH

- √ **MCC-H** for repress Cryo configuration

Node 1 3. √ PPRV caps installed on port, stbd Hatches

MO13Q 4. ARLK FAN B → ON

O2 REPRESS INITIATION

OCAC 5. Perform OCAC filter cleaning.
OCAC PWR → OFF

C5 6. DIRECT O2 vlv → OP

- When '**S78 O2 CONC**' or '**S66 CABIN PRESS**' message, DIRECT O2 vlv → CL

3.105 O2 REPRESS

(JNT OPS/7A - ALL/FIN 2)

Page 2 of 2 pages

8. **MCC-H** may ask for another cycle.
Wait for O2 to mix and O2 concentration to stabilize.
On call from **MCC-H**, repeat steps 5 --- 7.

OCAC 9. OCAC PWR → ON

10. ✓ **MCC-H** for post-repress cryo configuration

MO13Q 11. **On MCC GO,**
ARLK FAN B → OFF

12. Contact **MCC-H** for uplink of SM ALERT limit resets via TMBU, if desired.

SM ALERT	PARAM ID	LO EU
H2O LOOP ICH OUT T 1	0612744	35.0
2	0612724	35.0

3.106 N2 REPRESS

(JNT OPS/UF1 - ALL/FIN 1) Page 1 of 1 page

I

NOTE

1. Purpose is to pressurize the stack to 14.9 psia from 14.7 using orbiter N2.
2. Nitrogen will be introduced from the ODS Vestibule GN2 Transfer Panel at approximately 6 CFM, and will mix with air returning from station at over 100 CFM.
3. Avoid prolonged exposure in the ODS/Vestibule area during repress.

1. **MCC-H** will TMBU the following to the appropriate value for this vehicle (approximately 14.90 psia):

<u>B/U C&W</u>	<u>PARAM ID</u>	<u>HI EU</u>
CABIN P	0612405	

M013Q 2. ARLK FAN B – ON

ODS

Vest 3. FLOW → OPEN
GN2 Xfer VENT → OPEN
Pnl

ML86B:D 4. cb MNA MMU GN2 SPLY ISOL VLV A – cl
R13L MMU GN2 SPLY ISOL VLV A – OP (tb-OP)

5. When '**S66 CABIN PRESS**' message or **MCC** call
R13L MMU GN2 SPLY ISOL VLV A – CL (tb-CL)
ML86B:D cb MNA MMU GN2 SPLY ISOL VLV A – op
ODS Vest

GN2 Xfer 6. FLOW → CLOSED
Pnl VENT → CLOSED

7. **On MCC GO**
M013Q ARLK FAN B – OFF

This Page Intentionally Blank

3.107 GENERIC DEPRESS

(JNT OPS/7A - ALL/FIN 2)

Page 1 of 1 page

I

NOTE MCC will provide MET/EVENT and desired pressure values for use in this procedure. Expect possible dP/dT Klaxon alarm during depress.
--

MO10W 1. √14.7 CABIN REG INLET SYS 1, SYS 2 vlv (two) – CL

AW82B 2. AIRLK DEPRESS vlv cap – Vent, remove
AIRLK DEPRESS vlv – 0

SM 66 ENVIRONMENT

CRT 3. If PPO2 < 2.7 at anytime during depress
C5 DIRECT O2 vlv – OP

CRT 4. When CABIN PRESS = desired pressure
C5 DIRECT O2 vlv – CL
AW82B AIRLK DEPRESS vlv – CL
Install AIRLK DEPRESS vlv cap

MET/EVENT	DESIRED PRESSURE

This Page Intentionally Blank

3.108 GENERIC REPRESS

(JNT OPS/7A - ALL/FIN 3)

Page 1 of 2 pages

WARNING
Terminate all WCS activity during repress.

<u>NOTE</u>
MCC will provide MET/EVENT and desired pressure values for use in this procedure

1. Reset H/W C&W limits per Table 1.

Table 1.

PARAMETER NAME	C&W CHL	ENA/INH
CABIN O2 FLOW 1	14	INH
CABIN O2 FLOW 2	24	INH
CABIN N2 FLOW 1	54	INH
CABIN N2 FLOW 2	64	INH

2. Contact **MCC-H** for uplink of SM ALERT limit resets via TMBU, if desired.

Table 2.

B/U C&W	PARAM ID	VALUE
CABIN O2 FLOW 1	0612105	INH
CABIN O2 FLOW 2	0612205	INH
CABIN N2 FLOW 1	0612553	INH
CABIN N2 FLOW 2	0612554	INH
SM ALERT		LO EU
H2O LOOP ICH OUT T 1	0612744	33.0
2	0612724	33.0

- L2
3. O2/N2 CNTLR VLV SYS 1 – OP (N2)
2 – AUTO

- MO10W
4. O2 REG INLET SYS 2 vlv – OP

5. 14.7 CAB REG INLET SYS 1 vlv – OP

6. **On MCC GO**
14.7 CABIN REG INLET SYS 2 vlv – OP

7. SM 66 ENVIRONMENT

- CRT
MO10W
- When CABIN PRESS = desired pressure
- 14.7 CAB REG INLET SYS 1, SYS 2 vlv (two) – CL

Table 3.

MET/Event	Desired Pressure

3.108 GENERIC REPRESS

(JNT OPS/7A - ALL/FIN 3)

Page 2 of 2 pages

8. If required
 Go to PCS 1(2) CONFIG (FDF: ORB OPS, ECLS).
- MO10W
 L2 If not required
 O2 REG INLET SYS 2 vlv – CL
 O2/N2 CNTLR VLV SYS 2 – CL (O2)
9. Reset H/W C&W limits per Table 4.

Table 4.

PARAMETER NAME	C&W CHL	ENA/INH
CABIN O2 FLOW 1	14	ENA
CABIN O2 FLOW 2	24	ENA
CABIN N2 FLOW 1	54	ENA
CABIN N2 FLOW 2	64	ENA

10. Contact **MCC-H** for uplink of SM ALERT limit resets via TMBU, if desired.

Table 5.

B/U C&W	PARAM ID	VALUE
CABIN O2 FLOW 1	0612105	ENA
CABIN O2 FLOW 2	0612205	ENA
CABIN N2 FLOW 1	0612553	ENA
CABIN N2 FLOW 2	0612554	ENA
SM ALERT		LO EU
H2O LOOP ICH OUT T 1	0612744	35.0
2	0612724	35.0

3.109 CONFIGURE C&W FOR INGRESS/DEPRESS/REPRESS

(JNT OPS/7A - ALL/FIN 2)

Page 1 of 2 pages

I

NOTE

1. Tables below provide parameter FDA that will be changed prior to Orbiter Depress/Repress.
2. **MCC** will reset software limits via TMBU.

C&W CONFIGURATION

1. Reset H/W C&W limits per table.

PARAMETER NAME	C&W CHL	ENA/INH
CABIN PRESS	4	INH
CABIN O2 FLOW 1	14	INH
CABIN O2 FLOW 2	24	INH
CABIN PPO2 A	34	INH
CABIN PPO2 B	44	INH
CABIN N2 FLOW 1	54	INH
CABIN N2 FLOW 2	64	INH
CABIN FAN Δ P	74	INH

2. Contact **MCC** to TMBU the following limits to appropriate values for the given activity (depress or repress).

B/U C&W	PARAM ID	VALUE
CABIN PRESS	0612405	
CABIN O2 FLOW 1	0612105	
CABIN O2 FLOW 2	0612205	
CABIN PPO2 A	0612511	
CABIN PPO2 B	0612513	
CABIN N2 FLOW 1	0612553	
CABIN N2 FLOW 2	0612554	
CABIN FAN Δ P	0612556	
SM ALERT		
AV BAY FAN Δ P 1	0612642	
AV BAY FAN Δ P 2	0612647	
AV BAY FAN Δ P 3	0612658	
IMU FAN Δ P	0612869	
CABIN AIRLK P	0640101	
EXT AIRLK P	0640126	
CABIN O2 CONC	0922104	

If Spacehab present

B/U C&W	PARAM ID	VALVE
SH CAB PRESS	0472008	
SH CAB PPO2 - 1	0472012	
SH CAB PPO2 - 2	0472113	

3.109 CONFIGURE C&W FOR INGRESS/DEPRESS/REPRESS

(JNT OPS/7A - ALL/FIN 2)

Page 2 of 2 pages

C&W RESET

3. Reset H/W C&W.

PARAMETER NAME	C&W CHL	ENA/INH
CABIN PRESS	4	ENA
CABIN O2 FLOW 1	14	ENA
CABIN O2 FLOW 2	24	ENA
CABIN PPO2 A	34	ENA
CABIN PPO2 B	44	ENA
CABIN N2 FLOW 1	54	ENA
CABIN N2 FLOW 2	64	ENA
CABIN FAN Δ P	74	ENA

4. Contact **MCC** to TMBU the following parameters to the appropriate values.

B/U C&W	PARAM ID	VALUE
CABIN PRESS	0612405	
CABIN O2 FLOW 1	0612105	
CABIN O2 FLOW 2	0612205	
CABIN PPO2 A	0612511	
CABIN PPO2 B	0612513	
CABIN N2 FLOW 1	0612553	
CABIN N2 FLOW 2	0612554	
CABIN FAN Δ P	0612556	
SM ALERT		
AV BAY FAN Δ P 1	0612642	
AV BAY FAN Δ P 2	0612647	
AV BAY FAN Δ P 3	0612658	
IMU FAN Δ P	0612869	
CABIN AIRLK P	0640101	
EXT AIRLK P	0640126	
CABIN O2 CONC	0922104	

If Spacehab present

B/U C&W	PARAM ID	VALVE
SH CAB PRESS	0472008	
SH CAB PPO2 - 1	0472012	
SH CAB PPO2 - 2	0472113	

3.110 HANDOVER ATTITUDE CONTROL CMG TA TO ORBITER

(JNT OPS/8A - ALL/FIN 3/MULTI) Page 1 of 5 pages

OBJECTIVE:

Transfer mated stack attitude control from ISS to orbiter. Verify orbiter is in Free Drift, configure ISS to Free Drift, then assume mated stack control with orbiter.

1. VERIFYING ORBITER NOT IN CONTROL

C3(A6) √DAP configured per DOCKED CONFIGURATION DAP REFERENCE
(FDF: ORB OPS, REBOOST/DAP)

If ALT DAP required

O14:F √**MCC**
O15:F, √DAP: FREE
O16:F RJDA 1A L2/R2 MANF DRIVER – OFF
 RJD MANF L5/F5/R5 DRIVER – OFF
 Pri RJD LOGIC (eight) – ON

 √**MCC** FOR GO TO POWER UP Pri DRIVERS
 Pri RJD DRIVER (eight) – ON
 RJD MANF L5/F5/R5 DRIVER – ON

Orbiter ⇒ ISS, **MCC-H**, “Shuttle ready to begin controlling attitude of Mated Stack.”

2. GNC COMMAND RESPONSE COUNTERS RESET

PCS MCG: GNC Command Response Counters
 GNC Command Response Counters

sel Reset

Verify the Since Reset column values are all blank.

Do not close this window until the procedure is complete.

If while executing a command, the Command Accept counter on that display does not increment
Reselect GNC Command Response Counters to determine if a command was rejected.

√**MCC-H**

3. DETERMINING DESIRED MOMENTUM CONFIGURATION

The following information will be determined via ground call or OSTP.

Drift Reference Frame _____
Drift Momentum Vector X _____
Drift Momentum Vector Y _____
Drift Momentum Vector Z _____

3.110 HANDOVER ATTITUDE CONTROL CMG TA TO ORBITER

(JNT OPS/8A - ALL/FIN 3/MULTI)

Page 2 of 5 pages

NOTE

1. CMG 2 IG/OG angles have a known bias of -1.3/24.7 deg, respectively.
2. The PCS displays show a Software (S/W) and Firmware (F/W) value for the Current Angle. The S/W value is the angle with the calculated bias for CMG 2.
3. The S/W value is calculated by subtracting the bias from the Commanded Angle. If the Calculated Angle is greater than a magnitude of 180, then 360 is subtracted to obtain Current Angle.

CMG 1 IG/OG Angles, deg: ____/____
CMG 2 IG/OG Angles, deg: ____/____
CMG 3 IG/OG Angles, deg: ____/____
CMG 4 IG/OG Angles, deg: ____/____

4. VERIFYING INITIAL ATTITUDE CONTROL CONFIGURATION AND REMOVING INHIBITS

PCS

MCG: MCS Configuration

MCS Configuration

'MCS Moding'

Verify US GNC Mode – CMG TA

Verify RS SUDN Mode – CMG TA

Verify RS Control – Slave

'Attitude'

Verify Att Mnvr In Prog – No

'MCS Moding'

sel Drift

Drift

cmd Mode Transition Enable (Verify – Ena)

cmd Attitude Maneuver Enable (Verify – Ena)

cmd Att Cntl Shutdown Enable (Verify – Ena)

5. MODING US GNC FROM CMG TA TO DRIFT

Drift

'Momentum Servo'

NOTE

The purpose of this command is to change the Momentum Servo Reference Frame. Ignore the momentum vector components.

3.110 HANDOVER ATTITUDE CONTROL CMG TA TO ORBITER

(JNT OPS/8A - ALL/FIN 3/MULTI)

Page 3 of 5 pages

If Drift Reference Frame from step 3 is Inertial

cmd Inertial 0,0,0

Verify Commanded Drift Reference Frame – Inertial

If Drift Reference Frame from step 3 is Body

cmd Body 0,0,0

Verify Commanded Drift Reference Frame - Body

If Drift Reference Frame from step 3 is LVLH

cmd LVLH 0,0,0

Verify Commanded Drift Reference Frame - LVLH

'Moding'

Verify US Drift Available – Yes

cmd Mode to Drift

Verify US GNC Mode – Drift

ISS(**MCC-H**) ⇒ orbiter, "ISS is in Free Drift."

6. ASSUMING CONTROL WITH ORBITER

If orbiter airlock pressure ≥ 2.44 psi

If attitude is to be held in LVLH

C3(A6)

DAP: LVLH

If attitude is to be held in Inertial or XPOP

DAP: INRTL

GNC UNIV PTG

When rates are < 0.1 degrees/second/axis

C3(A6)

DAP: AUTO

If orbiter airlock pressure < 2.44 psi, perform RATE DAMPING FROM FREE DRIFT, (FDF: ORB OPS, REBOOST/DAP), then:

Orbiter ⇒ ISS, **MCC-H**, "Shuttle has established attitude control."

3.110 HANDOVER ATTITUDE CONTROL CMG TA TO ORBITER

(JNT OPS/8A - ALL/FIN 3/MULTI)

Page 4 of 5 pages

7. CONFIGURING US GNC AFTER HANDOVER

7.1 Moding US GNC to UDG and Positioning the CMG Gimbals

If CMG gimbal angles are to be updated, per step 3

MCG: MCS Configuration: UDG

UDG

cmd Mode to UDG

Verify US GNC Mode - UDG

MCG: CMG Configuration: Gimbal Angles

CMG Gimbal Angles

input CMG 1 Angles

IG deg: (as recorded in step 3)

OG deg: (as recorded in step 3)

cmd Set

Verify IG, OG Cmd Angle, deg – as commanded

Verify IG, OG Current Angle S/W, deg – moving to commanded targets

input CMG 2 Angles

IG deg: (as recorded in step 3)

OG deg: (as recorded in step 3)

cmd Set

Verify IG, OG Cmd Angle, deg – as commanded

Verify IG, OG Current Angle S/W, deg – moving to commanded targets

input CMG 3 Angles

IG deg: (as recorded in step 3)

OG deg: (as recorded in step 3)

cmd Set

Verify IG, OG Cmd Angle, deg – as commanded

Verify IG, OG Current Angle S/W, deg – moving to commanded targets

input CMG 4 Angles

IG deg: (as recorded in step 3)

OG deg: (as recorded in step 3)

3.110 HANDOVER ATTITUDE CONTROL CMG TA TO ORBITER

(JNT OPS/8A - ALL/FIN 3/MULTI)

Page 5 of 5 pages

cmd Set

Verify IG, OG Cmd Angle, deg – as commanded
Verify IG, OG Current Angle S/W, deg – moving to
commanded targets

* If the gimbals stop moving before the commanded angles
* are reached, repeat Set Angles command.

Verify CMG 1(2,3,4) IG, OG Current Angle S/W, deg – as
commanded
Verify CMG 1(2,3,4) Gimbals in Position – Yes
Verify CMG 1(2,3,4) IG, OG Rate, deg/s – 0.0,0.0

7.2 Updating US Momentum Servo Reference Frame and Momentum Vector

NOTE

If only two CMGs are available in drift mode, (0,0,0) momentum vector cannot be commanded per IFI-01143.

If a momentum bias is required

MCG: MCS Configuration: Drift

Drift

'Momentum Servo'

input Drift Reference Frame – (from step 3)
input Drift Momentum Vector X – (from step 3)
Y – (from step 3)
Z – (from step 3)

cmd Set

Verify Commanded Drift Reference Frame – as commanded
Verify Commanded Drift Momentum Vector X – as commanded
Y – as commanded
Z – as commanded

8. REPLACING INHIBITS TO PREVENT MODING

PCS

MCG: MCS Configuration: MCS Inhibits

MCS Inhibits

cmd Mode Transition Inhibit (Verify – Inh)
cmd Attitude Maneuver Inhibit (Verify – Inh)
cmd Desat Request Inhibit (Verify – Inh)
cmd Att Cntl Shutdown Inhibit (Verify – Inh)

This Page Intentionally Blank

3.111 HANDOVER ATTITUDE CONTROL ORBITER TO CMG TA

(JNT OPS/8A - ALL/FIN 4/MULTI) Page 1 of 3 pages

OBJECTIVE:

To switch mated stack attitude control responsibility from orbiter to ISS.

1. GNC COMMAND RESPONSE COUNTERS RESET

PCS

MCG: GNC Command Response Counters

GNC Command Response Counters

sel Reset

Verify the Since Reset column values are all blank.

Do not close this window until the procedure is complete.

If while executing a command, the Command Accept counter on that display does not increment
Reselect GNC Command Response Counters to determine if a command was rejected.

√**MCC-H**

2. VERIFYING INITIAL ATTITUDE CONTROL CONFIGURATION – FREE DRIFT

PCS

MCG: MCS Configuration

MCS Configuration

'MCS Moding'

Verify US GNC Mode – Drift (UDG)

Verify RS SUDN Mode – CMG TA (Indicator)

'MCS ORU Status'

Verify Min ORUs Avail – Yes

'Data Source and Quality'

Verify the following information

	<u>US Quality</u>
Attitude	Valid (Valid RS) (Degraded)
Rate	Valid (Valid RS) (Degraded)
State Vector	Valid (Valid RS) (Degraded)

3. VERIFYING DESAT ABORT STATUS

'Desat Information'

sel Manual CMG Desat

Manual CMG Desat

'Desaturation Commands'

3.111 HANDOVER ATTITUDE CONTROL ORBITER TO CMG TA

(JNT OPS/8A - ALL/FIN 4/MULTI)

Page 2 of 3 pages

If Abort In Progress – Yes

cmd Clear Desat Abort

Verify Abort in Progress – No

4. DETERMINING REQUIRED CCDB INFORMATION

Determine from OSTP or from **MCC-H** the CCDB information required for moding.

If this information is not recorded elsewhere, record it below

Version ID	_____
Cntl Type	_____
Ref Frame	_____
Cmd Att	Y _____
	P _____
	R _____
Slot #	_____

5. RS PREPARING FOR CMG TA

If RS Control – Master

MCC-M

YBT F1_45 Remove inhibit for change of Master

MCC-M ⇒ **MCC-H**, “Inhibit has been removed.”

6. PREPARING THRUSTERS FOR CMG DESAT

PCS

MCG: MCS Configuration

MCS Configuration

‘MCS Moding’

sel CMG TA

CMG TA

If Thrusters Available for CMG Desat – No

cmd RS Prepare Thrusters for CMG Desat

NOTE

The following signal may take up to 5 minutes to occur.

Verify Thrusters Available for CMG Desat – Yes

7. REMOVING INHIBITS TO ENABLE MODING

cmd Mode Transition Enable (Verify – Ena)

cmd Attitude Maneuver Enable (Verify – Ena)

cmd Desat Request Enable (Verify – Ena)

ISS(**MCC-H**) ⇒ orbiter, “ISS ready to begin controlling attitude of Mated Stack.”

3.111 HANDOVER ATTITUDE CONTROL ORBITER TO CMG TA

(JNT OPS/8A - ALL/FIN 4/MULTI) Page 3 of 3 pages

- C3(A6) 8. PLACING ORBITER INTO FREE DRIFT
DAP: FREE

Orbiter ⇒ ISS, **MCC-H**, “Shuttle is in Free Drift.”
- PCS 9. MODING FROM FREE DRIFT TO CMG TA
CMG TA
'Mode to CMGTA using'

For CCDB Slot # [X] identified in step 4
| **cmd** CCDB Slot [X]

| Verify Active CCDB Source Slot – as commanded
| Verify US GNC Mode – CMG TA
| Verify RS GNC Mode – CMG TA

ISS (**MCC-H**) ⇒ orbiter, “ISS has assumed attitude control.”
- MCC-M 10. REPLACING RS SUDN INHIBITS TO PREVENT MODING
If **MCC-M** commanding was performed in step 5
| YBT F1_46 Inhibit for change of Master – as needed
| YBT F1_82 Remove Indicator flag RS Mode – as needed

| **MCC-M** ⇒ **MCC-H**, “Inhibit for change of master has been set.”
11. REPLACING US INHIBITS TO PREVENT MODING

NOTE Desat Request remains enabled to permit automatic desaturation of the CMGs.
--

CMG TA

cmd Mode Transition Inhibit (Verify – Inh)
cmd Attitude Maneuver Inhibit (Verify – Inh)
- O14,
O15,
O16:F 12. RETURNING ORBITER TO NOMINAL CONFIGURATION
If ALT DAP, return to Group B powerdown
| PRI RJD DRIVER, LOGIC (sixteen) OFF
| RJDA-1A L2/R2 MANF DRIVER – ON

This Page Intentionally Blank

3.112 VDS SHUTTLE AUTO ROUTE - DEROUTE

(JNT OPS/LF1 - ALL/FIN/SPN) Page 1 of 5 pages

OBJECTIVE:

This procedure defines the steps needed to Auto Route/Deroute the orbiter video signal to/from the station.

NOTE

The user will need to coordinate with the shuttle team before starting this procedure. Each section can be performed separately.

Steps 1 to 10 Auto Route

Steps 11 to 13 Deroute

Steps 14 to 15 Reconnecting VTR cables

PCS 1. CHECKING VIDEO ROUTING SOFTWARE

C&T: Video

Video Overview

Verify Video Software – Enable (Green)

NOTE

1. If the user is not planning to use Orbiter Video Channel 1 (DCP 92), then skip to step 7.
2. Due to the wiring problem discovered on flight 5A.1, a jumper cable has been installed to cable W322P1 in order to get video to and from the orbiter.

CM1 2. CONNECTING ORBITER VIDEO LINE CHANNEL1 (DCP 92)

LAS5 Rack Interface Panel

If the VTR bypass cables are to be used

Perform {15.160 VTR BYPASS CABLE - NOMINAL DOCKED OPERATIONS (LAB1S5/CUP RWS)}, all (SODF: P/TV GEN: VIDEO CONFIGURATIONS: VTR BYPASS), then:

If VTR bypass cables are not used

2.1 Cable W1190P1 ←|→ Connector J37 (on the left)/(VTR2 to CVIU 6)

2.2 Orbiter Video Cable W0400P1 →|← J37 Connector (Orbiter Video Channel1/CVIU6)

NOTE

When the user does an auto route, select VTR2 in order to receive the orbiter video signal.

PCS 3. AUTO ROUTING VIDEO SIGNAL FROM ORBITER CH1

C&T: Video

Video Overview

'Video Routing Status'

3.112 VDS SHUTTLE AUTO ROUTE - DEROUTE

(JNT OPS/LF1 - ALL/FIN/SPN) Page 2 of 5 pages

sel (Destination Button)

'Full Screen Routing'

pick Source ID – 2 4 (VTR 2)

cmd Set

'Last Attempted Route'

NOTE

Depending on the type of route requested, the user may have to wait up to one minute before seeing In Progress go to done.

Verify Progress – Done

Verify Status – Valid Path

4. AUTO ROUTING VIDEO SIGNAL TO THE ORBITER

C&T: Video: VTR2

'VTR 2 Routing Status'

sel VTR2/Orbiter Ch 1

'Full Screen Routing'

pick Source ID – [XX] where [XX] is the source ID

cmd Set

'Last Attempted Route'

NOTE

Depending on the type of route requested, the user may have to wait up to one minute before seeing In Progress go to done.

Verify Progress – Done

Verify Status – Valid Path

5. POWERING ON COMMON VIDEO INTERFACE UNIT 6

PCS

C&T: Video: CVIU

'VSU 2'

sel CVIU 6

3.112 VDS SHUTTLE AUTO ROUTE - DEROUTE

(JNT OPS/LF1 - ALL/FIN/SPN) Page 3 of 5 pages

cmd RPC Position – Close (Verify – Cl)

CM1 6. COORDINATING VIDEO SIGNAL

LAB

6.1 Check that orbiter team has completed routing the video signal.

6.2 Check that (VTR2) Orbiter Channel 1 has been routed.

NOTE

If the user is not planning to use Orbiter Video Channel 2 (DCP 91), then skip to step 11.

CM1 7. CONNECTING ORBITER VIDEO LINE CHANNEL 2 (DCP 91)

LAP5 Rack Interface Panel

If the VTR bypass cables are to be used

Perform {15.170 VTR BYPASS CABLE - NOMINAL DOCKED OPERATIONS (LAB1P5/LAB RWS) STS VIEW}, all (SODF: P/TV GEN: VIDEO CONFIGURATIONS: VTR BYPASS), then:

If VTR bypass cables are not used

7.1 Cable Connector W1290P1 ←|→ J37 (on the left)/(VTR1 to CVIU 3)

7.2 Orbiter Video Cable W3356P1 →|← J37 Connector (Orbiter Video Channel2/CVIU3)

PCS 8. AUTO ROUTING VIDEO SIGNAL FROM ORBITER CH2

C&T: Video

Video Overview

'Video Routing Status'

sel (Destination Button)

(Destination Button)

'Full Screen Routing'

pick Source ID – 2 3 (VTR 1)

cmd Set

Video Overview

'Last Attempted Route'

NOTE

Depending on the type of route requested, the user may have to wait up to one minute before seeing In Progress go to done.

Verify Progress – Done

Verify Status – Valid Path

3.112 VDS SHUTTLE AUTO ROUTE - DEROUTE

(JNT OPS/LF1 - ALL/FIN/SPN) Page 4 of 5 pages

- PCS 9. POWERING ON COMMON VIDEO INTERFACE UNIT 3
C&T: Video: CVIU

'VSU 1'
- sel CVIU 3
-
- cmd** RPC Position – Close (Verify – Cl)
- CM1 10. COORDINATING VIDEO SIGNAL
LAB
10.1 Check that orbiter team has completed routing the video signal.
10.2 Check that (VTR1) Orbiter Channel 2 has been routed.
- PCS 11. CHECKING DESTINATION
C&T: Video

'Video Routing Status'
- Verify (Destination: Source) – Not blank
- PCS 12. DEROUTING VIDEO SIGNAL
C&T: Video

'Video Routing Status'
- sel (Destination Button)
- 'Deroute Video Signal'
- cmd** Deroute
- 'Last attempted Route'
- Verify Progress – Done
- 'Video Routing Status'
- Verify (Destination: Source) – blank

3.112 VDS SHUTTLE AUTO ROUTE - DEROUTE

(JNT OPS/LF1 - ALL/FIN/SPN) Page 5 of 5 pages

13. POWERING OFF COMMON VIDEO INTERFACE UNIT

PCS | If Orbiter Channel 2 was used
C&T: Video: CVIU
Video CVIU
'VSU 1'

sel CVIU 3

RPCM LAP51A4A A RPC 06

cmd RPC Position – Open (Verify – Op)

PCS | If Orbiter Channel 1 was used
C&T: Video: CVIU
Video CVIU
'VSU 2'

sel CVIU 6

RPCM_LAS52A3B_A_RPC_06

cmd RPC Position – Open (Verify – Op)

14. RECONNECTING VTR1

LAP5 Rack Interface Panel

If the VTR bypass cables were used

Perform {[15.150 VTR BYPASS CABLE - UNDOCKED OPERATIONS \(LAB1P5/LAB RWS\)](#)}, all (SODF: P/TV GEN: VIDEO CONFIGURATIONS: VTR BYPASS), then:

If VTR bypass cables were not used

- 14.1 Orbiter Video Cable W3356P1 ←|→ J37 Connector (Orbiter Video Channel2/CVIU3)
- 14.2 VTR Cable Connector W1290P1 →|← J37 (on the left)/(VTR1 to CVIU 3)

15. RECONNECTING VTR2

LAS5 Rack Interface Panel

If the VTR bypass cables were used

Perform {[15.140 VTR BYPASS CABLE - UNDOCKED OPERATIONS \(LAB1S5/CUP RWS\)](#)}, all (SODF: P/TV GEN: VIDEO CONFIGURATIONS: VTR BYPASS), then:

If VTR bypass cables were not used

- 15.1 Orbiter Video Cable W0400P1 ←|→ J37 Connector (Orbiter Video Channel1/CVIU6)
- 15.2 VTR Cable Connector W1190P1 →|← J37 (on the left)/(VTR2 to CVIU 6)

This Page Intentionally Blank

3.113 VDS SHUTTLE MANUAL ROUTE - DEROUTE

(JNT OPS/LF1 - ALL/FIN/SPN) Page 1 of 4 pages

OBJECTIVE:

This procedure defines the steps needed to manually route/deroute the orbiter video signal to the station.

NOTE

1. The user will need to coordinate with the Shuttle Team before starting this procedure. Each section can be completed separately.
Steps 1 to 8 Manual Route
Steps 9 to 11 Manual Deroute
Steps 12 to 13 Reconnecting VTR Cables
2. If the user is not planning to use Orbiter Channel 1, then go to step 5.

1. CONNECTING ORBITER VIDEO LINE CHANNEL1

CM1 LAS5 Rack Interface Panel

If the VTR bypass cables are to be used

Perform {15.160 VTR BYPASS CABLE - NOMINAL DOCKED OPERATIONS (LAB1S5/CUP RWS)}, all (SODF: P/TV GEN: VIDEO CONFIGURATIONS: VTR BYPASS), then:

If VTR bypass cables are not used

1.1 VTR2 Cable W1190P1 ←|→ J37 Connector (VTR2 to CVIU 6)

1.2 Orbiter Video Cable W0400P1 →|← J37 Connector (Orbiter Video Channel1/CVIU6)

NOTE

When the user does a manual route, select VTR 2 to receive the orbiter video signal.

2. ROUTING VIDEO SIGNAL

Refer to {2.603 VDS MANUAL ROUTE - DEROUTE}, all (SODF: C&T: NOMINAL: VIDEO), then:

3. POWERING ON COMMON VIDEO INTERFACE UNIT 6

PCS C&T: Video: CVIU

Video CVIU

'VSU 2'

sel CVIU 6

RPCM_LAS52A3B_A_RPC_06

cmd RPC Position – Close (Verify – CI)

3.113 VDS SHUTTLE MANUAL ROUTE - DEROUTE

(JNT OPS/LF1 - ALL/FIN/SPN) Page 2 of 4 pages

- CM1 4. COORDINATING VIDEO SIGNAL
LAB
4.1 Check that Orbiter Team has completed routing the video signal.
4.2 Check that (VTR2) Orbiter Channel 1 has been routed.

<u>NOTE</u> If the user is not planning to use Orbiter Channel 2, then skip to step 9.

- CM1 5. CONNECTING ORBITER VIDEO LINE CHANNEL2
LAP5 Rack Interface Panel
If the VTR bypass cables are to be used
 Perform {15.170 VTR BYPASS CABLE - NOMINAL DOCKED OPERATIONS (LAB1P5/LAB RWS) STS VIEW}, all (SODF: P/TV GEN: VIDEO CONFIGURATIONS: VTR BYPASS), then:
If VTR bypass cables are not used
 5.1 VTR1 Cable Connector W1290P1 ←|→ J37 Connector (VTR1 to CVIU 3)
 5.2 Orbiter Video Cable Connector W3356P1 →|← J37 Connector (Orbiter Video Channel2/CVIU3)

<u>NOTE</u> When the user does a manual route, select VTR 1 to receive the shuttle video signal.

6. ROUTING VIDEO SIGNAL
Refer to {2.603 VDS MANUAL ROUTE - DEROUTE}, all (SODF: C&T: NOMINAL: VIDEO), then:
7. POWERING ON COMMON VIDEO INTERFACE UNIT 3
PCS C&T: Video: CVIU
 Video CVIU
 'VSU 1'

sel CVIU 3

RPCM LAP51A4A A RPC06

cmd RPC Position – Close (Verify – Cl)

- CM1 8. COORDINATING VIDEO SIGNAL
LAB
8.1 Check that Orbiter Team has completed routing the video signal.
8.2 Check that (VTR1) Orbiter Channel 2 has been routed.

3.113 VDS SHUTTLE MANUAL ROUTE - DEROUTE

(JNT OPS/LF1 - ALL/FIN/SPN) Page 3 of 4 pages

9. CHECKING DESTINATION

PCS

C&T: Video

'Video Routing Status'

'Destination'

Verify (Destination: Source) – (not blank)

NOTE

When the user does a manual deroute, select either VTR 1 or VTR 2 to remove the shuttle video signal.

10. DEROUTING VIDEO SIGNAL

Refer to {2.603 VDS MANUAL ROUTE - DEROUTE} (SODF: C&T: NOMINAL: VIDEO), then:

11. POWERING OFF COMMON VIDEO INTERFACE UNIT

PCS

If Orbiter Ch 2 was used

C&T: Video: CVIU

'VSU 1'

sel CVIU 3

cmd RPC Position – Open (Verify – Op)

If Shuttle Ch 1 was used

C&T: Video: CVIU

'VSU 2'

sel CVIU 6

cmd RPC Position – Open (Verify – Op)

3.113 VDS SHUTTLE MANUAL ROUTE - DEROUTE

(JNT OPS/LF1 - ALL/FIN/SPN) Page 4 of 4 pages

12. RECONNECTING VTR1

LAP5 Rack Interface Panel

If the VTR bypass cables were used

Perform {[15.150 VTR BYPASS CABLE - UNDOCKED OPERATIONS \(LAB1P5/LAB RWS\)](#)}, all (SODF: P/TV GEN: VIDEO CONFIGURATIONS: VTR BYPASS), then:

If VTR bypass cables were not used

12.1 Orbiter Video Cable Connector W3356P1 ←|→ J37 Connector
(Orbiter Video Channel2/CVIU3)

12.2 VTR Cable Connector W1290P1 →|← J37 (VTR1 to CVIU 3)

13. RECONNECTING VTR2

LAS5 Rack Interface Panel

If the VTR bypass cables were used

Perform {[15.140 VTR BYPASS CABLE - UNDOCKED OPERATIONS \(LAB1S5/CUP RWS\)](#)}, all (SODF: P/TV GEN: VIDEO CONFIGURATIONS: VTR BYPASS), then:

If VTR bypass cables were not used

13.1 Orbiter Video Cable Connector W0400P1 ←|→ J37 Connector
(Orbiter Video Channel1/CVIU6)

13.2 VTR Cable Connector W1190P1 →|← J37 (VTR2 to CVIU 6)

3.115 OXYGEN TRANSFER SETUP

(JNT OPS/X2R4 - ALL/FIN 7/SPN/HC)

Page 1 of 7 pages

OBJECTIVE:

Equipment setup and reconfigure oxygen system in preparation for performing oxygen transfer from the shuttle cryo oxygen system to the ISS Airlock oxygen tanks using the Oxygen Recharge Compressor Assembly (ORCA).

TOOLS AND EQUIPMENT REQUIRED:

(NOD1P4_D)

GO2 Transfer Flex Hose Assy P/N V857-643003-002

ORCA O2 Outlet Line P/N 683-51901-19

(A/L1O1)

Powder-Free Gloves

Teflon Bags P/N 300045-08

Clean Room Tape P/N 3M/1251

Flashlight

Ear Plugs

(NOD1D4_G2)

ISS IVA Toolbox

Drawer 2:

5/32" Hex Head, 1/4" Drive

Driver Handle, 1/4" Drive

Drawer 3:

Inspection Mirror

1. REMOVING CLOSEOUT PANELS

- A/L1OA2 1.1 Unfasten A/L1OA2 closeout panel fasteners (Driver Handle, 1/4" Drive; 5/32" Hex Head, 1/4" Drive).
Temporarily stow A/L1OA2 Closeout Panel.

NOTE

To transfer O2 to the High P Tank, access to VL011 (O2 Xover Vlv) is required. VL011 is behind panel A/L1A2; however, once A/L1OA2 is removed, VL011 can be reached from above. Removal of panel A/L1A2 is at the crew's discretion.

- A/L1A1 If required, remove panel A/L1A2.
- A/L1A1 1.2 Reconfigure/remove EDDA and handrails as necessary for access to A/L1A2 panel.
- A/L1A2 1.3 Unfasten blue ESSS cover fasteners.
Cover is located ovhd aft of IV Hatch (Driver Handle, 1/4" Drive; 5/32" Hex Head, 1/4" Drive).
Temporarily stow ESSS cover panel.
- A/L1A2 1.4 Unfasten A/L1A2 closeout panel fasteners (Driver Handle, 1/4" Drive; 5/32" Hex Head, 1/4" Drive).
Temporarily stow A/L1A2 Closeout Panel.

3.115 OXYGEN TRANSFER SETUP

(JNT OPS/X2R4 - ALL/FIN 7/SPN/HC)

Page 2 of 7 pages

2. CONFIGURING ISS O2 SYSTEM

- A/L10A2 2.1 VL009 (O2 Lo P) → CLOSED
- A/L1A2 2.2 √VL011 (O2 Xover Vlv) – CLOSED
- PCS 2.3 Airlock: ECLSS: Oxygen System
AL Oxygen System
'O2 Low Pressure Supply Valve'
- √Actual Position – Open
- 'O2 Hi Pressure Supply Valve'
- √Actual Position – Closed

3. REDUCING ISS O2 SYSTEM PRESSURE TO AMBIENT

NOTE

1. When possible, connection and disconnection of QDs requires adjoining lines to be at approximately ambient pressure on both sides of the QD.
2. As the O2 system pressure bleeds down and O2 is introduced into the cabin, the following messages may be received:
'O2 Lo P Supply Pressure Low – A/L'
'PCA O2 Line Pressure Low – A/L'
'PCA O2 Line Pressure Low – LAB'
3. The messages will return to normal as the O2 system is repressurized (step 6).

- PCS Airlock: ECLSS: Oxygen System
AL Oxygen System
'AL PCA O2 Intro Valve'

cmd Open (√Position – Open)

'Low Pressure'

When PCA O2 Line Press < 160 kPa (23 psi) or **On MCC-H GO**, proceed.

'AL PCA O2 Intro Valve'

cmd Close (√Position – Closed)

3.115 OXYGEN TRANSFER SETUP

(JNT OPS/X2R4 - ALL/FIN 7/SPN/HC)

Page 3 of 7 pages

4. CONFIGURING PMA/ODS FOR O2 TRANSFER

ODS Vest
GO2 Xfer
Panel

4.1 ✓FLOW – CLOSED

WARNING

Opening the ODS Vestibule Transfer Panel Vent may cause a loud hissing noise. Crew in the vicinity should don ear plugs.

4.2 Don ear plugs

4.3 VENT → OPEN

4.4 Check GO2 Xfer Panel Pressure Gauge reading ~0 psi. Doff ear plugs

WARNING

Failure to maintain clean environment during oxygen system maintenance could result in fire hazard. If Gloves become contaminated, replace immediately with clean Gloves.

Minimize the amount of time open fluid connectors and caps/plugs are exposed to cabin air to prevent contamination of the oxygen system. Open connectors and caps/plugs can be covered by Teflon Bags or Powder-Free Gloves. Failure to comply could result in a fire hazard.

All fittings should be inspected for contaminants before mating. If debris is found, ✓**MCC-H**.

Inspect GO2 Transfer Flex Hose Assy for any cracks or anomalies. If found, ✓**MCC-H**.

4.5 Inspect GO2 Transfer Flex Hose Assy for any cracks or anomalies. If found, notify **MCC-H**.

4.6 Don Powder-Free Gloves.

NOTE

QDs must be closed to remove plugs and disconnect lines. As needed, refer to Figures 2 and 3 at the end of this procedure for information on the high-pressure quick disconnects.

4.7 Uncap GO2 Xfer Panel QD. Close GO2 Transfer Flex Hose Assy bent-end QD. Remove plug. Inspect both QDs for debris.

Install hose so that it can be routed along the ODS Flange as shown in Figure 1.

3.115 OXYGEN TRANSFER SETUP

(JNT OPS/X2R4 - ALL/FIN 7/SPN/HC)

Page 4 of 7 pages

GO2 Transfer Flex Hose Assy bent-end →|← GO2 Xfer Panel QD
Hard mate/open QD

Cover caps and plugs.

- PMA 4.8 Uncap Oxygen Recharge QD.
Close GO2 Transfer Flex Hose Assy straight-end QD.
Remove plug.
Inspect both QDs for debris.

GO2 Transfer Flex Hose Assy straight-end →|← Oxygen Recharge QD
Hard mate/open QD.

Cover caps and plugs.

- PMA/ODS 4.9 Secure GO2 Transfer Flex Hose Assy to PMA/ODS Extension Duct
and ODS Flange with Velcro straps.

- ODS Vest 4.10 VENT → CLOSED
GO2 Xfer
Panel

- 4.11 Doff Gloves.



Figure 1.- ODS Vestibule Xfer Panel Hose Routing.

5. CONFIGURING ORCA FOR O2 TRANSFER

PCS

- 5.1 Airlock: ECLSS: ORCA
RPCM AL1A4A B RPC 18

√RPC Position – Op

√Close Cmd – Inh

3.115 OXYGEN TRANSFER SETUP

(JNT OPS/X2R4 - ALL/FIN 7/SPN/HC)

Page 5 of 7 pages

5.2 Don new pair of Powder-Free Gloves.

A/L1OA2

5.3 Close O2 Recharge Line QD.
O2 Recharge Line ←|→ SPARE QD

Cover SPARE QD temporarily (Cap from QD011 will be used as a permanent cover in step 5.6.)

ORCA

5.4 Uncap O2 IN
Inspect both QDs for debris.

O2 Recharge Line →|← O2 IN
Hard mate/open QD.

Cover caps.

CAUTION

ORCA O2 Outlet Line QDs are keyed differently on each end. The hose has arrows near the QDs that indicate O2 flow direction. The flow direction through the hose is out of the ORCA and into QD011. Failure to install the hose correctly may result in damage to the QDs and hose.

5.5 Uncap O2 OUT.
Close ORCA O2 Outlet Line (MW ORCA OUT) QD.
Remove plug.
Inspect both QDs for debris.

ORCA O2 Outlet Line (MW ORCA OUT) →|← O2 OUT
Hard mate/open QD.

Cover caps and plugs.

A/L1OA2

5.6 Uncap QD011.
Close ORCA O2 Outlet Line (MW QD011) QD.
Remove plug.
Inspect both QDs for debris.

ORCA O2 Outlet Line (MW QD011) →|← QD011
Hard mate/open QD.

Cover caps and plugs.
Use cap from QD011 to cover SPARE QD.

5.7 Doff Gloves.

A/L1OA2

5.8 Unstow ORCA Power Cable and remove cap.

3.115 OXYGEN TRANSFER SETUP

(JNT OPS/X2R4 - ALL/FIN 7/SPN/HC)

Page 6 of 7 pages

- ORCA 5.9 ORCA Power Cable →|← MAIN POWER
- A/L10A1 5.10 √Flexible Ventilation Duct (TO IMV AIR RETURN/CONDITIONED AIR SUPPLY) →|← Conditioned Air Supply connection
- ORCA 5.11 Disengage spring-loaded locking pin to remove the cap, then:
Flexible Ventilation Duct (TO ORCA/OPEN CABIN) →|← ORCA
Flexible Ventilation Duct (TO ORCA/OPEN CABIN) ↻ Locked

6. VERIFYING O2 TRANSFER SYSTEM PRESSURE INTEGRITY

- 6.1 √**MCC-H** to verify proper cryo configuration
- ODS Vest
GO2 Xfer
Panel 6.2 FLOW → OPEN
- Middeck
Floor 6.3 Verify EMU O2 ISOL VLV – OPEN
- 6.4 Wait 5 minutes.
- PCS 6.5 Airlock: ECLSS: Oxygen System
AL Oxygen System
'Low Pressure'
Verify Supply Press > 4482 kPa (650 psi)
AL ECLSS
'Equipment Lock'
Verify dP/dt < 0.05 mmHg/min
- 6.6 Notify **MCC-H**, "Oxygen Transfer Setup complete."
- 6.7 √**MCC-H** to determine which oxygen tank to recharge
- If transferring to the High Pressure Tank, go to {3.116 HIGH PRESSURE TANK O2 TRANSFER} (SODF: JNT OPS: MATED OPERATIONS).
- If transferring to the Low Pressure Tank, go to {3.117 LOW PRESSURE TANK O2 TRANSFER} (SODF: JNT OPS: MATED OPERATIONS).

3.115 OXYGEN TRANSFER SETUP

(JNT OPS/X2R4 - ALL/FIN 7/SPN/HC)

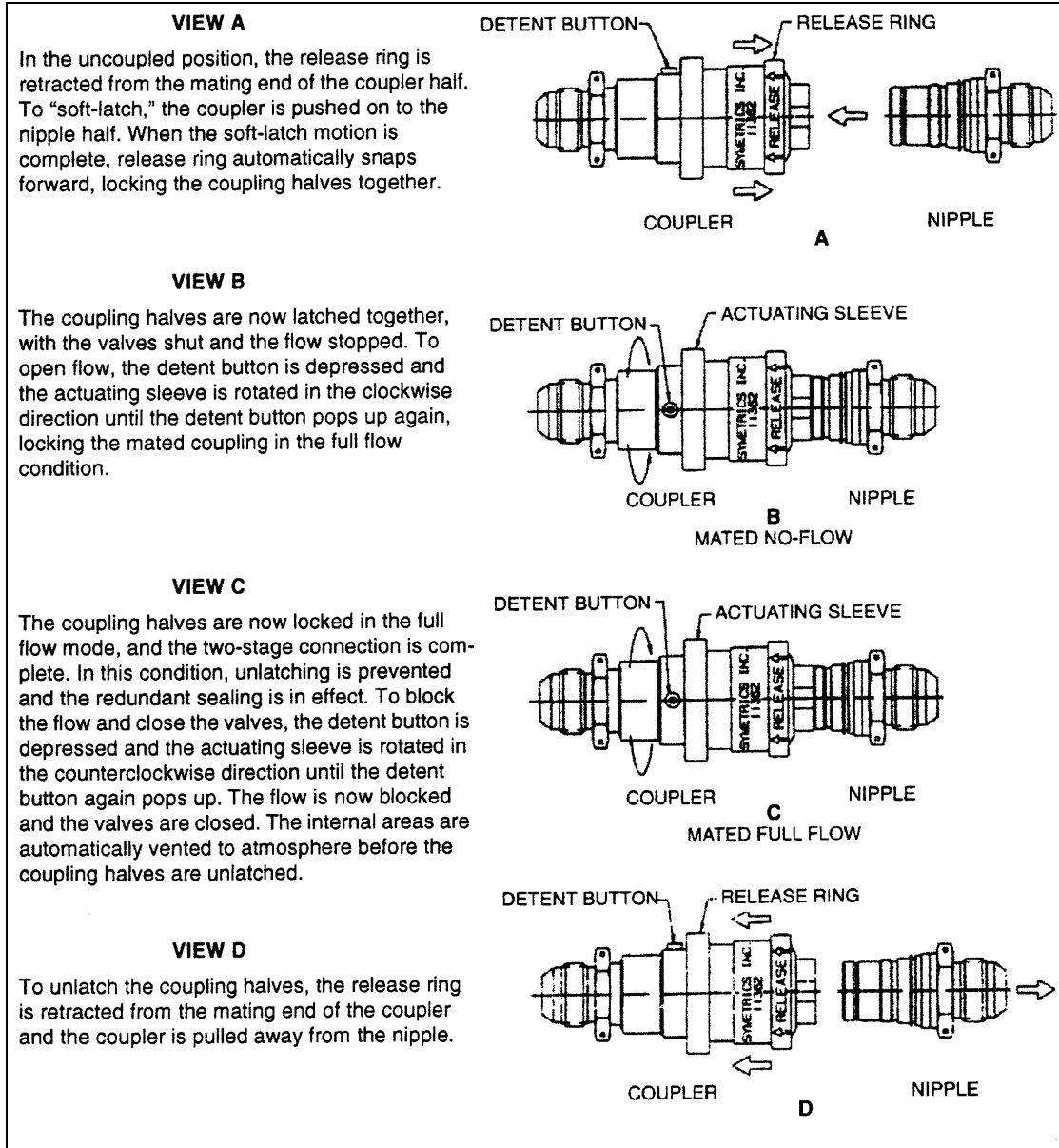

Figure 2.- Two-Stage High-Pressure QDs.

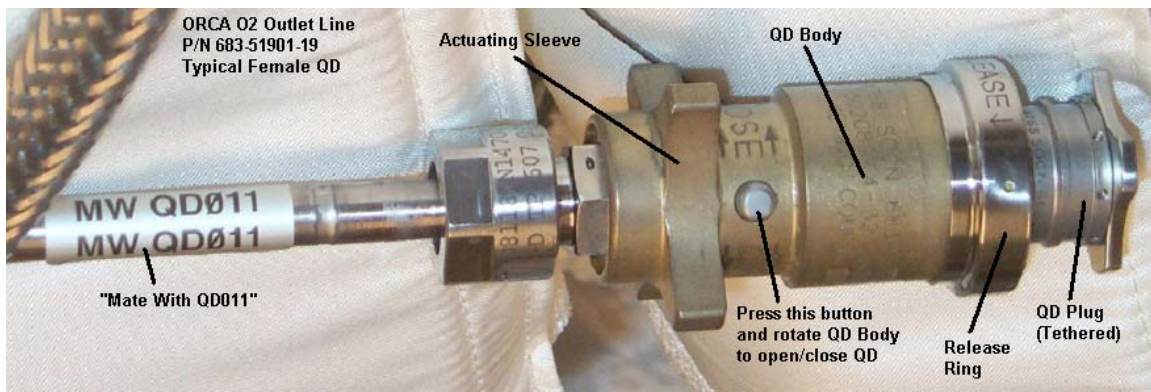

Figure 3.- High-Pressure QDs.

This Page Intentionally Blank

OBJECTIVE:

Transfer oxygen from the shuttle cryo oxygen system to the ISS Airlock high pressure oxygen tank using the Oxygen Recharge Compressor Assembly (ORCA).

<p><u>NOTE</u> MCC-H will nominally perform step 1 from the ground.</p>
--

- 1. CONFIGURING AL CCAA FOR ORCA OPS
 - MCC-H** 1.1 To raise the AL CCAA Fan speed to 5950 rpm and to set the Cabin temperature to 18° C in step 1.5, perform {2.503 CCAA FAN SPEED CHANGE} (SODF: ECLSS: NOMINAL: THC), then:
 - PCS** 1.2 C&W Summ

Caution & Warning Summary

 'Event Code Tools'

 sel Enable

Enable an Event

 input Event Code – 6 7 0 3 (AL1A1 CCAA Inoperative-A/L)

 cmd Execute
 - 2. INITIATING O2 TRANSFER
 - 2.1 Verify with **MCC-H** that step 1 is complete, then:
 - ML86B:C** 2.2 √cb MNB EXT AIRLK HTR LN ZN 1,2 (two) – cl
 √STRUC Z1/2/3 – cl
 √VEST Z1/2/3 – cl
 √cb MNA EXT AIRLK HTR LN ZN 1,2 (two) – op
 √STRUC Z1/2/3 – op
 √VEST Z1/2/3 – op
 - L1** If '**S88 H2O LOOP 1(2) TEMP**' message is received at any time during oxygen transfer, immediately perform the following
 H2O PUMP LOOP 1 – ON

 Contact **MCC-H**.

 If comm is not available, perform step 3 to terminate O2 transfer.
 - A/L1OA2** 2.3 √VL009 (O2 Lo P) – CLOSED
 - A/L1A2** 2.4 VL011 (O2 Xover Vlv) → OPEN
 - A/L1OA2** 2.5 √VL010 (O2 Hi P) – OPEN

3.116 HIGH PRESSURE TANK O2 TRANSFER
(JNT OPS/X2R4 - ALL/FIN 8/HC) Page 2 of 3 pages

ORCA
Status
Panel

2.6 Verify RPCM ON LED – ■

sw PUMP CONTROL → RUN

2.7 Report Cycle Counter reading to **MCC-H**.

PCS

2.8 Airlock: ECLSS: ORCA

RPCM AL1A4A B RPC 18

'Close Cmd'

cmd Enable ($\sqrt{\text{Close Cmd}} - \text{Ena}$)

'RPC Position'

cmd Close (Verify RPC Position – Cl)

2.9 Airlock: ECLSS: Oxygen System

AL Oxygen System

'High Pressure'

On MCC-H GO or when Supply Press ~16548 kPa (2400 psi),
proceed to step 3.

3. TERMINATING O2 TRANSFER

PCS

3.1 Airlock: ECLSS: ORCA

RPCM AL1A4A B RPC 18

'RPC Position'

cmd Open ($\sqrt{\text{RPC Position}} - \text{Op}$)

'Close Cmd'

cmd Inhibit ($\sqrt{\text{Close Cmd}} - \text{Inh}$)

A/L1A2

3.2 VL011 (O2 Xover Vlv) → CLOSED

PCS

3.3 C&W Summ

Caution & Warning Summary

'Event Code Tools'

sel Supress

Suppress Annunciation of an Event

input Event Code – 6 7 0 3 (AL1A1 CCAA Inoperative-A/L)

cmd Arm

cmd Execute

3.116 HIGH PRESSURE TANK O2 TRANSFER
(JNT OPS/X2R4 - ALL/FIN 8/HC) Page 3 of 3 pages

3.4 Report to **MCC-H**, "High Pressure Tank O2 Transfer complete."

On MCC-H GO, perform {[3.118 OXYGEN TRANSFER TEARDOWN](#)} or perform {[3.121 PREBREATHE USING SHUTTLE O2 SETUP \(POST O2 TRANSFER\)](#)} (SODF: JNT OPS: MATED OPERATIONS), then:

If LOS, and AOS not expected within 10 minutes, go to [3.118 OXYGEN TRANSFER TEARDOWN](#), steps 1 and 2 only (SODF: JNT OPS: MATED OPERATIONS).

This Page Intentionally Blank

OBJECTIVE:

Transfer oxygen from the shuttle cryo oxygen system to the ISS Airlock low pressure oxygen tank using the Oxygen Recharge Compressor Assembly (ORCA).

NOTE
MCC-H will nominally perform step 1 from the ground.

- MCC-H** 1. CONFIGURING AL CCAA FOR ORCA OPS
1.1 To raise the AL CCAA Fan speed to 5950 RPM and to set the Cabin temperature to 18° C in step 1.5, perform {2.503 CCAA FAN SPEED CHANGE} (SODF: ECLSS: NOMINAL: THC), then:
- PCS 1.2 C&W Summ
Caution & Warning Summary
'Event Code Tools'

sel Enable

Enable an Event

input Event Code – 6 7 0 3 (AL1A1 CCAA Inoperative-A/L)

cmd Execute
2. INITIATING O2 TRANSFER
2.1 Verify with **MCC-H** that step 1 is complete, then:
- ML86B:C 2.2 √cb MNB EXT AIRLK HTR LN ZN 1,2 (two) – cl
√STRUC Z1/2/3 – cl
√VEST Z1/2/3 – cl
√cb MNA EXT AIRLK HTR LN ZN 1,2 (two) – op
√STRUC Z1/2/3 – op
√VEST Z1/2/3 – op
- L1 If 'S88 H2O LOOP 1(2) TEMP' message is received at any time during oxygen transfer, immediately perform the following
H2O PUMP LOOP 1 – ON

Contact **MCC-H**.

If comm is not available, perform step 3 to terminate O2 transfer.
- A/L1A2 2.3 √VL011 (O2 Xover Vlv) – CLOSED
- A/L10A2 2.4 VL009 (O2 Lo P) → OPEN
- ORCA Status Panel 2.5 Verify RPCM ON LED – ■

sw PUMP CONTROL → RUN

3.117 LOW PRESSURE TANK O2 TRANSFER
(JNT OPS/X2R4 - ALL/FIN 6/HC) Page 2 of 3 pages

2.6 Report Cycle Counter reading to **MCC-H**.

PCS

2.7 Airlock: ECLSS: ORCA

'Close Cmd'

cmd Enable ($\sqrt{\text{Close Cmd}} - \text{Ena}$)

'RPC Position'

cmd Close (Verify RPC Position – Cl)

2.8 Airlock: ECLSS: Oxygen System

'Low Pressure'

When Supply Press ~16548 kPa (2400 psi) or
On MCC-H GO, proceed to step 3.

3. TERMINATING O2 TRANSFER

PCS

3.1 Airlock: ECLSS: ORCA

'RPC Position'

cmd Open ($\sqrt{\text{RPC Position}} - \text{Op}$)

'Close Cmd'

cmd Inhibit ($\sqrt{\text{Close Cmd}} - \text{Inh}$)

A/L10A2

3.2 VL009 (O2 Lo P) → CLOSED

3.3 C&W Summ

'Event Code Tools'

sel Suppress

input Event Code – 6 7 0 3 (AL1A1 CCAA Inoperative-A/L)

cmd Arm

cmd Execute

3.117 LOW PRESSURE TANK O2 TRANSFER

(JNT OPS/X2R4 - ALL/FIN 6/HC) Page 3 of 3 pages

3.4 Report to **MCC-H**, "Low Pressure Tank O2 Transfer complete."

On MCC-H GO, perform {3.118 OXYGEN TRANSFER TEARDOWN} or perform {3.121 PREBREATHE USING SHUTTLE O2 SETUP (POST O2 TRANSFER)} (SODF: JNT OPS: MATED OPERATIONS), then:

If LOS, and AOS not expected within 10 minutes, go to
| {3.118 OXYGEN TRANSFER TEARDOWN}, steps 1 and 2 only
| (SODF: JNT OPS: MATED OPERATIONS).

This Page Intentionally Blank

3.118 OXYGEN TRANSFER TEARDOWN

(JNT OPS/X2R4 - ALL/FIN 8/SPN/HC) Page 1 of 6 pages

OBJECTIVE:

Return the shuttle and ISS Airlock oxygen systems to their nominal configurations following oxygen transfer using the Oxygen Recharge Compressor Assembly (ORCA).

TOOLS AND EQUIPMENT REQUIRED

(A/L1O1)

Powder-Free Gloves

Teflon Bags P/N 300045-08

Clean Room Tape P/N 3M/1251

Flashlight

Ear Plugs

(NOD1D4_G2)

ISS IVA Toolbox

Drawer 2:

5/32" Hex Head, 1/4" Drive

Driver Handle, 1/4" Drive

Drawer 3:

Inspection Mirror

1. RECONFIGURING ISS O2 SYSTEM

A/L1OA2 1.1 √VL009 (O2 Lo P) – CLOSED

A/L1A2 1.2 √VL011 (O2 Xover Vlv) – CLOSED

ORCA 1.3 Verify RPCM ON LED – ■

Status
Panel

1.4 sw PUMP CONTROL → STOP/RESET

1.5 Report Cycle Counter reading to **MCC-H**.

2. REDUCING ISS O2 SYSTEM PRESSURE TO AMBIENT

NOTE

1. When possible, connection and disconnection of QDs requires adjoining lines to be at approximately ambient pressure on both sides of the QD.
2. As the O2 system pressure bleeds down and O2 is introduced into the cabin, the following messages may be received:
'O2 Lo P Supply Pressure Low – A/L'
'PCA O2 Line Pressure Low – A/L'
'PCA O2 Line Pressure Low – LAB'
3. These messages will return to normal as the O2 system is repressurized (step 4).

3.118 OXYGEN TRANSFER TEARDOWN

(JNT OPS/X2R4 - ALL/FIN 8/SPN/HC)

Page 2 of 6 pages

Middeck Floor 2.1 EMU O2 ISOL VLV → CLOSED

WARNING

Opening the ODS Vestibule Transfer Panel Vent may cause a loud hissing noise. Crew in the vicinity should don ear plugs.

2.2 Don ear plugs.

ODS Vest GO2 Xfer Panel 2.3 VENT → OPEN

2.4 Check GO2 Xfer Panel Pressure Gauge reading ~0 psi. Doff ear plugs.

PCS 2.5 Airlock: ECLSS: Oxygen System
AL Oxygen System
'O2 Low Pressure Supply Valve'

√Actual Position – Open

'AL PCA O2 Intro Valve'

cmd Open (√Position – Open)

'Low Pressure'

When PCA O2 Line Press < 160 kPa (23 psi) or **On MCC-H GO**, proceed.

'AL PCA O2 Intro Valve'

cmd Close (√Position – Closed)

ODS Vest GO2 Xfer Panel 2.6 VENT → CLOSED

2.7 FLOW → CLOSED

3. RECONFIGURING ORCA

ORCA 3.1 Disengage spring-loaded locking pin, then:
Flexible Ventilation Duct (TO ORCA/OPEN CABIN) ↻ Unlocked
Flexible Ventilation Duct (TO ORCA/OPEN CABIN) ←|→ ORCA
Cap ORCA connection.

3.2 Place free-end of Flexible Ventilation Duct (TO ORCA/OPEN CABIN) in Crew Lock.

3.3 ORCA Power Cable ←|→ MAIN POWER

3.118 OXYGEN TRANSFER TEARDOWN

(JNT OPS/X2R4 - ALL/FIN 8/SPN/HC)

Page 3 of 6 pages

- 3.4 Install cap on ORCA Power Cable.
Stow behind panel A/L10A2

WARNING

1. Failure to maintain clean environment during oxygen system maintenance could result in fire hazard. If Gloves become contaminated, replace immediately with clean Gloves.
2. Minimize the amount of time open fluid connectors are exposed to cabin air to prevent contamination of the oxygen system. Open connectors and caps/plugs can be covered by Teflon Bags or Powder-Free Gloves. Failure to comply could result in a fire hazard.
3. All fitting should be inspected for contaminants before mating. If debris is found, $\sqrt{\text{MCC-H}}$.

- 3.5 Don Powder-Free Gloves.

NOTE

QDs must be closed to disconnect lines. As needed, refer to Figure 1 at the end of this procedure for information on the high-pressure quick disconnects.

ORCA

- 3.6 Close O2 Recharge Line QD
O2 Recharge Line $\leftarrow| \rightarrow$ ORCA O2 IN
Inspect for debris.
Install cap on O2 IN.

NOTE

To ensure that all seals are engaged, female high pressure QDs should be reopened after the plugs are installed.

A/L10A2

- 3.7 Remove cap from SPARE QD.
Inspect both QDs for debris.

O2 Recharge Line $\rightarrow| \leftarrow$ SPARE QD
Hard mate/open O2 Recharge Line QD.
- 3.8 Close ORCA O2 Outlet Line (MW QD011) QD.
ORCA O2 Outlet Line (MW QD011) $\leftarrow| \rightarrow$ QD011

Inspect both QDs for debris.
Install cap on QD011.
Install plug on ORCA O2 Outlet Line (MW QD011).
Open ORCA O2 Outlet Line QD.

3.118 OXYGEN TRANSFER TEARDOWN

(JNT OPS/X2R4 - ALL/FIN 8/SPN/HC)

Page 4 of 6 pages

ORCA 3.9 Close ORCA O2 Outlet Line (MW ORCA OUT) QD.
ORCA O2 Outlet Line (MW ORCA OUT) ←|→ O2 OUT

Inspect both QDs for debris.
Install cap on O2 OUT.
Install plug on ORCA O2 Outlet Line (MW ORCA OUT).
Open ORCA O2 Outlet Line QD.

3.10 Doff Gloves.

4. VERIFYING ISS O2 SYSTEM PRESSURE INTEGRITY

A/L1A2 4.1 √VL011 (O2 Xover Vlv) – CLOSED

A/L1OA2 4.2 VL009 (O2 Lo P) → OPEN

4.3 √VL010 (O2 Hi P) – OPEN

PCS 4.4 Airlock: ECLSS: Oxygen System
AL Oxygen System
'Low Pressure'

Report Supply Press to **MCC-H**.

'High Pressure'

Report Supply Press to **MCC-H**.

AL ECLSS
'Equipment Lock'

Verify dP/dt < 0.05 mmHg/min

5. CONFIGURING PMA/ODS FOR NOMINAL OPERATIONS

5.1 Don new pair of Powder-Free Gloves.

PMA 5.2 Close GO2 Transfer Flex Hose Assy straight end QD.
GO2 Transfer Flex Hose Assy ←|→ Oxygen Recharge QD

Inspect both QDs for debris.
Install cap on Oxygen Recharge QD.
Install plug on GO2 Transfer Flex Hose Assy.

ODS Vest
GO2 Xfer
Panel 5.3 Close GO2 Transfer Flex Hose Assy bent-end QD
GO2 Transfer Flex Hose Assy ←|→ GO2 Xfer Panel QD

Inspect both QDs for debris.
Install cap on GO2 Xfer Panel QD.
Install plug on GO2 Transfer Flex Hose Assy.

3.118 OXYGEN TRANSFER TEARDOWN

(JNT OPS/X2R4 - ALL/FIN 8/SPN/HC)

Page 5 of 6 pages

5.4 Doff Gloves.

PMA/ODS 5.5 Remove GO2 Transfer Flex Hose Assy from PMA/ODS Extension Duct and ODS Flange.

6. INSTALLING CLOSEOUT PANELS

If required

A/L1A2 6.1 Install A/L1A2 Closeout Panel, snug fasteners (Driver Handle 1/4" Drive; 5/32" Hex Head, 1/4" Drive).

6.2 Install blue ESSS cover, snug fasteners.
Cover installs ovhd aft of IV Hatch (Driver Handle 1/4" Drive; 5/32" Hex Head, 1/4" Drive).

A/L1OA2 6.3 Install A/L1OA2 Closeout Panel, snug fasteners (Driver Handle 1/4" Drive; 5/32" Hex Head, 1/4" Drive).

6.4 Stow tools and equipment.
Stow GO2 Transfer Flex Hose Assy and ORCA O2 Outlet Line in NOD1P4_D.
Stow both hoses as straight as possible.

6.5 Notify **MCC-H**, "Oxygen Teardown complete."

7. CONFIGURING AL CCAA FOR NOMINAL OPERATIONS

NOTE

MCC-H will nominally perform step 7 from the ground.

MCC-H To lower the AL CCAA Fan speed to 3400 rpm and to set Cabin Temperature to 22° C in step 1.5, go to {2.503 CCAA FAN SPEED CHANGE} (SODF: ECLSS: NOMINAL: THC).

3.118 OXYGEN TRANSFER TEARDOWN

(JNT OPS/X2R4 - ALL/FIN 8/SPN/HC)

Page 6 of 6 pages

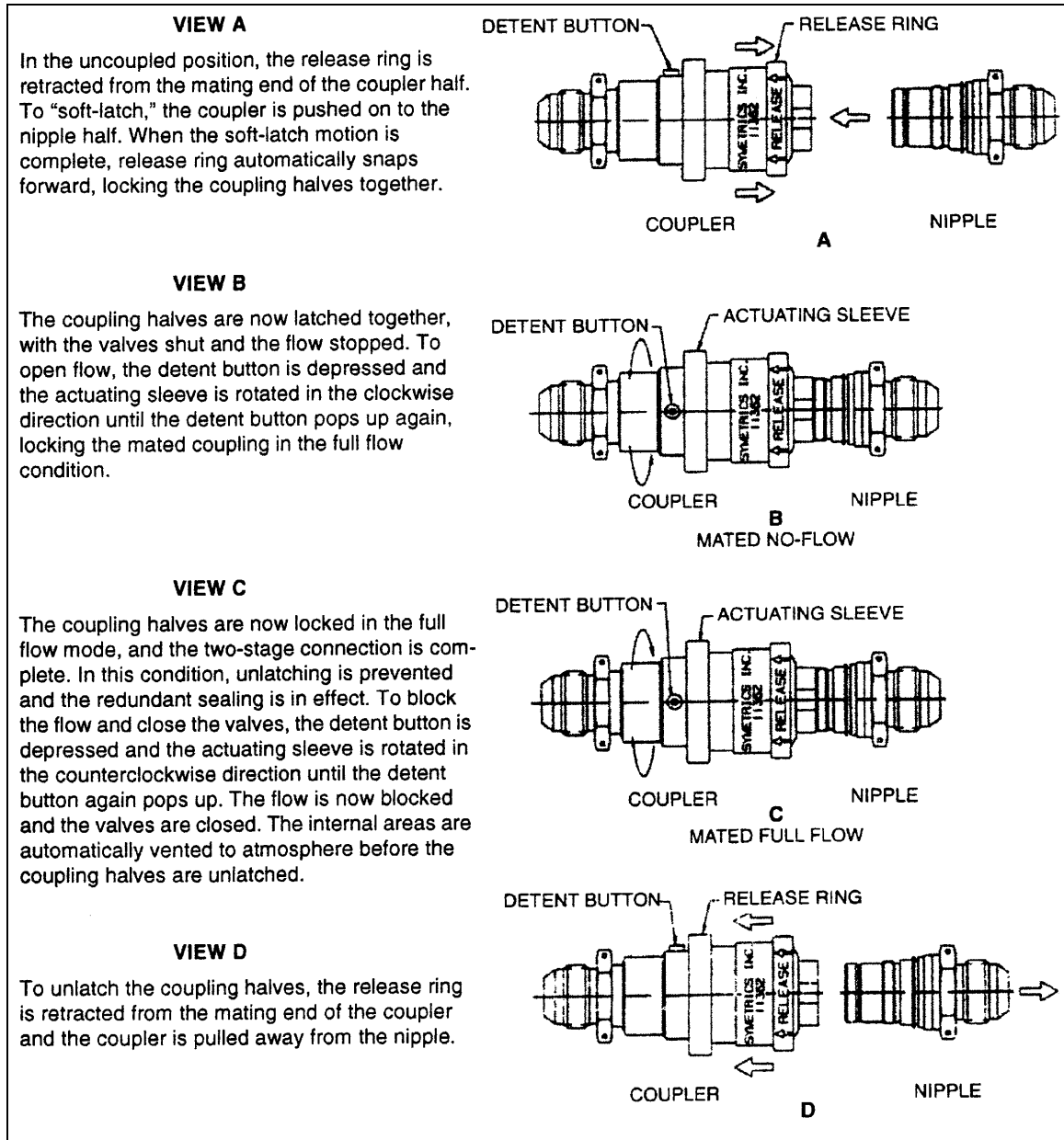

Figure 1.- Two-Stage High-Pressure QDs.

3.119 RADIATION AREA MONITOR DOSIMETERS - INSTALLATION OF DOSIMETERS ON ISS

(JNT OPS/E11/FIN 7)

Page 1 of 11 pages

OBJECTIVE:

To provide instructions and locations for deploying the Radiation Area Monitors (RAM) throughout ISS and for photographing each newly deployed RAM for ground verification purposes.

PARTS REQUIRED:

Radiation Area Monitors (17) P/N SEZ 33111519-303 S/N 1298-1314

1. UNSTOW RADIATION AREA MONITORS

Unstow Radiation Area Monitors using the 10Soyuz Resupply List in Unpack List as a reference.

NOTE

1. Radiation Area Monitor Dosimeters are color-coded.
2. For the 10Soyuz Mission
Deploy: blue Radiation Area Monitors
Return: white Radiation Area Monitors
3. Refer to Table 1 (SM), Table 2 (Node), Table 3 (A/L), or Table 4 (LAB) for exact locations.
4. Tables list locations sequentially from aft to forward.
5. Each labeled deploy location should have a piece of Velcro with a tether attached to it from previous installations.

2. EXCHANGE RADIATION AREA MONITORS

- 2.1 At each deployment site in Table 1 (SM), Table 2 (Node), Table 3 (A/L), or Table 4 (LAB)
 - 2.1.1 Remove white Radiation Area Monitor from deployed location, but leave the tether at the location. Stow white Radiation Area Monitor in Ziplock.
 - 2.1.2 Retrieve blue Radiation Area Monitor from Ziplock. Verify label corresponds to location decal.
 - 2.1.3 Attach blue Radiation Area Monitor to corresponding location.
Attach tether to Radiation Area Monitor
 - 2.1.4 Take two pictures of the deployed RAM: one close-up picture where the F.O.V. is the RAM and the panel on which its deployed, and one picture where the F.O.V. is further away where the RAM is identifiable in the approximate center of the frame to see the relation to the other panels.
- 2.2 Stow Ziplock with white Radiation Area Monitors for return using the 9Soyuz Return List in Unpack List as reference.

3.119 RADIATION AREA MONITOR DOSIMETERS - INSTALLATION OF DOSIMETERS ON ISS

(JNT OPS/E11/FIN 7)

Page 2 of 11 pages

2.3 Notify **MCC-H** when Radiation Area Monitor swapout is complete.

Table 1. Radiation Area Monitor Dosimeter Locations in Service Module

Dosimeter Number	ISS Interior Location Code	Dosimeter Location
SM#1	SM - P 242	Inside Port SM Crew Quarters, Outboard wall aft upper corner
SM#2	SM - P 442	Inside Starboard SM Crew Quarters, Outboard wall aft upper corner
SM#3	SM - P 339	Panel 339 aft section behind Treadmill, Upper center part of the panel
SM#4	SM - P 327	Panel 327, overhead, forward of Treadmill
SM#5	SM - P 307	Panel 307, TsP overhead, near center
SM#6	SM - W 14	Window #14, Transfer Compartment Adapter section, Stbd Nadir quadrant
10S/TEPC (s/n 1314)	TEPC	Directly on the surface of TEPC Detector

Table 2. Radiation Area Monitor Dosimeter Locations in Node 1

Dosimeter Number	ISS Interior Location Code	Dosimeter Location
Node 1 #1	NOD1P4_03	Closeout Panel on the port side of Aft Hatch on the Zenith end of the Closeout Panel NOD1P4_03
Node 1 #2	NOD1OP2	On the Zenith side of the footbridge across the Port Hatch
Node 1 #3	NOD1S1_02	Closeout on Stbd side near the Fwd Hatch Zenith side of the Closeout Panel NOD1S1_02

Table 3. Radiation Area Monitor Dosimeter locations in Air Lock

Dosimeter Number	ISS Interior Location Code	Dosimeter Location
#1	A/L1 AD3	Aft wall low outboard in large section
#2	A/L1 OF3	Forward wall High outboard in large section

Table 4. Radiation Area Monitor Dosimeter Locations in LAB

Dosimeter Number	ISS Interior Location Code	Dosimeter Location
Lab#1	LAB1 OS6	Starboard side standoff between starboard and ceiling
Lab#2	LAB1 D3	In the vicinity of the Lab window.
Lab#3	LAB1 PD2	Port side standoff between Deck and Port Rack
Lab#4	LAB1 OS0	Forward Closeout Panel starboard upper corner
Lab#5	LAB1 TESS	Ventilation grille in Temporary Sleep Station (TESS)

3.119 RADIATION AREA MONITOR DOSIMETERS - INSTALLATION OF DOSIMETERS ON ISS

(JNT OPS/E11/FIN 7)

Page 3 of 11 pages

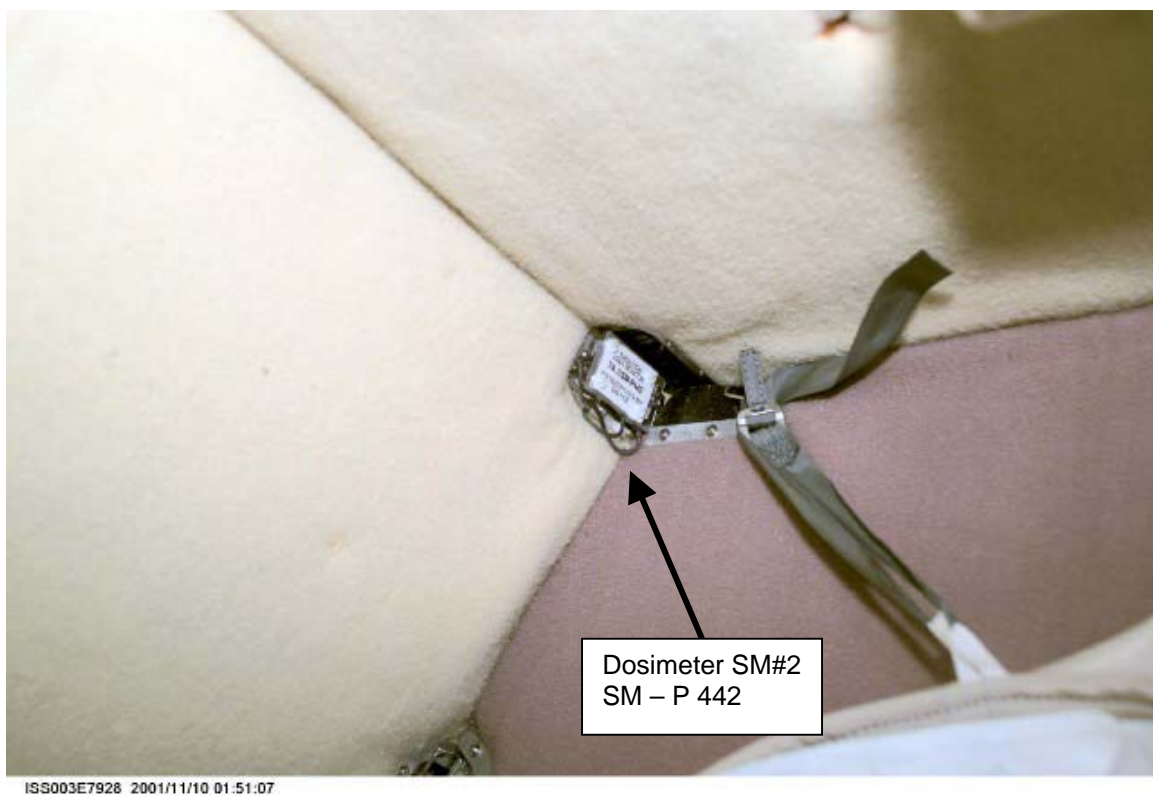
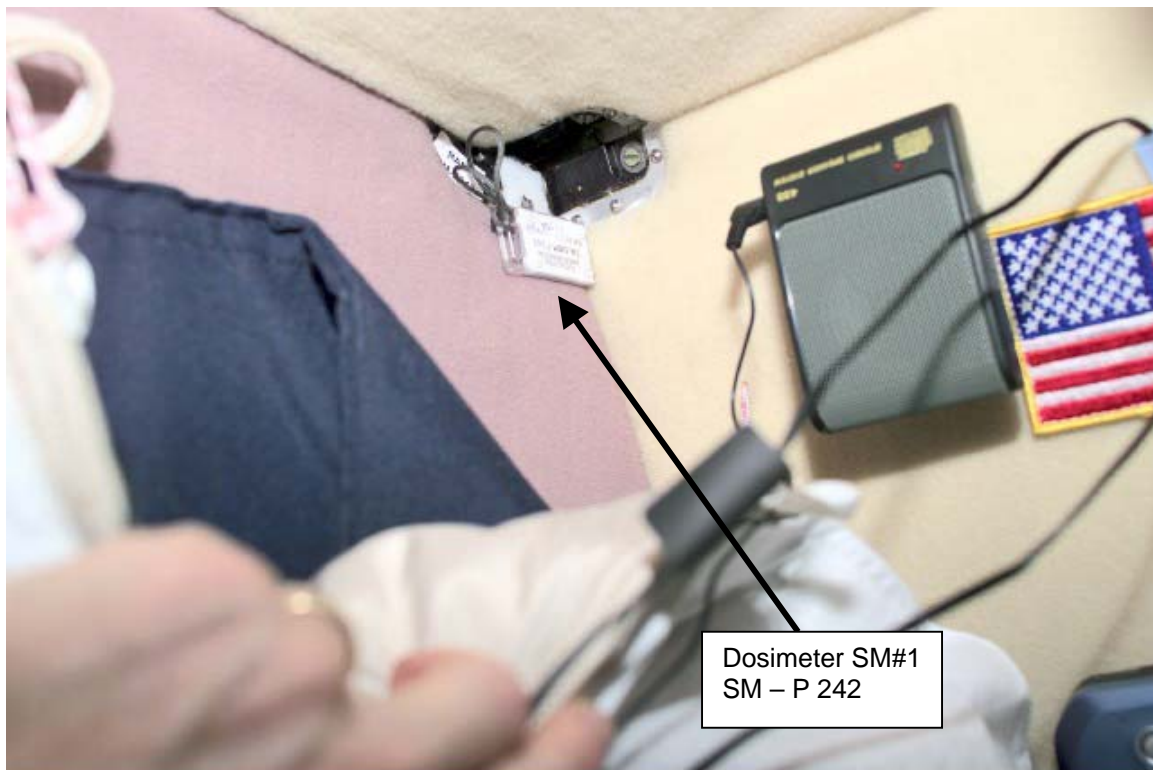

Figure 1.- Dosimeter SM#1 and SM#2.

3.119 RADIATION AREA MONITOR DOSIMETERS - INSTALLATION OF DOSIMETERS ON ISS

(JNT OPS/E11/FIN 7)

Page 4 of 11 pages

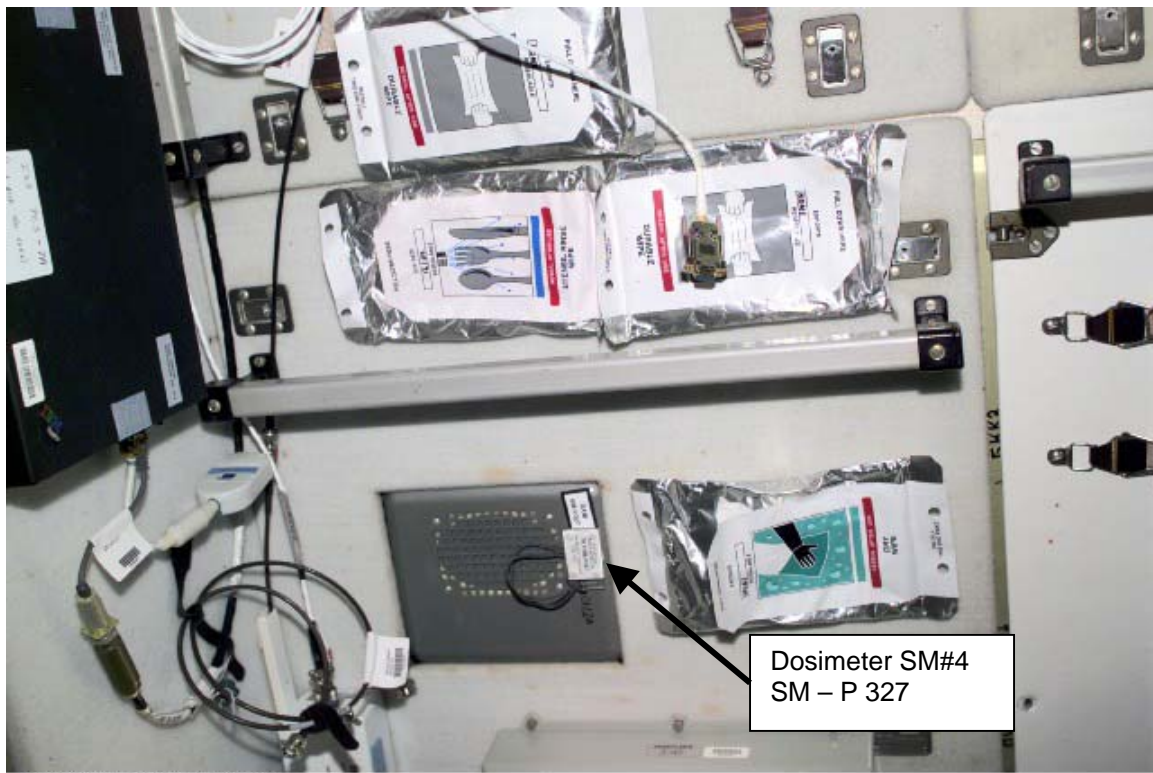
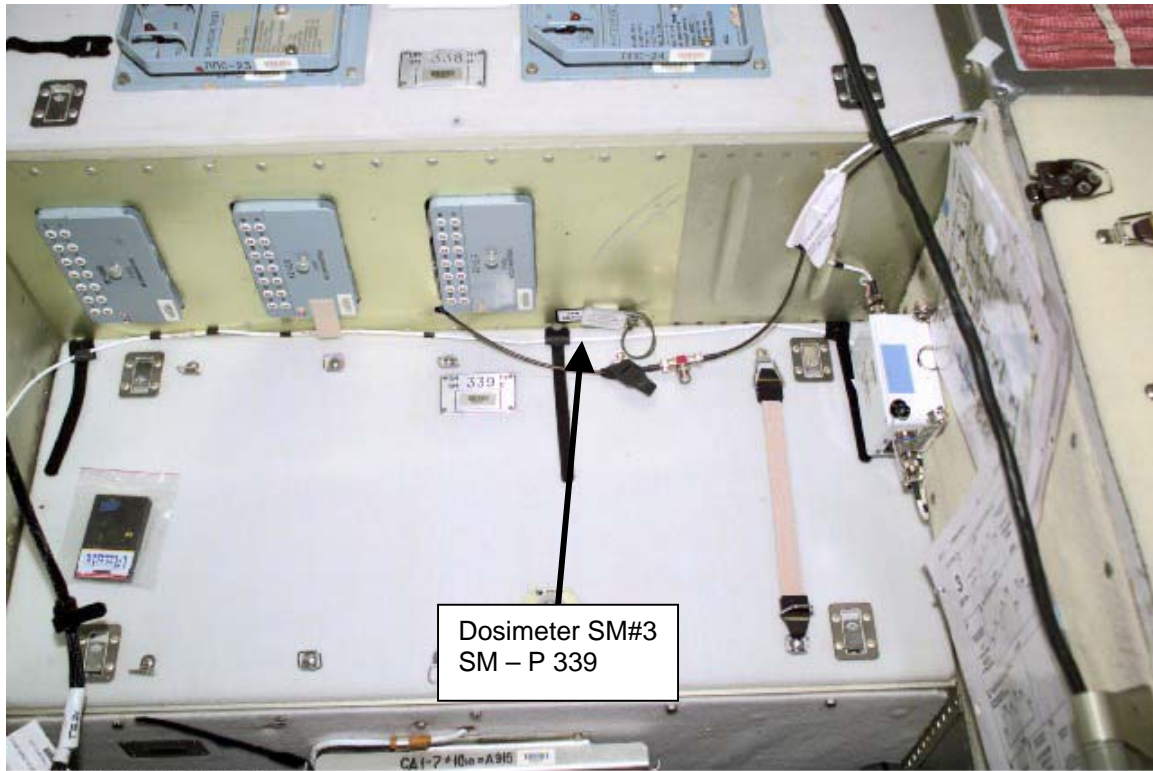

Figure 2.- Dosimeter SM#3 and SM#4.

3.119 RADIATION AREA MONITOR DOSIMETERS - INSTALLATION OF DOSIMETERS ON ISS

(JNT OPS/E11/FIN 7)

Page 5 of 11 pages

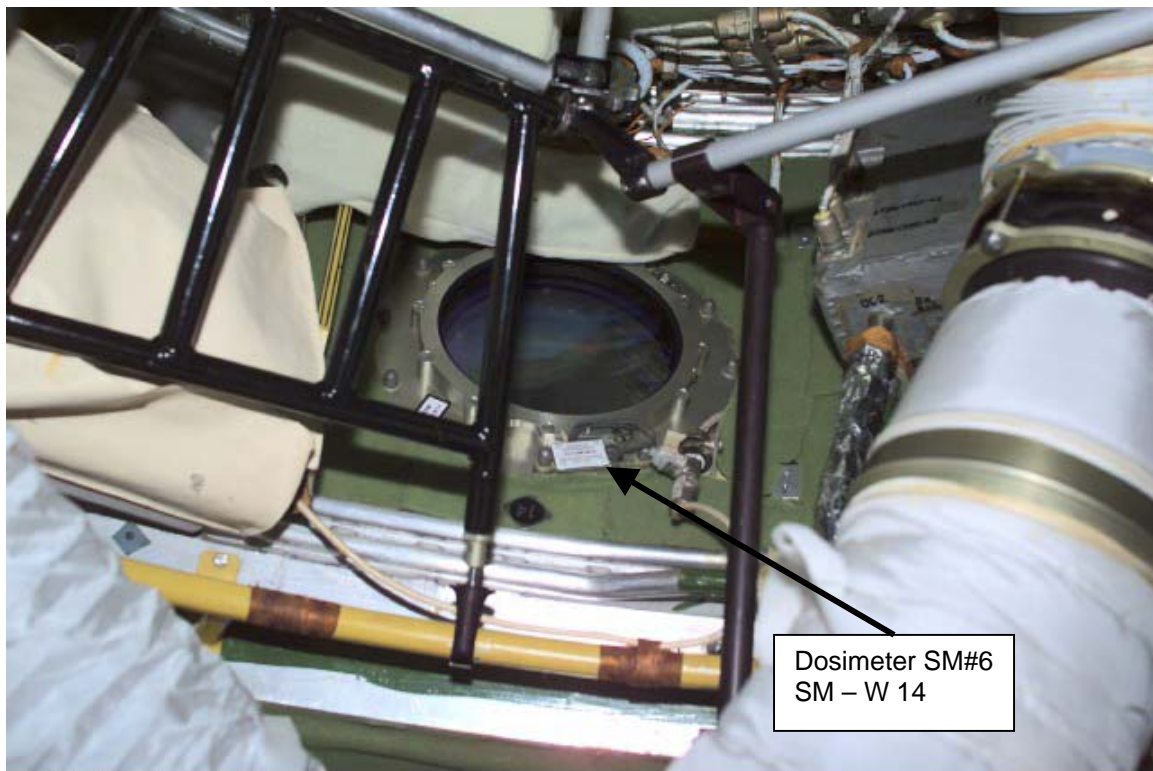

Figure 3.- Dosimeter SM#5 and SM#6.

3.119 RADIATION AREA MONITOR DOSIMETERS - INSTALLATION OF DOSIMETERS ON ISS

(JNT OPS/E11/FIN 7)

Page 6 of 11 pages

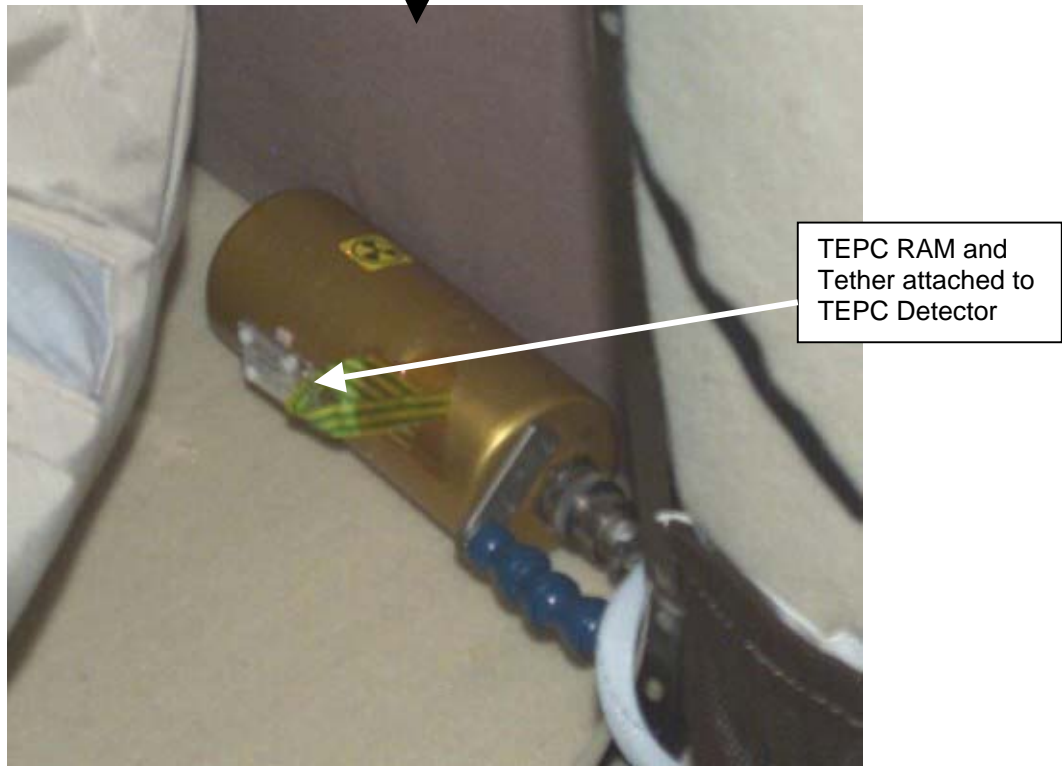

Figure 4.- TEPC Detector and RAM.

3.119 RADIATION AREA MONITOR DOSIMETERS - INSTALLATION OF DOSIMETERS ON ISS

(JNT OPS/E11/FIN 7)

Page 7 of 11 pages

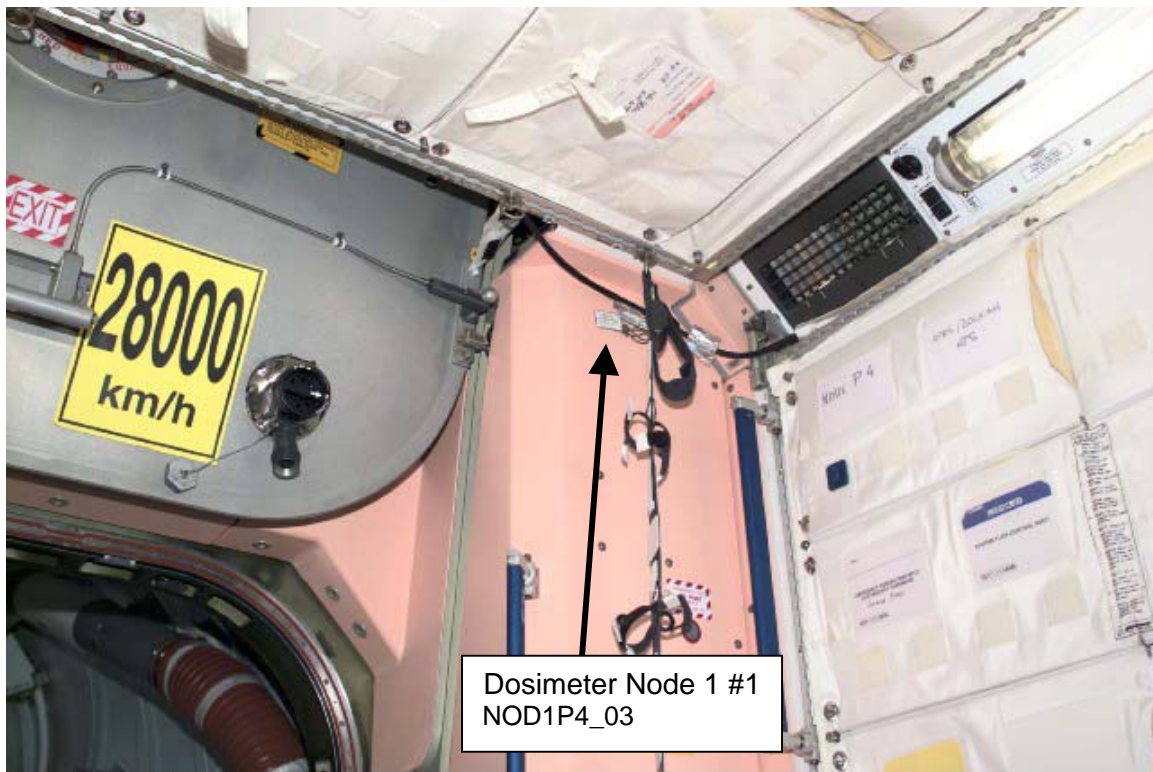

Figure 5.- Dosimeter Node 1 #1 and #2.

3.119 RADIATION AREA MONITOR DOSIMETERS - INSTALLATION OF DOSIMETERS ON ISS

(JNT OPS/E11/FIN 7)

Page 8 of 11 pages

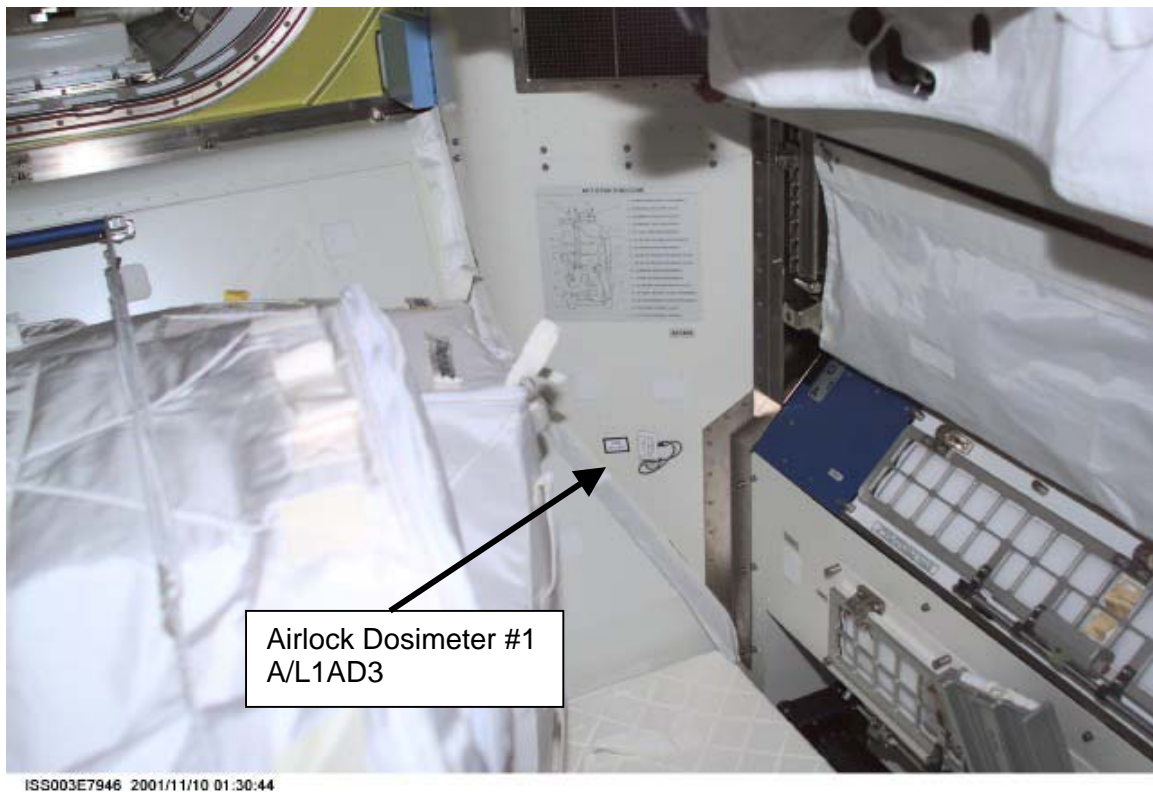
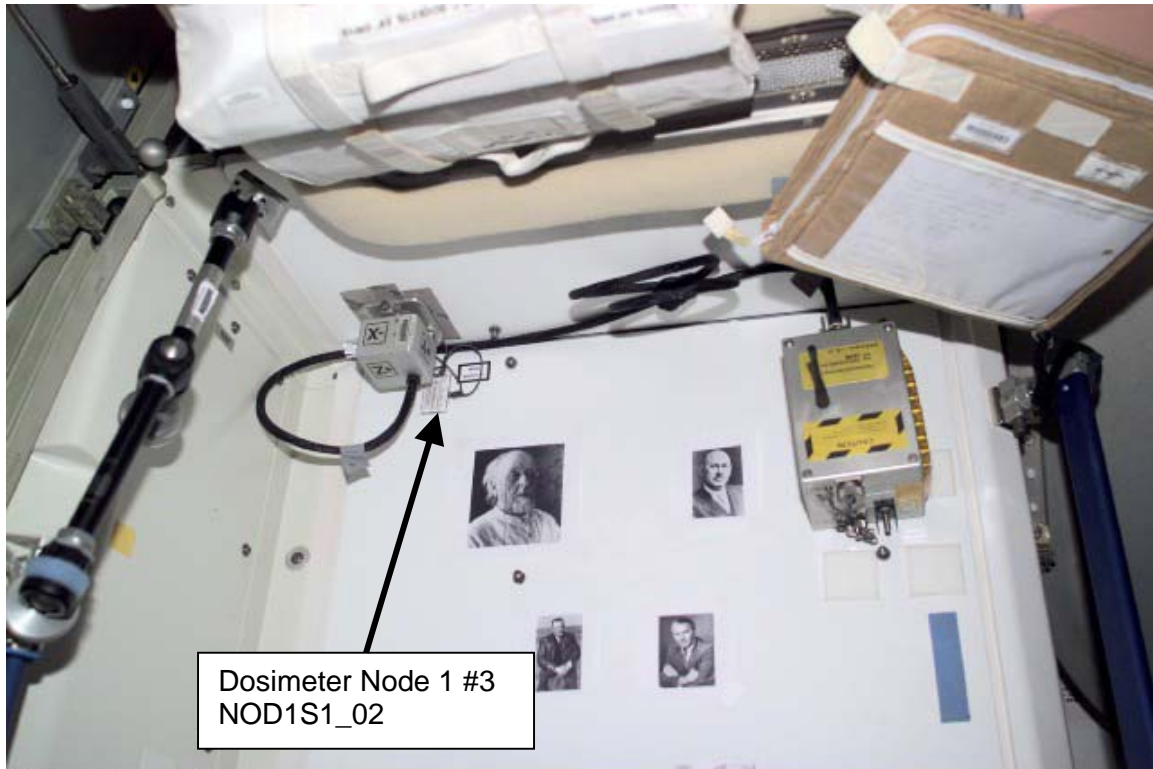

Figure 6.- Dosimeter Node 1 #3 and Airlock #1.

3.119 RADIATION AREA MONITOR DOSIMETERS - INSTALLATION OF DOSIMETERS ON ISS

(JNT OPS/E11/FIN 7)

Page 9 of 11 pages

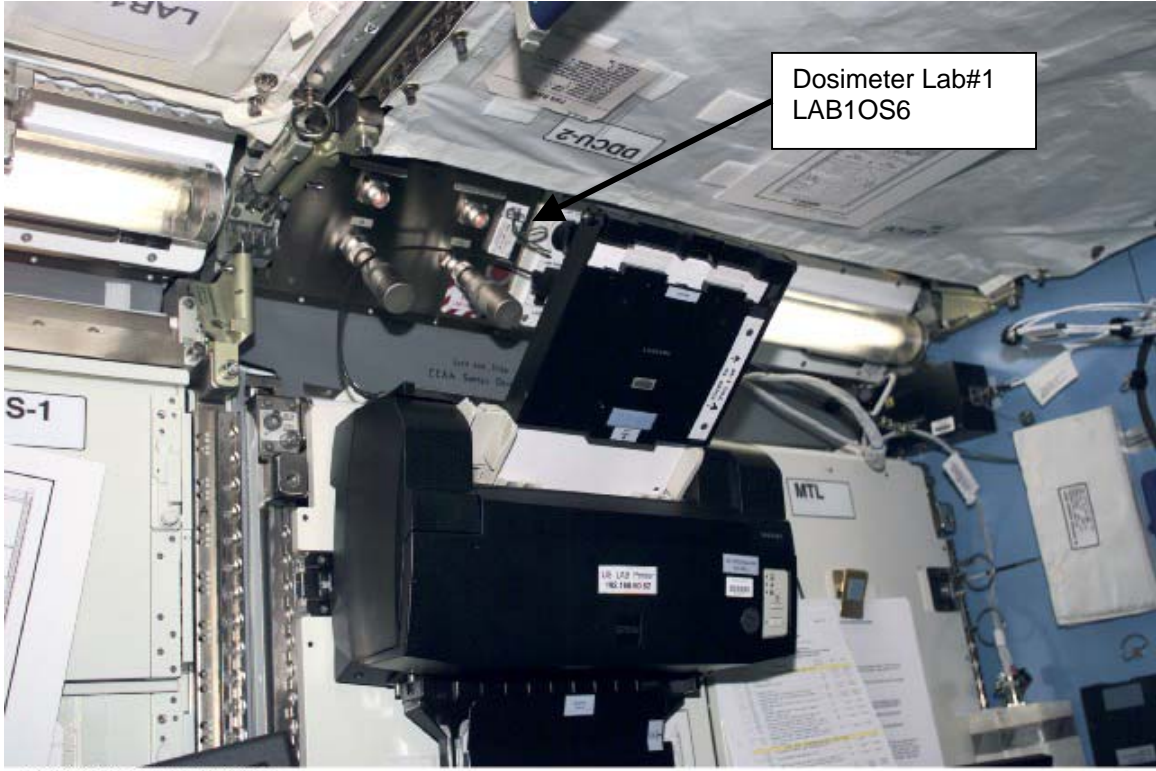
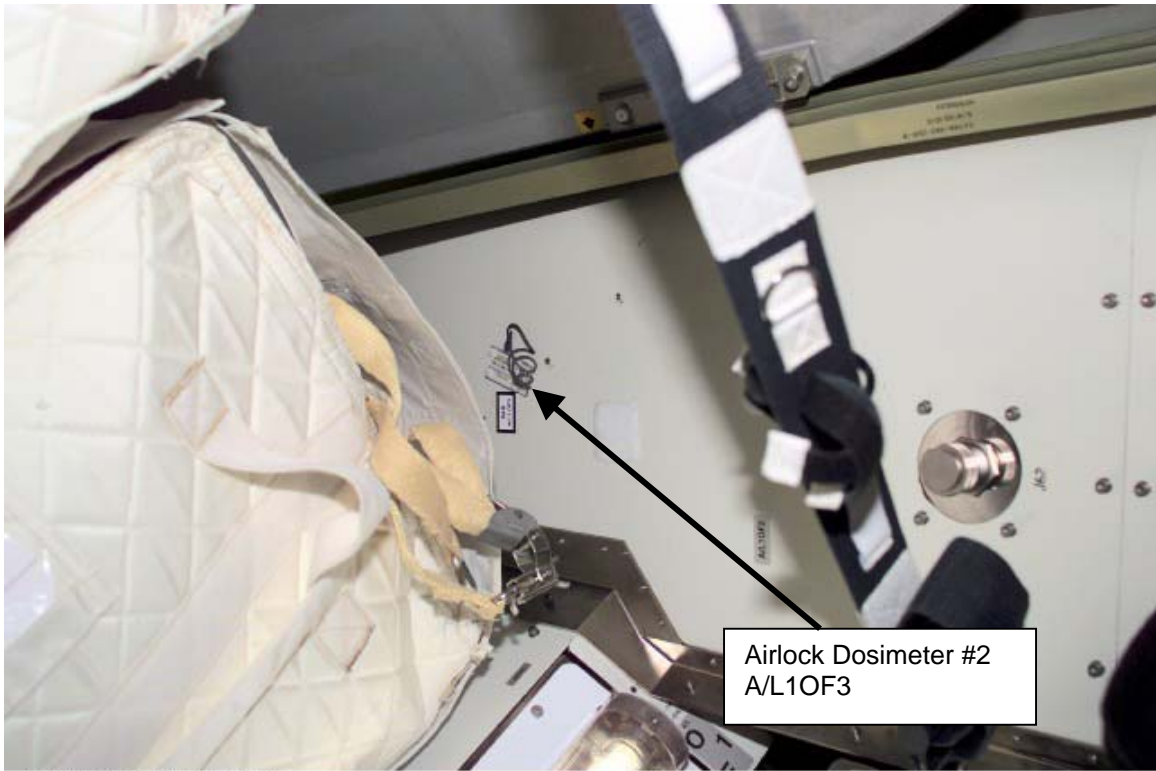

Figure 7.- Airlock Dosimeter and Lab#1.

3.119 RADIATION AREA MONITOR DOSIMETERS - INSTALLATION OF DOSIMETERS ON ISS

(JNT OPS/E11/FIN 7)

Page 10 of 11 pages

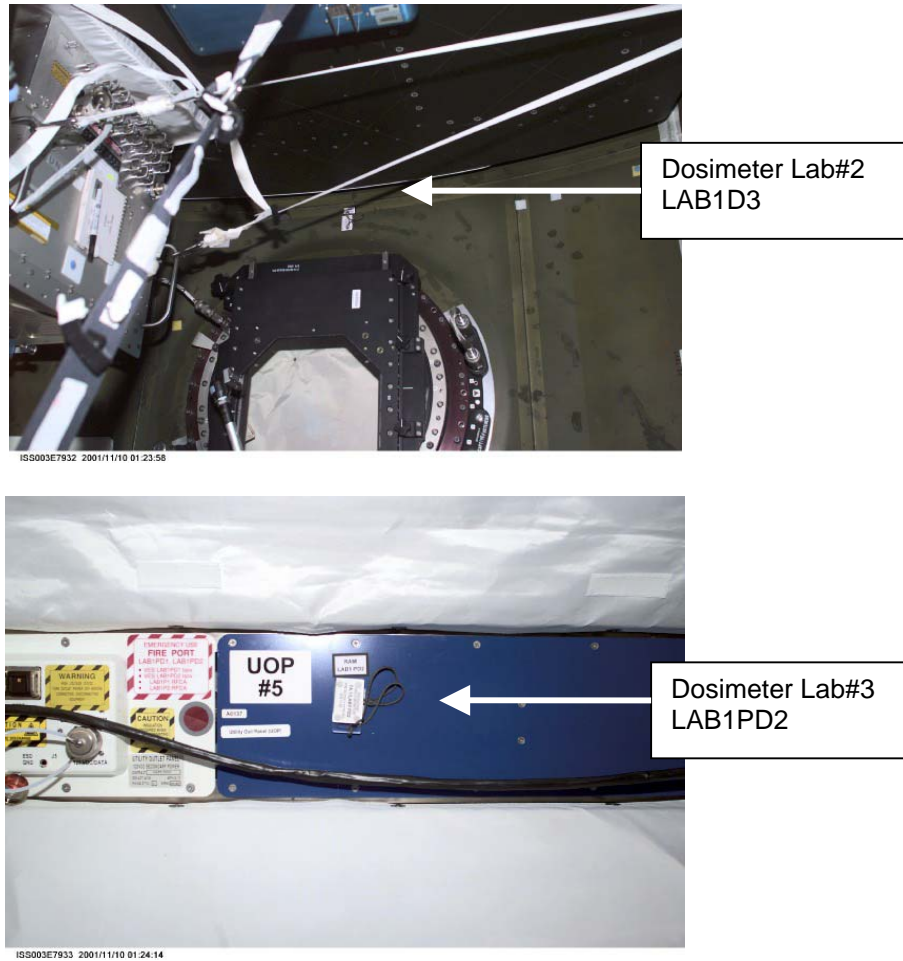

Figure 8.- Dosimeter Lab#2 and Lab#3.

3.119 RADIATION AREA MONITOR DOSIMETERS - INSTALLATION OF DOSIMETERS ON ISS

(JNT OPS/E11/FIN 7)

Page 11 of 11 pages

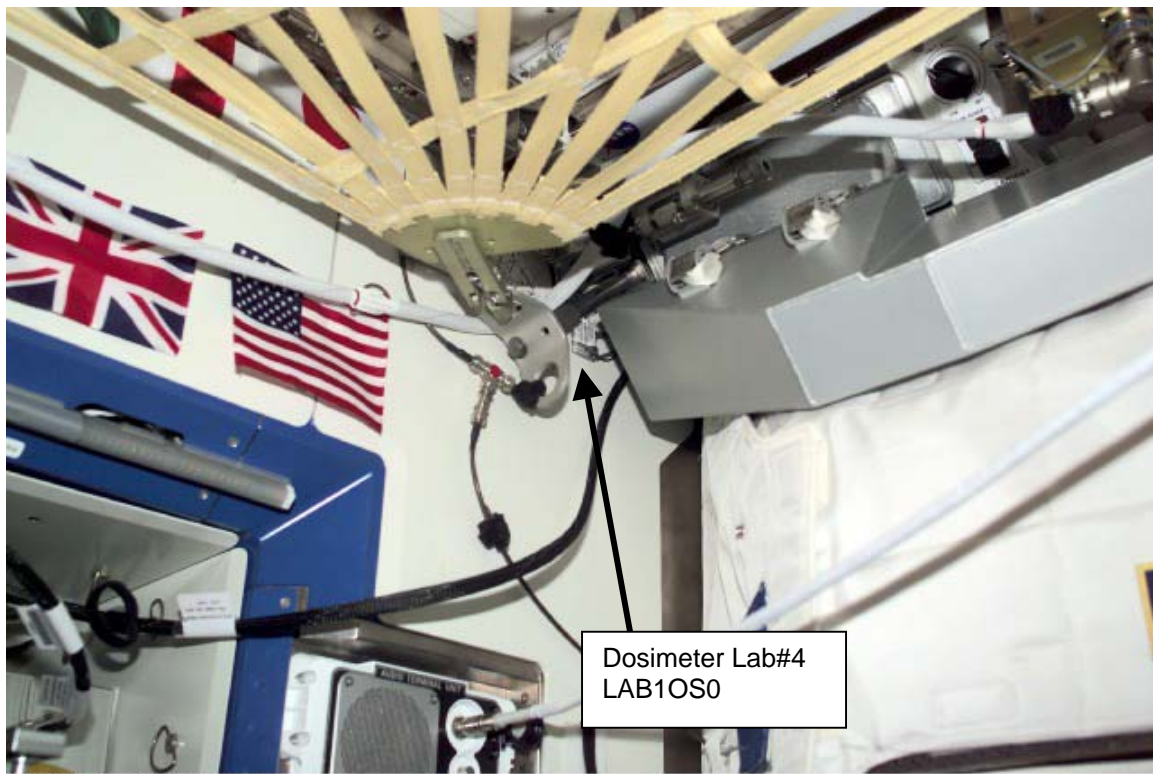

Figure 9.- Dosimeter Lab#4 and Lab#5.

This Page Intentionally Blank

3.120 PREBREATHE USING SHUTTLE O2 SETUP

(JNT OPS/X2R4 - ALL/FIN 4) Page 1 of 7 pages

OBJECTIVE:

Reconfigure equipment setup and oxygen system in preparation for performing EVA prebreathe using shuttle oxygen.

TOOLS AND EQUIPMENT REQUIRED:

(NOD1P4_D)

GO2 Transfer Flex Hose Assy P/N V857-643003-002

(A/L1O1)

Powder-Free Gloves

Teflon Bags P/N 300045-08

Clean Room Tape P/N 3M/1251

Flashlight

Ear Plugs

(NOD1D4_G2)

ISS IVA Toolbox

Drawer 2:

5/32" Hex Head, 1/4" Drive

Driver Handle, 1/4" Drive

Drawer 3:

Inspection Mirror

1. REMOVING CLOSEOUT PANELS

- A/L1OA2 1.1 Unfasten A/L1OA2 closeout panel fasteners (Driver Handle, 1/4" Drive; 5/32" Hex Head, 1/4" Drive).
Temporarily stow A/L1OA2 Closeout Panel.

NOTE

VL011 (O2 Xover Vlv) is behind panel A/L1A2; however, once A/L1OA2 is removed, VL011 can be reached from above.
Removal of panel A/L1A2 is at the crew's discretion.

- If required, remove panel A/L1A2.
- A/L1A1 1.2 Reconfigure/remove EDDA and handrails as necessary for access to the A/L1A2 panel.
- A/L1A2 1.3 Unfasten blue ESSS cover fasteners.
Cover is located ovhd aft of IV Hatch (Driver Handle, 1/4" Drive; 5/32" Hex Head, 1/4" Drive).
Temporarily stow ESSS cover panel.
- 1.4 Unfasten A/L1A2 closeout panel fasteners (Driver Handle, 1/4" Drive; 5/32" Hex Head, 1/4" Drive).
Temporarily stow A/L1A2 Closeout Panel.

3.120 PREBREATHE USING SHUTTLE O2 SETUP

(JNT OPS/X2R4 - ALL/FIN 4) Page 2 of 7 pages

2. CONFIGURING ISS O2 SYSTEM

- A/L10A2 2.1 VL009 (O2 Lo P) → CLOSED
- A/L1A2 2.2 √VL011 (O2 Xover Vlv) – CLOSED
- PCS 2.3 Airlock: ECLSS: Oxygen System
AL Oxygen System
'O2 Low Pressure Supply Valve'

√Actual Position – Open

3. REDUCING ISS O2 SYSTEM PRESSURE TO AMBIENT

NOTE

1. When possible, connection and disconnection of QDs requires adjoining lines to be at approximately ambient pressure on both sides of the QD.
2. As the Low Pressure O2 system pressure bleeds down and O2 is introduced into the cabin, the following messages may be received:
'O2 Lo P Supply Pressure Low - A/L'
'PCA O2 Line Pressure Low - A/L'
'PCA O2 Line Pressure Low - LAB'
3. The messages will return to normal as the O2 system is repressurized (step 6).

- PCS Airlock: ECLSS: Oxygen System
AL Oxygen System
'AL PCA O2 Intro Valve'

cmd Open (√Position – Open)

'Low Pressure'

When PCA O2 Line Press <160 kPa (23 psi) or **On MCC-H GO**, proceed.

'AL PCA O2 Intro Valve'

cmd Close (√Position – Closed)

4. CONFIGURING PMA/ODS O2 SYSTEM

- ODS Vest
GO2 Xfer
Panel 4.1 √FLOW – CLOSED

WARNING

Opening the ODS Vestibule Transfer Panel Vent may cause a loud hissing noise. Crew in the vicinity should don ear plugs.

- 4.2 Don ear plugs.

3.120 PREBREATHE USING SHUTTLE O2 SETUP

(JNT OPS/X2R4 - ALL/FIN 4) Page 3 of 7 pages

- 4.3 VENT → OPEN
- 4.4 Check GO2 Xfer Panel Pressure Gauge reading ~0 psi.
Doff ear plugs.

WARNING
Failure to maintain clean environment during oxygen system maintenance could result in fire hazard. If gloves become contaminated, replace immediately with clean gloves.
Minimize the amount of time open fluid connectors and caps/plugs are exposed to cabin air to prevent contamination of the oxygen system. Open connectors and caps/plugs can be covered by Teflon Bags or powder-free Gloves. Failure to comply could result in a fire hazard.
All fittings should be inspected for contaminants before mating. If debris is found, √ MCC-H .
Inspect GO2 Transfer Flex Hose Assy for any cracks or anomalies. If found, √ MCC-H .

- 4.5 Inspect GO2 Transfer Flex Hose Assy for any cracks or anomalies.
If found, √**MCC-H**.
- 4.6 Don powder-free Gloves.

<u>NOTE</u>
QDs must be closed to remove plugs and disconnect lines. As needed, refer to Figures 2 and 3 at the end of this procedure for information on the high-pressure quick disconnects.

- 4.7 Uncap GO2 Xfer Panel QD.
Close GO2 Transfer Flex Hose Assy bent-end QD.
Remove plug.
Inspect both QDs for debris.

Install hose so that it can be routed along the ODS Flange as shown in Figure 1.

GO2 Transfer Flex Hose Assy bent-end →|← GO2 Xfer Panel QD
Hard mate/open QD.
Cover caps and plugs.

3.120 PREBREATHE USING SHUTTLE O2 SETUP

(JNT OPS/X2R4 - ALL/FIN 4)

Page 4 of 7 pages



Figure 1.- ODS Vestibule Xfer Panel Hose Routing.

PMA

- 4.8 Uncap Oxygen Recharge QD.
Close GO2 Transfer Flex Hose Assy straight-end QD.
Remove plug.
Inspect both QDs for debris.

GO2 Transfer Flex Hose Assy straight-end →|← Oxygen Recharge QD
Hard mate/open QD.
Cover caps and plugs.

PMA/ODS

- 4.9 Secure GO2 Transfer Flex Hose Assy to PMA/ODS Extension Duct
and ODS Flange with Velcro straps.

ODS Vest
GO2 Xfer
Panel

- 4.10 VENT → CLOSED
- 4.11 Doff gloves.

5. CONFIGURING THE O2 RECHARGE LINE

- 5.1 Don new pair of powder-free Gloves.

A/L10A2

- 5.2 Close O2 Recharge Line QD.
O2 Recharge Line ←|→ SPARE QD
Cover SPARE QD temporarily (the cap from QD011 will be used as
a permanent cover in step 5.3).

- 5.3 Uncap QD011.
Inspect both QDs for debris.
O2 Recharge Line →|← QD011
Hard mate/open QD.
Use cap from QD011 to cover SPARE QD.

3.120 PREBREATHE USING SHUTTLE O2 SETUP

(JNT OPS/X2R4 - ALL/FIN 4) Page 5 of 7 pages

5.4 Doff Gloves.

6. VERIFYING O2 SYSTEM PRESSURE INTEGRITY

6.1 ✓ **MCC-H** to verify proper cryo configuration

ODS Vest
GO2 Xfer
Panel

6.2 FLOW → OPEN

Middeck
Floor

6.3 Verify EMU O2 ISOL VLV – OPEN

6.4 Wait 5 minutes.

PCS

6.5 Airlock: ECLSS: Oxygen System
AL Oxygen System
'Low Pressure'

Verify Supply Press > 5515 kPa (800 psia).
Verify PCA O2 Line Press: 689 to 930 kPa (100 to 135 psia).

AL ECLSS
'Equipment Lock'

Verify $dP/dt < 0.05$ mmHg/min.

C-Lk
A/L1A0

6.6 Unstow 60-ft PHA Bag #1.
Remove cap from Relief Valve, A/L PBA port.
Inspect for debris.
Relief Valve of 60-ft PHA Bag #1 →|← A/L PBA port

6.7 Don Mask.

PHA
mask

6.8 Mask O2 control → EMERGENCY

6.9 Momentarily pull Mask away from face.
✓ O2 flow

6.10 Mask O2 control → NORMAL

6.11 Doff Mask.

6.12 Relief Valve of 60-ft PHA Bag #1 ←|→ A/L PBA port
Depress Mask O2 control to bleed down line.
Install cap on Relief Valve, A/L PBA port.
Stow 60-ft PHA Bag #1 in C-Lk.

3.120 PREBREATHE USING SHUTTLE O2 SETUP

(JNT OPS/X2R4 - ALL/FIN 4) Page 6 of 7 pages

7. INSTALLING CLOSEOUT PANELS

If required

- | | |
|---------|--|
| A/L1A2 | <p>7.1 Install A/L1A2 Closeout Panel, snug fasteners
(Driver Handle 1/4" Drive; 5/32" Hex Head, 1/4" Drive).</p> <p>7.2 Install blue ESSS cover, snug fasteners.
Cover installs ovhd aft of IV Hatch (Driver Handle 1/4" Drive;
5/32" Hex Head, 1/4" Drive).</p> |
| A/L1OA2 | <p>7.3 Install A/L1OA2 Closeout Panel, snug fasteners
(Driver Handle 1/4" Drive; 5/32" Hex Head, 1/4" Drive).</p> <p>7.4 Stow tools and equipment.</p> <p>7.5 Notify MCC-H, "Prebreathe Using Shuttle O2 Setup complete."</p> |

3.120 PREBREATHE USING SHUTTLE O2 SETUP

(JNT OPS/X2R4 - ALL/FIN 4)

Page 7 of 7 pages

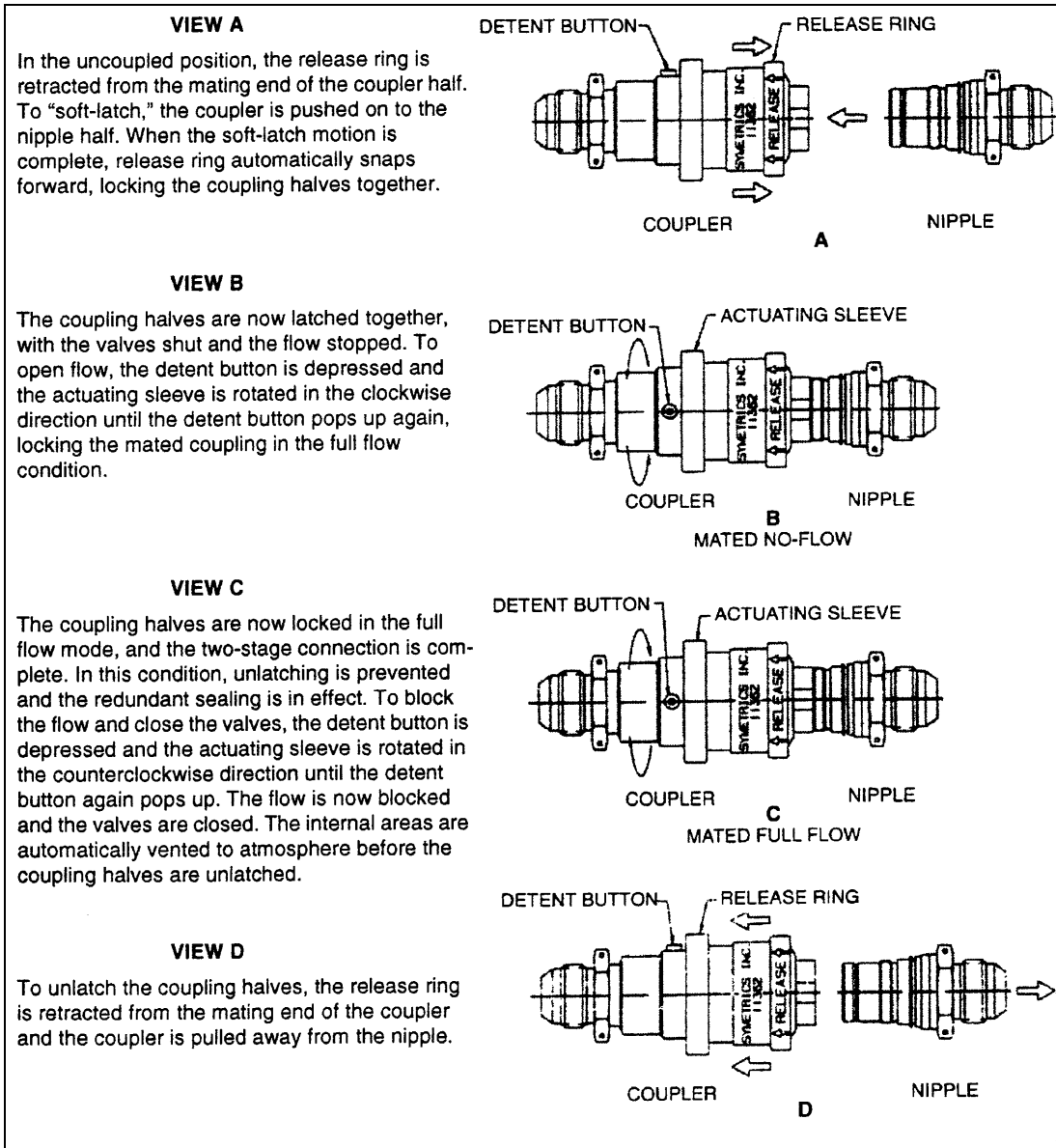

Figure 2.- Two-Stage High-Pressure QDs.

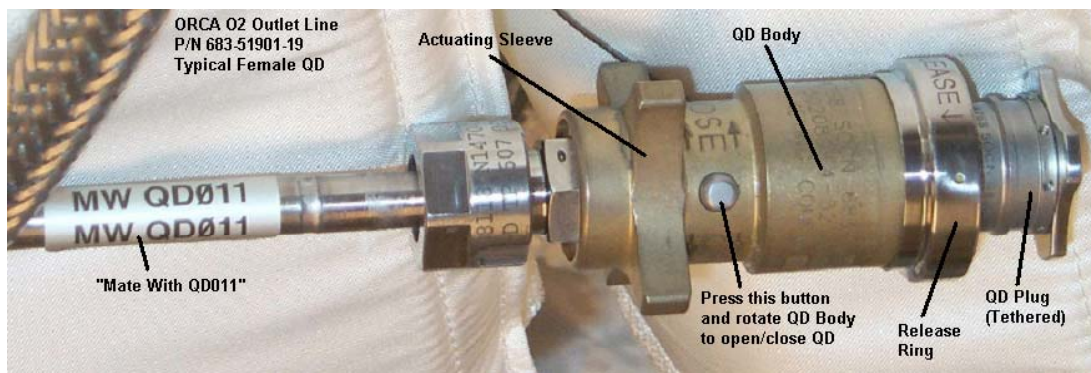

Figure 3.- High-Pressure QD.

This Page Intentionally Blank

3.121 PREBREATHE USING SHUTTLE O2 SETUP (POST O2 TRANSFER)

(JNT OPS/X2R4 - ALL/FIN 4)

Page 1 of 6 pages

OBJECTIVE:

Equipment setup and reconfigure oxygen system in preparation for performing EVA prebreathe using shuttle oxygen. The O2 Transfer Setup is the starting configuration.

TOOLS AND EQUIPMENT REQUIRED

(A/L1O1)

Powder-Free Gloves

Teflon Bags P/N 300045-08

Clean Room Tape P/N 3M/1251

Flashlight

Ear Plugs

(NOD1D4_G2)

ISS IVA Toolbox

Drawer 2:

5/32" Hex Head, 1/4" Drive

Driver Handle, 1/4" Drive

Drawer 3:

Inspection Mirror

1. RECONFIGURING ISS O2 SYSTEM

A/L1OA2 1.1 √VL009 (O2 Lo P) – CLOSED

A/L1A2 1.2 √VL011 (O2 Xover Vlv) – CLOSED

ORCA 1.3 Verify RPCM ON LED – ■

Status
Panel

1.4 sw PUMP CONTROL → STOP/RESET

1.5 Report Cycle Counter reading to **MCC-H**.

2. REDUCING ISS O2 SYSTEM PRESSURE TO AMBIENT

NOTE

1. When possible, connection and disconnection of QDs requires adjoining lines to be at approximately ambient pressure on both sides of the QD.
2. As the O2 system pressure bleeds down and O2 is introduced into the cabin, the following messages may be received:
'O2 Lo P Supply Pressure Low - A/L'
'PCA O2 Line Pressure Low - A/L'
'PCA O2 Line Pressure Low - LAB'
3. These messages will return to normal as the O2 system is repressurized (step 4).

3.121 PREBREATHE USING SHUTTLE O2 SETUP (POST O2 TRANSFER)

(JNT OPS/X2R4 - ALL/FIN 4)

Page 2 of 6 pages

ODS Vest
GO2 Xfer
Panel

2.1 FLOW → CLOSED

WARNING

Opening the ODS Vestibule Transfer Panel Vent may cause a loud hissing noise. Crew in the vicinity should don ear plugs.

2.2 Don ear plugs.

2.3 VENT → OPEN

2.4 Check GO2 Xfer Panel Pressure Gauge reading ~0 psi.
Doff ear plugs.

PCS

2.5 Airlock: ECLSS: Oxygen System
AL Oxygen System
'O2 Low Pressure Supply Valve'

√Actual Position – Open

'AL PCA O2 Intro Valve'

cmd Open (√Position – Open)

'Low Pressure'

When PCA O2 Line Press < 160 kPa (23 psi) or **On MCC-H GO**,
proceed.

'AL PCA O2 Intro Valve'

cmd Close (√Position – Closed)

ODS Vest
GO2 Xfer
Panel

2.6 VENT → CLOSED

3. RECONFIGURING ORCA

ORCA

3.1 Disengage spring-loaded locking pin, then:
Flexible Ventilation Duct (TO ORCA/OPEN CABIN) ↺ Unlocked
Flexible Ventilation Duct (TO ORCA/OPEN CABIN) ←|→ ORCA
Cap ORCA connection.

3.2 Place free-end of Flexible Ventilation Duct (TO ORCA/OPEN CABIN)
in Crewlock.

ORCA

3.3 ORCA Power Cable ←|→ MAIN POWER

3.4 Install cap on ORCA Power Cable and stow behind panel A/L10A2.

3.121 PREBREATHE USING SHUTTLE O2 SETUP (POST O2 TRANSFER)

(JNT OPS/X2R4 - ALL/FIN 4)

Page 3 of 6 pages

WARNING

1. Failure to maintain clean environment during oxygen system maintenance could result in fire hazard. If Gloves become contaminated, replace immediately with clean Gloves.
2. Minimize the amount of time open fluid connectors are exposed to cabin air to prevent contamination of the oxygen system. Open connectors and caps/plugs can be covered by Teflon Bags or Powder-Free Gloves. Failure to comply could result in a fire hazard.
3. All fittings should be inspected for contaminants before mating. If debris is found, $\sqrt{\text{MCC-H}}$.

3.5 Don Powder-Free Gloves.

NOTE

QDs must be closed to disconnect lines. As needed, refer to Figures 1 and 2 at the end of this procedure for information on the high-pressure quick disconnects.

ORCA

3.6 Close O2 Recharge Line QD.

O2 Recharge Line $\leftarrow| \rightarrow$ ORCA O2 IN

Inspect for debris.

Install cap on O2 IN.

Cover O2 Recharge Line QD temporarily.

NOTE

To ensure that all seals are engaged, female high pressure QDs should be reopened after the plugs are installed.

A/L10A2

3.7 Close ORCA O2 Outlet Line (MW QD011) QD

ORCA O2 Outlet Line (MW QD011) $\leftarrow| \rightarrow$ QD011

Inspect both QDs for debris.

Cover QD011 temporarily.

Install plug on ORCA O2 Outlet Line (MW QD011).

Open ORCA O2 Outlet Line QD.

3.8 Uncover QD011.

Uncover O2 Recharge Line QD.

Inspect for debris.

O2 Recharge Line $\rightarrow| \leftarrow$ QD011.

Hard mate/open QD.

3.121 PREBREATHE USING SHUTTLE O2 SETUP (POST O2 TRANSFER)

(JNT OPS/X2R4 - ALL/FIN 4)

Page 4 of 6 pages

- ORCA 3.9 Close ORCA O2 Outlet Line (MW ORCA OUT) QD
ORCA O2 Outlet Line (MW ORCA OUT) ←|→ O2 OUT

Inspect for debris.
Install cap on O2 OUT.
Install plug on ORCA O2 Outlet Line (MW ORCA OUT).
Open ORCA O2 Outlet Line QD.

- 3.10 Doff Gloves.

4. VERIFYING ISS O2 SYSTEM PRESSURE INTEGRITY

- 4.1 √**MCC-H** to verify proper cryo configuration

- ODS Vest
GO2 Xfer
Panel 4.2 FLOW → OPEN

- Middeck
Floor 4.3 Verify EMU O2 ISOL VLV – OPEN

- 4.4 Wait 5 minutes.

- PCS 4.5 Airlock: ECLSS: Oxygen System
AL Oxygen System
'Low Pressure'

Verify Supply Press > 5515 kPa (800 psia).
Verify PCA O2 Line Press: 689 to 930 kPa (100 to 135 psia).

AL ECLSS
'Equipment Lock'

Verify dP/dt < 0.05 mmHg/min.

- C-Lk
A/L1A0 4.6 Unstow 60-ft PHA Bag #1.
Remove cap from Relief Valve, A/L PBA port.
Inspect for debris.
Relief Valve of 60-ft PHA Bag #1 PHA →|← A/L PBA port

- 4.7 Don Mask.

- PHA
Mask 4.8 Mask O2 control → EMERGENCY

- 4.9 Momentarily pull Mask away from face.

√O2 flow

- 4.10 Mask O2 control → NORMAL

- 4.11 Doff Mask.

3.121 PREBREATHE USING SHUTTLE O2 SETUP (POST O2 TRANSFER)

(JNT OPS/X2R4 - ALL/FIN 4)

Page 5 of 6 pages

- 4.12 Relief Valve of 60-ft PHA Bag #1 ←|→ A/L PBA port
Depress Mask O2 control to bleed down line.
Install cap on Relief Valve, A/L PBA port.
Stow 60-ft PHA Bag #1 in C-Lk.

5. INSTALLING CLOSEOUT PANELS

If required

- | | |
|---------|--|
| A/L1A2 | <ol style="list-style-type: none">5.1 Install A/L1A2 Closeout Panel, snug fasteners (Driver Handle 1/4" Drive; 5/32" Hex Head, 1/4" Drive).5.2 Install blue ESSS cover, snug fasteners.
Cover installs ovhd aft of IV Hatch (Driver Handle 1/4" Drive; 5/32" Hex Head, 1/4" Drive). |
| A/L10A2 | <ol style="list-style-type: none">5.3 Install A/L10A2 Closeout Panel, snug fasteners (Driver Handle 1/4" Drive; 5/32" Hex Head, 1/4" Drive).5.4 Stow tools and equipment.
Stow ORCA O2 Outlet Line in NOD1P4_D.
Stow hose as straight as possible.5.5 Notify MCC-H, "Prebreathe Using Shuttle O2 Setup (Post O2 Transfer) complete. |

6. CONFIGURING AL CCAA FOR NOMINAL OPERATIONS

NOTE

MCC-H will nominally perform step 6 from the ground.

- | | |
|--------------|--|
| MCC-H | To lower the AL CCAA Fan speed to 3400 rpm and to set Cabin Temperature to 22° C in step 1.5, go to { 2.503 CCAA FAN SPEED CHANGE } (SODF: ECLSS: NOMINAL: THC). |
|--------------|--|

3.121 PREBREATHE USING SHUTTLE O2 SETUP (POST O2 TRANSFER)

(JNT OPS/X2R4 - ALL/FIN 4)

Page 6 of 6 pages

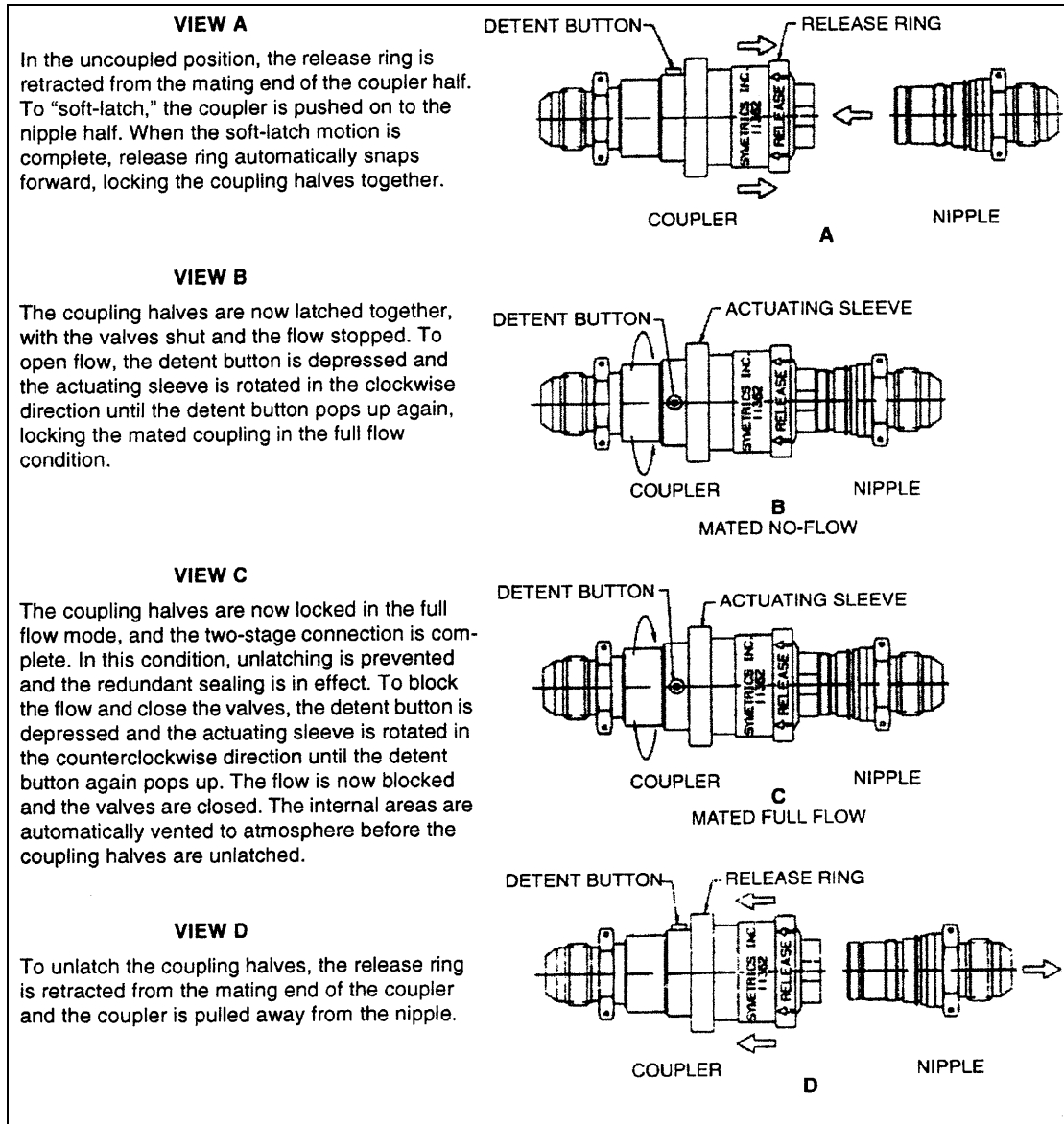

Figure 1.- Two-Stage High-Pressure QDs.

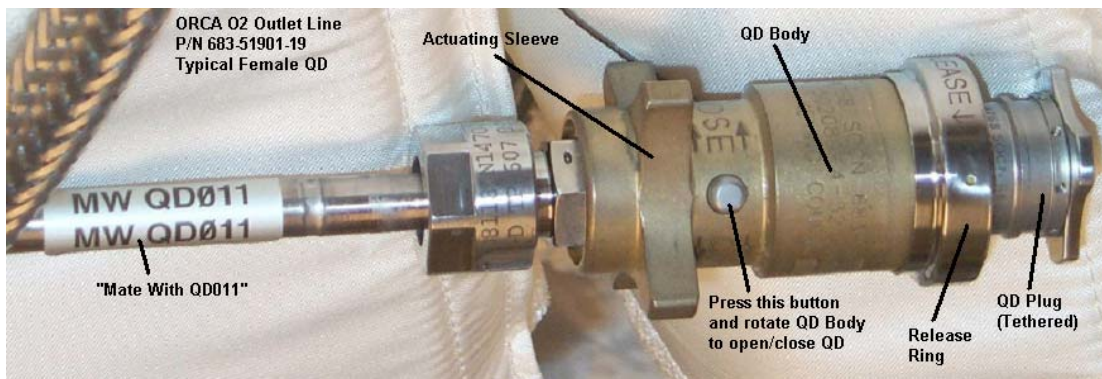

Figure 2.- High-Pressure QDs.

3.122 PREBREATHE USING SHUTTLE O2 TEARDOWN

(JNT OPS/X2R4 - ALL/FIN 4) Page 1 of 5 pages

OBJECTIVE:

Return the shuttle and ISS Airlock oxygen systems to their nominal configurations following EVA prebreathe using shuttle oxygen.

TOOLS AND EQUIPMENT REQUIRED

(A/L1O1)

Powder-Free Gloves

Teflon Bags P/N 300045-08

Clean Room Tape P/N 3M/1251

Flashlight

Ear Plugs

(NOD1D4_G2)

ISS IVA Toolbox

Drawer 2:

5/32" Hex Head, 1/4" Drive

Driver Handle 1/4" Drive

Drawer 3:

Inspection Mirror

1. REMOVING CLOSEOUT PANELS

- A/L1OA2 1.1 Unfasten A/L1OA2 closeout panel fasteners (Driver Handle, 1/4" Drive; 5/32" Hex Head, 1/4" Drive).
Temporarily stow A/L1OA2 Closeout Panel.

NOTE

VL011 (O2 Xover Vlv) is behind panel A/L1A2; however, once A/L1OA2 is removed, VL011 can be reached from above. Removal of panel A/L1A2 is at the crew's discretion

If required, remove panel A/L1A2.

- A/L1A1 1.2 Reconfigure/remove EDDA and handrails as necessary for access to the A/L1A2 panel.
- A/L1A2 1.3 Unfasten blue ESSS cover fasteners.
Cover is located ovhd aft of IV Hatch (Driver Handle, 1/4" Drive; 5/32" Hex Head, 1/4" Drive).
Temporarily stow ESSS cover panel.
- 1.4 Unfasten A/L1A2 closeout panel fasteners (Driver Handle, 1/4" Drive; 5/32" Hex Head, 1/4" Drive).
Temporarily stow A/L1A2 Closeout Panel.

2. VERIFYING ISS O2 SYSTEM CONFIGURATION

- A/L1OA2 2.1 √VL009 (O2 Lo P) – CLOSED
- A/L1A2 2.2 √VL011 (O2 Xover Vlv) – CLOSED

3.122 PREBREATHE USING SHUTTLE O2 TEARDOWN

(JNT OPS/X2R4 - ALL/FIN 4) Page 2 of 5 pages

PCS 2.3 Airlock: ECLSS: Oxygen System
AL Oxygen System
'O2 Low Pressure Supply Valve'

cmd Close (√Actual Position – Closed)

3. REDUCING ISS O2 SYSTEM PRESSURE TO AMBIENT

NOTE

1. When possible, connection and disconnection of QDs requires adjoining lines to be at approximately ambient pressure on both sides of the QD.
2. As the O2 system pressure bleeds down and O2 is introduced into the cabin, expect the following message:
'O2 Lo P Supply Pressure Low - A/L'
3. This message will return to normal as the O2 system is repressurized (step 5).

ODS Vest
GO2 Xfer
Panel

3.1 FLOW → CLOSED

WARNING

Opening the ODS Vestibule Transfer Panel Vent may cause a loud hissing noise. Crew in the vicinity should don earplugs.

3.2 Don ear plugs.

3.3 VENT → OPEN

3.4 √GO2 Xfer Panel Pressure Gauge reading ~0 psi
Doff ear plugs.

3.5 VENT → CLOSED

4. DISCONNECTING O2 RECHARGE LINE

WARNING

1. Failure to maintain clean environment during oxygen system maintenance could result in fire hazard. If Gloves become contaminated, replace immediately with clean Gloves.
2. Minimize the amount of time open fluid connectors are exposed to cabin air to prevent contamination of the oxygen system. Open connectors and caps/plugs can be covered by Teflon Bags or Powder-Free Gloves. Failure to comply could result in a fire hazard.
3. All fittings should be inspected for contaminants before mating. If debris is found, contact **MCC-H**.

3.122 PREBREATHE USING SHUTTLE O2 TEARDOWN

(JNT OPS/X2R4 - ALL/FIN 4) Page 3 of 5 pages

4.1 Don Powder-Free Gloves.

NOTE

QDs must be closed to disconnect lines. As needed, refer to Figure 1 at the end of this procedure for information on the high pressure quick disconnects.

A/L10A2 4.2 Close O2 Recharge Line QD.
O2 Recharge Line ←|→ QD011

4.3 Remove cap from SPARE QD.
Inspect both QDs for debris.
O2 Recharge Line →|← SPARE QD
Hard mate/open O2 Recharge Line QD.
Cover QD011 with cap from SPARE QD.

4.4 Doff Gloves.

5. VERIFYING ISS O2 SYSTEM PRESSURE INTEGRITY

A/L1A2 5.1 √VL011 (O2 Xover Vlv) – CLOSED

A/L10A2 5.2 VL009 (O2 Lo P) → OPEN

5.3 √VL010 (O2 Hi P) – OPEN

PCS 5.4 Airlock: ECLSS: Oxygen System
AL Oxygen System
'O2 Low Pressure Supply Valve'

cmd Open (√Actual Position – Open)

'Low Pressure'

Report Supply Press to **MCC-H**.

'High Pressure'

Report Supply Press to **MCC-H**.

AL ECLSS

'Equipment Lock'

Verify $dP/dt < 0.05$ mmHg/min.

3.122 PREBREATHE USING SHUTTLE O2 TEARDOWN

(JNT OPS/X2R4 - ALL/FIN 4) Page 4 of 5 pages

6. CONFIGURING PMA/ODS FOR NOMINAL OPERATIONS

6.1 Don new pair of Powder-Free Gloves.

PMA

6.2 Close GO2 Transfer Flex Hose Assy straight end QD.

GO2 Transfer Flex Hose Assy ←|→ Oxygen Recharge QD

Inspect both QDs for debris.

Install cap on Oxygen Recharge QD.

Install plug on GO2 Transfer Flex Hose Assy.

ODS Vest
GO2 Xfer
Panel

6.3 Close GO2 Transfer Flex Hose Assy bent-end QD.

GO2 Transfer Flex Hose Assy ←|→ GO2 Xfer Panel QD

Inspect both QDs for debris.

Install cap on GO2 Xfer Panel QD.

Install plug on GO2 Transfer Flex Hose Assy.

6.4 Doff Gloves.

PMA/ODS

6.5 Remove GO2 Transfer Flex Hose Assy from PMA/ODS Extension Duct and ODS Flange.

7. INSTALLING CLOSEOUT PANELS

If required

A/L1A2

7.1 Install A/L1A2 Closeout Panel, snug fasteners
(Driver Handle 1/4" Drive; 5/32" Hex Head, 1/4" Drive).

7.2 Install blue ESSS cover, snug fasteners.
Cover installs ovhd aft of IV Hatch (Driver Handle 1/4" Drive;
5/32" Hex Head, 1/4" Drive).

A/L10A2

7.3 Install A/L10A2 Closeout Panel, snug fasteners
(Driver Handle 1/4" Drive; 5/32" Hex Head, 1/4" Drive).

7.4 Stow tools and equipment.
Stow GO2 Transfer Flex Hose Assy in NOD1P4_D.
Stow hose as straight as possible.

7.5 Report to **MCC-H**, "Prebreathe using Shuttle O2 Teardown complete."

3.122 PREBREATHE USING SHUTTLE O2 TEARDOWN

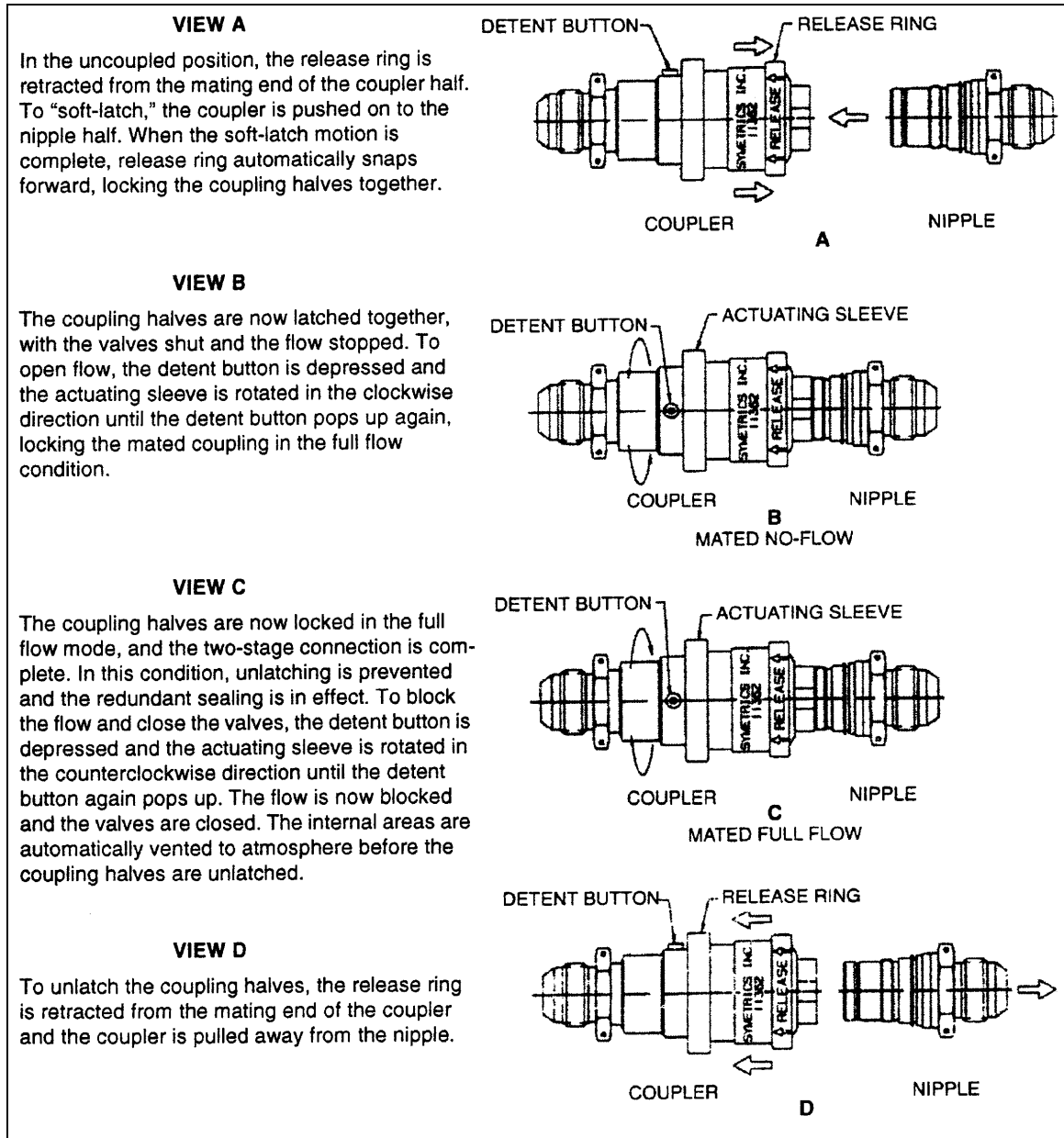

Figure 1.- Two-Stage High-Pressure QDs.

This Page Intentionally Blank

3.123 O2 TRANSFER SETUP (POST PREBREATHE USING SHUTTLE O2)

(JNT OPS/X2R4 - ALL/FIN 4)

Page 1 of 6 pages

OBJECTIVE:

Equipment setup and reconfigure oxygen system in preparation for performing oxygen transfer from the shuttle cryo oxygen system to the ISS Airlock oxygen tanks using the Oxygen Recharge Compressor Assembly (ORCA). The Prebreathe Using Shuttle O2 Setup is the starting configuration.

TOOLS AND EQUIPMENT REQUIRED

(NOD1P4_D)

ORCA O2 Outlet Line P/N 683-51901-19

(A/L1O1)

Powder-Free Gloves

Teflon Bags P/N 300045-08

Clean Room Tape P/N 3M/1251

Flashlight

Ear Plugs

(NOD1D_G2)

ISS IVA Toolbox

Drawer 2:

5/32" Hex Head, 1/4" Drive

Driver Handle 1/4" Drive

Drawer 3:

Inspection Mirror

1. REMOVING CLOSEOUT PANELS

- A/L1OA2 1.1 Unfasten A/L1OA2 closeout panel fasteners (Driver Handle, 1/4" Drive; 5/32" Hex Head, 1/4" Drive).
Temporarily stow A/L1OA2 Closeout Panel.

NOTE

To transfer O2 to the High P Tank, access to VL011 (O2 Xover Vlv) is required. VL011 is behind panel A/L1A2; however, once A/L1OA2 is removed, VL011 can be reached from above. Removal of panel A/L1A2 is at the crew's discretion.

If required, remove panel A/L1A2.

- A/L1A1 1.2 Reconfigure/remove EDDA and handrails as necessary for access to the A/L1A2 panel.
- A/L1A2 1.3 Unfasten blue ESSS cover fasteners.
Cover is located ovhd aft of IV Hatch (Driver Handle, 1/4" Drive; 5/32" Hex Head, 1/4" Drive).
Temporarily stow ESSS cover panel.
- 1.4 Unfasten A/L1A2 closeout panel fasteners (Driver Handle, 1/4" Drive; 5/32" Hex Head, 1/4" Drive).
Temporarily stow A/L1A2 Closeout Panel.

3.123 O2 TRANSFER SETUP (POST PREBREATHE USING SHUTTLE O2)

(JNT OPS/X2R4 - ALL/FIN 4)

Page 2 of 6 pages

2. VERIFYING ISS O2 SYSTEM CONFIGURATION

A/L10A2 2.1 √VL009 (O2 Lo P) – CLOSED

A/L1A2 2.2 √VL011 (O2 Xover Vlv) – CLOSED

PCS 2.3 Airlock: ECLSS: Oxygen System
AL Oxygen System
'O2 Low Pressure Supply Valve'

cmd Close (√Actual Position – Closed)

3. REDUCING ISS O2 SYSTEM PRESSURE TO AMBIENT

NOTE

1. When possible, connection and disconnection of QDs requires adjoining lines to be at approximately ambient pressure on both sides of the QD.
2. As the O2 system pressure bleeds down and O2 is introduced into the cabin, expect the following message:
'O2 Lo P Supply Pressure Low - A/L'
3. This message will return to normal as the O2 system is repressurized (step 5).

ODS Vest
GO2 Xfer
Panel 3.1 FLOW → CLOSED

WARNING

Opening the ODS Vestibule Transfer Panel Vent may cause a loud hissing noise. Crew in the vicinity should don ear plugs.

3.2 Don ear plugs.

3.3 VENT → OPEN

3.4 Check GO2 Xfer Panel Pressure Gauge reading ~0 psi.
Doff ear plugs

3.5 VENT → CLOSED

4. CONFIGURING ORCA FOR O2 TRANSFER

PCS 4.1 Airlock: ECLSS: ORCA
RPCM AL1A4A B RPC 18

√RPC Position – Op

√Close Cmd – Inh

3.123 O2 TRANSFER SETUP (POST PREBREATHE USING SHUTTLE O2)

(JNT OPS/X2R4 - ALL/FIN 4)

Page 3 of 6 pages

WARNING

1. Failure to maintain clean environment during oxygen system maintenance could result in fire hazard. If Gloves become contaminated, replace immediately with clean Gloves.
2. Minimize the amount of time open fluid connectors are exposed to cabin air to prevent contamination of the oxygen system. Open connectors and caps/plugs can be covered by Teflon Bags or Powder-Free Gloves. Failure to comply could result in a fire hazard.
3. All fittings should be inspected for contaminants before mating. If debris is found, $\sqrt{\text{MCC-H}}$.

4.2 Don Powder-Free Gloves.

NOTE

QDs must be closed to remove plugs and disconnect lines. As needed, refer to Figure 1 and 2 at the end of this procedure for information on the high pressure quick disconnects.

A/L10A2 4.3 Close O2 Recharge Line QD.

O2 Recharge Line $\leftarrow| \rightarrow$ QD011

Inspect for debris.
Cover QD011 temporarily.

ORCA 4.4 Uncap O2 IN. Inspect both QDs for debris.

O2 Recharge Line $\rightarrow| \leftarrow$ O2 IN

Hard mate/open QD.
Cover caps.

CAUTION

ORCA O2 Outlet Line QDs are keyed differently on each end. The hose has arrows near the QDs that indicate O2 flow direction. The flow direction through the hose is out of the ORCA and into QD011. Failure to install the hose correctly may result in damage to the QDs and hose.

ORCA 4.5 Uncap O2 OUT. Close ORCA O2 Outlet Line (MW ORCA OUT) QD. Remove plug. Inspect both QDs for debris.

ORCA O2 Outlet Line (MW ORCA OUT) $\rightarrow| \leftarrow$ O2 OUT

3.123 O2 TRANSFER SETUP (POST PREBREATHE USING SHUTTLE O2)

(JNT OPS/X2R4 - ALL/FIN 4)

Page 4 of 6 pages

Hard mate/open QD.
Cover caps and plugs.

- A/L10A2 4.6 Close ORCA O2 Outlet Line (MW QD011) QD.
Remove plug.
Uncover QD011.

Inspect both QDs for debris.
ORCA O2 Outlet Line (MW QD011) →|← QD011

Hard mate/open QD.
Cover caps and plugs.

- 4.7 Doff Gloves.

- A/L10A2 4.8 Unstow ORCA Power Cable and remove cap.

- ORCA 4.9 ORCA Power Cable →|← MAIN POWER

- A/L10A1 4.10 √Flexible Ventilation Duct (TO IMV AIR RETURN/CONDITIONED AIR SUPPLY) →|← Conditioned Air Supply connection

- ORCA 4.11 Disengage spring-loaded locking pin to remove the cap, then:
Flexible Ventilation Duct (TO ORCA/OPEN CABIN) →|← ORCA
Flexible Ventilation Duct (TO ORCA/OPEN CABIN) ↻ Locked

5. VERIFYING O2 TRANSFER SYSTEM PRESSURE INTEGRITY

- 5.1 √**MCC-H** to verify proper cryo configuration

- ODS Vest
GO2 Xfer
Panel 5.2 FLOW → OPEN

- Middeck
Floor 5.3 Verify EMU O2 ISOL VLV – OPEN

- 5.4 Wait 5 minutes.

- PCS 5.5 Airlock: ECLSS: Oxygen System
AL Oxygen System
'O2 Low Pressure Supply Valve'

cmd Open (√Actual Position – Open)

'Low Pressure'

Verify Supply Press > 4482 kPa (650 psi).

3.123 O2 TRANSFER SETUP (POST PREBREATHE USING SHUTTLE O2)

(JNT OPS/X2R4 - ALL/FIN 4)

Page 5 of 6 pages

AL ECLSS

'Equipment Lock'

Verify $dP/dt < 0.05$ mmHg/min.

5.6 Notify **MCC-H**, "O2 Transfer Setup(Post Prebreathe Using Shuttle O2) complete."

5.7 **MCC-H** to determine which oxygen tank to recharge

If transferring to the High Pressure Tank, go to {[3.116 HIGH PRESSURE TANK O2 TRANSFER](#)}, all (SODF: JNT OPS: MATED OPERATIONS).

If transferring to the Low Pressure Tank, go to {[3.117 LOW PRESSURE TANK O2 TRANSFER](#)}, all (SODF: JNT OPS: MATED OPERATIONS).

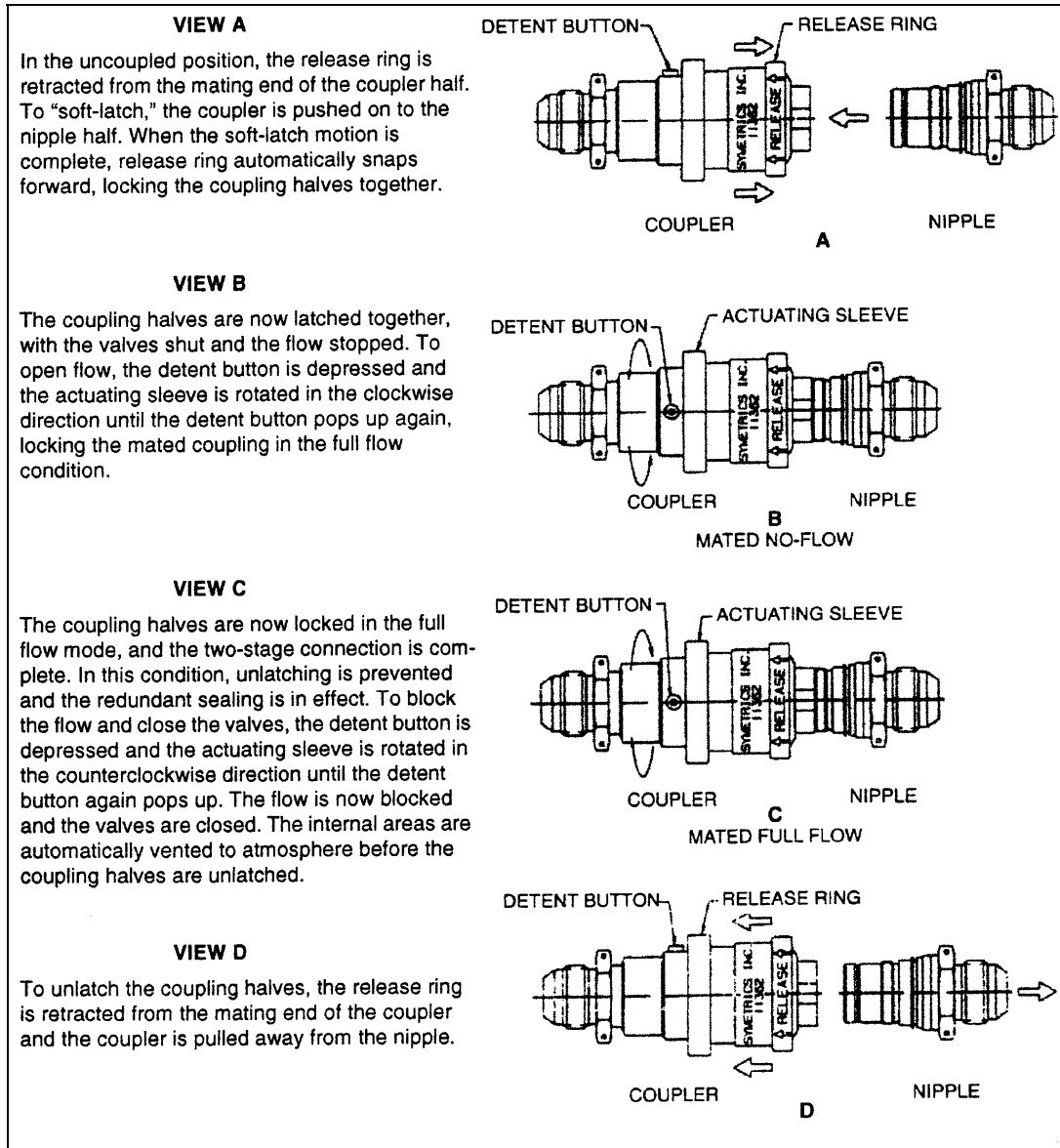

Figure 1.- Two-Stage High-Pressure QDs.

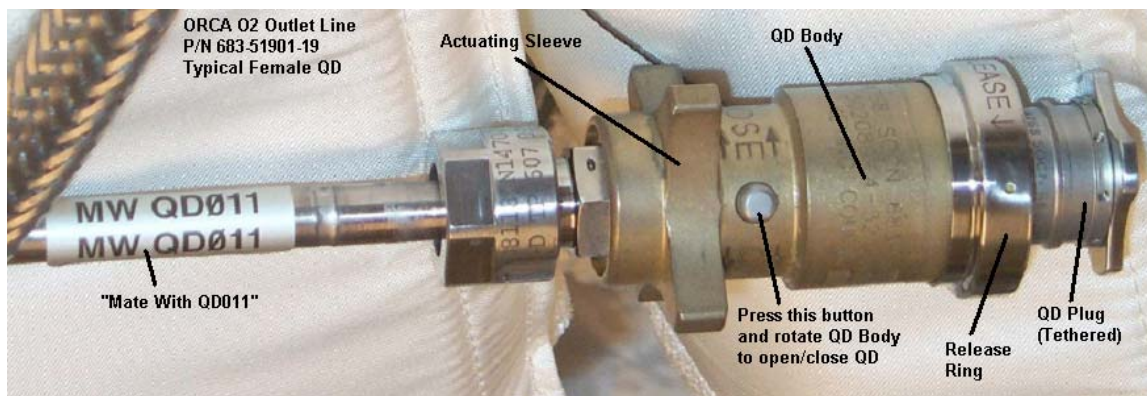

Figure 2.- High-Pressure QDs.

3.124 ACTIVE AND PASSIVE CBM INSPECTION CRITERIA

(JNT OPS/LF1/FIN 4)

Page 1 of 5 pages

OBJECTIVE:

Provides criteria and support data for use during inspection of a Passive Common Berthing Mechanism (PCBM). This includes elaborating on the criteria and providing examples of debris/damage that has been seen in the past.

NOTE

1. If using Camera(s) to perform inspection, use highest zoom possible.
2. If FOD found on MPLM PCBM, refer to Figure 4 for location description and corresponding ACBM bolt number.
3. Even with best available views some small percentage of CBM ring may be hidden behind an alignment guide (this lack of 100 % coverage is acceptable risk if no other view is available)

1. Verify Mating corridor clear of obstructions and in expected configuration. Refer to Figure 1.
2. Verify seals and surfaces clear of FOD (debris or damage). The PCBM must be clear of debris or damage/irregularities outside of conditions consistent with historical acceptance. Refer to Figures 2 and 3.
3. Verify the ability for CBM Seals to seal; refer to Figure 2. There must be a very high degree of confidence in the ability of at least one PCBM seal to completely seal against the ACBM interface.
4. If steps 1 to 3 cannot be definitively verified, delay mate for ground assessment.

If steps 1 to 3 are verified, ISS ↓ **MCC-H**, "PCBM Inspection complete."

3.124 ACTIVE AND PASSIVE CBM INSPECTION CRITERIA

(JNT OPS/LF1/FIN 4)

Page 2 of 5 pages

CBM Mating Corridor

The Mating Corridor is the area that the ACBM and PCBM move through when the two halves are mated. Note that the two halves may be misaligned up to 5 degrees or so in combined pitch/yaw and also have significant lateral or roll misalignments.

There should be no loose items near the sealing surface or the alignment features since these are contact surfaces. During a mating MLI should be restrained and back below the seals/sealing surfaces.

The image below provides a good indication of a "clean" PCBM in the nominal expected configuration for a mating event.

The entire 360° of PCBM ring should be inspected, however if viewing at an angle (as in photo below) small portions of the ring may be obstructed (by CBM Alignment guides, etc). This is considered acceptable.

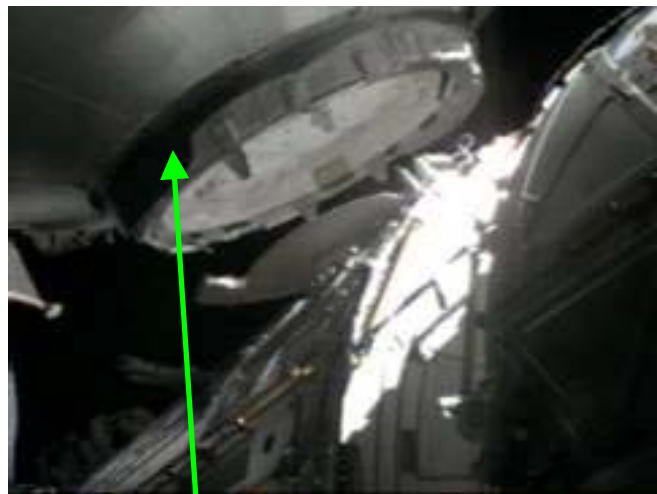

MPLM being moved in for mating with Node 1 (Flight 5A.1)

PMA3 being moved in for mating with Node 1 (Flight 3A)

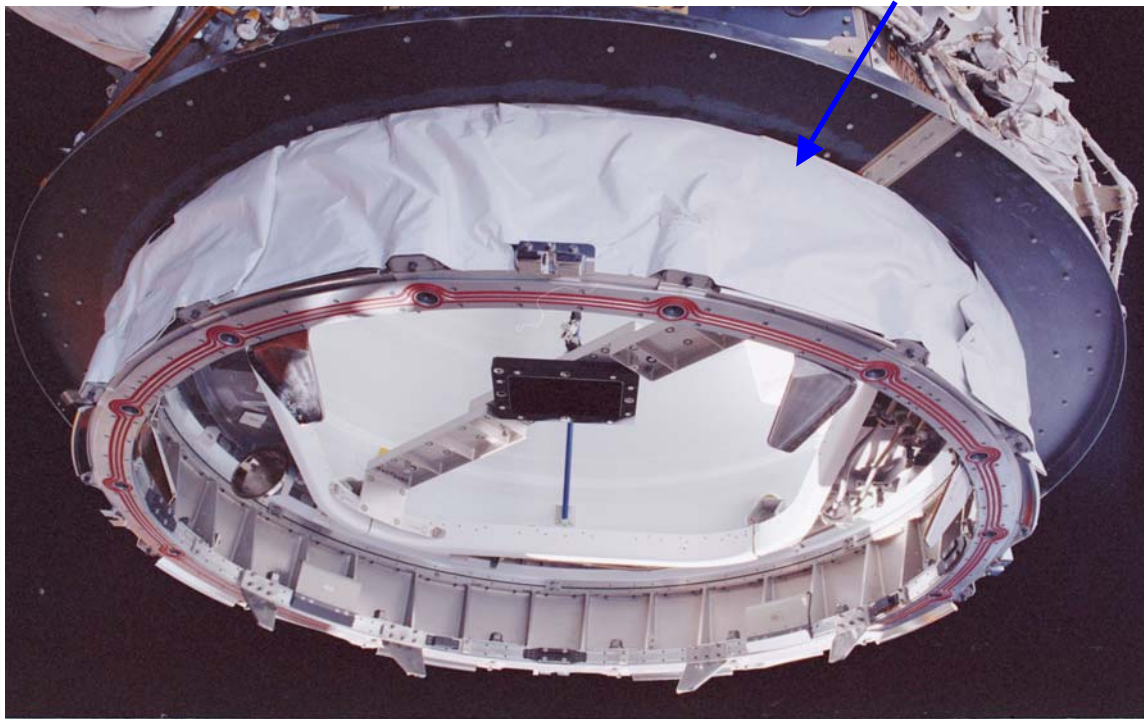

Figure 1.- CBM Mating Corridor Examples

3.124 ACTIVE AND PASSIVE CBM INSPECTION CRITERIA

(JNT OPS/LF1/FIN 4)

Page 3 of 5 pages

Seals and FOD

(Debris or Damage)

In general there should be no debris on the seals or seal interface and no damage (dings into metal, etc.).

Any FOD must be photo documented for ground assessment.

In some cases Flight rules may allow to press with mating if "soft" or stringy type FOD goes across one of the three seal beads (accept loss of pressure redundancy for one flight, especially if an MPLM and not permanent module).

Metallic or "hard" FOD can cause damage to the ACBM which will jeopardize not only this specific mating, but all future mates to that port.

Each seal has a thin coat of Braycote-601 lubricant which may look white when light is reflected on it. This lubricant is a nominal feature.

"Interlock Joint" between the four sections of the CBM Gasko-Seal

Gasko Seal Beads are shaped into a groove (not an O-Ring)

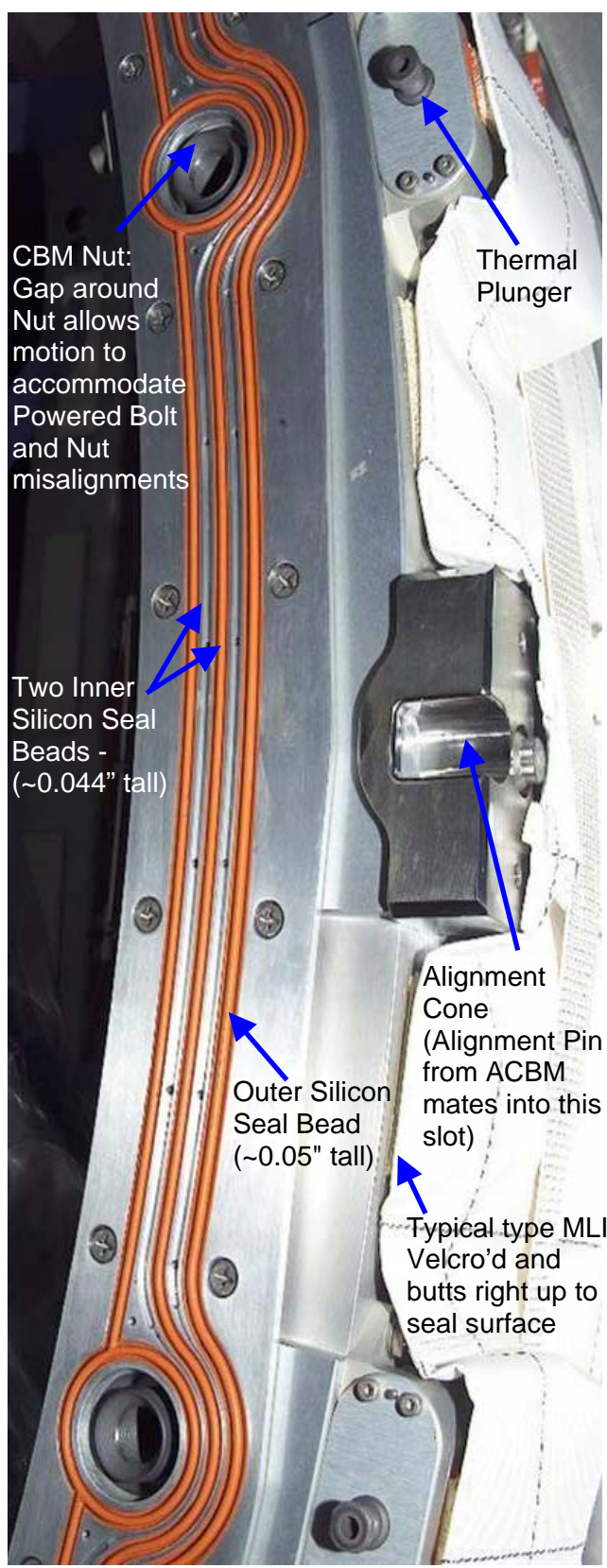
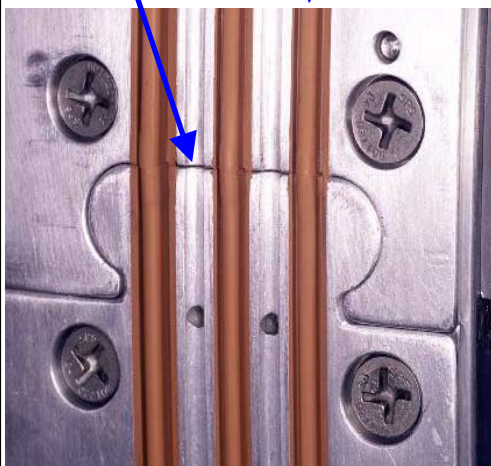

Figure 2.- PCBM Hardware, Seal and FOD Description

3.124 ACTIVE AND PASSIVE CBM INSPECTION CRITERIA

(JNT OPS/LF1/FIN 4)

Page 4 of 5 pages

History

Only one FOD event recorded for PCBM:

This case does not fall under the judgment of acceptable FOD per the procedure. No pre-mate inspection was performed.

FOD was compressed between the ACBM and PCBM during UF-2 and possibly previous mates. Ground inspection of MPLM after UF-2 revealed hard metallic FOD on seals and substrate. Material was confirmed to be Starblast (sandblasting residue from the Pad at KSC). While not clear when and how, it got onto the passive CBM prior to launch (some CBCS and other imagery support fact that FOD arrived with UF-2 MPLM, but cannot be determined conclusively).

Images below show the FOD and the resulting damage to metal substrate.

From image below on left, one can see FOD particles also on the side of the seal facing the CBM vestibule (vestibule on right side of this image). During the demate some small (< 5mmHg) pressure is still in the CBM vestibule and can blow FOD out across the seals and ring surface.

FOD during post UF-2 MPLM PCBM ground inspection [size ~.2" (5mm) across]



Image once FOD removed shows pitting on metal substrate.



Figure 3.- History of PCBM FOD

3.124 ACTIVE AND PASSIVE CBM INSPECTION CRITERIA

(JNT OPS/LF1/FIN 4)

Page 5 of 5 pages

NOTE

PCBM nut numbers shown in red (based on KSC nut numbering system). Blue numbers show the corresponding Active CBM Bolt Numbers. MPLM coordinate frame are for ground reference.

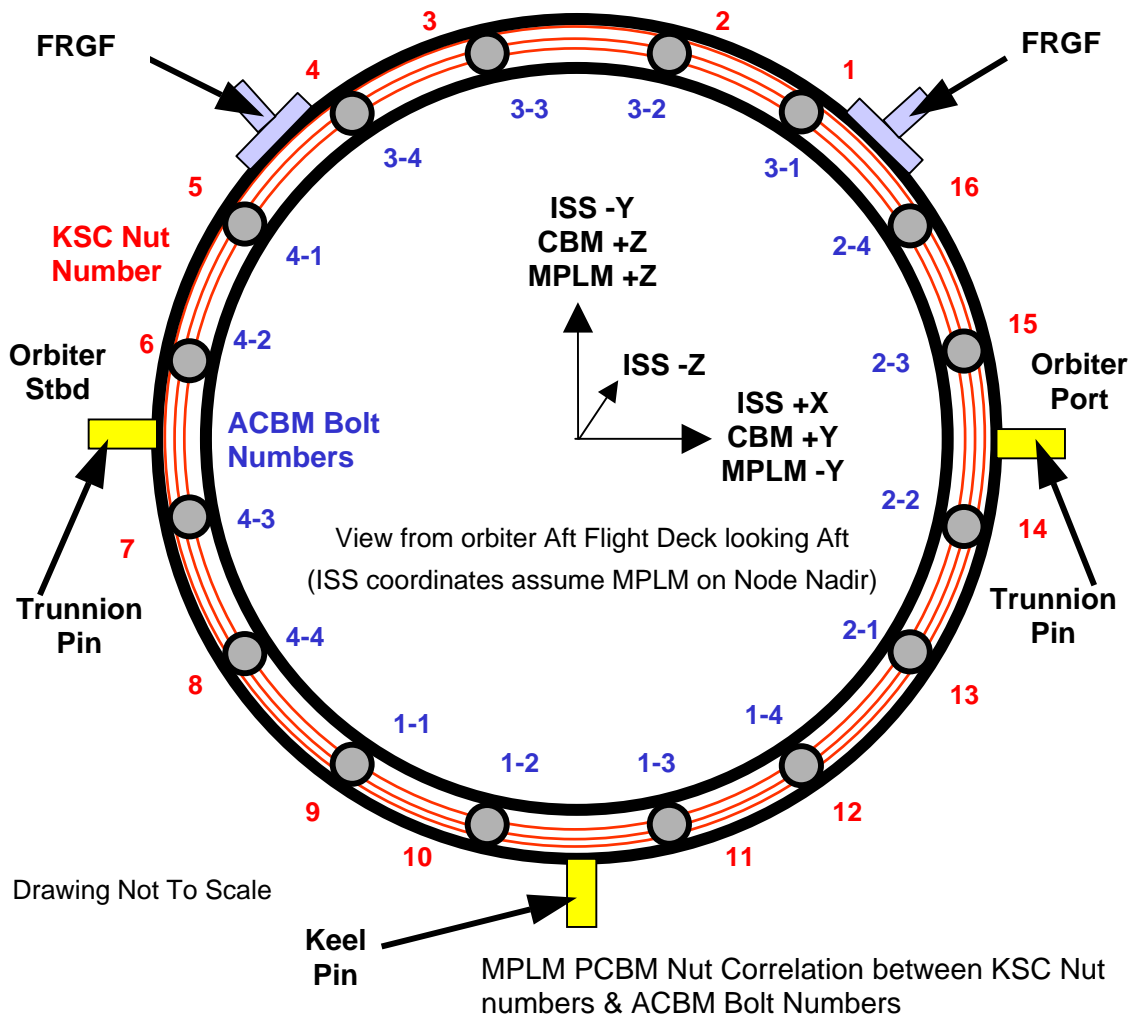

Figure 4.- MPLM Passive CBM as Viewed from the Shuttle Aft Flight Deck.

This Page Intentionally Blank

EGRESS STATION

EGRESS STATION

This Page Intentionally Blank

4.101 ISS INTERIM EGRESS

(JNT OPS/7A - ALL/FIN 4) Page 1 of 4 pages

I

SHUTTLE TOOLS AND EQUIPMENT REQUIRED

None

ISS TOOLS AND EQUIPMENT REQUIRED

Dry Wipes
Kapton Tape (P/N 7648A32)
Rubber Gloves

NOD1 10" Adjustable Wrench
D4_G2
PMA2 Docking Mechanism Accessory Kit
APAS Hatch Tool
Cleaning Pads
APAS Hatch Cover
Docking Target Standoff Cross Bag
Docking Target Base Plate Cover
1-1/2" Open End Wrench

TERMINATING IMV FLOW

PMA2 1. Open grille cover.
MO13Q 2. AIRLK FAN A(B) – OFF

3. DEACTIVATING LAB IMV FWD STBD FAN

PCS US Lab: ECLSS: IMV Fwd Stbd Fan
LAB IMV Fwd Stbd Fan

NOTE

Upon IMV Fan deactivation, rpm sensor registers 0 volts. MDM conversion translates 0 volts (0 counts) to 7164 ± 50 rpm. Reference 2A SPN 8437.

3.1 'Off'

cmd Arm (\sqrt Arm Status – Armed)

cmd Off (\sqrt State – Off)

3.2 sel RPCM LA2B B RPC 09

'RPC Position'

NOTE

A '?' may temporarily appear in the RPC data field. This is due to Shuttle ODS Booster Fan generating flow through the IMV duct and causing IMV fan rotation and back EMF.

cmd Open (\sqrt RPC Postion – Op)

4.101 ISS INTERIM EGRESS

(JNT OPS/7A - ALL/FIN 4) Page 2 of 4 pages

PCS

4. CLOSING LAB IMV FWD STBD VALVE
US Lab: ECLSS: IMV Fwd Stbd Vlv
LAB IMV Fwd Stbd Valve
'Close'

cmd Arm (√Arm Status – Armed)
cmd Close

√Position – In Transit

Wait 25 seconds, then:

√Position – Closed

5. DEACTIVATING LAB IMV FWD STBD VALVE
5.1 'Inhibit'

cmd Arm (√Arm Status – Armed)
cmd Inhibit (√State – Inhibited)

5.2 sel RPCM LA1B B RPC 16

'RPC Position'

cmd Open (√RPC Position – Op)

CONFIGURING IMV DUCTING

- Ext A/L 6. Disconnect PMA/ODS Interface Duct Segment from halo inlet flex duct.
- PMA2 7. Stow free-end of PMA/ODS Interface Duct Segment on PMA2 Handrail.
- Ext A/L 8. Connect external A/L halo inlet flex duct to halo cross duct with T-handle clamp.
- MO13Q 9. AIRLK FAN A(B) – ON
- √Airflow at halo

10. INSTALLING DOCKING TARGET

CAUTION

Donning of rubber gloves required in handling of Docking Target Standoff Cross and Docking Target Base Plate.

- 10.1 Release Hatch from PMA APAS Hatch Standoff.
- 10.2 Secure Hatch Standoff to PMA handrail.

4.101 ISS INTERIM EGRESS

(JNT OPS/7A - ALL/FIN 4) Page 3 of 4 pages

- 10.3 Remove APAS Hatch Cover.
Stow cover securely in PMA.
- 10.4 Remove Docking Target Base Plate Cover from Target Base Plate.
Stow cover in PMA2.
- 10.5 Remove Docking Target Standoff Cross from Standoff Cross Bag.
Stow Standoff Cross Bag in PMA2.

NOTE

Ensure key on Standoff Cross shaft is aligned with key-way on mating receptacle, and insert shaft until collar bottoms out on receptacle surface.

- 10.6 Insert Docking Target Standoff Cross into keyed receptacle on Docking Target Base Plate until shaft collar bottoms out.

NOTE

When all mating parts are correctly assembled, a groove on docking target Standoff Cross shaft should be visible above capnut (not recessed).

- 10.7 Ensure jamnut is positioned onto smaller, non-threaded diameter of Docking Target Base Plate receptacle.

Rotate capnut ↻ and tighten very firmly onto receptacle (10" Adjustable Wrench, 80-100 in-lbs design torque)

Thread jamnut onto receptacle, rotating ↻ until contact with capnut occurs.

While maintaining a ↻ torque on capnut, firmly tighten jamnut ↻ against capnut (1-1/2" Open End Wrench, 80-100 in-lbs design torque).

- 10.8 Stow 10" Adjustable Wrench in NOD1D4 G2.
Stow Docking Mechanism Accessory Kit in PMA.

CLOSING ODS HATCH

- ODS Hatch
11. Close ODS Hatch per decal.
 12. √EQUAL VLV (two) – OFF, capped

13. CLOSING APAS HATCH

- PMA2
- 13.1 Inspect Hatch Seals and seal surfaces for debris/damage.
Clean APAS Hatch Seals and surface with Cleaning Pads.
Close APAS Hatch.
- Select 'РАБОЧЕЕ ПОЛЖЕНИЕ' (Working Position) torque setting on Hatch Tool.

4.101 ISS INTERIM EGRESS

(JNT OPS/7A - ALL/FIN 4) Page 4 of 4 pages

Insert tool in hatch socket (ensure fully seated).
Rotate tool 3 to 4 turns in direction of '3ATP' (Close) arrow until tool clicks.

PMA2 13.2 APAS EQUAL VLV – CL

14. EGRESSING PMA

WARNING

PMA remains unventilated and should not be considered a habitable module. Restrict activity in PMA to stowage only.

Lab Fwd 14.1 Perform {1.1.521 U.S. HATCH SEAL INSEPECTION} (SODF: ISS IFM: COMMON: PREVENTIVE/S&M), then
Close Lab Fwd Hatch per decal.

14.2 Report to **MCC-H**, "ISS Interim Egress complete."

4.102 SHUTTLE/ISS DUCT REMOVAL AND HATCH CLOSING

(JNT OPS/7A - ALL/FIN 6)

Page 1 of 4 pages

SHUTTLE TOOLS AND EQUIPMENT REQUIRED

None

ISS TOOLS AND EQUIPMENT REQUIRED

Rubber Gloves

Hatch Enclosure Assembly P/N 683-60425

PMA2

Docking Mechanism Accessory Kit

APAS Hatch Tool

Cleaning Pads

APAS Hatch Cover

Docking Target Standoff Cross Bag

Docking Target Base Plate Cover

1-1/2" Open End Wrench

Braycote

Face O-Ring

Bore O-Ring

Kapton Tape P/N 7648A32

Dry Wipe

ISS IVA Toolbox

Drawer 1:

10" Long Adjustable Wrench

Drawer 2:

Ratchet, 1/4" Drive

7/16" Deep Socket, 1/4" Drive

(10-50 in-lbs) Trq Wrench, 1/4" Drive

TERMINATING IMV

MO13Q 1. AIRLK FAN A(B) – OFF

PCS

2. Deactivating Lab IMV Fwd Stbd Fan

LAB: ECLSS: IMV Fwd Stbd Fan

Lab IMV Fwd Stbd Fan

NOTE

Upon IMV Fan deactivation, rpm sensor register 0 volts. MDM conversion translates 0 volts (0 counts) to 7164 ± 50 rpm. Reference 2A SPN 8437.

2.1 'Off'

cmd Arm (√Status – Armed)

cmd Off (√State – Off)

√Speed, rpm: 7164 ± 50

2.2 sel RPCM LA2B B RPC 09

RPCM LA2B B RPC 09

4.102 SHUTTLE/ISS DUCT REMOVAL AND HATCH CLOSING

(JNT OPS/7A - ALL/FIN 6)

Page 2 of 4 pages

NOTE

A “?” may temporarily appear in the RPC data field. This is due to Shuttle ODS Booster Fan generating flow through the IMV duct and causing IMV fan rotation and back EMF.

cmd Open (√RPC Position – Op)

PCS

3. Closing Lab IMV Fwd Stbd Valve

LAB: ECLSS: IMV Fwd Stbd Vlv

Lab IMV Fwd Stbd Valve

3.1 ‘Close’

cmd Arm (√Status – Armed)

cmd Close

Wait 25 seconds, then:

√Position – Closed

3.2 ‘Inhibit’

cmd Arm (√Status – Armed)

cmd Inhibit (√State – Inhibited)

3.3 sel RPCM LA1B B RPC 16

RPCM LA1B B RPC 16

cmd Open (√RPC Position – Op)

WARNING

The PMA is unventilated at this time. Limit the amount of time spent in the PMA to the minimum required to complete the egress tasks.

REMOVING PMA/ODS DUCTING

Ext A/L 4. Disconnect PMA/ODS Interface Duct Segment from halo inlet flex duct.

PMA2 5. Stow free-end of PMA/ODS Interface Duct Segment on PMA2 handrail.

Ext A/L 6. Connect external A/L halo inlet flex duct to halo cross duct with T-handle clamp.

MO13Q 7. AIRLK FAN A(B) – ON

√Airflow at halo

4.102 SHUTTLE/ISS DUCT REMOVAL AND HATCH CLOSING

(JNT OPS/7A - ALL/FIN 6)

Page 3 of 4 pages

8. Install crosshair per numbered position

- ODS Vestibule
9. For each docking light
Remove locking pin.
Install docking light.
Install locking pin.
Remove outlet cap.
Connect cable.

10. INSTALLING DOCKING TARGET

CAUTION

When handling the Docking Target Standoff Cross or the Docking Target Base Plate, rubber gloves should be worn.

- PMA2
- 10.1 Release Hatch from PMA APAS Hatch Standoff.
Secure Hatch Standoff to PMA handrail.
Remove APAS Hatch Cover.
Stow cover securely in PMA.
 - 10.2 Remove Docking Target Base Plate Cover from Target Base Plate.
Stow cover in PMA2.
Remove Docking Target Standoff Cross from Standoff Cross Bag.
Stow Standoff Cross Bag in PMA2.

NOTE

Ensure key on Standoff Cross shaft is aligned with key-way on mating receptacle, and insert shaft until collar bottoms out on receptacle surface.

- 10.3 Insert Docking Target Standoff Cross into keyed receptacle on Docking Target Base Plate until shaft collar bottoms out.

NOTE

When all mating parts are correctly assembled, a groove on docking target Standoff Cross shaft should be visible above cap nut (not recessed).

- 10.4 Ensure jam nut is positioned onto smaller, non-threaded diameter of Docking Target Base Plate receptacle.

Rotate cap nut ↻ and tighten very firmly onto receptacle (10" Adjustable Wrench, 80-100 in-lbs design torque).

Thread jam nut onto receptacle, rotating ↻ until contact with cap nut occurs.

While maintaining a ↻ torque on cap nut, firmly tighten jam nut ↻ against cap nut (1-1/2" Open End Wrench, 80-100 in-lbs design torque).

- 10.5 Stow 10" Adjustable Wrench in NOD1 D4_G2.
Stow Docking Mechanism Accessory Kit in PMA.

4.102 SHUTTLE/ISS DUCT REMOVAL AND HATCH CLOSING

(JNT OPS/7A - ALL/FIN 6)

Page 4 of 4 pages

- ODS Hatch
11. [CLOSING ODS HATCH](#)
Close ODS Hatch per decal.
12. ✓EQUAL VLV (two) – OFF, capped
13. [PERFORM CO2 ABSORBER REPLACEMENT \(CUE CARD\)](#)
- PMA2
14. [CLOSING APAS HATCH](#)
- 14.1 Inspect Hatch Seals and seal surfaces for debris/damage.
Clean APAS Hatch Seals and surface with Cleaning Pads.
Close APAS Hatch.
- Select 'РАБОЧЧЕЕ ПОЛОЖЕНИЕ' (Working Position) torque setting on Hatch Tool.
Insert tool in hatch socket (ensure fully seated).
Rotate tool 3 to 4 turns in direction of '3ATP' (Close) arrow until tool clicks.
- PMA2
- 14.2 APAS EQUAL VLV → CL
15. [REMOVING PMA/LAB DUCTING](#)
- 15.1 PMA2 air duct jumper ←|→ Lab Fwd Stbd IMV flange, leaving V-band clamp on flange (Ratchet, 7/16" Deep Socket.)
- 15.2 IMV cap ←|→ PMA2 launch restraint, leaving V-band clamp on flange (Ratchet, 7/16" Deep Socket.)
- 15.3 PMA2 air duct jumper →|← PMA2 launch restraint. Secure with V-band clamp (Ratchet, 7/16" Deep Socket.)
Secure rest of flex duct to Closeout with Velcro Straps (two places).
- 15.4 Remove face and bore O-Rings on IMV Cap. Clean cap (Dry Wipe)
Don rubber gloves.
Lubricate new O-Rings with Braycote.
Install O-Rings on IMV Cap.
- 15.5 IMV cap →|← Lab Fwd Stbd IMV flange, torque V-Band clamp to 35 in-lb (Ratchet, 7/16" Deep Socket, (10-50 in-lbs) Trq Wrench).
- 15.6 Doff rubber gloves.
16. [CLOSING LAB FWD HATCH](#)
- 16.1 ✓All loose equipment removed from PMA2
- Lab Fwd
- 16.2 Perform {[1.1.521 U.S. HATCH SEAL INSPECTION](#)}, all (SODF: ISS IFM: COMMON: PREVENTIVE/S&M), then:
Close LAB Fwd Hatch per decal.
- ✓MPEV – CLOSED, capped
- 16.3 Report to **MCC-H**, "LAB Forward Hatch closed."
- 16.4 Install Hatch Enclosure Assembly (Velcro at 10 places)

4.103 ODS VESTIBULE/PMA DEPRESSURIZATION AND HATCH LEAK CHECK

I

(JNT OPS/7A - ALL/FIN 4) Page 1 of 1 page

1. √ ODS Hatch closed
2. √ ODS Hatch Equal vlv (two) – OFF, caps installed
- A6L 3. √ cb ESS 1BC(2CA) SYS PWR CNTL SYS 1(2): cl
4. √ SYS PWR MNA(MNB): ctr (tb-ON)
5. cb ESS 1BC(2CA) DEP SYS 1(2) VENT ISOL → cl
6. cb MNA(B) DEP SYS 1(2) VENT → cl
7. Check with ISS crew to verify that PMA2 APAS Hatch and Equalization Valve are closed before proceeding.
8. √ **MCC-H** for a go to depress

VEST DEP VLV SYS 1(SYS 2) VENT ISOL → OP (tb-OP)
VENT → OP (tb-OP)

If depressurizing the Vest only
Wait 5 minutes.

If depressurizing the Vest and PMA
Wait 15 minutes.

* If orbiter dP/dT or O2(N2) Flow Hi alarm during
* | depress
* | VEST DEP VLV SYS 1(SYS 2)
* | VENT, VENT ISOL (two) → CL (tb-CL)

9. VEST DEP VLV SYS 1(SYS 2) VENT → CL (tb-CL)

NOTE

Following a 10-minute thermal stabilization period, **MCC-H** will perform a 20-minute ODS Hatch and PMA APAS Hatch leak check (for Vest only depress), or a 30-minute ODS Hatch and Lab Fwd Hatch leak check (if depressurizing the Vest and PMA).

10. **On MCC-H GO**
VEST DEP VLV SYS 1(SYS 2) VENT → OP (tb-OP)

This Page Intentionally Blank

4.104 DUCT REMOVAL AND HATCH CLOSE (BYPASS CONFIG)

(JNT OPS/LF1 - ALL/FIN/SPN) Page 1 of 4 pages

OBJECTIVE:

This procedure is required to configure the orbiter and ISS for the booster fan bypass. This will allow deactivation of the booster fan to save cryo O2.

SHUTTLE TOOLS AND EQUIPMENT REQUIRED

None

ISS TOOLS AND EQUIPMENT REQUIRED

Rubber Gloves

Hatch Enclosure Assembly P/N 683-60425

PMA2

Docking Mechanism Accessory Kit

APAS Hatch Tool

Cleaning Pads

APAS Hatch Cover

Docking Target Standoff Cross Bag

Docking Target Base Plate Cover

1-1/2" Open End Wrench

Braycote

Face O-Ring

Bore O-Ring

Kapton Tape P/N 7648A32

Dry Wipe

ISS IVA Toolbox

Drawer 1:

10" Long Adjustable Wrench

Drawer 2:

Ratchet, 1/4" Drive

7/16" Deep Socket, 1/4" Drive

(10-50 in-lbs) Trq Wrench, 1/4" Drive

1. TERMINATING IMV

1.1 Deactivating Lab IMV Fwd Stbd Fan

PCS

US Lab: ECLSS: IMV Fwd Stbd Fan

Lab IMV Fwd Stbd Fan

NOTE

Upon IMV Fan deactivation, rpm sensor register 0 volts. MDM conversion translates 0 volts (0 counts) to 7164 \pm 50 rpm. Reference 2A SPN 8437.

1.1.1 'Off'

cmd Arm (\surd Status – Armed)

cmd Off (\surd State – Off)

\surd Speed, rpm: 7164 \pm 50

4.104 DUCT REMOVAL AND HATCH CLOSE (BYPASS CONFIG)

(JNT OPS/LF1 - ALL/FIN/SPN) Page 2 of 4 pages

1.1.2 sel RPCM LA2B B RPC 09

RPCM LA2B B RPC 09

NOTE

A “?” may temporarily appear in the RPC data field. This is due to Shuttle ODS Booster Fan generating flow through the IMV duct and causing IMV fan rotation and back EMF.

cmd Open (√RPC Position – Op)

PCS

2. CLOSING LAB IMV FWD STBD VALVE

US Lab: ECLSS: IMV Fwd Stbd Vlv

Lab IMV Fwd Stbd Valve

2.1 ‘Close’

cmd Arm (√Status – Armed)

cmd Close

Wait 25 seconds.

√Position – Closed

2.2 ‘Inhibit’

cmd Arm (√Status – Armed)

cmd Inhibit (√State – Inhibited)

2.3 sel RPCM LA1B B RPC 16

RPCM LA1B B RPC 16

cmd Open (√RPC Position – Op)

WARNING

The PMA is unventilated at this time. Limit the amount of time spent in the PMA to the minimum required to complete the egress tasks.

3. REMOVING PMA/ODS DUCTING

Ext A/L

3.1 Disconnect PMA/ODS Interface Duct Segment from halo inlet flex duct.

PMA2

3.2 Stow free-end of PMA/ODS Interface Duct Segment on PMA2 handrail.

Ext A/L

3.3 Connect external A/L halo inlet flex duct to halo inlet with T-handle clamp.

√Airflow at halo

4.104 DUCT REMOVAL AND HATCH CLOSE (BYPASS CONFIG)

(JNT OPS/LF1 - ALL/FIN/SPN) Page 3 of 4 pages

3.4 Install crosshair per numbered position.

ODS
Vestibule

- 3.5 For each docking light
- Remove locking pin.
 - Install docking light.
 - Install locking pin.
 - Remove outlet cap.
 - Connect cable.

4. INSTALLING DOCKING TARGET

CAUTION

When handling the Docking Target Standoff Cross or the Docking Target Base Plate, rubber gloves should be worn.

PMA2

- 4.1 Release Hatch from PMA APAS Hatch Standoff.
Secure Hatch Standoff to PMA handrail.
Remove APAS Hatch Cover.
Stow cover securely in PMA.
- 4.2 Remove Docking Target Base Plate Cover from Target Base Plate.
Stow cover in PMA2.
Remove Docking Target Standoff Cross from Standoff Cross Bag.
Stow Standoff Cross Bag in PMA2.

NOTE

Ensure key on Standoff Cross shaft is aligned with key-way on mating receptacle, and insert shaft until collar bottoms out on receptacle surface.

- 4.3 Insert Docking Target Standoff Cross into keyed receptacle on Docking Target Base Plate until shaft collar bottoms out.



NOTE

When all mating parts are correctly assembled, a groove on docking target Standoff Cross shaft should be visible above cap nut (not recessed).

- 4.4 Ensure jam nut is positioned onto smaller, non-threaded diameter of Docking Target Base Plate receptacle.

Rotate cap nut  and tighten very firmly onto receptacle (10" Adjustable Wrench, 80-100 in-lbs design torque).

Thread jam nut onto receptacle, rotating  until contact with cap nut occurs.

While maintaining a  torque on cap nut, firmly tighten jam nut  against cap nut (1-1/2" Open End Wrench, 80-100 in-lbs design torque).

- 4.5 Stow 10" Adjustable Wrench in NOD1 D4_G2.
Stow Docking Mechanism Accessory Kit in PMA.

4.104 DUCT REMOVAL AND HATCH CLOSE (BYPASS CONFIG)

(JNT OPS/LF1 - ALL/FIN/SPN) Page 4 of 4 pages

ODS Hatch	<p>5. <u>CLOSING ODS HATCH</u> Close ODS Hatch per decal.</p> <p>6. √EQUAL VLV (two) – OFF, capped</p> <p>7. <u>PERFORM CO2 ABSORBER REPLACEMENT (CUE CARD)</u></p>
PMA2	<p>8. <u>CLOSING APAS HATCH</u> 8.1 Inspect Hatch Seals and seal surfaces for debris/damage. Clean APAS Hatch Seals and surface with Cleaning Pads. Close APAS Hatch.</p> <p>Select 'РАБОЧЧЕЕ ПОЛОЖЕНИЕ' (Working Position) torque setting on Hatch Tool. Insert tool in hatch socket (ensure fully seated). Rotate tool three to four turns in direction of 'ЗАКР' (Close) arrow until tool clicks.</p>
PMA2	<p>8.2 APAS EQUAL VLV → CL</p> <p>9. <u>REMOVING PMA/LAB DUCTING</u> 9.1 PMA2 air duct jumper ← → Lab Fwd Stbd IMV flange, leaving V-Band clamp on flange (Ratchet, 7/16" Deep Socket.)</p> <p>9.2 IMV cap ← → PMA2 launch restraint, leaving V-Band clamp on flange (Ratchet, 7/16" Deep Socket.)</p> <p>9.3 Remove face and bore O-Rings on IMV Cap. Clean cap (Dry Wipe). Don rubber gloves. Lubricate new O-Rings with Braycote. Install O-Rings on IMV Cap.</p> <p>9.4 IMV cap → ← Lab Fwd Stbd IMV flange, torque V-Band clamp to 35 in-lbs [Ratchet, 7/16" Deep Socket, (10-50 in-lbs) Trq Wrench].</p> <p>9.5 PMA2 air duct jumper → ← PMA2 launch restraint. Secure with V-Band clamp (Ratchet, 7/16" Deep Socket.) Secure rest of flex duct to Closeout with Velcro Straps (two places).</p> <p>9.6 Doff rubber gloves.</p> <p>10. <u>CLOSING LAB FWD HATCH</u> 10.1 Check all loose equipment removed from PMA2.</p>
Lab Fwd	<p>10.2 Perform {1.1.521 U.S. HATCH SEAL INSPECTION}, all (SODF: ISS IFM: COMMON: PREVENTIVE/S&M), then: Close LAB Fwd Hatch per decal.</p> <p>√MPEV – CLOSED, capped</p> <p>10.3 Report to MCC-H, "LAB Forward Hatch closed."</p> <p>10.4 Install Hatch Enclosure Assembly (Velcro at 10 places).</p>

DEPARTURE

This Page Intentionally Blank

5.101 PMA2 PRE-DEPARTURE CONFIGURATION

(JNT OPS/LF1 - ALL/FIN 5/MULTI) Page 1 of 4 pages

I

OBJECTIVE:

Configure CCS Departure software and load controllers and PPLs for unmated configuration.

1. GNC COMMAND RESPONSE COUNTERS RESET

PCS

MCG: GNC Command Response Counters

GNC Command Response Counters

sel Reset

Verify the Since Reset column values are all blank.

Do not close this window until the procedure is complete.

If while executing a command, the Command Accept counter on that display does not increment
 Reselect GNC Command Response Counters to determine if a command was rejected.

√**MCC-H**

2. VERIFYING FLIGHT SPECIFIC PAD

MCC-H

If the following information is not recorded elsewhere, record it here.

Table 1. Post Departure Requirements

		ADO	Pri	B/U	Ver ID	Comments
1	Mass Properties	PS21				
2	CCDB SLOT 1	CA11				Undock Attitude
	CCDB SLOT 1 Yaw			N/A		
	CCDB SLOT 1 Pitch			N/A		
	CCDB SLOT 1 Roll			N/A		
3	Version ID for CCS PPL 181 - CCS RM PPL For GNC RM with or without Checkpointing to be loaded to all C&C MDMs				4002	If GNC RM with Checkpointing is to be inhibited for undocking, uplink PPL to all C&C MDMs. Must be built as File Uplink.

3. VERIFYING INITIAL CONDITIONS

PCS

MCG: MCS Configuration

MCS Configuration

'MCS Moding'

Verify US Station Mode – Prox Ops

Verify RS Station Mode – Prox Ops

Verify US GNC Mode – CMG TA (Drift)

Verify RS SUDN Mode – CMG TA (Indicator)

4. LOADING REQUIRED PPLs TO THE PRIMARY GNC MDM

MCC-H

For all PPLs designated in step 2 to be loaded to Primary GNC MDM, coordinate with ODIN.

5.101 PMA2 PRE-DEPARTURE CONFIGURATION

(JNT OPS/LF1 - ALL/FIN 5/MULTI) Page 2 of 4 pages

- MCC-H**
5. LOADING REQUIRED PPLs TO THE BACKUP GNC MDM
For all PPLs designated in step 2 to be loaded to Backup GNC MDM, coordinate with ODIN.
 6. LOADING REQUIRED PPLs TO THE C&C MDMS
For all PPLs designated in step 2 to be loaded to C&C MDMS, coordinate with ODIN.
 7. UPDATING UNDOCKING CCDB COMMANDED ATTITUDE

PCS

MCS Configuration
'CCDB Slots'

sel Cmd Att 1

Cmd Att 1

If Slot 1 Cmd Att Yaw, Pitch, Roll DOES NOT MATCH Yaw, Pitch, Roll in step 2

If in step 2, Yaw, Pitch, Roll is (0,0,0)

cmd YPR 0,0,0

If in step 2, Yaw, Pitch, Roll is not (,0,0,0)

input Yaw – (from step 2)

Pitch – (from step 2)

Roll – (from step 2)

cmd Set

Verify Slot 1 Yaw – (as commanded)

Pitch – (as commanded)

Roll – (as commanded)

8. SETTING MOMENTUM SERVO REFERENCE FRAME AND GNC INHIBITS

MCG: Dock and Undock: Pre Node 2 PMA 2 Undock

Pre Node 2 PMA 2 Undock

'System Configuration'

If Cmd'd Drift Ref Frame – LVLH(Body)

cmd Inertial

Verify Cmd'd Drift Ref Frame – Inertial

If Attitude Maneuver – Inh

cmd Enable (Verify – Ena)

If Att Cntl Shutdown – Inh

cmd Enable (Verify – Ena)

If Mode Transition – Inh

cmd Enable (Verify – Ena)

5.101 PMA2 PRE-DEPARTURE CONFIGURATION

(JNT OPS/LF1 - ALL/FIN 5/MULTI) Page 3 of 4 pages

If Desat Request – Inh
cmd Enable (Verify – Ena)

9. VERIFYING STATUS OF ACS MODING SIGNALS

Pre Node 2 PMA 2 Undock

'Undocking'

Verify Manual Undock Sequence Init – Not Init
Verify LA-1/LA-2 Interface Sealed – Yes/Yes
Verify LA-1/LA-2 Separation – No/No
Verify Docked Indication – Docked
Verify Departure Flag – No

10. INHIBITING GNC CHECKPOINTING

If GNC Checkpointing is to be inhibited for undocking, perform {2.702
| **DISABLE GNC CHECKPOINTING**}, all (SODF: MCS: NOMINAL:
| **CHECKPOINTING**), then:

11. SETTING BACK OFF TIME

Pre Node 2 PMA 2 Undock

'Pre Departure'

sel Back Off Time

Back Off Time

cmd 100 Seconds

Verify Pending Back Off Time: 100 (sec)
Verify Arm State – Arm

cmd Incorporate Pending Back Off Time

Verify Back Off Time: 100 (sec)
Verify Arm State – Disarm

12. SETTING POST DEPARTURE CONTROL MODE

Pre Node 2 PMA 2 Undock

'Pre Departure'

If Post Departure Control Mode – RS Control (CMG Only)
sel Post Departure Control Mode

Post Dprtr Cntl Mode

cmd CMG TA

Verify Post Departure Control Mode – CMG TA

5.101 PMA2 PRE-DEPARTURE CONFIGURATION

(JNT OPS/LF1 - ALL/FIN 5/MULTI) Page 4 of 4 pages

13. ENABLING DEPARTURE SOFTWARE

Pre Node 2 PMA 2 Undock

'Pre Departure'

sel PMA2 Automatic Departure SW

Automatic Departure SW

'PMA 2'

cmd Arm

Verify State – Arm

cmd Enable

Verify PMA 2 Undocking Vehicle – Shuttle

Verify PMA 2 Automatic Departure SW – Ena

Verify State – Disarm

14. VERIFYING TIME SINCE SEPARATION TELEMTRY

Pre Node 2 PMA 2 Undock

'Undocking'

Verify Time Since Separation: 0 (sec)

CAUTION

If the Time Since Separation is observed to be incrementing any time prior to planned departure, ISS may take attitude control after 100 seconds. IMMEDIATE ACTION IS REQUIRED.

* If the Time Since Separation is observed to be incrementing any
* time prior to planned departure, send all of the following
* commands to inhibit both the manual and automatic SW, even if
* either is already inhibited, to ensure the timer stops.

* **Pre Node 2 PMA 2 Undock**

* 'Pre Departure'

* sel PMA 2 Manual Departure SW

* **Manual Departure SW**

* 'PMA 2'

* **cmd Manual Departure SW Inhibit**

* Verify PMA 2 Undocking Vehicle – None

* Verify PMA 2 Manual Dprtr SW – Inh

* **cmd Automatic Departure SW Inhibit**

* Verify PMA 2 Automatic Dprtr SW – Inh

5.102 PMA2 DEPARTURE

(JNT OPS/LF1 - ALL/FIN 6/SPN/MULTI/HC) Page 1 of 4 pages

I

OBJECTIVE:

Confirm CCS Software is in the correct configuration, monitor departure and ensure proper functioning of the USOS software following separation. Manually incorporate post departure mass properties in US GNC. Confirm correct post departure control configuration.

NOTE

1. This procedure should be started about 25 minutes prior to orbiter departure.
2. Step 3 (Incorporating Post Departure PPLs) should be completed as soon as confirmation of the US GNC Mode - Drift.
3. In step 4, orbiter separation occurs and resumption of attitude control should occur at separation + 100 seconds. Otherwise, the crew will manually command to resume control.

1. GNC COMMAND RESPONSE COUNTERS RESET

PCS MCG: GNC Command Response Counters
GNC Command Response Counters

sel Reset

Verify the Since Reset column values are all blank.

Do not close this window until the procedure is complete.

If while executing a command, the Command Accept counter on that display does not increment
Reselect GNC Command Response Counters to determine if a command was rejected.

√ **MCC-H**

2. VERIFYING CORRECT CONFIGURATION

PCS MCG: Dock and Undock: Pre-Node 2 PMA 2 Undock
Pre Node 2 PMA 2 Undock
'System Configuration'

Verify US Station Mode – Prox Ops
Verify RS Station Mode – Prox Ops
Verify US GNC Mode – CMG TA (Drift)
Verify RS SUDN Mode – CMG TA (Indicator)

Verify Attitude Maneuver – Ena
Verify Att Cntl Shutdown – Ena
Verify Mode Transition – Ena
Verify Desat Request – Ena

5.102 PMA2 DEPARTURE

(JNT OPS/LF1 - ALL/FIN 6/SPN/MULTI/HC) Page 2 of 4 pages

'Pre Departure'

Verify Back Off Time: 100 (sec)
Verify Post Departure Control Mode – CMG TA
Verify PMA2 Automatic Departure SW – Ena
Verify Thrstr Avail for CMG Desat –Yes

'Undocking'

Verify LA-1/LA-2 Interface Sealed – Yes/Yes
Verify LA-1/LA-2 Separation – No/No
Verify Time Since Separation: 0
Verify Docked Indication – Docked
Verify Departure Flag – No

ISS ⇒ orbiter, "Station ready for undocking"

3. [INCORPORATING POST DEPARTURE PPLs](#)

NOTE

The orbiter crew will mode the mated stack to Free Drift at undock - 3 minutes.

This step must be completed after US GNC Mode – Drift is confirmed.

Pre Node 2 PMA 2 Undock

'System Configuration'

Verify US GNC Mode – Drift

If Active Mass Properties does not match Buffer Mass Properties

cmd Mass

Verify Active Mass Properties PPL Version ID matches Buffer Mass Properties PPL Version ID.

5.102 PMA2 DEPARTURE

(JNT OPS/LF1 - ALL/FIN 6/SPN/MULTI/HC) Page 3 of 4 pages

4. ORBITER SEPARATION

NOTE

1. The driving of the APAS Hooks open takes approximately 2 minutes.
2. The Docked Indication will remain Docked until the Time Since Separation of 100 seconds is reached.

Orbiter ⇒ ISS, "Physical Separation; executing SEP Burn"

Start manual timer.

Pre Node 2 PMA 2 Undock

'Undocking'

Wait up to 120 seconds for the following indication.

US GNC Mode – CMG TA
RS SUDN Mode – CMG TA

ISS ⇒ orbiter, "Station is in Attitude Control."

```
*****
* If US GNC Mode is not "Drift" and time since physical
* separation > 120 seconds
*   Pre Node 2 PMA 2 Undock
*   'Undocking'
*
*   cmd Not Docked
*
*   Verify Docked Indication – NOT Docked
*
*   'Other Commands'
*
*   cmd CMG TA Slot 1
*
*   Verify Active CCDB Source Slot – 1
*
*   cmd Hold Current Attitude
*
*   'System Configuration'
*
*   Verify US GNC Mode – CMG TA
*   Verify RS SUDN Mode – CMG TA
*
*   ISS ⇒ orbiter, "Station is in Attitude Control."
*****
```

5.102 PMA2 DEPARTURE

(JNT OPS/LF1 - ALL/FIN 6/SPN/MULTI/HC) Page 4 of 4 pages

5. RESUMING ATTITUDE CONTROL (GROUND STEPS)

MCC-H

If time since physical separation > 140 seconds and US GNC Mode is not

Drift

Pre Node 2 PMA 2 Undock

'Undocking'

cmd Not Docked

Verify Docked Indication – NOT Docked

'Other Commands'

cmd CMG TA Slot 1

Verify Active CCDB Source Slot: 1

cmd Hold Current Attitude

'System Configuration'

Verify US GNC Mode – CMG TA

Verify RS SUDN Mode – CMG TA

MCC-H ⇒ orbiter, ISS, "Station is in Attitude Control."

5.103 PMA2 POST DEPARTURE CONFIGURATION

(JNT OPS/LF1 - ALL/FIN 5/MULTI) Page 1 of 4 pages

I

OBJECTIVE:

Disable CCS Departure Software after orbiter departure. Verify appropriate MCS inhibits are set for stage operations.

1. GNC COMMAND RESPONSE COUNTERS RESET

PCS MCG: GNC Command Response Counters

GNC Command Response Counters

sel Reset

Verify the Since Reset column values are all blank.

Do not close this window until the procedure is complete.

If while executing a command, the Command Accept counter on that display does not increment
Reselect GNC Command Response Counters to determine if a command was rejected.

√**MCC-H**

2. VERIFYING FLIGHT SPECIFIC PAD

MCC-H If the following information is not recorded elsewhere, record it here.

Table 1. Version ID

		Version ID	
1	Version ID for CCS PPL 180 (ACS FDIR Adaptation Data) with RS ACS_Safing_Status set to "0" (off) to be loaded to Backup and Standby C&C MDM.	4002	Must be built as File Uplink and uplinked to the backup and standby C&C.
2	Version ID for CCS PPL 181 - CCS RM PPL For GNC RM with or without Checkpointing to be loaded to all C&C MDMs.	4003	If GNC RM with Checkpointing was inhibited for undocking and is now to be enabled uplink PPL to all C&C MDMs. Must be built as file uplink.

3. VERIFYING CONFIGURATION

PCS MCG: Dock and Undock: Pre-Node 2 PMA 2 Undock

Pre Node 2 PMA 2 Undock

'System Configuration'

Verify US Station Mode – Prox Ops
Verify RS Station Mode – Prox Ops
Verify US GNC Mode – CMG TA
Verify RS SUDN Mode – CMG TA

5.103 PMA2 POST DEPARTURE CONFIGURATION

(JNT OPS/LF1 - ALL/FIN 5/MULTI) Page 2 of 4 pages

'Undocking'

Verify LA-1/LA-2 Interface Sealed – No/No
Verify LA-1/LA-2 Separation – Yes/No
Verify Time Since Separation > 100 and incrementing
Verify Docked Indication – NOT Docked

4. ENABLING GNC CHECKPOINTING

If GNC Checkpointing is to be enabled after undocking, perform
{2.701 ENABLE GNC CHECKPOINTING}, all (SODF: MCS:
NOMINAL: CHECKPOINTING), then:

5. INHIBITING THE DEPARTURE SOFTWARE

NOTE

1. The Time Since Separation gets reset to zero by commanding the automatic departure software inhibit, but it does not get reset by commanding the manual departure software inhibit. There could be times when the automatic software was not used or already is inhibited, and it should still be commanded inhibited in this step to reset the timer.
2. If the Manual Undock Sequence Init command was sent, the software automatically inhibits the manual software. However, to configure the Manual Undock Seq Init telemetry to Not Init, the Manual Software must be commanded Inh even though its telemetry already reads Inh.

Pre Node 2 PMA 2 Undock

'Undocking'

If Manual SW Enable – Ena or Manual Undock Sequence Init – Init

Pre Node 2 PMA 2 Undock

'Pre Departure'

sel PMA2 Manual Departure SW

Manual Departure SW

'PMA 2'

cmd Manual Departure SW Inhibit

Verify PMA2 Undocking Vehicle – None
Verify PMA2 Manual Departure SW – Inh

Pre Node 2 PMA 2 Undock

'Undocking'

Verify Manual Undock Sequence Init – Not Init

5.103 PMA2 POST DEPARTURE CONFIGURATION

(JNT OPS/LF1 - ALL/FIN 5/MULTI) Page 3 of 4 pages

Pre Node 2 PMA 2 Undock

'Pre Departure'

If PMA2 Automatic Departure SW – Ena

Pre Node 2 PMA 2 Undock

'Pre Departure'

sel PMA 2 Automatic Departure SW

Automatic Departure SW

'PMA 2'

cmd Inhibit

Verify PMA 2 Undocking Vehicle – None

Verify PMA 2 Automatic Departure SW – Inh

Pre Node 2 PMA 2 Undock

'Undocking'

Verify Time Since Separation: 0

6. [ENABLING AUTO ATTITUDE CONTROL HANDOVER TO RS](#)

Pre Node 2 PMA 2 Undock

'Pre Departure'

sel Auto Att Control Handover to RS

Auto Att Control Handover to RS

'Enable'

cmd Enable

Verify Auto Att Control Handover – Ena

7. [REPLACING US GNC SOFTWARE INHIBITS](#)

Pre Node 2 PMA 2 Undock

'System Configuration'

cmd Attitude Maneuver Inhibit (Verify – Inh)

cmd Att Cntl Shutdown Inhibit (Verify – Inh)

cmd Mode Transition Inhibit (Verify – Inh)

5.103 PMA2 POST DEPARTURE CONFIGURATION

(JNT OPS/LF1 - ALL/FIN 5/MULTI) Page 4 of 4 pages

8. LOADING REQUIRED PPLs TO THE C&C MDMs

NOTE

The purpose of CCS PPL 180 is to enable the auto attitude control handover to RS in the Backup and Standby C&C MDMs, which is inhibited during docked operations.

For all PPLs designated in step 2 to be loaded to the C&C MDMs, to load PPL to the C&C MDMs, coordinate with ODIN.

9. CONFIGURING RS INHIBIT FOR STAGE OPERATIONS

MCC-M

YBL F8_10 (inf0=9, inf1=0) Enable RS automatic takeover due to Tier 1 Loss of Comm.

COMM/DATA

This Page Intentionally Blank

6.101 AUDIO LOSS OF DOCKED VOICE
(JNT OPS/UF1 - ALL/FIN 3) Page 1 of 2 pages

Loss of Voice to and/or from Docked Orbiter

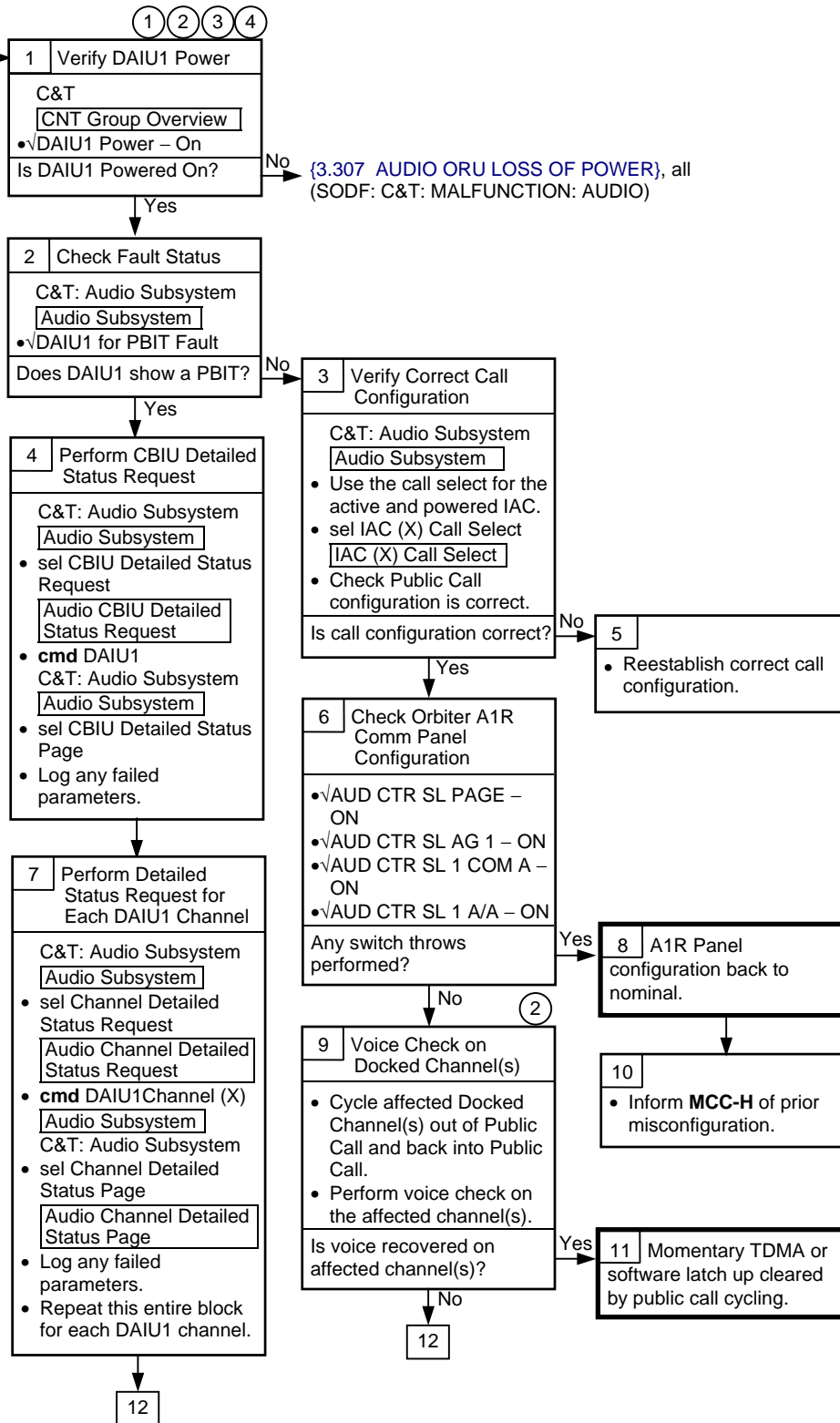

1 All displays in this procedure are on the PCS.

2 A filter located in the Russian Segment prevents voice from coming thru the RSA Channels when a Russian C&W tone is in alarm. If a Russian C&W tone is in alarm, voice from Russian Segment to the Orbiter should NOT be expected until all RS tones are acknowledged.

3 Performing an ABIT will remove the docked channels from their Public Calls and mode the DAIU to Standby after 2 minutes.

4 During troubleshooting of Hardline Docked Audio, crew should utilize alternate ship to ship communications via the BPSMU as a workaround.

6.101 AUDIO LOSS OF DOCKED VOICE
 (JNT OPS/UF1 - ALL/FIN 3) Page 2 of 2 pages

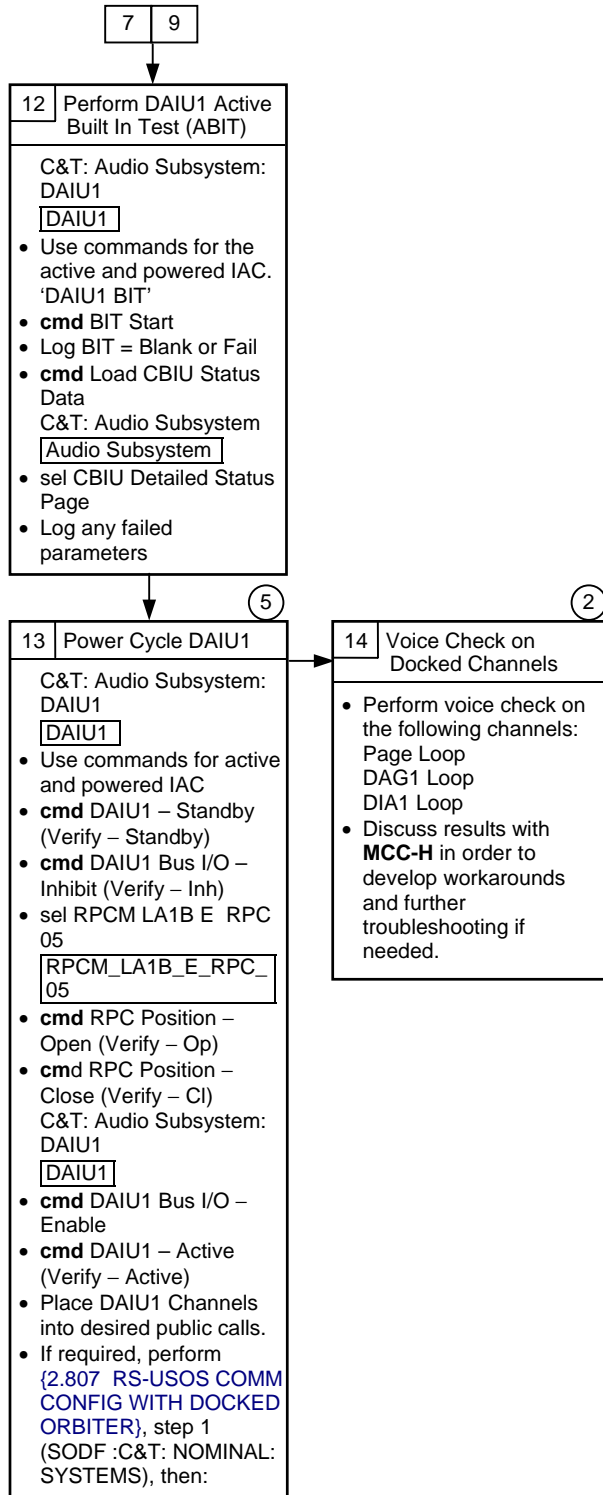

2
 A filter located in the Russian Segment prevents voice from coming thru the RSA Channels when a Russian C&W tone is in alarm. If a Russian C&W tone is in alarm, voice from Russian Segment to the Orbiter should NOT be expected until all RS tones are acknowledged.

5
 DAIU will go into Standby mode 2 minutes after being commanded active. DAIU has to be in the active mode in order to place Docked Audio Channels into a public calls.

6.102 AUDIO CONFIGURATION FOR PROXIMITY OPERATIONS VOICE COMM

(JNT OPS/7A - ALL/FIN 2)

Page 1 of 1 page

I

- PCS 1. ADD UHF1 VOICE LOOP
C&T: Audio: Audio Subsystem
Audio Subsystem

Determine which IAC is Active, IAC(X).

√IAC(X) – On and Active

'Audio ORUs'

sel AUAI1P
sel RPCM LAD22B A RPC 04
cmd Close

Verify Position – Close

'AUAI1P Bus IO'

cmd Enable

Verify AUAI1P Audio Bus IO – Enable

'AUAI1P State'

cmd Active

Verify AUAI1P State – Active

'Audio Displays Menu'

sel IAC(X) Call Select

√IAC(X) – On and Active

sel IAC(X) Call Select

'Public1'

sel Select
cmd UHF1

2. VERIFYING VOICE LOOP WAS ESTABLISHED

IAC(X) Call Select

√UH1 in Public1 T

This Page Intentionally Blank

6.103 HARDLINE AUDIO CONFIGURATION (ISS)

(JNT OPS/7A.1 - ALL/FIN 4)

Page 1 of 4 pages

I

NOTE

1. This procedure will be performed to establish the hardline communications path between ISS and the orbiter while docked. This configuration will link shuttle and station to ground, and station to shuttle by a single button push using any ATU in the lab as shown below.

2. Summary of Docked Audio Configuration

Big loop consist of: A/G1+DAG1+S/G1+RSA1

ISS only loop consist of: S/G2

STS only loop consist of: A/G2

ISS crew in the LAB may

Press 1 for:

“Big loop” station, shuttle, SSP **MCC** and ISS **MCC** on one loop.

Contains: Any ATU, GND1(S/G1), DAG1, RSA1 (SM Comm Panel (CP) 3)

Press 2 for:

ISS **MCC** to station only

Contains: Any ATU, RSA2, GND2(S/G2)

Press 3 for:

ICOM between ISS and orbiter

Contains: Any ATU, DIA1 (SM CP2)

This is NOT tied to the Russian Segment.

3. If CP2 and CP3 in Service Module are tied together, S/G 2 and/or ICOM A will be heard on the “big loop.”

1. POWERING OFF SSOR

Inform ISS that shuttle SSOR will be disabled and the next voice will be via hardline.

O6 UHF MODE sel – OFF

A1R AUD CTR UHF A/G 1(2) – OFF

MCC will uplink PCMMU/PDI/OIU configuration.

6.103 HARDLINE AUDIO CONFIGURATION (ISS)

(JNT OPS/7A.1 - ALL/FIN 4)

Page 2 of 4 pages

2. CONFIGURING SHUTTLE AUDIO

ISS will not be configured for voice until after step 5 is complete.

MCC-H or ISS crew perform steps 3 to 5.

A1R AUD CTR SL PAGE – ON
 A/G 1 – ON

√AUD CTR SL A/A – OFF

AUD CTR SL ICOM A – ON

3. POWERING ON DAIU

ISS Crew
PCS

C&T: Audio

sel DAIU1

sel RPCM LA1B E RPC 05

cmd RPC Position – Close (Verify – CL)

Verify which IAC is active and powered on, and use the commands for the active and powered IAC.

'IAC [X]' where [X] = Active and Powered IAC or

'DAIU1 Bus I/O'

cmd DAIU1 Bus I/O – Enable (Verify – Ena)

NOTE

DAIU will go into Standby mode 2 minutes after being commanded Active if not placed into a call. DAIU has to be in Active mode to place DAG1, DAA1 or DIA1 into a public call.

'DAIU1 State'

cmd DAIU1 State – Active (Verify – Active)

4. CONFIGURING ISS AUDIO SUBSYSTEM FOR DOCKED VOICE

ISS Crew

sel IAC (X) Call Select

'Public 1'

sel Call Setup

cmd GND1

cmd RSA1

cmd DAG1

6.103 HARDLINE AUDIO CONFIGURATION (ISS)

(JNT OPS/7A.1 - ALL/FIN 4)

Page 3 of 4 pages

IAC(X) Call Select

Verify – GND1 TL
Verify – RSA1 TL
Verify – DAG1 TL

'Public 2'

sel Call Setup
cmd GND2
cmd RSA2

IAC(X) Call Select

Verify – GND 2 TL
Verify – RSA2 TL

'Public 3'

sel Call Setup
cmd DIA1

IAC(X) Call Select

Verify – DIA1 TL

5. CREW CONFIGURING LAB ATU 1 AND LAB ATU 2 INTO PUBLIC CALLS

ISS Crew
AFT ATU
Lab1

ATU Lab1 pb → PTT 3,2,1

Verify ATU Display: 3 2G 1TG

FWD ATU
Lab2

ATU Lab2 pb → PTT 3,2,1

Verify ATU Display: 3 2G 1TG

ISS audio configuration must be complete prior to next step.
When complete, the configuration will be A/G1 and S/G1 in the "big loop,"
A/G 2 (STS only), S/G2 (ISS only), and ICOM between ISS and Lab.

6. ESTABLISHING VOICE CONTACT WITH ISS

As required, adjust volume.

Perform voice checks between STS crew and ISS crew in the LAB.

STS Loop	ISS Crew Response
ICOM A	From ISS ATU Lab1 or Lab2 by selecting pb 3
A/G 1	From ISS ATU Lab1 or Lab2 by selecting pb 1

6.103 HARDLINE AUDIO CONFIGURATION (ISS)

(JNT OPS/7A.1 - ALL/FIN 4)

Page 4 of 4 pages

7. RECONFIGURING ATU(S)

When comm checks complete, reconfigure FD/MD/CDR-BPSMU speakers for A/G as desired.

Ensure BPSMU ATU is configured to avoid feedback.

8. DECONFIGURING FROM UHF OPS

ISS Crew

Perform {2.210 AUDIO SUBSYSTEM DECONFIGURATION FROM UHF OPS} (SODF: C&T: NOMINAL: AUDIO), then:

Perform {2.702 UHF 1 ORU DEACTIVATION} (SODF: C&T: NOMINAL: UHF), then:

Go to {2.704 UHF 2 ORU DEACTIVATION} (SODF: C&T: NOMINAL: UHF).

6.104 HARDLINE AUDIO CONFIGURATION (ISS) BACKOUT

(JNT OPS/7A - ALL/FIN 4)

Page 1 of 5 pages

I

NOTE

1. This procedure will be performed to configure the SSOR and SSSR communications path between ISS and STS in preparation for undock. This configuration will link shuttle and station to ground, station to ground, and ISS US segment to Russian segment by a single button push using any ATU in the lab as shown below.
2. Summary of Undocked Audio Configuration
Big loop consist of: A/G1+UHF1(3)+S/G1+RSA1
ISS only loop consist of: S/G2
STS only loop consist of: A/G2

ISS crew in the LAB may

Press 1 for:
Ground (Station & Shuttle Joint Ops) and shuttle crew

Contains: Any ATU, GND1(S/G1), UHF1(3), RSA1 (SM Comm Panel 3)

Press 2 for:
Ground (Station only Ops)

Contains: Any ATU, RSA2, GND2(S/G2)
3. If CP 2 and CP 3 in Service Module are tied together, S/G 2 and/or ICOM A will be heard on the "big loop."

1. PREPARING STS SSOR FOR BACKOUT

STS Crew Inform ISS that shuttle SSOR will be activated and the next voice will be via UHF.
ISS audio will not be configured until after step 3 is complete.

R14:C √cb MNA UHF EVA – cl
 √cb MNC UHF EVA – cl

O6 √UHF SPLX/EVA PWR AMP – OFF
 MODE sel – EVA

√UHF SPLX/EVA XMIT FREQ: 259.7/414.2
 √SPLX SQUELCH – ON
 √EVA STRING: 1

UHF ENCRYPT – ON

MCC will uplink encryption key and configure the PCMMU/PDI/OIU configuration as required.

6.104 HARDLINE AUDIO CONFIGURATION (ISS) BACKOUT

(JNT OPS/7A - ALL/FIN 4) Page 2 of 5 pages

2. PREPARING ISS FOR BACKOUT

ISS Crew As required
or **MMC-H** 2.1 Powering On UHF 1
Perform {2.701 UHF 1 ORU ACTIVATION} {SODF: C&T: NOMINAL:
UHF}, then:

2.2 Configuring AUAI1P for UHF Voice
Verify which IAC is active and powered on, and use the commands
for the active and powered IAC.

PCS C&T: Audio: Audio Overview
Audio Overview

sel IAC[X] Call Select where [X] = Active and Powered IAC 1 or 2

IAC[X] Call Select
'Public 1'

sel Call Setup
cmd UHF1

IAC[X] Call Select
'Public 1'

Verify – UHF1 TL

PCS 2.3 Powering On AUAI2S for Redundant UHF Voice Path
C&T: Audio: Audio Overview: AUAI2S
AUAI2S

sel RPCM LAD11B A RPC 02
cmd RPC Position – Close (Verify – Cl)

2.4 Enabling F/O Bus I/O for AUAI2S
Verify which IAC is active and powered on, and use the commands
for the active and powered IAC.

AUAI2S
'IAC [X]' where [X] = Active and Powered IAC 1 or 2
'AUAI2S Bus I/O'

cmd AUAI2S Bus I/O – Enable (Verify – Ena)

6.104 HARDLINE AUDIO CONFIGURATION (ISS) BACKOUT

(JNT OPS/7A - ALL/FIN 4)

Page 3 of 5 pages

2.5 Activating and Configuring AUI2S for Redundant UHF Voice

NOTE

1. AUI2S will go into standby mode 2 minutes after being commanded active if it is not placed into a call.
2. AUI2S has to be in active mode to place UHF3 into a call.

Verify which IAC is active and powered on, and use the commands for the active and powered IAC.

AUI2S

'IAC [X]' where [X] = Active and Powered IAC 1 or 2
'AUI2S State'

cmd AUI2S State – Active (Verify – Active)

Audio Overview

sel IAC[X] Call Select where [X] = Active and Powered IAC 1 or 2

IAC[X] Call Select

'Public 1'

sel Call Setup

cmd UHF3

IAC[X] Call Select

'Public 1'

Verify – UHF3 TL

3. CONFIGURING SHUTTLE FOR SSOR AUDIO AND DISABLE HARDLINE AUDIO

STS Crew Verify SSOR and SSSR(UHF) are communicating.

SM 76 COMMUNICATIONS

√SSOR FRM SYNC 1 – YES

A1R AUD CTR SL A/G 1 – OFF
UHF A/G 1(2) – T/R

6.104 HARDLINE AUDIO CONFIGURATION (ISS) BACKOUT

(JNT OPS/7A - ALL/FIN 4)

Page 4 of 5 pages

4. ESTABLISHING UHF VOICE CONTACT BETWEEN ISS AND STS

Perform UHF voice checks with ISS crew.

STS Loop	ISS Crew Response
Any ATU – A/G1	From ISS ATU Lab1 or Lab2 by selecting pb 1

A1R If comm checks successful
AUD CTR SL PAGE – OFF
√A/A – OFF
ICOM A – ON

Continue with step 5.

5. ISS DOCKED AUDIO DECONFIGURATION

ISS Crew
or **MCC-H**
PCS

5.1 Hangup of DAG1 from Public Loop

C&T: AUDIO: AUDIO OVERVIEW

Audio Overview

sel IAC[X] Call Select where [X] = Active and Powered IAC

IAC[X] Call Select

'Public 1'

sel Hangup
cmd DAG1

IAC[X] Call Select

'Public 1'

Verify DAG1 TL removed from Public1.

PCS

5.2 Hangup of DIA1 from Public Loop

C&T: AUDIO: AUDIO OVERVIEW

Audio Overview

sel IAC[X] Call Select where [X] = Active and Powered IAC

IAC[X] Call Select

'Public 3'

sel Hangup
cmd DIA1

IAC[X] Call Select

'Public 3'

Verify DIA1 TL removed from Public3.

6.104 HARDLINE AUDIO CONFIGURATION (ISS) BACKOUT

(JNT OPS/7A - ALL/FIN 4)

Page 5 of 5 pages

- PCS 5.3 Deactivating DAIU1
C&T: AUDIO: AUDIO OVERVIEW: DAIU1
- Verify which IAC is active and powered on, and use the commands for the active and powered IAC.
-
- 'IAC [X]' where [X] = Active and Powered IAC or
'DAIU1 State'
- cmd** DAIU1State – Standby (Verify – Standby)
- PCS 5.4 Inhibiting F/O Bus I/O for DAIU1
C&T: AUDIO: AUDIO OVERVIEW: DAIU1
-
- Verify which IAC is active and powered on, and use the commands for the active and powered IAC.
- 'IAC [X]' where [X] = Active and Powered IAC or
'DAIU1 Bus I/O'
- cmd** DAIU1 Bus I/O – Inhibit (Verify – Inh)
- PCS 5.5 Powering Off DAIU1
C&T: AUDIO: AUDIO OVERVIEW: DAIU1
-
- sel RPCM LA1B E RPC 05
cmd RPC Position – Open (Verify – Op)

This Page Intentionally Blank

6.105 SSOR ACTIVATION

(JNT OPS/7A - ALL/FIN 5)

Page 1 of 1 page

I

- R14:C 1. √cb MNA UHF EVA – cl
 √MNC UHF EVA – cl
- O6 2. √UHF SPLX/EVA PWR AMP – OFF
 √SPLX/EVA XMIT FREQ: 259.7/414.2
 √EVA STRING: 1
 √UHF ENCRYPT – ON
 MODE – EVA
- A1R 3. AUD CTR UHF A/G 1 (2) – T/R
4. Perform voice checks as required after SSSR(UHF) and SSOR are within
 communicating range (about 10,000 feet).

SM 76 COMMUNICATIONS

√SSOR FRM SYNC 1 – YES

5. **MCC** uplinks encryption key # and PCMMU/PDI/OIU configurations as required.

This Page Intentionally Blank

6.106 SSOR DEACTIVATION

(JNT OPS/7A - ALL/FIN 3) Page 1 of 1 page

I

- O6 1. UHF MODE – OFF
- A1R 2. AUD CTR UHF A/G 1(2) – OFF
- 3. If required, **MCC** performs TFL/DFL configuration.

This Page Intentionally Blank

6.107 PCS SETUP - SHUTTLE

(JNT OPS/7A - ALL/FIN 3) Page 1 of 3 pages

MA16N 1. UNSTOWING PCS
Thinkpad (one) P/N SDZ39129262-303 S/N 6070 with B/C POC20617J
ORB Power Supply Adapter Cable 10' (one)
KIT, IBM THINKPAD (one 1553 Card and 22-inch Adapter Cable in each
Kit) (one)
ORB DC Power Cable 6' (one)
ORB DC Power Cable 10' (one)
ORB 1553 Data Cable 8' (one)
RS/ORB DC Power Supply (one)

Pwr Sply 2. POWER OFF VERIFICATION
√PCS 28V DC PWR SPLY switch – Off

For DC UTIL PWR outlet availability, refer to UTILITY OUTLET PLUG-IN
PLAN ORBIT CONFIGURATION (FDF, REF DATA FS, UTIL PWR).

L12 √DC Power 1 – OFF

3. PCS POWER AND DATA CABLE CONNECTIONS

(See Figure 1)

Connect 22" Adapter Cable to the 1553 PC Card for the PCS.
Insert 1553 PC Card into either PCS PCMCIA slot for the PCS.

Connect both Power Supply Adapter Cable 10' to PCS and to 28V DC
power supply outlets (J2).

L12 Connect PCS Power Supply Adapter Cable 10' to DC Power 1 Cabin P/L
power outlet (J2) and to 28V DC power supply outlet (J1).

Connect PCS ORB 1553 Data Cable 8' to (J103) outlet and to 1553 PC
Card Adapter Cable.

4. TURNING ON PCS

L12 DC Power 1 – ON

Pwr Sply PCS 28V DC PWR SPLY switch → On (Lt On)

PCS PCS Thinkpad PWR switch → On
Do not iconify PCSCDS Main Control Panel Window.

* If Status Box is not green, select CONNECT TO
* MDM button if the MDMs are on.

6.107 PCS SETUP - SHUTTLE

(JNT OPS/7A - ALL/FIN 3) Page 2 of 3 pages

NOTE

1. PCS connection to MDM is indicated by green in the Status Box and '**Connected**' message displayed in the PCSCDS Main Control Panel Window.
2. If MDM is not up and running and step 4 is executed, expect a PCS '**CW Server Error Msg**' and a '**CDS Signon Fail**'.
3. After connected to the MDM, if the PCS displays '**The MDM Connection has failed**', open the PCSCDS Main Control Panel Window and select CONNECT TO MDM button to reconnect. If no joy, perform {3.301 LOSS OF PCS TELEMETRY}, all (SODF: POC: MALFUNCTION: PCS E8 ALL).

Configure displays as desired.

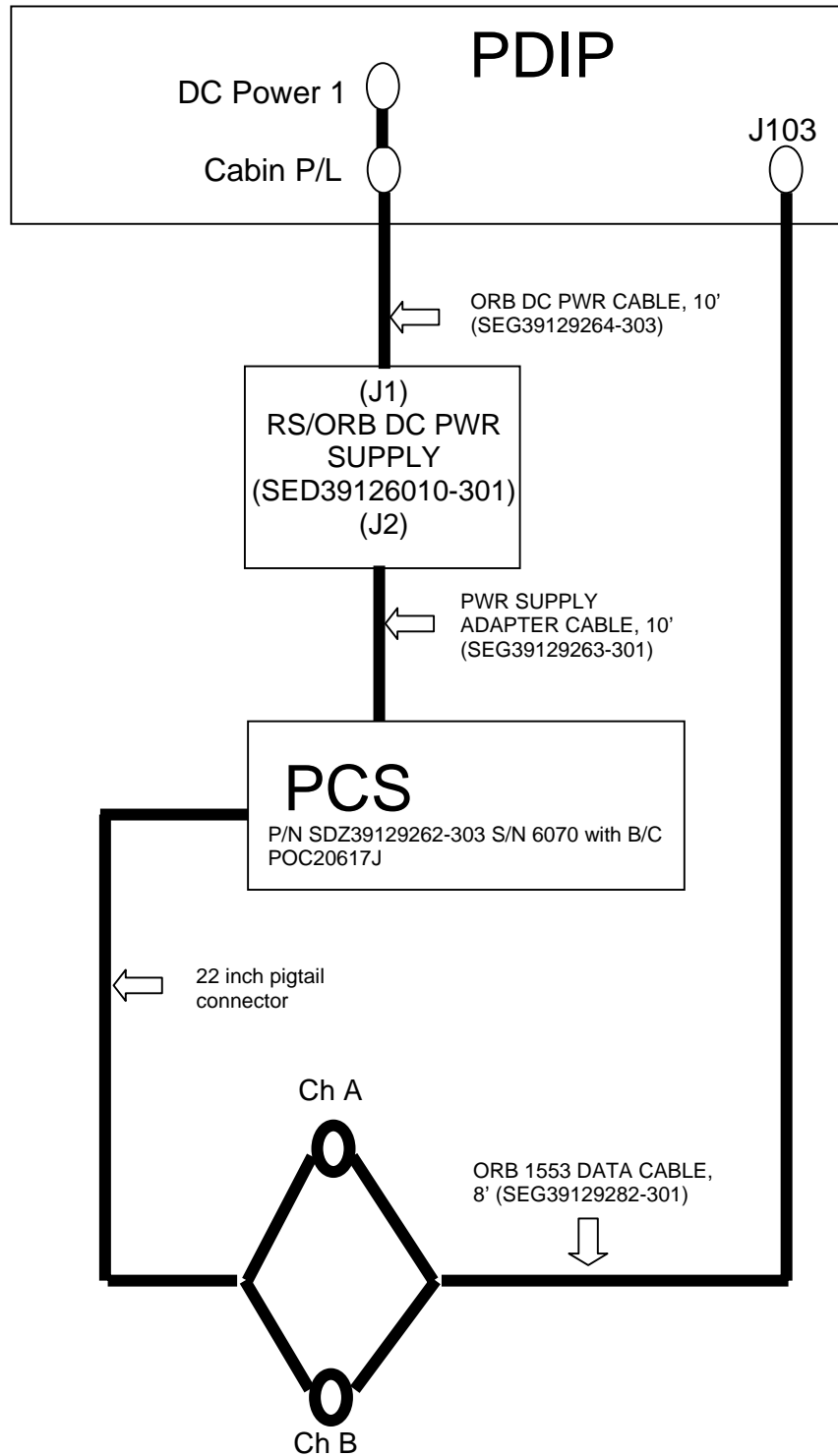

Figure 1.- AFD L12 PDIP Panel PCS Configuration.

NOTE

The 1553 Data Cable I/Fs with a 22-inch pigtail connector (Ch A & B) connects to the 1553 Card that inserts into the PC Card PCMCIA Upper slot in the PCS.

This Page Intentionally Blank

6.108 ICOM AUDIO CONFIG WITH HATCH CLOSED

(JNT OPS/LF1/FIN)

Page 1 of 1 page

NOTE

This procedure is not necessary if ICOM A through the DAIU is functional. Once complete, the CDR ATU can only be used to transmit on A/A, which will be used as the ICOM loop between shuttle and ISS. To transmit, use the XMIT button on the BPSMU

SHUTTLE CREW

- L5 1. √LEFT COMM POWER – ON
√BPSMU connected
- 06 2. LEFT AUDIO A/A – T/R
A/G 1 – RCV
A/G 2 – RCV
ICOM A – RCV
ICOM B – RCV

ISS CREW OR MCC-H

- PCS 3. CONFIGURING ISS FOR DAA CHANNEL IN PUBLIC 3
C&T: Audio Subsystem
Audio Subsystem
'Audio ORUs'

- √DAIU1 – Powered
√DAIU1 F/O Bus I/O – Enabled
√DAIU1 – Active

NOTE

Verify which IAC is active and powered on, and use the commands for the Active and Powered IAC.

sel IAC[X] Call Select where [X] = Active and Powered IAC 1(2)

IAC [X] Call Select
'Public3'

sel Call Setup

Public 3 Call Select
'Talk/Listen (T/L)'

cmd DAA1 TL

IAC [X] Call Select
'Public3'

Verify DAA1 TL

4. Perform Shuttle to ISS DAA voice check

This Page Intentionally Blank

2.302 ONBOARD FILE TRANSFER

(POC/4A - ALL/FIN B)

Page 1 of 4 pages

I

NOTE

The maximum size for one file transfer is 8 Megabytes (MB).

1. OPENING FILE TRANSFER WINDOW

PCS

PCSCDS Main Control Panel

sel Commands
sel File Transfer

File and Memory Transfer

NOTE

At this point, decide which file transfer to perform. The options include

1. Get a File Function - initiate a direct file or directory listing transfer from the C&C MDM or Payload MDM to PCS.
2. Put a File Function - initiate a direct file transfer from PCS to the C&C MDM or Payload MDM.
3. Indirect File Transfer Function - initiate an indirect file transfer between the C&C MDM and the Payload or JEM MDMs, between prime and backup C&C MDMs, or between prime and backup Payload MDMs.
4. Indirect Data Load Function - initiate an indirect transfer of a file from the C&C MDM to the memory of the GN&C MDMs, LAB CEU, or Cupola CEU.

To perform the Get a File Function, go to step 2.

To perform the Put a File Function, go to step 3.

To perform the Indirect File Transfer Function, go to step 4.

To perform the Indirect Data Load Function, go to step 5.

2. GETTING A FILE FUNCTION

PCS

File and Memory Transfer

sel Commands
sel Get a File

Get Remote File

sel Source Node (MDM that PCS is connected to)

'Abort on MSD Read Error'

sel True

2.302 ONBOARD FILE TRANSFER

(POC/4A - ALL/FIN B)

Page 2 of 4 pages

NOTE

On the Source is Directory radio button, select True when transferring a directory and select False when transferring a file.

'Source is Directory'

sel True or False as appropriate

True - for directory listing transfer

False - for file transfer

NOTE

1. Direct file transfers to and from the C&C MDM to PCS are only available if the PCS is connected on a control bus (i.e., not available in pass-through mode).
2. Due to limitations on the MDM, the source and target directory paths specified during transfers are limited to a total of 96 characters each. In addition, each directory and file name is limited to 32 characters.

Input Source Directory by keyboard or by File Select button (i.e., /fmt).

Input Source File by keyboard or by File Select button.

Input Target Directory by keyboard or by File Select button

(i.e., /export/home/PCSUser).

Input Target File by keyboard or by File Select button.

sel Apply

Go to step 6.

3. PUT A FILE FUNCTION

PCS

File and Memory Transfer

sel Commands

sel Put a File

Put Remote File

NOTE

1. Direct file transfers to and from the C&C MDM to PCS are only available if PCS is connected on a control bus (i.e., not available in pass-through mode).
2. Due to limitations on the MDM, the source and target directory paths specified during transfers are limited to a total of 96 characters each. In addition, each directory and file name is limited to 32 characters.

2.302 ONBOARD FILE TRANSFER

(POC/4A - ALL/FIN B)

Page 3 of 4 pages

Input Source Directory by keyboard or by File Select button
(i.e., /export/home/PCSUser).

Input Source File by keyboard or by File Select button.

sel Target Node (MDM that PCS is connected to)

Input Target Directory by keyboard or by File select button (i.e., /fmt).

Input Target File by keyboard or by File select button.

sel Apply

Go to step 6.

4. INDIRECT FILE TRANSFER FUNCTION

PCS

File and Memory Transfer

sel Commands

sel Indirect File Transfer

Indirect File Transfer

NOTE

Only certain combinations of source and target nodes are available for indirect transfers.

sel Source Node (Device to transfer from)

sel Target Node (Device to transfer to)

NOTE

1. Due to limitations on the MDM, the source and target directory paths specified during transfers are limited to a total of 96 characters each. In addition, each directory and file name is limited to 32 characters.
2. PCS must be connected to the MDM that the user wants to transfer files to or the MDM that the user wants to transfer files from.

Input Source Directory by keyboard (i.e., /fmt).

Input Source File by keyboard.

Input Target Directory by keyboard (i.e., /fmt).

Input Target File by keyboard.

sel Apply

Go to step 6.

2.302 ONBOARD FILE TRANSFER

(POC/4A - ALL/FIN B)

Page 4 of 4 pages

5. INDIRECT DATA LOAD FUNCTION

NOTE

Due to limitations on the MDM, the source and target directory paths specified during transfers are limited to a total of 96 characters each. In addition, each directory and file name is limited to 32 characters.

PCS

File and Memory Transfer

sel Commands
sel Indirect Data Load

Indirect Data Load

NOTE

This function is not available when PCS is connected to the Payload MDM.

sel Source Node – C&C Prime
sel Target Node (Platform to transfer to)

Input the Source Directory (i.e., /cdh).
Input the Source File (i.e., gnc3_3.b).
Input the Starting Address for the memory location on the Target Node to hold the transferred file.
Input the File Length, in decimal, of the file being transferred.

sel Apply

6. MONITORING THE FILE AND MEMORY TRANSFER

PCS

File and Memory Transfer

'Active Transfers'

Verify Transfer status – OK

Wait 4 minutes per megabyte of file size to be transferred.

'Completed Transfers'

Verify Transfer Status – COMPLETED

To perform another file transfer, go to step 1.

sel Commands
sel Close

Verify Shutdown

sel Yes

2.303 PCS DEACTIVATION

(POC/4A - ALL/FIN 4/HC) Page 1 of 2 pages

I

1. POWERING DOWN EPCS/PCS

Close all display windows.
Disconnect CDS from MDM.
Close CDS window.

At the taskbar on bottom of display,
sel EXIT

On Logout Confirmation window
sel OK

Wait for '**Type any key to continue**' message to appear.

If message does not appear within 90 seconds, then proceed.

	If shuttle AFD
PCS	PCS 1,2 Laptop pwr sw → Off
Pwr Sply	PCS1 28VDC Pwr Sply sw → Off (Lt Off) PCS2 28VDC Pwr Sply sw → Off (Lt Off)
A15	MNC DC UTIL PWR (J2) → Off
PDIP	PDIP DC POWER 2 → Off
	If in USOS
PCS	PCS Laptop pwr sw → Off
UOP	Push Power Button → On (Lt Off)
	If in SM
PCS	PCS Laptop pwr sw → Off
Pwr Sply	PCS 28VDC Pwr Sply sw → Off (Lt Off)
	If in FGB
PCS	PCS Laptop Pwr sw → Off
Pwr Sply	PCS 28VDC Pwr Sply sw → Off (Lt Off)
PEC-10/3	On Panel OUTLET PWR 10/3 AMPS (PEC-10/3) sw → OFF

2.303 PCS DEACTIVATION

(POC/4A - ALL/FIN 4/HC) Page 2 of 2 pages

2. DISCONNECTING EPCS/PCS POWER AND DATA CABLE

	If shuttle AFD
L12/A3	Disconnect both ORB 1553 Data Cables 8' from N1-1 (J103) and N1-2 (J107) and from the 22-inch Adapter Cable. Disconnect both the ORB DC Power Cable 6' and ORB DC Power Cable 10' from the RS/ORB DC power supply (J1) and the ORB DC outlets. Disconnect both the ORB Power Supply Adapter Cable 10' from the PCS DC power outlet and the RS/ORB DC power supply (J2).
	If in USOS
	Disconnect the DC Power Supply Adapter Cable 10' from the PCS and from the US DC Power Supply (120V) outlet (J2) Disconnect US DC Power and 1553 Cable (UOP to Power Supply and 760), 8 feet from the UOP, the US DC Power Supply (120V) outlet (J1), and 22-inch Adapter Cable
	If in SM
	Disconnect RS DC Power and 1553 Cable 8' to PCR outlet and the RS/ORB DC power supply outlet (J1) and the 22-inch Adapter Cable.
Pwr Sply	Disconnect the ORB Power Supply Adapter Cable 10' from the RS/ORB DC power supply outlet (J2) and from the PCS.
	If in FGB
	Disconnect RS DC Power and 1553 Cable 8' to PCR outlet and the RS/ORB DC power supply outlet (J1) and the 22-inch Adapter Cable.
Pwr Sply	Disconnect the ORB Power Supply Adapter Cable 10' from the RS/ORB DC power supply outlet (J2) and from the PCS.
P5C-10/3	Disconnect the cable, protruding from the GNC 2/RS Bus 8 (GNC 1/RS Bus 7) panel (cables are labeled 77KM-2120-1670 and 77KM-2120-2190, respectively), from the 10A connector on panel OUTLET PWR 10/3 AMPS (P5C-10/3).

3. STOWING EPCS/PCS

PCS Laptops
20V DC Power Cables 10'
1553 Card and 22-inch Adapter Cable

If shuttle AFD

Stow ORB DC Power Cable 6'
ORB DC Power Cable 10'
ORB 1553 Data Cables 8'
RS/ORB DC Power Supply

If ISS RS

Stow RS DC Power and 1553 Cable 8' in the FGB.
RS/ORB DC Power Supply

2.304 PCS LOG FILE SAVE

(POC/4A - ALL/FIN C)

Page 1 of 2 pages

I

PCS

1. CDS LOGS DUMP

If PCSCDS Main Control Panel is an icon, double-click the 'cds_ui' icon to restore it.

PCSCDS MAIN CONTROL PANEL

sel Commands
sel Update Log Files

Wait until Hard Drive Active indicator clears from LCD status bar.

2. SAVE LOGS

sel Arrow directly above PCS logo on CDE front panel
sel Save Logs

PCS save logs

Disregard text.
Press enter.

NOTE

1. The format to use for naming the directory <directory name> is: [user initials] logs [GMT day].
2. Use a different directory name each time you save the logs. If the logs need to be saved more than once in a day, append a number starting at "1" for the first log and increment it each time that the logs are saved that day. For example: abclogs230_2.

Enter directory name and press enter.

Verify message – savelogs completed

Press enter.

Right-click anywhere on empty desktop space.

Workspace Menu

sel Programs
sel Terminal

Type 'cd <directory name>'

2.304 PCS LOG FILE SAVE

(POC/4A - ALL/FIN C)

Page 2 of 2 pages

NOTE

Ensure the period is included in the following lines

Type 'cp -p /var/adm/messages* .'

Type 'cp -p /var/log/syslog* .'

PCS 3. VERIFYING THE LOGS HAVE BEEN SAVED

Type 'ls -l'

Verify Runtime_files/ and logs/ are in the directory.

Close the terminal window.

Inform **MCC-H** of the directory name used.

2.306 PCS RECONNECT

(POC/4A - ALL/FIN B)

Page 1 of 1 page

I

1. CDDF AND CDS SHUTDOWN

Close all display windows.
Disconnect CDS from MDM.
Close CDS window.

2. CONNECTING PCS TO MDM DATA

sel Arrow directly above PCS logo
sel Start/Restart PCS CDS

If popup window appears asking what time source to use

On EPCS
sel RS Time

On PCS
sel MDM Time

NOTE

A pop-up window may appear saying that the CW Server failed to start and it will be retried every 15 seconds.

sel Icon to open PCSCDS Main Control Panel Window

√Status Box is green and '**Connected**' is displayed in the PCSCDS Main Control Panel Window

Iconify PCSCDS Main Control Panel Window.

3. PCS FOR DISPLAYS CONFIGURATION

sel Arrow above PCS logo
sel Start PCS CDDF display

After approximately 1 minute, √'**Increment xA Home Page**' is displayed.

Displays may now be selected as desired.

This Page Intentionally Blank

2.307 PCS SCREEN CAPTURE

(POC/2R - ALL/FIN B)

Page 1 of 2 pages

I

1. OPENING SNAPSHOT WINDOW

Move the pointer to an open area on the desktop.
Press the right mouse button.

sel Programs
sel Snapshot...

2. TAKING SNAPSHOT

NOTE

You must have the window that you wish to snapshot open and uncovered.

Snapshot V3.X

sel box next to 'Hide Window During Capture'
sel Snap

NOTE

When you click on the window, the Snapshot Window will disappear for 8 --- 16 seconds.

Click on the window you want to take a snapshot of.

3. SAVING SNAPSHOT

NOTE

The image file will be saved in the /export/home/PCSUser directory.

Snapshot V3.X

sel View...

Image Tool V3.X File: Untitled

sel File
sel Save As...

Image Tool: Save As
'File Format'

sel Sun Raster
sel GIF

Save As...

Type over 'Untitled1' with the name that you wish to call the image followed by '.gif'.

2.307 PCS SCREEN CAPTURE

(POC/2R - ALL/FIN B)

Page 2 of 2 pages

NOTE

There will be a pop-up window with the message '**Saving to the GIF file format may result in a loss of data. Do you want to continue?**' The difference is negligible and can be ignored.

sel Save
sel Yes

Close the display and Snapshot application.

4. RETRIEVING AND VIEWING THE IMAGE

Right-click on any empty space on the desktop.

sel Programs
sel Image Viewer
sel File
sel Open...
sel <the desired file>
sel OK

Close Image View - Palette window.

2.309 TRANSFERRING LOG FILES TO FLOPPY DISK

(POC/4A - ALL/FIN B)

Page 1 of 1 page

I

1. PERFORMING PCS LOG FILES SAVE

Perform {2.304 PCS LOG FILE SAVE}, all (SODF: POC: NOMINAL: PCS) as needed, then:

2. RUNNING COPY LOGS TO FLOPPY UTILITY

sel Arrow directly above PCS logo

sel Copy PCS logs to floppy

Press Enter.

NOTE

If action fails, the following will be displayed:

If no disk in drive, insert diskette, try again.

If no floppy drive attached, shutdown, attach floppy drive, and reboot.

If floppy drive is attached after boot up, shutdown and reboot.

If floppy drive not seated properly, shutdown, re-seat, and reboot.

Input directory name from list of available directories listed in the Terminal Window.

sel OK

Verify Copy logs to floppy complete.

Press Enter.

Manually Eject Floppy Disk.

This Page Intentionally Blank

MALFUNCTION

This Page Intentionally Blank

S&M

CAUTION
ALARM

1.3.501 HATCH MECHANISM MALFUNCTION

(ISS IFM/3A - ALL/FIN 2/Paper on ISS)

Page 1 of 5 pages

Hatch Does Not Function Properly

1

WARNING

If at any time a crewperson may become isolated from his or her return vehicle, he or she must have a Ratchet, 1/4" Drive; 4" Ext, 1/4" Drive; and a 1/2" Socket, 1/4" Drive (mini-maglight is suggested). Also, a hardcopy of this procedure {1.3.501 HATCH MECHANISM MALFUNCTION} (SODF: ISS IFM: COMMON: CORRECTIVE/ S&M) is required with the isolated crewperson.

2

- If on domed IVA side, translate through Hatch to EVA side.

Is there access to the Ribbed (EVA) side of Hatch by ISS or shuttle crew?

3

Is the crew isolated from the Earth Return Vehicle?

4

- Verify MPEV/IMV Valves are open.
- Verify communications are established.

5

- **MCC**

Yes

6

Is full Hatch closure possible without isolating crew from return vehicle?

7

- **MCC**
- If the crew is isolated from return vehicle, crew should proceed to block 8 for troubleshooting (can pull PIP Pins and/or remove latches (1/2" Socket) as required to gain access.)

8

- Visually check Hatch for debris or damage which may prevent actuation (flashlight optional).
- Latches
- Tension rods
- PIP Pins
- Sliders
- Drive mechanism
- Pinion gear & Crank Mechanism
- Refer to Figure 3.

9

- Clear the mechanisms of debris.

10

Damaged component.

11

- **MCC-H**

Is there any debris or contamination present on the Hatch?

Are there any broken/bent parts?

No damage or debris

12

1 Tools stowed in ISS Tool kit or Airlock Contingency Toolkit (for disassembling/ removing Hatch in an emergency).

2 IVA side refers to smooth domed side. EVA side is ribbed mechanism side

3 No clear workaround. If Airlock, will remove IMV Valve for inspection/ recovery. Other locations may remove MPEV/PPRV (provides ~3" hole for inspection mirror/flashlight assessment of at least a portion of hatch). Other more destructive alternatives (window removal/breakage) may be required to get hatch open.

4 Need to balance crew risk vs. configuration/repair. Additional guidance expected to be:

- a. Leave 25" opening for egress if possible.
- b. If not 25" gap, place nonsharp hard object in Hatch opening to ensure it cannot close.
- c. If fully closed Hatch, follow warning at top of page (tools & procedure), verify comm where will isolate crew, and open all IMV/MPEV valves

5 Likely remove damaged component {1.2.507 Hatch Tension Rod/Latch R&R } (SODF: ISS IFM: COMMON: CORRECTIVE/ S&M) MCC will request imagery and scavenge spare component from another hatch.

1.3.501 HATCH MECHANISM MALFUNCTION

(ISS IFM/3A - ALL/FIN 2/Paper on ISS)

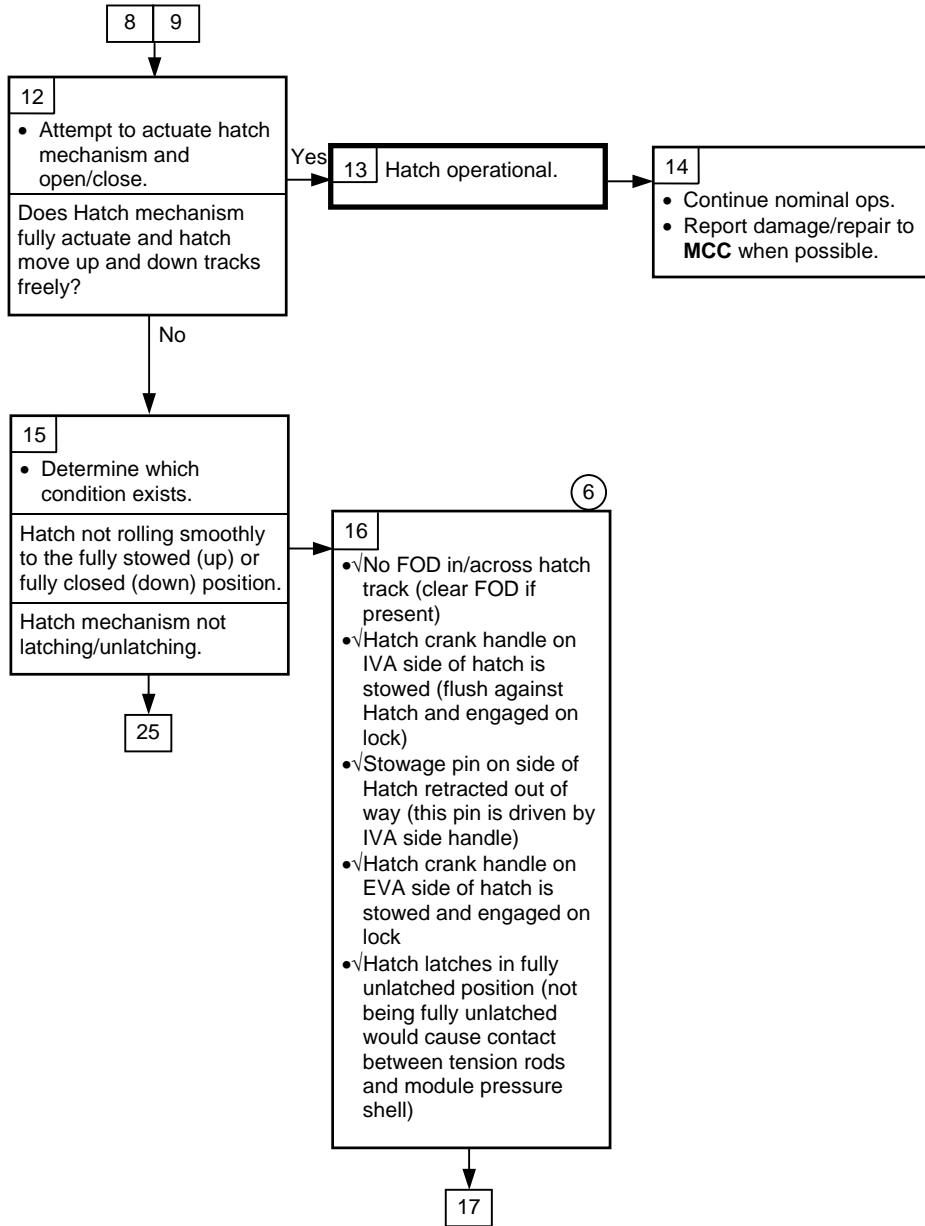

6 Block uses access to both IVA and EVA side of hatch.

1.3.501 HATCH MECHANISM MALFUNCTION

(ISS IFM/3A - ALL/FIN 2/Paper on ISS)

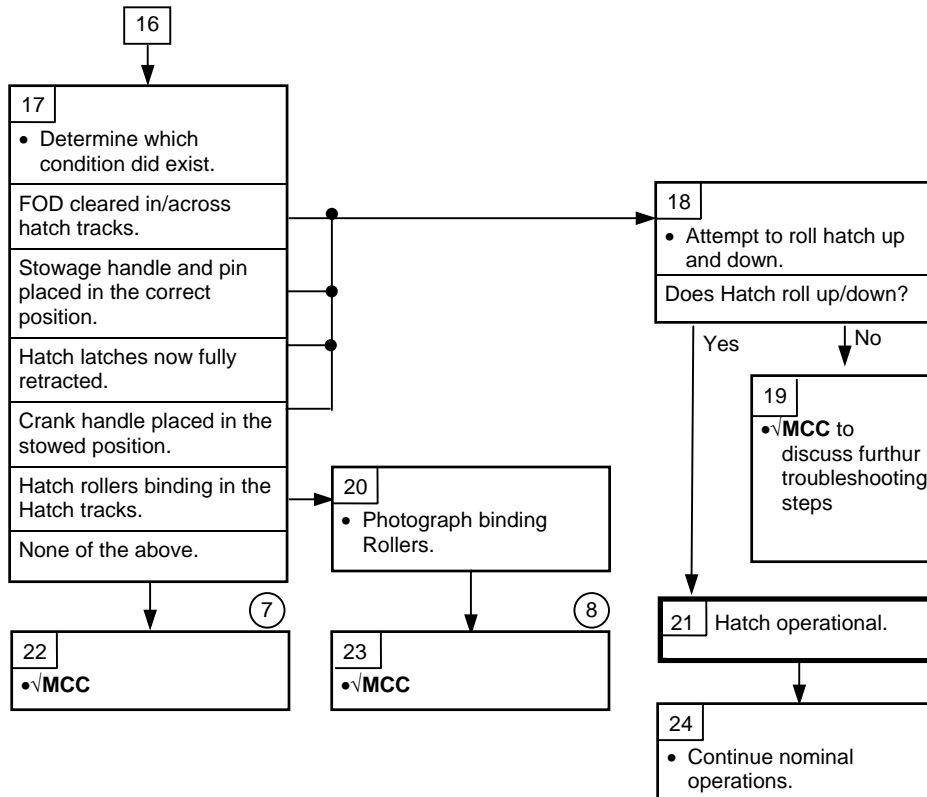

7 Some type of adjustment problem needs more detailed assessment. Crew may compare this Hatch to others to look for any differences which might explain these binding phenomena. For a hatch mechanism that fails to operate, may tape/rerelease tension rods per block 28 and leave Hatch open temporarily or do detailed troubleshooting right away.

8 MCC will likely have crew execute {1.2.523 US COMMON HATCH ROLLER ADJUSTMENT} (SODF: ISS IFM: COMMON: CORRECTIVE/S&M) to relieve binding.

1.3.501 HATCH MECHANISM MALFUNCTION

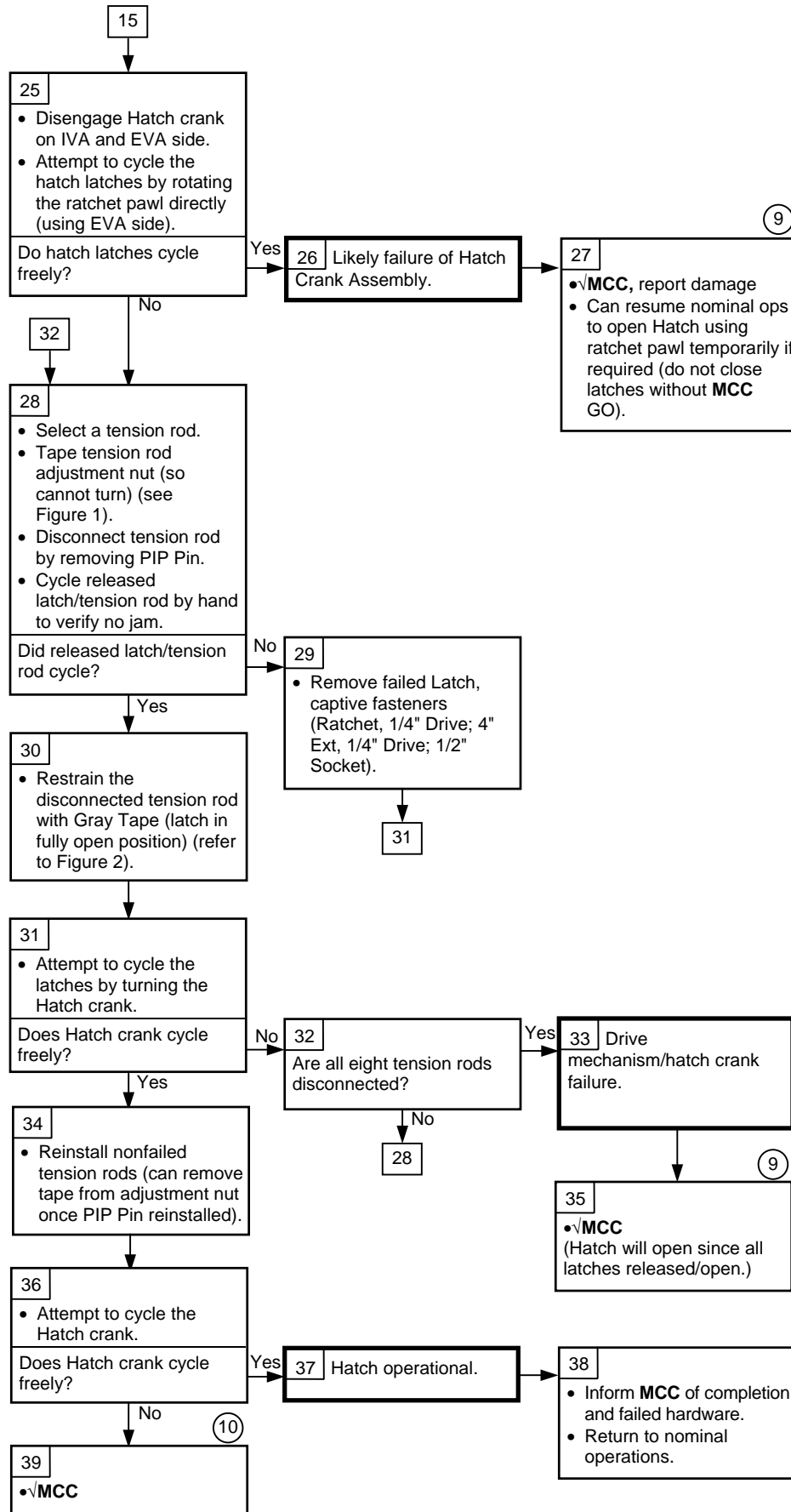

9
Some type of adjustment problem needs more detailed assessment. Crew may compare this Hatch to others to look for any differences which might explain these binding phenomena. For a hatch mechanism that fails to operate, may tape/rerelease tension rods per block 28 and leave Hatch open temporarily or do detailed troubleshooting right away.

10
The Hand Crank and Drive Assemblies cannot be R&R'ed on-orbit due noncaptive pieces inside the Hatch and adjustments. If this Hatch is critical (such as the Hatch to the PMA/shuttle or Node/Airlock, will likely direct crew to R&R Hatch (using a scavenge Hatch as the spare). This will likely take at least 3 hours (though 2 or more additional hours may be required for hatch adjustment). See {1.2.503 HATCH R&R} (SODF: ISS IFM: COMMON: CORRECTIVE/S&M)

1.3.501 HATCH MECHANISM MALFUNCTION

(ISS IFM/3A - ALL/FIN 2/Paper on ISS)

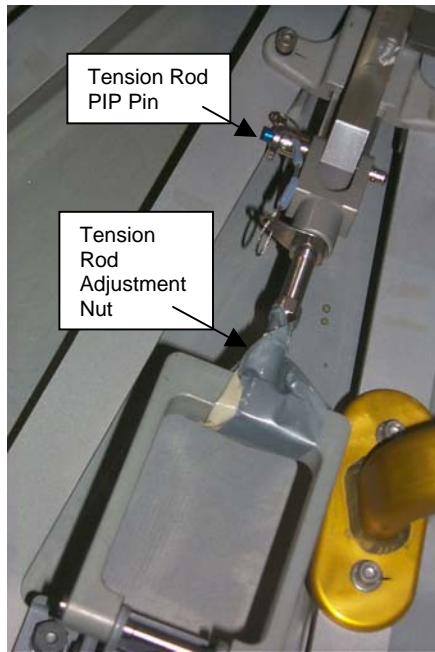

Figure 1.- Gray Tape.

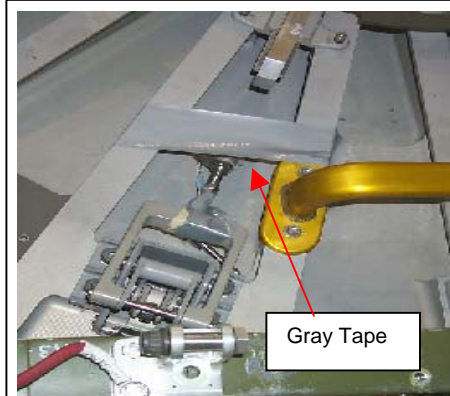

Figure 2.- Tension Rod Restrained.

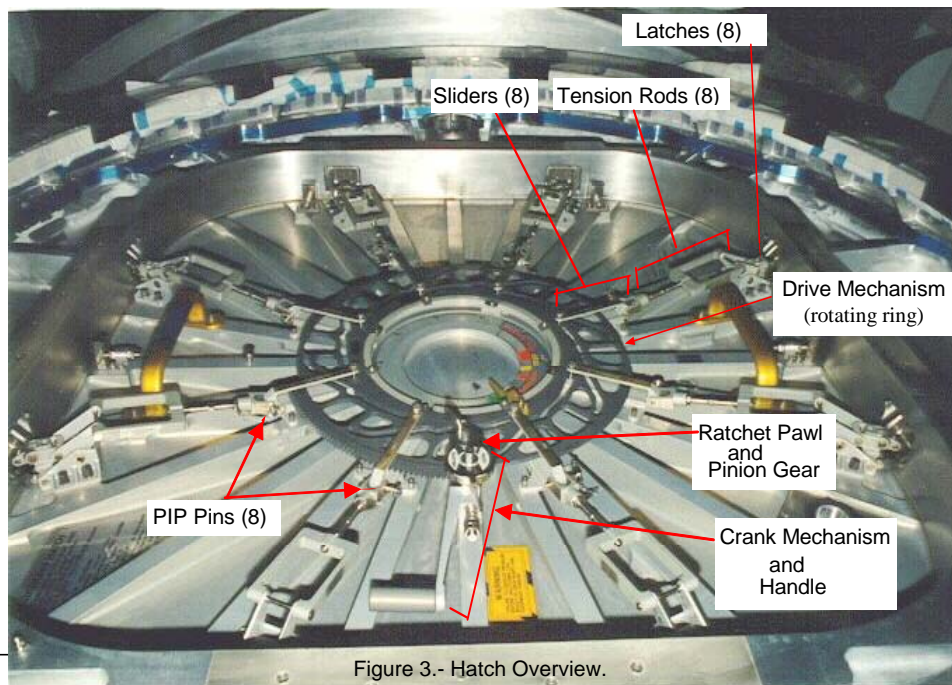

Figure 3.- Hatch Overview.

This Page Intentionally Blank

1. POWERING DOWN EPCS/PCS

Close all display windows.

If PCS does not accept inputs from the keyboard or mouse, go to step 2.

Disconnect CDS from MDM.

Close CDS window.

At the taskbar on bottom of display
sel EXIT

On Logout Confirmation window
sel OK

Wait for '**Type any key to continue**' message to appear.

If message does not appear within 90 seconds, then proceed to step 2.

2. TURNING OFF POWER

PCS Thinkpad pwr sw → Off

Wait 10 seconds.

3. TURNING ON POWER

PCS Thinkpad pwr sw → On

Perform steps 4 and 5 for e5A PCS only. PCS 5A and subsequent releases auto load PCS CDS and CDDF display.

4. CONNECTING EPCS/PCS TO MDM DATA

PCS2

After bootup, when taskbar appears at bottom of display
sel Arrow directly above PCS logo
sel Start/Restart PCS CDS
sel Icon to open PCSDCS Main Control Panel Window

√Status Box is green and '**Connected**' is displayed in the PCSCDS
Main Control Panel Window

Iconify PCSCDS Main Control Panel Window.

5. CONFIGURING PCS FOR DISPLAYS

sel Arrow above PCS logo
sel Start PCS CDDF display

After approximately 1 minute, √'**Increment xA Home Page**' is displayed.

Displays may now be selected as desired.

2.305 PCS REBOOT

(POC/8A - ALL/FIN 3)

Page 2 of 2 pages

```
*****  
* If GMT - <static> or telemetry fields in Caution &  
* Warning toolbar are cyan, go to {2.306 PCS  
* RECONNECT}, all (SODF: POC: NOMINAL: PCS).  
*****
```

Displays may now be selected as desired.

3.301 LOSS OF PCS TELEMETRY

(POC/EPCSR2 - ALL/FIN 3/Paper on ISS) Page 1 of 7 pages

MDM Connection Failed Message Box

MDM Connection Box Status - Purple

MDM Connection Box Status - Green But All Telemetry Fields Cyan

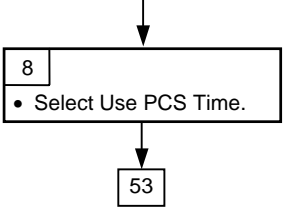
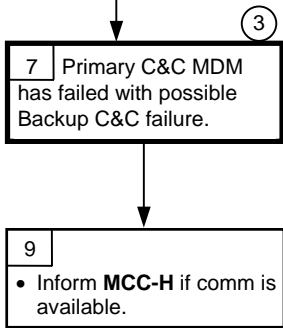
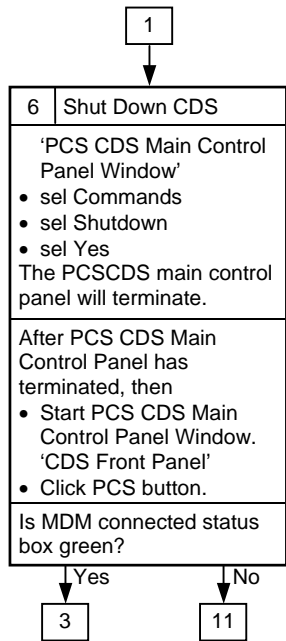
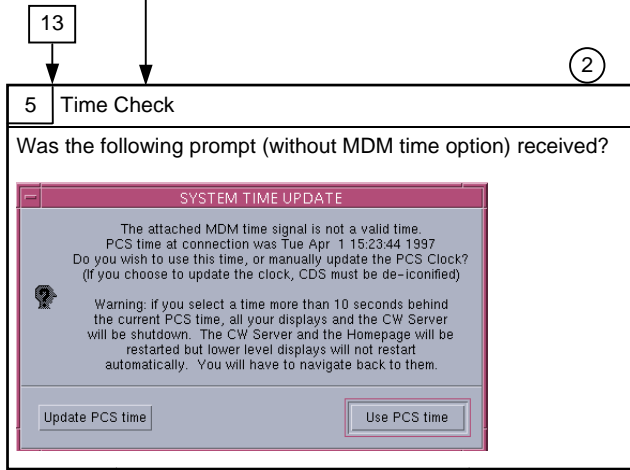
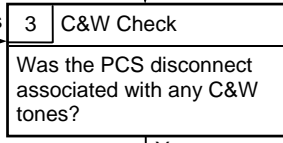
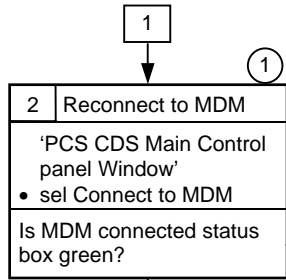
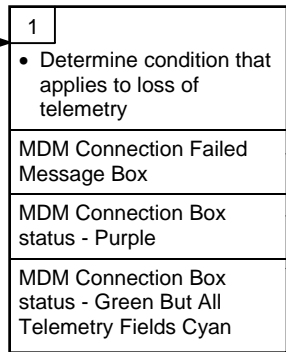

1 All displays in this procedure are on the PCS.

2 If prompted to use PCS time without a use MDM time prompt (see figure), this means a significant C&C MDM time change to 1992 has occurred and likely that all three C&Cs have transitioned.

3 Expect several C&W messages after a Primary C&C MDM failure with possible Backup C&C MDM failure.

3.301 LOSS OF PCS TELEMETRY

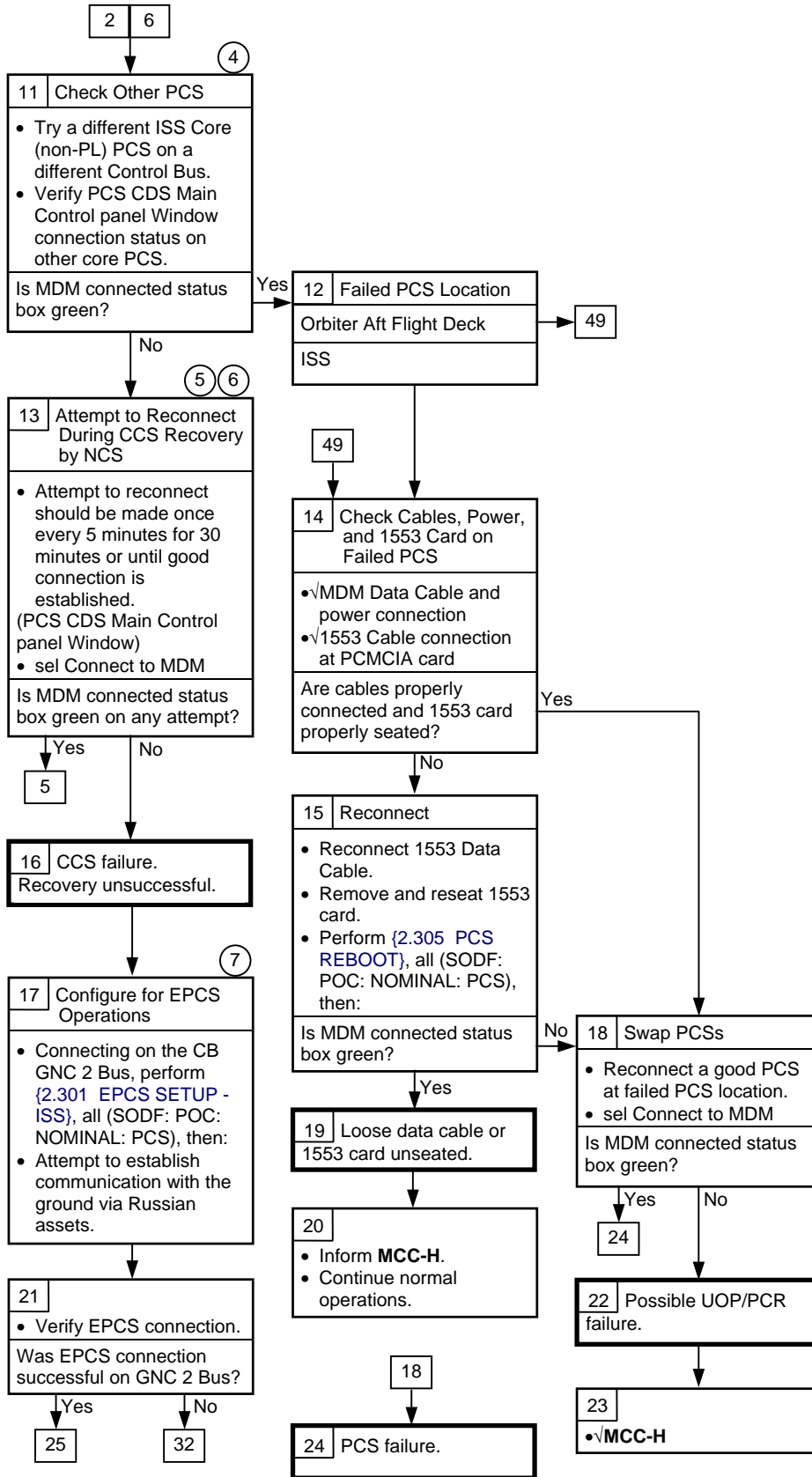

④
If in AFD, orbiter crew will need to contact station crew to determine if PCS is connected.

⑤
Probable CCS failure. Expect loss of communication with the ground. Connection should be periodically attempted during redundancy management operations to allow for good communication. Attempt should be made once every 5 minutes for 30 minutes. This can be attempted on any core/control bus PCS.

⑥
On the RS Laptop expect to see 'К!:Обнаружена потеря связи с С&С MDM' when the Node is trying to recover the C&C MDMs. If recovery is unsuccessful, expect the following RS C&Ws; 'Вкл трансп."OTHER" WARN' 'Вкл трансп."OTHER" CAUT.' 'К!:Обнаружен MDM Node1 как BC'.

⑦
NCS is now in control and in a pre-5A configuration. NCS has minimal insight into LAB functionality.

3.301 LOSS OF PCS TELEMETRY

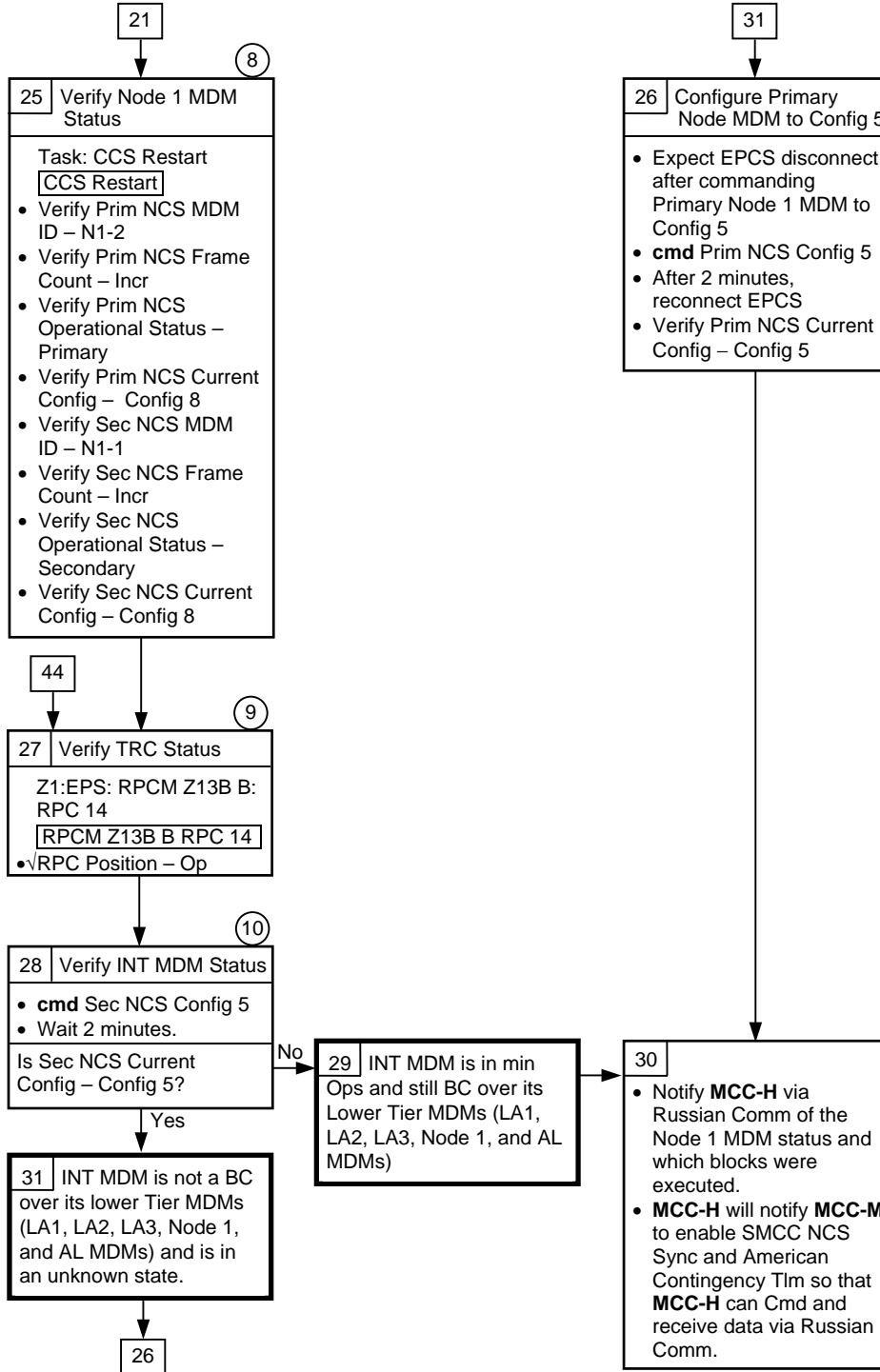

8 The Node 1 MDMs in Config 8 are Bus Controller (BC) on CB GNC (Node 1-2 is BC on CB GNC 2 and Node 1-1 is BC on CB GNC 1) and Remote Terminal (RT) on both LB SYS LAB 1,2.

9 This step is time critical. Without a C&C MDM there is a risk that the KU antenna will point at structure and damage itself with reflected energy.

10 Since there is no insight into the INT MDM, the Secondary Node MDM is commanded to Config 5. If the Node MDM remains in Config 8, that confirms that the INT MDM is in Min Ops and still BC on the LB SYS LAB 1,2. If the Node MDM changes to Config 5 after commanding it to Config 5 then that confirms that the INT MDM is not operational and no longer BC on the LB SYS LAB 1,2.

3.301 LOSS OF PCS TELEMETRY

(POC/EPCSR2 - ALL/FIN 3/Paper on ISS) Page 4 of 7 pages

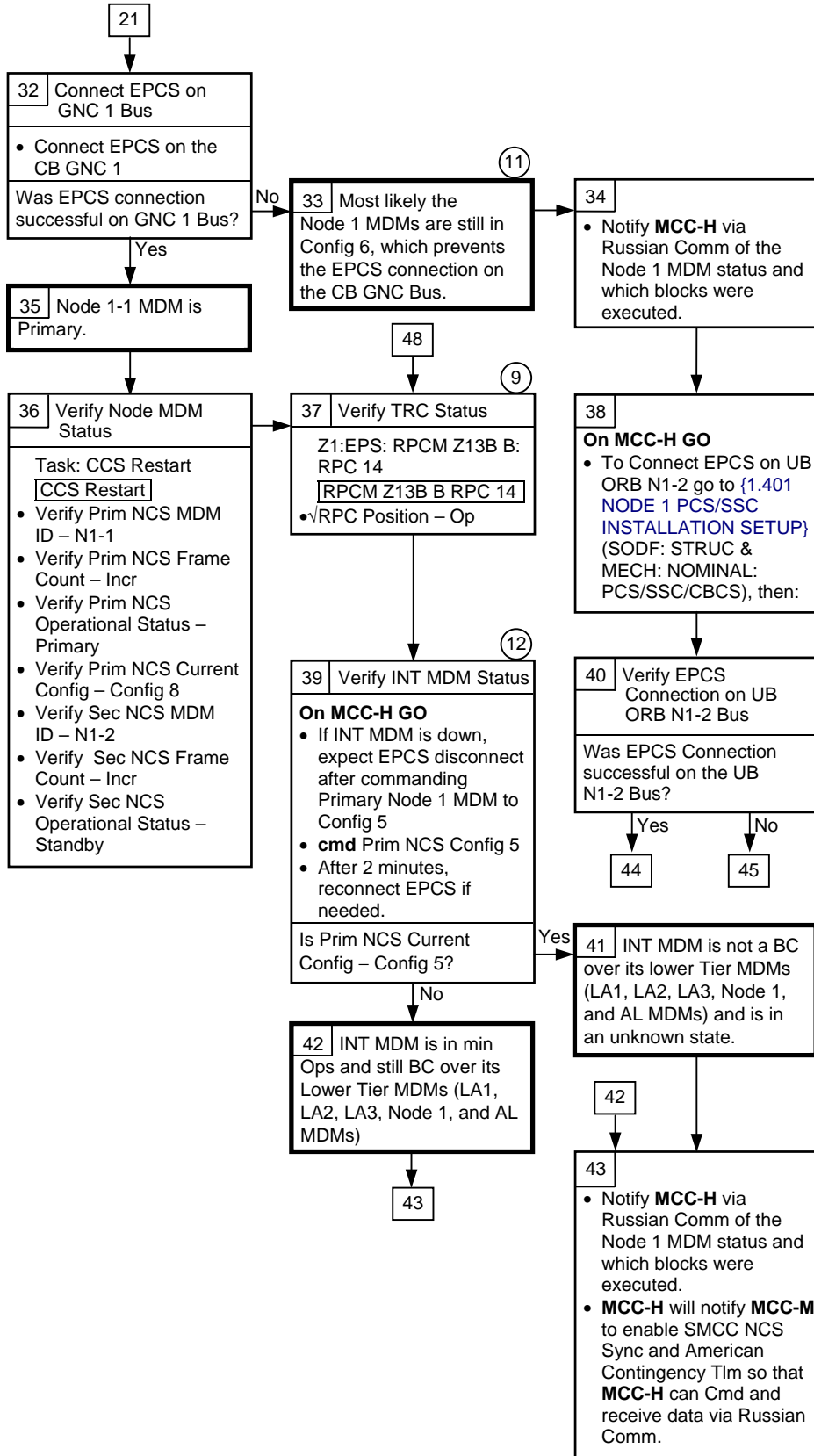

9 This step is time critical. Without a C&C MDM there is a risk that the KU antenna will point at structure and damage itself with reflected energy.

11 If the Node 1 MDMs are still in Config 6, then they are still RT on both CB GNC 1,2 and LB Sys LAB 1,2. The EPCS cannot connect on CB GNC 2(1) if the Node 1 MDM is in Config 6. The only option would be to connect the EPCS to UB ORB Bus, which requires building a PCR for the UB ORB Bus.

12 Since there is no insight into the INT MDM the Primary Node MDM is commanded to Config 5. If the Node MDM remains in Config 8 that confirms that the INT MDM is in Min Ops and still BC on the LB SYS LAB 1,2. If the Node MDM changes to Config 5 after commanding it to Config 5 then that confirms that the INT MDM is not operational and no longer BC on the LB SYS LAB 1,2.

3.301 LOSS OF PCS TELEMETRY

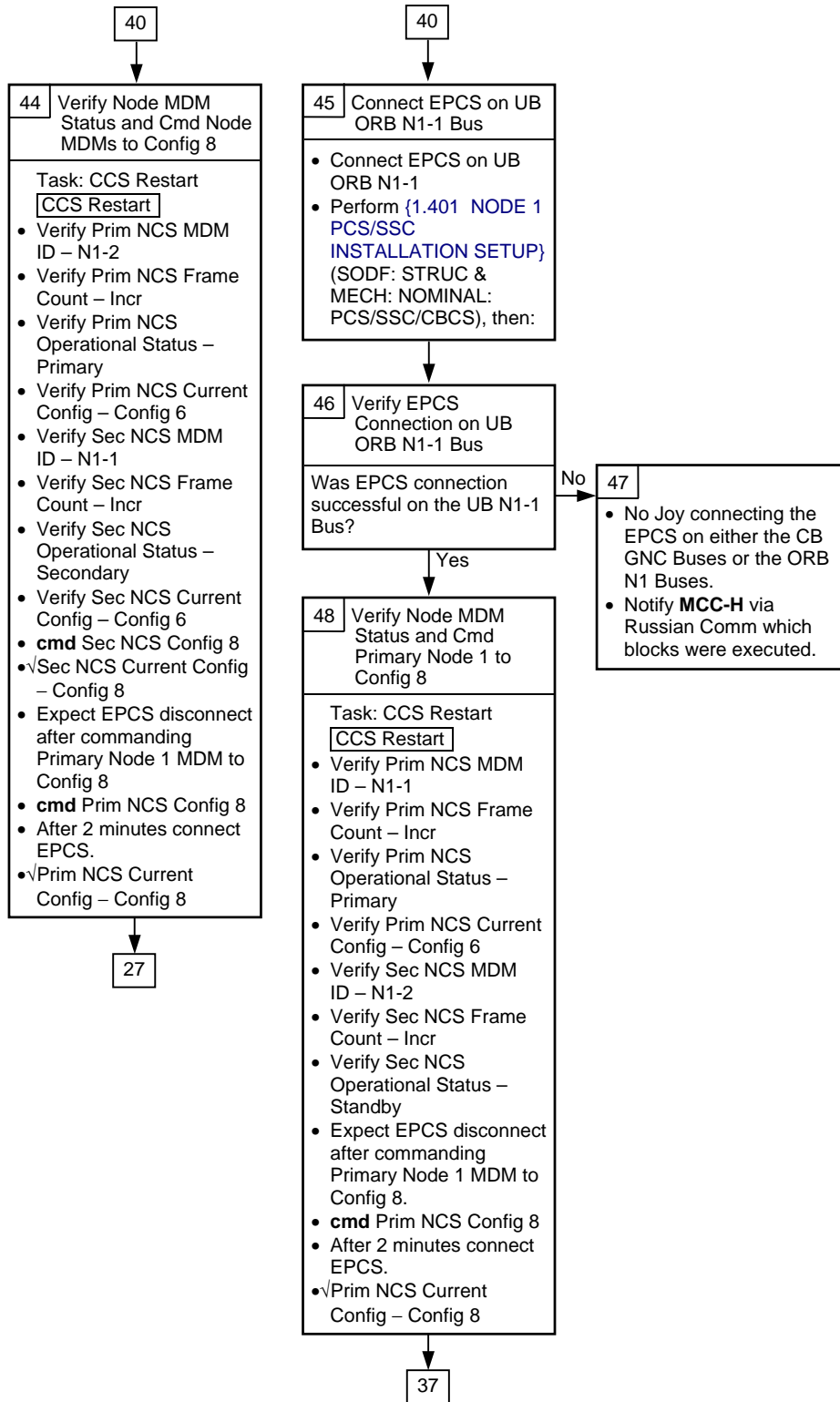

3.301 LOSS OF PCS TELEMETRY

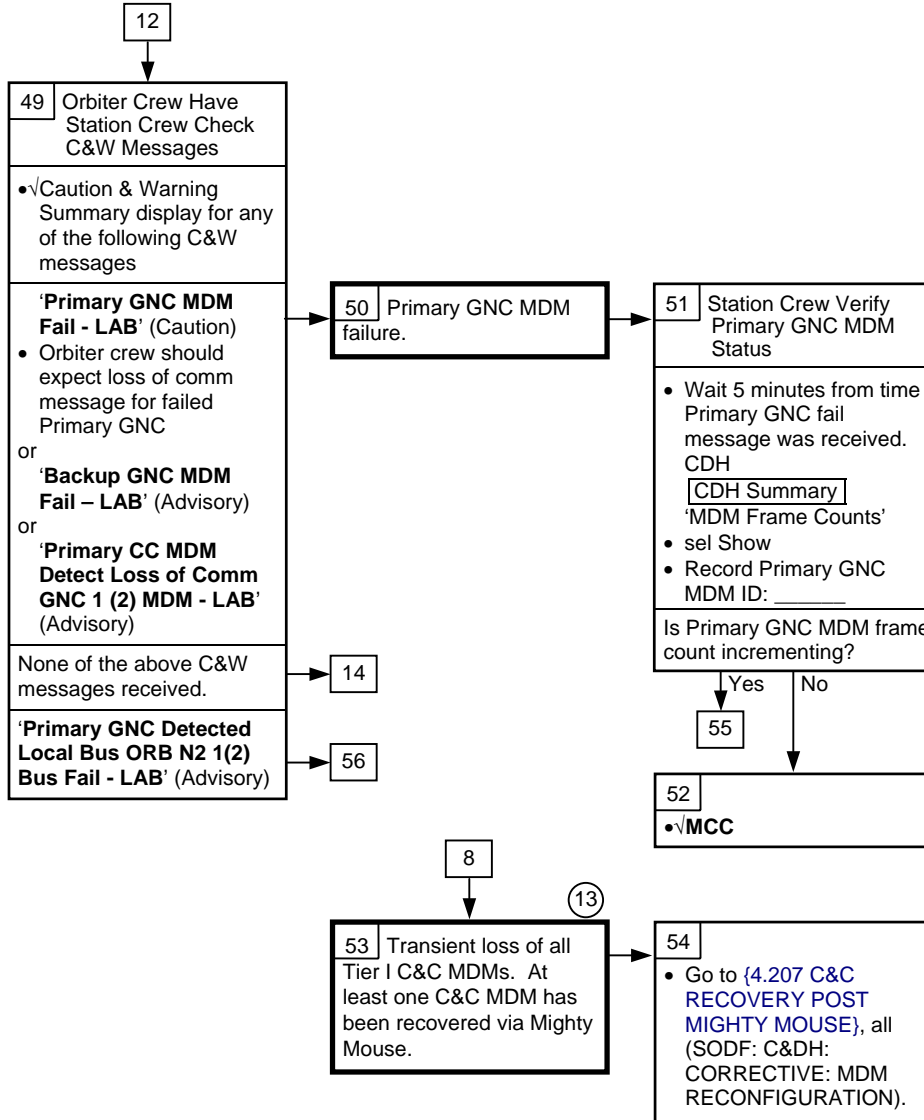

13
 Note that C&W event times may be mixed between current time for those in alarm before the C&C failure and new ones in the 1992 epoch. This is just a symptom of the CCS transition and cannot be corrected yet.

3.301 LOSS OF PCS TELEMETRY
 (POC/EPCSR2 - ALL/FIN 3/Paper on ISS) Page 7 of 7 pages

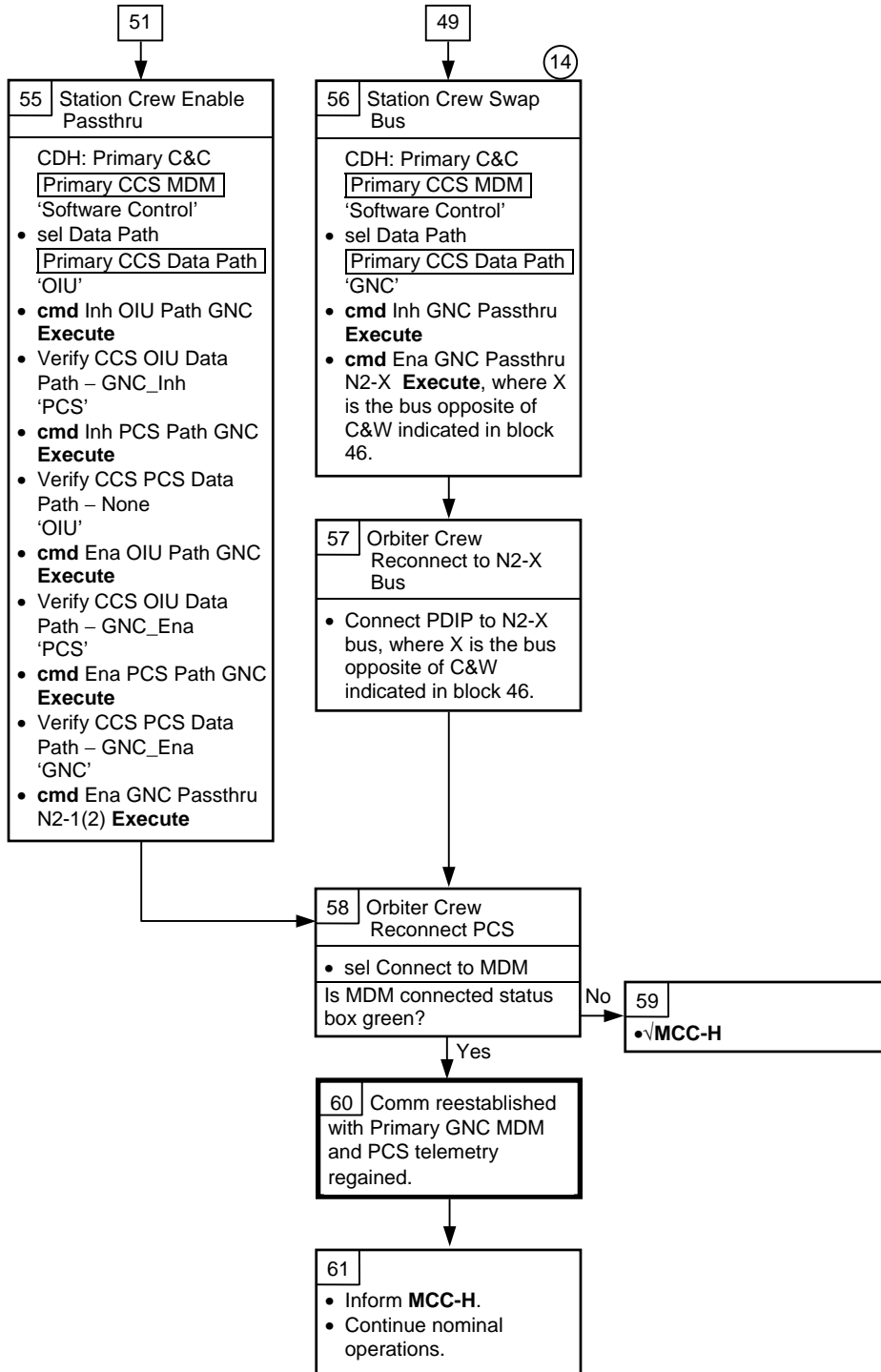

14
 No telemetry verification for GNC pass thru N2-1(2) is available. Select bus opposite of C&W indicated in block 49.

This Page Intentionally Blank

CONTINGENCY

CONTINGENCY

This Page Intentionally Blank

8.101 HANDOVER ATTITUDE CONTROL ORBITER TO RS THRUSTERS

(JNT OPS/8A - ALL/FIN 3/MULTI) Page 1 of 2 pages

OBJECTIVE:

Switch mated stack attitude control responsibility from orbiter to ISS. Verify ISS is in Free Drift and verify orbiter is Free Drift, assuming mated stack control for RS.

- PCS 1. VERIFYING INITIAL ATTITUDE CONTROL CONFIGURATION
MCG

MCG Summary

'MCG Status'
- Verify US GNC Mode – Drift(UDG,Standby,Wait)
Verify RS SUDN Mode – Indicator (CMGTA)
Verify ISS Attitude – Free Drift (No Control)
- MCC-M 2. PREPARING RS СУДН FOR ATTITUDE CONTROL HANDOVER
MCC-M will prepare the RS for handover by issuing the following commands per verified ground procedure
- YBT F1_45 Remove inhibit for change of Master as needed
YBT F1_17 Set BRO (Attitude control prop consumption limit; requires BRO value)
YBT F1_40 Manifolds and ДО for Attitude Control, select (requires some initial data for thruster configuration) as needed
[YB] for selection of proper RS Attitude Mode as needed
YBT F1_198 for preparation of thrusters for attitude control
- MCC-M** ⇒ ISS, **MCC-H**, “Russian Segment ready for handover.”
- C3(A6) 3. PLACING ORBITER INTO FREE DRIFT
DAP: FREE
- Orbiter ⇒ ISS, **MCC-H**, “Orbiter is in Free Drift.”
- RS Laptop 4. ASSUMING CONTROL WITH ISS (VIA ISS CREW OR MCC-M)
CM: TBM PROC

CM:TBM:Procedures

- sel F1_16 “Mode СУДН to active control using ДО”
cmd Execute
- CM: СУДН: Main

CM: СУДН: Main

- Verify RS GNC mode – Thruster (ДО) Only
- MCC-M YBT F1_46 Inhibit change of Master as needed
- ISS ⇒ **MCC-H**, **MCC-M**, “Russian Segment has assumed attitude control.”

8.101 HANDOVER ATTITUDE CONTROL ORBITER TO RS THRUSTERS

(JNT OPS/8A - ALL/FIN 3/MULTI) Page 2 of 2 pages

5. RETURNING ORBITER TO NOMINAL CONFIGURATION

If ALT DAP, return to Group B powerdown.

O14, PRI RJD DRIVER, LOGIC (sixteen) – OFF
O15, RJDA-1A L2/R2 MANF DRIVER – ON
O16:F

8.102 HANDOVER ATTITUDE CONTROL RS THRUSTERS TO ORBITER

(JNT OPS/8A - ALL/FIN 3/MULTI) Page 1 of 2 pages

OBJECTIVE:

Switch mated stack attitude control responsibility from ISS to orbiter. Verify orbiter is in Free Drift, configure ISS to Free Drift, and then assume mated stack control with orbiter.

1. VERIFYING INITIAL RS ATTITUDE CONTROL CONFIGURATION

RS Laptop

CM: СУДН Main

Verify RS GNC Mode – Thrusters (ДО) Only

2. VERIFYING ORBITER CONFIGURATION

C3

√DAP: A/FREE/VERN(ALT)

√DAP ____, ____ loaded

If ALT DAP required

√**MCC**

√DAP: FREE

RJDA 1A L2/R2 MANF DRIVER – OFF

RJD MANF L5/F5/R5 DRIVER – OFF

Pri RJD LOGIC (eight) – ON

√**MCC** FOR GO TO POWER UP Pri DRIVERS

Pri RJD DRIVER (eight) – ON

RJD MANF L5/F5/R5 DRIVER – ON

O14:F
O15:F,
O16:F

Orbiter ⇒ ISS, **MCC-H**, “Orbiter ready to begin controlling attitude of Mated Stack.”

3. CONFIGURING ISS TO FREE DRIFT (VIA ISS CREW OR **MCC-M**)

RS Laptop

CM: TBM PROC

sel F1_37 “Mode СУДН to Indicator, (ИР) with ОДУ OFF”

cmd Execute

CM: СУДН: Main

Verify RS GNC Mode – Indicator: Master

ISS ⇒ **MCC-H**, **MCC-M**: “Russian Segment has moded to Indicator. ISS is Free Drift.”

4. ASSUMING CONTROL WITH ORBITER

If required attitude per Flight Plan is LVLH

DAP – A/LVLH/VERN(ALT)

8.102 HANDOVER ATTITUDE CONTROL RS THRUSTERS TO ORBITER

(JNT OPS/8A - ALL/FIN 3/MULTI) Page 2 of 2 pages

If required attitude per Flight Plan is Inertial
DAP – A/INRTL/VERN(ALT)

GNC UNIV PTG

When rates are damped < 0.1 deg/sec/axis
DAP – A/AUTO/VERN(ALT)

Orbiter \Rightarrow ISS, **MCC-H**, "Orbiter has established Attitude Control."

8.103 PMA2 PRE-ARRIVAL CONFIGURATION (THRUSTERS)

(JNT OPS/LF1 - ALL/FIN 7/MULTI) Page 1 of 6 pages

OBJECTIVE:

Operational sequence used to configure the CCS Attitude Control System Moding software for docking on RS control.

PCS 1. GNC COMMAND RESPONSE COUNTERS RESET

MCG: GNC Command Response Counters

GNC Command Response Counters

sel Reset

Verify the Since Reset column values are all blank.

Do not close this window until the procedure is complete.

If while executing a command, the Command Accept counter on the display does not increment

Reselect GNC Command Response Counters to determine if a command was rejected.

√MCC-H

2. VERIFYING FLIGHT SPECIFIC PAD

If the following information is not recorded elsewhere, record it here.

Is Checkpointing normally enabled or inhibited? _____

Is Checkpointing to be enabled or inhibited for docking? _____

8.103 PMA2 PRE-ARRIVAL CONFIGURATION (THRUSTERS)

(JNT OPS/LF1 - ALL/FIN 7/MULTI) Page 2 of 6 pages

Table1. Pre-Arrival Requirements

Req'd for Pre-Arrival	ADO	Pri	B/U	Ver ID	Comments
1 Mass Properties	ps21			_____	Post Dock Mass Properties
2 CCDB SLOT X CCDB SLOT X Yaw CCDB SLOT X Pitch CCDB SLOT X Roll	ca1X			_____ _____ _____ _____	Post Docking attitude
3 Version ID for CCS PPL 180 (ACS FDIR Adaptation Data) with RS_ACS_Safing_Status set to "0" (off) to be loaded to the backup and standby C&C MDM.				_____	Must be built as File Uplink.
4 Version ID for CCS PPL 181 - CCS RM PPL for GNC RM with or without Checkpointing to be loaded on all C&C MDMs.				_____	If GNC RM with Checkpointing is to be inhibited for docking, uplink PPL to all C&C MDMs. Must be built as File Uplink.
5 Version ID for CCS PPL 216 - CCS PPL containing the commands to snap/hold US attitude control in CCDB slot 1 which execute if there is a TBM restart without context data.				_____	This PPL will be nulled out, thus not containing any commands, to prevent this snap/hold from occurring during mated ops and prevent a potential force fight.

3. VERIFYING INITIAL CONDITIONS

PCS

MCG

MCG Summary

'MCG Status'

Verify US Station Mode – Prox Ops
 Verify RS Station Mode – Prox Ops
 Verify RS SUDN Mode – Thrusters Only

'Primary GNC MDM'

Verify Frame Count – incrementing

'Backup GNC MDM'

Verify Frame Count – incrementing

8.103 PMA2 PRE-ARRIVAL CONFIGURATION (THRUSTERS)

(JNT OPS/LF1 - ALL/FIN 7/MULTI) Page 3 of 6 pages

4. LOADING PPLs TO THE PRIMARY GNC MDM

CAUTION

Since a PPL load error that corrupts memory in the Primary GNC would be checkpointed to the Backup GNC, checkpointing should be stopped until the Primary GNC is successfully loaded. Failure to do this may result in corrupted memory in both the Primary and Backup GNC MDMs.

PCS

4.1 Disabling Checkpointing in Primary GNC MDM

MCG: Dock and Undock: Pre-Node 2 PMA 2 Dock

Pre Node 2 PMA 2 Dock

'Pre Arrival'

If Pri GNC Checkpoint – Ena

sel Pri

Primary GNC Checkpointing Status

'Checkpoint Inhibit Status'

cmd Inh **Execute** (Verify – Inhibited)

Pre Node 2 PMA 2 Dock

sel Bkup

Backup GNC Checkpoint Status

Verify Idle Read/Start counter – incrementing

MCC-H

4.2 Loading the PPLs

For all PPLs designated in step 2 to be loaded to the Primary GNC MDM, coordinate with ODIN.

PCS

4.3 Enabling Checkpointing in Primary GNC MDM

If Checkpointing is normally enabled per step 2

MCG: Dock and Undock: Pre-Node 2 PMA 2 Dock: Pri

Primary GNC Checkpoint Status

'Checkpoint Inhibit Status'

cmd Ena **Execute** (Verify – Enabled)

Pre Node 2 PMA 2 Dock

sel Bkup

Backup GNC Checkpoint Status

Verify Idle Read/Start counter: 0

8.103 PMA2 PRE-ARRIVAL CONFIGURATION (THRUSTERS)

(JNT OPS/LF1 - ALL/FIN 7/MULTI) Page 4 of 6 pages

MCC-H 5. LOADING PPLS TO THE BACKUP GNC MDM

If Checkpointing is normally inhibited per step 2, or if loading PPLs that are not checkpointed in R4, which are GC, SD, and RG PPLs

For all PPLs designated in step 2 to be loaded to the Backup GNC MDM, coordinate with ODIN.

MCC-H 6. LOADING REQUIRED PPLs TO THE BACKUP/STANDBY C&C MDM

For all PPLs designated in step 2 to be loaded to the Backup and Standby C&C MDM, coordinate with ODIN.

7. CONFIGURING RUSSIAN SEGMENT FOR DOCKING

NOTE

MCC-M can send these commands any time prior to orbiter docking.

MCC-M

YBLQ F8_10 (inf0=9, inf1=1) Inhibit RS takeover due to Tier 1 Loss of Comm

YBLQ F1_44 Update unmated Mass Properties into TBM buffer for Joint Expedited Undocking and Separation (JEUS).

MCC-M will uplink cyclogram contents to channel 34 for JEUS.

MCC-M ⇒ **MCC-H**, "Step 7 complete."

PCS 8. UPDATING POST DOCKING CCDB COMMANDED ATTITUDE

MCG: MCS Configuration

MCS Configuration

'CCDB Slots'

8.103 PMA2 PRE-ARRIVAL CONFIGURATION (THRUSTERS)

(JNT OPS/LF1 - ALL/FIN 7/MULTI) Page 5 of 6 pages

For CCDB Slot X (from step 2)

sel Cmd Att X

Cmd Att X

If Slot X Yaw, Pitch, Roll does not match Yaw, Pitch, Roll in step 2

If in step 2, CCDB Slot X Yaw, Pitch, Roll is (0,0,0)

cmd YPR 0,0,0

If in step 2, CCDB Slot X Yaw, Pitch, Roll is not (0,0,0)

'Command Input'

input Yaw – (from step 2)

Pitch – (from step 2)

Roll – (from step 2)

cmd Set

Verify Slot X Yaw – (as commanded)

Pitch – (as commanded)

Roll – (as commanded)

9. VERIFYING STATUS OF ACS MODING SIGNALS

MCG: Dock and Undock: Pre-Node 2 PMA 2 Dock

Pre Node 2 PMA 2 Dock

'Final Approach'

Verify Manual Dock Sequence Init – Not Init

Verify LA-1, LA-2 Capture – No/No

Verify Arrival Flag – No

Verify Docked Indication – NOT Docked

10. INHIBITING GNC CHECKPOINTING

If GNC Checkpointing is to be inhibited for docking per step 2, perform

{2.702 DISABLE GNC CHECKPOINTING}, all (SODF: MCS:

NOMINAL: CHECKPOINTING), then:

11. ENABLING ARRIVAL SOFTWARE

Pre Node 2 PMA 2 Dock

'Pre Arrival'

sel PMA2 Manual Arrival SW

Manual Arrival SW

'PMA 2'

cmd Manual Arrival SW Enable

8.103 PMA2 PRE-ARRIVAL CONFIGURATION (THRUSTERS)

(JNT OPS/LF1 - ALL/FIN 7/MULTI) Page 6 of 6 pages

Verify PMA2 Docking Vehicle – Shuttle
Verify PMA2 Manual Arrival SW – Ena

Pre Node 2 PMA 2 Dock

'Pre Arrival'

sel PMA 2 Arrival Automatic Arrival SW

Automatic Arrival SW

'PMA 2'

cmd Enable

Verify PMA2 Docking Vehicle – Shuttle
Verify PMA2 Automatic Arrival SW – Ena

12. ENABLING APAS LEDs

Pre Node 2 PMA 2 Dock

'Pre Arrival'

sel LED Control SW

LED Control SW

cmd Enable

Verify LED Control SW – Ena
Verify LED State – On

13. VERIFYING STATUS OF AUTO HANDOVER

Pre Node 2 PMA 2 Dock

'Pre Arrival'

If Auto Att Control Handover to RS – Ena

cmd Arm

cmd Inhibit (Verify – Inh)

8.104 PMA2 ARRIVAL (THRUSTERS)

(JNT OPS/LF1 - ALL/FIN 6/MULTI)

Page 1 of 2 pages

OBJECTIVE:

Operational sequence used to monitor orbiter arrival on RS Thrusters and then mode RS SUDN to Indicator. ISS MCS is configured to allow for automatic moding to Free Drift and then orbiter arrival is monitored. The crew will command the ISS to Free Drift manually only if the automatic software does not complete the mode transition within 20 seconds of Capture Confirmed.

NOTE

1. Perform step 1 after orbiter has begun approach (Dock - 15 minutes).
2. Start step 2 when orbiter starts final approach (from 30 feet). RS GNC must mode to Indicator – Master within 65 seconds of the orbiter call of Capture Confirmed or the orbiter will execute a corridor backout. ISS crew commands RS GNC to Indicator – Master after 20 seconds ONLY if automatic software is not successful
3. Steps 3 and 4 provide manual commanding by the ground if the automatic, or crew, moding is unsuccessful.

- PCS
1. VERIFYING INITIAL CONFIGURATION
MCG: Dock and Undock: Pre-Node 2 PMA 2 Dock
Pre Node 2 PMA 2 Dock
'System Configuration'

Verify US Station Mode – Prox Ops
Verify RS Station Mode – Prox Ops
Verify RS SUDN Mode – Thrusters Only

'Pre Arrival'

Verify PMA 2 Manual Arrival SW – Ena
Verify PMA 2 Automatic Arrival SW – Ena

'Final Approach'

Verify LA-1/LA-2 Capture – No/No
Verify Arrival Flag – No
Verify Docked Indication – NOT Docked

2. FINAL APPROACH AND CAPTURE

Orbiter ⇒ ISS, "Initiating final approach."

Pre Node 2 PMA 2 Dock

'Final Approach'

Orbiter ⇒ ISS, "Capture confirmed."

Start manual timer.

Wait up to 20 seconds for the following indication.

Verify RS SUDN Mode – Indicator

8.104 PMA2 ARRIVAL (THRUSTERS)

(JNT OPS/LF1 - ALL/FIN 6/MULTI)

Page 2 of 2 pages

```
*****
* When time since capture confirmed > 20 seconds
*   | If RS SUDN Mode – Thrusters Only
*   |   | ‘Final Approach’
*   |   |
*   |   | √Manual SW Enable – Ena
*   |   |
*   |   | cmd Manual Dock Sequence Init (Verify – Init)
*   |   |
*   |   | Verify RS SUDN Mode – Indicator
*****
```

ISS ⇒ orbiter, “ISS is Free Drift.”

```
*****
* If at any time orbiter calls Failed Dock and proceeds
*   | to separation
*   |
*   | MCC-M will ensure that correct mass properties
*   | are uplinked before commanding RS to active
*   | attitude control.
*****
```

MCC-M

3. MODING TO FREE DRIFT - HOUSTON GROUND STEP

MCC-H

```
If time since Capture Confirmed > 30 seconds and RS SUDN Mode is
not Indicator
  MCG: Dock and Undock: Pre-Node 2 PMA 2 Dock
  Pre Node 2 PMA 2 Dock
  ‘Final Approach’

  √Manual SW Enable – Ena

  cmd Manual Dock Sequence Init (Verify – Init)

  Verify RS SUDN Mode – Indicator

  MCC-H ⇒ orbiter, ISS, “ISS is Free Drift.”
```

4. MODING TO FREE DRIFT - MOSCOW GROUND STEP

MCC-H

```
If time since Capture Confirmed > 40 seconds and RS SUDN Mode is
not Indicator
```

MCC-M

```
  MCC-H ⇒ MCC-M “Execute Step 4”
  YBL F8_4 Manual entry of Capture discrete with shuttle
```

MCC-H

```
  MCG: Dock and Undock: Pre-Node 2 PMA 2 Dock
  Pre Node 2 PMA 2 Dock
  ‘Final Approach’
```

Verify RS SUDN Mode – Indicator

MCC-H ⇒ orbiter, ISS, “ISS is Free Drift.”

8.105 PMA2 POST ARRIVAL CONFIGURATION (THRUSTERS)

(JNT OPS/LF1 - ALL/FIN 6/MULTI) Page 1 of 3 pages

OBJECTIVE:

Operational sequence used to disable the Arrival SW.

1. GNC COMMAND RESPONSE COUNTERS RESET

PCS MCG: GNC Command Response Counters

GNC Command Response Counters

sel Reset

Verify the Since Reset column values are all blank.

Do not close this window until the procedure is complete.

If while executing a command, the Command Accept counter on that display does not increment

Reselect GNC Command Response Counters to determine if a command was rejected.

√**MCC-H**

2. VERIFYING FLIGHT SPECIFIC PAD

If the following information is not recorded elsewhere, record it here.

Is Checkpointing to be enabled or inhibited? _____

Table 1.- Post Arrival Requirement

Req'd for Post Arrival	ADO	Pri	B/U	Ver ID	Comments
Version ID for CCS PPL 181 - CCS RM PPL FOR GNC RM with or without Checkpointing to be loaded to all C&C MDMS.					If GNC RM with Checkpointing was inhibited for docking and is now to be enabled, uplink PPL to all C&C MDMS. Must be built as File Uplink.

3. VERIFYING CORRECT CONFIGURATION

PCS MCG: Dock and Undock: Pre-Node 2 PMA 2 Dock

Pre Node 2 PMA 2 Dock

'System Configuration'

Verify US Station Mode – Prox Ops

Verify RS Station Mode – Prox Ops

Verify RS SUDN Mode – Indicator

4. LOADING REQUIRED PPLS TO THE C&C MDMS

MCC-H For all PPLs designated in step 2 to be loaded to the C&C MDMS, to load PPL to the C&C MDMS, coordinate with ODIN.

8.105 PMA2 POST ARRIVAL CONFIGURATION (THRUSTERS)

(JNT OPS/LF1 - ALL/FIN 6/MULTI) Page 2 of 3 pages

PCS 5. ENABLING GNC CHECKPOINTING
If GNC Checkpointing is to be enabled per step 2, perform {2.701
| ENABLE GNC CHECKPOINTING}, (SODF: MCS: NOMINAL:
| CHECKPOINTING), then:

6. DISABLING ARRIVAL SOFTWARE

NOTE

If the Manual Dock Sequence Init command was sent, the software automatically inhibits the manual software. However, to configure the Man Dock Seq Init telemetry to Not Init, the Manual Software must be commanded Inh even though its telemetry already reads Inh. After docking, if ISS attitude control is resumed while the telemetry reads Init, the ACS Moding software will automatically mode the ISS to Free Drift.

Pre Node 2 PMA 2 Dock

'Final Approach'

If Manual SW Enable – Ena, or Manual Dock Sequence Init – Init
'Pre Arrival'

sel PMA 2 Manual Arrival SW

Manual Arrival SW

'PMA 2'

cmd Manual Arrival SW Inhibit

Verify PMA 2 Docking Vehicle – None

Verify PMA 2 Manual Arrival SW – Inh

Pre Node 2 PMA 2 Dock

'Final Approach'

Verify Manual Dock Sequence Init – Not Init

Pre Node 2 PMA 2 Dock

'Pre Arrival'

sel PMA 2 Automatic Arrival SW

Automatic Arrival SW

'PMA 2'

cmd Arm (Verify – Arm)

cmd Inhibit

Verify PMA 2 Docking Vehicle – None

Verify PMA 2 Automatic Arrival SW – Inh

8.105 PMA2 POST ARRIVAL CONFIGURATION (THRUSTERS)

(JNT OPS/LF1 - ALL/FIN 6/MULTI) Page 3 of 3 pages

7. DISABLING LED CONTROL SOFTWARE

Pre Node 2 PMA 2 Dock

'Pre Arrival'

sel LED Control SW

LED Control SW

cmd Inhibit

Verify LED Control SW – Inh

Verify LED State – Off

8. VERIFYING APAS INDICATION OF HARD DOCK

NOTE

Perform this step after Hard Dock complete, which may take up to 17 minutes.

Pre Node 2 PMA 2 Dock

'Final Approach'

Verify LA-1, LA-2 Capture – No/No

If Docked Indication – NOT Docked

cmd Docked

Verify Docked Indication – Docked

9. INCORPORATING POST-ARRIVAL PPLS

PCS

Pre Node 2 PMA 2 Dock

'System Configuration'

cmd Mass

Verify Active Mass Properties PPL Version ID as expected per 8.103 PMA2 Pre-Arrival Configuration (Thrusters).

This Page Intentionally Blank

8.106 PMA2 PRE-DEPARTURE CONFIGURATION (THRUSTERS)

(JNT OPS/LF1 - ALL/FIN 8/SPN/MULTI) Page 1 of 6 pages

OBJECTIVE:

Operational sequence used to configure CCS Attitude Control System (ACS) Moding software to allow for RS GNC control after departure of orbiter.

1. VERIFYING FLIGHT-SPECIFIC PAD

If the following information is not recorded elsewhere, record it here.

Is Checkpointing normally enabled or inhibited? _____

Is Checkpointing to be enabled or inhibited for undocking? _____

Table 1. Post Arrivals Requirement

Req'd for Post Departure	ADO	Pri	B/U	Ver ID	Comments
1	Mass Properties	PS21			
2	Version ID for CCS PPL 181 - CCS RM PPL For GNC RM with or without Checkpointing to be loaded to all C&C MDMs.				If GNC RM with Checkpointing is to be inhibited for undocking, uplink PPL to all C&C MDMs. Must be built as File Uplink.

2. VERIFYING INITIAL CONDITIONS

PCS

MCG

MCG Summary

'MCG Status'

Verify US Station Mode – Prox Ops

Verify RS Station Mode – Prox Ops

Verify US GNC Mode – CMG TA (Drift, UDG)

Verify RS SUDN Mode – CMG TA (Indicator)

Verify RS Control – Slave (Master)

3. LOADING PPLS TO THE PRIMARY GNC MDM

CAUTION

Since a PPL load error that corrupts memory in the Primary GNC would be checkpointed to the Backup GNC, checkpointing should be stopped until the Primary GNC is successfully loaded. Failure to do this may result in corrupted memory in both the Primary and Backup GNC MDMs.

PCS

3.1 Disabling Checkpointing in Primary GNC MDM

MCG: Dock and Undock: Pre-Node 2 PMA 2 Undock

Pre Node 2 PMA 2 Undock

'Pre Departure'

8.106 PMA2 PRE-DEPARTURE CONFIGURATION (THRUSTERS)

(JNT OPS/LF1 - ALL/FIN 8/SPN/MULTI) Page 2 of 6 pages

If Pri GNC Checkpoint – Ena

sel Pri

Primary GNC Checkpoint Status
'Checkpoint Inhibit Status'

cmd Inh **Execute** (Verify – Inhibited)

Pre Node 2 PMA 2 Undock

sel Bkup

Backup GNC Checkpoint Status

Verify Idle Read/Start Counter – incrementing

MCC-H

3.2 Loading the PPLs

For all PPLs designated in step 1 to be loaded to the Primary GNC MDM, coordinate with ODIN.

PCS

3.3 Enabling Checkpointing in Primary GNC MDM

If Checkpointing is normally enabled per step 1

MCG: Dock and Undock: Pre-Node 2 PMA 2 Undock: Pri

Primary GNC Checkpoint Status
'Checkpoint Inhibit Status'

cmd Ena **Execute** (Verify – Enabled)

Pre Node 2 PMA 2 Undock

sel Bkup

Backup GNC Checkpoint Status

Verify Idle Read/Start Counter: 0

MCC-H

4. LOADING PPLS TO THE BACKUP GNC MDM

If Checkpointing is normally inhibited per step 1, or if loading PPLs that are not checkpointed in R4, which are GC, SD, and RG PPLs

For all PPLs designated in step 1 to be loaded to Backup GNC MDM, coordinate with ODIN.

5. LOADING REQUIRED PPLS TO THE BACKUP/STANDBY C&C MDM

For all PPLs designated in step 1 to be loaded to Backup and Standby C&C MDMs, coordinate with ODIN.

PCS

6. VERIFYING STATUS OF ACS MODING SIGNALS

MCG: Dock and Undock: Pre-Node 2 PMA 2 Undock

Pre Node 2 PMA 2 Undock

'Pre Departure'

8.106 PMA2 PRE-DEPARTURE CONFIGURATION (THRUSTERS)

(JNT OPS/LF1 - ALL/FIN 8/SPN/MULTI) Page 3 of 6 pages

Verify Auto Att Control Handover to RS – Inh

'Undocking'

Verify Manual Undock Sequence Init – Not Init

Verify LA-1/LA-2 Interface Sealed – Yes/Yes

Verify LA-1/LA-2 Separation – No/No

Verify Docked Indication – Docked

Verify Departure Flag – No

7. INHIBITING GNC CHECKPOINTING

If GNC Checkpointing is to be inhibited for undocking per step 1, perform
| {2.702 DISABLE GNC CHECKPOINTING},all (SODF: MCS: NOMINAL:
| CHECKPOINTING), then:

8. SETTING BACK OFF TIME

'Pre Departure'

sel Back Off Time

'Pending Time'

cmd 100 Seconds

Verify Pending Back Off Time: 100 sec

Verify Arm State – Arm

cmd Incorporate Pending Back Off Time

Verify Back Off Time: 100 sec

Verify Arm State – Disarm

9. SETTING POST DEPARTURE CONTROL MODE

'Pre Departure'

If Post Departure Control Mode – CMG TA (CMG Only)

sel Post Departure Control Mode

cmd RS Control

Verify Post Departure Control Mode – RS Control

8.106 PMA2 PRE-DEPARTURE CONFIGURATION (THRUSTERS)

(JNT OPS/LF1 - ALL/FIN 8/SPN/MULTI) Page 4 of 6 pages

10. ENABLING DEPARTURE SOFTWARE

NOTE

Due to SPN 3366, which is only applicable to CCS R4, the manual dock ACS Moding software will remain inhibited, and the ISS crew will command from the Russian Segment in the Departure procedure.

Pre Node 2 PMA 2 Undock

'Pre Departure'

sel PMA 2 Automatic Departure SW

Automatic Departure SW

'PMA 2'

cmd Arm

Verify State – Arm

cmd Enable

Verify PMA 2 Undocking Vehicle – Shuttle

Verify PMA 2 Automatic Departure SW – Ena

Verify State – Disarm

11. VERIFYING TIME SINCE SEPARATION TELEMTRY

Pre Node 2 PMA 2 Undock

'Undocking'

Verify Time Since Separation: 0

CAUTION

If the Time Since Separation is observed to be incrementing any time prior to planned departure, ISS will take attitude control after 100 seconds, which could result in a force fight or collision with the orbiter. IMMEDIATE ACTION IS REQUIRED to prevent ISS from taking attitude control.

8.106 PMA2 PRE-DEPARTURE CONFIGURATION (THRUSTERS)

(JNT OPS/LF1 - ALL/FIN 8/SPN/MULTI) Page 5 of 6 pages

```
*****
* If Time Since Separation is observed to be incrementing any time
* | prior to planned departure, send all of the following commands
* | to inhibit both manual and automatic SW, even if either is
* | already inhibited, to ensure timer stops.
* |
* | Pre Node 2 PMA 2 Undock
* | 'Pre Departure'
* |
* | sel PMA2 Manual Departure SW
* |
* | Manual Departure SW
* | 'PMA 2'
* |
* | cmd Manual Departure SW Inhibit
* |
* | Verify PMA 2 Undocking Vehicle – None
* | Verify PMA 2 Manual Dprtr SW – Inh
* |
* | cmd Automatic Departure SW Inhibit
* |
* | Verify PMA 2 Automatic Dprtr SW – Inh
*****
```

12. HANDOVER ATTITUDE CONTROL TO ORBITER

MCG: MCS Configuration

MCS Configuration

'MCS Moding'

If US GNC Mode – CMG TA

Perform {3.110 HANDOVER ATTITUDE CONTROL CMG TA TO ORBITER}, all (SODF: JNT OPS: MATED OPERATIONS), then:

MCG: MCS Configuration

MCS Configuration

'MCS Moding'

MCC-H

Verify RS SUDN Mode – CMG TA

13. PREPARING RUSSIAN SEGMENT FOR DEPARTURE

NOTE

RS Control must be Master for the ACS moding software to mode RS to thruster control after undocking.

8.106 PMA2 PRE-DEPARTURE CONFIGURATION (THRUSTERS)

(JNT OPS/LF1 - ALL/FIN 8/SPN/MULTI) Page 6 of 6 pages

If handover to orbiter occurred in step 12
MCC-M YBT F14_20 Take Master Flag from US and Mode RS to Indicator

MCC-H MCS Configuration
'MCS Moding'

Verify RS SUDN Mode – Indicator
Verify RS Control – Master

MCC-M Verify GTUBM_B13.B.14 = 1 Inhibit dynamic checking flag bit set

MCC-M will prepare thrusters for attitude control approximately 3 minutes prior to undocking.

YBT F1_198 Prepare thrusters for attitude control.

NOTE

1. **MCC-M** will also verify that Russian Segment is not using USOS calculated mass properties.
2. **MCC-M** mass properties will have been updated once station is in attitude control.

MCC-M ⇒ **MCC-H**, “Russian Segment is prepared for departure.”

8.107 PMA 2 DEPARTURE (THRUSTERS)

(JNT OPS/LF1 - ALL/FIN 5/MULTI) Page 1 of 3 pages

OBJECTIVE:

Operational sequence used to monitor departure and to ensure proper functioning of the USOS software after orbiter departure on RS Thrusters. The crew will command the ISS to attitude control manually only if the automatic software does not complete the transition within 120 seconds of Physical Separation.

NOTE

1. Step 2 in this procedure should be started about 25 minutes prior to orbiter departure.
2. Orbiter separation occurs in step 3 including crew steps to regain attitude control in contingency scenario.
3. Step 4 provides manual command by **MCC-M** if the automatic, or crew, moding is unsuccessful.

1. CONFIGURING FGB COMM PANEL

Setup headset on FGB Comm Panel for use during this procedure when using RS Laptop.

2. VERIFYING CORRECT CONFIGURATION

NOTE

The RS Control must be Master for the ACS Moding software to mode RS to thruster control after undocking.

PCS

MCG

MCG Summary

'MCG Status'

Verify US Station Mode – Prox Ops

Verify RS Station Mode – Prox Ops

Verify RS SUDN Mode – Indicator

Verify RS Control – Master

MCG: Dock and Undock: Pre-Node 2 PMA 2 Undock

Pre Node 2 PMA 2 Undock

'Pre Departure'

Verify Back Off Time: 100

Verify Post Departure Control Mode – RS Control

Verify PMA 2 Automatic Departure SW – Ena

'Undocking'

Verify LA-1 / LA-2 Interface Sealed – Yes/Yes

Verify LA-1 / LA-2 Separation – No/No

Verify Time Since Separation: 0

Verify Docked Indication – Docked

Verify Departure Flag – No

3. ORBITER SEPARATION

<u>NOTE</u>
1. Driving the APAS Hooks open takes approximately 2 minutes.
2. Approximately 100 seconds after physical separation, the automatic departure software should execute resulting in resumption of ISS attitude control. Also at this time, the Docked Indication will change to "Not Docked."
3. If the ISS is still in Free Drift after 120 seconds since physical separation, the crew will execute the star block to resume attitude control.
4. If the ISS is still in Free Drift after 140 seconds since physical separation, MCC-M will execute commands in step 4.

Orbiter ⇒ ISS, "Physical Separation."

Start manual timer.

Wait up to 120 seconds for the following indication.

RS Laptop CM: СУДН: Main
CM: СУДН: Main

Verify RS GNC mode – Thruster (ДО) Only

```

*****
* If RS GNC mode is not "Thruster (ДО) Only" and time since
* physical separation > 120 seconds.
*   CM: ЦБМ PROC
*   CM: ЦБМ: Procedures
*
*   YBЦ  F8_5 Manual entry of Undock discrete with shuttle
*
*   cmd Execute
*
*   CM: СУДН: Main
*   CM: СУДН: Main
*
*   Verify RS GNC mode – Thruster (ДО) Only
*
*   ISS ⇒ orbiter, "Station is in Attitude Control."
*****

```

ISS ⇒ orbiter, "Station is in Attitude Control."

8.107 PMA 2 DEPARTURE (THRUSTERS)

(JNT OPS/LF1 - ALL/FIN 5/MULTI) Page 3 of 3 pages

4. RESUMING ATTITUDE CONTROL – GROUND STEPS

NOTE

The Russian command, YBL F22_1, uses the JEUS cyclogram located in channel 34 to resume control. This cyclogram has a built in 100 second pause to allow the orbiter to back away, so attitude control should be resumed approximately 240 seconds after physical separation. There should not be an additional pause in the cyclogram to prepare thrusters.

MCC-H If time since physical separation > 140 seconds and RS SUDN Mode is not Thrusters Only
MCC-H ⇒ **MCC-M**, “Execute step 4.”

MCC-M YBL F22_1

MCC-H MCG: Dock and Undock: Pre-Node 2 PMA 2 Undock
Pre Node 2 PMA 2 Undock
'Undocking'

Verify RS SUDN Mode – Thrusters Only

MCC-H ⇒ orbiter, ISS, “Station is in Attitude Control.”

This Page Intentionally Blank

8.108 PMA2 POST DEPARTURE CONFIGURATION (THRUSTERS)

(JNT OPS/LF1 - ALL/FIN 8/MULTI) Page 1 of 4 pages

OBJECTIVE:

Operational sequence used to reconfigure the departure software on RS Thrusters.

1. GNC COMMAND RESPONSE COUNTERS RESET

PCS

MCG: GNC Command Response Counters

GNC Command Response Counters

sel Reset

Verify the Since Reset column values are all blank.

Do not close this window until the procedure is complete.

If while executing a command, the Command Accept counter on that display does not increment

Reselect GNC Command Response Counters to determine if a command was rejected.

√**MCC-H**

2. VERIFYING FLIGHT SPECIFIC PAD

If the following information is not recorded elsewhere, record it here.

Is Checkpointing to be enabled or inhibited? _____

Table 1. Version ID

		Version ID	
1	Version ID for CCS PPL 180 (ACS FDIR Adaptation Data) with RS ACS_Safing_Status set to "0" (off) to be loaded to Backup and Standby C&C MDM.	_____	Must be built as File Uplink and uplinked to the backup and standby C&C.
2	Version ID for CCS PPL 181 - CCS RM PPL For GNC RM with or without Checkpointing to be loaded to all C&C MDMs.	_____	If GNC RM with Checkpointing was inhibited for undocking, and is to be enabled now, uplink PPL to all C&C MDMs. Must be built as File Uplink.
3	Version ID for CCS PPL 216 - CCS PPL containing the cmds to snap/hold US attitude control in CCDB slot 1 which execute if there is a TBM restart without context data	_____	This PPL will be nulled out, thus not containing any commands, to prevent this snap/hold from occurring during mated ops and prevent a potential force fight.

8.108 PMA2 POST DEPARTURE CONFIGURATION (THRUSTERS)

(JNT OPS/LF1 - ALL/FIN 8/MULTI) Page 2 of 4 pages

PCS 3. [VERIFYING CORRECT CONFIGURATION](#)
MCG: Dock and Undock: Pre-Node 2 PMA 2 Undock
Pre Node 2 PMA 2 Undock
'System Configuration'

Verify US Station Mode – Prox Ops
Verify RS Station Mode – Prox Ops
Verify RS SUDN Mode – Thrusters Only

'Undocking'

Verify LA-1/LA-2 Interface Sealed – No/No
Verify LA-1/LA-2 Separation – Yes/Yes
Verify Time Since Separation > 100

If Docked Indication – Docked

cmd Not Docked

Verify Docked Indication – NOT Docked

4. [ENABLING GNC CHECKPOINTING](#)

If GNC Checkpointing is to be enabled per step 2

Perform {[2.701 ENABLE GNC CHECKPOINTING](#)}, all (SODF: MCS:
NOMINAL: CHECKPOINTING), then:

5. [INHIBITING THE DEPARTURE SOFTWARE](#)

NOTE

1. The Time Since Separation gets reset to zero by commanding the automatic departure software inhibit, but it does not get reset by commanding the manual departure software inhibit. So there could be times when the automatic software was not used or already is inhibited, and it should still be commanded inhibited in this step to reset the timer.
2. If the Manual Undock Sequence Init command was sent, the software automatically inhibits the manual software. However, to configure the Manual Undock Seq Init telemetry to Not Init, the Manual Software must be commanded Inh even though its telemetry already reads Inh.

Pre Node 2 PMA 2 Undock

'Undocking'

8.108 PMA2 POST DEPARTURE CONFIGURATION (THRUSTERS)

(JNT OPS/LF1 - ALL/FIN 8/MULTI) Page 3 of 4 pages

If Manual SW Enable – Ena, or Manual Undock Sequence Init – Init

Pre Node 2 PMA 2 Undock

'Pre Departure'

sel PMA 2 Manual Departure SW

Pre Node 2 PMA 2 Undock

'PMA 2'

cmd Manual Departure SW Inhibit

Verify PMA 2 Undocking Vehicle – None

Verify PMA 2 Manual Dprtr SW – Inh

Pre Node 2 PMA 2 Undock

'Undocking'

Verify Manual Undock Sequence Init – Not Init

Pre Node 2 PMA 2 Undock

'Pre Departure'

If PMA 2 Automatic Departure SW – Ena

or

'Undocking'

If Time Since Separation is increasing

'Pre Departure'

sel PMA 2 Automatic Departure SW

Automatic Departure SW

'PMA 2'

cmd Inhibit

Verify PMA 2 Undocking Vehicle – None

Verify PMA 2 Automatic Departure SW – Inh

Pre Node 2 PMA 2 Undock

'Undocking'

Verify Time Since Separation: 0

6. INCORPORATING MASS PROPERTIES

Pre Node 2 PMA 2 Undock

'System Configuration'

cmd Mass

Verify Active Mass Properties PPL Version ID as expected per step 1 of 8.106 PMA2 Pre-Departure Configuration (Thrusters).

8.108 PMA2 POST DEPARTURE CONFIGURATION (THRUSTERS)

(JNT OPS/LF1 - ALL/FIN 8/MULTI) Page 4 of 4 pages

- MCC-H** 7. LOADING REQUIRED PPLs TO BACKUP/STANDBY C&C MDM
Coordinate with ODIN prior to loading CCS PPLs designated in step 2
- MCC-M** 8. CONFIGURING RS INHIBIT FOR STAGE OPERATIONS
YBLQ F8_10 (inf0=9, inf1=0) Enable the RS automatic takeover due to Tier
1 Loss of Comm

8.109 ORCA SAFING

(JNT OPS/X2R4 - ALL/FIN 7/HC) Page 1 of 2 pages

OBJECTIVE:

Quickly safe the Oxygen Recharge Compressor Assembly (ORCA) in the event of an ORCA failure.

1. RECONFIGURING ISS O2 SYSTEM

If ORCA is still running

ORCA
Status
Panel

1.1 PUMP Control sw → STOP/RESET

1.2 Report any illuminated LEDs to **MCC-H**.

A/L10A2

1.3 VL009 (O2 Lo P) → CLOSED

1.4 VL010 (O2 Hi P) → CLOSED

A/L1A2

1.5 VL011 (O2 Xover Vlv) → CLOSED

2. REDUCING ISS O2 SYSTEM PRESSURE TO AMBIENT

NOTE

1. When possible, connection and disconnection of QDs requires adjoining lines to be at approximately ambient pressure on both sides of the QD.
2. As the O2 system pressure bleeds down and O2 is introduced into the cabin, the following messages may be received:
'O2 Lo P Supply Low - A/L'
'PCA O2 Line Pressure Low - A/L'
'PCA O2 Line Pressure Low - LAB'
3. The messages will return to normal as the O2 system is repressurized (Step 4).

ODS Vest
GO2 Xfer
Panel

2.1 FLOW → CLOSED

WARNING

Opening the ODS Vestibule Transfer Panel Vent may cause a loud hissing noise. Crew in the vicinity should don ear plugs.

2.2 Don ear plugs.

2.3 VENT → OPEN

2.4 Check GO2 Xfer Panel Pressure Gauge reading 0 psi.
Doff ear plugs.

8.109 ORCA SAFING

(JNT OPS/X2R4 - ALL/FIN 7/HC) Page 2 of 2 pages

PCS 2.5 Airlock: ECLSS: Oxygen System
AL Oxygen System
'O2 Low Pressure Supply Valve'

√Actual Position – Open

'AL PCA O2 Intro Valve'

cmd Open (√Position – Open)

'Low Pressure'

When PCA O2 Line Press < 160 kPa (23 psia) or **On MCC-H GO**, proceed.

'AL PCA O2 Intro Valve'

cmd Close (√Position – Closed)

ODS Vest
GO2 Xfer
Panel 2.6 VENT → CLOSED

3. RECONFIGURING ORCA

3.1 If time available, don powder-free Gloves.

NOTE

QDs must be closed to disconnect lines.

A/L10A2 3.2 ORCA O2 Outlet Line (MW QD011) ←|→ QD011

3.3 Remove cap from SPARE QD.
ORCA O2 Outlet Line (MW QD011) →|← SPARE QD

3.4 Install cap on QD011.

3.5 Doff gloves.

4. RETURNING ISS O2 SYSTEM TO NOMINAL CONFIGURATION

4.1 **On MCC-H GO**, proceed.

A/L10A2 4.2 VL009 (O2 Lo P) → Open

4.3 VL010 (O2 Hi P) → Open

EMERGENCY RESPONSE

**EMERGENCY
RESPONSE**

This Page Intentionally Blank

9.101 JOINT EXPEDITED UNDOCKING AND SEPARATION

(JNT OPS/8A - ALL/FIN 6/MULTI/HC)

Page 1 of 9 pages

NOTE

1. This Expedited undocking should be used for the following shuttle failures
Cabin leak
Loss of cooling (2 water coolant loops or 2 Freon coolant loops)
2. This Expedited undocking may be used for the following shuttle failures on **MCC** call
Non-isolatable prop leak
Loss of cooling (2 cabin fans)
Loss of 2 fuel cells
3. Entrance to this procedure based on Cabin Leak or Loss of Cooling scenario assumes that this procedure will be worked concurrently with the associated FDF ORB PKT and ENTRY PKT powerdown.
4. At least 20 minutes is required to perform mandatory activities (not including ISS SAFING actions) through physical separation (10 minutes for JOINT EMERGENCY EGRESS + 10 minutes for undocking).

An additional 45 minutes is required for ANY ATTITUDE SEPARATION (from physical separation to OMS TIG burn).

An additional 20 minutes is required for SHUTTLE EMERGENCY SEPARATION (from physical separation to OMS TIG burn).
5. If ISS SAFING results in jettison of hardware, jettison will be performed in step 10b of the JEUS just prior to undock.

313

9.101 JOINT EXPEDITED UNDOCKING AND SEPARATION

(JNT OPS/8A - ALL/FIN 6/MULTI/HC)

Page 2 of 9 pages

314

ISS CREW	SHUTTLE MS	SHUTTLE CDR/PLT
<p>1a. Report to shuttle crew, "JEUS in progress."</p> <div data-bbox="331 337 730 423" style="border: 1px solid black; padding: 5px; margin: 5px 0;"> <p style="text-align: center;">NOTE</p> <p>If ISS crew available, steps 2a to 4a should be performed in parallel.</p> </div> <p>2a. <u>ISS SAFING</u> As required, perform {9.102 ISS SAFING}, all (SODF: JNT OPS: EMERGENCY RESPONSE), then: Report to shuttle CDR, "ISS SAFING complete."</p> <p>3a. <u>JOINT EMERGENCY EGRESS</u> All crew return to home vehicle. If required, unstow and don masks.</p> <p>√Only ISS crew onboard ISS</p> <p>Perform {10.102 JOINT EMERGENCY EGRESS}, steps 3 to 4 (SODF: JNT OPS: CUE CARD), then:</p> <p>If ISS crew available Perform {10.102 JOINT EMERGENCY EGRESS}, steps 8 to 13 (SODF: JNT OPS: CUE CARD), then:</p> <p>4a. <u>FEATHER P6 SOLAR ARRAYS FOR DEPARTURE</u></p> <div data-bbox="331 1089 730 1198" style="border: 1px solid black; padding: 5px; margin: 5px 0;"> <p style="text-align: center;">NOTE</p> <p>It should take approx 8 minutes for solar arrays to reach feathered position.</p> </div> <p>PCS P6: EPS: BGA 2B sel Channel Targeted Modes</p> <div data-bbox="331 1289 657 1369" style="border: 1px solid black; padding: 5px; margin: 5px 0;"> <p style="text-align: center;">BGA 2B Ch Targeted Modes</p> <p>'Column = Non-Solar Tracking' 'Row = Directed Position'</p> </div>	<p>1b. Report to shuttle CDR, "JEUS in progress."</p> <div data-bbox="919 337 1350 423" style="border: 1px solid black; padding: 5px; margin: 5px 0;"> <p style="text-align: center;">NOTE</p> <p>If shuttle crew available, steps 2b to 4b should be performed in parallel.</p> </div> <p>2b. <u>ISS SAFING</u> As required, perform {9.102 ISS SAFING}, all (SODF: JNT OPS: EMERGENCY RESPONSE), then: Report to shuttle CDR, "ISS SAFING complete."</p> <p>3b. <u>JOINT EMERGENCY EGRESS</u> In coordination with ISS crew (if crew available), perform {10.102 JOINT EMERGENCY EGRESS}, all (SODF: JNT OPS: CUE CARD), then:</p> <p>4b. <u>VERIFYING APCU DEACT</u></p> <p>L12U √APCU 1,2 CONV – OFF √CONV tb – bp √OUTPUT RLY tb – bp √OUTPUT RLY – OPEN</p> <p>5b. Hold for shuttle CDR call, "Go for vestibule depress."</p>	<p>1c. Report to shuttle MS and ISS crew, "JEUS in progress."</p> <div data-bbox="1528 345 1906 464" style="border: 1px solid black; padding: 5px; margin: 5px 0;"> <p style="text-align: center;">NOTE</p> <p>Shuttle CDR will give final "GO" for Hatch closure (steps 14 to 18 of JOINT EMERGENCY EGRESS).</p> </div> <p>2c. <u>JOINT EMERGENCY EGRESS</u> All crew return to home vehicle. If required, unstow and don masks.</p> <p>√Only shuttle crew onboard shuttle</p> <p>CDR reports to MS, "GO for Hatch closure." √EVA crew not tethered to ISS</p> <p>3c. <u>UNDOCKING PREP (GET-AHEAD)</u> √MCC for separation maneuver required</p> <p>If no comm available If time to OMS TIG burn ≤ 1:10, or ISS SAFING actions required, assume Shuttle Emergency Separation.</p> <p>If not, assume Any Attitude Separation.</p> <p>O14, O15, O16:F Pri RJD DRIVER, LOGIC (sixteen) – ON</p> <p>O14, O15, O16:E cbs L, AFT DDU (four) – cl</p> <p>4c. When JOINT EMERGENCY EGRESS (and UTILIZE ISS ATMOSPHERE, if required for cabin leak) complete, CDR reports to MS, "GO for vestibule depress."</p>

9.101 JOINT EXPEDITED UNDOCKING AND SEPARATION

(JNT OPS/8A - ALL/FIN 6/MULTI/HC)

Page 3 of 9 pages

315

ISS CREW	SHUTTLE MS	SHUTTLE CDR/PLT
<p>input Cmded Angle – 1 5 0 deg cmd Set P6: EPS: BGA 4B sel Channel Targeted Modes BGA 4B Ch Targeted Modes 'Column = Non-Solar Tracking' 'Row = Directed Position' input Cmded Angle – 2 1 0 deg cmd Set</p> <p>5a. Hold for shuttle CDR call, "GO for ISS to Free Drift."</p>	<p>6b. <u>DEPRESSURIZING SHUTTLE VESTIBULE</u> On shuttle CDR "GO for vestibule depress"</p> <p>A6L √cb ESS 1BC SYS PWR CNTL SYS – cl √cb ESS 2CA SYS PWR CNTL SYS 2 – cl</p> <p>cb ESS 1BC DEP SYS 1 VENT ISOL – cl cb ESS 2CA DEP SYS 2 VENT ISOL – cl cb ESS MNA DEP SYS 1 VENT – cl cb ESS MNB DEP SYS 2 VENT – cl</p> <p>√SYS PWR SYS 1, SYS 2 tb (two) – ON VEST DEP VLV SYS 1,2 VENT ISOL (two) – OP (tb-OP) VEST DEP VLV SYS 1,2 VENT (two) – OP (tb-OP)</p> <p>7b. <u>ODS PREPARATION FOR UNDOCKING</u> If required, perform PMA-2 HOOKS OPEN (FDF: RNDZ, <u>APDS</u>), then: Perform DOCKING MECHANISM PWRUP (FDF: RNDZ, <u>APDS</u>), then:</p> <div style="border: 1px solid black; padding: 5px; text-align: center;"> <p>NOTE If Airlock Pressure < 8.0 psia, expect hooks motor drive to fail during operation.</p> </div> <p>Perform UNDOCKING PREP (FDF: RNDZ, <u>APDS</u>), then:</p> <p>Report to shuttle CDR, "UNDOCKING PREP complete."</p>	<p>5c. Hold for shuttle MS call, "UNDOCKING PREP complete."</p> <p>6c. When UNDOCKING PREP complete, √Spacelab A/G 1 – ON</p> <p>A1R CDR reports to ISS crew, "GO for ISS to Free Drift."</p>

9.101 JOINT EXPEDITED UNDOCKING AND SEPARATION

(JNT OPS/8A - ALL/FIN 6/MULTI/HC)

Page 4 of 9 pages

316

ISS CREW	SHUTTLE MS	SHUTTLE CDR/PLT
<p>6a. <u>MODING ISS TO FREE DRIFT</u> On shuttle CDR "GO for ISS to Free Drift"</p> <p>PCS MCG: MCS Configuration MCS Configuration 'MCS Moding'</p> <p>If ISS Att Cntl Config is CMG TA sel Drift Drift</p> <p>√Mode Transition – Ena √Attitude Maneuver – Ena √Att Cntl Shutdown – Ena</p> <p>'Moding'</p> <p>cmd Mode to Drift Verify US GNC Mode – Drift</p> <p>If ISS Att Cntl Config is Free Drift and RS Control is Slave Report to shuttle CDR, "ISS in Free Drift."</p>	<p>8b. Hold for shuttle CDR call, "GO for undocking."</p>	<p>7c. <u>CONFIGURING RCS FOR UNDOCKING</u> GNC_23_RCS Reselect manually deselected jets.</p> <p>CRT If performing Any Attitude Sep, configure for single – X jet JET DES F1F – ITEM 31 EXEC (*) JET DES F2F – ITEM 35 EXEC (*)</p> <p>NOTE Do not perform steps 8c to 9c until ready for undock.</p> <p>8c. <u>FLT CNTLR PWRUP</u> GNC_25_RM_ORBIT</p> <p>A6U SW RM INH – ITEM 16 (*) CRT FLT CNTLR PWR – ON SW RM INH – ITEM 16 (no *)</p> <p>9c. <u>CONFIGURING DAP FOR UNDOCKING</u> GNC_UNIV_PTG √Rates < 0.12°/sec</p> <p>A6U DAP: FREE GNC_20_DAP_CONFIG</p> <p>CRT X JETS ROT ENA, ITEM 7 EXEC (no*)</p> <p>If performing Any Attitude Sep, Config DAP A, B to A9, B9. If performing Shuttle Emergency Sep, Config DAP A, B to A7, B7.</p>

9.101 JOINT EXPEDITED UNDOCKING AND SEPARATION

(JNT OPS/8A - ALL/FIN 6/MULTI/HC)

Page 5 of 9 pages

317

ISS CREW	SHUTTLE MS	SHUTTLE CDR/PLT
<div data-bbox="331 293 722 467" style="border: 1px solid black; padding: 5px; margin-bottom: 10px;"> <p style="text-align: center;"><u>NOTE</u></p> <p>ISS crew will mode station back to attitude control following shuttle undock. Since comm between the two vehicles may not be available, crew will verify separation via PCS machine.</p> </div> <p>7a. Proceed to step 8a.</p>	<p>9b. <u>COMMAND UNDOCKING</u></p> <p>A7L On shuttle CDR "GO for undocking"</p> <p style="text-align: center;">*****</p> <ul style="list-style-type: none"> * If HOOKS 1(2) OP It failed ON * APDS PWR A → OFF * √A_{DS}, failed Its Off <p style="text-align: center;">*****</p> <p>APDS CIRC PROT OFF pb → push (√It On)</p> <p>-2:20 10b. pb UNDOCKING → push</p> <p>√HOOKS 1, HOOKS 2 CL It (two) – off</p> <p>CRT √HOOKS 1, HOOKS 2 POS < 92 % and decreasing</p> <p style="text-align: center;">*****</p> <ul style="list-style-type: none"> * If HOOKS 1(2) fail to drive (HOOKS 1(2) DRV CMD – OFF) * pb OPEN HOOKS – push * If HOOKS 1(2) appear to stop before reaching end-of-travel (HOOKS 1(2) POS > 4 % and not decreasing), allow for single motor drive time (~4:40) before performing pnl A7L pwr cycle <p style="text-align: center;">*****</p> <p>-1:30</p> <p>A7L 11b. √INTERF SEALED It – Off</p> <p>√RDY to HK It – Off (HOOKS 1, HOOKS 2 POS ~30 %)</p>	<p>10c. CDR report to MCC, "ISS SAFING complete, ISS in Free Drift, and DAP configured for undock" (if no comm, then proceed).</p> <p>√MCC for "GO" for undocking (if time permits and comm available), then: CDR reports to shuttle MS, "GO for undocking."</p> <p>11c. Hold for shuttle MS call, "Separation confirmed."</p>

9.101 JOINT EXPEDITED UNDOCKING AND SEPARATION

(JNT OPS/8A - ALL/FIN 6/MULTI/HC)

Page 6 of 9 pages

318

ISS CREW	SHUTTLE MS	SHUTTLE CDR/PLT
	<p>0:00 12b. CRT √HOOKS 1, HOOKS 2 OP Its (two) – on √HOOKS 1, HOOKS 2 POS: 4 % √UNDOCK COMPLETE It – on</p> <p>*****</p> <p>+2:20 * If HOOKS 1(2) fail to open (confirmed * by no physical separation) A7L * pb PWR OFF – push, then: * * √MCC (if time permits) * * <u>FIRE PYROS</u> A6L * PYRO PWR MN A, MN C (two) – * ON A7L * PYROS Ap, Bp, Cp (three) – ON * (√Its on) * PYRO CIRC PROT OFF pb – push * (√Its on) * ACT HOOKS FIRING pb – push * * Following separation * PYRO CIRC PROT ON pb – push * (√OFF It off) * PYROS Ap, Bp, Cp (three) – OFF * (√Its off) * PYROS PWR MN A, MN C (two) – A6L * OFF *</p> <p>*****</p> <p>Report to shuttle CDR, “Separation confirmed.”</p>	

9.101 JOINT EXPEDITED UNDOCKING AND SEPARATION

(JNT OPS/8A - ALL/FIN 6/MULTI/HC)

Page 7 of 9 pages

319

	ISS CREW	SHUTTLE MS	
<p>8a. <u>MODING ISS BACK TO ATTITUDE CONTROL</u></p> <p>PCS MCG: Docking Configuration <u>Docking Configuration</u> 'Orbiter Departure'</p> <p>When PMA2 Separation LA-1 or LA-2 = "Yes", or if shuttle separation is confirmed, wait 100 seconds then continue.</p> <p>RS Laptop CM: <u>ЦBM PROC</u> <u>CM: ЦBM: Procedures</u> sel F22_1 input param 1 – <u>3 4</u> input param 2 – <u>0</u> cmd Execute</p> <p>RS Laptop CM: <u>СУДН: Main</u> <u>CM: СУДН: Main</u> Verify RS GNC Mode – Thrusters (ДО) Only</p> <p>9a. <u>VERIFYING SOLAR ARRAYS IN COMMANDED POSITION</u></p> <p>PCS P6: EPS: BGA: 2B <u>BGA 2B</u> sel Channel Targeted Modes <u>BGA 2B Ch Targeted Modes</u> Verify Ch 2B Mode – Non-Solar Tracking Verify BGA Mode – Directed Position <u>BGA 2B</u> Verify Actual Angle: 150 deg P6: EPS: BGA: 4B <u>BGA 4B</u></p>	<p><u>POST-PHYSICAL SEPARATION</u></p> <p>13b. <u>DISABLING APDS CONTROL COMMANDS</u></p> <p>A7L PWR OFF pb – push √STATUS It (eighteen) – off</p> <p>14b. Reserved</p>	<p><u>POST-PHYSICAL SEPARATION</u></p> <p>12c. <u>PERFORMING SEPARATION BURN MANEUVERS</u></p> <p>On shuttle MS call, "Separation confirmed"</p> <p>If performing Emergency Separation Go to SHUTTLE EMERGENCY SEPARATION (FDF: RNDZ, <u>CONTINGENCY OPS</u>)</p> <p>If performing Any Attitude Separation Unstow HHL with Nightscope. Go to ANY ATTITUDE SEPARATION (FDF: RNDZ, <u>CONTINGENCY OPS</u>)</p>	

9.101 JOINT EXPEDITED UNDOCKING AND SEPARATION

(JNT OPS/8A - ALL/FIN 6/MULTI/HC)

Page 8 of 9 pages

320

ISS CREW	SHUTTLE MS	SHUTTLE CDR/PLT
<p>sel Channel Targeted Modes</p> <p>BGA 4B Ch Targeted Modes</p> <p>Verify Ch 4B Mode – Non-Solar Tracking</p> <p>Verify BGA Mode – Directed Position</p> <p>BGA 4B</p> <p>Verify Actual Angle: 210 deg</p>	<p>15b. Perform DOCKING MECHANISM PWRDN (FDF: RNDZ, <u>APDS</u>), then:</p> <p>16b. Go to PL SAFING (FDF: ORB PKT, <u>PL PWRDN</u>).</p> <div data-bbox="921 418 1270 568" style="border: 1px solid black; padding: 5px; margin: 10px 0;"> <p style="text-align: center;">NOTE</p> <p>The following steps will only be performed in the event that the EVA crew ingress was delayed until post separation.</p> </div> <p>R14 :C 17b. cb MNA UHF EVA – cl MNC UHF EVA – cl</p> <p>O6 18b. UHF SPLX/EVA XMIT FREQ -259.7/414.2 √UHF SPLX/EVA PWR AMP – OFF √EVA STRING – 1 MODE – EVA</p> <p>19b. AUD CTR UHF A/G 1 – TR A/G 2 – OFF A/A – OFF</p> <p>IVA ATU √AUD A/G1 – TR</p> <p>20b. Remove hardware from external airlock for EV crew ingress</p> <p>21b. Ext A/L Aft Hatch EQ VLV caps (two) – vent, remove</p> <p>22b. Close Inner A/L Hatch per decal.</p> <p>23b. Inner Hatch Equal vlv (two) – OFF, caps installed.</p> <p>24b. EVA crew: remove Ext A/L Aft Hatch thermal cover.</p> <p>25b. EVA crew: Ext A/L Aft Hatch EQ VLVs (two) – EMER</p>	

9.101 JOINT EXPEDITED UNDOCKING AND SEPARATION

(JNT OPS/8A - ALL/FIN 6/MULTI/HC)

Page 9 of 9 pages

ISS CREW	SHUTTLE MS	SHUTTLE CDR/PLT
	<p>*****</p> <ul style="list-style-type: none"> * If cabin dP/dT or O2(N2) Flow Hi alarm during airlock depress * EVA crew: Ext A/L Aft Hatch EQ VLVs (two) – OFF * IV crew: verify Inner Hatch closed and Inner Hatch EQ VLVs (two) – OFF <p>*****</p> <p>26b. EVA crew monitor Hatch ΔP gauge. When ΔP < 0.5 psi (~10 min), perform AIRLOCK INGRESS (Cuff C/L). Close Hatch. Engage latches.</p> <p>27b. Ext A/L Aft EQ VLVs (two) – OFF, install caps</p> <p>28b. Go to PRE-REPRESS/REPRESS (FDF: EVA C/L, <u>DEPRESS/REPRESS</u>).</p>	

321

This Page Intentionally Blank

9.103 UTILIZE ISS ATMOSPHERE

(JNT OPS/7A - ALL/FIN 1)

Page 1 of 1 page

I

UTILIZING ATMOSPHERE

	On Shuttle CDR request to use ISS atmosphere			
Lab Fwd	1. Lab Fwd MPEV → OP			
	2. Open Lab Fwd Hatch per decal.			
PMA2	3. APAS Hatch MPEV → OP Report to STS, MCC , "APAS MPEV open."			
ODS Hatch	4. ODS HATCH Equal vlv (two) – EMER			
	<table border="1"><tr><td style="background-color: yellow;">CAUTION</td></tr><tr><td>Minimum allowable ISS Pressure is 490 mmHg (9.5 psia).</td></tr></table>		CAUTION	Minimum allowable ISS Pressure is 490 mmHg (9.5 psia).
CAUTION				
Minimum allowable ISS Pressure is 490 mmHg (9.5 psia).				
PCS	5. <u>NODE 1: ECLSS</u>	<u>Lab ECLSS</u>		
[PO]	<u>NODE 1: ECLSS</u> or Russian Manometer [MB]	<u>Lab : ECLSS</u>		
	When ISS total pressure < 495 mmHg (9.57 psia), terminate flow to shuttle.			
PMA2	6. APAS Hatch MPEV → CL Report to STS, MCC , "APAS MPEV closed."			
ODS Hatch	7. ODS HATCH Equal vlv (two) → OFF, caps installed Report to ISS, MCC , "ODS Hatch Equalization vlvs closed."			
Lab Fwd	8. Close Lab Fwd Hatch per decal. Lab Fwd MPEV → CL			
	9. Lab Fwd IMV vlvs (two) → CL			

This Page Intentionally Blank

TMAX DETERMINATION

ORBITER + ISS ATMOSPHERE TO 9.5 PSIA NOMOGRAPH

Orbiter + ISS (7A.1 stage - all compartments, no MPLM)

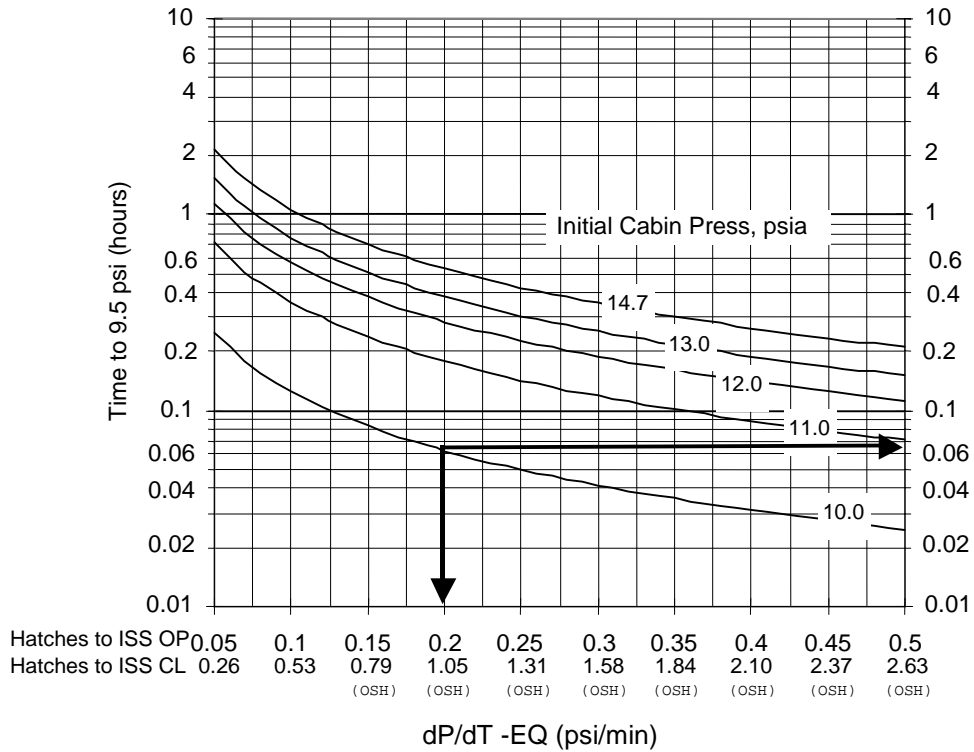

BASIS:

O2 Flow: on/off at 50 lb/hr after 10 min, with ppO2 > 2.2 psi, % O2
 Total Volume = 15255.4 ft3

This Page Intentionally Blank

CUE CARD

This Page Intentionally Blank

10.101 BIG LOOP REACTIVATION

(JNT OPS/7A - ALL/FIN 1) Page 1 of 2 pages

1. CONFIGURING DAIU1 FOR DOCKED VOICE

PCS

C&T: Audio: DAIU 1

'IAC [X]' where [X] = Active and Powered IAC 1 or 2

'DAIU 1 Bus I/O'

cmd DAIU 1 Bus I/O – Enable (Verify – Enabled)**NOTE**

DAIU 1 will go into Standby mode 2 minutes after being commanded Active if it is not placed into a call. DAIU 1 has to be in Active mode to place DIA1 or DAG 1 into a call.

'DAIU 1 State'

cmd DAIU 1 State – Active (Verify – Active)Audio Overviewsel IAC[X] Call Select where [X] = Active and Powered IAC 1 or 2

'Public 1'

sel Call Setup

cmd DAG1 (Verify – DAG1 in Public 1)

'Public 3'

sel Call Setup

cmd DIA1 (Verify – DIA1 in Public 3)

JNT OPS-4a/8A - ALL/A

TOP
BACK OF "10.101 BIG LOOP REACTIVATION"

HOOK
VELCRO

10.101 BIG LOOP REACTIVATION
(JNT OPS/7A - ALL/FIN 1) Page 2 of 2 pages

JNT OPS-4b/8A - ALL/A

HOOK
VELCRO

10.102 JOINT EMERGENCY EGRESS

(JNT OPS/7A - ALL/FIN 6) Page 1 of 2 pages

This cue card is executed to perform basic safing and return crews to their home vehicle in an emergency. Appropriate emergency procedures should then be executed.

EGRESSING TO HOME VEHICLE

1. If EV crew isolated in Joint Airlock
 - 1.1 Open Node 1 Stbd Fwd (Aft) IMV Valve
 - 1.2 Node Stbd Hatch MPEV → OPEN
Open Hatch per decal.
 If EV crew isolated in Crewlock with EV Hatch closed
 - 1.3 IV Hatch equalization vlv → NORM
Open Hatch.

2. If EV crew suited
 - 2.1 Perform {4.115 EXPEDITED SUIT DOFFING}, all applicable
Safer Doffing and Suit Doffing steps (SODF: ISS EVA SYS:
EMERGENCY), then:
 - 2.2 ✓Two EMUs on shuttle for return

3. If SSAS latching/bolting ops in progress
Skip to step 4

If SSRMS Ops in progress (no SSAS latching/bolting ops)

 - Apply SSRMS safing
 - SAFING → SAFE (Verify – Safed)

4. All crew return to home vehicle.
If required, unstow and don Masks.

DCP

- | | | |
|-------------------------------|----|---|
| ORCA
Status Pnl
A/L10A2 | 5. | If O2 transfer in progress <ol style="list-style-type: none"> sw PUMP Control → STOP/RESET VL009 (O2 Lo P) → CLOSED VL010 (O2 Hi P) → CLOSED |
| A/L1A2 | 6. | VL011 (O2 Xover Vlv) → CLOSED |
| A/L10A2 | | QD011 → Disconnected, capped
VL009 (O2 Lo P) → OPEN |

VERIFYING IMV VALVE CLOSURE

- | | | |
|------------|----|---|
| LAB
Fwd | 7. | ✓LAB Fwd Stbd IMV valve – CLOSED |
| | 8. | ✓LAB Fwd Hatch MPEV – CLOSED and uncapped |
| MO13Q | 9. | ✓AIRLK FAN A(B) – OFF |

JNT OPS-1a/8A - ALL/H

HOOK
VELCRO

10.102 JOINT EMERGENCY EGRESS

(JNT OPS/7A - ALL/FIN 6)

Page 2 of 2 pages

ODS Vest 10. FLOW → CL
GN2 Xfer √VENT – CL
Pnl

GO2 Xfer 11. FLOW → CL
Pnl √VENT – CL

HATCH CLOSURE PREP

ODS Vest 12. Demate GO2/GN2 hoses from ODS Xfer Pnl.
Clear Hatch pathway of cables, ducts, hoses.
Stow PMA/ODS duct and GO2/GN2 hoses in PMA.

APAS 13. Disconnect Hatch from Standoff.

14. Remove and stow covers for Hatch, Docking Target Baseplate.

15. Retrieve Standoff Cross and stow in ODS vestibule.

HATCH CLOSURES

On shuttle CDR call, "Go for Hatch closure."

16. Close LAB Fwd Hatch per decal.

APAS 17. Close APAS Hatch using tool.

Select 'РАБОЧЕЕ ПОЛОЖЕНИЕ' (Working Position) torque setting on Hatch Tool.

Insert tool in Hatch socket (ensure fully seated).

Rotate tool 3 to 4 turns in direction of 'ЗАКР' (Close) arrow until tool clicks.

Secure tool in PMA.

√APAS EQUAL VLV → CL

18. Install Standoff Cross by hand.

ODS 19. Close ODS Hatch per decal.

√EQUAL VLVS (two) – OFF, caps installed

20. Report to ISS, **MCC**, "LAB Fwd, APAS, and ODS Hatches closed."

JNT OPS-1b/8A - ALL/H

REFERENCE DATA

This Page Intentionally Blank

11.103 O2 AND N2 TRANSFER SCHEMATIC (JNT OPS/UF1 - ALL/FIN 2)

335

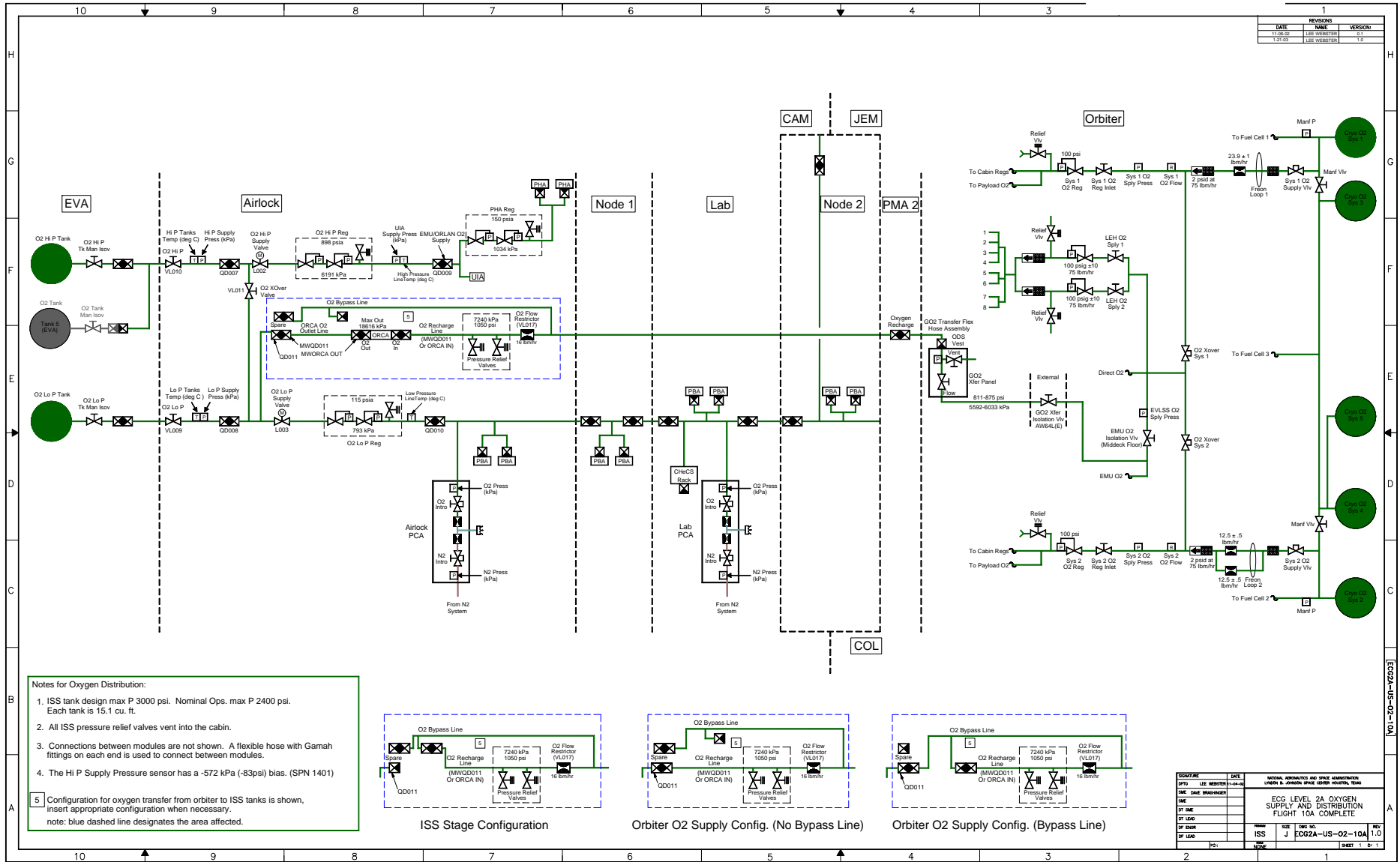

23 MAY 03

12734.doc

11.103 O2 AND N2 TRANSFER SCHEMATIC

(JNT OPS/UF1 - ALL/FIN 2) Page 2 of 2 pages

336

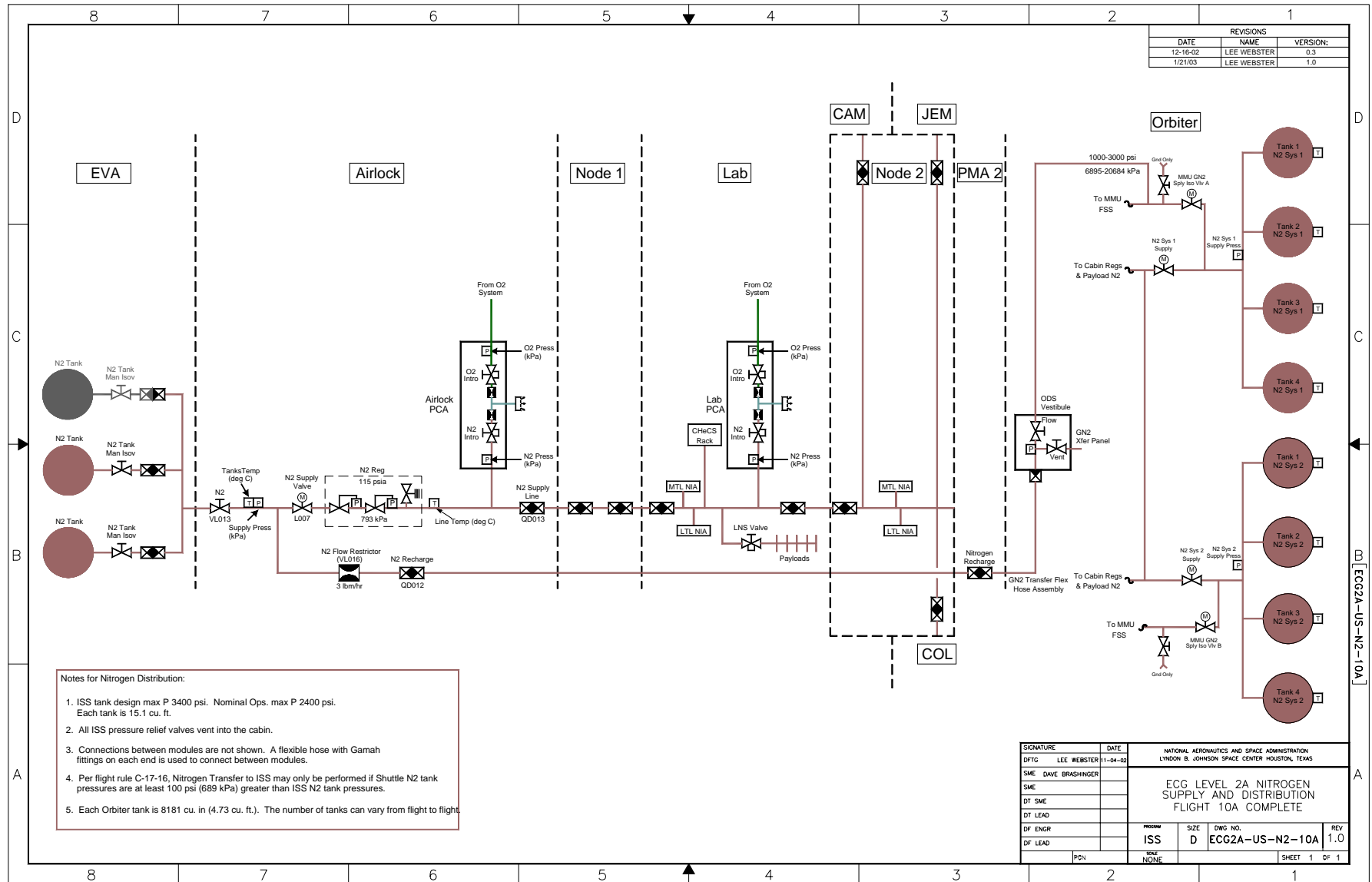

23 MAY 03

12734.doc



INTERNATIONAL SPACE STATION

ISS/SHUTTLE JOINT OPERATIONS

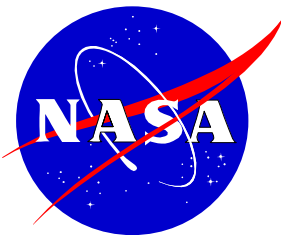



INTERNATIONAL SPACE STATION

ISS/SHUTTLE JOINT OPERATIONS

