

# Shuttle Operational Data Book

---

## Volume 1 Shuttle Systems Performance and Constraints Data

January 1988

**NASA**

National Aeronautics and  
Space Administration

Lyndon B. Johnson Space Center  
Houston, Texas

SHUTTLE OPERATIONAL DATA BOOK

VOLUME I

SHUTTLE SYSTEMS PERFORMANCE AND CONSTRAINTS DATA

PREPARED BY

FLIGHT DATA OFFICE

FLIGHT DATA AND EVALUATION OFFICE

ORBITER AND GFE PROJECTS OFFICE

SUBMITTED:

  
James W. Mistrot  
Book Manager

CONCURRENCE:

  
Walter J. Gaylor, Manager  
Flight Data Office

APPROVED:

  
Michael A. Collins, Jr., Manager  
Flight Data and Evaluation Office

NATIONAL AERONAUTICS AND SPACE ADMINISTRATION  
LYNDON B. JOHNSON SPACE CENTER  
HOUSTON, TEXAS

January 1988

## FOREWORD

The Shuttle Operational Data Book (SODB) is a single authoritative source of properly validated Shuttle operational performance data and integrated mass properties. The data within this revision are primarily based on the data from the flight results of the first 24 flights. These data will continue to be updated and expanded as additional flight results and evaluations are completed. Thus, the current data which most accurately and completely describe the Shuttle operational performance are presented. Data qualification will continue to progress until all data results from flight tests and flight operations are incorporated. The data included within the SODB have been validated by the cognizant NASA and contractor subsystem managers.

The Flight Data and Evaluation Office of the Orbiter and GFE Projects Office is the control authority for the SODB. This office is responsible for assuring that data are properly validated and for the preparation and publication of these data. Any need for additional data or to depart from the use of these data should be brought to the attention of the Flight Data and Evaluation Office (VF), Orbiter and GFE Projects Office, Lyndon B. Johnson Space Center.

## 1.0 INTRODUCTION

### 1.1 PURPOSE

The Shuttle Operational Data Book (SODB) is the single authoritative source of properly validated data which most accurately and completely describe the Shuttle operational performance capabilities and limitations. These data will be kept current and will be based on the highest level of data qualification available at that time; i.e., specification, estimation, studies, analyses, simulations, ground tests, flight tests, and flight operations. Due to the need for the standardization of Shuttle source data, the SODB shall be used as the standard operational data base for all mission design and planning, simulations, studies, and analyses.

### 1.2 CONTENT

The SODB consists of five volumes which are defined as follows:

- Volume I - Shuttle Systems Performance and Constraints Data
- Volume IA - Shuttle Systems Electrical Equipment List
- Volume II - Shuttle Mission Mass Properties Data
- Volume III - Shuttle Systems Analysis Data
- Volume IV - Orbiter Landing Emergency Rescue Data

Volume I is divided into eight sections. The text contains baseline data which are applicable to all vehicles of that type. Unless otherwise indicated, data values in the SODB do not include instrumentation inaccuracies.

Section 1.0, INTRODUCTION. The Introduction describes the purpose and contents of the SODB. The method of updating the SODB and lists of selected abbreviations/acronyms/symbols are also included in the Introduction.

Section 2.0, SHUTTLE SYSTEM CONFIGURATION AND COORDINATE SYSTEMS. This section contains pictorial representations of the Shuttle, showing locations, axes, station lines, dimensions, separation planes, etc. In addition, a standard set of Shuttle program coordinate systems is referenced. These data are intended as reference material for use throughout the book.

Section 3.0, SHUTTLE CONSTRAINTS AND OPERATIONAL LIMITATIONS. The data presented in this section include operational hardware limitations and constraints and the corresponding result if a limit is exceeded or a constraint is violated. The section is arranged by Orbiter subsystem for convenience. Constraints and limitations for the External Tank (ET) and the Solid Rocket Booster (SRB) follow the Orbiter.



Section 4.0, ORBITER PERFORMANCE AND OPERATIONAL DATA. This section contains the supporting discussion for the constraints and limitations presented in Section 3.0. It also contains descriptions of the fundamental performance of subsystems and subsystems components. Typically, fundamental data are used for system analyses and for the formulation of models for computer studies. Consequently, data are defined at a basic level and the user is responsible for properly utilizing the data for evaluation purposes.

Section 5.0, EXTERNAL TANK. This section provides External Tank description, performance capabilities, and consumables and support requirements data.

Section 6.0, SOLID ROCKET BOOSTER. This section provides Solid Rocket Booster description, performance capabilities, and consumables and support data.

Section 7.0, AERODYNAMICS. This section identifies the authoritative source for aerodynamic and flight performance characteristics data for the Shuttle.

Section 8.0, ASTRODYNAMIC CONSTRAINTS AND PARAMETERS. This section provides the values and associated uncertainties of the constants and models used in trajectory prediction.

### 1.3 AMENDMENTS

This document will be continuously amended to update and provide additional data as required. Amendments will be made as page additions, deletions, or replacements. Technical data changed by amendment will be denoted by an amendment number in the upper right-hand corner of the page and the location of the data change by a vertical bar in the page margin. Where the complete page constitutes a new addition to the SODB, no change bar will be placed in the margin. Since all sections are continuously being amended, it is imperative that amendments be inserted in sequential order.

### 1.4 ADDITIONAL DATA REQUIREMENTS

Any need for additional data or to depart from the use of data contained in the SODB should be brought to the attention of the Flight Data and Evaluation Office (VF), STS Orbiter and GFE Projects Office, Lyndon B. Johnson Space Center.

## 1.5 ABBREVIATIONS/ACRONYMS/SYMBOLS AND UNITS OF MEASURE

### 1.5.1 Abbreviations and Acronyms

A/amp	ampere
AA	air-to-air accelerometer assembly
ABA	dc amplifier, buffer, attenuator
ABE	arm based electronics
ABS	ammonia boiler system
ac	alternating current
accel	acceleration
ACCU	audio central control unit
ACIP	aerodynamic coefficient identification package
ACP	audio control panel
ACS	avionics cooling system
A/D	analog-to-digital
Adc	average direct current
ADC	air data computer
ADI	attitude director indicator
ADS	air data subsystem
ADTA	air data transducer assembly
AEC	automatic exposure control
AFD	aft flight deck
AF	Air Force air frame audio frequency aft fuselage
AFO	abort from orbit
AFSCF	Air Force Satellite Control Facility
AG	air-to-ground
AGC	automatic gain control
A-hr	ampere-hour
AKA	active keel actuator
ALC	automatic light control
A/L	airlock
ALSS	airlock support subsystem
AM	amplitude modulation
AMI	alpha-Mach indicator
AOA	abort-once-around
AOS	acquisition of signal
APCA	aft power controller assembly
APS	aft propulsion subsystem auxiliary power subsystem
APU	auxiliary power unit
APUS	auxiliary power unit subsystem
ARCS	aft reaction control subsystem
ARPCS	atmospheric revitalization pressure control subsystem
ARS	atmospheric revitalization subsystem
ASA	aileron surface actuator abort sensor assembly aerosurface amplifier aerosurface servo amplifier
ASD	Apollo standard detonator

ATC air traffic control  
 ATCO ambient temperature catalytic oxidizer  
 ATCS active thermal control subsystem  
 ATM atmosphere  
     auxiliary tape memory  
 ATO abort-to-orbit  
 ATU audio terminal unit  
 AUTO automatic  
 AVVI altitude vertical velocity indicator  
 B5D buffer 5 Vdc discrete  
 BER bit error rate  
 BF body flap  
 BFC backup flight control  
 BFCS backup flight control system  
 BFS backup flight system  
 BITE built-in test equipment  
 BOS bright object sensor  
 BOT beginning of tape  
 BR bit rate  
 BRM booster rocket motor  
 BSM booster separation motor  
 Btu British thermal unit  
 B/U backup  
 BW bandwidth  
 BX box  
 Ca altitude correction  
 CAPRI capacitor reset integrator  
 CB circuit breaker  
 C&T communications and tracking  
 C&W caution and warning  
 CCA communications carrier assembly  
 CCTV closed circuit television  
 CCU central control unit  
     camera control unit  
     crewman communications umbilical  
 CCV chamber coolant valve  
 CDC confined detonating cord  
 CDF confined detonating fuse  
 CDW command data word  
 c.g. center of gravity  
 CIU controller interface unit  
 CL center line  
 CLA color lens assembly  
 CM common mode  
 CMIB chassis - mother interconnect board  
 CMD command  
 CNTLR controller  
 C/O checkout  
     contamination overpressure  
 CO<sub>2</sub> carbon dioxide  
 COAS crewman optical alignment sight

COMSEC communications security  
 CPD converter, pulse to dc voltage  
 CPM cell performance monitor  
 CPR critical problem report  
 CPU central processing unit  
 CRT cathode ray tube  
 CSD Crew Systems Division  
 CSS control stick steering  
 CU copper  
 CVAD converter, voltage ac to dc  
 CVDA converter, voltage dc to ac  
 CVRD converter, variable resistance to dc voltage  
 CW command word  
 CWA caution and warning annunciator  
 CWE caution and warning electronics  
 CWLM caution and warning limit module  
 CWS caution and warning status display  
 Δ differential  
 ΔP differential pressure  
 ΔT differential temperature  
 ΔV differential velocity  
 DA data acquisition  
 deployment assembly  
 distribution assembly  
 double amplitude  
 D&C displays and controls  
 DAC data acquisition camera  
 DACBU data acquisition camera buffer unit  
 DAM double aluminized mylar  
 driver amplifier module  
 DAP digital autopilot  
 data acquisition plan  
 dB decibel  
 DBC data bus coupler  
 DBIA data bus isolation amplifier  
 dc direct current  
 DDU display driver unit  
 DECOM decommutate  
 def deflection  
 deg degree  
 DEU display electronics unit  
 DFJ development flight instrumentation  
 DFRF Dryden Flight Research Facility  
 dia/DIA diameter  
 DMA direct memory access  
 drive motor assembly  
 DME distance measuring equipment  
 DNA data not applicable  
 DOD Department of Defense  
 DPS data processing subsystem  
 dQ/dm specific heat input rate at constant pressure (Btu/lb)

DSC dedicated signal conditioner  
 DSN deep space network  
 DU display unit  
 EAFB Edwards Air Force Base  
 EAS equivalent airspeed  
 ECI earth centered inertia  
 ECL engine centerline  
 ECLSS environmental control and life support subsystem  
 ECO engine cutoff  
 ECU environmental control unit  
 EDV electro-depressurizing valve  
 EEL electrical equipment list  
 EF earth-fixed  
 EGT exhaust gas temperature  
 E.H. electrohydraulic  
 EI entry interface  
 EIC experiment intercom  
 EIRP effective isotropic radiated power  
 EIU engine interface unit  
 EKG electrocardiogram  
 electrocardiograph  
 electrocardiography  
 EMF electromotive force  
 EMI electromagnetic interference  
 EMU extravehicular mobility unit  
 eng engine  
 EOS emergency oxygen system  
 EOT end of tape, end of track  
 ESD engine shutdown  
 EPDC electrical power distribution and control  
 EPS electrical power subsystem  
 EPW electrical pulse width  
 ESD emergency shutdown  
 ET external tank  
 ETR Eastern Test Range  
 ETS energy transfer system  
 EVLSS extravehicular life support system  
 EVA extravehicular activity  
 evap evaporator  
 exp.eff. expulsion efficiency  
 F Fahrenheit  
 FDBK feedback  
 FC flight control  
 FCP fuel cell powerplant  
 FCS flight control system  
 FCV flow control valve  
 FDM frequency division multiplexer  
 FES flash evaporator system  
 Flt flight  
 F.L. forward link  
 FM frequency modulation  
 F/M flowmeter

FMS food management subsystem  
FOV field of view  
FPB fuel preburner

FPL	full power level
FPM	feet per minute
FPOV	fuel preburner oxidizer valve
FPV	flow proportioning valve
FRCS	forward reaction control subsystem
FRL	fuselage reference line
FRSI	felt reusable surface insulation
$F_t$	thrust
$F_u$	fuel
Fwd	forward
G/T	antenna gain/system noise temperature
g	gravity
grms	gravity root mean square
GAP	ground operations aerospace language automatic procedure
GBR	glass bead rating
GCILC	ground command interface logic controller
GCILU	ground command interface logic unit
GET	ground elapsed time
GFE	government furnished equipment
GFP	government furnished property
GG	gas generator
GGVM	gas generator valve module
GH	gaseous helium
$GH_2^e$	gaseous hydrogen
G.m.t.	Greenwich mean time
$GN_2$	gaseous nitrogen
$GO_2$	gaseous oxygen
GN&C	guidance, navigation, and control
GPC	general purpose computer
gpm	gallon per minute
grd	ground
GRTLS	glide return to landing site
GRV	ground relative velocity
GSTDN	ground spacecraft tracking and data network
GSE	ground support equipment
H	hysteresis
	horizontal
$\hat{h}$	altitude $\Delta$
HAC	heading alignment circle
HAS	hydraulic actuated solenoid
Hg	mercury
HGDS	hazardous gas detection system
$h_i$	indicated altitude
$h_2, H_2$	hydrogen
$H_2O$	water
hi rel	high reliability
HIU	headset interface unit
He	helium
HMS	history memory system
HNS	hexanitrostilbene
HMX	maximum altitude

hp	horsepower
HPFP	high pressure fuel pump
HPFT	high pressure fuel turbine
HPFTP	high pressure fuel turbopump
HPM	high performance motor
HPOP	high pressure oxidizer pump
HPOT	high pressure oxidizer turbine
HPOTP	high pressure oxidizer turbopump
HPU	hydraulic power unit
HRA	helmet retention assembly
HRD	high rate dosimeter
HRSI	high temperature reusable surface insulation
HSI	horizontal situation indicator
HUD	head up display
HUDE	head up display electronics
HWT	heavy weight tank
HX	heat exchanger
hyd	hydraulic
ICC	Interstate Commerce Commission
ICD	interface control document
ICOM	intercommunications
ICOM A	intercommunications A
ICOM B	intercommunications B
ID	inside diameter
IDT	image detector tube
IECM	induced environment contamination monitor
I/F	interface
IFOV	instantaneous field of view
I-load	initial-load
IML	inner moldline
IMU	inertial measurement unit
inbd	inboard
INTG	interrogator
I/O	input/output
IOM	input/output module
IOP	input/output processor
IPL	initial program load
ips	inch per second
IRIG	inter-range instrumentation group
ISL	inner structural line
Isp	specific impulse
It	total inertia
ITF	inverse transformation function
IVA	intravehicular activity
IVBC	integrated vehicle baseline configuration
JANNAF	Joint Army-Navy-Air Force
JPL	Jet Propulsion Laboratory
JSC	Johnson Space Center
KBI	keyboard interface
KBU	keyboard unit
kcal	kilocalorie
KEAS	knots equivalent airspeed
KOH	potassium hydroxide



KSC	Kennedy Space Center
LCA	load control assembly
LCH	launch
LCVG	liquid cooling and vent garment
L/D	lift-to-drag
LE	leading edge
LED	light emitting diode
LEH	launch/entry helmet
LES	launch entry suit
LESS	leading edge structural system
LG	landing gear
LH	left-hand
LHC	left-hand circular
LH <sub>2</sub>	liquid hydrogen
LiOH	lithium hydroxide
LMF	lower midfuselage
LO <sub>2</sub>	liquid oxygen
LON	launch on notice
LOS	loss of signal
	line of sight
LOX	liquid oxygen
LPFP	low pressure fuel pump
LPFT	low pressure fuel turbine
LPFTP	low pressure fuel turbopump
LPOP	low pressure oxidizer pump
LPOT	low pressure oxidizer turbine
LPOTP	low pressure oxidizer turbopump
LPS	Launch Processing System
LRSI	low temperature reusable surface insulation
LRU	line replaceable unit
LSB	least significant bit
LSC	linear-shaped charge
LV	local vertical
LVDT	linear voltage differential transformer
LVLH	local vertical, local horizontal
LWT	light weight tank
MA	master alarm
	metabolic analyzer
	middeck aft
	mission analysis
MAC	mean aerodynamic chord
MADS	modular auxiliary data system
man	manual
manip	manipulator
max	maximum
MCA	motor control assembly
MCC	main combustion chamber
	Mission Control Center
MCDS	multifunction cathode ray tube display system
MCIU	master control interface unit

MCM	MADS control module
MDCA	main distributor control assembly
MDF	mild detonating fuse
MDM	multiplexer/demultiplexer
ME	main engine
MEC	master events controller
MECO	main engine cutoff
m.e.t.	mission elapsed time
MET	mission elapsed time
MFV	main fuel valve
MJCA	midbody jettison controller assembly
MIA	multiplex interface adapter
MIL-STD	military standard
ML	mobile launcher moldline
MLA	monochrome lens assembly
MLG	main landing gear
MLI	multilayer insulation
MLP	mobile launcher platform
M/LR	maintenance/loop recorder
MLS	microwave landing system (MSBLS)
MM	mass memory main memory major mode man month
MN	main
MMH	monomethylhydrazine
MML	master measurement list
MMU	mass memory unit
MNVR	maneuver
MOV	main oxidizer valve
MPD	main dc power distributor assembly
MPL	minimum power level
MPM	manipulator positioning mechanism
MPS	main propulsion subsystem
MR	metabolic rate mixture ratio
MRL	manipulator retention latch
MSB	most significant bit
MSBLS	microwave scanning beam landing system
MSC	mode sequencing and control
MSFC	Marshall Space Flight Center
MSG	message
MSS	mission specialist station
MTEE	mean time environmental extremes
MTU	master timing unit
MUX	multiplexer
N <sub>2</sub>	nitrogen
N <sub>2</sub> O <sub>4</sub>	nitrogen tetroxide
NASA	National Aeronautics and Space Administration
N/A or NA	not applicable
NAV	navigation
NAVAID	navigation aid

NG	nose gear
NH <sub>3</sub>	ammonia
NLG	nose landing gear
NMT	no more than
NPSH	net positive suction head
NPSP	net positive suction pressure
NRZ	non-return to zero
NSI	NASA standard initiator
NSP	network signal processor
Nss	net positive suction speed
NWS	nose wheel steering
O.D.	outside diameter
O <sub>2</sub>	oxygen
O/F	oxidizer-to-fuel ratio
OFI	operational flight instrumentation
OFT	orbital flight test
OFP	orbital flight program
OI	operational instrumentation
OIC	operational intercom
OML	outer moldline
OME	orbital maneuvering engine
OMRSD	Operational Maintenance Requirements and Specification Document
OMS	orbital maneuvering subsystem
OPB	oxidizer preburner
OPF	Orbiter Processing Facility
OPOV	oxidizer preburner oxidizer valve
OPS	operations
	operational sequence
	oxygen purge system
	orbiter project schedules
OR	operations review
Orb	Orbiter
OSL	outer structural line
OSS	optics subsystem
outbd	outboard
OV	Orbiter vehicle
OX	oxidizer
pF	power factor
P	total pressure
P <sup>ac</sup>	total pressure
P <sup>c</sup>	chamber pressure
P <sub>s</sub>	static pressure
PAD	propellant acquisition device
PAM	pulse amplifier modulation
PAO	Public Affairs Office
PBAN	polybutadiene-acrylic acid acrylonitril
PBK	payload bay kit
PBP	preburner pump
PCA	power control assembly
PCL	power control list
PCM	pulse code modulation

PCMMU pulse code modulation master unit  
 PCR payload changeout room  
 pct percent  
 PDA power distribution assembly  
 PDI payload data interleaver  
 PDL Polymar Development Laboratory  
 PDU power drive unit  
 pilot display unit  
 PDRS payload deployment and retrieval system  
 PETN pentaerythrite tetranitrate  
 PF preflight  
 PFCS primary flight control system  
 PFS primary flight system  
 percent full scale  
 PHF position hold function  
 PIC pyrotechnic initiator controller  
 PL payload  
 PLB payload bay  
 PLBD OR PBD payload bay door  
 PLBF payload bay floodlight  
 plbk playback  
 PLSS portable life support system  
 PM performance monitor  
 phase modulation  
 pulse modulation  
 PMBT propellant mean bulk temperature  
 PMS performance monitoring system  
 POGO longitudinal oscillations  
 POP perpendicular to orbital plane  
 POR point of resolution  
 pp partial pressure  
 peak-to-peak  
 PPO<sub>2</sub> partial pressure oxygen  
 PRCS primary reaction control subsystem  
 PRD personal radiation dosimeter  
 Pri primary  
 PRLA payload retention latch actuator  
 PRM payload retention mechanism  
 PROM program read only memory  
 PRSA power reactant storage assembly  
 PRSD power reactant storage and distribution  
 PSG power subsystem group  
 PSK phase shift key  
 PSP payload signal processor  
 PSS payload specialist station  
 P/T pressure/temperature  
 PTC passive thermal control  
 PTT push-to-talk  
 PV and D purge, vent, and drain  
 PVT pressure/volume/temperature  
 QPSK quadrature phase shift key

qty	quantity
R	radius
RA	radar altimeter
RALT	radar altimeter
RAM	random access memory
RCC	reinforced carbon carbon
RCCB	remote control circuit breaker
RCRD	record
RCS	reaction control subsystem
RDR	raw data recorder
RDW	response data word
RDX	cyclotrimethylenetrinitramine
ref	reference
rev	revolution
RF	radio frequency
RGA	rate gyro assembly
RH	right hand
RHC	right-hand circular
	rotation hand controller
RHCS	rotation hand control system
RJD	reaction jet driver
RJDA	reaction jet driver aft
RJDF	reaction jet driver forward
R.L.	return link
RMS	remote manipulator system
rms	root mean square
RPC	remote power controller
RPL	rated power level
RS	redundant set
	redundancy status
	remote station
	right side
RSI	reusable surface insulation
R/SB	rudder/speed brake
RSS	range safety subsystem
	root sum square
RPTA	rudder pedal transducer assembly
RTCC	real time computer complex
RTLS	return to launch site
RTV	room temperature vulcanizing
RVDT	rotary variable differential transducer
RW	runway
S	second
	side
S&A	safe and arm
S/B	speed brake
SBTC	speed brake thrust control
SC	signal conditioner
SCA	Shuttle carrier aircraft
SCD	specification control document
	specification control drawings
SCF	satellite control facility
	spacecraft control facility
	sequenced compatibility firing

SCIM	standard cubic inches per minute
SCO	subcarrier oscillator
SCU	sequence control unit
SDC	software development computer spares disposition code
SEP	separation
SGLS	space ground link subsystem
SGSC	strain gage signal conditioner
SI	System International d'Unites <sup>1</sup>
SI/O	serial input/output
SIP	strain isolator pad
SLA	support and logistics area
SM	systems management
SMDC	shielded mild detonating cord
SMRD	spin motor rotation detector spin motor run detector
SMU	soft mockup
S/N	serial number
S.O.	solenoid operated
SODB	Shuttle Operational Data Book
SOP	secondary oxygen pack standard operating procedure
SPA	steering position amplifier
SPAR	SPAR Aerospace Ltd
SPEC	specification
SPI	surface position indicator
SPL	sound pressure level
SPS	samples per second
SPT	steering position transducer
SRB	solid rocket booster
SRM	solid rocket motor
SRSI	simulated reusable surface insulation
SSAT	Space Shuttle access tower
SSME	Space Shuttle main engine
SSO	Space Shuttle Orbiter
SSR	secondary surveillance radar
ST	star tracker
Stbd	starboard
STDN	Spaceflight Tracking and Data Network
STS	Space Transportation System
SW	switch
t	time
T	threshold time
T-0	time zero (lift-off)
TACAN	tactical air navigation
TAEM	terminal area energy management
TAG	technical air-to-ground
TAL	trans-Atlantic abort
tan	tangent

<sup>1</sup>See Table 1.6-I for listing of SI related acronyms.

TBD	to be determined
TBS	to be supplied
TCP	test and checkout procedure
TCS	thermal control subsystem
TD	touchdown
TDM	time division multiplexer
TDRS	Tracking and Data Relay Satellite
TE	trailing edge
TED	trailing edge down
temp	temperature
TEOS	tetraethyl orthosilicate
TEU	trailing edge up
TFOV	total field of view
THC	translation hand controller
tk	tank
TLD	thermoluminescent dosimeter
TLM	telemetry
TM	telemetry
	traffic model
	technical management
	time management
TMC	test monitoring console
TMS	trend monitoring system
TPS	thermal protection subsystem
TRANS DAP	transition digital autopilot
TTL	transistor-transistor logic
TV	television
TVC	thrust vector control
typ	typical
$\mu$ A	micro amperes
$\mu$ g	microgram
UCA	urine collection assembly
UHF	ultrahigh frequency
USAF	United States Air Force
v	velocity
	vertical
V	volt
Ve	equivalent velocity
Vmax	velocity, maximum
VAB	Vertical Assembly Building
Vac	volts, alternating current
VAFB	Vandenberg Air Force Base
VCM	volatile condensable material
VCO	voltage controlled oscillator
Vdc	volts, direct current
VERT	vertical
VHF	very high frequency
VOX	voice operated
vs	versus
VSWR	voltage standing wave ratio
w	word
WBSC	wide-band signal conditioner
WCCS	window cavity conditioning system
WCL	water coolant loop

WLA wide-angle lens assembly  
WM waste management  
WONG weight on nose gear  
WOW weight on wheels  
WP working pressure  
WRT with respect to  
W/WMS water/waste management subsystem  
Xcvr transceiver  
XMT transmit  
XMTR transmitter  
Xpndr transponder  
X-POP x-axis perpendicular to orbital plane  
XTA expanding tube assembly  
ZOTS ignition in injector passage  
ZrKClO<sub>4</sub> zirconium potassium perchlorate



### 1.5.2 Symbols

$>$	greater than
$<$	less than
$\geq$	greater than or equal to
$\leq$	less than or equal to
$\theta$	theta
$\pm$	plus or minus
$\Omega$	ohm
$\mu$	micro
$\approx$	approximately
$\approx$	approximately or equal to
$\propto$	varies as
$\infty$	infinity
$\beta$	beta, magnetic flux density
$\alpha$	alpha, acceleration (linear)
$\alpha_s$	solar absorptance
$\epsilon^s$	permittivity: mean error
$\epsilon_{ir}$	infrared emittance
$\sigma$	sigma, conductivity, also uncertainty
$\phi$	radiant flux or magnetic flux
$\Delta$	delta, difference
$\psi$	dialectic or electrostatic flux
$\delta$	differential
$\omega$	angular frequency
$k\Omega$	kilohm
$M\Omega$	megohm
$\mu\Omega$	microhm
$\Lambda$	equivalent conductivity
$\eta$	viscosity
$l$	length
$^\circ$	degree
$\%$	percent
$\rho$	density

### 1.5.3 Units of Measure

A	ampere
Ah	ampere-hour
bpi	bits per inch
bps	bits per second
cc	cubic centimeters
cc/hr	cubic centimeters per hour
cc/min	cubic centimeters per minute
cm	centimeters
cm/sec	centimeters per second
dB	decibel
dB <sub>i</sub>	decibel relative to an isotropic radiator
dB <sub>m</sub>	decibel per meter
dB <sub>V</sub>	decibel per volt
dB <sub>W</sub>	decibel per watt
deg	degree
deg/sec	degree per second
dynes/cm	dynes per centimeter
F	farad
	Fahrenheit
fps	feet per second
	frames per second
ft	foot or feet
ft/min	feet per minute
ft/sec	feet per second
ft <sup>3</sup>	cubic feet
g	gram
g/cc	gram per cubic centimeter
g/g	gram per gram
GHz	gigahertz
g/m	gram per meter
gpm	gallons per minute
H	henry
hr	hour
Hz	hertz
in	inch
ips	inch per second
in-lb	inch-pound
in <sup>3</sup> /hr	cubic inch per hour

k	thousand
kbps	kilobits per second
KEAS	knots equivalent airspeed
kHz	kilohertz
km	kilometer
kt	knots(s)
kW	kilowatt
lb	pound(s)
lbf	pound force
lb/ft <sup>2</sup>	pound per square foot
lbf/sec	pound force per second
lbm	pound mass
lb/min	pound per minute
lb/sec	pound per second
M	Mach
m	milli
Mbps	megabits per second
mg	milligram
MHz	megahertz
mi	mile
min	minute
ma	milliampere
mg	milligram
mJ	millijoule
ml	milliliter
mm	millimeter
mrad	milliradian
μ	micron
μsec	microsecond
microsec	microsecond
msec	millisecond
mV	millivolt
mW	milliwatt
μg	microgravity
n	nano
nF	nanofarad
nmi.	nautical mile
nsec	nanosecond
0-g	zero gravity
oz	ounce
p	pico
p-p	peak-to-peak
pF	picofarad
ppm	part per million
	pulses per minute
pps	pulse per second
psf	pound per square foot
psi	pound per square inch
psia	pound per square inch absolute

psid	pound per square inch differential
psig	pound per square inch gage
$\bar{q}$	dynamic pressure
$^{\circ}\text{R}$	degree Rankine
rad	radian
rad/sec	radians per second
rms	root mean square
rpm	revolutions per minute
sccs	standard cubic centimeters per second [standard pressure and temperature are 1 atmosphere (14.7 psi) and 20°C (68° F), respectively]
scc	standard cubic centimeters
scch	standard cubic centimeters per hour
scfm	standard cubic feet per minute
sec	second
V	volt
VA	volt-ampere
Vac	volts, alternating current
Vdc	volts, direct current
W	watt(s)
yr	years

## 1.6 METRIC CONVERSION

In view of the international aspects of the Space Shuttle Program and that many of the countries participating in the Program have converted to the internationally approved form of the metric system referred to as the SI (Systeme International d'Unites), the required data for using this system are provided.

### 1.6.1 Names and Symbols of the SI Units

The names and symbols used in the SI system are shown in table 1.6-I.

### 1.6.2 Conversion Factors

Table 1.6-II provides the multiplication factors required for converting numbers and miscellaneous units into corresponding numbers and SI units. The table is self-explanatory. The listing includes only relationships which are frequently encountered and omits the great multiplicity of unit combinations that are required for specialized purposes.

TABLE 1.6-I.- NAMES AND SYMBOLS OF SI UNITS  
(Paragraph 1.6.1)

<u>Quantity</u>	<u>Name of Unit</u>	<u>Symbol</u>
SI BASE UNITS		
length	meter	m
mass	kilogram	kg
time	second	s
electric current	ampere	A
thermodynamic temperature	kelvin	K
luminous intensity	candela	cd
amount of substance	mole	mol
SI DERIVED UNITS		
area	square meter	m <sup>2</sup>
volume	cubic meter	m <sup>3</sup>
frequency	hertz	Hz
mass density (density)	kilogram per cubic meter	kg/m <sup>3</sup>
speed, velocity	meter per second	m/s
angular velocity	radian per second	rad/s
acceleration	meter per second squared	m/s <sup>2</sup>
angular acceleration	radian per second squared	rad/s <sup>2</sup>
force	newton	N
pressure (mechanical stress)	pascal	Pa
kinematic viscosity	square meter per second	m <sup>2</sup> /s
dynamic viscosity	newton-second per sq. meter	N.s/m <sup>2</sup>
work, energy, quantity of heat	joule	J
power	watt	W
quantity of electricity	coulomb	C
potential difference, electromotive force	volt	V
electric field strength	volt per meter	V/m
electric resistance	ohm	Ω
capacitance	farad	F
magnetic flux	weber	Wb
inductance	henry	H
magnetic flux density	tesla	T
magnetic field strength	ampere per meter	A/m
magnetomotive force	ampere	A
luminous flux	lumen	lm
luminance	candela per square meter	cd/m <sup>2</sup>
illuminance	lux	lx
wave number	1 per meter	m <sup>-1</sup>
entropy	joule per kelvin	J/K
specific heat capacity	joule per kilogram kelvin	J/(kg.K)
thermal conductivity	watt per meter kelvin	W/(m.K)
radiant intensity	watt per steradian	W/sr
activity (of a radioactive source)	1 per second	s <sup>-1</sup>

TABLE 1.6-I.- NAMES AND SYMBOLS OF SI UNITS (Continued)  
(Paragraph 1.6.1)

<u>Quantity</u>	<u>Name of Unit</u>	<u>Symbol</u>
SI SUPPLEMENTARY UNIT		
plane angle	radian	rad
solid angle	steradian	sr

TABLE 1.6-II.- METRIC CONVERSION FACTORS  
(Paragraph 1.6.2)

<u>PHYSICAL QUANTITY</u>	<u>TO CONVERT FROM</u>	<u>TO</u>	<u>MULTIPLY BY</u>
Acceleration	feet/second <sup>2</sup>	meters/second <sup>2</sup> (m/sec <sup>2</sup> )	0.3048
Area	inches <sup>2</sup>	centimeters <sup>2</sup> (cm <sup>2</sup> )	6.4516
	feet <sup>2</sup>	meters <sup>2</sup> (m <sup>2</sup> )	0.0929
Density	slug/foot <sup>3</sup>	kilogram/meter <sup>3</sup> (kg/m <sup>3</sup> )	515.38
Energy	Btu	kilojoules (kJ)	1.055
	kWh	kilojoules (kJ)	3600.0
Force	pounds (force)	newton (N)	4.4482
Length	inches	centimeters (cm)	2.54
	feet	meters (m)	0.3048
	nautical miles	kilometers (km)	1.852
Luminance	lambert	candela/meter <sup>2</sup> (cd/m <sup>2</sup> )	3183.0
	foot-candle	lumen/meter <sup>2</sup> (lm/m <sup>2</sup> )	10.7639
Mass	pound (avoirdupois)	kilogram (kg)	0.45359
	slug	kilogram (kg)	14.5939
Power	Btu/hour	watts (W)	0.292875
	Btu/minute	watts (W)	17.5725
	Btu/hour-foot <sup>2</sup>	watts/meter <sup>2</sup> (W/m <sup>2</sup> )	3.1525



TABLE 1.6-II.- METRIC CONVERSION FACTORS (Concluded)  
(Paragraph 1.6.2)

<u>PHYSICAL QUANTITY</u>	<u>TO CONVERT FROM</u>	<u>TO</u>	<u>MULTIPLY BY</u>
Pressure	psia	millimeters of mercury (mmHg)	51.7147
	psia	newton/centimeter <sup>2</sup> (N/cm <sup>2</sup> )	0.6895
	psia	newton/meter <sup>2</sup> (N/m <sup>2</sup> )	6894.8
	pounds/foot <sup>2</sup>	newton/meter <sup>2</sup> (N/m <sup>2</sup> )	47.88
Temperature	Fahrenheit	Celsius (C) $t_c = (5/9) (t_f - 32)$	
	Fahrenheit	kelvin (K) $t_k = (5/9) (t_f - 32) + 273.16$	
	Fahrenheit	Rankine (R) $t_r = t_f + 459.7$	
Viscosity	centipoise	newton-second/meter <sup>2</sup> (Nsec/m <sup>2</sup> )	0.001
Volume	inch <sup>3</sup>	centimeter <sup>3</sup> (cm <sup>3</sup> )	16.387
	foot <sup>3</sup>	meter <sup>3</sup> (m <sup>3</sup> )	0.0283
	pint	liter (L)	0.47317
	gallon (U.S.)	liter (L)	3.7853

## 2.0 SHUTTLE SYSTEM CONFIGURATION AND COORDINATE SYSTEMS

This section defines the physical characteristics of the Shuttle System, the interface between the Shuttle elements, and certain detailed physical characteristics of those elements. Pictorial representations and descriptions showing station locations, station lines, dimensions, separation planes, and coordinate systems (with conventions and relationships) are provided.

- a. Shuttle System
  - 1. Assembled configuration Figure 2-1
  - 2. Engine numbering designation Figure 2-1
  - 3. Coordinate system inter-relationships Table 2-1
  - 4. Dynamic body axes Figure 2-2
  - 5. Elevations and stationing on launch pad A Figure 2-3
  - 6. Elements attach coordinates Figure 2-4
- b. Solid Rocket Boosters Configuration Figure 2-5
- c. External Tank Configuration Figure 2-6
- d. Orbiter
  - 1. Mission configuration Figure 2-7
  - 2. Dimensional parameters Table 2-2
  - 3. Orbiter projected areas vs. Orbiter attitude variation Table 2-3
  - 4. Motion referenced to body axes Figure 2-8
  - 5. Motion referenced to stability axes Figure 2-9
  - 6. Body flap elevon deflections Figure 2-10
  - 7. Rudder and speed brake deflections Figure 2-11
  - 8. Definition of control surface deflections, forces, and hinge moments Figure 2-12
- e. Orbiter/Carrier
  - 1. Ferry configuration and attach point coordinates Figure 2-13

TABLE 2-1.- SHUTTLE COORDINATE SYSTEM INTERRELATIONSHIPS<sup>a</sup>

From:	To:	
	Orbiter system	Shuttle system/ External tank system
Orbiter system $X_0, Y_0, Z_0$		$X_0 + 741.0 = X_{S/T}$ $Y_0 = Y_{S/T}$ $Z_0 + 336.5 = Z_{S/T}$
Shuttle system/ external tank system $X_S, Y_S, Z_S$ $X_T, Y_T, Z_T$	$X_{S/T} - 741.0 = X_0$ $Y_{S/T} = Y_0$ $Z_{S/T} - 336.5 = Z_0$	
Right booster $X_{RB}, Y_{RB}, Z_{RB}$	$X_{RB} - 198.0 = X_0$ $Y_{RB} + 250.5 = Y_0$ $Z_{RB} + 63.5 = Z_0$	$X_{RB} + 543.0 = X_{S/T}$ $Y_{RB} + 250.5 = Y_{S/T}$ $Z_{RB} + 400.0 = Z_{S/T}$
Left booster $X_{LB}, Y_{LB}, Z_{LB}$	$X_{LB} - 198.0 = X_0$ $Y_{LB} - 250.5 = Y_0$ $Z_{LB} + 63.5 = Z_0$	$X_{LB} + 543.0 = X_{S/T}$ $Y_{LB} - 250.5 = Y_{S/T}$ $Z_{LB} + 400.0 = Z_{S/T}$

<sup>a</sup>See figure 2-1 for Shuttle system element coordinate system relationships.

TABLE 2-2.- ORBITER DIMENSIONAL PARAMETERS

Component	Parameter	Value	Units
Total Vehicle	Planform area, $A_p$	4317 T/C On 3952 T/C Off Table 2-3	ft <sup>2</sup>
	Planform area, $A_p$ (P/L doors open)	4450 Table 2-3	ft <sup>2</sup>
	Frontal area, $A_F$	734 Table 2-3	ft <sup>2</sup>
	Side area, $A_S$	2396 Table 2-3	ft <sup>2</sup>
(body + exposed wing)	Surface wetted area	2715 T/C On 11136	ft <sup>2</sup>
	Length overall	122.17 (1466.06)	ft (in.)
	Reference length	Figure 2-7	
	Height, gear up	46.14 (553.68)	ft (in.)
	Height, on gear (static)	53.77 (645.22)	ft (in.)
	Span	78.06 (936.68)	ft (in.)
Body	Length	Figure 2-7	
	Depth, maximum ( $X_0 = 1280$ )	19.92 (239)	ft (in.)
	Width, maximum ( $X_0 = 1528.3$ )	22.0 (264)	ft (in.)
	Planform area	1914.4	ft <sup>2</sup>
	Surface wetted area	5634	ft <sup>2</sup>
	Base area (including OMS pods, 71 ft <sup>2</sup> )	436.7	ft <sup>2</sup>
	Cargo bay (diameter x length)	15 x 60	ft
	Planform area	2690	ft <sup>2</sup>
	Span	Figure 2-7	
	Aspect ratio	2.265	
Wing (includes body carry through)	Taper ratio	0.20	
	Sweep, leading edge	45	deg
	Sweep, trailing edge	-10.056148	deg
	Dihedral (at wing trailing edge)	3.5	deg
	Root chord ( $Y_0 = 0$ ) (theoret)		
	Length	57.44 (689.24)	ft (in.)
	c/4 station, $X_0$	1008.31	in
	Tip chord ( $Y_0 = 468.34$ )		
	Length	11.49 (137.88)	ft (in.)
	c/4 station, $X_0$	1338.8025	in.
	Incidence	+0.5	deg
	Airfoil section	0.0012-64 mod.	

TABLE 2-2.- ORBITER DIMENSIONAL PARAMETERS (Continued)

Component	Parameter	Value	Units
Wing, exposed	MAC, $\bar{c}$ ( $Y_0 = 182.13$ ) Length	39.57 (474.84)	ft (in.)
	$\bar{c}/4$ station, $X_0$	1136.83	
	Planform area (incl. glove)	2012.4	ft <sup>2</sup>
	Surface wetted area	4001.2	ft <sup>2</sup>
	Root chord ( $Y_0 = 108.0$ ) Length (incl. glove)	80.83 (970)	ft (in.)
	$c/4$ station, $X_0$	778.5	in.
	Incidence ( $Y_0 = 199.045$ )	+0.5	deg
	Airfoil section $Y_0 = 199.045$	0.0010 mod.	
	Sweep, glove	81	deg
	Inboard/outboard split line, $Y_0$	311	
Elevon (One side)	Area	206.57	ft <sup>2</sup>
	Span	28.87	ft
	Aspect ratio	4.03	
	MAC, $\bar{c}$ length	7.46 (89.5)	ft (in.)
Vertical tail (includes rudder and speed brake)	$\bar{c}/4$ station, $X_0$	1409.375	in.
	Distance from elevon centroid to hinge line	44.75	in.
	Deflection (elevon)	Figure 2-10	
	Planform area	413.25	ft <sup>2</sup>
	Span	26.31 (315.72)	ft (in.)
	Aspect ratio	1.675	
	Taper ratio	0.404	
	Sweep, leading edge	45	deg
	MAC, $\bar{c}$ length	16.65 (199.81)	ft (in.)
	Plain, $Z_0$	635.5	in.
$\bar{c}/4$ station, $X_0$	1463.35		

TABLE 2-2.- ORBITER DIMENSIONAL PARAMETERS (Concluded)

Component	Parameter	Value	Units
Vertical tail (Concluded)	Root cord length	22.37 (268.44)	ft (in.)
	Tip cord length	9.04 (108.48)	ft (in)
	Airfoil section (root - tip)	10° sym 60 percent - 40 percent double wedge	
	Sweep, trailing edge	26.2	deg
Rudder and speed brake	Planform area	97.148	ft <sup>2</sup>
	Span	16.55 (198.61)	ft (in.)
	$\bar{c}$ length	6.07 (72.84)	ft (in.)
	Plain, $Z_0$	670.41	in.
	$\bar{c}/4$ station, $X_0$	1575.77	in.
	Deflection, rudder (maximum)	Figure 2-11	
Deflection, speed brake (maximum)	Figure 2-12		
	Sweep, hinge line	34.83	deg
Body flap	Planform area	135.75	ft <sup>2</sup>
	Fuselage station of hinge line	Figure 2-10	
	Span (equivalent)	241.33	in.
	Chord	81	in.
	Deflection	Figure 2-10	

$X_0$  (Glove LE intersects body/based on OML, TPS incl) = 500.0 in,  
 $Y_0$  = 102.0 in.

Glove/wing theoretical intersection = 1024 in,  $Y_0$  = 188.0 in.

TABLE 2-3.- ORBITER PROJECTED AREAS VS ORBITER ATTITUDE VARIATION

A $\phi$ (roll) ft <sup>2</sup> (viewed from the side)			A $\alpha$ (pitch) ft <sup>2</sup> (viewed from the front)			A $\beta$ (yaw) ft <sup>2</sup> (viewed from the front)		
deg	Closed doors	Open doors	deg	Closed doors	Open doors	deg	Closed doors	Open doors
0	2396	2396	0	734	734	0	734	
10	3045	3132	10	1409	1495	10	1138	
20	3603	3772	20	2041	2211	20	1509	
30	4050	4300	30	2611	2860	30	1833	
40	4375	4695	40	3102	3422	40	2102	
50	4567	4948	50	3499	3879	50	2307	
60	4620	5051	60	3789	4220	60	2441	
70	4533	5000	70	3964	4432	70	2502	
80	4308	4798	80	4019	4509	80	2487	
90	3952	4450	90	3952	4450	90	2396	

NOTE: Equations used for projected areas are as follows:

$$A_{\alpha} \text{ (pitch)} = A_F \cos \alpha + A_P \sin \alpha$$

$$A_{\beta} \text{ (yaw)} = A_F \cos \beta + A_S \sin \beta$$

$$A_{\phi} \text{ (roll)} = A_S \cos \phi + A_P \sin \phi$$

$$A_F = 734 \text{ ft}^2$$

$$A_P \text{ Doors Closed} = 3952 \text{ ft}^2$$

$$A_P \text{ Doors Open} = 4450 \text{ ft}^2$$

$$A_S = 2396 \text{ ft}^2$$

A<sub>F</sub> and A<sub>S</sub> areas with payload bay doors open are assumed to be approximately the same as A<sub>F</sub> and A<sub>S</sub> with the doors closed.

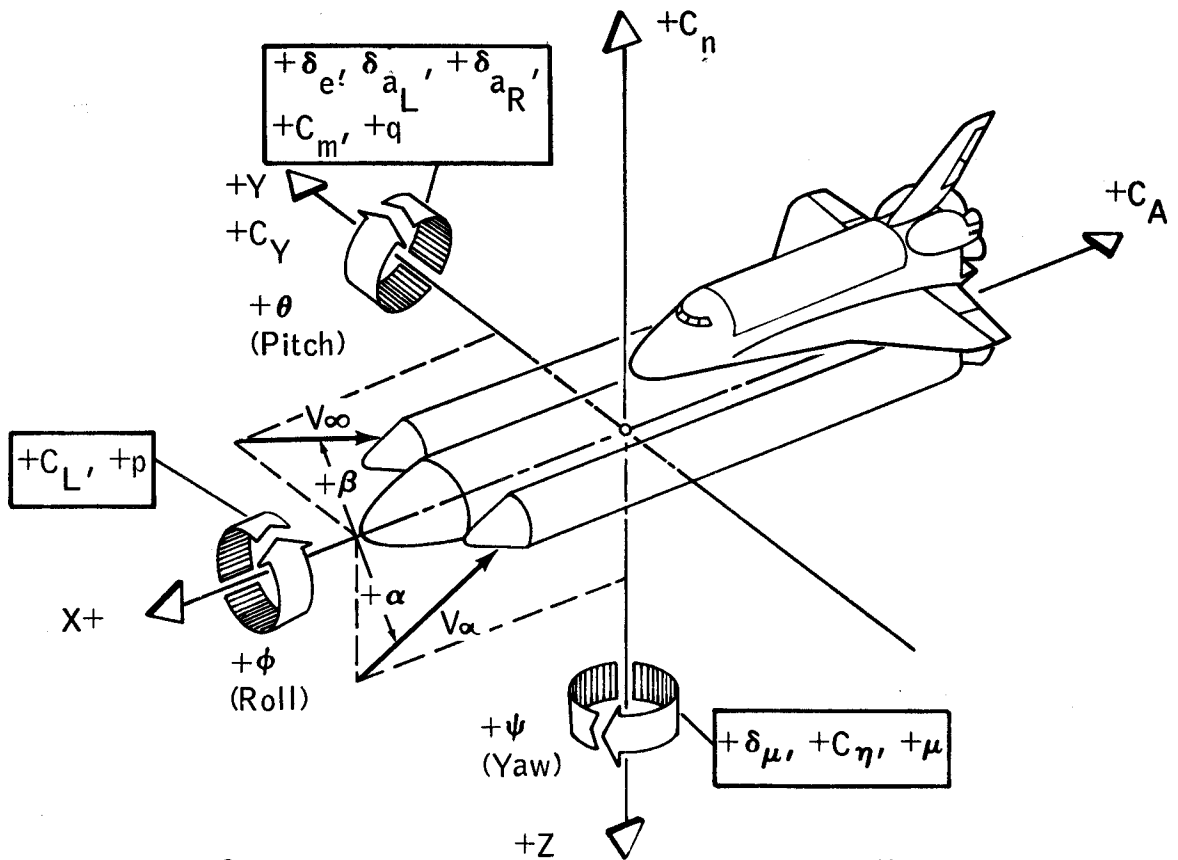

<u>Cause</u>	<u>Effect</u>
+ Angle of attack (+ $\alpha$ )	- Z airload
+ Angle of sideslip (+ $\beta$ )	- Y airload
+ Rudder deflection (+ $\delta_r$ )	+ Y rudder force
+ Elevon deflection (+ $\delta_e$ )	- Z elevon force
+ Gimbal deflection (pitch) (+ $\theta$ )	- Z thrust force
+ Gimbal deflection (yaw) (+ $\psi$ )	+ Y thrust force
+ Gimbal deflection (roll) (+ $\phi$ )	+ Moment about X-axis
+ Force	+ Acceleration and + load factor
+ Moment	+ Angular acceleration
+ Acceleration	+ Velocity
+ Load factor	- Inertia force
+ Angular acceleration	- Inertial moment
+ Velocity	+ Displacement
	When integrating from nose to tail
+ Force	+ Shear
+ Y shear	+ Bending moment about Z-axis
+ Z shear	- Bending moment about Y-axis
+ Torque	+ Torsional moment

Figure 2-2.- Shuttle system dynamic body axes .



37

2-9

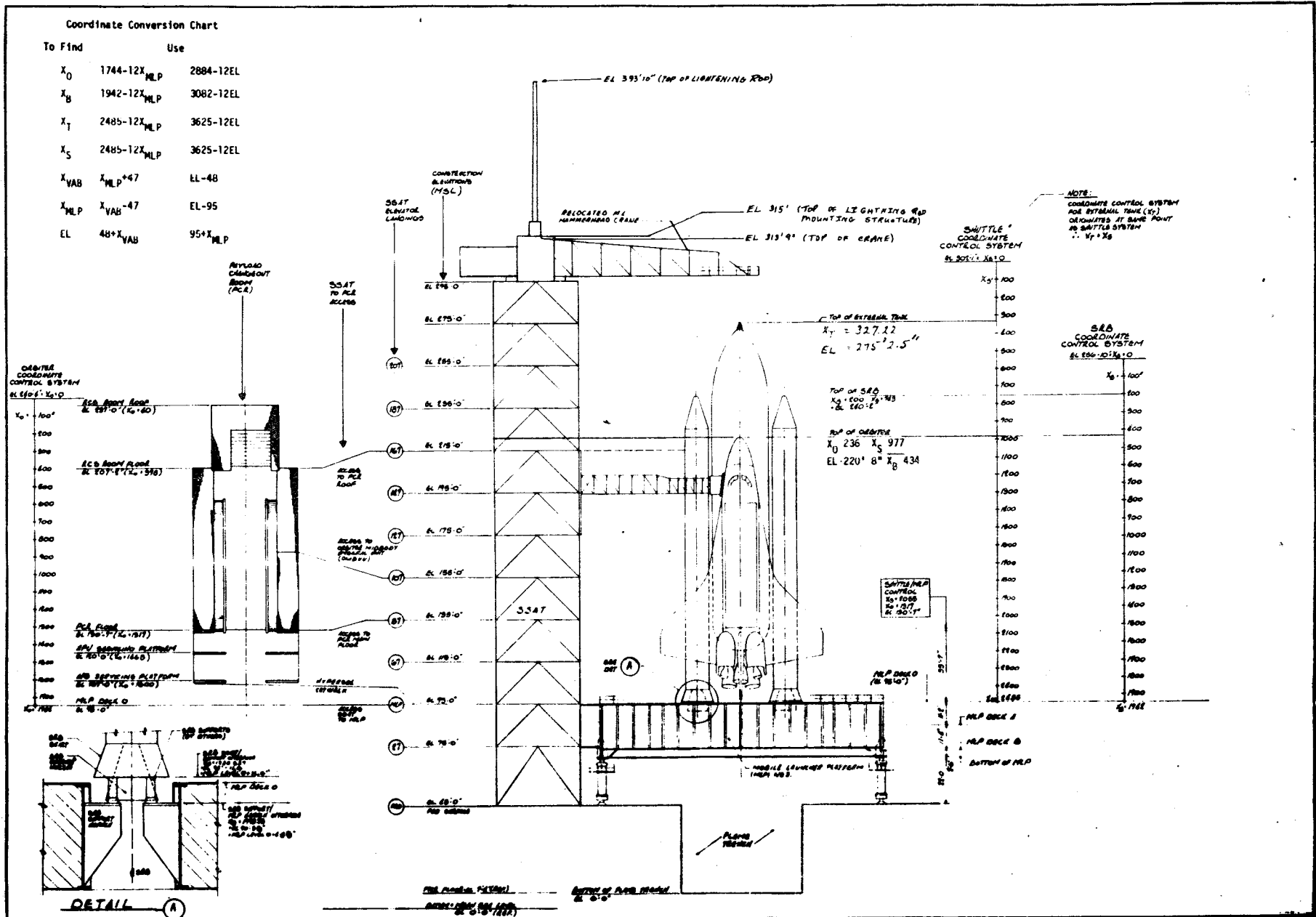

Figure 2-3.- Elevations and stationing on launch pad A.

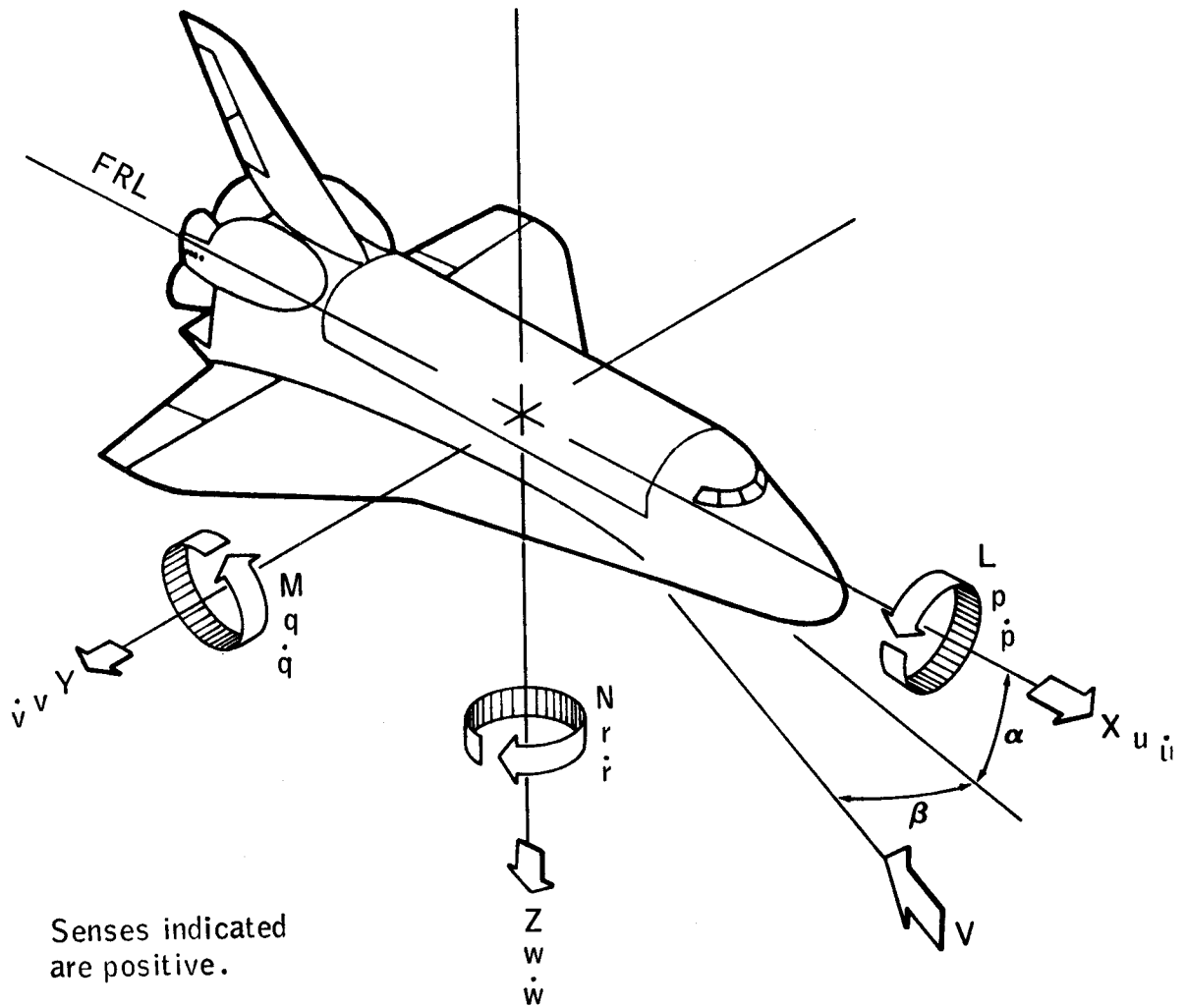

Figure 2-8.- Orbiter motion referenced to body axes .

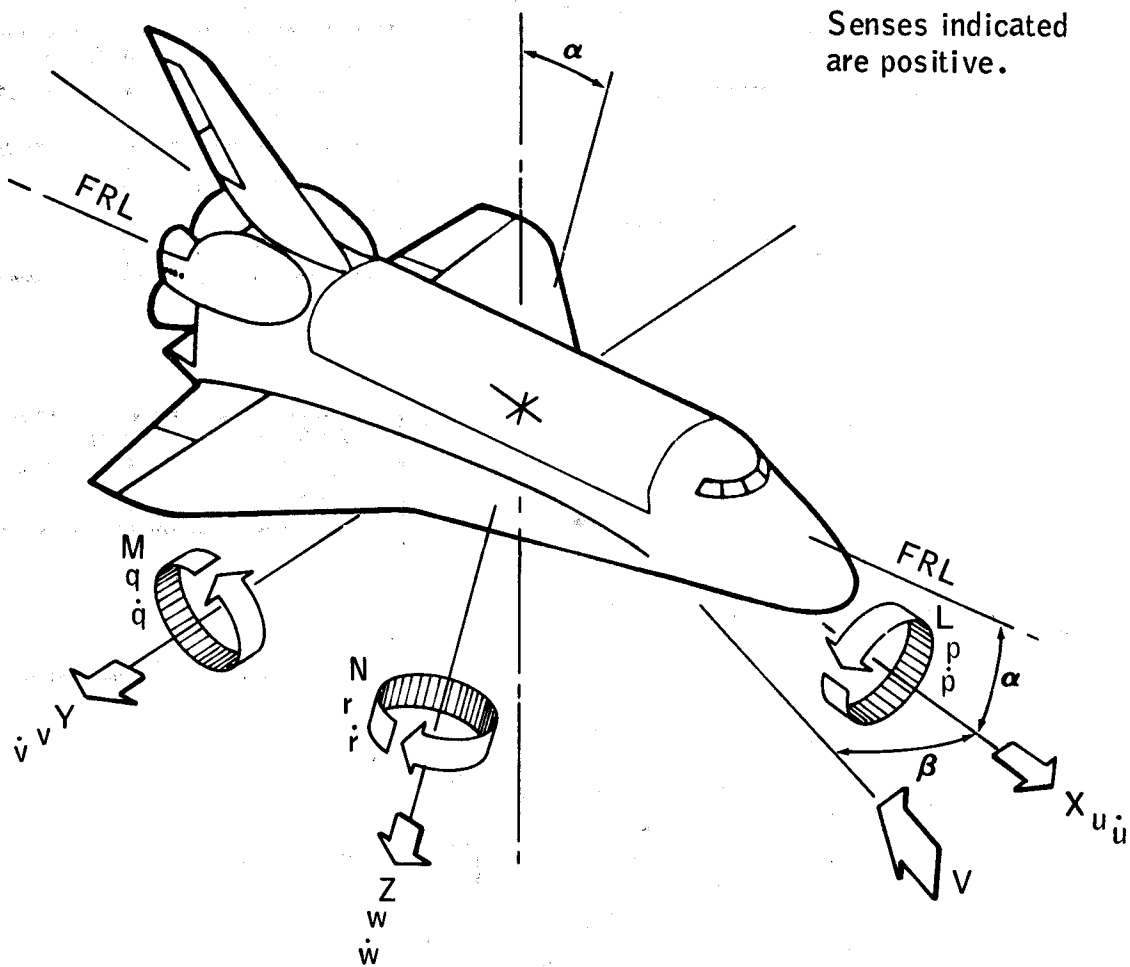
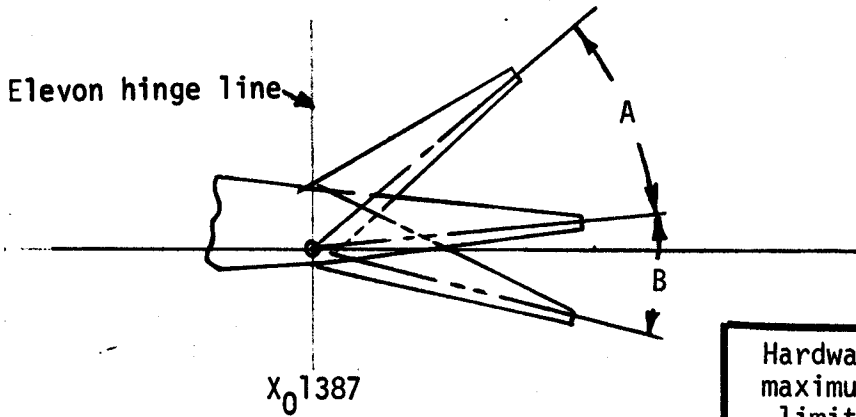
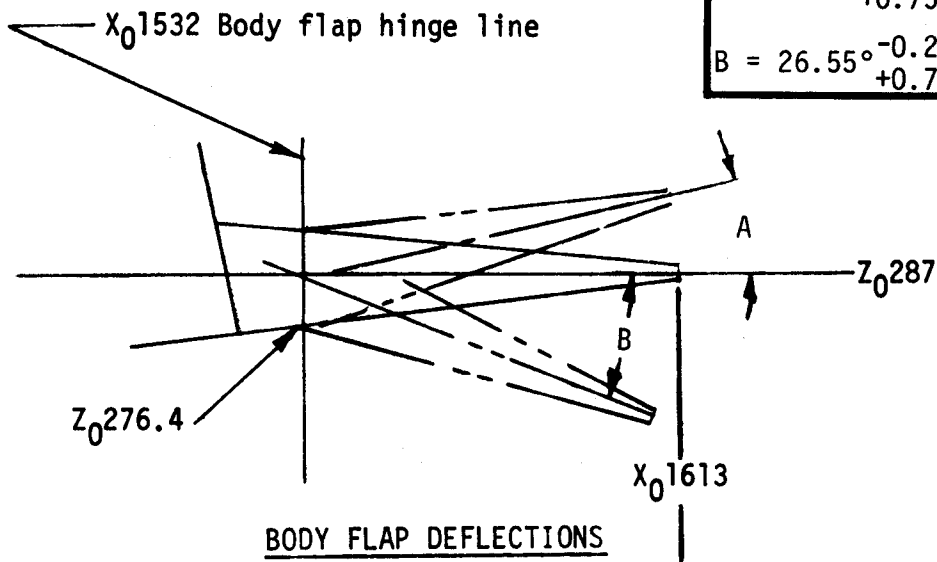

Figure 2-9.- Orbiter motion referenced to stability axes.



ELEVON DEFLECTIONS

Hardware maximum limit	Software maximum limit
$A = 36.5^\circ \pm 0.25$	$33^\circ$
$B = 21.5^\circ \pm 0.25$	$18^\circ$



BODY FLAP DEFLECTIONS

Hardware maximum limit	Software maximum limit
$A = 15.7 \begin{matrix} -0.25 \\ +0.75 \end{matrix}$	$11.7^\circ$
$B = 26.55^\circ \begin{matrix} -0.25 \\ +0.75 \end{matrix}$	$22.55^\circ$

Figure 2-10.- Body flap and elevon deflections

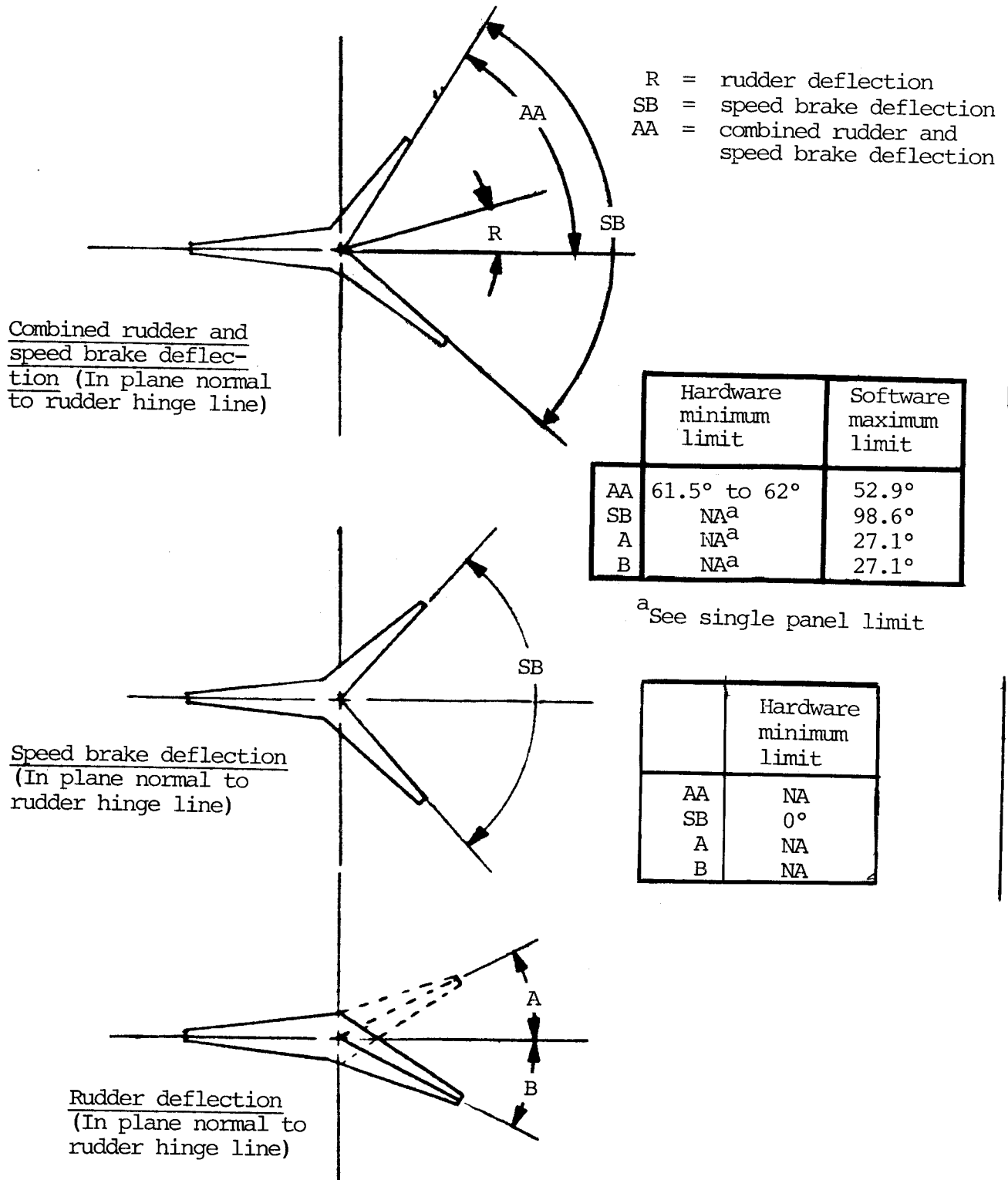
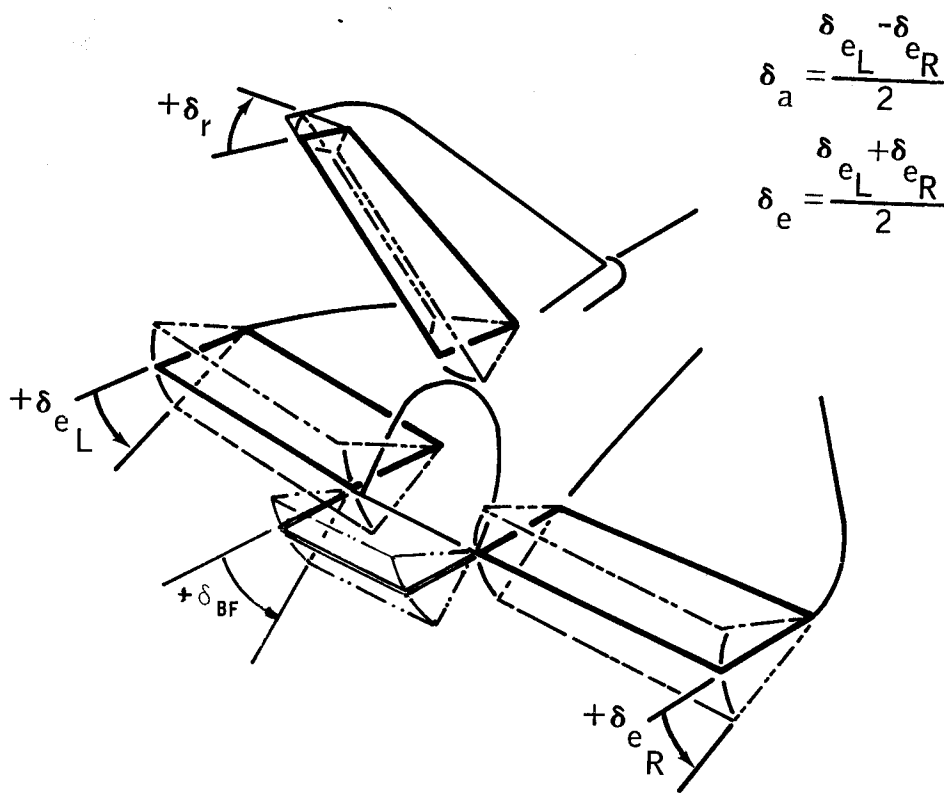

Figure 2-11.- Rudder and speed brake deflections.  
(Paragraph 2.1.4)



Positive deflection of	Angle	Force and moments	Hinge moment of surface
$\delta_e$	$-\theta, -\alpha$	$-C_m$	$-C_{h_e}$
$\delta_r$	$+\beta, -\psi$	$+C_y, -C_n$	$-C_{h_r}$
$\delta_a$	$+\phi$	$+C_l$	
$\delta_{eR}$	$-\phi$	$-C_l$	$-C_{h_{eR}}$
$\delta_{eL}$	$+\phi$	$+C_l$	$-C_{h_{eL}}$
$\delta_{BF}$	$-\theta, -\alpha$	$-C_m$	$-C_{h_{BF}}$

Figure 2-12.- Definition of control surface deflections, forces and hinge moments.

## TABLE OF CONTENTS

### Section

3.0	<u>SHUTTLE CONSTRAINTS AND LIMITATIONS</u>
3.1	<u>INTRODUCTION</u>
3.2	<u>CONSTRAINTS</u>
3.3	<u>LIMITATIONS</u>
3.4	<u>ORBITER CONSTRAINTS AND LIMITATIONS</u>
3.4.1	<u>Structures and Thermal Control/Protection</u>
3.4.1.1	Structures Subsystems
3.4.1.2	Thermal Control Subsystem
3.4.1.3	Thermal Protection Subsystem
3.4.1.4	Purge, Vent and Drain Subsystem
3.4.2	<u>Mechanical Subsystems</u>
3.4.2.1	Landing/Deceleration Subsystem
3.4.2.2	Attachment/Separation Mechanism Subsystem
3.4.2.3	Hatches, Payload Bay Doors, Radiators and Associated Mechanisms
3.4.2.4	Hydraulic Subsystems
3.4.2.5	Payload Deployment and Retrieval Subsystem
3.4.2.6	Operational Seat Subsystem
3.4.2.7	Atmospheric Flight Control Mechanisms
3.4.2.8	Space Shuttle Pyrotechnics
3.4.3	<u>Propulsion Subsystems</u>
3.4.3.1	Main Propulsion Subsystem (MPS)
3.4.3.2	Reaction Control Subsystems
3.4.3.3	Orbital Maneuvering Subsystem
3.4.4	<u>Power Subsystems</u>
3.4.4.1	Fuel Cell Powerplant Subsystem
3.4.4.2	Power Reactant Storage and Distribution Subsystem
3.4.4.3	Auxiliary Power Unit Subsystem
3.4.5	<u>Avionics Subsystems</u>
3.4.5.1	Guidance, Navigation and Control Subsystems
3.4.5.2	Communications and Tracking Subsystems
3.4.5.3	Caution and Warning Subsystem
3.4.5.4	Data Processing Subsystem
3.4.5.5	Instrumentation Subsystems
3.4.5.6	Electrical Power Distribution and Control Subsystem
3.4.6	<u>Environmental Control and Live Support Subsystems</u>
3.4.6.1	Atmospheric Revitalization Subsystem
3.4.6.2	Water/Waste Management Subsystem
3.4.6.3	Active Thermal Control Subsystem
3.4.6.4	Airlock Support Subsystem
3.4.6.5	Smoke Detection and Fire Suppression Subsystem
3.4.7	<u>Crew Systems</u>

## TABLE OF CONTENTS

### Section

3.5	<u>EXTERNAL TANK CONSTRAINTS AND LIMITATIONS</u>
3.5.1	<u>Structures and Thermal Protection Subsystems</u>
3.5.1.1	Structures Subsystem
3.5.1.2	Thermal Protection Subsystem
3.5.2	<u>Mechanical Subsystems</u>
3.5.2.1	ET/SRB Attachment Separation Subsystem
3.5.2.2	Mechanical Subsystem
3.5.3	<u>Propellant Storage Subsystem</u>
3.5.3.1	Propellant Storage
3.5.4	<u>Avionics Subsystems</u>
3.5.4.1	Range Safety Subsystem
3.5.4.2	Instrumentation Subsystem
3.5.4.3	Electrical Power Distribution and Control Subsystem
3.6	<u>SOLID ROCKET BOOSTER CONSTRAINTS AND LIMITATIONS</u>
3.6.1	<u>Structures and Thermal Protection Subsystems</u>
3.6.1.1	Structures Subsystem
3.6.1.2	Thermal Protection Subsystem
3.6.2	Electrical and Instrumentation Subsystem
3.6.2.1	Electrical Power Distribution and Control
3.6.2.2	Instrumentation
3.6.3	<u>Solid Rocket Motor Subsystem</u>
3.6.3.1	Solid Rocket Motor
3.6.4	<u>Thrust Vector Control</u>
3.6.4.1	Thrust Vector Control Characteristics
3.6.4.2	Auxiliary Power Unit Subsystems
3.6.4.3	Hydraulic Subsystem
3.6.4.4	Servoactuators
3.6.5	<u>Separation Subsystem</u>
3.6.6	<u>Recovery Subsystem</u>



### 3.0 SHUTTLE CONSTRAINTS AND LIMITATIONS

#### 3.1 INTRODUCTION

The data presented in this section include operational hardware limitations and constraints for the overall Space Shuttle vehicle and the corresponding result if a limit is exceeded or a constraint violated.

For convenience, the constraints and limitations are discussed in this section under individual subsystem headings. Supporting data are presented under similar headings in Sections 4.0, 5.0, and 6.0.

#### 3.2 CONSTRAINTS

Constraints are defined as those methods of operation or procedures for operation imposed upon hardware components/systems, which if violated, may affect crew safety, result in performance degradation, or affect mission timelines.

#### 3.3 LIMITATIONS

Limitations are defined as those measurable or detectable operational limits, which if exceeded, will affect crew safety or result in performance degradation.

#### 3.4 ORBITER CONSTRAINTS AND LIMITATIONS

The constraints and limitations for the Orbiter subsystems are presented in the following subparagraphs.

## 3.4.1 Structures and Thermal Control/Protection

## 3.4.1.1 Structures Subsystems

## CONSTRAINTS/LIMITATIONS

1. I-Load Dynamic Pressure.\*

The maximum dynamic pressure for ascent is limited by figure 3.4.1.1-1.

## RESULT IF EXCEEDED

Exceeding this limit could cause structural damage.

2. Day of Launch Dynamic Pressure.

The day of launch maximum dispersed dynamic pressure for ascent is limited by figure 3.4.1.1-2. The constraint is defined by requirements for TPS loads and by margins for flutter and buffet.

3. Day-of-Launch Load Indicators Limits.

Exceeding these limits could result in damage to the structure.

- a. Wing load-indicator limits are in table 3.4.1.1-1.
- b. Vertical tail load-indicator limits are in table 3.4.1.1-2.
- c. Side-window load-indicator limit is -3.4 psid. Refer to table 4.1.1-12 for load-indicator equation.
- d. OMS pod and aft Orbiter/ET load-indicator limits are in table 3.4.1.1-3.
- e. Aft fuselage/vertical tail attachment load-indicator limits are in table 3.4.1.1-4.
- f. ET load-indicator limits are in table 3.4.1.1-5.

4. Structural Loads

- a. Flight vehicle launch trajectory axial load factors must not exceed 3 g's.<sup>a</sup>
- b. Descent and landing phase flight restrictions are found in section 3.4.5.1.
- c. Orbiter landing weight
  - (1) Orbiter landing weight limitations:
    - (a) Landing conditions, sink rate vs. landing weight. See Figure 4.2.1-1.

Exceeding this limit can result in structural damage.

Possible damage to the Orbiter primary structure, MLG tires, wheels and/or struts.

\*NASA Data Source

<sup>a</sup>These load factors are static and do not include dynamic effects. These load factors also apply to all intact abort modes. For a failure condition with one SSME throttle stuck at 104 percent, the loads will exceed the 3g limit. This condition is acceptable for a one-time occurrence but is not a design requirement. If this failure occurs, a detailed loads analysis is required. The loads analysis will determine what structural inspection is required.

## 3.4.1.1

Structures Subsystems (Cont)CONSTRAINTS/LIMITATIONS

## RESULT IF EXCEEDED

- (b) Landing conditions, sink rate vs. cross-wind velocity. See Figure 4.2.1-2.
- (2) Nominal end-of-mission (EOM) Orbiter landing weight in excess of 211,000 lb (Figures 4.2.1-1 and 4.2.1-2 provide sink rate and cross-wind limitations) may be approved by Level II waiver up to a landing weight of 214,000 lb. EOM landing weight in excess of 214,000 lb must be approved by Level I.
- (3) Abort landing weight in excess of 240,000 lb may be approved by Level II waiver for RTLS aborts up to a landing weight of 244,000 lb. Abort landing weights above 244,000 lb for RTLS must be approved by Level I. TAL and AOA landing weights in excess of 240,000 lb must be approved by Level I.
- (NOTE: For landing weights > 207,000 lb, additional MLG restrictions are found in Rockwell International Report No. STS 82-0574; Structural Flight Restrictions for Orbiter Operational Flights, available from VF2/J. Mistrot.)
5. Maximum Cabin Crush Pressure. Exceeding this limit could cause structural damage.  
Maximum crush pressure is 1.0 psid for critical landing case.
6. Structural Temperatures.  
a. The structural bondline temperature limit is 350° F. Exceeding this limit could cause structural damage.  
b. For RSI/SIP bondline temperature limit, see paragraph 3.4.1.3.

3.4.1.1 Structures Subsystems (Cont)CONSTRAINTS/LIMITATIONS

- c. To preclude excessive temperature at the vertical tail structure, the maximum APU running times and wind conditions of figure 3.4.1.1-4 apply when there is a burning APU exhaust plume. For FRF APU operations running times can be increased by 4 minutes without causing the structure to exceed 350° F.
- 7. Payload Bay Vibration. The Orbiter vehicle payload bay attachment vibration environments must not exceed those specified in figure 3.4.1.1-4.
- 8. Cabin Windows.
  - a. Contact with cabin window glass must be avoided. No equipment experiment, or other items should be attached to any window glass surface. This includes all attachment methods (suction cups, tapes, etc.).
  - b. Protective covers or window shades must be installed on the overhead and rear-viewing windows at all times except when operations require that they be off. They must be installed at all times when the Orbiter is in an orientation and gravitational field in which an object could fall on a window if dropped by the crew.

RESULT IF EXCEEDED

Exceeding the temperature limits will result in structural damage.

Exceeding these vibration limits could cause damage to the attachments.

Glass coating may be damaged causing visual and/or strength degradation.

If an object impacts a window, there could be visual and/or strength degradation.

3.4.1.1 Structures Subsystems (Cont)  
CONSTRAINTS/LIMITATIONS  
 9. Limit SSME Gimbling When Orbiter  
Is On Landing Gears<sup>a</sup>

## RESULT IF EXCEEDED

Non-oscillatory re-positioning of the SSME may be performed when the Orbiter is on all three landing gears, without chocks, without braking, and without any additional force applied to the wheels, other than vehicle weight. In this configuration, the following restrictions apply:

In the event the gear is restrained and these limits are exceeded the gears may be damaged. This condition could result in exceeding the ultimate sideload capability of the nose gear.

Pitch Plane: Gimball rate is 3 degrees per second and the initial step input is less than 1/2 degree.

Yaw Plane: Only one SSME at a time is moved and the motion is in one direction, i.e., no sinusoidal gimbaling. The yaw motion is less than 2 degrees per second with 25 digital steps per second and the initial step input is less than 1/2 degree.

<sup>a</sup>In the initialization of OPS 9 software, a momentary step in excess of 1/2 degree may occur; if the landing gears are unrestrained at the time of the step, this occurrence is permissible.

TABLE 3.4.1.1-1.- WING LOAD-INDICATOR LIMITS (Paragraph 3.4.1.1)

Indicator	OV-099		OV-102		OV-103/OV-104		Load indicator equations	
	Factor	Limit	Factor	Limit	Factor	Limit		
A8	1.0	1000	1.0	1000	(1.05R) (1.20L)	1000	Table 4.1.1-5	
A14	1.0	-23644	(1.0R) (1.1L)	24180	(1.05R) (1.15L)	-23644		
A15	1.0	975	1.0	975	1.0	975		
A16	1.0	-16900	1.0	-16900	(1.25R) (1.25L)	-16600		
A17	(1.05R) (1.20L)	588	(1.0R) (1.15L)	600	(1.0 R) (1.15L)	640		
A18	1.0	-13964	1.0	-13964	1.0	-12900		
A19	1.0	496	1.0	544	1.0	465		
A20	(1.0 R) (1.05L)	-798	(1.0R) (1.05L)	-823	(1.0 R) (1.05L)	-820		
A21	1.0	787	1.0	865	1.0	772		
A22	1.0	-580	1.0	-604	1.0	-710		
Bending Moment Limit $M_x$								
OV-103 OV-104	23.8 x 10 <sup>6</sup> - (A8-725) x 4600				(As A8 increases, $M_x$ decreases)			
OV-102	26.4 x 10 <sup>6</sup> - (A8-815) x 4600							

TABLE 3.4.1.1-2 - VERTICAL TAIL LOAD INDICATOR LIMITS (Paragraph 3.4.1.1)

Indicator	Limit	Load indicator equation
VTR-X1 and VTL-X1	-38,880 lb +63,500 lb	Table 4.1.1-6
VTR-Z1 and VTL-Z1	-68,300 lb +95,000 lb	Table 4.1.1-6
VTR-2 and VTL-2	-113,300 lb +142,860 lb	Table 4.1.1-7
VT-3	± 84,400 lb	Table 4.1.1-8
VTR-5 and VTL-5	2 psi	Table 4.1.1-9
VTR-6 and VTL-6	+ 991 lb/in.	Table 4.1.1-10
VTR-7 and VTL-7	-30,300 psi +42,900 psi	Table 4.1.1-11

TABLE 3.4.1.1-3.- OMS POD AND AFT ORBITER/ET  
LOAD-INDICATOR LIMITS  
(Paragraph 3.4.1.1)

Indicator	Limit	Load indicator equation
OMSR-PT6	6214 lb	Table 4.1.1-13
OMSL-PT6	6214 lb	Table 4.1.1-13
AFTETLPZ	300,000 lb	Table 4.1.1-13
AFTETRPZ	300,000 lb	Table 4.1.1-13

TABLE 3.4.1.1-4.- AFT FUSELAGE/VERTICAL TAIL LOAD  
INDICATOR LIMITS  
(Paragraph 3.4.1.1)

Indicator	Limit	Load indicator equation
AFTFL1	35,457 lb	Table 4.1.1-14
AFTFR1	35,457 lb	Table 4.1.1-14
AFTFL3	209,468 lb	Table 4.1.1-15
AFTFR3	209,468 lb	Table 4.1.1-15
AFTFL4	1.0	Table 4.1.1-15
AFTFR4	1.0	Table 4.1.1-15

TABLE 3.4.1.1-5.- ET LOAD-INDICATOR LIMITS  
(Paragraph 3.4.1.1)

Indicator	Limit	Load indicator equation
L3-40 (LH <sub>2</sub> tank)	+10,000,000 lb	Table 4.1.1-16
L3-42 (LH <sub>2</sub> tank)	+10,000,000 lb	Table 4.1.1-16
L3-58 (LH <sub>2</sub> tank)	456.9 lb	Table 4.1.1-17
L3-89 (LH <sub>2</sub> tank)	-51,179 lb	Table 4.1.1-18
L4-10 (aft linkage)	481.0 lb	Table 4.1.1-19
L4-11 (aft linkage)	522.0 lb	Table 4.1.1-19

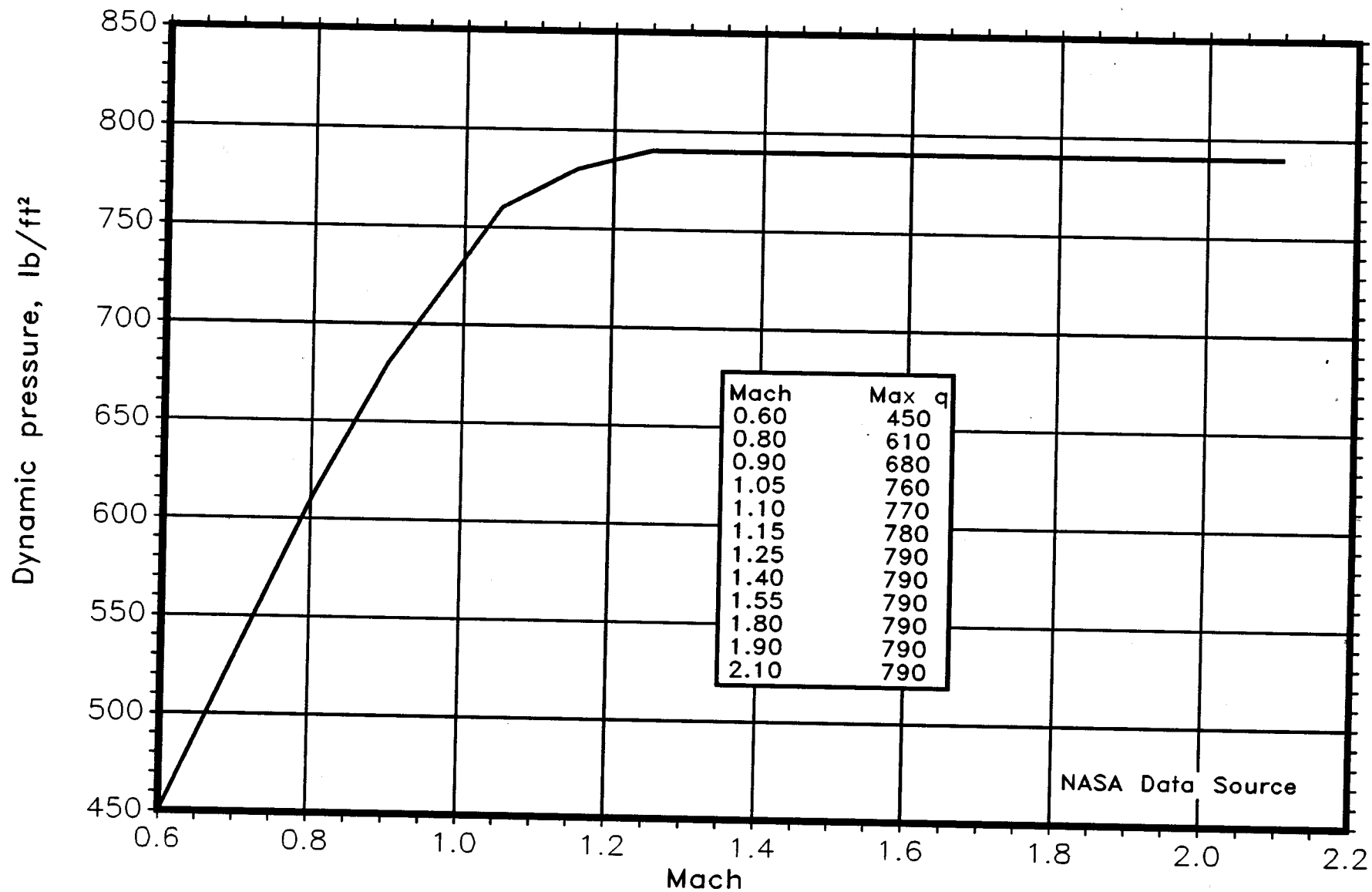

Figure 3.4.1.1-1.- I-load maximum dynamic pressure.  
(Paragraph 3.4.1.1)



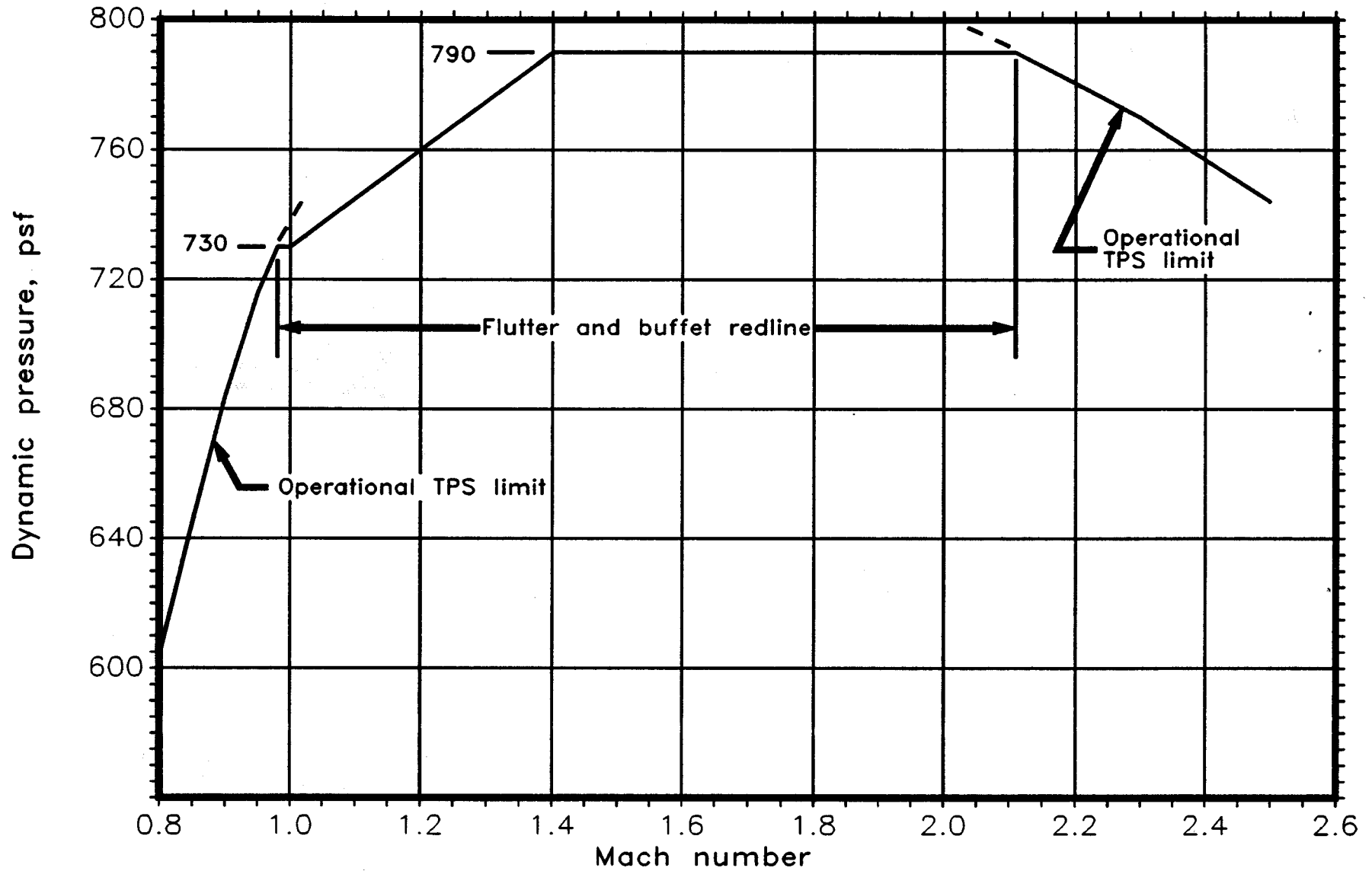

Figure 3.4.1.1-2.- Day of launch maximum dynamic pressure redline.  
(Paragraph 3.4.1.1)

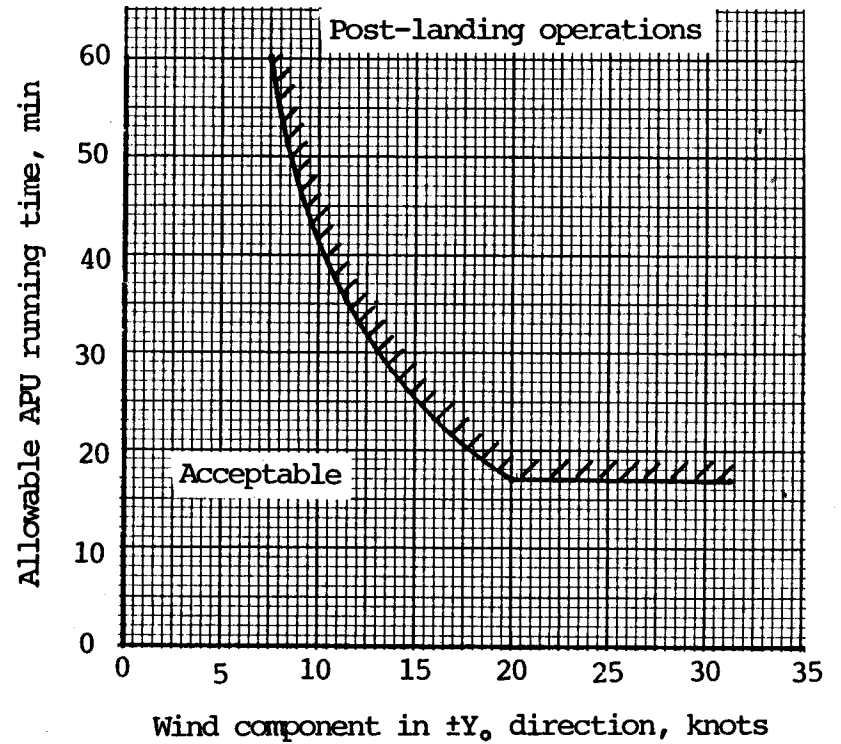
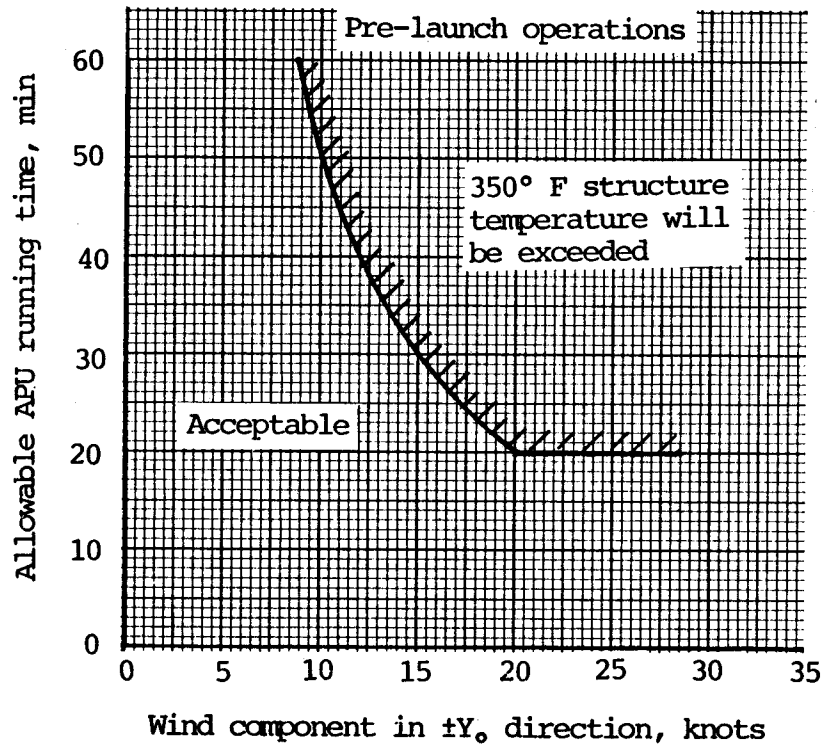
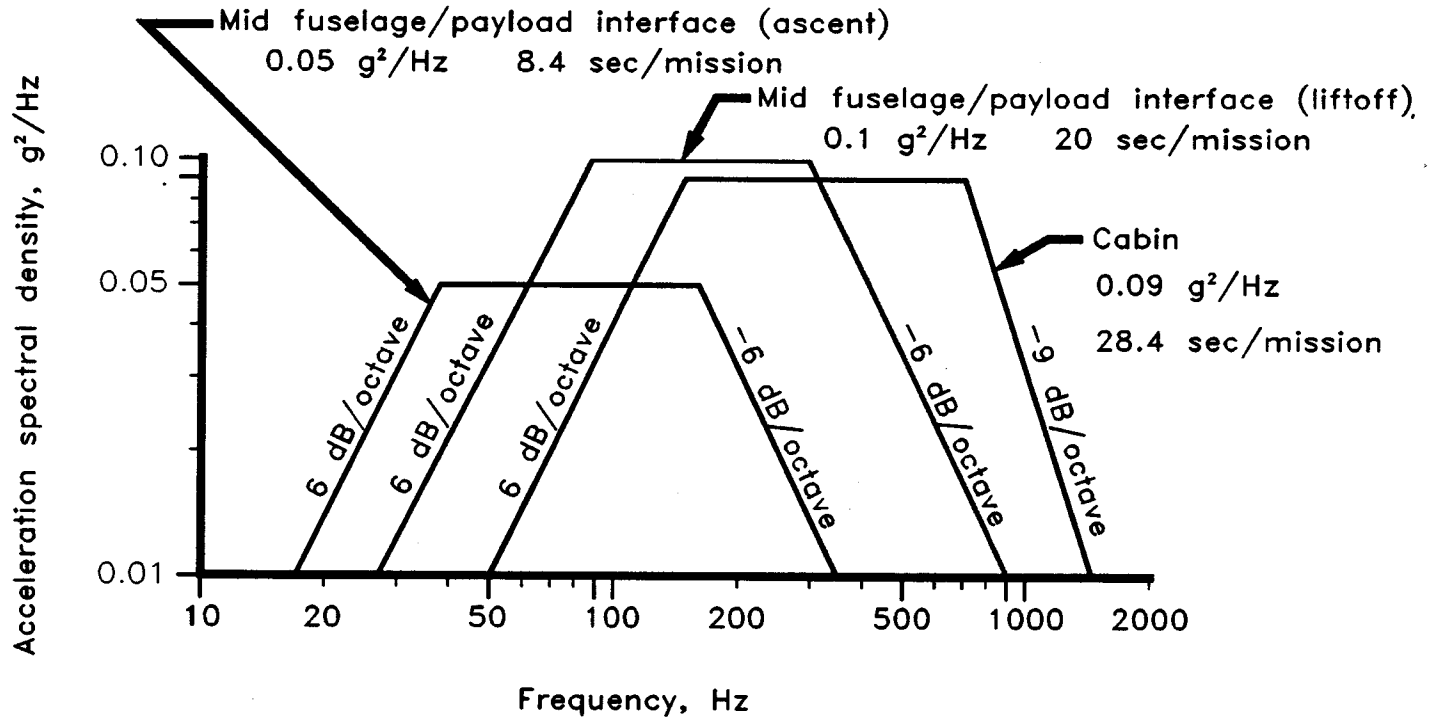

Figure 3.4.1.1-3.- Maximum allowable APU running times with burning plume.  
(Paragraph 3.4.1.1)

Note:

Actual vibration input to payloads will depend on transmission characteristics of mid fuselage - payload support structure and interactions with each payload's weight, stiffness and c.g.



These are typical of liftoff, transonic and maximum q flight

Figure 3.4.1.1-4.- Random vibration at mid fuselage main longeron payload attach points interface and in cabin.

## 3.4.1.2

Thermal Control Subsystem  
CONSTRAINTS/LIMITATIONS

## RESULT IF EXCEEDED

1. Subsystem Temperature Limits.

See applicable subsystem in this section (3.0).

2. Attitude Hold Limits.

## a. Radiator performance limits.

The maximum attitude hold, based on radiator performance, will vary between the limits given in table 3.4.1.2-1 for Beta angles < 60 and table 3.4.1.2-2 for Beta angles > 60.

Subsystem thermal hardware limits may be exceeded.

b. Subsystem thermal limits. The maximum attitude hold, based on subsystem thermal limits, at 0° to 20°, 20° to 60°, and 60° to 90° Beta angles for local vertical, orbital rate and solar inertial attitudes are given in table 3.4.1.2-3.

3. Overhead Window Seal Temperature Limit.

Attitude-hold durations are constrained by the overhead thermal window contamination seal lower temperature limit of -55° F (V09T1524).

Potential window failure or contamination seal breakage.

NOTE

Starting from Z LV attitude and then going to a Tail SI or Tail-Sun Orbital Rate attitude, OI measurement V09T1524 would reach -55° F in about 11.5 hours and 6.5 hours, respectively, for low to intermediate Beta angles.

4. Payload Bay Floodlight Restart Constraint.

See Section 3.4.5.6.

TABLE 3.4.1.2-1.- ATTITUDE-HOLD DURATIONS FOR  
 BETA ANGLES LESS THAN 60 DEGREES BASED  
 ON RADIATOR PERFORMANCE LIMITS  
 (Paragraph 3.4.1.2)

Payload-bay orientation	Attitude-hold time without radiator kit, <sup>a</sup> hrs	Attitude-hold time with radiator kit, <sup>a</sup> hrs
Direct earth	17	27
Direct solar (3-axis-inertial)	21	50

<sup>a</sup>Depending upon the combination of the following factors of Orbiter attitude, Orbiter and payload heat-rejection load profile, pre-entry thermal conditioning, stored water, Orbiter altitude and crew size, the maximum attitude-hold capability can be increased above the times given. Attitude-hold durations longer than the given number will impose constraints on mission variables such as vehicle orientations, orbital parameters, etc. Before the above attitude-hold durations can be repeated, the Orbiter must be placed in a preferred attitude to allow fuel-cell generated water accumulation and/or thermal conditioning.

TABLE 3.4.1.2-2.- ATTITUDE-HOLD DURATIONS FOR  
 BETA ANGLES GREATER THAN 60 DEGREES BASED  
 ON RADIATOR PERFORMANCE LIMITS  
 (Concluded)  
 (Paragraph 3.4.1.2)

Payload-bay orientation	Attitude-hold time without radiator kit, <sup>a</sup> hrs	Attitude-hold time with radiator kit, <sup>a</sup> hrs
Direct earth	12 accumulative <sup>b</sup> in the 6/3 mode	15 accumulative in the 6/3 mode <sup>b</sup>
Direct solar (3-axis-inertial)(90° Beta angle)	12	16

<sup>a</sup>Depending upon the combination of the following factors of Orbiter attitude, Orbiter and payload heat-rejection load profile, pre-entry thermal conditioning, stored water, Orbiter altitude and crew size, the maximum attitude-hold capability can be increased above the times given. Attitude-hold durations longer than the given number will impose constraints on mission variables such as vehicle orientation, orbital parameters, etc. Before the above attitude-hold durations can be repeated, the Orbiter must be placed in a preferred attitude to allow fuel-cell generated water accumulation and/or thermal conditioning.

<sup>b</sup>The Orbiter is designed for repeated cycles of a maximum 6-hour attitude hold with no attitude constraints, followed by 3 hours thermal conditioning. For analysis purposes, thermal conditioning shall be assumed to be barbecue of the Orbiter at 2 to 5 revolutions per hour about the X-axis with the orientation of the X-axis within  $\pm 20^\circ$  of the perpendicular to the sun vector. Upon reaching the attitude hold accumulative times for direct-earth viewing, the Orbiter must be placed in a preferred attitude to allow fuel-cell generated water accumulation before repeating the 6-hour hold cycles.

TABLE 3.4.1.2-3.- ATTITUDE-HOLD DURATIONS BASED ON SUBSYSTEM THERMAL LIMITS<sup>a,b</sup>  
(Paragraph 3.4.1.2)

Beta angle range, degrees	Generic attitudes		
	Local vertical (Earth inertial)	Orbital rate (Single-axis inertial)	Solar inertial (three-axis inertial)
0° to 20°	No general constraint - all vehicles	No general constraint - all vehicles	Nose sun constrained to $\leq$ 80 hours (MLG).
20° to 60°	No general constraint -	OV-102 constrained to 27 hours continuous or greater, figure 3.4.1.2-1, or to 6/32 <sup>D</sup> (bondlines). Exception: OV-102 unconstrained for tail sun with top-to-space (+50). OV-099 and subsequent constrained to 8.5 hours continuous or greater, figure 3.4.1.2-1, or to 6/3 <sup>D</sup> (bondlines). Tail or nose to sun with bottom to space constrained to $\leq$ 7 hours. (NLG lines OV-099 and subsequent)	Nose sun constrained to $\leq$ 80 hours (MLG).
20° to 60°	OV-102 constrained to 27 hours continuous or to 6/3 <sup>D</sup> (bondlines). OV-099 and subsequent constrained to 8.5 hours continuous or to 6/3 <sup>D</sup> (bondlines). Tail or nose toward sun with bottom toward space (i.e., +ZLV) at Beta $\geq$ 75° constrained to $\leq$ 7 hours (NLG lines - OV-099 and subsequent).	OV-102 constrained to 27 hours continuous or to 6/3 <sup>D</sup> (bondlines). OV-099 and subsequent constrained to 8.5 hours continuous or to 6/3 <sup>D</sup> (bondlines). Tail or nose to sun with bottom to space constrained to $\leq$ 7 hours (NLG lines - OV-099 subsequent).	Nose sun constrained to $\leq$ 80 hours (MLG). Side sun constrained to $\leq$ 42.5 hours (MLG). OME lines constrained in tail to sun to 9 hours continuous or greater, figure 3.4.1.2-2. Longer tail-to-sun operations must be flown in the 6/11 <sup>D</sup> mode.
60° to 90°	Less than 10 accumulative hours hold can be achieved in the 6/3 <sup>D</sup> mode; i.e., 6/3 followed by no more than 4 hours of hold. OME lines constrained in tail towards sun to 9 hours continuous or greater, figure 3.4.1.2-2. Longer tail toward sun operations must be flown in the 6/11 <sup>D</sup> mode. Bottom sun requires 8 to 12 (or more) hours PTC prior to EI (bottom bondlines)	Less than 10 accumulative hours hold can be achieved in the 6/3 <sup>D</sup> mode i.e., 6/3 followed by no more than 4 hours of hold. OME lines constrained in tail to sun to 9 hours continuous or greater, figure 3.4.1.2-2, longer tail-to-sun operations must be flown in the 6/11 <sup>D</sup> mode. Bottom sun requires 8 to 12 (or more) hours PTC prior to EI (bottom bondlines).	Bottom sun requires 8 to 12 (or more) hours PTC prior to EI (bottom bondlines).

<sup>a</sup>The following subsystem issues may constrain these attitudes and durations and a flight-by-flight assessment is required: MPM, payload retention fittings, vernier and primary heaters/firings; payload bay floodlights; PLBD closure; payload/payload bay solar trapping; wing glove structural gradient (OV-102); aft RCS yaw engines (ZOT); and hydraulic circulation pump operation.

<sup>b</sup>The Orbiter is designed for repeated cycles of a maximum 6-hour attitude hold with no attitude constraints, followed by 3 hours thermal conditioning. For analysis purposes, thermal conditioning shall be assumed to be barbecue operations of the Orbiter at 2 to 5 revolutions per hour about the X-axis with the orientation of the X-axis within  $\pm 20^\circ$  of the perpendicular to the sun vector. The 6/11 mode replaces the 3 hours of thermal conditioning with 11 hours of thermal conditioning.

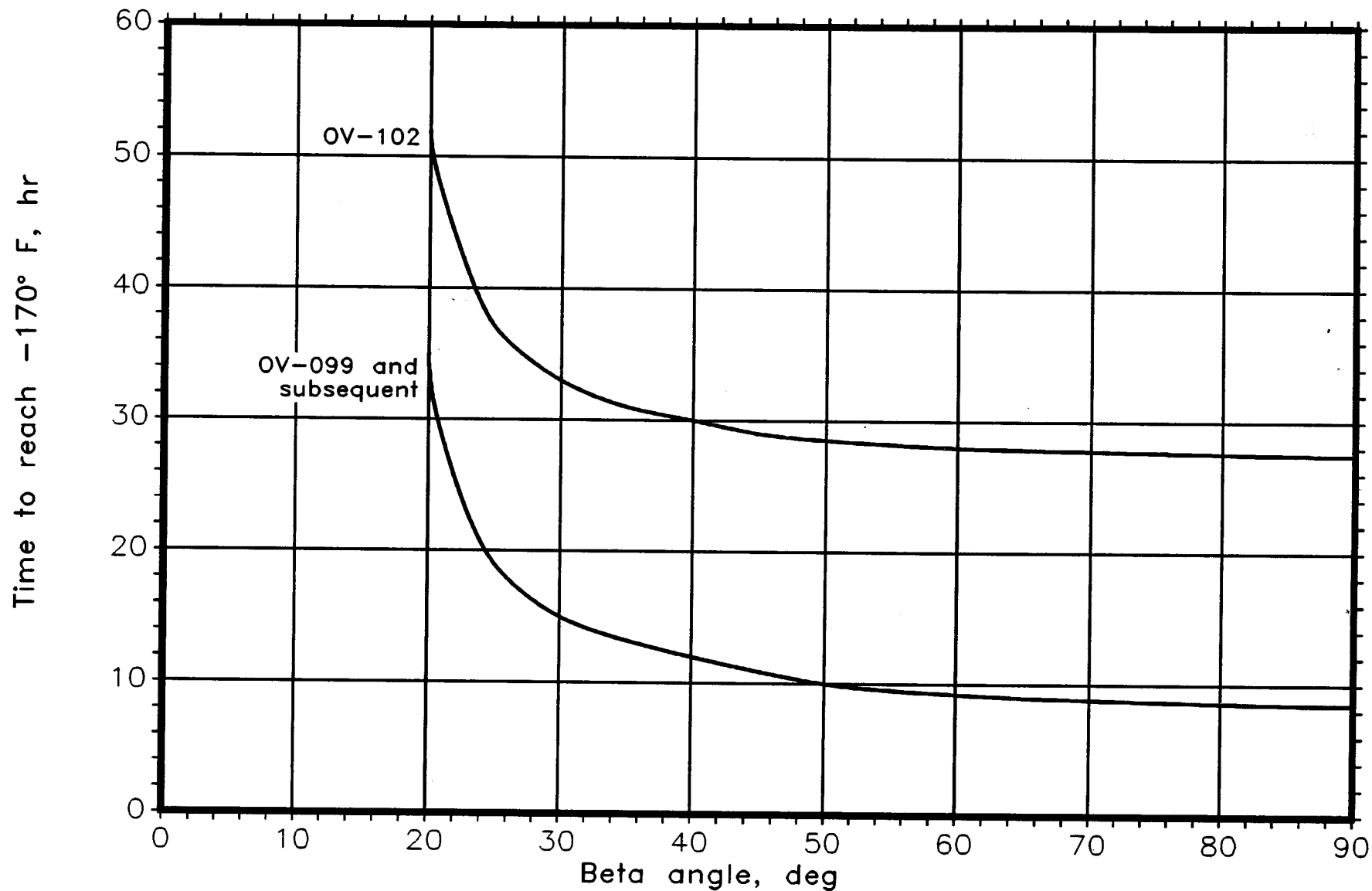

Figure 3.4.1.2-1.- Bondline constraint curves showing time to reach the  $-170^{\circ}$  F lower limit as a function of Beta angle (Table 3.4.1.2-3)



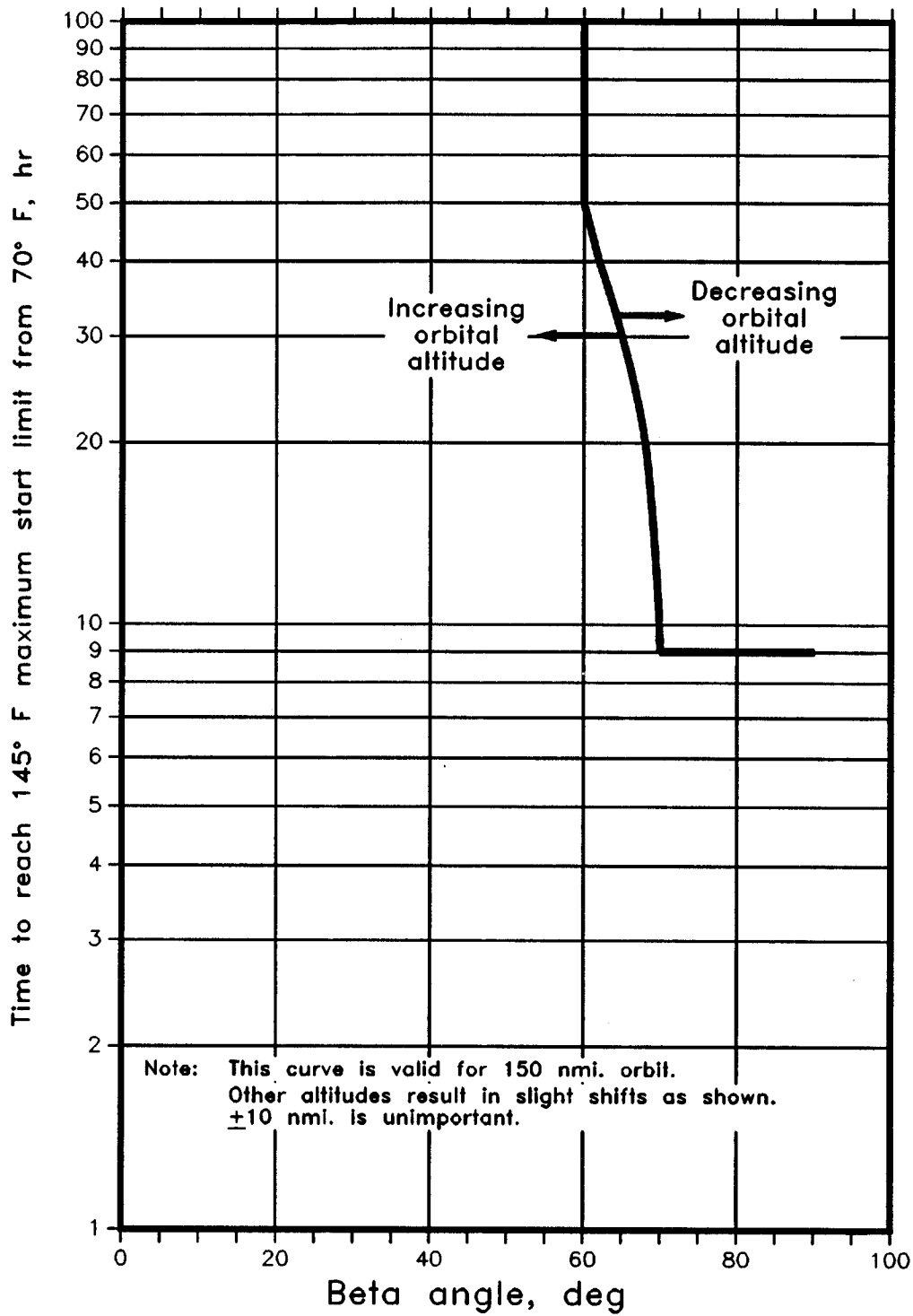

Figure 3.4.1.2-2.- Interim OME line constraint for a tail-sun orbit of 150 nmi. as a function of Beta angle.

(Table 3.4.1.2-3)

3.4.1.2-6

3.4.1.3

Thermal Protection Subsystem  
CONSTRAINTS/LIMITATIONS

1. TPS Components Temperature Limits. See table 3.4.1.3-1.
2. Structural Bondline Temperatures Prior to Deorbit.
  - a. OV-102 bondline temperatures - table 3.4.1.3-2.
  - b. OV-103 bondline temperatures - table 3.4.1.3-3.
3. Orbiter Structure Minimum Temperature. Table 3.4.1.3-2 identifies the Orbiter structure temperature measurements in the vicinity of the RSI tile bondline that must be maintained above -170° F.
4. RSI/SIP Bondline Maximum Temperature. The RSI/SIP bondline temperature limit is 550° F for 100-mission usage life. For single mission life, the temperature limit is 625° F.
5. Subsystem Temperature Limits Prior to Deorbit. The following TPS bondline temperatures must not be exceeded prior to a nominal entry.
  - a. FES topping nozzle, 135° F.
  - b. FES high load nozzle, 333° F.
  - c. Supply water dump nozzle, 85° F.
  - d. Water spray boiler vents, 184° F.
  - e. Waste water dump nozzle, 180° F.
  - f. Vacuum vent exit nozzle, 100° F.
  - g. Ammonia vent, 195° F.
- \*6. TPS Dynamic Pressure Limit  
The TPS must not be exposed to a dynamic pressure greater than shown in figure 3.4.1.3-1.
- \*7. OV-102 TPS Tile Limits
  - a. Sink speed at main gear touch-down must not exceed 6.0 ft/sec.
  - b. Flight load factors during entry are limited to a maximum of 2.0g.

RESULT IF EXCEEDED

Exceeding these limits could result in the bondline temperature exceeding the 350° F limit during entry, resulting in structural damage.  
The tile RTV bond will become brittle below -170° F. This could result in the loss of RSI tiles.

Exceeding this limit cause damage to the tile attachment system.

Exceeding the RSI/SIP bondline temperature of 550° F (625° F for single mission entry) during entry could cause damage to the tile attachment system.

Exceeding the structure bondline temperature limit during entry could result in structural damage.

Exceeding this limit could result in damage or loss of TPS.

Undensified tiles may be damaged.

\*NASA Data Source

TABLE 3.4.1.3-1.- THERMAL PROTECTION SUBSYSTEM COMPONENT TEMPERATURE LIMITS  
(Paragraph 3.4.1.3)

Components	Minimum Operating Temperature, °F	Critical Item and Results If Exceeded	Maximum Operating Temperature, °F	Critical Item and Results If Exceeded	Maximum Operating Temperature, °F	Critical Item and Results If Exceeded
			100-Mission Life		Single-Mission Life	
High temperature reusable surface insulation	-200	Bonding agent (RTV 560) becomes brittle below -170° F with possible failures below -200° F.	2300 <sup>a</sup> 2300 <sup>b</sup>	Performance degradation, possible surface cracking and shrinkage.	2600 <sup>a</sup> 2700 <sup>b</sup>	Performance degradation, possible surface cracking, shrinkage, opening of gaps, and structural over-temperature.
Low temperature reusable surface insulation	-200		1200		2000	
Felt reusable surface insulation	-200		700		1200	
Leading edge structural subsystem	c	NA	2680 <sup>d</sup>		3400 <sup>d</sup>	
Advanced flexible reusable surface insulation	-200	Bonding agent (RTV 560) becomes brittle below -170° F with possible failures below -200° F.	1200	Performance degradation. Fabric and thread becomes weak and brittle with possible failure due to air loads during ascent and descent.	1500 <sup>e</sup>	Performance degradation. Fusion of fibers in thread and fabric, possible failure of thread, fabric and insulation batting during the vehicle entry mode.
Thermal window pane	c	NA	1753	Glass turns viscous - structural failure.	NA	NA

<sup>a</sup>9.0 lb/ft<sup>3</sup> tile

<sup>b</sup>22.0 lb/ft<sup>3</sup> tile

<sup>c</sup>No lower limit identified

<sup>d</sup>Mission life not a direct function of maximum operating temperature.

<sup>e</sup>Certification testing to higher temperature levels, which include flight environment phenomena, is currently in process.

3.4.1.3-2

TABLE 3.4.1.3-2.- VEHICLE OV-102 STRUCTURAL BONDLINE TEMPERATURE  
PRIOR TO DEORBIT  
(Paragraph 3.4.1.3)

Description	Temperature measurement nos.	Maximum temperature prior to a nominal entry, °F	TPS material
Payload bay doors	V37T1000	185	FRSI
	V37T1002	95	FRSI
	V37T1004	95	FRSI
	V37T1006	185	FRSI
Left side	V09T1724	125	FRSI
	V09T1012	220	HRSI
	V09T1030	150	FRSI
	V34T1102	210	LRSI
	V34T1106	120	FRSI
	V43T4722	250	HRSI
Right side	V09T1014	NA	HRSI
	V09T1720	125	FRSI
	V09T1028	150	FRSI
	V34T1108	120	FRSI
	V34T1104	180	LRSI
	V43T5722	250	HRSI
Upper wing and fuselage	V09T1510	215	HRSI
	V09T1514	215	HRSI
	V09T1524	160	FRSI
	V09T1004	220	FRSI
	V09T1020	250	HRSI
	V09T1024	220	FRSI
	V09T1516	250	LRSI
Lower wing and fuselage	V09T1006	195	HRSI
	V09T1624	160	HRSI
	V09T1702	100	HRSI
	V09T1000	160	HRSI
	V09T1002	160	HRSI
	V09T1016	140	HRSI
	V09T1022	130	HRSI
	V34T1110	135	HRSI
	V34T1112	130	HRSI
	V09T1026	190	HRSI

TABLE 3.4.1.3-3.- VEHICLE OV-103 STRUCTURAL BONDLINE TEMPERATURE  
PRIOR TO DEORBIT  
(Paragraph 3.4.1.3)

Description	Temperature measurement numbers	Maximum temperature prior to a nominal entry, °F	TPS material
Payload bay doors	V37T1000	185	FRSI
	V37T1002	250	FI
	V37T1004	250	FI
	V37T1006	180	FRSI
Left side	V09T1724	250	FI
	V09T1012	220	HRSI
	V09T1030	150	LRSI
	V34T1102	205	FI
	V34T1106	250	FI
	V43T4722	250	HRSI
Right-side base heat shield	V09T1014	250	HRSI
	V09T1720	250	FI
	V09T1028	150	FI
	V34T1108	250	FI
	V34T1104	195	FI
	V43T5722	250	HRSI
Upper wing and fuselage	V09T1510	215	HRSI
	V09T1514	215	HRSI
	V09T1524	230	FI
	V09T1004	200	FRSI
	V09T1020	250	HRSI
	V09T1024	200	FRSI
	V09T1516	210	LRSI
Lower wing and fuselage	V09T1624	150	HRSI
	V09T1702	115	HRSI
	V09T1000	140	HRSI
	V09T1002	140	HRSI
	V09T1016	145	HRSI
	V09T1022	140	HRSI
	V34T1110	150	HRSI
	V34T1112	120	HRSI

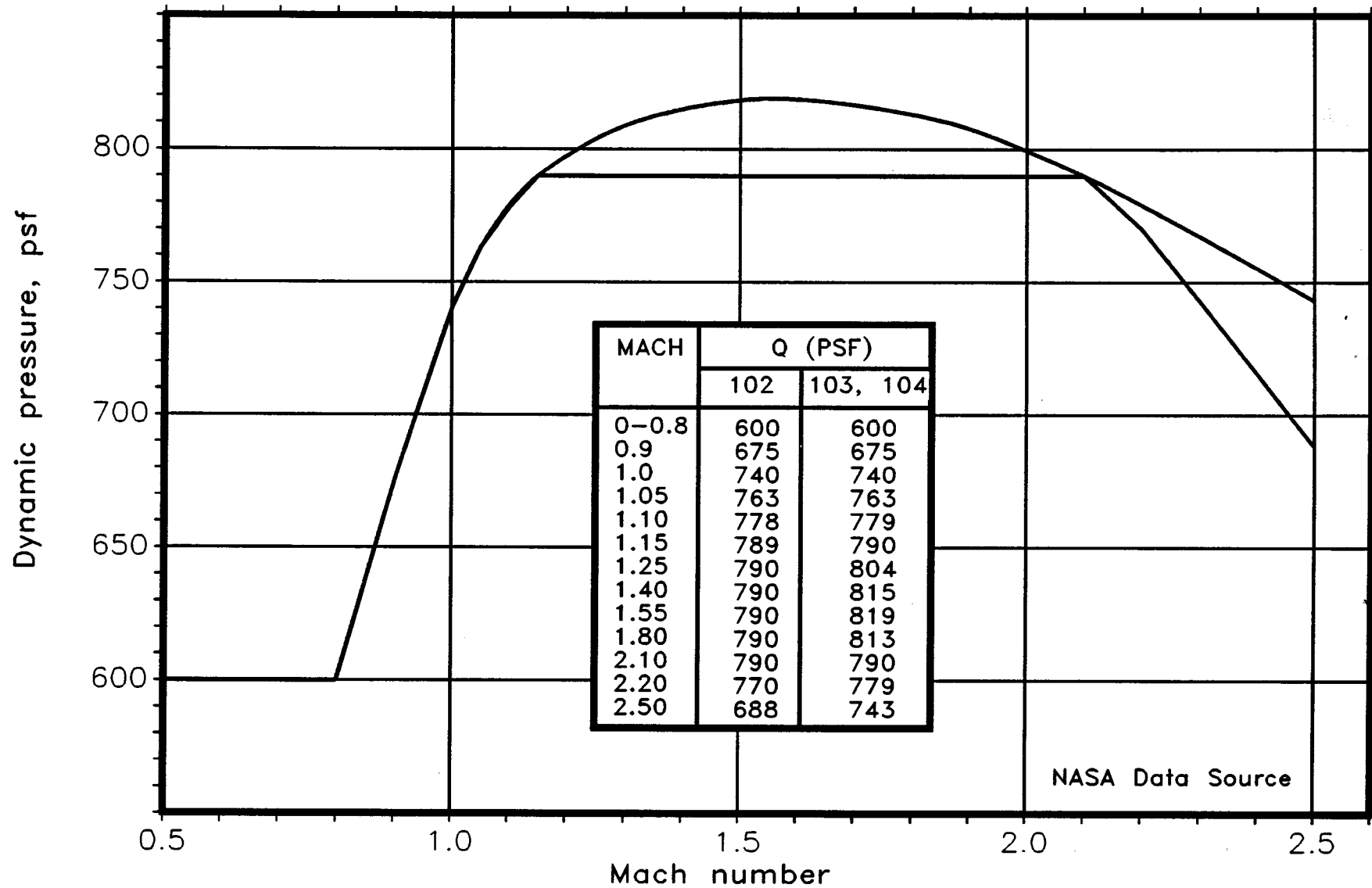

Figure 3.4.1.3-1.- TPS dynamic pressure limits  
(Paragraph 3.4.1.3)

3.4.1.4

Purge, Vent, and Drain (PV&D) Subsystem  
CONSTRAINTS/LIMITATIONS

RESULT IF EXCEEDED

1. PV&D Component Temperature Limits  
See table 3.4.1.4-1.
2. Positive Pressure. Positive pressure must be maintained in the Orbiter unpressurized compartments during ground purge operations.
3. Purge Activation. Purge must be activated within 45 minutes after touchdown.
4. Vent Door Operations.
  - a. MPS Propellant Dump During RTLS Abort. All vent doors must be closed during MPS propellant dump.
  - b. Entry.
    - (1) Doors 1/2 and 8/9 on the left-hand side may be open if an oxidizer leak is detected, otherwise, all vent doors must be closed and maintained closed throughout the high heat load phase of entry.  
Note: After all possible efforts have been made to close the vent doors, entry may be made with the failed vent doors open. This will not result in loss of crew or vehicle. Such entry will result in:
      - (a) Local overtemperature damage to the Orbiter structure
      - (b) Possible hazardous gas ingestion
      - (c) Possible overtemperature damage to payloads. Secondary effects of payload overtemperature must be considered when accepting vent door open entries.
    - (2) All vent doors must be fully open at and below 70,000 ft.

Compartments will become contaminated with atmospheric air.

Exceeds TCS, safety, and payload requirements.

Ingestion of hazardous gases into the Orbiter.

Structure and payload thermal design limits may be exceeded.

Below 70,000 ft, the  $\Delta P$  across the structure could cause structural damage.

5. Descent Propellant Dump During RTLS or TAL Aborts.  
Utilizing the current dump logic, the post-MECO ARCS dump must be

Exceedance can significantly increase the

3.4.1.4

Purge, Vent, and Drain (PV&D) Subsystem  
CONSTRAINTS/LIMITATIONS

5. Descent Propellant Dump (Continued)  
During RTLS or TAL Aborts.

limited to 88 seconds for RTLS  
and TAL aborts to minimize the  
potential flammable hazards.

The ARCS dump starts at initiation  
of MM602 + 20 seconds for RTLS  
and GRV at 8000 ft/sec for TAL.

RESULT IF EXCEEDED

potential flammable  
hazards in Orbiter  
compartments.



TABLE 3.4.1.4-1.- PURGE, VENT AND DRAIN SUBSYSTEM COMPONENT  
OPERATING TEMPERATURE LIMITS  
(Paragraph 3.4.1.4)

Components	Minimum Operating Temperatures, °F	Critical Item and Results If Exceeded	Maximum Operating Temperatures, °F		Critical Item and Results If Exceeded
			Long Term	Short Term	
WCCS relief valve	-70	Specification requirement	300	N/A	Specification requirement

TABLE 3.4.1.4-2.- PURGE, VENT AND DRAIN SUBSYSTEM COMPONENT NON-OPERATING  
TEMPERATURE LIMITS (Paragraph 3.4.1.4)

Components	Minimum Non-operating Temperatures, °F	Critical Item and Results If Exceeded	Maximum Non-operating Temperatures, °F		Critical Item and Results If Exceeded
			Long Term	Short Term	
WCCS relief valve	N/A	NA	N/A	N/A	N/A

3.4.2 Mechanical Subsystems

## 3.4.2.1 Landing/Deceleration Subsystems

## CONSTRAINTS/LIMITATIONS

## RESULT IF EXCEEDED

1. Temperature Limits.  
See table 3.4.2.1-1.
2. Retract/Circulation Valve Operation.  
The retract/circulation valve should remain closed subsequent to final ET mating except for on-orbit low pressure thermal control hydraulic fluid circulation.
3. Landing Crosswind.  
Maximum landing ground speed is 225 knots. Maximum landing crab angle is 6 degrees.
4. Orbiter Landing Weight.  
See paragraph 3.4.1.1
5. MLG Tire Pressure.  
Landing with tire pressure of < 256 psi in any MLG tire would require landing on concrete, no hard braking in minimum rudder steering, and minimum crosswinds.
- 5a. Best Runway for Tire Failure:<sup>a</sup>  
The following runway priorities, in order of availability, are recommended when a tire "failure" exists:
  - a. Edwards Concrete
  - b. Northrup
  - c. KSC
  - d. Edwards Lakebed
6. Gear Deployment Velocity.  
The maximum velocity for landing gear deployment is 297 KEAS.
7. Landing Velocity, Main Gear Sink Rate, and Nose Gear Loading.
  - a. Landing velocity. The maximum landing velocity is 225 KEAS. Reference figure 3.4.2.1-1 to compare equivalent airspeed (KEAS) to ground speed for specific environmental conditions.

<sup>a</sup>The final choice of runway should be a real-time decision based upon actual suspected condition of tires(s), weight of vehicle, and total environmental conditions at potential landing sites.

- 3.4.2.1 Landing/Deceleration Subsystems (Cont)  
CONSTRAINTS/LIMITATIONS
- |   |  |
|---|--|
| <p>b. Sink rate at main gear touchdown. Figure 4.2.1-1 shows the maximum main gear sink rate limit. Table 4.2.1-1 imposes further limits based on vehicle midfuselage strength limitations.</p> <p>c. Nose gear loading. The maximum allowable nose gear load/sink speed/pitching velocity must not exceed either of the limits specified below.</p> <p>(1) The maximum vertical load on the nose gear at touchdown must not exceed 90,000 pounds.</p> <p>(2) The maximum nose gear impact sink speed at nose gear touchdown must not exceed 11.5 ft/sec (9.9 deg/sec). Table 4.2.1-1 imposes further limits based on vehicle payload and weight configuration.</p> | <p>RESULT IF EXCEEDED</p> <p>Possible main gear and fuselage structural damage.</p><br><p>Possible nose gear and fuselage structural damage.</p> |
|---|--|
8. Nosewheel Steering  
Use GPC made for nosewheel steering (engage at entry interface).
- |   |   |
|---|---|
| <p>a. If GPC is not available direct mode can be used (engage direct after nosewheel slapdown).</p> <p>b. Should nosewheel response become abnormal during roll out with nosewheel steering active, nosewheel steering should be turned off. System will revert to free castor and steering can be accomplished by rudder and differential braking.</p> | <p>Engagement of direct nosewheel steering prior to touchdown could cause trip-out to free castor because of handover detection circuit. Vehicle direction may not be compatible with the pilot-selected direction.</p> |
|---|---|

3.4.2.1 Landing/Deceleration Subsystems (Cont)  
CONSTRAINTS/LIMITATIONS

9. Turn-over Angle. The static turn-over angle must not exceed 63 deg. (See figure 2-7 for definition of turn-over angle.)
10. Brakes.
  - a. Initial velocity for brake application, and primary mode of rollout steering should be in accordance with figures 4.2.1-2 and 4.2.1-3.
  - b. Any uncommanded brake pressure and/or one brake module applying > 180 psig is a constraint to landing.

## RESULT IF EXCEEDED

Exceeding this angle will cause Orbiter to turn over.

Energy limit of brake exceeded. Possible overrun of runway.

Brakes can develop torque causing reduced or no wheel spin-up resulting in tire wear or tire failure with potentially catastrophic results.

TABLE 3.4.2.1-1.- LANDING/DECELERATION SUBSYSTEM COMPONENT TEMPERATURE LIMITS  
(Paragraph 3.4.2.1)

Components	Minimum Operating Temperature, °F	Critical Item and Results If Exceeded	Maximum Operating Temperature, °F		Critical Item and Results If Exceeded	Minimum Nonoperating Temperature, °F	Critical Item and Results If Exceeded	Maximum Nonoperating Temperature, °F		Critical Item and Results If Exceeded
			Long Term	Short Term				Long Term	Short Term	
Main landing gear										
Shock strut assembly	-65	Oil viscosity, sealing of GN <sub>2</sub> and hydraulic fluid	200	200	Sealing of GN <sub>2</sub> and hydraulic fluid	-65	Sealing of GN <sub>2</sub> and hydraulic fluid	200	200	Sealing of GN <sub>2</sub> and hydraulic fluid
Extend/retract mechanisms	-65	Possible bearing problems	200	200	Unknown	-65	Unknown	200	200	Unknown
Door open/close mechanisms	-65	Possible bearing problems	200	200	Unknown	-65	Unknown	200	200	Unknown
Wheels/tires	-35 <sup>a</sup>	Tire rubber becomes brittle	b	131	Tire rubber upper temperature limit	-65	Tire rubber and seals become brittle causing greater air loss	200	250 <sup>c</sup>	Tire rubber limits
Brakes	-65 <sup>d</sup>	Sealing of hydraulic fluid	e	e	Beryllium melts	-65	Sealing of hydraulic fluid	200	200	Sealing of hydraulic fluid
Anti-skid (speed sensor only)	-35	Electrical components lower temperature limit; hydraulic fluid viscosity	275	275	Electrical components upper temperature limit	-65	Electrical components lower temperature limit	275	275 (400)	Electrical components upper temperature limit
Nose landing gear										
Shock strut assembly	-65	Oil viscosity, sealing of GN <sub>2</sub> and hydraulic fluid	200	200	Sealing of GN <sub>2</sub> and hydraulic fluid	-65	Sealing of GN <sub>2</sub> and hydraulic fluid	200	200	Sealing of GN <sub>2</sub> and hydraulic fluid
Extend/retract mechanisms	-65	Possible bearing problems	200	200	Unknown	-65	Unknown	200	200	Unknown
Door open/close mechanisms	-65	Possible bearing problems	200	200	Unknown	-65	Unknown	200	250 <sup>c</sup>	Unknown
Wheels/tires	-30 <sup>a</sup>	Tire rubber becomes brittle	200	200	Tire rubber upper temperature limit	-65	Tire rubber and seals become brittle causing greater air loss	200	250 <sup>c</sup>	Tire rubber limits
Steering damping	-30 <sup>a</sup>	Hydraulic fluid viscosity	175	175	Electrical components upper temperature limit	-65	Electrical components and seals lower temperature limits	175	175	Electrical components and seals upper temperature limits

<sup>a</sup>Limited performance.

<sup>b</sup>131° F is maximum touchdown temperature. Temperature may increase during rollout with no effect on function.

<sup>c</sup>Localized heating.

<sup>d</sup>Limited performance, however, heat of brakes would result in temperature increase. Note, this does not consider temperature of fluid in the lines to anti-skid valve.

<sup>e</sup>Designed to the heat generated during brake operation.

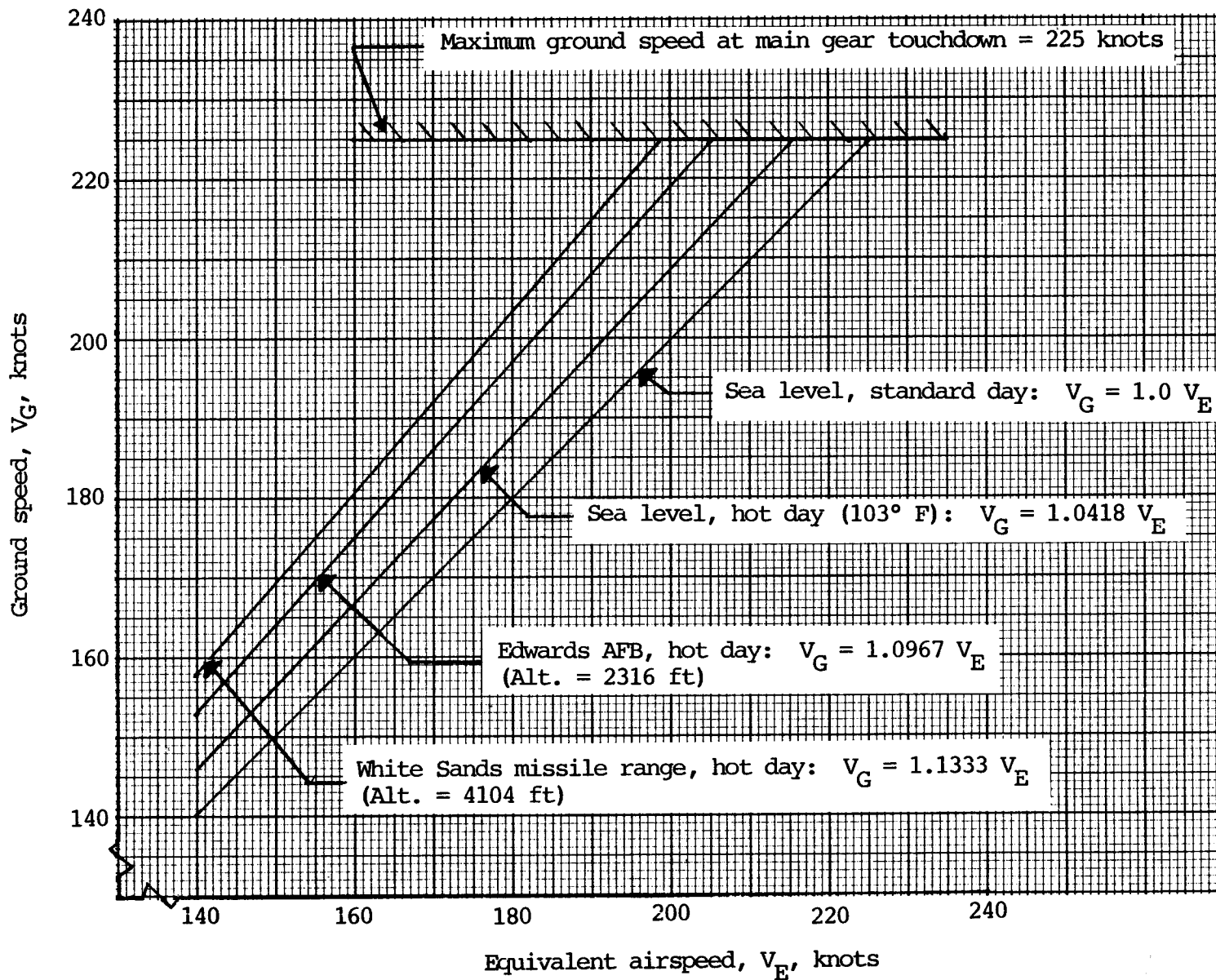

Figure 3.4.2.1-1.- Equivalent/ground airspeed relationships.  
(Paragraph 3.4.2.1)

TABLE 3.4.2.1-1.- LANDING/DECELERATION SUBSYSTEM COMPONENT TEMPERATURE LIMITS  
(Paragraph 3.4.2.1)

Components	Minimum Operating Temperature, °F	Critical Item and Results If Exceeded	Maximum Operating Temperature, °F		Critical Item and Results If Exceeded	Minimum Nonoperating Temperature, °F	Critical Item and Results If Exceeded	Maximum Nonoperating Temperature, °F		Critical Item and Results If Exceeded
			Long Term	Short Term				Long Term	Short Term	
Main landing gear										
Shock strut assembly	-65	Oil viscosity, sealing of GN <sub>2</sub> and hydraulic fluid	200	200	Sealing of GN <sub>2</sub> and hydraulic fluid	-65	Sealing of GN <sub>2</sub> and hydraulic fluid	200	200	Sealing of GN <sub>2</sub> and hydraulic fluid
Extend/retract mechanisms	-65	Possible bearing problems	200	200	Unknown	-65	Unknown	200	200	Unknown
Door open/close mechanisms	-65	Possible bearing problems	200	200	Unknown	-65	Unknown	200	200	Unknown
Wheels/tires	-35 <sup>a</sup>	Tire rubber becomes brittle	b	131	Tire rubber upper temperature limit	-65	Tire rubber and seals become brittle causing greater air loss	200	250 <sup>c</sup>	Tire rubber limits
Brakes	-65 <sup>d</sup>	Sealing of hydraulic fluid	e	e	Beryllium melts	-65	Sealing of hydraulic fluid	200	200	Sealing of hydraulic fluid
Anti-skid (speed sensor only)	-35	Electrical components lower temperature limit; hydraulic fluid viscosity	275	275	Electrical components upper temperature limit	-65	Electrical components lower temperature limit	275	275 (400)	Electrical components upper temperature limit
Nose landing gear										
Shock strut assembly	-65	Oil viscosity, sealing of GN <sub>2</sub> and hydraulic fluid	200	200	Sealing of GN <sub>2</sub> and hydraulic fluid	-65	Sealing of GN <sub>2</sub> and hydraulic fluid	200	200	Sealing of GN <sub>2</sub> and hydraulic fluid
Extend/retract mechanisms	-65	Possible bearing problems	200	200	Unknown	-65	Unknown	200	200	Unknown
Door open/close mechanisms	-65	Possible bearing problems	200	200	Unknown	-65	Unknown	200	250 <sup>c</sup>	Unknown
Wheels/tires	-30 <sup>a</sup>	Tire rubber becomes brittle	200	200	Tire rubber upper temperature limit	-65	Tire rubber and seals become brittle causing greater air loss	200	250 <sup>c</sup>	Tire rubber limits
Steering damping	-30 <sup>a</sup>	Hydraulic fluid viscosity	175	175	Electrical components upper temperature limit	-65	Electrical components and seals lower temperature limits	175	175	Electrical components and seals upper temperature limits

<sup>a</sup>Limited performance.

<sup>b</sup>131° F is maximum touchdown temperature. Temperature may increase during rollout with no effect on function.

<sup>c</sup>Localized heating.

<sup>d</sup>Limited performance, however, heat of brakes would result in temperature increase. Note, this does not consider temperature of fluid in the lines to anti-skid valve.

<sup>e</sup>Designed to the heat generated during brake operation.

## 3.4.2.2

Attachment/Separation Mechanism Subsystem  
CONSTRAINTS/LIMITATIONS

## RESULT IF EXCEEDED

1. Orbiter/ET Separation.<sup>a</sup> The separation of the Orbiter from the external tank will be inhibited by system software inhibit checks when recontact is likely. Exceeding the range of the values shown below will cause an inhibit to occur.
- a. For RTLS:<sup>b</sup> roll rate  $\pm 5.0^\circ/\text{sec}$ , pitch rate  $+0.25$  to  $-5^\circ/\text{sec}$ , yaw rate  $\pm 0.5^\circ/\text{sec}$ , angle of attack  $-2^\circ$  to  $-89^\circ$ , angle of sideslip  $\pm 2^\circ$ , roll attitude—none. Exceeding these attitudes or rates for RTLS could cause Orbiter and ET recontact and possible damage after separation.
- b. For AOA, ATO and mission continuation:  $\pm 0.7^\circ/\text{sec}$ . The limit rates for AOA/ATO and mission continuation were chosen to minimize dispersion at separation while still being well within the capability of the FCS.
- c. Deflection of the translation hand controller in any axis during ET separation (ET separation initiated, but not completed), will result in the automatic -Z RCS firing being inhibited or terminated.
2. Structural Release. The disconnect of all Orbiter/ET structural attachments must be initiated simultaneously. The maximum time delay from first to last disconnect release must not be  $> 20$  milliseconds. Exceeding this time delay limit could cause Orbiter and ET recontact and possible damage after separation.

<sup>a</sup>The attitude and rate-inhibit magnitudes of the FCS deadbands and separation software, when combined with sensor inaccuracies, will be designed to preclude attitudes and rates greater than those specified above.

<sup>b</sup>In RTLS, software will automatically override an inhibit after 6 seconds.



3.4.2.2

Attachment/Separation Mechanism Subsystem

CONSTRAINTS/LIMITATIONS

RESULT IF EXCEEDED

3. SRB/ET Separation. The separation of the SRB's from the Orbiter/ external tank will be inhibited by system software inhibit checks when recontact is likely. Exceeding the range of the values shown below will cause an inhibit to occur.

a. Sensed body rates

- (1) Roll  $> \pm 5^\circ/\text{sec}$ ,
- (2) Pitch  $> \pm 2^\circ/\text{sec}$ ,
- (3) Yaw  $> \pm 2^\circ/\text{sec}$

b. On-board computed pressure of  
 $\geq 63$  psf

Exceeding these rates could cause SRB and ET recontact and possible damage after separation.

## 3.4.2.3

Hatches, Payload Bay Doors, Radiators  
and Associated MechanismsCONSTRAINTS/LIMITATIONS

## RESULT IF EXCEEDED

1. Temperature Limits.

See table 3.4.2.3-1.

2. Differential Pressures.

a. Differential pressures across each hatch must be in the range shown below before the hatch may be opened.

May cause structural damage.

(1) Ingress/egress hatch

Prelaunch 0 to 0.7 psid

Orbital 0 to 1.6 psid

Postlanding -0.4 to 1.6 psid

(Hatch opening may be initiated at pressures > 1.6 psid, but hatch latch actuator handle must be momentarily stopped at vent position).

(2) Cabin/airlock hatch

Prelaunch 0 to 0.01 psid

Orbital 0 to -0.2 psid

Postlanding 0 to 0.01 psid

(3) Airlock/payload bay hatch

Prelaunch 0 to 0.01 psid

Orbital 0 to 0.2 psid

b. Differential pressures across each hatch during hatch closing operations for ingress/egress, cabin/airlock, and airlock/payload bay hatches must be in the range of 0 to 0.01 psid.

May cause structural damage.

3. Payload Bay Door Latch Configuration.

a. All payload bay door latches are required to be latched at lift-off.

Structural damage may occur to the doors and Orbiter primary structure.

b. Following on-orbit thermal conditioning, a benign entry<sup>a</sup> may proceed without one of the following latch(es) (single, pair or gang) engaged, if attempts to command engagement are unsuccessful.<sup>b</sup>

Structural damage may occur to the doors and Orbiter primary structure.

(1) Any single latch, or

(2) Any one pair of latches, or

(3) Any one of the eight latch gangs

(4 latches/gang).

<sup>a</sup>Benign entry is one which avoids off-nominal pitch up and steady state side slip maneuvers.

<sup>b</sup>To eliminate the possibility of blockage by debris at a door joint, door is to be cycled open to approximately the 50 percent position at least once to dislodge debris.

3.4.2.3 Hatches, Payload Bay Doors, Radiators,  
and Associated Mechanisms (Concluded)

CONSTRAINTS/LIMITATIONS

4. Radiator Mechanism Configuration.  
All deployable radiators must be  
stowed and latched prior to payload  
bay door closure.

RESULT IF EXCEEDED

Payload bay doors cannot  
be closed if radiators  
are not stowed (EVA or  
payload, RMS, slide wire,  
camera, and/or Ku-band  
antenna jettison required  
to close doors). Damage  
to radiator and/or  
payload may occur if  
radiators not stowed and  
latched.

TABLE 3.4.2.3-1.- HATCHES, DOORS, AND ASSOCIATED MECHANISMS TEMPERATURE LIMITS<sup>a</sup>  
(Paragraph 3.4.2.3)

Components	Minimum Operating Temperature, °F	Critical Item and Results If Exceeded	Maximum Operating Temperature, °F		Critical Item and Results If Exceeded	Minimum Nonoperating Temperature, °F	Critical Item and Results If Exceeded	Maximum Non-operating Temperature, °F		Critical Item and Results If Exceeded
			Long Term	Short Term				Long Term	Short Term	
<b>Hatches</b>										
Ingress/egress	-65	Attenuator fluid. Excessive damping causes high loads.	275	275	Attenuator fluid. Insufficient damping causes high shock loads.	NA	NA	275	NA	Attenuator fluid specification limit.
Airlock	-65	Hatch/latch actuator lubricant specification limit.	275	275	Hatch/latch actuator lubricant specification limit.	NA	NA	360	NA	Hatch/latch actuator lubricant specification limit.
Airlock/payload bay	-65	Hatch/latch actuator lubricant specification limit.	275	275	Hatch latch actuator lubricant specification limit.	NA	NA	360	NA	Hatch/latch actuator lubricant specification limit.
Tunnel adapter	-65	Hatch actuator lubricant specification limit.	275	275	Latch actuator lubricant specification limit.	NA	NA	NA	NA	NA
<b>Doors</b>										
Overhead emergency jet-tison window access door mechanism.	-150	Actuator lubricant specification limit.	350	350	Actuator lubricant specification limit.	NA	NA	NA	NA	NA
ET door drive actuator	-100	Specification limit	115	115	Specification limit.	-23	Specification limit	350	350	Specification limit
ET door center-latch actuator.	-100	Specification limit	115	115	Specification limit.	-23	Specification limit	350	350	Specification limit
ET door latch-drive actuator	-100	Specification limit	115	115	Specification limit.	-23	Specification limit	350	350	Specification limit
<b>Payload bay doors mechanisms.</b>										
Forward	-50	Thermal contraction	250	250	Actuator specification limit	-167	Specification limit	330	330	Specification limit
Aft	-50		250	250		-167		330	330	
Centerline	-100	Actuator specification	250	250		-167		330	330	
Drive	-65		157	157		-100		340	340	
<b>Vent doors</b>										
Forward fuselage	-170	Specification limit	330	330	Specification limit	-170		330	330	
PBD/Wing	-100	Specification limit	330	330	Specification limit	-100		330	330	
Midfuselage	-100	Specification limit	330	330	Specification limit	-100		330	330	
Aft fuselage	-100	Specification limit	330	330	Specification limit	-100		330	330	
<b>Mechanisms</b>										
Radiator mechanism.	-100	Actuator specification limit	250	250	Actuator specification limit	-167	Specification limit	330	330	Specification limit
Elevon seal panel attachment to panel.	-140	Specification limit	750		Specification limit	-140	Specification limit	750	750	Specification limit

<sup>a</sup>See table 3.4.5.1-1 for startracker door, air data probe deployment actuator, and yaw and brake panel temperature limits.

## 3.4.2.4

Hydraulic Subsystems  
CONSTRAINTS/LIMITATIONS

1. Temperature Limits.

a. Hydraulic system temperatures (any/all) less than  $-40^{\circ}$  F (as read in the Mission Control Center) except system 1 landing gear loop, and circulation pump body.

b. Hydraulic system 1 landing gear loop.

(1) MLG actuators and wheel well lines temperature  $< -35^{\circ}$  F.

(2) Mid-body lines temperature  $< -50^{\circ}$  F.

(3) Nose landing gear actuators and lines temperature  $< -10^{\circ}$  F.

c. Circulation pump body temperature (a measure of 1307 bulkhead temperature).

(1)  $< -10^{\circ}$  F

(2)  $< 20^{\circ}$  F

d. Hydraulic system temperatures (any/all) greater than  $275^{\circ}$  F (as read in the MCC) except as indicated in table 3.4.2.4-1 and except wheel brakes and APU/pump interface.

(1) Wheel brakes  $> +325^{\circ}$  F.

(2) APU/pump interface  $> 300^{\circ}$  F.

2. Pressures.

a. Maximum allowable supply line transient pressures -

(1) General: 4050 psig.

(2) Body flap: 4500 psig<sup>a</sup>.

b. Maximum allowable return lines transient pressures are 1500 psig.

## RESULT IF EXCEEDED

Hydraulic system may not be recoverable with main-pump high-pressure operation.

Exceeding the lower temperature limits at entry interface will negate hydraulic system as primary system for gear deployment.

Exceed  $\Delta P$  across filter module during main pump operation causing erratic BF and RSB brake action. Exceed start time allowable on circulation pump of 60 seconds. Degrade seals. For wheel brakes, fluid shall be replaced if temperature exceeds  $275^{\circ}$  F.

Exceeding these transients pressures<sup>a</sup> will exceed Orbiter system design criteria.

<sup>a</sup>The specification transient pressure of 4050 psig is relaxed to 4500 psig for the body flap supply line.

## Hydraulic Subsystems (Cont)

## CONSTRAINTS/LIMITATIONS

3. Start-up and Shutdown Sequence.  
Set flight control electrical controlling servoactuators to null prior to application of hydraulic pressure. Maintain electrical power on until pressure is reduced during APU shutdown interval.
4. Fluid Volume. Minimum reservoir fluid volume for servicing (assuming no oil charge in accumulators) is 1040 in<sup>3</sup> (56 percent) at 70° F. (Bootstrap and SSME accumulator charge, 100 in<sup>3</sup>; compressibility, 95 in<sup>3</sup>; external leakage, 56 in<sup>3</sup>; intersystem leakage, 507 in<sup>3</sup>; thermal contraction, 282 in<sup>3</sup>). For lift-off, the minimum volume is reduced to 884 in<sup>3</sup> (48 percent) at 70° F (reduction consists of accumulator oil charges, 61 in<sup>3</sup>; compliance, 95 in<sup>3</sup>).
5. Bootstrap Accumulator Precharge.  
The bootstrap accumulator must be precharged to 1650 to 1920 psia at 70° F.
6. SSME Return Accumulator Precharge.  
The SSME return accumulator must be precharged to 80 ±5 psia at 70° F.
7. Minimum Reservoir Pressure On-Orbit.  
If accumulator gas leakage is apparent, the circulation pump or APU should be started before the reservoir pressure decays below 15 psia. In an emergency, circulation or hydraulic pumps may be started with inlet pressures between 15 and 0.0 psia. Pump shutdown should be initiated if discharge pressure does not increase within 60 seconds (circulation pump) or within 15 seconds (main pump).

## RESULTS IF EXCEEDED

Without command, the servoactuators, with exception of the TVC, may move unpredictably and possibly cause damage to the vehicle or personnel. The TVC actuators will move at high velocity to mid-stroke (null). Insufficient reservoir volume lift-off can result in depletion of reservoir and pump starvation when APU is started during orbital return operations.

Excessive precharge can prevent the circulation pump from maintaining reservoir bootstrap pressure due to accumulator piston being bottomed out. Inadequate pressure will necessitate continuous circulation pump operation. Improper precharge will allow pressure transients in excess of the SSME ICD limits (270 psig maximum). The pump may fail to operate due to cavitation.

3.4.2.4 Hydraulic Subsystems (Cont)  
CONSTRAINTS/LIMITATIONS

## RESULT IF EXCEEDED

## NOTE

If the pressure is decaying due solely to oil leaking out of the bootstrap accumulator, the reservoir pressure will decay to a range of 41 to 48 psia (actual value depending on temperature and precharge pressure) at which time the pressure will abruptly drop to zero due to accumulator piston being bottomed out.

8. Circulation Pump Operation On-Orbit.

- a. Hydraulic fluid temperature must not be allowed to decrease below  $-4^{\circ}$  F as determined by any circulation pump temperature control sensor except for the following:
- (1) System 1 landing gear circuit and body flap lines.
  - (2) Rudder speed brake PDU indications for systems 1, 2 and 3.
  - (3) Body flap PDU indications for system 2 and 3.

Component and line temperatures could decrease below  $-10^{\circ}$  F (lines and actuators).

- b. Minimum operating temperature for circulation pump is  $+20^{\circ}$  F. Any circulation pump start below  $+20^{\circ}$  F should be reported and analyzed.

Circulation pump starts at less than  $+20^{\circ}$  F may affect the life of the pump.

9. Isolation Valve Operation.

- a. To operate landing gear isolation valves or TVC valves or TVC isolation valves when circulation pumps are off, allow 10 seconds for the circulation pump to come up to pressure ( $>180$  psia) and then hold the isolation valve position switch in the desired position for 5 seconds. This allows positive latching of the isolation valve in the desired position.

The isolation valve may not latch in the desired position.

## 3.4.2.4 Hydraulic Subsystems (Cont)

## CONSTRAINTS/LIMITATIONS

- |   |   |
|---|---|
| <p>b. To operate the landing gear isolation valves or TVC isolation valves with main hydraulic pump operating, hold the isolation valve position switch in the desired position for 5 seconds. This allows positive latching of the isolation valve in the desired position.</p> <p>10. <u>Main Landing Gear Valves.</u></p> <p>a. The landing gear retract/circulation valve must be closed during any main pump high pressure operation.</p> <p>b. The landing gear retract/circulation valve, dump valve, redundant shut-off valve, and the extend (control) valve must not be energized for more than a total of 30 minutes accumulated "on" time in any 1-hour period of time, for non-flow conditions only.</p> <p>11. <u>Water Spray Boiler.</u></p> <p>a. GN<sub>2</sub> tank pressure must be &gt; 175 psia.</p> <p>b. GN<sub>2</sub> regulator outlet pressure with the WSB GN<sub>2</sub> shutoff valve open:<br/>Minimum = 19.0 psig.<br/>Maximum = 33.5 psig.</p> <p>c. Vent temperature must be &gt; 127° F at APU start (sensor does not read below 122° F).</p> | <p>RESULT IF EXCEEDED</p> <p>The isolation valve may not latch in the desired position.</p> <p>The landing gear strut actuators retract shuttle valve will be powered into the retract position and will prevent gear extension if it does not return to the extend position.<br/>Heat from solenoid may damage valve seals and solder.</p> <p>Pressure regulator will not perform with inlet pressure &lt; 175 psia. Water spray bar will not operate properly at pressures below 19 psig. Pressure above 33.5 psig will overpressurize the water feed section (if relief valve stays closed). Vent temperature above 127° F indicates a working vent heater. A failed off heater may allow ice formation.</p> |
|---|---|



3.4.2.4 Hydraulic Subsystems (Cont)  
CONSTRAINTS/LIMITATIONS

## RESULT IF EXCEEDED

## NOTE

If the pressure is decaying due solely to oil leaking out of the bootstrap accumulator, the reservoir pressure will decay to 31 to 48 psia (depending on temperature and precharge pressure) at which time the pressure will abruptly drop to zero.

8. Circulation Pump Operation On-Orbit.

- a. No more than one circulation pump may be on at any time on orbit.
- b. Hydraulic fluid temperature must not be allowed to decrease below  $-4^{\circ}$  F as determined by any circulation pump temperature control sensor except for the following:
  - (1) System 1 landing gear circuit and body flap lines.
  - (2) Rudder speed brake PDU indications for systems 1, 2 and 3.
  - (3) Body flap PDU indications for system 2 and 3.
- c. Minimum operating temperature for circulation pump is  $+20^{\circ}$  F. Any circulation pump start below  $+20^{\circ}$  F should be reported and analyzed.

Electrical power usage will exceed design criteria, if more than one pump is operated at a time.  
Component and line temperatures could decrease below  $-10^{\circ}$  F (lines and actuators).

Circulation pump starts at less than  $+20^{\circ}$  F may affect the life of the pump.

9. Isolation Valve Operation.

- a. To operate landing gear isolation valves or TVC valves or TVC isolation valves when circulation pumps are off, allow 10 seconds for the circulation pump to come up to pressure ( $>180$  psia) and then hold the isolation valve position switch in the desired position for 5 seconds. This allows positive latching of the isolation valve in the desired position.

The isolation valve may not latch in the desired position.

## 3.4.2.4

## Hydraulic Subsystems (Cont)

## CONSTRAINTS/LIMITATIONS

- |  |   |
|--|---|
| <p>b. To operate the landing gear isolation valves or TVC isolation valves with main hydraulic pump operating, hold the isolation valve position switch in the desired position for 5 seconds. This allows positive latching of the isolation valve in the desired position.</p>   | <p><b>RESULT IF EXCEEDED</b><br/>The isolation valve may not latch in the desired position.</p>   |
| <p>10. <u>Landing Gear Retract/Circulation Valve.</u></p> <p>a. The landing gear retract/circulation valve must be closed during any main pump high pressure operation.</p> <p>b. The landing gear retract/circulation valve must not be energized for more than a total of 30 minutes accumulated "on" time in any 1-hour period of time, for non-flow conditions only.</p> | <p>The landing gear strut actuators retract shuttle valve will be powered into the retract position and will prevent gear extension if it does not return to the extend position.<br/>Heat from solenoid may damage valve seals and solder.</p>   |
| <p>11. <u>Water Spray Boiler.</u></p> <p>a. GN<sub>2</sub> tank pressure must be &gt; 175 psia.</p> <p>b. GN<sub>2</sub> regulator outlet pressure with the WSB GN<sub>2</sub> shutoff valve open:<br/>Minimum = 19.0 psig.<br/>Maximum = 33.5 psig.</p> <p>c. Vent temperature must be &gt; 130° F at APU start.</p> <p>d. Water temperature must be ≤ 125° F.</p>          | <p>Pressure regulator will not perform with inlet pressure &lt; 175 psia. Water spray bar will not operate properly at pressures below 19 psig. Pressure above 33.5 psig will overpressurize the water feed section. Vent temperature &lt; 130° F will allow ice formation. Temperatures &gt; 125° F may cause excessive controller temperature. Output of RVDT could drift and adversely affect opening of the pre-burner valve.</p> |
| <p>12. <u>Orbiter/SSME Interface.</u> Hydraulic fluid temperature must be ≤ 150° F at APU start during prelaunch, assuming a nominal 5 minutes to SSME start.</p>  |   |

- 3.4.2.4 Hydraulic Subsystems (Concluded)  
CONSTRAINTS/LIMITATIONS
- |  |  |
|--|--|
| <p>12. <u>Orbiter/SSME Interface.</u></p> <p>a. Hydraulic fluid temperature must be <math>\leq 150^{\circ}</math> F at APU start during prelaunch, assuming a nominal 5 minutes to SSME start.</p> <p>b. Hydraulic fluid temperature must be <math>&gt; 60^{\circ}</math> F at APU start during prelaunch assuming a nominal 5 minutes to SSME start.</p> <p>c. Must maintain a minimum of 200 psid<sup>a</sup> across SSME interface from start of circulation pump for warming flow to APU start during prelaunch.</p> <p>13. <u>Water Spray Boiler Vents Maximum Temperature Prior to Deorbit.</u><br/>Refer to paragraph 3.4.1.3.5d, Thermal Protection Subsystem.</p> <p>14. <u>Circulation Pump Operation.</u><br/>Prelaunch voltage supply to the circulation pump during startup must not exceed 30.5 Vdc.</p> | <p>RESULT IF EXCEEDED</p> <p>Output of RVDT could drift and adversely affect opening of the pre-burner valve.</p> <p>May result in damage to crankpins in the HAS valves during initial motion prior to launch.</p> <p>Risk freezing of hydraulic fluid in HAS valve actuators if continuous flow is not maintained through prelaunch.</p> <p>May exceed nominal time to achieve full operating pressure (slow start).</p> |
|--|--|

<sup>a</sup>Hydraulic pressure is allowed to drop below 250 psig/200 psid during major mode transition from OPS G9 to OPS G1 (approximately T-19 minutes). During prelaunch, the elevons drift from the null position. At OPS G1, the elevons are commanded to null. This elevon movement creates a momentary pressure drop that will not affect thermal conditioning.

TABLE 3.4.2.4-1.- HYDRAULIC SUBSYSTEM COMPONENT INLET FLUID TEMPERATURE LIMITS  
(Paragraph 3.4.2.4)

Components	Flight criteria						Non-flight criteria <sup>a</sup>				
	Minimum Operating Temperature, °F	Minimum Full Performance Operating Temperature, °F	Critical Item and Results If Exceeded	Maximum Performance Operating Temperature, °F	Maximum Operating Temperature, °F	Critical Item and Results If Exceeded	Minimum Non-operating Temperature, °F	Critical Item and Results If Exceeded	Maximum Non-operating Temperature, °F		Critical Item and Results If Exceeded
									Long <sup>b</sup> Term	Short Term	
Main pumps	-40	+35	Viscosity	240	275	Seals	-65	Seal leakage	240	275	Seal/system degradation
Electric-motor-driven pumps	+20	+35	Excessive power consumption	230	230	Electronics life	-65	Seal leakage	240	275	Seal/system degradation
Reservoir	-40	0	Viscosity	275	275	Seals	-65	Seal leakage	275	275	Seal/system degradation
Elevon actuators	-40	+35	Reduced load/rate performance	225	250	Seals	-65	Seal leakage	225	250	Seal/system degradation
Body flap PDU	-40	+35	Reduced load/rate performance	250	275	Seals	-65	Seal leakage	225	275	Seal/system degradation
Rudder/speedbrake PDU	-40	+45	Reduced load/rate performance	250	255	Seals	-65	Seal leakage	225	255	Seal/system degradation
TVC actuators	-50	+60	Reduced load/rate performance	230	250	Seals	-65	Seal leakage	225	250	Seal/system degradation
Bootstrap accumulator	-65	-50	Seal leakage	225	225	Seals	-65	Seal leakage	225	225	Seal/system degradation
SSME Return line accumulator	-65	-65	Viscosity	250	250	Seals	-65	Seal leakage	250	250	Seal/system degradation
Landing gear up circulation valve	-40	+35	Viscosity	275	275	Seals	-65	Seal leakage	275	275	Seal/system degradation
Landing gear redundant S.O. valve	-40	+35	Viscosity	275	275	Seals	-65	Seal leakage	275	275	Seal/system degradation

<sup>a</sup>For ground and ferry flight operations.

<sup>b</sup>Long term is typically 36 to 72 hours.

TABLE 3.4.2.4-1.- HYDRAULIC SUBSYSTEM COMPONENT INLET FLUID TEMPERATURE LIMITS (Continued)  
(Paragraph 3.4.2.4)

Components	Flight criteria						Non-flight criteria <sup>a</sup>				
	Minimum Operating Temperature, °F	Minimum Full Performance Operating Temperature, °F	Critical Item and Results If Exceeded	Maximum Performance Operating Temperature, °F	Maximum Operating Temperature, °F	Critical Item and Results If Exceeded	Minimum Non-operating Temperature, °F	Critical Item and Results If Exceeded	Maximum Non-operating Temperature, °F		Critical Item and Results If Exceeded
									Long <sup>b</sup> Term	Short Term	
Landing gear dump valve	-40	-40	Viscosity	275	275	Seals	-65	Seal leakage	275	275	Seal/system degradation
Landing gear selector valve	-40	+35	Viscosity	275	275	Seals	-65	Seal leakage	275	275	Seal/system degradation
Landing gear isolation valve	-40	0	Viscosity	275	275	Seals	-65	Seal leakage	275	275	Seal/system degradation
MPS/TVC isolation valve	-40	+35	Viscosity	275	275	Seals	-65	Seal leakage	275	275	Seal/system degradation
Filter modules	-40	+35	Viscosity	275	275	Seals	-65	Seal leakage	275	275	Seal/system degradation
Interface to main engine valves	+60	+60	Transducer accuracy for control of SSME HAS valves	240	240	Transducer accuracy for control of SSME HAS valves	-65	Seal leakage	240	240	Seal/system degradation
NLG steering actuator	-10	-10	Viscosity	250	275	Seals	-65	Seal leakage	275	275	Seal/system degradation
MLG brake valve module	-65	+30	Seals/Viscosity	250	275	Seals	-65	Seal leakage	275	275	Seal/system degradation
Line to brakes	-20	-20	Viscosity	250	275	Seals	-65	Seal leakage	275	275	Seal/system degradation
Line to SW valve	-40	+50	Anti-skid	250	275	Seals	-65	Seal leakage	275	275	Seal/system degradation
MLG Strut actuators	-35	-35	Viscosity	140	250	Seals	-65	Seal leakage	240	250	Seal/system degradation

<sup>a</sup>For ground and ferry flight conditions.

<sup>b</sup>Long term is typically 36 to 72 hours.

TABLE 3.4.2.4-1.- HYDRAULIC SUBSYSTEM COMPONENT INLET FLUID TEMPERATURE LIMITS  
(Paragraph 3.4.2.4) (Concluded)

Components	Flight criteria						Non-flight criteria <sup>a</sup>				
	Minimum Operating Temperature, °F	Minimum Full Performance Operating Temperature, °F	Critical Item and Results If Exceeded	Maximum Operating Temperature, °F	Maximum Operating Temperature, °F	Critical Item and Results If Exceeded	Minimum Non-operating Temperature, °F	Critical Item and Results If Exceeded	Maximum Non-operating Temperature, °F		Critical Item and Results If Exceeded
									Long <sup>b</sup> Term	Short Term	
NLG Strut actuators	-20	-20	Viscosity	160	250	Seals	-65	Seal leakage	240	250	Seal/system degradation
Landing gear uplock actuators	-35	-35	Viscosity	275	275	Seals	-65	Seal leak	240	275	Seal/system degradation
Brakes	-20	-10	Viscosity	275	325	Seals	-65	Seal leak	275	325	Seal/system degradation
Water spray boiler											
Hyd fluid	0	NA	Viscosity	275	275	Seals	-65	Seal leakage	275	275	Seal/system degradation
Water tank	+32	+32	H <sub>2</sub> O freezes	125	125	Controller over temperature	32	H <sub>2</sub> O freezes	212	212	H <sub>2</sub> O Boils
Vents	+130	+130	Icing	NA	NA	NA	NA	NA	NA	NA	NA
Hyd Heat exchanger	0	+15	Low outlet temperature	115	115	ECLSS full performance constraint	-65	ECLSS flight limit	150	150	ECLSS ground limit
APU/Pump interface	-40	+35	Viscosity	300	300	Seals	-65	Seal leakage	275	275	Seal/system degradation
Lines to BF PDU	-40	+35	c	275	275	Seals/leakage	-65	Seal leak	275	275	Seal/system degradation
Lines to elevon	-40	+75	c	275	275	Certification limit	-65	Certification limit	275	275	Certification limit
Lines to rudder speed brake	-40	+45	c	275	275	Certification limit	-65	Certification limit	275	275	Certification limit
System 1 lines to landing gear											
Mid-body	-50	-50	c	275	275	Seals/leakage	-65	Seal leak	275	275	Seal/system degradation
Nose	-10	-10	c	275	275	Seals/leakage	-65	Seal leak	275	275	Seal/system degradation
MLG wheel wells	-35	-35	c	275	275	Seals/leakage	-65	Seal leak	275	275	Seal/system degradation
Umbilical retractor actuator	0	+35	Viscosity	250	250	Seals	-90	Seal leak	240	250	Seal/system degradation

<sup>a</sup> For ground and ferry flight conditions.

<sup>b</sup> Long term is typically 36 to 72 hours.

<sup>c</sup> Insufficient response due to high oil viscosity.

## 3.4.2.5

## Payload Deployment and Retrieval Subsystem

## CONSTRAINTS/LIMITATIONS

## RESULT IF EXCEEDED

1. Temperature Limits.  
See table 3.4.2.5-1.
2. Maximum Allowable Attach Point Loads. Maximum loads are found in ICD 2-19001, Appendix I.  
Exceeding these loads may result in destruction of a particular retention mechanism and cause subsequent payload damage.
3. Payload Alignment Guides. Payload/PRLA loadings - Guide contact loads and latch contact loads are provided for in figure 4.2.5-15.  
Exceeding these limits may result in payload and/or retention mechanism damage.
4. Maximum Payload Release Limits.
  - a. Orbiter-to-payload rates:
    - (1) Attitude -  $\pm 0.5$  deg.
    - (2) Linear tip-off motion - less than 2 ft/sec.
    - (3) Angular tip-off rate -  $\pm 0.025$  deg/sec.
  - b. Orbiter-attached manipulator subsystem-to-payload rates:
    - (1) Linear tip-off motion - 0.1 ft/sec.
    - (2) Angular tip-off rate -  $\pm 0.015$  deg/sec.
5. Maximum Payload Dynamics Prior to Retrieval.
  - a. Payload rotation about any axis is limited to  $\pm 0.1$  deg/sec.
  - b. Maximum allowable relative velocity of payload and Orbiter at capture is limited to 0.1 ft/sec.
6. OMS Burns/RCS Thruster Firings During RMS Operations.
  - a. Refer to table 3.4.2.5-2.  
Excessive torque damage or break the RMS.  
Possible payload/Orbiter contact.
  - b. Keep the RMS away from the RCS plume zones during RCS firings. The regions (stay-out zones) are defined in table 3.4.2.5-3.  
Possible damage to the Kapton thermal insulation (temperature  $>750^{\circ}$  F) and possible degraded RMS operation.
7. Payload Bay Door Restriction.  
The payload bay doors must be opened to an angle  $\geq 85$  deg for the payload retention mechanism to operate.  
Possible payload/payload bay door contact.

3.4.2.5

Payload Deployment and Retrieval Subsystem (Cont)

CONSTRAINTS/LIMITATIONS

- |  |   |
|--|---|
| <p>8. <u>RMS End-Effector Operation.</u><br/>The RMS end-effector motor is limited to 120 seconds of continuous operation.</p> <p>9. <u>Maximum Allowable Operating Temperature - LED and ABE.</u><br/>a. Continued operation of the RMS is limited to 15 minutes, if the LED temperature(s) reach 172° F or the ABE temperature(s) reach 144° F.<br/>b. Remove all power to the RMS, if the LED temperatures reach 186° F or the ABE temperatures reach 157° F.</p> <p>10. <u>Minimum Allowable Operating Temperature - LED and ABE.</u> Upon receipt of low temperature warning (-4° F) for LED or ABE, heater power must be restored within 25 minutes<sup>a</sup>.</p> <p>11. <u>Manipulator Positioning Mechanism (MPM).</u> The MPM must be fully stowed for entry and landing. One of two shoulder indications plus one of four indications from the mid or aft pedestal is required to consider the MPM fully stowed.</p> <p>12. <u>Manipulator Retention Latches (MRL).</u> Two (2) of three (3) MRL's must be latched for entry and landing.</p> <p>13. <u>Orbiter UHF-Band (Underbelly) Antenna Radiating in the Air-to-Ground Simplex Mode Only.*</u><br/>The UHF (225 to 400 MHz) system emits a maximum field intensity of 22 V/m at 1 meter. The RMS sensitivity is 13 V/m at this frequency range. The RMS should not be driven closer than 2 meters from the radiating antenna.</p> | <p>RESULT IF EXCEEDED<br/>Possible burn out of end effector motor.</p> <p>Possible overheating, degraded performance or loss of RMS electronics.</p> <p>The lower survival temperature (ABE -58° F; LED -42° F) of components would be exceeded.</p> <p>Possible damage to Orbiter structure and/or RMS during entry and landing.</p> <p>Possible damage to Orbiter structure and/or RMS during entry or landing.</p> <p>RMS performance degradation and failure indications:<br/>a. Pitch tachometer.<br/>b. Arm-based electronics.<br/>c. End-effector power supply.<br/>RMS remoding required.</p> |
|--|---|

<sup>a</sup>Based on STS-3 data.

\*NASA Data Source.



TABLE 3.4.2.5-1.- PAYLOAD DEPLOYMENT AND RETRIEVAL SUBSYSTEM COMPONENT TEMPERATURE LIMITS  
(Paragraph 3.4.2.5)

Components	Minimum Operating Temperature, °F	Critical Item and Results If Exceeded	Maximum Operating Temperature, °F		Critical Item and Results If Exceeded	Minimum Non-operating Temperature, °F	Critical Item and Results If Exceeded	Maximum Non-operating Temperature, °F		Critical Item and Results If Exceeded
			Long Term	Short Term				Long Term	Short Term	
Remote manipulator subsystem	0 <sup>a</sup> -20 <sup>b</sup>	LED - May reach survival limit		+250	TBS	-120	TBS			
Manipulator positioning mechanism	-100	Lubrication limit - may result in latch malfunction	+240	+240	Specification limit-motor - may result in latch malfunction	-120	Specification limit	+240	+240	Structural limit
Payload retention mechanism										
Keel (AKA)	-100	Lubrication limit - may result in latch malfunction	350	350	Test limit - may result in latch malfunction	-200	Test limit - may result in latch malfunction	350	NA	Test limit
Longeron (PLRA)	-100	Lubrication limit - may result in latch malfunction	275	275	Test limit	-200	Test limit	275	NA	Test limit
Manipulator retention latch mechanism	-100	Rubber boot hardens	+240	+240	Test limit	-120	Test limit	+240	+240	Test limit

(a) Displayed temperature.

(b) Allowing for maximum undetected errors.

TABLE 3.4.2.5-2 - RMS/RCS/OMS OPERATIONAL CONSTRAINTS  
(Paragraph 3.4.2.5)

Arm condition	VRCS	PRCS <sup>a</sup>	OMS
Singularity or reach limit zone			
Arm loaded	None	Inhibit	Inhibit
Arm unloaded	None	Inhibit	Inhibit
Unloaded at rest	None	b	Inhibit
Loaded at rest			
W ≤ 32k lb	None	b	Inhibit
W ≥ 32k lb	None	Inhibit	Inhibit
Loaded in motion	None	Inhibit	Inhibit
Unloaded in motion	None	b	Inhibit
Test mode	None	Inhibit	Inhibit
Capture or release process	None	Inhibit	Inhibit
Arm in process of being latch or unlatched	None	Inhibit	Inhibit
Arm within 2 feet of Orbiter	None	Inhibit	Inhibit
Arm within 2 feet of Orbiter	None	Inhibit	Inhibit

Notes

<sup>a</sup>During RMS flight test objectives, the primary RCS may not be fired until 25 seconds after an RMS input has been removed (or 25 seconds after in-progress light is off). RMS flight test objectives may commence or proceed 20 seconds after primary RCS firing.

<sup>b</sup>Single-axis minimum rate (80 millisecc) primary RCS firing with interval between firings of sufficient time (3 min) to achieve steady-state condition are permitted.

TABLE 3.4.2.5-3.- RCS PLUME STAY-OUT ZONES FOR RMS  
(Paragraph 3.4.2.5)

(a) Primary RCS Stay-Out Zones

Firing rate	Stay-out zones <sup>a</sup>			
Continuous	X = 0, R = 200	X = 425, R = 150	X = 500, R = 100	X = 600, R = 0
6 sec	X = 0, R = 200	X = 200, R = 100	X = 340, R = 0	
80 msec	X = 0, R = 40	X = 130, R = 40	X = 160, R = 30	X = 180, R = 0

(b) Vernier RCS Stay-Out Zones

Firing rate	Stay-out zones <sup>a</sup>			
Continuous	X = 0, R = 18	X = 50, R = 18	X = 70, R = 10	X = 80, R = 0
80 msec	X = 0, R = 5	X = 30, R = 0		

<sup>a</sup> X = Distance in inches from thruster in direction of thruster plume.  
R = Lateral distance in inches from center of thruster.

3.4.2.6

Operational Seat Subsystem  
CONSTRAINTS/LIMITATIONS

RESULT IF EXCEEDED

1. Seat Adjustments During Ascent  
To SSME Shutdown.

a. With an ac bus failure, do not operate seat motors while switching alternate loads (cabin fan, H<sub>2</sub>O pump, and bay fan).

A SSME controller may switch to channel B in control.

b. With an ac bus failure, continuous seat adjustments of all 4 seat motors over a 2-minute period may affect the SSME controller.

A SSME controller may switch to channel B in control.

3.4.2.7

Atmospheric Flight Control Mechanisms  
CONSTRAINTS/LIMITATIONS

RESULT IF EXCEEDED

Temperature Limits.  
See table 3.4.2.7-1.

TABLE 3.4.2.7-1.- ATMOSPHERIC FLIGHT CONTROL MECHANISMS TEMPERATURE LIMITS  
(Paragraph 3.4.2.7)

Components	Minimum Operating Temperature, °F	Critical Item and Results If Exceeded	Maximum Operating Temperature, °F		Critical Item and Results If Exceeded	Minimum Non-operating Temperature, °F	Critical Item and Results If Exceeded	Maximum Non-operating Temperature, °F		Critical Item and Results If Exceeded
			Long Term	Short Term				Long Term	Short Term	
Rudder/speed-brake actuation subsystem										
Rudder/speed-brake PDU	-40	Seal leakage	275	NA	Seals	-65	Seal leakage	275	NA	Seal/system degradation
Rudder/speed-brake actuators and shafts	-100	Design value	275	NA	Material strength	-100	Design value	275	NA	Material strength
Body flap actuation subsystem										
PDU	-40	Seal leakage	275	NA	Seals	-65	Seal leakage	275	NA	Seal/system degradation
Actuators and shafts	-84	Design value	275	NA	Material strength	-84	Design value	275	NA	Material strength

3.4.2.8

Space Shuttle Pyrotechnics  
CONSTRAINTS/LIMITATIONS

RESULT IF EXCEEDED

No constraints have been  
identified for this subsystem.

3.4.2.8-1

3.4.3 Propulsion Subsystems

## 3.4.3.1 Main Propulsion Subsystem (MPS).

CONSTRAINTS/LIMITATIONSRESULT IF EXCEEDED

1. MPS Temperature Limits.  
See table 3.4.3.1-1.
2. Engine Propellant Pressure and Temperature Limits.
  - a.  $\text{LO}_2$ . After drainback, the  $\text{LO}_2$  engine inlet temperature and pressure must be 170 to 178 deg R and 103 to 111 psia at engine start, respectively (excluding instrumentation error).  
Engine controller will inhibit a start if the  $\text{LO}_2$  preburner discharge temperature is  $\geq 186.5$  deg R. GLS will inhibit a start if  $\text{LO}_2$  engine inlet temperature is  $< -289.2$  deg F at T-31 seconds.
  - b.  $\text{LH}_2$ . The  $\text{LH}_2$  engine inlet temperature must be 37 to 40 deg R and 43 to 47 psia at engine start, respectively (excluding instrumentation error).  
Engine controller will inhibit a start.
  - c. Mainstage operation. See figure 4.3.1-7.  
Possible pump cavitation and overspeed. Engine shutdown could result.
  - d. The earliest time that the  $\text{LH}_2$  ullage pressure switch can be opened for a 100-percent power level mission is after T+292 seconds with no venting; for a 104-percent power level mission, use T+370 seconds. See figure 3.4.3.1-1.  
 $\text{H}_2$  venting is unacceptable during first stage (below 150,000 ft) operations. Fire hazard, if vent valve fails to reseal.
3. Minimum Operating Net Positive Suction Pressure.
  - a. Nominal operating conditions for fuel.  
Low NPSP can cause overspeed conditions and uncontained engine damage. Figure 4.3.1-8.
  - b. Predictions for two FCV's failed closed at lift-off.
    - (1)  $\text{LH}_2$  NPSP vs. time
      - (a) 100 percent mission  
Figure 3.4.3.1-2
      - (b) 104 percent mission  
Figure 3.4.3.1-3
      - (c) 109 percent mission  
Figure 3.4.3.1-4
    - (2)  $\text{LH}_2$  NPSP vs. SSME HPFT discharge temperature  
Figure 3.4.3.1-5



## 3.4.3.1

## Main Propulsion Subsystem (Cont)

## CONSTRAINTS/LIMITATIONS

## RESULT IF EXCEEDED

## c. Minimum operating conditions

for  $O_2$ 

(1) NPSP requirements vs. power level

Figure 4.3.1-7

(2) Low level cutoff - no stuck throttle

Table 3.4.3.1-2

4. Engine Shutdown for Lockups

An SSME in hydraulic or electrical lockup when coupled with low vehicle performance resulting in low level cutoff may be manually shut down to prevent a violation of the engine  $LO_2$

NPSP requirements near MECO.

For low level cutoff with stuck throttle at higher power level:

a. Three engine operational - manually shut down one stuck throttle engine, if approaching low level cutoff.

b. Two engines operational - do not shut down stuck throttle engine, to maintain engine redundancy.

Low NPSP can cause HPOT overspeed conditions and uncontained engine damage.

Single SSME zero-g shutdown violates NPSP requirement with longer duration.

5. Engine Positioning After Shutdown.

Prior to entry, the upper engine must be at the null position in pitch and yaw and the lower engines positioned parallel to the Orbiter centerline in yaw and up  $10^\circ$  from null in pitch.

Minimizes aeroheating on the engine nozzles during entry.

6. Propellant System Dump.

a. For normal mission and AOA/ATO aborts, the propellant must be dumped from the main engines and Orbiter-MPS lines.

(1)  $LO_2$  is dumped through the engines and  $LH_2$  must be dumped through the fill/drain and recirculation/replenish systems.

Safes Orbiter for postlanding operations; reduces Orbiter mass for on-orbit operations. Overspinning of the HPOTP will occur, if  $LH_2$  is dumped through the engine.

3.4.3.1-2

### 3.4.3.1 Main Propulsion Subsystem (Cont) CONSTRAINTS/LIMITATIONS

- (2) Prior to dump, the LH<sub>2</sub> RTLS dump valves are opened to vent the LH<sub>2</sub> feed manifold.

Note: During ET/Orbiter separation, the GH<sub>2</sub> pressurization line is vented/vacuum inerted via the pressurization line disconnect. Flight data indicate that the vent time is approximately  $2 \pm 0.3$  seconds. Analysis of the pressure decay data indicate that the 0.006-lb GH<sub>2</sub> remaining at the end of MECO can all be vented during normal separation of the ET/Orbiter with less than 0.0003-lb GH<sub>2</sub> remaining.  
See figure 3.4.3.1-6.

- b. For RTLS abort, LH<sub>2</sub> must be dumped through the RTLS valve and fill and drain valves after ET separation. LO<sub>2</sub> must be vented through the engines and fill and drain valves.
  - c. The minimum time between engine shutdown and the start of propellant dumping is 20 sec.
  - d. The dump start is constrained to begin during an OMS or RCS settling burn.
  - e. The maximum time from the engine cutoff signal to completion of propellant dumping is 5 minutes.
7. Propellant System Inerting.  
The LO<sub>2</sub> and LH<sub>2</sub> propellant systems must be inerted by exposing system interiors to space vacuum (through the fill and drain valves), then pressurized with helium prior to atmospheric entry.

RESULTS IF EXCEEDED  
Loss of redundancy to protect against over-pressurization of LH<sub>2</sub> feedline.

Unacceptable quantities of propellants may remain on board resulting in vehicle damage and unacceptable c.g. control.

Inadequate time for engines to complete shutdown sequence.  
Inefficient dump due to unsettled propellant.

Failure to limits consumables required to provide hydraulic power to the engines. Manual extension of dump time will reduce consumable margins.

Unpredictable venting of propellants on-orbit (after completion of propellant system inerting); and system eliminates LH<sub>2</sub> relief during atmospheric entry.

3.4.3.1 Main Propulsion Subsystem (Cont)  
CONSTRAINTS/LIMITATIONS

## RESULTS IF EXCEEDED

8. Helium Tank Pressure/Temperature Limits. The following pressure/temperature limits must not be exceeded:

- a. Pressure at T-13 seconds.  
(helium fill termination) -  
(1) 4500 psia maximum.  
(2) 4000 psia minimum.

Overpressurization of system components. Insufficient mass of helium stored in the MPS helium tank to complete the mission.

b. Helium tank wall temperature (prior to purge sequence 4, approximately T-4 minutes).

- (1) Aft tanks  
-5 to +65 °F  
(2) Midbody tanks  
40 to 135 °F

Temperature may be lower than -80 °F/390 °R prior to MECO (RTL extended burn), if the minimum temperatures are less than -5 °F/455 °R aft and 45 °F/505 °R mid.

9. SSME Power Level<sup>a</sup>. The SSME's can only be commanded by Orbiter GN&C to power levels within the range of 65 percent (min) to 109 percent (max) of rated power level.

The SSME's are not designed for capability below 65 percent or above 109 percent. The controller will not respond to commands outside this range.

10. SSME Power Level-Sea Level. At altitudes below 8,700 feet, the minimum commanded thrust level is constrained by data shown in figure 3.4.3.1-7.

High nozzle side loads can result in nozzle damage from separated flow.

11. Ac Power Loss. Ac power must not fall below 100 Vrms for longer than 500 msec.

Ac power loss exceeding 500 msec will cause channel switchover or engine shutdown.

<sup>a</sup> Shuttle MPS performance has not been verified beyond a power level of 104 percent. Data in this section pertaining to performance above the 104 percent level is for information only and should not be used for mission planning under normal or intact abort modes. In the event of a contingency abort, flight rules allow manual selection of a maximum power level which may exceed 104 percent. The maximum level allowed by the Avionics is not the same for each flight, but is dependent upon payload mass and other mission requirements.

3.4.3.1 Main Propulsion Subsystem (Cont)  
CONSTRAINTS/LIMITATIONS

12. Application of SSME Hydraulic Pressure Prior to Entry. SSME controller power must be on, or 700-psia helium pressure must be applied prior to application of hydraulic pressure to SSME. During flight, if above conditions have not been met, helium shall be applied prior to 100,000 ft altitude during entry.
13. Hydraulic Supply to SSME. The pressure of the hydraulic fluid supplied to each SSME shall be 2700 to 3500 psig.
14. ET Separation with Open Disconnect Valves. If after ET/Orbiter after ET/Orbiter umbilical retraction, neither the closed indication for the 17-in. LO<sub>2</sub> disconnect valve nor the closed indication for the LH<sub>2</sub> 17-in. disconnect valve are received, ET/Orbiter separation must be delayed for 6 minutes.

In the nominal/AOA/ATO flight modes per the flight rules, the crew will allow a 6-minute lapse of time following the inhibit to allow the thrust level at the disconnect to decay below 1800 lb (see figures 3.4.3.1-2 and 3.4.3.1-3), and then issue the separation command manually. However, if an underspeed condition exists at MECO which requires an OMS burn prior to the end of the time lapse, ET separation will be commanded at not later than OMS TIG minus 1 minute 30 seconds, or sooner if required.

RESULT IF EXCEEDED

Inadvertent engine valve cycling can result in overspinning engine flow-meter or propellant system contamination.

Improper functioning of engine valves if minimum pressure is not maintained, and component damage if maximum limit is exceeded.

Excessive thrust from fail-open disconnect valves in ET can result in potential re-contact with the Orbiter. Figures 3.4.3.1-8 and 3.4.3.1-9.

3.4.3.1	Main Propulsion Subsystem (Cont)	RESULT IF EXCEEDED
	CONSTRAINTS/LIMITATION	
	14. <u>ET Separation with Open (Concluded)</u>	
	<u>Disconnect Valves.</u>	
	In the RTLS flight mode, the inhibit will be automatically overridden after 6 seconds have elapsed.	
	In the TAL flight mode, the inhibit will be manually overridden as soon as practicable. A manual -Z translation maneuver is required to prevent Orbiter/ET recontact.	
	15. <u>Engine 1 Gimbaling Restriction.</u>	Contact with OMS pod could cause tile/nozzle damage.
	The angulation restraint requirement defined by the expression $\text{pitch} + \text{yaw} \leq 13.7^\circ$ and $\text{pitch} < -5^\circ$ , wherein pitch and yaw are individually limited to not exceed $10.5^\circ$ pitch and/or $8.5^\circ$ yaw. This expression is applicable only to the up-pitch half of the gimbal pattern.	
	16. <u>Controller Power Up Restriction.</u>	Controller memory and therefore failure isolation would be lost.
	The main engine controller must not be powered up on-orbit, if a controller failure existed during ascent.	
	17. <u>Engine Controller Temperature.</u>	Overheating of electrical system components could occur.
	The controller power supply temperatures (E41T1150A, E41T2150A, and E41T3150A) must not exceed $175^\circ\text{F}$ . Power should be removed when ground-monitored temperatures reach $150^\circ\text{F}$ to provide a margin for uncertainties.	

3.4.3.1 Main Propulsion Subsystem (Cont)

CONSTRAINTS/LIMITATIONS

RESULT IF EXCEEDED

18. Structural Interference Between<sup>a</sup>  
SSME's, SSME and Body Flap, and  
SSME and OMS Engines.

- |   |   |
|---|---|
| a. SSME to SSME collision.<br>Table 3.4.1.3-3 shows the combinations of engine gimbals angles that result in contact between SSME nozzles.  | SSME nozzles could be damaged.                |
| b. Lower-SSME to body-flap collision. Figure 3.4.3.1-10 shows the combinations of body flap deflections and SSME pitch angles that result in contact between the body flap and SSME nozzle.                 | Damage to the body flap and SSME nozzle.      |
| c. Upper SSME to OMS engine collision. Table 3.4.1.3-4 shows the combinations of gimbals angles of the upper SSME and OMS engines that result in contact between the nozzles of SSME 1 and the OMS engines. | SSME and OMS engine nozzles could be damaged. |

<sup>a</sup>The analytical method and equations used to determine the potential collision between SSME's, SSME 2 and 3 and the body flaps; and between SSME 1 and the OMS engine nozzles can be found in Shuttle Operational Data Submittals R-414 and R-415, which may be obtained by contacting J. Mistrot/VF2/483-3314.

TABLE 3.4.3.1-1.- MAIN PROPULSION SUBSYSTEM COMPONENT TEMPERATURE LIMITS  
(Paragraph 3.4.3.1)

Components	Minimum Operating Temperature, °F	Critical Item or Results If Exceeded	Maximum Operating Temperature, °F		Critical Item or Results If Exceeded	Minimum Nonoperating Temperature, °F	Critical Item or Results If Exceeded	Maximum Non-operating Temperature, °F		Critical Item or Results If Exceeded
			Long Term	Short Term				Long Term	Short Term	
Engine Nozzle	-435	Nozzle material	NA	NA	NA	NA	NA	1200	NA	Material
Hydraulic fluid supply	60	Hydraulic fluid viscosity	185	240 <sup>a</sup>	Seals	40	Hydraulic fluid viscosity	NA	NA	NA
Orbiter Prevalves	-435	Material	170	NA	Seals	NA	NA	200	NA	Seals
Recirculation pumps	-435	Material	NA	150 <sup>b</sup>	Bearing limit	NA	NA	200	NA	Specification limits
Liquid level sensors <sup>c</sup>										
LO <sub>2</sub>	-363	Ice formation	500	NA	Lead wire	NA	NA	500	NA	Lead wire
LH <sub>2</sub>	-435	Ice formation	360	NA	Lead wire	NA	NA	360	NA	Lead wire
LO <sub>2</sub> ECO point sensor	-435		200	NA	Sensor	NA	Sensor	200	NA	Sensor
Cryogenic lines	-363/-435	LO <sub>2</sub> /LH <sub>2</sub> temperature	200 <sup>e</sup>	NA	LO <sub>2</sub> /LH <sub>2</sub> temperature	NA	NA	200	NA	LO <sub>2</sub> /LH <sub>2</sub> temperature
Helium tanks	-160	Operating requirements	200	NA	Tank pressure limit	-160	Operating requirements	200	NA	Tank pressure limit
Controller <sup>d</sup>	65	Electrical components	85 <sup>e</sup>	NA	Electrical components	NA	NA	NA	NA	NA
GN <sub>2</sub> supply	100	Pre-firing purging	165	NA	Materials	NA	NA	NA	NA	NA
MPS pressure lines	-100	LO <sub>2</sub> temperature	NA	600	Material integrity	-65	Temperature at altitude	200	NA	Material integrity
ET umbilical	-100	LO <sub>2</sub> temperature	NA	500	Seal surfaces	-65	Temperature at altitude	200	NA	Seal surfaces

<sup>a</sup>After APU shutdown, 240° F may occur during post-rollout circulation pump operation.

<sup>b</sup>Five (5) minutes limit without LH<sub>2</sub>.

<sup>c</sup>Located in ET tanks.

<sup>d</sup>External to components.

<sup>e</sup>105° F with propellants supplied to engine.

TABLE 3.4.3.1-2.-- MPS LO<sub>2</sub> LOW LEVEL CUTOFF  
(Paragraph 3.4.3.1)

MECO conditions	Nominal (65/65/65) <sup>a</sup>	RTLS (65/0/65) <sup>a</sup>	Press-to-MECO (91/0/91) <sup>a</sup>
MECO NPSP required, psi	6.0	6.0	7.34
Minimum MECO NPSP provided, psi	6.14 <sup>b</sup>	7.23	7.34 <sup>b</sup>
Residual required at MOV closure above Orbiter/SSME interface, lb	240	700	700
Minimum residual at MOV closure above Orbiter/SSME interface, lb	313	2135	1261

<sup>a</sup>SSME shutdown power levels.

<sup>b</sup>Any stuck throttle at higher power level will violate NPSP requirement.



TABLE 3.4.3.1-3.- COMBINATIONS OF GIMBAL ANGLES FOR SSME 1 AND 2 THAT  
 RESULT IN ZERO CLEARANCE BETWEEN NOZZLES (JUST TOUCHING)  
 (Paragraph 3.4.3.1)

Case	Combinations of gimbal angles that result in zero clearance between nozzles			
	SSME 1		SSME 2	
	Pitch ( $\delta_{p1}$ ), degrees	Yaw ( $\delta_{y1}$ ), degrees	Pitch ( $\delta_{p2}$ ), degrees	Yaw ( $\delta_{y2}$ ), degrees
1	10.5 <sup>a</sup>	0	-10.5 <sup>a</sup>	2.95
2	10.5 <sup>a</sup>	0	-7.52	0
3	10.5 <sup>a</sup>	0	-1.95	-8.5 <sup>a</sup>
4	10.5 <sup>a</sup>	8.5 <sup>a</sup>	0.69	-8.5 <sup>a</sup>
5	10.5 <sup>a</sup>	8.5 <sup>a</sup>	0	-5.40
6	10.5 <sup>a</sup>	8.5 <sup>a</sup>	-1.96	0
7	10.5 <sup>a</sup>	8.5 <sup>a</sup>	-7.47	8.5 <sup>a</sup>
8	10.5 <sup>a</sup>	-8.5 <sup>a</sup>	-10.5 <sup>a</sup>	-5.53
9	10.5 <sup>a</sup>	-8.5 <sup>a</sup>	-7.50	-8.5 <sup>a</sup>
10	0	8.5 <sup>a</sup>	-10.5 <sup>a</sup>	-5.40
11	0	8.5 <sup>a</sup>	-9.81	-8.5 <sup>a</sup>
12	10.5 <sup>a</sup>	-2.94	-10.5 <sup>a</sup>	0
13	7.52	0	-10.5 <sup>a</sup>	0
14	1.96	8.5 <sup>a</sup>	-10.5 <sup>a</sup>	0
15	-0.69	8.5 <sup>a</sup>	-10.5 <sup>a</sup>	-8.5 <sup>a</sup>
16	0	5.38	-10.5 <sup>a</sup>	-8.5 <sup>a</sup>
17	1.95	0	-10.5 <sup>a</sup>	-8.5 <sup>a</sup>
18	7.50	-8.5 <sup>a</sup>	-10.5 <sup>a</sup>	-8.5 <sup>a</sup>
19	10.5 <sup>a</sup>	5.48	-10.5 <sup>a</sup>	8.5 <sup>a</sup>
20	7.47	8.5 <sup>a</sup>	-10.5 <sup>a</sup>	8.5 <sup>a</sup>
21	10.5 <sup>a</sup>	5.38	0	-8.5 <sup>a</sup>
22	9.81	8.5 <sup>a</sup>	0	-8.5 <sup>a</sup>

<sup>a</sup>Corresponds to thrust vector controller actuator hard stop.

TABLE 3.4.3.1-3.- COMBINATIONS OF GIMBAL ANGLES FOR SSME 1 AND 3 THAT RESULT IN ZERO CLEARANCE BETWEEN NOZZLES (JUST TOUCHING) (continued)  
(Paragraph 3.4.3.1)

Case	Combinations of gimbal angles that result in zero clearance between nozzles			
	SSME 1		SSME 3	
	Pitch ( $\delta_{p1}$ ), degrees	Yaw ( $\delta_{y1}$ ), degrees	Pitch ( $\delta_{p3}$ ), degrees	Yaw ( $\delta_{y3}$ ), degrees
1	10.5 <sup>a</sup>	0	-10.5 <sup>a</sup>	-2.95
2	10.5 <sup>a</sup>	0	-7.52	0
3	10.5 <sup>a</sup>	0	-1.95	8.5 <sup>a</sup>
4	10.5 <sup>a</sup>	-8.5 <sup>a</sup>	0.69	8.5 <sup>a</sup>
5	10.5 <sup>a</sup>	-8.5 <sup>a</sup>	0	5.40
6	10.5 <sup>a</sup>	-8.5 <sup>a</sup>	-1.96	0
7	10.5 <sup>a</sup>	-8.5 <sup>a</sup>	-7.47	-8.5 <sup>a</sup>
8	10.5 <sup>a</sup>	8.5 <sup>a</sup>	-10.5 <sup>a</sup>	5.53
9	10.5 <sup>a</sup>	8.5 <sup>a</sup>	-7.50	8.5 <sup>a</sup>
10	0	-8.5 <sup>a</sup>	-10.5 <sup>a</sup>	5.40
11	0	-8.5 <sup>a</sup>	-9.81	8.5 <sup>a</sup>
12	10.5 <sup>a</sup>	2.94	-10.5 <sup>a</sup>	0
13	7.52	0	-10.5 <sup>a</sup>	0
14	1.96	-8.5 <sup>a</sup>	-10.5 <sup>a</sup>	0
15	-0.69	-8.5 <sup>a</sup>	-10.5 <sup>a</sup>	8.5 <sup>a</sup>
16	0	-5.38	-10.5 <sup>a</sup>	8.5 <sup>a</sup>
17	1.95	0	-10.5 <sup>a</sup>	8.5 <sup>a</sup>
18	7.50	8.5 <sup>a</sup>	-10.5 <sup>a</sup>	8.5 <sup>a</sup>
19	10.5 <sup>a</sup>	-5.48	-10.5 <sup>a</sup>	-8.5 <sup>a</sup>
20	7.47	-8.5 <sup>a</sup>	-10.5 <sup>a</sup>	-8.5 <sup>a</sup>
21	10.5 <sup>a</sup>	-5.38	0	8.5 <sup>a</sup>
22	9.81	-8.5 <sup>a</sup>	0	8.5 <sup>a</sup>

<sup>a</sup>Corresponds to thrust vector controller actuator hard stop.

TABLE 3.4.3.1-3.- COMBINATIONS OF GIMBAL ANGLES FOR SSME 2 AND 3 THAT RESULT IN ZERO CLEARANCE BETWEEN NOZZLES (JUST TOUCHING) (concluded) (Paragraph 3.4.3.1)

Case	Combinations of gimbal angles that result in zero clearance between nozzles			
	SSME 2		SSME 3	
	Pitch ( $\delta_{p2}$ ), degrees	Yaw ( $\delta_{y2}$ ), degrees	Pitch ( $\delta_{p3}$ ), degrees	Yaw ( $\delta_{y3}$ ), degrees
1 <sup>b</sup>	0	-5.69	0	5.69
2 <sup>b</sup>	0	-8.5	0	2.89
3 <sup>b</sup>	0	-2.89	0	8.5 <sup>a</sup>
4	-9.45	-8.5 <sup>a</sup>	9.45	8.5 <sup>a</sup>
5	9.45	-8.5 <sup>a</sup>	-9.45	8.5 <sup>a</sup>
6	-10.5 <sup>a</sup>	-8.5 <sup>a</sup>	8.39	8.5 <sup>a</sup>
7	-10.5 <sup>a</sup>	-8.5 <sup>a</sup>	0	4.52
8	10.5 <sup>a</sup>	-8.5 <sup>a</sup>	-8.43	8.5 <sup>a</sup>
9	10.5 <sup>a</sup>	-8.5 <sup>a</sup>	0	4.49
10	8.39	-8.5 <sup>a</sup>	-10.5 <sup>a</sup>	8.5 <sup>a</sup>
11	0	-4.52	-10.5 <sup>a</sup>	8.5 <sup>a</sup>
12	-8.43	-8.5 <sup>a</sup>	10.5 <sup>a</sup>	8.5 <sup>a</sup>
13	0	-4.49	10.5 <sup>a</sup>	8.5 <sup>a</sup>

<sup>a</sup>Corresponds to thrust vector controller actuator hard stop.

<sup>b</sup>Zero clearance exists for given yaw angles  $\delta_{y2}$  and  $\delta_{y3}$  for all cases where the pitch angles  $\delta_{p2}$  and  $\delta_{p3}$  are equal.

TABLE 3.4.3.1-4.- CLEARANCES BETWEEN NOZZLES OF SSME 1 AND OMS ENGINES  
(Paragraph 3.4.3.1)

Case 3 - SSME 1      Pitch:  $\delta_p = -5.6$  degrees  
                               Yaw:  $\delta_y = 8.5$  degrees

		Left OMS pitch angle ( $\delta_{pL}$ ), degrees						
		$\delta_{pL}$ -7°	-4°	-2°	0°	2°	4°	7°
Left OMS yaw angle ( $\delta_{yL}$ ), degrees	$\delta_{yL}$ 0°	6.10	5.56	5.26				
	-2°	4.46	3.89	3.56	3.28			
	-4°	2.86	2.25	1.90	1.60	1.36	1.15	0.94
	-6°	1.29	0.64	0.27	///	///	///	///
	-8°	-0.24	-0.93	-1.32	-1.66	-1.95	-2.27	-2.45
		///	///	///	///	///	///	///

Note:

Diagonally lined blocks correspond to regions of collision between nozzles of OMS and SSME 1.

Clearances between the nozzle of the SSME 1 and the right OMS can be determined from the table by changing the signs of the yaw gimbal angles for SSME 1 and the OMS engine and replacing left OMS with right OMS.

Clearances between the OMS and SSME 1 nozzle are shown in inches.

TABLE 3.4.3.1-4.- CLEARANCES BETWEEN NOZZLES OF SSME 1 AND OMS ENGINES  
(continued) (Paragraph 3.4.3.1)

Case 4 - SSME 1      Pitch:  $\delta_p = -4.5$  degrees  
                               Yaw:  $\delta_y = 8.5$  degrees

		Left OMS pitch angle ( $\delta_{pL}$ ), degrees						
		$\delta_{pL}$ -7°	-4°	-2°	0°	2°	4°	7°
Left OMS yaw angle ( $\delta_{yL}$ ), degrees	$\delta_{yL}$ 0°	6.73	6.09	5.72				
	-2°	5.11	4.43	4.03	3.69			
	-4°	3.51	2.80	2.38	2.01	1.70	1.43	1.11
	-6°	1.96	1.20	0.76	0.38	0.04	///	///
	-8°	0.43	-0.35	-0.81	-1.22	-1.58	-1.89	-2.25
			///	///	///	///	///	///

Note:

Diagonally lined blocks correspond to regions of collision between nozzles of OMS and SSME 1.

Clearances for the right OMS nozzle can be obtained by changing the signs of the yaw gimbal angles for SSME 1 and the OMS engine.

Clearances between the OMS and SSME 1 are shown in inches.

TABLE 3.4.3.1-4.- CLEARANCES BETWEEN NOZZLES OF SSME 1 AND OMS ENGINES  
(concluded). (Paragraph 3.4.3.1)

Case 5 - SSME 1     Pitch:  $\delta_p = 0$  degrees  
                          Yaw:  $\delta_y = 8.5$  degrees

		Left OMS pitch angle ( $\delta_{pL}$ ), degrees						
		$\delta_{pL} -7^\circ$	$-4^\circ$	$-2^\circ$	$0^\circ$	$2^\circ$	$4^\circ$	$7^\circ$
Left OMS yaw angle ( $\delta_{yL}$ ), degrees	$\delta_{yL} 0^\circ$	10.3	9.30	8.67				
	$-2^\circ$	8.75	7.68	7.03	6.42			
	$-4^\circ$	7.21	6.11	5.43	4.80	4.22	3.68	
	$-6^\circ$	5.70	4.57	3.87	3.22	2.61	2.06	1.32
	$-8^\circ$	4.24	3.07	2.34	1.55	1.05	0.48	/// -0.28 ///

**Note:**

Diagonally lined block corresponds to region of collision between nozzles of OMS and SSME 1.

Clearances for the right OMS nozzle can be obtained by changing the signs of the yaw gimbal angles for SSME 1 and the OMS engine.

Clearance shown between OMS and SSME 1 engine nozzles is given in inches.

3.4.3.1-16

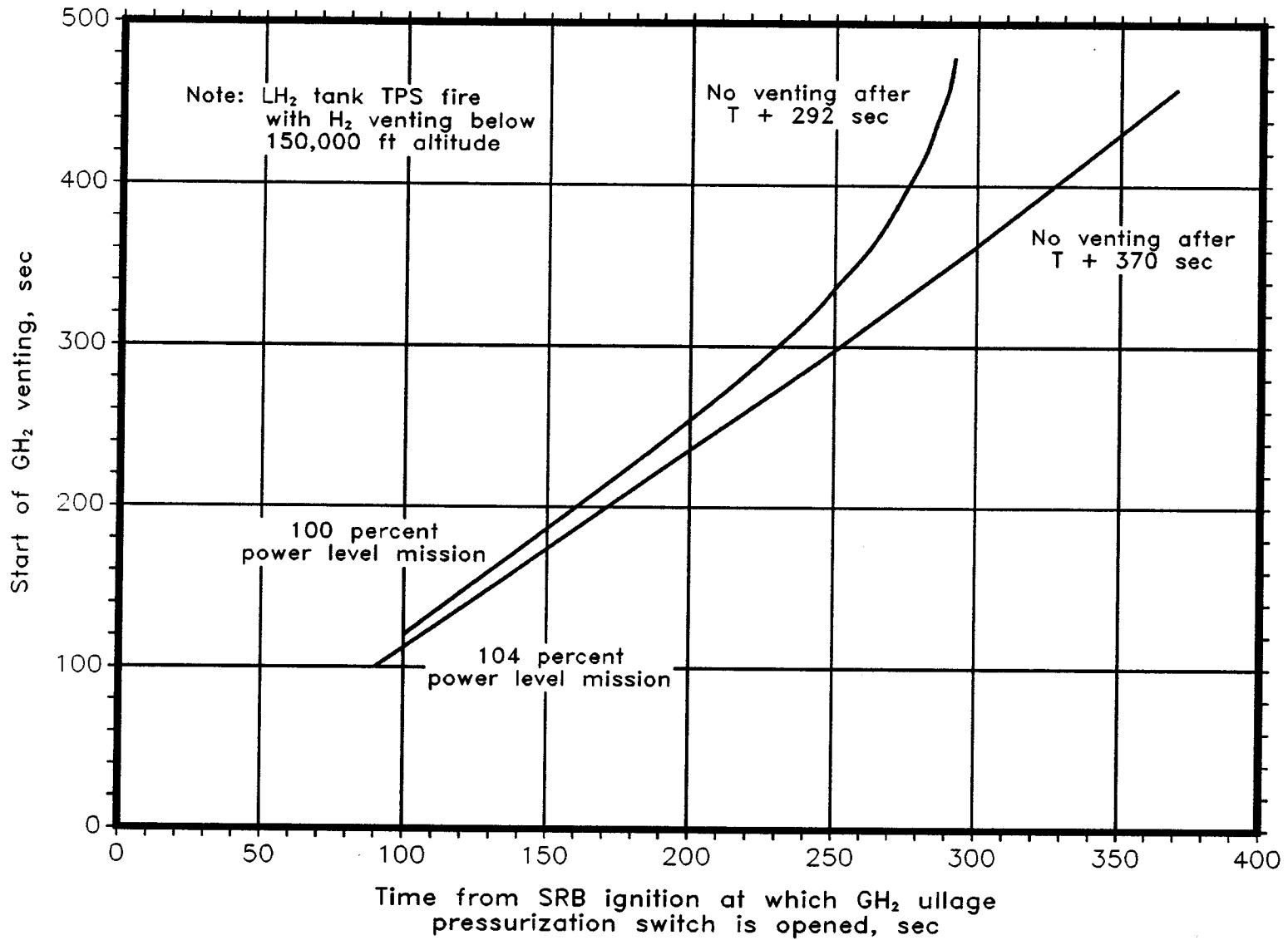

Figure 3.4.3.1-1.- GH<sub>2</sub> ullage pressure switch opening time vs. start of GH<sub>2</sub> venting.  
(2 GH<sub>2</sub> FCV's closed at lift-off)

(Paragraph 3.4.3.1)

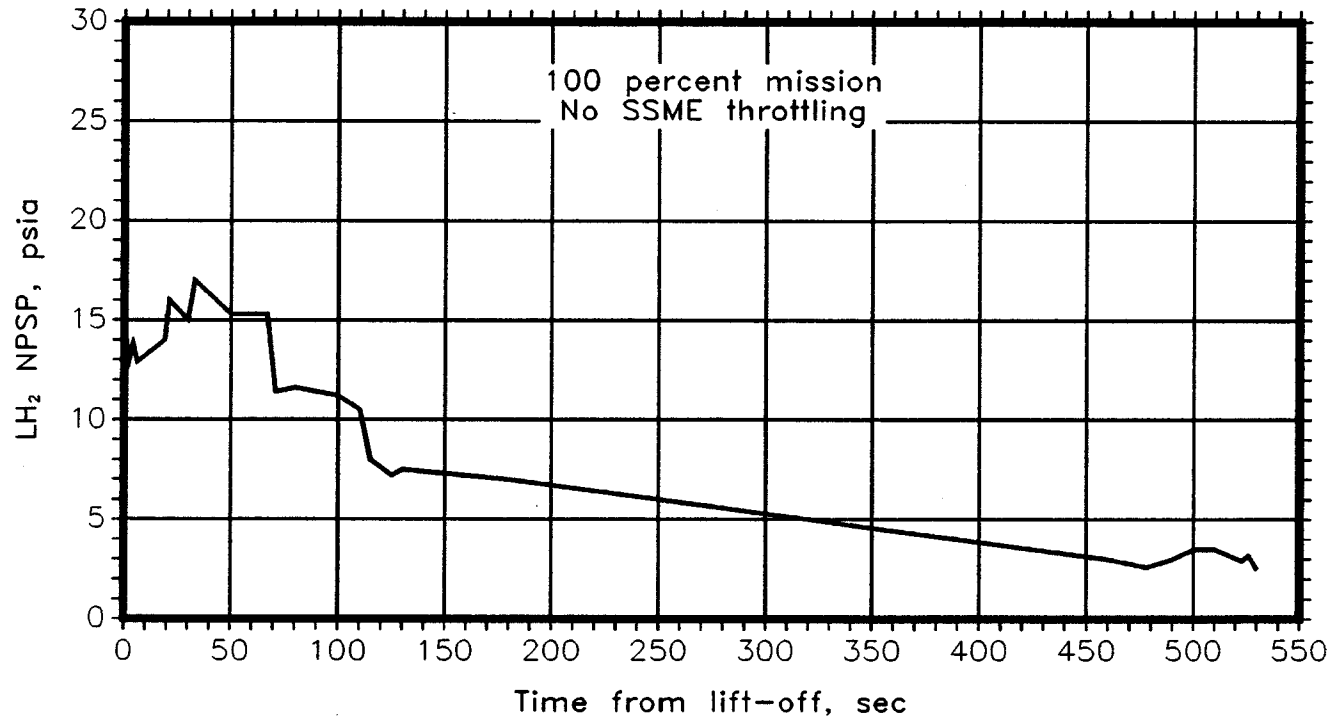

Figure 3.4.3.1-2.— NPSP prediction for LH<sub>2</sub> tank with two FCV's failed closed.  
(STS 41-D mission)  
(Paragraph 3.4.3.1)



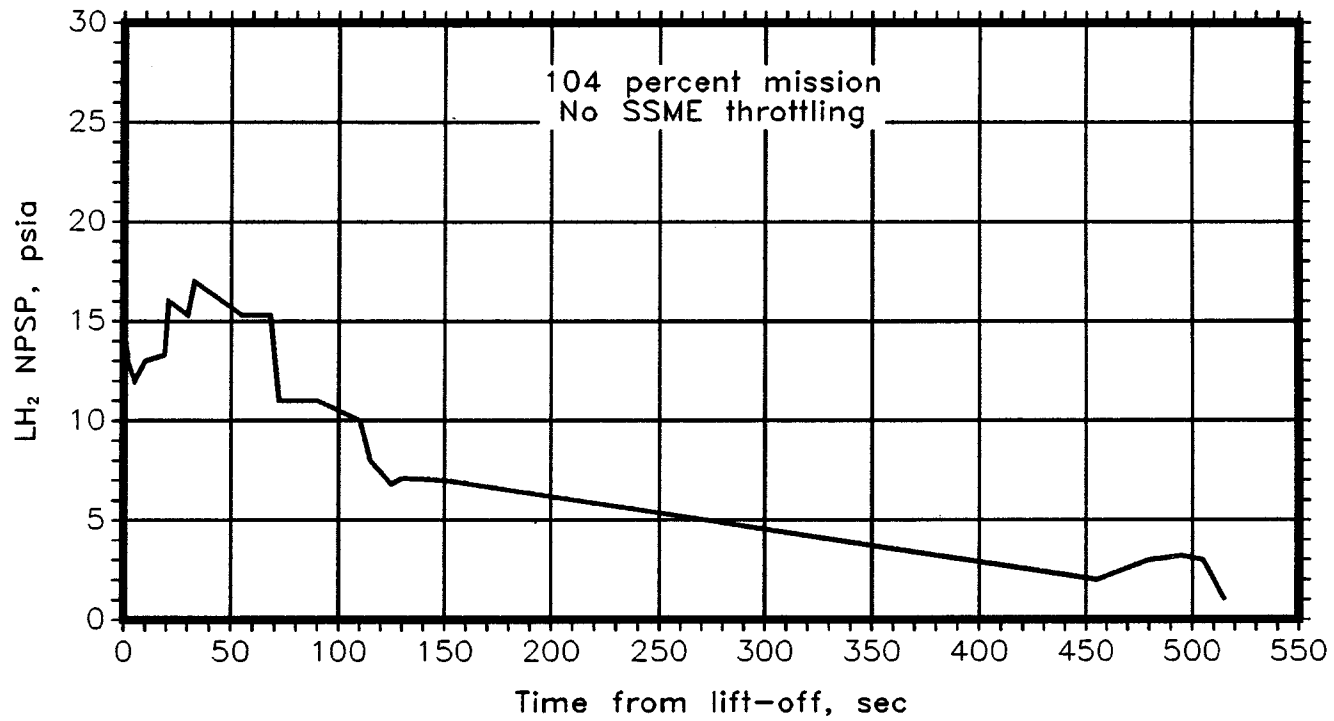

Figure 3.4.3.1-3.- NPSP prediction for LH<sub>2</sub> tank with two FCV's failed closed.  
(STS 51-G)

(Paragraph 3.4.3.1)

3.4.3.1-19

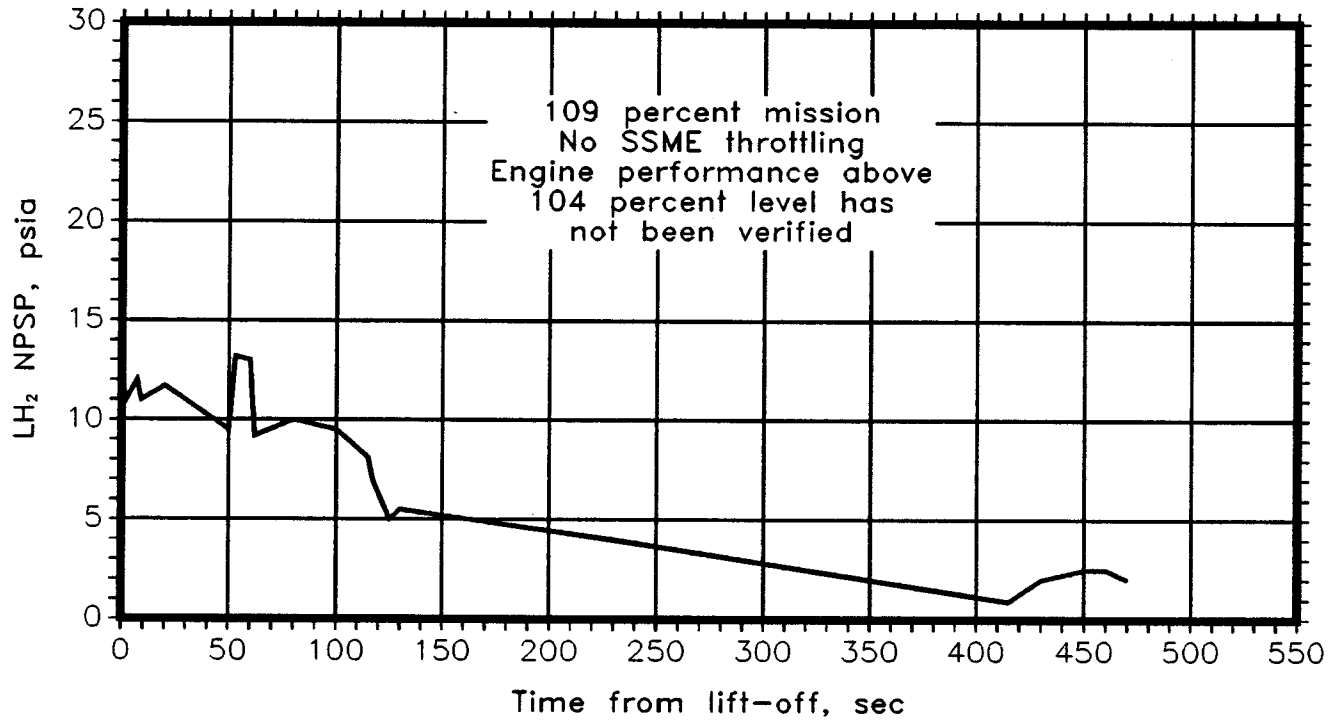

Figure 3.4.3.1-4.- NPSD prediction for LH<sub>2</sub> tank with two FCV's failed closed.

(Paragraph 3.4.3.1)

3.4.3.1-20

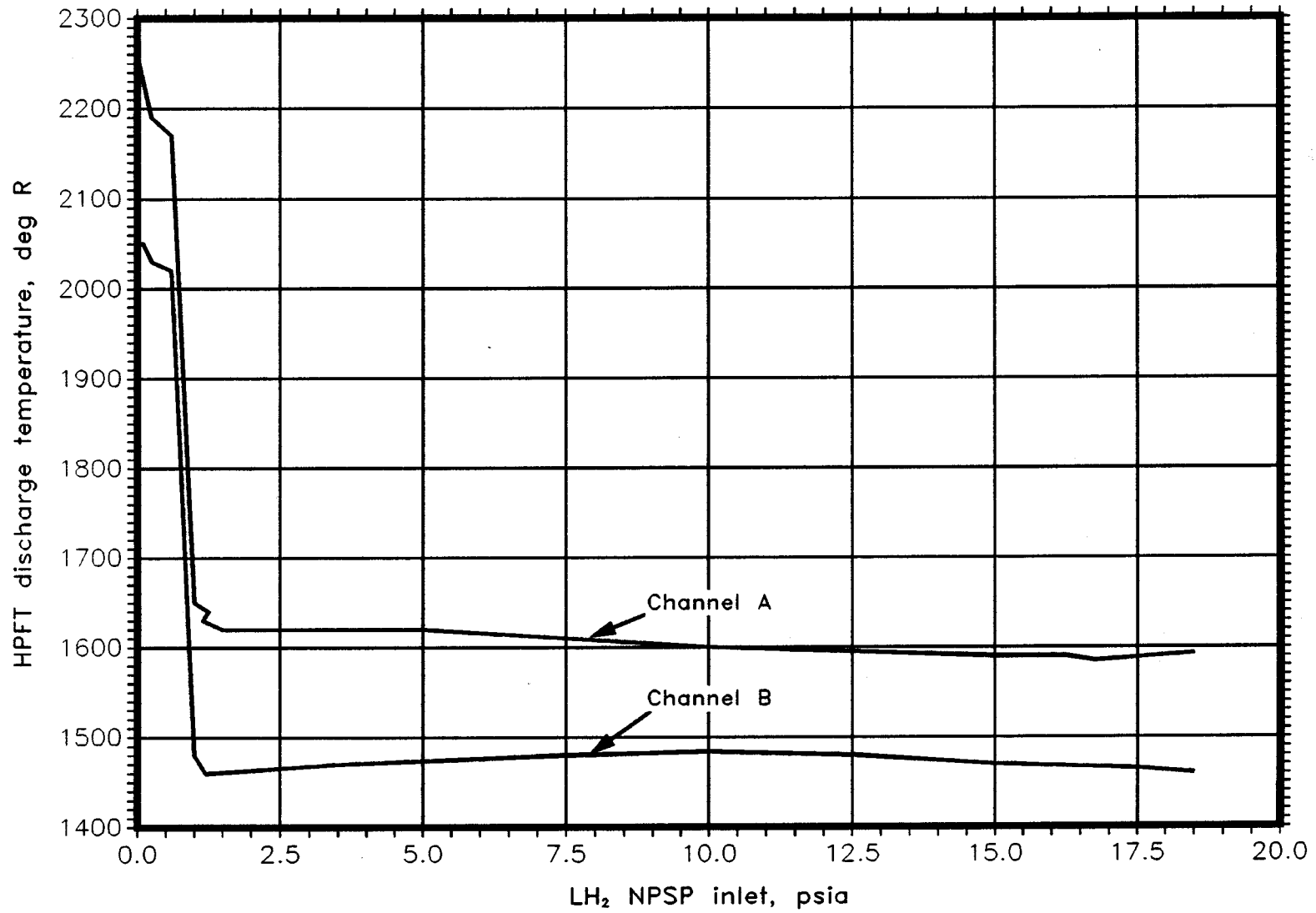
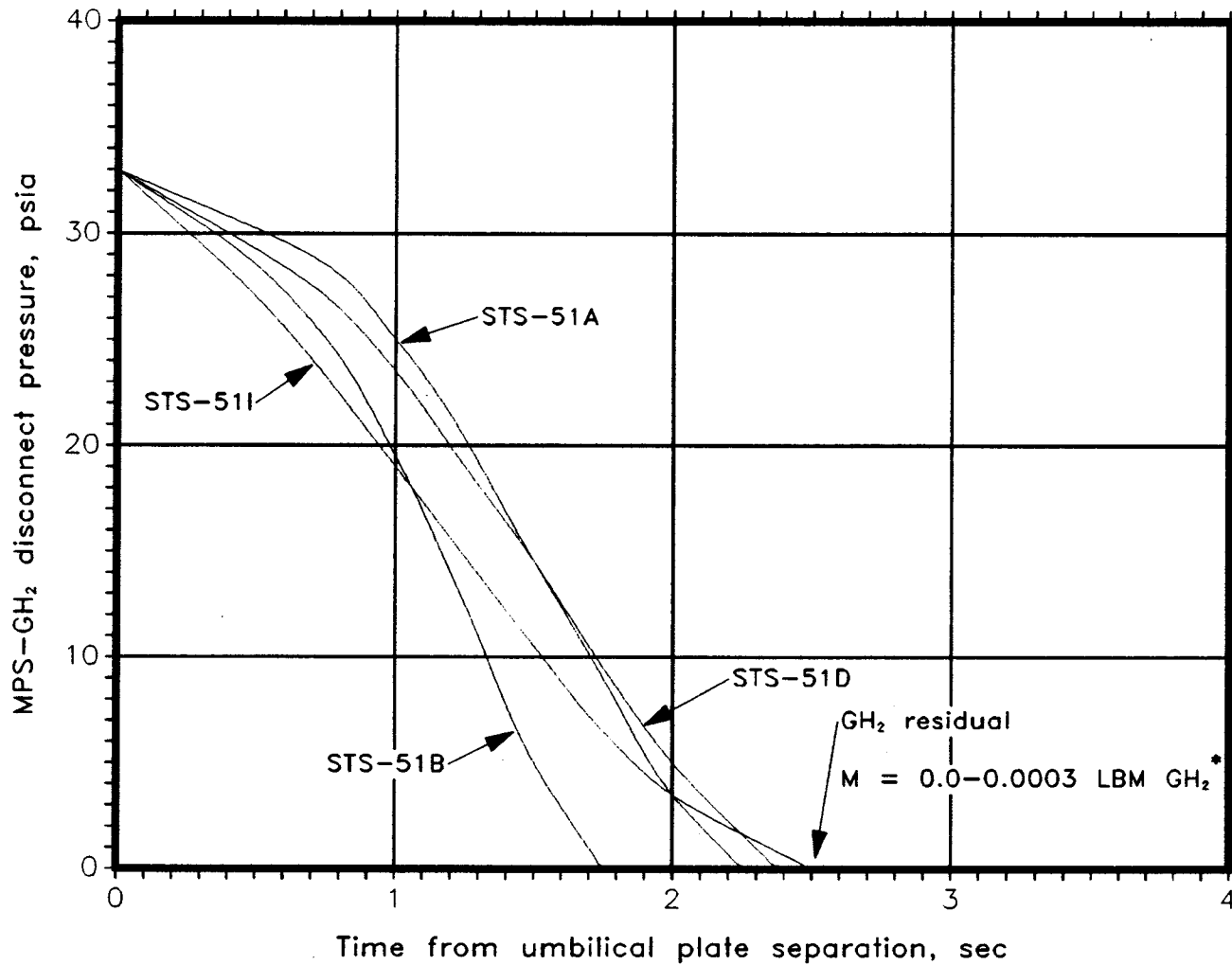

Figure 3.4.3.1-5.- SSME HPFT discharge temperature versus liquid hydrogen NPSP.

(Paragraph 3.4.3.1)



\*The five percent uncertainty in the final GH<sub>2</sub> residual is due to the pressure transducer instrumentation accuracy or  $\pm 2$  psi.

Figure 3.4.3.1-6.- LH<sub>2</sub> pressurization line venting time.

(Paragraph 3.4.3.1)

3.4.3.1-22

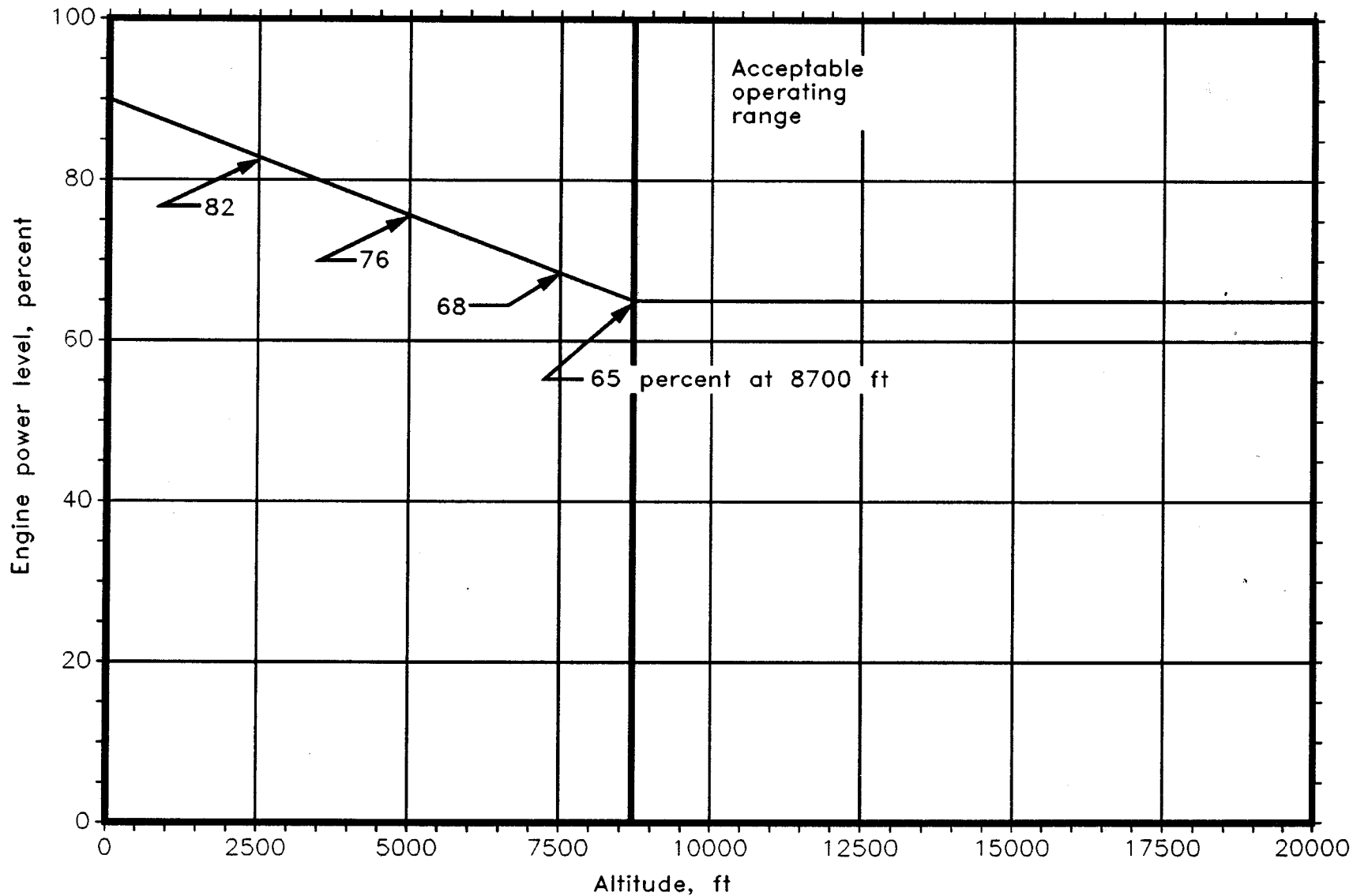

Figure 3.4.3.1-7.- Engine power level vs. altitude.  
(Paragraph 3.4.3.1 and 4.3.1.1)

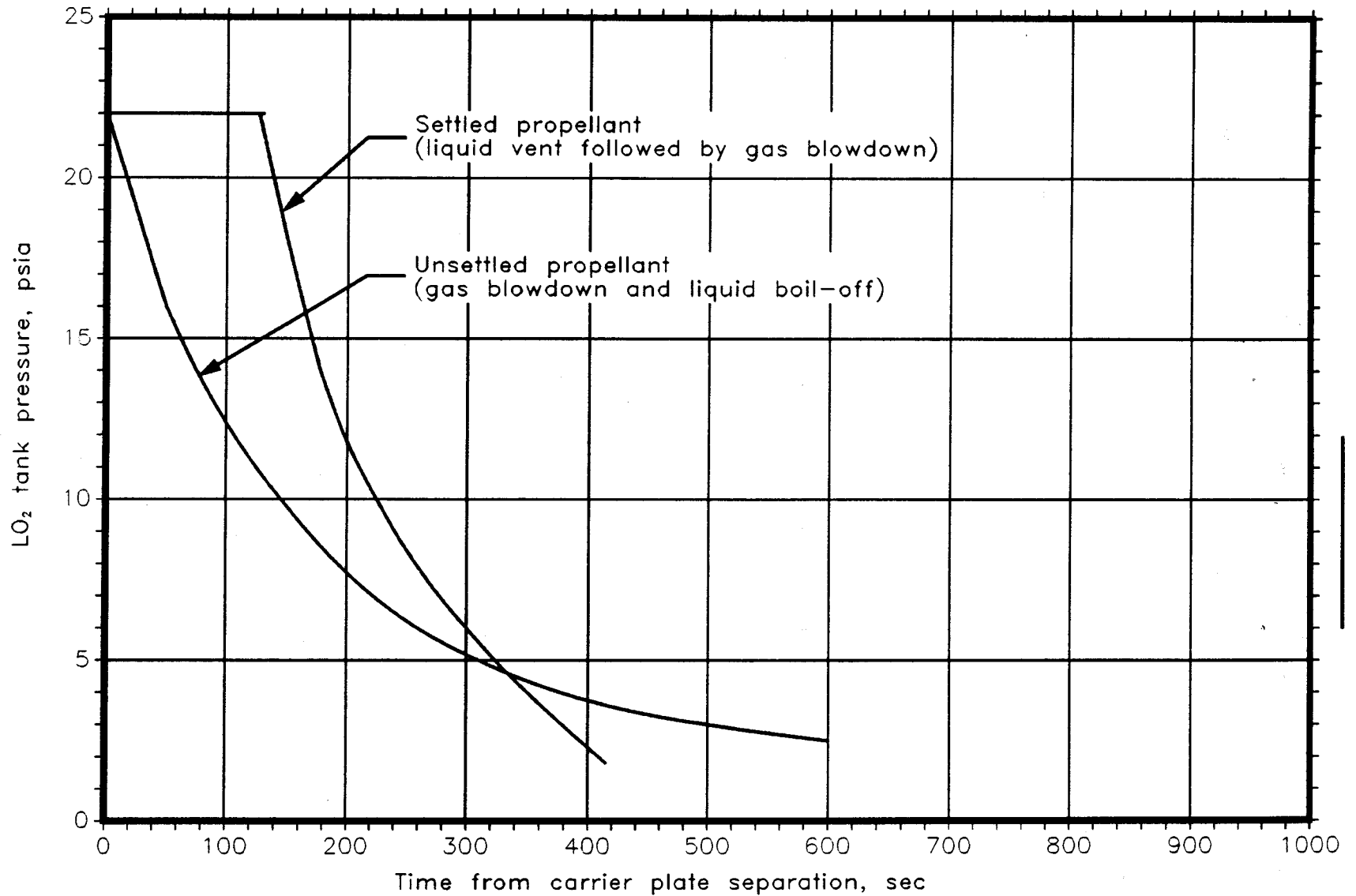

Figure 3.4.3.1-8.- ET LO<sub>2</sub> tank blowdown through failed 17 in. disconnect with LO<sub>2</sub> tank tumble system open.  
(Paragraph 3.4.3.1)

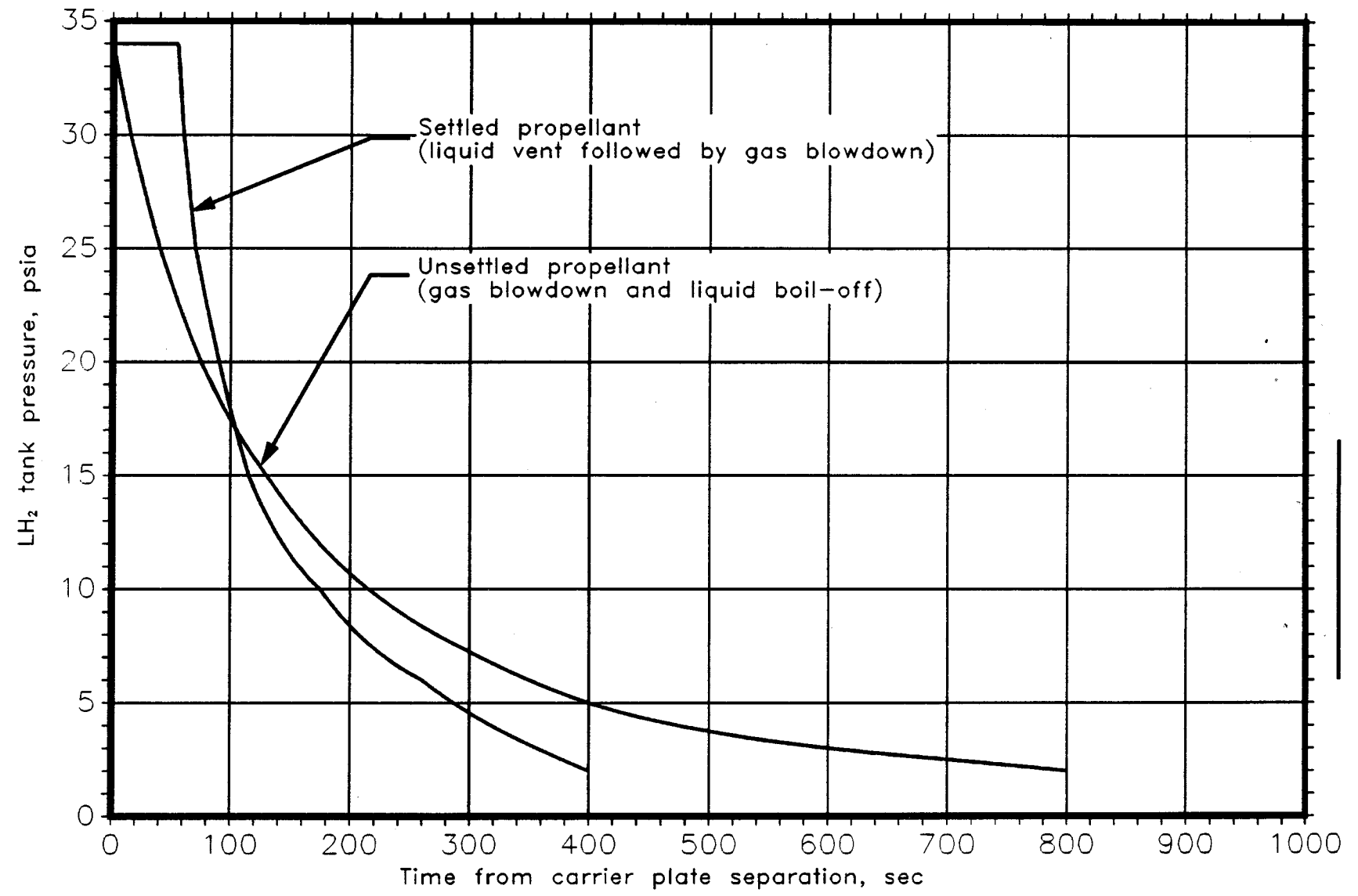

Figure 3.4.3.1-9.- ET LH<sub>2</sub> tank blowdown through failed 17 in. disconnect. (Paragraph 3.4.3.1)

## 3.4.3.1-25

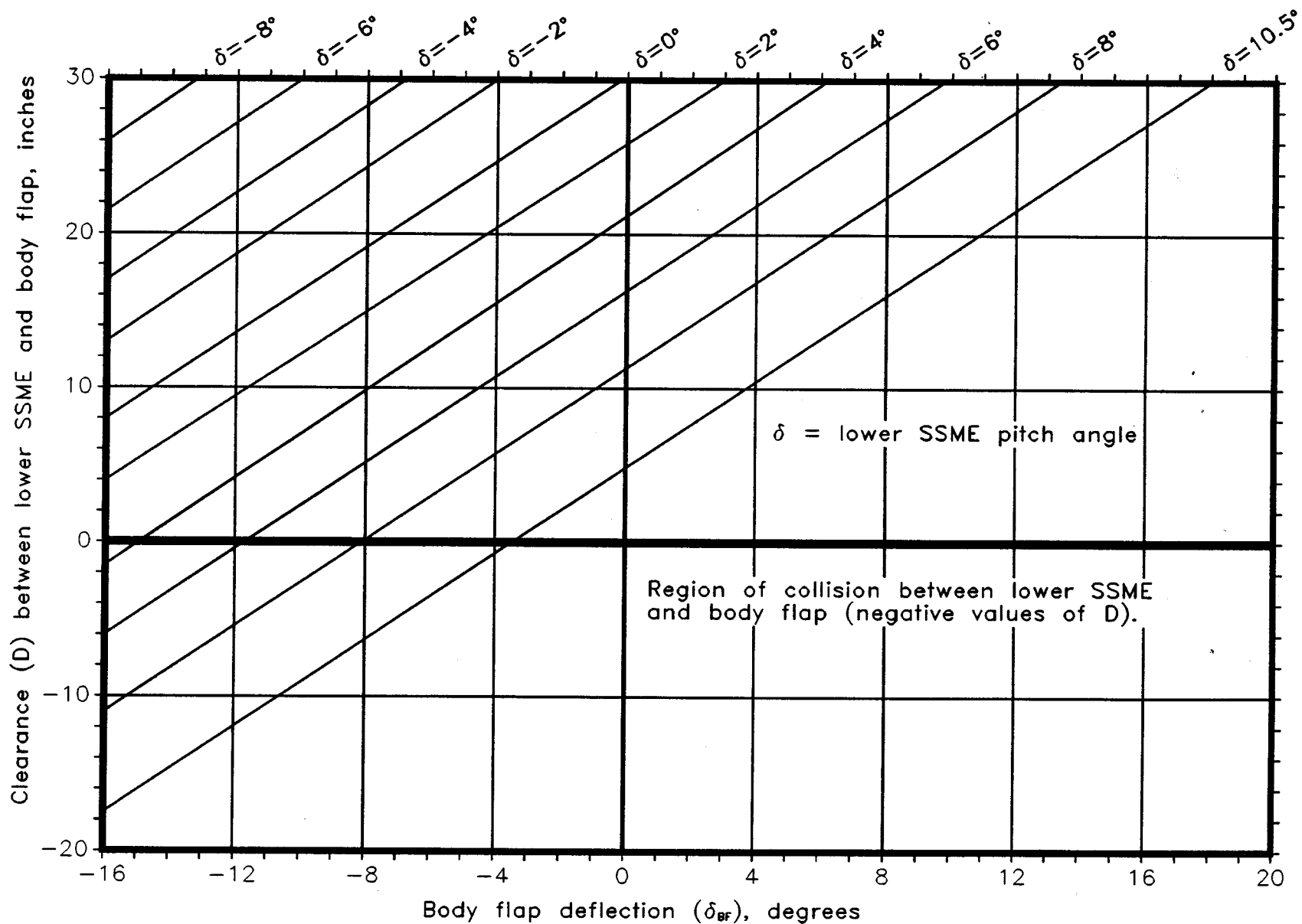

Figure 3.4.3.1-10.- Clearance between lower SSME and body flap as a function of Pitch gimbal angle ( $\delta$ ) for lower SSME and body flap deflection ( $\delta_{BF}$ ).  
(Paragraph 3.4.3.1)



## 3.4.3.2

Reaction Control Subsystems  
CONSTRAINTS/LIMITATIONS

## RESULT IF EXCEEDED

1. Temperature Limits.  
See table 3.4.3.2-1.
2. Helium Tank Pressure - Temperature Limits. See figure 4.3.2-15.
3. ARCS Propellant Landing Loads. No more than 1473 lb of oxidizer and 920 lb of fuel (99 percent of tank design load).<sup>a</sup>
4. RCS Thruster Firing During RMS Operations. See table 3.4.2.5-2.
5. Launch Constraints. ARCS propellant bulk temperatures at lift-off must be 74° F or above.
6. Manifold Repressurization.
  - a. If both the fuel and oxidizer manifold pressures are >130 psia, there is no constraint to repressurizing directly from the tank volume using the manifold isolation valve.
  - b. If either one of the fuel or oxidizer manifold pressures is < 130 psia (liquid in line) and the other is > 130 psia, there is no constraint to repressurizing directly from the tank volume using the manifold isolation valve.
  - c. If both the fuel and oxidizer manifold pressure are < 130 psia (liquid in lines), repressurization must be done using stage repressurization procedure.

Possible tank structural damage.

Analysis reflects that the bending moment due to landing with 99 percent tank load will not result in negative margins of safety on the midfuselage skin.

Excessive torque could damage or break manipulator arm.

Possible thruster damage during entry.

Engine valve bounce.

Engine valve bounce.

Engine valve bounce.

<sup>a</sup>The specification total landing weight and c.g. constraints (reference SODB Volume II, section 3.0) on the Orbiter still apply. If the maximum allowable specification weight for landing is exceeded due to 99 percent full ARCS tanks, the additional weight must be taken out of the payload.

- d. Evacuated manifolds should be repressurized using a read/write procedure to allow separate oxidizer and fuel pressurization. If read/write procedure is not possible, repressurize directly from the tank using the manifold isolation valve (one manifold at a time). However, repressurization of evacuated manifolds is not allowed unless required for crew/vehicle safety.

Surge pressures exceed design limit.

## 3.4.3.2

Reaction Control Subsystems (Cont)  
CONSTRAINTS/LIMITATIONS

## RESULT IF EXCEEDED

7. Crossfeed/Interconnect.

- a. Crossfeed/interconnect valve sequences should not connect propellant tank supplies except for the following cases with the limitations shown:
- (1) OMS-to-RCS contingency interconnect -
    - (a) OMS 0-to-50 psid higher pressure than RCS is allowed, zero-g operation only. Possible failure of tank bulkhead or ingestion of gas into propellant distribution system.
    - (b) RCS pressure higher is not recommended. Excessive propellant transfer from RCS to OMS.
  - (2) RCS-to-RCS contingency crossfeed in ascent or entry. Possible failure of tank bulkhead or ingestion of gas into propellant distribution system.
    - (a) Acceptable up to 55 psid tank  $\Delta P$  at anytime, with g level < 1.5 and temperatures > 46° F.
    - (b) Acceptable up to 80-psid tank  $\Delta P$  in ascent or low-g entry, if required for mission success.
  - b. Simultaneous shutdown to a no-flow condition during crossfeed/interconnect is limited to 5 thrusters. Excessive surge pressures.

8. Thruster Steady-State Firings.

- a. Nominal case Specification limit.
  - Primary - 150 sec maximum
  - Vernier - 125 sec maximum
- b. Single mission contingency case (Primary thrusters only) Possible structural damage due to over heating.
  - ARCS (+) X 800 sec maximum
  - FRCS (-) X 300 sec maximum
- c. Pre-MECO Aborts. Maximum expected burn time.
  - (Primary thruster only)
  - All ARCS - 550 sec. maximum

9. Thruster Duty Cycles.

- No more than 1000 'ON' commands on a vernier in 1 hour. Possible overheating of pressure transducer.

10. Thruster Minimum Inlet Pressure.

- a. No primary/vernier thruster operation below 185-psia tank pressure. Specification limit - possible unsafe thruster operation.
- b. Vernier thruster operation shall be terminated whenever the fuel tank pressure is 20 psid greater than the oxidizer tank pressure.

3.4.3.2 Reaction Control Subsystems (Cont)  
CONSTRAINTS/LIMITATIONS

RESULT IF EXCEEDED

11. Safe Operation of Primary Thrusters.

a. Aft RCS:

1. Minimum altitude:

- (a) Yaw thrusters to 70k ft.  
From 70k ft to 45k ft with minimum propellant temperature of 70° F<sup>a</sup> and a >4-second burn time on dormant manifolds prior to 70k ft. If required, to prevent mission impact, temperature limit may be reduced to 67° F with low risk of engine valve damage.
- (b) All other ARCS thrusters 165k ft.
- (c) Aborts to 70k ft for continuous burns only.  
No pulsing.
- (d) RTLS and TAL post-MECO ARCS propellant dump constraint.

Possible thruster damage. Valve leakage may not be detectable immediately, or during ground checkout. Valve leakage may occur during next mission when thrusters fired.

See paragraph 3.4.1.4-5

- 2. Minimum 'on' time 0.08 second above 125k ft and 0.320 second below 125k ft.

Possible thruster damage.

b. FRCS:

1. Minimum altitude:

- (a) Ascent and abort 165k ft.
- (b) On-orbit and entry 400k ft.

Adverse aerodynamic effects.

- 2. Minimum 'on' time 0.08 second.
- 3. A minimum altitude constraint of 125,000 feet<sup>b</sup> is applicable to the following thruster(s) firing(s) regardless of propellant temperatures.

Possible thruster damage. Firing of thrusters with titanium oxidizer splitters are susceptible to ZOTs.

POSITION	S/N
F1L	112
F3L	111
F1D	104
F2D	106
F2R	114
F2U	110
F3U	108
F1F	102

<sup>a</sup>Instrumentation error included.

<sup>b</sup>Firing below 125,000 ft is not currently certified.

3.4.3.2 Reaction Control Subsystems (Cont) CONSTRAINTS/LIMITATIONS	RESULT IF EXCEEDED
12. <u>Thruster Leak Management.</u>	
a. <u>Primary Thrusters</u>	Possible unstable thruster operation.
1. A primary thruster deselected by RM for a propellant leak may be reselected once the oxidizer and fuel injector temperatures warm up to > 65° F.	
2. For the prelaunch loss of an injector temperature, the thruster shall be put into last priority and not reselected unless needed to effect a safe end-of-mission. This provision is limited to one thruster per flight.	
b. <u>Vernier Thrusters</u>	
1. A vernier thruster deselected by RM for a propellant leak may be reselected once the oxidizer and fuel injector temperatures have been greater than 130° F for 3 hours.	Possible unstable thruster operation.
2. For the prelaunch loss of a single injector temperature, a thruster can still be used for nominal orbital operations. This provision is limited to one thruster per flight.	
13. <u>Thruster Injector Heaters.</u>	
a. Primary thruster heaters are considered lost if both the oxidizer and fuel injector temperatures exhibit a gradual cool down to < 50° F.	Possible propellant leak.
b. Vernier thrusters:	
1. Injector heater operational	Possible unsafe thruster operation.
(a) During vernier operation, the minimum allowable temperature is 130° F.	
(b) If the thruster has not fired for 1.5 hours, the minimum temperature limit can be reduced from 130° F to 90° F if:	
(1) Injector temperature decrease is less than 15° F/hr (between 130° F and 90° F)	

3.4.3.2 Reaction Control Subsystem (Cont)  
CONSTRAINTS/LIMITATIONS

RESULT IF EXCEEDED

13. Thrusters Injector Heaters.

b. Vernier thrusters: (Cont)

- (2) Chamber pressure must be zero
- (3) Thrusters first firing should be at least 10 seconds in duration

2. Injector heater failed off

- (a) Minimum injector temperature limit can be reduced from 130° F to 90° F if;

Possible unsafe thruster operation.

- (1) Injector temperature decrease is less than 2° F/min (between 130° F and 90° F)
- (2) Chamber pressure must be zero
- (3) Thrusters first firing should be at least 10 seconds in duration

14. Propellant Tank Performance.

a. Maximum number of primary thrusters firing per tank set.

Possible gas ingestion into propellant distribution system.

- (1) Normal mission/AOA/ATO mated coast/ET separation, on orbit  
FRCS - Five thrusters  
ARCS - Four thrusters
- (2) RTLS, TAL mated coast  
FRCS - Six thrusters  
ARCS - Seven thrusters
- (3) RTLS, TAL ET Separation  
FRCS - Five thrusters  
ARCS - Seven thrusters
- (4) Nominal mission entry  
ARCS - (PVT gaging ≥ 14 percent)  
Six thrusters for dump burn  
FRCS - (PVT gaging ≥ 0 percent)  
Four thrusters  
FRCS - Not used

3.4.3.2 Reaction Control Subsystems (Cont)  
CONSTRAINT/LIMITATIONS

## RESULT IF EXCEEDED

14. Propellant Tank Performance. (Cont)

- (5) RTLS, TAL, post ET SEP  
dump burns/entry  
ARCS - (PVT gaging >  
63.5 percent)  
Seven thrusters  
ARCS - (PVT gaging >  
14 percent)  
Six thrusters  
ARCS - (PVT gaging >  
0 percent)  
Four thrusters  
FRCS - Not used
- b. System Operation Procedures.
- (1) No pre-MECO firings.
- (2) FRCS off-load to 60 percent of tank design load (52 percent PVT) [See table 3.4.3.2-2 and paragraph 3.4.3.2-14d(1)]
- (3) No translation maneuvering in RCS crossfeed that exceeds firing four ARCS primary thrusters.
- (4) FRCS and ARCS burn durations are unlimited.
- c. Aft RCS tank failure management.
- (1) Normal mission, RTLS, and TAL-abort ET separation must be performed in crossfeed from a good RCS tank, if the pre-MECO failure resulted in the Orbiter PVT gaging quantity < 75 percent.
- (2) On-orbit primary thruster operations must be performed in crossfeed from a good RCS tank or interconnect from OMS after the OMS-1 burn, if pre-MECO failure resulted in Orbiter PVT gaging quantity < 75 percent. Constraint does not apply to vernier operation or high g ( $g \geq 0.05$ ) entry.
- NOTE
- Any loss of propellant prior to MECO will decrease the entry expulsion efficiency 11 percent.
- Possible gas ingestion into propellant distribution system.

## 3.4.3.2 Reaction Control Subsystems (Concluded)

## CONSTRAINTS/LIMITATIONS

- |  |  |
|--|--|
| <ul style="list-style-type: none"> <li>d. FRCS tank failure management           <ul style="list-style-type: none"> <li>(1) Normal mission, RTLS, and TAL abort ET separation must be performed using ARCS only, if the Pre-MECO failure or propellant usage resulted in the Orbiter PVT gaging quantity &lt; 52 percent.<sup>a</sup></li> </ul> </li> <li>15. <u>Helium Isolation Valves.</u><br/>Parallel helium isolation valves A and B should not be opened simultaneously.</li> <li>16. <u>Dc Isolation Valves.</u> <ul style="list-style-type: none"> <li>a. High-pressure helium isolation valve switches must be in GPC position within 1 hour after indication of electrical failure that can power both the open and closed coils.</li> </ul> </li> </ul> | <p>RESULT IF EXCEEDED<br/>Possible gas ingestion into propellant distribution system.</p> <p>May cause burst disk damage.</p> <p>When valves are closed and valve control switch is closed, single-point electrical failures can result in continuous power being applied to open and close coils causing close coil to short (high current) with possible additional electrical circuit damage. Will require valve replacement.</p> |
|--|--|

<sup>a</sup> Does not protect abort mated coast - ET separation capability following pre-MECO single main engine roll control usage. TBD lb (TBD percent PVT) additional propellant must be loaded for single engine roll control allocation. For STS-26, 328 lb additional propellant was loaded; this quantity must be loaded for subsequent flights (above 52 percent) until the correct quantity is determined.



TABLE 3.4.3.2-1.- REACTION CONTROL SUBSYSTEM COMPONENT TEMPERATURE LIMITS  
(Paragraph 3.4.3.2)

Components	During flight temperature limits				Ground/ferry flight temperature limits			
	Minimum Temperature, °F	Critical Item and Results If Exceeded	Maximum Temperature, °F	Critical Item and Results If Exceeded	Minimum Temperature, °F	Critical Item and Results If Exceeded	Maximum Temperature, °F	Critical Item and Results If Exceeded
Helium lines and components	20 <sup>a</sup>	Propellant freeze	150	Maximum certification temperature	-23	Minimum certification temperature	150	Maximum certification temperature
Helium storage bottle	-160	Minimum certification temperature	125/150 <sup>b</sup>	Design limit	-160	Minimum operating blowdown temperature	200	Maximum certification temperature
Propellant tank (bulk) ARCS	50/70 <sup>c</sup>	Minimum tank certification temperature/zots prevention	100 <sup>d</sup>	Tank expulsion efficiency certification	20	Oxidizer freeze	150	Maximum certification temperature
Propellant tank (bulk) FRCS	40	Minimum certification temperature	100 <sup>d</sup>	Maximum operating temperature	20	Oxidizer freeze	150	Maximum certification temperature
Propellant tank (skin)	40	Minimum thruster operating temperature	100 <sup>e</sup>	Maximum certification temperature	20	Oxidizer freeze	150	Maximum certification temperature
Propellant distribution system	40/70 <sup>c</sup>	Minimum thruster operating temperature/zots prevention	100/150 <sup>f</sup>	Maximum thruster operating temperature	20	Oxidizer freeze	150	Maximum certification temperature
Thruster, primary mounting flange	N/A	N/A	400 <sup>g</sup> 500 <sup>h</sup>	Maximum certification temperature	N/A	N/A	400 <sup>g</sup> 500 <sup>h</sup>	Maximum certification temperature
Nozzle (columbian)	N/A	N/A	2400	Operating limit	N/A	N/A	2400	Maximum specification temperature
Injector	+20(FU) +30(OX)	Leak detection temperature limit	800 <sup>i</sup>	Operating limit	15 <sup>j</sup>	Oxidizer freeze	800	Maximum specification temperature
Control valve	50 <sup>k</sup>	Leak prevention	150 <sup>l</sup>	Maximum certification temperature-seal life	50 <sup>k</sup>	Leak prevention	230 <sup>i</sup>	Maximum certification temperature

<sup>a</sup> Minimum temperature of helium flow media; -30° F normal operation, -140° F RTLS, minimum flow media through relief valve - 180° F.

<sup>b</sup> PVT < 85%, 150° F with propellant; PVT > 85%, 125° F with propellant.

<sup>c</sup> AFT RCS for entry. See section 3.4.3.2-11a.

<sup>d</sup> On-orbit; 85° F for ascent and aborts; 150° F fuel, 125° F oxidizer after last use on entry through safing.

<sup>e</sup> 150° F localized region permissible.

<sup>f</sup> 150° F - 5 second transient.

<sup>g</sup> Mounting flange temperature for ±Z and ±Y ARCS thrusters.

<sup>h</sup> Mounting flange temperature for ±X and forward RCS thrusters.

<sup>i</sup> 800° F injector face maximum temperature; 250° F maximum leak detection temperature instrument range.

<sup>j</sup> Allows for ΔT between injector and control valve.

<sup>k</sup> 40° F minimum certification temperature.

<sup>l</sup> See table L.

TABLE 3.4.3.2-1.- REACTION CONTROL SUBSYSTEM COMPONENT TEMPERATURE LIMITS (Concluded)  
(Paragraph 3.4.3.2)

During flight temperature limits				Ground/ferry flight temperature limits				
Components	Minimum Temperature, °F	Critical Item and Results If Exceeded	Maximum Temperature, °F	Critical Item and Results If Exceeded	Minimum Temperature, °F	Critical Item and Results If Exceeded	Maximum Temperature, °F	Critical Item and Results If Exceeded
Thruster, vernier mounting flange	N/A	N/A	400	Maximum certification temperature	N/A	N/A	400	Maximum certification temperature
Nozzle (Columbia)	N/A	N/A	2200	Operating limit	N/A	N/A	2400	Maximum specification temperature
Injector	130	Leak detection temperature limit	800 <sup>i</sup>	Operating limit	15 <sup>j</sup>	Oxidizer freeze	800	Maximum specification temperature
	90 <sup>m</sup>	Orbit minimum cold start						
Control valve and feedlines in AFT compartment	40	Minimum certification temperature	200 <sup>n</sup>	Maximum certification temperature - seal life	20	Oxidizer freeze	250 <sup>m</sup>	Maximum certification temperature
Test port couplings and lines (helium)	-65	Minimum certification temperature	150	Maximum certification temperature	-65	Minimum certification temperature	150	Maximum certification temperature
Test port couplings and lines (prop)	-30 (FU) +20 (OX)	Propellant freeze	150	Maximum certification temperature	-30 (FU) +20 (OX)	Propellant freeze	150	Maximum certification temperature

<sup>i</sup> 800° F injector face maximum temperature; 250° F maximum leak detection temperature instrument range.

<sup>j</sup> Allows for ΔT between injector for control valve.

<sup>m</sup> See section 3.4.3.2.13b.

<sup>n</sup> See table N.

Note L: RCS PRIMARY THRUSTER CONTROL VALVE TEMPERATURES					
Mission phase	Note (see below)	Temperature, °F	ΔP across valve, psid	Time duration per mission	Thruster usage
Prelaunch	d	40 to 100	50 to 320	Unlimited	Non-operating
Flight (nominal)	e	50 to 150 <sup>c</sup>	175 to 264	Mission duration	Operating
	f	150 to 230 max	175 to 300	1 hour	Non-operating
Flight (failure mode 1) <sup>a</sup>	g	40 to 150	175 to 350	1 hour/100 mission	Operating
Flight (failure mode 2) <sup>b</sup>	h	40 to 150	175 to 320	6 hours	Non-operating
Flight (Failure mode 3) <sup>c</sup>	i	30 (min)	175 to 320	12 hours/100 mission	Non-operating
	j	230 (maximum)	175 to 320	12 hours/100 mission	Non-operating
Post Flight	k	230 (maximum)	50 to 320	1 hour	Non-operating

<sup>a</sup>Failure mode 1: Pressurization system failure

<sup>b</sup>Failure mode 2: Manifold or tank isolation valves closed

<sup>c</sup>Failure mode 3: Heater failure

Notes:

<sup>d</sup>Pre-launch operations with or without propellant in line (also includes ferry flight)

<sup>e</sup>Nominal flight operations

<sup>f</sup>Entry and descent to landing after last use

<sup>g</sup>On-orbit operations with pressurization system failure

<sup>h</sup>On-orbit operations with manifold or tank isolation valve closed

<sup>i</sup>On-orbit operations with thruster heater failure

<sup>j</sup>Entry and descent to landing after on-orbit thruster heater failure

<sup>k</sup>Post landing operations

<sup>l</sup>May increase to 175° F for mission duration (operating) once per 100 missions

NOTE N: RCS VERNIER THRUSTER CONTROL VALVE TEMPERATURES

Mission phase	Note (See below)	Temperature °F	ΔP across valve (psid)	Time duration (per mission)	Thruster usage
Prelaunch	d	20 to 100	50 to 320	Unlimited	Non-operating
Flight (nominal)	e	130 to 200	175 to 264	Mission duration	Operating
	f	200 to 250 max	175 to 300	1 hour	Non-operating
	g	40 to 250	175 to 350	1 hour/100 missions	Operating
Flight (failure mode 2) <sup>b</sup>	h	40 to 195	175 to 320	6 hours	Non-operating
Flight (failure mode 3) <sup>c</sup>	i	30 minimum	175 to 320	12 hours/100 missions	Non-operating
	j	250 maximum	175 to 320	12 hours/100 missions	Non-operating
Post flight	k	250 maximum	50 to 320	1 hour	Non-operating

- <sup>a</sup> Failure mode 1: Pressurization system failure
- <sup>b</sup> Failure mode 2: Manifold or tank isolation valves closed
- <sup>c</sup> Failure mode 3: Heater failure

Notes:

- <sup>d</sup> Prelaunch operations with or without propellant in line (also includes ferry flight)
- <sup>e</sup> Nominal flight operations
- <sup>f</sup> Entry and descent to landing
- <sup>g</sup> On-orbit operations with pressurization system failure
- <sup>h</sup> On-orbit operations with manifold or tank isolation valve closed
- <sup>i</sup> On-orbit operations with thruster heater failure
- <sup>j</sup> Entry and descent to landing after on-orbit thruster heater failure
- <sup>k</sup> Post landing operations
- <sup>l</sup> May increase to 250° F for 2 hours (operating) per mission. Orbit minimum cold start is 90° F; see section 3.4.3.2.13b

135

3.4.3.2-11

TABLE 3.4.3.2-2.- REACTION CONTROL SUBSYSTEM CALCULATED LOADING DATA - (FRCS PARTIAL LOAD)<sup>a</sup>  
(Paragraph 3.4.3.2)

Parameters	Percent of full load											
	60 <sup>b</sup> (52 percent PVT)			70 <sup>b</sup> (63 percent PVT)			80 <sup>b</sup> (74 percent PVT)			90 <sup>b</sup> (85 percent PVT)		
Fluids/pressurant	Oxidizer, lb	Fuel, lb	Helium, psig	Oxidizer, lb	Fuel, lb	Helium, psig	Oxidizer, lb	Fuel, lb	Helium, psig	Oxidizer, lb	Fuel, lb	Helium, psig
Tank, including residuals (PVT)	935.7	591.7	525	1082.1	684.0	450	1228.7	776.4	375	1375.8	869.1	300
Tank, not including residuals <sup>c</sup>	908.5	572.0	525	1055.2	664.3	450	1202.1	757.2	375	1350.4	850.4	300

- Notes:
- <sup>a</sup> 1. The values shown include PVT, PV, totalizer, and residual inaccuracies.
  2. Use linear interpolation if load is between the values shown.
  3. Loads are based on PV check. Equalization pressure is approximately 185 psig when starting from helium pressure values shown.
  4. Load values do not include the propellants in the manifolds, (38 lb for oxidizer manifold and 21 lb for fuel manifold)
  5. Load propellants using GSE totalizer.
  6. Verify propellant load with PV check
    - (A) If difference is less than 30 lb oxidizer and 20 lb fuel, use PV load
    - (B) If difference is less than 55 lb oxidizer, 40 lb fuel, rerun PV check  
If the two PV checks are within 30 lb oxidizer and 20 lb fuel, use minimum PV load
    - (C) If difference is greater than 55 lb oxidizer and 40 lb fuel, adjust load to be within "6A" requirements.  
Rerun PV check and use PV load.
- <sup>b</sup> Target load values (lb) assure a minimum of specified percent partial design loads
- <sup>c</sup> Dry or horizontal drain to gas break prior to loading.

136

3.4.3.2-12

Amendment 220

NOTE N: RCS VERNIER THRUSTER CONTROL VALVE TEMPERATURES

Mission phase	Note (See below)	Temperature °F	ΔP across valve (psid)	Time duration (per mission)	Thruster usage
Prelaunch	d	20 to 100	50 to 320	Unlimited	Non-operating
Flight (nominal)	e	130 to 200	175 to 264	Mission duration	Operating
	f	200 to 250 max	175 to 300	1 hour	Non-operating
Flight (failure mode 1) <sup>a</sup>	g	40 to 250	175 to 350	1 hour/100 missions	Operating
Flight (failure mode 2) <sup>b</sup>	h	40 to 195	175 to 320	6 hours	Non-operating
Flight (failure mode 3) <sup>c</sup>	i	30 minimum	175 to 320	12 hours/100 missions	Non-operating
	j	250 maximum	175 to 320	12 hours/100 missions	Non-operating
Post flight	k	250 maximum	50 to 320	1 hour	Non-operating

- <sup>a</sup> Failure mode 1: Pressurization system failure
- <sup>b</sup> Failure mode 2: Manifold or tank isolation valves closed
- <sup>c</sup> Failure mode 3: Heater failure

Notes:

- <sup>d</sup> Prelaunch operations with or without propellant in line (also includes ferry flight)
- <sup>e</sup> Nominal flight operations
- <sup>f</sup> Entry and descent to landing
- <sup>g</sup> On-orbit operations with pressurization system failure
- <sup>h</sup> On-orbit operations with manifold or tank isolation valve closed
- <sup>i</sup> On-orbit operations with thruster heater failure
- <sup>j</sup> Entry and descent to landing after on-orbit thruster heater failure
- <sup>k</sup> Post landing operations
- <sup>l</sup> May increase to 250° F for 2 hours (operating) per mission. Orbit minimum cold start is 90° F; see section 3.4.3.2.13b

TABLE 3.4.3.2-2.- REACTION CONTROL SUBSYSTEM CALCULATED LOADING DATA - (FRCS PARTIAL LOAD)<sup>a</sup>  
(Paragraph 3.4.3.2)

Parameters	Percent of full load											
	60 <sup>b</sup>			70 <sup>b</sup>			80 <sup>b</sup>			90 <sup>b</sup>		
Fluids/pressurant	Oxidizer, lb	Fuel, lb	Helium, psig	Oxidizer, lb	Fuel, lb	Helium, psig	Oxidizer, lb	Fuel, lb	Helium, psig	Oxidizer, lb	Fuel, lb	Helium, psig
Tank, including residuals (PVT)	935.7	591.7	525	1082.1	684.0	450	1228.7	776.4	375	1375.8	869.1	300
Tank, not including residuals <sup>c</sup>	908.5	572.0	525	1055.2	664.3	450	1202.1	757.2	375	1350.4	850.4	300

- Notes:
- <sup>a</sup>1. The values shown include PVT, PV and totalizer inaccuracies.
  2. Use linear interpolation if load is between the values shown.
  3. Loads are based on PV check. Equalization pressure is approximately 185 psig when starting from helium pressure values shown.
  4. Load values do not include the propellants in the manifolds, (38 lb for oxidizer manifold and 21 lb for fuel manifold)
  5. Load propellants using GSE totalizer.
  6. Verify propellant load with PV check
    - (A) If difference is less than 30 lb oxidizer and 20 lb fuel, use PV load
    - (B) If difference is less than 55 lb oxidizer, 40 lb fuel, rerun PV check  
If the two PV checks are within 30 lb oxidizer and 20 lb fuel, use minimum PV load
    - (C) If difference is greater than 55 lb oxidizer and 40 lb fuel, adjust load to be within "6A" requirements.  
Rerun PV check and use PV load.

<sup>b</sup>Target load values (lb) assure a minimum of specified percent partial design loads

<sup>c</sup>Dry or horizontal drain to gas break prior to loading.

## 3.4.3.3

Orbital Maneuvering Subsystem  
CONSTRAINTS/LIMITATIONS

## RESULT IF EXCEEDED

- |   |  |
|---|--|
| <ol style="list-style-type: none"> <li>1. <u>Orbital Maneuvering Subsystem Temperature Limits.</u><br/>See table 3.4.3.3-1.</li> <li>2. <u>OMS Helium Tank Fill Envelope.</u><br/>See figure 4.3.3-11.</li> <li>3. <u>Maximum Positive Longitudinal Acceleration for Safe Engine Start and Operation.</u> The maximum positive longitudinal acceleration for safe engine start and operation is 3.0g.</li> <li>4. <u>Minimum Altitude for Safe Operation.</u> The minimum altitude for safe engine operation is 70,000 ft.</li> <li>5. <u>Engine ON/OFF Time Limitations.</u> <ol style="list-style-type: none"> <li>a. With normal shutdown purge:           <ol style="list-style-type: none"> <li>1. The minimum engine off-time between firings is 240 sec for normal operation and 30 sec for launch abort operation (after a minimum 15-second burn).</li> <li>2. Engine firings of &lt; 2 sec are prohibited. If an engine shuts off &lt; 2 sec after starting, it must not be restarted for at least 30 minutes.</li> </ol> </li> <li>b. Without shutdown purge:           <ol style="list-style-type: none"> <li>1. For a burn duration of at least 10 seconds, the engine must not be restarted for at least 10 minutes.</li> <li>2. For a burn duration of less than 10 seconds, the engine must not be restarted until all residual propellant has dissipated.</li> </ol> </li> <li>c. After propellant depletion, the engine must not be restarted.</li> </ol> </li> </ol> | <p>Insufficient helium for mission or tank overpressurization. Exceed design limit.</p> <p>Separated flow may cause nozzle extension over-heating and structural failure or burnthrough.</p> <p>Possible propellant freezing in injector and/or hard starts.</p> <p>Possible propellant freezing in injector and/or hard starts.</p> <p>Possible propellant freezing in injector and/or hard starts.</p> <p>No test data for this condition; possible propellant freezing in injector and hard starts.</p> <p>Engine may be damaged from depletion shutdown; residual gas in feed system may cause hard start.</p> |
|---|--|

Note: Engine hard start may cause uncontained engine damage.

3.4.3.3-1



3.4.3.3 Orbital Maneuvering Subsystem (Cont)  
CONSTRAINTS/LIMITATIONS

6. Propellant Loads.

- a. Minimum propellant load in the OMS tanks at launch is 2038 lb of fuel and 3362 lb of oxidizer per pod.
- b. Maximum propellant load in the OMS tanks is 4711.5 lb of fuel and 7743.5 lb of oxidizer per pod.
- c. An RCS settling burn is required prior to each OMS propellant usage post-MECO, if there is < 1308 lb of fuel and < 2158 lb of oxidizer per tank remaining after the pre-MECO burn. See table 3.4.3.3-2 for RCS settling requirements.
- d. Minimum propellant load in the tank aft compartment for normal zero-g engine startup and OMS/RCS interconnect operation is 504 lb of fuel and 831 lb of oxidizer. See table 3.4.3.3-2 for RCS settling requirements.
- e. At TAEM interface, oxidizer must be < 1707 lb/tank and fuel < 1032 lb/tank (~22 percent of tanked propellant).

7. OMS Operation in Interconnect/  
Crossfeed.

- a. OMS tank-to-OMS tank shall not be connected during OMS/RCS interconnect (except for aborts).
- b. Valve configuration will be such that during non-firing operation, OMS tank-to-OMS tank will not be connected.

RESULT IF EXCEEDED

OMS propellant acquisition screens not immersed in propellant are not certified for launch vibration environment. Exceed maximum load for structural certification.

Screens will dry out during boost and propellant may spill into forward compartment at MECO. Remaining aft compartment propellant may not be sufficient to provide gas-free outflow at engine start.

May not have adequate communication between the tank acquisition galleries and aft compartment bulk propellant.

Exceed OMS/RCS pod structural design loads.

Propellant transfer between tanks will increase OMS residual propellants. Same as 7a; also, if differential pressure between tanks exceeds 20 psid, acquisition screen damage may occur.

## 3.4.3.3

Orbital Maneuvering Subsystem (Cont).  
CONSTRAINTS/LIMITATIONS

- |   |   |
|---|---|
| <p>c. OMS tank-to-RCS tank may be connected per subparagraph 7 of paragraph 3.4.3.2 (RCS constraints).</p> <p>d. OMS-to-RCS interconnect is allowed only:</p> <p>(1) during ascent aborts with a positive (+X) settling force;</p> <p>(2) during any OMS firing;</p> <p>(3) during on-orbit operations.</p> <p>e. OMS-to-RCS interconnect is not allowed during entry phases when acceleration levels or propellant quantities violate constraints defined in figures 3.4.3.3-1, 3.4.3.3-2, and 3.4.3.3-3.</p> <p>f. OME minimum inlet pressure for pre-MECO interconnected abort dumps:</p> <p>(1) 2 OME + 24 RCS thrusters firing:<br/>196 psia (oxidizer)<br/>213 psia (fuel)</p> <p>(2) 1 OME + 18 RCS thrusters firing:<br/>183 psia (oxidizer)<br/>198 psia (fuel)</p> <p>8. <u>Maximum Number of OMS Starts.</u></p> <p>a. Acquisition system constraint. See subparagraph 16b of paragraph 3.4.3.3.</p> <p>b. Pneumatic system constraint. Nominally 15 starts and purges per OME to reach minimum regulator inlet pressure (depends on mission time and leakage). See figure 4.3.3-16.</p> <p>9. <u>OMS Burns During RMS Operations.</u><br/>Refer to table 3.4.2.5-2.</p> | <p>RESULT IF EXCEEDED<br/>See subparagraph 7 of paragraph 3.4.3.2.</p> <p>Will not maintain bubble-free propellant to RCS.</p> <p>Same as subparagraph d.</p> <p>Possible unsafe RCS thruster operation or deselection due to low manifold pressure.</p> <p>Inability to start engine.</p> <p>Excessive torque would damage or break the manipulator arm. Possible payload/Orbiter contact.</p> |
|---|---|

3.4.3.3-3

## 3.4.3.3 Orbital Maneuvering Subsystem (Cont)

## CONSTRAINTS/LIMITATIONS

10. Helium Isolation Valves.

The helium isolation valve switches must be in the GPC position at launch. (Valves must be in closed position during launch vibration, but in a ready-state for RTLS, TAL or ATO abort.)

11. Minimum Chamber Pressure (Pc).

a. Pc must be > 80 percent<sup>a</sup> (100 psia) when not in ullage blowdown mode.

b. Pc must be > 72 percent<sup>a</sup> (90 psia) in ullage blowdown mode. (OME inlet pressure > 158 psia).

12. Propellant Temperature. The absolute  $\Delta T$  between oxidizer and fuel bulk propellants must not exceed 10° F.

13. OME Start Envelope.  
See figure 4.3.3-12.

14. Engine Fuel Injector Temperature.  
The maximum allowable fuel injector temperature during operation of an OME is 260° F.

15. OMS Gaseous Nitrogen Accumulator Pressures.

a. Minimum pressure:

- (1) GN<sub>2</sub> tank isolation valve open = 244 psia<sup>b</sup>.
- (2) GN<sub>2</sub> tank isolation valve closed = 283 psia.

b. Maximum accumulator leak rate pre-burn and during engine start sequence: 334 sccs

RESULT IF EXCEEDED  
Possible valve damage.

Operation in this regime of unverified cooling and stability margins, accompanied by mixture ratio unbalance, may cause engine damage at mixture ratio extremes. Reduction in engine safety factors may cause engine damage due to overheating and/or combustion instability. Mixture ratio shifts result in decreased usable propellant.

Possible engine damage if operated outside the limit to which it was tested.

Possible uncontained engine damage.

Engine slow response time and combustion instability due to partially open engine ball valve.

Leakage through purge valves into fuel circuit could effect engine start transient and cause a hard start.

<sup>a</sup>Instrumentation error included

<sup>b</sup>Nitrogen tank pressure must be equal to or greater than accumulator pressure.

3.4.3.3 Orbital Maneuvering Subsystem (Cont)  
 CONSTRAINTS/LIMITATIONS  
 16. OMS Propellant Acquisition System.

## RESULT IF EXCEEDED

## a. OMS-to-RCS interconnect:

(1) Except for +X RCS, no RCS interconnect shall be made to OMS using a tank with a bulkhead screen failure. A decrease of > 1 percent in the aft compartment quantity (after the 14-second integration period) while the forward compartment still contains propellant is an indication of bulkhead screen failure.

Depletion of aft compartment propellant will lead to helium ingestion in the RCS engines and the OME (in subsequent OMS burns).

(2) When the forward RCS is being used for -X, RCS interconnect usage from OMS is limited by figure 3.4.3.3-4.

Depletion of aft compartment propellant will lead to helium ingestion in the RCS engines and the OME (in subsequent OMS burns).

(3) Subject to previous subparagraph (a1 and a2), RCS interconnect to OMS is constrained as follows:

Depletion of aft compartment propellant will lead to helium ingestion in the RCS engines and the OME (in subsequent OMS burns).

(a) OMS propellant quantity > 45 percent - no limitation on interconnect usage;

(b) OMS propellant quantity > 40 percent - no limitation on interconnect usage for attitude control;

(c) OMS propellant quantity of < 45 percent (general use) or < 40 percent (attitude control use only) see figure 3.4.3.3-4.

## b. OMS engines starts:

(1) OMS propellant quantity > 40 percent - no acquisition system constraint;

(2) OMS propellant quantity < 40 percent - see figure 3.4.3.3-4.

Depletion of aft compartment propellant will lead to helium ingestion in the RCS engines and the OME (in subsequent OMS burns).

3.4.3.3-5

3.4.3.3 Orbital Maneuvering Subsystem (Concluded).

CONSTRAINTS/LIMITATIONS

c. Maximum lateral acceleration - OMS usage is not allowed when acceleration levels or propellant quantities violate constraints in figures 3.4.3.3-5 and 3.4.3.3-6.

17. OMS Crossfeed Line Usage. The OMS crossfeed line must not be opened to the OMS or RCS tankage when the indicated crossfeed line pressure is less than vapor pressure plus instrumentation error.

RESULT IF EXCEEDED  
Acquisition screen breakdown will lead to helium ingestion and possible engine damage.

Potential component/feedline damage due to line pressure surges.

Propellant	Vapor pressure, psia	Instrumentation error, psia	Indicated crossfeed line pressure, psia
Fuel	1	34	35
Oxidizer	15	34	49

18. OMS Engine with Failed-Open Ball Valve.

- a. An OMS engine with a failed-open ball valve indicating a position of > 5 percent<sup>a</sup> and < 70 percent<sup>a</sup> open when not firing shall not be used unless the other engine has failed, and then only for the deorbit burn.
- b. An OMS engine with a failed-open ball valve indicating a position of > 70 percent<sup>a</sup> and < 100 percent<sup>a</sup> open when not firing shall be used only for the deorbit burn.

Failure of the redundant ball valve in the open position will result in loss of propellant.

19. Pod Heater Operation.

A and B system heater switches must not be in "AUTO" position at the same time.  
Loss of heater.

Local overheating of heater patch; failure of heater patch bond.

<sup>a</sup>Instrumentation error included

TABLE 3.4.3.3-1.- ORBITAL MANEUVERING SUBSYSTEM TEMPERATURE LIMITS FOR SYSTEM MONITORING  
(Paragraph 3.4.3.3)

Components	During flight temperature limits				Ground ferry/flight temperature limits			
	Minimum Temperature, °F	Critical Item and Results If Exceeded	Maximum Temperature, °F	Critical Item and Results If Exceeded	Minimum Temperature, °F	Critical Item and Results If Exceeded	Maximum Temperature, °F	Critical Item and Results If Exceeded
Engine valve	30	Minimum certification temperature	150	Maximum certification temperature	20	Oxidizer freeze	150	Maximum certification - seal life
Propellant (Fu. and Ox.) Engine feedline and components	30 <sup>b</sup>	Engine operating limit for engine start	125 <sup>a</sup>	Engine operating limit	20	Oxidizer freeze	150	Maximum certification temperature
Vehicle cross-feed lines and components	40	RCS operating limit	125	Engine operating limit	20	Oxidizer freeze	150	Maximum certification temperature
Engine fuel injector temperature	N/A	N/A	260	Thrust chamber burnout	N/A	N/A	N/A	N/A
Propellant tank (bulk)	40/55 <sup>c</sup>	Steady-state engine operating limit	100/85 <sup>c</sup>	Engine operating limit	20	Oxidizer freeze	100	Maximum certification temperature with propellant
Propellant tank (skin)	40	Steady-state engine operating limit	100/150 <sup>d</sup>	Structural certification limit	20	Oxidizer freeze	150	Structural certification limit
Helium lines and components	25	Minimum certification temperature	150	Maximum certification temperature	-30	Minimum certification temperature	150	Maximum certification temperature
Helium storage bottles	-160	Minimum certification temperature	200	Structural limit when bottle is loaded. Tank qualified limit	-160	Minimum certification temperature	200	Maximum certification temperature
Service panels: Coupling and lines	20 <sup>e</sup>	Minimum certification temperature	150	Maximum certification temperature	20	Minimum certification temperature	200	Maximum certification temperature

<sup>a</sup> Engine hot slug start transient restriction; see 4.3.3.4(d).

<sup>b</sup> Engine cold slug start transient restriction; see 4.3.3.4(d).

<sup>c</sup> Temperature limit for ascent phase engine operation.

<sup>d</sup> Propellant tank skin temperature is 100°F for launch and boost.

<sup>e</sup> MMH couplings lower limit is -30°F.

TABLE 3.4.3.3-2.- BURN TIMES REQUIRED FOR OMS PROPELLANT SETTLING  
(Paragraph 4.3.3.3)

Propellant quantity, percent	2 +X settling burn time, seconds	4 +X settling burn time, seconds
1	9.4	6.7
2	9.1	6.5
3	8.8	6.3
4	8.6	6.2
5	8.5	6.1
6	8.3	6.0
7	8.2	5.9
8	8.1	5.8
9	7.9	5.7
10	7.8	5.5
11	7.6	5.4

3.4.3.3-8

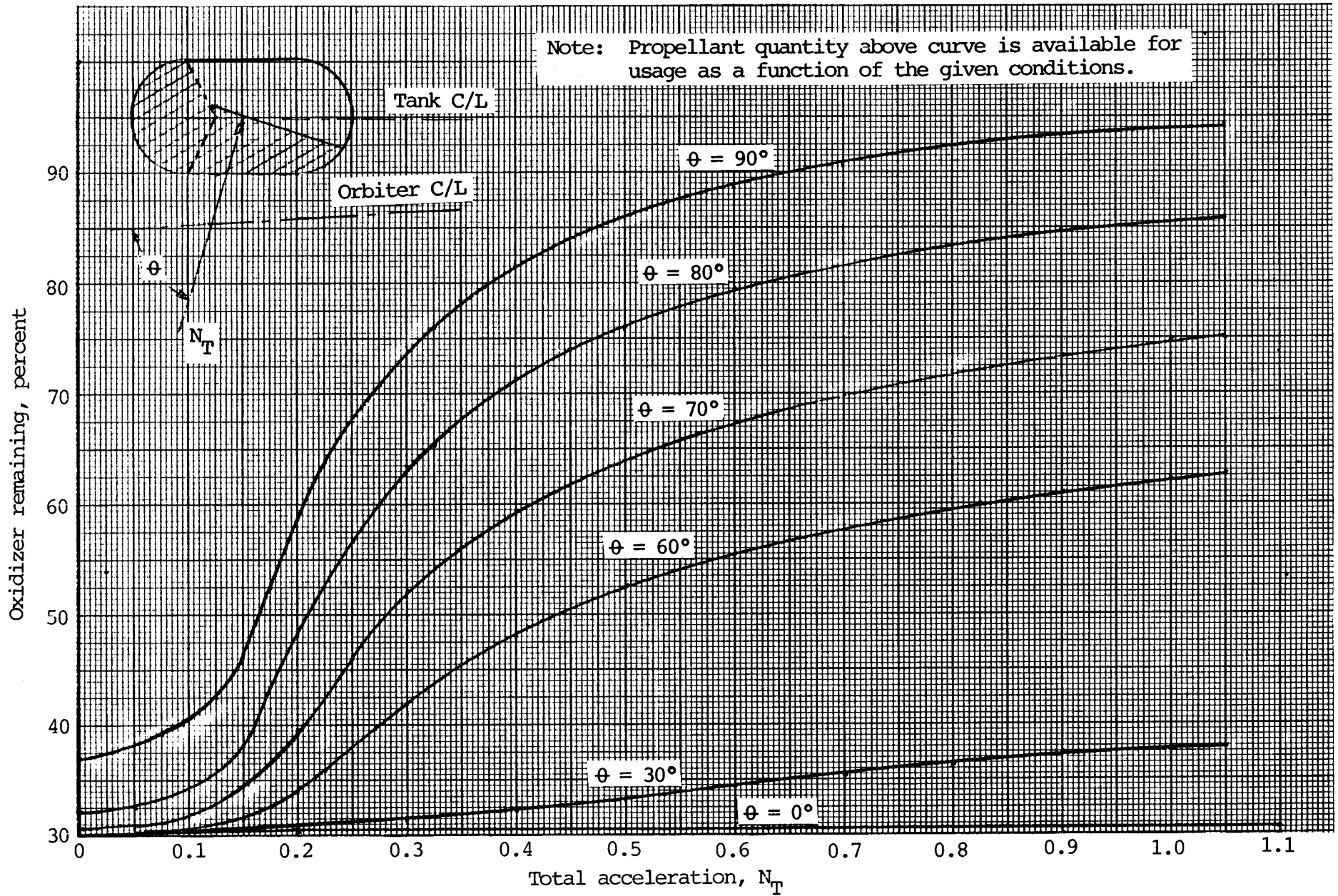

Figure 3.4.3.3-1.- Forward compartment flow limit - oxidizer tank.  
(Paragraph 3.4.3.3)



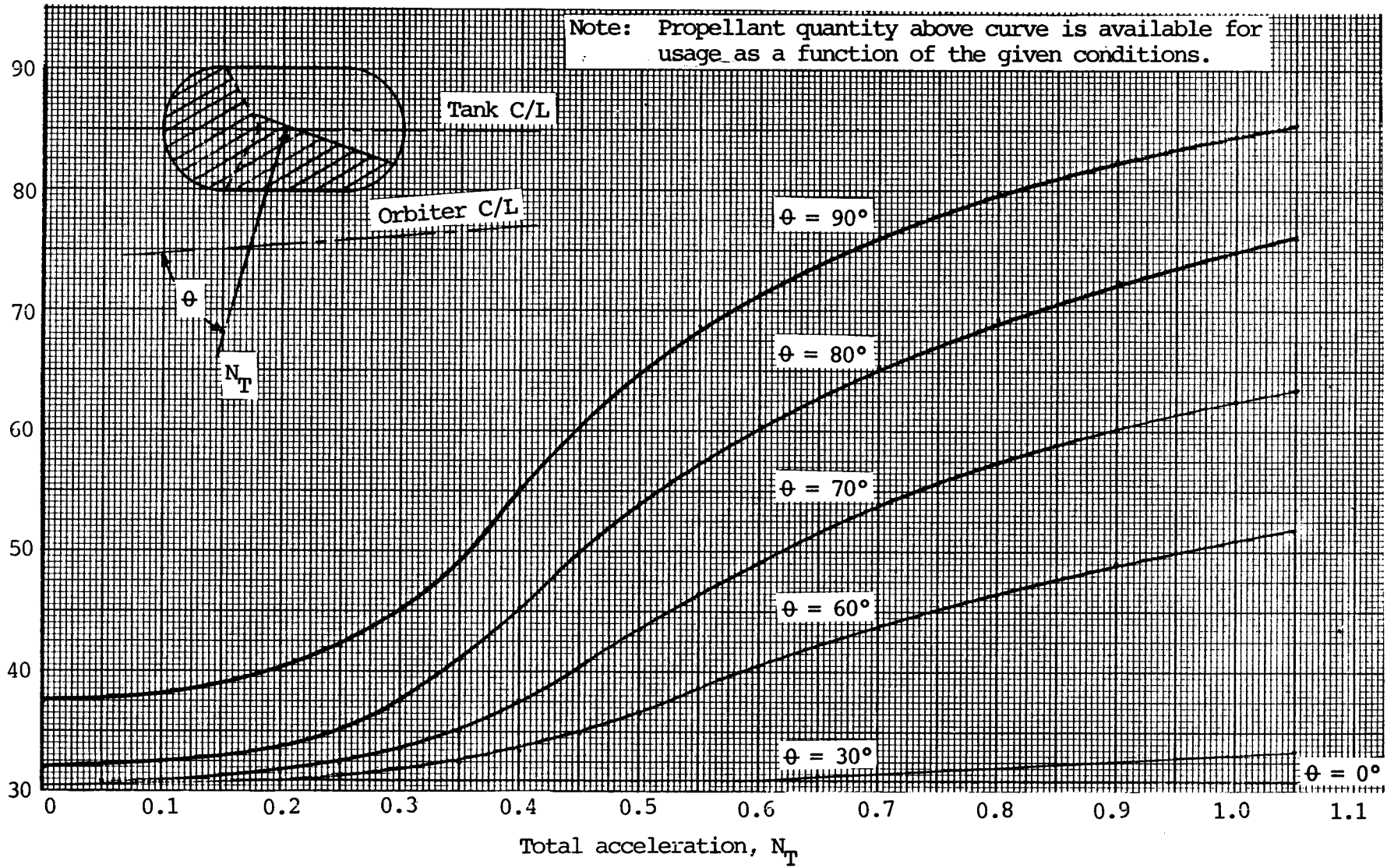

Figure 3.4.3.3-2.- Forward compartment flow limit - fuel tank.  
(Paragraph 3.4.3.3)

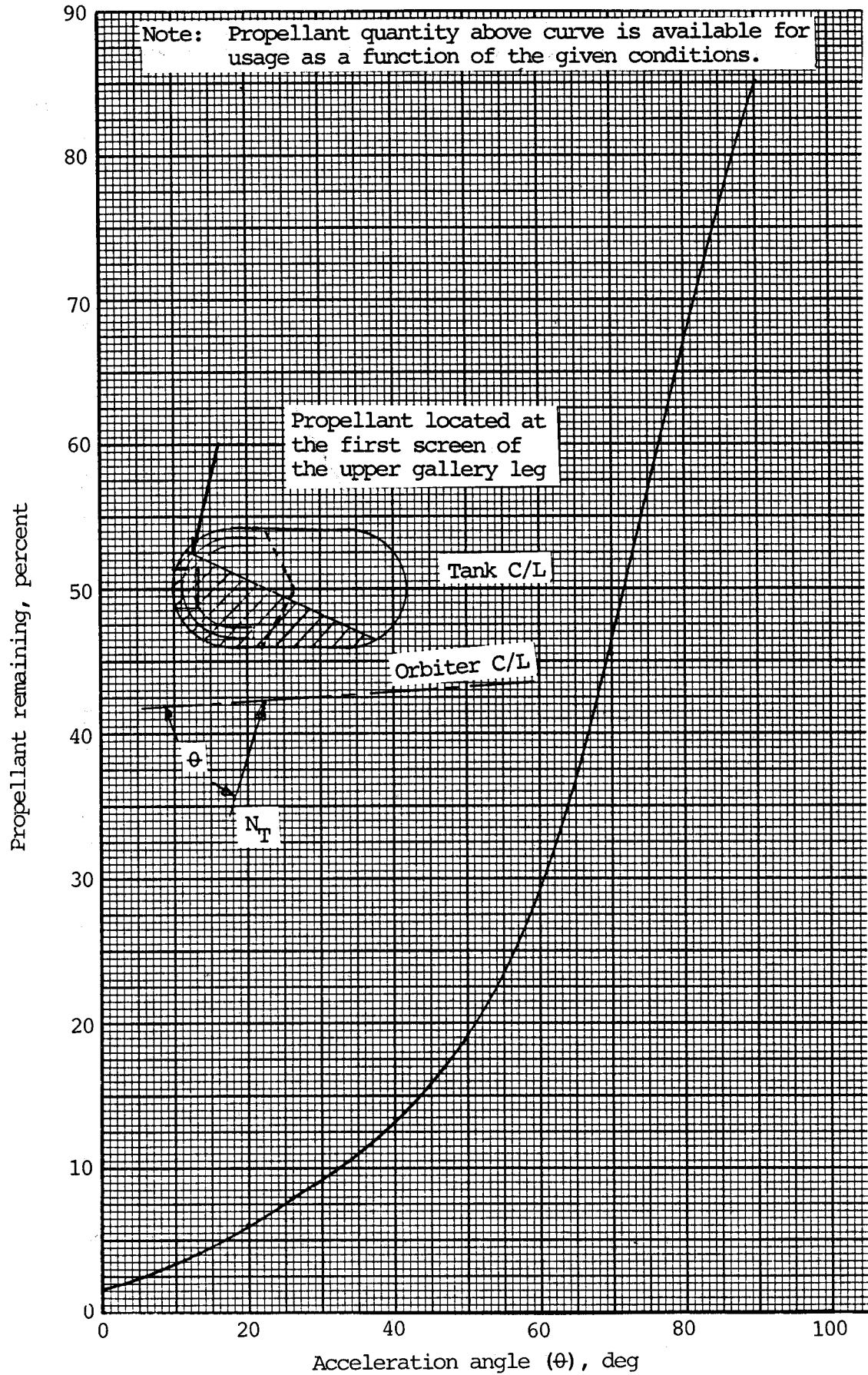
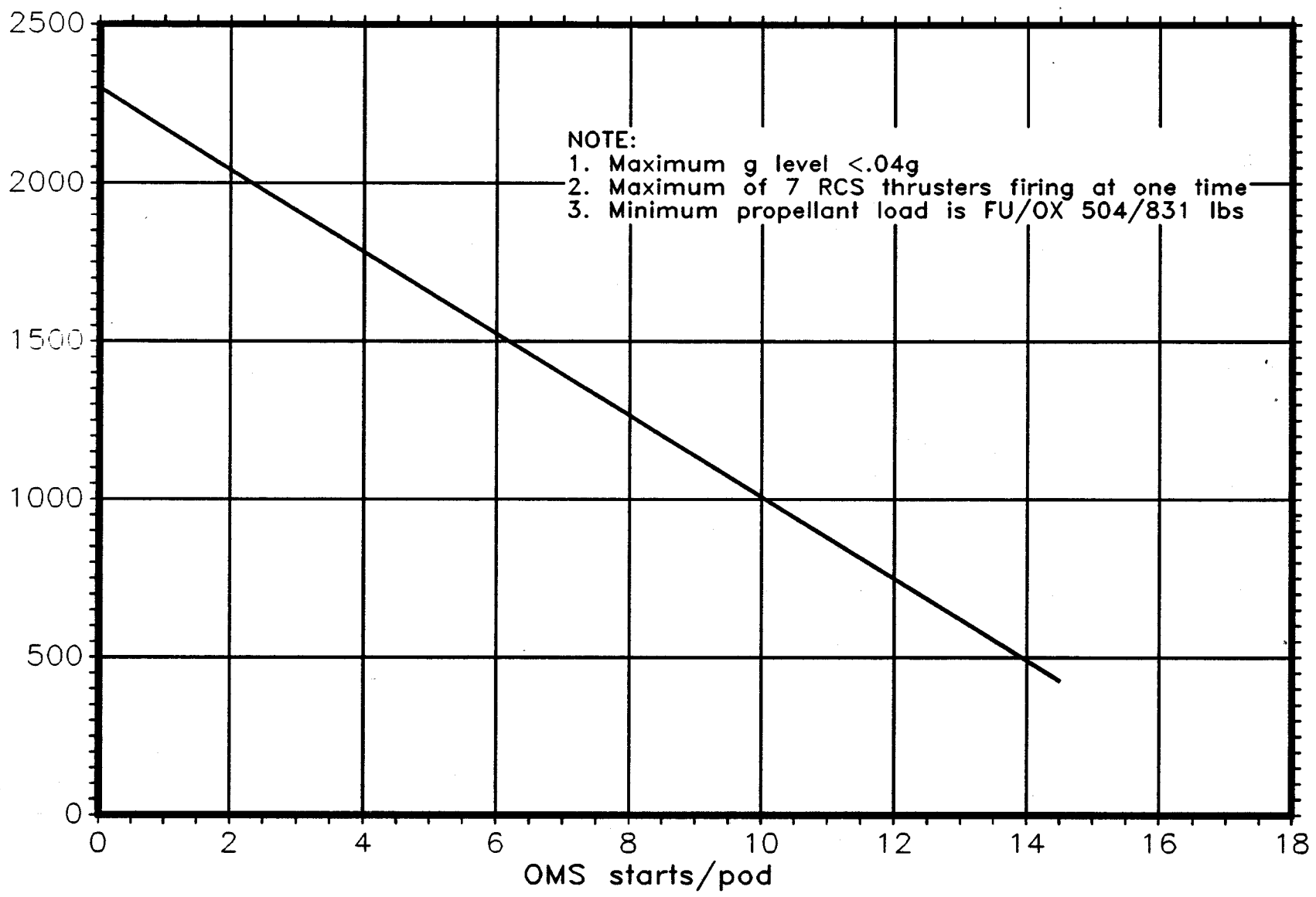

Figure 3.4.3.3-3.- Aft compartment limit, OME + 12 RCS, fuel or oxidizer tank.  
 149 (Paragraph 3.4.3.3)

150  
3.4.3.3-12  
Propellant available  
(Mixture ratio, 1.6:1)



NOTE:  
1. Maximum g level <.04g  
2. Maximum of 7 RCS thrusters firing at one time  
3. Minimum propellant load is FU/OX 504/831 lbs

Figure 3.4.3.3-4.- OMS propellant available to RCS through interconnect.  
(Paragraph 3.4.3.3)

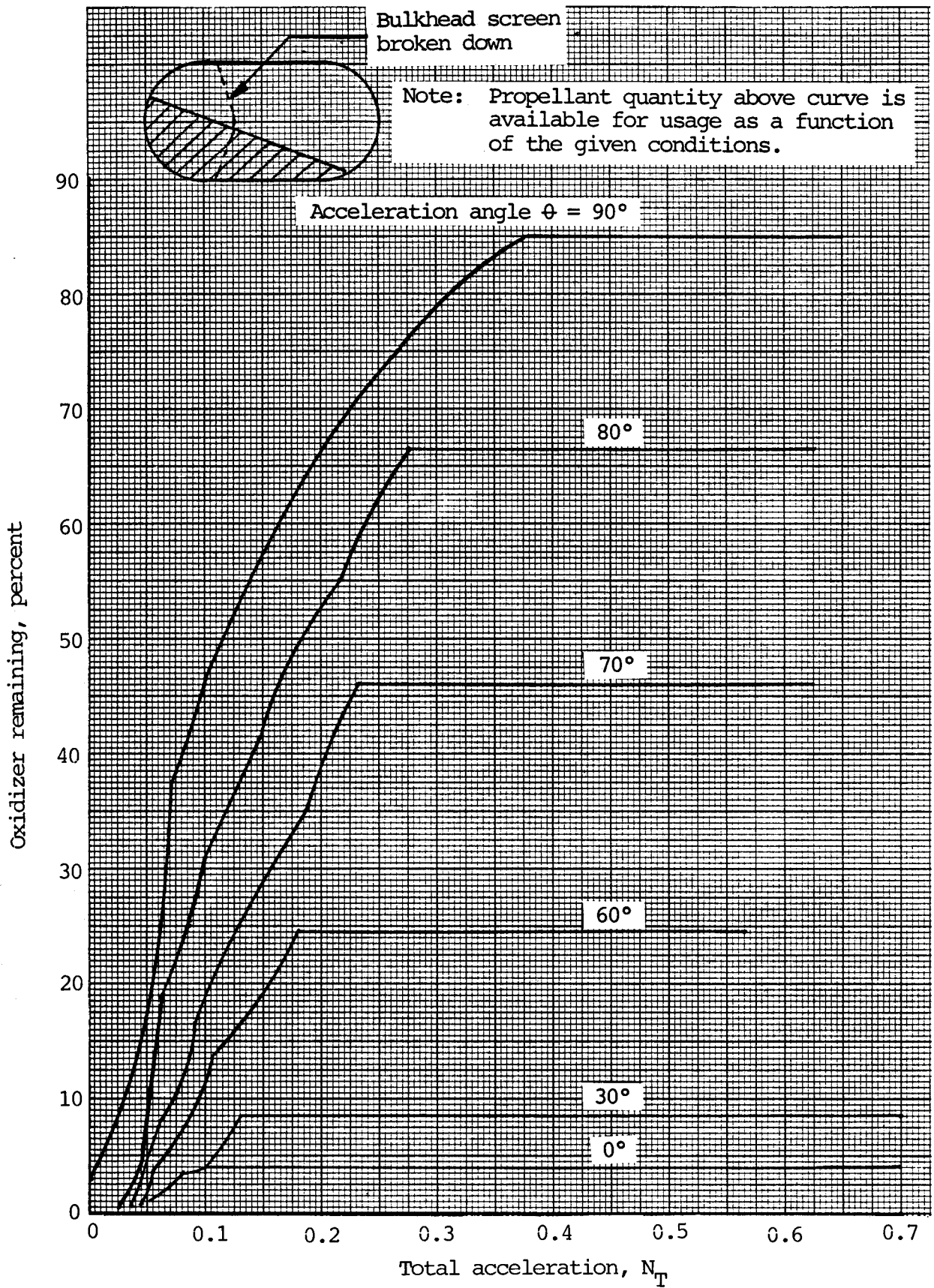

Figure 3.4.3.3-5.- Aft compartment limit, OME only, oxidizer tank.  
(Paragraph 3.4.3.3)

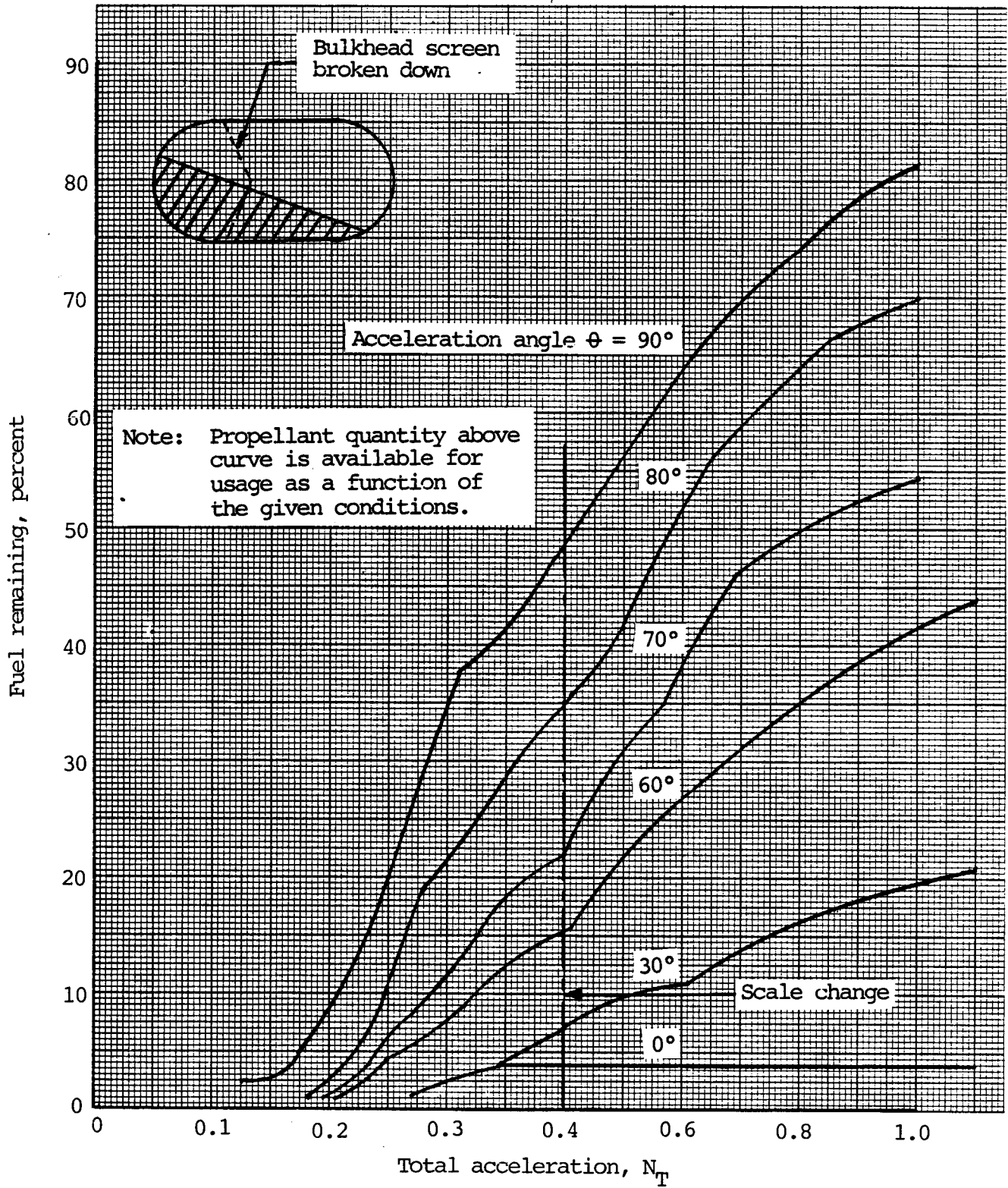

Figure 3.4.3.3-6.- Aft compartment limit, OME only, fuel tank.  
(Paragraph 3.4.3.3)

3.4.3.3-14

3.4.4 Power Subsystems

## 3.4.4.1 Fuel Cell Powerplant Subsystem

CONSTRAINTS/LIMITATIONS

## RESULT IF EXCEEDED

1. Temperature Limits<sup>a</sup>.  
See table 3.4.4.1-1.
2. FCP Power Output Limits. The FCP power output limits per FCP are as follows:
  - a. 7 kW Continuous (Below 2 kW, the output voltage may be above specification limits).
  - b. 10 kW One hour maximum.
  - c. 12 kW Fifteen minutes maximum (every 3 hr not to exceed 60 hr over the life of the FCP).
  - d. 16 kW Overload capacity. Ten minutes maximum at 26.5 Vdc.<sup>b</sup>
3. Maximum System Power Output. Maximum system power output must not exceed 36 kW.
4. Purge Limitations.
  - a. Each FCP must be purged for a minimum of 2 minutes.
  - b. Maximum of 12 hr between purges.

Accelerated performance decay. (See figure 4.4.1-4.) Possible FCP damage.

Exceeds FCP design capability. Possible FCP damage, including materials overheating and reactant leaking.  
Exceeds FCP design capability. Power levels >36 kW may exceed the ATCS design capability for some mission profiles.<sup>c</sup>

Degradation of FCP efficiency will be caused by an inert buildup in the reactant cavities of the fuel cell.  
FCP degradation. FCP will not meet transient load and voltage requirements.

<sup>a</sup>Information only. This capability will not be certified.

<sup>b</sup>Capability demonstrated by development data and analyses, but will not be certified.

<sup>c</sup>These limitations may be extended dependent upon detailed mission analysis.

3.4.4.1 Fuel Cell Powerplant Subsystem (Cont)  
CONSTRAINTS/LIMITATIONS

- c. Current output of an FCP during purge must not exceed 350 A (contingency operations- 430A)<sup>a</sup>.
- d. Heater operation.
- (1) Purge line heaters are sequenced "on" for a maximum of 27 minutes or until minimum line temperatures required for purge are attained.
  - (2) Purge line heaters are sequenced to remain on for 30 minutes after completion of purge.
- e. The final in-flight purge sequence must be initiated at least 2.5 hours prior to entry<sup>a</sup>.
- f. Maximum sustained purge period limited to 20 minutes.
5. FCP In-flight Shutdown/Restart Environment<sup>a</sup>.
- a. Environmental temperature must be maintained at  $\geq 40^{\circ}$  F for in-flight shutdown/restart. For temperatures  $< 40^{\circ}$  F, FCP's may be placed in standby, but only if further operation is required. (Standby configuration is FCP disconnected from the bus with pumps and heaters operating.)
  - b. Following any restart, a fuel cell must be operated on load for a minimum of 3 hours to restore proper electrolyte concentration.
6. FCP Degraded Performance<sup>a</sup>.
- a. The "Fuel Cell Cell Performance Monitor" (CPM) provides an analog output for each of three substacks from each fuel cell. Each of these output signals is proportional to the absolute value of the voltage difference

RESULT IF EXCEEDED  
FCP regulators may malfunction (external venting, leakage, pressure control) due to reactants' temperature being too low.  
Frozen particles may clog the purge lines.

Possible damage to purge line and nozzle heaters due to entry heating.  
Frozen particles may clog the purge lines.

Possible FCP damage from water freezing.

Possible power section damage due to uncontrolled electrolyte concentration.  
May do irreparable damage to the FCP.

<sup>a</sup>Capability demonstrated by development data and analysis, but will not be certified.

3.4.4.1 Fuel Cell Powerplant Subsystem (Cont)  
CONSTRAINTS/LIMITATIONS

## RESULT IF EXCEEDED

between the two halves of its substacks. Any voltage anomaly of 150 mV or greater indicates a failed FCP, which must be shut down.

b. A terminal voltage performance shift of  $\geq 0.5$  volts that is not related to inert buildup or thermal control indicates possible loss of fuel cell.<sup>a</sup>

7. Consecutive False Starts<sup>b</sup>. The total time accumulated for FCP consecutive false start attempts must not exceed 27 minutes for a 70° F environment or 17 minutes for a 40° F environment. After accumulating this time, the FCP must complete a start sequence and operate a minimum of 3 hours on load.

Possible H<sub>2</sub>O flooding of the FCP rendering it inoperative.

8. FCP Electrolyte Concentration

Limits<sup>b</sup>. The fuel cell powerplant electrolyte concentration limits are as follows:

a. Operating local concentration:

(1) Upper limit 48% KOH

Possible FCP failure due to reactant gas crossover through a dry electrolyte matrix.

(2) Lower limit 24% KOH

Possible FCP failure due to flooding of reactant chambers with electrolyte from a too wet electrolyte matrix.

b. Shutdown average concentration:

(1) Minimum limit 29% KOH for false starts.

Possible FCP inability to meet the consecutive false start constraint.

(2) Minimum limit 27% KOH one start.

Possible FCP inability to make one start from 40° F.

<sup>a</sup>Assumes the FCP is at thermal equilibrium with no internal heaters on. The FCP cell-performance monitor is a much more sensitive indicator of individual cell-performance loss and terminal voltage shift should be considered secondary to the CPM.

<sup>b</sup>Capability demonstrated by development data and analysis, but will not be certified.



3.4.4.1 Fuel Cell Powerplant Subsystem (Cont)  
CONSTRAINTS/LIMITATIONS

9. Water Vent System.

a. One set of H<sub>2</sub>O relief system and one set of H<sub>2</sub>O line heaters will be on continuously during FCP operation.

b. At least one fuel cell water discharge path shall remain open at all times.

10. FCP Coolant Return Temperature.

Maximum temperature 140° F. For ground operation, a maximum of 110° F at output power conditions from open circuit to 4 kW, and 140° F for power conditions > 4 kW.

11. FCP Stack Coolant Exit Temperature<sup>a</sup>.  
Figure 3.4.4.1-1.

12. FCP Condenser Exit Temperature<sup>a</sup>.  
140 to 160° F.

RESULT IF EXCEEDED

Water nozzle and alternate H<sub>2</sub>O system freezing. Loss of all three fuel cells, if primary water line to ECLSS storage tanks lost. Loss of all three fuel cells due to irrecoverable H<sub>2</sub> pump motor stall.

Possible damage to FCP due to overheating and flooding of reactant chambers with electrolyte from a too wet electrolyte matrix.

Possible FCP failure due to reactant gas crossover through a dry electrolyte matrix (high stack coolant exit temperature) or failure due to flooding of reactant chambers with electrolyte from a too wet electrolyte matrix (low stack coolant exit temperature).

Possible FCP failure due to reactant gas crossover through a dry electrolyte matrix (low condenser exit temperature) or failure due to flooding of reactant chambers with electrolyte from a too wet electrolyte matrix (high condenser exit temperature).

<sup>a</sup>Capability demonstrated by development data and analysis, but will not be certified.

3.4.4.1	Fuel Cell Powerplant Subsystem (Concluded)	RESULT IF EXCEEDED
	CONSTRAINTS/LIMITATIONS	
	13. <u>FCP Shutdown After a pH Discrete Set</u> <sup>a, b</sup> .	Contamination of potable water.
	FCP's shall be shutdown after 15 minutes of operation with a high pH.	Possible FCP damage.
	14. <u>Spacelab, FCP3, Power Requirements.</u>	
	Refer to paragraph 3.4.5.6, item 6.	
	15. <u>Coolant Pump and Hydrogen Pump.</u>	Loss of ability to maintain proper electrolyte and thermal control resulting in FCP damage due to overheating and electrolyte flooding. Emergency operation of the FCP without pumps for up to 9 minutes at at 7 kW is permitted during critical phases.
	Fuel cell coolant and H <sub>2</sub> pumps must be on continuously during FCP operation.	
	16. <u>FCP Stack Coolant Inlet Temperature.</u> <sup>a</sup>	
	176° F to 191° F	Possible failure due to reactant gas crossover through a dry electrolyte matrix (high stack coolant inlet temperature) or failure due to flooding of reactant chambers with electrolyte from a too wet electrolyte matrix (low stack coolant inlet temperature).
	17. <u>FCP H<sub>2</sub> Pump Current Sensor</u> <sup>a</sup>	
	0.28 to 0.65 Vdc	Possible fuel cell failure due to H <sub>2</sub> pump loss from motor overload or loss of input power.

<sup>a</sup>Capability demonstrated by development data and analysis, but will not be certified.

<sup>b</sup>In the absence of confirming cue (e.g., common pH sensor, CPM or H<sub>2</sub> pump current), shutdown may be delayed up to 1 hour total to permit crew check of potable water pH. Confirmation from common pH sensor may require up to eight minutes at nominal loads due to transport time. Transport time to the galley could require up to 20 minutes.

TABLE 3.4.4.1-1.- FUEL CELL POWERPLANT COMPONENT ENVIRONMENTAL TEMPERATURE LIMITS  
(Paragraph 3.4.4.1)

Components	Minimum Operating Temperature, °F	Critical Item and Results If Exceeded	Maximum Operating Temperature, °F		Critical Item and Results If Exceeded	Minimum Non-operating Temperature, °F	Critical Item and Results If Exceeded	Maximum Non-operating Temperature, °F		Critical Item and Results If Exceeded
			Long Term	Short Term <sup>a</sup>				Long Term	Short Term <sup>a</sup>	
FCP (external)	40 <sup>b, c</sup>	Product water may freeze.	170	220	Loss of proper electrolyte concentration and heat rejection control.	40 <sup>b</sup> (water system wet) -65 (water system drained and dried)	Product water may freeze.	150	190	Exceeds, storage design conditions.
Coolant lines	40 <sup>b</sup>	Improper FC-40 inlet conditions	140 (fluid inlet conditions)	140	Cannot maintain proper electrolyte concentration and heat rejection control.	40 <sup>b</sup>	Violates FC-40 inlet conditions at start-up	NA	NA	NA
Water lines	40 <sup>b</sup>	Product water may freeze.	120	220	Exceeds design temperatures. <sup>d</sup>	40 <sup>b</sup>	Product water may freeze.	NA	NA	NA
FCP stack	180	Electrolyte is too wet.	(1) 230	(1) (2) 250	(1) Electrolyte too dry, and reduced operational life (2) Material degradation	40 <sup>b</sup>	Water may freeze.	150	190	Exceeds storage design conditions.
H <sub>2</sub> O pressure relief valves	40 <sup>b</sup>	Product water may freeze	220	220	Exceeds design temperatures. <sup>d</sup>	40 <sup>b</sup>	Product Water may freeze.	NA	NA	NA

<sup>a</sup> < 3 minutes.

<sup>b</sup> Design limit to account for sensor inaccuracies.

<sup>c</sup> Exterior surface temperatures

<sup>d</sup> Since there has been no off-limit thermal testing, the results if exceeded are unknown.

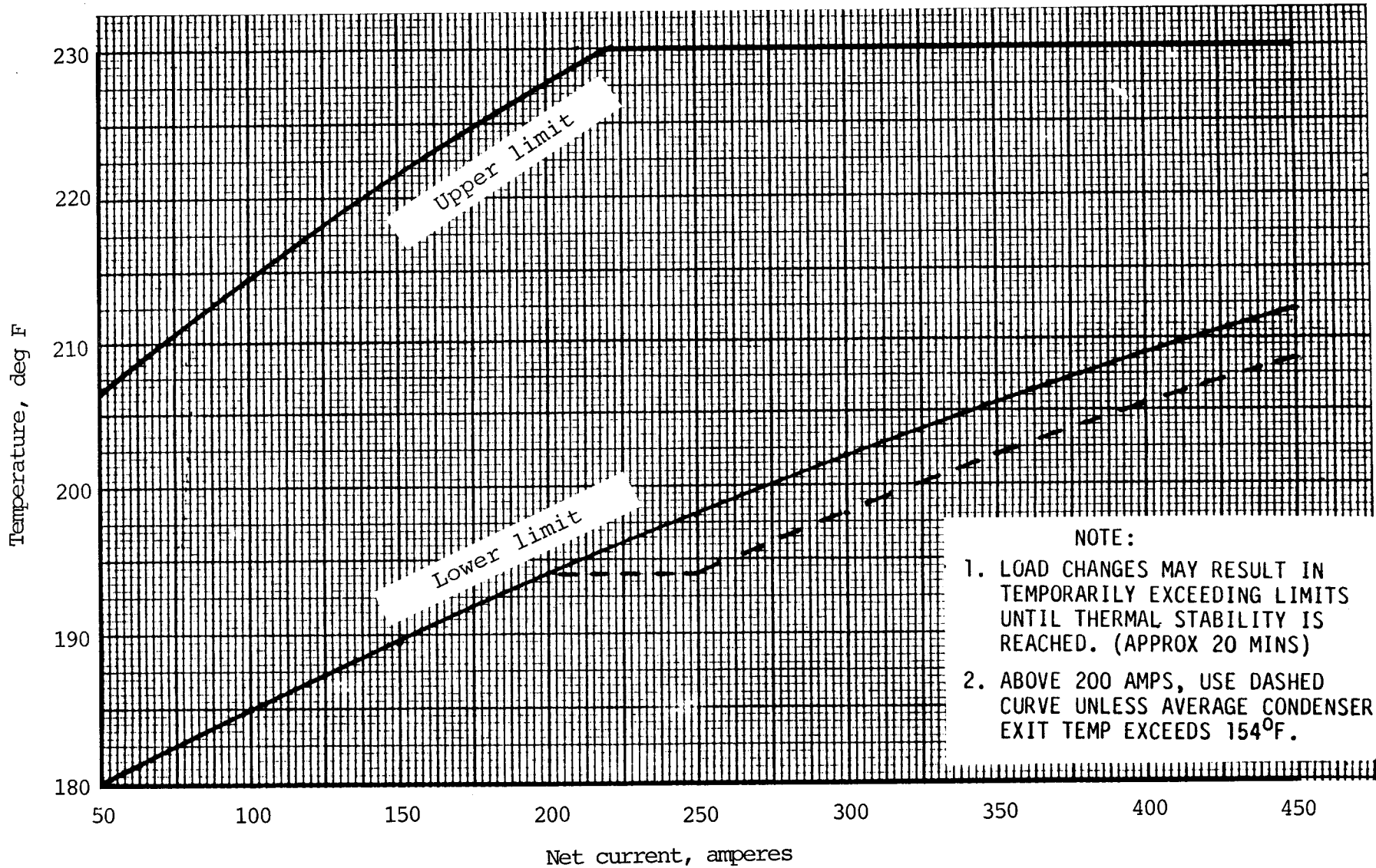

Figure 3.4.4.1-1.- Fuel cell powerplant stack exit temperature.  
(Paragraph 3.4.4.1)

TABLE 3.4.4.1-1.- FUEL CELL POWERPLANT COMPONENT ENVIRONMENTAL TEMPERATURE LIMITS  
(Paragraph 3.4.4.1)

Components	Minimum Operating Temperature, °F	Critical Item and Results If Exceeded	Maximum Operating Temperature, °F		Critical Item and Results If Exceeded	Minimum Non-operating Temperature, °F	Critical Item and Results If Exceeded	Maximum Non-operating Temperature, °F		Critical Item and Results If Exceeded
			Long Term	Short Term <sup>a</sup>				Long Term	Short Term <sup>a</sup>	
FCP (external)	40 <sup>b, c</sup>	Product water may freeze.	170	220	Loss of proper electrolyte concentration and heat rejection control.	40 <sup>b</sup> (water system wet) -65 (water system drained and dried)	Product water may freeze.	150	190	Exceeds, storage design conditions.
Coolant lines	40 <sup>b</sup>	Improper FC-40 inlet conditions	140 (fluid inlet conditions)	140	Cannot maintain proper electrolyte concentration and heat rejection control.	40 <sup>b</sup>	Violates FC-40 inlet conditions at start-up	NA	NA	NA
Water lines	40 <sup>b</sup>	Product water may freeze.	120	220	Exceeds design temperatures. <sup>d</sup>	40 <sup>b</sup>	Product water may freeze.	NA	NA	NA
FCP stack	180	Electrolyte is too wet.	(1) 230	(1) 250	(1) Electrolyte too dry, and reduced operational life (2) Material degradation	40 <sup>b</sup>	Water may freeze.	150	190	Exceeds storage design conditions.
H <sub>2</sub> O pressure relief valves	40 <sup>b</sup>	Product water may freeze	220	220	Exceeds design temperatures. <sup>d</sup>	40 <sup>b</sup>	Product Water may freeze.	NA	NA	NA

<sup>a</sup> ≤ 3 minutes.

<sup>b</sup> Design limit to account for sensor inaccuracies.

<sup>c</sup> Exterior surface temperatures

<sup>d</sup> Since there has been no off-limit thermal testing, the results if exceeded are unknown.

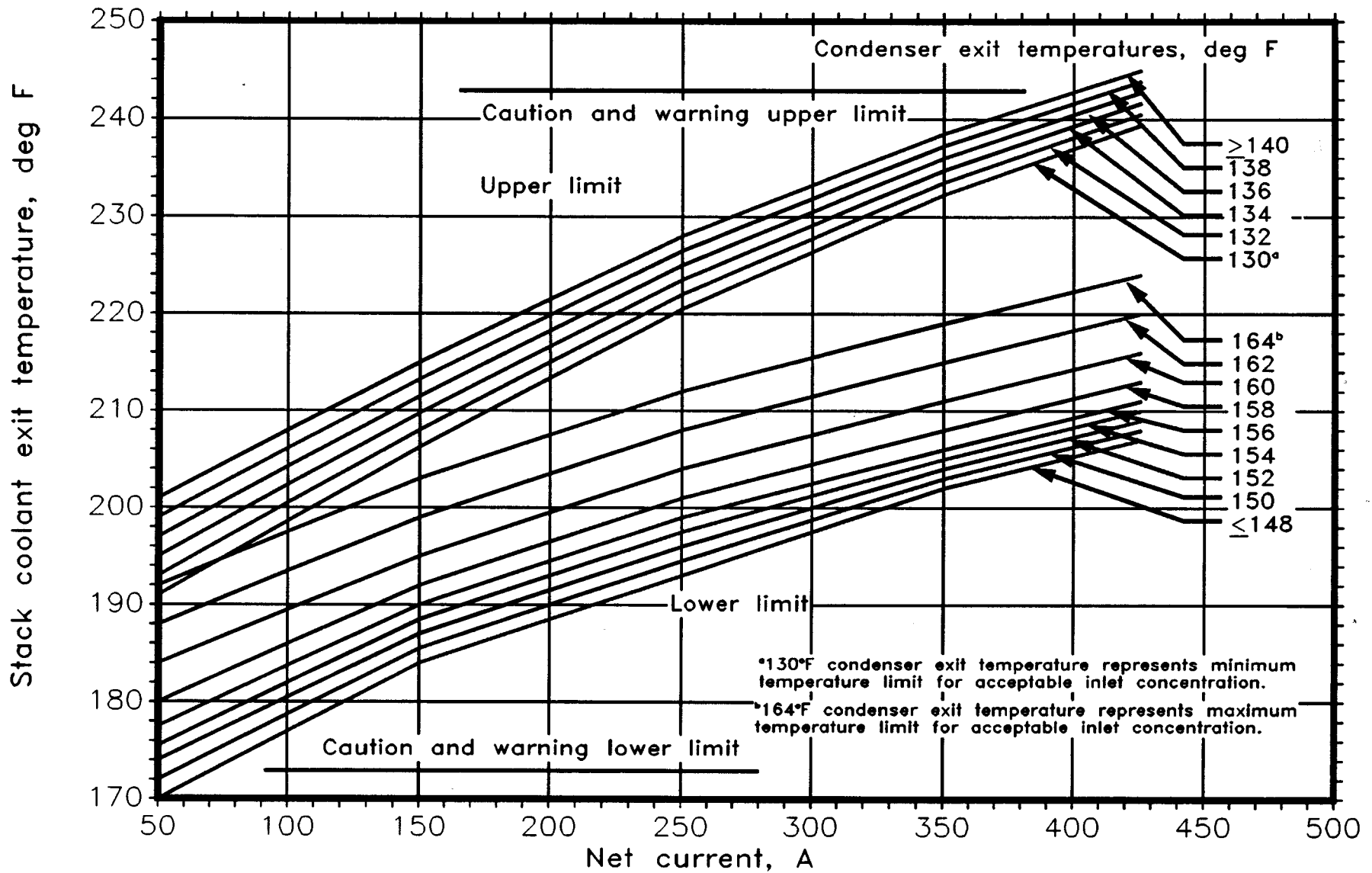

Figure 3.4.4.1-1.- Fuel cell powerplant stack exit temperature limits as a function of condenser exit temperature.

3.4.4.2

Power Reactant Storage and Distribution Subsystem

CONSTRAINTS/LIMITATIONS

RESULT IF EXCEEDED

1. PRSD Temperature Limits.  
See table 3.4.4.2-1.
2. Hydrogen Tank Maximum Operating Pressure. The maximum hydrogen tank pressure is 335 psia. The relief valve will open and limit pressure.
3. Hydrogen Tank Minimum Operating Pressure. The minimum hydrogen tank pressure is 100 psia. Loss of H<sub>2</sub> supply to FCP's.
4. Hydrogen Tank Maximum Heater Temperature.
  - a. The hydrogen tank maximum heater temperature is 200° F. Potential damage to tank structure.
  - b. For the baseline system, (tanks 1 and 2), when the tank quantity reaches 8.8 percent, the "A" and "B" heaters must be switched to "OFF". Possibility of depleting H<sub>2</sub> due to inaccuracy of quantity gaging system.
  - c. For tanks 3, 4 or 5, when the tank quantity reaches 2.9 percent, the "A" and "B" heaters must be switched to "OFF". Heater temperature may exceed 200° F.
5. Oxygen Tank Maximum Operating Pressure. The maximum oxygen tank pressure is 1050 psia. Relief valve will open and limit pressure.
6. Oxygen Tank Minimum Operating Pressure. The minimum oxygen tank pressure is 800 psia. Degraded flow to the launch entry helmets (LEH's).
7. Oxygen Tank Maximum Heater Temperature.
  - a. The oxygen tank maximum heater temperature is 350° F. Could ignite Teflon.
  - b. When the tank quantity reaches 50 percent, the "A" or "B" heater must be switched from "AUTO" to "OFF" (except for O<sub>2</sub> tank 4/5 combination). Heater temperature will exceed 350° F.
  - c. For the baseline system (tanks 1 and 2), when the tank quantity reaches 8.8 percent, the "A" and "B" heaters must be switched to "OFF". Possibility of depleting O<sub>2</sub> due to inaccuracy of quantity gaging system.
  - d. For tanks 3, 4 or 5, when the tank quantity reaches 6.0 percent, the "A" and "B" heaters must be switched to "OFF". Heater temperature may exceed 350° F.
8. Tank Loads.
  - a. Cryogenic oxygen tanks will be loaded to a minimum of 30 percent for a maximum of 25 missions, and ≥90 percent load for a maximum of 100 additional missions. Possible structural damage.

- 3.4.4.2 Power Reactant Storage and Distribution Subsystem
- CONSTRAINTS/LIMITATIONS
- b. Cryogenic Hydrogen tanks will be loaded to  $\geq 90$  percent for a maximum of 100 missions and as a minimum quantity will be pressurized to 200 psia with ambient temperature hydrogen gas for an additional 25 missions.
- RESULT IF EXCEEDED  
Possible structural damage.
9. Tank Pressure Cycles Per Lifetime (Useful Life)
- a. Oxygen tanks are constrained to 300 structural pressure cycles<sup>a</sup> per lifetime. Cycle threshold pressure (Pth) is 375 psia. Lifetime impact.
- b. Hydrogen tanks are constrained to 300 structural pressure cycles<sup>a</sup> per lifetime. Cycle threshold pressure (Pth) is 150 psia. Lifetime impact.

<sup>a</sup>A pressure cycle is defined as a pressurization of a pressure vessel to an absolute value greater than threshold pressure (Pth), followed by a decrease to a value less than Pth, or a pressure change occurring while the pressure vessel is at a pressure greater than Pth, such that there is a decrease in pressure greater in magnitude than Pth followed by an increase in magnitude greater than Pth.



TABLE 3.4.4.2-1.- HYDROGEN AND OXYGEN ASSEMBLY COMPONENT TEMPERATURE LIMITS  
(Paragraph 3.4.4.2)

Components	Minimum Operating Temperature, °F	Critical Item and Results If Exceeded	Maximum Operating Temperature, °F		Critical Item and Results If Exceeded	Minimum Non-operating Temperature, °F	Critical Item and Results If Exceeded	Maximum Non-operating Temperature, °F		Critical Item and Results If Exceeded
			Long Term	Short Term <sup>a</sup>				Long Term	Short Term	
Hydrogen and oxygen pressure relief modules and valve modules	NA	NA	140	197	Violate thermal design constraints <sup>b</sup>	NA	NA	NA	NA	NA
Hydrogen and oxygen tanks	NA	NA	110 <sup>c</sup>	197 <sup>d</sup>	c,d	NA	NA	NA	NA	NA
Hydrogen and oxygen signal conditioners of quantity gaging systems	-110	Degraded accuracy	110 <sup>c</sup>	197 <sup>d</sup>	c,d	NA	NA	NA	NA	NA

<sup>a</sup> < 15 minutes.

<sup>b</sup> Since there has been no off-limit thermal testing, the result if exceeded is unknown.

<sup>c</sup> Electrical components will exceed design temperatures.

<sup>d</sup> Vent tank and/or destroy insulation.

3.4.4.3 Auxiliary Power Unit Subsystem  
CONSTRAINTS/LIMITATIONS

## RESULT IF EXCEEDED

1. Temperature Limits.  
See table 3.4.4.3-1.
  2. Low Fuel Pressure Starts. (Normal)  
The minimum fuel pressure at the fuel pump inlet for APU start-up is 180 psia at sea level and 90 psia above 40,000 ft.
  3. Cold Oil Starts. The minimum lubrication oil temperature is 35° F at a fuel pump minimum inlet pressure of 100 psia and the hydraulic fluid temperature is 0° F for APU start-up.
  4. Lubrication Oil. The following two types of MIL-L-23699B oil listed in QPL-23699-8 dated 15 March 1976 are the only types of oil that can be used in the APU lubrication oil system.
    - a. Mobil Jet II - manufacturer's designation RM-247A; QUAL. O-1D, 4 February 1975.
    - b. Mobil Jet II - manufacturer's designation RM-246A; QUAL. O-1E, 5 May 1975.
  5. Hot Restart. Post-shutdown starts without active cooling must not be made until the turbine gas generator bed temperatures and injector temperatures (V46T0122A, V46T0222A, V46T0322A, V46T0174, V46T0274, and V46T0374) are below 415° F for soakback and 444° F if due to gas generator heater cycling or failure.
    - a. Active cooling of the gas generator is to be used only in contingencies when the normal cooldown period is not available.
    - b. An active-cooled hot restart must be aborted if the injector temperature (V46T0X74) does not give an indication of cooling in the first 150 seconds
- Slow turbine acceleration (low gas generator pressure) may result in an automatic underspeed shutdown. Utilize auto shutdown inhibit mode to accomplish start when pressure is below limits. Possibility of detonation exists.
- Excessive gearbox or hydraulic pump drag may result in an automatic underspeed shutdown. Utilize auto shutdown inhibit mode to accomplish start.
- Rapid lubrication oil filter clogging can occur if hydrazine leaks into the gear box and forms pentaerythritol or hydrazide, a wax-like substance.
- Explosive decomposition of hydrazine may occur in gas generator injector.
- Active cool restarts increase chamber pressure roughness, reducing gas generator life.
- Explosive decomposition of hydrazine may occur in the gas generator injector.

## 3.4.4.3

Auxiliary Power Unit Subsystem (Cont)  
CONSTRAINTS/LIMITATIONS

following start override initiation (V46TOX74 decreasing at T + 150 seconds).

- c. Do not start the APU if the fuel pump and GGVM temperature (V46T0112, V46T0192, V46T0171, V46T0172 and their equivalents for APU 2 and 3) exceed 200° F.
  - d. Do not start the APU if the fuel tank pressure is < 100 psia.
6. Fuel Pump and GGVM (gas generator valve module) Cooling System Isolation Valve. The water tank isolation valve must not be powered for a continuous period of longer than 4 hours which is the extent of test data. Should the valve be powered for 4 hours continuously, the time for cooldown to steady state is 10 hours.
  7. Fuel Isolation Valve Power. Do not power isolation valve for extended periods of time when the APU is not operating. For normal procedures, the isolation valve should be shut off within 5 minutes after APU is shut down; for contingencies, the valve must not remain open for more than 5 minutes after fault annunciation (160° F) on V46T1X75, V46T1X73. For ground testing, use a duty cycle of 20 minutes on, 4 hours off. During 4 hours off time, additional 1 minute on-time may be accumulated.
  8. Flight Control Loads. The hydraulic pump must be depressurized for APU start.
  9. Oil Pressure.
    - a. An APU must not be operated for extended periods of time with lubrication oil pressure >150 psia.

## RESULT IF EXCEEDED

Possible detonation may occur for starts with gas bubbles at > 200° F.

Possible detonation may occur for hot restarts at < 100 psia above 40,000 ft.

Valve temperature limit may be exceeded leading to possible loss of the cooling system function.

Valve is insulated and with no flow will overheat due to heat from solenoid. Coil temperature and hydrazine decomposition limits may be exceeded.

Hydraulic load demands will increase hydraulic pump cranking torque resulting in possible automatic underspeed shutdown of the APU.

Structural damage to the APU may occur.

## 3.4.4.3

Auxiliary Power Unit Subsystem (Concluded)  
CONSTRAINTS/LIMITATIONS

## RESULT IF EXCEEDED

- |   |   |
|---|---|
| <p>b. An APU must not be operated for extended periods of time with lubrication oil pressure &lt; 35 psia at sea level or 20.0 psia in orbit.</p>                                       | <p>Inadequate bearing and gear lubrication can cause overheating and failure.</p>             |
| <p>10. <u>Low Gearbox Pressure.</u> The APU should not be operated for extended periods of time with gearbox pressure below 2.0 psia.</p>   | <p>Potential lubrication oil pump damage and/or inadequate gearbox lubrication can occur.</p> |
| <p>11. <u>Failed GG Heaters.</u> The minimum safe gas generator/injector temperature for starting is +190° F.</p>   | <p>Unknown conditions exist.</p>  |
| <p>12. <u>GG Life.</u> The gas generator reaches its end of life when the chamber pressure roughness is <math>\geq</math> 300 psi peak-to-peak.</p>                                     | <p>If accompanied by spiking, possible rupture of gas generator may occur.</p>                |
| <p>13. <u>Exhaust duct.</u> The exhaust duct exceeds its qualification limit at <math>\geq</math> 1160° F.</p>  | <p>Possible structural failure of duct.</p>   |
| <p>14. <u>Seal cavity drain system.</u> For vacuum conditions with a large range of leakages, hydrazine will flash freeze and plug overboard drain line downstream of relief valve.</p> | <p>Loss of APU by flooding of gearbox with hydrazine.</p>                                     |

TABLE 3.4.4.3-1.- AUXILIARY POWER UNIT SUBSYSTEM COMPONENT TEMPERATURE LIMITS  
(Paragraph 3.4.4.3)

Components	Minimum Operating Temperature, °F	Critical Item and Results If Exceeded	Maximum Operating Temperature, °F		Critical Item and Results If Exceeded	Minimum Non-operating Temperature, °F	Critical Item and Results If Exceeded	Maximum Non-operating Temperature, °F		Critical Item and Results If Exceeded
			Long Term <sup>a</sup>	Short Term <sup>b</sup>				Long Term <sup>a</sup>	Short Term <sup>b</sup>	
Fuel tank	35	Hydrazine freezes at 35° F	125	125	Qualification limit	35	Hydrazine freezes at 35° F	125	125	Qualification limit
Fuel feed lines and line filter	35	Hydrazine freezes at 35° F	150	150	Maximum design fuel inlet temperature to APU	35	Hydrazine freezes at 35° F	(1) 150	(2) 290	(1) Maximum design fuel inlet temperature to APU (2) Decomposition rate limit
Fuel isolation valves	35	Hydrazine freezes at 35° F	150	150	Maximum design fuel inlet temperature to APU	35	Hydrazine freezes at 35° F	(1) 150	250	AF-E-411 Seat limit
Fuel service and test lines (static)	35	Hydrazine freezes at 35° F	220	290	Decomposition rate limit	35	Hydrazine freezes at 35° F	220	290	Decomposition rate limit
Fuel disconnect couplings: N <sub>2</sub> and N <sub>2</sub> H <sub>4</sub> Servicing	35	Hydrazine freezes at 35° F	160	160	Seal degrades (leaks).	35	Hydrazine freezes at 35° F	160	160	Seal degrades (leaks)
Test and high point bleed	35	Hydrazine freezes at 35° F	200	200	Qualification limit - adiabatic compression	35	Hydrazine freezes at 35° F	290	290	Decomposition rate limit
Fuel pump drain lines and can	35	Hydrazine freezes at 35° F	220	290	Decomposition rate limit	35	Hydrazine freezes at 35° F	220	290	Decomposition rate limit
Fuel pump drain relief valve	35	Hydrazine freezes at 35° F	150	150	Design limit. Hydrazine compatibility	35	Design limit. Hydrazine freezes at 35° F	150	150	Qualification limit
Lube oil lines and gearbox	35	Unacceptable lube oil viscosity	325	375	Structural limit of gearbox materials	35	Unacceptable lube oil viscosity	425	425	Unacceptable lube oil viscosity

<sup>a</sup> Continuous stabilized levels.

<sup>b</sup> Transient excursions which return to acceptable stabilized levels.

TABLE 3.4.4.3-1.- AUXILIARY POWER UNIT SUBSYSTEM COMPONENT TEMPERATURE LIMITS  
(Paragraph 3.4.4.3) (Continued)

Components	Minimum Operating Temperature, °F	Critical Item and Results If Exceeded	Maximum Operating Temperature, °F		Critical Item and Results If Exceeded	Minimum Non-operating Temperature, °F	Critical Item and Results If Exceeded	Maximum Non-operating Temperature, °F		Critical Item and Results If Exceeded
			Long <sup>a</sup> Term	Short <sup>b</sup> Term				Long <sup>a</sup> Term	Short <sup>b</sup> Term	
Insulation surface	NA	NA	425	425	Autogenous ignition temperature limit (fluids)	NA	NA	NA	NA	NA
APU Controller	30	Qualification limit <sup>h</sup>	125	125	Qualification limit - maximum cold-plate temperature	30	Qualification limit	150	190 (1 hr max)	Possible component failure
Fuel pump	35 <sup>c</sup>	Hydrazine freezes at 35° F	200	200	Qualification limit - adiabatic compression	35 <sup>c</sup>	Hydrazine freezes at 35° F	200	275 <sup>d</sup>	Qualification limit
Gas generator valve module	35 <sup>c</sup>	Hydrazine freezes at 35° F	200	200	Qualification limit	35 <sup>c</sup>	Hydrazine freezes at 35° F	200	275 <sup>d</sup>	Qualification limit
Gas generator	NA	NA	1700	1750	Exceeds turbine and gas generator limits	190 <sup>e</sup> /70 <sup>f</sup>	Reduced catalyst bed life. Slower starts. Hydrazine freezes at 35° F.	NA	NA	NA
Gas generator water cooling Tank	32	Water freezes	254	254	Qualification limit	32	Water freezes	254	254	Qualification limit
Lines	32	Water freezes	NA	212 to 328 <sup>g</sup>	Localized boiling - not critical	32	Water freezes	NA	212 to 328 <sup>g</sup>	Localized boiling - not critical
Valves	32	Water freezes	NA	210	Qualification limit	32	Water freezes	NA	210	Qualification limit

- <sup>a</sup>Continuous stabilized levels.
- <sup>b</sup>Transient excursions which return to acceptable stabilized levels.
- <sup>c</sup>Specification/qualification limit.
- <sup>d</sup>Qualification soak following shutdown at sea level.
- <sup>e</sup>With heaters operational.
- <sup>f</sup>APU start with failed heaters.
- <sup>g</sup>Dependent on tank pressure.
- <sup>h</sup>Minimum coldplate temperature.

169

3.4.4.3-5

TABLE 3.4.4.3-1.- AUXILIARY POWER UNIT SUBSYSTEM COMPONENT TEMPERATURE LIMITS  
(Paragraph 3.4.4.3) (Concluded)

Components	Minimum Operating Temperature, °F	Critical Item and Results If Exceeded	Maximum Operating Temperature, °F		Critical Item and Results If Exceeded	Minimum Non-operating Temperature, °F	Critical Item and Results If Exceeded	Maximum Non-operating Temperature, °F		Critical Item and Results If Exceeded
			Long <sup>a</sup> Term	Short <sup>b</sup> Term				Long <sup>a</sup> Term	Short <sup>b</sup> Term	
Fuel pump/GGVM water cooling Tank	32	Water freezes	254	254	Qualification limit	32	Water freezes	254	254	Qualification limit
Lines	32	Water freezes	NA	212 to 281 <sup>g</sup>	Localizes boiling - not critical	32	Water freezes	NA	212 to 281 <sup>g</sup>	Localized boiling - not critical
Valves	32	Water freezes	NA	210	Qualification limit	32	Water freezes	NA	210	Qualification limit
Controller	-65	Qualification limit	165	165	Qualification limit	-65	Qualification limit	165	165	Qualification limit

<sup>a</sup>Continuous stabilized levels.

<sup>b</sup>Transient excursions which return to acceptable stabilized levels.

<sup>g</sup>Dependent on tank pressure.

3.4.5 Avionics Subsystems3.4.5.1 Guidance, Navigation and Control SubsystemsCONSTRAINTS/LIMITATIONSRESULT IF EXCEEDED

- |  |  |
|--|--|
| <ol style="list-style-type: none"> <li>1. <u>Temperature Limits.</u><br/>See table 3.4.5.1-1.</li> <li>2. <u>GN&amp;C Component Self Test Limits.</u><br/>See table 3.4.5.1-2.</li> <li>3. <u>Star Tracker.</u> <ol style="list-style-type: none"> <li>a. The object being tracked must be <math>\geq 30</math> deg from the sun and <math>\geq 20</math> deg from the sunlit earth horizon.</li> <li>b. Object being tracked must not be brighter than -7 magnitude.</li> <li>c. Tracker must be warmed up for 15 minutes.</li> <li>d. Star tracker door maximum operating time - 14 sec to open or close.<br/><br/>Door motors can be operated for maximum of 120 sec in a stalled condition - followed by a cool-period of one hour.</li> <li>e. Star tracker doors should be closed prior to entry.</li> <li>f. Sun or horizon must not be in FOV when override is engaged.</li> </ol> </li> </ol> | <p>Probability that system has failed since <math>3\sigma</math> end-of-life values exceeded. Deselection is crew/ground option.</p> <p>Shutter will close and tracker will go into the auto mode until the bright source is removed.</p> <p>Shutter will close and remain closed until star tracker power is turned off and back on, or the "shutter open" override is commanded. Degraded performance.</p> <p>Switch power off after 14 sec if actuation not complete to prevent excessive torque limiter slippage and try again in 10 min.</p> <p>Door motors can possibly overheat.</p> <p>Possible loss of star tracker(s). Possible loss of portion of Navigation Base. Possible loss of star tracker light shades. Target suppress function will occasionally close and latch protective shutter. Requires crew manual override to unlatch and open. Possible severe damage or loss of star tracker function.</p> |
|--|--|



3.4.5.1	Guidance, Navigation and Control Subsystems (Cont)	CONSTRAINTS/LIMITATIONS	RESULT IF EXCEEDED
4.	<u>Air Data Probe Deployment.</u>	While the air data probe assembly is deployed, the probe heaters must be turned on when icy conditions may exist.	Possible ice buildup under icy conditions would cause performance degradation.
5.	<u>Navigation Sensors "On Time".</u>	If the navigation sensors have been turned off, they must be warmed up prior to their operation (data acquisition). Warm up times are as follows:	Warm up required for filaments and temperature stabilization.
	a.	Tacan 120 sec	
	b.	MSBLS 180 sec	
	c.	Radar altimeter 180 sec	
6.	<u>Inertial Measurement Unit</u>		Degraded performance.
	a.	<u>Temperature Limits.</u> (See table 3.4.5.1-3). The IMU must be at operating temperature (platform temperature 152° to 168° F; CAPRI temperature 142° to 158° F) prior to operational use.	
	* b.	Absolute Launch Limits for IMU Misalignments. <u>TBS</u>	
7.	<u>Inertial Measurement Unit Voltage Limits.</u>		
	a.	Input voltage to the inertial measurement unit must not fall below 15.8 Vdc.	Inertial measurement unit will shut down and not return to the operate mode for a period of 3.0 +0.75 -0.50 minutes after shutdown.
	b.	Inertial measurement unit operate discrete input, 5 ±1 Vdc, must not be inhibited for more than 1.0 sec minimum to 15.0 sec maximum while 28 Vdc is applied.	Inertial measurement unit will go into the warm-up/standby mode and not return to the operate mode for a period of 3.0 +0.75 -0.50 minutes.

\*NASA Data Source.

3.4.5.1

## Guidance, Navigation and Control Subsystems (cont)

## CONSTRAINTS/LIMITATIONS

## RESULT IF EXCEEDED

## 8. Primary Flight Control Subsystem.

- (a) No more than two ASA's and two ATVC's must be powered down with active hydraulic systems. The flight control system was designed to provide operational performance with a minimum of two active control strings (two ASA's and two ATVC's).
- (b) The hydraulic systems must be deactivated before a powered down ASA can be reactivated. The rudder/speed brake power drive unit (PDU) could be overpressurized with resulting damage to the PDU.
- (c) A minimum of two (out of four) unbypassed, unfailed channels are required for each actuator with hydraulics active (assuming the other two channels are bypassed). The loss of one of the last two channels will result in unknown performance degradation. This is considered a three-failure condition and exceeds design requirements.
- (d) No more than two FCS channels of any one actuator can be in a bypass state concurrently. Two channel operation is no-fault tolerant. An additional fault could produce damage to the rudder/speed brake PDU.
- (e) The allowable mismatch between an aerosurface command and the actual zero-surface position at the time the hydraulic systems are actuated is as follows:  
 (1) Speed brake  $\pm 2.0^\circ$  max  
 (2) Rudder  $\pm 1.43^\circ$  maximum  
 (3) Elevon  $\pm 2.03^\circ$  maximum  
 (4) SSME-TVC  $\pm 2.00^\circ$  maximum  
 $\pm 1.0^\circ$  maximum with ground hydraulics  
 The required flow may exceed APU pump supply capability with possible damage to the hydraulic systems. Fluctuations in hydraulic pressure could reactivate the brakes in the rudder/speed brake PDU, with possible damage to the PDU.
- (f) Elevon/Rudder/Speedbrake/SSME-TVC:  
 (1) If two channels in an actuator have failed hardover with the same polarity and have sequentially been bypassed, these channels shall not be commanded to reset simultaneously. Two-against-two force fight could occur resulting in four channel bypass which may cause loss of actuator/vehicle control.

## 3.4.5.1

## Guidance, Navigation and Control Subsystems (cont)

## CONSTRAINTS/LIMITATIONS

- |   | RESULT IF EXCEEDED  |
|---|---|
| (2) If any failed channel cannot be bypassed, the the remaining three channels shall be commanded to override so that the FDI function is inhibited.  | One additional channel failure can result in a two-against-two force fight which may lead to a three channel bypass and a subsequent loss of actuator/ vehicle control.   |
| (3) If two channels of an actuator have been bypassed, the remaining channels shall be commanded to override so that the FDI function is inhibited.   | One additional channel failure can result in a one-against-one force fight which may lead to a four-channel bypass and a subsequent loss of actuator/ vehicle control.  |
| (4) Prior to APU power-up which creates high hydraulic pressure (such as power-up before OPS-8 on-orbit checkout and OPS-3 entry operation), any previously failed channel of the effector system shall be manually bypassed. | A combination of one failure prior to the power-up and one latent failure (which cannot be detected until the power-up) may cause a two-against-two force fight which may lead to a four-channel bypass and a subsequent loss of actuator/ vehicle control. |
| (5) If any failed channel cannot be bypassed, the remaining three channels shall be commanded to OVERRIDE to inhibit the FDI function.  | One additional channel failure can result in a two-against-two force fight which may lead to a four-channel bypass and a subsequent loss of actuator/ vehicle control.  |
| (6) The actuation subsystems shall not be operated with two control channels assigned to one GPC unless one of the two channels is bypassed via the FCS channel switch.   | Failure of a GPC commanding two control channels could result in bypass of the remaining two channels and loss of control. In flight, loss of actuator control could result in loss of vehicle.   |

## g. Elevon:

- |   |   |
|---|---|
| (1) The effector system shall not be operated with more than three primary-pressure feedback loops open in an actuator. | The effector system can be unstable resulting in possible loss of surface/ vehicle control. |
|---|---|

## 3.4.5.1 Guidance, Navigation and Control Subsystems (cont)

## CONSTRAINTS/LIMITATIONS

## RESULT IF EXCEEDED

- (2) The magnitude of a step command to the effector system shall be limited to 2.03 degrees. The servovalve current prior to activation of the hydraulics with a pressure of 3000 psi shall be limited to 3.0 and 3.25 milliamperes for inboard and outboard elevons, respectively.
- (3) The elevon actuators shall not be driven into their mechanical hardstops.

The required hydraulic flow may exceed hydraulic pump-supply capability creating possible stress in the hydraulic systems.

Driver current oscillations could occur causing all four channels of the elevon actuation subsystem to be bypassed thus resulting in loss of actuator control and possible loss of vehicle if it should occur during flight.

## h. SSME-TVC

- (1) For each of the SSME TVC-actuation subsystems, the magnitude of the incremental change (step) in its position command shall be limited to two degrees for Orbiter hydraulics. Any subsequent change in the command shall be delayed so that the magnitude of the effective commanded rate does not exceed 10 degrees per second. For example, following a two-degree incremental change in the position command of one of the SSME TVC subsystems, no subsequent change in this command can occur for 200 milliseconds [2 degrees / (10 degrees/second) = 200 msec].

Four-channel bypasses of the affected SSME TVC actuators could occur resulting in loss of actuator control with possible collision of affected SSME's with other SSME's, body flap, and OMS. In flight, loss of actuator control could result in possible loss of the vehicle.

The required flow may exceed the supply capability of hydraulic pump with possible stress to the hydraulic systems.

## 3.4.5.1

## Guidance, Navigation and Control Subsystems (cont)

## CONSTRAINTS/LIMITATIONS

- |  |  |
|--|--|
| <p>(2) During SSME ignition, the FDI system for the SSME TVC actuators shall be inhibited by issuing Reset/Override commands to all of the SSME TVC channels. Once the chamber pressures of all three SSME's exceed 90 percent of their rated operating values, the FDI system shall be reactivated by removing the Reset/Override commands.</p> <p>(3) During SSME shutdown, the FDI system for all SSME TVC actuators shall be inhibited by issuing Reset/Override commands to the indicated channels.</p> <p>(4) The SSME TVC-actuation subsystem shall not be commanded in a manner such that their SSME's will collide with other SSME's, body flap, or OMS.</p> <p>i. RCS TBS</p> <p>j. OMS TBS</p> <p>9. <u>Rate Gyro Assembly Warm-up.</u><br/>The RGA must be warmed up 2 minutes prior to its use.</p> | <p>RESULT IF EXCEEDED</p> <p>SSME ignition-induced sideloads acting on the SSME's could momentarily overpower their TVC actuators causing all of their channels to be bypassed, resulting in loss of actuator control and possible collision of affected SSME's with other SSME's, body flap, or OMS.</p> <p>SSME shutdown-induced sideloads acting on the SSME's when shutdown at low altitudes could overpower their TVC actuators causing loss of actuator control due to four-channel bypasses with collision of affected SSME's with other SSME's, body flap, or OMS.</p> <p>Damage to SSME's body flap, and OMS could occur. In flight, collisions between effectors could result in loss of vehicle.</p> <p>Possible degradation of RGA performance prior to temperature stabilization.</p> |
|--|--|

## 3.4.5.1

## Guidance, Navigation and Control Subsystems (cont)

## CONSTRAINTS/LIMITATIONS

- |  |   |
|--|---|
| <p>10. <u>SRB Rate Gyro Assembly Usage Limit.</u> The SRB rate gyro assemblies shall not be used for more than one flight.</p> <p>11. <u>ET Separation with Open Disconnect Valves (Nominal/AOA/ATO).</u><br/>Refer to paragraph 3.4.3.1.</p> <p>12. <u>Nominal/AOA/ATO Separation RCS</u><br/>For nominal/AOA/ATO separation, the ET separation sequence must command RCS on one cycle (0.16 sec) prior to structural release and inhibit rotational commands for 2.96 sec starting at the RCS on command time. It can be overridden by the crew. This is not implemented for RTLS ET separation.</p> <p>13. <u>Normal, AOA and RTLS Descent and Landing Phase Structural Flight Restrictions.</u></p> <p>a. Pitch, Roll and Yaw Maneuvers vs Airspeed. The variation of the maximum allowable load factor for maneuver conditions are found in STS 82-0574.<sup>a</sup></p> <p>b. Rate of Descent. The rate of descent limit is found in STS 82-0574.<sup>a</sup></p> <p>c. Landing Approach. Final flare, just before main gear contact, limits are found in STS 82-0574.<sup>a</sup><br/>Main landing gear sink speed restrictions are found in Table 4.2.1-1.</p> <p>d. Landing. Landing limits are found in STS 82-0574.<sup>a</sup><br/>Orbiter landing restrictions: Sink rate and velocity at main gear touchdown are found in Table 4.2.1-1.</p> | <p>RESULT IF EXCEEDED<br/>Possible degradation of SRB in-flight performance because of the potential for undetectable SRB RGA pivot breakage occurring during post-SRB SEP or "towback" environment of previous flight.</p> <p>To prevent possible <u>Inhibit.</u> recontact between Orbiter and ET.</p> <p>Orbiter may sustain damage.</p> |
|--|---|

<sup>a</sup>Contact J. W. Mistrot/JSC/VF2/483-3314 for access to STS 82-0574.

## 3.4.5.1 Guidance, Navigation and Control Subsystems (Cont)

## CONSTRAINTS/LIMITATIONS

14. Landing.- The SRB separation switch (S-1) and ET separation switch (S-3) on panel C3 are to be placed into the AUTO position prior to entering MM304 to protect against premature activation of the FC landing SOP due to a jammed or inadvertently activated SEP pushbutton (S-2 or S-4). the switches (S-1, S-3) can safely be placed to the MAN/AUTO (S-1) and MAN (S-3) positions after main gear weight on wheels (WOW) signal.
15. Controllers
- a. The FLT CNTLR POWER switches Inadvertent firings of the (PNLS F6, F8 and A6) cause THC transient outputs when turned on. To prevent jet firings in MM201, the ORBITAL DAP, RCS JETS, VERNIER pushbutton must be lighted prior to switching FLT CNTLR POWER switches (PNLS F6 and A6) to on. Transients cannot be avoided if power switches are thrown in MM104, 105, 106, 301, 302, 303; therefore, procedures must avoid powering up crew station controllers in these modes.
- b. When the Flight Controller at Power Switch is turned on, turn the "Power Supply Good acceptable Discrete" will go on for one or two samples (0.2 to 0.4 second), go off approximately 1.5 seconds, and then go on and stay on.
- c. The FLT CNTLR PWR switch should not be turned off after engage of On-Orbit Auto maneuver, or if RCS thrusters should not be fired.
- RESULT IF EXCEEDED  
If either S-2 or S-4 are activated prior to WOW and subsequently, the nose goes below 0° pitch attitude, then the elevons lock-up in the load-relief position at approximately 6° down. This is an irreversible software condition.
- RCS thrusters will occur as the power transients travel through the THC, wasting fuel and causing undesirable accelerations.
- DDU PS ABC BITE toggling Flight Controller Power on is a normal, accept-phenomenon. BITE measurement indications should be ignored for a minimum of 3.0 seconds.
- The DAP will command thrusters to fire and will "Hot Stick" down-mode due to RHC transients larger than breakout threshold.

3.4.5.1 Guidance, Navigation and Control Subsystems (Concluded)  
 CONSTRAINTS/LIMITATIONS RESULT IF EXCEEDED

16. Flight Control Channel Switches

Simultaneous operation of the Flight Control Channel switches should be avoided to assure that one system is powered up at all times.

Momentary loss of vehicle control may result if four FCS channels are simultaneously bypassed.

The manual switching of the FCS channel switches from "override" to "Auto" or "Auto" to "override", due to the break-before-make design of the switches, causes power interruption/bypass and subsequent reset of the channel associated with the switch for each ASA and ATVC as follows:

- a. ASA 3-sigma bypass time  
 duration 0.51 to 1.37 seconds.
- b. ATVC 3-sigma bypassed time  
 duration 0.210 to 0.520 second.

For more specific detail see  
 SODB Vol. III



TABLE 3.4.5.1-1.- GUIDANCE, NAVIGATION AND CONTROL SUBSYSTEM COMPONENT TEMPERATURE LIMITS  
(Paragraph 3.4.5.1)

Components	Minimum Operating Temperature, °F	Critical Item and Results If Exceeded	Maximum Operating Temperature, °F		Critical Item and Results If Exceeded	Minimum Non-operating Temperature, °F	Critical Item and Results If Exceeded	Maximum Non-operating Temperature, °F		Critical Item and Results If Exceeded
			Long Term	Short Term				Long Term	Short Term	
Rate gyro assembly	-65 <sup>a</sup>	b	165 <sup>a</sup>	165 <sup>a</sup>	b	-65	Design test limit	165	190/1 <sup>c</sup> hr	b
Body-mounted accelerometers	0 <sup>a</sup>	b	145 <sup>a</sup>	145 <sup>a</sup>	b	-65	Design test limit	122	190/1 <sup>c</sup> hr 156/6 hr	Design test limit
Inertial measurement unit	15	Below 35° F, possible system degradation	125	125	Above 120° F, possible system degradation	-65	All integrated circuits. Std Military Spec. range	122	150	Fluid filled accelerometers will leak.
Star tracker	40	Degraded accuracy. Internal thermal compensation lower calibration limit is 40° F.	120 <sup>d</sup>	120 <sup>d</sup>	Image dissector tube (IDT). Above 120° F, the star tracker accuracy will be degraded.	-30	Lens assembly and mounting. Differential thermal contraction may cause permanent optical misalignment with degraded performance.	150	150	Image dissector tube (IDT). At 150° F, the IDT photocathode will degrade and eventually fail.
Door	-100	Specification limit	150		Specification limit	-100	Specification limit	350	350	Specification limit
Air data probe	-100	Possible loss of total sensor calibration	850 <sup>e</sup>	1000 <sup>f</sup>	Loss of all air data	-100 (probe stowed)	Possible loss of total temperature sensor calibration	350	350 (Probe stowed)	Loss of total temperature sensor calibration
Air data probe deployment actuator	-100	Electric motor (qualified to -100° F)	300	300	Electric motor (qualified to 300° F)	-100 (probe stowed)	Electric motor (qualified to -100° F)	350	350 (Probe stowed)	Electric motor (qualified to 330° F)
Air data transducer assembly	35 <sup>g</sup>	System accuracy degradation	100 <sup>g</sup>	100 <sup>g</sup>	System accuracy degradation	-65	Design test limit	122	150 <sup>c</sup>	Design test limit

<sup>a</sup> Minimum and maximum operating temperatures are for ambient air and are applicable if the mounting surface of the package to be cooled (for coldplate-mounted equipment) is maintained within a range of 30° F to 125° F and if the structural temperature (for structural-mounted equipment) is maintained within a range of 35° F to 120° F.

<sup>b</sup> Each case in which temperature limits are exceeded will have to be evaluated on an individual basis due to the many variables involved. Variables include items such as which temperature was exceeded - ambient or coldplate structure; the time duration that the limits were exceeded; and, the command activity and bus voltage during that time period.

<sup>c</sup> Package LRU is subjected to 190° F for 1 hour.

<sup>d</sup> Temperature at the startracker mounting interface.

<sup>e</sup> Temperature at total temperature sensor location. Probe qualified at 850° F for 2 minutes.

<sup>f</sup> Temperature at total temperature sensor location. Local flow conditions to produce 1000° F. Total temperature will exist at the start of probe deployment. However, the total temperature will decay in msec as flow velocities decrease as a function of the descent trajectory. The probe will heat to temperatures <850° F when deployed.

<sup>g</sup> ADTA transducers are calibrated (compensated) for these temperatures.

TABLE 3.4.5.1-1.- GUIDANCE, NAVIGATION AND CONTROL SUBSYSTEM COMPONENT TEMPERATURE LIMITS  
(Paragraph 3.4.5.1) (continued)

Components	Minimum Operating Temperature, °F	Critical Item and Results If Exceeded	Maximum Operating Temperature, °F		Critical Item and Results If Exceeded	Minimum Non-operating Temperature, °F	Critical Item and Results If Exceeded	Maximum Non-operating Temperature, °F		Critical Item and Results If Exceeded
			Long Term	Short Term				Long Term	Short Term	
Yaw and brake pedal	35	Actuator lubricant specification limit <sup>c</sup>	120	120	Actuator lubricant specification limit <sup>c</sup>	NA	NA	120	NA	Actuator lubricant specification limit
Aerosurface servo amp	-65 <sup>a</sup>		165 <sup>a</sup>	165 <sup>a</sup>		-65	Design test limit	165	165 <sup>d</sup>	Design test limit
Rotation hand controller	0 <sup>a,b</sup>	b,c	145 <sup>a</sup>	145 <sup>a</sup>	c	-65	Design test limit	122	150 <sup>d</sup>	Design test limit
Speedbrake/thrust controller	0 <sup>a,b</sup>	b,c	145 <sup>a</sup>	145 <sup>a</sup>	c	-65	Design test limit	122	150 <sup>d</sup>	Design test limit
Rudder pedal transducer assembly	0 <sup>a,b</sup>	b,c	145 <sup>a</sup>	145 <sup>a</sup>	c	-65	Design test limit	122	150 <sup>d</sup>	Design test limit
Reaction jet driver forward	0 <sup>a</sup>	c	145 <sup>a</sup>	145 <sup>a</sup>	c	-65	Design test limit	122	150 <sup>d</sup>	Design test limit
Reaction jet driver aft	-65 <sup>a</sup>	c	165 <sup>a</sup>	165 <sup>a</sup>	c	-65	Design test limit	165	165 <sup>d</sup>	Design test limit
Ascent thrust control amp	-65 <sup>a</sup>	c	165 <sup>a</sup>	165 <sup>a</sup>	c	-65	Design test limit	165	165 <sup>d</sup>	Design test limit
Translation hand controller	0 <sup>a,b</sup>	b,c	145 <sup>a</sup>	145 <sup>a</sup>	c	-65	Design test limit	122	150 <sup>d</sup>	Design test limit

<sup>a</sup>Minimum and maximum operating temperatures are for ambient air and are applicable if the mounting surface of the package to be cooled (for coldplate-mounted equipment) is maintained within a range of 30° F to 125° F and if the structural temperature (for structural-mounted equipment) is maintained within a range of 35° F to 120° F.

<sup>b</sup>Each case in which temperature limits are exceeded will have to be evaluated on an individual basis due to the many variables involved. Variables include items such as which temperature was exceeded - ambient or coldplate structure; the time duration that the limits were exceeded; and, the command activity and bus voltage during that time period.

<sup>c</sup>Package LRU is subjected to 190° F for 1 hour.

<sup>d</sup>Temperature at the startracker mounting interface.

TABLE 3.4.5.1-2.- GN&C COMPONENT SELF TEST LIMITS  
(Paragraph 3.4.5.1)

Component		Limits	
1. MLS	- Range - Azimuth - Elevation	15.2 nmi. ± .2 ±3.0 deg ± .1 6.0 deg ± .1	
2. TACAN	- Range - Bearing	0.0 nmi. +.5, -.0 180.0 deg ± 2.5	
3.	Radar altimeter	1,000 ft ± 100 ft	
4.	Accel- Y scale - Y bias - Z scale - Z bias	16.1 ft/sec <sup>2</sup> ± 1.7 0.0 ft/sec <sup>2</sup> ± 0.45 64.4 ft/sec <sup>2</sup> ± 6.7 0.0 ft/sec <sup>2</sup> ± 1.29	
5. RGA	- Roll scale	Test high +20.0 deg/sec ±1.12	Test low -20.0 deg/sec ±1.12
	- Roll bias	0.00 deg/sec ±0.35	0.00 deg/sec ±0.35
	- Pitch and yaw scale	+10.0 deg/sec ±0.56	-10.0 deg/sec ±0.56
	- Pitch and yaw bias	0.000 deg/sec ±0.19	0.000 deg/sec ±0.19
6. ADTA	- P static	Test high 0.814 in. Hg ± .001	Test low 24.888 in. Hg ± .001
	- P α center	5.475 in. Hg ± .002	29.529 in. Hg ± .002
	- P α upper	2.742 in. Hg ± .002	21.710 in. Hg ± .002
	- P α lower	1.710 in. Hg ± .002	14.715 in. Hg ± .002
	- T <sub>t</sub>	173.58 °C ± 0.02	18.52 °C ± 0.02
7. RPTA (2)		Full left and right ≥ 91 percent; null ≤ 9 percent <sup>a</sup>	

- <sup>a</sup>1. Values shown are for 0 psi compartment pressure differential.
2. Flight results for 14.7 psi crew compartment pressure differential listed below (and are repeatable for a given vehicle).
3. Flight results for OV-102 from STS-4 and STS-5.
4. Null value return to prelaunch value at 40,000 ft. (noted during STS-7 entry) was not confirmed by distortion analysis and geometry of pedal linkage.
5. Shifts for any crew compartment pressure differential except 14.7 psi were not analyzed.
- 6.

RPTA test condition	OV-102 percent		OV-103, percent		OV-104, percent	
	L RPTA, percent	R RPTA, percent	L RPTA, percent	R RPTA, percent	L RPTA, percent	R RPTA, percent
Null shift	L(-)3.5	L(-)3.5				
Decr. output at right pedal stop		3.5	3.9		To be supplied	
Incr. output at left pedal stop	Limited (>101)	Limited (>101)				

TABLE 3.4.5.1-2.- GN&C COMPONENT SELF TEST LIMITS - CONCLUDED  
(Paragraph 3.4.5.1)

Component	Limits	
8. SBTC (2)	Full aft $\geq$ 95 percent; full forward $\leq$ 5 percent	
9. RHC (2) - Pitch	<92 percent at soft stop, $\geq$ 92 percent at hard stop	
- Roll	<92 percent at soft stop, $\geq$ 92 percent at hard stop	
- Yaw	<88 percent at soft stop, $\geq$ 88 percent at hard stop	
RHC Null - Pitch, Roll, Yaw	<7 percent	
10. Aerosurface feedbacks-Rudder Channel to channel - Speed-shall not exceed brake	1.2 deg (3 $\sigma$ ) 2.2 percent (3 $\sigma$ )	
- Body flap	3 percent (3 $\sigma$ )	
- Elevon(4)	1.3 deg (3 $\sigma$ )	
11. AMI (2)	High	Low
- Alpha	+30 deg	+2 deg
- Accel	+30 ft/sec <sup>2</sup>	+20 ft/sec <sup>2</sup>
- M/Vel	Mach 3	20k ft/sec
- EAS	300 knots	20 knots
12. AVVI (2)		
- Alt accel	+3 ft/sec <sup>2</sup>	-2 ft/sec <sup>2</sup>
- Alt rate	+300 ft/sec	-200 ft/sec
- Alt	300k ft	+200 ft
- Radar alt	3k ft	200 ft
13. ADI (3)	High	Low
- R Att	300 deg	20 deg
- P Att	300 deg	20 deg
- Y Att	300 deg	20 deg
- R Rate	3 marks right	2 marks left
- P Rate	3 marks up	2 marks down
- Y Rate	3 marks right	2 marks left
- R Att err	3 marks right	2 marks left
- P Att err	3 marks up	2 marks down
- Y Att err	3 marks right	2 marks left
14. HSI (2) - Sel course	30 deg	200 deg
- Heading	300 deg	20 deg
- Pri bearing	30 deg	20 deg
- Sec bearing	300 deg	200 deg
- Pri miles	3000 nmi.	200 nmi.
- Sec miles	3000 nmi.	200 nmi.
- Course dev	1st dot right	1st dot left
- G/S dev	1st dot up	1st dot down
15. SPI (2)		
- LOB	-30 deg	-20 deg
- LIB	-30 deg	-20 deg
- RIB	-30 deg	-20 deg
- ROB	-30 deg	-20 deg
- Body flap	30 percent	20 percent
- Rudder	3 deg right	20 deg left
- Aileron	3 deg right	2 deg left
- Speedbrake	30 percent	20 percent
- Speed brake command	30 percent	20 percent

TABLE 3.4.5.1-3.- IMU PERFORMANCE DEGRADATION FOR OVER AND UNDER TEMPERATURE  
(Paragraph 3.4.5.1)

Parameter	Temperature sensitivity	Maximum error <sup>a</sup>
<u>Platform ready fail</u> <u>at 153.7°F (lower level)</u>		
2X accelerometer bias	±5 µg/°F	±31.5 µg
1X accelerometer bias	±40 µg/°F	±252 µg
2X accelerometer scale factor	±50 ppm/°F	±315 ppm
1X accelerometer scale factor	±100 ppm/°F	±630 ppm
Gyro restraint	±.003°/hr/°F	±.0189°/hr
Gyro scale factor Mod II	±250 ppm/°F	±1575 ppm
Gyro scale factor Mod IIC	±100 ppm/°F	±630 ppm
<u>Platform safe fail</u> <u>at 169.7°F (higher level)</u>		
2X accelerometer bias	±5 µg/°F	±48.5 µg
1X accelerometer bias	±40 µg/°F	±388 µg
2X accelerometer scale factor	±50 ppm/°F	±485 ppm
1X accelerometer scale factor	±100 ppm/°F	±970 ppm
Gyro restraint	±.003°/hr/°F	±.029°/hr
Gyro scale factor Mod II	±250 ppm/°F	±2425 ppm
Gyro scale factor Mod IIC	±100 ppm/°F	±970 ppm
<u>CAPRI ready fail</u> <u>(138°F)</u>		
Accelerometer bias	±4.9 µg/°F	±53.9 µg
Accelerometer scale factor	±53.8 ppm/°F	±591.8 ppm
<u>CAPRI safe fail</u> <u>(172.1°F)</u>		
Accelerometer bias	±4.9 µg/°F	±113.2 µg
Accelerometer scale factor	±53.8 ppm/°F	±1242.8 ppm
<u>Platform cluster thermostat</u> <u>(opens at 178° F)</u>		
Gyro restraint	±.003°/hr/°F	±.054°/hr
Gyro scale factor Mod II	±250 ppm/°F	±4500 ppm
Gyro scale factor Mod IIC	±100 ppm/°F	±1800 ppm
2X accelerometer bias	±5 µg/°F	±90 µg
1X accelerometer bias	±40 µg/°F	±720 µg
2X accelerometer scale factor	±50 ppm/°F	±900 ppm
1X accelerometer scale factor	±100 ppm/°F	±1800 ppm
<u>CAPRI thermostat</u> <u>(opens at 203° F)</u>		
Accelerometer bias	±4.9 µg/°F	±264.6 µg
Accelerometer scale factor	±53.8 ppm/°F	±2905.2 ppm

<sup>a</sup>Based on nominal CAPRI operating temperature of 149°F and nominal platform cluster temperature of 160°F.

3.4.5.2 Communications and Tracking Subsystems  
CONSTRAINTS/LIMITATIONS

## RESULT IF EXCEEDED

1. Equipment Temperature Limits.

a. See table 3.4.5.2-1.

b. The Ku-Band deployed assembly (DA) rate sensor assembly (RSA) heater for the MC409-0025-3006 is a 56 watt heater and will maintain a gyro temperature of  $144^{\circ} \pm 10^{\circ}$  F. The RSA heater for MC409-00250-3007 and up is an 18 watt heater. The 18 watt heater will maintain the gyro temperature, as indicated by telemetry, between  $135^{\circ}$  F and  $160^{\circ}$  F except for a cold soak environment which can result in a gyro temperature as low as  $100^{\circ}$  F. In event the RSA heater is deactivated (or fails off), the gyro temperature will not go below  $0^{\circ}$  F while the Ku-Band equipment is in STANDBY or ON. The DA is operational with a gyro temperature of  $0^{\circ}$  F including the capability to lock the gimbal.

At gyro temperature below  $0^{\circ}$  F the radar angle rate measurement error may exceed specification limits and scan (angle search) patterns may be distorted.

2. Television System.a. The TV cameras should not be operated above the caution and warning limit of  $113^{\circ}$  F.

b. Loss of cooling for more than 30 minutes can affect the following television equipment:

TV monitor, remote control unit, and video switching unit.

Camera performance degradation may occur starting at this point.

Performance degradation may occur.

c. The TV Laser Ranger must not be pointed directly into the sun.

Possible laser diode and filter damage.

3.4.5.2      Communication and Tracking Subsystem (Cont)  
 CONSTRAINTS/LIMITATIONS      RESULT IF EXCEEDED

3. Navigation Sensors "On Time".  
 Refer to Guidance, Navigation and Control Subsystem (paragraph 3.4.5.1).
4. Ground Command Interface Logic (GCIL).
  - a. GCIL Temperature Limits.  
 See table 3.4.5.6-1.
  - b. A GCIL input voltage level of less than 22 Vdc for a period between 400 microsec and 1.0 millisecc shall result "Revert To Panel" Mode/flag.      The "Revert To Panel" flag (measurement) shall remain set until a "Revert To in Panel" reset command is issued.
5. Orbiter KU-Band High Gain Steerable Antenna (Communication/Radar System).  
 The KU-Band system can emit a maximum of 10 Volts/meter (V/m) at the periphery of the standard (15-foot diameter) payload envelope for all locations in the payload bay with an  $X_0$  coordinate greater than 600.      If payload equipment sensitivity requires 10 V/m or less, antenna angle limitation may be instituted manually or the KU-band transmitter may be turned off.  
 Outside the protected obscuration zone, the maximum electric field intensity in the main beam could expose a payload to as much as 254 V/m 3 meters away from the antenna. Although closer proximity to the KU-band radar antenna is possible, thus exposing the payload to higher field intensities, such an approach by a payload to less than 3 meters of the antenna would represent a physical hazard to the Orbiter. For this reason, the exposure of a payload to the peak reactive fields of 304 V/m is not anticipated.
6. Orbiter UHF-Band (Underbelly) Antenna Radiating in the Air-to-Ground Simplex Mode Only.\*  
 See paragraph 3.4.2.5.

\* NASA Data Source

3.4.5.2

## Communication and Tracking Subsystem (Cont)

## CONSTRAINTS/LIMITATIONS

7. Ku-Band Deployed Assembly  
(Communications/Radar System).

The electrical connections between the deployed electronic assembly (DEA) and deployed mechanical assembly (DMA) are provided by a cable wrapped within the gimbal assembly. Antenna (gimbal) motion during pointing, stowing or scanning may introduce excessive cable friction which will degrade antenna performance or during stowing, may cause gimbal lock damage.

## RESULT IF EXCEEDED

Pointing. If excessive cable friction occurs from antenna angle designation, the friction will cause the antenna to continue to move (cycle) about the designated angle(s) with ever diminishing amplitude and the entire cycling phenomena lasting approximately 100 seconds. Cycling motion of the antenna about the designated angle(s) will not necessarily be apparent by observing the angle readout display in the crew module. The antenna motion itself (when observable) during cycling is apparent.

Cessation of the cycling restores the system to proper operation.

Stowing. To avoid the antenna cycling problem during stowing of the deployed assembly and thus prevent potential damage to the antenna gimbal locks, the antenna must be manually slewed to the antenna stowable position of minus  $29.4^{\circ} \pm 2.5^{\circ}$  in pitch and minus  $125.3^{\circ} \pm 2.5^{\circ}$  in roll prior to initiating the stowing of the deployed assembly. After the antenna has been positioned to these angles, then the deployed assembly may be stowed.

Scanning. To prevent deficient performance of the antenna that is caused by excessive friction in the cable wrap when scanning for a target during the SEARCH sequence, the cable wrap should be unwrapped first. This is accomplished by designating the antenna to the zenith position, i.e.,



3.4.5.2 Communications and Tracking Subsystems (Cont)

CONSTRAINTS/LIMITATIONS

7. Ku-Band Deployed Assembly  
(Comm/Radar System - Cont.)

RESULT IF EXCEEDED  
roll equal zero  $\pm 5^\circ$  and  
pitch equal zero  $\pm 5^\circ$ , by  
FAST manual steering mode.  
Then position the antenna  
ELEV slew switch momentarily  
up for 14  $\pm 2$  seconds. This  
cable unwinding motion is  
intended to remove the  
excessive friction in the  
cable wrap. The antenna may  
now be positioned to the  
desired location as required  
and the SEARCH initiated as  
required.

NOTE: When observing the  
antenna motion during the  
ELEV slew up for approxi-  
mately 14 seconds, the  
antenna motion should be a  
near pure alpha rotation of  
the gimbals to the negative  
stop, an automatic wrap  
around wherein the antenna  
will move to a position very  
close to the positive alpha  
stop and return to the  
original direction of  
motion.

8. KU-Band Radar Self Test  
Communication/Radar System).  
To perform a radar system self  
test with the deployed assem-  
bly fully deployed, the TWTA  
must be operating.

Since the TWTA is not  
operating, the deployed  
assembly and radar system  
self-test will fail.

9. KU-Band Communications  
Acquisition (Communication/  
Radar System).  
Acquisition of the TDRS can  
occur by the Ku-Band antenna  
by the KU-Band antenna sidelobe  
with TDRS radiation densities  
exceeding minus 113.9 dBW/m<sup>2</sup>.

If acquisition of the TDRS  
occurs on a sidelobe, normal  
operation (i.e., sequencing  
to the track mode) will not  
occur because of the weak  
signal and improper mono-  
pulse angle track functioning.  
The KU-band is prevented from  
acquiring on its main lobe when-  
ever a sidelobe detect occurs.  
Until main lobe acquisition  
occurs, normal operation is  
prevented.

## 3.4.5.2 Communications and Tracking Subsystems (Cont)

## CONSTRAINTS/LIMITATIONS

## RESULT IF EXCEEDED

10. KU-Band Deployed Assembly Stowing (Communication/Radar System). Orbiter accelerations should be limited to  $\pm 0.5 \text{ deg/sec}^2$  and Orbiter rates limited to 5 deg/sec during the gimbal locking sequence to assure proper gimbal locking. Damage to the gimbal locking mechanism may occur.
11. KU-Band Radar or Communication Tracking (Communications/Radar System). The accuracy of the measurement parameters of angle, angle rate, and range rate are reduced as a function of Orbiter accelerations. In a communications mode, the allowed loss is exceeded during Orbiter accelerations. Accuracy of measured radar parameters and communications tracking accuracy will be degraded and a break-track condition may occur during Orbiter accelerations resulting from primary RCS firing. Measured radar parameter accuracy and communications tracking accuracy will be within specified limits for Orbiter accelerations resulting from vernier thruster firings (i.e., for accelerations of approximately  $0.03 \text{ deg/sec}^2/\text{axis}$ ). Radar data from the Ku-band communications/radar system may be invalid if system is in radar operating mode, standby power. The invalid data could include the "data good" status flags as well as range, range rate, etc. In the event invalid radar data should be of concern, and standby operation is desired, the invalid data can be avoided by selecting communications operating mode and standby power. The equipment may fail self-test even though it is operating properly. This problem can be avoided by going to standby power momentarily (i.e. 3 to 5 seconds); send self-test command and and go to radar ON.
12. Ku-band Radar Data (Communications/Radar System). Radar data from the Ku-band communication/radar system is not controlled when the radar operating mode standby power is selected.
13. KU-Band Radar Self-Test (Communications/Radar System). The radar AGC can be set at a level that will preclude detection of the self-test target, if the equipment has been ON in the radar operating mode, prior to commanding self-test.

## 3.4.5.2

## Communications and Tracking Subsystems (Cont)

## CONSTRAINTS/LIMITATIONS

14. KU-Band Radar Passive-Coop Switching (Communications/Radar System). Switching from radar coop (active) target mode to radar passive target mode (or vice versa) while Ku-power is ON can result in EA-2 (Electronics Assembly -2) "hanging up" in the OFF state.
15. KU-Band Switching, Communications OFF or Communications to Radar. The following steps are required prior to switching from comm (communications) ON to OFF or STANDBY and when switching from the comm operating mode to the radar operating mode:
1. Set return link mode 1/mode 2 select to MODE 2.
  2. Set the modulation on/off select to ON.
16. KU-Band Steering Mode when Orbiter is Maneuvering, Radar Operations: Select Auto Steering Mode prior to starting orbiter maneuver to the TI burn attitude during rendezvous when using the Ku-Band radar. The Auto Steering Mode (or any Steering Mode other than GPC ACQ) should be selected when operating in radar and the line-of-sight angles to the target are (or may be as a result of orbiter maneuvers) outside of the normal radar operating region -- i.e. outside the 60 deg. half cone centered about the orbiter -Z-axis.

## RESULT IF EXCEEDED

Radar function is inoperative. This condition can be avoided by selecting the desired radar target mode prior to switching Ku-power ON. In the event it is desired to change target modes after the equipment is ON (in radar operating mode), the problem can be avoided by the following sequence:

- (1) KU-power to STANDBY.
- (2) Select desired target mode.
- (3) KU-power to ON.

Failure to follow these steps can result in leakage of the 1.875 GHz IF through the SPA and transmission of 15 GHz signals during radar operations. Anomalous readings of the transmitted rf power measurement may occur.

If the Ku-Band equipment is left in the GPC ACQ steering mode and the maneuver results in a loss of target, Ku-Band equipment will be commanded to perform a scan (angle search). A scan when the beta is large can result in sustained, large angle, oscillation of the antenna. In the event that sustained, large angle, oscillations are experienced, they can be stopped and normal operation restored by switching the power to STANDBY for four to six seconds and then back to ON. If the Ku-Band power is switched to OFF to stop sustained, large angle, oscillations, wait at least 15 seconds before switching power back to ON. (See 18 below)

## 3.4.5.2

## Communications and Tracking Subsystems (Cont)

CONSTRAINTS/LIMITATIONS	RESULT IF EXCEEDED
17. <u>Ku-Band Fast Manual Slew</u> : A prolonged fast manual slew maneuver with the beta angle large can result in a sustained, large angle, oscillation of the antenna when the slew command is removed.	This is the same phenomenon addressed in constraint number 16 except that the entry, or configuration just prior to entry into sustained large angle oscillations, is different. This phenomenon occurred one time out of every four or five attempts during System Development Testing while doing FAST Pitch DOWN maneuvers with beta near the negative stop -- i. e. approximately minus 84 degrees. Sustained, large angle, oscillations will not occur as a result of the "cable unwrap" maneuver described in constraint number 7 because the beta angle remains near zero deg. throughout the maneuver. In the event that sustained, large angle, antenna oscillations are experienced, they can be stopped and normal operation restored by switching the Ku-Band power to STANDBY for four to six seconds and then back to ON. If the power is switched to OFF to stop the oscillations, wait at least 15 seconds before switching power back to ON.

3.4.5.2

## Communications and Tracking Subsystems (Cont)

## CONSTRAINTS/LIMITATIONS

RESULT IF EXCEEDED

18. Clearing Ku-Band Internal Faults:(a) DEA Transmitter Faults:

The DEA has four transmitter fault protection circuits as follows:

- o Cathode Under Voltage
- o Cathode Over Voltage
- o Helix Current (or Body Current)
- o Transmitter Current

The cathode under voltage fault protection circuit is a non-latching circuit -- normal operation is resumed if/when the under voltage condition goes away.

The other circuits are latching circuits and have to be reset. Cathode over voltage and helix current faults can be reset by switching the Ku-Band equipment to STANDBY but the equipment must be switched OFF to reset a transmitter current fault.

(b) Low Voltage Power Supply Faults:

The low voltage power supplies (LVPS's) in the Ku-Band EA-1, EA-2, SPA, and DA (DEA) have internal fault protection circuits as follows:

- o Under Voltage
- o Over Voltage
- o Over Current

The under voltage protection circuit, which monitors the 28 Vdc input power, is non-latching; normal operation of LVPS will automatically be resumed when/if the fault condition clears. The other two fault protection circuits are latching and have to be reset by switching the Ku-Band equipment OFF.

Failure to follow the procedure for clearing transmitter and/or LVPS faults could result in the following problems:

- o Inability to isolate a transmitter current fault from a helix current fault or a cathode voltage fault.
- o If the Ku-Band power is off less than two seconds (step 6), the LVPS will not turn off and the transmitter current fault circuit will not be reset.
- o If the power is OFF more than seven seconds, the TWT filament time out will be reset. This will result in approximately four minutes delay before the TWT will come on which could be misinterpreted as a nonclearable fault or failure.
- o Switching the Ku-Band equipment from ON to OFF and then back to ON without waiting in STANDBY for 12 to 15 seconds (step 8) will result in transients on the high voltage wave forms that are considered undesirable.

3.4.5.2

## Communications and Tracking Subsystems (Cont)

## CONSTRAINTS/LIMITATIONS

RESULT IF EXCEEDED

18. Clearing Ku-Band Internal Faults (Concluded):

The procedure for resetting the latching fault circuits in the DEA transmitter and the LVPS's (and restoring normal operation if the condition causing the fault circuit to trip has gone away) is as follows:

1. Switch Ku-Band power to STANDBY.
2. Wait four to six seconds.
3. Switch Ku-Band power to ON.
4. If normal operation is restored, the problem was probably either a cathode over voltage or a helix (body) current fault and the condition causing the fault has cleared. If normal operation is not restored, proceed with step 5 below.
5. Switch Ku-Band to OFF.
6. Wait four to six second.
7. Switch Ku-Band power to STANDBY.
8. Wait 12 to 15 seconds.
9. Switch Ku-Band power to ON.

Note:

A DEA LVPS fault, either latching or non latching, will result in erratic antenna motion or a "runaway antenna". It may not be possible to distinguish between a DEA LVPS fault and a sustained, large angle, oscillation identified in constraints 16 and 17 above during real time orbital operations until after the fault reset/fault clearance procedure has been performed.

19. Ku-Band Equipment -- TransientsOn The Transmitted RF Power Measurement (V74E2511A):

Cycling of the Ku-Band deployed electronic assembly (DEA) heater causes transients on the Ku-Band RF power measurement. Transient magnitude is dependent on transmitter operation as follows:

- o Transmitter OFF (e.g. inhibited as a result of the gimbal position being within the obscuration zone, the transmitter OFF command,

Failure to recognize that the DEA heater cycling ON or OFF causes transients on the transmitted RF power measurement can result in the following false concerns:

- o RF power is being radiated when, in fact, no radiation is present.
- o RF power output is varying when, in fact, it is stable.
- o RF power output is higher than commanded.

3.4.5.2-9

## 3.4.5.2

## Communications and Tracking Subsystems (Concluded)

## CONSTRAINTS/LIMITATIONS

## RESULT IF EXCEEDED

19. Ku-Band Equipment -- TransientsOn The Transmitted RF PowerMeasurement (V74E2511A)(Concluded):

equipment operating in  
standby, etc.):

Measurement momentarily  
indicates essentially  
full power output.

o Transmitter on, full  
power output: Measure-  
ment may indicate a small  
momentary, increase in  
RF power output.

o Transmitter ON, Medium or  
Low power commanded (radar  
only): Measurement  
momentarily indicates  
essentially full power  
output.

20. Ku-Band Equipment -- DA Wiggle  
Test:

EA-1 will perform a wiggle test  
on the DA gimbal even though  
the DA is stowed (i.e. the  
transmit scan enable signal is  
LOW) if the Ku-Band equipment  
is switched to either STANDBY  
or ON after being OFF and the  
stow initiate signal is HIGH.

Possible damage to the  
antenna and/or orbiter.

Possible safety hazard.  
The DA gimbal motors are  
not explosion proof.

21. Ku-Band Communications

Uplink Command (Communications/  
Radar System). When the  
communications system is  
commanded on via an uplink  
command, a valid Channel 3  
selection must be made.

Failure to switch to  
Mode 2 Return Link. The  
Ku-Band is initialized at  
turn-on for a Mode 1  
Return Link. If a  
Channel 3 selection is  
not made after turn-on,  
the system will remain in  
Mode 1.

22. S-Band Power Amplifier  
Assembly Temperature  
Limits.

a. Power amplifier assembly  
(LRU) Table 3.4.5.2-1.

b. Collector 1 (V74T4514A)

c. Collector 2 (V74T4515A)

Irreparable damage to LRU  
may result if temperature  
limits are exceeded.  
+ 230° F maximum  
+ 230° F maximum

TABLE 3.4.5.2-1.- COMMUNICATIONS AND TRACKING SUBSYSTEM COMPONENT TEMPERATURE LIMITS  
(Paragraph 3.4.5.2)

Components	Minimum Operating Temperature, °F <sup>a</sup>	Critical Item and Results If Exceeded	Maximum Operating Temperature, °F		Critical Item and Results If Exceeded	Minimum Non-operating Temperature, °F	Critical Item and Results If Exceeded	Maximum Non-operating Temperature, °F		Critical Item and Results If Exceeded
			Long Term <sup>b</sup>	Short Term				Long <sup>b</sup> Term	Short <sup>c</sup> Term	
Audio CCU	-20	Off-limit temperature testing has not been done to determine critical temperature or critical item.	120	120	Off-limit temperature testing has not been done to determine critical temperature or critical item.	-65	Off-limit temperature testing has not been done to determine critical temperature or critical item.	150	200	Off-limit temperature testing has not been done to determine critical temperature or critical item.
Television system camera <sup>d</sup>	-20		140	140		-20		140	140	
Laser ranger sight	-4		130	130		-5		130	130	
Video recorder	+60		120	120		-20 <sup>e</sup>		120	120	
Payload and network signal processors	-20		120	120		-65		120	190	
FM signal processor	+35		120	120		-65		120	150	
S-band transponder	+35		110	120		-65		120	150	
S-band power amplifier	+35		120	120		-65		120	150	
S-band preamplifier	+35		120	120		-65		120	150	
S-band FM transmitter	+35		120	120		-65		120	150	
S-band antenna switch assembly	+35		120	120		-65		120	150	
S-band switch beam control assembly	-20		120	120		-65		120	190	
EVA/ATC transceiver	-20		120	120		-65		120	190	

<sup>a</sup> Surrounded by air - coldplate temperature 35° F

<sup>b</sup> In excess of 6 hrs

<sup>c</sup> One hr maximum

<sup>d</sup> Operating temperatures monitored (sit tube sensor) internal to camera. Alarm trips at 115° F and reads out on TV monitor and caution and warning.

<sup>e</sup> With tape not installed, with tape installed limit is 60° F.



TABLE 3.4.5.2-1.- COMMUNICATIONS AND TRACKING SUBSYSTEM COMPONENT TEMPERATURE LIMITS (Continued)  
(Paragraph 3.4.5.2)

Components	Minimum Operating Temperature, °F	Critical Item and Results If Exceeded	Maximum Operating Temperature, °F		Critical Item and Results If Exceeded	Minimum Non-operating Temperature, °F	Critical Item and Results If Exceeded	Maximum Non-operating Temperature, °F		Critical Item and Results If Exceeded
			Long Term	Short Term				Long <sup>b</sup> Term	Short <sup>c</sup> Term	
Ku-band deployment mechanism <sup>f</sup>	-100	Lubricant	160	NA	Test limit	-100	Test limit	300	NA	Test limit
Ku-band deployed assembly	g	Off-limit temperature testing has not been done to determine critical temperature or critical item.	g	g	Off-limit temperature testing has not been done to determine critical temperature or critical item.		Off-limit temperature testing has not been done to determine critical temperature or critical item.			Off-limit temperature testing has not been done to determine critical temperature or critical item.
1. Transmitter	0		176	200		-65		176	200	
2. Receiver	0		161	200		-65		161	200	
3. A-axis gimbal	0		155	185		-65		155	185	
4. B-axis gimbal	0		171	185		-65		171	185	
5. Antenna feed	0		191	250		-65		191	250	
6. Gyro	0		160	185		-65		160	185	
Ku-band Electronic assemblies 1 and 2	0 <sup>a</sup>	Off-limit temperature testing has not been done to determine critical temperature or critical item.	140 <sup>i</sup>	140 <sup>i</sup>	Off-limit temperature testing has not been done to determine critical temperature or critical item.	-65	Off-limit temperature testing has not been done to determine critical temperature or critical item.	120	150	Off-limit temperature testing has not been done to determine critical temperature or critical item.
Ku-band Signal processor	0 <sup>a</sup>		140 <sup>i</sup>	140 <sup>i</sup>		-65		120	150	
Payload interrogator	35 <sup>a</sup>		113 <sup>i</sup>	125 <sup>i</sup>		-65		120	150	
RALT	35 <sup>a</sup>		140 <sup>i</sup>	140 <sup>i</sup>		-65		160	190	
TACAN <sup>h</sup>	35		160	160		-65		150	190	
MSBLS	-65	None	160	160	None	-70	None	160	160	None

<sup>a</sup>Surrounded by air - coldplate temperature 35° F

<sup>b</sup>In excess of 6 hrs

<sup>c</sup>One hr maximum

<sup>f</sup>Mounted in the payload bay.

<sup>g</sup>The deployed assembly should not be operated on the ground or in space unless the indications of the six temperature sensors are within the maximum/minimum operating temperature ranges.

<sup>h</sup>TACAN must not be operated without air cooling. During a contingency situation in which there is an absence of air cooling, the unit may be operated for 3 minutes, but will probably not operate after 5 to 10 minutes.

<sup>i</sup>Surrounding air temperature; maximum cold plate temperature is 120° F.

TABLE 3.4.5.2-1.- COMMUNICATIONS AND TRACKING SUBSYSTEM COMPONENT TEMPERATURE LIMITS (Concluded)  
(Paragraph 3.4.5.2)

Components	Minimum Operating Temperature, °F <sup>a</sup>	Critical Item and Results If Exceeded	Maximum Operating Temperature, °F		Critical Item and Results If Exceeded	Minimum Non-operating Temperature, °F	Critical Item and Results If Exceeded	Maximum Non-operating Temperature, °F		Critical Item and Results If Exceeded
			Long Term	Short Term				Long <sup>b</sup> Term	Short <sup>c</sup> Term	
Antennas										
Ku-band microwave scan beam landing system (MSBLS)	-150	Dielectric lens. Parameter changes RF pattern degradation	270	350 <sup>j</sup>	Dielectric lens. Parameter changes RF pattern degradation	-150	Dielectric lens. Parameter changes RF pattern degradation	270	350	Dielectric lens. Parameter changes RF pattern degradation
L-band Tacan	-150	Polyimide foam (cavity filler). Parameter changes. RF pattern degradation.	270	350	Polyimide foam (cavity filler). Parameter changes. RF pattern degradation	-150	Polyimide foam (cavity filler). Parameter changes RF pattern degradation	270	350	Polyimide foam (cavity filler). Parameter changes RF pattern degradation
C-band altimeter	-150	Microspheres (cavity filler). RF pattern degradation	270	350 <sup>j</sup>	Microspheres (cavity filler). RF pattern degradation	-150	Microspheres (cavity filler). RF pattern degradation	270	350	Microspheres (cavity filler). RF pattern degradation
UHF	-150	Polyimide foam (cavity filler). RF pattern degradation	270	350 <sup>j</sup>	Polyimide foam (cavity filler). RF pattern degradation	-150	Polyimide foam (cavity filler). RF pattern degradation	270	350	Polyimide (cavity filler). RF pattern degradation
Hemi MC481-0070	-210	Polyimide glass. RF pattern degradation	270	350	Polyimide glass. RF pattern degradation	-210	Polyimide glass. RF pattern degradation	270	350	Polyimide glass. RF pattern degradation
S-band hemi/GPS MC481-0090	-160	Polyimide glass. RF pattern degradation	270	350 <sup>j</sup>	Polyimide glass. RF pattern degradation	-160	Polyimide glass. RF pattern degradation	270	350	Polyimide glass. RF pattern degradation
S-Band Payload MC481-0071	-210	Polyimide glass. RF pattern degradation	270	350	Polyimide glass. RF pattern degradation	-210	Polyimide glass. RF pattern degradation	270	350	Polyimide glass. RF pattern degradation
S-band quad switched beam MC481-0088	-160	Polyimide glass. RF pattern degradation	270	350 <sup>j</sup>	Polyimide glass. RF pattern degradation	-160	Polyimide glass. RF pattern degradation	270	350	Polyimide glass. RF pattern degradation

<sup>a</sup>Surrounded by air - coldplate temperature 35° F

<sup>b</sup>In excess of 6 hrs

<sup>c</sup>One hr maximum

<sup>j</sup>Radome window certified at center point to a maximum temperature of 500° F.

3.4.5.3 Caution and Warning Subsystem  
CONSTRAINTS/LIMITATIONS

1. Maximum system pressure is 30 psia.
  
2. Minimum system temperature is 35° F.
  
3. Maximum system temperature is 120° F.

RESULT IF EXCEEDED

Data based on hardware analysis. Any degradation or failure outside these parameters is not known at this time.

Equipment will be tested to these limits. Any degradation or failure outside these parameters is not known at this time.

Equipment will be tested to these limits. Any degradation or failure outside these parameters is not known at this time.

3.4.5.4

Data Processing Subsystems  
CONSTRAINTS/LIMITATIONS

1. Data Processing Components

Temperature Limits.

See tables 3.4.5.4-1 and  
3.4.5.4-2.

2. DEU/GPC Input Power. Input  
voltage to the DEU/GPC must not  
fall below 15 V/17.5 V for more  
than 400  $\mu$ sec.

3. Multiplexer/Demultiplexer Input  
Power. Both input power sources  
must not fall below 24 Vdc for  
more than 0.2 sec and must not  
fall below 22 Vdc for more than  
2.0 msec.

RESULT IF EXCEEDED

DEU/GPC will initiate  
shutdown sequence. There is  
an increased DEU/GPC failure  
rate (5.4 times steady-  
state) during the normal  
1-hour cooldown and 2-hour  
warmup due to thermal  
stress. However, there is  
no practical reliability  
penalty for power cycles at  
rates consistent with  
meaningful power conserva-  
tion measures.

Violation will cause all IOM  
subsystem signals to be set  
to a logic-zero state and  
the MDM power supplies will  
then turn off.

TABLE 3.4.5.4-1.- DATA PROCESSING SUBSYSTEM COMPONENT TEMPERATURE LIMITS  
(Paragraph 3.4.5.4)

Components	Minimum Operating Temperature, °F	Critical Item and Results If Exceeded	Maximum Operating Temperature, °F		Critical Item and Results If Exceeded	Minimum Non-operating Temperature, °F	Critical Item and Results If Exceeded	Maximum Non-operating Temperature, °F		Critical Item and Results If Exceeded
			Long Term	Short Term				Long Term	Short Term	
General purpose computer	-20 <sup>a</sup>	None specified Operation not verified below minimum temperature.	120	120	Electronic components exceed maximum case temperature.	-65	Electronic components exceed manufacturer's specified values.	120	150 <sup>b</sup>	None
Multiplexer/demultiplexer	-65 <sup>c</sup>	None	160 <sup>c</sup>	160 <sup>c</sup>	Electronic components exceed maximum case temperature.	-65	Electronic components exceed manufacturer's specified values.	165	165	None
Engine interface unit	-65	None	165	165	Electronic components exceed maximum case temperature.	-65	Electronic components exceed manufacturer's specified values.	165	165	None
Multifunction CRT display system	-20 <sup>d</sup>	None specified Operation not verified below minimum temperature.	120	120	Electronic components exceed maximum case temperature.	-65	Electronic components exceed manufacturer's specified values.	120	150 <sup>b</sup>	None
Mass memory unit	35 <sup>e</sup>	Magnetic tape binder degradation	105	105	Magnetic tape binder degradation	-10	Magnetic tape binder degradation	130	130	Magnetic tape
Multiplexer interface adapter Serial	-65	None specified Operation not verified below minimum temperature.	160	196 <sup>f</sup>	Semiconductor components exceed maximum junction temperature.	-65	Electronic components exceed manufacturer's specified values.	122 <sup>b</sup>	122 <sup>e</sup>	None
Dual	0	None specified Operation not verified below minimum temperature.	194	203 <sup>g</sup>	Semiconductor components exceed maximum junction temperature.	-65	Electronic components exceed manufacturer's specified values.	122 <sup>b</sup>	122 <sup>e</sup>	None
Data bus isolation amplifier	-65	None specified Operation not verified below minimum temperature.	165	165	Semiconductor components exceed maximum junction temperature.	-65	Electronic components exceed manufacturer's specified values.	122	150 <sup>b</sup>	None

<sup>a</sup> Compliance with functional performance requirements at 35° F and above

<sup>b</sup> For 6 hours a day

<sup>c</sup> Coldplates operating

<sup>d</sup> Functional compliance at 35° F

<sup>e</sup> Coldplate temperature 35° F to 130° F

<sup>f</sup> Test but not specified

<sup>g</sup> Expected but not specified

TABLE 3.4.5.4-2.- DATA PROCESSING SUBSYSTEM COMPONENT OPERATIONAL LIMITS FOR LOSS OF COOLING  
(Paragraph 3.4.5.4)

Component	Test Sequence <sup>a</sup>	Ambient Temp, <sup>b</sup> °F	Cold- plate Temp,°F	Coolant flow- rate, lb/min	Pressurized Cabin		Depressurized Cabin	
					Maximum operating time, min	Required cooldown time, hr.	Maximum operating time, min	Required cooldown time, hr.
GPC	Unit initially powered on. Following loss of cooling, unit allowed to operate until maximum allowable temperatures achieved, then powered off for cooldown. <sup>c</sup>	80	N/A	3.1 (IOP) 2.62(CPU)	26	4.5	20	No data
	Unit initially powered off. Following loss of cooling, unit powered on and allowed to operate until maximum allowable temperatures achieved. <sup>c</sup>	80	N/A	3.1 (IOP) 2.62(CPU)	56	4.5 <sup>d</sup>	45	No data
	Unit initially powered on. Following loss of cooling, unit immediately powered off for cooldown.	80	N/A	3.1 (IOP) 2.62(CPU)	No data	3.5	No data	No data
MCDS	Unit initially powered on. Following loss of cooling, unit allowed to operate until maximum allowable temperatures achieved, then powered off for cooldown. <sup>a</sup>	100	N/A	0.81 (DU) 1.93(DEU)	68	3	34	4
	Unit initially powered off. Following loss of cooling, unit powered on and allowable temperatures achieved. <sup>e</sup>	100	N/A	0.81 (DU) 1.93(DEU)	100	3 <sup>d</sup>	56	4 <sup>d</sup>
		77	N/A	0.81 (DU) 1.93(DEU)	132	No data	88	No data
MDM	Unit initially powered on. Following loss of cooling, unit allowed to operate.	145	120	Unknown <sup>f</sup>	No limit <sup>g</sup>	N/A <sup>h</sup>	No data <sup>i</sup>	No data

<sup>a</sup>Test sequences began with all conditions at steady-state prior to loss of force cooling.

<sup>b</sup>Ambient temperatures apply to pressurized-cabin cases only. For units which are forced-air cooled (GPC, MCDS), ambient temperature is also air inlet temperature.

<sup>c</sup>Maximum allowable temperature defined as a component junction temperature limit of 125° C (257° F). This temperature reflects a component specification limit and not an actual component destructive limit.

<sup>d</sup>Test sequence did not include a timed cooldown period. Required cooldown time for this case (unit initially powered off) is assumed to be the same test sequence with the unit initially powered on because in both cases, the unit is powered off when maximum temperatures achieved.

<sup>e</sup>Maximum allowable temperatures defined as a component junction temperature limit of 150° C (302° F). Actual testing was constrained to a junction temperature of 125° C (257° F) and data have been extrapolated to the 150° C (203° F).

<sup>f</sup>Flow rate as appropriate to maintain coldplate temperature of 120° F.

<sup>g</sup>After 2.5 hours, unit stabilized 11° F below the maximum allowable Singer MIA mounting surface temperature limit of 196° F (91° C).

<sup>h</sup>Although maximum temperatures were never achieved for this case, unit was powered off for cooldown. Temperature stabilized in 2 hours.

<sup>i</sup>Prior to the loss of forced cooling for this case, unit stabilized 11° F above the maximum allowable Singer MIA mounting surface temperature limit of 196° F (91° C). No further testing was done. Coldplate temperature was 125° F and coolant flow rate was appropriate to maintain a constant coldplate temperature.

3.4.5.5

Instrumentation Subsystems  
CONSTRAINTS/LIMITATIONS

RESULT IF EXCEEDED

1. Instrumentation Components

Temperature Limits.

See table 3.4.5.5-1. For MADS equipment temperature management data, see table 3.4.5.5-2 for OV-103 and OV-104.

2. Master Timing Unit.

a. The master timing unit requires a 12-hour warmup period prior to operation.

Specific accuracy and stability will not be achieved until the unit reaches operational temperature.

b. The master timing unit oscillator frequency shift is  $\pm 1$  part in  $10^7$  per day maximum.

Accuracy required to maintain time precision and keep the number of time updates to a minimum.

c. The MTU bite bits for "Voted Demand" accumulator channels A, B and C (3 BSR bits) may toggle, in any combination, as a result of PCM demand time sequence following time initialization.

No affect on time signals from MTU. Cycling power on operating PCM or switching to alternate PCM may correct condition.

3. Pulse Code Modulation Master Unit.

a. The 28 Vdc input power must not be interrupted for more than 400  $\mu$ sec.

PCMMU internal memories may be affected.

b. Input power to PCMMU must not fall below 22.0 Vdc.

PCMMU communications with all external devices may be immediately inhibited.

c. The 128 kbps programmable TLM formatter can not be updated by the GPC until the 128 kbps "fixed" TLM formatter is selected to output 128 kbps downlink.

PCMMU internal control logic will block GPC access to 128 kbps programmable memory.

d. Payload data interleaver (PDI) not on Orbiter or turned off.

PCMMU bit status register (BSR) may indicate bad for the following bits:

<u>Bit no.</u>	<u>Nomenclature</u>
4	128 kbps TLM downlink good
5	64 kbps TLM downlink good
11	OI ram parity good
12	PDI RAM parity good
15 <sup>a</sup>	No response MDM or PDI

<sup>a</sup>Only bit 15, if PDI is turned on then turned off.

- 3.4.5.5 Instrumentation Subsystems (Cont)  
 CONSTRAINTS/LIMITATIONS  
 e. Spacelab not on Orbiter.  
 But with PCMMU  
 PN/MC476-0130-07XX installed.

RESULT IF EXCEEDED  
 PCMMU BSR will indicate bad  
 for the following bit:  

Bit no.	Nomenclature
15	No response MDM or PDI

5. MADS Operating Temperature.  
 The OV-099 Orbiter midbody MADS equipment shelf temperature monitored by measurements (V78T9606A and V78T9607A on flights 1 through 5 and V78T9608A and V78T9607A on flights 6 and subsequent) is to be between 30° F and 140° F during all prelaunch, on-orbit, entry/landing and postlanding operations, that require data acquisition periods. Shelf temperature shall be 100° F maximum at MADS power-up prior to entry (about 1 hour prior to touchdown) to insure equipment temperature does not exceed the 140° F redline temperature at landing. The Orbiter OV-103 and OV-104 midbody MADS equipment shelf temperature is monitored by measurement V78T9607A, and shall be maintained within the same temperature limits specified for OV-99.
6. Pulse Code Modulation Multiplexer-MADS. The input power to the multiplexer must not fall below 22 Vdc or go above 37 Vdc. Multiplexer output may become inhibited.
7. Data Recorder - MADS.
- a. The steady-state limits for recorder input power is 25 Vdc to 31 Vdc.
  - b. Input power ranges of 22 Vdc to 25 Vdc and 31 Vdc to 35 Vdc are acceptable. (Capability to control the recorder completely will be maintained.) May result in degradation of operating performance.
  - c. Input power levels below 22 Vdc and above 35 Vdc. May result in degradation of operating performance and/or damage to recorder. Recorder BITE good signal will be deactivated.



## 3.4.5.5

## Instrumentation Subsystems (Cont)

## CONSTRAINTS/LIMITATIONS

## RESULT IF EXCEEDED

- |  |  |
|--|--|
| d. GSE interlock erase connector (at MCM J7 or associated cable harness connector) must be removed and flight connector (at MCM J8 or associated cable harness connector) must be installed prior to flight or data recording.             | No data will be recorded on data recorder.   |
| e. Data recorder must be erased and the tape repositioned to BOT prior to crew compartment closeout or before beginning each new data taking run.  | Recorder does not erase-before-write. Data write-over will result in data loss.  |
| f. Flight connector must be removed on MCM (at J8) or associated cable harness connector prior to initiation of erase mode.  | Record amplifier bias frequency may be recorded on the erased tracks. Incomplete erasure will result.  |
| g. Tape should reach BOT at the end of the second tape pass before issuing recorder pass no. 3 command (V78K9626Y).  | Total record time for pass no. 3 will be reduced.  |
| h. Recorder tape may require repositioning to assure a minimum of 1-hour continuous record time during entry through landing phase.  | Loss of data will result.  |
| i. Recording of 32 kbps PCM data on data recorder at 3 3/4 ips must be played back through driver amplifier module (C70-1181) at a tape speed of 15 ips.   | Driver amplifier module adjusted to optimize recorder playback at a speed of 15 ips. Playback at 3 3/4 ips will not provide adequate output. |
| j. Data recorder playback must be accomplished in the same direction as record.  | To preserve wideband data phasing and time correlation.  |
| k. If, while recording in pass no. 2, a playback forward command (manual-V78K9624E or uplink-V78K9624Y) is activated, the recorder must be allowed to reach EOT to reenable pass no. 2 prior to repositioning and resumption of recording. | Pass no. 1 data write-over will result in loss of data.  |
| l. The +28 Vdc input power must not be interrupted for more than 0.5 second while operating at a tape speed of 60 ips (rewind).  | Tape reel drive brake activation at 60 ips can cause tape mis-threading which results in permanent tape damage and data loss.                |

3.4.5.5

Instrumentation Subsystems (Concluded)  
CONSTRAINTS/LIMITATIONS

RESULT IF EXCEEDED

8. Frequency Division Multiplexer.

a. FDM must be powered up for a minimum of 10-seconds prior to application of calibrate command.

Calibration cycle may not enable.

b. The FDM auto-calibrate function command (manual or uplink) must be maintained for 1-second minimum to initiate the calibration cycle.

Calibration cycle not enabled.

9. Payload Data Interleaver.

a. The IRIG time tag attached to every minor/master frame of payload data increments incorrectly.

Seconds count - The count increments as follows:  
--17, 18, 19, 0, 21-- and  
--37, 38, 39, 60, 41--.

Minutes count - Same as seconds count.

b. The PDI 1.152 MHz receiver can distort duty cycle of the PCMMU 1.152MHz clock signal.

PDI BSR Bit 15 "PCM 1.152 MHz GOOD" can either toggle between good and bad or show solid bad.

TABLE 3.4.5.5-1.- INSTRUMENTATION COMPONENTS TEMPERATURE LIMITS  
(Paragraph 3.4.5.5)

Components	Minimum Operating Temperature, °F	Critical Item and Results If Exceeded	Maximum Operating Temperature, °F		Critical Item and Results If Exceeded	Minimum Non-operating Temperature, °F	Critical Item and Results If Exceeded	Maximum Non-operating Temperature, °F		Critical Item and Results If Exceeded
			Long Term	Short Term				Long Term	Short Term	
Pulse code modulation master unit	35	Parameters for integrated circuits will change with temperature.	120	120	Parameters for integrated circuits will change with temperature.	-65	Design limit	120	150	Delamination of printed circuit boards.
Payload data interleaver	35	Parameters for integrated circuits will change with temperature.	120	120	Parameters for integrated circuits will change with temperature.	-65	Design limit	120	150	Delamination of printed circuit boards.
GPE magnetic tape recorder	40	Magnetic tape binder degradation.	127 <sup>a</sup>	140 <sup>a</sup>	Magnetic tape binder degradation.	35	Magnetic tape binder degradation	127	140	Magnetic tape binder degradation.
Master timing unit (fwd)	35	Parameters for integrated circuits will change with temperature.	120	120	Parameters for integrated circuits will change with temperature.	-65	Design limit	120	150	Delamination of printed circuit boards.
Dedicated signal conditioner (fwd and aft)	-65	Design limit	160	160	Design limit	-65	Design limit	200	200	Design limit
Pulse code modulation multiplexer (MADS)	-45	Design limit	150 <sup>b</sup>	150 <sup>b</sup>	Output error may increase to 2.0 percent	-65	Design limit	230	230	Design limit
Data recorder (MADS)	35	Magnetic tape binder degradation.	120	120	Magnetic tape binder degradation.	35	Magnetic tape binder degradation	120	120	Magnetic tape binder degradation.
Strain gage signal conditioner (MADS)	20 <sup>b</sup>	Bias stability will change	165 <sup>b</sup>	165	Bias stability will change	-65	Temperature compensated components will change	165	165	Temperature compensated components will change.
Wideband signal conditioner (MADS)	20 <sup>b</sup>	Bias stability will change	165 <sup>b</sup>	165	Bias stability will change	-65	Temperature compensated components will change	165	165	Temperature compensated components will change.

<sup>a</sup> Long-term operating temperatures are at telemetry-indicated temperatures less than 120° F (127° F less 7° instrument error). Short-term operating temperatures above 120° F will shorten magnetic tape life. The extent of tape-life loss depends on the actual tape transport temperature, tape speed and duration of temperature exposure. Proper recorder operational management must be implemented in real-time to minimize operation of tape speeds above 60 ips of erase mode at temperatures above 120° F. Actual degradation at 140° F (bite-trip level) is not catastrophic and data record/playback to accomplish flight test objectives for any given flight should take precedence over a total number of missions required per tape life. A comparative analysis of playback data can provide justification for tape replacement and/or recorder maintenance. If OPS recorder redundancy is available, temperature management should be performed by placing the "hot" recorder in the standby mode when the head temperature telemetry indicates 120° F or higher.

<sup>b</sup> Component mounting heat sink "redline" maximum operating temperature is 140° F. Operation shall be terminated for cool-down cycle at 140° F. If the red-line is exceeded, damage to components may occur. The redline minimum operating temperature is 30° F for the components mounted on shelf 8 heat sink for data acquisition. Power application to these components will cause temperature rises as shown in table 3.4.5.5-2.

TABLE 3.4.5.5-1.- INSTRUMENTATION COMPONENTS TEMPERATURE LIMITS (Concluded)  
(Paragraph 3.4.5.5)

Components	Minimum Operating Temperature, °F	Critical Item and Results If Exceeded	Maximum Operating Temperature, °F		Critical Item and Results If Exceeded	Minimum Non-operating Temperature, °F	Critical Item and Results If Exceeded	Maximum Non-operating Temperature, °F		Critical Item and Results If Exceeded
			Long Term	Short Term				Long Term	Short Term	
Wideband FDM (MADS)	-65 (air)	Oscillator drift	165 <sup>b</sup> (air)	165 <sup>b</sup> (air)	Oscillator drift	-65	Temperature compensated components will change	165	165	Temperature compensated components will change
MADS Control module	0	Design limit	125	125	Sample timing intervals will increase.	-65	Design limit	165	165	Design limit

<sup>b</sup> Component mounting heat sink "redline" maximum operating temperature is 140° F. Operation shall be terminated for cool-down cycle at 140° F. If the red-line is exceeded, damage to components may occur. The redline minimum operating temperature is 30° F for the components mounted on shelf 8 heat sink for data acquisition. Power application to these components will cause temperature rises as shown in table 3.4.5.5-2.

TABLE 3.4.5.5-2. - MADS EQUIPMENT TEMPERATURE MANAGEMENT  
(Paragraph 3.4.5.5)

Site/ msn phase	System equipment operating	Temperature at initial activation, °F	Operating thermal rate increase time, minute /Δ1° F	Cool down	
				Method	Thermal rate decrease time minute /Δ1° F
OPF	Full system	System operation not con- strained by operating time with compartment opened and circulating ambient air by portable blower.		Power down equipment (PDE)	↓ 3.8
	PCM/SGSC				↓ 5.2
	FDM/WBSC				↓ 7.5
	PCM only				↓ 9.6
VAB	Full system	< 100	↑ 2.4	PDE	↓ 7.6
Pad	Full system	< 100	↑ 3.0	PDE	↓ 7.6
	PCM/SGSC	< 100	↑ 6.0	PDE	↓ 6.7
	FDM/WBSC	No constraint to operating time.		PDE	↓ 9.7
	PCM only			PDE	↓ 11.0
1 hr 43 min launch hold	Full system (2 hr. opera- tion)	85	↑ 1.8	PDE	N/A
launch (no hold)	Full system (17 min. opera- tion)	85	↑ 2.4	N/A	N/A
On- orbit <sup>a</sup>	PCM - Snapshot (with/without SGSC) <sup>b</sup>	No system thermal con- straint for operation in the snapshot mode within the operating temperature from 30° F to 140° F.		System cooldown prior to entry can be achieved in either snapshot or power- down mode to assure a shelf temperature of ≤100° F prior to entry initiation. The differ- ence in the shelf temper- ature rate between the snapshot and power-down modes is insignificant because of the extremely low snapshot duty cycle, with all other conditions equal. In the ZLV atti- tude and the shelf temp- erature at 140° F, it will require 15 hours to reach 100°F with the MADS system powered-off. In the top-sun attitude, for the same conditions, 38 hours is required to reach 100° F.	
	Full system- continuous	100	↑ 1.5		
	PCM only- continuous <sup>b</sup>	100	↑ 9.5		
Entry/ ldg.	Full system	< 100	↑ 2.3	MADS system powered down at touchdown + 5 minutes.	

<sup>a</sup>MADS continuous component operation on-orbit is not recommended (except just prior to entry) because of the rapid temperature rise rate associated with this condition.

<sup>b</sup>OV-103 (flights 1-6) incorporates an interim MADS control panel which does not contain the capability to control the SGSC independent of the MADS PCM MUX, during PCM MUX operation.

3.4.5.6

Electrical Power Distribution and Control Subsystems  
 CONSTRAINTS/LIMITATIONS RESULT IF EXCEEDED

1. EPDC Components Temperature Limits. See table 3.4.5.6-1.

2. Dc Voltage Limits. Voltage limits at load interfaces are: The extent of degradation to a subsystem as a result of exceeding the limits is subsystem dependent.

- a. Minimum steady-state -
  - (1) Intermittent loads 23 Vdc
  - (2) Continuous loads 24 Vdc
- b. Maximum steady-state -
  - (1) Main and control buses 32 Vdc (2 kW minimum bus load)
  - (2) Essential bus 38.5 Vdc (FCP open circuit volts)
- c. Ripple voltage -
  - (1) 0.9 V peak-to-peak maximum, any frequency.
  - (2) 1.6 V peak-to-peak total integrated.
- d. Transient limits:
  - (1) Voltage -
    - (a) Intermittent 21 to 36.7 Vdc (Normal switching) 37.0 Vdc (Abnormal and emergency switching).
    - (b) Continuous 22 to 36.7 Vdc (Normal switching) 37.0 Vdc (Abnormal and emergency switching).
  - (2) Recovery time < 200 msec.

3. Inverter Ac Bus Voltage Limits  
 Ac voltage limits (each phase) are as follows:

- a. Steady-state
  - (1) Continuous duty 115 ±5 Vrms.
  - (2) Intermittent duty equipment 115 <sup>+5</sup>/<sub>-7</sub> Vrms.

Exceeding these limitations will cause overvoltage or undervoltage conditions at the spacecraft subsystem using loads or static power inverter disconnect from the ac bus. This may result in subsystem degradation or interruption of power to the using loads.

- 3.4.5.6 Electrical Power Distribution and Control Subsystems (Continued)
- | CONSTRAINTS/LIMITATIONS   | RESULT IF EXCEEDED   |  |
|---|--|--|
| b. Transient:   |  |  |
| (1) Continuous duty equipment   | 115 ± 15 Vrms<br>20 msec recovery to steady-state limits.                            | Exceeding these limitations will cause overvoltage or undervoltage conditions at the spacecraft subsystem using loads or static power                      |
| (2) Intermittent duty equipment   | 115 <sup>+15</sup> / <sub>-17</sub> Vrms<br>20 msec recovery to steady-state limits. | inverter disconnect from the ac bus. This may result in subsystem degradation or interruption of power to the using loads.                                 |
| 4. <u>Ascent Minimum and Maximum Bus Voltages.</u> The bus voltages in table 3.4.5.6-2 must not be violated during ascent.  |  | Critical SRB and Orbiter LRU's may be shutdown or damaged.   |
| 5. <u>Spacelab, FCP3, Power Requirements.</u><br>FC3 STRUCT RTN power contractor must remain closed for Spacelab.   |  | Opening the structure return contactor could result in damage to fuel cell 3 since Spacelab loads rely on Orbiter to provide structural return connection. |
| 6. Payload Bay Floodlight Restart Constraint  |  | No hazards exist, but restart will be delayed.   |
| (a) Unblocked configuration-a minimum of 10 minutes is required before attempting to restart lights.  |  | Cool-down time is required for the pressure of the gas in the lights to decay. This will allow enough potential to be generated for the lights to turn on. |
| (b) Blocked configuration-for payload configurations that block radiation exchange between the PLBF and space (as determined by analysis):                        |  |  |
| (1) The nominal minimum off-time before restarting should be extended to 12 minutes for all payloads, including cylindrical payloads of 160 in. diameter or less. |  |  |

3.4.5.6 Electrical Power Distribution and Control Subsystems (Continued)  
CONSTRAINTS/LIMITATIONS RESULT IF EXCEEDED

- (2) The minimum off-time should be extended to 16 minutes for cylindrical payloads with a diameter greater than 160 in.



TABLE 3.4.5.6-1.- ELECTRICAL POWER DISTRIBUTION SUBSYSTEM COMPONENTS TEMPERATURE LIMITS  
(Paragraph 3.4.5.6)

Components, LRU <sup>a</sup>	Switched Power	Coldplate temperature, °F		Qualification test temperature, °F (on coldplate)		Acceptance test temperature, °F		Critical item and rationale	Thermal instrumentation
		Min	Max	Min	Max	Min	Max		
Static inverter	Yes	30	125	0	145	35	135	None	Yes (DFI)
Ground command interface logic	Yes	30	125	0	140 <sup>b</sup>	20	120	None	No
EMU battery charger and power supply	Yes	30	125	0	145	20	125	None	No
Inverter distribution and controller assembly	Yes	30	125	-45 <sup>c</sup>	165 <sup>c</sup>	d	d	None	No
Forward hybrid load controller assembly	No	30	125	-65 <sup>c</sup>	165 <sup>c</sup>	-45	145	None	No
Forward power controller assembly	No	30	125	-45 <sup>c</sup>	165 <sup>c</sup>	d	d	None	No
Forward motor controller assembly	Yes	30	125	-45 <sup>c</sup>	165 <sup>c</sup>	d	d	None	No
Mid-power controller assembly	No	30	125	-45	165	d	d	None	No
Mid-motor controller assembly	Yes	30	125	-45	165	d	d	None	No
Main distribution controller assembly	No	30	125	-45	165	d	d	None	No
Cryo Heater controller assembly	No	30	125	-45 <sup>c</sup>	165 <sup>c</sup>	d	d	None	No
Hybrid load controller assembly	No	30	125	-65	165	-45	145	None	No
Power controller assembly	No	30	125	-45 <sup>c</sup>	165 <sup>c</sup>	d	d	None	No
Motor controller assembly	Yes	30	125	-45 <sup>c</sup>	165 <sup>c</sup>	d	d	None	No
Master events controller	Yes	30	125	-65	165	20	120	None	No
Mid-body jettison controller assembly	No	30	125	-45	165	d	d	None	No
Promimity switch electronics	Yes	30	125	0	145	20	125	None	No
Backup flight controller	Yes <sup>e</sup>	30	125	0	140	20	120	None	No

<sup>a</sup>All listed LRU's are mounted on coldplate. Operational degradation due to LRU base temperatures exceeding coldplate limit will result. No data exists to permit determination of time from coldplate temperature limit exceedance to operational degradation.

<sup>b</sup>Application to maximum operating temperature and maximum short term and long term temperature.

<sup>c</sup>Qualified by similarity.

<sup>d</sup>Rockwell fabricated assemblies - acceptance vibration test performed at room temperature = 70° F.

<sup>e</sup>CPU/IOP power is also switched with this function.

TABLE 3.4.5.6-2.- MINIMUM AND MAXIMUM BUS VOLTAGES DURING ASCENT-NO FAILURES  
(Paragraph 3.4.5.6)

Item	Design voltages, Vdc <sup>a</sup>	
	Minimum	Maximum
Fuel cell		
V45V0100A	27.5	32
V45V0200A	27.5	32
V45V0300A	27.5	32
Main distribution control assembly		
V76V0100A	27.0	32
V76V0200A	27.0	32
V76V0300A	27.0	32
Forward power control assembly		
V76V3071A	26.2	32
V76V3072A	26.2	32
V76V3073A	26.2	32
Aft power control assembly (4,5,6)		
V76V3091A	26.1	32
V76V3092A	26.1	32
V76V3093A	26.1	32
Aft power control assembly (1,2,3)	26.1	32
Essential bus		
V76V0130A	25.5	38
V76V0230A	25.5	38
V76V0330A	25.5	38
Orbiter/SRB interface		
B76V1600C	26.15	32
B76V1601C	26.15	32
B76V2600C	26.15	32
B76V2601C	26.15	32
Control bus		
V76V0120A	24.8	32
V76V0121A	24.8	32
V76V0122A	24.8	32
V76V0220A	24.8	32
V76V0221A	24.8	32
V76V0222A	24.8	32
V76V0320A	24.8	32
V76V0321A	24.8	32
V76V0322A	24.8	32
Panel ML86B	25.5	32
Overhead panels, (014, 015, and 016)	25.5	32
Ac circuit breaker panels	114.8 Vac	120 Vac

<sup>a</sup>Unless specified otherwise.

3.4.6	<u>Environmental Control and Life Support Subsystems</u>		
3.4.6.1	<u>Atmospheric Revitalization Subsystem</u> CONSTRAINTS/LIMITATIONS		RESULT IF EXCEEDED
	1. <u>ARS Temperature Limits.</u>		
	See table 3.4.6.1-1.		
	2. <u>Maximum Carbon Dioxide Partial Pressure.</u>		
	a. Long term	7.6 mm Hg	The partial O <sub>2</sub> level will result in functional degradation, if the mask is removed for prolonged exposure.
	b. Maximum of 2 hr	15 mm Hg	Limited physiological degradation due to extended exposure.
	3. <u>Minimum Oxygen Partial Pressure.</u> The minimum O <sub>2</sub> partial pressure is 1.95 psia in an 8-psia cabin and 2.7 psia in a 14.7-psia cabin.		Hazardous N <sub>2</sub> level if mask is removed.
	4. <u>Minimum Cabin Pressure Limit.</u> The minimum cabin total pressure is 8 psia.		Lower pressure requires crew to prebreathe.
	5. <u>Water Coolant Loops.</u> Water in the dormant loop will be cycled for 6 minutes every 4 hours.		Water in the dormant loop may freeze.
	6. <u>Water Separator Operation.</u> The water separator will be "on" before and at least 5 minutes after ARC cabin fan activation/deactivation.		Possibility of excessive water in separator when separator is non-operative. This will damage motor and bearings.
	7. <u>Maximum percentage of Oxygen in Cabin.</u> The maximum percentage of O <sub>2</sub> allowed in the cabin is 30 percent <sup>a</sup> .		Material flammability limit of 30% O <sub>2</sub> actual during prebreathe for EVA with 10.2 psia cabin pressure provides no margin for materials certified for use within cabin.
	8. <u>Water Coolant Pump Operations.</u>		Mismatch in H <sub>2</sub> O/Freon flow rates and increased power consumption. (Pump can be restarted, if required.) Cavitation may occur.
	a. H <sub>2</sub> O pumps will be shutdown if one power phase is lost.		
	b. Minimum inlet pressure is 18.0 psia.		
	9. <u>*Toxic Exposure Limits in the Shuttle Cabin Breathing Atmosphere.</u>		Crew would have to abort the mission and/or don respirators. Toxic effects are central nervous system (CNS) depression resulting in mental impairment and a decrement in hand-eye coordination, liver toxicity and cardiac arrhythmias.
	a. Freon-21 (Dichloromono-fluoromethane (CHCl <sub>2</sub> F). A colorless, odorless, non-flammable gas at standard temperature and pressure.		

\*NASA Data Source

<sup>a</sup>The 30-percent figure is the limit and does not include cumulative tolerances from the PPO<sub>2</sub> sensor(s) and total cabin pressure sensor. The maximum indicated allowable percentage of oxygen is 28.5 percent to prevent exceeding the limit.

3.4.6.1 Atmospheric Revitalization Subsystem (Cont)

CONSTRAINTS/LIMITATIONS

- (1) Emergency exposure limits.  
See table 3.4.6.1-2.

- (2) It is recommended that even if the concentration remains below the emergency limits, the Pilot and Commander should don respirators at least 1 hour before landing.

RESULTS IF EXCEEDED

Symptoms of exposure to moderate concentrations include light headedness, shortness of breath, and narcosis.

Cannot ensure optimal mental alertness and manual dexterity for landing the Orbiter.

3.4.6.1-2

TABLE 3.4.6.1.1.- ATMOSPHERIC REVITALIZATION SUBSYSTEM TEMPERATURE LIMITS  
(Paragraph 3.4.6.1)

Components	Minimum Operating Temperature, °F	Critical Item and Results If Exceeded	Maximum Operating Temperature, °F		Critical Item and Results If Exceeded	Minimum Non-operating Temperature, °F	Critical Item and Results If Exceeded	Maximum Non-operating Temperature, °F		Critical Item and Results If Exceeded
			Long Term	Short Term				Long Term	Short Term	
O <sub>2</sub> storage tank	-65	Exceeds specification design limit <sup>a</sup>	160	160	Exceeds qualification test limits	NA	NA	NA	NA	NA
N <sup>2</sup> storage tank	-65	Exceeds specification design limit <sup>a</sup>	150 (b,c)	150 (b,c)	Exceeds qualification test limits	NA	NA	NA	NA	NA
Cabin humidity control heat exchanger	35	Exceeds specification design limit <sup>a</sup>	120	120	Exceeds qualification test limits	NA	NA	NA	NA	NA
Water gas separators	35	Exceeds specification design limit <sup>a</sup>	120	120	Exceeds qualification test limits	NA	NA	NA	NA	NA
Water coolant pump assembly	35	Exceeds specification design limit <sup>a</sup>	120	120	Exceeds qualification test limits	NA	NA	NA	NA	NA
Avionics heat exchanger	35	Exceeds specification design limit <sup>a</sup>	130	130	Excess qualification test limits	NA	NA	NA	NA	NA
Structural heating loops	35	Exceeds specification design limit <sup>a</sup>	120	120	Exceeds qualification test limits	NA	NA	NA	NA	NA
Water Chiller	35 <sup>d</sup>	Freezing of water in system will damage equipment and cause loss of operation.	NA	NA	NA	NA	NA	NA	NA	NA
Avionics air coolant		Exceeds specification design limit <sup>a</sup>			Exceeds qualification test limits	NA	NA	NA	NA	NA
Inlet	40		95	95						
Outlet	NA		130	130						
Avionics cold-plate H <sub>2</sub> O coolant <sup>2</sup>		Exceeds specification design limit <sup>a</sup>			Exceeds qualification test limits	NA	NA	NA	NA	NA
Inlet	35		120	120						
Outlet	NA		130	130						

<sup>a</sup>Since there has been no off-limit thermal testing, the results if exceeded are unknown.

<sup>b</sup>At 3600 psig.

<sup>c</sup>165° F for pressure < 3300 psig.

<sup>d</sup>Due to sensor inaccuracy, temperature could be as low as 32° F.

TABLE 3.4.6.1.2.- \*RECOMMENDED EMERGENCY EXPOSURE LIMITS FOR  
FREON-21 (DICHLOROMONOFLUOROMETHANE (CHCL<sub>2</sub>F))<sup>a</sup>  
(Paragraph 3.4.6.1)

Time	Concentration	
	Percent	PPM
0 - 2 hours	0.06	600
2 - 5 hours	0.048	480
5 - 8 hours	0.03	300
8 - 16 hours	0.02	200
16 - 24 hours	0.015	150
24 - 48 hours	0.005	50
48 - 72 hours	0.0015	15
3 - 7 days	0.001	10

<sup>a</sup>These recommended exposure limits are based on the assumption that the Orbiter Pilot and Commander would don respirators before deorbit so that they will not be mentally impaired during landing procedures, and on the assumption that the crew members would probably never receive such an exposure again.

\*NASA Data Source

3.4.6.2 Water/Waste Management Subsystem  
CONSTRAINTS/LIMITATIONS

RESULT IF EXCEEDED

1. Water/Waste Management Subsystem Temperature Limits. See table 3.4.6.2-1.
2. Supply water, waste water and vacuum vent dump nozzles maximum temperature limits prior to de-orbit. Refer to paragraph 3.4.1.3, Thermal Protection Subsystem.
3. Fan separator two phase (electrical) operation. Refer to paragraph 4.6.2.2.3b11.

TABLE 3.4.6.2-1.- WATER/WASTE MANAGEMENT SUBSYSTEM COMPONENTS TEMPERATURE LIMITS  
(Paragraph 3.4.6.2)

Components	Minimum Operating Temperature, °F	Critical Item and Results If Exceeded	Maximum Operating Temperature, °F		Critical Item and Results If Exceeded	Minimum Non-operating Temperature, °F	Critical Item and Results If Exceeded	Maximum Non-operating Temperature, °F		Critical Item and Results If Exceeded
			Long Term	Short Term				Long Term	Short Term	
Supply water tanks	50 <sup>a</sup>	Freezing of water in the system will damage equipment and cause loss of operation.	120	120	Qualification tested to 120° F.	NA	NA	NA	NA	
Supply water dump nozzle	45 <sup>a</sup>	Freezing of discharge water will clog the nozzle and result in loss of operation.	350	350	Structure at TPS penetration may be damaged. Will permit entry of hot plasma to mid-body during entry.	NA	NA	350	350	Structure at TPS penetration may be damaged. Will permit entry of hot plasma to mid-body during entry.
Lines	50 <sup>a</sup>		NA	NA						
Valves	50 <sup>a</sup>		200	200						
Vacuum vent exit	32	Nominal minimum operational temperature for waterbearing systems.	350	350	Structure at TPS penetration may be damaged. Will permit entry of hot plasma to mid-body during entry.	NA	NA	350	350	Structure at TPS penetration may be damaged. Will permit entry of hot plasma to middeck during entry.
Lines	32		b,c	b,c						
Fan/water separator	32	Freezing of water in the system will damage equipment and cause loss of operation.	90	90	Qualification tested to 90° F.	NA	NA	NA	NA	
Waste water dump nozzle	45 <sup>a</sup>	Freezing of discharge water will clog the nozzle and result in the loss of operation.	350	350	Structure at TPS penetration may be damaged. Will permit entry of hot plasma to mid-body during entry.	NA	NA	350	350	Structure at TPS penetration may be damaged. Will permit entry of hot plasma to mid-body during entry.
Lines	50 <sup>a</sup>		NA	NA						
Valves	50 <sup>a</sup>		200	200						
Waste water storage tank	50 <sup>a</sup>	Freezing of water in system will damage equipment and cause loss of operation.	120	120	Qualification tested to 120° F.	NA	NA	NA	NA	

<sup>a</sup> Minimum temperature at which a successful dump may be accomplished.

<sup>b</sup> Line external to cabin +350° F.

<sup>c</sup> Line internal to cabin +120° F.



## 3.4.6.3

Active Thermal Control Subsystems  
CONSTRAINTS/LIMITATIONS

## RESULT IF EXCEEDED

- |  |   |
|--|---|
| <ol style="list-style-type: none"> <li>1. <u>ATCS Temperature Limits.</u><br/>See table 3.4.6.3-1.</li> <li>2. <u>NH3 Boiler System Operation During Atmospheric Entry.</u><br/>In contingency situations, ABS may be activated at entry interface (EI) (0.1 g).</li> <li>3. <u>Flash Evaporator System During Atmospheric Entry.</u> Operation is restricted to exit pressures <math>\leq 0.162</math> psia; <math>\sim 100,000</math> ft indicated altitude (<math>h_i</math>).</li> <li>4. <u>FES Duct Temperatures</u> <ol style="list-style-type: none"> <li>a. The high-load duct temperatures must exceed <math>150^\circ\text{F}</math> prior to reinitiating high-load evaporator operation.</li> <li>b. The duct forward and aft section temperatures must exceed <math>100^\circ\text{F}</math> prior to topping FES activation.</li> </ol> </li> <li>5. <u>Radiator Bypass Valve.</u> While the payload bay doors are open, the radiator bypass valve must not be in the "bypass" position for periods <math>\geq 60</math> minutes in an attitude that minimizes earth and sun viewing.</li> <li>6. <u>FES topping nozzles, FES high load nozzle and ammonia vent maximum temperature limits prior to deorbit.</u><br/>Refer to paragraph 3.4.1.3, Thermal Protection Subsystem.</li> <li>7. <u>FCL Aft Coldplate Minimum Flow</u><br/>Minimum aft coldplate flow rate with radiators bypassed and flow proportioning module in the interchanger position is 240 lb/hr for 1 loop operation.</li> </ol> | <p>Loss of He pressurant if activated at <math>&lt; 0.1</math> g.</p> <p>System performance degradation.</p> <p>Possible duct icing.</p> <p>Possible duct icing.</p> <p>Possible rupture of radiator(s) by coolant freezing.</p> <p>Thermal limits of critical components may be exceeded if flow rate is less than minimum flow.</p> |
|--|---|

TABLE 3.4.6.3-1.- ACTIVE THERMAL CONTROL SUBSYSTEM COMPONENT TEMPERATURE LIMITS  
(Paragraph 3.4.6.3)

Components	Minimum Operating Temperature, °F	Critical Item and Results If Exceeded	Maximum Operating Temperature, °F		Critical Item and Results If Exceeded	Minimum Non-operating Temperature, °F	Critical Item and Results If Exceeded	Maximum Non-operating Temperature, °F		Critical Item and Results If Exceeded
			Long Term	Short <sup>a</sup> Term				Long Term	Short <sup>a</sup> Term	
Freon pump package	15	Elastomeric seals - leakage may occur.	120	180	Freon accumulator-Maximum allowable pressure may be exceeded	NA	ATCS operational during all mission phases.	NA	NA	ATCS operational during all mission phases.
Freon/water interchanger	32	Water system loss of cooling resulting from freezing water.	NA	NA	Vehicle temperatures do not approach maximum limits of hardware.	NA	ATCS operational during all mission phases.	NA	NA	ATCS operational during all mission phases.
Payload heat exchanger	32	Payload - loss of cooling resulting from freezing water	NA	NA	Vehicle temperatures do not approach maximum limits of hardware.	NA	ATCS operational during all mission phases.	NA	NA	ATCS operational during all mission phases.
Fuel cell, hydraulics and GSE heat exchanger	NA	ATCS operates above freezing point of fluids.	NA	NA	Vehicle temperatures do not approach maximum limits of hardware.	NA	ATCS operational during all mission phases.	NA	NA	ATCS operational during all mission phases.
Flow proportioning valves module	15	Elastomeric seals - leakage may occur	250	250	Actuator - hi-rel component degradation	0	Elastomeric seals - leakage may occur	250	250	Actuator - hi-rel component degradation
Interchanger and payload heat exchanger flow sensors	-40	Electronics - hi-rel component degradation	220	220	Electronics - hi-rel component degradation	NA	ATCS operational during all mission phases.	NA	NA	ATCS operational during all mission phases.
Instrumentation signal conditioner	-85	Electronics - hi-rel component degradation	180	220	Electronics - hi-rel component degradation	NA	ATCS operational during all mission phases.	NA	NA	ATCS operational during all mission phases.
GSE coolant couplings	NA	Elastomeric seals compatible with Freon temperatures.	NA	NA	Seals compatible with Freon temperatures.	-250	Elastomeric seals - seal degradation	500	500	Elastomeric seals - seal degradation
Freon pump and radiator couplings	NA	Elastomeric seals compatible with Freon temperature	NA	NA	Seals compatible with Freon temperatures.	NA	ATCS operational during all mission phases.	NA	NA	ATCS operational during all mission phases.
Freon servicing couplings	NA	Elastomeric seals compatible with Freon temperatures.	NA	NA	Seals compatible with Freon temperatures.	-65	Elastomeric seals - seal degradation	NA	NA	Vehicle temperatures do not approach maximum temperature limits
NH <sub>3</sub> boiler	-15	Orbiter cooling - insufficient tank expulsion pressure.	95	95	Increased NH <sub>3</sub> consumption - premature tank depletion.	-65	Electronics - hi-rel component degradation	95	130	NH <sub>3</sub> supply - relief valve venting would deplete supply

221

3.4.6.3-2

Amendment 220

TABLE 3.4.6.3-1.- ACTIVE THERMAL CONTROL SUBSYSTEM COMPONENT TEMPERATURE LIMITS  
(Paragraph 3.4.6.3) (Concluded)

Components	Minimum Operating Temperature, °F	Critical Item and Results If Exceeded	Maximum Operating Temperature, °F		Critical Item and Results If Exceeded	Minimum Non-operating Temperature, °F	Critical Item and Results If Exceeded	Maximum Non-operating Temperature, °F		Critical Item and Results If Exceeded
			Long Term	Short Term <sup>a</sup>				Long Term	Short Term <sup>a</sup>	
Flash evaporator assembly	32 <sup>b</sup>	Cabin cooling - loss of cooling resulting from freezing water in inter-changer.	131	131	Orbiter cooling - heat rejection capability of flash evaporator exceeded.	-65	Electronics - hi-rel component degradation	160	160	Elastomeric seals - seal degradation
Steam ducts	40	Flash evaporator - exhaust steam may freeze, clogging ducts.	300	375	Heaters, insulation, and bonding may be damaged.	-100	Heater electronics - hi-rel components degradation	300	375	Heaters, insulation and bonding may be damaged.
Topping and hi-load nozzle assemblies	40	Nozzle - exhaust steam may freeze.	600	600	Heaters - elements may be damaged.	-100	Heaters electronics - hi-rel components degradation.	600	600	Heaters, elements may be damaged
Radiator panels	-180	Radiator - Freon 21 freezes at -211° F.	NA	NA	ATCS fluid temperatures do not approach temperature limits.	-180	Radiator - Freon 21 freezes at -211° F.	150	185	Freon accumulator - capacity may be exceeded.
Radiator flow control assembly	-100	Electronics - hi-rel component degradation	NA	NA	ATCS fluid temperatures do not approach temperature limits.	-65	Electronics - hi-rel components degradation.	150	280	Electronics - hi-rel components degradation
FES feedwater lines	32	H <sub>2</sub> O freezes.	250 <sup>c</sup>	250 <sup>c</sup>	FES malfunctions.	32	H <sub>2</sub> O freezes.	250	250	H <sub>2</sub> O boils, resulting in excessive pressure.
FES feedwater accumulators	32	H <sub>2</sub> O freezes.	100	180	FES malfunctions.	32	H <sub>2</sub> O freezes.	250	250	H <sub>2</sub> O boils, resulting in excessive pressure.

<sup>a</sup> < 1 hour

<sup>b</sup> Freon temperatures lower than 32° F can produce freezing of water in ARS interface exchanger.

<sup>c</sup> Operation above 250° F is allowable for a period of 35 minutes. (Feedline heaters are certified to operate at 350° F continuously and at 400° F for 1 hour.) High-load FES feedwater line temperatures are allowed to remain above 250° F for longer than 35 minutes as long as normal heater cycling is verified by the accumulator feedwater line temperatures.

222

3.4.6.3-3

3.4.6.4

Airlock Support Subsystem

CONSTRAINTS/LIMITATIONS

1. Airlock Configuration During EVA's.

The thermal hatch cover must be closed during EVA's.

RESULT IF EXCEEDED

May freeze H<sub>2</sub>O panel and EMU servicing and cooling umbilicals (SCU's).

## 3.4.6.5

## Smoke Detection and Fire Suppression Subsystem

## CONSTRAINTS/LIMITATIONS

## RESULT IF EXCEEDED

- |   |                                       |
|---|---------------------------------------|
| 1. <u>Smoke Detector</u> . Maximum operating temperature is 130° F.   | Pump driver electronics may fail.     |
| 2. <u>Smoke Detection</u> . Air circulation through the avionics equipment by fans and cabin fans is required in each compartment for functional smoke detection. | Loss of smoke detection capability.   |
| 3. <u>Freon Tank</u> . Maximum operating temperatures are 130° F long term and 160° F short term. <sup>a</sup>  | Overpressure could result in rupture. |
| 4. <u>Hand-Held Extinguisher</u> . Maximum operating temperatures are 120° F long term and 155° F short term. <sup>a</sup>  | Overpressure could result in rupture. |

3.4.7 Crew Systems No constraints have been identified for this subsystem. (3.4.7.1-1)

<sup>a</sup> ≥ 1 hour

### 3.5 EXTERNAL TANK CONSTRAINTS AND LIMITATIONS

#### 3.5.1 Structures and Thermal Protection Subsystems

##### 3.5.1.1 Structures Subsystem

CONSTRAINTS/LIMITATIONS	RESULT IF EXCEEDED
1. <u>Structures Temperature Limits.</u> See table 3.5.1.1-1.	
2. <u>Acoustic Limits.</u> The external tank acoustic overall sound pressure levels are identified at their specified zones in table 3.5.1.1-2.	Not tested or designed to levels in exceedance. Possible component and/or structural failure.
3. <u>Vibration Limits.</u>	Not tested or designed to levels in exceedance. Possible component and/or structural failure.
a. <u>Sinusoidal vibration</u> The sinusoidal vibration limits of table 3.5.1.1-3 apply to all of the external tank.	
b. <u>Random vibration</u> The random vibration limits are in table 3.5.1.1-4.	

TABLE 3.5.1.1-1. - STRUCTURAL ALLOWABLE TEMPERATURES  
(Paragraph 3.5.1.1)

Item	Max temp, <sup>a</sup> °F	Critical item and results if exceeded	Min temp, °F	Critical Item and results if exceeded
Nose cone				
Skin	500	Factor of safety reduction and/or failure	-300	No impact
GO <sub>2</sub> vent fairings, louvers	1600		-300	
Conduit fairing	500		-300	
LO <sub>2</sub> tank				
Forward bulkhead	500	Factor of safety reduction and/or failure	-300	No impact
Ogive skin	450		-300	
Barrel skin	450		-300	
Aft bulkhead dome	0		-300	
Intertank				
Skin and stringer	450	Factor of safety reduction and/or failure	-200	No impact
Machined panel	250		-200	
Frames	250		-200	
Thrust beam	250		-200	
Thrust fitting	250		-200	
Access door	250		-200	
Umbilical plate	300		-423	
Umbilical plate frame	300		-423	
LH <sub>2</sub> tank				
Forward bulkhead	180	Factor of safety reduction and/or failure	-423	No impact
Cylindrical skin	127		-423	
Aft bulkhead	210		-423	
Frames	127		-423	
Interface attachments				
ET/ORB fwd strut	350	Factor of safety reduction and/or failure	-300	No impact
ET/ORB thrust strut	350		-423	
ET/ORB vertical strut	350		-300	
ET/ORB diagonal strut	400		-300	
Crossbeam	350		-300	
ET/SRB aft strut	500		-300	
Structural attachments				
LO <sub>2</sub> feedline bracket	350	Factor of safety reduction and/or failure	-300	No impact
Conduit/GO <sub>2</sub> pressure line/cable tray brackets	350		-300	
GH <sub>2</sub> pressure line bracket	350		-300	

<sup>a</sup>At MECO

TABLE 3.5.1.1-2. - ET MAXIMUM OVERALL SOUND PRESSURE LEVELS (SPL)  
 [NASA Reference Publication 1074, February 1981 and PCIN 15087]  
 (Paragraph 3.5.1.1)

Zone	Overall SPL, dB
Aft LH <sub>2</sub> bulkhead	165.5
Aft LH <sub>2</sub> tank cylinder, inboard	161.5 <sup>a</sup>
Aft attach crossbeam	165.5 <sup>a</sup>
Aft LH <sub>2</sub> tank cylinder, outboard	158.0
LH <sub>2</sub> tank cylinder, inboard	162.0 <sup>a</sup>
LH <sub>2</sub> tank cylinder, outboard	155.5
Intertank, internal	146.5
Intertank, external (+Z axis)	161.5 <sup>a</sup>
Forward Orbiter attach	170.5 <sup>a</sup>
Intertank, external -Y and +Y axes	175.0 <sup>a</sup>
Intertank, external -Z axis	153.5
LO <sub>2</sub> tank cylinder, external	160.5
Aft ogive, external	159.5 <sup>a</sup>
Forward ogive, external	159.5 <sup>a</sup>
ET nose cap, external	163.0
ET nose cap, internal	151.7

<sup>a</sup>Maximum at protuberance of zone.



TABLE 3.5.1.1-3. - SINUSOIDAL VIBRATION LIMITS

[NASA Reference Publication 1074, February 1981]  
 (Paragraph 3.5.1.1)

Item	Longitudinal Axis	Lateral Axis
For the ET nose cap/cover-plate, LO <sub>2</sub> ogive coverplate or coverplate support ring. Fwd ogive, X <sub>T</sub> 322-537	2 to 5 Hz at 0.6g peak 5 to 40 Hz at 0.6g peak	2 to 6 Hz at 1.4g peak 6 to 40 Hz at 1.4g peak
For all other locations on the ET.	2 to 5 Hz at 0.6g peak 5 to 40 Hz at 0.6g peak	2 to 5 Hz at 0.8g peak 5 to 40 Hz at 0.8g peak

TABLE 3.5.1.1-4. - ET RANDOM VIBRATION COMPOSITES  
(Paragraph 3.5.1.1)

[This table presents the maximum composites in g(rms) that have been considered in design and test. The actual random vibration criteria are defined in Reference Publication 1004, February 1981 and Change Order 1217, June 1981.]

Zone	Time in flight	Composites, g(rms)	
		Radial	Tangential
LH <sub>2</sub> structural rings (X <sub>T</sub> 1624 and X <sub>T</sub> 1377 - -Z axis)	Lift-off	32.2	29.3
	Boost	26.1	16.7
LH <sub>2</sub> structural ring (X <sub>T</sub> 1130 - -Z axis)	Lift-off	16.6	25.2
	Boost	10.0	12.4
Intertank (Station X <sub>T</sub> 1130 to X <sub>T</sub> 852 panels and rings near +Z axis)	Lift-off	31.0	22.9
	Boost	76.9	55.4
Intertank (Station X <sub>T</sub> 1130 to X <sub>T</sub> 852 panels and rings near -Y and +Y axes)	Lift-off	9.7	14.8
	Boost	43.2	75.3
SRB beam (Station X <sub>T</sub> 985)	Lift-off	5.0	5.0
	Boost	19.4	19.7
Intertank (Station X <sub>T</sub> 985) in panels and rings at -Z axis)	Lift-off	17.1	12.1
	Boost	16.0	10.6
Intertank (Station X <sub>T</sub> 1130 to X <sub>T</sub> 852 panels and rings near -Z axis)	Lift-off	29.6	21.0
	Boost	26.7	17.7
LH <sub>2</sub> forward bulkhead and gores (Station X <sub>T</sub> 1130 to X <sub>T</sub> 1008)	Lift-off	41.5	16.0
	Boost	48.1	14.2
LH <sub>2</sub> forward cap (Station X <sub>T</sub> 1008)	Lift-off	30.2	7.6
	Boost	28.0	7.6
LO <sub>2</sub> aft bulkhead and cap (Station X <sub>T</sub> 963 to X <sub>T</sub> 854)	Lift-off	11.7	7.3
	Boost	11.8	6.5
LO <sub>2</sub> cylinder (Station X <sub>T</sub> 852 to X <sub>T</sub> 747)	Lift-off	13.3	10.4
	Boost	33.4	23.8
Aft ogive (Station X <sub>T</sub> 747 to X <sub>T</sub> 537)	Lift-off	13.3	11.1
	Boost	33.3	25.0
Ogive forward section (Station X <sub>T</sub> 537 to X <sub>T</sub> 371)	Lift-off	40.1	10.4
	Boost	128.0	30.4

TABLE 3.5.1.1-4. - ET RANDOM VIBRATION COMPOSITES - CONCLUDED  
(Paragraph 3.5.1.1)

Zone	Time in flight	Composites, g(rms)	
		Radial	Tangential
Nose cap (X <sub>T</sub> 371 to X <sub>T</sub> 322)	Lift-off	38.6	11.5
	Boost	167.3	52.9
Nose cap coverplate or support rings (Station X <sub>T</sub> 371)	Lift-off	23.0	7.4
	Boost	23.0	7.4
LH <sub>2</sub> bulkhead	Lift-off	99.3	83.0
	Boost	85.0	68.4
LH <sub>2</sub> aft bulkhead cap and covers	Lift-off	64.0	53.3
	Boost	28.6	16.5
LH <sub>2</sub> cylinder (X <sub>T</sub> 2058 to X <sub>T</sub> 1624 inboard +Z axis)	Lift-off	41.1	19.7
	Boost	57.3	27.7
LH <sub>2</sub> cylinder (X <sub>T</sub> 1871 inboard)	Lift-off	19.5	27.6
	Boost	27.8	36.1
LH <sub>2</sub> cylinder (X <sub>T</sub> 2058 outboard)	Lift-off	41.1	19.7
	Boost	28.3	7.5
LH <sub>2</sub> cylinder (X <sub>T</sub> 2058 inboard)	Lift-off	14.1	19.4
	Boost	17.8	25.1
LH <sub>2</sub> cylinder (X <sub>T</sub> 1871, -Z axis ± 90°)	Lift-off	22.1	31.2
	Boost	8.4	10.7
LH <sub>2</sub> cylinder (X <sub>T</sub> 2058, -Z axis ± 90°)	Lift-off	14.1	19.4
	Boost	5.3	6.8
LH <sub>2</sub> cylinder (X <sub>T</sub> 1624 to X <sub>T</sub> 1123 inboard +Z axis)	Lift-off	41.0	12.6
	Boost	71.2	21.6
LH <sub>2</sub> structural rings (X <sub>T</sub> 1624 to X <sub>T</sub> 1377 inboard +Z axis)	Lift-off	28.1	24.2
	Boost	72.8	55.3
LH <sub>2</sub> cylindrical (X <sub>T</sub> 1624 to X <sub>T</sub> 1130, -Z axis)	Lift-off	45.6	14.0
	Boost	28.8	7.5
LH <sub>2</sub> structural rings (X <sub>T</sub> 1130 inboard +Z axis)	Lift-off	12.8	19.1
	Boost	24.6	32.9

3.5.1.2

Thermal Protection Subsystem  
CONSTRAINTS/LIMITATIONS

RESULT IF EXCEEDED

1. Thermal Protection Subsystem  
Component Temperature Limits.  
See table 3.5.1.2-1.

TABLE 3.5.1.2-1.- THERMAL PROTECTION SUBSYSTEM MATERIAL TEMPERATURE LIMITS  
(Paragraph 3.5.1.2)

Components	Minimum Operating Temperature, °F	Critical Item and Results If Exceeded	Maximum Operating Temperature, <sup>a</sup> °F	Critical Item and Results If Exceeded
CPR-488	-423	Potential debond	300	Potential debond
SLA-561	-423	Potential debond	400	Potential debond
BX-250	-423	Potential debond	200	Potential debond
MA-25S	-300	Potential debond	400	Potential debond
NCFI 22-65	-423	Potential debond	300	Potential debond
PDL	-423	Potential debond	200	Potential debond

<sup>a</sup>Bondline limit

3.5.2 Mechanical Subsystems

3.5.2.1 ET/SRB Attachment/Separation Subsystem  
CONSTRAINTS/LIMITATIONS RESULT IF EXCEEDED

No constraints have been identified  
for this subsystem.

3.5.2.2

Mechanical Subsystems

CONSTRAINTS/LIMITATIONS

1. Tumbling System Limits. Tumbling system pyrotechnic operating temperature limits range from -150° to 200° F. Voltage limits are:
  - a. No fire      One watt, one amp
  - b. All fire     5 amps for 2 msec.
2. Hazardous Gas Detection System Limits. Interface pressure of 7 psia to ambient is required. Interface flowrate requirements are 0.02 to 0.08 lb/min.

RESULT IF EXCEEDED

Temperatures in excess of these will cause auto-ignition (275° F is auto-ignition temperature). Stray current in excess of these limits may cause autofire. Conditions below these may cause misfire. The ET HGDS is passive. Ground operations pressure and flow rates established by GSE. If flow rates become too low, inadequate gas sampling might occur.

3.5.3 Propellant Storage Subsystem

3.5.3.1 Propellant Storage

CONSTRAINTS/LIMITATIONS

RESULT IF EXCEEDED

1. Propulsion Subsystem Temperature Limits. See table 3.5.3.1-1.



TABLE 3.5.3.1-1.- PROPULSION SUBSYSTEM COMPONENT ALLOWABLE TEMPERATURES  
(Paragraph 3.5.3.1)

Item	Temperature, °F	
	Maximum	Minimum
LO <sub>2</sub> subsystem		
Helium injector line check valve and filter	350	-320
Feedline	160 <sup>a</sup>	-297
Pressure line	650 (860 aeroheat spike)	-297
Diffuser	670	-297
Vent valve Flow media	540	-297
Local ambient	300	-297
Vent duct Flow media	540	-297
Local ambient	300	-297
Louver	950 at 120 sec 1600 at MECO	-297
Vent valve actuation line	300	-250
Tumble valve	200 (900 at exit area)	-320
Tumble manifold	500	-297
Tumble cartridge	200	-150
LH <sub>2</sub> subsystem		
Feedline - external	350	-423
Feedline - internal bellows	160 <sup>a</sup>	-423
Feedline - internal siphon	160 <sup>a</sup>	-423

<sup>a</sup>Non-operating

TABLE 3.5.3.1-1.- PROPULSION SUBSYSTEM COMPONENT ALLOWABLE TEMPERATURES  
(Concluded) (Paragraph 3.5.3.1)

Item	Temperature, °F	
	Maximum	Minimum
LH <sub>2</sub> subsystem (continued)		
Recirculation line		
Propellant carrier	100 at 90 sec 350 at MECO	-423
Shroud (jacket)	1200 at MECO	-423
Vent valve		
Flow media	170	-423
Local ambient	100	-175
Vent line		
External	0	-180
Internal	245	-423
Pressure line	245	-423
Diffuser	245	-423
Vent valve actuation line	300	-160
Vent valve sense line	300	-160
Intertank		
Pressure disconnect	340	-60
GH <sub>2</sub> vent disconnect	350	-420
GN <sub>2</sub> purge manifold	300	-160
Other		
Carrier-plate separation bolt	275	-200
Linear-shaped charge	350 (for 30 min.)	-300
Confined detonating fuse (GFP)	350 (for 30 min.)	-300
PETN Tip	250 (for 30 min.)	-300

TABLE 3.5.4.1-1.- RANGE SAFETY SYSTEM COMPONENT TEMPERATURE LIMITS  
(Paragraph 3.5.4.1)

Component	Temperature, °F	
	Minimum	Maximum
Directional coupler	-65	165
Antenna	-40	400
Hybrid coupler	-65	165
Integrated receiver decoder	20	135
Distributor	20	155
Safe and arm	20	165
NSD	-410	300
CDF manifold	-150	250
CDF assemblies	-319	250
Batteries	30	120
Linear-shaped charges	-300	350

TABLE 3.5.4.2-1.- ELECTRICAL SUBSYSTEM COMPONENT TEMPERATURE LIMITS  
(Paragraph 3.5.4.2)

Components	Minimum Operating Temperature, °F	Critical Item and Results If Exceeded	Maximum Operating Temperature, °F		Critical Item and Results If Exceeded	Minimum Non-operating Temperature, °F	Critical Item and Results If Exceeded	Maximum Non-operating Temperature, °F		Critical Item and Results If Exceeded
			Long Term	Short Term				Long Term	Short Term	
Pressure transducer (low) PD7400106-079	-30	Loss of sensor calibration	240	NA	NA	NA	Electrical component failures	NA	NA	Electrical component failures
Absolute and differential ullage gas pressure transducer PD7400098-079	40	Loss of sensor calibration	140	NA	NA	NA	Qualification limit	NA	NA	NA
PD7400098-039	0	V	75	NA		NA	Qualification limit	NA	NA	NA
Cryo liquid gas and hot gas temperature probe transducer PD7400095-009	0		73				Calibrated limit			
PD7400095-009	-430	Loss of sensor calibration	200	NA		NA	Wire insulation degradation	NA	NA	
PD7400095-139	-300		300	NA		NA		NA	NA	
PD7400095-149	-4		158	NA		NA		NA	NA	
PD7400095-089	-300	V	500	NA	V	NA	V	NA	NA	V

238

3.5.4.2-2

## 3.5.4.3

## Electrical Power Distribution and Control Subsystem

## CONSTRAINTS/LIMITATIONS

## RESULT IF EXCEEDED

1. Electrical Power.

Exceeding these limitations will cause the voltage level to be out of tolerance at the loads, resulting in possible loss in ET instrumentation and/or ET heaters.

(+28 Vdc)

## a. Steady-state:

- (1) Maximum 32 Vdc.
- (2) Minimum 26 Vdc.<sup>a</sup>

## b. Transient with recovery to steady-state limits in 200 msec.

- (1) Maximum 36.7 Vdc.
- (2) Minimum 22.7 Vdc.

## c. Ripple 0.9 V p-p (each frequency) including ripple component; 1.6 V p-p maximum total broadband.

## d. Voltage Spikes. Voltage spikes superimposed on normal line voltage will be two times line voltage or 100 V, whichever is less.

2. Tumbling.

- a. Arm Command - Safe and arm relay - 10W maximum.
- b. Fire Command - In arm position, pyrotechnic initiation is 200W maximum.

3. Heater Power.

## a. Bipod Heaters

- Long, 85 Vac at 1.0A.
- Short, 122 Vac at 1.0A.

## b. Aft strut heaters

- (1) LO<sub>2</sub> feedline bracket heater  
93<sup>2</sup>Vac @ 1.7 A.
- (2) LO<sub>2</sub> elbow bracket heaters,  
93<sup>2</sup>Vac @ 1.7 A.
- (3) LH<sub>2</sub> feedline bracket heaters,  
72<sup>2</sup>Vac @ 0.25 A.

<sup>a</sup>If including loss of fuel cell 1 or 3, the minimum voltage will be 25.3 Vdc. If fuel cell 2 is lost, voltage will be 0 Vdc.

### 3.6 SOLID ROCKET BOOSTER CONSTRAINTS AND LIMITATIONS

#### 3.6.1 Structures and Thermal Protection Subsystems

##### 3.6.1.1 Structures Subsystem

<u>CONSTRAINTS/LIMITATIONS</u>	<u>RESULT IF EXCEEDED</u>
1. <u>SRB Recovery Velocity</u> . The SRB recovery velocity must not exceed 85 ft/sec (vertical) and 45 ft/sec (horizontal) at water impact.	<u>TBS</u>
2. <u>Frustrum Recovery Vertical and Horizontal Velocity</u> . Frustrum recovery vertical and horizontal velocity must not exceed 55 ft/sec or 45 ft/sec, respectively.	Attrition will be excessive for higher velocities.
3. <u>Dynamic Pressure Limit</u> . Spent SRB dynamic pressure must be < 200 psf and Mach number < 0.6 at altitude of < 19,000 ft.	<u>TBS</u>
4. <u>Spent SRB Tumbling Rates</u> . Body tumbling rates of the spent SRB must not exceed Pitch <u>TBS</u> deg/sec. Yaw <u>TBS</u> deg/sec. Roll <u>TBS</u> deg/sec.	<u>TBS</u>
5. <u>Structures Temperature Limits</u> . See table 3.6.1.2-1.	
6. <u>Maximum Axial Acceleration</u> . Maximum axial acceleration during ascent must not exceed 3.0g.	Structural design limit of the SRB.
7. <u>Maximum Longitudinal Acceleration</u> . Maximum longitudinal acceleration must not exceed 1.2g at lift-off.	Structural design limit of the SRB.

TABLE 3.6.1.1.2-1.- SOLID ROCKET BOOSTER TEMPERATURE LIMITS  
(Paragraph 3.6.1.1.2)

Components	Minimum Operating Temperature of	Critical Item and Results If Exceeded	Maximum Operating Temperature of		Critical Item and Results If Exceeded	Minimum Non-operating Temperature of	Critical Item and Results If Exceeded	Maximum Non-operating Temperature of		Critical Item and Results If Exceeded
			Long Term	Short Term				Long Term	Short Term	
<u>Structures</u>										
Nose cone	TBS	TBS	300	350	TBS	TBS	TBS	TBS	TBS	TBS
Forward skirt	TBS	TBS	900	TBS	TBS	TBS	TBS	TBS	TBS	TBS
Solid rocket motor case	TBS	TBS	900	TBS	TBS	TBS	TBS	TBS	TBS	TBS
Aft skirt	TBS	TBS	900	TBS	TBS	TBS	TBS	TBS	TBS	TBS
Attachments	TBS	TBS	600	TBS	TBS	TBS	TBS	TBS	TBS	TBS
Solid rocket motor nozzle	TBS	TBS			TBS	TBS	TBS	TBS	TBS	TBS
<u>Mechanical</u>										
Pyrotechnics	0	TBS	200	TBS	TBS	TBS	TBS	TBS	TBS	TBS
Pilot parachute	20	TBS	200	TBS	TBS	TBS	TBS	TBS	TBS	TBS
Drogue parachute	20	TBS	200	TBS	TBS	TBS	TBS	TBS	TBS	TBS
Main parachute	20	TBS	200	TBS	TBS	TBS	TBS	TBS	TBS	TBS
Flotation bags	20	TBS	200	TBS	TBS	TBS	TBS	TBS	TBS	TBS
Flashlight	20	TBS	160	NA	TBS	NA	NA	NA	NA	NA
Battery	20	TBS	80	NA	TBS	NA	NA	NA	NA	NA
<u>Propulsion</u>										
Propellant (PBAN)	40	TBS	90	NA	TBS	NA	NA	NA	NA	NA
Igniters	TBS	TBS	TBS	NA	TBS	TBS	TBS	TBS	TBS	TBS
TVC GN <sub>2</sub> bottles	TBS	TBS	150	NA	TBS	TBS	TBS	TBS	TBS	TBS
TVC hydraulic oil reservoirs	TBS	TBS	150	NA	TBS	TBS	TBS	TBS	TBS	TBS
TVC gimbal actuators	40	TBS	250	NA	TBS	TBS	TBS	TBS	TBS	TBS
Separation motors	30	TBS	120	NA	TBS	TBS	TBS	TBS	TBS	TBS
<u>Electrical Power System</u>										
Batteries	34	TBS	122	NA	TBS	TBS	TBS	TBS	TBS	TBS
Avionics		TBS	160	NA	TBS	TBS	TBS	TBS	TBS	TBS
Beacons	-40	TBS	160	NA	TBS	TBS	TBS	TBS	TBS	TBS
Flasher	-40	TBS	TBS	NA	TBS	TBS	TBS	TBS	TBS	TBS
Dye marker	TBS	TBS	TBS	NA	TBS	TBS	TBS	TBS	TBS	TBS
Solar trans-mitter	TBS	TBS	TBS	NA	TBS	TBS	TBS	TBS	TBS	TBS
Pressure switch	TBS	TBS	TBS	NA	TBS	TBS	TBS	TBS	TBS	TBS
Pressure cartridge	TBS	TBS	TBS	NA	TBS	TBS	TBS	TBS	TBS	TBS
Antenna	-40	TBS	160	NA	TBS	TBS	TBS	TBS	TBS	TBS
Malfunction detection system	-40	TBS	160	NA	TBS	TBS	TBS	TBS	TBS	TBS
Flight recorder	-40	TBS	104	NA	TBS	TBS	TBS	TBS	TBS	TBS
Sequencers	-40	TBS	160	NA	TBS	TBS	TBS	TBS	TBS	TBS
Cabling	-54	TBS	250	NA	TBS	TBS	TBS	TBS	TBS	TBS

3.6.3 Solid Rocket Motor Subsystem

3.6.3.1 Solid Rocket Motor

CONSTRAINTS/LIMITATIONS

RESULT IF EXCEEDED

- |   |  |
|---|--|
| <ol style="list-style-type: none"><li>1. <u>Nominal Thrust Performance.</u> The nominal thrust profile must not exceed the limits as shown in figure 6.3.1-2.</li><li>2. <u>Ballistic Dispersions.</u> The ballistic dispersions must not exceed the limits shown in table 6.3.1-1.</li><li>3. <u>Thrust Differential.</u><ol style="list-style-type: none"><li>a. Ignition thrust differential must not exceed the limits shown in figure 6.3.1-3.</li><li>b. Steady-state thrust differential must not exceed the limits shown in figure 6.3.1-4.</li><li>c. Tailoff thrust differential must not exceed the limits shown in figure 6.3.1-5.</li></ol></li><li>4. <u>Ignition Characteristics.</u><ol style="list-style-type: none"><li>a. The ignition interval must be 170 to 340 msec.</li><li>b. The pressure rise rate must not exceed 109 psi for any 10-msec interval.</li><li>c. The thrust rise rate must not exceed 360,000 lbf for any 10-msec interval.</li><li>d. Variation between SRB-pair ignition must not exceed 9.3 msec.</li></ol></li><li>5. <u>Dynamic Thrust Vector.</u><br/>The dynamic thrust vector must not exceed the limits shown in figure 3.6.3.1-1.</li><li>6. <u>Propellant Bulk Temperature.</u><br/>The propellant bulk temperature must not exceed 40° to 90° F during motor operation.</li></ol> | <p>Performance requirements will not be met.</p> |
|---|--|



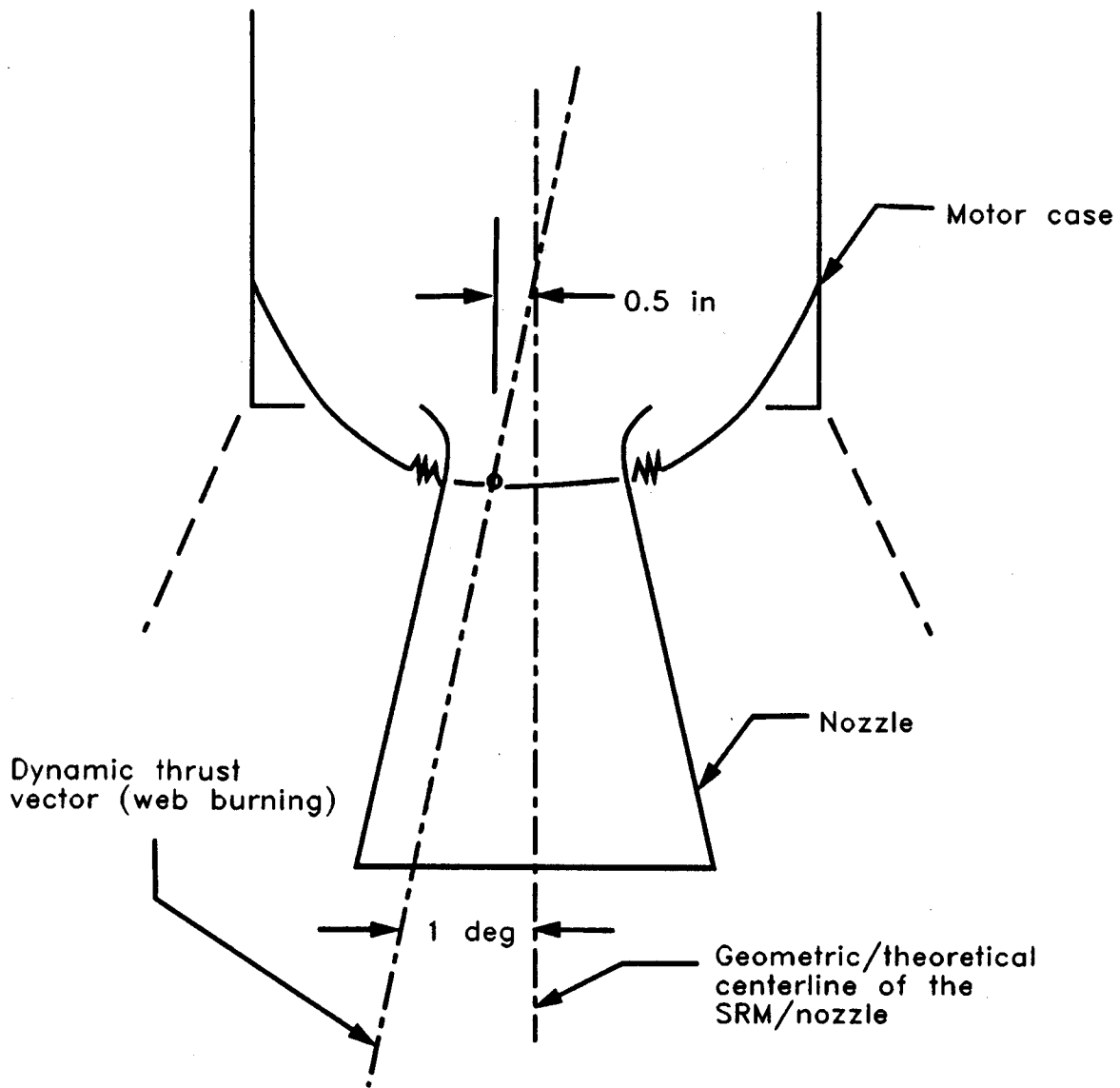

Note: The line of action shall be within 0.5 inches of the nozzle, SRM centerline. The line of action of the thrust vector, during web burning, shall be within 1.0 deg (half angle) of a line coincident with or parallel to the SRM/nozzle centerline

Figure 3.6.3.1-1.- SRB system thrust vector alignment.

3.6.4 Thrust Vector Control  
 3.6.4.1 Thrust Vector Control Characteristics  
 CONSTRAINTS/LIMITATIONS

1. SRB TVC Actuation Subsystem

- a. The SRB TVC-actuation subsystems shall not be operated with more than two of their four channels bypassed.
- b. At SRB hydraulic power-up, the magnitudes of the errors between the commanded and actual positions of the SRB TVC actuators must be 0.9 degree or less unless their FDI system is inhibited by issuing Reset/Override commands to all of the SRB TVC channels. Constraint does not apply to low-pressure operations (less than 2000 psi).
- c. Following bypasses of two channels in the same SRB TVC actuator, the FDI system for the two remaining channels shall be inhibited using Reset/Override commands.
- d. SRB TVC actuators with multiple failed channels that have been bypassed shall not be reactivated simultaneously. The bypass channels can be reactivated one at a time by issuing a Reset/Override command to one of the bypassed channels for a minimum of 140 milliseconds. A delay following the removal of the Reset/Override of at least an additional 300 milliseconds must be allowed for

RESULT IF EXCEEDED

The SRB TVC actuators were not designed for single-channel operation. With three channels bypassed, operating with only one active channel, the performance of the affected SRB TVC subsystems could be unacceptable. In flight, this condition could result in loss of the vehicle.

Four channel bypasses of the affected SRB TVC actuators could occur resulting in loss of actuator control. During a launch countdown, an on-pad launch abort will result.

Constraint attempts to prevent loss of actuator control due to inadvertent bypasses of the remaining active channels. After bypasses of two of the four channels, the FDI system is no longer capable of discriminating between failed and good active channels.

The FDI system for the SRB TVC-channel actuation subsystems is not designed to handle multiple TVC-channel failures that occur simultaneously.

Simultaneously reactivating more than one failed channel in a given TVC actuator could cause a four-channel bypass condition resulting in loss of actuator control. In flight, loss of actuator

## 3.6.4.1

## CONSTRAINTS/LIMITATIONS

the channel to re-bypass if the failed condition still exists. This procedure can then be repeated for the remaining bypassed channels.

- e. For each of the SRB TVC-actuation subsystems, the magnitude of the incremental change (step) in its position command shall be limited to 0.9 degree. Any subsequent change in the command shall be delayed so that the magnitude of the effective commanded rate does not exceed 5 degrees per second. For example, following a 0.9-degree incremental change in the position command of one of the SRB TVC subsystems, no subsequent change in this command can occur for 180 milliseconds  $[0.9 \text{ degree}/(5 \text{ degree/second}) = 180 \text{ milliseconds}]$ .
- f. If a failed channel cannot be bypassed resulting in the channel being dragged by the remaining three channels, the FDI system for the remaining three channels shall be inhibited by issuing Reset/Override commands to these channels.
- g. The SRB TVC-actuation subsystems shall not be operated with two control channels assigned to one GPC unless one of the two channels is bypassed via the FCS channel switch.

## RESULT IF EXCEEDED

control could result in loss of vehicle.

Four-channel bypasses of the affected SRB TVC actuator could occur resulting in loss of actuator control. In flight, four-channel bypass would result in loss of TVC function for the affected SRB axes with possible loss of vehicle.

The FDI system for the SRB TVC-actuation subsystem is not designed to handle any subsequent failure; the subsystem has had two failures with the inability to bypass the failed channel being the second failure. Constraint attempts to prevent loss of actuator control due to a subsequent failure that could result in bypassing the three remaining control channels.

Failure of a GPC commanding two control channels could result in bypass of the remaining two channels and loss of actuator control. In flight, loss of actuator control could result in loss of vehicle.

3.6.4.1

CONSTRAINTS/LIMITATIONS

- h. If two channels in the same SRB TVC-actuation subsystem bypass during ground tests, the hydraulic pressure shall be removed as quickly as possible.
- i. Following an SRB HPU failure, the sum of the magnitude of the commanded rates for the two SRB TVC actuators affected by the failure shall not exceed 6 degrees per second.

RESULT IF EXCEEDED

Bypass of two channels under test conditions could result in bypass of the remaining channels and loss of actuator control.

Four-channel bypasses of the affected SRB TVC actuators could occur due to excessive position errors caused by exceeding the hydraulic flow capability of the one remaining HPU. A four-channel bypass would result in loss of actuator control with possible loss of vehicle.

3.6.4.2

Auxiliary Power Unit Subsystems  
CONSTRAINTS/LIMITATIONS

1. Temperature Limits.  
See table 3.6.4.2-1.
2. Auxiliary Power Unit Heaters Energized. Auxiliary power unit heaters must be energized prior to auxiliary power unit activation to preheat bed at 200° F.

RESULT IF EXCEEDED

Catalyst bed may require preheating to preclude washout and to prolong bed life.

TABLE 3.6.4.2-1.- AUXILIARY POWER UNIT SUBSYSTEM COMPONENT TEMPERATURE LIMITS  
(Paragraph )

Components	Minimum Operating Temperature, °F	Critical Item and Results If Exceeded	Maximum Operating Temperature, °F		Critical Item and Results If Exceeded	Minimum Non-operating Temperature, °F	Critical Item and Results If Exceeded	Maximum Non-operating Temperature, °F		Critical Item and Results If Exceeded
			Long Term	Short Term				Long Term	Short Term	
Fuel tank	45	Hydrazine freezes at 35° F.	150		Safe operation limit of hydrazine from tank	TBS	TBS	TBS	TBS	TBS
Fuel lines and line filter	45	Hydrazine freezes at 35° F.	150		Safe operation limit of hydrazine from tank	TBS	TBS	TBS	TBS	TBS
Isolation valve	45	Hydrazine freezes at 35° F.	150		Safe operation limit of hydrazine from tank	TBS	TBS	TBS	TBS	TBS
Lube oil lines	45	Acceptable lube oil viscosity	290	a	Lube oil upper limit	TBS	TBS	TBS	TBS	TBS
Exhaust duct	NA	NA	1400		Strength limit on duct material	NA	NA	NA	NA	NA
Electrical components/wiring	-65	Compartment temperature	275		Compartment temperature	TBS	TBS	TBS	TBS	TBS
APU Controller	0	Loss of component accuracy at lower temperatures	125		Components upper limit	TBS	TBS	TBS	TBS	TBS
Fuel pump	45	Hydrazine freezes at 35° F.	155	a	Safe operation limit of hydrazine from pump	TBS	TBS	TBS	TBS	TBS
Modulating valve	45	Hydrazine freezes at 35° F.	155	a	Safe operation limit of hydrazine from pump	TBS	TBS	TBS	TBS	TBS
Shutoff valve	45	Hydrazine freezes at 35° F.	155	a	Safe operation limit of hydrazine from pump	TBS	TBS	TBS	TBS	TBS
Gas generator	200	Poisoning of catalyst bed occurs below 200° F.	1700		Turbine and generator life limits	TBS	TBS	TBS	TBS	TBS
Turbine housing surface	NA	NA	350		Compartment structure limit	TBS	TBS	TBS	TBS	TBS
Gear box	45	Acceptable lube oil viscosity	290	a	Lube oil upper limit	TBS	TBS	TBS	TBS	TBS

<sup>a</sup>Short-term excursion to higher temperature after shutdown allowable.

3.6.5

Separation Subsystem

CONSTRAINTS/LIMITATIONS

RESULT IF EXCEEDED

- |  |   |
|--|---|
| 1. <u>Rates</u> . Limit rates at separation:<br>Roll $\pm 5$ deg/sec<br>Pitch $\pm 2$ deg/sec<br>Yaw $\pm 2$ deg/sec | Possible recontact between separating elements. |
| 2. <u>Dynamic Pressure</u> . Limit dynamic pressure (q) at separation is 75 psf.                                     | Possible recontact between separating elements. |
| 3. <u>Angle-of-Attack</u> . Angle-of-attack limit at separation ( $\alpha$ ) is $\pm 15$ deg.                        | Possible recontact between separating elements. |
| 4. <u>Sideslip (<math>\beta</math>) Limit</u> . Sideslip ( $\beta$ ) limit at separation is $\pm 15$ deg.            | Possible recontact between separating elements. |
| 5. <u>SRM Thrust</u> . Maximum residual thrust, each SRB, at separation is 60,000 lbf.                               | Possible recontact between separating elements. |

3.6.4.3 Hydraulic Subsystem and 3.6.4.4. Servoactuators: no constraints

3.6.6

Recovery Subsystem

CONSTRAINTS/LIMITATIONS

1. Ascent Trajectory.

Ascent trajectory shall be designed such that the SRB nominal apogee shall not exceed 255,000 feet for midweight case SRB, 260,000 feet for lightweight case SRB, and 275,000 feet for filament wound case SRB.

2. Sea-State.

- a. Sea-state for SRB flotation must not exceed sea-state code 5. Capability must be provided to insure SRB flotation for at least 72 hours under these conditions.
- b. Sea-state for retrieval and transportation must not exceed sea-state code 4.

RESULT IF EXCEEDED

Exceeding apogee limits will reduce recovery probability below 99 percent.

Exceeds design limit for retrieval.



## 5.0 EXTERNAL TANK PERFORMANCE AND OPERATIONAL DATA

The External Tank (ET) performance and operational data are presented in the following subsections. External tank configuration and coordinate data and ET constraints and limitations are presented in Section 2.0 and 3.0 of this document, respectively.

## 5.1 STRUCTURES AND THERMAL PROTECTION SUBSYSTEMS

### 5.1.1 STRUCTURES SUBSYSTEM

Three primary structural elements comprise the ET structures system. They are the LO<sub>2</sub> tank, an intertank, and an LH<sub>2</sub> tank. The ET performs the following functions:

- a. Provides propellant tanks for the Orbiter
- b. Receives and distributes stress loads from and to the Orbiter and SRB's
- c. Provides load path continuity for the total Space Shuttle flight configuration. See figure 2-6 for this configuration.

#### 5.1.1.1 Liquid Oxygen Tank

- a. Length 592 in.
- b. Outside diameter (barrel) 331 in.
- c. Total volume (including ullage) 19,786 ft<sup>3</sup>

#### 5.1.1.2 Intertank

- a. Length 270 in.
- b. Outside diameter 331 in.
- c. Pressure vents
  1. Number 2
  2. Size 1.4 in. x 5.5 in.
  3. Area 6 in<sup>2</sup> per vent
  4. Total leak penetration area including two vents 53 to 66 in<sup>2</sup>
- d. In-flight intertank pressures 15.0 to 0.001 psia

#### 5.1.1.3 Liquid Hydrogen Tank

- a. Length 1160 in.
- b. Outside diameter 331 in.
- c. Volume (including ullage) under ambient conditions 53,518 ft<sup>3</sup>

#### 5.1.1.4 Nose Cap

- a. Length (with lightning rod) 44 in.
- b. Outside diameter 56 in.

## 5.1.2 THERMAL PROTECTION SUBSYSTEM

The thermal protection subsystem (TPS) consists of ablators and foams of several compositions applied by different methods. Super light ablator (SLA-561) is applied to components by a process of spraying, vacuum molding, bonding of premolded parts, screen net molding, nitrogen gas pressure net molding, and/or manual hand application (handpacked).

Martin Ablator, 25 sprayable (MA-25S) is sprayed directly onto the part, or built into slabs/panels by a continuous series of overlaying spray passes. This cured raw stock (slab/panel) is subsequently bonded to specific  $LO_2$  and  $LH_2$  cable trays and covers which enclose the RSS linear-shaped charges.

Sprayable Polyisocyanurate foam (CPR-488) is an "acreege foam" used on the  $LO_2$  tank, intertank, and  $LH_2$  tank barrel. Another sprayable polyisocyanurate foam with higher thermal stability characteristics (NCFI 22-65) is used for "acreege coverage" on the  $LH_2$  aft dome.

Polyurethane foam (BX-250) can be applied by either a spray or spray/pour process. This foam is used on the  $LO_2$  tank aft dome,  $LH_2$  tank forward dome,  $LH_2$  aft dome apex closeout, protuberance air load (PAL) ramps, multi-component detail parts, and other closeout functions. Another polyurethane foam (PDL-4034) is injected/poured into molds to form the  $LO_2$  and  $LH_2$  ice-frost ramps at respective cable tray support-bracket locations. The primary usage of this foam is for "in process" repair, closeout and repair of foam test locations.

A commercial grade polyurethane kit foam (Insta-Foam) is only used for off-site closeout of the "third hard point" at the ET aft end -Z axis.

The system also includes the use of phenolic thermal isolators between the  $LH_2$  tank and tank attachments to preclude the liquefaction of air on exposed metallic attachments and to reduce heat flow into the  $LH_2$ . See table 5.1.2-1.

Operational characteristics of TPS materials are shown in table 5.1.2-2.

## a. TPS materials characteristics

## 1. SLA-561

(a) Thermal conductivity at 75° F	0.055 Btu/ft-hr-°F
(b) Typical cross section	Figure 5.1.2-1
(1) 1506	16-19 lb/ft <sup>3</sup>
(2) 1508, 1509	15-17 lb/ft <sup>3</sup>
(3) 1510 I	25-35 lb/ft <sup>3</sup>
(4) 1510 II	17-23 lb/ft <sup>3</sup>
(5) 1530, 1531	15-20 lb/ft <sup>3</sup>
(c) Density	16 ±1 lb/ft <sup>3</sup>

## 2. CPR-488

(a) Thermal conductivity at 75° F	0.018 Btu/ft-hr-°F
(b) Typical cross section	Figure 5.1.2-2
(c) Density	2.1 - 2.6 lb/ft <sup>3</sup>

5.1.2-1

- |   |                              |
|---|------------------------------|
| 3. NCFI 22-65   |                              |
| (a) Thermal conductivity at 75° F   | 0.023 Btu/ft-hr-°F           |
| (b) Typical cross section   | Figure 5.1.2-2               |
| (c) Density   | 2.8 - 3.1 lb/ft <sup>3</sup> |
| 4. BX-250   |                              |
| (a) Thermal conductivity at 75°F  | 0.018 Btu/ft-hr-°F           |
| (b) Typical cross section   | Figure 5.1.2-2 <sub>3</sub>  |
| (c) Density   | 1.8 - 2.6 lb/ft <sup>3</sup> |
| 5. MA-25S   |                              |
| (a) Thermal conductivity at 75 °F   | 0.054 Btu/ft-hr-°F           |
| (b) Typical cross section   | Figure 5.1.2-3 and -4        |
| (c) Density   | 25 - 35 lb/ft <sup>3</sup>   |
| b. TPS configuration summary  |                              |
| 1. Lightweight tank 16, 20, 21, 22, and 27<br>(External tank 23, 27, 28, 29, and 34)  | Note a                       |
| 2. Lightweight tank 24, 25, 26, and 28 through 43<br>(External tank 31, 32, 33, and 34 through 50)  | Note a                       |
| 3. Lightweight tank 44 and subsequent<br>(External tank 51 and subsequent)  | Note a                       |
| c. TPS material thickness and usage   | Note a                       |
| d. Phenolic thermal isolators   |                              |
| The TPS uses phenolic thermal isolators between the LH <sub>2</sub> tank and tank attachments to preclude the liquefaction of or on exposed metallic attachments and to reduce heat flow into the LH <sub>2</sub> tank. |                              |
| 1. Location and thickness   | Table 5.1.2-1                |
| e. Thermal characteristics  | Table 5.1.2-2                |

<sup>a</sup>Data on the ET configuration summary were submitted on M1-1471 and are available from J. Mistrot VF2, 713-483-3314.

TABLE 5.1.2-1.- PHENOLIC THERMAL ISOLATOR  
(Paragraph 5.1.2)

Component	TPS Material	Thickness, in.
<u>Isolator requirements</u>		
ET/SRB aft attachment (4)	Glass phenolic	0.4
ET/ORB forward attachment (2)	Glass phenolic	0.37
ET/ORB aft vertical attachment (2)	Glass phenolic	0.4
ET/ORB aft diagonal attachment (1)	Glass phenolic	0.4
LO <sub>2</sub> feedline attachment (8)	Glass phenolic	0.55
GO <sub>2</sub> pressurization line/cable tray (14)	Glass phenolic	0.5
GH <sub>2</sub> pressurization line/cable tray (15)	Glass phenolic	0.5

TABLE 5.1.2.2.- THERMAL CHARACTERISTICS  
(Paragraph 5.1.2)

Material	Q Maximum, Btu/ft <sup>2</sup> - sec	Bondline temperature, °F	
		Maximum	Minimum
BX-250	4	200	-423
CPR-488	a	300	-423
SLA-561	30	400	-423
MA-25S	75	400	-300
NCFI 22-65	N/A	300	-423

<sup>a</sup>Practical use limits are 18 Btu/ft<sup>2</sup>-sec for thickness to 2 1/2 in.,  
( $r = 0.000858q^{1.53}$  based on clean/interface flow tests).

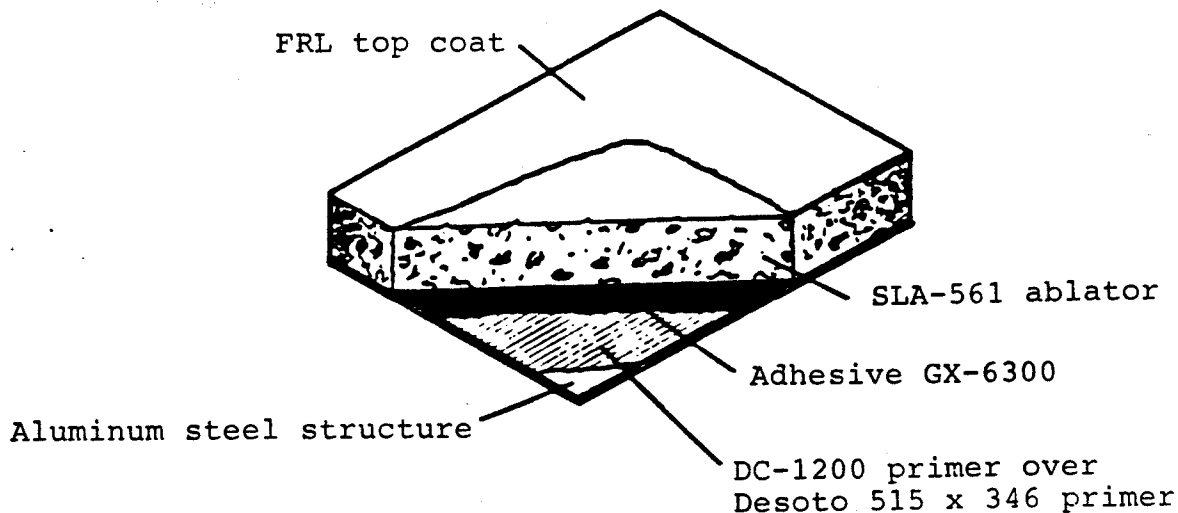

Figure 5.1.2-1.- SLA-561 typical cross section.  
(Paragraph 5.1.2)

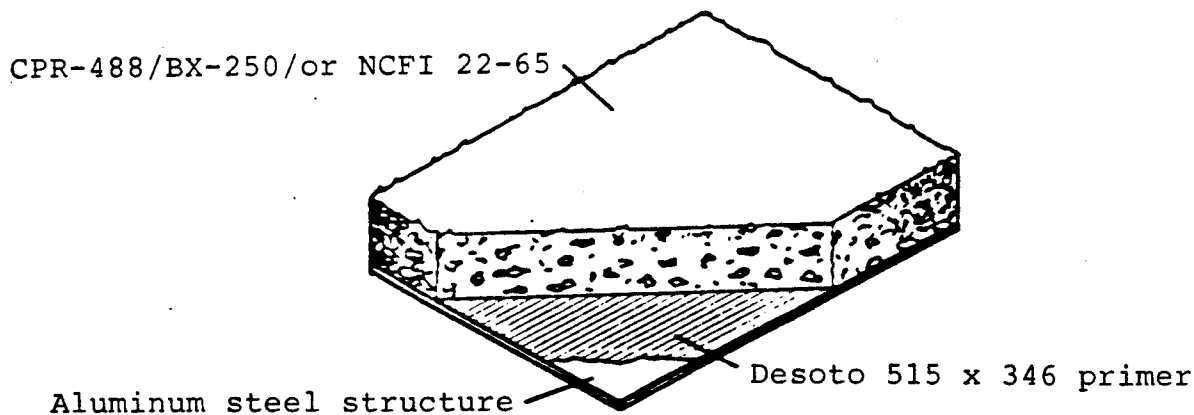

Figure 5.1.2-2.- CPR-488/BX-250/or NCFI 22-65 typical cross section.  
(Paragraph 5.1.2)

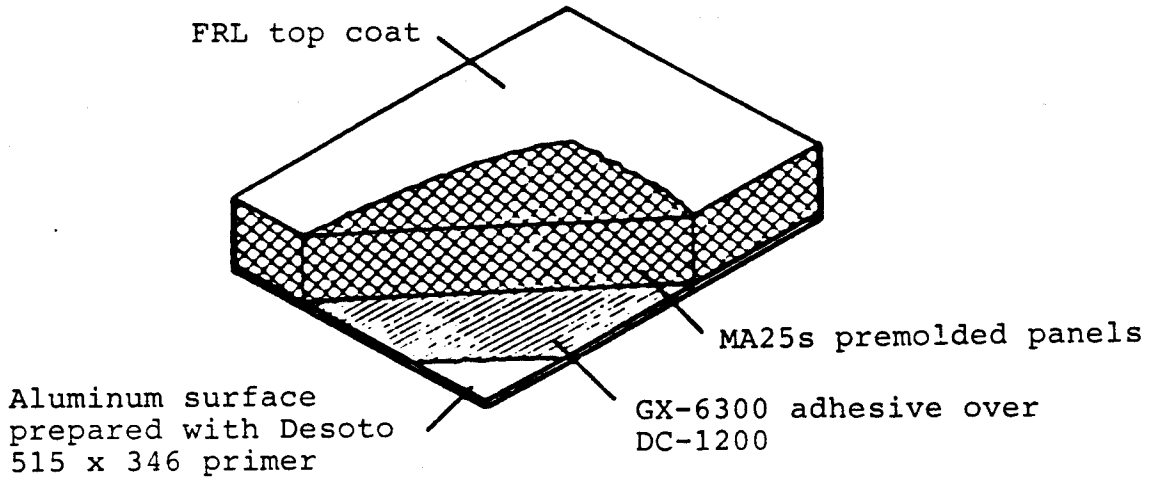

Figure 5.1.2-3.- Premolded MA25s typical cross section of RSS cable trays and cable tray covers. (Paragraph 5.1.2)

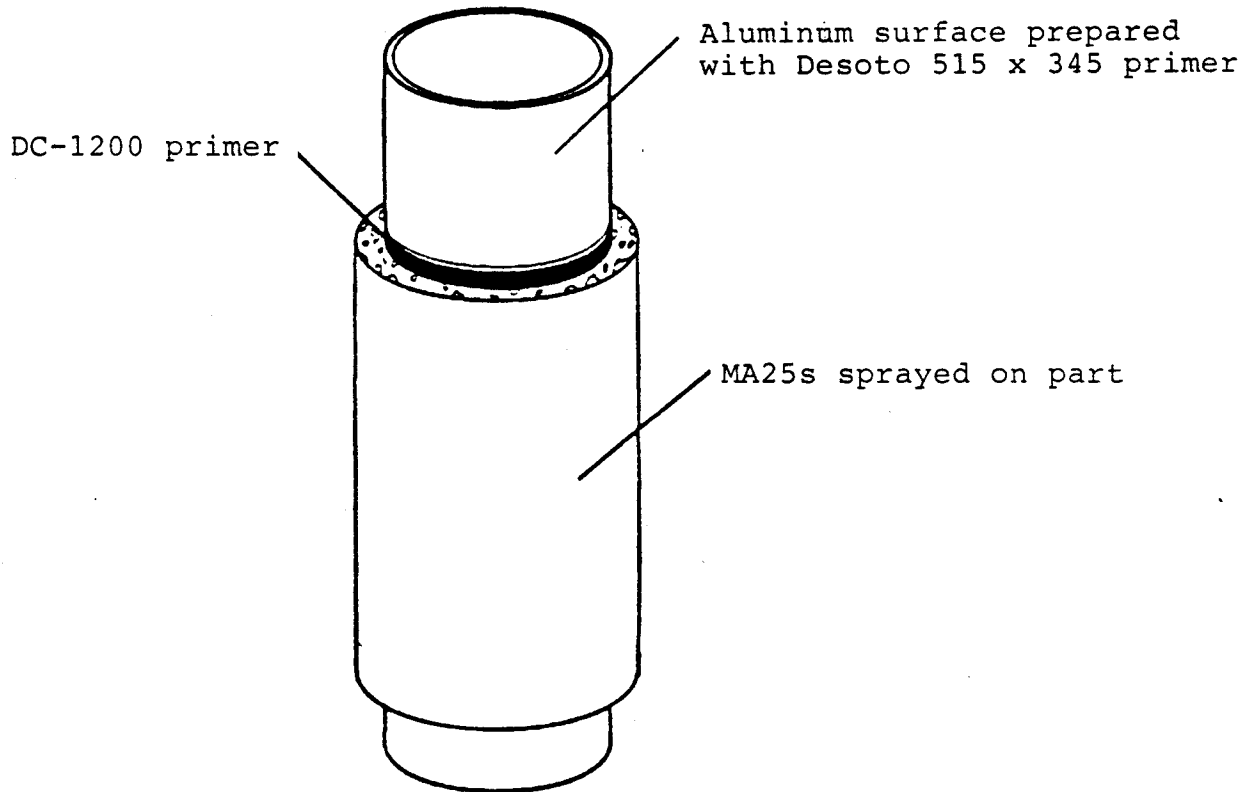

Figure 5.1.2-4.- Typical cross section of forward bi-pod struts with MA23s sprayed in place. (Paragraph 5.1.2)

250 h  
5.1.2-5

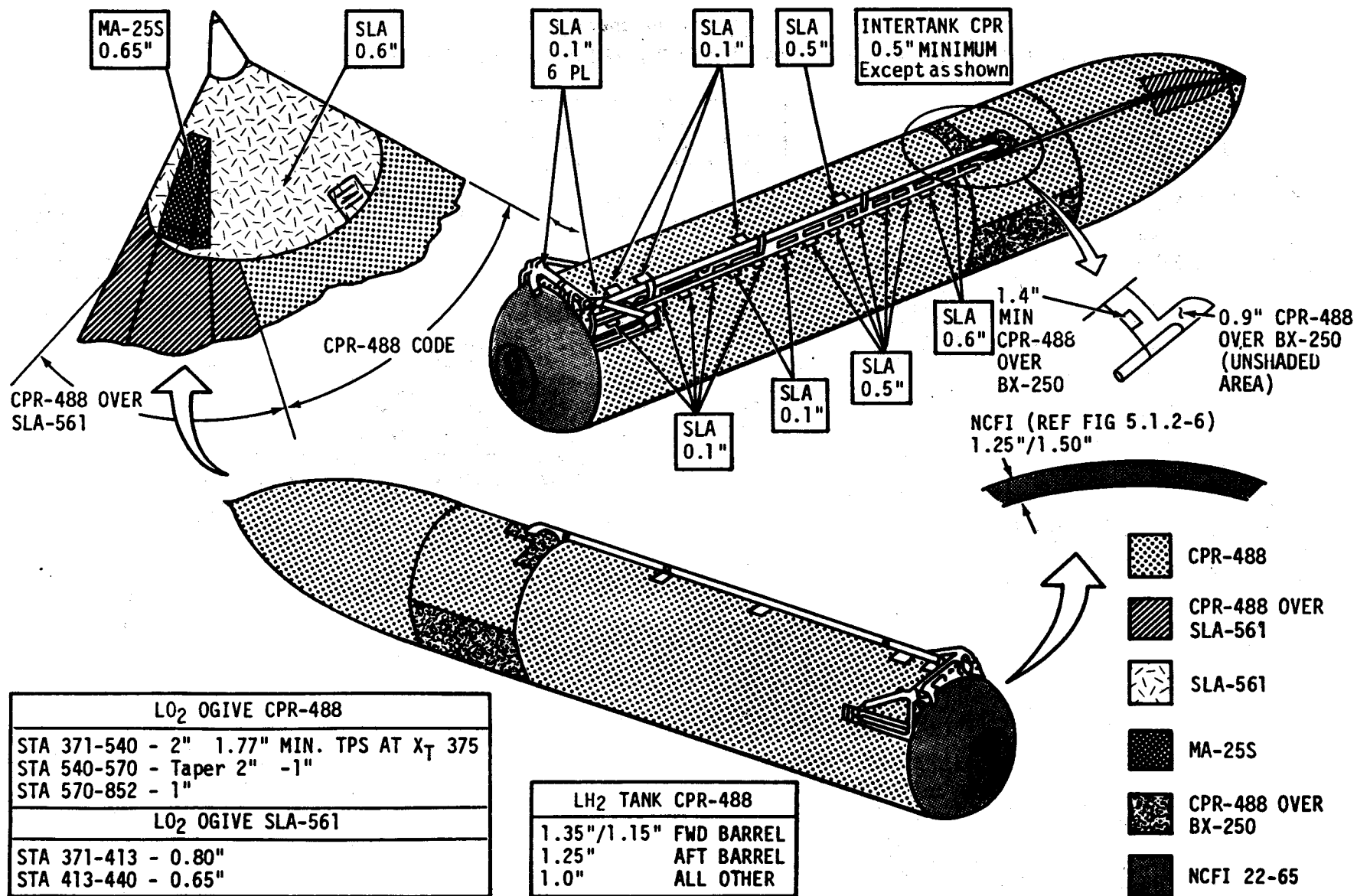

Figure 5.1.2-1.- TPS configuration summary - Block 6.  
(Paragraph 5.1.2)



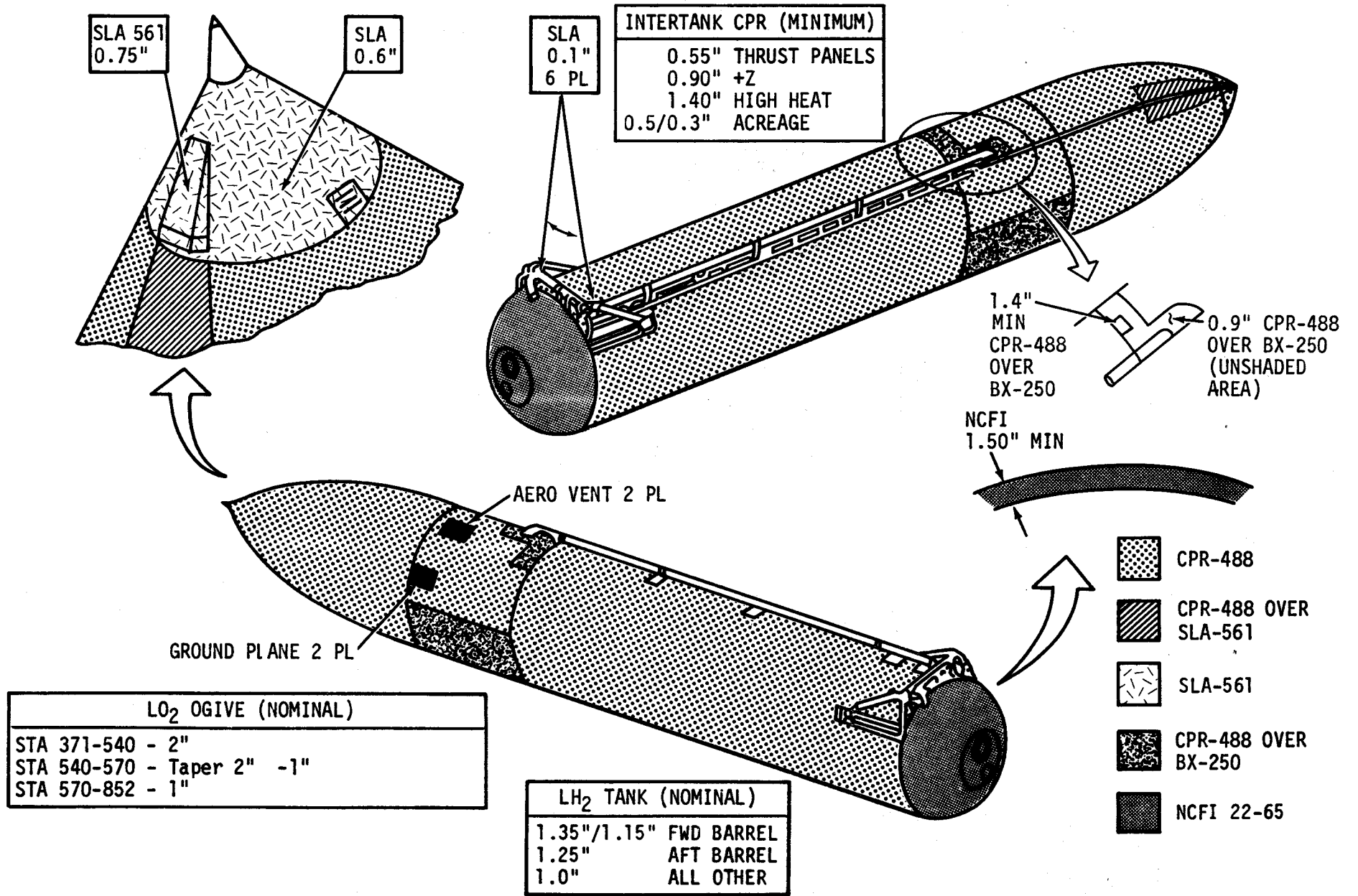
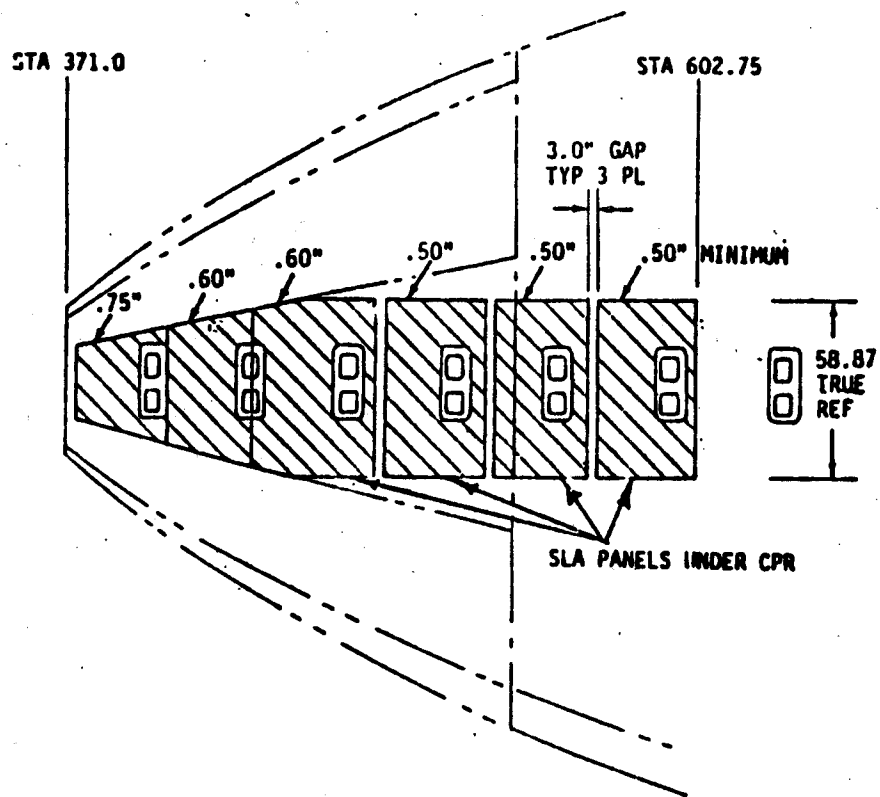

Figure 5.1.2-1.- TPS configuration summary - Block 7 (concluded).  
(Paragraph 5.1.2)



OGIVE CPR	
STA 371-540	2.0"
STA 540-570	Taper 2.0"-1"
STA 570-852	1"

Figure 5.1.2-2.-  $LC_2$  tank SLA panels - Block 7  
(Paragraph 5.1.2)

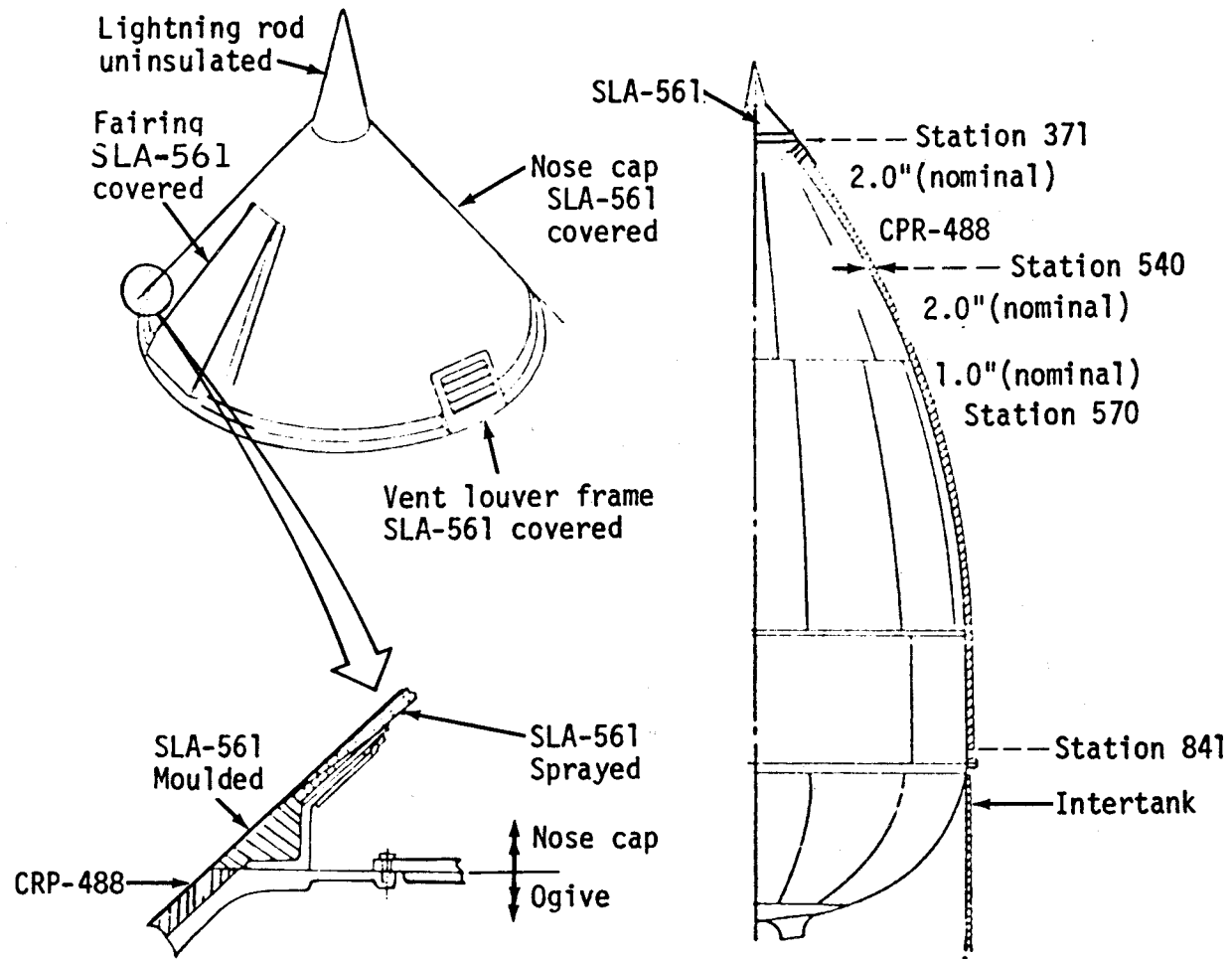

Figure 5.1.2-3.- Nose cap TPS coverage. Figure 5.1.2-4.- LO<sub>2</sub> tank TPS coverage.  
(Paragraph 5.1.2) (Paragraph 5.1.2)

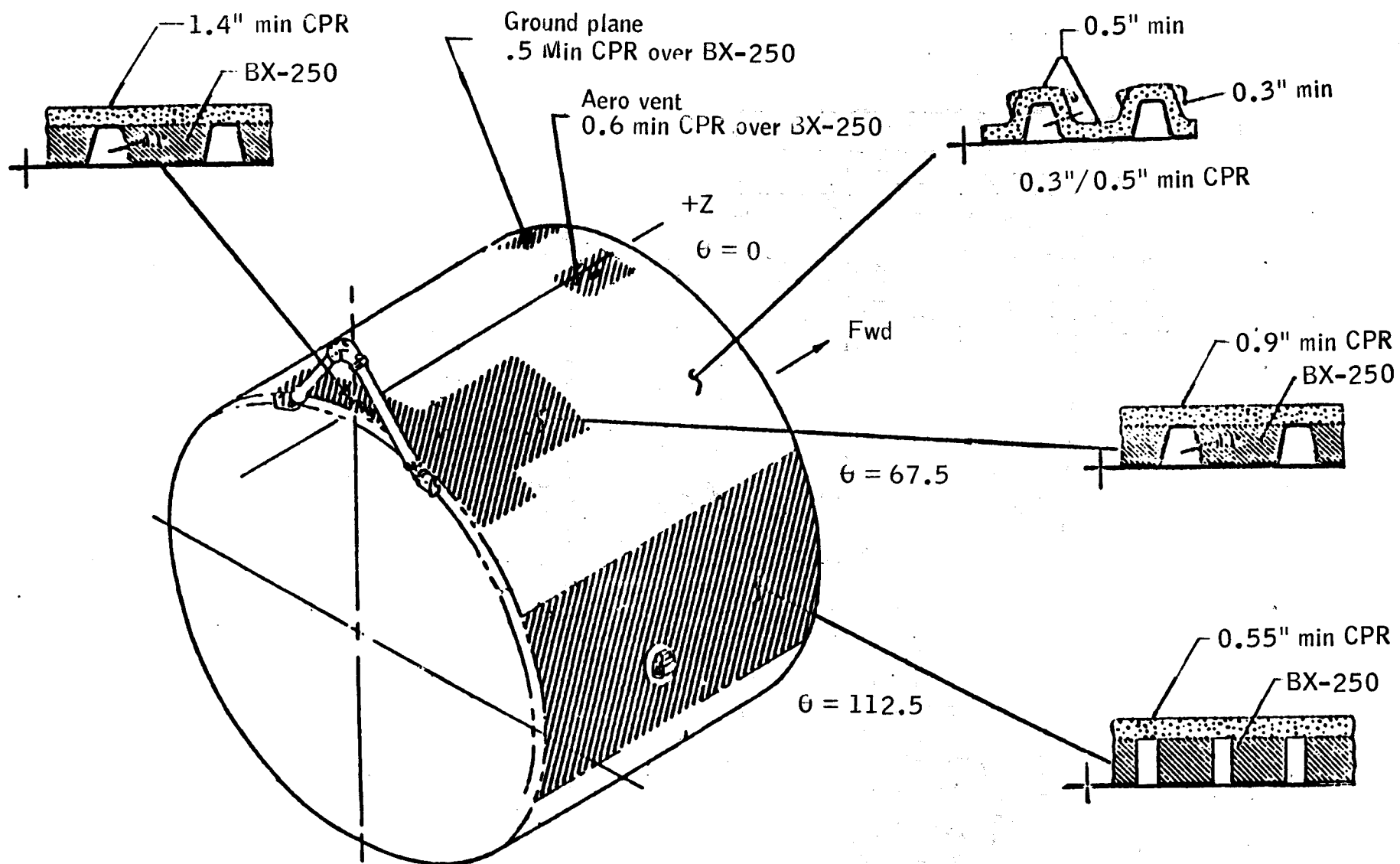
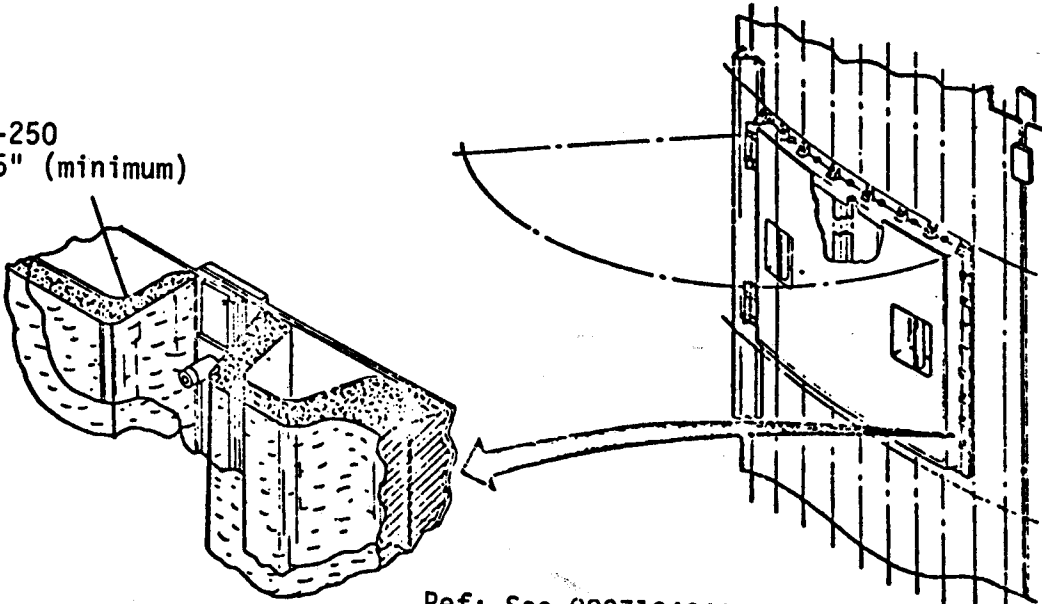

Figure 5.1.2-5.- Intertank TPS cross sections.  
(Paragraph 5.1.2)

BX-250  
0.5" (minimum)



Ref: See 80971048409  
for foam application  
to access door

Figure 5.1.2-6.- Intertank access door TPS coverage.  
(Paragraph 5.1.2)

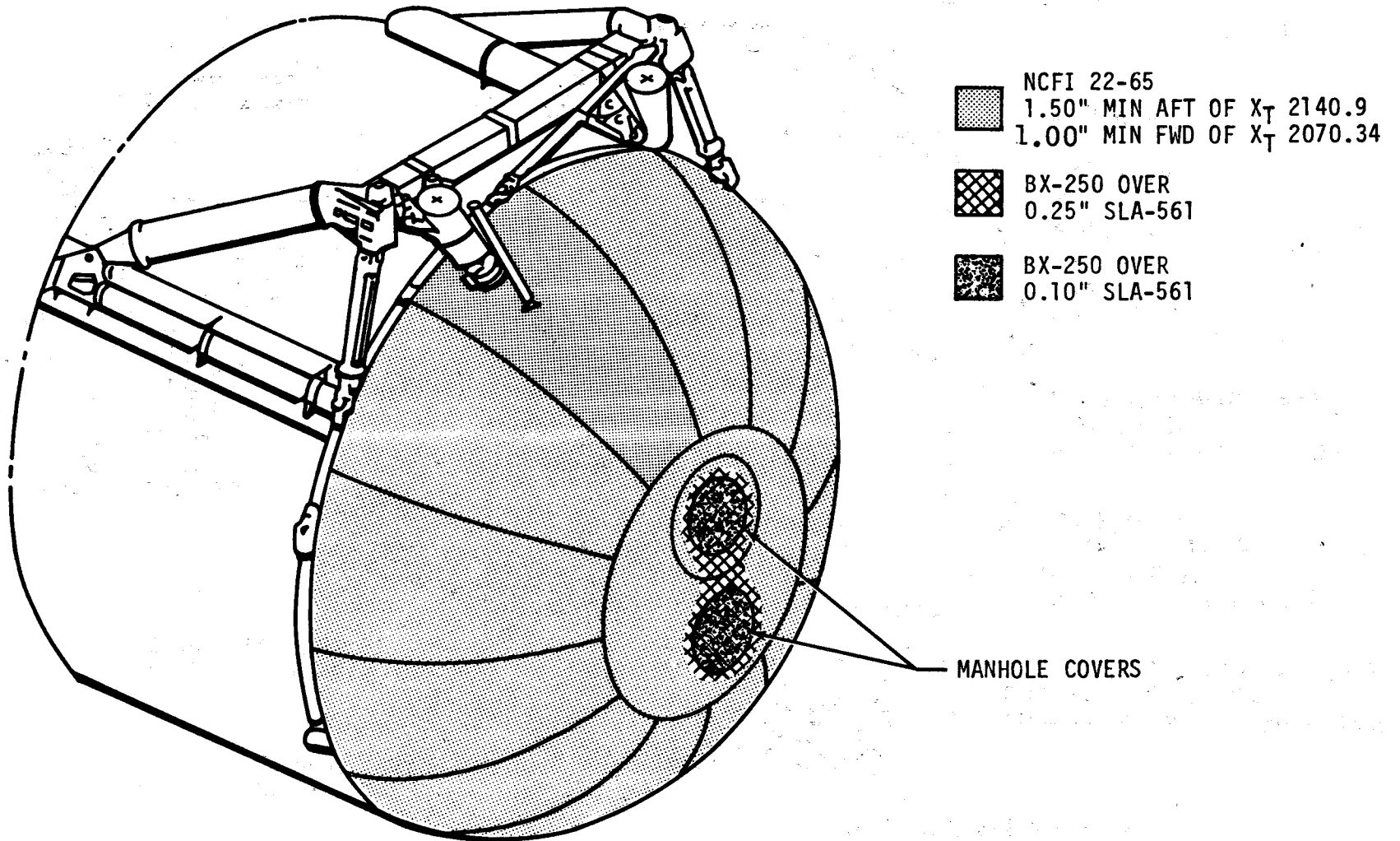

Figure 5.1.2-7.- Liquid hydrogen aft dome TPS configuration (lightweight tanks 4 and up).  
 (Paragraph 5.1.2)

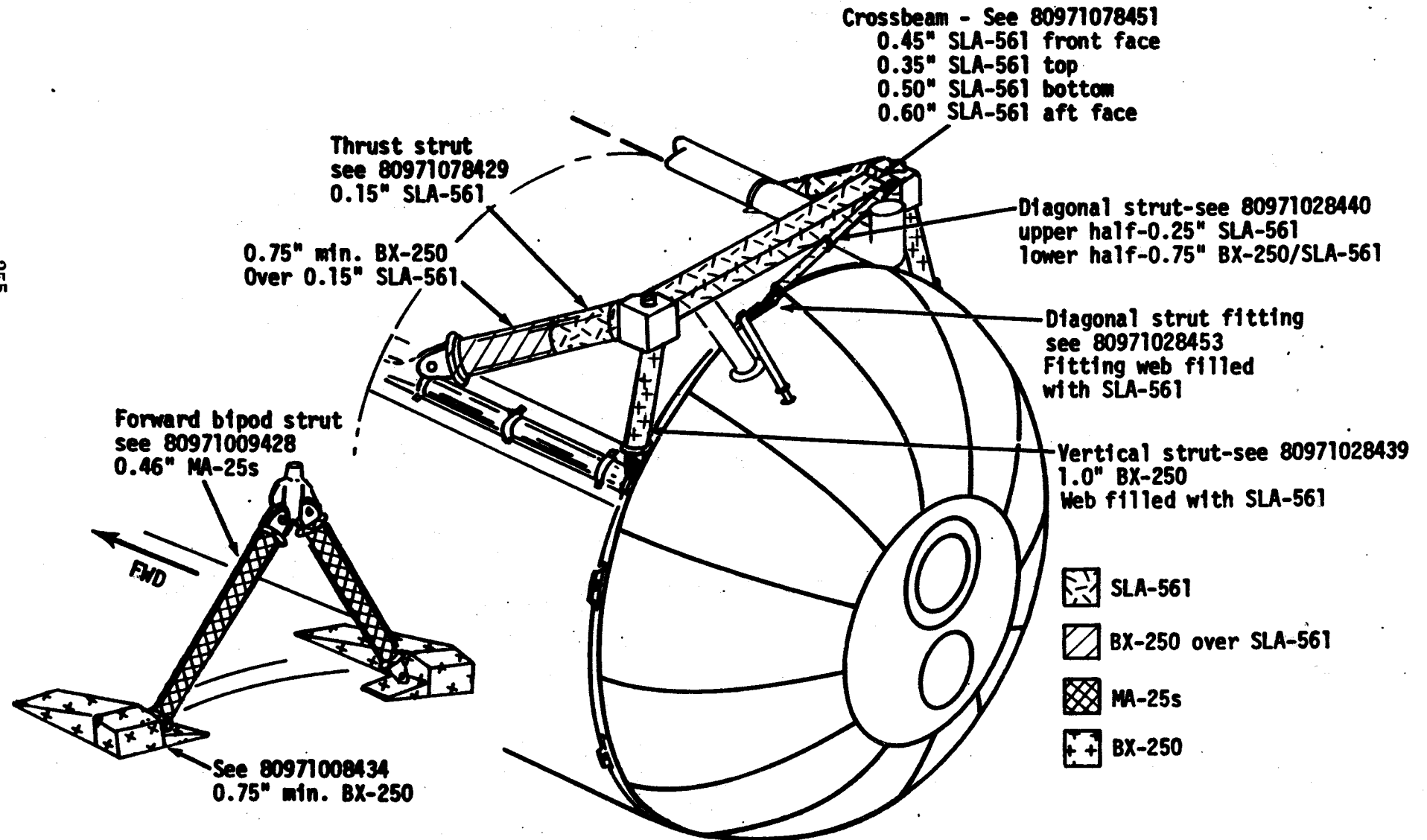
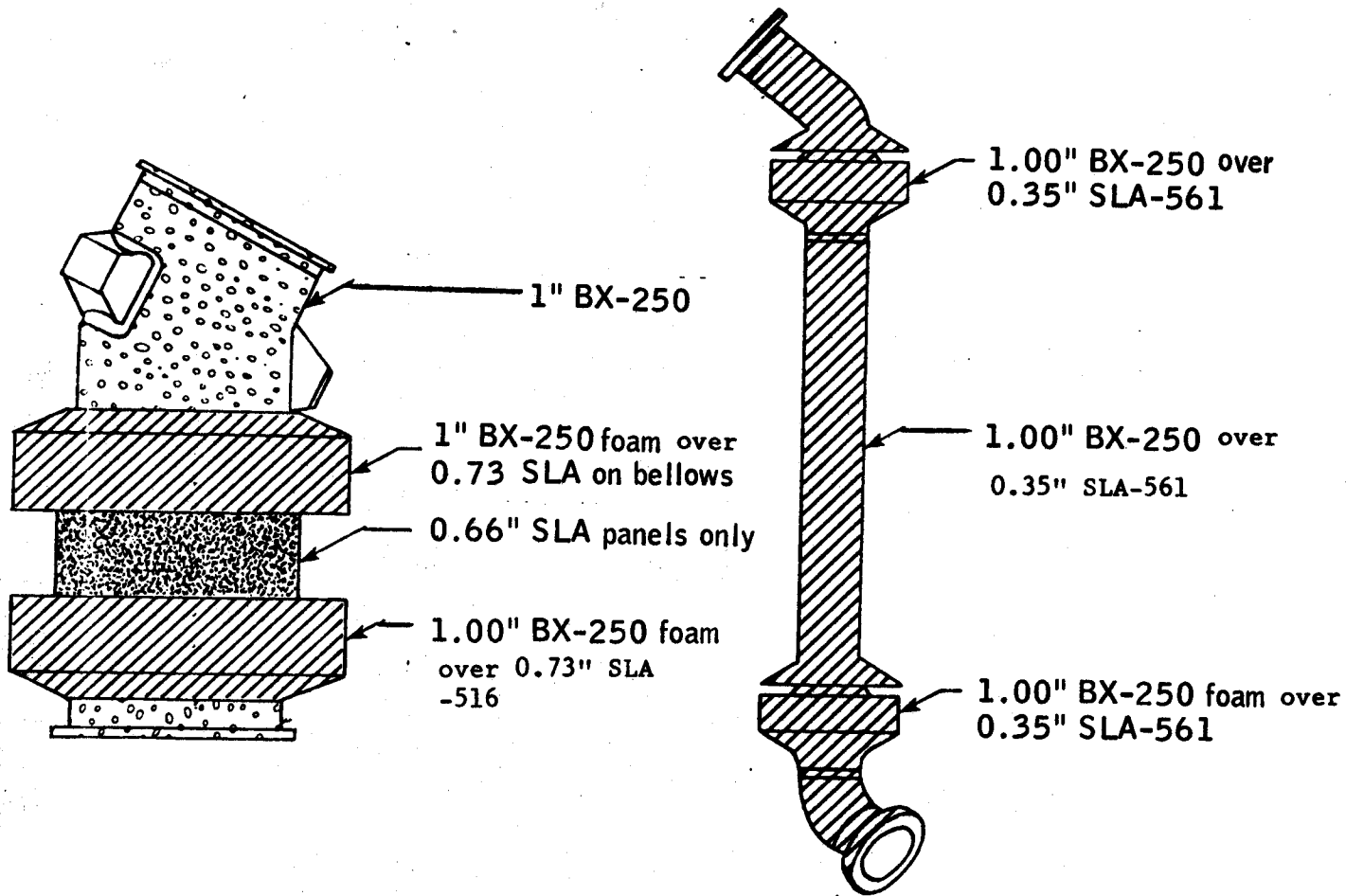

Figure 5.1.2-8.- ET/Orbiter interface attachments structure-TPS configuration.  
 (Paragraph 5.1.2)



LH<sub>2</sub> feedline  
 Ref: See 80971028410

LH<sub>2</sub> recirculation line  
 Ref: See 80971028411

Note: SLA thickness is minimal  
 BX-250 thickness is nominal

Figure 5.1.2-9.- LH<sub>2</sub> feedline and recirculation line - TPS configuration.  
 (Paragraph 5.1.2)



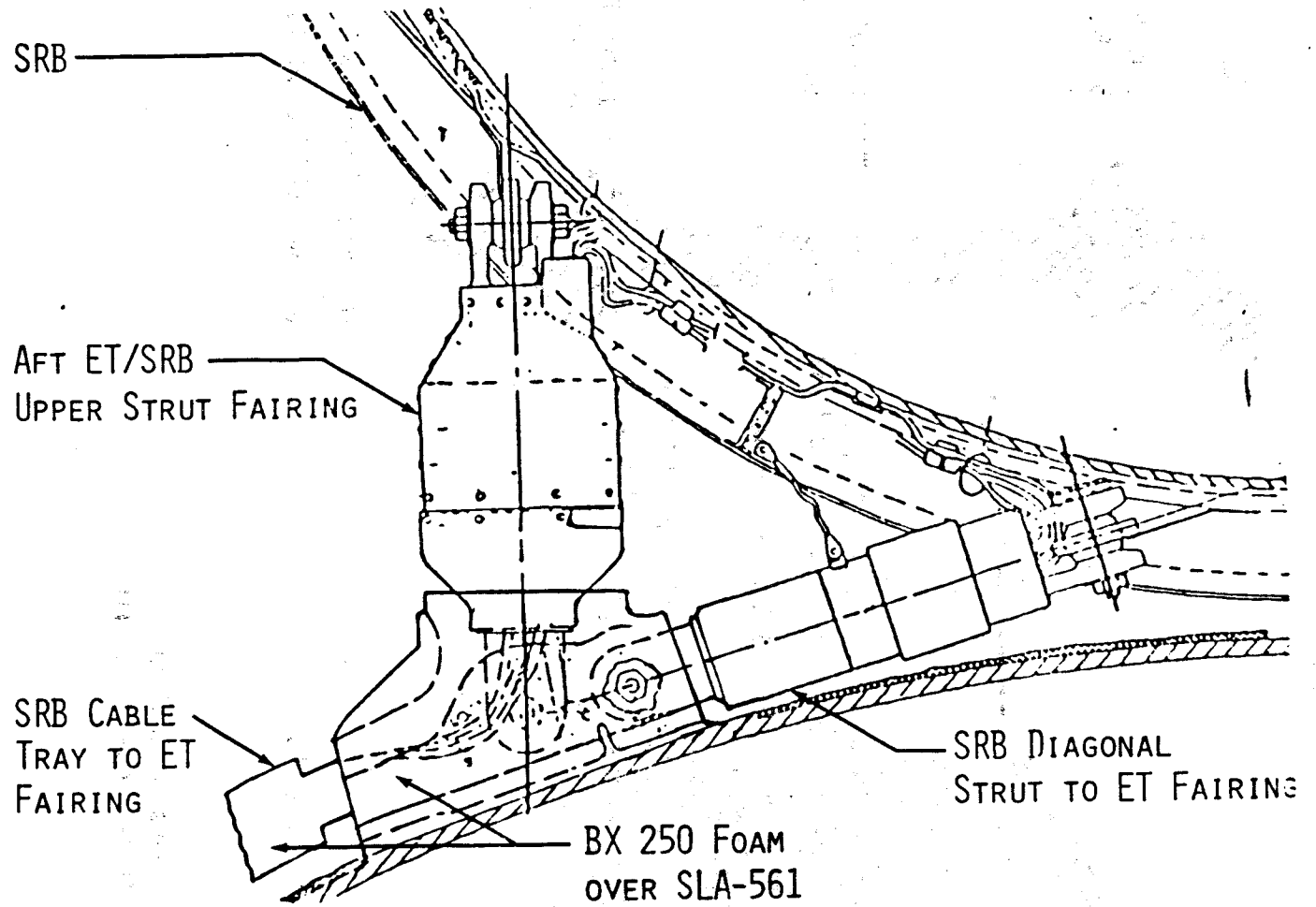
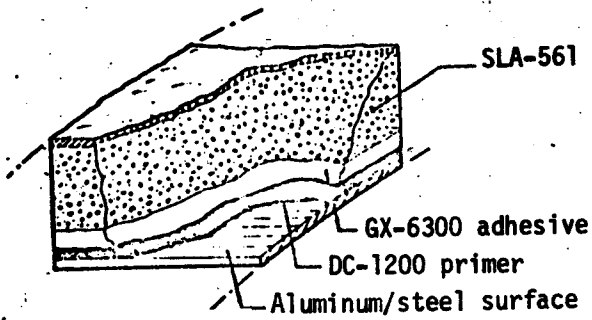

Figure 5.1.2-10.- Aft upper ET/SRB fitting - TPS configuration.  
(Paragraph 5.1.2)



Desoto 515x346 primer  
(Underneath DC-1200)

Figure 5.1.2-11.- SLA-561 typical cross section.  
(paragraph 5.1.2)

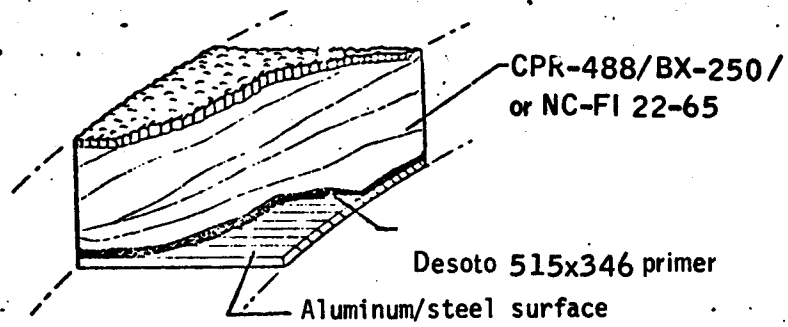
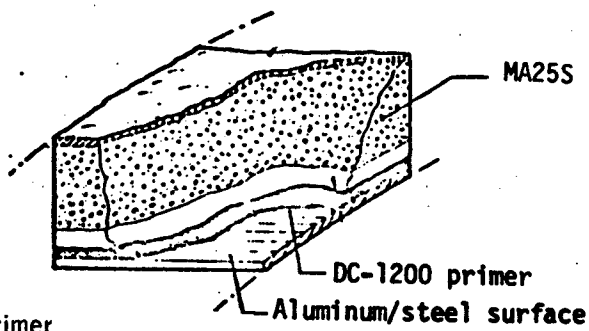

Figure 5.1.2-12.- CPR-488/BX-250/or NC-FI 22-65 typical cross section.  
(Paragraph 5.1.2)



Desoto 515x346 primer  
(Underneath DC-1200)

Figure 5.1.2-13.- MA25S typical cross section.  
(paragraph 5.1.2)

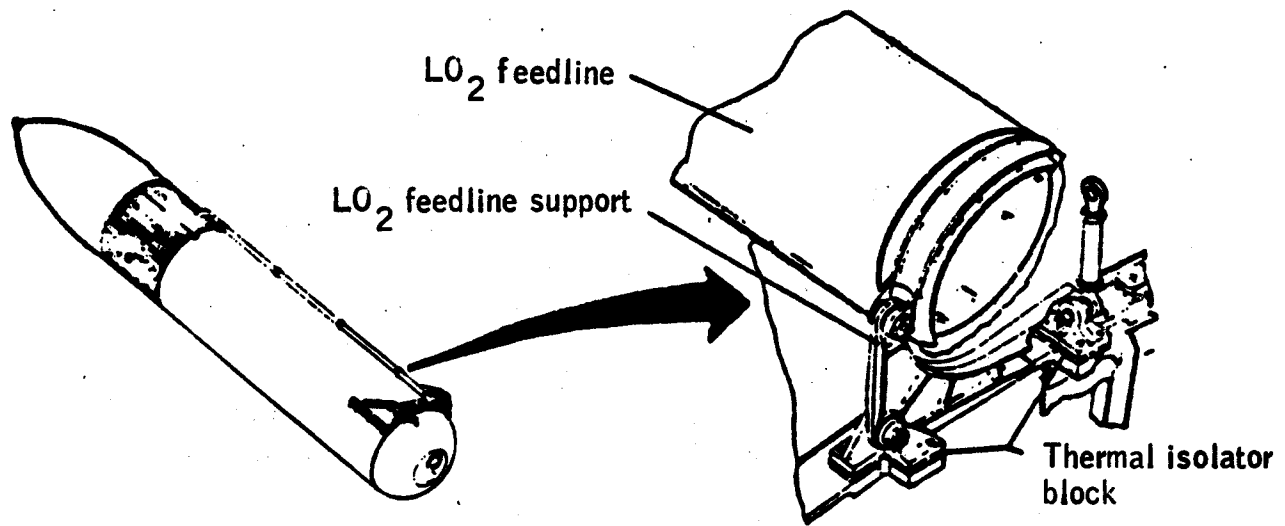

Figure 5.1.2-14.- LO<sub>2</sub> feedline thermal isolation.  
(Paragraph 5.1.2)

5.2  
5.2.1

**MECHANICAL SUBSYSTEM  
SRB/ET ATTACHMENT/SEPARATION SUBSYSTEM**

- a. SRB/ET separation system representation
  - 1. SRB/ET attachment locations
- b. SRB/ET separation system performance characteristics and parameters
- c. Separation operations

Figures 5.2.1-1 and  
5.2.1-2  
Figure 5.2.1-3  
Paragraph 4.5.1.1.6.2

Paragraph 4.5.1.1.6

5.2.2

**ORBITER/ET ATTACHMENT/SEPARATION SUBSYSTEM**  
See paragraph 4.2.2.

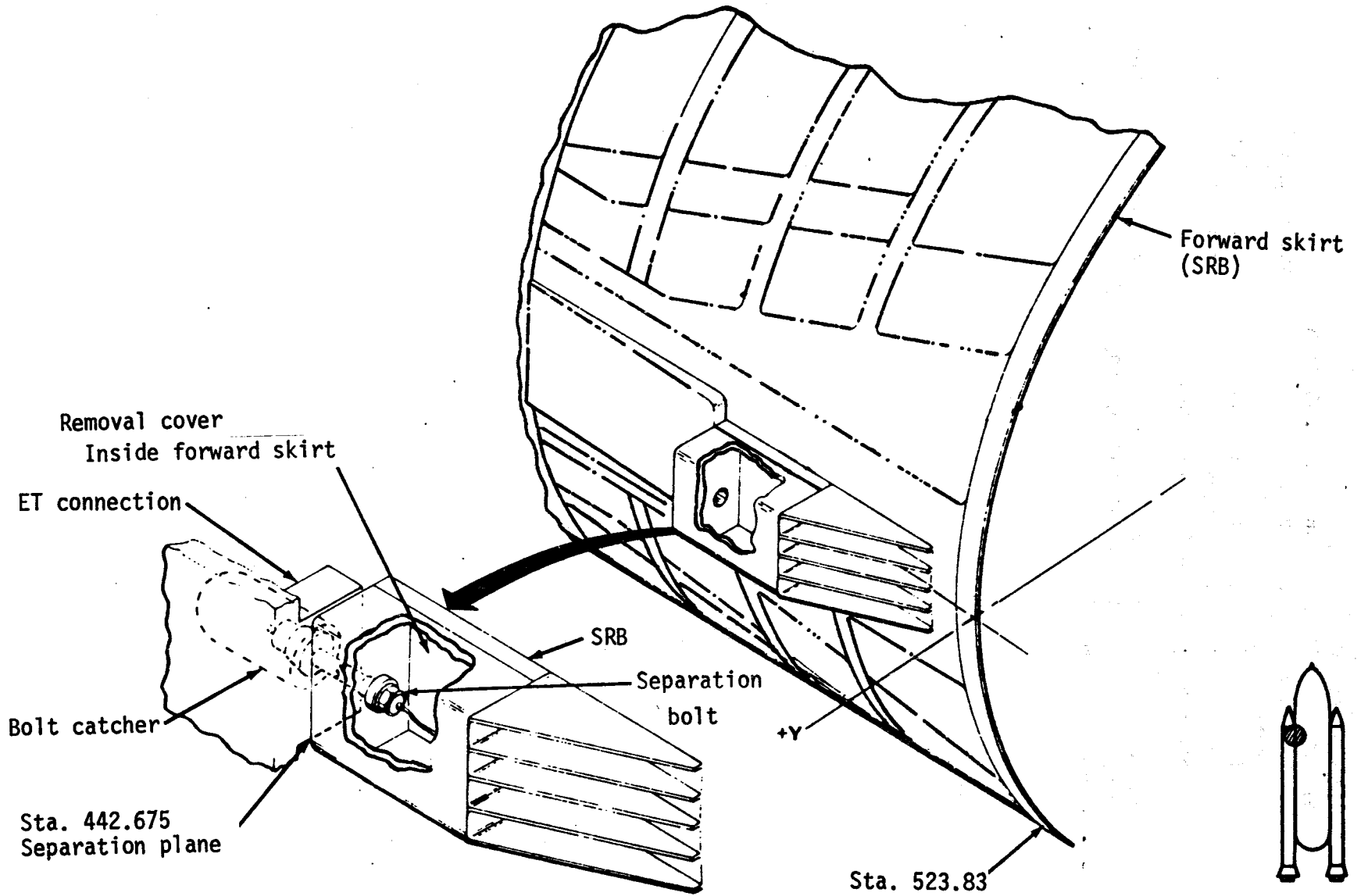

Figure 5.2.1-1.- ET/SRB forward attach fitting.  
(paragraph 5.2.1)

Section

- 5.3 PROPELLANT STORAGE SUBSYSTEM
- 5.3.1 PROPELLANT PROPERTIES
- 5.3.2 PROPELLANT TANKS
- 5.3.3 PROPELLANT PRESSURIZATION AND FEED SUBSYSTEM
- 5.3.4 FLUIDLINE CHARACTERISTICS
- 5.3.5 PROPELLANT STORAGE SUBSYSTEM THERMAL CONTROL

TABLE 5.3.1-1.- PROPERTIES OF LIQUID OXYGEN  
(Paragraph 5.3.1)

Item	Procurement limits	Delivered to interface <sup>a</sup>
Purity	99.6 percent by volume (maximum)	99.2 percent by volume (minimum)
Alkyne as acetylene	0.25 ppm by weight	1.55 ppm by weight (maximum)
Total hydrocarbons	50.0 ppm by volume as methane (maximum)	75.0 ppm by volume as methane (maximum)
Moisture	3.0 ppm by volume (maximum)	26.3 ppm by volume (maximum)
Particulate	1.0 mg/l (maximum) liquid only	

TABLE 5.3.1-2.- PROPERTIES OF LIQUID HYDROGEN  
(Paragraph 5.3.1)

Item	Procurement limits	Deliver to interface <sup>a</sup>
Total purity	99.995 percent by volume (minimum)	99.994 percent by volume (minimum)
Total gaseous impurities	50 ppm by volume (maximum)	60 ppm by volume (maximum)
Selected impurities (nitrogen, water and volatile hydrocarbons)	9.0 ppm by volume (maximum)	9.0 ppm by volume (maximum)
Specific impurities		
Oxygen plus argon	1.0 ppm by volume (maximum)	5.0 ppm by volume (maximum)
Helium	39.0 ppm by volume (maximum)	45.0 ppm by volume (maximum)
Carbon monoxide plus Carbon dioxide	1.0 ppm by volume (maximum)	1.0 ppm by volume (maximum)

<sup>a</sup>Requirements per SE-S-0073, Revision C.

## 5.3.2

## PROPELLANT TANKS

- |   |                                 |
|---|---------------------------------|
| a. Number   | 2 (one oxidizer,<br>one fuel)   |
| b. Nominal oxidizer tank total volume<br>(See Volume II for actual tank capacities and loadings)  |                                 |
| 1. Volume at 22 psig and -297 °F<br>(cryogenic)   | 19,672 ft <sup>3</sup>          |
| 2. Volume at 0 psig and 68 °F<br>unpressurized (ambient)  | 19,793 ft <sup>3</sup>          |
| c. Nominal fuel tank total volume<br>(See Volume II for actual tank capacities and loadings)  |                                 |
| 1. Volume at 29.3 psig and -423 °F<br>(cryogenic)   | 53,166 ft <sup>3</sup>          |
| 2. Volume at 0 psig and 68 °F<br>unpressurized (ambient)  | 53,545 ft <sup>3</sup>          |
| d. Oxidizer tank pressures <sup>a</sup>   |                                 |
| 1. Normal ullage pressure profile   | Figure 5.3.2-1                  |
| 2. Abort once around (AOA) profile  | Figure 5.3.2-2                  |
| 3. Return to launch site (RTL) profile  | Figure 5.3.2-3 and<br>5.3.2-4   |
| 3a. Transatlantic abort (TAL)   | Figure 5.3.2-5 and<br>5.3.2-6   |
| 4. Regulation control band  | 20 to 22 psig                   |
| 5. Maximum relief pressure  | 25 psig                         |
| 6. Factors of safety/proof factors  | Table 5.3.2-1                   |
| 7. Minimum tank ullage pressure during replenish mode of the tanking operation  | 0.0 psig                        |
| e. Fuel tank pressures <sup>a</sup>   |                                 |
| 1. Normal ullage pressure profiles  | Figure 5.3.2-7                  |
| 2. Minimum allowable liquid hydrogen ullage pressure  | Figure 5.3.2-8                  |
| 3. Abort once around (AOA) profile  | Figure 5.3.2-9                  |
| 4. Return to launch site (RTL) profile  | Figure 5.3.2-10<br>and 5.3.2-11 |
| 4a. Transatlantic abort (TAL)   | Figure 5.3.2-12 and<br>5.3.2-13 |
| 5. Regulation control band  | 32 to 34 psia                   |
| 6. Maximum relief pressure  | 37 psig                         |
| 7. Factors of safety/proof factors  | Table 5.3.2-1                   |
| 8. Minimum tank ullage pressure during replenish mode of the tanking operation  | 0.0 psig                        |
| f. Maximum facility back pressure for H <sub>2</sub> vent systems at a boiloff rate of 2.9 lb/sec   | 0.5 psig                        |
| g. Oxidizer gaging  |                                 |
| The oxidizer sensors provide LO <sub>2</sub> -level indication for control during loading and ≤ 5 percent level indication during flight. |                                 |

<sup>a</sup>The ullage profiles shown were predicted for STS-26. Subsequent predictions can be obtained by contacting J. Mistrot/VF2, 483-3314.



1. LO<sub>2</sub> loading control sensors

- (a) Type Warm-wire liquid-level sensors  
 (b) Number 8 active  
 (c) Sensor configuration within tank

<u>Sensor Level</u>	<u>Qty.</u>	<u>Location (X<sub>T</sub>)</u>
5%	1	917.3
98%	2	455.0
100% -	1	415.5
100%	2	412.6
100% +	1	409.5
OVERFILL	1	399.7

- (d) Accuracy (ET RSS contribution to total loading error) ± 0.41 percent  
 (e) Accuracy (overall RSS total loading error) ± 0.43 percent

## h. Fuel gaging

One set of fuel sensors provides LH<sub>2</sub>-level indication for control during loading and a ≤ 5-percent level indication during flight. A second set of fuel sensors provides a low-level indication for main engine cutoff and are also used for propellant loading. (The oxidizer low-level indication sensors are located in the Orbiter feed line.)

1. LH<sub>2</sub> loading control sensors

- (a) Type Warm-wire liquid-level sensors  
 (b) Number 12 active  
 (c) Sensor configuration within tank

<u>Sensor Level</u>	<u>Qty.</u>	<u>Location (X<sub>T</sub>)</u>
5%	1	2081.0
98%	2	1102.1
100% -	1	1048.6
100%	2	1044.6
100% +	1	1040.6
OVERFILL	1	1033.4

- (d) Accuracy (ET RSS contribution to total loading error) ± 0.30 percent
- (e) Accuracy (overall RSS total loading error) ± 0.35 percent
- 2. LH<sub>2</sub> low-level sensors (ECO sensors)
  - (a) Type Warm-wire liquid-level sensors
  - (b) Number 4
  - (c) Configuration within tank
    - XT - 2144.42
    - XT - 2144.45
    - XT - 2144.69
    - XT - 2144.77
  - (d) Accuracy
    - 1. Response time (wet-to-dry) 160 ms
    - 2. Level accuracy 0.02 inch at 0.1 ft/sec
  - (e) LH<sub>2</sub> outflow at the time of low-level signal 0.65 percent RPL (see figure 5.3.4-6)
- i. Propellant quantities shown below are at the uncovered times of the 5-percent level sensor under flight conditions. The values are based on ET tank volume/height tables with consideration to the level sensor locations and the induced surface angle at the sensor due to the vehicle acceleration vector.

<u>Propellant level</u>	<u>MPS total</u>	<u>External tank only</u>
Oxygen - 5 percent	75,651 lb	70,850 lb
Hydrogen - 5 percent	11,899 lb	11,534 lb

5.3.2-1.- DESIGN SAFETY FACTORS AND PROOF FACTORS FOR USE  
TEMPERATURES (Paragraph 5.3.2)

Component	Factors of safety		Proof factors <sup>a</sup>	
	Ultimate	Yield	Fracture controlled	Not fracture controlled
General structure				
Limit load				
Well defined	1.25	1.10	1.05 <sup>b</sup>	1.05
Other	1.40	1.10	1.05 <sup>b</sup>	1.05
Main propellant tanks (pressure only)				
Limit pressure	N/A	1.10	See note <sup>a</sup>	N/A
Maximum operating pressure	1.25-1.40 <sup>c</sup>	N/A	N/A	N/A
Combined pressure and loads				
Limit pressure	N/A	1.10	See note <sup>a</sup>	N/A
Maximum operating pressure	1.25-1.40 <sup>c</sup>	N/A	N/A	N/A
Loads (other than pressure)				
Well defined	1.25	1.10	See note <sup>a</sup>	N/A
Other	1.40	1.10	See note <sup>a</sup>	N/A
LH <sub>2</sub> tank aft dome elastic buckling	1.25	N/A	N/A	N/A
Propulsion system				
Propellant feed lines and all other lines ≥1.5 in. diameter, whichever is critical				
Limit pressure	1.50	1.25	1.20	1.20
Limit load	1.40	1.10	See note <sup>b</sup> See note <sup>d</sup>	1.05
Lines				
≤1.5 in. diameter				
Limit pressure	4.0	2.0	2.0	2.0
Hydraulic and pneumatic lines, high pressure vessels, actuating cylinders, valves, filters, and switches				
Limit pressure	2.0	1.5	1.5	1.5

See following page for footnotes a through d.

TABLE 5.3.2-1.- DESIGN SAFETY FACTORS AND PROOF FACTORS FOR USE TEMPERATURE (Concluded)  
(Paragraph 5.3.2)

<sup>a</sup>To obtain proof load or proof pressure, multiply the limit load or limit pressure by the proof factor. There shall be no detrimental yielding at proof load or proof pressure.

To determine proof factors for temperature other than use temperatures, use the following equations:

Fracture controlled components:

Proof factor = (test temperature)	$\frac{K_{IC} \text{ of material at proof temperature}}{K_{IC} \text{ of material at use temperature}}$	Proof factor  (Use temperature)
--------------------------------------	---	---------------------------------------

Not fracture controlled components:

Proof factor = (test temperature)	$\frac{F_{TY} \text{ of material at proof temperature}}{F_{TY} \text{ of material at use temperature}}$	Proof factor  (Use temperature)
--------------------------------------	---	---------------------------------------

<sup>b</sup>Aluminum alloys only.

<sup>c</sup>Ultimate Safety Factor Application

Use Safety Factor = 1.25 for well defined loads.

Use Safety Factor = 1.40 for all other loads.

The equivalent Factor of Safety (Eq. F.S.) is derived by the equation:

$$\text{Eq. F.S.} = \frac{1.25 (\text{well defined loads}) + 1.40 (\text{all other loads})}{\text{Total Loads}}$$

Eq. F.S. must be between the limits  $1.25 > \text{Eq. F.S.} < 1.40$ .

Should the Eq. F.S. exceed 1.40, the total limit load will be multiplied by a F.S. = 1.40. Should the Eq. F.S. be less than 1.25, the total limit load will be multiplied by F.S. = 1.25.

<sup>d</sup>Design Safety Factors - Unless otherwise noted, loads derived from off-nominal conditions shall not have the factors defined in Table 5.3.2-1 applied for design purposes except for one SSME (Space Shuttle Main Engine) out. One SSME out shall be based on the same factor of safety as no failure case.

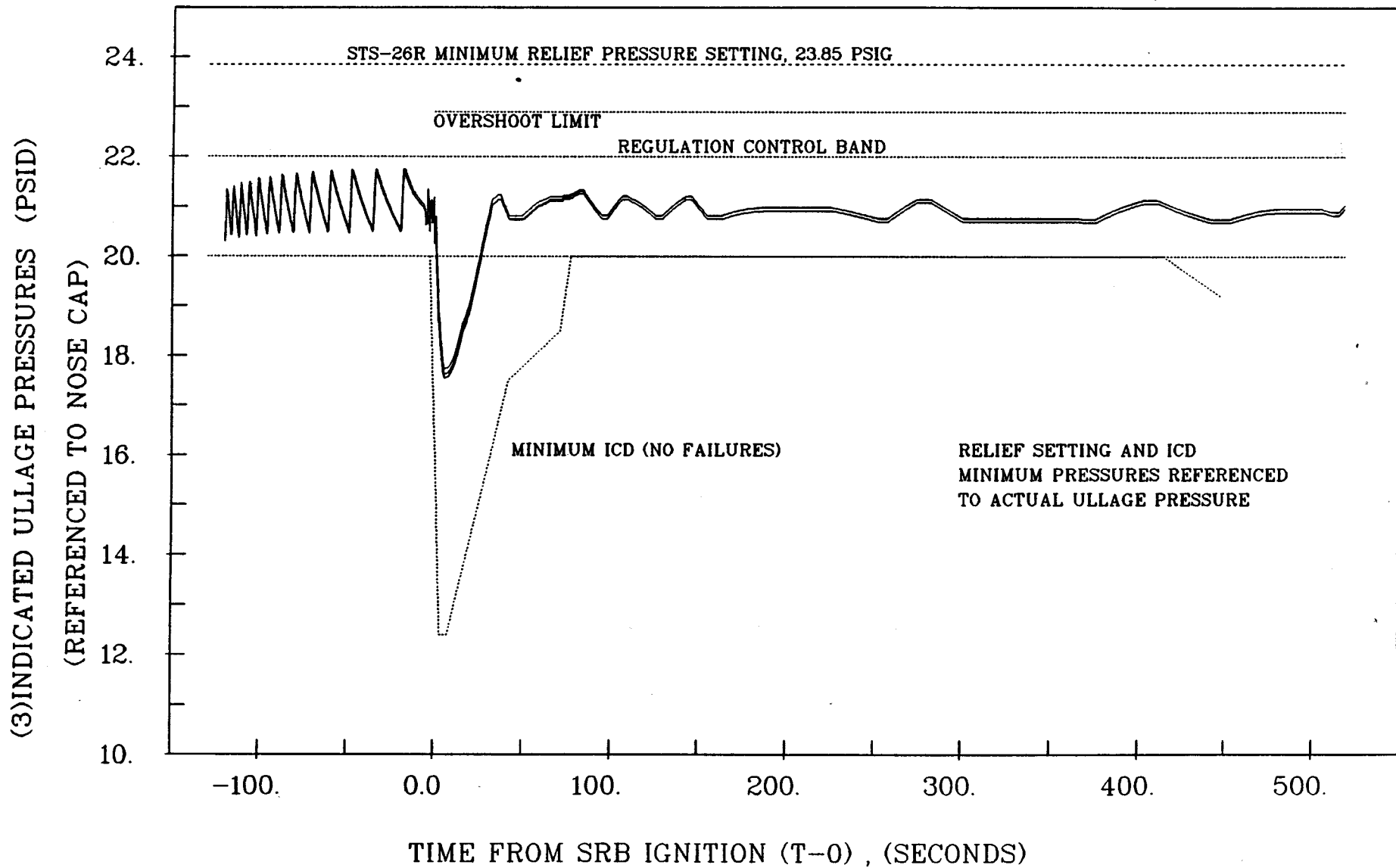

Figure 5.3.2-1.- Predicted STS-26 liquid oxygen tank ullage pressure, nominal.  
(Paragraph 5.3.2.)

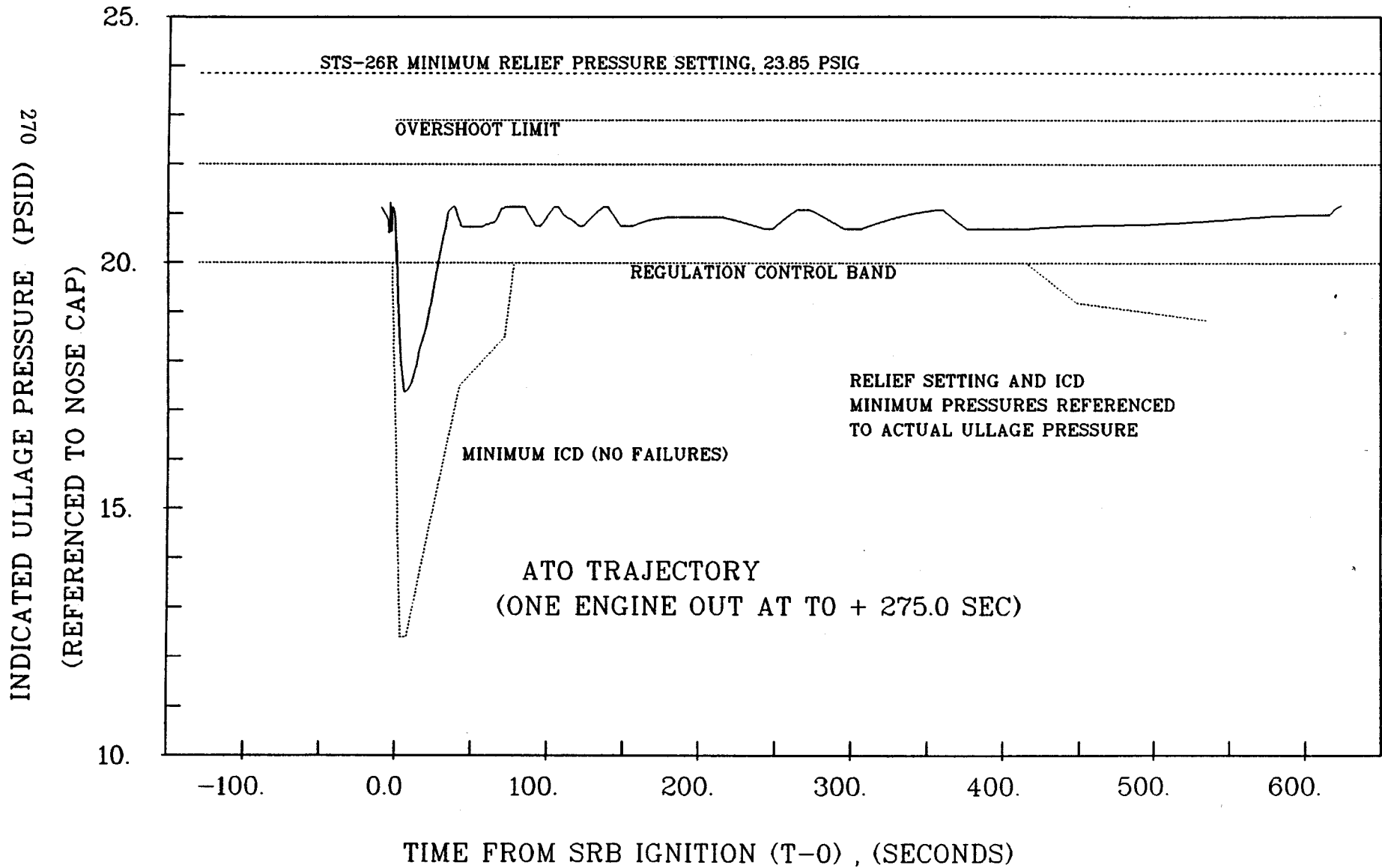

Figure 5.3.2-2.- Predicted STS-26 liquid oxygen tank ullage pressure, ATO.  
(Paragraph 5.3.2)

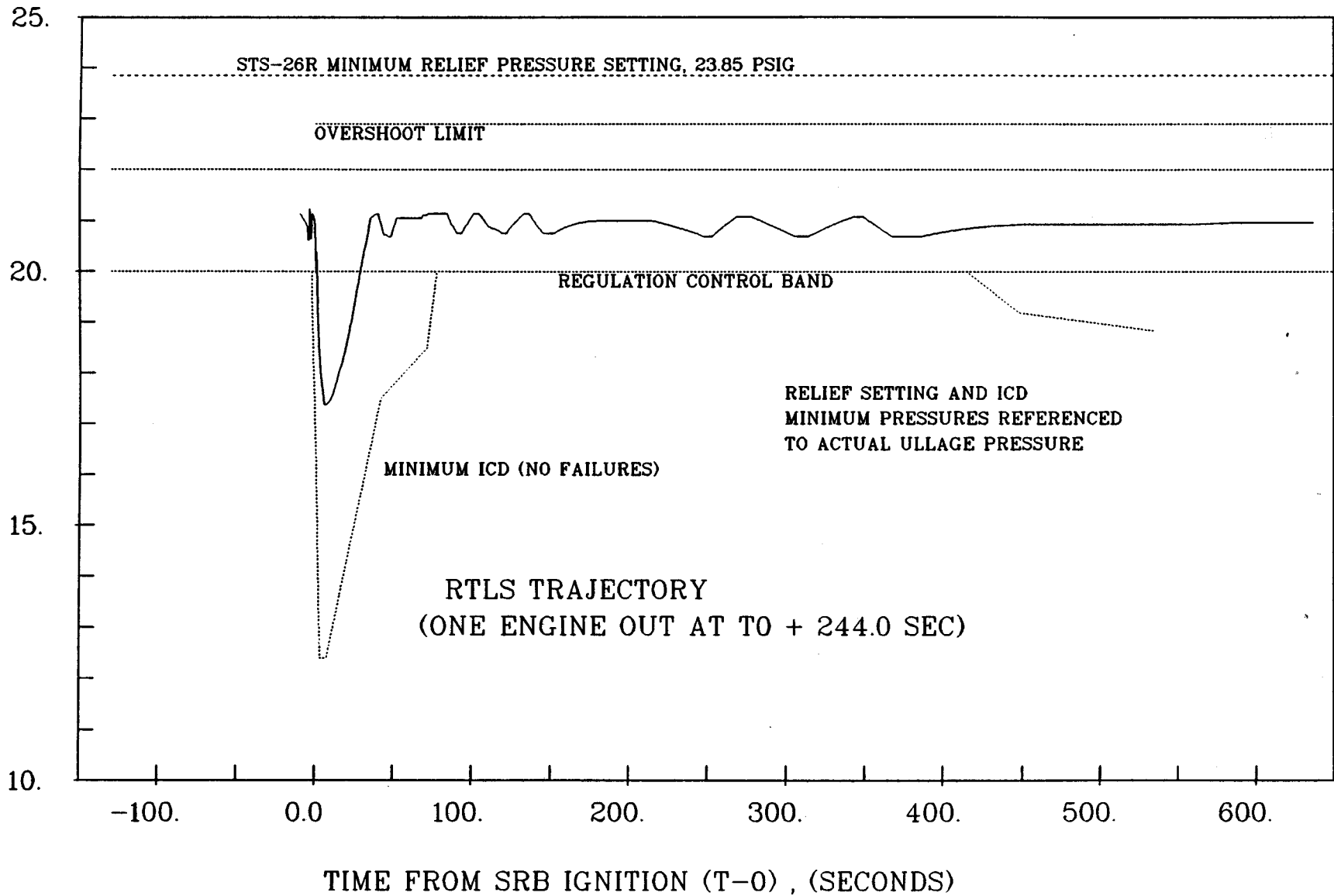

Figure 5.3.2-3.- Predicted STS-26 liquid oxygen tank ullage pressure, RTLS.  
(Paragraph 5.3.2)

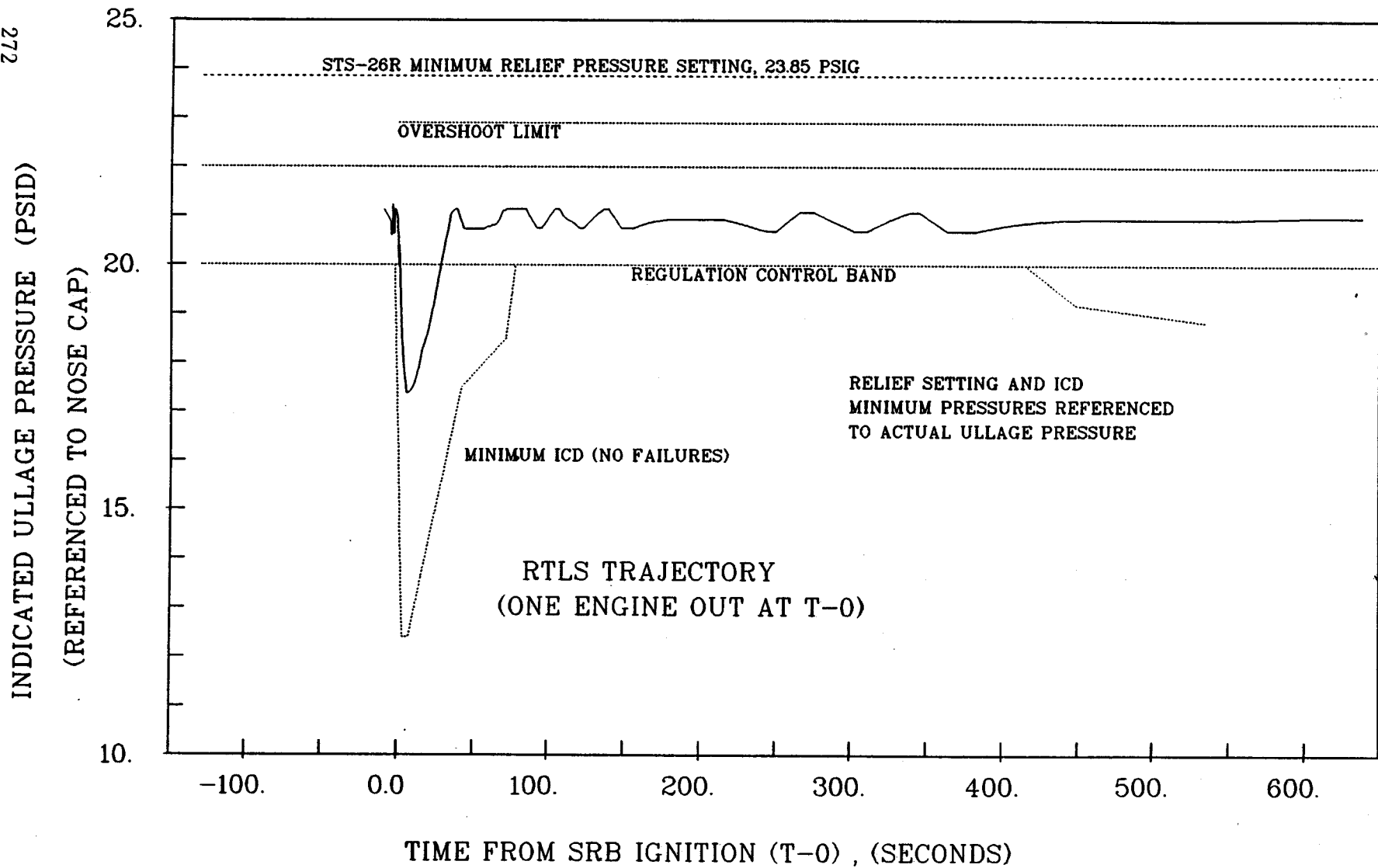

Figure 5.3.2-4.- Predicted STS-26 liquid oxygen tank ullage pressure, RTLS.

(Paragraph 5.3.2)



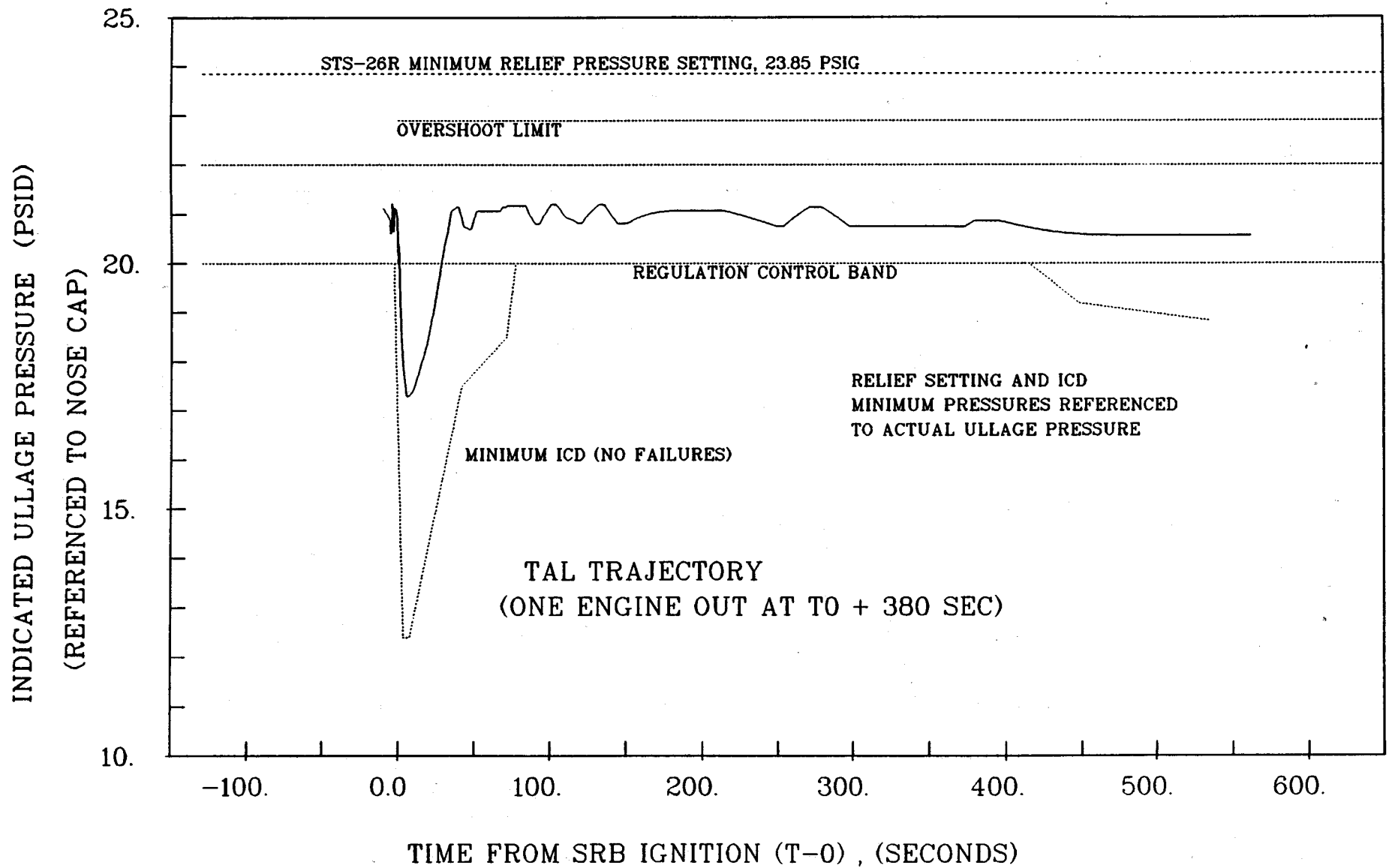

Figure 5.3.2-5.- Predicted STS-26 liquid oxygen tank ullage pressure, TAL.  
(Paragraph 5.3.2)

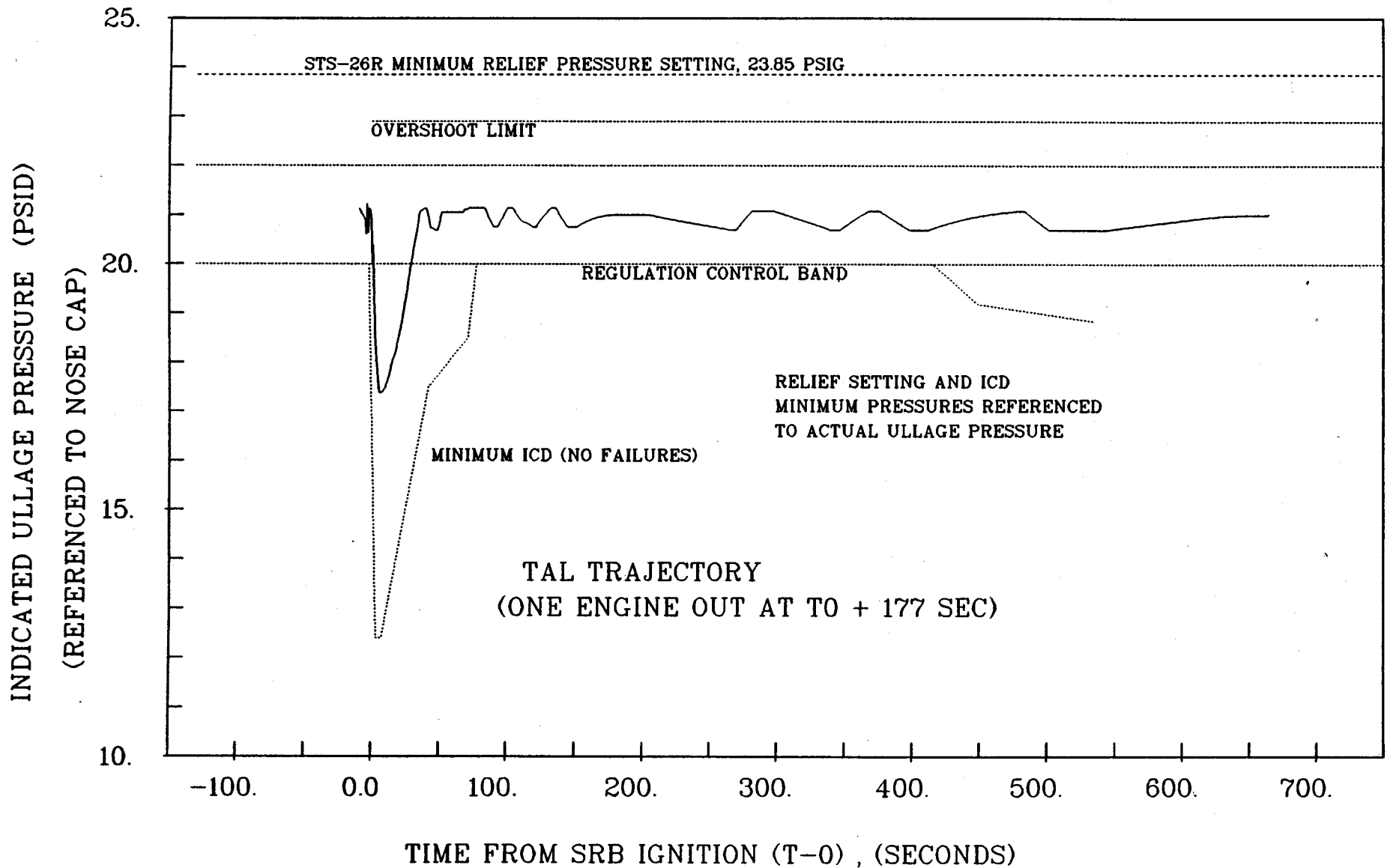

Figure 5.3.2-6.- Predicted STS-26 liquid oxygen tank ullage pressure, TAL.  
(Paragraph 5.3.2)

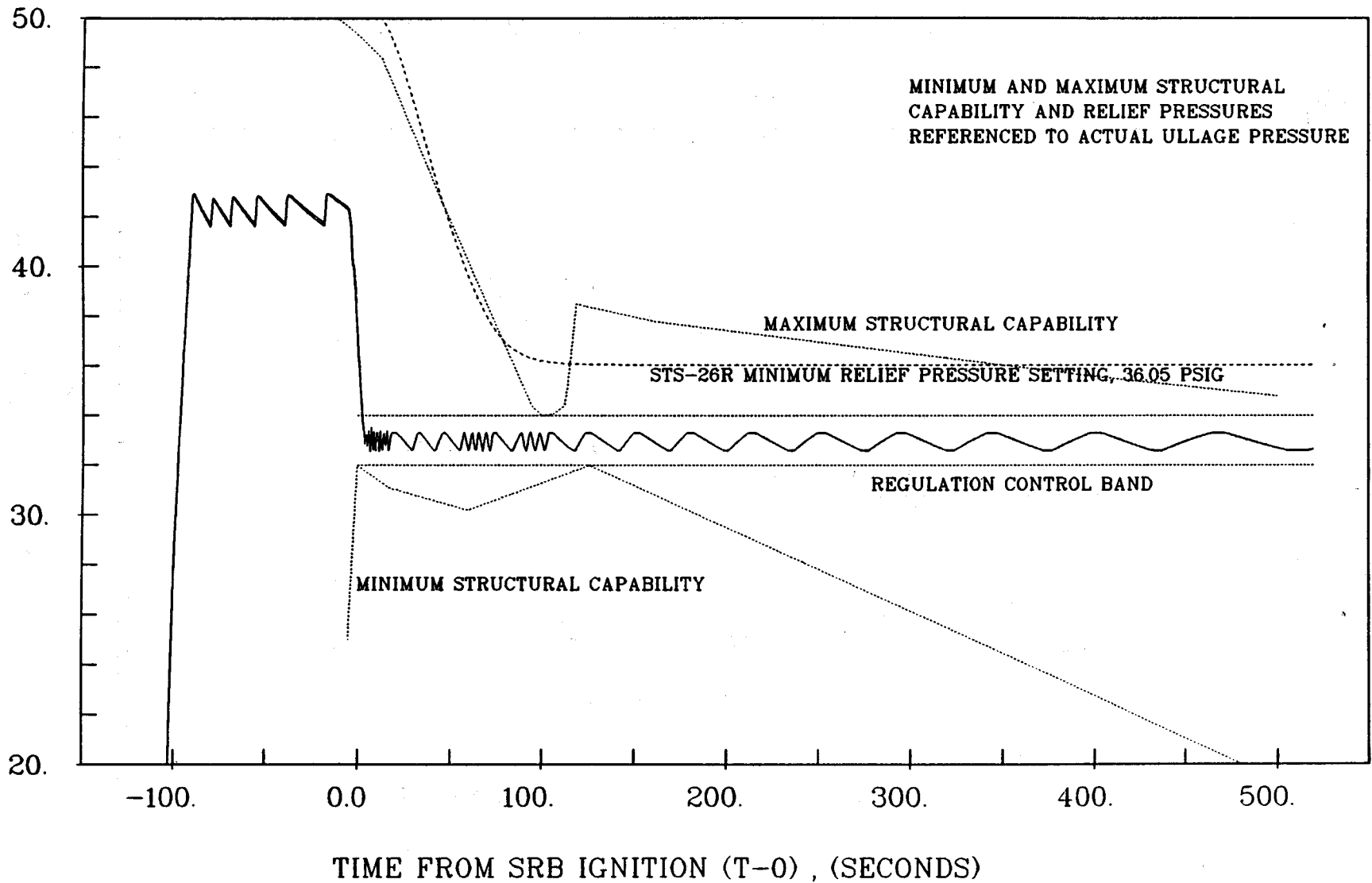
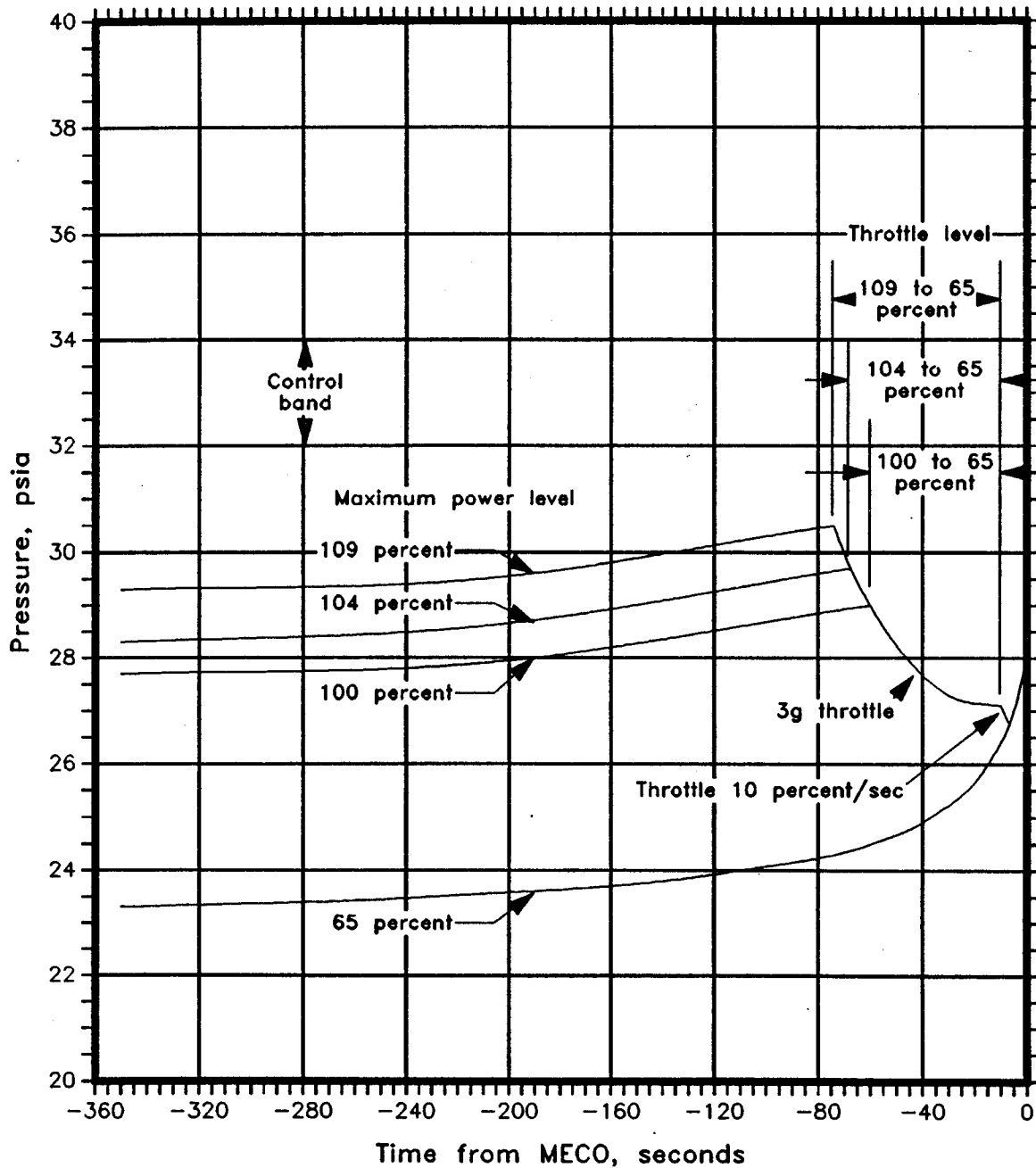

Figure 5.3.2-7.- Predicted STS-26 liquid oxygen tank ullage pressure, nominal.  
(Paragraph 5.3.2)



Notes:

1. Baseline LH2 ullage pressure control band = 32 to 34 psia
2. Curve maintains minimum LH2 net positive suction pressure of 4.8 at 65 percent  
5.3 at 100 percent  
5.43 at 104 percent  
5.6 at 109 percent
3. Best estimate heat load

Figure 5.3.2-8.- Minimum allowable liquid hydrogen ullage pressure.  
(Paragraph 5.3.2)

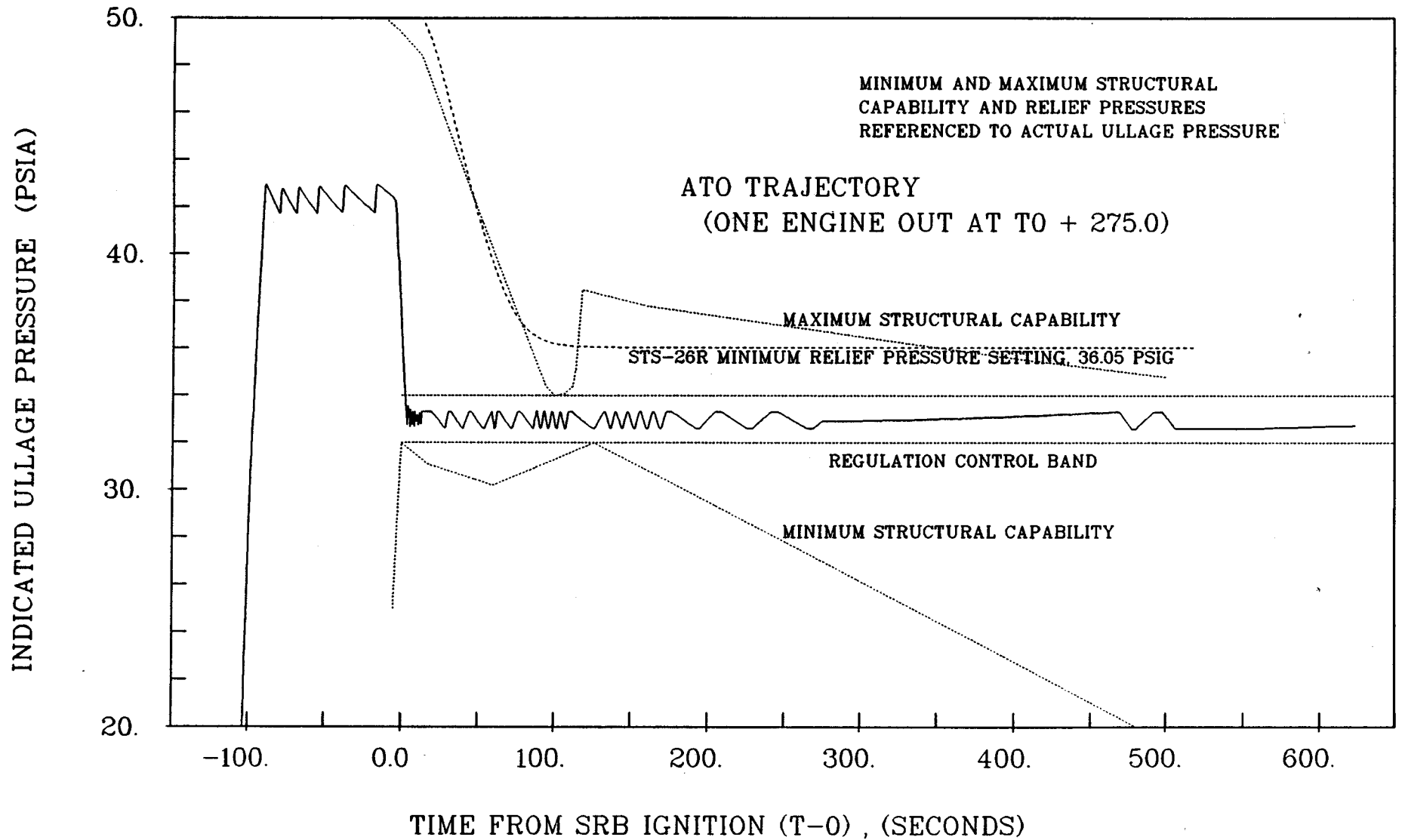

Figure 5.3.2-9.- Predicted STS-26 liquid hydrogen tank ullage pressure, ATO.  
(Paragraph 5.3.2)

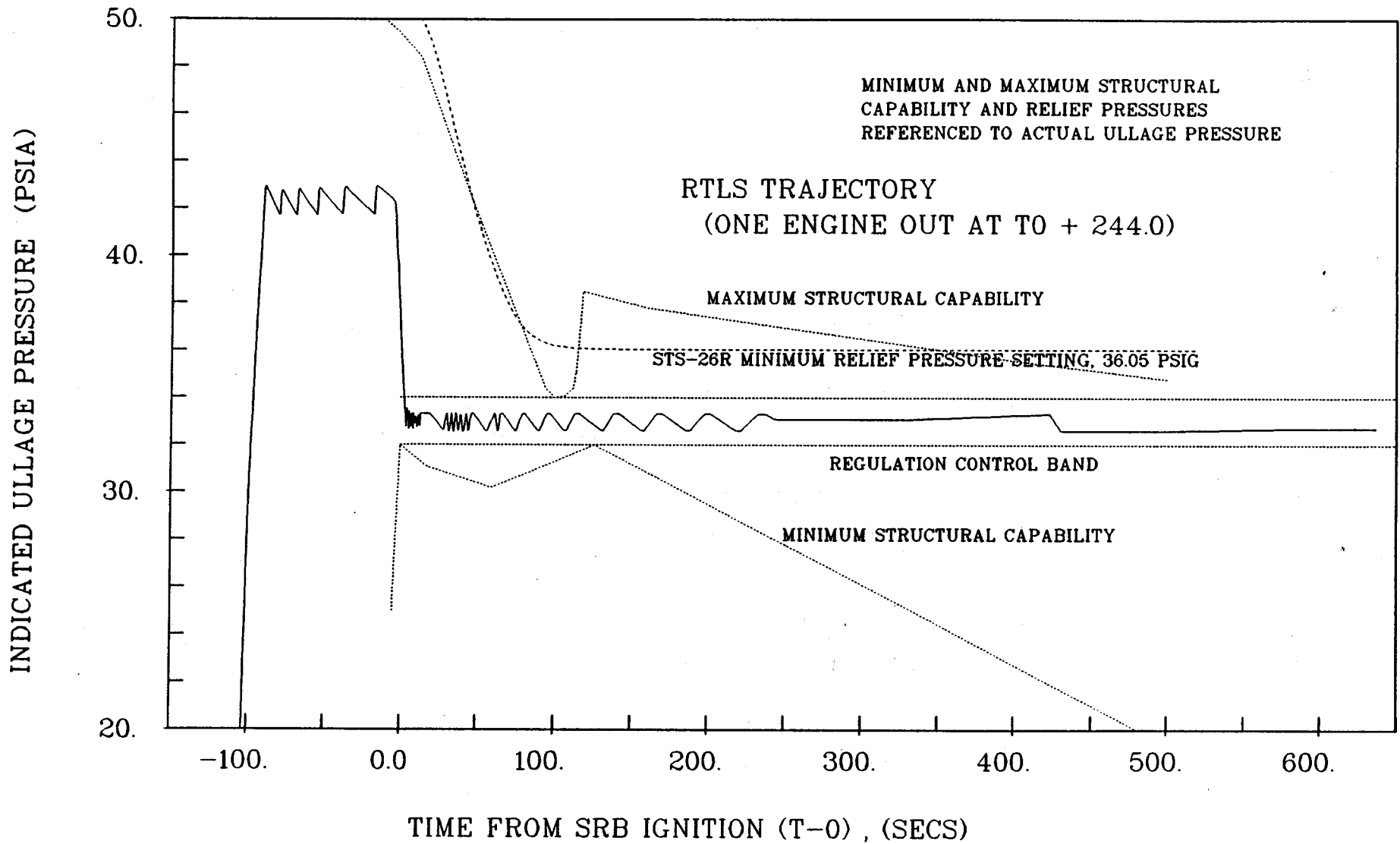

Figure 5.3.2-10.- Predicted STS-26 liquid hydrogen tank ullage pressure, RTLS.  
(Paragraph 5.3.2)

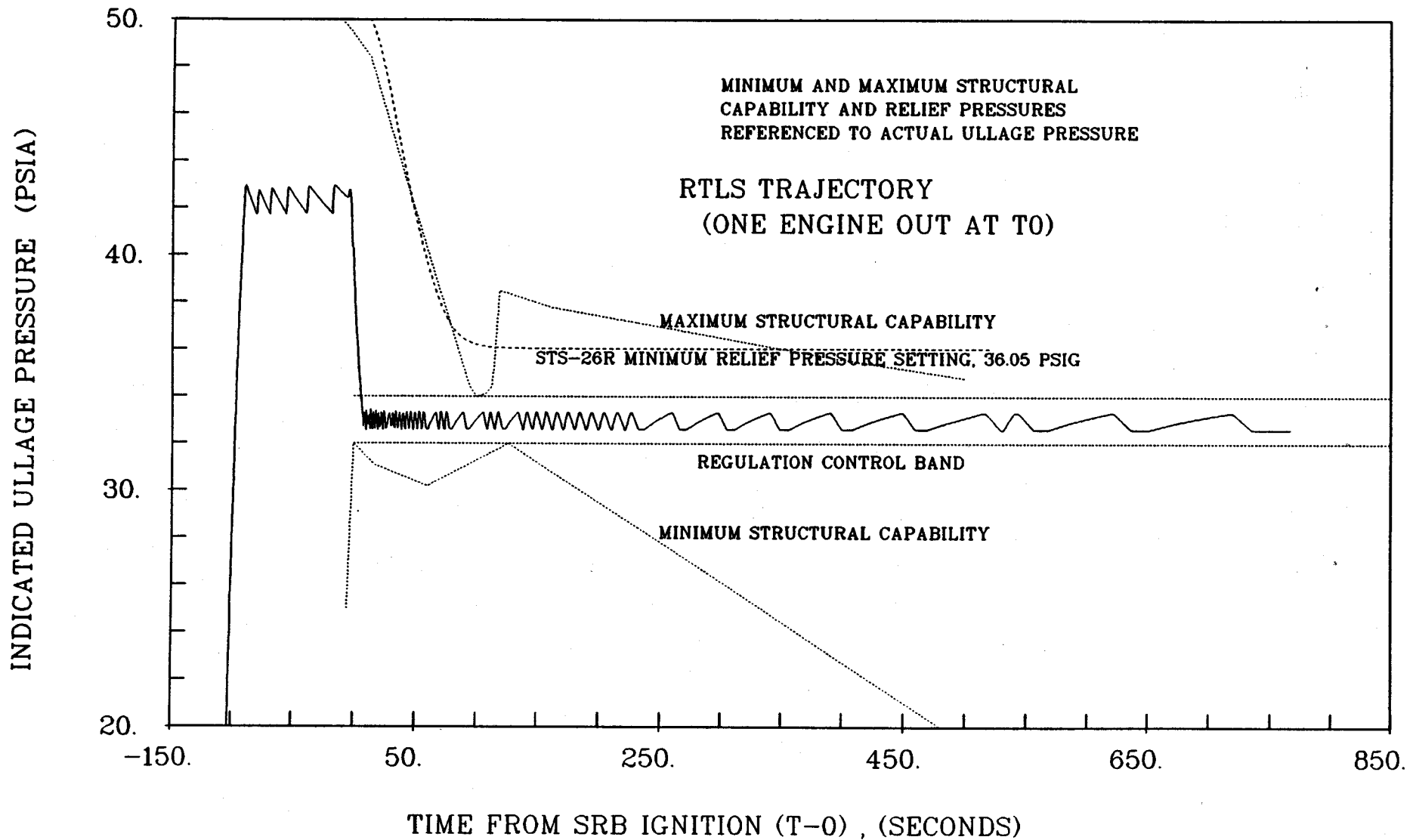

Figure 5.3.2-11.- Predicted STS-26 liquid hydrogen tank ullage pressure, RTLS.  
(Paragraph 5.3.2)

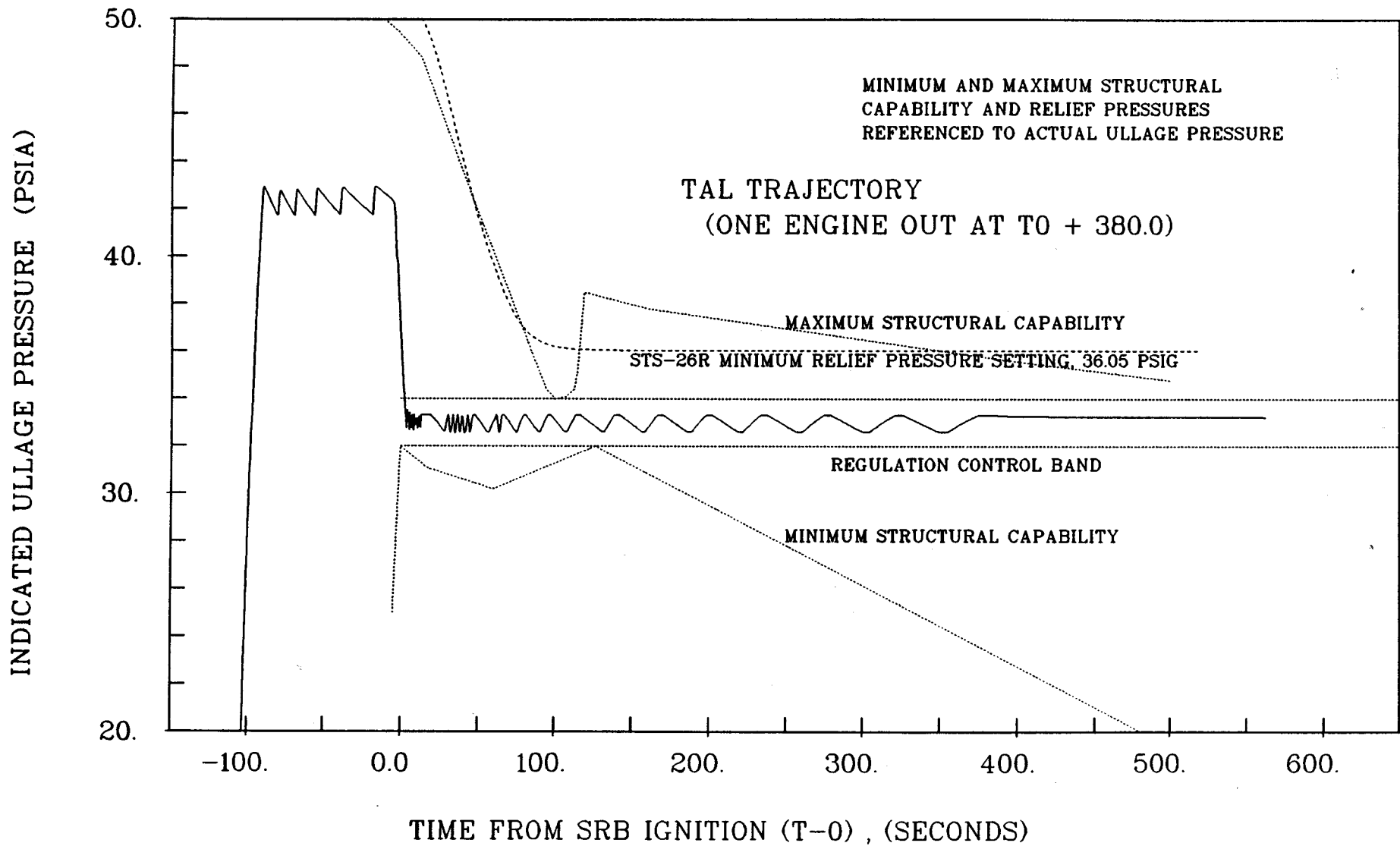

Figure 5.3.2-12.- Predicted STS-26 liquid hydrogen tank ullage pressure, TAL.  
(Paragraph 5.3.2)



INDICATED ULLAGE PRESSURE (PSIA)

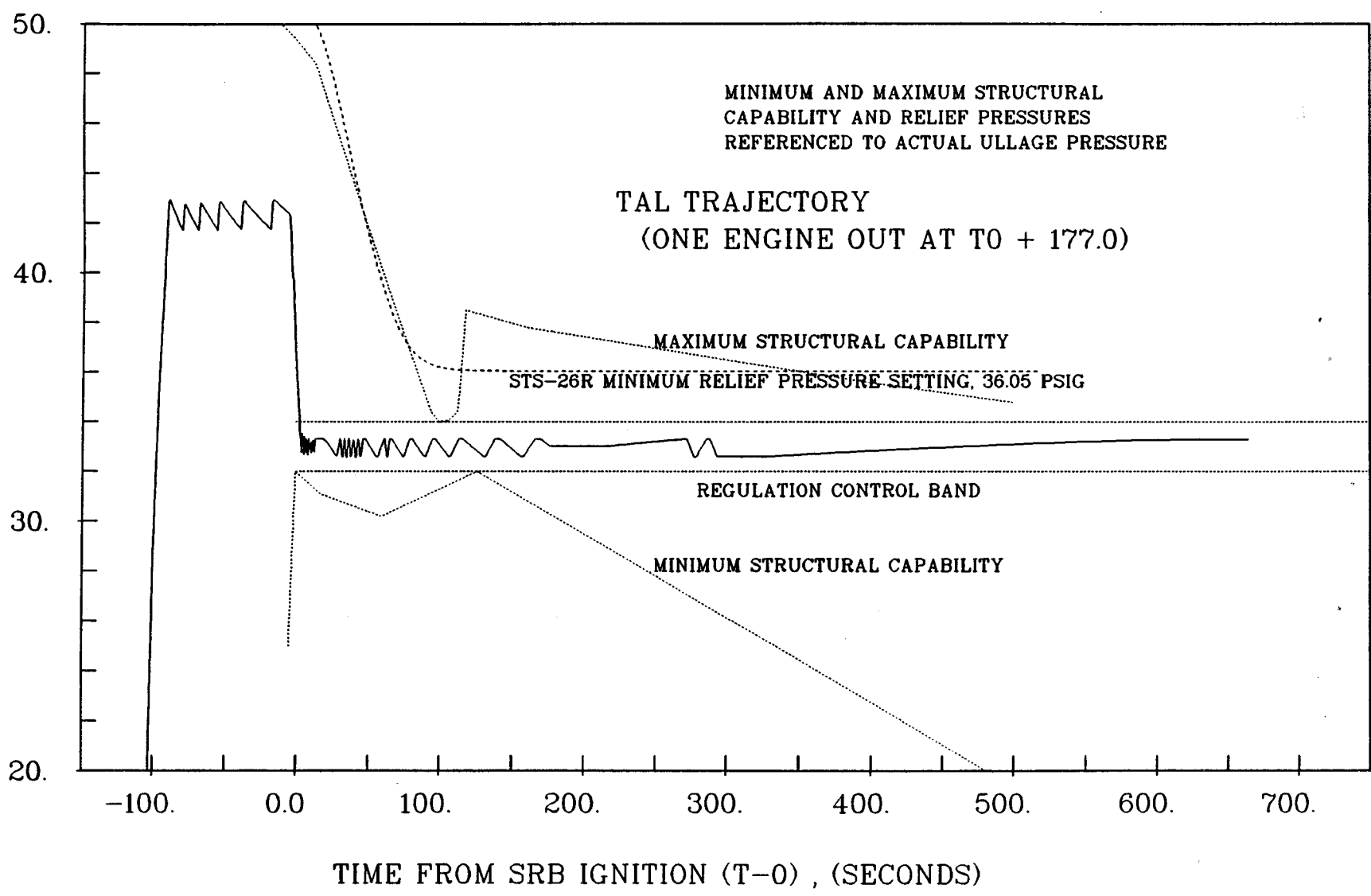

Figure 5.3.2-13.- Predicted STS-26 liquid hydrogen tank ullage pressure, TAL.  
(Paragraph 5.3.2)

## 5.3.3

## PROPELLANT PRESSURIZATION AND FEED SUBSYSTEM

- a. LO<sub>2</sub> tank vent/relief valve
- |  |  |
|--|--|
| 1. Force margins   | Figure 5.3.3-1                                     |
| 2. Open/close time   | 3 sec/17 sec (block 6)<br>4 sec/4.5 sec (block 7)  |
| 3. Operating pressure  | 0 to 25 psig                                       |
| 4. Ambient temperature   | -40° to 160° F                                     |
| 5. Flow media temperature  | -297° to 540° F                                    |
| 6. Relief and reseal pressure  | 24 ± psig and 22 psig (min)                        |
| 7. Main seat leakage   |  |
| (a) Non-vibration  | 250 scim maximum                                   |
| (b) Vibration  | 350 scim maximum                                   |
| 8. Vent flow rate  | 2.0 lb/sec at 2.0 psid                             |
| 9. Relief flow rate  | 9.8 lb/sec at 25 psig<br>tank pressure             |
| 10. Valve actuation pressure<br>(Helium supplied by ground<br>subsystem) | 750 ±50 psig                                       |
| 11. Operating life   |  |
| (a) Relief mode  | 500 cycles   |
| (b) Vent mode  | 5750 cycles  |
| 12. Vibration (with duct)  | X-axis 28.6 g(rms)<br>Y- and Z-axis<br>8.03 g(rms) |
- b. LH<sub>2</sub> tank vent/relief valve
- |  |  |
|--|--|
| 1. Force margins   | Figure 5.3.3-1                                       |
| 2. Open/close time   | 1.5 sec/5 sec (block 6)<br>2.0 sec/2.9 sec (block 7) |
| 3. Operating pressure  | 0 to 40 psig   |
| 4. Ambient temperature   | -175° to 100° F                                      |
| 5. Flow media temperature  | -423° to 170° F                                      |
| 6. Relief and reseal pressure  | 36 ± psig and 34 psig (min)                          |
| 7. Main seat leakage   |  |
| (a) Non-vibration  | 250 scim maximum                                     |
| (b) Vibration  | 350 scim maximum                                     |
| 8. Vent flow rate (minimum)  | 0.9 lb/sec at 0.22 psid                              |
| 9. Relief flow rate (minimum)  | 0.9 lb/sec at 37 psig<br>tank pressure               |
| 10. Valve actuation pressure<br>(Helium supplied by ground<br>subsystem) | 750 ±50 psig   |
| 11. Operating life   |  |
| (a) Relief mode  | 500 cycles   |
| (b) Vent mode  | 5750 cycles  |
| 12. Vibration  | X-axis 28.6 g(rms),<br>Y and Z-axes, 8.03 g(rms)     |

- c. LO<sub>2</sub> vent and flow control valve(s) failure effects
  - 1. FCV failed open, vent valve operational Figures 5.3.3-2 through 5.3.3-5
  - 2. FCV failed closed, vent valve operational Figures 5.3.3-6 through 5.3.3-9
  - 3. FCV failed open, vent valve failed closed Figures 5.3.3-10 through 5.3.3-12
  - 4. Interface GO<sub>2</sub> pressurant characteristics - one engine out, one pressure valve failed Figure 5.3.4-8
- d. LH<sub>2</sub> vent and flow control valve(s) failure effects
  - 1. FCV fail open, vent valve operational Figures 5.3.3-13 through 5.3.3-16
  - 2. FCV failed closed, vent valve operational Figures 5.3.3-17 through 5.3.3-20
  - 3. FCV failed open, vent valve failed closed Figures 5.3.3-21 through 5.3.3-23
  - 4. Interface GH<sub>2</sub> pressurant characteristics - one engine out; one pressure valve failed Figure 5.3.4-7
- e. ET altitude after MECO Figure 5.3.3-15
- f. Post separation LO<sub>2</sub> tank history  
Predicted LO<sub>2</sub> tank ullage pressure after MECO Figure 5.3.3-16
- g. Post separation LH<sub>2</sub> tank history  
Predicted LH<sub>2</sub> tank ullage pressure after MECO Figure 5.3.3-17
- h. Internal LH<sub>2</sub> feedline assembly
  - 1. operating pressure 0 to 55 psia maximum
  - 2. External pressure 0 to 18.3 psid
  - 3. Operating temperature 120° to -423° F
  - 4. Proof load 1.05 x limit load

Note: The failure cases shown were predicted for STS 51-B. Subsequent predictions can be obtained by contacting J. Mistrot/VF2, 483-3314.

5. Leakage	Bubble tight GN <sub>2</sub> at maximum operating pressure
6. Flow rate	489 lb/sec
7. Operating life	500 cycles linear and angular displacement
8. Vibration	23 g(rms)
9. Flow-induced vibration	4 mission cycles (bellows)
i. External LH <sub>2</sub> feedline	
1. Operating pressure	0 to 55 psia (maximum)
2. Operating temperature	350° to -423° F
3. Proof load	1.05 x limit load
4. Leakage	
a. Annulus	1 x 10 <sup>-6</sup> scc/sec
b. Pressure carrier	Bubble tight at maximum operating pressure
5. Flow rate	489 lb/sec
6. Life cycle (motion)	500 cycles linear and angular displacement
7. Vibration	22.4 g(rms)
8. Flow-induced vibration	4 mission cycles
j. LH <sub>2</sub> recirculation line assembly	
1. Operating pressure	0 to 55 psia
2. Operating temperature	350° to -423° F
3. Proof load	1.05 x limit load
4. Leakage	
a. Annulus	1 x 10 <sup>-6</sup> scc/sec
b. Pressure carrier	Bubble tight at maximum operating pressure
5. Flow rate (topping and recirculation)	16.0 lb/sec maximum
6. Operating life	500 cycles linear and angular displacement
7. Vibration	22.4 g (rms)
8. Flow-induced vibration	NA (Bellows incorporate liners)
k. GO <sub>2</sub> pressurization line	
1. Operating pressure	Ambient to 600 psia
2. Operating temperature	-297° F to 650° F
3. Proof load	1.05 x limit load
4. Ultimate load	1.40 x limit load
5. Leakage	Bubble tight by film solution or equivalent
6. Flow rate	8.1 lb/sec GO <sub>2</sub> (Max.)
7. Pressure drop	Δ P over system operating pressure range not to cause Interface pressure to exceed 600 psia.

- |  |   |
|--|---|
| 8. Operating life                      | 500 cycles linear and angular displacement  |
| 9. Vibration                           | 4.1 g(rms) to 76.9 g(rms)   |
| 10. Flow-induced vibration             | NA (Bellows Incorporate Liners)   |
| 1. GH <sub>2</sub> pressurization line |   |
| 1. Operating pressure                  | Ambient to 745 psia   |
| 2. Operating temperature               | -423° F to 110° F   |
| 3. Proof load                          | 1.05 x limit load   |
| 4. Ultimate load                       | 1.40 x limit load   |
| 5. Leakage                             | Bubble tight by film solution or equivalent   |
| 6. Flow rate                           | 4.07 lb/sec GH <sub>2</sub> (Max.)  |
| 7. Pressure drop                       | Δ P over system operating pressure range not to cause Interface pressure to exceed 723 psia |
| 8. Operating life                      | 500 cycles maximum linear and angular displacement  |
| 9. Vibration                           | 5.4 - 54.6 g(rms)   |
| 10. Flow-induced vibration             | NA (Bellows Incorporate Liners)   |

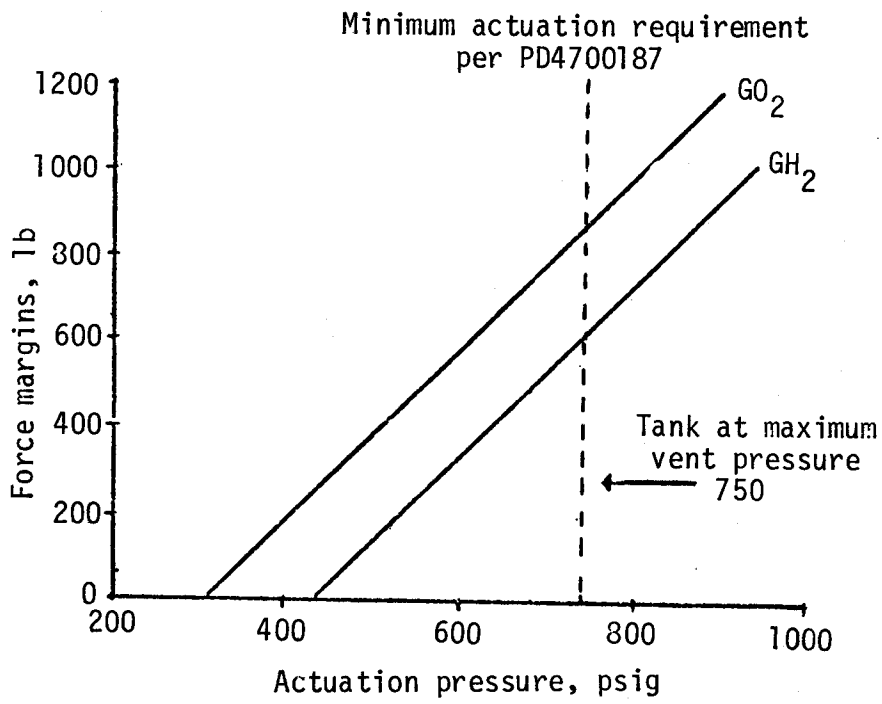

Figure 5.3.3-1.- ET vent valve force margins.  
(Paragraph 5.3.3)

5.3.3- 5

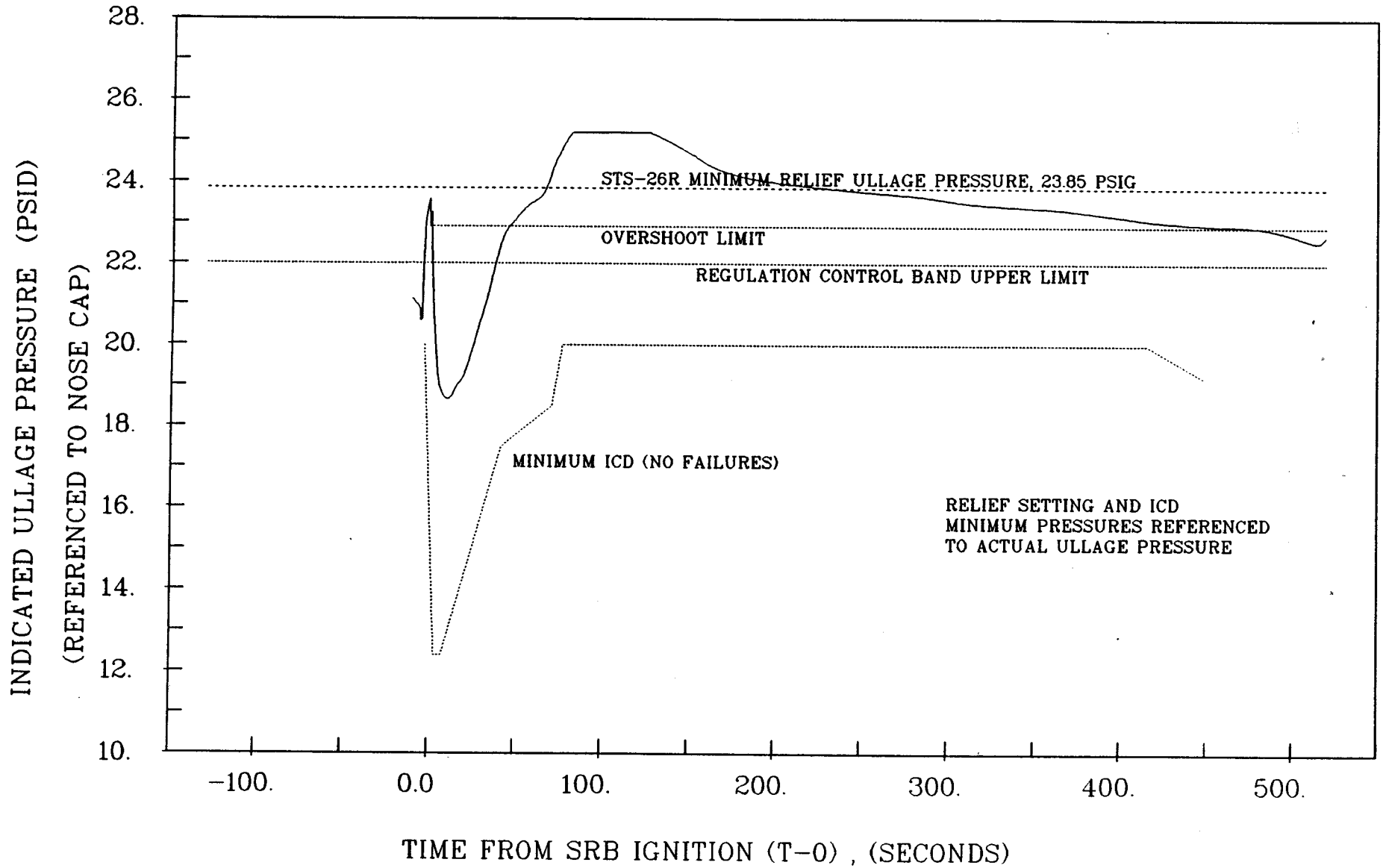

Figure 5.3.3-2.- Predicted STS-26 liquid oxygen tank ullage pressure with three flow control valves failed open and vent valve operational. (Paragraph 5.3.3)

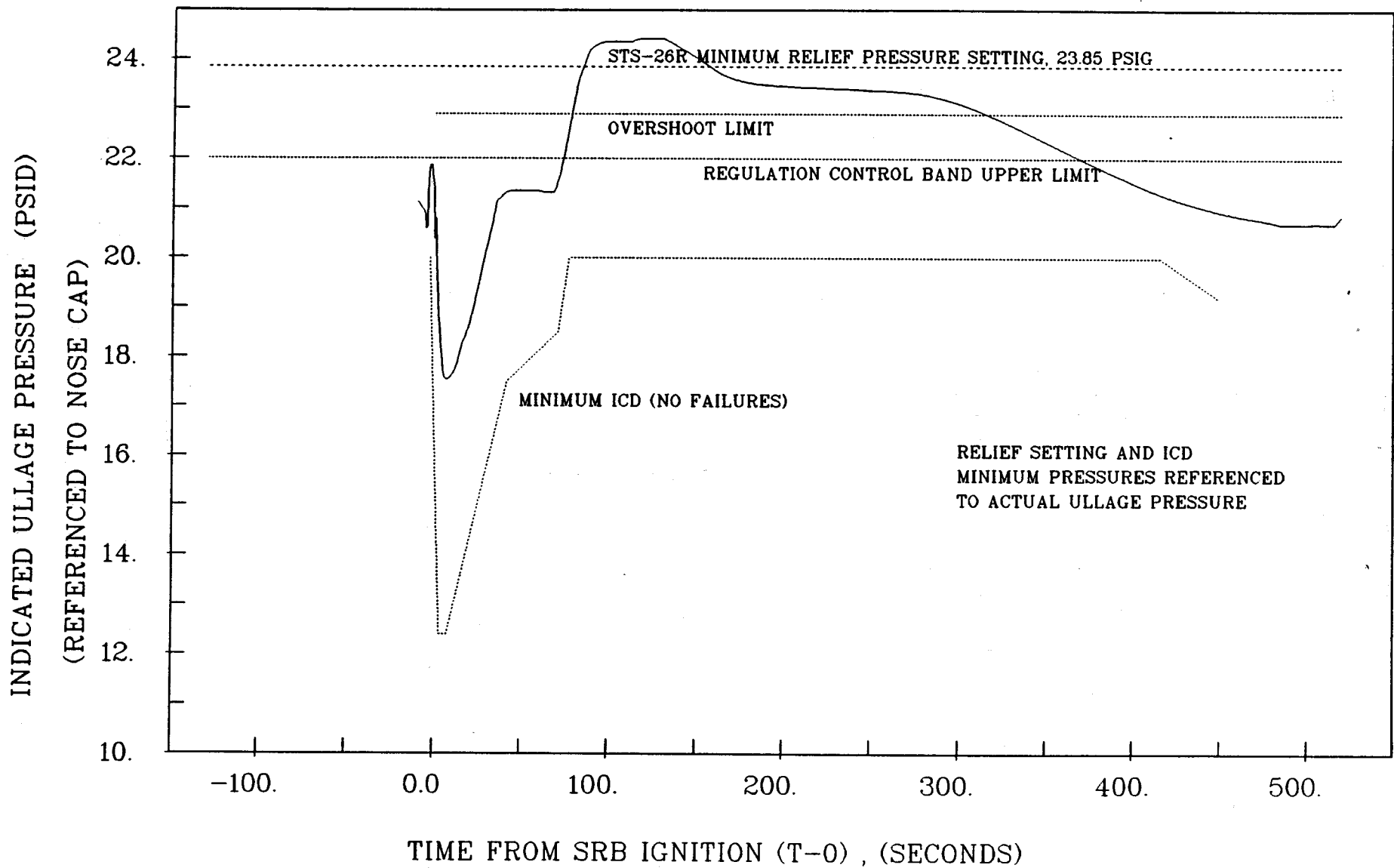

Figure 5.3.3-3.- Predicted STS-26 liquid oxygen tank ullage pressure with two flow control valves failed open and vent valve operational.  
(Paragraph 5.3.3)



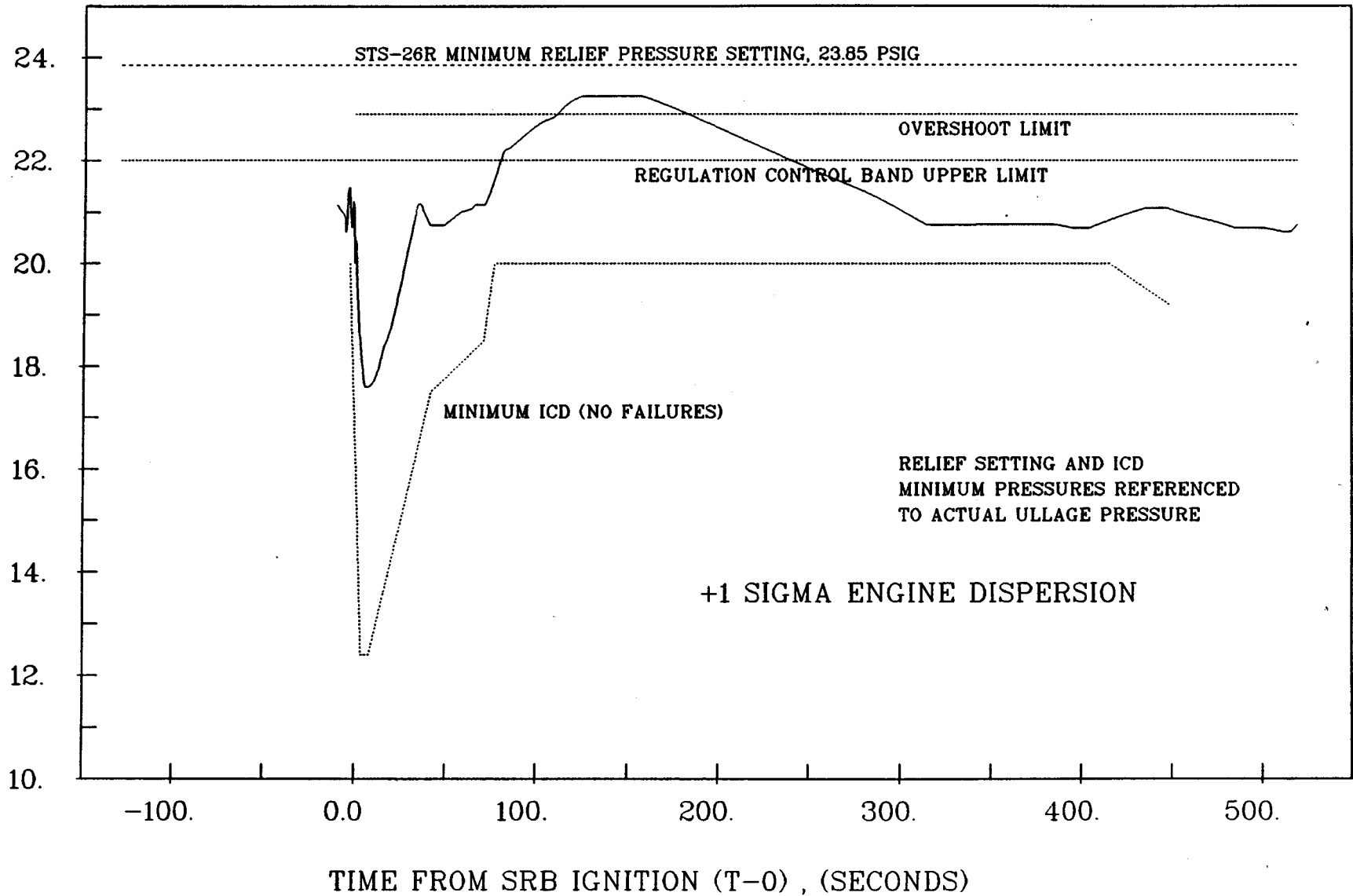

Figure 5.3.3-4.- Predicted STS-26 liquid oxygen tank ullage pressure with one flow control valve failed open and vent valve operational. (Paragraph 5.3.3)

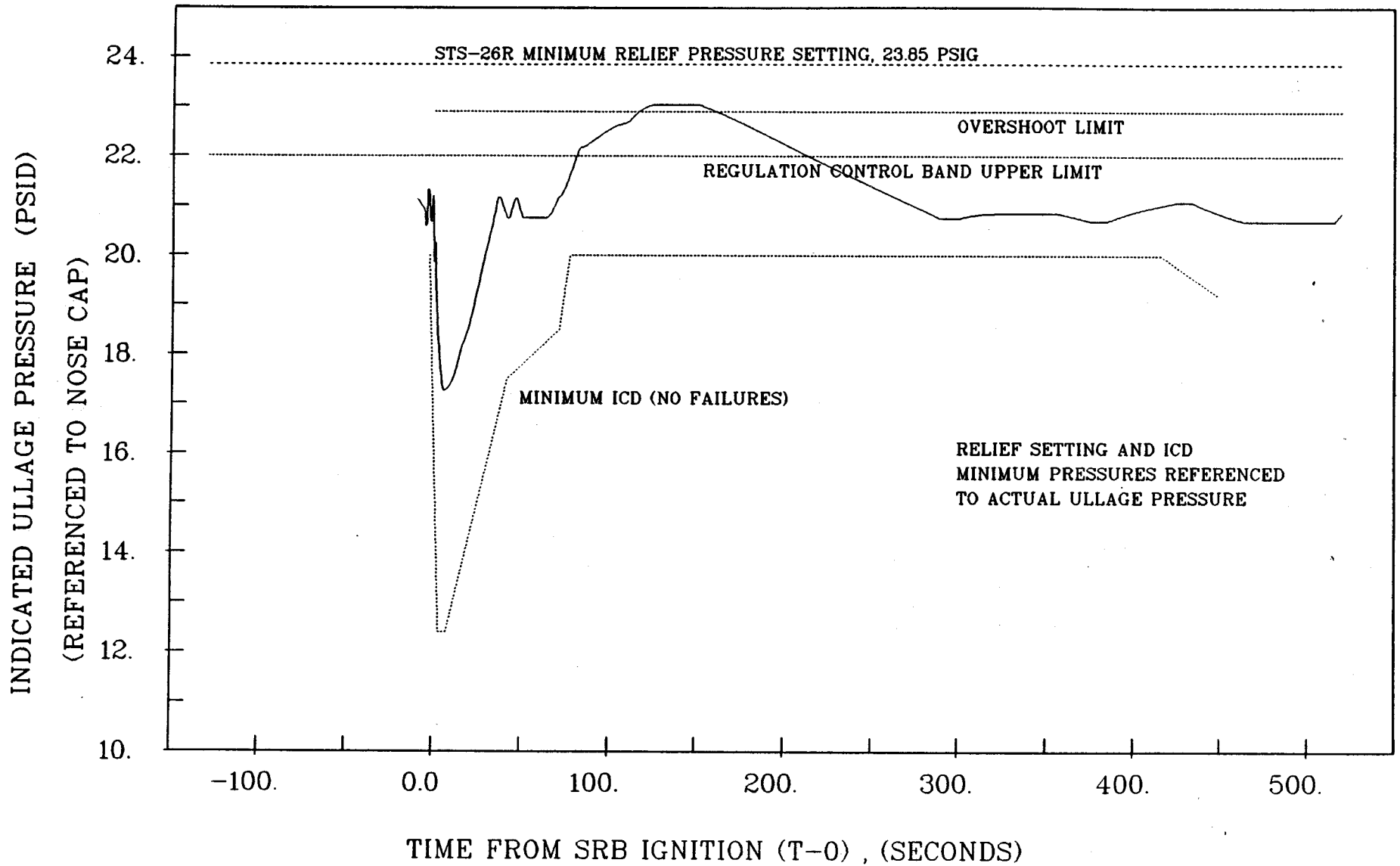

Figure 5.3.3-5.- Predicted STS-26 liquid oxygen tank ullage pressure with one flow control valve failed open and vent valve operational.  
(Paragraph 5.3.3)

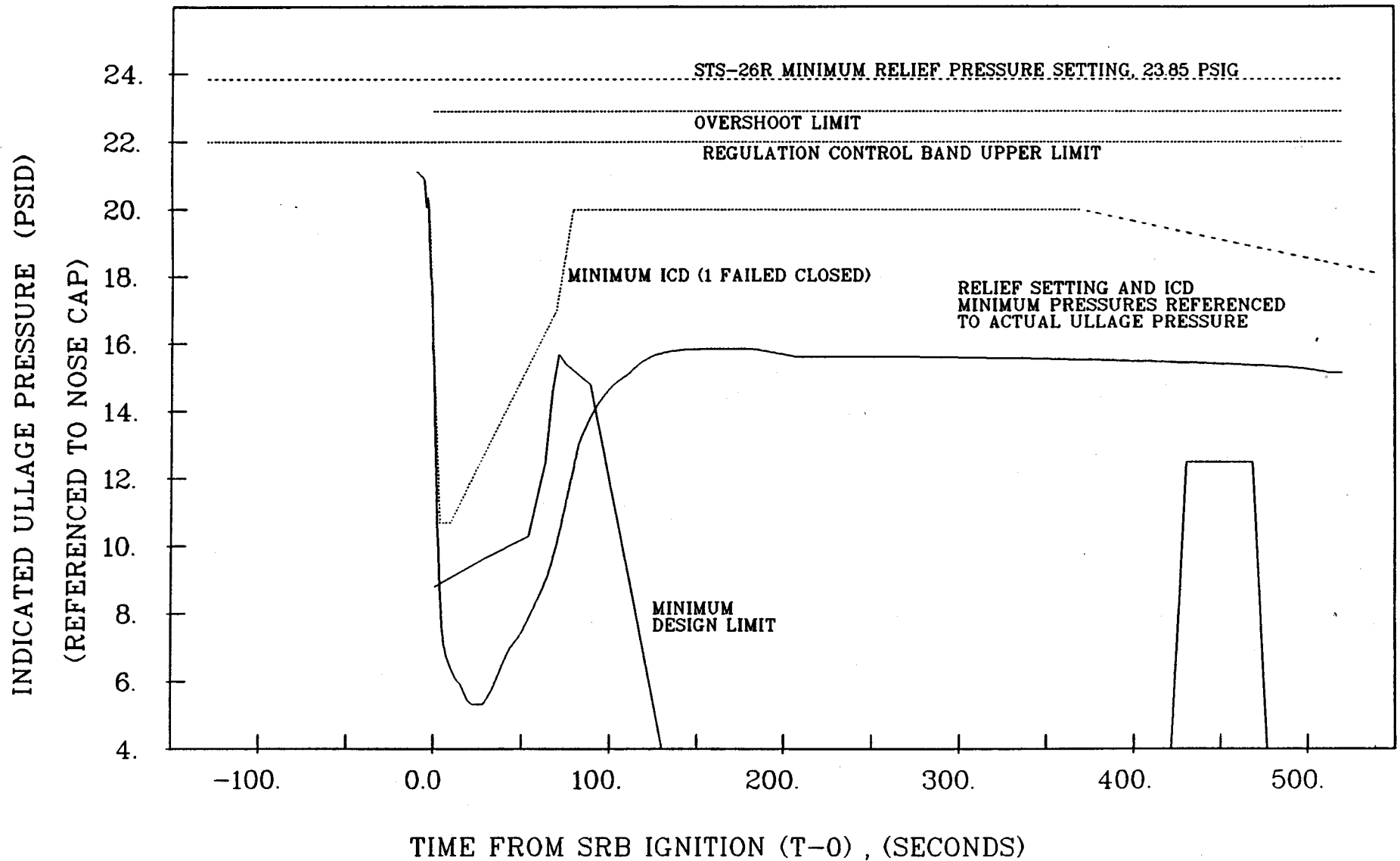

Figure 5.3.3-6.- Predicted STS-26 liquid oxygen tank ullage pressure with three flow control valves failed closed and vent valve operational. (Paragraph 5.3.3)

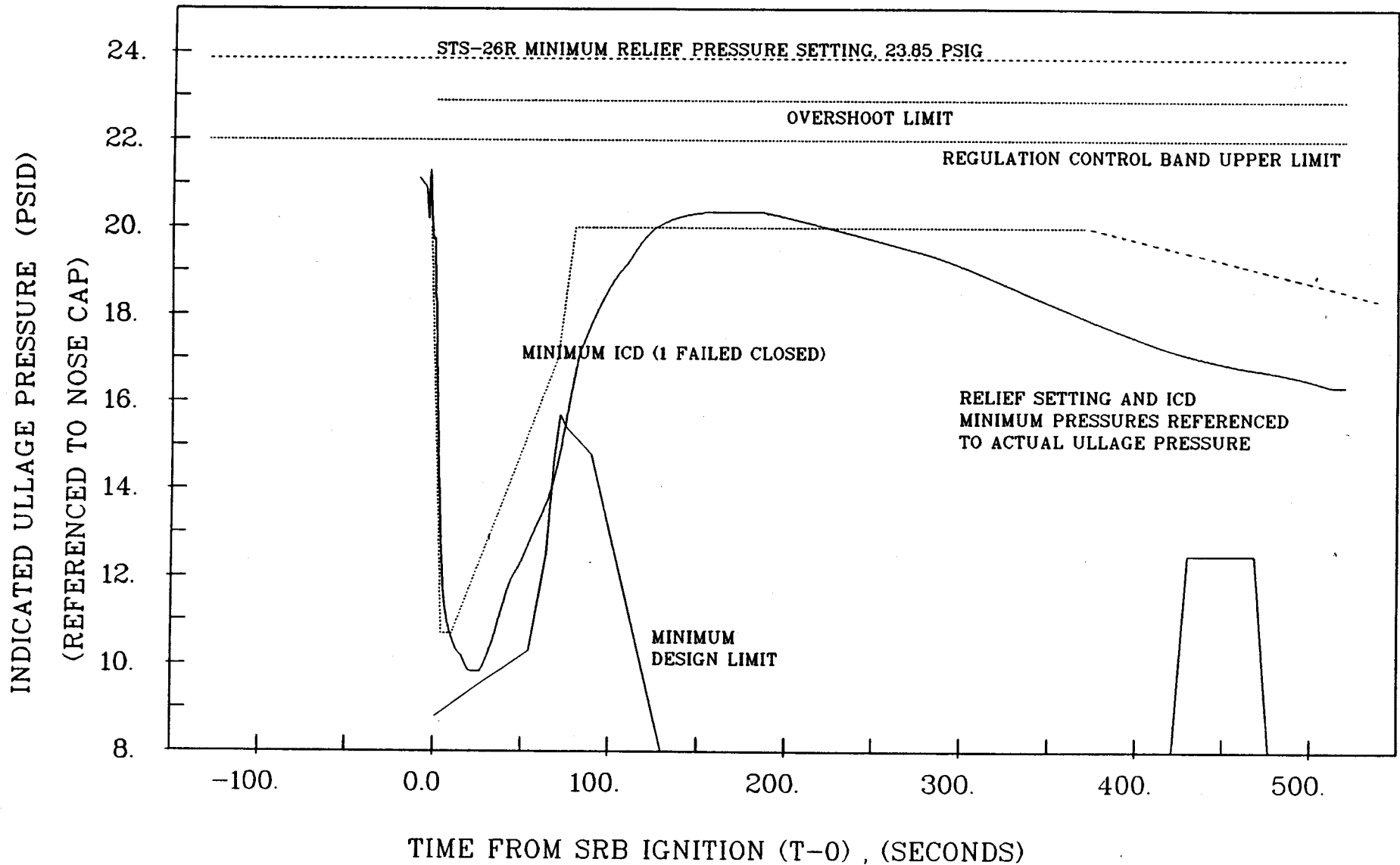

Figure 5.3.3-7.- Predicted STS-26 liquid oxygen tank ullage pressure with two flow control valves failed closed and vent valve operational. (Paragraph 5.3.3)

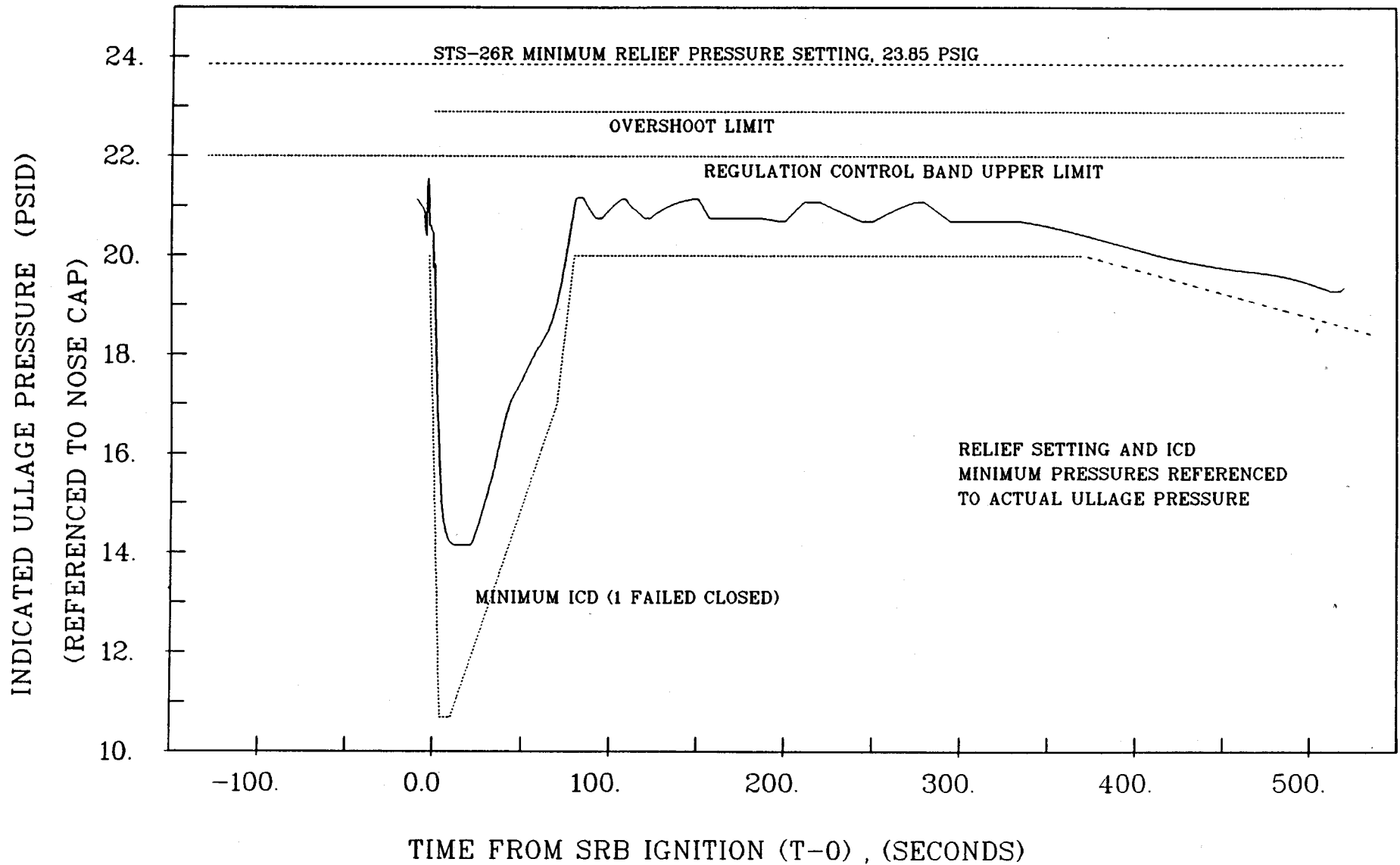

Figure 5.3.3-8.- Predicted STS-26 liquid oxygen tank ullage pressure with one flow control valve failed closed and vent valve operational. (Paragraph 5.3.3)

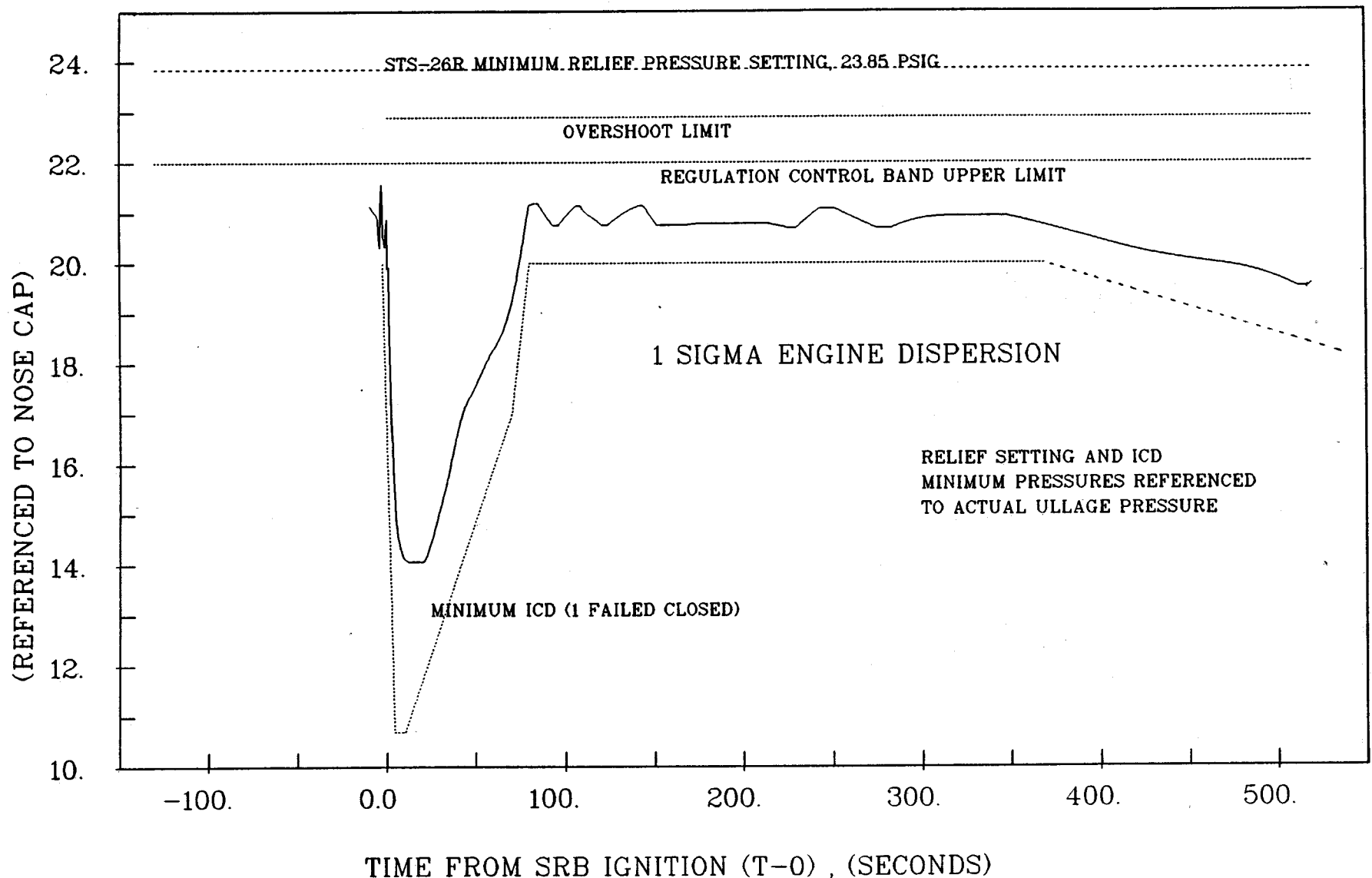

Figure 5.3.3-9.- Predicted STS-26 liquid oxygen tank ullage pressure with one flow control valve failed closed and vent valve operational. (Paragraph 5.3.3)

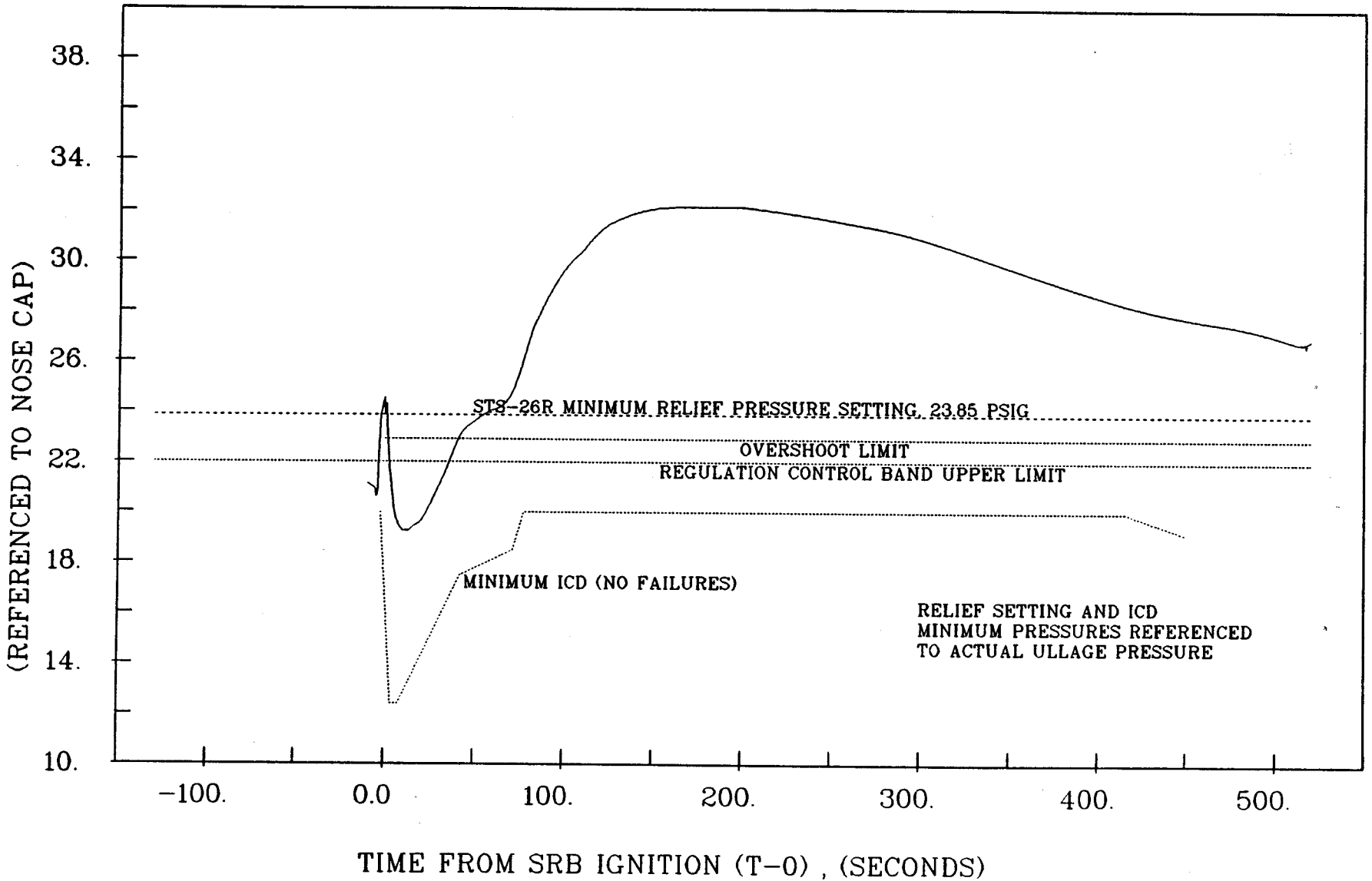

Figure 5.3.3-10.- Predicted STS-26 liquid oxygen tank ullage pressures with three flow control valves failed open and vent valve failed closed. (Paragraph 5.3.3)

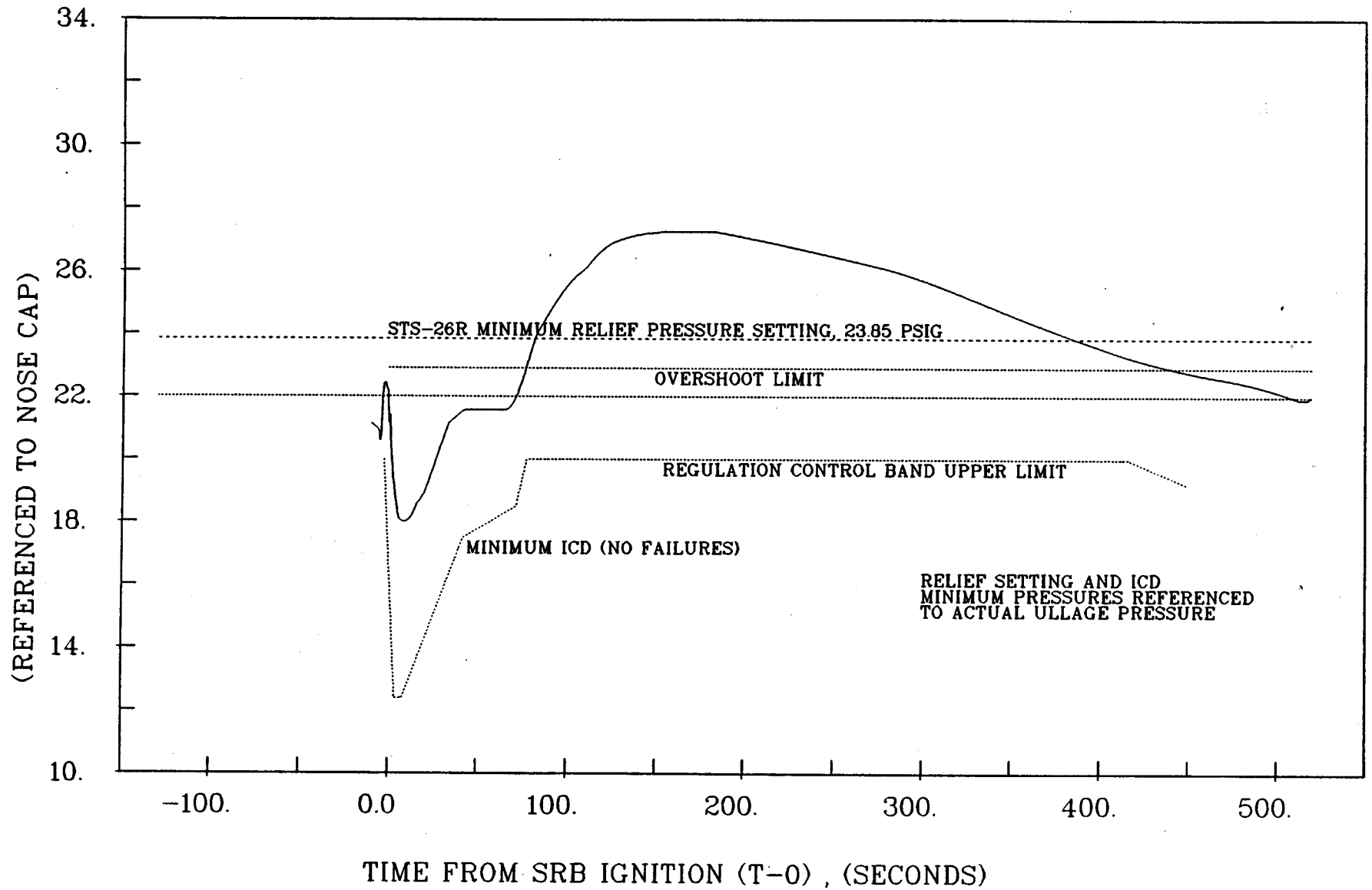

Figure 5.3.3-11.- Predicted STS-26 liquid oxygen tank ullage pressure with two flow control valves failed open and vent valve failed closed. (Paragraph 5.3.3)



297  
INDICATED ULLAGE PRESSURE (PSID)  
(REFERENCED TO NOSE CAP)  
5.3.3-16

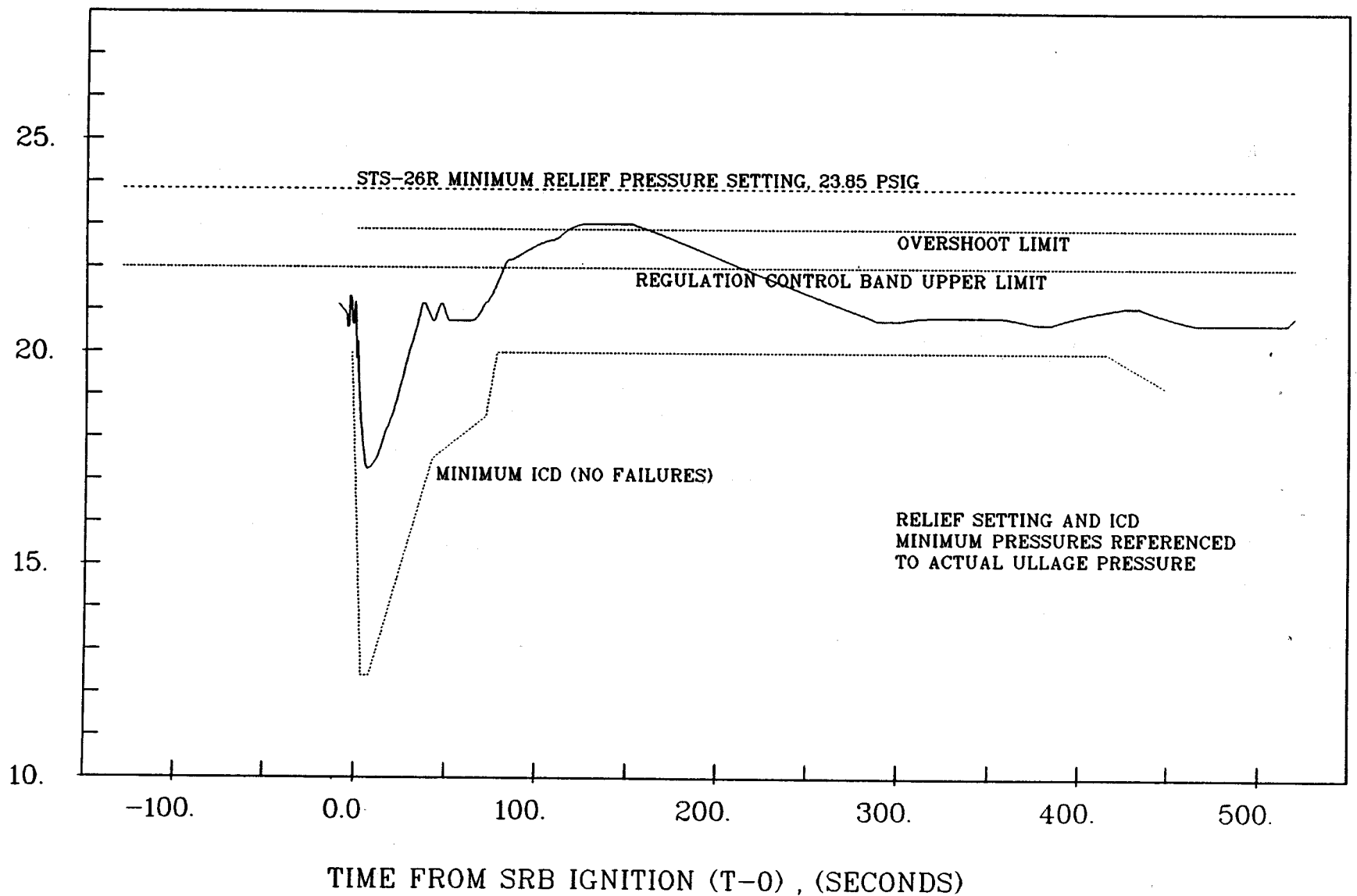

Figure 5.3.3-12.- Predicted STS-26 liquid oxygen tank ullage pressure with one flow control valve failed open and vent valve failed closed.  
(Paragraph 5.3.3)

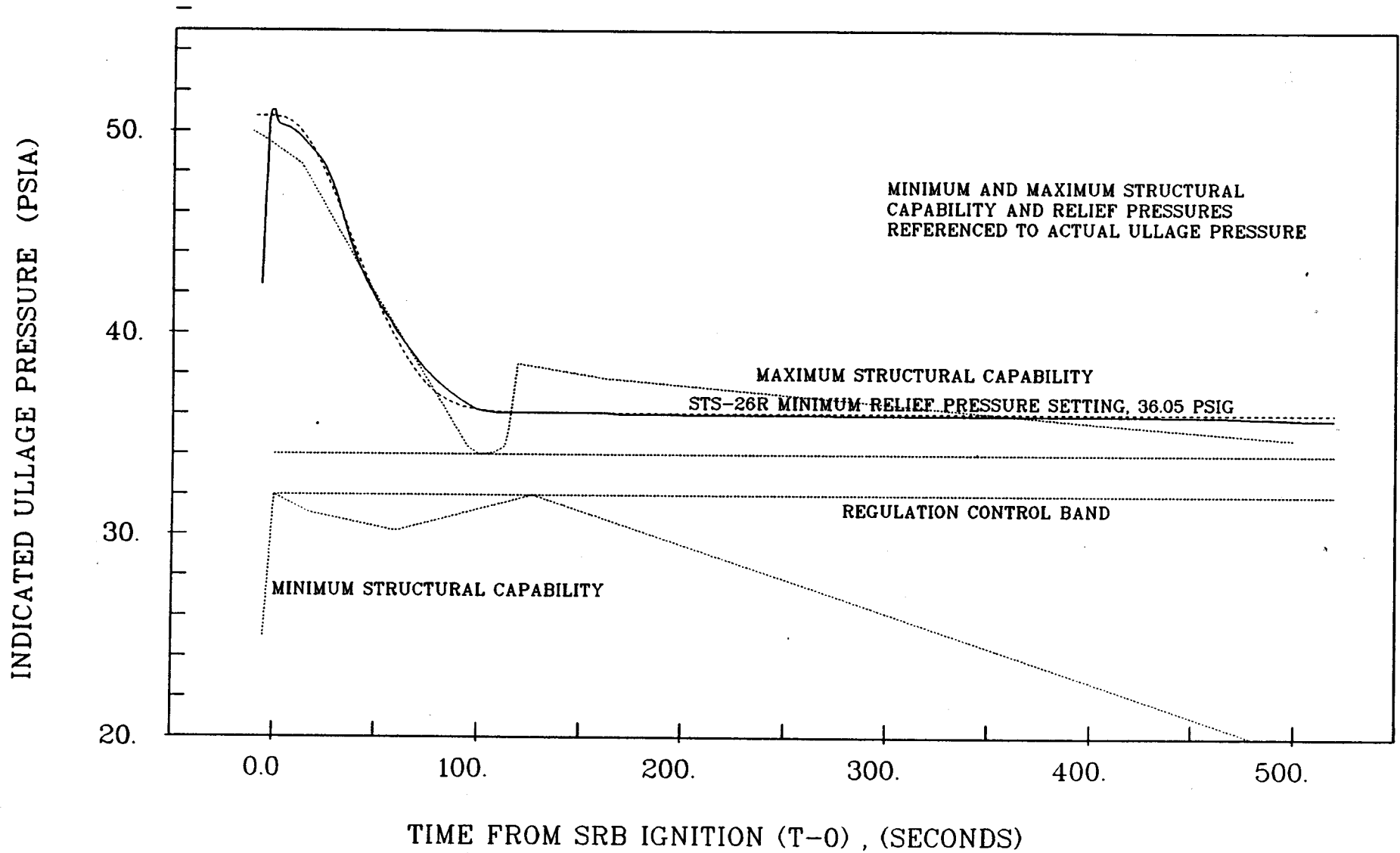

Figure 5.3.3.13.- Predicted STS-26 liquid hydrogen tank ullage pressure with three flow control valves failed open and vent valve operational. (Paragraph 5.3.3)

INDICATED ULLAGE PRESSURE (PSIA)

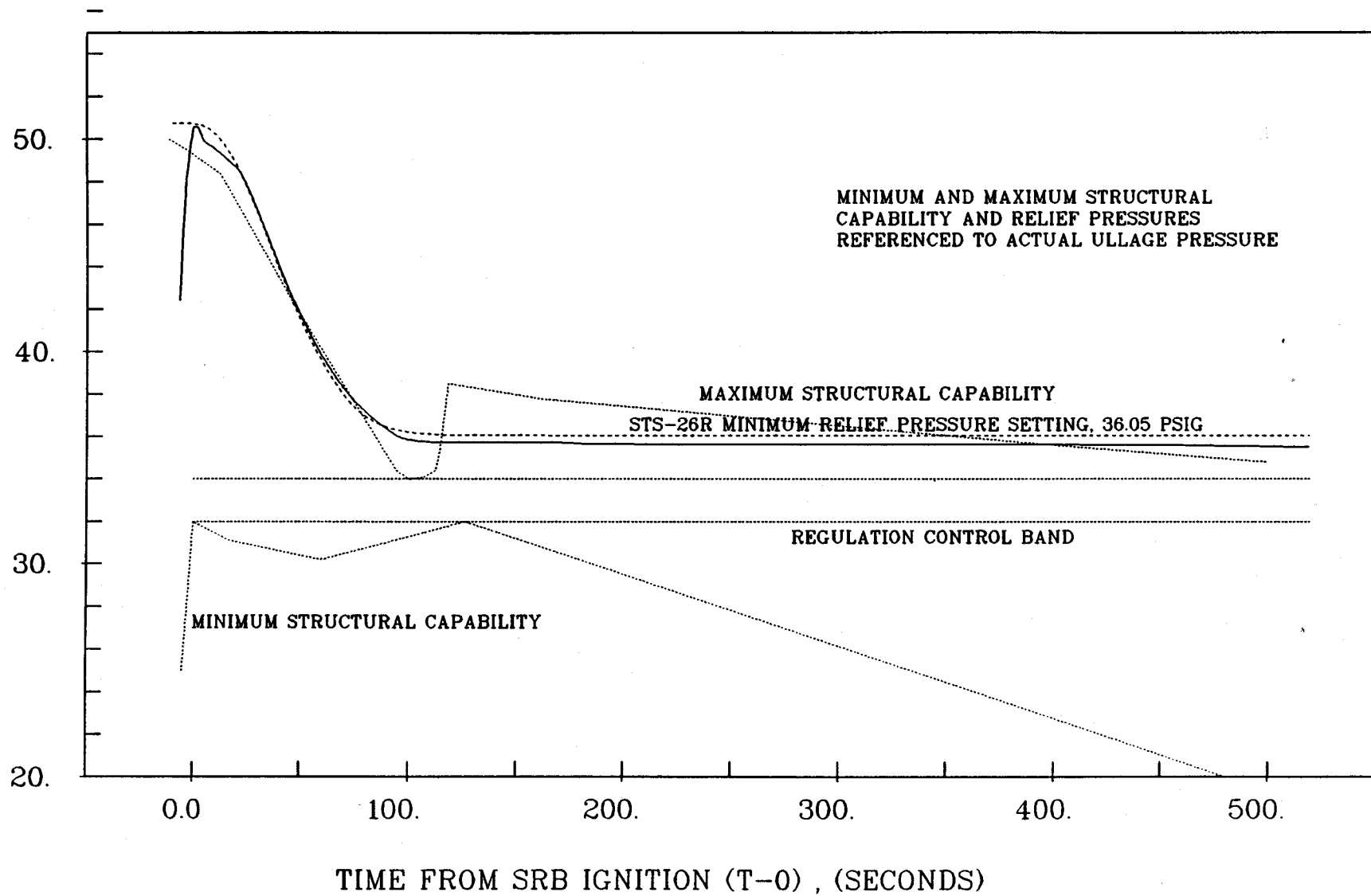

Figure 5.3.3-14.- Predicted STS-26 liquid hydrogen tank ullage pressure with two flow control valves failed open and vent valve operational. (Paragraph 5.3.3)

308  
5.3.3-19  
INDICATED ULLAGE PRESSURE (PSIA)

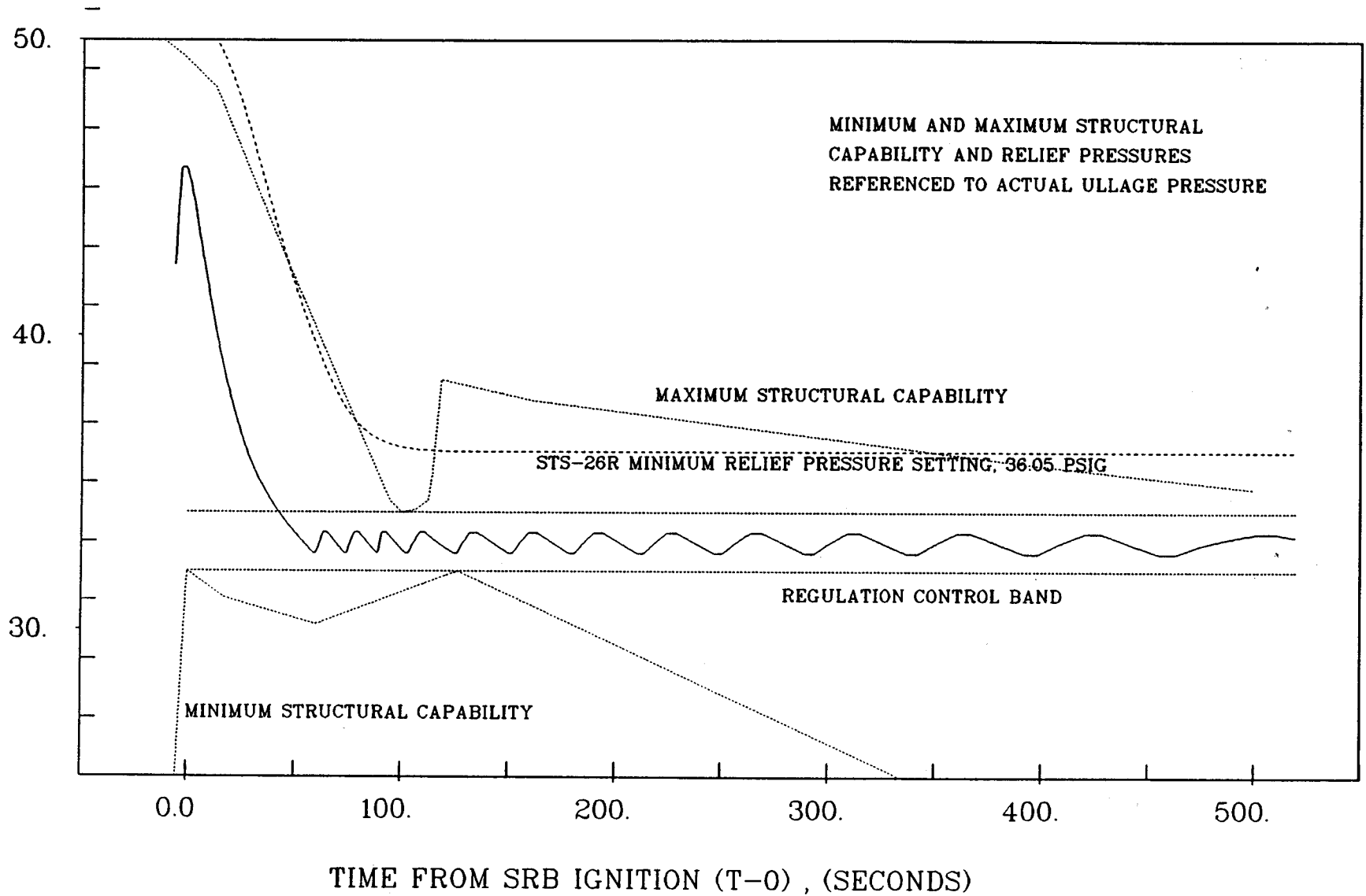

Figure 5.3.3-15.- Predicted STS-26 liquid hydrogen tank ullage pressure with one flow control valve failed open and vent valve operational. (Paragraph 5.3.3)

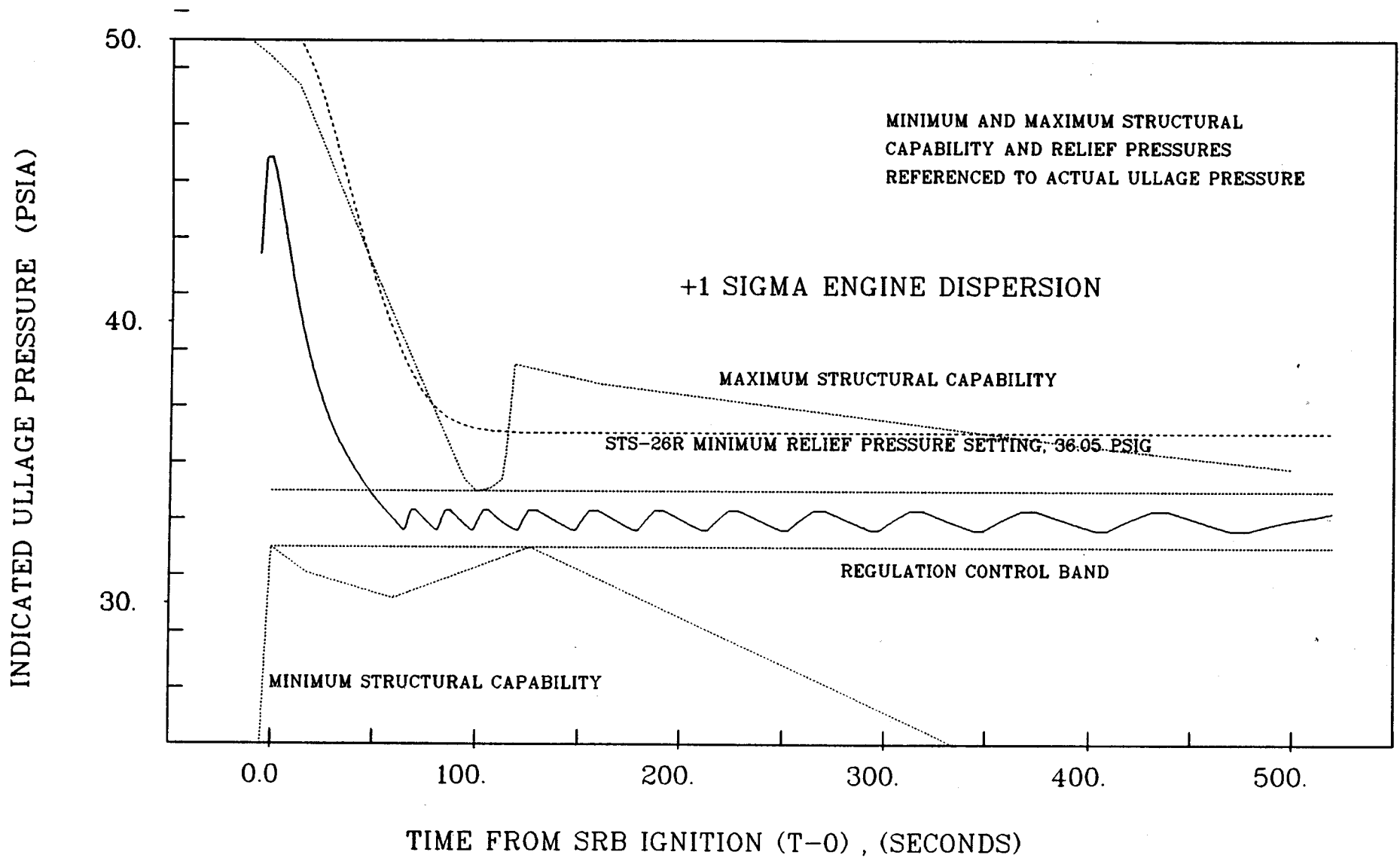

Figure 5.3.3-16.- Predicted STS-26 liquid hydrogen tank ullage pressure with one flow control valve failed open and vent valve operational. (Paragraph 5.3.3)

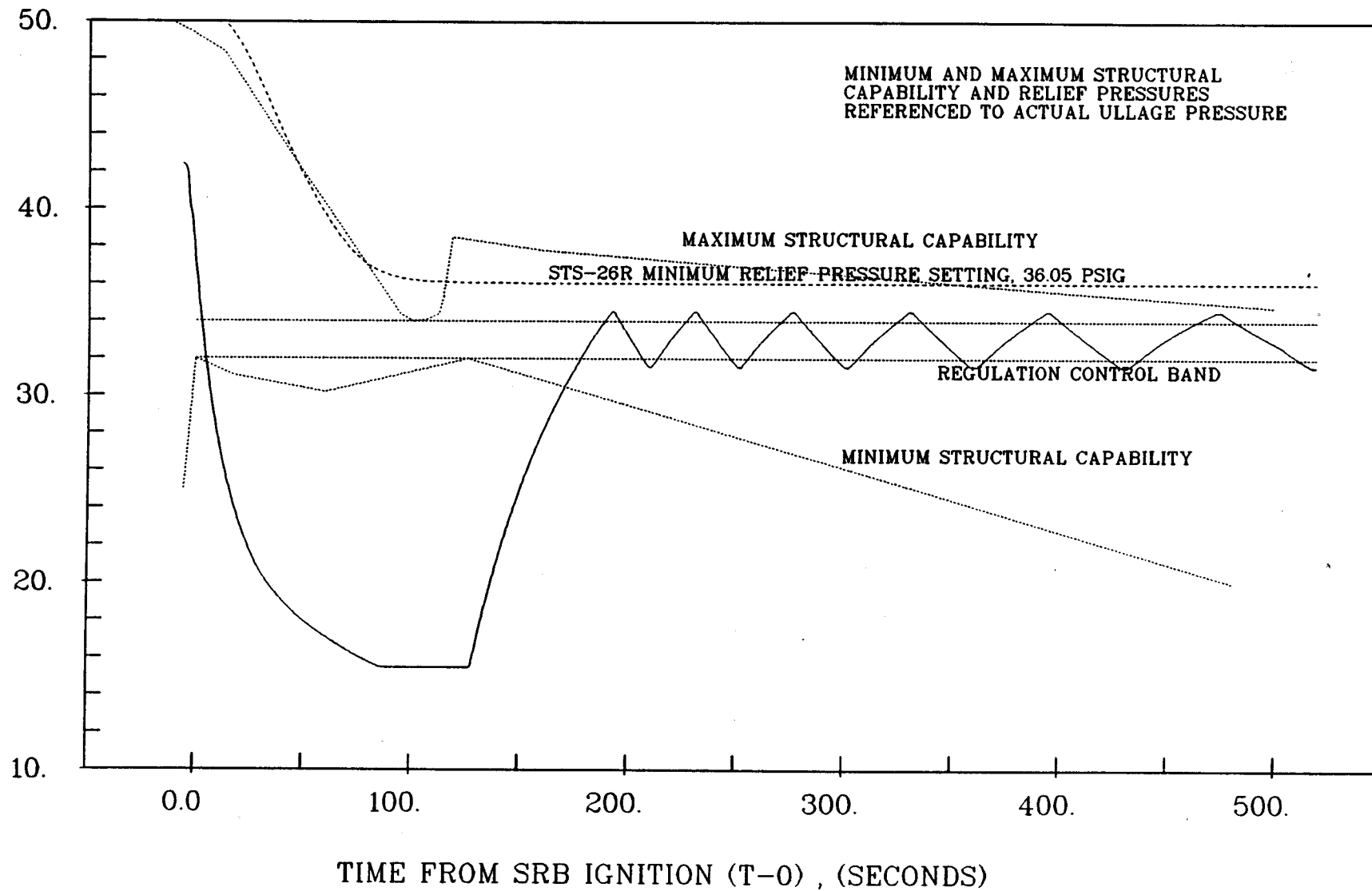

Figure 5.3.3-17.- Predicted STS-26 liquid hydrogen tank ullage pressure with three flow control valves failed closed and vent valve operational. (Paragraph 5.3.3)

INDICATED ULLAGE PRESSURE (PSIA)

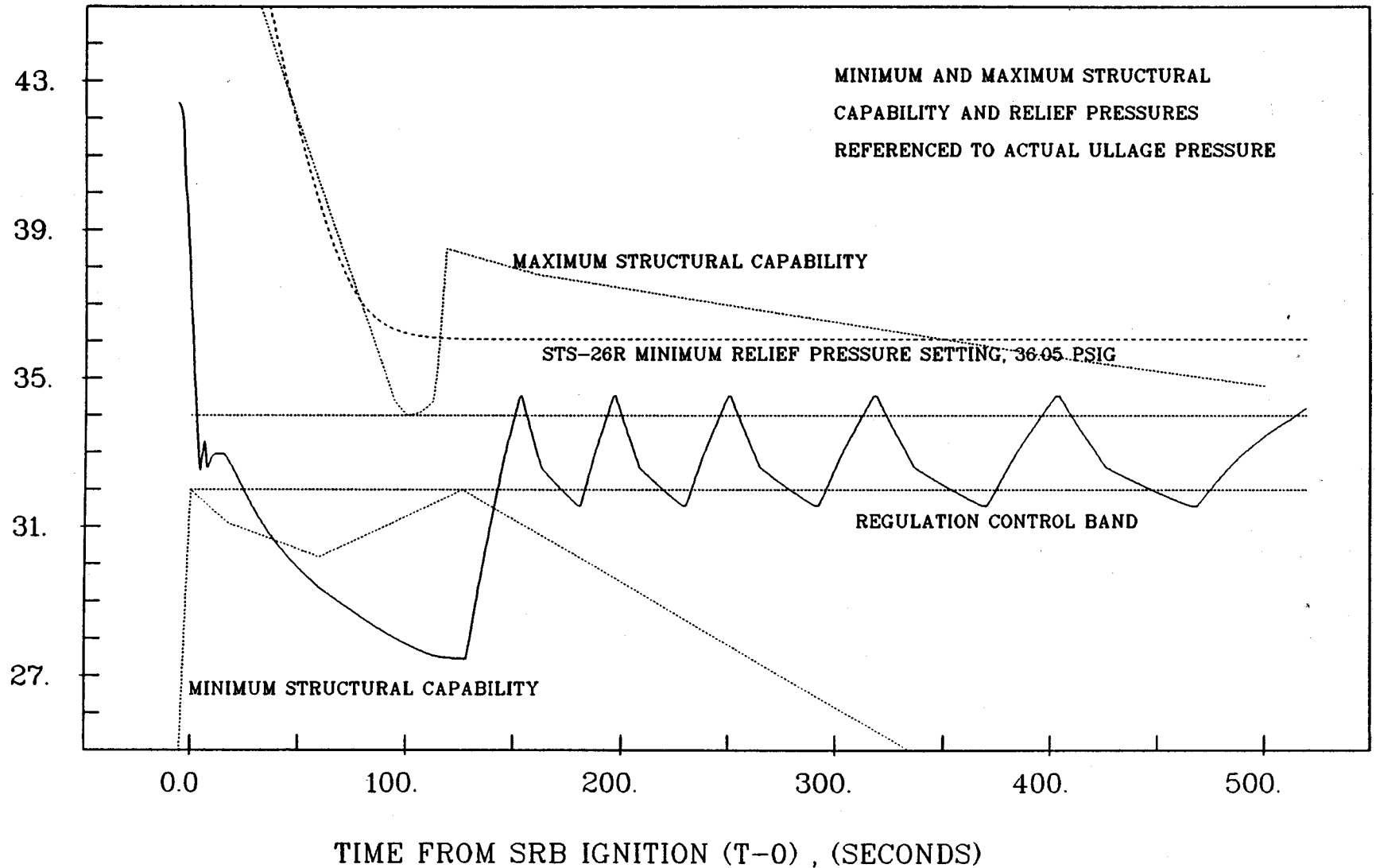

Figure 5.3.3-18.- Predicted STS-26 liquid hydrogen tank ullage pressure with two flow control valves failed closed and vent valve operational.  
(Paragraph 5.3.3)

INDICATED ULLAGE PRESSURE (PSIA)

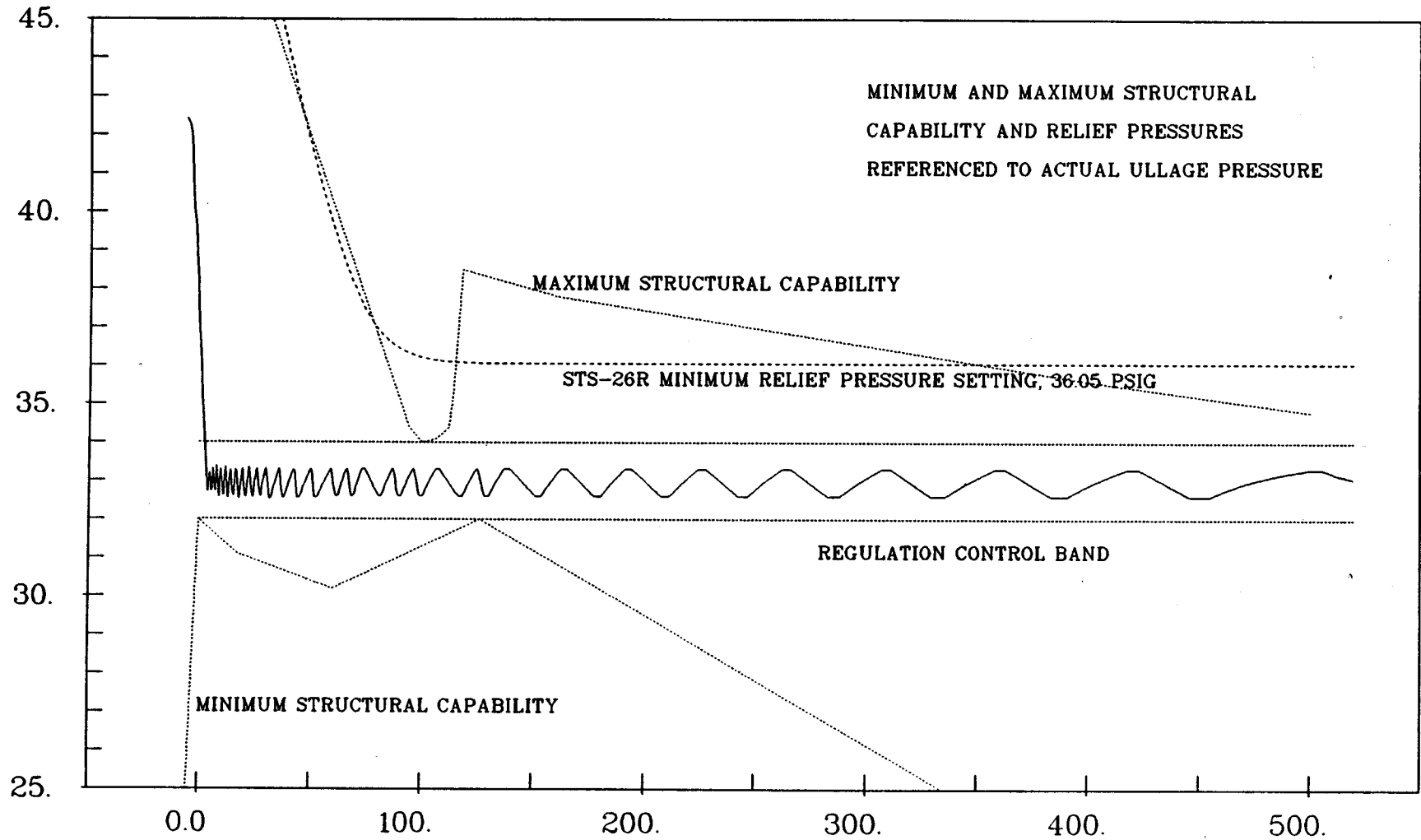

Figure 5.3.3-19.- Predicted STS-26 liquid hydrogen tank ullage pressure with one flow control valve failed closed and vent valve operational. (Paragraph 5.3.3)



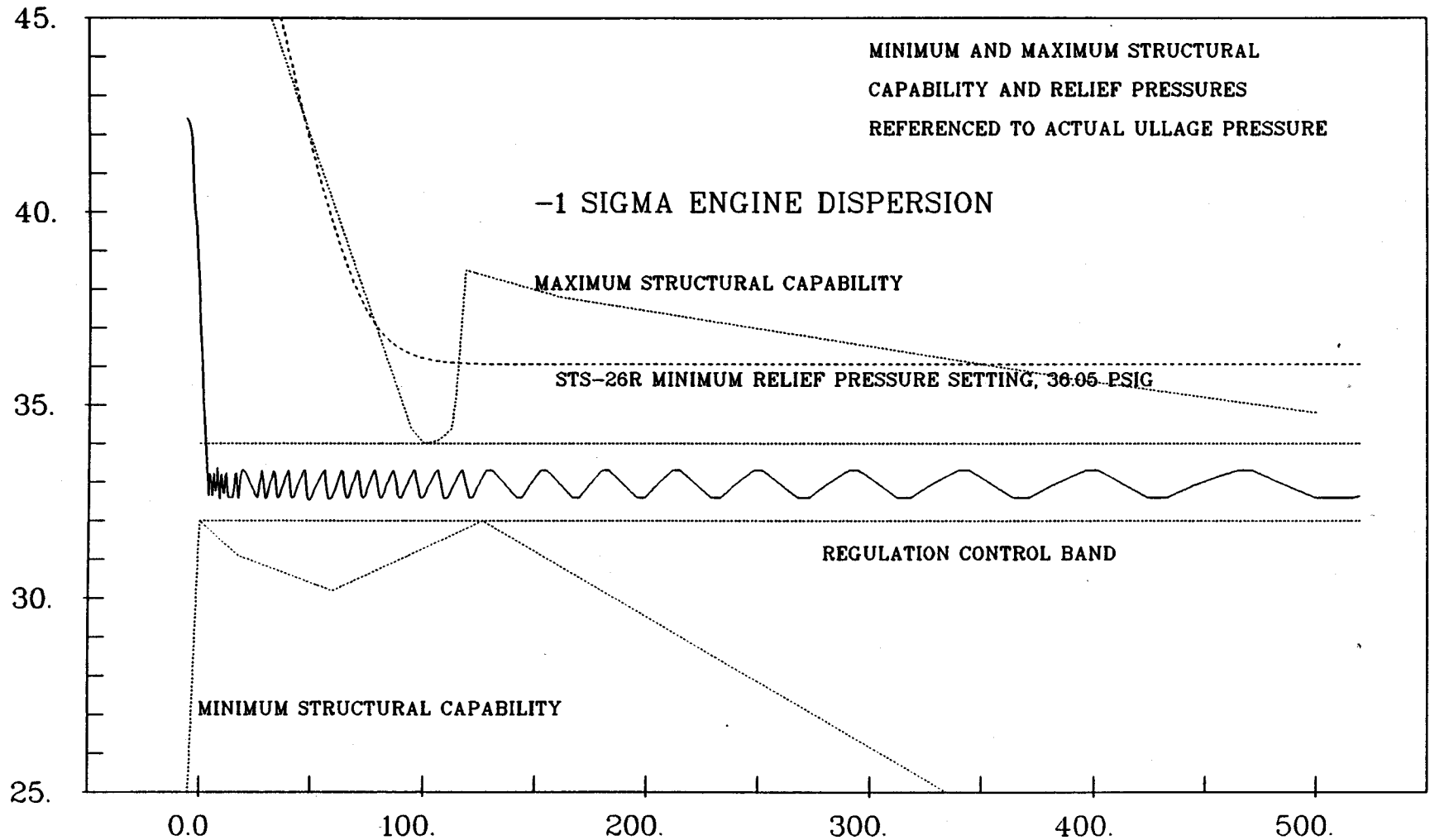

Figure 5.3.3-20.- Predicted STS-26 liquid hydrogen tank ullage pressure with one flow control valve failed closed and vent valve operational. (Paragraph 5.3.3)

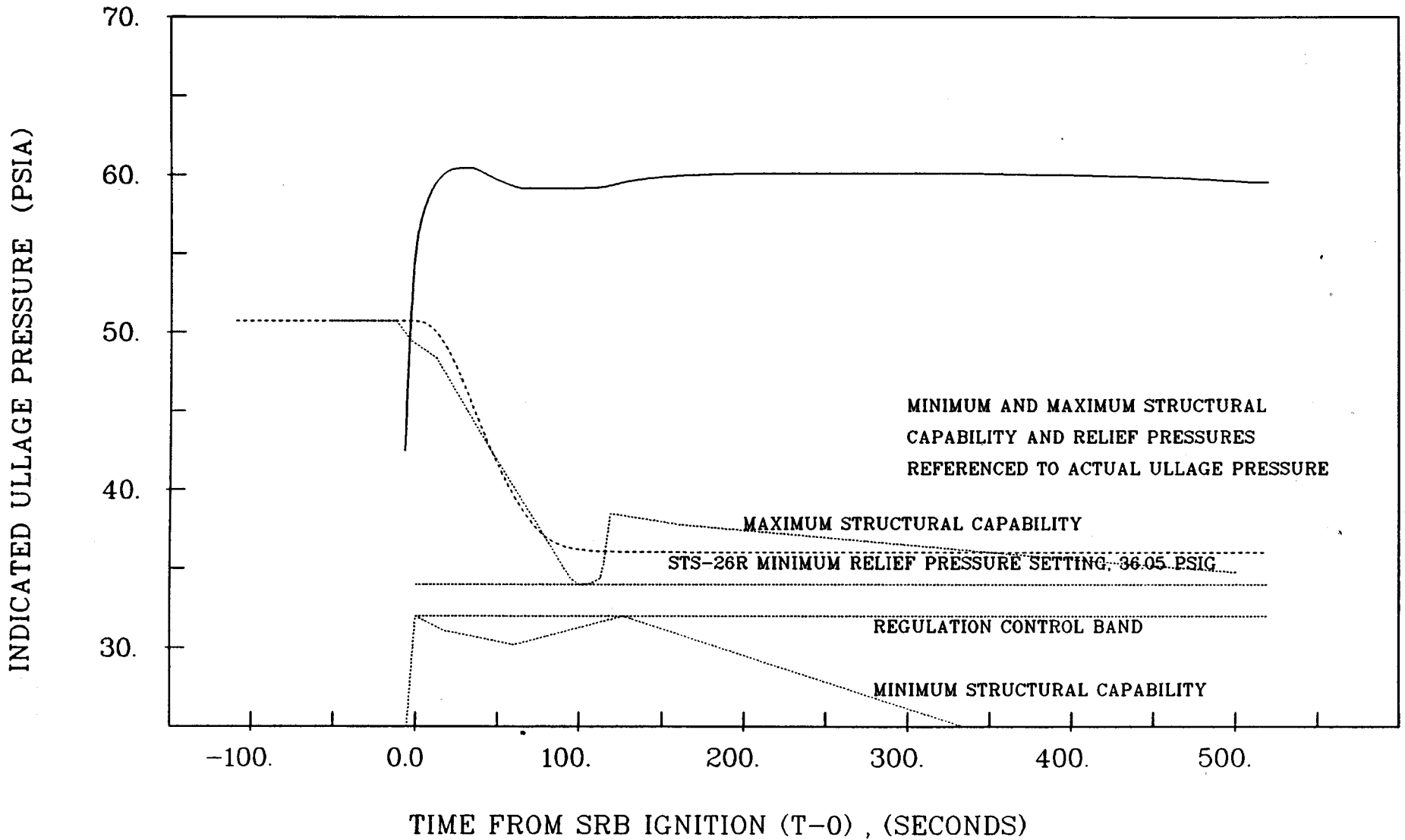

Figure 5.3.3-21.- Predicted STS-26 liquid hydrogen tank ullage pressure with three flow control valves failed open and vent valve failed closed. (Paragraph 5.3.3)

INDICATED ULLAGE PRESSURE (PSIA)

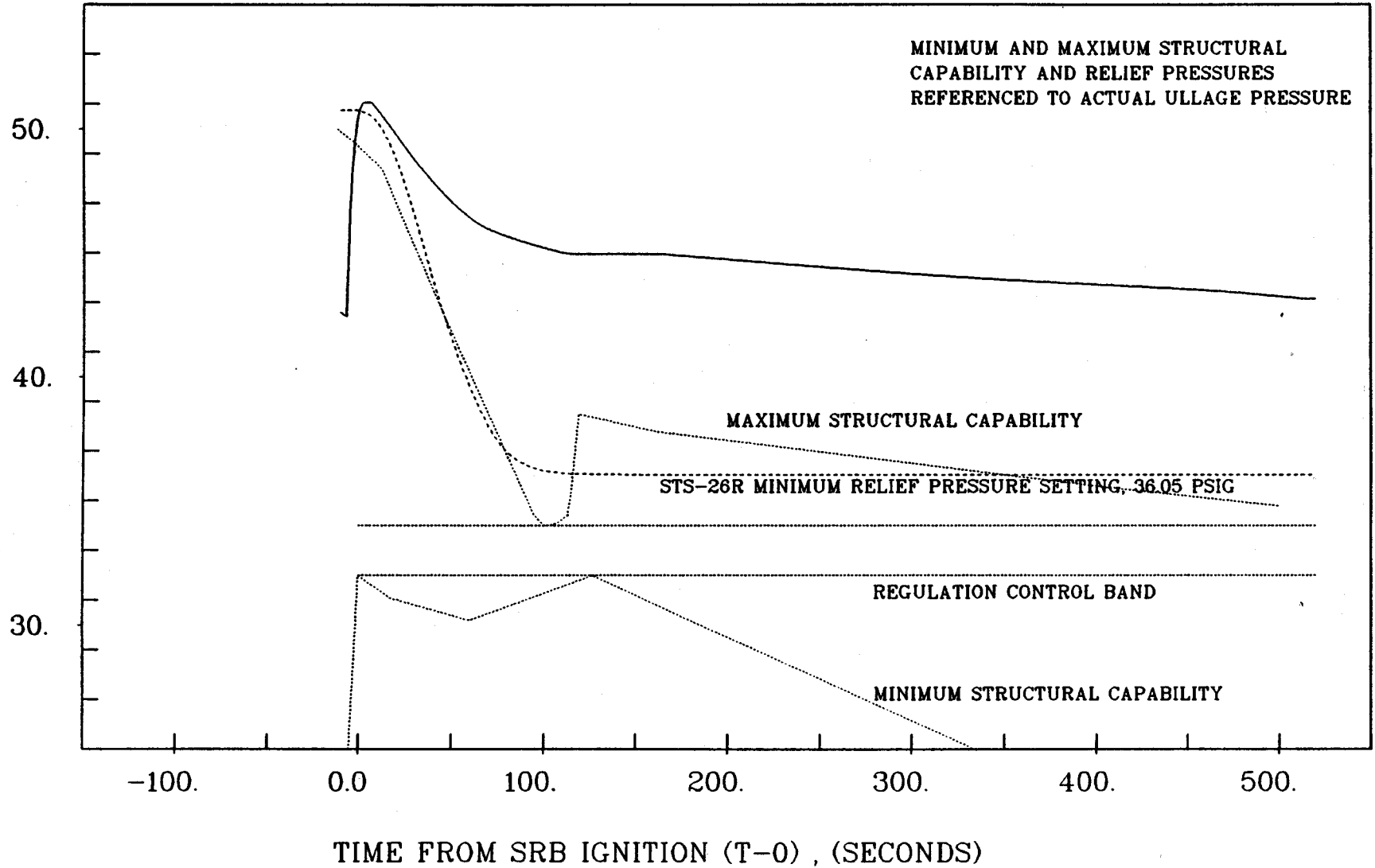

Figure 5.3.3-22.- Predicted STS-26 liquid hydrogen tank ullage pressure with two flow control valves failed open and vent valve failed closed.  
(Paragraph 5.3.3)

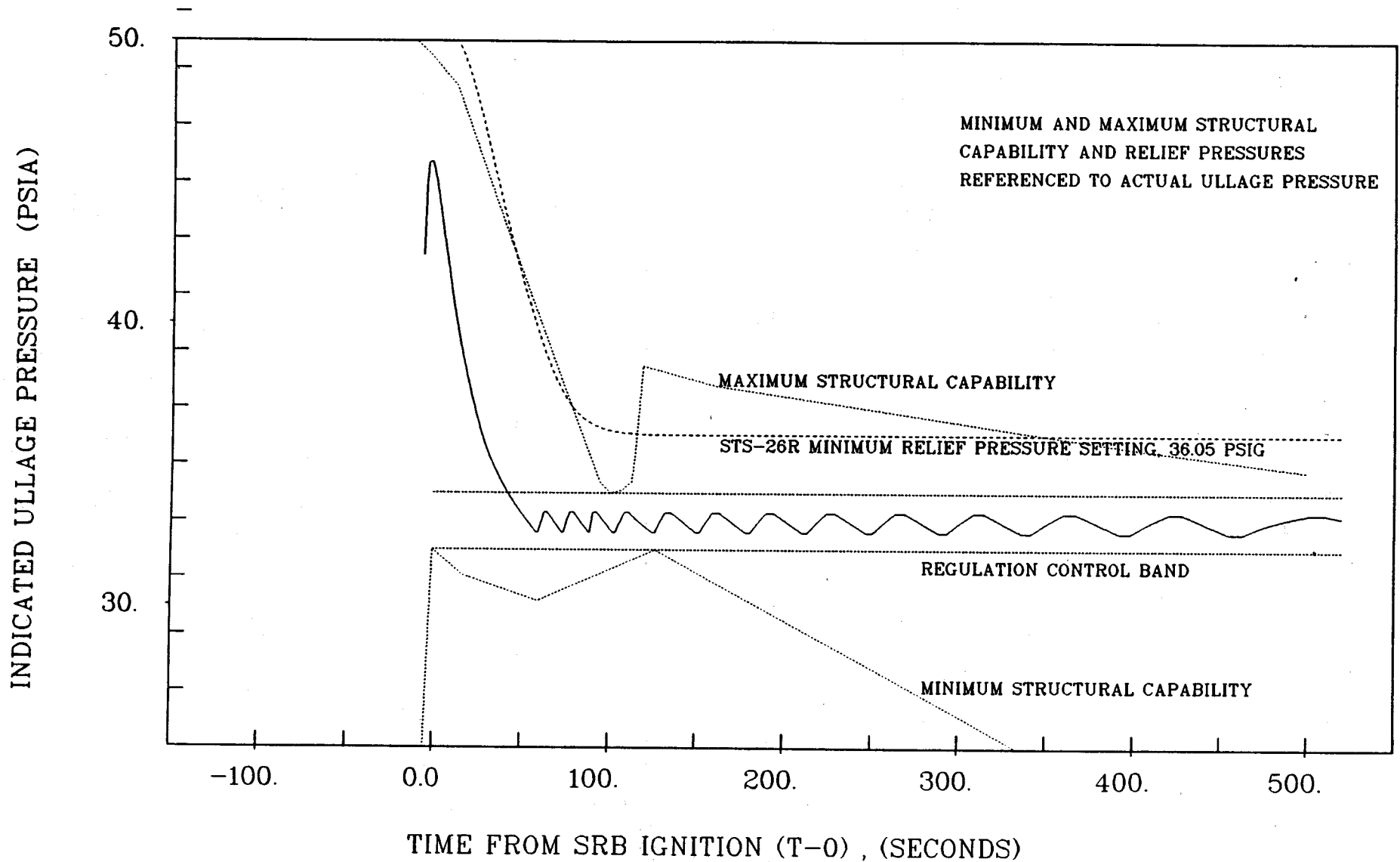

Figure 5.3.3-23.- Predicted STS-26 liquid hydrogen tank ullage pressure with one flow control valve failed open and vent valve failed closed.  
(Paragraph 5.3.3)

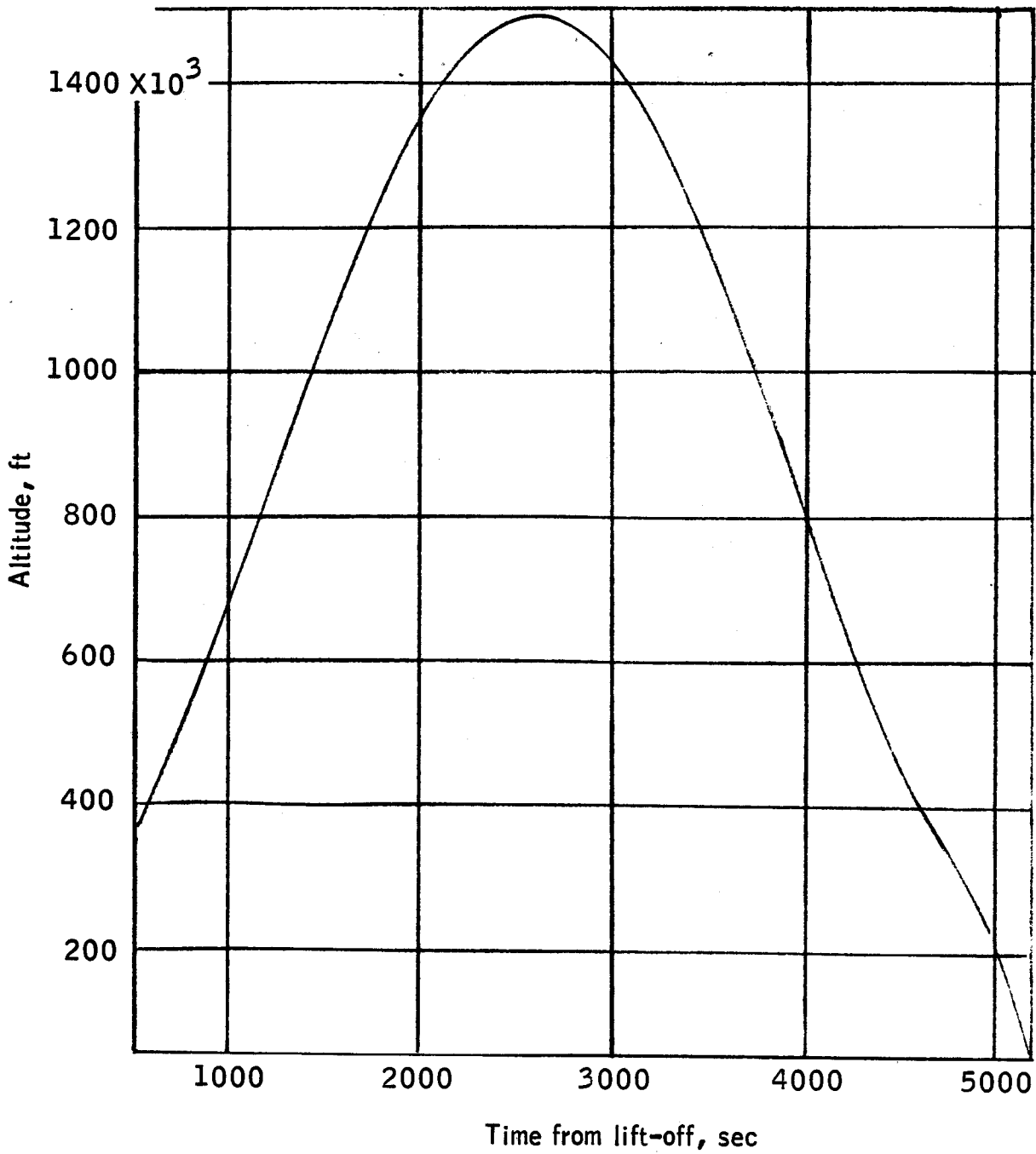

Figure 5.3.3-24.- Predicted external tank altitude after MECO.  
(Paragraph 5.3.3)

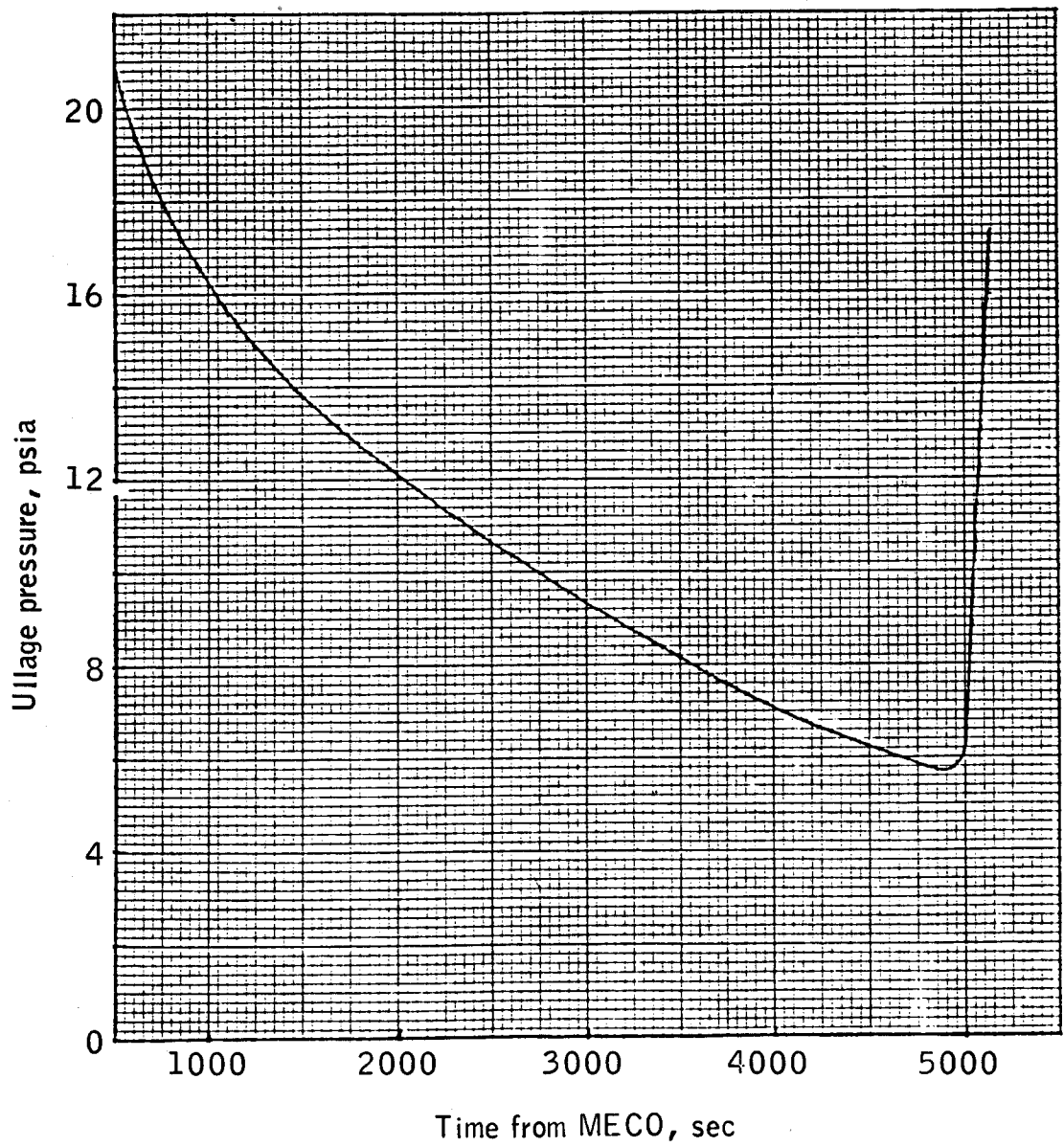

Figure 5.3.3-25.- Predicted liquid oxygen tank ullage pressure after MECO.

(Paragraph 5.3.3)

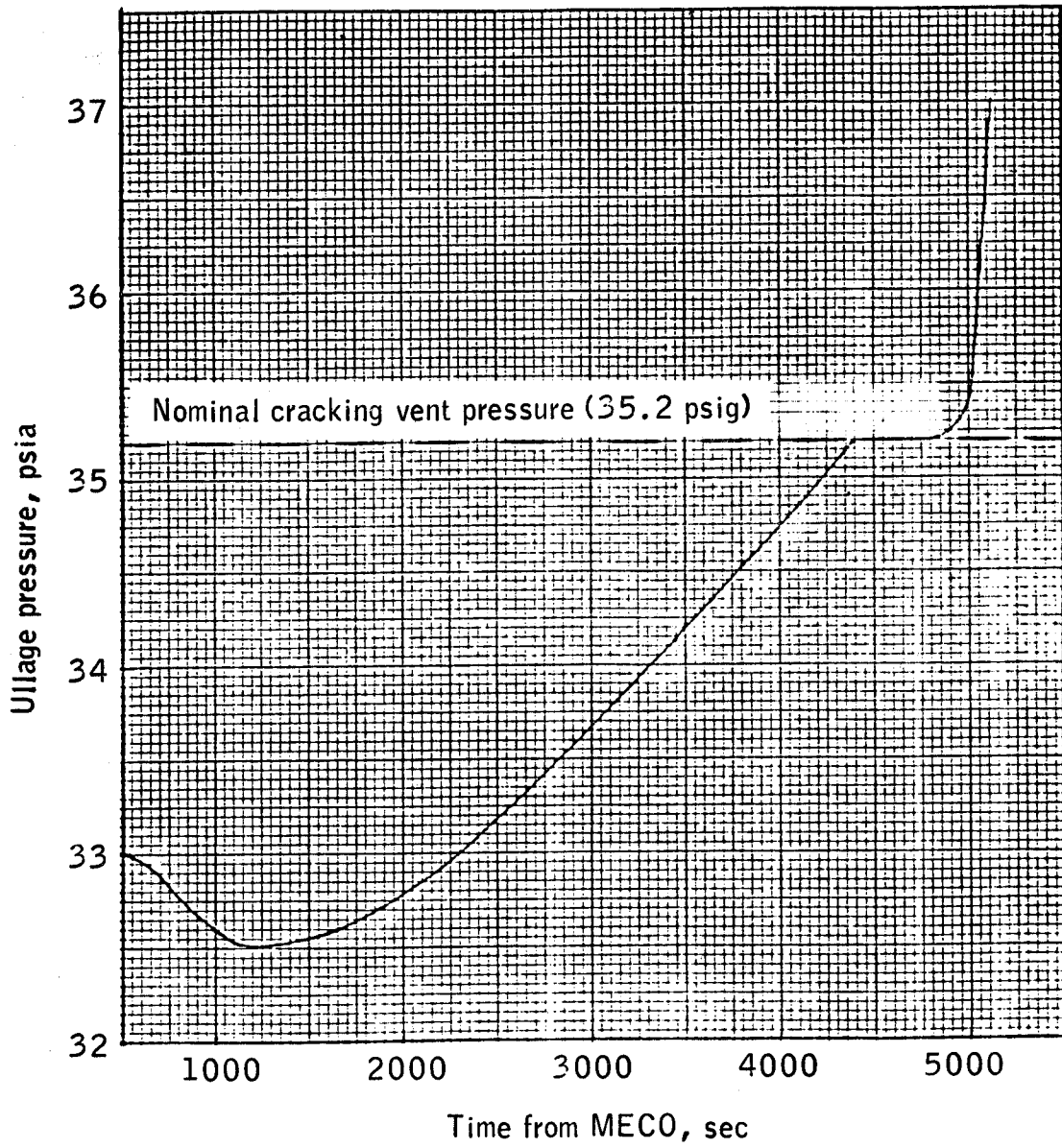

Figure 5.3.3-26.- Predicted liquid hydrogen tank ullage after MECO.  
 (Paragraph 5.3.3)

5.3.4

FLUIDLINE CHARACTERISTICS

- a. Orbiter/ET fluid separation interface conditions Table 5.3.4-1
- b. LO<sub>2</sub> fluidline characteristics
  - 1. Total interface pressure vs. interface temperature for prestart Figure 5.3.4-1
  - 2. Total interface pressure vs. interface temperature for main engine operation Figure 5.3.4-2
- c. LH<sub>2</sub> fluidline characteristics
  - 1. Total interface pressure vs. interface temperature for prestart Figure 5.3.4-3
  - 2. ORB/ET separation interface LH<sub>2</sub> temperature vs. ET mass remaining Figure 5.3.4-4
  - 3. LH<sub>2</sub> main feedline interface total pressure vs. LH<sub>2</sub> main feedline interface temperature during recirculation Figure 5.3.4-5
- d. LH<sub>2</sub> and LO<sub>2</sub> main engine operational flow rate requirements
  - 1. Orbiter/ET separation interface GH<sub>2</sub> pressurant Figure 5.3.4-6
  - 2. Orbiter/ET interface GO<sub>2</sub> pressurant characteristics Figure 5.3.4-7
  - 3. GHe flow rate vs. temperature for GO<sub>2</sub> pressurization line Figure 5.3.4-8
  - 4. GHe flow rate vs. temperature for GH<sub>2</sub> pressurization line Figure 5.3.4-9
- e. Predicted ET/Orbiter LO<sub>2</sub> interface drainback temperature
  - 1. OV-102 Figure 5.3.4-10
  - 2. OV-103 and OV-104 Figure 5.3.4-11
- f. Predicted engine inlet drainback temperature
  - 1. OV-102 Figure 5.3.4-12
  - 2. OV-103 and OV-104 Figure 5.3.4-13



TABLE 5.3.4-1.- ORBITER/ET FLUID SEPARATION INTERFACE CONDITIONS\*  
(Paragraph 5.3.4)

Line and number	Function	Flow direction	Media <sup>a</sup>	Operating flow rate, lbs/sec			Temperature, °R			Operating <sup>b</sup> pressure, psia		
				Minimum	Nominal	Maximum	Minimum	Nominal	Maximum	Minimum	Nominal	Maximum
LO <sub>2</sub> feedline- line 1	LO <sub>2</sub> Prechill	ORB to ET	GO <sub>2</sub>	8	16	32	162	N/A	580	15	25	40
	LO <sub>2</sub> Chilldown	ORB to ET	GO <sub>2</sub> /LO	8	24	32	162	168	170	15	30	70
	LO <sub>2</sub> Fast fill <sup>c</sup>	ORB to ET	LO <sub>2</sub>	174	N/A	790	162	166	170	60	85	105
	LO <sub>2</sub> Replenish to stabilize	ORB to ET	LO <sub>2</sub>	0 <sup>d</sup>	5.5	11	N/A	N/A	181	79	82	84
		ET to ORB	LO <sub>2</sub>	0 <sup>d</sup>	6	12	N/A	N/A	181	79	82	84
	LO <sub>2</sub> Steady state replenish <sup>e</sup>	ORB to ET	LO <sub>2</sub>	.55	1.15	1.85	N/A	N/A	183 <sup>f,g</sup>	79	82	84
	LO <sub>2</sub> Drain <sup>h</sup>	ET to ORB	LO <sub>2</sub>	300	530	790	162	164	170	20	60	95
	LO <sub>2</sub> Drainback <sup>i</sup> (5 minutes)	ET to ORB	LO <sub>2</sub>	18.1	19.85	21.6	170.5	N/A	180.7 <sup>j</sup>	79	92.5	106
	LO <sub>2</sub> Engine feed	ET to ORB	LO <sub>2</sub>	1680	2658	2945	162	N/A	170 <sup>g</sup>	20	100	201
	LO <sub>2</sub> Topping	ORB to ET	LO <sub>2</sub>	35	40	45	N/A	N/A	174	79	82	84
Tank purge <sup>m</sup>	ET to ORB	GN <sub>2</sub>	2.75	N/A	3.10	480	530	580	N/A	N/A	25	
Tank purge <sup>m</sup>	ET to ORB	GH <sub>e</sub>	0.25	0.30	0.35	480	530	580	N/A	N/A	25	
O <sub>2</sub> Press. Line - line 2	Ice/frost minimization <sup>k</sup>	ORB to ET	GH <sub>e</sub>	0.006	0.009	0.039	498	579	660	N/A	N/A	50
	O <sub>2</sub> Pre-pressurization	ORB to ET	GH <sub>e</sub>	0.25	0.30	0.35	480	530	580	60	80	106
	O <sub>2</sub> Pressurization <sup>n</sup>	ORB to ET	GO <sub>2</sub>	2.5	4.65	8.1	300	840	960	100	300	600
	Tank purge <sup>m</sup>	ORB to ET	GN <sub>2</sub>	2.75	N/A	3.10	480	530	580	N/A	N/A	600
	Tank purge <sup>m</sup>	ORB to ET	GH <sub>e</sub>	0.25	0.30	0.35	480	530	580	N/A	N/A	106
	LO <sub>2</sub> Emergency drain pressurization <sup>h</sup>	ORB to ET	GN <sub>2</sub>	2.75	N/A	3.10	480	530	580	N/A	N/A	600
LH <sub>2</sub> feedline- line 7	LH <sub>2</sub> Facility/ORB/ET/chill <sup>l</sup>	ORB to ET	GH <sub>2</sub> /LH	0	N/A	10	38	N/A	560	15	N/A	45
	LH <sub>2</sub> Fill transition and initial chill	ORB to ET	LH <sub>2</sub>	1	N/A	15	37	N/A	N/A	15	N/A	52
	LH <sub>2</sub> Fast fill <sup>o</sup>	ORB to ET	LH <sub>2</sub>	75	110	118	36.5	37	38	15	20	52
	LH <sub>2</sub> Drain	ET to ORB	LH <sub>2</sub>	50	80	118	36.5	37	40	32	34	36.5
	LH <sub>2</sub> Recirculation	ET to ORB	LH <sub>2</sub>	4	4.5	5	36.3	37	37.3	16.9	N/A	48
	LH <sub>2</sub> Engine feed	ET to ORB	LH <sub>2</sub>	281	444	492	36.5	37	40	30	35	50
	Tank purge <sup>m</sup>	ORB to ET	GH <sub>e</sub>	0.75	1.25	1.5	480	530	580	N/A	N/A	25
	Tank purge	ET to ORB	GH <sub>e</sub>	1.2	1.35	1.5	480	530	580	N/A	N/A	25

\*NOTE - For notes see pages 5.3.4-4.

313

5.3.4-2

TABLE 5.3.4-1.- ORBITER/ET FLUID SEPARATION INTERFACE CONDITIONS\*  
(Paragraph 5.3.4) (concluded)

Line and number	Function	Flow direction	Media <sup>a</sup>	Operating flow rate, lbs/sec			Temperature, °R			Operating <sup>b</sup> pressure, psia		
				Minimum	Nominal	Maximum	Minimum	Nominal	Maximum	Minimum	Nominal	Maximum
H <sub>2</sub> Press. Line - line 8	H <sub>2</sub> Pre-pressurization	ORB to ET	GH <sub>e</sub>	1.2	1.35	1.5	480	530	580	120	150	220
	H <sub>2</sub> Pressurization <sup>n</sup>	ORB to ET	GH <sub>2</sub>	0.45	2.10	4.07	300	525	565 <sup>n</sup>	100	300	745
	Tank purge <sup>m</sup>	ORB to ET	GH <sub>e</sub>	1.2	1.35	1.50	480	530	580	120	150	220
	Ice/frost minimization	ORB to ET	GH <sub>e</sub>	0.004	0.006	0.039	494	577	660	N/A	N/A	50
LH <sub>2</sub> Recirculation line - line 9	LH <sub>2</sub> Replenish	ORB to ET	LH <sub>2</sub> <sup>p</sup>	0	2 <sup>q</sup>	5	N/A	N/A	38.1	17	18	19
	LH <sub>2</sub> Replenish and recirculation	ORB to ET	LH <sub>2</sub> <sup>p</sup>	4	6.5	10	N/A	N/A	38.1	17	18	19
	LH <sub>2</sub> Recirculation	ORB to ET	LH <sub>2</sub> <sup>p</sup>	4	4.5	5	N/A	N/A	44.7	17	N/A	48
	LH <sub>2</sub> Topping	ORB to ET	LH <sub>2</sub> <sup>p</sup>	5	9	12	N/A	N/A	41	17	18	55
	LH <sub>2</sub> Topping and recirculation	ORB to ET	LH <sub>2</sub> <sup>p</sup>	9	13.5	16	N/A	N/A	41	17	18	55

\*NOTE - For notes see pages 5.3.4-4.

Table 5.3.4-1 notes:

- <sup>a</sup>Fluid procurement specifications and use limits are per SE-S-0073B.
- <sup>b</sup>For line 1, the maximum pressure including surge will not exceed 261 psia and this results from on Orbiter main engine shutting down from full power level prior to SRB burn-out at the maximum steady-state interface total pressure of 201 psia prior to shutdown. The maximum surge pressure of 110 psi results from the Orbiter main engines sequentially shutting down from full power level on the launch pad at a steady-state total pressure of 106 psia prior to shutdown. The minimum pressure during transients is equal to the LO<sub>2</sub> vapor pressure. For line 7, the maximum pressure including surge will not exceed 53 psia and this results from the Orbiter main engines sequentially shutting down from full power level on the launch pad at a steady-state total pressure of 46 psia prior to shutdown with a maximum surge of 7 psi. The total pressure during the engine start-transient shall not drop more than 6.0 psi below subsequent steady-state flow total pressure at the interface. For line 7, the maximum pressure prior to main engine start is not to exceed 55 psia. There is negligible surge in lines 2, 8, and 9.
- <sup>c</sup>The maximum integrated average LO<sub>2</sub> temperature during fast fill shall not exceed 166° R.
- <sup>d</sup>Zero flow conditions exists only during transition of flow from Orbiter to ET or ET to Orbiter.
- <sup>e</sup>Under steady-state conditions, ET boiloff due to heat leak may vary from 0.55 to 1.75 lb/sec. ET boiloff due to heat input from the Orbiter may vary from 0 to 0.1 lb/sec.
- <sup>f</sup>Will be maintained a minimum of 5 minutes prior to start of LO<sub>2</sub> drain-back. Maximum/minimum LO<sub>2</sub> interface temperatures are based on the range of Orbiter
- <sup>g</sup>LO<sub>2</sub> feed system heat loads listed below per Orbiter. See figures 5.3.4-11 through 5.3.4-16 from appropriate Orbiter LO<sub>2</sub> interface temperatures (ET/Orbiter and Orbiter/SSME) during drainback with anti-geyser line removed.

Orbiter	Heat leak, Btu/sec	
	Minimum	Maximum
OV-102	13.5	14.2
OV-103	16.3	17.3
OV-104	16.3	17.3

- <sup>h</sup>Pressurization and LO<sub>2</sub> drain rate limitation is required during LO<sub>2</sub> drain with LO<sub>2</sub> vent valve open. LO<sub>2</sub> drain rate shall not exceed 237 lb/sec.
- <sup>i</sup>Subsequent to the initiation of LO<sub>2</sub> drainback, a total of 5,700 lb of LO<sub>2</sub>, that is drained and boiled-off, is lost overboard prior to main engine start. A minimum drainback time of 4 minutes 50 seconds is required.
- <sup>j</sup>Operating pressure is not a functional requirement for ice/frost minimization. Interface pressure from ice/frost minimization flow shall not exceed 50 psia.
- <sup>k</sup>Worst case maximum temperature based on the Orbiter having the worst case maximum heat leak (OV-103). See figures 5.3.4-13 and 5.3.4-16 for drainback temperatures for Orbiter OV-103 and OV-104.
- <sup>m</sup>When purging to remove moisture, the purge gas and tank temperature must be 510° R or greater.
- <sup>n</sup>Minimum temperature is transient at Orbiter main engine start. Time to reach 90 percent of steady-state temperature is 15 seconds maximum.
- <sup>o</sup>Temperature excursions can occur up to 41° R for 200 seconds after initiation of fast fill.
- <sup>p</sup>May be 100-percent vapor (1.5 lb/sec maximum) at start of topping, replenish and recirculation, 50-percent vapor of volume maximum for steady-state conditions.
- <sup>q</sup>Under steady-state conditions, ET boiloff due to ET heat leak may vary from 0.6 to 0.9 lb/sec. ET boiloff due to heat input from the Orbiter may vary from 0 to 0.2 lb/sec.

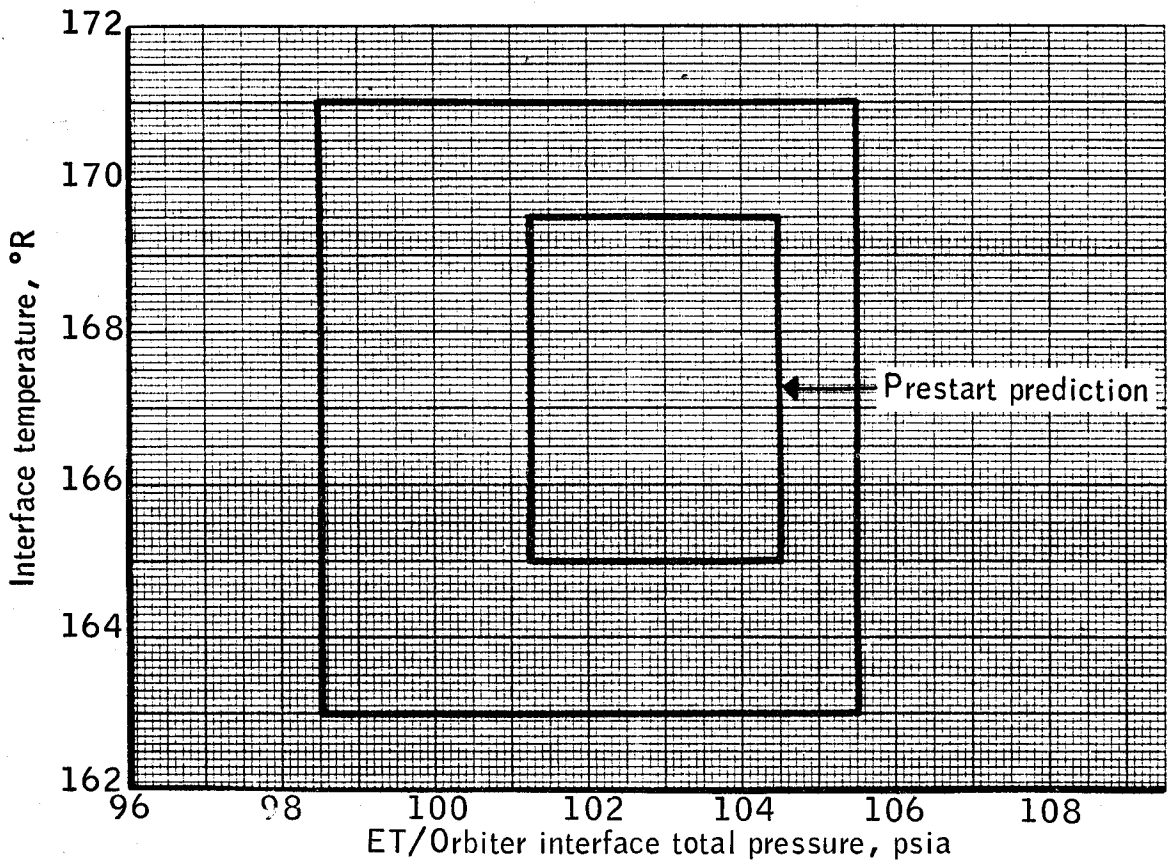

Figure 5.3.4-1.- Orbiter/ET separation interface L<sub>2</sub> prestart requirements.  
(Paragraph 5.3.4)

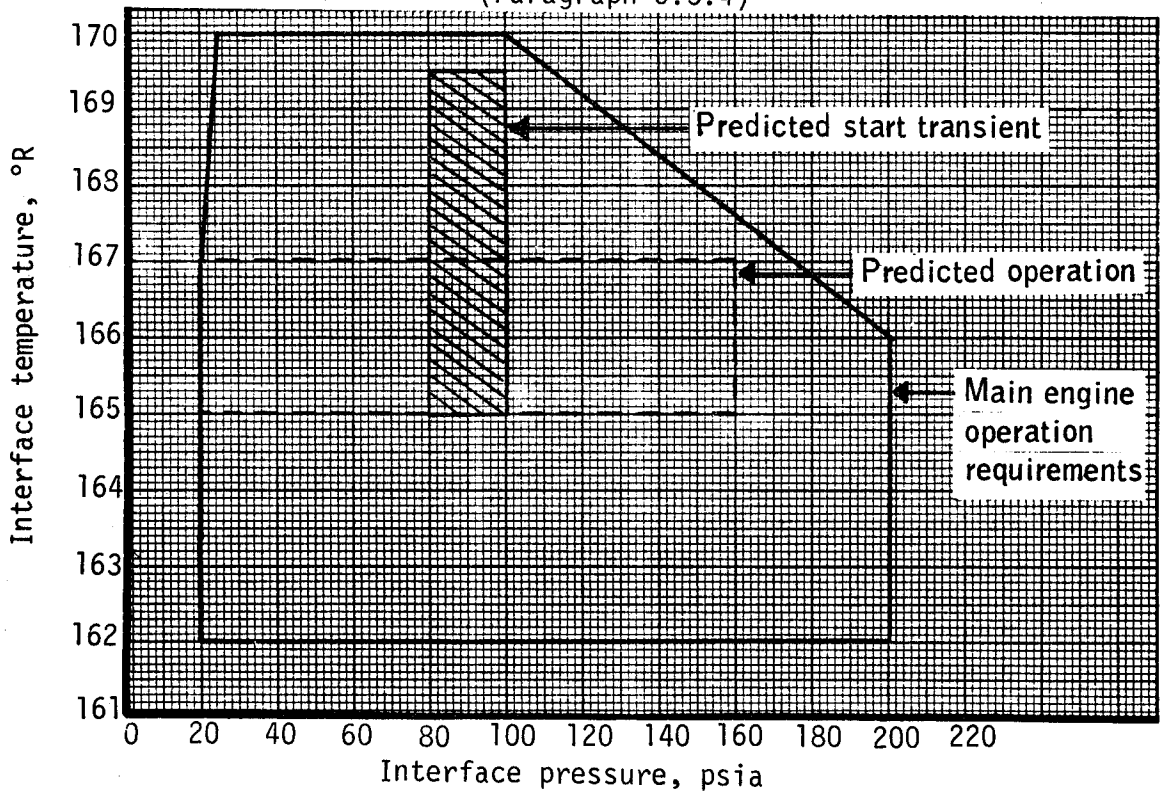

Figure 5.3.4-2.- Liquid oxygen Orbiter/ET interface pressure/temperature history during main engine operation.

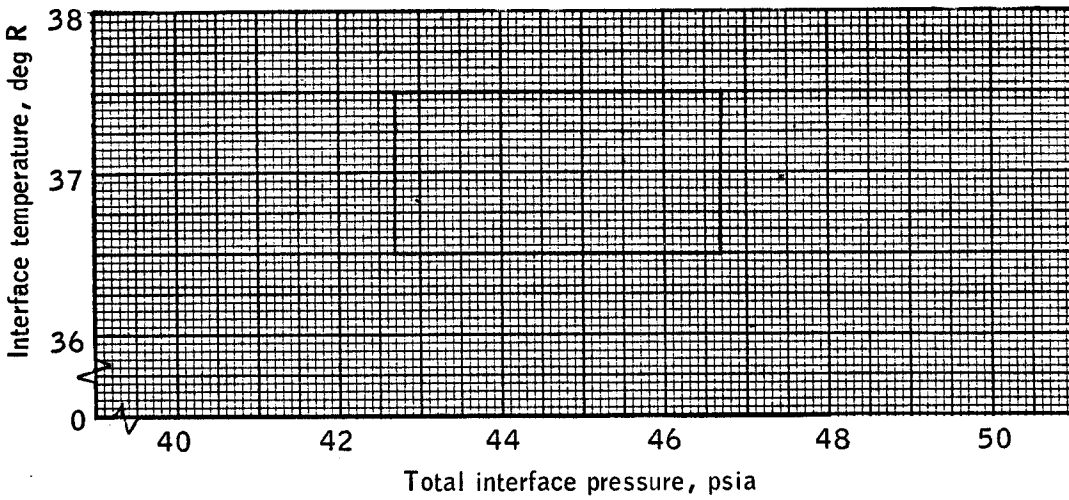

Figure 5.3.4-3.- Orbiter/ET separation interface liquid hydrogen prestart requirements.  
(paragraph 5.3.4)

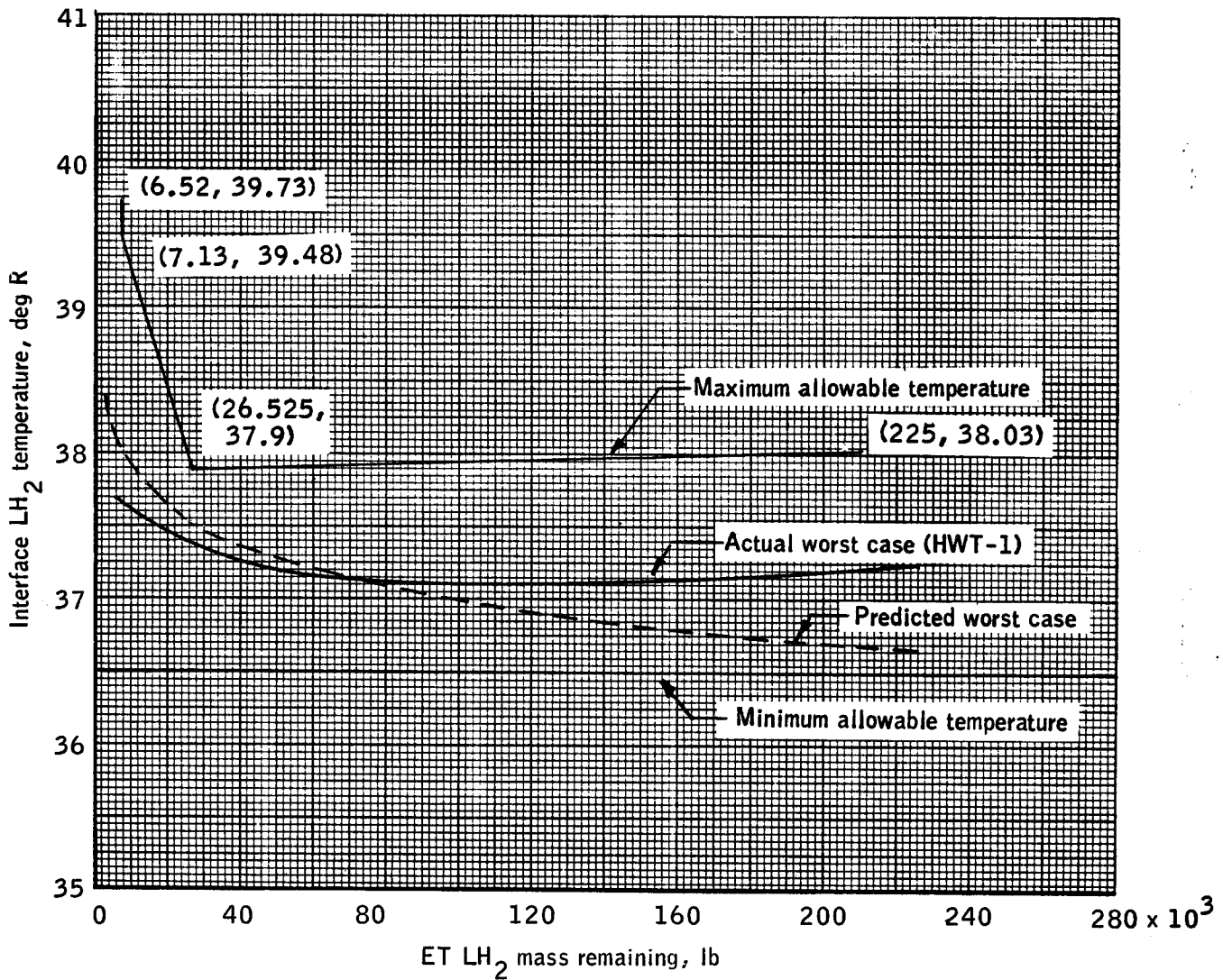

Figure 5.3.4-4.- Orbiter/ET separation interface liquid hydrogen temperature versus liquid hydrogen mass remaining.  
(paragraph 5.3.4)

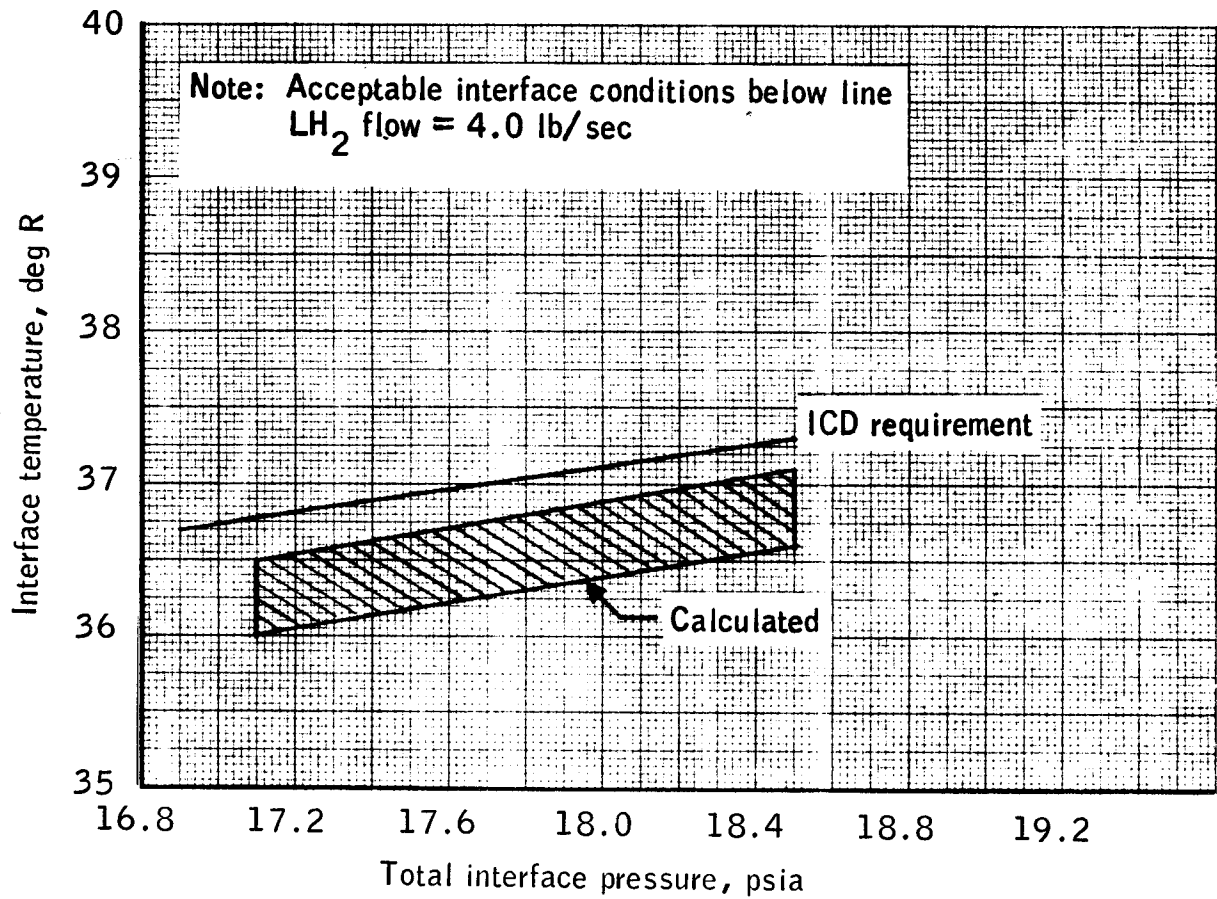
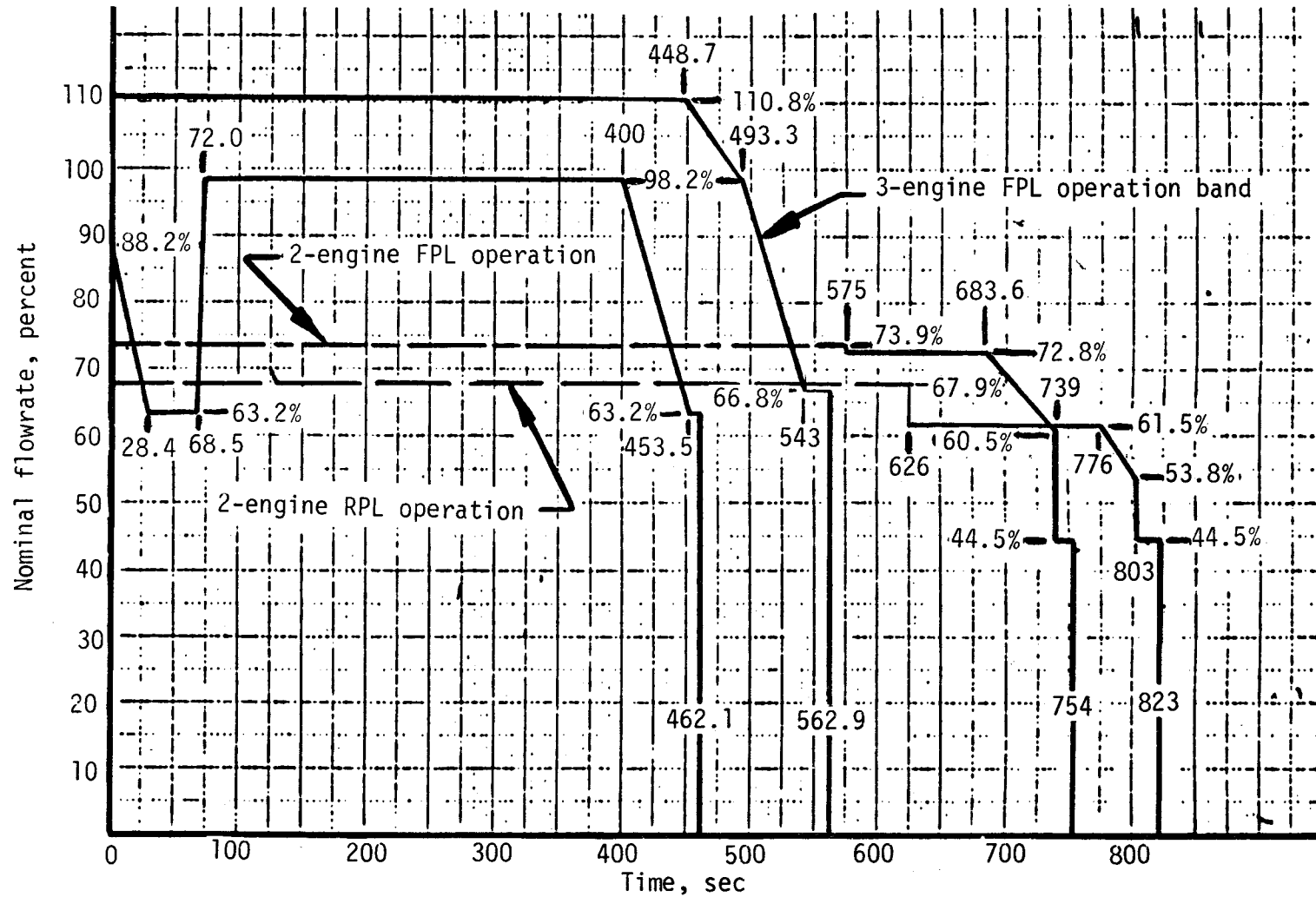

Figure 5.3.4-5.- Orbiter/ET separation interface liquid hydrogen main feedline propellant requirements during recirculation with liquid hydrogen tank unpressurized. (Paragraph 5.3.4)

## 5.3.4-8



Nominal flowrates:  $\text{LO}_2 = 2658 \text{ lb/sec}$   
 $\text{LH}_2 = 444 \text{ lb/sec}$

Figure 5.3.4-6.- Orbiter/ET separation interface  $\text{LH}_2$  and  $\text{LO}_2$  main engine operation flowrate requirements.  
 (Paragraph 5.3.4)

Flowrates are for nominal conditions (to be used for performance analysis only)

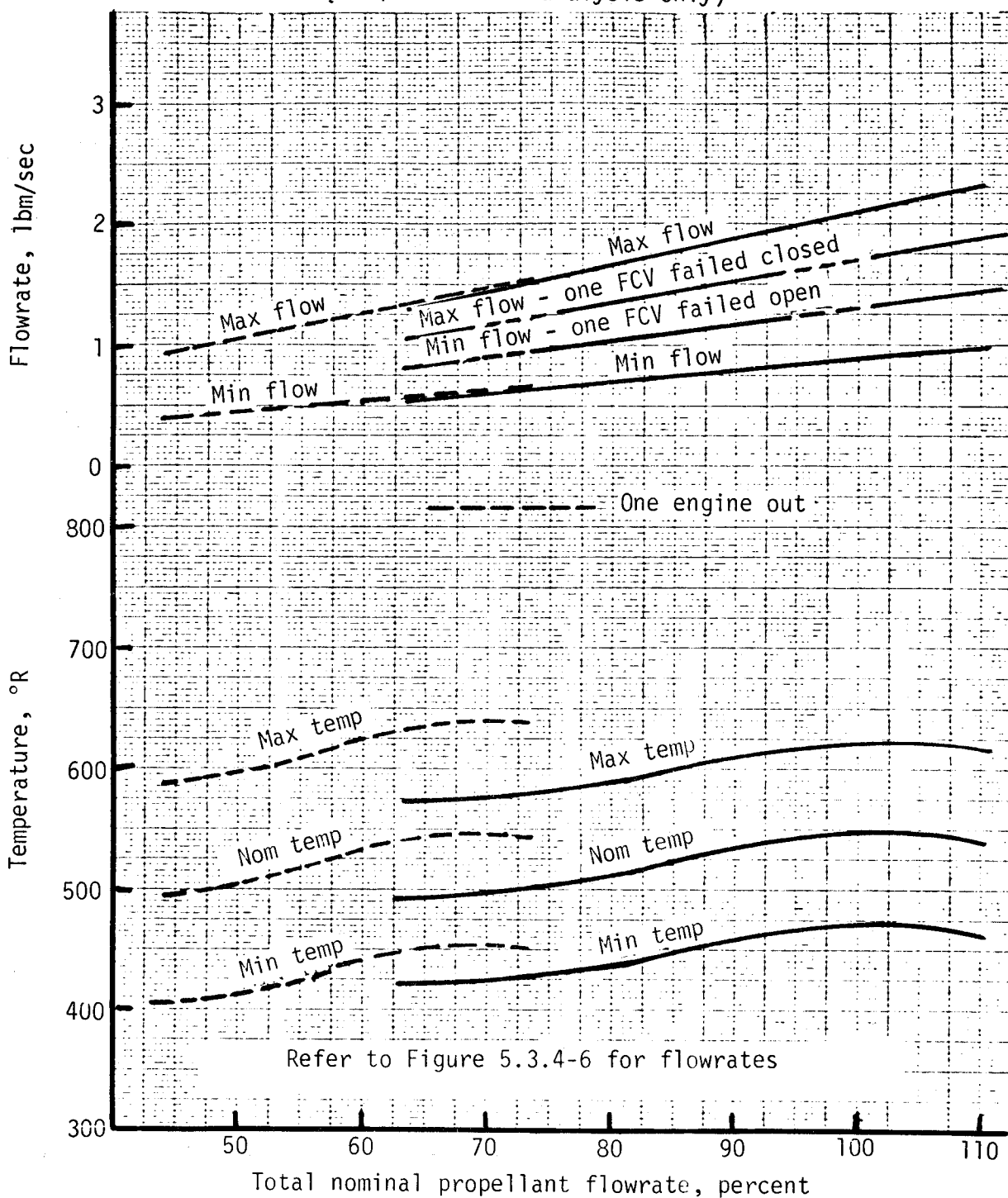

Figure 5.3.4-7.- Orbiter/ET interface  $\text{GH}_2$  pressurant characteristics. (Paragraph 5.3.4)



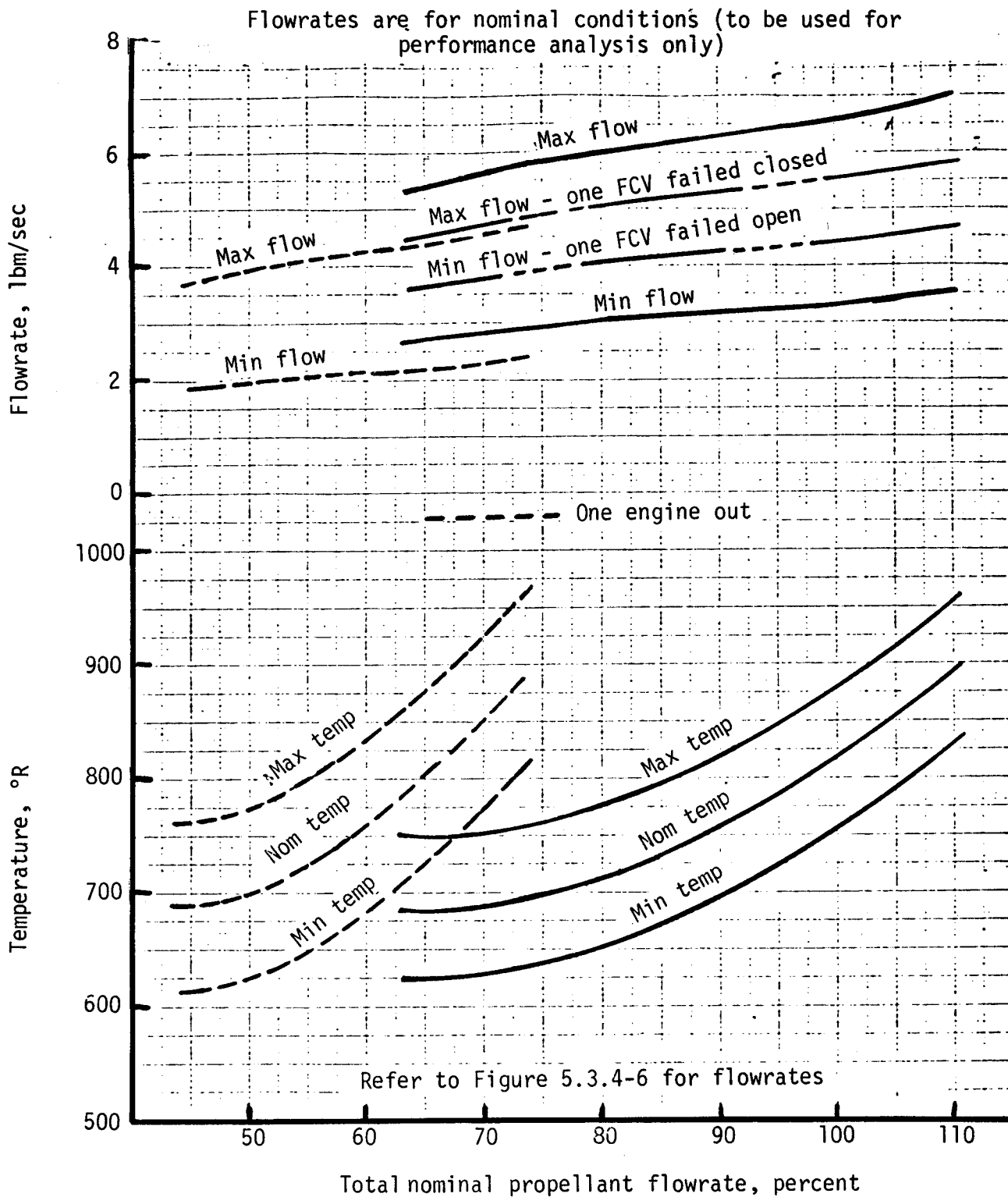

Figure 5.3.4-8.- Orbiter/ET separation interface  $GO_2$  pressurant characteristics. (Paragraph 5.3.4)

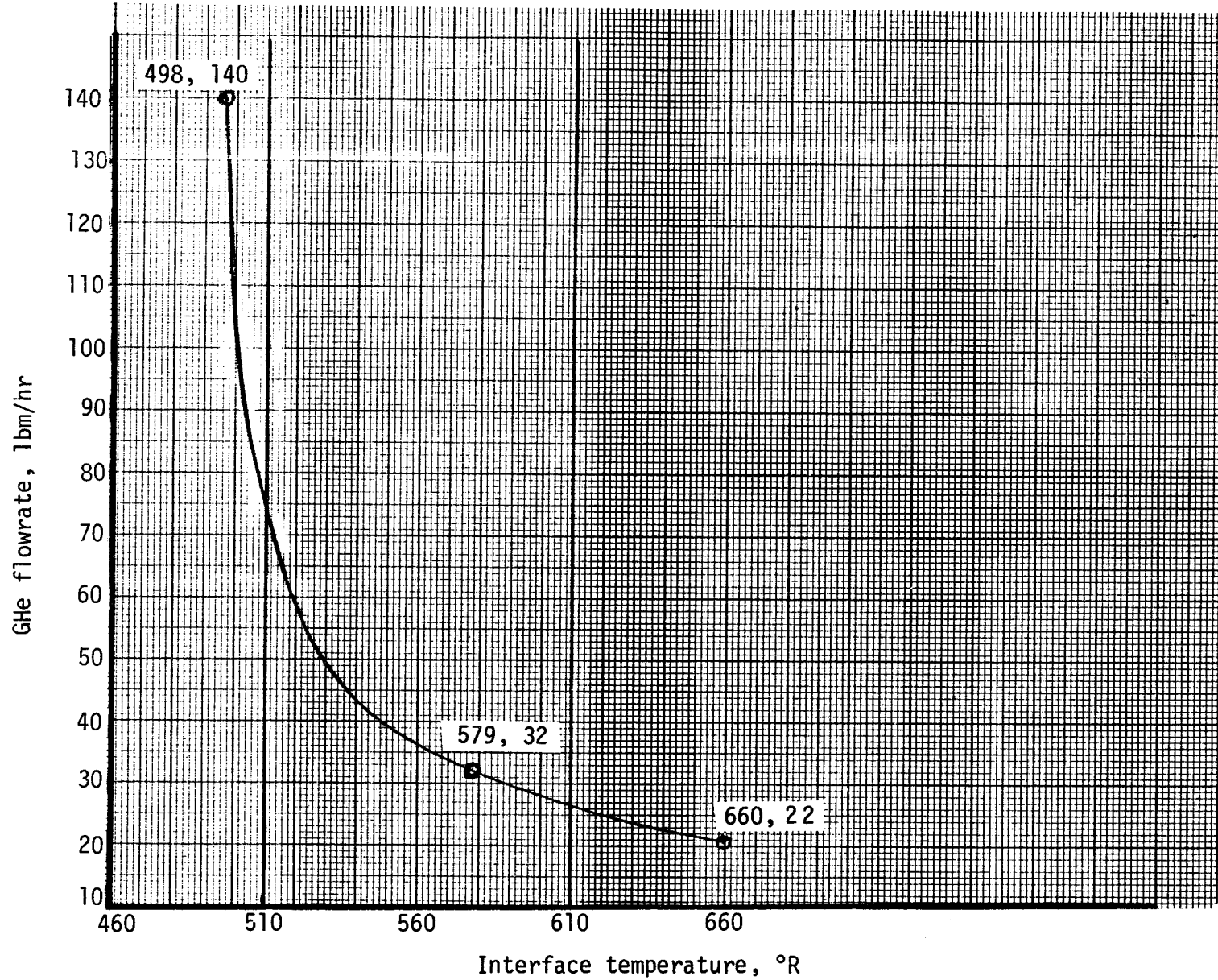

Figure 5.3.4-9.- GHe flow rate vs. temperature requirements (G02 pressurization line).  
(Paragraph 5.3.4)

## 5.3.4-12

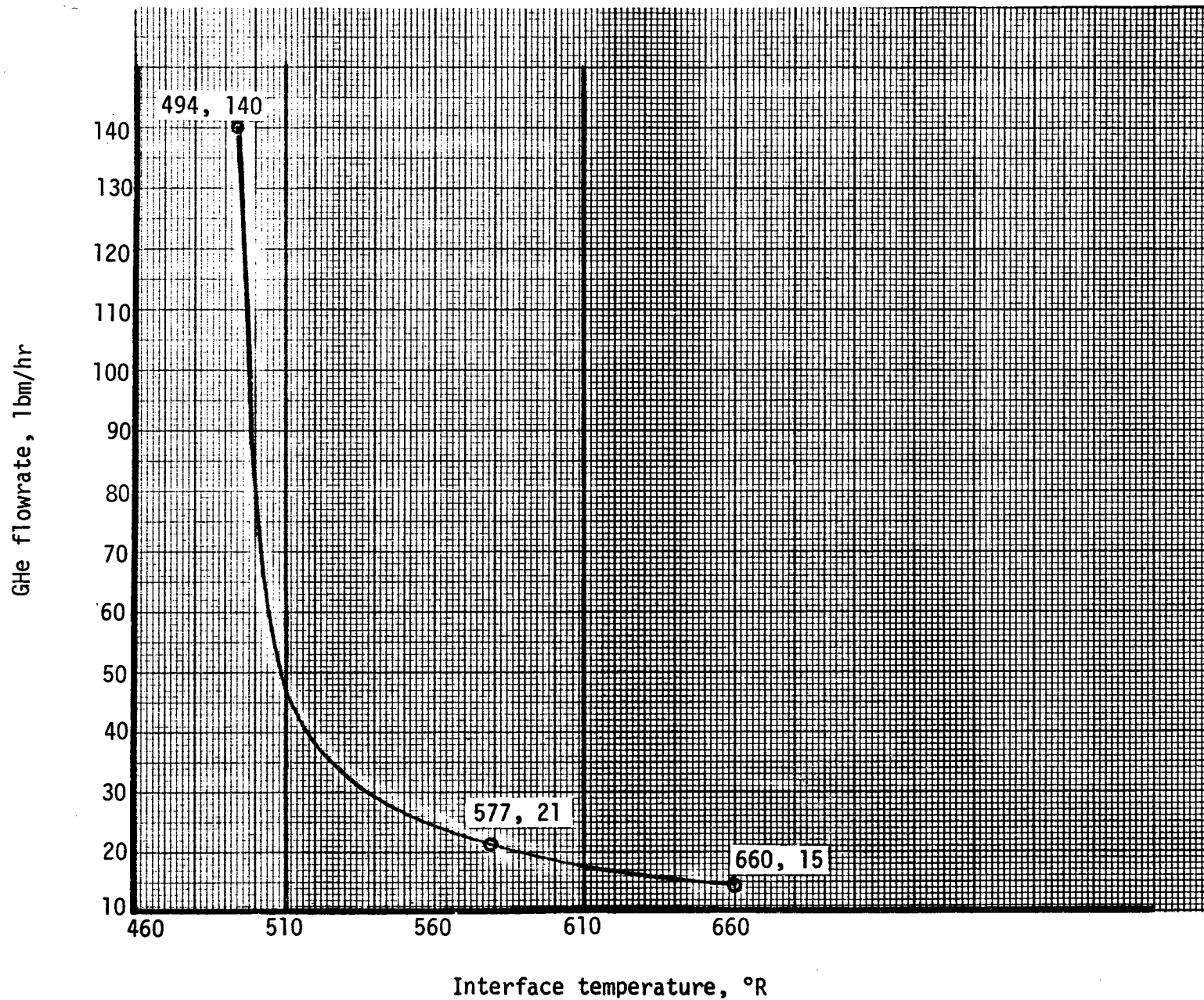

Figure 5.3.4-10.- GHe flow rate vs. temperature requirements (GH<sub>2</sub> pressurization line).  
(Paragraph 5.3.4)

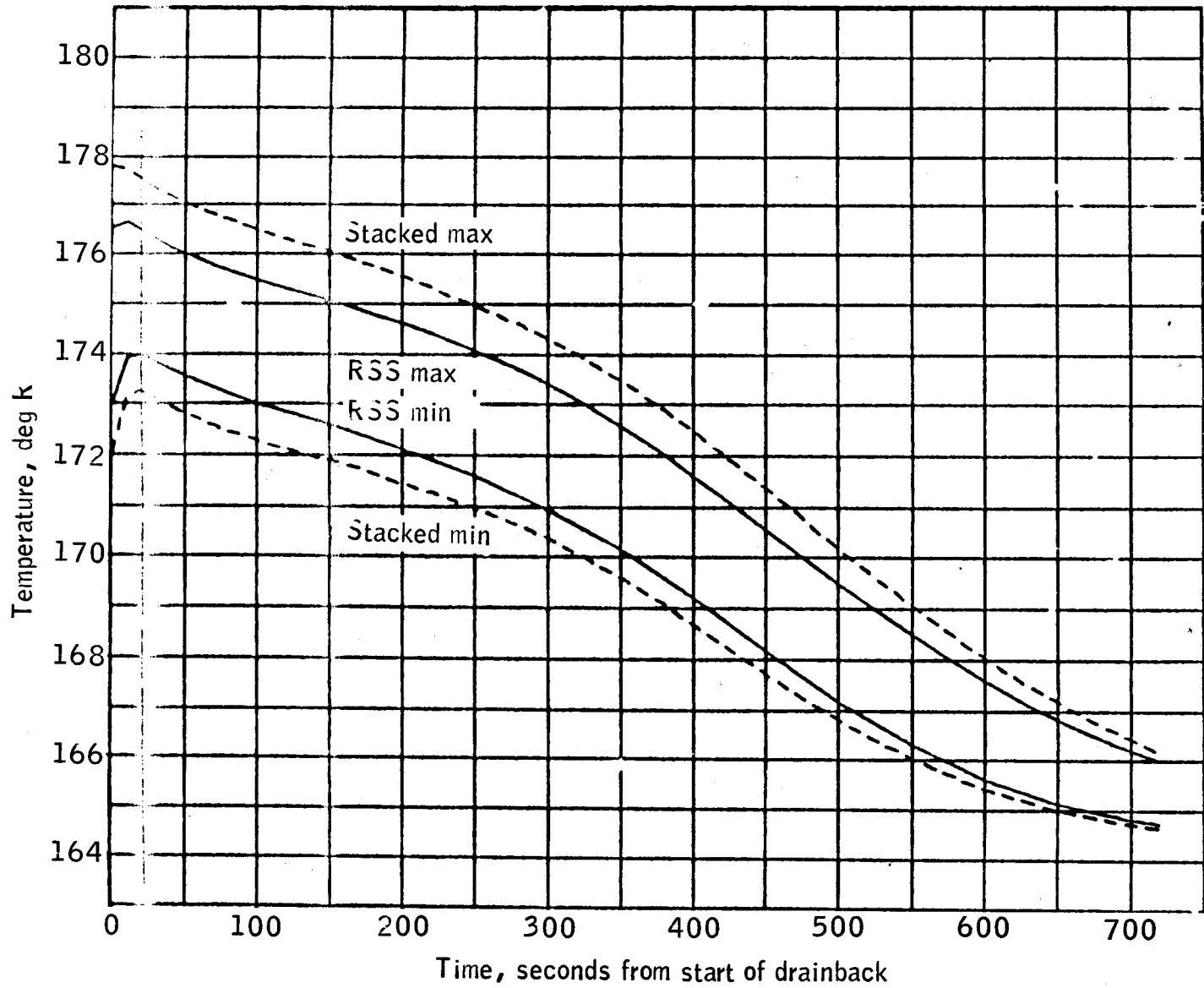

Figure 5.3.4-11.- GV-102 predicted ET-orbiter interface drainback temperature.

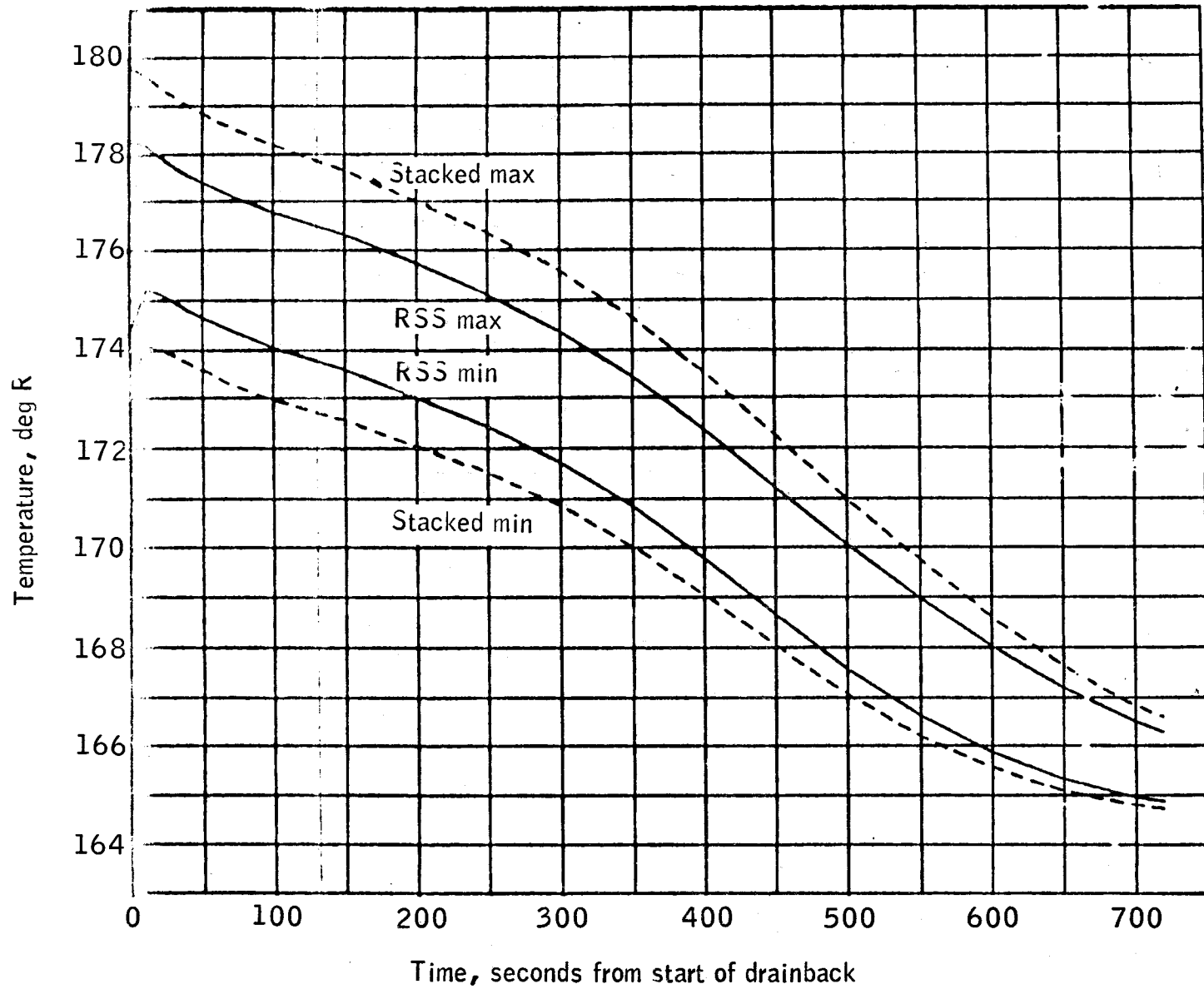

Figure 5.3.4-12.- OV-103 and OV-104 predicted ET-orbiter interface drainback temperature.

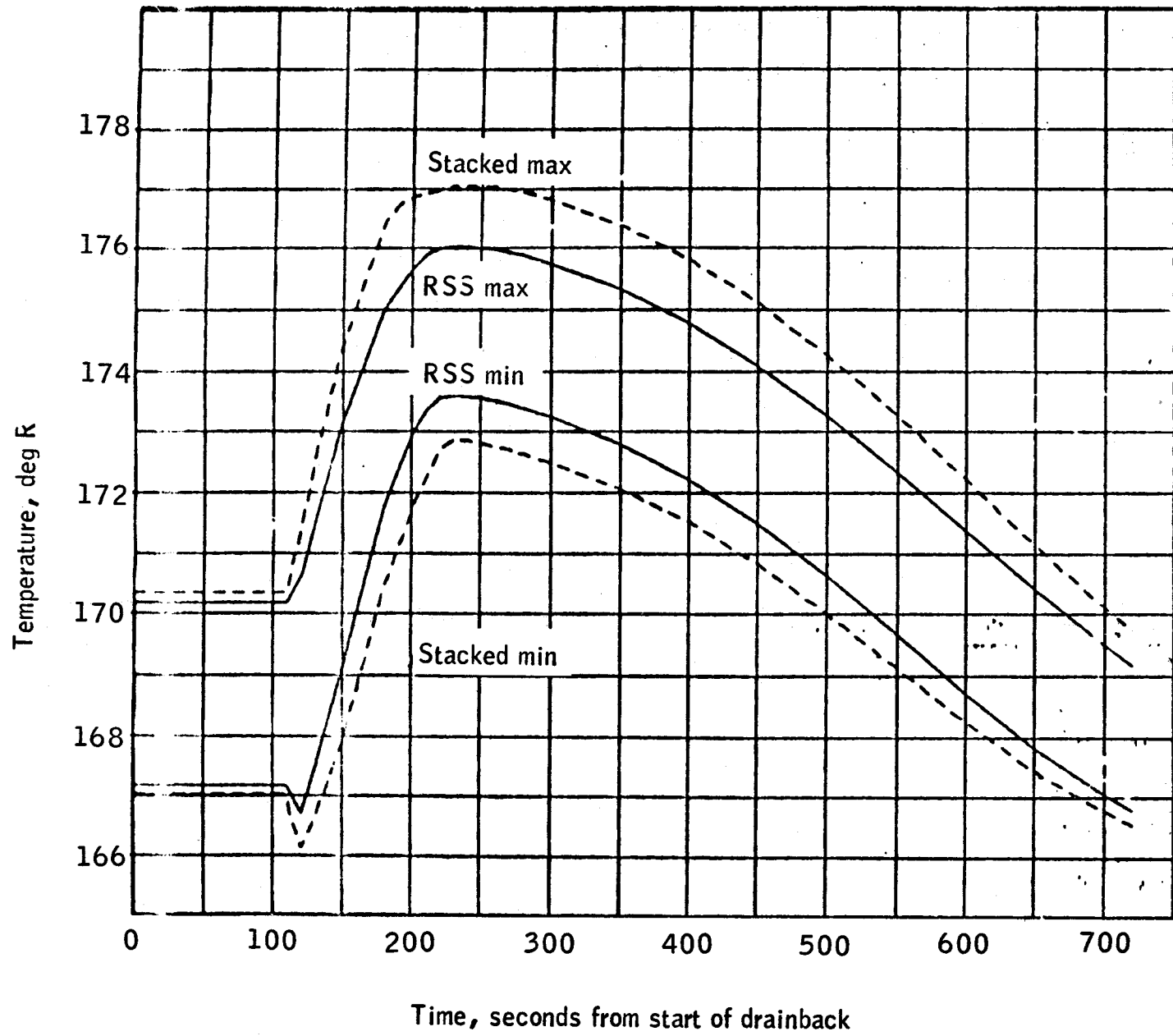

Figure 5.3.4-13.- CV-102 predicted engine inlet drainback temperature.

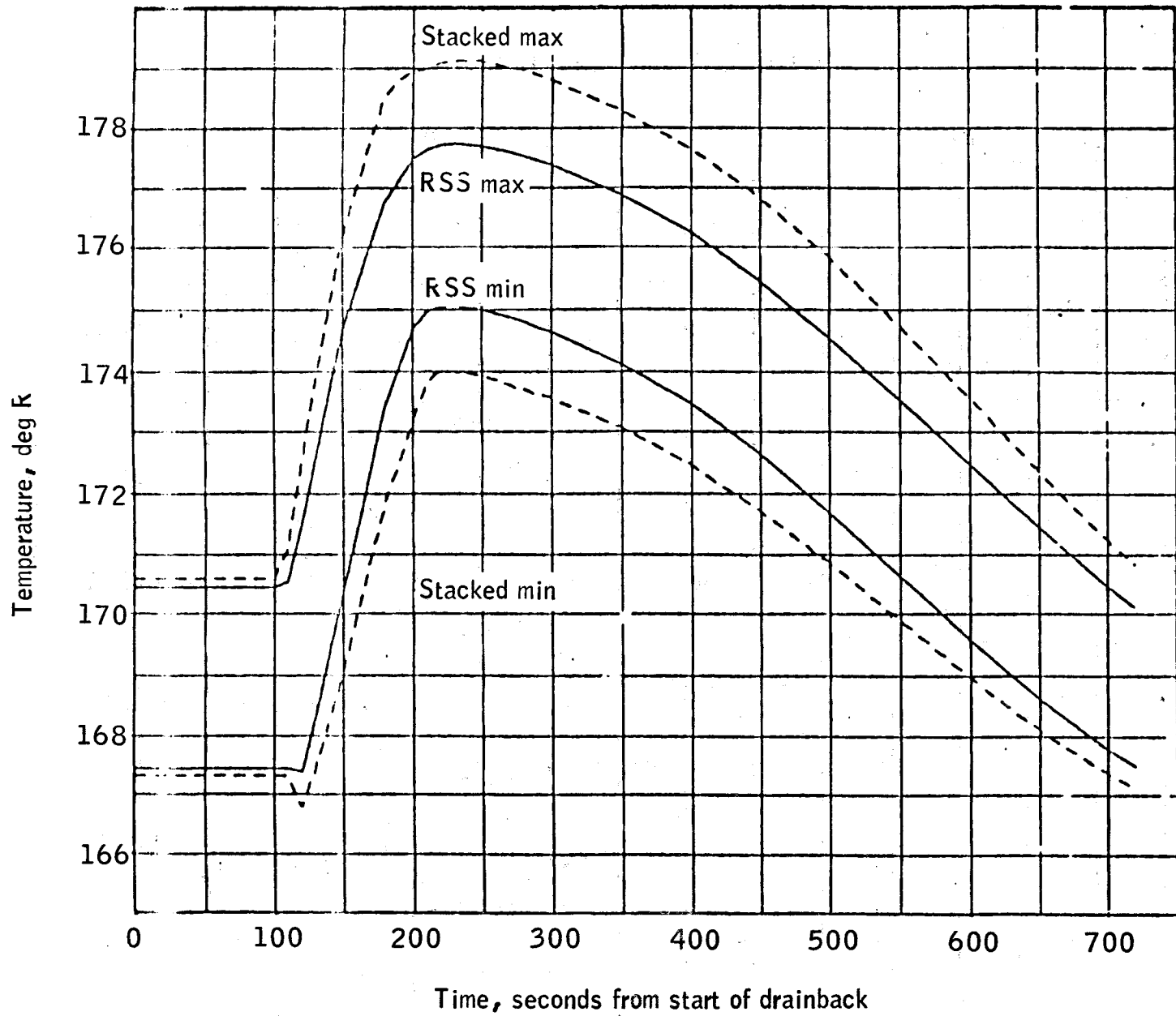

Figure 5.3.4-14.- OV-103 and OV-104 predicted engine inlet drainback temperature.

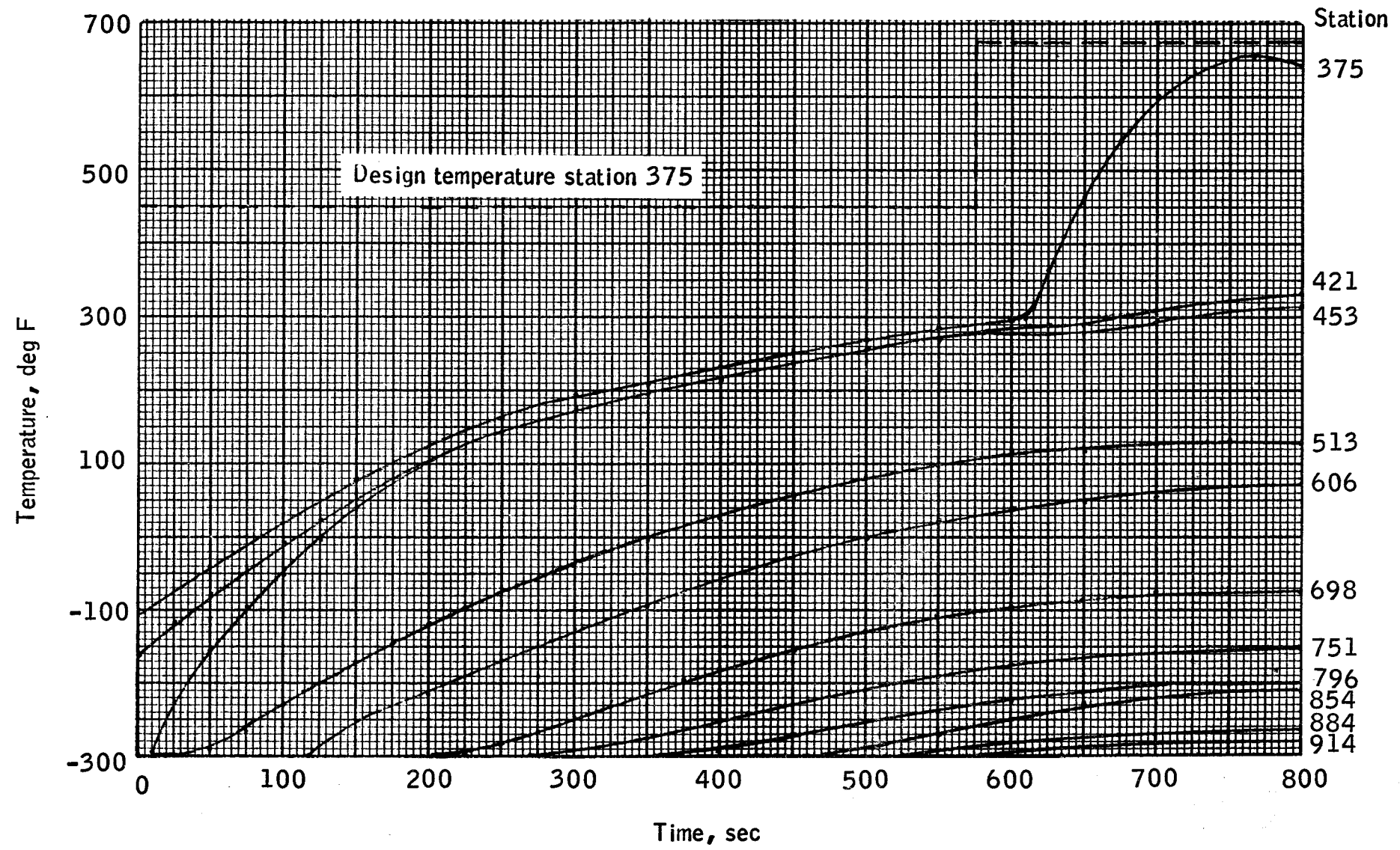

Figure 5.3.5-1.- LO<sub>2</sub> tank structural temperatures during ascent (LWT 16 and up).  
(Paragraph 5.3.5.2)



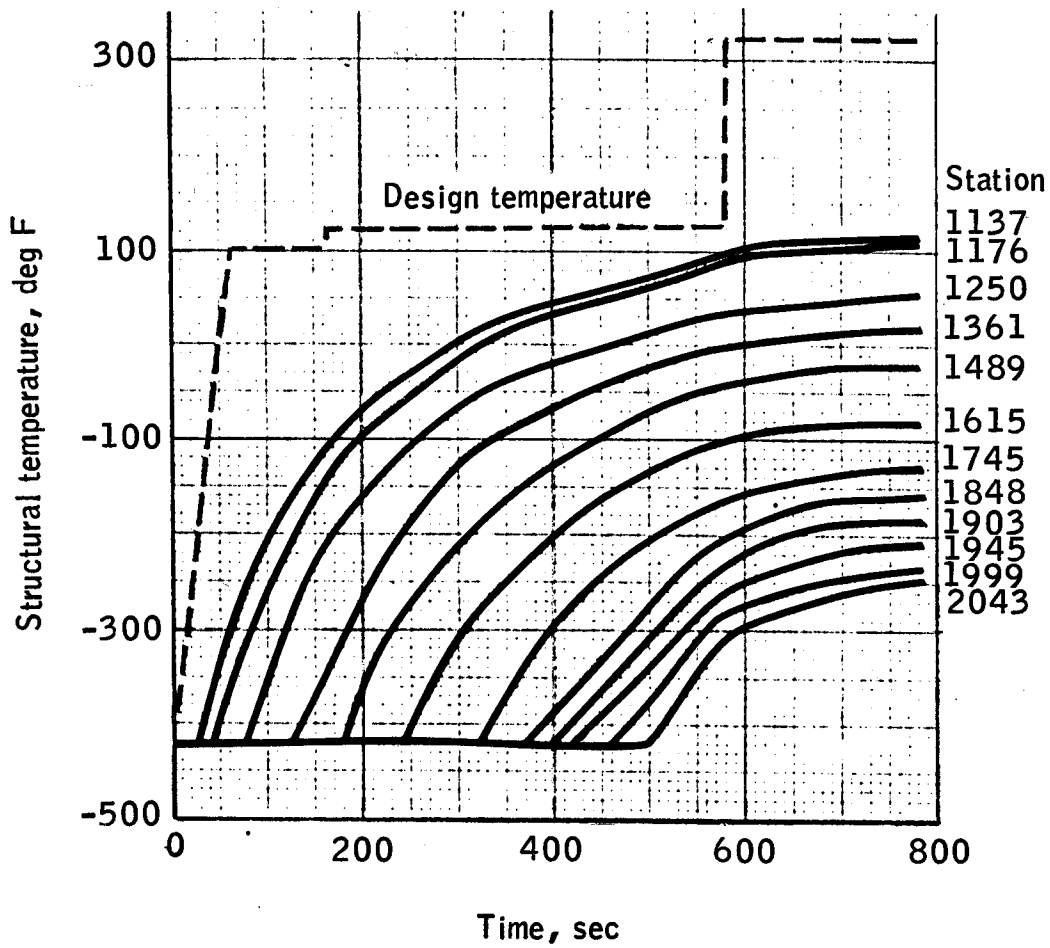

Figure 5.3.5-2.- LH<sub>2</sub> tank barrel structural temperatures during ascent.  
 (Paragraph 5.3.5.2)

5.4  
5.4.1

**AVIONICS SUBSYSTEMS  
INSTRUMENTATION**

a. Measurements	Appropriate MML
b. Command interface characteristics	Table 5.4.1-1
c. Sensor outputs	
1. Vent valve	3
2. Ullage temperature	2
3. Ullage pressure	6
4. LH <sub>2</sub> low level	4
5. Loading	16
6. Nose cap temperature	2
7. Intertank temperature	2
8. LO <sub>2</sub> Low range ullage pressure	2
9. Tumble system armed	1
10. RSS	22

TABLE 5.4.1-1.- COMMAND INTERFACE CHARACTERISTICS  
 (Paragraph 5.4.1)

Characteristics	Point sensor checkout	
	Tank	Orbiter
Element	Point sensor controller 22 gage - single conductor	MDM
Voltage	N/A	28 V $\pm$ 4V nominal
Load	20 mA	N/A
Sensor Impedance	LO <sub>2</sub> - 130 to 165 ohms LH <sub>2</sub> - 130 to 165 ohms	N/A
Cable resistance to sensors	LO <sub>2</sub> - 0.6 to 9.5 ohms LH <sub>2</sub> - 0.1 to 6.5 ohms	<u>TBS</u>
Timing	Continuous signal	Continuous signal

5.4.2  
5.4.2.1

**ELECTRICAL POWER DISTRIBUTION AND CONTROL**

**Power Requirements**

**a. Voltage**

- |                     |   |
|---------------------|---|
| 1. Maximum          | 32.0 Vdc  |
| 2. Minimum          | 26.0 Vdc  |
| 3. Ripple voltage   | 0.9 V p-p maximum at<br>any individual<br>frequency |
|                     | 1.6 V p-p broadband<br>(10 Hz to 150 kHz)           |
| 4. Transient limits | Figure 5.4.2-1                                      |

**b. AC voltage**

1. 85 Vac  $\pm$  0.85 Vac
2. 93 Vac  $\pm$  9.3 Vac
3. 72 Vac  $\pm$  7.2 Vac
4. 122 Vac  $\pm$  1.22 Vac

5.4.2.2

**ET Loads**

**a. LO<sub>2</sub> ullage low-range pressure transducer**

40 ma max.

**b. ET heaters**

- |   |   |
|---|---|
| 1. Bipod heater - Long                      | 1.0 amp $\pm$ 0.2 amp                       |
| - Short                                     | 1.0 amp $\pm$ 0.2 amp                       |
| 2. LO <sub>2</sub> feedline bracket heater  | 1.7 amp $\pm$ 0.32 amp                      |
| 3. LO <sub>2</sub> elbow bracket heaters    | 1.7 amp $\pm$ 0.32 amp/<br>heater           |
| 4. LH <sub>2</sub> feedline bracket heaters | 0.25 amp $\pm$ 0.06 amp/<br>pair of heaters |

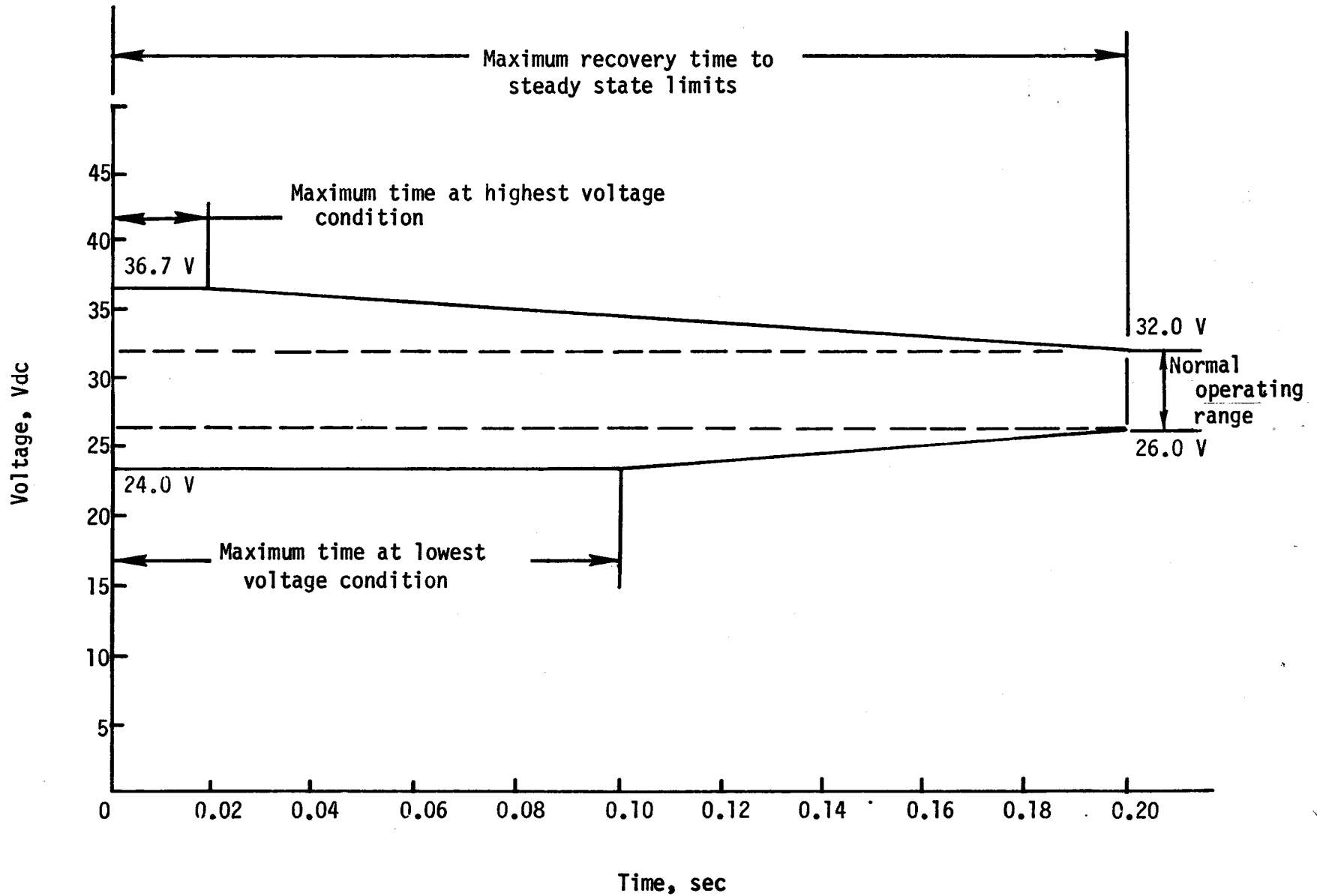

Figure 5.4.2-1.- Transient surge of dc voltage step function loci limits during normal equipment switching condition. (Paragraph 5.4.2)

### 5.4.3

#### TUMBLING SYSTEM

As a means of assuring ET impact in a defined landing area, the ET is made to tumble shortly after Orbiter/ET separation (Figure 5.4.3-1). The tumble system is initiated just prior to separation by the Orbiter. The ET receives an electrical signal that, via a relay switch module, fires the NSI detonator in the pyro cartridge. This opens a 2-inch valve mounted on the ogive forward ring forging. The residual  $GO_2$  is vented in the +Z axis, providing the required tumble thrust. The 2-inch pyrotumble valve mounts to the forward ring frame of the  $LO_2$  tank 16 degrees from the +Z axis toward the +Y axis.

- |                                    |                   |
|------------------------------------|-------------------|
| a. Venting thrust                  | 45 to 100 lbf     |
| b. Thrust location and direction   | Figure 5.4.3-1    |
| c. Pyro cartridge, valve actuation | Paragraph 4.2.9.2 |

Note: For internal TPS details see page 5.4.3-3.

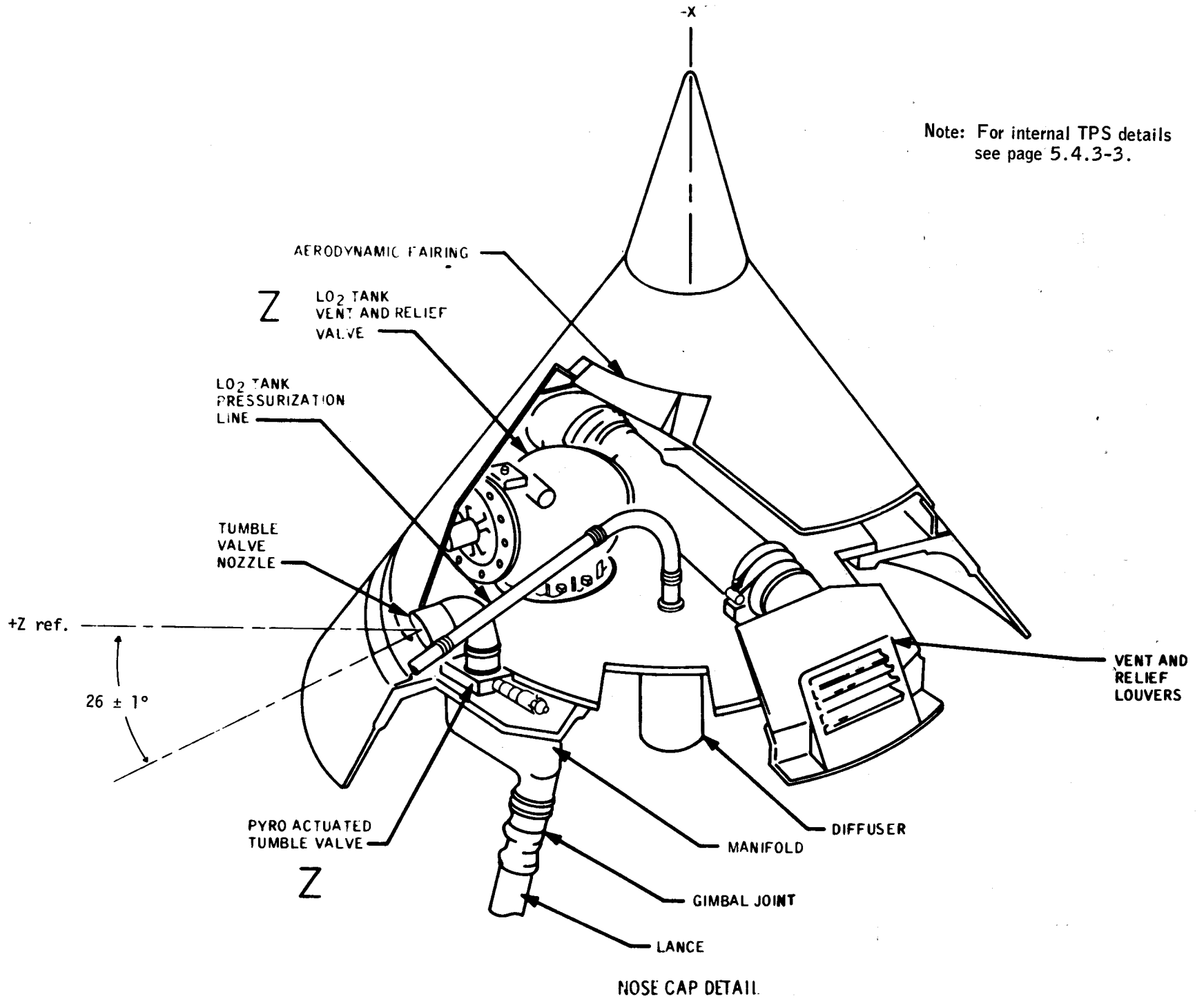

Figure 5.4.3-1. - ET tumble system.  
(Paragraph 5.4.3)

5.4.3-2

5.4.3-3

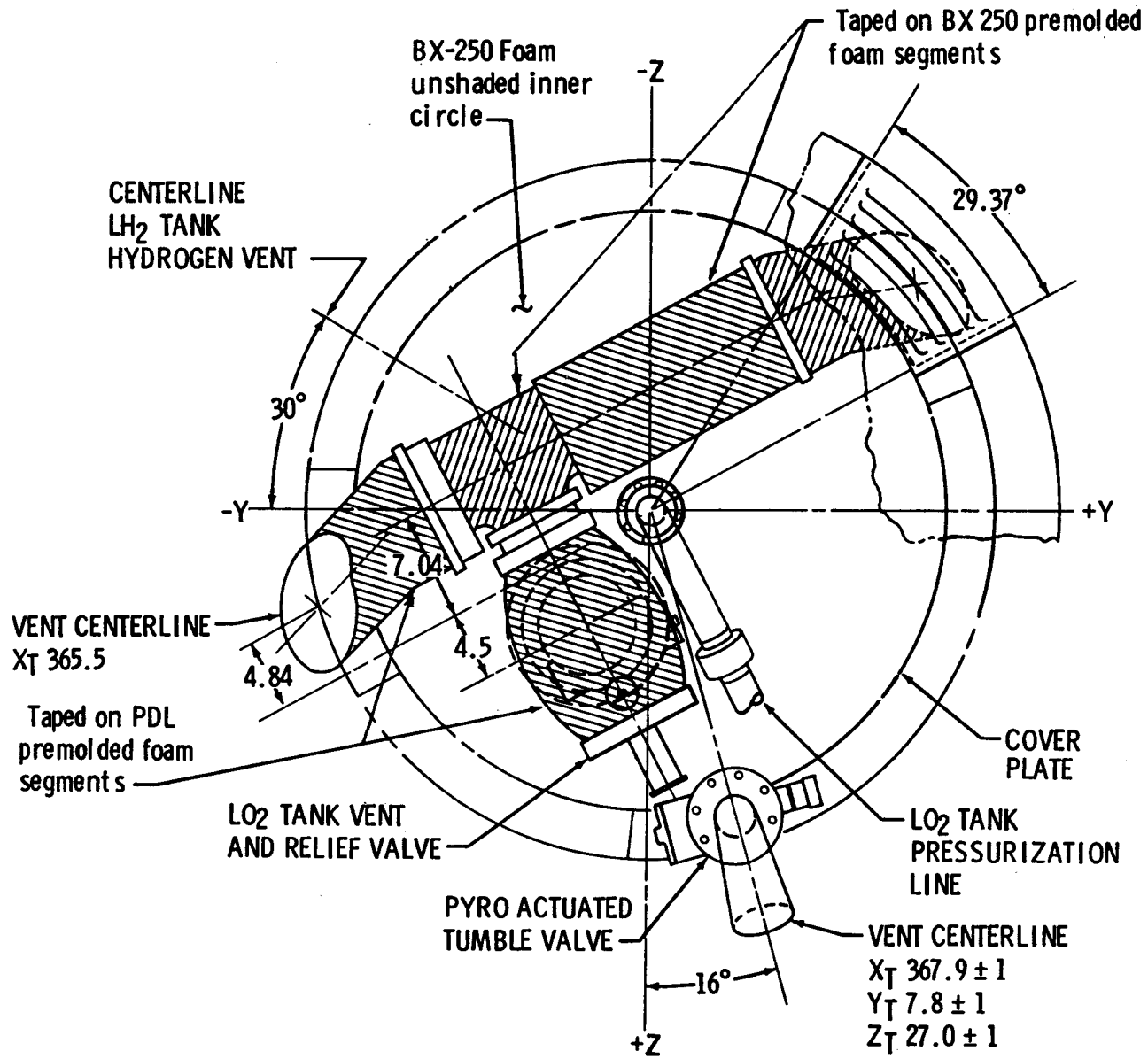

Figure 5.4.3-1.- ET tumble system (concluded).  
(Paragraph 5.4.3)



- 5.5 RANGE SAFETY SUBSYSTEM
- 5.5.1 RANGE SAFETY SUBSYSTEM CHARACTERISTICS
  - The range safety subsystem (RSS) provides a means for dispersing the ET propellants from lift-off to ET splashdown. It includes a redundant battery power source, a receiver/decoder and associated antenna and ordnance to provide the range safety capability. See figure 5.5.1-1.
  - 5.5.1.1 Antenna Characteristics
    - Refer to paragraph 6.7.1 for antenna data applicable to both the ET and SRB.
  - 5.5.1.2 Couplers
    - 5.5.1.2.1 Directional
      - Refer to paragraph 6.7.1.2.1 for directional coupler data applicable to both the ET and SRB.
    - 5.5.1.2.2 Hybrid
      - Refer to paragraph 6.7.1.2.2 for hybrid coupler data applicable to both the ET and SRB.
  - 5.5.1.3 Integrated Receiver Decoder
    - Refer to paragraph 6.7.1.3 for integrated receiver decoder data applicable to both the ET and SRB.
  - 5.5.1.4 ET Distributor Assembly Characteristics
    - The Shuttle RSS uses a single distributor assembly on each SRB and on the ET. The ET distributor is similar to that of the SRB with slight variations in packaging and circuitry. The distributor assembly acts as the control center for the "arm and fire" commands providing the interconnect between the ET and SRB distributors.
    - Refer to paragraph 6.7.1 for distributor assembly data applicable to both the ET and the SRB.
  - 5.5.1.5 Safe and Arm Device
    - Refer to paragraph 6.7.1 for safe and arm device data applicable to both the ET and SRB.
  - 5.5.1.6 RSS Battery Characteristics
    - a. Number 2
    - b. Battery load Figure 5.5.1-2
    - Refer to paragraph 6.7.1 for other RSS battery data applicable to both the ET and SRB.
  - 5.5.1.7 Linear Shaped Charge
    - a. Explosive charge 750 grains/ft of HMX
    - b. Operating temperature 350° F
    - c. Auto-ignition of HMX ≈450° F
  - 5.5.1.8 ET Destruct
    - Refer to paragraph 4.2.10.3.9 for operational sequence.

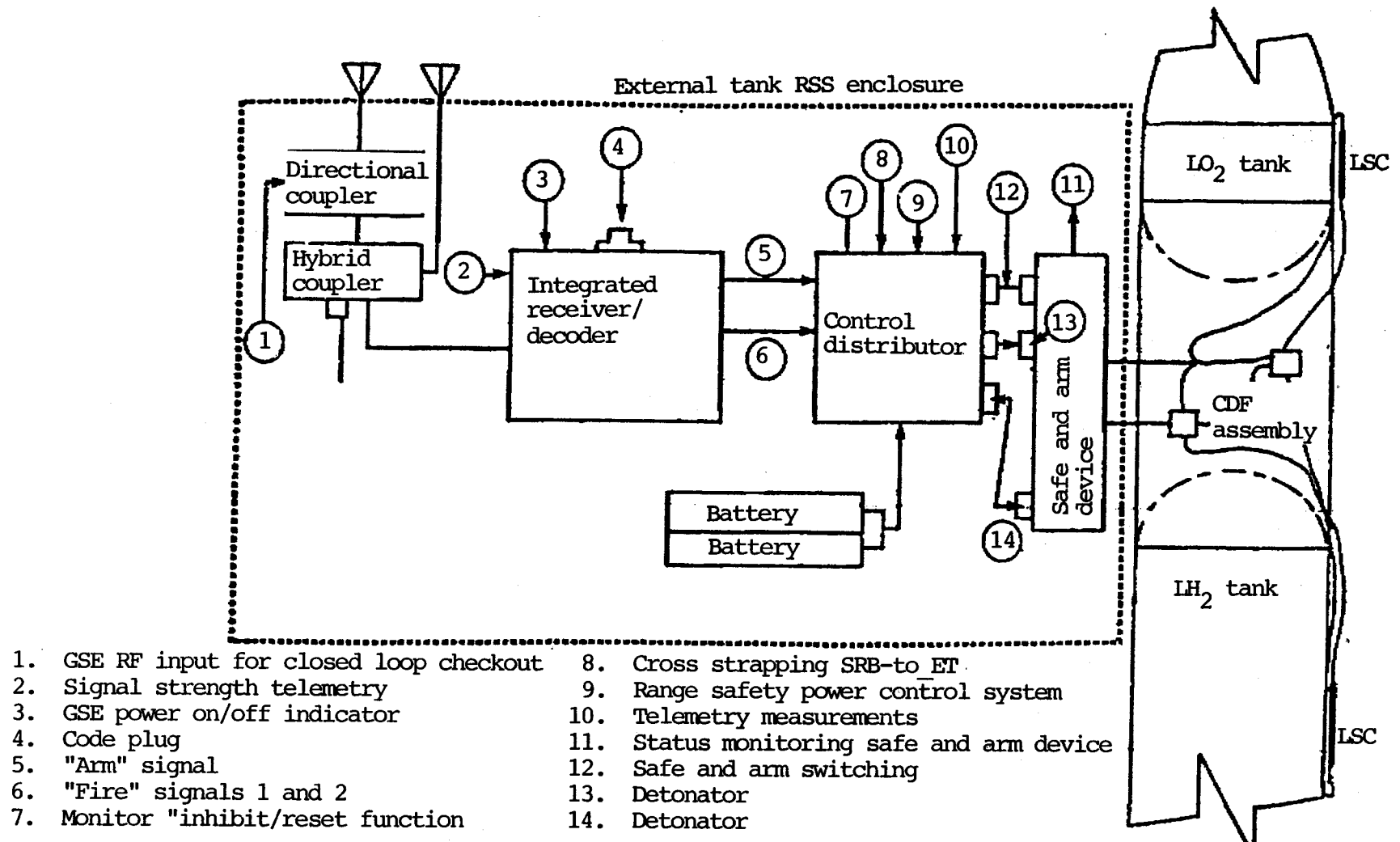
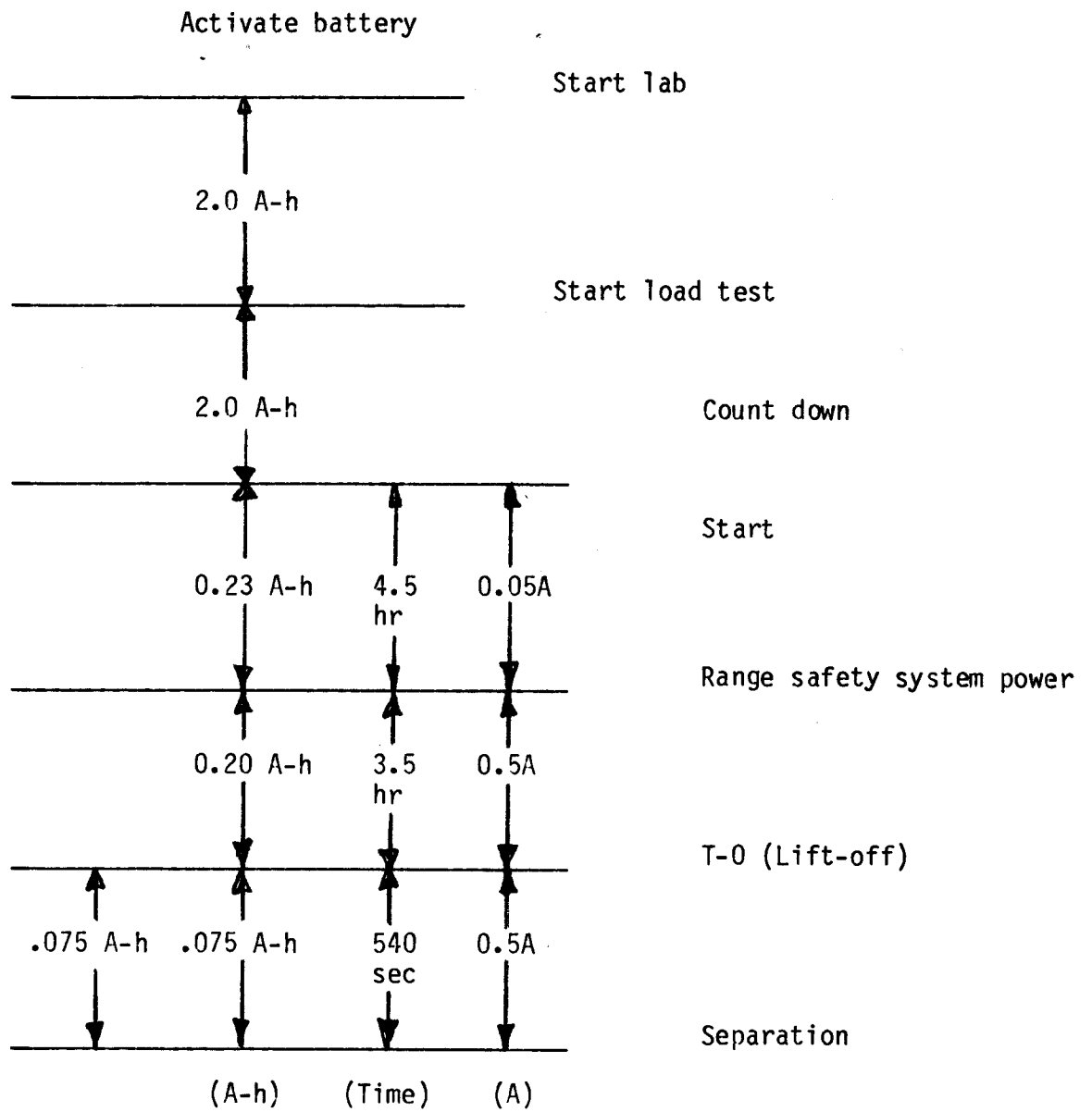

Figure 5.5.1-1.- Range safety system.  
(Paragraph 5.5.1)



Total flight requirement = .075 A-h  
 Contingency = 8.925 A-h  
 Lift-off requirement = 9 A-h

Figure 5.5.1-2.- External tank range safety system battery A/B ampere-hour requirement.  
 (Paragraph 5.5.1)

## TABLE OF CONTENTS

<u>Section</u>	
6.0	SOLID ROCKET BOOSTER PERFORMANCE AND OPERATIONAL DATA
6.1	STRUCTURES
6.1.1	STRUCTURES SUBSYSTEM
6.2	ELECTRICAL AND INSTRUMENTATION SUBSYSTEMS
6.2.1	ELECTRICAL POWER DISTRIBUTION AND CONTROL SUBSYSTEM
6.2.1.1	<u>Bus Characteristics</u>
6.2.1.2	<u>Electrical Power Loads</u>
6.2.1.3	<u>Pyrotechnic Initiator Controller</u>
6.2	ELECTRICAL AND INSTRUMENTATION SUBSYSTEMS
6.2.1	ELECTRICAL POWER DISTRIBUTION AND CONTROL SUBSYSTEM
6.2.2	INSTRUMENTATION SUBSYSTEM
6.2.2.1	<u>Flight Recorders</u>
6.2.2.2	<u>PCM Data System Multiplexer Format</u>
6.2.2.3	<u>Rate Gyro Assembly</u>
6.3	SOLID ROCKET MOTOR SUBSYSTEM
6.3.1	SOLID ROCKET MOTOR OPERATIONAL CHARACTERISTICS
6.3.1.1	<u>Single Motor Performance</u>
6.3.1.2	<u>SRM Performance Predictions</u>
6.3.1.3	<u>SRB Generic Performance Predictions</u>
6.3.1.3.1	Winter Season
6.3.1.3.2	Summer Season
6.3.1.4	<u>SRB Performance At Any PMBT</u>
6.3.2	PROPELLANT CHARACTERISTICS
6.3.3	IGNITER CHARACTERISTICS
6.3.4	NOZZLE CHARACTERISTICS
6.4	THRUST VECTOR CONTROL
6.4.1	THRUST VECTOR CONTROL CHARACTERISTICS
6.4.1.1	<u>Gimbal Capability</u>
6.4.2	AUXILIARY POWER UNIT SUBSYSTEM
6.4.3	HYDRAULIC SUBSYSTEM
6.4.4	SERVOACTUATORS
6.5	SEPARATION SUBSYSTEMS
6.5.1	BOOSTER SEPARATION MOTORS
6.5.2	ATTACHMENT/RELEASE MECHANISMS
6.6	RECOVERY SUBSYSTEM
6.6.1	PARACHUTE EQUIPMENT
6.6.2	FLOTATION EQUIPMENT
6.6.3	LOCATION AIDS
6.6.4	RECOVERY BATTERIES
6.7	RANGE SAFETY SUBSYSTEM
6.7.1	RANGE SAFETY SUBSYSTEM CHARACTERISTICS
6.7.1.1	<u>Antenna Characteristics</u>
6.7.1.2	<u>Couplers</u>
6.7.1.2.1	Directional
6.7.1.2.2	Hybrid
6.7.1.3	<u>Integrated Receiver-Decoder</u>
6.7.1.4	<u>SRB Distributor Assembly Characteristics</u>
6.7.1.5	<u>Safe and Arm Device</u>
6.7.1.6	<u>RSS Battery Characteristics</u>
6.7.1.7	<u>Recovery Battery Characteristics</u>
6.7.1.8	<u>SRB Destruct Assembly</u>

## 6.1 STRUCTURES

### 6.1.1 STRUCTURES SUBSYSTEM

The structural subsystem consists of the nose assembly, forward skirt, aft skirt, systems tunnel, ET attach ring, aft SRB/ET attachment struts, and secondary structure for mounting components of the other subsystems.

- |  |                 |
|--|-----------------|
| a. Maximum axial acceleration limit during ascent          | 3.0 g           |
| b. Maximum longitudinal acceleration limit during lift-off | 1.2 g           |
| c. SRB recovery limits                                     |                 |
| 1. Velocity at impact, vertical                            | 85 ft/sec       |
| 2. Maximum allowable sea-state for SRB recovery            | Paragraph 3.6.6 |
| d. SRB structural lifetime                                 | 40 uses         |

## 6.2.1 ELECTRICAL POWER DISTRIBUTION AND CONTROL

6.2.1.1 Bus Characteristics

The bus voltage characteristics listed below are applicable to both Orbiter and SRB supplied power.

- |  |                    |
|--|--------------------|
| a. Battery limits                      | 24 to 32 Vdc       |
| b. Orbiter bus limits                  | 26.15 to 32 Vdc    |
| c. Transient limits                    |                    |
| 1. Voltage                             | 22 to 36.7 Vdc     |
| 2. Recovery to steady-state limits     | 200 msec           |
| d. Ripple                              |                    |
| 1. Maximum individual ripple component | 0.9 V peak-to-peak |
| 2. Total broadband content             |                    |
| (a) 0.01 to 7 kHz                      | 1.6 V peak-to-peak |
| (b) Decrease per octave                | 40 dB              |
| (c) At 150 kHz                         | 0.002 V            |
| e. Spikes                              | Figure 6.2.1-1     |

6.2.1.2 Electrical Power Loads

- |  |       |
|--|-------|
| a. Maximum power transfer from Orbiter to each SRB |       |
| 1. Steady-state                                    | 410 W |
| 2. Intermittent                                    | 578 W |
| 3. LH SRB Bus A                                    | 289 W |
| 4. LH SRB Bus B                                    | 289 W |
| 5. RH SRB Bus A                                    | 289 W |
| 6. RH SRB Bus B                                    | 289 W |

6.2.1.3 Pyrotechnic Initiator Controller (PIC)

The PIC is a single-channel capacitor discharge device capable of firing one pyrotechnic device. Three signals must be present at the input to the PIC to generate the pyro firing output. These are ARM, Fire 1, and Fire 2.

Computer-initiated firing of a pyrotechnic is accomplished by transmitting the ARM, Fire 1, and Fire 2 commands to the master events controller, which translates and reformats these to +28 Vdc signals for use by the PIC. The ARM signal is transmitted first and charges the PIC capacitor to a nominal 40 V (minimum of 20 V). The capacitor arm signal (status) is monitored by the computer to measure this voltage. Fire 1 and Fire 2 are transmitted after a minimum delay of one second following initiation of ARM. The three signals remain on for a minimum of 50 msec. Prelaunch status tests are used to test firing signals. Dummy loads are connected to each PIC output before conducting this prelaunch test.

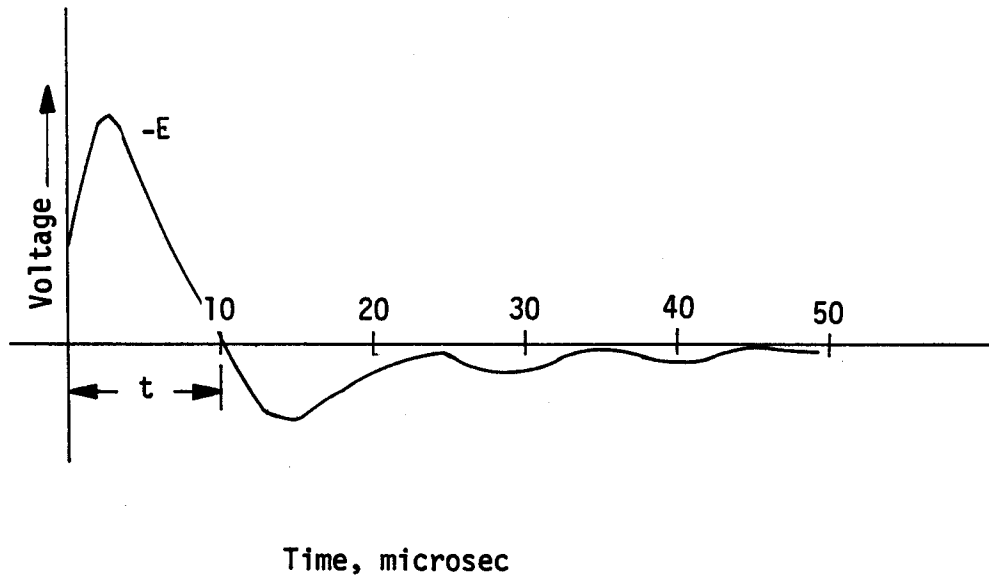

$E = 2$  times line voltage or 100 V, whichever is less  
 $t = 10$  microsec

Figure 6.2.1-1.- Voltage spike characteristics.  
 (paragraph 6.2.1.1)

6.2.1-2

## 6.2.2

INSTRUMENTATION

## 6.2.2.1

Flight Recorders

- |                       |   |
|-----------------------|---|
| a. Number             | 2 (one in each SRB)   |
| b. Recorder capacity  | 15 minutes  |
| c. Recorder speed     | 60 ips  |
| d. Playback speed     | 60 ips  |
| e. Data format        | Records in PCM and FM data format                                   |
| f. Recorder control   | Flight - inhibit/record, reverse<br>Ground - reproduce, rewind, off |
| g. Temperature limits | 32 - 120° F   |

## 6.2.2.2

PCM Data System Multiplexer Format

- |  |   |
|--|---|
| a. SRB DFI PCM multiplexer format  | Figure 6.2.2-1                              |
| b. PCM code  | Manchester II<br>Bi-phase-L                 |
| c. Bit rate  | 64 kbps                                     |
| d. Word length   | 8 bits per word<br>(no parity or sign bits) |
| e. Minor frame   | 50 words per minor frame                    |
| f. Major frame   | 16 minor frames per major frame             |
| g. Major frame rate  | 10 major frames per second                  |
| h. Sync words (the first three words of each minor frame)  |   |
| 1. Sync word 1   | 11111010                                    |
| 2. Sync word 2   | 11110011                                    |
| 3. Sync word 3   | 00100000                                    |
| i. Minor frame ID (fourth word of each minor frame). The ID word uses 4 bits of the 8-bit word beginning with the least significant bit (LSB). |   |
| 1. Minor frame 1   | 00000000                                    |
| 2. Minor frame 16  | 00001111                                    |
| j. Sample rate   | 160 sps                                     |
| k. Supercom rate   | 320 sps                                     |
| l. Subcom sample rates   | 80, 40, 20, 10 sps                          |
| m. Offset  | 60 mV                                       |
| 1. Input voltage   | Provides a count of                         |
| (a) $\leq -60$ mV  | 00000000 on the output                      |
| (b) 0 V  | 00000011 on the output                      |
| (c) 5.0 V  | 11111100 on the output                      |
| (d) $\geq 5.060$ V   | 11111111 on the output                      |

## 6.2.2.3

FM Data System

Those portions of the SRB wideband data that are presented to the Orbiter interface are frequency multiplexed into a complex analog signal. Not more than one such signal (data links) per SRB is presented to the interface. Capability is provided to stimulate the subcarrier oscillator inputs to determine that the oscillators are functioning within proper tolerances prior to each flight.



The output of those SRB FM multiplexers which are supplied to the Orbiter meet the following requirements and/or characteristics as described for individual subcarrier oscillators (SCO's).

- a. The data interface and/or characteristics conform to IRIG 106-71 (Frequency Division Multiplexing Telemetry Standard) and contain only SCO's that operate at standard IRIG frequency.
- b. Reference frequency oscillator 240 kHz
- c. Signal level One Vrms into a 70  $\Omega$  load
- d. Tape recorder bandpass 1.87 to 250 kHz
- e. Common mode voltage Up to 32 V of command mode voltage acceptable to Orbiter interface
- f. Pre-emphasis - each SCO output must be adjusted proportionally to the square root of its own BW to give a final tape-recorded output having approximately equal signal-to-noise ratios for all signals.
- g. Signal-to-noise ratio > 60 dB at the Orbiter/SRB interface

#### 6.2.2.4 Rate Gyro Assembly

The primary output of each RGA is two independently developed dc analog signals from each of two rate gyros proportional to angular rates about the pitch and yaw axes. These are routed to Orbiter MDM's as hard-wired signals. Rate gyro assembly test capability is provided by individual signals to stimulate gyro outputs in various axes and by spin motor run detection (SMRD) measurements, indicating correct gyro run speed. Both the test stimulation and measurement are routed through the SRB MDM's.

- a. Number per SRB 3
- b. RGA alignment accuracy  $\pm 0.25$  deg
- c. Analog dc rate outputs (differential line driver)
  1. Number per RGA 2
  2. Signal range  $\pm 5$  Vdc
  3. Impedance
    - (a) Source (maximum) 100  $\Omega$
    - (b) Load 500 k $\Omega$
    - (c) Loadoff (minimum) 100 k $\Omega$
  4. Phasing-positive vehicle rates cause the following dc analog rate output signal at Orbiter MDM output:
    - (a) Yaw Positive<sup>a</sup>
    - (b) Pitch Positive
  5. Scale factor
    - (a) Pitch - 0.50 Vdc/deg/sec  $\pm 10$  deg/sec
    - (b) Yaw - 0.50 Vdc/deg/sec  $\pm 10$  deg/sec
  6. Maximum dc offset
    - (a) Vibration environment 0.15 deg/sec
    - (b) Non-vibration environment 0.1 deg/sec

<sup>a</sup> Due to the SRB RGA mounting configuration, the yaw signal of the RGA LRU will be reversed. To correct this, there is a reversal in the yaw signal lines at the input to the Orbiter MDM so that the resulting Orbiter MDM output is positive for a positive yaw rate about the +Z vehicle body axis.

7. Maximum pitch and yaw 0.05 deg/sec  
 peak-to-peak noise on the dc  
 analog rate output signal at  
 the MDM over 0.02 Hz to 10 kHz  
 frequency change
8. Accuracy
- (a) Linear range
    - (1) Pitch ±10 deg/sec
    - (2) Yaw ±10 deg/sec
  - (b) Linearity ±0.05 deg/sec or ±2 percent  
 of applied rate to 10 deg/sec
  - (c) Scale factor accuracy 4.3 percent to 10 deg/sec  
 at 80° F
  - (d) Scale factor accuracy 5.1 percent to 10 deg/sec  
 over the temperature  
 range of 20° to 160° F
9. Frequency-dependent charac- Figure 4.5.1-6  
 teristics (gain and phase  
 angle vs. frequency)
- d. Discrete BITE stimuli inputs (bipolar)
- 1. Number per RGA 2
  - 2. Signal range
    - (a) Logic "1" 5 ±1.0 Vdc
    - (b) Logic "0" 0 ±0.5 Vdc
  - 3. Impedance
    - (a) Source 100 Ω
    - (b) Load—minimum in parallel 4000 Ω  
 with 500 pF ±10 percent
  - 4. Phasing-logic
    - (a) Gyro torque command "0"  
 stimulus not present
    - (b) Gyro torque command "1"  
 stimulus present
  - 5. Torquing polarity Table 6.2.2-1
- e. Rate gyro spin motor rotation detector (SMRD) output signals  
 (single-ended line driver):  
 The Orbiter/SRB measurement interface provides discrete SMRD  
 output signals from the RGA's to MDM's located in the SRB's.  
 Separate SMRD output signals are provided for each of the rate  
 gyros (pitch, yaw) in each SRB RGA.  
 When a gyro spin motor is running at synchronous speed, the  
 SMRD signal output for that gyro is a logic "1" (nominal 5  
 Vdc).
- 1. Number per RGA 2
  - 2. Signal range
    - (a) Logic "1" 5 ±1 Vdc
    - (b) Logic "0" 0 ±0.5 Vdc
  - 3. Impedance
    - (a) Source 100 Ω
    - (b) Load (minimum in parallel 4800 Ω  
 with 5000 pF  
 ±10 percent)

- 4. Phasing logic
  - (a) Spin motor out of sync "0"
  - (b) Spin motor in sync "1"

TABLE 6.2.2-1.- TORQUING POLARITY  
(Paragraph 6.2.2.4)

Channel	Pin logic signal connector				Torquing polarity
	Torque input <sup>a</sup>		Rate output <sup>b</sup>		
Pitch	31	(35)	(1)	3	Negative rate (clockwise about plus RGA pitch axis)
	(31)	35	1	(3)	Positive rate (counterclockwise about plus RGA pitch axis)
Yaw	33	(23)	(9)	11	Negative rate (clockwise about plus RGA yaw axis)
	(33)	23	9	(11)	Positive rate (counterclockwise about plus RGA yaw axis)

<sup>a</sup> A pin number enclosed by parentheses indicates a potential equal to or more negative than zero Vdc is required.

A pin number not enclosed by parentheses indicates a potential more positive than 1.0 Vdc is required.

<sup>b</sup> A pin number enclosed by parentheses indicates a potential more negative than zero Vdc.

A pin number not enclosed by parentheses indicates a potential more positive than zero Vdc.

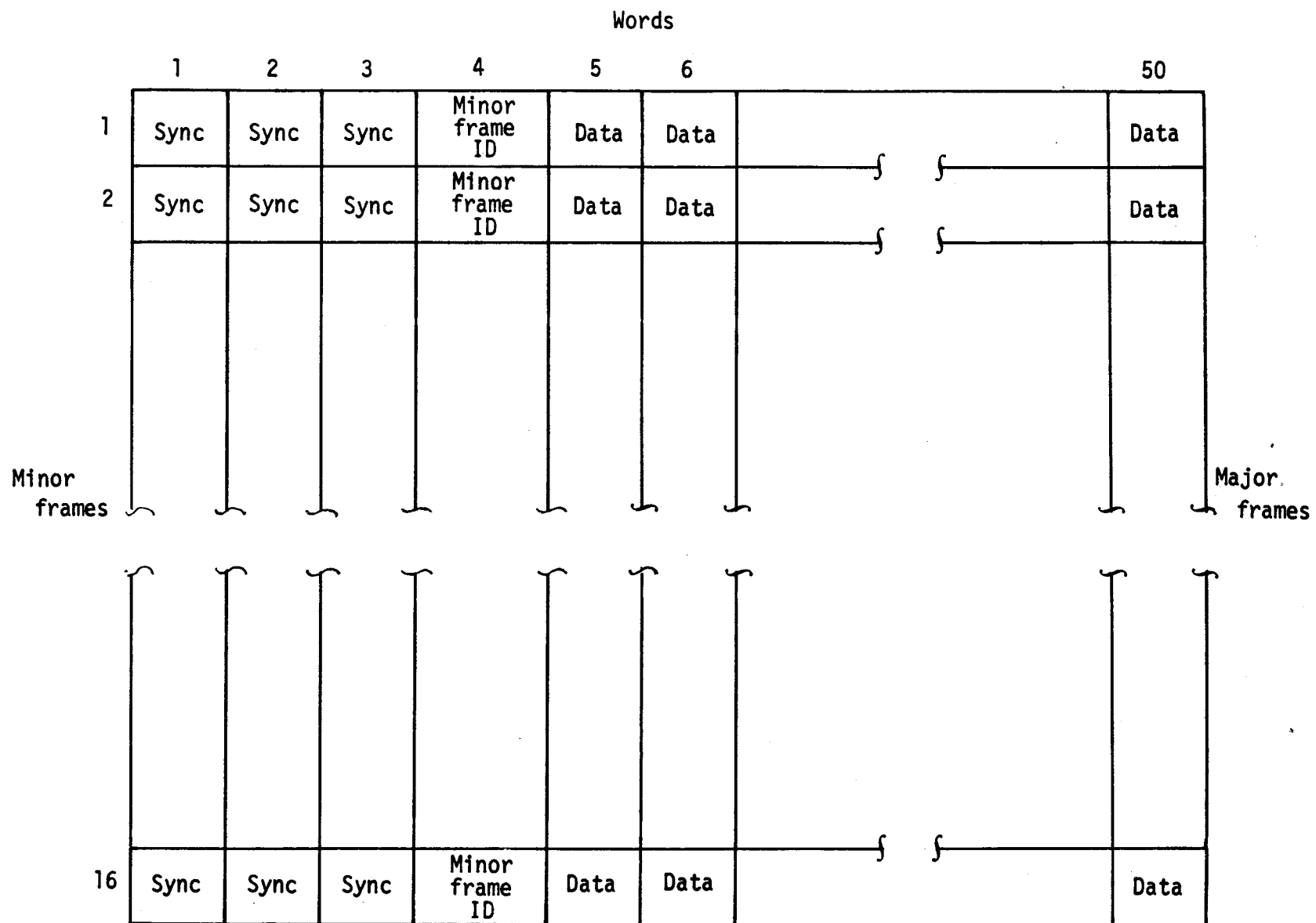

Figure 6.2.2-1.- Solid rocket booster development flight instrumentation pulse code modulation multiplexer format.  
(paragraph 6.2.2.3)

- 6.3.1 SOLID ROCKET MOTOR OPERATIONAL CHARACTERISTICS\*
- 6.3.1.1 Single Motor Performance (thrust relative to SRM-nozzle centerline)
- |   |                         |
|---|-------------------------|
| a. Number   | 2                       |
| b. Size   | Figure 2-5              |
| c. Thrust profile, HPM                                | Figure 6.3.1-2          |
| d. Ignition transient                                 | 170 to 340 msec         |
| e. Maximum rate of buildup during ignition transient  | 360,000 lbf per msec    |
| f. SRB thrust differential, 3 thrust time dispersions |                         |
| 1. Ignition   | Figure 6.3.1-3          |
| 2. Steady-state                                       | Figure 6.3.1-4          |
| 3. Tail-off   | Figure 6.3.1-5          |
| g. Propellant PMBT range                              | 40° to 90° F            |
| h. Operating altitude at PMBT of 40° to 90° F         | Sea level to 200,000 ft |
| i. Water entry  |                         |
| 1. Maximum vertical velocity                          | Paragraph 3.6.1.1       |
| 2. Entry angle  | 0 ± 5°                  |
| 3. Maximum horizontal velocity                        | 45 ft/sec               |
| j. Lifetime   | 20 uses <sup>a</sup>    |
- 6.3.1.2 SRB Performance Predictions
- |   |               |
|---|---------------|
| a. Nominal performance summary  | Table 6.3.1-1 |
| b. Predicted flight dispersions   | Table 6.3.1-2 |
| c. Eastern Test Range PMBT vs. day-of-year  | Table 6.3.1-3 |
| d. Western Test Range PMBT vs. day-of-year  | Table 6.3.1-4 |
| e. The thrust during ignition transient can be calculated for $0 \leq t_0$ , $t_1$ second can be calculated by modifying the thrust vs. time table on the appropriate data tape as follows:       |               |
| $\begin{array}{l} T_{\text{ignition}} \\ \text{transient} \\ \text{at } t_1 \end{array} = \begin{array}{l} T_{\text{table}} \\ \text{at } t_1 \end{array} - \begin{array}{l} T_{t_0} \end{array}$ |               |
| Ignition interval - The ignition interval is defined as the time interval from ignition command to a point where the headend chamber pressure has built up to 563.5 psia.                         |               |
| f. Thrust vs. time profile reductions for STS 51-E and subsequent.  | Table 6.3.1-5 |
| g. SRM-17 through SRM-21 3 sigma dispersions  | Table 6.3.1-6 |
| h. Filament-wound case SRM performance summary  | Table 6.3.1-7 |

<sup>a</sup>Use-filled with propellant plus fired or flown plus recovered plus refurbished plus tested plus reloaded.

\*NASA Data Source

6.3.1.2.1

SRB Thrust-time Performance Predictions

STS 51-L - Performance Prediction Data (Block Motor Prediction)  
(SODS J-766 A8)

- a. Launch data 1-23-86
- b. PMBT (PM) 60° F
- c. Propellant weight, left (WP<sub>A</sub>) 1,110,161 lb
- d. Propellant weight, right (WP<sub>B</sub>) 1,110,161 lb
- e. Burn rate, left (RB<sub>A</sub>) @ 70° F .3685 ips
- f. Burn rate, right (RB<sub>B</sub>) @ 70° F .3695 ips
- g. Burn rate, left @ 60° F .3660 ips
- h. Burn rate, right @ 60° F .3670 ips
- i. Baseline motor TC-LT-271-84-Nominal 2
  - 1. Burnrate @ 70° F (RB<sub>N</sub>) .3705 ips
  - 2. PMBT (PM<sub>N</sub>) 70° F
  - 3. Propellant weight (WP<sub>N</sub>) 1,110,273 lb
- j. Performance summary Table 6.3.1-10
- k. t Delay 4.8 seconds

The modification of thrust-time data for ΔPMBT, burn rate, and propellant can be calculated using table 6.3.1-12.

6.3.1.3

SRB Generic Performance Predictions

6.3.1.3.1

Winter Season, November 15 to April 15. The SRB motor data have been adjusted by -0.6 percent to be compatible to the IVBC-3 aerodynamics.

a. OV-102 - The thrust-time data are adjusted assuming a December 15 launch date at a PMBT = 63° F.

TC-272-83 burn rate @ PMBT = 80° F, ips	Winter generic burn rate @ PMBT = 80° F, ips	ΔPMBT, r <sub>B</sub> burn rate update, deg F	Winter generic environment, deg F	ΔPMBT modification, deg F
Left motor .370	.373	12.0	-17	-5
Right motor .371	.373	8.0	-17	-9

The modification of thrust-time data for ΔPMBT can be calculated using table 6.3.1-4.

b. OV-099 and OV-103 - The thrust-time data are adjusted assuming a December 15 launch date at a PMBT -63° F.

TC-61-84 burn rate @ PMBT = 70° F, ips	Winter generic burn rate @ PMBT = 70° F, ips	ΔPMBT, r <sub>B</sub> burn rate update, deg F	Winter generic environment, deg F	ΔPMBT modification, deg F
Left motor .3695	.3705	+4.0	-7.0	-3.0
Right motor .3695	.3705	+4.0	-7.0	-3.0

The modification of thrust-time data for ΔPMBT can be calculated using table 6.3.1-4.

6.3.1.3.2

Summer Season, May 15 to October 15.

- a. OV-102 - A reduction of the SRB motor data are not required. The thrust-time data are adjusted assuming a June 15 launch date at a PMBT = 78° F.

TC-272-83 burn rate @ PMBT = 80° F, ips	Summer generic burn rate @ PMBT = 80° F, ips	$\Delta$ PMBT, r <sub>B</sub> burn rate update, deg F	Summer generic environment, deg F	$\Delta$ PMBT modification, deg F
Left motor .370	.373	12.0	-2.0	10.0
Right motor .371	.373	8.0	-2.0	6.0

The modification of thrust-time data for  $\Delta$ PMBT can be calculated using table 6.3.1-4.

- b. OV-099 - The SRB motor data have been adjusted by -0.6 percent to be compatible to the IVBC-3 aerodynamics. The thrust-time data are adjusted assuming a June 15 launch date at a PMBT = 78° F.

TC-61-84 burn rate @ PMBT = 70° F, ips	Summer generic burn rate @ PMBT = 70° F, ips	$\Delta$ PMBT, r <sub>B</sub> burn rate update, deg F	Winter generic environment, deg F	$\Delta$ PMBT modification, deg F
Left motor .3695	.3705	4.0	8.0	12.0
Right motor .3695	.3705	4.0	8.0	12.0

The modification for thrust-time data of  $\Delta$ PMBT can be calculated using table 6.3.1-4.

Transition season, April 1 to May 31 and October 1 to November 30. The SRB motor data has been adjusted by -0.6 percent to be compatible to the IVBC-3 aerodynamics.

- a. OV-102 - The thrust-time data are adjusted assuming an October 15 launch date at PMBT = 76° F.

TC-356-83 burn rate @ PMBT = 60° F, ips	Transition generic burn rate @ PMBT = 80° F, ips	$\Delta$ PMBT, r <sub>B</sub> burn rate update, deg F	Transition generic environment, deg F	$\Delta$ PMBT modification, deg F
Left motor .367	.368	4.0	16.0	20.0
Right motor .366	.368	8.0	16.0	24.0

The modification for thrust-time data for  $\Delta$ PMBT can be calculated using table 6.3.1-4.



b. OV-099 - The thrust-time data are adjusted assuming an October 15 launch date at a PMBT = 76° F.

TC-61-84 burn rate @ PMBT = 70° F, ips	Transition generic burn rate @ PMBT = 70° F, ips	$\Delta$ PMBT, r <sub>B</sub> burn rate update, deg F	Transition generic environment, deg F	$\Delta$ PMBT modification, deg F
---	--	--	--	---

Left motor .3695	.3705	4.0	6.0	10.0
Right motor .3695	.3705	4.0	6.0	10.0

The modification for thrust-time data of  $\Delta$ PMBT can be calculated using table 6.3.1-4.

TABLE 6.3.1-1.- NOMINAL SOLID ROCKET MOTOR PERFORMANCE SUMMARY.  
(Paragraph 6.3.1.2)

Parameter	TC-356-83 @ PMBT = 60° F		TC-61-84 @ PMBT = 70° F	
	Left motor	Right motor	Left motor	Right motor
Action time total impulse, vac, lb-sec <sup>a</sup>	295.1 x 10 <sup>6</sup>	295.2 x 10 <sup>6</sup>	295.1 x 10 <sup>6</sup>	295.1 x 10 <sup>6</sup>
Average specific impulse, vac, sec <sup>a</sup>	266.4	266.4	266.0	266.0
Web time, sec	112.1	112.6	110.9	110.9
50 psia cue time, sec <sup>b</sup>	121.55	122.00	120.38	120.39
Action time, sec <sup>c</sup>	123.81	124.27	122.64	122.65
Separation time, sec	128.00	128.00	126.39	126.39
Web time average thrust, vac, lb <sup>a</sup>	2,583,400	2,574,200	2,598,900	2,598,400
Web time average head pressure, psia	660	658	668	668
Maximum vacuum thrust, lb <sup>a</sup>	3,242,500	3,234,500	3,314,200	3,315,300
Maximum headend chamber pressure, psia	918	915	924	924
Action time total impulse, vac, lb-sec <sup>a</sup>	295.3 x 10 <sup>6</sup>	295.3 x 10 <sup>6</sup>	295.5 x 10 <sup>6</sup>	295.3 x 10 <sup>6</sup>
Average specific impulse, vac, sec <sup>a</sup>	266.0	266.0	266.0	266.0
Web time, sec	110.4	110.4	109.4	109.4
50 psia cue time, sec <sup>b</sup>	119.90	119.86	118.87	118.92
Action time, sec <sup>c</sup>	122.16	122.12	121.13	121.18
Separation time, sec	125.90	125.90	124.92	124.92
Web time average thrust, vac, lb <sup>a</sup>	2,612,200	2,611,900	2,637,100	2,634,100
Web time average head pressure, psia	671	672	679	678
Maximum vacuum thrust, lb <sup>a</sup>	3,332,600	3,332,800	3,366,400	3,362,900
Maximum headend chamber pressure, psia	928	929	938	937

<sup>a</sup>Reduction of 0.6 percent incorporated into performance.

<sup>b</sup>Separation cue - The separation cue is defined as the time point at which the headend chamber pressure has decayed to 50 psia. Separation event occurs at 6 seconds after the last SRM to reach 50 psia of head pressure.

<sup>c</sup>End action time - The end of action time is defined as the time point at which the headend chamber pressure has decayed to 22.1 psia.

TABLE 6.3.1-2.- PREDICTED FLIGHT DISPERSIONS ( $\pm 3 \sigma$ )  
 (Paragraph 6.3.1.2)

Parameter	Motors A and B	Booster
Web time, percent	3.8	3.7
Web-time average thrust, percent	4.1	4.0
Total impulse, percent	1.0	0.7
Specific impulse, percent	0.7	0.5
Propellant weight, percent	0.3	0.21
Burnout weight, percent	1.4	0.99
Thrust-shape uncertainty, percent	3.0	3.0

TABLE 6.3.1-3.- EASTERN TEST RANGE PMBT VERSUS DAY-OF-YEAR  
(Paragraph 6.3.1.3)

Date		PMBT, °F	Date		PMBT, °F
January	1- 4	62	July	1-11	77
	5-23	61		12-31	78
	24-31	60			
February	1-26	60	August	1-31	78
	27-28	61	September	1-29	78
				30	77
March	1- 9	61	October	1- 8	77
	10-17	62		9-17	76
	18-24	63		18-23	75
	25-31	64		24-29	74
		30-31		73	
April	1- 6	65	November	1- 4	73
	7-12	66		5- 9	72
	13-18	67		10-14	71
	19-25	68		15-19	70
	26-30	69		20-24	69
May	1	69	25-29	68	
	2- 8	70	30	67	
	9-14	71	December	1- 4	67
	15-21	72		5- 9	66
	22-30	73		10-14	65
	31	74		15-19	64
June	1- 7	74		20-27	63
	8-15	75		28-31	62
	16-26	76			
	27-30	77			

TABLE 6.3.1-4. - WESTERN TEST RANGE PMBT VERSUS DAY-OF-YEAR  
(Paragraph 6.3.1.3)

Date	PMBT, °F	Date	PMBT, °F
January 1- 3	52	July 1-13	55
4-31	51	14-31	56
February 1-28	51	August 1- 4	56
		5-27	57
		28-31	58
March 1-31	51	September 1-30	58
April 1-11	51	October 1-30	58
12-30	52		
May 1-19	52	November 1-11	57
20-31	53	12-21	56
		22-30	55
June 1- 7	53	December 1- 9	54
8-24	54	10-19	53
25-30	55	20-31	52

TABLE 6.3.1-5. - SRB THRUST VS. TIME PROFILE REDUCTIONS FOR  
 STS 51-E AND SUBSEQUENT FLIGHTS<sup>a</sup>  
 (Paragraph 6.3.1.2)

Percentage of action time <sup>b</sup>	$\Delta$ Thrust, lb <sup>b</sup>
0	0
1.7	+23,500
4.0	+34,000
5.0	+20,500
8.0	+22,500
11.0	+18,000
15.0	+17,000
20.5	+9,000
29.0	+500
40.0	-5,500
60.0	-5,500
79.5	-6,500
82.0	+500
94.0	-18,500
100.0	0

<sup>a</sup>Reduce the SRB thrust vs. time profile at all time points by 0.736 percent. This value replaces the 0.6 percent value currently implemented.

<sup>b</sup>Adjust the SRB thrust by the increments and action times provided.

TABLE 6.3.1-6. - TC-271-84 PERFORMANCE SUMMARY ( $\pm 3$  SIGMA DISPERSIONS) FOR SRM-17  
THROUGH SRM-21 at PMBT = 60° F<sup>a</sup>  
(Paragraph 6.3.1.2)

Parameter	Nominal	Aft Segment -10 Mills	Aft Segment +10 Mills	Fwd Ctr Segment -10 Mills	Fwd Ctr Segment +10 Mills
Impulse at 20 sec, vacuum 10 <sup>6</sup> lb-sec <sup>b</sup>	64.37	63.77	65.02	63.91	65.12
Average specific impulse, vacuum, 10 <sup>6</sup> lb-sec <sup>b</sup>	172.9	171.0	174.8	171.3	175.2
Web time, sec	111.6	112.4	112.0	112.2	108.6
50 psia cue time, sec	121.18	121.04	121.39	122.65	118.76
Action time, sec	123.51	123.30	123.65	124.91	121.01
Separation time, sec	127.18	127.04	127.39	128.65	124.76
Web time average thrust, vacuum, lb <sup>b</sup>	2,596,000	2,580,000	2,590,000	2,566,000	2,656,000
Web time average head pressure, psia	664	660	662	656	678
Maximum vacuum thrust, lb <sup>b</sup>	3,314	3,283	3,359	3,290	3,362
Maximum head end chamber pressure, psia	918	910	926	912	927

<sup>a</sup>These dispersed predictions provide the ascent performance community with the expected variation of the thrust-time trace due to possible  $\pm 3$  sigma shifts in propellant burn rate across propellant raw material lots. The  $\pm 3$  sigma burn rate variation is approximately  $\pm 10$  mills.

These dispersed predictions are necessitated due to the casting facility incident at Thiokol on March 2, 1984, which resulted in the loss of a forward segment and an aft center segment from flight set SRM-17. These segments were recast using propellant planned for the aft segments. The aft segments were cast from propellant planned for SRM-18. Until SRM-22, propellant raw materials will continue to be borrowed and cast.

<sup>b</sup>No reduction incorporated into performance. See table 6.3.1-5, SRB Thrust vs. Time Profile Reductions for STS 51-E and Subsequent Flights.

TABLE 6.3.1-7. - BLOCK 2 FWC-2 PERFORMANCE PREDICTIONS SUMMARY @ 56° F.  
 (TC-FWC-2-298-85 NOM 2)  
 (Paragraph 6.3.1-2)

Parameter	Nominal performance
Action time total impulse, vacuum, $10^6$ lb-sec <sup>a</sup>	294.3
Average specific impulse, vacuum, sec <sup>a</sup>	265.8
Web time, sec	112.7
50 psia cue time, sec <sup>b</sup>	121.59
Action time, sec <sup>c</sup>	123.85
Separation time, sec	127.79

<sup>a</sup>Reduction of performance based upon table 6.3.1-5, SRB Thrust vs Time Profile Reductions for STS 51-E and Subsequent Flights.

<sup>b</sup>Separation cue - The separation cue is defined as the time point at which the headend chamber pressure has decayed to 50 psia. Separation event occurs at t Delay seconds after the last SRM reaches 50 psia of head pressure.

<sup>c</sup>End action time - The end of action time is defined as the time point at which the headend chamber pressure has decayed to 22.1 psia.



TABLE 6.3.1-8.- SRB MOTOR PERFORMANCE AT ANY PMBT

$$\begin{aligned} \text{Thrust desired} &= T(\text{Baseline motor}) \cdot e^{\pi K(\Delta\text{PMBT})} \cdot e^{(\sigma K - \pi K) \cdot \Delta\text{PMBT}, r_B} \\ \text{Time desired} &= t(\text{Baseline motor}) \cdot e^{\sigma K(\Delta\text{PMBT})} \\ I_{sp} \text{ desired} &= I_{sp}(\text{Baseline motor}) \cdot e^{(\pi K - \sigma K) \cdot \Delta\text{PMBT}} \cdot e^{(\sigma K - \pi K) \cdot \Delta\text{PMBT}, r_B} \end{aligned}$$

Where  $\pi K = 0.0011$   
 $\sigma K = 0.001063$

Baseline motors:  $T_c$ -75-84 @ 70° F  
 $T_c$ -117-84 @ 70° F  
 $T_c$ -61-84 @ 70° F  
 $T_c$ -272-83 @ 80° F  
 $T_c$ -356-83 @ 60° F

Table 6.3.1-9. - BLOCK MOTOR PREDICTIONS PERFORMANCE SUMMARY, PMBT = 70° F  
(Paragraph 6.3.1.2.1)

(a) TC-LT-271-84

Parameter	Lightweight Case		
	Nominal	Minimum	Maximum
Action time total impulse, vac, 10 <sup>6</sup> lb-sec	295.1 <sup>a</sup>	295.1 <sup>a</sup>	295.1 <sup>a</sup>
Average specific impulse, vac, sec	265.8 <sup>a</sup>	265.8 <sup>a</sup>	265.8 <sup>a</sup>
Web time, sec	110.4	113.7	107.2
50 psia cue time, sec	119.93	123.35	116.60
Action time, sec	122.24	125.66	118.91
Separation time, sec	125.93	129.35	122.60
Web time average thrust, vac, lb	2,608,700 <sup>a</sup>	2,532,500 <sup>a</sup>	2,686,000 <sup>a</sup>
Web time average head pressure, psia	671	650	692
Maximum vacuum thrust, lb	3,330,100 <sup>a</sup>	3,234,300 <sup>a</sup>	3,428,900 <sup>a</sup>
Maximum headend chamber pressure, psia	928	900	957

(b) TC-MD-271-84

Parameter	Midweight Case		
	Nominal	Minimum	Maximum
Action time total impulse, vac, 10 <sup>6</sup> lb-sec	294.8 <sup>a</sup>	294.8 <sup>a</sup>	294.8 <sup>a</sup>
Average specific impulse, vac, sec	265.8 <sup>a</sup>	265.8 <sup>a</sup>	265.8 <sup>a</sup>
Web time, sec	110.4	113.6	107.2
50 psia cue time, sec	119.91	123.31	116.60
Action time, sec	122.17	125.57	118.85
Separation time, sec	125.91	129.31	122.60
Web time average thrust, vac, lb	2,607,100 <sup>a</sup>	2,532,600 <sup>a</sup>	2,685,200 <sup>a</sup>
Web time average head pressure, psia	671	651	692
Maximum vacuum thrust, lb	3,327,200 <sup>a</sup>	3,231,700 <sup>a</sup>	3,426,100 <sup>a</sup>
Maximum headend chamber pressure, psia	928	900	957

<sup>a</sup>Reduction of 0.6% incorporated into performance

Table 6.3.1-10. - BLOCK 2 MOTOR PREDICTIONS PERFORMANCE SUMMARY, PMBT = 70° F  
 .(Paragraph 6.3.1.2.1)

(a) TC-LT-271-84

Parameter	Lightweight Case		
	Nominal 2	Minimum 2	Maximum 2
Action time total impulse, vac, 10 <sup>6</sup> lb-sec <sup>a</sup>	294.7	294.7	294.7
Average specific impulse, vac, sec <sup>a</sup>	265.4	265.4	265.4
Web time, sec	110.4	113.7	107.2
50 psia cue time, sec <sup>b</sup>	119.93	123.35	116.60
Action time, sec <sup>c</sup>	122.24	125.66	118.91
Separation time, sec	125.93	129.35	122.60

(b) TC-MD-271-84

Parameter	Midweight Case		
	Nominal 2	Minimum 2	Maximum 2
Action time total impulse, vac, 10 <sup>6</sup> lb-sec <sup>a</sup>	294.4	294.4	294.4
Average specific impulse, vac, sec <sup>a</sup>	265.4	265.4	265.4
Web time, sec	110.4	113.6	107.2
50 psia cue time, sec <sup>b</sup>	119.91	123.31	116.60
Action time, sec <sup>c</sup>	122.17	125.57	118.85
Separation time, sec	125.91	129.31	122.60

<sup>a</sup>Reduction of performance based upon table 6.3.1-5, SRB Thrust vs Time Profile Reductions for STS 51-E and Subsequent Flights.

<sup>b</sup>Separation cue - The separation cue is defined as the time point at which the headend chamber pressure has decayed to 50 psia. Separation event occurs at t Delay seconds after the last SRM to reach 50 psia of head pressure.

<sup>c</sup>End action time - The end of action time is defined as the time point at which the headend chamber pressure has decayed to 22.1 psia.

Table 6.3.1-11.- BLOCK 2 SRB FILAMENT WOUND CASE PERFORMANCE SUMMARY,  
 PMBT = 56° F (Paragraph 6.3.1.2.1)

Parameter	Filament wound case <sup>a</sup> (TC-FWC-271-84)			
	Nominal	Minimum	Max.- A	Max.- B
Action time total impulse, vac, 10 <sup>6</sup> lb-sec <sup>a</sup>	293.7	293.7	293.7	293.7
Average specific impulse, vac, sec	265.3	265.3	265.3	265.3
Web time, sec	112.1	115.5	108.8	106.3
50 psia cue time, sec <sup>b</sup>	121.74	125.29	118.31	115.70
Action time, sec <sup>c</sup>	124.00	127.56	120.57	117.96
Separation time, sec	128.61	132.16	125.18	122.57

<sup>a</sup>Reduction of performance based upon table 6.3.1-5, SRB Thrust vs Time Profile Reductions for STS 51-E and Subsequent Flights.

<sup>b</sup>Separation cue - The separation cue is defined as the time point at which the headend chamber pressure has decayed to 50 psia. Separation event occurs at t Delay seconds after the last SRM to reach 50 psia of head pressure.

<sup>c</sup>End action time - The end of action time is defined as the time point at which the headend chamber pressure had decayed to 22.1 psia.

Table 6.3.1-12. - BLOCK MOTOR PREDICTIONS, PERFORMANCE MODIFICATION EQUATIONS  
(Paragraph 6.3.1.2.1)

$$T_A = T_N \cdot e^{K1} \cdot KW_A^{1.53846}$$

$$T_B = T_N \cdot e^{K2} \cdot KW_B^{1.53846}$$

$$P_A = P_N \cdot e^{K1} \cdot KW_A^{1.53846}$$

$$P_B = P_N \cdot e^{K2} \cdot KW_B^{1.53846}$$

$$t_A = t_N \cdot e^{-K3} \cdot KW_A^{-.53846}$$

$$t_B = t_N \cdot e^{-K4} \cdot KW_B^{-.53846}$$

$$\omega_A = \omega_N \cdot e^{K3} \cdot KW_A^{1.53846}$$

$$\omega_B = \omega_N \cdot e^{K4} \cdot KW_B^{1.53846}$$

$$Isp_A = Isp_N \cdot e^{K5}$$

$$Isp_B = Isp_A$$

where

$$K1 = K6 (PM-PM_N) + K7 (PMRB_A)$$

$$K2 = K6 (PM-PM_N) + K7 (PMRB_B)$$

$$K3 = K7 (PM-PM_N + PMRB_A)$$

$$K4 = K7 (PM-PM_N + PMRB_B)$$

$$K5 = K9 (PM-PM_N)$$

$$K6 = .0011$$

$$K7 = .001063$$

$$K9 = .000037$$

$$K10 = 1474.274$$

$$PMRB_A = K10 \cdot \ln (RB_A/RB_N)$$

$$PMRB_B = K10 \cdot \ln (RB_B/RB_N)$$

$$KW_A = WP_A/WP_N$$

$$KW_B = WP_B/WP_N$$

A = Left motor

B = Right motor

N = Baseline motor

Motor Dimensions

6.3.1-17

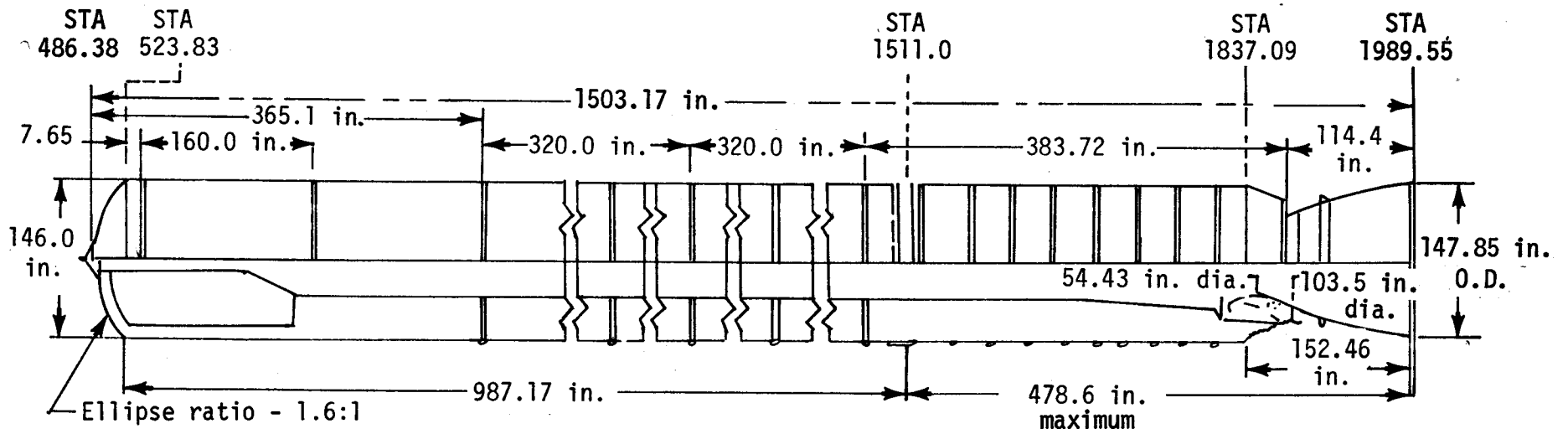

Figure 6.3.1-1.- SRM dimensions.  
(paragraph 6.3.1.1)

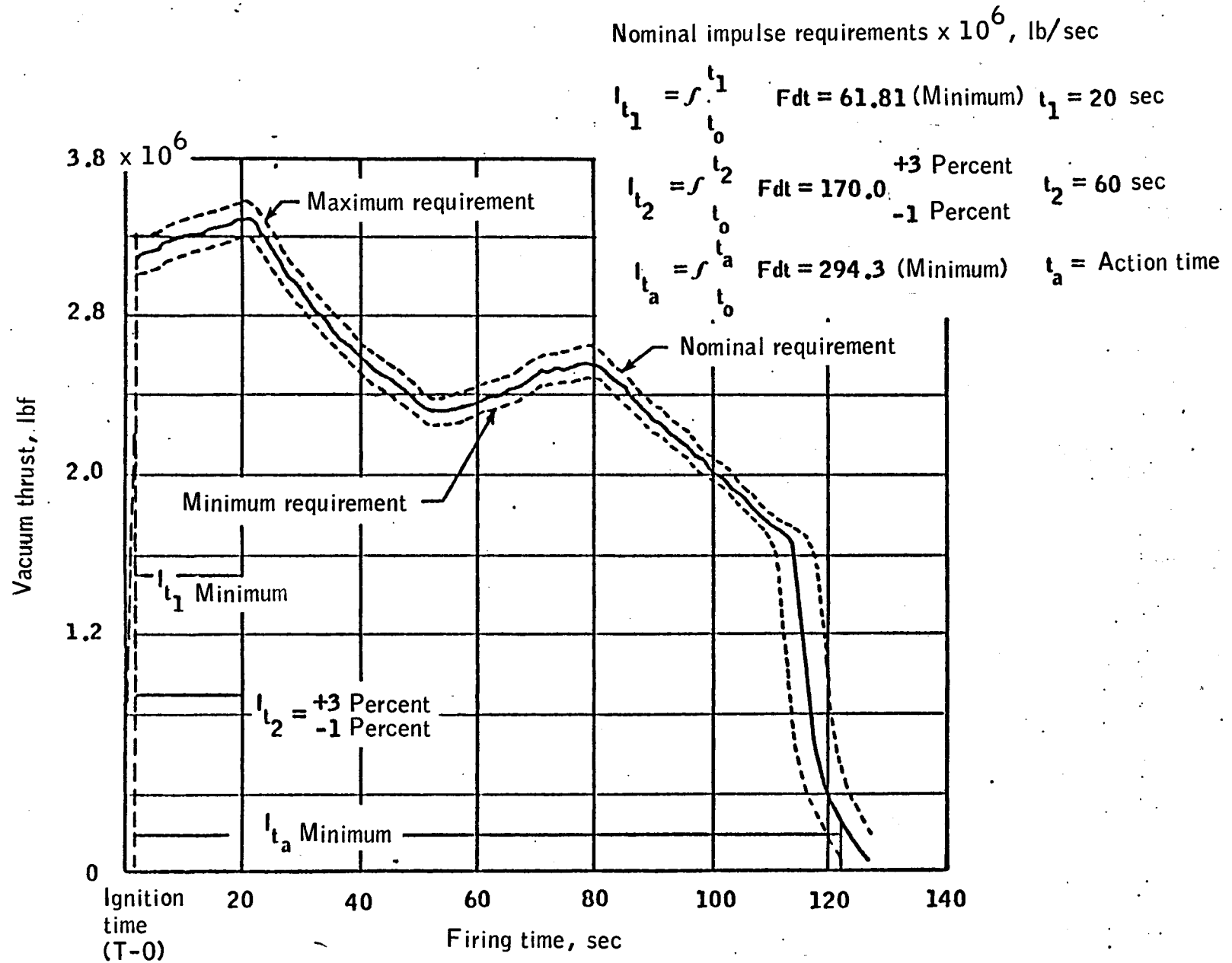

Figure 6.3.1-2.- HPM nominal performance requirements (vacuum, 60 deg F).

(Paragraph 6.3.1.1)

Figure 6.3.1-2.- HPM SRB Nominal Thrust Time Limits (Vacuum, 60° F)  
 (Continued) (Paragraph 6.3.1.1 and paragraph 3.6.3.1)

Time, sec	Vacuum thrust, 10 <sup>3</sup> lb		
	Minimum	Nominal	Maximum
2.0	2989.4	3081.9	3174.3
3.0	3015.0	3108.3	3201.5
4.0	3023.4	3116.9	3210.4
5.0	3034.6	3128.4	3222.3
6.0	3054.7	3149.1	3243.6
7.0	3077.3	3172.5	3267.6
8.0	3084.3	3179.7	3275.1
9.0	3094.8	3190.5	3286.2
10.0	3105.5	3201.5	3297.6
11.0	3113.6	3209.9	3306.2
12.0	3121.8	3218.4	3314.9
13.0	3131.4	3228.2	3325.1
14.0	3137.7	3234.7	3331.7
15.0	3144.5	3241.8	3339.0
16.0	3151.5	3249.0	3346.5
17.0	3159.1	3256.8	3354.5
18.0	3170.2	3268.3	3366.3
19.0	3177.2	3275.5	3373.7
20.0	3187.7	3286.3	3384.9
21.0	3196.8	3295.6	3394.5
23.0	3151.7	3249.2	3346.7
24.0	3097.0	3192.8	3288.6
25.0	3052.9	3147.4	3241.8
26.0	3010.4	3103.5	3196.6
27.0	2958.9	3050.4	3142.0
28.0	2911.2	3001.2	3091.2
29.0	2873.2	2962.1	3051.0
30.0	2842.5	2930.4	3018.3
31.0	2796.7	2883.2	2969.7
32.0	2762.4	2847.8	2933.2
33.0	2728.0	2812.4	2896.8
34.0	2694.3	2777.7	2861.0
35.0	2661.2	2743.5	2825.8
36.0	2630.8	2712.2	2793.6
37.0	2601.4	2681.9	2762.3
38.0	2572.0	2651.6	2731.1
39.0	2543.0	2621.6	2700.3
40.0	2514.1	2591.8	2669.6
41.0	2486.6	2563.5	2640.4
42.0	2463.3	2539.5	2615.7
43.0	2443.7	2519.2	2594.8
44.0	2423.4	2498.3	2573.3
45.0	2402.7	2477.0	2551.3
46.0	2380.4	2454.0	2527.6
47.0	2359.3	2432.3	2505.3
48.0	2342.8	2415.2	2487.7
49.0	2322.9	2394.8	2466.6



Figure 6.3.1-2.- HPM SRB Nominal Thrust Time Limits (Vacuum, 60° F)  
 (Continued) (Paragraph 6.3.1.1 and paragraph 3.6.3.1)

Time, sec	Vacuum thrust, 10 <sup>3</sup> lb		
	Minimum	Nominal	Maximum
50.0	2292.9	2363.8	2434.7
51.0	2262.8	2332.8	2402.8
52.0	2247.4	2316.9	2386.4
53.0	2243.4	2312.7	2382.1
54.0	2244.8	2314.2	2383.6
55.0	2248.1	2317.7	2387.2
56.0	2258.8	2328.7	2398.5
57.0	2264.2	2334.3	2404.3
58.0	2275.0	2345.4	2415.7
59.0	2289.0	2359.8	2430.6
60.0	2298.5	2369.6	2440.7
61.0	2306.1	2377.4	2448.7
62.0	2313.7	2385.2	2456.8
63.0	2329.6	2401.7	2473.7
64.0	2338.2	2410.5	2482.8
65.0	2341.5	2413.9	2486.4
66.0	2354.8	2427.6	2500.4
67.0	2375.7	2449.2	2522.7
68.0	2396.4	2470.5	2544.6
69.0	2407.7	2482.2	2556.6
70.0	2428.6	2503.7	2578.8
71.0	2449.8	2525.6	2601.3
72.0	2441.3	2516.8	2592.3
73.0	2445.3	2520.9	2596.6
74.0	2455.9	2531.8	2607.8
75.0	2451.6	2527.4	2603.3
76.0	2463.0	2539.2	2615.3
77.0	2475.2	2551.7	2628.3
78.0	2483.8	2560.6	2637.4
79.0	2481.0	2557.7	2634.4
80.0	2477.4	2554.0	2630.6
81.0	2458.5	2534.5	2610.5
82.0	2430.0	2505.2	2580.3
83.0	2396.5	2470.7	2544.8
84.0	2373.7	2447.1	2520.5
85.0	2353.3	2426.1	2498.9
86.0	2323.2	2395.0	2466.9
87.0	2292.9	2363.8	2434.7
88.0	2263.3	2333.3	2403.3
89.0	2237.2	2306.4	2375.6
90.0	2203.8	2272.0	2340.1
91.0	2196.2	2264.1	2332.0
92.0	2161.4	2228.2	2295.1
93.0	2141.7	2207.9	2274.2
94.0	2121.2	2186.8	2252.4
95.0	2101.5	2166.5	2231.5

Figure 6.3.1-2.-- HPM SRB Nominal Thrust Time Limits (Vacuum, 60° F)  
 (Concluded) (Paragraph 6.3.1.1 and paragraph 3.6.3.1)

Time, sec	Vacuum thrust, 10 <sup>3</sup> lb		
	Minimum	Nominal	Maximum
96.0	2071.6	2135.6	2199.7
97.0	2031.6	2094.4	2157.2
98.0	2012.6	2074.8	2137.1
99.0	1979.6	2040.8	2102.0
100.0	1962.8	2023.5	2084.2
101.0	1952.1	2012.5	2072.9
102.0	1927.4	1987.0	2046.6
103.0	1888.4	1946.8	2005.3
104.0	1857.2	1914.6	1972.1
105.0	1830.2	1886.8	1943.4
106.0	1803.3	1859.0	1914.8
107.0	1773.7	1828.6	1883.4
108.0	1743.8	1797.7	1851.7
109.0	1716.3	1769.3	1822.4
110.0	1650.0	1746.7	1799.1
111.0	1477.8	1723.2	1774.9
112.0	1185.1	1715.2	1766.7
113.0	861.3	1678.7	1751.3
114.0	620.4	1563.9	1730.8
115.0	499.7	1332.3	1718.0
116.0	416.0	1012.9	1692.5
117.0	335.8	721.8	1610.7
118.0	281.8	558.2	1449.6
119.0	228.9	463.9	1162.7
120.0	172.6	381.9	858.4
121.0	117.0	312.1	628.5
122.0	69.1	264.8	510.1
123.0	41.8	211.7	430.0
124.0	26.5	156.6	351.8
125.0	22.0	104.3	295.5
126.0	---	61.7	247.5
127.0	---	38.2	197.5
128.0	---	24.1	141.7

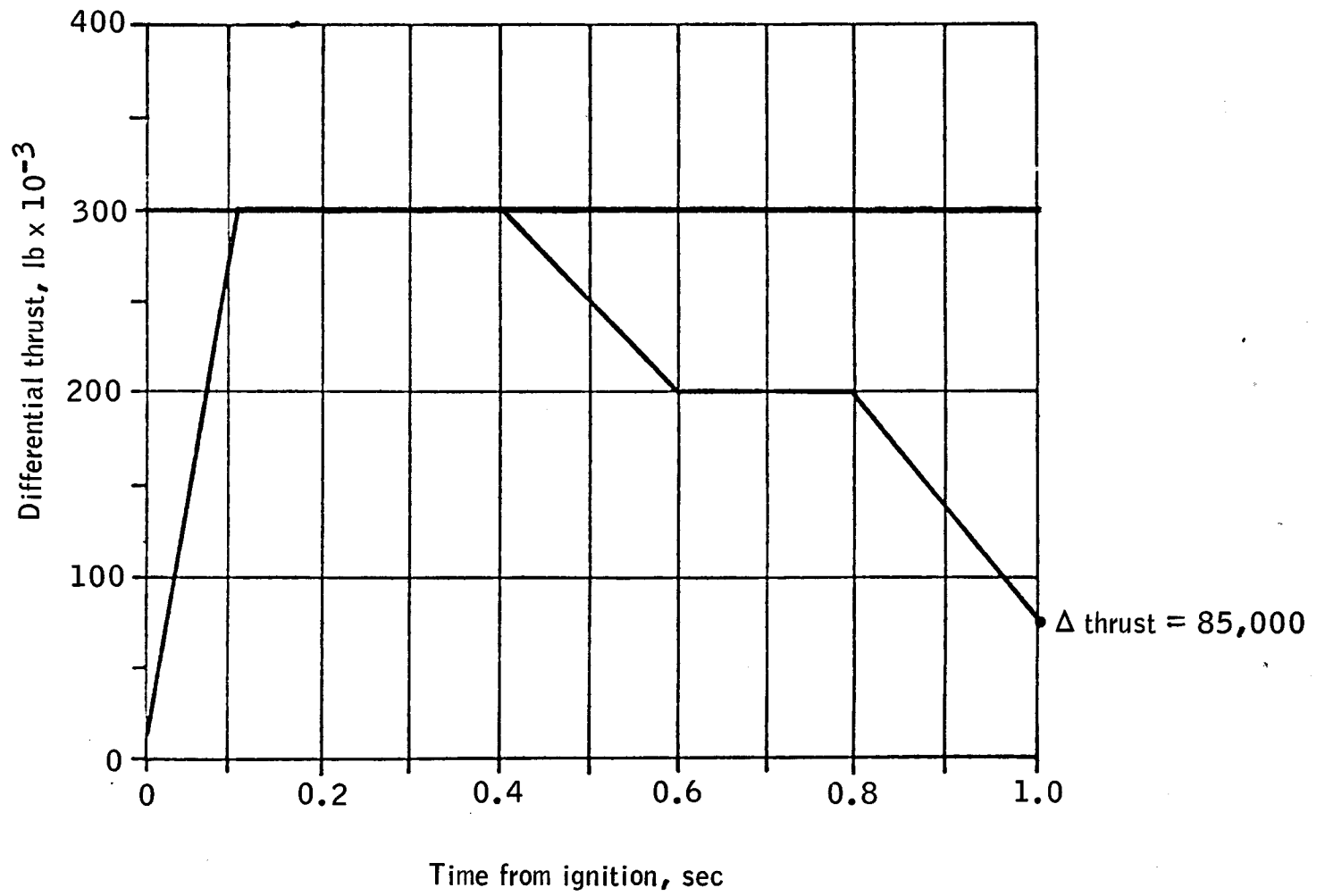

Figure 6.3.1-3.- Maximum allowable ignition thrust differential.  
(Paragraphs 6.3.1.1 and 3.6.3.1)

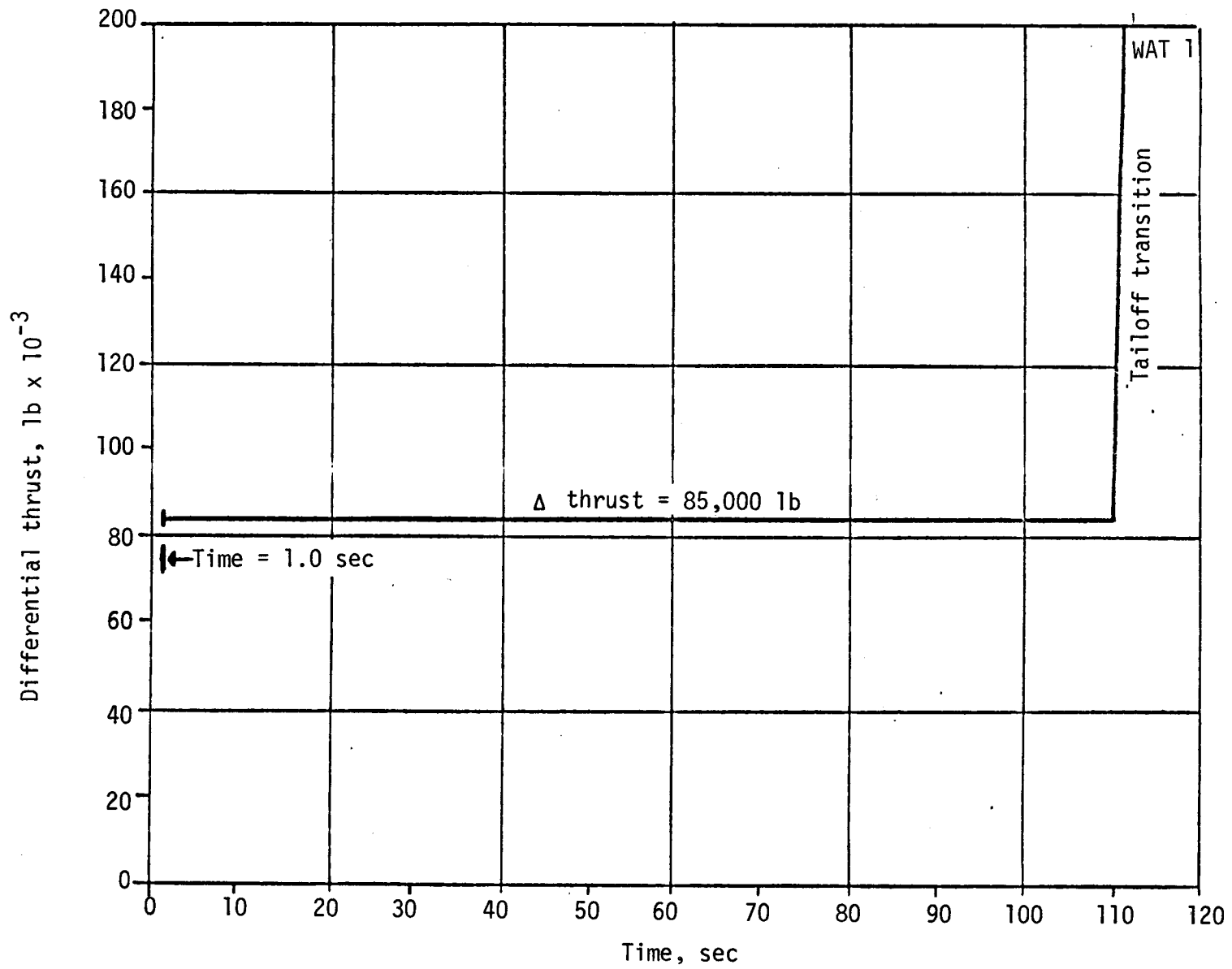

Figure 6.3.1-4.- SRB steady state thrust differential.  
(Paragraphs 6.3.1.1 and 3.6.3.1)

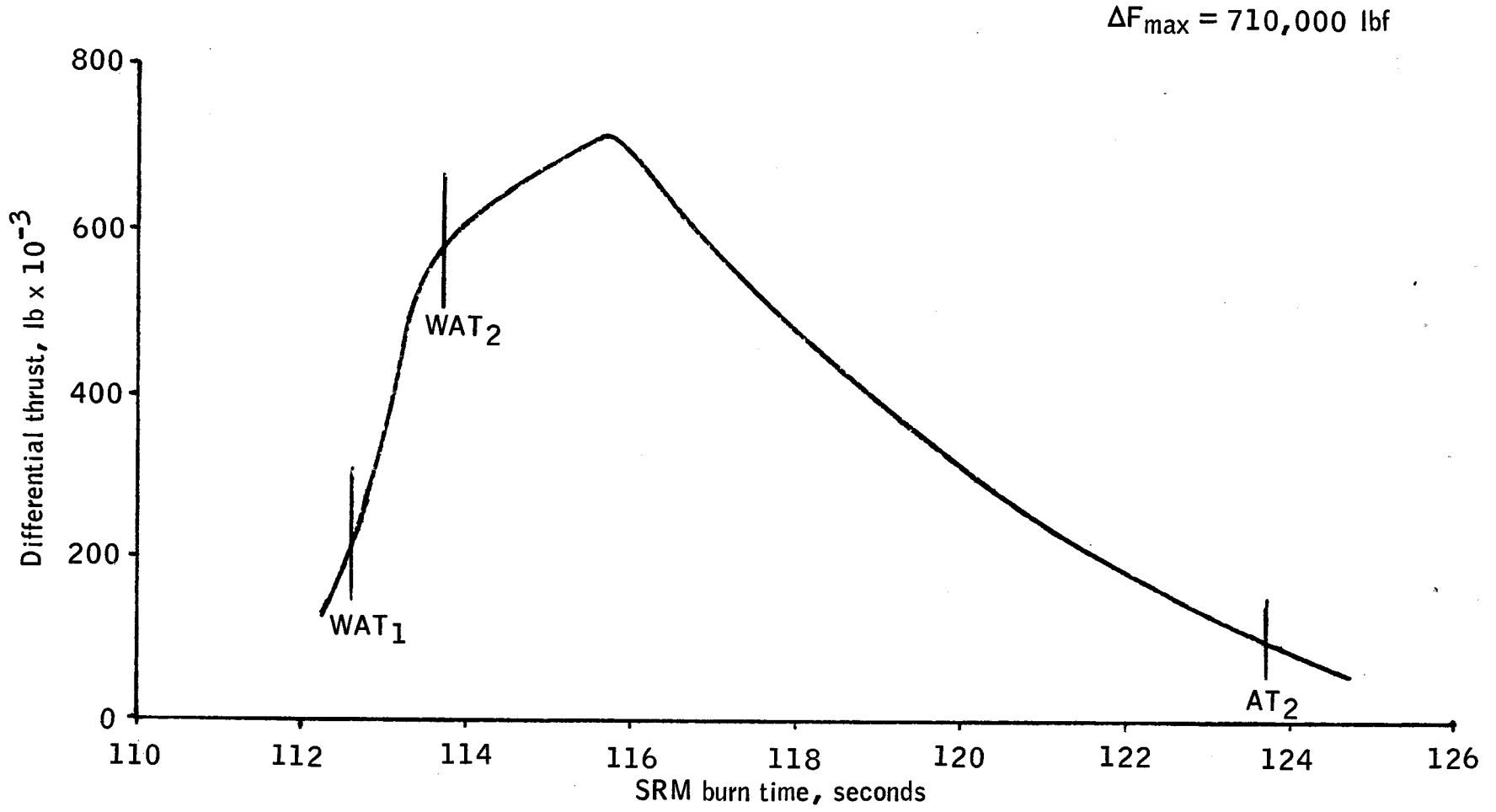

Figure 6.3.1-5.- SRM tailoff thrust differential.  
(Paragraphs 6.3.1.1 and 3.6.3.1)

6.3.2

PROPELLANT CHARACTERISTICS

- |                            |  |
|----------------------------|--|
| a. Type                    | TP-H1148, PBAN (polybutadiene-acrylic acid-acrylonitrile)<br>table 6.3.2-1 |
| b. Propellant weight       | See Volume II  |
| c. Grain configuration     | 11 point star and transitional to cylindrical perforate                    |
| d. Pressure range          | <u>TBS</u> to 950 psia   |
| e. PMBT                    |  |
| 1. Range                   | 40° to 90° F   |
| 2. Nominal                 | 60° F  |
| f. General Characteristics | Table 6.3.2-1  |

TABLE 6.3.2-1.- PROPELLANT CHARACTERISTICS  
(Paragraph 6.3.2)

Formulation	Percent by weight	Molecular weight	Enthalpy at 298.1° K, cal/mole			Density, gm/cc
Ammonium perchlorate	69.6	177.5	-70,590			1.95
Aluminum	16.0	26.981	0			2.699
Iron oxide	0.4	159.7	-197,300			5.120
PBAN polymer	12.04	100.0 <sup>a</sup>	-12,000			0.931
Epoxy curing agent	1.96	100.0 <sup>a</sup>	-28,300			1.129
Physical properties (JANNAF uniaxial)		Temperature				
		0	77	90		
Initial modulus, psi		5,953	646	502		
Strain at max stress, percent		33	44	43		
Tensile strength, psi		379	103	92		
Ballistic properties ( $P_c = 1,000$ psia, 60° F)		Chamber	Nozzle	Exit		
Flame temperature, °F		5,718	5,351	3,383		
Molecular weight, lb/lb-mole		28.48	28.69	29.33		
Specific heat ratio		1.142	1.144	1.184		
Blowing coefficient, corrosivity index		0.1072	0.1059	0.1038		
Characteristic velocity, fps				5,155		
Density, lb/in <sup>3</sup>				0.06347		
Burning rate at 1,000 psia (nominal and limits), in/sec						
40° F			0.396	±0.020		
60° F			0.408	±0.020		
90° F			0.426	±0.022		
Burning rate coefficient			0.03787			
Burning rate exponent			0.35			
Effective nozzle specific heat ratio			1.145			
Vacuum theoretical specific impulse, lb-sec/lb			276.2			
Expansion ratio			7.16			
Absolute viscosity of chamber gas, lbf-sec/in-ft			1.62 x 10 <sup>-7</sup>			

<sup>a</sup>Average molecular weight of polymer and ECA are 3,300 and 360. Values shown in table are consistent with heat of formation data.

6.3.3

IGNITER CHARACTERISTICS

- |   |                 |
|---|-----------------|
| a. Type   | TBS             |
| b. Number   | TBS             |
| c. General performance                                | Figure 6.3.3-1  |
| d. Temperature limits                                 | Table 3.6.1.2-1 |
| e. Grain point star                                   |                 |
| 1. Igniter  | TBS             |
| 2. Initiator  | 30 points       |
| f. Igniter burn time at nominal pressure of 2020 psia | 0.270 sec       |
| g. Initial mass flow rate                             | 560 lb/sec      |



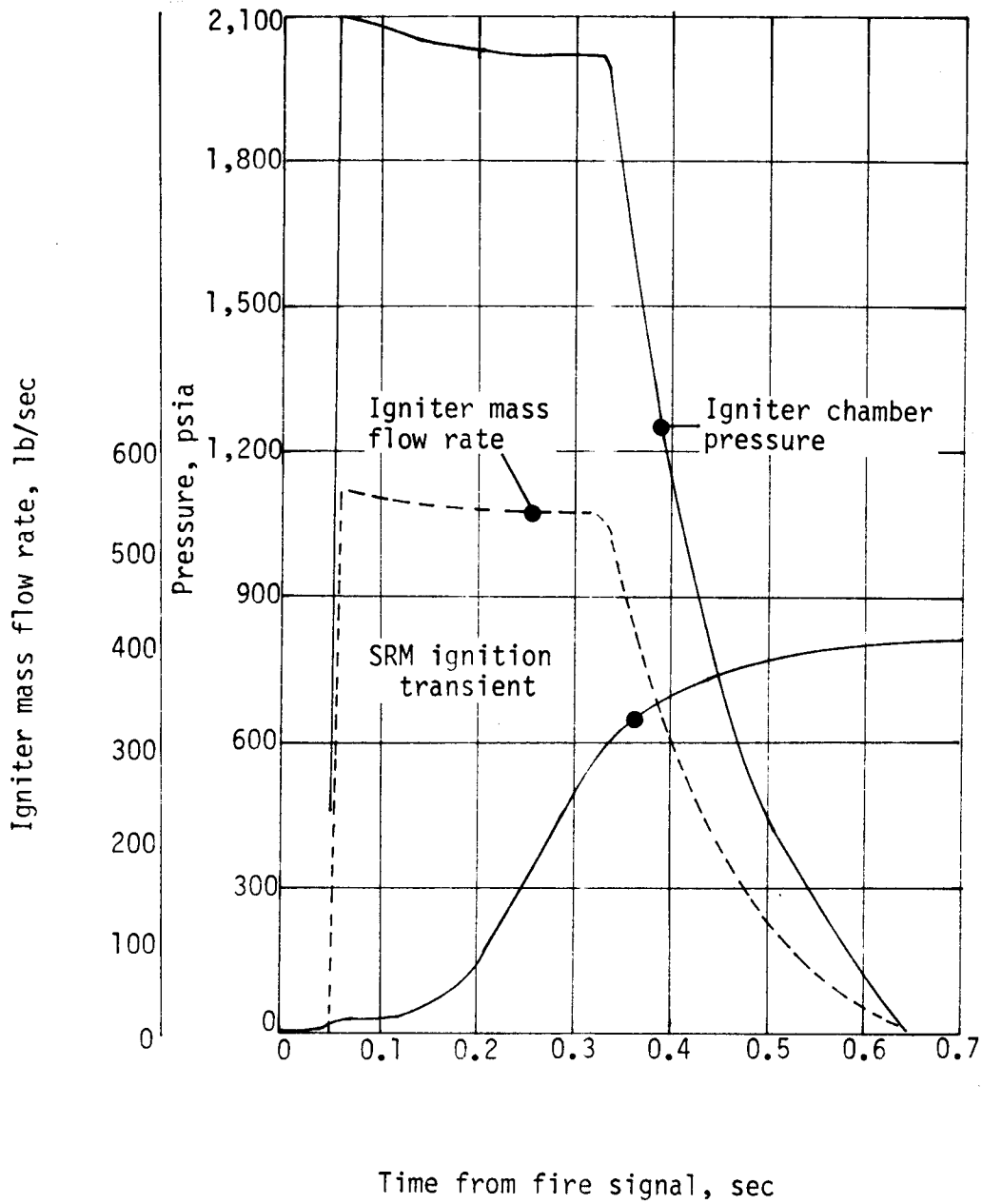

PMBT = 60° F

Figure 6.3.3-1.- SRM igniter performance.

(paragraph 6.3.3)

6.3.3-2

#### 6.3.4

#### NOZZLE CHARACTERISTICS

The nozzle assembly is a convergent-divergent movable design containing an aft pivot point flexible bearing as the gimbal mechanism. The nozzle is partially submerged to minimize erosive conditions in the aft end of the motor and to fit within envelope length limitations. The nozzle provides a suitable interface for the retrieval system, attach points for the TVC actuators, attachment structure to mate with the motor aft closure, capability for jettisoning a part of the aft exit cone after burnout, and an impact cushioning device to minimize potential damage upon water impact to the nozzle flexible bearing. The physical characteristics of the nozzle are listed in table 6.3.4-1. These characteristics are compatible with SRM performance requirements regarding thrust-time, movement constraints, geometric thrust vector, and dynamic thrust vector. The nozzle is a modular-type construction with parts grouped into assemblies to facilitate maximum reuse and refurbishment of structural members.

TABLE 6.3.4-1.- SOLID ROCKET BOOSTER NOZZLE CHARACTERISTICS  
(Paragraph 6.3.4)

Parameter	HPM
Nozzle type	Contoured
Expansion ratio	7.79:1
Unpressurized maximum diameter, in.	152.9
Pressurized maximum diameter, in.	154.91
Initial throat diameter, in.	53.90
Nozzle extension jettisonable	Yes
Nozzle length throat-to-exit, in.	154.195
Nozzle total length, in.	177.7
Submergence ratio	0.226
Initial L/RT	5.28
Exit cone, contoured	
Initial angle, deg	TBD
Turnback angle, deg	TBD
Exit angle, deg	TBD
Nozzle null position-pitch-WRT centerline, deg	0.0
Tolerance on null position - pitch, deg	1.0
Nozzle null position - yaw - away from actuators WRT centerline, deg	a
Tolerance on null position - yaw, deg	0.5

<sup>a</sup>Shifts accordingly with the increase in motor pressure.

## 6.4.1

## THRUST VECTOR CONTROL SUBSYSTEM

The thrust vector control (TVC) subsystem of each SRB consists of two servoactuators. These servoactuators serve to provide attitude control for each of the SRB's in response to control commands from GN and C computers via flight control electronics in the Orbiter vehicle. A servoactuator is located in each SRB aft skirt. One is designated rock and the other tilt. Each is driven by a hydraulic power unit (HPU).

## 6.4.1.1

Gimbal Capability

a. Pitch	Figure 6.4.1-1
b. Yaw	Figure 6.4.1-1
c. Overtravel	Figure 6.4.1-1
d. Velocity	Figure 6.4.1-1
e. Acceleration	2 rad/sec/sec
f. Normal engine position	
1. Static	0 deg (null)
2. Firing	<u>TBS</u> deg
3. Separation	<u>TBS</u> deg
4. Fail	0 deg (null)
g. Minimum time servoactuators retain null after separation	20 sec
h. Point of thrust application	
1. SRB left	
(a) $X_T$	<u>TBS</u>
(b) $Y_T$	-250
(c) $Z_T$	400
2. SRB right	
(a) $X_T$	<u>TBS</u>
(b) $Y_T$	250
(c) $Z_T$	400
i. Dynamic and geometric thrust alignment	Figures 6.4.1-2 and 6.4.1-3
j. TVC lifetime	20 uses

The SRM TVC design gimbal rate is  $+5^\circ/\text{sec}^*$ , under full load, simultaneously about each gimbal axis with two APU's operating ( $7.1^\circ/\text{sec}$ . Resultant nozzle deflection rate).

\* $+4.3^\circ/\text{sec}$  with one APU or actuator failed.

#### SRM nozzle deflections

7.1° control  
 0.5° geometrical misalignment  
 0.4° overtravel  
 8.0° Total

See note

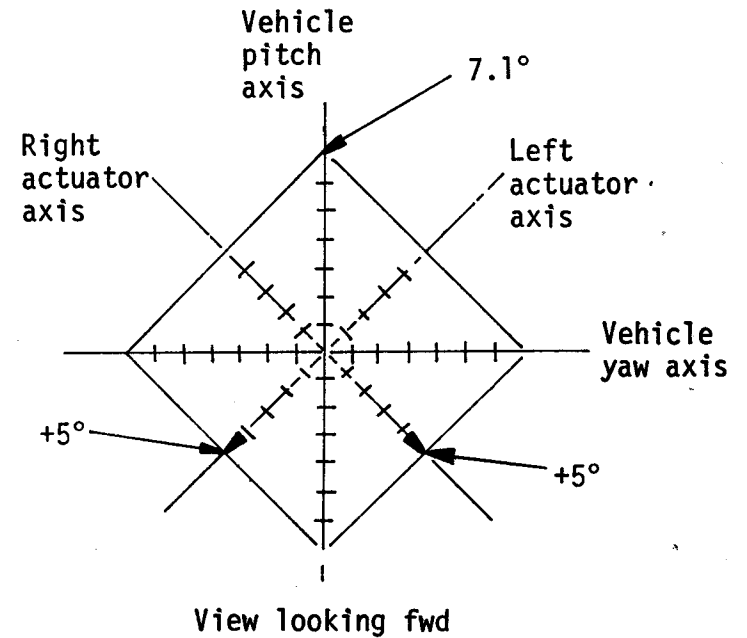

Note: The  $7.1^\circ$ ,  $0.5^\circ$  and  $0.4^\circ$  increments are taken in vehicle pitch/yaw axis: actuator travel requirements for flight control are  $+5^\circ$  travel

Figure 6.4.1-1.- SRM nozzle deflection.  
 (paragraph 6.4.1.1)

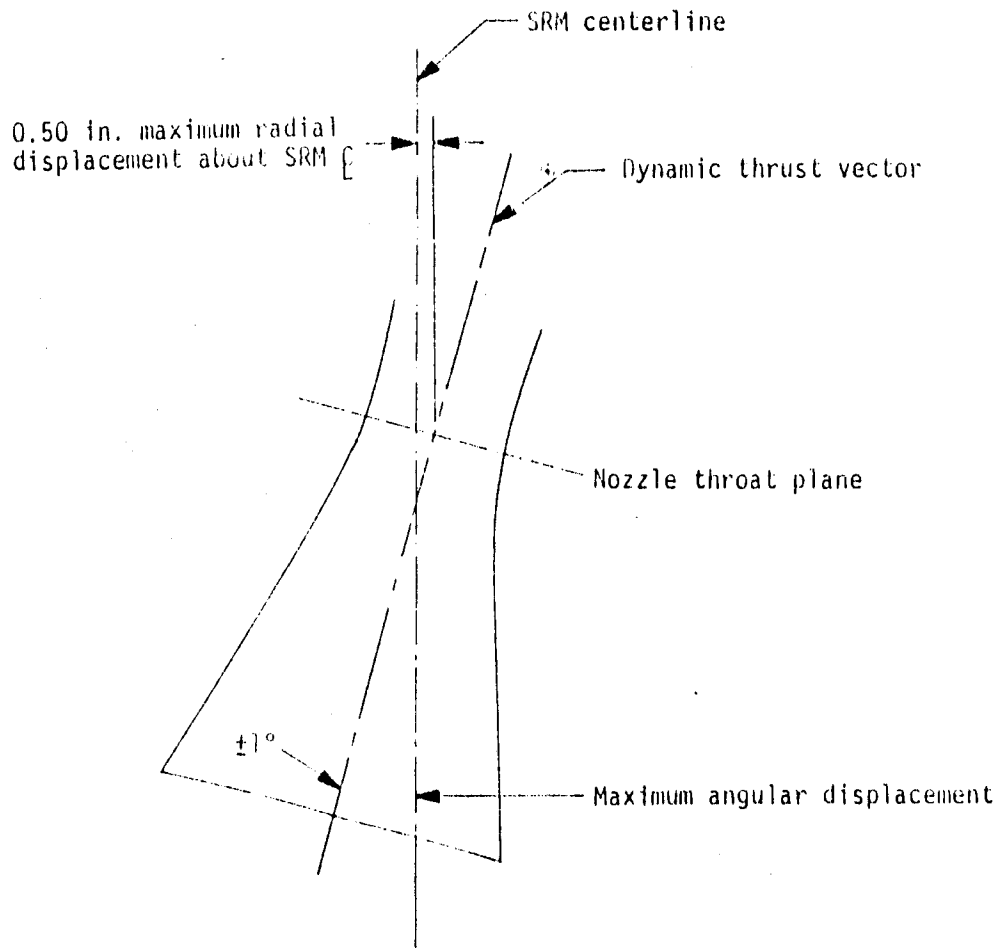

Figure 6.4.1-2.- Dynamic thrust vector alignment.  
 (paragraph 6.4.1.1)

6.4.1-3

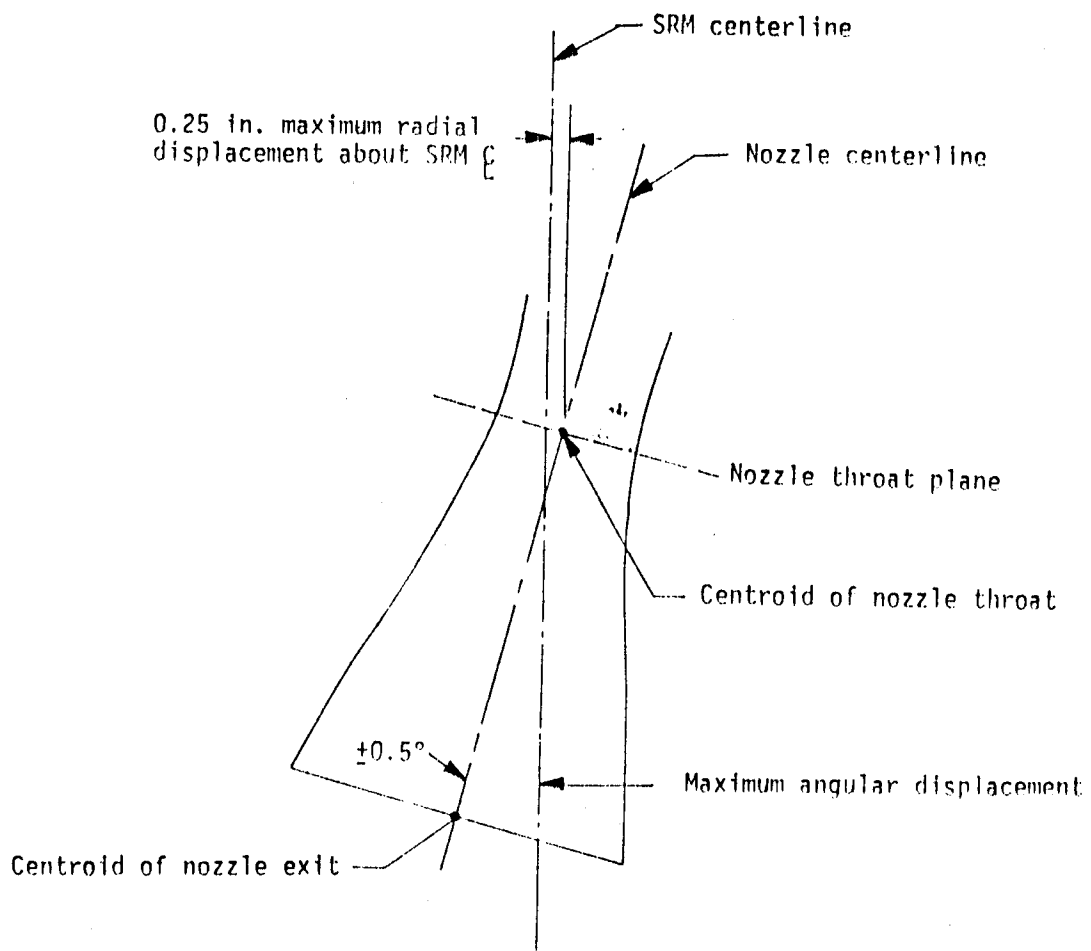

Figure 6.4.1-3.- Geometric thrust vector alignment.

(paragraph 6.4.1.1)

6.4.1-4

#### 6.4.2

##### AUXILIARY POWER UNIT SUBSYSTEM

The auxiliary power unit (APU) is the power source for the HPU. It is nominally controlled to 72,000 rpm's and, at this speed, is capable of delivering 135 hp to the gearbox input drive shaft. The subsystem is comprised of:

- a. Gas generator
- b. Fuel ( $N_2H_4$ ) pump
- c. Dual-pass reentry turbine
- d. Fixed ratio gear box
- e. Primary speed control valve (normally open)
- f. Secondary speed control valve (normally closed)
- g. Lubrication system
- h. Various check, service, and relief valves used to effect control and safety of the APU.



## 6.4.3

## HYDRAULIC POWER UNIT

## a. Components

1. Bootstrap reservoir
  - a. Flight load 70 ± 5 percent
  - b. Volume at 70 percent 490 in<sup>3</sup>
2. Fuel supply module
  - a. Volume 1760 to 1790 in<sup>3</sup>
  - b. N<sub>2</sub>H<sub>4</sub> load 825 to 908 in<sup>3</sup>
  - c. Pressure 385 ± 10 psia
  - d. Decay curve (for 120° of actuator motion) Figure 6.4.3-1
3. A variable displacement hydraulic pump
4. Hydraulic manifold
5. Filters
6. Manual and remote-controlled valves
7. Relief valves
8. Connecting tubing to form a closed-loop hydraulic system with two servoactuators.

## b. Capability

1. Each HPU is designed to supply primary hydraulic power to a single servoactuator in the TVC system.
2. Systems design also provides for a single HPU to power both servoactuators at a reduced response rate for contingency operation in the event of failure of either HPU.

## c. Location

Adjacent to each other in the aft skirt of each SRB

## d. Volume

1. A (Rock) System 1792.6 in<sup>3</sup>
2. B (Tilt) System 1723.3 in<sup>3</sup>

TABLE 6.4.4-1.- SRB TVC ACTUATOR POLARITY CONVENTIONS  
(Paragraph 6.4.4)

Shuttle Vehicle Maneuver	LH SRB		RH SRB	
	Rock actuator	Tilt actuator	Rock actuator	Tilt actuator
+ Pitch	-	+	+	-
- Pitch	+	-	-	+
+ Yaw	+	+	-	-
- Yaw	-	-	+	+
+ Roll	+	-	+	-
- Roll	-	+	-	+

+ indicates actuator extension

- indicates actuator retraction

## 6.4.4

## SERVOACTUATORS

The SRB TVC gimbal secondary actuators on the LH and RH SRB's are driven by electrical signals proportional to Orbiter computer-commanded gimbal position. For each actuator, three redundant signals are provided by three separate drive amplifiers, one signal for each of the three secondary actuator control channels. With two identical commands, the secondary actuator force sum action prevents a single erroneous command from effecting power ram motion. If the erroneous command persists for more than a predetermined time, pressure detectors activate a bypass valve, removing the defective channel hydraulic pressure, thus permitting the remaining channels to control the ram motion. A second failure with only two remaining active channels results in a force fight which again, if this condition persists for more than a predetermined time, causes a bypass of either or both of the channels. When more than one channel has been bypassed, a spring-loaded shutoff valve is unloaded to the shutoff position and the power ram is allowed to drive to null, with no pressure on the power spool. Failure monitors are provided for each channel to indicate that that channel has been bypassed. An isolation valve on each channel provides the capability of resetting a failed or bypassed channel. Each actuator ram is equipped with position transducers.

- |   |                        |
|---|------------------------|
| a. Number   | 2                      |
| b. Type   | Hydraulic              |
| c. Piston area  | 32.32 in <sup>2</sup>  |
| d. Stroke   | 12.8 in.               |
| e. Hinge moments as a function of extension rate and flow rate  |                        |
| 1. Pitch actuators  | <u>TBS</u>             |
| 2. Yaw actuators  | <u>TBS</u>             |
| f. Internal leakage   | <u>TBS</u>             |
| g. External leakage   | <u>TBS</u>             |
| h. Temperature limits   | Table 3.6.1.2-1        |
| i. Electrical characteristics   |                        |
| 1. Actuator gain with $\pm 50$ mA input (rock or tilt)  | $\pm 5$ deg            |
| 2. Gimbal position vs. command linearity  |                        |
| (a) No failed channels  | 5 percent              |
| (b) One failed channel  | 7 percent              |
| 3. Maximum current input not initiating gimbal motion from null   |                        |
| (a) No failed channels  | 1 mA                   |
| (b) One failed channel  | 1.5 mA                 |
| 4. Polarities   | Table 6.4.4-1          |
| 5. TVC failure position   | Null                   |
| 6. Time to failure position   |                        |
| (a) Nominal   | <u>TBS</u>             |
| (b) Limits  | <u>TBS</u> to 100 msec |
| j. Operational constraint: Single channel operation of the SRB-TVC actuation system is an unverified flight control mode. |                        |

TABLE 6.4.4-1.- SRB TVC ACTUATOR POLARITY CONVENTIONS  
(Paragraph 6.4.4)

Shuttle Vehicle Maneuver	LH SRB		RH SRB	
	Rock actuator	Tilt actuator	Rock actuator	Tilt actuator
+ Pitch	-	+	+	-
- Pitch	+	-	-	+
+ Yaw	+	+	-	-
- Yaw	-	-	+	+
+ Roll	+	-	+	-
- Roll	-	+	-	+

+ indicates actuator extension

- indicates actuator retraction

## 6.5.1

## BOOSTER SEPARATION MOTORS

a. Number	
1. Forward	4
2. Aft	4
b. Configuration	Figure 2-5
c. Thrust, vacuum (each motor)	
1. Minimum average (to end web action time)	18,500 lbf
2. Maximum	29,000 lbf
3. Nominal curve	Figure 6.5.1-1
4. Thrust orientation tolerances	Figure 6.5.1-2
d. Specific impulse (theoretical)	250 $\frac{\text{lbf} - \text{sec}}{\text{lbm}}$
e. Nominal vacuum total impulse over action time	17,615 lb-sec
f. Chamber pressure (max. expected operating pressure)	2220 psia
g. Nozzle area ratio	5.8:1
h. Nozzle throat area	7.709 in <sup>2</sup>
i. Nozzle locations and angles	Figure 2-5
j. Burn time	
1. Buildup	0.030 to 0.100 sec
2. Web action	≤ 0.805 sec
3. Time to P = $\frac{P_{\text{ewat}}^a}{2}$	≤ 1.05 sec
k. Operating temperature	30 to 120° F

<sup>a</sup>ewat - end web action time

6.5.1-2

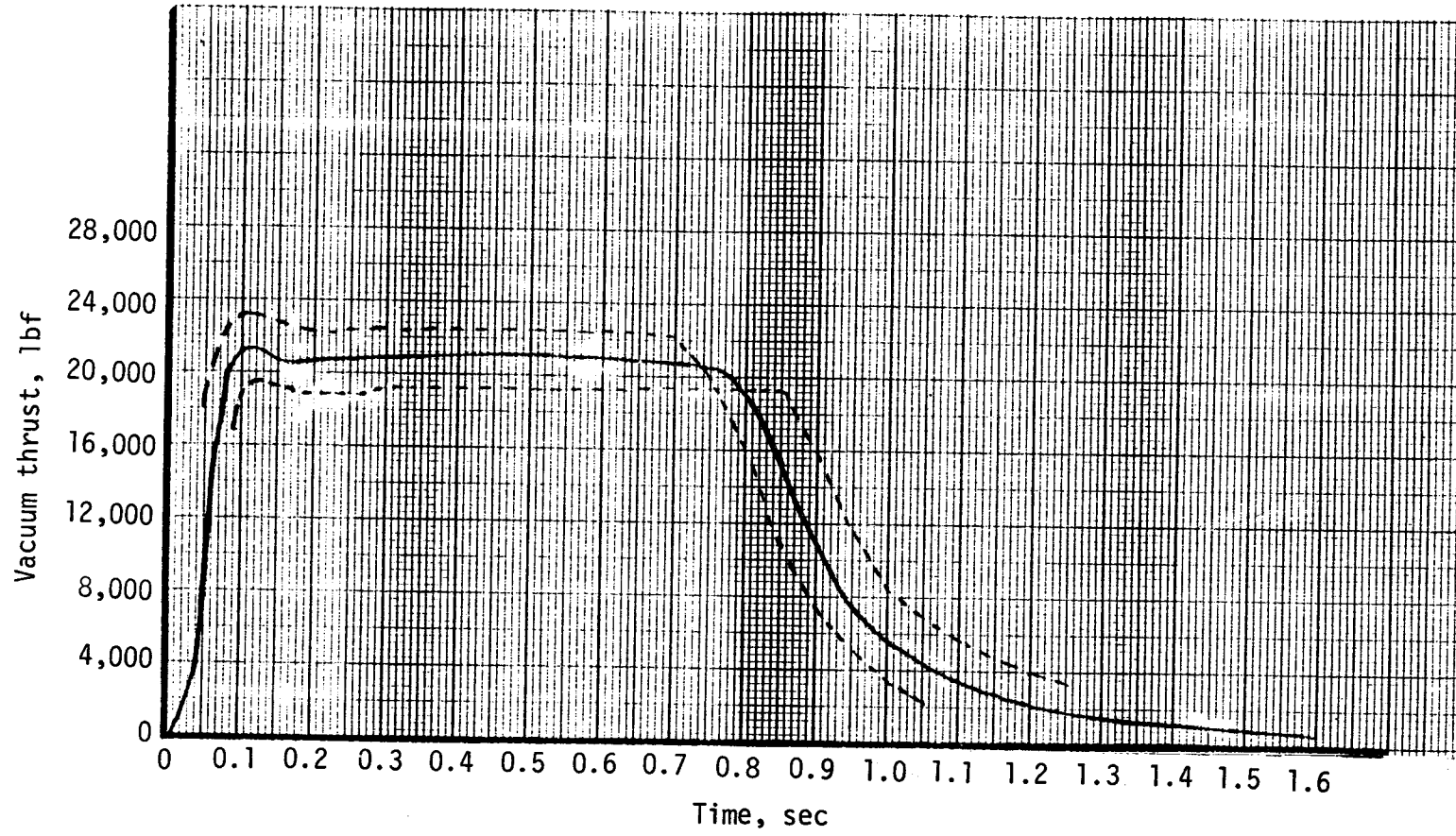

Figure 6.5.1-1.- Nominal vacuum thrust vs. time.  
(Paragraph 6.5.1)

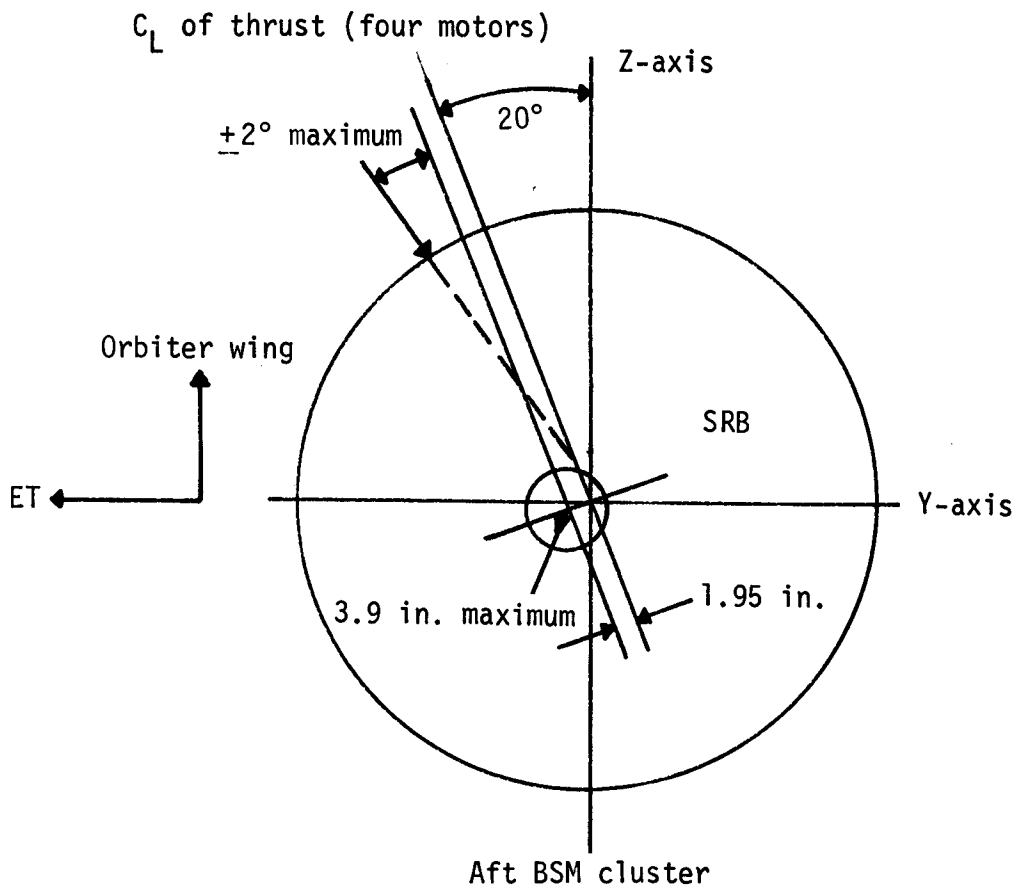
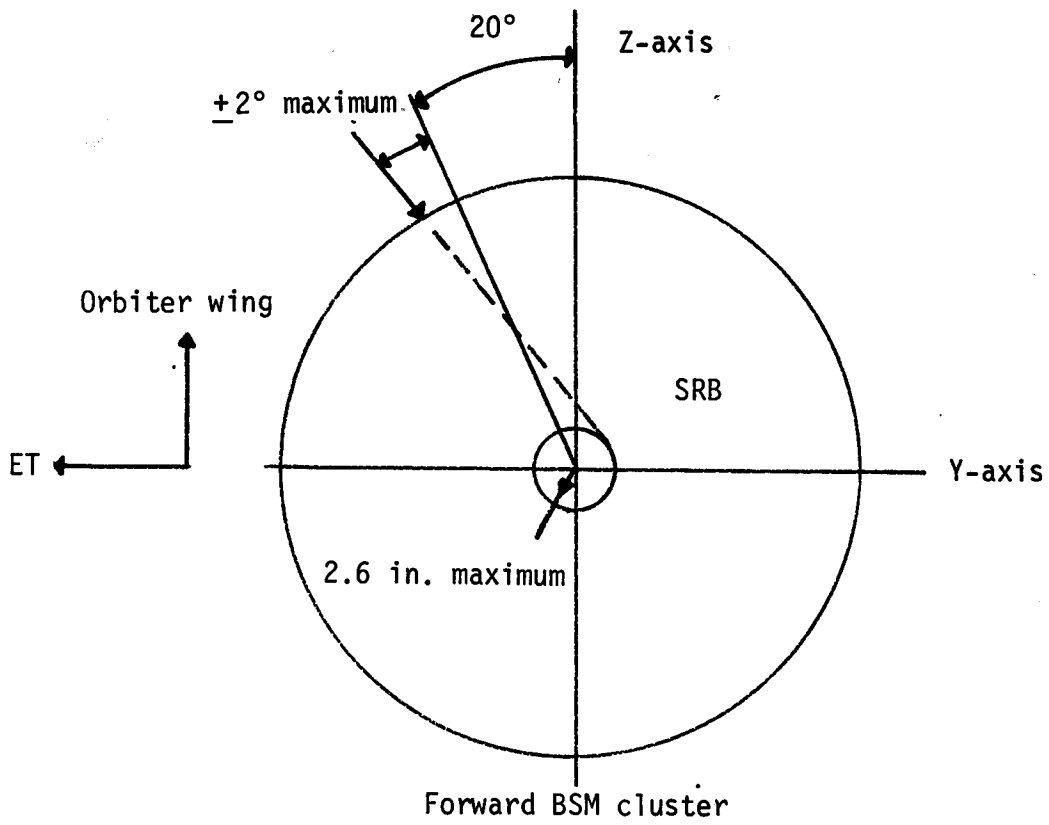

Figure 6.5.1-2.- Left SRB BSM cluster TVC orientation tolerances - viewed from the front. (paragraph 6.5.1)

6.5.2

**ATTACHMENT/RELEASE MECHANISMS**

The vacuum thrust of each cluster of four BSM's reaches 55,500 lb within 30 to 135 msec, and the release of all structural attachments occurs within 30 msec of the time the Fire 2 command crosses the Orbiter/SRB interface.

- a. Mechanical release
- b. Thrust/weight
- c. Separation requirements
- d. Pyrotechnics

≤ 500 ft-lb-sec

TBS

Paragraph 5.2

Paragraph 4.2.8.3



## 6.6 RECOVERY SUBSYSTEM

### 6.6.1

#### PARACHUTE EQUIPMENT

Parachute equipment consists of pilot, drogue, and main parachutes.

- |  |                |
|--|----------------|
| a. Parachute components                  | Figure 6.6.1-1 |
| b. Parachute aerodynamic characteristics | Table 6.6.1-1  |
| c. Parachute deployment sequence         | Figure 6.6.1-2 |
| d. Limit loads                           |                |
| 1. Pilot                                 | 14,515 lb      |
| 2. Drogue                                | 270,000 lb     |
| 3. Mains (cluster)                       | 521,000 lb     |
| e. Reefing strategy                      | Table 6.6.1-2  |

TABLE 6.6.1-1.- PARACHUTE AERODYNAMIC CHARACTERISTICS  
 (Paragraph 6.6.1)

Parameter	Pilot	Drogue	Main, each
Suspension lines, ft	18	108.5	132
Riser, ft	32	-	40
Number of risers	1	-	8
Porosity, percent	16	16	16
Diameter ( $D_o$ ), ft	11.5	54	115
Suspension line ( $L_s/D_o$ )	1.57	2.01	1.15
$L_s/D_o$ effective	1.57	1.94	1.45
Trailing distance (X), ft	50	108.5	172
$X/D_o$	4.35	1.94	1.50
$X/D_h$	2.88	6.05 (SRB) 8.63 (frustum)	9.91
$D_p/D_h$	0.44	2.07 (SRB) 2.95 (frustum)	4.24 7.4(3)
$C_{D0}$	.55 $\pm .04$	0.60 $\pm 0.04$ (SRB) 0.60 $\pm 0.04$ (frustum)	.60 $\pm .04$

Where X = distance between forebody and leading edge of canopy skirt  
 $D_o$  = canopy projected diameter  
 $D_h^p$  = maximum diameter of forebody

TABLE 6.6.1-2.- REEFING STRATEGY  
(Paragraph 6.6.1)

Reefing stages	Drogue parachute		Main parachutes	
	Time, sec	Percent, $C_D A$	Time, sec	Percent, $C_D A$
Stage I	0.00	0	0.00	0
	0.76	60	2.62	19
	7.00	60	10.00	19
Stage II	7.17	80	11.20	45
	12.00	80	17.00	45
	12.17	100	18.71	100

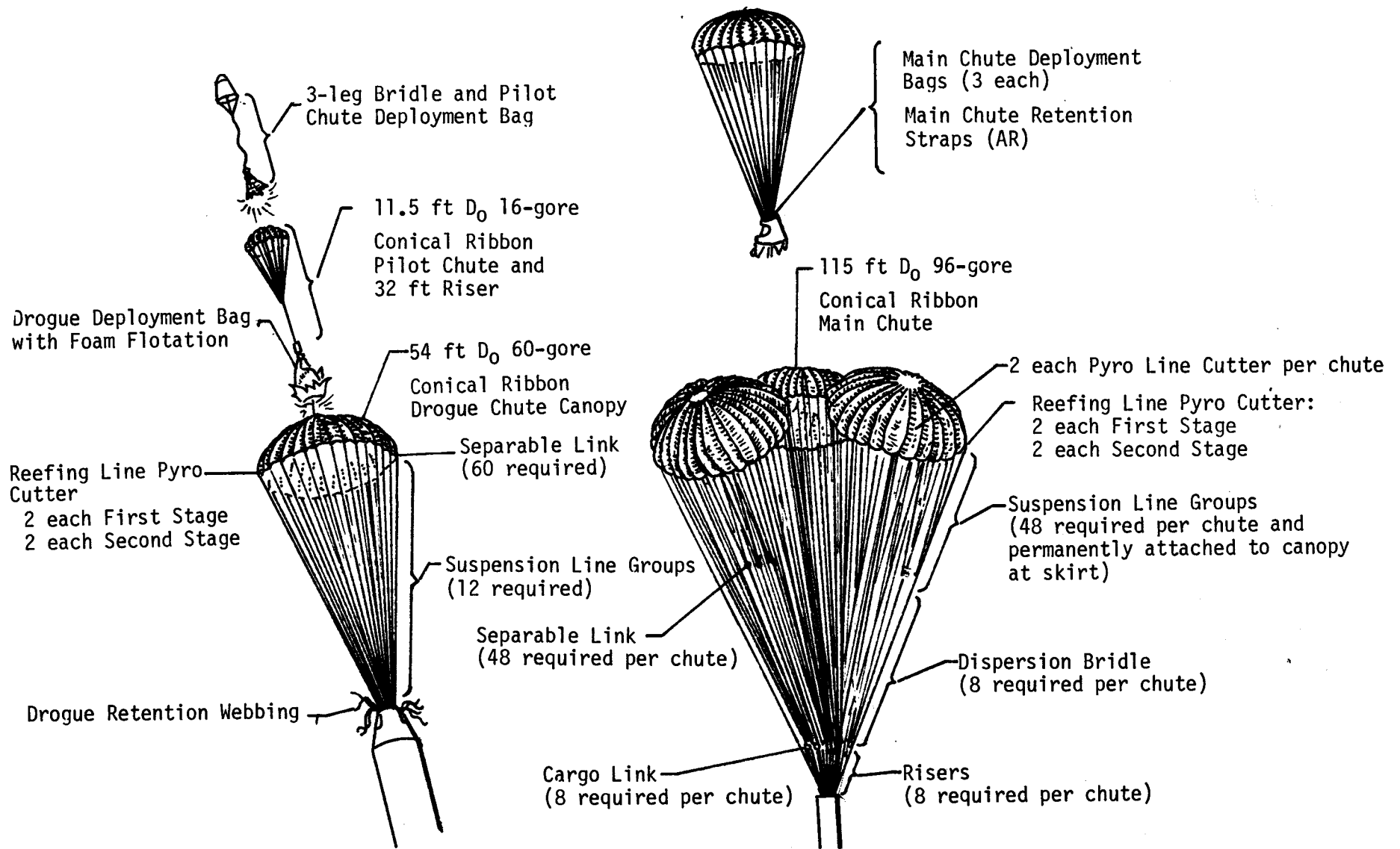

Figure 6.6.1-1.- Parachute components.  
(paragraph 6.6.1)

1. Nose Cap Jettison

$t = 0$  sec

$h = 15,400$  ft

$q = 210$  lb/ft<sup>2</sup>

Ejection rate (nominal) =

95 ft/sec

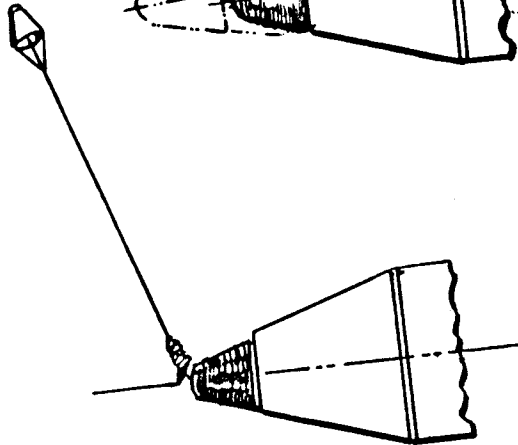
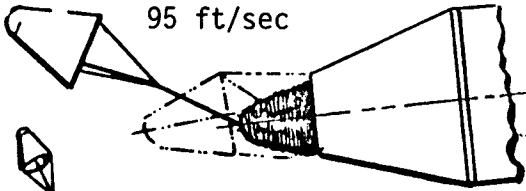

2. Pilot chute extraction

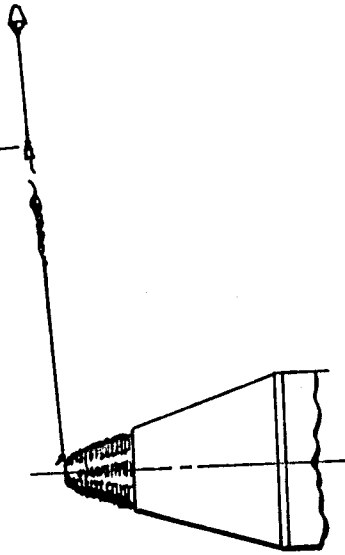

3. Pilot bag strip

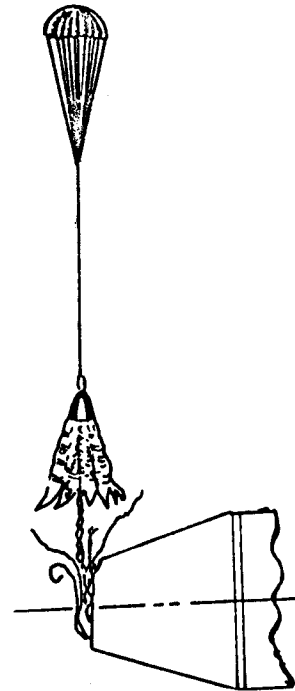

4. Drogue extraction

$t = 0.55$  sec

$h = 15,100$  ft

$q = 205$  lb/ft<sup>2</sup>

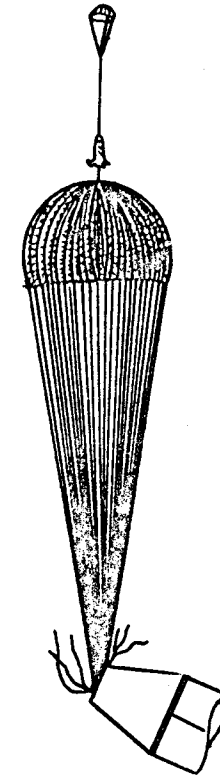

5. Drogue inflates to reefed position

1st reefed position

Percent  $C_{DA} = 60$

$t = 2.4$  sec

$h = 14,200$  ft

$q = 184$  lb/ft<sup>2</sup>

2nd reefed position

Percent  $C_{DA} = 80$

$t = 8.81$  sec

$h = 11,300$  ft

$q = 152$  lb/ft<sup>2</sup>

Figure 6.6.1-2.- Parachute deployment sequence.  
(Paragraph 6.6.1)

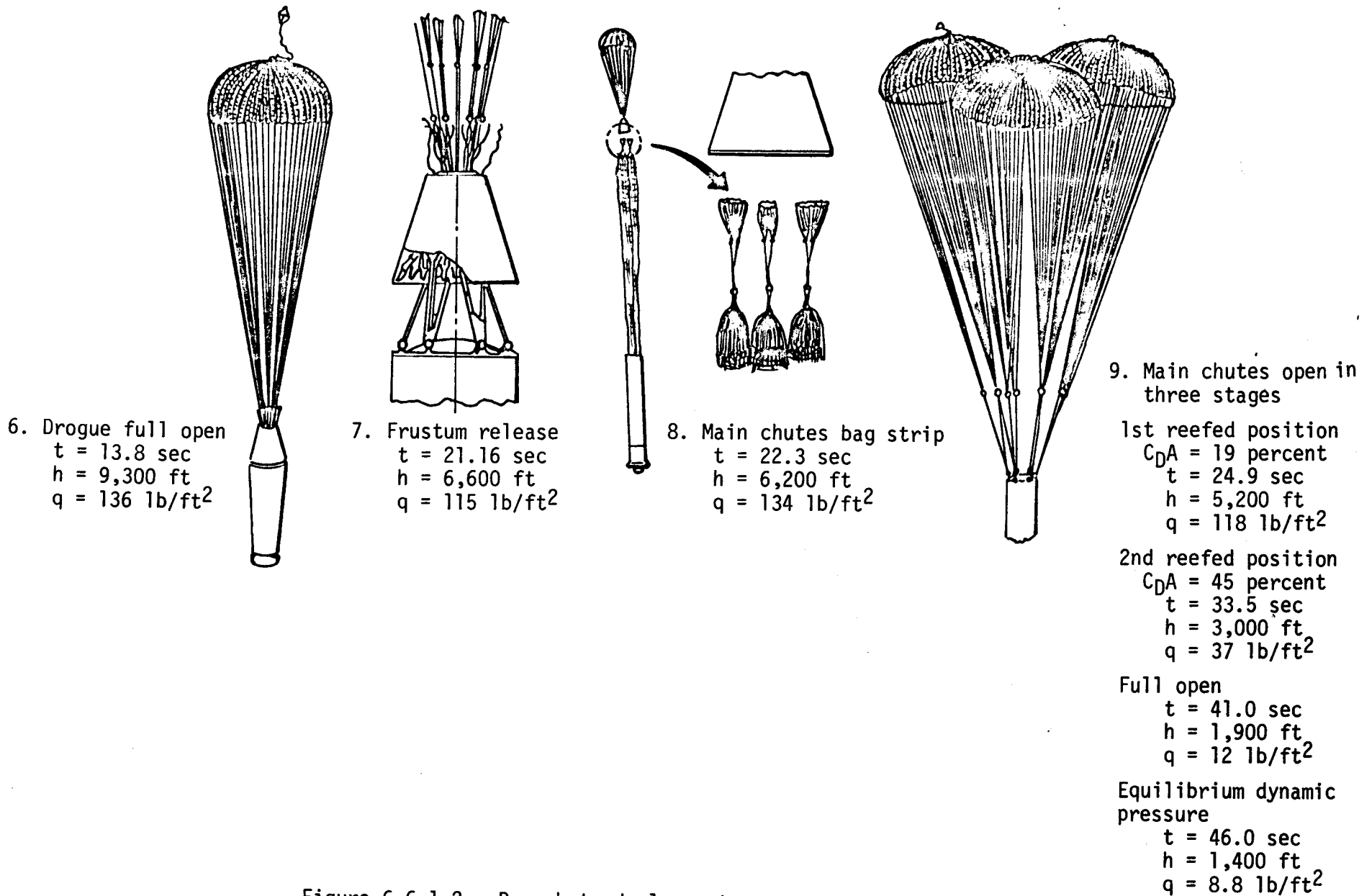

Figure 6.6.1-2.- Parachute deployment sequence - continued.  
 (Paragraph 6.6.1)

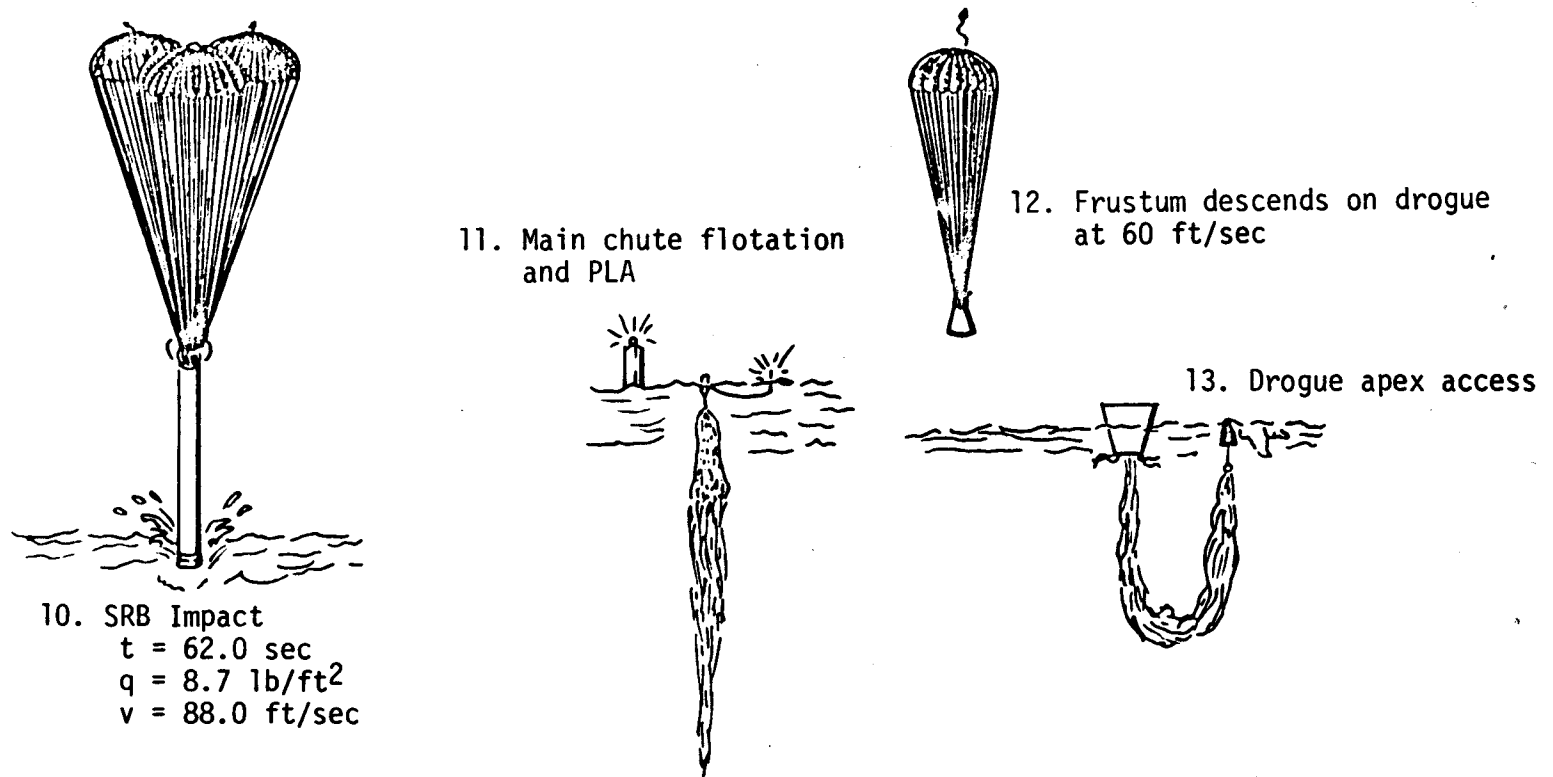

Figure 6.6.1-2.- Parachute deployment sequence - concluded.  
(Paragraph 6.6.1)

6.6.2

FLOTATION EQUIPMENT

a. Minimum flotation period in sea-state 5

1. Nominal

TBS

2. Range

72 to TBS hours



## 6.6.3

## LOCATION AIDS

Location aids include a transmitter, antenna, strobe/converter, battery and salt-water switch electronics. With the exception of the flashing light, the location aids are designed for a minimum operating life of 72 hours and are considered usable up to 20 times with refurbishment.

## a. SRB

## 1. Radar transponder

- |                                    |   |
|------------------------------------|---|
| (a) Range                          | 9 nmi.                                    |
| (b) Lifetime out of 72-hour period | 24 hrs                                    |
| (c) Frequency                      | 240 MHz - left SRB<br>242 MHz - right SRB |

## 2. Flashing light

- |  |        |
|--|--------|
| (a) Range with unrestricted visibility and wave heights of 2.9 m | 5 nmi. |
| (b) Actuation  | Impact |
| (c) Continuous operation lifetime                                | 72 hrs |

## b. Frustum

## 1. RF transmitter

- |                                   |   |
|-----------------------------------|---|
| (a) Range                         | 9 nmi.  |
| (b) Continuous operation lifetime | 72 hrs  |
| (c) Frequency                     | 240.8 MHz - left SRB<br>241.2 MHz - right SRB |

## 2. Flashing light

- |  |         |
|--|---------|
| (a) Range with unrestricted visibility and wave heights of 2.9 m | 5 nmi.  |
| (b) Actuation  | Impact  |
| (c) Continuous operation lifetime                                | 72 hrs  |
| (d) Operating lifetime, total                                    | 280 hrs |

## c. Main parachutes

## 1. RF transmitter

- |                                   |        |
|-----------------------------------|--------|
| (a) Range                         | 9 nmi. |
| (b) Continuous operation lifetime | 72 hrs |

## 2. Flashing light

- |  |        |
|--|--------|
| (a) Range with unrestricted visibility and wave heights of 2.9 m | 5 nmi. |
| (b) Actuation  | Impact |
| (c) Continuous operating lifetime                                | 72 hrs |

## 3. Sonar beacons

- |               |        |
|---------------|--------|
| (a) Range     | 3 nmi. |
| (b) Frequency | 10 kHz |

## 6.6.4

**RECOVERY BATTERY CHARACTERISTICS**

The SRB batteries provide all subsystem electrical energy after separation. Orbiter power is provided for all operation prior to separation.

a. Number	One per SRB
b. Type	Silver/zinc
c. Capacity	50 Ah
d. Useful life	One flight
e. Storage life	2 yrs
f. Stand time	90 days
g. Pressure relief valve	
1. Opens at	24 $\pm$ 2 psig
2. Closes at	12 $\pm$ 2 psig
h. Voltage	
1. Under load	28 $\begin{matrix} +4 \\ -2 \end{matrix}$ v
2. Open-circuit	37.7 V maximum
3. During all discharges	26 V minimum

## 6.7.1

### RANGE SAFETY SUBSYSTEM CHARACTERISTICS

The range safety subsystem is a triplex configuration which has one completely redundant subsystem on each SRB and a partially simplex system on the ET. Any one or all three subsystems is capable of receiving two command messages transmitted from the Air Force ground stations. The first of these messages, called "ARM," would allow the onboard logic to enable a "DESTRUCT" and would activate a light on both the commander and the pilot's display panels. The second message transmitted to the vehicle would be the "FIRE" command. See figure 6.7.1-1.

#### 6.7.1.1

##### Antenna Characteristics

a. Number	2 per SRB
b. Voltage standing wave ratio	1.5:1 maximum
c. Frequency range	406 to 420 MHz
d. Polarization	Left-hand circular
e. Operating life	1000 hr minimum
f. Useful life	20 flights minimum
g. Location	Figure 6.7.1-2

#### 6.7.1.2

##### Couplers

##### 6.7.1.2.1

##### Directional

a. Voltage standing wave ratio	1.25:1 maximum
b. Frequency range	406 to 420 MHz
c. Input impedance	50 $\Omega$
d. Insertion loss	0.30 dB maximum
e. Coupling	16 $\pm$ 3 dB
f. Directivity	24 dB minimum
g. Operating life	1000 hr minimum
h. Useful life	20 flights minimum

##### 6.7.1.2.2

##### Hybrid

a. Voltage standing wave ratio	1.25:1 maximum
b. Frequency range	406 to 420 MHz
c. Input impedance	50 $\Omega$
d. Power division and insertion loss	3.4 dB maximum
e. Isolation	24 dB minimum
f. Operating life	1000 hr minimum
g. Useful life	20 flights minimum
h. Storage life	5 yrs sheltered

#### 6.7.1.3

##### Integrated Receiver-Decoder

a. Tuned Frequency	416.5 MHz
b. Frequency deviation (operating)	$\pm$ 60 KHz
c. Operating bandwidth	$\pm$ 45 KHz
d. Quieting	15 dB at - 97 dBm
e. Telemetry output	4.75 at $\pm$ 0.25 Vdc

## 6.7.1.4

SRB Distributor Assembly Characteristics

The Shuttle RSS uses a single distributor assembly on each SRB and the ET. The ET distributor is similar to that of the SRB's with slight variations in packaging and circuitry. The SRB distributor assembly consists of two independent and physically isolated electrical assemblies "A" and "B". System "A" is powered from the range safety battery and controls the "safe and arm" (S & A) position switching of the S & A device. System "B" functions in the same manner with the exception of the S & A control. System "B" is powered by the recovery battery. The distributor assembly, including both systems "A" and "B," acts as the control center for the "arm and fire" commands providing the interconnect between the ET and SRB distributors.

a. Power input voltage range	24 to 32 Vdc
b. Input power	
1. Standby	6 W
2. Operating	12 W
c. Arm voltage	
1. Minimum	20 Vdc
2. Nominal	28 Vdc
3. Maximum	32 Vdc
4. Rise time	10 msec maximum
d. Arm current	0.500 A maximum
e. Arm duration	1.0 sec minimum (will be maintained 5 msec minimum after both fire commands have been issued)
f. Removal of arm command	
1. Capacitor bank voltage	Decreases to 1.5 Vdc maximum in less than 15 sec
2. Voltage of arm command in "Off" state	1.7 Vdc maximum
g. Fire 1 and Fire 2 commands	
1. Voltage	
(a) Minimum	20 Vdc
(b) Nominal	28 Vdc
(c) Maximum	32 Vdc
2. Current, each	10 mA maximum
3. Duration	10 msec minimum
4. Sequencing	Fire 1 command will either precede or be issued simultaneously with the Fire 2 command
h. Removal of fire commands	1.7 Vdc maximum (applied to fire command circuits in the "Off" state)
i. Initiator firing pulse energy at NSI detonator interface	100 mJ minimum within 5.0 msec
j. Initiator firing pulse current	40 A maximum
k. Operating life	5,000 hr minimum
l. Useful life	20 flights minimum
m. Storage life	10 yrs
n. Location	Figure 6.7.1-3

6.7.1.5

Safe and Arm Device

- |   |   |
|---|---|
| a. Autoignition and melting points                              | 275° F minimum                                |
| b. Insulation resistance  | 100 MΩ minimum at 500 Vdc                     |
| c. Solenoid or motor performance                                |   |
| 1. Net starting torque  |   |
| (a) 30 Vdc  | 0.75 ±0.05 in-lb                              |
| (b) 21 Vdc  | 0.25 ±0.05 in-lb                              |
| 2. Operating voltage  | 28 ±4 Vdc                                     |
| 3. Operating current  | 3 A maximum                                   |
| 4. Rotation   | 90 to 95° under no load<br>in 50 msec maximum |
| d. "Safe" position power on                                     |   |
| 1. Voltage input  | 28 ±4 Vdc                                     |
| 2. Elapsed time   | 90° rotation in 250 msec<br>maximum           |
| 3. Pin-to-pin voltage drop across<br>G-H, K-N, P-R, and S-T     | 750 mV maximum at 2.5 A                       |
| 4. Resistance check across pins<br>J-H, K-L, R-N, and T-U       | Open circuit                                  |
| e. "Armed" position power on                                    |   |
| 1. Voltage input  | 28 ±4 Vdc across pins<br>K and M              |
| 2. Elapsed time   | 90° rotation in 250 msec<br>maximum           |
| 3. Pin-to-pin voltage drop across<br>J-H, K-L, R-N, and T-U     | 750 mV maximum at 2.5 A                       |
| 4. Resistance check across pins<br>G-H, K-N, P-R, and S-T       | Open circuit                                  |
| f. Insulation resistance power off                              | 100 MΩ minimum at 500 Vdc                     |
| g. "Safe" position power off                                    |   |
| 1. Pin-to-pin and pin-to-case<br>voltage across F-M, and V-case | 750 mV maximum at 2.5 A                       |
| 2. Pin V to all other pins                                      | Open circuit                                  |
| h. Operating life   |   |
| 1. Electric   | 10 missions                                   |
| 2. Ordnance   | 1 cycle                                       |
| i. Useful life  | 10 flights                                    |
| j. Storage life   | 10 yrs minimum                                |
| k. Location   | Figure 6.7.1-3                                |

6.7.1.6

RSS Battery Characteristics

- |                          |                                 |
|--------------------------|---------------------------------|
| a. Type                  | Lithium mono-<br>fluorographite |
| b. Pressure relief valve |                                 |
| 1. Opens at              | 12 ±2 psig                      |
| 2. Closes at             | 8 ±1 psig                       |
| c. Voltage               |                                 |
| 1. Under load            | 26.7 V to 32.3 V                |
| 2. Open circuit          | 45.0 V maximum                  |
| 3. During all discharges | 26 V minimum                    |
| d. Operating life        | One mission                     |
| e. Useful life           | One flight                      |
| f. Storage life          | 2 yrs                           |

g. Stand time

90 days

h. Capacity

18 Ah

i. Number

One on each SRB

6.7.1.7

Recovery Battery Characteristics

Refer to paragraph 6.6.4.

6.7.1.8

SRB Destruct Assembly

Refer to paragraph 4.2.9.3 for linear-shaped charge (LSC) characteristics.

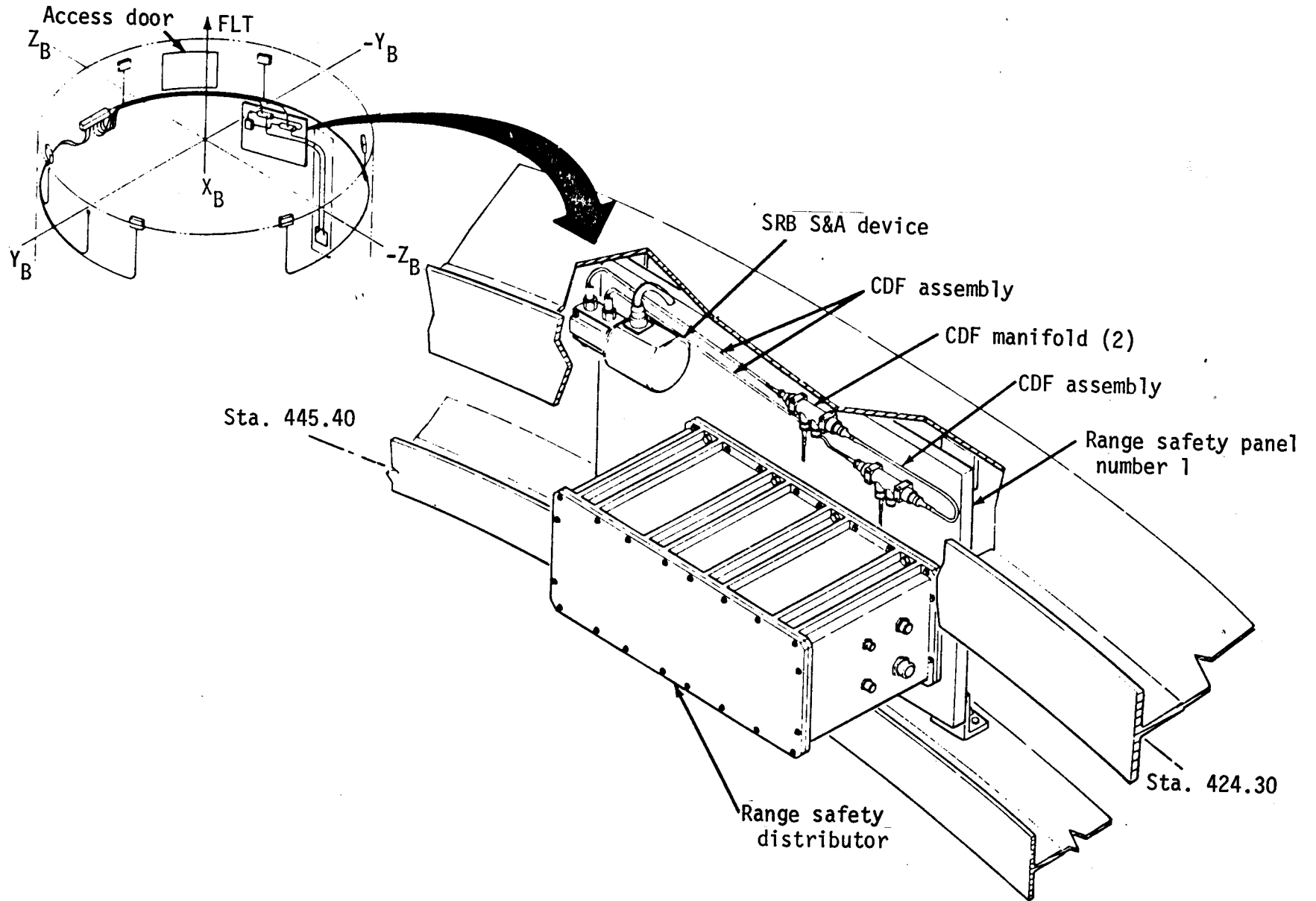

Figure 6.7.1-3.- RSS control panel mounting.  
(paragraph 6.7.1.6)

6.7.1-7

407

## 7.0 AERODYNAMICS\*

Aerodynamic data are available for the Shuttle vehicle in its various flight configurations.

For the Orbiter vehicle entry aerodynamic data, refer to the Aerodynamic Design Data Book, Volume I - Orbiter vehicle. SD72-SH-0060-1L-8, dated October 1978, and revised April 1982, and Flight Assessment Package for Orbiter Aerodynamics - FAD26 (JSC 22078), dated April 1986<sup>a</sup>.

For aerodynamic data on the Orbiter vehicle mated with the ET and SRB's, refer to the Operational Aerodynamic Data Book, Volumes I, II, and IV, STS 85-0118, dated September 1985.

To assist in the computational usage of these data, the basic aerodynamic data for the Orbiter vehicle and the mated vehicle have been digitized and recorded on magnetic tape in the GE MASS format, 1108 Exec II system. Four tapes are required for the Orbiter Vehicle (Volume I) and these are:

- a. Tape no. X13702 - FAD 26 - 6250-bpi density
- b. Tape no. X16931 - Flex - 6250-bpi density
- c. Tape no. X12550 - Rigid - 6250-bpi density
- d. Tape no. X23139 - RCS - 6250-bpi density

The tape required for the Orbiter vehicle mated with the ET and SRB (Volume II) is tape no. X12179 - OPS Aerodynamics Data Base - 6250-bpi density<sup>b</sup>.

These data tapes are available from NASA/JSC/ED3/D. B. Kanipe. A review of the data books should be made prior to using these tapes so that the user will be aware of the data limits of the various parameters. In addition, the format of the data on the tapes must be reviewed with JSC/ED3, so that the user may make optimal use of the tapes.

\*NASA Data Source

<sup>a</sup>Most current data for use in the Shuttle mission simulator.

<sup>b</sup>Tape no. X12214 - Backup tape - 6250-bpi density



## 8.0 ASTRODYNAMICS CONSTANTS AND PARAMETERS\*

This section presents the values and associated uncertainties of the constants and models used in trajectory prediction. A list of conversion factors and a description of the gravitational potential equation are also included.

Uncertainties ( $1\sigma$ ) are presented, if available. For consistent conversion between units, more decimal digits are given for some quantities than are justified by the uncertainties. The values presented are in agreement with those adopted by NASA Headquarters (ref.2).

A list of conversion factors is given in Section 1.0 and applies to all of the following data, with the exception of the constants used for the orientation of the earth's fixed coordinates relative to inertial coordinates. These are defined in Dashiell, J. and deVezin, H. G.: RTCC Requirements for Analytic Determination of Coordinate Transformations for the Earth and Moon for Skylab: MSC Internal Note No. 70-FM-224, January 26, 1971.

\*NASA Data Source

## 8.1

CONSTANTS AND PARAMETERS

## 8.1.1

## Angular Velocity of the Earth's Rotation With Respect to the Vernal Equinox

The earth's angular rotational velocity with respect to a precessing equinox and for inertial equinox for OFT (calendar year 1979) is as follows:

$$\omega_p = .7292115854918357 - 004 \text{ radians per second}$$

$$\omega_I = .7292115146459210 - 004 \text{ radians per second}$$

## 8.1.2

## Other Constants

This section defines values for the other constants used in the ground and onboard software. Many of these parameters are not basic constants, but are derived by using some defining assumption.

- a. Stellar aberration constant - the maximum aberration of a star observed from the earth occurs when direction of motion of observer is at right angles to line of sight to star. It is found by the following:

$$C_A = .993674 \times 10^{-4} \text{ rad}$$

- b. Mean molecular weight of air - the mean molecular weight of the 10 air constituents ( $N_2$ ,  $O_2$ , Ar,  $CO_2$ , Ne, He, Kr, Xe,  $CH_4$ , and  $H_2$ ) is found by:

$$M_o = \frac{\sum (n_i M_i)}{\sum n_i} = 28.9644 \text{ Kg/Kmol}$$

when  $n_i$  is number density and  $M_i$  is molecular weight.

- c. The gas constant - the constant factor in the equation of state for perfect gases is found by:

$$R^* = 8.31432 \times 10^{-3} \text{ Newton meter (Kmol} \cdot \text{K)}$$

- d.  $\underline{g M_o / R^*}$  - derived constant used in onboard calculations of density involving sea-level gravity, acceleration, mean molecular weight, and the gas constant:

$$g\_OVER\_R = .01041294 \text{ K}^0/\text{ft}$$

- e. Speed of sound constant - derived constant used in the calculation of the speed of sound. The speed of sound is defined by:

$$C_S = \left( \frac{\gamma R^* T_m}{M_o} \right)^{1/2}$$

where  $\gamma = 1.4$  and is the ratio of the specific heat of air at constant pressure to that at a constant volume (dimensionless).

Because  $\gamma$ ,  $R^*$ , and  $M_o$  are constants, they are combined for computational ease and the equation is written:

$$C_S = K \sqrt{T_m}$$

where  $K$  is the speed of sound constant

$$K = 65.77035 \text{ ft/sec/} \sqrt{K^o}$$

### 8.1.3 Gravitational Potential Function

The classical expression for the gravitational potential  $V$  exerted at a point in space located at a distance  $r$  from the center of the attracting body of radius  $R_E$  and gravitational parameter  $\mu_E$  is given in equation as:

$$V(r, \phi, \lambda) = \sum_{n=0}^{\infty} \frac{\mu_E R_E^n}{r^{n+1}} \sum_{m=0}^n P_{nm}(\sin \phi) \left[ C_{nm} \cos(m \lambda) + S_{nm} \sin(m \lambda) \right]$$

$\phi$  is latitude (geodetic)

$\lambda$  is longitude

where  $C_{nm}$  and  $S_{nm}$  are the harmonic coefficients of the potential

function and  $P_{nm}(\sin \phi)$  represents the associated Legendre functions of the first kind, of degree of  $n$  and order  $m$ . Because  $\sin \phi = z/r = u$ , where  $u$  is a direction cosine, the associated Legendre functions may be expressed as:

$$P_{nm}(u) = \frac{\cos^m \phi}{2^n n!} \frac{d^{n+m}}{du^{n+m}} (u^2 - 1)^n$$

The constants for real-time operations are:

$$C_{2,0} = -1082.7 \times 10^{-6}$$

$$C_{3,0} = 2.56 \times 10^{-6}$$

$$C_{4,0} = 1.58 \times 10^{-6}$$

$$C_{22} = 1.57 \times 10^{-6}$$

$$S_{22} = -.897 \times 10^{-6}$$

All others are zero.

(Higher order models are sometimes used for analysis and postmission trajectory reconstruction.)

#### 8.1.3.1 Equatorial Earth Radius (Gravitational)

$$\begin{aligned} 1 \text{ E.r.} &= .6378160000000000 + 007 \pm .50000 + 001 \text{ m} \\ 1 \text{ E.r.} &= .2092572178477690 + 008 \pm .16404 + 002 \text{ int. ft} \\ 1 \text{ E.r.} &= .3443930885519158 + 004 \pm .26998 - 002 \text{ nmi.} \\ 1 \text{ E.r.} &= .9999992160754699 + 000 \pm .78392 - 006 \text{ E.r. (MCC)} \end{aligned}$$

#### 8.1.3.2 Gravitational Parameter ( $GM_e = \mu_e = \mu\text{Earth}$ )

$$\begin{aligned} \mu_e &= .3986012000000000 + 015 \pm .40000 + 009 \text{ m}^3/\text{sec}^2 \\ \mu_e &= .1407646853278542 + 017 \pm .14126 + 001 \text{ (int. ft)}^3/\text{sec}^2 \\ \mu_e &= .6275027808522208 + 005 \pm .62970 - 001 \text{ (nmi.)}^3/\text{sec}^2 \\ \mu_e &= .1990931661816326 + 002 \pm .19979 - 004 \text{ (E.r.)}^3/\text{hr}^2 \text{ (MCC)} \end{aligned}$$

#### 8.1.3.3 Mass of the Earth

$$\begin{aligned} M &= .5973343323842350 + 025 \text{ kg} \\ M_e^e &= .1316896781981220 + 026 \text{ lbm} \end{aligned}$$

#### 8.1.4 Lunar Constants

##### 8.1.4.1 Earth-Moon Mass Ratio

$$M_e/M_m = 81.3010 (\pm 0.0010)$$

##### 8.1.4.2 Mean Lunar Radius

$$\begin{aligned} R &= .1738090000000000 + 007 \pm .70000 + 002 \text{ m} \\ R_m^m &= .5702395013123360 + 007 \pm .22966 + 003 \text{ int. ft} \\ R_m^m &= .9384935205183585 + 003 \pm .37797 - 001 \text{ nmi.} \\ R_m^m &= .2725062772756741 + 000 \pm .10975 - 004 \text{ E.r. (MCC)} \end{aligned}$$

### 8.1.4.3 Principal Axes

a = .1738570000000000 + 007 ± .70000 + 002 m  
a = .5703969816272966 + 007 ± .22966 + 003 int. ft  
a = .9387526997840173 + 003 ± .37797 - 001 nmi.  
a = .2725815340305558 + 000 ± .10975 - 004 E.r. (MCC)

b = .1738210000000000 + 007 ± .70000 + 002 m  
b = .5702788713910761 + 007 ± .22966 + 003 int. ft  
b = .9385583153347732 + 003 ± .37797 - 001 nmi.  
b = .2725250914643945 + 000 ± .10975 - 004 E.r. (MCC)

c = .1737490000000000 + 007 ± .70000 + 002 m  
c = .5700426509186352 + 007 ± .22966 + 003 int. ft  
c = .9381695464362851 + 003 ± .37797 - 001 nmi.  
c = .2724122063320720 + 000 ± .10975 - 004 E.r. (MCC)

Where a is directed toward the center of the earth, c is coincident with the moon's rotational axis, and b is perpendicular to a and c.

### 8.1.4.4 Gravitational Parameter for the Moon ( $GM_m = \mu_m = \mu$ Moon)

$\mu$  moon = .4902780000000000 + 013 ± .60000 + 008 m<sup>3</sup>/sec<sup>2</sup>  
 $\mu$  moon = .1731400417087798 + 015 ± .21189 + 010 (int. ft)<sup>3</sup>/sec<sup>2</sup>  
 $\mu$  moon = .7718260968373028 + 003 ± .94456 - 002 (nmi.)<sup>3</sup>/sec<sup>2</sup>  
 $\mu$  moon = .2448838571715250 + 000 ± .29969 - 005 E.r.<sup>3</sup>/hr<sup>2</sup> (MCC)

### 8.1.5 General Constants

#### 8.1.5.1 Astronomical Unit

AU = .1495978930000000 + 012 ± .50000 + 004 m  
AU = .4908067355643045 + 012 ± .16404 + 005 int. ft  
AU = .8077640010799136 + 008 ± .26998 + 001 nmi.  
AU = .2345469159233102 + 005 ± .78393 - 003 E.r. (MCC)

#### 8.1.5.2 Velocity of Light in a Vacuum

c = .2997925000000000 + 009 ± .30000 + 003 m/sec  
c = .9835711942257218 + 009 ± .98425 + 003 int. ft/sec  
c = .1618750000000000 + 006 ± .16199 + 000 nmi./sec  
c = .1692105801590269 + 006 ± .16933 + 000 E.r./hr (MCC)

#### 8.1.5.3 Gravitational Parameters for the Sun

$\mu$  sun = .1327124990000000 + 021 ± .15000 + 014 m<sup>3</sup>/sec<sup>2</sup>  
 $\mu$  sun = .4686697671960888 + 022 ± .52972 + 015 (int. ft)<sup>3</sup>/sec<sup>2</sup>  
 $\mu$  sun = .2089242635906454 + 011 ± .23614 + 004 (nmi.)<sup>3</sup>/sec<sup>2</sup>  
 $\mu$  sun = .6628718533157138 + 007 ± .74922 + 000 E.r.<sup>3</sup>/hr<sup>2</sup> (MCC)

## 8.2 EPHEMERIS TAPE SYSTEMS

### 8.2.1 DE19 Tape

The ephemeris tape system to be used for all missions is provided by JPL and is called the JPL Development Ephemeris Number 19 (DE19).

### 8.2.2 Tape System Conversion Factors

The following values are to be used to convert DE19 units to kilometers:

AU = 149 597 893 km (scale factor for planetary ephemeris)

$R_{em}$  = 6378.1492 km (scale factor for lunar ephemerides)

$\mu^{-1}$  = 81.301 (ratio of earth mass to moon mass)

GE = 398 601.2 km<sup>3</sup>/sec<sup>2</sup> (gravitational parameter of the earth)

## 8.3

### DRAG MODEL

#### 8.3.1

#### Reference Atmospheres

Seven reference atmospheres to be used are as follows:

- a. Jacchia
- b. U. S. Standard Atmosphere, 1962
- c. U. S. Standard Atmosphere Supplements, 1966
- d. Cape Kennedy Reference Atmosphere
- e. GLOBAL Reference Atmosphere
- f. Edwards Atmosphere
- g. Vandenberg Atmosphere

The MSFC-Modified Jacchia Model is a computerized version of Jacchia's Static Diffusion Model. This model and other mechanizations may be used for density computations between 120 and 1000 km. This model is dynamic because the values of the atmospheric parameters vary widely with geomagnetic activity, season, solar activity, and latitude. If predicted values of solar activity or geomagnetic activity are required, they may be obtained from the L. E. Norton, FM2/ Mission Design and Development Branch, Johnson Space Center.

The U. S. Standard Atmosphere (1962) is a static model in that the values of density are fixed with altitude. This model is primarily used as a standard for defining atmospheric properties and is accepted as the worldwide reference for air data devices. Note, however, that for altitudes in the interval of 300 to 500 km, the 1962 standard atmosphere is as much as 75 percent more dense than the Jacchia model. The standard 1962 atmosphere model is used in the MCC for mission operations in the Encke free-flight predictor whenever the spacecraft altitude is between 125 km and entry interface.

The U. S. Standard Atmosphere Supplements (1966) are a dynamic model very similar to the MSFC-modified Jacchia.

The Cape Kennedy Reference Atmosphere, which is sometimes referred to as the Patrick atmosphere, should be used for vehicle launch analysis and for launches from the Eastern Test Range. For launches from the Western Test Range, the Vandenberg reference should be used.

The four D global and Edwards AFB models are used for entry analysis, and the generation of operational profiles and dispersion analyses.

### 8.3.2 Drag Equations (for Orbit Operations)

$$\mathbf{R}_D = -\frac{1}{2} C_D \rho (A/M) (\dot{\mathbf{R}} - \boldsymbol{\Omega} \times \mathbf{R}) |\dot{\mathbf{R}} - \boldsymbol{\Omega} \times \mathbf{R}|$$

where

$$C_D = (CDF + CDN |\sin \alpha|^N)(1 - |\sin \beta|) + CDS |\sin \beta| + CDA |\sin 2\beta \sin \alpha|$$

and

$\alpha$  = angle of attack

$\beta$  = angle of side slip

CDF, CDN, CDS, CDA, N = fit coefficients associated with vehicle configuration

$C_D = 2.0$  (above 400 000 feet for constant area drag)

A = effective cross section area of vehicle

M = mass of vehicle

$\rho$  = density of atmosphere at given altitude ( $Z_1$ )

$\dot{\mathbf{R}}$  = inertial velocity vector of vehicle

$\mathbf{R}$  = position vector to vehicle from the center of earth

$\mathbf{R}_D$  = acceleration vector caused by drag

$\boldsymbol{\Omega}$  = earth's rotational vector = (0, 0,  $\omega$ )

$$z_1 = r - \frac{r}{d}$$

$$d = \left( \frac{x^2 + y^2}{a^2} + \frac{z^2}{b^2} \right)^{1/2}$$

$$r = (x^2 + y^2 + z^2)^{1/2}$$

for the ellipsoid used in the 1962 U. S. Standard Atmosphere,

$$a = 6.378\,178 \times 10^6 \text{ m}$$

$$b = 6.356\,797 \times 10^6 \text{ m}$$



#### 8.4 FISCHER EARTH MODEL

The following constants describe the Fischer earth model (1960), which is used for the location of radar stations and other earth surface features.

##### 8.4.1 Equatorial Earth Radius

a = .6378166000000000 + 007 m  
a = .2092574146981627 + 008 int. ft  
a = .3443934125269978 + 004 nmi.  
a = .1000000156784906 + 001 E.r. (MCC)

##### 8.4.2 Flattening

f = flattening = 1 - b/a  
f = 1/298.30 = 0.3352329869259135 x 10<sup>-2</sup>

##### 8.4.3 Polar Earth Radius

b = .6356784283607107 + 007 m  
b = .2085559148165061 + 008 int. ft  
b = .3432388922034075 + 004 nmi.  
b = .9966478263900521 + 000 E.r. (MCC)

##### 8.4.4 Eccentricity of Ellipsoid

$$e = \sqrt{\frac{a^2 - b^2}{a^2}}$$

$$e = .8181333401693114 - 001$$

$$e^2 = 2f - f^2$$

$$e^2 = .6693421622965943 - 002$$

## 8.5

EQUIVALENTS AND CONVERSION FACTORS

1 int. ft	=	.3048000000000000 + 000	m (exact)
1 nmi.	=	.1852000000000000 + 001	km (exact)
1 E.r.	=	.6378165000000000 + 004	km (exact for scaling) for MCC internal use
1 lbm	=	.4535923700000000 + 000	kg (exact)
1 hr	=	3600.000000000000 + 000	sec (exact)
1 rad	=	180/π	deg
1 deg	=	3600	arc sec
1 km	=	.5399568034557235 + 000	nmi.
1 m	=	.3280839895013123 + 001	int. ft
1 nmi.	=	.6076115485564304 + 004	int. ft
1 rad	=	.5729577951308233 + 002	deg
1 deg	=	.1745329251994329 - 001	rad
1 kg	=	.2204622621848776 + 001	lbm
1 int. stat. mi.	=	5280	ft (exact)
1 lbf	=	32.174048556	(int. ft/sec <sup>2</sup> ) lbm
π	=	.3141592653589793 + 001	(ref. 2)