

# Attitude and Pointing Flight Procedures Handbook

Operations Division  
Flight Activity Branch

Rev-A  
January 1985

UPDATE

**NASA**

National Aeronautics and  
Space Administration

**Lyndon B. Johnson Space Center**  
Houston, Texas

JOHN F. KENNEDY SPACE CENTER LIBRARY  
DOCUMENTS DEPARTMENT  
REFERENCE COPY

NASA JOHN F. KENNEDY SPACE CENTER



3 1772 00010 4395



MISSION OPERATIONS DIRECTORATE

REV-A

ATTITUDE AND POINTING FLIGHT PROCEDURES HANDBOOK

Prepared by:



David G. Edwards  
David G. Edwards  
Crew Activity Planning Section 1

Approved by:

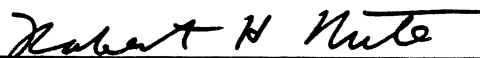

Robert H. Nute  
Robert H. Nute  
Crew Activity Planning Section 1

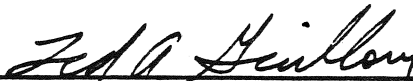

Ted A. Guillory  
Ted A. Guillory  
Chief, Flight Activity Branch

NATIONAL AERONAUTICS AND SPACE ADMINISTRATION  
Lyndon B. Johnson Space Center  
Houston, Texas



## CONTENTS

Section		Page
1	<u>DEFINITIONS/CONCEPTS</u> . . . . .	1-1
1.1	THE EARTH . . . . .	1-1
1.2	BETA ANGLE . . . . .	1-4
1.3	REFERENCE AXIS DEFINITION . . . . .	1-6
1.4	ATTITUDE DEFINITION . . . . .	1-18
1.5	QUATERNIONS . . . . .	1-20
2	<u>TIME REFERENCES</u> . . . . .	2-1
2.1	MEAN SOLAR DAY . . . . .	2-1
2.2	SIDEREAL TIME . . . . .	2-1
2.3	MISSION UNIQUE TIMES . . . . .	2-3
2.4	BASE DATE . . . . .	2-3
2.5	EPOCH . . . . .	2-6
2.6	JULIAN DATE . . . . .	2-6
2.7	GREGORIAN CALENDAR . . . . .	2-6
2.8	BESSELIAN SOLAR YEAR . . . . .	2-7
3	<u>ORBITS</u> . . . . .	3-1
3.1	DEFINITION OF COMMONLY USED ORBITAL ELEMENTS . . . . .	3-1
3.2	EPHEMERIS FILES FOR POINTING PROGRAMS . . . . .	3-1
3.3	BASIC EQUATIONS OF THE TWO-BODY PROBLEM . . . . .	3-3
3.4	PRECESSION AND NUTATION . . . . .	3-6
3.5	GROUNDTRACK . . . . .	3-6
3.6	GEOSYNCHRONOUS SATELLITE . . . . .	3-7
4	<u>TARGETS</u> . . . . .	4-1
4.1	GROUND TARGETS . . . . .	4-1
4.2	CELESTIAL TARGETS . . . . .	4-1
4.3	EPHEMERIS TARGETS . . . . .	4-5
4.4	GENERAL TARGET TERMS . . . . .	4-5
4.5	SOME SPECIAL GROUND TARGETS . . . . .	4-9
4.6	SOME COMMONLY USED TARGETS . . . . .	4-12
5	<u>POINTING VECTORS/LOOK ANGLES</u> . . . . .	5-1
5.1	PITCH/YAW SEQUENCE FOR POINTING VECTORS . . . . .	5-1
5.2	ROLL/PITCH ( $\phi, \theta$ ) SEQUENCE FOR POINTING VECTORS . . . . .	5-3
5.3	OMICRON ( $\Omega$ ) . . . . .	5-3
5.4	LOOK ANGLES . . . . .	5-5
6	<u>BASIC ASTRONOMY</u> . . . . .	6-1
6.1	CELESTIAL SPHERE . . . . .	6-1
6.2	M50 STAR CHART . . . . .	6-2
6.3	CELESTIAL TRACES . . . . .	6-3
6.4	CHARACTERISTICS OF THE SUN, MOON, AND PLANETS . . . . .	6-4

## CONTENTS

Section		Page
7	<u>VEHICLE HARDWARE</u> . . . . .	7-1
7.1	<u>ON-ORBIT ATTITUDE CONTROL SYSTEM OVERVIEW</u> . . . . .	7-1
7.2	<u>HARDWARE</u> . . . . .	7-2
7.2.1	<u>Jets - PRCS/VRCS</u> . . . . .	7-2
7.2.2	<u>OMS Engines</u> . . . . .	7-9
7.2.3	<u>Deriving Numbers</u> . . . . .	7-10
7.2.4	<u>DAP Panels</u> . . . . .	7-11
7.2.4.1	<u>DAP Panel in OPS 2</u> . . . . .	7-11
7.2.4.2	<u>DAP Panel in OPS 1 and 3 (On-Orbit)</u> . . . . .	7-13
7.2.5	<u>Star Tracker/COAS</u> . . . . .	7-13
7.2.6	<u>IMU's</u> . . . . .	7-14
7.2.7	<u>RGA's</u> . . . . .	7-14
7.2.8	<u>RHC's/THC's</u> . . . . .	7-14
7.2.9	<u>KBD's</u> . . . . .	7-15
7.2.10	<u>ADI's</u> . . . . .	7-15
7.2.11	<u>CRT's</u> . . . . .	7-16
8	<u>VEHICLE SOFTWARE</u> . . . . .	8-1
	<u>TBS</u>	
9	<u>NAVIGATION BASE</u> . . . . .	9-1
9.1	<u>STAR TRACKERS/STAR TABLE</u> . . . . .	9-1
9.2	<u>COAS</u> . . . . .	9-1
9.3	<u>ATTITUDE DETERMINATION</u> . . . . .	9-3
9.4	<u>ATTITUDE SENSE +X, -X, -Z</u> . . . . .	9-5
10	<u>COMMON POINTING PROBLEMS</u> . . . . .	10-1
10.1	<u>IMU ALIGNMENTS</u> . . . . .	10-1
10.1.1	<u>Dual Star Tracker IMU Alignment</u> . . . . .	10-1
10.1.2	<u>Single Star Tracker IMU Alignment</u> . . . . .	10-1
10.2	<u>ROLLING STAR TRACKER ALIGNMENT</u> . . . . .	10-2
10.3	<u>STAR PAIRS CUECARD</u> . . . . .	10-2
10.4	<u>TOP/BOTTOM SUN ATTITUDE</u> . . . . .	10-4
10.4.1	<u>Standard Top/Bottom Sun Attitude</u> . . . . .	10-4
10.5	<u>TAIL/NOSE SUN ATTITUDE AND TAIL SUN ROTR</u> . . . . .	10-4
10.5.1	<u>Standard Tail/Nose Sun Attitude</u> . . . . .	10-4
10.5.2	<u>Pre-Deorbit Prep Tail Sun Attitude</u> . . . . .	10-4
10.5.3	<u>Tail Sun ROTR</u> . . . . .	10-6
10.6	<u>PASSIVE THERMAL CONTROL (PTC)</u> . . . . .	10-6
10.7	<u>GRAVITY GRADIENT (GG)</u> . . . . .	10-6

## CONTENTS

Section		Page
10.8	KU-BAND AND TURTLES . . . . .	10-7
10.8.1	<u>Ku-Band</u> . . . . .	10-7
10.8.2	<u>Turtles</u> . . . . .	10-7
10.8.2.1	Turtles In General . . . . .	10-7
10.8.2.2	The Ku-Band Turtle . . . . .	10-13
10.9	CAP/ATL DEVELOPMENT . . . . .	10-16
10.10	PAM AND FRISBEE DEPLOYMENTS . . . . .	10-18
10:11	IUS/TDRS DEPLOYS . . . . .	10-20
11	<u>SOLVING SIMPLE ATTITUDE PROBLEMS</u> . . . . .	11-1
11.1	EXAMPLE ONE (MINIMUM MANEUVER) . . . . .	11-1
11.2	EXAMPLE TWO (TAIL SUN) . . . . .	11-4
	APPENDIX A STARS . . . . .	A-1
	APPENDIX B POINTING PROGRAMS . . . . .	B-1
	APPENDIX C COMMON UNITS AND DISTANCES . . . . .	C-1
	APPENDIX D VECTOR/MATRIX NOTATION . . . . .	D-1

## FLIGHT PROCEDURES HANDBOOK PUBLICATIONS

The following is a list of the Flight Procedures Handbooks of which this document is a part. These handbooks document integrated and/or flight procedures, sequences covering major STS crew activity plan phases.

<u>Title</u>	<u>JSC No.</u>
ASCENT/ABORTS	10559
ENTRY	11542
RENDEZVOUS/ORBITAL NAVIGATION	10589
ATTITUDE AND POINTING	10511
SPACELAB ACTIVATION/DEACTIVATION	10545
PROXIMITY OPERATIONS	12802
IMU ALIGNMENT	12842
POSTINSERTION DEORBIT PREPARATION	16219
ASCENT/ORBIT/ENTRY POCKET CHECKLISTS	16873
PAYLOAD ASSIST MODULE-D (PAM-D)	17862
INERTIAL UPPER STAGES (IUS)	18392
ORBIT OPERATIONS CHECKLIST	19648



FOREWORD

The Attitude and Pointing Flight Procedures Handbook is intended to be a generic document. Because of the nature of the material and the requirements for specific flights, some information will not agree. The purpose is to show what and how the information, display, or hardware is used (not necessarily to show specific constraints that can change from flight to flight). For future flights, updates will be made to reflect software/hardware changes that occur.

This document was jointly prepared by: Mark Brown, David Edwards, Steve Hoefer, John Holloway, Marion Griffin, Jim Kaidy, Bill Kimball, Mark Riggio, David Schurr, David Shulkin, and Ted Wang.

Comments and suggestions concerning this document are welcomed. Contact David G. Edwards, Crew Activity Planning Section 1 (DH4), NASA JSC, Houston, Texas 77058, or telephone (713) 483-2201.



**SECTION 1**  
**DEFINITIONS/CONCEPTS**

**1.1 THE EARTH**

**Earth** - The planet which we inhabit, the fifth in order of size and third in order of distance from the Sun. Astronomical symbol  $\oplus$ . It has a diameter of 7718 miles, a period of 365.26 days, and a mean distance of 92,900,000 miles from the Sun.

Webster's Dictionary

In more general terms, the Earth is an irregular semi-solid spheroid having a random distribution of its mass that complicates orbit predictions and the location of objects on its surface. There are two basic problems posed by the Earth; namely, how to model its shape and its mass.

The Earth's shape, of course, resembles a spherical balloon that is being compressed from the top and bottom (fig. 1-1). It has long been recognized that a planar section through the Earth north to south is very nearly an ellipse. The semi-major axis would equate to the equatorial radius and the semi-minor to the polar radius. By assuming the cross section at any longitude to be an ellipse, the distance of any surface point from the center of the Earth can be found by geometry. The first approximations of the Earth in this manner were made in the early 1800's and have continued ever since.

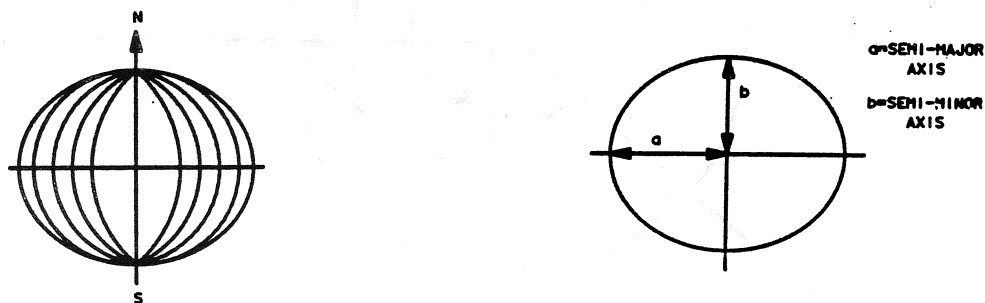

Figure 1-1.- Oblate Earth.

Mission Planning and Analysis Division (MPAD) and Mission Operations Directorate (MOD) have adopted for standardization the model as developed by Fischer in 1960. In his model, the semi-major axis equals  $2.0925724 \times 10^7$  feet and the semi-minor axis equals  $2.0855573 \times 10^7$  feet. It is relative to this elliptical reference that all MOD programs determine Earth positions and altitudes.

From an orbital mechanics standpoint, the distribution of mass in the Earth is important only as it affects the gravity field. From basic mechanics, the mutual attraction between two point masses is

$$\vec{F} = \frac{Gm_1m_2\vec{R}}{R^3} = m\vec{A}_g = m \left[ \nabla \bar{U}(X,Y,Z) \right]$$

When the larger mass is the Earth, this equation is simply the mass of the orbiting body times the acceleration of gravity. In reality, the Earth is not a point mass or a spherical object with uniform distribution, which introduces considerable error. To account for this error, the acceleration due to gravity is treated as a variable over the surface of a spherical Earth (fig. 1-2). The magnitudes of the individual acceleration components normal to the surface are then used to build a function describing the variation of acceleration over the surface.

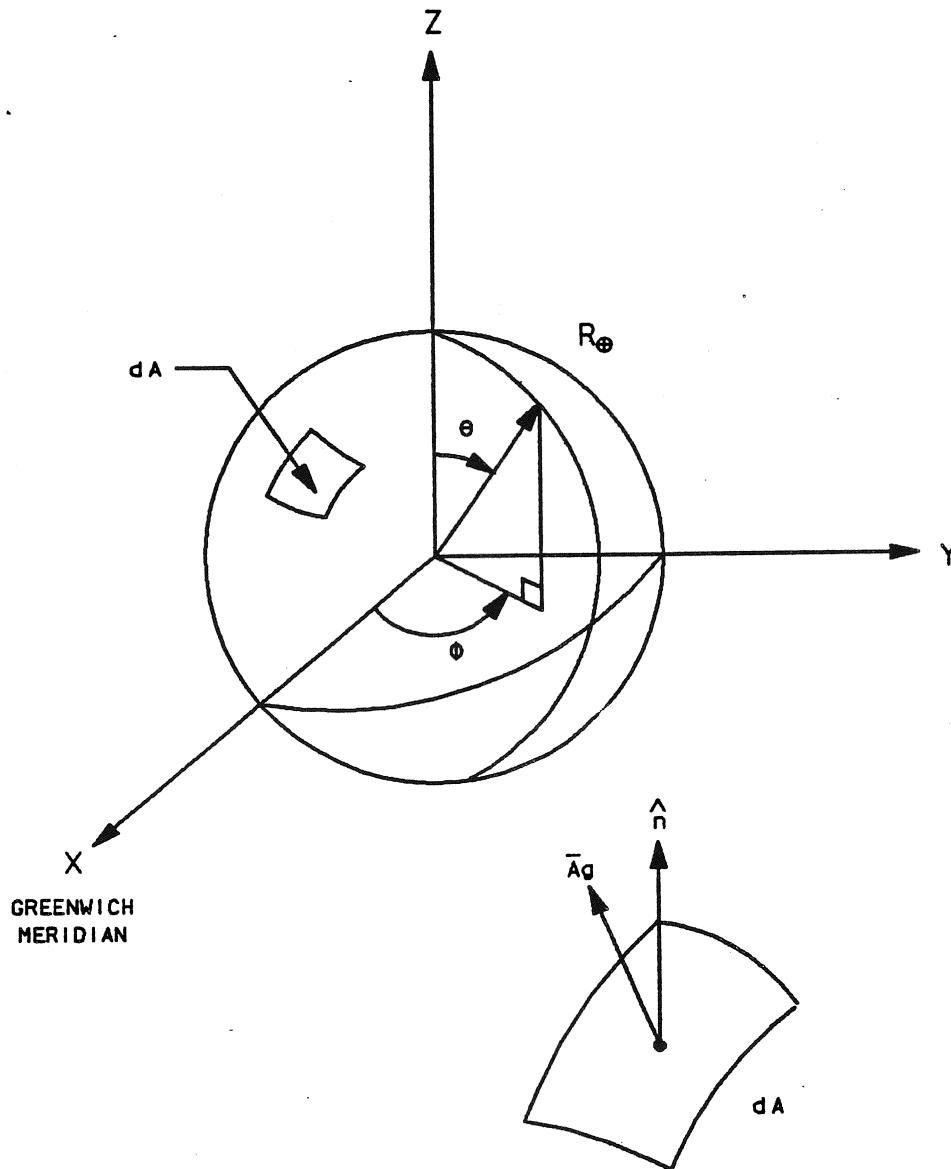

3283. ART, 3

Figure 1-2.- Variation of gravity over the Earth's surface.

This problem is normally worked in polar coordinates, where the radius of the Earth,  $R_{\oplus}$ , is held constant,  $\theta$  equals latitude, and  $\phi$  equals the longitude. Since gravity is a conservative force, the acceleration is reduced to a potential function  $U$ . The function describes the energy in the gravitational field where the gradient of the potential function equals the force per unit mass. The solution is a polynomial

$$U(R, \theta, \phi) = \frac{GM}{R} \sum_{n=0}^{\infty} \sum_{m=0}^n \left( \frac{R}{R_{\oplus}} \right)^{-n} P_n^m(\cos\theta) \left[ S_{nm} \sin(m\phi) + C_{nm} \cos(m\phi) \right]$$

The first few terms look like this

$$U = \frac{GM}{R} \left[ 1 - \frac{J_2 R_{\oplus}^2}{2R^2} (3\sin^2\theta - 1) - \frac{J_3 R_{\oplus}^3}{2R^3} (5\sin^3\theta - 3\sin\theta) - \frac{J_4 R_{\oplus}^4}{8R^4} (35\sin^4\theta - 30\sin^2\theta + 3) \right]$$

The important thing to notice is that for a given orbit the only unknowns in this equation are the  $J$  terms (fig. 1-3). The  $J$ 's are real constants that have been evaluated using satellite observations. The  $J$ 's have physical meaning which is worth examining.

$J_2$  is equal to  $1.08228 \times 10^{-3}$  and represents effects due to the equatorial bulge

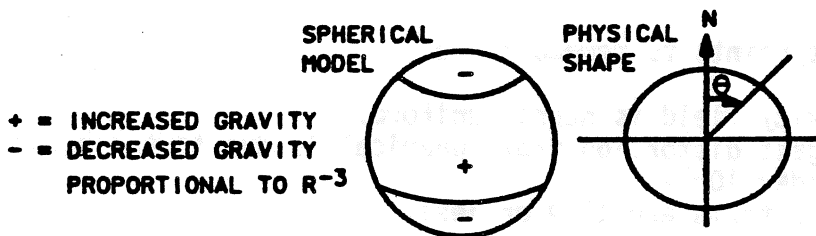

(a) Effects of  $J_2$  term.

$J_3$  is equal to  $-2.3 \times 10^{-6}$  and accounts for any egg shape effects

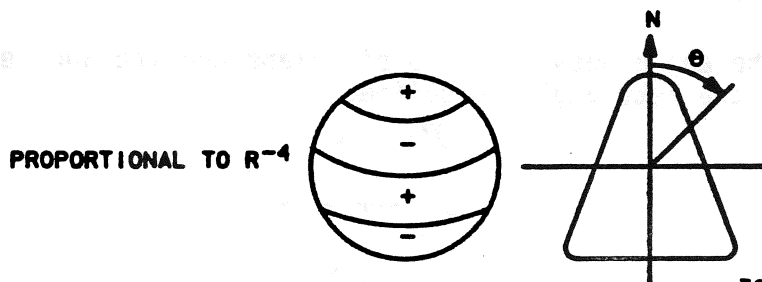

(b) Effects of  $J_3$  term.

3282. ART, 4.

Figure 1-3.-  $J$  term effects.

$J_4$  is equal to  $-2.12 \times 10^{-6}$  and accounts for another odd effect

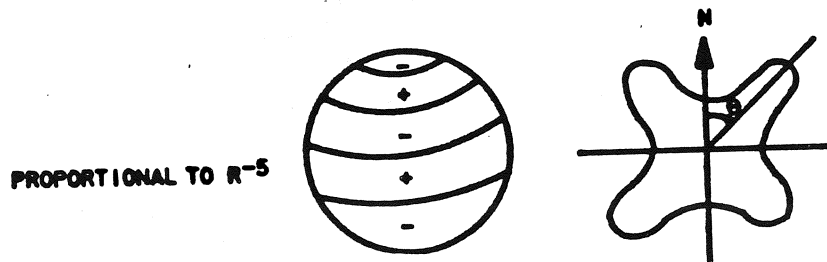

(c) Effects of  $J_4$  term.

Other higher order J terms account for distortions of different types

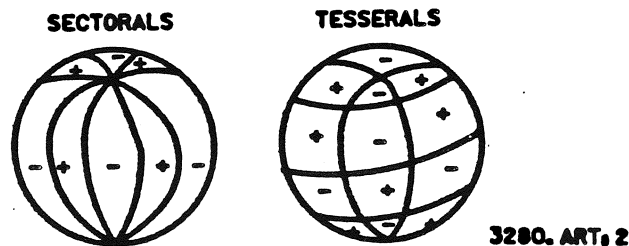

(d) Effects of higher order terms.

Figure 1-3.- (Concluded).

The salient points to remember are

- The gravity field is nearly uniform.
- The largest distortion from spherical is due to the equatorial bulge and is of order  $10^{-3}$ .
- All other terms are  $10^{-6}$  or less.

The required accuracy in orbital prediction solely determines how many terms should be accounted for in modeling the Earth.

### 1.2 BETA ANGLE ( $\beta$ )

Beta angle is the angle between the orbit plane and the Sun vector. Mathematically, the beta angle is defined as

$$\vec{H} = \vec{R} \times \vec{V}$$

$$\vec{S} = \text{Sun vector}$$

$$\beta = \sin^{-1}(\hat{H} \cdot \hat{S})$$

Figure 1-4 shows examples of positive and negative beta angles for a given Sun inclination of  $8^\circ$ .

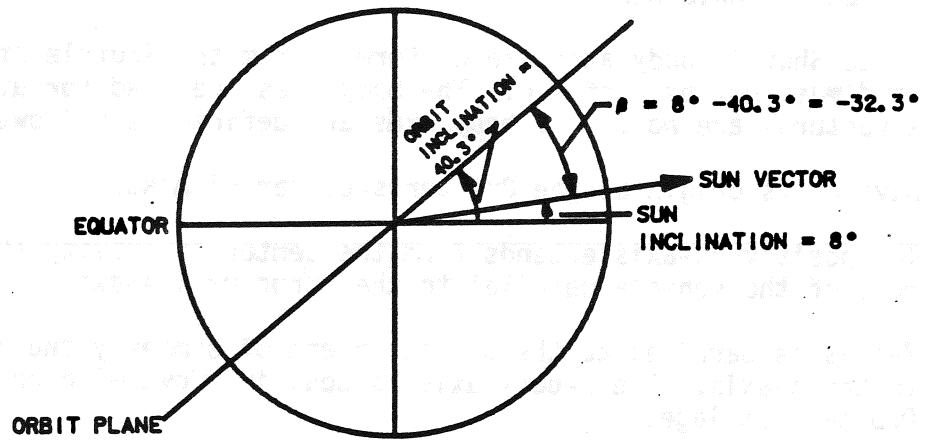

(a) Maximum negative  $\beta$  angle condition for a given orbit plane (ascending/descending nodes perpendicular to the Sun vector).

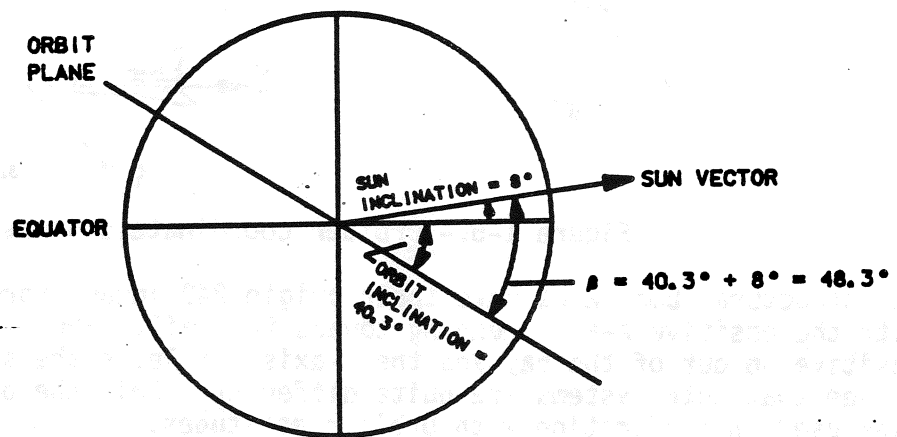

(b) Maximum positive  $\beta$  angle condition for a given orbit plane (ascending/descending nodes perpendicular to the Sun vector).

Figure 1-4.-  $\beta$  angle.

### 1.3 REFERENCE AXIS DEFINITION

The Space Shuttle body axes are different from the Shuttle structural body axes and must not be confused. The body axes are used for attitudes while the structural are not. The body axes are defined as follows

- Having its origin at the Orbiter's center of mass.
- The positive X-axis extends from the center of gravity (CG) through the nose of the vehicle parallel to the structural X-axis.
- Z-axis is parallel to the Orbiter plane of symmetry and is perpendicular to the X-axis. The Z-body axis is positive down with respect to the Orbiter fuselage.
- The Y-body axis completes the right hand orthogonal system.

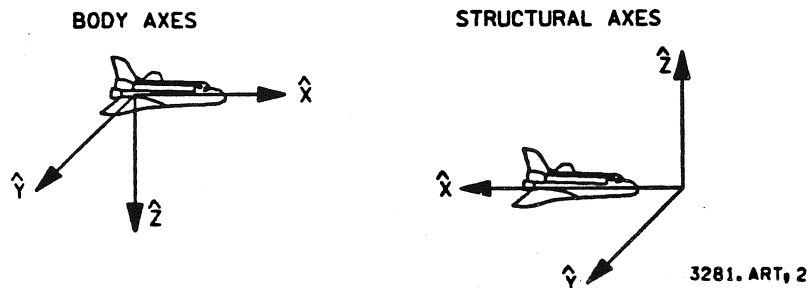

Figure 1-5.- Orbiter coordinate systems.

The structural body axes have their origin 240 inches forward of the nose with the positive X-axis running toward the tail. The Z-structural axis is positive up out of the bay and the Y-axis completes the system. It is easy to see that both systems are quite different. Only the body axis system is ever used in conjunction with Orbiter attitudes.

Of the many reference frames available, three are used most often. These are Mean of 1950 inertial, Starball (SB), and Local Vertical Local Horizontal (LVLH).

The Mean of 1950 coordinate system (M50) is inertially fixed relative to the stars and has its axes origin at the center of the Earth. It is relative to this coordinate frame that all star positions are referenced by astronomers. The X-axis is defined as pointing at the first point of Aries as it existed on 1 Jan 1950. The first point of Aries is where the Earth's equatorial plane and the Sun's orbit (ecliptic) plane intersect. The two points where these planes intersect are the vernal and autumnal equinoxes. Since the Sun lies on the Earth's Equator on these days, there are equal periods of day and night. The M50 +X axis is defined as passing through the vernal (spring) equinox. The +Z axis extends up through the Earth's North Pole. The M50 system is one of many Earth-centered inertial (ECI) systems in use. The ECI systems are popular because the stars maintain constant positions.



In reality the stars do exhibit small random motions which necessitate minor updates to their positions every 5 or 10 years.

When the Orbiter body axes and M50 axes are aligned, the Orbiter M50 attitude is by definition a pitch, yaw, roll of 0,0,0. Notice that the Orbiter bay points to the Earth's South Pole and that the Orbiter X-Y plane lies in (or is parallel to) the Earth's equatorial plane. Astronomers plot the positions of the stars on star charts which are referenced to the M50 system. Astronomers prefer to use a right ascension/declination system to describe star positions instead of unit vectors.

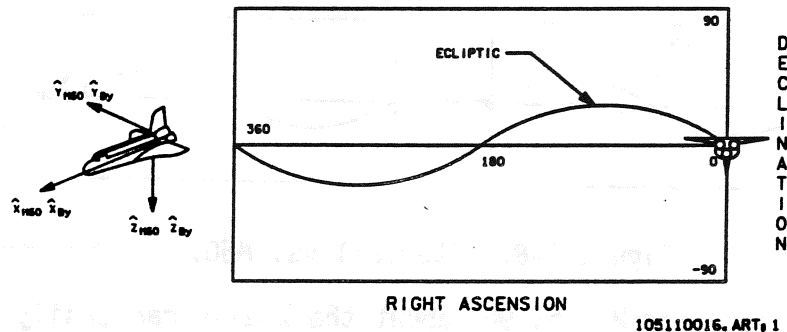

Figure 1-6.- M50 system.

For a star located by unit vector U

$$U_x = \cos (DEC) \cos (RA)$$

$$U_y = \cos (DEC) \sin (RA)$$

$$U_z = \sin (DEC)$$

or solved for right ascension and declination

$$RA = \tan^{-1} \left( \frac{U_y}{U_x} \right)$$

$$DEC = \sin^{-1} \left( U_z \right)$$

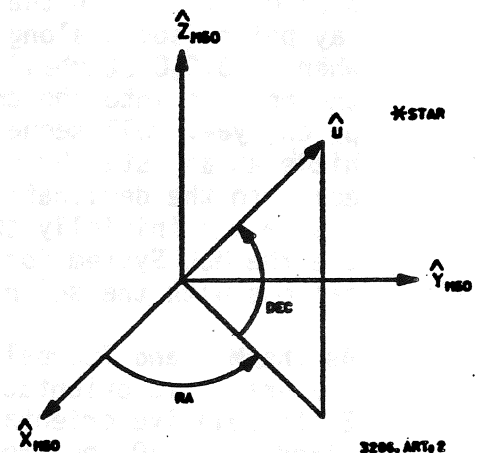

Figure 1-7.- RA, DEC.

Almost all star tables list the right ascension and declination positions of the stars relative to the Mean of 1950 reference frame. It is necessary to explain how a star chart works in order to explain the Starball (SB) reference system.

Early on in the space program there was concern about the ability of a crew in space to locate and identify stars so that the attitude and position of their vehicle could be determined. A simple system was needed that would allow the crew to look up the position of a star on a star chart and then

maneuver their vehicle to point at it. The solution was to define an inertial reference frame rotated 90° from M50.

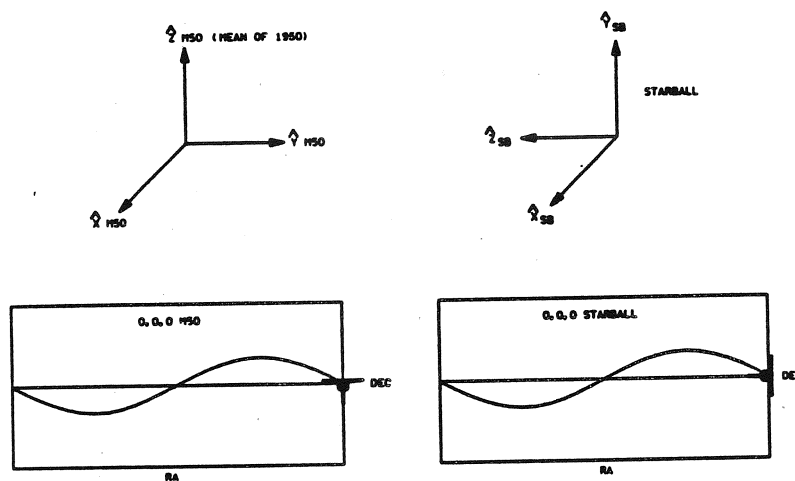

Figure 1-8.- Starball vs. M50.

105110018, ART. 8

The advantage to rotating M50 by 90° about the X-axis can easily be seen on star charts. When the Orbiter is in a 0,0,0 attitude relative to M50, the bay points south along negative declination with the nose into the chart. When in 0,0,0 Starball, the Orbiter X-Z plane lies along right ascension and the nose is into the chart. Since the Orbiter performs all maneuvers in a pitch, yaw, roll sequence, the crew can easily point the nose of their vehicle at any star by pitching equal to the right ascension and then yawing equal to the declination. It was for this simple reason that the Starball system was initially chosen. Recently, the Johnson Space Center decided to use the M50 System for Orbiter attitudes in order to facilitate communications with the scientific community and other NASA centers.

As the M50 and Starball frames were picked for their ease in maintaining star-relative orientations, so was the LVLH system picked for maintaining Earth-relative orientations. The LVLH reference frame is not inertially fixed like M50, but rotates with the Orbiter's position vector. The LVLH +Z axis (local vertical) is parallel to the radius vector, positive from the Orbiter's center of mass to the center of the Earth. The LVLH +Y axis is pointed in the direction of the negative angular momentum vector. The LVLH +X axis (local horizontal) completes the orthogonal coordinate system. The +X axis lies in the orbit plane in the direction of the velocity vector, but is only identical to the velocity vector for perfectly circular orbits. When the Orbiter is in an LVLH 0,0,0 attitude, the belly points to the center of the Earth and the nose points in the local horizontal direction. When the Orbiter is placed in a specific LVLH attitude, it will remain in the same Earth-facing orientation as it orbits the Earth. When the LVLH frame is viewed from the M50 or Starball frames, it can be seen to rotate once per orbital period. Relating a rotating reference frame like LVLH to a fixed frame like M50 requires that the rotation matrix relating the two frames be a function of time. However, for a specific time, this matrix is constant which permits an easy translation from one frame to another.

The other reference frames that may be encountered are described in figures 1-9 through 1-16. In each case the orientation of individual axes will differ slightly. Some use the true Earth rotational pole instead of a mean while others are concerned with the true Earth Equator instead of a mean. Regardless of which frame is chosen, it can always be related to the others by simple rotation matrices.

At this point it should be made clear what is meant by the terms mean and true as they relate to reference frames. The M50 reference frame, for example, uses a right ascension (RA) and declination (DEC) system to define a point in inertial space. The origin of RA is fixed by imposing the condition that when the DEC of the Sun is observed to be zero in March (vernal equinox), its RA is also zero. If a star is observed on successive nights (at the same time), it will be found that its RA and DEC changes by amounts that are often perceptible in a single day. The change is due largely to the motions of the equator and equinox rather than the motions of the stars. These motions are caused by gravitational effects which cause the Earth's North Pole to precess and nutate (see chapter 3.4). Besides precession and nutation, there is another effect producing changes in RA and DEC that is called aberration. The principal of aberration is stated as follows: two neighboring observers in relative motion will see the same object in different directions. The angular difference is the ratio of their relative velocity to the velocity of light, multiplied by the sine of the angle between the line of sight to the object and the observers relative velocity vector and in the direction of the velocity vector. The RA's and DEC's of stars that are immediately observed are called apparent RA's and DEC's. If the effects of aberration are removed from an apparent RA and DEC, the coordinates are then said to be referred to the true equator and true equinox of date. If the effects of nutation are also removed, the coordinates are then said to be referred to the mean equator and the mean equinox of date. If the coordinates are further corrected for precession from a specific epoch - such as 1950.0; the coordinates are said to be referred to the mean equator and the mean equinox of 1950.0, or for brevity M50.

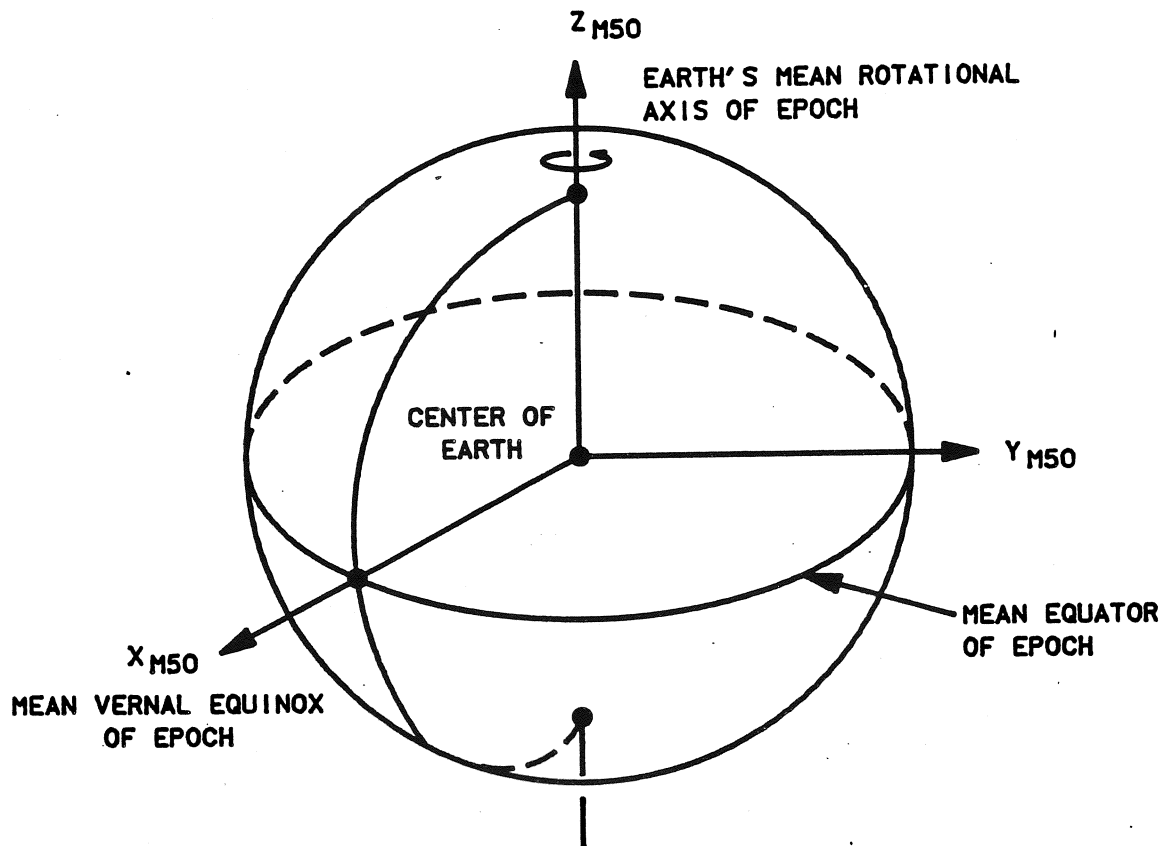

105110019. ART, 1

**NAME:** Aries Mean Equator and Equinox of 1950 (M50) reference-axis system. The M50 system is a specific case of the general MEE system.

**ORIGIN:** The center of the Earth.

**ORIENTATION:** The epoch is the beginning of Besselian year 1950 or Julian ephemeris date 2433282.423357.

The  $X_{M50}$ - $Y_{M50}$  plane is the mean Earth's Equator of epoch.

The  $X_{M50}$ -axis is directed towards the mean vernal equinox of epoch.

The  $Z_{M50}$ -axis is directed along the Earth's mean rotational axis of epoch and is positive north.

The  $Y_{M50}$ -axis completes a right-handed system.

**CHARACTERISTICS:** Inertial, right-handed Cartesian system.

Figure 1-9.- Aries-Mean-of-1950 system.

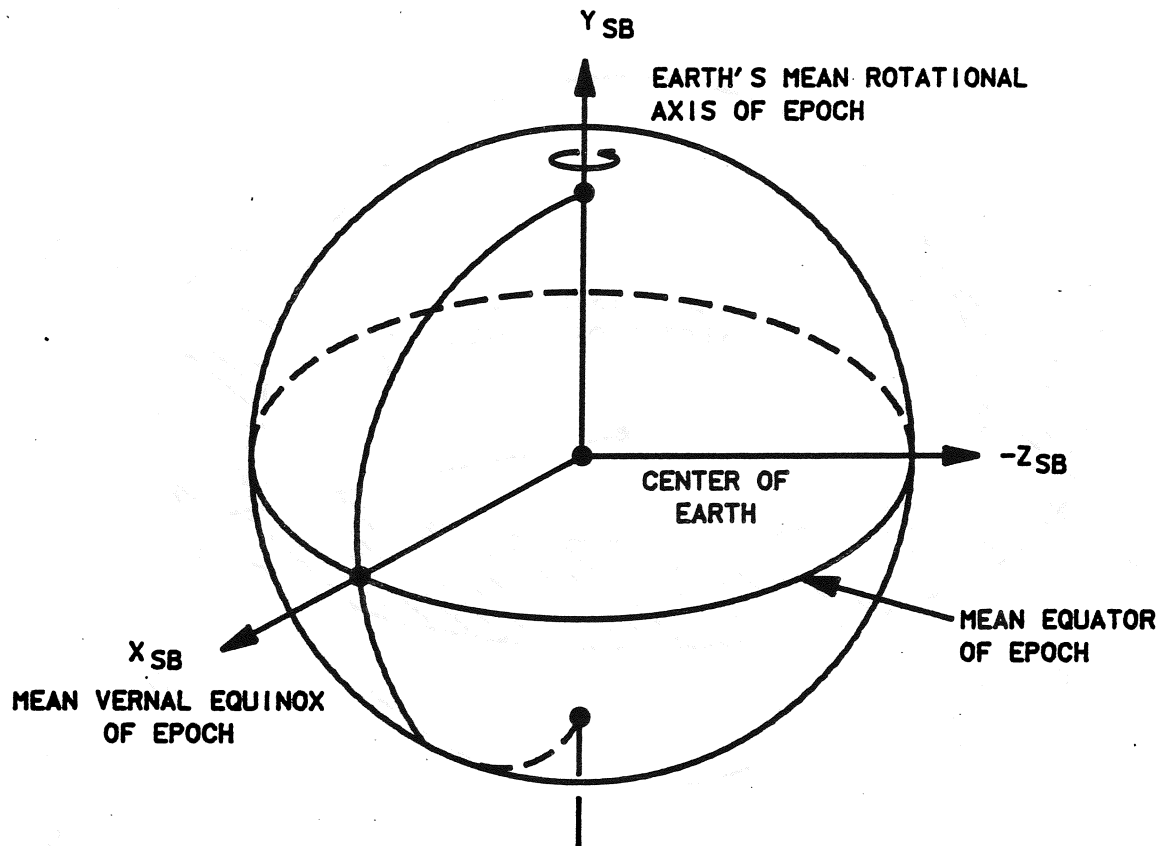

105110110.ART, 1

**NAME:** Starball (SB)

**ORIGIN:** The center of the Earth.

**ORIENTATION:** The epoch is the beginning of Besselian year 1950 or Julian ephemeris date 2433282.423357.

The  $X_{SB}-Z_{SB}$  plane is the mean Earth's Equator of epoch.

The  $X_{SB}$ -axis is directed towards the mean vernal equinox of epoch.

The  $Y_{SB}$ -axis is directed along the Earth's mean rotational axis of epoch and is positive north.

The  $Z_{SB}$ -axis completes a right-handed system.

**CHARACTERISTICS:** Inertial, right-handed Cartesian system.

Figure 1-10.- Starball (SB).

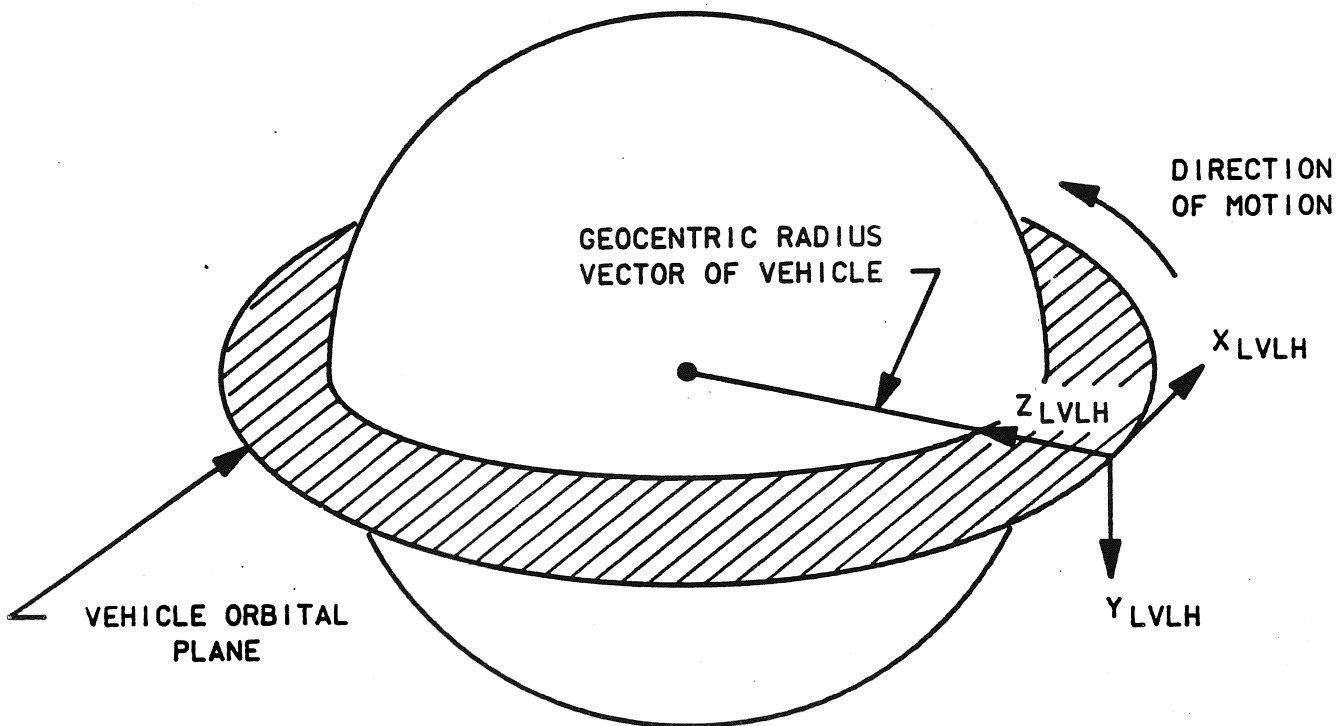

3301. ART, 1

**NAME:** Local Vertical Local Horizontal (LVLH) reference-axis system.

**ORIGIN:** Vehicle center of mass.

**ORIENTATION:** The LVLH +Z axis (local vertical) is parallel to the radius vector, positive from the Orbiter's center of mass to the center of the Earth.

The LVLH +Y axis is pointed in the direction of the negative angular momentum vector.

The LVLH +X axis (local horizontal) completes the orthogonal coordinate system. The +X axis lies in the orbit plane in the direction of the velocity vector, but is only identical to the velocity vector for perfectly circular orbits.

**CHARACTERISTICS:** Quasi-inertial, right-handed Cartesian system.

Figure 1-11.- LVLH reference-axis system.

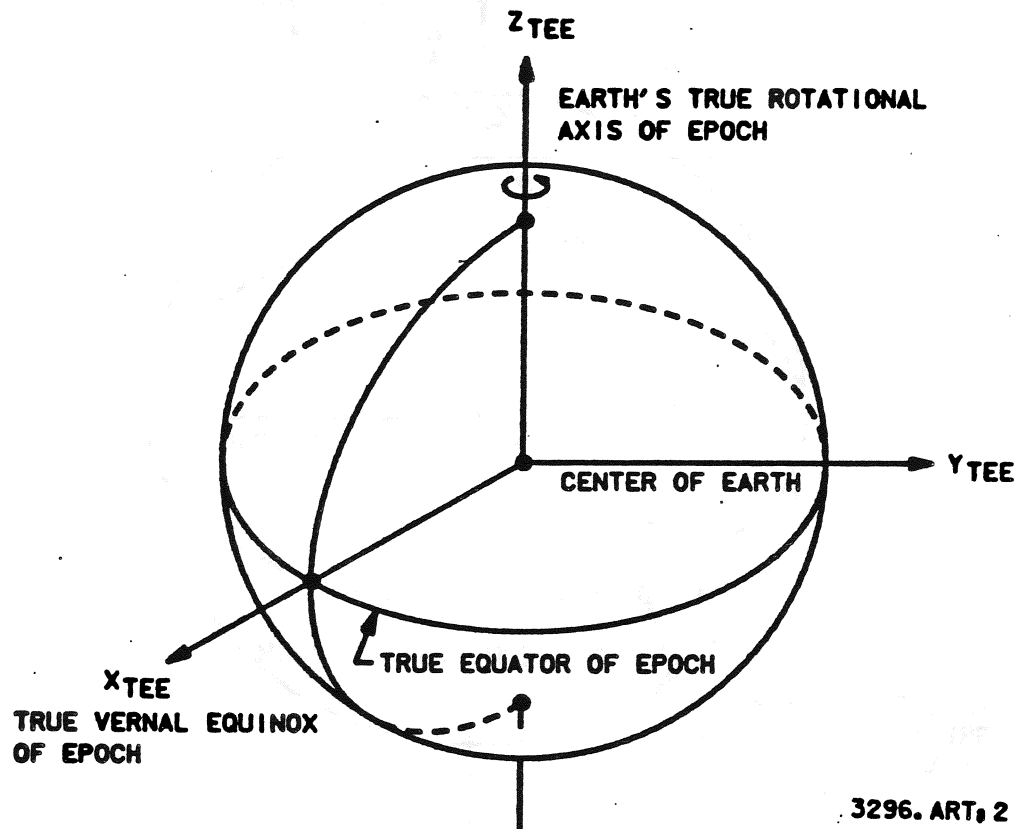

**NAME:** True Equator and Equinox of epoch (TEE) reference-axis system.

**ORIGIN:** The center of the Earth.

**ORIENTATION:** The epoch is defined to be 0 hours 0 minutes 0 seconds Greenwich Mean Time (GMT) on the user-specified base date.

The  $X_{TEE}$ - $Y_{TEE}$  plane is the Earth's true equatorial plane of epoch.

The  $X_{TEE}$ -axis is directed towards the true vernal equinox of epoch.

The  $Z_{TEE}$ -axis is directed along the Earth's true rotational axis of epoch and is positive north.

The  $Y_{TEE}$ -axis completes the right-handed system.

**CHARACTERISTICS:** Inertial, right-handed Cartesian system.

Figure 1-12.- True-of-epoch system.

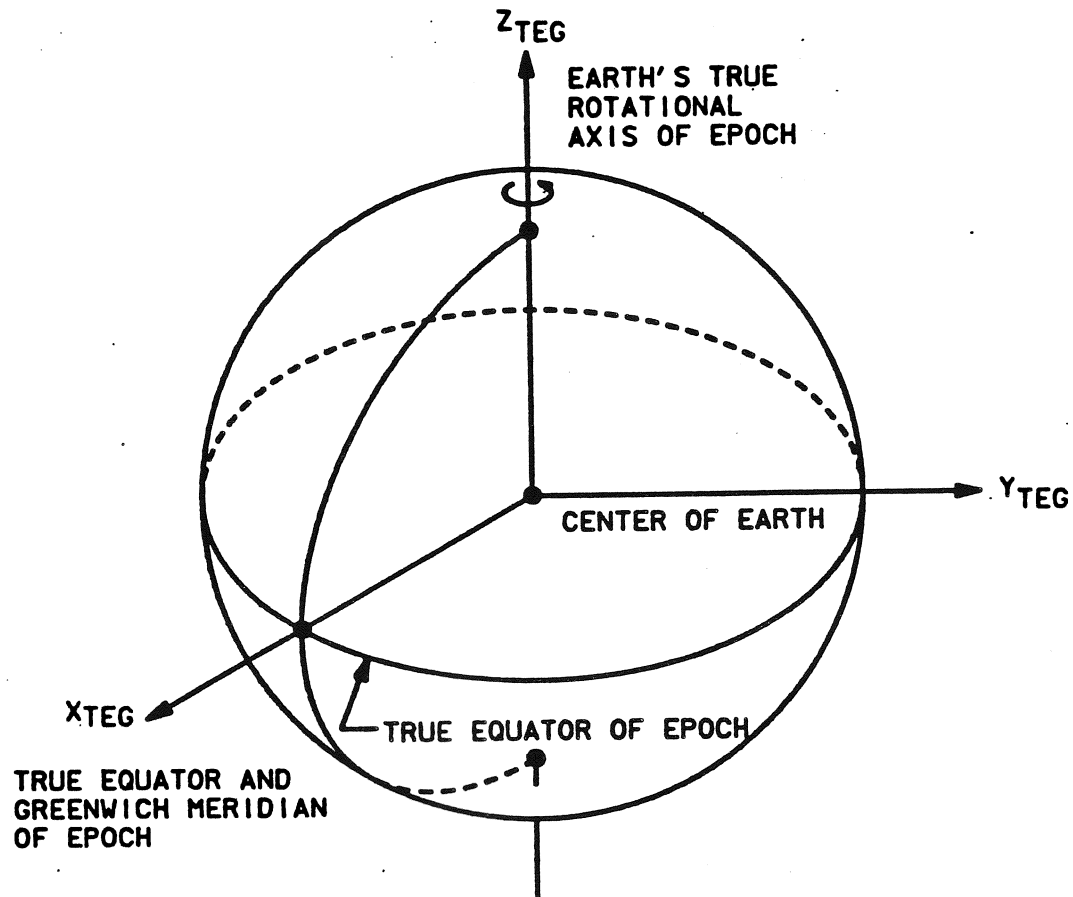

**NAME:** True Equator and Greenwich meridian of epoch (TEG) reference-axis system.

**ORIGIN:** The center of the Earth.

**ORIENTATION:** The epoch is defined to be 0 hours 0 minutes 0 seconds GMT on the user-specified base date.

The  $X_{TEG}$ - $Y_{TEG}$  plane is the Earth's true equatorial plane of epoch.

The  $X_{TEG}$ -axis passes through the Greenwich meridian of epoch.

The  $Z_{TEG}$ -axis is directed along the Earth's true rotational axis of epoch and is positive north.

The  $Y_{TEG}$ -axis completes the right-handed system.

**CHARACTERISTICS:** Inertial, right-handed Cartesian system.

Figure 1-13.- True-Greenwich-of-epoch system.



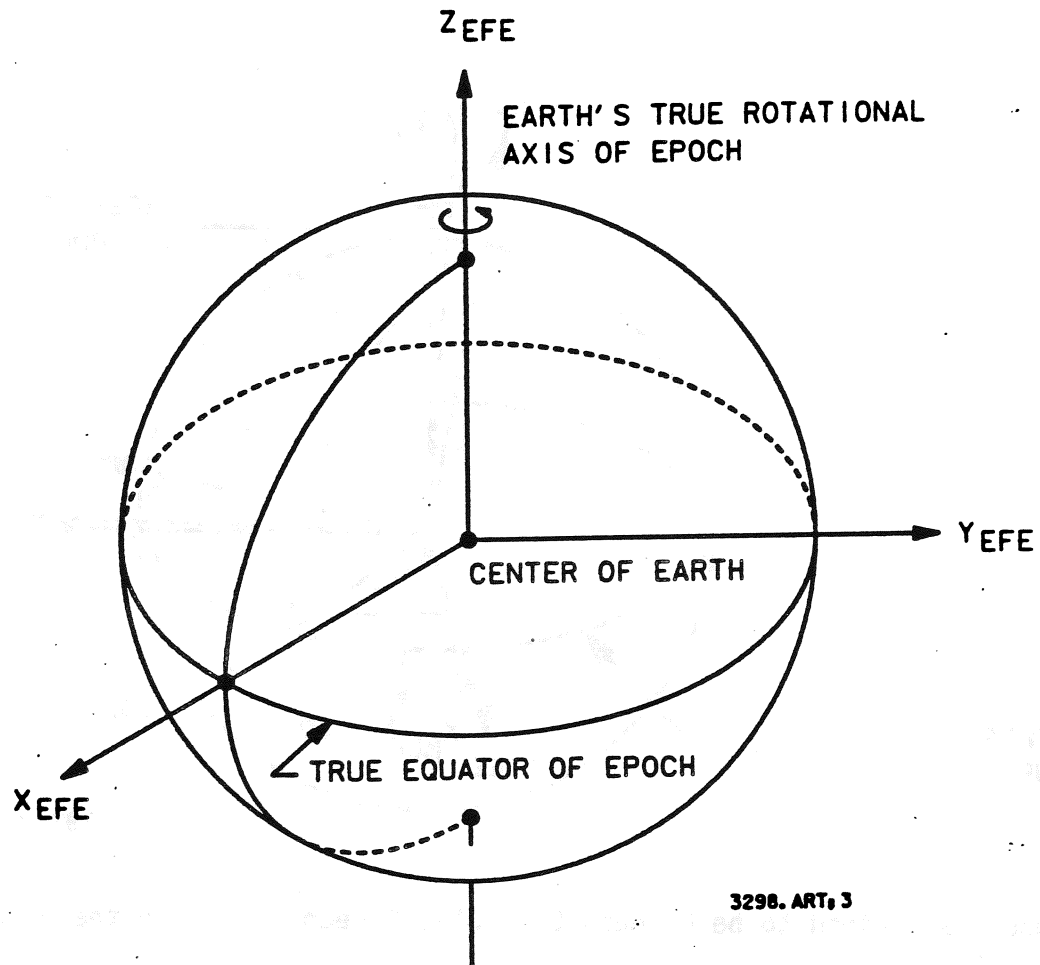

**NAME:** Earth-Fixed Equatorial (EFE) of epoch reference-axis system.

**ORIGIN:** The center of the Earth.

**ORIENTATION:** The epoch is defined to be 0 hours 0 minutes 0 seconds GMT on the user-specified base date.

The XEFE-YEFE plane is the Earth's true Equator of epoch.

The XEFE-axis passes through the Greenwich meridian.

The ZEFE-axis is directed along the Earth's true rotational axis of epoch and is positive north.

The YEFE-axis completes the right-handed system.

**CHARACTERISTICS:** Rotating, right-handed Cartesian system.

Figure 1-14.- Earth-fixed equatorial system.

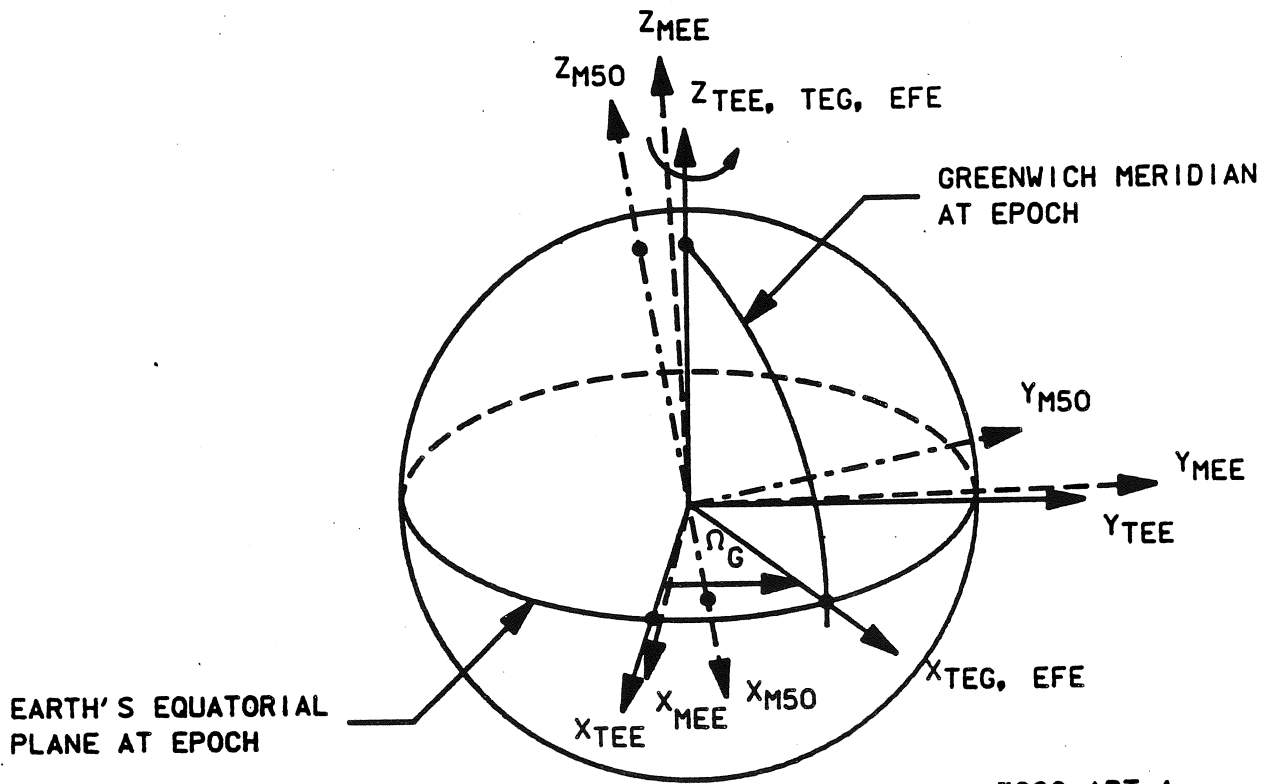

3299. ART, 1

Epoch is defined to be 0 hours 0 minutes 0 seconds GMT on the user-specified base date.

\_\_\_\_\_ defines the TEE, TEG, and EFE axis systems at epoch.

- - - - - defines the MEE axis system at epoch.

- - - - - defines the M50 axis system at epoch.

$\Omega_G$  defines the right ascension of Greenwich at epoch

NOTE: The angles between the reference axes are not to scale; they have been exaggerated for purpose of illustration.

Figure 1-15.- Illustration of relative orientation of reference-axis systems at epoch.

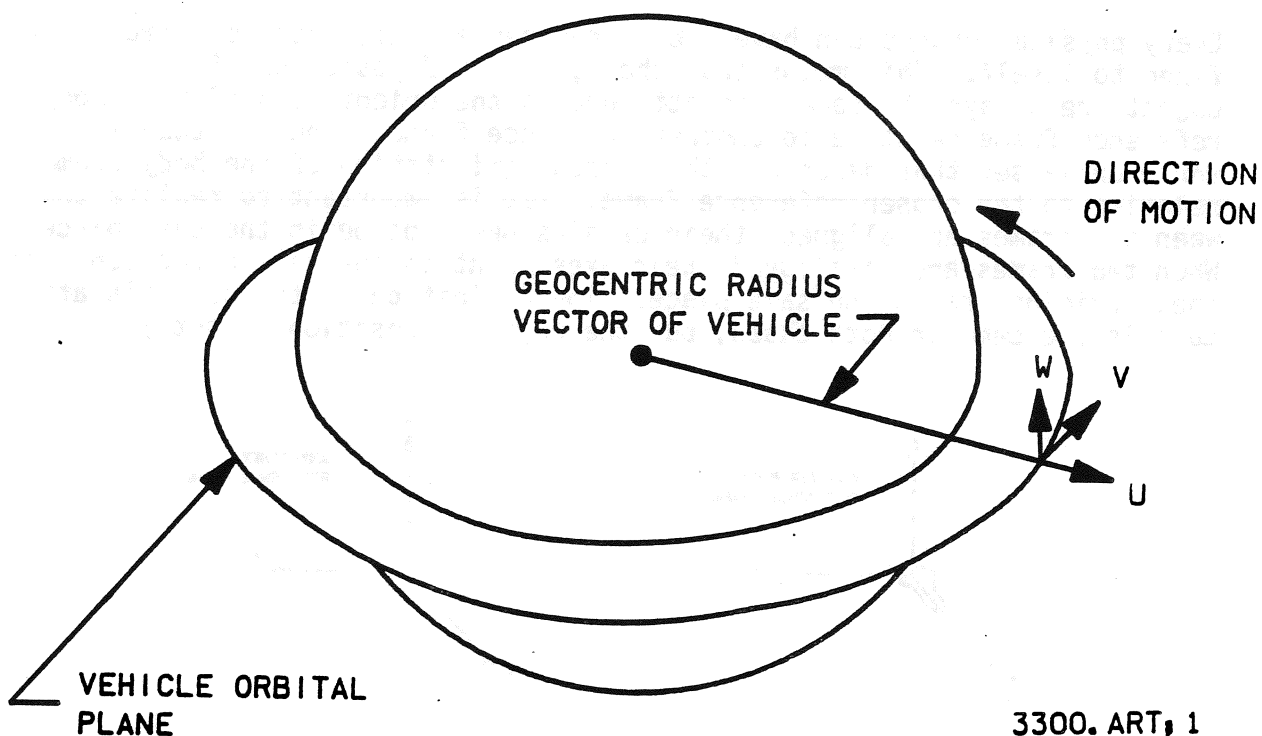

**NAME:** UVW reference-axis system.

**ORIGIN:** Vehicle center of mass.

**ORIENTATION:** The U-V plane is the instantaneous orbit plane at the time of interest.

The U-axis lies along the geocentric radius vector to the vehicle and is positive radially outward.

The W-axis lies along the instantaneous orbital angular momentum vector at epoch and is positive in the direction of the angular momentum vector.

The V-axis completes a right-handed system.

**CHARACTERISTICS:** Quasi-inertial, right-handed Cartesian coordinate system. This system is quasi-inertial in the sense that it is treated as an inertial coordinate system, but it is redefined at each point of interest.

Figure 1-16.- UVW reference-axis system.

1.4 ATTITUDE DEFINITION

Every physical object can have a body reference frame that is permanently fixed to itself. This means that the X, Y, and Z positions of parts of this object are always the same. An attitude is the orientation of this body reference frame relative to another reference frame. The attitude is the three angle set that describes the current orientation of the body frame relative to the chosen reference frame. (It is important to realize that when two frames are aligned, their origins need not be in the same place. When two frames are co-aligned their axes point in the same directions and their origins are in the same place. The definition of the object's attitude is the same in both cases, but the object's position is not.)

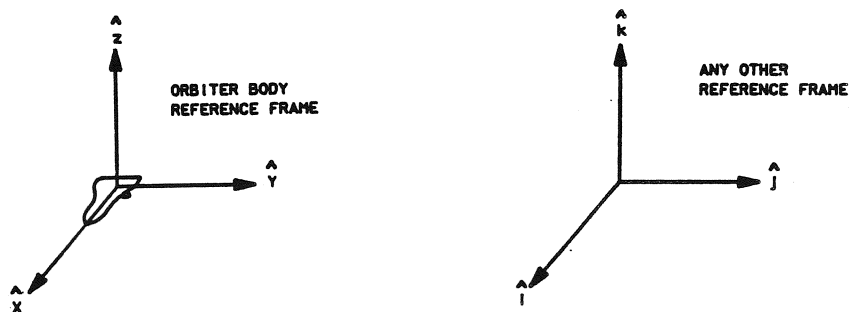

Figure 1-17.- Reference systems.

The definition of the three angles that define a body's attitude is a simple matter of choice. A set which is widely accepted and in use here consists of Euler angles. These angles represent three successive rotations of a coordinate frame from an initially aligned state to a final orientation. These rotations are performed about the object's body axes in a specific sequence. Each axis has, by convention, been given a number which refers to a rotation about that axis in accordance with the right hand rule. A rotation about the body X-axis is called a one(1) rotation; a rotation about the body Y-axis is called a two(2) rotation; and a rotation about the body Z-axis is called a three(3) rotation. Any sequence of these rotations (1, 2, 3 or 2, 3, 1, etc.) can represent the body attitude. Again, by convention, we use a 2, 3, 1 rotation sequence for the Orbiter which equates to a pitch, yaw, and roll.

The reason Euler angles are widely used is due to their mathematical flexibility. To demonstrate this, consider two sets of axes initially co-aligned that have been rotated by  $\theta_1$  degrees about the X-axis. Since  $\hat{X}, \hat{Y}, \hat{Z}$  and  $\hat{i}, \hat{j}, \hat{k}$  are unit vectors (refer to Appendix D for vector/matrix notation used in this book), the two reference frames are related by

$$\begin{aligned} \hat{X} &= \hat{i} \\ \hat{Y} &= \hat{j} \cos \theta_1 + \hat{k} \sin \theta_1 \\ \hat{Z} &= -\hat{j} \sin \theta_1 + \hat{k} \cos \theta_1 \end{aligned}$$

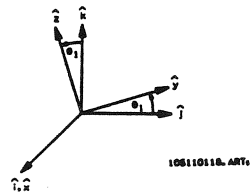

Figure 1-18.- A positive roll.

This can be expressed in terms of a matrix as

$$\begin{bmatrix} \hat{x} \\ \hat{y} \\ \hat{z} \end{bmatrix} = \begin{bmatrix} 1 & 0 & 0 \\ 0 & \cos \theta_1 & \sin \theta_1 \\ 0 & -\sin \theta_1 & \cos \theta_1 \end{bmatrix} \begin{bmatrix} \hat{i} \\ \hat{j} \\ \hat{k} \end{bmatrix} \quad \text{'1' rotation of } \theta_1 \text{ degrees}$$

This 3 X 3 matrix is called a rotation matrix and represents a '1' rotation. In a similar manner a '2' (pitch) rotation would be expressed as

$$\begin{bmatrix} \hat{x} \\ \hat{y} \\ \hat{z} \end{bmatrix} = \begin{bmatrix} \cos \theta_2 & 0 & -\sin \theta_2 \\ 0 & 1 & 0 \\ \sin \theta_2 & 0 & \cos \theta_2 \end{bmatrix} \begin{bmatrix} \hat{i} \\ \hat{j} \\ \hat{k} \end{bmatrix} \quad \text{'2' rotation of } \theta_2 \text{ degrees}$$

A '3' (yaw) rotation would be expressed as

$$\begin{bmatrix} \hat{x} \\ \hat{y} \\ \hat{z} \end{bmatrix} = \begin{bmatrix} \cos \theta_3 & \sin \theta_3 & 0 \\ -\sin \theta_3 & \cos \theta_3 & 0 \\ 0 & 0 & 1 \end{bmatrix} \begin{bmatrix} \hat{i} \\ \hat{j} \\ \hat{k} \end{bmatrix} \quad \text{'3' rotation of } \theta_3 \text{ degrees}$$

These matrices will always have the same pattern of ones and zeros. The sines and cosines will also be the same, differing only in which sine term gets the minus sign. The real advantage of Euler sequences is that a sequence of these rotations is simply the matrix product of the individual rotation matrices in the order in which they occurred. For our purposes, we always deal with a 2, 3, 1 sequence which when multiplied out equates to

$$\begin{bmatrix} \hat{x} \\ \hat{y} \\ \hat{z} \end{bmatrix} = \begin{bmatrix} \cos \theta_2 \cos \theta_3 & \sin \theta_3 & -\sin \theta_2 \cos \theta_3 \\ -\cos \theta_2 \sin \theta_3 \cos \theta_1 + \sin \theta_2 \sin \theta_1 & \cos \theta_3 \cos \theta_1 & \sin \theta_2 \sin \theta_3 \cos \theta_1 + \cos \theta_2 \sin \theta_1 \\ \cos \theta_2 \sin \theta_3 \sin \theta_1 - \cos \theta_3 \sin \theta_1 & -\cos \theta_3 \sin \theta_1 & -\sin \theta_2 \sin \theta_3 \sin \theta_1 + \cos \theta_2 \cos \theta_1 \end{bmatrix} \begin{bmatrix} \hat{i} \\ \hat{j} \\ \hat{k} \end{bmatrix}$$

This is equivalent to saying that the current vehicle orientation (or reference frame  $\hat{x}, \hat{y}, \hat{z}$  orientation) is equivalent to a specific sequence of rotations from reference frame  $\hat{i}, \hat{j}, \hat{k}$ . The angles  $\theta_1, \theta_2,$  and  $\theta_3$  represent the vehicle roll, pitch, and yaw. In addition, it can be shown that this rotation matrix is equivalent to a single rotation about a single vector. This eigen vector and eigen angle will be discussed more under quaternions. By varying the pitch, yaw, and roll of the vehicle, we can place the vehicle in any orientation to the reference axes.

Although vehicle maneuvers are modeled by pitch, yaw, roll rotations, the actual attitude of the vehicle is written in a roll, pitch, yaw sequence due simply to convention.

## 1.5 QUATERNIONS

Euler's theorem states that the general motion of a rigid body with one point fixed is a rotation about an axis through the point, where the axis is called the axis of rotation. We can consider the Orbiter center of mass as our fixed point with any reference frame having its origin there also. It's important to remember that for attitudes, the origin of the desired reference frame can be placed anywhere.

We have shown before that the rotation of the Orbiter from one orientation to another can be expressed as a rotation matrix.

$$\begin{bmatrix} \hat{A} \\ \hat{A} \\ \hat{A} \\ \hat{Z} \end{bmatrix}^2 = \begin{bmatrix} m_{11} & m_{12} & m_{13} \\ m_{21} & m_{22} & m_{23} \\ m_{31} & m_{32} & m_{33} \end{bmatrix}^2 \begin{bmatrix} \hat{B} \\ \hat{B} \\ \hat{B} \\ \hat{K} \end{bmatrix}^1 \quad \text{or} \quad [\hat{A}] = [M] [\hat{B}]$$

In this example, where  $[\hat{A}]$  is the final position and  $[\hat{B}]$  is the initial position, it doesn't matter if we are talking about a specific attitude relative to the reference frame or about going from one attitude to another; the process is the same, only the numbers change (refer to Appendix D for vector/matrix notation used in this book). The process of solving for the equivalent rotation axis and rotation angle in mathematics is known as an eigen value problem where

$$[M][\bar{E}] = \lambda[\bar{E}] \quad \text{for } \lambda = \text{real number}$$

which states that there exists a non-zero vector  $[\bar{E}]$  which when multiplied by scalar  $\lambda$  has the same direction and sense as  $[M][\bar{E}]$ . This equates to saying that

$$([M] - \lambda[I])[\bar{E}] = 0 \quad \text{where } I = \text{identity matrix}$$

and requires that the determinant of

$$([M] - \lambda[I]) \text{ equal zero.}$$

The solutions to this determinant are called eigen values which when substituted back into the original equation yield the eigen vectors  $[\bar{E}_i]$  of  $[M]$ . There will be normally two solutions which are opposite in directions. We always use the vector positive in terms of right hand rotations. The magnitude of the rotation comes directly from the terms in  $[M]$  by

$$\text{eigen angle} = 2 \cos^{-1} \left[ 0.5(1 + m_{11} + m_{22} + m_{33})^{1/2} \right]$$

A quaternion is just a different expression for the eigen vector and eigen angle.

The four components making up a quaternion are defined as follows

$$q_0 = 0.5 \sqrt{1 + m_{11} + m_{22} + m_{33}} = \cos (\mu/2)$$

$$q_1 = \cos (\alpha) \sin (\mu/2)$$

$$q_2 = \cos (\beta) \sin (\mu/2)$$

$$q_3 = \cos (\gamma) \sin (\mu/2)$$

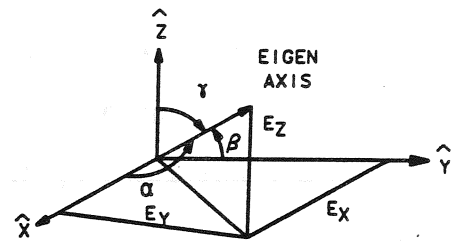

105110119. ART, 3

Figure 1-19.- Quaternion eigen axis.

where

$\mu$  = Net rotation about the eigen axis

$\alpha$  = angle between the eigen axis and X-reference axis

$\beta$  = angle between the eigen axis and Y-reference axis

$\gamma$  = angle between the eigen axis and Z-reference axis

To demonstrate how the process works, consider an Orbiter attitude defined as

$$\begin{array}{l} \text{Roll} = 45^\circ \\ \text{Pitch} = 0^\circ \\ \text{Yaw} = 90^\circ \end{array} \quad \text{where} \quad \begin{array}{l} \text{Roll} = \theta_1 \\ \text{Pitch} = \theta_2 \\ \text{Yaw} = \theta_3 \end{array}$$

as used before. Knowing that a pitch, yaw, roll Euler sequence was used, we can build the direction cosine matrix [M] for this attitude

$$[M] = \begin{bmatrix} 0 & 1 & 0 \\ -.7071 & 0 & .7071 \\ .7071 & 0 & .7071 \end{bmatrix}$$

the characteristic equation turns out to be

$$\lambda^3 - .7071 \lambda^2 + .7071 \lambda - 2(.7071)^2 = 0$$

which has one real root of  $\lambda = 1$ . Substitution yields

$$\begin{array}{l} X_1 = X_2 \\ X_1 = 0.4142 X_3 \end{array}$$

which when converted to a unit vector yields the eigen axis components

$$\hat{E} = \begin{array}{l} E_x = -0.3574 \\ E_y = -0.3574 \\ E_z = -0.8628 \end{array}$$

Note: -1 used as unit vector for right hand rule

From [M] we can obtain the eigen angle by

$$\mu = \text{eigen angle} = 2 \cos^{-1} [0.5(1 + m_{11} + m_{22} + m_{33})^{1/2}]$$

$$\mu = 2 \cos^{-1} [0.5 (1+0+0+.7071)^{1/2}] = 98.42^\circ$$

and

$$q_0 = 0.5 [1 + m_{11} + m_{22} + m_{33}]^{1/2} = 0.65328$$

$$q_1 = \cos (\alpha) \sin (\mu/2) = \cos [\cos^{-1}(-.3574)] \sin(98.42/2) = -.27059$$

$$q_2 = \cos (\beta) \sin (\mu/2) = \cos [\cos^{-1}(-.3574)] \sin(98.42/2) = -.27059$$

$$q_3 = \cos (\gamma) \sin (\mu/2) = \cos [\cos^{-1}(-.86285)] \sin(98.42/2) = -.6532$$

so:

$$\text{Roll} = 45$$

$$\text{Pitch} = 0$$

$$\text{Yaw} = 90$$

equals

$$E_x = -.3574$$

$$E_y = -.3574$$

$$E_z = -.8628$$

$$\text{eigen angle} = 98.42^\circ$$

equals

$$q_0 = 0.65328$$

$$q_1 = -.27059$$

$$q_2 = -.27059$$

$$q_3 = -.6532$$

Quaternions are used in telemetry because they can represent a nine-element cosine matrix with four numbers. Although they are difficult to derive by hand, they are ideal for computers. Consult the references for more on quaternion algebra, etc. Normally, we do not use quaternions directly - only the roll, pitch, and yaw equivalents.



## SECTION 2 TIME REFERENCES

The dimension of time is fixed to our lives in a very dramatic way. All of our daily affairs are governed by some time reference system. Without a time reference, there would be no ability to reference past events or to make future plans. This is especially true in the sciences where a time reference is almost a necessity. When the scientist or engineer analyzes or conducts some event, that event must be time tagged. Some time references are standard throughout the world and some are unique to the aerospace world. All time references are measured by the rotation of the Earth in relation to the passage of some heavenly body across one's meridian.

### 2.1 MEAN SOLAR DAY

The Sun, more than any other heavenly body, governs our lives. Its motion dictates our active and non-active periods. It is for this reason that ordinary time (i.e., the time we use to conduct daily affairs) is reckoned by the Sun. Therefore, in general, when the terms "hours, minutes, and seconds" are used it is understood to mean units of mean solar time. An apparent solar day is defined to be the time between two successive upper transits of the Sun across one's local meridian. The average of all apparent solar days throughout the year defines one 24 hour period of mean solar time (i.e., 1 mean solar day). This is actually determined by assuming the Earth is in a circular orbit whose period matches that of the true orbit and whose axis of rotation is perpendicular to the orbital plane. There are 365-1/4 of these mean solar days in one year. The year is the interval of time between passages of the Sun through the slowly precessing vernal equinox. The Earth must rotate slightly more than one revolution on its axis during the 24-hour mean solar time period. This fact will be understood after sidereal time is explained and figure 2-1 is referenced.

### 2.2 SIDEREAL TIME

Although the stars are flying away from us at millions of miles per hour, they appear to remain fixed over relatively long periods of time from our reference point on Earth. This is due, of course, to the vastness of the universe. Because of this apparent non-movement in relation to one another, the stars are used to set up an inertial frame of reference against which all other reference frames can be analyzed. One day of sidereal time (i.e., 24 hours sidereal time) is defined to be the amount of time required for the Earth to rotate once on its axis in relation to the fixed stars. This is the time between two successive upper transits of a reference star across one's local meridian. This action occurs about once every 23h56m04s of ordinary solar time. The Sun, Earth, and star relationships are shown in figure 2-1 and the time relationships between mean solar and sidereal time are shown in table 2-I.

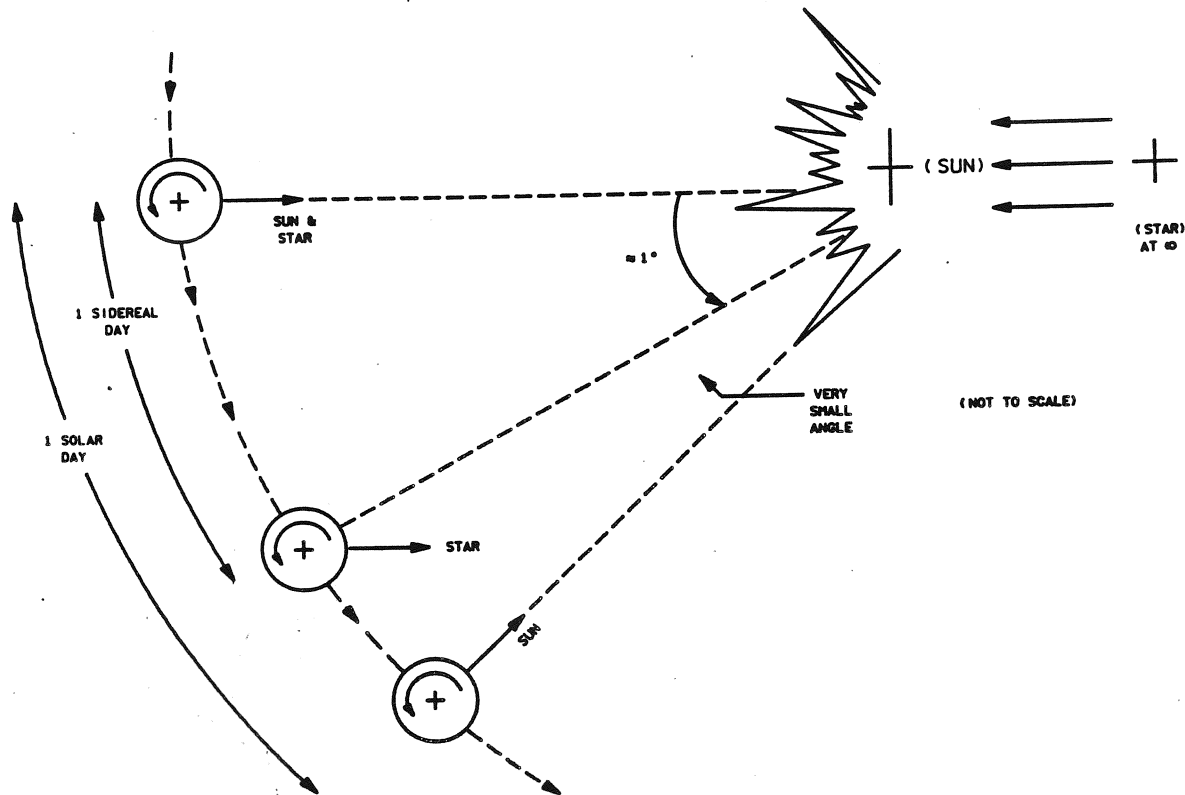

Figure 2-1. Sidereal day vs. solar day.

106110021-ART. 1

TABLE 2-I

1 day of mean solar time	= 1.00274 days of mean sidereal time
	= 24h03m56s of mean sidereal time
1 day of mean sidereal time	= 0.99727 days of mean solar time
	= 23h56m04s of mean solar time

As figure 2-1 shows, since the Earth has moved approximately  $1^\circ$  of arc along its orbital path, it must rotate slightly more than  $360^\circ$  for the Sun to cross the same meridian. This equates to about 4 extra minutes of rotation or .00274 extra arc degrees along the orbital path. Throughout the year there are  $365\frac{1}{4}$  solar days while there are  $366\frac{1}{1000}$  sidereal days. Sidereal noon time is defined to be 0h0m0s when the vernal equinox is on the local meridian. This means that sidereal time is the hour angle of the vernal equinox. The hour angle is the angle between the meridian and the line of right ascension (RA) of the star in question (measured towards the west through a full  $360^\circ$ ). Each  $15^\circ$  of RA is equivalent to 1 hour; therefore, the hour angle of any star can be converted to sidereal time. Equivalently, sidereal time is equal to the instantaneous RA of the meridian.

Sidereal time is related to a star's RA in the following manner:  
 SIDEREAL TIME = RA of STAR + Hr Angle of STAR. Figure 2-2 should help to clarify the above statements.

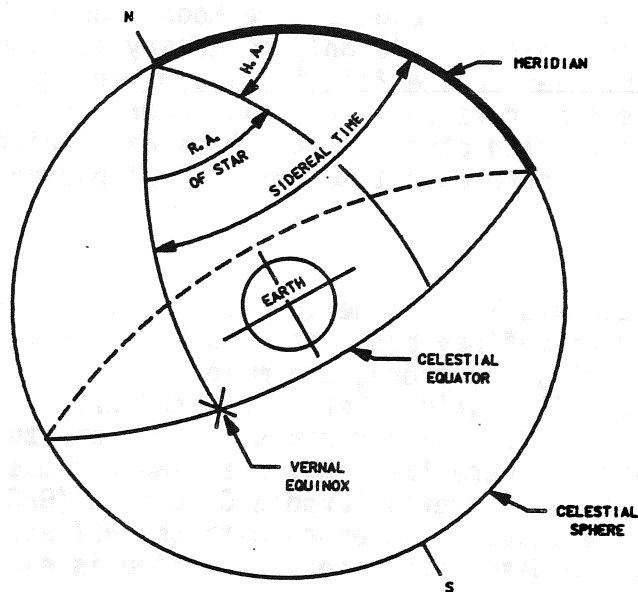

105110022. ART. 1

Figure 2-2.- Sidereal time.

### 2.3 MISSION UNIQUE TIMES

The mean solar time on the Greenwich meridian is called Greenwich mean time (GMT), universal time (UT) or Zulu (Z) time. Since each 15° of Earth rotation is equivalent to 1 hour, GMT can be converted to local time (or vice versa) by adding or subtracting the correct angle (1 hr = 15° long) of the Greenwich meridian from the local longitude. When it comes to dealing with missions, there are 5 types of times which are used as references. These are Internal Elapsed Time (IET), GMT of lift-off (L/O), Mission Elapsed Time (MET), Phase Elapsed Time (PET) and Time of Ignition minus (TIG-). Each of these times is referenced to each other and to universal time in some unique way. In order to set up these new time references, it is necessary to establish a user specified base date.

### 2.4 BASE DATE

This is a user specified year, month and day. It is defined to be 0h0m0s Greenwich zone time on the user specified year, month and day. In the Shuttle program, the base date is set to be 12:00 A.M. GMT (midnight) on the day of the launch. Therefore 12:00 A.M. GMT is 0h0m0s base date for whatever day the launch is occurring. This time is also defined as an "Epoch." It is at this time that the axis systems (MEE, TEE and TEG) are defined (i.e., the R, N, and P matrices are stored). R, N, and P are matrices that represent the rotation, nutation, and precession of the Earth. Rotation is

the angle between the Greenwich meridian and the M50 X-axis; precession accounts for the movement of the Earth's rotational axis against the celestial sphere. A third effect, nutation, is a small sinusoidal motion on top of the circular precessional motion. Nutation is caused by the gravitational pull on the Earth's bulge by the Moon. Once the R, N and P matrices are set at the base date, it is only necessary to consider the rotation effect for the remainder of the flight. The other two components are negligible. The five time references are all referenced in some respect, either directly or through each other, to the base date which is in turn referenced to GMT. These five reference times are all displayed in Mission Control.

① IET

Internal Elapsed Time is defined as an event time which is measured from the user defined base date. One of the main events dealt with is lift off (L/O); therefore, the main IET time dealt with is the  $\Delta t$  time between 12 midnight before L/O and L/O. All Orbiter time tagged events (i.e., L/O, state vectors, burns, attitudes, etc.) are stored as IET times. These IET times are used for most of the computation processes of the General Purpose Computers (GPC's). The pointers, however, are usually concerned with the MET equivalent of these events, to be discussed later. IET time is expressed in days, hours, minutes and seconds.

② GMT L/O

Greenwich mean time of lift-off is an event time which is measured from the beginning of the year of the specified base date. It is expressed in day of base date year and time of day in hours, minutes and seconds. The day of the year is an integral count from the beginning of the base date year, negative in years before the base date year and positive in years after.

Example:	<div style="border: 1px solid black; padding: 5px; display: inline-block;">           Base Date Year (1983)         </div>	Dec 31, 1983 noon GMT → 365/12:0:0
		Jan 1, 1984 noon GMT → 366/12:0:0
		Dec 31, 1982 noon GMT → -1/12:0:0

③ MET

Mission Elapsed Time is another event time which is measured from some user defined reference time. Since the name implies the amount of time which has elapsed since the mission started, it is only reasonable to set L/O as the user defined reference. In this way, all mission activities are measured as the  $\Delta t$  to or from L/O. Negative MET corresponds to times before L/O of the mission and positive MET corresponds to times after L/O of the mission. MET is expressed in days, hours, minutes and seconds.

④ PET

Phase Elapsed Time is yet another event time which is measured from some user defined reference time. One may wish to pick an activity such as the beginning of an Extra Vehicular Activity (EVA). PET is also expressed in days, hours, minutes, and seconds. PET can be used as a back up MET, or it can be used to reference events to some time other than L/O.

⑤ TIG-

Time of Ignition minus is used as a countdown time. It is the  $\Delta t$  time before some future event occurs (e.g., TIG-3:30). The event will occur at TIG- = zero. The event is usually a burn but TIG- can also be used for other targeting information or simply as a countdown clock. The following graph shows how these five reference times (IET, GMT L/O, MET, PET and TIG-) are all related to a particular mission.

MISSION - STS 6  
LAUNCH - NOON APR 4, 1983 GMT

YEAR: 1983

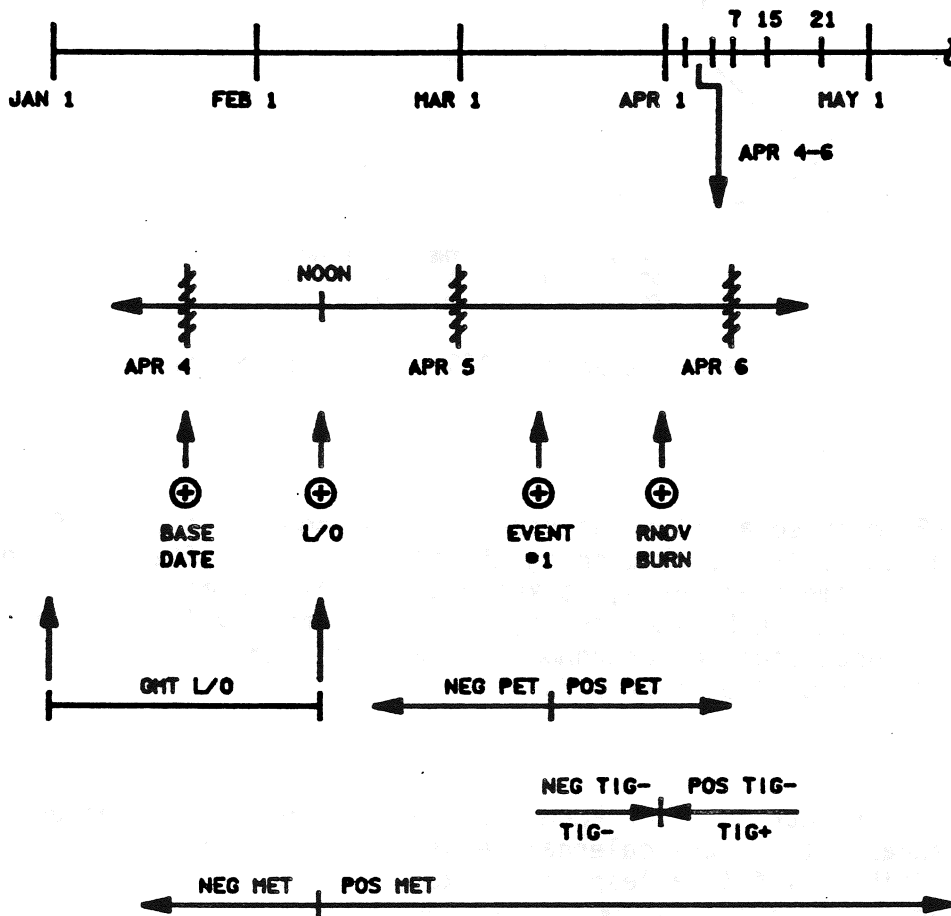

3324. ART. 2

Figure 2-3.- Time relationships.

## 2.5 EPOCH

Epoch is defined to be a specified date, usually the date of some historical event, to which the coordinates and other data for a celestial body are referenced, or from which a new time period is measured. An example of referencing to a particular epoch is the Mean of 1950 (M50) coordinate system. It is a cartesian coordinate system whose x-axis is aligned with the mean vernal equinox of epoch, z-axis is aligned with the Earth's mean rotational axis of epoch, and y-axis completes the right handed system. The epoch is the beginning of the Besselian year 1950. Mean denotes an average direction for the vernal equinox, or the rotational axis for that epoch. The average is used to remove the short period nutation motions of the Earth. The M50 coordinate system is shown in figure 2-4.

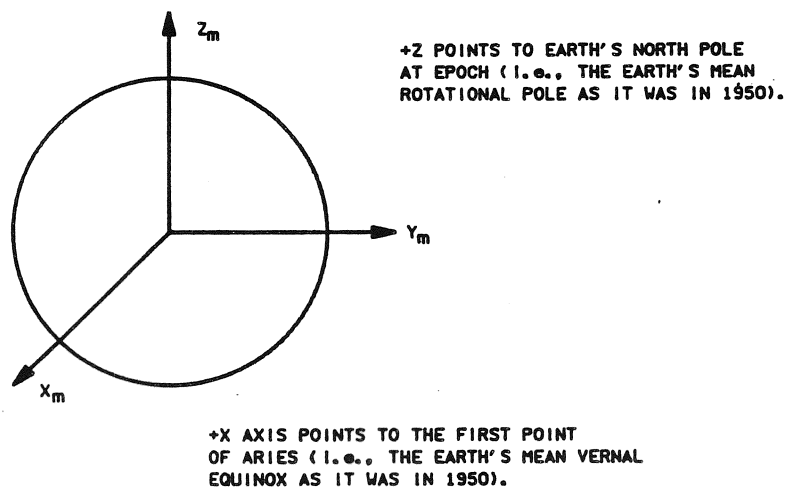

Figure 2-4.- Mean of 1950 Coordinate System.

## 2.6 JULIAN DATE

Prior to 1925 mean solar time was reckoned from noon instead of from midnight. The mean solar day beginning at noon, 12 hours after the midnight that began the same civil date, is known as the astronomical day. To facilitate chronological reckoning, the system of Julian Day (JD) numbers maintains a continuous count of astronomical days, beginning with JD 0 on 1 Jan 4713 B.C., Julian proleptic calendar.

## 2.7 GREGORIAN CALENDAR

The calendar was introduced by Pope Gregory XIII in 1582 to replace the Julian calendar. It is the calendar we use today. Every year that is exactly divisible by 4 is a leap year, except for centesimal years, which must be exactly divisible by 400 to be leap years.

## 2.8 BESSELIAN SOLAR YEAR

The period is of one complete revolution of the fictitious mean Sun in right ascension beginning at the instant when the right ascension is  $280^\circ$ . The beginning of the Besselian year is denoted with the notation .0 (e.g., 1950.0). Besselian time 1950.0 does not coincide with 1950 Jan 0<sup>d</sup>.0000 U. T.





## SECTION 3 ORBITS

### 3.1 DEFINITION OF COMMONLY USED ORBITAL ELEMENTS

There are five independent orbital elements which describe the size, shape and orientation of an orbit. A sixth element is needed to locate the position of a satellite in an orbit at a particular time. These six elements are described below and are shown in figure 3-1.

- a Semi-major axis - a constant defining the size of an elliptical orbit.
- e Eccentricity - a constant defining the shape of the conic orbit.
- I Inclination - the angle between the north polar axis of the Earth and the angular momentum vector.
- $\Omega$  The right ascension of the ascending node - the angle measured eastward from the X-axis along the Equator to that intersection with the orbit plane where the satellite passes from south to north. In the case where the inclination is zero, the ascending node is defined to be the right ascension of the vehicle.
- $\omega$  The argument of perigee - the angle measured in the orbit plane from the ascending node to perigee in the direction of travel in the orbit. In the case of eccentricity equals zero, perigee is defined to be at the ascending node.
- f True anomaly - the geocentric angular displacement of the vehicle measured in the orbit plane from perigee and positive in the direction of travel.

These six elements are not the only ones which can completely describe an orbit. There are other quantities which can also be used. For example, the true anomaly may be replaced by the time of perigee. Which set of orbital elements chosen to describe an orbit depends on what data are available.

### 3.2 EPHEMERIS FILES FOR POINTING PROGRAMS

An ephemeris defines the position and velocity of an orbiting body as a function of time. The ephemeris files used by the pointing programs are derived from flight specific supertapes which are generated by Trajectory Division. Each supertape consists of a collection of state vectors taken at one minute intervals for an entire flight duration. Each state vector consists of a position vector, a velocity vector and a corresponding time tag. The collection of these vector pairs on the supertape completely describes the ephemeris of the Shuttle during a particular flight. Once a supertape is received from MPAD, it is loaded into the CAPS computer system where the

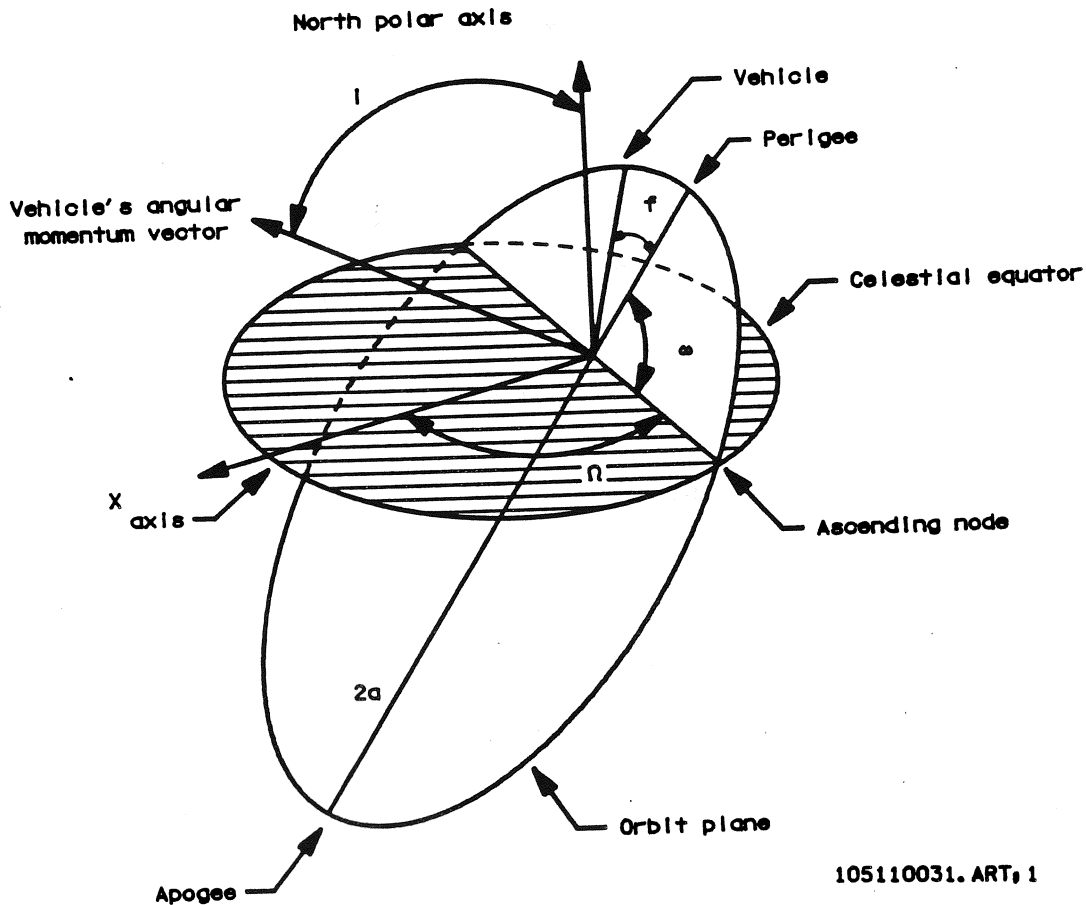

105110031. ART, 1

Figure 3-1.- Orbital elements.

timeliners use the data for Crew Activity Plan generation. Since the pointers use a mini-computer rather than the CAPS system for attitude calculations, a smaller, more convenient ephemeris file must be generated from the supertape. This is done by extracting state vectors from the supertape normally at 12-hour intervals during the flight. State vectors are also taken before important events such as satellite deploys and after orbit perturbing events such as on-orbit burns. This smaller collection of state vectors gives orbit information only at the specific times of the chosen vectors. In order to fill the gaps left between the vectors, the ability to propagate a vector forward or backward in time is necessary. To do this the state vectors are loaded into an ephemeris generating program which converts the state vectors into sets of invariant elements. These elements can be propagated to any time desired.

There are nine invariant elements used in the ephemeris files. Six of the elements are the common orbital elements described in the previous section. The other three elements help describe the orbit plane perturbations due to the gravitational effects of an oblate Earth (e.g., regression of nodes, rotation of the line of apsides). These nine elements are:

- AK Semi major axis
- EK Eccentricity
- GK Argument of perigee
- IK Inclination
- HK Ascending node longitude
- MK Mean anomaly: The angle that would exist between the perigee of the orbit and the satellite if in the time since leaving perigee the satellite had travelled at a constant angular velocity equal to the mean motion. The angle is positive in the direction of travel.
- ETA Mean motion: The average angular velocity of the spacecraft with respect to the center of the Earth over one complete orbit.
- GDOT Rate of change of the argument of perigee.
- HDOT Rate of change of the ascending node longitude.

### 3.3 BASIC EQUATIONS OF THE TWO-BODY PROBLEM

Because of the extensive discussion of this subject in literature, only a brief review will be made here. Consult the references for greater detail and specific propagation techniques.

Newton's law of universal gravitation expresses the mutual gravitational attraction of two objects by

$$\bar{F}_g = \frac{-Gm_1m_2\bar{R}}{R^3}$$

where "G" is the universal gravitational constant. Since the force due to gravity will result in each of the masses being accelerated we can write

$$\bar{F}_g = -\frac{Gm_1m_2\bar{R}}{R^3} = m_1\bar{A}_1 = m_2\bar{A}_2$$

Because we have assumed that

$$\bar{R} = \bar{R}_1 - \bar{R}_2$$

we can express

$$\bar{A}_1 = \ddot{\bar{R}}_1 \text{ and } \bar{A}_2 = \ddot{\bar{R}}_2$$

with which we can express the acceleration of each mass as a function of its gravitational attraction to the other.

$$m_1 \ddot{\bar{R}}_1 = m_1 \bar{A}_1 = - \frac{Gm_1 m_2 \bar{R}}{R^3}$$

$$\ddot{\bar{R}}_1 = - \frac{Gm_2 \bar{R}}{R^3}$$

And for  $m_2$ :

$$\ddot{\bar{R}}_2 = - \frac{Gm_1 \bar{R}}{R^3}$$

If these two equations are subtracted we get

$$\ddot{\bar{R}} = \ddot{\bar{R}}_1 - \ddot{\bar{R}}_2 = - \frac{G(m_1 + m_2) \bar{R}}{R^3}$$

where

$$\ddot{\bar{R}} = - \frac{G(m_1 + m_2) \bar{R}}{R^3}$$

is called the two-body equation. It is important to remember that it has been assumed that both bodies are spherically symmetric and can accurately be modeled as point masses. In addition, no effects due to geopotential, air drag, solar wind, or other bodies have been included. When we assume  $m_1$ , to be the Earth and  $m_2$  to be a satellite, this equation can be further simplified to

$$\ddot{\bar{R}} = - \frac{\mu_{\oplus} \bar{R}}{R^3} \quad \text{where } m_1 + m_2 \approx m_1 \\ \text{and } Gm_1 = Gm_{\oplus} = \mu_{\oplus}$$

where  $\mu_{\oplus} = 1.407646882 \times 10^{16} \text{ ft}^3/\text{sec}^2$ .

It is also important to realize that this differential equation cannot be solved in a closed form. How to predict the position of a satellite at a future time is known as the Kepler problem since Kepler was the first person to accurately do so. Since then many other techniques have been developed as is evident from a brief review of the literature on the subject. All methods involve some type of iterative technique. For a traditional two-body orbit with no external forces, the individual classical orbital elements do not change and are called invariant. In the real world there are many forces that perturb an orbit and render an invariant approach inaccurate.

There are four general classes of perturbative forces with which we are concerned. These are geopotential, air drag, third-body, and radiation pressure. The perturbations of an orbit due to geopotential result from the irregular mass distribution in the Earth. As was shown earlier, the major effect is due to  $J_2$  and is  $10^{-3}$  less than the two-body force. Higher order terms are  $10^{-6}$  or less in magnitude. Air drag is another force of interest for low Earth orbits. Air drag is difficult to account for

$$\bar{A}_D = \bar{F}_D / m = \frac{\frac{1}{2} \rho \bar{V}^2 A C_D}{m}$$

$A$  = cross sectional area  
 $C_D$  = drag coefficient  
 $\rho$  = density of air  
 $\bar{V}$  = velocity

due to the direct effect of density. The upper atmosphere of the Earth changes continuously due to solar heating, radiation pressures, and gravitational effects. The density and thickness of the atmosphere vary throughout the orbit. This variation can have a significant effect on orbit predictions. The primary third-body that bothers our orbits is the Moon. The force due to the Moon is as follows:

$$\bar{A}_m = \frac{\bar{F}_m}{m_s} = \frac{\ddot{\bar{R}}_{ms}}{m_s} = - \frac{GM_m \bar{R}_{ms}}{R_{ms}^3}$$

$\bar{R}_{ms}$  = vector from satellite to Moon  
 $\bar{M}_m$  = mass of Moon

$$\bar{A}_m = - \frac{\mu_m \bar{R}_{ms}}{R_{ms}^3} \text{ where } \mu_m = Gm_m = 1.7314 \times 10^{14} \text{ ft}^3/\text{sec}^2$$

It is considerable and needs to be accounted for. The fourth class of force stems from the radiation pressure of the Sun. This force has a magnitude

$$\bar{A}_R = \frac{\bar{F}_R}{m_s} = \left( \frac{E}{C} \right) \frac{AG \bar{R}}{m_s R^3}$$

$E$  = solar constant  
 $C$  = speed of light  
 $A$  = cross sectional area  
 $G$  = reflectivity factor

smaller than the others but can have a significant effect over a long period of time.

The accelerations due to these perturbing forces are added onto the two-body equations and integrated

$$\frac{\ddot{\bar{R}}}{R^3} = \frac{-\mu \bar{R}}{R^3} + \bar{A}_g + \bar{A}_D + \bar{A}_m + \bar{A}_R$$

where  
 $\bar{A}_g$  = acceleration due to geopotential  
 $\bar{A}_D$  = acceleration due to drag  
 $\bar{A}_m$  = acceleration due to the Moon  
 $\bar{A}_R$  = acceleration due to radiation pressure

Neglecting the specific mathematical techniques used for this integration, there are two basic perturbation methods. The first is called variation of parameters. This method assumes that for every discrete piece of the actual orbit there is a reference orbit that will coincide at that point. The orbital parameters (elements) are then varied continuously around the actual orbit. This method is only as good as the models used for the perturbing forces. The second technique uses osculating (kissing) elements. It differs from variation of parameters in that it generates the invariant elements at a point where the actual orbit and reference orbit touch and then propagates these invariant elements forward until a predefined error occurs between the two orbits. A new set of invariant elements is then generated to zero out the error and then propagated forward. Most propagators use osculating elements.

### 3.4 PRECESSION AND NUTATION

The vernal and autumnal equinoxes are defined by the line of intersection of the Earth's equatorial plane with the ecliptic plane. This line of intersection precesses to the west about 50 arc-seconds per year. The precession is due to the Sun and Moon's gravitational pull on an oblate Earth. This pull produces a torque on the Earth which causes the Earth's rotational axis to sweep out a  $23\frac{1}{2}^\circ$  half angle cone every 26,000 years. As the rotational axis sweeps out the cone, the equinoxes precess to the west. There is another torque on the Earth produced by the Moon's gravitational pull. The Moon's orbit plane precesses with a period of 18.6 years due to the Sun's perturbative effects. Thus, the Moon's pull on the Earth also has a period of 18.6 years. The result of this pull causes a nodding effect to be superimposed on the westward procession of the equinoxes. This is called nutation.

### 3.5 GROUNDTRACK

A satellite orbiting a non-rotating Earth traces out a great circle with its groundtrack. When you allow for the Earth's rotation, the satellite's orbit plane essentially remains fixed in space while the Earth rotates under it. The effect of this rotation is to displace the groundtrack to the west with each revolution of the satellite. The amount of this displacement equals the number of degrees the Earth rotates during one orbital period plus the negligible amount due to the westward drift of the orbital plane. See figure 3-2.

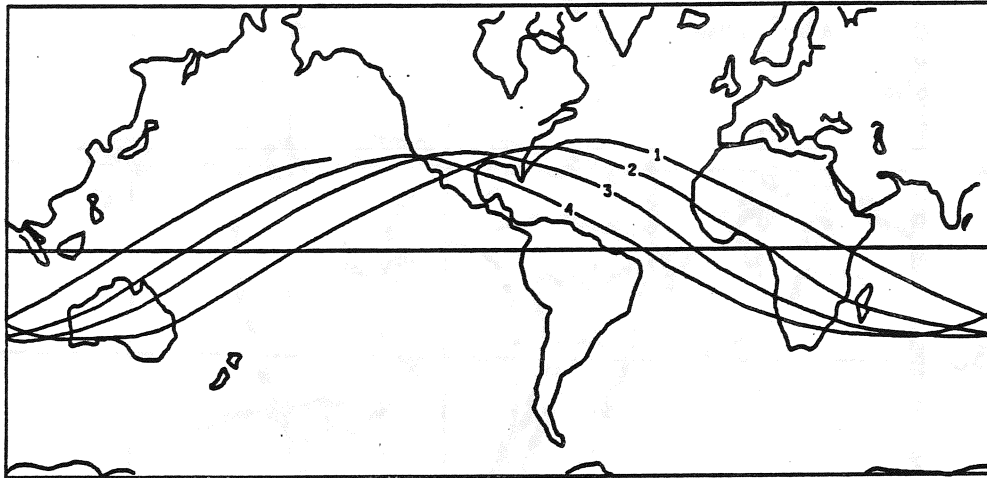

3824. ART, 2

Figure 3-2.- Groundtrack.

Consider the case of a satellite which has a 90 minute orbital period. The amount of displacement per revolution is approximately

$$\frac{360^\circ}{24 \text{ hr}} \times \frac{1 \text{ hr}}{60 \text{ min}} \times \frac{90 \text{ min}}{\text{rev}} = \frac{22.5^\circ}{\text{rev}}$$

The maximum latitude north or south of the Equator which the satellite obtains is equal to the inclination of the orbit. Note that for a retrograde orbit the most northerly or southerly latitude of the orbit is  $180^\circ$  minus the inclination.

A term which should be mentioned here is the suborbital point or subsatellite point. This point defines the instantaneous groundtrack of an orbiting body.

### 3.6 GEOSYNCHRONOUS SATELLITE

A satellite is said to be in a geosynchronous orbit if it is at such an altitude that its angular velocity matches the rotation of the Earth. The altitude which accomplishes this is 19,300 nautical miles. If the geosynchronous orbit has no inclination, the satellite seems to sit motionless over some point on the Earth's Equator. However, if the orbit has non-zero inclination the groundtrack of the satellite will trace out figure eights as shown in figure 3-3.

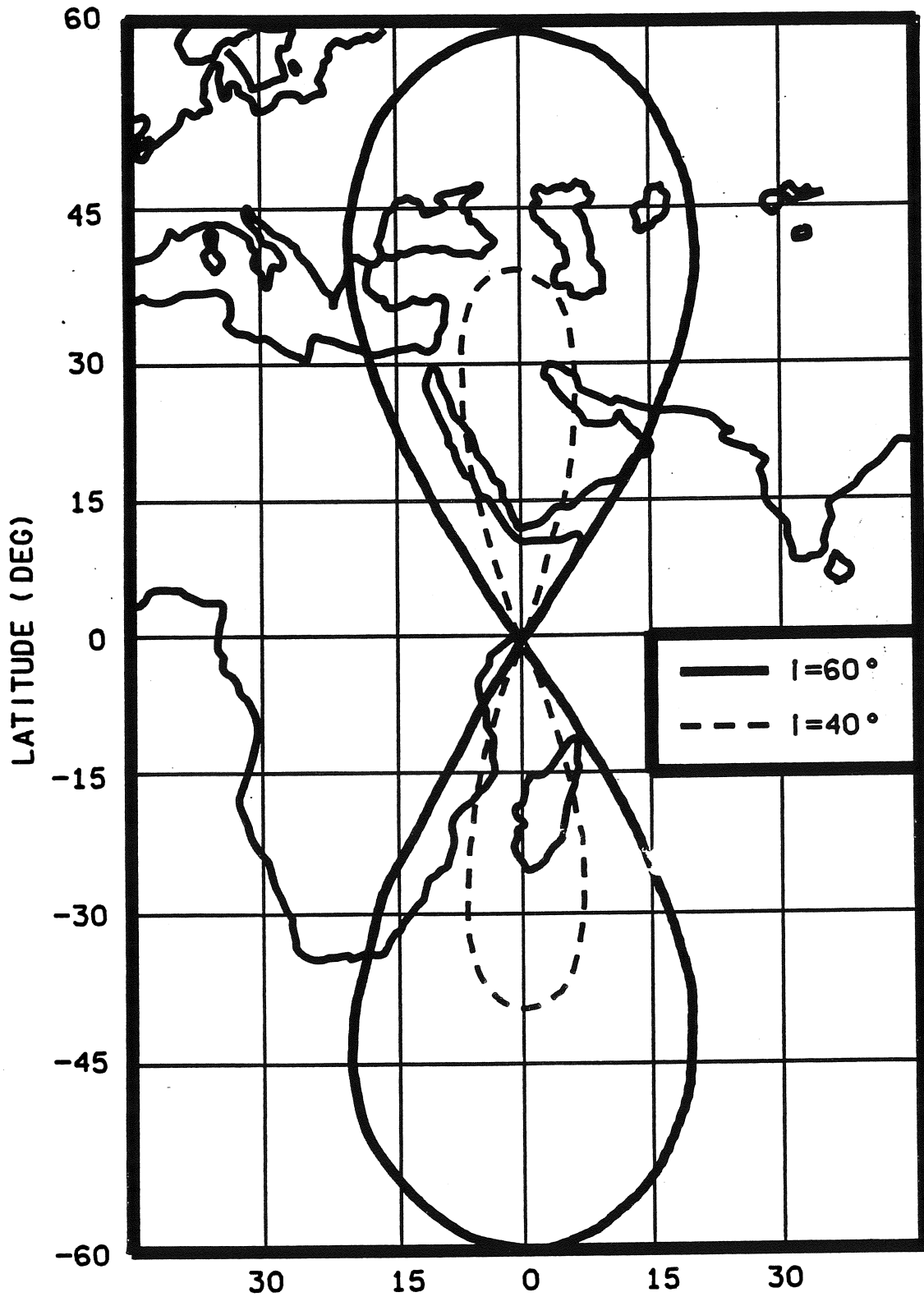

LONGITUDE DEVIATION (DEG)  
Figure 3-3.- Geosynchronous satellite.

105110033. ART. 2



## SECTION 4 TARGETS

When solving pointing problems, it is often necessary to determine the direction and sometimes the distance of one or more targets from the Orbiter. Any point on the Earth or on the celestial sphere can be designated a target for pointing purposes. Any body or vehicle traveling in a known orbit can also be used as a target. Even direction vectors can be used as "targets." To point "at" a vector, the body pointing vector is simply pointed in the same direction as the vector. Inertial direction vectors, that is, vectors fixed in inertial space, can be treated just like celestial targets, since any inertial direction vector points at a unique point on the celestial sphere. Non-inertial vectors, such as the Orbiter velocity vector, can also be used as targets.

For the purpose of discussion, it is useful to divide all targets into three broad categories: ground, celestial, and ephemeris targets. These categories are more than merely arbitrary divisions, as each type of target requires a different method to determine its location relative to the Orbiter.

### 4.1 GROUND TARGETS

A ground target is any target that has a fixed Earth latitude and longitude and a fixed, finite altitude above the Earth's surface (that is, above the reference ellipsoid). Space Flight Tracking and Data Network (STDN) ground stations, geographical features, and geosynchronous satellites are all examples of ground targets.

### 4.2 CELESTIAL TARGETS

Just as a ground target is located by its Earth latitude and longitude, so a celestial target is located at a fixed right ascension and declination. It is important to note that all celestial targets have unchanging right ascension and declination. The Sun, Moon, and planets, although they appear on the star chart, are not fixed; they trace out paths on the celestial sphere. The Sun and planets, however, move so slowly on the celestial sphere (1°/day or less) that for many purposes they may be considered fixed. Any right ascension and declination can be used as a celestial target - even if there is no star at the indicated point. As mentioned before, any direction vector fixed in inertial space, such as a M50 direction vector, points at a fixed right ascension and declination and can be equated to a celestial target.

Right ascension and declination are closely related to longitude and latitude on the Earth's surface. A star is "straight up" from a point on the Earth with a geodetic latitude equal to its declination. A star with a declination of 30° can appear to pass directly overhead only to an observer at a geodetic latitude of 30°. This is because for objects at great distances, geodetic latitude has the same definition as declination-it is the angle between the

equatorial plane and the local vertical (upwards) direction, and is positive "above" and negative "below" the equatorial plane.

However, for nearby objects (such as orbiting spacecraft, for example) geodetic latitude and declination are not equal. This is because the line representing a certain geodetic latitude is parallel to, but not coincident with a line of equal declination. For targets at infinite distance, this doesn't matter—any two parallel lines less than about 100 million miles apart point at practically the same spot on the celestial sphere. But for nearby targets, this distance between the lines of geodetic latitude and equivalent declination becomes significant. In order to see stars behind an orbiting target that are at the same declination as the target, the ground observer must be at a geocentric latitude equal to the target's declination. However, at this position the target will appear to be somewhat south of directly overhead. Refer to figure 4-1.

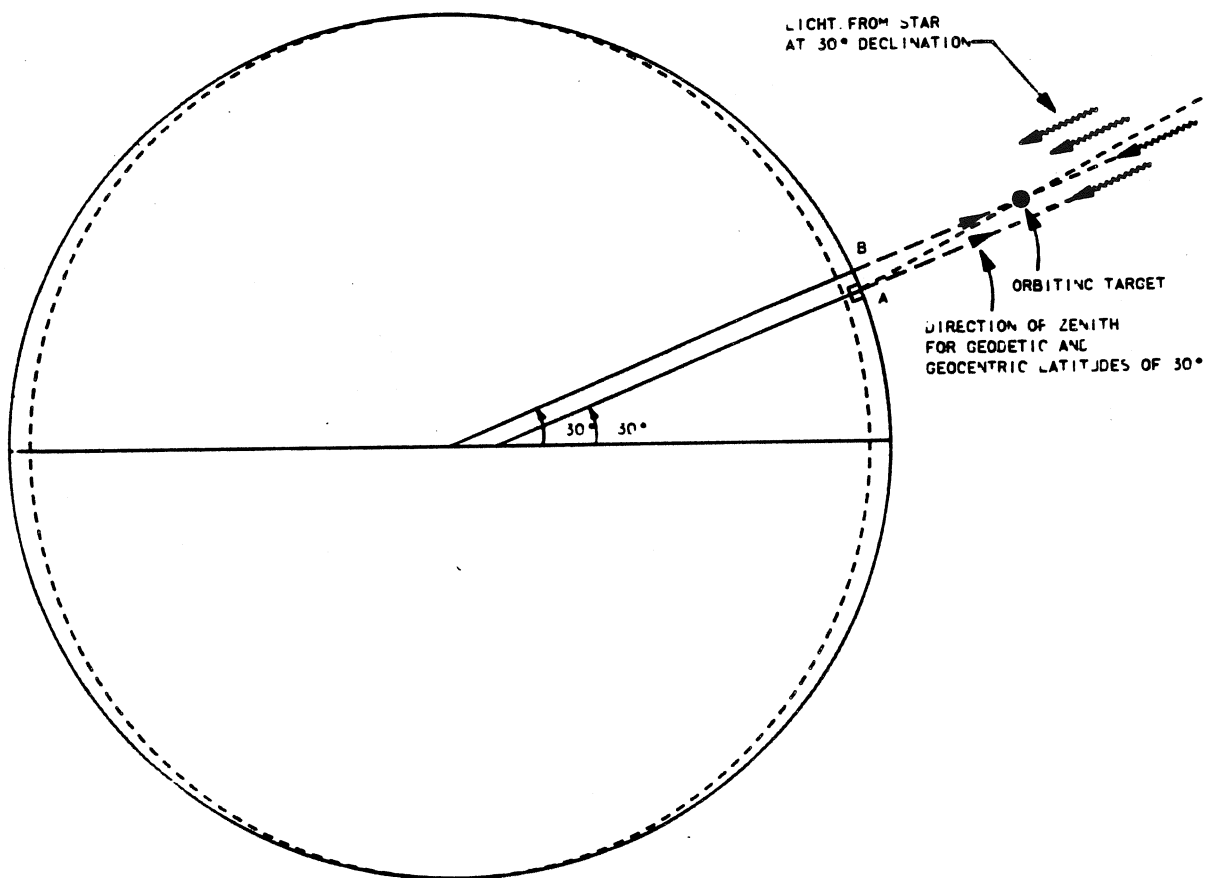

A=POINT ON SURFACE WITH GEODETIC LATITUDE OF 30°  
 B=POINT ON SURFACE WITH GEOCENTRIC LATITUDE OF 30°

10-110041. ART. 1

Figure 4-1.- Geodetic vs. geocentric latitude.

Right ascension is also closely related to longitude, but due to the Earth's rotation, the relationship is constantly changing. To determine the longitude corresponding to a given right ascension, a parameter called the Greenwich hour angle (GHA) must be considered.

- Greenwich Hour Angle (GHA) - The Greenwich hour angle is defined as the angle from the vernal equinox eastward to the projection of the prime (Greenwich) meridian onto the celestial sphere. In other words, it is the right ascension of the zenith at the prime meridian. If the GHA is  $30^\circ$ , it means that if a person stood on the prime meridian and looked straight up, the person would be looking at a point with a right ascension of  $30^\circ$ .

As can be seen in figure 4-2, the right ascension and the longitude of a given pointing vector from center of Earth (C.O.E.) are related by the following rule:

$$\begin{aligned} \text{RA} &= \text{LONG (in } ^\circ\text{E of prime meridian)} + \text{GHA (in degrees)} \\ \text{LONG (in } ^\circ\text{E of prime meridian)} &= \text{RA} - \text{GHA (in degrees)} \end{aligned}$$

An adjustment is needed because right ascension goes from  $0^\circ$  to  $360^\circ$  and longitude is measured between  $-180^\circ$  (180 W) and  $180^\circ$  (E). Negative (west) longitudes are converted to east longitudes simply by adding  $360^\circ$ ; east longitudes greater than  $180^\circ$  can be converted to west longitudes by subtracting  $360^\circ$ .

As an example, the direction vector  $\bar{R}$  in figure 4-2 has a longitude of  $78^\circ$  E; since the GHA is  $30^\circ$ , the vector's right ascension is  $78+30=108^\circ$  RA.

Note that due to the rotation of the Earth, the Greenwich hour angle is constantly increasing; when it reaches  $360^\circ$  it is back to 0. In order to be able to convert from inertial (RA fixed) to Earth (longitude (LONG) fixed) coordinates and back at some time  $t_1$ , it is necessary to know the GHA at some reference time ( $t_0$ ) and the angular velocity of the Earth ( $W$ ). Then the current GHA can be calculated and the transformation can be done as follows (units for GHA,  $W$ , and  $t$  are degrees, deg/sec, and sec, respectively):

$$\begin{aligned} \text{GHA}(t_1) &= \text{GHA}(t_0) + (t_1 - t_0)W \\ \text{RA}(t_1) &= \text{LONG} + \text{GHA}(t_1) \text{ (for earth-fixed vector)} \\ \text{or} \\ \text{LONG}(t_1) &= \text{RA} - \text{GHA}(t_1) \text{ (for inertial vector)} \end{aligned}$$

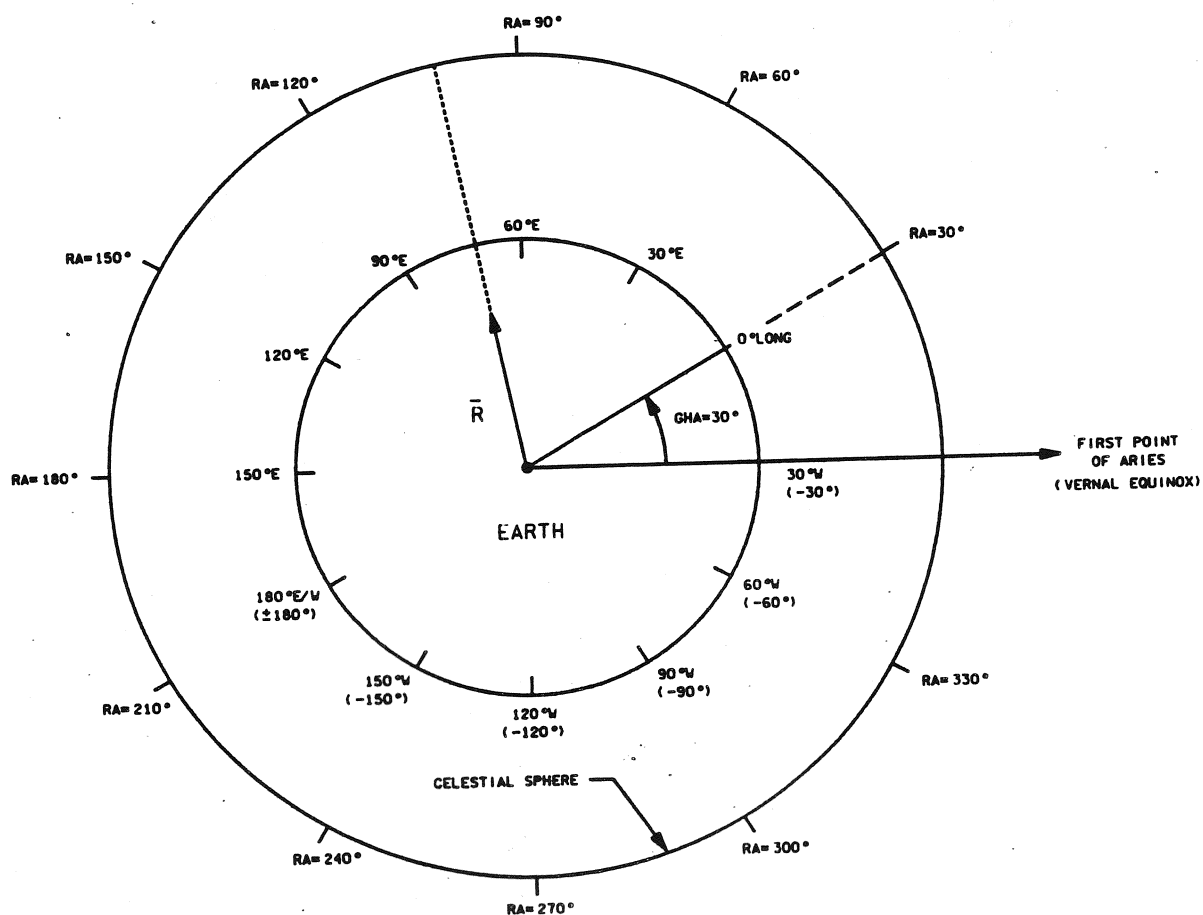

105110042. ART. 1

Figure 4-2.- GHA - View from above North Pole

- Area and Volume Targets (Celestial and Ground)** - It is sometimes necessary to determine when the Orbiter is passing through a certain volume of space, or whether it is passing over a certain area of the ground. For this reason, a few ground or celestial volume targets have been defined. A volume that is fixed relative to the Earth is a ground volume target; the South Atlantic anomaly is one of these. A volume fixed relative to the celestial sphere is a celestial volume target. Ground and celestial area targets are defined similarly. An area on the surface of the Earth defined by the longitude and latitude of its vertices or its center is a ground area target. An area of the celestial sphere defined in terms of right ascension and declination is a celestial area target.

The usual pointing questions that arise concerning area and volume targets are the following:

- When will the Orbiter enter and exit the volume target?
- When will the Orbiter's ground trace enter and exit the ground area target?
- What are the maximum and minimum elevations of the Sun relative to the ground area target for a particular time span?
- What attitude will allow a particular instrument to point at (or avoid pointing at) a celestial area target?

#### 4.3 EPHEMERIS TARGETS

Any target that is traveling in a known orbit can be used as an ephemeris target. An ephemeris is a collection of state vectors, each with a specific time for which it is valid, which, together describe the orbit of the target over a period of time. These vectors may be stored as pairs of position and velocity vectors, or as is the case for all the pointing ephemeris files, as sets of invariant orbital elements calculated from the vectors themselves. Examples of ephemeris targets are the Sun, the Moon, and other vehicles and satellites in Earth orbit.

#### 4.4 GENERAL TARGET TERMS

- Target AOS/LOS - The acronyms AOS and LOS mean Acquisition of Signal and Loss of Signal. For pointing purposes, AOS means the time or position at which the target becomes visible (i.e., has an unobstructed line of sight) to the Orbiter, and LOS is the position or time at which the line of sight becomes obstructed, usually by the Earth (for Ku-band transmissions, LOS often occurs when the line of sight of the antenna becomes obstructed by the Orbiter body). We might also refer to a target as "being AOS" or "being LOS." This simply means that the target has or does not have an unobstructed line-of-sight to the Orbiter currently.
- CPA and TCA to Target - CPA means Closest Point of Approach. This is the point on the Orbiter's orbit which is closest to the target. For celestial targets, which are at an infinite distance, CPA has little physical meaning. For such targets, a better definition of CPA is the point on the Orbiter's path whose direction (from C.O.E.) most nearly coincides with the direction of the target. Time of Closest Approach (TCA) is simply the time at which the Orbiter reaches CPA (figs. 4-3 and 4-4).

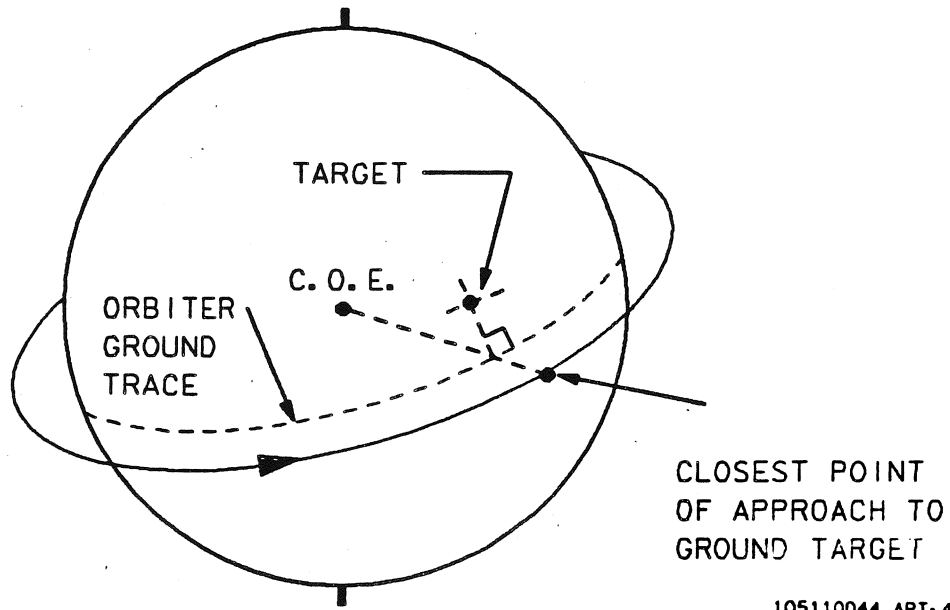

105110044. ART. 4

Figure 4-3.- CPA/TCA to ground target (oblique view).

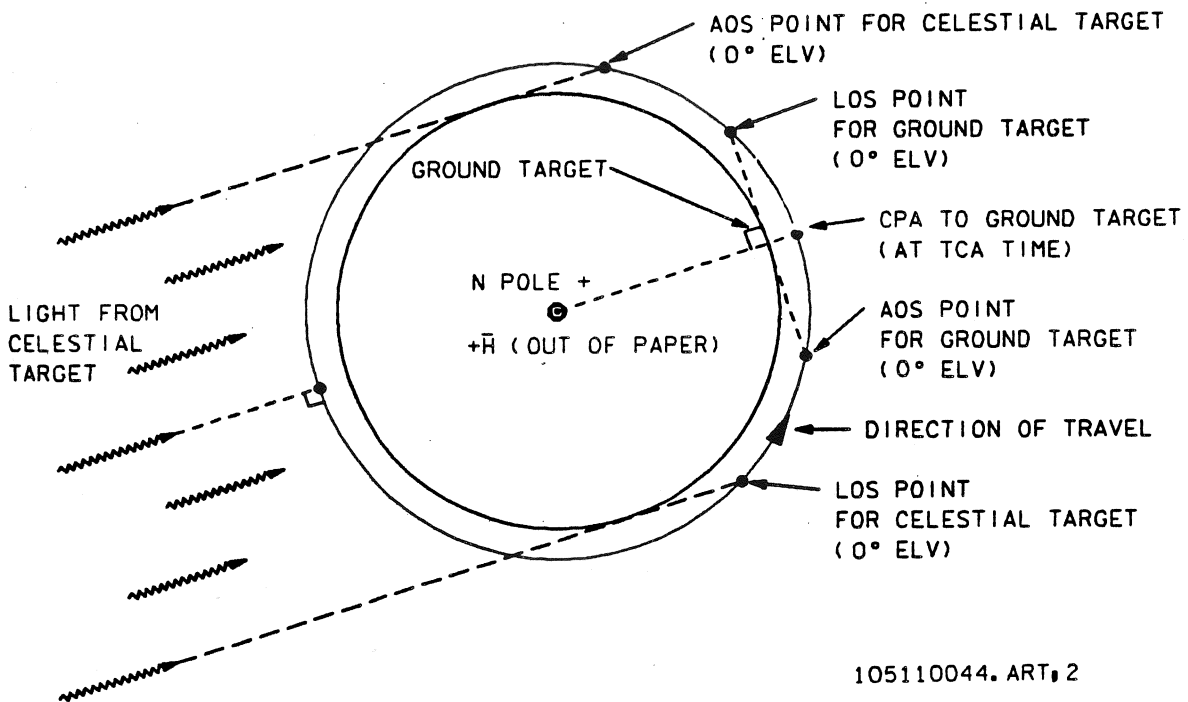

105110044. ART. 2

Figure 4-4.- AOS/TCA/LOS for celestial and ground targets (view from direction of +H)

- Elevation - Elevation of a target is the angle of a target above the ground or physical horizon. For pointing problems, the elevation is defined in two different ways, depending on the target type. For celestial, ephemeris, and extremely high ground targets (such as Tracking and Data Relay Satellites (TDRS)), elevation is defined from the Orbiter's point of view. The target's elevation in these cases means its distance in degrees above the horizon as seen by the Orbiter (fig. 4-5).

For normal ground targets, the above definition is not very useful. For these, elevation is better defined from the target's point of view. That is, for normal ground targets, elevation is defined as the angle of the Orbiter above local horizontal as seen by the ground target (fig. 4-6).

- AOS, LOS and Minimum Elevation - In order to determine accurate AOS/LOS times for a variety of targets under varying conditions, using a variety of instruments, it is often necessary to specify a minimum elevation angle for AOS. This means the target must be a certain minimum number of degrees above the Earth's horizon (or, in the case of a normal ground target, that the Orbiter must be a certain number of degrees above local horizontal) before we are sure we will have the target AOS. Many of our pointing programs require an input from the user of the elevation angle. The elevation angle being asked for is the minimum elevation for AOS.

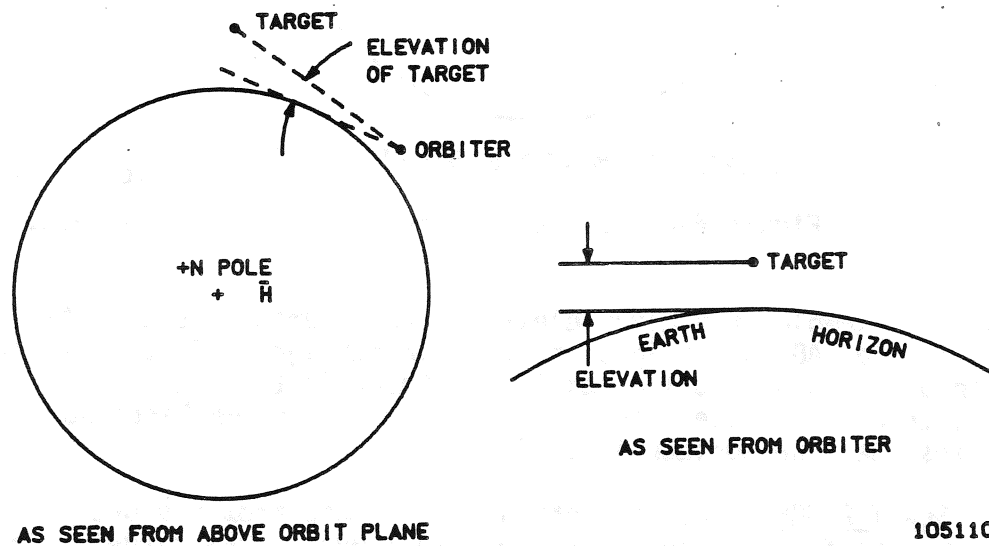

105110045. ART. 1

Figure 4-5.- Elevation for celestial and ephemeris targets:

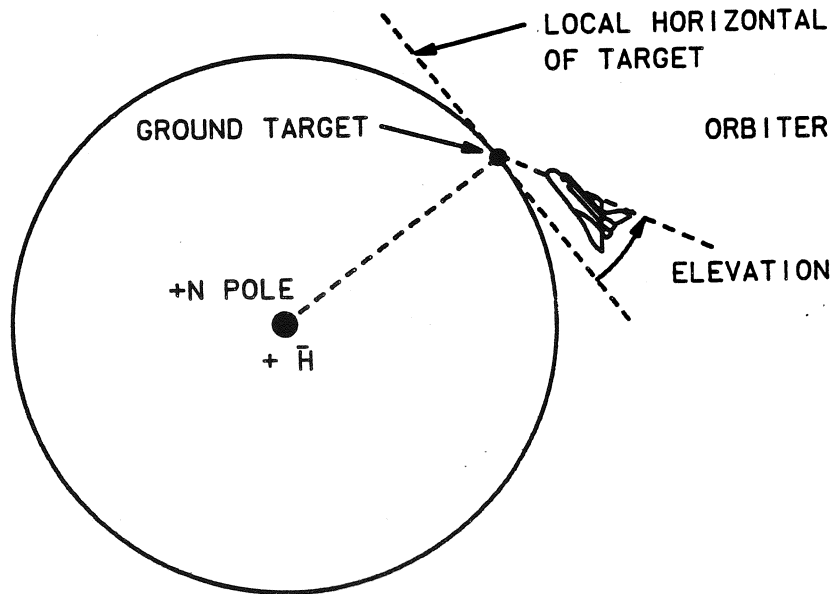
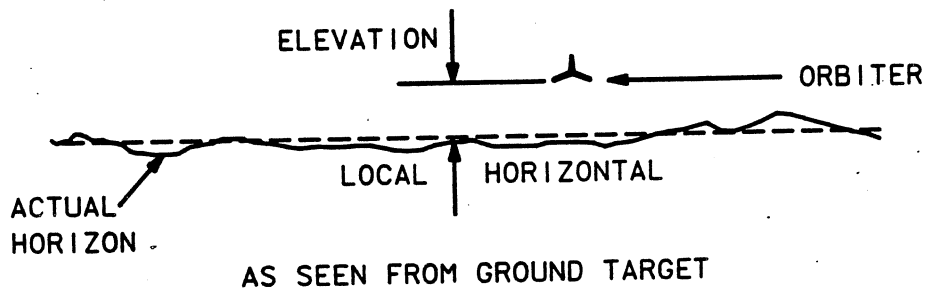

AS SEEN FROM ABOVE ORBIT PLANE

105110046.ART, 1

Figure 4-6.- Elevation for normal ground targets.

A good example of minimum elevation requirements is the star tracker elevation for AOS of navigation stars in daylight. Since the star trackers can be damaged by being pointed at too-bright objects, it is required that a star be at an elevation of  $20^\circ$  or more from the Earth horizon during times when the horizon is sunlit.

- **SLANT RANGE** - The straight-line distance from the Orbiter to the target may be found by computing the magnitude of the target relative position vector and converting it into appropriate units.
- **DEPRESSION ANGLE** - The angle between local horizontal and the Earth's horizon as seen from the Orbiter.



#### 4.5 SOME SPECIAL GROUND TARGETS

Ground targets have previously been defined as targets with a fixed Earth latitude, longitude and altitude. Now some exceptions to these rules must be dealt with. The following targets, while confined to the surface of the Earth, are not at a fixed latitude and longitude; instead, their Earth coordinates vary with the position of the Sun, the position of the Orbiter, and with the rotation of the Earth. Each of these special targets is defined and discussed individually.

- Sub Solar Point - This is the point on the surface of the Earth at which the Sun appears to be directly overhead at a given time. Obviously, due to the rotation of the Earth and its motion in its orbit, the sub-solar point changes continually. The path traced out by the sub-solar point on the surface of the Earth over a period of time is the ground trace of the Sun. The (geodetic) latitude and longitude of the sub-solar point can be determined as follows:

$$\begin{aligned} \text{LAT}_J &= \text{DECLINATION}(\text{SUN}) \quad (+ \text{ equals north, } - \text{ equals south}) \\ \text{LON}_J &= \text{RIGHT ASCENSION}(\text{SUN}) - \text{GHA} \end{aligned}$$

Since the right ascension of the Sun, the declination of the Sun, and the GHA are constantly changing, the latitude and longitude of the sub-solar point are also constantly changing. The sub-solar point is a non-fixed ground target.

- Sub-Orbital Point - The sub-orbital point is simply the point on the surface of the Earth directly below (toward C.O.E. from) the Orbiter. The path traced out on the surface of the Earth by the sub-orbital point over a period of time is the ground trace of the Orbiter.
- Glory Point - The glory point is defined as the point on the Earth's surface where the shadow of the Orbiter (caused by the Sun) falls. It is called the glory point due to a rare phenomenon of reflection of an image of the Sun directly back along the line to the Sun, which results in the appearance from the vehicle of a bright spot on the ground right where the shadow of the vehicle ought to be (fig. 4-7).

As a target, the glory point is best described as a non-inertial pointing vector. The direction to the glory point (when it exists) is the negative of the Sun pointing vector. Thus, if the Orbiter's  $\theta, \phi$  to the Sun is  $100, 0$ , for example, the  $\theta, \phi$  to the glory point (if it exists) will be the look angles of a vector on the same line but pointing in the opposite direction:  $\theta = (180-100)$  or  $80, \phi = (0+180)$  or  $180$  (fig. 4-8).

The reason for the qualifying statement "if the glory point exists" is shown in figure 4-7. If the Orbiter is in position 1, the glory point is in the direction of the negative Sun-pointing vector, as shown. If the Orbiter is at position 2, the anticipated direction of the glory point is still along the negative Sun-pointing vector, but this vector never intersects the surface of the Earth. Thus, at position 2, the glory point does not exist.

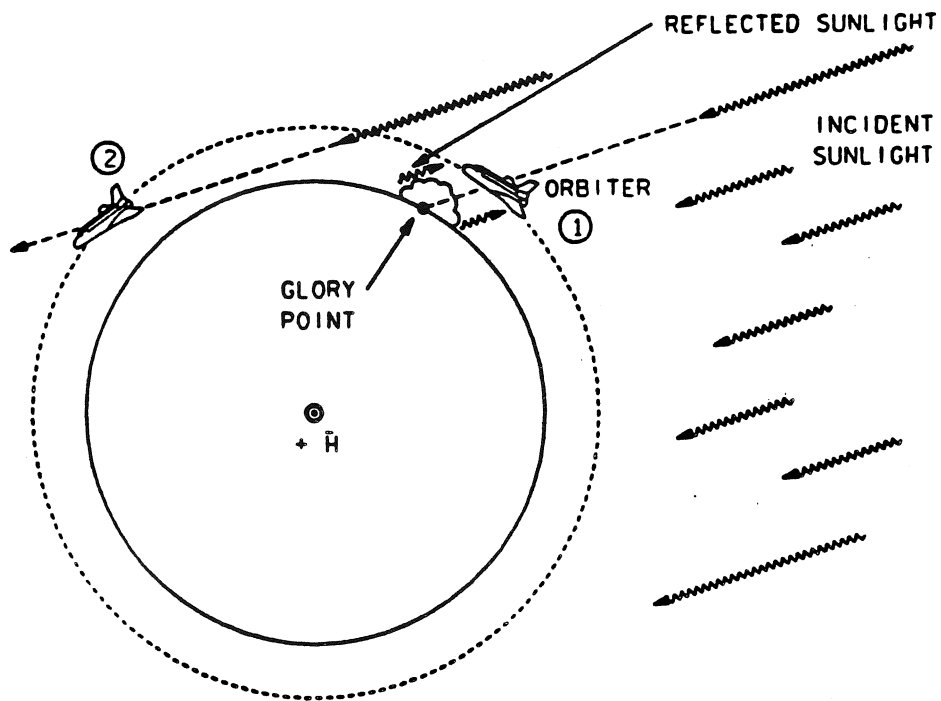

Figure 4-7.- Definition of "Glory Point"  
(view from above orbit).

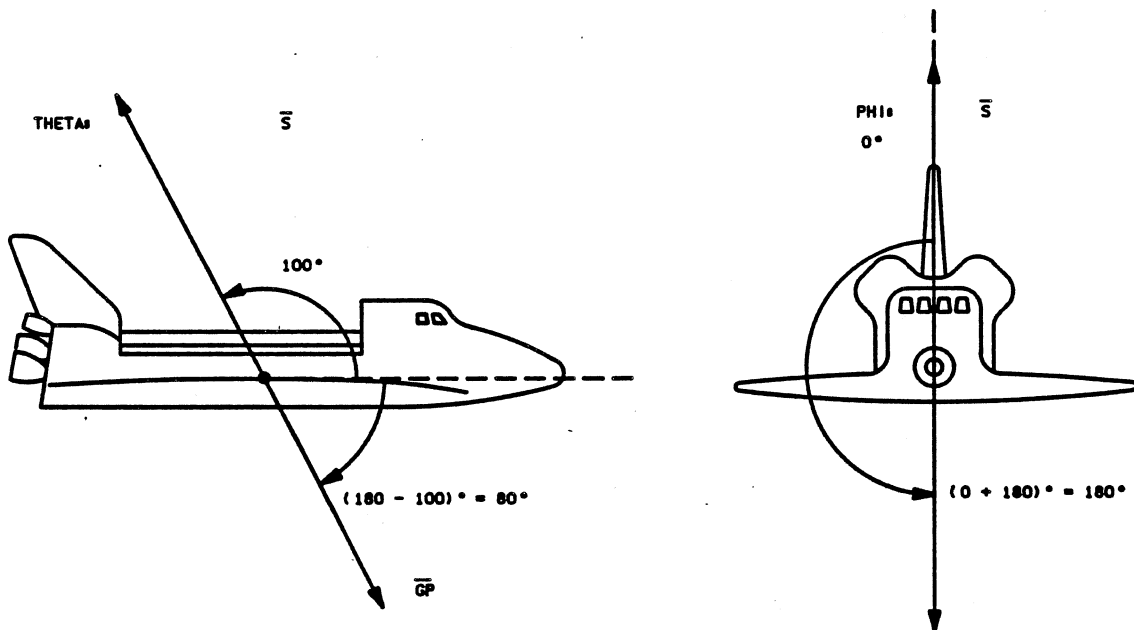

Figure 4-8.-  $\theta$ ,  $\phi$  for negative Sun pointing vector. 105110048.ART.1

A general formula for determining the look angles to the glory point:

$$\theta_{GP} = 180 - \theta_S$$

$$\text{if } 0 \leq \phi_S < 180: \phi_{GP} = 180 + \phi_S$$

$$\text{if } 180 \leq \phi_S < 360: \phi_{GP} = \phi_S - 180$$

NOTE: The glory point exists whenever the shadow of the Orbiter falls on the surface of the Earth.

- **Glitter Point** - The glitter point is a similar concept to glory point. Geometrically speaking, it is the point on the surface of the Earth, lying in the C.O.E. - Orbiter - Sun plane, at which the elevation of the Sun from the local horizontal is equal to the elevation of the Orbiter from local horizontal. This is the point on the Earth at which the main reflected image of the Sun appears to an observer on the Orbiter (fig. 4-9).

Like the glory point, the glitter point exists only part of the time. The glitter point exists any time the Orbiter is in sunlight. As the Orbiter approaches the dark limb of the Earth, the Sun and the glitter point merge (sunset). Calculation of the glitter pointing vector is somewhat more involved than the glory point calculation and is beyond the scope of this handbook.

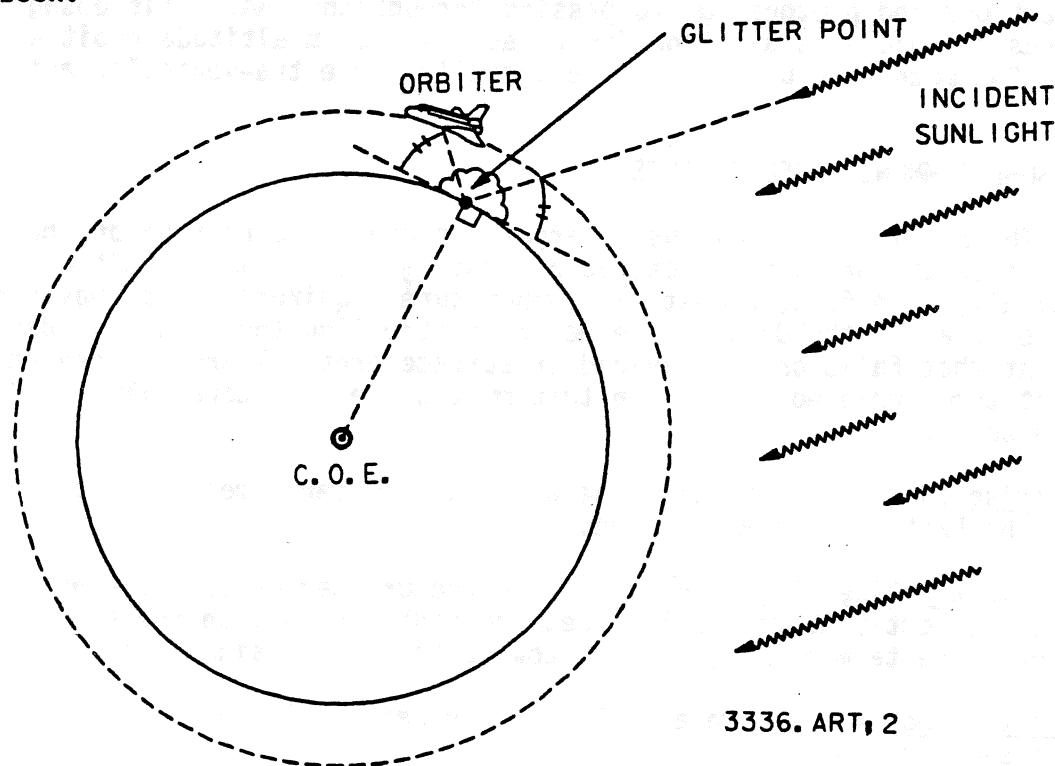

Figure 4-9.- Definition of "Glitter Point" (view from above orbit plane).

- South Atlantic Anomaly (SAA) - This is the only volume target with which we are presently concerned. The South Atlantic anomaly is actually a portion of the Van Allen radiation belts. The Van Allen belts are regions surrounding the Earth which contain high energy radiation due to an effect of the Earth's magnetic field that is not fully understood. These belts extend from about 300 nm altitude to nearly 500 nm, and are important to us because any long-term exposure to their radiation is detrimental. Because the magnetic poles of the Earth are offset and tilted relative to the geographical poles, and due to anomalies in the Earth's magnetic field, the Van Allen belts are not a uniform distance from the surface of the Earth. In the region known as the South Atlantic anomaly, they extend much closer to the surface (down to 80 nm). Because of the radiation hazard and increased exposure of EVA crewmembers, EVA's are planned to occur when the Orbiter will not be passing through the SAA. Also some scientific instruments and film have to be shut down or stowed during passage through the SAA. In order to determine and control the doses of radiation the astronauts are exposed to, it is necessary to know how much time the Orbiter spends in the South Atlantic anomaly; for this reason it has been defined as a ground volume target. A map of the anomaly is shown in figure 4-10.

NOTE: Current Shuttle flights (at 28.5 deg inclination and about 150-165 nm altitude) expose the astronauts to about 7-8 m rad/day of high energy electrons and protons due to passing through the SAA. This dosage increases rapidly as altitude increases. A 250 nm altitude orbit would make the SAA much more undesirable, especially for extra-vehicular activities.

#### 4.6 SOME COMMONLY USED TARGETS

Sun - The Sun is a commonly used target because the direction of the Sun relative to the Orbiter affects both lighting and thermal conditions drastically. In fact, almost all temperature requirements for payloads and surface areas of the Orbiter are met by controlling the amount of direct sunlight that falls on the payload or surface area. There are several important terms related to the Sun that must be defined carefully. They are listed below.

- Sunrise (SR) - This is the time when the Orbiter comes out from the shadow of the Earth into the sunshine.
- Terminator Rise (TR) - The time when the Orbiter crosses the point in its orbit directly above the line between night and day on the surface of the Earth (the terminator), heading toward the bright side of the Earth.
- Orbital Noon - The time exactly halfway between SR and SS. This time is the same as TCA.
- Terminator Set (TS) - The time when the Orbiter passes the point on its orbit directly over the line on the Earth's surface separating day and night, heading toward the dark half of the Earth.

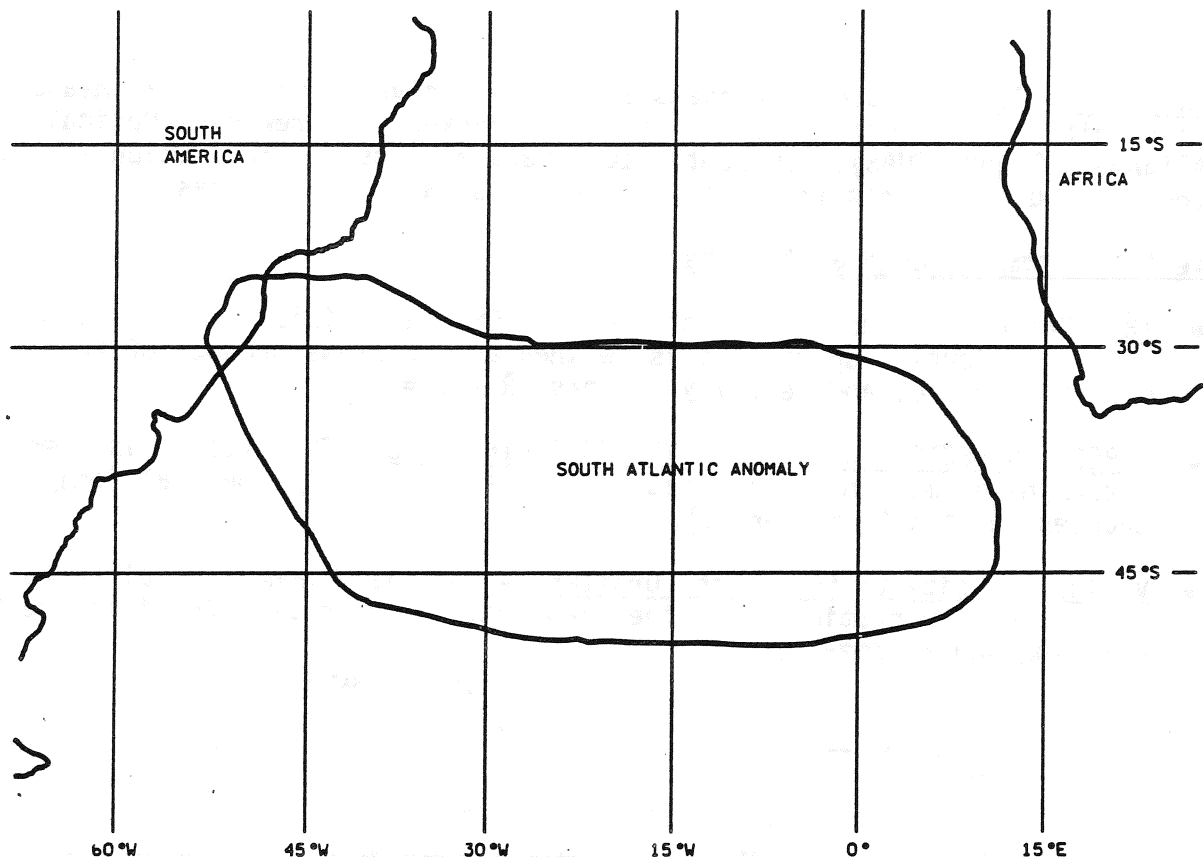

Figure 4-10.- South Atlantic anomaly.

- Sunset - The time when the Orbiter enters the shadow of the Earth.
- Orbital Midnight - The time exactly halfway from SS to SR.

NOTE: A dark horizon appears "ahead" of the Orbiter approximately 4 minutes before terminator set. In the same way, a dark horizon remains "behind" the Orbiter for about 4 minutes after terminator rise. See figure 4-11.

Moon (C.O.M.) - The Moon is used as a target primarily to keep the star trackers away from it. The Moon has a period of about 27.3 days, and a mean distance from the Earth of 384,000 km or 207,560 nm (from the center of mass of the Earth-Moon system). The distance from C.O.E. to C.O.M. is about 210,140 nm.

TDRS - The TDRS satellites are treated as very high ground targets. TDRS EAST (TDRE) is currently located at LAT = 0°, LONG = 41° W, ALT = 19,323 nm. TDRS WEST (TDRW) will be at LAT = 0°, LONG = 141° W, ALT = 19,323 nm.

C.O.E. - Center of Earth is primarily used as a target to determine which portion of the celestial sphere is occulted by the Earth. C.O.E. is always easy to locate; the negative of the Orbiter position vector gives both its direction and distance from the Orbiter.

**Navigation Stars** - Used as targets almost exclusively for Inertial Measurement Unit (IMU) alignments using the star trackers or Crew(man) Optical Alignment Sight (COAS). Currently 100 stars are used as navigation stars. They are numbered from 11 to 110 in the celestial target tables.

**Vectors commonly used as targets:**

- $+\bar{H}$  - The angular momentum vector of the Orbiter. This vector is almost fixed in inertial space. It is defined as the cross product of the Orbiter's radius and velocity vectors ( $\bar{R} \times \bar{V} = \bar{H}$ ).
- **DIRECTION VECTOR FROM C.O.E. TO DESCENDING NODE** - This vector is used for determining omicron in some cases, and is also nearly inertial (only changes about  $1/2^\circ$  per orbit).
- $\bar{V}$  (The velocity vector of the Orbiter) - This is a non-inertial vector that is nearly stationary in the LVLH frame. It is used for instrument pointing and rendezvous.

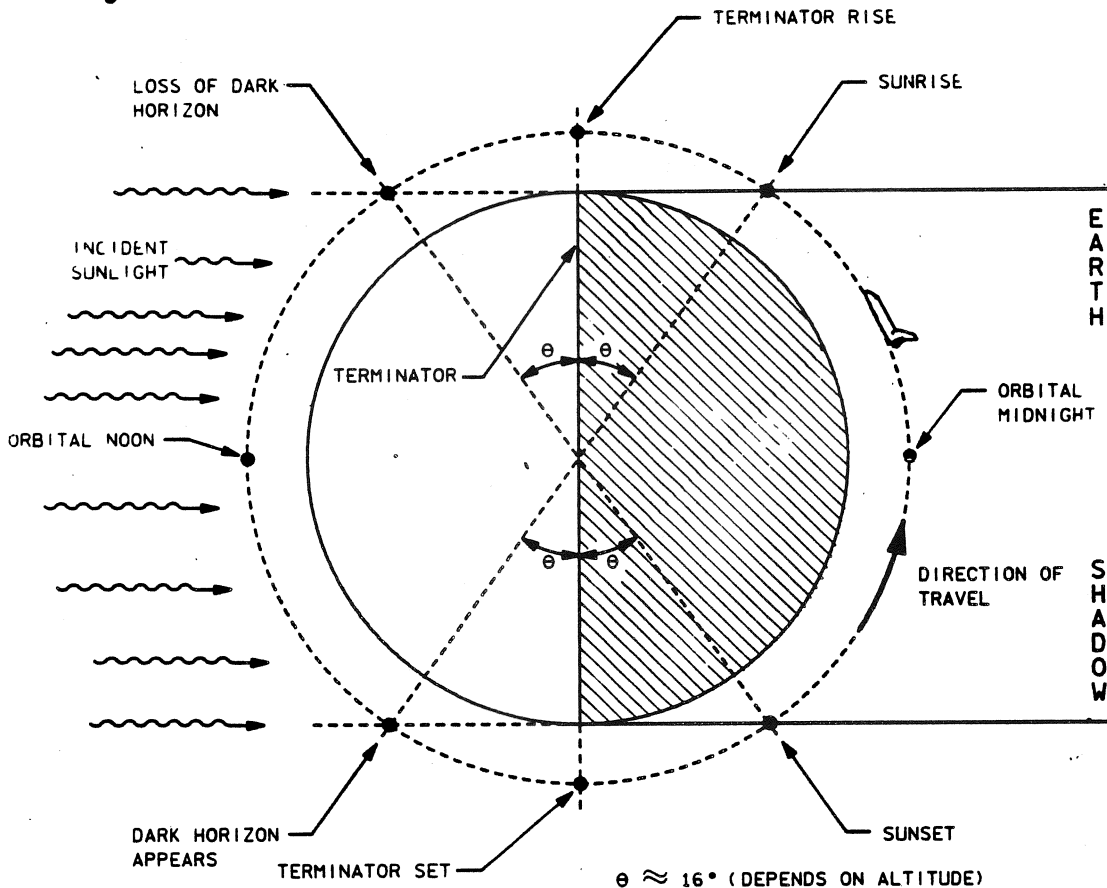

Figure 4-11.- The Sun as a target - definition of terms.  
(View from above orbit plane).

## SECTION 5 POINTING VECTORS/LOOK ANGLES

For the Shuttle program, a body pointing vector (BPV) is a vector relative to and fixed to the Orbiter's body axis coordinate system. It can take on any orientation desired. It is technically a unit vector defined in a two-step Euler sequence; i.e., pitch/yaw, roll/pitch, etc. While the pointing programs will allow for practically any sequence, the onboard software will accept inputs only in pitch/yaw. The use of this vector is to point it in a desired direction which is accomplished by maneuvering the Orbiter to an orientation such that the BPV points at a specified target which defines that direction. For the onboard software, the name of BPV is altered to body vector (BV) because it serves a dual purpose. The first use of this vector is as described above. The second use is as an axis of rotation about which the Orbiter can rotate. This is accomplished with the ROT option of universal pointing. The vector is defined the same except, of course, that there is no target involved. Direction of rotation can be determined using the right hand rule for the vector defined. This second use of the vector will not be described further in this section.

By definition, an Euler sequence is an ordered sequence of rotations made with respect to the new reference frame (which resulted from the previous rotation). Although there are several Euler sequences that can be used to define a BPV, only two will be discussed (pitch/yaw and roll/pitch) as they are the most commonly used. For other sequences, the descriptions below can be extrapolated as required.

### 5.1 PITCH/YAW SEQUENCE FOR POINTING VECTORS

The pitch/yaw Euler sequence can be visualized by considering the Orbiter as fixed in the center of a sphere with its wings pointing at the poles and its nose pointing at the equator. The equator of the sphere corresponds to a great circle of pitch and the meridians correspond to great circles of yaw (fig. 5-1). The vector ( $V_b$ ), which is to be pitched and yawed, is the +X axis of a reference frame which is initially coaligned with the Orbiter's body axis system. The first rotation of the sequence is about the Orbiter +Y body axis and it rotates  $V_b$  along the equator sweeping out pitch. From the point where  $V_b$  stops pitching, a second rotation about the new +Z axis (of the rotated reference frame) rotates  $V_b$  along a great circle of yaw. These two rotations define the position of a BPV relative to the Orbiter. The pitch angle is reckoned from the Orbiter +X body axis. A positive pitch corresponds to a right hand rotation about the Orbiter's +Y body axis. The yaw angle is reckoned from the Orbiter's X-Z plane. A positive yaw corresponds to a right hand rotation about the new +Z axis of the rotated reference frame. The limits of pitch are  $0^\circ$  to  $359.99^\circ$  and the limits of yaw are  $0^\circ - 90^\circ$  and  $270^\circ$  to  $359.99^\circ$ . The pitch/yaw Euler sequence is not commutative.

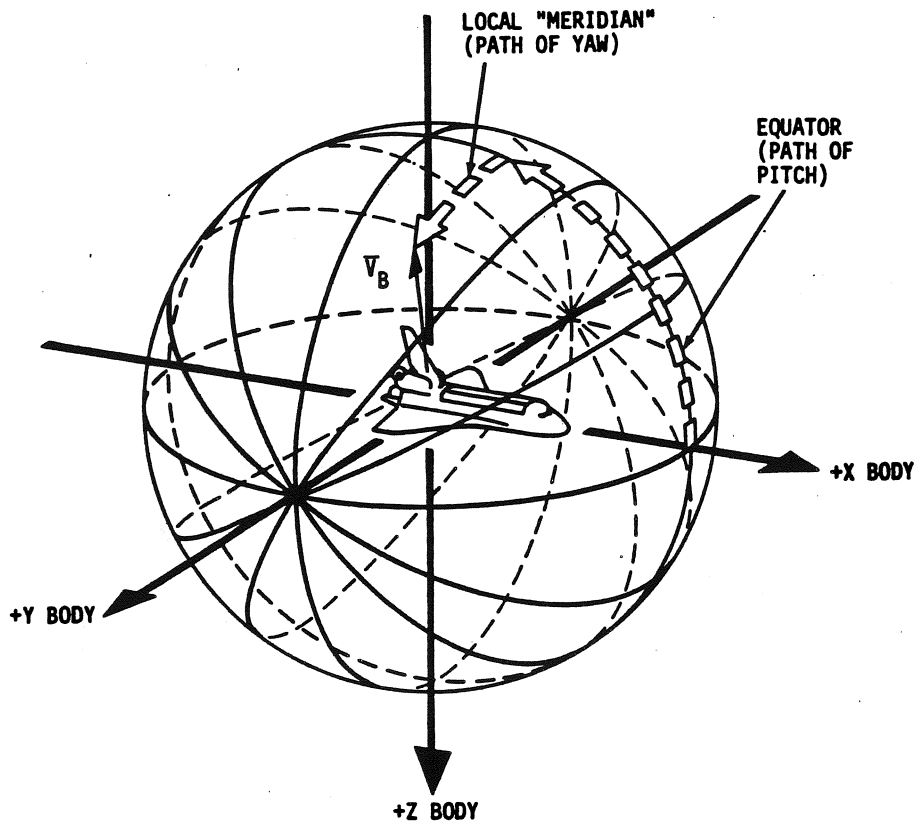

Figure 5-1.- Pitch/yaw sequence.

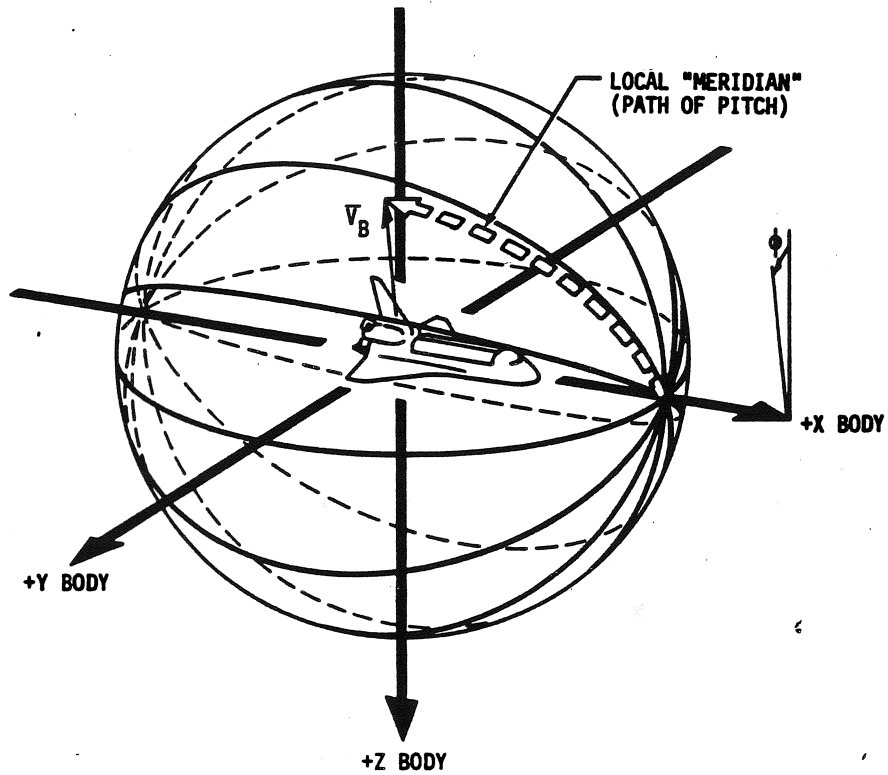

Figure 5-2.- Roll/pitch sequence.



## 5.2 ROLL/PITCH ( $\phi, \theta$ ) SEQUENCE FOR POINTING VECTORS

The roll/pitch Euler sequence can be visualized similarly to the pitch/yaw sequence by considering the Orbiter as fixed in the center of a sphere. However, the orientation of the Orbiter relative to the sphere is different. The nose and tail of the Orbiter are pointing at the poles and the wings are pointing at the equator. In this case, the equator corresponds to a great circle of roll and the meridians correspond to great circles of pitch (fig. 5-2). The vector ( $V_B$ ), which is to be rolled and pitched, is the +X axis of a reference frame which is initially coaligned with the Orbiter's body axis system. The first rotation of the sequence is about the Orbiter's +X body axis and it axially rotates  $V_B$ , thus sweeping out roll. From the point where  $V_B$  stops rolling, a second rotation about the new +Y axis (of the rotated reference frame) rotates  $V_B$  along a great circle of pitch. These two rotations define the position of a BPV relative to the Orbiter. The roll angle is reckoned from the Orbiter's X-Z plane. A positive roll corresponds to a right hand rotation about the Orbiter's +X body axis. The pitch angle is reckoned from the rotated frame's +X axis. A positive pitch corresponds to a right hand rotation about the new +Y axis of the rotated reference frame. The limits of roll are  $0^\circ$  to  $359.99^\circ$  and the limits of pitch are  $0^\circ$  to  $179.99^\circ$ . The roll/pitch Euler sequence is not commutative.

## 5.3 OMICRON (OM)

A body pointing vector which is pointed at a target does not have a unique orientation since the vehicle can be anywhere within  $360^\circ$  about the vector's line of sight and still satisfy the problem. It is the function of the omicron angle to specify the orientation of the Orbiter about the body vector's line of sight. Omicron is used with the track option of universal pointing in the onboard software.

Omicron is the angle between two particular planes. The first plane is defined by the target vector (the vector which is defined to be from the Orbiter's position to the target's position) and the negative angular momentum vector ( $-\vec{H}$ ). The second plane is defined by the BPV and the Orbiter's +Y axis. Then the BPV of the second plane is coaligned with the target vector of the first. Thus, omicron is the angle between the first and second planes, defined above, and is measured positively about the target vector using the right hand rule as taken from the first to the second plane.

Another way to define omicron is to say it is the angle between the vector formed by the cross product of the target vector and  $-\vec{H}$  and the vector formed by the cross product of the BPV and the Orbiter +Y axis. Also, omicron is again measured as positive, resulting in a clockwise rotation from the first vector into the second vector with respect to the target vector, or mathematically

$$OM = \sin^{-1} \left( \text{target vector} \times \frac{\bar{V} \times \bar{R}}{|\bar{V}| |\bar{R}|} \right) \times (\overline{BPV} \times \bar{Y})$$

where  $\bar{V} \times \bar{R} = -\bar{H}$  and  $|\bar{V}| |\bar{R}|$  unitizes  $-\bar{H}$  for consistency.

Although the above definitions are satisfactory, there exist two singularity cases. One case is the situation where the BPV is coincident with the + or -Y axis for the second plane. No unique solution exists for that plane. In this case the -Z axis is substituted for the +Y axis; i.e., the second plane is redefined by the BPV and the -Z axis. The situation which would cause the other case to exist is when the target vector is coincident with + or -H for the first plane. As with the first case, there is no unique solution. For this case the descending node vector of the (each) orbit concerned is substituted for -H in the first plane.

Omicron can be a difficult concept to visualize. One attempt to illustrate it is shown in figure 5-3. The example pictured shows the target as the center of the Earth which is typical for an LVLH attitude. Figure 5-4 shows all the standard axis LVLH Euler angle attitudes with the equivalent body vector and omicron required as inputs for universal pointing. The picture for any attitude in question can be mentally placed in the dotted box Earth orbit picture to aid in visualizing it.

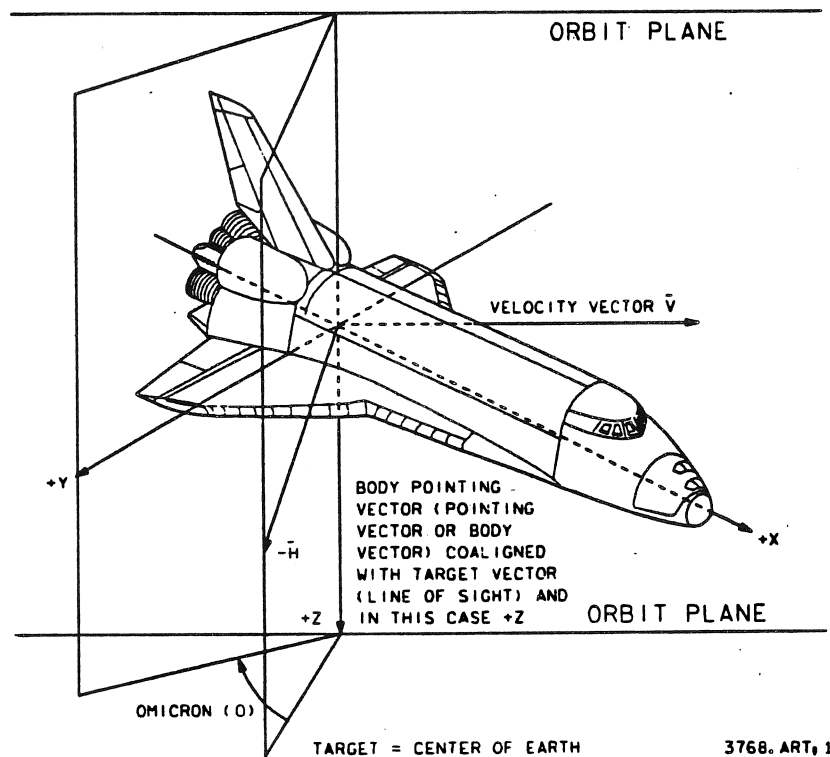
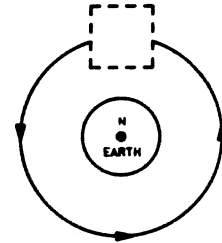

Figure 5-3.- Omicron measurement, LVLH example.

- INSTRUCTIONS
- SELECT ORIENTATION.
  - REFERENCE CORRESPONDING OMICRON BLOCK FOR THE BODY POINTING VECTOR (BPV).
  - OR
  - CHOOSE DESIRED BPV.
  - SELECT OMICRON.
  - THEN
  - PLACE PICTURE IN DOTTED SQUARE. (DO NOT ROTATE.)



BLOCK	ORIENTATION	LVLH ATTITUDE, DEG (P, Y, R EULER SEQUENCE)			BPV SEQUENCE P, Y	OMICRON			
		ROLL	PITCH	YAW		1 0°	2 90°	3 180°	4 270°
1	+XLV (PLBD FWD)	0°	270°	0°	+X P=0, Y=0				
2	+XLV (PLBD SOUTH)	90°	270°	0°					
3	+XLV (PLBD AFT)	180°	270°	0°					
4	+XLV (PLBD NORTH)	270°	270°	0°					
1	+XLV (PLBD AFT)	0°	90°	0°	-X P=180, Y=0				
2	+XLV (PLBD NORTH)	270°	90°	0°					
3	+XLV (PLBD FWD)	180°	90°	0°					
4	+XLV (PLBD SOUTH)	90°	90°	0°					
1	+ZLV (NOSE FWD)	0°	0°	0°	+Z P=270, Y=0				
2	+ZLV (NOSE SOUTH)	0°	0°	90°			REAR		FRONT
3	+ZLV (NOSE AFT)	180°	180°	0°					
4	+ZLV (NOSE NORTH)	0°	0°	270°					
1	-ZLV (NOSE AFT)	0°	180°	0°	-Z P=90, Y=0				
2	-ZLV (NOSE NORTH)	0°	180°	270°			FRONT		REAR
3	-ZLV (NOSE FWD)	180°	0°	0°					
4	-ZLV (NOSE SOUTH)	0°	180°	90°					
1	+YLV (PLBD SOUTH)	90°	0°	0°	+Y P=0, Y=90				
2	+YLV (NOSE SOUTH)	0°	90°	90°			REAR		FRONT
3	+YLV (PLBD NORTH)	270°	180°	0°					
4	+YLV (NOSE NORTH)	0°	270°	270°					
1	-YLV (PLBD SOUTH)	90°	180°	0°	-Y P=0, Y=270				
2	-YLV (NOSE NORTH)	0°	90°	270°			FRONT		REAR
3	-YLV (PLBD NORTH)	270°	0°	0°					
4	-YLV (NOSE SOUTH)	0°	270°	90°					

105110054. ART 1

Figure 5-4.- Omicron examples.

### 5.4 LOOK ANGLES

Look angles are used to determine where a target is in relation to the Orbiter. This is a line of sight problem which is solved exactly like the pointing vectors; i.e., pitch-yaw or phi-theta. The distinction between the two is that a body vector is forced to the required sequence angles and then the Orbiter oriented to point that vector to a target, whereas the look angles are the angles that define line of sight to a target for a given attitude and time.



## SECTION 6 BASIC ASTRONOMY

### 6.1 CELESTIAL SPHERE

The "celestial sphere" is an imaginary sphere of infinite radius which shares a common center and equatorial plane with that of the Earth. The sphere is fixed with respect to the stars. It is useful to work with this model since it allows us to assign coordinates to all objects in space. Analogous to the Earth's longitude and latitude is the celestial sphere's right ascension and declination. A right ascension of  $0^\circ$  is arbitrarily chosen to be the intersection of the ecliptic plane with the Earth's equatorial plane at the vernal equinox. Currently, we use the point of intersection on January 1950 also known as "Mean of 50" or M50. The right ascension of an object is then measured eastward (while looking "into" the sphere) and ranges from  $0^\circ$  to  $360^\circ$ . Right ascension is also measured in hour angles (circles). Basically, there are  $15^\circ$  in 1 hour angle. Declination is measured from  $90^\circ$  South (South Pole) to  $90^\circ$  North (North Pole). See figure 6-1 for a graphical representation of the celestial sphere.

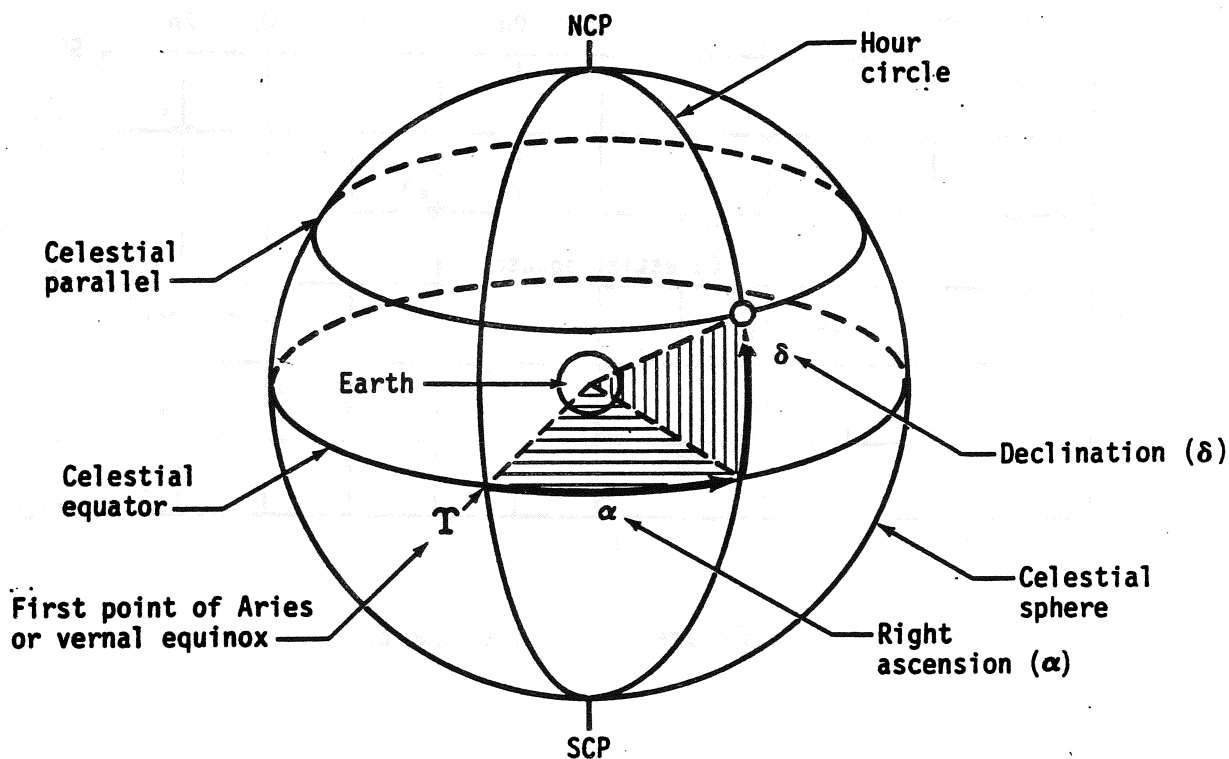

Figure 6-1.- Celestial sphere.

6.2 M50 STAR CHART

We have all seen a mercator projection (flat map of the Earth) containing the outlines of continents and locations of cities. Likewise, we can also "flatten" the celestial sphere on a two dimensional map. This map is called the M50 Star Chart. A basic and important difference between the world map and the Star Chart is the viewer's perspective. The world map represents the Earth as the viewer is looking "at" or "into" the Earth. The Star Chart represents the locations of celestial bodies as the viewer is looking "out" the celestial sphere. While declination remains the same, "east" is now towards your left on the chart. The "M50 star chart" further defines the 0° right ascension and 0° declination to be the intersection of the ecliptic with the Earth's equatorial plane at the "mean" vernal equinox (0h GMT on Jan. 1, 1950).

Note that for our pointing programs we sometimes use a star chart that is not a Mercator projection. This chart is simply a two-dimensional rectangular plot of right ascension and declination.

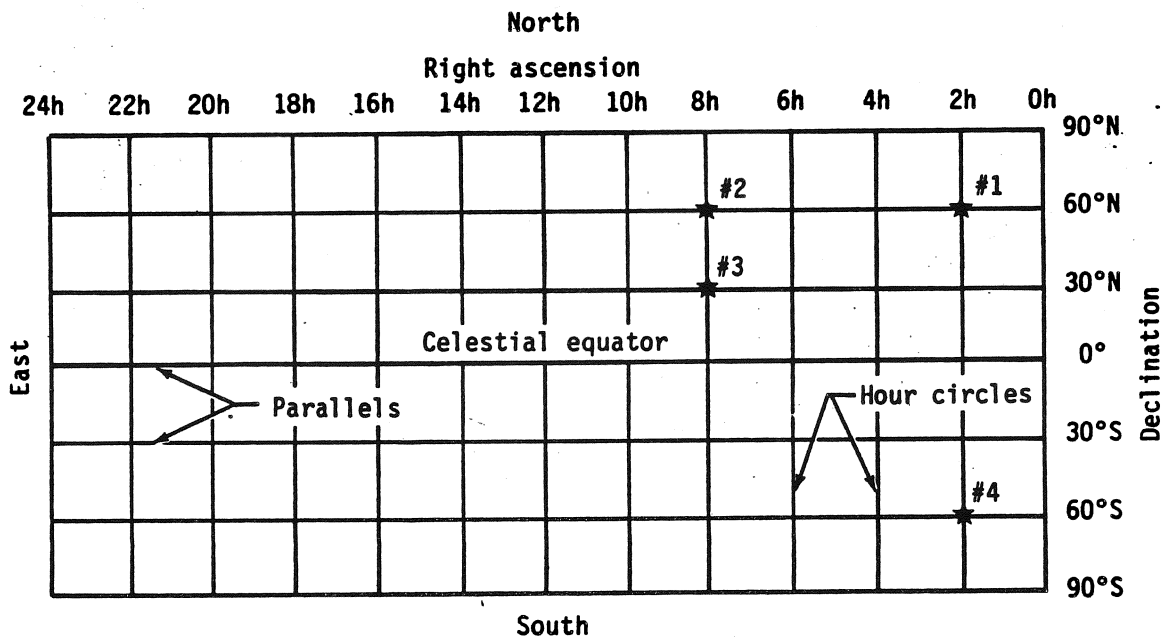

Figure 6-2.- Star chart.

### 6.3 CELESTIAL TRACES

A celestial trace is very much like a ground trace except that the star chart on which the traces is represented is "inside out." The trace a typical satellite makes will appear to head left. Likewise, the paths the sun and moon make also will be toward the left.

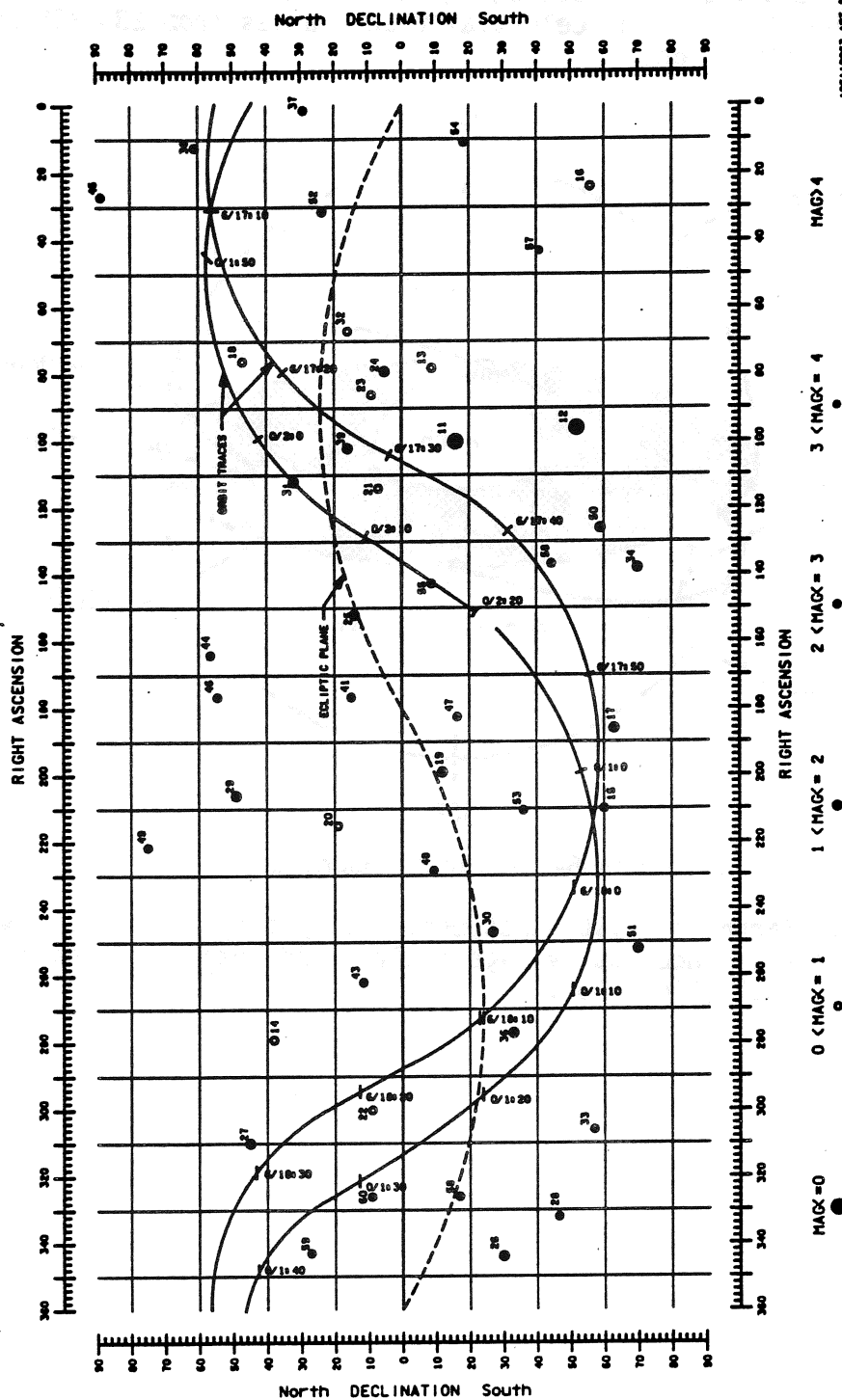

Figure 6-3.- Celestial trace.

#### 6.4 CHARACTERISTICS OF THE SUN, MOON, AND PLANETS

The Sun is a small medium-size star around which all the planets in our solar system revolve. It is the brightest object in the sky with a visual magnitude of about  $-27$  (typical navigation stars have magnitudes ranging from  $-1.43$  to  $2.81$  visual magnitude). The Sun is approximately 93 million miles from the Earth and travels about  $1^\circ$ /day on the celestial sphere (i.e., in relation to the stars). The celestial trace ranges from  $23\text{-}1/2^\circ$  South to  $23\text{-}1/2^\circ$  North declination.

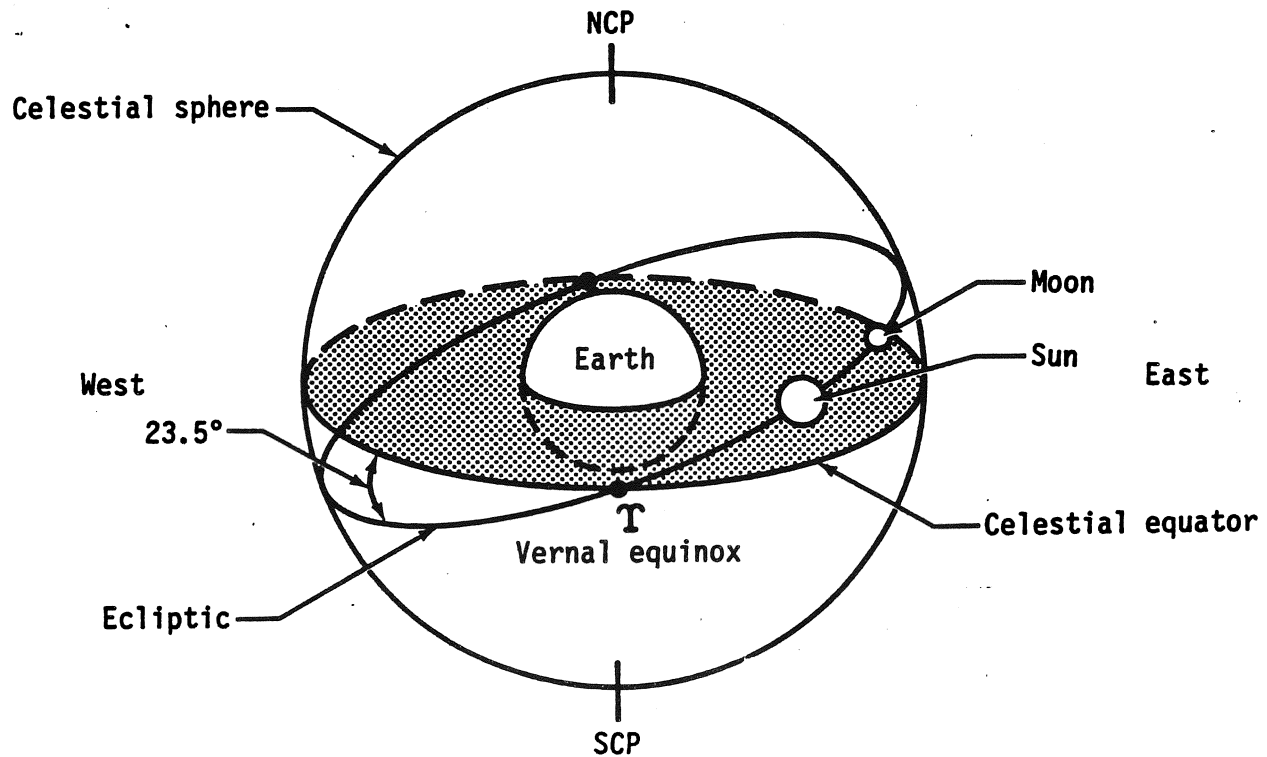

Figure 6-4.- Earth, Moon, and Sun.

The Moon is an Earth satellite that essentially shows one side towards the Earth at all times since its average orbital and rotational periods are approximately equal (fig. 6-5).



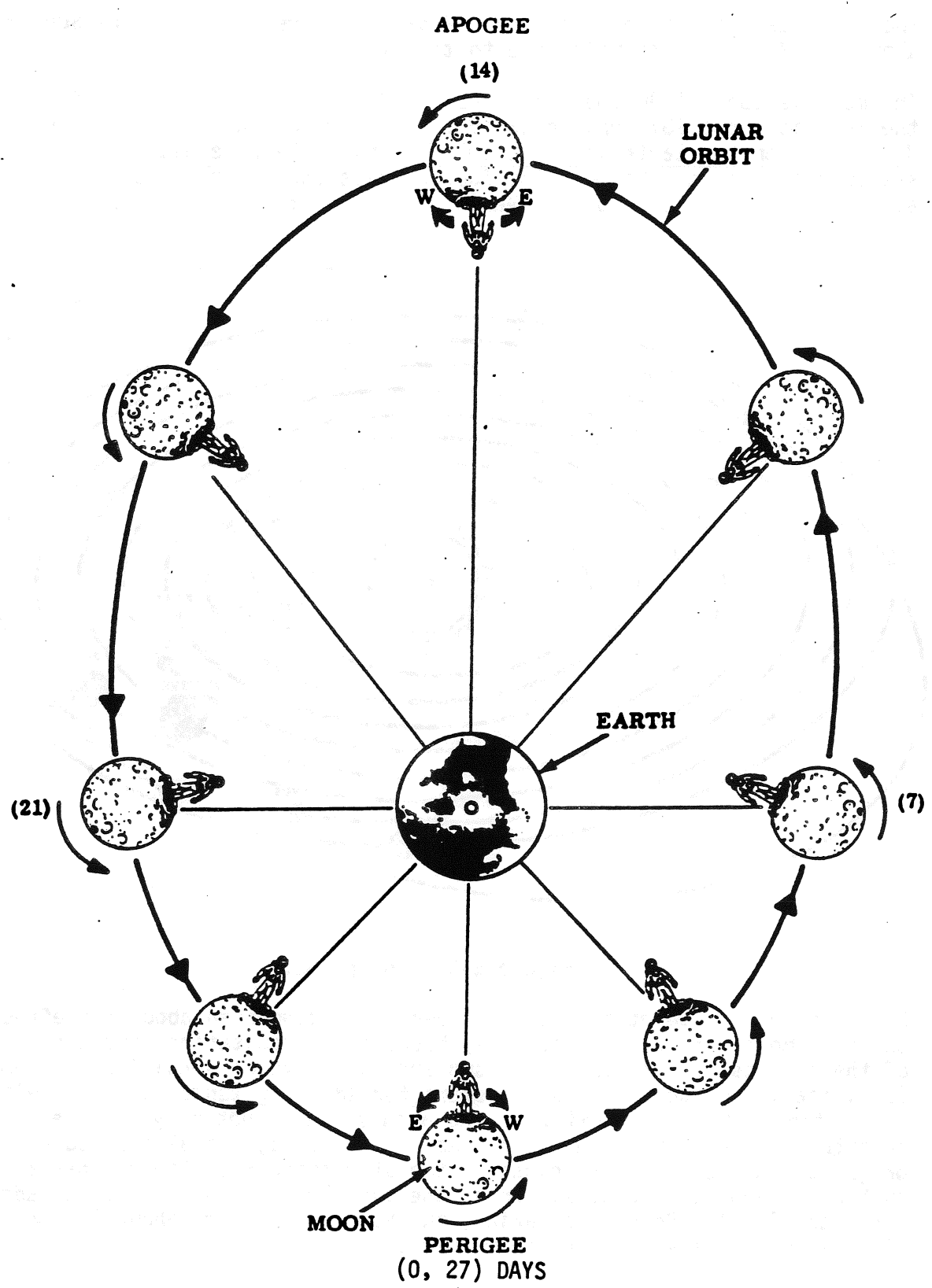

Figure 6-5.- The Moon's orbit.

The Moon has a period of about 29-1/2 days with reference to the Sun and about 27-1/3 days with reference to the stars.

The mass is about 1/80 and volume about 1/49 of the Earth. The diameter of the Moon is about 1877 nmi compared to 6888 nmi of the Earth. The mean distance from the Earth is about 207,561 nmi. The nine planets in our solar system are described below. The four planets that we need to be concerned about for star occultation are Venus, Mars, Jupiter, and Saturn.

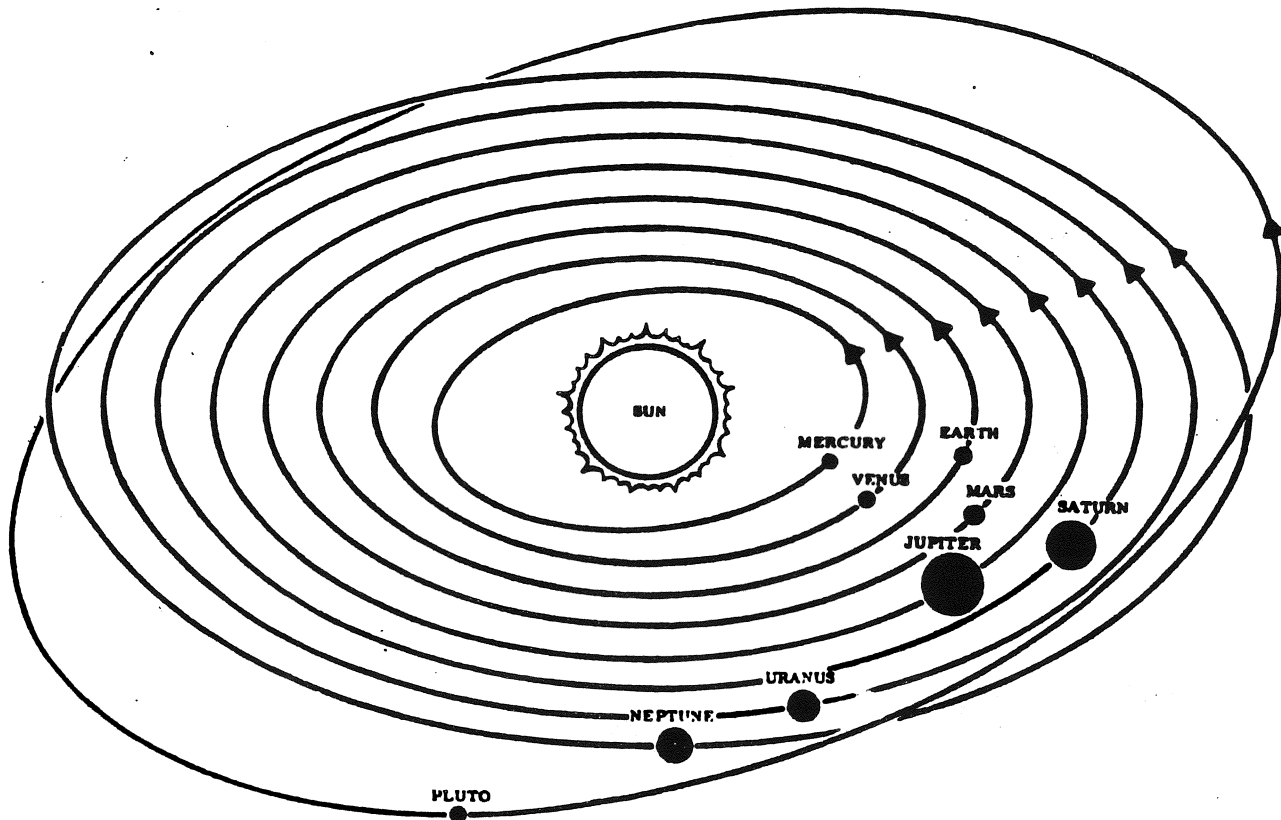

Figure 6-6.- The planets.

From a pointer's point of view, we need to be concerned about the effects of the Sun, Moon, and planets not only because of occultation, but also because of the effects of brightness the sun and moon have on sensitive instruments. Specifically, we do not consider stars for IMU alignments that fall within 30° of the Sun's center and 8° of the Moon's center not only because the brightness might damage the star trackers' sensors, but also because the bright object sensor might close on the star trackers. Other constraints such as avoidance or acquisition of the sun for payloads need to be addressed for each flight. Roughly speaking, the Sun and Moon are about 1/2° wide in diameter with respect to the star chart.

## SECTION 7 VEHICLE HARDWARE

### 7.1 ON-ORBIT ATTITUDE CONTROL SYSTEM OVERVIEW

The following functional schematic (fig. 7-1) shows the major hardware and software interfaces composing the attitude control system.

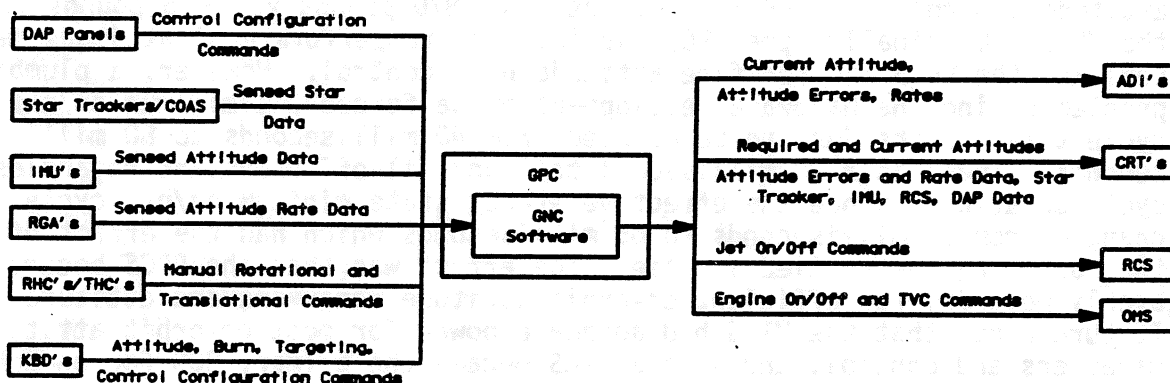

105110071. Art. 3

Figure 7-1.- HW/SW interfaces.

- DAP - Digital Automatic Pilot
- IMU - Inertial Measurement Unit
- RHC - Rotational Hand Controller
- THC - Translational Hand Controller
- KBD - Keyboard
- ADI - Attitude Directional Indicator
- CRT - Cathode Ray Tube
- RCS - Reaction Control System
- OMS - Orbiter Maneuvering System
- COAS - Crew Optical Alignment Sight
- RGA - Rate Gyro Assembly
- GPC - General Purpose Computer
- GNC - Guidance, Navigation, Control

#### References:

For hardware data, see "Shuttle Operational Data Book" (SODB), JSC 08934.

For software data, see "Functional Subsystem Software Requirements" (FSSR), SD 76-SH-0003 - On-Orbit Guidance; 0006 - On-Orbit Navigation; 0009 - On-Orbit Flight Controls; 0020 - Displays.

## 7.2 HARDWARE

### 7.2.1 Jets - PRCS/VRCS

The Reaction Control System (RCS) is designed to control the Orbiter independently in each of three axes. The jets are so located and oriented to provide this control. There are two independent sets of jets - the Primary RCS (PRCS) and the Vernier RCS (VRCS), either of which is capable of attitude control. The PRCS jet thrust is ~870 pounds vs. ~25 pounds for the VRCS. Originally, the PRCS was intended to perform most attitude maneuvers and the VRCS was for fine attitude hold control. However, a plumbing problem during the hardware development phase forced the minimum on/off cycle time for the jets to be doubled from 40 milliseconds to 80 milliseconds. There is a 15 millisecond tail-on/tail-off transient regardless of cycle duration. Hence the effective steady state minimum on/off cycle changed from 25 milliseconds to 65 milliseconds which had the effect of more than doubling the applied impulse. The effect was that the PRCS became overly powerful for efficient on-orbit attitude maneuvers and attitude hold. It turned out that the VRCS had adequate power for most on-orbit attitude maneuvers and control, and so the VRCS became the primary RCS for on-orbit use.

A schematic diagram of the RCS is shown in figure 7-2. Notice the direction of the body axes and imagine the jets to be tied to the Orbiter body. Study the thruster ID code and functional grouping of the jets. Note that the VRCS jets are all on manifold 5, and only VRCS jets are on manifold 5. Find all six of the VRCS jets. Notice the uses that might be made of the jets in each group. For example, Group 1 jets are only good for -X translational maneuvers while group 13 might be used in combination with group 14 for pitch control; group 13 might be used in combination with group 14 and group 4 for pitch control; group 13 might be used in combination with group 12 for roll control; group 13 might be used in combination with groups 14, 5, and 6 for -Z translation maneuvers.

Notice that the VRCS is, by geometry, incapable of controlled translation maneuvers. Hence, the VRCS is only used for attitude control while the PRCS is used both for attitude control and translation maneuvers. Also note that, relative to the Orbiter body reference frame, there are no up-firing VRCS jets which is an important feature to many payloads when they are located in and around the payload bay.

Table 7-I contains a tabulation by command and by group of the PRCS jets commanded on for a rate change in each axis and direction. Note, for on-orbit attitude control commands, only one jet per group is commanded on (the others provide backup redundancy). Control configurations will be discussed later.

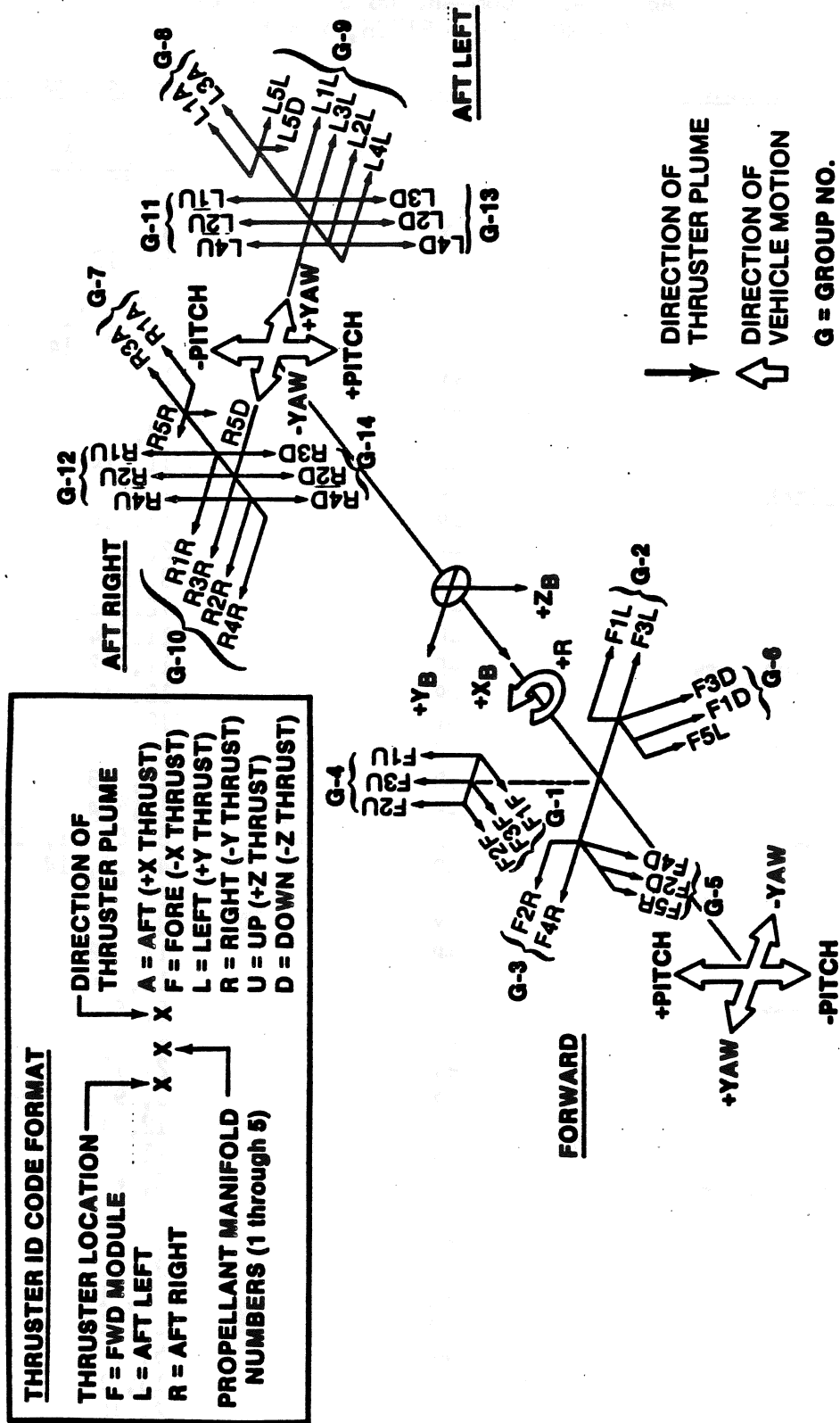

Figure 7-2.- Schematic of RCS.

TABLE 7-I.- COMMANDING OF PRCS JETS  
(R = ROLL, P = PITCH, Y = YAW)

<u>Control configuration</u>	<u>Command</u>	<u>Groups commanded on</u>
Normal	+P	5, 6, 11, 12
	-P	4, 13, 14
	+Y	2, 10
	-Y	3, 9
	+R	12, 13
	-R	11, 14
Tail-only yaw	+P	5, 6, 11, 12
	-P	4, 13, 14
	+Y	10
	-Y	9
	+R	12, 13
	-R	11, 14
Tail-only pitch	+P	11, 12
	-P	13, 14
	+Y	2, 10
	-Y	3, 9
	+R	12, 13
	-R	11, 14
Tail-only pitch, yaw	+P	11, 12
	-P	13, 14
	+Y	10
	-Y	9
	+R	12, 13
	-R	11, 14
Nose-only yaw	+P	5, 6, 11, 12
	-P	4, 13, 14
	+Y	2
	-Y	3
	+R	12, 13
	-R	11, 14
Nose-only pitch	+P	5, 6
	-P	4
	+Y	2, 10
	-Y	3, 9
	+R	12, 13
	-R	11, 14
Nose-only pitch, yaw	+P	5, 6
	-P	4
	+Y	2
	-Y	3
	+R	12, 13
	-R	11, 14
Low-Z	+P	5, 6
	-P	13, 14
	+Y	2, 10
	-Y	3, 9

TABLE 7-I.- Concluded

<u>Control configuration</u>	<u>Command</u>	<u>Groups commanded on</u>
Low-Z (Cont)	+R	13
	-R	14
Low-Z, tail-only yaw	+P	5, 6
	-P	13, 14
	+Y	10
	-Y	9
	+R	13
	-R	14

Low-Z, tail-only pitch configuration will be ignored by the software.

Table 7-II contains a tabulation by command and by group of the VRCS jets commanded on for a rate change in each axis and direction. Note that while there is complete redundancy with the PRCS jets, there is no redundancy within the VRCS, hence only one control configuration. However, control for attitude maneuvers or attitude hold is still possible with either or both side-firing jets (groups 9, 10) failed off. If any of the other vernier jets fail, the VRCS is inoperative.

TABLE 7-II.- COMMANDING OF VRCS JETS

<u>Command</u>	<u>Groups commanded on</u>
+P	5, 6
-P	13, 14
+Y	6, 10
-Y	5, 9
+R	6(*), 9, 13
-R	5(*), 10, 14

(\*) The number of jets commanded on for roll control varies with rate change required. Groups 5, 6 are usually not commanded on for roll. See section 4.2.2.2.1 of the Orbiter Flight Control FSSR (SD 76-SH-0009) to determine exactly which jets will be commanded on.

Table 7-III contains some equations, facts and numbers for "ballpark" calculations relative to the RCS. The equations are useful for "sizing" the pulse sizes to load in the DAP CONFIG SPEC display to obtain a desired pulse duration with flight software.

TABLE 7-III.- MISC DAP EQUATIONS AND PARAMETERS

Rotation pulse - Number of DAP cycles

$$\text{No. DAP cycles} = \frac{\text{Pulse size (from DAP config.) (Round up)}}{\text{MAG CNTL ACCEL} \times 0.08 \text{ sec (DAP cycle)}}$$

MAG CNTL ACCEL: Constant for each flight  
 Different values for each axis  
 Verniers and primaries different  
 MSID's PRCS V95U8853C, -4C, -5C      FC FSSR (09) Sec. 4.1  
 VRCS V95U8856C, -7C, -8C

Translation pulse - Number of DAP cycles

$$\text{No. DAP cycles} = \frac{\text{Vehicle Mass (I-Load)} \times \text{Pulse Size (from DAP conf.)}}{\text{MAG CNTL FORCE} \times 0.08 \text{ sec (DAP cycle)}}$$

MAG CNTL FORCE: Constant for each flight  
 Different values for each axis  
 V97U2957C (X-axis), -8C (Y-axis), -9C (Z-axis)  
 From FC FSSR, Appendix B

Some nominal values - STS-7: These values usually are the same for all flights. If critical, check for your flight.

	<u>MAG CNTL ACCEL</u>		<u>Vehicle Mass 6984 Slugs</u>	
	<u>Verniers</u>	<u>Primaries</u>	<u>MAG CNTL FORCE</u>	
R	0.0230	0.8	X	1733
P	0.0135	0.9	Y	1742
Y	0.0156	0.6	Z	3055

DA6 has the books where general as well as flight specific data can be found. If you need assistance in using the books, personnel are usually there to help you.



TABLE 7-IV.- ROTATIONAL AND TRANSLATIONAL ACCELERATIONS RESULTING FROM ROTATIONAL AND TRANSLATIONAL RCS COMMANDS (Assumes 200K lb Orbiter)

EFFECTS (AT CG) OF RCS MANEUVERS							
Rotation Maneuvers							
Axis	Linear ft/sec <sup>2</sup>			Angular ft/sec <sup>2</sup>			
	X	Y	Z	R	P	Y	
VERNIER	+P	-.00026	.00000	-.00573	.0002*	.0187	0
	-P	.00000	.00000	-.00781	0	-.0082	0
	+R	.00000	.00390	-.00400	.0220	.0051	.0011
	-R	.00000	-.00390	-.00400	-.0220	.0051	-.0011
	+Y	-.00013	-.00114	-.00296	-.0031	.0092	.0155
	-Y	-.00013	.00114	-.00296	.0031	.0092	-.0155
PRIMARY	+P	-.009	.00000	.076	.020	1.137	.0005
	-P	.063	.00000	-.045	-.013	-.730	-.0005
	+R	.034	.039	.043	.934	.086	-.022
	-R	.034	-.039	.048	-.931	.032	.022
	+Y	-.004	.0003	.004	-.222	-.010	.657
	-Y	-.004	-.0008	.004	.222	-.009	-.668
Translation Maneuvers							
PRIMARY	+X	.279	.00000	.049	-.0003	-.021	-.00001
	-X	-.286	.00000	.039	-.002	-.114	-.00003
	+Y	-.004	.283	.004	.390	-.009	.210
	-Y	-.004	-.283	.004	-.390	-.010	-.210
	+Z(H)	-.016	.00000	1.276	.003	.156	.00000
	+Z(N)	-.005	.00000	.426	.001	.041	-.00000
	-Z	.128	.00000	-.583	.0003	.016	.00001

\*Non-zero component results from CG offset.

To determine the effect of a command, determine its duration in seconds and multiply each of the rotational and translational acceleration components by the duration.

If the command duration is known in terms of a number of DAP cycles, multiply the number of DAP cycles by 0.08 (80-millisecond DAP cycle) and subtract 0.015 (the tail-on/tail-off transient effect) to obtain effective steady-state duration.

Tables 7-V and 7-VI contain the rotational and translational acceleration data for the nose- and tail-only pitch and yaw and the low-Z options for PRCS control. (These modes will be discussed later.)

TABLE 7-V.- LOW Z MODE ACCELERATIONS

Axis	Jets	Rotation, deg/sec <sup>2</sup>			Translation, ft/sec <sup>2</sup>		
		Roll	Pitch	Yaw	X	Y	Z
+Roll	L3D	.399	-.176	-.062	.034	.051	-.093
-Roll	R3D	-.398	-.176	.062	.034	-.051	-.093
+Pitch	F3D, F4D	.004	.657	.000	-.008	.000	-.204
-Pitch	L3D, R3D	.000	-.349	.000	.067	.000	-.184
+Yaw	F3L, R3R	-.244	-.001	.659	-.003	.000	.001
-Yaw	F4R, L1L	.242	-.000	-.667	-.003	-.000	.001
+X	L3A, R3A	-.000	-.023	.000	.273	.000	.048
-X	F1F, F2F	-.001	-.108	-.000	-.280	.000	.038
+Y	F3L, L1L	.335	-.001	.181	-.003	.280	.001
-Y	F4R, R3R	-.337	-.001	-.188	-.003	-.280	.001
+Z	F1F, F3F, L3A, R3A	-.001	-.131	-.000	-.007	.000	.086
-Z	F3D, F4D, L2D, L3D, R2D, R3D	.005	-.012	.000	.124	.000	-.564

TABLE 7-VI.- PRIMARY RCS ACCELERATIONS - NOSE, TAIL OPTIONS

Axis	Jets	Rotation, deg/sec <sup>2</sup>			Translation, ft/sec <sup>2</sup>		
		Roll	Pitch	Yaw	X	Y	Z
Nose only							
+Pitch	F3D, F4D	.004	.657	.001	-.008	.000	-.204
-Pitch	F3U	-.003	-.447	-.000	-.005	.000	.139
+Yaw	F3L	.046	-.000	.420	-.003	.139	.000
-Yaw	F4R	-.046	-.000	-.420	-.003	-.139	.000
Tail only							
+Pitch	L1U, R1U	.000	.512	-.000	.000	-.000	.278
-Pitch	L3D, R3D	.000	-.349	.000	.067	.000	-.184
+Yaw	R3R	-.288	-.001	.234	.001	-.138	.001
-Yaw	L1L	.286	-.001	-.241	.001	.138	.001

### 7.2.2 OMS Engines

Refer to figure 7-3. The OMS engine gimbals allow the two engines' thrust vectors to be independently pointed several degrees in any direction relative to the CG. This allows complete attitude control with the OMS engines alone during normal two-engine OMS burns. For a single-engine OMS burn, there is no roll control capability, so roll is normally controlled with the RCS in this case.

There is an RCS "wraparound" thrust vector control (TVC) capability to augment the OMS TVC. It is invoked in an axis whenever the attitude error in that axis exceeds 5°. When the RCS wraparound is invoked, RCS jets are fired to help the OMS drive the Orbiter attitude in the desired direction.

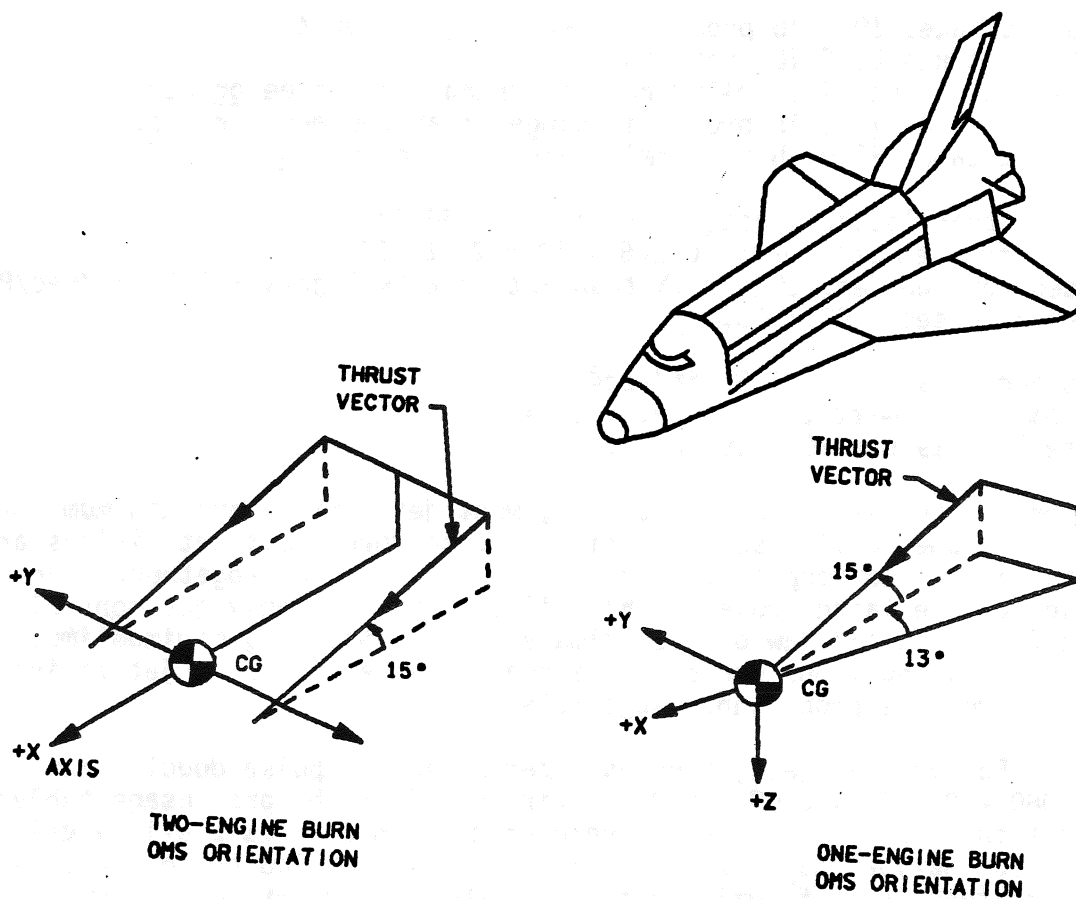

Figure 7-3.- OMS engine alignment.

3825. ART, 1

### 7.2.3 Deriving Numbers

Miscellaneous OMS and RCS data and formulas for deriving some useful "ballpark" numbers are as follows

<u>Engine</u>	<u>Specific Impulse, sec</u>	<u>Thrust per Engine lb</u>	<u>Prop flow rate lb/sec</u>	<u>Mixture ratio O/F</u>
OMS	313.2	6000	19.16	1.65
PRCS	280.0	870	3.11	1.60
VRCS	260.0	24	0.09	1.60

The following are for a 200K lb Orbiter

For OMS, it takes 19.5 lb prop/foot per sec (FPS) of  $\Delta V$ .

For RCS, it takes 22.5 lb prop/FPS.

It takes 1.8 FPS/nautical mile (nmi) of change in apogee or perigee.

For OMS, it takes 70.2 lb prop/nmi change in apogee and perigee.

For RCS, it takes 81.0 lb prop/nmi change in apogee and perigee.

Two-jet +X translational acceleration is 0.266 ft/sec<sup>2</sup>.

To get  $\Delta V$  for ten-sec burn:  $0.266 \times 10 = 2.66$  FPS.

Prop used for two-jet, 10-sec +X translation 2 PRCS jets x 3.11 lb/sec/PRCS jet x 10 sec = 62.2 lb.

Two-OMS acceleration is 1.93 ft/sec<sup>2</sup>.

To get  $\Delta V$  for ten-sec burn:  $1.93 \times 10 = 19.3$  FPS

Prop used 2 x 19.6 x 10 = 383.2 lb.

After the FCS settles into an attitude, most jet firings are minimum impulse, i.e., one 80-millisecond firing. Furthermore, most jet firings are doublets, i.e., two coupled or semi-coupled jets firing together. (An exception to the latter rule is the tail-only or nose-only jet control options for pitch and yaw on the primary jets.) Assuming minimum impulse, doublet jet firings, one can derive a reasonable estimate of jet firing frequency from the propellant usage rate.

Example: For vernier jets, prop used per minimum impulse doublet is  $2 \times (0.080 - 0.015) \times 0.09 = 0.01$  lb/firing. From the prop usage tables we find that the prop usage rate for vernier jets in a minus Z axis local vertical (or payload bay down) (-ZLV), Y axis perpendicular to orbit plane (YPOP) attitude in a 150 nmi orbit, 1° attitude deadband is 0.84 lb/hr. Hence firings per hour =  $\frac{0.84 \text{ lb/hr}}{0.01 \text{ lb/firing}} = 84$  or a little more than one per minute.

## 7.2.4 DAP Panels

### 7.2.4.1 DAP Panel in OPS 2

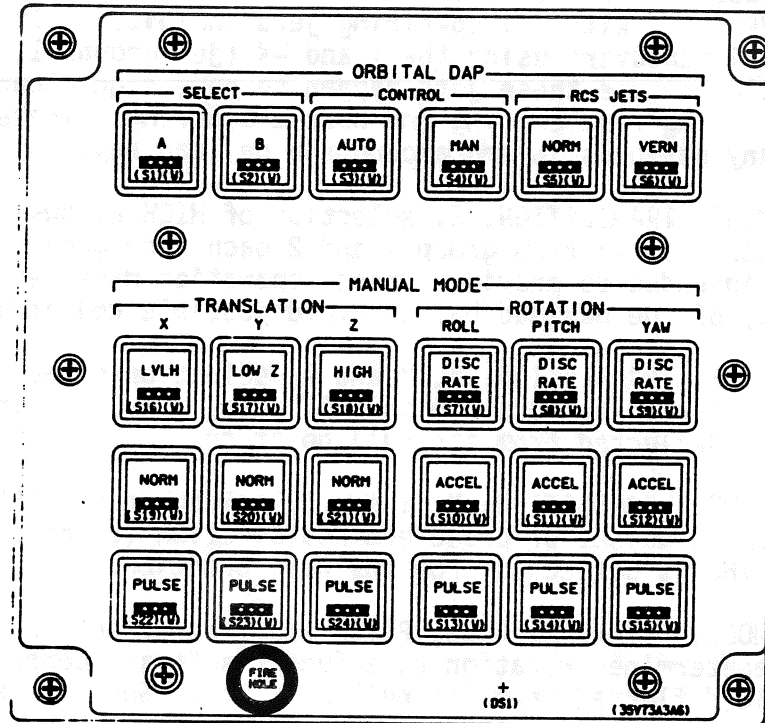

105110074, 51E, 1

Figure 7-4.- DAP panel in OPS 2.

There is a DAP panel at each of the following locations: the center console between the commander's and pilot's station and the aft crew station. The DAP panel allows selection of any one of several control modes. The selections are made by depressing the labeled pushbutton indicators (PBI's). Selections made at any station apply and are appropriately indicated at all stations.

In the first row under SELECT, the two PBI's allow selection of either of two sets of control parameters which reside in the software. Under CONTROL, the selection of AUTO puts the attitude control system under software control. Selection of MAN puts attitude control system under manual control with the RHC in one of several possible submodes. Under RCS JETS, selection of NORM results in the software commanding only to PRCS jets for attitude control. Selection of VERN results in the software commanding only VRCS jets.

Under MANUAL MODE, TRANSLATION, X, selection of Local Vertical/Local Horizontal (LVLH) (which is mutually exclusive with both AUTO and MAN) allows manual control with the RHC within the LVLH reference frame. Obviously, this mode has nothing to do with translation maneuvers - this PBI, and the LOW Z PBI next to it, were unused in the original panel/DAP design. These

two modes were late DAP add-ons and so these two PBI's were used to provide for their selection.

Under MANUAL MODE, TRANSLATION, Y, selection of LOW Z allows for attitude control with PRCS but with all up-firing jets inhibited. It also allows for +Z translational maneuvers using the + and -X (jet groups 1, 7 and 8) jets. This is possible because these jets happen to have significant +Z thrust components resulting from canting and nozzle scarfing. These are important features to many payloads in and around the payload bay.

Under MANUAL MODE, TRANSLATION, Z, selection of HIGH allows for +Z translation using 7 RCS jets (3 from group 4 and 2 each from groups 11 and 12). This mode was intended to provide a fast separation maneuver from a payload in the vicinity of the payload bay to avoid possible collision.

Under MANUAL MODE, TRANSLATION, X, Y and Z, selection of NORM provides for continuous translation maneuvers with PRCS jets, i.e., continuous as long as the THC is held deflected from its null position.

Under MANUAL MODE, TRANSLATION, X, Y and Z, selection of PULSE provides single translation pulses of predetermined duration (under software control) each time the THC is deflected from its null position.

Under MANUAL MODE, ROTATION, ROLL, PITCH and YAW, selection of DISC RATE provides a predetermined rotation rate (under software control) as long as the RHC is held deflected from its null position. When the RHC is returned to its null position, the rotation rate is damped.

Under MANUAL MODE, ROTATION, ROLL, PITCH and YAW, selection of ACCEL provides continuous rotational acceleration as long as the RHC is held deflected from its null position. When the RHC is returned to its null position, the acceleration ceases but the rotation rate continues under the momentum of the vehicle.

Under MANUAL MODE, ROTATION, ROLL, PITCH and YAW, selection of PULSE provides single rotation pulses of predetermined duration (under software control) each time the RHC is deflected from its null position. The rate that was introduced by the pulse continues under the momentum of the vehicle when the RHC is returned to its null position.

ACCEL and PULSE are "free" rotation submodes, i.e., in these submodes the vehicle attitude is allowed to drift around under the momentum of the vehicle and any external disturbance torques as long as the RHC is in its null position. Note that the ORBITAL DAP, CONTROL must have MAN or LVLH selected for any of the MANUAL MODE, ROTATION submodes to be in effect. However, there are two ways to select MAN: one way is to depress the PBI and the other is to deflect the RHC which automatically selects MAN except when LVLH is selected. LVLH is selected only by depressing the LVLH PBI position.

The following are a few useful miscellaneous facts about the DAP panel.

- A and B DAP selections are mutually exclusive.
- LVLH, AUTO and MAN are mutually exclusive as are NORM and VERN.
- Under TRANSLATION, NORM and PULSE are mutually exclusive in any axis. In the Z axis, HIGH is mutually exclusive with NORM and PULSE. LOW Z is compatible with either Z NORM or PULSE.
- ROTATION DISC RATE, ACCEL and PULSE are all mutually exclusive in any single axis.

#### 7.2.4.2 DAP panel in OPS 1 and 3 (On-Orbit)

In OPS 1 and 3, there is only one DAP configuration available and only the PRCS for attitude control, and so the SELECT and RCS JETS PBI's are not functional. AUTO/MAN are selectable and as in OPS 2, AUTO provides for attitude maneuvers under software control and MAN provides for maneuvers under manual control with the RHC.

In OPS 1 and 3, the only PRCS translational mode available corresponds to the NORM mode in OPS 2. However, since there are no other choices, none of the PBI's under TRANSLATION is functional.

In OPS 1 and 3, only DISC RATE and PULSE are selectable by the PBI's so the ACCEL submode PBI's are not functional. In the Primary Avionics Software System (PASS), DISC RATE and PULSE are selectable by axis as in OPS 2 but in the Backup Flight System (BFS), selection in any axis results in the same selection in all axes.

#### 7.2.5 Star Trackers/COAS

The star trackers measure the positions of stars; their locations in space are stored in the software. The software can also calculate the positions of the stars based upon the present IMU gimbal angles. The difference in the measured positions and the calculated positions of a pair of stars forms the basis for an update of the IMU's. The software is configured to reject any star that is not within 0.5° of where it should be as reckoned by IMU measurements and so it is necessary to perform an IMU alignment (update) before the IMU's drift beyond 0.5°. In practice, the IMU's are aligned about every 12 hours. If the IMU's drift or tumble out of the 0.5° limit, it is necessary to recover the IMU's alignment with a COAS star alignment.

The COAS is a manual sighting device for sighting on stars. It is hard mounted in either of two Orbiter windows (forward, +X, or overhead, -Z). The crew must visually identify the star being sighted on and enter the ID in the software. It is necessary to maneuver the Orbiter to get the star centered in the COAS reticle upon which occurrence the crewmember must send a signal (mark) to the software that the star is centered. Sightings on a

pair of stars form the basis for an IMU alignment which should get the IMU's back within the 0.5° limit so that a more accurate alignment should then be possible using the star trackers.

Refer to the IMU Alignment Flight Procedures Handbook for geometric relationships between the star trackers and the Orbiter and COAS reticle pattern.

#### 7.2.6 IMU's

The IMU's serve as the attitude data source for all flight phases from launch minus 20 minutes until landing. In OPS 2, the IMU's also serve as the source of attitude rate data - the rates are derived by dividing attitude deltas by the time interval between attitude measurements.

The IMU's also contain accelerometers which measure linear acceleration. The delta velocity (delta-V) between successive measurements is determined by interpolating acceleration between measurements and integrating the interpolated acceleration over the time interval.

Refer to the IMU Alignment Flight Procedures Handbook for details of operation and geometric relationships between the IMU's and the Orbiter body reference frame.

#### 7.2.7 RGA's

The rate gyros serve as the attitude rate data source in GNC OPS 1 and OPS 3 only. The gyros must be on and operating before transitioning into either of these OPS.

#### 7.2.8 RHC's/THC's

There are three flight control RHC's (as opposed to the RMS RHC) - one at the commander's station, one at the pilot's station, and one at the aft station. There are two flight control THC's - one at the commander's station and one at the aft station.

When powered, the operation of these hand controllers causes selected RCS jets to fire resulting in Orbiter motion (rotation or translation) in the direction of the hand motion.

The aft station controllers are functional only in OPS 2. The "sense" of the aft station controllers is selectable to -X or -Z. The -X sense is used when the crewmember is viewing and working with something outside the aft window and the -Z sense is used when the crewmember is viewing and working with something outside the overhead window. The aft controllers are mounted at about a 45° angle (halfway between) the normal -X and -Z positions. This



is the result of a compromise in order to get by with one set of controllers at the aft station. By selecting the appropriate sense, the feeling and response to the controllers are satisfactory.

#### 7.2.9 KBD's

There is a keyboard at the commander's station, the pilot's station and at the aft station. The keyboard at the aft station is active only in OPS 2. The keyboards are used to enter data and commands for software-controlled attitude maneuvers, to enter target data for translational maneuvers, to control the star trackers and IMU's, and to change control parameters in the DAP software.

The Crew Software Interface Workbook is a good source of information on the keyboards and CRT's operation.

#### 7.2.10 ADI's

There is an ADI at the commander's station, the pilot's station and at the aft station. The ADI at the aft station is active only in OPS 2.

The ADI's provide an analog attitude display relative to any of three selectable reference frames. The reference frames are selectable by means of a 3-position switch labeled INRTL/REF/LVLH. The INRTL and REF positions represent inertial reference frames, i.e., frames that bear a fixed relationship to the M50 reference frame. The LVLH position represents the LVLH reference frame explained earlier.

The ADI's also display "attitude errors" and body attitude rates. Attitude errors are calculated from the difference between the current attitude and the required attitude (required attitude as reckoned by the GNC software). The attitude difference is represented in the software as an error quaternion which is resolved into three body axis components. In general, these errors will not be the same as the Euler angle (R, P, Y) differences, although they will be close when the errors are small. The body attitude rates (or simply rates) are also resolved rates.

The error and rate needles are mechanized to indicate the "fly-to" sense. What this means is that to fly out the error in an axis using the RHC, you would deflect the RHC in that axis in the same sense (+ or -) that the error needle in that axis is deflected. For example, if the pitch error needle is deflected upward with respect to the cockpit seated position, you would deflect the RHC so as to command the Orbiter to pitch up to reduce the pitch error. The rate needles also indicate the fly-to sense, i.e., to reduce the rate in an axis, you would deflect the RHC in that axis in the direction indicated by the rate needles.

For a more detailed description of the ADI's, see the "GNC Dedicated Displays Workbook."

### 7.2.11 CRT's

There are three CRT's located between the commander's station and the pilot's station and one CRT at the aft station. The CRT's provide for the output of digital data to the crew. They also echo the crew's keystrokes as commands are constructed through the keyboard.

The Crew Software Interface Workbook is a good source of information on the keyboards and CRT's operation.

**SECTION 8**  
**VEHICLE SOFTWARE**

**TBS**



## SECTION 9 NAVIGATION BASE

### 9.1 STAR TRACKERS/STAR TABLE

To be able to reorient the Orbiter's IMU's, the position of the Orbiter must be determined in inertial space, and the error in the IMU's calculated. To determine actual position, the vehicle has two star trackers, the -Y and -Z, mounted 87.65° apart. Sightings are taken on two stars whose vectors in inertial space are accurately known onboard, and from these sightings the actual vehicle attitude is determined. Currently, the software contains a navigation star catalog of 100 stars (only 50 are good in OPS 3) which are listed in Appendix A. To perform an alignment, two stars must be acquired by the star trackers and stored in the star table. The stars can be picked up by either tracker (even both by the same tracker) and must have  $90^\circ \pm 55^\circ$  angular separation. For two working star trackers, there are 418 star pairs which can be acquired by maneuvering to an inertial attitude and have one navigation star in each tracker. Some of these (the 50 nav stars) are listed in Appendix A, along with the two M50 attitudes associated with each pair.

In order to avoid damage to the star trackers, a Bright Object Sensor is attached which closes the shutter before the more sensitive star tracker sensor acquires the object. The resulting constraints are

- 30° from center of Sun
- 8° from center of Moon
- 20° from Bright Earth Horizon
- 3° from Dark Earth Horizon (airglow occultation, not bright-object constraint)

As stars are acquired and recognized, they are loaded into the star table; the pair closest to 90° (within  $\pm 55^\circ$ ) is selected as the best pair, and older stars are bumped out. The logic used is shown in figure 9-1.

### 9.2 COAS

If all attitude reference is lost, the vehicle cannot be maneuvered to any known attitude without first aligning the IMU's. The star trackers can't be used because the error between the actual star position and the software calculated star position now is much greater than what the software filter (.5°) will accept. The COAS is used to perform an initial alignment after which a star tracker align can be done. To perform a COAS align, the crew manually maneuvers to put a nav star in the COAS field-of-view and takes a mark as the star passes through the crosshairs. This is repeated using a second star that is at least 35° away from the first. An alignment can now be done. For a COAS alignment, the crew must be able to identify the navigation stars and select one. Therefore, it is highly desirable to perform the alignment at night, or at least 90° from the Sun, to keep light off of the COAS so the stars can be seen. Also, the brighter the star, the

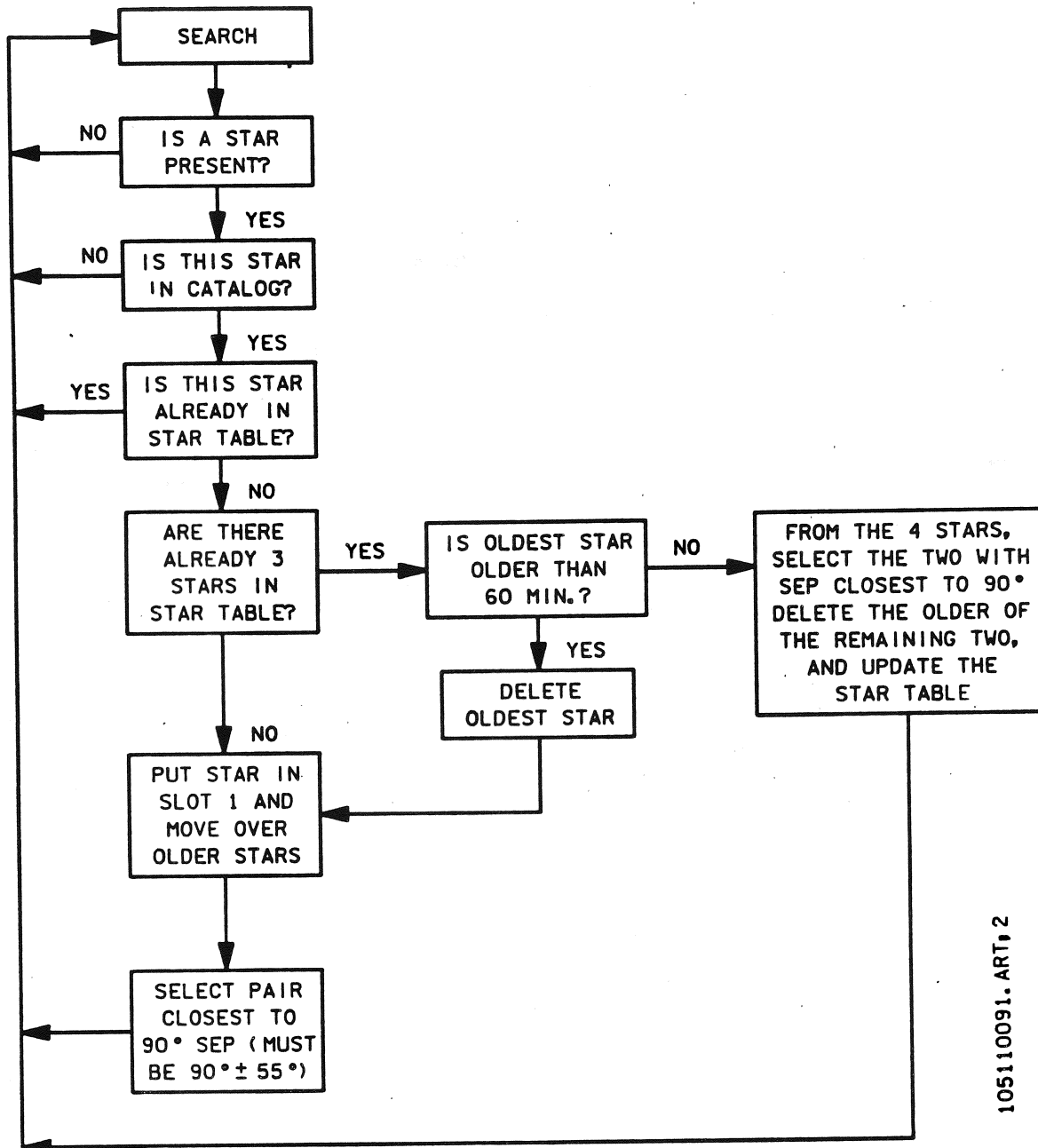

105110091. ART. 2

Figure 9-1.- Star Tracker table logic automatic search mode.

easier it is to find in the sky. Therefore, the ideal stars will be two bright stars at night at least  $35^\circ$  apart. COAS star pair separation angles are given for the brightest stars in Appendix A.

COAS calibrations are performed after orbit insertion. These are done with a good IMU reference immediately following an IMU alignment. The purpose of the calibration is to update the software's knowledge of the COAS center-line line of sight with respect to the Navigation Base. The COAS line-of-sight will shift slightly from prelaunch orientation due to structural relief from having 1-g conditions. The calibrated COAS is now more accurate if a COAS alignment is needed later.

### 9.3 ATTITUDE DETERMINATION

The Orbiter is equipped with three inertial measurement units (IMU's) which are used for attitude and position estimation. These three IMU's are mounted on the navigation base which is a metal beam that is supposed to maintain a constant orientation with respect to the rest of the vehicle. Each IMU can be considered as a rigid metal box which contains a cluster of instruments suspended inside a set of gimbals. A cluster (or stable member) is a flat plate with two accelerometers and two gyroscopes bolted to it. The gyroscopes are mounted with the spin axis of one parallel to the plate's surface and the other perpendicular to it. When the gyros are spun up, they hold the plate inertially fixed (attitude-wise). As the Orbiter maneuvers, the near frictionless gimbals allow the cluster to maintain its inertial orientation. The orientation of the cluster to the IMU case is determined from the gimbal angles (resolver angles). Each cluster has a set of structural axes associated with it where X and Y are in the plane of the plate and Z is down. Twenty minutes prior to lift-off, the IMU clusters are frozen with respect to inertial space. The cosine matrix defining its M50 attitude is called a reference stable member matrix (REFSMMAT). The resolver angles from the gimbals allow the GPC's to calculate an IMU cluster to IMU case matrix. Since the orientation of each IMU case relative to the Orbiter body axis is constant, the actual Orbiter attitude can be determined by

$$\begin{bmatrix} M \\ \end{bmatrix}_{ADI}^{OB} = \begin{bmatrix} A \\ \end{bmatrix}_{CASE}^{OB} \begin{bmatrix} B \\ \end{bmatrix}_{CLUSTER}^{CASE} \begin{bmatrix} C \\ \end{bmatrix}_{M50}^{CLUSTER} \begin{bmatrix} D \\ \end{bmatrix}_{ADI}^{M50}$$

where  $\begin{bmatrix} C \\ \end{bmatrix}_{M50}^{CLUSTER} = \text{REFSMMAT}$

$\begin{bmatrix} B \\ \end{bmatrix}_{CLUSTER}^{CASE}$  is from resolver angles

$\begin{bmatrix} D \\ \end{bmatrix}_{ADI}^{M50}$  is the RELMAT

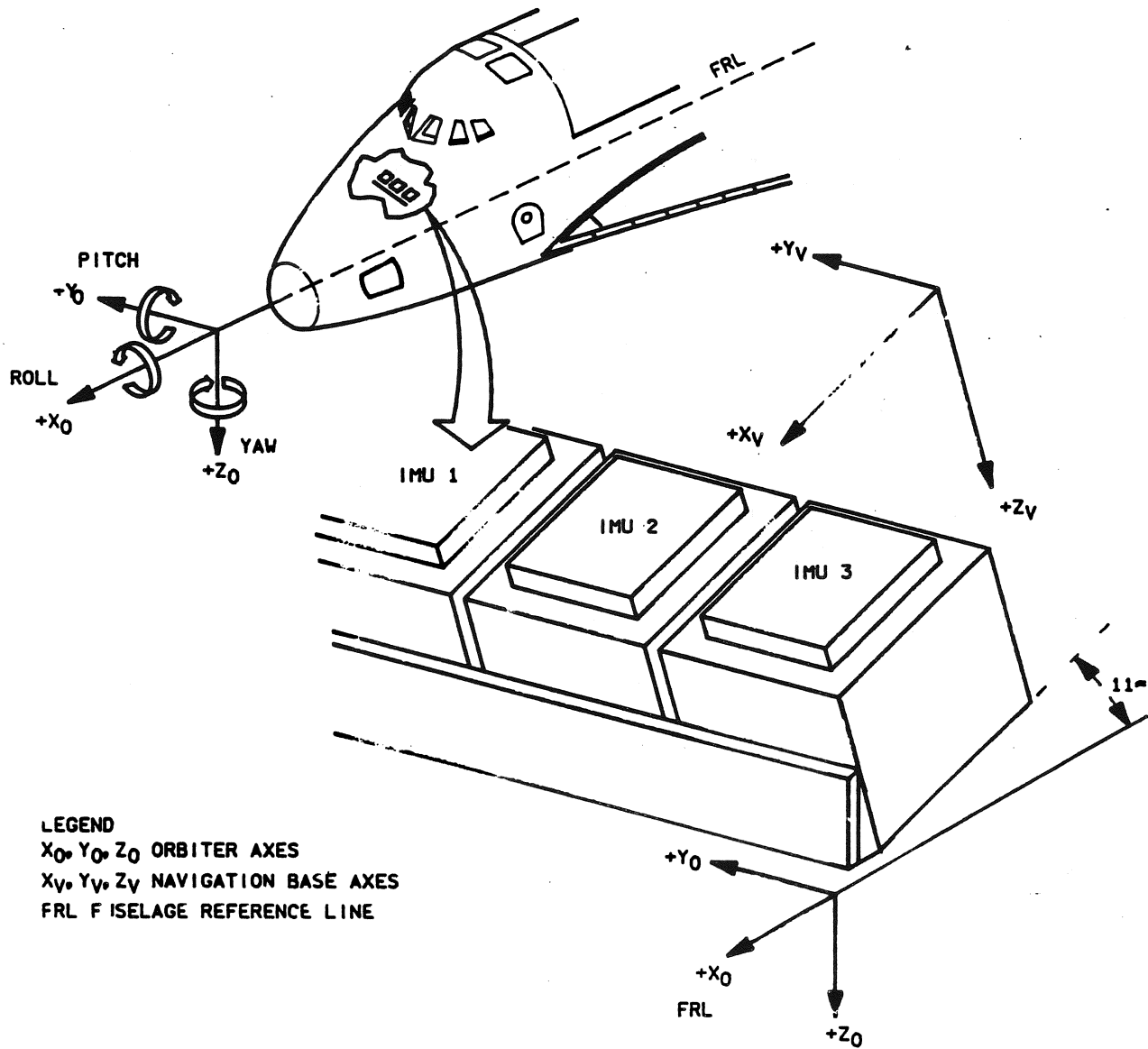

105110092. 51E. 1

Figure 9-2.- The IMU location.

Each IMU case is aligned to the Orbiter body slightly differently than the others and each cluster is aligned differently to M50 for redundancy. Because the gyros on each platform are not perfect, the clusters will eventually drift. The amount of the drift is determined by star tracker or COAS star sightings. The GPC figures out the actual orientation of each cluster in M50 and compares it to its respective REFSMMAT. The error is removed by a star align, a matrix align, or an IMU to IMU align. A star align physically repositions the clusters by torquing gyros until their actual orientation agrees with their REFSMMAT's. A matrix align simply changes the REFSMMAT to agree with the current cluster orientation. An IMU to IMU align torques one (or two) IMU(s) to its (their) required REFSMMAT orientation while using another IMU as an inertial reference. The GPC filters the outputs of the IMU's and comes up with a "best guess" of Orbiter attitude in M50. This attitude is displayed on the crew attitude direction indicators



(ADI) in either M50 or LVLH. The GPC calculates the direction cosine matrix, called a relative matrix (RELMAT), to do the conversion. Currently, the ADI displays M50 attitudes, thus the RELMAT is an identity matrix. In addition, if the crew uses the aft station, which has an attitude sense other than +X, another matrix called a sense matrix is used to adjust the orientation of the ADI to -X or -Z.

#### 9.4 ATTITUDE SENSE +X, -X, -Z

In addition to the forward ADI's which always operate in the +X sense, there is an aft ADI which may operate in the -X or -Z sense. Selection is accomplished by the ADI SENSE switch located in the aft station. This switch allows the ADI angles to indicate the orientation of either a -X sense axis system or a -Z sense axis system, depending on whether the crewmember is viewing through the payload bay (-X) windows, or the overhead (-Z) window.

The three ADI sense systems are depicted in figure 9-3 along with the respective transformation matrices which relate the sense system to the body system.

Note that the sense systems are fixed in the body system and are named according to the body axis which defines the primary sense axis.

	Sense (+X)	Sense (-X)	Sense (-Z)	(AMZ)
<p><b>Sense Axis System (SA)</b></p> <p>AX = ADI +x Sense                      AMX = ADI -x Sense                      AMZ = ADI -z Sense</p>				
<p><b>Body System</b></p>				
<p><b>[s]<sup>BY</sup> Matrix</b>                      SA                      (orientation of body with respect to the sense axes)</p> <p>Note: <math>[s] - [s]^T</math></p>	$\bar{T}_{BY} = \begin{pmatrix} 1 & 0 & 0 \\ 0 & 1 & 0 \\ 0 & 0 & 1 \end{pmatrix} \bar{T}_{AX}$	$\bar{T}_{BY} = \begin{pmatrix} -1 & 0 & 0 \\ 0 & -1 & 0 \\ 0 & 0 & 1 \end{pmatrix} \bar{T}_{AMX}$	$\bar{T}_{BY} = \begin{pmatrix} 0 & 0 & -1 \\ 0 & -1 & 0 \\ -1 & 0 & 0 \end{pmatrix} \bar{T}_{AMZ}$	

3775. ART 1

Figure 9-3.- ADI sense axis systems.

Note the following for the -X sense:

- Roll<sub>-x</sub> is positive from -YBY to +ZBY (equivalent to Orbiter negative roll).
- Pitch<sub>-x</sub> is positive from +ZBY to -XBY (equivalent to Orbiter negative pitch).
- Yaw<sub>-x</sub> is positive from -XBY to -YBY (equivalent to Orbiter positive yaw).

Note the following for the -Z sense:

- Roll<sub>-z</sub> is positive from -YBY to -XBY (equivalent to Orbiter negative yaw).
- Pitch<sub>-z</sub> is positive from -XBY to -ZBY (equivalent to Orbiter negative pitch).
- Yaw<sub>-z</sub> is positive from -ZBY to -YBY (equivalent to Orbiter negative roll).

TABLE 9-I.- ADI ATTITUDE SENSE CONVERSION

From -x Sense to +x Sense (AMX → AX)	$\begin{bmatrix} -1 & 0 & 0 \\ 0 & -1 & 0 \\ 0 & 0 & 1 \end{bmatrix}$	AX AMX
From +x Sense to -x Sense (AX → AMX)	$\begin{bmatrix} -1 & 0 & 0 \\ 0 & -1 & 0 \\ 0 & 0 & 1 \end{bmatrix}$	AMX AX
From -z Sense to +x Sense (AMZ → AX)	$\begin{bmatrix} 0 & 0 & -1 \\ 0 & -1 & 0 \\ -1 & 0 & 0 \end{bmatrix}$	AX AMZ
From +x Sense to -z Sense (AX → AMZ)	$\begin{bmatrix} 0 & 0 & -1 \\ 0 & -1 & 0 \\ -1 & 0 & 0 \end{bmatrix}$	AMZ AX
From -z Sense to -x Sense (AMZ → AMX)	$\begin{bmatrix} 0 & 0 & 1 \\ 0 & 1 & 0 \\ -1 & 0 & 0 \end{bmatrix}$	AMX AMZ
From -x Sense to -z Sense (AMX → AMZ)	$\begin{bmatrix} 0 & 0 & -1 \\ 0 & 1 & 0 \\ 1 & 0 & 0 \end{bmatrix}$	AMZ AMX

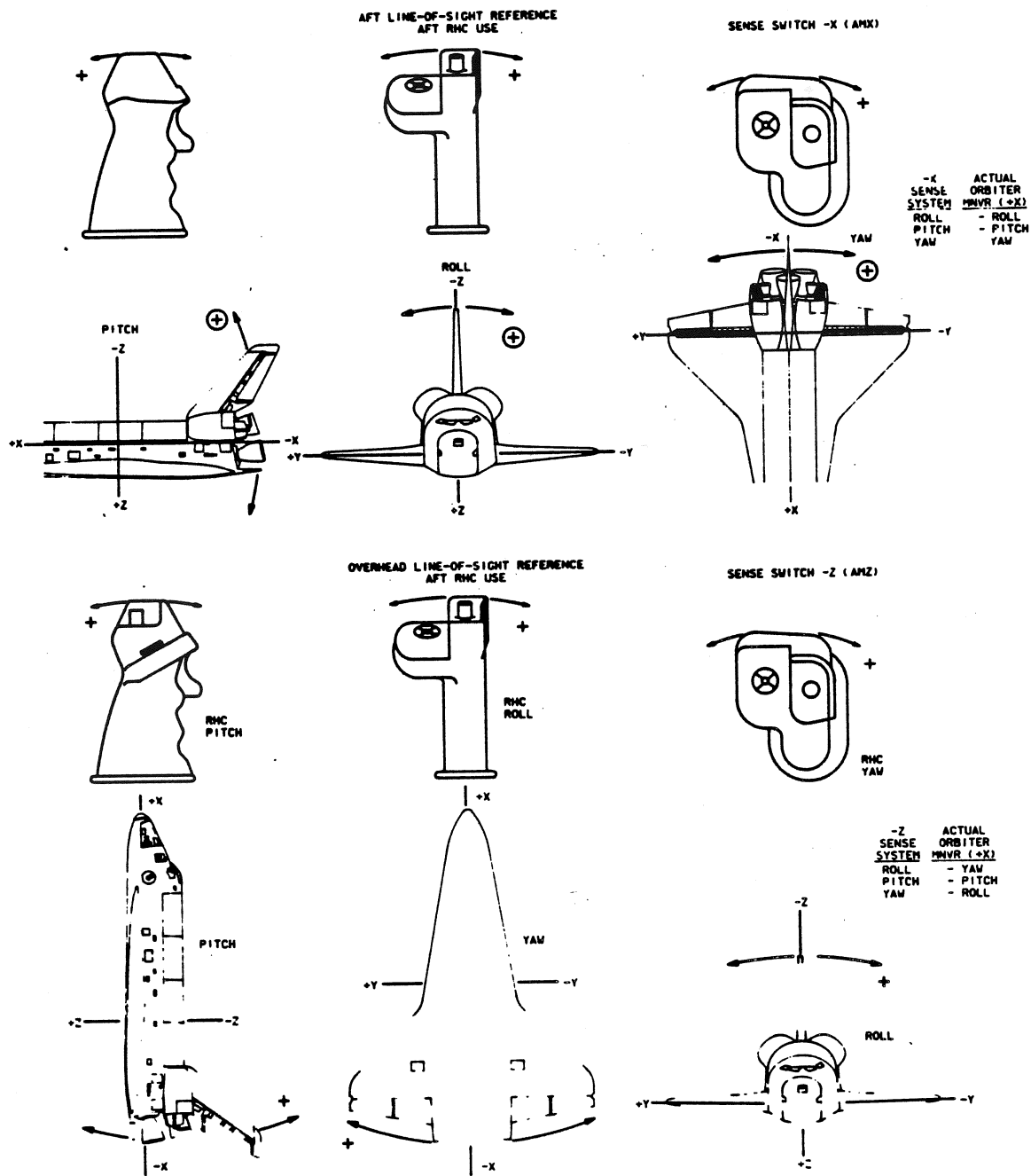

Figure 9-4.- Aft and overhead line-of-sight reference, aft RCS use.

105110094.516a.1

## SECTION 10 COMMON POINTING PROBLEMS

### 10.1 IMU ALIGNMENTS

The Inertial Measurement Units (IMU's) are designed and built to keep reference to inertial space accurately. However, due to physical limitations, they need to be brought back into alignment from time to time. Basically, there are three ways to accomplish this. One way is aligning an IMU or two to another IMU which is known to be in better alignment. The second way is to do a matrix alignment, and the third way is to do a star alignment. The star alignment is the concern of the pointing officer and the subject of this section.

#### 10.1.1 Dual Star Tracker IMU Alignment

The concept here is to find an attitude such that one star tracker will "see" a star and the other tracker will "see" some other star at the same time - a time at which both stars are available and unobscured. The stars to be used are from the 100 navigation star catalog stored in the Orbiter's software (see Appendix A). Since the star tracker's separation angle is fixed ( $87.65^\circ$ ) and star pair separation varies, a limited quantity of star pairs can be used with this technique. The pairs used fall into a "five degree filter," that is, the separation of each star pair must be within plus or minus  $5^\circ$  of the star tracker's separation angle. Also since the stars are "inertially fixed," there are only two possible attitudes for each pair (second attitude reverses stars in trackers). Fortunately, these attitudes are catalogued and appear in Appendix A. The attitudes were computed to split the difference between the tracker's separation angle and each pair's angular separation.

Computer programs exist for the pointing computers, flight design system (FDS), and the mission operations computer (MOC) to aid in the determination of star alignment information. Some of these programs are listed in Appendix B.

#### 10.1.2 Single Star Tracker IMU Alignment

A "single star tracker" star align is usually done when one star tracker is unusable for some reason. It involves maneuvering to an attitude to acquire a star in the usable tracker, usually a dual star tracker attitude, and then maneuvering to another attitude to acquire the second star, using the same tracker. The constraints which apply to the dual star tracker align also apply to the single star tracker align.

## 10.2 "ROLLING" STAR TRACKER IMU ALIGNMENT

The rolling alignment is a technique developed to save propellant and make non-critical alignments generic. It involves initiating a rotation about one of the body axes allowing the trackers to sweep through the celestial sphere picking up stars at random. The rotation can be initiated in any attitude (LVLH or inertial) and will be an LVLH ROTR or inertial ROTR accordingly. The LVLH ROTR requires that the LVLH digital autopilot (DAP) button be pressed, the axis of rotation be freed on the DAP panel (pulse), and the rotation put in with the rotational hand controller (RHC). For the inertial ROTR, it is simply a rotation option on universal pointing. The desired rotation rate is  $0.2^\circ/\text{sec}$ . Vernier control is usually desired and at  $.2^\circ/\text{sec}$ , one complete revolution is made in 30 minutes. Logically, the time to do this type of alignment is during a dark pass when the Sun and higher Earth horizon constraints won't impede star acquisition.

Two stars are needed to do an alignment as in the previous cases, but selection is broader since the stars aren't constrained by the separation of the star trackers plus the  $5^\circ$  filter. Stars in the table with separations between  $35^\circ$  and  $145^\circ$  can be used for an alignment.

A study was done on the probability of picking up stars between  $35^\circ$  and  $145^\circ$  using the LVLH ROTR. The result was 98 percent for both trackers during a dark pass and 92 percent during the day (for the 100 NAV star case during the dark, it was 99 percent plus). In the event that no stars are picked up, the rotation is to be repeated on the succeeding night pass, or a standard alignment is to be made.

## 10.3 STAR PAIRS CUECARD

A star pairs cuecard is two sides of a page in the orbit OPS checklist flight supplement which enables the crew to select a star pair for dual or single IMU star tracker alignment any time during the mission. The pointers develop this card and it is relatively straightforward for the majority of the Shuttle trajectories.

In form, the backside of the card is a graphical representation of various star pairs acquisition times set against a three orbit timescale background (fig. 10-1). This side is designed so that its edge can be placed against the timescale in the Crew Activity Plan (CAP). The time for alignment is chosen and selection made of the star pair whose acquisition time span fits well enough to complete the alignment. The theory of the card is that from the beginning of a mission to the end, the stars rise and set in a regular pattern, orbit to orbit. In reality, the orbit's precession over time, any orbit changes, Sun/Moon/planets movements over time, and tracker star magnitude limitations have to be considered. This complicates the problem, but usually not enough to prevent solution.

**BACKUP STAR PAIRS**

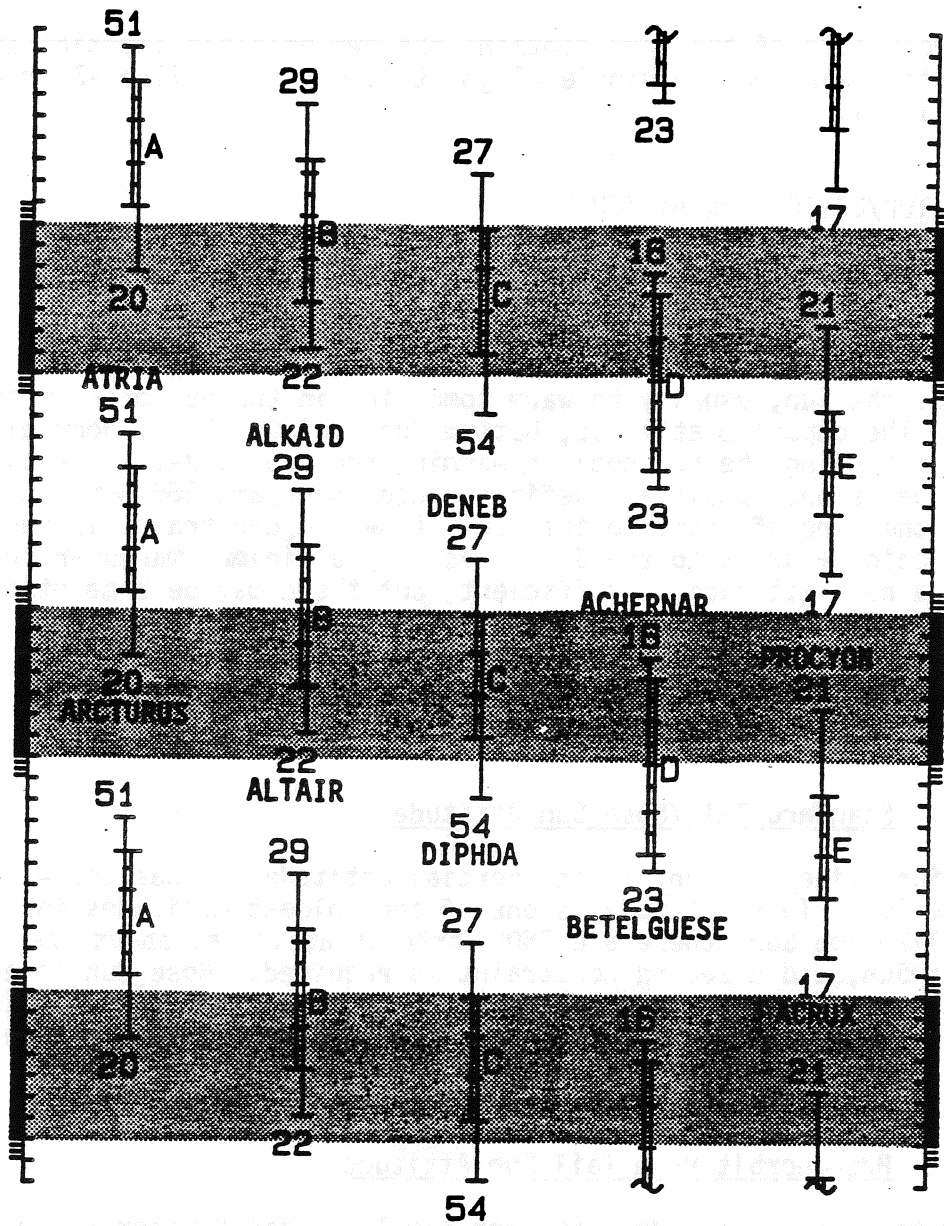

Data Applicable 08/29/83 - 09/05/83

FS 2-3

STS-8/FIN A,1

Figure 10-1.- Back side of star pairs cue card.

Lengthy missions, severe orbit deviation and bad luck of the draw for Sun/Moon/planets in regard to star acquisition are beyond the scope of this book.

The front side of the card contains the two possible inertial attitudes for each star pair and the single align attitudes for failed -Z or -Y trackers (fig. 10-2).

## 10.4 TOP/BOTTOM SUN ATTITUDE

### 10.4.1 Standard Top/Bottom Sun Attitude

Quite simply, top Sun is an inertial attitude which points the -Z body axis towards the Sun, usually to warm something in the bay or keep the underside cold. The opposite attitude, bottom Sun, points the +Z body axis towards the Sun keeping the bay cool or warming the underside. In either case, the attitude is not completely defined since there are 360° worth of attitudes about the line of sight to the Sun. A second constraint is required (the first being + or -Z to the Sun). Usually a minimum maneuver from a previous or to a next attitude is sufficient, but there may be some other constraint which is flight specific (Ku-band, etc.).

## 10.5 TAIL/NOSE SUN ATTITUDE AND TAIL SUN ROTR

### 10.5.1 Standard Tail/Nose Sun Attitude

Tail Sun, like top Sun, is an inertial attitude but has the -X axis pointed at the Sun. This attitude is one of the coldest attitudes for the Orbiter. Also like top Sun, there are 360° worth of attitudes about the line of sight to the Sun, and a second constraint is required. Nose Sun is a semi-cold attitude directed at cooling the aft section of the Orbiter. In some cases, it is desired for warming the nose, particularly the front wheelwell. Constraints are applied to nose Sun as they are for tail Sun.

### 10.5.2 Pre-deorbit Prep Tail Sun Attitude

Prior to entering the deorbit prep timeline, the Orbiter is in a special tail Sun attitude, designed to "cold soak" the radiators and keep the Sun out of the crewmembers' eyes. This is done by selecting a body vector of pitch = 184° and yaw = 0° and pointing it at the Sun. The second constraint is satisfied by an omicron of typically either 90° or 270°. The crew uses these inputs in the track option of universal pointing. The period of tail Sun usually lasts from deorbit minus 5 hours to minus 3 hours 30 minutes.



GNC

PAIR	ANG SEP	BACKUP STAR PAIRS PAD					
		ATT SET 1			ATT SET 2		
		DUAL S TRK		SINGLE S TRK	DUAL S TRK		SINGLE S TRK
A	92.4	R + 21.3 P + 133.3 Y + 338.8 -Y 51 -Z 20	R + 287.2 P + 117.9 Y + 343 -Y 20 -Z 51	R + 111.2 P + 137 Y + 353.6 -Y 20 -Z 51	R + 254.7 P + 296.7 Y + 13.1 -Y 20 -Z 51	R + 161.9 P + 309.1 Y + 22.6 -Y 51 -Z 20	R + 342.5 P + 306.2 Y + 1.3 -Y 51 -Z 20
B	83.8	R + 173.2 P + 33.7 Y + 50.9 -Y 29 -Z 22	R + 77.8 P + 48.6 Y + 40.6 -Y 29 -Z 29	R + 267.4 P + 20.6 Y + 39.6 -Y 22 -Z 29	R + 107.1 P + 227.1 Y + 324.1 -Y 22 -Z 29	R + 16 P + 218.4 Y + 317.4 -Y 29 -Z 22	R + 177.5 P + 202.6 Y + 330.2 -Y 29 -Z 22
C	83.7	R + 73 P + 279.7 Y + 322.1 -Y 54 -Z 27	R + 337.6 P + 263.6 Y + 313.6 -Y 54 -Z 27	R + 152.8 P + 270.3 Y + 334.3 -Y 27 -Z 27	R + 212.7 P + 77.5 Y + 44.1 -Y 27 -Z 54	R + 114.3 P + 97.4 Y + 42.5 -Y 54 -Z 27	R + 298.2 P + 76.1 Y + 15.3 -Y 54 -Z 27
D	82.9	R + 253.1 P + 161.8 Y + 331.8 -Y 23 -Z 16	R + 173.4 P + 173.3 Y + 341.8 -Y 23 -Z 16	R + 343.5 P + 172.6 Y + 320.4 -Y 16 -Z 23	R + 11.2 P + 358.4 Y + 19 -Y 16 -Z 23	R + 292.3 P + 343.7 Y + 23.5 -Y 23 -Z 16	R + 92.2 P + 6 Y + 31.8 -Y 23 -Z 16
E	86.6	R + 268.4 P + 195 Y + 24.5 -Y 21 -Z 17	R + 177 P + 205.3 Y + 36.3 -Y 21 -Z 17	R + 350.5 P + 206.8 Y + 14.9 -Y 17 -Z 21	R + 10.8 P + 31 Y + 324.3 -Y 17 -Z 21	R + 276.2 P + 15.3 Y + 330.9 -Y 21 -Z 17	R + 100.3 P + 37.9 Y + 337.7 -Y 21 -Z 17

Data Applicable 08/29/83 - 09/05/83  
 SINGLE S TRK MIN MNVR OPT  
 TGT ID = 11-60 NAV STAR #  
 BODY VECTOR = 5

	-Z S TRK	-Y S TRK
P	87.7	0
Y	358	280.6

FS 2-2

STS-8/FIN A,1

Figure 10-2.- Front side of star pairs cue card.

### 10.5.3 Tail Sun ROTR

Often referred to as the coldest attitude for the Orbiter payload bay, tail Sun ROTR is a rotating inertial attitude which keeps the -X axis pointed at the Sun while phasing the rotation (about the plus or minus X axis) to keep the bay pointed away from the Earth. This attitude is usually used for vehicle thermal bending tests or to meet specific payload constraints. The Orbiter typically stays in this type of attitude for several hours which allows roll angle error to creep in, an undesirable effect. This occurs because only three decimal places can be input into the discrete rate of the DAP spec while the orbital period rate (which determines the rotation rate) can obviously be more. In most cases, several degrees in roll error are acceptable. The method currently used to minimize the error is to adjust the attitude such that the error is zero at the midpoint of the rotation time, thereby splitting it in half for the beginning and end.

### 10.6 PASSIVE THERMAL CONTROL (PTC)

Passive Thermal Control (PTC) is another inertial attitude rotation (about the plus or minus X axis), but maintains the Sun in the Y, Z plane during rotation. The purpose of PTC is to warm the Orbiter evenly, much like meat being turned on a spit over a fire (consequently the nickname of "barbeque mode" was coined). It is also used for various payloads as thermal constraints may dictate.

In universal pointing, there exists a body vector called "PTC axis" which is a vector pitched down  $2^\circ$  from the +X axis. The theory behind a rotation about this axis is reduced prop consumption. Sometimes this axis is selected instead of +X body axis. Practice has shown that this is insignificant, and the X-axis is almost always used.

### 10.7 GRAVITY GRADIENT (GG)

Gravity gradient for the Shuttle is a supposedly stable attitude(s) which is controlled not by RCS but rather by a combination of balanced differential gravitational and aerodynamic forces on the body. Differential gravitation is nothing more than the effect of gravitational force falling off with the square of the distance from a body, but limited to the physical upper and lower "altitudes" of the Orbiter. It is the center of mass of the Orbiter which defines the "particle" orbit, but the vehicle protrudes above and below the center and is thereby subjected to the differential gravity. The aerodynamic forces mentioned are the forces which affect the vehicle due to motion through the atmosphere at orbital altitudes just as any projectile motion is affected near the ground.

The combined forces are very small and only a few attitudes are known to exist for the Orbiter where the forces are balanced enough to allow stability.

Even the known attitudes are very difficult to establish successfully and will vary according to altitude, inclination, time of year, etc. Gravity gradient is established by maneuvering the vehicle to the GG attitude and turning off the RCS which puts the Orbiter in free drift. The Orbiter should then maintain the attitude with minor fluctuations. The type of attitude which GG approximates is LVLH. A perfect example of this is our own Moon which keeps only one side facing the Earth all the time.

The purpose of GG is typically propellant conservation and the need for no RCS firings during some payload tests and experiments. A more detailed analysis of GG can be found in an informal note numbered CG5-81-88.

## 10.8 KU-BAND AND TURTLES

### 10.8.1 Ku-Band

With the advent of the tracking and data relay satellites, near continuous communication (COMM) has become a reachable goal. However, data can be downlinked in the highest data rates only when the attitude allows the Ku-band antenna to have a line of sight to the TDRS which is unblocked by the Orbiter's body. A given attitude can be evaluated as to whether or not it allows unblocked line of sight and when. Also an attitude may be generated to satisfy a required line of sight problem. To do so requires use of various pointing programs. Part of the problem of knowing when a line of sight is blocked or not depends upon the definition of blockage boundaries. Currently, this blockage demarcation is set at 5° above the Orbiter body as viewed from the Ku-band antenna dish. A chart has been developed to incorporate this blockage. The chart allows graphical analysis when used in conjunction with the pointing programs and is referred to as one of the "turtles" which is the next topic of discussion.

### 10.8.2 Turtles

#### 10.8.2.1 Turtles In General

A turtle is an Orbiter look angle chart which usually has some form of body blockage and/or antenna pattern superimposed on it. The generation concept of the basic pitch-yaw and roll-pitch look angle chart is shown in figures 10-3 through 10-6 (other Euler sequence look angle charts would have a similar development). Blockage, when it is used, is taken from the "point of view" of some point located on the Orbiter or payload in the bay. Each point defined will "see" its spherical field of view blocked by the Orbiter's (and payloads') structure differently from some other point. Consequently, an infinite number of blockage plots could be created. Examples of turtles are included in this section (figs. 10-7, 10-8). It can be seen that some of the resulting blockage patterns give the viewer the impression of a reptilian turtle shell, hence the name "turtles."

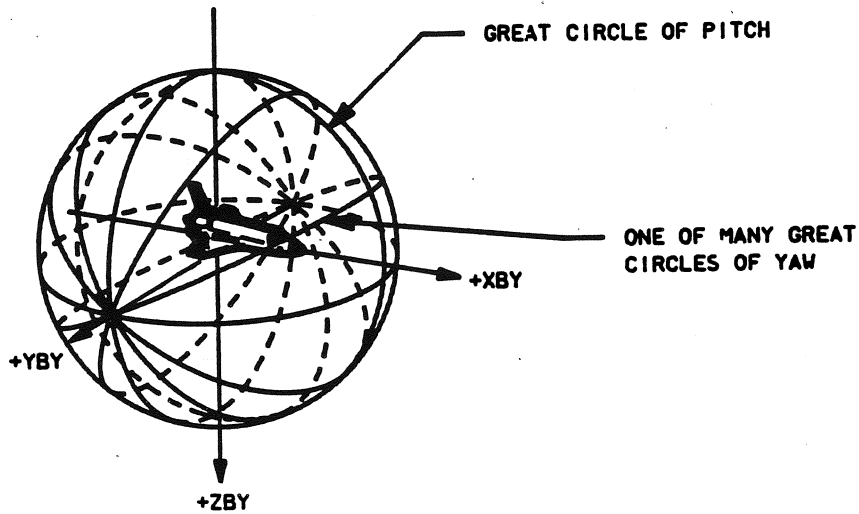

TO BEGIN GENERATION OF THE  
FLAT CHART, THE POLES OF THE  
SPHERE ARE STRETCHED OPEN...

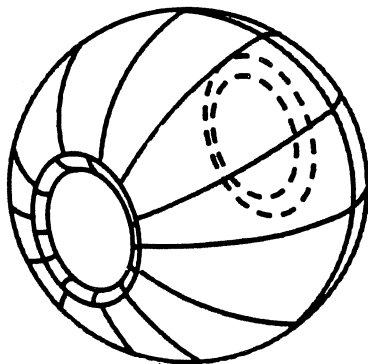

...TO FORM A CYLINDER. NEXT THE  
LINE OF YAW AT PITCH EQUALS 180°  
IS CUT ACROSS. THE CYLINDER IS THEN  
OPENED UP AND LAID FLAT WITH THE  
OUTSIDE FACING THE VIEWER. SEE NEXT  
PAGE.

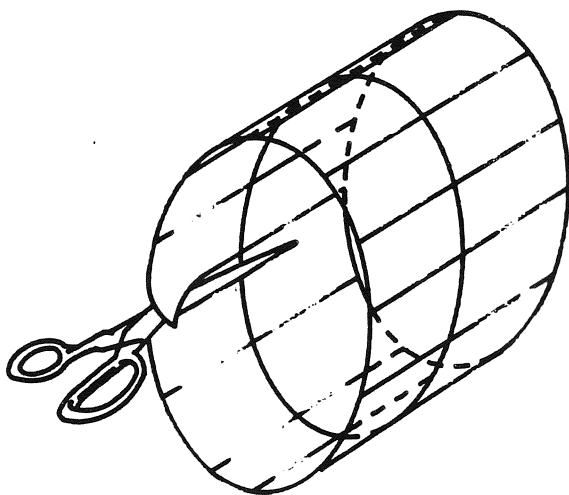

Figure 10-3.- Generation of a pitch/yaw look angle chart.

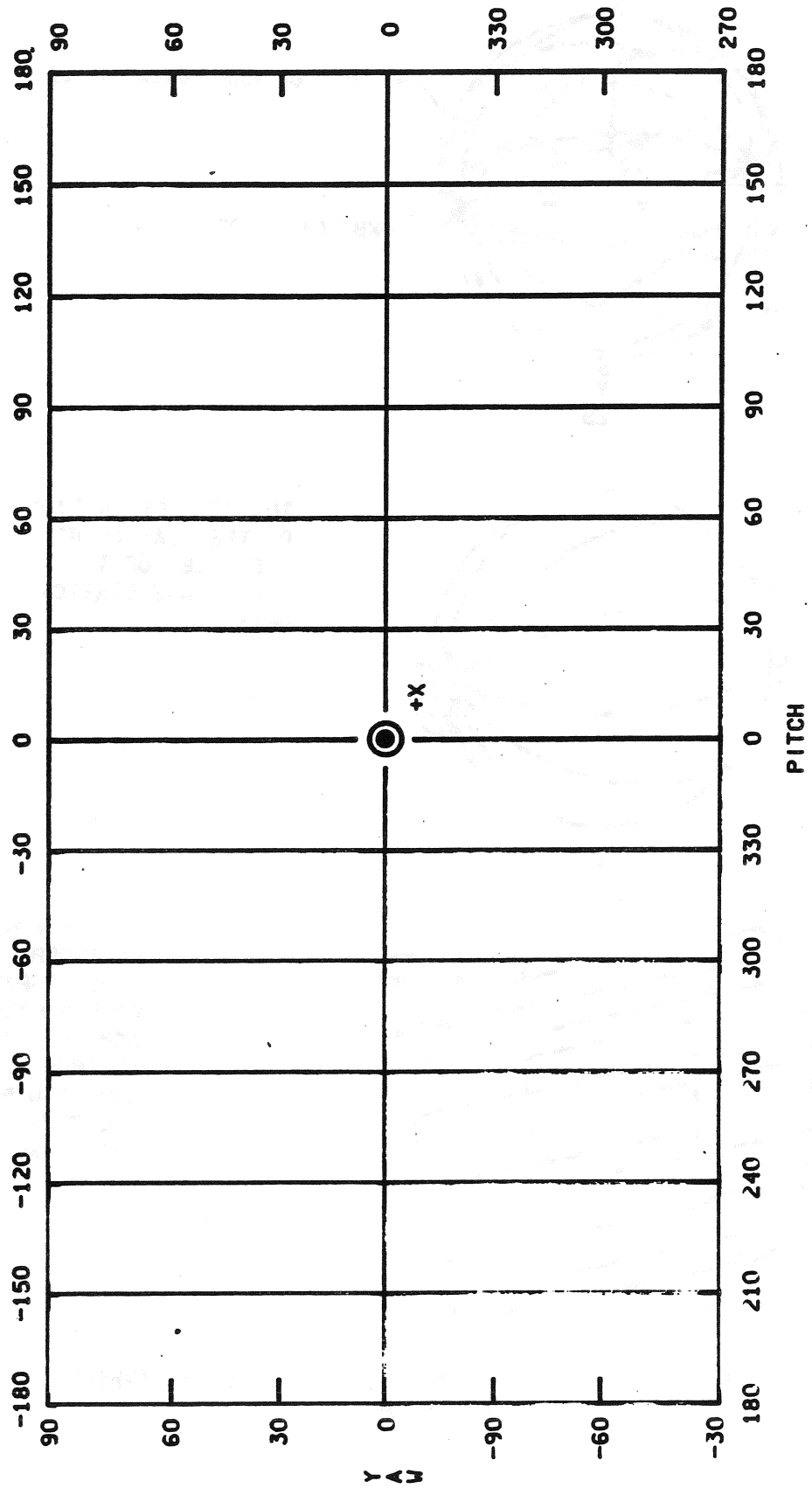
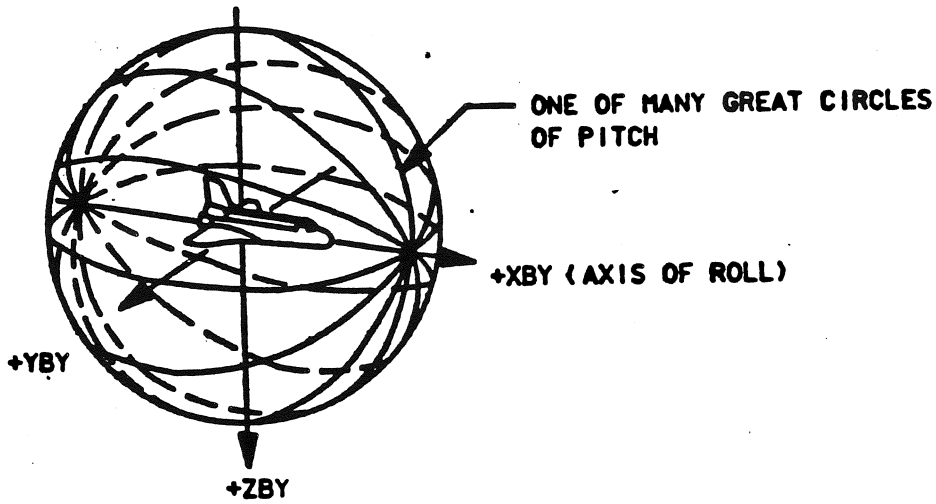
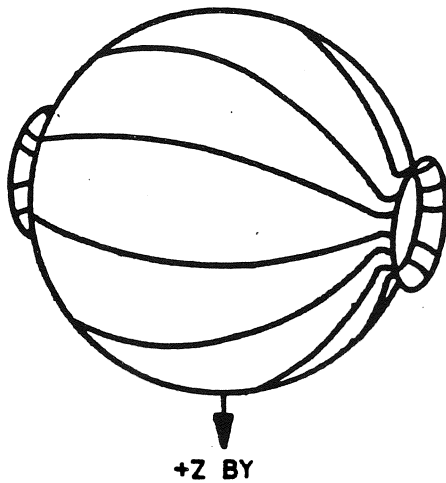

Figure 10-4.- Pitch/yaw chart.

105110104.51E, 1



TO BEGIN GENERATION OF THE FLAT CHART, THE POLES OF THE SPHERE ARE STRETCHED OPEN...



... TO FORM A CYLINDER. NEXT, THE LINE OF PITCH AT ROLL EQUALS  $0^\circ$  IS CUT ACROSS. THE CYLINDER IS THEN OPENED UP AND LAID FLAT WITH THE OUTSIDE FACING THE VIEWER. SEE NEXT PAGE.

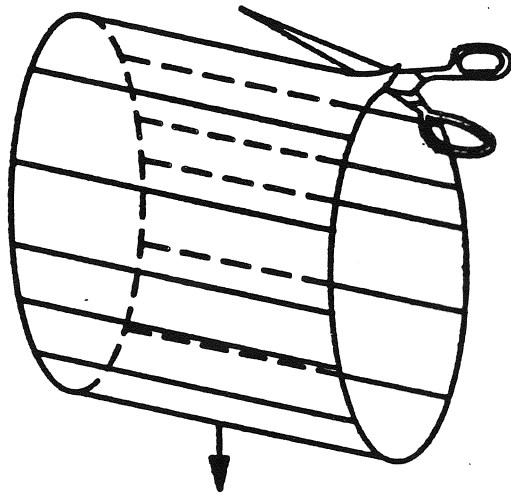

Figure 10-5.- Generation of a roll-pitch (Phi-Theta) look angle chart.

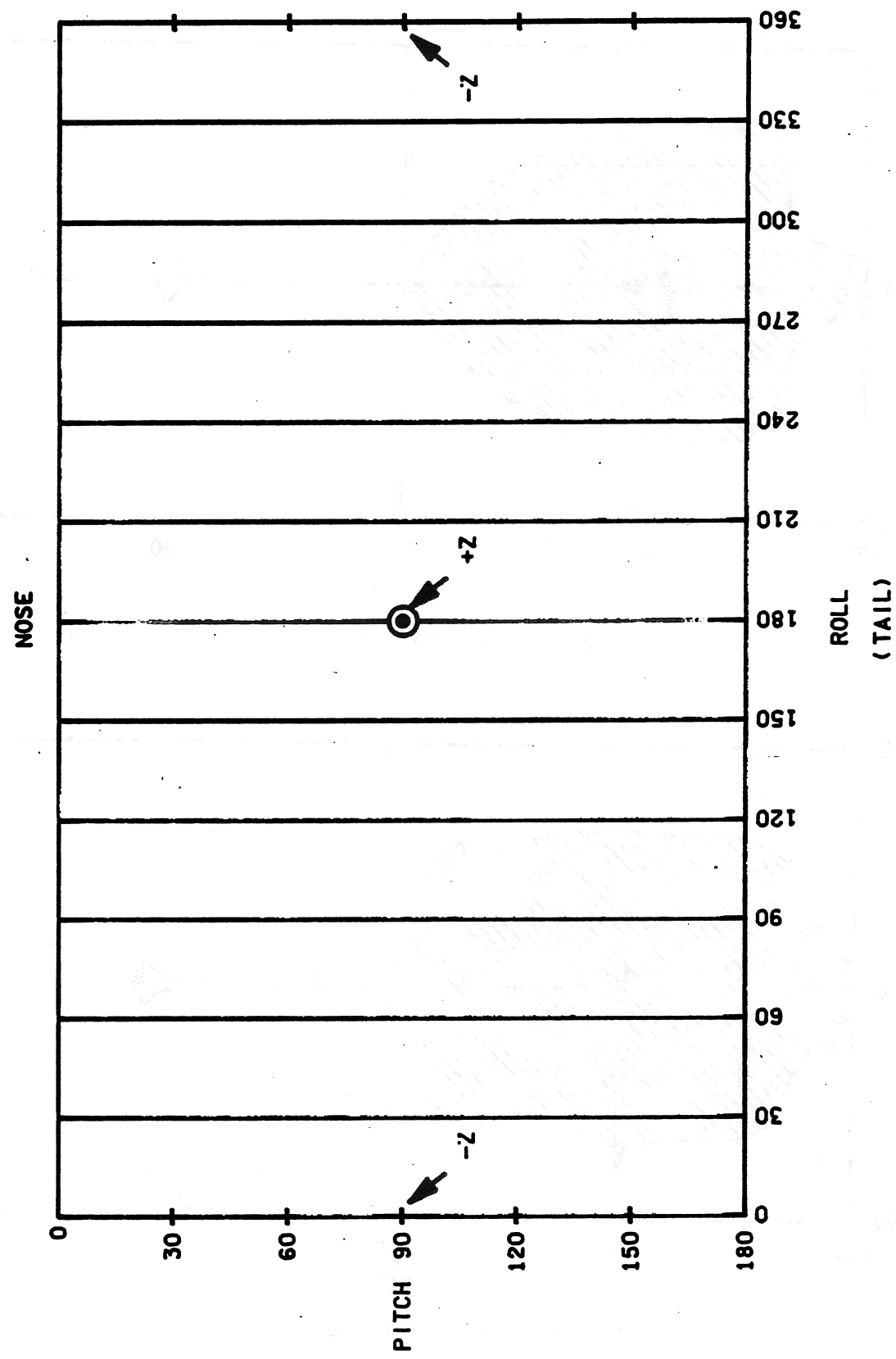

Figure 10-6.- Roll/pitch chart.

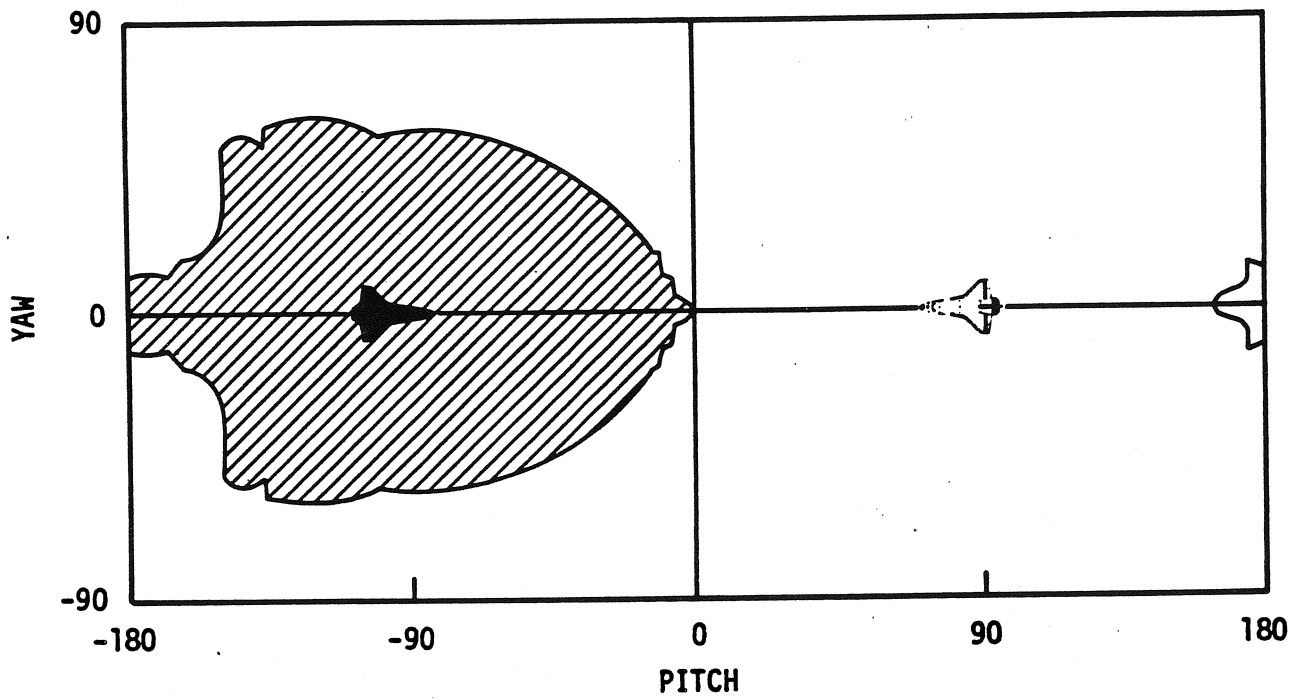

Figure 10-7.- SYNCOM Turtle.

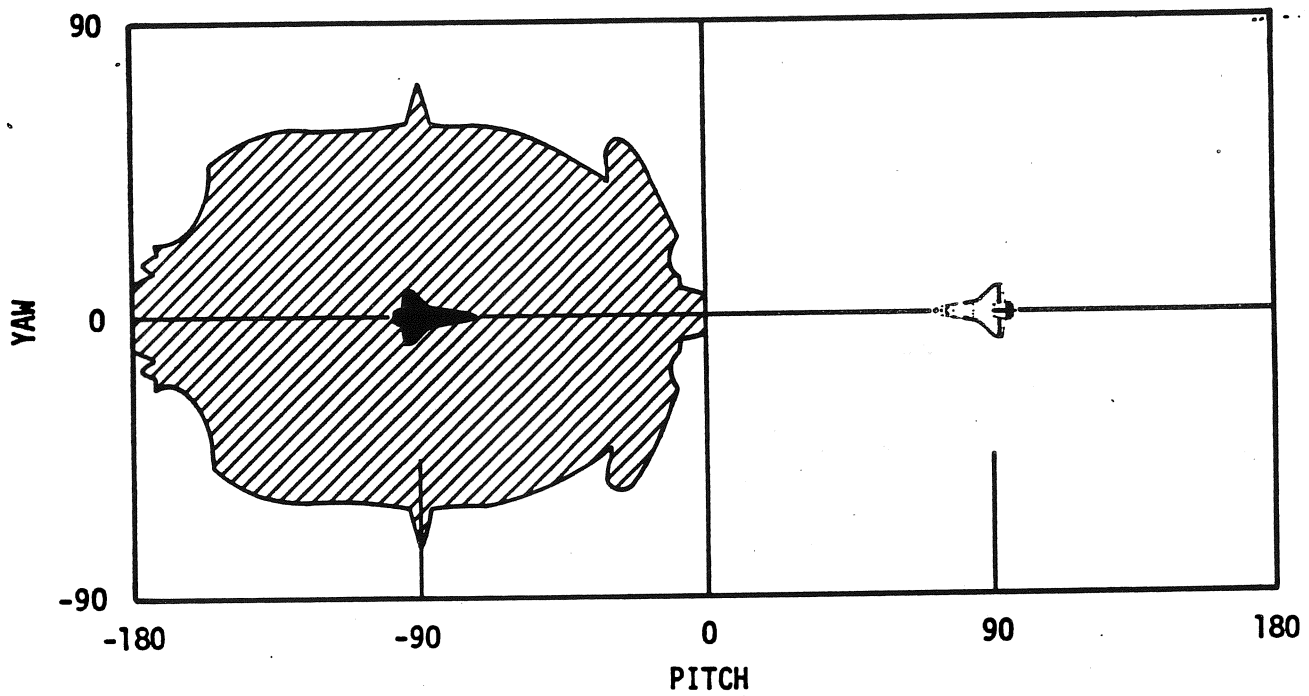

Figure 10-8.- TELSAT Turtle.



The pointing programs use the charts for plotting lines of sight to various targets in various attitudes. This gives the pointer a visual "feel" of where an object is relative to the Orbiter, but more importantly, it gives the time a target comes in or out of the blocked region for a given attitude or maneuver sequence. The importance is realized when payload constraints are brought into play. For example, a portion of the payload may not be able to tolerate Sun exposure so it is necessary to evaluate or find attitudes which will satisfy the constraint.

#### 10.8.2.2 The Ku-Band Turtle

A special blockage chart has been developed for the Ku-band which is used in conjunction with the computer programs to provide high data acquisition and loss times based on current attitude or maneuver in progress. Its "point of view" origin point is the Ku-band radar antenna. As mentioned earlier, the blockage on the chart begins at 5° above the body, but other blockage diagrams may be used. The resulting blockage for Ku-band is shown in figures 10-9 and 10-10. The chart in this case is viewed from the inside out unlike other turtles.

KU-BAND AZIMUTH/ELEVATION LOOK ANGLE FIELD OF VIEW WITH ORBITER BODY BLOCKAGE STARTING AT 5° ABOVE BODY. NOTE DEPLOYED KU-BAND DISH ANTENNA JUST IN FRONT OF STARBOARD DOOR

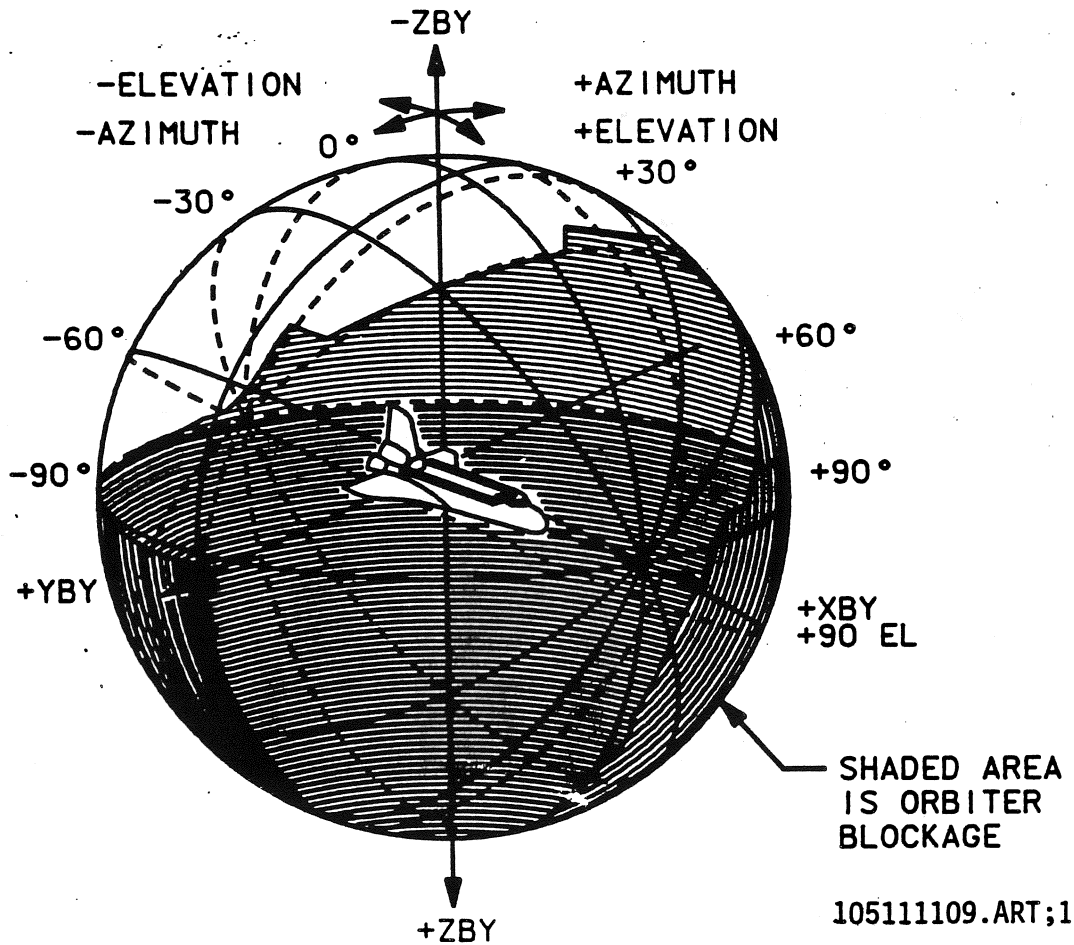

Figure 10-9.- Ku-band antenna obscuration zone.

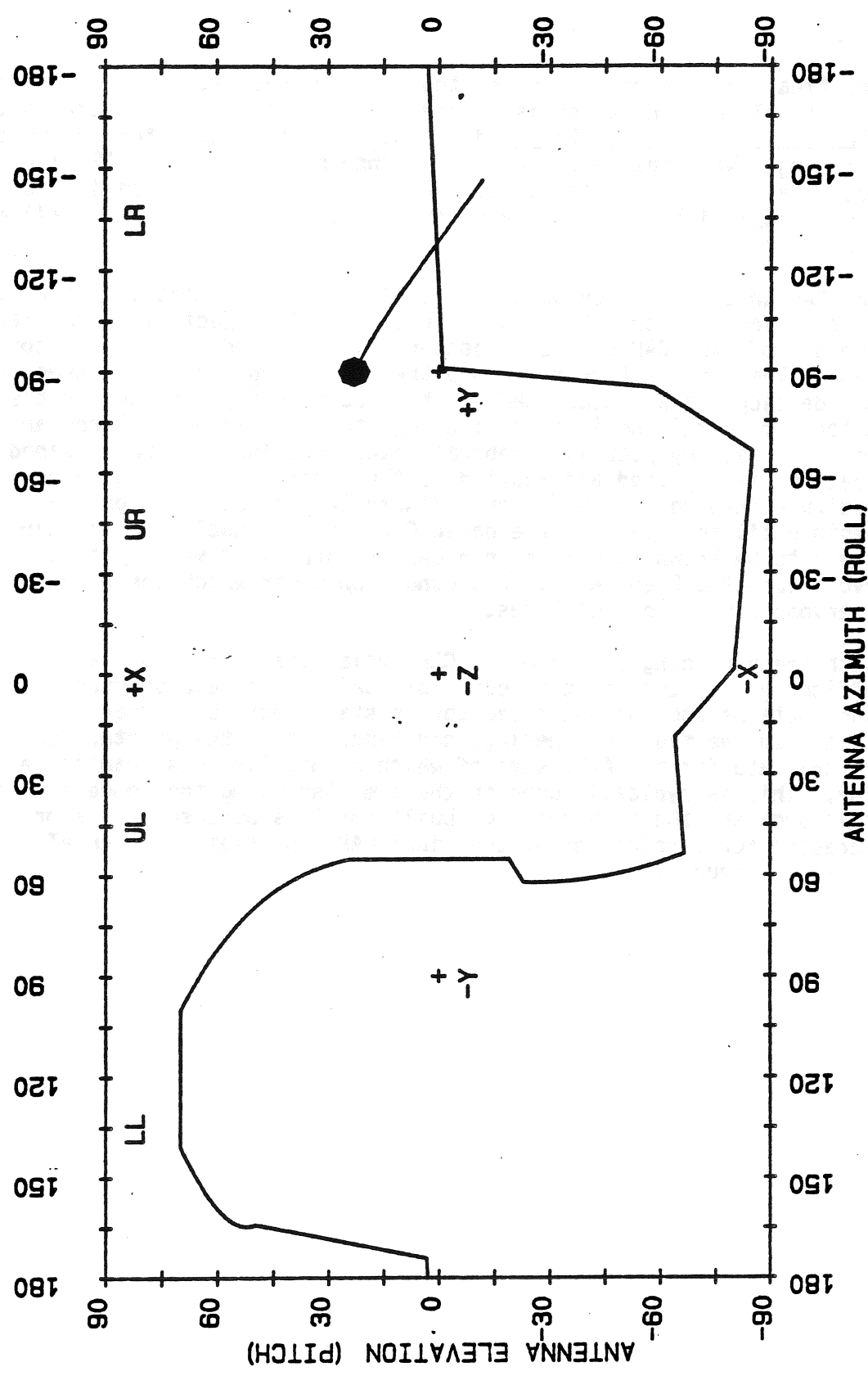

Figure 10-10.- Ku-band blockage chart.

## 10.9 CAP/ATL DEVELOPMENT

The final documented product of the pointer prior to a flight is the attitude timeline (ATL) which is founded on a trajectory and a crew activity plan (CAP). The trajectory and CAP must exist in some form prior to any ATL building. When complete, the ATL is incorporated in the CAP although it is not usually flown. Flights with large numbers of time-critical maneuvers, such as Spacelab flights, may carry an ATL onboard from which all maneuvers are performed.

The CAP undergoes three phases of evolution: preliminary, basic, and final. There is an ATL for the final CAP. A trajectory is generated in support of each CAP by the Trajectory Division and stored on a computer tape. The tape is then read into the CAP's computer. All three phases of CAP development are supported by the lead pointing officer for the flight by attending formal and informal meetings to learn about payloads and their constraints, any peculiar problems, etc. The information obtained from the meetings is digested and applied to ATL generation. Since there is no attitude information in the preliminary CAP, actual data generation doesn't begin until the start of the basic CAP cycle. Usually, everything which needs to be known to finish both CAP and ATL isn't known yet so an ongoing evolution of CAP and ATL is the condition under which the pointer (and everyone else involved) lives.

With the beginning of the basic CAP cycle, the lead flight activities officer gets a copy of the best known CAP to the lead pointer. The pointer then obtains some of the trajectory's state vectors to create a trajectory file. In the midst of meetings and discussions, the pointer generates the actual data for the ATL, some of which eventually gets transcribed into the CAP. This is typically done on the computer using the concepts outlined in this book and the many programs built for this purpose. This process is repeated for development of the final CAP. An example of an ATL page is shown in figure 10-11.

Attitude Timeline

MET	MNVR OPTION		DAP	E/S	REMARKS	EVENT
1 0/01:10:00	TRK TGT=2 BV=3( 90.00, 0.00) OM=100.00	A1 AUTO NORM	DSC 0.200 DB AT 5.00 DB RT 0.20	EARTH 0 90 0 0	LVLH R+100 P+ 0 Y+ 0	-ZLV +XVV
2 0/03:10:00 21:00	MNVR R+ 84.00 P+176.00 Y+338.00	A1 AUTO VERN	DSC 0.200 DB AT 1.00 DB RT 0.02	SUN 0 96 0 163	-ZST:21 -YST:49	IMU/COAS (A1)
3 0/03:59:00 04:11:48 DAP B7	MNVR R+282.50 P+150.00 Y+343.40	A1 AUTO VERN	DSC 0.200 DB AT 1.00 DB RT 0.02	SUN 0 90 0 315		TDRS/ATMOS
4 0/08:45:00 59:41 DAP B6	MNVR R+311.37 P+318.64 Y+ 42.72	A1 AUTO VERN	DSC 0.200 DB AT 1.00 DB RT 0.02	SUN 0 117 0 359		VWFC#1
5 0/09:18:00 30:12 DAP B6	MNVR R+103.97 P+215.62 Y+341.92	A1 AUTO VERN	DSC 0.200 DB AT 1.00 DB RT 0.02	SUN 0 108 0 165		VWFC#2
6 0/11:23:00 34:16	MNVR R+326.00 P+359.00 Y+311.00	A1 AUTO VERN	DSC 0.200 DB AT 1.00 DB RT 0.02	SUN 0 24 0 8		TRIM BURN
7 0/12:00:00 09:08 DAP B6	MNVR R+116.78 P+191.05 Y+331.51	A1 AUTO VERN	DSC 0.200 DB AT 1.00 DB RT 0.02	SUN 0 95 0 139		VWFC#3
8 0/13:00:00 13:56	MNVR R+284.00 P+194.00 Y+ 7.00	A1 AUTO VERN	DSC 0.200 DB AT 1.00 DB RT 0.02	SUN 0 130 0 329	-ZST:43 -YST:15	IMU ALIGN (B2)
9 0/13:29:00 43:10 DAP B6	MNVR R+ 91.63 P+241.13 Y+356.24	A1 AUTO VERN	DSC 0.200 DB AT 1.00 DB RT 0.02	SUN 0 119 0 195		VWFC#4
10 0/14:19:00 27:32 DAP B6	MNVR R+157.82 P+329.47 Y+355.99	A1 AUTO VERN	DSC 0.200 DB AT 1.00 DB RT 0.02	SUN 0 73 0 147		VWFC#5
11 0/16:06:00 09:31 DAP B6	MNVR R+172.99 P+290.84 Y+357.32	A1 AUTO VERN	DSC 0.200 DB AT 1.00 DB RT 0.02	SUN 0 97 0 132		VWFC#6
12 0/17:29:00 42:58 DAP B7	TRK TGT=2 BV=5(177.90, 0.00) OM= 90.00	A1 AUTO VERN	DSC 0.200 DB AT 1.00 DB RT 0.02	EARTH 0 178 0 360	LVLH R+270 P+ 90 Y+358	-XLV -YVV BIASED

CAP/51B/FIN

\*\*\*ALL ATTITUDES IN MEAN OF 1950\*\*\*

Figure 10-11.- Attitude timeline page.

## 10.10 PAM AND FRISBEE DEPLOYMENTS

PAM and frisbee-type deployed spacecraft are spin-stabilized, non-guided vehicles. In order for the Perigee Kick Motor (PKM) to initiate the proper transfer orbit, the Orbiter must orient the spacecraft's spin axis (thrust vector) in the appropriate inertial burn attitude. For PAM deploys, the spin axis is the Orbiter's  $-Z$  axis. For frisbee deploys, the spin axis is the Orbiter's  $+X$  axis. Both types are spring ejected from the payload bay along the  $-Z$  axis.

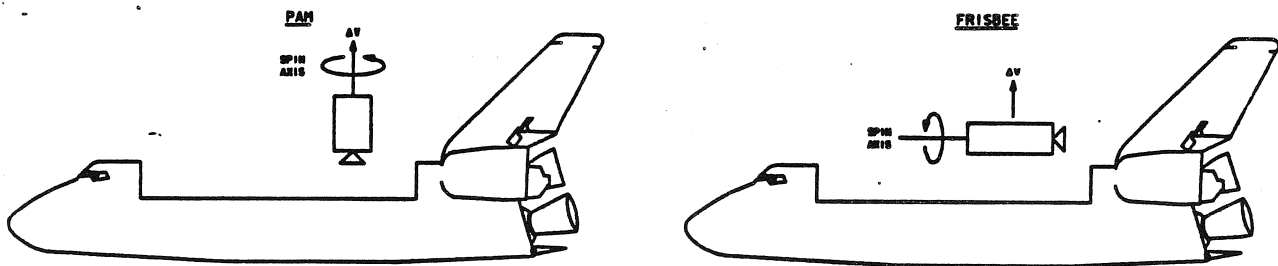

Figure 10-12.- PAM and FRISBEE deploy.

The target vector for the spin axis is determined real time by the flight dynamics officer and the pointer through an iterative computation cycle. The customer provides a Relative Right Ascension, a M50 Declination, and a  $\Delta$ Time (see fig. 10-14). The Relative Right Ascension is added to the M50 Right Ascension of the injection node (the equatorial crossing at which the burn takes place) and with the declination defines the spin axis target. The deploy time is 45 minutes less  $\Delta T$  prior to the injection node. The spring ejection  $\Delta V$  is incorporated into the orbit at that time, and the new orbit propagated to the injection node. The whole process is repeated until the solution converges.

The deploy attitude is determined by aligning the payload spin axis with the spin axis target. For PAM deploys, the secondary constraint points a wing at the Sun to provide maximum shading for the payload. For frisbee deploys, the secondary constraint has the spring  $\Delta V$  in the orbit plane, towards the center of the Earth.

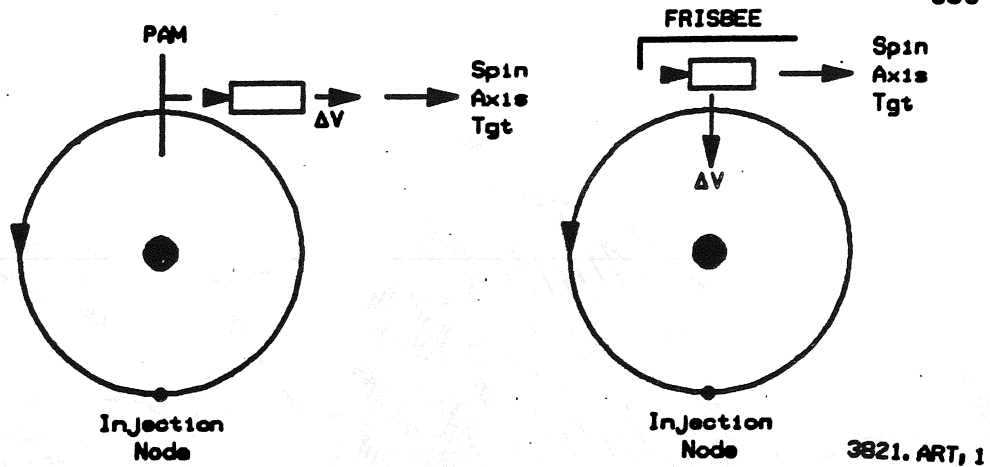
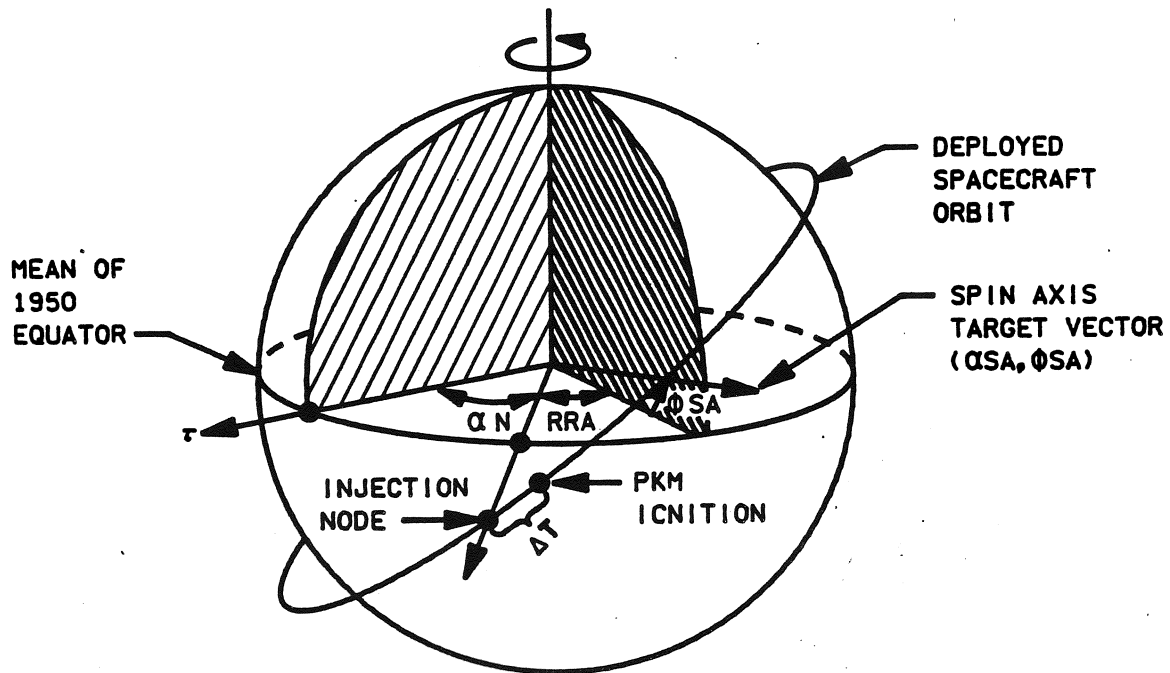

Figure 10-13.- PAM and FRISBEE orientations.

After deploying the satellite, the Orbiter will perform a separation burn to increase the range of PKM ignition to 10 nmi. In order to protect the Orbiter windows from the PKM particle plume, the Orbiter maneuvers to a Window Protect Attitude prior to PKM ignition. This attitude puts the PAM 55° to 70° below the Orbiter's nose at ignition.



- $\tau = M_{50}$  RIGHT ASCENSION=0  
 $\alpha_{SA} = M_{50}$  RIGHT ASCENSION OF SPIN AXIS TARGET  
 $\alpha_N = M_{50}$  RIGHT ASCENSION OF INJECTION NODE (CROSSING OF  $M_{50}$  EQUATOR)  
 RRA = RELATIVE RIGHT ASCENSION  
 $\alpha_{SA} = \alpha_N + RRA$   
 $\phi_{SA} = M_{50}$  DECLINATION OF SPIN AXIS TARGET  
 $\Delta T =$  TIME AFTER  $M_{50}$  NODE OF PKM IGNITION  
 DEFINITION OF TARGETING PARAMETERS: RRA, DEC, AND  $\Delta T$

105111014.51E: 1

Figure 10-14.- Description of targets.

### 10.11 IUS/TDRS DEPLOYS

Inertial Upper Stage (IUS) deploys differ from Payload Assist Module (PAM) type deploys in that the deploy attitude is not the same as the Solid Rocket Motor (SRM-1) attitude. The IUS is a self-maneuvering vehicle with its own stable platform. It is programmed to calculate its own SRM-1 burn attitude and then to maneuver to it. Because of its autonomous nature, our concern is simply to deploy the TDRS/IUS and then safely separate from it.



The deploy attitude in the past was driven by two constraints: first, the Sun could not shine on the payload while in the bay of the Orbiter, and second, the Sun had to be within  $30^\circ$  of the payload -X axis at deploy. The IUS is attached to a tilt table which elevates it from a  $0^\circ$ , or stowed position, to  $29^\circ$  for check out and to  $58^\circ$  for deploy. All inertial attitudes prior to deploy kept the Sun on the belly centerline and deploy itself was defined as a pitch/yaw of  $238^\circ/0^\circ$  to the Sun. MPAD and the flight dynamics officers (FIDO's) used the LVLH equivalent of the inertial attitude to design their separation sequence.

Using a specific inertial attitude for deploy and a separation (SEP) sequence based on its LVLH equivalent caused considerable confusion about what to do with changes in deploy time, early/late Orbital Maneuvering System (OMS) burns, etc. In some cases, inertial attitudes were preserved while in others, LVLH was preserved. It became quite clear a more generic way of doing deploys was needed.

The result of work toward that end was an "any time" deploy sequence. The central idea to this approach is to deploy the payload such that its relative velocity post deploy is purely out of plane. This can be done by tracking the Sun with an omicron of  $90^\circ$  or  $270^\circ$  to point the nose out of plane.

The definition of deploy attitude, then, is

$$\begin{aligned} \text{PITCH} &= -(75 + |\beta|) \\ \text{YAW} &= 0 \\ \text{OMICRON} &= 90 (+\beta) \text{ or } 270 (-\beta) \end{aligned}$$

where the pitch of  $75^\circ$  comes from vector addition (fig. 10-15).

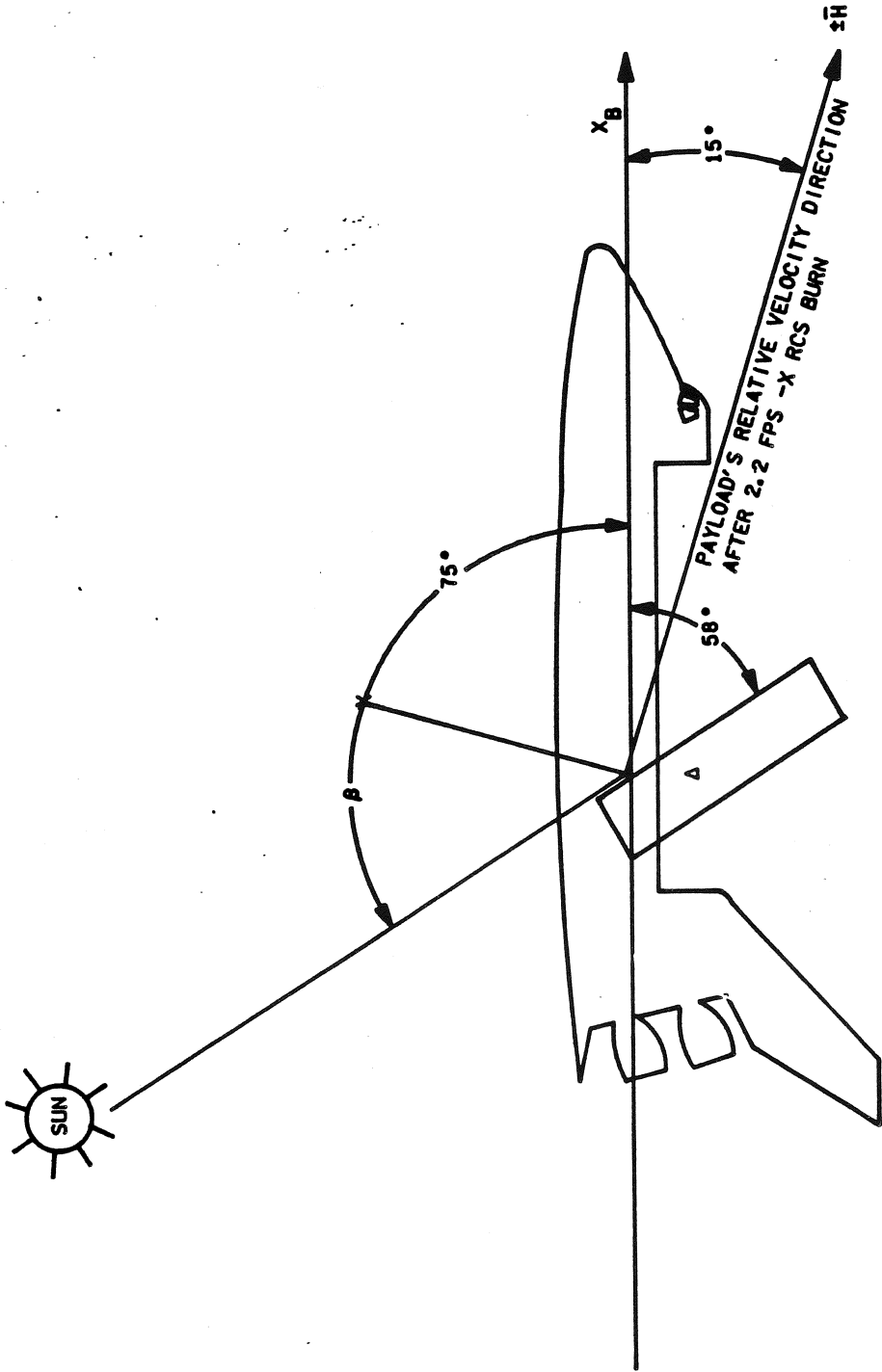

105111012.51E4.1

Figure 10-15.- IUS deploy attitude.

Since the relative motion of the payload is always out of plane regardless of where in the orbit deploy takes place, the FIDO's and MPAD were able to design an LVLH constant SEP sequence.

OMS SEP ATTITUDE

PITCH = 164° to COE  
 YAW = 70°  
 OMNICRON = 270°

LVLH R 90°  
 P 20°  
 Y 16°

VIEWING ATTITUDE

PITCH = 119° to COE  
 YAW = 18.6°  
 OMNICRON = 270°

LVLH R 90°  
 P 71.4°  
 Y 61°

WINDOW PROTECTION

PITCH = 169.9° to COE  
 YAW = 41.0°  
 OMNICRON = 307.7°

LVLH R 56.9°  
 P 61.5°  
 Y 32.3°

Using this method the only variable is the  $\beta$  angle.



SECTION 11  
SOLVING SIMPLE ATTITUDE PROBLEMS

Two simple examples are presented here to help illustrate how pointing problems are solved.

### 11.1 EXAMPLE ONE (MINIMUM MANEUVER)

Given a current Orbiter ADI inertial attitude of roll = 45°, pitch = 0°, and yaw = 90°, find the minimum maneuver attitude to point the -Z star tracker at star 11.

The ADI attitude can be expressed as a cosine matrix [M] where:

$$\begin{matrix} \text{OB} \\ \text{[M]} \\ \text{ADI} \end{matrix} = \begin{bmatrix} 0 & 1 & 0 \\ -.7071 & 0 & .7071 \\ .7071 & 0 & .7071 \end{bmatrix}$$

where OB represents the Orbiter body axes.

The center of the -Z star tracker is defined in the Orbiter body frame as a pitch of 87.73° and a yaw of -1.97°. This can also be expressed as a rotation matrix with a roll equal to zero. The matrix is formed using the same 2, 3, 1 cosine matrix built before. For a pitch of 87.73 and a yaw of -1.97 this will equal:

$$\begin{matrix} \text{-ZST} \\ \text{[-ZST]} \\ \text{OB} \end{matrix} = \begin{bmatrix} .0395 & -.0343 & -.998 \\ .00135 & .999 & -.0342 \\ .999 & 0 & .0396 \end{bmatrix}$$

Star 11 has a right ascension of 100.7° and a declination of -16.65°. As was shown before, this can be converted to a unit vector in the mean of 1950 frame by:

$$\begin{aligned} U_x &= \cos(\text{DEC}) \cos(\text{RA}) = -0.1778 \\ U_y &= \cos(\text{DEC}) \sin(\text{RA}) = 0.9414 \\ U_z &= \sin(\text{DEC}) = -.2865 \end{aligned} \quad \text{or} \quad \begin{aligned} \text{Pitch} &= -58.1^\circ \\ \text{Yaw} &= -70.3^\circ \end{aligned}$$

and into a 2,3,1 cosine matrix equal to:

$$\begin{matrix} \text{STAR} \\ \text{[U]} \\ \text{M50} \end{matrix} = \begin{bmatrix} .1781 & -.9414 & .2861 \\ .4975 & .3370 & .7992 \\ -.8489 & 0 & .5284 \end{bmatrix}$$

In addition, the constant rotation matrix relating the ADI and M50 reference frames is

$$[M]_{\text{ADI}}^{\text{OB}} = [M]_{\text{M50}}^{\text{OB}} [R]_{\text{ADI}}^{\text{M50}}$$

where [R] is the RELMAT which, currently at JSC, is defined as

$$[R]_{\text{ADI}}^{\text{M50}} = \begin{bmatrix} 1 & 0 & 0 \\ 0 & 1 & 0 \\ 0 & 0 & 1 \end{bmatrix} \text{ and } [M] \text{ is}$$

the current vehicle attitude.

Solving for the current attitude in M50 yields

$$[M]_{\text{M50}}^{\text{OB}} = [M]_{\text{ADI}}^{\text{OB}} [RT]_{\text{M50}}^{\text{ADI}}$$

The position of the -Z star tracker in M50 can be expressed as

$$[P]_{\text{M50}}^{-\text{ZST}} = [-\text{ZST}]_{\text{OB}} [M]_{\text{M50}}^{\text{OB}}$$

and so  $[P]_{\text{M50}}^{-\text{ZST}} = [-\text{ZST}]_{\text{OB}} [M]_{\text{ADI}}^{\text{OB}} [RT]_{\text{M50}}^{\text{ADI}}$

We can express the separation between the -ZST and the star with a matrix [N] where:

$$[U]_{\text{M50}}^{\text{STAR}} = [N]_{\text{-ZST}}^{\text{STAR}} [P]_{\text{M50}}^{-\text{ZST}}$$

so  $[N]_{\text{-ZST}}^{\text{STAR}} = [U]_{\text{M50}}^{\text{STAR}} [PT]_{\text{-ZST}}^{\text{M50}}$

substituting for [P] we get

$$[N]_{\text{-ZST}}^{\text{STAR}} = [U]_{\text{M50}}^{\text{STAR}} [R]_{\text{ADI}}^{\text{M50}} [MT]_{\text{OB}}^{\text{ADI}} [-\text{ZSTT}]_{\text{-ZST}}^{\text{OB}}$$

We want to change the vehicle attitude [M] such that the -ZST is looking at the star. This means that the reference frames locating the -ZST and the star will be aligned, or

$$[N] \begin{matrix} \text{STAR} \\ -ZST \end{matrix} = [I]$$

If we define [N] as identically [I] we can solve for the new vehicle attitude directly by

$$[I] \begin{matrix} \text{STAR} \\ -ZST \end{matrix} = [U] \begin{matrix} \text{STAR} \\ \text{M50} \end{matrix} [R] \begin{matrix} \text{M50} \\ \text{ADI} \end{matrix} [M1T] \begin{matrix} \text{ADI} \\ \text{OB} \end{matrix} [-ZSTT] \begin{matrix} \text{OB} \\ -ZST \end{matrix}$$

where [M1] is the new vehicle attitude.

Solving for [M1] we get

$$[M1] \begin{matrix} \text{OB} \\ \text{ADI} \end{matrix} = [-ZSTT] \begin{matrix} \text{OB} \\ -ZST \end{matrix} [I] \begin{matrix} -ZST \\ \text{STAR} \end{matrix} [U] \begin{matrix} \text{STAR} \\ \text{M50} \end{matrix} [R] \begin{matrix} \text{M50} \\ \text{ADI} \end{matrix}$$

Notice that the only variables are [U] and [-ZST]. The attitude that will point any instrument at any stellar target can be found simply by substituting in the appropriate values for [U] and [-ZST].

$$[M1] \text{ when multiplied out equals: } \begin{bmatrix} .603 & .371 & .706 \\ .765 & .015 & .644 \\ .229 & -.928 & .293 \end{bmatrix} \begin{matrix} \text{OB} \\ \\ \text{ADI} \end{matrix}$$

Since the matrix elements represent the products and sums of the sine and cosine functions in the 2,3,1 matrix discussed in section 1.1, we can solve for the attitude of the Orbiter as 89.1°, 310.5°, and 21.8° in roll, pitch, and yaw. From the initial and final attitude cosine matrices, the Eigen vector and angle can be obtained.

$$\begin{aligned} \text{Eigen angle} &= 68.4^\circ \\ \text{Eigen axis} &= \text{pitch } 204.2^\circ \\ &\quad \text{yaw } -85.6^\circ \end{aligned}$$

Although this example was worked using cosine matrices, it also could have been done using quaternions.

## 11.2 EXAMPLE TWO (TAIL SUN)

In the case of a contingency deorbit, the crew needs the capability onboard to compute a tail Sun attitude for entry. Thus, a computer program needs to be written that, for a given day of the year, will output a M50 inertial attitude that points an Orbiter body vector of pitch =  $185^\circ$ , yaw =  $0^\circ$  to the Sun. This tail Sun attitude could soak the radiators for entry. A discussion of this problem follows.

When the Orbiter is in a roll =  $0^\circ$ , pitch =  $0^\circ$ , yaw =  $0^\circ$  M50 inertial attitude its position relative to the celestial sphere is as shown in figure 11-1.

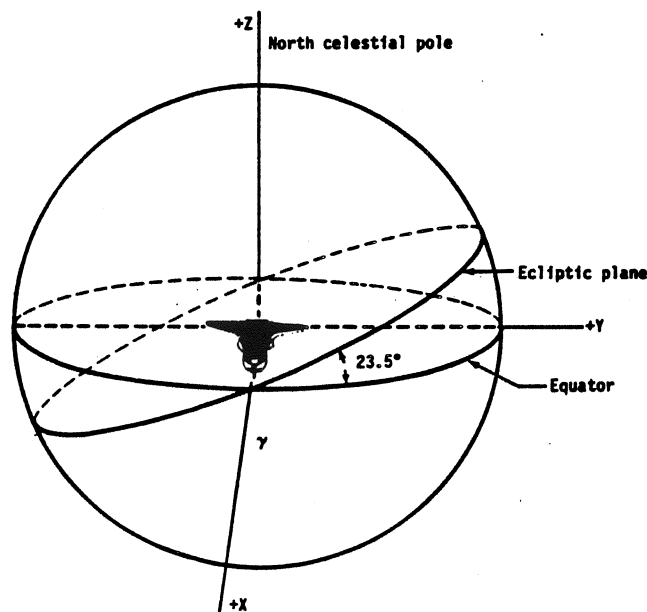

Figure 11-1.- Orbiter null orientation.

The Orbiter's nose points at the vernal equinox and the +Z body axis points at the celestial North Pole. To simplify this problem, the Orbiter is first rolled a positive  $23\frac{1}{2}^\circ$  in order to align the plane of the wings with the ecliptic plane (fig. 11-2).



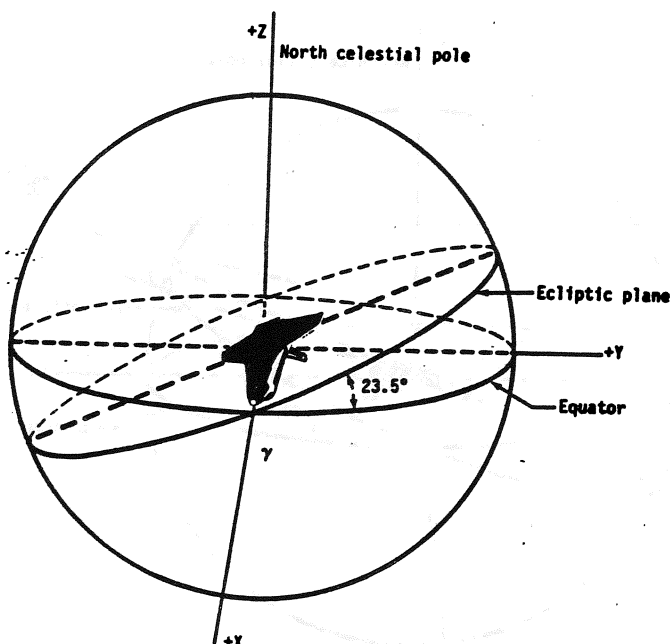

Figure 11-2.- Orbiter with 23-1/2° roll.

Now, a simple yaw maneuver is all that is required to point the tail of the Orbiter at any Sun position. To determine the necessary yaw angle, an expression must be derived which, for a given day of the year, will give the angle along the ecliptic plane from the vernal equinox to the Sun. This expression follows

$$\theta = \left[ \left( \frac{(DOY + 284) \text{ MOD } 365}{365.25} \right) 360^\circ + 175^\circ \right] \text{ MOD } 360^\circ$$

DOY stands for day of year. The number 284 is the number of days in a year (365) minus the day of the vernal equinox (day 81). Note that by adding 175° to the Sun angle, the Orbiter's tail will be pointed to within 5° of the Sun when a maneuver of yaw =  $\theta$  is done. This yaw bias sets up for a positive roll of 90° which puts the Sun on the belly of the Orbiter. This final rotation achieves the desired tail Sun orientation (figs. 11-3 and 11-4).

\*One thing that has to be taken into account at this point is the fact that the Sun does not move along the ecliptic plane in a uniform manner due to the eccentricity of the Earth's orbit. Thus, a fudge factor can be added to the 175° to compensate for this fact and the equation for  $\theta$  becomes

$$\theta = \left[ \left( \frac{(DOY + 284) \text{ MOD } 365}{365.25} \right) 360^\circ + 173^\circ \right] \text{ MOD } 360^\circ$$

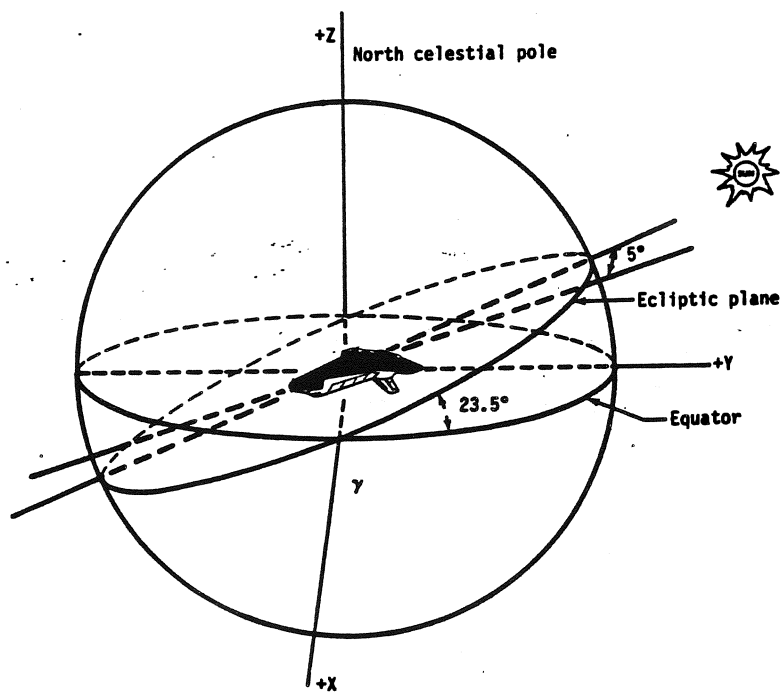

Figure 11-3.- Yaw to within  $5^{\circ}$  of Sun.

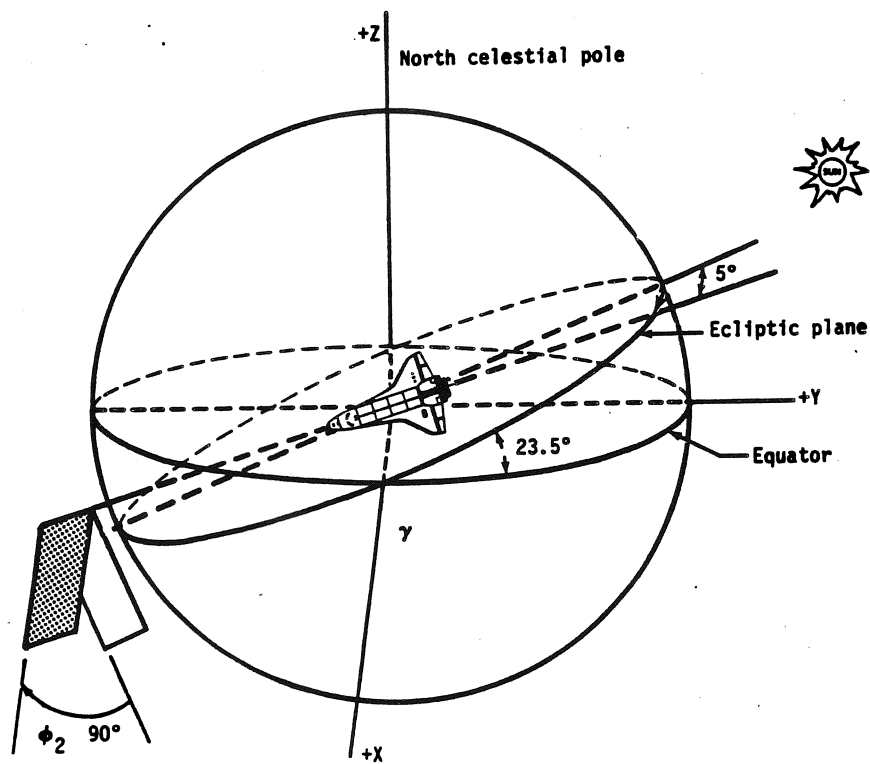

Figure 11-4.- Roll  $90^{\circ}$ .

Thus, three rotations,  $\phi_1$ ,  $\theta$ ,  $\phi_2$  in a roll, yaw, roll sequence will provide the required inertial orientation for the tail Sun attitude. Now, the direction cosine matrix for a roll, yaw, roll sequence is

$$R(\phi_1, \theta, \phi_2) = \begin{bmatrix} \cos\theta & \cos\phi_1 \sin\theta & \sin\phi_1 \sin\theta \\ -\sin\theta \cos\phi_2 & \cos\phi_1 \cos\theta \cos\phi_2 & \sin\phi_1 \cos\theta \cos\phi_2 \\ \sin\theta \sin\phi_2 & -\cos\phi_1 \cos\theta \sin\phi_2 & -\sin\phi_1 \cos\theta \sin\phi_2 \\ -\sin\phi_1 \sin\phi_2 & -\sin\phi_1 \cos\phi_2 & +\cos\phi_1 \cos\phi_2 \end{bmatrix}$$

To extract the roll, pitch, yaw values (in a pitch, yaw, roll sequence) the following equations can be used

$$R = \tan^{-1}\left(\frac{-M_{32}}{M_{22}}\right)$$

$$P = \tan^{-1}\left(\frac{-M_{13}}{M_{11}}\right)$$

$$Y = \tan^{-1}\left(\frac{-M_{12}}{\sqrt{1 - M_{12}^2}}\right)$$

These equations give roll, pitch, yaw values for the tail Sun attitude, but they do not take into account which quadrants the angular values are in. A discussion of the logic which determines quadrant locations is beyond the scope of this text.

There are several methods which could have been used to solve the tail Sun problem. The method chosen is perhaps not the easiest, but it works and the logic of this solution can be translated into a useful computer program.



APPENDIX A

STARS

CELESTIAL TARGET ID	NAME	RIGHT ASCENSION	DECLINATION (+/-)	MAG	S20
C011	SIRIUS	100.7316	-16.6562	-1.43	3.150
C012	CANOPUS	95.7107	-52.6676	-0.75	1.500
C013	RIGEL	78.0333	-8.2581	0.13	0.861
C014	VEGA	278.8134	38.7382	0.03	0.803
C015	HADAR	210.0684	-60.1330	0.59	0.745
C016	ACHERNAR	23.9647	-57.4905	0.47	0.691
C017	ACRUX	185.9523	-62.8221	0.83	0.667
C018	CAPELLA	78.2489	45.9459	0.08	0.514
C019	SPICA	200.6384	-10.9014	0.97	0.513
C020	ARCTURUS	213.3353	19.4253	-0.05	0.488
C021	PROCYON	114.1654	5.3459	0.37	0.477
C022	ALTAIR	297.0903	8.7379	0.76	0.369
C023	BETELGEUSE	88.1161	7.3995	0.42	0.308
C024	BELLATRIX	80.6121	6.3060	1.64	0.274
C025	REGULUS	151.4258	12.2122	1.35	0.269
C026	FOMALHAUT	343.7260	-29.8891	1.16	0.267
C027	DENEK	309.9313	45.1008	1.25	0.254
C028	AL NA'IR	331.2740	-47.2054	1.74	0.205
C029	ALKAID	206.3914	49.5621	1.86	0.197
C030	ANTARES	246.5840	-26.3230	0.91	0.193
C031	CASTOR	112.8513	31.9985	1.58	0.191
C032	ALDEBARAN	68.2627	16.4087	0.86	0.191
C033	PEACOCK	305.4260	-56.8980	1.94	0.188
C034	MIAPLACIDUS	138.1618	-69.5103	1.68	0.187
C035	NUNKI	283.0414	-26.3613	2.03	0.183
C036	KAUS AUSTRALIS	275.2130	-34.4114	1.85	0.158
C037	ALPHERATZ	1.4504	28.8131	2.06	0.148
C038	NAVI	13.4184	60.4464	2.39	0.146
C039	ALHENA	98.7062	16.4432	1.92	0.137
C040	MIRFAK	50.1854	49.6848	1.79	0.116
C041	DENEbola	176.6233	14.8507	2.14	0.112
C042	ALPHECCA	233.1436	26.8808	2.24	0.110
C043	RASALHAGUE	263.1539	12.5931	2.07	0.109
C044	MERAK	164.7108	56.6511	2.37	0.096
C045	POLARIS	27.2247	89.0289	2.02	0.096
C046	PHECDA	177.8039	53.9728	2.44	0.090
C047	GIENAH	183.3065	-17.2643	2.58	0.089
C048	ZUBENESCHEMALI	228.5770	-9.2000	2.61	0.087
C049	KOCHAB	222.7061	74.3598	2.08	0.063
C050	AVIOR	125.3720	-59.3480	1.86	0.076
C051	ATRIA	250.8380	-68.9395	1.92	0.074
C052	HAMAL	31.0888	23.2257	2.00	0.072
C053	MENKENT	210.9275	-36.1293	2.06	0.071
C054	DIPHDA	10.2720	-18.2605	2.02	0.070
C055	ALPHARD	141.2824	-8.4406	1.97	0.068
C056	AL SUHAIL	136.5385	-43.2299	2.21	0.054
C057	ACAMAR	44.0906	-40.5039	2.91	0.054
C058	DENEK ALGEDI	326.0731	-16.3579	2.83	0.050
C059	SCHEAT	345.3384	27.8123	2.42	0.047
C060	ENIF	325.4323	9.6447	2.39	0.046

CELESTIAL TARGET ID	NAME	RIGHT ASCENSION	DECLINATION (+/-)	MAG	S20
C061	ALNILAM	83.4188	-1.2322	1.69	0.256
C062	EL NATH	80.7827	28.5657	1.65	0.218
C063	NAOS	120.4563	-39.8613	2.25	0.196
C064	SAIPH	86.3458	-9.6858	2.05	0.177
C065	ALIOTH	192.9605	56.2308	1.77	0.164
C066	MENKALINAN	88.9644	44.9447	1.90	0.139
C067	ETA CENTAURI	218.0800	-41.9397	2.31	0.132
C068	KAPPA SCORPII	264.7561	-39.0066	2.41	0.130
C069	ALGOL	46.2267	40.7644	2.12	0.129
C070	MUHLIFAIN	189.6846	-48.6857	2.17	0.117
C071	ZETA CENTAURI	208.1013	-47.0435	2.55	0.112
C072	ALUDRA	110.5292	-29.2044	2.44	0.109
C073	ACRAB	240.6311	-19.6705	2.63	0.106
C074	THETA CARINAE	160.2917	-64.1319	2.76	0.102
C075	ZETA OPHIUCHI	248.6005	-10.4673	2.56	0.097
C076	ALPHA MUSCAE	188.5443	-68.8604	2.71	0.094
C077	ALGENIB	2.6642	14.9055	2.84	0.090
C078	GAMMA LUPI	232.9499	-41.0005	2.78	0.089
C079	MARKAB	345.5676	14.9355	2.48	0.086
C080	EPSILON PERSEI	58.6232	39.8670	2.89	0.085
C081	PHACT	84.4592	-34.1000	2.64	0.084
C082	SABIK	256.8773	-15.6640	2.42	0.083
C083	THETA AURIGAE	89.0784	37.2104	2.62	0.080
C084	ALPHA ARAE	261.9925	-49.8396	2.95	0.076
C085	MU SCORPII	252.1195	-37.9639	3.03	0.076
C086	ALDERAMIN	319.3493	62.3737	2.45	0.076
C087	ZOZCA	167.8642	20.7966	2.56	0.071
C088	ZETA CAN. MAJ.	94.5983	-30.0400	3.02	0.070
C089	ARNEB	82.6308	-17.8567	2.57	0.067
C090	ZETA PERSEI	57.7460	31.7366	2.85	0.065
C091	ALPHIRK	322.0061	70.3412	3.23	0.065
C092	MIRACH	16.7330	35.3552	2.05	0.065
C093	ICEN	199.4411	-36.4499	2.73	0.064
C094	COR CAROLI	193.4204	38.5885	2.89	0.064
C095	BETA GRUIS	339.9241	-47.1467	2.11	0.063
C096	DELTA CYGNI	295.8530	45.0081	2.87	0.061
C097	ALMACH	30.2055	42.0904	2.10	0.060
C098	ZUBENELGENUBI	222.0262	-15.8359	2.75	0.060
C099	GAMMA GRUIS	327.7277	-37.6012	3.01	0.059
C100	GAMMA TRI. AUS.	228.5511	-68.4972	2.89	0.058
C101	IZAR	220.7003	27.2840	2.70	0.056
C102	ELTAMIN	268.8607	51.4937	2.22	0.055
C103	ARICH	189.7765	-1.1756	2.74	0.054
C104	ZETA AQUILAE	285.7778	13.7867	2.99	0.054
C105	EPSILON CYGNI	311.0502	33.7846	2.46	0.051
C106	ANKAA	5.9564	-42.5808	2.40	0.051
C107	RHO PUPPIS	121.3526	-24.1585	2.81	0.047
C108	BETA TRIANGULI	31.6419	34.7513	2.80	0.046
C109	PI SAGITTARII	286.6975	-21.1053	2.88	0.046
C110	ZETA HERCULIS	249.8454	31.6954	2.81	0.046

M50 SPLIT DIFFERENCE IMU ALIGN ATTITUDES (50 NAV STARS)

PAIR				-Z ST: Star 1			-Z ST: Star 2		
	Star1	Star2	Sep	R	P	Y	R	P	Y
1	11	15	84.8	73.7	37.6	0.7	198.3	201.8	7.7
2	11	44	90.5	102.8	160.6	346.4	172.2	329.8	28.2
3	11	51	91.8	70.6	20.7	6.0	199.9	184.6	1.7
4	11	54	85.3	95.1	296.1	22.1	172.9	104.6	351.8
5	12	19	90.2	72.6	71.3	311.6	219.9	224.1	53.6
6	12	31	86.0	144.9	175.6	352.6	125.3	358.7	25.0
7	13	17	90.6	91.1	37.2	347.5	184.4	203.6	24.8
8	13	26	89.6	76.6	311.9	0.4	195.6	116.5	8.7
9	13	38	85.2	92.4	218.0	17.0	176.4	25.9	356.3
10	14	19	87.8	299.5	234.3	27.1	335.6	61.0	316.0
11	14	26	91.4	281.5	118.9	319.9	343.7	309.8	24.8
12	14	41	89.9	275.1	274.1	37.3	8.3	111.9	310.4
13	14	52	91.4	235.2	36.9	337.7	29.4	235.4	18.3
14	15	25	86.0	201.9	219.3	311.8	48.1	66.5	52.3
15	15	42	89.1	340.4	11.0	308.2	297.0	182.0	35.3
16	15	43	84.1	349.2	23.3	338.0	284.4	193.5	7.0
17	15	58	88.0	339.2	44.1	43.8	280.8	210.1	300.6
18	16	23	82.9	172.0	150.6	16.0	100.7	341.0	358.5
19	16	30	88.9	20.0	343.9	319.3	262.2	145.0	31.4
20	16	37	88.4	49.8	282.9	75.9	173.3	52.7	293.3
21	16	53	86.2	46.9	12.6	291.7	262.3	151.1	62.6
22	16	59	91.3	26.0	307.1	64.4	206.9	85.1	295.5
23	17	20	85.0	2.2	26.9	290.7	289.1	184.3	54.8
24	17	21	86.6	184.7	205.3	346.4	81.5	40.0	24.7
25	17	26	85.6	351.2	38.8	65.1	236.8	173.5	284.5
26	18	41	85.0	81.5	117.2	48.5	177.3	279.3	323.5
27	18	54	88.7	113.2	311.6	319.5	167.0	119.5	56.5
28	18	57	91.7	132.2	347.6	339.3	139.5	166.3	38.4
29	19	21	87.6	202.3	256.1	359.7	67.7	92.5	7.2
30	19	33	88.8	320.7	104.7	46.3	295.0	275.8	296.7
31	19	49	86.4	270.9	346.5	287.9	338.9	189.8	57.1
32	20	31	88.2	213.0	296.5	349.8	54.4	134.4	13.5
33	20	51	92.4	312.3	150.6	42.8	320.4	332.6	299.5
34	21	29	87.4	75.3	149.1	344.0	201.6	312.3	24.1
35	21	38	90.6	102.5	222.6	340.2	173.9	30.9	34.2
36	21	45	84.6	93.3	192.5	337.8	184.7	358.1	34.7
37	21	49	89.7	83.8	175.6	338.4	194.7	339.3	31.8
38	22	29	83.8	290.6	304.1	20.5	344.9	133.3	323.6
39	22	51	84.0	285.1	185.8	331.2	342.7	14.9	13.2
40	22	52	90.2	243.6	54.9	6.4	30.2	252.1	348.4
41	22	53	92.1	295.0	225.0	344.5	335.3	51.1	358.8
42	23	34	84.1	101.2	25.5	4.1	170.4	195.4	10.6
43	23	37	83.5	89.9	251.9	356.2	183.4	58.8	16.1
44	23	41	86.7	91.0	115.1	9.9	179.3	282.7	3.0
45	23	46	83.8	88.0	154.5	7.5	182.8	321.5	4.6
46	24	34	85.2	103.1	27.2	357.1	169.8	197.3	17.8
47	24	45	83.1	86.1	191.6	10.6	183.8	358.2	1.1
48	24	46	89.1	89.6	154.5	13.3	179.9	321.9	359.3
49	24	59	91.7	79.1	251.9	358.8	193.5	56.9	10.9
50	25	40	87.8	142.8	255.2	321.4	125.3	79.2	56.2
51	26	30	82.9	347.3	290.8	315.9	290.1	100.3	28.5
52	26	43	88.3	347.7	302.3	356.4	282.7	112.7	348.6
53	26	50	85.3	202.8	135.0	308.5	44.6	344.3	54.9
54	27	30	91.7	327.2	210.4	353.0	303.8	26.8	349.6
55	27	36	85.5	326.8	196.1	332.0	305.4	12.6	10.5
56	27	48	90.5	326.2	223.8	13.2	303.4	40.0	329.4
57	27	54	83.7	237.6	77.9	308.9	15.0	282.6	44.5
58	28	43	85.0	344.4	320.8	351.9	286.7	132.2	352.5
59	28	48	91.7	334.4	303.4	314.5	300.6	117.0	28.5
60	28	52	88.6	229.3	96.2	60.9	71.5	310.6	302.6

M50 SPLIT DIFFERENCE IMU ALIGN ATTITUDES (50 NAV STARS)

PAIR				-Z ST: Star 1			-Z ST: Star 2		
	Star1	Star2	Sep	R	P	Y	R	P	Y
61	28	56	88.6	206.4	157.4	315.4	46.2	2.8	47.7
62	29	30	83.9	344.7	152.4	21.5	281.2	321.7	323.4
63	29	39	88.5	198.7	318.4	6.3	73.0	154.2	1.8
64	29	53	85.8	332.4	168.6	50.6	287.2	335.4	292.9
65	30	56	85.4	239.1	208.0	4.4	34.0	45.4	351.7
66	30	60	84.5	306.0	58.2	9.9	326.1	241.5	332.6
67	31	37	90.9	100.8	255.0	324.6	180.7	59.6	49.1
68	31	47	83.5	75.6	88.6	37.3	186.2	251.4	332.9
69	31	50	91.9	114.7	15.8	32.6	153.7	189.3	344.2
70	32	46	87.7	85.7	155.3	28.6	179.9	321.3	343.6
71	32	49	87.8	73.8	184.7	22.8	192.2	348.6	346.4
72	32	50	88.7	117.1	33.7	353.5	155.6	207.6	23.3
73	32	56	86.3	119.6	49.1	1.4	152.0	224.1	15.6
74	33	47	91.6	256.9	234.6	295.2	352.3	80.0	52.5
75	33	59	91.2	309.6	24.2	52.4	326.1	209.5	290.0
76	34	39	90.3	167.1	193.2	358.6	102.5	22.7	16.5
77	34	41	88.6	131.7	147.1	290.6	161.2	305.1	86.9
78	34	54	84.9	85.2	294.0	78.9	155.1	81.8	296.2
79	35	47	90.7	268.9	242.3	328.9	356.5	75.8	18.3
80	35	50	92.3	243.2	179.7	345.0	24.3	16.8	9.0
81	36	50	83.0	240.1	182.3	350.0	28.7	19.5	5.2
82	36	54	83.8	262.9	181.9	30.5	18.9	300.4	320.0
83	36	57	91.5	241.6	139.1	18.7	36.1	337.6	337.3
84	36	59	90.9	291.8	42.7	26.0	344.7	232.3	318.1
85	37	39	88.3	181.4	59.4	29.1	94.7	252.6	343.9
86	37	43	91.0	1.4	243.1	3.8	267.3	49.9	344.0
87	38	42	86.9	8.7	207.4	33.0	250.5	8.1	317.7
88	38	43	88.7	8.0	210.9	1.7	261.3	16.5	347.6
89	38	58	85.7	24.6	229.7	294.6	272.7	19.8	55.2
90	39	47	89.9	84.0	85.0	19.3	183.8	251.1	352.2
91	40	57	90.3	142.1	2.7	326.0	126.8	186.0	51.6
92	41	43	83.5	8.5	108.9	339.3	266.3	274.6	9.5
93	41	50	85.0	179.9	287.6	76.0	115.4	133.4	299.4
94	42	60	87.7	304.4	90.0	325.0	325.1	273.6	17.5
95	43	44	84.1	259.9	317.0	1.1	12.7	151.9	349.0
96	43	47	84.3	273.8	241.2	11.7	1.3	74.1	335.4
97	44	48	83.9	11.9	145.9	29.5	248.6	307.0	322.0
98	44	52	91.1	165.1	314.7	310.6	89.3	154.5	63.6
99	48	49	83.6	272.3	343.8	315.2	350.0	177.9	30.9
100	48	50	88.7	247.9	202.6	33.8	35.8	43.8	321.2
101	48	55	86.0	230.9	248.6	3.6	41.5	86.4	354.9
102	48	56	85.2	240.4	219.9	25.3	39.7	59.5	331.4
103	49	60	84.1	343.6	150.9	294.3	298.3	318.2	49.2
104	50	54	86.3	89.2	292.7	67.8	162.8	91.0	306.7
105	51	54	82.8	267.7	104.3	67.3	52.5	336.0	286.8
106	51	55	89.0	204.5	199.6	323.9	52.8	41.6	40.5
107	55	57	89.9	125.7	302.7	43.6	143.5	119.3	333.9
108	57	59	87.4	53.9	276.6	50.6	198.2	71.3	314.9
109	57	60	87.8	38.6	300.7	31.6	221.4	99.8	328.0



## APPENDIX B

### LISTING OF POINTING PROGRAMS

<u>Program name</u>	<u>Brief description</u>
AFILE	Prints out an attitude timeline for publication using the output from ATL2.
ALIGN	Determines available and best star pairs for IMU alignments for a certain time using a given ephemeris.
ALIGN2	Determines the best star pairs for a flight with which to determine the star pairs cue card.
ALOS	Determines and plots lines of sight to celestial, ground, and orbiting targets.
ASPECT	Converts an input attitude to either LVLH or inertial. Also computes look angles to Earth, Moon, and Sun.
ATL1	Creates an attitude timeline data file.
ATL2	Generates attitude maneuver times and Earth/Sun look angles for a given attitude timeline data file.
FP	Computes times when various targets are within line-of-sight of the Orbiter. Also, calculates ground track data and landing site deorbit opportunity times.
FP1	Calculates star AOS/LOS for a given time and ephemeris.
M	Calculates maneuvers between two attitudes.

Program name

Brief description

PLOT

Plots fields of view, ground tracks, etc. on mercator and cylindrical Earth maps. Also plots on celestial star charts and rectangular/zenith projections.

RADEC

Calculates  $\Delta V$ 's due to spring ejection for a deployed payload and deploy time.

SS

Offline spacecraft sighting program. Computes instrument pointing angles and the Orbiter attitude required to point at specific targets.

TDRS

Determines Ku-band AOS/LOS for a flight using the output from ATL2.

VCEP

Vector conversion program which converts supertape vector inputs into sets of invariant elements. Calculates the ephemeris data for Sun, Moon, and RNP matrix at base reference time.

VCEP1

Permits user to change the lift-off date and time of an existing ephemeris file.

## APPENDIX C

### COMMON UNITS AND DISTANCES

#### Earth parameters

Equatorial radius:  $1 \text{ E.R.}_{\oplus} = 0.2092574146981627 \times 10^8 \text{ ft}$   
 $1 \text{ E.R.}_{\oplus} = 0.637816600000000 \times 10^7 \text{ mi}$   
 $1 \text{ E.R.}_{\oplus} = 0.3443934125269978 \times 10^4 \text{ nmi}$

Gravitational parameter:  $\mu_e = 0.1407646853278542 \times 10^{17} \text{ ft}^3/\text{sec}^2$   
 $\mu_e = 0.6275027808522208 \times 10^5 \text{ nmi}^3/\text{sec}^2$

Polar radius:  $R_p = 0.2085559148165061 \times 10^8 \text{ ft}$   
 $R_p = 0.635678428367107 \times 10^7 \text{ mi}$   
 $R_p = 0.3432388922034075 \times 10^4 \text{ nmi}$

Mass of Earth:  $M_e = 0.1316896781981220 \times 10^{26} \text{ lbm}$

Angular rotation with respect to:

Precessing equinox:  $\omega_p = 0.7292115854918357 \times 10^{-4} \text{ rad/sec}$

Inertial equinox:  $\omega_I = 0.7292115146459210 \times 10^{-4} \text{ rad/sec}$

#### Solar parameters

Mean Earth to Sun distance:  $4.9081250 \times 10^{11} \text{ ft}$   
 $9.295691 \times 10^7 \text{ mi}$   
 $8.077888 \times 10^7 \text{ nmi}$

Gravitational parameter:  $\mu_s = 0.4686697671960888 \times 10^{22} \frac{\text{ft}^3}{\text{sec}^3}$

$\mu_s = 0.2089242635906454 \times 10^{11} \frac{\text{nmi}^3}{\text{sec}^2}$

Sun - Earth mass ratio:  $M_s/M_e = 333432$

Distended angle:  $\text{d.a.} = 0.5 \text{ deg}$

### Lunar parameters

Mean Earth to Moon distance:  $1.246719 \times 10^9$  ft  
 $2.36121 \times 10^5$  mi  
 $2.051874 \times 10^5$  nmi

Mean Lunar Radius:  $R_m = 0.570239501312336 \times 10^7$  ft  
 $R_m = 1.079978500000 \times 10^3$  mi  
 $R_m = 0.9384935205183585 \times 10^3$  nmi

Gravitational Parameter:  $\mu_m = 0.1731400417087798 \times 10^{15}$  ft<sup>3</sup>/sec<sup>2</sup>  
 $\mu_m = 0.7718260968373028 \times 10^3$  nmi<sup>3</sup>/sec<sup>2</sup>

Earth-Moon mass ratio:  $M_e/M_m = 81.301$

### Equivalents and conversion factors

1 int. ft.	= 0.3048 meter (exact)
1 nmi	= 1.852 Km (exact)
1 lbm	= 0.45359237 Kg (exact)
1 radian	= $180/\pi$ degrees
1 degree	= 3600 arc seconds
1 Km	= 0.5399568034557235 nmi
1 meter	= 3.280839895013123 int. ft.
1 nmi	= 6076.115485564304 int. ft.
1 radian	= 57.29577951308233 degrees
1 degree	= 0.01745329251994329 radian
1 Kg	= 2.204622621848776 lbm
1 int. stat. mile	= 5280 ft. (exact)
1 lbf	= 32.174048556 (int. ft/sec <sup>2</sup> ) lbm
$\pi$	= 3.141592653589793

APPENDIX D

VECTOR/MATRIX NOTATION

Because of the various types of notations that have been used and the confusion that can result, a few words of clarification are appropriate.

$\bar{x}$  Denotes a real vector composed of orthogonal vectors where each orthogonal vector equals a scalar times a unit vector.

$\hat{x}$  Denotes a unit vector

$[\bar{x}]$  Denotes the matrix of orthogonal scalar components in sequence from axis 1 thru 3

$[\hat{x}]$  Denotes reference frame x defined by the unit vector triad

$[x]$  Denotes a  $3 \times 3$  cosine matrix

$[x]_A^B$  Denotes rotations used in going from reference frame A to frame B.

$$\begin{bmatrix} x \\ y \\ z \\ \hat{x} \\ \hat{y} \\ \hat{z} \end{bmatrix}$$



1951

1952

1953

1954

FLIGHT PROCEDURES  
HANDBOOK  
CORE DISTRIBUTION LIST  
12/84

JSC  
CB/Chief (3)  
DA8/Office  
DF/Chief  
DF2/Head (3)  
DF6/Head (3)  
DF63/Head (3)  
DG/Chief (4)  
Rockwell (10)  
DG6/ASC-ENT Sect. (3)  
Orb-Payload Sys.  
Sect. (3)  
Library (150)  
UH34/Head (3)  
DH4/Flt Act Br (17)  
DH6/Branch Off. (3)  
JM2/Technical Library  
(3)  
MP2/R. B. Ramsell  
ZR1/MCC Library (3)

FLIGHT PROCEDURES  
HANDBOOK  
ATTITUDE AND POINTING  
DELTA DISTRIBUTION  
12/84

JSC  
DG6/Office (20)  
DH4/D. G. Edwards (40)