

Attitude and Pointing Handbook

SECTION 1
ASTRONOMICAL CONCEPTS AND REFERENCES

1.1 THE EARTH

Earth - The planet which we inhabit, the fifth in order of size and third in order of distance from the Sun. Astronomical symbol \oplus . It has a diameter of 7718 miles, a period of 365.26 days, and a mean distance of 92,900,000 miles from the Sun.

Webster's Dictionary

In more general terms, the Earth is an irregular semisolid spheroid having a random distribution of its mass that complicates orbit predictions and the location of objects on its surface. There are two basic problems posed by the Earth; namely, how to model its shape and its mass.

The shape of the Earth, of course, resembles a spherical balloon that is being compressed from the top and bottom (fig. 1-1). It has long been recognized that a planar section through the Earth north to south is very nearly an ellipse. The semimajor axis would equate to the equatorial radius and the semiminor to the polar radius. By assuming the cross section at any longitude to be an ellipse, the distance of any surface point from the center of the Earth can be found by geometry. The first approximations of the Earth in this manner were made in the early 1800's and have continued ever since.

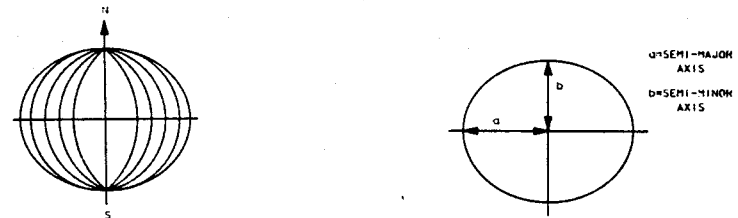

Figure 1-1.- Oblate Earth.

Mission Planning and Analysis Division (MPAD) and Mission Operations Directorate (MOD) have adopted, for standardization, the model as developed by Fischer in 1960. In his model, the semimajor axis equals 2.0925724×10^7 feet and the semiminor axis equals 2.0855573×10^7 feet. It is relative to this elliptical reference that all MOD programs determine Earth positions and altitudes.

From an orbital mechanics standpoint, the distribution of mass in the Earth is important only as it affects the gravity field. From basic mechanics, the mutual attraction between two point masses is

$$F = \frac{Gm_1m_2R}{R^2} = m\Lambda_R = m \left[\nabla U(X,Y,Z) \right]$$

Operations Division
 Flight Activity Branch

Revision B
 February, 1988



National Aeronautics and
 Space Administration

Lyndon B. Johnson Space Center
 Houston, Texas

When the larger mass is the Earth, this equation is simply the mass of the orbiting body times the acceleration of gravity. In reality, the Earth is not a point mass or a spherical object with uniform distribution; this condition introduces considerable error. To account for this error, the acceleration due to gravity is treated as a variable over the surface of a spherical Earth (fig. 1-2). The magnitudes of the individual acceleration components normal to the surface are then used to build a function describing the variation of acceleration over the surface.

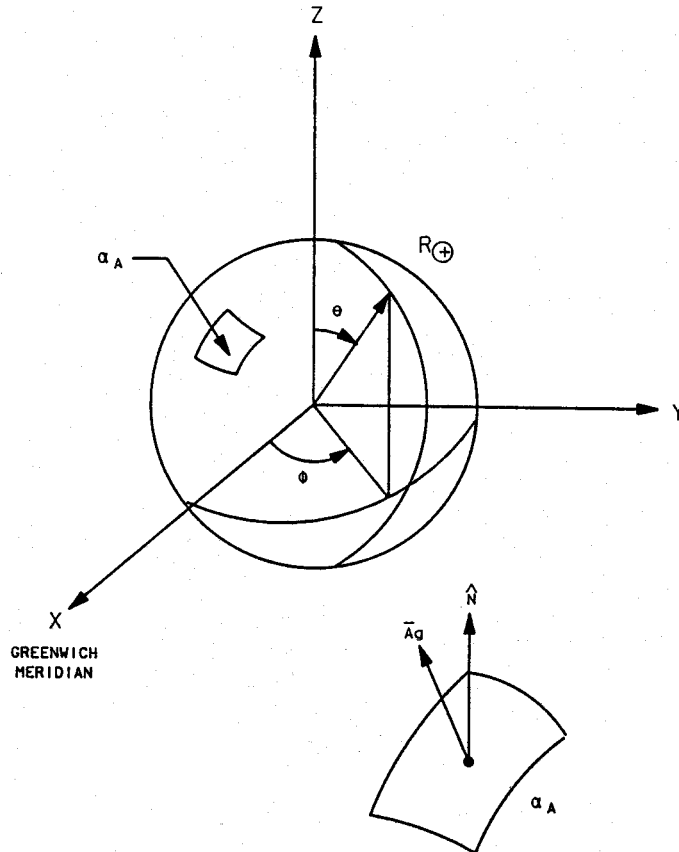

10511012. ART. 1

Figure 1-2.- Variation of gravity over the surface of the Earth.

This problem is normally worked in polar coordinates, where the radius of the Earth, R_{\oplus} , is held constant, θ equals colatitude, and ϕ equals the longitude. Since gravity is a conservative force, the acceleration is reduced to a potential function U . The function describes the energy in the gravitational field where the gradient of the potential function equals the force per unit mass. The solution is a polynomial

$$U(R, \theta, \phi) = \frac{GM}{R} \sum_{n=0}^{\infty} \sum_{m=0}^n \left(\frac{R}{R_{\oplus}}\right)^{-n} P_n^m(\cos\theta) \left[S_{nm} \sin(m\phi) + C_{nm} \cos(m\phi) \right]$$

The first few terms look like this

$$U = \frac{GM}{R} \left[1 - \frac{J_2 R_{\oplus}^2}{2R^2} (3\sin^2\theta - 1) - \frac{J_3 R_{\oplus}^3}{2R^3} (5\sin^3\theta - 3\sin\theta) - \frac{J_4 R_{\oplus}^4}{8R^4} (35\sin^4\theta - 30\sin^2\theta + 3) \right]$$

The important thing to notice is that for a given orbit the only unknowns in this equation are the J terms (J's) (fig. 1-3). The J's are real constants that have been evaluated using satellite observations. The J's have a physical meaning that is worth examining.

J_2 is equal to 1.08228×10^{-3} and represents effects due to the equatorial bulge

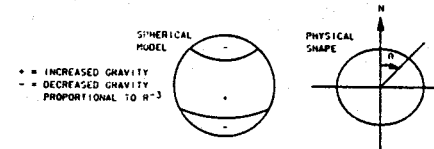

(a) Effects of J_2 term.

J_3 is equal to -2.3×10^{-6} and accounts for any egg shape effects

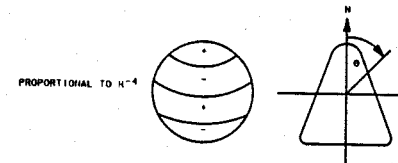

(b) Effects of J_3 term.

Figure 1-3.- J-term effects.

J_4 is equal to -2.12×10^{-6} and accounts for another odd effect

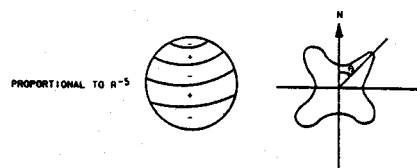

(c) Effects of J_4 term.

Other higher order J terms account for distortions of different types

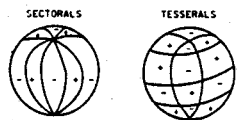

10511013. ART. 1

(d) Effects of higher order terms.

Figure 1-3.- (Concluded).

3

The salient points to remember are

- The gravity field is nearly uniform.
- The largest distortion from spherical is due to the equatorial bulge and is of order 10^{-3} .
- All other terms are 10^{-6} or less.

The required accuracy in orbital prediction solely determines how many terms should be accounted for in modeling the Earth.

1.2 BASIC ASTRONOMY

1.2.1 Beta Angle (β)

Beta angle, stated simply, is the angle of the Sun vector to the orbit plane. The Sun vector is defined as a vector with its origin at the center of the Earth extending to the center of the Sun. A positive beta angle indicates the Sun is north of the orbit plane; a negative beta angle indicates the Sun is south of the orbit plane. Figures 1-4 and 1-5 show examples of positive and negative beta angles for a given Sun inclination of 8° .

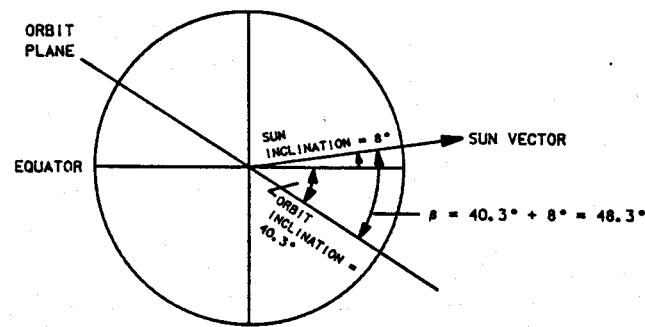

Maximum negative β angle condition for a given orbit plane (maximum means ascending/descending nodes perpendicular to the Sun vector).

Figure 1-4.- Maximum negative β angle.

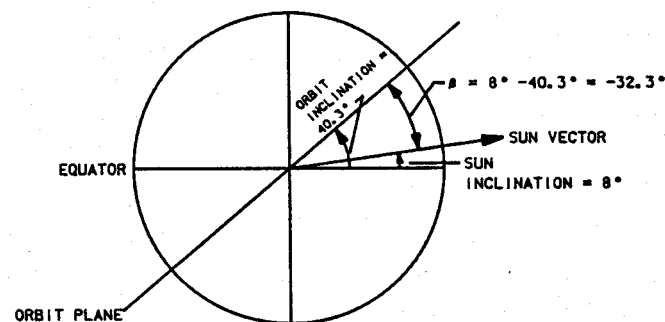

Maximum positive β angle condition for a given orbit plane (maximum means ascending/descending nodes perpendicular to the Sun vector).

Figure 1-5.- Maximum positive β angle.

Mathematically the beta angle can be derived from the representation of the orbit plane

where \vec{S} is the Sun vector
 \vec{r} is the radius vector
 \vec{V} is the velocity vector
 \vec{H} is the angular momentum vector
 β is the beta angle.

By definition

$$\vec{H} \cdot \vec{S} = \|\vec{H}\| \|\vec{S}\| \cos \delta$$

$$\delta = 90 - \beta$$

By trigonometric identity

$$\cos \delta = \sin(90 - \delta)$$

From the above

$$\frac{\vec{H} \cdot \vec{S}}{\|\vec{H}\| \|\vec{S}\|} = \cos \delta$$

$$\vec{H} \cdot \vec{S} = \cos \delta$$

$$= \sin(90 - \delta)$$

$$= \sin \beta$$

$$\therefore \beta = \arcsin(\vec{H} \cdot \vec{S})$$

which is the formula commonly used in attitude and pointing algorithms to compute beta angle.

Although not readily apparent in the above derivation, beta angle is primarily a function of the orbital inclination i . For a given orbital inclination the maximum and minimum possible values of beta are $i \pm 23.5^\circ$, the inclination of the Sun's orbit in the ecliptic plane to the celestial equator. The resulting beta angle for a given trajectory is a function of launch date and time. For a given launch date, the resulting beta angle for the injection orbit will change as a function of the lift-off time. The beta angle will also change noticeably for a fixed lift-off time over a period of several weeks.

Figures 1-6 and 1-7 illustrate these properties of beta angle as a function of lift-off time and lift-off date for inclinations of 28.5° and 57° respectively, at specific altitudes. Each contour represents a specific value of beta angle. The beta angle for a given lift-off time and date can be determined by finding the intersection of these two points on the beta

chart and interpolating between the curves. As an example, the beta angle for an $i = 28.5^\circ$ launch at 12:00 GMT on June 29 is approximately $+5^\circ$.

These beta contour charts are a product of Flight Design and can be a big help in planning attitude options which may change with beta angle. Although the dates given on the charts are for 1988, the data is identical for any calendar year as long as all ephemeris data is referenced to the Mean of 1950 system.

Beta angle, orbital inclination, and orbital altitude will determine the maximum amount of sunlight for a given orbit. For typical Shuttle orbital heights of 150 to 250 n. mi., it is possible to have sunlight over the entire orbit for orbital inclinations of approximately 50° or more. As beta angle changes throughout a flight, due to precession of the orbital plane and Earth orbital motion, a trajectory can go from having very short night passes, to terminators only, to 100 percent daylight in the course of several days. Identifying and understanding this phenomenon is very important to pointing operations, particularly where inertial measurement unit (IMU) alignments or crew optical alignment sight (COAS) calibrations are concerned. Figure 1-8 illustrates this effect as a function of orbital altitude and inclination.

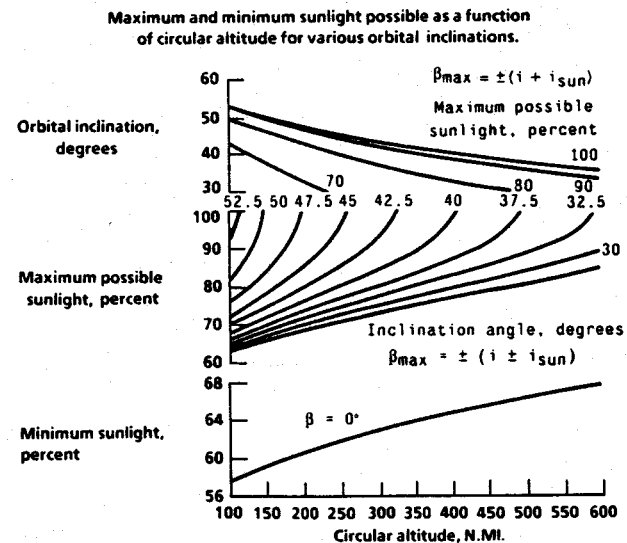

Figure 1-8. Maximum and minimum sunlight for circular orbits as a function of orbital altitude and inclination.

1-7

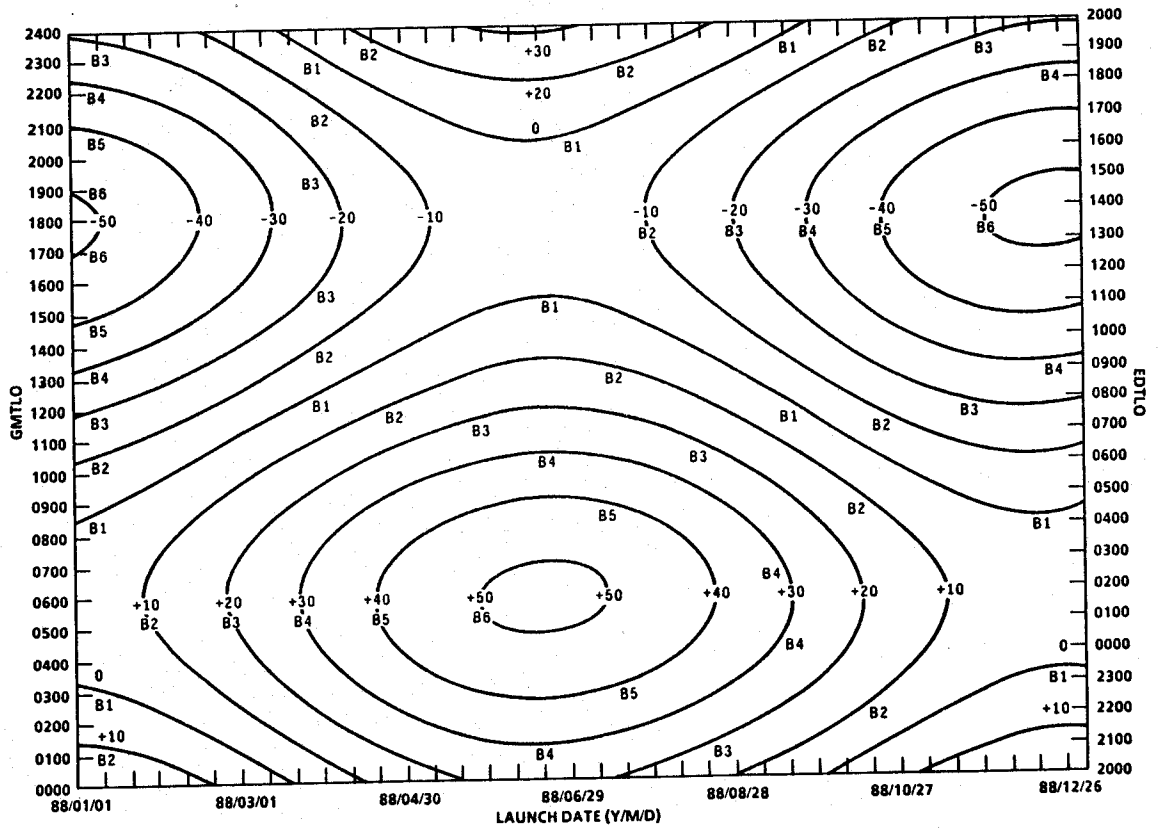

Figure 1-6. Beta contour chart for $i = 28.5^\circ$.

1-8

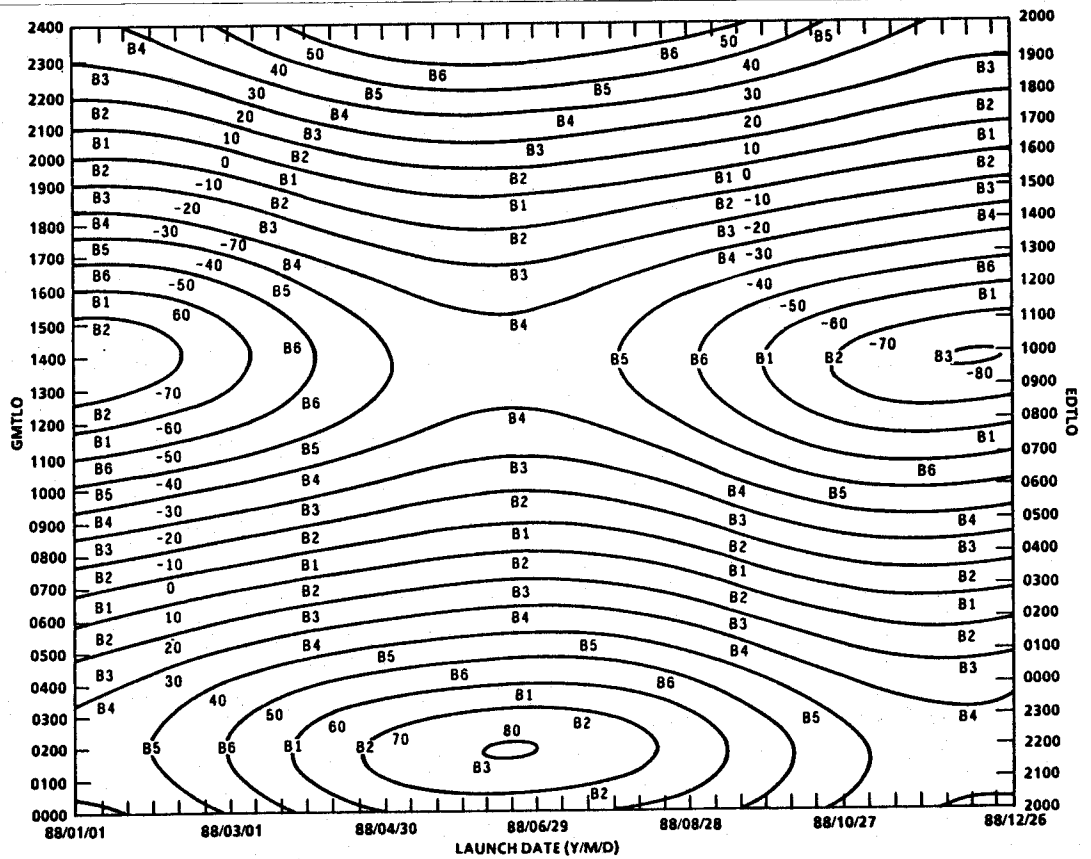

Figure 1-7. Beta contour chart for $i = 57^\circ$.

1.2.2 Characteristics of the Sun, Moon, and Planets

The Sun is a medium-size star around which all the planets in our solar system revolve. It is the brightest object in the sky with a visual magnitude of about -27 (typical navigation stars have magnitudes ranging from -1.43 to 2.81 visual magnitude). The Sun is approximately 93 million miles from the Earth and travels about 1 deg/day on the celestial sphere (i.e., in relation to the stars). The celestial trace ranges from 23-1/2° south to 23-1/2° north declination. See figure 1-9.

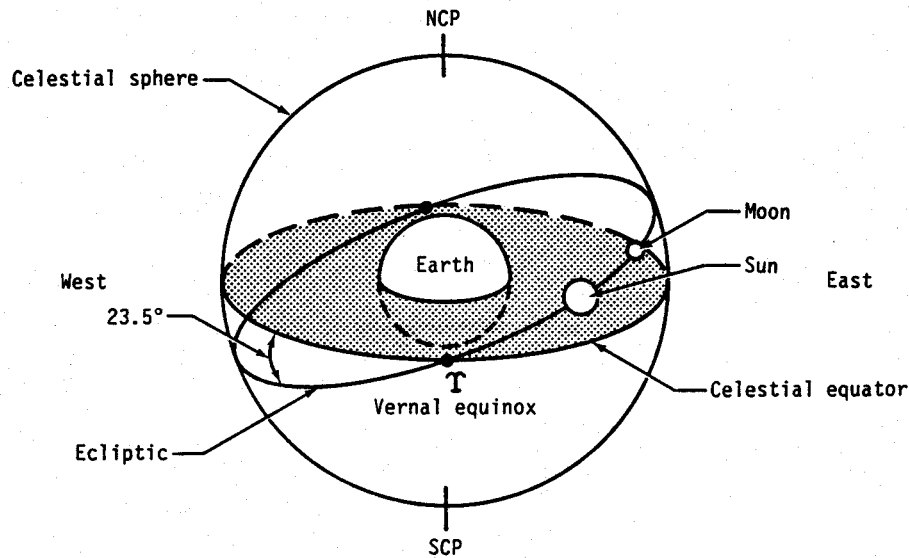

Figure 1-9.- Earth, Moon, and Sun.

The Moon is an Earth satellite that essentially shows one side towards the Earth at all times since its average orbital and rotational periods are approximately equal (fig. 1-10).

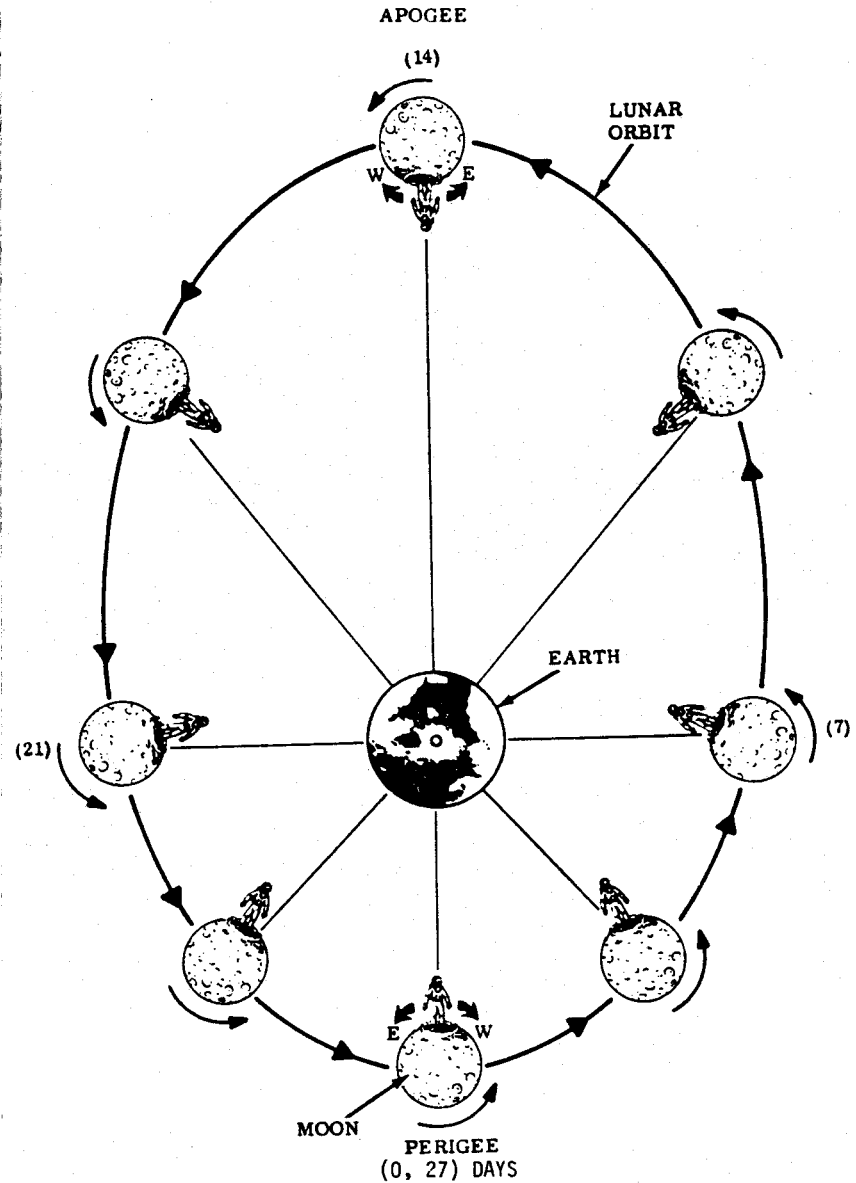

Figure 1-10.- The orbit of the Moon.

The Moon has a period of about 29-1/2 days with reference to the Sun and about 27-1/3 days with reference to the stars.

The mass is about 1/80 and volume about 1/49 of the Earth. The diameter of the Moon is about 1877 n. mi. compared to 6888 n. mi. of the Earth. The mean distance from the Earth is about 207,561 n. mi. The nine planets in our solar system are described below in figure 1-11. The four planets that we need to be concerned about for star occultation are Venus, Mars, Jupiter, and Saturn.

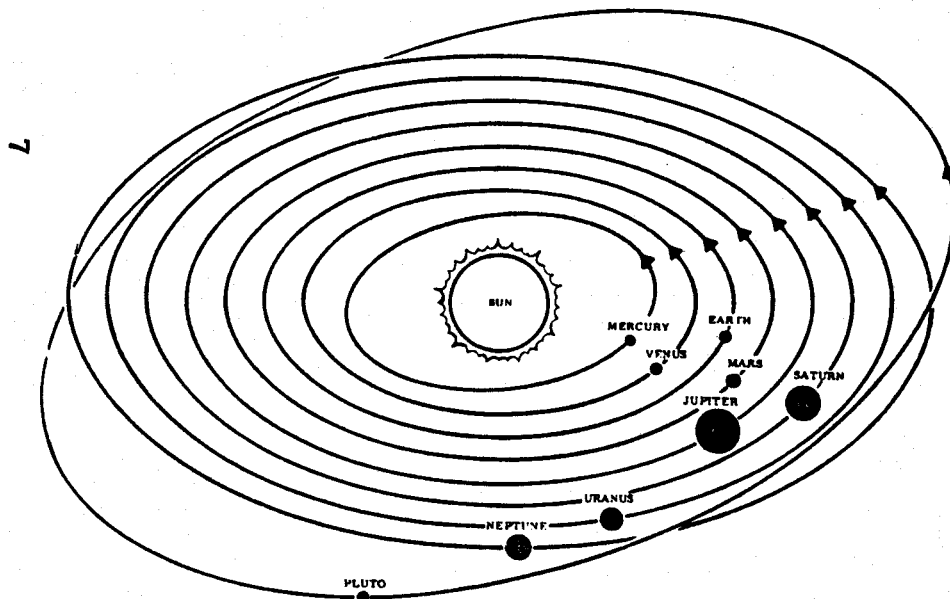

Figure 1-11.- The planets.

With respect to pointing, we need to be concerned about the effects of the Sun, Moon, and planets, not only because of occultation, but also because of the effects of brightness the Sun and Moon have on sensitive instruments. Specifically, we do not consider stars for IMU alignments that fall within 30° of the center of the Sun and 8° of the center of the Moon, not only because the brightness might damage the star trackers sensors, but also because the bright object sensor might close on the star trackers. Other constraints such as avoidance or acquisition of the Sun for payloads need to be addressed for each flight. Roughly speaking, the Sun and Moon are about 1/2° wide in diameter with respect to the star chart.

1.2.3 Celestial Sphere

The celestial sphere is an imaginary sphere of infinite radius that shares a common center and equatorial plane with those of the Earth. The sphere is fixed with respect to the stars. It is useful to work with this model since it allows us to assign coordinates to all objects in space. Analogous to the longitude and latitude of the Earth is the right ascension and declination of the celestial sphere. A right ascension of 0° is arbitrarily chosen to be the intersection of the ecliptic plane with the equatorial plane of the Earth at the vernal equinox. Currently, we use the point of intersection on January 1, 1950 also known as Mean of 50 (M50). The right ascension of an object is then measured eastward (while looking "into" the sphere) and ranges from 0° to 360°. Right ascension is also measured in hour angles (circles). Basically, there are 15° in one hour angle. Declination is measured from 90° south (-90°), the South Pole, to 90° north (+90°), the North Pole. See figure 1-12 for a graphical representation of the celestial sphere.

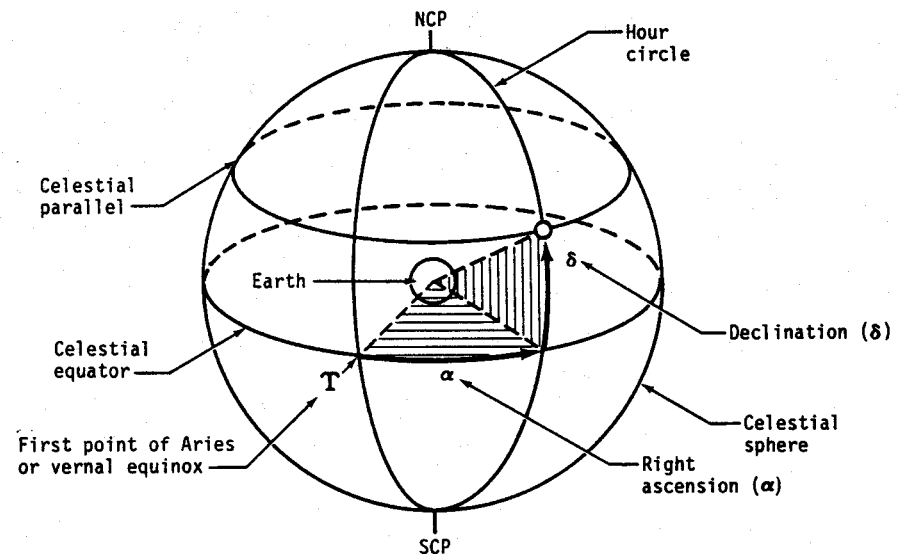

Figure 1-12.- Celestial sphere.

1.2.4 Maps and Charts

Maps and charts are essential to the pointer. As a visual aid for solving problems, both real time and in the development of pointing products, the various charts (and the computer programs associated with them) are able to transform conceptually difficult problems into a "readily accessible and easy to read format." Different situations require different types of charts. This section will discuss the construction, associated distortion, and uses of those maps and charts primarily used in the Pointing Office.

1.2.4.1 Simple Cylindrical or Cartesian

As the name implies, this is the simplest representation of a sphere on a flat surface. The spherical coordinates of a point are plotted directly on an equal-spaced grid. This "wet noodle" unwrapping can be seen in figure 1-13. This type of "projection" is obviously prone to distortion, especially east-west stretching of the poles (fig. 1-14). Even so, it has the important property of representing the entire sphere, which is not always the case in map projection. For this reason, it is used more than any other chart within the Pointing Office.

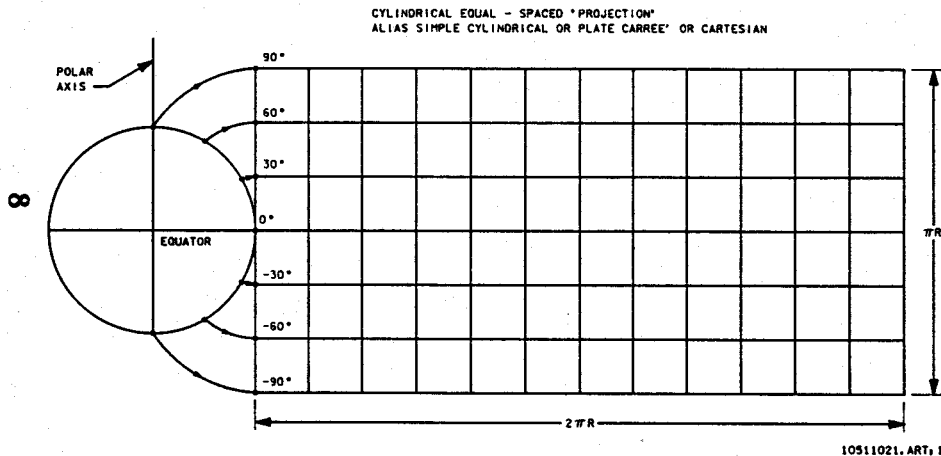

Figure 1-13.- Cylindrical equal-spaced projection.

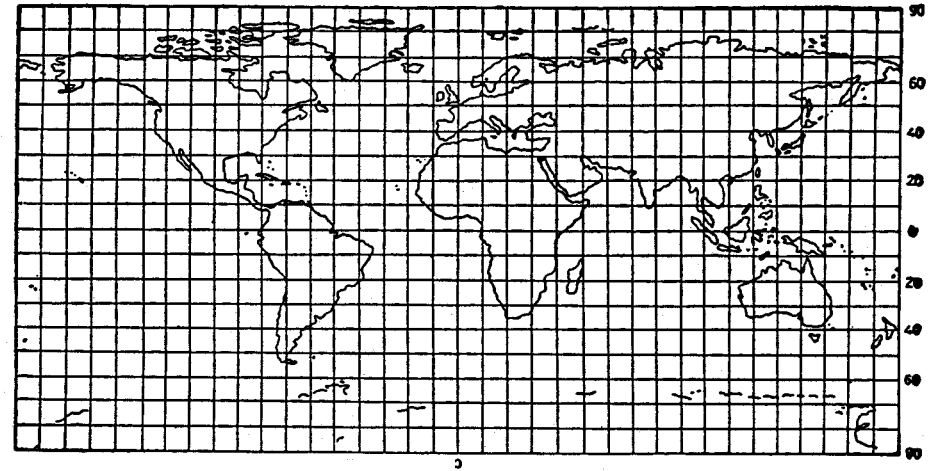

Figure 1-14.- Simple cylindrical map of the world.

Internally, cartesian plots are used for star charts and turtles.

- **Star Charts** - In their basic form, these charts depict the inertially fixed nav stars. They can also include the positions of the Sun, Moon, and visible planets for a given mission time. Computer programs are used to superimpose information on these charts. The line of sight (LOS) of an "instrument" can be shown for a given time, or shown changing over time, due to orbital motion or a maneuver. Likewise, a field of view (FOV) can be plotted, for example, to determine what stars will be in view of the trackers. The celestial trace of the Orbiter can also be plotted against the background of the sky.
- **Turtles** - With star charts the sky was held fixed, while an LOS or FOV was shown moving. For turtles, or blockage diagrams, the FOV is held fixed, while objects in the sky or on the ground are shown passing through. Turtles, their construction, and use are discussed in a later section.

1.2.4.2 Perspective Projection

In an effort to more accurately represent the surface features of a sphere on a flat chart, various projection techniques have been tried, both geometric and mathematical. Figure 1-15 is a simple geometric projection with the observer's perspective at the center of the sphere. The LOS to the parallels is extended out to a cylinder tangent at the Equator. The results, when applied to a map of the world, are shown in figure 1-16. Note

that this has the same east-west distortion as did the Cartesian, but that the north-south stretching is now extremely exaggerated. This type of projection is only useful up to about 70° LAT, as the poles extend out to infinity. At this point, mathematical techniques are employed to modify this simple projection approach, so that a more realistic projection results.

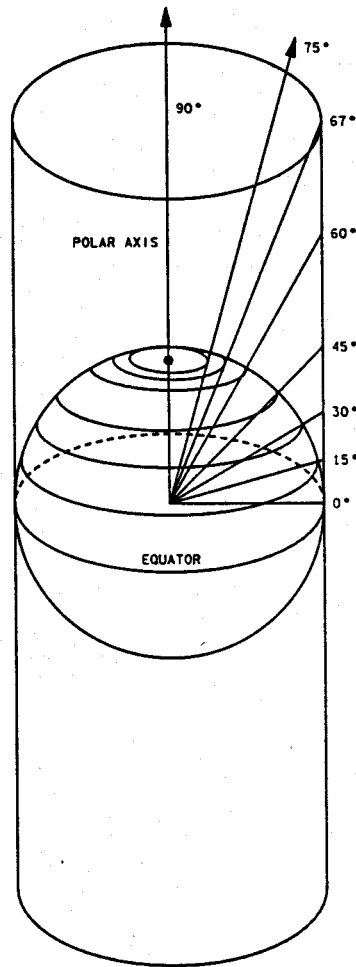

10511024. ART, 1

Figure 1-15.- Cylindrical projection construction.

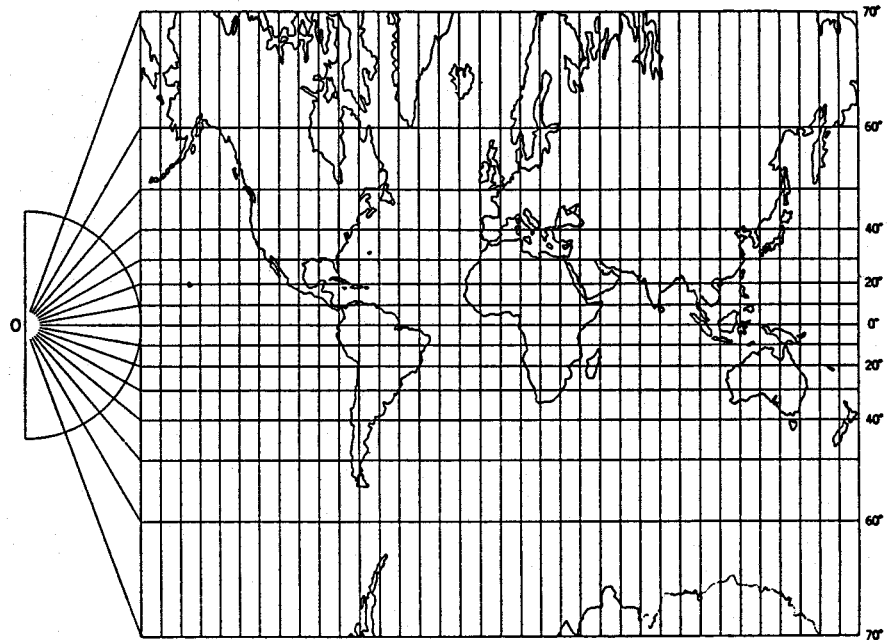
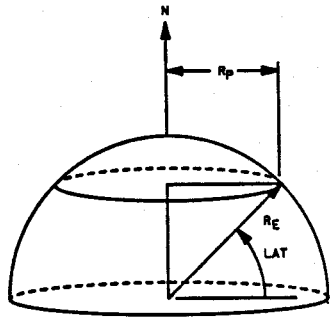

Figure 1-16.- Perspective projection upon a tangent cylinder.

1.2.4.3 Mercator Projection

The Mercator projection is perhaps the most commonly used today (though not as much in the Pointing Office). Mercator's approach was to balance the east-west and north-south distortions for each point on the map. In this way, small areas show nearly their true shape, but when comparing objects at the Equator to those at higher latitudes, the scale is no longer the same. To achieve this, Mercator used some simple trigonometric relations. Since meridians on a globe converge at the poles, a degree of longitude at the Equator is longer than a degree of longitude at higher latitudes. But on most rectangular maps, the meridians are drawn parallel. Assuming a spherical Earth, this causes an east-west stretch by a factor of $\text{SEC}(\text{LAT})$. See development in figure 1-17.



$$\frac{R_E}{R_P} = \text{SEC}(LAT)$$

since $S = R\theta$,

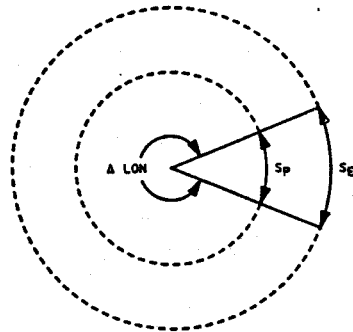

$$\frac{S_E}{S_P} = \text{SEC}(LAT)$$

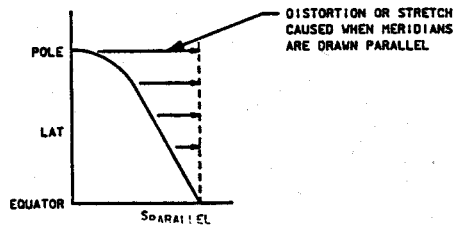

Figure 1-17.- Mercator relations.

To compensate for this east-west stretch, Mercator applied the same amount of stretch in latitude. The result is a chart with the meridians equally spaced, but with the spacing of the parallels increasing at a rate of $\text{SEC}(LAT)$ (fig. 1-18). This type of projection does not equate to any kind of tangent cylinder construction, as is evident in figure 1-19. It is purely a mathematical transformation. When compared to the Cartesian, the following relationships are found:

$$LON_{Mercator} = LON_{Cartesian}$$

$$LAT_{Mercator} = LAT_{Cartesian} \int_{\theta=0}^{\theta=LAT} \text{SEC}(\theta) d\theta$$

$$= LAT_{Cartesian} \{ LN | \text{SEC}(LAT) + \text{TAN}(LAT) | \}$$

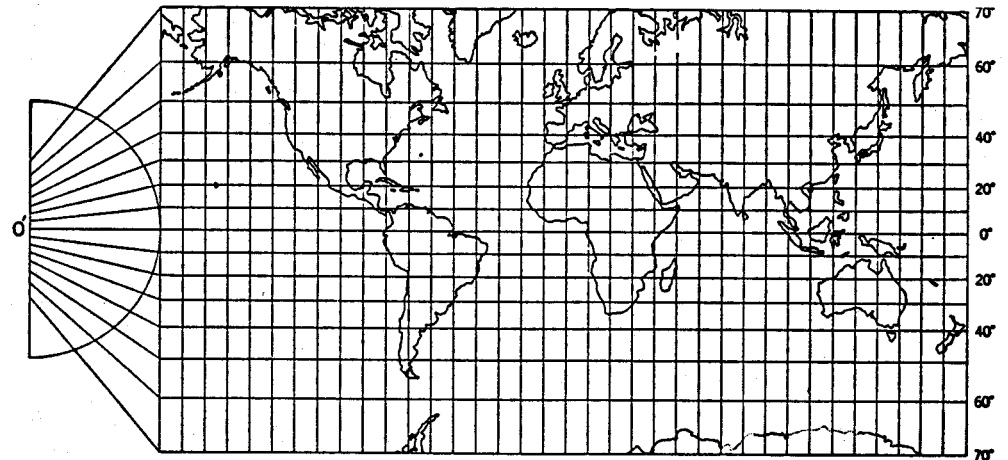

Figure 1-18.- Mercator projection - a comparison.

11

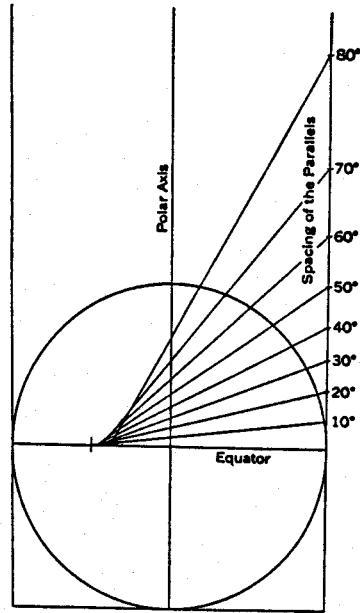

Figure 1-19.- Mercator projection showing spacing of the parallels.

The rectangular star charts used by the crew are Mercator projections, as is their world map. In the Pointing Office, a different type of mathematical projection, similar to Mercator, is used for the world map.

1.2.4.4 Miller Cylindrical

With the Mercator projection, latitudes above about 70° could not be shown practically. In an effort to represent more land area, the Miller cylindrical was born. The equations relating Miller to Cartesian are as follows:

$$LON_{Miller} = LON_{Cartesian}$$

$$LAT_{Miller} = LAT_{Cartesian} (3 LN |TAN \{0.4 ATAN |1.0067385 TAN (LAT) + 45\}|)$$

Figure 1-20 shows a Miller projection and an approximate tangent cylinder representation.

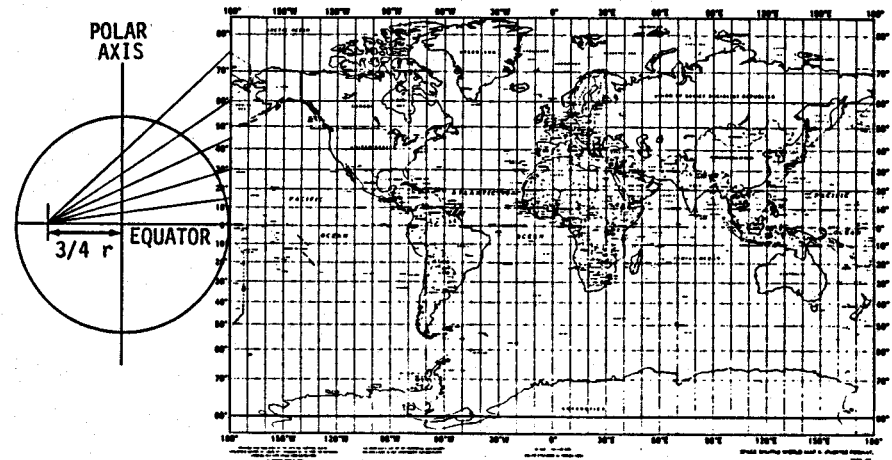
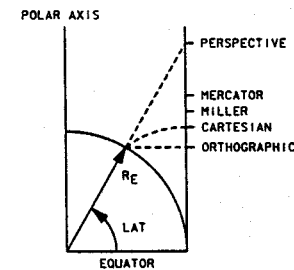

Figure 1-20.- Miller cylindrical.

Its uses are similar to the Cartesian star charts. Computer generated LOS and FOV can be plotted on the Miller world map. Also, the ground track of the Orbiter can be shown.

Figure 1-21 is a relative comparison of distortion among the four types of projections discussed so far, along with an orthographic projection. (Orthographic projections are perspectives with the observer placed at infinity.) The east-west stretch in longitude is the same for all projections, but the north-south stretch varies greatly.



10511029. ART. 3

Figure 1-21.- A comparison of north-south stretch produced by various projection techniques.

1.2.4.5 Azimuthal Equidistant Polar Projection

This type of polar projection is very easily constructed. As with the Cartesian, the meridians as well as the parallels are equally spaced. Concentric, equally spaced circles define the parallels, while the meridians are represented by equally spaced radii. Figure 1-22 shows the results when applied to the Northern Hemisphere.

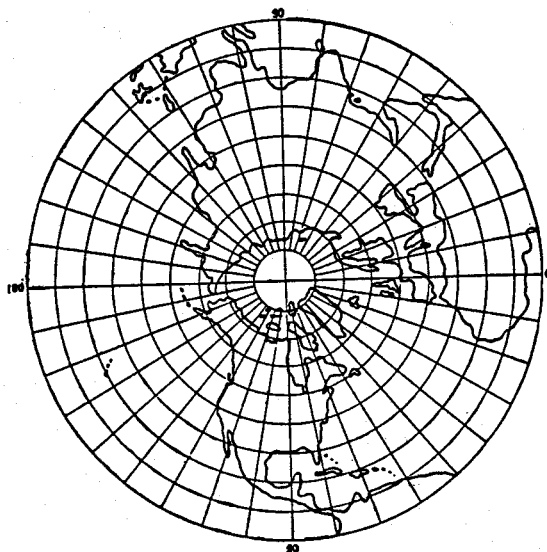

Figure 1-22.- Azimuthal equidistant polar projection.

This type of projection has obvious advantages when trying to represent the polar regions. For this reason, polar star charts of this construction are used in tandem with the rectangular Mercator projections.

1.2.5 M50 Star Chart

We have all seen a Mercator projection (flat map of the Earth) containing the outlines of continents and locations of cities. Likewise, we can also "flatten" the celestial sphere on a two dimensional map. This map is called the M50 star chart. A basic and important difference between the world map and the star chart is the viewer's perspective. The world map represents the Earth as the viewer is looking "at" or "into" the Earth. The star chart represents the locations of celestial bodies as the viewer is looking "out" the celestial sphere. While declination remains the same, "east" is now towards your left on the chart. The M50 star chart further defines the 0° right ascension (RA) and 0° declination (DEC) to be the intersection of the ecliptic with the equatorial plane of the Earth at the mean vernal equinox (0h Greenwich mean time (GMT) on January 1, 1950).

Note that for our pointing programs we sometimes use a star chart that is not a Mercator projection. This chart is simply a two-dimensional rectangular plot of RA and DEC.

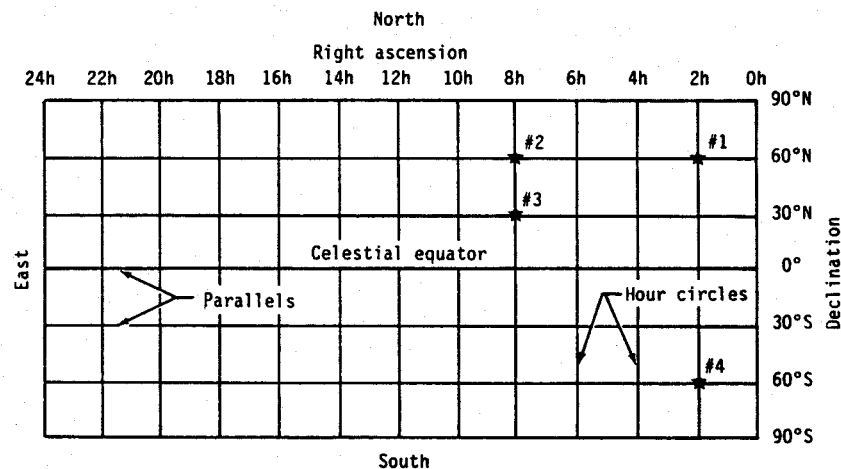

Figure 1-23.- Star chart.

1.2.6 Celestial Traces

A celestial trace is very much like a ground trace, except that on the star chart where the trace is represented, the trace appears "inside out." The trace a typical satellite makes will appear to head left. Likewise, the paths the Sun and Moon make also will be toward the left. See figure 1-24.

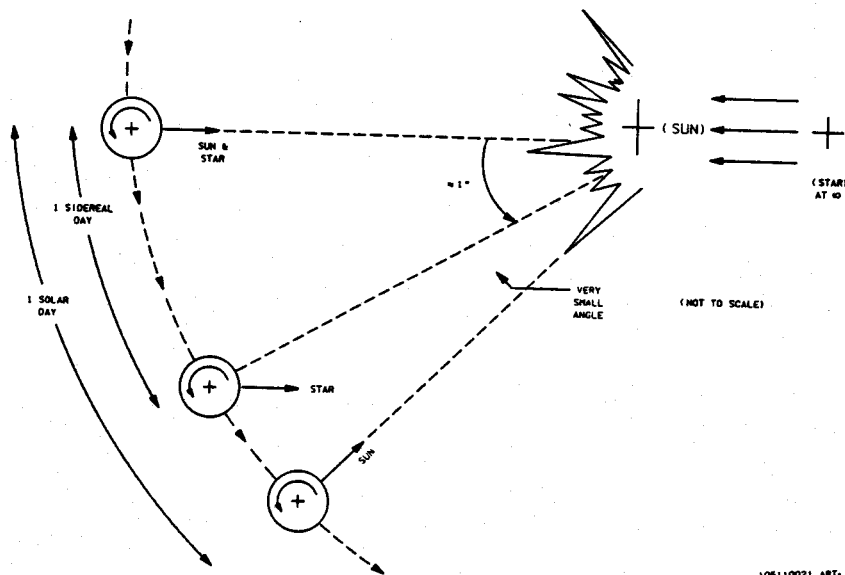

Figure 1-25. Sidereal day vs. solar day.

TABLE 1-I.- SOLAR VS. SIDEREAL TIME RELATIONSHIPS

1 day of mean solar time	= 1.00274 days of mean sidereal time
	= 24h03m56s of mean sidereal time
1 day of mean sidereal time	= 0.99727 days of mean solar time
	= 23h56m04s of mean solar time

As figure 1-25 shows, since the Earth has moved approximately 1° of arc along its orbital path, it must rotate slightly more than 360° for the Sun to cross the same meridian. This equates to about an extra 4 minutes of rotation or an extra 0.00274 arc degrees along the orbital path. Throughout the year there are 365-1/4 solar days while there are 366-1/1000 sidereal days. Sidereal noon time is defined to be 0h0m0s when the vernal equinox is on the local meridian. This means that sidereal time is the hour angle of the vernal equinox. The hour angle is the angle between the meridian and the line of RA of the star in question (measured towards the west through a full 360°). Each 15° of RA is equivalent to 1 hour; therefore, the hour angle of any star can be converted to sidereal time. Equivalently, sidereal time is equal to the instantaneous RA of the meridian.

Sidereal time is related to the RA of a star in the following manner:
 Sidereal time = RA of Star + hour angle of Star. Figure 1-26 should help to clarify the above statements.

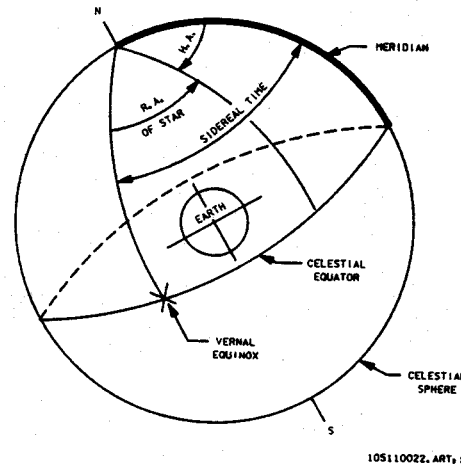

Figure 1-26.- Sidereal time.

1.3.3 Julian Date

Prior to 1925 mean solar time was reckoned from noon instead of from midnight. The mean solar day beginning at noon, 12 hours after the midnight that began the same civil date, is known as the astronomical day. To facilitate chronological reckoning, the system of Julian day (JD) numbers maintains a continuous count of astronomical days, beginning with JD 0 on January 1, 4713 B.C., Julian proleptic calendar.

1.3.4 Gregorian Calendar

The calendar was introduced by Pope Gregory XIII in 1582 to replace the Julian calendar. It is the calendar we use today. Every year that is exactly divisible by 4 is a leap year, except for centesimal years, which must be exactly divisible by 400 to be leap years.

1.3.5 Besselian Solar Year

The period is of one complete revolution of the fictitious mean Sun in RA beginning at the instant when the RA is 280°. The beginning of the Besselian year is denoted with the notation .0 (e.g., 1950.0). Besselian time 1950.0 does not coincide with January 1950 0d.0000 UT.

1.3.6 Mission Unique Times

The mean solar time on the Greenwich meridian is called GMT, universal time (UT) or Zulu (Z) time. Since each 15° of Earth rotation is equivalent to 1 hour, GMT can be converted to local time (or vice versa) by adding or subtracting the correct angle (1 hour = 15° long) of the Greenwich meridian from the local longitude. When it comes to dealing with missions, there are five types of times which are used as references. These are internal elapsed time (IET), GMT of lift-off (L/O), mission elapsed time (MET), phase elapsed time (PET), and time of ignition minus (TIG-). Each of these times is referenced to each other and to UT in some unique way. In order to set up these new time references, it is necessary to establish a user-specified base date.

1.3.7 Base Date

This is a user-specified year, month, and day. It is defined to be 0h0m0s Greenwich zone time on the user specified year, month, and day. In the Space Shuttle program, the base date is set to be 12:00 a.m. GMT (midnight) on the day of the launch. Therefore 12:00 a.m. GMT is 0h0m0s base date for whatever day the launch is occurring. This time is also defined as an epoch. It is at this time that the axis systems mean equator and equinox of epoch (MEE), true equator and equinox of epoch (TEE) and true equator and Greenwich meridian of epoch (TEG) are defined (i.e., the rotation (R), nutation (N), and precession (P) matrices are stored). Rotation is the angle between the Greenwich meridian and the M50 X-axis; precession accounts for the movement of the rotational axis of the Earth against the celestial sphere. A third effect, nutation, is a small sinusoidal motion on top of the circular precessional motion. Nutation is caused by the gravitational pull on the bulge of the Earth by the Moon. Once the R, N, and P matrices are set at the base date, it is only necessary to consider the rotation effect for the remainder of the flight. The other two components are negligible. The five time references are all referenced in some respect, either directly or through each other, to the base date which is in turn referenced to GMT. These five reference times are all displayed in the Mission Control Center (MCC).

a. IET

IET is defined as an event time that is measured from the user defined base date. One of the main events dealt with is L/O; therefore, the main IET dealt with is the Δt time between 12 midnight before L/O and L/O which is GMT L/O. All Orbiter time tagged events (i.e., L/O, state vectors, burns, attitudes, etc.) are stored as IET times. These IET times are used for most of the computation processes of the general purpose computers (GPC's). The pointers, however, are usually concerned with the MET equivalent of these events, to be discussed later. IET time is expressed in days, hours, minutes, and seconds.

b. GMT L/O

GMT of L/O is an event time which is measured from the midnight before launch to L/O. It is expressed in time of day in hours, minutes, and seconds at GMT.

c. MET

MET is another event time that is measured from some user-defined reference time. Since the name implies the amount of time that has elapsed since the mission started, it is only reasonable to set L/O as the user-defined reference. In this way, all mission activities are measured as the Δt to or from L/O. Negative MET corresponds to times before L/O of the mission and positive MET corresponds to times after L/O of the mission. MET is expressed in days, hours, minutes, and seconds.

d. PET

PET is yet another event time that is measured from some user-defined reference time. One may wish to pick an activity such as the beginning of an extravehicular activity (EVA) or a rendezvous burn. PET is also expressed in days, hours, minutes, and seconds. PET can be used as a backup MET, or it can be used to reference events to some time other than L/O.

e. TIG-

TIG- is used as a countdown time. It is the Δt time before some future event occurs (e.g., TIG-3:30). The event will occur at TIG- = zero. The event is usually a burn but TIG- can also be used for other targeting information or simply as a countdown clock. The following graph shows how these five reference times (IET, GMT L/O, MET, PET, and TIG-) are all related to a particular mission. See figure 1-27.

MISSION - STS 6
 LAUNCH - NOON APR 4, 1983 GMT

YEAR: 1983

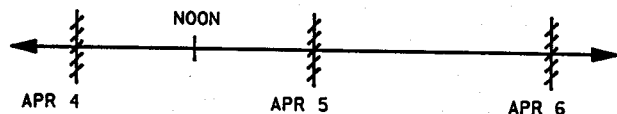
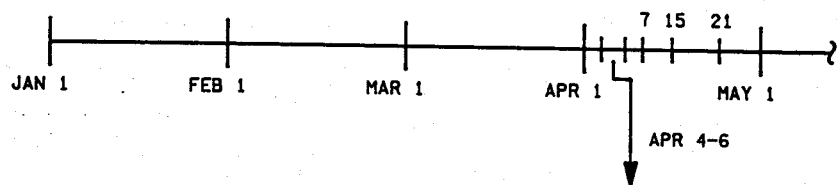

16

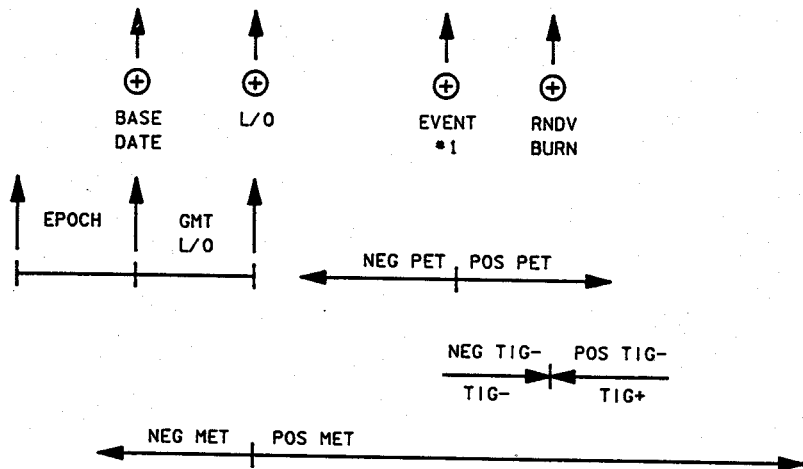

10511214. ART, 1

Figure 1-27.- Time relationships.

1.3.8 Epoch

Epoch is defined to be a specified date, usually the date of some historical event, to which the coordinates and other data for a celestial body are referenced, or from which a new time period is measured. An example of referencing to a particular epoch is the M50 coordinate system. It is a Cartesian coordinate system whose X axis is aligned with the mean vernal equinox of epoch, Z axis is aligned with the Earth mean rotational axis of epoch, and Y axis completes the right handed system. The epoch is the beginning of the Besselian year 1950. Mean denotes an average direction for the vernal equinox, or the rotational axis for that epoch. The average is used to remove the short period nutation motions of the Earth. The M50 coordinate system is shown in figure 1-28.

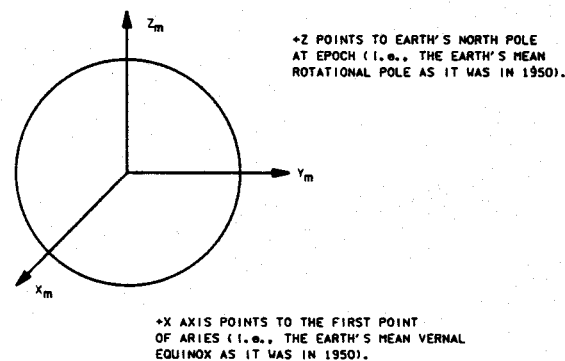

Figure 1-28.- M50 coordinate system.

SECTION 2 ORBITS

2.1 DEFINITION OF COMMONLY USED ORBITAL ELEMENTS

There are five independent orbital elements that describe the size, shape and orientation of an orbit. A sixth element is needed to locate the position of a satellite in an orbit at a particular time. These six elements are described below and are shown in figure 2-1.

- a Semimajor axis - a constant defining the size of an elliptical orbit.
- e Eccentricity - a constant defining the shape of the conic orbit.
- I Inclination - the angle between the north polar axis of the Earth and the angular momentum vector.
- Ω Right ascension (RA) of the ascending node - the angle measured eastward from the X axis along the Equator to that intersection with the orbit plane where the satellite passes from south to north. In the case where the inclination is zero, the ascending node is defined to be the RA of the vehicle.
- ω Argument of perigee - the angle measured in the orbit plane from the ascending node to perigee in the direction of travel in the orbit. In the case of eccentricity equals zero, perigee is defined to be at the ascending node.
- f True anomaly - the geocentric angular displacement of the vehicle measured in the orbit plane from perigee and positive in the direction of travel.

These six elements are not the only ones which can completely describe an orbit. There are other quantities which can also be used. For example, the true anomaly may be replaced by the time of perigee. The set of orbital elements chosen to describe an orbit depends on the data that is available.

2.2 EPHEMERIS FILES FOR POINTING PROGRAMS

An ephemeris defines the position and velocity of an orbiting body as a function of time. The ephemeris files used by the pointing programs are derived from flight-specific supertapes which are generated by the Trajectory Division. Each supertape consists of a collection of state vectors taken at 1-minute intervals for an entire flight duration. Each state vector consists of a position vector, a velocity vector, and a corresponding time tag. The collection of these vector pairs on the supertape completely describes the ephemeris of the Space Shuttle during a particular flight. Once a supertape is received from MPAD, it is loaded

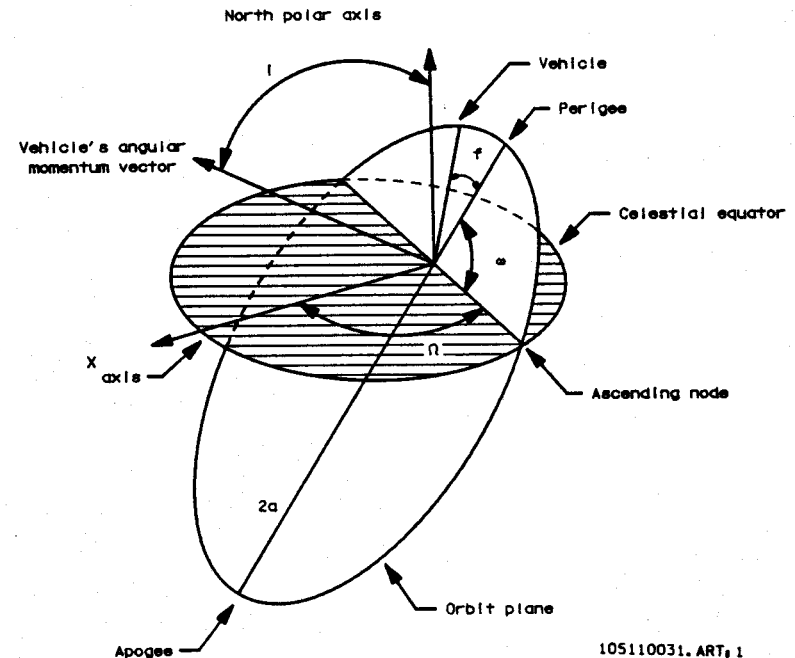

Figure 2-1.- Orbital elements.

into the crew activity pointing system (CAPS) computer system where the timeliners use the data for crew activity plan (CAP) generation. Since the pointers use a minicomputer rather than the CAPS system for attitude calculations, a smaller, more convenient ephemeris file must be generated from the supertape. This is done by extracting state vectors from the supertape normally at 12-hour intervals during the flight. State vectors are also taken before important events such as satellite deploys and after-orbit perturbing events such as on-orbit burns. This smaller collection of state vectors gives orbit information only at the specific times of the chosen vectors. In order to fill the gaps left between the vectors, the ability to propagate a vector forward or backward in time is necessary. To do this the state vectors are loaded into an ephemeris generating program which converts the state vectors into sets of invariant elements. These elements can be propagated to any time desired.

There are nine invariant elements used in the ephemeris files. Six of the elements are the common orbital elements described in the previous section. The other three elements help describe the orbit plane perturbations due to the gravitational effects of an oblate Earth (e.g., regression of nodes, rotation of the line of apsides). These nine elements are:

- AK Semimajor axis
- EK Eccentricity
- GK Argument of perigee
- IK Inclination
- HK Ascending node longitude
- MK Mean anomaly: The angle that would exist between the perigee of the orbit and the satellite if in the time since leaving perigee the satellite had travelled at a constant angular velocity equal to the mean motion. The angle is positive in the direction of travel.
- ETA Mean motion: The average angular velocity of the spacecraft with respect to the center of the Earth over one complete orbit.
- GOOT Rate of change of the argument of perigee.
- HDOOT Rate of change of the ascending node longitude.

2.3 BASIC EQUATIONS OF THE TWO-BODY PROBLEM

Because of the extensive discussion of this subject in literature, only a brief review will be made here. Consult the references for greater detail and specific propagation techniques.

Newton's law of universal gravitation expresses the mutual gravitational attraction of two objects by

$$\vec{F}_g = \frac{-Gm_1m_2\vec{R}}{R^3}$$

where "G" is the universal gravitational constant. Since the force due to gravity will result in each of the masses being accelerated we can write

$$\vec{F}_g = -\frac{Gm_1m_2\vec{R}}{R^3} = m_1\vec{A}_1 = m_2\vec{A}_2$$

Because we have assumed that

$$\vec{R} = \vec{R}_1 - \vec{R}_2$$

we can express

$$\vec{A}_1 = \ddot{\vec{R}}_1 \text{ and } \vec{A}_2 = \ddot{\vec{R}}_2$$

with which we can express the acceleration of each mass as a function of its gravitational attraction to the other.

$$m_1\ddot{\vec{R}}_1 = m_1\vec{A}_1 = -\frac{Gm_1m_2\vec{R}}{R^3}$$

$$\ddot{\vec{R}}_1 = -\frac{Gm_2\vec{R}}{R^3}$$

And for m_2 :

$$\ddot{\vec{R}}_2 = -\frac{Gm_1\vec{R}}{R^3}$$

If these two equations are subtracted we get

$$\ddot{\vec{R}} = \ddot{\vec{R}}_1 - \ddot{\vec{R}}_2 = -\frac{G(m_1+m_2)\vec{R}}{R^3}$$

where

$$\ddot{\vec{R}} = -\frac{G(m_1+m_2)\vec{R}}{R^3}$$

is called the two-body equation. It is important to remember that it has been assumed that both bodies are spherically symmetric and can accurately be modeled as point masses. In addition, no effects due to geopotential, air drag, solar wind, or other bodies have been included. When we assume m_1 to be the Earth and m_2 to be a satellite, this equation can be further simplified to

$$\ddot{\vec{R}} = -\frac{\mu_\oplus\vec{R}}{R^3} \quad \text{where } m_1+m_2 \approx m_1 \text{ and } Gm_1 = Gm_\oplus = \mu_\oplus$$

where $\mu_\oplus = 1.407646882 \times 10^{16} \text{ ft}^3/\text{sec}^2$.

It is also important to realize that this differential equation cannot be solved in a closed form. How to predict the position of a satellite at a future time is known as the Kepler problem since Kepler was the first person to accurately do so. Since then many other techniques have been developed as is evident from a brief review of the literature on the subject. All methods involve some type of iterative technique. For a traditional two-body orbit with no external forces, the individual classical orbital elements do not change and are called invariant. In the real world there are many forces that perturb an orbit and render an invariant approach inaccurate.

There are four general classes of perturbative forces that concern us. These are geopotential, air drag, third body, and radiation pressure. The perturbations of an orbit due to geopotential result from the irregular mass distribution in the Earth. As was shown earlier, the major effect is due to J_2 and is 10^{-3} less than the two-body force. Higher order terms are 10^{-6} or less in magnitude. Air drag is another force of interest for low Earth orbits. Air drag is difficult to account for

$$\bar{A}_D = \bar{F}_D / m = \frac{\frac{1}{2} \rho \bar{V}^2 A C_D}{m}$$

A = cross sectional area
 C_D = drag coefficient
 ρ = density of air
 V = velocity

due to the direct effect of density. The upper atmosphere of the Earth changes continuously due to solar heating, radiation pressures, and gravitational effects. The density and thickness of the atmosphere vary throughout the orbit. This variation can have a significant effect on orbit predictions. The primary third body that bothers our orbits is the Moon. The force due to the Moon is as follows:

$$\bar{A}_m = \frac{\bar{F}_m}{m_s} = \frac{\ddot{\bar{R}}_{ms}}{R_{ms}^3} = - \frac{GM_m \bar{R}_{ms}}{R_{ms}^3}$$

\bar{R}_{ms} = vector from satellite to Moon
 M_m = mass of Moon

$$\bar{A}_m = - \frac{\mu_m \bar{R}_{ms}}{R_{ms}^3} \text{ where } \mu_m = Gm_m = 1.7314 \times 10^{14} \text{ ft}^3/\text{sec}^2$$

It is considerable and needs to be accounted for. The fourth class of force stems from the radiation pressure of the Sun. This force has a magnitude

$$\bar{A}_R = \frac{\bar{F}_R}{m_s} = \left(\frac{E}{C} \right) \frac{AG \bar{R}}{m_s R^3}$$

where E = solar constant
 C = speed of light
 A = cross sectional area
 G = reflectivity factor

smaller than the others but can have a significant effect over a long period of time.

The accelerations due to these perturbing forces are added onto the two-body equations and integrated

$$\ddot{\bar{R}} = \frac{-\mu \bar{R}}{R^3} + \bar{A}_g + \bar{A}_D + \bar{A}_m + \bar{A}_R$$

where \bar{A}_g = acceleration due to geopotential
 \bar{A}_D = acceleration due to drag
 \bar{A}_m = acceleration due to the Moon
 \bar{A}_R = acceleration due to radiation pressure

Neglecting the specific mathematical techniques used for this integration, there are two basic perturbation methods. The first is called variation of parameters. This method assumes that for every discrete piece of the actual orbit there is a reference orbit that will coincide at that point. The orbital parameters (elements) are then varied continuously around the actual orbit. This method is only as good as the models used for the perturbing forces. The second technique uses osculating (kissing) elements. It differs from variation of parameters in that it generates the invariant elements at a point where the actual orbit and reference orbit touch and then propagates these invariant elements forward until a predefined error occurs between the two orbits. A new set of invariant elements is then generated to zero out the error and is then propagated forward. Most propagators use osculating elements.

2.4 PRECESSION AND NUTATION

The vernal and autumnal equinoxes are defined by the line of intersection of the equatorial plane of the Earth with the ecliptic plane. This line of intersection precesses to the west about 50 arc-seconds per year. The precession is due to the gravitational pull of the Sun and Moon on an oblate Earth. This pull produces a torque on the Earth that causes the rotational axis of the Earth to sweep out a $23\text{-}1/2^\circ$ half-angle cone every 26,000 years. As the rotational axis sweeps out the cone, the equinoxes precess to the west. There is another torque on the Earth produced by the gravitational pull of the Moon. The orbit plane of the Moon precesses with a period of 18.6 years due to the perturbative effects of the Sun. Thus, the pull of the Moon on the Earth also has a period of 18.6 years. The result of this pull causes a nodding effect to be superimposed on the westward procession of the equinoxes. This is called nutation.

2.5 GROUNDTRACK

A satellite orbiting a nonrotating Earth traces out a great circle with its groundtrack. When you allow for the rotation of the Earth, the orbit plane of the satellite essentially remains fixed in space while the Earth rotates under it. The effect of this rotation is to displace the groundtrack to the west with each revolution of the satellite. The amount of this displacement equals the number of degrees the Earth rotates during one orbital period plus the negligible amount due to the westward drift of the orbital plane. See figure 2-2.

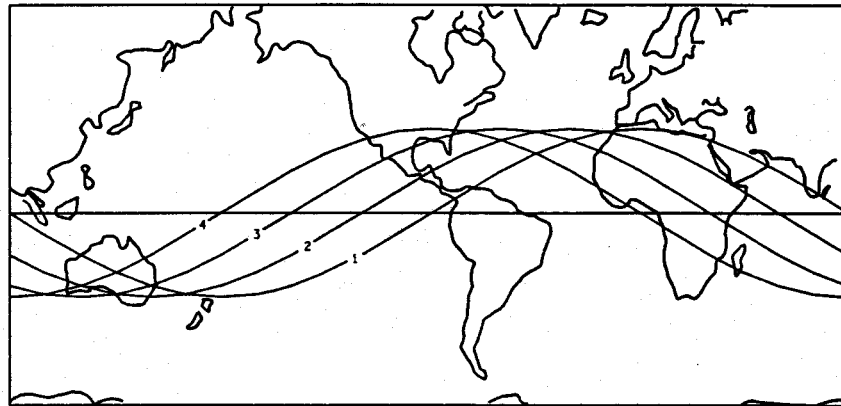

Figure 2-2.- Groundtrack.

10511F61.ART.1

Consider the case of a satellite which has a 90-minute orbital period. The amount of displacement per revolution is approximately

$$\frac{360^\circ}{24 \text{ hr}} \times \frac{1 \text{ hr}}{60 \text{ min}} \times \frac{90 \text{ min}}{\text{rev}} = \frac{22.5^\circ}{\text{rev}}$$

The maximum latitude north or south of the Equator that the satellite obtains is equal to the inclination of the orbit. Note that for a retrograde orbit the most northerly or southerly latitude of the orbit is 180° minus the inclination.

A term that should be mentioned here is the suborbital point or subsatellite point. This point defines the instantaneous groundtrack of an orbiting body.

2.6 GEOSYNCHRONOUS SATELLITE

A satellite is said to be in a geosynchronous orbit if it is at an altitude so that its angular velocity matches the rotation of the Earth. The altitude that accomplishes this is 19,300 nautical miles (n. mi.) If the geosynchronous orbit has no inclination, the satellite seems to sit motionless over some point on the equator of the Earth. However, if the orbit has non-zero inclination, the groundtrack of the satellite will trace out figure eights as shown in figure 2-3.

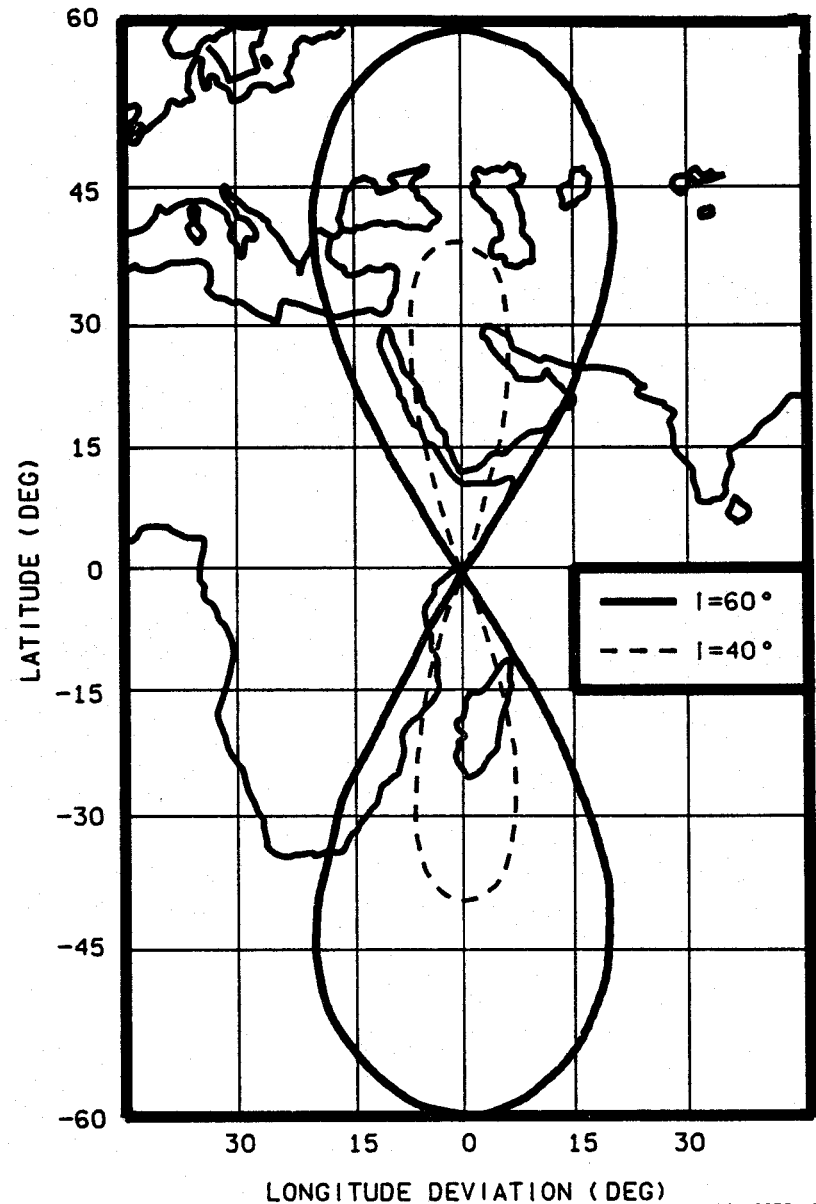

Figure 2-3.- Geosynchronous satellite.

105110033.ART.2

SECTION 3
ATTITUDE DEFINITIONS AND DYNAMICS

3.1 REFERENCE AXIS DEFINITION

The Space Shuttle body axes are different from the Shuttle structural body axes and must not be confused. The body axes are used for attitudes while the structural axes are not. See figure 3-1. The body axes are defined as follows:

- a. A body axis has its origin at the Orbiter center of mass.
- b. The positive X axis extends from the center of gravity (c.g.) through the nose of the vehicle parallel to the structural X axis.
- c. The Z axis is parallel to the Orbiter plane of symmetry and is perpendicular to the X axis. The Z-body axis is positive down with respect to the Orbiter fuselage.
- d. The Y-body axis completes the right-hand orthogonal system.

21

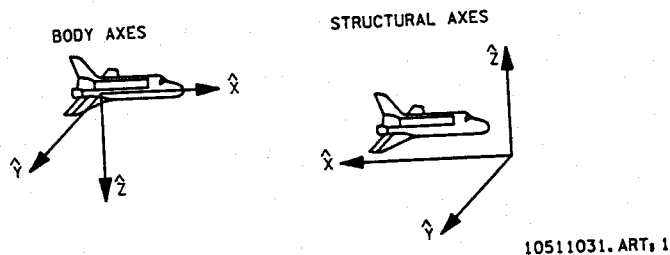

Figure 3-1.- Orbiter coordinate systems.

The structural body axes have their origins 236 inches forward of the nose and 340 inches below the nose tip with the positive X axis running toward the tail. The Z structural axis is positive up out of the bay and the Y axis completes the system. It is easy to see that the two systems are quite different. Only the body-axis system is ever used in conjunction with Orbiter attitudes.

Of the many reference frames available, three are used most often. These are M50 inertial, starball (SB), and local vertical local horizontal (LVLH).

The M50 is inertially fixed relative to the stars and has its axes origin at the center of the Earth. It is relative to this coordinate frame that all star positions are referenced by astronomers. The X axis is defined as pointing at the first point of Aries as it existed on January 1, 1950. The first point of Aries is where the equatorial plane of the Earth and the orbit plane of the Sun (ecliptic plane) intersect. The two points where

these planes intersect are the vernal and autumnal equinoxes. Since the Sun lies on the Earth equator on these days, there are equal periods of day and night. The M50 +X axis is defined as passing through the vernal (spring) equinox. The +Z axis extends up through the Earth north pole. The M50 system is one of many Earth-centered inertial (ECI) systems in use. The ECI systems are popular because the stars maintain constant positions. In reality the stars do exhibit small random motions which necessitate minor updates to their positions every 5 or 10 years.

When the Orbiter body axes and M50 axes are aligned (fig. 3-2), the Orbiter M50 attitude is by definition a pitch, yaw, roll of 0,0,0. Notice that the Orbiter bay points to the Earth south pole and that the Orbiter X-Y plane lies in (or is parallel to) the Earth equatorial plane. Astronomers plot the positions of the stars on star charts that are referenced to the M50 system. Astronomers prefer to use an RA and DEC system to describe star positions instead of unit vectors. See figure 3-3.

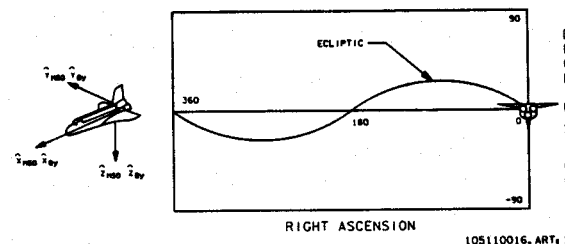

Figure 3-2.- M50 system.

For a star located by unit vector U

$$U_x = \cos (DEC) \cos (RA)$$

$$U_y = \cos (DEC) \sin (RA)$$

$$U_z = \sin (DEC)$$

or solved for RA and DEC

$$RA = \tan^{-1} \left(\frac{U_y}{U_x} \right)$$

$$DEC = \sin^{-1} \left(U_z \right)$$

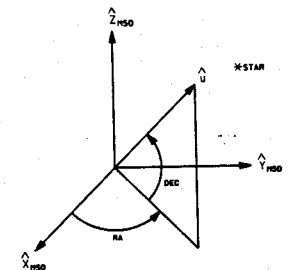

Figure 3-3.-RA, DEC.

Almost all star tables list the RA and DEC positions of the stars relative to the M50 reference frame. It is necessary to explain how a star chart works in order to explain the SB reference system.

Early in the space program there was concern about the ability of a crew in space to locate and identify stars so that the attitude and position of their vehicle could be determined. A simple system was needed that would allow the crew to look up the position of a star on a star chart and then maneuver their vehicle to point at it. The solution was to define an inertial reference frame rotated 90° from M50. See figure 3-4.

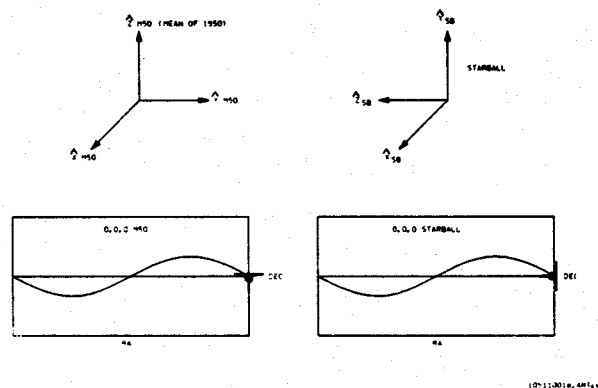

Figure 3-4.- SB vs. M50.

The advantage to rotating M50 by 90° about the X axis can easily be seen on star charts. When the Orbiter is in a 0,0,0 attitude relative to M50, the bay points south along negative declination with the nose into the chart. When in 0,0,0 SB, the Orbiter X-Z plane lies along RA and the nose is into the chart. Since the Orbiter performs all maneuvers in a pitch, yaw, roll sequence, the crew can easily point the nose of their vehicle at any star by pitching equal to the RA and then yawing equal to the DEC. It was for this simple reason that the SB system was initially chosen. Recently, the Johnson Space Center decided to use the M50 system for Orbiter attitudes in order to facilitate communications with the scientific community and other NASA centers.

As the M50 and SB frames were picked for their ease in maintaining star-relative orientations, so was the LVLH system picked for maintaining Earth-relative orientations. The LVLH reference frame is not inertially fixed like M50, but rotates with the Orbiter position vector. The LVLH +Z axis (local vertical) is parallel to the radius vector, positive from the Orbiter center of mass to the center of the Earth. The LVLH +Y axis is pointed in the direction of the negative angular momentum vector. The LVLH +X axis (local horizontal) completes the orthogonal coordinate system. The +X axis lies in the orbit plane in the direction of the velocity vector, but is only

identical to the velocity vector for perfectly circular orbits. When the Orbiter is in an LVLH 0,0,0 attitude, the belly points to the center of the Earth and the nose points in the local horizontal direction. When the Orbiter is placed in a specific LVLH attitude, it will remain in the same Earth-facing orientation as it orbits the Earth. When the LVLH frame is viewed from the M50 or SB frames, it can be seen to rotate once per orbital period. Relating a rotating reference frame like LVLH to a fixed frame like M50 requires that the rotation matrix relating the two frames be a function of time. However, for a specific time, this matrix is constant which permits an easy translation from one frame to another.

The other reference frames that may be encountered are described in figures 3-5 through 3-16. In each case the orientation of individual axes will differ slightly. Some use the true Earth rotational pole instead of a mean while others are concerned with the true Earth equator instead of a mean. Regardless of which reference frame is chosen, that frame can always be related to the others by simple rotation matrices.

At this point it should be made clear what is meant by the terms mean and true as they relate to reference frames. The M50 reference frame, for example, uses an RA and DEC system to define a point in inertial space. The origin of RA is fixed by imposing the condition that when the DEC of the Sun is observed to be zero in March (vernal equinox), its RA is also zero. If a star is observed on successive nights (at the same time), it will be found that its RA and DEC change by amounts that are often perceptible in a single day. The change is due largely to the motions of the equator and equinox rather than the motions of the stars. These motions are caused by gravitational effects which cause the Earth's north pole to precess and nutate (see chapter 3.4). Besides precession and nutation, there is another effect producing changes in RA and DEC that is called aberration. The principal of aberration is stated as follows: two neighboring observers in relative motion will see the same object in different directions. The angular difference is the ratio of their relative velocity to the velocity of light, multiplied by the sine of the angle between the line of sight to the object and the observer's relative velocity vector and in the direction of the velocity vector. The RA's and DEC's of stars that are immediately observed are called apparent RA's and DEC's. If the effects of aberration are removed from an apparent RA and DEC, the coordinates are then said to be referred to the true equator and true equinox of date. If the effects of nutation are also removed, the coordinates are then said to be referred to the mean equator and the mean equinox of date. If the coordinates are further corrected for precession from a specific epoch, such as 1950.0, the coordinates are said to be referred to the mean equator and the mean equinox of 1950.0, or for brevity, M50.

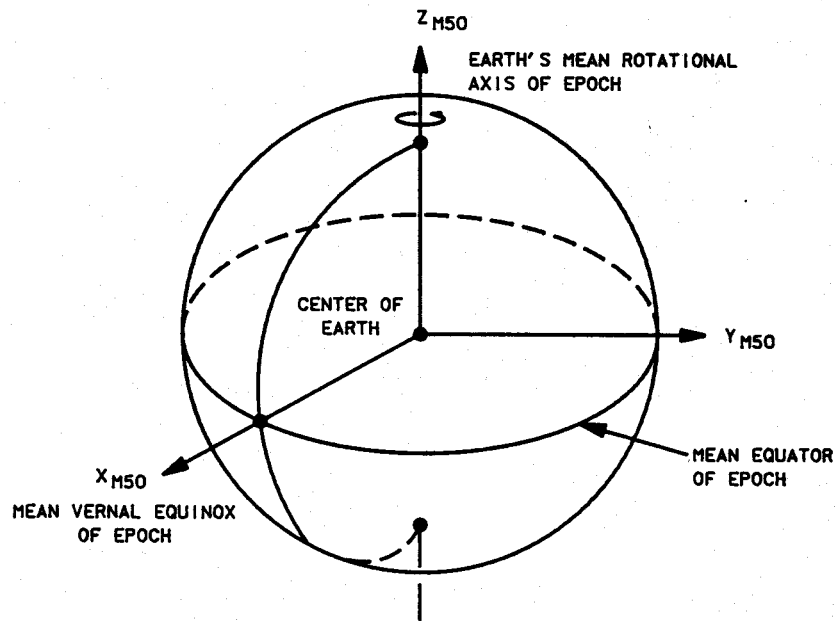

105110019. ART, 1

NAME: Aries-Mean-equator and equinox-of-1950 reference-axis system. The M50 system is a specific case of the general MEE system.

ORIGIN: The center of the Earth.

ORIENTATION: The epoch is the beginning of Besselian year 1950 or Julian ephemeris date 2433282.423357.

The X_{M50} - Y_{M50} plane is the mean Earth equator of epoch.

The X_{M50} -axis is directed towards the mean vernal equinox of epoch.

The Z_{M50} -axis is directed along the Earth mean rotational axis of epoch and is positive north.

The Y_{M50} -axis completes a right-handed system.

CHARACTERISTICS: Inertial, right-handed Cartesian system.

Figure 3-5.- Aries-Mean-of-1950 system.

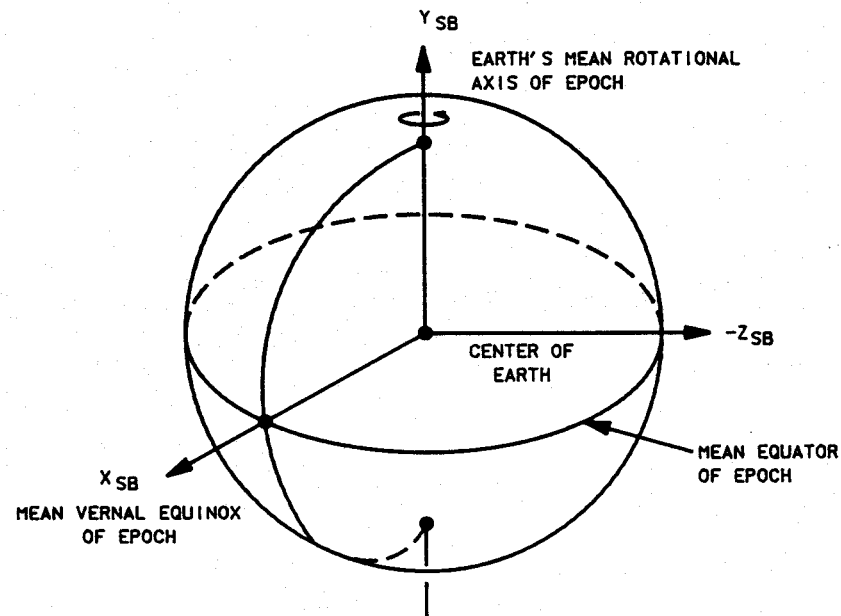

105110110. ART, 1

NAME: Starball

ORIGIN: The center of the Earth.

ORIENTATION: The epoch is the beginning of Besselian year 1950 or Julian ephemeris date 2433282.423357.

The X_{SB} - Z_{SB} plane is the mean Earth equator of epoch.

The X_{SB} -axis is directed towards the mean vernal equinox of epoch.

The Y_{SB} -axis is directed along the Earth mean rotational axis of epoch and is positive north.

The Z_{SB} -axis completes a right-handed system.

CHARACTERISTICS: Inertial, right-handed Cartesian system.

Figure 3-6.- Starball.

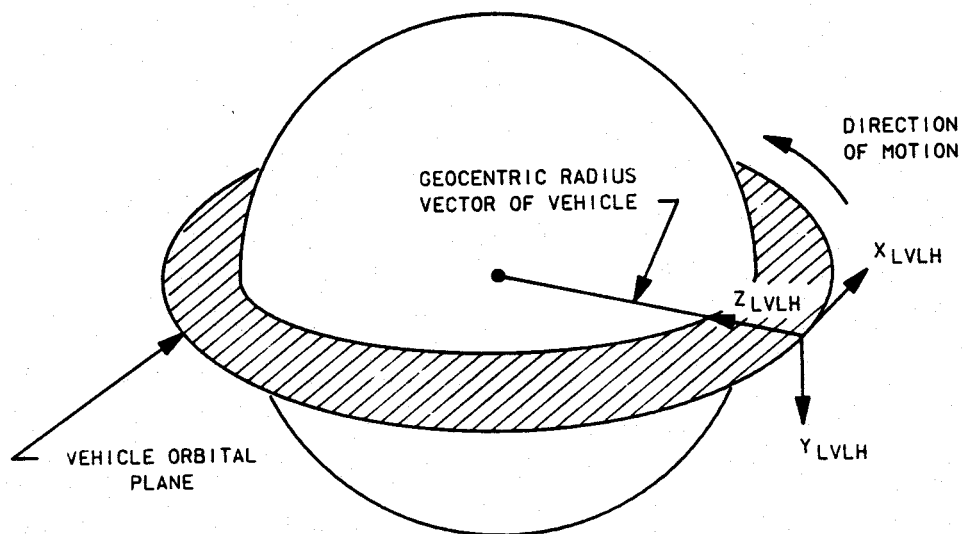

3301. ART. 1

NAME: Local vertical local horizontal reference-axis system.

ORIGIN: Vehicle center of mass.

ORIENTATION: The LVLH +Z axis (local vertical) is parallel to the radius vector, positive from the Orbiter center of mass to the center of the Earth.

The LVLH +Y axis is pointed in the direction of the negative angular momentum vector.

The LVLH +X axis (local horizontal) completes the orthogonal coordinate system. The +X axis lies in the orbit plane in the direction of the velocity vector, but is only identical to the velocity vector for perfectly circular orbits.

CHARACTERISTICS: Center of Earth relative, right-handed Cartesian system.

Figure 3-7.- LVLH reference-axis system.

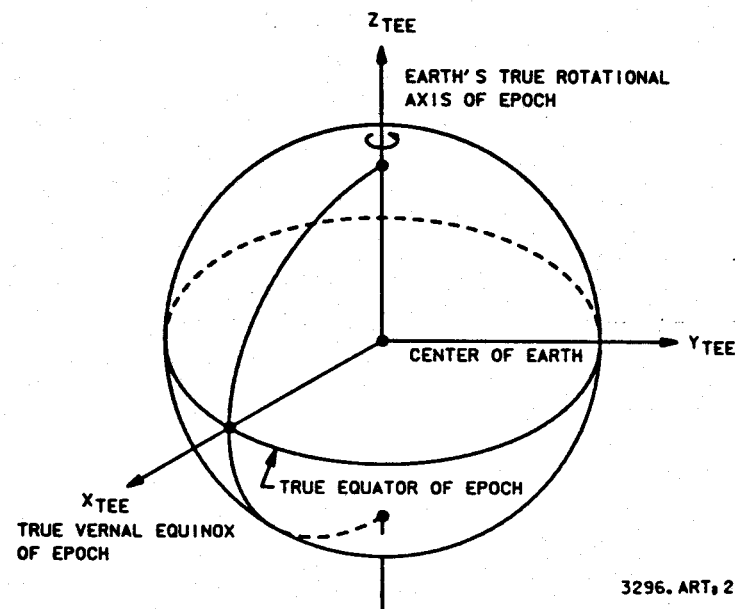

3296. ART. 2

NAME: True equator and equinox of epoch reference-axis system.

ORIGIN: The center of the Earth.

ORIENTATION: The epoch is defined to be 0 hours 0 minutes 0 seconds GMT on the user-specified base date.

The X_TEE-Y_TEE plane is the Earth true equatorial plane of epoch.

The X_TEE-axis is directed towards the true vernal equinox of epoch.

The Z_TEE-axis is directed along the Earth true rotational axis of epoch and is positive north.

The Y_TEE-axis completes the right-handed system.

CHARACTERISTICS: Inertial, right-handed Cartesian system.

Figure 3-8.- True-of-epoch system.

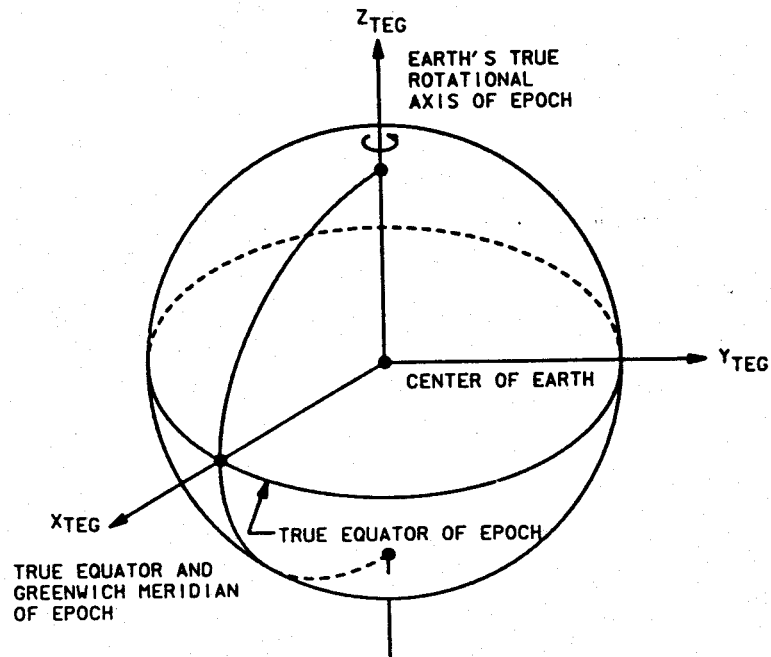

NAME: True equator and Greenwich meridian of epoch reference-axis system.

ORIGIN: The center of the Earth.

ORIENTATION: The epoch is defined to be 0 hours 0 minutes 0 seconds GMT on the user-specified base date.

The X_{TEG} - Y_{TEG} plane is the Earth true equatorial plane of epoch.

The X_{TEG} -axis passes through the Greenwich meridian of epoch.

The Z_{TEG} -axis is directed along the Earth true rotational axis of epoch and is positive north.

The Y_{TEG} -axis completes the right-handed system.

CHARACTERISTICS: Inertial, right-handed Cartesian system.

Figure 3-9.- True-Greenwich-of-epoch system.

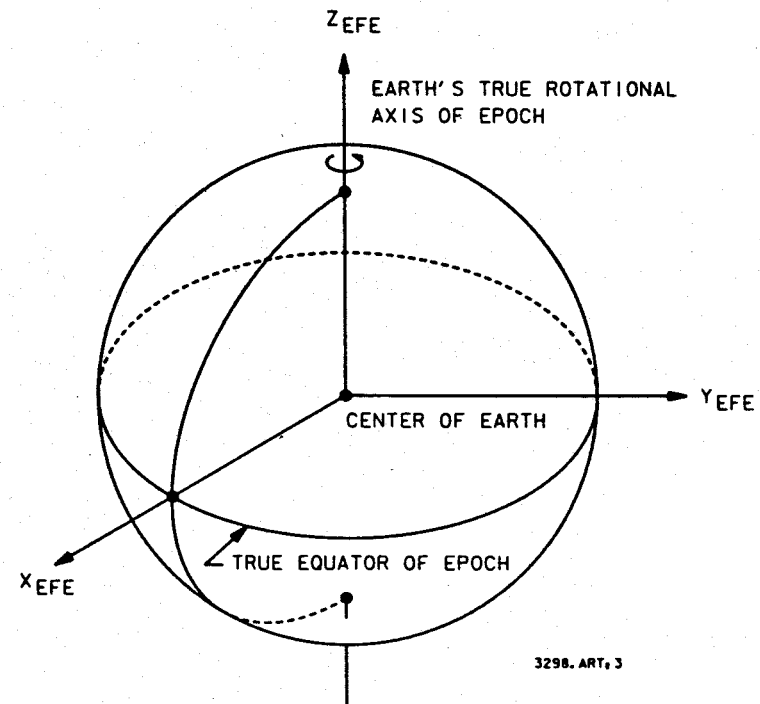

NAME: Earth-fixed equatorial (EFE) of epoch reference-axis system.

ORIGIN: The center of the Earth.

ORIENTATION: The epoch is defined to be 0 hours 0 minutes 0 seconds GMT on the user-specified base date.

The X_{EFE} - Y_{EFE} plane is the Earth true equator of epoch.

The X_{EFE} -axis passes through the Greenwich meridian.

The Z_{EFE} -axis is directed along the Earth's true rotational axis of epoch and is positive north.

The Y_{EFE} -axis completes the right-handed system.

CHARACTERISTICS: Rotating, right-handed Cartesian system.

Figure 3-10.- Earth-fixed equatorial system.

26

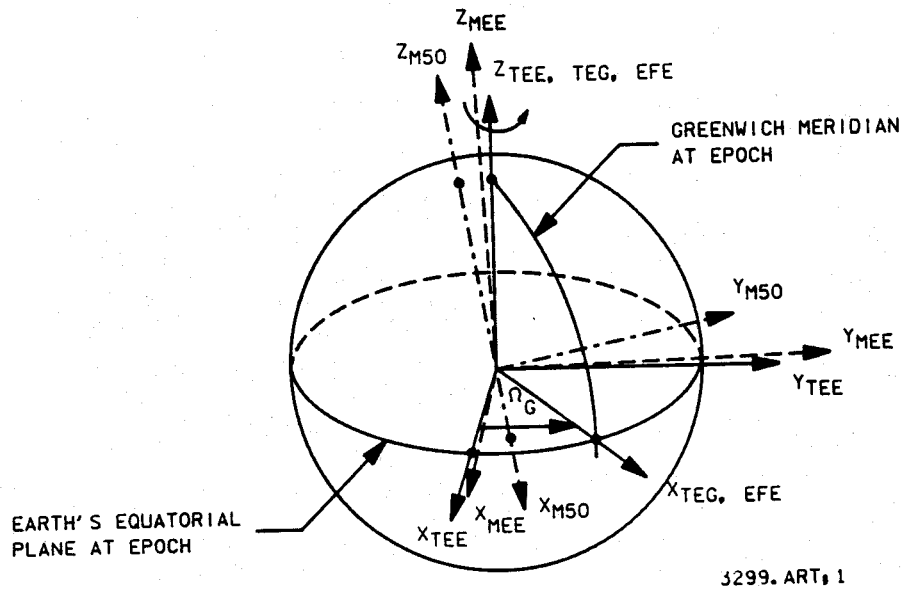

Epoch is defined to be 0 hours 0 minutes 0 seconds GMT on the user-specified base date.

- _____ defines the TEE, TEG, and EFE axis systems at epoch.
- defines the MEE axis system at epoch.
- . - . - . defines the M50 axis system at epoch.
- Ω_G defines the right ascension of Greenwich at epoch

NOTE: The angles between the reference axes are not to scale; they have been exaggerated for purpose of illustration.

Figure 3-11.- Illustration of relative orientation of reference-axis systems at epoch.

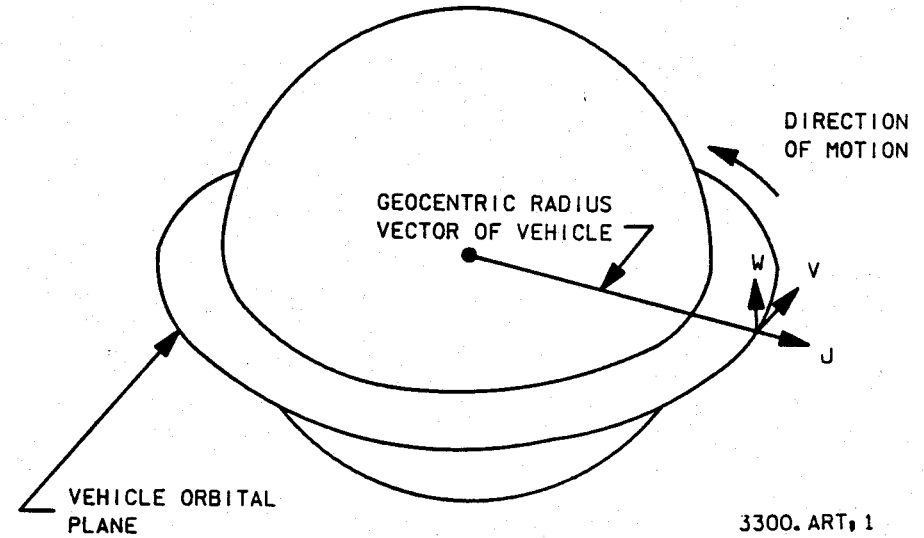

NAME: UVW reference-axis system.

ORIGIN: Vehicle center of mass.

ORIENTATION: The U-V plane is the instantaneous orbit plane at the time of interest.

The U axis lies along the geocentric radius vector to the vehicle and is positive radially outward.

The W axis lies along the instantaneous orbital angular momentum vector at epoch and is positive in the direction of the angular momentum vector.

The V axis completes a right-handed system.

CHARACTERISTICS: Quasi-inertial, right-handed Cartesian coordinate system. This system is quasi-inertial in the sense that it is treated as an inertial coordinate system, but it is redefined at each point of interest.

Figure 3-12.- UVW reference-axis system.

3.2 ATTITUDE DEFINITION

Every physical object can have a body reference frame that is permanently fixed to itself. See figure 3-13. This means that the X, Y, and Z positions of parts of this object are always the same. An attitude is the orientation of this body reference frame relative to another reference frame. The attitude is the three angle set that describes the current orientation of the body frame relative to the chosen reference frame. (It is important to realize that when two frames are aligned, their origins need not be in the same place. When two frames are coaligned their axes point in the same directions and their origins are in the same place. The definition of the attitude of the object is the same in both cases, but the position of the object is not.)

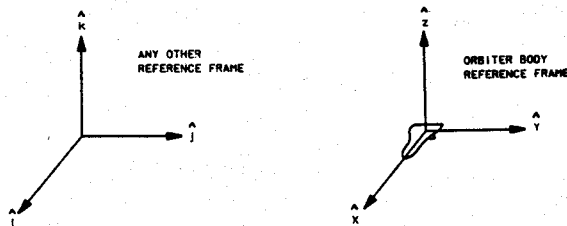

Figure 3-13.- Reference systems.

The definition of the three angles that defines the attitude of a body is a simple matter of choice. A set that is widely accepted and in use here consists of Euler angles. These angles represent three successive rotations of a coordinate frame from an initially aligned state to a final orientation. These rotations are performed about the body axes of the body in a specific sequence. Each axis has, by convention, been given a number which refers to a rotation about that axis in accordance with the right hand rule. A rotation about the body X axis is called a one rotation; a rotation about the body Y axis is called a two rotation; and a rotation about the body Z axis is called a three rotation. Any sequence of these rotations (1, 2, 3 or 2, 3, 1, etc.) can represent the body attitude. Again, by convention, we use a 2, 3, 1 rotation sequence for the Orbiter which equates to a pitch, yaw, and roll. See figure 3-14.

The reason Euler angles are widely used is due to their mathematical flexibility. To demonstrate this, consider two sets of axes initially coaligned that have been rotated by θ_1 degrees about the X axis. Since X, Y, Z and i, j, k are unit vectors (refer to appendix D for vector/matrix notation used in this book), the two reference frames are related by

$$X = i$$

$$Y = j \cos \theta_1 + k \sin \theta_1$$

$$Z = -j \sin \theta_1 + k \cos \theta_1$$

Figure 3-14.- A positive roll.

This can be expressed in terms of a matrix as

$$\begin{bmatrix} X \\ Y \\ Z \end{bmatrix} = \begin{bmatrix} 1 & 0 & 0 \\ 0 & \cos \theta_1 & \sin \theta_1 \\ 0 & -\sin \theta_1 & \cos \theta_1 \end{bmatrix} \begin{bmatrix} i \\ j \\ k \end{bmatrix} \quad \text{'1' rotation of } \theta_1 \text{ degrees}$$

This 3 X 3 matrix is called a rotation matrix and represents a '1' rotation. In a similar manner a '2' (pitch) rotation would be expressed as

$$\begin{bmatrix} X \\ Y \\ Z \end{bmatrix} = \begin{bmatrix} \cos \theta_2 & 0 & -\sin \theta_2 \\ 0 & 1 & 0 \\ \sin \theta_2 & 0 & \cos \theta_2 \end{bmatrix} \begin{bmatrix} i \\ j \\ k \end{bmatrix} \quad \text{'2' rotation of } \theta_2 \text{ degrees}$$

A '3' (yaw) rotation would be expressed as

$$\begin{bmatrix} X \\ Y \\ Z \end{bmatrix} = \begin{bmatrix} \cos \theta_3 & \sin \theta_3 & 0 \\ -\sin \theta_3 & \cos \theta_3 & 0 \\ 0 & 0 & 1 \end{bmatrix} \begin{bmatrix} i \\ j \\ k \end{bmatrix} \quad \text{'3' rotation of } \theta_3 \text{ degrees}$$

These matrices will always have the same pattern of ones and zeros. The sines and cosines will also be the same, differing only in which sine term gets the minus sign. The real advantage of Euler sequences is that a sequence of these rotations is simply the matrix product of the individual rotation matrices in the order in which they occurred. For our purposes, we always deal with a 2, 3, 1 sequence which when multiplied out equates to

$$\begin{bmatrix} X \\ Y \\ Z \end{bmatrix} = \begin{bmatrix} \cos \theta_2 \cos \theta_3 & \sin \theta_3 & -\sin \theta_2 \cos \theta_3 \\ -\cos \theta_2 \sin \theta_3 \cos \theta_1 + \sin \theta_2 \sin \theta_1 & \cos \theta_3 \cos \theta_1 & \sin \theta_2 \sin \theta_3 \cos \theta_1 + \cos \theta_2 \sin \theta_1 \\ \cos \theta_2 \sin \theta_3 \sin \theta_1 - \cos \theta_3 \sin \theta_1 & -\cos \theta_3 \sin \theta_1 & -\sin \theta_2 \sin \theta_3 \sin \theta_1 + \cos \theta_2 \cos \theta_1 \end{bmatrix} \begin{bmatrix} i \\ j \\ k \end{bmatrix}$$

This is equivalent to saying that the current vehicle orientation (or reference frame X, Y, Z orientation) is equivalent to a specific sequence of rotations from reference frame i, j, k. The angles θ_1 , θ_2 , and θ_3 represent the vehicle roll, pitch, and yaw. In addition, it can be shown that this rotation matrix is equivalent to a single rotation about a single vector. This eigen vector and eigen angle will be discussed more under quaternions. By varying the pitch, yaw, and roll of the vehicle, we can place the vehicle in any orientation to the reference axes.

Although vehicle maneuvers are modeled by pitch, yaw, roll rotations, the actual attitude of the vehicle is written in a roll, pitch, yaw sequence due simply to convention.

3.3 QUATERNIONS

Euler's theorem states that the general motion of a rigid body with one point fixed is a rotation about an axis through the point, where the axis is called the axis of rotation. We can consider the Orbiter center of mass as our fixed point with any reference frame also having its origin there. It's important to remember that for attitudes, the origin of the desired reference frame can be placed anywhere.

We have shown before that the rotation of the Orbiter from one orientation to another can be expressed as a rotation matrix.

$$\begin{bmatrix} \hat{x} \\ \hat{y} \\ \hat{z} \end{bmatrix}^2 = \begin{bmatrix} m_{11} & m_{12} & m_{13} \\ m_{21} & m_{22} & m_{23} \\ m_{31} & m_{32} & m_{33} \end{bmatrix}^2 \begin{bmatrix} \hat{x} \\ \hat{y} \\ \hat{z} \end{bmatrix}^1 \text{ or } [\hat{A}] = [M] [\hat{B}]$$

In this example, where [A] is the final position and [B] is the initial position, it doesn't matter if we are talking about a specific attitude relative to the reference frame or about going from one attitude to another; the process is the same, only the numbers change (refer to appendix D for vector/matrix notation used in this book). The process of solving for the equivalent rotation axis and rotation angle in mathematics is known as an eigen value problem where

$$[M][\vec{E}] = \lambda[\vec{E}] \text{ for } \lambda = \text{real number}$$

which states that there exists a non-zero vector [E] that when multiplied by scalar λ has the same direction and sense as [M][E]. This equates to saying that

$$([M] - \lambda[I])[\vec{E}] = 0 \text{ where } I = \text{identity matrix}$$

and requires that the determinant of

$$([M] - \lambda[I]) \text{ equal zero.}$$

The solutions to this determinant are called eigen values that when substituted back into the original equation yield the eigen vectors [E_i] of [M]. There will be normally two solutions that are opposite in directions. We always use the vector positive in terms of right hand rotations. The magnitude of the rotation comes directly from the terms in [M] by

$$\text{eigen angle} = 2 \cos^{-1} [0.5(1+m_{11} + m_{22} + m_{33})^{1/2}]$$

A quaternion is just a different expression for the eigen vector and eigen angle.

28

The four components making up a quaternion are defined as follows:

$$q_0 = 0.5 (1 + m_{11} + m_{22} + m_{33})^{1/2} = \cos (\mu/2)$$

$$q_1 = \cos (\alpha) \sin (\mu/2)$$

$$q_2 = \cos (\beta) \sin (\mu/2)$$

$$q_3 = \cos (\gamma) \sin (\mu/2)$$

where

μ = Net rotation about the eigen axis

α = angle between the eigen axis and X-reference axis

β = angle between the eigen axis and Y-reference axis

γ = angle between the eigen axis and Z-reference axis

To demonstrate how the process works, consider an Orbiter attitude defined as

$$\begin{array}{ll} \text{Roll} = 45^\circ & \text{Roll} = \theta_1 \\ \text{Pitch} = 0^\circ & \text{Pitch} = \theta_2 \\ \text{Yaw} = 90^\circ & \text{Yaw} = \theta_3 \end{array} \text{ where}$$

as used before. Knowing that a pitch, yaw, roll Euler sequence was used, we can build the direction cosine matrix [M] for this attitude

$$[M] = \begin{bmatrix} 0 & 1 & 0 \\ -.7071 & 0 & .7071 \\ .7071 & 0 & .7071 \end{bmatrix}$$

the characteristic equation turns out to be

$$\lambda^3 - .7071 \lambda^2 + .7071 \lambda - 2(.7071)^2 = 0$$

that has one real root of λ = 1. Substitution yields

$$\begin{array}{l} X_1 = X_2 \\ X_1 = 0.4142 X_3 \end{array}$$

so that when converted to a unit vector yields the eigen axis components (-1 used as a unit vector for right hand rule)

$$\hat{E} = \begin{array}{l} E_x = -0.3574 \\ E_y = -0.3574 \\ E_z = -0.8628 \end{array}$$

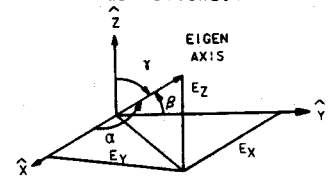

105110119. ART. 3
Figure 3-15.- Quaternion eigen axis.

Note: There is an important difference between the standard mathematical computation and the Orbiter software computation. The mathematical computation uses a M50-to-body quaternion, whereas the Orbiter software uses a body-to-M50 quaternion.

Consequently, the pointing software (M program) has incorporated this into its computations. The vector elements of the quaternion are multiplied by -1 to convert the M50-to-body quaternion to a body-to-M50 quaternion which is what the ICD says is downlinked from the Orbiter.

From [M] we can obtain the eigen angle by

$$\mu = \text{eigen angle} = 2 \cos^{-1}[0.5(1 + m_{11} + m_{22} + m_{33})^{1/2}]$$

$$\mu = 2 \cos^{-1}[0.5 (1+0+0+.7071)^{1/2}] = 98.42^\circ$$

and

$$q_0 = 0.5 [1 + m_{11} + m_{22} + m_{33}]^{1/2} = 0.65328$$

$$q_1 = \cos(\alpha) \sin(\mu/2) = [\cos \cos^{-1}(-.3574)] \sin(98.42/2) = -.27059$$

$$q_2 = \cos(\beta) \sin(\mu/2) = [\cos \cos^{-1}(-.3574)] \sin(98.42/2) = -.27059$$

$$q_3 = \cos(\gamma) \sin(\mu/2) = [\cos \cos^{-1}(-.86285)] \sin(98.42/2) = -.6532$$

so:

Roll = 45		$E_x = -.3574$		$q_0 = 0.65328$
Pitch = 0	equals	$E_y = -.3574$	equals	$q_1 = -.27059$
Yaw = 90		$E_z = -.8628$		$q_2 = -.27059$
		eigen angle = 98.42°		$q_3 = -.6532$

Quaternions are used in telemetry because they can represent a nine-element cosine matrix with four numbers. Although they are difficult to derive by hand, they are ideal for computers. Consult the references for more on quaternion algebra, etc. Normally, we do not use quaternions directly - only the roll, pitch, and yaw equivalents.

3.4 ATTITUDE SENSE +X, -X, -Z

In addition to the forward attitude direction indicators (ADI's) which always operate in the +X sense, there is an aft ADI which may operate in the -X or -Z sense. Selection is accomplished by the ADI SENSE switch located in the aft station. This switch allows the ADI angles to indicate the orientation of either a -X sense axis system or a -Z sense axis system, depending on whether the crewmember is viewing through the payload bay (-X) windows or the overhead (-Z) window.

The three ADI sense systems are depicted in figure 3-16 along with the respective transformation matrices that relate the sense system to the body system.

Note that the sense systems are fixed in the body system and are named according to the body axis which defines the primary sense axis.

Note the following for the -X sense (see fig. 3-17):

- Roll_{-x} is positive from -Y_{BY} to +Z_{BY} (equivalent to Orbiter negative roll).
- Pitch_{-x} is positive from +Z_{BY} to -X_{BY} (equivalent to Orbiter negative pitch).
- Yaw_{-x} is positive from -X_{BY} to -Y_{BY} (equivalent to Orbiter positive yaw).

Note the following for the -Z sense:

- Roll_{-z} is positive from -Y_{BY} to -X_{BY} (equivalent to Orbiter negative yaw).
- Pitch_{-z} is positive from -X_{BY} to -Z_{BY} (equivalent to Orbiter negative pitch).
- Yaw_{-z} is positive from -Z_{BY} to -Y_{BY} (equivalent to Orbiter negative roll).

Table 3-I shows the transformation matrices used for conversion from one ADI attitude sense to another.

TABLE 3-I.- ADI ATTITUDE SENSE CONVERSION

From -x Sense to +x Sense (AMX → AX)	$\begin{bmatrix} -1 & 0 & 0 \\ 0 & -1 & 0 \\ 0 & 0 & 1 \end{bmatrix}$	AX AMX
From +x Sense to -x Sense (AX → AMX)	$\begin{bmatrix} -1 & 0 & 0 \\ 0 & -1 & 0 \\ 0 & 0 & 1 \end{bmatrix}$	AMX AX
From -z Sense to +x Sense (AMZ → AX)	$\begin{bmatrix} 0 & 0 & -1 \\ 0 & -1 & 0 \\ -1 & 0 & 0 \end{bmatrix}$	AX AMZ
From +x Sense to -z Sense (AX → AMZ)	$\begin{bmatrix} 0 & 0 & -1 \\ 0 & -1 & 0 \\ -1 & 0 & 0 \end{bmatrix}$	AMZ AX
From -z Sense to -x Sense (AMZ → AMX)	$\begin{bmatrix} 0 & 0 & 1 \\ 0 & 1 & 0 \\ -1 & 0 & 0 \end{bmatrix}$	AMX AMZ
From -x Sense to -z Sense (AMX → AMZ)	$\begin{bmatrix} 0 & 0 & -1 \\ 0 & 1 & 0 \\ 1 & 0 & 0 \end{bmatrix}$	AMZ AMX

3.5 ATTITUDE DETERMINATION

The Orbiter is equipped with three inertial measurement units (IMU's) that are used for attitude and position estimation. These three IMU's are mounted on the navigation base which is a metal beam that is supposed to maintain a constant orientation with respect to the rest of the vehicle. See Figure 3-18. Each IMU can be considered as a rigid metal box which contains a cluster of instruments suspended inside a set of gimbals. A cluster (or stable member) is a flat plate with two accelerometers and two gyroscopes bolted to it. The gyroscopes are mounted with the spin axis of one parallel to the surface of the plate and the other perpendicular to it. When the gyros are spun up, they hold the plate inertially fixed (attitude-wise). As the Orbiter maneuvers, the near frictionless gimbals allow the cluster to maintain its inertial orientation. The orientation of the cluster to the IMU case is determined from the gimbal angles (resolver angles). Each cluster has a set of structural axes associated with it where X and Y are in the plane of the plate and Z is down. Twenty minutes prior to lift-off, the IMU clusters are frozen with respect to inertial space. The cosine matrix defining its M50 attitude is called a reference stable member matrix (REFSMMAT). The resolver angles from the gimbals allow the GPC's to calculate an IMU cluster to IMU case matrix. Since the orientation of each IMU case relative to the Orbiter body axis is constant, the actual Orbiter attitude can be determined by

$$\begin{bmatrix} M \\ \text{ADI} \end{bmatrix}^{\text{OB}} = \begin{bmatrix} A \\ \text{CASE} \end{bmatrix}^{\text{OB}} \begin{bmatrix} B \\ \text{CLUSTER} \end{bmatrix}^{\text{CASE}} \begin{bmatrix} C \\ \text{M50} \end{bmatrix}^{\text{CLUSTER}} \begin{bmatrix} D \\ \text{ADI} \end{bmatrix}^{\text{M50}}$$

where $\begin{bmatrix} C \\ \text{M50} \end{bmatrix}^{\text{CLUSTER}}$ = REFSMMAT

$\begin{bmatrix} B \\ \text{CLUSTER} \end{bmatrix}^{\text{CASE}}$ is from resolver angles

$\begin{bmatrix} D \\ \text{ADI} \end{bmatrix}^{\text{M50}}$ is the RELMAT

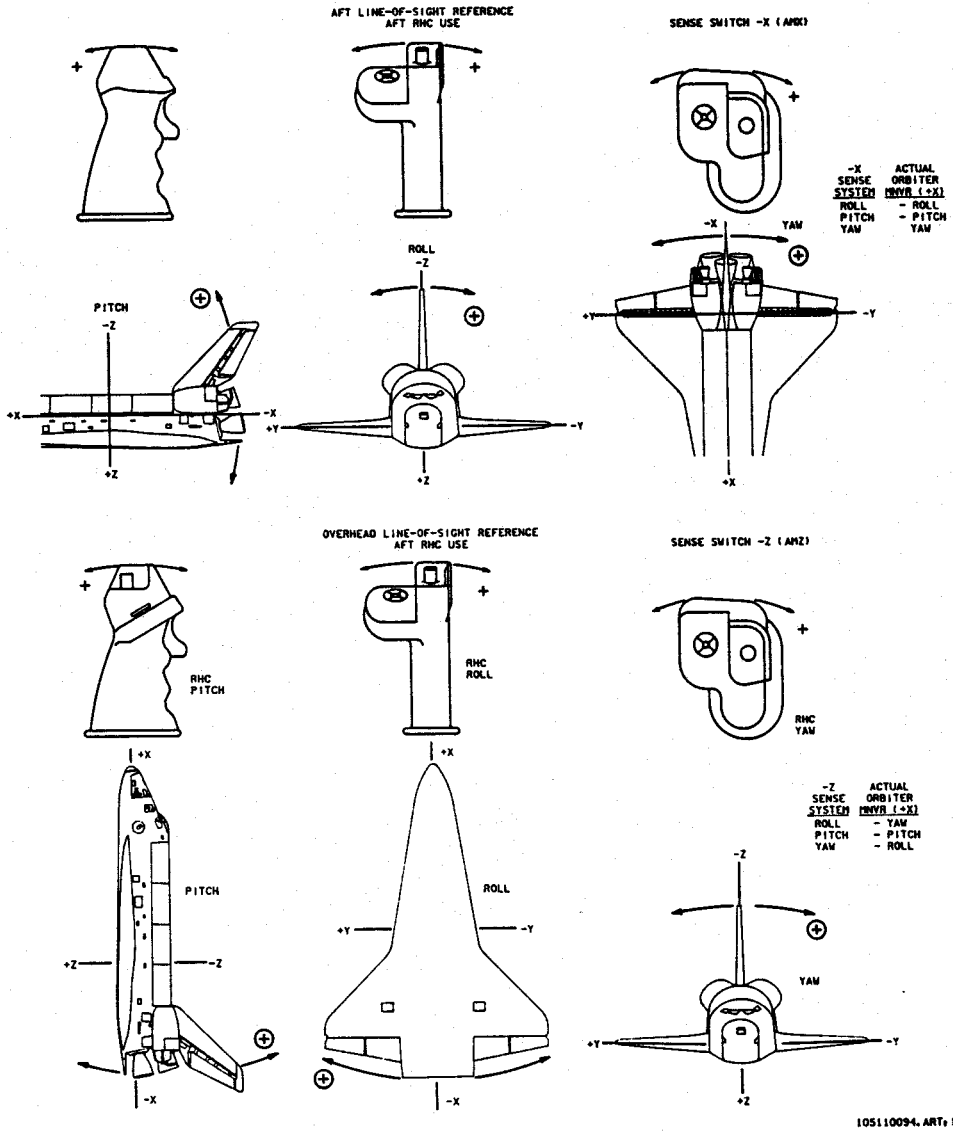

Figure 3-17.- Aft and overhead line-of-sight references, aft RHC use.

<p>Sense Axis System (SAI)</p> <p>AX = ADI +x Sense ANX = ADI -x Sense ANZ = ADI -z Sense</p>	+x Sense (AX)	-x Sense (ANX)	-z Sense (ANZ)
	<p>Body System</p>		
<p>SA Matrix</p> <p>(Orientation of body with respect to the sense axes)</p> <p>Note: $[S] = [S]^T$</p>	$T_{BY} = \begin{bmatrix} 1 & 0 & 0 \\ 0 & 1 & 0 \\ 0 & 0 & 1 \end{bmatrix}$ <p>BY AX</p>	$T_{ANX} = \begin{bmatrix} -1 & 0 & 0 \\ 0 & -1 & 0 \\ 0 & 0 & 1 \end{bmatrix}$ <p>BY ANX</p>	$T_{ANZ} = \begin{bmatrix} 0 & 0 & -1 \\ 0 & -1 & 0 \\ -1 & 0 & 0 \end{bmatrix}$ <p>BY ANZ</p>

Figure 3-16.- ADI sense axis systems.

10511316, ART. 1

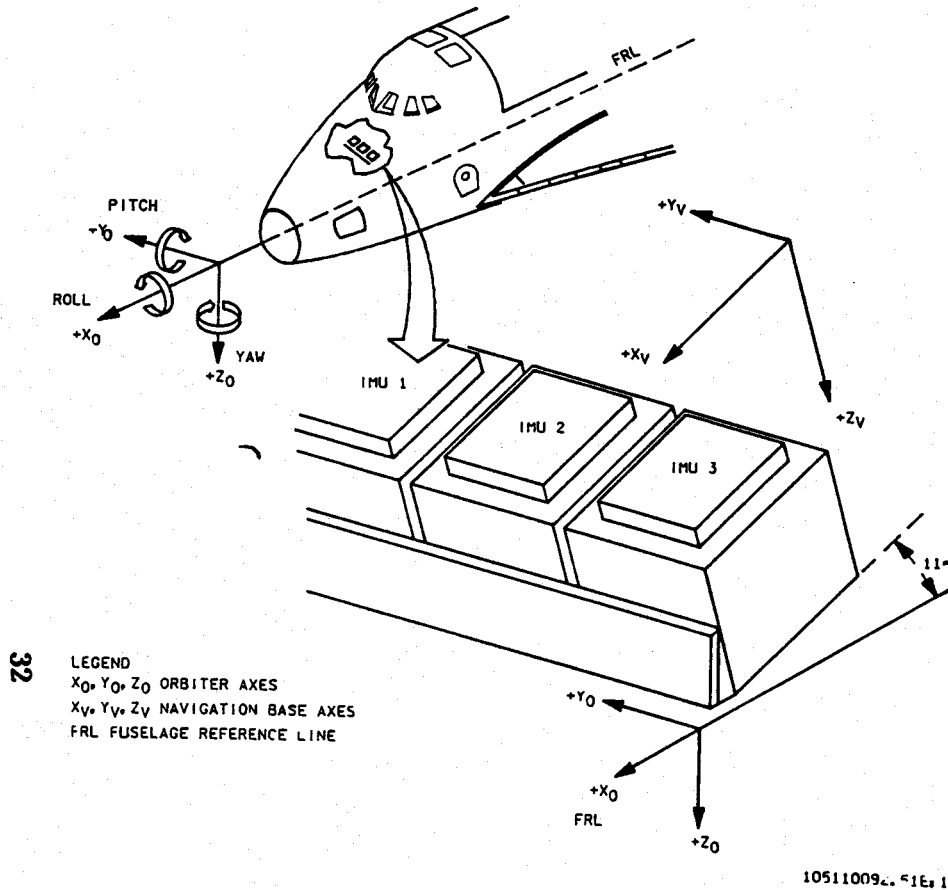

Figure 3-18.- The IMU location.

Each IMU case is aligned to the Orbiter body slightly differently than the others and each cluster is aligned differently than the M50 for redundancy. Because the gyros on each platform are not perfect, the clusters will eventually drift. The amount of the drift is determined by star tracker or COAS star sightings. The GPC figures out the actual orientation of each cluster in M50 and compares it to its respective REFSMMAT. The error is removed by a star align, a matrix align, or an IMU-to-IMU align. A star align physically repositions the clusters by torquing gyros until their

actual orientation agrees with their REFSMMAT's. A matrix align simply changes the REFSMMAT to agree with the current cluster orientation. An IMU-to-IMU align torques one or two IMU's to the required REFSMMAT orientation while using another IMU as an inertial reference. The GPC filters the outputs of the IMU's and comes up with a "best guess" of Orbiter attitude in M50. This attitude is displayed on the crew ADI's in either M50 or LVLH. The GPC calculates the direction cosine matrix, called a relative matrix (RELMAT), to do the conversion. Currently, the ADI displays M50 attitudes, thus the RELMAT is an identity matrix. In addition, if the crew uses the aft station that has an attitude sense other than +X, another matrix called a sense matrix is used to adjust the orientation of the ADI to -X or -Z.

SECTION 4
POINTING VECTORS/LOOK ANGLES/POINTING INSTRUMENTS

For the Space Shuttle program, a body pointing vector (BPV) is a vector relative to, and fixed to, the Orbiter body axis coordinate system. The BPV can take on any orientation desired. It is technically a unit vector defined in a two-step Euler sequence; i.e., pitch/yaw, roll/pitch, etc. While the pointing programs will allow for practically any sequence, the onboard software will accept inputs only in pitch/yaw. The use of this vector is to point it in a desired direction which is accomplished by maneuvering the Orbiter to an orientation so that the BPV points at a specified target which defines that direction. For the onboard software, the name of BPV is altered to body vector (BV) because it serves a dual purpose. The first use of this vector is as described above. The second use is as an axis of rotation about which the Orbiter can rotate. This is accomplished with the ROT option of universal pointing. The vector is defined the same except, of course, that there is no target involved. Direction of rotation can be determined using the right hand rule for the vector defined. This second use of the vector will not be described further in this section.

33

4.1 POINTING VECTORS

By definition, an Euler sequence is an ordered sequence of rotations made with respect to the new reference frame (that resulted from the previous rotation). Although there are several Euler sequences that can be used to define a BPV, only three will be discussed (pitch/yaw, roll/pitch, and azimuth/elevation) as they are the most commonly used. For other sequences, the descriptions below can be extrapolated as required.

4.1.1 Pitch/Yaw Sequence for Pointing Vectors

The pitch/yaw Euler sequence can be visualized by considering the Orbiter as fixed in the center of a sphere with its wings pointing at the poles and its nose pointing at the equator. The equator of the sphere corresponds to a great circle of pitch and the meridians correspond to great circles of yaw. The vector (V_B) that is to be pitched and yawed is the +X axis of a reference frame that is initially coaligned with the Orbiter body axis system. The first rotation of the sequence is about the Orbiter +Y body axis and it rotates V_B along the equator sweeping out pitch. From the point where V_B stops pitching, a second rotation about the new +Z axis (of the rotated reference frame) rotates V_B along a great circle of yaw. These two rotations define the position of a BPV relative to the Orbiter. The pitch angle is reckoned from the Orbiter +X body axis. A positive pitch corresponds to a right-hand rotation about the Orbiter +Y body axis. The yaw angle is reckoned from the Orbiter X-Z plane. A positive yaw corresponds to a right-hand rotation about the new +Z axis of the rotated reference frame. The limits of pitch are 0° to 359.99° and the limits of yaw are 0° to 90° and 270° to 359.99° . The pitch/yaw Euler sequence is not commutative. See figure 4-1.

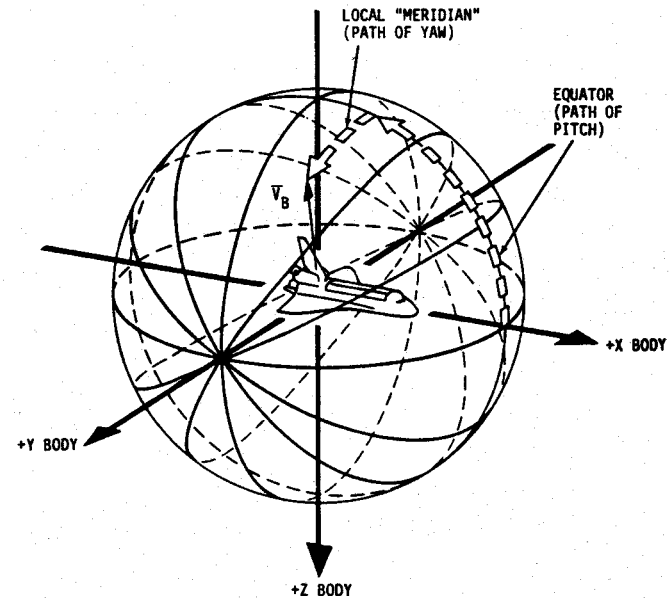

Figure 4-1.- Pitch/yaw sequence.

4.1.2 Roll/Pitch (ϕ, θ) Sequence for Pointing Vectors

The roll/pitch Euler sequence can be visualized similarly to the pitch/yaw sequence by considering the Orbiter as fixed in the center of a sphere. However, the orientation of the Orbiter relative to the sphere is different. The nose and tail of the Orbiter are pointing at the poles and the wings are pointing at the equator. In this case, the equator corresponds to a great circle of roll and the meridians correspond to great circles of pitch. The vector (V_B) that is to be rolled and pitched is the +X axis of a reference frame that is initially coaligned with the Orbiter body axis system. The first rotation of the sequence is about the Orbiter +X body axis and it axially rotates V_B , thus sweeping out roll. From the point where V_B stops rolling, a second rotation about the new +Y axis (of the rotated reference frame) rotates V_B along a great circle of pitch. These two rotations define the position of a BPV relative to the Orbiter. The roll angle is reckoned from the Orbiter X-Z plane. A positive roll corresponds to a right hand rotation about the Orbiter +X body axis. The pitch angle is reckoned from the rotated frame's +X axis. A positive pitch corresponds to a right hand rotation about the new +Y axis of the rotated reference frame. The limits of roll are 0° to 359.99° and the limits of pitch are 0° to 179.99° . The roll/pitch Euler sequence is not commutative. See figure 4-2.

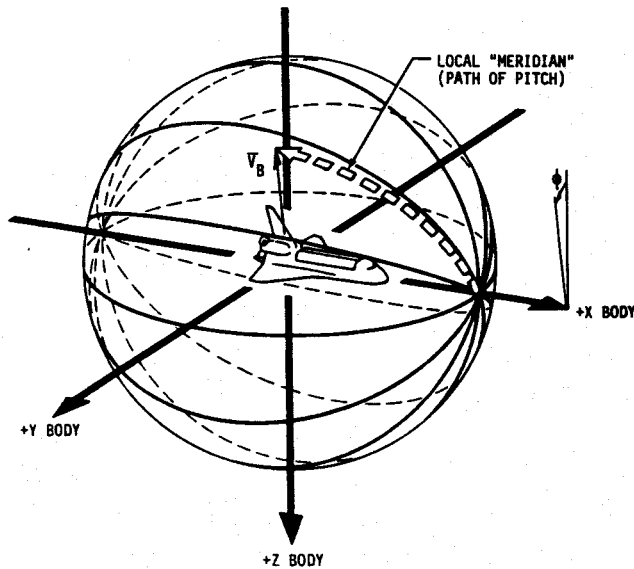

Figure 4-2.- Roll/pitch sequence.

4.1.3 Azimuth/Elevation Sequence for Pointing Vectors

The azimuth/elevation (AZ/EL) Euler sequence is another noncommutative roll/pitch sequence; however, the pointing vector origin is along the Orbiter -Z axis instead of the Orbiter +X axis. This sequence is generally used in connection with the Ku-band antenna, S-band antennas, and look angles to TDRS. The AZ/EL Euler sequence can be visualized by considering the Orbiter as fixed in the center of a sphere, with the nose and tail pointing at the poles and the Orbiter Y-Z plane corresponding to the equator. In this case, the Orbiter X-Y plane corresponds to a great circle of roll, and the meridians correspond to great circles of pitch (fig. 4-3). The vector (V_B) which is to be rolled and pitched is the -Z axis of a reference frame that is initially coaligned with the Orbiter body axis system. The first rotation is about the Orbiter -X body axis, and it sweeps out roll in the Orbiter Y-Z plane. From the point where V_B stops rolling, a second rotation about the new -Y axis (of the rotated reference frame) rotates V_B along a great circle of pitch. These two rotations define the position of a BPV relative to the Orbiter. The azimuth angle is reckoned from the Orbiter X-Z plane. A positive azimuth corresponds to a right-hand rotation about the Orbiter -X body axis. The elevation angle is reckoned from the -Z axis of the rotated frame. A positive elevation corresponds to a right-hand rotation about the new -Y axis of the rotated reference frame. The limits of azimuth are -180° to $+180^\circ$, and the limits of elevation are -90° to $+90^\circ$.

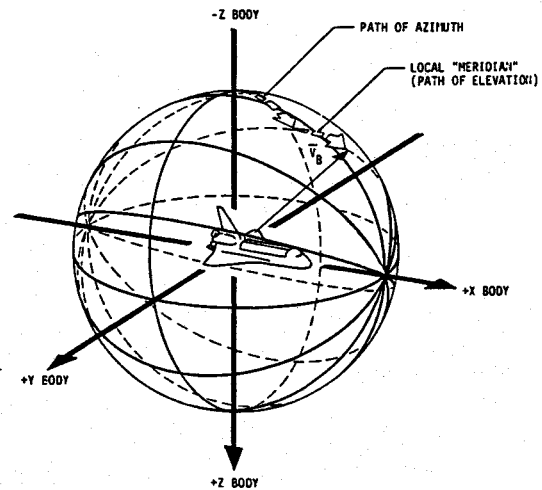

Figure 4-3.- Azimuth, elevation sequence.

4.2 OMICRON

A body pointing vector that is pointed at a target does not have a unique orientation since the vehicle can be anywhere within 360° about the line of sight of the vector and still satisfy the problem. It is the function of the omicron angle to specify the orientation of the Orbiter about the line of sight of the body vector. Omicron is used with the track option of universal pointing in the onboard software.

Omicron is the angle between two particular planes. The first plane is defined by the target vector (the vector that is defined to be from the Orbiter position to the target position) and the negative angular momentum vector ($-H\text{-bar}$). The second plane is defined by the BPV and the Orbiter's +Y axis. Then the BPV of the second plane is coaligned with the target vector of the first. Thus, omicron is the angle between the first and second planes, defined above, and is measured positively about the target vector using the right-hand rule as taken from the first to the second plane.

Another way to define omicron is to say it is the angle between the vector formed by the cross product of the target vector and $-H$ and the vector formed by the cross product of the BPV and the Orbiter +Y axis. Also, omicron is again measured as positive, resulting in a clockwise rotation from the first vector into the second vector with respect to the target vector, or mathematically

$$OM = \sin^{-1} (\text{target vector} \times \frac{\bar{V} \times \bar{R}}{|\bar{V}||\bar{R}|}) \times (\overline{BPV} \times \bar{Y})$$

where $\bar{V} \times \bar{R} = -\bar{H}$ and $|\bar{V}||\bar{R}|$ unitizes $-\bar{H}$ for consistency.

Although the above definitions are satisfactory, there exist two singularity cases. One case is the situation where the BPV is coincident with the + or -Y axis for the second plane. No unique solution exists for that plane. In this case the -Z axis is substituted for the +Y axis; i.e., the second plane is redefined by the BPV and the -Z axis. The situation that would cause the other case to exist is when the target vector is coincident with + or -H-bar for the first plane. As with the first case, there is no unique solution. For this case the descending node vector of the (each) orbit concerned is substituted for -H-bar in the first plane.

Omicron can be a difficult concept to visualize. One attempt to illustrate this concept is shown in figure 4-4. The example pictured shows the target as the center of the Earth that is typical for an LVLH attitude. Figure 4-5 shows all the standard axis LVLH Euler angle attitudes with the equivalent body vector and omicron required as inputs for universal pointing. For aid in visualization, the picture for any attitude in question can be mentally placed in the dotted box Earth-orbit picture.

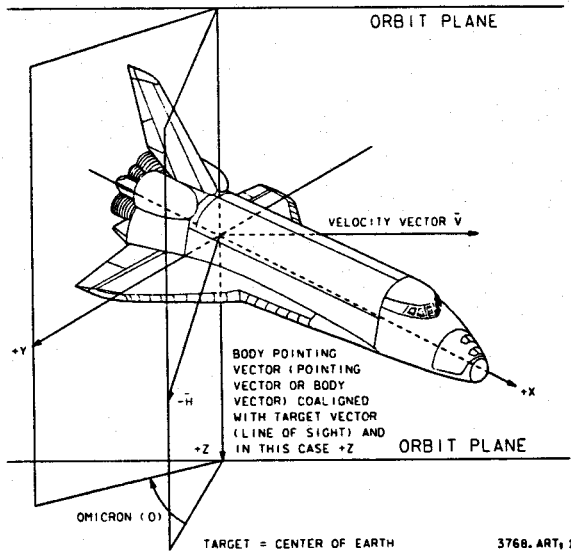
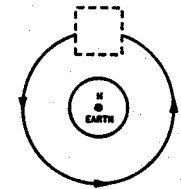

Figure 4-4.- Omicron measurement, LVLH example.

- INSTRUCTIONS
- SELECT ORIENTATION.
 - REFERENCE CORRESPONDING OMICRON BLOCK FOR THE BODY POINTING VECTOR (BPV).
 - OR
 - CHOOSE DESIRED BPV.
 - SELECT OMICRON.
 - THEN
 - PLACE PICTURE IN DOTTED SQUARE. (DO NOT ROTATE.)



BLOCK	ORIENTATION	LYLH ATTITUDE, DEG (P, Y, R EULER SEQUENCE)			BPV SEQUENCE P, Y*	OMICRON			
		ROLL	PITCH	YAW		1 0°	2 90°	3 180°	4 270°
1	+XLV PLBD FWD	0°	270°	0°	+X P=0, Y=0				
2	+XLV PLBD SOUTH	90°	270°	0°					
3	+XLV PLBD AFT	180°	270°	0°					
4	+XLV PLBD NORTH	270°	270°	0°					
1	-XLV PLBD AFT	0°	90°	0°	-X P=180, Y=0				
2	-XLV PLBD NORTH	270°	90°	0°					
3	-XLV PLBD FWD	180°	90°	0°					
4	-XLV PLBD SOUTH	90°	90°	0°					
1	+ZLV NOSE FWD	0°	0°	0°	+Z P=270, Y=0				
2	+ZLV NOSE SOUTH	0°	0°	90°					
3	+ZLV NOSE AFT	180°	0°	0°					
4	+ZLV NOSE NORTH	0°	0°	270°					
1	-ZLV NOSE AFT	0°	180°	0°	-Z P=90, Y=0				
2	-ZLV NOSE NORTH	0°	180°	270°					
3	-ZLV NOSE FWD	180°	0°	0°					
4	-ZLV NOSE SOUTH	0°	180°	90°					
1	+YLV PLBD SOUTH	90°	0°	0°	+Y P=0, Y=90				
2	+YLV NOSE SOUTH	0°	90°	90°					
3	+YLV PLBD NORTH	270°	180°	0°					
4	+YLV NOSE NORTH	0°	270°	270°					
1	-YLV PLBD SOUTH	90°	180°	0°	-Y P=0, Y=270				
2	-YLV NOSE NORTH	0°	90°	270°					
3	-YLV PLBD NORTH	270°	0°	0°					
4	-YLV NOSE SOUTH	0°	270°	90°					

10511045, ART, 1

Figure 4-5.- Omicron examples for TGT = COE.

4.3 LOOK ANGLES

Look angles are used to determine where a target is in relation to the Orbiter. This is a line-of-sight problem that is solved exactly like the pointing vectors; i.e., pitch-yaw or phi-theta or AZ/EL. The distinction between the two is that a body vector is forced to the required sequence angles and then the Orbiter oriented to point that vector to a target, whereas the look angles are the angles that define line of sight to a target for a given attitude and time.

Some typical look angles of various targets are given in the following example plots. See figures 4-6 through 4-9. The plots show general trends for different types of attitudes. Actual look angles are trajectory-dependent.

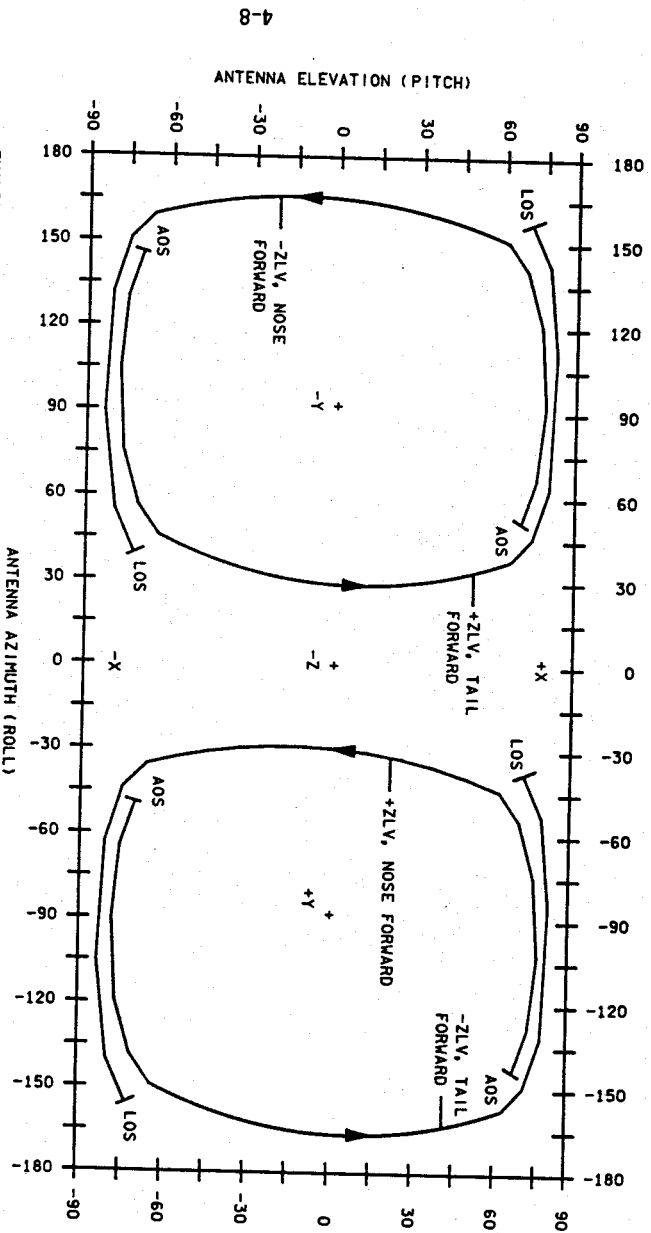

Figure 4-7.- TDRS look angles (LVH).

JSC-10511

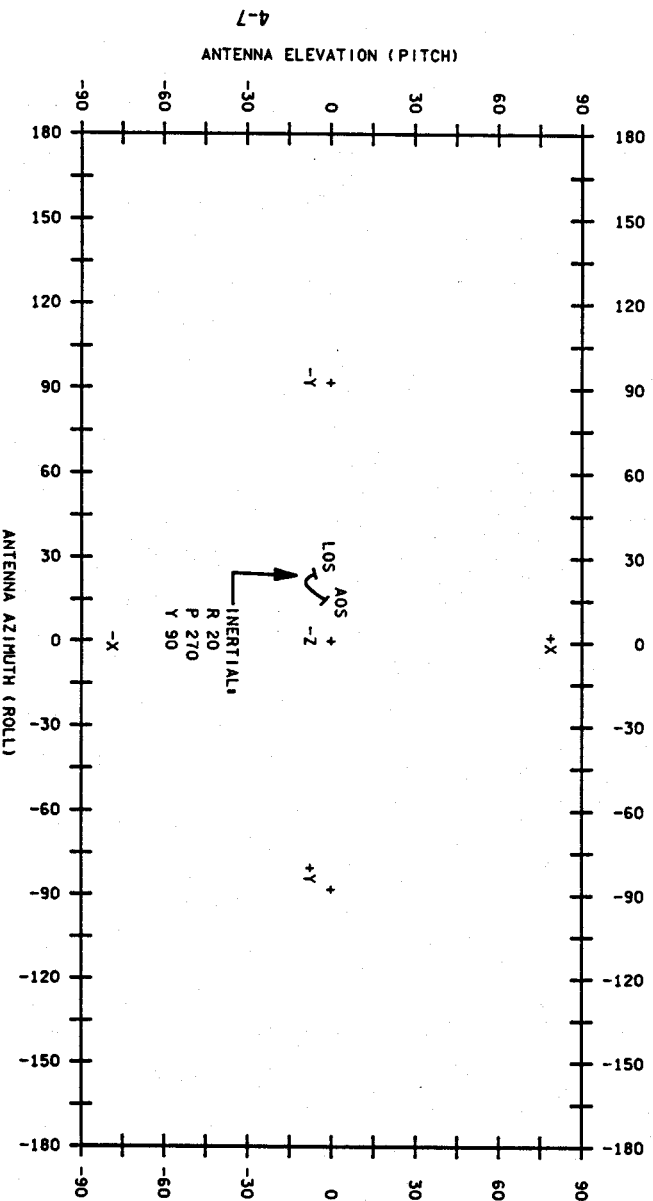
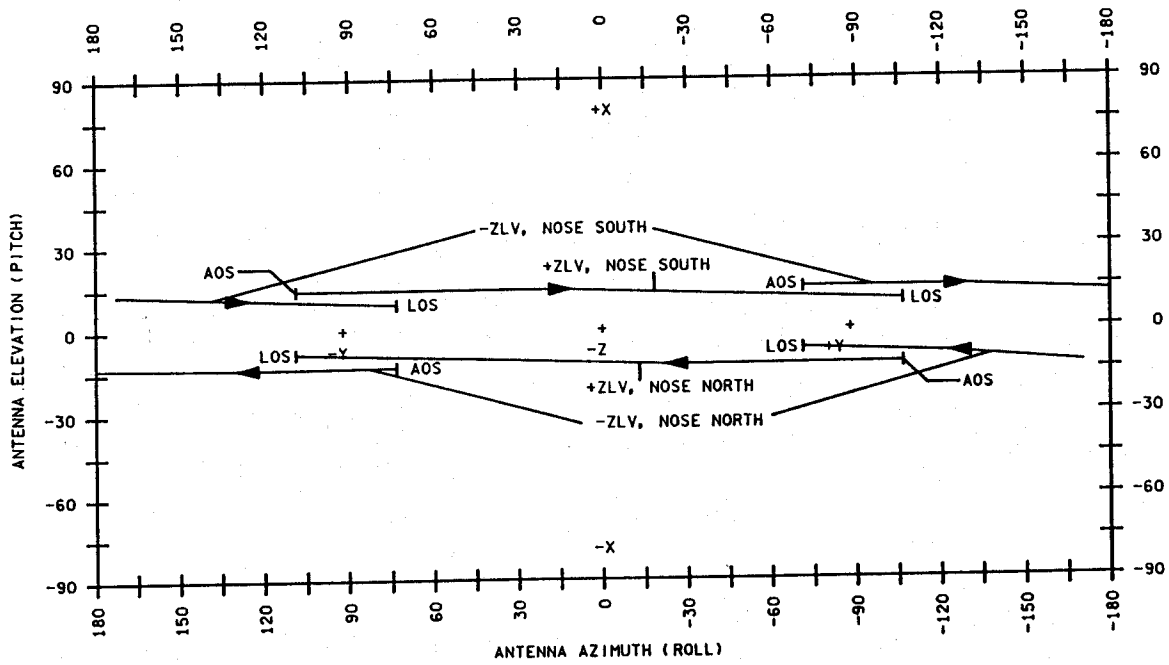

Figure 4-6.- TDRS look angles (inertial).

JSC-10511

4-9



EXAMPLE:
AZ/EL LOOK ANGLES TO TDRS EAST DURING THE PERIOD OF TIME
WHEN TDRS EAST IS IN VIEW OF THE ORBITER (LVLH ATTITUDES)

10511048. ART, 1

Figure 4-8.- TDRS look angles (LVLH).

JSC-10511

4-10

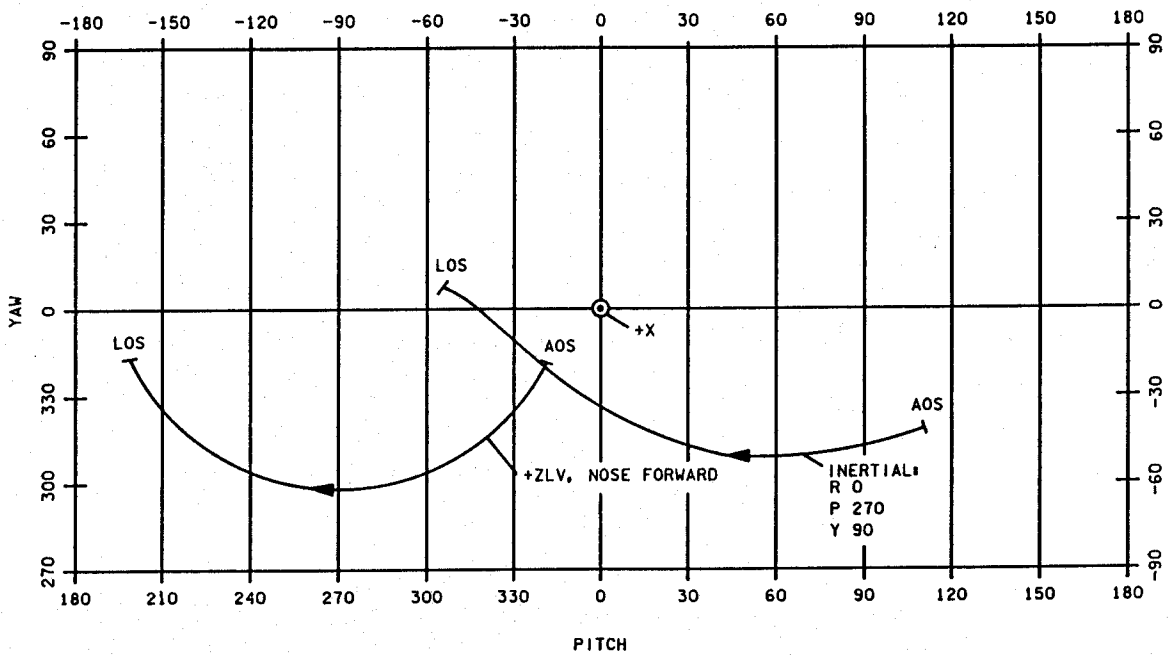

EXAMPLE:
PITCH/YAW LOOK ANGLES TO A GROUND SITE (HTS) DURING THE
PERIOD OF TIME WHEN THE SITE IS IN VIEW OF THE ORBITER
(INERTIAL AND LVLH ATTITUDES)

10511049. ART, 1

Figure 4-9.- Ground site look angles.

JSC-10511

4.4 POINTING INSTRUMENTS

Pointing vectors are utilized in the pointing offline and MOC programs as instruments. The MOC instruments are updated with the G04 MED and the off-line instruments with the IFILE program.

Instrument line-of-sight vectors are referenced to an instrument coordinate system developed by applying a roll (ϕ), pitch (θ), roll (ϕ) sequence to the instrument mounting frame (same as Orbiter body frame if mount matrix = identity). Each instrument is described by a three-digit instrument type. The third number of the instrument type describes which axis of this new coordinate system lies along the instrument line-of-sight vector or boresight. The first two numbers of the type describe the rotation sequence to be applied to this coordinate system in order to point the instrument line of sight at a target. The instrument axis and rotation sequence numbering system is as follows:

- 1 = +X (+roll)
- 2 = +Y (+pitch)
- 3 = +Z (+yaw)
- 4 = -X (-roll)
- 5 = -Y (-pitch)
- 6 = -Z (-yaw)

For example, the instrument S13 is designed to point the -Z COAS with an H,V sequence. The ϕ, θ, ϕ sequence (90, 90, 90) points the +X axis of the instrument coordinate system along the Orbiter +Y, the +Z along the Orbiter -Z, and the +Y along the Orbiter +X. Its instrument type is 243. The third number of the instrument type is 3; therefore, the instrument line-of-sight vector lies along the +Z axis of the instrument coordinate system (Orbiter -Z). The first two numbers of the type, 2-4, indicate that the H, V sequence is described by a +pitch then a -roll about the +X axis of the instrument coordinate system.

Instrument reticle ID, either 0 or 1 indicates whether the instrument rotation sequence is dependent (Euler) or independent, respectively. The H, V sequences used for the two trackers and two COAS's are independent sequences, while all others are Euler.

The instrument mount matrices identify the orientation of the initial coordinate system (before applying ϕ, θ, ϕ) with respect to the Orbiter body axes. Instruments with an identity mount matrix have the initial coordinate system aligned with the Orbiter axes.

The most commonly used instrument, S04, corresponds to a pitch, yaw Euler sequence from an initial vector along the Orbiter +X axis. Other useful instruments are as follows: S01 = roll, pitch sequence from +X; S02 = H, V sequence from the -Z star tracker boresight; S03 = H, V sequence from the -Y star tracker boresight; and S18 = yaw, pitch (AZ, EL) sequence from -Z (used for the Ku-band antenna).

4.5 FIELD OF VIEW

An Orbiter FOV is developed for the pointing offline program by applying rotation sequences to an instrument centerline, describing points around the FOV perimeter. For example, the -Z star tracker FOV (FOV 11) is modeled with an S02 instrument and 26 H, V rotation sequences describing a 10° by 10° square.

The following plot shows the -Y star tracker FOV movement across the star field for various LVLH attitudes. Note that if an inertial attitude is held, the tracker FOV will remain fixed with respect to the star field.

SECTION 5
TARGETS

When solving pointing problems, it is often necessary to determine the direction and sometimes the distance of one or more targets from the Orbiter. Any point on the Earth or on the celestial sphere can be designated a target for pointing purposes. Any body or vehicle traveling in a known orbit can also be used as a target. Even direction vectors can be used as "targets." To point "at" a vector, the body pointing vector is simply pointed in the same direction as the vector. Inertial direction vectors, that is, vectors fixed in inertial space, can be treated just like celestial targets, since any inertial direction vector points at a unique point on the celestial sphere. Non-inertial vectors, such as the Orbiter velocity vector, can also be used as targets.

For the purpose of discussion, it is useful to divide all targets into three broad categories: ground, celestial, and ephemeris targets. These categories are more than merely arbitrary divisions, as each type of target requires a different method to determine the target location relative to the Orbiter.

39

5.1 GROUND TARGETS

A ground target is any target that has a fixed Earth latitude and longitude and a fixed, finite altitude above the surface of the Earth (that is, above the reference ellipsoid). Space Flight Tracking and Data Network (STDN) ground stations, geographical features, and geosynchronous satellites are all examples of ground targets.

5.2 CELESTIAL TARGETS

Just as a ground target is located by its Earth latitude and longitude, so a celestial target is located at a fixed RA and DEC. It is important to note that all celestial targets have unchanging RA and DEC. The Sun, Moon, and planets, although they appear on the star chart, are not fixed; they trace out paths on the celestial sphere. The Sun and planets, however, move so slowly on the celestial sphere (1 deg/day or less) that for many purposes they may be considered fixed. Any right ascension and declination can be used as a celestial target - even if there is no star at the indicated point. As mentioned before, any direction vector fixed in inertial space, such as an M50 direction vector, points at a fixed RA and DEC and can be equated to a celestial target.

RA and DEC are closely related to longitude and latitude on the surface of the Earth. A star is "straight up" from a point on the Earth with a geodetic latitude equal to its declination. A star with a DEC of 30° can appear to pass directly overhead only to an observer at a geodetic latitude of 30°. This is because for objects at great distances, geodetic latitude has the same definition as declination; it is the angle between the equatorial plane

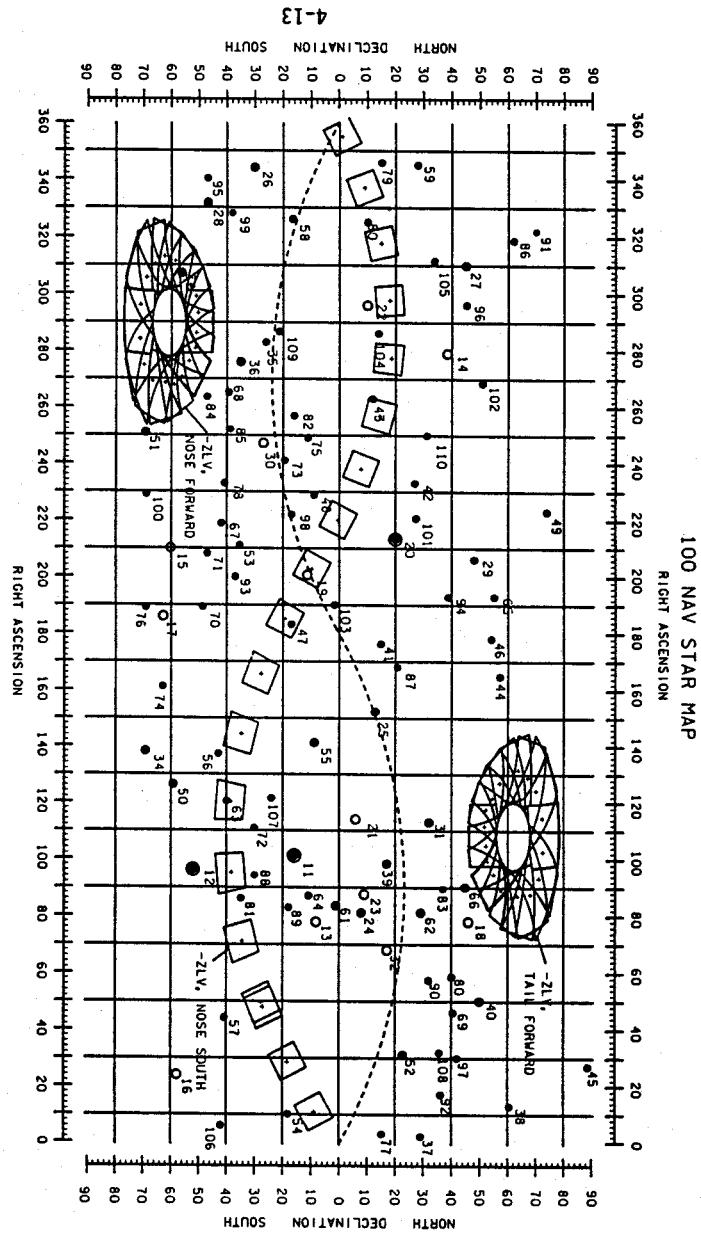

Figure 4-10.- The -Y star tracker FOV plot.

10511451, ART. 2

the angle between the equatorial plane and the local vertical (upwards) direction, and is positive "above" and negative "below" the equatorial plane.

However, for nearby objects (such as orbiting spacecraft, for example) geodetic latitude and declination are not equal. This is because the line representing a certain geodetic latitude is parallel to, but not coincident with, a line of equal declination. For targets at infinite distance, this doesn't matter as any two parallel lines less than about 100 million miles apart point at practically the same spot on the celestial sphere. But for nearby targets, this distance between the lines of geodetic latitude and equivalent declination becomes significant. In order to see stars behind an orbiting target that are at the same declination as the target, the ground observer must be at a geocentric latitude equal to the declination of the target. However, at this position, the target will appear to be somewhat south of directly overhead. Refer to figure 5-1. Figure 5-2 shows an exaggerated distinction between geodetic and geocentric latitude.

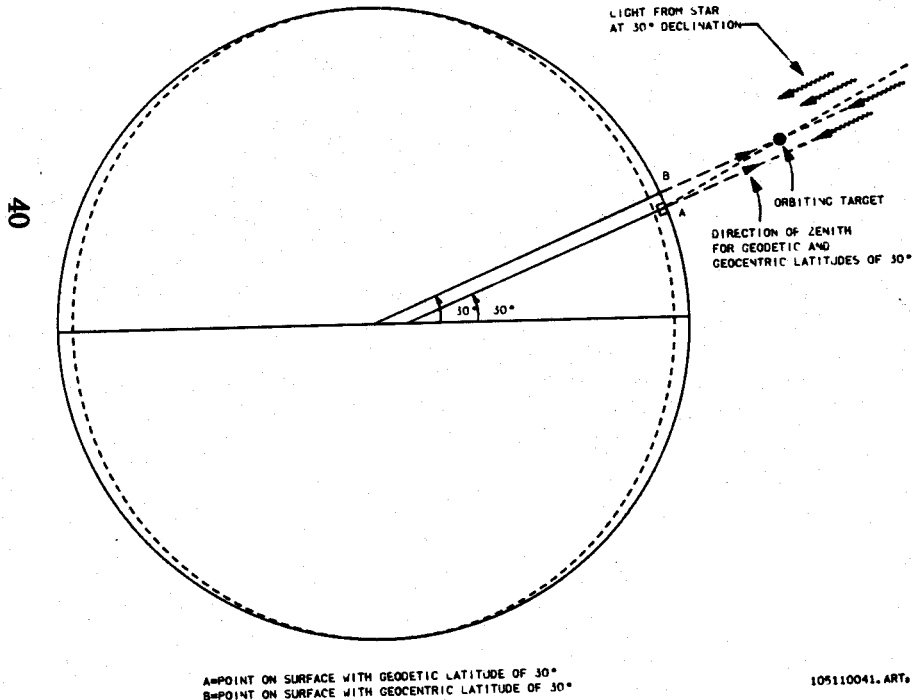

Figure 5-1.- Geodetic vs. geocentric latitude.

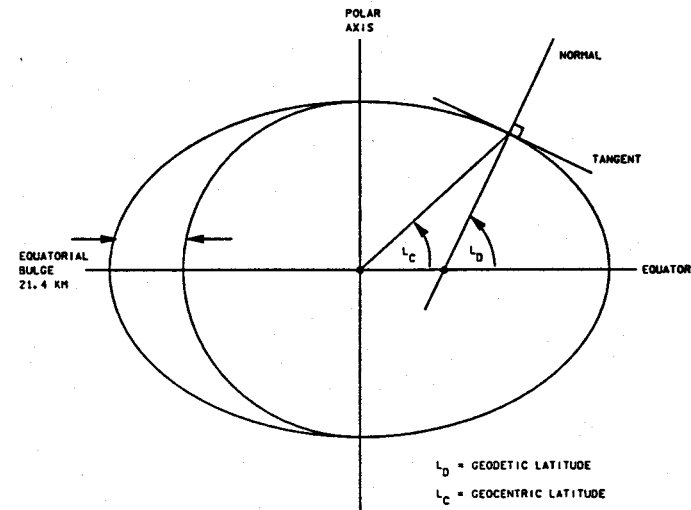

Figure 5-2.- Geodetic and geocentric latitude. (Fundamentals of Astrodynamics, Bate, Mueller, White)

RA is also closely related to longitude, but due to the rotation of the Earth, the relationship is constantly changing. To determine the longitude corresponding to a given RA, a parameter called the Greenwich hour angle (GHA) must be considered.

- **Greenwich Hour Angle** - The GHA is defined as the angle from the vernal equinox eastward to the projection of the prime (Greenwich) meridian onto the celestial sphere. In other words, it is the RA of the zenith at the prime meridian. If the GHA is 30°, it means that if a person stood on the prime meridian and looked straight up, the person would be looking at a point with a RA of 30°.

As can be seen in figure 4-2, the RA and the longitude of a given pointing vector from center of Earth (COE) are related by the following rule:

$$\begin{aligned} \text{RA} &= \text{LON (in } ^\circ\text{E of prime meridian)} + \text{GHA (in degrees)} \\ \text{LON (in } ^\circ\text{E of prime meridian)} &= \text{RA} - \text{GHA (in degrees)} \end{aligned}$$

An adjustment is needed because RA goes from 0° to 360° and longitude is measured between -180° (180 W) and 180° (E). Negative (west) longitudes are converted to east longitudes simply by adding 360°; east longitudes

greater than 180° can be converted to west longitudes by subtracting 360°. As an example, the direction vector R in figure 5-3 has a longitude of 78° E; since the GHA is 30°, the vector right ascension is 78+30=108° RA.

Note that due to the rotation of the Earth, the GHA is constantly increasing; when it reaches 360° it is back to 0. In order to be able to convert from inertial (RA fixed) to Earth (longitude (LON) fixed) coordinates and back at some time t_1 , it is necessary to know the GHA at some reference time (t_0) and the angular velocity of the Earth (W). Then the current GHA can be calculated and the transformation can be done as follows (units for GHA, W , and t are degrees, degrees/second, and seconds, respectively):

$$\begin{aligned} \text{GHA}(t_1) &= \text{GHA}(t_0) + (t_1 - t_0)W \\ \text{RA}(t_1) &= \text{LON} + \text{GHA}(t_1) \text{ (for earth-fixed vector)} \\ \text{or} \\ \text{LON}(t_1) &= \text{RA} - \text{GHA}(t_1) \text{ (for inertial vector)} \end{aligned}$$

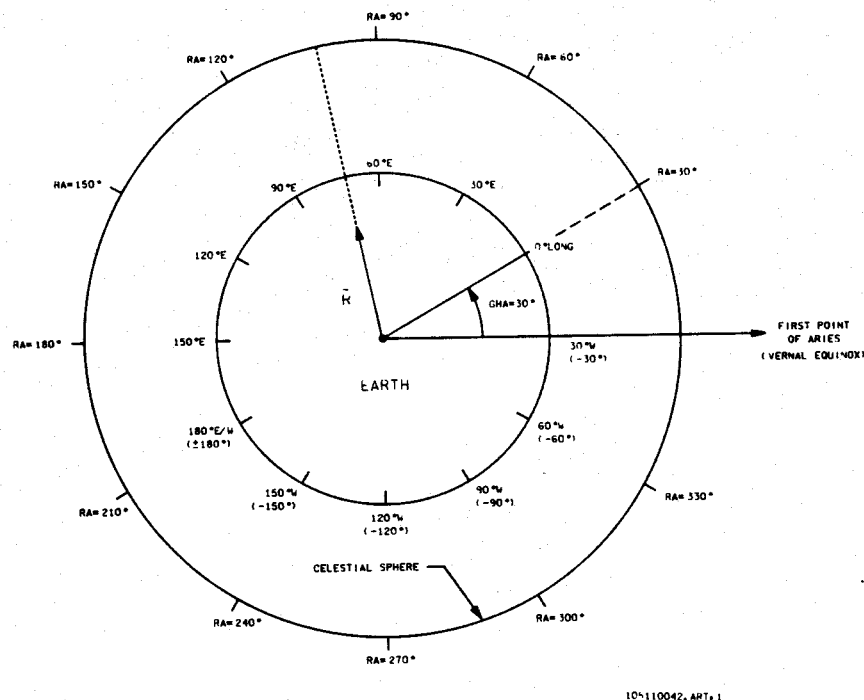

Figure 5-3.- GHA - view from above North Pole.

- **Area and Volume Targets (Celestial and Ground)** - It is sometimes necessary to determine when the Orbiter is passing through a certain volume of space, or whether it is passing over a certain area of the ground. For this reason, a few ground or celestial volume targets have been defined. A volume that is fixed relative to the Earth is a ground volume target; the South Atlantic anomaly is one of these. A volume fixed relative to the celestial sphere is a celestial volume target. Ground and celestial area targets are defined similarly. An area on the surface of the Earth defined by the longitude and latitude of its vertices or its center is a ground area target. An area of the celestial sphere defined in terms of right ascension and declination is a celestial area target.

The usual pointing questions that arise concerning area and volume targets are the following:

- When will the Orbiter enter and exit the volume target?
- When will the Orbiter ground trace enter and exit the ground area target?
- What are the maximum and minimum elevations of the Sun relative to the ground area target for a particular time span?
- What attitude will allow a particular instrument to point at (or avoid pointing at) a celestial area target?

5.3 EPHEMERIS TARGETS

Any target that is traveling in a known orbit can be used as an ephemeris target. An ephemeris is a collection of state vectors, each with a specific time that is valid, that together describe the orbit of the target over a period of time. These vectors may be stored as pairs of position and velocity vectors, or as is the case for all the pointing ephemeris files, as sets of invariant orbital elements calculated from the vectors themselves. Examples of ephemeris targets are the Sun, the Moon, and other vehicles and satellites in Earth orbit.

5.4 GENERAL TARGET TERMS

- **Target AOS/LOS** - The acronyms AOS and LOS mean acquisition of signal and loss of signal. For pointing purposes, AOS means the time or position that the target becomes visible (i.e., has an unobstructed line of sight) to the Orbiter, and LOS is the position or time that the line of sight becomes obstructed, usually by the Earth. (For Ku-band transmissions, LOS often occurs when the line of sight of the antenna becomes obstructed by the Orbiter body.) We might also refer to a target as "being AOS" or "being LOS." This simply means that the target currently has, or does not have, an unobstructed line of sight to the Orbiter.

- **CPA and TCA to Target** - CPA means closest point of approach. This is the point on the orbit of the Orbiter that is closest to the target. For celestial targets that are at an infinite distance, CPA has little physical meaning. For such targets, a better definition of CPA is the point on the Orbiter path where the direction (from COE) most nearly coincides with the direction of the target. Time of closest approach (TCA) is simply the time that the Orbiter reaches CPA (figs. 5-4 and 5-5).

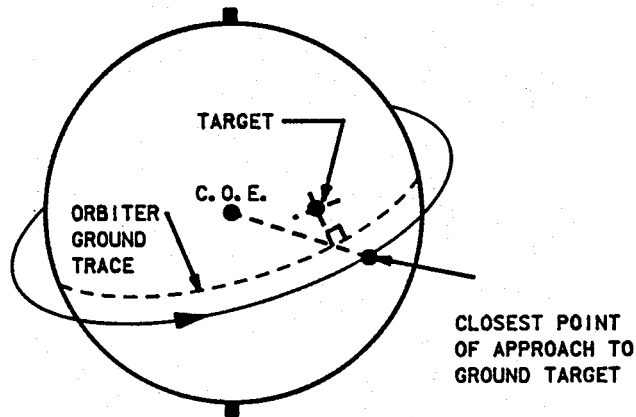

10511054. ART, 1

Figure 5-4.- CPA/TCA to ground target (oblique view).

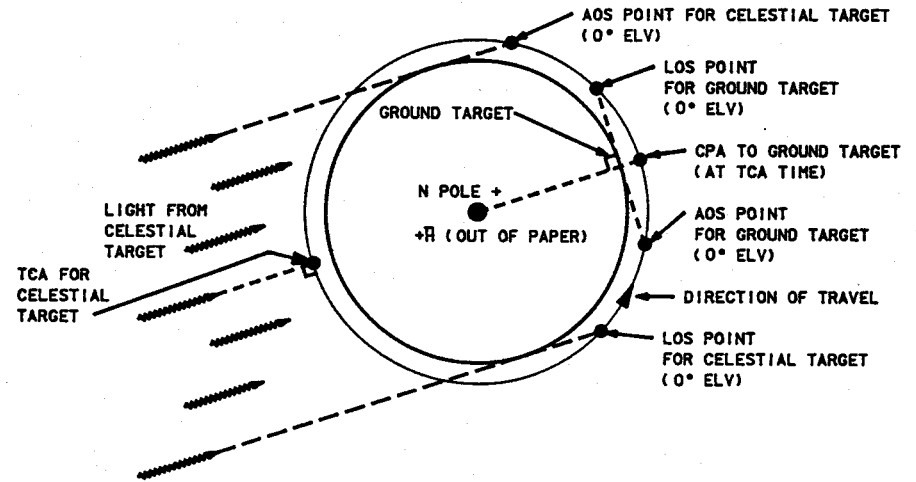

10511055. ART, 1

Figure 5-5.- AOS/TCA/LOS for celestial and ground targets (view from direction of +H-bar).

- **Elevation** - Elevation of a target is the angle of a target above the ground or physical horizon. For pointing problems, the elevation is defined in two different ways, depending on the target type. For celestial, ephemeris, and extremely high ground targets (such as tracking and data relay satellites (TDRS's)), elevation is defined from the Orbiter point of view. The target elevation in these cases means the distance in degrees above the horizon as seen by the Orbiter (fig. 5-5).
For normal ground targets, the above definition is not very useful. For these, elevation is better defined from the target point of view. That is, for normal ground targets, elevation is defined as the angle of the Orbiter above local horizontal as seen by the ground target (fig. 4-6).
- **AOS, LOS and Minimum Elevation** - In order to determine accurate AOS/LOS times for a variety of targets under varying conditions, using a variety of instruments, it is often necessary to specify a minimum elevation angle for AOS. This means the target must be a certain minimum number of degrees above the horizon of the Earth (or, in the case of a normal ground target, the Orbiter must be a certain number of degrees above local horizontal) before we are sure we will have the target AOS. Many of our pointing programs require an input from the user of the elevation angle. The elevation angle being asked for is the minimum elevation for AOS.

A good example of minimum elevation requirements is the star tracker elevation for AOS of navigation stars in daylight. Since the star trackers can be damaged by being pointed at too-bright objects, it is required that a star be at an elevation of 20° or more from the Earth horizon during times when the horizon is sunlit.

- **Slant Range** - The straight-line distance from the Orbiter to the target may be found by computing the magnitude of the target relative position vector and converting it into appropriate units.
- **Depression Angle** - The angle between local horizontal and the Earth horizon as seen from the Orbiter.

5.5 SOME SPECIAL GROUND TARGETS

Ground targets have previously been defined as targets with a fixed Earth latitude, longitude, and altitude. Now some exceptions to these rules must be dealt with. The following targets, while confined to the surface of the Earth, are not at a fixed latitude and longitude; instead, their Earth coordinates vary with the position of the Sun, the position of the Orbiter, and with the rotation of the Earth. Each of these special targets is defined and discussed individually.

- **Subsolar Point** - This is the point on the surface of the Earth where the Sun appears to be directly overhead at a given time. Obviously, due to the rotation of the Earth and the motion in its orbit, the subsolar point changes continually. The path traced out by the subsolar point on the surface of the Earth over a period of time is the ground trace of the Sun. The (geodetic) latitude and longitude of the subsolar point can be determined as follows:

$$\text{LAT}_j = \text{DECLINATION}(\text{SUN}) \quad (+ \text{ equals north, } - \text{ equals south})$$

$$\text{LON}_j = \text{RIGHT ASCENSION}(\text{SUN}) - \text{GHA}$$

Since the right ascension of the Sun, the declination of the Sun, and the GHA are constantly changing, the latitude and longitude of the subsolar point are also constantly changing. The subsolar point is a non-fixed ground target.

- **Suborbital Point** - The suborbital point is simply the point on the surface of the Earth directly below (toward COE from) the Orbiter. The path traced out on the surface of the Earth by the suborbital point over a period of time is the ground trace of the Orbiter.
- **Glory Point** - The glory point is defined as the point on the Earth surface where the shadow of the Orbiter (caused by the Sun) falls. This point is called the glory point due to a rare phenomenon of reflection of an image of the Sun directly back along the line to the Sun, which results in the appearance, from the vehicle, of a bright spot on the ground right where the shadow of the vehicle ought to be (fig. 5-7).

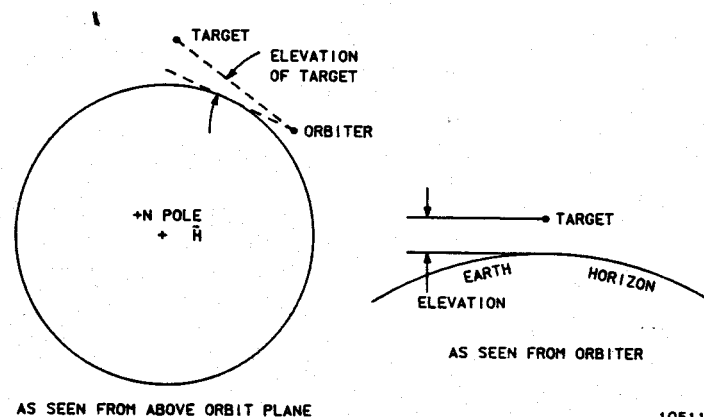

Figure 5-6.- Elevation for celestial and ephemeris targets.

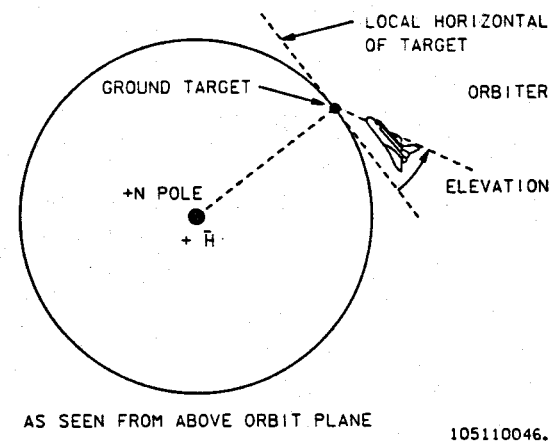
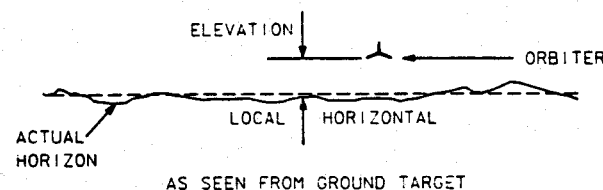

Figure 5-7.- Elevation for normal ground targets.

As a target, the glory point is best described as a non-inertial pointing vector. The direction to the glory point (when it exists) is the negative of the Sun pointing vector. Thus, if the Orbiter θ, ϕ to the Sun is $100^\circ, 0^\circ$, for example, the θ, ϕ to the glory point (if it exists) will be the look angles of a vector on the same line but pointing in the opposite direction: $\theta = (180-100)$ or 80° , $\phi = (0+180)$ or 180° (fig. 5-8).

The reason for the qualifying statement "if the glory point exists" is shown in figure 5-9. If the Orbiter is in position 1, the glory point is in the direction of the negative Sun-pointing vector, as shown. If the Orbiter is at position 2, the anticipated direction of the glory point is still along the negative Sun-pointing vector, but this vector never intersects the surface of the Earth. Thus, at position 2, the glory point does not exist.

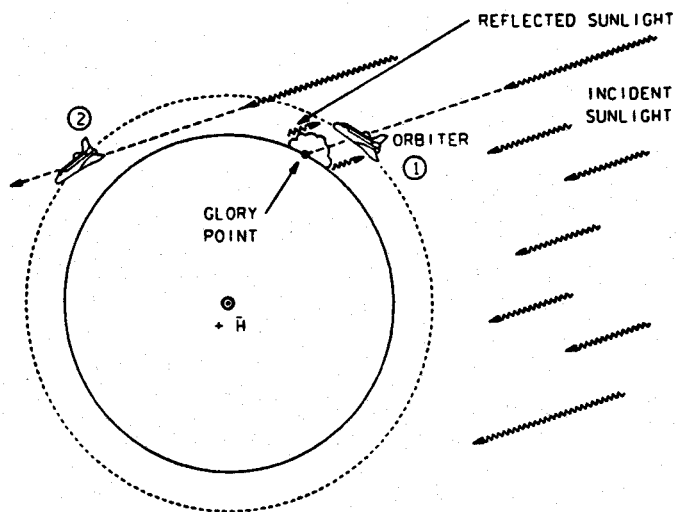

Figure 5-8.- Definition of "glory point" (view from above orbit).

44

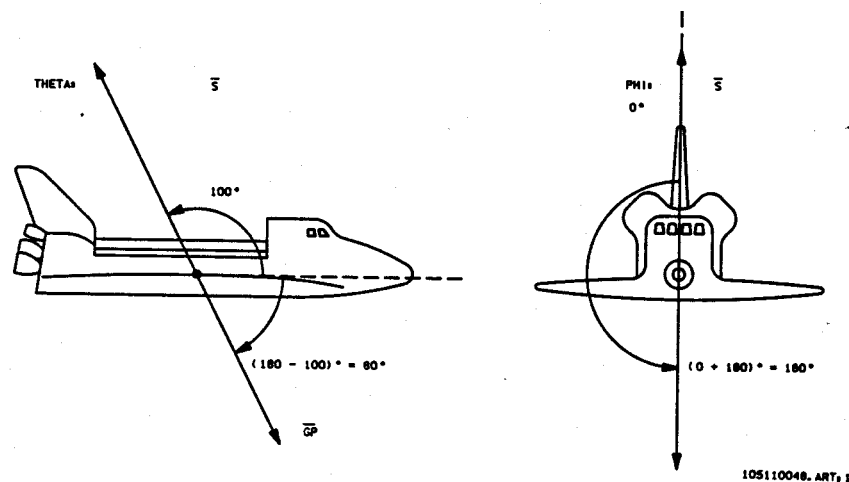

Figure 5-9.- θ, ϕ for negative Sun pointing vector.

A general formula for determining the look angles to the glory point:

$$\begin{aligned} \theta_{GP} &= 180 - \theta_S \\ \text{if } 0 \leq \phi_S < 180: \quad \phi_{GP} &= 180 + \phi_S \\ \text{if } 180 \leq \phi_S < 360: \quad \phi_{GP} &= \phi_S - 180 \end{aligned}$$

Note: The glory point exists whenever the shadow of the Orbiter falls on the surface of the Earth.

- **Glitter Point** - The glitter point is a similar concept to glory point. Geometrically speaking, it is the point on the surface of the Earth, lying in the COE - Orbiter - Sun plane, where the elevation of the Sun from the local horizontal is equal to the elevation of the Orbiter from local horizontal. This is the point on the Earth where the main reflected image of the Sun appears to an observer on the Orbiter (fig. 5-10).

Like the glory point, the glitter point exists only part of the time. The glitter point exists any time the Orbiter is in sunlight. As the Orbiter approaches the dark limb of the Earth, the Sun and the glitter point merge (sunset). Calculation of the glitter pointing vector is somewhat more involved than the glory point calculation and is beyond the scope of this handbook.

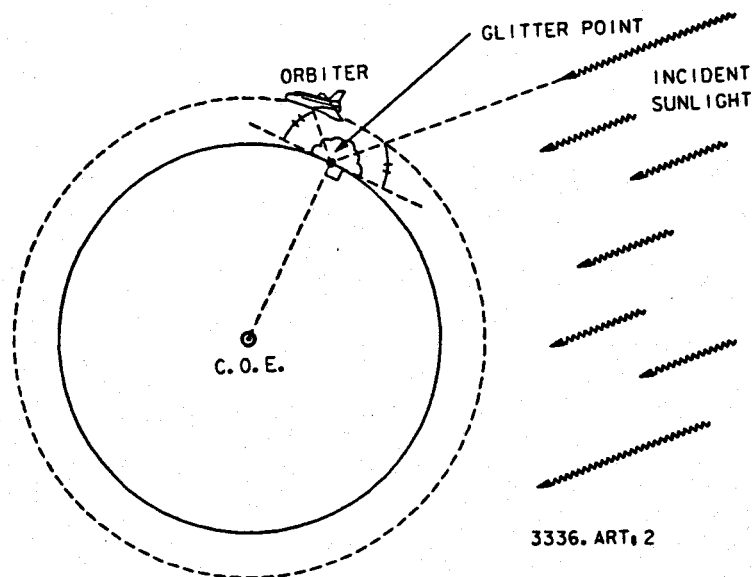

Figure 5-10.- Definition of "glitter point" (view from above orbit plane).

45

- **South Atlantic Anomaly (SAA)** - This is the only volume target that presently concerns us. The SAA is actually a portion of the Van Allen radiation belts. The Van Allen belts are regions surrounding the Earth that contain high-energy radiation due to an effect of the Earth magnetic field that is not fully understood. These belts extend from about 300 n. mi. altitude to nearly 500 n. mi., and are important to us because any long-term exposure to their radiation is detrimental. Because the magnetic poles of the Earth are offset and tilted relative to the geographical poles, and due to anomalies in the Earth magnetic field, the Van Allen belts are not a uniform distance from the surface of the Earth. In the region known as the SAA, they extend much closer to the surface (down to 80 n. mi.). Because of the radiation hazard and increased exposure of EVA crewmembers, EVA's are planned to occur when the Orbiter will not be passing through the SAA. Also some scientific instruments and film have to be shut down or stowed during passage through the SAA. In order to determine and control the doses of radiation the astronauts are exposed to, it is necessary to know how much time the Orbiter spends in the SAA; for this reason it has been defined as a ground volume target. A map of the anomaly is shown in figure 5-11.

Note: Current Space Shuttle flights (at 28.5° inclination and about 150 to 165 n. mi. altitude) expose the astronauts to about 7 to 8 m rad/day of high energy electrons and protons due to passing through

the SAA. This dosage increases rapidly as altitude increases. A 250 n. mi. altitude orbit would make the SAA much more undesirable, especially for EVA's.

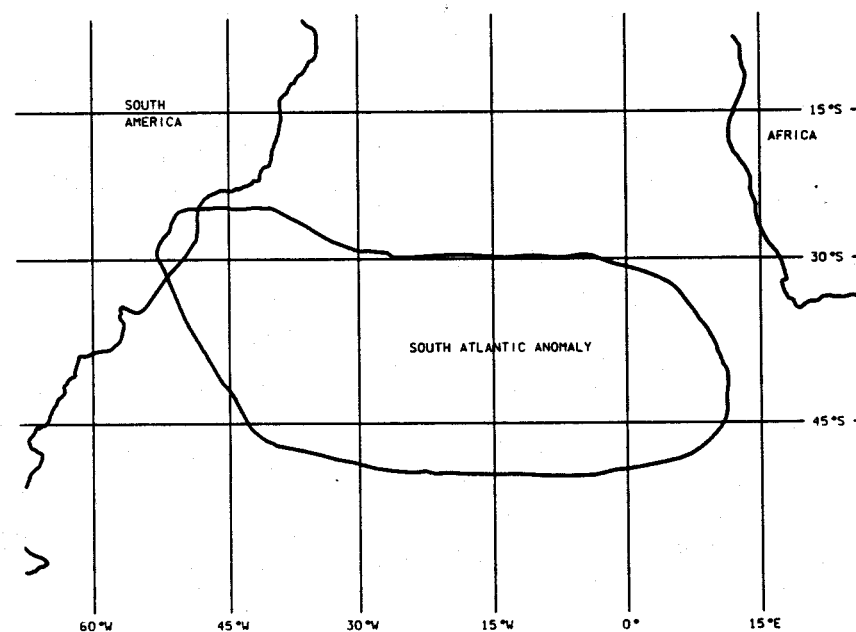

Figure 5-11.- South Atlantic anomaly.

5.6 SOME COMMONLY USED TARGETS

Sun - The Sun is a commonly used target because the direction of the Sun relative to the Orbiter drastically affects both lighting and thermal conditions. In fact, almost all temperature requirements for payloads and surface areas of the Orbiter are met by controlling the amount of direct sunlight that falls on the payload or surface area. There are several important terms related to the Sun that must be carefully defined. They are listed below.

- **Sunrise (SR)** - This is the time when the Orbiter comes out from the shadow of the Earth into the sunshine.

- **Terminator rise (TR)** - The time when the Orbiter crosses the point in its orbit directly above the line between night and day on the surface of the Earth (the terminator), heading toward the bright side of the Earth.
- **Orbital noon** - This time is the TCA for the sun.
- **Terminator set (TS)** - The time when the Orbiter passes the point on its orbit directly over the line on the Earth surface separating day and night, heading toward the dark half of the Earth.
- **Sunset** - The time when the Orbiter enters the shadow of the Earth.
- **Orbital midnight** - The time exactly halfway from noon to noon.

Note: A dark horizon appears "ahead" of the Orbiter approximately 4 minutes before TS. In the same way, a dark horizon remains "behind" the Orbiter for about 4 minutes after TR. See figure 5-12.

Moon (COM) - The Moon is used as a target primarily to keep the star trackers away from it. The Moon has a period of about 27.3 days, and a mean distance from the Earth of 384,000 km or 207,560 n.mi. (from the center of mass of the Earth-Moon system). The distance from COE to COM is about 210,140 n.mi.

TDRS - The TDRS satellites are treated as very high ground targets. TDRS EAST (TDRE) is currently located at LAT = 0°, LON = 41° W, ALT = 19,323 n.mi. TDRS WEST (TDRW) will be at LAT = 0°, LON = 171° W, ALT = 19,323 n.mi.

COE - Center of Earth is primarily used as a target to determine which portion of the celestial sphere is occulted by the Earth. COE is always easy to locate; the negative of the Orbiter position vector gives both the direction and distance from the Orbiter.

Navigation Stars - Used as targets almost exclusively for IMU alignments using the star trackers or COAS. Currently 100 stars are used as navigation stars. They are numbered from 11 to 110 in the celestial target tables.

Vectors commonly used as targets:

- **$\pm H$ -bar** - The angular momentum vector of the Orbiter. This vector is almost fixed in inertial space. It is defined as the cross product of the Orbiter radius and velocity vectors ($R \times V = H$); therefore, it is perpendicular to the orbit plane.
- **Direction vector from COE to descending node** - This vector is used for determining omicron in some cases, and is also nearly inertial (only changes about 1/2° per orbit).
- **V-bar (the velocity vector of the Orbiter)** - This is a non-inertial vector that is nearly stationary in the LVLH frame. It is used for instrument pointing and rendezvous.

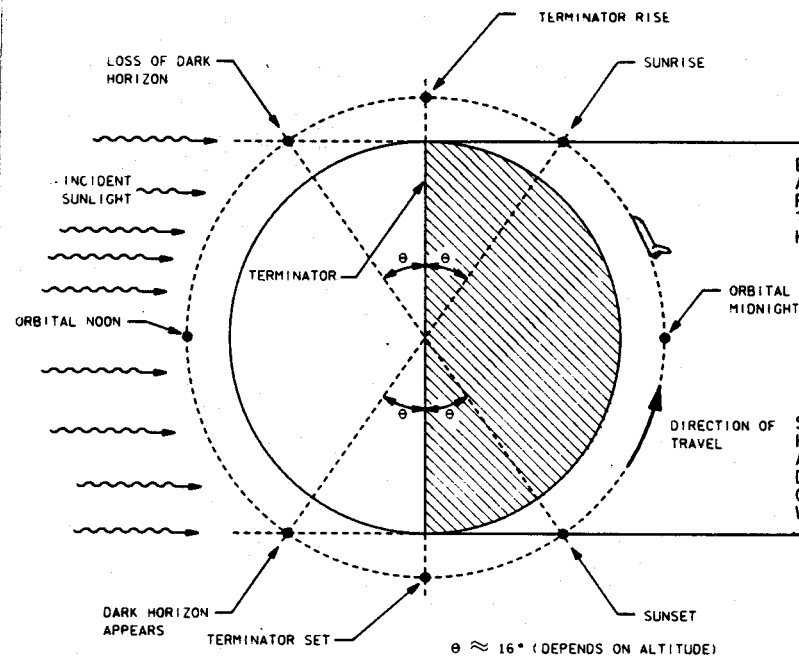

Figure 5-12.- The Sun as a target - definition of terms (view from above orbit plane).

SECTION 6
COMMON POINTING PROBLEMS

6.1 IMU ALIGNMENTS

The IMU's are designed and built to keep reference to inertial space accurately. However, due to physical limitations, they need to be brought back into alignment from time to time. Basically, there are three ways to accomplish this. One way is aligning an IMU, or two, to another IMU that is known to be in better alignment. The second way is to do a matrix alignment, and the third way is to do a star alignment. The star alignment is the concern of the pointing officer and the subject of this section.

6.1.1 Dual Star Tracker IMU Alignment

The concept here is to find an attitude so that one star tracker will "see" a star and the other tracker will "see" some other star at the same time - a time when both stars are available and unobscured. The stars to be used are from the 100 navigation star catalog stored in the Orbiter software (see appendix A). Since the star tracker separation angle is fixed (87.65°) and star pair separation varies, a limited quantity of star pairs can be used with this technique. The pairs used fall into a 5° filter, that is, the separation of each star pair must be within plus or minus 5° of the star tracker separation angle. Also since the stars are inertially fixed, there are only two possible attitudes for each pair (second attitude reverses stars in trackers). Fortunately, these attitudes are cataloged and appear in appendix A. The attitudes were computed to split the difference between the star tracker separation angle and the angular separation of each pair.

Computer programs exist for the pointing computers, flight design system (FDS), and the mission operations computer (MOC) to aid in the determination of star alignment information. Some of these programs are listed in appendix B.

6.1.2 Single Star Tracker IMU Alignment

A "single star tracker" star align is usually done when one star tracker is unusable for some reason. It involves maneuvering to an attitude to acquire a star in the usable tracker, usually a dual star tracker attitude, and then maneuvering to another attitude to acquire the second star, using the same tracker. The constraints which apply to the dual star tracker align also apply to the single star tracker align.

6.1.3 Stars of Opportunity IMU Alignment

Real-time, the GNC officer monitors ground displays to follow the star table data which is telemetered from the onboard GNC SPEC 22. (Refer to section 8, onboard displays.) The star table data shows the stars that are recognized by the star trackers as they are "seen" in the as-flown Orbiter attitudes; these are referred to as stars of opportunity. The star table logic determines which stars are placed in the star table. When the star trackers have picked up two stars that have an angular separation of $90^\circ \pm 55^\circ$ and an angular error of less than 0.08° , that pair may be selected for alignment, provided neither of the stars has been in the table for more than 1 hour. This method eliminates the need to maneuver to a specific inertial attitude to perform the IMU alignment. Generally, this kind of alignment is not planned preflight, except in cases where an IMU alignment has to be performed during a timeframe when maneuvers are not recommended (i.e., tracking arc).

6.1.4 "Rolling" Star Tracker IMU Alignment

The rolling alignment is a technique developed to save propellant and make noncritical alignments generic. It involves initiating a rotation (ROTR) about one of the body axes allowing the trackers to sweep through the celestial sphere picking up stars at random. The rotation can be initiated in any attitude (LVLH or inertial) and will be an LVLH ROTR or inertial ROTR accordingly. The LVLH ROTR requires that the LVLH digital autopilot (DAP) button be pressed, the axis of rotation be freed on the DAP panel (pulse), and the rotation put in with the rotational hand controller (RHC). For the inertial ROTR, it is simply a rotation option on universal pointing. The desired rotation rate is 0.2 deg/sec. Vernier control is usually desired, and at 0.2 deg/sec, one complete revolution is made in 30 minutes. Logically, the time to do this type of alignment is during a dark pass when the Sun and higher Earth horizon constraints will not impede star acquisition.

Two stars are needed to do an alignment as in the previous cases, but selection is broader since the stars are not constrained by the separation of the star trackers plus the 5° filter. Stars in the table with separations between 35° and 145° can be used for an alignment.

A study was done on the probability of picking up stars between 35° and 145° using the LVLH ROTR. The result was 98 percent for both trackers during a dark pass and 92 percent during the day (for the 100 nav star case during the dark, it was 99 percent plus). In the event that no stars are picked up, the rotation is to be repeated on the succeeding night pass, or a standard alignment is to be made.

6.2 STAR PAIRS CUE CARD

The star pairs cue card is located in the guidance, navigation, and control (GNC) section of the Orbit Operations Checklist Flight Supplement. It is

intended to be a quick reference for the availability of IMU alignment star pairs at any point along the orbit. The card covers a 4.5 hour (three consecutive orbit) timespan with each tick mark representing 5 minutes. By itself, the card can provide star AOS/LOS information with respect to the orbital day/night cycle. The size and time scaling of the card allow it to be placed alongside the detailed pages in the CAP for quick correlation of star availability with the MET timescale and events in the timeline. See figure 6-1.

6.2.1 Day/Night Bands

The tick marks are augmented by terminator and night bands. These bands indicate where the Orbiter will encounter terminator rise/set and orbital darkness with respect to star availability. The period of orbital darkness is ziptoned across the width of the card for easy identification.

6.2.2 Star Pairs

The star pairs are labeled A, B, C, D for reference. Generally, three to four star pairs are adequate to provide coverage over the entire orbit. Star pairs are selected for a given trajectory based on AOS duration; avoidance of proximity to the Sun, Moon, and bright planets; and acceptable star tracker magnitudes. By convention, the night pair is designated pair A, with the subsequent letters representing the subsequent star pairs acquired in the remainder of the orbit. An additional star pair is provided during the period of the orbital darkness. This COAS pair is a star pair dedicated for use in COAS IMU alignments. The COAS pair may sometimes be identical to the A pair if that pair is comprised of COAS stars (e.g., stars with visual magnitudes >+1.0 to provide easy identification and visibility). An angular separation between the two stars of >35° is required to make a valid COAS pair. It should be noted that if pair A cannot be used as the COAS pair, pair A will contain one star suitable for COAS viewing. This is done to support the -Z COAS calibration following an IMU align during the first 2 flight days. The star pair A1 attitude will nominally be calculated to place the COAS star in the -Z tracker and the second star in the -Y tracker so the COAS cal can be performed without maneuvering from the IMU align attitude.

6.2.3 Star AOS/LOS

Star AOS/LOS is represented by a vertical line for each star in the pair. AOS and LOS bars at the end of the vertical lines represent the rise and set of the stars. The times shown are conservative in that they are given for the orbits with the latest AOS and earliest LOS for the duration of the flight plus 2 extension days. Pair availability will probably be longer than what is shown for a given point in the flight. The star pair AOS interval is calibrated by tick marks at 5-minute increments for reference.

48

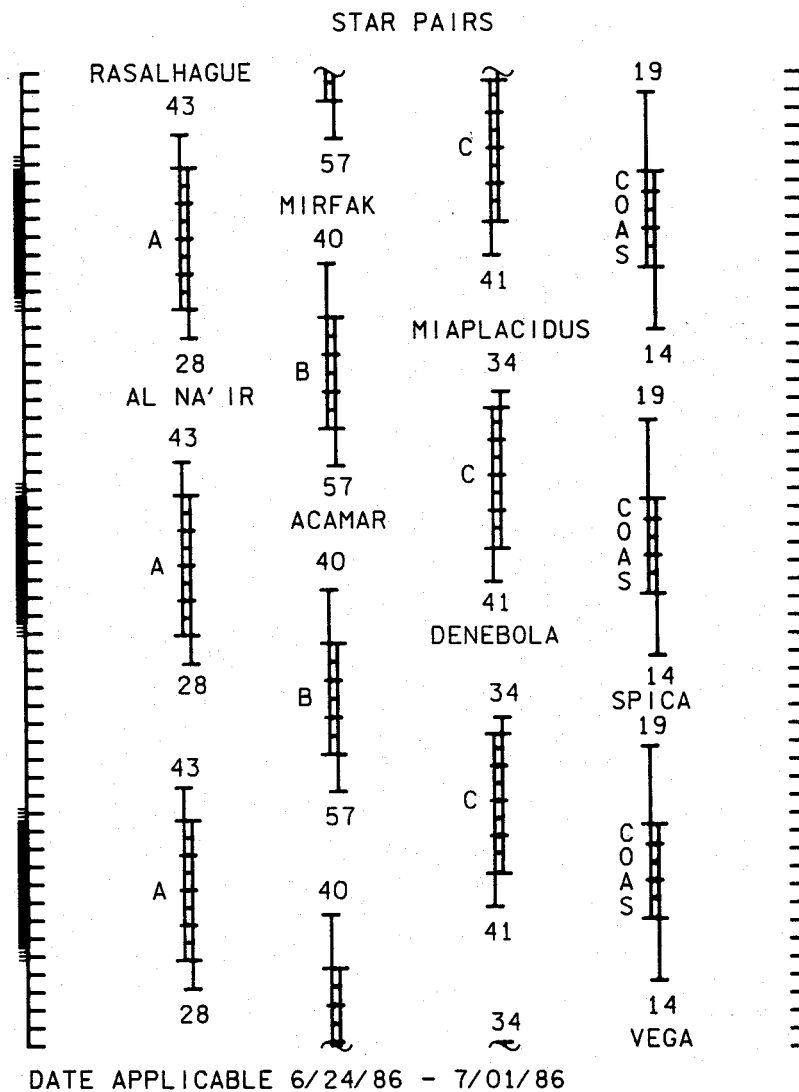

10511601.ART, 3

Figure 6-1.- Star pairs cue card.

6.2.4 Nav Stars

The star numbers given correspond to the standard 100 navigational star catalog designations although only the first 50 stars are presently used for star pairs cue card generation. While the complete 100 nav star catalog is available in operations sequence (OPS) 2 software, GPC memory constraints limit the available stars to the first 50 in OPS 3. Since the cue card might be required to support IMU aligns in OPS 3, only the first 50 nav stars are used. The new GPC's will have sufficient memory to contain the entire 100 nav star catalog in OPS 2 and OPS 3. After the GPC changeout, the 100 nav star catalog will be used for cue card generation. The proper name of each nav star is given along with its number as a reference.

6.2.5 Data Applicable

These dates indicate the period for which the star pairs and star pairs cue card are valid assuming a nominal launch time. Movement of the Sun, Moon, bright planets, and orbital precession during the course of a flight can result in changes in star pair availability or loss of individual star pairs. Launch slips can alter star availability AOS duration and shift star availability relative to the day/night cycle. Launch slips from the nominal time on one day to the nominal time on subsequent days have a benign effect on the cue card. The card is normally usable for several days of nominal launch times. Launch slips within the daily window usually impact the cue card more severely due to the inertial rotation of the orbit plane for such cases. Any required updates to the onboard data would be generated real time by the pointing officer and uplinked to the crew.

6.3 STAR PAIRS PAD

The star pairs PAD accompanies the star pairs card in the Orbit Operations Checklist Flight Supplement. For classified flights these items are currently located in the CAP. The PAD provides attitude data for the cue card star pairs and other related information. See figure 6-2.

6.3.1 Attitude Set 1/Attitude Set 2

Two attitude sets are provided for each star pair which allows the stars to be reversed in the individual trackers. Set 1 is prime but set 2 may be used to provide a shorter maneuver to an IMU alignment attitude. This is particularly useful if the IMU align occurs in a busy section of the attitude timeline. All attitudes are inertial +X sense attitudes in the M50 system.

STAR PAIRS PAD

PAIR	ANG SEP	ATT SET 1				ATT SET 2			
		DUAL S TRK		SINGLE S TRK		DUAL S TRK		SINGLE S TRK	
		-Y	-Z	-Y	-Z	-Y	-Z	-Y	-Z
A	85.0	-Y: 43 R+ 344 -Z: 28 P+ 321 Y+ 352	R+ 259 -Z: 43 P+ 311 Y+ 3	R+ 70 -Y: 28 P+ 332 Y+ 1	-Y: 28 R+ 287 -Z: 43 P+ 132 Y+ 353	R+ 202 -Z: 28 P+ 136 Y+ 7	R+ 14 -Y: 43 P+ 146 Y+ 348		
B	90.3	-Y: 40 R+ 127 -Z: 57 P+ 186 Y+ 52	R+ 38 -Z: 40 P+ 187 Y+ 37	R+ 233 -Y: 57 P+ 163 Y+ 49	-Y: 57 R+ 142 -Z: 40 P+ 326 Y+ 3	R+ 59 -Z: 57 P+ 10 Y+ 312	R+ 220 -Y: 40 P+ 345 Y+ 323		
C	88.6	-Y: 34 R+ 161 -Z: 41 P+ 305 Y+ 87	R+ 43 -Z: 34 P+ 337 Y+ 73	R+ 295 -Y: 41 P+ 258 Y+ 73	-Y: 41 R+ 132 -Z: 34 P+ 147 Y+ 291	R+ 64 -Z: 41 P+ 167 Y+ 276	R+ 183 -Y: 34 P+ 108 Y+ 294		

PAIR	COAS ALIGN ATTITUDE 1		ANG SEP	COAS ALIGN ATTITUDE 2	
	+X COAS	NOSE UP		+X COAS	NOSE UP
C	19 R+ 306 P+ 168 Y+ 340	14 R+ 30 P+ 281 Y+ 310	88	14 R+ 234 P+ 347 Y+ 18	
O					
A					
S	-Z COAS	19 R+ 212 P+ 284 Y+ 311	88		

PAIR	SINGLE S TRK MIN MNVR OPT	
	TGT ID = 11-110 NAV STAR #	BODY VECTOR = 5
	-Z S TAK	-Y S TAK
P	87.7	0
Y	358	280.6

Data Applicable 6/24/88 - 7/ 1/88

Figure 6-2.- Star pairs PAD.

6.3.2 Angular Sep

The angular separation between the two stars is given for informational purposes. The star tracker boresights are separated by an 87.65° angle, making this the optimum angular separation for an IMU alignment. All selected star pairs have angular separations of 87.65° ±5°.

6.3.3 Dual Star Tracker Attitudes

These are the attitudes for nominal dual tracker IMU alignments. The attitudes are "split difference" in that they place both stars in the plane formed by the star tracker boresights, biasing the stars so that they are equidistant from the boresights of individual trackers. The bias of the stars from the boresights is equal for attitude set 1 and set 2.

6.3.4 Single Star Tracker Attitudes

Used for the case of loss of one star tracker, these attitudes are provided to individually place each star in the working tracker. The single tracker attitudes are nearly pure rolls (there is slight yaw component) of 85° to 90° from the corresponding dual tracker attitudes. The actual amount of roll is dependent on the biasing of the star positions from the star tracker boresights.

As an example, for loss of the -Z star tracker, single tracker aligns can be done as follows. With reference to the enclosed sample star pairs pad,

- a. Maneuver to dual attitude A1 and track star 43 in the -Y tracker.
- b. Maneuver to single -Y attitude A1 and track star 28 in the -Y tracker.

Since dual tracker attitude A1 placed star 43 in -Y and star 28 in -Z, the maneuver to single -Y A1 is a positive roll.

If dual attitude A2 had been used for the first maneuver, then the single -Y A2 attitude would be used to provide a positive roll to the second star.

For loss of the -Y star tracker, a single tracker align can be done using -Z as follows:

- a. Maneuver to dual attitude A1 and track star 28 with the -Z tracker.
- b. Maneuver to single -Z attitude A1 and track star 43 with the -Z tracker.

Since dual attitude A1 placed star 28 in -Z and star 43 in -Y, the maneuver to single -Z attitude A1 is a negative roll.

If dual tracker A2 had been used for the first maneuver, then the single -Z A2 attitude would be used to provide a negative roll to the second star.

To summarize the options for single star tracker operations:

<u>-Z star tracker+</u>		<u>-Y star tracker+</u>	
Option 1	Option 2	Option 1	Option 2
(1) Dual A1	(1) Dual A2	(1) Dual A1	(2) Dual A2
+ Roll	+ Roll	-Roll	-Roll
+	+	+	+
(2) Single -Y A1	(2) Single -Y A2	(2) Single -Z A1	(2) Single -Z A2

6.3.5 Single Star Tracker Min MNVR Option

This block provides an alternate means of obtaining a star in a specific tracker. A track option using the desired star number (where the nav star number corresponds to the target ID on universal pointing) is selected followed by body vector 5 and the pitch, yaw coordinates of the appropriate tracker. By not specifying the Omicron angle and initiating the track option with item 19, a minimum maneuver results. Once in attitude, the Orbiter is free to rotate about the pointing vector since the Omicron has not been specified.

6.3.6 COAS Align Attitudes

The COAS align block consists of attitudes to support COAS IMU alignment using either the +X COAS or the -Z COAS. For either case, the two attitudes are separated by a pure pitch maneuver equal to the angular separation between the two COAS stars. Typical COAS star separations are in the range of 35° to 145°.

If a fairly accurate attitude reference is available in OPS 2 or 3, a helpful technique in executing the COAS align from the +X COAS would be to fly to the first attitude using the appropriate maneuver display, placing the +X ADI ATT switch in the REF position, and depressing the ATT REF pb prior to enabling COAS SIGHT mode. This action will zero the ADI at the first star attitude. Once sufficient COAS marks are taken, the second attitude can be obtained by an auto maneuver using a maneuver display or by making a manual pitch maneuver equal to the angular separation between the two stars. Since the ADI has been zeroed in REF at the first attitude, the pitch angle can be easily monitored using the +X ADI.

The attitudes are calculated so that maneuvering from attitude 1 to attitude 2 will be a positive pitch on the +X ADI equal to the angular separation. The maneuver from attitude 2 to attitude 1 will be a negative pitch on the +X ADI equal to the angular separation.

50

The same technique can be used with slight modification for the -Z COAS in OPS 2. With a fairly accurate attitude reference, universal pointing can be used to fly to the first star attitude. The aft ADI sense switch should be placed in the -Z sense and the ADI taken to REF and zeroed by depressing the ATT REF pb prior to enabling COAS SIGHT mode. Once sufficient COAS marks are taken, the second attitude can be obtained by using an auto maneuver with universal pointing or by making a manual pitch maneuver between the two attitudes equal to the angular separation of the two stars.

In the -Z sense the same pitch convention will hold. A positive pitch on the -Z sense ADI will be seen when maneuvering from attitude 1 to attitude 2, while a negative pitch on the -Z sense ADI will be seen when maneuvering from attitude 2 to attitude 1. The difference is that a positive pitch in -Z sense corresponds to a tail-up motion of the Orbiter. A negative -Z sense pitch corresponds to a tail-down motion of the Orbiter.

The manual pitch maneuver technique is used in GNC SSR-2: Star Align Using COAS Data, pages 8-24, of the Mal book, that contains the procedures for executing COAS IMU alignments.

To note the positive nature of the attitude 1 to attitude 2 pitch in both senses, arrows are included in the angular separation column of the COAS block.

6.3.7 Data Applicable

Dates identical to those used on the star pairs cue card to indicate the period for which the star pairs are valid. The attitude data is independent of time as long as the M50 coordinate system is used.

For question or comments contact Mark Severance, Attitude and Pointing Office, code DH4, phone X34458, or any other pointing officer.

6.4 TOP/BOTTOM SUN ATTITUDE

6.4.1 Standard Top/Bottom Sun Attitude

Quite simply, top Sun is an inertial attitude which points the -Z body axis towards the Sun, usually to warm something in the bay or keep the underside cold. The opposite attitude, bottom Sun, points the +Z body axis towards the Sun keeping the bay cool or warming the underside. In either case, the attitude is not completely defined since there are 360° worth of attitudes about the line of sight to the Sun. A second constraint is required (the first being + or -Z to the Sun). Usually a minimum maneuver from a previous or to a next attitude is sufficient, but there may be some other constraint which is flight specific (Ku-band, etc.).

6.5 TAIL/NOSE SUN ATTITUDE AND TAIL SUN ROTR

6.5.1 Standard Tail/Nose Sun Attitude

Tail Sun, like top Sun, is an inertial attitude but has the -X axis pointed at the Sun. This attitude is one of the coldest attitudes for the Orbiter. Also like top Sun, there are 360° worth of attitudes about the line of sight to the Sun, and a second constraint is required. Nose Sun is a semicold attitude directed at cooling the aft section of the Orbiter. In some cases, it is desired for warming the nose, particularly the front wheelwell. Constraints are applied to nose Sun as they are for tail Sun.

6.5.2 Pre-Deorbit Prep Tail Sun Attitude

Prior to entering the deorbit prep timeline, the Orbiter is in a special tail Sun attitude, designed to "cold soak" the radiators and keep the Sun out of the crewmembers' eyes. This is done by selecting a body vector of pitch = 184° and yaw = 0° and pointing it at the Sun. As a secondary constraint, an omicron of 90° or 270° is typically used to maximize bay-to-Earth orientation. The crew uses these inputs in the track option of universal pointing. The period of tail Sun usually lasts from deorbit minus 5 hours to deorbit minus 3 hours 30 minutes.

6.5.3 Tail Sun ROTR

Often referred to as the coldest attitude for the Orbiter payload bay, tail Sun ROTR is a rotating inertial attitude that keeps the -X axis pointed at the Sun while phasing the rotation (about the plus or minus X axis) to keep the bay pointed away from the Earth. This attitude is usually used for vehicle thermal bending tests or to meet specific payload constraints. The Orbiter typically stays in this type of attitude for several hours; this allows roll angle error to creep in, an undesirable effect. This occurs because only three decimal places can be input into the discrete rate of the DAP SPEC while the orbital period rate (which determines the rotation rate) can obviously be more. In most cases, several degrees in roll error are acceptable. The method currently used to minimize the error is to adjust the attitude such that the error is zero at the midpoint of the rotation time, thereby splitting it in half for the beginning and end.

6.6 PASSIVE THERMAL CONTROL

Passive thermal control (PTC) is another inertial attitude rotation (about the plus or minus X axis), but maintains the Sun in the Y, Z plane during rotation. The purpose of PTC is to warm the Orbiter evenly, much like meat being turned on a spit over a fire (consequently the nickname of "barbecue mode" was coined). It is also used for various payloads as thermal constraints may dictate.

In universal pointing, there exists a body vector called "PTC axis" which is a vector pitched down 2° from the +X axis. The theory behind a rotation about this axis is reduced prop consumption. Sometimes this axis is selected instead of the +X body axis. Practice has shown that this is insignificant, and the +X axis is almost always used.

6.7 GRAVITY GRADIENT

Gravity gradient (GG) for the Shuttle is a supposedly stable attitude(s) which is controlled not by reaction control system (RCS) but rather by a combination of balanced differential gravitational and aerodynamic forces on the body. Differential gravitation is nothing more than the effect of gravitational force falling off with the square of the distance from a body, but limited to the physical upper and lower "altitudes" of the Orbiter. It is the center of mass of the Orbiter which defines the "particle" orbit, but the vehicle protrudes above and below the center and is thereby subjected to the differential gravity. The aerodynamic forces mentioned are the forces which affect the vehicle due to motion through the atmosphere at orbital altitudes just as any projectile motion is affected near the ground.

The combined forces are very small and only a few attitudes are known to exist for the Orbiter where the forces are balanced enough to allow stability.

Even the known attitudes are very difficult to establish successfully and will vary according to altitude, inclination, time of year, etc. GG is established by maneuvering the vehicle to the GG attitude and turning off the RCS which puts the Orbiter in free drift. The Orbiter should then maintain the attitude with minor fluctuations. The type of attitude which GG approximates is LVLH. A perfect example of this is our own Moon which keeps only one side facing the Earth all the time.

The purpose of GG is typically propellant conservation and the need for no RCS firings during some payload tests and experiments. A more detailed analysis of GG can be found in an informal note numbered CG5-81-88.

6.7.1 Gravity Gradient Description

GG can best be explained by considering two equal masses separated by a rigid rod of length 2ℓ. The c.g. of a dumbbell shaped object is at a distance "r" from the center of the Earth.

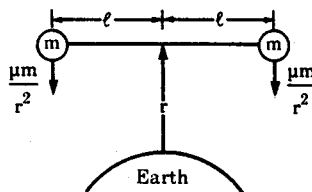

6-11

52

The force on each mass is $\frac{\mu m}{r^2}$ and the torques produced by these forces act about the c.g. of the system. The moment arms and forces are the same for each mass; therefore, the sum of the torques equals zero.

$$\sum T = \frac{\ell \mu m}{r^2} - \frac{\ell \mu m}{r^2} = 0$$

That is, the object is in an equilibrium position. However this is an unstable equilibrium because if the system is disturbed, it will not return to the original position but instead tend to rotate about the c.g. The force on the mass nearest to the Earth center will increase as its "r" decreases, just as the force on the other mass will decrease as its "r" increases. This yields a net torque which rotates the dumbbell toward a vertical position.

The dumbbell will rotate indefinitely if there are no additional interferences in the system. However, with the introduction of aerodynamic drag, the system may eventually stabilize in a vertical position. In this position the forces acting on each mass are not equal, but are parallel to the moment arms and therefore produce no net torque.

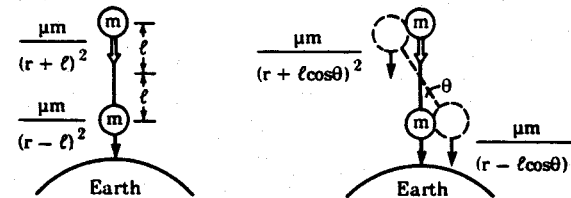

This is considered a stable equilibrium attitude since a perturbation in the system will result in a net torque which returns the dumbbell to the vertical position. The net torque is due to the fact that the force on the "lower" mass is greater than the force on the "higher" mass. Therefore, the "lower" mass is pulled back toward the Earth. Thus the idea of GG emerges.

6.7.2 Gravity Gradient Applied to the Space Shuttle

GG attitude control is theoretically a method of maintaining a stable attitude without the use of jets. Several payloads have requested RCS "controlled" GG attitudes. This orientation is advantageous in that the attitude will be maintained with jet firings, yet the firings will be minimized since GG forces will help hold the Orbiter in attitude. The following paragraphs deal only with "free drift" (no jet) GG control.

Payloads which require a low-g or a minimum RCS-contaminated environment may find "free drift" GG control desirable. GG control may also eventually be used during sleep periods following the loss of vernier jets. There are,

however, many factors in the real world which affect GG stability and the ability to predict stable attitudes.

Space Shuttle GG attitudes are designed to balance GG and aerodrag forces. Aerodrag on the Orbiter produces a torque about the c.g. which tends to align the c.g. and center of pressure with the velocity vector so that the center of pressure is trailing (similar to the effect of a feather on an arrow which moves the center of pressure aft and causes the arrow to fly straight). The c.g. stays relatively fixed on orbit while the center of pressure is a function of the surface profile into the velocity vector. In general, an attitude which nulls the aerodynamic torque (aligns the c.g. and the center of pressure with the velocity vector) would result in a nonzero GG torque. This problem is solved by finding attitudes such that the GG and aerodynamic torques are equal and opposite.

The determination of a balanced attitude is a difficult procedure due to uncertainties in physical conditions. Atmospheric pressure (therefore aerodrag) decreases with increasing altitude. Thus, the balance attitude will change as altitude changes. Elliptical orbits produce cyclic changes in the atmospheric pressure. Also, atmospheric pressure is greater on the sunlit side of the Earth due to the higher energy of the particles. Solar activity increases the upper atmospheric density and therefore aerodrag. Oscillatory motion results due to these atmospheric variations.

In general, there will be some error in the computed attitudes due to uncertainties in the knowledge of the center of pressure, the center of gravity, the principal axes, and atmospheric pressure variations. If no outside disturbances occur, restoring torques due to the initial attitude error would cause the Orbiter to oscillate with an amplitude equal to the attitude error. However, as previously stated, atmospheric pressure variations throughout the orbit will induce further oscillations.

Stable gravity gradient attitudes place the Orbiter with the nose or tail to the Earth (resembling a vertical dumbbell). GG forces tend to hold the X principal axis to the local vertical. Note that there is an approximate 2° offset of the X principal axis from the X body axis. There are three stable GG attitudes with the nose to Earth and three with the tail to Earth. They are as follows:

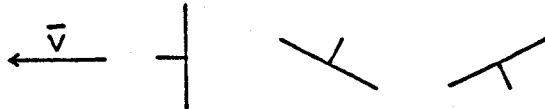

The body roll about the X principal axis for the stable attitudes is determined from aerodynamic considerations. For the bay into the velocity vector attitude, roll stability is achieved by placing the center of pressure in the orbit plane behind the c.g. so that the aerodynamic torque is zero. For the bay out-of-plane attitudes, a gyroscopic torque is

produced which tends to rotate the bay further out of plane. The torque is due to the natural tendency of a body to attempt to rotate about one of its principal axes if currently rotating about an axis offset from its principal axes. The Orbiter in a GG attitude is actually rotating in the inertial frame, therefore, it will tend to rotate about the Z principal axis for the bay out-of-plane cases since this axis is most nearly out of plane. Stability is achieved for these attitudes by placing the center of pressure so that the aerodynamic torque about the X axis balances this gyroscopic torque.

The GG free drift (ORB OPS, RCS) procedure describes the six stable attitudes. The attitudes listed place the Orbiter with the bay into the velocity vector or with a $\pm 70^\circ$ roll from belly into the velocity vector. It must be remembered that these attitudes are approximations and more accurate attitudes depend on orbital conditions (altitude, beta angle, atmospheric pressure, etc.) and vehicle mass properties. The ORB OPS attitudes, however, will be used if more accurate numbers are not available. The GNC's have the task of calculating stable GG attitudes.

GG stability also depends on rate and attitude errors at the time of initiation. Residual rates on the vehicle at the time of free drift are unavoidable since the RCS control torques are delivered in discrete pulses. The rates result in movement away from the release attitude. Restoring torques will counteract the rates, thereby causing oscillation. The ORB OPS procedure requires minimum rates be achieved before GG is initiated. Vernier jets give minimum rates at initiation because the vernier pulses are much smaller than the primary pulses. If vernier jets are not available, primary jets with low Z and tail-only yaw will be used.

Orbiter thermal constraints must be considered when determining the amount of time a GG attitude can be maintained. Major thermal constraints on attitude-hold durations include temperature limits on forward fuselage window seals, payload bay doors, and RCS propellant. The ON setpoints of the aft RCS heaters are below the minimum propellant temperature limit. Therefore, RCS propellant constraints require the aft pods be in either a relatively cool orientation so the temperature sensors are cooled and heaters activated, or a very warm orientation so the bulk propellant is heated above its minimum temperature. From this standpoint, a nose to Earth GG attitude that cools the aft pods is more desirable. OV-102 presents an additional problem in that its forward vernier heaters are undersized. Therefore, OV-102 vernier jets can only remain off for 6 to 9 hours.

The CORE Interface Control Document (ICD) (revision, August 25, 1986) lists the Orbiter attitude constraints (shown in table 6-I) based on a consideration of the thermal requirements. The attitude durations are intended as a baseline for STS planners. According to the CORE ICD, nose-down GG attitudes lend themselves to longer attitude-hold durations than do tail-down attitudes. It should be noted, however, that these duration limits are actually dependent on thermal conditioning requirements, heat rejection management, altitude, and attitude history. It is also possible that the listed GG durations may require recovery in a more thermally benign attitude.

The attitudes given in table 6-1 are only estimations of GG attitudes since the Orbiter will oscillate from the release attitude in random fashion. The amount of time in GG may be further limited if the attitude oscillations are phased with the orbital period in such a way that the same side of the Orbiter continually faces the Sun.

TABLE 6-I.- ORBITER VEHICLE ATTITUDE CONSTRAINTS

Orbiter orientation	Orbiter attitude hold duration limits * (hours)		
	$0^\circ \leq \beta \leq 20^\circ$	$20^\circ \leq \beta \leq 60^\circ$	$60^\circ \leq \beta \leq 90^\circ$
Tail LV, belly to Sun	160	12	7
Tail LV, side to Sun	160	12	7
Tail LV, bay to Sun	160	120	48 to 160
Tail LV, side to Sun	160	120	48 to 160
Tail LV, side to Sun	160	160	160

*Orbiter-attitude hold periods are based on a consideration of both passive and active thermal control (PTC and ATC) system limits. PTC limits are referenced from steady-state conditions at each beta angle. ATC limits reflect a nominal on-orbit supply water quantity (478 lb), 245 lb supply water redline, 22 kW fuel cell power, 18 lb/hr water production, 110° F radiator Freon inlet temperature, seven crewmembers, deployed forward radiator configuration, and eight radiator panels.

6.7.3 Real-Time Results

GG tests have been performed on seven flights: STS-1, 3, 4, 41-D, 51-C, 61-A, and 61-C. The results are shown in table 6-II. In general, GG attitudes have been observed to oscillate in sinusoidal wave fashion. Pitch and yaw oscillations of $\pm 2^\circ$ to 8° and roll oscillations of $\pm 10^\circ$ to 30° out of attitude are inevitable. A slow buildup to steady state conditions occurs over a period of two to four orbits.

Oscillatory motion during real-time tests is caused by residual rates, atmospheric pressure variations, and initial attitudes that do not perfectly balance GG and aerodrag forces. GG stability has been shown also to be affected by venting and tile outgassing. Tests indicate that waste collection system (WCS) collections and fuel cell purges do not seem to disturb the vehicle a significant amount. In general, it can be said that normal venting (dumps, purges, etc.) probably will not tumble the vehicle; however, it may cause larger than normal roll oscillations.

54

TABLE 6-II.- REAL-TIME GRAVITY GRADIENT RESULTS

Flight (STS) no.	Alt. (NM)	Test duration (min:sec)	Approx. attitude (roll, pitch, yaw)	Oscillation period (min:sec)	Maximum oscillation (degrees)	Comments
1	145	03:20	+XLV, -ZVW	01:35 00:40 01:10	60 8 4	Roll deviated 60° in one direction, then oscillated about new origin (± 30°)
3	128	01:45	+XLV, -ZVW	00:40 00:30 00:35	13 2 3	
4	172	00:30	+XLV, rolled 80° from +ZVW	Roll: *diverged 220° Pitch: *diverged 12° Yaw: *diverged 6°		Instability caused by outgassing of rain-soaked tiles
4	172	05:00	+XLV, rolled 66° from +ZVW	01:15 00:40 00:35	25 3 8	
41-D-1	160	01:45	+XLV, rolled 80° from +ZVW	Not 00:45 00:30	28 6 3	An entire roll oscillation was not completed
51-C-1	---	01:40	+XLV, -ZVW	*Dvrg 00:40 00:20 100°	*dvrg 6 2 100°	Unstable attitude
51-C-2	---	01:20	+XLV, -ZVW	*Dvrg 01:00 00:35 100°	*dvrg 5 2 10°	Unstable attitude
51-C-3	---	01:00	-XLV, rolled 6° from +ZVW	*Dvrg 00:40 00:20 100°	*dvrg 5 3 100°	Unstable attitude
61-A-1	176	08:00	+XLV, rolled 82° from +ZVW	01:00 00:30 00:30	13 4 7	Three WCS collections were performed during test (caused roll amplitudes to increase)
61-A-2	176	08:30	+XLV, rolled 82° from +ZVW	01:30 00:30 00:40	17 4 4	One fuel cell purge was performed during test
61-A-3	176	11:00	+XLV, rolled 82° from +ZVW	01:25 00:40 00:30	11 3 4	Seven WCS collections were performed during test
61-A-4	176	12:00	+XLV, rolled 82° from +ZVW	01:20 00:30 00:30	13 3 4	
61-A-5	176	08:00	+XLV, rolled 85° from +ZVW	01:40 00:40 00:30	13 3 2	
61-C-1	178	01:30	+XLV, -ZVW	*Dvrg 00:50 00:30 30°	*dvrg 6 3 30°	Unstable attitude

*Attitude angles diverged to the given values by the end of the test. Orbiter did not oscillate back to release attitude in the given axis.

Many payloads have requested +ZVV GG attitudes to keep sensitive instruments in the payload bay out of the ram direction. Real-time results for STS 51-C and 61-C (table 6-II) show that roll deviations of anywhere from 10° to 100° result during +ZVV tests lasting approximately 1½ hours. Even though this attitude is theoretically unstable and its roll deviation unpredictable, short term attitude-hold periods may be performed.

GG seems to be a viable control mode based on real-time tests. However, not enough data has been obtained to draw definite conclusions about the effects of physical conditions on oscillatory amplitudes. GG attitude control still has only limited predictability even with known mass properties, known atmospheric and orbital conditions, and minimum rates at release.

6.7.4 References

Marion Griffin, DH4, Attitude and Pointing.

Gravity Gradient memorandum, Rick Hieb, March 30, 1981.

Space Shuttle Program Thermodynamic Design Data Book - Thermal Control System, C. R. Miller, J. L. Schaefer, September 1985.

STS Gravity Gradient Attitude Control presentation, Charles K. Alford, April 10, 1986.

6.8 KU-BAND AND TURTLES

6.8.1 Ku-Band

With the advent of the TDRS, near continuous communication (COMM) has become a reachable goal. However, data can be downlinked in the highest data rates only when the attitude allows the Ku-band antenna to have a line of sight to the TDRS that is unblocked by the Orbiter body. A given attitude can be evaluated as to whether or not it allows an unblocked line of sight and when a line of sight is blocked. Also an attitude may be generated to satisfy a required line-of-sight problem. To do so requires use of various pointing programs. Part of the problem of knowing when a line of sight is blocked depends upon the definition of blockage boundaries. Currently, this blockage demarcation is set at 5° above the Orbiter body as viewed from the Ku-band antenna dish. A chart has been developed to incorporate this blockage. The chart allows graphical analysis when used in conjunction with the pointing programs and is referred to as one of the "turtles" that is the next topic of discussion.

6.8.2 Turtles (Blockage Diagrams)

6.8.2.1 Turtles in General

A turtle is an Orbiter look-angle chart that usually has some form of body blockage and/or antenna pattern superimposed on it. The generation concept of the basic pitch-yaw and roll-pitch look-angle chart is shown in figures 6-3 through 6-6 (other Euler sequence look-angle charts would have a similar development). Blockage, when it is used, is taken from the "point of view" of some point located on the Orbiter or on the payload in the bay. Each point defined will "see" its spherical field of view blocked by the Orbiter (and payloads) structure differently from some other point. Consequently, an infinite number of blockage plots could be created. To create a single turtle for a payload, the highest point structurally is used to generate the blockage diagram. Examples of turtles are included in this section (figs. 6-7 and 6-8). It can be seen that some of the resulting blockage patterns give the viewer the impression of a reptilian turtle shell, hence the name "turtles."

The pointing programs use the charts for plotting lines of sight to various targets in various attitudes. This gives the pointer a visual "feel" of where an object is relative to the Orbiter, but more importantly, it gives the time a target comes in or out of the blocked region for a given attitude or maneuver sequence. The importance is realized when payload constraints are brought into play. For example, a portion of the payload may not be able to tolerate Sun exposure so it is necessary to evaluate or find attitudes which will satisfy the constraint.

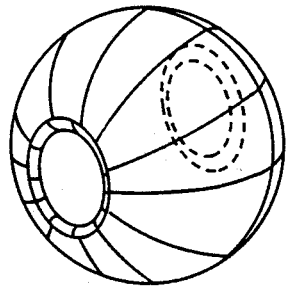
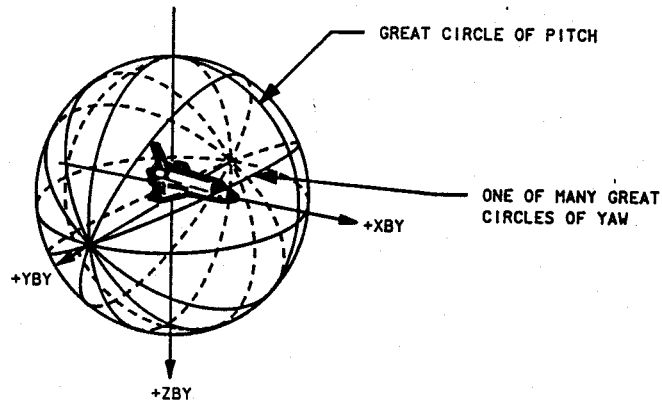

TO BEGIN GENERATION OF THE FLAT CHART, THE POLES OF THE SPHERE ARE STRETCHED OPEN...

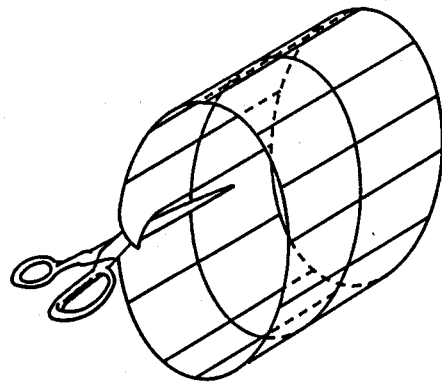

...TO FORM A CYLINDER. NEXT THE LINE OF YAW AT PITCH EQUALS 180° IS CUT ACROSS. THE CYLINDER IS THEN OPENED UP AND LAID FLAT WITH THE OUTSIDE FACING THE VIEWER. SEE NEXT PAGE.

10511063. ART, 1

Figure 6-3.- Generation of a pitch/yaw look-angle chart.

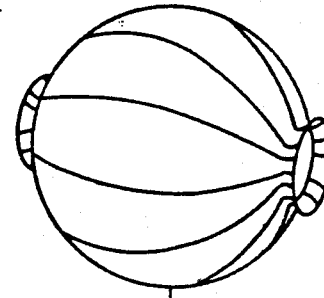
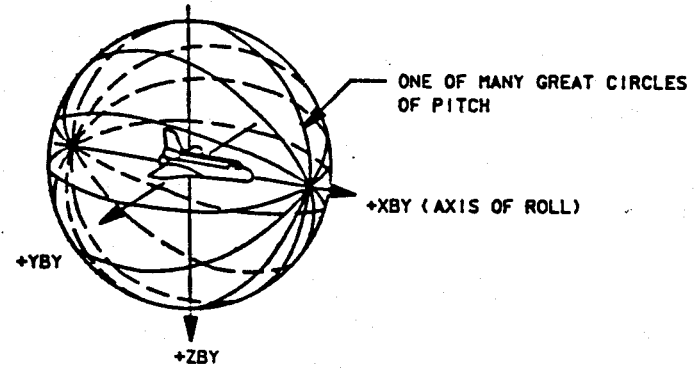

TO BEGIN GENERATION OF THE FLAT CHART, THE POLES OF THE SPHERE ARE STRETCHED OPEN...

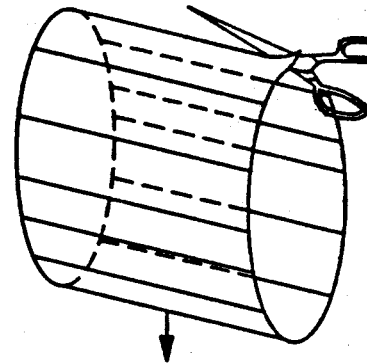

... TO FORM A CYLINDER. NEXT, THE LINE OF PITCH AT ROLL EQUALS 0° IS CUT ACROSS. THE CYLINDER IS THEN OPENED UP AND LAID FLAT WITH THE OUTSIDE FACING THE VIEWER. SEE NEXT PAGE.

Figure 6-5.- Generation of a roll-pitch (phi-theta) look-angle chart.

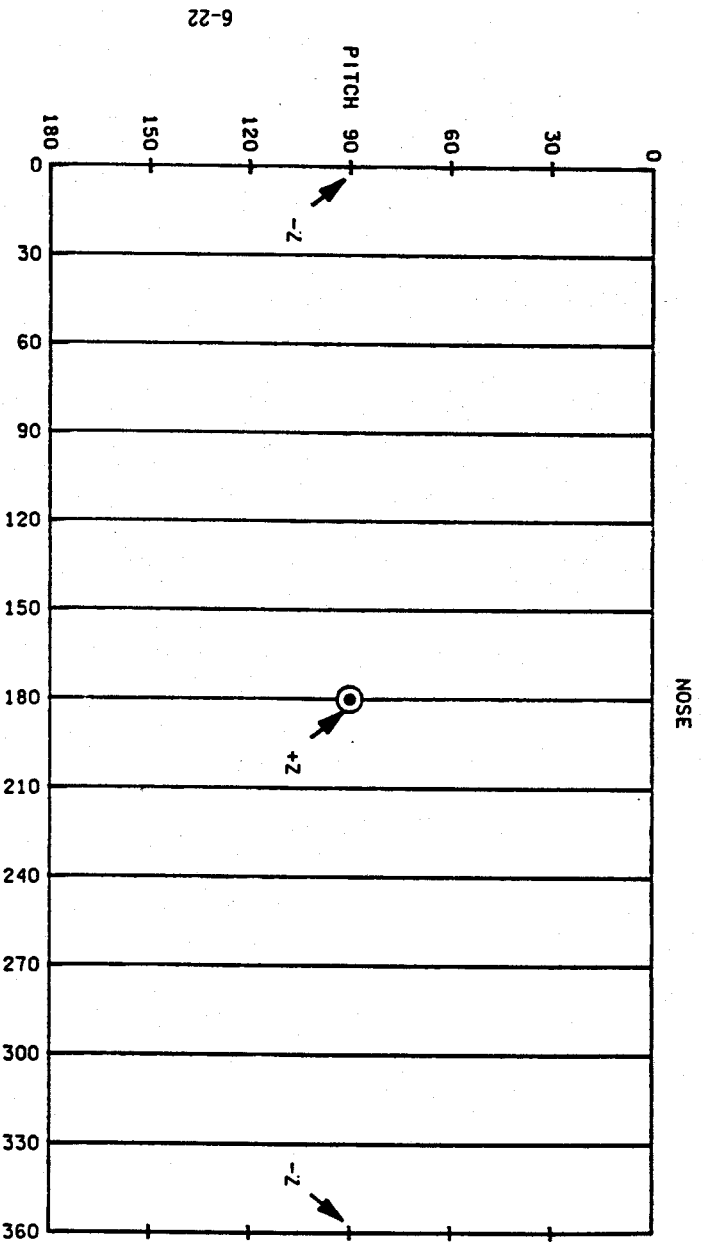

Figure 6-6.- Roll/pitch chart.

JSC-10511

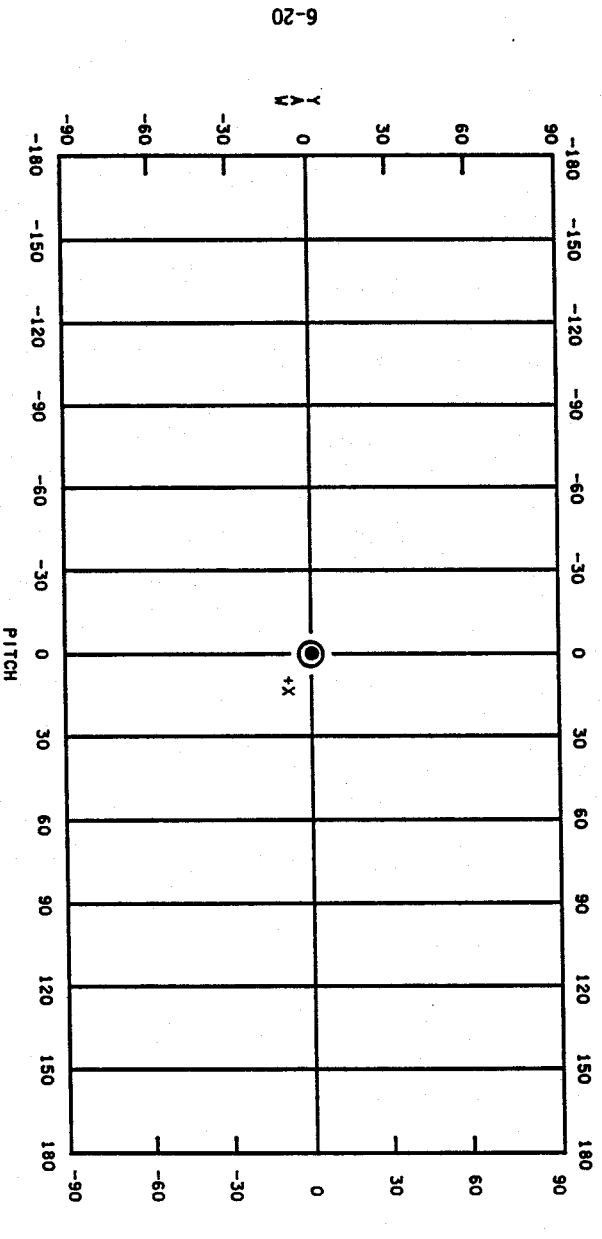

Figure 6-4.- Pitch/yaw chart.

JSC-10511

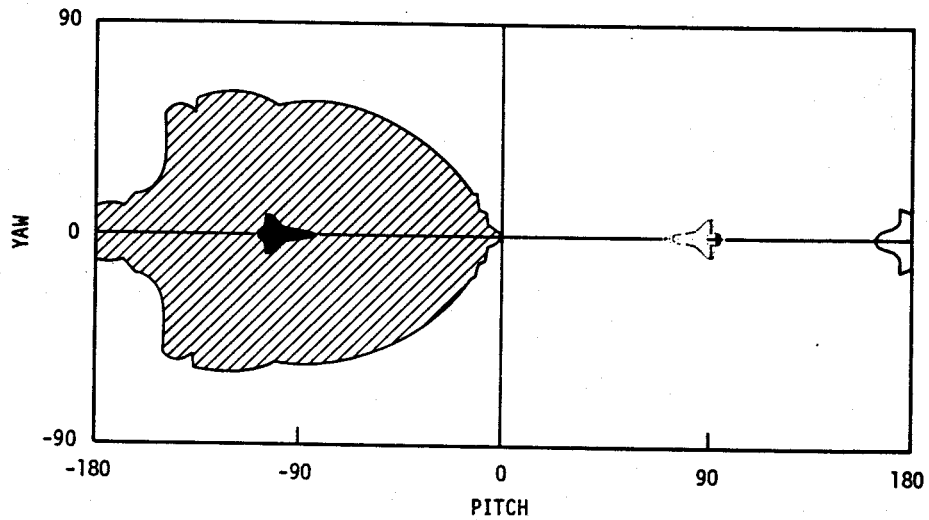

Figure 6-7.- SYNCOM turtle.

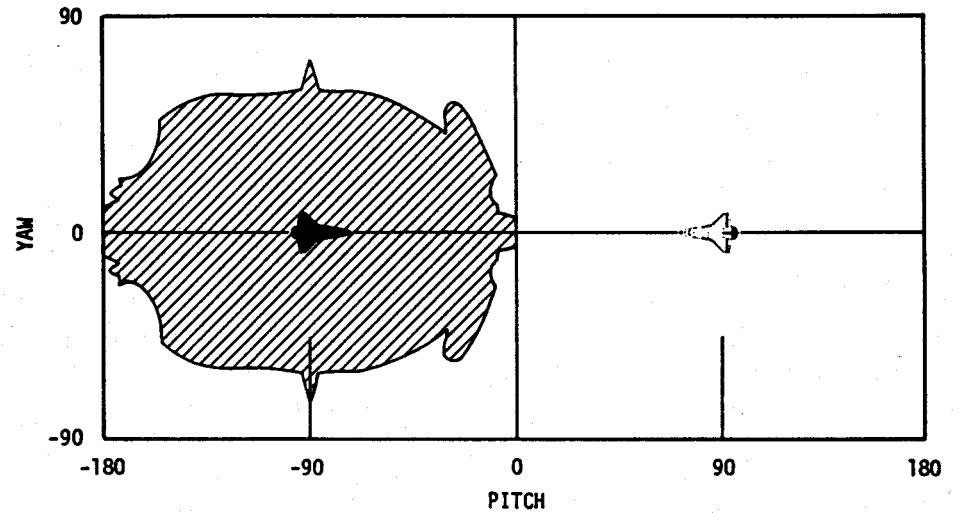
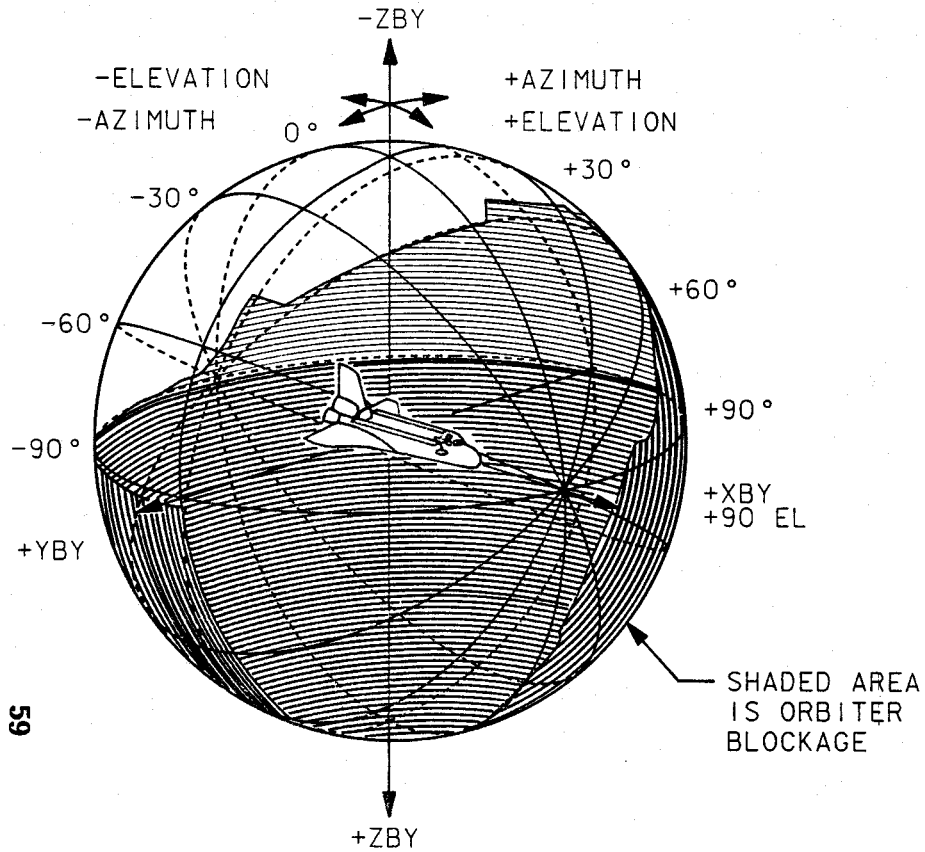

Figure 6-8.- TELSAT turtle.

6.8.2.2 The Ku-Band Turtle

A special blockage chart has been developed for the Ku-band that is used in conjunction with the computer programs to provide high data acquisition and loss times based on current attitude or maneuver in progress. Its "point of view" origin point is the Ku-band radar antenna. As mentioned earlier, the blockage on the chart begins at 5° above the body, but other blockage diagrams may be used. The resulting blockage for Ku-band is shown in figures 6-9 and 6-10. The chart in this case is viewed from the inside out unlike other turtles.

KU-BAND AZIMUTH/ELEVATION LOOK ANGLE FIELD OF VIEW WITH ORBITER BODY BLOCKAGE STARTING AT 5° ABOVE BODY. NOTE DEPLOYED KU-BAND DISH ANTENNA JUST IN FRONT OF STARBOARD DOOR



10511069. ART, 4

Figure 6-9.- Ku-band antenna obscuration zone.

59

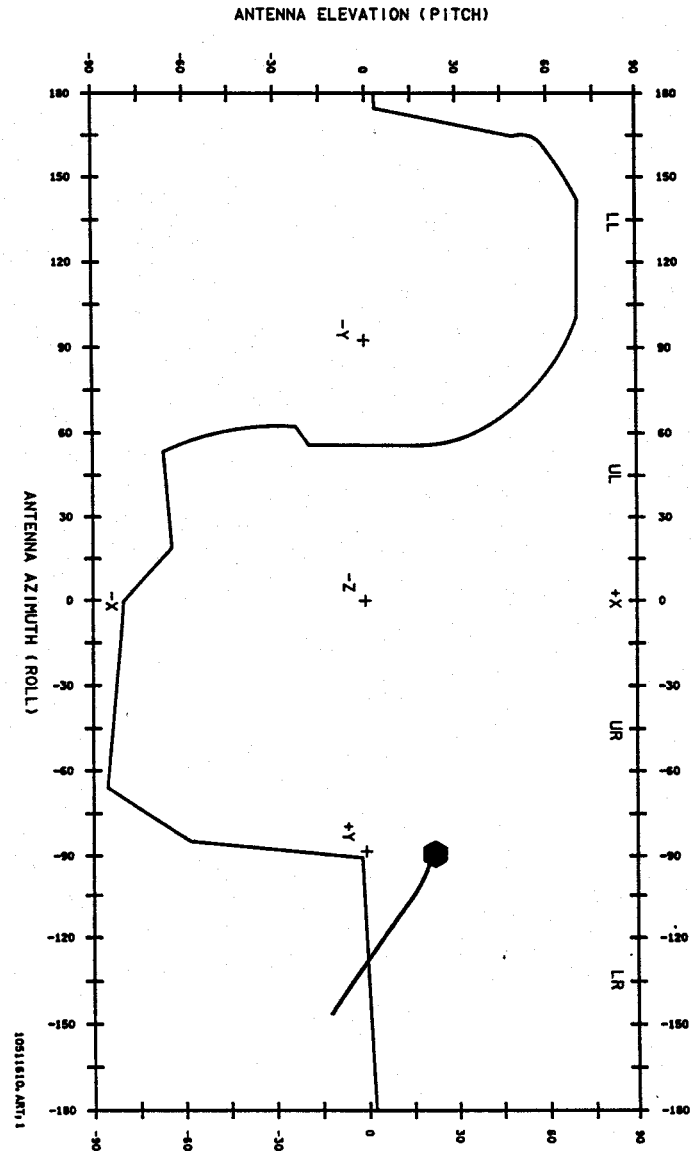

Figure 6-10.- Ku-band blockage chart (mask).

Figure 6-11 shows the deployed Ku-band antenna. Two gimbals are provided for roll (α gimbal) and pitch (β gimbal) to facilitate antenna steering. The α gimbal provides 360° of rotation with a fixed mechanical stop angle at a certain value of α . The β gimbal provides 162° of movement with two fixed mechanical stops. The stops are necessary to prevent cable binding. The stops result in two noncoverage zones, a 4° region around the pole and a 32° region in the trunnion area, as shown.

Considerations for Ku-band blockage modes

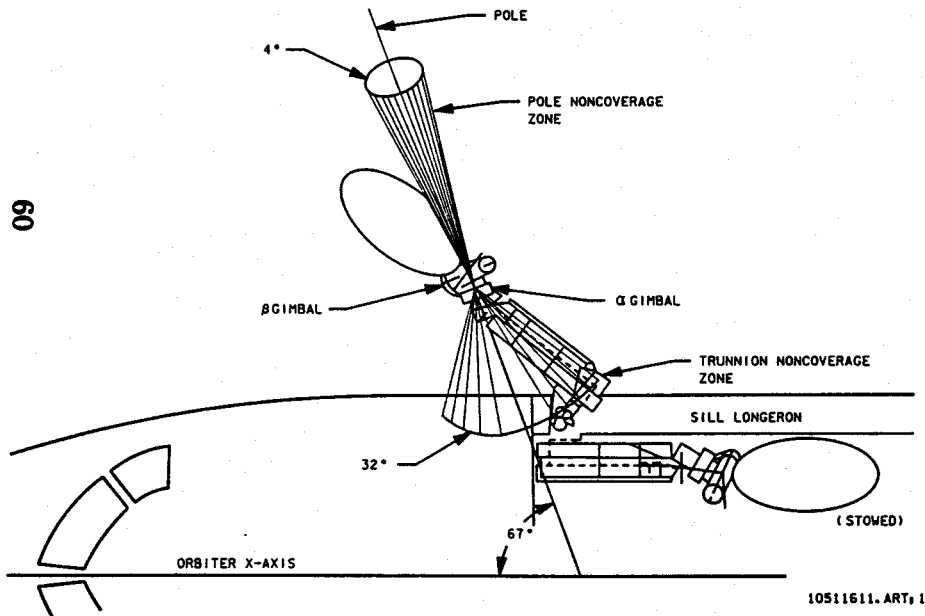
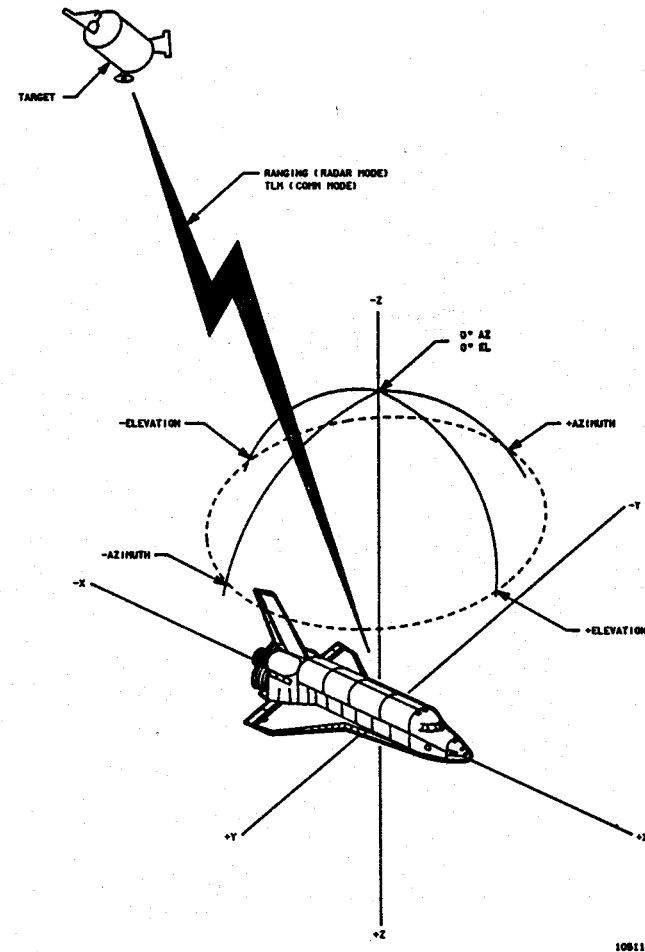

Figure 6-11.- Ku-band antenna.

α and β coordinates are used for actual gimbal commands for antenna pointing. The position of the antenna is displayed in terms of azimuth and elevation on panel A2 and on the SM OPS 201 ANTENNA display. These angles are obtained by coordinate transformation of the α and β values. The azimuth and elevation coordinate system is shown in figure 6-12.



Positive azimuth: Measured in direction away from -Z along -Y, as shown.

Positive elevation: Measured along +X toward Orbiter nose, as shown.

Initial antenna deploy position: 0°EL, 0°AZ

Figure 6-12.- Azimuth/elevation sequence.

6.9 CAP/ATL DEVELOPMENT

The final documented product of the pointer prior to a flight is the attitude timeline (ATL) that is founded on a trajectory and a CAP. The trajectory and CAP must exist in some form prior to any ATL building. When complete, the ATL is incorporated into the CAP although it is not usually flown. Flights with large numbers of time-critical maneuvers, such as Spacelab flights, may carry an ATL onboard from which all maneuvers are performed.

The CAP undergoes three phases of evolution: preliminary, basic, and final. There is an ATL for the basic and the final CAP. A trajectory is generated in support of each CAP by the Trajectory Division and stored on a computer tape. The tape is then read into the CAP computer. All three phases of CAP development are supported by the flight lead pointing officer with his attending formal and informal meetings to learn about payloads and their constraints, any peculiar problems, etc. The information obtained from the meetings is digested and applied to ATL generation. Since there is no attitude information in the preliminary CAP, actual data generation doesn't begin until the start of the basic CAP cycle. Usually, everything that needs to be known to finish both CAP and ATL isn't known yet so an ongoing evolution of CAP and ATL is the condition under which the pointer (and everyone else involved) lives.

With the beginning of the basic CAP cycle, the lead flight activities officer gets a copy of the best known CAP to the lead pointer. The pointer then obtains some of the trajectory state vectors to create a trajectory file. In the midst of meetings and discussions, the pointer generates the actual data for the ATL; some eventually gets transcribed into the CAP. This is typically done on the computer using the concepts outlined in this book and the many programs built for this purpose. This process is repeated for development of the final CAP. An example of an ATL page is shown in figure 6-16.

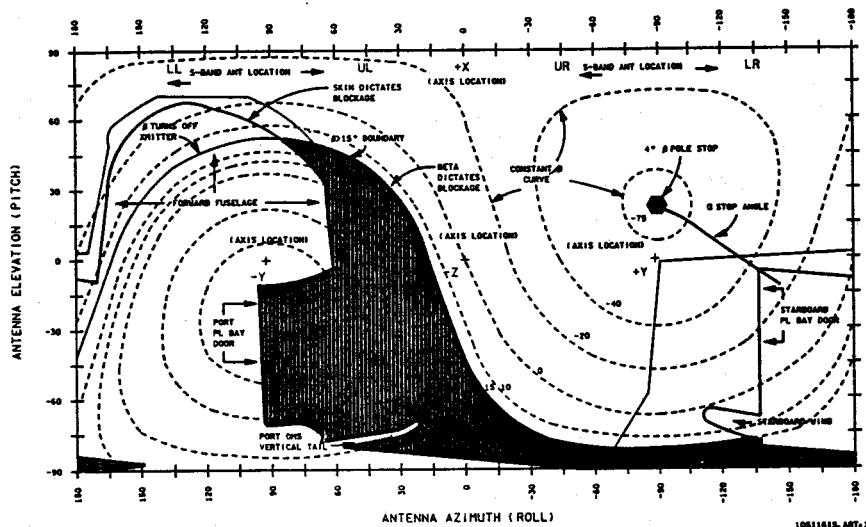

Figure 6-15.- Ku-band blockage (beta only).

It should be noted that the areas outside of the $\beta > 15^\circ$ termination will not be protected and RF transmission into these surfaces is a possibility. The body blockage outside the $\beta > 15^\circ$ termination will not inhibit RF transmission although the TDRS-to-Orbiter forward link is lost. Three modes of RF termination are available in the COMM mode

- a. Nominal mask
- b. Modified mask as function of β selectable through uplink
- c. β curve termination, selectable through uplink

Attitude Timeline

MET	MNVR OPTION	DRP	E/S	REMARKS	EVENT	
1 0/01:10:00 21:04	TRK TGT=2 BV=3(90.00, .00) OM= 77.00	A1 AUTO NORM	DSC .200 DB AT 5.00 DB RT .20	EARTH T 90 P 0	LVLH R+ 0 P+180 Y+283	BIASED -ZLV NOSE NORTH
2 0/04:19:00 32:54	MNVR R+ 35.00 P+ 66.00 Y+ 53.00	B1 AUTO VERN	DSC .200 DB AT 1.00 DB RT .02	SUN T 93 P 190		TDRS DIRECT CHECK ATT
3 0/05:25:50 34:18	TRK TGT=4 BV=5(254.00, .00) OM=270.00 DEPLOY: 0/06:05:50	A11 AUTO VERN	DSC .200 DB AT 1.00 DB RT .01	SUN T 106 P 180	INRTL R+156 P+276 Y+ 22	TDRS DEPLOY ATTITUDE
4 0/06:06:50	ROT BV=5(.00,270.00)	A11 MAN NORM	DSC .460 DB AT 1.00 DB RT .20		ROT R+156 START P+276 ATT Y+ 22	-2.2 FPS SEP AND BEGIN -70 DEG PITCH
5 0/06:06:58	ROT BV=5(.00,270.00)	A11 MAN NORM	DSC .920 DB AT 1.00 DB RT .20		ROT R+155 START P+280 ATT Y+ 20	SEP CUTOFF CONTINUE -70 DEG PITCH
6 0/06:08:10	CANCEL	A11 MAN NORM	DSC .200 DB AT 1.00 DB RT .20	SUN T 36 P 180	INRTL R+151 P+338 Y+347	END OF -70 DEG PITCH
7 0/06:13:50 17:51	MNVR R+ 48.00 P+127.00 Y+ 73.00	B1 AUTO NORM	DSC .500 DB AT 3.00 DB RT .20	SUN T 123 P 118	TIG 0/06:24:50	OMS SEP ATTITUDE
8 0/06:25:50 31:36	TRK TGT=1 BV=3(90.00, .00) OM= .00	B1 AUTO NORM	DSC .500 DB AT 3.00 DB RT .20			IUS VIEWING ATTITUDE
9 0/06:46:50 51:58	TRK TGT=1 BV=5(310.00, .00) OM= .00	B1 AUTO NORM	DSC .500 DB AT 3.00 DB RT .20			WINDOW PROTECT ATTITUDE
10 0/07:12:50	CANCEL	B1 MAN VERN	DSC .200 DB AT 1.00 DB RT .02	SUN T 85 P 149	INRTL R+158 P+236 Y+299	INRTL HOLD
11 0/08:18:00 23:47	MNVR R+185.00 P+205.00 Y+346.00	A1 AUTO VERN	DSC .200 DB AT 1.00 DB RT .02	SUN T 137 P 100		IMU ALIGN PAIR A1
12 0/08:35:00 46:11	TRK TGT=2 BV=3(90.00, .00) OM=180.00	A1 AUTO VERN	DSC .200 DB AT 1.00 DB RT .02	EARTH T 90 P 0	LVLH R+180 P+ 0 Y+ 0	-ZLV NOSE FWD

8-2

CAP/26T/BAS A

ALL ATTITUDES IN MEAN OF 1950

Figure 6-16.- Attitude timeline page.

6.10 PAYLOAD ASSIST MODULE/FRISBEE DEPLOYMENTS

6.10.1 Payload Assist Module/Frisbee Stage

Payload assist module (PAM) upper stages and Frisbee-type deployed spacecraft are spin-stabilized, unguided stages. At deployment the PAM/payload combination is spinning at a rate of 25 to 100 rpm, depending on individual spacecraft requirements. The spin axis of the PAM is aligned with the Orbiter -Z axis; for Frisbee deploys, the spin axis is the +X axis. See figure 6-17.

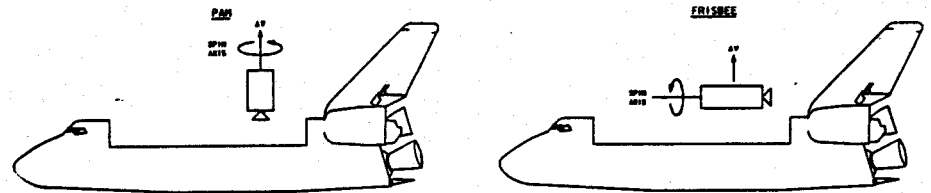

Figure 6-17.- PAM and FRISBEE deploy.

Both the PAM and Frisbee burns are posigrade with an out-of-plane component determined by the payload weight and orbital inclination. In the case of the PAM, the PAM/payload is deployed in the retrograde direction. The PAM is ejected by four springs that impart a retrograde deployment velocity of approximately 2.5 ft/s. The Frisbee-type spacecraft is also deployed along the Orbiter -Z body axis, but in the orbit plane, toward the COE. The PAM-D solid rocket motor can be seen in figure 6-18.

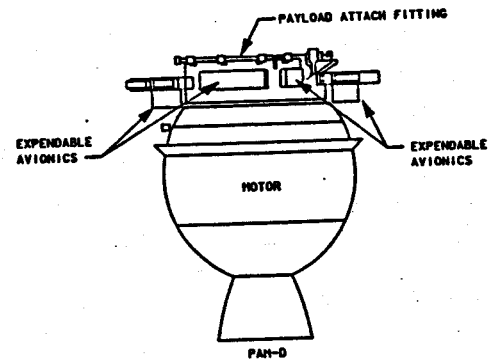

Figure 6-18.- PAM-D solid rocket motor.

10511618. ART: 2

Although the following applies mostly to PAM's, the basic principles also apply to Frisbee deployables. Deploy opportunities must meet payload thermal, lighting, and tracking requirements for predeploy, deploy, and postdeploy operations. These requirements are directly affected by date and time of launch. The spacecraft requirements also influence times for perigee kick motor (PKM) and apogee kick motor (AKM) firings. Two launch opportunities exist with near noon and midnight GMT launches.

For maximum efficiency, the PKM is fired on a nodal crossing. The PAM/payload is then placed in a modified Hohmann transfer orbit. The PKM firing is controlled by a timer that is programmed to fire the PKM 45 minutes after deployment; as a result, the deploy occurs approximately at the nodal crossing (one-half revolution) prior to PKM. The AKM firing is also designed to occur at a nodal crossing and is ground controlled. Several transfer orbits provide necessary phasing to reach the desired geosynchronous position and instrument calibration.

In order to deploy either a PAM or Frisbee-type payload, the deploy attitude must aim the stage in the right direction so that 45 minutes later the burn is executed properly. After deploy, the Orbiter must perform a separation burn to preclude recontact or plume impingement on, or by, the payload.

6.10.2 Target Description

For PAM and Frisbee deploys, targeting data is used to point the spacecraft for the PKM burn. The customer determines this data by first deciding upon a desired position in geosynchronous orbit, followed by the required transfer orbits needed to meet this requirement. The intersection of the initial transfer orbit with the Shuttle parking orbit defines the targeting data. These data consist of a relative right ascension (RRA), DEC, and offset time, delta T.

The RRA is added to the RA of the injection node to find a spin axis target right ascension. The DEC of the spin axis target is the customer-supplied DEC. The spin axis of the spacecraft is pointed at this spin axis target. The time for PKM ignition is found by adding the offset time to the injection node time; positive offset time results in PKM ignition after the nodal crossing. The deploy time is found by subtracting 45 minutes from the PKM ignition time. See figure 6-19.

6.10.3 Deploy Attitude

As was mentioned earlier, PAM/Frisbee deployables are unguided and hence cannot maneuver themselves to a PKM burn attitude; the Orbiter must do this for them. The deploy attitude for both types points the spin axis of the stage/spacecraft at the spin axis target described above. This is the primary requirement of the deploy attitude.

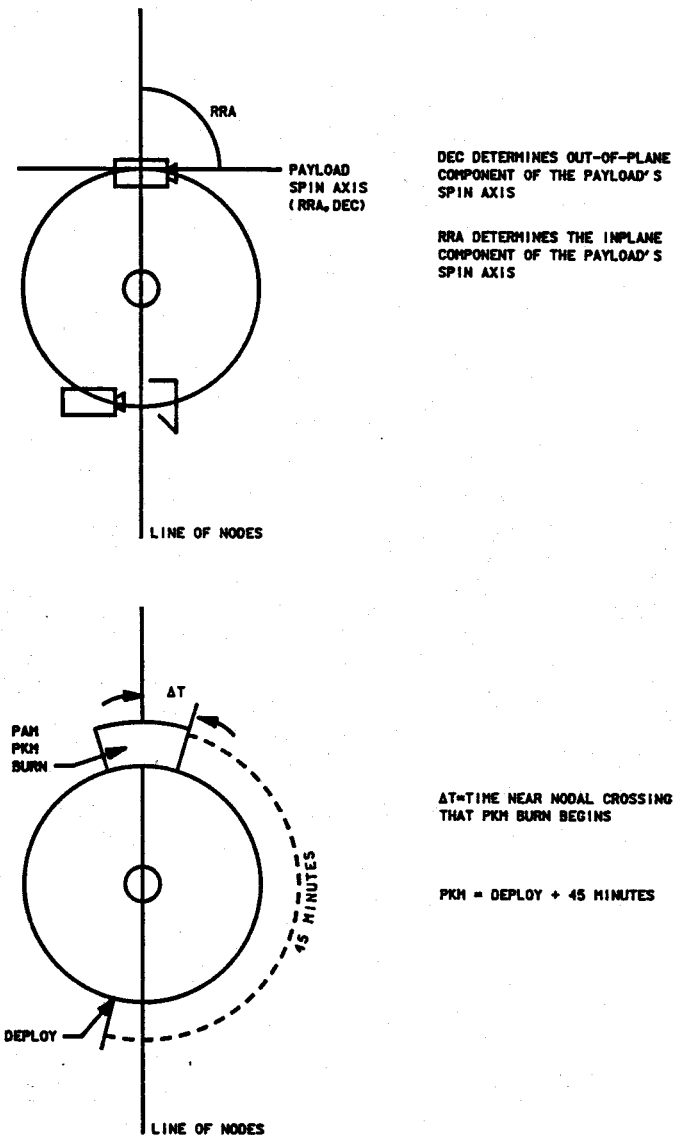

Figure 6-19.- Spin axis target and deploy time.

10511619. ART: 1

64

The secondary constraint for PAM's is to protect the PAM spacecraft from the Sun while the Orbiter is in deploy attitude. This is done by pointing the Orbiter left wing at the Sun. This orientation provides maximum protection to the spacecraft.

The secondary pointing constraint for Frisbee-type payloads is to place the relative ejection velocity vector of the payload in the Orbiter orbit plane toward the Earth. This is done by pointing the Orbiter left wing at the angular momentum vector. See figure 6-20.

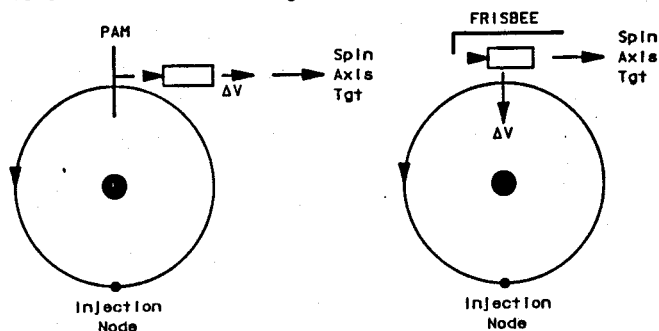

105110620.ART, 1

Figure 6-20.- PAM and Frisbee orientations.

6.10.4 PAM/Frisbee Postdeploy Sequence

After deploy the PAM moves below and in front of the Orbiter, with a range at PKM of about 3.5 n. mi. if no other Orbiter separation is performed. Frisbee-type payloads, since they are deployed radially, end up in front of the Orbiter with a range at PKM of only about 0.8 n. mi. if no further separation is done. Clearly, minimum Orbiter separation burns are needed for both PAM's and Frisbees to achieve a minimum PKM range that protects a 10X tile damage limit. (The Orbiter will sustain 10 times the accepted tile abrasion limit. This limit is based on an assumed lifetime of the Orbiter tiles, which is 100 flights.)

The OMS burn must be done in a way that minimizes plume impingement on the payload. The time for the OMS burn can be determined based on acceptable Orbiter plume impingement on the payload. Since the Orbiter is drifting behind and above the payload in the case of PAM's, delaying the separation burn reduces plume impingement. Acceptable levels of plume impingement on the payload can be met if the separation burn is delayed 5 minutes to 15:00 (min:sec) PET, or 15 minutes after deploy. This requirement can be met by a wings level, bay-to-Earth attitude, i.e.; -ZLV, at OMS time of ignition, although the actual OMS burn attitude is inertial. However, this attitude is not quite -ZLV, due to the 16° cant of the OMS engines. The burn attitude also allows the crew to watch the deployed PAM or Frisbee.

The next segment of the separation sequence was designed to meet payload postdeploy communications requirements. The payload monitor attitude allows the Orbiter payload interrogator (PI) antenna to keep a line of sight to the PAM; this attitude is -ZLV. The separation sequence is simplified since the OMS burn attitude at TIG is near -ZLV, hence the maneuver to the payload monitor attitude is small. The Orbiter maintains this attitude from 18:00 PET to 29:00 PET, at which time the maneuver to the window-protect attitude is initiated.

The window-protect attitude protects the Orbiter from the plume of the PKM burn. This is done by aiming a body vector ($P = 310, Y = 0$) at the PAM/spacecraft. This will protect the Orbiter windshield and the aft RCS from the PKM plume impingement. The second requirement is to point the +X body axis at the spin axis target. This keeps the PAM/spacecraft in the Orbiter X-Z plane during the burn; it will move up the Orbiter belly as the burn progresses. An omicron is computed to come up with an attitude that meets both requirements. The tiles can withstand some abrasion, but the forward windows cannot. This is because any damage to these windows could obscure the commander's vision during landing. The window protect attitude depends on the relative motion of the PAM/spacecraft and the Orbiter. This relative motion is in turn determined by the deploy attitude and by the OMS separation burn.

6.10.5 References

A Guide to PAM/Frisbee Deployables, D. G. Edwards, Basic, August 19, 1986.
PAM-D Flight Procedures Handbook, P. W. Burrets, Basic, January 27, 1984.

6.11 IUS DEPLOYMENTS

6.11.1 IUS Description

The inertial upper stage (IUS) has the dimensions shown in figure 6-21. It weighs 32,545 lb and can carry a spacecraft weighing up to 5000 lb.

The IUS is not deployed like the PAM; it slides off an attachment ring on a tilt table. The IUS comes out of the payload bay at an angle of 58° (above the Orbiter +X body axis) with an ejection velocity of only about 0.4 ft/s.

Another difference between the PAM and the IUS is the guidance system on the IUS. The IUS is not a "point and shoot" type stage like the PAM. It contains a closed-loop guidance system called gamma guidance that makes the IUS a "smart stage." Since the IUS has a closed-loop guidance system, it also has its own internal state vector and a stable platform.

Gamma guidance computes a sequence of maneuvers based on certain trajectory control variables. These variables are impulsive TIG times of the maneuvers and three direction cosines defining the thrust vector direction of each maneuver.

To get to geosynchronous orbit, the IUS uses a four-burn sequence: two major burns at perigee and apogee of the transfer orbit, each followed by an RCS trim burn to take out any trajectory dispersions. For the purpose of control variable selection, the IUS trajectory is broken into a series of phases. A phase is defined as a coast arc together with the following burn arc. At each phase of the trajectory, guidance uses a combination of control variables to accomplish the burns.

One important fact concerning the IUS is that it can be turned off if necessary by a master safe command. The IUS can be turned back on by either the ground, the crew, or the Orbiter.

Because the IUS is an autonomous stage, IUS deploy attitudes differ from PAM deploy attitudes. The primary concern is to deploy the IUS and payload and then safely separate from them.

6.11.2 Early Deploy Attitudes

IUS payloads must be shielded from the Sun while in the deploy attitude; the TDRS satellite is an example of such a payload.

Initially, the Orbiter required deployment attitude, expressed in terms of the LVLH frame at the nominal deployment time, varied according to the final destination of the IUS payload, IUS injection node (ascending or descending), and time of the year.

Because the deploy attitude must protect the payload from the Sun, the LVLH attitude varied continuously and the desired orientation for deployment only occurred at one particular point in the orbit. The deviation of the LVLH attitude from nominal can become significant if some contingency makes it necessary to deploy more than 2 to 3 minutes on either side of the nominal deploy time.

As a result, it was very difficult to predict if such postdeploy requirements as avoiding recontact, preventing RCS plume impingement on the payload, and keeping the payload visible to the crew and the PI might be violated by early or late deployment. Clearly, a more general method of deploying IUS-class payloads was required.

6.11.3 Anytime Deploy Attitude

To alleviate the problems described above, the "anytime" IUS deploy technique was developed. A number of advantages are inherent in this technique. The deploy and orbital maneuvering subsystem (OMS) burn attitudes are simply defined in terms of variables that are easily visualized references such as beta angle and position of the Sun. These are easily converted to input values to universal pointing, making the deploy attitude far more standardized than before. Furthermore, the postdeploy maneuver sequence is insensitive to launch time, deploy time, and the final destination of the IUS payload. The reason for this insensitivity is that

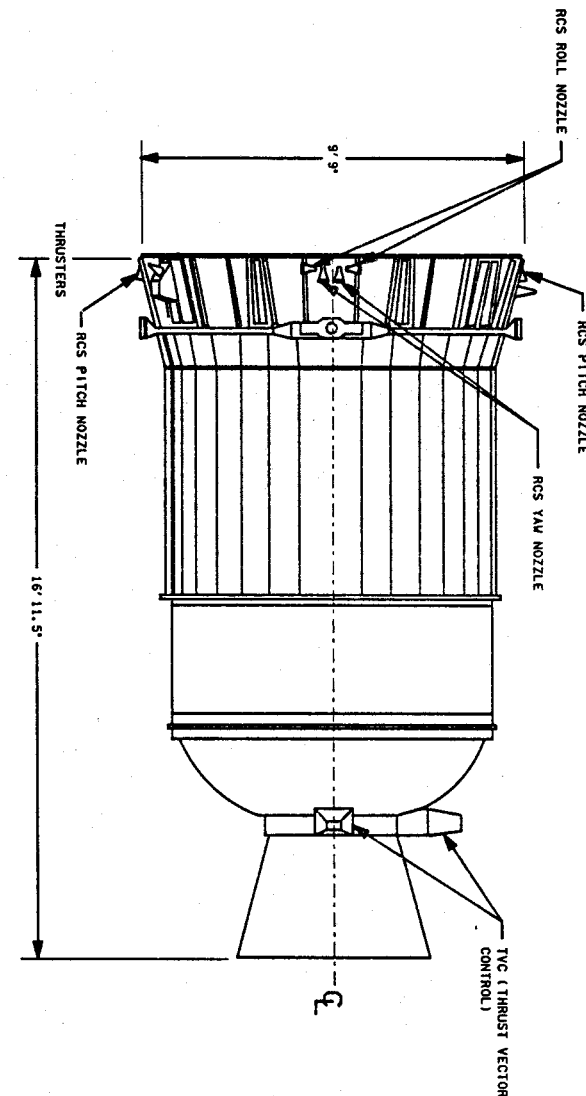

Figure 6-21.- IUS.

10511621.ART.2

the relative motion prior to execution of the OMS burn is normal to the orbit plane, this being the primary advantage to the anytime deploy sequence.

6.11.3.1 Anytime Deploy Sequence - Description of Deploy Attitude

The anytime deploy attitude can be expressed as an LVLH attitude at orbital noon with the following Euler angles:

$$P = 90^\circ$$

$$Y = \pm 75^\circ$$

$$R = \pm 90^\circ$$

where the yaw and roll angles are given the sign of the beta angle. However, the universal pointing values used to attain the deploy attitude are

$$TGT = 4 \text{ (center of Sun)}$$

$$P = 360 - (75 + |\text{beta angle}|)$$

$$Y = 0$$

$$OM = 90 \text{ (+beta) or } 270 \text{ (-beta)}$$

Since we are tracking the Sun, the attitude is essentially inertial, so that the Orbiter X-axis is pitched 15° away from the orbital angular momentum vector (H-bar) toward the Sun, with the Sun lying on the Orbiter plane of symmetry (X-Z plane) and hence shining on the belly.

If we think of the celestial sphere to be two hemispheres divided by the orbit plane, this attitude places the Orbiter tail and Sun in the same hemisphere. Assuming a deployment orbit inclination of 28.5° , the pitch angle to the line of sight to the Sun will always lie between -75° and -127° ; this should assure that the payload is always shaded by the Orbiter structure.

The effects of the delta velocity produced by the IUS spring ejection mechanism, rotation of the Orbiter produced by the deploy, and the canting of the -X RCS thrust line due to nozzle scarfing (Orbiter backs away after deploy; more on this to follow) combine to produce, at the end of the -X burn, a relative velocity vector that is inclined 15° away from the Orbiter +X body axis (see fig. 6-22). The deploy attitude insures that the relative trajectory of the deployed IUS/payload will coincide almost exactly with the LVLH Y axis; i.e., out of plane. This is why the X axis of the Orbiter is pitched 15° away from H-bar, as opposed to being aligned with it.

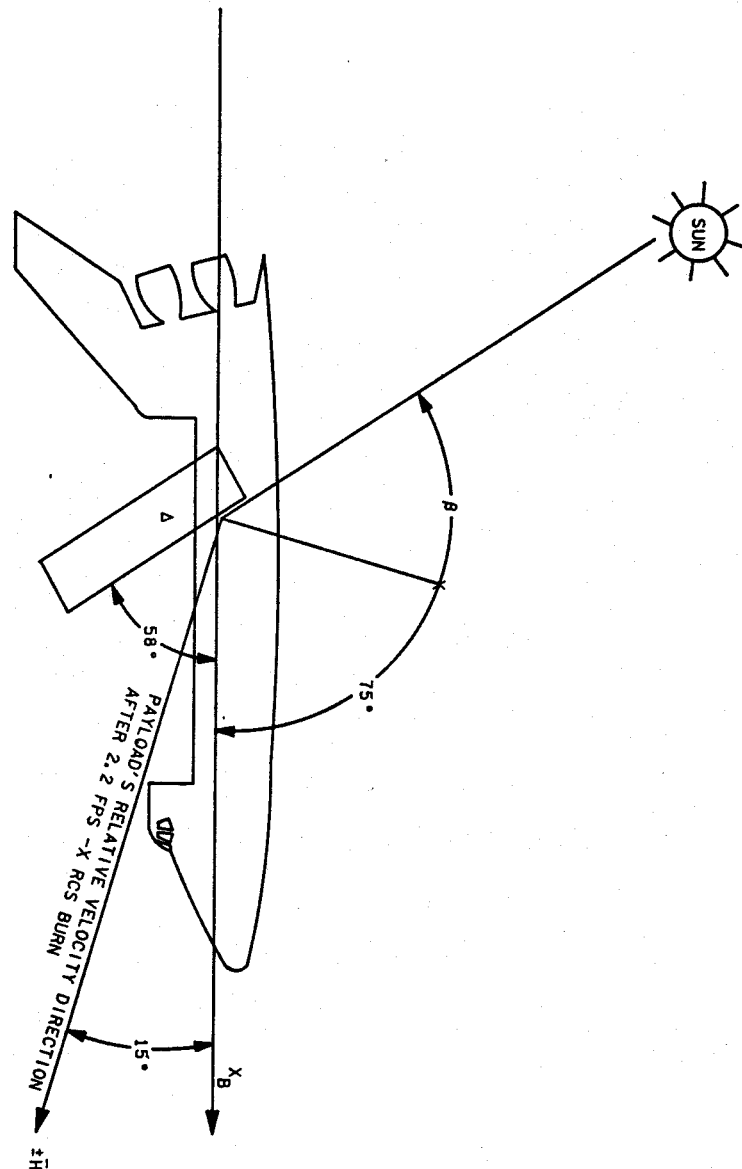

Figure 6-22. - IUS deploy attitude.

10511622.ART1 1

6.11.4 IUS Postdeploy Sequence

After the IUS has been deployed, the crew executes a 2.2 ft/s -X RCS burn at 1:00 (min:sec) PET; i.e., 1 minute after deploy. The -X burn induces a pitch rate of about -0.8 deg/sec that is allowed to continue until the Orbiter has pitched downward 70° from the deploy attitude. Upon reaching this attitude (at about 2:15 PET), inertial attitude hold is initiated. This causes the payload trajectory in the Orbiter body frame to be aligned essentially with the -Z body axis, and 10 minutes after deploy, a separation distance of more than 1000 ft.

At 7:00 PET the crew maneuvers the Orbiter to the OMS separation attitude. An attitude is chosen to keep the deployed IUS near the -Z body axis where it is visible to the crew and the PI antenna. Another reason for preferring the -Z body position is that the IUS/payload is better protected against RCS plume impingement, at least as long as the low-Z mode is used for PRCS operations (usual practice during the deploy sequence as it inhibits upward firing jets).

The OMS burn attitude is defined such that the Orbiter plane of symmetry is normal to the orbit plane. As long as the OMS thrust vector is in the orbit plane and the IUS/payload lies on the normal to the orbit plane, at OMS TIG the IUS/payload will be almost always 16° ahead of the -Z body axis in the Orbiter plane of symmetry. This is because the OMS thrust vector is pitched down almost 16° from the Orbiter +X body axis.

Relative to the LVLH system, the nominal two-engine OMS separation burn is

$P =$ desired LVLH pitch of thrust vector

$Y = \pm 16^\circ$ (approximate)

$R = \pm 90^\circ$

where the yaw and roll angles are given the sign of the beta angle. The yaw angle depends on the Orbiter center of mass. The burn attitude will differ from the nominal in the case of a single-engine OMS burn. In any event, the line of sight to the payload will change a few degrees in the Orbiter body frame.

The maneuver to viewing attitude is executed as soon as possible after the OMS separation burn. Here the deployed IUS/payload is tracked with the -Z body axis via the rendezvous navigation feature of universal pointing. The original Orbiter state vector transferred predeploy becomes the target vehicle. The purpose of this attitude is to maintain PI lock for data exchange between the Orbiter and the IUS.

The window protect attitude also uses rendezvous navigation. The IUS/payload is tracked with the following:

$P = 310^\circ$

$Y = 0^\circ$

$-20^\circ \leq OM \leq +20^\circ$

This puts the IUS/payload 50° below the +X body axis and keeps the IUS plume off the windshield and the aft RCS. The omicron depends on the LVLH thrust direction of the IUS. The maneuver is executed at 39:00 PET so that the Orbiter is in window protect attitude at solid rocket motor, burn-1 (SRM-1), which occurs at 60:00 MET.

6.11.5 References

Analysis of an "Anytime" Deployment Sequence for Certain Sun-Sensitive IUS Payloads, S. W. Wilson, TRW memorandum no. SN - 37788, March 25, 1983.

FDO Briefing on IUS Deployments, B. L. Jones, DH3-84-308, December 12, 1984.

SECTION 7
ORBITER ATTITUDE CONTROL HARDWARE

7.1 ON-ORBIT ATTITUDE CONTROL SYSTEM OVERVIEW

The following functional schematic (fig. 7-1) shows the major hardware and software interfaces composing the attitude control system.

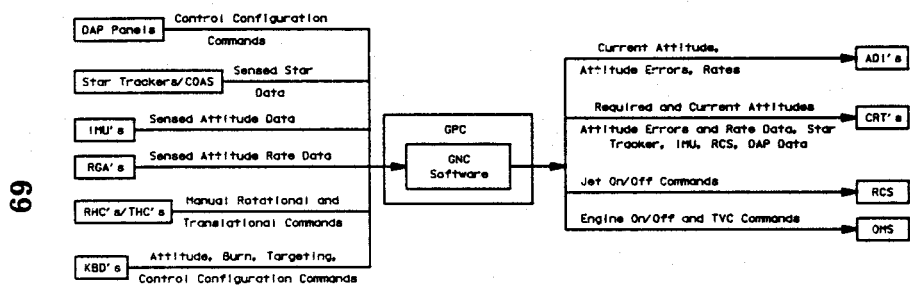

105110071, Art. 3

Figure 7-1.- Hardware/software interfaces.

DAP - digital automatic pilot
 IMU - inertial measurement unit
 RHC - rotational hand controller
 THC - translational hand controller
 KBD - keyboard
 ADI - attitude direction indicator
 CRT - cathode ray tube
 RCS - reaction control system
 OMS - orbiter maneuvering system
 COAS - crew optical alignment sight
 RGA - rate gyro assembly
 GPC - general purpose computer
 GNC - guidance, navigation, control

References:

For hardware data, see Shuttle Operational Data Book (SODB), JSC-08934.

For software data, see Functional Subsystem Software Requirements (FSSR), SD 76-SH-0003 - On-Orbit Guidance; 0006 - On-Orbit Navigation; 0009 - On-Orbit Flight Controls; 0020 - Displays.

7.2 HARDWARE

7.2.1 Jets - PRCS/VRCS

The RCS is designed to control the Orbiter independently in each of three axes. The jets are so located and oriented to provide this control. There are two independent sets of jets - the primary RCS (PRCS) and the vernier RCS (VRCS); either of these systems is capable of attitude control. The PRCS jet thrust is ~870 lb vs. ~25 lb for the VRCS. Originally, the PRCS was intended to perform most attitude maneuvers and the VRCS was intended for fine attitude hold control. However, a plumbing problem during the hardware development phase forced the minimum on/off cycle time for the jets to be doubled from 40 milliseconds to 80 milliseconds. There is a 15-millisecond tail-on/tail-off transient regardless of cycle duration. Hence the effective steady state minimum on/off cycle changed from 25 milliseconds to 65 milliseconds which had the effect of more than doubling the applied impulse. The effect was that the PRCS became overly powerful for efficient on-orbit attitude maneuvers and attitude hold. It turned out that the VRCS had adequate power for most on-orbit attitude maneuvers and control, so the VRCS became the primary RCS for on-orbit use.

A schematic diagram of the RCS is shown in figure 7-2. Notice the direction of the body axes and imagine the jets to be tied to the Orbiter body. Study the thruster ID code and functional grouping of the jets. Note that the VRCS jets are all on manifold 5, and only VRCS jets are on manifold 5. Find all six of the VRCS jets. Notice the uses that might be made of the jets in each group. For example, Group 1 jets are only good for -X translational maneuvers while group 13 might be used in combination with group 14 for pitch control; group 13 might be used in combination with group 14 and group 4 for pitch control; group 13 might be used in combination with group 12 for roll control; group 13 might be used in combination with groups 14, 5, and 6 for -Z translation maneuvers.

Notice that the VRCS is, by geometry, incapable of controlled translation maneuvers. Hence, the VRCS is only used for attitude control while the PRCS is used both for attitude control and translation maneuvers. Also note that, relative to the Orbiter body reference frame, there are no up-firing VRCS jets. This is an important feature to many payloads when they are located in and around the payload bay.

Table 7-I contains a tabulation by command and by group of the PRCS jets commanded on for a rate change in each axis and direction. Note, for on-orbit attitude control commands, only one jet per group is commanded on (the others provide backup redundancy). Control configurations will be discussed later.

TABLE 7-I.- COMMANDING OF PRCS JETS

[R = roll, P = pitch, Y = yaw]

Control configuration	Command	Groups commanded on
Normal	+P	5, 6, 11, 12
	-P	4, 13, 14
	+Y	2, 10
	-Y	3, 9
	+R	12, 13
Tail-only yaw	-R	11, 14
	+P	5, 6, 11, 12
	-P	4, 13, 14
	+Y	10
	-Y	9
Tail-only pitch	+R	12, 13
	-R	11, 14
	+P	11, 12
	-P	13, 14
	+Y	2, 10
Tail-only pitch, yaw	-Y	3, 9
	+R	12, 13
	-R	11, 14
	+P	11, 12
	-P	13, 14
Nose-only yaw	+Y	10
	-Y	9
	+R	12, 13
	-R	11, 14
	+P	5, 6, 11, 12
Nose-only pitch	-P	4, 13, 14
	+Y	2
	-Y	3
	+R	12, 13
	-R	11, 14
Nose-only pitch, yaw	+P	5, 6
	-P	4
	+Y	2, 10
	-Y	3, 9
	+R	12, 13
	-R	11, 14
	+P	5, 6
	-P	4
	+Y	2
	-Y	3
	+R	12, 13
	-R	11, 14

Figure 7-2.- Schematic of RCS.

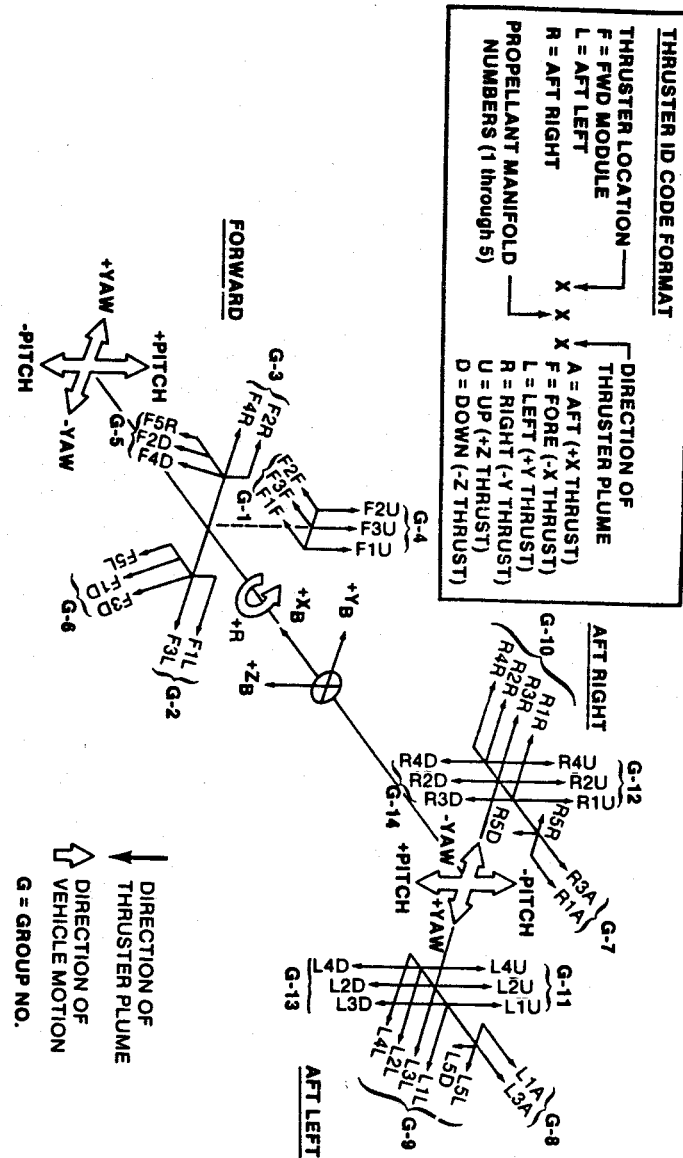

TABLE 7-I.- Concluded

<u>Control configuration</u>	<u>Command</u>	<u>Groups commanded on</u>
Low-Z	+P	5, 6
	-P	13, 14
	+Y	2, 10
	-Y	3, 9
	+R	13
Low-Z, tail-only yaw	-R	14
	+P	5, 6
	-P	13, 14
	+Y	10
	-Y	9
	+R	13
	-R	14

Low-Z, tail-only pitch configuration will be ignored by the software.

Table 7-II contains a tabulation by command and by group of the VRCS jets commanded on for a rate change in each axis and direction. Note that while there is complete redundancy with the PRCS jets, there is no redundancy within the VRCS, hence only one control configuration. However, control for attitude maneuvers or attitude hold is still possible with either or both side-firing jets (groups 9, 10) failed off. If any of the other vernier jets fail, the VRCS is inoperative.

TABLE 7-II.- COMMANDING OF VRCS JETS

<u>Command</u>	<u>Groups commanded on</u>
+P	5, 6
-P	13, 14
+Y	6, 10
-Y	5, 9
+R	6(*), 9, 13
-R	5(*), 10, 14

(*) The number of jets commanded on for roll control varies with rate change required. Groups 5, 6 are usually not commanded on for roll. See section 4.2.2.2.1 of the Orbiter Flight Control FSSR (SD 76-SH-0009) to determine exactly which jets will be commanded on.

Table 7-III contains some equations, facts, and numbers for "ballpark" calculations relative to the RCS. The equations are useful for "sizing" the pulse sizes to load in the DAP CONFIG SPEC display to obtain a desired pulse duration with flight software.

TABLE 7-III.- MISC DAP EQUATIONS AND PARAMETERS

Rotation pulse - Number of DAP cycles

No. DAP cycles = $\frac{\text{Pulse size (from DAP config.) (round up)}}{\text{MAG CNTL ACCEL} \times 0.08 \text{ sec (DAP cycle)}}$

MAG CNTL ACCEL: Constant for each flight
Different values for each axis
Verniers and primaries different
MSID's PRCS V95U8853C, -4C, -5C FC FSSR (09) sec. 4.1
VRCS V95U8856C, -7C, -8C

Translation pulse - Number of DAP cycles

No. DAP cycles = $\frac{\text{Vehicle Mass (I-Load)} \times \text{Pulse Size (from DAP conf.)}}{\text{MAG CNTL FORCE} \times 0.08 \text{ sec (DAP cycle)}}$

MAG CNTL FORCE: Constant for each flight
Different values for each axis
V97U2957C (X-axis), -8C (Y-axis), -9C (Z-axis)
From FC FSSR, appendix B

Some nominal values - STS-7: These values usually are the same for all flights. If critical, check for your flight.

	<u>Rotation pulse</u>		<u>Translation pulse</u>	
	<u>MAG CNTL ACCEL</u>		<u>Vehicle Mass 6984 slugs</u>	<u>MAG CNTL FORCE</u>
	<u>Verniers</u>	<u>Primaries</u>		
R	0.0230	0.8	X	1733
P	0.0135	0.9	Y	1742
Y	0.0156	0.6	Z	3055

DP has the books where general as well as flight-specific data can be found. If you need assistance in using the books, personnel are usually there to help you.

TABLE 7-IV.- ROTATIONAL AND TRANSLATIONAL ACCELERATIONS RESULTING FROM ROTATIONAL AND TRANSLATIONAL RCS COMMAND

[Assumes 200K lb Orbiter]
Effects (at CG) of RCS maneuvers

Axis	Linear ft/sec ²			Angular ft/sec ²			
	X	Y	Z	R	P	Y	
Rotation maneuvers							
+P	-0.00028	0.00000	-0.00573	0.0002*	0.0187	0	
-P	.00000	.00000	-.00781	0	-.0082	0	
+R	.00000	.00390	-.00400	.0220	.0051	.0011	3-
-R	.00000	-.00390	-.00400	-.0220	.0051	-.0011	jet
+Y	-.00013	-.00114	-.00296	-.0031	.0092	.0155	
-Y	-.00013	.00114	-.00296	.0031	.0092	-.0155	
+P	-.009	.00000	.076	.020	1.137	.0005	
-P	.063	.00000	-.045	-.013	-.730	-.0005	
+R	.034	.039	.043	.934	.086	-.022	
-R	.034	-.039	.048	-.931	.032	.022	
+Y	-.004	.0003	.004	-.222	-.010	.657	
-Y	-.004	-.0008	.004	.222	-.009	-.668	
Translation maneuvers							
+X	.279	.00000	.049	-.0003	-.021	-.00001	
-X	-.286	.00000	.039	-.002	-.114	-.00003	
+Y	-.004	.283	.004	.390	-.009	.210	
-Y	-.004	-.283	.004	-.390	-.010	-.210	
+Z(N)	-.016	.00000	1.276	.003	.156	.00000	
+Z(N)	-.005	.00000	.426	.001	.041	-.00000	
-Z	-.128	.00000	-.583	.0003	.016	.00001	

*Nonzero component results from CG offset.

To determine the effect of a command, determine its duration in seconds and multiply each of the rotational and translational acceleration components by the duration.

If the command duration is known in terms of a number of DAP cycles, multiply the number of DAP cycles by 0.08 (80-millisecond DAP cycle) and subtract 0.015 (the tail-on/tail-off transient effect) to obtain effective steady-state duration.

Tables 7-V and 7-VI contain the rotational and translational acceleration data for the low-Z and the nose-only and tail-only pitch and yaw options for PRCS control. (These modes will be discussed later.)

TABLE 7-V.- LOW-Z MODE ACCELERATIONS

Axis	Jets	Rotation, deg/sec ²			Translation, ft/sec ²		
		Roll	Pitch	Yaw	X	Y	Z
+Roll	L3D	0.399	-0.176	-0.062	0.034	0.051	-0.093
-Roll	R3D	-.398	-.176	.062	.034	-.051	-.093
+Pitch	F3D, F4D	.004	.657	.000	-.008	.000	-.204
-Pitch	L3D, R3D	.000	-.349	.000	.067	.000	-.184
+Yaw	F3L, R3R	-.244	-.001	.659	-.003	.000	.001
-Yaw	F4R, L1L	.242	-.000	-.667	-.003	-.000	.001
+X	L3A, R3A	-.000	-.023	.000	.273	.000	.048
-X	F1F, F2F	-.001	-.108	-.000	-.280	.000	.038
+Y	F3L, L1L	.335	-.001	.181	-.003	.280	.001
-Y	F4R, R3R	-.337	-.001	-.188	-.003	-.280	.001
+Z	F1F, F3F, L3A, R3A	-.001	-.131	-.000	-.007	.000	.086
-Z	F3D, F4D, L2D, L3D, R2D, R3D	.005	-.012	.000	.124	.000	-.564

TABLE 7-VI.- PRIMARY RCS ACCELERATIONS - NOSE, TAIL OPTIONS

Axis	Jets	Rotation, deg/sec ²			Translation, ft/sec ²		
		Roll	Pitch	Yaw	X	Y	Z
Nose only							
+Pitch	F3D, F4D	0.004	0.657	0.001	-0.008	0.000	-0.204
-Pitch	F3U	-.003	-.447	-.000	-.005	.000	.139
+Yaw	F3L	.046	-.000	.420	-.003	.139	.000
-Yaw	F4R	-.046	-.000	-.420	-.003	-.139	.000
Tail only							
+Pitch	L1U, R1U	.000	.512	-.000	.000	-.000	.278
-Pitch	L3D, R3D	.000	-.349	.000	.067	.000	-.184
+Yaw	R3R	-.288	-.001	.234	.001	-.138	.001
-Yaw	L1L	.286	-.001	-.241	.001	.138	.001

7.2.2 OMS Engines

Refer to figure 7-3. The OMS engine gimbals allow the thrust vectors of the two engines to be independently pointed several degrees in any direction relative to the c.g. This action allows complete attitude control with the OMS engines alone during normal two-engine OMS burns. For a single-engine OMS burn, there is no roll control capability, so roll is normally controlled with the RCS in this case.

There is an RCS "wraparound" thrust vector control (TVC) capability to augment the OMS TVC. The TVC is invoked in an axis whenever the attitude error in that axis exceeds 5°. When the RCS wraparound is invoked, RCS jets are fired to help the OMS drive the Orbiter attitude in the desired direction.

73

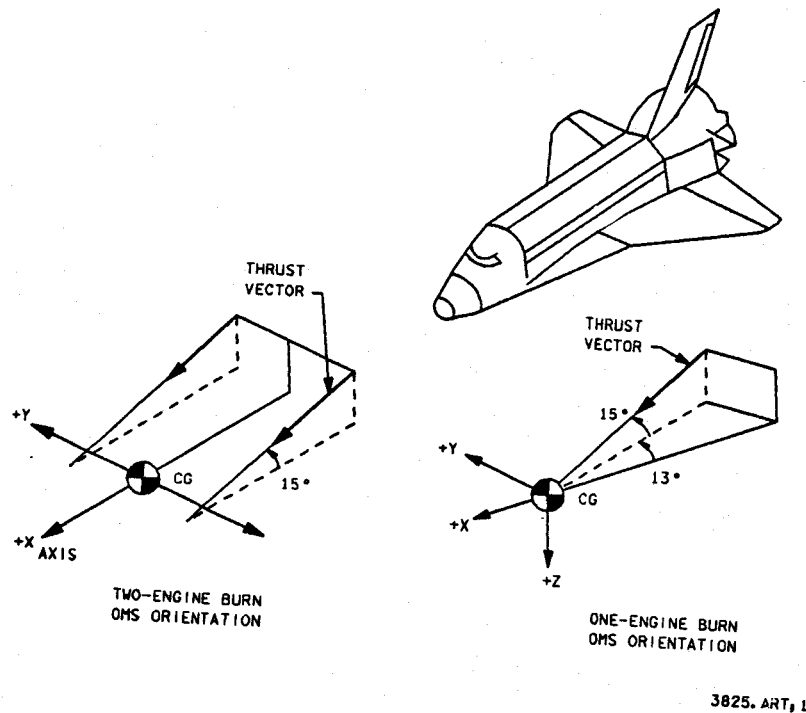

Figure 7-3.- OMS engine alignment.

7.2.3 Deriving Numbers

Miscellaneous OMS and RCS data and formulas for deriving some useful "ballpark" numbers are as follows:

Engine	Specific impulse, sec	Thrust per engine, lb	Prop flow rate, lb/sec	Mixture ratio, O/F
OMS	313.2	6000	19.16	1.65
PRCS	280.0	870	3.11	1.60
VRCS	260.0	24	0.09	1.60

The following are for a 200K lb Orbiter:

For OMS, it takes 19.5 lb prop/ft/s of ΔV .

For RCS, it takes 22.5 lb prop/ft/sec.

It takes 1.8 ft/sec per n. mi. of change in apogee or perigee.

For OMS, it takes 70.2 lb prop/n. mi. change in apogee and perigee.

For RCS, it takes 81.0 lb prop/n. mi. change in apogee and perigee.

Two-jet +X translational acceleration is 0.266 ft/sec².

To get ΔV for 10-sec burn: $0.266 \times 10 = 2.66$ ft/sec.

Prop used for two-jet, 10-sec +X translation, 2 PRCS jets \times 3.11 lb/sec/PRCS jet \times 10 sec = 62.2 lb.

Two-OMS acceleration is 1.93 ft/sec².

To get ΔV for 10-sec burn: $1.93 \times 10 = 19.3$ ft/sec.

Prop used, $2 \times 19.6 \times 10 = 383.2$ lb.

After the FCS settles into an attitude, most jet firings are minimum impulse; i.e., one 80-millisecond firing. Furthermore, most jet firings are doublets; i.e., two-coupled or semicoupled jets firing together. (Exceptions to the latter rule are the tail-only and nose-only jet control options for pitch and yaw on the primary jets.) Assuming minimum impulse, doublet jet firings, one can derive a reasonable estimate of jet-firing frequency from the propellant-usage rate.

Example: For vernier jets, prop used per minimum impulse doublet is $2 \times (0.080 - 0.015) \times 0.09 = 0.01$ lb/firing. From the prop usage tables we find that the prop usage rate for vernier jets in a minus Z axis local vertical (or payload bay down) (-ZLV), Y axis perpendicular to orbit plane (YPOP) attitude in a 150 n. mi. orbit, 1° attitude deadband is 0.84 lb/hr. Hence firings per hour = $\frac{0.84 \text{ lb/hr}}{0.01 \text{ lb/firing}} = 84$ or a little more than one per minute.

7.2.4 DAP Panels

7.2.4.1 DAP Panel in OPS 2

There is a DAP panel at each of the following locations: the center console between the commander's and pilot's stations and the aft crew station. The DAP panel allows selection of any one of several control modes. The selections are made by depressing the labeled pushbutton indicators (PBI's). In nominal OPS 2 operations, selections made at any station apply and are appropriately indicated at all stations. See figure 7-4.

In the first row under SELECT, the two PBI's allow selection of either of two sets of control parameters which reside in the software. Under CONTROL, the selection of AUTO puts the attitude control system under software control. Selection of MAN puts attitude control system under manual control with the RHC in one of several possible submodes. Under RCS JETS, selection of NORM results in the software's commanding only to PRCS jets for attitude control. Selection of VERN results in the software's commanding only VRCS jets.

Under MANUAL MODE, TRANSLATION, X, selection of LVLH (which is mutually exclusive with both AUTO and MAN) allows manual control with the RHC within the LVLH reference frame. Obviously, this mode has nothing to do with

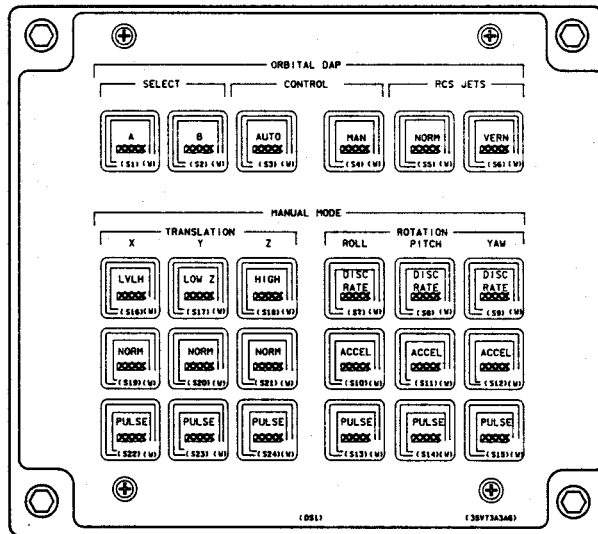

Figure 7-4.- DAP panel in OPS 2.

translation maneuvers; this PBI and the LOW Z PBI next to it were unused in the original panel/DAP design. These two modes were late DAP add-ons, so these two PBI's were used to provide for their selection.

Under MANUAL MODE, TRANSLATION, Y, selection of LOW Z allows for attitude control with PRCS but with all up-firing jets inhibited. It also allows for +Z translational maneuvers using the +X and -X (jet groups 1, 7, and 8) jets. This is possible because these jets happen to have significant +Z thrust components resulting from canting and nozzle scarfing. These are important features to many payloads in and around the payload bay.

Under MANUAL MODE, TRANSLATION, Z, selection of HIGH allows for +Z translation using nine RCS jets (three from group 4 and three each from groups 11 and 12). This mode was intended to provide a fast separation maneuver from a payload in the vicinity of the payload bay to avoid possible collision.

Under MANUAL MODE, TRANSLATION, X, Y, and Z, selection of NORM provides for continuous translation maneuvers with PRCS jets; i.e., continuous as long as the THC is held deflected from its null position.

Under MANUAL MODE, TRANSLATION, X, Y, and Z, selection of PULSE provides single translation pulses of predetermined duration (under software control) each time the THC is deflected from its null position.

Under MANUAL MODE, ROTATION, ROLL, PITCH, and YAW, selection of DISC RATE provides a predetermined rotation rate (under software control) as long as the RHC is held deflected from its null position. When the RHC is returned to its null position, the rotation rate is damped.

Under MANUAL MODE, ROTATION, ROLL, PITCH, and YAW, selection of ACCEL provides continuous rotational acceleration as long as the RHC is held deflected from its null position. When the RHC is returned to its null position, the acceleration ceases but the rotation rate continues under the momentum of the vehicle.

Under MANUAL MODE, ROTATION, ROLL, PITCH, and YAW, selection of PULSE provides single rotation pulses of predetermined duration (under software control) each time the RHC is deflected from its null position. The rate that was introduced by the pulse continues under the momentum of the vehicle when the RHC is returned to the null position.

ACCEL and PULSE are "free" rotation submodes; i.e., in these submodes the vehicle attitude is allowed to drift around under the momentum of the vehicle and any external disturbance torques as long as the RHC is in its null position. Note that the ORBITAL DAP, CONTROL must have MAN or LVLH selected for any of the MANUAL MODE, ROTATION submodes to be in effect. However, there are two ways to select MAN: one way is to depress the PBI and the other is to deflect the RHC; this automatically selects MAN except when LVLH is selected. LVLH is selected only by depressing the LVLH PBI position.

The following are a few useful miscellaneous facts about the DAP panel:

- A and B DAP selections are mutually exclusive.
- LVLH, AUTO, and MAN are mutually exclusive as are NORM and VERN.
- Under TRANSLATION, NORM and PULSE are mutually exclusive in any axis. In the Z-axis, HIGH is mutually exclusive with NORM and PULSE. LOW Z is compatible with either Z NORM or PULSE.
- ROTATION DISC RATE, ACCEL, and PULSE are all mutually exclusive in any single axis.

7.2.4.2 DAP Panel in OPS 1 and 3 (On-Orbit)

In OPS 1 and 3, there is only one DAP configuration available and only the PRCS for attitude control, so the SELECT and RCS JETS PBI's are not functional. AUTO/MAN are selectable and as in OPS 2, AUTO provides for attitude maneuvers under software control and MAN provides for maneuvers under manual control with the RHC.

In OPS 1 and 3, the only PRCS translational mode available corresponds to the NORM mode in OPS 2. However, since there are no other choices, none of the PBI's under TRANSLATION is functional.

In OPS 1 and 3, only DISC RATE and PULSE are selectable by the PBI's, so the ACCEL submode PBI's are not functional. In the primary avionics software system (PASS), DISC RATE and PULSE are selectable by axis as in OPS 2 but in the backup flight system (BFS), selection in any axis results in the same selection in all axes.

7.2.5 Star Trackers/COAS

The star trackers measure the positions of stars; their locations in space are stored in the software. The software can also calculate the positions of the stars based upon the present IMU gimbal angles. The difference in the measured positions and the calculated positions of a pair of stars forms the basis for an update of the IMU's. The software is configured to reject any star that is not within 0.5° of where it should be as reckoned by IMU measurements, so it is necessary to perform an IMU alignment (update) before the IMU's drift beyond 0.5° . In practice, the IMU's are aligned about every 12 hours. If the IMU's drift or tumble out of the 0.5° limit, it is necessary to recover the IMU alignment with a COAS star alignment.

The COAS is a manual sighting device for sighting on stars. It is hard mounted in either of two Orbiter windows (forward, +X, or overhead, -Z). The crew must visually identify the star being sighted on and enter the ID in the software. It is necessary to maneuver the Orbiter to get the star centered in the COAS reticle. When this occurs, the crewmember must send a signal (mark) to the software that the star is centered. Sightings on a

pair of stars form the basis for an IMU alignment that should get the IMU's back within the 0.5° limit so that a more accurate alignment should then be possible using the star trackers.

Refer to the IMU Alignment Flight Procedures Handbook for geometric relationships between the star trackers and the Orbiter and COAS reticle pattern.

7.2.5.1 Star Trackers/Star Table

To be able to reorient the Orbiter IMU's, the position of the Orbiter must be determined in inertial space, and the error in the IMU's calculated. To determine actual position, the vehicle has two star trackers, the -Y and -Z, mounted 87.65° apart. Sightings are taken on two stars whose vectors in inertial space are accurately known onboard, and from these sightings the actual vehicle attitude is determined. Currently, the software contains a navigation star catalog of 100 stars (only 50 are good in OPS 3) that are listed in appendix A. To perform an alignment, two stars must be acquired by the star trackers and stored in the star table. The stars can be picked up by either tracker (even both by the same tracker) and must have $90^\circ \pm 55^\circ$ angular separation. For two working star trackers, there are 418 star pairs which can be acquired by maneuvering to an inertial attitude and have one navigation star in each tracker. Some of these (the 50 nav stars) are listed in appendix A, along with the two M50 attitudes associated with each pair.

In order to avoid damage to the star trackers, a bright object sensor is attached that closes the shutter before the more sensitive star tracker sensor acquires the object. The resulting constraints are

- 30° from center of Sun
- 8° from center of Moon
- 20° from bright Earth horizon
- 3° from dark Earth horizon (airglow occultation, not bright-object constraint)

As stars are acquired and recognized, they are loaded into the star table; the pair closest to 90° (within $\pm 55^\circ$) is selected as the best pair, and older stars are bumped out. The logic used is shown in figure 7-5.

7.2.5.2 COAS

If all attitude reference is lost, the vehicle cannot be maneuvered to any known attitude without first aligning the IMU's. The star trackers can't be used because the error between the actual star position and the software calculated star position now is a much greater value than the software filter (0.5°) will accept. The COAS is used to perform an initial alignment and then a star tracker align can be done. To perform a COAS align, the crew manually maneuvers to put a nav star in the COAS field-of-view and takes a mark as the star passes through the crosshairs. This is repeated

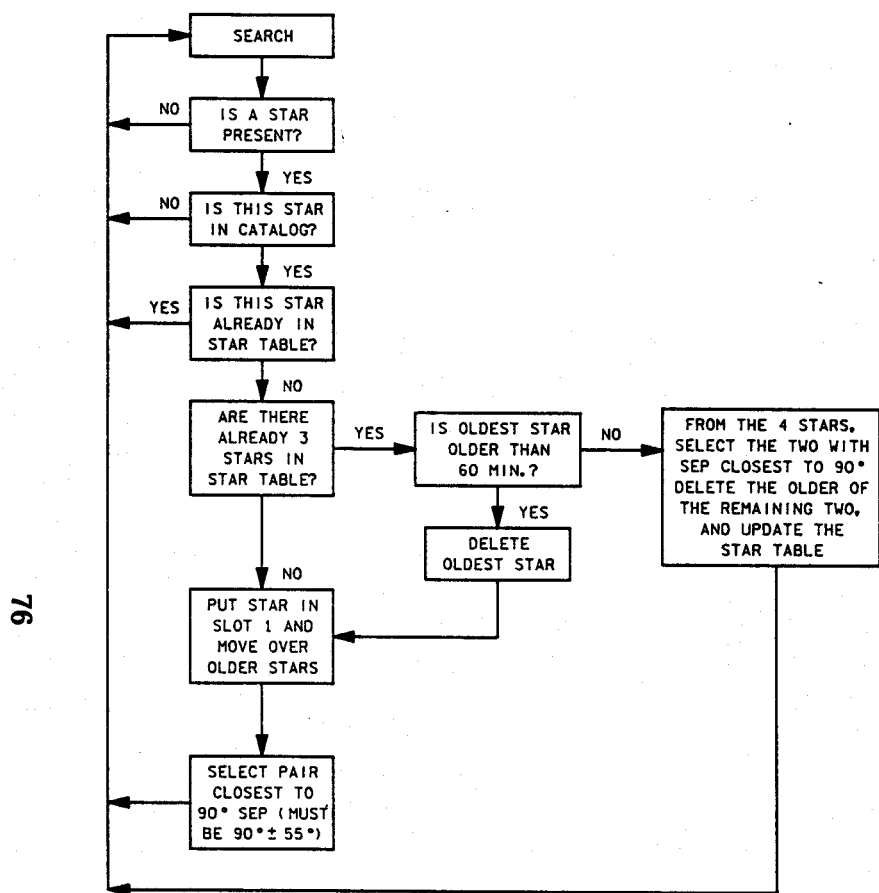

Figure 7-5.- Star tracker table logic automatic search mode.

using a second star that is at least 35° away from the first. An alignment can now be done. For a COAS alignment, the crew must be able to identify the navigation stars and select one. Therefore, it is highly desirable to perform the alignment at night, or at least 90° from the Sun, to keep light off of the COAS so the stars can be seen. Also, the brighter the star, the easier it is to find in the sky. Therefore, the ideal stars will be two bright stars at night at least 35° apart. COAS star-pair separation angles are given for the brightest stars in appendix A.

COAS calibrations are performed after orbit insertion. These calibrations are done with a good IMU reference immediately following an IMU alignment. The purpose of the calibration is to update the software knowledge of the COAS center-line line of sight with respect to the navigation base. The COAS line of sight will shift slightly from prelaunch orientation due to structural relief from having one-g conditions. The calibrated COAS is now more accurate if a COAS alignment is needed later.

7.2.6 IMU's

The IMU's serve as the attitude data source for all flight phases from launch minus 20 minutes until landing. In OPS 2, the IMU's also serve as the source of attitude rate data; the rates are derived by dividing attitude deltas by the time interval between attitude measurements.

The IMU's also contain accelerometers which measure linear acceleration. The delta velocity (ΔV) between successive measurements is determined by interpolating acceleration between measurements and integrating the interpolated acceleration over the time interval.

Refer to the IMU Alignment Flight Procedures Handbook for details of operation and geometric relationships between the IMU's and the Orbiter body reference frame.

7.2.7 RGA's

The rate gyros assemblies (RGA's) serve as the attitude rate data source in GNC OPS 1 and OPS 3 only. The gyros must be on and operating before transitioning into either of these OPS.

7.2.8 RHC's/THC's

There are three flight control RHC's (as opposed to the RMS RHC): one at the commander's station, one at the pilot's station, and one at the aft station. There are two flight control translation hand controllers (THC's): one at the commander's station and one at the aft station.

When powered, the operation of these hand controllers causes selected RCS jets to fire resulting in Orbiter motion (rotation or translation) in the direction of the hand motion.

The aft station controllers are functional only in OPS 2. The "sense" of the aft station controllers is selectable to -X or -Z. The -X sense is used when the crewmember is viewing and working with something outside the aft window and the -Z sense is used when the crewmember is viewing and working with something outside the overhead window. The aft controllers are mounted at about a 45° angle (halfway between) the normal -X and -Z positions. This

is the result of a compromise in order to get by with one set of controllers at the aft station. By selecting the appropriate sense, the feeling and response to the controllers are satisfactory.

7.2.9 ADI's

There is an ADI at the commander's station, the pilot's station, and at the aft station. The ADI at the aft station is active only in OPS 2.

The ADI's provide an analog attitude display relative to any of three selectable reference frames. The reference frames are selectable by means of a 3-position switch labeled INRTL/REF/LVLH. The INRTL and REF positions represent inertial reference frames, i.e., frames that bear a fixed relationship to the M50 reference frame. The LVLH position represents the LVLH reference frame explained earlier.

The ADI's also display "attitude errors" and body attitude rates. Attitude errors are calculated from the difference between the current attitude and the required attitude (required attitude as reckoned by the GNC software). The attitude difference is represented in the software as an error quaternion that is resolved into three body-axis components. In general, these errors will not be the same as the Euler angle (R, P, Y) differences, although they will be close when the errors are small. The body attitude rates (or simply rates) are also resolved rates.

The error and rate needles are mechanized to indicate the "fly-to" sense. What this means is that to fly out the error in an axis using the RHC, you would deflect the RHC in that axis in the same sense (+ or -) that the error needle in that axis is deflected. For example, if the pitch-error needle is deflected upward with respect to the cockpit seated position, you would deflect the RHC so as to command the Orbiter to pitch up to reduce the pitch error. The rate needles also indicate the fly-to sense, i.e., to reduce the rate in an axis, you would deflect the RHC in that axis in the direction indicated by the rate needles.

For a more detailed description of the ADI's, see the GNC Dedicated Displays Workbook.

7.2.10 Antennas

7.2.10.1 S-Band Antennas

The Orbiter S-band PM system provides two-way communications between the Orbiter and ground sites (GSTDN and RTS), either directly to and from the sites or through TDRS. Four sets of dual-beam quad antennas provide S-band PM communications if a line of sight exists between an antenna and a ground site or TDRS satellite. The four quad antennas are mounted at 90° intervals

around the forward fuselage. Each quad antenna can direct its beam forward or aft; therefore, there are effectively eight quad antenna positions:

Upper left forward	Lower right forward
Upper left aft	Lower right aft
Upper right forward	Lower left forward
Upper right aft	Lower left aft

Antenna selection from among the eight positions is normally performed with the purpose of optimizing look angles to a preferred ground site or TDRS satellite. Selection can be controlled manually via the panel C3 rotary switch, automatically via the SM GPC (panel C3 rotary switch in GPC), or with a real-time command. A real-time command can be uplinked or entered by the crew on SPEC 1 DPS UTILITY. The quad antenna selection is shown on the ANTENNA display.

The Orbiter S-band FM system provides a one-way link for transmitting data directly from the Orbiter to a ground site (GSTDN or RTS). Two hemiantennas provide S-band FM communications if a line of sight exists between an antenna and a site. The antennas are mounted to the forward fuselage, in the X-Z plane, over and under the flight deck area. An upper antenna covers the upper (-Z) hemisphere, while a lower antenna covers the lower (+Z) hemisphere.

As with the quad antennas, hemiantennas are normally selected in order to optimize look angles to a ground site. Selection can be controlled manually (panel AIR switch), automatically via the SM GPC (panel AIR switch in GPC), or with a real-time command (uplinked or input by crew). The hemiantenna selection is shown on the ANTENNA display.

The circularly polarized payload interrogator (PI) antenna provides for RF communication between the Orbiter and detached payloads. A communication link is strongest if the payload line of sight is along the Orbiter -Z axis. As the line of sight deviates from -Z, more signal from the PI and payload antenna is required to maintain a link. As the payload gets farther away from the Orbiter, the signals become weaker. Theoretically, when a payload is close to the Orbiter, the signals are strong enough so that Orbiter attitude will not matter. When the payload is at a distance of several miles, a good communication link is possible if the payload line of sight is within +40° of the -Z axis. The PI antenna is mounted on the upper forward fuselage between the overhead windows. See figure 7-6.

7.2.10.2 Ku-Band Antenna

The Orbiter Ku-band system provides two-way RF communications between the Orbiter and the ground through a TDRS satellite and also functions as rendezvous radar system by supplying target range and range rate information. The Ku-band antenna provides for Ku comm and radar only if a line of sight exists between the Ku antenna and the selected TDRS satellite or the rendezvous target.

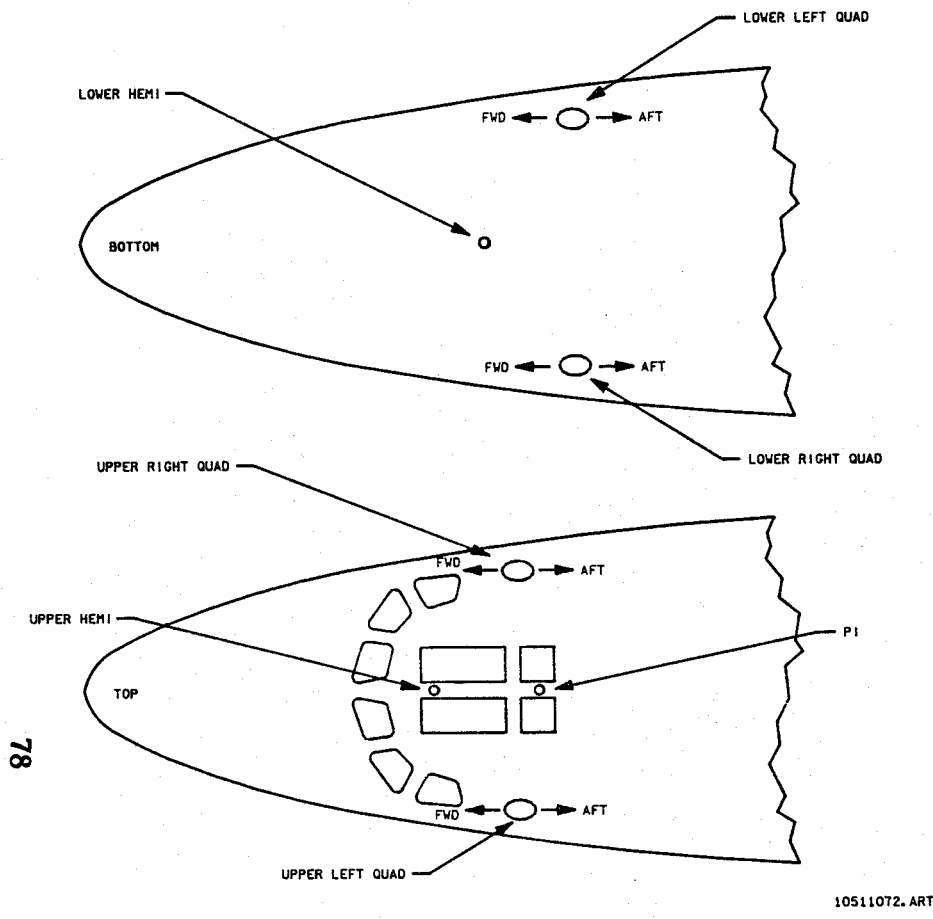

Figure 7-6.- S-band antenna locations.

10511072.ART

The Ku-band antenna (figure 7-7) is attached to the forward starboard sill longeron. In the initial deployed position, the antenna pole is in the X-Y plane and 67° away from the +X axis (figure 7-8). The antenna is composed of a parabolic dish and two gimbals: one for roll (α gimbal) and one for pitch (β gimbal) movement. The α gimbal provides 360° roll movement with a fixed mechanical stop at a certain value of α . The β gimbal provides 162° pitch movement with two fixed mechanical stops. The mechanical stops prevent wrap around of the control cables. The β stops result in a 4° noncoverage zone outboard, along the pole, and a 32° noncoverage zone toward the payload bay (figure 7-9).

In addition to the noncoverage areas, there are also obscuration zones in which the Ku-band antenna beam is obstructed by parts of the Orbiter body. The obscuration zones may include areas extending outward from the Orbiter skin, depending on which blockage mode is being used.

The actual antenna gimbal angles are converted to beam line-of-sight AZ/EL angles and are displayed on panel A2 and the ANTENNA display. In the deployed position, the antenna beam is initially parallel to the Orbiter -Z axis (AZ/EL = $0^\circ/0^\circ$). Positive azimuth movements of the beam are toward the -Y and positive elevation movements are toward the +X (figure 7-10). The Ku-band antenna is positioned either manually (panel A1U) or automatically (panel A1U switch in GPC) to optimize the beam line of sight to a TDRS satellite or to a rendezvous target.

7.2.11 Keyboards

There is a keyboard at the commander's station, the pilot's station, and at the aft station. The keyboard at the aft station is active only in OPS 2. The keyboards are used to enter data and commands for software-controlled attitude maneuvers, to enter target data for translational maneuvers, to control the star trackers and IMU's, and to change control parameters in the DAP software.

The Crew Software Interface Workbook is a good source of information on keyboard and cathode ray tube (CRT) operation.

7.2.12 CRT's

There are three CRT's located between the commander's station and the pilot's station and one CRT at the aft station. The CRT's provide for the output of digital data to the crew. They also echo the crew's keystrokes as commands are constructed through the keyboard.

The Crew Software Interface Workbook is a good source of information on the operation of the keyboards and CRT's.

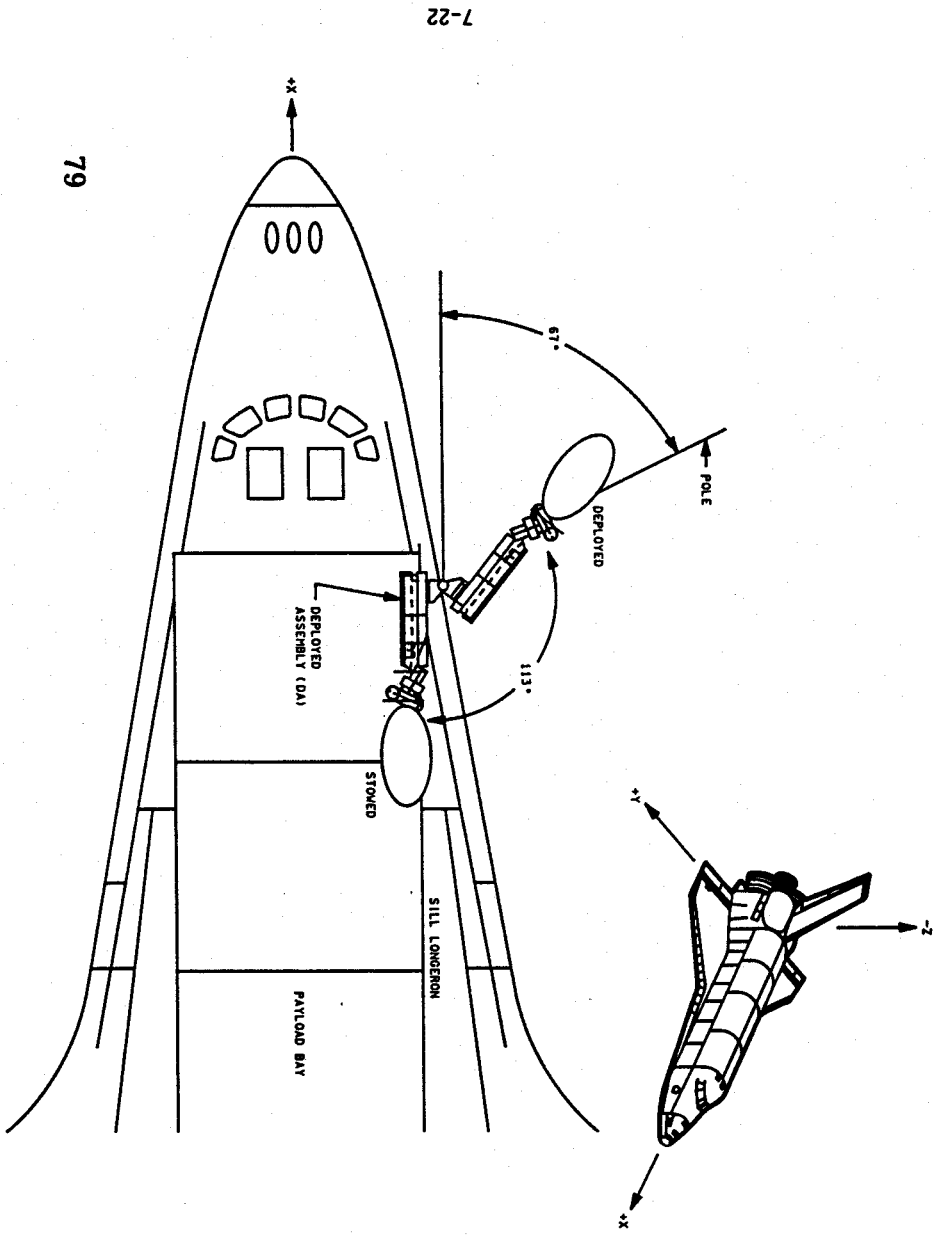

Figure 7-8.- Deployed antenna location.

79

7-22

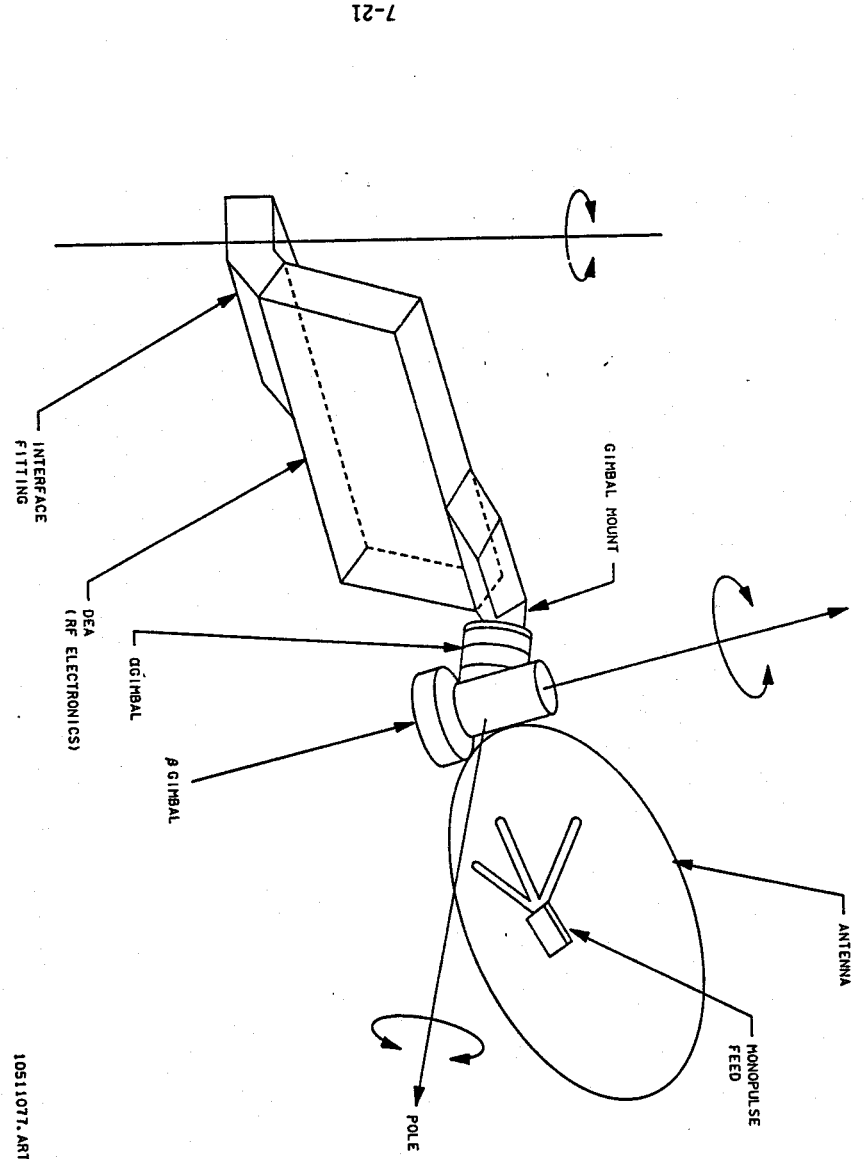
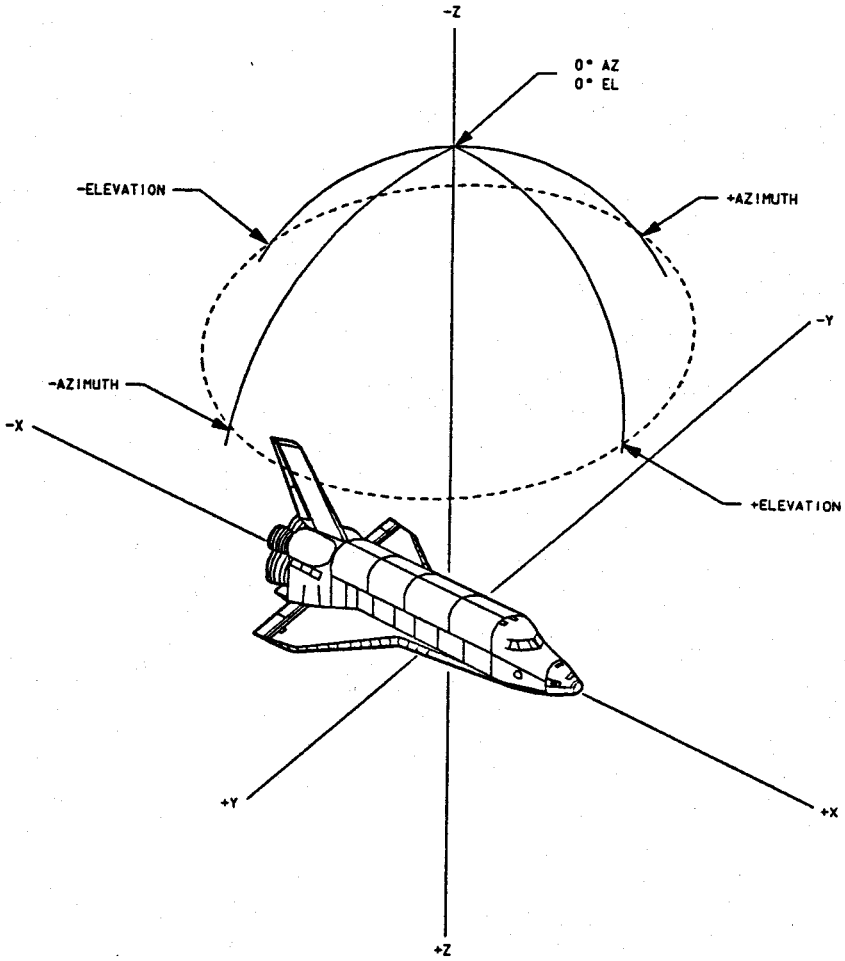

Figure 7-7.- Ku-band antenna.

7-21



10511710. ART 6

Figure 7-10.- Antenna coordinate system.

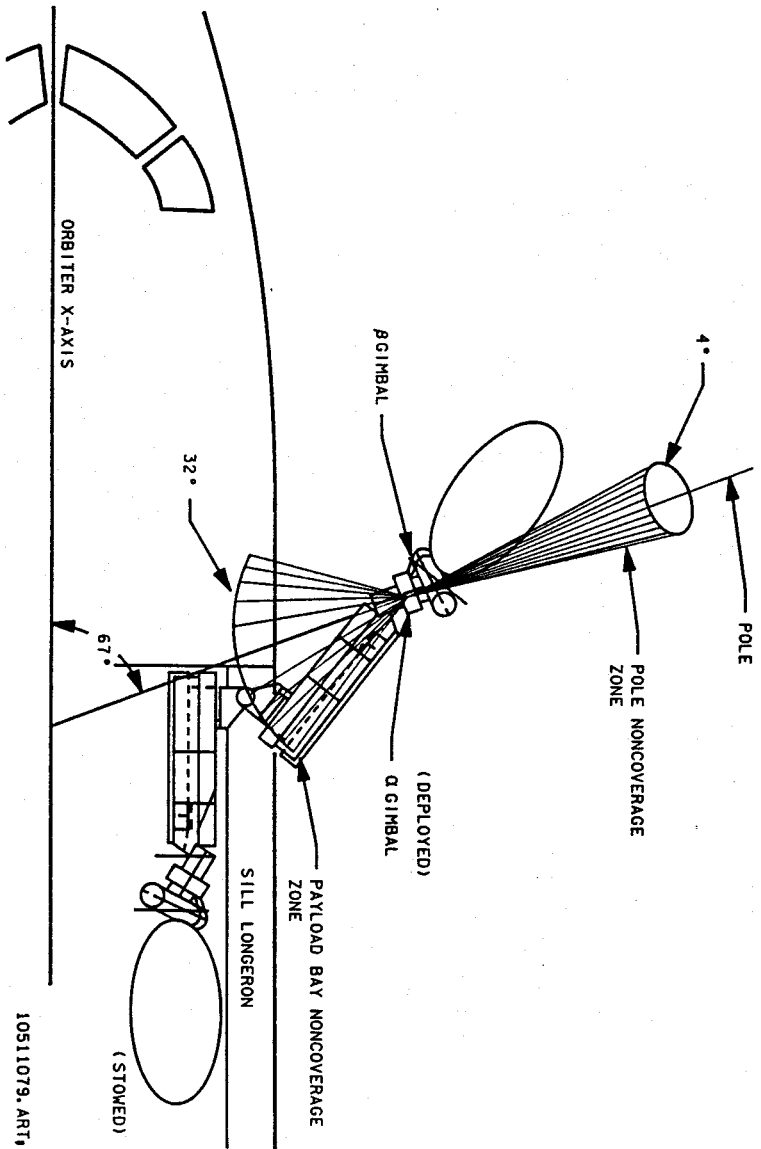

10511079. ART 2

Figure 7-9.- Noncoverage zones.

SECTION 9
SOLVING SIMPLE ATTITUDE PROBLEMS

Two simple examples are presented here to help illustrate how pointing problems are solved.

9.1 EXAMPLE ONE (MINIMUM MANEUVER)

Given a current Orbiter ADI inertial attitude of roll = 45°, pitch = 0°, and yaw = 90°, find the minimum maneuver attitude to point the -Z star tracker at star 11.

The ADI attitude can be expressed as a cosine matrix [M] where:

$$[M]_{\text{ADI}}^{\text{OB}} = \begin{bmatrix} 0 & -.7071 & .7071 \\ 1 & 0 & 0 \\ 0 & .7071 & .7071 \end{bmatrix}$$

81

where OB represents the Orbiter body axes.

The center of the -Z star tracker is defined in the Orbiter body frame as a pitch of 87.73° and a yaw of -1.97°. This can also be expressed as a rotation matrix with a roll equal to zero. The matrix is formed using the same 2, 3, 1 cosine matrix built before. For a pitch of 87.73 and a yaw of -1.97 this will equal:

$$[-ZST]_{\text{OB}}^{-ZST} = \begin{bmatrix} .0395 & .00135 & .0343 \\ -.0343 & .999 & 0 \\ -.999 & -.0342 & .0396 \end{bmatrix}$$

Star 11 has a right ascension of 100.7° and a declination of -16.65°. As was shown before, this can be converted to a unit vector in the mean of 1950 frame by:

$$\begin{aligned} U_x &= \cos(\text{DEC}) \cos(\text{RA}) = -0.1778 \\ U_y &= \cos(\text{DEC}) \sin(\text{RA}) = 0.9414 \\ U_z &= \sin(\text{DEC}) = -.2865 \end{aligned} \quad \text{or} \quad \begin{aligned} \text{Pitch} &= -58.1^\circ \\ \text{Yaw} &= +70.3^\circ \end{aligned}$$

and into a 2,3,1 cosine matrix equal to:

$$[U]_{\text{M50}}^{\text{STAR}} = \begin{bmatrix} .1781 & -.4975 & -.8489 \\ .9414 & .3370 & 0 \\ .2861 & -.7992 & .5284 \end{bmatrix}$$

In addition, the constant rotation matrix relating the ADI and M50 reference frames is

$$[M]_{\text{ADI}}^{\text{OB}} = [M]_{\text{M50}}^{\text{OB}} [R]_{\text{ADI}}^{\text{M50}}$$

where [R] is the RELMAT which, currently at JSC is defined as

$$[R]_{\text{ADI}}^{\text{M50}} = \begin{bmatrix} 1 & 0 & 0 \\ 0 & 1 & 0 \\ 0 & 0 & 1 \end{bmatrix} \text{ and } [M] \text{ is}$$

the current vehicle attitude.

Solving for the current attitude in M50 yields

$$[M]_{\text{M50}}^{\text{OB}} = [M]_{\text{ADI}}^{\text{OB}} [RT]_{\text{M50}}^{\text{ADI}}$$

The position of the -Z star tracker in M50 can be expressed as

$$[P]_{\text{M50}}^{-ZST} = [-ZST]_{\text{OB}}^{-ZST} [M]_{\text{M50}}^{\text{OB}}$$

$$\text{and so } [P]_{\text{M50}}^{-ZST} = [-ZST]_{\text{OB}}^{-ZST} [M]_{\text{ADI}}^{\text{OB}} [RT]_{\text{M50}}^{\text{ADI}}$$

We can express the separation between the -ZST and the star with a matrix [N] where:

$$[U]_{\text{M50}}^{\text{STAR}} = [N]_{\text{-ZST}}^{\text{STAR}} [P]_{\text{M50}}^{-ZST}$$

$$\text{so } [N]_{\text{-ZST}}^{\text{STAR}} = [U]_{\text{M50}}^{\text{STAR}} [PT]_{\text{-ZST}}^{\text{M50}}$$

substituting for [P] we get

$$[N]_{\text{-ZST}}^{\text{STAR}} = [U]_{\text{M50}}^{\text{STAR}} [R]_{\text{ADI}}^{\text{M50}} [MT]_{\text{OB}}^{\text{ADI}} [-ZSTT]_{\text{-ZST}}^{\text{OB}}$$

We want to change the vehicle attitude [M] such that the -ZST is looking at the star. This means that the reference frames locating the -ZST and the star will be aligned, or

$$[N] \begin{matrix} \text{STAR} \\ -ZST \end{matrix} = [I]$$

If we define [N] as identically [I] we can solve for the new vehicle attitude directly by

$$[I] \begin{matrix} \text{STAR} \\ -ZST \end{matrix} = [U] \begin{matrix} \text{STAR} \\ \text{M50} \end{matrix} [R] \begin{matrix} \text{M50} \\ \text{ADI} \end{matrix} [M^1] \begin{matrix} \text{ADI} \\ \text{OB} \end{matrix} [-ZSTT] \begin{matrix} \text{OB} \\ -ZST \end{matrix}$$

where M¹ is the new vehicle attitude.

Solving for M¹ we get

$$[M^1] \begin{matrix} \text{OB} \\ \text{ADI} \end{matrix} = [-ZSTT] \begin{matrix} \text{OB} \\ -ZST \end{matrix} [I] \begin{matrix} -ZST \\ \text{STAR} \end{matrix} [U] \begin{matrix} \text{STAR} \\ \text{M50} \end{matrix} [R] \begin{matrix} \text{M50} \\ \text{ADI} \end{matrix}$$

Notice that the only variables are [U] and [-ZST]. The attitude that will point any instrument at any stellar target can be found simply by substituting in the appropriate values for [U] and [-ZST].

[M¹] when multiplied out equals:

.603	.371	.706	OB
.765	.015	.644	
-.229	-.928	.293	ADI

Since the matrix elements represent the products and sums of the sine and cosine functions in the 2,3,1 matrix discussed in section 1.1, we can solve for the attitude of the Orbiter as 89.1°, 310.5°, and 21.8° in roll, pitch, and yaw. From the initial and final attitude cosine matrices, the Eigen vector and angle can be obtained.

Eigen angle = 68.4°
 Eigen axis = pitch 204.2°
 yaw -85.6°

Although this example was worked using cosine matrices, it also could have been done using quaternions.

9.2 EXAMPLE TWO (TAIL SUN)

In the case of a contingency deorbit, the crew needs the capability onboard to compute a tail Sun attitude for entry. Thus, a computer program needs to be written that, for a given day of the year, will output a M50 inertial attitude that points an Orbiter body vector of pitch = 185°, yaw = 0° to the Sun. This tail Sun attitude could soak the radiators for entry. A discussion of this problem follows.

When the Orbiter is in a roll = 0°, pitch = 0°, yaw = 0° M50 inertial attitude its position relative to the celestial sphere is as shown in figure 9-1.

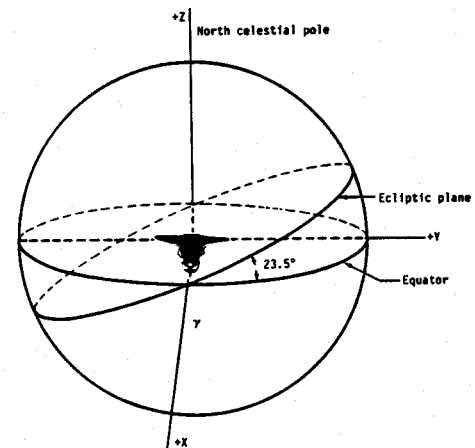

Figure 9-1.- Orbiter null orientation.

The Orbiter nose points at the vernal equinox and the +Z body axis points at the celestial North Pole. To simplify this problem, the Orbiter is first rolled a positive 23-1/2° in order to align the plane of the wings with the ecliptic plane (fig. 9-2).

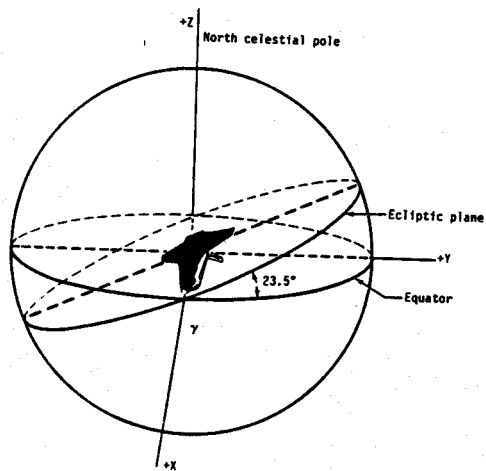

Figure 9-2.- Orbiter with 23-1/2° roll.

Now, a simple yaw maneuver is all that is required to point the tail of the Orbiter at any Sun position. To determine the necessary yaw angle, an expression must be derived that, for a given day of the year, will give the angle along the ecliptic plane from the vernal equinox to the Sun. This expression follows

$$\theta = \left[\left(\frac{(DOY + 284) \text{MOD } 365}{365.25} \right) 360^\circ + 175^\circ \right] \text{MOD } 360^\circ$$

DOY stands for day of year. The number 284 is the number of days in a year (365) minus the day of the vernal equinox (day 81). Note that by adding 175° to the Sun angle, the Orbiter tail will be pointed to within 5° of the Sun when a maneuver of yaw = θ is done. This yaw bias sets up for a positive roll of 90° which puts the Sun on the belly of the Orbiter. This final rotation achieves the desired tail Sun orientation (figs. 9-3 and 9-4).

*One thing that has to be taken into account at this point is the fact that the Sun does not move along the ecliptic plane in a uniform manner due to the eccentricity of the Earth's orbit. Thus, a fudge factor can be added to the 175° to compensate for this fact and the equation for θ becomes

$$\theta = \left[\left(\frac{(DOY + 284) \text{MOD } 365}{365.25} \right) 360^\circ + 173^\circ \right] \text{MOD } 360^\circ$$

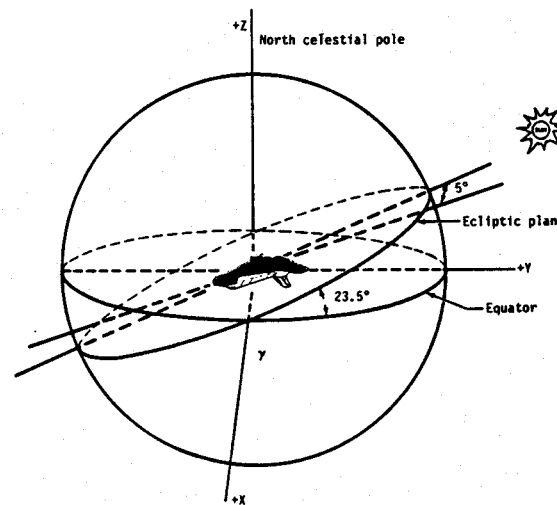

Figure 9-3.- Yaw to within 5° of Sun.

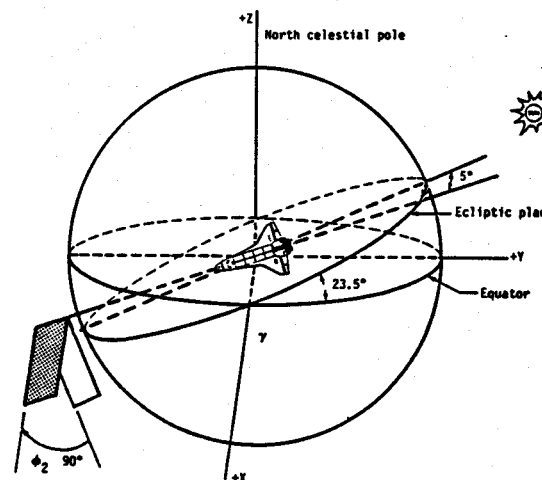

Figure 9-4.- Roll 90°.

Thus, three rotations, ϕ_1 , θ , ϕ_2 in a roll, yaw, roll sequence will provide the required inertial orientation for the tail Sun attitude. Now, the direction cosine matrix for a roll, yaw, roll sequence is

$$R(\phi_1, \theta, \phi_2) = \begin{bmatrix} \cos\theta & \cos\phi_1 \sin\theta & \sin\phi_1 \sin\theta \\ -\sin\theta \cos\phi_2 & \cos\phi_1 \cos\theta \cos\phi_2 & \sin\phi_1 \cos\theta \cos\phi_2 \\ -\sin\theta \sin\phi_2 & -\sin\phi_1 \sin\theta \cos\phi_2 & +\cos\phi_1 \sin\theta \cos\phi_2 \\ \sin\theta \sin\phi_2 & -\cos\phi_1 \cos\theta \sin\phi_2 & -\sin\phi_1 \cos\theta \sin\phi_2 \\ -\sin\theta \cos\phi_2 & -\sin\phi_1 \cos\theta \cos\phi_2 & +\cos\phi_1 \cos\theta \cos\phi_2 \end{bmatrix}$$

To extract the roll, pitch, yaw values (in a pitch, yaw, roll sequence) the following equations can be used

$$R = \tan^{-1}\left(\frac{-M_{32}}{M_{22}}\right)$$

$$P = \tan^{-1}\left(\frac{-M_{13}}{M_{11}}\right)$$

$$Y = \tan^{-1}\left(\frac{-M_{12}}{\sqrt{1 - M_{12}^2}}\right)$$

These equations give roll, pitch, yaw values for the tail Sun attitude, but they do not take into account which quadrants the angular values are in. A discussion of the logic which determines quadrant locations is beyond the scope of this text.

There are several methods which could have been used to solve the tail Sun problem. The method chosen is perhaps not the easiest, but it works and the logic of this solution can be translated into a useful computer program.

APPENDIX A
STARS

CELESTIAL TARGET ID	NAME	RIGHT ASCENSION	DECLINATION (+/-)	MAG	S20
C011	SIRIUS	100.7316	-16.6562	-1.43	3.150
C012	CANOPUS	95.7107	-52.6676	-0.75	1.500
C013	RIGEL	78.0333	-8.2581	0.13	0.861
C014	VEGA	278.8134	38.7382	0.03	0.803
C015	HADAR	218.0684	-60.1330	0.59	0.745
C016	ACHERNAR	23.9647	-57.4905	0.47	0.691
C017	ACRUX	185.9523	-62.8221	0.83	0.667
C018	CAPELLA	78.2489	45.9459	0.08	0.514
C019	SPICA	200.6384	-10.9014	0.97	0.513
C020	ARCTURUS	213.3353	19.4253	-0.05	0.488
C021	PROCYON	114.1654	5.3459	0.37	0.477
C022	ALTAIR	297.0903	8.7379	0.76	0.369
C023	BETELGEUSE	88.1161	7.3995	0.42	0.308
C024	BELLATRIX	80.6121	6.3060	1.64	0.274
C025	REGULUS	151.4258	12.2122	1.35	0.269
C026	FOMALHAUT	343.7260	-29.8891	1.16	0.267
C027	DENEK	309.9313	45.1008	1.25	0.254
C028	AL NA'IR	331.2740	-47.2054	1.74	0.205
C029	ALKAID	206.3914	49.5621	1.06	0.197
C030	ANTARES	246.5840	-26.3230	0.91	0.193
C031	CASTOR	112.8513	31.9985	1.58	0.191
C032	ALDEBARAN	68.2627	16.4087	0.86	0.191
C033	PERCOCK	305.4260	-56.8980	1.94	0.188
C034	MIAPLACIDUS	138.1618	-69.5103	1.68	0.187
C035	NUNKI	283.0414	-26.3613	2.03	0.183
C036	KAUS AUSTRALIS	275.2130	-34.4114	1.85	0.158
C037	ALPHERATZ	1.4504	28.8131	2.06	0.148
C038	NAVI	13.4184	60.4464	2.39	0.146
C039	ALHENA	98.7062	16.4432	1.92	0.137
C040	MIRFAK	50.1854	49.6848	1.79	0.116
C041	DENEbola	176.6233	14.8507	2.14	0.112
C042	ALPHECCA	233.1436	26.8808	2.24	0.110
C043	RASALHAGUE	263.1539	12.5931	2.07	0.109
C044	MERAK	164.7108	56.6511	2.37	0.096
C045	POLARIS	27.2247	89.0289	2.02	0.096
C046	PHECDA	177.8039	53.9728	2.44	0.090
C047	GIENAH	183.3065	-17.2643	2.58	0.089
C048	ZUBENESCHEMALI	228.5770	-9.2000	2.61	0.087
C049	KOCHAB	222.7061	74.3598	2.08	0.063
C050	AVIOR	125.3720	-59.3480	1.86	0.076
C051	ATRIA	250.8380	-60.9395	1.92	0.074
C052	HAMAL	31.0888	23.2257	2.00	0.072
C053	MENKENT	210.9275	-36.1293	2.06	0.071
C054	DIPHDA	10.2720	-18.2605	2.02	0.070
C055	ALPHARD	141.2824	-8.4406	1.97	0.068
C056	AL SUHAIL	136.5385	-43.2299	2.21	0.054
C057	ACAMAR	44.0906	-40.5039	2.91	0.054
C058	DENEK ALGEDI	326.0731	-16.3579	2.83	0.050
C059	SCHIEAT	345.3384	27.8123	2.42	0.047
C060	ENIF	325.4323	9.6447	2.39	0.046

CELESTIAL TARGET ID	NAME	RIGHT ASCENSION	DECLINATION (+/-)	MAG	S20
C061	ALNILAM	83.4188	-1.2322	1.69	0.256
C062	EL NATH	80.7827	28.5657	1.65	0.218
C063	NAOS	120.4563	-39.8613	2.25	0.196
C064	SAIPH	86.3458	-9.6858	2.05	0.177
C065	ALIOTH	192.9605	56.2308	1.77	0.164
C066	MENKALINAN	88.9644	44.9447	1.90	0.139
C067	ETA CENTAURI	218.0800	-41.9397	2.31	0.132
C068	KAPPA SCORPII	264.7561	-39.0066	2.41	0.130
C069	ALGOL	46.2267	40.7644	2.12	0.129
C070	MUHLIFAIN	189.6846	-48.6857	2.17	0.117
C071	ZETA CENTAURI	208.1013	-47.0435	2.55	0.112
C072	ALUDRA	110.5292	-19.2044	2.44	0.109
C073	ACRAB	240.6311	-29.6705	2.63	0.106
C074	THETA CARINAE	160.2917	-64.1319	2.76	0.102
C075	ZETA OPHIUCHI	248.6005	-10.4673	2.56	0.097
C076	ALPHA MUSCAE	188.5443	-68.8604	2.71	0.094
C077	ALGENIB	2.6642	14.9055	2.84	0.090
C078	GAMMA LUPI	232.9499	-41.0005	2.78	0.089
C079	MARKAB	345.5676	14.9355	2.48	0.086
C080	EPSILON PERSEI	58.6232	39.8670	2.89	0.085
C081	PHACT	84.4592	-34.1000	2.64	0.084
C082	SABIK	256.8773	-15.6640	2.42	0.083
C083	THETA AURIGAE	89.0784	37.2104	2.62	0.080
C084	ALPHA ARAE	261.9925	-49.8396	2.95	0.076
C085	MU SCORPII	252.1195	-37.9639	3.03	0.076
C086	ALDERAMIN	319.3493	62.3737	2.45	0.076
C087	ZOZCA	167.8642	20.7966	2.56	0.071
C088	ZETA CAN. MAJ.	94.5983	-30.0400	3.02	0.070
C089	ARNEB	82.6308	-17.8567	2.57	0.067
C090	ZETA PERSEI	57.7460	31.7366	2.85	0.065
C091	ALPHIRK	322.0061	70.3412	3.23	0.065
C092	MIRACH	16.7330	35.3552	2.05	0.065
C093	ICEN	199.4411	-36.4499	2.73	0.064
C094	COR CAROLI	193.4204	38.5885	2.89	0.064
C095	BETA GRUIS	339.9241	-47.1467	2.11	0.063
C096	DELTA CYGNI	295.8530	45.0081	2.87	0.061
C097	ALMACH	30.2055	42.0904	2.10	0.060
C098	ZUBENELGENUBI	222.0262	-15.8359	2.75	0.060
C099	GAMMA GRUIS	327.7277	-37.6012	3.01	0.059
C100	GAMMA TRI. AUS.	228.5511	-68.4972	2.89	0.058
C101	IZAR	220.7003	27.2840	2.70	0.056
C102	ELTANIN	268.8607	51.4937	2.22	0.055
C103	ARICH	189.7765	-1.1756	2.74	0.054
C104	ZETA AQUILAE	285.7778	13.7867	2.99	0.054
C105	EPSILON CYGNI	311.0502	33.7846	2.46	0.051
C106	ANKRA	5.9564	-42.5008	2.40	0.051
C107	RHO PUPPIS	121.3526	-24.1585	2.81	0.047
C108	BETA TRIANGULI	31.6419	34.7513	2.80	0.046
C109	PI SAGITTARII	286.6975	-21.1053	2.88	0.046
C110	ZETA MERCULIS	249.8454	31.6954	2.81	0.046

M50 SPLIT DIFFERENCE IMU ALIGN ATTITUDES (50 NAV STARS)										
PAIR		-Z ST: Star 1			-Z ST: Star 2					
Star1	Star2	Sep	R	P	Y	R	P	Y		
1	11	15	84.8	73.7	37.6	0.7	198.3	201.8	7.7	
2	11	44	90.5	102.8	160.6	346.4	172.2	329.8	28.2	
3	11	51	91.8	70.6	20.7	6.0	199.9	184.6	1.7	
4	11	54	85.3	95.1	296.1	22.1	172.9	104.6	351.8	
5	12	19	90.2	72.6	71.3	311.6	219.9	224.1	53.6	
6	12	31	86.0	144.9	175.6	352.6	125.3	358.7	25.0	
7	13	17	90.6	91.1	37.2	347.5	184.4	203.6	24.8	
8	13	26	89.6	76.6	311.9	0.4	195.6	116.5	8.7	
9	13	38	85.2	92.4	218.0	17.0	176.4	25.9	356.3	
10	14	19	87.8	299.5	234.3	27.1	335.6	61.0	316.0	
11	14	26	91.4	281.5	118.9	319.9	343.7	309.8	24.8	
12	14	41	89.9	275.1	274.1	37.3	8.3	111.9	310.4	
13	14	52	91.4	235.2	36.9	337.7	29.4	235.4	18.3	
14	15	25	86.0	201.9	219.3	311.8	48.1	66.5	52.3	
15	15	42	89.1	340.4	11.0	308.2	297.0	182.0	35.3	
16	15	43	84.1	349.2	23.3	338.0	284.4	193.5	7.0	
17	15	58	88.0	339.2	44.1	43.8	280.8	210.1	300.6	
18	16	23	82.9	172.0	150.6	16.0	100.7	341.0	358.5	
19	16	30	88.9	20.0	343.9	319.3	262.2	145.0	31.4	
20	16	37	88.4	49.8	282.9	75.9	173.3	52.7	293.3	
21	16	53	86.2	46.9	12.6	291.7	262.3	151.1	62.6	
22	16	59	91.3	26.0	307.1	64.4	206.9	85.1	295.5	
23	17	20	85.0	2.2	26.9	290.7	289.1	184.3	54.8	
24	17	21	86.6	184.7	205.3	346.4	81.5	40.0	24.7	
25	17	26	85.6	351.2	38.8	65.1	236.8	173.5	284.5	
26	18	41	85.0	81.5	117.2	48.5	177.3	279.3	323.5	
27	18	54	88.7	113.2	311.6	319.5	167.0	119.5	56.5	
28	18	57	91.7	132.2	347.6	339.3	139.5	166.3	38.4	
29	19	21	87.6	202.3	256.1	359.7	67.7	92.5	7.2	
30	19	33	88.8	328.7	104.7	46.3	295.0	275.8	296.7	
31	19	49	86.4	270.9	346.5	287.9	338.9	189.8	57.1	
32	20	31	88.2	213.0	296.5	349.8	54.4	134.4	13.5	
33	20	51	92.4	312.3	150.6	42.8	320.4	332.6	299.5	
34	21	29	87.4	75.3	149.1	344.0	201.6	312.3	24.1	
35	21	38	90.6	102.5	222.6	340.2	173.9	30.9	34.2	
36	21	45	84.6	93.3	192.5	337.8	184.7	358.1	34.7	
37	21	49	89.7	93.8	175.6	338.4	194.7	339.3	31.8	
38	22	29	83.8	290.6	304.1	20.5	344.9	133.3	323.6	
39	22	51	84.0	285.1	185.8	331.2	342.7	14.9	13.2	
40	22	52	90.2	243.6	54.9	6.4	30.2	252.1	348.4	
41	22	53	92.1	295.0	225.0	344.5	335.3	51.1	358.8	
42	23	34	84.1	181.2	25.5	4.1	170.4	195.4	10.6	
43	23	37	83.5	89.9	251.9	356.2	183.4	58.8	16.1	
44	23	41	86.7	91.0	115.1	9.9	179.3	282.7	3.0	
45	23	46	83.8	88.0	154.5	7.5	182.8	321.5	4.6	
46	24	34	85.2	103.1	27.2	357.1	169.8	197.3	17.8	
47	24	45	83.1	86.1	191.6	10.6	183.8	358.2	1.1	
48	24	46	89.1	89.6	154.5	13.3	179.9	321.9	359.3	
49	24	59	91.7	79.1	251.9	358.8	193.5	56.9	10.9	
50	25	40	87.8	142.8	255.2	321.4	125.3	79.2	56.2	
51	26	30	82.9	347.3	290.8	315.9	290.1	100.3	28.5	
52	26	43	88.3	347.7	302.3	356.4	282.7	112.7	348.6	
53	26	50	85.3	202.8	135.0	308.5	44.6	344.3	54.9	
54	27	30	91.7	327.2	210.4	353.0	303.8	26.8	349.6	
55	27	36	85.5	326.8	196.1	332.0	305.4	12.6	10.5	
56	27	48	90.5	326.2	223.8	13.2	303.4	40.0	329.4	
57	27	54	83.7	237.6	77.9	308.9	15.0	282.6	44.5	
58	28	43	85.0	344.4	320.8	351.9	286.7	132.2	352.5	
59	28	48	91.7	334.4	303.4	314.5	300.6	117.0	28.5	
60	28	52	88.6	229.3	96.2	60.9	71.5	310.6	302.6	

85

M50 SPLIT DIFFERENCE IMU ALIGN ATTITUDES (50 NAV STARS)
 -Z ST1 Star 1 -Z ST1 Star 2

PAIR	Star 1	Star 2	Sep	R	P	Y	R	P	Y
61	28	56	88.6	206.4	157.4	315.4	46.2	2.8	47.7
62	29	30	83.9	344.7	152.4	21.5	281.2	321.7	323.4
63	29	39	88.5	198.7	318.4	6.3	73.0	154.2	1.8
64	29	53	85.8	332.4	168.6	50.6	287.2	335.4	292.9
65	30	56	85.4	239.1	208.0	4.4	34.0	45.4	351.7
66	30	60	84.5	386.0	58.2	9.9	326.1	241.5	332.6
67	31	37	90.9	100.0	255.0	324.6	180.7	59.6	49.1
68	31	47	83.5	75.6	88.6	37.3	186.2	251.4	332.9
69	31	50	91.9	114.7	15.0	32.6	153.7	189.3	344.2
70	32	46	87.7	85.7	155.3	28.6	179.9	321.3	343.6
71	32	49	87.8	73.0	184.7	22.8	192.2	348.6	346.4
72	32	50	88.7	117.1	33.7	353.5	155.6	207.6	23.3
73	32	56	86.3	119.6	49.1	1.4	152.0	224.1	15.6
74	33	47	91.6	256.9	234.6	295.2	352.3	80.0	52.5
75	33	59	91.2	389.6	24.2	52.4	326.1	209.5	290.0
76	34	39	90.3	167.1	193.2	358.6	102.5	22.7	16.5
77	34	41	88.6	131.7	147.1	290.6	161.2	305.1	86.9
78	34	54	84.9	85.2	294.0	78.9	155.1	81.8	296.2
79	35	47	90.7	268.9	242.3	328.9	356.5	75.8	18.3
80	35	50	92.3	243.2	179.7	345.0	24.3	16.8	9.0
81	36	50	83.0	240.1	182.3	350.0	28.7	19.5	5.2
82	36	54	83.8	262.9	101.9	30.5	18.9	300.4	320.0
83	36	57	91.5	241.6	139.1	18.7	36.1	337.6	337.3
84	36	59	90.9	291.8	42.7	26.0	344.7	232.3	318.1
85	37	39	88.3	181.4	59.4	29.1	94.7	252.6	343.9
86	37	43	91.0	1.4	243.1	3.3	267.3	49.9	344.0
87	38	42	86.9	8.7	207.4	33.0	250.5	8.1	317.7
88	38	43	88.7	8.0	210.9	1.7	261.3	16.5	347.6
89	38	58	85.7	24.6	229.7	294.6	272.7	19.0	55.2
90	39	47	89.9	84.0	85.0	19.3	183.8	251.1	352.2
91	40	57	90.3	142.1	2.7	326.0	126.8	186.0	51.6
92	41	43	83.5	8.5	108.9	339.3	266.3	274.6	9.5
93	41	50	85.0	179.9	287.6	76.0	115.4	133.4	299.4
94	42	60	87.7	304.4	90.0	325.0	325.1	273.6	17.5
95	43	44	84.1	259.9	317.0	1.1	12.7	151.9	349.0
96	43	47	84.3	273.8	241.2	11.7	1.3	74.1	335.4
97	44	48	83.9	11.9	145.9	29.5	248.6	307.0	322.0
98	44	52	91.1	165.1	314.7	310.6	89.3	154.5	63.6
99	48	49	83.6	272.3	343.8	315.2	350.0	177.9	30.9
100	48	50	88.7	247.9	202.6	33.8	35.8	43.8	321.2
101	48	55	86.0	230.9	240.6	3.6	41.5	86.4	354.9
102	48	56	85.2	240.4	219.9	25.3	39.7	59.5	331.4
103	49	60	84.1	343.6	150.9	294.3	298.3	318.2	49.2
104	50	54	86.3	89.2	292.7	67.8	162.0	91.0	306.7
105	51	54	82.8	267.7	184.3	67.3	52.5	336.0	286.8
106	51	55	89.0	204.5	199.6	323.9	52.8	41.6	40.5
107	55	57	89.9	125.7	302.7	43.6	143.5	119.3	333.9
108	57	59	87.4	53.9	276.6	50.6	198.2	71.3	314.9
109	57	60	87.8	38.6	300.7	31.6	221.4	99.8	320.0

APPENDIX B
 LISTING OF POINTING PROGRAMS

Program name	Brief description	Program	Brief description
AFILE	Prints out an attitude timeline for publication using the output from ATL2.	FP	Computes times when various targets are within line of sight of the Orbiter. Also, calculates groundtrack data and landing site deorbit opportunity times.
ALIGN	Determines available and best star pairs for IMU alignments for a certain time using a given ephemeris.	FPI	Calculates star AOS/LOS for a given time and ephemeris.
ALIGN2	Determines the best star pairs for a flight to determine the star pairs cue card.	GFILE	Reads/writes to ground target data base.
AMP	Predicts attitude maneuver.	IFILE	Reads/writes to instrument data base.
ASPECT	Converts an input attitude to either LVLH or inertial. Also computes look angles to Earth, Moon, and Sun.	LOS	Determines and plots lines of sight to celestial, ground, and orbiting targets.
ATLXFER	Transmits attitude timeline comments to CAPS system.	M	Predicts maneuvers in one frame of reference.
ATL1	Creates an attitude timeline data file.	PAD	Draws star pairs PAD.
ATL2	Generates attitude maneuver times and Earth/Sun look angles for a given attitude timeline data file.	PLOT	Plots ground, celestial, and position traces for lines of sight on celestial and ground charts.
BFILE	Reads/writes to BIAS data base.	QCARD 1	Draws 1-hour star pair cue card bar chart.
CFILE	Reads/writes to celestial target data base.	QCARD 5	Draws 5-hour star pair cue card bar chart.
DA	Computes depression angle.	RADEC	Calculates ΔV 's due to spring-ejection for a deployed payload and deploy time.
DFILE	Reads/writes to DAP data base.	RESET	Generates rotation attitudes.
DO	Generate deorbit timeline.	RLFILE	Reads/writes to RELMAT database.
FOVFILE	Reads/writes to field of view data base.	RMS	Generates payload, Orbiter, and RMS attitudes (inertial).
		RMSLV	Generates payload, Orbiter, and RMS attitudes (LVLH).

APPENDIX C
ASTRONOMICAL CONSTANTS

<u>Program name</u>	<u>Brief description</u>
ROLL	Generates Orbiter roll attitudes.
ROSTIM	Generates stars of opportunity for IMU alignments for a given Orbiter attitude.
RSV	Reads state vectors from ephemeris file.
SS	Offline spacecraft sighting program. Computes instrument pointing angles and the Orbiter attitude required to point at specific targets.
SSPLOT	Computes TDRS direct check attitudes in a timely manner.
STARC	Plots Moon, Sun, planets, orbit traces on star charts.
T	Subtracts two times.
TDRS	Determines Ku-band AOS/LOS for a flight using the output from ATL2.
TIMEP	Converts two times.
TRAJP	Trajectory propogator.
TVR	Generates thrust vector roll and attitudes.
VCEP	Vector conversion program which converts supertape vector inputs into sets of invariant elements. Calculates the ephemeris data for Sun, Moon, and RNP matrix at base reference time.
VCEP1	Permits user to change the lift-off date and time of an existing ephemeris file.
XHAIRS	Generates planar separation between two star pairs.
XYZ	Converts from M50 X, Y, Z to RA, DEC

Speed of light	$c = 299\,792\,458 \text{ m/s}$
Universal constant of gravitation	$G = 6.672 \times 10^{-11} \text{ m}^3/\text{kg}\cdot\text{s}^2$
Unit distance	$A = 0.149\,597\,870 \times 10^{12} \text{ m}$
<u>Earth Parameters</u>	
Equatorial radius	$R_E = 6378\,140 \text{ m}$
Flattening factor	$f = 1/298.257$
Polar radius	$R_p = R_E \cdot (1-f)$ $= 6356\,755 \text{ m}$
Geocentric gravitational constant	$GE = 0.398\,600\,5 \times 10^{15} \text{ m}^3/\text{s}^2$
Earth mass	$M_\oplus = GE/G$ $= 0.597\,42 \times 10^{25} \text{ kg}$
Obliquity of ecliptic (M50)	$\epsilon = 23^\circ.445\,376$
Angular rotation rate w.r.t.:	
Inertial equinox	$\Omega_i = 0.729\,211\,514\,645\,921\,0 \times 10^{-4} \text{ rad/s}$
Precessing equinox	$\Omega_p = 0.729\,211\,585\,491\,835\,7 \times 10^{-4} \text{ rad/s}$
<u>Solar Parameters</u>	
Distended angle	d.a. $\approx 0^\circ.5$ (time dependent)
Heliocentric gravitational constant	$GS = 0.132\,712\,438 \times 10^{21} \text{ m}^3/\text{s}^2$

APPENDIX D
VECTOR/MATRIX NOTATION

Solar mass $M_{\odot} = GS/G$
 $= 0.198\ 91 \times 10^{31}$ kg

Sun-Earth mass ratio $M_{\odot}/M_{\oplus} = GS/GE$
 $= 332\ 946$

Lunar Parameters

Mean Moon-Earth dist. $a = 60.2665 \cdot R_E$

Mean lunar radius $R_{\zeta} = 1738\ 000$ m

Moon-Earth mass ratio $\mu = 0.012\ 300\ 02$

Lunar mass $M_{\zeta} = \mu \cdot M_{\oplus}$
 $= 0.734\ 83 \times 10^{23}$ kg

Lengths of mean months:

Synodic	(new moon to new moon)	29.530 589 days
Anomalistic	(perigee to perigee)	27.554 550 days
Sidereal	(fixed star to fixed star)	27.321 662 days
Tropical	(equinox to equinox)	27.321 582 days
Draconic	(node to node)	27.212 221 days

Because of the various types of notations that have been used and the confusion that can result, a few words of clarification are appropriate.

\bar{x} Denotes a real vector composed of orthogonal vectors where each orthogonal vector equals a scalar times a unit vector.

\hat{x} Denotes a unit vector.

$[\bar{x}]$ Denotes the matrix of orthogonal scalar components in sequence from axis 1 through 3.

$[\hat{x}]$ Denotes reference frame x defined by the unit vector triad

$$\begin{bmatrix} x \\ y \\ z \end{bmatrix}$$

$$\begin{bmatrix} \hat{x} \\ \hat{y} \\ \hat{z} \end{bmatrix}$$

$[x]$ Denotes a 3×3 cosine matrix

$[x]_{A}^B$ Denotes rotations used in going from reference frame A to frame B.

88

CONVERSION FACTORS

1 ft = 0.3048 m (exact)
 1 mi = 5280 ft (exact)
 1 n. mi. = 1852 m (exact)

1 lbm = 0.453 592 37 kg (exact)
 1 slug = 32.174 048 556 lbm

n = 3.141 592 653 589 793
 1 deg = $180/n$

APPENDIX E
ACRONYMS

ADI attitude direction indicator
 AKM apogee kick motor
 AOS acquisition of signal
 ATC active thermal control
 ATL attitude timeline
 AZ azimuth

BFS backup flight system
 BPV body pointing vector
 BV body vector

c.g. center of gravity
 CAP crew activity plan
 CAPS crew activity planning system
 COAS crew optical alignment sight
 COE center of Earth
 COM center of Moon
 COMM communication
 CPA closest point of approach
 CRT cathode ray tube

DAP digital autopilot
 DEC declination

ECI Earth-centered inertial
 EFE Earth fixed equatorial
 EL elevation
 EVA extra vehicular activity

FDS flight design system
 FOV field of view
 FSSR functional subsystem software requirements
 ft/s feet per second

GG gravity gradient
 GHA Greenwich hour angle
 GMT Greenwich mean time
 GNC guidance, navigation, and control
 GPC general purpose computer

ICD Interface Control Document
 IET internal elapsed time
 IMU inertial measurement unit
 IUS inertial upper stage

J's J terms
 JD Julian day

KBD keyboard

L/O lift-off
 LAT latitude
 LON longitude
 LOS loss of signal, line of sight
 LVLH local vertical local horizontal

M50 Mean of 1950
 MCC Mission Control Center
 MEE mean equator and equinox of epoch
 MET mission elapsed time
 MOC mission operations computer
 MOD Mission Operations Directorate
 MPAD Mission Planning and Analysis Division

N nutation
 n. mi. nautical mile

OMS orbital maneuvering subsystem
 OPS operations sequence

P precession
 PAM payload assist module
 PASS primary avionics software system
 pb pushbutton
 PBI pushbutton indicator
 PET phase elapsed time
 PKM perigee kick motor
 PRCS primary reaction control system
 PTC passive thermal control
 PI payload interrogator

R rotation
 RA right ascension
 RCS reaction control system
 REFSMMAT reference stable member matrix
 RELMAT relative matrix
 RGA rate gyro assembly
 RHC rotational hand controller
 ROT/ROTR rotation
 RRA relative right ascension

SAA South Atlantic anomaly
 SB starball
 SEC secant
 SODB Shuttle Operations Data Book
 SR sunrise
 SS sunset
 STDN Space flight tracking and data network

JSC-10511

TCA	time of closet approach
TDRS	tracking and data relay satellite
TEE	true equator and equinox of epoch
TEG	true equator and Greenwich meridian of epoch
THC	translational hand controller
TIG-	time of ignition minus
TR	terminator rise
TS	terminator set
TVC	thrust vector control
UT	universal time
VRCS	vernier reaction control system
WCS	waste collection system
Z	Zulu