

# Flight Procedures Handbook

100 100 11  
c.1  
JSC  
10539

Ascent/Aborts

Crew Training and Procedures  
Division  
Flight Activities Branch  
Final  
February 1, 1980

INTRODUCTION

1

ASCENT FLIGHT  
PHASE DESCRIPTION

2

ASSUMPTIONS, GUIDELINES,  
AND CONSTRAINTS

3

CREW OPERATIONS

4

PROCEDURES MATRICES

5

*Supersedes T 78-11765*

TECHNICAL MANUAL  
BUILD 1-1-80

Johnson Space Center  
Houston, Texas 77058



National Aeronautics and  
Space Administration

Lyndon B. Johnson Space Center  
Houston, Texas

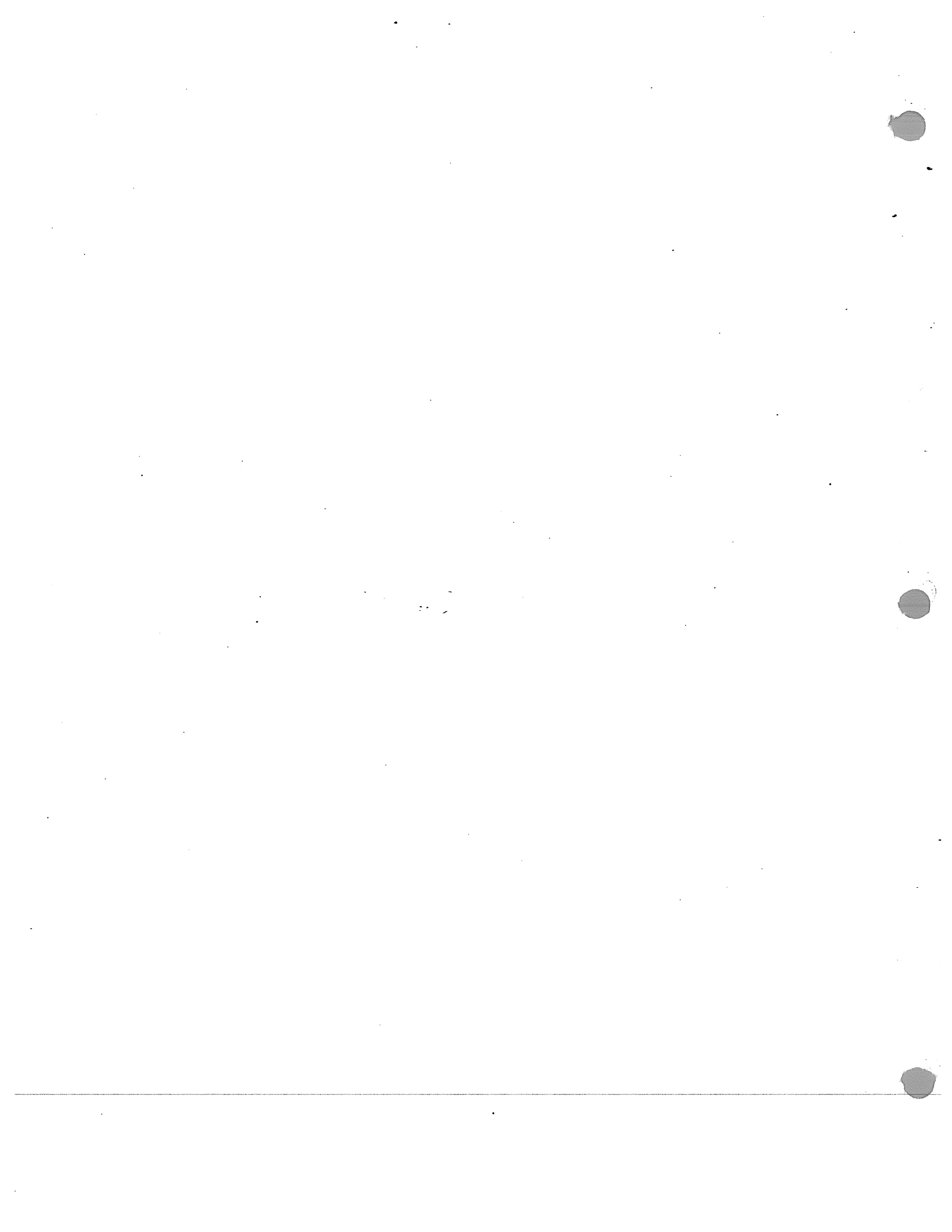

## ACKNOWLEDGMENT

Major contributions to the Ascent/Aborts Flight Procedures Handbook were made by the following individuals:

David L. Westgate  
Charles O. Lewis  
Sutton L. Graham  
John M. Compton  
Dennis L. Bentley  
J. Scott Burd  
Ardith Perry

It is requested that any organization having comments concerning this document contact Pearline E. Collector, Flight Activities Branch, CG5, telephone (713) 483-4471.

## FLIGHT PROCEDURES HANDBOOK PUBLICATIONS

The following is a list of the Integrated Flight Procedures Handbooks of which this document is a part. These handbooks document integrated and/or flight procedural sequences covering major STS crew activity plan phases.

<u>Title</u>	<u>JSC/FOD document No.</u>
ASCENT/ABORTS	10559/LA-B-11180-4A
ENTRY	11542/LA-B-11180-4B
RENDEZVOUS/ORBITAL NAVIGATION	10589/LA-B-11180-4C
ORBITAL TRANSLATION	10588/LA-B-11180-4D
ATTITUDE AND POINTING	10511/LA-B-11180-4G
STS WORKDAY	10541/LA-B-11180-4H
SPACELAB ACTIVATION	10545/LA-B-11180-4J
SPACELAB DEACTIVATION	12803/LA-B-11180-4K
CREW DATA MANAGEMENT	12985/LA-B-11180-4M
PROXIMITY OPERATIONS	12802/LA-B-11180-4P
IMU ALIGNMENT	12842/LA-B-11180-4Q
DEPLOYED PAYLOAD	16191/LA-B-11180-4R
POSTINSERTION DEORBIT PREPARATION	16219/LA-B-11180-4S

## CONTENTS

Section		Page
1.	<u>INTRODUCTION</u> . . . . .	1-1
1.1	PURPOSE . . . . .	1-1
1.2	SCOPE . . . . .	1-1
1.3	REFERENCES . . . . .	1-1
1.4	ABBREVIATIONS AND ACRONYMS . . . . .	1-3
2.	<u>ASCENT FLIGHT PHASE DESCRIPTION</u> . . . . .	2-1
2.1	ASCENT FLIGHT PHASE . . . . .	2-1
2.2	NOMINAL . . . . .	2-4
2.3	ATO ABORT . . . . .	2-8
2.4	AOA ABORT . . . . .	2-9
2.5	RTLS ABORT . . . . .	2-10
2.6	CONTINGENCY ABORT . . . . .	2-15
2.7	BACKUP FLIGHT SYSTEM ASCENT . . . . .	2-15
3.	<u>ASSUMPTIONS, GUIDELINES, AND CONSTRAINTS</u> . . . . .	3-1
3.1	SOURCE . . . . .	3-1
3.2	FLIGHT DATA FILE ORGANIZATION . . . . .	3-1
3.3	FLIGHT CREW . . . . .	3-5
3.4	TRAJECTORY, GUIDANCE, NAVIGATION, AND CONTROL . . . . .	3-17
4.	<u>CREW OPERATIONS</u> . . . . .	4-1
4.1	<u>ASCENT CREW MONITORING AND CONTROL DEVICES</u> . . . . .	4-1
4.1.1	<u>Onboard Ascent Event Reference</u> . . . . .	4-1
4.1.2	<u>Cockpit CRT Displays</u> . . . . .	4-2
4.1.3	<u>Dedicated Displays</u> . . . . .	4-36
4.1.4	<u>OMS Targeting Scheme</u> . . . . .	4-46
4.2	<u>ASCENT SEQUENCE OF EVENTS</u> . . . . .	4-57
4.2.1	<u>Nominal</u> . . . . .	4-61
4.2.2	<u>Abort Once Around (AOA)</u> . . . . .	4-103
4.2.3	<u>Return to Launch Site (RTLS)</u> . . . . .	4-112
4.2.4	<u>Contingency Abort</u> . . . . .	4-132
5.	<u>PROCEDURE MATRICES</u> . . . . .	5-1
5.1	<u>INTRODUCTION</u> . . . . .	5-1

## TABLES

Table		Page
3-1	ASCENT/ABORT FLIGHT DATA FILE USE SUMMARY . . . . .	3-2
3-2	REACH/VISIBILITY ENVELOPE . . . . .	3-7
4-1	COCKPIT CRT DISPLAYS . . . . .	4-3
4-2	ASCENT DEDICATED DISPLAYS SUMMARY . . . . .	4-38
4-3	OMS 1/2 OPTIONS (CYCLE 2) . . . . .	4-51
4-4	OMS 1/2 TARGETS (CYCLE 2) . . . . .	4-52
4-5	SUMMARY LIST OF EVENTS . . . . .	4-58
4-6	FUEL DISSIPATION ATTITUDE AND PITCHAROUND PROPELLANT REMAINING . . . . .	4-113
4-7	TACAN MATRICES . . . . .	4-124
4-8	MACH/ $\alpha$ /H PROFILE (CONTINGENCY ABORT) . . . . .	4-138
5-1	ASCENT PROCEDURES MATRIX - NOMINAL (LAUNCH THROUGH INSERTION) . . . . .	5-3
5-2	ASCENT PROCEDURES MATRIX - AOA (MM 301 TRANSITION THROUGH LANDING) . . . . .	5-21
5-3	ASCENT PROCEDURES MATRIX - RTLS (STAGING THROUGH LANDING) . . . . .	5-27

## FIGURES

Figure		Page
2-1	Ascent flight phase . . . . .	2-2
2-2	Ascent ground track . . . . .	2-3
2-3	Ascent elevon schedule . . . . .	2-6
2-4	Typical RTLS profile . . . . .	2-11
3-1	Prelaunch and powered ascent (<1.5g) reach/visibility for panel 06 . . . . .	3-8
3-2	Prelaunch, ascent, and entry reach/visibility for panel 07 . . . . .	3-9
3-3	Prelaunch and powered ascent (<1.5g) reach/visibility for panel 08 . . . . .	3-10
3-4	Powered ascent (<1.5g) reach/visibility for panel L2 . . . . .	3-11
3-5	Powered ascent (<1.5g) reach/visibility for panels C2 and C3 . . . . .	3-12
3-6	Powered ascent (<1.5g) reach/visibility for panel 05 . . . . .	3-13
3-7	Powered ascent (<1.5g) reach/visibility for panel 09 . . . . .	3-14
3-8	Powered ascent (<1.5g) reach/visibility for panel R2 . . . . .	3-15
3-9	Nominal ascent sensed acceleration . . . . .	3-16
4-1	Major mode flow . . . . .	4-5
4-2	XXXXXX TRAJ (primary system) display . . . . .	4-9
4-3	XXXXXX TRAJ 1 (BFS) display . . . . .	4-12
4-4	XXXXXX TRAJ 2 (BFS) display . . . . .	4-15
4-5	RTLS TRAJ 2 (BFS) display . . . . .	4-19
4-6	CONT ABORT display . . . . .	4-21
4-7	VERT SIT 1 (primary system and BFS) display . . . . .	4-24
4-8	XXXXX MNVR YYYYY (primary system and BFS) display . . . . .	4-29
4-9	GNC SYS SUMM displays . . . . .	4-32
4-10	SM systems displays (BFS) . . . . .	4-33
4-11	OVERRIDE (primary system, SPEC 51) . . . . .	4-35
4-12	Ascent GNC dedicated display . . . . .	4-37
4-13	OMS 1 TARGETS Cue Card . . . . .	4-55
4-14	OMS 2 TARGETS Cue Card . . . . .	4-56
4-15	SSME throttle schedule . . . . .	4-65
4-16	SRB SEP sequence . . . . .	4-68
4-17	OMS target selection using the ABORT rotary . . . . .	4-98
4-18	RTLS pitcharound maneuver . . . . .	4-114
4-19	RTLS ET SEP transition region . . . . .	4-119
4-20	Alpha recovery, Nz hold, and alpha transition phases . . . . .	4-121
4-21	Proposed GRTLS elevon schedule . . . . .	4-121
4-22	RTLS ET umbilical doors closure sequence . . . . .	4-122
4-23	RTLS speed brake schedule . . . . .	4-125
4-24	Alpha reference (Cycle 2) . . . . .	4-127
4-25	Ejection trajectory . . . . .	4-140

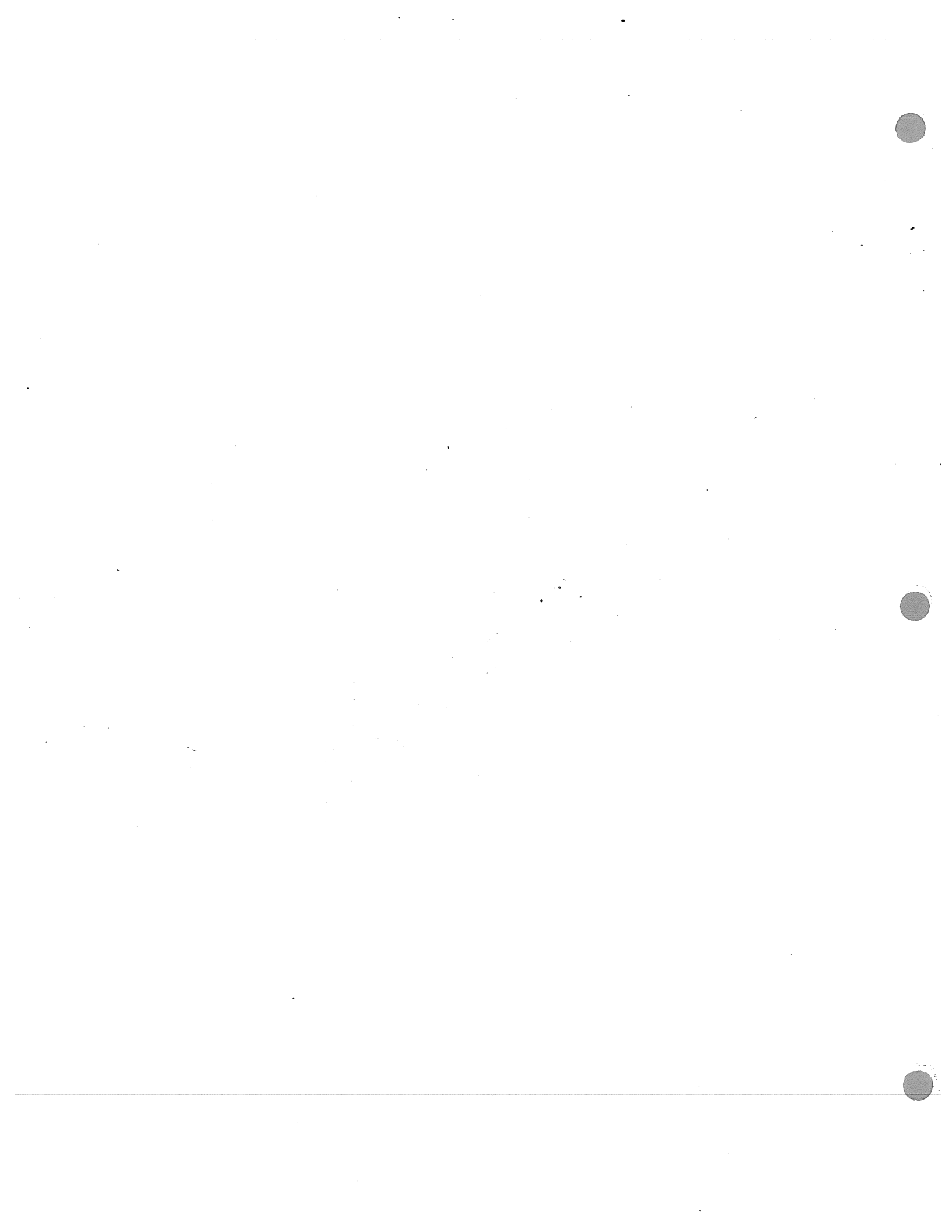





1

INTRODUCTION

## SECTION 1 INTRODUCTION

### 1.1 PURPOSE

The purpose of this document is to present Shuttle ascent and abort flight procedures along with sufficient rationale and supporting information to give the user a complete understanding of the ascent portion of a flight. This handbook has been prepared for Shuttle Transportation System (STS) flight crews and ground operations personnel as an ascent flight phase training supplement and as a ready reference for refresher information. This handbook reflects the essence of decisions of the Ascent Flight Techniques Panel and techniques developed in simulators.

### 1.2 SCOPE

The overall objective of this handbook is to be general enough to cover the ascent and abort flight phases for all Orbital Flight Test (OFT) flights; however, the dynamic nature of the Shuttle development program precludes complete satisfaction of this objective. This handbook uses the STS-1 Operational Flight Profile (OFP) Cycle 2 and the STS-1 Ascent Checklist, Preliminary, Revision D, as its base.

This handbook covers the following flight phases.

- o Nominal ascent
- o Abort To Orbit (ATO) abort
- o Abort Once Around (AOA) abort
- o Return to Launch Site (RTLS) abort
- o Contingency abort

For each of the phases listed, this handbook includes the sequence of trajectory and systems events as well as the interrelationship of the crew and systems for monitoring and flying the Orbiter. It is assumed that the user is already knowledgeable about Shuttle systems.

This document is written under the authority vested in the Flight Operations Directorate, Crew Training and Procedures Division, for definition, development, validation, and control of all crew procedures for Orbiter operations for NASA manned missions, as specified by the Space Shuttle Program Manager Directive No. 9A, dated September 23, 1974.

### 1.3 REFERENCES

1. Space Shuttle Orbital Flight Test Level C Functional Subsystem Software Requirements; Part A; Guidance - Ascent. SD 76-SH-0002E, Aug. 15, 1979.
2. Space Shuttle Orbital Flight Test Level C Functional Subsystem Software Requirements; Part B; Navigation - Ascent/RTLS. SD 76-SH-0005C, Aug. 15, 1979.

3. Space Shuttle Orbital Flight Test Level C Functional Subsystem Software Requirements; Part C; Flight Control - Ascent. SD 76-SH-0008,1C, Aug. 15, 1979.
4. Space Shuttle Orbital Flight Test Level C Functional Subsystem Software Requirements; Part C; Flight Control - Trans DAP. SD 76-SH-0008,2D, Aug. 15, 1979.
5. Space Shuttle Orbital Flight Test Level C Functional Subsystem Software Requirements; Part C; Flight Control - GRTLS DAP. SD 76-SH-0008,3C, Aug. 15, 1979.
6. Space Shuttle Orbital Flight Test Level C Functional Subsystem Software Requirements; Part E; Subsystem Operating Programs - Flight Control Sensors/Controllers. SD 76-SH-0015B, Nov. 19, 1979.
7. Space Shuttle Orbital Flight Test Level C Functional Subsystem Software Requirements; Part E; Flight Control Effectors. SD 76-SH-0016B, Aug. 15, 1979.
8. Space Shuttle Orbital Flight Test Level C Functional Subsystem Software Requirements; Displays and Controls, Book 1. SD 76-SH-0020C, July 15, 1979.
9. Space Shuttle Orbital Flight Test Level C Functional Subsystem Software Requirements; Sequence Requirements. SD 76-SH-0026B, Aug. 15, 1979.
10. Backup Operating System Program Requirements Document; Specification MG038101. Rockwell Document, Jan. 1979.
11. Flight Requirements Document, STS-1, Basic. JSC 10780, Jan. 1979.
12. Space Shuttle Orbiter Project; Computer Program Development Specification, Vol. I, Book 9.5; STS Flight Software Initialization Load. SS-P-0002-195, April, 1979.
13. Space Shuttle Program Orbiter Project; Computer Program Development Specification, Vol V; OFT Level B GN&C. SS-P-0002-510L, May 15, 1979.
14. Space Shuttle Program Orbiter Project; Computer Program Development Specification, Vol V; OFT Level B Vehicle Utility. SS-P-0002-550H, Sept. 4, 1979.
15. STS-1 Operational Flight Profile; Profile Summary, Vol. II. JSC 13663, May, 1979.
16. STS-1 Operational Flight Profile; Ascent Profile - Cycle 2, Vol. III. JSC 14483, Jan., 1979.
17. STS-1 Operational Flight Profile; Abort Analysis - Cycle 2, Vol. VI. JSC 14483, May, 1979.

18. Baseline OFT Abort Plan. JSC 13111, Oct., 1977.
19. Shuttle Operational Data Book; Change 92. JSC 08934, May, 1979.
20. OV102 Orbiter System Operating Procedures. JSC 12766, April 1, 1979.
21. OV102 Space Shuttle Systems Handbook, Rev-A. JSC 11174, May 1, 1979.
22. STS-1 Ascent Checklist, Rev-D. JSC 12800, Oct. 2, 1979.
23. Space Shuttle Controlled Operational Nomenclature. JSC 11189, March, 1978.
24. Space Shuttle Crew Procedures Management Plan. JSC 08969, Sept. 28, 1979.
25. Space Shuttle Crew Procedures Management Plan; Appendix H - Space Shuttle Flight Data File Preparation Standards. JSC 09958, Dec. 14, 1979.
26. OFT Detailed Design Specification; Vol. III - Application: Guidance, Navigation, and Control. JSC 13105, Sept., 1978.
27. Ascent Flight Techniques Panel Minutes; Flight Operations Directorate.
28. OFT Flight Rules, Preliminary Rev-B. JSC 12820, June 11, 1979.

#### 1.4 ABBREVIATIONS AND ACRONYMS

A/L	Approach and Landing
A/L	Autoland
AA	Accelerometer Assembly
ACK	Acknowledge
ADI	Attitude Direction Indicator
ADTA	Air Data Transducer Assembly
AERO	Aerodynamic
AMI	Alpha/Mach Indicator
AOA	Abort Once Around
AOS	Acquisition of Signal
APU	Auxiliary Power Unit
ASC	Ascent
ATCS	Active Thermal Control Subsystem
ATO	Abort To Orbit
ATVC	Ascent Thrust Vector Control
AVVI	Altitude/Vertical Velocity Indicator
BF	Body Flap
BFC	Backup Flight Controller
BFS	Backup Flight System
BRG	Bearing
BU	Backup
c.g.	Center of gravity

C/W	Caution and Warning
CDI	Course Deviation Indicator
CDR	Commander
C/O	Checkout
CO	Cutoff
COAS	Crewman Optical Alignment Sight
CONT	Contingency
CPDS	Computer Program Development Specification
CR	Change Request
CRT	Cathode Ray Tube
CSL	Command Signal Limiter
CSS	Control Stick Steering
DAP	Digital Autopilot
DDU	Display Driver Unit
DED	Dedicated
DEU	Display Electronic Unit
DFI	Development Flight Instrumentation
DIP	Display Interface Processing
DISP	Display (Function)
DPS	Data Processing Software System
DTO	Detailed Test Objective
EAFB	Edwards Air Force Base
EAS	Equivalent Air Speed
ECLSS	Environmental Control and Life Support System
EES	Emergency Ejection Suit
EGT	Exhaust Gas Temperature
EI	Entry Interface
ENA	Enable
EOW	Energy Over Weight
EPS	Electrical Power System
ET	External Tank
E/W	Energy Over Weight
EXEC	Execute
FA	Flight Aft-MDM
FB	Feedback
FCS	Flight Control System
FDA	Fault Detection and Annunciator
FDF	Flight Data File
FF	Flight Forward-MDM
FPR	Flight Performance Reserve
FRF	Flight Readiness Firing
FTO	Functional Test Objectives
FTR	Flight Test Requirements
FWD	Forward
GNC	Guidance, Navigation, and Control
GPC	General Purpose Computer
GRTLS	Glide Return To Launch Site
GS	Glide Slope
GSI	Glide Slope Indicator
GSTDN	Ground Spacecraft Tracking and Data Network

HA	Altitude at Apogee
HAC	Heading Alignment Cylinder
HDG	Heading
HORIZ	Horizontal
HPFT	High-pressure Fuel Turbopump
HPOT	High-pressure Oxidizer Turbopump
HSD	Horizontal Situation Display
HSI	Horizontal Situation Indicator
HYD	Hydraulic
I/F	Interface
IECM	Induced Environmental Contamination Monitor
I-LOAD	Initialization Load
IMU	Inertial Measurement Unit
IPL	Initial Program Load
KSC	Kennedy Space Center
LCC	Launch Control Center
LCH	Launch
L/D	Lift-to-drag Ratio
LDG	Landing
LH2	Liquid Hydrogen
LPS	Launch Processing System
LOS	Loss of Signal
LOX	Liquid Oxygen
LVLH	Local Vertical Local Horizontal
LVIY	Local Vertical Inertial Yaw
M	Mach
MAN	Manual
MANF	Manifold
MC	Mission Complete
MCC	Mission Control Center
MCDS	Multifunction CRT Display System
MDM	Multiplexer/Demultiplexer
ME	Main Engine
MECO	Main Engine Cutoff
MEP	Minimum Entry Point
MET	Mission Elapsed Time
MLS	Microwave Landing System
MM	Major Mode
MNVR	Maneuver
MPL	Minimum Power Level
MPS	Main Propulsion System
MS	Moding, Sequencing and Control
MSBLS	Microwave Scan Beam Landing
MVR	Maneuver
Nz	Normal Acceleration
OBS	Operational Biomedical System
OPF	Operational Flight Profile
OFT	Orbital Flight Test

OMS	Orbital Maneuvering System
OPS	Operations
P	Roll Rate
PASS	Primary Avionics Software System
pb	Pushbutton
PBI	Pushbutton Indicator
Pc	Chamber Pressure
PCMMU	Pulse Code Modulation Master Unit
PDP	Post-Insertion Deorbit Prep
PFS	Primary Flight System
PL	Payload
PLT	Pilot
PPD	Powered Pitchdown
PRI	Primary
PRO	Proceed
PRTLS	Powered Return To Launch Site
$\bar{q}$	Dynamic Pressure
Q	Pitch Rate
R	Yaw Rate
RA	Radar Altimeter
RCS	Reaction Control System
RCVR	Receiver
REF	Reference
REI	Range At Entry Interface
RF	Radio Frequency
RGA	Rate Gyro Assembly
RHC	Rotational Hand Controller
RNG	Range
RPL	Rated Power Level
RPTA	Rudder Pedal Transducer Assembly
R/S	Range Safety
RS	Redundant Set
RSS	Range Safety System
RTLS	Return to Launch Site
SAF	Safety
SBTC	Speed Brake Thrust Controller
SEC	Secondary
SEP	Separation
SEQ	Sequence
SM	Systems Management
SOP	Subsystem Operating Program
SPEC	Specialists (Function)
SPI	Surface Position Indicator
SRB	Solid Rocket Booster
SSME	Space Shuttle Main Engine
STDN	Space Tracking Data Network
STG	Staging
SV	State Vector
S/W	Software
sw	Switch



tacan	Tactical Air Command and Navigation
TAEM	Terminal Area Energy Management
TBD	To Be Determined
TDRSS	Tracking and Data Relay Satellite System
TFF	Time to Free Fall
TFL	Telemetry Format Load
THC	Translational Hand Controller
THROT	Throttle
TIG	Time of Ignition
TMECO	Time of Main Engine Cutoff
TPF	Transfer Phase Final
TPS	Thermal Protection System
TTA	Time To Apogee
TTC	Time To Circularization
TTP	Time To Perigee
TVC	Thrust Vector Control
$V_i$	Inertial Velocity
$V_{rel}$	Relative Velocity
VU	Vehicle Utility
WP	Way Point
WONG	Weight On Nose Gear
WOW	Weight On Wheels



ASCENT FLIGHT  
PHASE DESCRIPTION

2



**ASCENT FLIGHT  
PHASE DESCRIPTION**

## SECTION 2 ASCENT FLIGHT PHASE DESCRIPTION

### 2.1 ASCENT FLIGHT PHASE

The ascent flight phase is comprised of those activities a crew performs to prepare for launch, to monitor ascent performance, and to perform the Orbital Maneuvering System (OMS) burns required for a nominal, Abort To Orbit (ATO), or Abort Once Around (AOA) ascent through the OMS 2 burn. The ascent flight phase is shown in figure 2-1 and the ground track is shown in figure 2-2. The nominal ascent covered in this document begins before lift-off and ends shortly after the OMS 2 burn into a 150-n. mi.-altitude circular orbit.

The ATO ascent phase begins at abort initiation and ends shortly after the second OMS burn (ATO 2) into a 105-n. mi.-altitude circular orbit. The AOA begins at abort initiation or failure identification and continues through crew egress. The contingency abort begins at second-engine failure and continues through crew ejection.

The Backup Flight System (BFS) ascent is basically the same as other ascents but with reduced capability. A description of each flight phase is included in this section. The profile used for these descriptions is the Operational Flight Profile, Cycle 2 for STS-1. The events identified in these descriptions that have crew interface are expanded in section 4, Ascent Crew Monitoring and Control.

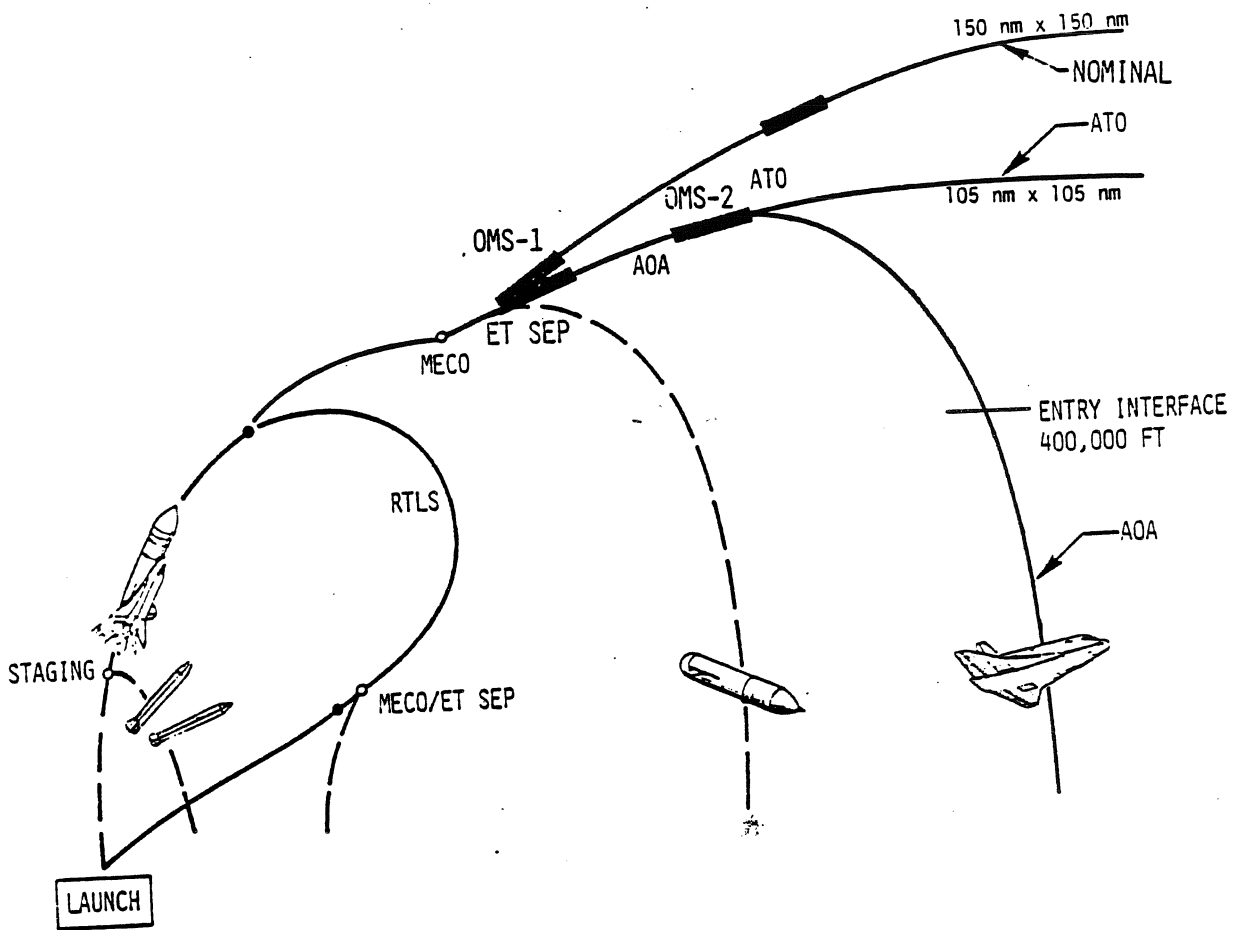

Figure 2-1.- Ascent flight phase.

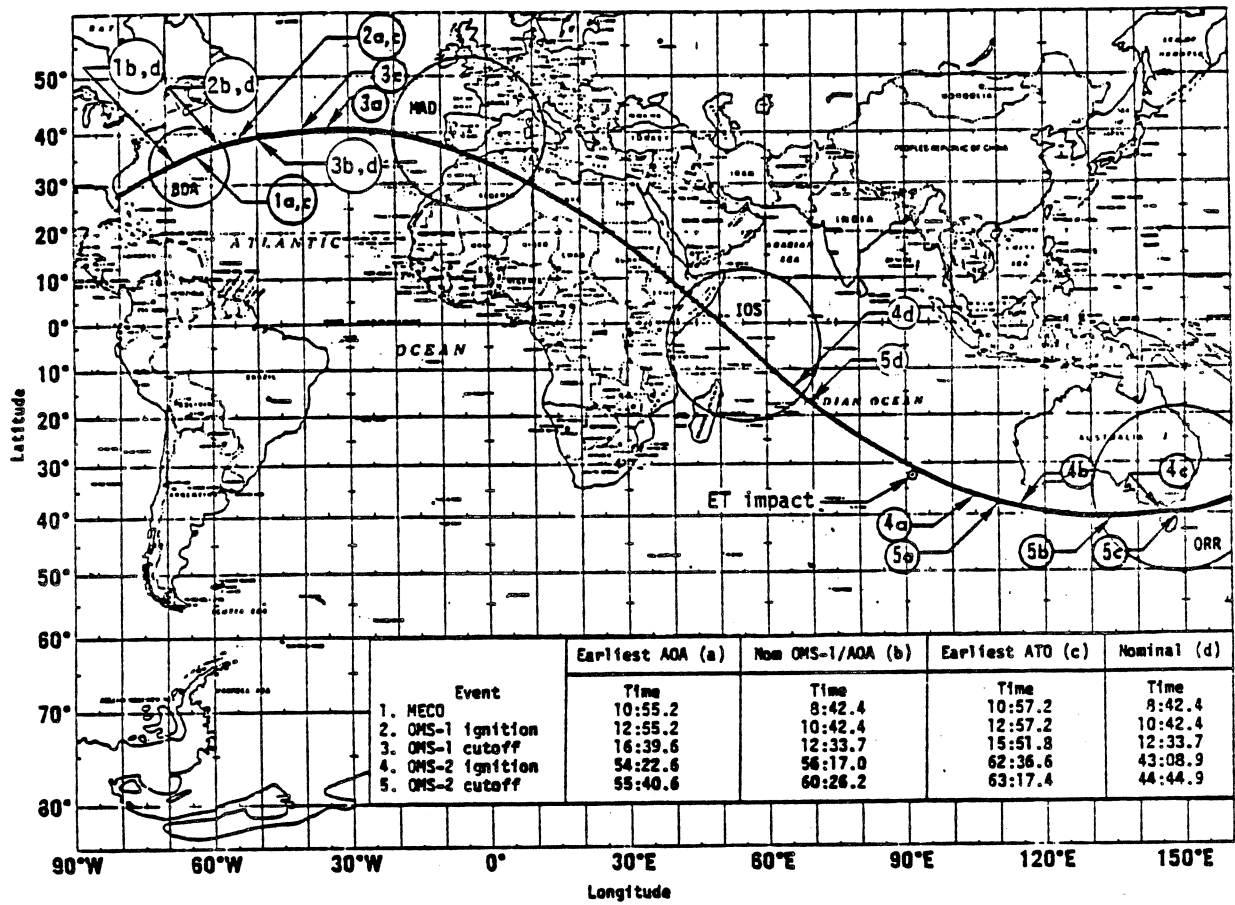

Figure 2-2.- Ascent ground track.

## 2.2 NOMINAL

The ascent phase for a nominal flight will normally be performed using the automatic mode; however, if it is determined that the automatic system is not guiding the vehicle on the proper trajectory, it is possible for the crew to use manual guidance and throttling. The manual mode can also be used in abort cases. Either the automatic or manual modes can be used to maneuver the Orbiter into a safe orbit or to perform an abort in basically the same manner. Techniques peculiar to the powered-flight manual mode are described in section 4.

The crew ingresses the Orbiter at lift-off minus 1 hr and 50 min. The computers' configuration is four computers running the precount Guidance, Navigation, and Control (GNC) OPS 9 software and the fifth computer loaded with the BFS software in standby. The ground crew assists the flight crew into the seats, and configures switches for lift-off that the flight crew cannot reach. The ground crew will close the side hatch by T-1:10:00. When in the seats, the crew will conduct an intercom and air-to-ground voice check. Kennedy Space Center (KSC) does an abort advisory check in OPS 9 with the crew. The crew will monitor preflight checks done by the ground. After the side hatch is closed, the cabin leak check starts. One hr before lift-off, the Inertial Measurement Unit (IMU) is aligned by the ground.

At ~T-50 min, the crew will turn on the water boiler controllers and the boiler N2 supply to prepare for Auxiliary Power Unit (APU) startup. At T-30 min, there is the capability for a first-stage guidance polynomial update using the day-of-launch winds. The OMS GN2 is prepressurized so the ground can check its status. The crew will open the cabin vent valves to allow cabin pressure to reach ambient pressure.

At T-25 min, the crew initiates the one-shot Primary Avionics Software System (PASS)-BFS transfer and performs air-to-ground voice checks at this time. At T-20 min, the crew will transition the PASS General Purpose Computers (GPC's) from OPS 9 to OPS 1. After OPS 1 has been loaded as indicated by the OPS 1 display appearing on the CRT and a ground call, the BFS GPC is placed in RUN and transitioned to OPS 1. The Launch Processing System (LPS) commands a memory dump to verify the load. The crew overrides LPS helium isolation valve control.

The IMU software configures from a velocity tilt mode to a biased inertial mode at the transition to OPS 1. One-g and Earth rate drift compensation factors are used to determine platform torquing requirements to cover the mode transition period and to maintain a predefined launch alignment until the platform becomes inertial at T-12 sec. In the inertial mode, compensation is limited to the zero-g factors used to ensure accurate inertial operation.

The Mission Control Center (MCC) and the Launch Control Center (LCC) perform an abort advisory check with the crew. At T-9 min, there is a planned 10-min hold and the 'GO/NO GO' for launch calls are given. The ground launch sequencer which is the automatic LPS takes control at T-9 min. If there is a recycle after this time, it will recycle to this point.



The APU's and hydraulics are powered at ~T-5 min. The crew monitors the Main Propulsion System (MPS) helium topping off, and near lift-off, turns on the Development Flight Instrumentation (DFI) recorders, closes the cabin vent valves, configures the heaters for launch, arms the OMS engine, inhibits APU shutdown, and turns on a camera. At T-35 sec, the vent doors start opening for launch. The vent opening is staggered at six 5-sec intervals. The position of the vents is verified prior to launch by the Redundant Set (RS) launch sequence. The crew has no way to monitor or control the vent doors during OPS 1.

The LPS controls the countdown sequence until T-25 sec, when the flight software takes control of the sequence. The flight software continues to watch for an LPS-generated hold through main engine start and until it commands Solid Rocket Booster (SRB) ignition.

The crew will monitor the start of the Space Shuttle Main Engines (SSME's) on the Pc gauges. When all three engines have achieved a 90-percent Rated Power Level (RPL) plus 2.75 sec, the SRB's are ignited and lift-off occurs. If all engines do not achieve a 90-percent RPL within 4.6 sec, an orderly shutdown of the engines will occur automatically. At lift-off, the major mode changes to first stage (MM 102) which has an open loop guidance system based on relative velocity. The crew will call 'LIFT-OFF.'

The vehicle rises vertically until it clears the service tower. At tower clear, handover of ground control occurs from the LCC to the MCC. At ~T+7 sec, when relative velocity reaches 121.2 ft/s, first-stage steering commences with a pitch, yaw, and roll maneuver which puts the crew heads down and aligned with the launch azimuth. The crew will call 'MANEUVER INITIATE.' When the maneuver stabilizes, the Attitude Direction Indicator (ADI) reference switch is moved to Local Vertical Local Horizontal (LVLH). As dynamic pressure rises, the loads on the vehicle rise. To provide load relief for the elevons, the elevons follow an I-loaded schedule (fig. 2-3) of position based on relative velocity. Loads are further minimized by augmenting the schedule as a result of the sensed differential hydraulic pressure across the elevon secondary actuators. To provide vehicle load relief, the gains in the flight control system are adjusted to emphasize load relief and to deemphasize the vehicle's ability to follow the reference trajectory. These gain changes are based on sensed normal acceleration ( $N_z$ ) and result in the vehicle turning into the wind. The vehicle load relief starts at  $V_r = 547$  ft/s (Mission Elapsed Time (MET) ~25 sec) and ends at  $V_r = 2628$  ft/s (MET ~91 sec), and the elevon schedule starts at lift-off and ends at  $V_r = 2627$  ft/s (MET ~91 sec). There is no way for the crew to monitor or control these activities. At ~32 sec, the SSME's are throttled down to 65 percent to limit maximum dynamic pressure ( $\bar{q}$ ) to 580 psf. The maximum  $\bar{q}$  occurs at ~52 sec and the engines are throttled back up to 100 percent at 59 sec. At the altitude (100,000 ft) that it is not safe to eject, the crew will get a 'NEGATIVE SEATS' call from MCC and the shuttlebug will pass the 100K tick mark on the BFS, ASCENT TRAJ 1 display on Cathode Ray Tube (CRT) 3. Throughout powered flight, the crew monitors vehicle attitude on the ADI to compare with cue card values. An altitude-vs.-velocity trajectory plot is available from the ASCENT TRAJ 1 display for additional information. The attitude errors from the primary system shown on the ADI are compared to the attitude errors from the BFS shown on the TRAJ display to indicate differences between the primary

system and the BFS. In addition, GNC SYS SUMM is on CRT 2 for systems monitoring. Dedicated displays available during ascent are the ADI, Horizontal Situation Indicator (HSI), Alpha/Mach Indicator (AMI), and Attitude/Vertical Velocity Indicator (AVVI) (sec. 4.1.3).

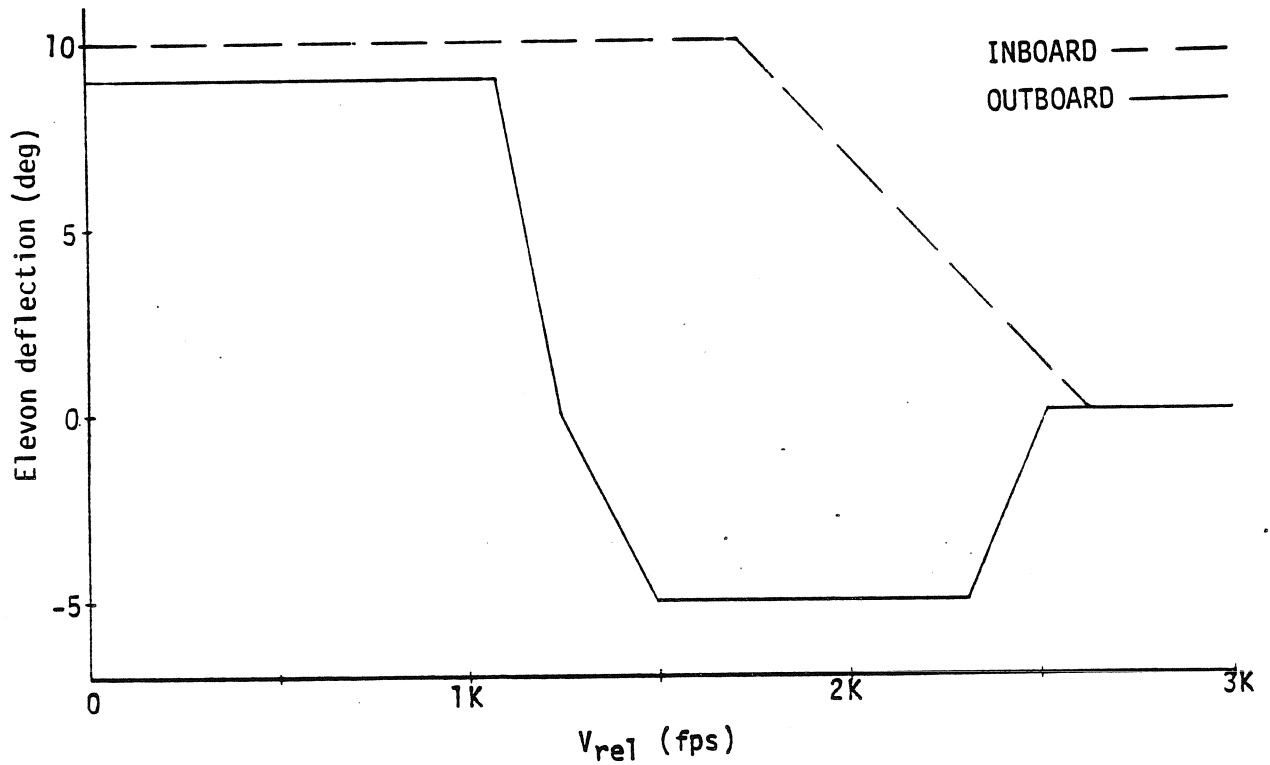

Figure 2-3.- Ascent elevon schedule.

When  $\bar{q}$  is below the SRB separation limit, MCC will call 'GO FOR SRB SEP.' At  $\sim T+2$  min, the crew should observe the SRB 'PC < 50' discrete appearing on the CRT display, and should expect SRB staging about  $\sim 4$  sec later.

The vehicle will be in attitude hold during the staging sequence, but will commence second-stage closed-loop guidance steering when guidance converges. The crew will observe guidance initiation on the ADI and by TMECO stabilization on the ASCENT TRAJ display.

The crew will verify that the flash evaporators are working, get an 'EVAP IS GO' call, and turn on the flash evaporator duct and nozzle heaters. Second-stage guidance targets to a specific inertial velocity, flight path angle, radius (altitude), inclination, and longitude of ascending node. Initially, the trajectory is shaped to allow for reaching the target following shutdown of one SSME at  $T_{fail}$  which presently occurs at  $T+4:00$ . MCC will call 'PRESS TO MECO' when at least an AOA can be performed if an engine fails. At  $T_{fail}$ , the software is moded to assume that no engine failure will occur. The vehicle then pitches down from the lofted 'engine-out' trajectory and flies to the target on a three-engine trajectory. This pitch maneuver is about  $25^\circ$ .

MCC will call 'NEGATIVE RETURN' when RTLS capability no longer exists; 'SINGLE ENGINE, THERMAL' when the procedure is to press to MECO in the automatic mode if two engines fail; 'SINGLE ENGINE PRESS FOR MECO' when at least a shallow AOA can be done if two engines fail. When the acceleration level reaches 3g at  $\sim T+7:40$ , the SSME's will begin throttling back to maintain 3g until 6 sec prior to MECO. At that time, the engines are throttled down to 65 percent to prepare them for shutdown. As the MECO target is approached, guidance relinquishes control of the MECO position parameters and concentrates on flightpath angle and inertial velocity. Approximately 5 sec before MECO, a fine cutoff mode is entered and guidance controls only for the inertial velocity of MECO.

MECO occurs at  $\sim T+8:43$ . Manual MECO may be commanded via engine power switches on panel R2 or the engine shutdown pushbuttons on panel C3. At MECO, an attitude hold is started using the Reaction Control System (RCS).

The first activities that occur after MECO are the monitoring of External Tank (ET) Separation (SEP) and the -Z RCS translation maneuver. The crew can determine that ET SEP has been commanded by observing the MAIN ENGINE STATUS lights on panel F7 extinguish. While waiting for SEP to occur, the crew will verify roll  $>170^\circ$ . The SSME's are positioned for the MPS dump during this SEP sequence, but the crew cannot monitor this. As soon as a 4-ft/s -Z translation is completed, the software transitions to the insertion major mode and the OMS 1 MNVR EXEC display comes up on the CRT with the I-loaded OMS 1 targets automatically loaded. The crew then verifies both roll and yaw  $<10^\circ$  about  $180^\circ$  and  $0^\circ$ , respectively, for ET SEP. If true, a 4-ft/s (Translational Hand Controller (THC) for 24 sec) +Y translation maneuver is performed. The MCC will inform the crew if the nav state will be updated or if an abort is required. A 'GO' for APU shutdown will also be made by MCC prior to Bermuda Loss of Signal (LOS). The crew verifies the burn target in both the PASS and BFS, and then maneuvers to the burn attitude. The burn is enabled by keying 'EXEC' within 15 sec before the Time of Ignition (TIG). OMS 1 TIG is set to occur 1 min 43 sec after ET SEP. For the nominal case, this will make OMS 1 ignition at

MECO+2 min. During the burn, the crew monitors the burn on the OMS 1 MNVR EXEC display, SYS SUMM 2 display, and dedicated gauges. After completion of the OMS 1 burn, the crew nulls any residual delta velocity to less than 2 ft/s with the RCS using the THC, and notes any anomalies. At Bermuda LOS the crew will block all uplink.

The MPS Liquid Oxygen (LOX) dump automatically starts when the OMS 1 burn is initiated. The Liquid Hydrogen (LH2) dump starts 10 sec after the LOX dump is terminated. The dump will normally not be monitored by the crew. However, the crew will allow at least 3 min 21 sec to pass between initiation of the burn and APU shutdown to ensure completion of the dump and the stowing of the engines. In addition, the BDY FLP pb lights on panels F2 and F4 will extinguish when the SSME's are stowed.

After the APU shutdown, the crew activates the flash evaporator feedline and cryo tank heaters. The crew then transitions the software to the OMS 2 insertion mode, causing the OMS 2 MNVR EXEC display to come up on the CRT with the I-loaded OMS 2 burn set up and the targeting parameters on it. The crew enters the OMS trim values, and then 'loads' the targets. The commander verifies the targeting parameters while the pilot powers down the MPS and begins the MPS vacuum inerting procedure. This inerting is scheduled for ~30 min and will be terminated 5 min prior to the OMS 2 burn. After the MPS H2 PRESS LINE VENT has been open for at least 1 min, the pilot will close it and then proceed with ET umbilical door closure. The doors will be closed in OPS 1 to take advantage of the software backup procedure if any problem with the hardware is encountered. Thus, it is desirable for the doors to be closed prior to the Madrid Acquisition of Signal (AOS), where moding to OPS 3 will be accomplished, if required (AOA).

At Madrid AOS, the crew will enable uplink and perform an I/O RESET. The procedure to block all uplink at LOS and block none at AOS will be done at every station pass during ascent and entry. The crew will then give MCC the status of the OMS 1 burn and will receive verification of the proper OMS 2 target and whether the nav state needs updating. The Orbiter will be maneuvered to the burn attitude and the OMS switches checked. The ejection seats will then be safed and adjusted. The Indian Ocean Site AOS will be available for part of the OMS 2 burn. This burn is initiated at the approximate time apogee is reached. The crew enables and monitors the burn as they did for OMS 1. The burns are normally flown automatically; however, the crew can take control with the Rotational Hand Controller (RHC) and fly manually at any time. At the completion of the burn, the Orbiter is in the desired orbit. The crew will note the postburn status, then reconfigure the OMS/RCS for on-orbit use. The crew transitions the software to the insertion coast major mode which terminates the ascent phase: The crew will then use the Post-Insertion Deorbit Prep (PDP) checklist.

### 2.3 ATO ABORT

The ATO aborts have been designed so that the Orbiter can reach a safe orbit after an engine failure. ATO is the preferred abort mode. ATO may be performed because of certain systems failures as identified in the Flight

Rules. The MCC is prime for identifying the abort mode. The selection is made by a crewman positioning the ABORT MODE selector on panel F6 to ATO or by using the ATO OMS targets. The initiation is normally accomplished after MECO. For STS-1, the MECO targets for nominal, ATO, and an AOA are the same and there is no pre-MECO OMS dump for ATO or AOA. The abort initiation is accomplished after MECO to ensure that RTLS and contingency capability are retained as long as possible and to take maximum advantage of observed performance in making the ATO-vs.-AOA abort mode determination. For STS-1, the OMS 1 target for an ATO and an AOA is the same. By having a common target, the only decision which needs to be made before the OMS 1 burn is whether or not an abort is required (150-n. mi. vs. 105-n. mi. orbit). The final decision on the abort mode (ATO vs. AOA) can be made after OMS 1.

The procedures used for the ascent portion of an ATO are the same as the normal procedures except the OMS 1 and 2 burn targets change. These targets will allow the Orbiter to achieve a 105-n. mi.-circular orbit after two OMS burns. After this safe orbit is achieved, the mission may be continued as long as possible in that orbit, additional burns may be made to raise the orbit, or the mission may be ended early.

#### 2.4 AOA ABORT

The AOA aborts have been designed for a single-engine failure case. That is the assumption in this description; however, a three-engine AOA would be similar. AOA may be performed because of certain systems failures as identified in the Flight Rules. The MCC is prime for deciding the abort mode. If it is decided that a fast return is required after RTLS abort capability is lost, then an AOA will be chosen. The earliest an engine can fail and an AOA be performed is ~3 min 40 sec MET. An AOA abort is initiated by the crewman positioning the ABORT MODE selector on panel F6 to AOA and pushing the ABORT pushbutton or by using the AOA OMS targets. This action will normally be taken following MECO. The title on the OPS display reflects the abort selection (i.e., via the ABORT MODE switch and ABORT pushbutton). For STS-1, the ATO and AOA OMS 1 burns have the same target. Thus, for MECO underspeeds which allow ATO or AOA aborts, the crew will downmode to ATO for the OMS 1 burn. This allows time after the OMS 1 burn to decide on the proper abort mode. However, once the APU's are deactivated, AOA capability exists only if a hot restart is used. Thus, MCC will decide before Bermuda LOS if an AOA is likely, and inform the crew to only depress hydraulics. A final decision will then be made at Madrid. For STS-1, AOA selection pre-OMS 1 will give a shallow AOA target solution based on there being a large underspeed condition at MECO.

Events up until Madrid AOS will occur nominally except hydraulics will be depressed, the times will change, and the OMS 1 burn will have different target parameters.

Over the Madrid Ground Spacecraft Tracking and Data Network (GSTDN) site, if the decision to do an AOA is made, the crew will reconfigure the Data Processing System (DPS) to the entry configuration (GNC OPS 3). If an AOA abort mode is selected, these targets are calculated while in GNC OPS 1 and carried across the transition to OPS 3. MM 105 (AOA TRANS) is used to

carry parameters from GNC OPS 1 to GNC OPS 3 and the transition to OPS 3 is not completed until the targets have been verified. When the reconfiguration is complete, the deorbit maneuver display comes up on the CRT with the I-loaded deorbit burn set up and targeting parameters displayed. If an AOA is not selected, it can still be performed by the crew transitioning from OPS 105 to OPS 301 and then manually entering the AOA deorbit targets. The AOA parameters will not be carried over to OPS 3 since AOA selection is not made.

The TIG of the burn is adjusted such that the range from Entry Interface (EI) (400,000 ft) to the target landing site is approximately the reference range. The crew then adjusts the seats, maneuvers to the deorbit burn attitude, and prepares for the burn. The vent doors are closed for entry. At Indian Ocean Site AOS, the crew will receive deorbit and landing pads from MCC.

The MPS vacuum inerting will be terminated by the pilot ~10 min before the deorbit burn. The MPS helium system is activated and if required the forward RCS is dumped to control the center of gravity (c.g.) for entry. After the burn, a maneuver to EI attitude will be accomplished along with a postdeorbit burn check. EI occurs ~18 min after the deorbit burn. Procedures from EI to landing are the same as nominal entry except hydraulics are repressed at  $\bar{q} = 1$ .

## 2.5 RTLS ABORT

The RTLS abort is the intact abort mode that provides the capability for a suborbital return of the Orbiter, crew, and payload directly to the KSC Shuttle landing field within ~22 min after lift-off for aborts initiated during the first 282 sec of ascent. The RTLS was basically designed as a response to early loss of thrust of a single SSME, but its inherent capabilities also provide a three-SSME return capability for time-critical failures requiring an immediate return early in ascent.

RTLS is subdivided into powered-flight, separation, and glide-flight regimes. The RTLS ET SEP maneuver makes the transition from the Orbiter/ET powered-flight configuration to the Orbiter glide-flight configuration. A typical RTLS trajectory profile is presented in figure 2-4, which indicates the associated flight regimes.

### Powered RTLS

The Powered RTLS (PRTLS) is that portion of RTLS during which the SSME's are burning. It begins when the abort is initiated and terminates at MECO. If an RTLS is required, it is initiated in second stage after 2:30 MET for two-SSME or 4:20 for three-SSME by placing the ABORT MODE selector in RTLS and pushing the ABORT pushbutton. This also signals the start of the PRTLS propellant dissipation phase. At this time, the title of the TRAJ display changes from ASCENT to RTLS and the OPS from 103 to 601. This phase is designed to continue powered flight downrange to dissipate fuel at a constant thrust attitude (function of when the engine failed) until the pitcharound maneuver is performed. At pitcharound, the OMS/RCS

burns are started. This phase is not used for late RTLS aborts ( $t > 255$  sec) where pitcharound would be performed immediately. Except for the latter, pitcharound is delayed until the MPS propellant remaining is just sufficient to achieve the required RTLS MECO targets.

The pitcharound maneuver is essentially an inplane pitch maneuver (excluding yaw steering effects) at  $\sim 10$  deg/s to orient the Orbiter/ET configuration in a heads-up attitude, pointing back toward the launch site (retrograde). Once the pitcharound has occurred, flyback guidance will be initiated to null the downrange velocity and add sufficient uprange velocity for the Orbiter return. During the flyback phase, the vehicle will be explicitly targeted to the altitude, flightpath angle, and range-velocity line. Also, active SSME throttling will be performed to make final adjustments to the MPS propellant remaining to allow for a satisfactory ET SEP (less than 2 percent excess MPS propellant remaining in the ET) and to remain below the 3g acceleration level. All OMS/RCS propellant dumps should be completed before the Powered Pitchdown (PPD) maneuver to minimize the dynamic effects near MECO.

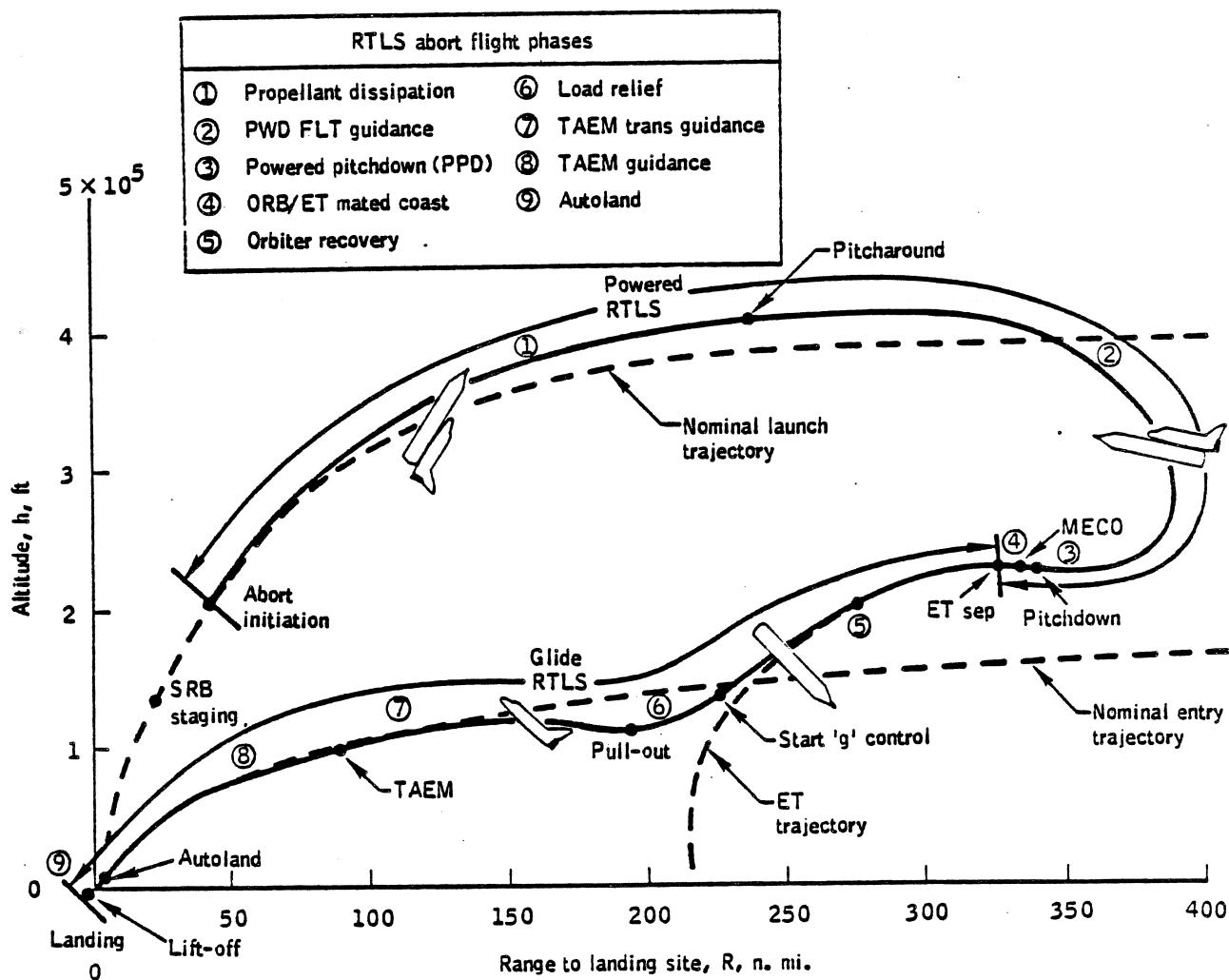

Figure 2-4.- Typical RTLS profile.

The final PRTLS phase is the PPD phase. This phase starts ~20 sec before MECO where active MECO targeting is terminated. The PPD takes the mated vehicle from a relatively high angle of attack to the required separation attitude ( $\alpha = -4^\circ$ ,  $\beta = 0^\circ \pm 2^\circ$ ) and pitch rate ( $Q = -0.25$  deg/s). MECO will then be performed when the desired cutoff velocity has been achieved based on the MECO range-velocity line.

The crew will monitor the PRTLS trajectory on the ADI, HSI, AMI, AVVI, and CRT displays (RTLS TRAJ 2 (BFS), RTLS TRAJ (PASS)).

### RTLS ET Separation

At the MECO command, the glide RTLS Digital Autopilot (DAP) is enabled, and at zero thrust, the ascent DAP is terminated. The last guidance-commanded attitude is maintained through confirmation of MECO and initiation of the ET SEP sequence. The ET SEP is commanded and a 10-sec -Z translation with four forward and six aft RCS jets is performed. After 5 sec, selected -Z jets may be turned off for roll/pitch control. The -Z translation ends when at least 10 sec have elapsed and  $\alpha > 10$  deg.

### Glide RTLS

Glide RTLS (GRTLS) begins at the end of the Orbiter -Z translation and terminates at landing. Also, at completion of the translational maneuver, the GPC's will transition to MM 602, or the crew can select OPS 602 via the keyboard. In either case, the VERT SIT 1 display will appear on the CRT for monitoring the RTLS entry to the nominal Terminal Area Energy Management (TAEM) interface. For GRTLS, the VERT SIT 1 and 2, the HORIZ SIT, GNC SYS SUMM 1, and the dedicated displays will be used to provide information.

The GRTLS consists of eight flight phases which correspond to the guidance codes used during GRTLS. Seven of these phases are contained within the GRTLS TAEM guidance which guides the Orbiter through all of the GRTLS flight phases from the end of the Orbiter -Z translation to the approach and landing interface on final approach. The final phase is the approach and landing phase. The first three phases of the GRTLS TAEM guidance are unique to this guidance mode and the last four phases are identical to those of the TAEM guidance for normal entry. The first three phases of the GRTLS TAEM guidance - alpha recovery, the Nz hold, and the alpha transition phases - are required to stabilize the trajectory following the Orbiter/ET SEP with  $\alpha$  transition incorporating range control. The remaining four phases of the GRTLS guidance - the S-turn, acquisition, heading alignment, and prefinal phases - accomplish the additional ranging, if necessary, and are identical to those phases of the TAEM guidance used for normal entry with two exceptions. The energy per unit weight, altitude, and dynamic pressure references are extended to higher speeds to include all possible conditions where the trajectory is stabilized following the load relief maneuver. In addition, to provide greater energy control, the bank angle limit during the S-turn is increased from  $30^\circ$  for nominal entry to  $50^\circ$  for GRTLS.



Alpha recovery phase: The alpha recovery phase begins at the end of the Orbiter -Z translation burn and maneuvers the Orbiter attitude from the low angle of attack required for separation to the high angle of attack and a wings-level attitude in preparation for a low-speed entry. This attitude is maintained until transition to the Nz hold phase. For STS-1, the constant angle of attack for the alpha recovery phase is  $50^{\circ}$ , which minimizes the peak dynamic pressure experienced during GRTLS. The choice of an alpha of  $50^{\circ}$  also helps to assure that adequate Orbiter lateral control will be maintained during the pullout portion of the Nz hold phase. Following the Orbiter -Z translation, the Orbiter pitches up at a 2-deg/s rate to the recovery angle of attack. At MM 602 transition, an MPS fuel dump is initiated. The MPS dump is scheduled to terminate at Mach = 4.5 to eliminate potential fire or explosion hazards from ingestion of vapors through fuselage vents.

Attitude control during this phase is accomplished by aft RCS thrusters and by aerodynamic surface effectors. Use of the aft roll and pitch RCS thrusters is terminated when dynamic pressures of 10 psf and 20 psf, respectively, are reached. The aft yaw jets remain active to assist in lateral control until Mach 1. The elevons and body flap are activated upon transition to MM 602. The GRTLS flight control system schedules the elevons and controls the body flap to null the elevator trim command. When a dynamic pressure of 20 psi is reached, the speed brake is activated to enhance lateral stability by increasing the Orbiter positive pitching moment.

The recovery angle of attack is maintained until the Nz increases to within 0.35g of the desired Nz (2g) during the Nz hold phase. Switching to the Nz hold phase before reaching the desired Nz provides for a smooth transition into the Nz hold phase with minimum Nz overshoot.

Nz hold phase: The Nz hold phase maintains the normal load factor at a predetermined value by reducing the angle of attack as dynamic pressure increases. To minimize aerodynamic loads, the Orbiter is maintained in a wings-level attitude during this phase. For STS-1, the commanded Nz for this phase is a constant 2g's (can be monitored on the AMI ACCEL tape) allowing a 0.5g margin from the structural design limit. Also, during this phase, alpha must be greater than alpha reference (fig. 4-24) to allow sufficient lateral controllability margins, particularly in the presence of aerodynamic variations, and to meet the transition criteria from this phase to alpha transition.

To prevent execution of maneuvers that could induce subsequent high aerodynamic loads and unfavorable flight conditions, all ranging techniques, including S-turns, are inhibited during this phase.

After arresting the descent rate ( $\dot{H} > -250$ ), and if alpha > alpha reference, the guidance switches to the alpha transition phase.

Alpha transition phase: During this phase, an angle of attack command is generated as a linear function of Mach number (can be monitored on the VERT SIT 1 Mach- $\alpha$  profile), and a bank maneuver is performed either to null any heading errors to the Heading Alignment Circle (HAC) tangency

point or to dissipate excess energy by turning away from the nearest HAC (S-turns). The maximum bank angle for this phase is 50°.

Because the alpha recovery and the Nz hold phases are both open loop with regard to energy management and sufficient energy must be available to cope with open-loop energy losses from headwinds and unfavorable Lift-To- Drag Ratio (L/D) variations, GRTLS is intentionally targeted to produce an excess energy state at the initiation of the  $\alpha$ -transition phase. Therefore, S-turns will be started nominally during the  $\alpha$  transition phase, and in most cases will be completed prior to initiation of the nominal TAEM phases. The transition to the nominal TAEM phases and from MM 602 to MM 603 occurs at Mach 3.2. Also, the Orbiter symbol on VERT SIT 1 will transfer from the  $\alpha$ -Mach profile to the range altitude lines at Mach 3.2.

GRTLS TAEM phases: As stated previously, the remaining four phases of GRTLS guidance - S-turn, acquisition, heading alignment, and prefinal phases - are identical to the phases of the nominal TAEM guidance except for:

1. The energy per unit weight, altitude, and dynamic pressure references are extended to higher speeds to include all possible conditions existing when the trajectory is stabilized following the load relief maneuver.
2. To provide greater energy control, the bank angle limit during S-turn is increased from 30° for normal entry to 50° for GRTLS.

Nominal TAEM interface and the MM 603 transition both take place at Mach 3.2. At TAEM interface (MM 603 transition), one of two things will occur:

1. If the vehicle was in an S-turn at the MM 603 transition, the TAEM S-turn phase will be initiated and the S-turn continued until the Energy Over Weight (E/W) is below the S-turn termination reference, at which time the TAEM acquisition will begin.
2. If the vehicle was not S-turning at the MM 603 transition, the TAEM acquisition phase will be initiated and the E/W will be tested to determine if an S-turn is required. If an S-turn is required, the TAEM S-turn phase will be initiated. If no S-turn is required, guidance will remain in the TAEM acquisition phase.

GRTLS approach and landing: Autoland guidance for GRTLS is identical to the autoland guidance for approach and landing in nominal entry. This guidance incorporates five phases: the trajectory capture, steep glide slope, flare and shallow glide slope, final flare, and the touchdown phases. Autoland guidance is initiated when the TAEM/autoland interface conditions are met (~13,000 ft altitude) and processes guidance commands through rollout. The HORIZ SIT display is used during this phase.

For STS-1, the crew will manually fly the Orbiter from ~32,000 ft through landing and rollout while monitoring the vehicle's auto guidance.

## 2.6 CONTINGENCY ABORT

The contingency abort is a non-intact abort caused by two or more SSME failures before ~7:00 during ascent; it results in a crew ejection at 10,000 feet. With a two-engine failure at T+7:00 or later, the AOA MECO target can be reached. Failures before this will require a crew ejection. The RTLS MECO can be reached if the loss of the second engine occurs ~30 seconds or less before the MECO target. In this case, guidance will be provided for MM 602. Other contingency aborts will normally not have scheduled guidance.

There are three critical phases to the contingency abort: single-engine powered flight, ET SEP, and entry. In all cases of multiple-engine failure, the vehicle will be flown manually (Control Stick Steering (CSS)). For engines out at lift-off, CSS will not be engaged until after the roll is completed. The attitude profile of the vehicle will depend on when the second engine failed. Generally, the idea is to get the mated vehicle to a vertical thrust attitude with the bottom of the Orbiter pointed in the direction of the velocity vector. For the region where  $\dot{H} < 500$  ft/s, this entails an attitude of  $100^\circ$  (REF ADI). For the region where  $\dot{H} > 500$  ft/s and  $H > 60$  n. mi., it will be necessary to null the positive rate and then pitch up to  $100^\circ$ . For the region where  $V_i = 10,000$  ft/s to  $V_i = 14,000$  ft/s (retrothrust region), the attitude is 10 times the Mach number (e.g.,  $V_i = 12,000$  ft/s,  $r = 120^\circ$ ). This retroattitude decreases velocity such that the thermal constraints will not be violated.

When the vehicle enters the sensible atmosphere, that is, when the Equivalent Airspeed (EAS) starts to build up, the Orbiter is pitched down to an angle of attack ( $\alpha$ ) =  $0^\circ \pm 5^\circ$  and sideslip angle ( $\beta$ ) =  $0^\circ \pm 5^\circ$ . It is probably more important to have a negative pitch rate than to meet an exact  $\alpha$  or  $\beta$  limit. The ET is separated via the fast SEP sequence. Crew task loading is high; therefore the commander should fly pitch and roll and the pilot should control sideslip, throttling of the remaining engine, and ET SEP.

After ET SEP, a -Z translation for 3 sec is input and the Orbiter is pitched up to an  $\alpha = 50^\circ$ . As the g's build up, the target  $N_z$  (~3g's) is held by decreasing alpha until pullout. After pullout, a Mach-alpha profile is flown until an EAS of 200 kt, which is flown down to 10,000 feet where the crew ejects.

The c.g. is adjusted within control limits for gliding flight by burning off excessive OMS propellant before MECO and RCS propellant after MECO. The dump is started as soon as possible after the loss of the second engine via an item entry on the CONT ABORT display (SPEC 52).

## 2.7 BACKUP FLIGHT SYSTEM ASCENT

A BFS is provided for ascent and entry in case of a primary flight system failure. The ascent will be basically the same whether the Orbiter is using the primary flight system or the BFS. Therefore, this description will be limited to differences between an ascent using the primary system and the BFS.

The BFS is functionally independent of the primary system and provides limited display and control capabilities. When the BFS is not engaged, the required data are obtained by 'listening' to data requested by the primary system as well as some transfer data obtained directly from the primary system.

The BFS software provides navigation, guidance, flight control, fault detection, displays and controls, systems management, and sequencing. It uses the same algorithms and guidance laws as the PASS to deliver the same performance, but with reduced capability. The BFS performs some functions in the preengage phase that the PASS does not. These functions include S-band antenna management, flash evaporator/ammonia boiler activation/deactivation, APU fuel quantity gauging, hydraulic water boiler quantity gauging, and the fuel cells' total current and power calculations. If the BFS is not operating properly, the S-band antenna management and flash evaporator activation will be performed manually for ascent.

The BFS provides nominal ascent, ATO, AOA, and RTLS capability. Contingency abort capability is not provided. No manual guidance capability is provided for ascent or PRTLS and no automatic flight control capability is provided for the OMS burns, entry, or GRTLS.

Crew displays and controls are limited in the BFS. Preengage, one CRT will be dedicated to the BFS. Ascent displays available are listed in table 4-1. The ADI and HSI are the only dedicated flight instruments driven during ascent. Some of the Caution and Warning (C&W) lights and meter-type instruments are not supported by the BFS. Many switches are not supported since they are not required because of the reduced capability.

Prelaunch, the BFS software is loaded into GPC 5. It is turned to 'RUN' immediately after the primary systems' software is transitioned from OPS 9 to OPS 1; however, the BFS cannot be engaged until after lift-off. The BFS can be engaged anytime during ascent via the pushbutton on top of either RHC. Once engaged, it is not possible to return to the PASS until after the PASS is loaded from memory (Initial Program Loaded (IPL'd)).

After lift-off, the BFS tracks the primary system status. Crew procedures relative to the BFS are monitoring the BFS preengage via the dedicated CRT. If needed, the BFS can then be engaged via either engage button on the RHC. Verification of engagement is made via the BFS light on eyebrow panels F2 and F4 and the loss of PASS displays.

---

ASSUMPTIONS, GUIDELINES,  
AND CONSTRAINTS

---



**3**

**ASSUMPTIONS, GUIDELINES,  
AND CONSTRAINTS**

SECTION 3  
ASSUMPTIONS, GUIDELINES, AND CONSTRAINTS

3.1 SOURCE

Numerous assumptions, guidelines, and constraints influence the development of the ascent checklist and cue cards. Most are identified in Flight Rules, the Flight Test Requirements, the Shuttle Operational Data Book, the Operational Flight Profile, and other program documents. This section provides a repository for those that are not recorded in other documents.

3.2 FLIGHT DATA FILE ORGANIZATION

1. In the Ascent Checklist Abort Once Around (AOA) Abort section, all times are representative of an AOA resulting from the loss of a single Space Shuttle Main Engine (SSME) at the earliest time that will allow an AOA abort.
2. All approved ascent and abort Orbital Maneuvering System (OMS) burn targets will be listed in the Ascent Checklist and all except AOA deorbit targets are listed on cue cards. The quantity of AOA deorbit targets, probability of use, and time available for use were factors that precluded placing this data on cue cards.
3. An Ascent Pocket Checklist containing quick-look reference material and short-form malfunction procedures will be available during ascent. During the first and second stages, execution of these procedures will be via cue cards.
4. For STS-1, first and second stages, Return to Launch Site (RTL) and contingency abort procedures will be published in 'long form' for review and training purposes in the Ascent Checklist, but inflight execution will be via cue cards. The Flight Data File (FDF) articles used during ascent/aborts are shown in table 3-1.
5. The Ascent Checklist follows the guidelines set forth in the Space Shuttle Flight Data File Preparations Standards, JSC-09958. Some format standards that may not be familiar are listed below.
  - a. A '✓' beside a switch callout means to verify that the switch is in that position and if it is not, to put it in that position.
  - b. Cathode Ray Tube (CRT) changes are shown in rectangular boxes whether the change is automatic or via crew input, except for OPS or major mode transitions or clearing the fault page. If a display has to be called by the spec number, the number will be listed in the rectangle.
  - c. Time-critical activities are marked with a '▶' to the left of the activity.

- d. As a reminder to configure uplink during Loss-Of-Signal (LOS) and Acquisition-Of-Signal (AOS) periods, (UPLINK BLK- ALL) is placed on the line with LOS calls and (UPLINK BLK- NONE) with AOS calls.
- e. OMS target parameters that are I-loaded (i.e., without keyboard input) are listed with an equal sign (=) between the parameter and the parameter number. If keyboard inputs are necessary, they are listed with a dash (-) and the item number.

TABLE 3-1.- ASCENT/ABORT FLIGHT DATA FILE USE SUMMARY<sup>a</sup>

Flight phase	FDF Article
Nominal ascent	
Prelaunch	Ascent C/L, Prelaunch and/or LCC call
Powered flight	Ascent Cue Cards RTLS Flight Rules <sup>b</sup> Ascent Procedures Press to MECO <sup>b</sup> Ascent ADI - Nominal Ascent ADI - Eng Out <sup>b</sup> ADI Error/Rate Switch (Ascent/Entry) Evap Out T High Cdr Comm Plt Comm O2 High Htr T ESS Bus V Low MPS Cdr Bus Loss Cabin Fan Failure GNC/RCS FC Stack & Exit T BCE Bypass MPS Dump
Post-MECO	Ascent Cue Cards Ascent Procedures OMS 1 Targets - Graph OMS 1 Burn Ascent Pocket C/L <sup>b</sup>

Cue Cards  
of Ascent Pkt C/L  
procedures<sup>b</sup>

<sup>a</sup>Ascent Flight Data File Articles:  
 Ascent Checklist  
 Ascent Pocket Checklist  
 Cue Cards (listed by title)  
 Entry Pocket Checklist (AOA only)

<sup>b</sup>Used if required because of off-nominal conditions.



TABLE 3-1.- ASCENT/ABORT FLIGHT DATA FILE USE SUMMARY (Continued)<sup>a</sup>

Flight phase	FDf Article
OMS 1	Ascent Cue Cards OMS 1 Burn Ascent Burn Monitor <sup>b</sup> Ascent Pocket C/L <sup>b</sup>
Post-OMS 1	Ascent C/L Ascent Cue Card OMS 2 Target - Graph Ascent Pkt C/L <sup>b</sup>
OMS 2	Ascent Cue Cards OMS 2 Burn (2 Eng) OMS 2 Burn (1 Eng) <sup>b</sup> OMS 2 Burn (RCS) <sup>b</sup> Ascent Burn Monitor <sup>b</sup> Ascent Pkt C/L <sup>b</sup>
Post-OMS 2	Ascent C/L Ascent Pkt C/L <sup>b</sup>
Go to Post-insertion Deorbit Prep Book	
Failures that have integrated procedures	
ET Feedline Disconnect Valve Failure - Post- MECO (from fail- ure identifica- tion)	Ascent C/L, FDLN DISC VLV FAIL Ascent Pkt C/L <sup>b</sup> Ascent Cue Cards OMS 1 Target - Graph OMS 1 Burn
OMS 1	Same as Nominal Ascent OMS 1.
Post-OMS 1	Ascent C/L, FDLN DISC VLV FAIL, then to Ascent C/L, Post-OMS 1. Then use the same FDF scheme as nominal ascent.

<sup>a</sup>Ascent Flight Data File Articles:

Ascent Checklist  
Ascent Pocket Checklist  
Cue Cards (listed by title)  
Entry Pocket Checklist (AOA only)

<sup>b</sup>Used if required because of off-nominal conditions.

TABLE 3-1.- ASCENT/ABORT FLIGHT DATA FILE USE SUMMARY (Continued)<sup>a</sup>

Flight phase	FDF Article		
Delayed OMS 1 - Post-MECO (from time it is de- termined that OMS 1 TIG delay greater than 4 min)	Same FDF as ET Feedline Disconnect Valve Failure except DELAYED OMS 1 is used instead of FDLN DISC VLV FAIL.		
Aborts			
ATO	Same as Nominal Ascent.		
AOA Post-OMS 1	Same as nominal ascent until post-OMS 1. After MAD AOS Ascent C/L, AOA Ascent Cue Cards OMS 2 Targets - Graph Entry Pkt C/L <sup>b</sup> Entry Cue Cards The remainder of AOA uses: Ascent C/L, AOA Entry Cue Cards (as used for nominal entry) Entry Pkt C/L <sup>b</sup>		
PRTL	<table border="0"> <tr> <td style="vertical-align: top;">                     Ascent Cue Cards                      Ascent Procedures                      RTL - Powered RTL                      ADI Error/Rate Switch (Ascent/Entry)                      Evap Out T High                      Cdr Comm                      Plt Comm                      O2 High Htr T                      ESS Bus V Low                      MPS                      Cdr Bus Loss                      Cabin Fan Failure                      GNC/RCS                      FC Stack &amp; Exit T                      BCE Bypass                      MPS Dump                      RTL Dump                 </td> <td style="vertical-align: middle; padding-left: 20px;">                     Cue Cards of                      Ascent Pkt C/L                      procedures<sup>b</sup> </td> </tr> </table>	Ascent Cue Cards Ascent Procedures RTL - Powered RTL ADI Error/Rate Switch (Ascent/Entry) Evap Out T High Cdr Comm Plt Comm O2 High Htr T ESS Bus V Low MPS Cdr Bus Loss Cabin Fan Failure GNC/RCS FC Stack & Exit T BCE Bypass MPS Dump RTL Dump	Cue Cards of Ascent Pkt C/L procedures <sup>b</sup>
Ascent Cue Cards Ascent Procedures RTL - Powered RTL ADI Error/Rate Switch (Ascent/Entry) Evap Out T High Cdr Comm Plt Comm O2 High Htr T ESS Bus V Low MPS Cdr Bus Loss Cabin Fan Failure GNC/RCS FC Stack & Exit T BCE Bypass MPS Dump RTL Dump	Cue Cards of Ascent Pkt C/L procedures <sup>b</sup>		

<sup>a</sup>Ascent Flight Data File Articles:

- Ascent Checklist
- Ascent Pocket Checklist
- Cue Cards (listed by title)
- Entry Pocket Checklist (AOA only)

<sup>b</sup>Used if required because of off-nominal conditions.

TABLE 3-1.- ASCENT/ABORT FLIGHT DATA FILE USE SUMMARY (Concluded)<sup>a</sup>

Flight phase	FDF Article
GRTLS	Ascent Cue Cards RTLS - Glide RTLS ET Umbilical Door Closure <sup>b</sup> Ascent Pkt C/L <sup>b</sup>
Contingency	Ascent Cue Cards TBS

<sup>a</sup>Ascent Flight Data File Articles

Ascent Checklist

Ascent Pocket Checklist

Cue Cards (listed by title)

Entry Pocket Checklist (AOA only)

<sup>b</sup>Used if required because of off-nominal conditions.

### 3.3 FLIGHT CREW

1. Reach and visibility limitations exist that constrain the crew's ability to perform various functions. When they are securely strapped into the ejection seats, the crew does not have access to the complete forward flight deck. The constraints are a function of the Pressure Suit, helmet, seat height (7-in. total travel), seat backangle, crew-member, Orbiter orientation, and acceleration forces along the x-axis. The reach and visibility envelopes are summarized in table 3-2 and figures 3-1 to 3-8.

During prelaunch when the Orbiter is vertical, the seat backangle is 20° forward of the Z-axis, and the crew is suited and strapped into the seats. The seats can be moved as needed, but will probably be full down for launch. The reach/visibility envelope for prelaunch is also valid for powered ascent when g's are low (<1.5).

When the g's are above ~1.5, crew upper-body mobility is constrained. During a portion of ascent, the sensed acceleration is above 1.5g for nominal ascent as shown in figure 3-9. During this time, the crew's heads and shoulders are pinned to the seat. The crew must use their hands to move the helmet, if needed, for improved visibility. The seats can be moved up if necessary so that the crewmen can reach switches. It takes ~25 sec for the seat to travel a full cycle (e.g., full down to full up to full down).

During ascent (after Main Engine Cutoff (MECO)) and entry, the crew's reach/visibility is constrained by being suited and strapped into the seat. However, the complete forward flight deck is accessible for ascent after MECO if the crew partially unstraps.

The crew will operate some critical switches in the blind (i.e., by feel) if necessary, but only on a limited exception basis. Wicket extenders and mirrors have been developed to aid the crew in the case of in the blind operations of some switches. Any group of switches that have wicket extenders (fence) next to them will be manipulated as a group.

The switches that may be operated in the blind are listed below.

<u>Panel</u>	<u>Switch</u>
C3	VIB SHUT DN
C3	ET SEP sw
C3	AUDIO CENTER
C3	OI PCMMU PWR
C3	S-BAND PM CONTROL
C3	S-BAND PM ANTENNA
C3	MASTER DFI POWER
R2	L He INTERCONNECT
R2	LH2 ULLAGE PRESS
05/09	AUDIO CONTROL
08	FWD RCS sw's
08	OMS CROSSFEED sw's

2. The commander will normally maintain the LEFT CRT SEL switch on panel C2 in the '1' position and the pilot will keep the RIGHT CRT SEL switch in the '2' position except when accessing CRT 3. This is intended to preclude concurrent accessing of CRT 3 by the two crewmen.
3. Because of g loads that exist during a ditch (water landing) and the potential for structural damage, crew ejection is preferable (AFTP #36).
4. Translational maneuvers must be performed by the commander. The pilot handles manual throttle requirements. For a manual RTLS, it is recommended that the attitude control task for the Powered Pitchdown (PPD) be a shared maneuver, with the commander flying pitch and the pilot controlling roll and yaw.

TABLE 3-2.- REACH/VISIBILITY ENVELOPE

Prelaunch and powered ascent (<1.5g)		Powered ascent (>1.5g)		Ascent (after MECO) and entry	
Panel	Visibility	Panel	Visibility	Panel	Visibility
L5	A11 <sup>a</sup>	L5	None <sup>b</sup>	L5	A11
L4	A11	L4	None	L4	A11
L1	A11	L1	A11	L1	A11
L2	A11	L2	Partial <sup>c</sup> (fig. 3-4)	L2	A11
F1	A11	F1	None	F1	A11
F2	A11	F2	A11	F2	A11
F6	A11	F6	A11	F6	A11
F7	A11	F7	A11	F7	A11
C2	A11	C2	A11	C2	A11
C3	A11	C3	Partial (fig. 3-5)	C3	A11
O1	A11	O1	A11	O1	A11
O2	A11	O2	A11	O2	A11
O5	A11	O5	Partial (fig. 3-6)	O5	A11
O6	Partial (fig. 3-1)	O6	None	O6	A11
O7	Partial (fig. 3-2)	O7	Partial (fig. 3-2)	O7	Partial (fig. 3-2)
O13	None	O13	None	O13	None
O14	None	O14	None	O14	None
O15	None	O15	None	O15	None
O16	None	O16	None	O16	None
O17	None	O17	None	O17	None
O8	Partial (fig. 3-3)	O8	None	O8	A11
O9	A11	O9	Partial (fig. 3-7)	O9	A11
O3	A11	O3	A11	O3	A11
F4	A11	F4	A11	F4	A11
F8	A11	F8	A11	F8	A11
F9	A11	F9	A11	F9	A11
R1	A11	R1	A11	R1	A11
R2	A11	R2	Partial (fig. 3-8)	R2	A11
R4	A11	R4	None	R4	A11
R6	None	R6	None	R6	None

<sup>a</sup>A11 - All of panel accessible.

<sup>b</sup>None - None of panel accessible.

<sup>c</sup>Partial - Some of panel accessible as shown in figure.

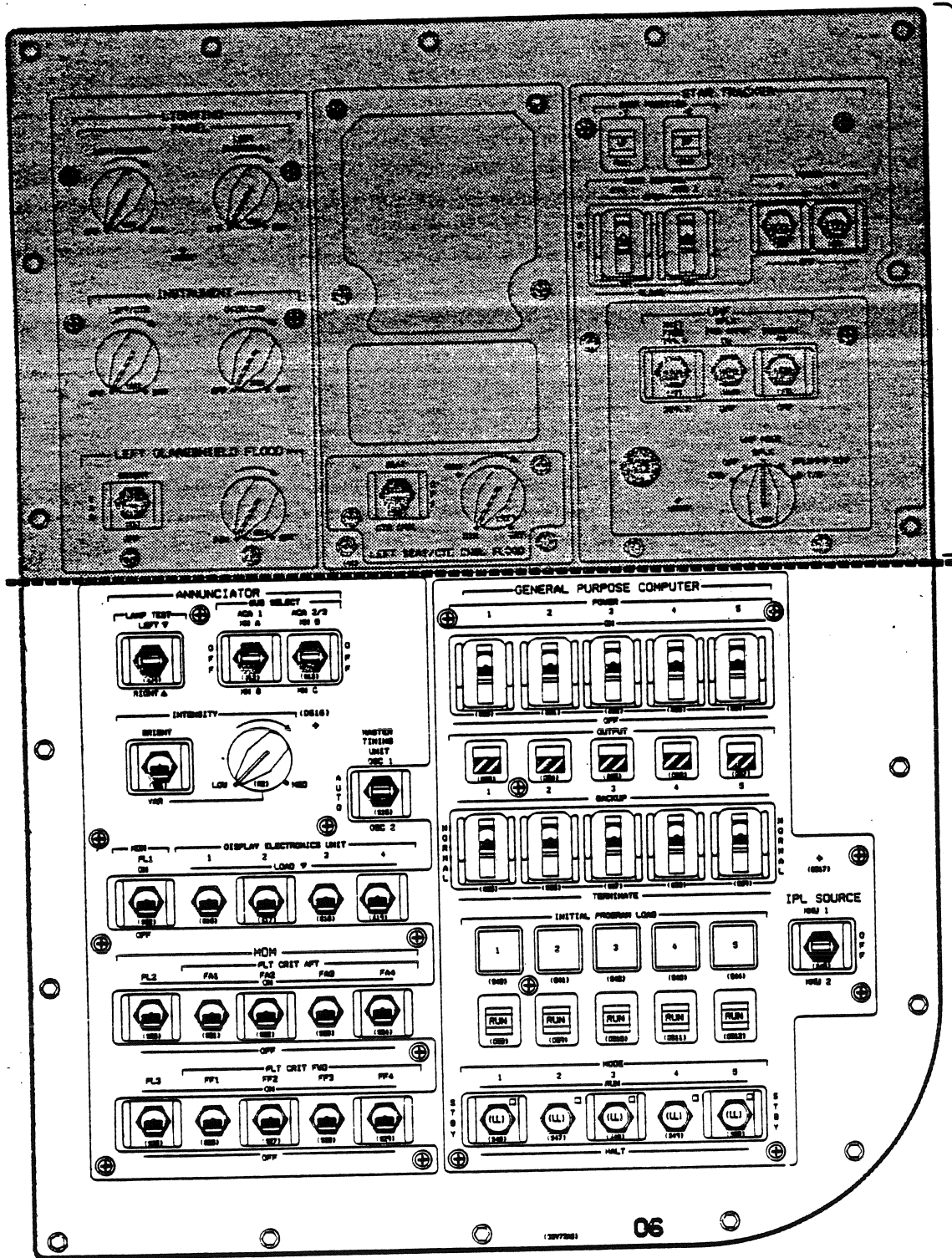

Figure 3-1.- Prelaunch and powered ascent (<1.5g) reach/visibility for panel 06.

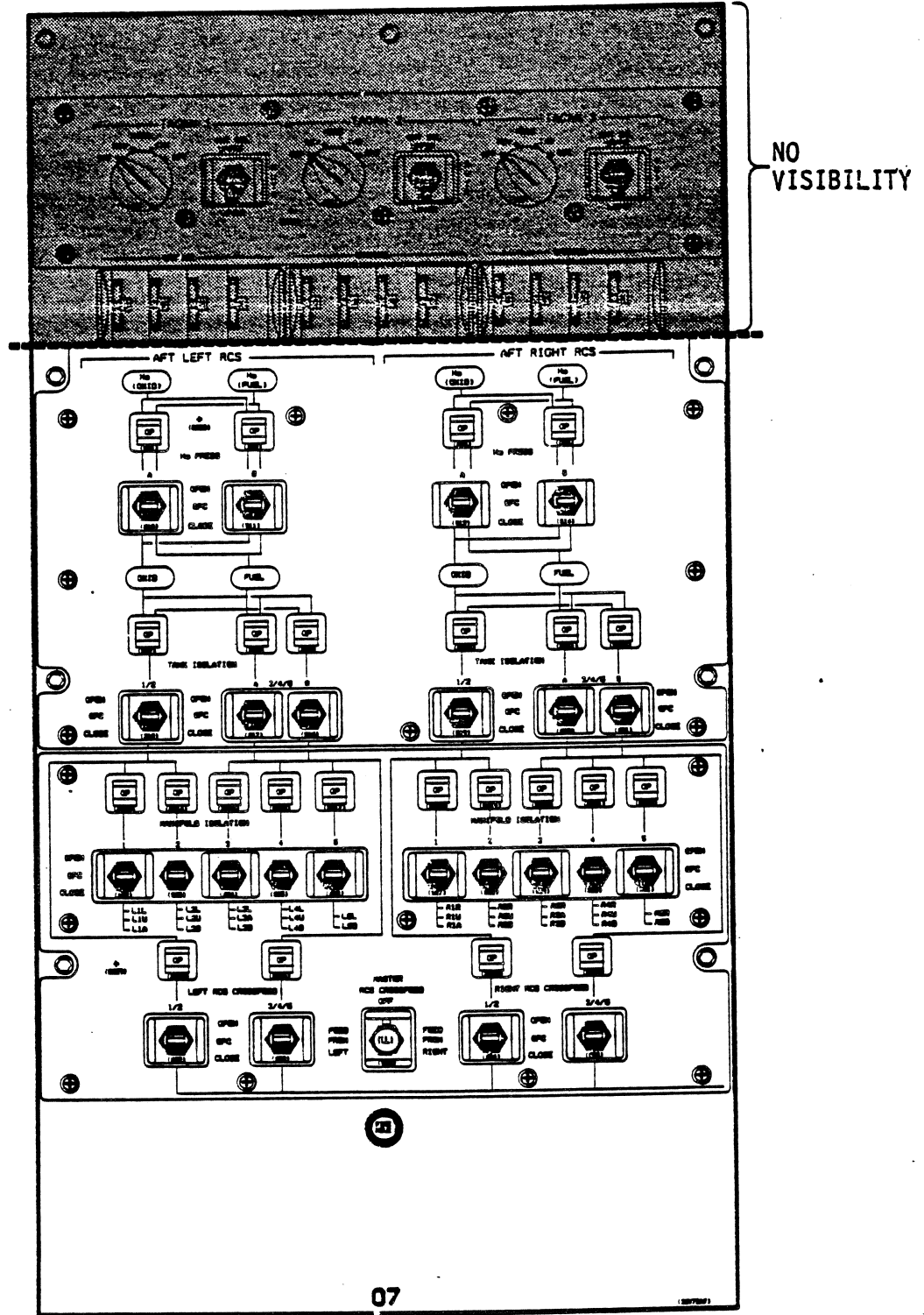

Figure 3-2.- Prelaunch, ascent, and entry reach/visibility for panel 07.

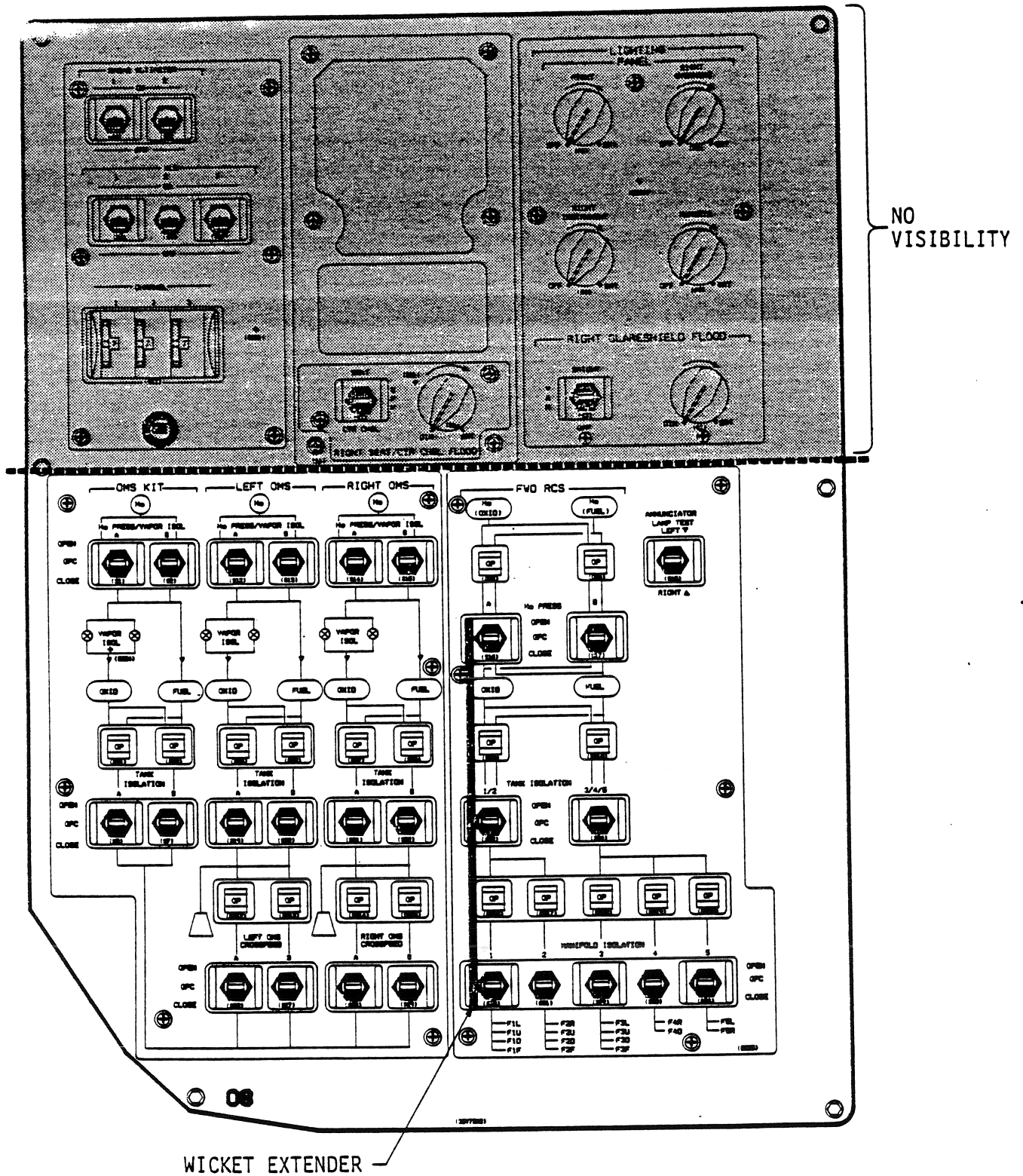

Figure 3-3.- Prelaunch and powered ascent (<1.5g) reach/visibility for panel 08.



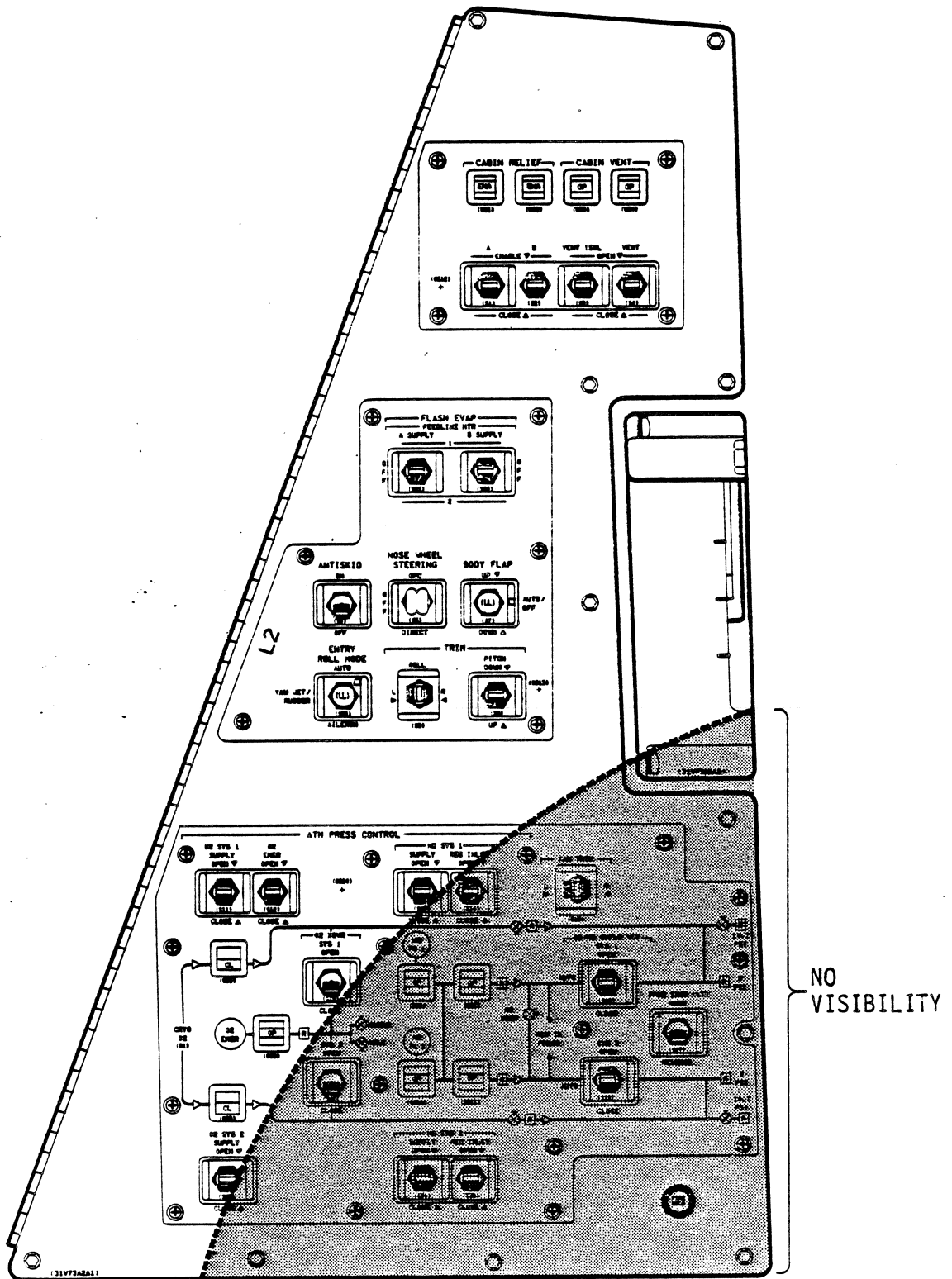

Figure 3-4.- Powered ascent (<1.5g) reach/visibility for panel L2.

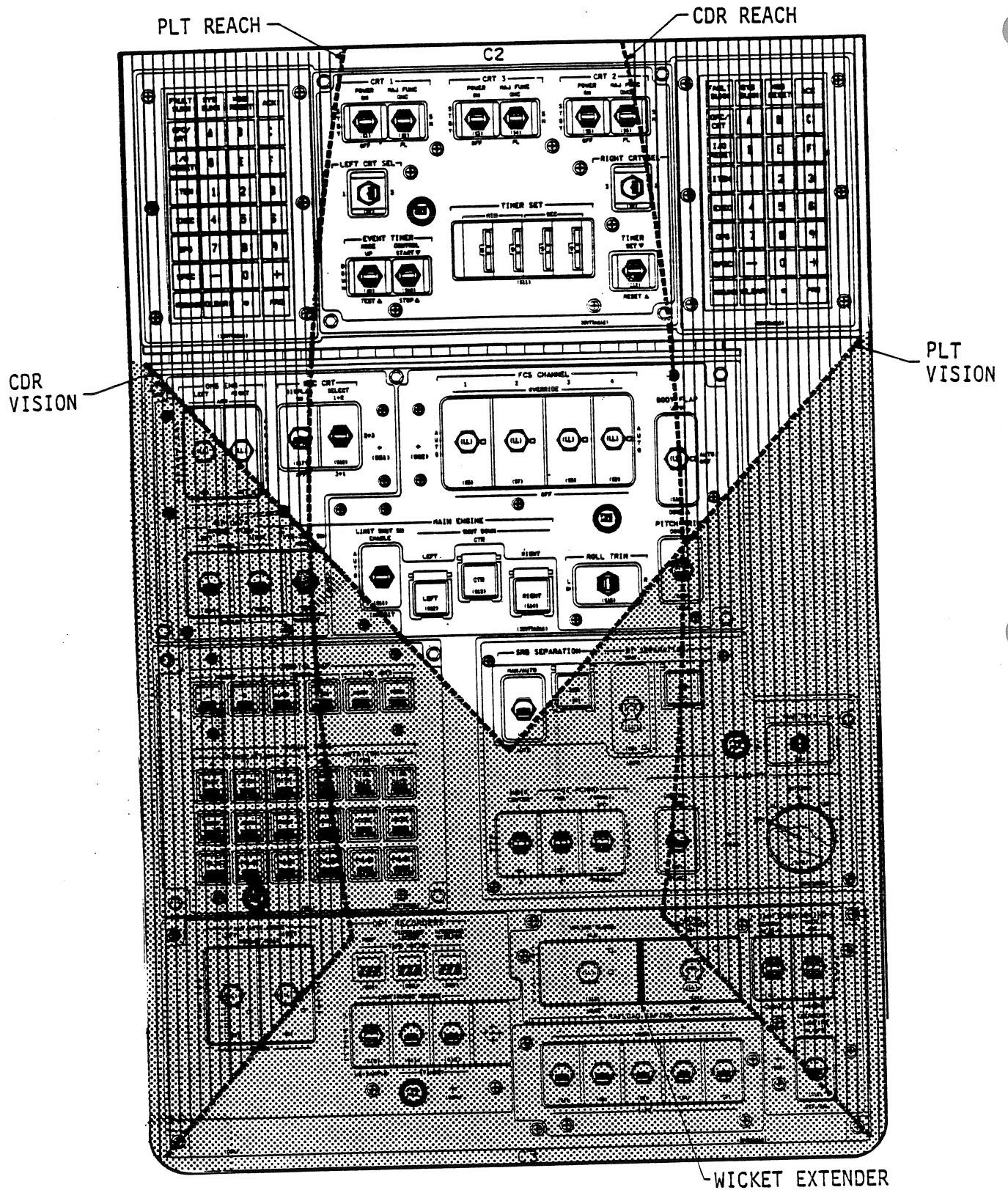

Figure 3-5.- Powered ascent (<1.5g) reach/visibility for panels C2 and C3.

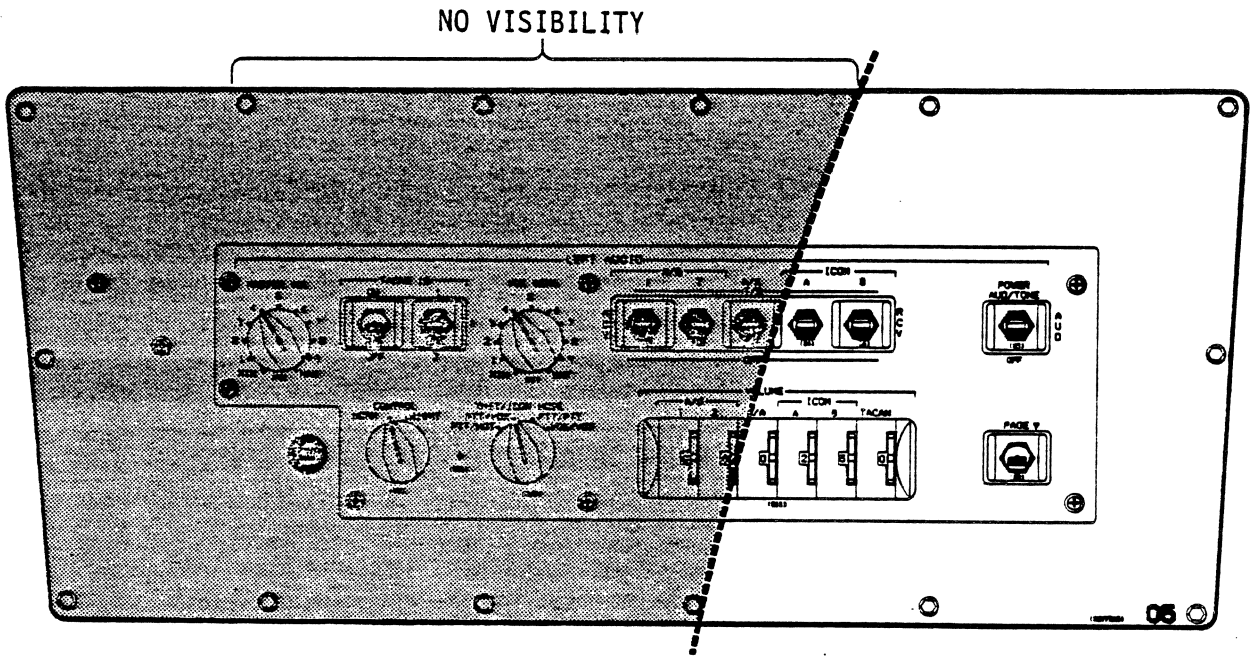

Figure 3-6.- Powered ascent (<1.5g) reach/visibility for panel 05.

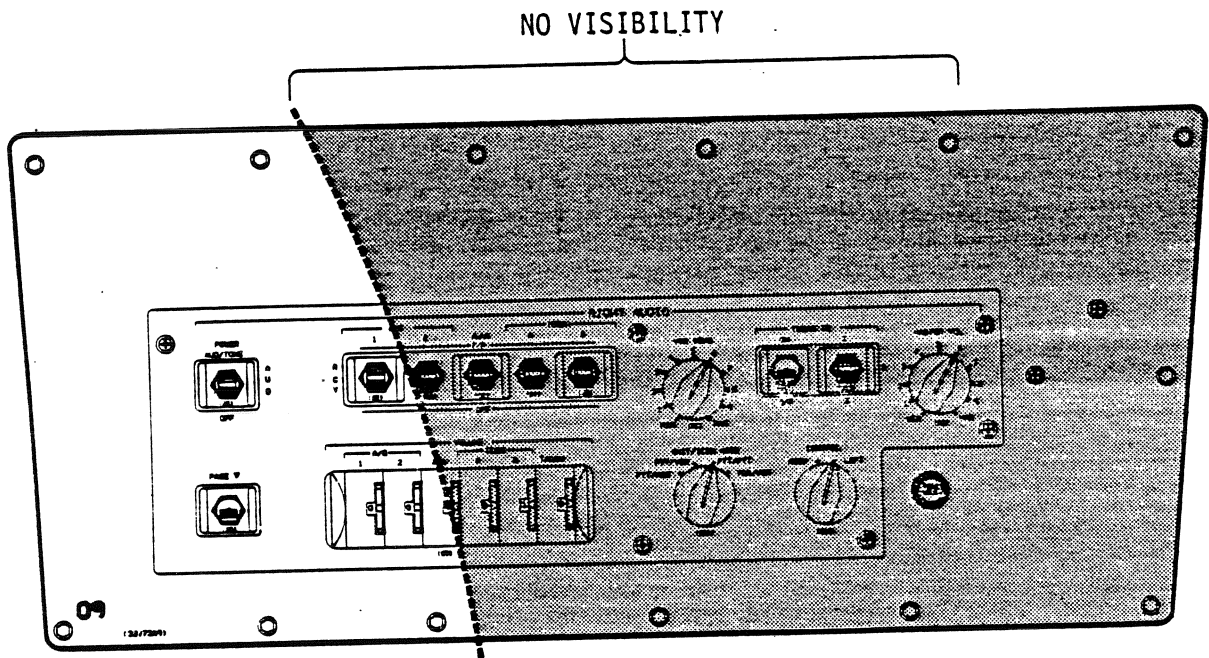

Figure 3-7.- Powered ascent ( $<1.5g$ ) reach/visibility for panel 09.

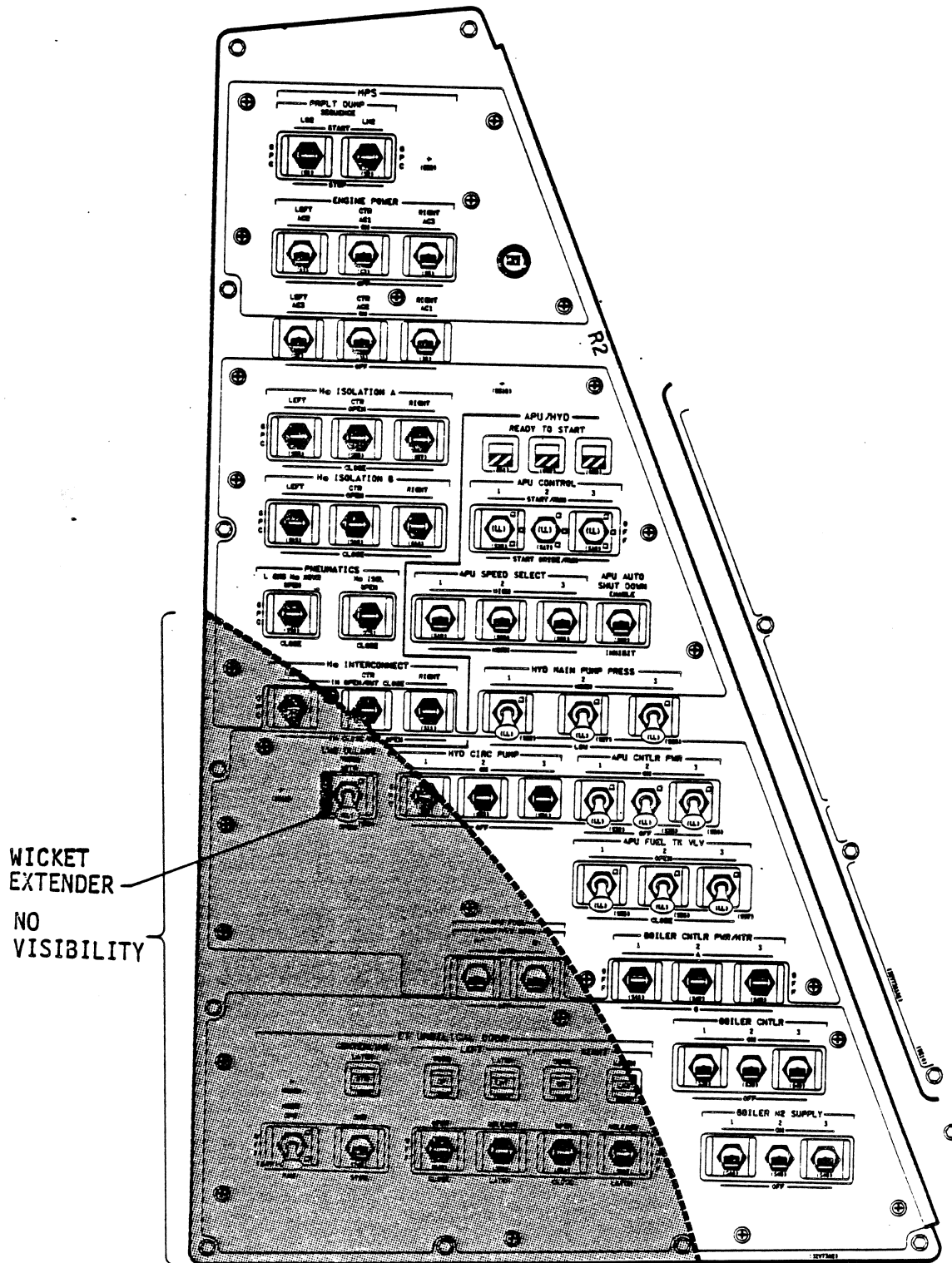

Figure 3-8.- Powered ascent (<1.5g) reach/visibility for panel R2.

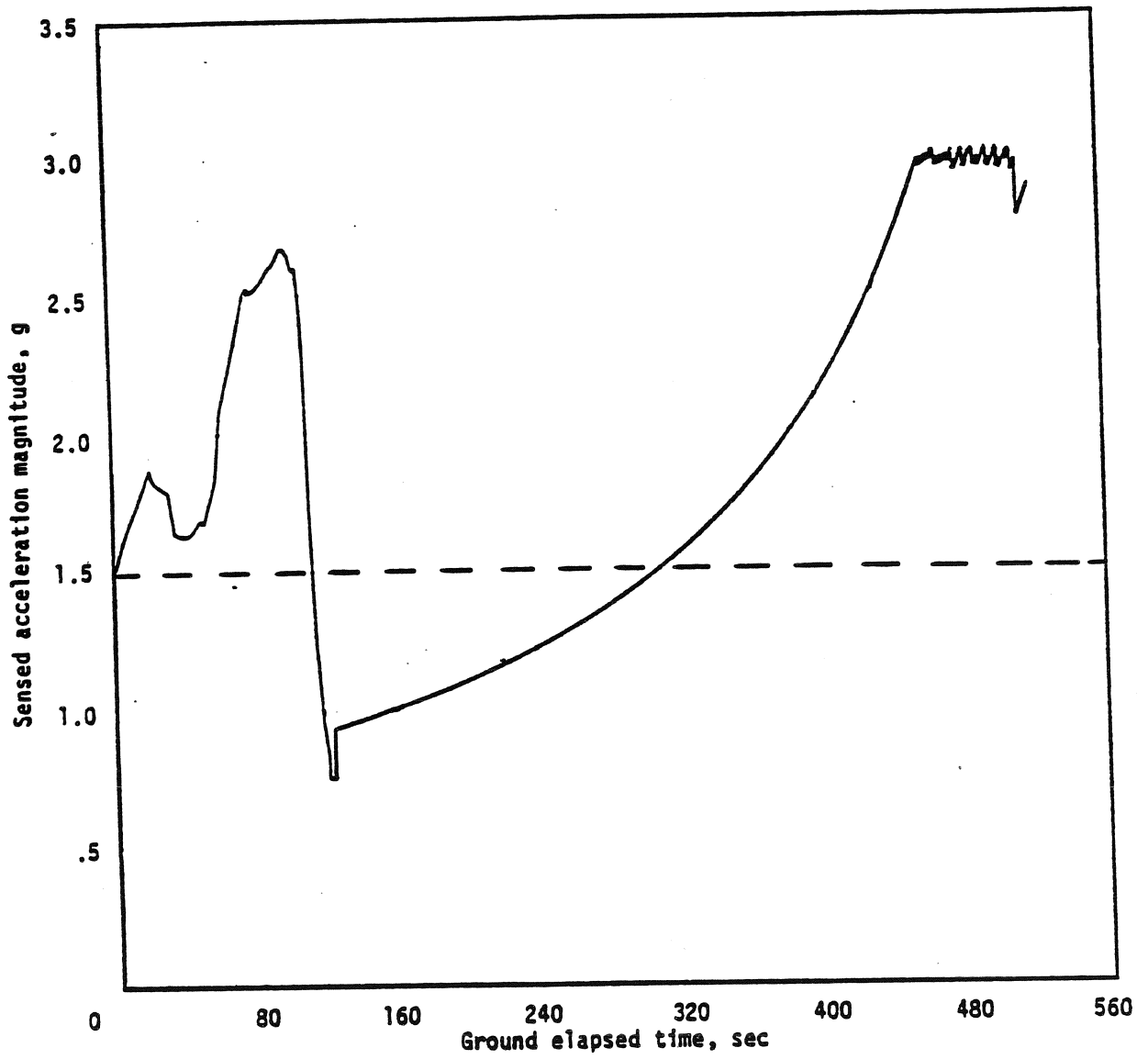

Figure 3-9.- Nominal ascent sensed acceleration.

#### 3.4 TRAJECTORY, GUIDANCE, NAVIGATION, AND CONTROL

1. To preclude an unacceptable post-MECO flightpath angle if an SSME throttle fails at 100-percent thrust during an RTLS, the three-engine RTLS abort will not be selected until T+260 sec (4 min 20 sec) (AFTP #37).
2. When choosing an RTLS abort for loss of an SSME, the abort will be selected no earlier than T+150 sec because post-SRB separation alpha limiting continues until this time (AFTP #43).
3. The Mission Control Center (MCC) must confirm auto guidance status prior to any crew action to return to auto after manual takeover.
4. To ensure adequate vehicle control during Solid Rocket Booster (SRB) tailoff, the forward loop gain whose switches are on panel F6 must be the high value even if all SSME's are thrusting at SRB shutdown. The switch positions are: GAIN PITCH switch - LO FWD and GAIN ROLL/YAW switch - NOM.
5. The Reaction Control System (RCS) -Z and +X transitions must not be commanded concurrently while crossfeeding from a single pod since up to 10 aft jets might be activated.
6. When a single OMS engine is being fed from a single OMS propellant supply system, the RCS should not be interconnected to that system. This is to prevent roll control jet firings from causing pressure spikes that result in unstable OMS combustion (AFTP #43).
7. An OMS burn in excess of 278 sec will result in an aft RCS structure temperature above the 350° F redline limit. No RCS jets should be fired; however, no single-mission damage is expected if the jets must be used.
8. The crew must depress the appropriate MAIN ENGINE SHUTDOWN pushbutton to enable single-engine roll control following the loss of a second SSME if the limit shutdown and vibration shutdown switches are in auto. When only one SSME is thrusting, the RCS is required for roll control. This roll control is activated whenever the software recognizes the loss of two main engines. The software recognizes engine status from either the engine status word or from the shutdown switches on panel C3. The only non-catastrophic failure mode for a second SSME prior to enabling the main engine limit and the vibration shutdown logic at single engine press to MECO results from dual electrical failures that disable the engine controller. This failure results in the termination of data retrieval from the engine, and the Data Processing System (DPS) would generate a data path failure indication. This leaves the shutdown switches as the only means available to advise the software that the second engine was lost.

During first stage, the second engine failure is indistinguishable from a data path failure to the crew.

The MCC will advise the crew of the required action. If communication is not available, first-stage two-engine failures will be handled by contingency abort techniques.

During second stage, the crew may use the engine shutdown pushbutton based on acceleration, roll rate, and display cues and/or an MCC call (AFTP #40).

9. If a forward RCS pressurization failure occurs, the crew will isolate the pressurization and propellant systems to conserve the thrusting capability for the External Tank (ET) Separation (SEP)(AFTP #34).
10. The flight software will not be transitioned to OPS 3 on an AOA until completion of the dump sequence including SSME stow. The dump sequence resides in OPS 1 only. The transition to OPS 3 would terminate the dump before sufficient propellant had been expelled to attain a vehicle center of gravity (c.g.) that is safe for entry. This would also cause an undesirable step command to stow the engine.
11. Since the Backup Flight System (BFS) does not look at the Main Propulsion System (MPS) dump switches, the dump must be performed in auto if on the BFS. Therefore, the dump will always start with the OMS 1 burn. For a delayed OMS 1 burn while in BFS, the Auxiliary Power Units (APU's) must be placed in depress and returned to normal shortly before the delayed OMS 1 Time of Ignition (TIG) in order to have hydraulics power for the SSME actuators during and following the dump.
12. To avoid guidance transients, delta navigation state vector updates must be entered at least 15 sec before TIG for any OMS burn. If required, the OMS 1 burn will be delayed to Madrid to ensure that a delta state is properly incorporated.
13. Preflight-determined nominal gimbal trims will always be loaded before the OMS 2 burn. The trims are required to eliminate an Attitude Direction Indicator (ADI) error needle displacement caused by an error in the information the trim integrator has concerning the location of the vehicle c.g.
14. After ET SEP, the crew will not start the Y translation until the -Z translation is complete. If the Translational Hand Controller (THC) is moved out of detent while the automatic -Z translation is being commanded, it will terminate. The SEP COMPLETE flag will not be set unless the 4-ft/s -Z maneuver is completed. If this situation exists, a manual transition to MM 104 is required.
15. When turned ON, the FLT CNTLR PWR switches on panels F6 and F8 cause THC transient outputs. To prevent these transients, the FLT CNTLR PWR will not be turned from 'OFF' to 'ON' in MM's 104, 105, 106, 301, 302, or 303.
16. The BFS will not be engaged prior to tower clear to preclude aft ET/SRB contact with the tower due to engine gimbaling when the BFS attempts to correct for Primary Avionics Software System (PASS) problems.



CREW OPERATIONS

4  
B  
5



## SECTION 4 CREW OPERATIONS

### 4.1 ASCENT CREW MONITORING AND CONTROL DEVICES

The primary role of the crew during ascent is to monitor the performance of the automatic sequencing, guidance, navigation, flight control, propulsion, and other critical systems. If performance is not acceptable, the crew will intervene as required to promote mission success and personnel and vehicle safety. Cockpit-dedicated instruments and Cathode Ray Tube (CRT) displays that present critical ascent parameters for determining vehicle performance and trajectory state are available. Uplinked advisory data and onboard cue cards will also be available to assist the crew in the monitoring and control task.

The purpose of this section is to present data on the crew use of the cockpit flight displays and controls during ascent and aborts. Trajectory data used in this section are from the STS-1 Operational Flight Profile, Cycle 2.

#### 4.1.1 Onboard Ascent Event Reference

During ascent, the events in the checklist are keyed to Mission Elapsed Time (MET) or the Time of Ignition (TIG) of the Orbital Maneuvering System (OMS) burns. The following explains the reference notation and when each reference is used:

1. The MET is the primary event reference throughout ascent. The MET is set to zero at Solid Rocket Booster (SRB) ignition and is shown on the mission timer on the first line of all CRT's and on panel O3, and on the event timer on panel F7. Prelaunch, the MET on the CRT and O3 shows Greenwich Mean Time (GMT).
2. The TIG of the OMS burns is used at times close to the OMS burns. This time is displayed on the CRT timer (second line on the CRT). It counts down to the ignition of the OMS, then counts up. See the XXXXX MNVR XXXXX display description for more details. Prelaunch and during main stage, this timer will be zeroed.
3. The EVENT TIME on panel F7 can be controlled by the crew. It is set to count down to launch from T-9 min. The EVENT TIMER resets at SRB ignition and then shows MET.

Before launch (while in OPS 9), the crew can set the CRT timer; however, after transition to OPS 1, a launch hold or recycle would invalidate the time because the CRT timer cannot be reset in MM 101. The CRT timer is not reset at lift-off, but the EVENT TIME and MET are reset. Therefore, the CRT timer is not used prelaunch or during main stage.

The event references for Abort Once Around (AOA) entry are the same as in nominal entry. For further information, see the Entry Procedures Handbook, JSC 11542.

#### 4.1.2 Cockpit CRT Displays

The displays available to the crew for ascent and aborts are shown in table 4-1. Since the displays available depend on the major mode, the major mode flow is shown in figure 4-1. The three CRT displays on the forward panels are managed by the crew to maximize crew insight into the status of Orbiter operations. CRT displays will be called as necessary to monitor, check status, or reconfigure systems, but the basic configuration assumed for normal operations is:

1. CRT 1 (left) - XXXXX TRAJ or XXXXXX MNVR XXXXX
2. CRT 2 (right) - GNC SYS SUMM 1 or XXXXXX MNVR XXXXX
3. CRT 3 (center) - [BFS] XXXXX TRAJ X or XXXXXX MNVR XXXXX  
(SM or GNC SYS SUMM as required)

The configuration for an Abort To Orbit (ATO) is the same as for normal ascent. For an AOA, the configuration through the first OMS burn is the same as normal ascent and then is the same as normal entry. For a Return To Launch Site (RTL), the configuration during the powered phase corresponds to ascent, and during the glide phase, the configuration corresponds to entry.

When the Backup Flight System (BFS) is engaged, there are only two CRT's available automatically. Preengage, no more than one CRT is normally driven by the BFS. Any CRT can be driven by the BFS if the GPC/CRT function on the keyboard is used. The BFC DISP SEL switch is set in 3 + 1 so that CRT 3 can be driven by BFS preengage, and CRT 3 and CRT 1 are driven automatically postengage. The configuration for the displays with the BFS engaged is:

1. CRT 1 (left) - XXXXX TRAJ X or XXXXX MNVR XXXXXX
2. CRT 2 (right) - Assigned to BFS when time permits, then the CRT is used as needed to monitor systems.
3. CRT 3 (center) - As required to check the status of systems, any reconfiguration change required, or XXXXX TRAJ or XXXXX MNVR XXXXXX.

TABLE 4-1.- COCKPIT CRT DISPLAYS

Display number	CRT display title	OPS 0	OPS 9 (GNC)	OPS 1	OPS 6 (RTLS)	OPS 3 (AOA)	BFS
0001	GPC MEMORY	X					
1011 <sup>a</sup>	(LAUNCH) TRAJ			X			
1021 <sup>a</sup>	(ASCENT) TRAJ <sup>b</sup>			X			
1031 <sup>a</sup>	(ASCENT) TRAJ <sup>b</sup>			X			
1041 <sup>a</sup>	(OMS 1) MNVR (EXEC) <sup>c</sup>			X			X
1051	(OMS 2) MNVR (EXEC) <sup>d</sup>			X			X
1061	(OMS 2) MNVR (COAST) <sup>e</sup>			X			X
3011	(DEORB) MNVR (COAST)					X	X
3021	(DEORB) MNVR (EXEC)					X	X
3031	(DEORB) MNVR (COAST)					X	X
3041 <sup>f</sup>	ENTRY TRAJ 1					X	X
	ENTRY TRAJ 2					X	X
	ENTRY TRAJ 3					X	X
	ENTRY TRAJ 4					X	X
	ENTRY TRAJ 5					X	X
3051 <sup>a,f</sup>	VERT SIT 1					X	X
	VERT SIT 2					X	X
6011	(RTLS) TRAJ				X		
6021 <sup>a,f</sup>	VERT SIT 1				X		X
6031 <sup>a,f</sup>	VERT SIT 1				X		X
	VERT SIT 2				X		X
9011	GPC MEMORY		X				

<sup>a</sup>Displays described in this section.

<sup>b</sup>In MM's 102 and 103, the nominal display is ASCENT; with RTLS, AOA, or ATO selected, it is RTLS, AOA, or ATO, respectively.

<sup>c</sup>In MM 104, the nominal display is OMS 1; with an ATO selected, it is ATO 1; with an AOA selected, it is AOA 1.

<sup>d</sup>In MM 105, the nominal display is OMS 2. With an ATO selected, the display will be ATO 2. With an AOA selected, the display will be AOA MNVR TRANS. The crew will transfer to OPS 3 to perform the AOA OMS 2 burn as the deorbit maneuver upon being informed that AOA 2 targeting is complete by a flashing OPS 301. The targets for the burn will be computed in OPS 1 and carried across to OPS 3. However, an AOA can also be performed by manually transitioning to OPS 3 and inputting the AOA targets without selecting AOA.

<sup>e</sup>In MM 106, the nominal display is OMS 2. With an ATO selected, the display will be ATO 2.

<sup>f</sup>Displays described in the Entry Flight Procedures Handbook.

TABLE 4-1.- COCKPIT CRT DISPLAYS (Concluded)

Display number	CRT display title	OPS 0	OPS 9 (GNC)	OPS 1	OPS 6 (RTL5)	OPS 3 (AOA)	BFS
0	GPC MEMORY	X	X	X	X	X	
1	DPS UTILITY		X				
2	TIME		X				
6	GPC/BUS STATUS		X				
18 <sup>g</sup>	GNC SYS SUMM 1			X	X	X	x <sup>h</sup>
19 <sup>g</sup>	GNC SYS SUMM 2						X
20	DAP CONFIG						
50 <sup>i</sup>	HORIZ SIT			X	X	X	X
51 <sup>g</sup>	OVERRIDE			X	X	X	
52 <sup>g</sup>	CONT ABORT			X	X		
99	FAULT	X	X	X	X	X	X
100	GTS DISPLAY		X				
101	SENSOR SELF-TEST		X				
102	RCS/RGA/ADTA		X				
104	GND IMU CNTL/MON		X				
105	TCS CONTROL		X				
110	BUS/BTU STATUS		X				
1011 <sup>g</sup>	LAUNCH TRAJ 1						X
1021 <sup>g</sup>	(ASCENT) TRAJ 1						X
1031 <sup>g</sup>	(ASCENT) TRAJ 2						X
6011 <sup>g</sup>	RTL5 TRAJ 2						X
0001	BFS MEMORY						X
0001 <sup>g</sup>	THERMAL						x <sup>j</sup>
78 <sup>g</sup>	SM SYS SUMM 1						x <sup>j</sup>
79 <sup>g</sup>	SM SYS SUMM 2						x <sup>j</sup>

<sup>g</sup>Displays described in this section.

<sup>h</sup>GNC SYS SUMM displays in the backup system are not the same displays as in the primary systems.

<sup>i</sup>Displays described in the Entry Flight Procedures Handbook.

<sup>j</sup>THERMAL, SM SYS SUMM 1, and SM SYS SUMM 2 are Systems Management (SM) displays.

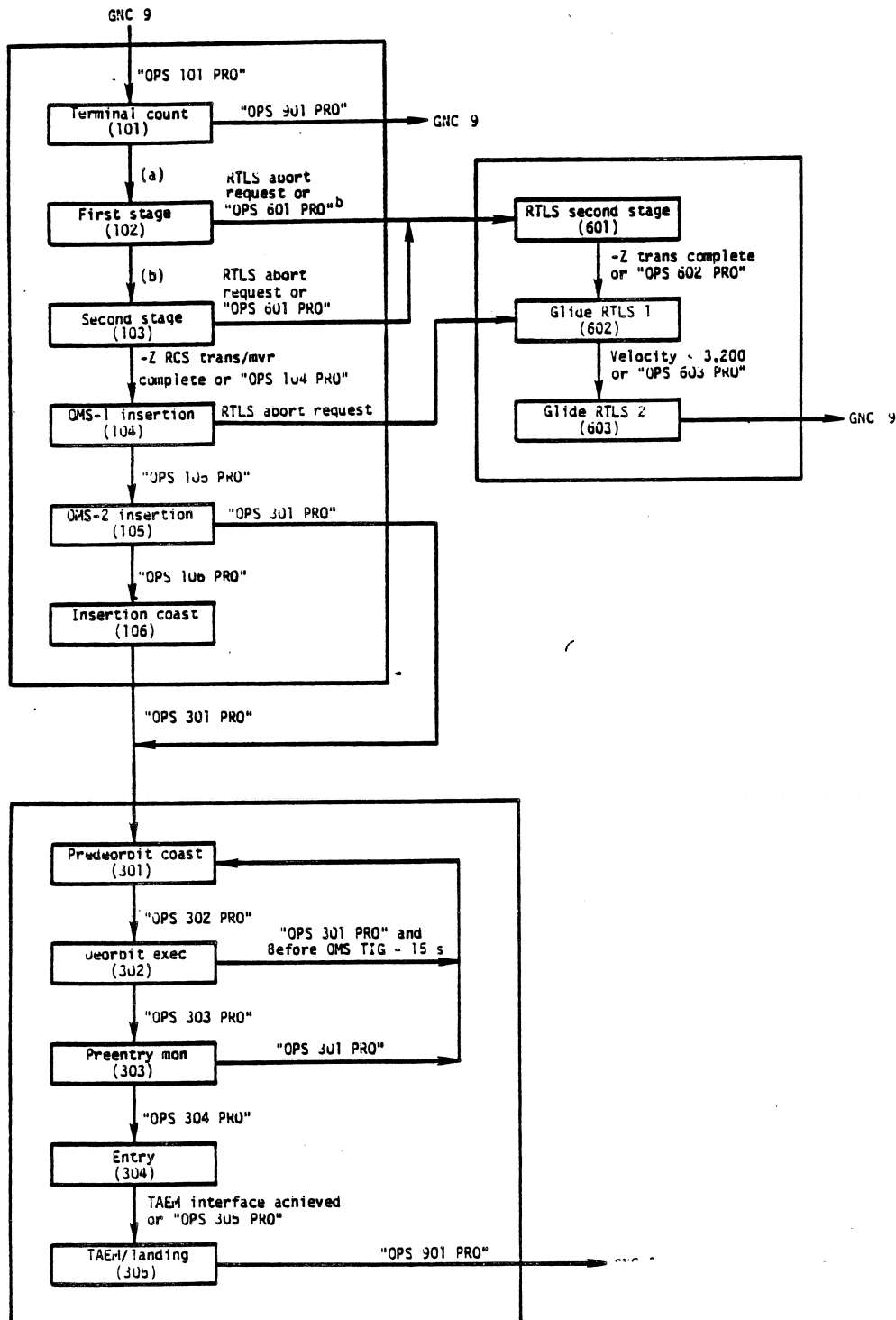

<sup>a</sup>All SSME's 90 percent RPL, no countdown holds, +2.75 sec time delay, and no FRF flag (SRB ignition).  
<sup>b</sup>( $P_c \leq 50$  or  $\dot{M}ET \leq 123$  sec) + 4 sec and attitude rates within limits or manual switch enabled and closed (SRB SEP complete).  
 (Information in this figure is from COMPUTER PROGRAM DEVELOPMENT SPECIFICATION, Vol. V, Book 1, GNC.)

Figure 4-1.- Major mode flow.

## XXXXXX TRAJ (Primary System)

### Description

This display is called up in MM 101 and is also available in MM's 102, 103, and 601 (fig. 4-2). The title is dynamic and reads LAUNCH in MM 101, ASCENT in MM's 102 and 103 (AOA, ATO, or RTLS if one of these aborts is selected), and RTLS in MM 601.

There are three different second-stage profiles plotted on the display. The rightmost profile is a nominal ascent profile plotted as a function of altitude above the Fisher ellipsoid (ft) vs. magnitude of  $V_{rej}$  (ft/s). The center (inner) profile represents an engine out at lift-off with RTLS selected at 2:30, and is plotted as a function of altitude above the Fisher ellipsoid (ft) vs. horizontal component of downrange  $V_{rej}$  ( $V_{HORIZ\_DNRNG}$ ) in ft/s. The line off the top of the nominal ascent line represents the last-time two-SSME RTLS abort profile (for cycle 2 - engine out at 4:29, RTLS selected at 4:34) plotted as a function of altitude above the Fisher ellipsoid vs.  $V_{HORIZ\_DNRNG}$ . The altitude scale goes from 140,000 to 525,000 ft while the velocity scale goes from -7,000 to +10,000 ft/s.

The current vehicle state is indicated by a moving triangle with the 30- and 60-sec predictors represented by circles. The triangle and circles are plotted as a function of altitude above the Fisher ellipsoid vs. magnitude of  $V_{rej}$  for a nominal ascent, but change to functions of altitude above the Fisher ellipsoid vs.  $V_{HORIZ\_DNRNG}$  when RTLS is selected. Both the altitude and velocity come from navigation (either the ascent or RTLS User Parameter Processing (UPP)).

The GO tick mark represents the earliest time the vehicle can sustain a single-SSME failure at which a 'press-to-Main Engine Cutoff (MECO)' capability is available (240 sec for cycle 2) assuming:

1. 5-min launch hold
2. 95-percentile abort wind dispersion allowance
3. No pre-MECO OMS/RCS burns
4. Guided MECO for nominal SRB and Space Shuttle Main Engine (SSME) propulsion performance assuming no greater than a 50-percent probability of the External Tank (ET) impacting within the 200-n. mi. landmass boundaries, but sufficient OMS propellant to provide AOA capability for:
  - a.  $-3 \sigma$  ascent performance
  - b.  $-3 \sigma$  OMS FPR
  - c. 80 ft/s nav dispersions
  - d. OMS ballast requirements
  - e. Nominal AOA target line
  - f. 2-min OMS-1 TIG delay



The RTLS tick mark represents the latest time the vehicle can sustain a single-SSME failure and still perform an RTLS (269 sec for cycle 2) assuming:

1.  $-3 \sigma$  ascent propulsion performance
2. 5-min launch hold
3. 95-percent worst case launch hold
4. 5-sec crew delay in selecting RTLS

The scale across the top represents delta range ( $\Delta R$ ) where  $\Delta R$  is defined as the glide range potential based on the energy state (function of the horizontal component of downrange  $V_{rel}$  and flightpath angle from the RTLS UPP) minus the range to the runway threshold (from RTLS UPP) in n. mi. The PD and PD 3 tick marks represent the  $\Delta R$  at which Powered Pitchdown (PPD) is initiated for a two-SSME RTLS (-68 n. mi. for cycle 2) and a three-SSME RTLS (-99 n. mi. for cycle 2), respectively. In both cases, PPD occurs 20 sec before MECO. The CO tick is the  $\Delta R$  where MECO should occur and is biased by -3 n. mi. so that zero thrust and zero  $\Delta R$  will occur simultaneously. The  $\Delta R$  scale starts at -143 n. mi. on the right and goes to +17 n. mi. on the left. The  $\Delta R$  symbol (triangle) is only driven during RTLS.

The scale on the left is delta  $\dot{H}$  ( $\Delta \dot{H}$ ), where  $\Delta \dot{H}$  is defined as the  $\dot{H}$  from navigation (RTLS UPP) minus a reference  $\dot{H}$  from a table of  $\dot{H}$  vs.  $\Delta R$  for an engine out at 150 sec. The limits on the scale are 200 ft/s (top) to -200 ft/s (bottom). The  $\Delta \dot{H}$  symbol is displayed only for an RTLS, for  $V_{HORIZ\_DNRNG} < 0$ , and if  $-550 < \Delta R < -50$ . The symbol will flash if off-scale.

The digital readouts follow:

1. 'TMECO' is the predicted time of MECO in minutes and seconds. The time comes from guidance and is displayed after SRB SEP.
2. 'PRPLT' is the propellant remaining in the ET (in percent) and is calculated in the XXXXX TRAJ DIP in MM's 103 and 601.
3. 'PC < 50' will be displayed when the chamber pressure on both SRB's falls below 50 psi within 5.9 sec of each other. This is displayed when a discrete from the SRB Separation (SEP) sequencer is set.
4. 'SEP INH' will be displayed flashing if the SRB or ET SEP constraints as determined by the SRB or ET SEP sequencer are violated. For ET SEP, the crew also gets a class 3 alert and 'ET SEP INH' message at the bottom of the CRT.

The two lines which bracket the end of the last-time two-SSME RTLS abort profile (lower left of the CRT) represent the ET SEP  $\bar{q}$  constraints. The top line represents  $\bar{q} = 2$  psf and the bottom line represents  $\bar{q} = 10$  psf.

## Use

The XXXXXX TRAJ display is used primarily to monitor or manually fly the Shuttle trajectory on a velocity-vs.-altitude plot.

## Nominal, AOA, or ATO

The Shuttle symbol and predictors should remain on the rightmost profile and will appear immediately after SRB SEP. If in Control Stick Steering (CSS), the crew will vary the pitch angle ( $\theta$ ) to stay on the profile. If the Shuttle symbol is past the 'GO' tick and a single SSME fails, the crew will press to MECO with Mission Control Center (MCC) concurrence. If the Shuttle symbol is past the RTLS tick, an RTLS can no longer be successfully performed.

The TMECO readout will become active in MM 103 and will indicate to the crew that second-stage guidance is converged when the time is stable. At  $T_{fail}$ , guidance recalculates TMECO on the assumption of three engines instead of two engines. The PRPLT, PC < 50, and SEP INH readouts perform as discussed earlier. If PC < 50 does not occur (PC < 50 not displayed), SRB SEP cannot be performed either automatically or manually until the backup cue is issued at an MET of 2:13.

The  $\Delta\dot{H}$  and  $\Delta R$  scales are not driven for nominal, AOA, or ATO missions.

## RTLS

The Shuttle symbol and predictors will appear immediately after SRB SEP either on the nominal profile line or slightly to the left and below the nominal line if an SSME failed in the first stage. Once an RTLS abort is selected (>2:30 for a two-SSME RTLS, 4:20 for a three-SSME RTLS), the Shuttle symbol and predictors will immediately jump to the left (now plotting  $V_{HORIZ\_DNRNG}$  instead of  $V_{rel}$  magnitude) and depending on the SSME out time, track the engine out at lift-off profile, the last-time two-SSME RTLS profile, or somewhere between the two. For a three-SSME RTLS, the symbol and predictors should track very close to the last-time two-SSME RTLS profile. If in CSS, the crew will vary the pitch angle ( $\theta$ ) to stay on the appropriate profile.

The  $\Delta\dot{H}$  scale is provided as an aid to the crew in maintaining the optimum flyback profile. During flyback, the crew will fly the altitude-vs.-velocity profiles using the 30- and 60-sec predictors. The vehicle should then be close to following the optimum  $\dot{H}$  vs.  $\Delta R$  profile. The  $\Delta\dot{H}$  scale, which represents  $\dot{H}$  error, will become active when  $V_{HORIZ\_DNRNG} = 0$  if  $-550 < \Delta R < -50$ . The crew will vary  $\theta$  to null out any errors on the  $\Delta\dot{H}$  scale, keeping  $\Delta\dot{H} = 0$ , to stay on the desired profile and to assure an acceptable gamma at MECO. This assumes that the crew is flying the vehicle in CSS. If auto or BFS control is active, the crew will use the  $\Delta\dot{H}$  scale as a monitoring device.  $\Delta\dot{H}$  is no longer valid after the start of PPD.

The  $\Delta R$  scale will indicate when PPD should be initiated for a two- or three-SSME RTLS (PD or PD3 tick), and when MECO should be initiated (CO tick). The  $\Delta R$  indicator (triangle) will appear at the far right of the scale when an RTLS is initiated and remain there until  $\Delta R$  is less than 143 n. mi.

The Propellant (PRPLT) readout will be used by the crew to monitor the initiation or as a manual backup to initiate the Powered Pitcharound (PPA). The PPA maneuver is automatically initiated based on vehicle mass or manually initiated based on a PPA time from MCC or on percent PRPLT remaining as backup cue.

The rest of the digital readouts have the same use and function as for nominal ascent.

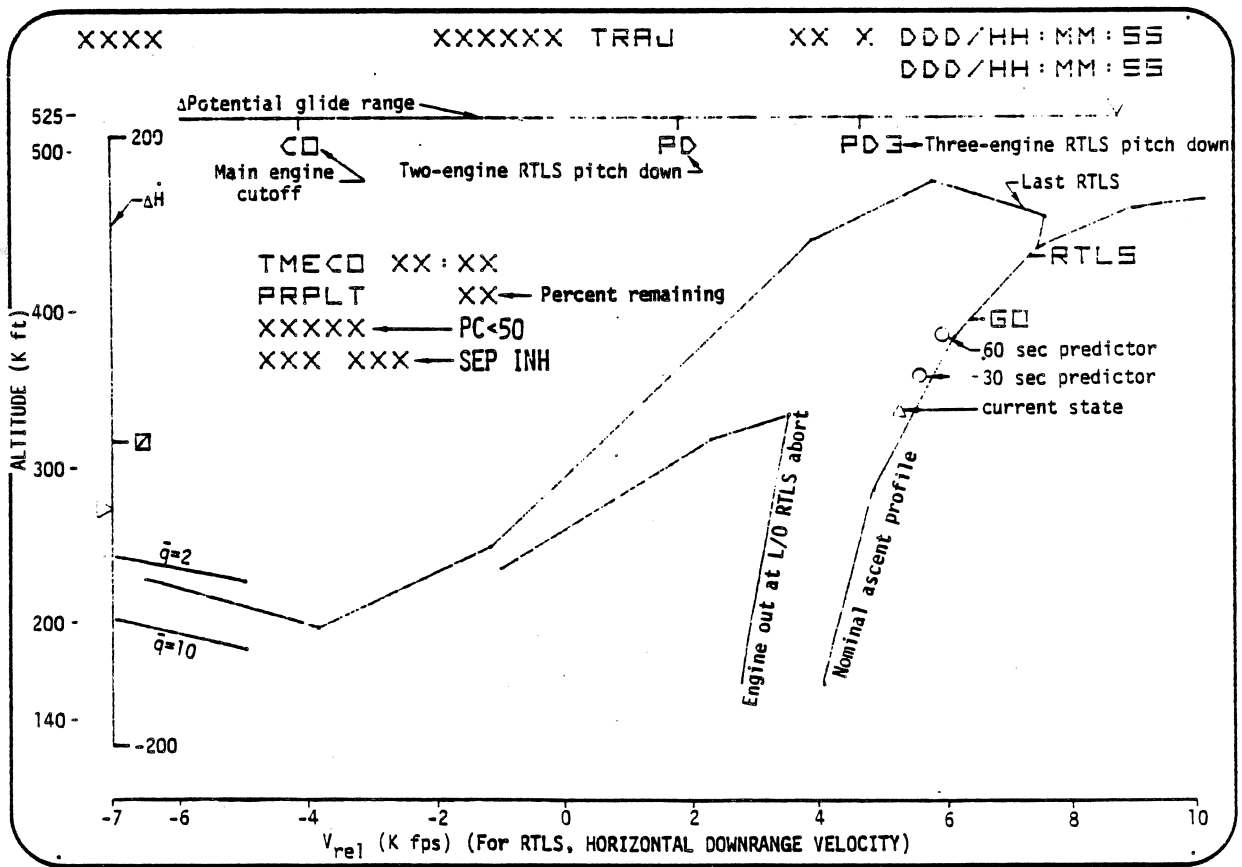

Figure 4-2.- XXXXXX TRAJ (primary system) display.

## XXXXXX TRAJ 1 (BFS)

### Description

This display is called up in MM 101 and is available in MM 102 (fig. 4-3). The title is dynamic and reads LAUNCH in MM 101 and ASCENT in MM 102 (ATO, AOA, or RTLS if an abort is selected).

The central plot represents a nominal first-stage ascent plotted as a function of altitude above the Fisher ellipsoid vs. the magnitude of relative velocity. The altitude scale is from 0 to 170,000 ft and the velocity from 0 to 5000 ft/s. Tick marks on the profile show the Local Vertical Inertial Yaw (LVIIY) Attitude Direction Indicator (ADI) pitch angles which should be flown at that point on the nominal profile. The horizontal line intersecting the profile corresponds to the maximum safe ejection altitude.

The current vehicle state is shown by a moving triangle with a 20-sec predictor represented by a circle. The altitude and velocity used to plot the current vehicle state comes from navigation (ascent UPP).

The scale on the left displays Equivalent Air Speed in Knots (KEAS) with the current KEAS shown by a triangle. The triangle will flash if the maximum  $\bar{q}$  as represented by KEAS for that mission (458 KEAS for STS-1) is exceeded. The Staging (STG) tick corresponds to the max. SRB\_SEP  $\bar{q}$  constraint. Because of uncertainties in the onboard-computed  $\bar{q}$ , a SEP inhibit value of 55 psf as the maximum allowable onboard computer  $\bar{q}$  is necessary to protect the real  $\bar{q}$  limit of 75 psf. Therefore, the current display will be changed to put the STG tick at 55 psf, 130 KEAS.

The digital readouts are as follows:

1. 'PC < 50' will be displayed whenever both SRB PC's fall below 50 psi within 5.9 sec of each other. The BFS does not have a delta time check. This is displayed when a discrete from the BFS SRB SEP sequencer is set.
2. 'T' is a digital readout of the throttle command from guidance in percent. The range is from 65 to 100 percent.
3. 'SEP INH' will be displayed flashing if the SRB SEP constraints are violated. The SEP INH discrete is set by the SRB SEP sequencer.
4. 'R', 'P', and 'Y' are the BFS-computed roll, pitch, and yaw errors, and are displayed before BFS engage for comparison with the Primary Avionics Software System (PASS) ADI error needles. Signs of the error values will be U (pitch up), D (pitch down), L (roll or yaw left), and R (roll or yaw right) to indicate fly-to errors.

## Use

Before BFS engage, the XXXXXX TRAJ 1 display is used as a supplement to cue cards to monitor or manually fly the first-stage trajectory. Whether BFS is engaged or not, this display is the only CRT display to monitor the first-stage trajectory.

## Nominal, AOA, ATO

The Shuttle symbol and predictors should track the profile through SRB SEP. If in CSS and before BFS engage, the crew can vary the pitch angle ( $\theta$ ) to fly the trajectory while using the LVIY pitch attitude tick marks as references. After BFS engage, there is no CSS in OPS 1. For loss of comm, the ejection altitude reference line will be used as an indication of the highest safe ejection altitude.

The KEAS scale provides the current KEAS ( $\bar{q}$ ) as calculated in the BFS. If the KEAS indicator is above the STG tick during SRB SEP, there will be a SEP INH due to  $\bar{q}$  and the 'SEP INH' readout will flash.

The 'PC < 50', 'SEP INH', and 'T' digital readouts are active and perform as discussed earlier (description section). If 'PC < 50' is not displayed, SRB SEP cannot be performed automatically or manually until a backup cue is set at an MET of 2:13.

The BFS-computed roll, pitch, and yaw errors can be compared to the Primary Flight System (PFS) ADI errors before BFS engage to obtain an indication of the health of the BFS system and the validity of its displays, assuming the PFS is working properly. The BFS-displayed errors will also tell the crew what attitude changes to expect when the BFS is engaged. After the BFS is engaged, the errors are displayed on the ADI and not on the CRT display.

## RTLS

Procedurally, an RTLS will not be selected in first stage because the trajectories and GNC operations are identical whether or not an RTLS is selected. The trajectory and GNC operations change based on engine out.

If an SSME fails in first stage, guidance will automatically loft the trajectory ( $\theta$  will increase  $1^\circ$  to  $2^\circ$ ) whether or not an RTLS is selected.

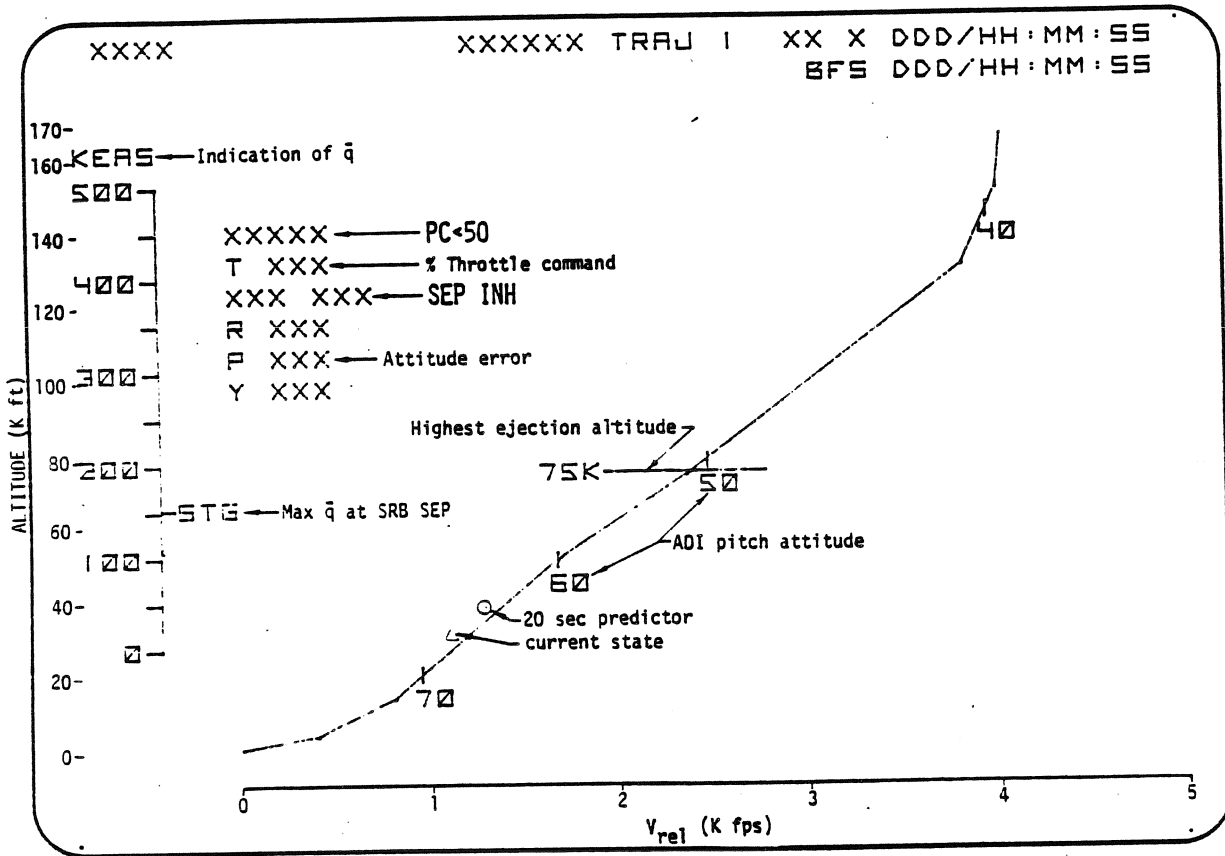

Figure 4-3.- XXXXXX TRAJ 1 (BFS) display.

## XXXXXX TRAJ 2 (BFS)

### Description

This display comes up at the transition to MM 103 and is only available in MM 103 (fig. 4-4). The title is dynamic and will read ASCENT, ATO, or AOA.

The single profile represents a nominal second-stage ascent plotted as a function of altitude above the Fisher ellipsoid vs. inertial velocity. The altitude scale goes from 140,000 to 525,000 ft and the velocity scale from 5,000 to 26,000 ft/s. The GO and RTLS tick marks have the same definition and application as on the XXXXXX TRAJ (primary system). The final segment of an AOA trajectory may be plotted as a dashed line if significantly different from the nominal trajectory.

The current vehicle state is represented by a moving triangle and the predicted states for 30 and 60 sec into the future are shown by circles. The altitude and velocity used to plot the current vehicle state comes from navigation (ascent UPP).

The scale on the left displays  $\Delta\dot{H}$  in ft/s, where  $\Delta\dot{H}$  is the actual radius (altitude) rate from navigation minus the nominal radius (altitude) rate for the present velocity. The current  $\Delta\dot{H}$  is shown by a triangle. The nominal radius rate is derived from a table of altitude rate vs. relative velocity. Two tables are loaded. One is for an engine out at the press-to-MECO boundary, and the other is for nominal. For STS-1, both tables are loaded for the engine-out case; therefore,  $\Delta\dot{H}$  is only valid if this occurs. The triangle will flash if off-scale.

The scale across the top is inertial velocity from 25,000 to 26,000 ft/s with a Cutoff (CO) tick at 25,559 ft/s and an AOA Cutoff (ACO) tick if substantially different from nominal. CO represents the nominal MECO point biased by ~100 ft/s for thrust tailoff and a manual MECO. The current inertial velocity is indicated by a triangle and comes from navigation. The triangle is initialized at 25,000 ft and remains there until  $V_I > 25,000$  ft/s.

The vertical scale near the center of the display shows the total load factor in g's. The scale goes from 2 to 3.5g's with the current value indicated by a triangle. The triangle will flash if 3g's is exceeded.

The digital readouts follow:

1. 'H' is a readout of the present radius (altitude) rate from navigation.
2. 'R', 'P', and 'Y' are the BFS-computed roll, pitch, and yaw errors and are displayed before BFS engage for comparison with the PASS ADI error needles. The signs of the error values will be U (pitch up), D (pitch down), L (roll or yaw left), and R (roll or yaw right) to indicate fly-to errors.

3. 'T' is the throttle command in percent. The range is from 65 to 100 percent and the value comes from guidance.
4. 'TMECO' is the predicted time of MECO in minutes and seconds. The time comes from guidance and the stability of the time indicates whether or not guidance is converged.
5. 'SEP INH' will be displayed flashing if the ET SEP constraints are violated and the ET SEP inhibit is set by the ET SEP sequencer.

#### Use

The XXXXXX TRAJ 2 display is used as a supplement to the XXXXXX TRAJ (PFS) and cue cards to monitor or manually fly the second-stage trajectory. After the BFS is engaged, this display becomes the only CRT display for monitoring the second-stage trajectory.

#### Nominal, AOA, ATO

The Shuttle symbol and predictors should track the profile all the way through MECO. If in CSS and before BFS engage, the crew can use pitch ( $\theta$ ) to stay on the trajectory. CSS is not available after BFS engage. If the triangle is past the 'GO' tick and a single SSME fails, the crew will press to MECO with MCC concurrence. If the triangle is past the RTLS tick, RTLS can no longer be successfully performed.

The  $\Delta \dot{H}$  scale is used as an indicator to help get the proper  $\dot{H}$  at MECO.

The inertial velocity scale across the top can be used to monitor or manually back up the proper engine cutoff (MECO) point.

The g scale can be used to monitor or manually perform 3g throttling.

The ' $\dot{H}$ ', 'T', 'SEP INH', and 'TMECO' readouts perform as discussed earlier (description section).

The R, P, and Y digitals are used as described for XXXXXX TRAJ 1 (BFS) display.

#### RTLS

This display is not available in MM 601.



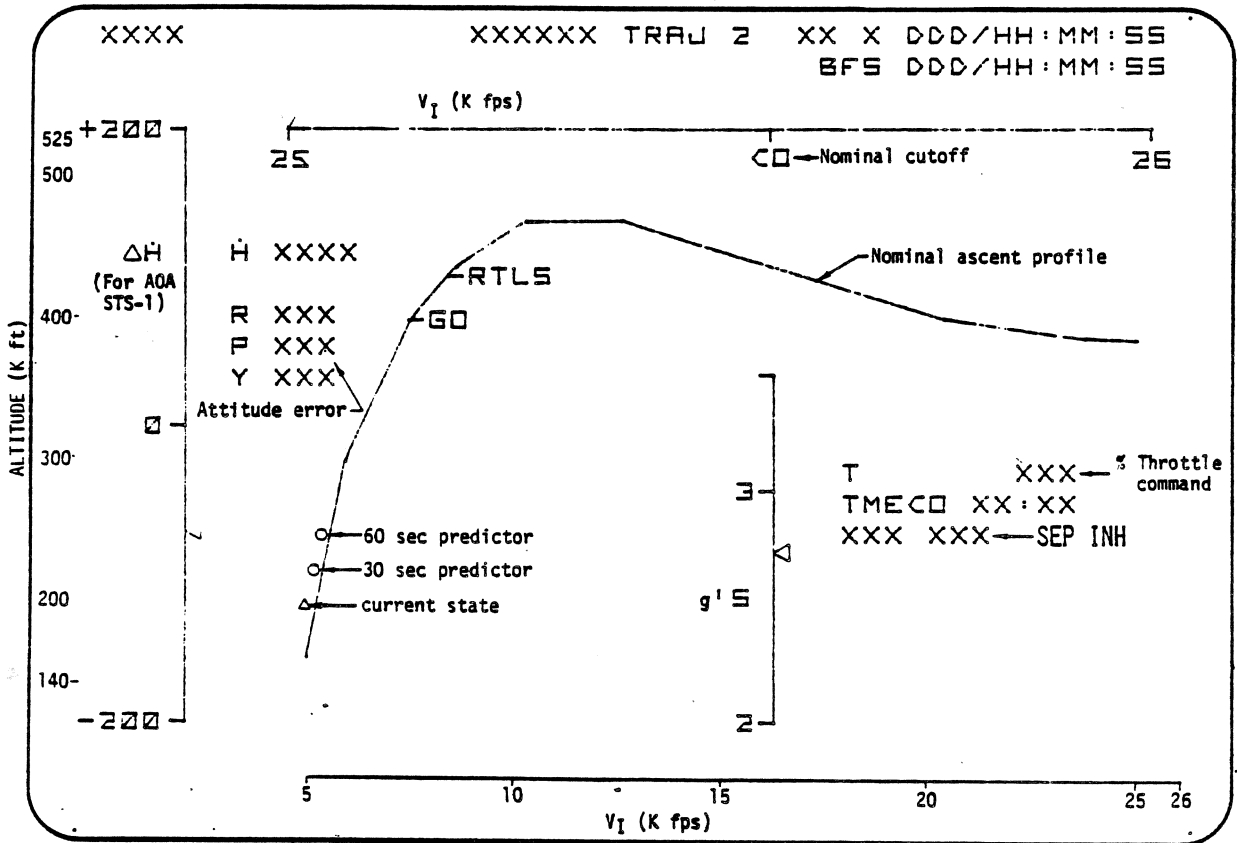

Figure 4-4.- XXXXXX TRAJ 2 (BFS) display.

## RTLS TRAJ 2 (BFS)

### Description

This display comes up when an RTLS abort is selected in second stage and is only available in MM 601 (fig. 4-5).

The central plots represent the same second-stage profiles as on the XXXXXX TRAJ (primary system) display. The rightmost portion represents a nominal ascent profile, the center (inner) profile represents an engine out at lift-off with an RTLS selected at 2:30, and the top line coming off the nominal ascent profile represents the last-time two-SSME RTLS abort profile (for cycle 2, two-engine out at 4:29, RTLS selected at 4:34). However, unlike the XXXXXX TRAJ display, all the profiles are plotted as a function of altitude above the Fisher ellipsoid vs. the horizontal component of downrange  $V_{rel}$  ( $V\_HORIZ\_DNRNG$ ). The altitude scale goes from 140,000 to 525,000 ft while the velocity scale goes from -7,000 to 10,000 ft/s.

The current vehicle state is shown by a moving triangle with 30- and 60-sec predictors represented by circles. The altitude and  $V\_HORIZ\_DNRNG$  used to plot the current vehicle state comes from navigation (RTLS UPP).

The two lines which bracket the end of the last-time two-SSME RTLS abort profile (lower left of the CRT) represent the ET separation  $\bar{q}$  constraints. The top line represents  $\bar{q} = 2$  psf and the bottom  $\bar{q} = 10$  psf.

Also associated with the central plot is a vertical line labeled zero which intersects the plots and represents the point where  $V\_HORIZ\_DNRNG$  equals zero. The sign attached to the velocity changes from plus to a minus at this point to prevent doubling back.

The scale on the left represents  $\Delta\dot{H}$  and alpha. The  $\Delta\dot{H}$  is defined as the  $\dot{H}$  from navigation minus a reference  $\dot{H}$  from a table of  $\dot{H}$  vs.  $\Delta R$  for an engine out at 150 sec (same as XXXXXX TRAJ). The limits on the scale are 200 ft/s<sup>2</sup> (top) to -200 ft/s<sup>2</sup> (bottom). The  $\Delta\dot{H}$  symbol, a triangle, is only displayed for  $V\_HORIZ\_DNRNG < 0$  and if  $-550 < \Delta R < -50$ . The symbol will flash if off-scale.

The alpha scale uses a triangle to indicate the current nav-derived alpha. The indicator will not flash if off-scale. The scale limits are from +4° (top) to -12° (bottom).

The scale across the top is delta range ( $\Delta R$ ) where  $\Delta R$  is defined as glide range potential based on energy state (function of  $V\_HORIZ\_DNRNG$  and flightpath angle from navigation) minus the range to the runway threshold from navigation in n. mi. The PD and PD3 tick marks represent the  $\Delta R$  at which PPD is initiated for a two-SSME RTLS (-68 n. mi. for cycle 2) and a three-SSME RTLS (-99 n. mi. for cycle 2), respectively. In both cases, PPD occurs 20 sec before MECO. The CO tick is the  $\Delta R$  when MECO should occur and is biased by -3 n. mi. so that zero thrust and zero  $\Delta R$  will occur simultaneously. The  $\Delta R$  scale starts at -143 n. mi. on the right and goes to +17 n. mi. on the left. The  $\Delta R$  symbol is a triangle and

is initiated at the far right of the scale and remains there until  $\Delta R > -143$  n. mi. This scale is identical to the  $\Delta R$  scale on the XXXXXX TRAJ display.

The g's scale is the total load factor in g's with a triangle indicating total load factor. The triangle will flash if the load factor exceeds 3g's.

The digital readouts follow:

1. ' $\beta$ ' is the sideslip angle from navigation in deg.
2. ' $\alpha$ ' is the angle of attack from navigation in deg.
3. ' $\dot{H}$ ' is the altitude (radius) rate from navigation in ft/s.
4. 'TMECO' is the predicted time of MECO from guidance. It reads in min and sec from lift-off.
5. 'PRPLT' is the percentage of propellant remaining in the ET. This value is calculated in the RTLS TRAJ 2 DIP.
6. 'SEP INH' is displayed flashing just below the 'TMECO' readout if the ET SEP inhibit discrete is set by the ET SEP sequence.
7. 'T' is the commanded throttle setting in percent. The value comes from guidance.
8. 'R', 'P', 'Y' are the ADI errors in roll, pitch, and yaw computed by the BFS. They are displayed before BFS engage for comparison with the PASS ADI error needles. The signs of the error values will be U (pitch up), D (pitch down), L (roll or yaw left), and R (roll or yaw right) to indicate fly-to errors.

#### Use

The RTLS TRAJ 2 display is used as a supplement to the XXXXXX TRAJ to monitor or manually fly the Powered RTLS (PRTLS) trajectory. After the BFS is engaged, this display becomes the only CRT display for monitoring the PRTLS trajectory.

#### Nominal, AOA, ATO

Not applicable; this display is only up for an RTLS abort, MM 601.

#### RTLS

This display will appear on the BFS CRT immediately after an RTLS (MM 601) is selected. Depending on the engine-out time, the Shuttle symbol and predictors will track the engine out at lift-off profile, the last-time two-SSME RTLS profile, or somewhere between the two profiles. For a three-SSME RTLS, the symbol and predictors should track very close to the last-time two-SSME RTLS profile. If in CSS and before BFS engage, the crew

will vary pitch ( $\theta$ ) to stay on the appropriate profile. CSS is not available after BFS engage.

The  $\Delta H$  scale is used as described for the XXXXXX TRAJ (primary system) display.

The alpha scale will be used primarily after PPD to monitor alpha during the mated coast and the ET SEP sequence.

The  $\Delta R$  scale will indicate when PPD should be initiated for a two- or three-SSME RTLS (PD or PD3 tick), and when MECO should be initiated (CO tick).

The g's scale will be used to monitor the total load on the vehicle. Three-g throttling is not needed for an RTLS.

The  $\beta$ ,  $\alpha$ ,  $\dot{H}$ , T, and SEP INH readouts perform as discussed earlier.

The TMECO readout will provide the MECO time as calculated by guidance. It will also tell the crew that the BFS second-stage PRTLS guidance is converged when the time is stable.

The PRPLT readout will be used to monitor the initiation or as a manual backup (before BFS engage) to initiate the PPA. The PPA maneuver is automatically initiated based on vehicle mass and manually initiated based on a PPA time from MCC or on the percentage of propellant remaining as a backup cue.

The R, P, and Y digitals are used as described for the XXXXXX TRAJ (BFS) display.

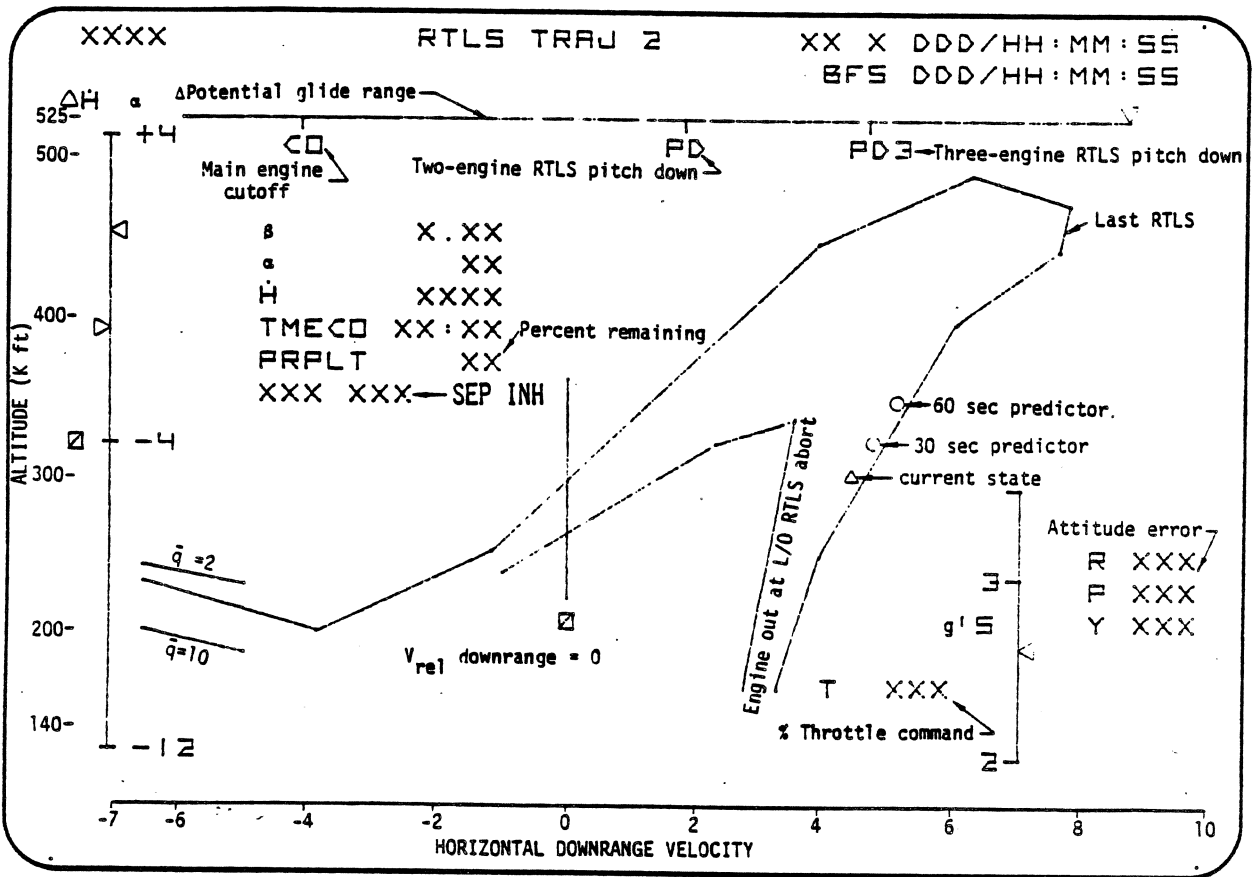

Figure 4-5.- RTLS TRAJ 2 (BFS) display.

## CONT ABORT (Primary System, SPEC 52)

### Description

The contingency abort display provides trajectory information which helps the crew to manually fly the Orbiter in a contingency abort regime (i.e., with two or three SSME's out). The display is available in OPS 1 and OPS 6 by performing a SPEC 52 PRO. The BFS does not support this display.

The contingency abort display is shown in figure 4-6 with both cycle 2 and cycle 3 lines. The plot is a function of apogee inertial velocity (0 to 26,000 ft/s) and apogee altitude (200,000 to 550,000 ft). The cycle 2 line is the long four-segment line; the leftmost segment represents a  $\bar{q}$  of 800 psf; the next two segments represent the body flap surface temperature limits; and the rightmost represents the elevon surface temperature limit. The structural and thermal limits will be exceeded if MECO occurs above the line. For cycle three, there will be two lines on the display. The leftmost line is the time-critical SEP boundary line and the rightmost vertical line is the single-engine thermal boundary line.

The DUMP START and STOP (items 1 and 2) allow the crew to start or stop the OMS/RCS propellant dumps for c.g. control during the glide phase. Neither item is selected when the display is initialized and an '\*' appears next to the number when it is executed.

The current vehicle position is indicated by a triangle. Dashed lines for a nominal ascent and last RTLS profile are drawn on figure 4-6 for reference.

### USE

This display can show the crew what attitude region the Orbiter is in. If a second engine should fail while to the left of the time-critical boundary, it is necessary to pitch to the proper attitude and separate from the ET immediately. Between the time-critical SEP boundary and the single-engine thermal boundary, the Orbiter is in the 'stand-on-the-tail' region. The Orbiter is maneuvered to a vertical thrust attitude with the +Z axis pointed in the direction of the velocity vector. To the right of the single-engine thermal boundary, the Orbiter would continue the flight in an attempt to reach the MECO target.

The cycle two line shows the crew if the vehicle will exceed any structural or thermal constraints during entry on a contingency abort. If the vehicle is above one of the cycle two lines when MECO occurs, one of the limits will be exceeded.

ITEM 1 EXEC or ITEM 2 EXEC allows the crew to start or stop a contingency OMS/RCS dump for c.g. control. Since the CONT ABORT display can be called during an RTLS abort, the dump can be started during the RTLS if the auto RTLS OMS/RCS dump malfunctions. The dump will stop at an I-loaded time (125 sec for STS-1) after it is started if it has not been stopped manually.



## VERT SIT 1 (Primary System and BFS)

### Description

This display comes up at MM 602 transition for Glide Return To Launch Site (GRTLS) or MM 305 transition for a nominal entry. The only portion of the display that will be described in this writeup is the Mach-alpha profile in the upper left corner of the display. The remainder of the display is described in the Entry Flight Procedures Handbook. The profile described below is for cycle 2 data.

The Mach-alpha profile (dashed line) is used during the alpha transition phase of GRTLS guidance and represents the Mach-alpha profile that guidance is attempting to fly (fig. 4-7). The dashed Mach-alpha profile line moves from Mach 6 and alpha =  $20^\circ$  (upper-right of dashed line) to an alpha of  $16^\circ$  at Mach 4 (bend in line) where alpha is held constant down to Mach 3 (lower left of dashed line). The current vehicle state is indicated by a symbol in the shape of an Orbiter at a fixed orientation. The symbol can represent a vehicle state anywhere between alphas of  $8^\circ$  to  $24^\circ$  and Mach 3 to 6.

Below the dashed line is a solid line representing a lateral/directional trip boundary defined for  $3\sigma$  aero with two RCS jets available for trim. The solid line moves from alpha =  $10^\circ$  at Mach 6 down to alpha =  $8^\circ$  at Mach 3.

### Use

This display is used primarily to monitor or fly the alpha transition phase of GRTLS and to monitor the energy state of the Orbiter, whether it is flying in auto or CSS during and after the alpha transition phase.

### Nominal, ATO, AOA

This display is not available for nominal ascent, or the ascent portion of aborts.

### RTLS

The VERT SIT 1 comes up at MM 602 transition (end of -Z translation) with the Energy Over Weight (E/W) scale and digital data being active, and the Orbiter symbol pegged above the upper-right portion of the Mach-alpha dashed line at Mach 6 and alpha =  $24^\circ$ . Only the E/W scale and digital data will be active during the first two phases of GRTLS ( $\alpha$ -recovery and Nz hold). Since a constant alpha ( $50^\circ$ ) is flown during  $\alpha$ -recovery and Nz is held at  $64.4 \text{ ft/s}^2$  (2g) during Nz hold, the VERT SIT 1 is not used until the alpha transition phase.



The Shuttle symbol will start moving once the vehicle state falls within the scaling of the Mach-alpha plot on the display ( $\alpha < 24^\circ$ , Mach  $< 6$ ); however, the Mach-alpha profile (dashed line) is not followed until the descent rate is less than 250 ft/s. If the E/W symbol is at S-Turn (STN) and flashing, an S-turn will be performed while flying the Mach-alpha profile until E/W falls below STN.

The Mach-alpha profile is followed until the Orbiter symbol switches to the altitude/range lines. This occurs at Mach 3.2, the MM 603 transition point. The  $\theta$  scale becomes active at the same time.

After the Shuttle symbol switches to the altitude/range lines (Mach 3.2) the E/W scale becomes the prime readout since kinetic energy is the most important parameter to control. Whether in auto or CSS, if the E/W symbol is below NOM (Orbiter low on energy), fly 200 KEAS (max. Lift-To- Drag (L/D)) and hold until energy is nominal. If the E/W symbol is above NOM (Orbiter high on energy), fly 300 KEAS and hold until energy is nominal. Once the E/W scale is at nominal, altitude control can be used to fly towards the altitude/range reference line (middle line).

The  $\theta$  scale is used when default Air Data Transducer Assembly (ADTA) is being used and  $V_{rel} < 1500$  ft/s. This scale gives information to correct situations in which auto control may command  $\theta$  out of limits and exceed the  $\bar{q}$  limits ( $140 \leq \bar{q} \leq 300$ ).

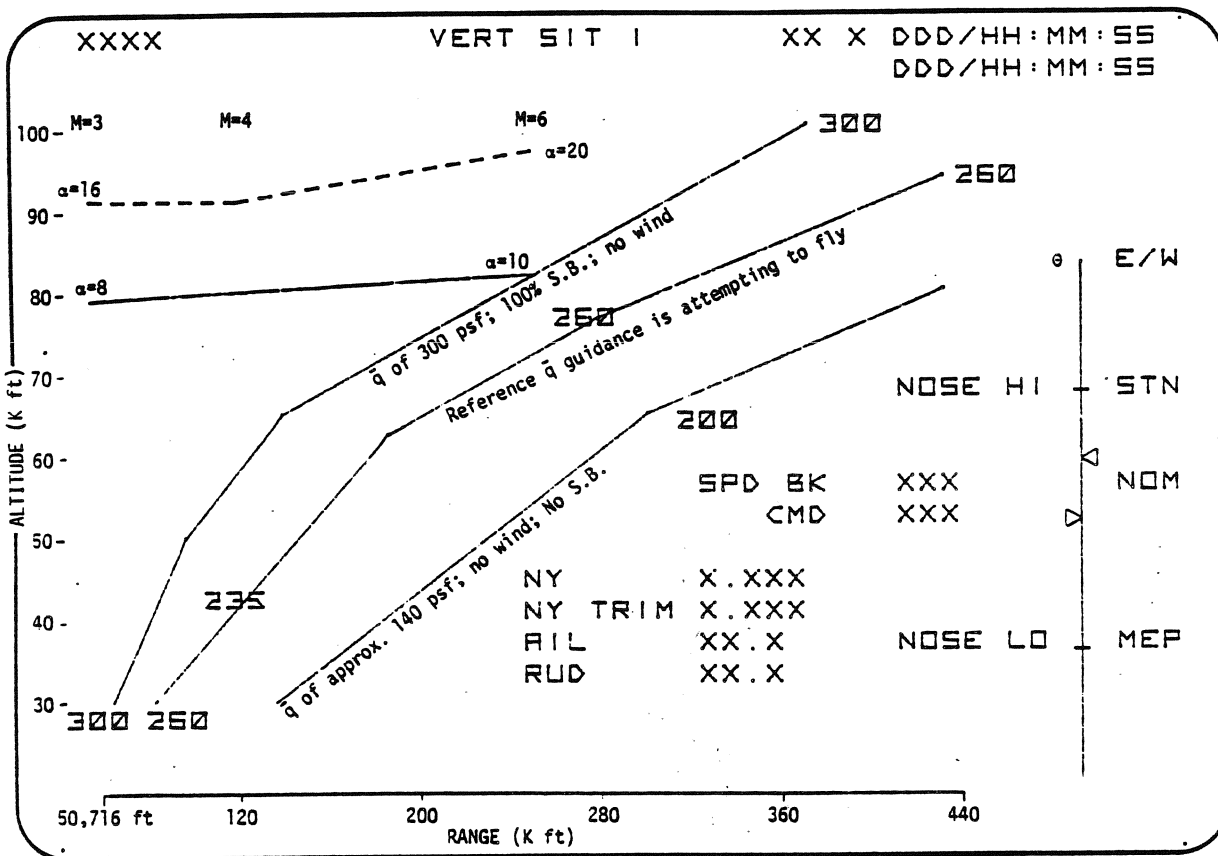

Figure 4-7.- VERT SIT 1 (primary system and BFS) display.

## XXXXX MNVR YYYYY (Primary System and BFS)

This display is available in MM's 104, 105, 106, 301, 302, and 303 (fig. 4-8). The title is dynamic and reads the appropriate I-loaded maneuver to be performed. The purpose of the display is to provide a means of inputting maneuvers, evaluating their effects on the trajectory, and adjusting parameters as required.

The display parameters and their functions are:

1. GMBL CK (item 1) provides the capability to initiate the automatic OMS TVC check of the gimbals in OPS 1 or 3. This will not normally be used during ascent or AOA.
2. SEL PRI/SEC provides the capability to select the primary or secondary gimbal drive system independently on both the left and right OMS engines. An OFF selection is also available to power down the respective gimbal drive system. The gimbals are initialized to the primary gimbal drive system and can be changed by selection any time the MNVR display is available. Gimbal selection will remain across OPS transitions. Normally, the primary gimbals will be selected for ascent.
3. BURN ATT provides the guidance-computed ADI 'inertial' burn attitude in roll, pitch, and yaw for MM's 104, 105, 301, and 302. In MM 303, it displays a premission I-loaded desired attitude which can be changed by item entry. On AOA, the item entry may be used in MM 303 to enter the appropriate Entry Interface (EI)-5 min attitude required for entry.
4. The lower left side of the display contains various burn data:
  - a. The apogee (HA) and perigee (HP) altitude values in n. mi. above the earth for both the targeted and current conditions.
  - b. A time display shows Time To Apogee (TTA) or Time To Perigee (TTP) in OPS 1. If the orbit conditions have an apogee and perigee difference less than 5 n. mi., the display shows a Time To Circularization (TTC) and the time field becomes blank. In OPS 3, time to 400,000 feet (Time To Free Fall (TFF)) is shown.
  - c. In OPS 3, a range (REI) from 400,000 feet to the target landing site is displayed in n. mi. This field is blank in OPS 1.
  - d. The dynamic word 'EXEC' begins flashing at the time of OMS ignition minus 15 sec, and continues flashing until 'EXEC' is performed at which time the word disappears. An 'EXEC' prior to the TIG-15 sec will not enable the burn. Ignition will not occur unless the entry is made. 'EXEC' after TIG enables the burn immediately.
  - e. Total delta velocity ( $\Delta VTOT$ ) required for the burn is displayed in ft/s.
  - f. The predicted burn time (TGO) is displayed prior to the burn, and the actual burn time remaining during the burn is displayed in min:sec.
  - g. The velocity-to-be-gained in each vehicle body axis is displayed in ft/s. Postburn residuals are verified by these parameters.

5. OMS TRIM angles in degrees are displayed and can be changed by item entry. For the OMS 1 burn in ascent, these trim values are I-loaded and should appear when in OPS 104. Burns after OMS 1 will be automatically trimmed to the last burn's gimbal positions unless manually changed. The BFS does not track PASS gimbals during the burn preengaged. Thus I-loaded values will remain on the display and need changing. If BFS is engaged, the trims will change just like with the PASS.
6. ENG SEL item entries are provided to select both OMS, left OMS, right OMS, or +X RCS. In addition, guidance will use the selected engine in computing its calculations for the burn. The both OMS selection is initialized for the OMS 1 burn in OPS 104. Subsequent use of the display will reflect the last selected engine option, even after OPS transitions.
7. OMS PURGE is enabled to purge the OMS engines with N<sub>2</sub> automatically after completion of the burn. The purge can be inhibited by item entry, but will be reenabled any time the display is called up. This parameter is not supported by the BFS.
8. WT, total Orbiter weight in pounds, can be updated by entering the appropriate value. This function is automatically calculated by the MNVR DIP the first time the display is called up. A change will be manually entered any time the Orbiter mass is miscalculated by guidance.
9. SURF DRIVE provides the capability to move the flight control surfaces for hydraulic fluid thermal conditioning in OPS 3-only (MM's 301, 302, and 303). This will not normally be used on an AOA.
10. FRCS DUMP provides the capability to arm, dump, and turn off a forward RCS propellant dump during MM's 301, 302, and 303. A forward RCS dump will normally be accomplished on an AOA before the deorbit burn.
11. Targeting information is displayed in the lower-right section for various Powered Explicit Guidance (PEG) modes. Specific PEG 4 I-loaded targets are automatically entered depending on major mode and abort mode selected.
  - a. TIG is the desired mission elapsed time of ignition in days:hr:min:sec. For the first mission, a TIG in the past should not be loaded. A TIG load is required for both PEG 4 and PEG 7 targets.
  - b. C1 and C2 are coefficients of the line equation ( $V_{\text{vert}} = C1 + C2 V_{\text{hor}}$ ) which define the desired flightpath angle for PEG 4. C1 is in ft/s and C2 is a scalar. For all burns going into orbit, both C1 and C2 are zero.
  - c. HT is the PEG 4 targeted radius (height) in n. mi. In OPS 1, this is the targeted height (HA or HP) required for the burn. In OPS 3, it is the targeted EI height - 400,000 ft or 66 n. mi.
  - d.  $\theta$ T is a PEG 4 parameter. In OPS 1, it is the angle between the launch site and the desired target radius at the end of the coast phase. In OPS 3, it is the angle between the deorbit burn TIG and EI. A value greater than 360 can not be manually loaded. However, guidance will use the minus 360 multiple.
  - e. PRPLT is the total OMS propellant in lb to be used in OPS 3 by the deorbit burn. It includes the propellant required for the in-plane target plus the propellant to be wasted in order to achieve a planned c.g. and mass. The sign of the quantity defines the side of the orbital plane where wasting is preferred. If the value needs to be changed after the initial load, a flash-

- ing 'LOAD' must be present to refresh the display with the new number. Wasting can be cancelled by entering zero during the burn.
- f. An external delta velocity targeting (PEG 7) option can be exercised by inputting the desired delta velocities needed in the local vertical reference system at ignition.
  12. 'LOAD' flashing occurs anytime any of the above targeting parameters is changed with the exception of a propellant input. An item entry must be made to send the loaded targets to guidance for a solution, with the exception of the OPS 104 OMS 1 burn which is automatically loaded.
  13. ST CRT TMR initiates the CRT event timer to count down to the loaded TIG. Item entry must be initiated to start this function except for the OPS 104 OMS 1 burn which is automatic. This parameter should not be initiated until after guidance has completed its computations for the loaded target.

Nominal, ATO, and AOA OMS 1 - At MM 104 transition (at the end of the 4-ft/sec -Z translation following ET SEP), the display automatically loads and computes the OMS 1 target. The crew checks to see if the nominal target is the desired target by the OMS 1 target cue card. Two of the parameters on the display are used to make this determination -  $\Delta VTOT$  and TGT HP. If an abort target is desired, selection of the abort will be made with the rotary switch on panel F6 and the pushbutton pushed. The display title will change to indicate the selected abort and also show the abort target. After a short delay for guidance calculations, the targeted burn data will be displayed automatically. If a delayed target is required, it must manually be entered by the crew. For a nominal MECO, the TTA should be around 15 min (-24:00 MET) and the current HA and HP should be 80 and 15 respectively. If an underspeed occurred at MECO, these numbers will be somewhat less depending on the amount of underspeed.

After the appropriate target is selected, the crew compares the burn attitude displayed with the inertial ADI and maneuvers to that attitude. A check of the targets in the BFS is made to compare them with the PASS.

If there is an engine failure before the burn, no attempt will be made to retrim the gimbals or reselect the proper engine. Instead the burn will be started with both engines selected, allowing the software to downmode to the appropriate selection. In certain delayed burn cases where +X RCS is planned, the crew may select the RCS burn. After an OMS failure is annunciated, the crew must turn the affected OMS engine off. This makes guidance aware of the failure so that it can accurately display the correct information. After the burn, residuals in any axis greater than 2 ft/s will be nulled with the Translational Hand Controller (THC).

Nominal or ATO OMS 2 - MM 105 will be manually called up by the crew after the completion of OMS 1. An I-loaded OMS 2 target will appear on the display, but will not be loaded. The crew will verify the target selection with the OMS 2 target cue card. OMS trim values will be entered on the display along with the desired OMS 2 engine selection and target if different from what is already there. Targets are then loaded and the CRT timer started. The BFS target and its solutions are compared with the PASS. The crew again compares the CRT burn attitude displayed with the ADI and then

maneuvers to that attitude. The crew's interface with the display is similar to OMS 1. There are no residual requirements after the burn as long as an 80-n. mi. perigee is reached.

AOA Deorbit - If an AOA is decided on, then the deorbit burn replaces the OMS 2 burn. The crew follows the same procedures up to going into MM 105. Once AOA is decided and after the ET umbilical doors are closed, the crew will transition to OPS 3 and enter the appropriate AOA deorbit target. Since this is a deorbit burn, a PRPLT value will be entered for c.g. and weight management.

After the deorbit target is loaded, the Range To Entry Interface (REI) is checked to verify that it is the desired range. If not, the range is corrected by a checklist chart which allows the crewman to adjust TIG. Changing TIG causes 'LOAD' to flash which requires the crew to reload. After loading, a maneuver to burn attitude is as before.

Approximately 8 min before the deorbit burn, a forward RCS dump will be performed if required. The dump will normally continue until 56 percent of the propellant remains. This is done by item entry on the display. Interface with the display during the burn is similar to the other burns. If it is necessary to stop fuel wasting during the burn, it can be done simply by entering a zero value for PRPLT on the display. After the burn, any residuals greater than 2 ft/s will be nulled using the THC.

The crew will then mode into MM 303. The display will blank all computed values and display only BURN ATT. This attitude is an I-loaded value and represents the EI-5 attitude for a nominal AOA entry after an ATO (AOA) OMS 1 burn.

Since AOA deorbits may be performed under different conditions (e.g., shallow entry), the attitude required at EI-5 will vary. If the attitude required is different from the I-loaded value, the crew will enter the required value and then maneuver to this attitude.

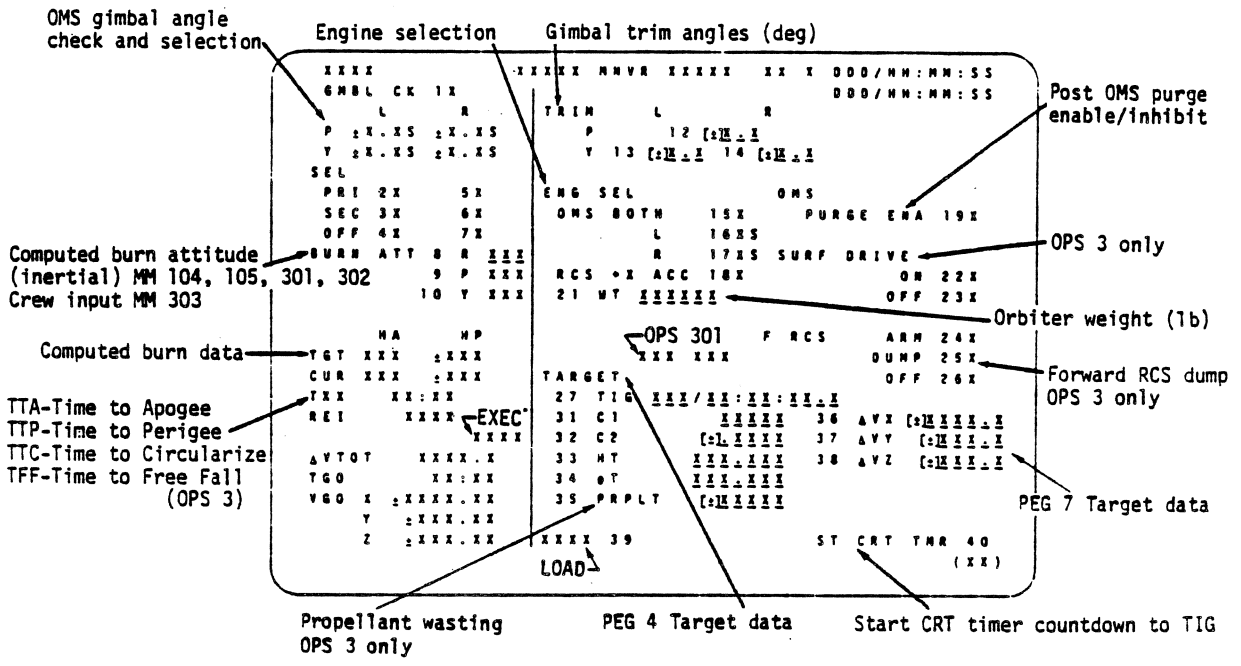

Figure 4-8.- XXXXX MNVR YYYYY (primary system and BFS) display.

## SYS SUMM DISPLAYS

The SYS SUMM displays are the principal means of monitoring the performance of Orbiter flight-critical systems. The parameters displayed were chosen to support the Caution & Warning (C&W) function by aiding the crew in determining the proper response to alarms. These displays can be called by SYS SUMM or SPEC key sequence with the CRT major function switch in proper position (GNC or SM).

### GNC SYS SUMM 1 (Primary System SPEC 18) (fig. 4-9)

The Reaction Control System (RCS) jet manifold status indicators are displayed for each of the three RCS modules and each manifold (except number 5 for ascent and entry). The ISOL VLV positions are the initialized positions in MM 102 and may not be the true valve positions. Computed aerosurface positions and loading status are displayed during OPS 3 and 6. The Data Processing System (DPS) indicates when GPC's are voted failed or fail to sync. The DPS also provides a summary status of flight-critical data paths.

The Flight Control System (FCS) channel Input/Output (I/O) error and failure indicators are displayed in OPS 1 for SRB, MPS, and aerosurface actuators, but in OPS 3, the I/O error and failure indicators are displayed only for the aerosurface actuators. NAV sensor status is displayed in the following situations:

<u>Sensor</u>	<u>OPS</u>
IMU	1, 2, 3, 6, & 8
ACC & RGA	1, 3, & 6
TAC, MLS, ADTA	3 & 6

CNTRLR status is displayed as follows (PASS only):

<u>Controller</u>	<u>OPS</u>
None	1
RHC*, THC*, SBTC	3, 6, 2, & 8

\*Aft CNTRLR's are active in OPS 2 & 8 only.

### GNC SYS SUMM 1 (SPEC 18, BFS) (fig. 4-9)

The aerosurface positions and loading status are only supported in OPS 3. The DPS provides failure indication for each data path. The FCS CH status indicates actuator bypass manual deselection or comm faults. NAV status is supported as follows: IMU in OPS 1, 3, and 6; TAC and ADTA in OPS 3 and MM's 602 and 603.

For the MPS, helium tank, regulator, and helium system pressures in psia are displayed for each engine. External tank ullage pressure and manifold pressure for LH2 and LO2 are displayed; this is only supported in MM's 101, 102, 103, and 601.



#### GNC SYS SUMM 2 (SPEC 19, BFS only) (fig. 4-9)

This display is available only in BFS for ascent and aborts and is used for monitoring Orbiter RCS and OMS system performance. The RCS helium pressure, tank pressure, and manifold pressure in psia and PRPLT quantity in percent are displayed for oxidizer and fuel in each pod. RCS jet manifold status indicates the position of the RCS manifold isolation valves. Jet fail and manifold 5 status are not driven in the BFS. The OMS helium, oxidizer and fuel tank pressures, nitrogen regulator and tank pressures, and engine oxidizer and fuel inlet pressures are displayed in psia for the left and right pods. The position of the left and right engine nitrogen pressure valves are displayed as open or closed. The left and right one and two engine bipropellant valves' position are displayed in percentage open.

#### THERMAL (BFS) (fig. 4-10)

Systems Management (SM) is available only in the BFS for ascent and aborts. The THERMAL display is the BFS SM OPS display. The HYD SYS TEMP section displays the temperature ( $^{\circ}\text{F}$ ) of the hydraulic fluid in the actuator/pressurization system of the aerosurface control system. The HTR TEMP system denotes only out-of-limits conditions. This section of the display is presented in such a way as to direct the crew to a specific switch (or set of switches) to correct the malfunction. It should be noted that some heaters are off at launch to save electrical power in main stage and this display will allow the crew to check for out-of-limit conditions. The FREON LOOP and H<sub>2</sub>O section displays parameter values necessary to support flash evaporator thermal monitoring.

#### SM SYS SUMM 1 (BFS SPEC 78) (fig. 4-10)

Systems Management (SM) is only available in the BFS for ascent and aborts. The emergency parameters, fire and decompression ( $dP/dT$ ), are displayed. Electrical power (ac and dc) distribution parameters and fuel cell characteristics are displayed. Significant STS life support parameters are also displayed.

#### SM SYS SUMM 2 (BFS SPEC 79) (fig. 4-10)

The cryogenic parameters for O<sub>2</sub> and H<sub>2</sub> tank pressure and O<sub>2</sub> heater temperature are displayed. The Auxiliary Power Unit (APU) system, arranged according to system flow path and avionics bay parameters, is displayed. Hydraulics system and hydraulic water boilers and thermal control parameters are also displayed.

```

XXXX/XXX/018 GNC SYS SUMM 1 XX X DDD/HH:MM:SS
                      DDD/HH:MM:SS
RCS JETISOL
MANFFAILVLV SURF POS NOM DPS 1 2 3 4 5
F1XXX XXS L 08 XXX.XS XXS GPC S S S S S
2XXX XXS IB XXX.XS XXS MDM FF S S S S
3XXX XXS R 10 XXX.XS XXS FA S S S S
4XXX XXS 00 XXX.XS XXS
5XXX XXS
L1XXX XXS ATL XXX.X
2XXX XXS RUO XXX.X FCS CH 1 2 3 4
3XXX XXS SPD BRK XXX.X S S S S
4XXX XXS BOV FLP XXX.X
5XXX XXS
6XXX XXS
7XXX XXS
8XXX XXS
9XXX XXS
CUTLR 1 2 3
RMC L S S S
R S S S
A S S S
TNC L S S S
A S S S
SBTC L S S S
R S S S
NAV 1 2 3 4
IMU S S S
ACC S S S S
RGA S S S S
TAC S S S
HLS S S S
AOTA S S S S

```

```

XXXX/XXX/018 GNC SYS SUMM 1 XX X DDD/HH:MM:SS
                      BFS DDD/HH:MM:SS
SURF POS NOM DPS 1 2 3 4
L 08 XXX.XS XXS MDM FF S S S S
IB XXX.XS XXS FA S S S S
R 10 XXX.XS XXS PL S S
00 XXX.XS XXS
ATL XXX.X
RUO XXX.X FCS CH 1 2 3 4
SPD BRK XXX.X S S S S
BOV FLP XXX.X
NAV 1 2 3 4
IMU S S S
TAC S S S
AOTA S S S S
NPS L C R
HE TK P XXXS XXXS XXXS
REG P XXXS XXXS XXXS
OP/AT XXXS XXXS XXXS
LN2 LO2
ET ULL P XXXS XXXS
MANF P XXXS XXXS
(XX)

```

```

XXXX/XXX/019 GNC SYS SUMM 2 XX X DDD/HH:MM:SS
                      BFS DDD/HH:MM:SS
RCS JETISOL
HE OXID FU MANFFAIL VLV OMS L R
TK P HE XXXXS XXXXS TK P HE XXXXS XXXXS
TK P XXXXS XXXXS 2XXX XXS OXID XXXXS XXXXS
F QTY XXXXS XXXXS 3XXX XXS FU XXXXS XXXXS
1/2 QTY XXXXS XXXXS 4XXX XXS N2 TK P XXXXS XXXXS
3/4 QTY XXXXS XXXXS 5XXX XXS REQ P XXXXS XXXXS
HE P XXXXS XXXXS L1XXX XXS P VLV XXS XXXS
TK P XXXXS XXXXS 2XXX XXS ENG IN P XXXXS XXXXS
L QTY XXXXS XXXXS 3XXX XXS OXID XXXXS XXXXS
1 QTY XXXXS XXXXS 4XXX XXS FU XXXXS XXXXS
3 QTY XXXXS XXXXS 5XXX XXS VLV 2-1 XXXXS XXXXS
4 QTY XXXXS XXXXS
R HE P XXXXS XXXXS R1XXX XXS
TK P XXXXS XXXXS 2XXX XXS
QTY XXXXS XXXXS 3XXX XXS
1 QTY XXXXS XXXXS 4XXX XXS
3 QTY XXXXS XXXXS 5XXX XXS
4 QTY XXXXS XXXXS
(XX)

```

Figure 4-9.- GNC SYS SUMM displays.

```

XXXX/XXX/078      SM SYS SUMM 1  XX 1 000/HH:MM:SS
                   BFS 000/HH:MM:SS

EMERGENCY
SMOKE      1/A  2/B  DC VOLTS  1/A  2/B  3/C
AV BAY 1  XX.XS XX.XS  FC      XX.XS XX.XS XX.XS
          2  XX.XS XX.XS  WAIN   XX.XS XX.XS XX.XS
          3  XX.XS XX.XS  CHTL  AB  XX.XS XX.XS XX.XS
AP/AT     X.XXS                      OC  XX.XS XX.XS XX.XS
                                       CA  XX.XS XX.XS XX.XS
                                       ESS  XX.XS XX.XS XX.XS

CABIN      AC
PRESS      XX.XS          VOLT 0A  XXXS XXXS XXXS
PP02       X.XS  X.XS    0B  XXXS XXXS XXXS
FAN AP     X.XXS          0C  XXXS XXXS XXXS
H2 OUT T   XXXS          AMP  0A  XX.XS XX.XS XX.XS
O2 FLOW    XX.XS XX.XS    0B  XX.XS XX.XS XX.XS
H2 FLOW    XX.XS XX.XS    0C  XX.XS XX.XS XX.XS

FUEL CELL
INU FAN   AIS BXS CXS  AMPS  XXXS XXXS XXXS
REAC VLV  XXS  XXS  XXS
TOTAL AMPS XXXS  STACK T  XXXXS XXXXS XXXXS
RW  XXS  EXIT T  XXS  XXS  XXS
COOL P  XXXS  XXS  XXXS
PUMP XXS  XXS  XXS
(XX)

```

```

XXXX/XXX/079      SM SYS SUMM 2  XX 1 000/HH:MM:SS
                   BFS 000/HH:MM:SS

CRYO TR  1  2  3  4
H2 PRESS  XXXS XXXS XXXS XXXS
O2 PRESS  XXXS XXXS XXXS XXXS
HTR       T1 XXXS XXXS XXXS XXXS
          T2 XXXS XXXS XXXS XXXS
-----
APU       1  2  3  HVB  1  2  3
TEMP EGT  XXXS XXXS XXXS PRESS XXXS XXXS XXXS
H/U EGT  XXXS XXXS XXXS ACUM P  XXXS XXXS XXXS
OIL IN   XXXS XXXS XXXS RSVR T  XXXS XXXS XXXS
OIL OUT  XXXS XXXS XXXS QTY  XXXS XXXS XXXS
GG OCB   XXXS XXXS XXXS
INJ      XXXS XXXS XXXS W/B
SPEED S  XXXS XXXS XXXS H2O QTY XXXS XXXS XXXS
FUEL QTY XXXS XXXS XXXS BVP VLV XXXS XXXS XXXS
PHP LK P  XXS  XXS  XXS
OIL OUT P XXXS XXXS XXXS

THERM CHTL  1  2
AV BAY      H2O PUMP P  XXXS XXXS
TEMP       FREQN FLOW  XXXS XXXS
FAN AP     X.XS  X.XS  X.XS  EVAP OUT T  XXXS XXXS
(XX)

```

```

0001/ /          THERMAL  XX 1 000/HH:MM:SS
                   BFS 000/HH:MM:SS

H2O SYS TEMP  BOYFLP  RD/SB  L  OB  L  IB  R  IO  R  OB
ACTR  XXXS XXXS XXXS XXXS XXXS XXXS XXXS
PRIME  XXXS XXXS XXXS XXXS XXXS XXXS
STBY 1  XXXS XXXS XXXS XXXS XXXS XXXS
STBY 2  XXXS XXXS XXXS XXXS XXXS XXXS

HTR TEMP      L/A      R/B      FREQN LOOP  1  2
PRPLT        SSSSSSS  SSSSSSS  ACCUM QTY  XXXS XXXS
POB          SSSSSSS  SSSSSSS  RAD IN T  XXXS XXXS
OMS CRSPD    SSSSSSS
EVAP
HI  LOAD  SSS
TOP  DUCT  SS
NOZ  S
FDLN      SSSS  SSSS
          1  2  3
H2O CLR/HTR  S  S  S
APU
GG/FU PHP  SSSS  SSSS  SSSS
TR/FU LN  SSSSSS  SSSSSS  SSSSSS

```

Figure 4-10.- SM systems displays (BFS).

## OVERRIDE (Primary System, SPEC 51)

### Description

This display is available during OPS 1, 3, and 6 (fig. 4-11). It allows the crew to select switch modes ABORT, ET SEP, ET UMB DR, and ENTRY ROLL MODE; to deselect or reselect ADTA, IMU, or hydraulic system; or to override any RCS manifold valve dilemma that causes RM to set the manifold valve closed.

### Use

ABORT MODE is active in MM's 102, 103, 104, and 105. It allows the crew to select an abort mode (item 1 or 2) and initiate the abort (item 3). This allows abort initiation if the ABORT MODE switch and ABORT pushbutton on panel F6 fail. For this case, selection of an RTLS can be performed by keyboard entry of 'OPS 601 PRO.'

ET SEP can be moded or SEP commanded during OPS 1 or MM 601. If the ET SEP switches on panel C3 fail during OPS 1, the crew will get the message ET SEP - MAN and during MM 601, ET SEP - AUTO. This indicates the default mode of the switches. In OPS 1, the ET SEP mode can be put in AUTO via item 4 or allowed to go back to manual by selecting item 4 a second time. In MM 601, an item 4 will set the MECO CONFIRMED flag. Item 5 sets the separation discrete in the same manner that pushing the ET SEP pushbutton does.

ET UMB DR provides backup to dedicated switches for closing the ET umbilical doors. It is only legal in MM's 104, 105, and 106.

RCS RM sets valve status to CLOSE for an RCS manifold valve microswitch dilemma. Item 7 sets the valve status to OPEN on any valve in dilemma and puts the jets without previous failures back in the jet availability table.

The Inertial Measurement Unit (IMU) status and the IMU selected are also displayed on this display. Also, the crew can deselect or reselect an IMU.

ADTA derived altitude, angle of attack, and Mach are displayed. Also, the crew can deselect or reselect an ADTA. This is blank in OPS 1.

Priority Rate Limiting (PRL) (of hydraulics systems) items provide the crew the ability to manually override automatic systems management, and to reselect the automatic systems management after selecting the manual mode of operations. It is initialized in the AUTO mode. This is only good in MM's 101, 102, 103, 304, and 305 and OPS 6.

The ENTRY ROLL MODE switch position from RM is displayed. Should the switch fail, the crew can select the AUTO position. This is legal only in MM's 304, 305, 602, and 603.

The VENT DOOR CNTL allows opening and closing commands to all vent doors. This control is only active in OPS 3 and MM's 602 and 603.

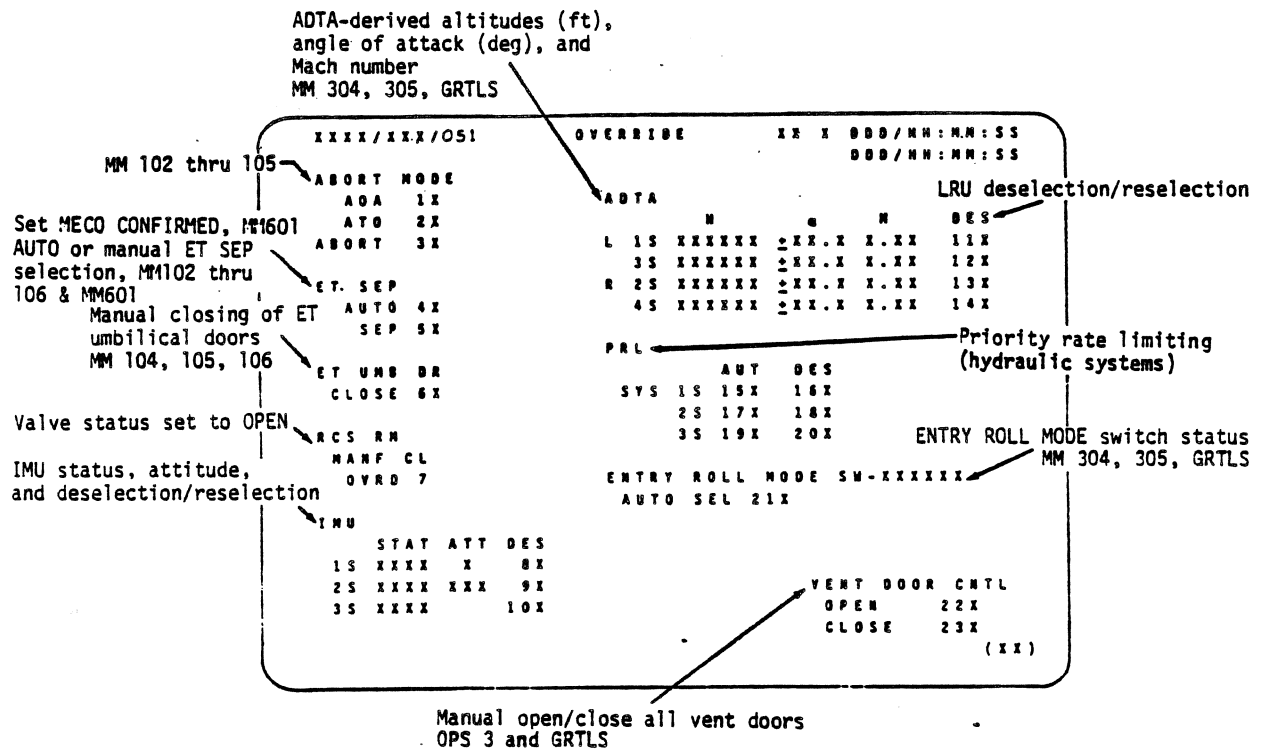
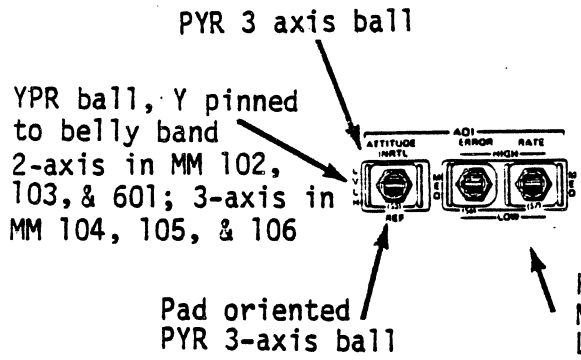
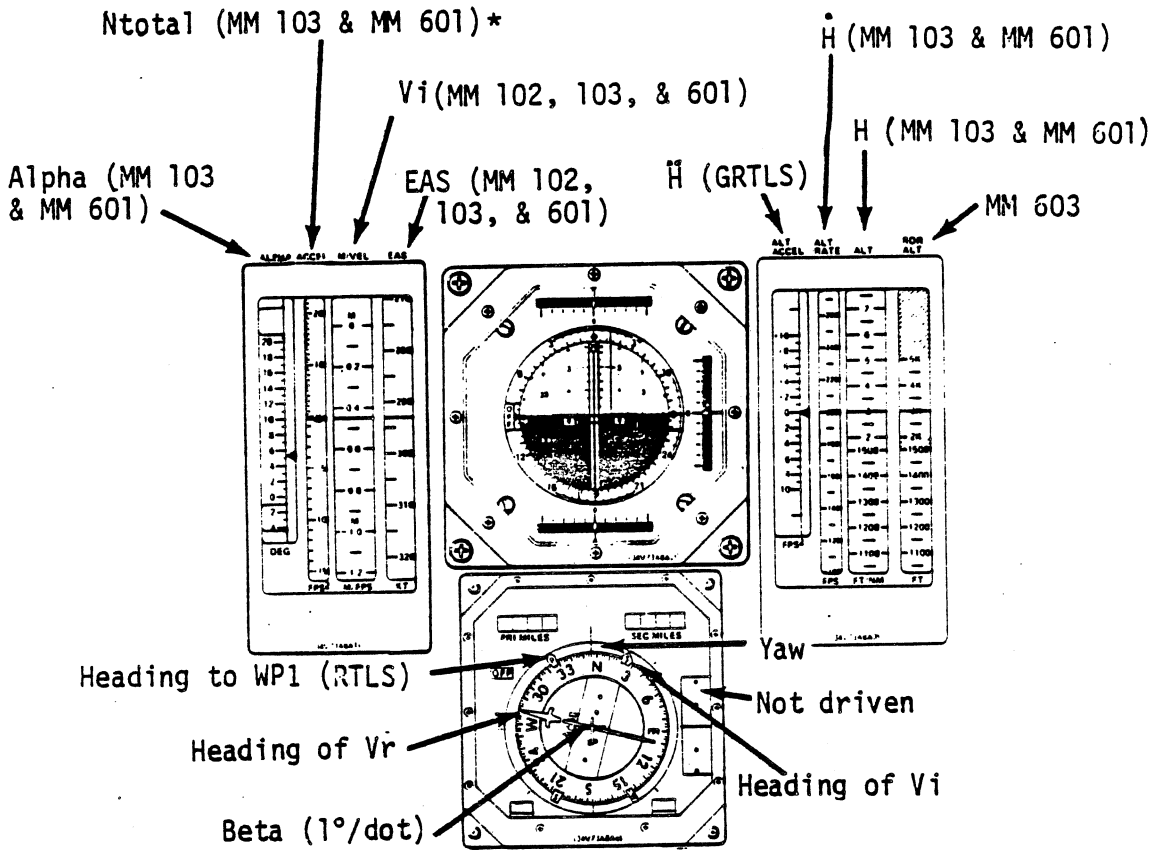

Figure 4-11.- OVERRIDE (primary system, SPEC 51).

### 4.1.3 Dedicated Displays

In addition to the CRT displays, dedicated displays are used in ascent to monitor the Orbiter performance or to fly the Orbiter. In this section, the displays normally used during ascent and aborts are described. A description of displays for glide RTLS (MM's 602 and 603) is not included because it is the same as entry (MM's 304 and 305); any exceptions will be noted. The ascent GNC dedicated displays are shown in figure 4-12. A summary of the dedicated displays and lights is given in table 4-2.



Note: Dedicated displays are driven in GRTLS (MM 602 & MM 603) as they are in ENTRY (MM 304 & MM 305) except:

\* AMI ACCEL displays  $N_z$  in MM 602

- HIGH - 10
- MED - 5
- LOW - 1

Figure 4-12.- Ascent GNC dedicated display.

TABLE 4-2.- ASCENT DEDICATED DISPLAYS SUMMARY

Name	Location	Use
ADI <sup>a</sup>	F6, F8	Trajectory monitoring of roll, pitch, and yaw; attitude, attitude rate and errors.
ADI ATTITUDE switch <sup>a</sup>	F6, F8	INRTL - PYR three-axis ball referenced to nominal OMS 2 TIG. LVLH - YPR two-axis ball with Y pinned to belly band. Active during MM's 102, 103, & 601. In MM's 104, 105, & 106, PYR three-axis ball. REF - PYR three-axis ball referenced to pad-oriented inertial relmat to Orbiter attitude when ATT REF pb is pushed.
ADI ERROR and RATE <sup>a</sup> switches	F6, F8	Full-scale selection for the ADI HIGH is 10, MED is 5, & LOW is 1.
HSI <sup>a</sup>	F6, F8	Ascent - MM's 101 to 103: Primary bearing - constant except in MM 601 - bearing to WP1 Secondary bearing - bearing of Vi-vector Course pointer - heading of Vr Course dev scale - $\beta$ (1 <sup>0</sup> /dot) Heading - yaw  GRTLS: Displays pictorial view of vehicle wrt various navigation points. Provides magnetic heading, course pointer, displacement of vehicle to left or right of course, displacement above or below glide slope, primary and secondary bearings, and miles to selected nav points.

<sup>a</sup>Described in this section.



TABLE 4-2.- ASCENT DEDICATED DISPLAYS SUMMARY (Continued)

Name	Location	Use
HSI SOURCE switches	F6, F8	Determines source of vehicle position data & which of 3 TACAN or MLS receivers to use (GRTLS).
HSI MODE switch	F6, F8	Determines display mode - ENTRY, TAEM, APPROACH (GRTLS).
ALPHA/MACH Ind (AMI) <sup>a</sup>	F6, F8	Shows: ALPHA ( $\alpha$ in MM's 103 & 601) ACCEL (total load in MM's 103 & 601) & (Nz in MM's 602) M/VEL (inertial vel) EAS (MM's 102, 103, & 601)
ALTITUDE/VERTICAL VELOCITY Ind (AVVI) <sup>a</sup>	F6, F8	Shows: ALT ACCEL (GRTLS) ALT RATE (H) (MM's 103 & 601) ALT (H) (MM's 103 & 601) RDR ALT (MM 603)
AIR DATA switch	F6, F8	Selects data from NAV or ADS for use on the AMI or AVVI for (GRTLS).
RADAR ALTM switch	F6, F8	MM 603 selects data from radar altimeter 1 or 2 and displays it on RDR ALT on AVVI.
ABORT light	F6	Indication to abort. Only the control center can illuminate this light.
RCS COMMAND light	F6	Indication of the RCS activity during GRTLS.
MPS PRESS gauges	F7	Engine status/throttling.

<sup>a</sup>Described in this section.

TABLE 4-2.- ASCENT DEDICATED DISPLAYS SUMMARY (Concluded)

Name	Location	Use
MAIN ENGINE STATUS lts	F7	Amber lights indicate engine status - hydraulic or electronic lockup or commanded or data path failure. Red lights indicate MECO or shutdown limit exceeded when they illuminate, and ET SEP commanded when they extinguish.
OMS PRESS gauges	F7	OMS burn or OMS dump status.
RANGE SAFE ARM light	F7	Warning of Range Safety System (RSS) being armed.
Surface Position Ind (SPI)	F7	Not driven in ascent, but for GRTLS it provides position indication of aerosurfaces.
HYDRAULIC gauges	F8	Hydraulic pressure and quantity.
APU gauges	F8	APU fuel and water quantity, exhaust gas temperature, fuel pressure, and oil temperature.
FREON EVAP OUT TEMP gauge	01	Flash evaporator activation indication.
FCS MODE light <sup>a</sup>	F2, F4	Indicates the mode (AUTO/CSS) and whether gain change has been changed for pitch and roll/yaw. Indicates the mode (AUTO/MAN) for body flap and speed brake/thrust control. Backup Flight Control (BFC) light indicates when BFS is engaged. The BODY FLAP light extinguishes when the engines are stowed in OPS 1.
EVENT SEQUENCE light	F2, F4	Not used during ascent; during GRTLS & AOA entry, works as in entry.
ACCEL (g meter)	F7	Normal (Z-body) acceleration.

<sup>a</sup>Described in this section.

## Attitude Direction Indicator

The ADI's on panels F6 and F8 are used during ascent and aborts. The ADI's provide Orbiter attitude, attitude rate, and attitude error information. Each ADI has dedicated controls which affect only the ADI with which the control is associated except the ATT REF pushbutton. The ATT REF pushbutton affects all ADI's.

The ADI ATTITUDE switch selects the frame of reference for the attitude display of the corresponding ADI.

INRTL - The Inertial (INRTL) reference frame during ascent is based on the nominal OMS 2 ignition point in the trajectory. This frame provides an ADI reading at nominal OMS 2 ignition of pitch =  $0^{\circ}$ , yaw =  $0^{\circ}$ , and roll =  $180^{\circ}$ .

LVLH - During powered ascent (MM's 102, 103, and 601), the Local Vertical Local Horizontal (LVLH) position is called 'LVIY' and is a rotating reference frame defined by Z = down (along negative of M50 position vector) and X = downrange (normal to plane formed by the M50 position vector and a unit vector normal to the desired insertion plane), and Y completing the right-hand system. For LVIY, the attitude is processed in a yaw/pitch/roll sequence; however, the ADI is driven to zero in yaw so that the ball becomes simply a pitch/roll display. The yaw angle is shown on the Horizontal Situation Indicator (HSI) display and represents yaw with respect to the desired insertion plane. The HSI yaw is not driven unless at least one ADI ATTITUDE switch on the forward panels is in the LVLH position. Therefore, the LVIY shows a simple Earth-referenced pitch/roll display on the ADI.

During MM's 104 through 106, the LVLH ADI display reverts to three-axis drive and a pitch/yaw/roll sequence. The reference frame is defined as +Z toward the Earth center, +Y in the opposite direction of the Orbiter momentum vector, and +X completing the right-hand system. The LVLH frame is not a fixed system; it is computed based on the state vector and time.

REF - The Reference (REF) position causes the ADI attitude to be based on an inertial reference frame. The REF frame at lift-off is a system based on the nominal launch azimuth: Z = down, X = along the desired Orbiter azimuth at insertion, and Y completes the system. The REF frame can be redefined by depressing the ATT REF pushbutton.

Depressing the ATT REF pushbutton updates the REF frame to the current Orbiter body axis orientation. The update is independent of ADI ATTITUDE switch position and affects the REF frame for all ADI's. An ADI whose ATTITUDE switch is in the REF position when an ATT REF pushbutton is depressed will jump to  $0^{\circ}$  in all axes.

During ascent, the ADI ATTITUDE switch is manipulated as necessary to give the crew an easy way to monitor Orbiter attitude and performance. At lift-off in the LVLH position (LVIY frame), the ADI is at the  $+90^{\circ}$  pitch singularity for an extended period. Therefore, a deadband of  $+2^{\circ}$  is employed to cause the ADI to remain frozen in roll until after pitch maneuver initiate (yaw is pinned to zero). The frozen roll is

55.3° which is the LVIY roll angle anticipated when the Orbiter breaks out of the 2° deadband in pitch.

Because of this, the LVLH position is not selected at lift-off and the inertial REF frame with respect to launch is selected until after tower clear and the pitch and roll maneuver. Then, the LVLH position is selected on at least one ADI for the rest of powered ascent. Prior to the OMS 1 burn, INRTL is used so that the attitude can be checked against the OMS 1 attitude on the OMS 1 MNVR EXEC display. The REF frame can be redefined at the OMS 1 ignition attitude to give the crew an easy means of monitoring the burn. The OMS 2 burn is monitored in the INRTL position.

The ADI RATES are redundancy management-selected roll, pitch, and yaw body rates from the RGA's. The full-scale values for ADI RATES are HIGH = 10°/s, MED = 5°/s, and LOW = 1°/s.

The ADI ERRORS represent total attitude error in body axes (the difference between the actual body attitude and the desired or commanded body attitude). The first-stage ADI errors include load relief effects (Ny, Nz feedback); i.e., the needle deflection can be nulled without having to distinguish load relief from actual trajectory errors. The full-scale values for ADI ERRORS are HIGH = 10°, MED = 5°, and LOW = 1°. The ADI attitude errors from the primary system can be compared with the attitude errors from the BFS on the XXXXX TRAJ X display to indicate how closely the primary and backup systems agree.

For invalid or missing data in any or all axes, the ADI will continue to be driven, but the OFF flag will appear. If any rate or error parameter is considered invalid, the indicator will be driven out of sight; should the parameter later become valid, that indicator will be driven again.

During BFS operations, only the left-side ATTITUDE switch and ATT REF pushbutton are processed. The attitude OFF flag cannot be driven in BFS. The source of attitude knowledge is one of the IMU's selected by an algorithm based on IMU-to-IMU misalignment.

For RTLS aborts, the ADI attitudes will be in accordance with the ADI ATTITUDE switches (INRTL, LVLH, or REF) until MM 602, and topodetic pitch/roll, yaw = 0 after that. For RTLS errors, the roll needle will always be the total body roll attitude error (like the nominal case: body roll attitude differenced with the guidance-limited roll command). Pitch error will be the same in MM 602 as in MM 304 (alpha error) except for the Nz hold phase, when it will display Nz error, and the same in MM 603 as in MM 305 before and after touchdown (Nz error before; slapdown pitch rate error after). The yaw error is the same throughout MM's 602 and 603 as in the nominal case (estimated sideslip, from ATT PROC for  $\bar{q} < 20$ , then from aerojet DAP for  $\bar{q} \geq 20$ ).

In BFS, during MM's 304 and 305 and MM's 602 and 603, the attitude becomes LVLH in pitch/roll, with yaw zero as in the primary system.

## Horizontal Situation Indicator

The HSI's on panels F6 and F8 are used to monitor automatic guidance and provide information needed by the crew to fly manually. The HSI provides a pictorial view of vehicle location with respect to various navigation points. The left and right HSI displays and controls are identical.

During powered ascent MM's 102, 103, and 601, the HSI provides information relative to the target insertion orbit. The glide slope deviation, primary range, and secondary range are not driven.

The heading represents yaw. 'North' on the compass card points along the target insertion plane. The heading of the body +X axis with respect to the target insertion plane is read at the lubber line. The yaw is not displayed unless at least one ADI ATTITUDE switch is in the LVLH position.

The course pointer provides the heading of the Earth-relative velocity vector with respect to the target insertion orbit plane.

The course deviation indicator deflection indicates the estimated sideslip angle; i.e., the angle between the body X-axis and the relative velocity vector.

The primary bearing pointer is not driven in MM's 101, 102, or 103. During MM 601, the pointer indicates the heading to the landing site area (way point 1).

The secondary bearing provides the heading of the inertial velocity vector with respect to the target insertion orbit plane.

Because the ascent HSI parameters are computed from the nav state, the flags for parameters that are driven are never visible. The GLIDE SLOPE and RANGE flags are always visible. The OFF flag is used for loss of power. When the BFS is engaged, it drives the HSI exactly as the PASS does.

In GRTLs, MM's 602 and 603, the HSI works as it does in entry, MM's 304 and 305.

## Alpha/Mach Indicator

The Alpha/Mach Indicators (AMI's) are driven with nav-derived parameters during powered ascent MM's 102, 103, and 601.

ALPHA displays the angle of attack in MM's 103 and 601. The scale is from  $-18^{\circ}$  to  $60^{\circ}$ . During MM's 102, the ALPHA flag is displayed.

ACCEL displays the total load factor (computed lift/weight) in MM's 103 and 601. The scale is  $-50$  to  $+100$  ft/s<sup>2</sup>. During MM 102, the ACCEL flag is displayed.

M/VEL displays the magnitude of the inertial velocity vector during MM's 102, 103, and 601. The scale is from Mach 0 to Mach 4 and 4,000 to 24,000 ft/s.

EAS displays equivalent airspeed in MM's 102, 103, and 601. The scale is from 0 to 500 knots. EAS is used as an indication of the dynamic pressure.

The AMI is not processed by the BFS during ascent since the BFS ascent trajectory displays provide this data. In MM's 602 and 603, the AMI works as it does in MM's 304 and 305, except ACCEL displays Nz in MM 602.

#### Altitude/Vertical Velocity Indicator

The Altitude/Vertical Velocity Indicators (AVVI's) are driven with nav-derived parameters during powered flight. The AVVI is not driven in MM 102 and altitude acceleration and radar altitude are not driven during ascent.

ALT displays the altitude with respect to the runway in MM's 103 and 601. The scale is from 1,100 to 400,000 ft and 40 to 165 n. mi. The ft and n. mi. scales overlap between 40 and 61 n. mi.

ALT RATE displays the radial component of the inertial velocity in MM 103 and  $\hat{A}$  ellipsoid in MM 601. The scale is from -2940 to 2940 ft/s.

#### FCS Mode Pushbutton Indicators

For AOA entry and GRTLS, these pushbutton indicators (pbi's) work as they do in normal entry except in GRTLS they are initialized in AUTO instead of MAN/CSS.

For ascent, the pitch and roll/yaw axes are both in AUTO or CSS, but AUTO and CSS are mutually exclusive of each other. These are initialized in AUTO and can be downmoded for manual steering in all axes by pushing any CSS pbi. The Rotational Hand Controller (RHC) is not hot stick. The control can be returned to the automatic system by pushing an AUTO pbi. The lights on the pbi's correspond to the control modes.

The GAIN ENA pbi's enable and disable the gain selected on the GAIN switches on panel F6. The three-position GAIN switches have a value of 1 for the upper two positions and 0.5 for the lower position. When the gain is enabled, the error signal on the axis chosen is multiplied by the value of the gain as determined by the GAIN switch. If the switch is in the lower position and GAIN ENA pushed, which reduces the error signal, the vehicle will respond in a slow and sluggish manner. The gain cannot be higher than 1 to speed the response of the vehicle. When the GAIN ENA pbi is initially pushed, the light behind it is lit. However, if the light is extinguished by depressing the pbi another time, the gain value reverts to 1 regardless of the position of the GAIN switch. The decision to use these pbi's is made by the crew.

The SPD BRK/THROT pbi indicates the mode of the Main Propulsion System (MPS) throttle during ascent. The manual throttle is selected by the pilot pushing the takeover pushbutton on the Speed Brake Thrust Controller (SBTC) (the SPD BRK/THROT light will go out) and moving the SBTC until the throttle command matches the automatic command (the SPD BRK/THROT MAN

light will illuminate). The takeover pushbutton is then released and the crew has manual throttle. The commander's SBTC does not work during ascent. The crew must perform MECO if the manual throttle is selected. To return throttle to automatic, the SPD BRK/THROT pbi is pushed. When the pilot has manual control of the throttle, his MAN light is illuminated, but the commander's SPD BRK/THROT light is not illuminated.

The BODY FLAP pbi is only used to indicate when the MPS dump sequence is finished; therefore, the SSME's are stowed and the APU can be turned off. The other pbi's extinguish at SSME zero thrust (MECO confirmed +3.75 sec), but the BODY FLAP pbi extinguishes when SSME stow is complete.

The BFC light is illuminated when the BFS is engaged via the pushbutton on the RHC.

#### 4.1.4 OMS Targeting Scheme

After MECO, the Orbiter is in an approximate 80 x 15-n. mi. orbit. This orbit will result in the Orbiter following the external tank and crashing into the Indian Ocean unless an OMS burn is performed to raise the orbit. To raise the orbit, a two-burn sequence is performed. The first burn primarily raises apogee, while the second burn is performed at apogee to raise perigee and thus circularizes the orbit. This type of burn minimizes the total delta velocity ( $\Delta V$ ) required to achieve orbital conditions.

For STS-1, targeted MECO conditions for aborts (ATO and AOA) are the same as nominal MECO. The main way these conditions may not be met is with a fuel-depletion shutdown resulting in an underspeed. An OMS 1 target is a fixed target, and an underspeed will increase the total  $\Delta V$  required to achieve that target. The nominal OMS 1 burn raises apogee to 150 n. mi. while the ATO and AOA OMS 1 burn raises apogee to 105 n. mi. Therefore, for a given MECO condition, the OMS 1  $\Delta V$  requirement will be less for an ATO (AOA) than the nominal.

In addition to velocity at MECO, a positive gamma (flightpath angle) is desired. On a nominal MECO for STS-1 with a positive gamma, the 80-n. mi. apogee is not achieved until 15 min after MECO. The greater the underspeed at MECO, the closer apogee moves to MECO until apogee actually precedes MECO and the Orbiter is heading toward perigee. If this occurs, the OMS 1  $\Delta V$  requirement will also increase and will continue to increase the longer the OMS 1 burn is delayed. For this reason, it was decided to burn at the nominal time (MECO+2 min) or as soon as practical thereafter for an underspeed.

Generally, the OMS 1 burn for an ATO will be different from an AOA even though both had 105-n. mi. apogees. However, upon closer examination of an AOA for STS-1, it was found that the ATO OMS 1 target could be used with very little increase in total  $\Delta V$  to complete an AOA. Using this information, the crew can now burn to the ATO OMS 1 target and delay making a final decision between ATO or AOA until the OMS 2 burn.

Up to certain underspeed MECO conditions, the ATO OMS 1 target can be used to make at least a steep AOA entry. Beyond these conditions, another target (AOA-S) will be used. This target allows a shallow AOA entry with the altitude only reaching an apogee of 80 n. mi. It will require all the OMS plus some aft RCS for total  $\Delta V$  in the worst case (underspeed ~650 ft/s). This target will be I-loaded behind the AOA-S position on the abort rotary and will only be used post-MECO to cover the large underspeed case. Larger underspeeds will require a contingency abort.

Certain system failures may occur causing a delay in the OMS 1 burn. Analysis of  $\Delta V$  requirements for delayed cases indicates that the burn can be delayed until Madrid AOS (TIG = 20:43) as long as a nominal MECO is achieved. This allows the crew time to check the failure, accurately determine their situation, and retarget the OMS 1 burn without rushing. A delay of the nominal OMS 1 burn will cause a slight increase in OMS 1  $\Delta V$  even though the Orbiter is still climbing to apogee. This is caused by preserving the AOA



deorbit burn capability should it be required later. The deorbit burn is performed at apogee and must meet certain entry conditions. Therefore, the delayed OMS 1 nominal burn is done non-optimally to place the 150-n. mi. apogee at the required location.

A delay of the ATO OMS 1 burn will cause a decrease in the OMS 1  $\Delta V$ . This is because the OMS 1 burn for a 105-n. mi. apogee preserving AOA deorbit is more optimal when performed closer to nominal MECO apogee. The delayed ATO OMS 1 target also has one unique feature. The orbit obtained by this burn is 105 x 80 n. mi., and does not require an OMS 2 burn unless desired, since an 80-n. mi. perigee is considered safe for a two-day mission. There is one additional delayed OMS 1 target from a nominal MECO, called delayed AOA-S. This target only reaches an apogee of 90 n. mi. and is followed only by an AOA shallow deorbit burn. It is used when MECO is nominal, but certain system failures cause a major loss of  $\Delta V$  potential.

For STS-1, there are twelve identified sets of OMS 1/2 targets. These targets represent all the known viable combinations of nominal, ATO, and AOA missions. The OMS 1 burn always preserves the capability for an AOA deorbit burn. All burns are optimized for a 2-min slip in ignition (TIG) with a total allowable slip of 4 min without retargeting. If an underspeed occurs at MECO, the OMS 1 burn will not be delayed. Any OMS 2 burn which goes to orbit may be terminated by shutting off the burn once a safe perigee is reached (HP = 80). This procedure will be used mainly when a failure has decreased the total amount of onboard  $\Delta V$  potential. All twelve sets of targets are designed to be handled by OMS  $\Delta V$ . Some RCS  $\Delta V$  is available for use if an AOA is performed. Table 4-3 is a list of these twelve options showing the resulting mission and its  $\Delta V$  requirements. Table 4-4 is a list of these options showing the PEG 4 target parameters to be loaded. Those targets which reside in the I-loaded software are indicated by the word 'I-load.' Targets requiring crew input of at least one parameter are indicated by the word 'manual.'

Following is a brief description of the twelve OMS target options. These targets are for STS-1 cycle 2 and may change for following cycles. Times and  $\Delta V$ s are representative only and should not be used as fact.

Option 1: Nominal OMS 1 - Nominal OMS 2

This is the nominal set of targets for the first mission. The OMS 1 burn changes the orbit to 150 x 65 n. mi. The OMS 2 burn circularizes the orbit to 150 x 150 n. mi.

Option 2: Nominal OMS 1 - Steep AOA

This set of targets performs the nominal OMS 1 to a 150 x 65-n. mi. orbit from a nominal MECO. An AOA deorbit is then performed for OMS 2. This AOA is normally performed by the crew selecting AOA with the abort rotary switch post-OMS 1. The appropriate deorbit I-loaded targets will then appear in the DEORB MNVR COAST display after moding software from OPS 105 to OPS 301. If desired, the crew may proceed from OPS 105 to OPS 301 without selecting AOA and then manually type in the appropriate deorbit target.

Option 3: Nominal OMS 1 - Shallow AOA

This set of targets is like option 2 except that a shallow deorbit entry is made. This deorbit target must be manually entered in the MNVR display after moding into OPS 3. Note that the time between the OMS 1 and OMS 2 burn is less than thirteen minutes. This target would only be used when a severe total- $\Delta V$ -available problem occurred after OMS 1 TIG. If the problem had occurred before OMS 1, the crew would have downmoded to a different OMS 1 target. However, if the problem is not caught quickly enough, the crew will not have time to prepare for this burn. If this occurs, then only option 2 is available.

Option 4: Delayed Nominal OMS 1 - Nominal OMS 2

This set of targets delays the nominal OMS 1 burn. The only known failure to cause this is a feedline disconnect valve failure. A nominal MECO must occur with no other failures causing a downmode to ATO. The crew must manually change TIG and  $\theta$  for the OMS 1 burn. It can be noted that the OMS 1  $\Delta V$  requirement increases by delaying the burn (see option 1). The OMS 2 burn circularizes the orbit (150 x 150 n. mi.). To do this, the crew must change the TIG to 1 min prior to the time apogee is reached. One min is subtracted from this time to average out the 2-min burn time.

Option 5: Delayed Nominal OMS 1 - Steep AOA

This set of targets is like option 4 except that an AOA deorbit OMS 2 burn is performed. This option will be used if a failure occurs after the delayed OMS 1 burn is started which requires an AOA deorbit. The deorbit targets must be manually entered in OPS 3.

Option 6: ATO OMS 1 - ATO OMS 2

This set of targets is used with a MECO underspeed. However, the underspeed may only be of such a magnitude that at least

an AOA entry using OMS propellant can be performed. The OMS 1 burn raises apogee to 105 n. mi. The OMS 1  $\Delta V$  shown in the table represents the largest ATO OMS 1 burn  $\Delta V$  allowed in which an ATO mission may be continued. The targets are automatically loaded when ATO is selected as the abort mode. The OMS 2 burn circularizes the orbit to 105 n. mi. These targets come up automatically in the MNVR display after the crew modes into OPS 105. However, the crew must change the TIG to 30 sec prior to the time of apogee.

Option 7: ATO OMS 1 - Steep AOA

This set of targets is the same as option 6 except that a steep AOA entry is performed for OMS 2. The amount of MECO underspeed allowable is increased along with the OMS 1  $\Delta V$  requirement from option 6. The OMS 1  $\Delta V$  shown in table 4-3 is the largest OMS 1 ATO  $\Delta V$  allowed in which an AOA steep entry may be performed. The OMS 2 targets must be manually loaded in OPS 3, since an AOA abort selection is not allowed in software after an ATO OMS 1 burn.

Option 8: ATO OMS 1 - Shallow AOA

This set of targets is the same as option 7 except that a shallow AOA entry is performed for OMS 2. The OMS 1  $\Delta V$  requirement is the same as option 7. If a failure occurs after ATO OMS 1 TIG which decreases the amount of onboard  $\Delta V$  available, this option may be exercised. The OMS 2 targets must be manually loaded in OPS 3.

Option 9: Delayed ATO OMS 1 - ATO OMS 2

This set of targets delays the ATO OMS 1 burn after nominal MECO. This target set will be used for failures resulting in a decrease in onboard  $\Delta V$  available when the failure is known before the OMS 1 burn. However, it cannot handle severe  $\Delta V$  losses (e.g., both OMS helium tanks failed). This OMS 1 burn results in a 105 x 80-n. mi. orbit. As such, there is no need to perform an OMS 2 burn unless it is decided to circularize the orbit. This OMS 1 target may be entered manually or by selecting ATO abort with the rotary switch. If the abort is selected, the TIG must be changed. If an OMS 2 is performed, the targets may be manually entered, or if an ATO is selected, only TIG needs to be changed. The TIG will be set 30 sec prior to apogee.

Option 10: Delayed ATO OMS 1 - Steep AOA

This set of targets is the same as option 9 except that an AOA deorbit is performed. It will be used when a subsequent failure after the delayed ATO OMS 1 requires an AOA abort. OMS 1 is identical to option 9. The crew will manually enter the deorbit targets in OPS 3. Note that the deorbit burn targets are the same as option 7.

Option 11: AOA-S OMS 1 - Shallow AOA

This set of targets will be used for severe underspeeds where the ATO OMS 1 burn cannot be used because of the high  $\Delta V$  requirement. The OMS 1 burn targets are automatically loaded after an AOA-S abort is selected with the rotary switch. The burn raises apogee to 80 n. mi. and requires an AOA shallow deorbit burn for OMS 2. After moding into OPS 3, the deorbit targets will automatically appear on the MNVR display.

Option 12: Delayed AOA Shallow OMS 1 - Shallow AOA

This set of targets will be used when the conditions at MECO are nominal, but the onboard  $\Delta V$  potential has been severely degraded (i.e., two OMS helium tank failures). The OMS 1 burn is delayed closer to MECO apogee so that the  $\Delta V$  requirement is reduced. In addition, a shallow AOA deorbit burn is performed to minimize the  $\Delta V$  requirement. The deorbit target is manually entered by the crew in OPS 3.

TABLE 4-3.- OMS 1/2 OPTIONS (CYCLE 2)

Options	MECO state	OMS 1 target	OMS 1 TIG/ $\Delta V$	OMS 2 target	OMS 2 $\Delta V$	Deorbit $\Delta V$	Total $\Delta V$	Mission
1	Nominal 0 < USPD < 80	Nominal I-load	MECO+2 206	Nominal I-load	184	260/* 207	650/* 597	Nominal
2	Nominal 0 < USPD < 80	Nominal I-load	MECO+2 206	AOA I-load	148	N/A	354	AOA
3	Nominal 0 < USPD < 80	Nominal I-load	MECO+2 206	AOA shallow manual	38	N/A	244	AOA shallow
4	Nominal 0 < USPD < 80	Nominal manual	MECO+12 240	Nominal manual	133	260/* 207	633/* 580	Nominal
5	Nominal	Nominal	MECO+12 240	AOA manual	165	N/A	405	AOA
6	Underspeed 80 < USPD < 200	ATO I-load	MECO+2 323	ATO I-load	75	232/* 150	630/* 548	ATO
7	Underspeed 200 < USPD < 360	ATO I-load	MECO+2 474	AOA manual	149	N/A	623	AOA
8	Underspeed 200 < USPD < 360	ATO I-load	MECO+2 474	AOA shallow manual	84	N/A	558	AOA shallow
9	Nominal 0 < USPD < 80	ATO I-load	MECO+12 165	ATO manual	50	232/* 150	215	ATO 4 REV
10	Nominal 0 < USPD < 80	ATO I-load	MECO+12 165	AOA manual	140	N/A	305	AOA
11	Underspeed 630 > USPD > 360	AOA shallow I-load	MECO+2 810	AOA shallow I-load	33	N/A	343	AOA shallow
12	Nominal 0 < USPD < 80	AOA shallow manual	MECO+12 108	AOA shallow manual	64	N/A	172	AOA shallow

\* The top number is the  $\Delta V$  for steep entry and the bottom number is the  $\Delta V$  for shallow entry.

TABLE 4-4.- OMS 1/2 TARGETS (CYCLE 2)

Option No.	MECO state	OMS 1 (C1 = 0, C2 = 0)				OMS 2					
		Targets	TIG(min)	HT(n. mi.)	T(deg)	Targets	TIG(min)	C1	C2	HT(n. mi.)	T(deg)
1	Nominal	Nominal I-load	10:43	149	157	Nominal I-load	43:09 (SEP+34:10.0)	0.0	0.0	157	337
2	Nominal	Nominal I-load	10:43	149	157	AOA I-load	53:14	14,738	-.5912	66	87
3	Nominal	Nominal I-load	10:43	149	157	AOA shallow manual	23:42	17,216	-.6795	66	195
4	Nominal	Nominal manual	20:43	149	237	Nominal manual	MET+TTA-01:00	0.0	0.0	157	337
5	Nominal	Nominal I-load	20:43	149	237	AOA manual	38:47	15,542	-.6210	66	147
6	USPD	ATO I-load	MECO+2	106	231	ATO I-load	MET+TTA-00:30	0.0	0.0	105	51
7	USPD	ATO I-load	MECO+2	106	231	AOA manual	52:10	14,589	-.5852	66	82
8	USPD	ATO I-load	MECO+2	106	231	AOA shallow manual	33:48	20,035	-.7872	66	161
9	Nominal	ATO manual	20:43	106	231	ATO I-load	MET+TTA-00:30	0.0	0.0	105	51
10	Nominal	ATO manual	20:43	106	231	AOA manual	52:10	14,589	-.5852	66	82
11	USPD	AOA shallow	MECO+2	30	193	AOA shallow manual	51:16	20,924	-.8211	66	74
12	Nominal	AOA shallow manual	20:43	90	146	AOA shallow manual	52:31	20,266	-.7966	66	67

### OMS 1/2 Target Cue Cards

After MECO, the crew uses the OMS 1 target cue card (fig. 4-13) to determine which OMS 1 target to use. MCC is prime for calling the target since they know how accurate the onboard nav state is. However, without comm, the crew would have to make this decision themselves. Onboard nav is then assumed to be good and the cue card is used to decide on the proper OMS 1 target.

The graph on the right side of the OMS 1 card is used to determine the abort mode needed based on underspeed. Once the crew is in OPS 104, the nominal target solution is displayed on the MNVR display. The OMS 1  $\Delta V$  TOT requirement is plotted against the targeted HP on the graph. If this point is below the nominal target line, the nominal OMS 1 target can be used. If the point is above the line, an ATO abort will be selected with the rotary switch. A new target solution is then made by software based on the ATO target. This new  $\Delta V$  TOT is then plotted against the new targeted HP on the graph. If this point falls below the ATO target line, the ATO target can then be used. If the point is above the line, an AOA-S abort will be selected with the rotary switch. A new target solution is then made by software based on the AOA-S target. This new  $\Delta V$  TOT must then be less than 870 ft/s to perform the AOA-S. Otherwise, a contingency abort must be performed.

The chart on the left side of the OMS 1 target card is used to determine which OMS 1 target to use based upon certain system failures up to this time. In addition, this chart shows the corresponding OMS 2 target requirement. Note that all the system failures require a delayed OMS 1 burn. This assumes a nominal MECO and that performance can be gained by delaying the burn. In the event of both a systems failure and an underspeed, the underspeed target will always take precedence. However, certain combinations of underspeed and system failures require the lower abort mode. For example, an ATO underspeed occurs, but two OMS helium tanks have failed. An on-time AOA-S would be performed if enough  $\Delta V$  is available; otherwise, a contingency abort would be performed.

The OMS 2 target cue card (fig. 4-14) will be used after the OMS 1 burn to determine the proper OMS 2 target. The total OMS 1  $\Delta V$  burned is plotted against the current HP if an underspeed has occurred. The section of the graph in which this point falls determines the appropriate OMS 2 target - ATO, AOA, or AOA shallow. The scales on the right side of the graph are used if an OMS tank or helium failure occurred before the OMS 1 burn since the total  $\Delta V$  available is significantly reduced. The targets at the bottom of the graph are for nominal OMS 2 burns to a 150-n. mi. orbit based on nominal or delayed nominal OMS 1.

The chart on the left side of the OMS 2 target card is used to determine which OMS 2 target to use based on the failure(s) up to this time. As noted above, the underspeed target takes precedence over a systems failure target. If both an underspeed and a system failure have occurred, the lower abort mode must be used. For example, if an ATO underspeed which required an ATO OMS 2 and a cabin leak which required an AOA have occurred, the AOA OMS 2 would be performed.

EXAMPLE: Underspeed at MECO, left OMS PRPLT tank failure plus the loss of two H2O loops. For OMS 1, the H2O loops require no target action and the OMS failure indicates a delayed ATO; however, after getting into MM 104, the OMS 1  $\Delta V$  is 400 and the targeted HP is 50. This indicates an on-time ATO OMS 1. Therefore, ATO will be selected and burned on time. OMS 1  $\Delta V$  changes to a  $\Delta V$  of 320. After OMS 1, the OMS 2 target cue card is checked. Since there was an OMS PRPLT failure, the scale on the right which indicates '1 OMS TK FAIL' must be used. Entering a  $\Delta V$  of 320 with an HP of 50 indicates AOA shallow. The failure of the two H2O loops also indicates AOA; however, a shallow AOA must be performed because of the other problems.



### OMS 1 TARGETS

FAILURE	OMS 1 TARGET	OMS 2
OMS - 1 He TK 1 PRPLT TK 2 PRPLT TKS (diff prplt) 2 OMS ENG	DELAYED ATU: TIG 20:43 C <sub>1</sub> 0 C <sub>2</sub> .0 H <sub>1</sub> 106 θ <sub>1</sub> 231	N/R (REV 4 DEORB)
OMS - 2 He TK ::::HOOK:::: ::::VELCRO:::: ::::::::::	DELAYED AOA-S: TIG 20:43 C <sub>1</sub> 0 C <sub>2</sub> .0 H <sub>1</sub> 90 θ <sub>1</sub> 146	AOA-S
FEEDLINE DISC VLV	DELAYED NOM: TIG 20:43 C <sub>1</sub> 0 C <sub>2</sub> .0 H <sub>1</sub> 149 θ <sub>1</sub> 237	NOM

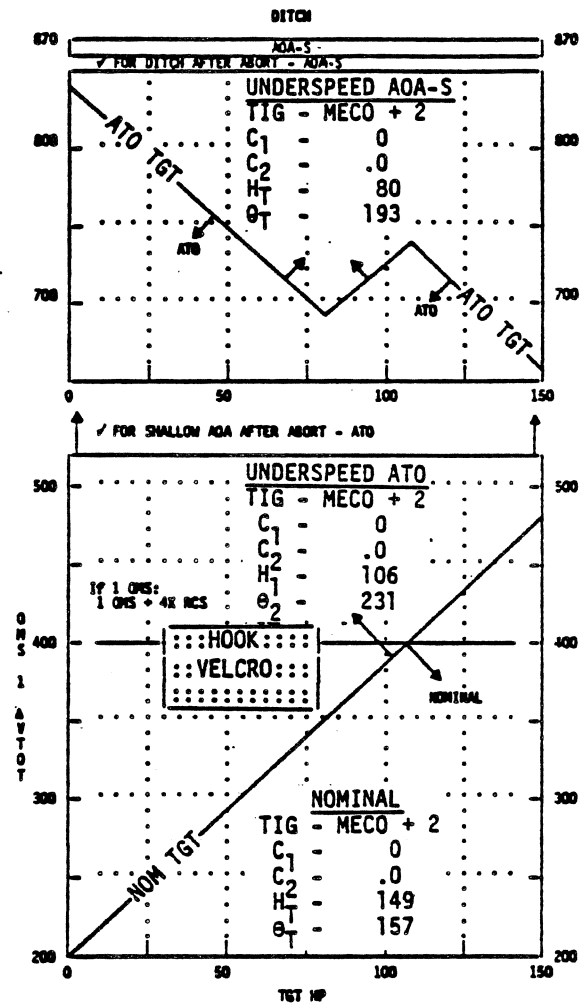
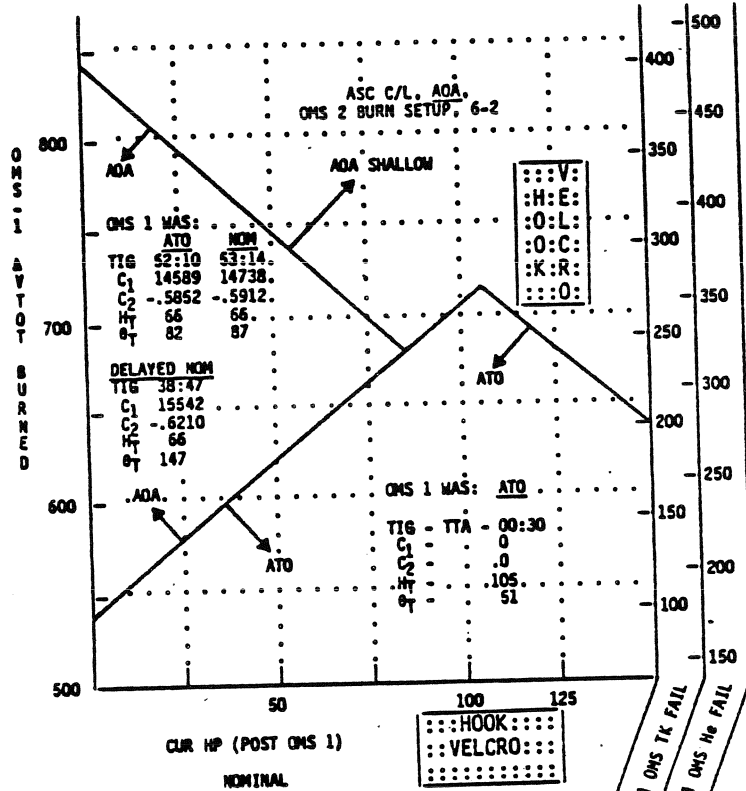

Figure 4-13.- OMS 1 TARGETS Cue Card.

BACK OF 'OMS 1 TARGETS'

FAILURE	OMS 2 TARGET
OMS - 1 of 2 H <sub>2</sub> TKS 1 PRPLT TK 2 PRPLT TKS (diff prplc) 2 OMS ENG	Nominal/ATO CUT OFF @ Hp = 80 (REV 4 DEC88)
OMS - 2 PRPLT TKS (same prplc) RCS - 2 AFT TKS (same prplc) 2 H <sub>2</sub> O LOOPS 3 IRU FANS 3 AY BAY FANS (BAYS 1,2) CABIN LEAK (dP/dT > .11)	ADA/ADA-S



OMS 1	OMS 1 DELAYED
TIG - 43:09	TIG - TTA - 01:00
C1 - 0	C1 - 0
C2 - 0	C2 - 0
HT - 157	HT - 157
BT - 337	BT - 337

Figure 4-14.- OMS 2 TARGETS Cue Card.

## 4.2 ASCENT SEQUENCE OF EVENTS

A summary listing of the ascent and abort sequences of events starting before lift-off and continuing through the second OMS burn for nominal and ATO, through landing for AOA and RTLS, and through ejection for contingency abort are given in table 4-5. For each of the events, data sheets have been prepared that present the following information:

- o Name of the event.
- o Best onboard cues and displays for monitoring when the event occurs.
- o The crew action associated with the event; i.e., monitor, awareness only, or procedural steps to be taken.
- o A general discussion covering event-related operational data such as configuration changes as a result of the event, ground interface support, procedures rationale, crew techniques for monitoring and controlling the event, major changes in performance capabilities or constraints due to the event, and any backup procedures associated with the event.

TABLE 4-5.- SUMMARY LIST OF EVENTS

Time hr:min:s	Cue	Event	Page
1:50:00 to Lift-off		<u>Nominal</u> Prelaunch activities	4-61
00:00	Physiological	Lift-off/vertical rise	4-63
~00:07	ADI & physiological	Initial roll/pitch & yaw maneuver	4-64
00:35 to 00:57	MPS PRESS Pc	q̄ limiting throttling	4-65
02:00	MM change	SRB separation	4-66
~02:00	FREON EVAP OUT TEMP decreasing	Flash evaporator and heater activation	4-69
02:09	TMECO stable	Close loop guidance initi- ate	4-70
04:00	ADI attitudes	T <sub>fail</sub> pitch maneuver	4-71
07:40	MPS PRESS Pc	3g throttling	4-72
08:43	ENG STATUS lts-red	Main Engine Cutoff (Meco)	4-73
08:58	ENG STATUS lts-off	ET separation	4-75
09:04	MM change	-Z RCS translation & evasive maneuver	4-77
10:43	OMS Pc	OMS 1	4-79
10:43		MPS propellant dump	4-80
14:04	BDY FLAP lt out or MPS dump + 3:21	APU/HYD shutdown or hydraulic depress	4-82
~14:30		Heater activation	
	After entering MM 105	Major mode change OMS 2 burn setup	4-84
		MPS powerdown and MPS vacuum inerting	4-86
		ET umbilical door closure	4-88
		OMS 2 burn preparation and attitude maneuver	4-89
	After MAD LOS	Seat safing and adjust- ment	4-90
	OMS 2 TIG-5	Vacuum inerting terminate	4-86
43:09	OMS Pc	OMS 2 (OPS 1)	4-91
		OMS/RCS postburn recon- figuration	4-92
~52:00		Enter postinsertion procedures (PDP)	
	Any LOS or AOS	Uplink block and unblock	4-93
		Manual control in powered flight	4-94
	SSME STATUS lts & Pc gauge	SSME failure	4-96

TABLE 4-5.- SUMMARY LIST OF EVENTS (Continued)

Time min:s	Cue	Event	Page
		Abort initiation	4-97
		BFS engagement	4-99
	'SEP INH' & low rates	Feedline disconnect valve failure	4-100
	OMS 1 TIG slip >4 min	Delayed OMS 1 burn procedures	4-102
	After MAD AOS	<u>Abort Once Around (AOA)</u> Reconfigure DPS for entry (AOA)	4-103
		OMS 2 burn setup	4-84
		OMS burn TIG adjust (AOA)	4-104
		Seat safing and adjustment	4-90
		OMS burn preparation and attitude maneuver	4-89
	OMS 2 TIG-10 min	Close vent door (AOA)	4-106
		Vacuum inerting terminate	4-86
	OMS Pc	Forward RCS dump (AOA)	4-107
		OMS 2 (AOA deorbit burn)	4-109
		OMS/RCS postburn reconfiguration	4-92
		Tacan channel selection (AOA)	4-110
	EI to landing	AOA entry and postlanding deltas from nominal entry	4-111
		<u>Return To Launch Site (RTL)</u>	
	Abort initiation	MPS throttling (3-eng RTL)	4-112
	Abort initiation	Fuel dissipation attitude (RTL)	4-113
	Time and ET PRPLT remaining	Pitcharound maneuver (RTL)	4-114
	Pitcharound initiate	Pre-MECO OMS/RCS dump (RTL)	4-115
MECO-00:20		Powered pitchdown (RTL)	4-116
00:00	ENG STATUS lts-red	MECO (RTL)	4-117
00:12.5 to 00:22.5	ENG STATUS lts-off	ET SEP, -Z translation (RTL)	4-118
00:22.5	Major mode change	MM 602 transition, alpha recovery phase, elevon and body flap activation (RTL)	4-120

TABLE 4-5.- SUMMARY LIST OF EVENTS (Concluded)

Time min:s	Cue	Event	Page
	ET UMBILICAL DOOR tbs	ET umbilical doors closure (RTLS)	4-122
		MPS dump (RTLS)	4-123
		Tacan AOS and management (RTLS)	4-124
	KEAS = 54 & 77	Pitch & roll RCS jets deactivation and speed brake operation (RTLS)	4-125
	KEAS = 121	RCS activity light recon- figuration (RTLS)	4-126
	1.65 g's	Nz hold phase (RTLS)	4-127
	H = 120K	Ammonia boiler activation, S-turns (RTLS)	4-128
	$\dot{H} > -250$	Alpha transition phase, (RTLS)	4-129
	M 3.2	Transition to MM 603, nominal TAEM interface (RTLS)	4-130
		RTLS TAEM and postlanding deltas from nominal entry	4-131
		<u>Contingency Abort</u>	
	2nd SSME failure	OMS PRPLT dump (contin- gency abort)	4-132
	2nd SSME failure	Manual takeover (contin- gency abort)	4-133
	KEAS > 2 and increasing	Powered pitchdown (contin- gency abort)	4-134
	$\alpha = 0^{\circ} \pm 5^{\circ}$	MECO, ET SEP, & -Z trans- lation (contingency abort)	4-135
	$\beta = 0^{\circ} \pm 2^{\circ}$	MM 602 (contingency abort)	4-136
		Nz hold (contingency abort)	4-137
	$\dot{H} = -250$	Alpha transition (pullout) (contingency abort)	4-138
		Fast separation	4-139
	H = 10,000 ft	Crew ejection	4-140

#### 4.2.1 Nominal

### PRELAUNCH ACTIVITIES

#### DISCUSSION

Prelaunch activities are controlled by Kennedy Space Center (KSC). The crew ingresses the Orbiter about two hours before lift-off. The ground crew will aid the flight crew in ingressing the Orbiter and the seats. The crew performs an intercom and Air to Ground (A/G) voice check to verify all communication loops are working. Before the ground crew egresses, KSC performs an OPS 9 abort advisory check with the crew and the ground crew configures for launch those switches the flight crew cannot reach. Crew reach and visibility limitations are described in section 3.

After hatch closure, a cabin leak check is started by allowing the cabin pressure to increase. Later the cabin vent valves are opened so that cabin can vent to ambient pressure, then the valves are closed for launch.

The crew turns on the H2O boiler controller and N2 supply in preparation for APU activation. The OMS ENG switches are placed in ARM/PRESS for 15 sec to allow the OMS system to pressurize so the ground can verify it.

At T-25 minutes, an A/G voice check is done in the launch configuration. At this time, a PASS to BFS transfer is done. This is done in OPS 9 shortly before entering OPS 1 so that the BFS will have the IMU calibration and launch polynomial update data.

At T-20 min, OPS 1 is loaded into the PASS GPC's, the BFS GPC is placed to RUN and OPS 1 is loaded. The ground will command a dump and verify the OPS 1 load. The HORIZ SIT display is set up in case an RTLS is necessary. The helium system is reconfigured for launch. An OPS 1 abort advisory check is made from both the MCC and the Launch Control Center (LCC).

At T-9 min, there is a planned 10-min hold and all areas give a 'GO FOR LAUNCH.' T-9 min is the recycle point if any is needed after this time. The ground launch sequencer has control from this point.

At T-6 min, the crew sets the APU system up for APU start. The APU's are started at T-5 min. If all three APU's are not started by T-4 min, the LPS will 'hold' the launch.

After the APU-start, final configuration for launch is done and the cabin vent valves are closed. Heaters are turned off because of ascent electrical power considerations. The OMS engines are armed and pressurized so they will be ready to dump propellant in the case of an abort.

The C&W memory is cleared so that prelaunch alerts will not be read after lift-off. The APU automatic shutdown is inhibited so that a false APU indication cannot shut down an APU and its associated SSME. The volume on the communications system is adjusted as loud as possible without distortion to overcome the SRB/MPS noise. Finally, 30 sec to launch the 16 mm camera on the commander is turned on - 'CDR -SMILE.'

The configuration of the cockpit at lift-off is such that systems necessary for ascent and aborts are activated; this results in most systems being activated. All circuit breakers are closed except when they save power or are never operated in flight. The circuit breakers that are open at lift-off for power savings include the aft ADI, H2O line heater, and MLS. Circuit breakers are also left open on equipment that is not used during flight (e.g., H2O alternate pressure valve, Ku-equipment, and the landing gear arm/down reset).



LIFT-OFF/VERTICAL RISE

CUE

Clocks reset  
Motion  
Attitude hold  
Major mode change

DISPLAYS

MET and EVENT TIMER  
ADI  
CRT

CREW ACTION

Monitor.

MET  
-00:07            SSME START  
                  ✓MPS PRESS Pc (three) > 90%

NOTE

If Pc < 90 in 4.6 sec or any MAIN ENG  
STATUS lt amber prior to SRB ignition,  
sequential shutdown occurs

00:00            LIFT-OFF

1: GNC ASCENT TRAJ  
3: BFS, GNC ASCENT TRAJ 1

DISCUSSION

Lift-off is from KSC. Lift-off occurs when all three SSME's reach 90 percent RPL plus 2.75 sec and the SRB's are ignited. The redundant set launch sequencer controls the sequence of events leading to lift-off. The vehicle is oriented on the pad with the -Z body axis (tail) pointed south. At lift-off (SRB ignition), MET and event timers are zeroed, major mode changes from prelaunch (MM 101) to first stage (MM 102). Vertical rise starts when the thrust-to-weight ratio is 1 (~0.3 sec after SRB ignition). The vertical rise phase is an attitude hold commanded by the first two points of each of the guidance attitude tables and is designed to guarantee tower clearance for the worst performance case. Tower clearance is defined as the point at which the base of the SRB nozzle is above the top of the tower lightning rod. For STS-1, this point is at 7 sec with a relative velocity of 121.2 ft/s and a delta altitude of ~363 ft.

Crew action during lift-off and vertical rise is to monitor the automatic sequence. If the roll maneuver is not initiated, manual guidance/throttle will be initiated. The ADI is set to the REF position for lift-off. This provides an inertial launch referenced ball.

## INITIAL ROLL/PITCH & YAW MANEUVER

### CUE

Attitude change

### DISPLAY

ADI

### CREW ACTION

Monitor.

00:07 TOWER CLEAR

MNVR initiate

00:30(R180)MNVR complete  
ADI ATT (two) - LVLH

### DISCUSSION

This maneuver starts at tower clearance and stabilizes at about 30 sec MET. This maneuver has three objectives:

1. Roll to a heads-down, wings-level attitude within accelerations and rates of  $2^{\circ}/s^2$  and  $9^{\circ}/s$ , respectively.
2. Hold a constant yaw heading, optimized for earliest press to MECO until wings level and then smoothly transition to zero sideslip at about 30 sec MET.
3. Pitch at a specified rate for 10 sec, followed by a smooth transition into load relief at about 30 sec MET, which results in a max.  $\bar{q}$  of 578 psf. For the STS-1 trajectory, wings-level occurs at 24 sec MET, and the initial yaw heading is  $64^{\circ}$ .

As soon as the roll maneuver is complete, the crew switches to an LVIY ADI ball. This is a YPR ball, with yaw set to zero. The yaw angle is presented on the HSI compass card with N being referenced to the insertion plane.

q̄ LIMITING THROTTLING

CUE

Pc change  
EAS

DISPLAYS

MPS PRESS Pc  
AMI EAS, CRT

CREW ACTION

Monitor.

00:32(1.8M) Throttle down to 65%

00:52 Max q̄ (EAS = 412)

00:59(2.2M) Throttle up to 100%

DISCUSSION

For STS-1, the maximum dynamic pressure ( $\bar{q}$ ) during ascent is limited to 605 psf. At ~32 sec MET, the three SSME's are throttled down from 100 to 65 percent to stay within this limit, and then throttled back up to 100 percent after max.  $\bar{q}$ . The profile is shown in figure 4-15. This profile is based on  $V_{re}$ , but the crew monitors it based on  $V_I$  and time. If  $\bar{q}$  throttling fails to occur, the crew will take over manual throttle and guidance, and perform the task. If only one engine fails to throttle down or up, no action is required prior to MECO.

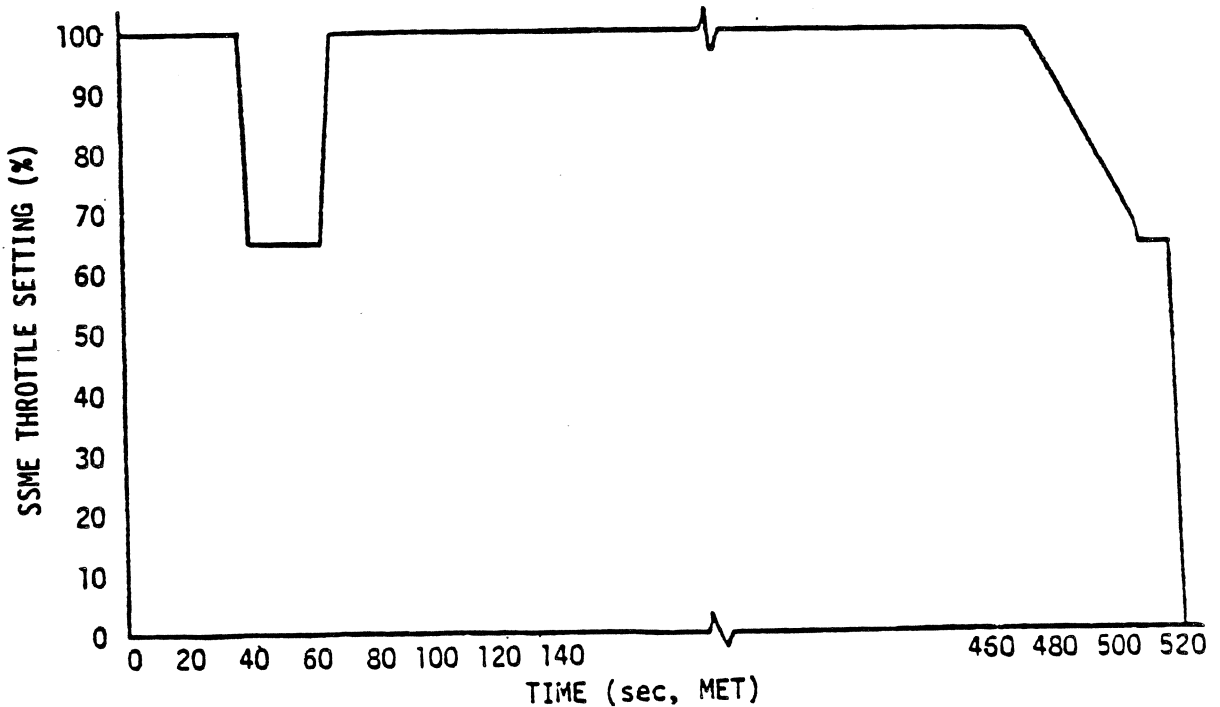

Figure 4-15.- SSME throttle schedule.

## SRB SEPARATION

### CUE

MCC call 'GO for SEP'  
'Pc < 50' or MET 2:13  
Major mode change

### DISPLAY

ASCENT TRAJ display

### CREW ACTION

Monitor, report SEP and backup if necessary.

01:52 GO FOR SRB SEP - MCC Report  
(130k ft) (EAS = 139)

02:00 'Pc < 50' (CRT) (Backup 2:13)

\* If 'SEP INH': \*  
\* ✓ATT RATES < 5,2,2 and MCC GO \*  
\* for SRB SEP, or if rates \*  
\* increasing at 'SEP INH' + 5 sec \*  
\* C3 SRB SEP - MAN/AUTO \*  
\* SRB SEP pb - SEP \*

02:05 SRB SEP - Report

3: BFS, GNC ASCENT TRAJ 2

### DISCUSSION

Automatic SRB SEP should occur at MET between 2:04 and 2:05. The crew should expect it shortly after 'Pc < 50' appears on the ASCENT TRAJ display. However, it must be noted that the SRB SEP sequence will occur only if MECO (three engines out) has not yet occurred. Loss or shutdown of three SSME's during first-stage flight will set a software MECO CONFIRMED flag which will prevent the SRB sequence from starting.

After T+100 seconds, the sequence monitors both the left and right SRB chamber pressures and normally begins the SEP process when both chamber pressures drop below 50 psia. A backup time (currently an I-loaded value of 131.7 sec, changing to 133) is available for the sequence. Should all Pc sensors fail 'high' on one SRB, the sequence will not begin until the backup time is reached to assure that SEP is not attempted with excessive SRB thrust. The backup time represents the latest time that a slow-burning SRB could have some residual tailoff thrust from combustion chamber pressures not exceeding 50 psia. Should all Pc sensors fail 'low' on an SRB, the respective times at which the left and right SRB chamber pressures drop below 50 psia are noted. If the interval which these two times establish exceeds an I-loaded maximum differential (5.9 sec), then the sequence will not begin until the backup time is reached. If this time differential is not exceeded, the SEP sequence is initiated when the second engine Pc drops below 50 psia. The crew has no way to start the sequence.

The SRB SEP sequence includes delays for thrust decay to acceptable limits and delays to permit nulling of the SRB nozzles.

The automatic sequence monitors selected rate gyro roll, pitch and yaw rates and compares their absolute values to computed limits comprised of a constant plus the product of rate slope and  $\bar{q}$ . If the RGA rates exceed the computed limits or if the  $\bar{q}$  exceeds an I-loaded limit, SRB SEP will be inhibited and the crew will be alerted.

Note that this scheme may not produce hard-rate limits, but rather ones that are inversely dependent upon  $\bar{q}$ . The rate limits are:

Currently	STS-1
$\bar{q} < 63 \text{ psf}$	$\bar{q} < 55 \text{ psf}$
$P < -.164 \bar{q} + 17.32^\circ/\text{s}$	$P < 5^\circ/\text{s}$
$Q < -.089 \bar{q} + 8.66^\circ/\text{s}$	$Q < 2^\circ/\text{s}$
$R < -.020 \bar{q} + 3.46^\circ/\text{s}$	$R < 2^\circ/\text{s}$

Should a 'SEP INH' occur, the sequence will halt and will resume when the out-of-limit condition has been corrected or the crew manually overrides the inhibit by selecting SRB SEP - MAN/AUTO and depressing the SRB SEP pushbutton. MCC will advise the crew when  $\bar{q}$  is within the limit with a GO FOR SRB SEP. If an inhibit condition then occurs due to vehicle rates, but the rates are converging, the crew will take no action. The automatic SEP sequence must be initiated prior to having an abort gap because of retention of the SRB's. If the rates are divergent, the crew will override and perform a manual SEP 5 sec after 'SEP INH' occurs. This time preserves the abort mode overlap even if the sequence is started on the backup timer and prevents overriding the inhibit too early. If the vehicle rates are within limits and an inhibit condition occurs, it should be assumed erroneous and the crew will override after the MCC call. A simplified SRB SEP sequence is shown in figure 4-16.

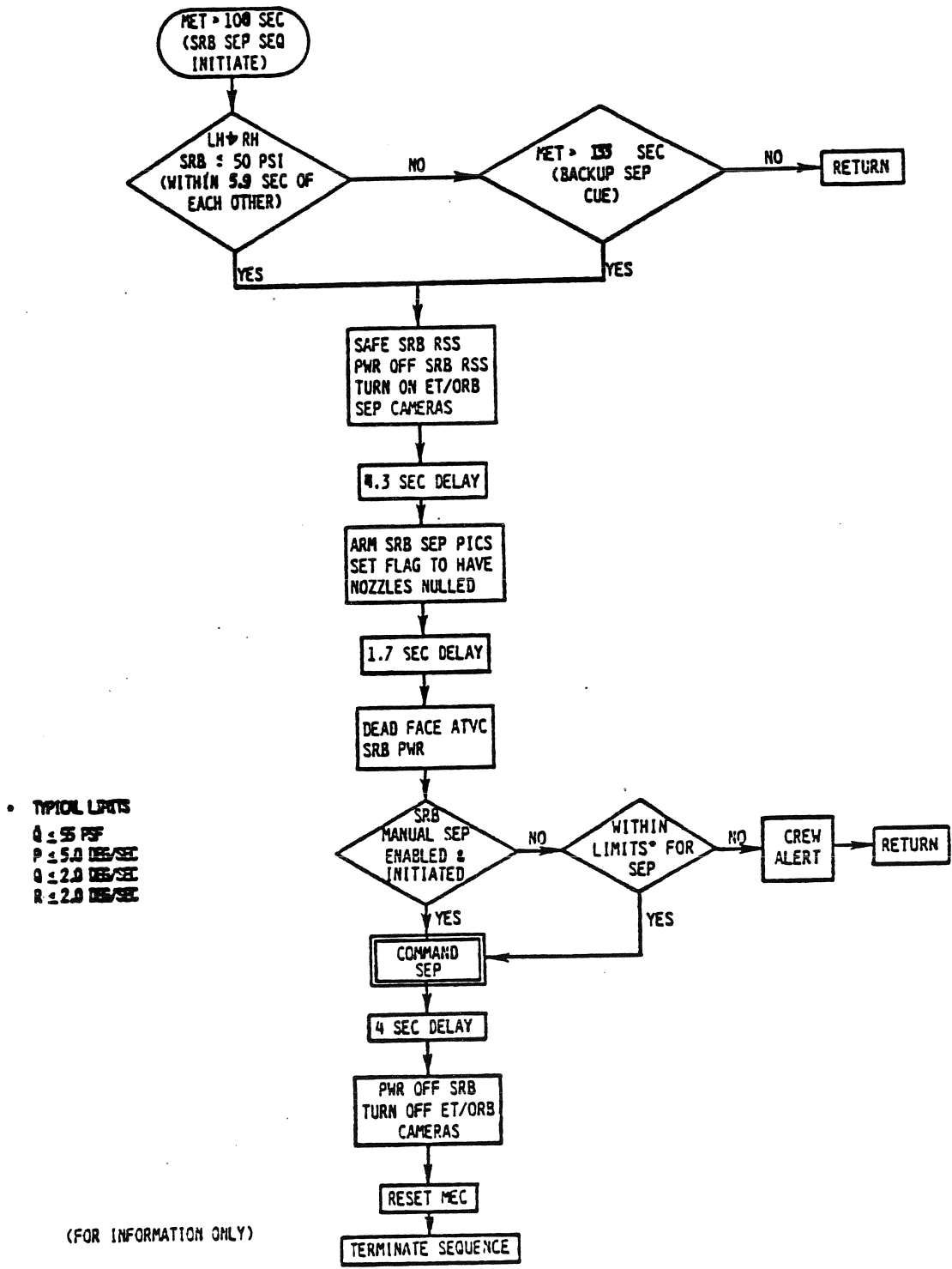

- TYPICAL LIMITS
- Q ≤ 95 PSF
- P ≤ 5.0 DEG/SEC
- Q ≤ 2.0 DEG/SEC
- R ≤ 2.0 DEG/SEC

(FOR INFORMATION ONLY)

Figure 4-16.- SRB SEP sequence.



CLOSE LOOP GUIDANCE INITIATE

CUE

Attitude change  
TMECO stable

DISPLAY

ADI  
ASCENT TRAJ

CREW ACTION

Monitor.

02:09 GUID INITIATE - TMECO stable

* If not stable in 10 sec and no	*
* comm:	*
* F2 PITCH OR ROLL/YAW pb - CSS	*
* C3 R SBTC takeover pb - push	*
* Match auto throttle	*
* Release pb	*

DISCUSSION

At the end of the attitude hold that follows SRB SEP, closed-loop guidance is initiated. It will take 4 to 8 sec for guidance to converge and start commanding. At the start of closed-loop guidance, alpha is limited to no more than  $5^\circ$  to help smooth the transition into closed-loop guidance.

Crew action for guidance not converging after 10 sec is to take over CSS and manual throttle and fly manually to MECO. If there is no communication problem, MCC will call the crew for appropriate action. The TMECO that appears at this time will be greater than the normal time of MECO because the guidance is assuming that an engine will fail at  $T_{fail}$  (presently 4:00) and the trajectory will be lofted.



## T-FAIL PITCH MANEUVER

### CUE

Attitude change  
TMECO change

### DISPLAY

ADI  
ASCENT TRAJ

### CREW ACTION

Monitor.

### DISCUSSION

In order to get the earliest press-to-MECO capability, guidance assumes that an engine will fail at the mode boundary. This lofts the trajectory until guidance starts assuming no engine failures, if no engines have failed before  $T_{fail}$ . This produces a discontinuity at  $T_{fail}$ . The pitch maneuver started at  $T_{fail}$  is  $\sim 25^\circ$ , but the rate of this maneuver will not exceed 3 deg/s. TMECO should now converge to the proper time.

Crew action for guidance not converging is to takeover CSS and manual throttle.

### 3g THROTTLING

#### CUE

Pc decreasing  
'g'

#### DISPLAY

MPS PRESS Pc  
ASCENT TRAJ 2  
AVVI, ACCEL

#### CREW ACTION

Monitor.

#### DISCUSSION

Near the end of second stage, the engines are automatically throttled down to maintain 3g's in order to stay within structural and physiological constraints. The nominal g-profile the crew will monitor is shown in figure 3-9. If throttle down does not occur to maintain a 3g acceleration ( $96.5 \text{ ft/s}^2$ ), the automatic guidance is not working properly. Therefore, the crew will initiate manual guidance/throttle and thus have to manually shut down the engines.

## MAIN ENGINE CUTOFF (MECO)

### CUE

Red status lights  
Physiological cues

### CREW ACTION

Monitor.

- \* If MAN THROT and  $V_I = 25,500$  \*
- \* C3 MAIN ENG SHUT DN \*
- \* pb (three) - L,CTR,R \*

08:43 MECO ( $V_I = 25,668$  fps)

✓MAIN ENG STATUS lts (three) - ON (red)

- \* For 'MPS DATA or CMD' \*
- \* R2 Affected eng \*
- \* ENG PWR (two) - OFF \*
- \* \*
- \* If more than one eng: \*
- \* CRT2 GNC, OPS 104 PRO \*

### DISCUSSION

About 7 sec to MECO, the SSME's are commanded to begin throttling at 10 percent/s to 65-percent thrust level. The throttle will be close to 65 percent because of 3g throttling. Once achieved, the SSME's are held at that thrust level until the velocity target has been achieved. MECO occurs about 8 min 43 sec MET so that velocity after tail off will be 25,668 ft/s. At MECO, an attitude hold is commanded using the RCS to minimize attitude rates for ET SEP.

The crew will not normally back up MECO. If the crew is manually throttling the engines, at a velocity of 25,500, they will shut down the engines using the shutdown pushbuttons. By leading the cutoff by this amount, MECO should occur at the appropriate velocity or a little over. If there have been indications of engine trouble prior to MECO (MPS command path failure or data path failure that might mask a command path failure), the crew may cut off an engine by the ENGINE POWER switches on R2. Shutdown - via power switches will be done after the crew has an indication that the other engines are shut down. For STS-1, the MECO targets for nominal, ATO, and AOA are the same target.

### DISPLAY

MAIN ENGINE STATUS lights

The red portion of the MAIN ENGINE STATUS lights will come on at MECO. An example of trajectory parameters at MECO is given in section 5. The MPS dump cannot be accomplished on any engine which is shut down via the ENGINE POWER switches. MECO CONFIRMED starts the ET SEP sequence. If the power switches have been used or data path failures occur on more than one engine, the MECO CONFIRMED flag is not set and the ET SEP sequence will not start until the flag is set by 'OPS 104 PRO.'

## ET SEPARATION

### CUE

Red status lights out  
Physiological cues

### DISPLAY

MAIN ENGINE STATUS lights

### CREW ACTION

Monitor.

ET SEP (MECO+17)

✓MAIN ENG STATUS lts (three) - off

- \* If 'SEP INH', check rates: \*
- \* For rates  $\leq .5$ , .5, .5 assume \*
- \* Fdln Disc Vlv failure and go \*
- \* to FDLN DISC VLV FAIL \*
- \* \*
- \* For rates  $> .5$ , .5, .5 wait for \*
- \* rates to damp \*

To override inhibits:

C3 ET SEP - MAN  
ET SEP pb - push

### DISCUSSION

The crew has the ability to start the automatic ET SEP sequence, to inhibit it, or to override automatic inhibits with the ET SEP switch and pushbutton.

The nominal ET SEP is initiated when the SSME OPS sequence sets the MECO CONFIRMED flag. The ET SEP sequence will then run cyclicly, performing major functions such as umbilical unlatch and retract; wait for engine pre-valves to be commanded closed; ET tumble system arm; electrical deadfacing; inhibit and SEP mode checks; and finally, structural SEP. The sequence will check pitch, roll, and yaw rates, LH<sub>2</sub> and LO<sub>2</sub> feedline disconnect valve positions, and the status of flight aft Multiplexer/Demultiplexer (MDM) numbers 2, 3, and 4. If any rate exceeds one-half deg/s (I-load) or if a valve or MDM malfunction is detected, SEP will be inhibited and a crew alert generated. The condition that caused the inhibit must be satisfied or overridden before the sequence will continue. Unlike RTLS ET SEP, there is no timed bypass of inhibiting conditions. If a 'SEP INH' occurs, the rates are checked. If the rates are within limits, the crew will go to the FEEDLINE DISCONNECT VALVE FAIL section of the Ascent Checklist. Then, the MPS manifold pressure is checked and if it is increasing, manual SEP is performed (SEP INH may be due to MDM failures). If the MPS manifold pressure is not increasing, assume a feedline disconnect valve failure. If ET SEP inhibit is caused by a feedline disconnect valve failed 'open,' the crew will wait 6 min to allow ET pressure blowdown to minimize the possibility of recontact after SEP due to the impulse of escaping propellant

from the ET. An MPS propellant dump will be performed manually during the wait period. The ET will then be separated manually.

If the inhibit is due to excessive rates, the crew will wait for the rates to dampen. The auto sequence will then resume and separate the ET. The crew can inhibit the auto ET SEP sequence any time by placing the ET SEP switch to MAN. The sequence will resume when the ET SEP switch is returned to AUTO.

## -Z RCS TRANSLATION AND EVASIVE MANEUVER

### CUE

Physiological cues  
Major mode change

### DISPLAY

OMS 1 MNVR EXEC display

### CREW ACTION

Monitor and perform maneuver.

$\sqrt{R} > 170^{\circ}$   
ET SEP  
-Z XLATION COMPLETE

GNC OMS 1 MNVR EXEC  
BFS, GNC OMS 1 MNVR EXEC

$\sqrt{R, Y}$  ERROR  $\leq 10$

\* If not: \*  
\* Delay to TIG -1:19 then \*  
\* mnvr to R, Y  $\leq 10$  \*

If roll for ET SEP  $\geq 170^{\circ}$ :  
Perform +Y xlation for 24 sec

\* If not: \*  
\* Perform -Y xlation for \*  
\* 24 sec \*

### DISCUSSION

The RCS jet firing is inhibited just prior to structural release from the ET to preclude possible damage at the forward attach fitting. Immediately following structural SEP of the Orbiter from the ET (within 0.05 sec following mechanical release), inertial attitude hold is initiated and the Orbiter performs a high-mode RCS -Z translation maneuver. An attitude deadband of  $0 \pm 3.0$  deg/axis and a rate deadband of  $0 \pm 0.3$  deg/s/axis are maintained during the maneuver. Four forward and six aft RCS jets are used to achieve a translational  $\Delta V_z$  of -4.0 ft/s. Thrust duration for the nominal SEP is ~5 sec. The -Z translational  $\Delta V$  assures Orbiter clearance from the arc of a rotating ET. The major mode will change at the end of the -Z translation maneuver. The Orbiter continues to coast away from the ET in the inertial attitude hold mode (with an attitude deadband of  $\pm 3.5$  deg/axis and a rate deadband of  $\pm 0.3$  deg/s/axis) to obtain additional vertical clearance. The crew has the capability to perform this maneuver manually using the THC. If the THC is taken out of detent, the rest of the maneuver must be performed manually as the automatic -Z translation will not reestablish command of the maneuver.

A 24-sec ET evasive burn (4 ft/s) will be performed along the Orbiter Y-axis following the ET SEP -Z maneuver. The burn accomplishes two goals.

First, it removes the Orbiter from the plane of the ET, and second, it possibly allows the crew to observe the ET prior to performing the OMS 1 burn. The direction of the burn is dependent upon the Orbiter LVLH attitude at SEP (nominally P, Y, R = 0°, 0°, 180°). If the roll attitude is less than 170°, the burn will be in the -Y direction. If the SEP attitude is equal to or greater than 170°, the burn will be in the +Y direction.

The time the burn occurs is related to velocity and attitude dispersions. If an overspeed in excess of 25 ft/s exists at MECO or if an attitude dispersion greater than 10° exists in any axis at ET SEP, the Y-axis burn will be delayed for 20 sec after the -Z maneuver burn has been completed. (On STS-1, the burn will be delayed only for roll or yaw axes attitude dispersions.) The yaw and roll dispersions will be reduced to 10° or less prior to the Y-axis burn, which will then be performed as described above. If the MECO velocity and attitude dispersions are within limits, the Y-axis burn will be accomplished immediately after the -Z burn.

After the evasive maneuvers are complete, the crew will maneuver to the OMS 1 burn attitude.



## OMS 1

### CUE

OMS Pc > 90  
Error needle movement  
TGO & VGO decreasing  
Physiological cues

### DISPLAYS

OMS PRESS gauge  
ADI  
OMS 1 MNVR EXEC display

### CREW ACTION

Verify or enter OMS target.  
Key 'EXEC' when flashing on CRT display.  
Monitor burn.

### DISCUSSION

Upon completion of the -Z translation maneuver, the software is moded automatically to MM 104 with OMS 1 MNVR EXEC being the underlying display. I-loaded OMS 1 targets are automatically loaded and displayed on this display. The crew will confirm the targeting results, and then maneuver to the burn attitude indicated. The CRT timer will be counting to TIG. When this timer gets to T-15 sec, guidance starts updating target parameter values continually. At the same time, the word 'EXEC' starts flashing on the display and an 'EXEC' keystroke by the crew provides the computer with the go-for-burn indication.

When the CRT timer reaches zero and 'EXEC' has been executed, the engines commence firing. If 'EXEC' has not been executed, the burn would start immediately upon execution of the keystroke. The engine burn can be monitored with the OMS chamber pressure meter on panel F7. During the burn, the following items can be monitored on the MNVR display.

1. Present gimbal position
2. Desired vehicle attitude (burn attitude in the inertial coordinates)
3.  $\Delta V$  total (total velocity vector value) decreasing to zero
4. Time To Go (TGO) counting down to zero
5. Velocity To Go (VGO) decreasing in value
6. Current HA should be approaching the targeted HA

At the completion of the burn, the engines will automatically purge themselves (unless inhibited by the crew via an entry on the MNVR display), and the crew will disable the engine by turning OFF the LT & RT OMS ENG switches on panel C3. Residual  $\Delta V$ 's remaining after the burn will then be nulled by the commander with the THC. OMS 1  $\Delta V$  requirements are <2 ft/s in each axis.

Burns will normally be performed with both engines; however, each engine is capable of performing the required burn. If one engine fails during the burn, the remaining engine takes full control. Guidance reinitializes TGO based on the new engine configuration only after the failed engine has been turned off. If both engines have failed, the crew must interconnect RCS to a good OMS propellant tank and complete the burn manually using the THC.

## MPS PROPELLANT DUMP

### CUE

L02 prevalve open  
L02 manifold pressure decreases  
Body flap light out

### DISPLAY

GNC SYS SUMM 1 (BFS)

### CREW ACTION

Monitor.  
R2 ✓MPS PRPLT DUMP SEQ L02 - GPC  
      ✓LH2 - GPC

* Manual Dump						*
*	C	Perform +X xlation for 5 sec				*
*	P			Hyd fail or SSME		*
*				shutdown via POWER sw		*
*	AUTO			1 fail	2 fail	*
*	TIG	L02 dump - START		TIG (or 5 sec + X)		*
*	1 + 45	- STOP		2+45	3+45	*
*	3 + 21	APU SHUTDOWN		4+21	5+21	*
*						*

### DISCUSSION

Overboard dumping of residual propellants is required after ET SEP. There are approximately 5400 lb of trapped propellants in the Orbiter which represent an overall c.g. shift of nearly 7 in. Trapped LH2 poses a hazard during entry since it may combine with atmospheric oxygen to form a potentially explosive mixture. In addition, if not dumped, the propellants will outgas, causing low-level accelerations not sensed by guidance, and thus creating navigation errors. Finally, if the pressure relief valves should hang up, these propellants may rupture the lines causing serious damage if not dumped within a reasonable time after MECO. To avoid this possibility, the dump will always be performed with an on-time OMS 1 burn or manually if the OMS 1 burn is delayed more than 4 min.

The dump sequence will be automatically initiated at OMS 1 ignition if the MPS PRPLT DUMP SEQUENCE L02 switch on panel R2 is in the GPC position. The first step of the dump sequence positions the SSME's to a dump position. Then the trapped L02 in the feedline manifold will be expelled, under pressure by the helium subsystem, through the three MPS engine bells.

After the L02 dump, the GPC will automatically initiate the LH2 dump (if the MPS PRPLT DUMP SEQUENCE LH2 switch on panel R2 is in the GPC position). The LH2 dump will be similar to the L02 dump, after which the GPC will terminate the dump and stow the SSME's for entry. After ~3 min 21 sec from the start of the dump, the SSME's should be stowed and can be noted by the crew when the BODY FLP pb light goes out. The APU's can then be shut down.

If desired, the MPS dump can be manually started by the crew anytime after MECO+10 sec. Even when started manually, all valve opening and closing sequences are still automatic. After completion of the LOX dump, the pilot must place the MPS PRPLT DUMP SEQUENCE LO2 switch to STOP to start the LH2 dump (assuming the LH2 switch is not in STOP). The manual dump will be used when the OMS 1 burn is delayed a significant amount of time. For an AOA, transition to OPS 3 will not be made until the SSME's are stowed (3 min 21 sec from dump initiate).

If BFS is engaged, the dump can only be performed automatically; i.e., started by the OMS 1 burn with no manual dump extensions. In addition, for STS-1 the BDY FLP pb light will not indicate SSME stow. Thus, the crew must manually time the dump to know when APU/HYD can be deactivated or depressed.

APU/HYD SHUTDOWN or HYD DEPRESS

CUE

Body flap pb - light out (SSME's stowed)  
OMS 1 TIG+3 min 21 sec

CREW ACTION

Shutdown the APU's; or if on an AOA, depress hydraulics.

APU/HYD SHUTDOWN (Not AOA)

- F4 ✓BDY FLP pb - light out (PASS only)  
(MPS stowed) (~3 min 21 sec)
  
- R4 MPS/TVC ISOL VLV (three) - CLOSE (tb-CL)
  
- R2 BOILER CNTLR (three) - OFF  
APU CNTL (three) - OFF (MA)  
FUEL TK VLV (three) - CLOSE  
FUEL PUMP/VLV COOL A - AUTO  
CNTLR PWR (three) - OFF  
BOILER N2 SPLY (three) - OFF  
APU AUTO SHUTDOWN - ENABLE

- \* HYD DEPRESS (AOA only) \*
- \* \*
- \* F4 ✓BDY FLP pb - light out (PASS only) \*
- \* (MPS stowed) (~3 min 21 sec) \*
- \* R4 MPS/TVC ISOL VLV (three) - CLOSE \*
- \* (tb-CL) \*
- \* R2 HYD MAIN PUMP PRESS (three) - LOW \*
- \* (MA) \*
- \* APU AUTO SHUTDOWN - ENABLE \*

DISCUSSION

Due to the limited APU fuel onboard the Orbiter, it is necessary to shutdown the APU's as soon as they are no longer needed for ascent. This occurs after the SSME's are stowed at the completion of the MPS DUMP SEQUENCE (see MPS PROPELLANT DUMP EVENT).

Prior to Bermuda LOS, MCC will give the crew a GO for APU shutdown. This call will be made only if all systems and trajectory support at least an ATO mission. The crew then shuts down the APU's on time or when the BDY FLP lt goes out as called for in the checklist. If an AOA abort is likely, the MCC will then ask the crew to only depress the hydraulics. A final decision would then be made during the Madrid STDN pass. For AOA, hydraulics will stay depressed until  $\bar{q} = 1$  during the entry phase. If APU's are shutdown then an AOA is required a hot restart of the APU's will be done.

If the BFS is engaged, the body flap pb light will not indicate when the SSME's are stowed. In addition, the MPS dump is only automatic and performed at OMS 1 ignition. Thus, the crew must time the dump after OMS 1 ignition for 3 min and 21 sec before the APU/HYD SHUTDOWN or the HYD DEPRESS procedure is initiated.

OMS 2 BURN SETUP

CUE

After entering MM 105

DISPLAY

OMS 2 MNVR EXEC

CREW ACTION

Verify and load the OMS 2 Targets

OMS 2 BURN SETUP

✓OMS 2 TARGETS Cue Card

CRT1 TRIM L,R - ITEM 12 +0.4 -6.5  
+6.5 EXEC

\* For single engine burn (good \*  
\* engine:) \*  
\* TRIM L - ITEM 13 + 5.2 EXEC \*  
\* R - ITEM 14 - 5.2 EXEC \*  
\* ENG SEL L - ITEM 16 EXEC \*  
\* R - ITEM 17 EXEC \*  
\* \*  
\* For RCS burn: \*  
\* RCS +X - ITEM 18 EXEC \*

✓Nominal target:

TIG = 43:09  
C1 = 0  
C2 = .0  
HT = 157  
θT = 337

DISCUSSION

After completion of the OMS 1 burn, the crew will go to MM 105 to prepare for the OMS 2 burn. The appropriate target will be determined using the OMS 2 TARGET cue card, and will be verified by the MCC during the Madrid STDN pass. If an AOA is required, the targets will not be loaded until the software is moded into OPS 3. This is because θT is determined differently in OPS 3 than in OPS 1. θT is the angle between the launch site and the desired target radius at the end of the coast phase in OPS 1 and is the angle between the deorbit burn TIG and EI in OPS 3. The value listed in the checklist is only good in OPS 3.

The OMS gimbals must be trimmed to the appropriate value before the OMS 2 burn. Prior to the OMS 1 burn, these trim values are set by I-loads. However, for follow-on burns, the setting at the completion of the previous burn is used. In BFS, the trim is not updated through the OMS burn if BFS

is not engaged. Since this may not be the desired trim, the crew will re-set them as required. After the appropriate target and trims are entered, the crews load them by item entry and verify that a good solution is made both in the primary and backup.

MPS POWER DOWN AND MPS VACUUM INERTING

CUE

DISPLAY

L02 and LH2 manifold pressure decay

MPS ENG MANF meter

CREW ACTION

MPS POWERDOWN

R2 MPS ENG PWR (six) - OFF  
He ISOL A,B (six) - CLOSE  
✓He INTERCONNECT (three) - GPC  
R4 ENG CNTLR HTR (three) - AUTO

MPS VACUUM INERTING ACT

R2 MPS He ISOL A L - OPEN  
B L - OPEN  
PNEU L ENG He XOVR - OPEN  
✓He ISOL - OPEN  
  
R4 MPS L02 PREVLV (three) - CLOSE  
Wait 2 sec . . . . - OPEN  
Wait 2 sec . . . . - GPC

NOTE

MA may occur for He press

R4 MPS H2 PRESS LINE VENT - OPEN  
(Start Watch)  
PRPLT FILL/DRAIN  
LH2 INBD - CLOSE  
OUTBD - CLOSE  
L02 INBD - CLOSE  
OUTBD - CLOSE  
  
Wait 2 sec:  
LH2 INBD - OPEN  
OUTBD - OPEN  
L02 INBD - OPEN  
OUTBD - OPEN

(OMS 2)▶ VACUUM INERTING TERMINATE  
(TIG-5)

R4 MPS PRPLT FILL/DRAIN  
LH2, L02 OUTBD (two) - CLOSE  
Wait 10 sec . . . . - GND  
LH2, L02 INBD (two) - GND  
R2 MPS He ISOL A L - CLOSE  
B L - CLOSE  
PNEU L ENG He XOVR - CLOSE  
He ISOL - CLOSE



## DISCUSSION

After completion of the MPS DUMP, the MPS will be powered down and vacuum inerted by the pilot. Vacuum inerting allows any traces of L02 and LH2 left over after the propellant dump to be vented into space. Both the L02 lines and the LH2 lines will be inerted simultaneously. The inerting will be performed for ~30 min (terminating 5 min prior to OMS 2); after which time, the pilot will close the lines. During the inerting, a definite pressure decay should be noted in both the L02 and LH2 lines. Vacuum inerting will also be performed on an AOA until OMS 2 TIG-10 minutes.

ET UMBILICAL DOOR CLOSURE

CUE

ET doors and latches indicate closed on R2

DISPLAY

SPEC 52, OVERRIDE

CREW ACTION

ET UMBILICAL DOOR CLOSURE

R2 ET UMB DR:  
MODE - MAN  
CTRLINE LATCH - STOW  
After 6 sec, CTRLINE LATCH tb-STO  
L,R DOOR (two) - CLOSE (tb-bp)  
After 24 sec, L,R DOOR tb-CL  
L,R LATCH (two) - LATCH (tb-bp)  
After 6 sec, L,R LATCH tb-LAT

\* If doors not closed: \*  
\* \* \*  
\* 2: GNC 51 OVERRIDE \*  
\* \* \*  
\* ET UMB DR CLOSE - ITEM 6 EXEC \*

DISCUSSION

The ET umbilical doors must be closed prior to entry. In addition, there is a software backup in case of a switch failure. However, the software backup is only available in OPS 1. Thus, to be safe, the crew should always insure that the doors are closed prior to leaving OPS 1. Prior to door closure, the crew initiates the MPS VACUUM INERTING. In this procedure, the MPS H2 PRESS LINE VENT is opened to expel any hydrogen in the line through the umbilical door opening for at least one minute. The umbilical doors should not be closed until this line has been closed to avoid trapping any hydrogen in the well.

OMS 2 BURN PREP and ATTITUDE MANEUVER

CUE

OMS 2 burn selection  
MCC 'GO' for target and nav state

DISPLAY

OMS 2 MNVR EXEC

CREW ACTION

Set switches to proper burn configuration  
Maneuver to burn attitude

OMS BURN PREPARATION

- 08 L,R OMS  
✓He PRESS/VAP ISOL A (two) - GPC  
B (two) - CLOSE  
TK ISOL (four) - OPEN (tb-OP)  
XFEED (four) - CLOSE (tb-CL)
- C6 Install OMS 2 BURN and ASCENT BURN  
MONITOR Cue Cards (F6/F8)

OMS 2 BURN ATTITUDE MNVR

- F6/F8 ✓FLT CNTLR PWR - ON  
✓ADI ATT - INRTL  
RHC Mnvr to Burn Attitude

3: BFS, GNC SYS SUMM 2

DISCUSSION

After the appropriate OMS 2 target has been set up and concurred on by MCC, the pilot configures the OMS/RCS switches for the burn. The commander maneuvers the vehicle to the burn attitude. Both crewmembers install the appropriate OMS Cue Cards for the burn.

SEAT SAFING AND ADJUSTMENT

CUE

After Madrid LOS

DISPLAY

None

CREW ACTION

Safe ejection seats.

For on orbit

SEAT SAFING AND ADJUSTMENT

Open Visor

Remove from pocket and install:

Panel Jett T-Handle Pin

Scramble Handle Clip

D-Ring Pin

Vent and retract Backangle

DISCUSSION

After Madrid LOS, the crew will install ejection safety pins and retract the seat backangle and adjust the height if needed to the entry position. If an AOA had been decided on, then the seats would remain hot, and the crew would only retract the backangle and adjust the seat height for entry.

OMS 2 (OPS 1)

CUE

OMS Pc > 90  
Error needle movement  
TGO & VGO decreasing  
Physiological cue

DISPLAYS

OMS PRESS gauge  
ADI  
OMS 2 MNVR EXEC display

CREW ACTION

Verify or enter OMS targets.  
Key 'EXEC' when flashing on CRT display.  
Monitor burn.

DISCUSSION

The OMS 2 burn is identical to the OMS 1 burn with the following exception: the OMS 2 burn is done in MM 105 and the crew must initiate 'LOAD' to receive targetting results and must start the CRT timer. During the burn, current HP should be approaching the targeted HP. There are no residual  $\Delta V$  requirements for the OMS 2 burn as long as a safe orbit condition is achieved.

The software will not allow downmoding to AOA or ATO after the 'EXEC' is keyed. Downmoding from ATO to AOA is not a legal software transition post-OMS 1.

OMS/RCS POST BURN RECONFIGURATION

CUE

OMS 2 burn complete

CREW ACTION

Configure OMS and RCS for on-orbit (or entry if AOA).

For on orbit

OMS/RCS POST BURN RECONFIGURATION

- 07 AFT L,R RCS
  - He PRESS A (two) - GPC (tb-OP)
  - B (two) - CLOSE (tb-CL)
  - TK ISOL (six) - OPEN (tb-OP)
  - XFEED (four) - CLOSE (tb-CL)
  
- 08 FWD RCS
  - He PRESS A - GPC (tb-OP)
  - B - CLOSE (tb-CL)
  
- L,R OMS
  - He PRESS/VAP ISOL (four) - CLOSE
  - ✓TK ISOL (four) - OPEN (tb-OP)
  - ✓XFEED (four) - CLOSE (tb-CL)

DISCUSSION

The pilot will safe the OMS after the OMS 2 burn and configure the RCS for on-orbit use. If the OMS 2 burn is an AOA deorbit burn, the OMS is safed and the RCS is configured for entry.

UPLINK BLOCK & UNBLOCK

CUE

Communications Acquisition of  
Signal (AOS) or Loss of  
Signal (LOS)

DISPLAYS

None

CREW ACTION

At LOS:

C3 UPLINK BLOCK - ALL

At AOS:

C3 UPLINK BLOCK - NONE  
I/O RESET EXEC

Example: \*\*\*\*\* MAD LOS (UPLINK BLK - ALL) \*\*\*\*\*  
\*\*\*\*\* MAD AOS (UPLINK BLK - NONE) \*\*\*\*\*

DISCUSSION

Uplink is blocked any time the vehicle does not have communications with the ground to keep unwanted uplink from being accepted by the Orbiter. This is done automatically during on-orbit (OPS 2), but has to be done manually via the UPLINK BLOCK switch for ascent (OPS 1) and entry (OPS 3). When uplink is allowed again (UPLINK BLOCK - NONE), an I/O RESET has to be executed to reestablish the interface with the NSP's.

When the ground informs the crew of LOS or AOS, they will remind them to do this by saying 'CONFIGURE FOR LOS (or AOS).'

## MANUAL CONTROL IN POWERED FLIGHT

### CUE

Indication that automatic system is not working properly (refer to Flight Rules).  
CSS light

### DISPLAY

CSS pbi  
SPD BK/THROT pbi

### CREW ACTION

NOTE: Crew will also select manual throttle if in CSS.

Specific procedures are as follows:

#### First stage -

Fly ADI and HSI angle as a function of time per the ASCENT ADI Cue Card.  
Throttle for  $\bar{q}$  control per ASCENT PROC Cue Card.  
Maintain attitude hold through SRB staging.

#### Second stage -

Fly profile using current position and predictor on the CRT display until off-scale on the display.  
Fly attitude, altitude, and altitude rate as a function of velocity per the ASCENT ADI Cue Card using the AMI, AVVI, and ADI.  
Fly yaw profile on the HSI per ASCENT ADI Cue Card.  
Throttle for 3g control.  
Perform manual MECO via the shutdown pb's when  $V_I = 25,500$  on the AMI.

#### Powered RTLS -

Fly propellant dissipation phase using the attitude on the powered RTLS Cue Card.  
When propellant remaining reaches cue card quantity or time from MCC, pitch around at  $10^\circ/\text{sec}$  to point nose back toward launch site,  $\theta \sim 45^\circ$ .  
Fly profile on CRT display,  $V_{rel}$  on tail.  
At  $V_{rel} = 0$ , fly  $V_{rel}$  and WPI pointer on nose.  
When  $\Delta H$  indicator becomes active, fly  $\Delta H = 0$ .  
At MECO minus 20 sec (tick mark on CRT) pitch down to  $\alpha = -4 \pm 2^\circ$ ,  $\beta = 0 \pm 2^\circ$  and maintain that attitude.  
When  $\Delta R = CO$  tick mark on the CRT display, perform manual MECO via the shutdown pb's.

#### Engine Out (not RTLS) -

$V_I < 9K$  ft/s - Fly ASCENT ADI - ENG OUT Cue Card,  $V_I$  on nose.  
 $V_I > 9K$  ft/s - Fly ASCENT ADI - NOMINAL Cue Card.

### DISCUSSION

Manual steering capability is available in MM's 102, 103, and 601 whenever any CSS pushbutton on either eyebrow panel is pushed. Control is in all three axes via either Rotational Hand Controller (RHC).



Manual steering is a rate command/attitude hold system. Rates are proportional to stick displacement, and the vehicle holds attitude whenever the stick is in detent. The attitude held is that which exists when rates are damped to less than 1 deg/s following a maneuver. Whenever manual steering is selected, guidance continues to run and provides steering needles on the ADI and performs the MECO task. Whenever manual guidance is selected, manual throttle (which inhibits automatic MECO) will be selected because guidance could go unconverged and provide erroneous signals that could command a premature MECO.

Manual throttle can be selected by the pilot by pushing the takeover pushbutton on the Speed Brake Thrust Controller (SBTC) and moving the throttle until the SPD BK/THROT MAN light on the eyebrow panel illuminates, indicating that manual command matches auto command. The takeover pushbutton is then released and the crew has manual throttle control (only the SBTC on the pilot's side is functional). The crew must shut down the engines at the desired MECO whenever manual throttle is selected. This is done via the three engine shutdown pushbuttons on panel C3 or as a backup via the engine power switches on panel R2.

Assuming that auto guidance is the only failure, crew procedures for using manual guidance consist of selecting the manual mode via the CSS pushbutton and flying the appropriate trajectory per cue card and as depicted on the CRT display. It is desirable for the piloting task to be split between the crewmembers as the workload can be fairly heavy for a single pilot. It is recommended that one pilot fly the vertical problem while the other controls the horizontal situation.

## SSME FAILURE

### CUE

Red or amber status lights  
Pressure decay  
SM alert  
MCC call  
Physiological cues

### DISPLAY

MAIN ENGINE STATUS lt  
MPS PRESS PC gauge

### DISCUSSION

The amber MAIN ENGINE STATUS lights on panel F7 will be lit and an SM alert issued for any of the following conditions.

Command Path Failure- Two-command channel lost.

Data Path Failure - Both PRI and SEC data lost.

Electronic Lockup - Loss of flow meter data used for mixture ratio control results in main engine controller freezing engine at last commanded position.

Hydraulic Lockup - One or more of the following engine valves is outside of position limits.

- o Main fuel valve
- o Main oxid valve
- o Oxid preburner oxid valve
- o Chamber coolant valve

Throttling capability is lost.

If engine is running in hydraulic lockup at MECO, it will be shut down pneumatically.

The red MAIN ENGINE STATUS lights will be lit if an engine redline limit is exceeded or the engine is in a shutdown phase. The LIMIT SHUTDN and VIB SHUTDN switches on panel C3 enable or inhibit the engine controller-initiated shutdown based on limits. If the switch is in the AUTO position, the shutdown is inhibited after one engine shuts down.

If an engine fails, the pilot will turn off the AC BUS SENSORS to preclude a second engine shutdown due to a faulty ac bus sensor if an ac phase is lost. Other crew action for an engine failure will depend upon the ascent performance capability remaining after the failure which, in turn, is dependent upon the time of failure. Crew options will range from selecting an RTLS for an early failure to pressing on to MECO for later failures. RTLS will be selected at 2:30 for an engine out in first stage. Abort mode (AOA, ATO, or nominal) will be selected after MECO for late engine out.

After the single-engine press-to-MECO boundary, if an engine is out the MAIN ENG LIMIT SHUTDN is enabled and the VIB SHUTDN is reset. Then if a second engine shuts down the LIMIT SHUTDN switch is placed in INHIBIT.

## ABORT INITIATION

### CUE

Failure and flight rule  
MCC call  
Abort light  
OMS  $\Delta V$  required

### DISPLAYS

ASCENT TRAJ  
ASCENT TRAJ 2  
OMS 1 MNVR EXEC

### CREW ACTION

F6 ABORT MODE - as required  
ABORT pb - push

or

Crew entering abort OMS  
targets

### DISCUSSION

MCC is prime for abort mode calls and MCC can illuminate the ABORT pb. In the no-communication case, the crew will decide to initiate aborts in accordance with flight rules and techniques for the failure that has occurred. The intact aborts have been designed for an SSME failure, but can be accomplished with no engines failed and in some areas with two engines failed.

An RTLS abort will be selected for early loss of one SSME or other systems problems that require an immediate return. An RTLS will be selected after 2:30 MET but before 4:34 assuming a 5-sec crew decision time for a 2-SSME RTLS and at 4:20 MET for a 3-SSME RTLS. Abort selection for an RTLS will always be delayed until 2:30. For the three engine case, the potential for a stuck throttle at 100 percent (command path failure) exists. Since an operative engine, even one stuck at 100 percent, will not be prematurely shutdown, and since it will not be possible to throttle three engines to duplicate two engines at 100 percent, unacceptable flight path angles will exist after MECO unless abort initiation is delayed until 4:20.

For STS-1, ATO's and AOA's will not be selected until post-MECO since MECO targets are common for nominal, ATO, and AOA. Selection of the various abort modes pre- and post-OMS 1 results in different targets. The abort selection logic available via the ABORT MODE rotary and ABORT pbi is illustrated in figure 4-17.

If no abort is selected pre-OMS 1 and OMS 2, nominal targets will be used resulting in a 150 x 150-n. mi. orbit. If ATO is selected post-OMS 1, a targeted 150 x 105-n. mi. orbit will be obtained. However, for STS-1, if it is desired to raise perigee to only 105 n. mi., then the nominal OMS 2 burn target will be used and then manually terminated by the crew. If AOA is selected post-OMS 1, a nominal steep deorbit will be targeted and the 'OPS 301' message will appear on the AOA MNVR TRANS display. If ATO is selected pre-OMS 1 and not changed, the ATO targets will be used resulting in a 105 x 105-n. mi. orbit after the OMS 2 burn. Downmoding from ATO

to AOA-S pre-OMS 1 is legal and may be accomplished if desired. However, downmoding post-OMS 1 is not a legal software transition.

If AOA-S is selected pre-OMS 1, the AOA-S targets will be used resulting in an 80-n. mi. apogee OMS 1 followed by a shallow AOA deorbit target.

Upmoding is not a legal transition with the rotary switch. However, in some cases, upmoding may be accomplished simply by manually entering the desired target. A full explanation of OMS targeting can be found in section 4.1.4.

If it is necessary to do a contingency abort (non-intact abort), the crew will select the CONT ABORT (SPEC 52) display and follow the contingency abort procedures.

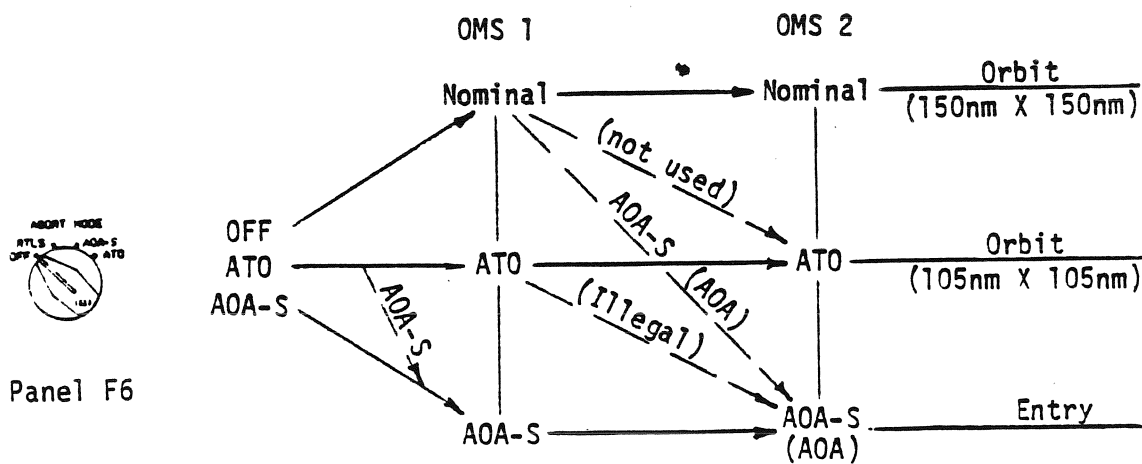

Figure 4-17.- OMS target selection using the ABORT rotary.

## BFS ENGAGEMENT

### CUE

Indication that primary system is not working properly (refer to Flight Rules).  
BFC light

### CREW ACTION

To initiate BFS:  
RHC BFS engage pb - push

Crew procedural differences after BFS has been engaged are as follows:

First and second stage:  
No manual capability.  
ADI & HSI are the only dedicated displays.

OMS burns:  
Manual steering using attitude error needles during OMS burns.  
No manual control of MPS dump (dump will occur automatically at OMS 1 TIG). Body flap pbi does not indicate engines stowed.

After OMS 2:  
IPL primary system and disengage BFS.

### DISCUSSION

The discussion of the BFS is given in section 2.7. The BFS can be engaged by either crewman via the BFS engage pushbutton on the top of the RHC.

## FEEDLINE DISCONNECT VALVE FAILURE

### CUE

ET SEP INHIBIT

### DISPLAY

ASCENT TRAJ 2  
C&W Class 3 message

### CREW ACTION

Determine if 'SEP INH' is caused by feedline disconnect valve failure. Follow FEEDLINE DISCONNECT VALVE FAILURE procedures, section 4 in Ascent Checklist.

### DISCUSSION

After MECO and prior to ET SEP, LO2 and LH2 valves on either side of the ET and the Orbiter close, shutting off the flow of hydrogen and oxygen between the two. If either of these valves is open at ET SEP with pressure in the lines, a propulsive moment will be induced at SEP, probably causing the Orbiter to contact the ET. To avoid this, the software checks that these valves are closed prior to SEP. If not, a 'SEP INH' message is flashed on the CRT. This message will also appear if rates in any of the three axes exceed half a degree or there are multiple flight aft MDM failures.

If the 'SEP INH' message occurs, the crew verifies that the rates are less than half a degree. If so, they turn to section 4 (FEEDLINE DISCONNECT VALVE FAILURE) of the checklist. An 'OPS 104 PRO' is made to check the current apogee and perigee as well as the total  $\Delta V$  required for the OMS 1 burn. If an underspeed had occurred at MECO, the crew must SEP and get the OMS 1 burn off prior to reaching apogee. If not, they follow the checklist FEEDLINE DISCONNECT VALVE FAILURE procedures.

The ET SEP switch is placed to the manual position to avoid SEP occurring unexpectedly. The crew calls up the GNC SYS SUMM display in the BFS to check the MPS manifold pressures. If both LO2 and LH2 pressures are increasing, the crew can assume the valves closed and that the problem was caused by sensor failure or by multiple flight aft MDM failures. They then manually SEP and return to the nominal procedures. If the pressures in either manifold are not increasing, the crew must assume the failure is real and stay on the ET for 6 min from MECO. Because of a pressure buildup in the side without the failure, the crew must manually start a dump of the MPS in the lines of the Orbiter. This dump requires a ullage, which is performed by a manual +X translation. If the BFS is engaged, the MPS dump can only be done automatically at the start of the OMS 1 burn.

The next thing the crew does is verify the OMS 1 target and load it on the MNVR EXEC display. This will be a delayed burn with a TIG of T+20:43 over MADRID STDN.

After the MPS dump is complete the APU's are shutdown if going on to orbit, or the hydraulics are depressed if AOA.

A roll or yaw error greater than ten degrees about 180 and 0, respectively, during this time will be nulled. Otherwise, no maneuvering will be required.

After 6 min from MECO, the crew will push the ET SEP pb which will continue the SEP sequence, allowing the Orbiter to separate from the ET 6 sec later. The crew performs the +Y maneuver to avoid the plane of the ET, then maneuvers to the OMS 1 burn attitude. The burn is performed using the OMS 1 Cue Cards. After the burn, the crew goes to MM 105 and loads the appropriate OMS 2 target except for AOA deorbit OPS 3 targets. This completes the unique procedures required for the feedline disconnect valve failure. Thus, the crew returns to the nominal checklist starting with the MPS powerdown procedure.

## DELAYED OMS 1 BURN

### CUE

OMS 1 performed at Madrid

### DISPLAY

OMS 1 MNVR EXEC

### CREW ACTION

Retarget OMS 1 to Madrid at T+20:43  
Follow DELAYED OMS 1 procedures, section 5 in Ascent Checklist

### DISCUSSION

A delayed OMS 1 burn is a planned delayed burn which is performed at T+20:43 over Madrid. A delayed burn will not be performed if an underspeed condition exists at MECO. It will be used if selected known system failures exist prior to the nominal OMS 1. The nominal procedures are used through the evasive SEP maneuver, at which time a decision is made to delay. A delay can also be caused by both OMS engines failing to light, giving the crew time to retarget and try to determine the cause of failure. A TIG slip is not a delayed burn. This simply means that the targets stay the same and are burned late. For STS-1, TIG slips should not exceed 4 min or else large  $\Delta V$  penalties will result. In a delayed burn, at least TIG is changed and usually  $\theta T$  also. A delayed burn is possible because after a nominal MECO, time to apogee is still later than the delayed burn.

Once a delayed OMS 1 is decided, the crew will perform a manual MPS dump, then shutdown the APU's or depress the hydraulics when the dump is completed. The correct delayed OMS 1 target will be loaded and the vehicle maneuvered to the burn attitude. After the burn, the crew goes to MM 105 and loads the appropriate OMS 2 target except for AOA deorbit OPS 3 targets. This completes the unique procedures required for a delayed OMS 1 burn. Thus, the crew returns to the nominal checklist starting with the MPS power-down procedure.



#### 4.2.2 Abort Once Around (AOA)

##### RECONFIGURE DPS FOR ENTRY (AOA)

##### CUE

AOA abort  
After ET UMBILICAL DOOR CLOSURE

##### CREW ACTION

✓OPS 301 flashing (if AOA selected)  
GNC, OPS 301 PRO  
BFS, GNC, OPS 106 PRO  
BFS, GNC, OPS 301 PRO  
GNC, OPS 302 PRO

1: GNC DEORB MNVR EXEC | 2: GNC DEORB MNVR EXEC |  
3: BFS, GNC DEORB MNVR EXEC |

##### DISCUSSION

If an AOA deorbit is desired after the OMS 1 burn, the software must be transitioned from OPS 1 (ascent) to OPS 3 (deorbit). Prior to transitioning, the MPS dump must be completed and the ET umbilical doors closed. Both the MPS dump sequence and the backup mode to closing the doors are only in the OPS 1 software.

If AOA has been selected with the abort rotary and the software is in OPS 105, the MNVR display will have an 'OPS 301' message flashing on it. If AOA has not been selected, the crew will transition to OPS 3 anyway. Since the BFS does not DK listen to OPS transitions, it must be moded separately. BFS will not allow a transition from OPS 105 to OPS 301 unless AOA is selected. Thus, BFS will always be moded to OPS 106 first, then to OPS 301. Finally, the software will be moded to OPS 302 which has the deorbit burn software mode.

OMS BURN TIG ADJUST (AOA)

CUE

Reference range on chart and REI  
(Range to Entry Interface from the  
landing site) on DEORB MNVR EXEC  
display do not agree

DISPLAY

DEORB MNVR EXEC

CREW ACTION

OMS BURN TIG ADJUST (if reqd)

CRT Determine  $\Delta$  TIG:  
← Range too short Range too long →

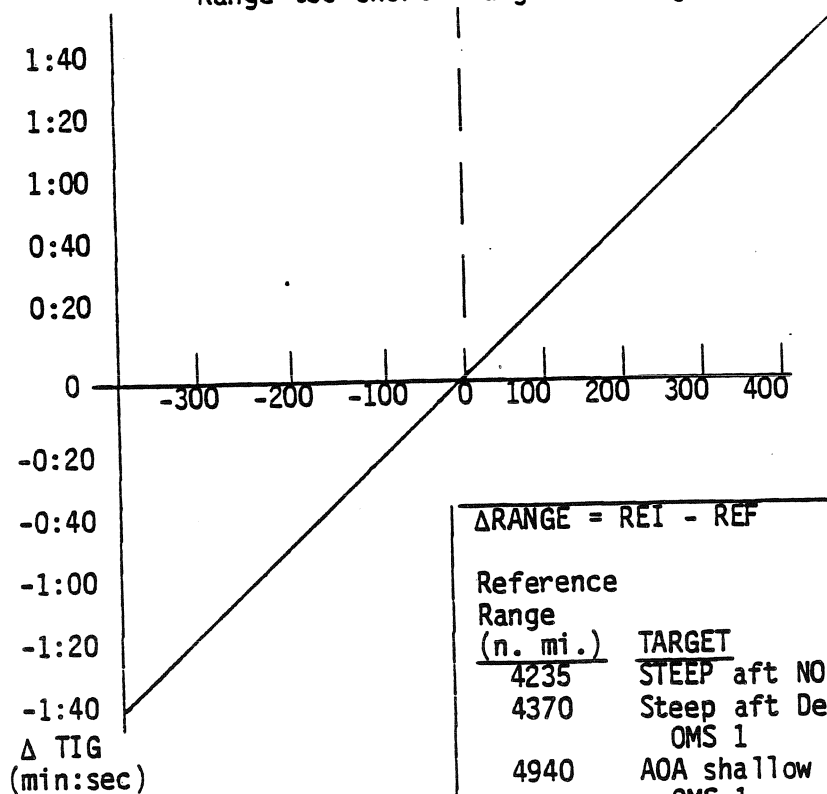

$\Delta$ RANGE = REI - REF	
Reference Range (n. mi.)	TARGET
4235	STEEP aft NOM/ATO OMS 1
4370	Steep aft Delayed Nom OMS 1
4940	AOA shallow aft Nom OMS-1
5375	All other shallow

Enter new TIG  
LOAD - ITEM 39 EXEC  
ST CRT TMR - ITEM 40 EXEC  
✓  $\Delta$  Range < 50  
If  $\Delta$  Range > 50, readjust TIG

## DISCUSSION

The deorbit TIG on AOA aborts can be wrong because the time is a variable depending on when ET SEP occurs. All other parameters in the target are correct. Thus, when the targets are loaded with an approximate TIG, the solution required for deorbit may not be what is needed. To correct this, the REI solution is compared with a reference range. If this delta is greater than 50 n. mi., the chart is used to change TIG such that the appropriate REI is achieved. This way, TIG for a specific target will always be at a fixed location which makes it possible for the MCC to accurately predict and verify the deorbit solution.

CLOSE VENT DOOR (AOA)

CUE

In OPS 3

DISPLAY

GNC OVERRIDE (SPEC 51)

CREW ACTION

CLOSE VENT DOOR

NOTE

If OMS 1 RCS He or TK PRESS  
leak, do not perform this pro-  
cedure until EI +5.

|2: GNC 51 OVERRIDE|

CRT2 VENT DOOR CNTL CLOSE - ITEM 23 EXEC

DISCUSSION

Prior to entry, the vents are required to be closed. Since they are opened during ascent automatically, they must be closed manually by the crew when an AOA is performed. This is done by an item entry on the OVERRIDE display before the deorbit burn. However, if there is an OMS/RCS He or tank pressure leak, the doors will remain open until EI +5 to allow inerting overboard as long as possible. They will then be closed by the crew. If BFS is engaged, the doors must be closed by an item entry on the HORIZ SIT display.

FORWARD RCS DUMP (AOA)

CUE

Excessive FRCS quantity on panel 03

DISPLAY

DEORB MNVR EXEC

CREW ACTION

Dump forward RCS to manage C.G. control

Determine dump time (off nominal)

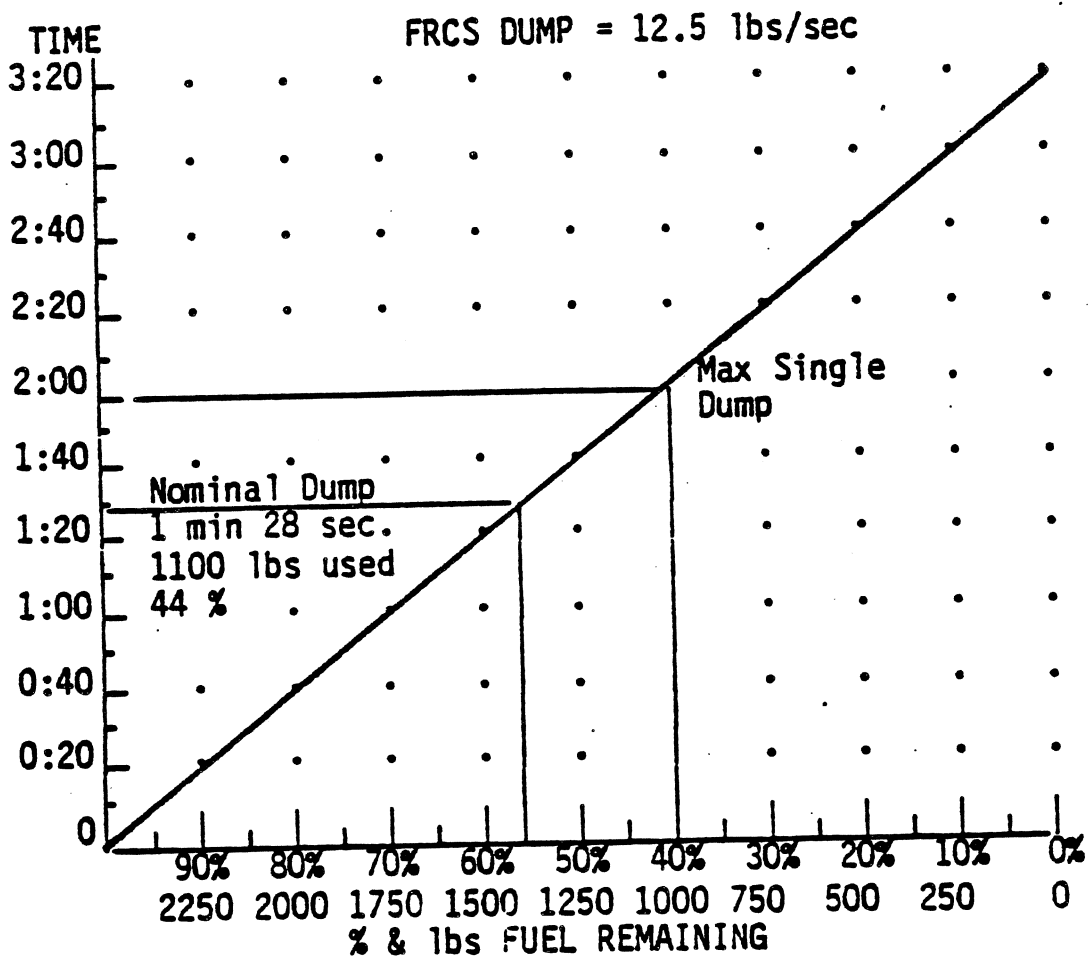

CRT2 F RCS ARM - ITEM 24 EXEC  
DUMP - ITEM 25 EXEC  
(Start Watch)  
Wait 1 min 28 sec, then  
F RCS OFF - ITEM 26 EXEC

## DISCUSSION

A forward RCS dump on an AOA allows for greater control for c.g. management and a lighter vehicle at landing. Prior to the dump, vehicle c.g. is determined based on a fixed forward RCS quantity remaining at EI (56 percent). Certain systems failures negate the need for the dump or require that a new dump value be calculated; i.e., an OMS propellant tank failure such that its propellant is trapped onboard must be negated c.g.-wise as much as possible with forward RCS. It is desired to do the dump before the OMS burn. If there is any problem with the dump, the OMS burn can be recalculated to compensate for the problem, or at worst end up with an aft c.g. Otherwise, a possible undesirable forward c.g. could exist.

The dump is performed by an item entry on the DEORB MNVR EXEC display and is active only in MM's 301, 302, and 303. Four forward jets are fired at a total rate of 12.5 lb/s. Time is used to calculate the amount of fuel to dump, instead of the RCS quantity gauge on O3 which may have up to a 10-percent error during the dump. The dump is stopped by another item entry.

OMS 2 (AOA DEORBIT BURN)

CUE

AOA abort  
OMS Pc > 90  
Error needle movement  
TGO and VGO decreasing  
Physiological cue

DISPLAYS

OMS PRESS guage  
ADI  
DEORB MNVR EXEC

CREW ACTION

Key 'EXEC' when flashing on CRT display.  
Monitor burn.

DISCUSSION

The OMS 2 AOA deorbit burn is identical to the nominal deorbit burn. In fact, the crew will use the Deorbit Burn Cue Cards for the AOA deorbit burn. This burn will nominally be performed out of plane since a large amount of OMS fuel wasting is required for AOA. The target is good for burn delays up to 3 min. Retargeting must be done for longer delays. The residual  $\Delta V$  requirement for the deorbit burn is 2 ft/s and will be nulled by the crew manually with the THC if required.

TACAN CHANNEL SELECTION (AOA)

CUE

MM 304

DISPLAY

HORIZ SIT

CREW ACTION

Manually select appropriate tacan station on thumbwheels.

TACAN CHANNEL SELECTION

2: GNC 50 HORIZ SIT

07 TACAN MODE (three) - T/R  
CH (three) - 041X  
MODE (three) - GPC  
✓ANT SEL (three) - AUTO

DISCUSSION

The manual tacan station selected during ascent is for Kennedy Space Center. On an AOA flight, this selection must be changed to a station used for the AOA entry. Since the crew is still strapped in their seats, they are unable to see, but can reach the tacan selection thumbwheels. To overcome this problem, the HORIZ SIT display is used to show the tacan selected. The display does not show tacan selection until MM 304. Therefore, once in MM 304, the tacan is moded to T/R so that HORIZ SIT will display the manual tacan selected by the thumbwheels. After rotating the thumbwheels to the appropriate station, the tacan is then moded back to auto. The manual position (T/R) is usually not used during entry, but is a backup.



## AOA ENTRY AND POSTLANDING DELTAS FROM NOMINAL ENTRY

### DISCUSSION

Procedurally, an AOA entry is basically the same as a nominal entry with the exception of repressing hydraulics at a  $\bar{q} = 1$ . The major difference is the entry ground track, which on an AOA approaches the United States from a southwesterly direction.

Instead of using nominal postlanding procedures for AOA, the contingency procedures for STS-1 are used because Northrup Strip does not have the ground support equipment available at KSC and Edwards.

### 4.2.3 Return to Launch Site (RTLS)

#### MPS THROTTLING (3-ENG RTLS)

##### CUE

Abort initiation (3-SSME RTLS only)  
End of pitcharound maneuver

##### DISPLAYS

RTLS TRAJ 2 (BFS)  
MPS Pc gauges

##### CREW ACTION

Monitor.

F7 ✓MPS PRESS Pc - 100% (2 eng)  
- 67% (3 eng)

##### DISCUSSION

At abort initiation for a 3-SSME RTLS, the SSME's will be throttled back to 67 percent to simulate a 2-SSME RTLS. For a 2-SSME RTLS, the throttles will remain at 100 percent when the abort is initiated. In both cases, the throttles will remain at 67 percent or 100 percent from abort initiation until the pitcharound maneuver is completed.

Once the pitcharound is completed, the throttles will be moved to 95 percent for a 2-SSME RTLS and 70 percent for a 3-SSME RTLS. These values are initial settings only, and the throttles may be varied (~3 to 5 percent) during the flyback phase to ensure that there will not be more than 2 percent of the ET propellant remaining at MECO.

MPS throttling on the flyback phase is used for fine weight control in conjunction with the flyback thrust attitude. If it appears that the vehicle will have excessive fuel at MECO, the operative engines will throttle down and a higher thrust attitude will preserve the vertical thrust component at the expense of the horizontal component. The increased flyback time will more than compensate for the reduced propellant flow with the net result that more fuel will be dissipated during flyback. The converse is true if it appears that the vehicle will be short of fuel. If a three-engine RTLS is being flown, the engines will be throttled down to resemble the two-engine case. Thus, prior to pitcharound, the three engines will be throttled to 67 percent. Trajectory and times are close to the same for both cases. If manual throttle is selected after pitcharound, a return to auto will not regain throttling for weight control. The throttle setting will remain at the last commanded manual setting.

FUEL DISSIPATION ATTITUDE (RTLS)

CUE

RTLS Abort

DISPLAYS

ADI  
RTLS TRAJ  
RTLS TRAJ 2 (BFS)

CREW ACTION

Monitor.

DISCUSSION

Once an RTLS abort is initiated, the vehicle will pitch to a fuel dissipation attitude (pitch attitude) which is held constant with respect to the inertial reference frame until the start of pitcharound. The pitch attitude varies from 66° for an SSME-out at lift-off to 22° for an SSME-out at 4:00 MET as shown in table 4-6. There is a table in the checklist and on the POWERED RTLS Cue Card which gives the fuel dissipation attitude and ET propellant remaining at pitcharound vs. engine-out time as a backup to the time provided by MCC. An RTLS abort will not be initiated earlier than 2:30. For RTLS aborts selected late (after 4:15), the vehicle will not assume a fuel dissipation attitude, but will pitcharound immediately.

TABLE 4-6.- FUEL DISSIPATION ATTITUDE AND PITCHAROUND PROPELLANT REMAINING

ENG OUT TIME	$\theta$	PITCH AROUND at PRPLT REMAINING (10 deg/sec)
LIFT OFF	66	33%
:30	63	37%
1:00	58	40%
:30	51	43%
2:00	44	46%
:30	39	48%
3:00	34	48%
:30	28	49%
4:00	22	49%
After 4:15 4:29		Immediately Last RTLS

## PITCHAROUND MANEUVER (RTLS)

### CUE

ET propellant remaining  
Time from MCC  
Pitch rate =  $-10^{\circ}/s$

### DISPLAYS

RTLS TRAJ  
ADI  
Clock  
RTLS TRAJ 2 (BFS)  
OMS Pc

### CREW ACTION

Monitor.

Copy pitcharound time from MCC: \_\_\_\_\_ : \_\_\_\_\_

✓ Pitcharound at time received  
from MCC ( $10^{\circ}/s$  to  $\theta \sim 45^{\circ}$ )

- \* If no comm: \*
- \* Use table for pitcharound \*
- \* time based on ET propellant \*
- \* remaining \*

### DISCUSSION

This pitcharound maneuver is essentially an inplane pitch maneuver at approximately  $10^{\circ}/s$  to orient the Orbiter/ET configuration in a heads-up attitude, pointing back toward the launch site (retrograde). Once the pitcharound has occurred, flyback guidance will be initiated to null the downrange velocity and add sufficient uprange velocity for the Orbiter to glide to the RTLS runway.

For late RTLS aborts ( $t > 4:15$ ), pitcharound will be performed immediately. Except for the late RTLS, pitcharound is delayed to dissipate excess propellant until the MPS propellant remaining is sufficient to achieve the required RTLS MECO targets. Fuel Dissipation attitude and pitcharound propellant which gives the ET propellant remaining at pitcharound vs. engine-out time as a backup to the time of pitcharound received from MCC is shown in table 4-6. Coarse weight control is achieved by selection of the time to begin the constant rate pitcharound. MPS throttling is used for fine weight control after pitcharound.

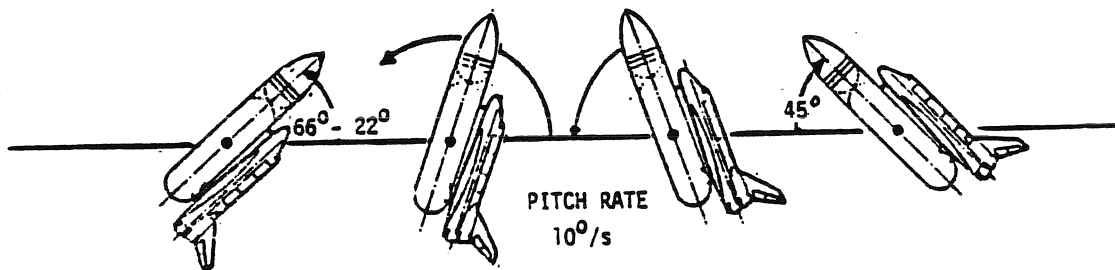

Figure 4-18.- RTLS pitcharound maneuver.

PRE-MECO OMS/RCS DUMP (RTLS)

CUE

Pitcharound initiation

DISPLAYS

OMS PRESS Pc gauge  
RCS/OMS PRPLT QTY

CREW ACTION

Monitor.

      ✓ OMS dump  
F7      OMS PRESS Pc  
03      RCS/OMS PRPLT QTY

DISCUSSION

This sequence is presently undergoing extensive changes. The I-loaded values given here are representative and not current values. The RCS dump will be accomplished post-ET SEP so that -Z translation capability will be guaranteed.

Two important requirements during an RTLS are achieving the proper c.g. (66.25 percent) and weight for vehicle control during entry and landing. This task is partially accomplished by dumping (burning) OMS/RCS propellants to a predetermined level. The OMS and RCS propellant dump is at pitcharound initiation and terminated 244.3 (I-load) sec later. This schedule is fixed for RTLS, regardless of the abort time. At pitcharound, the OMS engines ignite and burn for 244.3 (I-load) sec. Shortly after pitcharound, the OMS tanks also provide propellant, via an automatic interconnect, to 24 RCS (20 null and 4 +X) which burn for approximately 118 sec. An automatic tank reconnect then takes place and RCS fuel is burned through 12 RCS for 31.39 (I-load) sec. This procedure lightens the Orbiter and improves the c.g. by dumping over 17,000 lb of aft loaded OMS & RCS fuel. The Orbiter has a relatively narrow range of acceptable longitudinal and lateral c.g. locations. Failure to burn the planned amount of OMS (RCS to a lesser extent) propellants can result in reduced static margin and pitch stability problems, lateral stability problems, or a combination of both.

## POWERED PITCHDOWN (RTLS)

### CUES

Range ( $\Delta R$  bug on RTLS TRAJ or  
RTLS TRAJ 2 reaches PD mark)  
Time  
Pitch rate =  $-.250/s$

### DISPLAYS

RTLS TRAJ  
ADI  
RTLS TRAJ 2 (BFS)

### CREW ACTION

Monitor.  
✓ Powered Pitchdown to  
 $\alpha = -40$ ,  $\beta = 00$

### DISCUSSION

This maneuver starts approximately 20 sec prior to MECO where active MECO targeting is terminated. It takes the mated vehicle from a relatively high angle of attack to the required separation attitude ( $\alpha = -40$ , pitch rate =  $-.250/s$ ). MECO will then be performed when the desired cutoff velocity has been achieved based on the MECO range-velocity line. The auto guidance will stabilize the vehicle at least 5 sec prior to MECO. At the start of PPD, the SSME's are throttled back to 65 percent.

If CSS has been selected, manual throttle will be selected also. The crew should throttle back to 65 percent at the start of pitchdown. MECO must be accomplished manually when the  $\Delta R$  bug reaches 'CO' (cutoff). For three-engine RTLS cases, pitchdown must be started earlier. For this reason, a 'PD3' mark is incorporated on the RTLS TRAJ displays.

## MECO (RTLS)

### CUES

$\Delta$ R bug reaches CO tick  
Sensed deceleration  
Engine Pc gauges fall to zero  
MAIN ENGINE STATUS lts - red

### DISPLAYS

RTLS TRAJ  
RTLS TRAJ 2 (BFS)  
AMI (ACCEL)

### CREW ACTIONS

Monitor. MECO should occur as the  $\Delta$ R bug approaches CO.

\* If MAN THROT and  $\Delta$ R Bug at CO: \*  
\* C3 MAIN ENG SHUTDN pb - \*  
\* (three) - L, CRT, R \*

F7  $\checkmark$ MAIN ENG STATUS lts (three) - ON (red)

\* If CMD or DATA PATH FAIL: \*  
\* R2 Affected eng MPS ENG PWR \*  
\* (two) - OFF \*

### DISCUSSION

Active targeting for MECO begins when the RTLS abort mode is activated and terminates when the PPD phase occurs approximately 20 sec prior to MECO. Specific MECO targets are range, velocity, and flightpath angle. A target altitude is selected, consistent with velocity, to keep dynamic pressure within limits. Prior to MECO, engine throttling to 65 percent should occur. The GPC's should signal MECO when the MPS countdown timer reaches 0 sec or an MPS propellant depletion signal is received. If in manual throttle, the MAIN ENGINE SHUTDOWN pb's should be used. If a command or data path failure exists, then the appropriate ENGINE POWER switches (two per engine on panel R2) should be placed in OFF. This is because a data path failure will mask a command path failure. It should be noted that an MPS dump cannot be accomplished for any engine which has been shut down by the ENGINE POWER switches on panel R2. If data path failure or power switch shutdown occurs on more than one engine, the crew will perform an ITEM 4 EXEC (ET SEP - AUTO) on the OVERRIDE display to start the ET SEP.

If the engines are not shut down at MECO time, a  $\Delta$ R error will be generated due to the vehicle possessing incorrect energy in relationship to the landing site. With a normal RTLS MECO, some excessive energy is planned. With an MPS overburn, the additional energy will require a much larger S-turn.

## ET SEP, -Z TRANSLATION (RTLS)

### CUES

MAIN ENGINE STATUS lights out  
Time (12.6 sec after MECO command)

### DISPLAYS

MAIN ENGINE STATUS lts  
RTLS TRAJ 2 (BFS)  
ADI  
Rudder position indicator  
AMI  
HSI

### CREW ACTION

Monitor the auto SEP sequence and subsequent -Z translation.

#### ✓Attitude

Alpha =  $4^{\circ} +2$  or  $-85$

Beta =  $0^{\circ} +2$

Pitch rate =  $-25^{\circ}/\text{sec} +.5$  or  $-4.75$

Yaw rate =  $0^{\circ}/\text{sec} +.5$

Roll rate =  $0^{\circ}/\text{sec} +5.0$

### ET SEP (MECO+13)

✓MAIN ENG STATUS lts (three) - OFF

#### NOTE

If 'SEP INH', auto seq will  
perform SEP in 6 sec

Rudder activated for yaw control

-Z XLATION complete (10 sec,  $\alpha > 10^{\circ}$ )  
MM 602 Transition

### DISCUSSION

ET SEP occurs 12.6 sec after MECO command. The SEP sequence begins at MECO and is accomplished in the auto mode without crew intervention. If there is a reason for delay of ET SEP, placing the mode switch in the MAN position will delay the SEP until returned to AUTO or the ET SEP pushbutton is pushed. In the MAN mode, ET SEP will not occur unless the SEP pushbutton is depressed, which will initiate a fast sep.

If the SEP constraints have been violated, the auto sequence will be inhibited for up to 6 sec. The sequence constantly checks to see if out-of-limits conditions have been satisfied. If so, the sequence continues. If not, after 6 sec (18.3 sec after MECO), the alpha, beta, and rate constraints will be ignored and the ET will separate without any crew intervention. At ET SEP, the red main engine status lights go out.



Immediately following the ET SEP, the vehicle starts a -Z translation maneuver. This maneuver is initiated using four forward and six aft RCS jets.

The RCS jets perform a -Z translation for 5 sec, then a controlled pitchup at  $20^\circ/\text{s}$  to an angle attack of  $50^\circ$ . When the angle of attack is greater than  $10^\circ$  and 10 sec have elapsed, transition to MM 602 will occur. This -Z translation is performed to prevent recontact with the ET and prepare for the  $\alpha$  recovery phase of GRTLS. The crew will be able to manually back up this maneuver using the THC and RHC. Five sec after physical separation, the rudder is activated to provide augmented roll control.

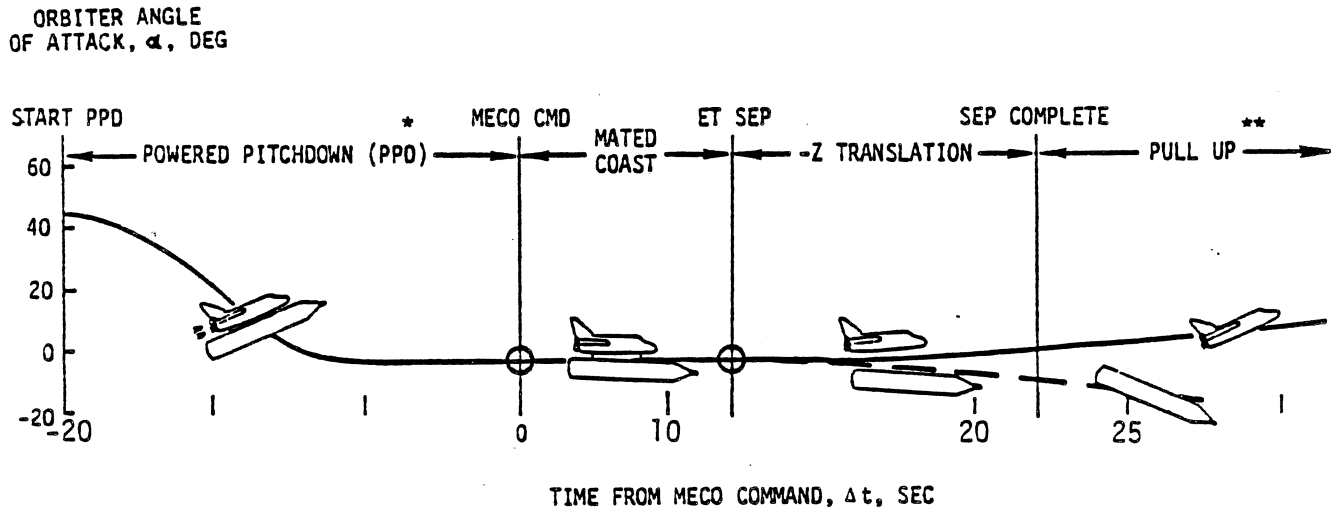

\* PPD IS 20 SEC FOR OFT  
 \*\* PULL UP  $\dot{\alpha} = 2 \text{ DEG/SEC}$  TO  $\alpha = 50 \text{ DEG}$

Figure 4-19.- The RTLS ET separation transition region.

MM 602 TRANSITION, ALPHA RECOVERY PHASE, ELEVON AND BODY FLAP  
ACTIVATION (RTLS)

CUE

Attitude rates  
End of -Z translation (10 sec &  $\alpha > 10^\circ$ )  
CRT display changes - VERT SIT 1 appears

DISPLAY

ADI  
AMI  
VERT SIT 1 display

CREW ACTION

Monitor. If VERT SIT 1 does not appear at the end of the -Z translation burn, the crew will perform an 'OPS 602 PRO'.

1: GNC VERT SIT 1  
3: BFS, GNC VERT SIT 1

NOTE

On MM 602 transition, elevons  
and body flap activated

Monitor  $\alpha$  recovery ( $\alpha = 50^\circ$ )

$\alpha$  - RECOVERY PHASE

DISCUSSION

The transition to MM 602 occurs at the end of the -Z translation burn (10 sec from ET SEP and  $\alpha > 10^\circ$ ) and initiates the alpha recovery phase of GRTLS. This phase changes the Orbiter attitude from the low angle of attack ( $\alpha$ ) required for separation to the high  $\alpha$  ( $50^\circ$ ) and a wings-level attitude in preparation for atmospheric flight. This attitude is maintained until the normal load factor increases to within 0.35g of the constant normal acceleration value (2g) used for the Nz hold phase. The value of the angle of attack influences the subsequent aerodynamic loads experienced by the Orbiter, the minimum ( $\alpha$ ) experienced during the Nz hold phase, and the Orbiter range potential. There is no energy management performed during this phase. The ADI pitch error needle displays the  $\alpha$  error during the alpha transition phase. Following the -Z translation burn, the Orbiter pitches up at  $20^\circ/\text{s}$  to an  $\alpha$  of  $50^\circ$ . The alpha recovery, Nz hold, and alpha transition phases are shown in figure 4-20.

Attitude control after the ET SEP burn is accomplished by both RCS thrusters and aerodynamic surfaces until 77 KEAS ( $\bar{q} = 20$ ), when the RCS pitch and roll thrusters have both been deactivated. The GRTLS flight control system automatically schedules the elevons and controls the body flap to null the elevator trim command. Pitch will be provided by the elevons and RCS jets.

At the MM 602 transition, the elevon trim will start ramping to  $5^\circ$  down. The GRTLS elevon trim schedule is shown in figure 4-21. This is a proposed trim schedule, but is the one that is compatible with the new approved GRTLS speed brake schedule. The current approved elevon schedule is not the optimum one for the new change in the GRTLS guidance phases and for the new

approved speed brake schedule (fig. 4-23). At the MM 602 transition, the FCS pbi's are initiated in AUTO - this is different than MM 304 transition for STS-1.

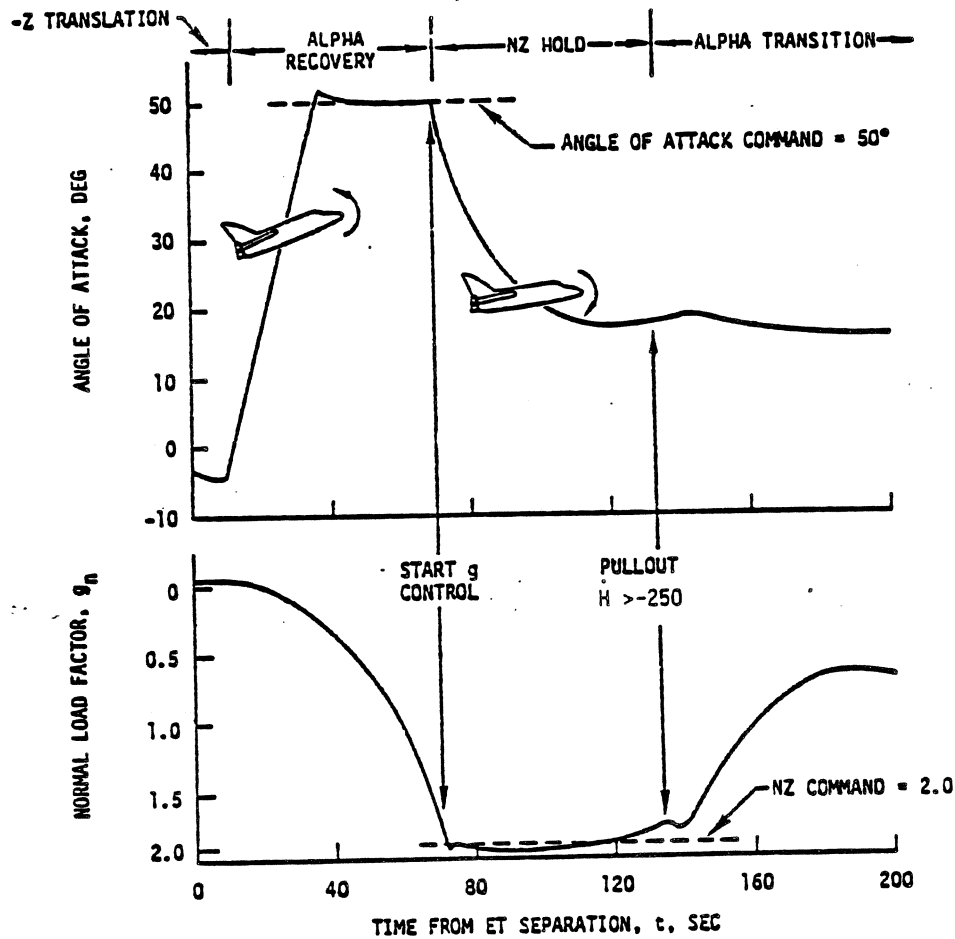

Figure 4-20.- Alpha recovery, Nz hold, and alpha transition phases.

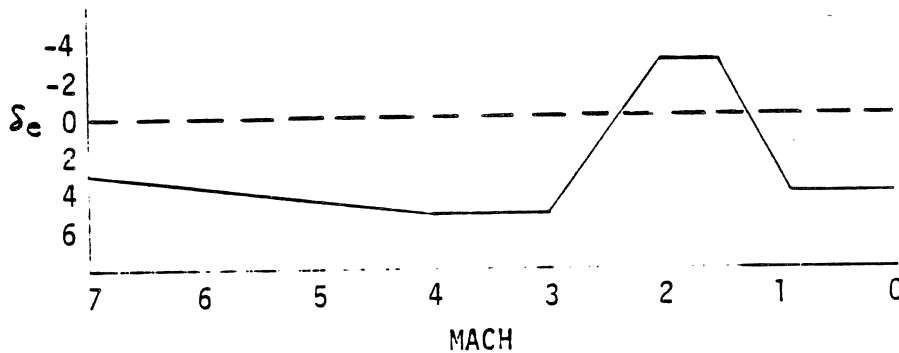

Figure 4-21.- Proposed GRTLS elevon schedule.

## ET UMBILICAL DOORS CLOSURE (RTLS)

### CUE

MM 602 transition

### DISPLAY

VERT SIT 1

### CREW ACTION

R2 ✓CTRLINE LATCH tb - STO (ET DOORS closing)

* If not STO:		*
* ET UMB DR MODE SW - MAN		*
* CTRLINE LATCH - STOW	*	*
* LATCH tb - STO	*	*
* L,R, (two) - CLOSE	*	*
* LATCH (two) - LATCH	*	*
* L,R tb (two) - CL	*	*
* LATCH tb (two) - LAT	*	*

### DISCUSSION

For an RTLS, the ET umbilical doors are closed automatically with the sequence starting 2 sec after ET SEP. The first step in this sequence is to stow the centerline latch and then sequence allows 6 sec for this. Therefore, 8 sec after ET SEP, the centerline latch should be stowed with the talkback indicating STO. MM 602 transition occurs 10 sec after ET SEP and by this time the centerline latch talkback should be indicating STO, giving a very good indication to the crew that the automatic sequence is working properly. If the talkback does not show STO, the automatic sequence is not working properly and the crew should manually close the doors using the ET UMBILICAL DOOR CLOSURE Cue Card.

If the ET umbilical doors are not closed, the aerodynamic characteristics of the Orbiter could be adversely affected, along with the possibility of the doors ripping loose and damaging portions of the vehicle.

The automatic sequence will take 66 sec to close the doors. The sequence should terminate at ~ TMECO+1:20.

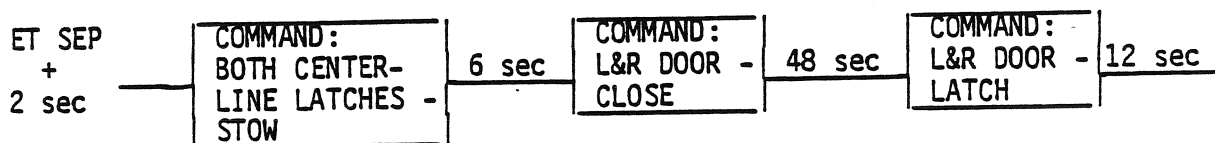

Figure 4-22.- RTLS ET umbilical doors closure sequence.

MPS DUMP (RTLS)

CUE

MM 602 transition

DISPLAY

VERT SIT 1  
Engine manifold pressure

CREW ACTION

None - crew awareness.

DISCUSSION

Failure to dump MPS propellants will result in a c.g. position further aft than desired, reducing the static margin and pitch stability. The fuselage vent doors should be closed during LH2 dumping (they are closed automatically at the MM 602 transition). MPS dumping is completely automatic during RTLS and will stop at  $V_{rel} = 4500$  ft/sec. LH2 is dumped overboard through a special 1-1/2 in. line on the port side of the aft fuselage. LO2 venting is done through the engine nozzles. LH2 dumping is aided by helium pressure and may be considered completed when a noticeable drop is observed on the engine manifold pressure gauges.

TACAN AOS and MANagements (RTLS)

CUE

MM 602 transition

DISPLAY

VERT SIT 1  
HORIZ SIT  
HSI

CREW ACTION

As soon after the MM 602 transition as possible, call HORIZ SIT and using the TACAN MANAGEMENT matrix, select AUTO, FORCE, or INHIBIT for the tacan's. After tacan lockon, pilot selects tacan as the HSI source.

DISCUSSION

Before lift-off, the HORIZ SIT display is configured as it is for nominal entry. On MM 602 transition, the Orbiter is within range of the tacan stations. Therefore, as soon as possible after the transition, the crew should call up the HORIZ SIT and by using the TACAN MANAGEMENT matrix in the checklist and table 4-7, the ratios and residuals on the HORIZ SIT, and with MCC concurrence, place tacan in AUTO, INHIBIT, or FORCE. It is highly desirable to have any needed NAV updated using tacan data before ranging starts. If communications with MCC are lost and have not been re-established by 110,000 ft altitude, there is a NO COMM TACAN matrix (table 4-7) that will be used to update NAV. This is the same as for nominal entry.

TABLE 4-7.- TACAN MATRICES

RATIO <1	RATIO >1		ONE TACAN LOCKED	NO LOCK			
<b>TACAN MANAGEMENT</b>							
MCC: AUTO	MCC: INH (+Δ STATE) or FORCE or ZERO Δ STATE or CHG TACAN CH		MCC: DESELECT MISSING TACAN(S)				
<b>NO COMM TACAN</b>							
AUTO	<b>TROUBLESHOOT</b>		Below V = 5.5K  DESELECT MISSING TACANS, then -  AUTO	Below V = 5.5K  TAC (three) - LWR ANT TAC (three) - T/R			
		<table border="1" style="width: 100%;"> <tr> <th style="width: 50%;">IF BAD TACAN</th> <th style="width: 50%;">IF BAD NAV</th> </tr> <tr> <td style="text-align: center;">AUTO</td> <td style="text-align: center;">If 1st acq- FORCE</td> </tr> <tr> <td></td> <td style="text-align: center;">IF NOT - ZERO Δ STATE</td> </tr> </table>			IF BAD TACAN	IF BAD NAV	AUTO
IF BAD TACAN	IF BAD NAV						
AUTO	If 1st acq- FORCE						
	IF NOT - ZERO Δ STATE						

## PITCH AND ROLL RCS JETS DEACTIVATION, SPBK OPERATIONS (RTLS)

### CUE

KEAS = 54 Roll jets inactive  
KEAS = 77  
    SPBK activated, opening to 100%  
    Pitch jets inactive

### DISPLAY

VERT SIT 1 display  
AMI (EAS)  
RCS lights  
Speed brake indicator  
GNC SYS SUMM 1 display

### CREW ACTION

Monitor speed brake opening. Crew awareness for pitch and roll jet deactivation.

### DISCUSSION

Use of the aft roll and pitch RCS thrusters is terminated when dynamic pressures of 10 and 20 psf, respectively, are reached. The aft yaw jets, which are used as the primary mode for lateral control during low dynamic pressure, remain available to assist the ailerons and rudder for lateral control until Mach = 1.0.

When a dynamic pressure of 20 psf is reached, the speed brake is ramped from 0 to 98.6° (100 percent) relative to the hingeline to enhance lateral stability by allowing the elevons to be trimmed down (puts elevons in air-stream). The approved speed brake schedule for GRTLS is shown in figure 4-23.

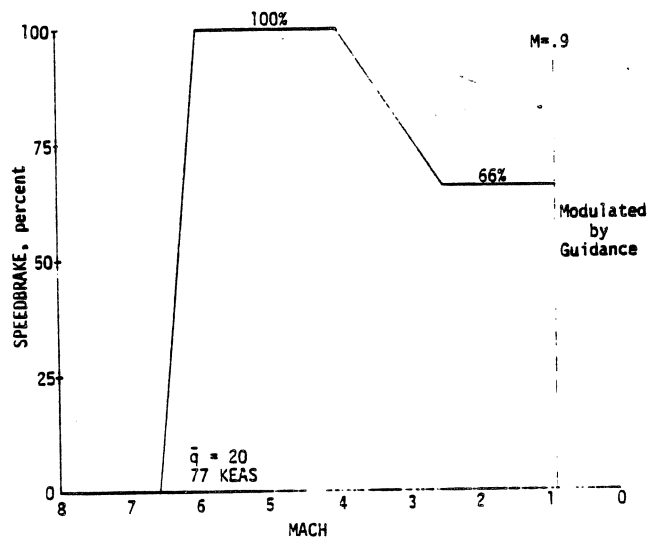

Figure 4-23.- RTLS speed brake schedule.

## RCS ACTIVITY LIGHT RECONFIGURATION (RTLS)

### CUE

121 KEAS ( $\bar{q}$  = 50 psf)

### DISPLAY

AMI

### CREW ACTION

#### Monitor:

KEAS = 121 RCS activity lts reconfigured:

ROLL lts - 3 or 4 yaw jets

PITCH lts - elevon rate saturation

### DISCUSSION

At  $\bar{q}$  = 50 psf, the roll and pitch RCS activity lights are reconfigured by software to indicate the FCS workload to the crew. Both left and right sides of the roll light will illuminate simultaneously if three or four yaw jets are commanded on by the FCS. The lights indicate commands from the FCS to the jet select logic, not actual jet firings. Also, since the minimum on-time for an RCS jet is 80 msec, the commands to the light have been lengthened to allow the crew time to identify which light has flashed.

Both halves of the pitch light will illuminate if Priority Rate Limiting (PRL) issues a flag for elevon rate saturation; i.e., either the left or right elevon is driving at 20°/s or greater.



### Nz HOLD PHASE (RTLS)

#### CUE

Nz approaches Nz desired minus 0.35g (2.0 - .35 = 1.65g for STS-1), alpha starts decreasing, Nz increases to Nz desired.

#### DISPLAY

VERT SIT 1  
Normal accelerometer  
AMI (ACCEL)  
ADI

#### CREW ACTION

Monitor.

Nz = 53 fps<sup>2</sup> Nz HOLD PHASE  
(1.65g's)

Nz constant at 64 ft/s<sup>2</sup> (2g's)

#### DISCUSSION

If alpha does not start a gradual decrease from 50° as Nz = 1.65g (53 ft/s<sup>2</sup>), an Nz overshoot (Nz > 2g) will occur. Excessive g loading could cause structural damage or failure, but could also dissipate energy to the extent that, if sustained too long, it would impact RTLS range capability.

The Nz hold phase is open loop. It begins from an initial angle of attack of 50° (fig. 4-20). As the Orbiter descends into the atmosphere,  $\bar{q}$  increases with increasing density. This causes Nz to increase. When Nz actual is within 0.35g of Nz desired, the alpha will decrease gradually as Nz actual builds to Nz desired (2.0g (64 ft/s<sup>2</sup>) for STS-1). Alpha will then be gradually decreased to maintain Nz desired. All ranging techniques, including S-turns, are inhibited during this phase. The Nz hold phase is terminated when  $\dot{H} > -250$  and alpha > alpha reference (fig. 4-24). Guidance then switches to the alpha transition phase. The ADI pitch error needle displays Nz error during this phase and AMI ACCEL displays Nz in MM 602.

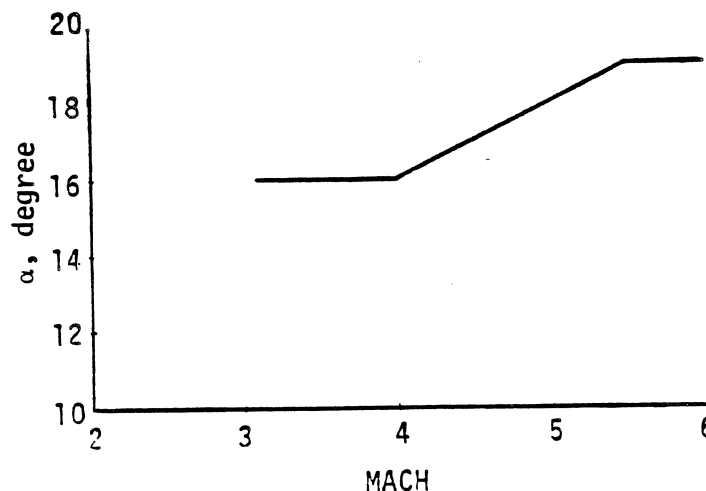

Figure 4-24.- Alpha reference (Cycle 2).

AMMONIA BOILER ACTIVATION (RTLS)

CUE

H = 120,000 ft

DISPLAY

AVVI

CREW ACTION

Monitor.

h = 120,000; NH3 boiler active

- \* NH3 BOILER not active: \*
- \* If FREON EVAP OUT TEMP hi, \*
- \* NH3 CNTLR (two) - SEC/ON \*

DISCUSSION

At 120,000 ft, the ammonia boiler will be automatically activated by the GPC. Activation will be monitored by MCC, and a call will be made to the crew if the event has not taken place. Onboard confirmation of NH<sub>3</sub> boiler activation can be made by noting the temperature on the FREON EVAP OUT TEMP display on panel 01. Also, the 'Freon loop' C&W will trigger when the loop is higher than 60°F. If automatic activation fails to take place, the crew action is L1: NH<sub>3</sub> BOILER (two) - SEC/ON.

## ALPHA TRANSITION PHASE, S-TURNS (RTLS)

### CUE

$\dot{H} > -250$  ft/sec and  $\alpha > \alpha$  reference

### DISPLAY

VERT SIT 1  
AVVI  
AMI  
ADI

### CREW ACTION

#### Monitor:

Orbiter on MACH -  $\alpha$  profile (VERT SIT 1)  
S-turn

### DISCUSSION

The  $\alpha$ -transition phase guidance logic is initiated and the  $N_z$  hold phase terminated when  $\dot{H} > -250$  ft/sec and  $\alpha > \alpha$  reference. During this phase, an angle of attack command is generated as a linear function of Mach number which can be monitored on the VERT SIT 1 Mach- $\alpha$  profile (fig. 4-7). Also, a bank maneuver is performed either to null any heading errors to the Heading Alignment Circle (HAC) tangency point or to dissipate excess energy by turning away from the HAC (S-turns). The maximum bank angle for this phase is  $50^\circ$ . The ADI pitch error needle displays  $\alpha$  error for this phase.

Because the  $\alpha$ -recovery and the  $N_z$  hold phases are both open loop with no regard to energy management, and sufficient energy must be available to cope with open loop energy losses from headwinds and unfavorable L/D variations, GRTLS is intentionally targeted to produce an excess energy state at the initiation of the  $\alpha$ -transition phase. Therefore, S-turns will nominally be started, and in most cases completed, during the  $\alpha$ -transition phase. The starting and stopping of S-turns can be monitored on the VERT SIT 1 using the E/W scale.

At Mach = 3.2, the  $\alpha$ -transition phase will end and guidance will start the nominal TAEM phases. Software will mode from MM 602 to MM 603, and the Orbiter symbol on VERT SIT 1 will switch from the Mach-alpha profile to the range-altitude lines.

TRANSITION TO MM 603, NOMINAL TAEM INTERFACE (RTLS)

CUE

Mach = 3.2

DISPLAY

AMI  
VERT SIT 1  
ADI

CREW ACTION

Monitor.  
Mach = 3.2 TAEM ACQUISITION PHASE  
MM 603 TRANSITION

\* If no transition 'GNC, OPS 603 PRO' \*

DISCUSSION

Nominal TAEM interface and the MM 603 transition occur at Mach = 3.2. At TAEM interface, guidance will do one of two things:

1. If the vehicle was in an S-turn at the MM 603 transition, the TAEM S-turn phase will be initiated and the S-turn continued until the E/W is below the S-turn termination reference, at which time the TAEM acquisition phase will begin.
2. If the vehicle was not S-turning at the MM 603 transition, the TAEM acquisition phase will be initiated and the E/W will be tested to determine if an S-turn is required. If an S-turn is required, the TAEM S-turn phase will be initiated. If no S-turn is required, guidance will stay in the TAEM acquisition phase.

The GRTLS TAEM guidance phases - S-turn, acquisition, heading alignment, and prefinal - are identical to the nominal entry TAEM guidance except:

1. The energy per unit weight, altitude, and dynamic pressure references are extended to higher speeds to include all possible conditions existing when the trajectory is stabilized following the load relief maneuver.
2. To provide greater energy control, the bank angle limit during S-turn is increased from 30° to 50°.

The ADI pitch error needle starts displaying Nz error at TAEM interface. Also at MM 603 transition (TAEM interface), the Orbiter symbol on VERT SIT 1 switches from the Mach- $\alpha$  profile to the range-altitude lines.

## RTLS TAEM AND POSTLANDING DELTAS FROM NOMINAL ENTRY

### DISCUSSION

The MPS/TVC ISOL valves must be closed by the crew before the low altitude/high maneuvering regions of TAEM to prevent PRL. Another constraint on these valves is that they must remain open during the MPS dump which means they cannot be closed until after Mach = 4.5.

The LG HYD ISOL valves must be open to allow hydraulic pressure to the landing gear system. Nominally, the valves are opened automatically at MM 602 transition. The crew must verify that the valves are opened prior to gear deployment although it is not required that it be done at exactly Mach = 3.2. This is checked at Mach = 2.9 on nominal entry.

For RTLS, the MLS's are OFF. They are turned OFF prelaunch to conserve electrical power. Since the MLS switches are hard to reach and see, they are not activated for RTLS.

The rest of the events, starting with deploying the air data probes, are very similar, if not identical, to the nominal entry events. The postlanding procedures for RTLS are the same as for nominal end of mission except that the hydraulic load test is not done.

#### 4.2.4 Contingency Abort

##### OMS PROPELLANT DUMP (CONTINGENCY ABORT)

##### CUE

2nd SSME failed

##### DISPLAY

CONT ABORT, SPEC 52

##### CREW ACTION

CRT3 DUMP START - ITEM 1 EXEC (CONT ABORT display)

##### DISCUSSION

During a contingency abort, ~15,000 lb of OMS propellant must be dumped (burned) to achieve a proper c.g. for the contingency entry. The dump is started with an 'ITEM 1 EXEC' on the CONT ABORT display. The abort sequencer turns on the 2 OMS engines and interconnects OMS propellant to 24 RCS jets. The 2 OMS engines and the 24 RCS jets burn ~100 lb/sec of OMS propellant. The dump will terminate on an OMS quantity level (currently 8.6 percent) which allows enough OMS fuel for single-engine roll control during powered flight.

Failure to dump the OMS propellant results in an aft c.g. which causes the elevons to trim farther 'down.' As the g's rapidly build during the Nz hold phase, more down elevon is required to push the nose over to limit the g's, but there is not enough hydraulic force (hinge moment stall) and over g/loss of control occurs.

MANUAL TAKEOVER (CONTINGENCY ABORT)

CUE

2nd SSME failed and not in  
Auto Continuation region

DISPLAY

CONT ABORT Display  
ADI  
AMI  
AWI

CREW ACTION

CSS pb - push

DISCUSSION

Manual takeover is required for most contingency aborts because there is no auto guidance. However, if the Orbiter is close enough to a MECO target when the second SSME fails, the auto guidance will not be terminated and will fly the Orbiter to the target.

The thrust-to-weight ratio is usually less than one with a single SSME burning, and the Orbiter must be maneuvered to a near vertical attitude. This attitude minimizes the high sink rate and allows the Orbiter to fly back down to the atmosphere where a powered pitchdown and fast sep are executed.

POWERED PITCHDOWN (CONTINGENCY ABORT)

CUE

EAS = 2 kt

DISPLAY

AMI  
ADI

CREW ACTION

Upon reaching sensible atmosphere (indicated on EAS tape), throttle down to 65 percent, pitchdown to  $\alpha = 0$  deg, and initiate fast SEP.

DISCUSSION

This manual maneuver takes the mated vehicle from a vertical thrust attitude to an angle of attack of  $0^\circ \pm 5^\circ$  which is required for a successful ET SEP. The pitch rate should not exceed  $5^\circ/\text{sec}$  with single-engine flight control. Throttling the single engine to 65 percent minimizes the cross coupling during the pitchdown maneuver.



MECO, ET SEP, & -Z Translation (CONTINGENCY ABORT)

CUE

$\alpha = 0^\circ \pm 5^\circ$  &  $\beta = 0^\circ \pm 2^\circ$

DISPLAY

AMI  
HSI

CREW ACTION

C3 ET SEP - MAN  
pb - push

DISCUSSION

In MM 601, the fast SEP sequence is initiated by the ET SEP pushbutton. The fast SEP sequence will immediately shut down the SSME and ~3 sec later will fire the SEP bolts. At SEP, the -Z translation jets are commanded on (four fwd and six aft). But, because of the CSS control mode, the DAP will hold attitude by turning off some of the ten -Z jets. To ensure a clean SEP, the procedure is to command a -Z translation with the THC for a minimum of 3 sec. A pitchup can be commanded with the RHC simultaneously with the -Z command, but the DAP will not see it until the THC is released.

MM 602 (CONTINGENCY ABORT)

CUES

ET SEP plus 10 seconds  
and  $\alpha > 10$  deg

DISPLAY

VERT SIT 1 Display  
Clock  
AMI

CREW ACTION

If the previous major mode was MM 601, the event will be automatic. If the previous mode was MM 104, the crew will enter 'OPS 602 PRO.' After transition to MM 602, the crew will manually pitch the Orbiter up to  $\alpha = 50$  deg.

DISCUSSION

At the transition to MM 602, the elevons and body flap are activated and the VERT SIT 1 display comes up. At this time, the PLT must position the speed brake and body flap to predetermined angles based on velocity and flight path angle. These optimum positions will relieve control surface hinge moments during the pullout.

Nz HOLD (CONTINGENCY ABORT)

CUES

Target Nz approached

DISPLAY

CONT ABORT (SPEC 52)  
AMI  
AVVI

CREW ACTION

Pitch down to maintain target Nz

DISCUSSION

The target Nz will be computed with the equation  $Nz_{cmd} = \dot{h}@1g/1000 + .5$ . Snapshotting the  $\dot{h}$  that the Orbiter is experiencing as it pulls one g ( $|\dot{h}|_{max.}$ ) at a known angle of attack ( $50^\circ$ ) is an indirect indication of flightpath angle. The above equation was obtained empirically using sim data where acceptable peak dynamic pressures were experienced when flying the correlated Nz command. The Nz command will vary from 2.0 to 3.5g.

ALPHA TRANSITION (PULLOUT) (CONTINGENCY ABORT)

CUE

$\dot{h} = -250$

DISPLAY

AVVI.  
AMI

CREW ACTION

Roll 70 deg to kill the phugoid.  
Fly the MACH- $\alpha$ - $\dot{h}$  profile in the checklist (Table 4-8).

DISCUSSION

At  $\dot{h} = -250$ , a 70-deg roll will tend to kill the phugoid. The  $\alpha$  observed at  $\dot{h} = -250$  should be held until the Mach- $\alpha$ - $\dot{h}$  profile is intercepted.

However, at velocities of Mach  $< 6$ , it may be more desirable to maintain wings level and accept the phugoid because of the possible lateral/directional control problems in the Mach 5 to 3 region.

TABLE 4-8.- MACH/ $\alpha$ / $\dot{h}$  PROFILE (CONTINGENCY ABORT)

M	$\alpha$	$\dot{h}$
16	40	-150
15	40	-150
14	40	-165
13	40	-180
12	38	-200
11	38	-200
10	35	-200
9	33	-210
8	30	-220
7	28	-230
6	23	-240

## FAST SEPARATION

### CREW ACTION

In first stage (MM 102) or powered RTLS (MM 601):

C3 ET SEP - MAN  
- SEP

### DISCUSSION

The fast-SEP feature is incorporated in the ET SEP sequence and is available in MM's 102 and 601. This feature clears the Orbiter from the SRB/ET stack in first stage, provides a method of bypassing RTLS ET SEP limits, and provides SEP capability for contingency aborts.

When in MM 102 or MM 601, selecting manual ET SEP and depressing the SEP pb sets the FAST SEP flag in the software. When this occurs, the sequence will no longer test for alpha or beta limits, pitch, roll, or yaw rate limits, feedline or commfault constraints, but will proceed to fire the structural SEP PIC's within ~ 3 sec.

In MM 102, fast separation would be used for loss of control, range safety violation, and 3-SSME-out cases. If three SSME's fail in first stage, assuming good data paths exist, a software MECO CONFIRMED flag will be set which will prevent the SRB SEP sequence from occurring and software moding to MM 103. With three dead SSME's and thrusting SRB's, loads developed on the Orbiter/ET attachment fittings could produce a pole vault type SEP with resulting high alpha and beta values. This could cause catastrophic structural damage which could even preclude ejection. Furthermore, the probability of recontact is high. For this reason, ejection below 100,000 feet is preferable. Above 100,000 feet, the vehicle should be ridden through SRB burnout if possible before attempting fast SEP.

Fast sep is available in MM 601 for RTLS or contingency abort situations. For RTLS tank separations, the RLTS SEP sequence looks at alpha, beta and pitch, roll, and yaw rate limit parameters. Should an auto SEP inhibit condition occur due to a limit being exceeded, the sequence will set the crew alert and continue to test the limits. The sequence will resume when all parameters tested are within limits or when 6 sec have elapsed, whichever comes first. Therefore, there is little point in selecting fast SEP unless rates are becoming wildly divergent or  $\dot{q}$  is increasing very rapidly.

For contingency aborts, fast SEP is the primary method of ET-Orbiter SEP since it bypasses limit parameters, and because it is faster than normal SEP, it allows several more seconds of single engine burn time to reduce entry  $\dot{q}$ .

The fast SEP will separate the SRB and ET if in first stage or the ET if in PRTLS as fast as possible. If an engine is running when fast SEP is initiated the engine will be shutdown and SEP will occur. The crew will follow contingency abort procedures after fast SEP. Fast SEP in the present software does not work correctly.

CREW EJECTION

CUE

H = ~10,000 ft

DISPLAY

AVVI

CREW ACTION

Slow to ~200 kt  
Eject

DISCUSSION

The altitude setting of the main parachute baro switch is 10,000 ft. However, if the Orbiter is close to land or a ship, the ejection could be delayed to a lower altitude. The ejection trajectory is shown in figure 4-25.

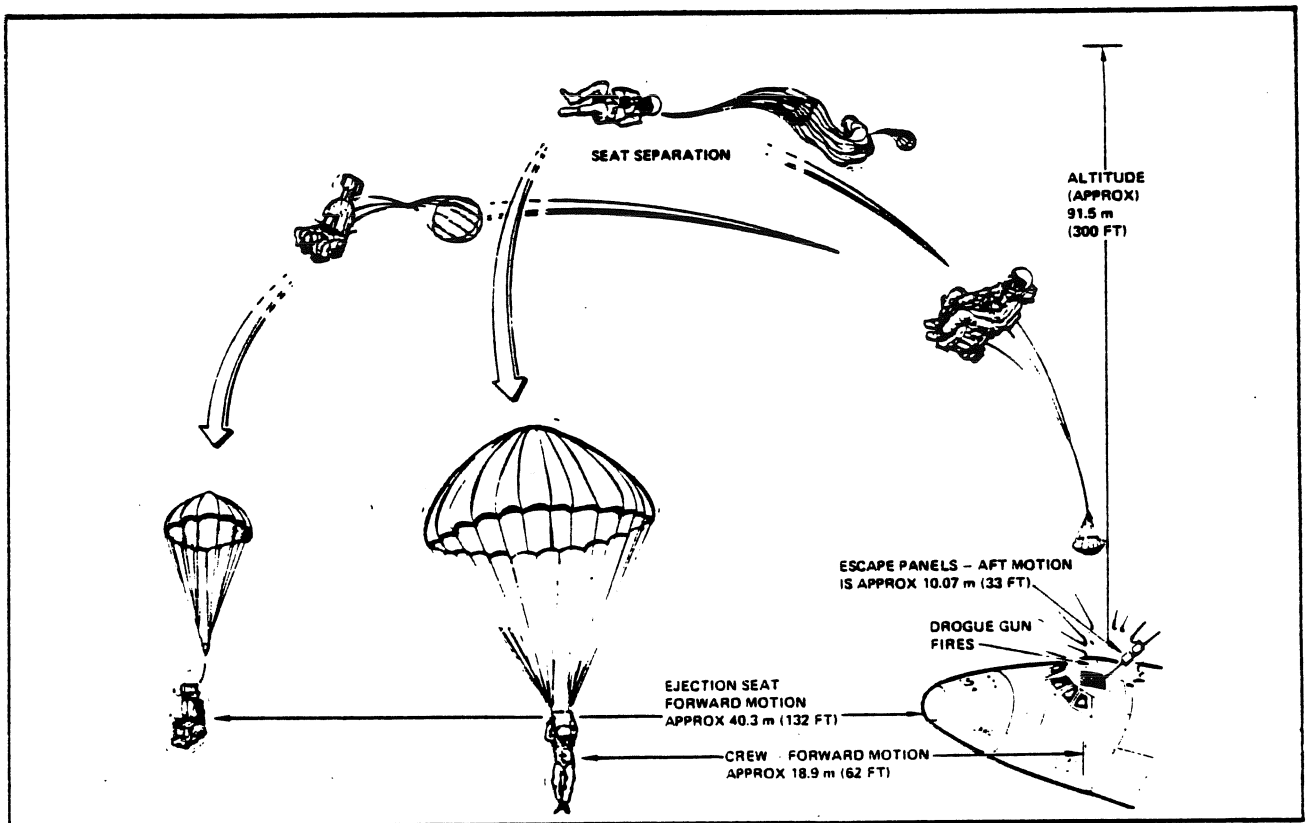

Figure 4-25.- Ejection trajectory.

PROCEDURES MATRICES







SECTION 5  
PROCEDURES MATRICES

5.1 INTRODUCTION

This section consists of tables that summarize the significant aspects of nominal ascent, Abort Once Around (AOA), and Return To Launch Site (RTLS) flight regimes. The tables were prepared to correlate flight procedure-defined activities with time consistent flight software, trajectory, and vehicle systems data.



TABLE I. - COUNTDOWN SEQUENCE.

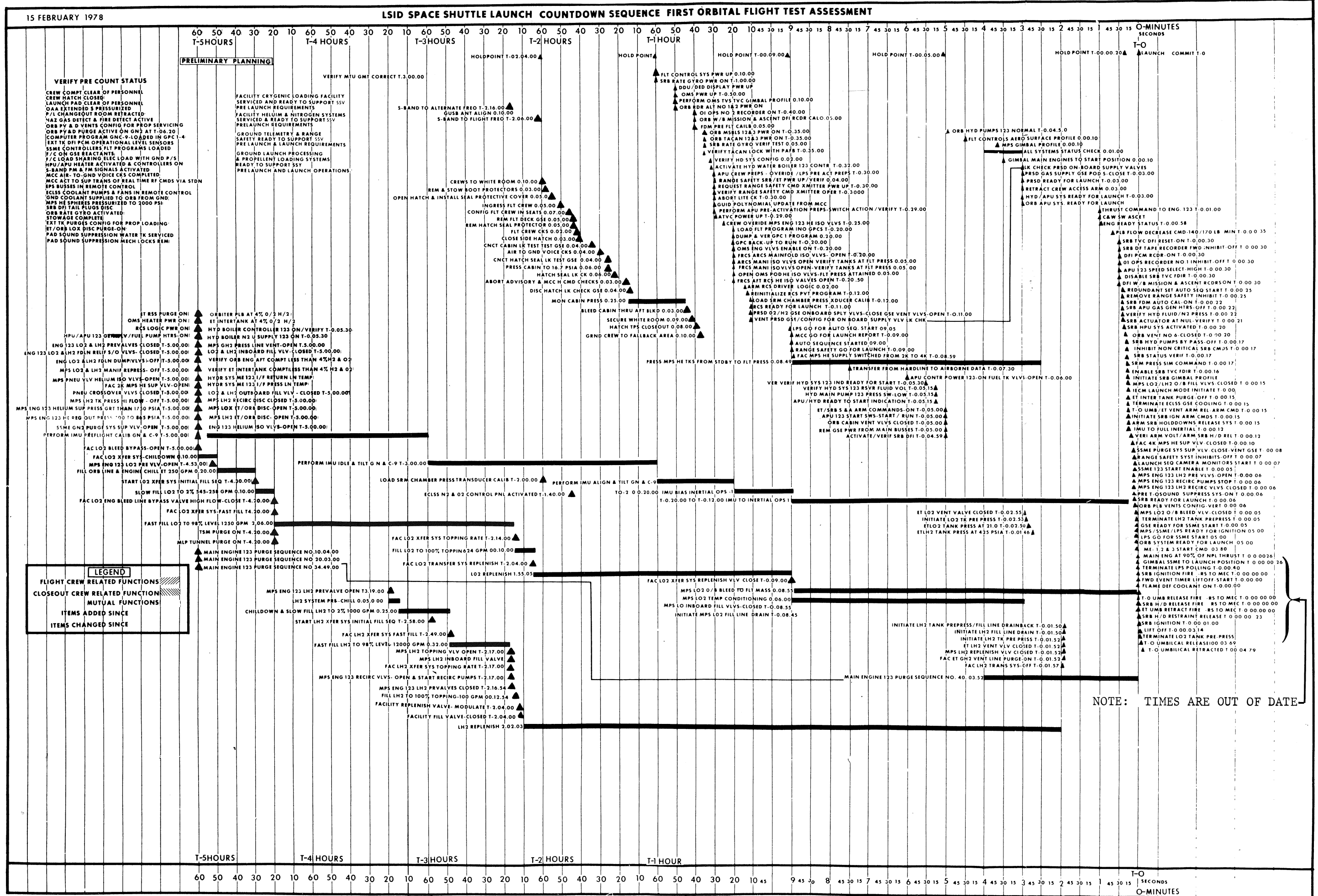

TABLE I. - COUNTDOWN SEQUENCE