

Rendezvous and Proximity Operations Handbook

Mission Operations Directorate
Flight Design & Dynamics Division

Basic
May 16, 1988

 * NOTE: This marked-up reprint of the BASIC edition is
 * being published to support mission operations for the
 * LDEF rendezvous and near-term contingency rendezvous
 * activities; only obvious typographical and reference
 * errors have been corrected. A full REV A update to
 * this handbook can be expected in mid-1990 following
 * additional flight experience and analysis activities.
 * *****



National Aeronautics and
Space Administration

Lyndon B. Johnson Space Center
Houston, Texas

Mission Operations Directorate
Rendezvous and Proximity Operations
Handbook

BASIC

May 16, 1988

Prepared by:

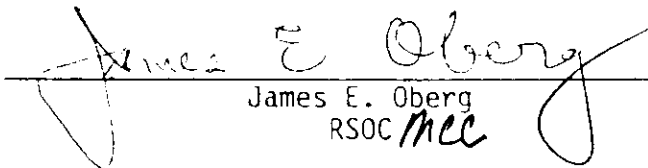
James E. Oberg
RSOC *mcc*

Approved by:

Don L. Pearson
Head, Orbit Dynamics Section

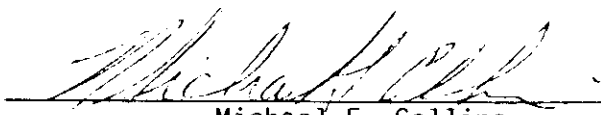
Michael F. Collins
Chief, Orbit Analysis Branch

National Aeronautics and Space Administration
Lyndon B. Johnson Space Center
Houston, Texas

ACKNOWLEDGEMENTS

The material in this book could never have been collected and verified without highly professional support from the following:

Steve Bernhardt (navigation)	Paul Kramer (engineering)
Harry Black (INCO)	Robert Lea (NAV)
Bill Britz (flight software)	Chris Meyer (PROX OPS)
Phil Burley (FDO)	Todd Miller (rendezvous)
Joseph Carroll (tethers)	Steve Nagel (crew)
Palmer Chiu (prox ops)	Claude Nicollier (crew)
Milt Contella (rendezvous)	Marty O'Hare (INCO)
Dave Dannemiller (rendezvous)	Oscar Olszewski (guido)
Alan Fox (rendezvous)	Don Pearson (rendezvous)
Rick Gavin (rendezvous)	Fisher Reynolds (IUS separation)
Marion Griffir (pointer)	Mark Rolwes (rendezvous)
Dave Harshman (rendezvous)	Dan Sedej (rendezvous)
Rick Hieb (crew)	Eric Sorensen (rendezvous)
Rick Hill (prox ops)	Mark Thomas (rendezvous)
Michael Hurt (separations)	Michael Veres (rendezvous)
Eduardo Jezierski (rendezvous)	Brian Ward (rendezvous)
Gary Johnson (breakouts)	Ed Whitsett (MMU)
Dan Johnston (rendezvous)	James Webb (GNC)
Brian Jones (flight dynamics)	Alan Wylie (navigation)
Chuck Knarr (flight director)	

Comments and critiques should be addressed to James Oberg, RSOC/JSC-DM43, x38014.

Dedication

This book is a monument to the work of Duane Mosel (1940-1986),
"Rendezvouser Supreme," leader/colleague/friend.

CONTENTS

Section		Page
1	<u>INTRODUCTION</u>	1-1
1.1	<u>PURPOSE</u>	1-1
1.2	<u>APPROACH</u>	1-2
1.3	<u>STS-UNIQUE FEATURES</u>	1-2
1.4	<u>REFERENCES</u>	1-3
1.5	<u>ABBREVIATIONS/ACRONYMS</u>	1-3
2	<u>BACKGROUND INFORMATION</u>	2-1
2.1	<u>DEFINITION</u>	2-1
2.2	<u>CREW ASSIGNMENTS</u>	2-3
2.3	<u>REFERENCE SYSTEMS</u>	2-4
2.3.1	<u>Relative Motion Plots</u>	2-4
2.3.2	<u>Vector definitions</u>	2-7
2.4	<u>ORBITAL MECHANICS EFFECTS</u>	2-7
2.4.1	<u>Relative Motion of Two Objects Orbiting In Proximity</u>	2-8
2.4.1.1	<u>Above/Below (R-BAR (Radial) Separation)</u>	2-9
2.4.1.2	<u>Lateral (out of plane)</u>	2-10
2.4.1.3	<u>Ahead/Behind (V-BAR separation)</u>	2-10
2.4.2	<u>Effects of Maneuvers from a Stable Relative Position</u>	2-11
2.4.2.1	<u>Ahead/Behind (V-BAR Burn)</u>	2-12
2.4.2.2	<u>Out of Plane</u>	2-13
2.4.2.3	<u>Radial (Up/Down)</u>	2-13
2.4.3	<u>Use of Orbital Mechanics</u>	2-14
2.4.3.1	<u>Orthogonal Braking</u>	2-15
2.4.3.2	<u>Motion along the R-BAR</u>	2-16
2.4.3.3	<u>Approach Along the V-BAR</u>	2-17
2.5	<u>RENDEZVOUS PARAMETERS</u>	2-18
2.5.1	<u>Range</u>	2-18
2.5.2	<u>Range Rate</u>	2-20
2.5.3	<u>Elevation</u>	2-20
2.5.3.1	<u>Radar Elevation</u>	2-20
2.5.3.2	<u>COAS Elevation</u>	2-20
2.5.3.3	<u>STRK Elevation</u>	2-20
2.5.4	<u>Azimuth</u>	2-20
2.5.4.1	<u>Radar Azimuth</u>	2-20
2.5.4.2	<u>COAS Azimuth</u>	2-21
2.5.5	<u>Elevation Rate</u>	2-21
2.5.6	<u>Azimuth Rate</u>	2-22
2.6	<u>TARGET VISIBILITY</u>	2-22
2.6.1	<u>Illumination</u>	2-22
2.6.2	<u>Position Relative to the Sun</u>	2-22
2.6.3	<u>Position Relative to Horizon</u>	2-24
2.7	<u>OTHER FORCES</u>	2-24
2.7.1	<u>Differential Drag</u>	2-24
2.7.2	<u>Differential Nodal Regression Effects</u>	2-27
2.8	<u>TYPES OF RENDEZVOUS MANEUVERS</u>	2-28

Section		Page
2.8.1	<u>Generic NC, or Phase Adjust (or "closing")</u>	2-28
2.8.2	<u>Generic NH, or Differential Height Adjust (DHA)</u>	2-29
2.8.3	<u>Generic NPC, or Plane Change</u>	2-29
2.8.4	<u>Generic NCC, or Corrective Combination</u>	2-29
2.8.5	<u>Generic NSR, or Coelliptic</u>	2-29
2.8.6	<u>Generic Ti, or Transition Initiation (Ti)</u>	2-29
2.8.7	<u>Generic MC, or Midcourse</u>	2-30
2.8.8	<u>Generic TF, or Terminal Phase Final</u>	2-30
2.9	<u>TYPICAL RENDEZVOUS</u>	2-30
2.9.1	<u>Maneuvers</u>	2-30
2.9.1.1	The Actual NC Maneuver(s)	2-32
2.9.1.2	The Actual NH Maneuver(s)	2-32
2.9.1.3	The Actual NSR Maneuver	2-32
2.9.1.4	The Actual NPC Maneuver	2-32
2.9.1.5	The Actual NCC Maneuver	2-32
2.9.1.6	The Actual Ti Maneuver	2-33
2.9.1.7	The Actual Midcourse Maneuver(s)	2-33
2.9.1.8	The Actual TF Maneuver	2-33
2.9.2	<u>Out of Plane Control Theory and Practice</u>	2-33
2.9.2.1	Initial Conditions	2-33
2.9.2.2	Early Burns	2-33
2.9.2.3	NCC	2-34
2.9.2.4	Ti	2-35
2.9.2.5	OOP null	2-35
2.9.2.6	Proximity Operations	2-36
2.9.3	<u>Typical Sensor Passes</u>	2-37
2.9.3.1	First On-Board Acquisition	2-37
2.9.3.2	Radar Acquisition	2-37
2.9.3.3	Final Sensor Acquisition	2-37
3	<u>TOOLS FOR RENDEZVOUS</u>	3-1
3.1	<u>ATTITUDE DETERMINATION/CONTROL</u>	3-1
3.1.1	<u>Universal Pointing (UNIV PTG, or UP) (OPS 201)</u>	3-1
3.1.1.1	Options	3-2
3.1.1.2	Attitude Monitor	3-5
3.1.1.3	Enhanced Universal Pointing	3-5
3.1.2	<u>Rotational Hand Controller and Translational Hand Controller</u>	3-7
3.1.3	<u>SENSE Switch Options</u>	3-8
3.1.4	<u>Attitude Direction Indicator (ADI)</u>	3-12
3.2	<u>DIGITAL AUTO PILOT (DAP)</u>	3-13
3.2.1	<u>DAP Management</u>	3-13
3.2.2	<u>DAP Configuration (Spec 20)</u>	3-15
3.2.3	<u>DAP Pushbuttons</u>	3-16
3.2.3.1	AUTO/MAN Selection	3-17
3.2.3.2	LVLH	3-17
3.2.3.3	NORM/VERN Jet Select	3-17
3.2.3.4	Translation Submodes (NORM Jets Required; MAN, MAN LVLH, and AUTO)	3-18
3.2.3.5	Manual Rotational Submodes	3-19

Section	Page	
3.2.3.6	Applications	3-19
3.2.4	<u>Low Z Operations</u>	3-21
3.2.4.1	Plume Impingement (PI) Issues	3-21
3.2.4.2	Low Z Operations	3-21
3.3	RENDEZVOUS/PROX OPS SENSORS	3-22
3.3.1	<u>Star Tracker</u>	3-22
3.3.1.1	Control Switches	3-22
3.3.1.2	Capabilities	3-22
3.3.1.3	Lines of sight	3-25
3.3.2	<u>S TRK/COAS CNTRL (SPEC 22)</u>	3-25
3.3.2.1	ST Target Acquisition	3-26
3.3.2.2	End ST NAV PASS	3-29
3.3.3	<u>Crew Optical Alignment Sight (COAS)</u>	3-30
3.3.3.1	System characteristics	3-30
3.3.3.2	Position Verification	3-30
3.3.3.3	RNDZ NAV Marks	3-31
3.3.4	<u>Rendezvous Radar (RR)</u>	3-31
3.3.4.1	Switches	3-33
3.3.4.2	Parameters	3-36
3.3.4.3	Other ANTENNA display (SM201) options	3-38
3.3.4.4	Self Test	3-38
3.3.4.5	Configure for RNDZ Radar TGT Acquisition	3-39
3.3.4.6	RR Cue Card	3-40
3.3.4.7	Radar Effects on Target	3-41
3.3.5	<u>Closed Circuit Television</u>	3-42
3.3.5.1	Locations	3-43
3.3.5.2	CONTROL/DISPLAY	3-43
3.3.5.3	Triangulation Technique	3-43
3.3.5.4	Keel/Pallet	3-43
3.3.5.5	RMS WRIST	3-47
3.3.5.6	Other PLB cameras	3-48
3.3.6	<u>CCTV/Overlay</u>	3-49
3.3.7	<u>Other Ranging Devices</u>	3-51
3.3.7.1	Laser Rangefinder	3-51
3.3.7.2	Stadimetric Binoculars	3-51
3.3.7.3	Global Positioning System	3-51
3.3.7.4	Other	3-51
3.3.8	<u>Orbiter Lights</u>	3-51
3.3.9	<u>Target-Mounted Sensors</u>	3-52
3.3.10	<u>Target-Mounted Tracking Aids</u>	3-52
3.4	NAVIGATION	3-54
3.4.1	<u>REL NAV (SPEC 033)</u>	3-54
3.4.1.1	Parameters	3-55
3.4.1.2	Processing	3-56
3.4.1.3	REL NAV Spec Manipulation	3-57
3.4.1.3.1	<u>RNDZ NAV enable (Item 1)</u>	3-57
3.4.1.3.2	<u>Ku-band antenna enable function (Item 2)</u>	3-57
3.4.1.3.3	<u>Sensor measurement enable (Item 3)</u>	3-58
3.4.1.3.4	<u>State vector select (Item 4)</u>	3-58
3.4.1.3.5	<u>State vector update</u>	3-59

Section	Page	
3.4.1.3.6	<u>Powered Flight NAV Controls and Displays</u> (Items 5, 6, 7)	3-59
3.4.1.3.7	<u>State vector transfer (Items 8, 9, 10, 11)</u>	3-60
3.4.1.3.8	<u>RNDZ NAV filter (Items 12-25)</u>	3-61
3.4.1.3.9	<u>RNDZ angle sensor data selection (Items 12, 13, 14)</u>	3-61
3.4.1.3.10	<u>NAV rates (SLOW RATE, Item 15)</u>	3-62
3.4.1.3.11	<u>COVAR REINIT (Item 16)</u>	3-62
3.4.1.3.12	<u>Residuals</u>	3-62
3.4.1.3.13	<u>Residual edit ratio</u>	3-64
3.4.1.3.14	<u>Mark history, accept/reject</u>	3-64
3.4.1.3.15	<u>AIF switch (EDIT OVRD - AUT/INH/FOR, Items 17-25)</u>	3-65
3.4.1.4	<u>Editing Contingencies</u>	3-66
3.4.1.4.1	<u>STRK Marks</u>	3-66
3.4.1.4.2	<u>RR Marks</u>	3-67
3.4.1.4.3	<u>RR/STRK Marks</u>	3-67
3.4.1.4.4	<u>COAS Marks</u>	3-67
3.4.1.5	<u>Definition of Stages of Relative Navigation</u>	3-67
3.4.1.5.1	<u>Search</u>	3-68
3.4.1.5.2	<u>Detection</u>	3-68
3.4.1.5.3	<u>Acquisition</u>	3-68
3.4.1.5.4	<u>Lock-On</u>	3-68
3.4.1.5.5	<u>Data into REL NAV</u>	3-68
3.4.1.5.6	<u>Data meets "accept" criteria</u>	3-68
3.4.1.5.7	<u>AIF to "AUTO" (or "FORCE")</u>	3-68
3.4.1.5.8	<u>Marks pass edit check</u>	3-68
3.4.1.5.9	<u>NAV converged (operationally)</u>	3-69
3.4.1.5.10	<u>NAV converged (mathematically)</u>	3-69
3.4.1.5.11	<u>End of tracking pass</u>	3-69
3.4.1.6	<u>Improved REL NAV</u>	3-69
3.4.2	<u>State Vector Management</u>	3-71
3.4.2.1	<u>State Vector Select</u>	3-71
3.4.2.2	<u>FLTR-TO-PROP Transfer</u>	3-71
3.5	<u>TARGETING (SPEC 034)</u>	3-72
3.5.1	<u>General Description</u>	3-73
3.5.1.1	<u>Target Sets</u>	3-73
3.5.1.2	<u>Targeting Computation Techniques</u>	3-75
3.5.2	<u>Inputs to ORB Targeting</u>	3-75
3.5.2.1	<u>Target Number (Item 1)</u>	3-75
3.5.2.2	<u>T1 TIG (Item 2-5)</u>	3-76
3.5.2.3	<u>Elevation Angles (EL-Item 6)</u>	3-77
3.5.2.4	<u>Relative Position Items</u>	3-77
3.5.2.5	<u>T2 TIG (Items 13-16)</u>	3-78
3.5.2.6	<u>Delta-T (Item 17)</u>	3-78
3.5.2.7	<u>T2 Relative Position (ΔX, ΔY, ΔZ, Items 18-20)</u>	3-78
3.5.2.8	<u>Base Time (Items 21-24)</u>	3-79
3.5.3	<u>Controls</u>	3-79
3.5.3.1	<u>T2 to T1 (Item 25)</u>	3-79
3.5.3.2	<u>LOAD (Item 26)</u>	3-79
3.5.3.3	<u>COMPUTE T1 (Item 27)</u>	3-80
3.5.3.4	<u>COMPUTE T2 (Item 28)</u>	3-80

Section	Page
3.5.4	<u>Predictor Match (PRED MATCH)</u> 3-81
3.5.5	<u>Alarms</u> 3-81
3.5.5.1	TGT ΔT 3-81
3.5.5.2	TGT-ITER 3-82
3.5.5.3	TGT EL ANG 3-82
3.5.6	<u>Maneuvers</u> 3-82
3.5.7	<u>Out-of-Plane Procedures</u> 3-83
3.5.8	<u>Operational Constraints</u> 3-83
3.6	<u>CONTROL</u> 3-86
3.6.1	<u>PADS</u> 3-86
3.6.1.1	Basic Information 3-87
3.6.1.2	Other Systems Data 3-88
3.6.1.3	Ti Delay PAD 3-88
3.6.1.4	MC PADS 3-88
3.6.2	<u>ORBIT MNVR EXEC (MM 202)</u> 3-90
3.6.2.1	OMS BOTH/L/R, RCS SEL (Items 1-4) 3-90
3.6.2.2	Thrust Vector Roll (Item 5) 3-91
3.6.2.3	Time of Ignition (Items 10-13) 3-91
3.6.2.4	PEG 7 (Items 19-21) 3-91
3.6.2.5	LOAD (Item 22) 3-91
3.6.2.6	TIMER (Item 23) 3-92
3.6.2.7	Guidance Downmoding 3-92
3.6.2.8	Burn Attitude (BURN ATT, Items 24-26) 3-92
3.6.2.9	Maneuver execute (Item 27) 3-92
3.6.2.10	Time To Next Apsis (TXX XX:XX) 3-93
3.6.2.11	Burn-related parameters 3-93
3.6.2.12	Operational Constraints 3-93
3.6.3	<u>AXIS-BY-AXIS BURNS</u> 3-96
3.7	<u>DPS</u> 3-97
3.7.1	<u>Configuration for Rendezvous</u> 3-97
3.7.2	<u>Off-Nominal DPS Configurations</u> 3-97
3.7.3	<u>OPS Transition Effects</u> 3-97
3.7.3.1	RNDZ NAV Termination 3-98
3.7.3.2	ORB TGting 3-103
3.7.3.3	Attitude Control 3-103
3.7.3.4	Star Tracker 3-103
3.7.3.5	Other Effects 3-103
3.8	<u>OMS/RCS ISSUES</u> 3-103
3.8.1	<u>RCS Cross-Coupling</u> 3-103
3.8.1.1	Translation effects 3-105
3.8.1.2	LOS Cross-Coupling Effects 3-110
3.8.1.3	VRCS Effects 3-110
3.8.1.4	Cross-Coupling Examples 3-112
3.8.2	<u>Plumes</u> 3-114
3.8.2.1	RCS Plumes 3-114
3.8.2.2	OMS Plume 3-114
3.8.2.3	PL Plume 3-114
3.8.3	<u>Failure Modes</u> 3-114
3.8.3.1	Jet Fail On 3-114
3.8.3.2	OMS Overburn 3-119

Section		Page
3.2.3.3	Loss of VRCS	3-119
3.2.3.4	Loss of Low Z Mode	3-119
3.8.4	<u>Quantities</u>	3-120
3.8.4.1	Rendezvous OMS/RCS PRPLT PAD	3-120
3.8.4.2	Typical Propellant Consumption	3-121
3.8.4.3	Propellant Saving Techniques	3-122
3.8.5	<u>Special Burns</u>	3-123
3.8.5.1	RCS Axis-by-Axis	3-123
3.8.5.2	RNDZ OMS BURN	3-123
3.9	<u>OTHER SYSTEMS</u>	3-126
3.9.1	<u>Auxilliary Power Unit (APU)</u>	3-126
3.9.2	<u>PDRS</u>	3-127
3.9.3	<u>EVA</u>	3-127
3.9.4	<u>IMU</u>	3-128
4	<u>RNDZ PROCEDURE SEQUENCES</u>	4-1
4.1	<u>STANDARD OPERATIONS FLOW</u>	4-1
4.1.1	<u>Configure DPS</u>	4-5
4.1.2	<u>Set SM Timer</u>	4-5
4.1.3	<u>Configure Aft Flight Station</u>	4-5
4.1.4	<u>Ku Band Self Test</u>	4-6
4.1.5	<u>NSR burn (as required)</u>	4-6
4.1.6	<u>Enable RNDZ Navigation S/W</u>	4-7
4.1.7	<u>Initialize ORB TGT</u>	4-7
4.1.8	<u>Established RNDZ DAP</u>	4-7
4.1.9	<u>Perform NC (Phasing) Burn</u>	4-8
4.1.10	<u>Initiate -Z Target Tracking</u>	4-10
4.1.11	<u>First STRK Acquisition</u>	4-10
4.1.12	<u>Configure NAV For STRK data</u>	4-10
4.1.13	<u>STRK NAV Data Acceptance</u>	4-11
4.1.14	<u>SV Selection</u>	4-11
4.1.15	<u>Off-Nominal SV</u>	4-12
4.1.16	<u>End ST Pass</u>	4-12
4.1.17	<u>Perform NH Burn (if required)</u>	4-12
4.1.18	<u>Configure for Radar Target Acquisition</u>	4-13
4.1.19	<u>Target NCC Burn (Preliminary)</u>	4-13
4.1.20	<u>Second Star Tracker Target Acquisition</u>	4-15
4.1.21	<u>STRK Configuration</u>	4-15
4.1.22	<u>REL NAV Management</u>	4-15
4.1.23	<u>State Vector Management</u>	4-16
4.1.24	<u>Target NCC Burn (Intermediate)</u>	4-16
4.1.25	<u>End STRK NAV</u>	4-16
4.1.26	<u>Target NCC Burn (Final)</u>	4-17
4.1.27	<u>Solution Selection</u>	4-17
4.1.28	<u>Execute NCC Burn</u>	4-19
4.1.29	<u>Maneuver to -Z Track Attitude From -Y ST</u> <u>(off nominal)</u>	4-19
4.1.30	<u>Perform Radar Lockon</u>	4-19
4.1.31	<u>Initiate RR NAV</u>	4-19
4.1.32	<u>Off-Nominal RR NAV</u>	4-21

Section	Page
4.1.33	<u>Target Ti Burn (Preliminary)</u> 4-21
4.1.34	<u>Target Ti Burn (Intermediate)</u> 4-23
4.1.35	<u>Perform RR Auto Track Acquisition (off nominal)</u> 4-23
4.1.36	<u>Target Ti Burn (Final)</u> 4-23
4.1.37	<u>Solution Selection</u> 4-24
4.1.38	<u>Execute Ti Burn</u> 4-24
4.1.39	<u>Ti As Multi-Axis RCS Burn</u> 4-24
4.1.40	<u>Load/Execute Delay Burn (off nominal)</u> 4-25
4.1.41	<u>RMS Operations</u> 4-26
4.1.42	<u>Target MC1 Burn (Preliminary)</u> 4-26
4.1.43	<u>Verify Target Track Post Ti</u> 4-27
4.1.44	<u>ST Target Acquisition Post Ti With Confirmed Radar</u> <u>System Failure</u> 4-27
4.1.45	<u>SV Management</u> 4-29
4.1.46	<u>Off-Nominal Radar OPS</u> 4-29
4.1.47	<u>If Delay Burn Was Performed (off-nominal)</u> 4-29
4.1.48	<u>Target MC1 Burn (Intermediate/Final)</u> 4-29
4.1.49	<u>Execute MC1 Burn</u> 4-30
4.1.50	<u>End ST Navigation For Post Ti Data Pass</u> <u>(off-nominal)</u> 4-30
4.1.51	<u>Target MC2 (Preliminary/Intermediate)</u> 4-30
4.1.52	<u>Execute RNDZ Breakout If No Sensor Data Or If No Filter</u> <u>Convergence (off nominal)</u> 4-32
4.1.53	<u>CCTV Configuration</u> 4-32
4.1.54	<u>Perform Manual Out-of-Plane Null</u> 4-32
4.1.55	<u>Target MC2 Burn (Final)</u> 4-33
4.1.56	<u>Perform MC2</u> 4-34
4.1.57	<u>If In -Y ST Track ATT, Return to -Z Axis Target Track</u> <u>(off-nominal)</u> 4-34
4.1.58	<u>Target and Perform MC3 Burn</u> 4-34
4.1.59	<u>Timeline Notes for No Radar Final Phase</u> <u>(off-nominal)</u> 4-34
4.1.60	<u>Target and Perform MC4 Burn</u> 4-35
4.1.61	<u>Establish Inertial Line of Sight Rates</u> 4-35
4.1.62	<u>Reconfigure RR</u> 4-36
4.1.63	<u>Configure UP For V-BAR</u> 4-37
4.1.64	<u>Follow Range Braking Gates</u> 4-37
4.1.65	<u>If Range = 200 Feet Before Reaching V-BAR</u> <u>(off-nominal)</u> 4-38
4.1.66	<u>Configure DAP For Proximity Operations</u> 4-38
4.1.67	<u>Establish V-BAR</u> 4-39
4.1.68	<u>Adjust Closing Rate as Required</u> 4-40
4.1.69	<u>Configure Ku-Band System for Communications</u> 4-40
4.1.70	<u>Inside 60 Feet, Deselect Low Z DAP Mode</u> 4-40
4.1.71	<u>Null Rates to Perform Target Capture</u> 4-41
4.1.72	<u>Perform Flyaround of Target (off-nominal)</u> 4-41
4.1.73	<u>Capture Target With RMS</u> 4-41
4.1.74	<u>Disable Rendezvous Navigation</u> 4-41
4.2	<u>RENDEZVOUS VARIATIONS</u> 4-42
4.2.1	<u>Delayed Rendezvous</u> 4-42

Section		Page
4.2.1.1	Several Hours Delays	4-42
4.2.1.2	24-Hour Delays	4-42
4.2.2	Preplanned Optional Return	4-43
4.2.3	<u>Contingency (Unplanned) Rendezvous</u>	4-43
4.2.4	<u>Ground-Up Rendezvous</u>	4-44
4.2.5	Multiple Rendezvous	4-44
4.2.6	Rendezvous From Above	4-44
4.2.7	Maneuverable Target	4-45
4.2.8	<u>Elliptical TGT Orbit</u>	4-45
4.3	<u>RENDEZVOUS CUE CARDS</u>	4-45
4.3.1	<u>Execute RCS Burn Cue Card</u>	4-45
4.3.2	<u>RR Auto Track ACQ Cue Card</u>	4-45
4.3.3	<u>COAS Navigation Cue Card</u>	4-45
4.3.4	<u>Rendezvous OMS/RCS PRPLT PAD</u>	4-47
4.3.5	<u>RNDZ OMS BURN</u>	4-47
4.3.6	<u>PROX OPS Cue Card</u>	4-47
4.3.6.1	RR/COAS Angle	4-47
4.3.6.2	FWD CCTV POSITION	4-47
4.3.6.3	Flyaround Velocity	4-49
4.3.6.4	V-BAR Approach Rate	4-49
4.3.7	<u>Breakout</u>	4-49
4.4	<u>FAILURE PROCEDURES</u>	4-50
4.4.1	<u>Loss of Star Tracker(s)</u>	4-50
4.4.2	<u>Radar Hard/Data Fail</u>	4-50
4.4.3	<u>Loss of Verniers</u>	4-58
4.4.4	<u>Loss of Low Z Mode</u>	4-58
4.4.5	<u>Loss of Aft THC, RHC</u>	4-58
4.4.6	<u>Loss of EE CCTV</u>	4-58
4.5	<u>BACKOUT</u>	4-59
4.6	<u>BREAKOUT</u>	4-59
4.6.1	<u>Pre-Ti Breakout</u>	4-60
4.6.2	<u>Ti to V-BAR Breakout</u>	4-61
4.6.2.1	For Insufficient Propellant	4-61
4.6.2.2	If No TGT Sensor Data	4-61
4.6.2.3	If Only Pre-Ti TGT Sensor Data	4-61
4.6.2.4	If Post-Ti TGT Sensor Data	4-61
4.6.2.5	To Continue the RNDZ Post MC4	4-63
4.6.3	<u>Post-V-BAR Arrival</u>	4-63
4.7	<u>RELATIVE MOTION PLOTS</u>	4-63
4.8	<u>FLIGHT DATA FILE DOCUMENTATION</u>	4-63
5	<u>PROXIMITY OPERATIONS TECHNIQUES RATIONALE</u>	5-1
5.1	<u>STATIONKEEPING</u>	5-1
5.1.1	<u>Stationkeeping Control</u>	5-1
5.1.1.1	Attitude Control	5-2
5.1.1.2	Translation Control	5-2
5.1.2	<u>Classification of Techniques</u>	5-3
5.1.2.1	Close In	5-5
5.1.2.2	Short Range	5-6
5.1.2.2.1	<u>Inertially stabilized target</u>	5-6

Section	Page	
5.1.2.2.2	<u>Target attitude fixed relative to LVLH frame</u>	5-7
5.1.2.2.3	<u>TGT rotating at arbitrary rate</u>	5-8
5.1.2.3	<u>Medium Range</u>	5-9
5.1.2.4	<u>Long Range</u>	5-9
5.1.2.5	<u>Very Long Range</u>	5-11
5.1.3	<u>Operational Groundrules and Constraints</u>	5-11
5.2	<u>FLYAROUND/TRANSITION</u>	5-11
5.2.1	<u>LVLH ORB-Rate In-Plane Flyaround</u>	5-13
5.2.1.1	<u>Clockwise Orbit Rate Flyaround</u>	5-13
5.2.1.2	<u>Counterclockwise Orbit Rate Flyaround</u>	5-14
5.2.2	<u>LVLH Out of Plane</u>	5-15
5.2.3	<u>Arbitrary Rate Flyarounds</u>	5-15
5.2.3.1	<u>Single Axis</u>	5-15
5.2.3.2	<u>Multiple-Axis Auto Rotation Maneuver</u>	5-15
5.2.3.3	<u>LVLH (Inertial) Orbiter/TGT Alignment Procedure</u>	5-16
5.2.3.4	<u>Manual Rotation Maneuver</u>	5-17
5.2.4	<u>Auto Targeted Trajectory</u>	5-17
5.2.5	<u>LOS Rate Techniques</u>	5-17
5.3	<u>FINAL APPROACH</u>	5-21
5.3.1	<u>Braking Techniques</u>	5-21
5.3.1.1	<u>Normal Z-axis Mode Braking</u>	5-21
5.3.1.2	<u>Low Z Mode Braking</u>	5-22
5.3.1.3	<u>X-Axis Mode Braking</u>	5-23
5.3.1.4	<u>Orbital Mechanics Effects Braking</u>	5-24
5.3.2	<u>Final Approach Techniques</u>	5-25
5.3.2.1	<u>Direct Approach</u>	5-25
5.3.2.2	<u>V-BAR Approach</u>	5-28
5.3.2.3	<u>R-BAR Approach</u>	5-29
5.3.2.4	<u>Inertial Approach</u>	5-34
5.4	<u>SEPARATION</u>	5-35
5.4.1	<u>Nominal</u>	5-36
5.4.1.1	<u>Spring Ejection (PAM)</u>	5-36
5.4.1.2	<u>Spring Ejection (IUS)</u>	5-42
5.4.1.3	<u>RMS Deploy - Generic</u>	5-44
5.4.1.4	<u>RMS Deploy (SPARTAN - class)</u>	5-46
5.4.1.5	<u>RMS Deploy (HST - class)</u>	5-48
5.4.2	<u>Generic Sep Procedure</u>	5-49
5.4.2.1	<u>Set Up Aft Station</u>	5-49
5.4.2.2	<u>Obtain Visual Contact Through OVHD Window</u>	5-50
5.4.2.3	<u>Null Closing Rate</u>	5-50
5.4.2.4	<u>Perform RR ACQ (If Desired)</u>	5-51
5.4.2.5	<u>Obtain -1 FPS Opening Rate</u>	5-51
5.4.2.6	<u>Perform Out-of-Plane MNVR</u>	5-52
5.4.2.7	<u>Perform Final SEP</u>	5-53
5.4.2.8	<u>Maneuver To Minimum Drag Attitude (-ZLV)</u>	5-54
5.4.3	<u>Contingency</u>	5-54
5.4.3.1	<u>Rendezvous Breakout Procedure</u>	5-55
5.4.3.2	<u>Prox OPS Breakout Procedure</u>	5-56
5.4.3.3	<u>Jettison</u>	5-57
5.4.3.4	<u>Inadvertent Release</u>	5-62

TABLES

Table		Page
4-1	PROPELLANT PENALTY	4-25
4-2	RR/ST STATUS/ACTION	4-51
4-3	BREAKOUT MANEUVER SELECTION	4-60
5-1	SUMMARY OF STATIONKEEPING CLASSIFICATIONS	5-4
5-2	SUMMARY OF STATIONKEEPING CONTROL	5-5

FIGURES

Figure		Page
1-1	Handbook entry points and interrelationship	1-1
2-1	Relative motion plot, circular orbits	2-5
2-2	Relative motion plot, elliptical chaser orbit	2-5
2-3	Tangential orbits	2-6
2-4	Intersecting orbits	2-7
2-5	Target-centered frame (rotating at ORB rate)	2-8
2-6	Radial separation relative motion	2-9
2-7	Out-of-plane parallel motion	2-10
2-8	Two satellites on V-BAR	2-11
2-9	V-BAR burn effects	2-12
2-10	Impulse out of plane	2-13
2-11	R thrusting effects	2-14
2-12	Orthogonal braking	2-15
2-13	Orbital mechanics effects in separating	2-16
2-14	Orbital mechanics effects in braking	2-17
2-15	V-BAR approach technique	2-19
2-16	Orbiter vehicle coordinate system and Ku-band antenna slewing directions	2-21
2-17	Angle to the Sun during terminal phase	2-23
2-18	Horizon depression angle as a function of orbital attitude	2-24
2-19A	Illustrative differential drag effects, Orbiter and small free-flier,* as a function of orbital attitude	2-25
2-19B	Drag effects on function of Orbiter and payload attitude variations	2-26
2-20	Plane shift due to equatorial bulge	2-28
2-21	Typical target centered relative motion (ground up rendezvous)	2-31
2-22	Out-of-plane motion	2-34
2-23	Spectrum of rendezvous sensors	2-36
3-1	The UNIV PTG (OPS 201) display	3-1
3-2	RHC soft/hard stop logic	3-7
3-3	Aft station control, sense switch	3-9
3-4A	Aft and overhead line-of-sight references, aft RCH use	3-10
3-4B	Aft and overhead line-of-sight references, aft THC use	3-11
3-5	Aft station ADI displays and controls	3-12
3-6	DAP configurations for rendezvous/prox ops	3-14
3-7	The DAP CONFIG (SPEC 20) display	3-15
3-8	Panel A6	3-18
3-9	RCS plume overpressure for LOW Z and NORMAL Z mode (lb/ft ²)	3-20
3-10	Panel O6	3-23
3-11	STRK/COAS geometry	3-24
3-12	The S TRK/COAS CNTL display	3-26

Figure		Page
3-13	S TRK TARGET ACQ procedure	3-27
3-14	STRK search pattern	3-29
3-15	END S TRK NAV procedure	3-29
3-16	The COAS reticle pattern (-Z view from AFT crew station)	3-31
3-17	Orbiter body coordinate system and RR coordinate system	3-32
3-18	Panel A1U	3-34
3-19	RR steering modes	3-36
3-20	Panel A2	3-37
3-21A	Configure for RR TARGET ACQ	3-39
3-21B	RR AUTO TRACK ACQ	3-41
3-22	Induced volts/meter on target	3-42
3-23	Panel A7U. Camera command & video input/output	3-44
3-24	Panel A3	3-44
3-25	Use of bulkhead cameras tilt angles to determine range	3-45
3-26	Triangulation chart	3-46
3-27	Keel camera	3-47
3-28A	Use of RMS wrist camera to determine range rate	3-48
3-28B	EE CCTV object motion overlay	3-49
3-29	Typical ranging overlay	3-50
3-30	Effect of corner reflectors on radar cross section	3-53
3-31	The REL NAV (SPEC 033) display	3-55
3-32	ORB TGT display	3-74
3-33	Projected TGT sets	3-76
3-34	Typical BURM PAD	3-87
3-35	Ti delay pad	3-88
3-36	Typical MC PAD	3-89
3-37	The ORBIT MMVR EXEC (MM202) display	3-89
3-38	RNDZ NAV safing	3-99
3-39	RHDZ NAV recovery	3-101
3-40	DAP vs translational cross-coupling (unit loss ratio value) * = same as NORM	3-105
3-41	RCS jets	3-106
3-42	RCS axis cross-coupling values	3-107
3-43	PRCS cross-coupling ratios	3-108
3-44	PRCS off-nominal cross-coupling ratios	3-109
3-45	TGT LOS cross coupling aft THC, -Z sense 200 foot range	3-109
3-46	VRCS cross-coupling	3-111
3-47	VRCS cross coupling ratios	3-113
3-48	Normal Z RCS plume pressure fields	3-115
3-49	Low Z RCS plume pressure fields	3-116
3-50	ONS plume for single engine burn	3-117
3-51	Safe distance for firing liquid propulsion engines	3-118
3-52	Rendezvous ONS/RCS PRPLT PAD	3-120
3-53	RCS BURM cue card	3-123
3-54	Periom. RNDZ ONS Burn	3-124
3-55	ONS 2/Orbit ONS burns cue card	3-125

Figure		Page
4-1	Spartan rendezvous profile	4-2
4-2	Spartan rendezvous profile	4-3
4-3	Spartan rendezvous profile	4-4
4-4	Configure aft flight station for RNDZ	4-6
4-5	Perform NC burn	4-9
4-6	Perform NH burn	4-13
4-7	Target NCC burn	4-14
4-8	RR navigation	4-20
4-9	Target Ti burn	4-22
4-10	Execute Ti burn	4-24
4-11	Load delay burn	4-26
4-12	TARGET MC 2 (Preliminary solution)	4-30
4-13	LONG/SHORT terminology	4-31
4-14	Manual out-of-plane null	4-33
4-15	Target MC2 (final solution)	4-33
4-16	Establish inertial LOS rates	4-35
4-17	Configure for V-BAR	4-36
4-18	Braking gates	4-37
4-19	"HOT" approach ("short" case)	4-38
4-20	Transition to V-BAR	4-39
4-21	Establish V-BAR	4-39
4-22	Adjust closing rate	4-40
4-23	Disable rendezvous NAV	4-41
4-25	COAS navigation cue card	4-46
4-26	PROX OPS cue card	4-48
4-27	RROX OPS sensor trigonometry	4-49
4-28	RR Fail	4-52
4-29	Region determinator	4-54
4-30	Dispersed sunrise points	4-55
4-31	Uncompensated coupling effects	4-56
4-32	Calculation of $-X \Delta V$ required to stop on V-BAR	4-57
4-33	Relative motion plots	4-63
5-1	Inertially stabilized target	5-7
5-2	Target fixed in LVLH reference frame	5-8
5-3	Auto ellipse	5-10
5-4	Transition geometry	5-12
5-5	Flyaround of an LVLH attitude hold TGT	5-13
5-6	Counterclockwise flyaround	5-14
5-7	Trim Orbiter/TGT alignment	5-16
5-8	Transition to the V-BAR	5-18
5-9	Orbiter stabilized on the V-BAR	5-19
5-10	Angle rates versus V-BAR stability	5-20
5-11	Angle rates versus V-BAR approach	5-21
5-12	Normal Z axis braking	5-22
5-13	Low Z axis braking	5-23
5-14	+X axis braking	5-23
5-15	Orbital mechanics forces during an R-BAR approach	5-24
5-16	Typical final approach techniques	5-26

Figure		Page
5-17	Direct approach to close-in stationkeeping	5-27
5-18	V-BAR approach	5-28
5-19	Generic R-BAR approach technique	5-29
5-20	Typical R-BAR approach profile	5-30
5-21	LDEF R-BAR approach	5-32
5-22	ESTABLISH R-BAR procedure	5-33
5-23	Post-grapple maneuvers	5-34
5-24	PAM/Orbiter ejection attitude	5-37
5-25	Orbiter/PAM-D separation trajectory (due to ejection ΔV only)	5-38
5-26	OMS plume on PAM-D at SFP burn initiate	5-39
5-27	Orbiter attitude at PAM ejection	5-40
5-28	View of PAM-D SEP from aft station through overhead window (PL shown every 30 sec)	5-41
5-29	Orbiter window protection attitude at SRM ignition	5-42
5-30	Typical RMS deploy geometry (Orbiter below PL)	5-44
5-31	Orbiter separation following RMS deploy (PL-centered LVLH frame of reference)	5-45
5-32	Set up aft station checklist	5-49
5-33	Visual contact through OVHD window checklist	5-50
5-34	Null closing rate checklist	5-50
5-35	Perform RR ACQ checklist	5-51
5-36	Obtain ~ 1 FPS opening rate checklist	5-51
5-37	Perform out of plane MNVR checklist	5-52
5-38	Perform final SEP checklist	5-53
5-39	Maneuver to minimum drag attitude checklist	5-54
5-40	Rendezvous breakout procedure checklist	5-55
5-41	PROX OPS breakout procedure checklist	5-56
5-42	AUTO MNVR to -XLV checklist	5-58
5-43	Configure CCTV's checklist	5-59
5-44	"Damp Rate" checklist	5-59
5-45	Separation checklist	5-60
5-46	Second SEP burn	5-60
5-47	New attitude	5-61
5-48	Orbiter separation trajectory following RMS and/or PL jettison	5-61
5-49	Generic ("1-2-3") separation	5-62
6-1	FCR console layout	6-1
6-2	Rendezvous real-time support	6-2
6-3	RNDZ team	6-3
6-4	RNDZ display in MCC	6-4
7-1	Origin of "Gravity-Gradient" forces	7-5
7-2	Line-tension techniques	7-10
7-3	Tethered OPS control display	7-15
7-4A/B	CCTV arrangement/TSS-D boom/pallet	7-17
7-5	Deployment technique	7-18
7-6	Hanging release	7-19

SECTION 1 INTRODUCTION

1.1 PURPOSE

The purpose of the document is to conceptualize the rendezvous (RNDZ) mission phase and to define the techniques and procedures required to perform the Orbiter/target vehicle RNDZ and proximity operations (PROX OPS). The use of this document is to serve as a source of procedures and flight techniques information for flight data file (FDF) development, and to provide rationale and background for all RNDZ operators (flight crew, Mission Control Center (MCC), mission design, payload reps, etc.).

This book represents an attempt to distill and organize the accumulated wisdom of the RNDZ procedures group, the rendezvous analysis groups in navigation (NAV), systems, guidance, flight dynamics, pointing, and other specialists, along with the experience accumulated by flight crews in the 1983-1985 period.

The various possible user entry points are shown in figure 1-1, along with the logic flow and interrelationships of the different sections.

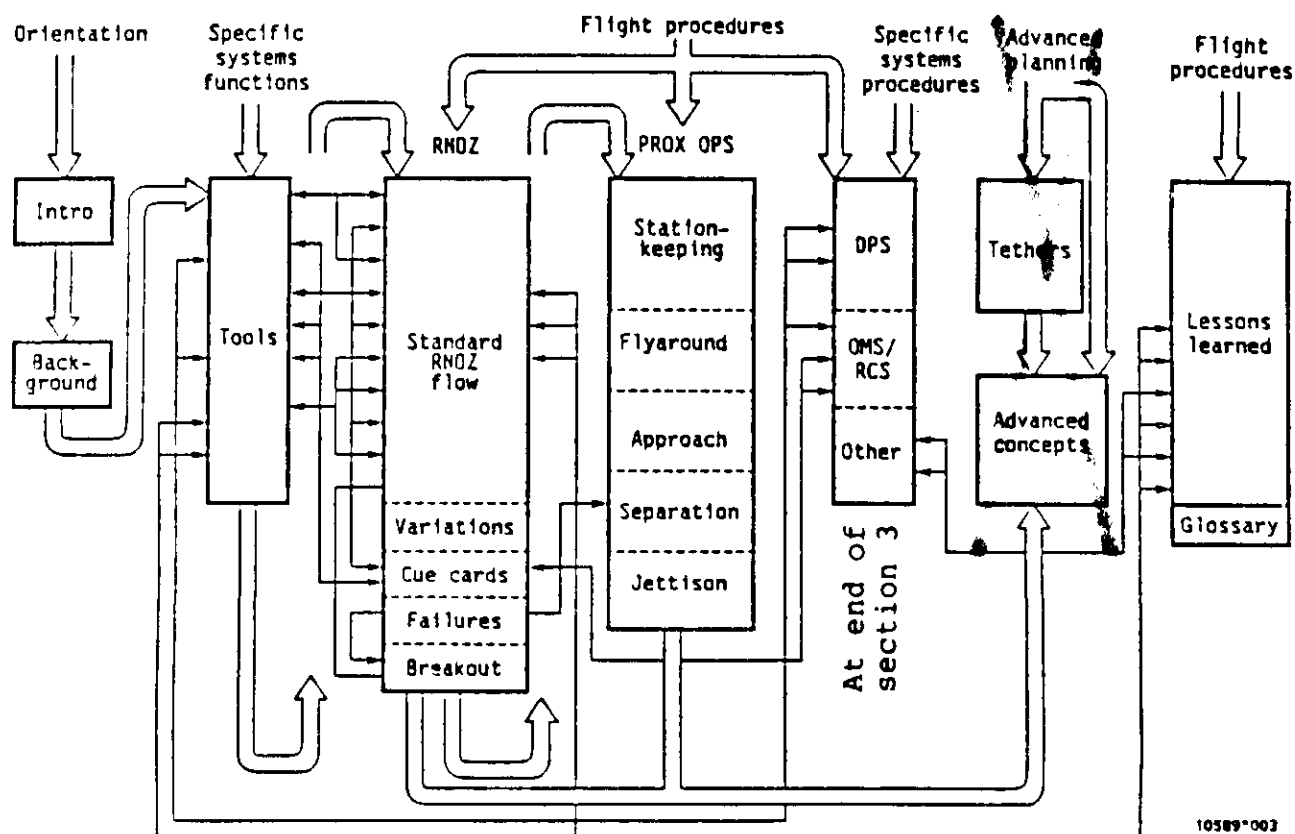

Figure 1-1.- Handbook entry points and interrelationships.

1.2 APPROACH

This handbook consists of sections on background principles, on tools and techniques, on actual procedures and rationale, and on considerations relevant to future RNDZ missions. Depending on the needs and background of the user, it can be entered at several points. It can serve as a summary/review, as a reference, as a menu of existing procedures, as a guide for defining novel procedures; above all, it is meant to be useful to the spaceflight operations community as a whole.

1.3 STS-UNIQUE FEATURES

Significant changes in vehicle systems and RNDZ mission design have occurred since the RNDZ missions during Gemini, Apollo, and Skylab (1965-1975). These changes required a deliberate and careful reappraisal of all phases of orbital RNDZ as the Space Transportation System (STS) accomplishes it. Some of these changes are:

- A. Targets (TGT's) no longer have transponders, which used to allow ranging at 300 n. mi. The passive "skin track" radar mode only acquires at a range of 10 to 15 n. mi. No target-mounted transponders are currently manifested.
- B. The variety of potential RNDZ TGT's and mission scenarios has greatly expanded. For example, the STS is the first NASA program capable of rendezvous with debris.
- C. Optical sighting techniques have changed. Rather than direct crew sighting through a wide-angle optical system, an automatic star tracker (ST) is provided - but this requires accurate Orbiter pointing to work. Manual pointing is possible through the crewman optical alignment sight (COAS).
- D. The arrangement of the Orbiter reaction control system (RCS) thrusters was dictated by aerodynamic concerns (Apollo command service module (CSM) RCS quads were aligned purely on a geometric basis) which results in significant axis cross-coupling and unwanted translation effects from attitude maneuvers (MNVR's) (the verniers are worse offenders than the primaries). This impacts accuracy of state vector (SV) propagation and of crew control during PROX OPS.
- E. The ground tracking coverage has changed. There is going to be voice and telemetry (TM) contact throughout most of the orbit via the Tracking and Data Relay Satellite System (TDRSS). Tracking coverage for ground navigation is a mixture of three different systems: the S-band Doppler sites of the Ground Spacecraft Tracking and Data Network (GSTDN), the C-band skin-track sites of the Department of Defense (DoD), and Tracking and Data Relay Satellite (TDRS). For secure missions, the GSTDN is replaced by the DoD's Remote Tracking Station (RTS) S-band sites.

F. Although redundancy exists in Orbiter systems such as data processing system (DPS), inertial measurement units (IMU's), etc., many RNDZ NAV sensors are single string.

1.4 REFERENCES

Attitude and Pointing Flight Procedures Handbook (~~January 1982~~) **REVB (FEB 1988)**
 Vol XIV Payload Accommodations Document (JSC 07700)
 RNDZ 2102 Rendezvous/Proximity Operations Workbook
 Rendezvous Navigation Sensor Characteristics Review, MPAD, February 1985,
 JSC-20355.

1.5 ABBREVIATIONS/ACRONYMS

A/G	air to ground
ACQ	acquisition
ACS	attitude control system
ADI	attitude direction indicator
AIF	auto/inhibit/force switch (SPEC 33)
AOS	acquisition of signal
APU	auxiliary power unit
ARCS	aft RCS
ATT DB	attitude deadband
AUTO	automatic
AVG G	average G (acceleration)
AZ	azimuth to target
AZ-DOT (AZ)	azimuth rate
BODY VECT	body vector
BOS	bright object sensor (star tracker)
bp	barber pole (on a talkback)
CB	constant bandwidth
CCTV	closed circuit television
CCW	counterclockwise
CDR	commander (crewmember)
c.g.	center of gravity
c.m.	center of mass
CMD	command
CNCL	cancel
COAS	crewman optical alignment sight
COMM	communication
CR	change request
CRT	cathode ray tube
CSM	command service module
CW	clockwise
C-W	Clohessy-Wiltshire
CUR	current telemetry vector

D	dimension, as in "two-D meter"
DAP	digital autopilot
DB	deadband
deg/s	degrees per second
DH	differential height
D/N	day/night
DELTA-V	delta velocity
DoD	Department of Defense
dps	degrees per second
DPS	data processing system
DR	discrepancy report
ΔH	delta height between target orbit and chaser
ΔV	delta velocity
ΔT	delta time
DTO	detailed test objective
EE	end effector (of RMS)
EL	elevation of target
EL-DOT (ÉL)	elevation rate
ET	elapsed time (also PET)
EVA	extravehicular activity
EXEC	execute
FD	flight day
PDF	flight data file
FDIR	fault detection, identification, and reconfiguration
FDO	flight dynamics officer
FLTR	filtered (SV)
FOD	Flight Operations Directorate (now MOD)
FOV	field of view
fps	feet per second
FRCS	forward RCS
FSL	Flight Simulation Laboratory
FSW	flight software
ft	feet
ft/s	foot per second
fwd	forward
g	acceleration due to gravity
G&C	guidance and control
GCIL	ground control interface logic
GG	gravity gradient stabilization
GNC	guidance, navigation, and control
GPC	general purpose computer
GPS	general processing subsystem global positioning system
H	orbital height (above surface)
H-BAR	angular momentum vector
HST	Hubble Space Telescope

IAH	inertial attitude hold
I'CONNECT	OMS-to-RCS interconnect
I-load	initial load (software)
IMU	inertial measurement unit
INRTL	inertial
IRT	integrated rendezvous target
ISF	Industrial Space Facility
kft	kilofeet (1000 feet)
KITE	kinetic isolation tether experiment
K-load	constant FSW I-load
LDEF	Long Duration Exposure Facility
LED	light emitting diode
LEO	low Earth orbit
LOS	line of sight
LOSA	line-of-sight angle
LRU	line replaceable unit; i.e., any "black box"
LVLH	local vertical/local horizontal
MC	midcourse correction maneuver
MCC	Mission Control Center (Houston)
MECO	main engine cutoff
MET	mission elapsed time
MM	major mode, software
MMU	Manned Maneuvering Unit
MMU	mass memory unit
MNVR	maneuver
MOD	Mission Operations Directorate (formerly FOD)
MPAD	Mission Planning and Analysis Division
mr	milliradian
MS	mission specialist (crewmember)
mV	stellar magnitude
n. mi.	nautical miles
NAV	navigation
NC	phasing maneuver ("C" for "catch-up")
NCC	corrective combination maneuver
NH	height maneuver
NLOS	normal to line-of-sight
NPC	plane change maneuver
NSR	rendezvous coelliptic maneuver
NSTS	National Space Transportation System (office)
OH	overhead
OI	operational increment (flight software release)
OMS	orbital maneuvering system
OMV	orbital maneuver vehicle
OOP	out of plane
OPS	operational sequence, software

OPS-0	idle mode
ORB	orbital
OTV	orbital transfer vehicle
PAD	preliminary advisory data
PAM	Payload Assist Module
pb	pushbutton
PDP	Plasma Diagnostic Package
PDRS	payload deployment and retrieval system
PET	phase elapsed time
PI	plume impingement
PIR	problem incident report (now called DR)
PL	payload
PLB	payload bay
PLBD	payload bay doors
PLT	pilot (crewmember)
PMG	plasma motor generator
PNL	panel
POCC	Payload Operations Control Center
POP	perpendicular to orbital plane
PRCS	primary RCS
PREL	preliminary
PROX OPS	proximity operations phase
PS	payload specialist
PTC	passive thermal control
R	range to target
R-BAR (\bar{R})	radius vector axis
R-DOT (\dot{R})	range rate to target, (+) opening, (-) closing
RCS	radar cross section
RCS	reaction control system
RED	radar enhancement device
REL	relative
REL	release (flight software)
REV	revolution about Earth, usually about 90 minutes in LEO
rf	radio frequency
RFPHB	Rendezvous Flight Procedures Handbook
RHC	rotational hand controller
RM	redundancy management
RMS	Remote Manipulator System
RNDZ	rendezvous
ROT	rotation
rpm	revolutions per minute
RPY	roll-pitch-yaw
RR	rendezvous radar
RSS	"root of sum of squares"
sec	seconds
SEDS	small expendable deployment system
SEP	separation
SES	Shuttle Engineering Simulator
SK	stationkeeping

SM	systems management
SMM	Solar Maximum Mission Satellite
SMRM	Solar Max rescue mission (STS 41-C)
SMS	Shuttle mission simulator
SOR	stable orbit rendezvous
SPARTAN	Shuttle Pointed Autonomous Research Tool for Astronomy (a retrievable free-flier)
SPAS	Shuttle pallet satellite
SPEC	specialist display, flight software
SQRT	square root
SR	sunrise
SRM	solid rocket motor
SS	sunset
	Space Station
STDN	Spaceflight Tracking and Data Network
STRK	Star trackers (preferred)
STS	Space Transportation System
SUM	summary
SV	state vector
SYS	system
t	time
tb	talkback
TBD	to be determined
TBS	to be supplied
TDRS	Tracking and Data Relay Satellite
TM	telemetry
TF	terminal phase final
TGT	target
THC	translation hand controller
THETA (Θ)	elevation angle of target from Orbiter (local horizontal)
TI	transition initiate maneuver (former acronym for Ti)
Ti	transition initiate maneuver
TIG	time of ignition
TPS	Thermal Protection System
TRK	tracking
TS	target suppress (feature of star tracker)
TSS	tethered satellite system
TSS-D	TSS deployer mechanism
TSS-S	TSS satellite
TVC	thrust vector control
TVR	thrust vector roll
TWT	traveling wave tube (in K-band RR)
UNIV PTG	universal pointing
UP	universal pointing
UPP	user parameter processing (in GPC's)
V	velocity
V-BAR (\bar{V})	velocity vector axis
VEL	velocity
VERN	vernier

VGO	velocity to go
VRCS	vernier RCS
VV	velocity vector
X	cross, as in "X-hair"
XLV	X local vertical
Y	Orbiter/target out-of-plane distance (kft)
Y-DOT	Orbiter/target out-of-plane rate (fps)
YLV	Y local vertical
ZLV	Z local vertical

SECTION 2 BACKGROUND INFORMATION

2.1 DEFINITION

A RNDZ, simply stated, is accomplished when two spacecraft, each in its own orbit, are brought together by a series of systematic and separate MNVR's designed to achieve a gentle meeting at a particular point in an orbit.

One of the two spacecraft is termed the target vehicle and is usually above and ahead of the second spacecraft, which is normally called the chaser. Traditionally the TGT vehicle has been launched first into an unchanging orbit; then, RNDZ MNVR's are performed by the chaser vehicle. The launch windows for the chaser vehicle are normally established so the orbital insertion of the chaser is in the plane of the TGT vehicle, with allowance for differential nodal regression due to initial altitude differences. Once the orbits are coplanar, that is, having a wedge angle between them of 0° , the RNDZ problem becomes two dimensional (altitude and downrange).

After orbit insertion, an orbit adjustment is made to affect the in-plane phase angle between the two vehicles. The RNDZ profile is designed to accommodate a wide range of phase angles at the in-plane launch point. From orbital mechanics it is known that the angular rate of the chaser vehicle, which is launched into a lower orbit, is greater than that of the higher orbiting TGT vehicle. Thus, the chaser will begin to catch up and the phase angle will decrease. The exact catch-up rate depends on the size of the relative orbits.

The chaser vehicle executes orbit shaping MNVR's, based on NAV data from ground sensors and from a succession of on-board sensors. The final MNVR segment of this sequence causes the trajectory of the chaser vehicle to intercept the trajectory of the TGT vehicle. Several small MNVR's are usually planned after this intercept MNVR to assure the chaser remains on an intercept trajectory.

Once close to the TGT vehicle a series of braking MNVR's are performed to prevent the chaser vehicle from flying by, or into, the TGT. Depending on the type of TGT, these MNVR's may be done in close or out at some greater range. Following the braking MNVR's, a stable condition relative to the TGT vehicle (known as stationkeeping) is achieved. At this point, the RNDZ phase is concluded and any further adjustments to the relative positions of the two vehicles fall under the title PROX OPS phase.

PROX OPS can be defined intuitively as the operation of one orbiting spacecraft in the vicinity of another. In more practical terms, it can be defined as a mission phase during which various dynamic trajectory management tasks are conducted manually by one of two coordinating satellites while in the near vicinity of the other. More specifically the relative position and rates are sufficiently stabilized and small (usually

< 0.5 n. mi. and 1 ft/s) so as to preclude the requirement for rendezvous (with all attendant navigation, targeting, and MNVR execution) in order to restore proximity.

PROX OPS includes the traditional functions of stationkeeping, transition (flyaround), approach, and separation. But new functions have been added, ranging from inspection, grappling, or Manned Maneuvering Unit (MMU) operations and retrieval, to various novel medium- and long-range stationkeeping techniques required by STS payloads. Additionally, concerns related to hardware (such as sensor performance, or RCS jet plume impingement), software, and crew procedures are much more important with the STS than previously with Apollo.

This section has presented a simplified explanation. The task of RNDZ and stationkeeping with another orbiting vehicle can become quite complicated. For this reason a standardized set of systematic MNVR's is designed to accomplish the following:

- Maximize the probability of success.
- Achieve the RNDZ at a particular point in the orbit (dictated primarily by lighting conditions) with a single fixed crew timeline, generated a year before the flight.
- Accommodate all potential phasing conditions and requirements
- Optimize the use of crew time in orbit
- Minimize the amount of propellant used
- Optimize the use of onboard NAV sensor capabilities

These tasks break down into ^{several} five basic components, each of which is to be addressed in detail in this handbook. They are:

- Vehicle control
- NAV
- Targeting
- MNVR guidance
- Terminal phase manual trajectory control (including braking operations)
- PROX OPS

Different techniques are used to "control" the Orbiter trajectory during RNDZ and PROX OPS. RNDZ operations utilize closed loop guidance, navigation, and control to achieve a desired relative state. PROX OPS utilize crew visual observations and piloting techniques (along with universal pointing (UP) attitude control) to achieve a desired relative state. ^{3a1}

Navigation starts with ground tracking of both vehicles. When the relative range decreases to several hundred miles, onboard relative NAV can be used. Relative NAV involves the manner in which the various tracking sensors (radar, STRK, and COAS) are operated with the goal of improving the accuracy of the onboard relative state. After sufficient NAV data have been processed, the crew targets the required velocity correction for the subsequent RNDZ MNVR. This involves computation of a solution using the targeting equations. After maneuvering to the burn attitude and making the other necessary preparations, the crew initiates the MNVR at time of ignition (TIG). RCS burns are executed manually with the translational hand controller (THC). However, orbital maneuvering system (OMS) burn execution is more automatic and only requires the crew to monitor the system and guidance parameters on the cathode ray tube (CRT) display (and push the execute key prior to TIG). Upon MNVR completion, the cycle repeats itself with additional relative NAV. After the final post-Ti midcourse MNVR, the crew can manually achieve stationkeeping by:

- Translating normal to the line of sight (LOS) to maintain an intercept trajectory
- Translating (braking) along the LOS to achieve a velocity match

Other tasks which are not unique to RNDZ operations, but are performed during this phase, should be noted. These include:

- Ground-targeted OMS burns
- IMU alignments
- Systems management
- Orbiter/MCC communications interface

Therefore, to ensure accurate NAV it is necessary to minimize IMU drift, and an alignment is scheduled at the beginning and end of each day, and prior to the rendezvous phase. Systems management is the ongoing function of monitoring the non-guidance, navigation, and control(GNC)-related systems. Communications between the MCC and the crew include uplinks (SV's, accelerometer bias, gyro compensation), MCC MNVR voice pads, and burn status reports.

2.2 CREW ASSIGNMENTS

Three crewmembers are normally sufficient to perform a RNDZ. Exact allocation of crewmembers and of functions may be at the discretion of the commander (CDR), but the following guidelines reflect experience and analysis. Assignments of the previously defined tasks to the RNDZ crewmembers are based primarily on the crewmember's major areas of responsibilities during other mission phases, timeline division of duties, and their location in the crew station.

One crewmember would assume the major responsibility for the flight control system, which involves the targeting and execution of all translation and attitude maneuvers (RCS and OMS). The duties include maneuver preparation, guidance monitoring, and the execution of the Orbiter MNVR's required during terminal phase braking operations. During periods of low flight control activity, this crewmember handles the communications (COMM) with the MCC, performs guidance, navigation, and control systems monitoring activities, and assists the second RNDZ crewmember as required.

The main responsibility of additional RNDZ crewmembers during the RNDZ phase could be the management of the NAV sensors and software. The first crewmember's assistance, however, may be required for the data taking and computation of any backup MNVR solutions. The IMU alignments are performed by another crewmember as required during the non-NAV periods. Another RNDZ crewmember also performs certain systems monitoring functions with primary responsibility in the area of systems management (SM) related systems.

The division of duties between the RNDZ crewmembers is not exact and will require some overlap when dictated by the timeline.

With RMS operations added in, another crewmember becomes necessary at the aft control station. Flight experience has shown that many extra foot-loop restraints were required (including one on the aft wall so a crewmember could "stand" there to work forward CRT's); further, careful attention is needed to coordinate who goes where, and when.

2.3 REFERENCE SYSTEMS

2.3.1 Relative Motion Plots

The motion of a chaser satellite relative to a TGT satellite (in a nearly circular orbit) can be viewed from several different reference frames. Traditionally, orbits are viewed in a geocentric inertial frame. However, for orbital RNDZ a TGT-centered curvilinear frame rotating at orbital rate (thus maintaining local vertical/local horizontal (LVLH) orientation) is much more convenient in terms of conceptualization. The following paragraphs discuss chaser satellite orbits in both frames.

If the chaser is in a lower, circular orbit (fig. 2-1), its relative motion will be a constant velocity path at a constant ΔH below the TGT. The chaser overtakes and passes the TGT because of its greater orbital velocity. The rule of thumb is: relative horizontal displacement (or downtrack growth rate) is about 10 times the average ΔH per revolution about Earth (REV).

295a. ART. 2

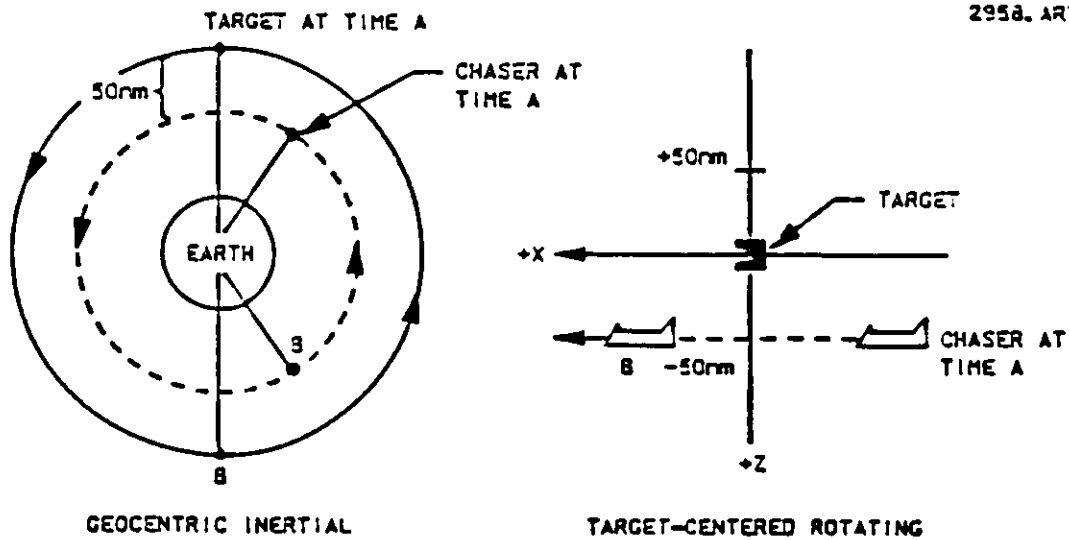
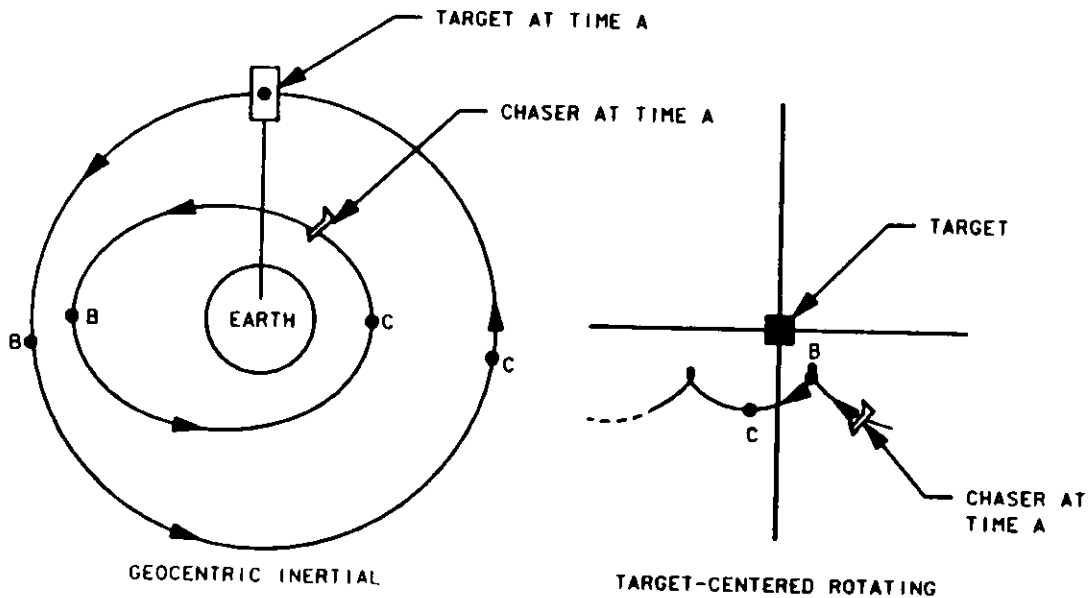

Figure 2-1.- Relative motion plot, circular orbits.

If the chaser is in an elliptical orbit below the TGT (fig. 2-2), it, of course, is going faster at perigee and slower at apogee. Relative to the TGT, the chaser moves more and more slowly the higher it gets, to the point that at chaser apogee the TGT may actually be going faster (this makes the relative motion plot of the chaser position appear to double back on itself for a brief interval near apogee, when the TGT is actually outdistancing the chaser).



2957. ART. 5

Figure 2-2.- Relative motion plot, elliptical chaser orbit.

The next step is for the elliptical orbit of the chaser to actually touch the target orbit (fig. 2-3). The final approach trajectory is thus seen to be from below and ahead of the TGT. To match orbits, the chaser must then raise its perigee to the TGT altitude by increasing its velocity (firing in the direction of the flight path).

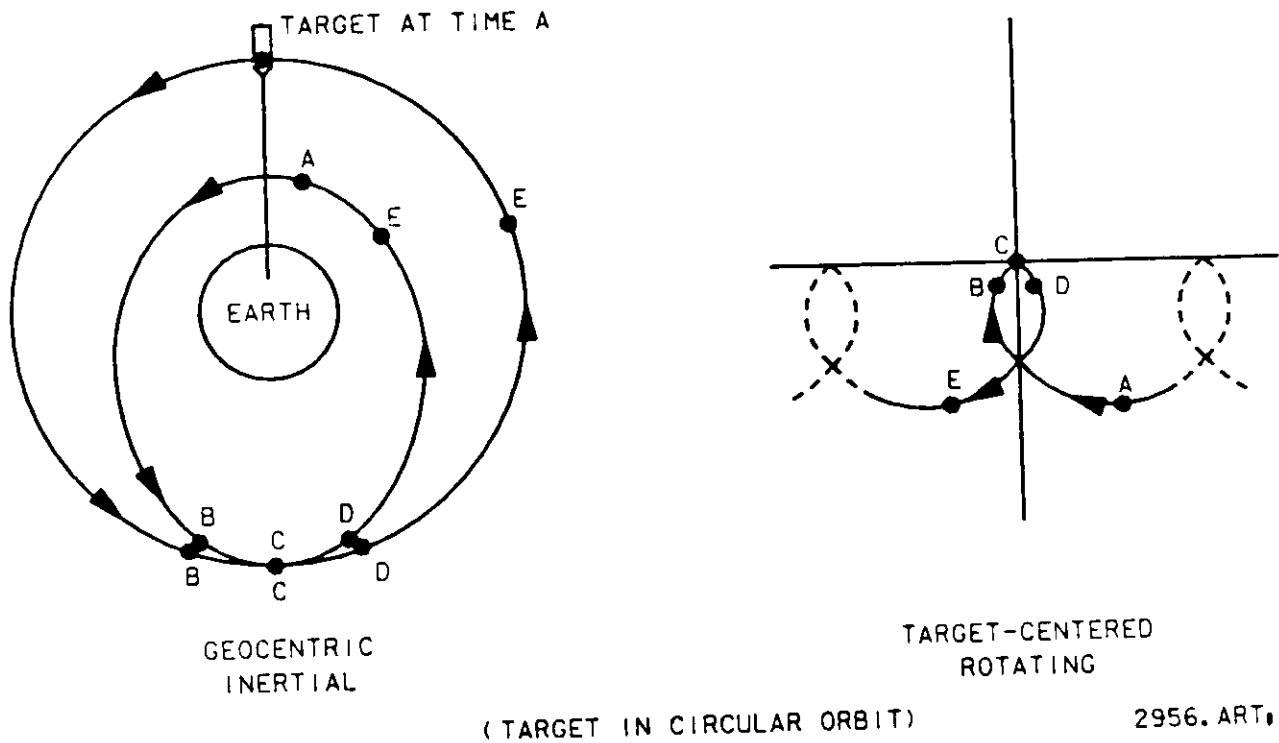

Figure 2-3.- Tangential orbits.

In practice, final approach trajectories utilize elliptical orbits which cross that of the TGT (fig. 2-4). The chaser makes a final burn at apogee (the T_i burn), so intercept occurs less than 360° later. This results in a "hot" approach in which the chaser closes in on the target stationary against a stellar (inertial) dark background, with a finite range rate at intercept (thus, real-life dispersions will not have as great an effect on the trajectory as they would in the case of a minimum-energy, Hohmann-type transfer.) At this point the crew takes manual control, bleeds down the range rate, and completes the rendezvous.

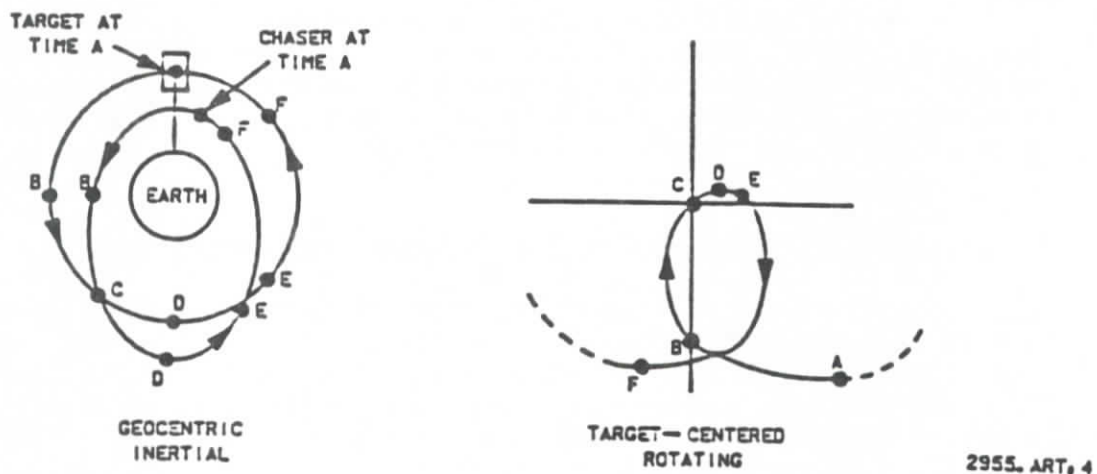

Figure 2-4.- Intersecting orbits.

In figure 2-21, the relative motion plot of a Solar Maximum rescue mission (SMRM)-type RNDZ shows examples of these above types of motion during various mission phases.

2.3.2 Vector Definitions

The V-BAR is along the direction of circular satellite motion, positive ahead. The R-BAR is the direction to the center of the Earth, positive is down. The H-BAR, or angular momentum vector, completes the three dimensional framework and points positive to the left (on posigrade orbits this is north). Alternately, R is down, H is as in classical dynamics, and V completes the orthogonal system. Note that for noncircular orbits, V-BAR only aligns exactly with the dynamical velocity vector at apogee and perigee; otherwise, it can be up to a few tenths of a degree off.

The XYZ coordinate nomenclature is also used for this local vertical frame. X is along the V-BAR, Z is downward along the R-BAR, and Y completes the righthand frame. The UVW framework is local vertical inertial, with $+U = -R$, $V = V\text{-BAR}$, and W completing the frame.

2.4 ORBITAL MECHANICS EFFECTS

The common-sense approach towards the laws of motion is based on everyday experience combined with familiarity with Newton's Laws concerning action-reaction and $F = MA$, etc. A thrust in a direction will cause motion in that inertial direction, along a straight line and at a speed proportional to the original thrust. Disturbing forces can slow down that motion or shift its direction.

or speed up

The laws of motion of two independent objects orbiting the Earth in close proximity to each other, however, are not as well grounded in "common

sense". Newton's Laws still apply, of course, but orbital mechanics effects resulting from the inverse square force field often alter the "common sense" results of simple directional thrusting when viewed in the target-centered (non-inertial) rotating frame. Although the resulting relative motion is not necessarily intuitive, it is predictable.

2.4.1 Relative Motion of Two Objects Orbiting in Proximity

This discussion uses a TGT-centered frame of reference, rotating at orbital rate to stay level with the local horizontal plane (fig. 2-5). Imagine two satellites flying formation in approximately circular low-Earth orbit (100-300 n. mi altitude, period about 90 minutes) with parallel velocity vectors in this frame and identical drag characteristics. One is the TGT and the other (usually the Orbiter) is the chaser.

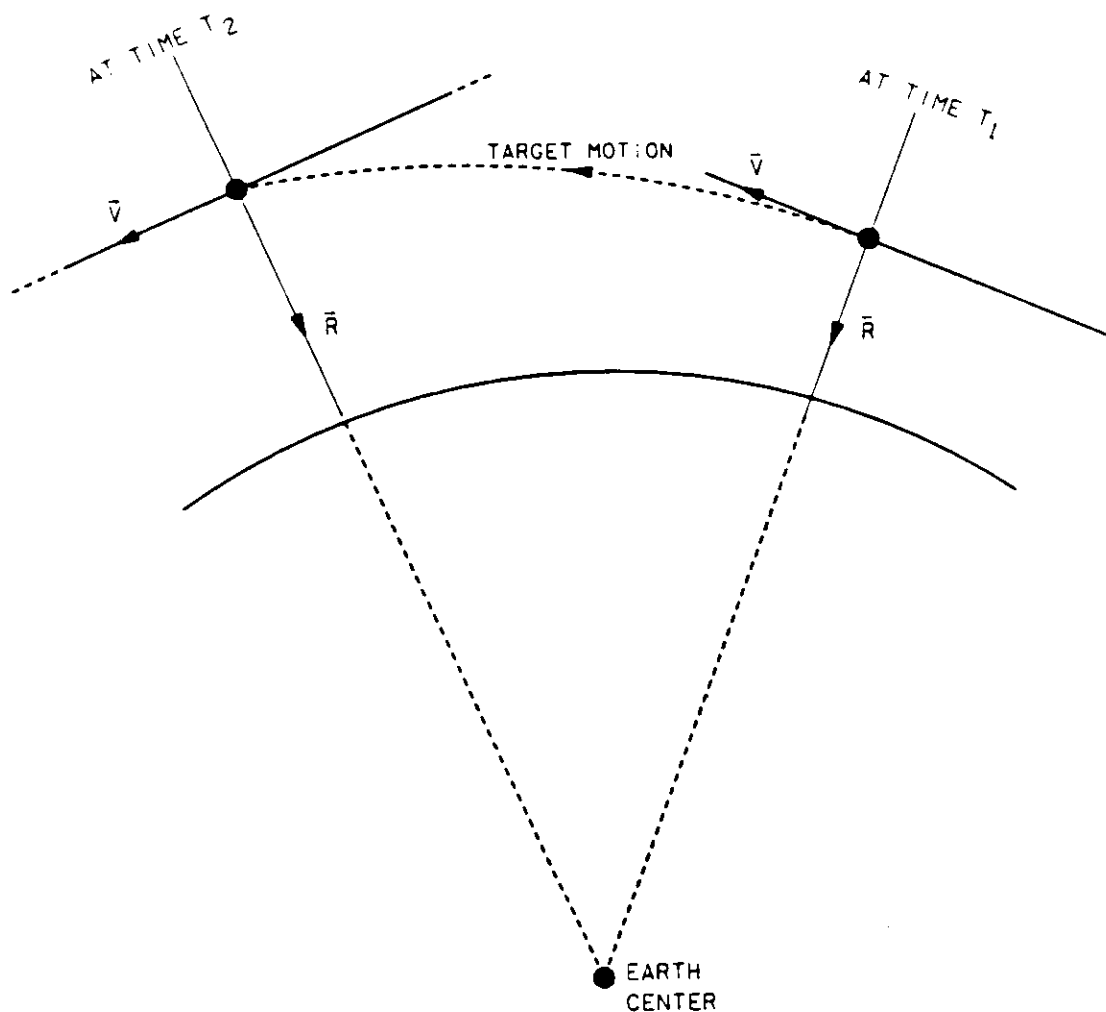

1223, ART. 4

Figure 2-5.- Target-centered frame (rotating at ORB rate).

2.4.1.1 Above/Below (R-BAR (Radial) Displacement)

If the two objects are co-planar and are initially on the same R-BAR (radius vector) at different altitudes and both are in stable circular orbits, they will drift apart at a constant horizontal rate due to the difference in orbital velocities at these different altitudes (fig. 2-6). If the chaser is above the target, it will drift behind; if below, it will pull ahead. A rule of thumb is that this horizontal displacement per REV is approximately ten times the vertical difference (the analytical solution is 3π times the separation).

Two objects are said to be in co-elliptic orbits if the orbits' apsides are aligned and the difference in apogee height is the same as the difference in perigee height. In terms of orbital parameters, $a_e = a_e$.

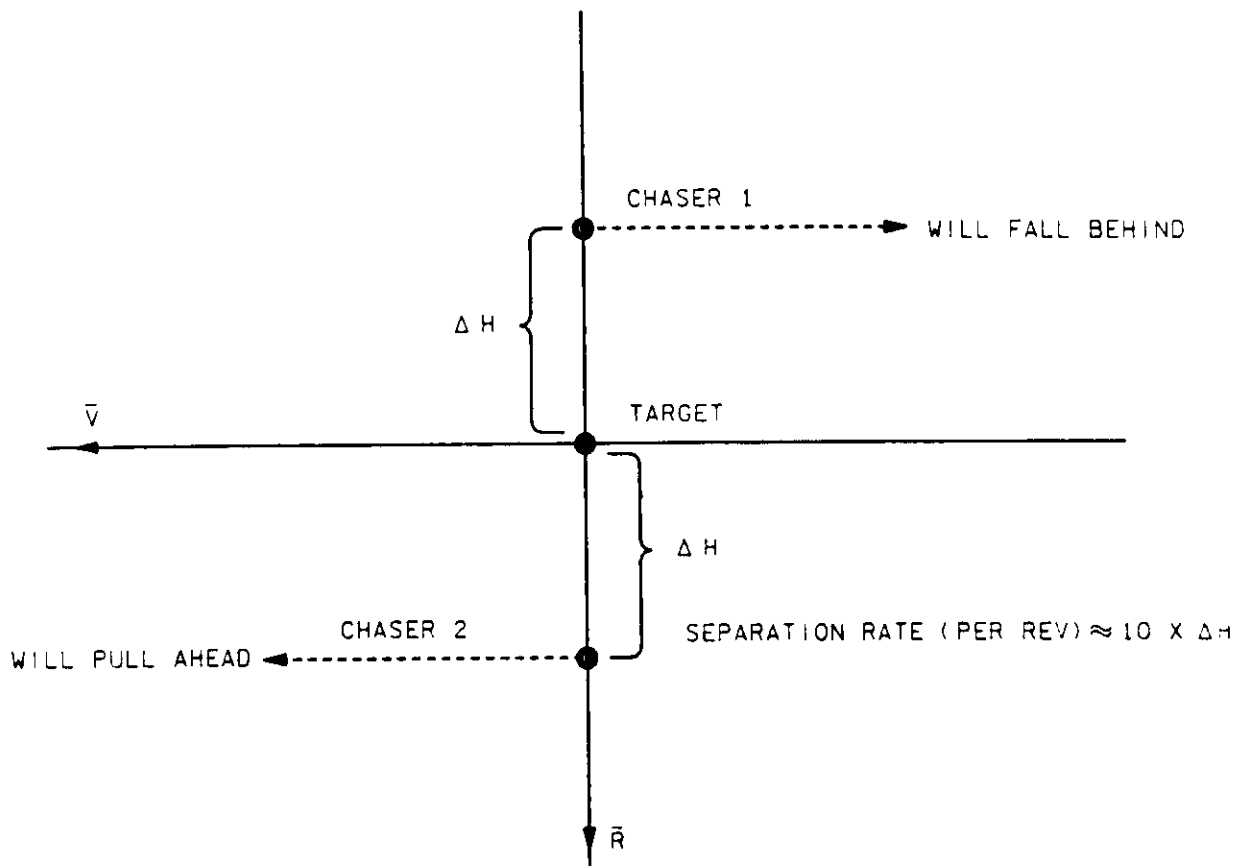

1223. ART. 5

Figure 2-6.- Radial separation relative motion.

2.4.1.2 Lateral (out of plane)

If the two objects are at the same altitude and velocity, but are not coplanar, with their LOS perpendicular to their V-BAR (fig. 2-7), they will cross each other's path twice per orbit in a series of scissors maneuvers (in a sinusoidal fashion). Starting at a given range (the maximum out-of-plane separation), the position of the objects will coincide after a quarter REV (about 22 minutes) and then be at the same distance apart, but on opposite sides after 45 minutes (half a REV). At the completion of one full 90-minute REV they will again be at their original positions with their original relative motion.

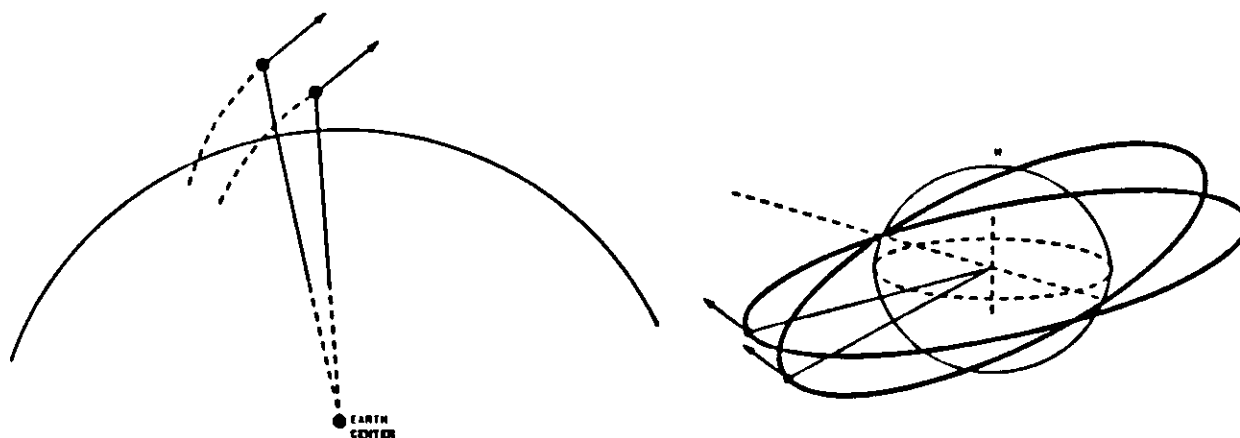

1223. ART. 8

(This is not a stable formation!)

Figure 2-7.- Out-of-plane parallel motion (two views at max separation).

2.4.1.3 Ahead/Behind (V-BAR displacement)

If the objects are co-planar and at the same altitude and velocity (fig. 2-8), they will maintain their initial relative displacement and motion. That is, they will be in a stationary relative position.

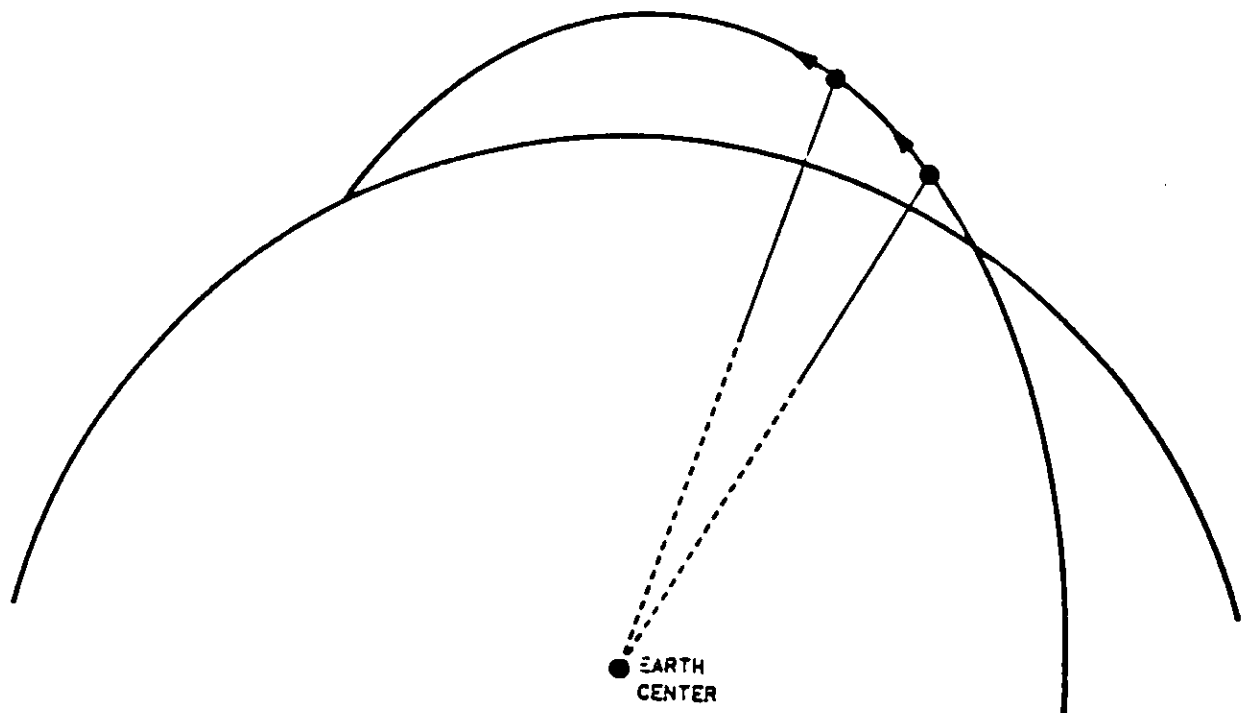

1223. ART. 3

Figure 2-8.- Two satellites on V-BAR.

2.4.2 Effects of Maneuvers from a Stable Relative Position

Imagine the two co-orbiting objects in a stable formation, the chaser ahead (that is, on the +V-BAR) of the TGT. Small ΔV 's by the chaser can have dramatic results. The following examples are based on a 1 ft/s pulse (e.g., a 5-second firing of two RCS jets); different impulse sizes can be scaled linearly within a reasonable range. Altitude differences are reflected in multiple values, one for 150 n. mi. and the other for 250 n. mi.

Note that since small burns perpendicular to the velocity vector do not effectively alter the total velocity (and energy) of the satellite, they do not change its orbital period. Hence, they lead to closed, repeating cycles (with respect to a TGT-centered frame of reference) which return to the same point every REV (it is a "periodic" displacement). In quantitative terms, since the speed of the satellite is about 25,000 ft/s, a perpendicular burn of about 10 ft/s gives a new speed only slightly different from the initial value (actually, 25,000.002 ft/s).

However, burns which are parallel to the velocity vector alter the total energy of the satellite, and in turn cause cumulative relative displacements from the starting point, or "open" curves. This is called a "secular" displacement.

If a burn has components in different directions, the result can be approximated by vector additions of the results of each component.

2.4.2.1 Ahead/Behind (V-BAR Burn)

Thrusting towards the TGT from ahead of it (retrograde thrust) will cause initial movement toward the TGT. However, orbital mechanics effects will then cause the chaser to begin dropping and slowing within 10 minutes (after traveling about 300 feet in the desired direction while dropping the same amount), and then start pulling away from the TGT (fig. 2-9). The same maneuver toward the target, executed from behind the target, will cause the chaser to initially approach, but then gain altitude and start falling behind the TGT. Each REV, the chaser will be about an additional 17,000 feet further away from the target (without orbital mechanics effects, one would expect to move about 5400 feet per REV in a direction toward the TGT). The motion (in the "from behind" case) is due to the fact that the chaser is now in an elliptical orbit approaching apogee, and hence slowing; that orbit has a longer period than the original one, and therefore the chaser arrives back at its starting point somewhat later.

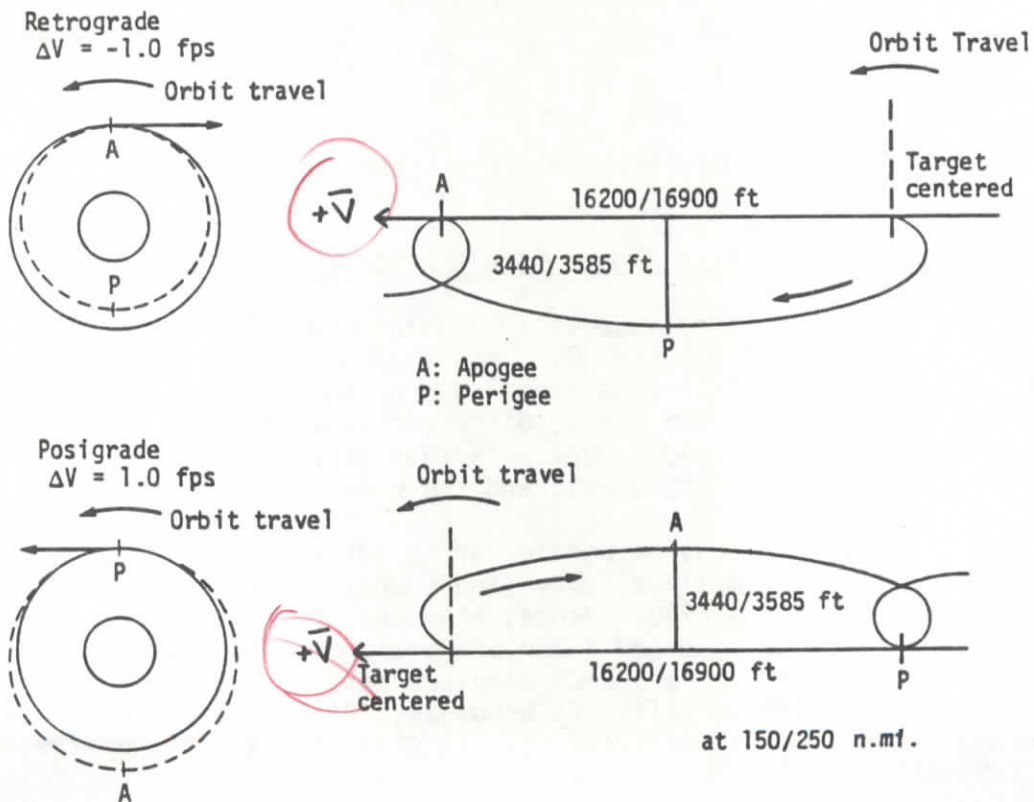

Figure 2-9.- V-BAR burn effects.

2.4.2.2 Out Of Plane

Thrusting horizontally out of plane (OOP) will cause initial motion in the desired direction, but that motion will slow and come to a halt after about 22 minutes (one quarter REV) (fig. 2-10). The chaser will have moved 900 feet off to the side (if there were no orbital mechanics effects, it would have moved 1300 feet and still be moving). The chaser will then swing back towards its initial position and pass through the position (with velocity opposite to the starting value) 45 minutes (half a REV) after the maneuver. The chaser then swings out to the other side the same amount and continues the cycle indefinitely. Deviations in altitude and along V-BAR are negligible. What has happened is that the orbit plane has been slightly tilted (about 450 ft/s is required to tilt the plane 1° , which is equivalent to a max separation of about 60 n. mi).

See section 2.9.2 for OOP control strategy.

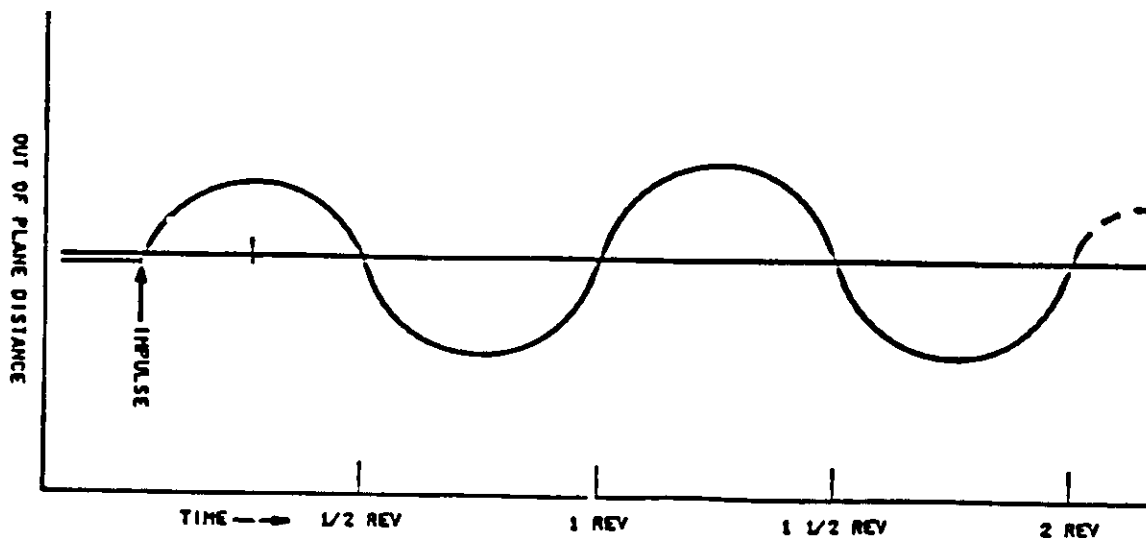

Figure 2-10.- Impulse out of plane.

2.4.2.3 Radial (Up/Down)

Thrusting radially outwards (that is, away from the center of the Earth, or "up") creates an initial vertical motion in the desired direction, but the chaser then begins falling behind its original position while the upwards motion slows and stops (fig. 2-11). A quarter REV (22 minutes) after the impulse, it is about 900 feet higher (it would have been 1300 feet higher and still moving, if it hadn't been for orbital mechanics effects) and about 1700 feet behind its original position, with all motion in the horizontal direction. Drifting downwards as well as backwards, and 45 minutes (half a REV) after maneuver execute, the chaser drops through its original altitude

at a range of about 3500 feet from where it started. It then continues in this "football" trajectory, dropping but moving forward, then rising and resuming its original position after a full orbit. The motion then repeats, subject to outside perturbations.

Thrusting radially inwards (downwards) creates the same-sized "football" orbit which first pulls ahead and then backwards in its 90-minute cycle.

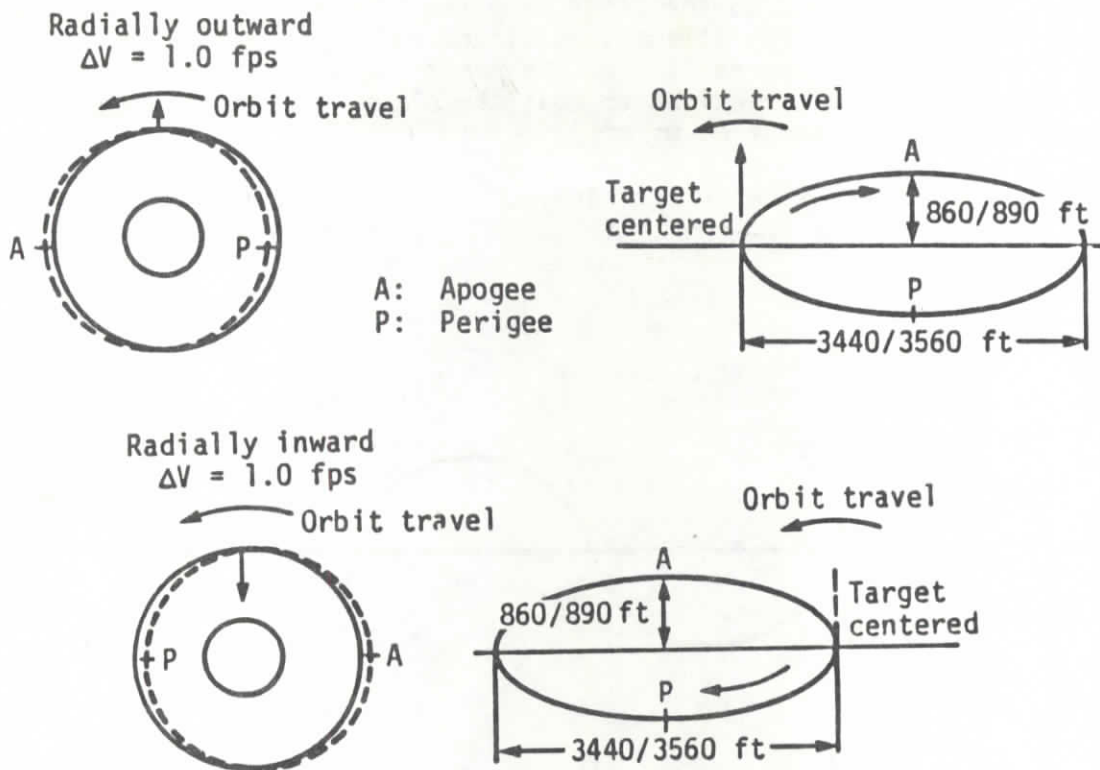

Figure 2-11.- \bar{R} thrusting effects.

2.4.3 Use of Orbital Mechanics

For final approach to a TGT and for subsequent stationkeeping, it may be desirable to minimize RCS plume impingement on the TGT and to minimize forward reaction control system (FRCS) usage. In certain strategies, "orbital mechanics" can be used to obtain braking effects, somewhat like "free" RCS translation impulses. These useful effects are achieved by actual RCS burns which can be designed to be orthogonal (at right angles) to the chaser-target LOS. This avoids plume impingement, and if the burns can be arranged to be +X Orbiter body axis, also avoids substantial FRCS usage. See figure 2-12.

Of the following three techniques (orthogonal braking, R-BAR approach, and V-BAR approach), only the last is normally used in STS operations. The others may have important applications in future operations.

2.4.3.1 Orthogonal Braking

A technique called orthogonal braking uses +X axis braking. In order to reduce the possibility of plume impingement on the TGT, the +X burns are made perpendicular to the LOS to the TGT vehicle. In this technique, orbital mechanics effects, supplemented by the +X jet firings, result in the Orbiter braking with respect to the TGT (fig. 2-12). The braking scheme is accomplished by placing the Orbiter in the TGT track mode, with the -Z axis pointed toward the TGT. Trajectory analysis is done on the ground preflight to determine the targeted points, with a specified time interval between them (5 minutes or so). These positions and times for the braking maneuvers are part of the flight software I-loads. This software is also used to compute the magnitude of the thrust necessary to intercept the specified offset position using only RCS firings perpendicular to the TGT LOS.

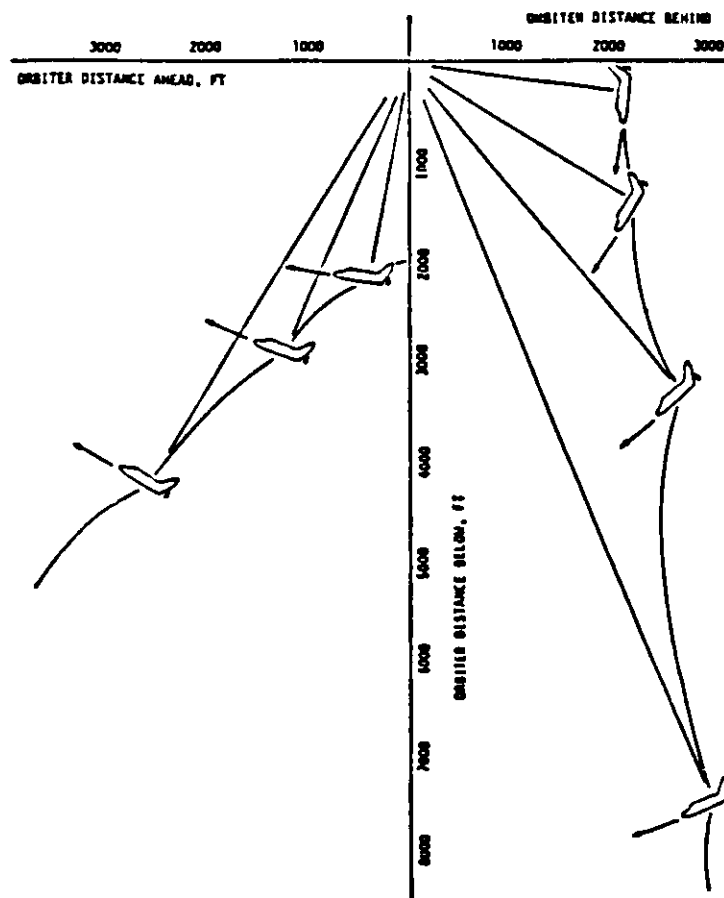

Figure 2-12.- Orthogonal braking.

2.4.3.2 Motion Along Up The R-BAR

Orbital mechanics effects can provide an apparent braking force for an R-BAR approach. This technique minimizes PRCS thrusting toward the TGT (theoretically zero).

The sequence in figure 2-13 illustrates a separation technique. Assume the Orbiter is 1000 feet below the target with zero relative velocity (fig. 2-13-A). If no crew action is taken, the Orbiter will begin moving down and ahead because its orbital velocity is not sufficient to maintain an orbit that is coelliptic (that is, has the same orientation of semi-major axis and has the same ΔH at apogee and perigee) with the TGT (fig. 2-13-B). An LVLH attitude hold mode is used to automatically maintain the Z axis parallel to R-BAR (Orbiter X axis aligned with V-BAR) while the forward firing primary reaction control system (PRCS) thrusters are used to null the forward movement and maintain the Orbiter on R-BAR. The Orbiter accelerates radially downward from the TGT (fig. 2-13-C).

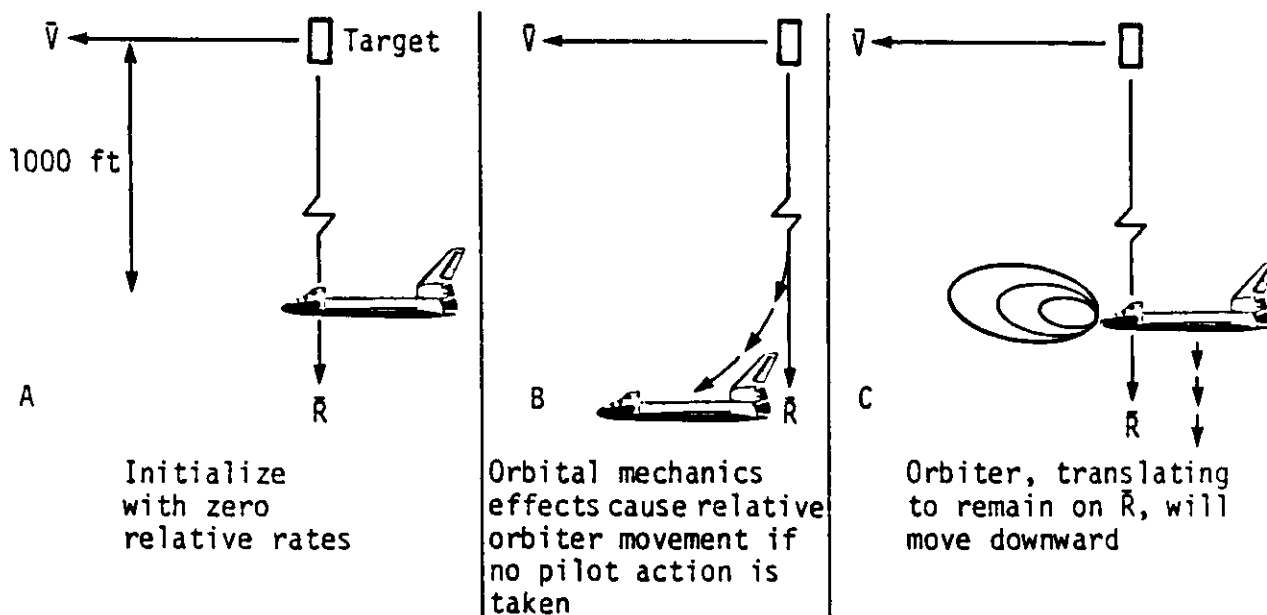

Figure 2-13.- Orbital mechanics effects in separating.

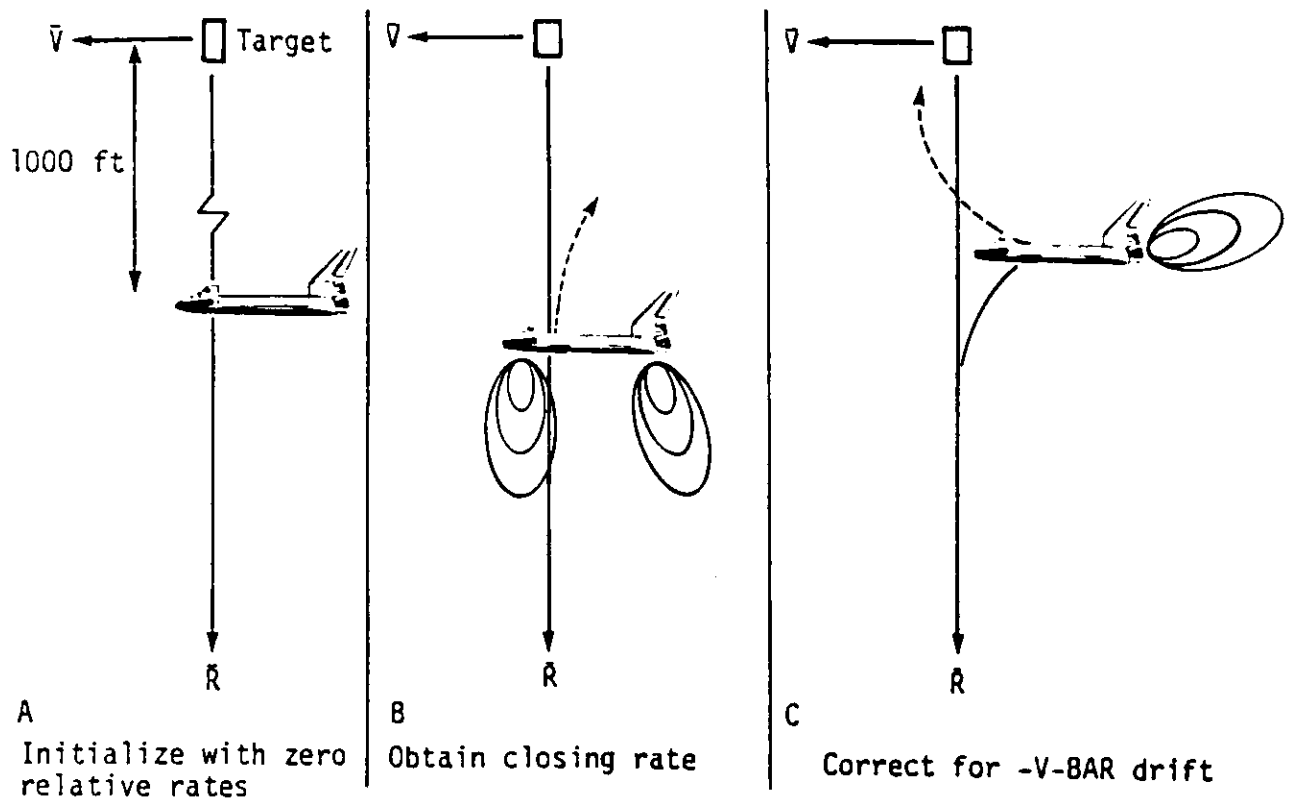

Figure 2-14.- Orbital mechanics effects in braking.

Orbiter approaches to the target can be controlled in a similar manner. As in figure 2-13-A, initialize the Orbiter on the R-BAR but this time with a sufficient closing rate (see fig. 5-20). Orbital mechanics effects will then cause the Orbiter to move up in altitude and drift behind the target (fig. 2-14-B). Then +X body axis burns are used to return to the R-BAR while still rising. The Orbiter then maintains itself essentially on the R-BAR, closing on the target with only subsequent +X burns as needed.

The R-BAR approach can also be considered in terms of the orbital parameters of the two vehicles. The Orbiter is at apogee in an elliptical orbit in figure 2-13-A. As it moves away from apogee, its altitude decreases and its speed increases - hence, in figure 2-13-B, it will pull ahead of, and further below the TGT which is in a circular orbit with constant velocity. Thrusting retrograde (fig. 2-13-C) will provide short-term counteraction to the forward drift, but will make the tendency to drift down even worse. The R-BAR closing approach dynamics are similar.

2.4.3.3 Approach Along The V-BAR

The V-BAR approach is initiated with a THC pulse directed toward the TGT (aft RCS canting adds a component slightly above [below] the local horizontal), if ahead of [behind] the target. If leading the TGT, this

small ΔV component results in a trajectory which rises a small distance above V-BAR before beginning to fall relative to the TGT. This normal ΔV component is obtained from Orbiter translation cross-coupling from a -Z acceleration (toward the TGT) into the +X axis (normal to V-BAR). If no corrections were performed at the V-BAR crossing, the Orbiter would eventually fall below V-BAR and move farther ahead of the TGT (dashed line in fig. 2-15). This is because the ΔV applied was primarily a retrograde burn which lowers the other side of the orbit. The reduced average orbit altitude of the Orbiter causes a difference in orbital rates (i.e., Orbiter traveling faster than target), and the Orbiter moves ahead of the TGT. Therefore, to maintain a closing rate, the crew must thrust up (normal to the TGT LOS) at each V-BAR crossing to produce a series of trajectory hops until the capture distance is achieved. Note that because of RCS cross-coupling, firing the Orbiter +X jets to maintain altitude also slows the closing rate. (The thrusting up has the theoretical effect of reducing the gravitational acceleration on the Orbiter, which allows it to maintain the same altitude as the TGT at a lower velocity, resulting in the Orbiter being overtaken by the target satellite.) To stabilize the Orbiter at a desired range, RCS firings toward the TGT (acceleration away from the target) is required in order to restore full circular orbital velocity to the Orbiter.

2.5 RENDEZVOUS PARAMETERS

Sensors are used by the crew during rendezvous to obtain information about the relative position of the Orbiter with respect to the TGT. This information is then utilized to determine translation corrections which may be needed based on desired position. Some parameters can also be computed by NAV or by manipulation of timed marks of other parameters.

The parameters used are range (R), range rate ("R-DOT"), elevation (EL), azimuth (AZ), pitch inertial angle rate (EL-DOT), and roll inertial angle rate (AZ-DOT).

2.5.1 Range

Ordinarily, R is considered to be the LOS distance between the Orbiter center of mass (c.m.) and the TGT c.m. However, the reference point for the raw data is not really the Orbiter c.m., but is the sensor itself and this is noticeable during PROX OPS. (This offset is accounted for in GN&C FSW for proper navigation.) The rendezvous radar (RR) (see section 3.3.4.2) provides range from the TGT to the Ku-band antenna; the closed circuit television (CCTV) tilt technique (section 3.3.5.3) provides distance from TGT to the Orbiter structure (i.e., "clearance"); the angular size technique (section 3.3.6) provides range to the visual sensor (CCTV or eyeball). There can be both proportional (scale) and constant delta (offset) biases.

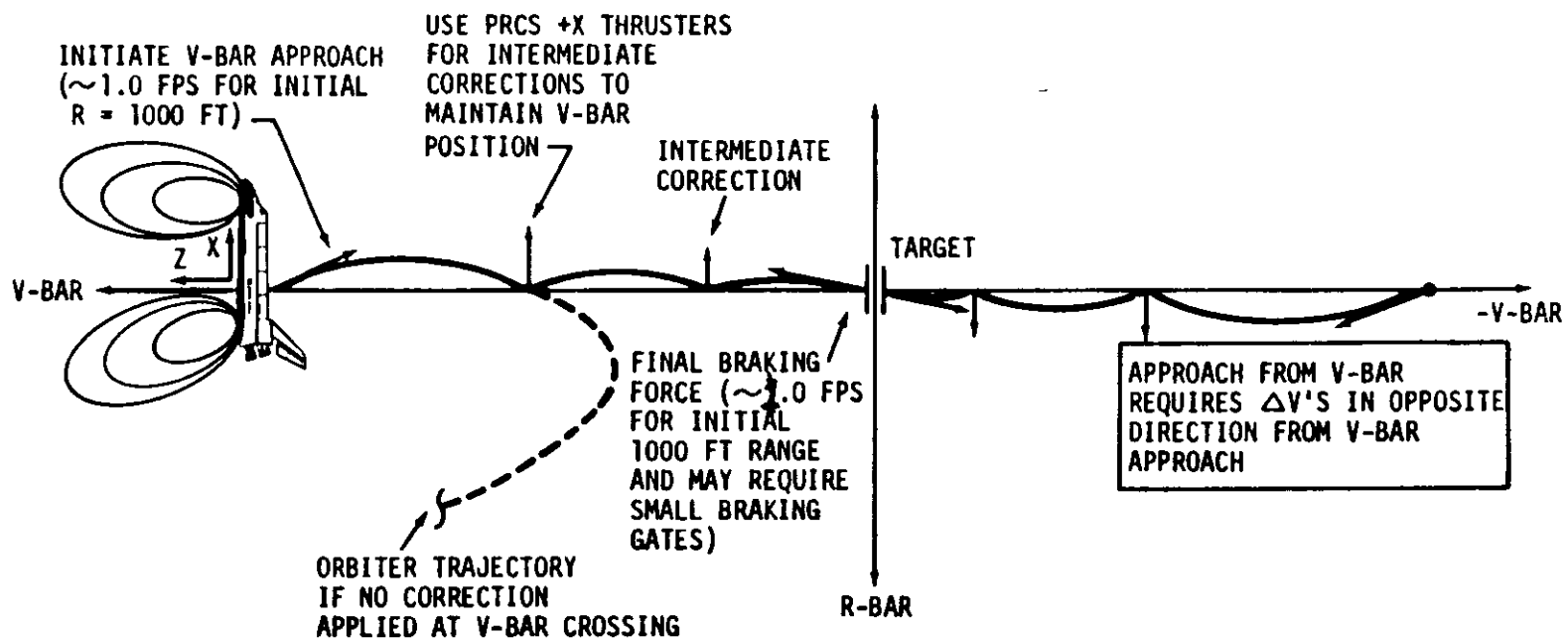

Figure 2-15.- V-BAR approach technique.

2.5.2 Range Rate

R-DOT is the rate at which the range measurement is changing with respect to time; positive is an opening rate, negative is a closing rate. This can be observed directly by a sensor (e.g., RR) or computed using successive range marks.

2.5.3 Elevation

2.5.3.1 Radar Elevation

The RR null position is along the Orbiter -Z axis. The radar EL is then the pitch position of the radar relative to its null position ($\pm 90^\circ$); positive sense - antenna LOS motion toward the Orbiter nose, the +X axis (fig. 2-16).

2.5.3.2 COAS Elevation

COAS elevation is the vertical position (Orbiter X, Z plane), in degrees, of the target position in the COAS field-of-view relative (FOV) to the Orbiter -Z axis. This is assuming the COAS is aligned perfectly with the Orbiter -Z axis. Whenever the Orbiter -Z axis is aligned parallel to the V-BAR, with the Orbiter X axis in the TGT orbital plane, this angle provides an indication of the $\pm X$ axis thrusting required to drive the Orbiter back to the V-BAR. See section 3.3.3 for details.

2.5.3.3 STRK Elevation

See section 3.3.1 for -Z and -Y STRK angles.

2.5.4 Azimuth

2.5.4.1 Radar Azimuth

The AZ is the roll position of the radar relative to its null position ($\pm 180^\circ$); positive sense - antenna LOS motion toward the Orbiter left wing, or -Y axis (fig. 2-16).

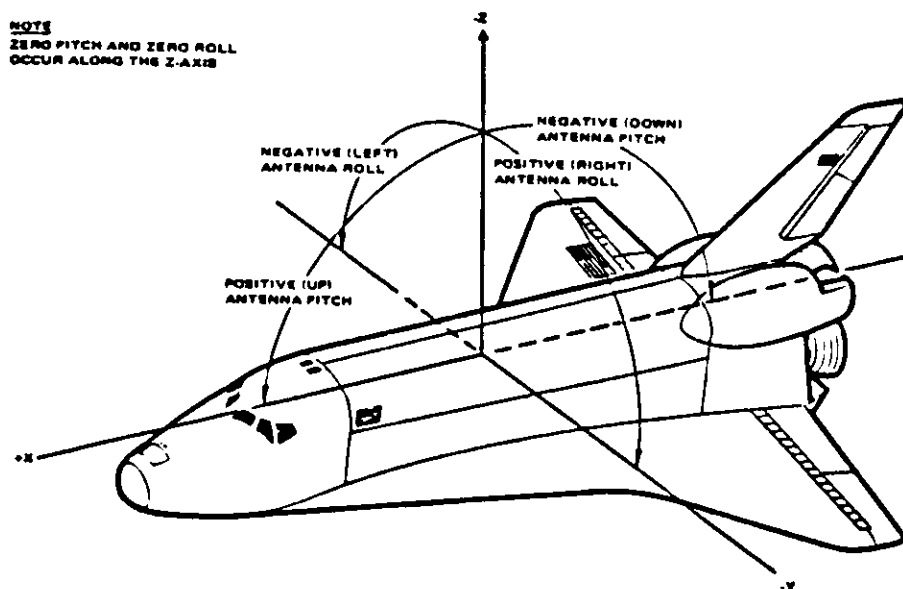

Figure 2-16.- Orbiter vehicle coordinate system and Ku-band antenna slewing directions.

Radar EL and AZ are the target LOS angles which provide the crew with the antenna position relative to the Orbiter -Z axis. Assuming radar TRK and Orbiter attitude with -Z axis parallel to V-BAR, then EL and AZ provide an indicator of Orbiter position relative to TGT V-BAR (since at close ranges the TGT V-BAR and Orbiter V-BAR essentially coincide), and consequently the thrusting direction required to drive back the TGT V-BAR. These angles are useful primarily during the night side of the orbit, when the TGT is not visible in the COAS.

2.5.4.2 COAS Azimuth

COAS azimuth is the horizontal position (Orbiter Y, Z plane), in degrees, of the TGT position in the COAS FOV relative to the Orbiter -Z axis. This is assuming the COAS is properly aligned. Whenever the -Z axis is aligned parallel to the V-BAR with the Orbiter X axis in the TGT orbital plane, this angle provides an indication of the $\pm Y$ axis thrusting required to drive the Orbiter back to the V-BAR.

2.5.5 Elevation Rate

Elevation rate (EL-DOT) is the pitch inertial angle rate. Positive sense is toward the +X Orbiter axis.

2.5.6 Azimuth Rate

Azimuth rate (AZ-DOT) is the roll inertial angle rate. Positive sense is toward the -Y Orbiter axis.

EL-DOT and AZ-DOT are the components of the inertial angle rate of the Orbiter-TGT LOS, transformed into the Orbiter X, Z and Y, Z body planes, respectively.

2.6 TARGET VISIBILITY

Of great concern to naked-eye observation of a TGT is its illumination, its position relative to the Sun, and its position relative to the horizon.

2.6.1 Illumination

The portion of an orbit in which a TGT is lit by the Sun can range from little more than a half all the way to total (100 percent). This is a function of target altitude, inclination, and beta angle. Sunlit (passive) illumination is critical for COAS and STRK observation.

2.6.2 Position Relative to the Sun

Looking toward the Sun makes observing a TGT very difficult, both from the direct solar glare, the glare induced on the windows, and the fact that it is the nonilluminated side of the TGT facing the observer. No observations are generally planned when the TGT is within 20° of the Sun, but glare conditions certainly exist even farther out.

Preferred operating relative positions (assuming low beta angle) are with the Sun behind the observer, or off to the side of the observer-TGT line of sight. For a situation with the Orbiter ahead of the TGT, this is satisfied in the period between orbital sunrise and orbital noon; for an Orbiter behind a TGT, the interval is approximately orbital noon to sunset. This geometry is taken into account during operations planning.

It is also generally preferred that the TGT be a diffuse reflector rather than a "shiny" specular reflector. Because diffuse reflection provides more uniform reflection at all angles, there is less concern for loss of TGT visual for certain TGT attitudes relative to the LOS. Specular reflection is particularly obvious from solar panels tracking the Sun.

Terminal phase of the rendezvous profile is designed to optimize lighting conditions. As seen in figure 2-17, the LOS to the Sun is kept far from the target LOS.

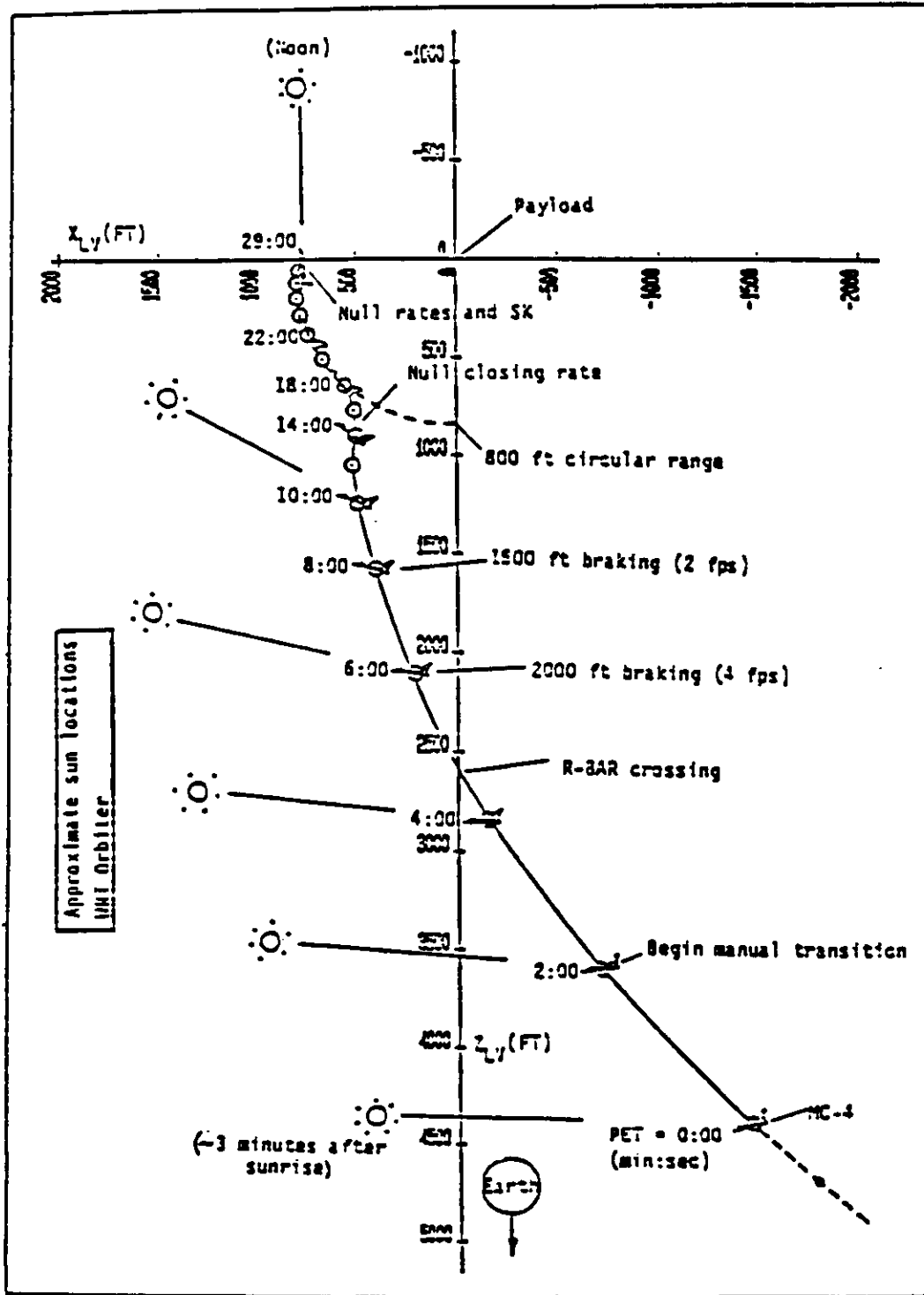

Figure 2-17.- Angle to sun during terminal phase (note: disregard obsolete procedure at 800 feet).

2.6.3 Position Relative to Horizon

The angle between the Orbiter-centered LVLH "horizontal" vector and the Earth horizon is a function of Orbiter altitude. Because of the altitude of the Orbiter, the Earth horizon lies significantly below the "horizontal" vector. The amount of depression is shown in figure 2-18. This becomes important during periods of attempted observation when the Orbiter is at a higher altitude than the target. Both eyeball (including COAS) and STRK visibility are adversely affected near and below a sunlit horizon.

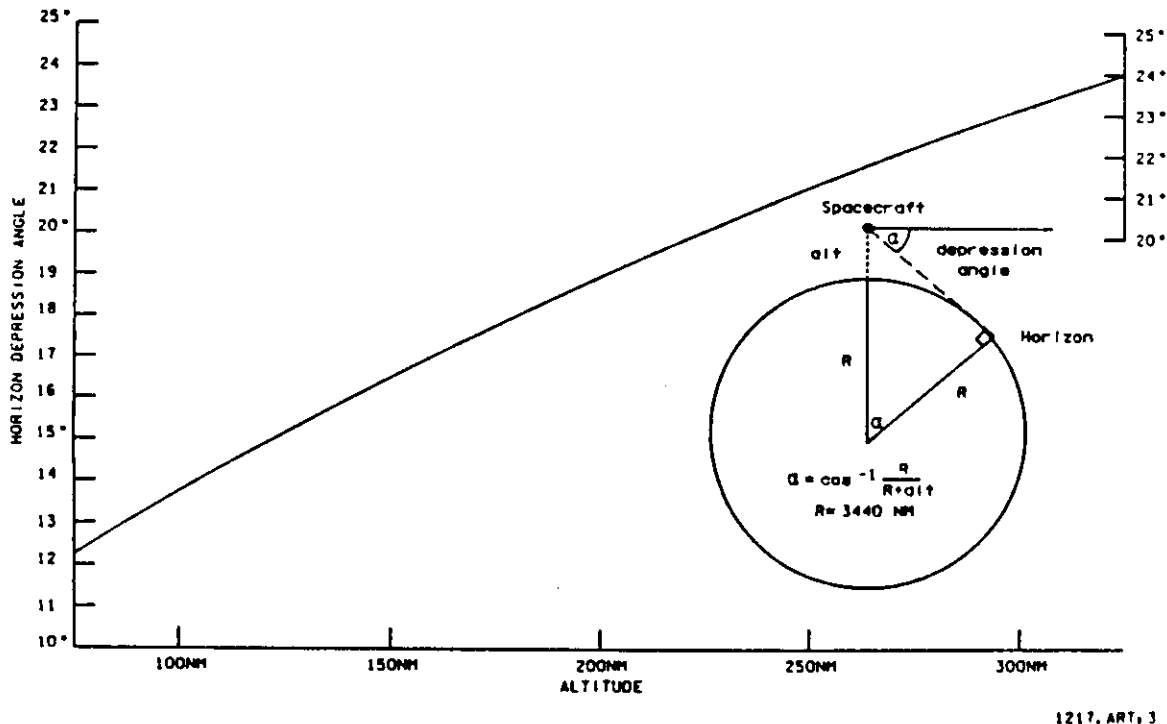

Figure 2-18.- Horizon depression angle as a function of Orbital altitude.

2.7 OTHER FORCES

Several other forces affect the relative orbital motion of satellites. Both atmospheric drag and Earth oblateness will affect satellites differently depending mainly on their altitudes.

2.7.1 Differential Drag

Differential drag effects can produce unexpected relative motions or can be utilized productively (particularly in gentle separation MNVR's). Typical differential drag effects are shown in figures 2-19 A and B.

The atmospheric drag on a satellite is a function of satellite size, mass, geometry, attitude, and orbital altitude. Two nearby satellites usually have some difference in atmospheric drag. If the difference is small, it

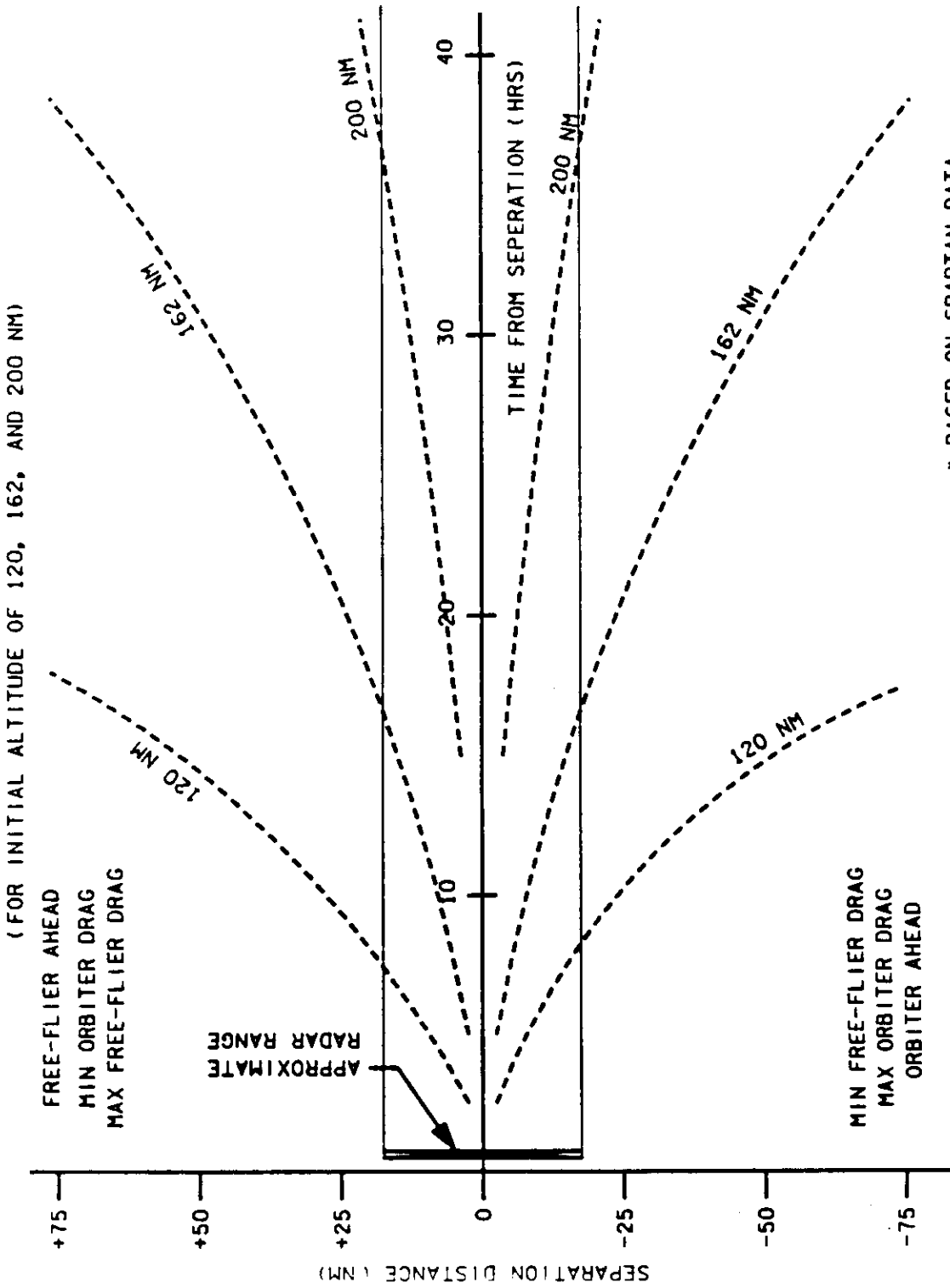

Figure 2-19A.- Illustrative differential drag effects, Orbiter and small free-flier,*
as function of orbital altitude. 1218.ART, 3

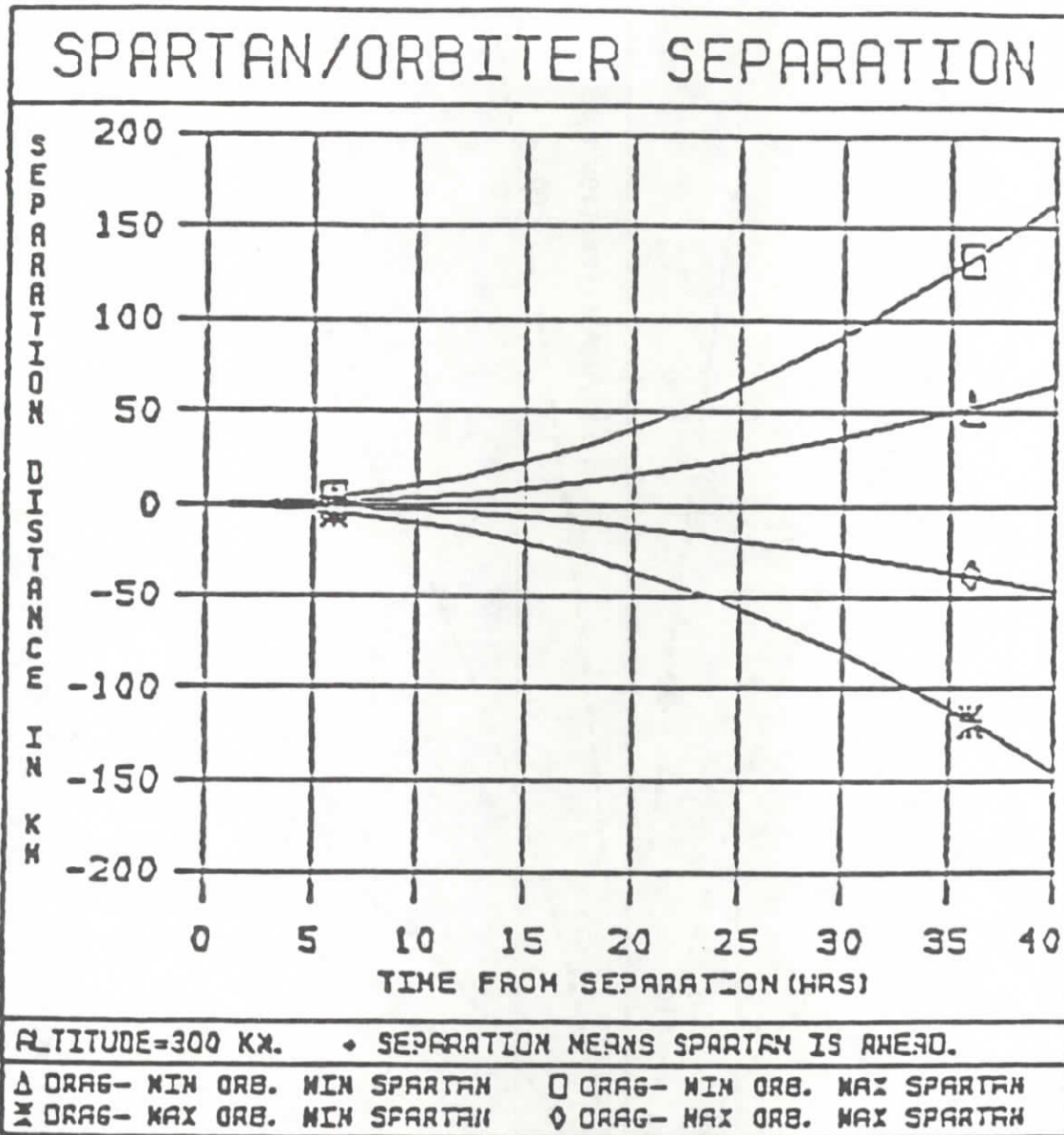

Figure 2-19B.- Drag effects ^{as} on function of Orbiter and payload attitude variations.

can be ignored; if it is large, it can introduce separations of thousands of feet per REV.

For differential drag effects, atmospheric density is the same for both objects. Typically, since volume is proportional to the cube of radius while area is proportional to the square of radius, and since deceleration due to drag is proportional to area divided by mass (which is directly related to volume for a constant mass density), then in general the larger the body the less significant the drag effects if the density of the 2 vehicles is about the same. For non-symmetrical objects, attitude is also important since the frontal area affects drag (e.g., the Orbiter in XLV Y-POP has about three times the drag as the Orbiter in ZLV Y-POP).

For example, a 1-meter diameter tracking sphere weighing 34 pounds would pull ahead of the Orbiter by 3 miles per REV and drop about 1 mile per REV, at 160 n. mi.; at 120 n. mi., it would pull ahead by 15 miles per REV while dropping 4 miles. Figures 2-19 A and B show typical SPARTAN-class differential drag effects.

Another example of how differential drag can cause motion which seems contrary to "common sense" is a case involving a spacecraft which has very low density particles (e.g., "snowflakes") separating from it. Drag will quickly cause the particles to lose energy and fall into a lower orbit where they will pick up speed and pull ahead of the spacecraft. An example of this was MA-6 in 1962. From the spacecraft, ice particles appeared to be accelerating away forward, which in one sense they were, because their drag was greater than that of the spacecraft. Understandably, this was not obvious at the time, and the motion of the particles (the "fireflies") caused some bafflement.

2.7.2 Differential Nodal Regression Effects

The oblateness of the Earth causes the orbital plane of a satellite in posigrade orbit to be displaced westward by several degrees per day. The magnitude of this displacement is affected by orbital inclination and altitude (orbits with steeper inclinations and/or higher altitudes are less affected by the perturbing force of the oblate mass). See figure 2-20.

Through an equation derived from geophysics principles, the precession rate (in degrees per day) can be calculated:

$$\text{rate} = -9.98 (\cos i) (r/a) + 3.5$$

where r = Earth radius
 a = orbital semimajor axis
 (assuming low eccentricity)

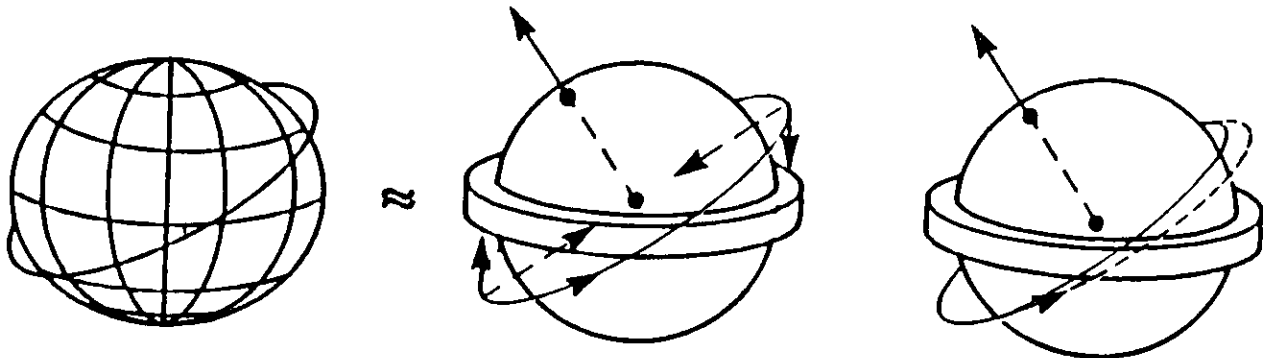

Figure 2-20.- Plane shift due to equatorial bulge.

Two near-coplanar orbits with different altitudes will have different nodal rates, and hence a relative differential rate. The lower orbit will precess faster relative to the higher orbit. These effects are small: at 28° and about 150 n. mi., the differential rate is about 27 ft. per REV per 1000 ft. of average altitude separation. This effect is accounted for in both ground and onboard RNDZ targeting; this effect is small enough to be disregarded in all RNDZ manual phase and PROX OPS maneuvering.

2.8 TYPES OF RENDEZVOUS MANEUVERS

Specific terminology has evolved which is applied to different types of rendezvous maneuvers. The "N" preceding the maneuver type once referred to the REV number of the maneuvers (orbits on which they were executed, counted from the ascending node); subsequently it became a meaningless and redundant designator. Note that the following descriptions pertain to the standard STS stable orbit rendezvous (SOR) profile.

2.8.1 Generic NC, or Phase Adjust (or "closing")

This is a horizontally executed MNVR targeted to obtain the desired offset position from the target (phase angle) at a future time. It controls the X axis curvilinear distance. It is a ground-targeted burn. There usually are more than one such burn. The phasing maneuver (NC) burns typically adjust catchup rate by adjustment of orbital period. They accommodate the phasing at the actual time of launch.

2.8.2 Generic NH, or Differential Height Adjust (HA)

This is a horizontally executed MNVR targeted to a differential height from the TGT at some future time. It controls the Z axis distance. It is ground targeted

2.8.3 Generic NPC, or Plane Change

This is an out-of-plane MNVR which places the chaser into the phantom plane of the TGT. The phantom plane is the actual plane of the TGT offset by the amount of differential nodal regression calculated to occur between the MNVR and the desired inplane time. In addition, the MNVR must be located at a common node between the chaser and phantom TGT planes. If the future time to be inplane is not identified, the MNVR will place the chaser in the actual plane of the target at the time of the MNVR. This burn controls the Y axis distance. It is ground-targeted.

2.8.4 Generic NCC, or Corrective Combination

This is a Lambert-targeted MNVR to correct the chaser trajectory to achieve a desired offset position from the target. It controls all axes. This MNVR is a combination of three MNVR's: NC, NH, and NPC. It is ground targeted and also targeted onboard with Orbiter sensor data.

Note that in general it is very advantageous to combine orbit adjust burns and plane changes, since they are perpendicular to each other and the resulting burn is an RSS combination, which is usually much more economical than making each burn separately. However, this may not be possible if the maneuver is to be located at an orbit apsis and a common node.

2.8.5 Generic NSR, or Coelliptic

This is a MNVR targeted to put the chaser in an orbit coelliptic to the TGT. Coelliptic is defined as a condition where there are coincident lines of apsides and equal differential altitudes at both apogee and perigee. The "SR" of "NSR" once stood for "Slow Rate."

2.8.6 Generic Ti, or Transition Initiation (Ti)

This is a Lambert-targeted MNVR which places the chaser on an intercept trajectory with the TGT. It occurs several minutes before noon. It is targeted for 320° transfer, to achieve "hot" closing trajectory and maintain good lighting for manual braking and proximity operations. Do not confuse "Ti" with the "T1" designation used in orbit targeting; their similarity is an unfortunate coincidence.

2.8.7 Generic MC, or Midcourse

These are also Lambert-targeted maneuvers placing the chaser on an intercept trajectory. Each midcourse MNVR corrects minor dispersions using more and more accurate tracking data.

Note that in general, a midcourse will be made as it is realized that intercept will not occur. If it is farther than expected, the Orbiter must go faster, and this is done by entering a lower orbit, so the midcourse direction is downwards; if the target is closer than expected, the Orbiter must slow down by entering a higher orbit, and this is done by performing a midcourse correction upwards. Other requirements are second-order effects. Note that we are talking about only fractions of one complete revolution from the actual midcourse maneuver point until final intercept; in the long-term, such up and down burns do not, of course, alter the total orbital period, but they can and do alter the speed of the chaser along portions of each revolution.

2.8.8 Generic TF, or Transition Finalization

This is the second maneuver of the Lambert pair $T_i - TF$ (or MC-TF). This MNVR is designed to null the relative rates between the TGT and chaser at the intercept point. It is not a guided MNVR executed by the crew. However, the braking gates and the V-BAR stabilization burn cumulatively approximate a "TF burn." The term "TF" does not appear in the actual FDF.

2.9 TYPICAL RENDEZVOUS

The RNDZ is performed by making MNVR's and sensor passes.

2.9.1 Maneuvers

A typical RNDZ plan involves a series of maneuvers of the types described above. Figure 2-21 shows typical relative motion for a ground-up RNDZ profile. A typical on-orbit RNDZ profile can be seen in figures 4-1, 4-2, and 4-3.

The highest "humps" in the trajectory of the chaser represents the relative apogee between the TGT and chaser vehicles; if the TGT is in a circular orbit, this will also be the apogee of the chaser. The lowest "humps" in the trajectory of the chaser represent the relative perigee between the TGT and the chaser vehicles. If the TGT is in a circular orbit, this will also be the perigee of the chaser.

From peak to peak is one revolution (from relative apogee to relative apogee).

Phase angle and differential height (DH) are both noted on the figure.

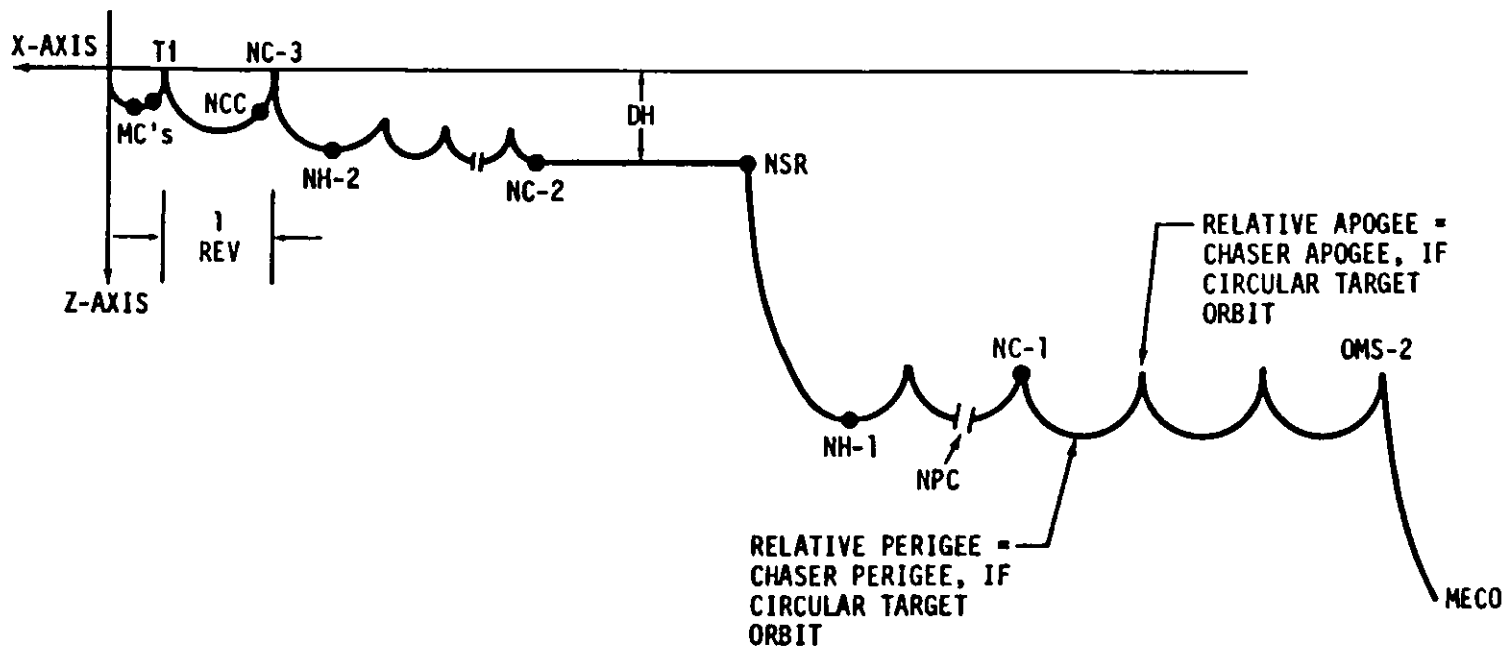

Figure 2-21.- Typical target centered relative motion (ground-up rendezvous).
Distance behind along X axis is proportional to PHASE ANGLE (θ).

2.9.1.1 The Actual NC Maneuver(s)

Most RNDZ plans will contain several NC MNVR's, the first one being OMS-2. Typically, the flight dynamics officer (FDO) will try to schedule at least one NC MNVR per flight day. The reason for multiple NC MNVR's is that they control the X axis (downtrack) distance; this is the direction that is affected most by attitude maneuvers, water dumps, mis-modeled drag, and propagation errors because of the secular effects. Radial and out-of-plane distances induce periodic (cyclic) motion.

The phasing profile has a great effect on the available launch window.

2.9.1.2 The Actual NH Maneuver(s)

Usually there is at least one NH maneuver in the RNDZ profile, that maneuver controlling the relative distance to the target altitude. Some profiles will contain multiple NH maneuvers, if there are intermediate altitudes that need to be achieved.

2.9.1.3 The Actual NSR Maneuver

There is usually only one NSR maneuver in the RNDZ profile, although there could be more. It is desirable to go coelliptic with the target so that future maneuvers may be initiated based on orbital lighting.

2.9.1.4 The Actual NPC Maneuver

There is typically one NPC maneuver in each RNDZ profile so that the Orbiter will be inplane with the TGT at the desired time. This applies mostly to ground up RNDZ plans, since its primary purpose is to remove ascent planar dispersions.

Other than being executed at a common node, placement of the NPC maneuver is completely arbitrary since it is designed to put the Orbiter inplane with the TGT vehicle at T_i .

2.9.1.5 The Actual NCC Maneuver

There is only one NCC maneuver which is targeted with the onboard computers after some sensor data has been obtained (it is also targeted on the ground). It occurs 225° (about one hour) before T_i , and aims for a point 48,600 feet (8 n. mi) trailing and 1,200 feet above the V-BAR, inplane with the TGT.

2.9.1.6 The Actual Ti Maneuver

There is only one Ti - TF combination to initiate transition to manual phase. It begins three minutes before orbital noon, at a time determined by the ground, and spans a 320° transfer to intercept. Current strategy places this burn near orbiter apogee.

2.9.1.7 The Actual Midcourse Maneuver(s)

There can be up to four midcourse maneuvers. MC1 is about 8 minutes before sunset; MC2 is at a 28.5° elevation angle to the target and is targeted with a 125' transfer to target intercept. *MC3,4 follow at 10 min intervals.*

2.9.1.8 The Actual TF Maneuver

This would theoretically occur about 10 minutes after MC4, but before that point, the final orbit-matching burns are made manually based on range rate and out-the-window LOS to target. A generic TF burn is not targeted or performed.

2.9.2 Out of Plane Control Theory and Practice

There will always be an initial planned planar separation between a chaser orbit and the target orbit. Propulsive burns are designed to reduce unplanned out-of-plane motion to zero at final approach. Some aspects of this strategy were described in passing in the previous sections, but this section addresses the issue directly and exclusively.

Section 3.5.7 discusses several aspects of using the ORB TGT function to assist in out-of-plane control on the day of rendezvous.

2.9.2.1 Initial Conditions

Between any two orbital planes there is a line of nodes which is defined by the intersection of those two planes. That line moves naturally due to orbital mechanics effects such as differential nodal regression, if the two orbits have different altitudes. Usually the chaser is in a lower orbit, and its strategy is to move into a phantom plane which itself will shift into the actual target plane due to these orbital mechanics effects. See figure 2-22.

Initial OOP dispersions are due mainly to ascent yaw steering for ground-up RNDZ's and to IMU alignment or maneuver trim errors on deploy/retrieval RNDZ's.

Reserved for Fig. 2-22

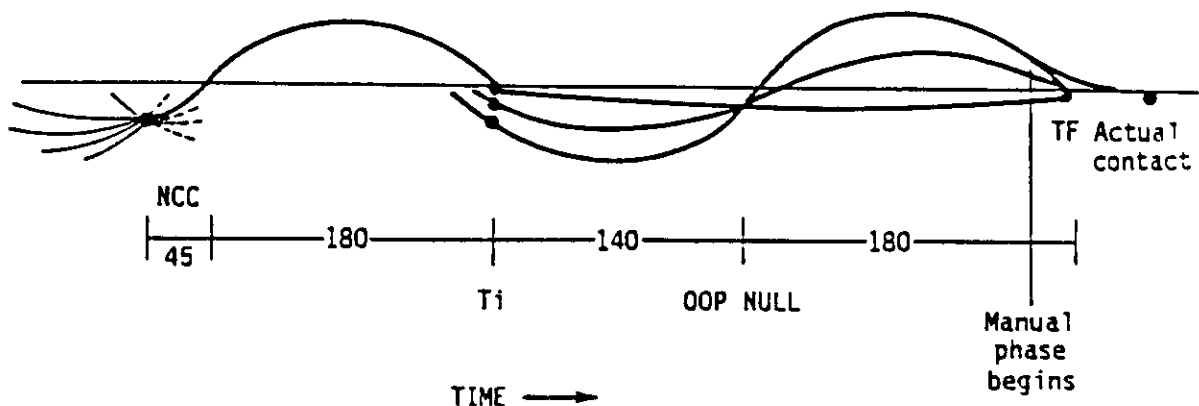

Figure 2-22.- Out-of-plane-motion.

2.9.2.2 Early burns

Long prior to the final rendezvous, an NPC burn (there can be more than one) occurs with the specific purpose of providing a zero Y and Y-DOT at T_i . To save propellant, designers (pre-flight) and flight controllers (real time) try to combine a portion of these NPC burns (with a pure Y component) with other maneuvers such as NC, NH, or NSR burns which nominally have no planar functions (and thus no Y components). The consequent RSSing of two such burns results in both being achieved for a delta-V substantially less than their linear sums.

2.9.2.3 NCC

NCC attempts to place T_i in plane to the best of NAV's knowledge: to place the T_i burn at node (T_i TIG is when the chaser crosses the target plane). This burn thus drives the chaser back through the orbit plane in about 11 minutes. See figure 2-22, which shows various approach trajectories to the NCC point versus a unique post-NCC trajectory.

2.9.2.4 T_i

If NCC is targeted and executed perfectly, T_i occurs in the target plane (i.e., at a node) and with perfect T_i targeting and execution the Orbiter remains inplane from then on. In the real world this usually doesn't happen (NCC is targeted and executed imperfectly, so T_i TIG occurs somewhat out of plane) and there will be further OOP motion. To set up the desired final

approach conditions, the next node must be set to a point 140° ahead, so final intercept ("TF") then occurs in plane after 320° ($140^\circ + 180^\circ$) of travel. This aim point, TF, is where the chaser would physically intercept the target if no manual braking burns occurred; it would occur at about MC4 + 10, with a relative velocity of about 5 ft/s, approaching relative apogee (but not yet there). Naturally, manual phase operations (e.g., braking gates) slow the final approach well before this point and thus significantly delay contact beyond this time. If there is any OOP motion at TF, it must be detected out the COAS or on RR angle rates, and nulled manually. Usually, however, the Orbiter and target are essentially coplanar by this point.

Because of NAV dispersions and NCC trims, Ti TIG usually occurs at some nonzero Y point (i.e., measurably off the target plane). In that case, to achieve the desired mode 320° (and also 140°) in the future the Ti Y component will push the chaser away from the target plane (it may already be headed away), and maximum separation will occur 50° (about 12 minutes) after Ti TIG. The size of this maximum separation is proportional to how far the Ti burn turned out to be out of plane (fig. 2-22 shows this effect).

Since MC1 is also targeted to the same node as Ti was, it does not significantly alter the subsequent nodes, if REL NAV supporting Ti and Ti trimming was very good.

2.9.2.5 OOP Null

The final node prior to TF occurs about halfway between MC1 and MC2 (nominally, MC1 + 13 minutes). At this point, relative navigation data displayed to the crew on SPEC 33 is used to perform the burn: first, the crew notes the actual in-plane time (Y becomes zero), and then the crew monitors the proper size of their manual RCS burns made to prevent further out-of-plane swings (Y-DOT is driven to zero). The burn can be made over a span of several minutes without seriously impacting the out-of-plane situation.

If this burn is not performed properly, the same Y-DOT can and must be manually removed half a REV (45 minutes) later, post-MC4, with the crew in the manual phase (nominally, RR data allows NAV to produce reliable Y and Y-DOT values, and the target can also be viewed out the COAS). This correction can also be facilitated by knowledge of the former Y-DOT at the missed OOP point or by nulling OOP rates as soon as possible after the nominally scheduled time.

Procedural matters for executing this burn are discussed in section 4.1.54 (and fig. 4-14).

2.9.2.6 Proximity Operations

For final approach, and for stationkeeping, plane control is an entirely manual function based on visual/RR LOS motion. The crew should have the OOP situation under control by V-BAR arrival, and certainly by the time DAP LOW Z is entered. The best method is to use small THC pulses to start the target moving toward the center of the COAS and then, as it crosses the centerline, input an equal number of pulses in the opposite direction to stop the motion.

Any remaining Y-DOT is of sufficiently small scale that it causes essentially no orbital mechanics effects (the short time scale of PROX OPS maneuvering also induces this) and therefore "OOP" (any Y components of relative position) now can be handled as pure inertial relative motion and corrected directly as detected.

2.9.3 Typical Sensor Passes

Prior to the first acquisition on by on-board sensors, all information on the Orbiter-target relative state is computed (both on the ground and on-board) from separate inertial Orbiter and target SV's produced by ground tracking; the onboard SV's are uplinked from the MCC (the target SV is not used on board until entry into RNDZ NAV). To facilitate accurate ground NAV (and hence the best possible SV's), there can be periods when some Orbiter activities may be restricted to the extent of avoiding propulsive activities such as vents, excessive attitude maneuvering, and water dumps.

The strategy of onboard sensor passes is to progress to successively more precise knowledge of the Orbiter-target relative state by use of a sequence of sensors and appropriate navigation software (see fig. 2-23).

Note that sensor data history (when and if data was acquired and how many marks were received) is one of the two criteria for when to abort the RNDZ (see section 4.4); propellant is the other criteria.

2.9.3.1 First On-board Acquisition

Prior to NCC, 2 sensor passes are desired (typically star tracker) to support the first onboard targeted MNVR, NCC. These sensor data reduce errors in the relative state caused by ground tracking inaccuracies, maneuver trim errors, translational cross-coupling, and trajectory dispersions.

The fault-down philosophy for these sensor passes is:

- -Z Star tracker
- -Y Star tracker
- COAS

2.9.3.2 Radar Acquisition

Between corrective combination MNVR (NCC) and Ti, RNDZ radar data is available to support the Ti computation. There is no fault-down during this time period because the Orbiter is between sunrise and noon, looking toward the Sun.

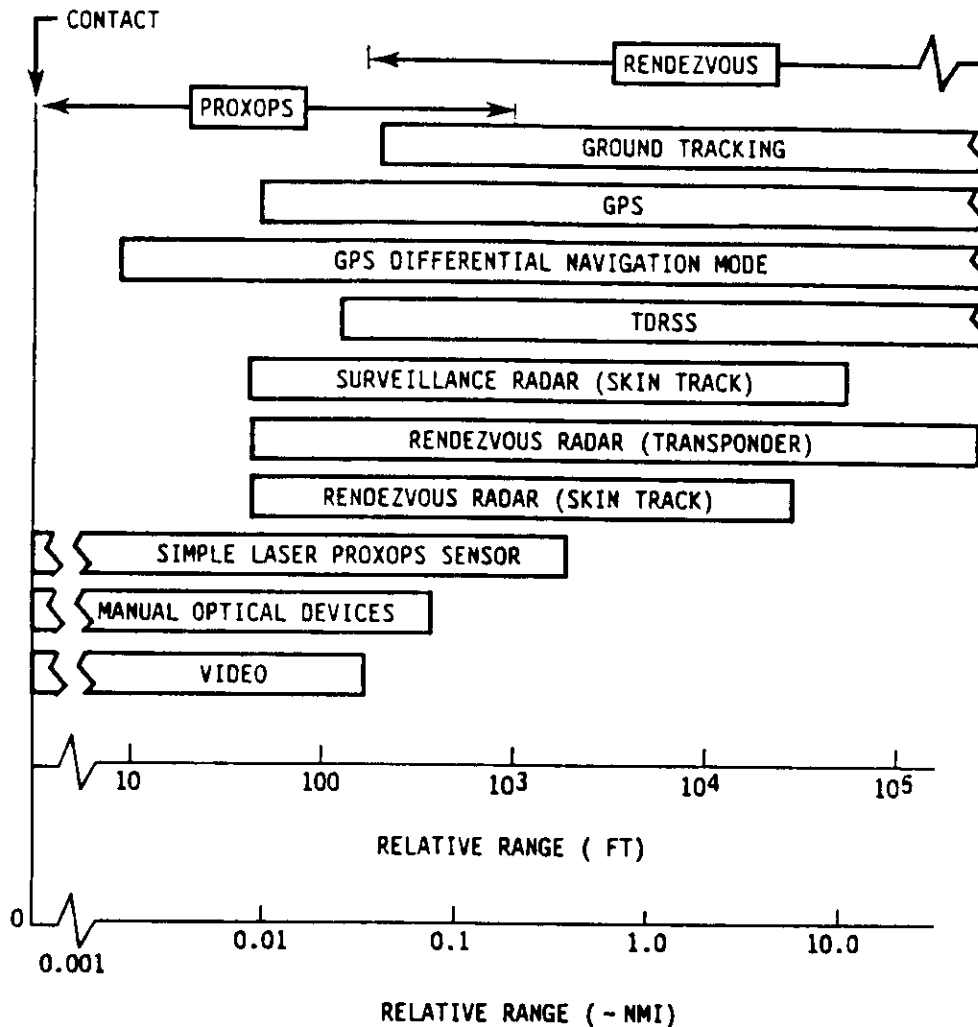

Figure 2-23.- Spectrum of rendezvous sensors.

10589*004

2.9.3.3 Final Sensor Acquisitions

After Ti, as much sensor data as possible is desired to support the midcourse corrections. The general fault-down philosophy is:

- Rendezvous radar
- -Z star tracker
- -Y star tracker
- COAS

2.10 Pre-Day-of-Rendezvous Navigation

An appreciation of the impact of pre-day-of-rendezvous ground tracking on support of the initial conditions on rendezvous day (in particular, state vectors) can be useful in understanding certain constraints on the timeline. This afterthought is meant to complete this handbook's discussion of RNDZ NAV issues.

Generic NAV accuracies and rendezvous tracking requirements are defined in NSTS 07700, VOL XIV, Appendix 6. These are considered to be very conservative. Mission-specific analyses always are performed for rendezvous flight design. Specific target-related tracking requirements will be in specific PIP's. Detailed ground procedures and NAV-related information can be found in "ON-ORBIT GROUND NAVIGATION CONSOLE HANDBOOK", JSC IN # 20768, and in the "FDO CONSOLE HANDBOOK", from which the following treatment is adapted.

The philosophy for rendezvous is to go into any maneuver or targeting phase with the best possible state vector, especially as the day of rendezvous approaches. Every additional tracking site provides more data to update the ground's knowledge, and will be utilized even if it is the first station after a maneuver. Phasing between the chaser and the target is the hardest dynamic process to control, and this requires precise knowledge of the object's semimajor axis (and hence its period). That element must be periodically determined (requiring several REV's of quiet tracking) and then adjusted as needed with an NC burn.

Although there is no single pre-defined tracking arc for a rendezvous profile, the FDO's will be trying to have fresh Orbiter and TGT SV's prior to the preliminary maneuvers plan. The TGT SV tends to change very little with time (typically there are no attitude maneuvers, vents, etc.), so a SV which is several REV's old is still considered adequate for computations. But the quality of the Orbiter SV can depend on particular on-orbit crew activities.

The main unmodeled perturbations on the Orbiter's trajectory are attitude maneuvers. It is thus desirable to minimize them on the evening before rendezvous day, after that day's NC phasing burn. This means eliminating standard IMU alignments (which require an attitude maneuver that cross-couples into unwanted translation). IMU alignments can be accomplished instead by taking stars of opportunity during the sleep period with the Orbiter nose in a north or south orientation.

Water dumps introduce small impulses, so they cannot be permitted prior to critical maneuvers unless the induced SV errors can be tracked out before the maneuver computation. The effects of water dumps on Orbiter trajectory have not been predictable. An alternate procedure is to run the flash evaporator (FES), which has very little effect on trajectory.

By observing these constraints, the Orbiter will hit the desired offset on rendezvous morning for the last NC burn before T_i , and the FDO won't get any trajectory surprises. Following several more periods of intensive ground tracking of both vehicles, the Orbiter itself will begin on-board tracking of the target (see section 2.9).

SECTION 3
TOOLS FOR RENDEZVOUS

Performance of orbital RNDZ and PROX OPS is enabled by numerous hardware and software tools on the Orbiter. This section is a summary of their capabilities and basic operational characteristics relevant to RNDZ and PROX OPS usage. Discussion is intended to be more detailed than in other available literature, but also more narrowly focused. Subsequent sections will discuss specific applications of these tools to real RNDZ and PROX OPS profiles.

The material in this section, both tool descriptions and general procedures for use of those tools, can be considered "subroutines" for sections 4 and 5, which consist of specific procedures rationale narratives for RNDZ operations (section 4) and PROX OPS (section 5).

3.1 ATTITUDE DETERMINATION/CONTROL

For determination and control of Orbiter attitude, the crew uses the OPS 201 display (Universal Pointing), along with the attitude direction indicator (ADI) and the hand controllers.

3.1.1 Universal Pointing (UNIV PTG, or UP) (OPS 201)

UNIV PTG (fig. 3-1) is the MM 201 display and provides the crew with four mutually-exclusive options for automatic (AUTO) attitude control with respect to the forward (+X) ADI reference frame. Three options are universal

2011/ /	UNIV PTG	XX X	DDD/HH:MM:SS
CUR MNVR COMPL XX:XX:XX			DDD/HH:MM:SS
1 START TIME XXX/XX:XX:XX			
		CUR	FUT
MNVR OPTION	START	MNVR	18 X X
5 R XXX.XX		TRK	19 X X
6 P XXX.XX		ROT	20 X X
7 Y XXX.XX		CNCL	21
TRK/ROT OPTIONS	ATT MON		
8 TGT ID XXX	22 MON AXIS X XX		
	ERR TOT 23X		
	ERR DAP 24X		
9 RA XXX.XXX		ROLL	PITCH
10 DEC ±XX.XXX		CUR	XXX.XX XXX.XX XXX.XX
11 LAT ±XX.XXX		REQD	XXX.XX XXX.XX XXX.XX
12 LON ±XXX.XXX		ERR	±XXX.XX ±XXX.XX ±XXX.XX
13 ALT ±XXXXX.X		RATE	±XX.XXX ±XX.XXX ±XX.XXX
14 BODY VECT X			
15 P XXX.XX			
16 Y XXX.XX			
17 OM XXX.XX			

(XX)

Figure 3-1.- The UNIV PTG (OPS 201) display.

in that they are defined by data inputs made by the crew. The other option is a cancel option that holds the inertial attitude that is current at the time the option is selected. It terminates any other current or future AUTO option. These options are accomplished automatically only if the digital autopilot (DAP) is in AUTO.

The first option is the maneuver (MNVR) option. It allows the crew to maneuver the Orbiter to a specified inertial attitude at a specified start time.

The second option is the tracking (TRK) option. It allows the crew to orient the Orbiter to point a specified body vector at another orbiting vehicle, an Earth target, center of Earth (for local vertical local horizontal (LVLH) hold), center of Sun, or a celestial target (specified coordinates or target navigation star number) at a specified start time.

The third option is the rotation (ROT) option. It allows the crew to rotate (always clockwise) the Orbiter inertially about a specified body vector at the DAP selected rate, beginning at a specified start time.

The fourth option is the cancel (CNCL) option. It allows the crew to deselect any other option and hold attitude automatically about the existing inertial attitude at the time the cancel option is selected.

Also provided is the capability to monitor vehicle attitude parameters in roll, pitch, and yaw body coordinates.

3.1.1.1 Options

For detailed explanation of the general capabilities of UNIV PTG, see the Attitude/Pointing Flight Procedures Handbook (JSC-10511). The following discussion is concentrated on the specific use of UP in RNDZ and PROX OPS.

- a. CUR MNVR COMPL - The current maneuver completion (CUR MNVR COMPL) time is shown in hrs:mins:secs when a maneuver (MNVR or TRK) is in progress until the attitude is within 1° of desired, at which time it is frozen. The time is also frozen if a maneuver is in progress and the DAP LVLH mode is selected. Time is reset to zero if a maneuver is in progress and CANCEL is selected. The completion time remains unchanged if a maneuver is not in progress and the DAP MAN or LVLH, or ROT option, or CANCEL is selected.
- b. START TIME (items 1 through 4) is designated in days/hrs:mins:secs mission elapsed time (MET) for the selected control option. Display is initialized with the time at zero.
- c. TRK/ROT OPTIONS - Item 8 selects the TGT identification for the TRK option. "Orbiting Vehicle" is ID number 1 and center of Earth is number 2; the LOS is determined from the SV's of the Orbiter and the TGT vehicle. Item 14 selects the body vector (BODY VECT) which is pointed

along the LOS for the TRK options. The BODY VECT identifiers are as follows:

- 1 is +X ;
- 2 is -X ;
- 3 is -Z ;
- 4 is PTC (passive thermal control), about 2° below +X;
- 5 is Selectable, using items 15 and 16 to define the BODY VECTOR. (P and Y must be positive.)

NOTE: In practice +X is used for PTC ROT's, instead of PTC axis.

Any attempt to load other identifiers will result in an illegal entry message. The identifier will be initially loaded with 1 (one).

Item 17 selects the omicron angle desired for the TRK option. With this item, the user can specify the attitude orientation of the Orbiter about the selected body pointing vector used in the TRK attitude option. A precise definition of "omicron" is found in the Attitude/Pointing Flight Procedures Handbook.

The omicron item is blanked when a new TGT ID is entered. If the item is still blank when the TRK attitude option (item 19) is selected, two-axis TRK will be implemented. In this mode, the Orbiter-selected body-pointing vector is aligned with the TGT LOS with a minimum attitude change in which the maneuver transfer angle (often called "eigenangle") is minimized. This means that the Orbiter will track the TGT with the specified TRK body vector, but that the Orbiter orientation about that body pointing vector (omicron) will not be fixed. Instead, it will vary such that the total required rotation is minimized. If an omicron-angle restraint is input in item 17 and the TRK option is selected, three-axis TRK will be used. In this mode, both the pointing requirement and the omicron-angle constraint are imposed in making computations.

If omicron is not blank, entering a body vector ID in item 14 initiates the flashing of omicron. The flashing is terminated when a value of omicron is entered or when an attitude option is selected.

The allowable range for omicron is 0° to 359.99°. User input outside this range results in an ILLEGAL ENTRY message. The value of omicron is initialized to zero, and three-axis TRK is selected.

- d. START MNVR, TRK, ROT (items 18, 19, 20) provide selection of the MNVR, TRK, or ROT control option. Initiation of a control option depends on the START TIME entered in items 1 through 4. If the START TIME is zero, current (CUR), or in the past and DAP is AUTO, the control option is initiated upon selection, a "*" appears in the CUR column next to the selected option, and any other option is deselected (no "*"). If the START TIME is in the future, the selected control option is initiated at that time and in the interim a "*" appears in the future (FUT) column

next to the selected option. The selected option in progress ("*" in the CUR column) drives the REQD attitude, ERR, and the ADI error needles.

Control option initiation must be preceded by DAP AUTO. If a future start time is within 30 seconds of current time and AUTO has not been selected, a class 3 alert and "SEL AUTO" message is generated. Data may be entered for a single future control option during execution of the current option.

When the START TIME entered for the future option equals current time, the "*" in the FUT column is blanked and "*" displayed in CUR column. If the previous control option is active, it is deselected (no "*"). If a future option has been selected and then data are changed prior to the future start time via keyboard inputs, the future option will be deselected (no "*"), and CANCEL (CNCL) will be automatically selected. The crew must repeat selection of the desired future option.

The three control options are terminated/inhibited by: (a) selection of MNVR (item 27) on the MM 202 ORBIT MNVR EXEC display (which maneuvers to the specified burn attitude); (b) selection of LVLH or MAN pushbutton (pb); (c) moving an RHC out of detent; (d) selection of the CANCEL option, or (e) OMS/RCS ignition. Providing that CANCEL has not been executed, a control option is reinitiated by: (a) exiting MM 202 (ORBIT MNVR EXEC) back to MM 201 (which is the only legal transition) or (b) selecting the AUTO DAP pb.

- e. CANCEL (item 21) deselects both current and future control options and initiates inertial attitude hold at the current attitude. The display is initialized with item 21 selected. When in DAP AUTO and CNCL is selected, attitude errors are displayed with respect to the current attitude when the CNCL option was executed. This attitude reference is maintained in a subsequent selection of a MAN MNVR and return to AUTO DAP. Reselection of the CNCL option zeroes these attitude errors. Then errors are displayed with respect to the current attitude regardless of DAP configuration.

Even in MM 202, selecting LVLH on the orbital DAP control panel reinitiates the LVLH processing done by UNIV PTG processor, but does not reinitiate any other AUTO MNVR mode.

After a transition from MM 201 to MM 202 or OPS 8 and a subsequent transition back to MM 201, the item select status that existed prior to cancellation is shown on the UNIV PTG display. The UNIV PTG display is initialized only when OPS 2 is entered from an OPS other than OPS 8.

Selecting the LVLH attitude mode via pushbutton inhibits the cyclic processing of the selected AUTO attitude option (item 18-20) until the LVLH attitude mode is deselected.

3.1.1.2 Attitude Monitor

Select ERR TOT (Item 23) or ERR DAP (Item 24) at crew option. DAP errors show effects of attitude deadbanding (ATT DB), and allow crew to anticipate RCS firings to maintain attitude; TOT errors allow monitoring how far the Orbiter is out of a desired attitude (e.g., a track attitude, such as used to maintain V-BAR). When the ADI error needles are displaying TOTAL ERROR, they display DAP ERROR by simply selecting ITEM 24 on UNIV PTG. No cycling of the DAP is required to make the ITEM 24 take effect.

3.1.1.3 Enhanced Universal Pointing

For software release OI 12 with the new general purpose computers (GPC's), there will be a major upgrade of UP/DAP capabilities. Their applications to RNDZ are as yet undefined, but are likely to be extensive. The following description is intended for future users so they will have a proper understanding of Orbiter capabilities after the UP/DAP modification. Closer to the operational date of this new capability, this entire section will be replaced with a new section.

The UP upgrade is via CR 79879. It is a companion to CR 79862.

In the upgraded UP, up to 25 future AUTO MNVR's will be contained in a "maneuver table" (each entry can be loaded, edited, or canceled). Each maneuver will have its own ID number, start time, and DAP/jet selection (currently only a single "future option" can be stored, and DAP/jet select can be made from pb's only for the maneuver (designated "MNVR"). A second DAP load and jet selection are entered in the maneuver definition to specify the configuration to be used when the the desired attitude has been reached or tracking hold has been established (designated "HOLD"). For the ROT option, which never "ends," no such entry is made. If a current maneuver is canceled, the DAP/jet select reverts to those last loaded prior to the beginning of that current maneuver.

The future maneuver stack can be enabled or inhibited by item entry. As entries are made/edited in this table, it is automatically put in chronological order. In another upgrade, DAP's can be called up by number (e.g., DAP "ALL") rather than making individual entries on SPEC 20. These future AUTO maneuver's will be loadable by I-load (activated upon entry into OPS 2 from any legal OPS except OPS 8), uplink, as well as by keyboard (at present, only keyboard loads are possible); they can be downlisted (one maneuver per UP cycle) for verification.

Once a maneuver becomes "current", it can only be manipulated in certain restricted ways. It can only be canceled by crew input, not by uplink.

Another major upgrade involves maneuver options. A "tracking/rotation" (TRK/ROT) option is added, which allows rotation (at a constant rate) to be performed about the pointing vector during TRK operations. LVLH reference frame becomes available (in addition to inertial frame as currently) for output angles (attitude and attitude error and rates) and for attitude/

rotation maneuvers. That is, rotation about a body axis in LVLH frame will be possible. Lastly, rotation direction (now always clockwise (CW)) becomes selectable, CW or counterclockwise (CCW).

A new OPS 201 display has been designed to allow control and monitoring of these new capabilities. The current maneuver (if any) and the next 11 maneuvers (if any) from the table are displayed. New messages have been created to alert crew if a new maneuver is loaded into the table whose start time is in conflict with an existing maneuver. When a maneuver is within 30 seconds of beginning, but the crew has not enabled the AUTO processing by selecting DAP AUTO, the message "SEL AUTO" will appear on the message line.

The data defining each maneuver is similar to the data defining the current single future maneuver. To illustrate this, the following list of parameters in the 25-deep maneuver table is given:

- | | | |
|-----|------------|---|
| 1. | GMTS | Maneuver start time in GMT, dd/hh/mm/ss |
| 2. | LC_FLAG | Load/cancel flag (1 = loaded, 0 = cancelled) |
| 3. | UL_FLAG | Maneuver uplink flag (1 = loaded, 0 = cancelled) |
| 4. | M_DAP | Maneuver DAPLOAD (1-15 = A1-A15, 16-30 = B1-15) |
| 5. | H_DAP | Hold DAPLOAD (same as 4) |
| 6. | M_JETS | Maneuver jet selection (1 = primary, 0 = vernier) |
| 7. | H_JETS | Hold jet selection (1 = primary, 0 = vernier) |
| 8. | OPT_FUT | maneuver type (1 = att, 2 = TRK, 3 = ROT) |
| 9. | FRAME | If #8 = 1 or 3, Frame Indicator (1 = inertial, 0 = LVLH) |
| | THREE AXIS | If #8 = 2, Three axis TRK flag (1 = 3 axis, 0 = 2 axis) |
| 10. | OMICRON | Only if #8 = 2 (TRK) and #9 = 1 (3 axis), Omicron angle for 3-axis TRK MNVR, degrees
" + " = CW, " - " = CCW |
| 11. | TGT_ID | Target ID for track (#8 must be 2) |
| 12. | BODV-ID | Body Vector ID (#8 must be 2 or 3) |
| 13. | TGT_RA | If #8 = 2 and #11 = 5, MED, star right ascension, deg |
| | TGT_LON | 3, MED, surface target longitude, deg |
| 14. | TGT_DEC | If #8 = 2 and #11 = 5, MED, star declination, deg |
| | TGT_ALT | 3, MED, surface target altitude, NM |
| 15. | TGT_LAT | If #8 = 2 and #11 = 3, MED, surface target latitude, deg |
| | ROLL1 | If #8 = 1, roll euler angle (frame is given in #9) |
| 16. | PITCH1 | If #8 = 1, pitch euler angle (frame is given in #9) |
| | PITCH | If #8 = 2 or 3 and #12 = 5,
body vector pitch euler angle for MED input, deg |
| 17. | YAW1 | If #8 = 1, yaw euler angle (frame is given in #9) |
| | YAW | If #8 = 2 or 3 and #12 = 5,
body vector yaw euler angle for MED input, deg |

The individual keystrokes on the new OPS 201 display will be defined in detail in a future edition of this ~~target~~ handbook.

3.1.2 Rotational Hand Controller and Translational Hand Controller

The rotational hand controller (RHC) and THC (aft station, panels A7U and A8) are used to provide input commands to the DAP, which then (depending on DAP configuration) outputs appropriate RCS jet fire commands. The THC outputs single commands when deflected; the RHC has a soft stop and hard stop feature that outputs separate signals which can be interpreted differently depending on DAP mode (fig. 3-2).

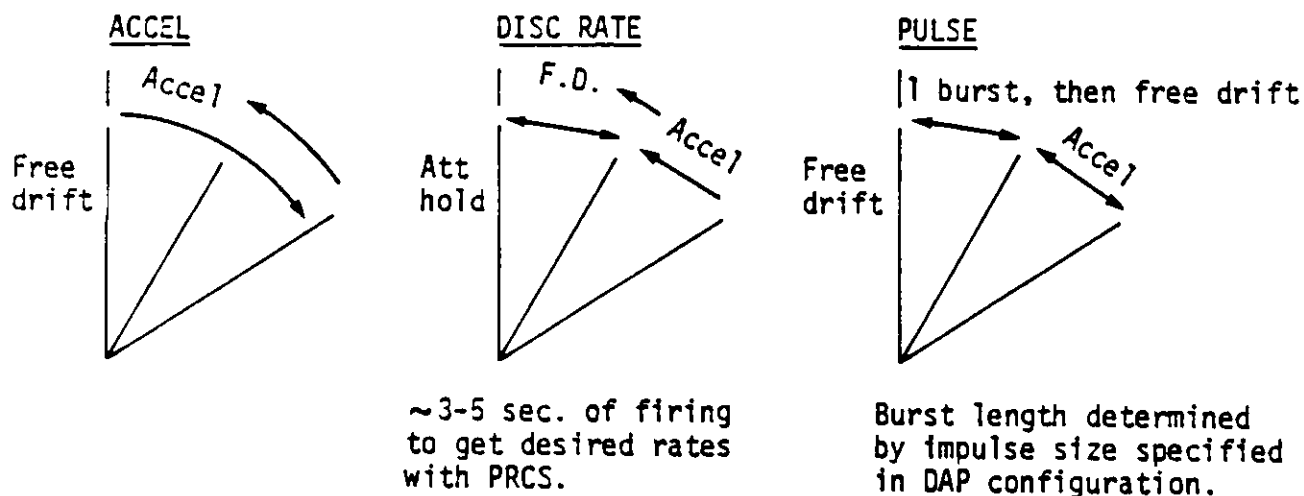

Figure 3-2.- RHC soft/hard stop logic.
F.D. is FREE DRIFT

Detailed descriptions of the functioning of the RHC and THC can be found in the Attitude/Pointing Flight Procedures Handbook and the Controllers Workbook.

Visualizing THC/RHC control modes in the two aft sense options can be facilitated by imagining an Orbiter being grasped by the hand on the RHC/THC, where the gross deflections of the RHC/THC are duplicated in same-sense motions of the actual Orbiter. The "sense" is down the crewmember's arm: -X has the Orbiter tail pointing down the arm and its top up; -Z has the Orbiter top pointing down the arm with its nose up. This is directly analogous to the forward RHC/THC +X sense mode.

3.1.3 SENSE Switch Options

The SENSE switch (panel A6U) allows the RHC and THC to command relative to the current control axis, either -X or -Z depending on whether the crewmember (at the aft crew station) is viewing through the payload bay PLB windows or the overhead windows (fig. 3-3). The vehicle motions induced by RHC and THC deflections are relative to the desired control axis as selected by the SENSE switch position (figs. 3-4A and 3-4B).

For RNDZ/PROX OPS applications, the proper setting of this switch is -Z. This is true especially for post-Ti through grapple, and for separation as well. The crew may also select this at any other time. The only proper use of -X sense is as a backup to the forward THC for translation, particularly for burn completion.

or in extreme cases to maintain ^{+Z} redundancy against multiple THC contact failures.

3.1.4 See page 3-12

3.1.5 "FWD Tank Constraint" issues [written 5/18/1988]

A significant consideration in Orbiter attitude control is the DAP implementation of old constraints on the maximum number of forward RCS jets which can fire simultaneously. Too high a number was once thought to create the possibility of helium ingestion in the FRCS tanks, so a high limit of 3 FRCS jets was apparently implemented in FSW. Later, flight experience and hardware analysis relaxed this concern, and so CR 69781 was approved to remove this constraint. However, this limit's implementation in FSW and in simulators was clouded in the return-to-flight era (1987-1988) since proper paper trails could not be followed. Close coordination with DM43 specialists is required for an up-to-date appreciation of the real status of this issue. Analysis of FSW code was incomplete as of publication date.

Impact on proximity operations procedures (particularly separation sequences from large payloads) can be significant and surprising. For example, while in low Z mode (NORM-NORM-NORM) a prolonged -Z translation (2 +X jets and 2 -X jets) can create a pitch down which soon exceeds the deadband and thus commands a pitch up using two forward down-firing jets. To satisfy the constraint, the DAP cuts off one of the -X jets for the duration of this pitch up firing (several seconds), but leaves the two +X jets on, causing an X-axis imbalance and a consequent +X small translation. So instead of a nearly pure -Z translation (as commanded) this THC input results in a departure vector tilted forward about 30 degrees, possibly leading to RMS/PL contact. NOTE: Performing such a separation in PULSE mode avoids this difficulty.

should this be +Z?

AFT STATION CONTROL

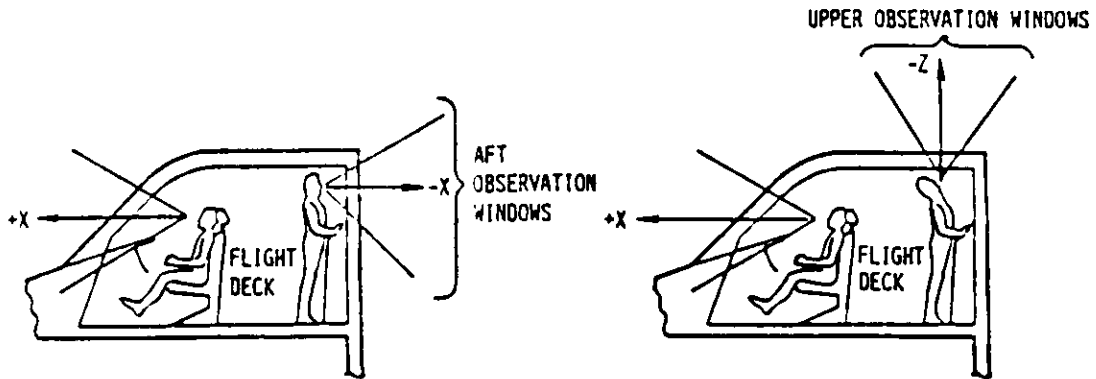

- TWO SETS OF WINDOWS-AFT (-X) AND OVERHEAD (-Z)
- ONE SET OF AFT STATION CONTROLS (RHC & THC)
- MUST ESTABLISH A VISUAL CONTROL REFERENCE BASED ON THE LINE OF SIGHT
- DONE WITH THE AFT SENSE SWITCH

AFT SENSE SWITCH

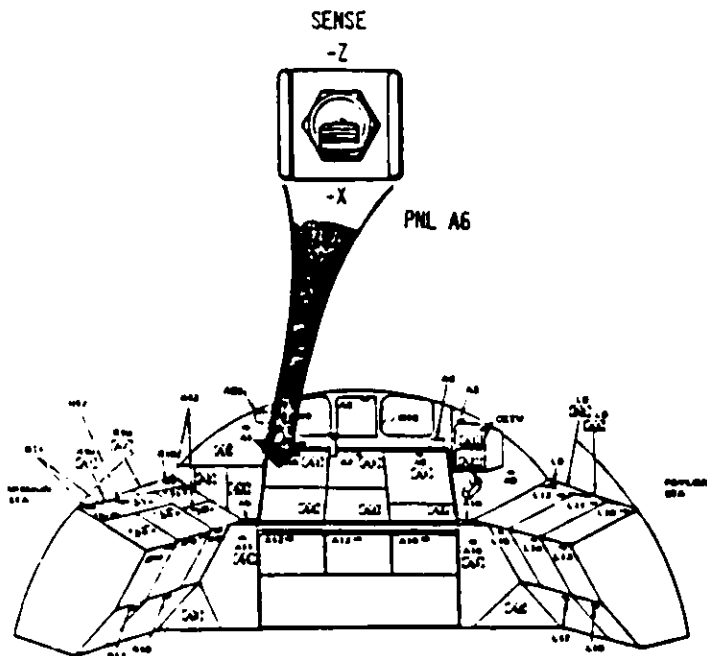

-Z SELECTS THE CONTROLLER & ADI REFERENCE ABOUT THE -Z AXIS, IE, OVERHEAD LINE-OF-SIGHT REFERENCE.

-X SELECTS THE CONTROLLER & ADI REFERENCE ABOUT THE -X AXIS, IE, AFT LINE-OF-SIGHT REFERENCE.

AFT STATION

Figure 3-3.- Aft station control, sense switch.

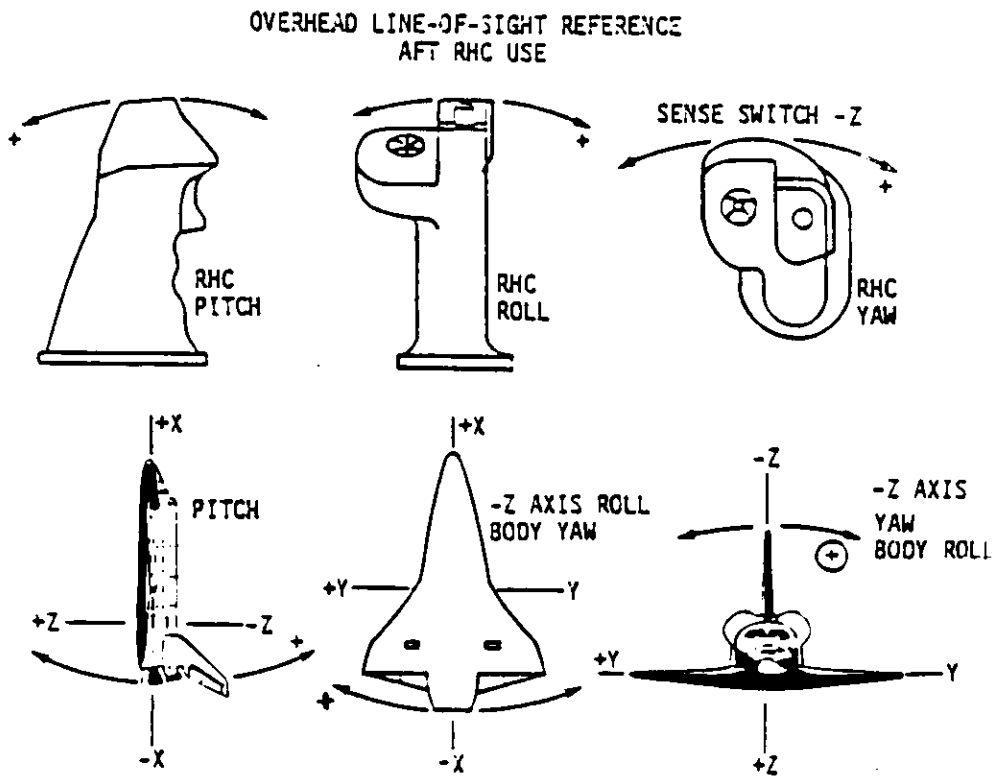
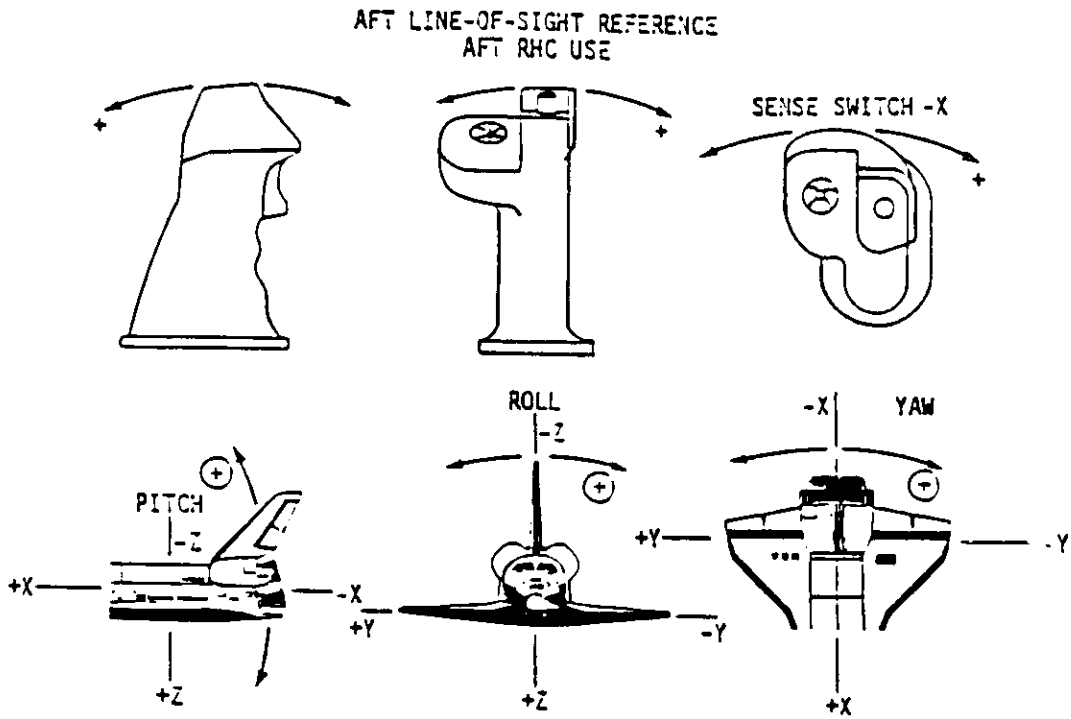

Figure 3-4A.- Aft and overhead line-of sight references, aft RHC use.

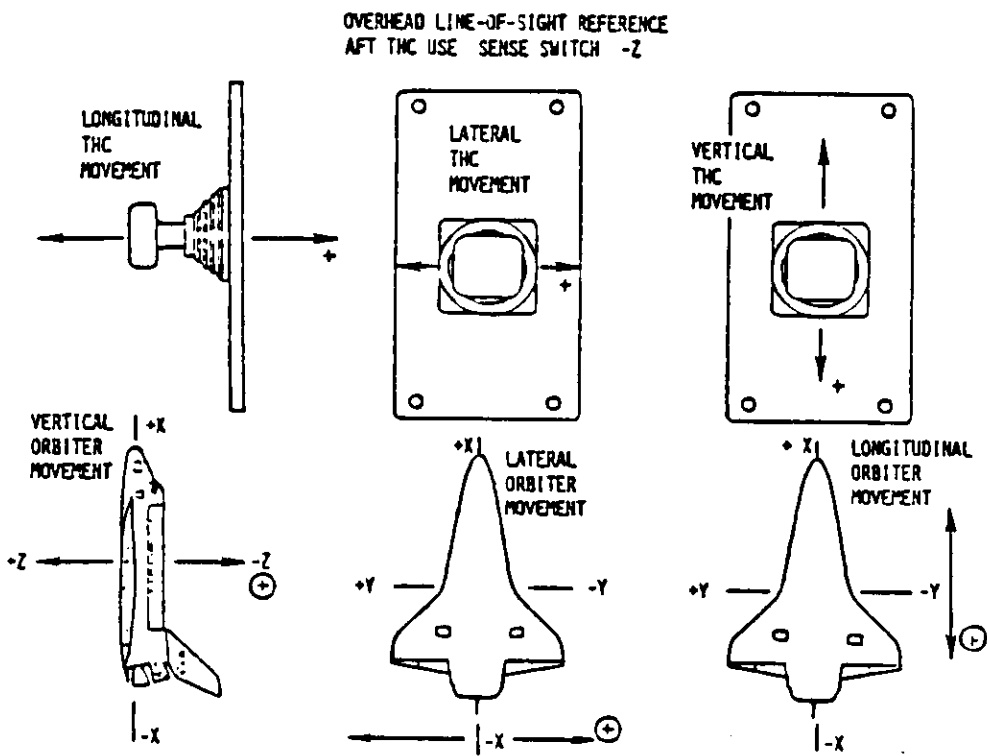
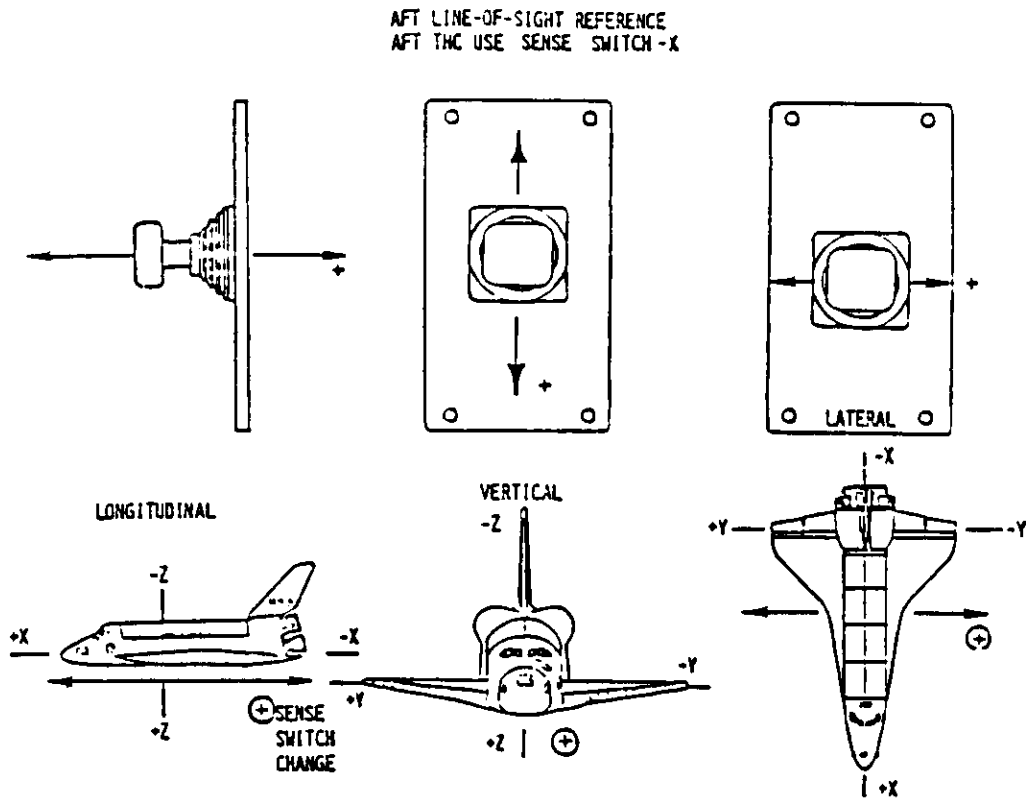

Figure 3-4B.- Aft and overhead line-of sight references, aft THC use.

3.1.4 Attitude Direction Indicator (ADI)

The ADI is a crew-observed hardware instrument that provides indications of the Orbiter pitch, yaw, and roll attitude via a gimballed ball (fig. 3-5).

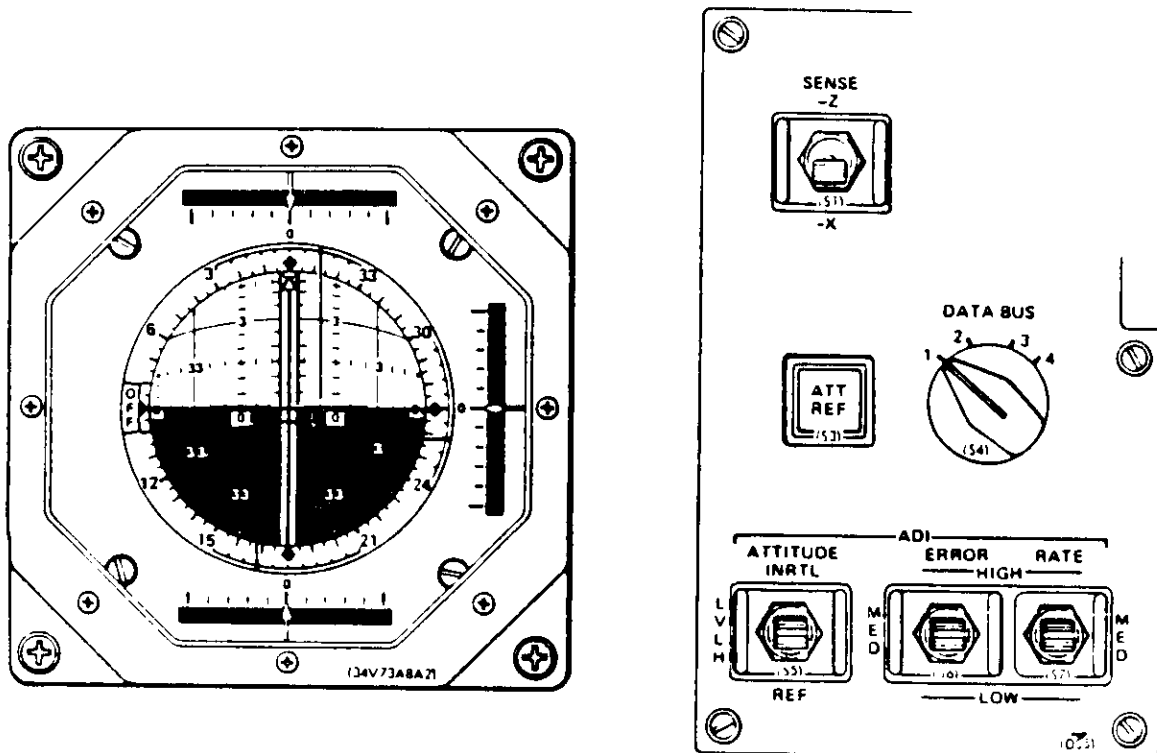

Figure 3-5.- Aft station ADI displays and controls.

Attitude errors are shown by three metered position needles; attitude rates are indicated by three metered position pointers. Top is roll, right side is pitch, bottom is yaw. The scale for each of the three ADI's is controlled by the ADI scale switches; the aft switch is on panel A6U. Each ADI can be set to an error level of high, medium, or low (10, 5, or 1, with the units "degrees" (error) or "deg/s" (error rate)); RNDZ procedures call for selection of "MED." When change from AUTO to MAN is made on the DAP, the ADI error needles will reflect the desired tracking or MNVR attitude loaded on UNIV PTG. See section 3.1.1.2 for the effect of ERR TOT/DAP selection.

The ADI error needles change when the DAP is moded to LVLH. The error needles go to zero. When the LVLH pushbutton is pressed, the current Orbiter attitude is defined as the reference LVLH ADI attitude, making the attitude error zero.

The ADI attitude switch selects the ADI reference frame desired for display on the ADI. The switch selections are INRTL, LVLH, and REF. The INRTL and REF reference frames are defined by I-loaded RELMAT's (inertial system is M50). The crew can also set up their present attitude as the REF reference frame for future reference by pressing the ATT REF pb on panel A6U.

The SENSE switch allows the aft ADI angles to indicate the orientation of either a -X sense axis system or a -Z sense axis system depending on whether the crewmember is viewing through the payload bay (-X) windows or the overhead (-Z) window. These sense-axis systems (-X, -Z) are fixed in the body, and the ADI displays the pitch, yaw, and roll of the sense system axes with respect to the ADI reference frame as defined by the RELMAT. More details on the use of the SENSE switch are in section 3.1.3.

A more detailed discussion of the ADI can be found in the Attitude/Pointing Flight Procedures Handbook.

3.2 DIGITAL AUTO PILOT (DAP)

The Orbiter DAP is controlled by the crew via the DAP CONFIG (SPEC 20) display and the DAP pushbuttons. Different values of attitude/rate deadbands (DB's) and translation/rotation pulse sizes are selected during different mission phases in order to best accommodate the often-conflicting requirements for MNVR timelines, pointing accuracy, and propellant economy.

In practical terms for this application, the major differences between DAP A and DAP B are pulse size for the PROX OPS DAP's and pulse plus rotation maneuver size in the RNDZ DAP's. While in the RNDZ DAP's, when DAP B is called for, it is because a higher maneuver rate is required. That is, DAP A will be used for attitude control with vernier jets and DAP B will be used for attitude maneuver with normal jets. DAP A also has a translational pulse size that is twice as large as DAP B.

3.2.1 DAP Management

The first requirement for RNDZ-specific DAP values is to minimize differences between the standard A1/B1 values and the values for RNDZ (called A9/B6) and for PROX OPS (called A10/B7). Specific differences are justified by phase-unique and payload-unique features (e.g., see section 4.1.66)

For translation pulse, DAP A is traditionally larger than DAP B. For RNDZ, they are 0.1 and 0.05 ft/s; for PROX OPS, they are 0.05 and 0.01 ft/s (the 0.01 value results in the smallest possible pulse size, 80 milliseconds).

For rotation during RNDZ, there is the need for occasional fast maneuvers. The DAP B has a 0.5 deg/s NORM discrete rate. During PROX OPS and most attitude maneuvers during the RNDZ, a slow rotation rate (0.2 deg/s) is used for both DAP's A and B, both NORM and VERN. Occasionally there is a need to maneuver at the higher 0.5 deg/s rate (e.g., post-Ti if radar fails, the crew needs to get back to -Z target track fast to get STRK NAV marks).

For DB's, the large values for A1/B1 are reduced to values which have proven suitable in flight and in ground simulations. For RNDZ and PROX OPS, the values are 2° (NORM) and 1° (VERN) for both DAP's A and B (the standard values are 5/1 and 3/1). The values of these DAP's are shown in figure 3-6.

During the RNDZ, in general DAP A is selected. DAP B is used for higher rotational precision (such as during COAS marks), finer translational control (V-BAR approach), or higher attitude rates (such as during maneuver to/from Ti burn attitude). Jet selection is nominally VERN, with NORM for translation or 0.5 deg/s maneuvers; AUTO is nominally selected, to allow UP control for TGT track or for maneuvering to attitude; MAN is selected to execute burns or for INRTL ATT hold; LVLH is seldom used.

During the PROX OPS phase, in general DAP B is selected for stable periods or where fine translational control is required. DAP A is selected during dynamic operations because of the greater control authority defined by RCS pulse/discrete values. The VERN/NORM and AUTO/MAN selections are the same as during the RNDZ phase. See section 5.1.1.1 for operational details.

For heavy payloads such as Long Duration Exposure Facility (LDEF), the CNTL ACCEL values are set to zero during rendezvous and PROX OPS.

Note: The upper and lower limits on selectable DB parameters are as follows for NORM (VERN) jets:

attitude hold (deg)	0.10 (0.01)	to 40 (40)
discrete rate (deg/s)	0.05 (0.002)	to 2 (1)
rot pulse (deg/s)	0.04 (0.001)	to 1 (0.5)
trans pulse (ft/s)	0.01	to 5

		RENDEZVOUS		PROX OPS		SPEC 20 ITEM NO	
DAP		A9	B6	A10	B7	A	B
<u>TRANSLATION</u>							
PULSE	FT/SEC	0.10	0.05	0.05	.01	1	15
<u>ROTATION</u>							
DISC RT	NORM	0.200	0.500	0.200	0.200	2	16
	VERN	0.200	0.200	0.200	0.200	3	17
PULSE	NORM	0.10	0.04	0.10	0.04	4	18
	VERN	0.010	0.002	0.010	0.002	5	19
<u>DEADBAND</u>							
ATT	NORM	2.00	2.00	2.00	2.00	8	22
	VERN	1.000	1.000	1.000	1.000	9	23
RATE	NORM	0.20	0.20	0.20	0.20	10	24
	VERN	.020	.020	.020	.020	11	25

Figure 3-6.- DAP configurations for rendezvous/PROX OPS.

The tail-only/nose-only option is not currently planned for use. However, multiple jet failures, vernier reaction control system (VRCS) failures, or forward prop being critically low, may lead to such a configuration.

3.2.2 DAP Configuration (SPEC 20)

DAP CONFIG (fig. 3-7) is a GNC specialist function available in OPS 2. Among other things, it allows the crew to specify the size of attitude and rate DB's and the magnitude of discrete/pulse RCS attitude/translation maneuver's.

Two sets of numbers are maintained (designated "A" and "B") and can be readily changed during a flight. In practice, the primary difference between DAP A and DAP B will be the translation pulse size, with DAP A having the larger. Selection of "A" and "B" is via console pb (section 3.2.3.).

The significance of the DAP A(B) item entries is as follows:

- 1(15) is PULSE, a means of specifying the desired ΔV (ft/s) resulting from a single THC deflection. Multiple deflections are additive.

XXXX/020/		DAP		CONFIG		XX	X	DDD/HH:MM:SS	DDD/HH:MM:SS
TRANSLATION		A		B					
PULSE		1	<u>X.XX</u>	15	<u>X.XX</u>				
ROTATION									
DISC RATE	NORM	2	<u>X.XXX</u>	16	<u>X.XXX</u>				
	VERN	3	<u>X.XXX</u>	17	<u>X.XXX</u>				
PULSE	NORM	4	<u>X.XX</u>	18	<u>X.XX</u>				
	VERN	5	<u>X.XXX</u>	19	<u>X.XXX</u>				INERTIAS
COMP	NORM	6	<u>.XX</u>	20	<u>.XX</u>			29 IX	<u>X.XXX</u>
	VERN	7	<u>.XXX</u>	21	<u>.XXX</u>			30 IY	<u>X.XXX</u>
								31 IZ	<u>X.XXX</u>
DEADBAND									
ATT	NORM	8	<u>XX.XX</u>	22	<u>XX.XX</u>				
	VERN	9	<u>XX.XXX</u>	23	<u>XX.XXX</u>				
RATE									
	NORM	10	<u>X.XX</u>	24	<u>X.XX</u>				
	VERN	11	<u>.XXX</u>	25	<u>.XXX</u>				
JET OPT									
	P	12	<u>X</u>	26	<u>X</u>				
	Y	13	<u>X</u>	27	<u>X</u>				
CNTL ACCEL									
		14	<u>X</u>	28	<u>X</u>				

(XX)

Figure 3-7.- The DAP CONFIG (SPEC 20) display.

- 2(16) and 3(17) are DISC RATE for primary and vernier jets respectively; they are used to specify the desired rotational rate (deg/sec) to be achieved for a discrete rate manual command (MAN or MAN LVLH), or for an AUTO MNVR, AUTO MNVR to TRK attitude, and for AUTO ROT.
- 4(18)/5(19) are PULSE, or the primary/vernier values used to specify the rotational rate (deg/s) resulting from each single manual RHC pulse command. Multiple deflections are additive.
- 6(20)/7(21) are COMP, used to specify the threshold ROT rate (deg/s) for a given axis resulting from a rate command about another axis. When that threshold is reached, the DAP will command jets to reduce the rate. Note that an entry of zero implies that the DAP will attempt to compensate for all cross-coupling, but it actually disables ROT compensation. Minimum entry to enable ROT COMP is 0.113 deg/s primary RCS (PRCS) and 0.003 deg/s (VRCS).

At the present time, ROT COMP is not used nominally, due to high fuel use and incompatibility with any DAP mode other than free drift. Instead, normal DAP attitude hold is used to minimize undesired cross-coupling effects.

- 8(22)/9(23) is attitude (ATT), used to specify the attitude DB's (degrees) for primary/vernier jets.
- 10(24)/11(25) is RATE, used to specify the rate DB's (deg/s) for primary/vernier jets.

In addition, various jet options can be selected (for primary jets only). The options are "normal" (1), "nose only" (2), and "tail only" (3). For pitch, one can choose the option with item 12(26); for yaw, the choice of option is via item 13(27); there is no option for roll, since it is always tail only, PRCS. Translations are always "normal"; control is always "normal" anytime VRCS is selected.

3.2.3 DAP Pushbuttons

The DAP pb's on panel A6 (fig. 3-8) allow selection of various control modes in the Orbiter response to RHC/THC input commands from a crewmember or AUTO commands from the DAP. An identical set of pb's is on panel C3. Note that the specific DAP lights illuminated on the forward and aft panels will not necessarily be identical. In particular, since the forward RPY indicators are always in the +X sense while the aft RPY indicators can be in -X sense or -Z sense, any mixed configuration (e.g., DISC-PULSE-DISC) may not look the same on both panels. Thought must be given to which axis in which sense is being specified by each light.

The on-orbit DAP functions are DAP A or B with AUTO, MAN, or LVLH rotation modes selected, and a choice of NORM or VERN jets. There is also a choice of DISC RATE, ACCEL, or PULSE manual (MAN) ROT submodes selectable by axis. With NORM jets selected, the following translational submodes are available: PULSE and NORM (ACCEL) in all axes, HIGH Z (high ACCEL), NORM Z, and LOW Z (upfiring jets inhibited always) for +Z translations.

DAP's A and B each represent different sets of control parameters for the DAP. These parameters can be seen on the DAP CONFIG specialist function (SPEC 20), and can also be changed through keyboard item entries on this display (section 3.2.2). These changes are invoked after the item execution, if the parameter changed is applicable to the currently selected DAP (A or B and NORM or VERN). The following modes and submodes are available for DAP on-orbit operation.

3.2.3.1 AUTO/MAN Selection

AUTO enables execution by the DAP of AUTO maneuvers commanded by use of the UNIV PTG display (section 3.1.1); MAN enables execution of the selected ROT submodes manually commanded through the RHC.

Note: Any input from an RHC causes automatic downmode from AUTO to MAN.

3.2.3.2 LVLH

With DISC RATE selected in all three axes and with the LVLH mode selected, the LVLH attitude that existed at the time of selection of LVLH will be held fixed within the LVLH frame until changed by use of the RHC. The RHC can be used with LVLH selected to change the LVLH attitude. While out of detent, the Orbiter maneuvers at DISC RATE. When the RHC returns to detent in any axis, the LVLH attitude in that axis is held fixed again. This mode would be used manually for precise PROX OPS attitude control in the near vicinity of a target, an example being flyaround (section 5.2) of an LVLH-stabilized target.

Note: For LVLH mode to work, at least one ADI must be in LVLH mode. Otherwise, required computations will not be performed and resulting attitude will be unpredictable.

3.2.3.3 NORM/VERN Jet Select

Primary RCS (PRCS or NORM) and vernier RCS (VRCS or VERN) jets can be used for attitude hold and maneuvers. NORM jets must be selected for translation maneuvers. With primaries selected, there is a choice through the DAP CONFIG display (SPEC 20) via the JET OPT for tail jets only, or nose jets only to be used for pitch/yaw control (in VRCS rotation is always a combined tail/nose function).

3.2.3.4 Translation Submodes (NORM Jets Required; MAN, MAN LVLH, and AUTO)

- PULSE X, Y, or Z - With this submode selected, each deflection of the THC will result in a change in velocity of the magnitude specified for TRANSLATION PULSE on the DAP CONFIG display for the selected DAP (A or B) in the axis and direction (+ or -) of the THC deflection.

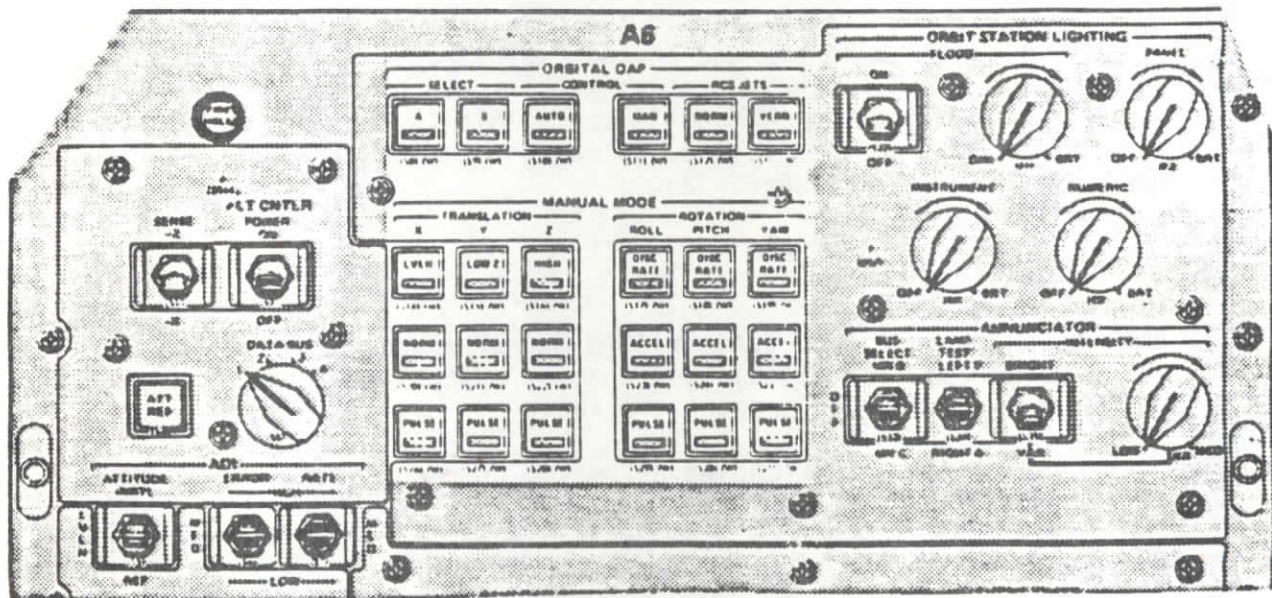

Figure 3-8.- Panel A6.

- NORM, X, Y, or Z - With one of these submodes selected, continuous acceleration will occur at whatever level is available with the commanded jets for the axis and direction (+ or -) of the THC deflection as long as the THC is deflected.
- HIGH Z - An ACCEL submode that is available for +Z translation only. Selection of this submode fires more jets than are fired for the NORM =Z command. This option is currently not used.
- LOW Z - Low Z is a submode that takes advantage of some +Z thrust components that exist for both the +X and -X translational jets. To get the +Z translation, the +X and -X translational jets are fired simultaneously so that the jets nearly cancel the X components of each other and combine the small +Z components. The result is a small +Z velocity change at about 10 times the normal prop usage. See section 3.2.4 for applications. The RCS plume overpressures for low Z MODE versus NORMAL Z MODE are shown in figure 3-9. Low Z translations also affect pitch and roll, since upfiring jets are inhibited. This results in significant -Z translational cross-coupling (see section 6.2.1), but reduces the duty cycle for attitude maintenance.

3.8.1

huh?

3.2.3.5 Manual Rotational Submodes

- DISC RATE - ROLL, PITCH, or YAW - With the DAP mode MAN and the submode DISC RATE, when the RHC is deflected out of the detent (but not past the soft stop) in an axis, jets are fired until an angular rate is achieved in that axis equal to DISC RATE specified in the DAP CONFIG display for the selected DAP (A or B) and selected jet option (NORM or VERN). When the rate is achieved, the jets are turned off until the RHC is returned to detent in that axis unless the jets are momentarily required to maintain attitude or rates within the DB's. When the RHC is returned to detent in an axis, the attitude in that axis is snapshotted and jets are fired to stop the rate in that axis and to begin holding the snapshotted attitude.

If the RHC is deflected beyond the soft stop while in DISC RATE (and any DAP mode/submode), jets are fired continuously, giving a constant angular acceleration (in the axis and sense of the RHC deflection) until the RHC is backed out of the soft stop, at which time the jets are turned off. When the RHC is returned to detent, the attitude is snapshotted and jets are turned on to stop the angular rates and initiate hold about the snapshotted attitude. In effect, this provides an ACCEL mode if the RHC is deflected past the soft stop, and a free drift mode when returning the RHC from the soft stop while between the soft stop and detent. See figure 3-2 in section 3.1.2.

- ACCEL - ROLL, PITCH, or YAW - When the DAP mode is MAN/ACCEL and the RHC is deflected out of detent, a fixed number of jets is fired to provide constant angular acceleration as long as the RHC is out of detent in the axis and sense of the deflection. When the RHC is returned to detent, the jets are turned off, but the angular rates continue. The result is a free mode since the attitude is uncontrolled when the RHC is in detent (free drift at the existing angular rates).
- PULSE - ROLL, PITCH, or YAW - When the DAP mode is MAN/PULSE and the RHC is deflected out of detent, jets are fired just long enough to achieve the angular rate change specified on the DAP CONFIG display for rotation pulse for the axis and sense of the RHC deflection. PULSE is also a free drift mode.

3.2.3.6 Applications

These DAP options can be used as follows:

For free drift, select MAN PLS/PLS/PLS. See section 5.4.1.5 for example.

For inertial attitude hold, select MAN DISC/DISC/DISC. See section 4.1.61 for example.

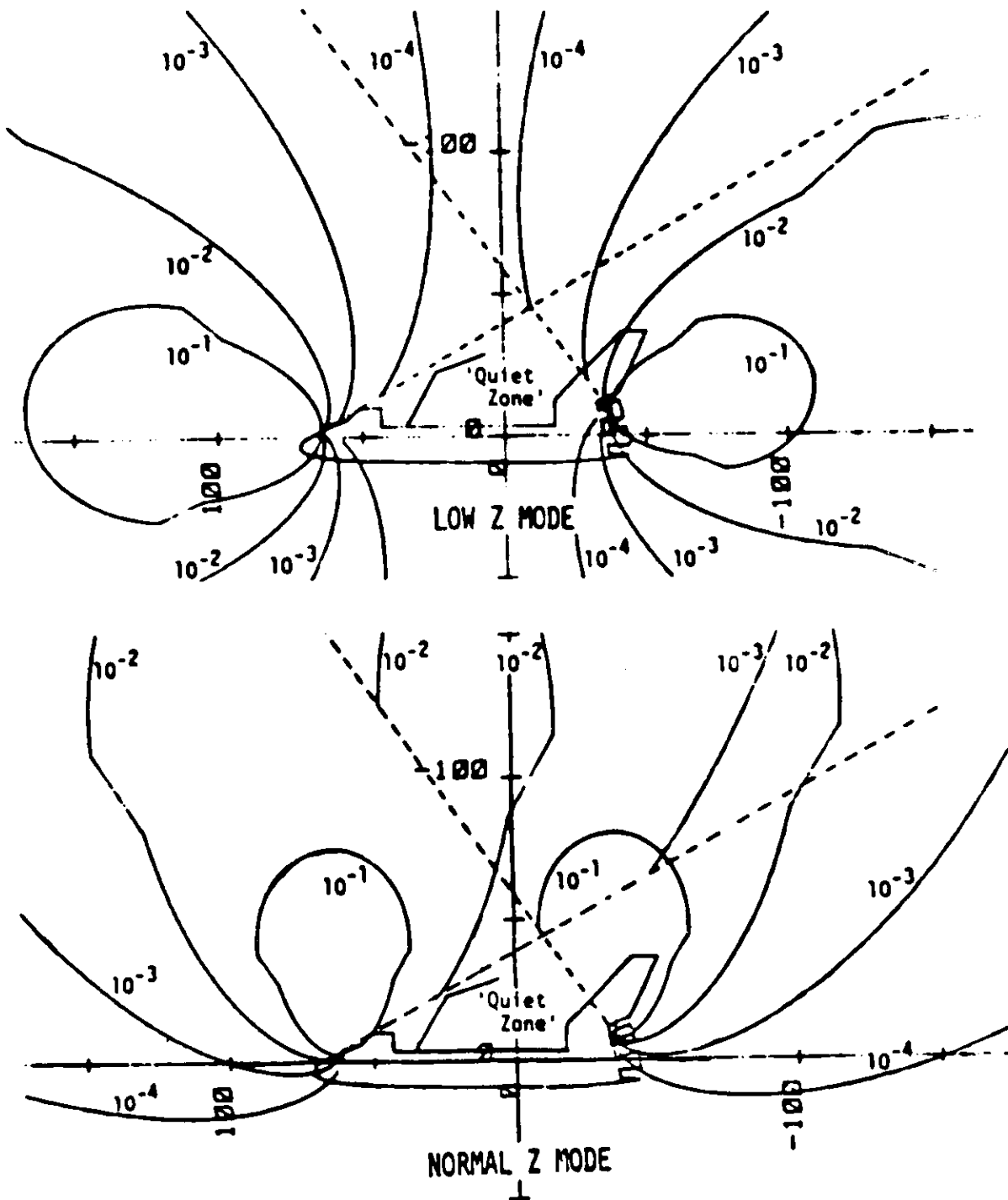

Figure 3-9.- RCS plume overpressure for LOW Z and NORMAL Z mode (1b/ft²).

3.2.4 Low Z Operations

3.2.4.1 Plume Impingement (PI) Issues

Within about 1000 feet, attention should be given to effects of RCS jet firings. One effect is contamination by combustion products and/or unburned propellants; the other effect is disturbance of the target attitude and position by the plume overpressure. Choice of low Z mode (and the expense associated with it) is made based on those factors. Due to shadowing by Orbiter structure, a target close above the PLB may be out of the RCS plumes, and normal Z mode may be resumed while the target remains in this zone (see fig. 3-9). A full discussion of propellant plume issues is found in section 3.8.2.

3.2.4.2 Low Z Operations

The low Z DAP mode (mentioned in section 3.2.3.4 and described and illustrated in section 5.3.1.2) was designed to minimize both types of RCS PI on targets. A given technique that offers acceptable PI effects in one of these areas may or may not satisfy acceptable limits in the other. Low Z does minimize PI effects at a direct cost of about 10-12 times the NORM Z fuel usage. However, the penalty of low Z operations is not limited to this increase in fuel usage. Due to cross-coupling effects (see section 6.2.1) resulting from braking, -X translations, and VRCS attitude control, only about one-half of a given commanded braking pulse is actually received. Further, there is a tendency for rapid buildup of a closing rate during stationkeeping or precisely scheduled range/range-rate V-BAR approaches, due in large part to cross-coupling from +/- Y translations. These rates can reach 0.2 ft/s or more, requiring more braking, resulting in a vicious circle. These effects can be particularly serious when trying to establish V-BAR stationkeeping following the manual phase of the RNDZ, either while in low Z mode, or especially if the low Z mode is selected prematurely. Prop usage rates of 8 to 12 pounds per minute are not unheard of (4-6 pounds per minute is more common), much higher than the 1 to 1.5 pounds per minute for normal stationkeeping. Usage can be controlled to 2 pounds per minute or less by taking great care in stabilizing on the V-BAR at the precise position required for the desired range (see PROX OPS cue card, section 4.3.5) prior to selecting low Z. Stabilizing on the V-BAR following a RNDZ in the low Z mode is not recommended.

3.8.1

Flight experience has revealed several common mistakes involving use of low Z mode. First, during approach, some crews have exited low Z mode using loss of radar lock (80 to 90 feet) as the cue, when in fact the target is not yet in the Orbiter body "shadow" (less than 50 to 60 feet range, directly over the PLB). Second, during PROX OPS, the low Z mode select pb may be pushed repeatedly, leaving the DAP back in low Z when the pilot believed it was in NORM Z. Great care must be exercised since propellant consumption can be critical and, under marginal conditions, be cause for calling a PROX OPS BREAKOUT if usage is excessive.

3.3 RENDEZVOUS/PROX OPS SENSORS

Prior to the day of RNDZ, on-board NAV sensors are not required since the ground is targeting all MNVR's and the relative separation of the Orbiter and TGT is sufficiently large. On the day of RNDZ, with no functioning NAV sensors, flight rules specify to proceed to Ti (this is done in the hope of acquiring sensor data or visual acquisition) and then breakout post-Ti if no acquisition.

3.3.1 Star Tracker

The two star trackers (STRK or S TRK) (-Y and -Z) are nominally used to take sightings on stars so as to align the IMU's. They also can track TGT satellites and provide angular data for use in onboard relative NAV. Their nominal TGT brightness range is from +3 to -8 stellar magnitude (brightness is monitored in the MCC, but is not displayed on board).

During RNDZ operations, the purpose of the star trackers is to provide Orbiter body-axis measurements of the TGT LOS. This is called "target track mode."

Lighting constraints limit STRK operations to conditions when the TGT is illuminated. For a standard RNDZ profile from behind and below, this occurs during the period between orbital noon and sunset. This period could be extended if the TGT has appropriate artificial lighting systems. Such extensions should help reduce dispersions in a radar fail case.

3.3.1.1 Control Switches

The STRK control switches are found on panel 06 (fig. 3-10) and involve power and door control. Door position is shown on talkbacks.

3.3.1.2 Capabilities

Each STRK has a $10^\circ \times 10^\circ$ square FOV. There is a bright object sensor (BOS) which closes a protective shutter (or door) over the STRK optics when the STRK is pointing within 16° to 19° of the sunlit Earth limb, or 30° of the Sun or 8° of any other magnitude -12 object, (e.g., the Moon).

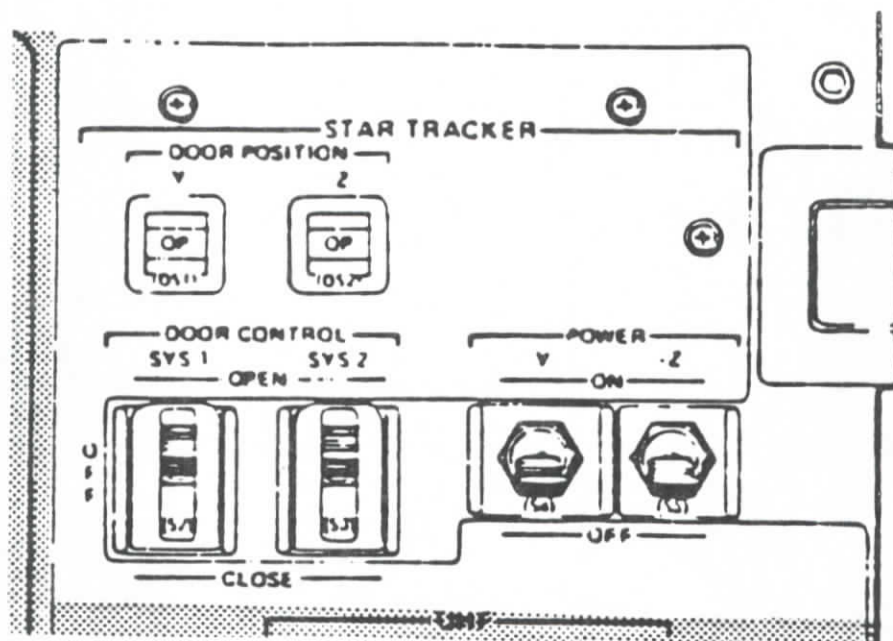

Figure 3-10.- Panel 06.

On STS-8, STRK tests were conducted near the sunlit Earth limb. The lowest +3 magnitude star angle above horizon at acquisition was 13° , when the boresight angle was 12° . Background noise and false tracks increased dramatically after this last track. Lower angles might be possible by offsetting the boresight to above the target, or by use of STRK thresholding (ITEM 13, 14) for brighter TGT's (this option is not currently utilized). Angles below 5° - 7° are considered impossible due to the horizon in the FOV. All baselined RNDZ profiles involve targets 20° - 30° above the limb.

When the shutter is closed, the crew gets a closed indication, but cannot tell if it was due to the TGT suppress (TS) or BOS. The hardware fix for this included raising the TS spec limit from -8 magnitude to -12 magnitude, and setting the TS to 1 magnitude brighter than the BOS. The TS range for OV 102 and 099 (-8 magnitude) was 1.7 n. mi. for Solar Maximum Mission (SMM) and 1.4 n. mi. for integrated rendezvous target (IRT), and in fact on STS 41-C the shutter did close during RNDZ at a range of about 1 n. mi.

When commanded to track a TGT, the STRK will center on coordinates provided by NAV and will search a 1° by 1° square. If after 4 seconds the TGT is not acquired, the STRK will search its entire FOV for 20 seconds, at which time a warning message is displayed to the crew if the TGT was not found. If the TGT is acquired, the STRK scans a 12-arc second cruciform track centered on the TGT every 42 milliseconds. The TGT will be tracked until it leaves the FOV or the STRK is commanded to stop.

Once locked on, tracking continues across the FOV at up to 0.2 deg/s with guaranteed accuracy and up to 0.5 deg/s with reduced accuracy.

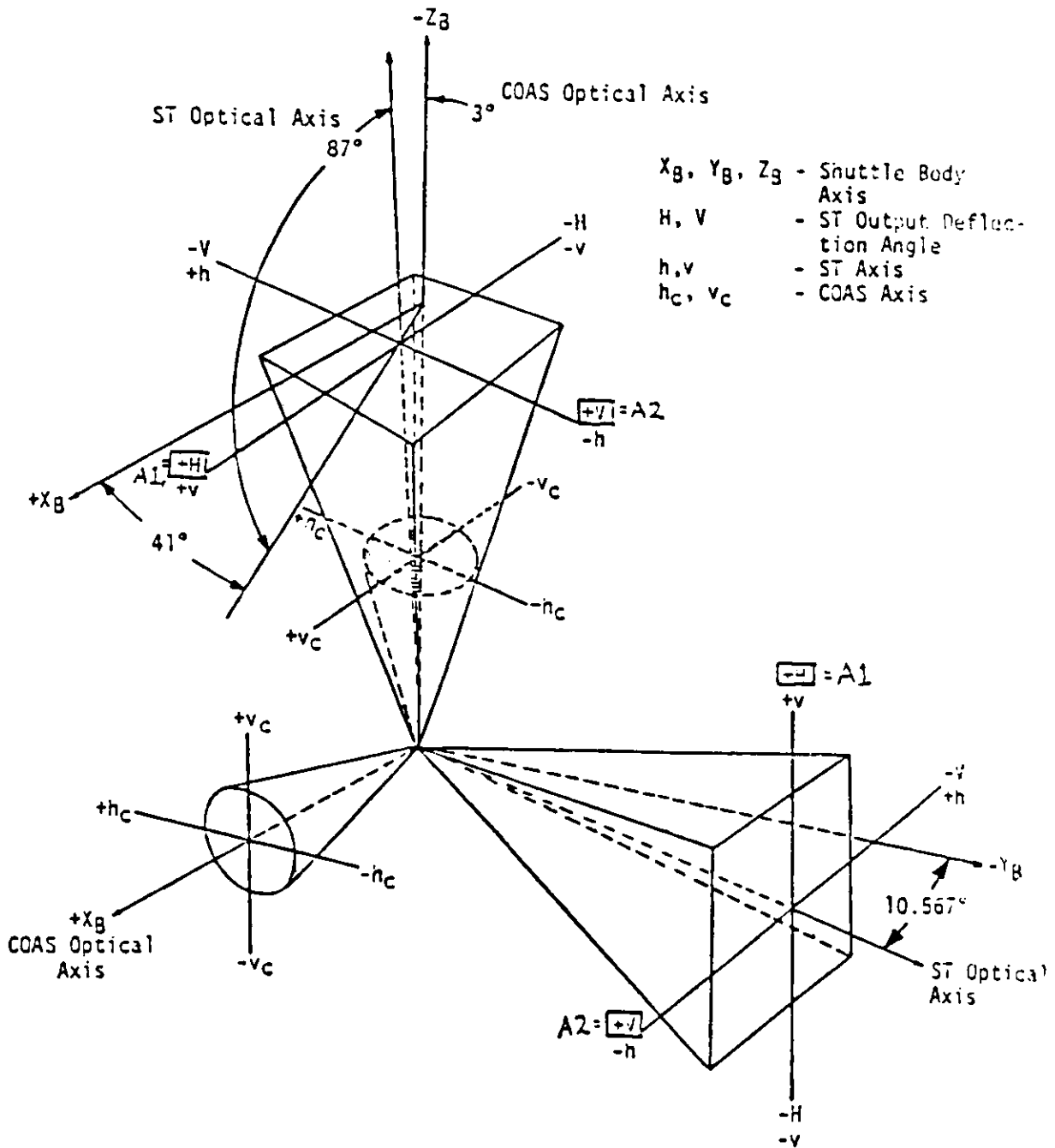

Figure 3-11.- STRK/COAS geometry.

If the TGT passes within $1/4^\circ$ of a bright star, the lock may jump over to that star. The filter will recognize this if it has already processed enough data; the remedial action is to break track and search again.

There is a potential problem with Orbiter-related trash (or ice), which could remain in range for a few REV's. The Y STRK is particularly susceptible to picking up ice shaken loose from a previous water dump.

Star sighting data from the first seven STS missions indicated a total star sighting one-sigma error of 0.016° . This includes STRK bias and noise, as well as IMU structural and resolver errors. The error is far less than the specification value.

Newer?

3.3.1.3 Lines of sight

The orientation and coordinate systems of the STRK are shown in figure 3-11. The optical axes of the STS are slightly offset from the Orbiter axes. For -Z, it is inclined 3° in a plane rotated 41° from the Orbiter +X axis toward the -Y axis; for -Y, it is in the Orbiter X-Y plane and is rotated 10.567° from the Orbiter -Y axis into the +X axis. For precise Orbiter pointing, therefore, the boresighted trackers are:

	P	Y	OM
-Y	0	280.6	90
-Z	87.7	358	0

Note: For the -Z STRK, for procedural convenience, pointing is usually done along the pure -Z axis, which introduces several degrees offset from the precise boresight. If the combination of SV pointing error and attitude deadbanding is large enough and in the appropriate (or inappropriate, from the Orbiter point of view) direction, the TGT could be out of the FOV. For this reason, small attitude DB's (0.5°) are recommended for target acquisition. Pointing the exact -Z STRK boresight may slightly improve this problem as well.

3.3.2 S TRK/COAS CNTL (SPEC 22)

S TRK/COAS CNTL (fig. 3-12) provides a means of monitoring and controlling STRK operation. It also provides data and controls for COAS operation and calibration, as well as supporting data for IMU alignments.

The STRK can be placed in the TGT track mode via Items 5 and 6 (OPS 2 only). These are mutually exclusive: putting the second STRK in TGT TRK will automatically downmode the first one to TERM/IDLE. For each STRK, TGT TRK and STAR TRK are mutually exclusive; however, one STRK can be in TGT TRK while the other is in STAR TRK. Normally the -Z STRK will be selected. Angle data from the STRK is treated in the REL NAV display (section 3.4).

XXXX/O22/	S TRK/COAS CNTL		XX X	DDD/HH:MM:SS	
				DDD/HH:MM:SS	
S TRK CNTL	-Y	-Z	S TABLE	1	2 3
SELF-TEST	1X	2X	TRK ID	XXX	XXX XXX
STAR TRK	3X	4X	Δ MIN	XXX	XXX XXX
TGT TRK	5X	6X	ANG DIF	XXX.X	XXX.X XXX.X
BREAK TRK	7	8	ERR	XX.XX	XX.XX XX.XX
TERM/IDLE	9X	10X	SEL	17X	18X 19X
			S TABLE CLR	20	
S TRK	-Y	-Z	COAS		
REQD ID	11 XXX	12 XXX	REQD ID	21	XXX
TRK ID	XXX	XXX	ΔDEG X		±X.X
S PRES	X	X	Y		±X.X
ΔANG	±X.XX	±X.XX	SIGHT MODE	22X	
THOLD	13 X	14 X	ACCEPT	23	
SHUTTER	XX	XX	CAL MODE	24X	
MAN OP	15X	16x	DES	25X	
STATUS	XXXXXXXXXX	XXXXXXXXXX	POS	+X 26X	-? 27X
	XXXX	XXXX	ΔBIAS	X.XX	X.XX
			UPDATE	28	29

(XX)

Figure 3-12.- The S TRK/COAS CNTL display.

The "S PRES" (STAR PRESENT) indicator signifies that lock-on (and closed-loop tracking) has begun.

The shutter for the -Y (-Z) STRK can be locked open by selecting ITEM 15 (16). This should be done only after the crewmember has made a visual check out the appropriate window to confirm that no bright object is within 30' of the tracker LOS. The shutter control should be placed in the AUTO mode as soon as possible because direct exposure to a bright source could cause a tracker to fail.

Note: In flight, on rare occasion the crew has had to perform ITEM 15 to manually open the shutter.

3.3.2.1 STRK Target Acquisition

This step occurs during RNDZ operations, as shown in section 4.1.11 and 4.1.21. The steps are shown in figure 3-13; steps dealing with REL NAV are discussed in section 4.1.13.

One of the orbiter IMU's is deselected if the Orbiter is currently operating at the three-IMU level. This is done to force IMU redundancy management (RM) to remain locked onto a single IMU (the lowest numbered one) for

3321' IMU DES

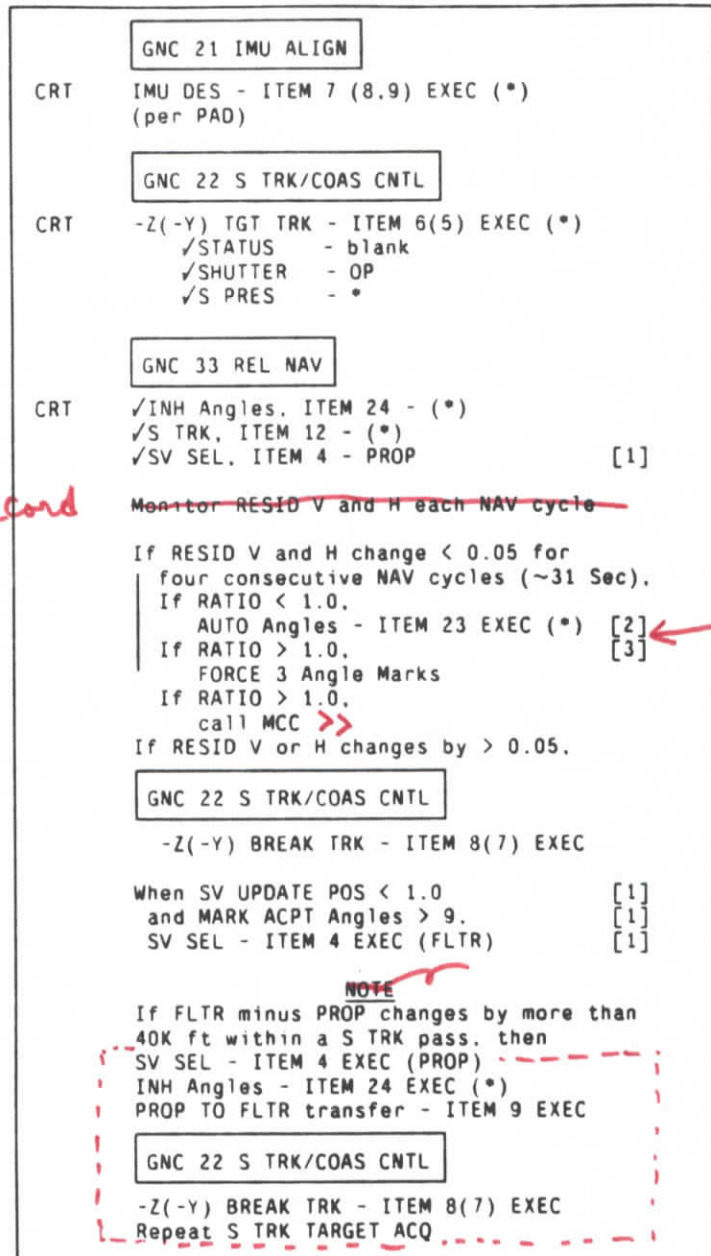

Record POS u/D

Figure 3-13.- S TRK TARGET ACQ procedure.

- Notes:
- [1] Omitted on subsequent acquisitions
 - [2] Subsequently, always precede with: FLTR to PROP - ITEM 8 EXEC
 - [3] Subsequently, there are three stages for recovery (4.1.22)

3.9.4

attitude data throughout the STRK pass (see section ~~6.3.4~~). The reason for this is as follows. At the three line replaceable unit (LRU) level, RM midvalue selects IMU data for use as attitude reference. Under normal operations all three IMU's are closely aligned and RM cycles between the units. Although the slight amount of misalignment between the units is not enough to affect most Orbiter operations, it is enough so that when applied to the STRK data in NAV it adds unnecessary noise to the SV calculations.

Note that the attitude deltas between IMU's is very small and is of concern because the STRK's are extremely accurate pointing instruments, and the slight attitude reference deltas show up as SV updates. When operating using RR or COAS as the source of angular data on the TGT, the IMU deselection is not required due to the granularity of RR and COAS angle data.

3321 \approx Measurement incorporation will be inhibited prior to sensor acquisition. This allows the crew to assess the quality of the data prior to its incorporation into the filter.

3321 \approx The STRK's are commanded to the TGT track mode. This configures the data path such that the STRK software gets its pointing designate information from the NAV function for initial TGT lock-on. The STRK status is also verified satisfactory with no error messages, an open shutter, and an indication of TGT sighting. The informational displays for each tracker (REQD ID through STATUS) work the same way for a TGT as they do for a star.

During its search, the STRK first covers a 1° by 1° cruciform pattern centered about the designated pointing offsets. If a TGT acquisition is not accomplished during the offset scan, the STRK scans the entire 10° by 10° field of view in a raster scan pattern (see fig. 3-14). The offset scan is accomplished in approximately 4 seconds, and the full field scan takes 20 seconds. At the end of this time, if the STRK has still not acquired the target, the STRK waits in idle until it receives another search command. The STRK software issues the search command every 60 seconds.

The "no target" status is displayed after one search has failed, until the next search is commanded.

A bad STRK can be distinguished from a bad NAV state by using the COAS. At STRK acquisition, the crew sights the TGT through the COAS. If the TGT is centered while the residuals and ratios are high, the NAV state is good and the tracker is bad. If the TGT is not centered, the NAV state may be off and the tracker may (or may not) be bad.

3321 \approx To determine if the tracker has locked on to something other than the TGT, the crew must watch the STRK RESID V and H values on the REL NAV display. If the values change by more than 0.05 every NAV cycle, then the tracker has locked on to something other than the TGT. For example, the residuals would change approximately 4° per minute, if the tracker were locked on to an inertially stable object (a star). To force the tracker to resume looking for the TGT, a BREAK TRK should be executed for that STRK. Flight experience has shown that occasional star lock-ons can be expected.

33215 Variation

The second STRK acquisition is somewhat modified (see section 4.1.20 and 4.1.22). Procedures for STRK fail cases are discussed in section 4.4.1.

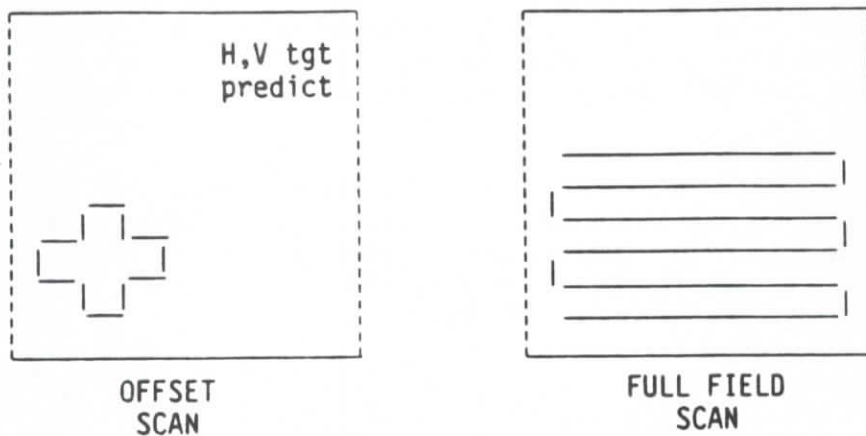

Figure 3-14.- STRK search pattern.

3.3.2.2 End STRK NAV PASS

This procedure is shown in fig. 3-15; it is called out from sections 4.1.16 and 4.1.25 in the RNDZ procedure narrative.

The crew inhibits the sensor data path to the NAV filter in order to be sure that no erroneous data gets incorporated into the SV calculations. The most likely false lock-on would be to a star, and this is quite likely to happen after sunset.

The crew places the STRK's in the terminate/idle (TERM/IDLE) mode to eliminate the cyclic displaying of NO TARGET to the crew while the target is not sufficiently illuminated to support acquisition.

Finally, the crew reconfigures to the nominal on-orbit three-IMU set after the STRK pass is complete.

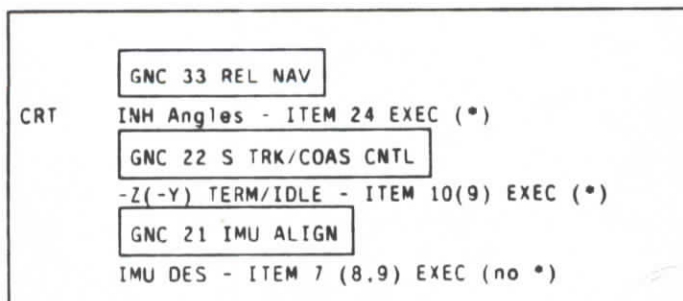

Figure 3-15.- END S TRK NAV procedure. ✓ OK

3.3.3 Crew Optical Alignment Sight (COAS)

The COAS is a sighting unit that can show TGT position relative to either Orbiter -Z or +X axes. The unit bolts into position either on panel 01 in front of window W3 (for +X view, from commander (CDR) seat), or on panel 019 below the aft overhead starboard window W7 (for -Z view, from the aft flight deck). The aft overhead window is the standard COAS position for PROX OPS and RNDZ.

During RNDZ operations, the COAS allows the crew to determine Orbiter body-axis angle measurements of the LOS to the TGT. These angle marks can be input to REL NAV if needed (nominal procedures do not use them). TGT LOS angles observed through the COAS are also crucial to manual control after the final midcourse MNVR (section 4.1.61).

The crew uses the COAS to monitor angular position of the TGT relative to the -Z Orbiter axis. If the Orbiter attitude is maintained fixed relative to the TGT inertial or LVLH frame, the Orbiter position relative to that frame can be determined from these angles (e.g., above or below or off to side of desired LOS). Appropriate translation MNVR's can then be made to correct this position.

Proper determination of desired TGT depression angle during PROX OPS is discussed in section 4.3.6.

3.3.3.1 System Characteristics

There is a 5° radius circle of hatch marks in the middle of the COAS FOV. The entire COAS FOV has a radius of 20° (fig. 3-16). The COAS coordinate system is designated "X, Y" which corresponds to vehicle body coordinates. That is, at the aft crew station, crewmember facing aft, +X is "up" in the COAS (and forward along the Orbiter X axis) and +Y is "left" in the COAS (and to the right along the Orbiter Y axis, facing forward).

The -Z axis is not precisely at 0,0 in the COAS FOV (on 099, for example, it was at -0.562, -0.159 at 15 psi). Cabin pressure levels also have measurable effect on COAS alignment, as the crew compartment ceiling flexes. The crew must perform COAS pointing direction calibration for current pressure level, before NAV use.

3.3.3.2 Position Verification

Observation of the TGT position in the COAS can provide a confidence check on the convergence of onboard NAV (the TGT will get closer and closer to the -Z point, slightly offset from 0,0 in the COAS when the Orbiter is in TGT track mode with -Z axis selected.). Also, troubleshooting problems with the -Z STRK involves looking at the target through the COAS to see if some gross NAV error is mispointing the STRK.

RR AUTO TRACK ACQ

A1U KU - AUTO TRK
 SLEW ELEV - as reqd to EL = 0
 (or to EL as seen in COAS)
 SLEW AZIMUTH reqd to AZ = 0
 (or to AZ as seen in COAS)
 ✓ KU TRACK tb - gray
 If KU TRACK tb - bp,
 KU SEARCH - SEARCH (tb-gray)
 If no lock-on within one min,
 KU-GPC

COAS NAVIGATION

CRT GNC 22 S TRK/COAS CNTL
 COAS: SIGHT MODE - ITEM 22 EXEC
 REQD ID - ITEM 21 +1 EXEC

GNC 33 REL NAV
 INH Angles - ITEM 24 EXEC (*)
 If TGT in COAS FOV,
 FLTR TO PROP - ITEM 8 EXEC
 COAS - ITEM 14 EXEC (*)

A6U FLT CNTLR PWR - ON
 DAP ROT: DISC/PULSE/PULSE
 DAP: as reqd
 RHC: Center TGT in COAS
 ATT REF pb - push
 If mark acceptable,
 FORCE Angles - ITEM 25 EXEC

CRT Repeat COAS marks as reqd

A6U When COAS marks complete,
 DAP: A/AUTO/VERN
 DAP ROT: DISC/DISC/DISC
 FLT CNTLR PWR - OFF



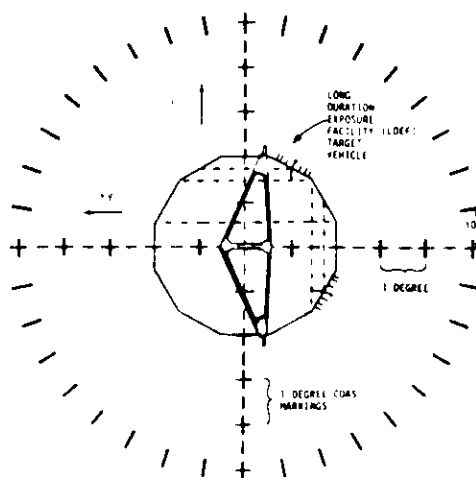

Figure 3-16.- The COAS reticle pattern (-Z view from aft crew station).

3.3.3.3 RNDZ NAV Marks

In a multiple failure case, the COAS can be used to take NAV marks. Since this involves pointing the entire Orbiter (and hitting the ATT REF pb when the TGT reaches the crosshairs), it can be very fuel-expensive and tedious. Generally, one crewmember takes the marks and a second crewmember forces them on REL NAV. The accuracy of this technique remains uncertain.

The operational use of the COAS for NAV is described in section 4.3.3.

3.3.4 Rendezvous Radar (RR)

During RNDZ operations, the RR is GNC's only direct source of R/R-DOT measurements and a secondary source of target LOS angles (STRK angles are more accurate at longer ranges). The RR can also provide angle rate data but when TGT angular size is greater than radar beamwidth (1.6° at 3 dB), beam wandering across the TGT can generate spurious angle rates.

Techniques to enhance radar trackability of the TGT are discussed in section 3.3.10.

The RR shares the steerable 3-foot diameter dish antenna with the Ku-band link to the TDRS. It is a 50-watt pulse system operating around 13.883 GHz, employing frequency agility (cycles through five frequencies to enhance TGT detection and tracking), designed to acquire and track a TGT (with a radar cross section of at least 1 square meter) at a range of 10 miles.

Note: A TGT-mounted transponder could increase that range to 300 miles but no manifested TGT's have such equipment (onboard H/W and S/W could support it). RR hardware design limits skin track ranges to 80 feet minimum and 27.2 n. mi. maximum.

EL and AZ output from the RR are in a body aligned coordinate system centered at the antenna system. The coordinate system is shown in figure 3-17. SHAFT and TRUNNION are in the radar antenna system and RESIDS are computed in that coordinate system.

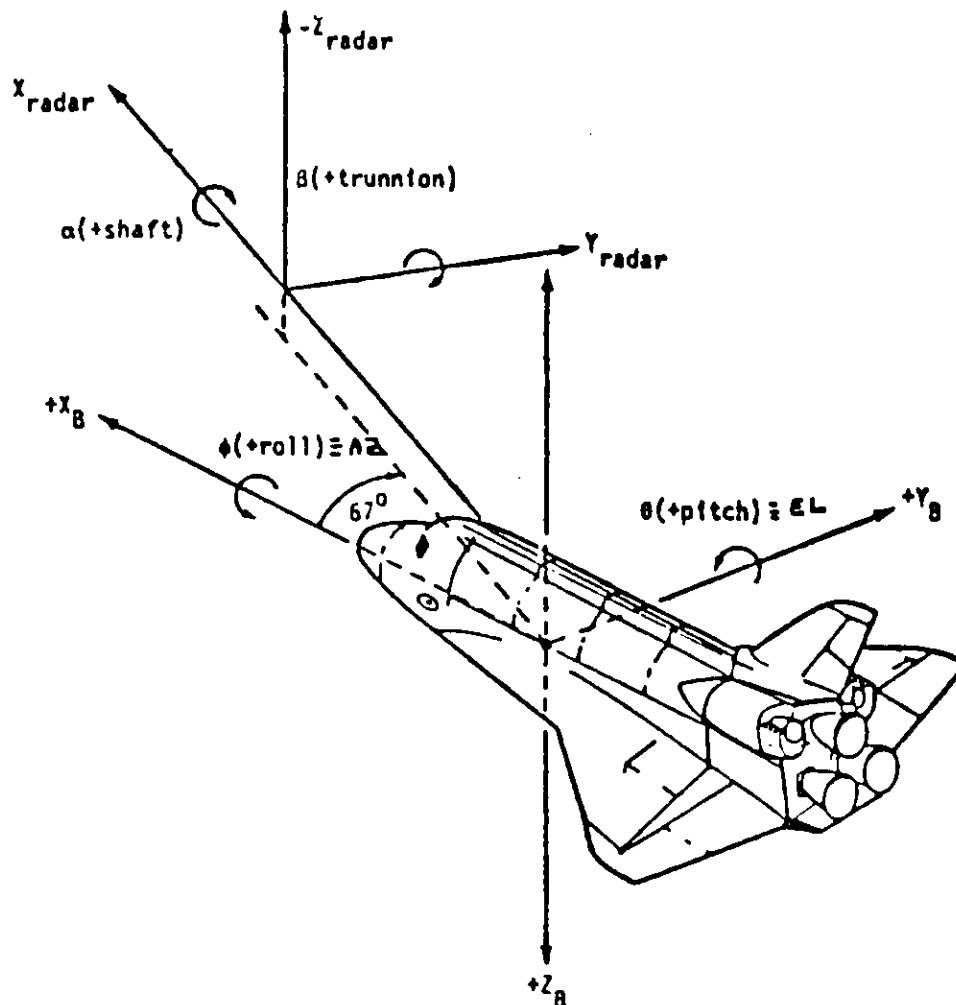

Figure 3-17.- Orbiter body coordinate system and RR coordinate system.

Although the radar can be used in any pointing region not obscured, it is generally assumed that the TGT lies near the -Z axis. In fact, at angles greater than about 30°, radar data becomes too inaccurate for use by RNDZ NAV.

3.3.4.1 Switches

The RR is controlled from panel A1U (fig. 3-18).

The following switch options are available:

- POWER - To go from OFF to STANDBY or ON, warmup takes about 3-1/2 minutes.
- MODE - RDR COOP: Assumes transponder on TGT (~~see section 8.4.3.2~~)
 - RDR PASSIVE: Assumes skin track only
 - COMM: No RNDZ function

Note: The antenna pointing depends not on MODE (COMM or RDR) but on whether KU ANT ENA (ITEM 2 on REL NAV) is enabled. When ITEM 2 is enabled, the Ku-band antenna TGT-pointing data is shipped from GNC to the SM GPC. This allows SM to automatically point the Ku antenna at the TGT when the KU ANT switch is in the GPC or GPC DESIG position. This is true whether the MODE switch is in the RADAR or COMM position. When ITEM 2 is enabled, TDRS antenna pointing (ITEMS 12, 13, 14 on SM ANTENNA) via the KU ANT switch is inhibited. The TDRS state vector is still maintained by GNC and will be used when ITEM 2 is disabled. See section 3.4.1.3 for details on ITEM 2.

- RADAR OUTPUT - HIGH, MED, LOW: During SEARCH the RR will be cycled through all power levels at or below the switch setting, lower power first. Once lock-on occurs the power is set to the switch setting. If the RR breaks lock and the system is in GPC, 20 seconds later the search begins again automatically, but power level does not cycle unless the designated range is less than 2550 feet; if the switch is in AUTO TRACK, a new SEARCH must be manually initiated, and power level will cycle. When tracking a TGT at a range of 640 feet or less the power level automatically drops from the switch setting level to bypass mode. Automatic downmoding is required only to protect the receiver, and will not necessarily protect the TGT if track is broken or if a SEARCH is initiated. To protect the TGT, the manual downmoding must be used.

Therefore, in practice, during an approach it is advised to manually switch from high to medium power and from medium to low power at appropriate ranges (2 n. mi. and 1 n. mi. have been proposed for a 1-square meter radar cross section (RCS) TGT, but in practice a signal strength check will be included). This will keep field strength below 20 V/m on the TGT. This is payload dependent, and usually they want low power inside 800 feet.

could

()

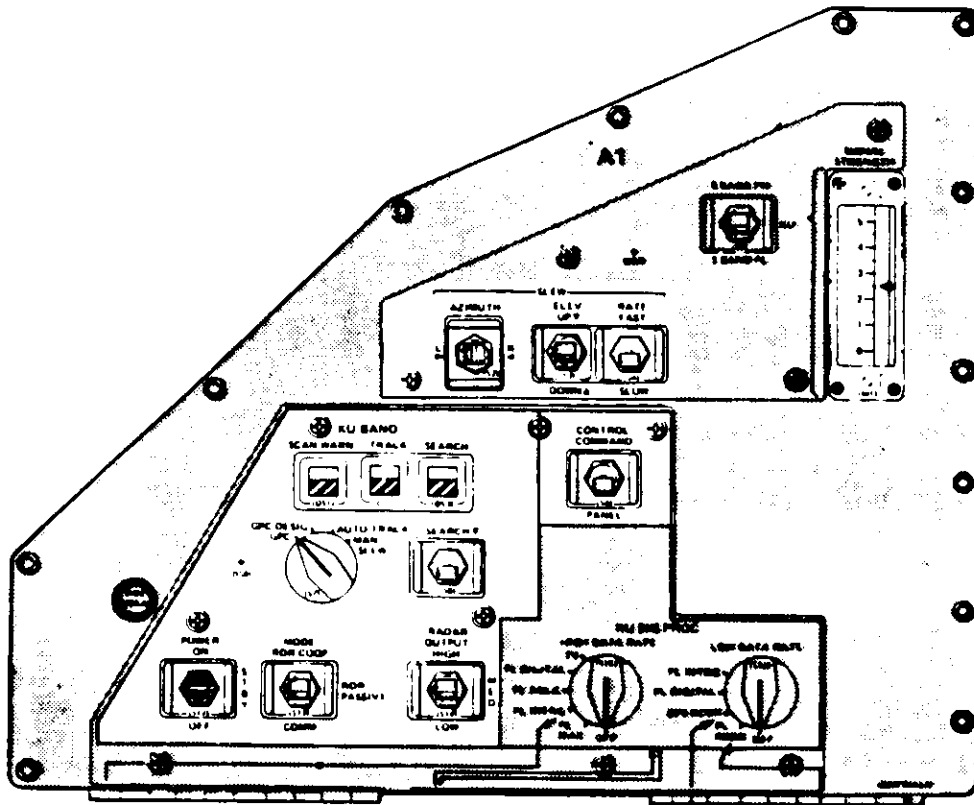

Figure 3-18.- Panel A1U.

- Antenna steering rotary switch (fig. 3-18). These modes and their application to RNDZ are summarized in figure 3-19.
 - GPC: This is "GPC acquisition." The antenna will point to the SM GPC-commanded AZ and EL, and will perform range and closed-loop angle TRK once the TGT is acquired. If the TGT is not acquired, the antenna is automatically commanded to search (in a spiral scan) around the designated point. The angle of search depends on expected range: it is $\pm 30^\circ$ at 8 miles, $\pm 20^\circ$ at 12 miles, $\pm 5^\circ$ at 300 miles.
 - GPC DESIG: The GPC GPC provides a TGT position vector which the SM GPC uses to aim the radar. There is no search pattern initiated. Range/rate data are provided if the SV estimate was close enough and a strong enough signal is returned. No closed-loop angle TRK is provided in this mode, but the designated angles are updated every 2 seconds.

Note: The Ku-band GPC DESIG position should not be selected when the antenna is in the obscuration zone. When the antenna tracks a TGT into the obscuration zone, the GPC reorients the antenna so it can pick up the TGT as it clears the other side of the zone. When GPC DESIG is selected with the TGT in the obscuration zone, the GPC doesn't have any history from which to make a reemergence prediction, so the antenna may rotate around endlessly. This is why the procedures call for RR-AUTO TRK when this situation occurs.

- AUTO TRACK: This begins with manual antenna pointing control, followed by a manually initiated search. The antenna does a spiral scan about the pointing direction at the time search is initiated, at all ranges, to a width of $\pm 30^\circ$. Once the TGT is detected, automatic angle and range TRK is provided. Note: The antenna can be manually slewed in this mode. *→ until TRACK indicator is set*
- MAN SLEW: The RR is pointed manually; there is no scan, but all ranges are searched within the 1.6° full-angle (for 3dB) cone of the radar beam. If a TGT is acquired, standard range/rate data are provided. To break track on a TGT, go to MAN SLEW, then slew the antenna away a few degrees until the TRACK talkback (tb) goes barber pole (bp).

Note: Valid RR angle data is available only in GPC or AUTO TRK modes and if the antenna is free to slew.

- SEARCH (momentary contact) - This command only works if the rotary switch is in AUTO TRACK and no TGT is currently being tracked. The antenna will then begin a spiral search pattern.
- CONTROL - PANEL: The panel switches have absolute control.
 - COMMAND: The only functions which can be commanded from the ground via the ground control interface logic (GCIL) unit despite the current position of the power and mode switches are: COMM power ON/STANDBY/OFF.

Note: Regardless of the control switch position, the ground can uplink six command loads to the SM GPC which will configure the Ku-band system via the serial input/output (SIO): KU/serial I/O enable, range estimate AUTO/MIN, radar self test ON/OFF, antenna inertial stabilization ON/OFF (GPC designate mode only), obscuration mask ON/OFF, and traveling wave tube (TWT) amplifier ON/OFF. There are no current plans to utilize this capability.

- SLEW - These switches allow manual slewing of the antenna. Two rates are allowed: low (0.4 deg/s) and high (20 deg/s). Elevation and azimuth are defined in an Orbiter body frame (see figure 2-16) along the -Z axis, with elevation corresponding to Orbiter pitch (+ is toward the nose) and azimuth corresponding to Orbiter body roll (+ is toward the right looking out OH window; i.e., the port wing).

In Man and auto track (pre detect) only.

	Uses TGT SV for ant EL, AZ	If not pointed at target*	Angles good to NAV and ADI LOS needles	Perform closed-loop tracking	Rendezvous/ PROX OPS phase usage
GPC ACQ	Yes	Search angle dependent on expected range	Yes	Yes	Normally, always on approach
GPC DES	Yes	No search	No	No	Never (TDRS COMM only)
AUTO TRACK	No	Search to $\pm 30^\circ$ angle	Yes	Yes	Backup mode to GPC ACQ. Likely to be needed post deploy, then switch to GPC ACQ after NAV converged
MAN SLEW	No	No search	No	No	Possibly for space station at $R \leq 2-3n.mi.$

* If pointed at target, RR locks on in all modes.

Figure 3-19.- RR steering modes.

- See OMV CONS M/B P-9-3 (WATL hold)*
- SIGNAL STRENGTH meter - This shows how much power is being reflected back from the target and is a function of range, transmitted power, and radar cross section. *discuss units*
 - TALKBACKS - TRACK is gray if tracking, bp otherwise.
 - SCAN WARN is gray if the beam is within about 5° of the Orbiter body, bp otherwise. When SCAN WARN is on, RF transmission is disabled, but this has been overridden. So for RR OPS the indicator is a NO OP.
 - SEARCH is gray if searching, bp otherwise. After 1 minute maximum, SEARCH automatically times out. It will repeat in GPC acquisition mode about new designate angles after a 20-second delay.

3.3.4.2 Parameters

Range, range rate, azimuth, and elevation are measured along the LOS to the TGT (The RR directly measures relative range rate via Doppler tracking of the TGT). The values are displayed on the REL NAV SPEC function (section 3.4.1) and on an aft crew station dedicated display meter (select R/R-DOT or EL/AZ).

The RR data are displayed on panel A2 (fig. 3-20) with a pair of LED digital displays which represent either range (in kft) and range rate (in ft/s) or (depending on position of the DIGI-DIS SELECT switch) elevation and azimuth angles (degrees, Orbiter -Z reference). The elevation and azimuth inertial LOS TGT angle rates (in mr/sec) are always displayed on a two-D meter (scale is selectable, X1 or X10); the mr (milliradians) unit is useful because multiplying mr/s by range (in kft) gives normal to line of sight (NLOS) rate in ft/s, with respect to an inertial frame centered on TGT. The elevation and azimuth angles and rates allow maintenance of Orbiter position on the TGT V-BAR, even in darkness when the COAS is not usable (see section 4.3.6 for desired c.g.-offset depression angles).

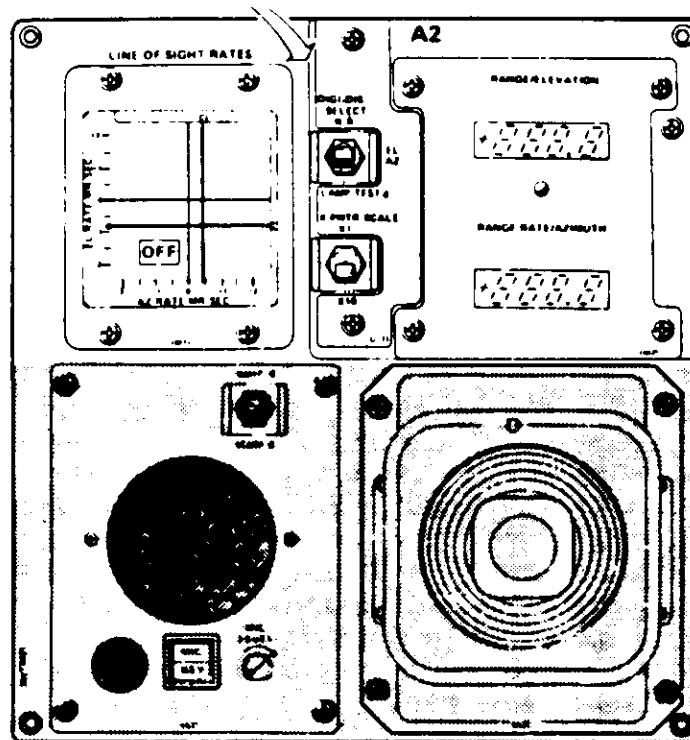

Figure 3-20.- Panel A2.

The elevation and azimuth inertial LOS angle rates provide information on relative position rates normal to the LOS to the TGT and are independent of Orbiter body attitude as they are referenced to the radar gyro (inertial reference) frame. Once close to the TGT, they become unusable due to beam wandering and random relative motion. In fact, flight experience indicates that, at all ranges, LOS rates as displayed on panel A2 jitter far too much to be useful as procedures criteria. Proper filtering may improve this.

A "detect" flag is set (but not displayed onboard) when a return signal is first received. Once the return passes a Ku-band electronic assembly internal validity check, "DATA GOOD" flags are set and closed-loop tracking can begin. The data can now be used in REL NAV.

Performance ⁱⁿ Extremes

JSC-10589

3.3

The

- 1 Max range
- 2 Min range
- 3 Max RDOT
- 4 Min sig strength
- 5 Large TGT angular size
- 6 Fast spin tgt

The
en
pr

fixed in hardware, and
software scrub.

):

to the TGT
from TGT

line of
ing is
close range.

low clutter
OPS
t was later
convenient

3.3.4.4 Self-Test

update w/ POST-32 insights ?

The Ku-band system is put through a self-test of its circuitry early in the RNDZ phase. While the self-test in itself is not always an absolute indication of a failed or operational radar system, it does provide insight into the system should some anomaly become apparent later in the profile.

The system is configured to the RDR PASSIVE mode for self-test. The system can be tested in the COMM mode, but in the RDR PASSIVE mode the radar processor is tested as well as the electronics assembly and deploy mechanism. For self-test to pass, the radar system power output must be at HIGH.

The system control is put to MAN SLEW to keep the antenna from receiving gimbal commands to follow the TDRS at the completion of the test. One of the system peculiarities occurs when the system is placed into the communications mode while the TDRS is obscured by Orbiter body blockage. In this situation, the antenna could possibly begin oscillating from one gimbal stop to another until the TDRS exits blockage.

When the panel is properly configured, the system control is transferred from ground command to onboard by selecting CNTL - PNL.

The SIGNAL STRENGTH meter is set to register for Ku so the crew can monitor the progress of the self-test; range/range rate is selected on the digital display so the crew can tell if the system passed or failed self-test; and cross pointer scaling is set to its high resolution display so the crew can more accurately monitor LOS rates during PROX OPS. Self-test is initiated via the appropriate item entry on the SM ANTENNA display and lasts about 3 minutes. During the test, several simulated TGT inputs are sent through the system, and the crew will see the SCAN WARN, TRACK, and SEARCH panel talkbacks cycle to gray from barberpole. At test completion, a pass (888.8) or fail (333.3) indication will be given on the digital display (panel A2) and on the REL NAV display in the range slot.

At test conclusion, the crew cancels the self-test command (ITEM 7) and reconfigures the Ku system. Before going back to ground command, the mode switch is put back into COMM, but the antenna pointing is not reconfigured back to GPC from MAN SLEW to avoid gimbal oscillations. During the next ground acquisition of signal (AOS), the MCC will verify that the TDRS is not in blockage before configuring back to GPC pointing control of the antenna.

Flight experience has shown that the RR self-test has failed about half the time, but the RR has always performed properly for RNDZ and PROX OPS.

3.3.4.5 Configure for RNDZ Radar TGT Acquisition

This procedure is shown in figure 3-21A; it is called out in section 4.1.18 of the RNDZ procedures rationale narrative.

	GNC 33 REL NAV	
CRT	KU ANT ENA -	ITEM 2 EXEC (*)
	GNC. I/O RESET	EXEC
A1U	KU MODE	- RDR PASSIVE
	KU	- GPC
	✓ KU RDR OUTPUT	- HI
	KU CNTL	- PNL
A2	DIGI-DIS SEL	- R/RDOT

Figure 3-21A.- configure for RR
TARGET ACQ.

Because of the pulse repetition techniques used by ~~for~~ the RR, the maximum possible unambiguous range for TGT acquisition is just under 164 kft (27 n. mi.). To avoid acquiring confusing and inaccurate data at longer ranges, the system is configured to the radar mode after the Orbiter-to-TGT predicted range is less than 150 kft. ? range = ct

STS-32
No NAV
until
.....

Speed of electromagnetic waves multiplied by pulse repetition frequency of the RR system while in long range track mode gives the total distance traveled by one RR pulse before the next pulse is sent. Dividing by 2 gives the one-way distance from Orbiter to TGT that allows a single RR pulse to be sent, reflected off the TGT, and returned to the Orbiter before another RR pulse is sent.

If the RR did acquire a TGT at longer ranges, a second RR pulse would have already been sent by the time the initial pulse was returned. In this case the RR would interpret the returning initial pulse as being a return of the second pulse off of a TGT close to the Orbiter. The interpreted TGT range would be approximately 164 kft less than the actual range to the TGT.

The radar is put into the RDR PASSIVE mode for TGT's without radar transponders on them (the RDR COOP mode for aided TGT's has not yet been validated on the STS). The KU switch is placed in the GPC position so that

the radar can automatically receive pointing estimates for where to search for the TGT from the Orbiter GPC's. In the GPC mode of operation, the RR performs a spiral search for the TGT every 80 seconds until lock-on. The search pattern begins at the GPC designated gimbal angles and covers a 30° half angle cone. The spiral search takes 60 seconds to complete, after which the RR receives new designate angles, drives to those designates, and waits for the next search command. HIGH power on the RADAR OUTPUT switch is required to support TGT acquisition at maximum ranges. Once the panel has been properly set up, the control of the radar system is transferred from ground command (CMD) to onboard control panel (PNL) via the KU CNTL switch.

Interface software is set up for the Ku system to receive pointing designates from the GN&C software for the RNDZ TGT by executing KU ANT ENA. Without this item executed, the Ku designates come from the SM software and are for the TDRS satellite selected for communication. The GNC I/O RESET executed later initiates this interface processing.

NAV software is configured such that angle data will be input from the RR system instead of the STRK or COAS by executing ITEM 13 on the REL NAV display. Even if angles are still selected from STRK or COAS, the R and R-DOT are exclusively from the RR and are thus always selected (there is no choice).

The DIGI-DIS SEL is set to monitor range and range rate. Until lock-on, this value will be zero and will show data only after the TGT is detected. If the meter were configured to display AZ and EL, the crew would see the designated pointing angles displayed prior to acquisition and then actual angles after acquisition. Since designate angles should be close to actual, if the panel were set to angle data, it would not be obvious by viewing the meter if an acquisition had occurred or not.

Whenever either RR angle exceeds 30°, radar angle measurements will be inhibited by crew action. This is because angle data is considered valid only within a band plus or minus 30° from the line-of-sight of the RR. (Ref: Onboard Navigation Systems Characteristics, Dec. 1981, section 7; JSC-14675; 79-FM-5, Rev 1)

3.3.4.6 RR ~~Cue Card~~ **AUTO TRACK**

contingency procedure
 A standard procedure for RR AUTO TRACK acquisition is shown on the RNDZ OPS ~~cue card~~ below (fig. 3-21B). The antenna is manually pointed towards where the TGT really should be; if lock-on still fails, return to GPC/ACQ mode (pointed by NAV), and the last hope is that target radar reflectivity characteristics (range and/or attitude) will improve enough to allow acquisition.

KU - AUTO TRK Slew antenna to Elev 0, Az 0 (or Elev, Az as seen in COAS) Ku TRACK tb - gray If no TRK (Ku TRACK tb - bp) KU SEARCH - SEARCH (tb-gray) If no lock-on within one minute, KU - GPC	<i>see 39</i>
--	---------------

Figure 3-21B.- RR AUTO TRACK ACQ.

3.3.4.7 Radar Effects on Target

The electromagnetic pulse from the Ku-band antenna must be powerful enough to allow a sufficiently strong echo to return off the TGT. Since inverse square law dissipation occurs on both the outbound and inbound legs, the total energy loss follows an inverse fourth power law. This feature suggests that a radar powerful enough for tracking an object several miles away could be powerful enough to damage its electronics when it gets to within several hundred feet. This is true, even with the option of reducing power during approach (see section 4.1.62 for a discussion of these procedures).

Figure 3-22 shows the induced electrical charge in volts/meter caused by the Ku-band radar at its four power settings, as a function of range.

When operating in any power mode, when the Ku-band system detects range < 640 feet it will automatically command "bypass power," which reduces power to 40 dB below high (there is no other way, either from onboard or MCC, to instigate this mode). If the system breaks lock it will jump to the power setting on the panel (HIGH, or MEDIUM [12 dB below HIGH], or LOW [24 dB below HIGH]) momentarily before detecting R < 640 and resuming "bypass mode".

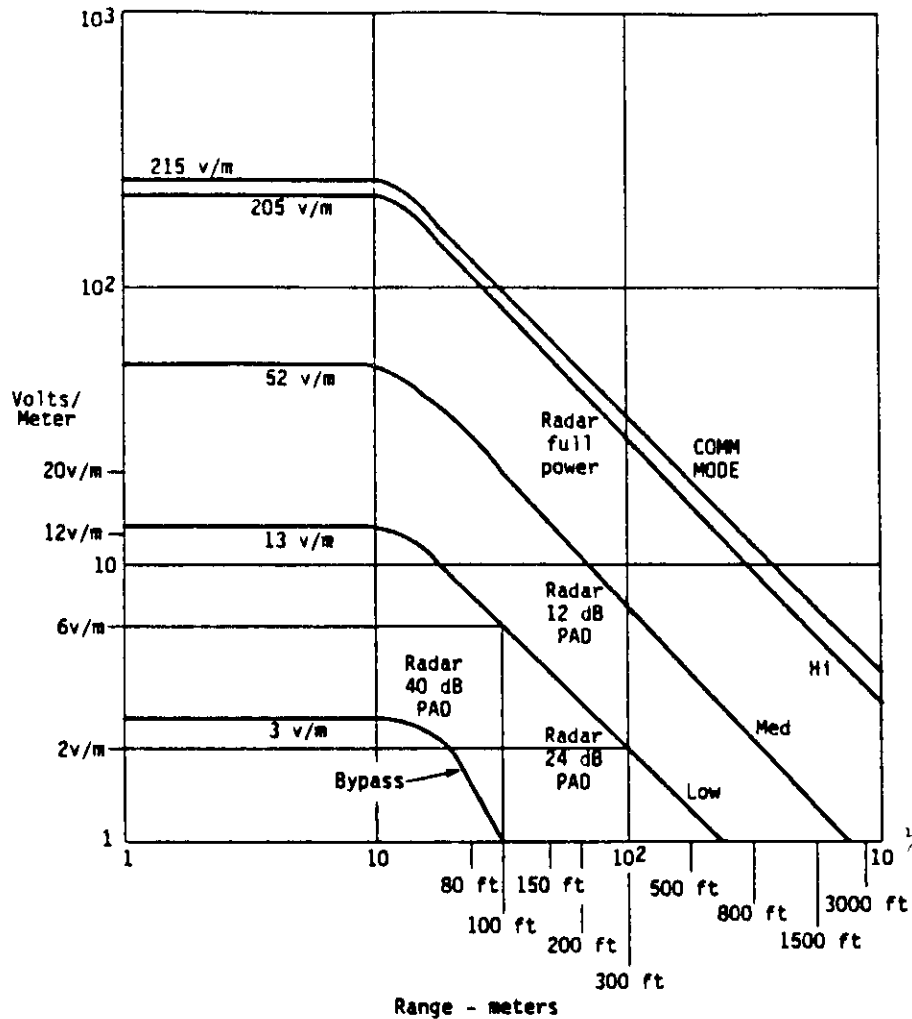

10589*005

Figure 3-22.- Induced volts/meter on target.

3.3.5 Closed Circuit Television

Although installed for other purposes, the CCTV's are also used as important range/rate sensors.

The fields of view of the CCTV's are as follows:

There are normal lenses (usually on the PLB A, B, C, and D cameras and the RMS EE) with focal lengths of 18 mm to 108 mm (zoom of 6:1) and wide angle lenses (RMS elbow and sometimes per PL request on PLB B and C) with focal lengths of 8.2 mm to 25 mm (zoom of 3:1). The following values apply for focus set to far and underscan on, and they refer to the horizontal scale on the CCTV monitor, in degrees: normal-lenses zoom-out is 40.9, zoom-in 6.6; wide-angle lenses zoom-out is 83.3, zoom-in is 29.5.

Note: Adjusting the focus will affect the width of the normal lens FOV, with zoom-out FOV changing from 40.9 to 33 as the focus is changed from "far" to "near," and zoom-in FOV changing from 6.6 to 5.8 as the focus is changed from "far" to "near"; however, for rendezvous and PROX OPS, the focus will always be set to "far." With the wide lens, changing focus will hardly affect width of FOV at all.

3.3.5.1 Locations

There can be four bulkhead-mounted CCTV's in the PLB, designated A (forward port), B (aft port), C (aft starboard), and D (forward starboard); two RMS cameras (elbow and wrist); and possibly keel and pallet cameras. Selection and control of camera operations is made via panel A7U (fig. 3-23); the two monitors are on panel A3 (fig. 3-24). Camera pan and tilt angles are shown on the CCTV monitors in the monitor "data on" mode.

*These angles are not
downloaded*

3.3.5.2 Control/Display

On each of the two CCTV monitors, the camera ID, pan, tilt, and camera over-temperature can be displayed (selectable via the DATA SWITCH ON/OFF on the monitor). Crosshairs can also be displayed (selectable via the X HAIR ON/OFF toggle switch). Two camera scenes can be multiplexed onto one monitor, but in this case only camera ID information can be displayed; neither pan/tilt nor crosshairs can be displayed.

3.3.5.3 Triangulation Technique

Forward and aft bulkhead camera tilt angles are obtained by the crewmember after the TGT has been centered in the FOV (fig. 3-25). By use of triangulation (see chart, fig. 3-26), the range to the TGT can be determined (it is then biased by the distance from the forward camera to the roof of the crew compartment, to provide a pure "clearance" reading where "0" is contact). The error sensitivity of this technique is a function of tilt angle, and the range estimates become degraded at angles of greater than about 80° (ranges greater than 200 feet).

The CCTV cameras must be "zeroed" ahead of time and possibly during RNDZ phase if the tilt encoders are disturbed. This is done in the CCTV CONFIG block by pointing camera A at camera B (and vice versa) and hitting PAN/TILT-RESET switch for both; repeat for cameras C and D.

See section 4.3.6 for values of forward (FWD) PLB CCTV tilt angle on V-BAR, as function of range.

3.3.5.4 Keel/Pallet

For some payloads (e.g., LDEF or TSS), one or more of the bulkhead cameras may be remounted inside the PLB. A keel-mounted camera will look right up

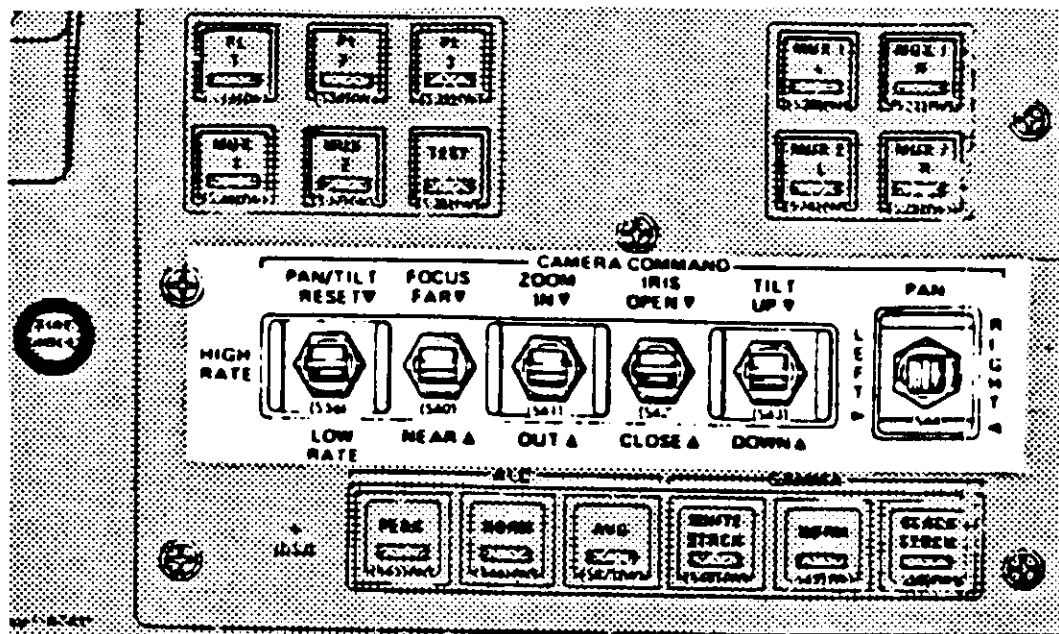
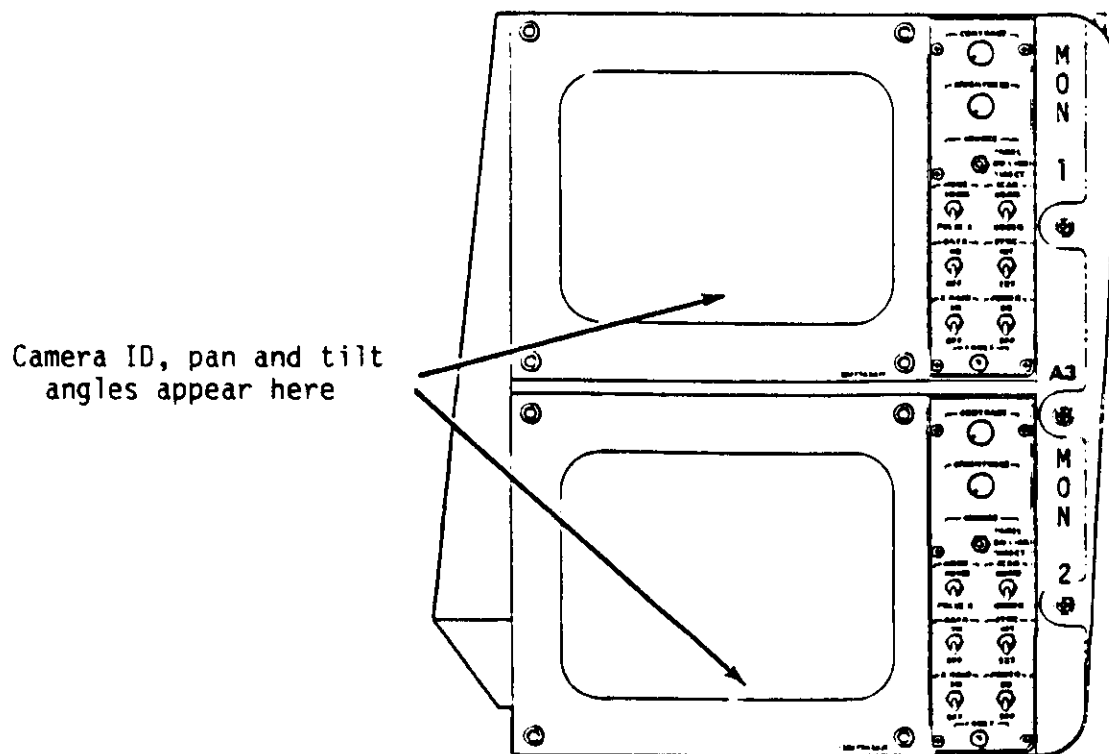

Figure 3-23.- Panel A7U. Camera command & video input/output.



Camera ID, pan and tilt angles appear here

Figure 3-24.- Panel A3.

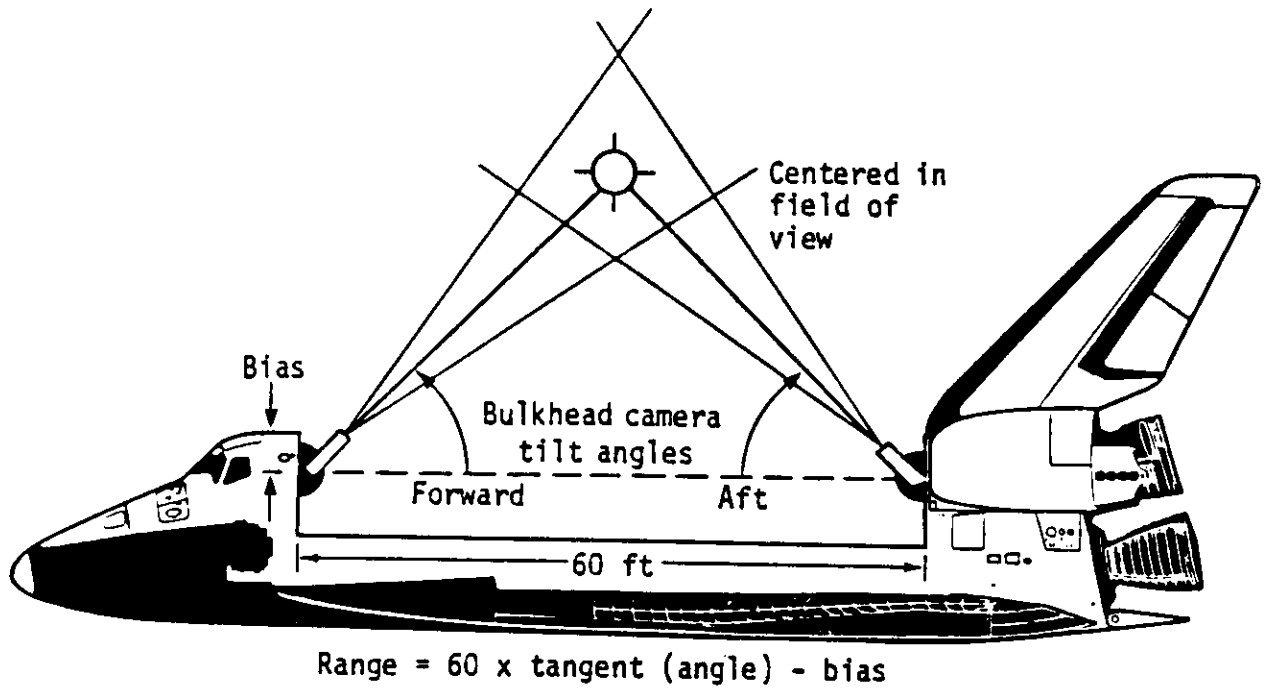

Figure 3-25.- Use of bulkhead cameras tilt angles to determine range.

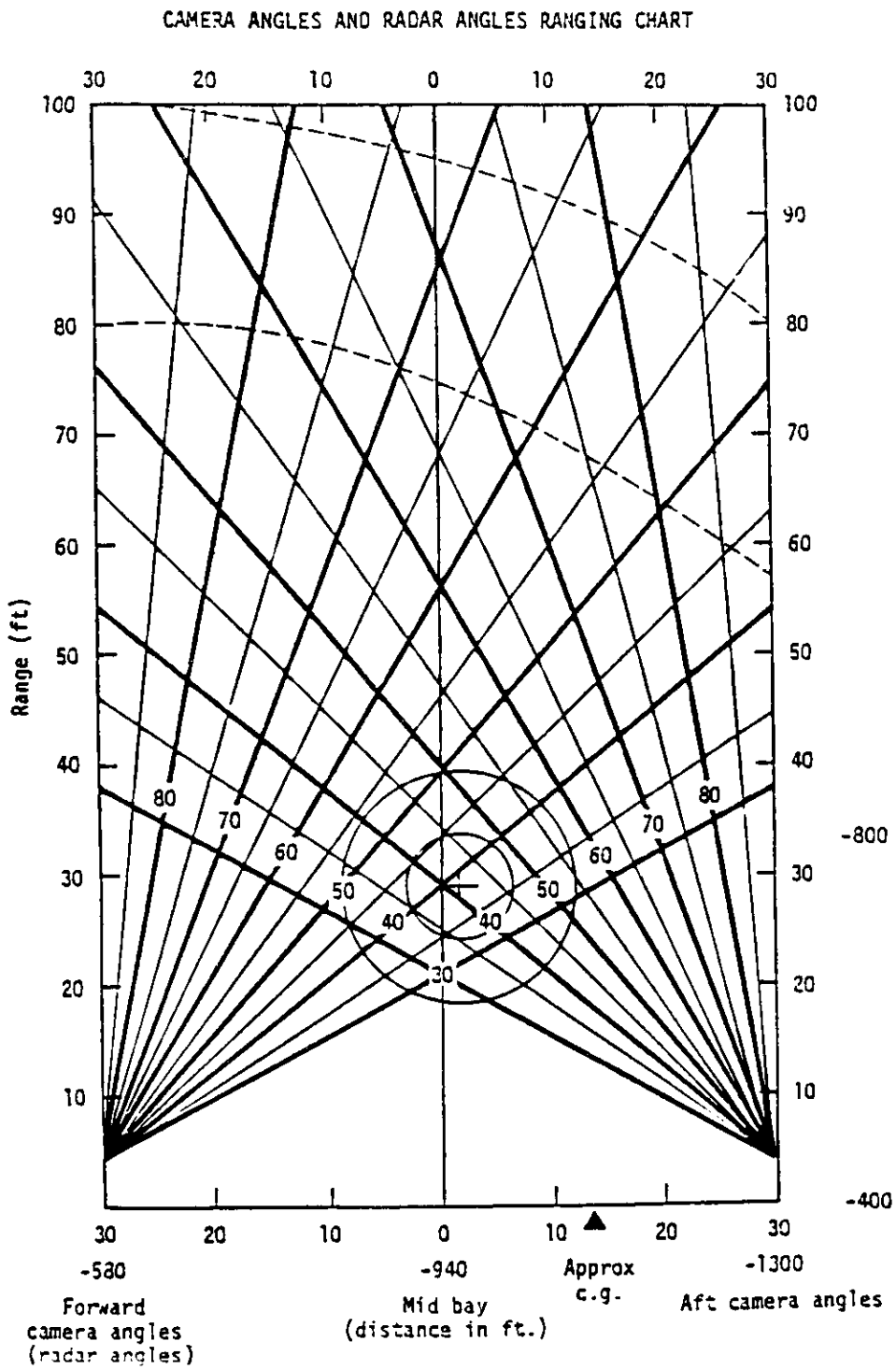

Figure 3-26.- Triangulation chart.

(Note: RMS EE coordinates also provided here.)

the $-Z$ axis; it will have no tilt/pan control. Both Orbiter X and Y axis deviations can readily be detected and controlled using such a view. (See fig. 3-27.)

3.3.5.5 RMS Wrist

With the RMS in grapple position, the wrist camera FOV is normal to the $-Z$ axis. Motion of the payload in this view is the prime indicator of fine closing rates just prior to final stationkeeping and grapple (fig. 3-28a). Rates along Orbiter X axis are also monitored here.

The RMS elbow camera (if installed) could be used as a backup to the RMS wrist camera. Pan/tilt orientation for this camera must be manually adjusted. In such a case, it might be preferable to perform grapple over the COAS, using aft bay CCTV's for rate measurement. See section 4.4.6 for failure recovery discussion.

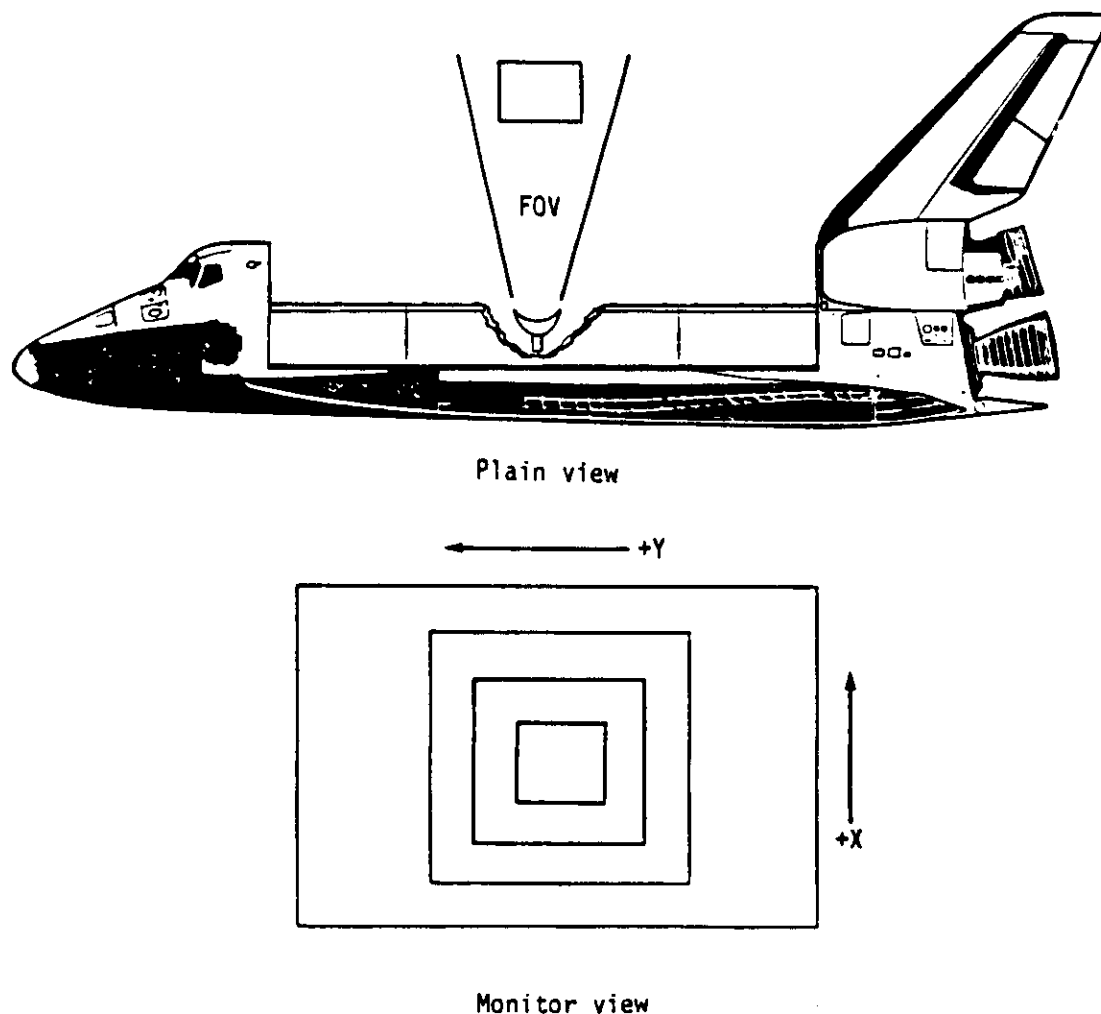

Figure 3-27.- Keel camera.

As an aid to visualizing Orbiter-relative motion of an object being observed in the EE CCTV, a transparent overlay (fig. 3-288) is included in Flight Data File (FDF) for installation over the appropriate CCTV monitor.

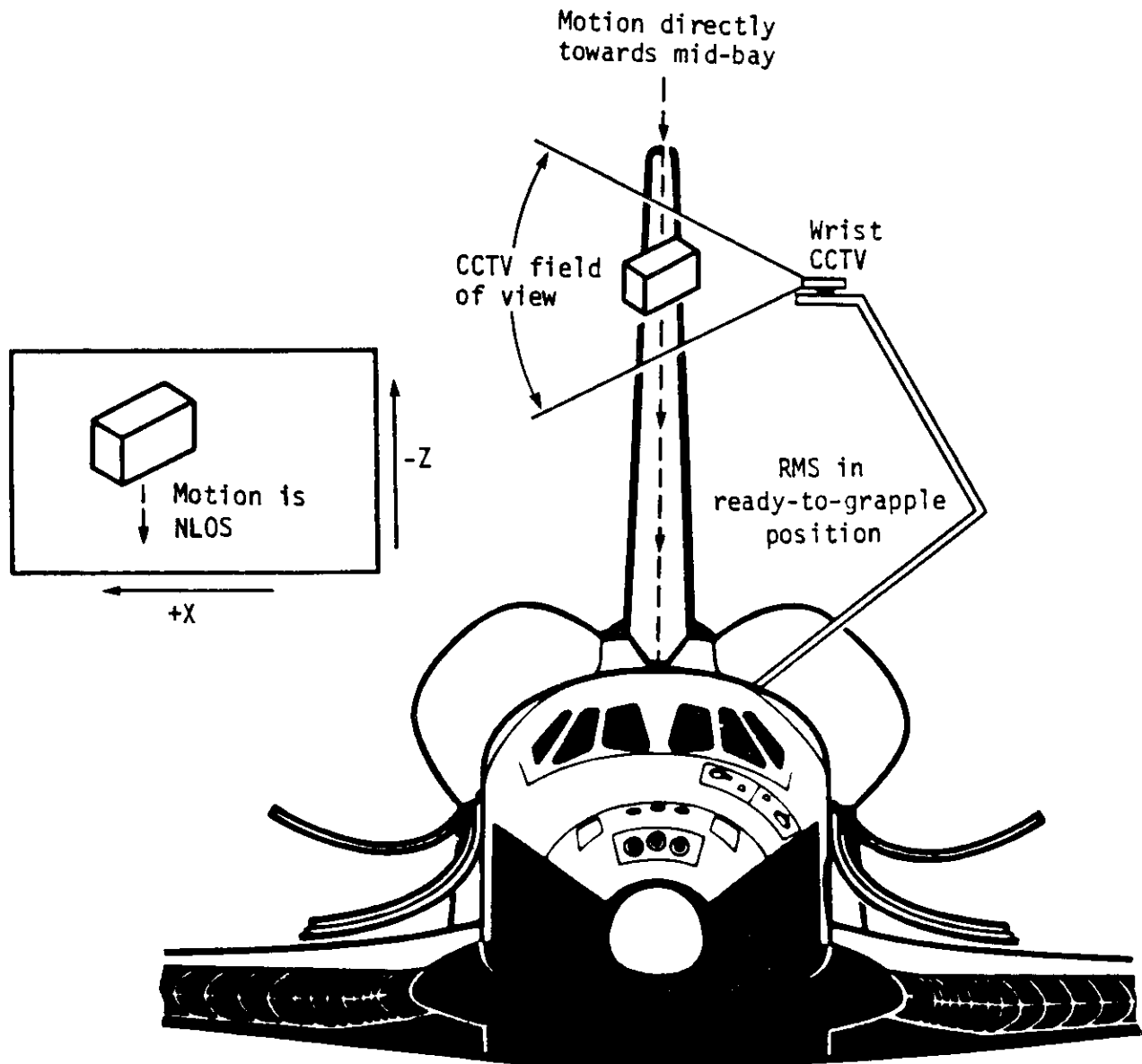

Figure 3-28A.- Use of RMS wrist camera to determine range rate.

3.3.5.6 Other PLB cameras

Depending on mission cargo mix, there may be other CCTV's in the PLB viewing up the $-Z$ axis (e.g., Earth observation systems). Their utility to RNDZ and PROX OPS must be determined on a mission-by-mission basis.

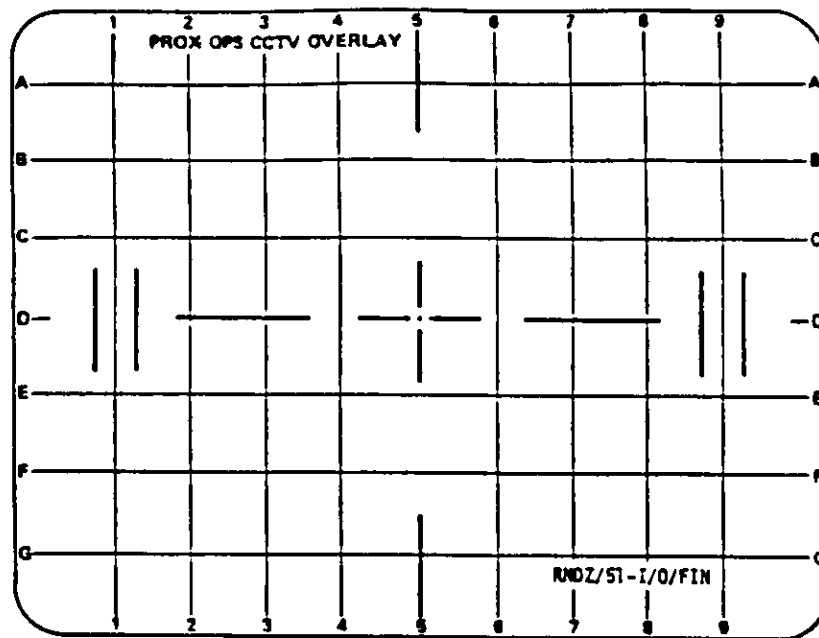

Figure 3-28B.- EE CCTV object motion overlay.

3.3.6 CCTV/Overlay

A variety of methods exist to estimate distance to a TGT in the event of radar failure. Within 200 feet, CCTV elevation angle is used, and COAS subtended angle can be used out to about 1000 feet, depending on the size of the TGT. A crewmember's binocular vision can provide excellent ranging estimates out to 60 to 80 feet; judgements based on TGT angular size are probably good to 200 to 400 feet, depending on TGT size. A combination of hardware, geometry, and human factors limitations degrade the accuracy of these methods as range increases. The most reliable technique is use of TGT angular size on CCTV screens.

In current practice, if the radar is failed, there is only one method of determining range at distances much beyond 1000 feet with reasonable accuracy. For payloads the size of Solar Maximum Mission (SMM) or long-duration exposure facility (LDEF), range can be estimated from about 40 to 6000 feet, with a mean error (based on SES experience) of about 3 percent to 4 percent. Procedurally, the crew configures the CCTV cameras for either full or no zoom. The TGT is approximately centered, then the bottom line of the applicable range ruler (fig. 3-29) is placed atop the screen image of one end of the optimum axis. Range is read where the other end of the axis falls. A gross estimate of range rate may also be obtained using the rulers and a stopwatch or HP41CV program, although SES experience shows that range rate accuracy is poor (mean error of 50 percent). Essentially, the rulers can only be relied upon to provide a "sense" of the range rate; e.g., opening or closing; fast or slow. In practice, it is best to wait until two or three ruler hacks are taken that give consistent R-DOT, before performing translation to adjust R-DOT. However, it may not be possible to wait that long.

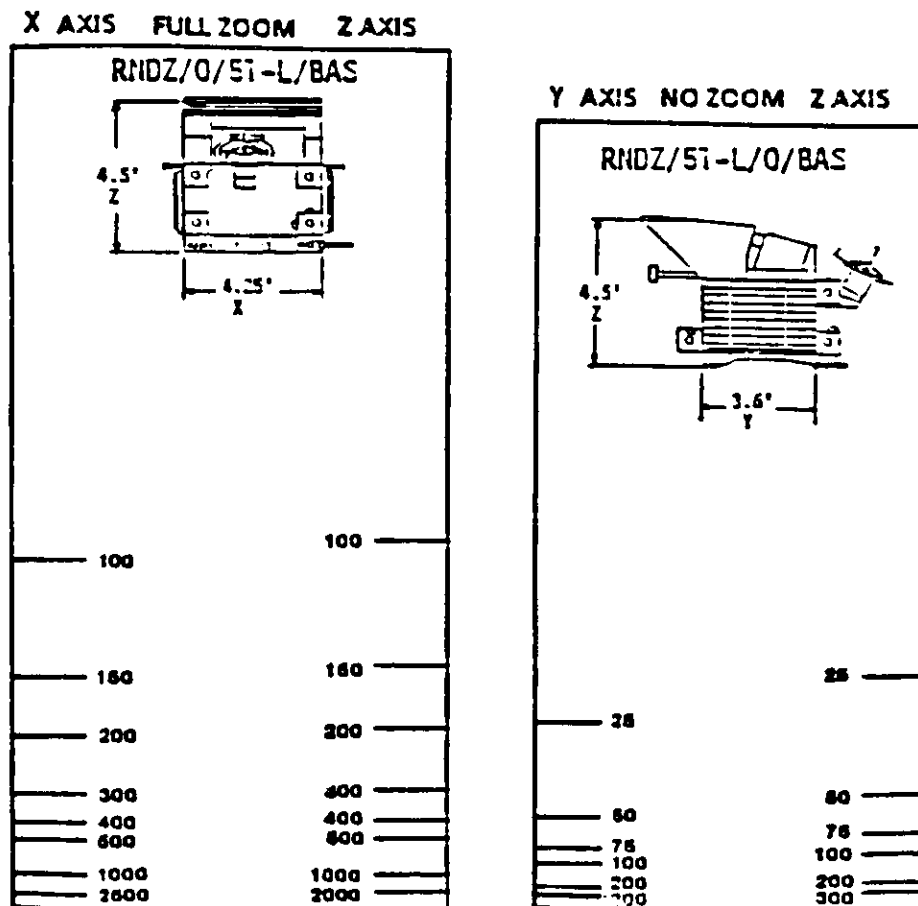

Figure 3-29.- Typical ranging overlay.

Flight experience has shown that image blooming caused by overbrightness from Sun reflections off the TGT can seriously degrade the utility of this procedure. The displayed CCTV image can be rendered useless during these phases. Current CCTV H/W improvements may help with this problem; manual camera iris control is also useful.

Note: Underscan should be selected on the CCTV's when using the ranging rulers. The rulers can be made either way, but are made up for underscan because DOD requirements for downlist TV preclude the use of operating without underscan. Underscan (switch selectable) creates a blank border around the CCTV monitor image, which insures that no edge overlap scenes are being downlinked. However, it also results in a 6 percent reduction in image size on the CCTV monitor.

3.3.7 Other Ranging Devices

3.3.7.1 Laser Rangefinder

A laser rangefinder was operated on early RNDZ missions. Originally conceived as part of an AUTO-focusing system for the CCTV system, it was mounted on a PLB TV camera, and range and range rate readouts were displayed on a CCTV screen. The device was effective out to a range of perhaps 400 feet. Experience was unsatisfactory and this particular device was not used subsequently.

In principle, such devices (with improvements) can be very useful as close range sensors for space station docking. With ranges of up to several miles, such devices make terminal phase much easier, especially when range and rate data can be fed directly into NAV. Hardware development is underway on such a device.

3.3.7.2 Stadimetric Binoculars

This optional equipment, first flown on STS 51-A and highly recommended by the crew, consists of 8X binoculars with tick-marked reticle (5-milliradian increments). In conjunction with an HP41C program for angle-to-range conversion, it provided an accurate and easy-to-use backup ranging device.

3.3.7.3 Global Positioning System

Use of the global positioning system (GPS) for relative NAV may someday be feasible. Equipment on both Orbiter and TGT process GPS data and then difference the pseudorange data for relative motion NAV. This technique would allow GPS systematic biases to cancel out. For a single user, expected accuracy is to within 35 feet in position, and 1 ft/s in rates; however, relative positions would be accurate to within 3 to 10 feet. Use of this technique would require new NAV software in the Orbiter, and to date this has not been approved.

3.3.7.4 Other

Other NAV technologies have been proposed for determining the SV of the Orbiter. These include "TACAN NAV" and "TDRS NAV." Neither has been implemented or scheduled, and thus they have no relevance to current or planned RNDZ operations. Advanced systems for space station RNDZ NAV are discussed in chapter 8.

3.3.8 Orbiter Lights

For nighttime viewing of TGT's through the COAS along the -Z axis, a spotlight is mounted on the forward PLB bulkhead and projects a 10° beam

(half intensity at edges). The light is a 230-watt metal halide device providing about 1200 candlepower. Brightness is sufficient to determine TGT attitude at 700 feet, where the beam width is about 100 feet. The light is controlled from a switch on panel A1.

The six PLB lights already installed do provide some nighttime TGT illumination capability, but the overhead docking light increases intensity in its beam by about 30 percent. At low light levels this is quite significant.

There is also another light atop the CCTV on the RMS wrist. Note that for PL's in the bay, some or all of the PLB lights may have to be kept off for PL thermal constraints.

A specialized portable xenon light (called the "streamlight") is available as an optional item for night stationkeeping. It throws a lot more light (one million candlepower) than regular Orbiter lights, and crews (the first was 51-A) highly recommend it. The light is fastened on a camera bracket at one overhead window and plugs into utility power; stowed, it and its own power converter take up one full middeck locker. It is a big power user and gives off a lot of heat. In-cabin use is constrained by window transmissivity.

3.3.9 Target-Mounted Sensors

Some TGT's have their own attitude sensors and make such data readily available for display onboard the Orbiter and on the ground. Where such attitude data exists or can be derived, every effort should be made to make it available to the crew during PROX OPS.

3.3.10 Target-Mounted Tracking Aids

Various TGT characteristics are desirable for enhancing the ability of the Orbiter crewmember to determine TGT range and attitude.

In terms of visual tracking, it is desirable that the TGT not have high-gloss surfaces which can cause specular reflections of sunlight (flat white paint is a good scheme). Furthermore, ranging through the COAS can be facilitated if some visible features of the TGT (either structures or markings) are sized appropriately so as to subtend angles of 2° at 100 feet and at 30 feet (that's a true linear dimension of 3.5 feet and 1 foot, respectively); this is a desirable, but not required, feature.

Reflection characteristics of the TGT can be enhanced by use of reflective tape. Visibility out to 500 feet can be achieved.

Spartan radar cross section measurements
without corner reflectors

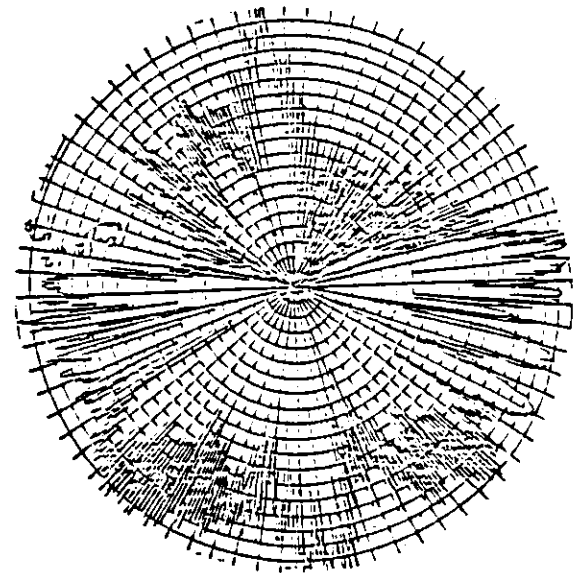
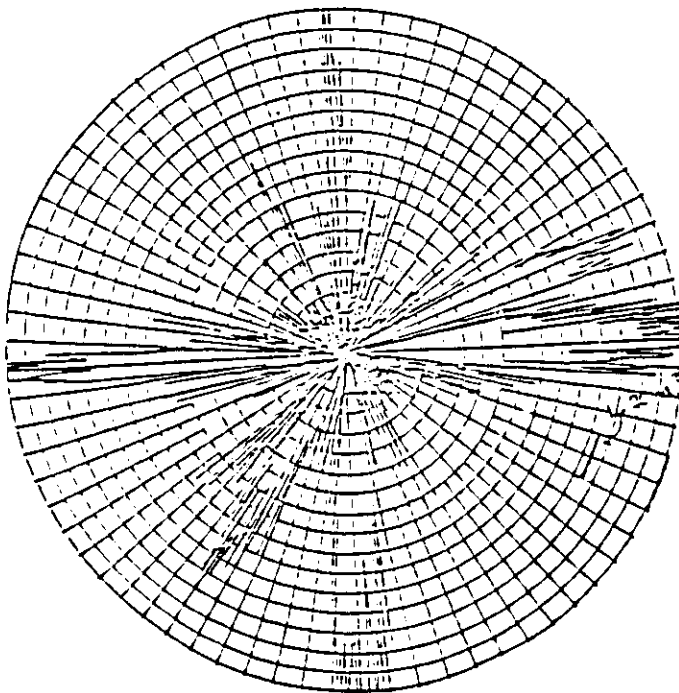

Spartan radar cross section measurements
with corner reflectors

Figure 3-30.- Effect of corner reflectors on radar cross section.

In terms of lighting, if the reflection of the TGT characteristics or Orbiter pointing is inadequate to provide visual cues at night (regarding TGT relative position, orientation, and grapple fixture location), then running lights are highly desirable, with the following characteristics:

- Capability exists for flight-crew on-off commanding.
- Lights are steady-state with intensity of 1.0 candlepower on the beam cone centerline, decreasing to 10 percent of maximum at $\pm 80^\circ$.
- If flashing lights are required (due to power limitations), the rate should be more than once per second.
- The optimum number of lights is eight (of equal brightness), located orthogonally with respect to target coordinate frame, with color coding as follows: port - red (two), starboard - green (two), and bottom - yellow (four).
- A minimum of two lights should be provided on spin-stabilized TGT's.

Radar reflectivity can be enhanced through the use of simple corner reflectors (fig. 3-30), which significantly increase the radar cross section of the target.

In terms of close-in radar TRK, a radar enhancement device (RED) can be used to prevent beam wandering over a TGT of large angular extent; this can reduce noise in the range and range rate measurements. At long ranges a RED can be expected to provide more distant radar tracking capability.

3.4 NAVIGATION

The task of NAV is to find out where one object is located and is moving, relative to a reference frame or another moving object. This section describes the use of the REL NAV SPEC, the theory of Orbiter SV management, and the stages through which onboard sensor data pass into SV knowledge.

3.4.1 REL NAV (SPEC 033)

Relative navigation (REL NAV) (fig. 3-31) is available in OPS 2. It provides the crew with relative state information and translational thrust monitor capability for the RNDZ, PROX OPS, and PL deployment/retrieval phases of the mission. It also provides data and controls for RNDZ NAV operations using the STRK, RR, and COAS. NAV filter controls are provided to allow manual control of NAV data from the STRK, RR, or COAS, depending on which are being used.

RNDZ NAV ENA IX SV UPDATE					000/HH:MM:SS			
KU ANT	ENA 2X	POS XX.XX			AVG G ON	5X		
MEAS	ENA 3X	VEL XX.XX			AVX	±XX.XX		
NAV						AVY	±XX.XX	
SV SEL	4 XXXX	RR XXXX			AVZ	±XX.XX		
RNG	XXXX.XXX	RNG	XXXX.XXXS			AVTOT	XX.XX	
A	±XXXX.XX	A	±XXXX.XXS			RESET	COMPNT 6	
B	XXX.XX	EL	±XXX.XS			TOT	7	
Y	±XX.XX	AZ	±XXX.XS			SV TRANSFER		
V	±XXX.X	WP	±XX.XS			FLTR	MINUS	PROP
MODE	XX:XX:XX	WR	±XX.XS			POS	XX.XX	
FILTER								
S TRK	12X	RR	13X	COAS	14X			
STAT	XXXXXXXXXX	OFFSET	X ±X.X			FLTR	TO	PROP
	XXXX	Y	±X.X			PROP	TO	FLTR
SLOW RATE	15X				ORB	TO	TGT	10X
COVAR	REINIT	16X	MARK	MIST		TGT	TO	ORB
	RESID	RATIO	ACPT	REJ		EDIT OVRD		
RNG	±XX.XX	X.X	XXX	XXS		AUT	INH	FOR
A	±XX.XX	X.X	XXX	XXS		17X	18X	19X
V/EL/Y	±X.XX	X.X	XXX	XXS		20X	21X	22X
M/AZ/X	±X.XX	X.X	XXX	XXS		23X	24X	25X

Figure 3-31 - The REL NAV (SPEC 033) display.

Interaction with Orbiter DPS actions can affect REL NAV's processing, as specified in section 3.7.

The NAV data is used to update the Orbiter SV. However, FSW can conceivably be changed so sensor data would improve the TGT state instead of the Orbiter state, but not through a simple ITEM entry on the REL NAV display. The present design has an I-loaded flag that determines which state will be updated by the Kalman filter. This flag could only be changed in I-load, or by a G-MEM via crew input or by uplink.

Note: Although FLTR is the SPEC abbreviation of "FILTER," use of the abbreviation "FILT" is widespread in documentation with identical meaning.

occasionally format

3.4.1.1 Parameters

The RR determined relative state information includes the following (compare to generic RNDZ parameters in section 2.5 and RR-specific parameters in section 3.3.4):

- RNG: Line of sight range (kft) between the vehicles.*

- R-DOT: Range rate (ft/s); sign convention is positive opening, negative closing.*
Note: Both raw radar and NAV values are displayed for RNG and R-DOT.
- EL: Pitch position (elevation) of the radar antenna gimbal relative to its -Z null position ($\pm 90^\circ$); positive sense - antenna motion toward the +X Orbiter axis.*
- AZ: Roll position (azimuth) of the radar antenna gimbal relative to its -Z null position ($\pm 180^\circ$); positive sense - antenna motion toward -Y Orbiter axis.*
- ωP or EL-DOT: Pitch inertial angle rate (\pm mr/sec); positive sense - antenna motion toward the +X Orbiter axis (mr = milliradians).*
- ωR or AZ-DOT: Roll inertial angle rate (\pm mr/sec); positive sense - antenna motion toward the -Y Orbiter axis.*

*This radar information will be displayed whether or not RNDZ NAV is enabled, as long as there is a data path through FF3. The same data can also be seen on crew station panel A2. After the radar locks on to the TGT, there are still down arrows on the REL NAV display for a short period of time. This happens because the software is conducting a data good check on the radar data and until the discrete becomes GOOD the down arrows will remain. RR data may still be good enough for manual phase.

- θ - (Theta): The angle between the Orbiter V-bar and the UNIV PTG body vector (ignoring effects of deadbanding). If UNIV PTG is tracking the TGT with the -Z axis, θ is the elevation angle of the TGT with respect to the chaser V-bar.
- Y - The out-of-plane distance (kft). Positive sense is along negative angular momentum vector of the TGT, or to the right when heads up, facing forward. For posigrade orbits, this is south.
- Y-DOT - The out-of-plane rate (ft/s), same sense as Y.
- NODE - The MET time hh:mm:ss of the next nodal crossing between TGT and Orbiter. This is generally unusable with current flight software precisions since the Orbiter and TGT are always so close to being co-planar.

3.4.1.2 Processing

RNDZ NAV processes sensor data to update the SV and covariance matrix in OPS 2 under the following conditions:

- a. NAV is on a measurement processing cycle, which occurs every other 3.84-second cycle. This is, marks are incorporated every 8 seconds (two NAV processing cycles).

- b. Sensed acceleration (CONT ACC) for this cycle is $< 20,000 \mu g$ (i.e., no OMS burn in progress, since a single OMS burn gives about $34,000 \mu g$).
- c. Data are flagged good.
- d. Auto/Inhibit/Force (AIF) switch is not set to INH.
- e. Data residual passes the NAV residual edit test.
- f. If in MM 202, MEAS ENA is on.

Note: Even though both radar and STRK output data at a rate faster than it can be used by software, RNDZ NAV simply snapshots the data when it is needed; it does not average the values.

3.4.1.3 REL NAV SPEC Manipulation

All item entries may require up to 8 seconds for response to appear.

3.4.1.3.1 RNDZ NAV enable (Item 1). - This item is used to transition between the basic orbit NAV and RNDZ NAV. It is a flip-flop item and is inhibited on initial display call-up whenever entering OPS 2. An asterisk will appear when RNDZ NAV is enabled.

The PROP SV is created as a copy of the FLTR SV, and the FLTR SV is enabled for sensor data incorporation. During RNDZ NAV, the TGT SV and the Orbiter/TGT covariance matrix are also maintained (in addition to two Orbiter SV's) using preloaded acceleration models and external sensor data (STRK, RR, COAS), if available. In non-RNDZ NAV, only the Orbiter FLTR SV is maintained; the TGT SV is not propagated and no external sensor data are used to update the Orbiter SV. If RNDZ NAV is not enabled, the following parameters are blanked: RNG, R-DOT, θ , Y , and Y-DOT.

When RNDZ NAV is enabled, the COVAR MATRIX is also initialized along with the mark accept/reject counters. Enabling RNDZ NAV does not change previous values of the AIF flags, the sensor selected as angle source, and the KU ANT enable flag. See sections 4.1.6 and 3.7.3 for operational use of this feature.

Note: A TGT SV must be ^{within} ~~less than~~ 15 hours ^{of current time} ~~old~~ to allow enabling of RNDZ NAV.

3.4.1.3.2 Ku-band antenna enable function (Item 2). - Execution of Item 2 results in the GNC GPC's passing the ~~GNC~~ relative state, which is necessary for Ku-band antenna management, to the SM GPC. SM commands the antenna through MDM PL1. This tells the radar where to point to acquire the TGT. Recall that the RR is part of the Ku-band antenna system, and that this function is controlled by the SM OPS 2 GPC. Prior to RR acquisition of a TGT, this item must be enabled and a GNC I/O reset performed. When this item is selected, the antenna is pointed at the target, no matter what the RR MODE switch says. See section 3.3.4.1.

3.4.1.3.3 Sensor measurement enable (Item 3). - This item, MEAS ENA, is used to enable the RNDZ NAV software to use onboard sensor data (RR, STRK, COAS) to update the filtered SV in MM 202. Even with the AIF's (EDIT OVRD selection) set to AUTO (items 1, 17, 21, 23 selected), onboard sensor data are not utilized in MM 202 unless the MEAS ENA item is selected. Even then, external sensor measurements can only be incorporated in MM 202 NAV if the total sensed acceleration is less than a threshold value (currently 20,000 μg). When that threshold is reached, such as during an OMS burn, only the IMU data are used to update the Orbiter SV. This item is not applicable in MM 201, and an attempt to use it in MM 201 will result in an ILLEGAL ENTRY message. In MM 202, execution of Item 3 will cause an "*" to appear when the capability is enabled in the software. This may take up to 8 seconds to be initiated. Upon return to MM 201, MEAS ENA will be automatically disabled and the "*" will disappear.

Current (mid-1987) thinking is to leave MEAS ENA off when in MM 202, since presumably enough RR data has been obtained in the period leading up to MM 202 transition (approximately 8 minutes prior to Ti TIG) for a good TGT'ing solution. If MEAS ENA were set "on," additional RR marks would be taken during this period and would presumably be improving knowledge of the Orbiter-to-target relative state. However, the Orbiter is moving to a BURN ATT, which was computed when the MNVR was loaded (Item 22) on ORBIT MNVR EXEC. Lambert guidance takes over just prior to the time of ignition (TIG -15 seconds) and computes a "new improved" BURN ATT (based on these recent RR marks) which may significantly differ from the one issued earlier if the maneuver is small. The problem is that the crew has no way of quickly (in several seconds) determining if this BURN ATT update truly reflects a genuinely improved knowledge of the SV, or is due to some guidance or tracking anomaly.

If RR acquisition occurs sufficiently in advance of the pre-Ti MM 202 transition, the small additional improvement potentially generated by more RR marks during maneuver to BURN ATT is considered to be insufficient justification for risking the dilemma of a sudden "surprise" at TIG -15 seconds. If RR lock-on is late and only a few marks are available for Ti targeting, the issue is more debatable. One possible way out is to then have MEAS ENA on during the maneuver to attitude and then reload the MNVR in ORBIT MNVR EXEC. Any change to BURN ATT will then show up with 1 to 2 minutes for decision, rather than 5 to 10 seconds. This issue is still being worked and final discussions will be reflected in specific mission RNDZ books. *unresolved*

3.4.1.3.4 State vector select (Item 4). - Item 4 allows the crew to control the source of the Orbiter SV for use in relative state data being displayed on REL NAV, and being sent to UNIV PTG, targeting, on-orbit guidance, and downlink to the MCC real-time monitoring. Item 4 is a flip-flop that alternately selects "filtered" or "propagated" Orbiter SV data. Upon execution, the word "FLTR" or "PROP," as applicable, will be displayed to the right of the item number. This item is initialized in "PROP." The filtered SV is an SV that incorporates RNDZ NAV filter data derived from RR, STRK, or COAS measurements. The propagated SV is a separate Orbiter SV which is not updated by RNDZ NAV filter inputs. The philosophy for practical SV management is described in section 3.4.2, plus in 4.1.14 and 4.1.22.

3.4.1.3.5 State vector update.- This section of the display shows the filtered SV correction in position (POS) and velocity (VEL) resulting from use of sensor data from the previous cycle. This is used to evaluate convergence of the filtered NAV state, particularly early in a sensor pass.

3.4.1.3.6 Powered flight NAV controls and displays (Items 5, 6, 7).- The upper right-hand portion of the display includes displays and controls useful during powered flight. In particular, item 5 is used to enable/disable the interface between Orbiter NAV and IMU-accumulated sensed-velocity data; nominal condition is interface enabled. In the nominal modes the NAV software continuously monitors the IMU accumulated sensed-velocity data and incorporates it if the observed ΔV exceeds a threshold value. AVG G comes up "on" in MM 201, but it may be toggled with ITEM 5 EXEC; AVG G is always "on" in MM 202 and ITEM 5 EXEC will result in an ILLEGAL entry message.

When AVG G is off, IMU-sensed velocities are not used in updating the Orbiter SV. With this type of modeling, RCS translations or rotations made manually by a crewmember with the THC or RHC will not be accounted for in the navigational model until observed with the on-board NAV sensors. Thus, before any such MNVR is made in MM 201, AVG G should be on.

In the upper right-hand portion of the display, a translation thrust monitor capability is possible when AVG G is enabled. The velocity gained along each of the X, Y, and Z body component axis, as well as the total velocity gained, will be displayed. The individual velocity component registers will increment or decrement according to the sense of the velocity change, whereas the total velocity will increment due to the absolute magnitude of any velocity change. An item number is provided (Item 6) to reset all of the component registers to zero, and another item number (Item 7) is used to reset the total velocity register to zero. The first time in OPS 2 that this display is called, these values will be zeroed. Thereafter, they will reflect the values which were available the last time the display was terminated (that is, the values become static when AVG G is OFF).

Current planning is for the AVG G switch to always be on. Experience has shown that the displayed velocity deltas are not particularly useful over a long period of time because of IMU noise accumulation. The only known reason to turn AVG G off would be if a new GPC IPL is required and GNC has been unable to uplink IMU accel compensations. The AVG G switch would be set to off until GNC has had a chance to do the IMU uplinks. There are no other known situations.

Note: There is currently a question of what the AVG G threshold value should be. The problem is to have a value high enough to eliminate accelerometer bias from being accepted by NAV, yet low enough to include all the uncoupled ROT maneuvers which affect the SV. It appears (minutes of Rendezvous Flight Techniques Panel 5, Sept. 9, 1983) that a threshold of less than 0.1 ft/s will be needed to detect 0.2 deg/s vernier RCS MNVR's which cause translation cross-coupling. The current IMU accelerometer 1-sigma bias is 50 μ g's (0.0016 ft/s/sec) corresponding to 0.01 ft/s over one NAV cycle (7.3 sec). This question is still being worked. Current limit is set to 0.06, a

1990
status
?

"best compromise." IMU LSB allows pulses as low as 0.0345 ft/s to be measured.

3.4.1.3.7 State vector transfer (Items 8, 9, 10, 11).- Four item controls are provided for the transfer of SV's. Item 8 transfers the filtered Orbiter SV to the propagated Orbiter SV slots, and item 9 transfers the propagated Orbiter SV to the filtered Orbiter SV slots (this is called "FLTR RESTART"). FLTR to PROP occurs for several different rationales which are explained in detail in section 3.4.2.2.

Item 10 transfers the Orbiter FLTR SV to the TGT SV slots, and item 11 transfers the TGT SV to the Orbiter FLTR SV slot.

If a TGT TO ORB SV transfer (which replaces the FLTR SV) were done inadvertently, an easy, though not perfect, recovery would be to do a PROP TO FLTR SV transfer. The problem arises when an inadvertent ORB TO TGT state transfer is executed. Supposedly, the MCC plans to have a TGT SV ready for uplink at every AOS just in case something like this happens. The only other alternative is to keep repeating a COVAR REINIT followed by a few forced marks until data is accepted automatically.

Whenever any of the four transfer items are executed, an asterisk (*) will be displayed next to the appropriate item number while the selected transfer is in progress. The appearance and removal of the asterisk (*) will have a time delay depending on the NAV processing rate (the asterisk is displayed for only one NAV cycle). Items 8, 9, 10, and 11 are mutually exclusive; execution of any of these items while a transfer is in progress will be illegal. In addition, these four items are legal only while RNDZ NAV is enabled ("*" displayed by Item 1).

FLTR→PROP (Item 8) is nominally performed just after the beginning of each sensor acquisition period, and is a means of providing an up-to-date backup SV if for some reason the FLTR state wanders off (e.g., lock onto a star or debris). It is performed at this time because it appears that the Orbiter FLTR SV is good enough to attain acquisition.

PROP→FLTR (Item 9) is for contingency use, presumably in a situation such as just described where the FLTR state diverges and a FLTR SV restart is required.

ORB→TGT (Item 10) is primarily designed to provide an SV for deployed payloads, particularly nonimpulsive deployments such as via RMS (see section 5.4.1.4). TGT→ORB (Item 11) is provided for use after RNDZ completion. At that time it is quite possible that the TGT state will be more accurately known than the ORB state (currently, there is no planned utilization of this option). Note that items 9, 10, and 11 also cause a COVAR REINIT (see item 16).

Two parameters, FLTR MINUS PROP POS and VEL, indicate the difference between the propagated and filtered SV's. The FLTR MINUS PROP position value (in kft) can be used to evaluate how much the Orbiter FLTR SV has changed during a sensor pass. This assessment is particularly meaningful if data problems

were observed during the sensor pass. The POS and VEL values can be used to verify a successful FLTR TO PROP SV transfer; they should drop to zero. The VEL value is computed incorrectly and should be disregarded.

3.4.1.3.8 RNDZ NAV FILTER (Items 12 to 25).- Data from the RR, STRK, or COAS must pass a NAV filter residual edit test before it can be used to update NAV (the Orbiter SV and target/Orbiter covariance matrix). In the bottom third of this display, the results of this filter test and some crew controls are located. This allows the crew to monitor the condition of the filter and the external sensor measurements. In particular, the RR range and range rate residual edit test results are displayed, as well as the results for the selected sensor angle data (STRK-V/H; RR-EL/AZ; COAS-Y/X).

3.4.1.3.9 RNDZ angle sensor data selection (Items 12, 13, 14).- While RNDZ NAV is enabled with Item 1, the following external sensor data may be processed: RR elevation, azimuth, range and range rate, STRK horizontal and vertical angles, and COAS horizontal and vertical angles. The RR range and range rate are always processed by NAV as long as the RR DATA GOOD flag indicates valid data. However, only one of STRK, RR, or COAS will be used as a source of angle data as selected by the crew via items 12, 13, or 14, respectively. These are mutually exclusive items. Once again, a DATA GOOD flag for the selected external sensor must be "on" and residual edit test must be passed in order to be used in NAV. Also, the sensor must be in the appropriate mode. In particular, the RR must not be in a self-test mode, the STRK must be in the TGT track mode, and the COAS data (with COAS sight mode selected) must not have been previously processed and must not be stale (age exceeding 2 minutes) to be usable.

The display is initialized with STRK angle data selected (Item 12). When a new angle source is selected, a delay of up to 8 seconds will be experienced before the asterisk switches to the new source.

Note: When taking radar, STRK, or COAS marks, the software does not always take into account the sensor location relative to the Orbiter c.g. It does so only for the radar. Although data displayed on the CRT and LED's is based on position relative to the radar dish, they are converted to an Orbiter c.g. reference frame before being incorporated into the FLTR state. Thus, radar residuals and ratios are displayed based on the c.g. frame. On the other hand, STRK and COAS residuals and ratios are based on the location of the sensor; data is not converted to the c.g. reference frame before updating the FLTR state.

Also included in the RNDZ angle sensor select section is information used to monitor STRK operation. The STRK/COAS CNTL display is used to select which STRK (-Y or -Z) is to be in the TGT track mode. The status of the selected STRK will be displayed below Item 12, and can be one of the following: (blank), STRK FAIL, STRK PASS, NO TARGET, OUT FOV, or HI RATE (FALSE TRK was called for in the original design, but was not implemented). Below this status, a BITE indication can be driven when a failure has been detected for the selected STRK.

If the -Z STRK is being used, the offset angles (see section 3.3.3 for an explanation of COAS angles X and Y coordinate system) that represent the displacement of the TGT being tracked (by the -Z STRK) in the -Z COAS field of view will appear. These offset angles allow the crewman to locate the TGT that the -Z STRK is TRK in the COAS. This field is driven whenever there is a star present in the -Z STRK and the STRK is in target track or star track mode. It is updated every 1 second; the values are static when the STRK is searching.

3.4.1.3.10 NAV rates (SLOW RATE, Item 15).- The SV is updated in NAV at one of two rates. Current I-loads for slow and fast rate have been set identical, at 8 seconds per cycle, the fastest rate at which NAV can process STRK marks. Item 15 is a flip-flop item which can be used to select the desired rate, if future I-loads are no longer set to the same value. The first time the display is called in OPS 2, the asterisk will be present. If RNDZ NAV is not enabled, execution of this item is illegal.

3.4.1.3.11 COVAR REINIT (Item 16).- This will reinitialize the covariance matrix to preset I-load values or, if one or more covariance uplinks has been executed in the MCC, to the latest set of uplinked values. When the covariance matrix reinitializes, it resets differently depending on which angle sensor is selected, because it has different biases for each sensor. An "*" is displayed next to this item while the reinitialization is occurring. If RNDZ NAV is not enabled, this is an illegal entry. This is executed only as a contingency operation.

A covariance matrix is uplinked from the MCC, once before RNDZ phase and then again post-Ti with narrower limits (if acquisition by RR has occurred). There are six other ways the covariance matrix can be reinitialized besides this manual item entry, and they are listed in the "Mark History" paragraph, below.

COVAR REINIT is used when a sensor is apparently locked on to the TGT, but ratios are >1.0 so the marks won't get into the filter. Performing an "ITEM 16" will reopen up the filter (assuming that previous sensor marks have been taken; in cases when no sensor data has been taken in a long time, the matrix may actually get smaller) and reduce the ratios (if this does not work, the next step is to force a few marks). See section 3.4.1.3.13 for an explanation of edit ratios.

COVAR REINIT can be used to assist data incorporation when the Orbiter and target SV's are incorrect. Suppose the crew accidentally executes an ITEM 10 (ORB TO TGT transfer). If the Orbiter is less than a couple of miles from the TGT, the covariance matrix will accept radar data and converge on a fairly accurate relative Orbiter and TGT state even though the Orbiter SV will be wrong. Once converged, Lambert targeting (SPEC 34) could be used to compute a burn solution. At large separation distances, a COVAR REINIT may not be enough, so 1 or 2 marks may have to be forced until $RATIO < 1.0$ is satisfied and marks can be taken automatically.

3.4.1.3.12 Residuals.- A residual is calculated by taking the difference between the NAV computed estimate of the relative position of the Orbiter

and TGT, and the observed measurement using sensor data (STRK, RR, COAS). If RNDZ NAV is enabled and sensor(s) are correctly configured and are tracking the TGT, the residuals are computed and displayed for RR range and range rate, and for the selected sensor angle data (V/EL/Y, H/AZ/X). These data are blanked when RNDZ NAV is inhibited; if data are missing or invalid, the data remains static.

Angle residuals are monitored by the crew for approximately 30 seconds at the beginning of each TGT acquisition to ensure that the sensor is not locked onto a star or debris. The sensor is left in INH until the stability criteria is met.

The coordinate system of the angle residuals displayed in the V/EL/Y and H/AZ/X lines is confusing. The three labels are intended to correspond to the three angle sensors (STRK, RR, COAS respectively) and their inconsistent coordinate system references make it difficult to associate the residuals with any reference. See figure 3-11. In practice it is not necessary for the crew to appreciate the distinction between the two angles.

On the -Z STRK: the V/EL/Y line is "V" and means "azimuth" (related to the slightly tilted -Z STRK boresight), positive V toward the -Y wing; the H/AZ/X is "H," corresponding to elevation angle, positive H towards the nose (+X). In this sense the X and Y designations in the same line do actually closely correspond to the X, Y offset coordinates of the COAS (+X toward nose, +Y to left when facing aft, matching Orbiter body axes). It is important to note that the sign of the V (or azimuth) residual and the Y offset coordinate are opposite.

For the -Y STRK, V/EL/Y is "azimuth" from the -Y STRK boresight (approximately 11° toward nose from pure -Y), positive toward +X axis (nose), and H/AZ/X is "elevation" from out the -Y STRK boresight to the -Z axis (positive) or +Z axis (negative).

The COAS offset angles will be displayed any time the -Z tracker star present discrete is set. This discrete will be driven by a star or the TGT when the tracker is in STAR TRK or TGT TRK.

For RR, EL and AZ (or "roll and pitch") are not body axis elevation and azimuth (which is what EL and AZ mean in the RR section of the display in the upper center area). They correspond instead to physical antenna pointing angles, the trunnion (beta) and shaft (alpha) angle residuals (see fig. 3-15). As such they are hard to relate to the real body axes (to convert body axis frame to antenna frame, rotate the X axis about the Z axis to the right (+X into +Y) by 67°).

For the -Z COAS NAV data source option, EL and AZ are reverse of what they seemed for the STRK (see fig. 3-14). V/EL/Y is elevation in the COAS (in the COAS frame this is the X coordinate) and H/AZ/X is the azimuth (in the COAS frame this is the Y coordinate). The Y and X in the display text were originally named because the measurements are rotations about the Y and X axes.

For X COAS angles the residual V/EL/Y is measured in the XZ body plane with a positive measurement from +X towards +Z (an angle of depression). The residual H/AZ/X would actually correspond to a residual of azimuth angles since positive is measured from +X to +Y (nose to right wing). Thus if a perfect mark was taken and the COAS was perfectly aligned with the +X body axis then a positive V/EL/Y residual would indicate the TGT estimated LOS is above the true LOS and a positive H/AZ/X would indicate the estimated LOS is to the left wing side of the true LOS. If the radar is locked on simultaneously with X COAS tracking, then $EL = 23^\circ \pm E$ and $AZ = -90^\circ \pm S$ where E and S are functions of noise and bias in the radar system.

3.4.1.3.13 Residual edit ratio.- The residual edit ratio is the ratio of the magnitude of the actual measurement residual divided by a multiple of the expected residual based on the current covariance matrix. The residual edit ratio is computed for use in the data edit test inside NAV. A data measurement is edited if its residual ratio is greater than 1. The ratios update on the display in an 8-second cycle. See also 3.4.1.3.11.

In calculating a RATIO on the REL NAV display, the RNDZ NAV filter uses a value that is 6 times the expected error (covariance matrix and filter weighting). For example, the current covariance (which contains 1-sigma NAV uncertainties) starts at 20 kft in X. After a COVAR REINIT, a RATIO of 1.0 would reflect an error of 120 kft.

3.4.1.3.14 Mark history, accept/reject.- The number of NAV marks of each type (range, range rate, angle 1, angle 2) that have been accepted or rejected by the RNDZ NAV filter will be displayed.

These ACC/REJ counters are all reset to zero under the following conditions:

- a. After a burn (probably OMS) of more than 20,000 μg
- b. After covariance matrix reinitialization, either by execution of item 16 or by other actions as follows:
 - (1) Entering RNDZ phase (RNDZ NAV set to "*")
 - (2) Orbiter SV uplink during RNDZ phase
 - (3) Target SV uplink during RNDZ phase
 - (4) PROP \rightarrow FLTR SV transfer
 - (5) ORB \rightarrow TGT SV transfer
 - (6) TGT \rightarrow ORB SV transfer
- c. When the angles input data source (STRK, RR, COAS) is changed (angle counters only)

When more than a K-loaded number (currently 3) of sequential marks are rejected, a down arrow will be driven in the status column of that measure-

ment type, an alert message ("NAV EDIT") will appear and a tone will be heard.

This down arrow is removed when the data are manually forced and the ratio test is passed for one mark, or when more than a K-loaded number (currently 2) of sequential acceptable marks occur.

3.4.1.3.15 AIF switch (EDIT OVRD - AUT/INH/FOR, Items 17-25).- The displayed residuals, ratios, accept, and reject counters serve as the basis for the crew decision as to how external measurement data are to be processed by the NAV filter. Three mutually exclusive options are available to the crew for each of the range (Items 17, 18, 19), range rate (Items 20, 21, 22), and selected sensor angle data (Items 23, 24, 25). These are as follows:

- a. AUTO: Valid sensor data passing the residual edit test are to be automatically used to update the SV and covariance matrix.
- b. INHIBIT: Valid sensor data are to be used for computing residual and ratio values but are not to be used to update the SV and covariance matrix. Thus, when in INHIBIT, the ACCEPT/REJECT counters will not be incremented.
- c. FORCE: The edit test criterion is relaxed, since the maximum allowable residual ratio used in the NAV filter edit test is increased to a higher value (currently last mark + 0.2). Valid data will be used to update the SV and covariance matrix only if the new edit criterion is met on the next residual edit test. These new test criteria are in effect for only one NAV cycle. The control then reverts to the previously selected option (AUT or INH). An "*" appears beside the FORCE item only while the control is in effect. For angles from COAS, the force option is the nominal mode for processing the data. The force input applies to the last COAS mark taken within the previous 2 minutes. However, NAV does not necessarily incorporate the COAS mark since it still could fail the ratio test, but this is not likely.

Note: When forcing COAS marks on the REL NAV display, the threshold (last RATIO value plus 0.2) is applied to the last forced and accepted mark, not to the last mark taken by pushing the ATT REF button.

When the display is first called in OPS 2, the INHIBIT items will be selected. These items are applicable both when RNDZ NAV is enabled in MM 201, and also in MM 202 when the MEAS ENA item is selected.

For all tracking passes, measurement incorporation will be inhibited prior to sensor acquisition. Inhibiting data prior to sensor acquisition allows the crew to assess the quality of the sensor data prior to its incorporation into the filter.

Note that the documented error message FALSE TRK will never appear on the display. The discrete that drives the message is used to update the reject

counter instead of displaying the message FALSE TRK. A problem incident report DR was written against the software, but instead of fixing the discrepancy, the requirement has been waived.

3.4.1.4 Editing Contingencies

The AIF switches on REL NAV are used to control flow of data from sensors into NAV. For all sensor acquisition intervals, measurement processing will be inhibited until the crew determines that the sensor acquisition was successful. At that time the crew will select AUTO, and NAV will begin to process the sensor data to update the Orbiter SV.

3.4.1.4.1 STRK Marks.- For STRK acquisition, there is a ^{small} ~~same~~ risk that the STRK will lock-on to a star instead of the target, so the crew must monitor residuals and residual ratios for at least four consecutive NAV cycles. They should then select AUTO when residual growth is less than 0.05° for four measurement processing cycles and residual ratios are less than 1. If the residuals indicate TGT lock-on, but the ratios remain greater than 1, perform the following steps sequentially until the ratio drops below 1, then proceed with the timeline.

- a. Break track and reacquire TGT. If residual editing continuously occurs, most likely the STRK has either locked onto a star, or has a malfunction, or very large relative state errors are present. To prevent bad measurements from being incorporated into the filter, breaking lock and reacquiring the TGT is the desirable first step because it does not update anything in the relative navigation state.
- b. Reinitialize covariance matrix. If the covariance matrix has been reduced by measurement incorporation, reinitializing the covariance will expand it and allow larger updates to be incorporated into the filter (i.e., it enlarges the acceptance criteria). Incorporating these larger updates should correct the relative SV, which will stop the residual editing.
- c. Force up to three measurements (select AIF = FORCE for three marks). If covariance reinitialization is not sufficient to prevent residual editing, data can be forced into the filter (this enlarges the acceptance criteria still further). Three consecutive measurements should correct the relative SV sufficiently to stop the residual editing. If measurements continue to be edited, a generic problem may exist and, most likely, forcing more measurements will not improve the situation.
- d. Filter restart (propagated to filtered SV transfer). This assumes an unusable totally ruined FLTR SV. An SV restart eliminates all data incorporated into the filtered SV since the last filtered-to-propagated SV transfer. This is a last-resort procedure to correct the RNDZ NAV relative state.

At the end of the STRK pass, and before sunset, it is required that the STRK angles be set to INH in REL NAV to prevent the corruption of the FLTR SV if the STRK locks on to a star.

3.4.1.4.2 RR Marks.- For RR acquisition, the crew must monitor the radar data flags to verify no down arrows and verify that ratios are less than 1. Under these conditions, they would select AUTO. If after repeated RR acquisitions the ratios remain greater than 1, the following steps should be performed sequentially until the ratio drops below 1 (at that point, proceed with the timeline).

- a. Reinitialize covariance matrix. (See b. above.)
- b. Perform FLTR-to-PROP SV transfer. By this point the NCC burn has been performed, based on multiple STRK passes. If the onboard-targeted ΔV was within 3 sigma of the ground solution, this should validate the FLTR SV and it should be saved.
- c. Either select AIF = FORCE three times (to force three marks), which is the primary method, or wait for STRK data post-Ti to help resolve the impasse. If the FLTR SV has given a reasonable targeting solution for the NCC burn, perform FORCE. If FORCE is unsuccessful in that the RR data cause the FLTR SV to diverge, execute a filter restart (PROP TO FLTR) and then wait for the post-Ti STRK data.

3.4.1.4.3 RR/STRK Marks.- Post-Ti the crew will have both STRK and RR data available. Approaching Ti, the following procedure is used:

- a. Initial condition is ANG SELECT = RADAR and all AIF = AUTO.
- b. To perform Ti, go to MM 202, select ANG AIF = INH, perform burn, return to MM 201, when back in attitude select ANG AIF = AUTO.

3.4.1.4.4 COAS Marks.- A discussion of COAS marks is found in sections 3.3.3.3, 4.1.14, and 4.3.3.

3.4.1.5 Defining The Stages of Relative Navigation

The process of acquiring and utilizing onboard sensor data consists of several distinct events and criteria, each of which have been discussed individually elsewhere. A summary review of these events in proper sequence can allow an appreciation of their interrelationships, and can provide a view of the precise stages through which relative navigation progresses. The precise meaning of each of these stages is summarized below.

3.4.1.5.1 Search.- The STRK and/or RR sensors perform their programmed search patterns, or the crewmember looks through the COAS or on the CCTV monitor.

3.4.1.5.2 Detection.- The presence of the target is reflected by sensor monitoring software, but "DATA GOOD" flags are not yet set. Alternately, the target is spotted visually or on CCTV.

3.4.1.5.3 Acquisition.- "Data Good" flags are set on the RR parameters by the Ku-band hardware, and these are displayed; "S PRES" is displayed for the STRK. For STRK, see section 3.3.2.1; for RR, see section 3.3.4.5 and 4.1.30. For COAS, the equivalent phase is performed manually, with the crewmember noting the LOS angles.

3.4.1.5.4 Lock-on.- This implies that the sensor is performing closed-loop tracking with sensor data, aiming the sensor or the Orbiter based on this data. Only the RR and STRK are capable of "lock-on", and nominally they lock on as soon as they acquire.

There are RR configurations in which acquisition is not followed by lock-on but in which range and range rate marks may be used by relative navigation. Angle data should remain inhibited.

The COAS inherently cannot perform "lock-on", although with man-in-the-loop operation this function can be approximated.

3.4.1.5.5 Data into REL NAV.- This happens as soon as RR "DATA GOOD" flags are set, as long as the data path from sensor to GN&C GPC's is good. Sensor data is being processed by SPEC 33 for display purposes only, and RESID's and RATIO's (defined in 3.4.1.3.12 and 13) are being computed and displayed/downlinked.

3.4.1.5.6 Data meets "accept" criteria.- Data as displayed on REL NAV passes the RATIO/RESID editing criteria, as defined in navigation blocks in RNDZ BOOK. For STRK, see section 4.1.13; for RR, see sections 4.1.31 and 4.1.32.

3.4.1.5.7 AIF to "AUTO" (or "FORCE").- The crew manually modes AIF flags to "AUTO" (section 3.4.1.3.15) for incorporating sensor data into the GN&C navigation FSW computations to improve the FLTR SV. The ACC/REJ counters increment. Edit checking begins.

For COAS NAV, the marks are taken with the ADI REF pb, have their RESID/RATIO's displayed, and are then always individually incorporated into REL NAV by use of the AIF "FORCE" option.

3.4.1.5.8 Marks pass edit check.- The RESID's of each parameter meet edit criteria as defined by COVAR matrix (section 3.4.1.3.11). RR marks are converted from a sensor-centered to an Orbiter-cg-centered frame; STRK and COAS marks are not converted. They then are used to shrink the COVAR matrix and to improve the FLTR SV.

The commonly-used phrases "RR NAV" and "STRK NAV" refer to this stage. The "Sensor data" criterion used in Flight Rules also is best defined by this stage.

3.4.1.5.9 NAV converged (operationally).- In practice, for STRK, 40 marks will give "operational convergence". Other criteria include the SV POS update being less than 0.5 kft for the last four marks, or in general "SV POS/VEL updates small and stable".

This situation means that the FLTR SV is "good enough" for performing targeting: "good enough" is defined by the predictable errors being less than dispersions to be expected from other sources such as IMU errors or burn trim uncertainties. The FLTR solution will normally be better than either the PROP solution or the ground solution.

3.4.1.5.10 NAV converged (mathematically).- Additional marks continue to improve the FLTR SV and the accuracy of the FLTR solution, up to a point. After this point, the scatter of the NAV marks is such that no improvement in SV knowledge is made by incorporating further marks. For STRK, this occurs at about 120 marks.

3.4.1.5.11 End of tracking pass.- The sensor may be unable to continue taking marks (for STRK or COAS, at sunset; for RR, beyond a certain range or with a changed target attitude reducing its radar cross section). Generally, however, the tracking pass can end when the FLTR SV has fully profited from the marks and there is no advantage to taking more marks. At this point, the FLTR SV should be superior to the PROP SV. In practice, the sensor may be left locked-on to the target as long as feasible, but relative navigation is not the driver on this.

3.4.1.6 Improved REL NAV

Based on actual RNDZ mission experience, improvements to the REL NAV SPEC function have been developed and documented in CR 79735. These improvements may be implemented in the near future, once the new GPC's are installed on the Orbiter fleet. For the sake of future users, the following descriptive material outlines the expected new capabilities of REL NAV once the proposed improvements are in force. At that point, this entire section will be updated by a PCN to this book.

As outlined on the CR, the display changes include:

- a. Add arm/fire logic to RNDZ NAV ENA function. The "ITEM 1" will be the "ARM", and "ITEM 2" will cause execution of the RNDZ NAV state flip-flop. This will insulate the crew from inadvertently turning off RNDZ NAV and thus losing the current propagated state, which is serving as a backup SV. An inadvertent drop of RNDZ NAV complicates SV management plans.
- b. Modify thrust monitor computations of displayed ΔV 's. This will prevent incorporation of IMU noise, especially absolute values of same.
- c. Add display of PET (HH:MM:SS) and PROP SV (HH:MM:SS) age. The MET base time for the PET clock is entered on the TIME SPEC. The SV age clock is reset whenever the PROP SV is updated by uplink or item entry transfer.

This eases the crew mental timekeeping computation/comparison workload, allowing straightforward references to the FDF RNDZ Book and standard separation profiles.

- d. Add ARM/FIRE logic to SV transfer items. A special "ITEM 13" toggle is set prior to executing an ITEM 9, 10, 11, or 12 for all SV transfers. This will prevent inadvertent loss of one SV when the other is copied over it.
- e. Add accept/reject counter reset ITEM. This is ITEM 41 (RESET CNTR). It will give a quick count of marks during the current sensor pass, which is used as a cue to decide on "convergence."
- f. Add navigated elevation angle display. This is displayed both for FLTR-PROP and for currently-used SV (the angle between the projection of a line joining the Orbiter and the TGT into the orbit plane, and the Orbiter local horizontal plane, 0° to 360°). In addition, the angle between the projection of the Orbiter tracking body vector (selected on UP) into the orbit plane and the local horizontal (0° to 360°) is also displayed. This replaces a laborious manual crew task and aids in the plotting of Orbiter trajectory on "Relative Motion Plots" (section 4.7), which is valuable to alert crew to off-nominal dispersion trends.
- g. Change time OF nodal crossing (in MET) to time TO nodal crossing (countdown in MM:SS). This is used as alert for imminent performance of out-of-plane-null burn post MC1, and relieves the crew from the requirement for constant monitoring and mentally estimating trends of Y and Y-DOT.
- h. Add STRK TGT present indicators. This is an easier feedback of status, and relieves crew of need to call up STRK/COAS SPEC repeatedly.
- i. Add COAS offset angles for RR. This allows visual observation through COAS of object being tracked by RR, especially if object is dim against star background.
- j. Modify display to show only the coordinate system for the RNDZ sensor which is supplying angle data. This enhances readability and reduces potential crew confusion.
- k. Delete filter slow-rate item. This is never used; originally it was intended to use STRK only every 16 seconds, to keep CPU time down.
- m. Add FLTR-PROP angle data. See "f", above.
- n. Expand RR status text field. This enhances readability and reduces potential of crew confusion.
- o. Blank residuals and ratios when data-good flag from sensor is off. This enhances readability and reduces distractions.

Further, the CR makes some changes to other displays. On the TIME DISPLAY, it adds PET SET controls and PET ALARM SET controls. On ORB TGT, it adds PET clock. On IMU ALIGN display, it provides crew control for updating the ΔV threshold as part of the thrust monitoring update to the REL NAV display.

3.4.2 State Vector Management

Three SV's are maintained aboard the Orbiter: The TGT SV, a filtered (sensor data) Orbiter SV (called FLTR), and a propagated Orbiter SV (called PROP) using IMU ΔV 's only. The management philosophy for the Orbiter SV has undergone considerable evolution due to SES experience, NAV analysis, RNDZ mission profile documentation development, and actual flight experience.

The crew is required to manage these SV's during various RNDZ mission phases by performing appropriate SV selection, transfers, and editing (AIF switches) via item entries on the REL NAV display (section 3.4.1).

3.4.2.1 State Vector Select

Upon entry into RNDZ phase (sections 4.1.6 and 4.1.14), the STATE VECTOR SELECT option is initialized to PROP. The setting will be manually changed to FLTR after 10 marks have been accepted by the filter for each measurement type appropriate for the active sensor, and when SV UPDATE POSITION is less than the following convergence criteria: for STRK, 1000 feet; for RR, 300 feet.

RNDZ burns are done using the most accurate SV. This will be the PROP state until the first good NAV sensor pass, then it will be the FLTR state. The PROP state then becomes a "backup" state, to be used if the FLTR state somehow becomes corrupted by bad data. See section 4.1.27 on "Solution Selection."

3.4.2.2 FLTR-TO-PROP Transfer

The crew will exercise a FLTR-TO-PROP SV transfer at the beginning of each new sensor tracking interval (excluding the first), to update the PROP SV with the up-to-date FLTR SV. The PROP vector will then be a better SV for any required future FLTR restart. The FLTR-TO-PROP transfer will not be exercised until after successful acquisition of the target with the tracking sensor (since if the acquisition is not successful, an independent Orbiter SV - the PROP SV - will be available to attempt acquisition again). Successful acquisition is regarded as confirmation of the goodness of the FLTR SV. Following acquisition, the crew will monitor the residuals, residual ratios, and sensor data-good for at least four NAV cycles (approximately 30 seconds) before executing the FLTR-TO-PROP transfer.

These FLTR-TO-PROP SV transfers will usually be conducted at the following times:

- a. After STRK acquisition (second pass), but prior to enabling the STRK data into the filter. Criteria are growth in residuals less than 0.05° over successive NAV cycles (every 8 seconds) and residual ratios less than 1. This is to save the current best estimate SV before putting sensor data into it, on the chance that the sensor data may subsequently degrade rather than improve the SV. A good practice is to keep a "proven SV" in the PROP slot for fall back in the event of FLTR SV problems (see section 4.1.22).
- b. After RR acquisition pre-Ti, but prior to enabling the radar data into the filter. Criteria are radar data flags good (no down arrow) and residual ratios less than 1 (see 4.1.31).
- c. Post-Ti, after the STRK or RR acquisition, but prior to enabling the data into the filter (section 4.1.45). Criteria are STRK angle residuals growth over about 30 seconds is less than 0.05° and all measurement residual ratios less than 1.

Caution: A FLTR-TO-PROP is generally not performed in the middle of a sensor pass because there is no positive test to determine if the FLTR SV is good.

3.5 TARGETING (SPEC 034)

Targeting is defined as the computation of the necessary MNVR required to transfer the Orbiter to a desired state or position at a desired time.

Rendezvous targeting begins with launch. During ascent the Orbiter is steered to the proper insertion orbital plane. This depends on the target's orbital plane and the phase angle at MECO. OMS2 is the first on-orbit rendezvous maneuver: it is a phasing maneuver targeted with the MCC rendezvous targeting processor (RTP). The MCC performs all rendezvous targeting until the range to the target decreases to about 200 n. mi., at which time onboard relative NAV sensors begin to measure the relative state more precisely than ground tracking of both vehicles. 40

Even within the last 200 miles, several maneuvers for phasing, altitude, and planar adjustment are targeted only on the ground. This is due to STS FSW algorithm limitations which were imposed in 1978 during a software scrub to make room for higher priority FSW. Only two-impulse rendezvous targeting software survived that scrub.

Before the 1978 scrub there were two separate onboard software packages which were expected to be incorporated into the FSW. One was a scrubbed-down version of the RTP which had Lambert 2-impulse maneuvers and coelliptic maneuvers; it also allowed a maneuver to be scheduled at geometric elevation angles, while transfer times between maneuvers could be scheduled in fractions of orbital periods or in minutes. The other package was the Prox

Ops Specialist Function which would perform CW targeting for terminal phase rendezvous (ranges < 5 n. mi.) since it was at that time just becoming evident that the Orbiter's FRCS was not large enough to support manual braking with the proposed double-coelliptic profile with a differential altitude of 10 n. mi.

During the scrub effort, essentially the Lambert 2-impulse scheme was extracted from the "onboard RTP" and placed into the Prox Ops Specialist Function, and the combination was renamed "ORBIT TARGETING" (SPEC 34). About 5 years later, the double coelliptic profile concept was dropped in favor of the stable orbit rendezvous (SOR) technique which solved the FRCS limitations.

While the "targeting" for PROX OPS is normally a manual function, performed by the crew with the aid of procedures which use raw sensor data and rules-of-thumb, most RNDZ translation MNVR's use Orbit targeting with AUTO maneuver execution (e.g., see sections 4.1.9 and 4.1.38).

The ORBIT TGT display is SPEC 34 and is available in GN&C OPS 2. (See figure 3-32.) This display and the associated orbit targeting software give the crew the capability to generate a software targeted two-MNVR set. The first MNVR is targeted to move the Orbiter from a predicted position to a desired TGT relative position in a given amount of time (ΔT). The second MNVR is targeted to null the Orbiter velocity relative to the TGT. The targeted MNVR outputs of this software are displayed to the crew on the ORBIT TGT SPEC are also available as inputs to the MNVR execution software and CRT display, ORBIT MNVR EXEC in MM 202. The ORBIT TGT display is divided into three sections: inputs, controls, and maneuvers.

One warning on MCC monitoring of onboard targeting activities: of all the parameters on the targeting SPEC, only "TGT ID" is currently downlisted. If the crew modifies a TGT set (deliberately or inadvertently), the MCC cannot see it. The MCC does not see PRED MATCH or BASE TIME.

3.5.1 General Description

In general, a sequence of RNDZ, braking, stationkeeping, or transition MNVR's can be performed by selecting the appropriate TGT set and executing the computation with the ORBIT TGT display, then executing the MNVR with the aid of the ORBIT MNVR EXEC display in MM 202 and repeating that procedure for each remaining MNVR in the sequence.

3.5.1.1 Target Sets

One of 40 targeting sets can be chosen by the crew via Item 1 on the ORBIT TGT display. The possible TGT sets are part of the I-load and may be changed by ground uplink or by crew manual input. In most cases, each TGT set has a nominal time (T1) associated with it when the first MNVR should occur and the desired position, with respect to the target (ΔX , ΔY , ΔZ) where the Orbiter should be a given amount of time (ΔT) later. In this

case, the elevation of the TGT with respect to the Orbiter local horizontal is not usually used to determine T1. (Item 6 is zero.)

When the target set ID is entered in Item 1, the following will appear with data: Items 2-6, 17, 18, 19, 20.

These parameters are used by the targeting software to compute the first burn of the specified two-impulse MNVR sets. This computation is not made until a COMPUTE T1, Item 27, is executed. When the COMPUTE T1 item is executed, the other Items (7-12, 13-16) in the input list will be computed and displayed. Items 7-12 ($\Delta X/\Delta NRNG$, ΔY , $\Delta Z/\Delta H$, ΔX , ΔY , ΔZ) show the Orbiter relative position (kft) and velocity (ft/s) with respect to the TGT-centered rotating curvilinear reference frame, at the input-time T1 based on current onboard NAV information. Items 13-16 (T2 TIG) represent the time of the second MNVR of the two-impulse set and are computed based on the T1 and TIG time and the given ΔT .

As will be described later, the computed ΔV 's (ΔVX , ΔVY , ΔVZ , total ΔVT) necessary for the first burn will appear in the MNVR section of the display and will also be passed to the on-orbit guidance software (MM 202). The burn is not executed, however, until it is subsequently loaded with the ORBIT MNVR EXEC display. The burn is then executed (section 3.6.2) either automatically (OMS only) following a crew entry to the ORBIT MNVR EXEC display, or manually by the crewmember using the THC (RCS only).

2021/034/		ORBIT TGT		1 003/22:58:38	
				000/00:01:00	
MNVR	TIG	ΔVZ	ΔVY	ΔVX	ΔVT
2	3/22:59:30	+ 20.1	9.6	+ 4.2	+ 22.7
INPUTS			CONTROLS		
1	TGT NO	-2		T2 TO T1	25
2	T1 TIG	3/22:59:30		LOAD	26
6	EL	[*] 00.00		COMPUTE T1	27
7	$\Delta X/\Delta NRNG$	[*] 60.84		COMPUTE T2	28
8	ΔY	[*] 00.00			
9	$\Delta Z/\Delta H$	[*] 60.76			
10	ΔX	[*] 85.24			
11	ΔY	[*] 9.56			
12	ΔZ	[*] 5.37			
13	T2 TIG	4/00:00:01			
17	ΔT	-00.00			
18	ΔX	[*] 21.12			
19	ΔY	[*] 00.00			
20	ΔZ	[*] 60.76			
21	BASE TIME	3/21:12:12			

Figure 3-32.- ORB TGT display.

Other options are available using this display. For example, with the elevation option, the T1 time is determined onboard and is the time when the TGT LOS is the specified number of degrees (Item 6) from the Orbiter local horizontal axis. This also resets the base time. As an example of another user option, if the input ΔT time (Item 17) is negative, a flag is set in the S/W such that a new T2 time will be computed with an algorithm which ensures that the second burn is accomplished in a direction orthogonal to the TGT LOS. This could be used in orthogonal braking. Current procedures do not use this option.

Another option includes user input of a T2-TIG in Items 13 to 16, with ΔT (ITEM 17) set equal to zero. Then the software will compute ΔT for the user. Finally, the user may input what he feels is the true relative state of T1 via Items 7 to 12. After these are subsequently loaded via Item 26, the software will utilize the "required relative state" to determine the ΔV maneuver when Item 27 is requested. As an example, if the crew used alternate ranging devices (e.g., ranging rulers) while stationkeeping on the V-BAR when the Ku-band radar has failed, they could load the resulting range into Item 7 and set Items 8 to 12 to zero. They could then compute a maneuver to transfer to the -R-BAR or some other point in some transfer time ΔT .

Current planning includes a midcourse burn (MC2, section 4.2.4.4) targeted on elevation, but no use of orthogonal braking (possibly with space station).

3.5.1.2 Targeting Computation Techniques

A detailed discussion of Lambert targeting versus Clohessy-Wiltshire (C-W) targeting is found in Appendix B of the Rendezvous/Proximity Operations workbook (February 1985). In practical terms, the following brief treatment explains the different procedural options available to the crew.

In MM 202, burns may be executed with either Lambert iterative guidance or with constant or external ΔV targets. The former must be targeted onboard, using the Lambert computation technique; the latter may be targeted onboard using the C-W computation technique, or the ΔV 's may be manually entered from written pads (see section 3.6.1). The choice of Lambert vs C-W targeting is specified in the MNVR table defined by I-load.

Computations for Lambert targeting were once expected to take much longer to solve, but that disadvantage never materialized and targeting now typically takes 10 to 30 seconds. Its advantages include dynamic retargeting in the event of a TIG slip. The only practical advantage of the C-W technique is its ability to handle multi-REV targeting, and that advantage is not needed for current RNDZ strategies. Hence the current policy is to perform all onboard targeting using Lambert guidance, while doing ground-targeted burns in "external ΔV " (PEG 7) mode.

3.5.2 Inputs to ORB Targeting

3.5.2.1 Target Number (Item 1)

As stated earlier, the capability exists to load 40 predefined MNVR's in the I-load preflight. These MNVR's may be changed through ground G-MEM writes, or by the crew through Items 2-20 and execution of a LOAD item (Item 26) on this display. For each TGT set there is a flag internal to the software which is set to identify whether Lambert targeting or the closed form Clohessy-Wiltshire equations will be used in the targeting. These flags are part of the I-load and can be changed by the ground or by the crew via GPC memory modification using the GPC MEMORY SPEC (There is no known reason for wanting to do this). The number entered with Item 1 will retrieve the necessary targeting inputs for that MNVR set from memory and display them in the appropriate locations on the display. An example of the projected TGT sets is given in figure 3-33. Other target sets are either blank C-W or blank Lambert, so they can be called up and filled in as specified by the MCC for off-nominal situations. Note that transitions out of OPS 2 will result in the reinitialization of the original I-loads upon subsequent return into OPS 2. In the following sections, assume that a TGT number has been entered in Item 1.

Target set ID	MNVR to be computed
9	NCC
10	Ti
11	MC1
12	MC2
13	MC3
14	MC4
19	MC2 on TIME

Figure 3-33.- Projected TGT sets.

3.5.2.2 T1 TIG (Item 2-5)

These items specify the time (days, hours, minutes, seconds) in MET of the first burn, in the 2-impulse pair. If the COMPUTE T1 item (Item 27) is executed when the T1 TIG is in the past (as may happen, if a burn is missed, or if it is recomputed due to high velocity residuals following the first execution of the burn), or is less than an I-loaded interval (currently 1 minute) in the future, a new T1 TIG will automatically be computed as the current time plus the predefined I-loaded interval (currently 1 minute) and the transfer time will be decremented accordingly. Also this will cause software to ignore any inputs in Items 7-12, and instead, the software will use the onboard navigated state at that new T1 TIG time. It is also possible to change the T1 TIG through a keyboard entry to Items 2-5. In this case, the word LOAD will flash next to Item 26, and after the input

values are verified, they will be loaded into the I-loaded slots for the T1 TIG for that TGT set after execution of Item 26.

The I-loaded T1 TIG times are actually loaded in the software as times referenced to the "base time" (Items 21-14). (See section 3.5.2.8). This was done to make it easy to slip a full RNDZ plan: just change the BASE TIME and all T1-TIG's will be adjusted accordingly.

3.5.2.3 Elevation Angle (EL-Item 6)

This item refers to the elevation angle, positive up, to the TGT. If the EL = 0, the elevation angle option is ignored and the input T1 TIG and associated values will be used. However, for certain MNVR's such as MC2, an elevation angle $\neq 0$ (such as 28°) will be loaded. When this is the case, the T1 TIG time is determined by the onboard software as the time nearest the T1 TIG time at which the elevation angle is equal to value given in Item 6.

The angle tolerance is approximately 0.3° . If ORB TGT cannot satisfy this tolerance, an SM class 3 alarm (EL ANG) is issued (see section 3.5.5).

For current RNDZ profiles, the MC2 burn is targeted on elevation (see section 4.1.51).

Note that the crewmember can change a TGT set based on elevation angle to one based on the TIG time by reloading an elevation angle of zero. Loading zero does not force an elevation search for 0" so it will use the specified TIG.

It is possible for a burn based on elevation not to set the BASE TIME equal to the T1 TIG time. This can happen when the TGT set is computed with an initial displayed T1 TIG time in the past. When the TGT set is computed the elevation angle will be ignored, but not removed from the display. The TIG will be 1 minute in the future and the ΔT will be decremented accordingly.

3.5.2.4 Relative Position Items (T1 $\Delta X/DNRNG$, ΔY , $\Delta Z/\Delta H$, $\Delta X-DOT$, $\Delta Y-DOT$, $\Delta Z-DOT$ - Items 7-12)

These items show the Orbiter relative position (kft) and velocity (ft/s) with respect to the TGT at the T1 TIG time. If they are all zeros, or if the T1 TIG time is in the past, all of their values will be computed and displayed based on the onboard NAV information at the time a COMPUTE T1 (Item 27) is executed.

Alternately, values can be manually entered for Items 7-12 which will be used in the targeting algorithms as the assumed correct relative position and velocity of the Orbiter at the T1 TIG time regardless of the onboard NAV software. When one of Items 7-12 is entered, the LOAD item (Item 26) will flash until it is executed. Execution of this item actually loads the values in the INPUTS section of the display which are then used in the

computations (relative state keyed in, but not loaded, is completely ignored). This provides a means for overriding the NAV state, although this is not used in any nominal procedures. The crew can get back to the onboard vector by calling a new TGT set.

3.5.2.5 T2 TIG (Items 13-16)

This item represents the time in MET of the second MNVR of the two-impulse set. If ΔT (Item 17) is not zero, a COMPUTE T1 (Item 27) will cause the T2 TIG to be calculated and displayed. If the T2 TIG is in the past when a COMPUTE T2 is done, it will be reset to current time plus a predefined ΔT , and the MNVR is computed using the NAV state vector at the new T2 TIG time. A "COMPUTE T2" does not update items 7-12.

NOTE: If a TGT set is computed (ITEM 27) with a T1 TIG in the past, targeting won't still attempt to get to the T2 point in the ΔT specified in the TGT set. When the TGT set is computed, the T1 TIG will be changed to the present time plus 1 min. The ΔT will also change an equal amount to reflect time elapsed since the original T1 TIG. The T2 TIG will remain the same.

Undesirable results may follow if the crewmember tries to compute a burn with a TIG in the past greater than the ΔT in the TGT set. Because the time change is greater than the ΔT , a negative time change is seen as a request for orthogonal braking and the S/W will try to compute a solution accordingly. This may result in an iteration alarm, a lengthy computation time, and an erroneous solution.

3.5.2.6 Delta-T (Item 17)

The transfer time in minutes between the first MNVR time (T1 TIG) and the second MNVR time (T2 TIG) is represented by ΔT . If ΔT is zero, it will be computed based on the T2 and T1 TIG times when a COMPUTE T1 is executed. If ΔT is negative on execution of a COMPUTE T1, both ΔT and T2 TIG will be computed based on an algorithm used in orthogonal braking and will be displayed. The algorithm computes the ΔT (and thus the new T2 TIG) necessary to ensure that the second burn of the two-burn MNVR set occurs normal to the LOS from the Orbiter to the TGT.

3.5.2.7 T2 Relative Position (ΔX , ΔY , ΔZ - Items 18-20)

These parameters represent the desired Orbiter relative position (kft) at the T2 time (ΔT after T1 TIG - Items 13-16). This is the TGT position for the first COMPUTE T1. If a COMPUTE T2 is done, a burn will be computed that will null the relative velocity between the Orbiter and TGT at the T2 TIG time, regardless of these values.

3.5.2.8 Base Time (Items 21-24)

This is the time from which subsequent MNVR's are calculated. As was stated earlier, each MNVR time in each MNVR set is stored as a ΔT added to a base time. Thus, in general, an entire RNDZ can be slipped without adjusting T1 TIG times. The base time is originally an I-loaded value. It automatically changes when the elevation angle search option is enabled for a Lambert-targeted MNVR. It is reset to be that MNVR's computed T1 TIG time. Thus, the base time is updated to the MC2 time when the MC2 MNVR is computed based on an elevation search (this is the only burn currently targeted on elevation). This forces subsequent MNVR's to occur at times relative to the elevation angle time.

This time is defined in MET and is used to anchor onboard calculations for burn execution to a specific instant during the mission. The I-loaded set of burn parameters for the Orbit-targeting software includes only a relative time tag for each translational burn and requires a mission timeline-specific MET anchor. By using this scheme, the entire RNDZ profile can be moved to various times in the mission, and only the base time needs to be updated. The base time for ORB TGT has been defined to be the ignition time of the Ti burn, although any time would work as long as the appropriate relative time tags were loaded as part of the I-loaded burn parameter set.

In loading the base time the crew calls up TGT set number 1 before entering the data, because loading the base time can alter the I-loaded data set, and TGT set no. 1 is an unused blank data set. Calling up an unused TGT set when they change BASE TIME is for protection. When it is first called up, it displays TGT set zero. Changing any item in that TGT set will write it into an unpredictable memory location not allocated to the 40 TGT sets. Subsequently, calling up TGT set zero will result in an ILLEGAL ENTRY.

3.5.3 Controls

3.5.3.1 T2 to T1 (Item 25)

This item forces the T2 TIG time of the previous MNVR set to be transferred to the T1 TIG slot of the currently called MNVR set. This is useful, for example, in orthogonal braking where the ΔT and T2 TIG times for each MNVR are recomputed in order to ensure that the burn at T2 is normal to the TGT LOS. In this case, it is desirable to target the next two-impulse MNVR set with the new T1 MNVR TIG being at the previously defined T2 TIG. This is not currently used.

3.5.3.2 LOAD (Item 26)

Execution of this item loads item entry data values into the data slot for use by the targeting software. They actually overwrite the I-loaded values so that if that MNVR set is again requested via ITEM 1, the newly loaded values will appear. If any item entry (except TGT NO) in the INPUTS section

Due to omission of a range check

ORBIT TGT

is made, the word LOAD flashes until Item 26 is executed. After it is executed, it will remain static until a new item is entered in the INPUT section.

3.5.3.3 COMPUTE T1 (Item 27)

Execution of this item results in the software calculating the first MNVR of the specified two-MNVR set. The calculated results are displayed in the MNVR section of the display and are also output to guidance for display on the ORBIT MNVR EXEC display. Also, all of the items in the INPUTS section of the display will fill in. An "*" will be driven beside Item 27 until the calculations are complete (7-10 seconds for both Lambert targeting and for C-W targeting). As soon as the T1 computation is complete, the GN&C CRT timer will start counting down to the T1 TIG (it is stopped by a MM 202 transition or a LOAD on MNVR EXEC, and must then be restarted).

A targeting computation during a burn execution is not ignored, but is held and executed immediately when the burn is completed (i.e., when TGO = 0). Therefore, the crew must not initiate an orbit targeting computation during a burn, or the burnout velocity-to-go (VGO) residuals on the MNVR EXEC display will be lost.

There are no reasons why a preliminary TGT solution cannot be computed while the Orbiter is maneuvering to a new attitude after the maneuver. In fact, loading the TGT set early gives the advantage of having the CRT timer start counting down to the burn sooner (e.g., post T_i , the preliminary MC1 solution is called out to be calculated on the way back to track attitude).

3.5.3.4 COMPUTE T2 (Item 28)

This item is used to initiate the calculation of the second MNVR of the two-impulse set. This second MNVR is calculated to null the relative velocity at the T2 TIG. As stated earlier, if the T2 TIG is in the past, it will be updated to the current time plus a delta. An "*" is driven by Item 28 until the MNVR calculations are complete. When the calculations are complete, the required ΔV 's are displayed in the MNVR section of the display and are passed to guidance awaiting execution. Also, the GN&C CRT timer will start counting down to the T2 TIG.

Note that execution of an Item 28 (COMPUTE T2) while the computation for Item 27 is still in progress, and vice versa, is illegal, and an ILLEGAL ENTRY message will be generated if that is attempted.

If the crewmember calls up a TGT set and does a COMPUTE T2 before doing a COMPUTE T1, the software will calculate the ΔV required to null rates at the last computed T2 time, which was saved internally during the last MNVR computation. Therefore, a COMPUTE T1 must always be performed before performing a COMPUTE T2.

If the crewmember executes a COMPUTE T2 with a T2 TIG in the past, the new T2 TIG will be the present time plus 1 min. All relative rates at the T2 ignition point will be nulled out.

This compute option not currently used.

3.5.4 Predictor Match (PRED MATCH)

Predictor match gives the distance (in feet) to which the onboard orbit predictor was matched in targeting. In other words, this is a readout of the GNC GPC selfcheck of how well the targeting logic can compute the given MNVR. The GPC's will make 3 to 10 iterations in calculating the burn solution, and will stop iterating when a solution has a predictor match ≤ 250 feet or for elevation angle $\pm 0.30^\circ$ (it will always make at least 3 iterations). There is a practical relationship between a small value of predictor match and the quality of the solution. Failure to achieve these tolerance limits in ten iterations results in a fault message.

As a result of precise PROX OPS flying requirements on 51-F, the predictor match was set to 2 feet for that flight, and points were hit to within 30 to 50 feet (with the time between the maneuver and arrival at the desired offset point being 7 minutes). This distance was larger than 2 feet primarily because of maneuver trim residuals and onboard computer precision limitations affecting Lambert guidance and their error effects propagating through the 7 minutes.

Note: To perform such precise flying, another targeting constant, eps-mu (a tolerance inside of a second iteration), must also be changed (from E-6 to E-7).

3.5.5 Alarms

There are three SM alerts which can appear while using ORB TGT display (see also their impacts in section 3.5.9, items "g", "i", "j", and "k"). They are:

3.5.5.1 TGT ΔT

This occurs when software tries to compute a solution whose ΔT results in a transfer angle near 180° or 360° ("near" as defined by an I-loaded value, currently about ± 2 min or $\pm 8^\circ$), whose ΔT requires a parabolic transfer, around multirev transfer time singularities, or during an iteration failure in the orthogonal braking logic. The crew should check the transfer time and, if necessary, correct input errors. If using multirev capability, decrement ΔT by 10 minutes and retarget. If using orthogonal braking, override the option by reselecting the TGT set and removing the minus sign.

3.5.5.2 TGT-ITER

This can appear when using Lambert targeting. It can result when ORB TGT makes 10 iterations without reaching a solution. Crew should check PRED-MATCH and if it looks good, execute the MNVR anyway.

3.5.5.3 TGT EL ANG

This appears during Lambert targeting when the software exceeds the maximum number of iterations in planning a burn based on elevation angle, or when the desired elevation angle is not achievable. Targeting will indicate what angle the iteration stopped at by displaying it in ITEM 6. The ΔV 's displayed on ORBIT TGT pertain to the displayed angle. Crew should check displayed angle and if it's good enough, execute the MNVR.

If the displayed value is near the desired value, then it is likely that the failure was due to maximum iterations; in this case, it is possible to recall the TGT set and retarget. The iterations will then begin from the end of the last set of iterations and continue for 10 more iterations. If value is highly divergent, the burn should not be executed; instead, the crewmember should remove elevation angle and use preflight T1 (TGT SET 19).

Note: Display of this message is considered highly unlikely and is not expected to occur, even with any anticipated trajectory dispersions.

3.5.6 Maneuvers

This section identifies parameters for one of either of the two-impulse MNVR's which has been computed. A MNVR using COMPUTE T1 is that required to intercept the desired position in a desired time, and a MNVR using COMPUTE T2 is that required at the intercept time to null relative motion (as observed in a target-centered rotating curvilinear reference frame). Quantities displayed in this section for each MNVR include:

- a. XX - The target number on which the MNVR is based
- b. X - An indicator (*) that the TIG is in the past
- c. TIG - The impulsive ignition time (days, hours, minutes, seconds) in MET
- d. VX - The LVLH X-component of the targeted ΔV (ft/s)
- e. VY - The LVLH Y-component of the targeted ΔV (ft/s)
- f. VZ - The LVLH Z-component of the targeted ΔV (ft/s)
- g. VT - The magnitude of the targeted ΔV (ft/s)

Note that these solutions are not downlisted.

3.5.7 Out-Of-Plane Procedures

Out-of-plane dispersions are handled both by ORB TGT and later manually based on REL NAV. The ground-targeted NPC ("plane change") burn done early in the RNDZ phase removes out-of-plane dispersions observed via ground tracking. Onboard optical tracking pre-NCC provides additional relative orbital plane knowledge. This is used by ORB TGT for NCC targeting, to place T_i in plane. Subsequent T_i targeting (using post-NCC onboard radar tracking) places TGT intercept in plane, as well as can be done with these observations. In doing this, another node is created half a REV before intercept, and it is at this node that the RNDZ checklist calls for a manual plane correction to trim out all remaining out-of-plane error.

The theoretical background for out-of-plane control is given in section 2.9.2; the actual procedures are specified in 4.1.19 (Target NCC), 4.1.33 (Target T_i), and 4.1.54 (perform OOP null).

3.5.8 Operational Constraints

The orbit targeting software for flight software FSW version OI-7 still has several minor problems (see OI-7 Program Notes, JSC-19320, PN-OI7), as described below. The operational constraints they impose are as follows:

- a. An elevation angle search for an elevation angle which cannot be obtained may take more than 15 minutes to complete. The long computation time results from an incompatible elevation angle which cannot arise in normal operations. A large relative SV update prior to an orbit targeting elevation angle search could produce this problem, for example. The inconsistency with the requirements will be resolved by CR #69491B, approved for OI-11.
- b. An infinite software loop is possible when targeting Lambert MNVR's with a 180° transfer angle, but another coding error accidentally prevents the software from getting into the loop. A CR fix (#69133C) is approved for version OI-11. Such transfers are not planned for nominal RNDZ profiles.
- c. A precision problem exists in the elevation angle computation. The problem occurs only for small phase angles. For a ΔH of 1 n.mi., the elevation angle computation breaks down around 50° . This is not really a limitation, since the baselined RNDZ profile operates at about 28° elevation angle at a ΔH of 2 n. mi. (see section 4.1.51). CR #69491B has been written to correct the problem, and has been approved for OI-11.
- d. Upon initial call up of the ORB TGT display (SPEC 34) after entering OPS 2 from another OPS, the selected TGT set is initialized to 0. If a COMPUTE T1 (Item 27), or a LOAD (Item 26), or a COMPUTE T2 (Item 28) is then requested, undesirable results may occur. These include:
 1. Targeting may require several minutes to complete.

2. One or more GPC errors may occur.
3. Various targeting alarms may be annunciated.

Therefore, the crewmember should not request a COMPUTE T1 for TGT set 0 or when ΔT and T2 TIG are both zero. The crewmember must not request a LOAD for TGT set 0 (it could write zeroes into data locations not allocated to ORB TGTing). Any results displayed after performing any of these requests should be ignored. The orbit targeting protection CR #69491B adds protection to orbit targeting from operating on a non-existent (zero) TGT set; this CR has been written and approved for flight software version OI-11.

- ✓ e. Orbit targeting allows the crewmember to define the Orbiter state (at T1 TIG) for a Lambert MNVR in terms of a TGT state and a keyboard input target centered relative state. The targeting algorithm will compute a MNVR based on the input relative state and transfer the MNVR information to the ORBIT MNVR display. When load is executed for the ORBIT MNVR EXEC display, neither the ORB MNVR display nor on-orbit guidance has knowledge that an input relative state was used. Consequently, an Orbiter state (at T1 TIG) is generated based on the current Orbiter state from on-orbit user parameter processing. This situation results in a targeted MNVR different from the intended MNVR. The degree of difference in the MNVR's may or may not be observable when comparing orbit targeting display data against ORBIT MNVR exec display data, but in either case the resultant MNVR will not yield the expected results.

Because the difference between the computed MNVR and the desired MNVR may not be readily observable, it is recommended that the relative offset state targeting technique not be used in PROX OPS. If it is desired to use the technique, either of the following workarounds is recommended:

1. Use the C-W targeting algorithm rather than Lambert (see section 3.5.12); or
2. Manually transfer the Lambert targeting data to the PEG 7 portion of the MNVR EXEC display and perform an external ΔV MNVR.

- ✓ f. The value displayed for T1 TIG (Item 2 on the orbit targeting display, SPEC 34) may be 1 second less than the actual value of TIG used by guidance after the following sequence is performed:

1. The displayed TGT set data is stored into the predefined TGT set storage locations via an ORB TGT load (Item 26);
2. That same TGT set is evoked again, via item 1. Note that an intervening compute T1 (Item 27) or compute T2 (Item 28) makes no difference.

If a compute T1 is then done, the value displayed for T2 TIG (Item 13) may be 1 second less than the actual value used by guidance. The CRT

timer will countdown to the correct TIG, and the correct value is used for computing the targeting and guidance solutions. The correct value of TIG will be displayed on the ORB MNVR EXEC display (MM 202 OPS display). The crewmember should refer to ORB MNVR EXEC display for the correct value of TIG if TGT set data is loaded and then used again.

- g. When a compute T1 (Item 27) is requested for a Lambert TGT set, a transfer time alarm may be annunciated if targeting is unable to find a solution. This alarm produces the CRT message "TGT ΔT " (see section 3.5.5.1). Under some circumstances when this alarm is annunciated, the PRED MATCH field on the ORB TGT display is required to display a large value. As the large value required to be displayed has too many digits for the PRED MATCH field, a value of zero is displayed instead.

The crewmember should not execute the resulting MNVR if the "TGT ΔT " message is annunciated for a Lambert TGT set and the PRED MATCH field displays zero.

CR #69837A has been written and approved for FSW version OI-11. This CR changes the FSW such that when max iterations occur in the omega ΔT time computation, the alarm TGT ΔT is annunciated and PRED MATCH is set to 999999.

- h. For a small Lambert MNVR of less than 5 ft/s, the VGO on the MNVR EXEC display incorrectly increases by an amount of 0.4 to 0.9 ft/s when the VGO corrector task is cycled at 10 to 15 seconds prior to TIG. The effect becomes less as TIG approaches and is correct at a time less than 4 seconds after TIG. This is due to the initiation of Lambert guidance prior to TIG and is negligible for MNVR's of larger ΔV 's. This anomaly was predicted to occur in 1978, but was not fixed because of a crew desire to have a visual indication that guidance is cycling.

The crewmember can avoid possibly inefficient maneuvering by not starting the trim of VGO's for axis-by-axis MNVR's until TIG.

CR #69568A has been written and approved for FSW version OI-11 which will eliminate transient errors in ΔV total displayed on the ORBIT MNVR EXEC display before TIG when a small midcourse correction burn using Lambert guidance is executed.

- i. If a load computation (Item 22 on ORBIT MNVR EXEC display) is requested for a Lambert guided burn and the "TGT ITER" or "TGT ΔT " alarm is annunciated during the computation, the following guidance parameters will be incorrect: VGO, TGO, total ΔV , burn attitude, TGT apogee, and TGT perigee. The data may appear reasonable, but they are incorrect.

The crewmember should not execute the resultant MNVR. Reenter any portion of the TGT data to downmode from Lambert to external ΔV guidance, and recompute the solution.

- j. If a burn is being executed using Lambert guidance and the "TGT ITER" or "TGT ΔT " alarm is annunciated, the following guidance parameters will

be incorrect: VGO, TGO, total ΔV . The total ΔV will be in excess of 100 ft/s, with the VGO components and TGO correspondingly large. If the DAP is in AUTO mode, the Orbiter will maneuver to the incorrect burn attitude and maintain the incorrect body rates. Correct values for all of these parameters may be restored after four seconds.

The crewmember should terminate the burn immediately. If there is not enough time to set up and execute a corrective MNVR before the next scheduled MNVR, expect the next scheduled MNVR to be off nominal in order to correct for the aborted burn. If there is time to do a corrective MNVR, compute the corrective MNVR solution on the ORB TGT display using the same TGT set as for the aborted burn. To ensure successful execution of the corrective MNVR, the MNVR should be done using external ΔV guidance rather than Lambert guidance, although Lambert guidance may work. Beware of 180° and 360° transfer time singularities.

- ✓ k. If a compute T1 (Item 27) is requested for a Lambert TGT set and the "TGT ITER" or the "TGT ΔT " alarm is annunciated during the computation, the resultant MNVR solution will probably be incorrect. The VGO's displayed on the orbit TGT display are expected to be grossly in error, but they may appear reasonable when they are really are not. The resultant MNVR-solution computed solution is required to verify this. In addition, the ground may see multiple GPC errors during the computation.

The crewmember should not execute the resultant MNVR unless comparison with the ground solution indicates the solution is good. Otherwise, check that the input data for the TGT set is reasonable. Especially ensure that the transfer time does not yield a 180° or 360° transfer angle. If the input data is correct, recomputing the MNVR may produce a successful solution. If recomputation fails and a ground-computed MNVR is available, enter the ground-computed MNVR on the ORBIT MNVR EXEC display and execute. If out of contact with the ground, manually transfer the data to a CW TGT set and compute the MNVR solution using C-W targeting. Note that if the MNVR uses orthogonal braking, TGT data must also be transferred for the next TGT set as well.

3.6 CONTROL

Once a desired change in orbit has been defined ^{by} targeting, it should be performed by "maneuver execution". This involves performing a propulsive burn to create a controlled ΔV .

3.6.1 PADS

Numerical data define MNVR's which can then be input to the MNVR EXECUTE display; this data is written on prepared forms called "BURN PADS", found in the RNDZ checklist. The burn data may be calculated several times (e.g., preflight, preliminary, intermediate, and/or final) and entered on the form

each time. The preflight data is entered in the parenthesised fields; the multiple sets of "onboard solutions" is a unique feature of the Ti PAD.

3.6.1.1 Basic Information

The following information is needed for the performance of a burn (see fig. 3-34):

- Engine select
- Thrust vector roll, degrees
- Trim load (P, LY, RY)
- Vehicle weight, pounds
- TIG in MET
- PEG7 ΔV 's (X, Y, Z) in LVLH, ft/s

PRELIMINARY ORBITAL MNVR PAD FOR TI (PREFLIGHT)

OMS BOTH 1

()	()
-----	-----

L 2

()	()
-----	-----

R 3

()	()
-----	-----

RCS SEL 4

()	()
-----	-----

}

()	()
()	()
()	()

 MULTI-AXIS

TV ROLL 5

()	()	()
-----	-----	-----

TRIM LOAD

P 6

()	()	()	()
-----	-----	-----	-----

 (() -)

LY 7

()	()	()	()
-----	-----	-----	-----

 (() -)

RY 8

()	()	()	()
-----	-----	-----	-----

 (() -)

WT 9

()	()	()	()	()	()
-----	-----	-----	-----	-----	-----

 ()

TIG 10

()	()	()	()	()	()	()	()	()	()	()	()
-----	-----	-----	-----	-----	-----	-----	-----	-----	-----	-----	-----

 (/ : : -)

PEG7 TGTS

ΔV_X 19

()	()	()	()	()	()	()	()
-----	-----	-----	-----	-----	-----	-----	-----

 (() -)

ΔV_Y 20

()	()	()	()	()	()	()	()
-----	-----	-----	-----	-----	-----	-----	-----

 (() -)

ΔV_Z 21

()	()	()	()	()	()	()	()
-----	-----	-----	-----	-----	-----	-----	-----

 (() -)

MNVR ATT

R 24

()	()	()	()
-----	-----	-----	-----

 ()

P 25

()	()	()	()
-----	-----	-----	-----

 ()

Y 26

()	()	()	()
-----	-----	-----	-----

 ()

ΔV_{TOT}

()	()	()	()
-----	-----	-----	-----

 (-)

TGO

()	()	()	()
-----	-----	-----	-----

 (:)

VGO X

()	()	()	()	()	()	()	()
-----	-----	-----	-----	-----	-----	-----	-----

 (() -)

VGO Y

()	()	()	()	()	()	()	()
-----	-----	-----	-----	-----	-----	-----	-----

 (() -)

VGO Z

()	()	()	()	()	()	()	()
-----	-----	-----	-----	-----	-----	-----	-----

 (() -)

HA

()	()
-----	-----

 HP

()	()
-----	-----

 (MA)

()	()
-----	-----

 (HP)

()	()
-----	-----

TGT

()	()	()	()
-----	-----	-----	-----

 () (())

NOTES

OMS GMBL CK:

PRE POST-BURN

L PRI

()

()

L SEC

()

()

R PRI

()

()

R SEC

()

()

RCS I'CNCT:

()

 L OMS \rightarrow RCS

()

 R OMS \rightarrow RCS

()

 NONE

DOWN MODE OPTIONS:

()

 2 OMS \rightarrow 1 OMS \rightarrow RCS

()

 2 OMS \rightarrow 1 OMS

()

 1 OMS \rightarrow RCS

()

 NONE

OMS HE REG TEST. L/R OMS HE P/VAP ISOL

GPC OP CL

A

()

()

()

B

()

()

()

MMU DES

()

ONBOARD SOLUTIONS

PREL FLTR

()	()	()	()
()	()	()	()
()	()	()	()

1ST INTER FLTR

()	()	()	()
()	()	()	()
()	()	()	()

2ND INTER FLTR (IF REQD)

()	()	()	()
()	()	()	()
()	()	()	()

FINAL FLTR

()	()	()	()
()	()	()	()
()	()	()	()

PROP (IF REQD)

()	()	()	()
()	()	()	()
()	()	()	()

LIMITS

ΔV_X (-)

ΔV_Y (-)

ΔV_Z (-)

ΔV_{TOT}

Figure 3-34.- Typical BURN PAD.

3.6.1.2 Other Systems Data

Performance of a burn may involve systems reconfiguration, which can be specified either on a cue card or on the burn pad. For example: OMS gimbal check (left/right, primary/secondary, pre/postburn) may be specified; OMS HE regulator (A,B), both sides, may be set to GPC/OP/CL; RCS interconnect may be altered. In addition, systems reconfigurations which are associated not with the burn but with some activity which closely follows the burn, may also be specified (e.g., IMU deselect, which actually is associated with the subsequent STRK pass. See sections 3.3.2.1 and 3.9.4).

3.6.1.3 Ti Delay PAD

The Ti burn is a convenient point to stop the RNDZ for one or more REV's, if needed. Instead of burning the nominal Ti pad, the crew loads a special pad read-up from the MCC (fig. 3-35). Use of this pad is discussed in section 4.1.40 in the RNDZ procedures rationale narrative.

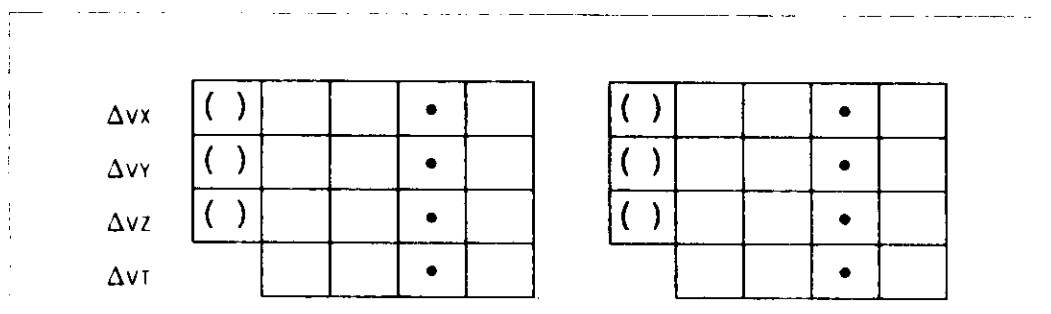

Figure 3-35.- Ti delay pad.

3.6.1.4 MC PADS

The post-Ti midcourse burns are usually small and are done axis-by-axis. Since there is no ground solution to check against, a "3-sigma variation" value is computed preflight for use as a confidence check (fig. 3-36).

The 3-sigma limits on the MC1 thru MC4 burns are for information only. They are the maximum expected value of the targeting solutions. The values are mission and burn dependent. If the limits are exceeded, the burn should still be executed, if REL NAV and the sensors being used look good.

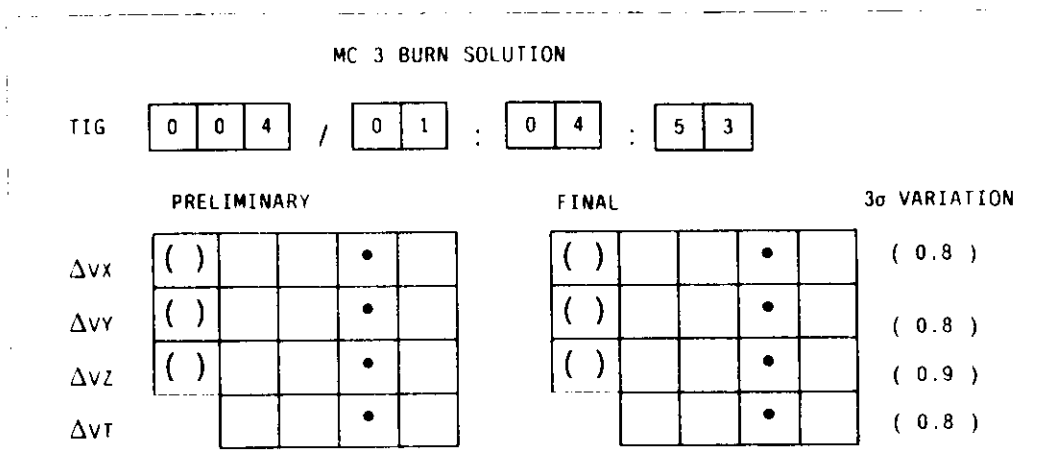

Figure 3-36.- Typical MC PAD.

3.6.2 ORBIT MNVR EXEC (MM 202)

This is the OPS display in GNC MM 202. It provides the crew with a means for inputting and executing MNVR's, evaluating their effects on the trajectory, and adjusting parameters as necessary (fig. 3-37). It can be used during long-range stationkeeping and separation as well as RNDZ.

In general, this display provides the crew interface for monitoring and control of the functions contained in MM 202. These include the controls to maneuver the Orbiter to a burn attitude, and to monitor, guide, and control the vehicle while executing a translational MNVR, or while executing the burns used in the RNDZ mission phases. The same display is used during ascent, orbit, and entry, with the difference being the title (ASCENT/ORBIT/DEORBIT MNVR EXEC/COAST). Thus, there are some items on this display that are not used in OPS 2 (e.g., PEG 4 TGT's, Items 14-18; REI-range to entry interface status, Items 35-39).

RNDZ MNVR's will be trimmed to VGO less than 0.2 ft/s in each axis. Normally, on-orbit MNVR's are not considered delta-velocity critical for flight safety or mission success, and therefore, no strict trim requirements are set. However, RNDZ MNVR's are typically considered critical for mission success and should be trimmed more accurately. Based on flight experience, 0.2 ft/s in each axis is the smallest residual consistently achievable by crew input. This accuracy is required during RNDZ operations to keep deviations from the planned profile to a minimum.

202 / /	ORBIT MNVR EXEC	XX X DDD/HH:MM:SS
OMS BOTH 1X		DDD/HH:MM:SS
L 2XS	BURN ATT	XXXX
R 3XS	24 R XXX	AVTOT XXXX.X
RCS SEL 4X	25 P XXX	TGO XX:XX
5 TV ROLL XXX	26 Y XXX	
TRIM LOAD	MNVR 27X	VGO X ±XXXX.XX
6 P ±X.X		Y ±XXX.XX
7 LY ±X.X	REI XXXX	Z ±XXX.XX
8 RY ±X.X	TXX XX:XX	
9 WT XXXXXX	GMBL	HA HP
10 TIG	L R	TGT XXX ±XXX
XXX/XX:XX:XX.X	P ±X.XS ±X.XS	CUR XXX ±XXX
TGT PEG 4	Y ±X.XS ±X.XS	
14 C1 XXXXX		35 ABORT TGT XX
15 C2 ±X.XXXX	PRI 28X 29X	
16 HT XXX.XXX	SEC 30X 31X	FWD RCS
17 θT XXX.XXX	OFF 32X 33X	ARM 36X
18 PRPLT ±XXXXX		DUMP 37X
TGT PEG 7	GMBL CK 34X	OFF 38X
19 ΔVX ±XXXX.X		SURF DRIVE
20 ΔVY ±XXX.X	XXXXXXX	ON 39X
21 ΔVZ ±XXX.X		OFF 40X
XXXX 22/TIMER 23		(XX)

Figure 3-37.- The ORBIT MNVR EXEC (MM 202) display.

Note that ORB MNVR EXEC would be used only to execute targeted translation MNVR's (via OMS or RCS). For other translation MNVR's, such as manual stationkeeping or V-BAR approach, the thrust monitor capability on REL NAV may be used to monitor manual translation command inputs from the THC, executed by RCS jets.

From flight experience, crews have suggested adding some features to OPS 202. These include the capability to perform RCS burns under GPC control and the display of time-to-go in current attitude maneuver (which is displayed in OPS 201). There are no current plans to implement these suggestions.

The RNDZ related functions of the display are described in this section. This is not a complete description of the functioning of the SPEC. For a detailed explanation of the entire display, see the OPS Dictionary or the GNC Display FSSR.

3.6.2.1 OMS BOTH/L/R, RCS SEL (Items 1-4)

These mutually exclusive items allow the user to select whether both OMS engines, or just the left or right one, or the RCS jets will be used in the upcoming MNVR. If an OMS failure is declared by fault detection, identification and reconfiguration (FDIR), a down arrow will appear in the status column next to item 2 or 3 (L or R OMS engine). The down arrow and FDI are reset if item 1 (BOTH) is subsequently selected. If item 4 is selected

(RCS SEL), the burn attitude and burn duration time computations for the targeted MNVR will be made, assuming that 2 +X RCS thrusters will be used to produce a +X acceleration. A required burn attitude will be computed to align the Orbiter +X effective thrust vector with the required thrust vector with the specified TV roll. These data will appear in Items 24-26.

3.6.2.2 Thrust Vector Roll (Item 5)

This item allows the crew to select the Orbiter orientation, in terms of roll, about the thrust vector during an OMS burn. Roll angles from 0° to 359° can be input, with 0° being heads up. It is initialized the first time to an I-loaded value (180° or heads down so the horizon is visible), and retains that value until user intervention. From then on, it comes up with the previously used value which can be changed by the user. TVR is valid only for a +X attitude burn (either +X RCS or OMS). The value of the TVR is determined by the right hand rule about the thrust vector, zero heads-up in LVLH.

3.6.2.3 Time of Ignition (Items 10-13)

These items represent the TIG in MET (DAYS/HR:MIN:SEC). A check is made by the software to ensure that a time entered in this item is realistic (within 5 minutes in the past, or 12 hours in the future). If it is not a realistic time, an illegal entry message will be generated.

3.6.2.4 PEG 7 (Items 19-21)

These items are used to input the three external ΔV 's (ft/s) in the local vertical system at ignition. When COMPUTE is performed in ORB TGT SPEC, the results are automatically transferred here (ITEM 22 must then be executed to LOAD).

Note: The burn ΔV 's may be different between the ORBIT MNVR EXEC display and the ORBIT TGT display for Lambert maneuvers. There are three reasons for this possible difference: Both displays use the current SV when computing the burn solution, but because they are used at different times some ΔV discrepancy results. If it is a Lambert targeted burn, Lambert will run through one iteration cycle when the targets are loaded on ORBIT MNVR EXEC, updating the previously computed targets for any sensed accelerations or NAV marks taken. Beginning at TIG-15 seconds, the ORBIT MNVR EXEC display starts receiving continuous updates from Lambert guidance, as compared to the ORBIT TGT display that computes the burn targets only once.

3.6.2.5 LOAD (Item 22)

The word LOAD will flash any time the display is called up in OPS 2. Once the LOAD item is executed, the word LOAD will cease flashing and the engine

selection, trim, vehicle weight, and TGT data items will be sent to guidance. Also, certain display parameters will be computed, including burn attitude, total ΔV , targeted apogee/perigee, burn time, and required ΔV in body components. The CRT timer will stop and reset to zero.

Later, if the engine selection, trim, vehicle weight, or TGT data items are altered by crew input or by ground uplink prior to burn enable or after burn completion, the word LOAD will flash, and it will be necessary to retarget the MNVR to keep Lambert guidance. Such an entry will terminate all burn guidance computations and the load-dependent parameters will blank. Any change of these targeting or setup parameters while the burn is enabled, or prior to burn completion, will be treated as an illegal entry.

3.6.2.6 TIMER (Item 23)

The GNC CRT timer may be started to count down to TIG via this item. It may already have been counting since ORB TGTing targeted the burn, but moding to 202 or execution of LOAD stopped it.

3.6.2.7 Guidance Downmoding

The active guidance mode (Lambert or external ΔV) is displayed at the bottom of the middle column. Any changes to entries on the left-hand side of MNVR EXEC will cause an automatic downmoding from Lambert to external ΔV guidance mode. To return to Lambert guidance mode, the crew must call up ORB TGT, load and recompute targets, resume MNVR EXEC, and load results. Inadvertent guidance downmoding can cause trouble with procedures which are not executed in a crisp, careful fashion. Deliberate downmoding can be achieved by intentionally changing an entry on SPEC 34 or MM 202; there are currently no known reasons for doing this.

3.6.2.8 Burn Attitude (BURN ATT, Items 24-26)

The burn attitude at ignition in degrees, with respect to the FWD ADI inertial reference frame, will appear by these items after crew execution of the load ITEM (Recall that the roll orientation about the thrust vector was specified in Item 5.) The BURN ATT items may not be used for data entry in OPS 2. Such an attempt would result in an ILLEGAL ENTRY message. The burn attitude generates ADI attitude error such that the crew can maneuver to the desired attitude. In OPS 2, this maneuver may be done automatically with the next item.

3.6.2.9 MNVR execute (Item 27)

This item enables an AUTO DAP maneuver to the desired burn attitude (given in Items 24, 25, and 26). While the maneuver is in progress, an asterisk will appear next to Item 27. If ITEM 27 has not been selected, it will be enabled automatically 10 to 15 seconds before TIG with initiation of cyclic

guidance. If it is not desired to maneuver to the burn attitude at TIG, the DAP must be placed in MAN or LVLH mode. If DAP is not in AUTO, the "*" will not appear. Note that in MM 202, the ADI error needles are referenced to BURN ATT when this item is executed.

3.6.2.10 Time to Next Apsis (TXX XX:XX)

A time is displayed (MIN:SEC) which is the time to next apsis. An alphanumeric title next to the time will read TTA if apogee is the next apsis, TTP if perigee is the next apsis, or if apogee and perigee differ by less than 5 n. mi., the time will be blank and the title will read TTC ("C" for circularization).

3.6.2.11 Burn-related parameters

Several parameters used during a burn will be displayed in the upper right-hand corner of this display.

- EXEC: This is when OMS is selected only. At TIG -15 sec, the word EXEC will appear and will flash until a keyboard EXEC is performed, at which time the characters will disappear. Ignition is inhibited until this entry is made. If the EXEC entry is made after the specified TIG, the MNVR starts immediately following the EXEC entry. Releasing the display prior to enabling the MNVR (e.g., transitioning to MM 201, OPS 3, or OPS 8) cancels that MNVR.
- ΔV TOT: This parameter identifies the predicted total ΔV of the targeted MNVR.
- TGO: This parameter reflects the predicted burn length (MIN:SEC) before TIG occurs. After ignition, it reflects the remaining burn time.
- VGO X/Y/Z: These parameters show the velocity to go componentwise in ft/s with respect to the vehicle body axis system. These values can be used by the crewmember to manually execute the required RCS burn using the THC (see section 3.6.3).
- HA, HP TGT/CUR: These parameters reflect apogee (HA) and perigee (HP) information in nautical miles for the current orbit trajectory (CUR) and for the predicted postburn orbit (TGT).

3.6.2.12 Operational Constraints

The OI-7 Program Notes (JSC-19320) lists the following operational constraints on MM 202, "ORB MNVR EXEC." Constraints on SPEC 34 also will impact MM 202 operations, see section 3.5.9, items "e", "h", and "i."

a. Attitude maneuver to unknown attitude.

On the MNVR DISP, once an AUTO MNVR (Item 27) to a desired "BURN ATT" (Items 24 through 26) is initiated, an asterisk will appear next to Item 27 to indicate that the maneuver is in progress. Once this AUTO MNVR has been initiated, this asterisk remains next to Item 27 until:

- (1) A new TGT Item is entered on the display (Items 1 through 21 except Item 18) and causes the values for "BURN ATT" to blank, but the vehicle continues to maneuver to the old "BURN ATT" (as indicated by the asterisk next to Item 27).
- (2) If a new load Item (Item 22) is entered on display, this causes a new "BURN ATT" to be computed and displayed, but the vehicle continues maneuvering to the old "BURN ATT."

In response to this problem, the crew should do the following. If an AUTO MNVR to a desired "BURN ATT" is in progress (asterisk next to Item 27) and either of the above is performed, mode the DAP to manual and back to AUTO to avoid confusion regarding the attitude to which the vehicle is maneuvering.

b. Orbit DAP RCS burns while not at guidance attitude.

Problems arise in two cases if it is desired to execute an axis-by-axis guided RCS burn in manual mode while holding some attitude other than the guidance determined burn attitude:

- (1) Without executing the MNVR Item on the ORBIT MNVR EXEC display: a maneuver to the burn attitude will begin if the AUTO mode is selected any time between TIG-15 and cutoff. Solution is to not select AUTO during this interval.
- (2) Including execution of the MNVR Item: A maneuver to the burn attitude will begin if the AUTO mode is selected any time between execution of the MNVR Item and transition out of MM 202. Solution is to prevent the maneuver, by not selecting AUTO between execution of the MNVR Item and transition out of MM 202. To interrupt the maneuver, select manual, and then AUTO (does not work during burn).

c. OPS Transition with target track active.

When an OPS mode recall (with GPC TGT set change) or OPS 2 to 8 transition is executed with RNDZ NAV enabled, RNDZ NAV will be disabled afterwards and will not be propagating the TGT SV. If the UNIV PTG TGT track option (Item 19 on the UP display) was active at the time of the OPS mode recall or OPS transition, UNIV PTG will continue to track the last computed TGT state. This may cause undesirable RCS activity. After an OPS mode recall, UNIV PTG will continue the last computed relative state. After an OPS 2 to 8 transition, the relative state is lost, and multiple GPC errors will result from operations on zero vectors.

This situation can be prevented by canceling the TGT TRK (Item 21 on the UNIV PTG display) before executing the OPS mode recall or transition. The jet firings can be stopped by moding the DAP to manual.

The GPC errors can be stopped by a PRO to MM 201 followed by canceling the TGT TRK.

If this situation occurs, a TGT state uplink is required to resume tracking. This is implemented in procedures discussed in section 6.1.3.1.

d. Stale SV after orbit OPS transition

On-orbit NAV does not execute and compute the Orbiter SV until between four and seven seconds after completion of an OPS mode recall with TGT set change or an OPS transition. During this period, the M50 to LVLH transformation quaternion will be stale and will cause the following anomalous behaviors:

- (1) The attitude displayed on any ADI for which the LVLH reference is selected will be incorrect until the SV is recomputed on the next NAV cycle (4 seconds). The crew should be aware of this.
- (2) If the DAP manual LVLH mode is initialized after the transition or recall, and before NAV runs, the commanded LVLH attitude will be based upon a stale SV. If NAV was inactive long enough during the transition or recall, and the Orbiter rates were high enough, a maneuver could result after NAV is reactivated. The crew should avoid the LVLH mode PBI during the transition or recall and for 7 seconds after resumption of GNC processing to preclude this RCS activity. Otherwise be aware of the problem.
- (3) If the DAP manual LVLH mode or a UNIV PTG Earth-relative or center-of-Earth track option is activated prior to the transition or recall, the DAP will operate on an attitude error based in part on stale data. This could result intransient jet firings until the SV is updated. The crew should be aware of this.

This constraint is flagged in section 3.7.3.4.

e. IMU data loss during MM 202 preburn maneuver:

If all IMU data is lost for at least 960 ms during a MM 202 preburn altitude maneuver, the DAP will downmode to manual rotation (MAN ROT) pulse. This downmode normally terminates the maneuver.

However, two problems may occur, if the DAP was not in the AUTO mode at any time between the start of the maneuver and the time the IMU data was lost, and:

- (1) If the IMU data is restored while in MM 202, the maneuver will re-activate immediately (Note: The DAP will remain in the MAN ROT pulse mode). Sequential transitions to MM 201 and back to MM 202 in between the loss and restoration of IMU data will not affect this situation. The crew response should be as follows.

If the IMU data is restored while in MM 202, and,

- (a) It is desired to terminate the maneuver, execute a mode transition to MM 201, or cycle the DAP mode to AUTO, then MAN, then back to AUTO.
- (b) It is desired to continue the maneuver, either:
- Use the RHC to manually maneuver the vehicle (in any desired rotational submode) according to the ADI, or
 - Select the AUTO mode.
- (2) If the IMU data is restored while in MM 201, the maneuver will reactivate immediately upon re-entry into MM 202, unless an OPS transition out of OPS 2 is executed before returning to MM 202. The crew response should be that if the data is restored while in MM 201, either
- (a) Execute an OPS transition prior to the next entry into MM 202, or,
- (b) Mode the DAP to the AUTO mode prior to the next transition into MM 202. Then, once in MM 202, cycle the DAP mode to MAN and then back to AUTO.

This constraint is flagged in section 3.7.3.4.

3.6.3 AXIS-BY-AXIS BURNS

Under certain circumstances the ΔV required is performed in OPS 202 while holding an arbitrary attitude. There could be some compelling reason to maintain that attitude (e.g., viewing requirement, Sun angle, etc.), or the burn might be small enough that the RCS cost in maneuvering to +X and back exceeds the efficiency loss in burning axis by axis. In this case, the EXEC command is not needed and the entire burn is manually executed the same way a +X burn is trimmed postguided cutoff.

The axes are trimmed in the sequence of X, then Y, then Z, unless Z is negative and thus is to be trimmed first. This sequence minimizes the impacts of translational coupling (section ~~6.2.1~~).

3.8.1.1

This procedure is fully defined in section 3.8.5.1.

3.7 DPS

Proper processing and maintenance of RNDZ-related data is crucial to mission success. A variety of DPS activities can impact this processing, not always in obvious ways.

3.7.1 Configuration for Rendezvous

The GPC's are configured such that if either of the two computers fails during the RNDZ, vehicle attitude and translational control are maintained. This is especially important when the Orbiter is in close proximity to the TGT, and it is important for crew safety to be able to perform evasive MNVR's, should the need arise.

Stringing is accomplished to satisfy this requirement. Initially, strings 1 and 3 are on GPC 1, and 2 and 4 are on GPC 2 (NBAT is "1212").

3.7.2 Off-Nominal DPS Configurations

During actual rendezvous missions, a three-GPC redundant set has occasionally been established for redundancy reasons.

3.7.3 OPS Transition Effects

Performing OPS mode recalls or OPS transitions during the RNDZ phase can have significant impact on procedures. Where possible, such transitions should be delayed to the PROX OPS phase or later.

OPS mode recalls that are associated with the addition/deletion of a GPC to/from the GNC redundant set result in a number of undesirable secondary effects because of the momentary passage through OPS zero, particularly when rendezvous NAV is enabled. Among these are the disabling of RNDZ NAV, loss of the propagated NAV state, covariance matrix reinitialization, possible bad NAV measurements being incorporated into the filtered NAV state, an undesired attitude maneuver accompanied by the "pegging" of the ADI error needles, GPC errors, and increased propellant usage.

In addition, DPS OPS transitions are performed in accordance with several malfunction procedures. As a minimum, RNDZ NAV is disabled. In some cases, base time, target state vector, covariance matrix, and universal pointing can also be lost. GPC errors may also occur.

3.7.3.1 RNDZ NAV Termination

RNDZ NAV is terminated any time OPS 2 is left (see section 3.6.2.12, item "c"). This will happen when an OPS transition (OPS 2-X-2) is performed (for X = 8 or X = 3) or when a GPC is add/deleted to/from the set by performing an OPS/mode recall. RNDZ NAV is not terminated due to restringing.

In the ORB PKT C/L procedure for "PASS GNC GPC (1st FAIL)", there are steps which call out:

IF RNDZ NAV Enabled:

~~Perform RNDZ NAV SAFING~~

DAP-free drift
GNC UNIV PTC
CNCL - ITEM 21 EXEC (no #)

(fig 3-38) →

and after the DPS manipulations

IF RNDZ NAV REQ'D:

Perform RNDZ NAV Recovery

The ~~two~~ ⁶ procedures, ~~for safing and for recovery~~, ^{is} are found in figures ~~3-38~~ ⁶ and ~~3-39~~. Their specific uses and rationales are described below in three subsections.

- a. The OPS 2-8-2 transition is necessary when starting an APU. The *relevant* procedures are located in the orbit operations checklist, "G2 to G8 Transition" and "G8 to G2 Transition." *self RNDZ NAV is running and UP TGT ID=1, go to free drift and cancel tracking.*
RNDZ NAV will be terminated on departure from OPS 2 since it is not supported in OPS 8. On return to OPS 2 the NAV software level, called "OPS overlay" (highest or last level), is read from the MMU. This means all NAV software at the "OPS overlay" level is in an I-loaded state. Target SV, covariance matrix, and base time are all lost. RNDZ NAV and KU ANT functions are terminated because they are not supported in OPS 8.

(Text continues on page 3-102.)

modification to



```

If OPS MODE recall (ADD/DELETE GPC
TO/FROM Redundant Set)

DAP: FREE DRIFT
GNC UNIV PTG
CNCL - ITEM 21 EXEC (*)
If OPS TRANSITION (G2 to G8/G3)
Before OPS transition :
.....If MNVR for APU leak reqd.....
-Y FOR STRK (+Y for RR)
GNC UNIV PTG
TGT ID +1
BODY VECT +5
P +0
Y +280.6 (+90)
OM +90 (+180)
TRK - ITEM 19 EXEC (*)
DAP: B/AUTO/NORM,
When in att, DAP: A/AUTO/VERN
NOTE: Do not take RR Angle data
while in +Y attitude
.....

CRT GNC 34 ORBIT TGT
Record Base Time ___/___:___:___
    
```

Figure 3-38.- RNDZ NAV safing *in ORBIT PCL*

After returning to OPS 2, the MCC uplinks a new TGT SV (RNDZ NAV cannot be enabled until this is done) and COV MATRIX. The crew enables RNDZ NAV and KU ANT and returns to TGT TRK, then selects appropriate angle sensor (RR, STRK, or COAS, initiated as STRK) and incorporates sensor data into NAV when appropriate.

(if required) the PROX OPS

If OPS MODE recall (add/delete GPC to/from redundant set)

CRT

GNC 33 REL NAV

Inhibit RNG - ITEM 18 EXEC
 RDOT - ITEM 21 EXEC
 Angles - ITEM 24 EXEC

[Note: * will not change until RNDZ NAV enabled]

RNDZ NAV ENA - ITEM 1 EXEC (*)
~~✓ KU ANT ENA - ITEM 2 as reqd~~
~~GNC I/O reset EXEC~~

CRT

GNC UNIV PTG

~~✓ TGT ID, BODY VECT, P, Y, OM~~
 TRK - ITEM 19 EXEC (*)
~~DAP: A/AUTO/VERN~~

CRT

GNC 33 REL NAV

~~Auto RNG - ITEM 17 as reqd~~
~~RDOT - ITEM 20 as reqd~~
~~Angles - ITEM 23 as reqd~~

~~When SV UPDATE POS < 1.0 (0.3 if RR)~~
~~and MARK ACCEPT > 9,~~
~~SV SEL - ITEM 4 EXEC (FLTR)~~

(MORE)

Figure 3-39.- RNDZ NAV recovery.

RNDZ NAV RECOVERY

If Recovery from OPS MODE RECALL
(add/delete GPC to/from redundant set)

GNC 33 REL NAV

(Note: Asterisks will not change until
RNDZ NAV is enabled)

CRT

Inhibit RNG - ITEM 18 EXEC
RDOT - ITEM 21 EXEC
Angles - ITEM 24 EXEC
RNDZ NAV ENA - ITEM 1 EXEC (*)

GNC UNIV PTG

TRK - ITEM 19 (CUR - *)

If Recovery from OPS TRANSITION (G8/G3
to G2)

GNC 34 ORBIT TGT

TGT NO - ITEM 1 +1 EXEC
Set BASE TIME to T_i TIG (T_i Burn Pad,
2-20)
LOAD - ITEM 26 EXEC

GNC 33 REL NAV

Upon MCC uplink of TGT SV,
RNDZ NAV ENA - ITEM 1 EXEC (*)

NOTE

If RNDZ NAV not enabled (no *),
DO NOT PROCEED

Select appropriate target track attitude

GNC UNIV PTG

	<u>-Z</u>	<u>-Y (STRK)</u>	<u>+Y (RR)</u>
TGT ID	+1	+1	+1
BODY VECT	+3	+5	+5
P		+0	+0
Y		+280.6	+90
OM	+0	+90	+180

TRK - ITEM 19 (cur - *)

DAP ROT: DISC/DISC/DISC

C3

DAP: VERN
DAP: A/AUTO

If NAV sensor data available:

If STRK NAV

perform S TRK TARGET ACQ [6] , 2-9 >>

If RR NAV

CRT

GNC 33 REL NAV

KU ANT ENA - ITEM 2 (*)
GNC I/O RESET - EXEC
perform RR NAVIGATION [15] , 2-19 >>

RNDZ NAV RECOVERY

RNDZ NAV
RECOVERY

function	RNDZ NAV enable	OPS Mode recall	G3/G8 transition	Available remedy
Angle Source	Keeps last	OK	= STRK	REL NAV (per C/L) ITEM 12,13 for ST.RR
KU ANT ENA	Keeps last	OK	off	REL NAV, ITEM 2 EXEC
AIF flags	Keeps last	Keeps last	INH	REL NAV item entries (C/L) ITEM 17,20,23 AUI R.R. and
TGT SV	OK	OK	Gone	MCC uplink
BASE TIME	OK	OK	Gone	ORB TGT item entries (PAD)
UP options (incl TGT trk)	OK	OK	-XLV/ same	UP item entries, from C/L
UP track sel	OK	Cancel	Cancel	UP ITEM 19, per C/L
RNDZ NAV ENA	..	Gone	Gone	REL NAV, ITEM 1 EXEC
DV DISPs	OK	set to zero	set to zero	none
Mark counters	=0	=0	=0	none
FLTR, PROP values	FLTR ->PROP	FLTR ->PROP	FLTR ->PROP	none
SV sel	PROP	PROP	PROP	REL NAV, ITEM 4
STRK mode		Term/ idle	Term/ idle	S TRK/COAS CNTL (22) • ITEM 5,6 for ST -Y,-Z
CONV MX	Initial- ized	Initial- ized	Initial- load	none

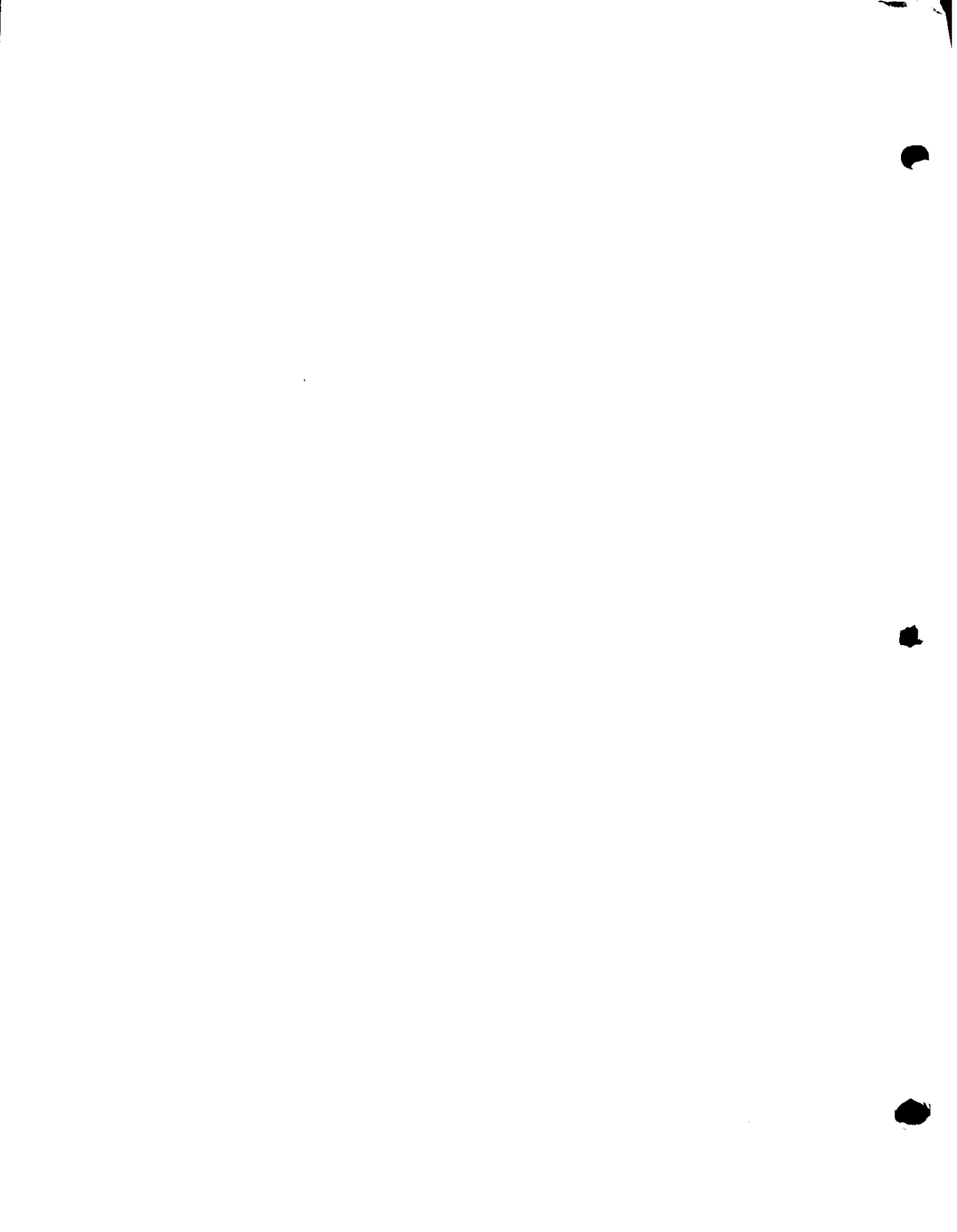

If OPS TRANSITION (G8/G3 to G2)

~~After returning to OPS 2:~~

After ground uplink of TGT SV, ~~COV MATRIX,~~

CRT

GNC 33 REL NAV

RNDZ NAV ENA - ITEM 1 EXEC (*)
 ✓KU ANT ENA - ITEM 2 as reqd
 GNC I/O reset - EXEC

CRT

GNC UNIV PTG

✓TGT ID, BODY VECT, P, Y, OM
 TRK - ITEM 19 EXEC (*)
 DAP: A/AUTO/VERN

CRT

GNC 33 REL NAV

S TRK (RR, COAS) - ITEM 12 (13, 14) EXEC (*)

Auto RNG - ITEM 17 as reqd
 RDOT - ITEM 20 as reqd
 Angles - ITEM 23 as reqd

When SV UPDATE POS < 1.0 (0.3 if RR) and MARK ACCEPT > 9,
 SV SEL - ITEM 4 EXEC (FLTR)

CRT

GNC 34 ORBIT TGT

TGT NO - ITEM 1 +1 EXEC *Ti TIG (Ti BURN PAD)*
 Set BASE TIME, ITEM 21 to ~~value as recorded above~~
 LOAD - ITEM 26 EXEC

(MORE)

Figure 3-39.- Continued.

copy page from CRNDZ

.....If MNVR for APU leak was reqd.....

· After APU burn complete, mnvr to reqd TGT TRK attitude:

· -Z TGT TRK (-Y STRK)

· **GNC UNIV PTG**

· TGT ID +1

· BODY VECT +3 (+5)

· P +90 (+0)

· Y +0 (+280.6)

· OM +0 (+90)

· TRK - ITEM 19 EXEC (*)

· DAP: B/AUTO/NORM,

· When in att, DAP: A/AUTO/VERN

· NOTE: Do not take RR angle data while in -Z TGT TRK att (if appropriate)

.....

M/L/M/L/GEN A 9

Figure 3-39.- Concluded.

If an actual maneuver to APU burn attitude was required, the crew performs the steps shown in figure 3-39, *to resume target track.*

- b. The OPS 2-3-2 transition is used any time it is necessary to use the master X-feed switch (not available in OPS 2). It is also possibly used in RCS/OMS leak isolation. Another use is if both G2 GPC's fail. *None of these uses have occurred in flight and none is expected.*

check pages

The procedures are located in malfunction procedures: G2/G8 TO G3 TRANS (5-119); G3 TO G2/G8 TRANS (5-119); TWO GPC FAIL (5-62).

The effect is similar to an OPS 2-8-2 transition, and the fix is the same as OPS 2-8-2 transition.

- c. Adding a GPC to the redundant set (OPS/Mode recall) is an OPS transition, even though it is not readily obvious. Any time a GPC is brought into the set an OPS MODE RECALL is performed.

The procedure is located in the Orbit Pocket Checklist (PASS GNC GPC (1st FAIL)) and in the malfunction procedures (PASS GNC GPC (1st FAIL); SINGLE GPC FAIL (5-60); DPS RECONFIG FOR LOSS OF AV BAY COOLING (5-82); GNC REASSIGNMENT (5-104)).

(5-6)

The ITEM 21 (CNCL) is performed to prevent annunciation of GPC errors due to divide-by-zero, and pegging of ADI needles.

The effect of an OPS MODE RECALL is slightly different from an OPS TRANSITION. If a GPC is brought into the set, the crew will change the GPC TGT set in the NBAT and then perform an OPS/Mode recall (OPS XXX

PRO). This momentarily takes all GPC's in the set to OPS 0 to synchronize them and then returns them to the appropriate OPS (in this case OPS 2). RNDZ NAV is terminated upon leaving OPS 2 (RNDZ NAV is not supported in OPS-0). Upon return to OPS 2, the "OPS overlay" software is read from the G2 GPC, not the MMU. This means one comes back into OPS 2 in basically the same configuration in which one is left, except RNDZ NAV is not automatically reenabled. The target SV is not being propagated; when RNDZ NAV is reenabled, the TGT SV is propagated forward to the current time. Also, when RNDZ NAV is manually re-enabled, a FLTR to PROP and COVAR REINIT are automatically performed and the PROP SV is automatically selected.

A ~~table~~ of all these impacts and remedies is in fig 3-39.

3.7.3.2 ORB TGT'ing

Computation is terminated and must be manually restarted.

still exists but

3.7.3.3 Attitude Control

Failure to go to free drift on transition to OPS 8 can have damaging effects. Since the TGT SV is frozen (it tracks where the TGT was when OPS 2 was left), the DAP can get confused if it hits a DB; multiple jet firings may result. There would also be a large attitude maneuver when OPS 2 is resumed.

3.7.3.4 Star Tracker

OPS transition (8 to 2 or 2/0/2 for set change) will cause STRK processing to go to TERM IDLE. The STRK acquisition procedure must be performed after returning to OPS 2.

3.7.3.5 Other Effects

The covariance matrix and NAV sensor mark counters are reset. Also, see section 3.6.2.12 for MM202 OPS constraints involving DPS transitions (especially items "d" and "e").

3.8 OMS/RCS ISSUES

3.8.1 RCS Cross-Coupling

Due to the awkwardly unsymmetric alignments of the physical arrangement of the RCS jets (fig. 3-41), commanded translation/rotation maneuvers in one axis tend to induce motion in other axes as well. This effect is called "cross-coupling." It can have significant impact on manual flying during RNDZ terminal phase and PROX OPS.

A complete description of Orbiter PRCS-induced acceleration is given in figure 3-42. To be useful for understanding the magnitude of the problem, however, a better representation would show the relative accelerations normalized (that is, the desired acceleration is set to "1," and the sizes of the other accelerations proportioned accordingly). Such a cross-coupling ratio table is given in figure 3-43 (normal and low-Z modes) and figure 3-44 (nose only and tail only modes), and should be taken only as an indicator of relative cross-coupling effects.

In order to make quantitative comparisons of rotation and translation cross-couplings, a proportionality constant had to be derived to allow unitless ratios to be computed. The scheme was developed to set this proportionality constant to the value that gave equal ratios of each type of motion cross-coupling to the primary commanded motion; that is, once properly adjusted, the ratio of commanded rotation rates to the undesired induced translation rates would be the same as the ratio of commanded translation rates to the undesired induced rotation rates. A satisfactory value was found to be approximately 3 times the translation rates in feet; in practice, this creates equivalence (1 deg = 3 feet) at a range of about 150 to 200 feet, where in fact much PROX OPS maneuvering occurs. Because this is an arbitrary scheme, the values in the proportional tables must be used properly and not misinterpreted. However, the tables do provide qualitative cross-coupling ratios which are entirely consistent with, and often explain some superficially puzzling dynamics aspects of, both simulations and flight experience.

In examining the translational impacts of specific RCS firings, one further step is necessary. Where any translation is directly induced, that is immediately added to the totals; where a rotation is induced, that rotation is nulled with a "perfect" opposite rotation command and the translational impacts of that theoretical maneuver are added to the totals. This computation algorithm continues until all rotational impacts have been nulled. This technique will provide useful results, but in the real world there may actually be overcorrection for the rotational cross-couplings, with consequently different total translational impact.

The "attitude hold" section for rotation maneuvers is computed by performing a unit rotation maneuver and then immediately nulling it with an opposite sense rotation maneuver, restoring rates to zero in that axis. The induced rates in other axes are then computed and nulled, and the resultant translational cross-couplings are summed.

Not surprisingly, the different DAP modes give markedly different amounts of translational cross-coupling from the same sized rotation maneuvers. These are shown in figure 3-40, where the roll-pitch-yaw coupling into Orbiter body X and Z axes are displayed (there is no significant coupling into the Y axis). DAP NORM is the lowest (the "cleanest") on this scale, and the TAIL-ONLY and NOSE-ONLY options are also both quite "clean." At the opposite extreme, vernier jets are the "dirtiest" in terms of translational cross-coupling from rotation maneuvers, especially in that such cross-coupling occurs exclusively in the -Z axis. DAP LOW Z is almost as bad, and since

some DAP configurations call for larger rotation rates, the total cross-coupling magnitude will be greater.

DAP mode:	In X axis:	In Z axis:	Avg:
NORM (R,P,Y)	+0.26,+0.00,+0.26	+0.26,+0.02,+0.00	0.1
LOW Z (R,P,Y)	+0.50,+0.50,+0.00	-2.00,-2.00,-0.00	0.8
Tail Only (R,P,Y)	* ,+0.50,+0.00	* ,+0.00,+0.00	0.2
Nose Only (R,P,Y)	* ,+0.00,+0.00	* ,+0.00,+0.00	0.1
VERN (R,P,Y)	+0.00,+0.00,+0.00	-1.50,-2.00,-2.00	0.9

Figure 3-40.- DAP vs translational cross-coupling (unitless ratio value) * = same as NORM.

3.8.1.1 Translation Effects

The analysis generates some very useful insights into cross-coupling effects, and conforms to experience in flight and in simulators. The following effects should be specifically noted (assume Orbiter is on TGT V-BAR, tail-to-earth and bay-to-TGT):

NORM ROLL: This is clearly the "dirtiest" maneuver, with measurable cross-coupling in every other degree of freedom except yaw. This is far worse in low Z.

NORM +/-X: This induces significant +Z (braking) translations, and thus the closing rate needs to be put back in (see section 3.2.4.2 and 4.4.2). This is also true in low-Z +X, but it is not true in low-Z -X.

NORM -Z (closing): These pulses also induce significant +X ("up") translation. Same in low-Z.

LOW-Z +Z (braking): In free drift, this induces major negative pitch; in attitude hold, the translation pulse loses half its force in the subsequent counteraction of attitude deviation.

Low-Z +/-Y: When in attitude hold, these firings induce major -Z (closing) rates, more than half the size of the commanded Y-axis translation.

ROLL/PITCH deadbanding: In NORM, this generally induces a small +Z (away from TGT) force; in low-Z, however, this induces a major -Z (closing) force. In low-Z, minus pitch also produces a significant +X translation.

TAIL-ONLY: This off-nominal control mode has several unique cross-coupling characteristics. Pitch induces a powerful Z translation, and

Thruster location

F = fwd module
 L = aft left
 R = aft right

Propellant manifold numbers
 (1 through 5)

Direction of thruster plume

A = +X
 F = -X
 L = +Y
 R = -Y
 U = +Z
 D = -Z

RH/RCS

↓ Direction of thruster plume
 ↑ Direction of vehicle motion
 - rotation only

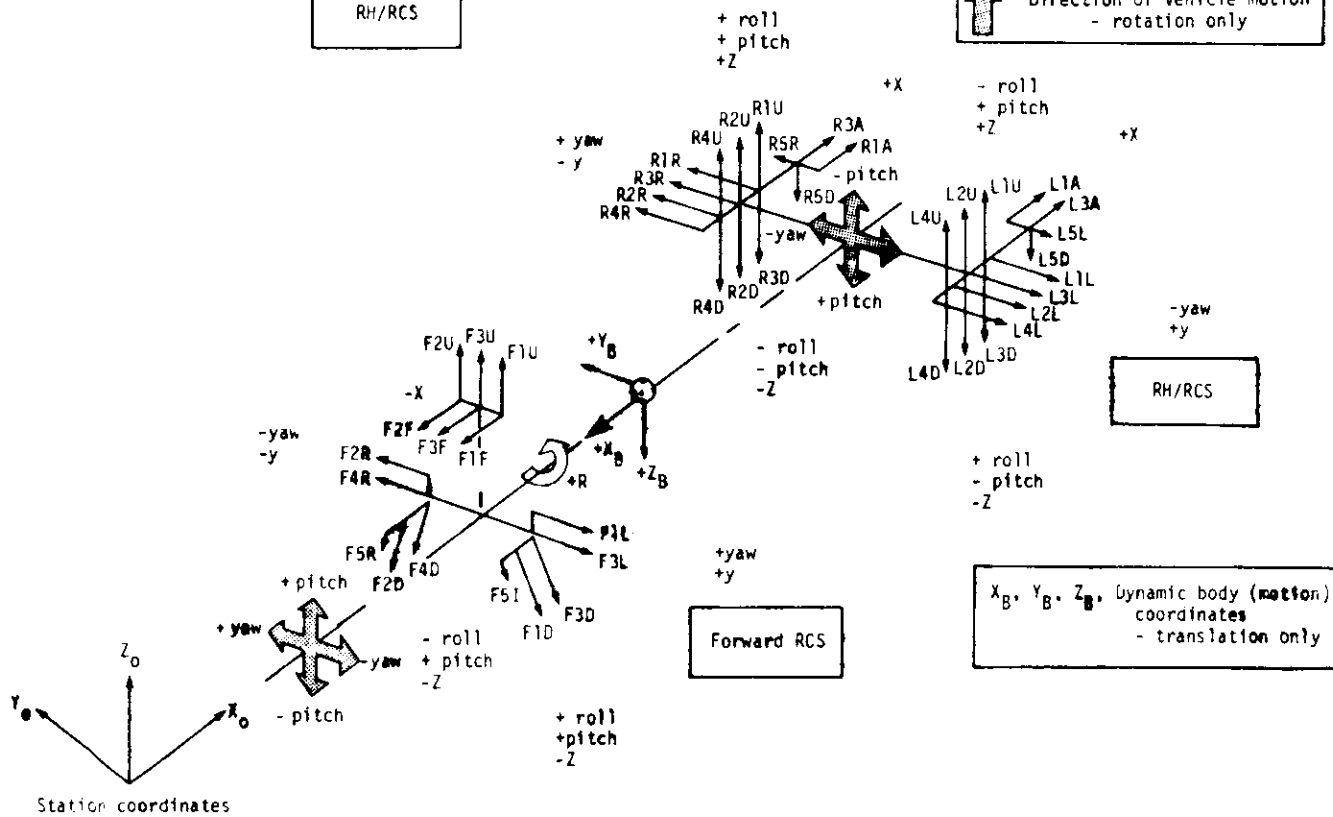

Figure 3-41.- RCS jets.

Orbiter's Acceleration Rates

Orbiter data for STS-7 PLBD closed (End of Mission)
 $I_{xx}, I_{yy}, I_{zz} (S.FT.^2)$ 924,014.1 , 8,783,800.4 , 7,084,860.2
 $I_{xy}, I_{xz}, I_{yz} (S.FT.^2)$ 3,668.3 , 196,815.6 , -710.1
 $X_{cg}, Y_{cg}, Z_{cg} (in.)$ 1,105.1 , -0.4 , 376.2
 Orbiter Weight (lbf) 214,046.4

DAP Config	Jet Group	Jets Fired	rate in X_0 (FT/S ²)	rate in Y_0 (FT/S ²)	rate in Z_0 (FT/S ²)	roll rate (Deg/S ²)	pitch rate (Deg/S ²)	yaw rate (Deg/S ²)
NORM	+roll	R1U,L3D	0.03170	0.03842	0.04468	0.87813	0.08571	-0.03082
NORM	-roll	L1U,R3D	0.03170	-0.03842	0.04468	-0.87521	0.08478	0.03054
NORM	+pitch	F4D,F3D,L1U,R1U	-0.00743	0.00000	0.07004	0.00586	1.21710	0.00005
NORM	-pitch	F3U,L3D,R3D	0.05858	0.00000	-0.04190	-0.00473	-0.82895	-0.00013
NORM	+yaw	F3L,R3R	-0.00268	0.00023	0.00080	-0.27285	-0.00118	0.88088
NORM	-yaw	F4R,L1L	-0.00268	-0.00023	0.00080	0.27093	-0.00094	-0.88853
NORM	+X	R3A,L3A	0.25778	0.00000	0.04548	0.00044	-0.02227	-0.00045
NORM	-X	F2F,F1F	-0.28458	0.00000	0.03807	0.00017	-0.11278	0.00049
NORM	+Y	F3L,L1L	-0.00268	0.28182	0.00080	0.31098	-0.00101	0.17908
NORM	-Y	F4R,R3R	-0.00268	-0.28182	0.00080	-0.31268	-0.00109	-0.18674
NORM	+Z	F3U,L1U,R1U,	-0.00477	0.00000	0.39382	0.00672	0.07387	0.00018
NORM	-Z	F4D,F3D,L3D,L2D,R3D,R2D	0.11928	0.00000	-0.53898	-0.00950	-0.03658	-0.00043
Low Z	+Z	F1F,F2F,R3A,L3A	-0.00680	0.00000	0.08154	0.00081	-0.13504	0.00004
Low Z	+roll	L3D	0.03188	0.04790	-0.08866	-0.38733	-0.18287	-0.08782
Low Z	-roll	R3D	0.03188	-0.04790	-0.08866	-0.39209	-0.18329	0.08764
Low Z	+pitch	F4D,F3D	-0.00748	0.00000	-0.19238	-0.00004	0.88045	-0.00008
Low Z	-pitch	L3D,R3D	0.08338	0.00000	-0.17330	-0.00478	-0.38818	-0.00019
Tail only	+pitch	L1U,R1U	0.00003	0.00000	0.28242	0.00588	0.53885	0.00010
Tail only	-pitch	L3D,R3D	0.08338	0.00000	-0.17330	-0.00478	-0.38818	-0.00019
Tail only	+yaw	R3R	0.00050	-0.13070	0.00072	-0.29287	-0.00063	0.24708
Tail only	-yaw	L1L	0.00050	0.13070	0.00072	0.29095	-0.00047	-0.25473
Nose only	+pitch	F4D,F3D	-0.00748	0.00000	-0.19238	-0.00004	0.88045	-0.00008
Nose only	-pitch	F3U	-0.00480	0.00000	0.13140	0.00004	-0.48278	0.00008
Nose only	+yaw	F3L	-0.00318	0.13092	0.00008	0.02002	-0.00053	0.43381
Nose only	-yaw	F4R	-0.00318	-0.13092	0.00008	-0.02002	-0.00046	-0.43380

Figure 3-42.- RCS axis cross-coupling values.

3-107

JSC-10589

...The Orbiter also gets these:

For cmded accels...		In free drift						Under attitude hold			
		X	Y	Z	R	P	Y	X	Y	Z	
NORM-Z	ROLL	+	+1/9	+1/8	+1/7	⊗	+1/10	0	0.26	0	0.26
		-	+1/9	-1/8	+1/7	⊗	+1/10	0			
	PITCH	+	0	0	+1/6	0	⊗	0	0.20	0	0.02
		-	+1/5	0	-1/7	0	⊗	0			
	YAW	+	0	0	0	-1/2	0	⊗	0	0	0
		-	0	0	0	+1/2	0	⊗			
	+X	⊗	0	+1/6	0	0	0	+1.00	0	0.17	
	-X	⊗	0	+1/7	0	-1/7	0	-1.00	0	0.17	
	+Y	0	⊗	0	+1/3	0	+1/4	0.04	+0.95	-0.07	
	-Y	0	⊗	0	-1/3	0	-1/4	0.04	-0.95	-0.07	
	+Z	0	0	⊗	0	0	0	0	0	+1.00	
	-Z	+1/5	0	⊗	0	0	0	+0.20	0	-1.00	
LOW-Z	ROLL	+	+1/4	+1/3	-1/2	⊗	-1/2	-1/6	0.5	0	-2
		-	+1/4	-1/3	-1/2	⊗	-1/2	+1/6			
	PITCH	+	0	0	-1	0	⊗	0	0.5	0	-2
		-	+1/2	0	-1	0	⊗	0			
	YAW	±	same as NORM-Z						0 to .5	0	0 to -1
		+X	same as NORM-Z						+1.00	0	0.17
	-X	same as NORM-Z						-1.00	0	0	
	+Y	same as NORM-Z						0.12	±0.83	-0.50	
	+Z	-1/12	0	⊗	0	-1/2	0	0.08	0	0.50	
	-Z	same as NORM-Z						+0.20	0	-1.00	

FPH810589*002

Figure 3-43.- PRCS cross-coupling ratios.

		Free drift						Attitude hold			
		X	Y	Z	R	P	Y	X	Y	Z	
TAIL-ONLY	PITCH	+	0	0	+1	0		0	.5	0	0
		-	+1/2	0	-1	0		0		0	
	YAW	+	0	-2	0	-1	0		0	0	0
		-	0	2	0	+1	0		0	0	0
NOSE-ONLY	PITCH	+	0	0	-1	0		0	0	0	0
		-	0	0	+1	0		0	0	0	0
	YAW	+	0	+1	0	0	0		0	0	0
		-	0	-1	0	0	0		0	0	0

roll = same as nominal

HOBK10589*001

Figure 3-44.- PRCS off-nominal cross-coupling ratios.

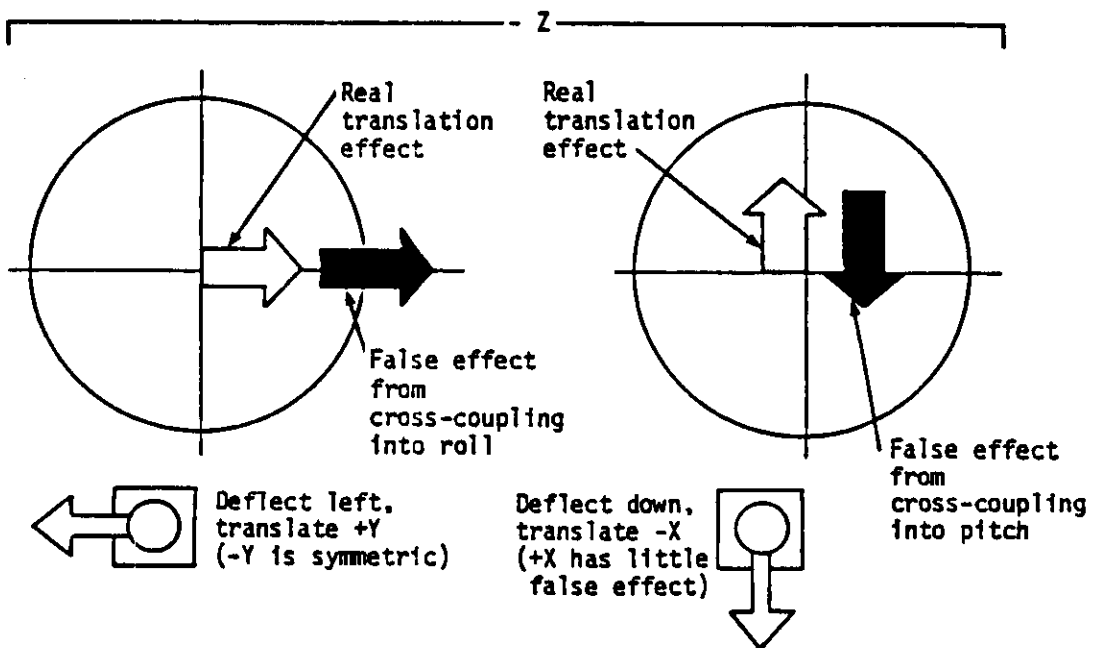

Figure 3-45.- TGT LOS cross coupling aft THC, -Z sense 200 foot range.

Motion shown is prior to hitting DB.

pitch also induces significant +X translation. Yaw induces an extremely powerful Y translation and noticeable X and Z translations as well. All other control modes are identical to normal control.

NOSE-ONLY: This off-nominal control mode also has its own peculiar cross-coupling characteristics. In pitch, translational effects are the mirror-image of tail-only control (but with no X effects); in yaw they are also the opposite sense to tail-only, but much reduced.

3.8.1.2 LOS Cross-Coupling Effects

When observing a target out the overhead window, the crewmember may command RCS translation maneuvers perpendicular to the LOS in order to control Orbiter/TGT relative position (in a "fly to" mode). Because of induced rotations, the initial LOS motion of the TGT may be momentarily misleading (see fig. 3-45). The following examples are based on a target at a range of 200 feet:

NORM/LOW-Z "+Y" translation: Commanding a +Y pulse (to the left, when facing aft) results in angular rates due both to translation and also momentarily to rotation (until a DB is hit). Both rates are to the right, but the momentary rotation-induced LOS motion is FOUR TIMES the size of the translation-induced LOS rate. The translation-induced rate only gets as large as the rotation-induced rate at a range of 50 feet.

NORM/LOW-Z "-Y" translation: Symmetric opposite to +Y.

NORM/LOW-Z "-X" translation: Commanding a -X pulse results in a translation-induced LOS motion upwards and a rotation-induced motion downwards (the Orbiter performs a minus pitch). At 200 feet, the translation-induced rate is slightly smaller than the rotation-induced rate, so the TGT will actually appear to move downwards, opposite to the desired (and commanded) sense, at least until a DB is hit. At 100 feet, the motion will clearly be in the proper direction, but only a fraction of the actual true LOS rate due to rotation-induced LOS motion, until deadbanding occurs.

NORM/LOW-Z "+X" translation: Rotational rates are very small.

These effects accentuate the need for the crewmember to be patient after performing translation pulses, to see the LOS motion after deadbanding, and not be misled by the initial LOS rates (which may contain deceptive rotation-induced components).

3.8.1.3 VRCS Effects

Vernier RCS jets induce their own cross-coupling, and although the jets are smaller than primary jets, their geometry is even more awkward. The accelerations are shown in figure 3-46 (both free drift and attitude hold,

RCS/DAP RESPONSE MATRIX
JET SELECT OPTION V, NO COMPENSATION
(FREE DRIFT)

*****ACCELERATIONS*****
TRANSLATIONAL (FT/SEC/SEC) ROTATIONAL (DEG/SEC/SEC)

CMD	X	Y	Z	R	P	Y
+ROL	-0.00006	0.00699	-0.00483	<u>0.02417</u>	0.00557	0.00119
-ROL	-0.00006	-0.00699	-0.00483	<u>-0.02418</u>	0.00553	-0.00119
+PCH	0.00025	0.00000	-0.00544	0.00009	<u>0.02060</u>	0.00000
-PCH	0.00012	0.00000	-0.00404	-0.00009	<u>-0.00909</u>	-0.00000
+YAW	-0.00012	-0.00108	-0.00281	-0.00311	0.01009	<u>0.01717</u>
-YAW	-0.00012	0.00108	-0.00281	0.00319	0.01010	<u>-0.01717</u>

RCS/DAP RESPONSE MATRIX
JET SELECT OPTION V, ROT COMPENSATION
(ATTITUDE HOLD)

*****ACCELERATIONS*****
TRANSLATIONAL (FT/SEC/SEC) ROTATIONAL (DEG/SEC/SEC)

CMD	X	Y	Z	R	P	Y
+ROL	0.00001	0.00707	-0.00781	<u>0.02433</u>	0.00000	0.00000
-ROL	0.00001	-0.00707	-0.00780	<u>-0.02446</u>	0.00000	0.00000
+PCH	-0.00025	-0.00003	-0.00545	0.00000	<u>0.02063</u>	0.00000
-PCH	0.00012	0.00003	-0.00406	0.00000	<u>-0.00907</u>	0.00000
+YAW	0.00002	-0.00015	-0.00827	0.00000	0.00000	<u>0.01733</u>
-YAW	-0.00002	0.00019	-0.00830	0.00000	0.00000	<u>-0.01733</u>

Figure 3-46.- VRCS Cross-Coupling.

where ALL attitude cross-coupling is taken out and converted into translation cross-coupling), and a normalized ratio table is given in figure 3-47.

The most striking observation is that ALL vernier firings wind up inducing translational cross-couplings of roughly equivalent size in the same body axis, the -Z direction. During the rendezvous phase, over a long period of time, such translational cross-coupling could induce significant downtrack errors in Orbiter position, despite the individually minute force of each single firing. The firings do not randomly cancel out; instead, they accumulate preferentially in one Orbiter body direction.

3.8.1.4 Cross-Coupling Examples

Several examples can illustrate the role that translational cross-coupling can play in rendezvous and PROX OPS trajectories. (See figure 3-47.)

During quiescent periods of PROX OPS, even just simple pitch/yaw deadbanding in low Z mode or in verniers can quickly introduce a clear-cut -Z translation. Analysis (confirmed by SES simulations) indicates that a rule-of-thumb for this -Z translation is "35 to 40 pounds of propellant per -Z ft/s"; that is, the expenditure of 35 to 40 pounds of propellant through the RCS during attitude hold will result in a cross-coupling translation of 1 ft/s in the -Z direction. Use of propellant consumption to monitor this -Z buildup may be more reliable than watching AVG G on SPEC 33 (REL NAV) due to IMU noise accumulation and the fact that much of the cross-coupled -Z acceleration would be below the threshold of measurement by AVG G. The time period in which this -Z buildup occurs will vary depending on how stable the Orbiter attitude was when attitude hold was initiated. This -Z buildup effect is liable to be significant during close-range stationkeeping and especially during gentle separations; failure to monitor it could quickly lead to the appearance of uncomfortable closing rates. Note that in efficiency this result is not far different from a deliberate RCS axis-by-axis translation burn.

Maneuvering to attitude can induce trajectory dispersions whose severity depends on the DAP mode. Assuming an Orbiter in target track, nose to Earth, an 0.2 deg/s attitude maneuver to nose-forward heads-up for a +X burn and subsequent return to target track will induce translational cross-coupling. If the maneuver is performed in NORM, the total velocity deviation is about 0.022 ft/s, mainly in the -R-BAR (up) direction, and this can be safely disregarded since the burn itself is only trimmed to 0.200 ft/s. However, if both the attitude maneuvers are performed in VERN, the significant propellant savings are offset by a much higher velocity impact: the total deviation is about 0.213 ft/s, 10 times that with the NORM jets, and much of that (about 0.1 ft/s) is in the +V-BAR direction (25 times as much as with DAP NORM), which accumulates downtrack error. The result would be as serious as a sloppy trim of burn residuals, and this could definitely be apparent on subsequent navigation and targeting.

		Free drift					Attitude hold			
		X	Y	Z	R	P	Y	X	Y	Z
ROLL	+	0	+1	-1/2	<input type="checkbox"/>	+1/4	0	0	+1	-1.5
	-	0	-1	-1/2	<input type="checkbox"/>	+1/4	0	0	-1	
PITCH	+	0	0	-1	0	<input type="checkbox"/>	0	0	0	-2
	-	0	0	-1	0	<input type="checkbox"/>	0	0	0	
YAW	+	0	-1/5	-1/2	-1/5	+1/2	<input type="checkbox"/>	0	0	-2
	-	0	+1/5	-1/2	+1/5	+1/2	<input type="checkbox"/>	0	0	

HDBK10589*001

Figure 3-47.- VRCS cross-coupling ratios.

3.8.2 Plumes

Plumes from rocket engines are of concern due both to dynamic effects on payloads and to contamination. These concerns impact engine firing procedures, both for the Orbiter and for payloads.

3.8.2.1 RCS Plumes

The influence of RCS plume effects on PROX OPS flight techniques is discussed in section 3.2.4, Low Z Operations. The RCS plume overpressures near the Orbiter are shown in figure 3-~~48~~⁴⁹.

The RCS plumes (both NORM Z and low Z) at greater ranges (out to 1400 feet) are shown in figures 3-48 and 3-49.

3.8.2.2 OMS Plume

The OMS plume for a single engine burn is shown in figure 3-50, out to about half a mile. See also figure 5-26 in section 5.4.1, Nominal Separation.

3.8.2.3 PL Plume

PROX OPS restrictions on payload thrusting are illustrated in figure 3-51. The source is the memo, Safe Distance for Firing of Liquid Propellant Engines, NS2/83-L167, from LA/Manager, NSTSPO, dated June 10, 1983.

3.8.3 Failure Modes

Various types of OMS/RCS failures can impact RNDZ and PROX OPS procedures.

3.8.3.1 Jet Fail On

The concern for a failed-on PRCS jet is a momentary disturbance to Orbiter attitude. Although opposing jets would automatically try to compensate (if in proper DAP mode), the initial perturbation could be significant in terms of translational velocity and attitude (e.g., instrument pointing or docking misalignment). If the opposing jets were able to overcome the failed-on jet, an attitude oscillation would occur as the vehicle was driven back to within the attitude/rate DB's. If the opposing jets were then turned off, this would allow the failed-on jet to again drive the Orbiter out of the DB resulting in more translation. A fail-on vernier jet would produce the same scenario, but attitude/rate offsets would be smaller.

There is a single-point failure which can cause this to occur, which involves the shorting out of either of two output transistors in the reaction jet driver. However, Rockwell has reported that the mean time between failures for these transistors is five billion hours (about half a million years).

Low Z RCS plume pressure fields

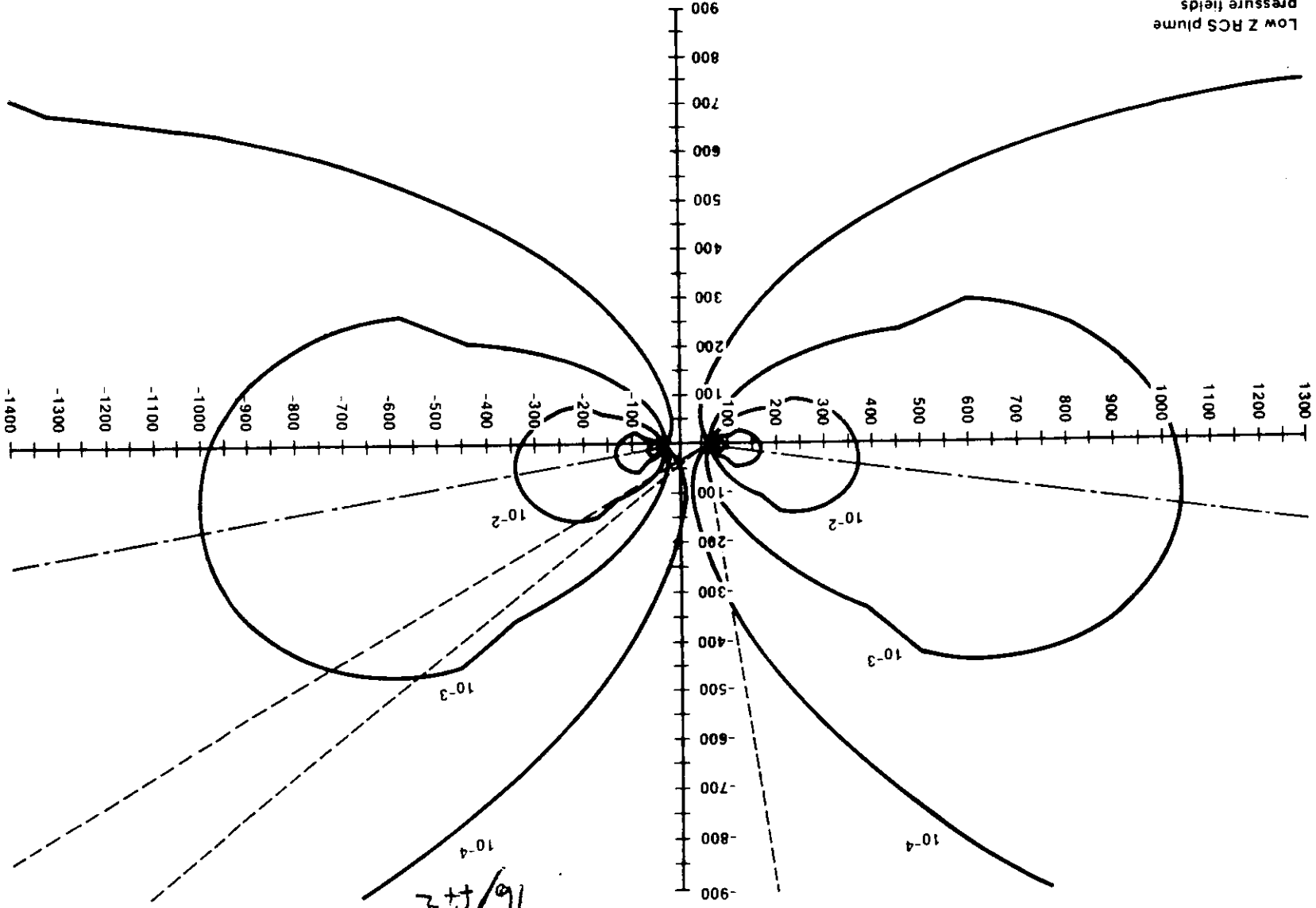

Figure 3-49.- Low Z RCS plume pressure fields.

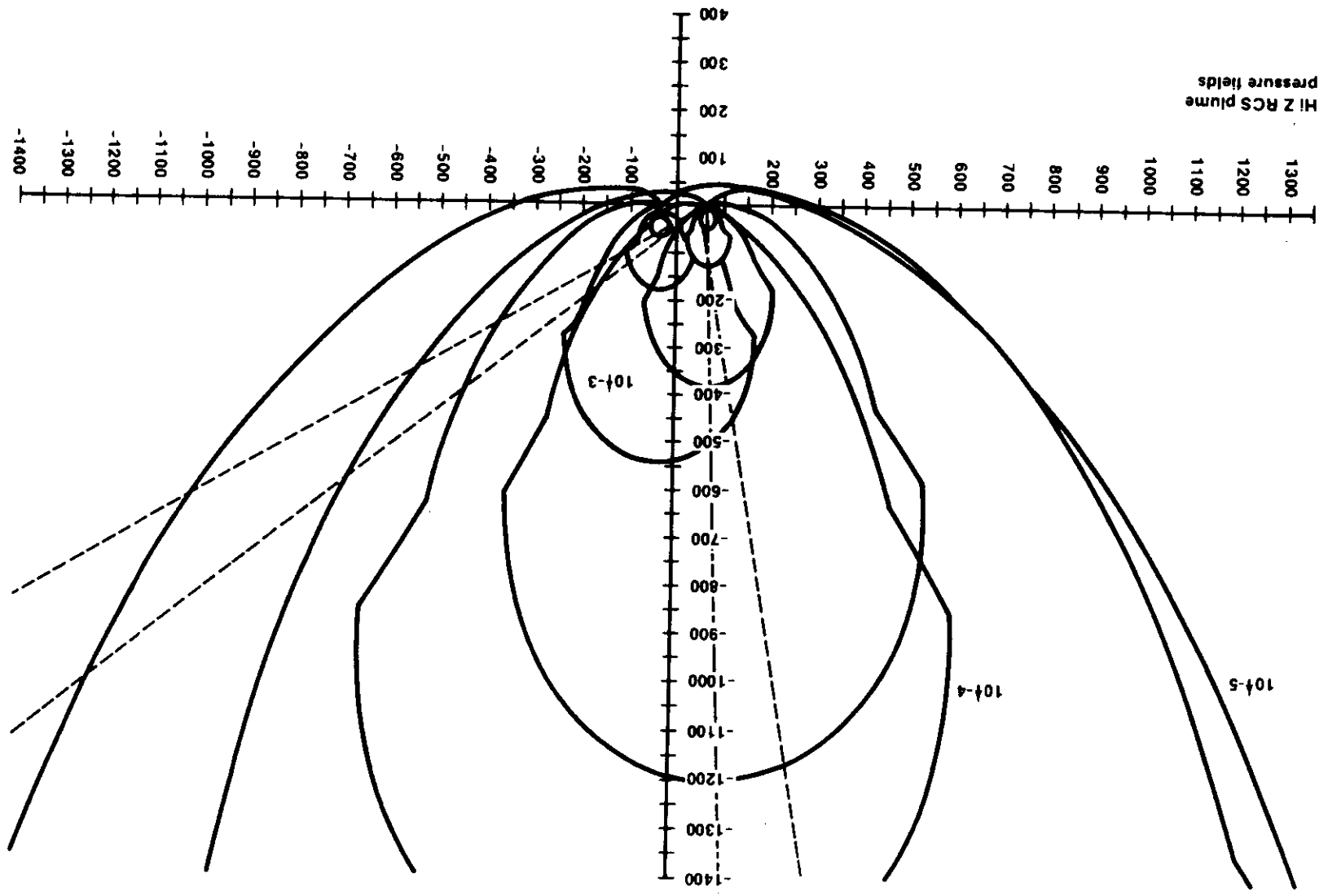

Figure 3-48.- Norm Z RCS plume pressure fields.

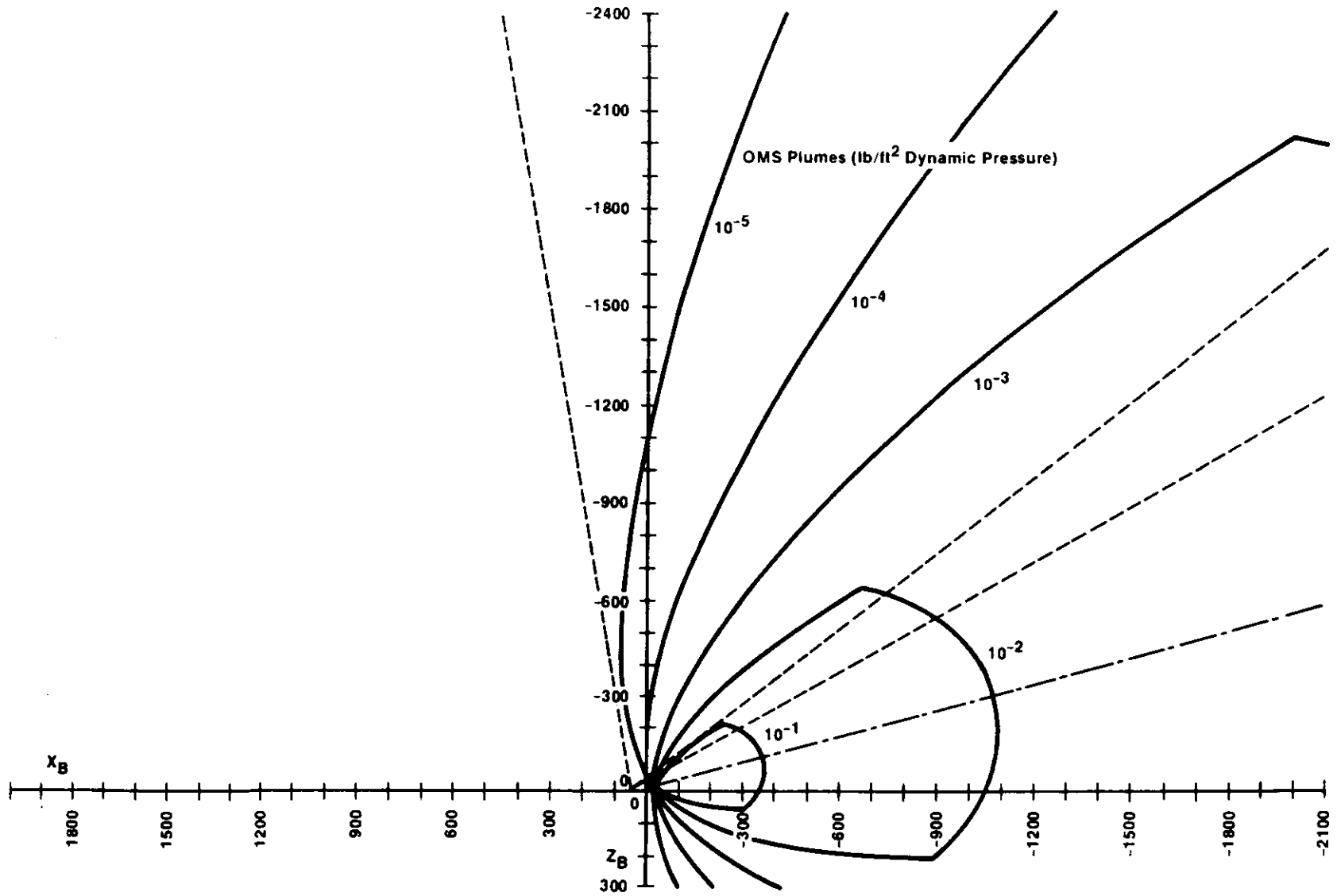
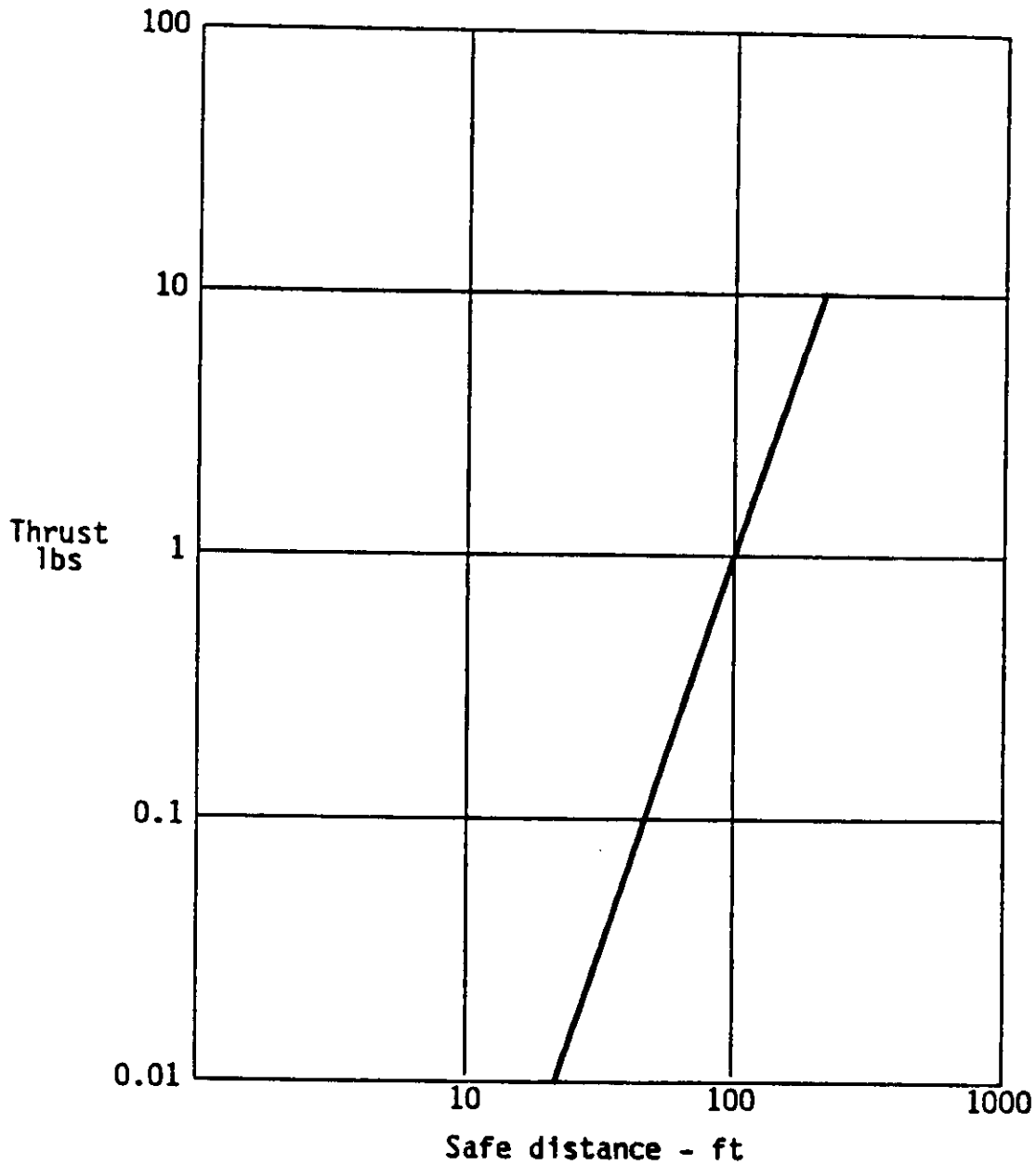

Figure 3-50.- OMS plume for single engine burn.



10589*004

Figure 3-51.- Safe distance for firing liquid propulsion engines (paragraph 3.8.2.2).

In practice, the possibility of a failed-on jet has been handled informally by crews. On STS 51-F, during precise PROX OPS phases, the pilot was stationed in the forward cockpit with the responsibility of shutting off the proper manifold should a fail-on occur.

The current belief is that such a failure is highly unlikely and therefore does not require procedures to guard against it.

3.8.3.2 OMS Overburn

Failure to perform AUTO cutoff at VGO = 0 may occur due to a GPC failure during the burn if both valves have coil open commands strung together. In response, the crew manually takes ARM PRESS SW(s) to OFF. It is probably cheapest and safest to trim out the extra-high residuals immediately rather than waiting until the next scheduled burn; this is especially true at Ti. Flight experience has been that in the first 25 STS missions there have been 5 on-orbit GPC failures, none during OMS burns. Significant analysis has not been performed.

3.8.3.3 Loss of VRCS

See section 4.4.3.

3.8.3.4 Loss of Low Z Mode

See section 4.4.4.

3.8.4 Quantities

3.8.4.1 Rendezvous OMS/RCS PRPLT PAD

This pad (fig. 3-52) is used to reconfigure the OMS/RCS system due to low prop levels, and to abort the RNDZ, if required, due to low prop levels. Usage is defined in section 4.3.4. If breakout is performed, it provides a "disable RNDZ NAV" procedure.

RENDEZVOUS PRPLT PAD	
When L or R RCS QTY < <input type="text" value="1"/>	:
ICNCT: L OMS to RCS (ORB PKT, RCS)	
When <input type="text" value="G23"/> L OMS/RCS QTY > <input type="text" value="2"/>	:
ICNCT TK SWITCH: From L to R OMS FEED (ORB PKT, RCS)	
When <input type="text" value="G23"/> R OMS/RCS QTY > <input type="text" value="3"/>	:
ICNCT RETURN (ORB PKT, RCS)	
<hr/>	
When L or R RCS QTY < <input type="text" value="4"/>	:
or when FRCS QTY < <input type="text" value="5"/>	:
DAP: NO LOW Z	
<hr/>	
When L or R RCS QTY < <input type="text" value="6"/>	:
or when FRCS QTY < <input type="text" value="7"/>	:
If prior to Ti, Do not perform Ti	
If after Ti, but prior to VBar arrival Perform RNDZ BREAKOUT (<u>Contingency Operations</u>)	
If post VBar arrival, Perform <u>PROX OPS BREAKOUT</u> (Cue Card)	

Figure 3-52.- Rendezvous OMS/RCS PRPLT PAD.

The first "bingo" quantity is the RCS level at which OMS interconnect is to be established. This is measured in RCS percent (1 percent RCS = 22 pounds of propellant), with the gauge (panel 03) counting down from 100 percent to 0 percent; typical interconnect bingo numbers are 50 to 60 percent. If the rendezvous phase is entered with an interconnect configuration already established, the value in this field is "N/A" for "not applicable."

The standard procedure is to interconnect first from the left OMS, with the total usage monitored on SPEC 23 (RCS), "OMS+RCS QTY" for "L." The units of this parameter are OMS percent (1 OMS percent = 129 pounds of propellant), counting up from 0 percent to a maximum interconnect of about 8.3 percent. Gauging is performed in the GPC by counting RCS jet pulses. Once the crew notices that a specified amount of L OMS propellant has been interconnected, they switch the interconnect to R OMS for another specified amount. Following that amount, the RCS system is manually returned to straight feed.

RCS quantities are then used to determine exit from DAP low Z mode; unlike the first set of RCS quantities (L or R only), this set includes FRCS as well as ARCS. Usually the ARCS values are the same as those provided in the first (top) RCS bingo specifications.

After an additional amount of RCS straight feed into NORM Z mode, the breakout bingo values are reached. Various options are available depending on where the crew is in the rendezvous profile.

The "post breakout reconfiguration" procedure performs the same essential steps as the standard post-rendezvous "disable rendezvous navigation" block, section 4.1.74 in the nominal rendezvous narrative.

3.8.4.2 Typical Propellant Consumption

The expected OMS/RCS consumption rates are provided in the CAP maneuver tables and consumables curves. Variations in preplanned operations will impact consumption and the following data is offered as an aid to estimating such impacts.

For propulsive maneuvers, the ΔV in ft/s converts to pounds of propellant via these equivalences: 1 ft/s costs about 22 lb through the OMS, 25 lb through the +X RCS, and about 35-40 lb through multiaxis RCS (about a third to a half out of the FRCS).

Once the final midcourse maneuvers are completed, the Orbiter begins manual phase, which involves nearly continuous thrusting.

The following propellant usages are derived from analysis of the 51-I and 51-L profiles:

	FWD(1 σ)	AFT(1 σ)	Total(1 σ)
Manual Phase (MC4+2 to V-BAR)			
Nominal	88(35)	159(40)	242(70)
Radar Fail	241(71)	289(93)	530(130)
V-BAR Approach (400 ft - 35 ft)	35(20)	65(20)	100(35)
35 ft Stationkeeping (LB/MIN)			
+V-BAR	0.20(0.2)	0.6(0.6)	0.8(0.7)
INERTIAL	0.59(0.39)	1.00(0.59)	1.58(0.94)
+V-BAR (LOW Z)	0.5	1.5	2.0
Align Maneuver (Per Axis) (Usually two reqd)	22(7)	39(16)	61(21)

These values represent smooth, skilled flying after proper training, with all sensors operable (except as noted).

Note: MMU reserve from 35 feet, no low Z, uses about total 257 (127), with 101 (52) from forward

Precise predictions will be prepared as required by the MCC.

3.8.4.3 Propellant Saving Techniques

In propellant-limited situations, RNDZ and PROX OPS may continue with special care to the following guidelines:

- Stay in verniers as long and as often as possible.
- To conserve FRCS, use TAIL ONLY control mode.
- Stay out of low Z as much as possible. Get R-DOT and out-of-plane situation under control (0.1 - 0.2 ft/sec) before 200 feet so that no inputs need be made until NORM Z can be resumed.
- Performing translations based on overhead window LOS to TGT, carefully observe Orbiter DB's prior to THC inputs; only make inputs when near center of DB.
- In controlling out-of-plane dispersions, start as early as possible, wait for the NODE to put in the pulses, watch the deadbands, and do not fight orbital mechanics effects.



RCS BURN (+ X, -X, Multi-axis)

OPS 202 PRO

GNC ORBIT MNVR EXEC

✓RCS SEL, ITEM 4 - *

Enter or verify TGT data

LOAD - ITEM 22 EXEC

TIMER - ITEM 23 EXEC

If +X BURN,

DAP: A/AUTO/VERN (B/NORM as reqd)

MNVR - ITEM 27 EXEC (*)

If radar ops,

KU - AUTO TRK

GNC 33 REL NAV

INH Angles - ITEM 24 EXEC (*)

TIG-0:30

FLT CNTLR PWR - ON

DAP TRANS: as reqd

ROT: DISC/DISC/DISC

If Multi-axis,

| DAP: A/LVLH/NORM

If +X OR -X,

DAP: A/MAN/NORM

TIG

If VGO Z is neg, Z,X,Y seq,
otherwise, X,Y,Z

THC: Trim VGOs < 0.2 fps

FLT CNTLR PWR - OFF

OPS 201 PRO

DAP: VERN

DAP: A/AUTO

If radar ops, when in att,

KU - GPC

✓KU TRACK tb - gray

GNC 33 REL NAV

AUT Angles - ITEM 23 EXEC (*)

CUE CARDS

3.8.5 Special Burns

RNDZ and PROX OPS require specialized applications of OMS/RCS propulsion capabilities.

3.8.5.1 RCS ^{Burn} Axis-by-Axis

For axis-by-axis burns (section 3.6.3), RCS is used to manually achieve the targeted ΔV 's. The RCS BURN cue card is shown in figure 3-53, and specific call-outs of this procedure are defined in section 4.3.1.

```

TIG - 2:00
  OPS 202 PRO
  GNC ORBIT MNVR EXEC
  ✓TGT data loaded
  LOAD - ITEM 22 EXEC
  TIMER - ITEM 23 EXEC
TIG -0:30
  FLT CNTLR PWR - ON
  DAP TRANS: as reqd
  ROT: DISC/DISC/DISC
  DAP: A/MAN/NORM
TIG
  THC - Trim VGO's < 0.2 ft/s

  If VGO Z is neg. Z,X,Y seq.
  otherwise, X,Y,Z

  OPS 201 PRO
  DAP: A/AUTO/VERN
  FLT CNTLR PWR - OFF
  
```

Figure 3-53.- RCS BURN cue card.

This cue card may be entered from burn blocks where some operations (e.g., OPS 202 PRO item 22, 23 EXEC) may already have been executed. In that case do not repeat these steps.

The basis for this technique is described in section 3.6.3.

3.8.5.2 RNDZ OMS Burn

Specific call-outs of this procedure are defined in section 4.3.5. When performed for RNDZ maneuvers, the OMS burn (3-54) differs somewhat from the standard ORBIT OPS procedure. The KU antenna is moded to AUTO track if this is the Ti burn. Residuals trimming is specified to <0.2 ft/s. RCS engine select is explicitly selected as the default for the next burn. Resumption of UNIV PTG is explicitly called out. Nominal RNDZ DAP's are used.

RNDZ OMS BURN

✓DAP A9, B6
Install OMS 2/ORBIT OMS BURNS Cue Cards (two) and
OMS BURN MONITOR Cue Cards (two) (F6,F8)

CRT OPS 202 PRO
 IGNC ORBIT MNVR EXEC
 IGNC SYS SUMM 2
 Load TGT data per burn pad
 LOAD - ITEM 22 EXEC
 TIMER - ITEM 23 EXEC

C3 ✓Burn data per burn pad
 DAP: B/AUTO/VERN,NORM as reqd
 DAP TRANS: as reqd
 DAP ROT: DISC/DISC/DISC

CRT MNVR - ITEM 27 EXEC (*)
 If RR OPS,

A1U KU - AUTO TRACK
 IGNC 33 REL NAVI
 Inh Angles - Item 24 EXEC (*)
 When mnvr to att complete,

C3 DAP: A/AUTO/VERN

O8 ✓L,R OMS TK ISOL (four) - Per Pad

TIG -2:00

F7/F8 FLT CNTLR PWR (two) - ON
 Perform OMS 2/ORBIT OMS BURNS
 Cue Card, then

 THC: Trim residuals < 0.2 fps

F7/F8 FLT CNTLR PWR (two) - OFF
O8 L,R OMS He PRESS/VAP ISOL (four) - CL
CRT RCS SEL - ITEM 4 EXEC (*)
 Perform OMS GMBL CK per burn pad

 * If down arrow(s) or M(s), *
 * select good GMBL *

C3 DAP: B/MAN/NORM
CRT OPS 201 PRO
C3 DAP: B/AUTO/NORM
 When in attitude,
 DAP: A/AUTO/VERN

A1U If RR OPS,
 KU - GPC

Figure 3-54.- Perform RNDZ OMS Burn

HOOK
VELCRO

OMS 2/ ORBIT OMS BURNS

HOOK
VELCRO

ASC-2a/30/A,O/A

/MM105/202(302)
 /BURN ATT (INRTL) then REF, pb - push
 /ENG SEL CNTL PWR (two) - ON **
 /DAP - AUTO(PASS)/DISC /DAP TRANS - NORM
 /GIMBAL TRIM
 2 engine: P = +0.4 LY = -5.7 RY = +5.7
 1 engine: P = +0.4 LY = +5.2 RY = -5.2
 L,R OMS He PRESS/VAP ISOL A (two) - OP
 wait 2 sec B (two) - GPC (OP for SE
 burn)

	GPC	OP	CL
ORB BURN A			
B			

TIG-2 SEL OMS ENG(s) - ARM/PRESS (/P VLVs OP)
 If P VLV CL: Aff OMS ENG - OFF

WARNING
 Do not burn affected engine if:
 OMS N2 TK P < 470(564) (NONCRIT
 He TK P < 640 BURN)
 FU ENG IN P < 216(244)
 OX ENG IN P < 151(244)

ΔVTOT: OMS XFEED RETURN (Planned Single Engine)

-:15 EXEC **
 If OMS ENG Pc MSG and non critical burn - Affected Eng - OFF
 If Leaking OMS PROP burn RCS + X TIG -15 sec to OMS IGN + 1 sec
 :00 TIG ** (/Pc, ΔVTOT, ENG VLVs; start watch)
OMS PRPLT FAIL:
 * HP < 85 (CONTINUE BURN): *
 * Failed OMS ENG - OFF *
 * /XFEED (two) - CL *
 * TK ISOL (two) - CL *
 * He PRESS (two) - CL *
 * HP > 85 (STOP BURN): *
 * OMS ENG (two) - OFF *
 * /Failed OMS XFEED (two) - CL *
 * TK ISOL (two) - CL *
 * He PRESS (two) - CL *
OMS ENG FAIL:
 * ASCENT or CRIT O/O (Continue Burn) *
 * Failed ENG - OFF *
 * OMS XFEED at → 1/2 ΔVTOT at FAIL *
RCS COMPLETION: (Hp < 85 or CRIT O/O) *
 * Interconnect to either OMS that was ENG FAIL *
 * THC + X (Hp = 85) *
 * Post burn, AFT RCS RECONFIG *
 CUTOFF **
 + :02 OMS ENG(s) - OFF
 If Orbit Critical Burn,
 Trim all axes residuals < 0.2 fps
 Otherwise
 Trim all axes residuals < 2 fps



HOOK
VELCRO
OMS 2/
ORBIT OMS
BURNS
HOOK
VELCRO

ASC/ALL/A, O/BAS A, 9

✓MM105/202(302)
 ✓BURN ATT (INRTL) then REF, pb - push
 ✓ENG SEL CNTL PWR (two) - ON --
 ✓DAP - AUTO(PASS)/DISC ✓DAP TRANS - NORM
 ✓GIMBAL TRIM
 2 engine: P = +0.4 LY = -5.7 RY = +5.7
 1 engine: P = +0.4 LY = +5.2 RY = -5.2
 L,R OMS He PRESS/VAP ISOL A (two) - OP, then GPC
 (OP for SE burn)
 wait 2 sec B (two) - GPC (OP for SE
 burn)

	GPC	OP	CL
ORB BURN			
A			
B			

TIG-2 SEL OMS ENG(s) - ARM/PRESS (✓P VLVs OP)

WARNING

Do not burn affected engine if:

OMS N2 TK P < 470(523) (NONCRIT
He TK P < 640 BURN)
FU ENG IN P < 216(226)
OX ENG IN P < 151(238)

ΔVTOT: OMS XFEED (Planned Single Engine)

-:15 EXEC -
 If Leaking OMS PROP burn RCS + X TIG -15 sec to
 OMS IGN + 1 sec
 :00 TIG - (/Pc, PVTOT, ENG VLVs; start watch)
 • OMS PRPLT FAIL: •
 • HP < 100 (CONTINUE BURN): •
 • Failed OMS ENG - OFF •
 • ✓XFEED (two) -CL •
 • TK ISOL (two) -CL •
 • He PRESS (two) -CL •
 • HP > 100 (STOP BURN): •
 • OMS ENG (two) - OFF •
 • ✓Failed OMS XFEED (two) -CL •
 • TK ISOL (two) -CL •
 • He PRESS (two) -CL •
 • OMS ENG FAIL: •
 • ASCENT or CRIT O/O (Continue Burn) •
 • Failed ENG - OFF •
 • OMS XFEED at → 1/2 ΔVTOT at FAIL •
 • RCS COMPLETION: (Hp < 80 or CRIT O/O) •
 • Interconnect to either OMS that was ENG FAIL •
 • THC + X (Hp = 80) •
 • Post burn, AFT RCS RECONFIG •
 CUTOFF •
 + :02 OMS ENG(s) - OFF
 Trim inplane X,Z residuals < 2 fps

Figure 3-55.- OMS 2/Orbit OMS burns cue card.

After initiating the maneuver to burn attitude, the crew configures the propellant system pressurization valves. The OMS helium pressure/vapor isolation valves (A and B sides) are configured per instructions from the MCC. As part of the program to run on-orbit checks for redundant systems whenever possible, the A and B valves are configured so as to utilize the path with the least amount of flight usage. Most RNDZ OMS burns are classified as critical for mission success (the on-orbit NC2 burn is a crew safety maneuver because of potential for target impact if not performed) and therefore usually do require system redundancy during the burn. For a problem during execution, the crew completes the burn per downmoding instructions on the BURN PAD. At TIG-2:00 the crew powers on their flight control systems (the THC and RHC) and continues executing the burn. After exiting the cue card procedures, the crew uses the THC and manually trims out the residual ΔV 's by selecting the PRCS and the manual translational mode he/she desires (PULSE or NORM), and then deflecting the THC until the displayed values of velocity to go (VGO) are less than 0.2 ft/s. The crew then powers down the flight controller systems and closes the helium pressurization valves. If required by the MCC, the crew performs an OMS thrust vector control (TVC) gimbal check on the appropriate gimbal system(s). This is also a part of the in-flight redundant system checkout program.

3.9 OTHER SYSTEMS

3.9.1 Auxiliary Power Unit (APU)

The need to burn a leaking APU at the wrong time during a RNDZ can seriously affect procedures. Over an hour period, the force of about 4 pounds in the +Z direction can introduce a ΔV of 2 ft/s, causing extremely serious NAV impacts and trajectory dispersions late in the RNDZ. To avoid this, such a burn (if absolutely unavoidable) should be performed out of plane to negate possible down-range errors; post-Ti, this cannot be done without impacting sensors, so the ΔV hit must be swallowed and taken out at the midcourse burns. Note that it is unlikely that an APU will be burned during a RNDZ because if the leak is tiny, burning the APU can be delayed, and if the leak is large, it can be expected that the RNDZ will be terminated with the appropriate breakout, followed by APU burn and deorbit prep.

The acceleration is well below the limit of detectability by the IMU accelerometers.

For more details, see "APU Venting Effects on the Rendezvous - Day Trajectory," W. R. Britz, RSOC, September 1987.

*RNDZ cIL needs to include
A8L PORT RMS HTR A,B (two) - AUTO
one hour before powerup*

JSC-10589

3.9.2 PDRS

Track and capture training is normally conducted with translational rates up to 0.2 ft/sec and rotational rates of up to 0.3 deg/s simultaneously in all axes (pitch, yaw and roll). The training translational rate capability is generally considered to be unreasonable due to the potential hazards of attempting to grapple a translating target. In general, the translational rates would have been nulled by the Orbiter pilot during the terminal phases of the PROX OPS approach operations. The training rotational rates are considered to be reasonable. The flight specific rules governing any given flight will usually restrict these rates even further in order to prevent damage to the arm or the target.

RMS operations are mentioned in 4.1.41 in terms of use of the wrist CCTV. Problems which may frustrate PL recovery capability can be grounds for RNDZ delay, either at Ti or well before.

3.9.3 EVA

When an EVA and a RNDZ are occurring together, it is most important that the respective timelines be well coordinated. In particular, crewmembers may have to switch off tasks, since EVA normally involves two EVA crewmembers and one IVA crewmember and RNDZ (with or without RMS ops) involves two or three crewmembers.

The following items must be considered in preparing timelines:

- a. The pre-breathe in EMU's needs to be started about the same time as Ti.
- b. RMS is generally powered up immediately after Ti; it can be delayed, but should not be planned to occur prior to Ti.
- c. Performance of the RR-FAIL procedures can get crowded by the EMU pre-breathe and/or the RMS powerup. Remember the RR-FAIL procedures take priority.
- d. Depending on the history of the RNDZ, the post-Ti NAV can be very critical to the successful completion of the rendezvous; therefore, two crewmembers should be dedicated full-time to RNDZ OPS on the flight deck during this phase.
- e. Selection of crewmember responsibilities (the flight crew does this) may require moving up or delaying activities from their nominal time slots.

Several other systems are impacted by joint RNDZ/EVA operations:

- a. Extended use of the PLB cameras may lead to their overheating. Since maximum possible EVA coverage is highly desired, the cameras will remain powered up long after the completion of the rendezvous. To shorten the total interval of camera powering, do not plan to perform PLB camera operations earlier than T_i .
- b. EMU problems can be a leading candidate for T_i delay.

3.9.4 IMU

The IMU is not used directly as a RNDZ sensor, but inertial attitude information from the IMU is processed by the RNDZ NAV software along with information from the RNDZ angle sensors. The three RNDZ sensors - radar, STRK, and COAS - measure angles in their respective coordinate systems, which are fixed with respect to the body coordinate system. The IMU supplies the necessary transformation from body coordinates to M50 coordinates. Therefore, any errors in the IMU attitude will result in errors in the incorporation of angular data into the RNDZ NAV filter. These IMU angular errors will appear to the filter as sensor measurement errors. IMU attitude errors as small as 0.01° will noticeably affect REL NAV.

An effort is made in the development of crew procedures to place an IMU alignment immediately before the beginning of the first navigation period (usually STRK) in a RNDZ profile. The need for an IMU alignment as close as possible to the beginning of the first STRK pass is due to the fact that IMU drift rate is large compared to STRK one-sigma expected bias.

A problem occurred on STS 41-C as a result of the way attitude processing is performed by the IMU redundancy management (RM) logic. With all three IMU's operating properly, the attitude RM logic should select the IMU with the smallest attitude error relative to the other two IMU's ("midvalue select"). If the errors between each of the three IMU's are nearly equal, then the RM may frequently change the selected IMU. This problem occurred on the first and second STRK passes of the first RNDZ of STS 41-C. This IMU switching appeared to the filter as a measurement noise of approximately 0.1° - much larger than expected from either the STRK or the IMU. Consequently, the filter believed the measurement and updated the Orbiter SV accordingly. Each time the selected IMU changed, a large update was made to the SV. To avoid these errors, one IMU is now deselected for the duration of each STRK pass, thus forcing RM to consistently send the lowest-numbered IMU's value to NAV.

This process is described in detail in section 3.3.2.1 on "STRK Target Acquisition".

SECTION 4 RNDZ PROCEDURE SEQUENCES

This section is the heart of the flight procedures rationale narrative, and is an entry point into the entire book. As each step is listed, described, and explained, in depth citations are given to specific background sections in chapter 3.

A standard last few REV's of the on-orbit rendezvous profile is narrated in section 4.1, where all the operations in the FDF Rendezvous book are described and explained. Differences with other rendezvous sequences are discussed, and in section 4.2 the features of rendezvous variations are described.

Specific rendezvous procedures sequences include both cue cards (described and explained in sec. 4.3) and off-nominal procedures (described and explained in sec. 4.4). In addition, procedures for post-rendezvous back-out (sec. 4.5) and for anytime break-outs (sec. 4.6) are referenced, with attention given to rationale for selection and execution.

Lastly, questions of procedures documentation are addressed. Relative motion plots are described in section 4.7, and generic documentation rationale for FDF is discussed in section 4.8.

4.1 STANDARD OPERATIONS FLOW

As a model for RNDZ, the updated and generalized version of the ~~STS-51-L (Spartan-Halley) checklist~~ is used. All steps are consistent with other current standard rendezvous profiles, ~~such as in the Contingency Rendezvous book~~. Relative motion plots are given in figures 4-1, 4-2, and 4-3.

The following specific procedures are intended to be strung along the pages of the flight-specific FDF RENDEZVOUS CHECKLIST and thus comprise the "contents" referred to in paragraph 4.8 on FDF management. This book is entered from an explicit call-out in the ~~CAP~~. Every 30-minute period is portrayed on a right-hand page and consists of a timeline with AOS, SR/SS, and DAP information, line by line action specifications or numbered block call-outs, and specific blocks themselves, each containing an integrated procedure; left-hand pages may contain burn pads or more numbered blocks referenced from right-hand pages or other blocks, or they may be marked "This Page Intentionally Left Blank". Also included on the 30-minute pages should be entries for expected MCC uplinks (e.g., voiced-up PAD's, MNVR CMD loads, COVAR MATRIX loads, etc.) and periodic notations of nominal range (kft) and range rate (ft/s) to target. The book's timeline ends with an explicit directive to return to a specific point in the ~~GAP~~.

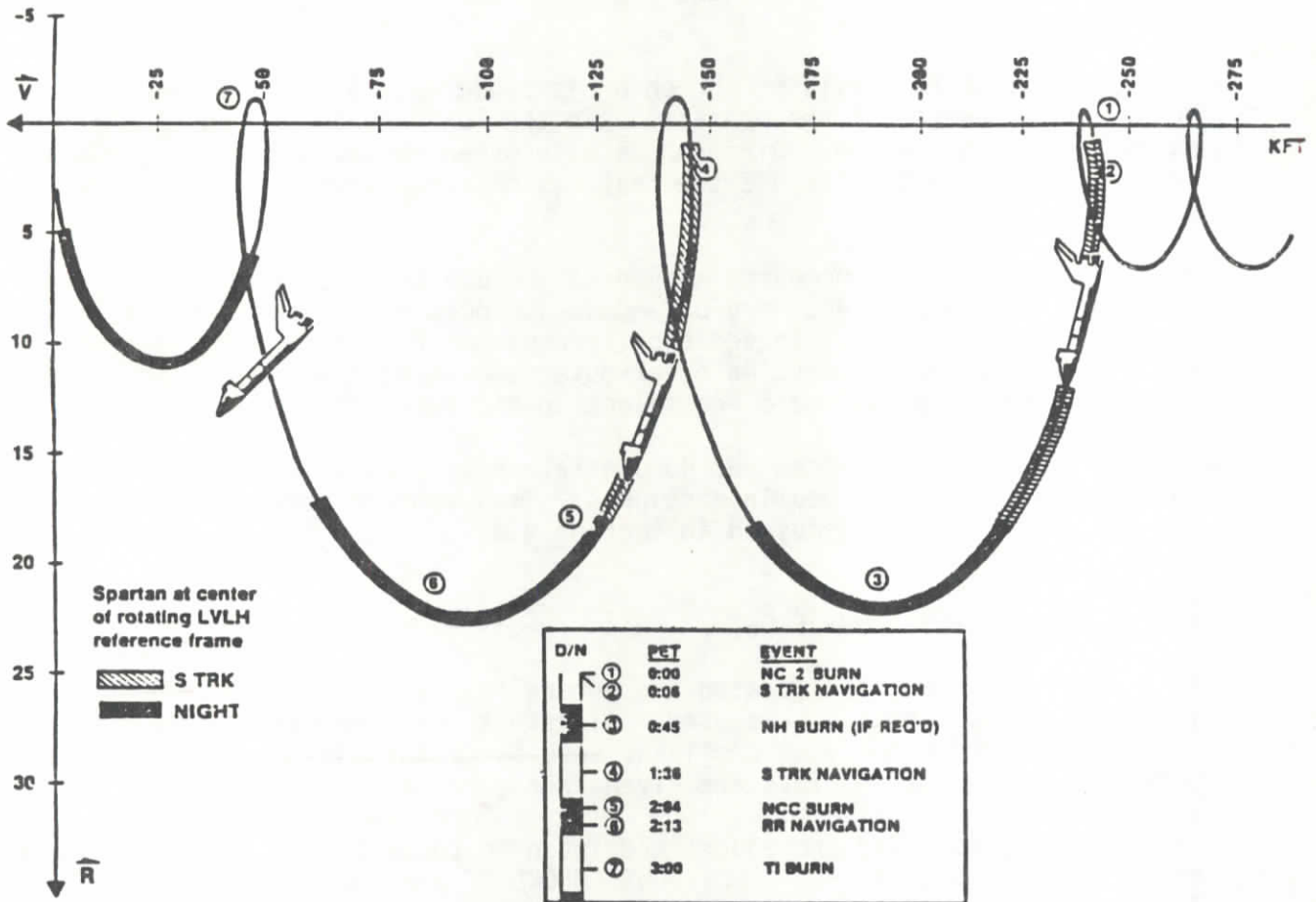

Figure 4-1. ~~Spartan rendezvous profile.~~

CRNDZ

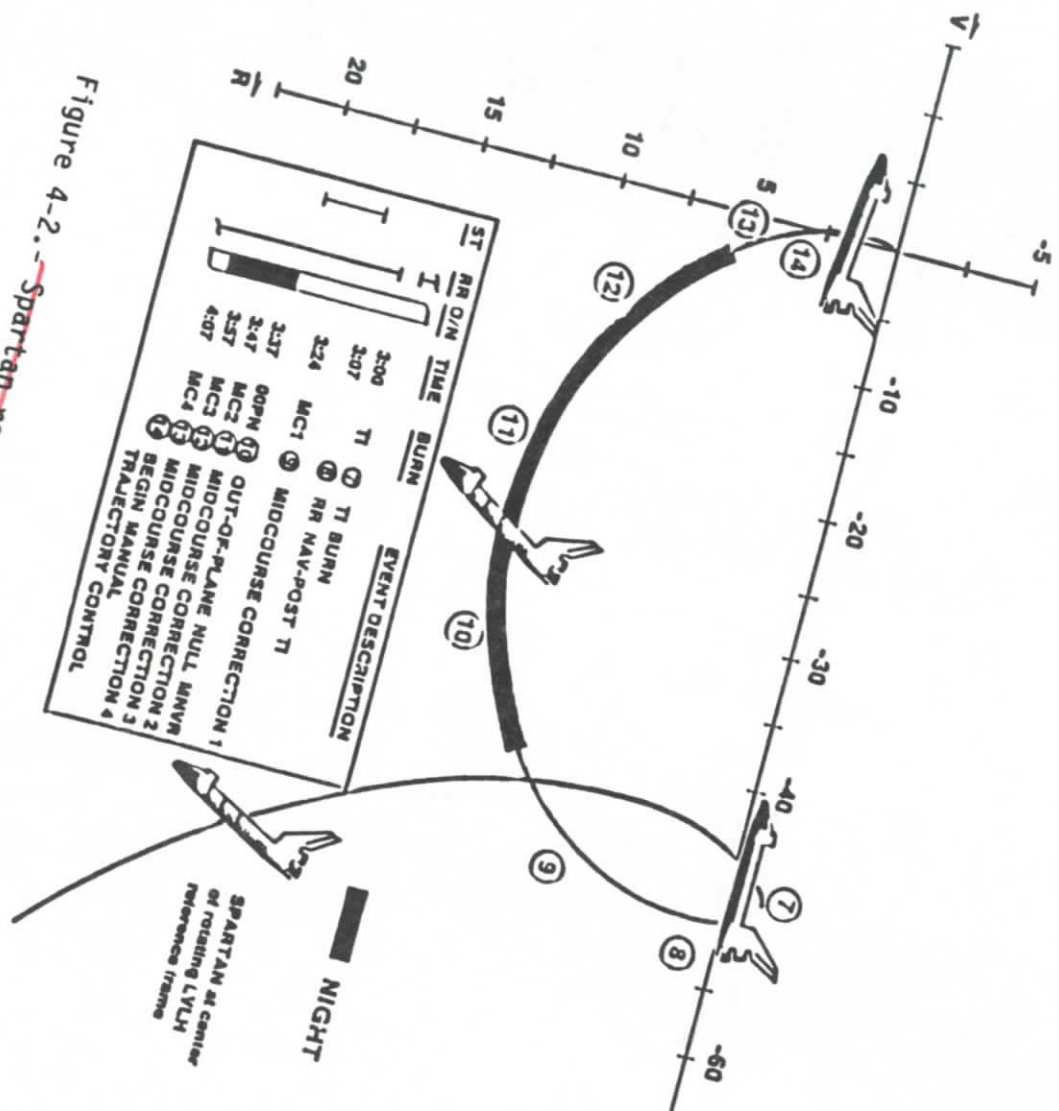

Figure 4-2. Spartan rendezvous profile.

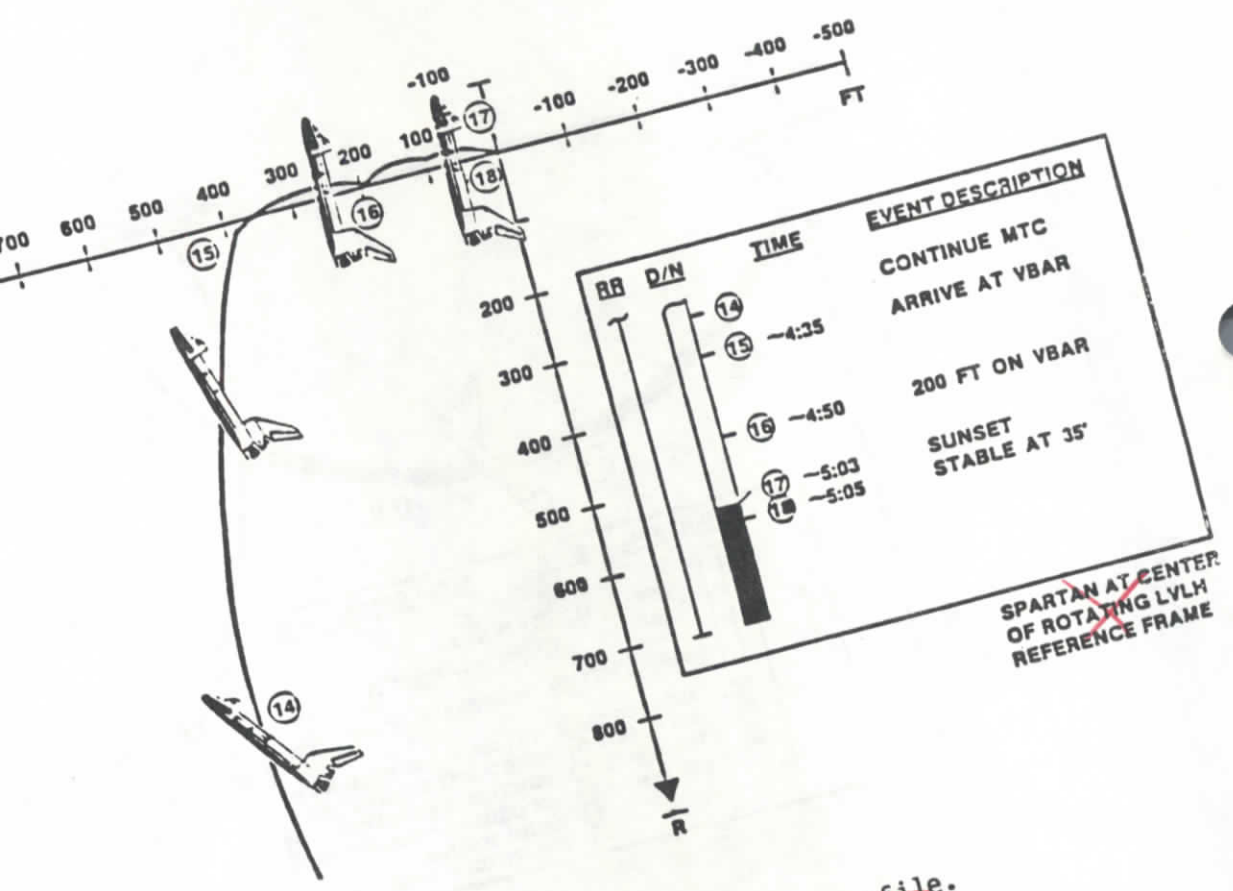

Figure 4-3.- Spartan rendezvous profile.
CR NDZ

4.1.1 Configure DPS

(See section ~~6.1.1.~~
3.7.)

4.1.2 Set SM Timer

The crew performs the step: "Set SM TIMER counting up to ~~NC TIG (SPEC 2).~~"

*SPEC 2 PRO
ITEM 2 EXEC (MET)
ITEM 17 + D + H + M + S
ITEM 12
RESUME
Ti TIG per BURN PAD*

The events that make up a RNDZ are not scheduled as individual items during an STS mission. The various procedures are timed in specific sequences relative to each other, to lighting conditions, or to target-referenced apogee/perigee occurrences. As such, the RNDZ timeline can, and should, be moved as a complete entity during a mission, if the need arises. To be as flexible as possible in supporting preflight mission planning and real-time mission operations, the RNDZ timeline was developed on a phase elapsed time (PET) scale. The reference time (00:00 = HH:MM) is usually defined as occurring at the ~~NC~~ burn. The crew utilizes the SM CRT timer in order to have an onboard timer set up as a reference for the RNDZ PET. The GNC computer timer is not used because one of the outcomes of targeting an onboard RNDZ burn using ORB TGT is that the GNC timer is automatically reset to count down to the burn ignition and would therefore overwrite the PET reference.

(which is also the BASE TIME = 0 for maneuver targeting)

4.1.3 Configure Aft Flight Station

This block is shown in figure 4-4; this configuration can be done as the very first RNDZ action, ahead of the preceding two sections. The aft ADI is configured with its attitude coordinate system reference set to the LVLH coordinate reference. This reference is selected to support crew monitoring of Orbiter attitude and relative motion profile. The error and rate switches are set so that the crew has the most accurate display of data without truncating data. In these settings the error display is to $\pm 5^\circ$ and the rate to ± 1 deg/s. The sense switch is set to the -Z position since this is the axis parallel with the crew LOS as they monitor the TGT out the overhead windows and through the COAS.

To prepare for subsequent operations the crew installs the COAS in the -Z (window 7) position and unstows and installs the cue cards needed for RNDZ.

A6U	ADI ATT - LVLH	
	ERR - MED	
	RATE - LO	
	SENSE - -Z	
R13L	✓KU ANT - GND	
A1U	✓PWR - ON	
	KU MODE - RDR PASSIVE	}
	RADAR OUTPUT - HIGH	
	- MAN SLEW	
	CNTL - PNL	
	SIG STRENGTH set	✓ KU
	SLEW RATE - as reqd	
A2	DIGI-DIS <u>SEL</u> - R/RDOT	
	X-PNTR SCALE - X1	
CRT	SM ANTENNA	
	<i>SELF TEST -</i> ITEM 7 EXEC (*)	
	NOTE	
	SELF TEST runs about 3 min	
A1U	✓KU SCAN WARN tb - gray	
	✓TRACK tb - gray	
	✓SEARCH tb - gray	
A2	✓RANGE - 888.8	
CRT	SELF TEST - ITEM 7 EXEC (no *)	
A2	DIGI-DIS <u>SEL</u> - EL/AZ	
A1U	KU MODE - COMM	
	✓KU <u>MAN SLEW</u>	
	KU CNTL - CMD	
	Install -Z COAS	
	Install RNDZ OPS Cue Card <i>(two)</i>	
	Install <u>PROX OPS</u> Cue Card	

Figure 4-4.- Configure aft flight station for RNDZ.

4.1.4 Ku-Band Self Test

(See section 3.3.4.4.)

4.1.5 NSR burn (as required)

For reasons stated in section 2.9.1.3, an NSR burn sometimes is performed prior to the last NC burn. Although this profile did not have one, some ground-up rendezvous will and all long-duration, on-orbit separation/rendezvous profiles probably will.

The burn is performed just like a standard RNDZ OMS BURN (fig. 3-54), except that postburn the RCS ENG SEL is not automatic, and the UP is selected to TRACK.

4.1.6 Enable RNDZ Navigation S/W

To begin the propagation of the various SV's required for RNDZ and to enable processing for onboard sensor data taking, the crew enables RNDZ NAV via an item entry (ITEM 1). The crew also verifies that SV SEL is PROP; that RNG, R-DOT, and angles are INH; and that S TRK (ITEM 12) is "*". See section 3.4.1.3 for background.

At this point, a software check is made to verify that the stored SV for the TGT has a time tag within 15 hours of the current time. If the check is passed, the TGT SV is propagated to current time using the SUPER G propagator, and the current Orbiter SV (stored as the FLTR SV) is automatically copied into the PROP SV location. If the TGT SV time tag is greater than 15 hours away from (before or after) current time, RNDZ NAV will not begin processing due to the excessive amount of time and inaccuracies involved in propagating the stored vector to current time. Also, if there is no TGT SV at all, RNDZ NAV will also not begin processing. No message or "*" is displayed.

The onboard Orbiter and TGT NAV states will be initialized by ground uplink prior to initiation of RNDZ NAV. An onboard software restriction prohibits entering RNDZ NAV if the time tag of the TGT SV is older than 15 hours. The target SV time tag I-load is normally zero; therefore, without a ground uplink of the TGT SV, RNDZ NAV cannot be enabled. It is also desirable for both ground and onboard to have the most accurate Orbiter and TGT SV's available, and hence the most accurate relative SV to initialize RNDZ NAV for the first onboard NAV sensor tracking interval. This allows the filter to rapidly determine the "true" relative state and prevents undesirable transients caused by large updates.

Once RNDZ NAV is enabled, the REL NAV display is verified to be in its initialized configuration.

4.1.7 Initialize ORB TGT

The ORBIT TGT function is initialized by loading in the base time for burn calculations. For clarity and non-ambiguity, the FDF wording is:

TGT NO - ITEM 1 + 1 EXEC

Set BASE TIME to Ti TIG (Ti Burn PAD, [page citation])

LOAD - ITEM 26 EXEC

This was chosen carefully based on actual checklist experience with a variety of wordings.

See section 3.5.2.8 for detailed rationale.

4.1.8 Establish RNDZ DAP

The DAP is configured for RNDZ usage by loading parameters as specified by DAP's coded A9 and B6. The primary items of interest for RNDZ are the

translational pulse sizes, rotational discrete rates, ATT DB, and jet option selection.

Translational pulse size of 0.10 ft/s in DAP A gives the coarse control and 0.05 ft/s in DAP B gives the fine control necessary to effectively trim out the targeted translational burns, and also control the trajectory during the manual final phase corrections.

Rotational discrete rates are set to 0.2 deg/s (the standard Orbiter maneuver rate) except for DAP B primary RCS (NORM) which is set to 0.5 deg/s in order to maneuver quickly if necessary.

ATT DB sizes are based on several interrelationships. First, it is desirable to have the NORM ATT DB as large as possible because the primary RCS (PRCS) uses large amounts of propellant in tight ATT DB's. Secondly, to provide accurate pointing for sensor acquisition and crew monitoring, the ATT DB needs to be as small as is practical in all DAP configurations and for all jets. Lastly, in order to keep from constantly initiating small but costly attitude maneuvers back to attitude after performing PRCS translations, the NORM ATT DB should be no more than twice as large as the vernier ATT DB. This is due to the fact that the DAP phase plane logic initiates a DISC rate maneuver back to attitude when the Orbiter attitude errors exceed twice the specified ATT DB. In solving for the ATT DB values, a reasonable solution was a 1.0° VERN ATT DB and a 2.0° NORM ATT DB.

The jet option selection is set to 1 (full up nose and tail control) to provide coupled ROT's when on the PRCS. Either nose- or tail-only options introduce noticeable translational delta velocities when operating on the PRCS.

4.1.9 Perform NC (Phasing) Burn

The NC burn is calculated to place Ti burn position 8 n. mi. (48,600 feet) trailing the TGT. To effectively move the downrange position of Ti without affecting its altitude, the NC burn is executed at an integral multiple of the orbital period prior to Ti.

~~NC is performed on a RCS BURN (with RNDZ DMS BURN if large enough)~~
A typical NC burn block is shown in figure 4-5. The NC burn is performed using TIG and ΔV 's that have been ground calculated and voiced to the crew (a command load is also sent up to MM202). NC TIG is usually one or two REV's prior to Ti.

In the case of a ground-up RNDZ, NC is usually prograde, raising relative perigee and thereby decreasing the phasing rate. The major driver for temporal placement of the NC burn is the length of the crew workday on the day of RNDZ. Therefore, NC is usually done one REV before Ti to shorten the total time period required to perform the RNDZ.

For on-orbit rendezvous profiles, however, the NC burn usually is retrograde, lowering relative perigee and thereby increasing the Orbiter closing rate on the TGT. This is the case because the Orbiter is either drifting

	GNC UNIV PTG
	CNCL - ITEM 21 EXEC OPS 202 PRO
	GNC ORBIT MNVR EXEC
CRT	Load TGT data per pad LOAD - ITEM 22 EXEC TIMER - ITEM 23 EXEC
C3	✓ Burn data per pad ✓ DAP: A/AUTO/VERN ✓ DAP ROT: DISC/DISC/DISC ✓ DAP TRANS: As reqd
CRT	MNVR - ITEM 27 EXEC (*)
TIG -2:00 **	Perform EXECUTE RCS BURN (Cue Card, <u>RNDZ OPS</u>)

Figure 4-5.- ~~Perform NC burn.~~*Load TARGET TRACK*

farther behind the TGT or just slowly closing. NC is usually done two REV's before Ti to reduce the ΔV (and therefore propellant) required, if time is available.

Depending on the total velocity to burn, the MNVR will be executed using either the RCS or the OMS. The OMS guidance system has been developed such that with 2 seconds remaining in an OPS 202 burn, a countdown mode is entered, and the software no longer iterates on the required remaining ΔV to burn, but rather calculates when to terminate the burn. This can result in substantial burn residuals that the crew needs to trim manually. In addition, the system configuration required for an OMS burn is more complicated than for an RCS burn and is only exercised when the velocity to be burned is large enough to warrant the extra system manipulation. *✓* If the preflight analysis has shown the burn to require use of the OMS, the procedure will nominally be included in the RNDZ checklist. If in-flight trajectory dispersions result in ~~NC being performed using the OMS~~, the crew would use the RNDZ OMS BURN procedures (sec. 3.8.4-1). *5.2*

AP for C RNDZ, use RCS

For either ~~translational control system~~, the initial onboard setup by the crew is the same. *RCS or OMS (as planned/short) requiring*

Depending on the profile, the crew may cancel the UNIV PTG option in effect (via ITEM 21). This is done to prevent unnecessary attitude maneuvers after the completion of the burn operations. After the NC burn, the crew will need to maneuver the Orbiter to a TGT TRK attitude to support STRK acquisition of the TGT. Canceling the UNIV PTG option ensures that the Orbiter will not begin maneuvering to the pre-NC burn attitude, once the burn is complete and OPS 201 is reentered.

The crew transitions the GNC GPC's to OPS 202 for burn execution and enters the burn targeting data per the uplinked pad. The data is loaded and the GNC burn countdown timer is initiated. The onboard calculations for resulting burn duration, apogee, perigee, and attitude are verified by comparison

with the uplinked data. *If the burn is to be TX,* The crew verifies that the DAP is configured as required for an attitude maneuver, and then initiates the maneuver via ITEM 27 execution.

The remainder of the burn procedures differ depending on the translational system to be used for the burn.

RCS NC BURN: At 2 minutes prior to TIG, the crew begins the procedures specified for an RCS burn on the RNDZ OPS cue card (sec.3.8.5.1). It should be noted that the cue card procedure was written for an RCS burn which is performed in a random attitude, as is the case for the midcourse correction (MC) burns. Since the NC burn is done in single-axis burn attitude, several of the cue card steps are done early to allow time for the maneuver to attitude, so these steps need not be repeated at TIG-2:00. *more often (+X)*

OMS NC BURN: See section 3.8.5.2 for rationale.

Before returning to OPS 201 and continuing RNDZ operations, the DAP is configured to be under VRCS control so that subsequent attitude maneuvers are not begun by the PRCS.

4.1.10 Initiate -Z Target Tracking

After the NC burn is complete and the GPC's are back in OPS 201, the crew begins a maneuver to track the TGT with the -Z axis for -Z STRK TGT acquisition or with the -Y STRK, if the -Z STRK is known to be failed. Since NC was performed just prior to orbit noon, lighting conditions after the burn should be favorable for TGT acquisition (fig. 4-1). The maneuver to track attitude is done on PRCS in DAP B to utilize the 0.5 deg/s rate and arrive in track attitude as quickly as possible and begin taking sensor data; return to DAP A VERN when maneuver is completed.

4.1.11 First STRK Acquisition

(See section 3.3.2.1.)

4.1.12 Configure NAV for STRK data

The NAV software is verified to be in proper configuration for processing of STRK data. Initial setup ensures that the source of angle data to be incorporated is the STRK's, the uplinked propagated SV is selected as input to user parameter processor (UPP) while the filtered SV is being sent the initial sensor marks in case of erroneous or large updates, and that the angles are inhibited from AUTO incorporation in order to allow crewmembers to verify proper target lock-on.

4.1.13 STRK NAV Data Acceptance

The SV selection is made when the SV POS update is less than 1.0 K ft. At STRK acquisition ranges it is felt that the Orbiter body pointing vector will be locked on to the TGT within the Orbiter ATT DB at this point. Typical error is about 1000 feet at 30 miles. ~~Disregard SV U/D VEL.~~

The angle residual (RESID) value is a measure of the angular error between the predicted LOS to the target and the detected LOS. A star will have an angular rate of 0.5° per 8-second cycle, which is 10 times the threshold for rejection of marks. If the STRK has locked on to the TGT and Orbiter is in TGT track attitude hold, the RESID value need not be zero, but should remain constant. It is not important that the value of the RESID is less than 0.05, but that it remains at a constant value ± 0.05 . A constant RESID value indicates that the predicted state for the target is slightly offset from the actual. Changing values indicate that the STRK has locked onto an object that has an angular rate with respect to the predicted target position, such as a star or debris in the vicinity of the Orbiter. The value of 0.05 was selected as the criteria for determination of lock-on based on estimations of system noise and granularity.

For the usual Orbiter attitude during this phase (nose to Earth), if the STRK locks on to a star, the affected residuals will depend on which STRK is active. For the Z STRK, the H RESID will change, and for the Y STRK, the V RESID will change. Such behavior by the residuals is positive proof that star lock-on has occurred.

If the 0.05 criteria is met for four NAV cycles (four to ensure repeatability) the target lock-on is assumed to be correct, and the software is set to automatically incorporate data marks into the NAV filter that update the Orbiter FLTR SV once the crew selects AUTO.

If the filtered minus-propagated SV changes by more than 40 kft during a single STRK pass, the STRK data is considered bad and has corrupted the filtered state. See section 4.1.15.

4.1.14 SV Selection

In order to have a consistent SV input to UPP during the TGT acquisition, the propagated SV remains selected until the filtered SV "settles down," and no large updates are seen. Once again, analysis has shown that for STRK NAV when the position updates to the SV are less than 1.0 kft, and more than nine marks have been accepted into the filter, the filtered SV has converged to the point where it can be selected as the source of Orbiter SV data in UPP.

The propagated SV will be selected for the UPP until the beginning of the first relative TRK interval. The filtered SV will be selected:

- a. If 10 STRK measurements have been accepted with the last SV position update less than 1.0 kft

- b. If 10 RR measurements have been accepted with the last SV position update less than 0.3 kft
- c. If three COAS measurements have been accepted

Accepting 10 STRK or RR measurements prior to selecting the filtered SV for the UPP prevents filter vector transients from reaching the UPP. Also, if bad measurements are incorporated into the filtered SV (e.g., tracking a star with the STRK, tracking with a side lobe with the RR), this delay allows the crew to take appropriate action to prevent use of the corrupted state. Because COAS processing takes longer, only three marks are taken prior to selecting the filtered state vector. (Ref: Charles Stark Draper Lab Memo 10E-94-07, appendix A; Apr. 19, 1984.) Analysis shows that most pointing error has been removed after nine marks.

4.1.15 Off-Nominal SV

Analysis has shown that the initial SV data should not be in error by more than 40 kft and, therefore, if the updates to the SV exceed 40 kft in a single STRK data pass, lock-on was probably false and the data should be erased (another alternative is an IMU is failing). In this case, the propagated SV is reselected as the source of data to UPP. The sensor data is inhibited from being incorporated into NAV any further, and the filtered SV is overwritten with the unpolluted propagated SV. The STRK is then commanded to break lock with the TGT it has been tracking, and the acquisition process is begun again.

4.1.16 End STRK Pass

(See section 3.3.2.2.)

4.1.17 Perform NH Burn (if Required)

To control the differential altitude between the Orbiter and the TGT on the day of RNDZ, an NH MNVR may be included in the RNDZ sequence (fig. 4-6). Often, the differential altitude between the Orbiter and the TGT has been properly adjusted prior to entering the RNDZ procedures and an NH burn is not required. If, however, the projected T_i relative altitude differs significantly from premission design, the NH burn will be performed. Should an adjustment be required, the rationale and procedures for burn execution are the same as for the NC burn.

In the extremely unlikely event that $\Delta VT > 6$ ft/s, perform NH using the RNDZ OMS BURN cue card. If the ground solution shows >2 ft/sec from the FRCS, a +X RCS burn will be performed.

Done via RCS cue card

```

OPS 202 PRO
  GNC ORBIT MNVR EXEC
CRT   Load TGT data per pad
      LOAD - ITEM 22 EXEC
      TIMER - ITEM 23 EXEC
      ✓Burn data per pad
TIG -2:00 **
      Perform EXECUTE RCS BURN (Cue Card, RNDZ OPS)

```

Figure 4-6.- ~~Perform NH burn.~~ *delete*

4.1.18 Configure for Radar Target Acquisition

(See section 3.3.4.5)

4.1.19 Target NCC Burn (Preliminary)

The NCC burn (fig. 4-7) is aimed at the Ti point, 48.6 kft behind and 1.2 kft above the target, and in plane. The trailing distance is chosen based on expected trajectory dispersions and RR acquisition limits. The delta height is chosen empirically to reduce MC2 TIG slips and thus maintain manual phase lighting. Being in plane with the target at Ti allows the planar error to be nulled in a propellant-efficient manner.

Establishing a 225° transfer from NCC to Ti was based on several factors. With Lambert targeting, 360° transfers will not control delta altitude or out-of-plane errors, and 180° transfers will not control planar errors. Waiting as long as possible (typically until orbital sunset) allows maximum time for relative NAV to incorporate sensor data. A compromise of 225° was selected because it controls phase, delta altitude, and out-of-plane errors; it is close to orbital sunset to allow sufficient STRK data to be incorporated; and it is large enough to be propellant efficient.

The theoretical basis for out-of-plane control is described in section 2.9.2.

Prior to the beginning of the second STRK data pass, a preliminary calculation of the NCC burn is performed using the onboard Orbiter targeting software. As is the case for the preliminary solution for all the onboard calculated burns, this initial targeting exercise serves two purposes: it gives a very early indication of the onboard estimate of burn ΔV 's, and it begins the GNC GPC timer counting down to the burn TIG.

```

..Final Solution.....
. OPS 202 PRO
. ✓ENGINE SELECTION CORRECT ← CRT
.....
CRT ✓SV SEL correct

GNC 34 ORBIT TGT
TGT NO - ITEM 1 +9 EXEC
✓TGT Set data:
T1 TIG = BASE TIME - 0/00:56:18
EL      +0
ΔT      +56.3
ΔX      -48.60
ΔY      +0
ΔZ      -1.20
COMPUTE T1 - ITEM 27 EXEC

Note solution in pad
Final solution
.....
. If > 40 marks in current sensor pass and
. SV UPDATE POS < 0.5, Burn FLTR soln
. If FLTR within ground solution limits, Burn
. FLTR soln
. If PROP within ground solution limits, Burn
. PROP soln
. If none of the above, Burn ground soln EXT ΔVs
.....

```

GNC ORBIT MNVR EXEC

Record Note solution in pad for the last 4 marks

Figure 4-7.- Target NCC burn.

ΔT value is typical only

Before performing the targeting, the crew verifies that the SV source for the calculations is as expected. Nominally the FLTR SV will be selected, but depending on the circumstances (mainly, sensor failures time history), the PROP SV may still be the prime source of the UPP state data. The crew and ground need to be aware of the source of the burn solution.

The TGT set for the NCC burn is called up by entering the appropriate TGT number, and then the I-loaded data for the TGT set is verified. The TIG displayed in MET is verified to be equal to the base time as loaded earlier (see 4.1.7) plus the relative time stored as part of the TGT set. The elevation (EL) in degrees, the delta time in minutes, and the targeted offset position in k/ft are all verified to be the correct values. The crew then computes (ITEM 27) the burn solution. If any of the data displayed is not as expected, the crew overwrites the affected data entry, loads (ITEM 26) the new value into memory for that TGT set, and recalls that TGT set to confirm the proper data was saved before computing a solution. This is done because the burn calculation is based on the data stored in memory for the displayed TGT set, not on the displayed data itself. For informational purposes the crew notes the burn solution in their checklist.

Because the REL NAV systems of the Orbiter can provide the most accurate and current states for the Orbiter and TGT, orbit targeting (SPEC 34) is utilized to compute MNVR's on the day of RNDZ, beginning with the first MNVR (NCC). Orbit targeting is designed to schedule MNVR's relative to a

specified base time. By doing so, the entire maneuver plan can be shifted in time by updating just one I-load rather than every MNVR target set. Typically, the initial base time is set to T_i TIG near orbital noon. Since orbit targeting has no lighting software and the GRID/SPOC computer currently cannot support this computation, the ground will provide the initial base time.

4.1.20 Second Star Tracker Target Acquisition

The procedures used in the first STRK acquisition (sec. 3.3.2.1) are slightly different from all subsequent acquisitions due to the fact that the first acquisition had no history of sensor data taking. In the initial acquisition, the covariance matrix was configured with wide data acceptance criteria and the propagated and filtered SV's were identical. In subsequent acquisitions, the covariance and the filtered SV have been updated based on sensor data. Analysis of valid TGT lock-ons can therefore utilize more sources of data to determine accurate and valid TGT acquisition. Special procedures are also needed if the -Y STRK is being used. Note also that on entering this box, the SV SEL (ITEM 4) is now FLTR, not PROP, so that check statement (fig. 3-13) is eliminated.

The STRK procedures in sections 4.1.20, 4.1.21, and 4.1.22 are essentially identical to the STRK procedures for RR fail post- T_i , as described in section 4.4.2.

4.1.21 STRK Configuration

All of the configuration setups are the same as for the first STRK pass (sec. 3.3.2.1).

4.1.22 REL NAV Management

Because the filtered SV now has some incorporated sensor data, the filtered SV and the propagated SV now differ and the covariance has been shaped based on the data acquired. The procedures for acceptance of subsequent sensor data utilize these differences in the determination of valid lock-on condition.

If the RESID values pass the 0.05 test as in the first acquisition, the data is not immediately assumed to be valid as in the first acquisition. If the RATIO is confirmed to be less than 1.0, the data being accumulated by the sensor is within error boundaries as defined by the covariance and is assumed good. The FLTR SV which was used as the initial estimate for TGT lock-on has been proven to be correct since a valid lock-on occurred (see section 3.4.2.2) and it is then "saved" away in the PROP SV location (via a "FLTR TO PROP - ITEM 8 EXEC" line). This is done to provide a proven backup SV should the subsequent sensor data corrupt the FLTR SV. After the SV transfer, the NAV filter is configured to automatically accept STRK angle measurements.

If, however, the RATIO value is greater than 1.0, the crew now has several actions to take. The first assumes that the covariance has inappropriately tightened its data acceptance criteria thereby causing the data to result in a RATIO greater than 1.0. By reinitializing the covariance to the last uplinked values (usually those sent for the beginning of the RNDZ), the acceptance criteria is opened up. This is done via a "COVAR REINIT - ITEM 16 EXEC" line.

At this point, the crew begins their data analysis again by verifying RESID V and H VALUES, as well as rechecking the RATIO to verify it as now less than 1.0. If it is, they perform a FLTR TO PROP transfer and begin AUTO data collection as is called out in the first part of the "If" statement. If not, perform the "problems" steps specified in section 3.4.1.7 (on the checklist this will now be items 2 and 3, "FORCE 3 Angle Marks" and "PROP TO FLTR - ITEM 9 EXEC").

4.1

4.1.23 State Vector Management

(See section 4.1.15)

4.1.24 Target NCC Burn (Intermediate)

After approximately 70 data marks (about 10 minutes, when SV updates are small and stable) of STRK data, the NAV filter should "settle down" and the subsequent updates to the FLTR SV should be small. At this point, the crew calculates an intermediate solution for the NCC burn to get an early indication of the impact the new STRK data is having on the FLTR SV, and therefore on the burn solution. To calculate a valid burn solution, the crew must first recall the TGT set, even though the TGT set data still appears on the screen from the preliminary targeting. If a burn solution is requested and the displayed relative state values (ITEM's 6 to 12) are non-zero, orbit-targeting software will calculate a new solution, but will assume that the displayed relative state values currently in memory are still correct. Recalling the TGT set blanks out the previous values so that a new solution for the burn is computed.

If at this time the total ΔV to be burned appears to be approaching or greater than 6 ft/s, the crew should perform another burn calculation early enough to support a maneuver-to-burn attitude and OMS system configuring. If the crew waited until TIG-4:00 to do their final burn solution as in the standard timeline, it would be too late to maneuver to attitude and still get NCC performed in time.

4.1.25 End STRK NAV

(See section 3.3.2.2)

4.1.26 Target NCC Burn (Final)

At 4 minutes prior to TIG, the final solution for the NCC burn is calculated (fig. 4-7). If the total ΔV to be burned was estimated at greater than 6 ft/s during the intermediate solution, the final burn calculation should be accomplished earlier (approximately TIG -10:00) in order to allow time enough to maneuver to OMS burn attitude.

Before executing the final onboard calculation, the crew transitions the GPC's to OPS 202. This halts data collection and ensures that the SV used for calculating the final burn solution will not be updating from the time the final solution is calculated until the burn is executed. This is important for the NCC and Ti burns because ΔV comparison is part of the decision process that the crew goes through in determining whether or not to burn the onboard solution. Remember that even though the software is configured for AUTO (ITEMS 17, 20, or 23) in OPS 202, sensor data is not incorporated into the FLTR SV unless an ITEM 3 (MEAS ENA) has been executed. The ITEM 3 is only valid in 202; it is an ILL ENTRY in 201.

The crew recalls the TGT set and calculates the final burn solution. At this point the crew has several independent NCC burn solutions and must decide which solution is the best to execute.

Note that all onboard MNVR's will be targeted at least twice: once soon after the previous maneuver, then again shortly before TIG (as late in the NAV pass as possible).

The intent in choosing 4 minutes before TIG (as opposed to 6, 8, or 10 minutes) as the time to do the final targeting solution was to have a time as close as possible to the burn (more sensor marks are taken to improve the state), but far enough away so that the crew doesn't have to rush to get the burn off.

Note that verification of RCS engine selection should have been done prior to entering this box (i.e., before leaving MM 202 after the last burn). If ORB TGT'ing has already been executed, a change on the left side of ORB MNVR EXEC causes a Lambert burn to downmode to external ΔV . If this occurs, the crew can recall and recompute the TGT set on ORB TGT'ing. If not, the crew can proceed with the axis-by-axis burn with any engine selected. In that case, since the VGO's will be correct and that's all the crew is "flying to," the only real difference is that for an OMS selection the EXEC will flash (it can be ignored) and the TGO and burn attitude will be wrong (they should be ignored also).

4.1.27 Solution Selection

The hierarchy of priority for burn solutions has the FLTR SV solution as the most desirable source of burn calculation, followed by the onboard PROP SV solution and the ground calculated burn delta velocities. If the onboard FLTR SV has had greater than 40 STRK data marks incorporated during the pass just completed, and if the updates to SV position are less than 0.5 kft for

the last 4 marks, the FLTR SV has operationally converged and is the best source of relative state data, so it is therefore used for the NCC burn execution. After 40 STRK marks, the major transients in SV convergence are over and the filtered result is more accurate than the SV used for TGT acquisition. During the first 40 marks, filter performance can actually result in SV divergence leading to degraded burn solutions. The marks are specified to have occurred during the sensor pass just completed, rather than the earlier STRK pass to ensure that the data is current, and to serve as a rough order of magnitude data validation.

Note: Four consecutive marks with SV position errors less than 0.5 kft was added to this criterion to eliminate transient effects and to ensure the filter state was stable. (Ref: Charles Stark Draper Lab Memo 10E-84-03, STS-13 Rendezvous Nav Study)

Obtaining and incorporating COAS NAV marks is a time consuming manual task. Forty marks in a single COAS pass is unrealistic. Furthermore, statistical studies show that after the first few COAS marks, updates to the filtered state are somewhat random and do not significantly contribute to the improvement of the relative state. Therefore, since the COAS can never meet this criterion of sufficient NAV data, this rule does not apply to it.

If these criteria are not met, the burn solution based on the FLTR SV is compared with the ground computed ΔV 's. If FLTR SV and ground solutions agree on an axis-by-axis basis to within \pm the LIMITS values given in the NCC BURN SOLUTION pad, the burn is executed using the FLTR SV calculations. These limits are the root-sum-squared differences of the premission-calculated 3-sigma values for the ground and onboard NCC burn ΔV 's solutions.

The onboard filtered solution, even without sufficient relative NAV data, will be as good or better than the propagated or ground solutions because it may have some REL NAV data incorporated plus any IMU sensed ΔV 's since the ground initialization SV. Agreement with the ground solution serves as a gross quality check for the onboard solution and, therefore, only needs to fall within the 3-sigma comparison limits.

Next in priority for usage is the onboard PROP SV solution. If the FLTR SV solution passes neither of the above criteria, the PROP SV solution is compared to the ground solution and is executed if it agrees within the limits.

The onboard propagated solution will be better than the ground solution because it has been computed on either the ground initialization state vector plus any IMU sensed ΔV 's, or a filtered SV containing REL NAV data from a previous sensor pass that had been saved via a FLTR to PROP transfer. Agreement with the ground solution serves as a gross quality check for the onboard solution and, therefore, only needs to fall within the 3-sigma comparison limits.

As a last resort, if none of the above criteria are met, the crew manually loads and executes the ground solution for the NCC ΔV 's.

Perform
4.1.28 Execute NCC Burn *perform*

Unless the NCC burn velocity has increased to the point where an OMS burn is required, the crew ~~executes~~ the burn using the PRCS and trimming out the required ΔV 's while staying in the TGT TRK attitude. The detailed procedures for burn execution are included on the "~~Execute~~ RCS Burn" cue card (see sec. 4.3.1). *RCS*

4.1.29 Maneuver To -Z Track Attitude From -Y STRK (Off-Nominal)

If the -Y STRK has been in use for TGT data taking, the Orbiter will be in TGT track attitude with the -Y STRK pointing at the TGT. Since the next sensor to acquire the TGT in the profile sequence is the RR, and since its boresight axis is along the -Z axis, the Orbiter will need to be maneuvered to a -Z axis TGT tracking attitude. Although use of the -Y STRK was terminated earlier, the maneuver is not initiated until the NCC burn execution is complete to avoid complication during the burn (the burn normally occurs just after sunset).

4.1.30 Perform Radar Lock-on

During the radar acquisition (fig. 4-8), the Orbiter attitude is such that the -Z body axis is pointing at the estimated TGT position. Since the RR system boresight ($AZ = EL = 0$) is fairly closely aligned with the Orbiter -Z, the RR AZ and EL angles should be nearly zero if the main beam has acquired the desired TGT. If this is not the case, the RR may have acquired via one of the beam side lobes, and the crew should break track and allow the system to reacquire. If no lock-on has occurred by $R = 60$ kft, the crew performs the RR AUTO TRACK ACQ ~~cue card~~ (sec. 4.3.2).

procedure

4.1.31 Initiate RR NAV

After the RR hardware has indicated a TGT lock-on, the compatibility of the data with the NAV state is confirmed by monitoring the RATIO. Unlike with the STRK, in a typical RNDZ environment, it is highly improbable that the RR could be locked on to anything other than the desired RNDZ TGT. Therefore, it is not a question of determining a valid acquisition, but rather of data compatibility. See figure 4-8.

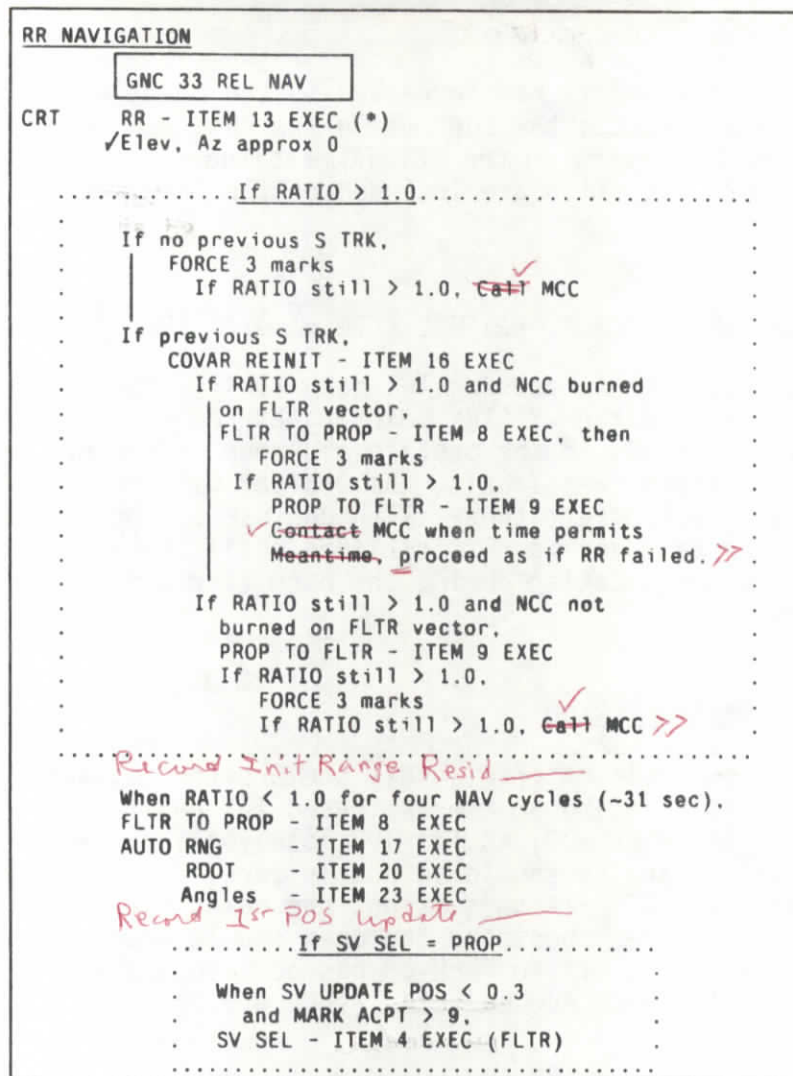

Figure 4-8.- RR navigation.

If the RATIO is less than 1.0 for range, range rate, and angles, the crew saves the FLTR vector used for acquisition by copying it to the PROP location before beginning to accept RR data into the NAV filter (see 3.4.2.2). Unlike with the optical devices, radar provides range and range rate information as well as angles, and each of these parameters must be individually accepted into the SV processing. At this point, if the PROP SV is still selected as input to UPP, the crew monitors FLTR SV convergence and selects it for UPP usage when greater than nine marks in each of range, range rate, and angle are collected, and the SV position updates are down to less than 0.3 kft.

Several consecutive measurement cycles allow transients to settle and the crew to assess the quality of the data. Stable measurements are an indirect indication that the radar sensor is locked onto the TGT with the main lobe

instead of a side lobe. Residual ratios less than one indicate that the measurements, if accepted by selecting AUTO, will not be edited by the NAV filter.

Recall that in the condition where $RATIO > 1.0$, performance of the specified steps is continued until the condition fails, then return to top of the conditional statement, where $RATIO < 1.0$ is performed and procedure is continued. Do not perform all the steps by rote, but exit as soon as one of the steps has forced $RATIO < 1$. See next section.

4.1.32 Off-Nominal RR NAV

If the $RATIO$ happens to be greater than 1.0, there are two cases to consider. In the first, there has been a valid STRK acquisition previously in the RNDZ, and in the second, the RR data is the first onboard sensor data to be acquired.

If previous STRK data has been incorporated into the FLTR, the high $RATIO$ value may be the result of the covariance having converged too tightly; therefore, the first crew action is to do a COVAR REINIT. If the $RATIO$ is still too high, the crew questions the validity of the FLTR SV by looking at the past usage of that state. If the NCC burn was performed using ΔV 's calculated using the FLTR SV (see 4.1.27), the SV is assumed good. The FLTR SV is copied into the PROP SV, and three marks are forced into whichever parameter(s) has the high $RATIO$ value. If the $RATIO$ remains above 1.0 for any of the three radar parameters or if the FLTR SV was not used for NCC, the FLTR SV is overwritten with the PROP SV and acquisition is attempted again.

With no previous STRK data in the FLTR SV, the covariance is already open and the FLTR and PROP SV's are the same. Therefore, the only alternative to try to bring down the $RATIO$ is to force three data points into the NAV filter.

The above discussions for $RATIO$ greater than 1.0 apply easily when all three radar parameters have high $RATIO$ values. If one or two parameters only are above the 1.0 limit, the related crew action is based on the overall complexion of the RNDZ. Have there been radar hardware problems/glitches? Was there a lot of noise in the STRK data? Are the $RATIO$'s for two of the parameters near zero while one parameter fluctuates?

For example, if two parameters have near zero $RATIO$'s while one parameter has greater than 1.0, it may be prudent to do a FLTR TO PROP transfer and configure the two "good" parameters to AUTO incorporation into NAV and see if their impact on the FLTR SV causes the ratio of the third parameter to drop below 1.0. For noisy data that sometimes has $RATIO$ values greater than 1.0, that procedure may also be advisable, although on MCC call it may be possible to put all three parameters into AUTO and allow the NAV software to reject the out-of-limit data takes while filtering the remainder of the

data. The Kalman filter and the sizing of the covariance should keep damaging data out of the FLTR SV. These conditions have never been observed in flight.

4.1.33 Target Ti Burn (Preliminary)

A preliminary solution for the Ti burn is calculated (fig. 4-9). The Ti TGT set is I-loaded as TGT set no. 10. Since the Ti TIG was selected as the reference time for orbit targeting, the T1 TIG time displayed should equal base time. The transfer time is equal to 320° of orbital travel and the ~~target~~ ^{amr} point is a ^{target} TGT intercept.

GNC 34 ORBIT TGT

CRT TGT NO - ITEM 1 +1 0 EXEC
 ✓TGT Set data:
 T1 TIG = BASE TIME
 EL +0
 ΔT +80.1
 ΔX +0
 ΔY +0
 ΔZ +0
 COMPUTE T1 - ITEM 27 EXEC

Note solution in pad.

Figure 4-9.- Target Ti burn.

Ti TIG is chosen so that MC4 occurs 3 minutes after orbital sunrise. Typically, this equates to 3 minutes prior to orbital noon for Ti TIG.

The 320° transfer to intercept is a byproduct of placing orbital sunrise 3 minutes prior to MC4, protecting an STRK pass post-Ti, and requiring zero inertial line-of-sight rates at manual control initiation.

By performing Ti above the V-BAR, MC2 time slips are decreased because the expected dispersion ellipse begins to line up, or "point," to the TGT.

Ti is targeted to intercept, rather than any offset point (e.g., 1000 ft down the TGT V-BAR), because this allows the selection of a trajectory which has the crucial quality of near constant inertial LOS rates to TGT for terminal phase. This characteristic provides a "fly-to" target (especially for radar fail) and this is deemed a mandatory piloting aid.

The ground solution limits referred to in the Ti BURN PAD are the RSS of the preflight predicted ground solution errors and the predicted 3-sigma onboard solution errors, and represent the maximum expected difference between the final onboard solution and the in-flight ground solution. If, for some reason, the onboard solution is suspect, the limits will be used to evaluate the agreement between solutions.

4.1.34 Target Ti Burn (Intermediate)

After the NAV filter has converged (>40 marks accepted and SV position updates <500 ft), an intermediate solution for Ti is calculated. Remember that the target set must be recalled in order to get a valid burn solution. As with earlier burns, if the total ΔV to be burned is large enough, the crew may be instructed to execute the Ti burn using the OMS. Additionally, if the burn is less than 4 ft/s, the crew may be instructed to perform the burn by burning out the velocities axis by axis while maintaining the TGT TRK attitude. The 4-ft/s value was selected to minimize the amount of forward reaction control system (FRCS) propellant used. As a groundrule, if performing a burn axis by axis will result in greater than 2 ft/s being burned out of the FRCS, the burn should be replanned to be a +X RCS burn. Due to the Orbiter attitude at Ti, and based on the nominal burn ΔV 's, a multiaxis Ti execution can be estimated to be 50 percent FRCS and 50 percent ARCS. A 4-ft/s burn, therefore, would probably result in a 2-ft/s FRCS usage and is the upper limit for multiaxis execution.

4.1.35 Perform RR Auto Track Acquisition (Off-Nominal)

If the RR has not acquired the TGT by the time the range to the TGT has decreased to less than 60 kft, the crew attempts an acquisition using the AUTO track mode of RR operation. At approximately 60 kft, the probability of acquiring a TGT with a 0.5-square-meter radar cross section approaches 100 percent. The detailed AUTO track acquisition procedures ~~are on the RNDZ OPS cue card and are explained in sections 3.3.4.6 and 4.3.2.~~

15

4.1.36 Target Ti Burn (Final)

Before targeting the final solution for the Ti burn, the crew transitions the GNC GPC's to OPS 202. As for the NCC burn, this is done to terminate sensor data processing into the FLTR SV so that burn solution comparisons are done based on nonchanging state data. If the Ti burn is to be executed using the OMS or the +X PRCS, the proper engine selection needs to be made on the MNVR EXEC display as well as the desired thrust vector roll (TVR) angle, Orbiter weight, and the engine gimbal trim angles. After being correctly loaded into the display, the data is then loaded (ITEM 22) into software in order to put the data onto the downlist for MCC visibility. On the REL NAV display the crew verifies that the source of SV data is correctly configured and then (if burn is +X) inhibits the incorporation of angle data into the NAV state. Since the GNC GPC's are already in OPS 202, this has no immediate effect. The inhibit is done to preclude the acceptance of inaccurate RR angle data into the filter immediately after the Ti burn is complete and the crew transitions back into OPS 201. The data would be inaccurate because the Orbiter will be maneuvered out of -Z axis TGT tracking attitude for the burn and RR gimbal angle measurement accuracies decrease as the antenna is pointed away from its -Z boresight.

RENDEZVOUS

The OMS/RCS PRPLT PAD should be checked at this point (sec. 4.3.4) and then periodically afterwards for the remainder of the rendezvous operations.

4.1.37 Solution Selection

The same rationale as in 4.1.27 (NCC) is used for this burn. The values of the comparison LIMITS are different since trajectory dispersions at Ti differ from those that can be expected at NCC.

4.1.38 Execute Ti Burn

The FDF block for this action is shown in figure 4-10. This is a mission-critical burn which sets up an intercept with the target. It is generally posigrade with some radial component. It is very time critical and cannot be slipped more than a few minutes.

Due to possible vehicle blockage of radar LOS to TGT, the Ku-band pointing mode is set to prevent the antenna from thrashing around in case of loss of track. If the burn is performed in LOMS (as is usual), vehicle angles should allow RR track to be maintained. Burns in ROMS, both OMS's, or +X RCS can result in RR break track. In that case, DAP B is used to get back to track attitude ASAP.

4.1.39 Ti As Multiaxis RCS Burn

See section 3.6.3 for discussion of this variation. A major driver for this decision may be a requirement for as much target tracking as possible. Propellant savings may also be a consideration.

OR
just RCS burn →

```

PERFORM TI BURN [T8]
.....
. If Ti is OMS Burn,
. go to RNDZ OMS BURN
. (CONTINGENCY OPERATIONS)
.....
[GNC ORBIT MNVR EXEC]
CRT  ✓TGT data loaded
      LOAD - ITEM 22 EXEC
      TIMER - ITEM 23 EXEC
C3   DAP TRANS: As reqd
      DAP ROT: DISC/DISC/DISC
      DAP: A/AUTO/VERN
      If mnvr to burn att reqd,
CRT  MNVR - ITEM 27 EXEC (x)
A1U  KU - AUTO TRACK
      [GNC 33 REL NAV]
      Inh Angles - ITEM 24 EXEC (x)
TIG -00:30
F7/F8 - FLT CNTLR PWR - ON
      DAP: A/MAN/NORM
TIG
      THC: Trim VGOs < 0.2 fps
F7/F8 - FLT CNTLR PWR - OFF
      OPS 201 PRO
C3   DAP: VERN
      DAP: A/AUTO
      If no RR lock,
      DAP: B/AUTO/NORM
  
```

4.1.40 Load/Execute Delay Burn (Off-Nominal)

Should a situation arise prior to execution of the Ti burn that requires a delay in the completion of the RNDZ, performing the RNDZ DELAY burn places the Orbiter in a safe trajectory relative to the TGT. This allows the crew and ground to assess the status of the problem and decide whether or not to continue with the RNDZ. See figure 4-11. Skip to section 4.1.47 for subsequent crew activity.

For short delays (one or two REV's), the ground will compute a phasing MNVR to return to the Ti position based on the most current onboard relative state, and will voice the MNVR target sets to the crew during the RNDZ sequence (see sec. 3.6.1.3). Desirable lighting conditions will be maintained as long as there is an integral number of REV's between the original and new Ti MNVR's. The crew has expressed an interest in remaining at least 6 n. mi. from the target when Ti is positioned at 8 n. mi.; the ground can easily accommodate this desire. Typically, a short delay will always be executed prior to a long delay.

A long delay (greater than two REV's) requires an opening rate to eliminate the need for the crew to continuously monitor the target. Long delays usually involve at least one crew sleep cycle. A 1-n. mi./orbit opening rate corresponds to a 0.3-ft/s MNVR assuming the current closing rate has been nulled. Typically, if propellant is available, the delay MNVR would be targeted to the point where the final phasing MNVR was executed (=40 n. mi. trailing); this corresponds to an opening rate of 2.7 n. mi. per REV. Doing a larger than 1-n. mi./orbit opening rate MNVR reduces the probability of waking the crew to execute an additional opening rate MNVR. Also, the second RNDZ trajectory would be similar to the original trajectory.

Unfortunately, there is a propellant penalty for executing a Ti delay (see table 4-1). The magnitude of this penalty is dependent on the specific delay scenario. The table assumes a one-REV return to Ti.

TABLE 4-1.- PROPELLANT PENALTY

Scenario	Approximate penalty
1 or 2-REV delay	6 ft/s
24-hour delay Minimum phasing (23 n. mi.)	11 ft/s
24-hour delay Nominal phasing (40 n. mi.)	25 ft/s

In a loss of COMM case, the crew can target a rough Ti delay burn by targeting the T2 burn after NCC; this is supposed to be a burn which nulls Orbiter motion with respect to the TGT at Ti. This is not a verified procedure.

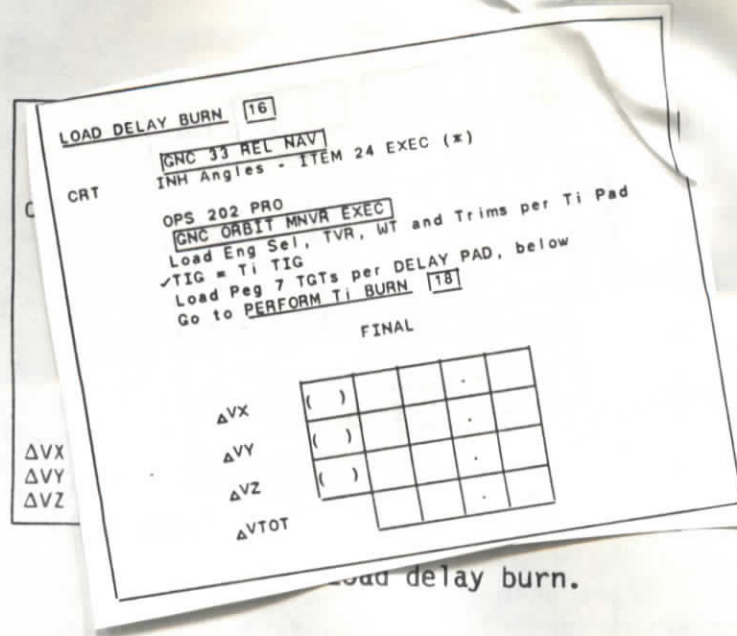

4.1.41 RMS Operations

As discussed in section 3.3.5.5, the RMS wrist CCTV camera is a critical, close-in PROX OPS sensor. Also, problems with the RMS will impact plans for final approach (sec.3.9.2). The RMS cannot be deployed pre-Ti. This is because it could be an OMS burn and there would be too much stress on the brakes.

Rms Powerup and RMS MNVR to FOISE FOR PROX OPS follow Ti.

4.1.42 Target MC1 Burn (Preliminary)

The midcourse burns are targeted to intercept. Their BURN PADS are described in section 3.6.1.4 and they are burned axis by axis (sec. 3.6.3). The targeting terminology is:

$$T1 TIG = \text{BASETIME} + _ / _ : _ : _$$

MC1 (target set no.11) occurs about 8 minutes before sunset. Waiting until then allows most of the post-Ti REL NAV data to be incorporated into the MC1 computation while still being executed early enough to be propellant efficient. Also, orbital sunset minus 8 minutes leaves enough time between MC1 and MC2 for the manual out-of-plane (OOP) null.

Note: The MC burns may be done even with the tail-only RCS option, since tail-only mode is ignored by translations, so axis-by-axis translations can be done. If the intention is to make sure that all of the propellant comes out the aft RCS, however, the Orbiter must maneuver to +X burn attitude. This is not recommended for use.

Onboard solutions will be selected for all midcourse correction MNVR's. This is because the ground has no capability to improve the relative state information between the Orbiter and target for the midcourse correction MNVR computations. This is due to ground tracking uncertainties and the relatively close proximity of the two vehicles. Hence, the Orbiter solution for these MNVR's will always be selected.

In general, midcourse correction MNVR's, except MC2, will not be executed unless additional target sensor data has been obtained since the previous MNVR. This logic is subject to further analysis.

The rationale for this is as follows: Midcourse correction MNVR's are designed to correct the Orbiter intercept trajectory based on the most current relative state information. Since no additional relative state information is available, these MNVR's will only correct for trim errors or attitude maneuver effects. However, the onboard navigated state used to compute the MNVR could be in error by an amount as large as the computed MNVR. Hence, there is no real benefit to executing these MNVR's and they can be deleted to save propellant.

MC2 (sec. 4.1.51) is currently an exception to this rule. It is executed on an elevation angle to ensure the manual control trajectory is "standard." Also, MC2 must be targeted at least once so orbit targeting can automatically redefine its base time (MC2 TIG) for the MC3 and MC4 computations. Otherwise, the ground would have to supply the new base time and the crew would have to manually load it.

4.1.43 Verify Target Track Post-Ti NAV

*fig 4-11B
POST-TI NAV
block*

Before trying to configure for TGT acquisition, the crew verifies that the Orbiter is in proper TGT TRK attitude, usually -Z towards the TGT, and that the DAP is properly configured. The Ku system is placed back into its GPC mode so if a break-lock occurs on the TGT, the software will use GPC-supplied angle designates to automatically command a search pattern to reacquire the TGT.

Even though STRK angles are more accurate than radar angles, STRK marks are not preferred past Ti. The STRK's can define angles to a greater accuracy than the radar, but the accuracy decreases as the distance to the TGT decreases because the TGT is no longer a point source, and also because the angle data is not converted to the Orbiter c.g. frame. From Ti on in, the sensors are roughly equivalent, but the radar is more convenient to use. Also, of course, STRK is lighting-dependent, and optical tracking may be affected by target geometry and orientation.

If at this point it is known that the RR is inoperable, the crew attempts to use the STRK or COAS to collect REL NAV data on the TGT.

4.1.44 STRK Target Acquisition Post-Ti With Confirmed Radar System Failure

In the event of RR failure post-Ti, the crew is directed to a contingency block titled "STRK TARGET ACQ - RR FAIL." This contingency is described in detail in section 4.4.2, and is summarized as follows:

The hierarchy of sensor desirability is based on the accuracy of the resulting SV. The crew first attempts to perform a -Z STRK acquisition. This gives high accuracy while maintaining the -Z track attitude. This attitude

allows the crew to monitor the TGT in the COAS, and also eliminates the need for another attitude maneuver later in the profile to prepare for manual phase. Should the -Z STRK not be operable, however, the procedures call for the crew to give up TGT viewing and attitude continuity by attempting to acquire the TGT in the -Y STRK (as long as there is sufficient time to get to attitude before sunset). The -Z COAS is used only if no other sensors are functioning because the COAS data is less accurate than that of the STRK's, and because COAS data taking is a manual pointing operation resulting in higher fuel usage and fewer data points.

An IMU is deselected to stop IMU RM from changing the reference IMU during data taking (see sec. 3.9.4), and the DAP is verified to be configured for a 1° attitude deadband (DAP select A) and on the vernier control jets.

With the Orbiter operating on a 1° ATT DB and in a -Z target track attitude, the TGT should be within approximately 1° of the COAS centerline, assuming that the COAS misalignment with the body -Z axis is small. If the TGT is off COAS center by greater than 1°, it may be due to TGT SV inaccuracies in calculating the pointing direction toward the TGT. In this case, if the -Z STRK has not already acquired the TGT, it may be necessary to use the COAS to update the SV so that STRK has an initial pointing designate accurate enough to support TGT acquisition. With a valid -Z STRK acquisition the COAS data is not required. If COAS data is required, the crew takes marks on the TGT and incorporates data into the SV until the angular RESID's are less than 0.5°. At this point the SV pointing designate information should be accurate enough for the STRK to acquire the TGT in the 1° offset scan mode. The crew should then attempt to perform an STRK TGT acquisition instead of continuing to use up time and propellant pursuing further COAS data takes.

The following is a desperate last-ditch measure.

If only the -Y STRK is functional at this point (i.e., if the RR and the -Z STRK are known to be hard-fail permanently), the crew begins a rapid attitude maneuver to point the -Y STRK boresite at the predicted TGT position. For the maneuver, DAP select B and the primary RCS (NORM) are used to implement a rotational rate of 0.5 deg/s. After the maneuver is completed (approximately 3 minutes, unless the faster DAP B is selected), attitude control is reconfigured back to the vernier RCS to take advantage of the smaller ATT DB and vehicle rates possible when using these jets.

System configuration and data acceptance criteria are the same as for previous STRK data passes.

If after 5 minutes of attempted TGT acquisition the STRK still cannot lock on to the TGT, the crew is instructed to return to -Z target track attitude, if not already there, and begin taking COAS NAV marks. Five minutes allows the STRK to perform several 60-second field-of-view searches. With the short amount of time available for gathering optical data on the TGT, and with the upcoming trajectory correction maneuvers, it is important for the crew to take COAS marks often and for as long as possible to provide the best possible SV data. The best procedure is to take five marks early in

the pass and five marks late in the pass, and to take advantage of changing relative geometry.

4.1.45 SV Management

If valid RR track is established, the crew performs a FLTR TO PROP transfer to save the pre-Ti data (sec. 3.4.2.2), and then configures the RR angles back to the AUTO incorporation mode.

4.1.46 Off-Nominal Radar OPS

If the RR has not yet attained a TGT lock-on, but is not known to be failed, the crew attempts to acquire a lock-on by utilizing the AUTO TRACK mode of operation (see "cue cards" in sec. 3.3.4.6). If there is still no acquisition, the crew assumes that the Orbiter-to-TGT range may be the reason. The Orbiter is maintained in the -Z-to-TGT attitude in hopes that the RR will lock on as the Orbiter approaches the TGT. The crew inhibits range, range rate, and angle data acceptance into the NAV filter. If the -Z STRK is functioning, the crew performs an STRK acquisition. Otherwise they perform COAS data takes. If at any time during the STRK or COAS data taking should the RR acquire the TGT, the NAV inputs are reconfigured to use the RR data because of the increased SV accuracy obtained through the use of range and range rate data.

4.1.47 If Delay Burn Was Performed (Off-Nominal)

If Ti Delay has been performed, a number of activities will occupy this extra 90 minutes.

First, retargeting Ti with the new base time received from the MCC will restart the counter. As a first approximation, add 90 minutes to the old base time.

Second, since the TIG is near orbital noon, an STRK pass can begin soon afterwards. Take STRK marks until near sunset; continue to take RR marks.

Essentially, the checklist is reentered at Ti TIG -1:30 (without doing NCC again!). Another STRK pass is performed (see sec. 4.1.20), and Ti is approached again. If there is good RR tracking, the MCC may advise the crew to not perform the STRK pass.

4.1.48 Target MCI Burn (Intermediate/Final)

With the advantage of an SV improved by post-Ti tracking, the MCI burn is targeted twice more.

Perform
 4.1.49 Execute MC1 Burn

Except in highly unusual circumstances (e.g., badly executed Ti burn), this will be a small axis-by-axis RCS burn. It is possible that the burn TGT's will be less than the desired trim limits; in that case there is no need to execute the burn.

An explanation of the direction of midcourse burns is found in section 2.8.7.

4.1.50 End STRK Navigation for Post-Ti Data Pass (Off-Nominal)

This procedure is utilized if the STRK is used to gather target data post-Ti due to a failed RR, or if STRK angle data is desired over RR data.

At sunset, the angle input to NAV is inhibited so that erroneous STRK data is not incorporated should the STRK lock onto another light source. Since the only possible sensor data for the remainder of the RNDZ is radar data, the software is set up to accept RR angles should they become available.

The STRK's are placed in their TERM/IDLE mode and the shutter doors are confirmed to not be latched open.

At the end of each STRK pass, the IMU's are reselected to configure back to the three-LRU level.

If radar data becomes available as the Orbiter closes on the TGT, the crew is instructed to monitor and accept the data, using criteria laid out in the RR NAVIGATION block (see 4.1.30, 4.1.31, 4.1.32).

*mention
ST →
Maniq
if RR?*

4.1.51 Target MC2 (Preliminary/Intermediate)

The second midcourse burn differs from others in that the TIG is tied to an Orbiter-target LOS elevation angle rather than a preset clock time. The preliminary targeting block is shown in figure 4-12.

```

    CRT    ✓  SV SEL correct
           GNC 34 ORBIT TGT
           TGT NO - ITEM 1 + 1 2 EXEC
           ✓  TGT Set data:
           T1 TIG = BASE TIME +0/00:47:00
           EL +26.6
           ΔT +33.1
           ΔX +0
           ΔY +0
           ΔZ +0
           Note Nominal T1 TIG in pad
           COMPUTE T1 - ITEM 27 EXEC

           Note solution in pad and inform MCC
    
```

Figure 4-12.- Target MC2 (preliminary solution).

The use of an elevation angle as a cue for MNVR execute forces a standardized final approach profile to the TGT and maintains lighting conditions. Such a profile has a known LOS rate regardless of the range dispersions prior to MC2. It involves essentially zero inertial line-of-sight rates during the crucial final minutes of the approach. This allows straightforward, out-the-window monitoring to give crewmembers cues for any off-nominal trajectory and to define direct "fly-to" corrective MNVR's. This burn shapes the intercept to occur in 125° (32 minutes) of orbit travel. It is cued to occur when the elevation angle of the TGT is about 28° . This occurs near orbital midnight.

In general, if the T_i point was long, then MC2 will be delayed, and if the T_i point was short, MC2 will be early. Flight experience has been that T_i tends to be long (late MC2 also equals early orbital sunrise relative to manual takeover).

Note: The terms "long" and "short" as applied to T_i (and any other RNDZ MNVR locations) refer explicitly to range from TGT, not to range from previous MNVR point. Thus, T_i is "long" if the TIG location is farther than expected from the TGT; however, from the point of view of earlier burns, the same result could be viewed as having fallen "short" of the aim point, as in artillery terminology. To avoid ambiguity, always refer "long" and "short" to the range-to-TGT, not range-from-starting-point. See figure 4-13.

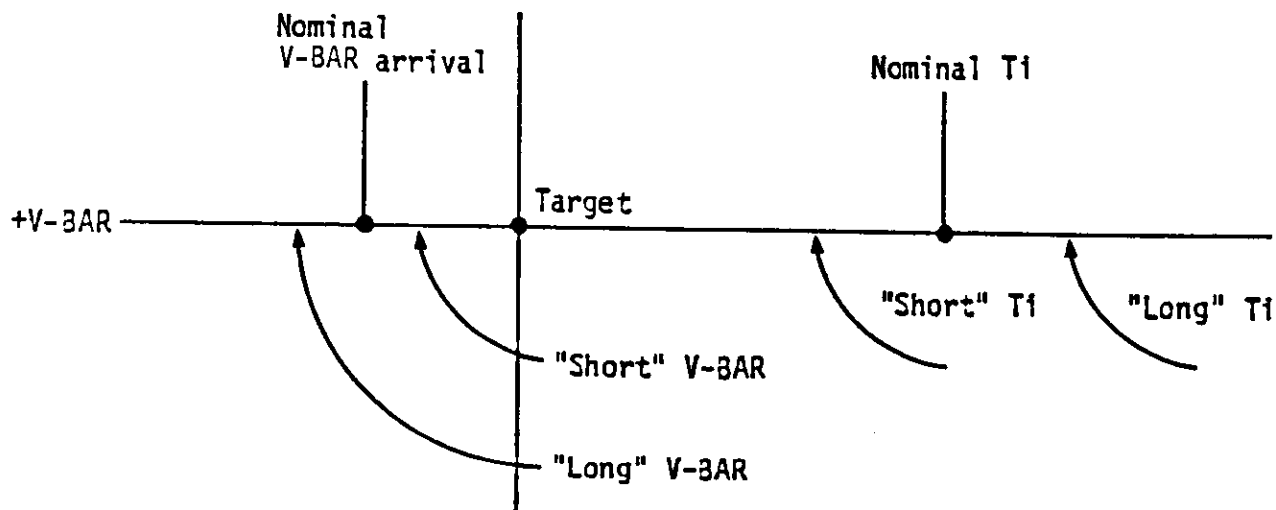

Figure 4-13.- Long/short terminology.

At some point, lighting can no longer be sacrificed to maintain a "standard" manual control trajectory. That limit was chosen to be minus 3 ("early") to plus 7 ("late") minutes from the nominal TIG. This will maintain sunrise between MC3 and MC4 and ensure a lighted manual control initiation at MC4 plus 2 minutes.

See section 4.1.42 for a discussion of rationale for sensor fail MC2 targeting.

See section 3.5.5.3 for discussion of possible ORB TGT alarm "TGT EL ANG."

Acquisition of additional tracking data may result in significant changes to the MC2 TIG (several minutes) for the intermediate targeting. Each new TIG should be read down to the MCC since the solutions are not downlisted.

4.1.52 Execute RNDZ Breakout If No Sensor Data Or If No Filter Convergence (Off-Nominal)

See section 4.6 for discussion. The ~~OMS/RCS~~ ^{RENDEZVOU} PRPLT PAD (sec. 4.3.4) may also be the cause of a BREAKOUT call near this point.

4.1.53 CCTV Configuration

If required, power up CCTV and VTR per cue card, set SCAN to UNDERSCAN, perform PAN/TILT RESET and load new tapes in VTR's.

CCTV CONFIG 31

A3
A7U

If reqd, pwr up CCTV, VTR per
TV/VTR Cue Card
MON 1,2 SCAN to UNDERSCAN
MON 1 - Camr A
MON 2 - Camr B
Aim A at B and B at A
PAN/TILT - RESET for both; aim
both at (or near) PAN 0, TILT 90
Repeat for Camr C & D
Use A & B for data recording
Put new tape in VTR

Out-of-Plane Null

axis-by-axis RCS burn (fig. 4-14) is performed based on REL NAV. Ti had set up a 180° transfer from this useful monitoring of the Y and Y-DOT parameters on REL NAV. Though Ti is supposed to create a node (Orbiter/target) a REV prior to intercept (see sec. 3.5.7), the actual time the node occurs can vary by up to 10 minutes due to NAV updates. When executed using Y thrusters, the burn drives Y-DOT to zero, so Y should not increase substantially afterwards.

If the burn is missed, the Y-DOT component should be nulled ASAP and the rest of the planar difference will have to be taken out manually during terminal phase. While this complicates that operation, it is certainly doable. See section 2.4.2.2 for a theoretical discussion of the orbital dynamics effects.

Flight experience has shown that the Ti burn is often successful in nulling out-of-plane rates to the point that the subsequent manual burn is not required. Generally the Y-DOT is a couple tenths of a foot per second.

```

GNC 33 REL NAV
When Y = 0
FLT CNTLR PWR - ON
DAP:A/AUTO/NORM
DAP TRANS: as reqd
THC - null YDOT

If -Z-AXIS TRACK,
  +YDOT = FWD THC left
           AFT THC right
If -Y S TRK TRACK,
  +YDOT = FWD THC down
           AFT THC out

DAP:A/AUTO/VERN
FLT CNTLR PWR - OFF

```

Figure 4-14.- Manual out-of-plane null.

4.1.55 Target MC2 Burn (Final)

Once the last MC2 solution is computed (fig. 4-15), its TIG is compared to the preflight TIG, and the "TIG slip" is noted. Note that the "slip" can be in either direction, either ahead ("later") or back ("earlier").

```

✓ SV SEL correct
GNC 34 ORBIT TGT
CRT TGT NO - ITEM 1 +1 2 EXEC
COMPUTE T1 - ITEM 27 EXEC
✓ TIG change between -3 and +7 min

.....If TIG Change <-3 OR >+7 min.....
.
. Set BASE TIME to (Nominal MC2 TIG -3,+7 min)
. as appropriate.
. Load - ITEM 26 EXEC
. TGT NO - ITEM 1 +1 9 EXEC
. ✓ TGT Set data
. T1 TIG = (BASE TIME)
. EL +0
. ΔT +33.1
. ΔX +0
. ΔY +0
. ΔZ +0
. COMPUTE T1 - ITEM 27 EXEC
.....
Set EVENT TIMER counting to MC 2 TIG
Note solution and inform MCC

```

Figure 4-15.- Target MC2 (final solution).

A different TGT set (one based on time rather than elevation) is called up when TIG slips more than -3 or +7 minutes. The reason MC2 must be done within a particular time interval is that this burn will determine the lighting for the manual phase. A TIG slip greater than -3 or +7 minutes causes unacceptable orbital lighting conditions during manual terminal phase. (Sunrise must occur by MC4.) Changing BASE TIME prior to calling up the new target set allows the new BASE TIME to be changed by FSW in all sets. This saves keystrokes and simplifies crew procedures.

The reason for the new set is procedural. The new TGT set number is a quick indicator in the MCC that MC2 is being done on time rather than elevation angle. This is to avoid any possible confusion by seeing the old TGT set number selected.

4.1.56 Perform MC2

The burn is executed like any other axis-by-axis burn.

4.1.57 If in -Y STRK Track ATT, Return to -Z Axis Target Track (Off-Nominal)

If the -Y STRK had been used post-Ti, the Orbiter will still be in the -Y STRK TGT TRK attitude. In order to support the manual phase operations, it is necessary for the Orbiter to be aligned with its -Z axis pointing toward the TGT. The maneuver to the -Z axis TGT TRK attitude is delayed until after MC2 so that the approximately 8-minute-long attitude maneuver does not interfere with the execution of the OOP null or MC2. If the actual execution time of the OOP null and MC2 are such that it could be accomplished earlier, the crew has the option to execute the maneuver anytime after sunset.

4.1.58 Timeline Notes for No Radar Final Phase (Off-Nominal)

In the case of a failed RR, the crew will take over manual control of the trajectory at the earliest possible moment. This is done to keep the trajectory dispersions small in the manual phase.

The crew begins manual translational control at sunrise, based on out-of-the-window observation of the TGT.

A detailed discussion of this contingency is found in section 4.4.2.

4.1.59 Target and Perform MC3 Burn

This burn is scheduled to occur exactly 10 minutes after MC2. This has no significance other than correcting the trajectory so dispersions do not accumulate. It may be small enough to be skipped.

Post-Ti target acquisition can be accomplished through any one of four NAV sensors; the RR, the -Z or -Y STRK, or the COAS. All things considered, the RR is by far superior for RNDZ NAV purposes, but is also subject to the most single point failures, and is the most difficult to check out prior to the RNDZ activities (self-test pass or fail is not necessarily significant. See sec. 3.3.4.4). Either STRK is next in priority, since angle marks can be taken more accurately, more frequently, and with less propellant use than COAS marks. In addition, STRK's are typically used on a daily basis for IMU alignments, and so their operational status is known with a high degree of confidence prior to RNDZ initiation. The COAS is the last in priority, with no reasonable failure modes that would preclude its use.

In accordance with the relative usefulness of the sensors for NAV purposes, a hierarchy has been established for failure downmoding. A known RR failure is treated differently than a lack of TGT lock-on due to unknown causes. If the RR is known to be failed (mechanical problems with the Ku antenna, etc.), the first downmode is to the -Z STRK (see procedure in 4.1.44 in RNDZ rationale narrative). If the STRK is known to be failed, then the -Y STRK is the next choice. Before maneuvering, however, the COAS is used as a quality check on the NAV state. If necessary, COAS marks are taken to improve the NAV state accuracy and ensure that the target will be within the 1° small scan of the tracker, increasing the probability of acquisition. If the -Z STRK is thought to be working but fails to lock on, then NAV accuracy or TGT spectral characteristics (brightness, variability, etc.) are suspected to be the problem, so the -Y STRK is not anticipated to be an improvement. Thus, rather than wasting time in an attitude maneuver, COAS marks are taken, if possible. At the crew's discretion, -Z STRK acquisition can be reattempted.

Similarly, if the RR does not have a known failure, then lack of lock-on is assumed to be a result of NAV errors or insufficient signal return. To overcome NAV inaccuracy, manual slewing and acquisition with the RR are attempted first (sec. 3.3.4.6). Still failing to acquire, the downmode is to the -Z STRK. Even if the -Z STRK is known to be failed, in this situation the COAS will be used rather than the -Y STRK, since the -Y STRK acquisition attitude makes it impossible for the RR to lock on due to body blockage.

If no RR lock-on has been established by MC3, then at sunrise (usually -7 minutes after MC3) a manual takeover is performed. MC3 and MC4 are not executed since no new sensor data has been incorporated since MC2, and also because it is considered imperative to establish proper LOS rates as early as possible. If visual acquisition is not available by MC4 + 5 minutes, a breakout MNVR must be performed ASAP. This MNVR is sized to ensure no recontact throughout the 3-sigma ellipse of dispersions.

The arrival of sunrise is a critical moment because at that point the TGT becomes visible and the procedure can begin. If the TGT is equipped with lights, the procedure can begin even earlier (the earlier the better).

When visual acquisition is accomplished, the Orbiter is pitched to bring the TGT to the COAS horizontal, and yawed until the LVLH yaw is zero. The pitch

allows for determination of in-plane errors, and the yaw is performed to unmask any planar errors. Having accomplished the pitch, it is possible to determine the "theta angle," which is the in-plane angle from the Orbiter V-bar to the target line of sight. From the associated table (fig. 4-29), the dispersion region can be determined.

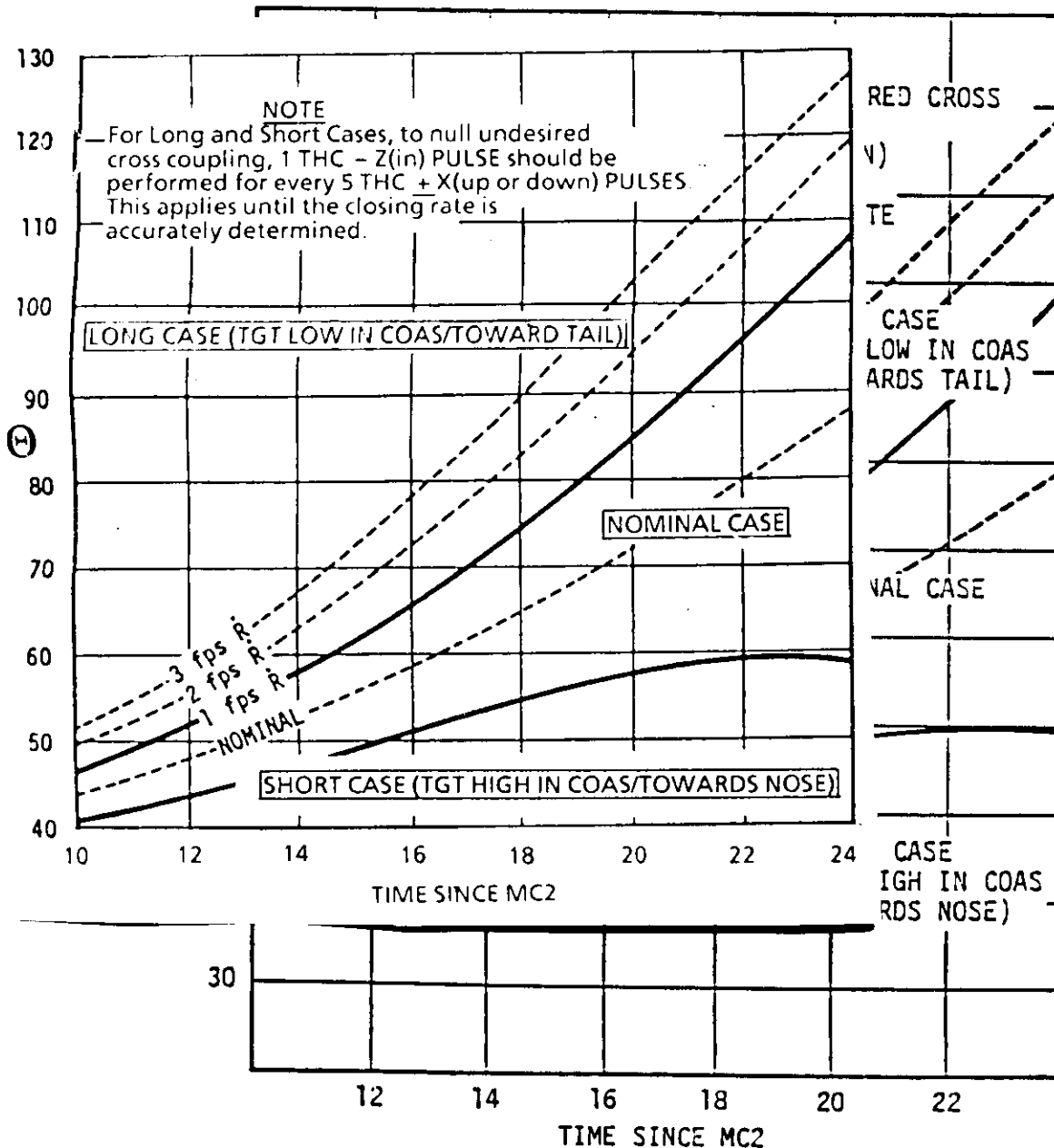

Figure 4-29.- Region determinator.

Note: The lines in figure 4-29 are empirically derived from analysis of a large number of ground simulations. They are valid for circular orbits only.

The logic behind the "theta" vs. "time since MC2" table (fig. 4-29) is as follows:

Prior to manual takeover the Orbiter attitude will follow a nominal time history, since without sensor data, NAV can only assume that a nominal trajectory is being flown. At sunrise, the NAV error will be suddenly exposed. As shown in figure 4-30, if the trajectory is short, the TGT will appear high in the COAS, and if the trajectory is long, the TGT will appear low. The great majority of cases will fall near enough to the nominal trajectory that nominal procedures can be followed. For sufficiently short or long trajectories, however, simulator experience has shown that nominal procedures will not result in a successful RNDZ, so special techniques must be used. The table delineates the boundaries of the "acceptably nominal" trajectories.

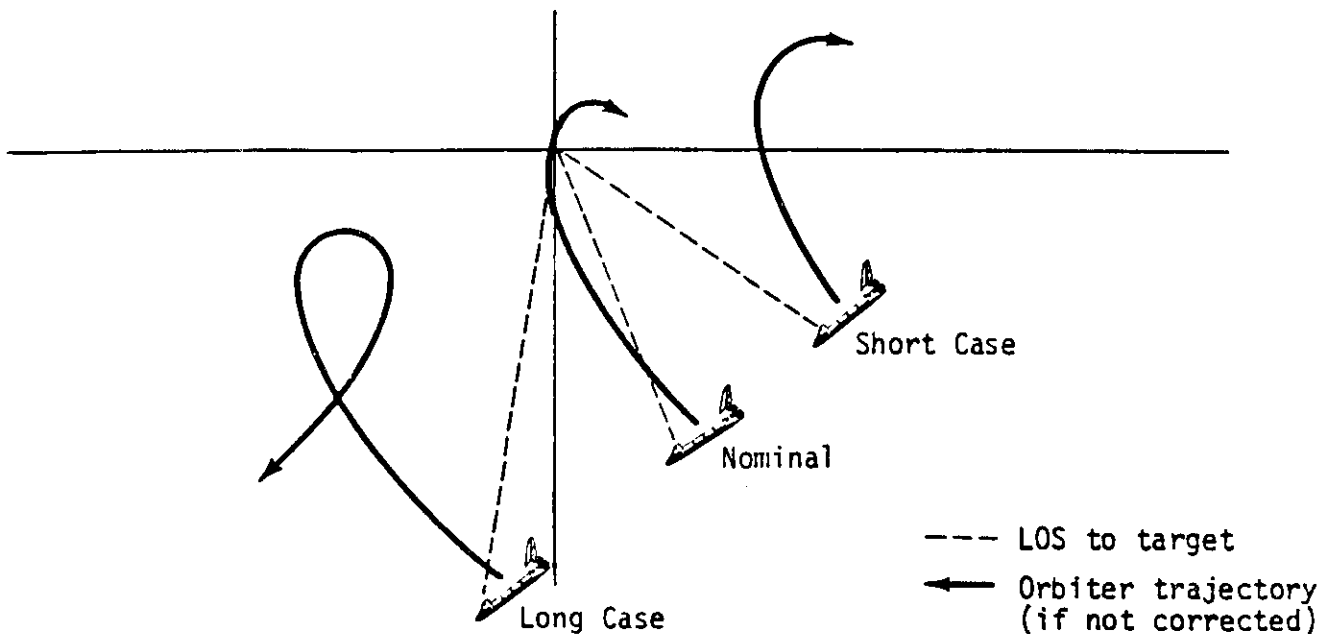

Figure 4-30.- Dispersed sunrise points.

For the family of trajectories that fall in the "short" category, it can be seen that many Orbiter +X corrections will be required to force the trajectory back towards the nominal path. Due to cross-coupling of X into +Z, this thrusting activity will tend to null the closing rate, and if not compensated for will turn a short case into a long case, as shown in figure 4-31. The final result of this is an unsuccessful RNDZ, since the change in range rate is difficult to detect with the RR failed, and the V-BAR arrival will be too far away to allow for closure within daylight. To compensate for this cross-coupling, the procedure calls for application of one Orbiter -Z pulse for every five $\pm X$ pulses (the theoretical background for this rule of thumb is found in sec. 3.8.2). Note that it is very easy on short cases to initially overcorrect with +X, requiring subsequent -X; both contribute to +Z coupling. An important procedural point (that can only be driven home in the simulator) is that it is necessary to make the $\pm X$ corrections when visual cues suggest that they are required. Anticipating help from orbital mechanics effects, or thinking that error is "in the right direction," will usually result in an unsuccessful RNDZ. Many of these trajectories seem to "fall off the cliff," if errors are not corrected relatively quickly.

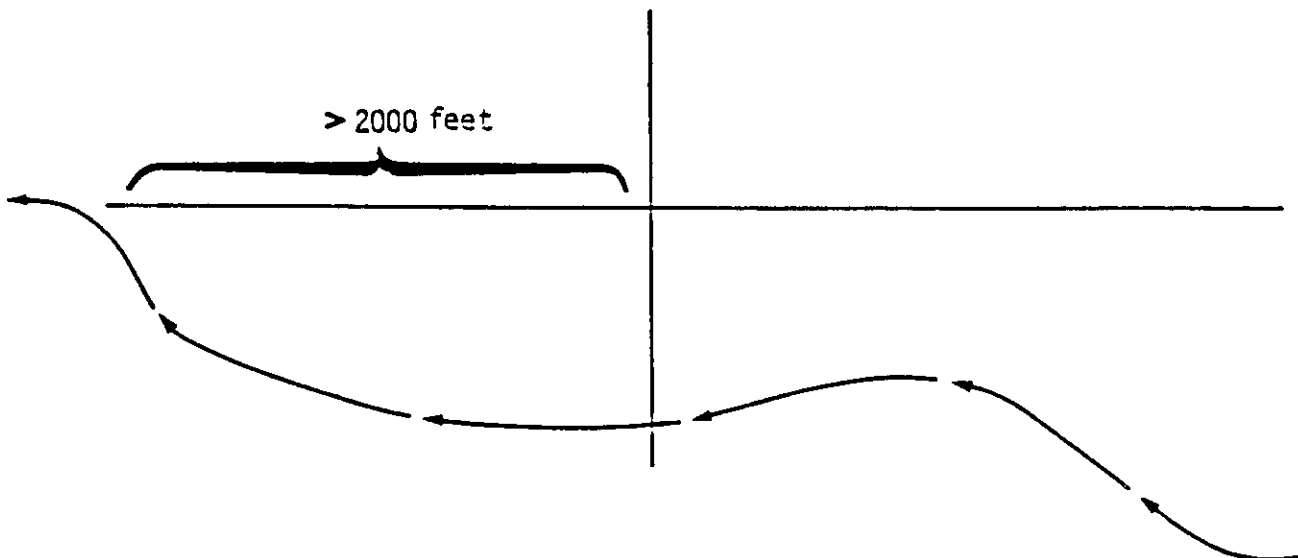

Figure 4-31.- Uncompensated coupling effects.

the change in TGT size over a period of time. Accuracy, braking gates are not used on a no-radar case, be monitored to ensure reasonable closing rates.

ers

will call out the following procedure for loss of

RNDZ DAP with TAIL ONLY CNTL from the beginning of the RNDZ burn. Use NOSE and TAIL (full up) CNTL during and burn.

entirely on OMS/RCS PROP consumption. If MCC decides entities have sufficient margins, this control mode (and the it entails - see sec. 3.2.1) can be waived and full control be selected. 3.8.1.1

Loss of Low Z Mode

Low Z mode the TGT will suffer less plume impingement effects. Loss of impact expected TGT attitude and rates during final approach to However, RNDZ and PROX OPS would probably continue on the nominal

payload separation MNVR's (e.g., Space Telescope) require use of low contamination concerns. Unavailability of low Z mode may delay until IFM restores capability or replanning can be accomplished.

4.5 Loss of Aft THC, RHC
for RNDZ and possibly long-range stationkeeping, operations can be conducted from the forward THC/RHC's; close range flying is unacceptable. The only reason to proceed with RNDZ/PROX OPS at all is if some IFM promises to restore aft capability.

4.4.6 Loss of EE CCTV

Since the EE CCTV is a crucial PROX OPS sensor (see sec. 3.3.5.5), its failure will seriously impact procedures. The TGT must be moved up over the right rear window for better visibility by the RMS operator. Since it then is no longer in the plume shadow, DAP must be moded to low Z. Aft PLB CCTV's can be used to monitor Z axis sense motion.

Alternative procedures involving use of the RMS elbow CCTV have not been worked out.

Note: Loss of PDRS results in effective loss of EE CCTV, although it is conceivable that the elbow CCTV could still be used while the RMS is stowed.

4.5 BACKOUT

Certain systems failures, as specified in the flight rules, may disallow Orbiter operations within 200 feet of a TGT (e.g., loss of translation capability in any axis or loss of redundant +Z capability). Under such conditions the Orbiter will move out to the 200-foot point, go to normal Z control mode (usually), and begin stationkeeping while the problems are being resolved. From this point the Orbiter will either resume approach or perform PROX OPS breakout.

Caution: Once back out at 200 feet, use of RR may remain inhibited due to payload restrictions on induced electric field intensity. Even in low power, the antenna can induce high currents before automatically dropping to bypass mode.

4.6 BREAKOUT

The "breakout" MNVR is a separation MNVR performed at an unplanned point in the RNDZ sequence. Nominal separation MNVR's are described in section 5.4.2; breakout MNVR's, described in detail in section 5.4.3, must be quick, simple, and safe across a wide variety of initial conditions.

Note that choice of NORM Z or LOW Z for the separation is made on a payload-specific basis, mainly on the issue of whether the payload must be preserved for later return (on a subsequent rendezvous).

Two distinct types of breakout MNVR's have been defined and documented in the FDF RNDZ books, Rendezvous and PROX OPS. Once a "breakout" has been called, the choice must be made as to which available procedure is to be executed. These, or alternate procedures such as the nominal separation or no burn at all, are chosen by the MCC based on table 4-3.

TABLE 4-3.- BREAKOUT MANEUVER SELECTION

Time frame	Procedure	Usual key driver
Pre-Ti	Usually no burn (FDO defines maneuver)	Orbiter systems
Ti (RNDZ abort)	Usually no burn (FDO defines maneuver)	Orbiter systems
*Delay (1-2 REV's)	Per Ti Delay pad	Orbiter systems
*Delay (24 hr)	Follows Ti Delay (FDO defines maneuver)	Orbiter systems
Ti to sunset (ASAP at sunset)	RNDZ breakout (3 ft/s OOP, followed by 3 ft/s retro 15 min later)	Sensors
Sunset to MC2	RNDZ breakout (3 ft/s OOP, followed by 3 ft/s retro 15 min later)	Orbiter systems
MC2 to MC3	None	Orbiter systems
MC3 to V-bar	RNDZ breakout (3 ft/s OOP, followed by 3 ft/s retro 15 min later)	Propellant quantities
V-bar (or near)	PROX OPS breakout (2 ft/s posigrade)	Propellant quantities OR other flight rule (e.g., GNC redundancy)
Elsewhere	Flight specific OR Generic Sep, Orb OPS C/L (1 ft/s away, 2 ft/s OOP, 3 ft/s posigrade)	Propellant quantities OR other flight rule (e.g., GNC redundancy)

4.6.1 Pre-Ti Breakout

Prior to Ti, a ground-computed breakout MNVR will be executed, if necessary, to guarantee a safe miss distance between the Orbiter and TGT. This is because prior to Ti, dispersions and the lack of a standard RNDZ profile prevent designing a "canned" breakout MNVR. The ground will compute a MNVR, if required, to ensure the Orbiter avoids the TGT by a safe distance. Typically, not executing a preplanned phasing MNVR will provide an acceptable miss distance.

4.6.2 Ti to V-BAR Breakout

Between Ti and V-BAR arrival, the breakout MNVR sequence will be a 3 ft/s out-of-plane MNVR (nominally Orbiter $\pm Y$ body axis) away from the TGT plane, followed 15 minutes later by a 3 ft/s retrograde MNVR (Orbiter +X body axis). This procedure is called "Rendezvous Breakout," and its rationale is found in section 5.4.3.1.

This breakout will be performed for the following reasons:

4.6.2.1 For Insufficient Propellant

For insufficient propellant or Orbiter system problems, the sequence will be initiated at orbital sunset, MC2, MC3, or ASAP if post-MC3. For reasons other than TGT sensor data, the breakout MNVR sequence should be initiated at the earliest acceptable point in the trajectory. Analysis indicates that orbital sunset to MC2, and at or post-MC3, are acceptable points in the trajectory to initiate the sequence. The earlier the sequence is initiated, the greater the TGT miss distance.

4.6.2.2 If No TGT Sensor Data

If no TGT sensor data (RR, STRK, COAS) has been obtained by orbital sunset, the sequence will be initiated at orbital sunset. With no TGT sensor data, the actual relative position between the Orbiter and TGT is not known with sufficient accuracy to complete the RNDZ. The sequence initiation was delayed until orbital sunset to allow maximum time for post-Ti sensors to obtain the TGT. The out-of-plane MNVR at sunset does not contribute to the TGT miss distance and could be deleted in real time as long as the retrograde MNVR is executed at orbital sunset plus 15 minutes.

4.6.2.3 If Only Pre-Ti TGT Sensor Data

If only pre-Ti TGT sensor data (RR, STRK, COAS) has been obtained, the sequence will be initiated no later than MC4 unless the TGT is acquired visually or with another sensor (RR is only current candidate). With pre-Ti TGT sensor data, trajectory dispersions are reduced. The sequence initiation can be delayed until MC4 and still provide an acceptable TGT miss distance. The retrograde MNVR does not contribute to the target miss distance and could be deleted in real time.

4.6.2.4 If Post-Ti TGT Sensor Data

If post-Ti TGT sensor data (RR, STRK, COAS) has been obtained, but is no longer available, the sequence will be initiated no later than MC4 plus 5 minutes unless the TGT is acquired visually or with another sensor (if all sensors are lost after this point, perform breakout immediately). With post-Ti TGT sensor data, the trajectory dispersions are reduced even more

and the sequence initiation can be delayed until MC4 plus five minutes while still providing an acceptable miss distance (500 ft c.m. to c.m.). Again, the retrograde MNVR does not contribute to the TGT miss distance and could be deleted in real time.

4.6.2.5 To Continue the RNDZ Post-MC4

To continue the RNDZ post-MC4 plus 5 minutes, visual acquisition or RR is required. Subsequently, if both of these are lost, the sequence will be initiated ASAP. Without visual acquisition or RR data (the crew is electronically "seeing" the TGT), it is not possible to continue manual control. The entire breakout MNVR sequence is required once manual control has been initiated.

4.6.3 Post-V-BAR Arrival

Post-V-BAR arrival the breakout MNVR will be as described in section 5.4.3.2, PROX OPS Breakout, with its rationale. Motivation for PROX OPS BREAKOUT can include propellant limits, flight rules invocation, or serious target or Orbiter systems failures.

4.7 RELATIVE MOTION PLOTS

Included in the RNDZ checklist is a set of Orbiter/TGT relative motion plots in TGT-centered polar coordinates (fig. 4-33). These are designed to allow the crew to plot their progress through the RNDZ and note any course deviations.

The specified angle assumes the Orbiter is in -Z axis TGT track. It can be read off the aft ADI; alternate values as seen on the forward ADI are also given.

4.8 FLIGHT DATA FILE DOCUMENTATION

A typical mission rendezvous or proximity operations book consists of a number of standard sections:

- Acronyms
- List of cue cards
- Contents
- Flight profile (charts)
- Detailed timelines (30 minutes per right-hand page) and pads

RELATIVE MOTION
FROM PRE TV

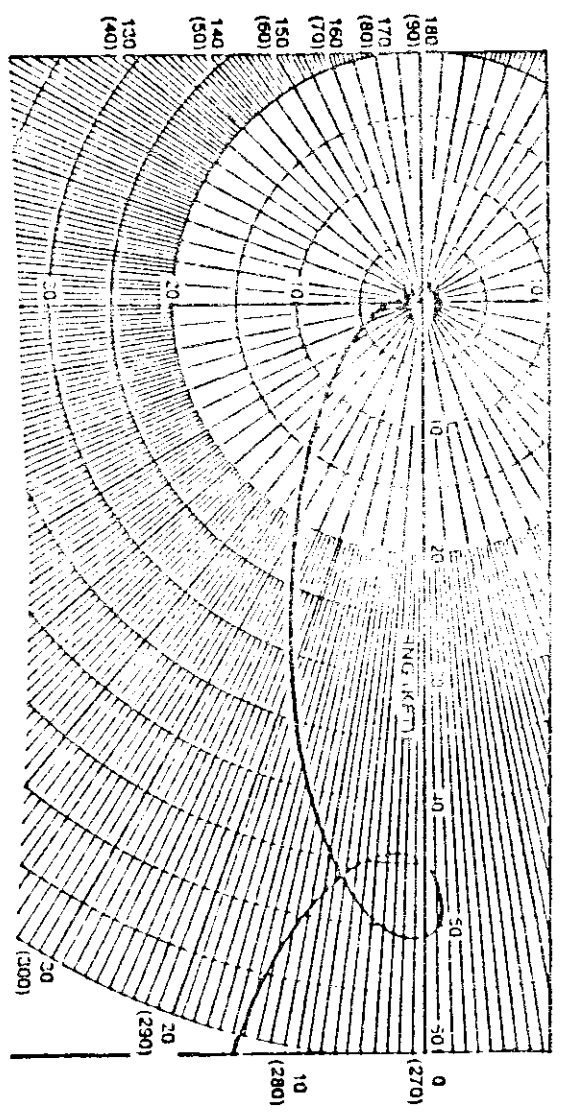

TERMINAL PHASE RELATIVE MOTION

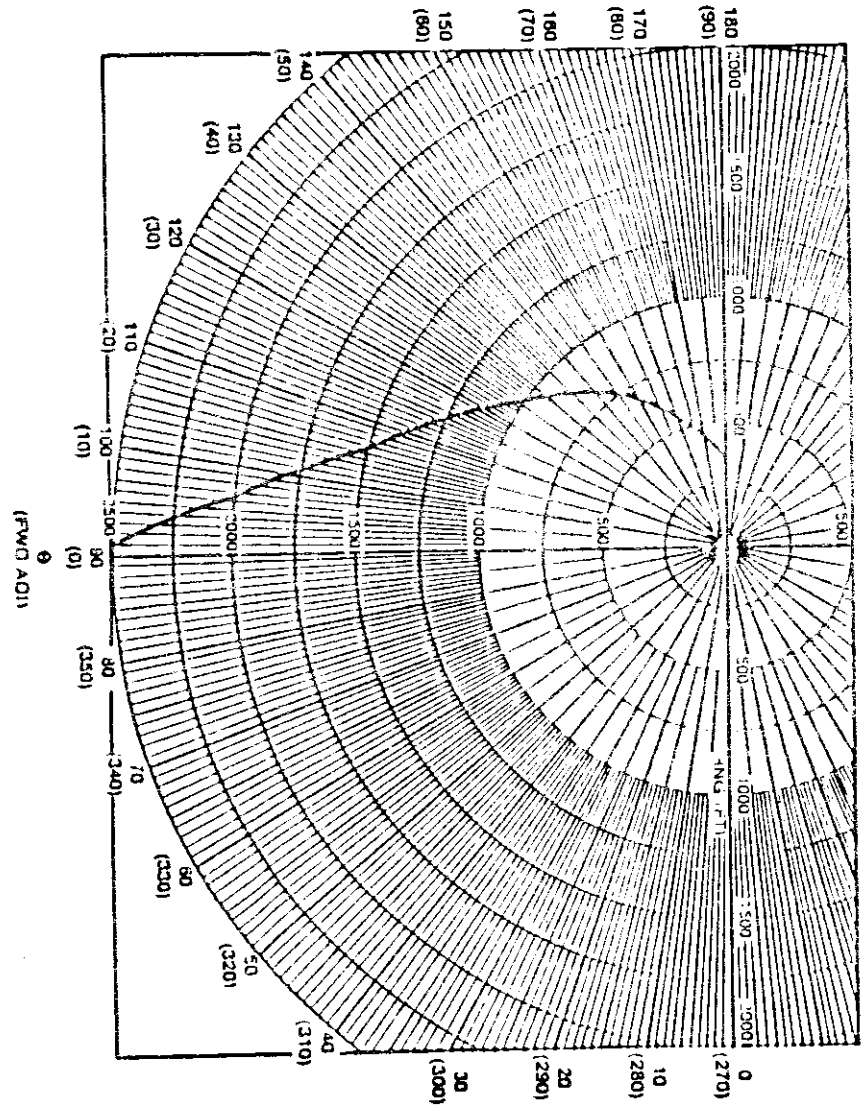

Figure 4-33.- Relative motion plots.

- Contingency operations (radar fail, loss of VRCS, DPS reconfiguration, RNDZ OMS burn, separations)
- Reference data (flight rules, targeting data, DAP configurations, relative motion plots, etc.)
- Ranging charts and rulers
- Cue cards (one set ^e pure text, one set with velcro layout)
- Notes (baseline trajectory and mission day)

The rationale for location and format of deploy/SEP/RNDZ procedures is given below. This philosophy applies to all missions where there is a scheduled nominal rendezvous or a planned contingency rendezvous. Examples of the former are STS 41-C (Solar Max repair) or STS 51-L (Spartan-Halley). An example of the latter is STS-30 (Hubble Space Telescope (HST)). Some missions (such as Spartan or the HST) involve deploy of a payload early in the mission, followed by either a nominal rendezvous (Spartan) or a planned contingency rendezvous (HST) 2 or 3 days later. For this type of mission (which may generically be referred to as "Spartan-type missions"), the predeploy, deploy, separation, postseparation, and rendezvous procedures should all be contained in the Rendezvous book. The exact point during predeploy operations at which the crew switches to the RNDZ book, and the level of detail of the predeploy procedures contained in the RNDZ book, will be determined for each flight depending on its unique requirements. In addition, for very complex missions requiring a high degree of crew coordination or procedural integration, nondeploy related payload or scientific operations can be included to varying levels of detail, such as on STS 51-F (Spacelab 2/Plasma Diagnostics Package (PDP)) proximity operations.

For Spartan-type missions, there are two main considerations, format and location. The Rendezvous book format has been a standardized format since the early Apollo days, containing an event timeline and detailed procedures, along with information concerning relative motion, GSTDN and TDRS coverage, day/night cycles, DAP settings, navigation schedules, and a variety of contingency procedures, cue cards, and supporting reference data. Unlike other checklists, it is compatible with DM43's Rendezvous and Proximity Operations Procedures Master Data Base (i.e., a radar acquisition procedure in the deploy section looks similar to that which the crew would see in the rendezvous section). As such, the format would be the same for pre- and postdeploy operations; it is used during crew and flight controller training, integrated sims, real-time support, and on-orbit operations.

Many payloads are very sensitive to contingencies during deploy, and most deploys are tied to specific times, lighting, or other trajectory events, such as particular beta angle or TDRS acquisition for a specified period of time pre- and/or postdeploy. Some deploy contingencies requiring special procedures are: unavailability of the low Z DAP mode; no-RMS deploy; single-joint RMS deploy; and late deploy. Sometimes these procedures are so different from the nominal, or are otherwise so complex or critical, that

completely new contingency sections of the book need to be written. The rendezvous format easily accommodates these problems with a minimum of confusion and maximum crew coordination. Finally, the rendezvous format easily accommodates the integration of systems procedures (RMS, communications, OMS/RCS, payload systems, etc.).

From the preceding paragraphs it is possible to see many reasons why it is important that deploy and separation procedures be incorporated in the Rendezvous book for Spartan-type missions. There are, however, other reasons. It is highly desirable to have in one book all rendezvous-related procedures; i.e., those involving the integrated rendezvous GN&C hardware and software systems, especially when dealing with a two (or more) body problem. This provides the maximum continuity between deploy/separation and rendezvous procedures, especially during those critical moments just prior to and following the actual deploy when the minimum amount of confusion and the maximum possible level of crew and flight controller coordination is mandatory to ensure that the deploy is properly accomplished for both reasons of mission success and crew safety. Additionally, DM43 has means to establish a performance history of the sensors and navigation system. Also, it is easier for both the crew and flight controllers if all deploy and rendezvous maneuver pads are in one book, along with the propellant GO/NO GO pads and flight rules.

There is a need to check out the navigation sensors (radar and star tracker) at an early point in the mission (immediately following deploy), not only to satisfy the MCC that the sensor itself and the associated hardware and software are working properly, but also to get an idea of how the sensor interacts with the individual payload. In other words, was there any problem in acquiring the target, and did it stay locked on out to the expected range? Were there any problems in tracking the target, perhaps caused by its rotation, surface, or RF characteristics? These are among the target RF and optical characteristics and questions that can have an impact on the rendezvous timeline and procedures, and can be confirmed by using the sensors postdeploy. On some missions, there are nominally planned phasing burns, or other targeted maneuvers, designed to maintain the Orbiter within a desired area "near" (6 to 12 miles) the payload for a period of time up to several hours postdeploy. It is therefore critical to acquire the target and begin navigating immediately following deploy, and the best way to do this is to keep the crew in a checklist with the rendezvous format (preferably the Rendezvous book) throughout the entire procedure, thus ensuring maximum continuity and crew coordination.

In summary, by having a completely integrated checklist with all predeploy, deploy, separation, postseparation, and rendezvous procedures in one book as described above, the best possible level of mission support can be provided, both preflight and real time. This is a philosophy and methodology which has withstood the test of time and the test of actual on-orbit operations. It works well both for the people who develop techniques and provide real-time support, and for the people who use the procedures on orbit. But most importantly, it offers the best assurance of accomplishing the mission.

4.10 In-Flight C/L Utilization

Normally there will be three copies of the rendezvous checklist on board the Orbiter. They are stowed in a middeck locker for use after orbit operations begin. A sample cover sheet for such a checklist is shown in figure 4-34.

Crew handling of the checklist follows STS norms and standards. Cue cards are positioned at the disgression of the crewmembers using them. CCTV monitor overlays are on clear plastic with velcro tabs for affixing to the CCTV monitors. MCC calls will be made to the specific page number of the checklist. The crew will be familiar with this checklist from ground simulation activities.

National Space Transportation System	JSC-20848
FLIGHT DATA FILE	
 Contingency Rendezvous 	
Don't Leave Earth Without It	
 Mission Operations Directorate Flight Design & Dynamics Division 	
Generic November 21, 1986	
 National Aeronautics and Space Administration Lyndon B. Johnson Space Center Houston, Texas	

Figure 4-34.- FDF Rendezvous Checklist (Typical)

SECTION 5 PROXIMITY OPERATIONS TECHNIQUES RATIONALE

PROX OPS include stationkeeping, flyarounds, final approach to grapple, and separation.

One mission commander had made this extremely perceptive observation about PROX OPS: "This is not just a knowledge type operation, it's a skill-type operation that requires continuous training to develop and maintain at skill level. Knowing how to do it is not enough. You have to develop the skill so you can do it time and time again and be repeatable."

5.1 STATIONKEEPING

During PROX OPS, stationkeeping techniques are required to maintain the Orbiter in a desired position relative to the TGT, either in a TGT-inertial or LVLH-referenced frame. The zone of proximity stationkeeping operations is limited to ranges and relative velocities within which RNDZ operations are not required to achieve repeated close approach. Typically, $R \leq 1000$ feet, with rates in each axis ≤ 1 ft/s.

Under the requirement that the Orbiter maintain a position in the TGT-centered LVLH frame, the Orbiter is usually positioned along the TGT +V-BAR, with UNIV PTG controlling the Orbiter attitude as -X to Earth and omicron of zero (PLB to TGT). Thus, the TGT will be trailing the Orbiter. Assuming zero differential drag between the Orbiter and the TGT, V-BAR positions are the only ones which are theoretically stable. This results in the most efficient type of stationkeeping, because minimal propellant is required to maintain the Orbiter c.m. at the same altitude and coplanar with the target c.m. SES experience shows one can maintain a position at 1000 ± 30 feet on the V-BAR for about 100 pounds of propellant per REV, using an optimum VCRS/PRCS technique (NORM Z).

Stationkeeping on the TGT radius vector (R-BAR) is usually undesirable due to operational complexity and the high propellant usage penalty required to stay on the R-BAR (theoretical analysis provides a rule of thumb for extra usage, above and beyond normal stationkeeping usage, as approximately 0.5 lb/ft of separation, per REV).

5.1.1 Stationkeeping Control

During stationkeeping activities, the crew must judge when Orbiter attitude and/or translation corrections are necessary, and make corrections manually.

5.1.1.1 Attitude Control

Depending on the type of stationkeeping, the Orbiter attitude is maintained automatically either in an inertial or an Earth TRK mode. The Orbiter attitude control system, which provides the Orbiter with the capability to maintain the proper attitude for stationkeeping, consists of the UNIV PTG function, the LVLH mode, and the inertial attitude hold mode.

The size of the ATT DB is also of concern in stationkeeping since it must be selected based on a compromise between two conflicting trends. For attitude considerations alone, the basic tradeoff has always been between narrow DB's (which give high attitude precision and incur high propellant usage for attitude control) and wide DB's (which saves propellant for attitude control). However, from the point of view of maintaining a desired stationkeeping position, a narrow DB allows the pilot to more easily discern actual position errors (and make immediate translation corrections) while a relatively large DB tends to mask increasing position errors. If a large altitude differential is allowed to build up, this creates relative orbital mechanics forces which drive the Orbiter off its desired position and requires costly translation burns to counteract. Thus the most economical DB must be selected based on a compromise between attitude control propellant usage (which suggests narrower DB's) and translation propellant usage. Normally, 2° PRCS and 1" VRCS DB's are used as the "best compromise." See section 3.2.1.

Universal Pointing - UNIV PTG, which is defined MM201 keyboard entries and activated via the AUTO pb, provides for maintaining a specified attitude with respect to a reference frame (such as LOS to center of Earth). The main contribution of UNIV PTG to stationkeeping is this ability to automatically maintain a desired attitude or to maneuver to a specified attitude. This reduces the number of degrees of freedom of the Orbiter from six to three (translation only), so the crewmember can concentrate on a more manageable piloting task.

LVLH Mode - The LVLH mode keeps the Orbiter in a fixed position relative to a rotating reference frame.

An example of use is an out-of-plane flyaround in the local horizontal plane of a TGT which is LVLH-stabilized. The MNVR is performed with pulses in the Orbiter roll axis, while pitch and yaw are automatically maintained relative to LVLH (see section 5.2.2).

Inertial hold - The inertial attitude hold mode is needed when the Orbiter is required to be fixed in the inertial frame. The inertial attitude hold mode is primarily for close-in stationkeeping or approach to grapple to an inertially stabilized payload.

5.1.1.2 Translation Control

During stationkeeping, translation control is necessary to help maintain the position of the Orbiter relative to the TGT. The primary purpose of the

translation control is to maintain the Orbiter c.m. in the vicinity of the target V-BAR within some predetermined range limits.

Using COAS cross-field-of-view drift, or RR digital angle rates, or CCTV, a crewmember knows the direction of normal LOS rates and can perform corrections using the THC. RR data may provide much more precise readings which allow the crewmember to avoid overshooting/undershooting corrections and thus avoid rates propagating into large trajectory dispersions. In the Orbiter body frame, these rates represent the normal to the LOS (NLOS) motion of the Orbiter trajectory relative to the TGT, and thus the required information for making NLOS translation corrections to the trajectory. Also, by appropriate attitude orientation of the Orbiter, the EL and AZ will represent the Orbiter in-plane and out-of-plane position, respectively, of the Orbiter relative to the TGT V-BAR.

A confined ("tight") form of stationkeeping performed during short and medium range ($R < 1000$ ft) operations maintains the Orbiter within relatively small limits (e.g., ATT DB $\pm 1^\circ$) around the optimum stationkeeping point by appropriate thrusting in all Orbiter axes. A less confined form of manual stationkeeping ("loose") used during medium and long range ($R > 1000$ ft) operations makes more efficient use of orbital mechanics forces as an aid to translation control, thereby reducing the need for translating in certain Orbiter axes.

The two basic types of translation guidance are automatic and visual. This refers to the method of determining required corrections, which are then always executed by the crew manually.

- Automatic translation guidance is accomplished by using navigated (i.e., GPC filter processed) relative state data to determine where crew-executed translation inputs are required for relative position corrections. The sensor data is used to update the relative state, which is then used to compute corrective MNVR's based on the orbit targeting algorithms.
- Visual translation guidance is accomplished by crew processing of TGT relative position information for determination of the approximate translation corrections. This relative state information comes from direct visual contact with the TGT (NLOS sense and approximate rates), and from raw RR data for LOS/NLOS value and rates information.

5.1.2 Classification of Techniques

For convenience, stationkeeping operations are classified by range (close in, short, medium, and long), and there are significant differences between these techniques used at different ranges. These differences are summarized in tables 5-1 and 5-2.

TABLE 5-1.- SUMMARY OF STATIONKEEPING CLASSIFICATIONS

Type	Close-in	Short	Medium	Long
Range	-35 ft	< 200 ft	200-1000 ft	1000 - 2000 ft
Duration (roughly)	≤ 1 rev	≤ 1 rev	1-2 rev's	2 revs to 1 day
Primary source of relative state information	Eyeball, EE CCTV	CCTV, RR, COAS + eyeball	CCTV, RR, COAS + eyeball	CCTV, RR, COAS + eyeball
Direct visual contact*	Required	Required	Required **	Desirable **
Orbital mechanics effects on maneuvers	Ignored	Ignored	Utilized	Efficiently utilized
Plume impingement concerns	Usually in quiet zone	Significant	Usually insignificant	insignificant
Control technique	<ul style="list-style-type: none"> • Manual • Tight 	<ul style="list-style-type: none"> • Manual • Tight 	<ul style="list-style-type: none"> • Manual • Tight or loose 	<ul style="list-style-type: none"> • Automatic (elliptical) • Manual (loose)
Application	<ul style="list-style-type: none"> • Trim/align relative ATT for grapple/manhandling • 3 body OPS(MMU) • Photography/activation of disabled PL 	<ul style="list-style-type: none"> • Final stage of retrieval • Short term TGT checkout • Set up proper Orbiter/TGT geometry • 3 body OPS (MMU) 	<ul style="list-style-type: none"> • Final approach preparation • Short term TGT checkout • Three-body operations (MMU) • RMS preparation • Waiting for proper lighting • Troubleshoot Orbiter problems 	<ul style="list-style-type: none"> • Stand off • Long term TGT checkout

*Must have RR or visual/CCTV contact at all times.

**TGT must have lights or reflectors if night operations required. Momentary loss of contact acceptable if under stable conditions, precise stationkeeping.

TABLE 5-2.- SUMMARY OF STATIONKEEPING CONTROL

Type	Close-in	Short	Medium	Long
Range	~ 35 ft	< 200 ft	200-1000 ft	1000 - 2000 ft
RMS	Ready to grapple	Ready to grapple	Ready to grapple	Stowed
Attitude hold	As required (combination of free/IAH or free/LVLH)	Usually matched to TGT	LVLH with -Z toward TGT	LVLH with -Z toward TGT
Orbiter X axis	As required	As required for approach	In TGT orbital plane	In TGT orbital plane
DAP	Usually NORM Z	LOW Z	NORM Z if outside plume sphere of influence	NORM Z

5.1.2.1 Close In

Close in stationkeeping techniques are required after the Orbiter has achieved a stable position near the TGT. Alignment with the desired TGT axis may or may not have been achieved.

Since close-in stationkeeping is done at 35 feet, orbital mechanics effects are ignored. Flying is done strictly from a combination of out-the-window and RMS EE CCTV camera views, still in the -Z sense.

At 35 feet, most payloads will remain in the "quiet zone," safe from plume impingement effects. Therefore all operations can be done in the "norm Z" mode. However, for very large PL's, such as the Hubble Space Telescope (HST) or LDEF, low Z may be necessary, especially if some type of Orbiter/TGT alignment maneuver is required. Also, if the payload drifts forward or aft of the "quiet zone," low Z should be selected until it resumes its position over the PLB.

Close-in stationkeeping is a "tight" stationkeeping technique, which, although easy to fly, requires the pilot's constant attention. Its common uses are waiting for proper PL geometry for grapple or preparing for final Orbiter/TGT alignment maneuvers, MMU flyover operations, or close-inspection activation of a disabled payload.

5.1.2.2 Short Range

Short range stationkeeping techniques are generally required after the Orbiter has already been positioned on the correct TGT final approach axis (i.e., that axis along which the Orbiter must approach in order to execute RMS grapple), or in the case of checkout operations, on any designated TGT axis. They may also be required immediately after TGT release.

The range is generally within the plume sphere of influence ($60 \text{ ft} < R < 200 \text{ ft}$). At these ranges, orbital mechanics effects can be effectively ignored. The time interval associated with close-in operations is usually less than 1 orbit.

Two primary tasks involved during short range operations are matching the attitude rates of the Orbiter with those of the TGT (to within 0.1° deg/s and translating to maintain the correct relative position on the desired TGT axis. Thus, short-range stationkeeping generally requires visual translation guidance techniques.

"Tight" stationkeeping is the suitable technique used for short-range operations, which put emphasis on the use of the COAS for maintaining the Orbiter relative position on the desired TGT axis. The CCTV's are the primary source of LOS control during the last 200 feet of the final approach to grapple (see figs. 3-25 and 3-27). After the RR loses lock, they also become the primary source of range and range rate polarity information.

The different types of short-range stationkeeping techniques are:

- Orbiter stationkeeping with respect to an inertially stabilized TGT
- Orbiter stationkeeping with respect to a TGT fixed in the LVLH frame (while rotating at orbit rate).
- Orbiter stationkeeping with respect to a TGT rotating at an arbitrary rate relative to the LVLH frame or the inertial frame.

5.1.2.2.1 Inertially stabilized target.- This method presumes that the TGT is inertially stabilized, with the aid of some type of control system, or is spin-stabilized (fig. 5-1). In order to keep the same relative attitude geometry, the Orbiter must also maintain inertial hold. This then requires that the Orbiter translate continuously (with respect to the LVLH frame centered on the TGT) to stay on the desired TGT axis and maintain the desired range.

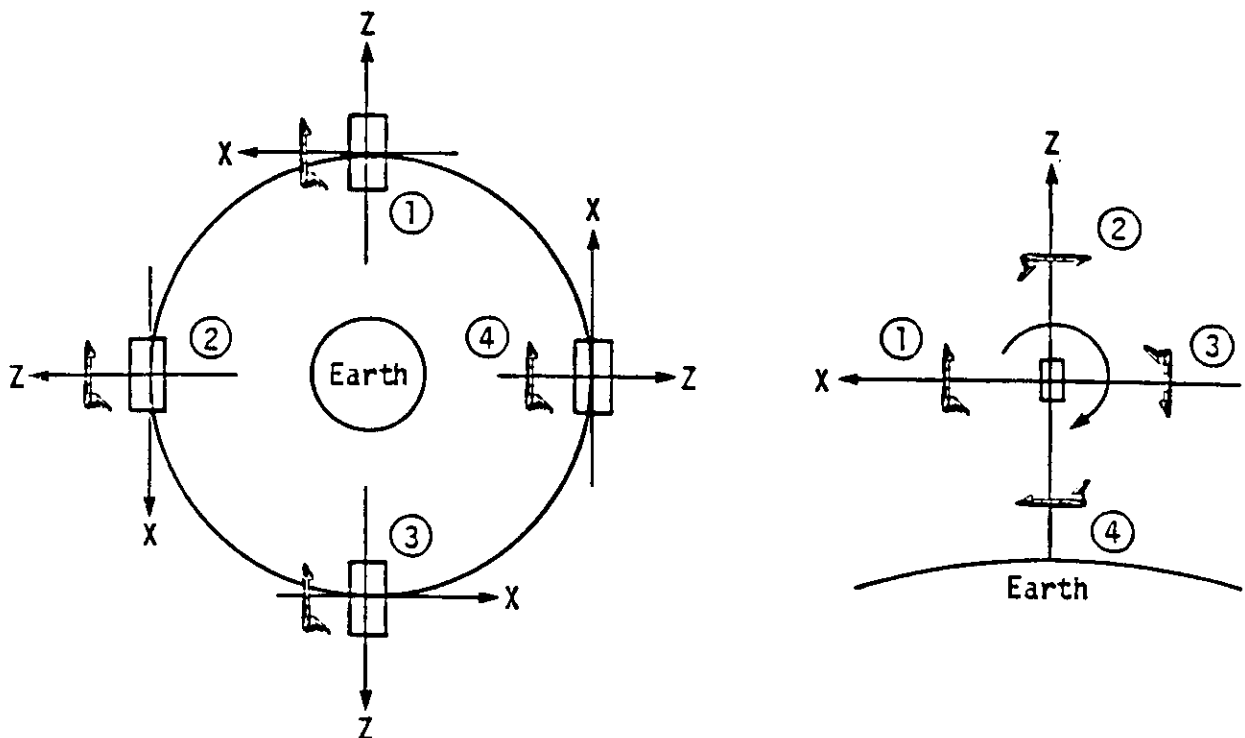

Stationkeeping WRT inertially stabilized target

Figure 5-1.- Inertially stabilized TGT.

The Orbiter DAP automatically maintains inertial hold, while the crew uses the COAS and CCTV for NLOS and LOS translation correction information.

5.1.2.2.2 Target attitude fixed relative to LVLH frame.- A TGT may be maintaining a constant attitude relative to the LVLH frame (and therefore rotating in the inertial frame at orbit rate). The TGT attitude may be controlled either actively with an attitude control system or passively by gravity gradient torques. In either case, the Orbiter maintains a fixed position and attitude with respect to the TGT LVLH reference frame (fig. 5-2).

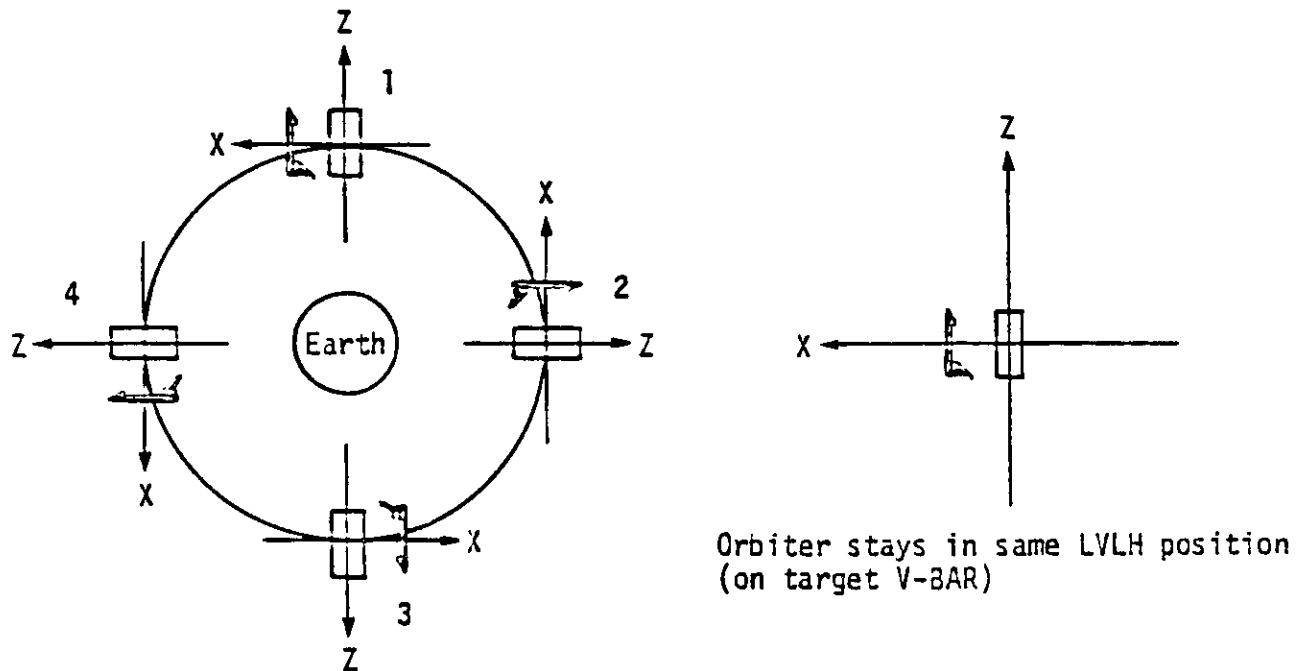

Station keeping WRT target rotating
in inertial frame at Orbital rate
(i.e., target attitude fixed relative
to LVLH frame)

Figure 5-2.- TGT fixed in LVLH reference frame.

Orbiter attitude is controlled automatically by either UNIV PTG (with selection of a proper Orbiter body vector pointed at the Earth) or by selection of the LVLH mode (UNIV PTG is the preferred technique). Translation is controlled manually as in the previous case; however, the amount of thrusting required is considerably reduced, due to the stable nature of LVLH fixed position stationkeeping.

Note: This applies only if the Orbiter is close to the V-BAR of the TGT. If we have LVLH stationkeeping with a large out-of-plane offset, and/or above/below the V-BAR, then this does not apply.

5.1.2.2.3 TGT rotating at arbitrary rate.- Under certain circumstances, the Orbiter may be required to perform short-range stationkeeping with a TGT which is rotating at an arbitrary rate about an arbitrary axis, relative to the LVLH frame. This type of stationkeeping would be needed if the TGT experienced the loss of its control system (active system failed, or passive system disturbed by some external torque such as plume impingement) causing the TGT to rotate at an arbitrary rate inertially about a principal axis of inertia, thus making it difficult for the Orbiter to initiate grapple procedures.

5.1.2.3 Medium Range

Medium-range stationkeeping is required primarily during preparation for final approach, and generally at a range outside of the TGT plume sphere of influence (approximately $200 < R < 1000$ ft). Other situations which may require medium-range stationkeeping operations include three-body operations (such as operations with an MMU crewmember), RMS activation, delay to await proper final approach lighting conditions, or troubleshooting Orbiter systems problems. The time period associated with medium-range stationkeeping is approximately one to two orbits.

Medium-range operations are controlled using manual translation techniques. The technique emphasizes maintenance of the c.m. of the Orbiter about the $TGT \pm V\text{-BAR}$ and direct visual contact with the TGT (i.e., tight stationkeeping as described in section 5.1.2.2). Since the CCTV is relatively inaccurate and ineffective over this range interval, the primary source of relative state information is the radar. With a visible TGT, the COAS and CCTV would still be useful for NLOS position determination.

For medium range, brief loss of direct visual contact is acceptable as long as stable stationkeeping has already been established. This was done on 51-F when loss of contact was approximately 4 minutes. This should be considered the longest allowable "blind" period.

5.1.2.4 Long Range

Long-range stationkeeping becomes appropriate during long-term ground or internal payload checkout and/or activation, or during three-body operations where a free-flyer is sent over from the Orbiter to perform some payload-related task. The ranges associated with long-range operations are between 1000 feet and radar acquisition range (however, for ranges greater than approximately 2000 feet the stationkeeping would not be considered a pure PROX OPS task and a rendezvous would most likely be required). The time period may range from two orbits to approximately 1 day.

Long-range stationkeeping operations can be automatically controlled, relying primarily on the use of navigated state data. For long-range stationkeeping the TGT appears visually as a point source of light, and direct uninterrupted visual contact with the TGT may not be possible (e.g., night time stationkeeping). However, the radar can provide the majority of the required relative position information. Use of one of the manual V-BAR control techniques is possible if raw radar data is available. Direct visual contact would serve as a useful supplement to the radar, but would not be sufficient alone as a source of long-range stationkeeping information (range and rates are needed).

For longer ranges and longer stationkeeping periods, manual techniques become somewhat laborious and expensive, and it is desirable to utilize some form of automated techniques whereby the Orbiter NAV system is utilized to determine when corrective maneuvers are required. The radar system is still required as a sensor for purposes of keeping the REL Orbiter/TGT SV current. A typical AUTO technique (fig. 5-3) uses an algorithm which attempts to maintain the Orbiter c.m. within some predefined boundary centered at some range on the TGT V-BAR. Whenever the Orbiter c.m. approaches the boundary, a maneuver based upon the current navigated REL state is computed and executed to drive the c.m. back to the center. Upon arriving at the center, a maneuver is computed and executed to null all rates relative to the TGT. The process repeats itself again after the Orbiter c.m. again drifts out to the boundary.

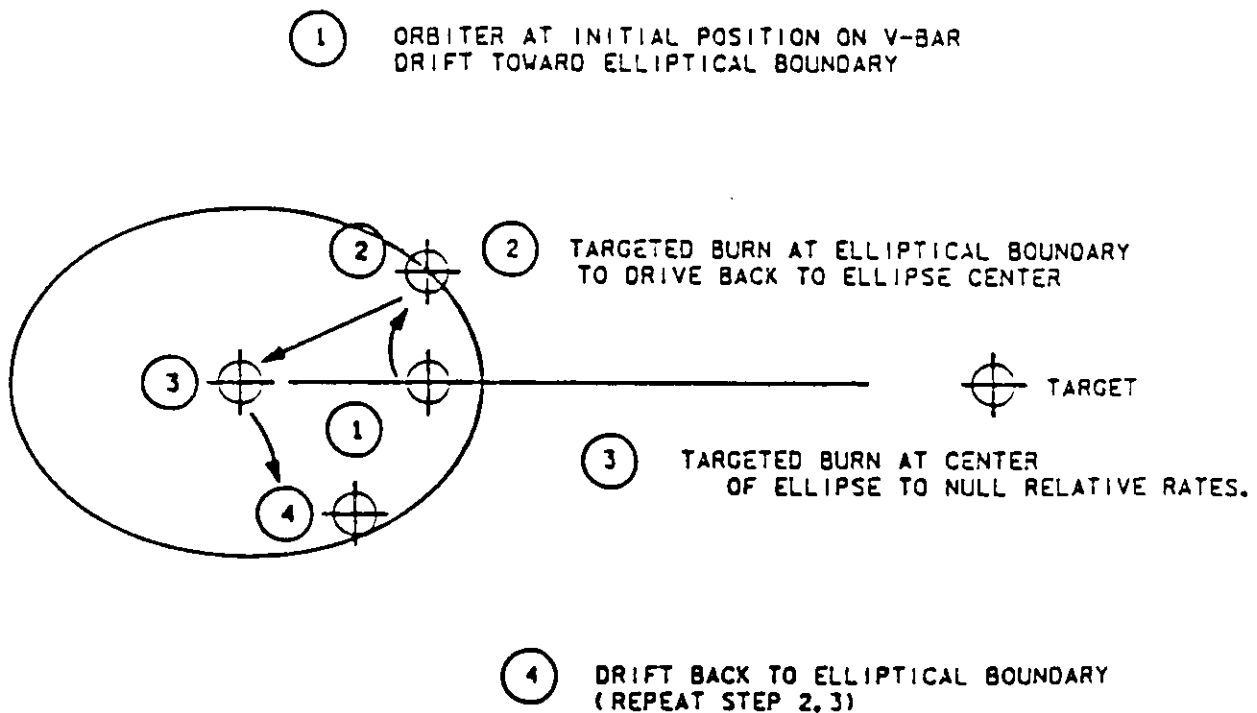

Figure 5-3.- Point stationkeeping.

5.1.2.5 Very Long Range

Under certain circumstances it may be desirable to perform stationkeeping at ranges from 1 mile to maximum radar track range and for periods of several REV's to a full day. In practice it has always been preferred to initiate a slow separation and perform another rendezvous the following day. However, requirements may force such very long-range stationkeeping and its resulting complications (e.g., 24-hour crew awake cycles and intermittent TDRS COMM). This falls outside of true PROX OPS.

5.1.3 Operational Groundrules and Constraints

For planning actual stationkeeping operations, the following groundrules and constraints should be observed (source, MOD memo DM4-86-62, Nov. 25, 1986).

Manual stationkeeping on the V-BAR axis for ranges on the order of or less than 1000 feet may be planned for a duration not to exceed a full crew work-day, (i.e., Crew Scheduling Constraints, Crew Procedures Management Plan, appendix K). This would require dedication of two qualified crewmembers and could not be scheduled on consecutive days. Due to disturbance from the FRCS firings, stationkeeping should not occur when any member of the crew has a sleep shift. This stationkeeping could be further limited by forward RCS propellant limitations which depend on other mission activities and details of the mission specific stationkeeping activities such as low-Z stationkeeping, failed VRCS, etc.

As a gauging point, it should be noted that with a full forward RCS loading available for the stationkeeping activity, the duration of the stationkeeping on the V-BAR will be limited to less than 20 hours due to stationkeeping costs of about 100 pounds per revolution plus retrieval at the end of the crew day followed by redeployment for additional stationkeeping. Stationkeeping will cost considerably more if not on the V-BAR.

5.2 FLYAROUND/TRANSITION

Flyaround is a PROX OPS task which generally involves maneuvering the Orbiter (active vehicle) from one point to another point relative to the TGT (passive vehicle). In particular, flyarounds require that the Orbiter, with appropriate translation corrections, maintain approximate constant range from a TGT while moving from one relative position to another in the TGT LVLH reference frame. Generally, the Orbiter maintains a specified body vector pointed toward the TGT throughout this phase. This axis is generally the Orbiter -Z axis since it provides COAS LOS TGT visibility and is the optimum radar track axis (fig. 5-4).

"Transition" is more general in scope in that it includes any operation which results in Orbiter movement from one point to any arbitrary point relative to the TGT in the TGT LVLH reference frame (i.e., range is not

necessarily maintained constant). Whereas flyaround maneuvers are generally flown in a manual mode since they require constant maneuvering, transition maneuvers may be automatically targeted.

The requirement to perform a transition or a flyaround may result from several situations such as the need to perform payload inspection, the requirement to support detached PL experiment operations by appropriate Orbiter relative positioning, or the requirement to move from a final RNDZ point (initial stationkeeping point) to a final stationkeeping point from which grappling operations can be initiated.

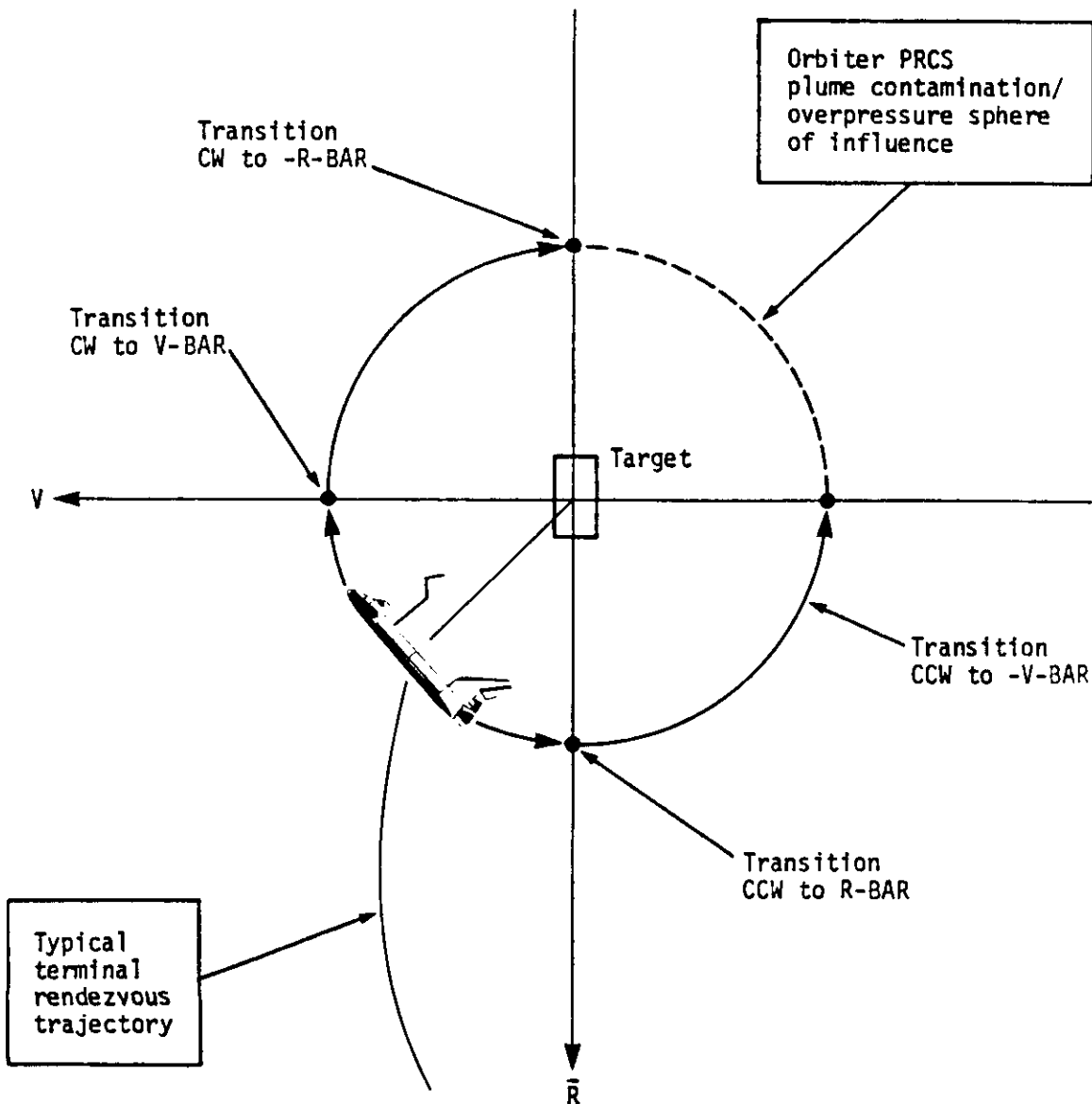

Figure 5-4.- Transition geometry.

5.2.1 LVLH ORB-Rate In-Plane Flyaround

An Orbiter LVLH in-plane flyaround (fig. 5-5 or 5-6) follows a trajectory which remains in the TGT orbit plane. The technique employed to execute this trajectory is dependent on the angular displacement between the initial and final stationkeeping points as well as the required time of transfer. Generally, the shortest path consistent with minimum propellant usage is chosen. When time of transfer must be minimized, an arbitrary flyaround rate greater than orbit rate may be selected.

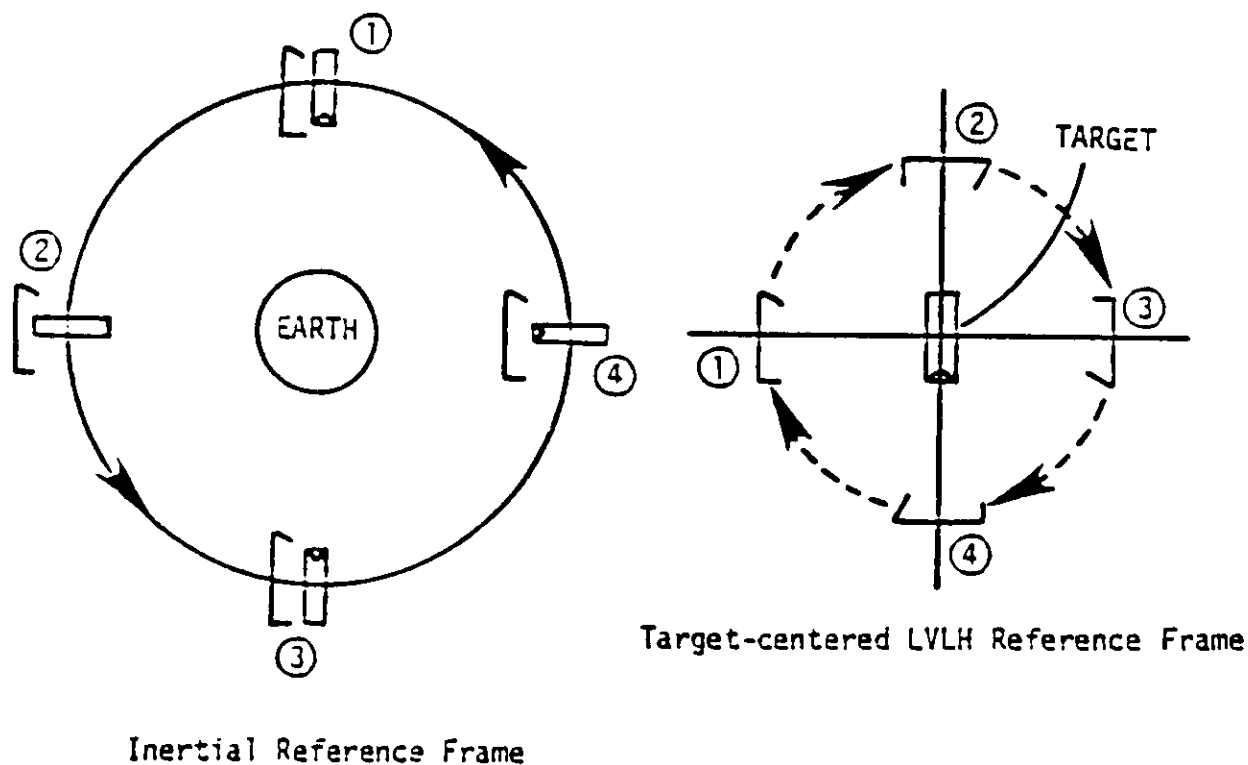

Figure 5-5.- Flyaround of an LVLH attitude hold TGT.

5.2.1.1 Clockwise Orbit Rate Flyaround

Whenever possible, a CW flyaround (fig. 5-5) is selected since it takes advantage of orbital dynamics forces which tend to assist the angular change required to establish and maintain the flyaround (i.e., posigrade maneuvers assist below the TGT and retrograde maneuvers assist above the TGT). The flyaround technique is further simplified by selecting the flyaround rate to be orbit rate (approximately 4 deg/min at 150 n. mi.). For example, an orbit rate flyaround of a TGT would imply a 360° rotation around the TGT in exactly one orbit of travel. The LOS from the Orbiter to the TGT would remain inertially fixed throughout this type of flyaround.

Procedurally, the orbit rate flyaround requires that the Orbiter initiate, by "seat of the pants" flying, the proper X axis translation ΔV for a 360° flyaround in one orbit for the desired flyaround range (as indicated by zero inertial elevation angle rate from the radar or by maintaining the TGT stationary in the COAS), and then simply maintain the Orbiter in inertial attitude hold. This proper rate is shown on the PROX OPS cue card (section 4.3.6). Due to initial MNVR dispersions, cross-coupling effects, orbital mechanics effects, and differential drag, small translation corrections must be made (done manually out the window) during the flyaround to maintain the appropriate range and flyaround rate.

5.2.1.2 Counterclockwise Orbit Rate Flyaround

In certain cases, a CCW rotation flyaround may be executed (fig. 5-6), within a significantly shorter transfer time than using a CW rotation, and there is not an appreciable propellant penalty. This was the case on STS 51-D. In fact, it is cheaper and quicker to go from the V-BAR to the R-BAR by a CCW rotation than a CW rotation. Plume impingement on the target is also reduced because the thruster firings required due to orbital mechanics are toward the target. However, for a given angular displacement (measured clockwise) and transfer time, the CCW rotation requires more propellant. This is due to the fact that (1) the Orbiter must now maintain a pitchdown rate in order to keep the TGT along the $-Z$ COAS LOS (twice orbit rate for a CCW orbit rate flyaround), and (2) the orbital dynamics forces are now operating in conflict with the desired trajectory motion. That is, when the Orbiter is below the TGT and performs the appropriate retrograde X axis translation ΔV for the orbit rate CCW rotation, the resulting trajectory is downward, and considerable translation corrections must be made to force the trajectory back to a constant range, in an upward direction. Most flyarounds are therefore executed in the CW direction.

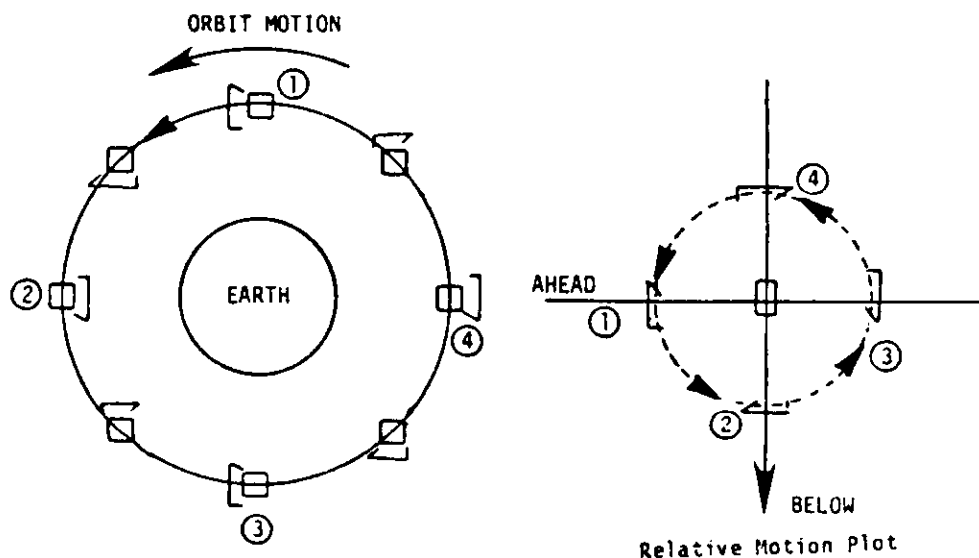

Figure 5-6.- Counterclockwise flyaround.

5.2.2 LVLH out of Plane

A flyaround may also be executed out of plane (in the TGT local horizontal plane). The Orbiter is placed in manual ROT (free drift) PULSE mode in one axis and maintains AUTO attitude hold in the other two axes. For example, if roll is the axis that is to be maintained manually by the crew, pitch and yaw would be in LVLH hold and the Orbiter translations would be performed as required to maintain the proper flyaround rate.

5.2.3 Arbitrary Rate Flyarounds

5.2.3.1 Single Axis

Some situations require a flyaround in a shorter time than ORB rate will allow. In this case, several options are available. One option, called AUTO ROTATION, uses the single-axis AUTO ROT option of UNIV PTG. Although the pilot probably would not mix modes, the task is then to use the THC as required to keep the TGT in the COAS and maintain constant range. This option is limited to pure in-plane flyarounds, performed one axis at a time, since the ROT option fixes the two nonrotating axes inertially. A second option called MANUAL ROTATION can be used in either an inertial (DAP MAN) mode or LVLH (DAP LVLH) mode. In this case, the desired axis of rotation is placed in free (PULSE) and the other two in hold (DISC RATE). The pilot task here is to use the RHC to maintain the desired flyaround rate (pilot would monitor rate on UP and the appropriate rate needle), and then use the THC to accomplish the flyaround. Complicating this technique is the fact that rotation and translation maneuvers cross-couple significantly, which makes it difficult for the pilot to maintain the flyaround rate and still do the required translations. Constant monitoring and correction of rotation rate is required.

5.2.3.2 Multiple-Axis Auto Rotation Maneuver

An arbitrary rate, multiple axes flyaround technique is used primarily for transition to a final approach axis of an inertially stabilized TGT. The approach axis may be pointed in any direction and the TGT may be rotating at a rate other than orbit rate. The flyaround may be an in-plane or an out-of-plane translation, performed manually with the THC and RHC. This is a very challenging task and is not recommended.

This maneuver may be used when the final Orbiter attitude at final approach is known and can be input to the DAP. The Orbiter performs an eigenaxis (i.e., the axis of minimum rotation between two attitudes) rotation maneuver, with manual translations made to keep the TGT centered in the COAS and to maintain a constant range. It is very complex to set up, and therefore manual rotations are generally preferred. However, if done in the proper direction (CW versus CCW for in-plane maneuvers) it can be relatively easy to fly.

5.2.3.3 LVLH (INERTIAL) Orbiter/TGT Alignment Procedure

For an arbitrary (and preredezvous unknown) TGT attitude, the following procedure was developed for STS 51-I (see fig. 5-7) and was generalized for the contingency book. There are other procedures to accomplish this, but this is very straightforward and is probably the easiest. One axis is corrected at a time. The alternative is to perform a simple inertial approach straight in.

<u>LVLH (INERTIAL) ORBITER/TGT ALIGNMENT</u>	
<u>CAUTION</u>	
	-Z Sense Roll/Yaw (A6U) are the reverse of +X Sense Roll/Yaw (C3)
	Maintain -0.2 to -0.3 deg/sec rotation rate
A6U	✓SENSE - -Z ✓DAP TRANS: PULSE/PULSE/PULSE DAP: B/LVLH (MAN)/NORM ✓DAP ROT: DISC/DISC/DISC
	Align ROLL, if reqd DAP ROT: PULSE/DISC/DISC RHC (ROLL) and THC as reqd When Aligned, DAP ROT: DISC/DISC/DISC
	Align PITCH, if reqd DAP ROT: DISC/PULSE/DISC RHC (PITCH) and THC as reqd When Aligned, DAP ROT: DISC/DISC/DISC
	Align YAW, if reqd DAP ROT: DISC/DISC/PULSE RHC (YAW) and THC as reqd When Aligned, DAP ROT: DISC/DISC/DISC
	DAP: B/LVLH (MAN)/VERN, NORM as reqd

Figure 5-7.- Trim Orbiter/TGT alignment.

It must be emphasized that 0.2 deg/s is plenty fast enough as an angle rate, even if it does not look that way out the window. The crew is advised not to go free drift in more than one axis at a time.

5.2.3.4 Manual Rotation Maneuver

A manual rotation maneuver is required when the final necessary Orbiter approach attitude is not known. The pilot gets his cues for starting and stopping the rotational maneuvers either from out-the-window (or CCTV) view of the payload or from checklist procedures. It is performed one axis at a time by repeated application of the ROT techniques described in 5.2.3.

For short-range stationkeeping with a TGT rotating at an arbitrary rate, the Orbiter must manually establish a matched rotation rate (possibly in three axes) while simultaneously translating to stay on the desired TGT axis. While the two previous cases (TGT inertial and TGT LVLH) only required three degrees of manual control (translation), this technique requires six degrees of manual control (ROT and translation). Manual ROT control is required since the AUTO modes require either Orbiter attitude fixed to the inertial or LVLH reference frame (i.e., either zero or orbit rate relative to the inertial frame). This maneuver is tricky since the Orbiter will be rotating about its own c.g., which will be some distance from the nominal grapple position. The best maneuver rate is between 0.2 and 0.3 deg/s. While the vehicle is still controllable at higher rates, fuel usage increases dramatically. In this situation, one may, for instance, prefer to do LVLH stationkeeping on the TGT V-BAR, and perform a rotating grapple.

As already described in section 5.1.2.1, since close-in operations are done at 35 feet, orbital mechanics effects are ignored. Flying is done strictly from a combination of out-the-window and RMS EE CCTV camera views, with delicate eye and hand coordination using the THC and RHC. Attention must also be given to the attitude rates displayed on UNIV PTG (OPS 201) to ensure that the desired rate is achieved and maintained. As in all phases of RNDZ/PROX OPS beginning with the initiation of manual trajectory control, the -Z sense is used exclusively for reasons of consistency and ease of piloting. DAP B/MAN/NORM usually works best.

5.2.4 Auto Targeted Trajectory

This is done (as on STS 51-F) with a general two-impulse maneuver, which requires good onboard NAV for generation of targeting SV's. It is generally required when there is a ΔT constraint in maneuvering from one arbitrary point to another arbitrary point relative to a payload. The NAV targeting maneuver execute logic is used instead of the thrust monitor function. Certain orbit targeting I-loads need to be "tuned" for operations at PROX OPS ranges (see discussion in section 3.5.4.). The automated rotation maneuvering may be used as a backup in the event of RR failure. However, this must be carefully planned preflight, as on STS 51-F (see discussion in appendix A).

5.2.5 LOS Rate Techniques

The Orbiter-to-TGT radar LOS rate tends to jitter due to beam wandering, but when smoothed (either mentally, via some TGT characteristic, or via some as-

yet undeveloped sensor), this parameter may be able to provide a valuable cue for PROX OPS piloting, especially for performing in-plane MNVR's in the vicinity of the V-BAR. The following discussion deals with a candidate procedure not yet validated or flown.

The inertial LOS rates are displayed on the cross pointer as EL and AZ rates on the A2 panel (fig. 3-20) and on SPEC 33 (REL NAV) (fig. 3-31) as ω_P (for EL rate) and ω_R (for AZ rate) on the RR column. These rates specify how much the LOS, a line from the Ku-band radar antenna to the TGT, is moving with respect to the inertial space, referenced on the RR EL/AZ coordinate system.

First, consider the case of a transition to the V-BAR, as is done at the final portion of a rendezvous maneuver (fig. 5-8). The Orbiter achieves inertial stabilization by selection of DAP MAN/DISC, maintaining the TGT in the COAS FOV by THC inputs. Evidently, for such a transition, the RR EL LOS rate is going to be about zero, depending on the THC corrections required in the +X or -X direction to maintain the TGT in the COAS. The LOS to the TGT, then, is going to rotate with respect to the LVLH TGT centered frame at the orbital rate, that is about 4 deg/min, or 1.16 mrad/sec (in what follows, this value is rounded to 1.1 mrad/sec):

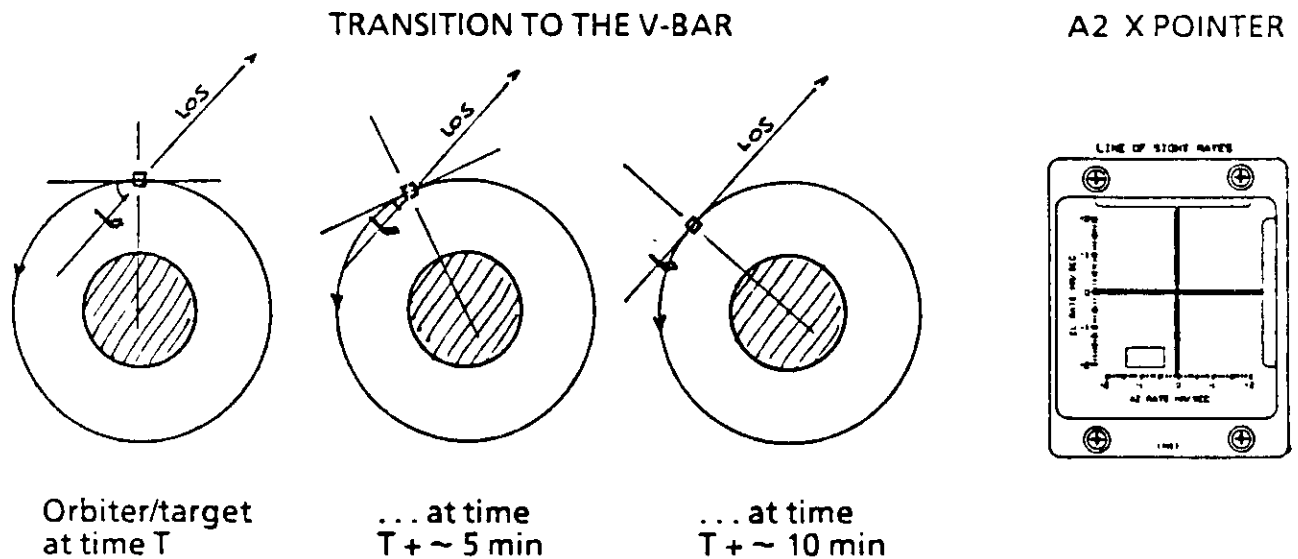

Figure 5-8.- Transition to the V-BAR.

When on the V-BAR (fig. 5-9), to stay there, the Orbiter must null its upward motion. The crewman uses the THC in the -X direction, preferably in the pulse mode, to take away about as many ft/s of +X motion as range to the TGT is in kft (1 ft/s for 1000 ft range, for instance). Previously, of course, the crew must have set up the UNIV PTG to have the -X body vector tracking the center of the Earth upon reaching the V-BAR, at which point

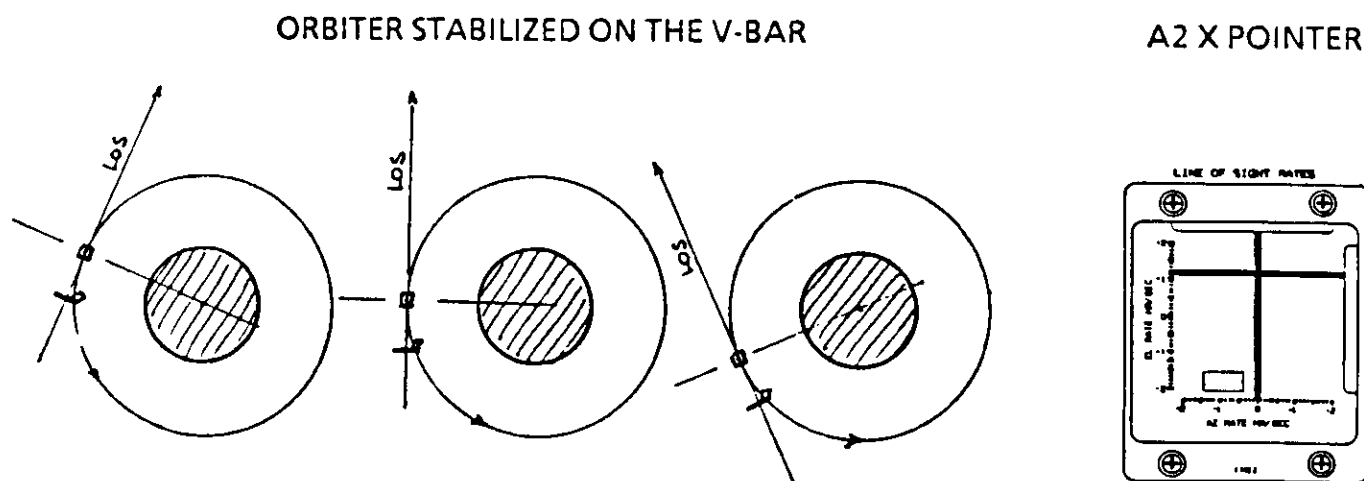

Figure 5-9.- Orbiter stabilized on the V-BAR.

select DAP AUTO. The -X translation MNVR that is performed in order to brake on the V-BAR will cause the EL LOS rate to increase. When it shows 1.1 mrad/sec, or thereabouts, the Orbiter is established on the V-BAR. The LOS, rotating with respect to the inertial space at the orbital rate of 1.1 mrad/sec, will then evidently remain fixed with respect to the TGT centered LVLH frame.

The EL LOS rate is not expected to tell anything about whether the Orbiter is approaching the TGT, or going away from it, or maintaining range. But over a period of time a closing R-DOT will cause a fall below the V-BAR, and the EL LOS rate will become higher than 1.1 mrad/sec. An opening R-DOT will, on the contrary, go above the V-BAR, and EL LOS rate will go below 1.1 mrad/sec (see fig. 5-10).

Instead of using the A2 panel crosspointer, the crew can, of course, use WP on the REL NAV display. A good value indicating proper stabilization on the V-BAR is 1.1. For any value above that, the Orbiter is going down. For a value below that, the Orbiter is going up.

YOU ARE COMING DOWN, BELOW
THE V-BAR

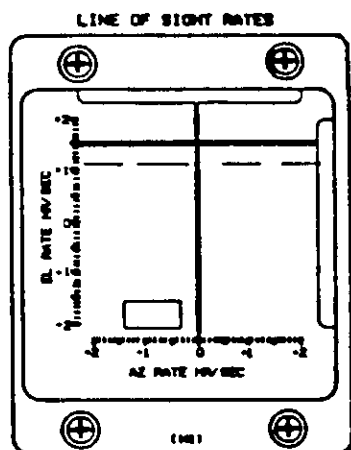

YOU ARE GOING UP, ABOVE
THE V-BAR

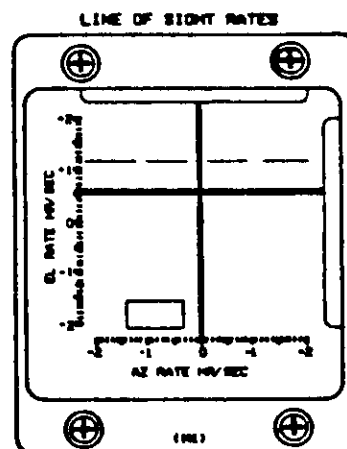

Figure 5-10.- Angle rates versus V-BAR stability

EL LOS rate is also useful to consider in a V-BAR approach (see fig. 5-11). After proper stabilization on the V-BAR, the crew establishes the desired closing range rate with the THC, and initiates a +X translation of such an amplitude as to reduce the EL LOS rate from 1.1 to about 0.7 or 0.8 mrad/sec. The crew knows then that it is getting a small amplitude hop above the V-BAR. EL rate will slowly increase. When the Orbiter gets again 1.1 mrad/sec, the tangent of the trajectory in the LVLH frame is passing through the TGT, but the Orbiter still is above the V-BAR. Whenever the crew visually ascertains that it is again on the V-BAR, they translate in +X again to bring its EL rate below 1.1 mrad/sec. The crew continues that way until it is at the stationkeeping range.

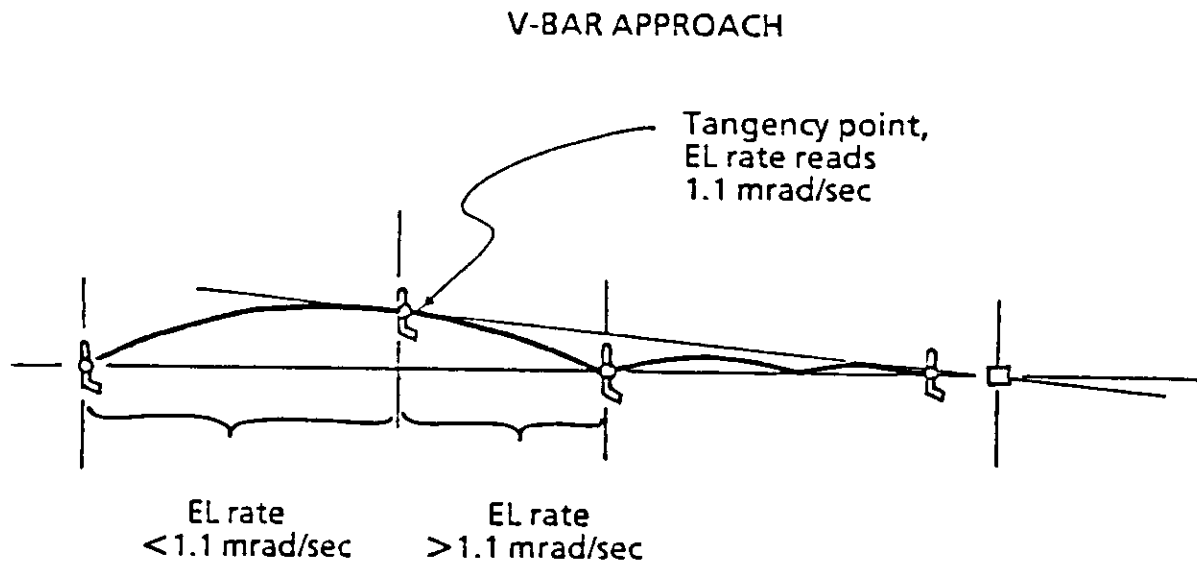

Figure 5-11.- Angle rates versus V-BAR approach

5.3 FINAL APPROACH

The final approach phase includes various braking and approach techniques.

5.3.1 Braking Techniques

The braking segments typically occur near TGT intercept and reduce relative velocity to near zero. The technique to be used for braking is greatly dependent upon the approach trajectory. For example, the technique used for a direct RNDZ intercept must reduce a large relative velocity, whereas the technique used just prior to capture must null only a small closing velocity. It is not the intent of this section to define the possible braking approach profiles, but to describe the thrusting techniques by which the Orbiter can achieve a stabilized relative position. Four techniques will be discussed, three involving the use of the PRCS and one (already discussed in section 2.4.3) using more dynamic orbital mechanics effects.

5.3.1.1 Normal Z-Axis Mode Braking

The normal Z-axis braking technique uses the up-firing PRCS thrusters to achieve a braking force directed in the +Z Orbiter body direction. This technique would be used in the case where the Orbiter -Z axis was pointed along the LOS to the TGT (fig. 5-12). Because the thrusters firing along the -Z axis provide the braking force, this technique results in the greatest amount of PRCS plume impingement on the TGT. Either the TGT must be insensitive to plume

contamination/overpressure, or braking must occur outside of a contamination/overpressure sphere where plume effects are negligible. However, this orientation does allow crew monitoring of the TGT through the overhead window and use of the RR.

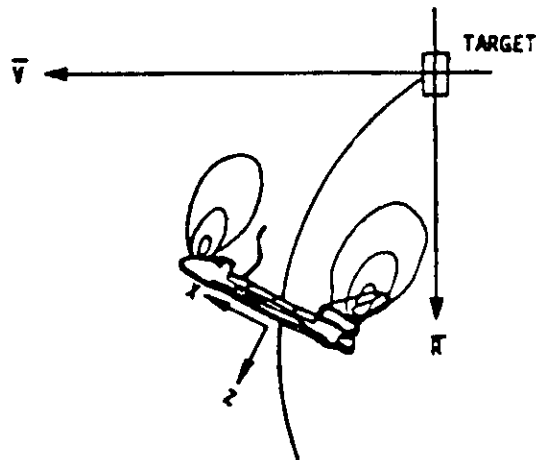

Figure 5-12.- Normal Z axis braking.

The braking force would normally be applied to achieve a range/range rate profile that is optimized to account for Orbiter PRCS acceleration, trajectory dispersions, and TGT sensitivity to PRCS plume. The RNDZ radar is normally used to determine actual range/range rate. Control of the relative velocity normal to the LOS during braking is accomplished by PRCS thrusting to achieve a specified inertial LOS rate. This rate is read directly from the radar LOS rate display (panel A2) or observed by monitoring TGT drift in the COAS reticle.

5.3.1.2 Low Z Mode Braking

The low Z-axis mode braking technique is the standard technique used (as a modification to normal Z axis mode braking) to reduce the PRCS plume in the Orbiter -Z direction. As described in section 3.2.4, the technique uses the cant of the aft firing thrusters and the scarfing of the forward firing thrusters to produce a resultant force in the +Z direction (fig. 5-13). The $\pm X$ axis firing is controlled by the DAP to produce a near zero force in the X axis direction. The propellant penalty (12 times NORM Z for same $-\Delta V$) is minimized by using the low Z axis braking mode only in the interval from the boundary of the PRCS plume sphere of influence to the close-in point over the PLB, where the TGT is "shadowed" by Orbiter structure, and reducing the total braking ΔV inside the sphere to the smallest possible value.

Because of severe cross-coupling effects (see section 3.8.1.3), Y-axis translations induce higher closing rates, requiring expensive braking maneuvers. Consequently such translations should be avoided in this mode.

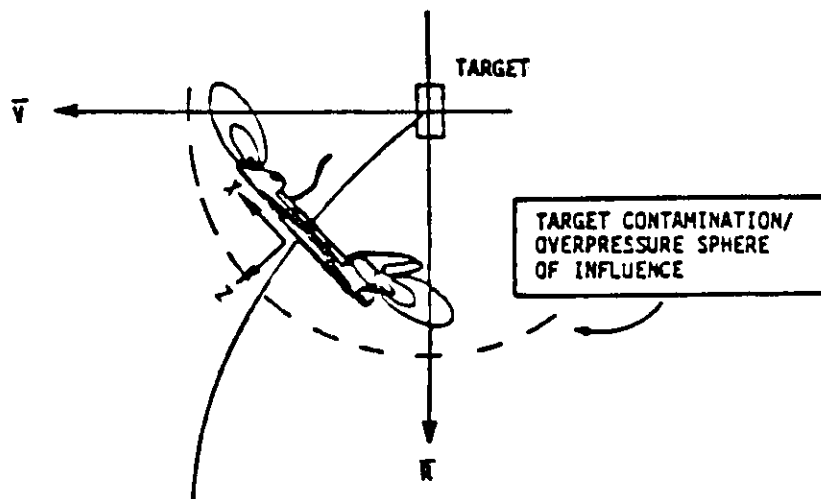

Figure 5-13.- Low Z axis braking.

5.3.1.3 X-Axis Mode Braking

The +X or -X axis thrusters could provide the braking force; however, operational constraints would normally preclude their usage. The +X axis braking mode (nose first) would not be desirable since it requires almost totally forward-pod propellant usage, which should be minimized. The -X (tail first) braking mode has the advantage that it minimizes forward-pod propellant usage; however, TGT visibility (crew and radar) would not be possible when thrusting along the TGT LOS (fig. 5-14). This technique of braking is not recommended for use due to the limited visual capabilities and plume concerns. Another concern with this type of braking is the safety issue involved with the clearance between the Orbiter tail and the TGT.

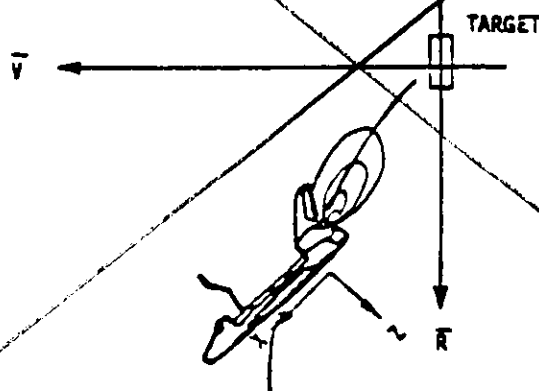

Figure 5-14.- +X axis braking.

5.3.1.4 Orbital Mechanics Effects Braking

Although not strictly a braking technique, orbital mechanics effects can provide a small separation force (see section 2.4.3). The relative position of the Orbiter with respect to the TGT can result in range opening or closing tendencies during PROX OPS.

For example, a TGT approach along R-BAR (from above or below the TGT) will result in a braking force which is a function of the differential altitude or range to the TGT (fig. 5-15). The greater the range, the greater the constantly acting separation force. The technique for establishing an approach trajectory to produce this R-BAR braking force is discussed in section 5.3.2.3. Compare the sizes of that "thrust" to RCS effects: two -X jets cross-couple into a momentary 240-pound +Z thrust; two +X jets cross-couple into a momentary 300-pound +Z thrust. In practice, the RCS cross-coupling dominates the small orbital mechanics forces for ranges less than several hundred feet. Outside that range, the forces are significant when one notes that they are constantly acting, whereas Orbiter jets are only sporadically fired.

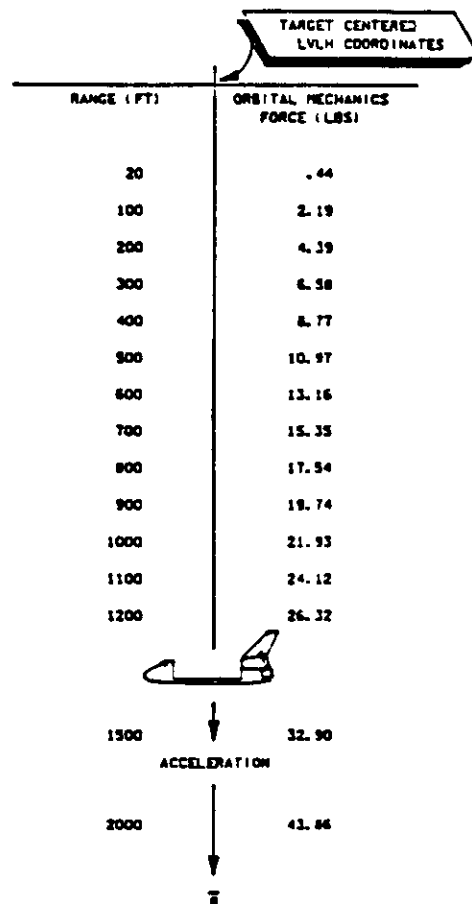

Figure 5-15.- Orbital mechanics forces during an R-BAR approach.

5.3.2 Final Approach Techniques

The selection of a final approach technique is greatly dependent upon the TGT sensitivity to Orbiter thruster plume impingement. Several techniques have been evaluated and shown to be operationally feasible. Each requires a different amount of ΔV to be nulled by thrusting in the direction of the TGT using one of the braking methods discussed above.

The approach techniques are illustrated in figure 5-16.

- Direct approach - used on rendezvous intercept trajectory with relatively large ΔV to be nulled (not typically used in the STS program).
- V-BAR approach - used for approach from ahead (+V-BAR) or behind (-V-BAR) with relatively small ΔV to be nulled.
- R-BAR approach - used for approach from above (-R-BAR) or below (+R-BAR) with theoretically zero ΔV to be nulled.
- Inertial approach - used for approach to an inertially stabilized TGT which is rotating relative to the LVLH reference frame.

Current analysis, simulations, and actual flight experience have led to the choice of V-BAR as the preferred approach technique. However, the flight procedures techniques associated with all these approaches are discussed in detail below.

5.3.2.1 Direct Approach

The direct approach can also be described as rendezvous intercept to a close-in stationkeeping position (fig. 5-17). The magnitude and direction of the intercept ΔV to be nulled are dictated by the maneuver targeting which produced an intercept trajectory. The intercept ΔV is gradually reduced by a series of braking thrusts that follow the low range/range rate profile as shown. Throughout the approach, the Orbiter is either in inertial (preferred) or LVLH attitude hold with the TGT centered in the COAS. The crew applies thrust normal to the LOS as needed to null off-nominal LOS rates. (Intercept targeting can be designed to produce either zero or ORB rate inertial LOS rates during the braking phase, although the advantage of the latter has never been demonstrated.) The radar would normally be used to determine range and LOS angle rate data.

The most efficient braking method would be the normal Z-axis mode since it provides maximum translation control authority. The low Z-axis mode can be used to significantly reduce PRCS plume effects on the TGT during the last few range/range rate gates; however, the substantial propellant consumption penalty must be considered in using this technique.

This technique has not been used since the Skylab program, when plume impingement concerns were much less than today (due to the small mass of the Apollo and the large size and mass of Skylab), and when the robust in-line docking mechanisms provided safety margins to closing rate dispersions.

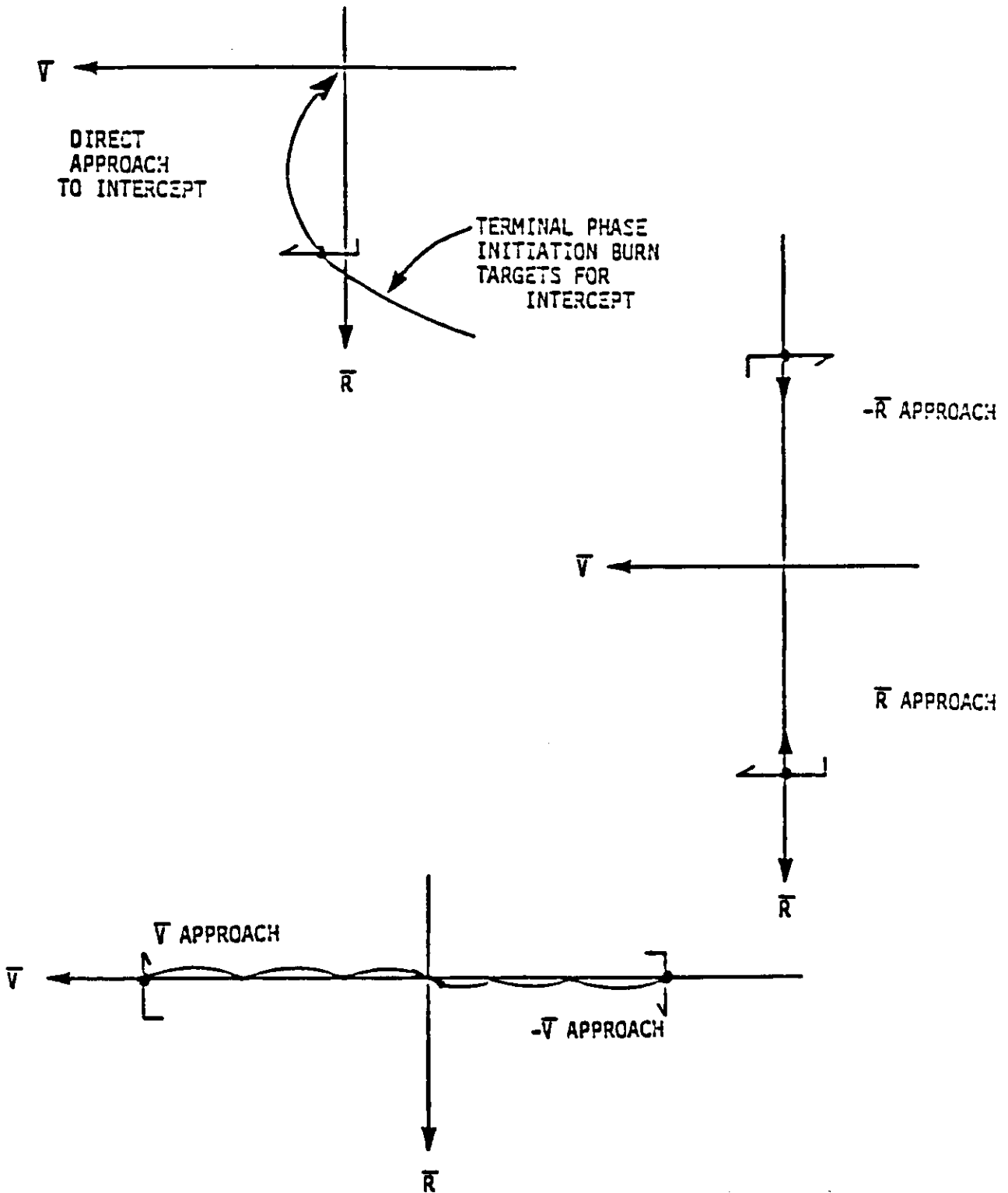

Figure 5-16.- Typical final approach techniques.

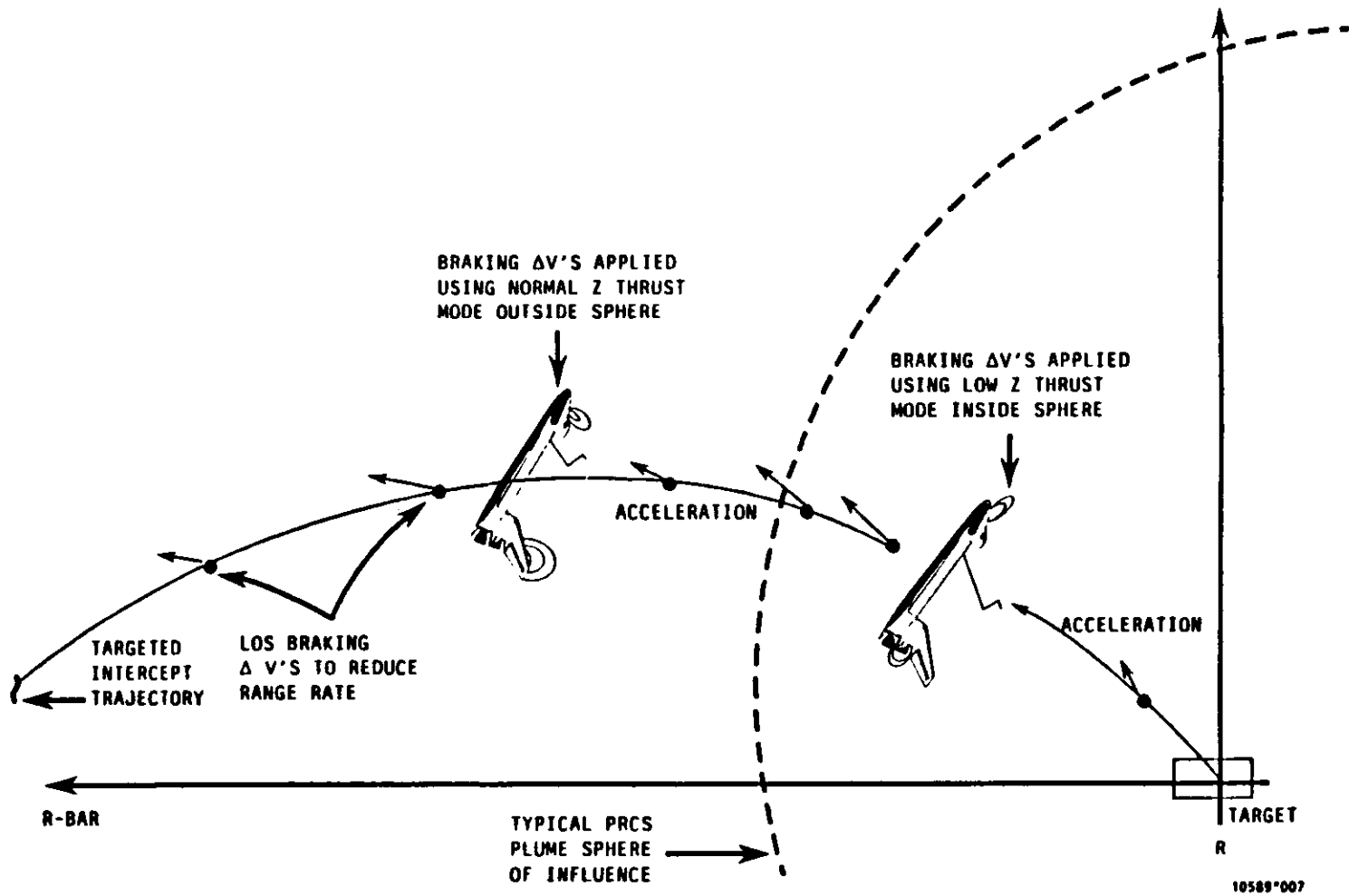

Figure 5-17.- Direct approach to close-in stationkeeping.

5.3.2.2 V-BAR Approach

The V-BAR approach technique assumes medium-range stationkeeping on V-BAR has been established ahead of the TGT (fig. 5-18); no -V-BAR (trailing the TGT) technique has ever been attractive. The approach is initiated with a ΔV directed toward the TGT (and with some +X from cross-coupling). Orbital mechanics effects (section 2.4.3.3) tend to slow the approach, making the Orbiter fall below the V-BAR and then reverse motion away from the TGT. Therefore, to maintain a closing rate for a +V-BAR approach, the crew must thrust up (normal to the TGT LOS) at each V-BAR crossing to maintain the Orbiter above the V-BAR axis. This then produces a series of trajectory hops until capture distance is achieved. The magnitude of the initial and intermediate ΔV 's is a function of range and magnitude of the NLOS rates.

During the approach, the Orbiter attitude is being automatically pitched at orbit rate (using a -X to Earth attitude hold mode), with the X-, Z-body axis continuously aligned with the R-BAR and V-BAR axes, respectively. The crew monitors the TGT drift in the COAS (or CCTV aligned along -Z) and applies the X-axis translations as required.

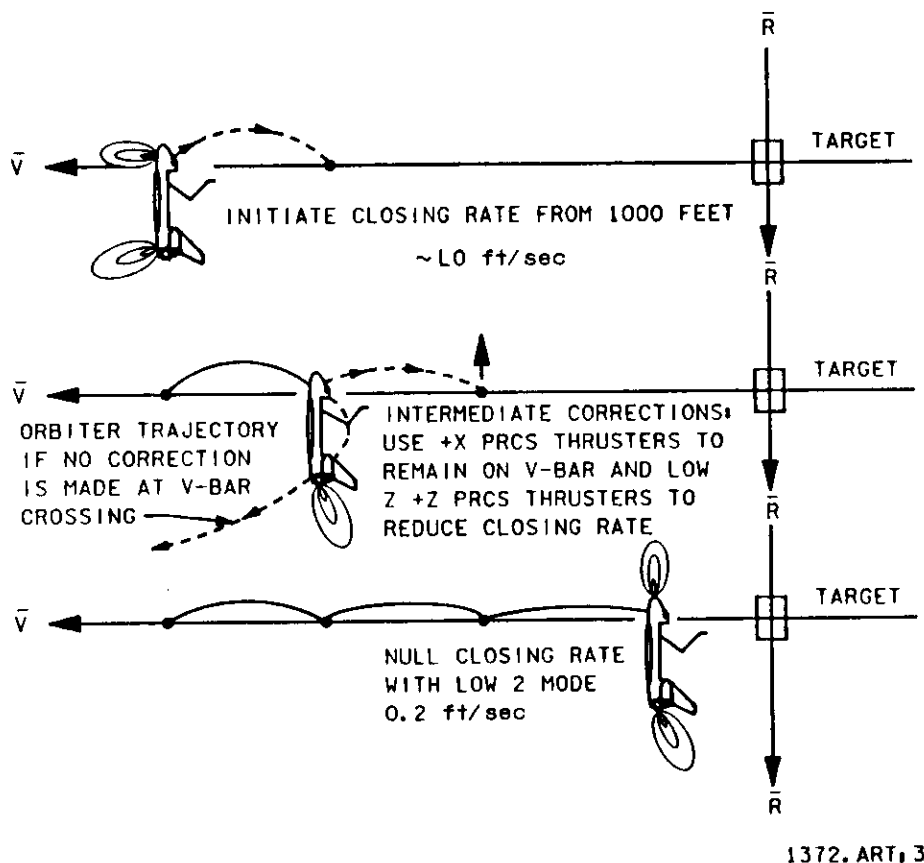

Figure 5-18.- V-BAR approach.

Predetermined braking gates will be used to null the closing rate (established to initiate the approach) prior to RMS grapple. This closing rate should be gradually nulled, with the NORM Z/low Z braking mode as required, to minimize PRCS plume effects on the TGT.

The +V-BAR approach procedures and rationale are described in detail at the end of the RNDZ in chapter 4, beginning at section 4.1.63 through section 4.1.71.

The +V-BAR approach is the preferred choice for a number of operational reasons. Current RNDZ methods schedule optical tracking so that V-BAR arrival occurs at noon. Also, +V-BAR arrival allows use of Orbiter attitude already held during manual phase RNDZ. For stationkeeping, +V-BAR also facilitates the quickest visual TGT acquisition at sunrise.

5.3.2.3 R-BAR Approach

The R-BAR approach utilizes both PRCS thruster cross-coupling and orbital mechanics effects to provide the braking force. This technique minimizes PRCS thrusting toward the TGT (practically zero). In practical application, however, the crew applies a series of small thrusts to "walk" up the radius vector (fig. 5-19). This piecemeal approach allows correction for errors made while initially determining and applying the proper closing rate.

The theoretical R-BAR technique requires the use of an analytically derived R-BAR approach profile chart (fig. 5-20), or handheld calculator program (currently nonexistent). Sample data has been plotted on the chart (dashed line) to show a typical approach where the initial closing rate at 1000 feet ($R\text{-DOT} = 1.5 \text{ ft/s}$) was sized to take the Orbiter to 600 feet; the next correction applied at 670 feet ($R\text{-DOT} = 1.0 \text{ ft/s}$) was sized to take the Orbiter to 400 feet; the next correction applied at 500 feet ($R\text{-DOT} = 0.7 \text{ ft/s}$) was sized to take the Orbiter to 300 feet, and so forth. Range and range rate measurements must, of necessity, be very accurate at short ranges; hence, radar data is recommended.

Because of the sensitivity of the R-BAR technique to range/range rate errors, a supplemental PRCS braking method may have to be used. If the $R\text{-DOT}$ at the retrieval position exceeds the limit for RMS capture, the low Z axis braking mode is recommended to null $R\text{-DOT}$ without producing direct PRCS plume impingement on the TGT.

This technique has not been operationally used to date. However, -R-BAR approach techniques have been developed in the SES for planned use during the LDEF retrieval mission and were documented in the original STS 51-D FDF.

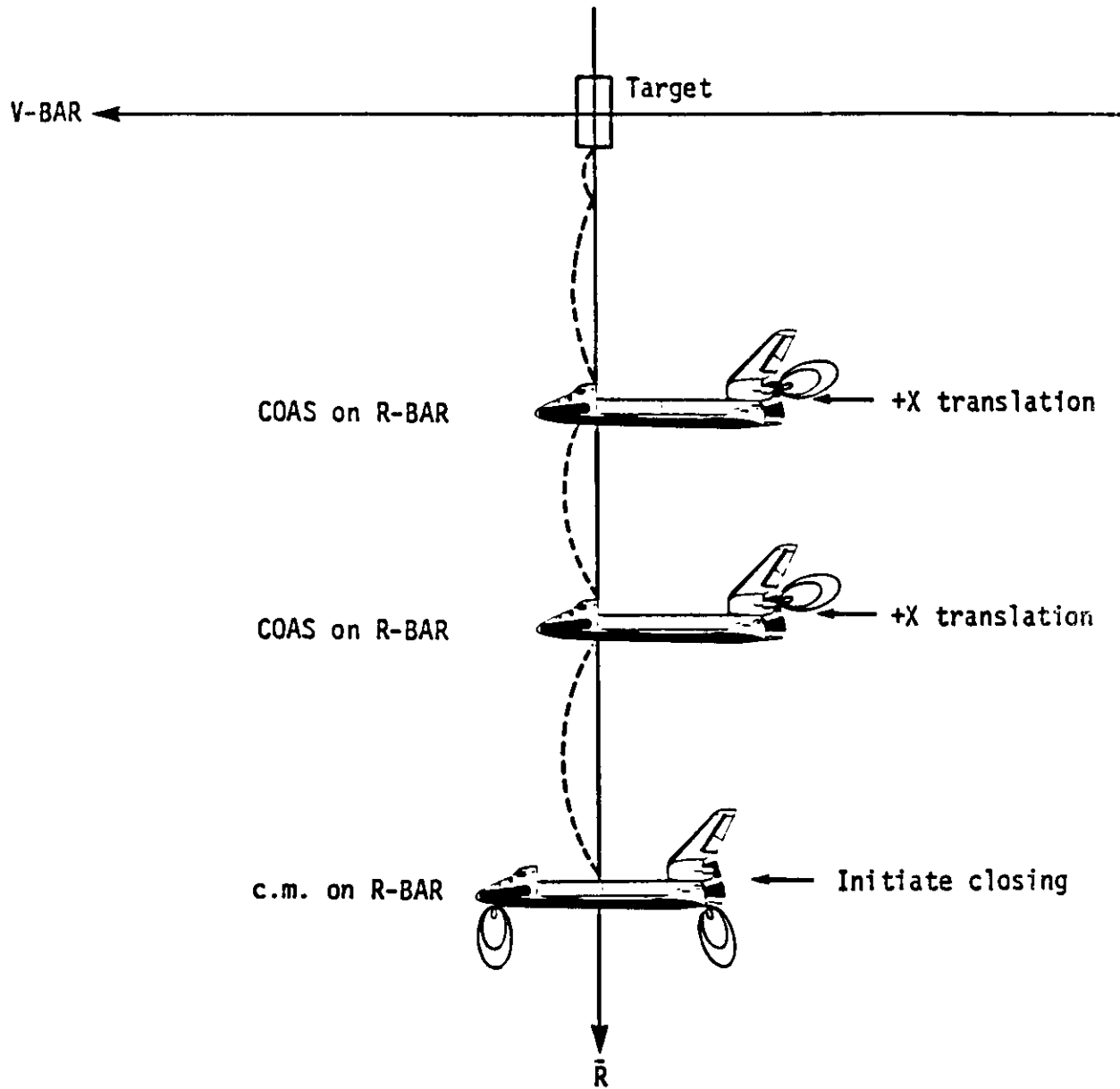

Figure 5-19.- Generic R-BAR approach technique.

5-37

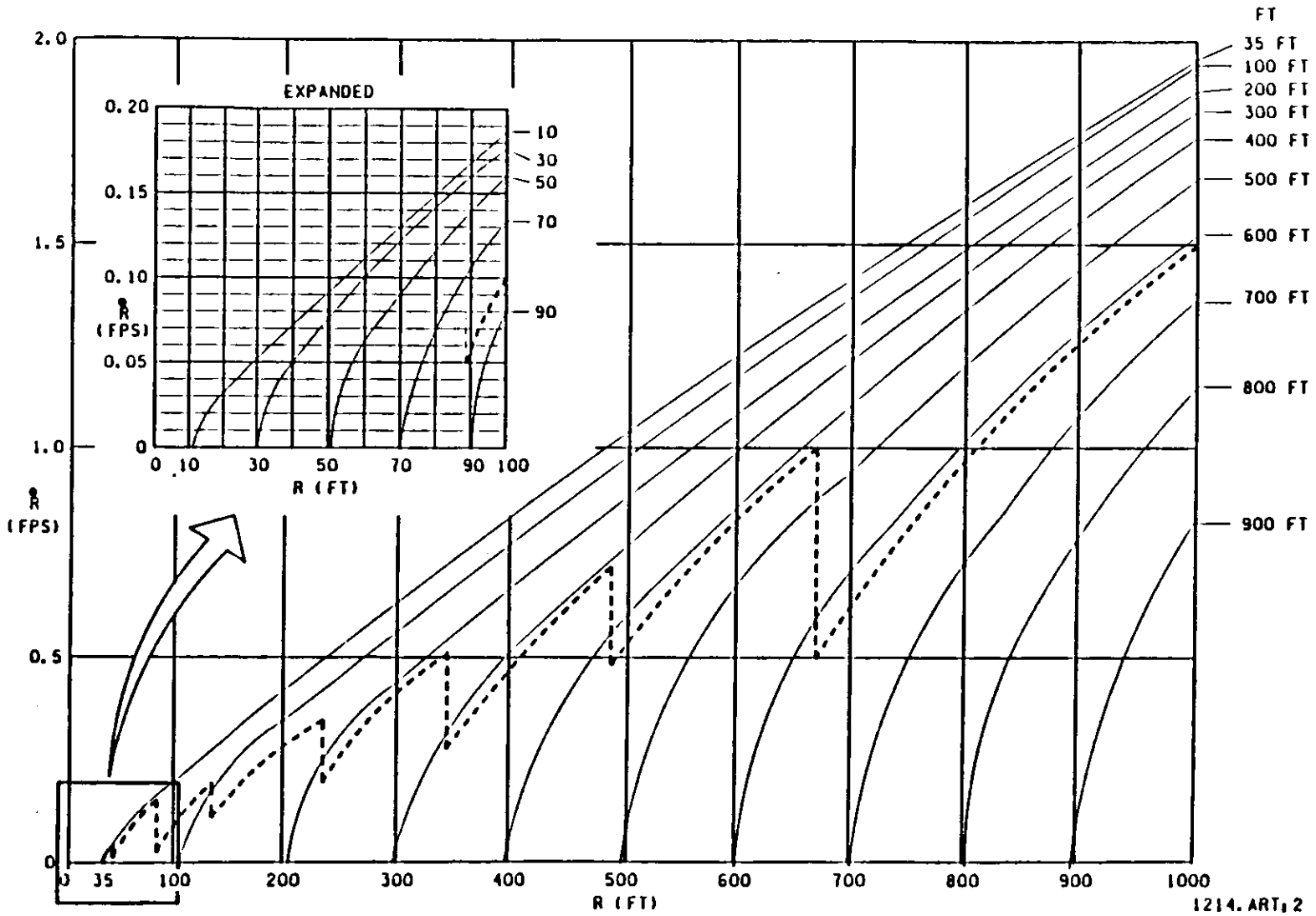

Figure 5-20.- Typical R-BAR approach profile.

JSC-10589

Rendezvous and manual phase procedures are identical to those described in section 4, up through establishment of inertial LOS rates (section 4.1.61); braking gates are the same as those described in section 4.1.64.

Due to contamination concerns for LDEF, DAP low Z is selected at a range of 1000 ft.

The next stage is to configure for final approach, and this follows closely the standard "Reconfigure RR" (section 4.1.62), "Configure UNIV PTG for V-BAR" and "Configure DAP for PROX OPS" (section 4.1.66), with one exception. The BODY VECT ID on UP is selected as +3 (the -Z axis) if the -R-BAR approach is intended (otherwise it is +2, as usual).

The approach profile is illustrated in figure 5-21.

The "400 FT TRANSITION" occurs at R = 400 feet, which nominally occurs at the V-BAR crossing. The R-DOT is nulled while the Orbiter is in inertial hold, and an inertial flyaround begins as the THC is commanded as required to maintain TGT in top of COAS. The 90° flyaround should take about 22

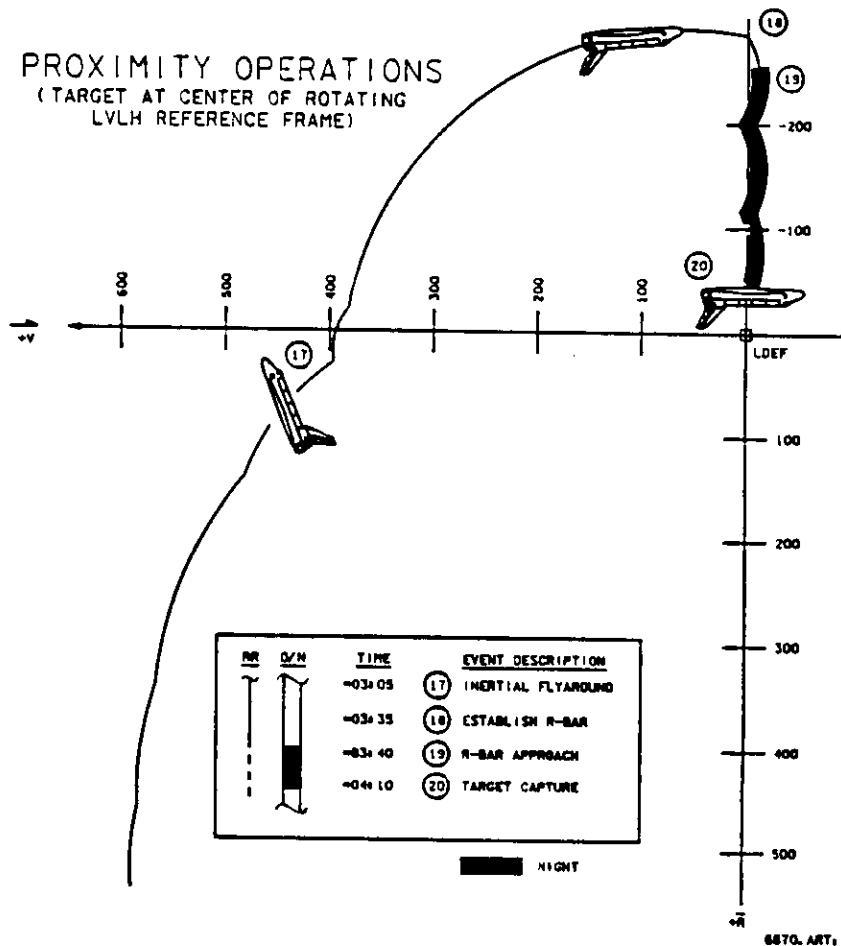

Figure 5-21.- LDEF R-BAR approach.

minutes and terminate with the Orbiter 350 feet directly above the TGT in bay-to-Earth tail-forward attitude, just prior to sunset. Cue is the ADI LVLH pitch = 270°.

The "ESTABLISH -R-BAR" block is shown in figure 5-22.

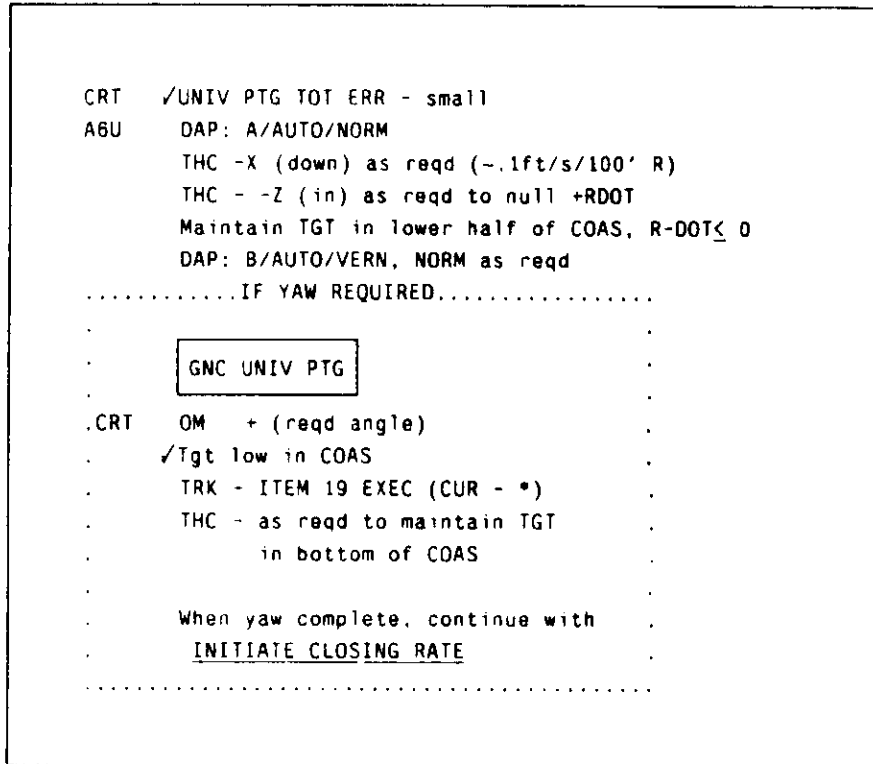

Figure 5-22.- ESTABLISH -R-BAR procedure.

At sunset, INITIATE CLOSING RATE is performed by using THX inputs to establish the required R-DOT (if at 400 feet, -0.4 ft/s; if at 300 feet, -0.3 ft/s; etc) and then as required to maintain the TGT in the lower half of the COAS. Low Z braking is performed as required through the last braking gate (at 200 feet, -0.2 ft/s). From 300 feet, approach should take about 20 minutes.

When RR breaks lock, perform CONFIGURE KU-BAND FOR COMM exactly as in section 4.1.69.

When TGT is in EE camera, then perform THX +Z to null rates (as in section 4.1.71). Perform RMS capture (as in section 4.1.73) and DISABLE RNDZ NAV (as in section 4.1.74).

Once the TGT is grappled (about at sunrise), adjust attitude as follows with maneuver to -ZLV, -XVV, as shown in figure 5-23 checklist.

CDR	When LDEF in HOVER position: BRAKES - ON. MNVN TO -ZLV, -XVV
	Config DAP B to B8
	GNC UNIV PTG
CRT	✓TGT ID +2 ✓BODY VECT +3 (-Z) OM +0 TRK - ITEM 19 EXEC (CUR - *)
A6U	DAP: B/AUTO/VERN
	When attitude MNVR complete,
CDR	✓DAP ROT: PULSE/PULSE/PULSE DAP: B/MAN/VERN
MS1	<u>LDEF BERTH</u>

Figure 5-23.- Post-grapple maneuvers

5.3.2.4 Inertial Approach

The inertial approach technique is required for payloads which are inertially stabilized in at least two axes. The technique breaks down into two phases: a constant range flyaround to the appropriate payload approach axis and the final approach to RMS grapple range. The two phases could be combined.

The flyaround phase is performed at some range (such as 35 feet) close enough to allow CCTV ranging and to keep the target in the plume shadow (minimizing plume effects). Two types of flyaround techniques are utilized, depending on whether the target attitude, relative to the Orbiter reference frame, is known or not. If the TGT attitude is known, the multi-axis Auto rotation maneuver flyaround technique, described in section 5.2.3.2, would be used. If the TGT attitude is unknown, one of the manual rotation maneuver techniques, described in section 5.2.3 would be used. The multi-axis rotation maneuver technique is obviously the more efficient, as it rotates the Orbiter about the optimum axis (eigenaxis), thereby minimizing the translation corrections required to achieve the payload final approach axis. Manual rates up to 0.2 to 0.3 deg/s are utilized.

Upon arrival on the target final approach axis, the final approach phase begins. The Orbiter is maintained in inertial attitude hold and a closing rate of about 0.2 ft/s is initiated toward the target. During the approach, NLOS rates, as detected in the COAS, are nulled by THC deflections. Upon arrival at the desired grapple range, all relative rates are nulled and capture operations commence.

5.4 SEPARATION

Separation is a PROX OPS task involving the execution of a translation maneuver or sequence of translation maneuvers, which result in an opening (separation) rate between two orbiting satellites. Either or both of the satellites may take an active role in performing these maneuvers. Since one of the two satellites is usually a PL, originally located (berthed) in the Orbiter PL bay, the term "PL" is normally used (vs. TGT) in separation techniques discussions.

The separation problem differs significantly from other phases of PROX OPS. These differences can be summarized as items which either simplify (advantage) or complicate (disadvantage) this task relative to the other PROX OPS tasks.

In some cases, only appendages of a PL are to be jettisoned so that the main body can be returned to Earth. Since the PL may still be on the RMS, the Orbiter would not be able to perform an active separation maneuver. However, the Orbiter would prefer to perform an attitude maneuver such that the appendages would separate in the most advantageous direction to avoid both near-term and long-term recontact. Here, preflight analysis of relative drag characteristics and jettison ΔV is crucial.

Advantages:

- The problem begins with a well known REL SV.
- Orbiter burns and attitude maneuvers can be expected to follow a canned sequence, making propellant consumption predictable.
- Confidence in the separation trajectory reduces crew monitoring requirements. (Dispersions have not yet had a chance to build up.)

Disadvantages:

- Many PL's have tight deploy attitude and rate error requirements.
- Some PL's have upper stage boosters which pose a potential hazard to the Orbiter.
- For RMS deployed PL's, checkout may not be completed until after deploy, requiring an Orbiter recapture capability, sometimes for several hours or days. This may require contingency RNDZ planning.

- There may be relatively low confidence in PL control system characteristics.

A review of these points indicates that flying the Orbiter is a simpler task for separation than it is for the other PROX OPS tasks. On the other hand, the frequency of deploy missions versus retrieval missions points out the importance of an efficient solution to the separation problem.

In the design of a separation sequence, many factors must be considered, but five general concerns stand out:

- Orbiter/PL (or appendage) recontact, both short term and long term.
- Crew visibility of the PL.
- Orbiter plume impingement on the PL, both RCS and OMS.
- PL plume impingement on the Orbiter, particularly for PL's on an upper stage such as the PAM or IUS.
- Crew safety relative to hazardous PL control system performance.

For many PL's, these may be somewhat contradictory and require a relative weighing on a case by case basis.

5.4.1 Nominal

PL's may be nominally deployed by spring ejection or RMS release.

5.4.1.1 Spring Ejection (PAM)

Since most deployments involve spring ejection, this clearly calls for a simple, standardized, efficient separation sequence which minimizes training requirements. This will result in a sequence which may not necessarily be optimized for a specific mission, but will reduce mission preparation effort.

For payload assist modules (PAM-D's) deployment, there are two important booster characteristics which drive separation sequence design. First, attitude control is accomplished solely by spinning the upper stage at a high rate, e.g., 50 rpm. This fixes the Orbiter attitude at deployment in two axes, leaving the third free to rotate about the deploy LOS. Second, this is a solid rocket booster, which for the PAM-D has a built-in 45-minute "fuse" which cannot be safed postdeploy.

To further constrain the deploy situation, in general the PAM-D will burn very nearly posigrade, with an out-of-plane component determined by PL weight and orbital inclination. Thus, 45 minutes (1/2 rev) earlier, the PAM-D must usually be ejected retrograde, as indicated in figure 5-24.

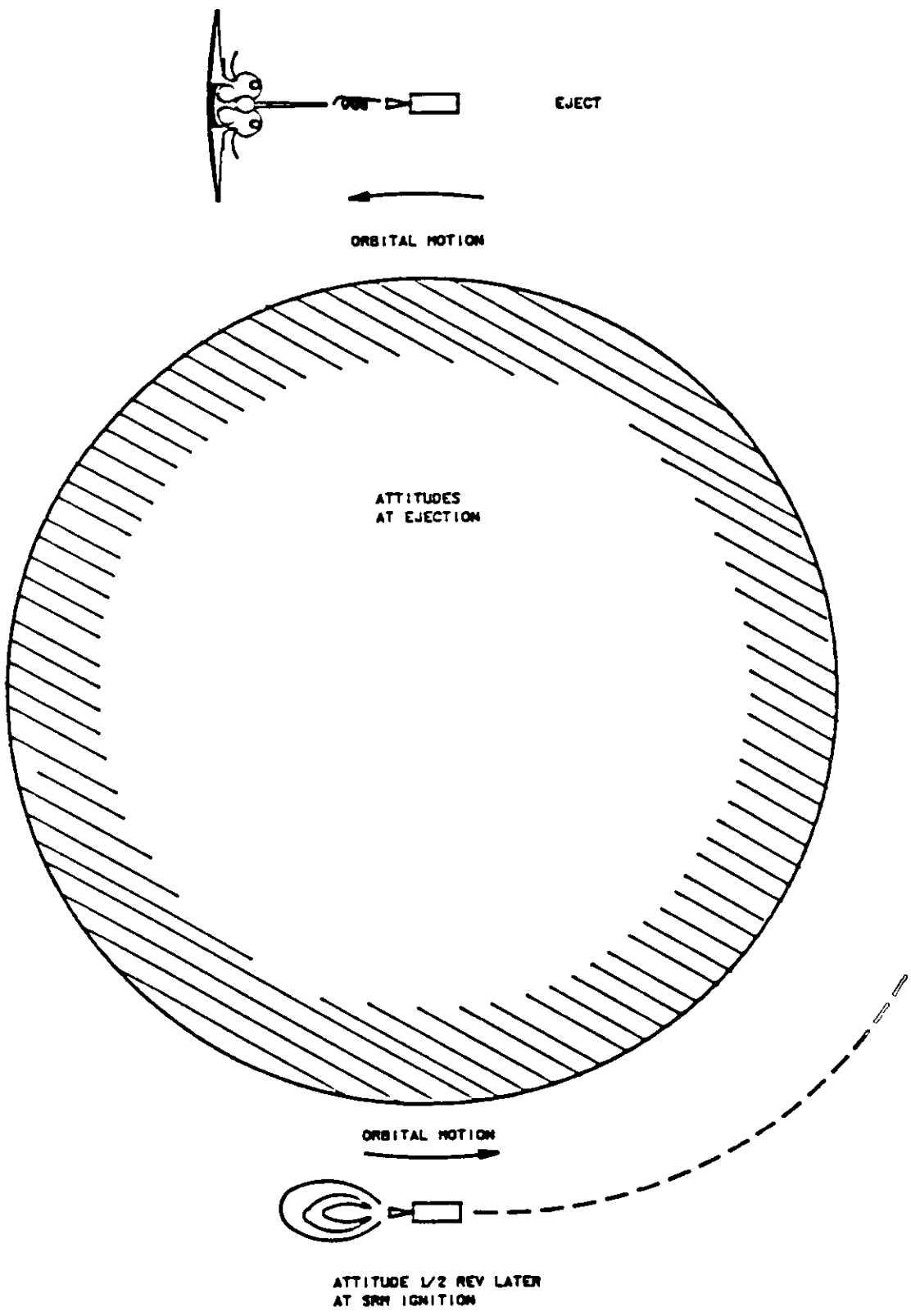

Figure 5-24.- PAM/Orbiter ejection attitude.

1278. ART. 1

The ejection velocity is on the order of 2.4 to 2.8 ft/s (1.5 to 2.0 ft/s for PAM-D-II's), resulting in a relative motion trajectory as shown in figure 5-25 with the coordinate system rotating at ORB rate and centered on the PL. From the figure it can be seen that in 1/2 REV, at SRM ignition, the Orbiter will be above and behind the PAM-D. Given this initial data, analysis was conducted to determine what Orbiter separation was required to ensure a lifetime TPS erosion of < 10 percent based on design lifetime of 100 STS missions. (This number is based on MDTSCO Design Note No. 1.4-3-016.) Using a manifest which at that time indicated a total of 135 upper-stage firings over the first 100 STS flights, a criteria of 0.074 percent erosion per flight was established. If no additional ΔV is added by the Orbiter, the separation resulting from the spring ejection alone will result in a plume impingement on the Orbiter TPS of about eight times the accepted level. Although this is not a safety problem for one flight, it is clear that in general an Orbiter burn is required to increase separation distance.

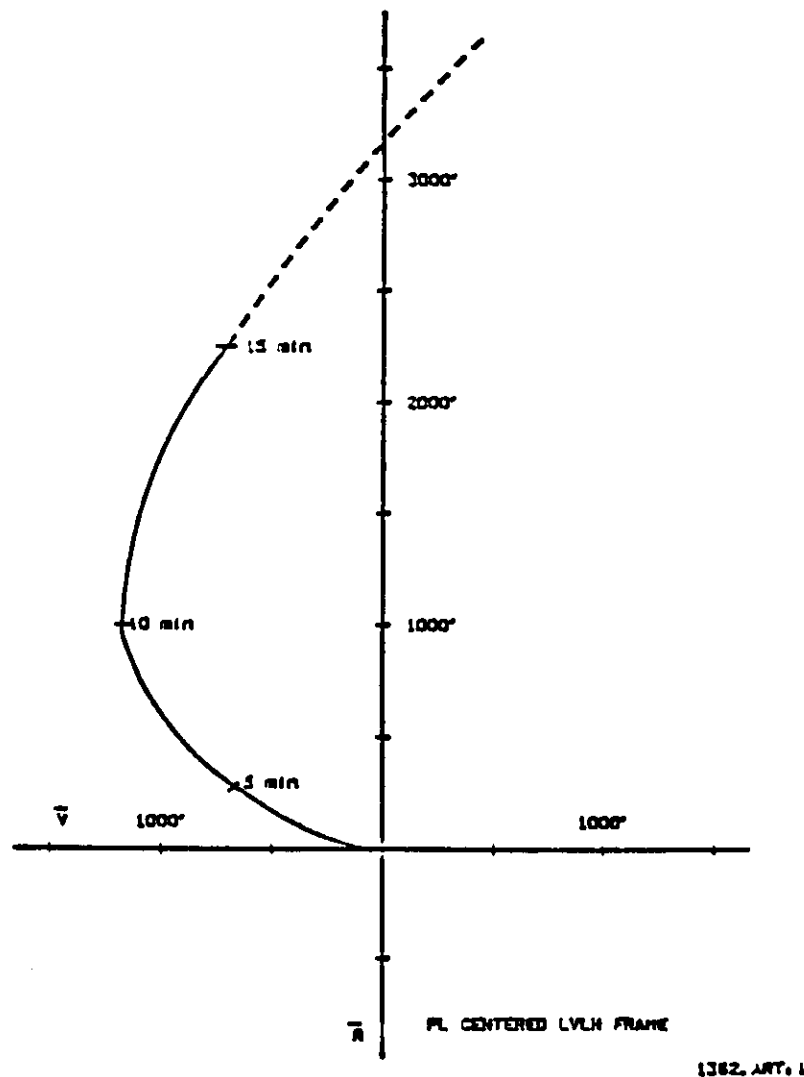

Figure 5-25.- Orbiter/PAM-D separation trajectory
(due to ejection ΔV only).

To achieve maximum separation at SRM ignition, the Orbiter OMS burn should be scheduled as early as possible after deploy, although about 10 minutes are required to get ready for the burn. Estimating then that SRM ignition will occur about 35 minutes after the OMS burn, it can be shown that the plume impingement on the Orbiter can be minimized if the upper stage thrust vector is about 15° above posigrade. With this choice made, it is then possible to determine a time for the OMS burn, based on acceptable Orbiter plume impingement on the TGT. If the burn is delayed until deploy +15 minutes, the plume overpressure on the PL will be $< 10^{-4}$ lb/ft², which was chosen as an acceptable level (fig. 5-26). Coincidentally, due to the 16° cant of the OMS engines, which places the thrust vector through the Orbiter c.g., it is possible to do the burn in -ZLV, wings level. This allows for a convenient manual "out the window" backup burn.

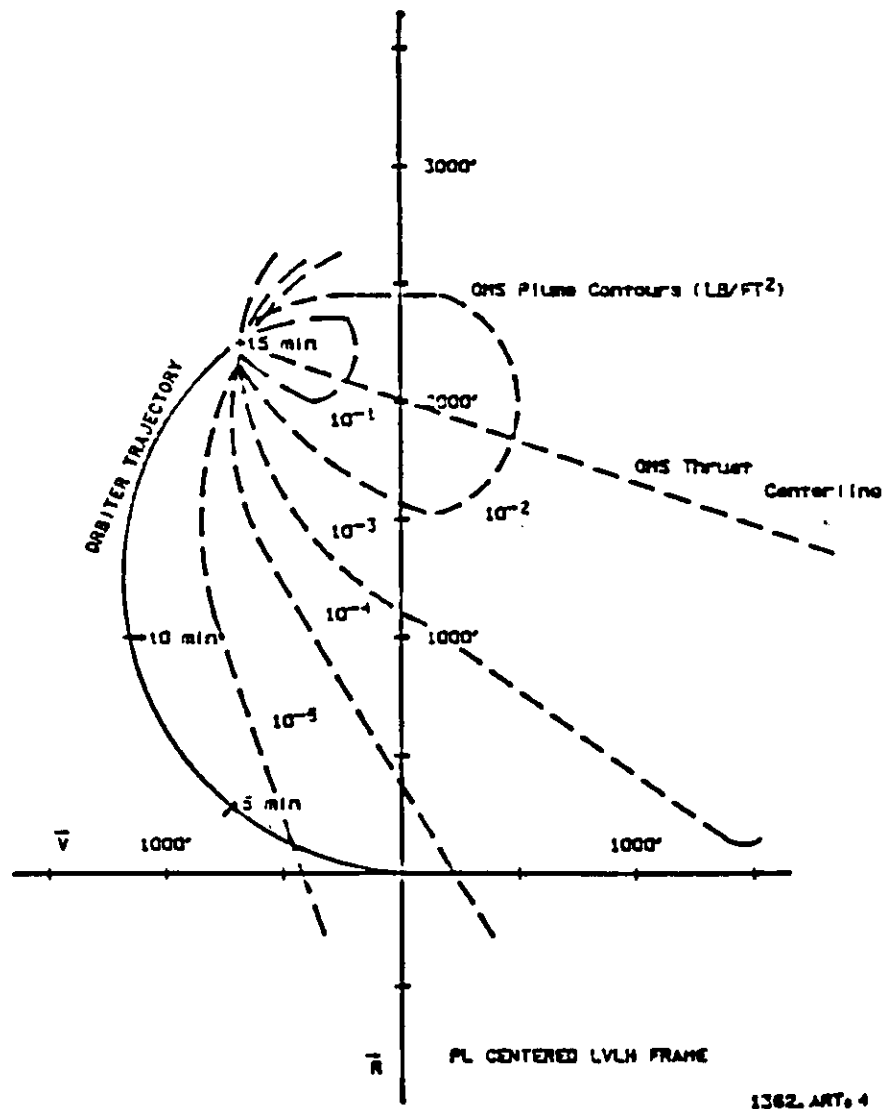
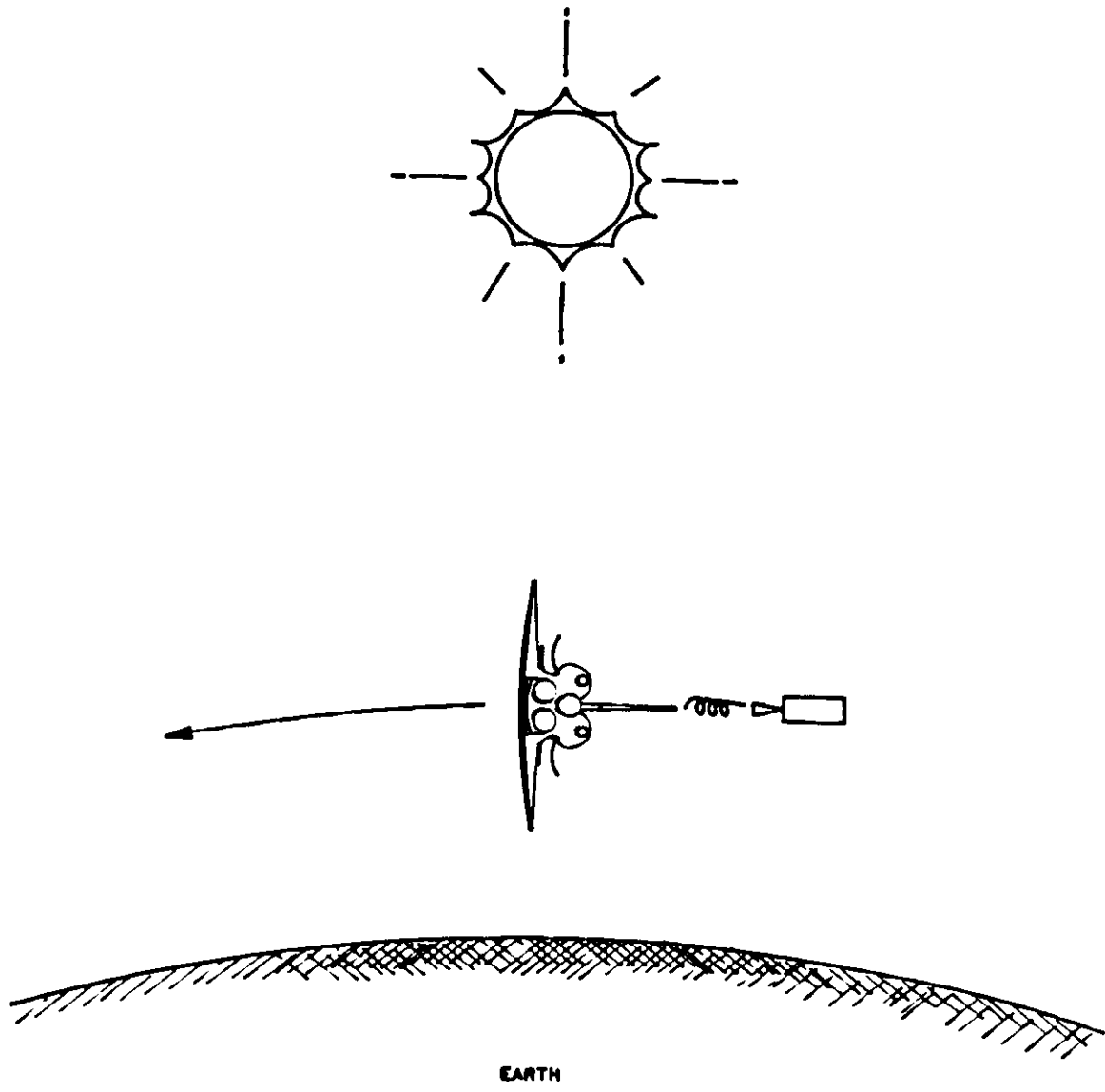

Figure 5-26.- OMS plume on PAM-D at SEP burn initiate.

Continuing to work backwards to deploy, we can now constrain the third Orbiter degree of freedom to minimize the maneuver to the OMS burn attitude, resulting in a -XLV deploy attitude. However, since the PAM-D must be ejected near orbit noon (or midnight) to meet thermal constraints, this may, for some beta angles, violate the groundrule of no Sun within $\pm 20^\circ$ of the PL LOS during deploy and SEP. To solve this problem, the Orbiter is rotated such that the X-axis is out of plane at deploy, as shown in figure 5-27.



1278. art, 1

Figure 5-27.- Orbiter attitude at PAM ejection.

It should also be pointed out that this entire sequence was designed around the requirement for direct crew visual acquisition of the PL until completion of the OMS burn, and the track of the PL through the overhead window is shown in figure 5-28.

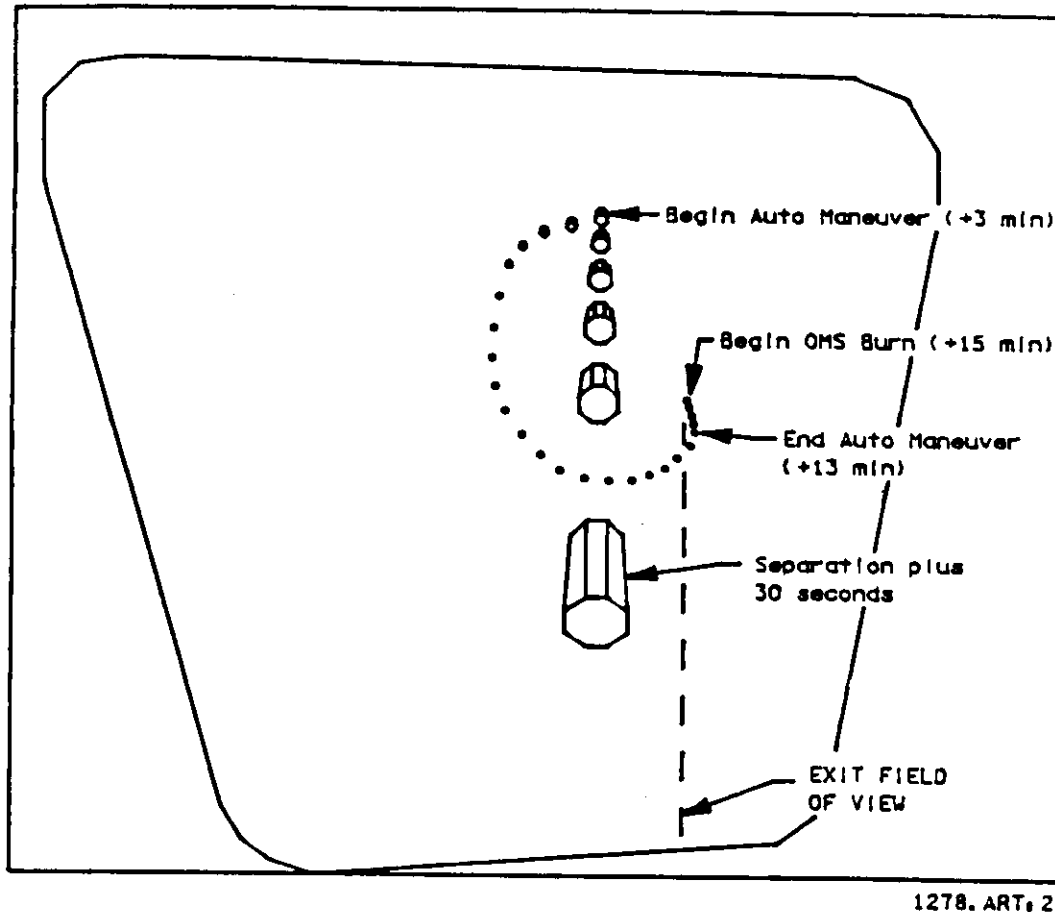

Figure 5-28.- View of PAM-D SEP from aft station through overhead window (PL shown every 30 sec).

The final issue is the Orbiter protection attitude to be maintained during the PAM-D SRM firing. Tile damage is minimized by placing the PL LOS at an angle to the Orbiter belly, as shown in figure 5-29. This attitude is maintained inertially for about 6 minutes after SRM ignition to allow the Orbiter to pass through the flow field. Current planning places the Orbiter at an angle of 50° to the PL LOS. The orientation is maintained through use of REL NAV functions.

Separation sequences are described in detail in the "Payload Assist Module Delta Class (PAM-D) Flight Procedures Handbook," JSC-20315, Final, May 15, 1985.

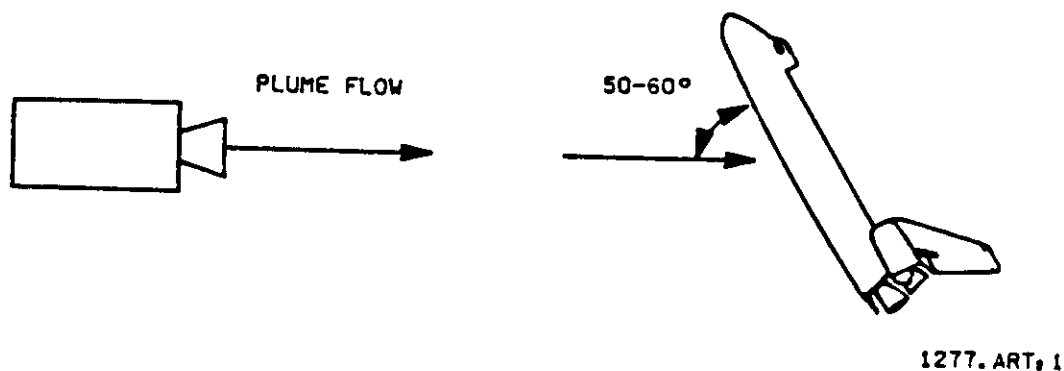

Figure 5-29.- Orbiter window protection attitude at SRM ignition.

5.4.1.2 Spring Ejection (IUS)

The IUS class of spring ejected payloads presents a different kind of problem from the PAM. Standardization is equally important, and two generic deploy sequences have been designed; they are called "ascending node solid rocket motor (SRM)" and "descending node SRM". The IUS has an active attitude control system (ACS), which allows greater flexibility for Orbiter attitude at ejection. The IUS/PL is spring ejected at 0.4 ft/s, at an angle of 58° above the Orbiter +X axis, with the Orbiter holding a solar track attitude via a selectable body vector that places the Sun on the belly of the Orbiter. This allows the IUS/PL to depart along the Orbiter shadow (until soon after the -X burn). Thus, the IUS/PL deploy vector has a marked out-of-plane component. The small Orbiter separation burn also has a large out-of-plane component. In fact, the Orbiter attitude at deploy is such that the relative motion between the IUS/PL and the Orbiter after the backoff maneuver is purely out of plane (the IUS/PL departs horizontally to one side of the V-BAR, while the Orbiter departs horizontally to the other side). These characteristics require that the Orbiter will have to be more active during IUS separation than during PAM separation.

Both ascending node and descending node SRM sequences have similar separation profiles. Deploy occurs with DAP in free drift and low Z mode. There is a 1-minute coast following ejection, followed by a 2.2 ft/s -X RCS burn (8 seconds on THC), still in free drift. Cross-coupling provides a negative pitch rate (0.8 deg/s), and the crew nulls this rate when the Orbiter has pitched down 70° by selecting inertial attitude hold (DAP ROT: DISC/DISC/DISC). This places the IUS line of sight out the overhead windows. The solar tracking option on UP is canceled (ITEM 21 EXEC). To minimize RCS contamination on the PL, the Orbiter stays in low Z mode and delays maneuver to the OMS burn attitude until deploy + 8:00 minutes. This attitude is computed so that a line of sight exists between the IUS and the Orbiter payload interrogator (PI) antenna for postdeploy commanding (including SV transfers) and telemetry.

The OMS burn is computed considering both Orbiter/PL separation at SRM ignition and also subsequent orbit management (e.g., deorbit burn requirements and cross-range for landing). This specialized planning is done because the size of the OMS burn for the IUS is greater than for a PAM deploy (a larger separation is needed since the IUS SRM is larger than the PAM SRM). In general the burn for ascending injections will be about 38 ft/s pitched down 20° from local horizontal, and for descending injections it will be about 30 ft/s pitched down 5°. No low Z is selected just prior to entering the OMS 2/ORBIT OMS BURN cue card.

Following the OMS burn the Orbiter maneuvers to a payload viewing attitude which tracks the IUS with the Orbiter -Z axis (the maneuver is performed in NORM jets). Loss of IUS/PI lock occurs about +32:00. At deploy + 39:00 the Orbiter maneuvers (in NORM) to window-protect attitude, which is identical to that of the PAM attitude described above, and maintains attitude for at least 6 to 10 minutes after SRM TIG. The minimum safe range for SRM ignition is 10 n. mi.; after nominal separation and 55 minutes, range is 25.1 n. mi., and after 67 minutes range is 51.6 n. mi.

Note that rendezvous navigation (SPEC 33) is utilized for Orbiter pointing after the separation maneuver. RNDZ NAV is enabled about 30 minutes prior to deploy, after MCC (FDO) has uplinked a target state vector. About 5 minutes before deploy, the crew must perform an ORB to TGT SV transfer (SPEC 33, ITEM 10 EXEC) to refresh the target SV. The IUS spring separation ΔV is not represented in this SV but is small enough to ignore due to its being lost in the noise of the large OMS separation burn. This attitude pointing is required to maintain PI lock for data exchange between IUS and Orbiter. Target track also simplifies maneuvering to window protect attitude, by simply selecting body vector = 5 (Orbiter defined pitch/yaw) and loading P = 310, Y = 0, OM = 0.

IUS SRM ignition occurs over the Equator for equatorial geosynchronous missions (interplanetary missions will not be so constrained). For the ascending node option, SRM ignition is 67 minutes after deploy, and for descending node it is 55 minutes after deploy. These times are set in order to maintain Orbiter perigee in the northern hemisphere following the OMS burn scheduled at deploy + 19 minutes. However, if there are to be significant postdeploy maneuvers which affect perigee, this consideration loses weight. For many new payloads, these considerations are also not significant and the TIG may follow deploy by anywhere between 55 and 67 minutes. A future standardized TIG of +60 minutes is under consideration.

IUS guidance can actually accommodate an off-nominal deploy at any point in the orbit. In this contingency, the IUS knows to delay ignition until the next opportunity.

For IUS deploy procedures detailed rationale, see "IUS Flight Procedures Handbook", Basic, Rev B, March 1985, JSC-18392, sections 3.4.3 ("Deploy IUS/TDRS") and 3.4.5 ("Postdeploy Separation Maneuver"), and "Inertial Upper Stage Deploy Procedures for Flight Dynamics Officers", IUS PROC 2142, Rev B, January 24, 1986. The foregoing discussion only summarizes the procedures and rationales.

5.4.1.3 RMS Deploy - Generic

PL's deployed by the RMS will typically be unique, with specific requirements that must be handled on a case-by-case basis. However, for many PL's it is anticipated that an R-BAR separation will be optimal because of low plume impingement on the PL because of utilization of orbital mechanics effects. In this scheme, the Orbiter begins in a ZLV attitude, above or below the PL depending upon relative drag and/or mission continuation requirements. Assuming for the moment that these constraints place the Orbiter below the PL, we have the relative geometry shown in figure 5-30. This selection criterion is usually required payload attitude.

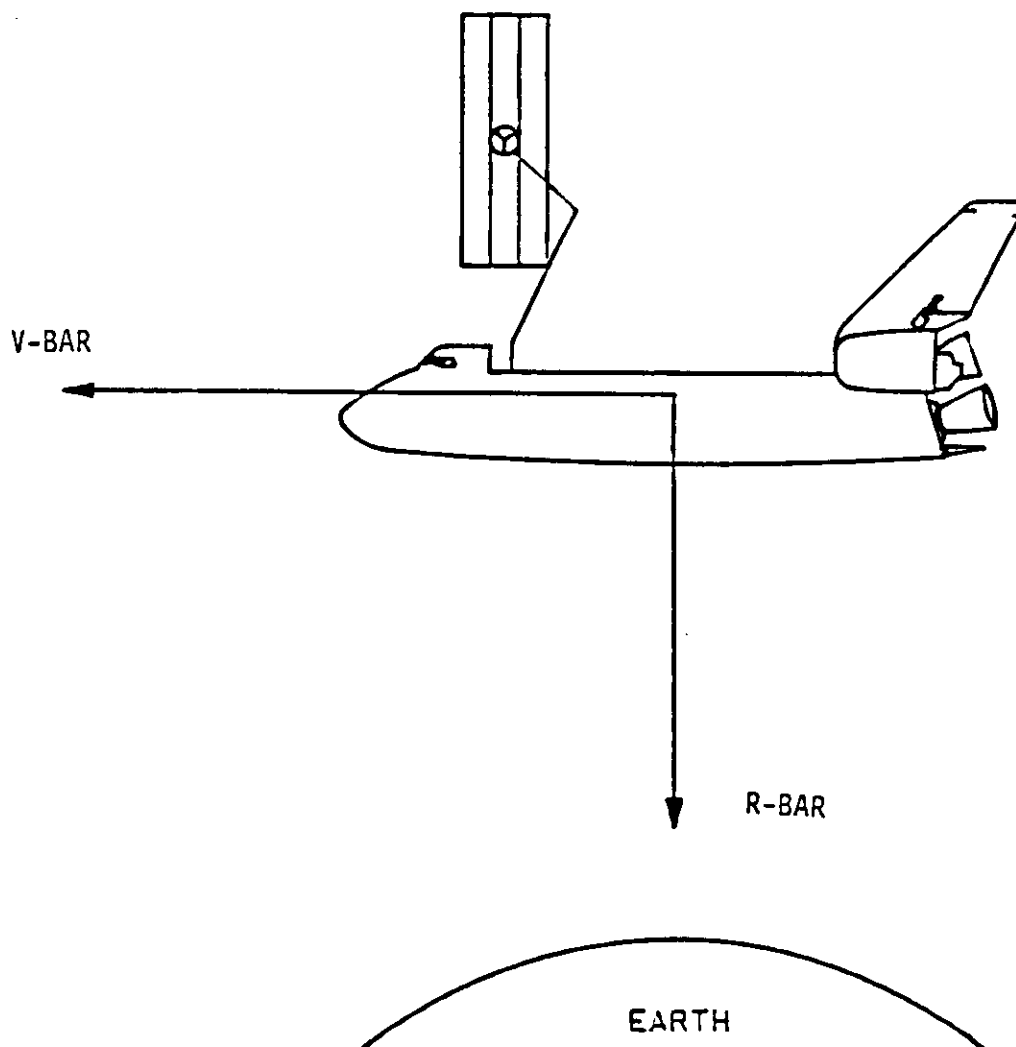

1277.ART, 2

Figure 5-30.- Typical RMS deploy geometry (Orbiter below PL).

At the time of PL release, a small opening rate will begin to develop, strictly due to the differential orbit altitude. However, this opening rate is so small that it is not practical, in the general case, to depend solely on it. So while the PL is in the "quiet zone," a small opening rate is added using low Z, of <0.5 ft/s. This will tend to force the Orbiter down, and because of orbital mechanics, in front of the PL (fig. 5-31).

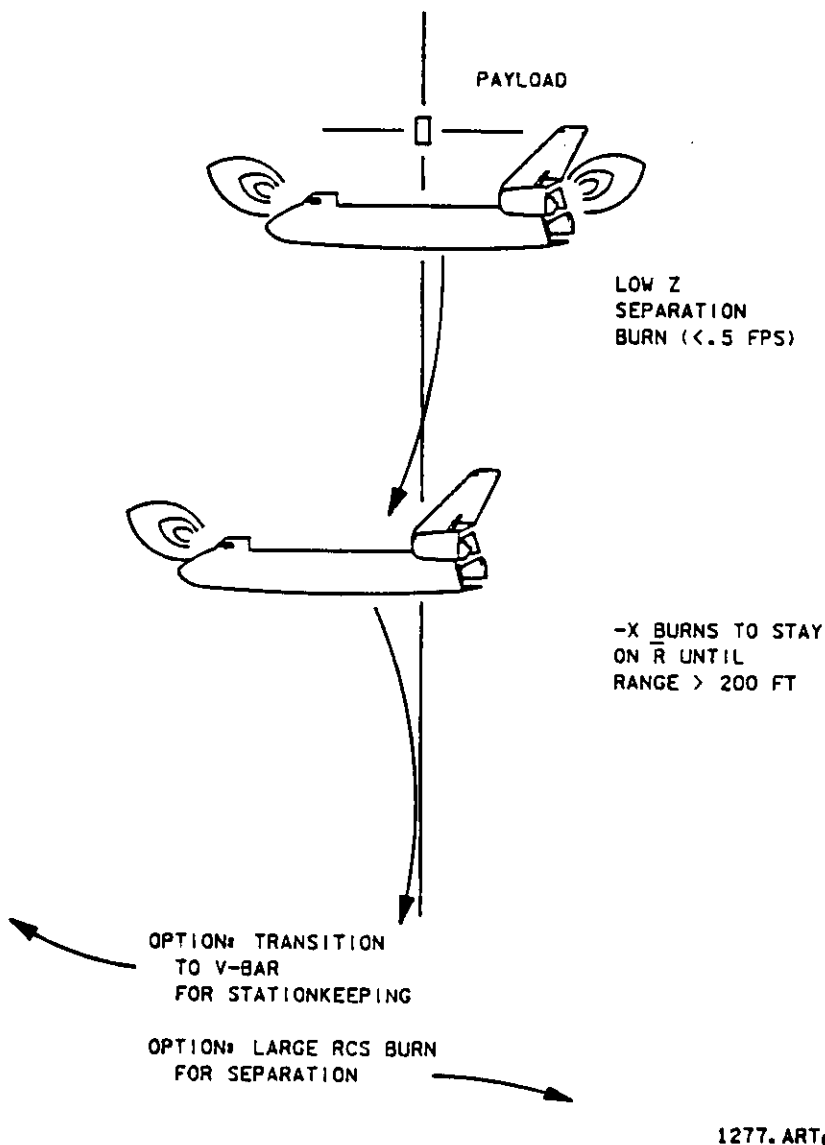

Figure 5-31.- Orbiter separation following RMS deploy (PL-centered LVLH frame of reference).

However, since it is a radial burn, with no other forces acting on the system, recontact would occur in one REV. So until a separation of about 200 feet, retrograde MNVR's are performed as required to keep the Orbiter on the R-BAR. This has the effect of lowering the Orbiter orbit and increasing the opening rate. Then as the Orbiter drifts below and in front of the PL, an option is available. If required, the Orbiter may transition up to the V-BAR and stationkeep during PL checkout. Or a larger separation MNVR with the RCS may be performed, providing a large opening rate and removing the requirement for crew monitoring of the PL.

It can be seen that in this sequence no thrusters are ever fired directly at the PL, reducing plume overpressure and contamination to a minimum.

For a PL which is not plume sensitive at all, it is likely that starting with the Orbiter on the PL V-BAR will be very fuel efficient. In this case, no radial burns are required, and maximum separation can be achieved in an efficient Hohmann fashion.

Many other separation profiles have been proposed, both for the general case and for specific PL's. Due to lack of definition and/or general application, these will be discussed as needed in supplemental documentation.

5.4.1.4 RMS Deploy (SPARTAN-class)

Separation profiles for SPARTAN-type payloads must be individually crafted due to highly variable mission-specific factors. These include payload pointing requirements, grapple fixture locations, and crew constraints on the variety of nominal versus contingency deploy profiles and RMS procedures.

Although the first SPARTAN mission was 51-G, that profile should not be considered a model for later profiles. The 51-L profile would be a much better guide to design such a profile, and the following discussion is based on that mission.

Configuration of aft station for deploy is essentially identical to configuration for rendezvous (fig. 4-4) except that on the SM ANTENNA SPEC following self-test, the "RDR RNG MIN" is selected (ITEM 2), and the -Z COAS and various cue cards are not installed. DPS configuration is also identical (section 6.1.1).

RMS operations to power up, to grapple, and to unlatch, unberth, and maneuver the payload are standardized; see the 51-L SPARTAN book.

Rendezvous navigation is enabled similar to that for rendezvous (section 4.1.6), but with several distinct differences. First, RR is the selected sensor (ITEM 13). Second, an ORB to TGT SV transfer is performed (ITEM 10 EXEC) since the starting point is known.

The Orbiter is maneuvered to release attitude about 45 minutes predeploy. For 51-L the attitude was approximately belly forward, left wing down, nose left of orbit motion.

After release, the Orbiter stationkeeps for about 10 minutes to observe the SPARTAN maneuvers which signify proper payload functioning. If there are no maneuvers, the SPARTAN is retrieved and berthed.

The separation burn is performed "no low Z," 2.0 ft/s +Z, 5 seconds on the THC (out). Low Z is then selected. This is a posigrade burn along the V-BAR.

Following separation, radar acquisition is performed after about 3 minutes. If there is no lock-on within 2 more minutes, the crew performs the "AUTO TRACK ACQ" cue card (section 4.3.2). If the RR fails, the crew waits until the scheduled STRK ACQ block, and performs S TRK NAV.

RR navigation during separation is similar to that performed for the first radar acquisition in rendezvous, section 4.1.31 and figure 4-8, with the following modifications. COVAR REINIT (ITEM 16 EXEC) is immediately performed, since this is the first navigation processing. Since SV SEL initially is PROP, the optional block is performed and SV SEL becomes FLTR. Following that, on the SM ANTENNA display the RDR RNG AUTO is selected (ITEM 1), replacing the previously selected RDR RNG MIN. Since there was no previous S TRK, the "RATIO > 1.0" test fails through to the second test, with "Force 3 marks" being the only corrective action taken. Once NAV data is being accepted, the Orbiter goes to -Z axis target track with OM = +180.

The separation profile looks very much like figure 5-48, with the Orbiter moving forward and higher, then curving back and passing about 2000 feet above the payload at about 19 minutes after separation.

Approximately one REV after deploy, STRK acquisition is performed. In general this procedure is similar to the rendezvous S TRK TARGET ACQ procedure discussed in section 3.3.2.1 (fig. 3-13), with several significant differences as follows. Once a star present is detected, angles (currently in "accept" for RR data) must be inhibited (ITEM 12 EXEC), and the STRK must be selected (ITEM 12 EXEC). Currently, the FLTR SV is selected. Once STRK marks are accepted, the FLTR SV (which has been validated through the accomplishment of a successful STRK lock-on) is saved away in PROP (the same thing is done, for the same reasons, after the second STRK acquisition during nominal rendezvous operations -- see section 4.1.22). If there is no STRK acquisition after 5 minutes, the crew goes to contingency procedure for "S TRK TARGET ACQ - RR FAIL."

After about 2 hours the separation sequence terminates. Rendezvous navigation is disabled much as in section 4.1.74, with some additions: the UP tracking is canceled (ITEM 21 on UP), and IMU DES on GNC 21 IMU ALIGN is performed via ITEM 7 (8,9), (no*); i.e., the deselected IMU is reselected. Finally, Ku-band is configured for COMM (same as section 4.1.69). The specialized rendezvous book is exited until the retrieval rendezvous begins approximately 36 hours later.

5.4.1.5 RMS Deploy (HST Class)

Some payloads are large and heavy and have very stringent contamination constraints during deployment. Examples are the LDEF and the HST (also the SMM and ERBS). The following separation profile is a generic description based on HST preliminary procedures.

There are two burns planned for HST separation, labeled SEP 1 and SEP 2. Deploy pads are prepared for both: SEP 1 is preplanned and the only real-time specified data is TIG; SEP 2 is a second RCS burn which requires TIG plus updated data on TV roll, vehicle weight, plus PEG 7 ΔV 's. An IMU DES (deselect) is also specified in anticipation of an STRK pass.

Deploy attitude for HST will be biased +X solar inertial, and deployment occurs near orbit noon. The result will be an approximately belly-forward tail-down Orbiter attitude (-XLV, YPOP), but with the +Z axis somewhat to the left or right of the V-BAR depending on beta angle.

Release accuracy for LDEF and SMM was required to be within 0.01 deg/s of desired rates. For all large payloads (HST included), free drift is maintained for 60 to 120 seconds prior to release, in an effort to minimize attitude rates on the payload following release.

SEP 1 is a 0.5 ft/s low Z mode posigrade burn for LDEF, SMM, and HST. SEP 2 is performed approximately one quarter REV later, when the Orbiter is about 600 feet above the HST on the R-BAR, and is 1 ft/s posigrade NORM Z mode from the -X RCS. A standard RMS powerdown procedure follows the SEP 2 burn.

Alternate candidate separation profiles include a sunrise deploy down the +R-BAR (see the SPAS profile, STS-7), with low Z mode 0.25 ft/s RCS followed by -X firings to maintain position on R-BAR until a range of several hundred feet. At a range of 500 feet a +X burn may be performed to accomplish final separation (other variations are also under consideration). These options are driven almost entirely by payload requirements.

For HST/LDEF/SMM, RR acquisition and navigation are performed similar to Spartan-class deploys. Target track is established with the Orbiter -Z axis. Approximately one REV after deploy, for HST an STRK pass is performed as on the SPARTAN-class deploy missions. At 2 hours into the deploy, rendezvous NAV is terminated and the Ku-band is reconfigured for COMM mode.

5.4.2 Generic Sep Procedure

An all-purpose separation procedure (the "1-2-3 maneuver") has been developed and validated for generic use. Possible applications include PL deploy, postrepair/inspection departure, and some types of PROX OPS breakout. It is especially applicable if the Orbiter is in an inertial hold and has left the TGT V-BAR, or if the Orbiter/TGT relative position is not well known.

The procedure is found in the FDF ORB OPS C/L. Procedural rationale is described in the following sections.

5.4.2.1 Set Up Aft Station

This step is shown in figure 5-32.

A6U	✓SENSE - as reqd
	DAP: A/MAN/NORM
	DAP TRANS: as reqd
	DAP ROT: DISC/DISC/DISC
	FLT CNTLR PWR - ON

Figure 5-32.- Set up aft station checklist.

DAP TRANS options are pilot's choice depending on the size of closing rate. Over 1 ft/s should be done in DAP TRANS:NORM, with transition to DAP TRANS:PULSE for the last half foot/second of translation.

5.4.2.2 Obtain Visual Contact Through OVHD Window

This step is shown in figure 5-33.

DAP ROT: as reqd RHC - as reqd When adequate visual contact obtained, DAP ROT: DISC/DISC/DISC

Figure 5-33.- Visual contact through OVHD window checklist.

This establishes TGT LOS near the Orbiter -Z axis in preparation for translation maneuvers. The DAP ROT options are chosen based on how far and fast the -Z axis must be rotated.

5.4.2.3 Null Closing Rate

This step is shown in figure 5-34.

THC - +Z (dn - -X SENSE) (out - -Z SENSE) as req'd to null closing rate

Figure 5-34.- Null closing rate checklist.

Range rate may be known from initial conditions, from known maneuver history, or (most likely) by direct visual observation when very close (inside RR track range) to TGT.

5.4.2.4 Perform RR ACQ (If Desired)

This step is shown in figure 5-35.

A1U	KU MODE - RDR PASSIVE RADAR OUTPUT - HI KU - AUTO TRACK KU CNTL - PNL Slew antenna to target ✓KU TRACK tb - gray If no TRK. KU SEARCH - SEARCH (tb-gray) If no lock-on within one minute. repeat SEARCH as convenient
-----	--

Figure 5-35.- Perform RR ACQ checklist.

This may only occur after separating beyond radar track minimum range. Note that radar is in AUTO track since there is no PL SV to automatically provide navigated pointing angles.

5.4.2.5 Obtain ~1 FPS Opening Rate

This step is shown in figure 5-36.

A6U	DAP TRANS: NORM/NORM/NORM THC - +Z for 3 sec • If Low Z (MCC call) • • THC - +Z for 12 sec •
-----	---

Figure 5-36.- Obtain ~1 FPS opening rate.

The THC sense is the same as in section 5.4.2.3 for nulling the closing rate. The 3-second burn imparts the desired opening rate. Actual ΔV may be monitored on the AVG G display on SPEC 33, but such precision is not required for a successful safe separation. This is the "1" part of the "1/2/3" MNVR.

5.4.2.6 Perform Out-Of-Plane MNVR

This step is shown in figure 5-37.

```

          |GNC UNIV PTG|
          |-----|
CRT      CNCL - ITEM 21 EXEC
        GNC. OPS 202 PRO

          |GNC ORBIT MNVR EXEC|
          |-----|

        RCS SEL - ITEM 4 EXEC (*)

        Set TIG to current time +2:00
        TGT PEG 7  $\Delta V_x$  - ITEM 19 +0 EXEC
                    $\Delta V_y$  - ITEM 20 +2 EXEC
                    $\Delta V_z$  - ITEM 21 +0 EXEC
        LOAD - ITEM 22 EXEC
        TIMER - ITEM 23 EXEC

        ✓VGO Z ≥ 0: if VGO Z < 0, then
        * TGT PEG7  $\Delta V_y$  - ITEM 20 -2 EXEC *
        * LOAD - ITEM 22 EXEC *
        * TIMER - ITEM 23 EXEC *
        * ✓VGO Z ≥ 0 *

        DO NOT MNVR TO BURN ATT

A6U      At TIG deflect THC to null VGOs
  
```

log TIG

Figure 5-37.- Perform out-of-plane MNVR checklist.

If the burn VGO, displayed in body coordinates, shows a -Z component, this means that the intended out-of-plane maneuver will take the Orbiter directly back through the TGT plane. In this case, reload MNVR EXEC with a -2 ft/s Y burn.

The test of VGO Z simply ensures that the out-of-plane burn is away from the TGT. This is the "2" part of the "1/2/3" maneuver.

5.4.2.7 Perform Final SEP

This step is shown in figure 5-38.

GNC ORBIT MNVR EXEC	
CRT	✓RCS SEL - ITEM 4 (*)
	If $\Delta V Y$ (Block 6) is +2
	TV ROLL - ITEM 5 +2 7 0 EXEC
	If $\Delta V Y$ (Block 6) is -2
	TV ROLL - ITEM 5 +0 9 0 EXEC
	Set TIG to TIG from last step + 15:00
	TGT PEG 7 ΔV_x - ITEM 19 +3 EXEC
	ΔV_y - ITEM 20 +0 EXEC
	ΔV_z - ITEM 21 +0 EXEC
	LOAD - ITEM 22 EXEC
	TIMER - ITEM 23 EXEC
	DAP: A/AUTO/NORM
	At TIG -8:00; MNVR - ITEM 27 EXEC (*)
A6U	At TIG deflect THC to null VGOs
	AFT FLT CNTLR PWR - OFF

Figure 5-38.- Perform final SEP checklist.

The $\Delta V Y$ check determines which direction out of plane was burned on the previous maneuver, to select the most easily reached TVR. The plan is to make this burn about one quarter of a REV later, which is at the point of maximum out-of-plane separation (about 2000 feet for a 2 ft/s burn). The burn is large enough to perform with +X RCS jets. This is the "3" part of the "1-2-3" maneuver.

5.4.2.8 Maneuver To Minimum Drag Attitude (-ZLV)

This step is shown in figure 5-39.

A6U	DAP: A/AUTO/VERM
CRT	GNC. OPS 201 PRO
	GNC UNIV PTG
	✓TGT ID - 2
	BODY VECT -3
	OM - 180
	START TRK - ITEM 19 EXEC (CUR *)

Figure 5-39.- Maneuver to minimum drag attitude (-ZLV) checklist.

Drag is of concern because of potential differential drag effects (section 2.7.1). Hence, the -Z axis is pointed to Earth center, and tail is rotated into +V-BAR.

5.4.3 Contingency

Contingency separation procedures can be divided into several broad classes: those which allow an Orbiter maneuver to a planned deploy attitude, and those which result from an inadvertent deployment or must be performed from a random relative position to the TGT.

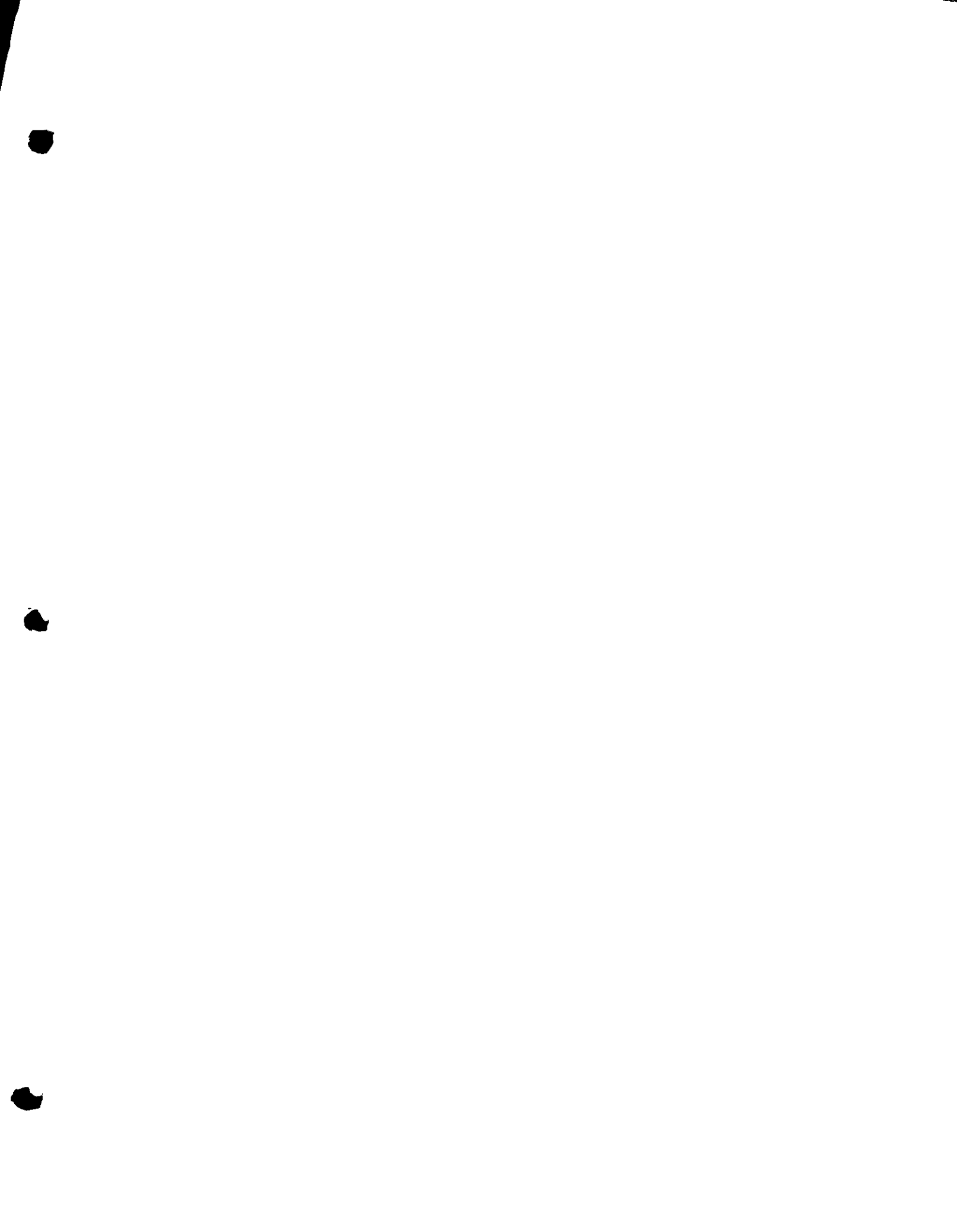

RNDZ BREAKOUT

NOTE

This procedure may be performed anytime between Ti and VBar arrival and assumes the orbiter is at or near -Z axis TGT TRK attitude (OM = 0)

1. 3 fps out of plane

C3 DAP: A/MAN/NORM, NO LOWZ
✓DAP ROT: DISC/DISC/DISC
DAP TRANS: NORM/NORM/NORM
F7/F8 FLT CNTLR PWR - ON

IGNC 33 REL NAVI
CRT If Y>0:
FWD THC: +Y (right) 12 sec
(AFT THC: left)
If Y<0:
FWD THC: -Y (left) 12 sec
(AFT THC: right)
F7/F8 FLT CNTLR PWR - OFF
Record out of plane TIG ___/___:___:___

2. 3 fps retrograde

CRT OPS 202 PRO
IGNC ORBIT MNVR EXECI
✓RCS SEL - ITEM 4 (*)
TV ROLL - ITEM 5 +0 EXEC
Set TIG to out of plane TIG +15:00
TGT PEG 7 VX - ITEM 19 -3 EXEC
VY - ITEM 20 +0 EXEC
VZ - ITEM 21 +0 EXEC
LOAD - ITEM 22 EXEC
TIMER - ITEM 23 EXEC

TIG -8:00

C3 MNVR - ITEM 27 EXEC
A1U DAP: B/AUTO/NORM
KU - AUTO TRK

TIG

F7/F8 FLT CNTLR PWR - ON
THC: Trim VGOs < 0.2 fps
F7/F8 FLT CNTLR PWR - OFF
C3 DAP: A/MAN/VERN

CRT OPS 201 PRO
IGNC UNIV PTGI

✓TGT ID +1
✓BODY VECT +3
OM +180 EXEC
C3 DAP: A/AUTO/VERN
C3 TRK - ITEM 19 EXEC (CUR - *)

RNDZ
BREAKOUT

5.4.3.1 Rendezvous Breakout Procedure

This breakout has two periods of applicability, from the sunset after T_i until MC2, and from MC3 until PROX OPS. If breakout criteria are met between MC2 and MC3, breakout must be delayed until MC3. The reason for this is that between these intervals an OOP miss cannot be guaranteed (TGT contact may be possible). See figure 5-40.

Perform out of plane $\Delta V = 3$ fps away from TGT plane (THC - 12 sec in DAP TRANS: NORM) After 15 min, perform retrograde $\Delta V = 3$ fps OPS 202 PRO <u>GNC ORBIT MNVR EXEC</u> ✓ RCS SEL - ITEM 4 (*) TV ROLL - ITEM 50 +0 EXEC Set TIG to out-of-plane burn +15:00 TGT PEG 7 ΔV_x - ITEM 19 -3 EXEC ΔV_y - ITEM 20 +0 EXEC ΔV_z - ITEM 21 +0 EXEC LOAD - ITEM 22 EXEC TIMER - ITEM 23 EXEC At TIG -8:00; MNVR - ITEM 27 EXEC (*) DAP: B/AUTO/NORM (✓ ROT DISC RATE = .5) At TIG deflect THC to null VGOs

Figure 5-40.- Rendezvous breakout procedure checklist.

During flight techniques discussions, there was a strong desire to develop a single, propellant-efficient breakout maneuver sequence independent of relative position. The result was a 3 ft/s out-of-plane maneuver away from the TGT plane, followed 15 minutes later by a 3 ft/s retrograde maneuver. This sequence provides an Orbiter c.m. to TGT c.m. miss distance of at least 500 feet. Because of trajectory dispersions, this sequence cannot be initiated everywhere between T_i and V-BAR arrival. Specific initiation times have been established depending on Orbiter propellant, Orbiter system status, and the TGT sensor data history (sec. 4.6.2).

In section 4.6.2, the note "nominally Orbiter Y body axis" was included to define which propulsion system contained the propellant for the out-of-plane maneuver (bingos). This note assumes a Y-POP, -Z TGT track Orbiter attitude driven by the use of either the RR, -Z STRK, or the COAS. If the -Y STRK is used, the Orbiter attitude would be inconsistent with the Y body thrusters providing an out-of-plane maneuver. A maneuver to burn attitude is prohibited because of the delay in initiating the sequence and the loss of TGT acquisition while still on an intercept trajectory. In this scenario, the propellant for the out-of-plane maneuver would have to come from another

propulsion system. Similarly, the note "Orbiter +X body axis" was included for the retrograde maneuver. However, this maneuver is executed in burn attitude.

Further information on this breakout maneuver sequence can be found in Orbit Flight Techniques No. 82 (Nov. 17, 1987) minutes.

5.4.3.2 PROX OPS Breakout Procedure

This procedure is shown in figure 5-41.

```

If on +V-BAR.
  Perform 2 fps posigrade burn
  (THC +Z. 5 sec in DAP TRANS: NORM, NO LOW Z)

If on -Vbar,
  Perform 2 fps retrograde burn
  (THC - +Z. 5 sec in TRANS: NORM, NO LOW Z)

If on -Rbar or in transition +Vbar to -Rbar,
  Perform 1 fps burn away from the target
  (THC - +Z. 3 sec in TRANS: NORM, NO LOW Z)
  After 10 min. perform 1 fps posigrade burn
  (multi-axis)
  |GNC ORBIT MNVR EXEC|
  ✓RCS SEL. ITEM 4 - (*)
  TIG = Initial sep + 10 min
  PEG 7 ΔVX = +1, ΔVY = 0, ΔVZ = 0
  LOAD - ITEM 22 EXEC
  TIMER - ITEM 23 EXEC
  DAP: A/AUTO/NORM
  TIG - null VGOs

If none of the above, or if inertial stationkeeping
has been initiated, perform SEP MANEUVER (ORB OPS)

```

Figure 5-41.- PROX OPS breakout procedure.

Post-V-BAR arrival, the abort maneuver sequence will be:

- A. If stable on the +V-BAR, perform 2 ft/s posigrade MNVR (nominally Orbiter +Z body axis, NORM Z translation mode) ASAP. If stable on the -V-BAR, perform 2 ft/s retrograde MNVR (nominally Orbiter +Z body axis, NORM Z translation mode) ASAP. While on the +V-BAR where the relative position of the Orbiter and TGT is well defined, a single abort MNVR can be performed. If stationkeeping, 2 ft/s will produce approximately a 5 n. mi. per REV opening rate; if closing or opening when the MNVR is executed, the opening rate will be proportionately smaller or greater, respectively. The direction of the MNVR was chosen to ensure no immediate recontact with the TGT. The note "nominally Orbiter +Z body

axis, NORM Z translation mode" was included to define which propulsion system contained the propellant for this MNVR (bingos).

- b. If stable on the -R-BAR or initially transitioning from the +V-BAR to the -R-BAR, with the TGT in view out the Orbiter overhead window, perform 1 ft/s away from the TGT (nominally Orbiter +Z body axis, NORM Z translation mode) followed 10 minutes later by a 1 ft/s posigrade MNVR (Orbiter +X body axis). A -R-BAR approach differs from the more standard V-BAR approach by including a transition from the +V-BAR to the -R-BAR and then stationkeeping on the -R-BAR. During this time frame, a more propellant-efficient abort maneuver sequence than the "generic" separation maneuver exists. This sequence is consistent with the V-BAR approach abort maneuver sequence. The 1 ft/s MNVR away from the TGT produces an initial opening rate so the 1 ft/s posigrade MNVR can be performed with no potential for recontact. This sequence will initiate an opening rate of 2.5 to 5 n. mi. per REV depending on the relative position of the Orbiter and TGT when the sequence is executed. The notes "nominally Orbiter +Z body axis, NORM Z translation mode" and "Orbiter +X body axis" were included to define which propulsion systems contained the propellant for these MNVR's (bingos).
- c. If neither "a" nor "b" applies, perform separation maneuver in orbit OPS checklist ASAP (see section 5.4.2). If neither condition a nor b, the relative position of the Orbiter is not well-defined. Hence, the "generic" separation maneuver in the Orbit OPS checklist should be used. This procedure is independent of relative position (within PROX OPS) and will initiate an overall opening rate of 5 to 10 n. mi. per REV depending on the relative position when the sequence is initiated.

During an inertial approach, inertial stationkeeping, or flyaround, the Orbiter crosses the +V-BAR and 25 percent of the time flies above, and in front of, the TGT. If the Orbiter is at one of these relative positions, the abort maneuver sequences described in a and b could be used and 4 ft/s propellant could be saved. However, it is unwise to have more than one abort procedure during a given piloting task. Hence, only the "generic" separation procedure is used.

5.4.3.3 Jettison

Jettison is the class of contingency procedure where the actual Orbiter/PL separation is accomplished through deliberate crew action. Numerous jettison scenarios can be constructed, including the following:

- RMS - required if the RMS cannot be berthed and/or stowed, and the PLBD therefore cannot be closed.
- Ku-band antenna - required if the antenna cannot be stowed, therefore the PLBD cannot be closed.

- PL - required if a PL which was unberthed (but not intended to be deployed) cannot be reberthed, or if a PL not intended to be deployed has become unsafe for deorbit.
- PL/RMS - may be required if the RMS end effector cannot be removed from the grapple fixture (may be able to remove via EVA).

In all of these jettison situations, a simple efficient Orbiter separation can be performed. This technique places the Orbiter XLV, vertical stabilizer trailing. The jettison, which is nonimpulsive in all of these cases, is performed, followed by a 1 ft/s posigrade Orbiter translation. After about 2 minutes (roughly 130 feet of separation), another 1 ft/s posigrade Orbiter burn is accomplished to achieve a larger opening rate. The rationale for the two-burn sequence is that the first burn initiates opening with minimum tumbling due to plume, and the second burn gives greater desired SEP rate. This was specifically developed for RMS. The subsequent relative motion is shown in figure 5-46.

The RMS jettison procedure is found in the PDRS (A11) book, and the KU-80 ANT JETTISON is found in the ORB OPS book. The actual steps and rationale, plus differences between them, are described below (xxx refers to jettisoned object).

1. Prepare for jettison and perform between sunrise and noon if possible. This enhances visibility of xxx during initial separation.
2. AUTO MNVR to -XLV. See figure 5-42.

CRT	GNC UNIV PTG
	✓START TIME at least 15 min prior to sunrise
	✓TGT ID +2 (earth center)
	BODY VECT +2 (-X axis)
	OM +0
	Initiate TRK
A6U	DAP:A/AUTO/VERN
A6U	FLT CNTLR PWR - ON
	EVENT TIMER MODE - UP
	CNTL - STOP
	TIMER - RESET
A7U	✓Lighting - as reqd

Figure 5-42.- AUTO MNVR to - XLV checklist.

3. Several pages of xxx systems operations follow. In PDRS, this leads to last step: "Guillotine Wires at Shoulder."
4. Configure CCTV's to monitor jettison. (see figure 5-43).

```

Perform TV ACT, VTR ACT, TV/VTR Cue Card
CCTV MON 1 - A
          2 - B
Point CCTVs as reqd (FOR PDRS, POINT B CCTV
                    AT RMS SHOULDER JOINT)
Put new tape in VTR

```

Figure 5-43.- Configure CCTV's checklist.

5. At sunrise, "Damp Rates" and check to be in jettison attitude. (See figure 5-44).

```

A6U      DAP ROT: DISC/DISC/DISC
          TRANS: PULSE/PULSE/NORM
If VERN jets avail
| DAP: A/MAN/VERN
If VERN jets not avail
  DAP: B/MAN/NORM
Wait until rates damped, then
DAP A/MAN/NORM
for PDRS, DAP ROT: PULSE/PULSE/PULSE (free drift)
✓SENSE - as reqd
When rates damped, then
VTR - PLAY/RCD/RUN

```

Figure 5-44.- "Damp Rates" checklist.

A gentle separation is most critical for the PDRS because any attitude disturbances could lead to tumbling and potential recontact with Orbiter while still at close range.

6. Perform jettison (and PDRS, start timer).

7. Separate (see figure 5-45).

<u>NOTE</u>	
After JETT. initiate opening rate ASAP. Minimize other THC/RHC inputs	
Maintain xxx in B CCTV	
JETT+	
0:01	WHEN JETTISON COMPLETE. TRANSLATE AWAY THC +Z. 2 sec (1 ft/sec) (-X sense: THC dn) (-Z sense: THC out)

Figure 5-45.- Separation checklist.

This second burn (fig. 5-46) can be performed either on time (after 2 minutes, for PDRS) or on range (at 100 ft, for Ku-band). Although they should be equivalent, it is important to observe the jettisoned object and verify that both conditions are met.

SENSE - as reqd
THC +Z. 2 sec (1 ft/sec) (-X sense: THC dn) (-Z sense: THC out)
Maintain visual contact with xxx in OVHD window using RHC

Figure 5-46.- Second SEP burn.

The jettisoned body is kept in visual acquisition by the crew as long as possible to verify the opening rate, and from figure 5-48 it can be seen that after about 20 minutes this places the Orbiter in -ZLV. Since all PL's and appendages which have been studied to date have higher relative drag than the Orbiter, and -ZLV is the lowest Orbiter drag profile, this will provide a further long-term opening rate as the other body tends to drop lower and therefore travel faster. In a jettison situation where deorbit will follow closely after jettison, a mirror image separation can be performed such that each burn will be retrograde. In this case the relative drag effects can be ignored.

8. Go to new attitude when xxx no longer visible (see figure 5-47).

A6U	FLT CNTRLR PWR - OFF
	<u> GNC UNIV PTG </u>
	✓TGT ID +2
	BODY VECT +3
	OM +0
	START TRK - ITEM 19 EXEC (CUR *)
A6U	DAP: A/AUTO/VERN

Figure 5-47.- New attitude checklist.

9. Perform systems cleanup.

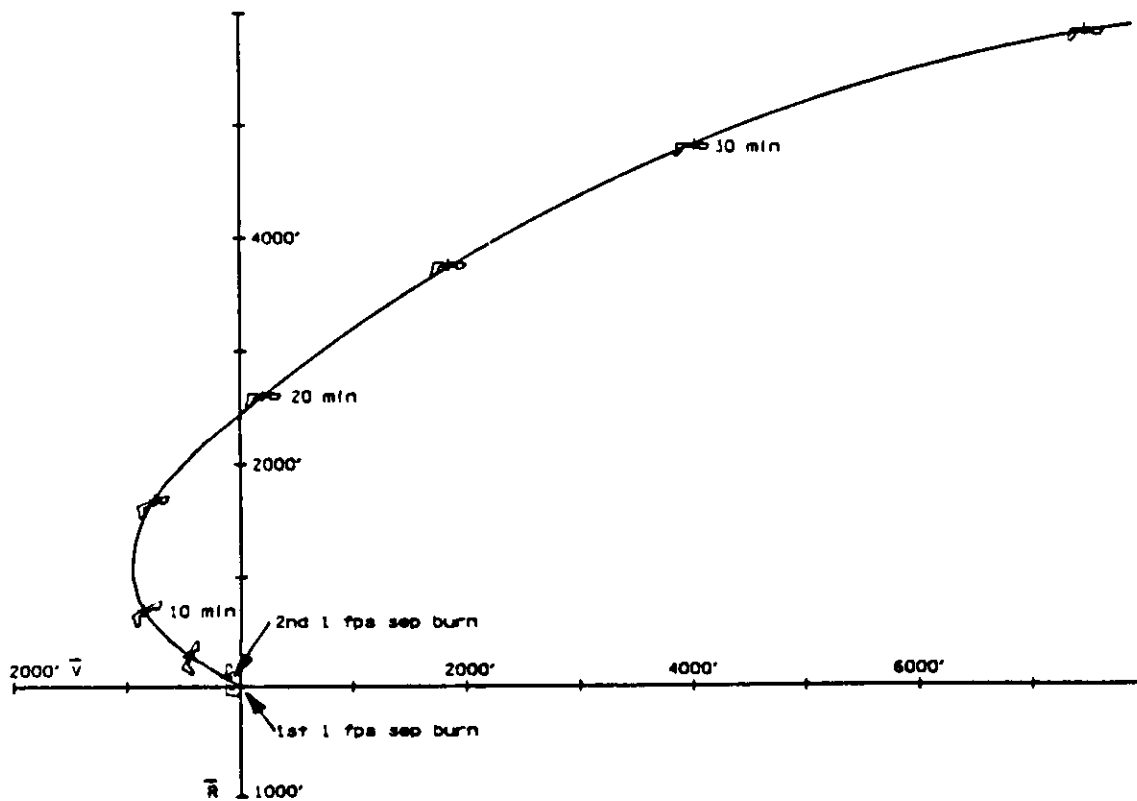

1364. ART. 1

Figure 5-48.- Orbiter separation trajectory following jettison.

5.4.3.4 Inadvertent/Immediate Release

Although inadvertent/immediate release is generally considered to be highly unlikely, it is a sufficiently serious situation to require some attention. The major difficulty with an inadvertent/immediate release is that in general it can happen with the Orbiter in any LVLH attitude, so simply backing away from the body is not the answer. If the back-off maneuver happens to be out of plane, a recontact situation may occur half a REV later. If the back-off were radial, recontact could occur one REV later. A procedure which can handle the general case is the generic "1-2-3 burn" described in 5.4.2, especially beginning in step 5. See figure 5-49.

This procedure does not necessarily provide for crew visibility of the other body throughout the SEP sequence, but is an efficient and relatively simple procedure, minimizing crew training.

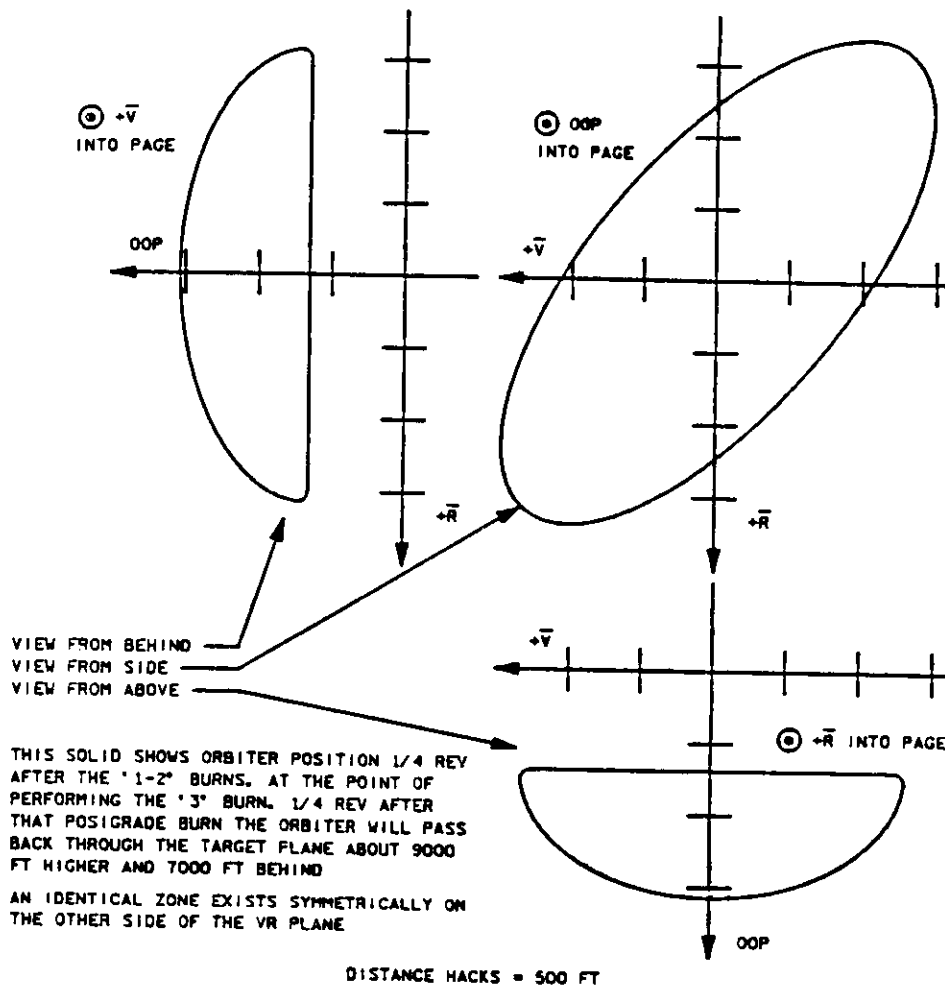

10589549. ART. 2

Figure 5-49.- Generic ("1-2-3") Separation

5.2 FLYAROUND

A flyaround is a PROX OPS task which involves maneuvering the Orbiter (active vehicle) from one point to another point relative to the TGT (passive vehicle) in the TGT LVLH frame. The term "transition" once meant any operation which resulted in Orbiter movement relative to the TGT (range not necessarily constant), while a "flyaround" specifically required that the Orbiter maintain approximately constant range while moving from one relative position to another. The term "flyaround" has come to refer to any relative movement, with or without constant range.

Level B G&C require that the TGT must be maintained in view from the Orbiter. This visibility requirement is satisfied by pointing the -Z axis toward the TGT, thus allowing the crew to view the TGT through the overhead window (and the COAS); this also gives the best orientation for RR tracking of the TGT (see fig. 5-4A). Since the crew is controlling the vehicle from the aft flight deck and is viewing the target out the overhead window, the aft THC and RHC sense should be -Z.

The requirement to perform a flyaround may result from situations such as the need to perform payload inspection, the requirement to support detached payload experiment operations by appropriate Orbiter relative positioning, or the requirement to move from an initial stationkeeping point (after a RNDZ) to a point from which grappling can be initiated.

The impact of orbital mechanics effects depends on the range and on the duration of the maneuver. For close-in flyarounds (about 35 ft), such effects can be disregarded. For ranges of several hundred feet, orbital mechanics effects can be significant.

The PROX OPS DAP B usually works best due to small translation pulse size. As in all PROX OPS phases, the crew should be aware of the limited insight provided to the MCC by telemetry. They should keep the MCC informed by periodically reporting what they are seeing and doing.

The different transition techniques and their applicability under different conditions are illustrated in fig. 5-4B.

5.2.1 Inertial In-Plane Flyaround

During an inertial in-plane flyaround, a combination of DAP control and pilot THC inputs makes the Orbiter translate and rotate around the TGT. Motion is clockwise when viewed in the traditional LVLH frame with +VBAR to the left (fig. 5-5).

This is the easiest flyaround procedure to perform. However, since this maneuver is always performed with a zero inertial attitude rate (about 4 deg/min or 0.07 deg/sec in the LVLH reference frame), the time to rotate to a desired orientation can be quite long (up to one complete REV).

The maneuver is initiated by placing the Orbiter in inertial attitude hold and then maintaining the TGT in the COAS or RMS EE field of view using the THC. From a position on the TGT +VBAR with Orbiter tail-to-Earth, the initial translation is radial up (-Z in the LVLH frame and +X in Orbiter body axes). This starts a "football" trajectory (section 2.4.2.3) around the target.

Since the flyaround is performed with constant range, THC corrections must be made along the Orbiter-TGT LOS (Orbiter +/- Z axis). Also, since in a pure football the inertial LOS rates to the TGT are not zero, NLOS corrections are needed to keep the TGT in COAS FOV (mainly X body axis).

In some situations, a fast maneuver may be required. Also, since this maneuver is strictly an inplane flyaround, the Orbiter may not be able to be aligned with some TGT orientations (such as if the TGT grapple fixture is on the opposite side of the orbit plane from the RMS). For these cases, more complex flyaround maneuvers are necessary and are described below.

5.2.2 Manual Rotation Flyaround

This technique (fig. 5-6) is good for any TGT relative orientation, including out of plane flyarounds. The pilot receives cues for starting and stopping from out-the-window views of the TGT orientation (it is not necessary to know the desired final attitude in advance). This is the primary technique for aligning the orbiter to the proper grapple attitude w.r.t. the TGT for unknown TGT orientation.

This procedure can be performed for both inertially and LVLH stabilized TGTs. It was originally developed for the inertially stabilized SYNCOM on STS-51I (see appendix A). The procedure was later generalized to include an LVLH flyaround technique for inclusion into the Contingency RNDZ FDF (fig 5-7).

Depending on the TGT's attitude hold mode, the pilot places the DAP in either inertial or LVLH attitude hold. This technique is then performed in each axis (roll, pitch, or yaw), one axis at a time, until the correct alignment is achieved.

For each axis (roll, pitch, or yaw), the pilot places the active axis in free drift (DAP ROT PULSE) and, using the RHC, manually inputs a rotation rate of 0.2 to 0.3 deg/sec (as seen on the UNIV PTG display). It must be emphasized that this is plenty fast enough even it may not look that way out the window (it is 3-4 times faster than inertial).

During this rotation, the pilot must then keep the TGT in the COAS or RMS EE FOV using the THC for NLOS corrections; he also must make LOS corrections as needed to maintain range within limits. Due to cross coupling effects, these THC inputs can change the active axis rotation rate (see section 3.8.1). Therefore, the pilot must carefully monitor and maintain this rate throughout the maneuver. When the trim in that axis is finished, that axis is placed back in inertial or LVLH hold (DAP ROT DISC) so the DAP can null out the rotation rates. THC inputs are made as required to keep the TGT in the FOV.

As required, the above sequence is repeated for another axis.

5.2.3 Negative Inertial In-Plane Flyaround

In some cases in which the relative Orbiter/TGT position would require an excessive duration for a clockwise flyaround, a negative inertial flyaround may be performed (fig. 5-7). For example, an inertial flyaround from the +VBAR to the +RBAR would take 3/4 rev, or about 67.5 min, while a negative inertial flyaround would take 1/4 rev, about 22.5 min, to get to the same relative position.

In LVLH, the "negative" flyaround is opposite to the inertial flyaround, thus the name. However, in the inertial frame, the flyaround rate is twice LVLH rate. This used to be called "counterclockwise" (CCW).

For a 90 degree angular displacement, this technique costs less than a regular inertial flyaround. Another advantage here is that RCS jet firings generally occur away from the TGT, so TGT plume contamination is much reduced.

This technique was performed during the STS-51DR mission to fly under the SYNCOM TGT. It can be performed as a special case of a manual rotation flyaround (5.2.2, above), or it can make use of the UP ROT option (as such it is generalized in section 5.2.4.1.2, below). It is best to command the +Z axis to center of Earth and then use THC only. This flyaround can also be performed by setting the ROT vector in UNIV PTG to the Orbiter -Y body axis (section 5.2.4.1.1). The latter technique may be twice as fast as the negative inertial technique.

5.2.4 FSW-assisted Flyarounds

The existing capabilities of Orbiter FSW provide several techniques for performing much more flexible flyarounds than can be done with manual inputs alone. Both UP (DPS 201) and ORB TARGET (SPEC 34) can be used.

5.2.4.1 Universal Pointing Function Assisted Flyarounds

In some cases where the TGT attitude is constant and can be determined precisely (is well known pre-flight or can be observed in real-time), the UNIV PTG function provides two methods which can be used to aid the flyaround task. They are:

- 1) mnvr to an inertial attitude;
- 2) auto rotation mnvr.

These are inertial maneuvers and as such should only be used if the TGT is inertially stabilized.

These techniques have several advantages. The flyaround can occur at a higher rate than inertial (4 deg/min), and it is not restricted to LVLH in-plane trajectories.

Both these maneuvers require only that the pilot use the THC to keep the TGT in the COAS or RMS EE FOV, because the DAP is controlling the change in Orbiter attitude.

5.2.4.1.1 Maneuver to an Inertial Attitude

If the TGT is in a known inertial attitude, the MNVR option of UNIV PTG may be used to rotate the Orbiter to a specific inertial attitude which, together with manual translations to maintain the TGT LOS, places it in the desired relative position. This inertial attitude is input via the UNIV PTG display, items 5, 6, and 7 (corresponding to roll, pitch, and yaw inertial Euler angles). Item 18 starts the rotation maneuver. The pilot performs NLOS corrections using the THC; if a constant range is needed, LOS corrections will also be required.

One drawback of this maneuver is that the flyaround direction is not immediately obvious in the case where the inertial attitude is called up in real time. As a result, the pilot may not know the direction that the TGT will initially move in the COAS or RMS EE FOV. For RMS ops, this can be tricky because the TGT can move directly toward the EE requiring immediate pilot inputs on the THC to avoid a collision.

5.2.4.1.2 Auto Rotation Maneuver

This technique uses the ROT option on the UNIV PTG display. The pilot inputs a pitch and yaw body pointing vector, via items 15 and 16, about which to rotate. To keep the rotations simple and easy to predict, this ROT vector is usually an Orbiter body axis. Once the rotation is initiated, THC corrections are performed as in section 5.2.4.1 above.

This maneuver was developed for the STS-51DR mission (a simple -Y rotation) and was also used on the STS-51G Spartan mission (contingency rotation in all 3 axes).

5.2.4.2 Targeted Prox Ops Flyarounds

This procedure uses SPEC 34 ORBIT TGT to calculate the translational burns required to move the Orbiter around the TGT; the burns are then performed in ORB MNVR EXEC. The TGT track mode of UNIV PTG is used to keep the -Z axis of the Orbiter pointed at the TGT. These target sets are determined pre-mission to ensure a trajectory of constant range.

The advantage of this procedure is that all aspects of the flyaround (except for trimming the VGO's) are performed automatically by the Orbiter FSW. However, this method is only as good as the sensor data being incorporated into the navigated relative state of the Orbiter.

This technique was developed for the STS-51F Plasma Diagnostics Package (PDP) mission. The Orbiter was repeatedly required to be in an exact position relative to the PDP at a certain time.

Certain orbit targeting I-loads need to be "tuned" for operations at PROX OPS ranges (see discussion in section 3.5.4).

A manual technique to approximate this maneuver was developed which used the MNVR to an inertial attitude (section 5.2.4.1.1) option on UNIV PTG to point the Orbiter in the correct direction with the pilot maintaining the PDP in the COAS FOV and a constant range from the PDP using the THC.

The manual technique had a high crew workload and required constant crew attention to attain the desired points.

-----RESUME TEXT at section 5.2.5 LOS Rate Techniques -----

PTG to the Orbiter -Y body axis (section 5.2.4.1.1). The latter technique may be twice as fast as the negative inertial technique.

5.2.4 FSW-assisted Flyarounds

The existing capabilities of Orbiter FSW provide several techniques for performing much more flexible flyarounds than can be done with manual inputs alone. Both UP (OPS 201) and ORB TARGET (SPEC 34) can be used.

replace section 5.2 (through 5.2.4), RPOHB pp. 5-11 to 5-17.
dougherty/oberg/pearson/section may 5, 1989
ADD new illustration 5-4B (TRANSITION TECHNIQUES)
Reverse numbering of figures 5-6 and 5-7

SECTION 6 MCC REAL-TIME SUPPORT

During rendezvous and proximity operations, the on-orbit MCC shift will be supplemented by a special group of flight controllers (the "Rendezvous Team"). A specialized "RNDZ Flight Dynamics Officer" is also on console, along with support personnel. The FCR operator, in the "Trench" (lowest and front-most FCR row) between FDO/TRAJ and GN&C/PROP, is called the "Rendezvous Guidance and Procedures Officer (GPO)", call sign "RENDEZVOUS" (see figure 6-1); he has overall responsibility for the proper performance of the RNDZ C/L.

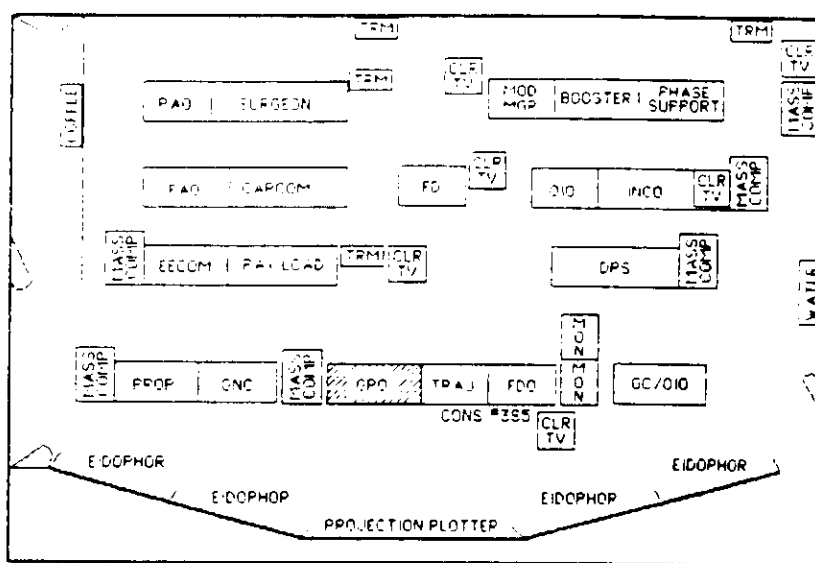

Figure 6-1.- FCR console layout.

Supporting the RNDZ GPO in the TRAJ MPSR are three consoles: Rendezvous Procedures Support ("RPS"), Orbit Navigation ("ONAV"), and Orbit Targeting ("TARGET"). A summary chart of RNDZ team members is shown in fig. 6-2. The detailed specifications of their duties, procedures and reference materials are found in the "Rendezvous GPO Team Console Handbook", JSC-22339, PRELIM, May 16, 1988, and the "Flight Dynamics Officer Console Handbook", BASIC, to appear 1988; this section provides a brief overview for operational understanding of real-time mission support.

The interrelationship and communications flows of the RNDZ Team FC's are shown in figure 6-3. The RNDZ team personnel come from the Orbit Dynamics Section (DM43), Orbit Analysis Branch (DM4), Flight Design and Dynamics Division (DM), Mission Operations Directorate of NASA-JSC, with support from the Orbit Analysis and Procedures unit (RS16), Orbit Flight Analysis Group, Flight Design and Dynamics Department, Mission Operations Division, of the Rockwell Shuttle Operations Company.

The RNDZ FDO prepares and uplinks all maneuver command loads and all state vectors (Orbiter and target) as needed; he also prepares the maneuver PAD's which are voiced up. The RNDZ GPO is responsible for uplinking the covariance matrix, which acts as a filter on raw onboard navigation data being processed to improve the FLTR SV; he also prepares SEP PAD's as required.

The RNDZ GPO represents the office which has prepared the FDF RNDZ C/L (normally, the RNDZ GPO on duty during execute shift has personally been involved with the mission for 1 to 2 years and has been intimately involved in the actual procedures development and documentation work). During on-orbit operations the RNDZ team follows procedures execution and verifies proper performance, recommends contingency techniques/procedures as needed, follows the mission with attention to impacts on RNDZ procedures due to other systems anomalies, and keeps the MCC team aware of impending activities and their priorities. Navigation anomalies are analyzed and crew choice of proper SV and maneuver solutions is verified.

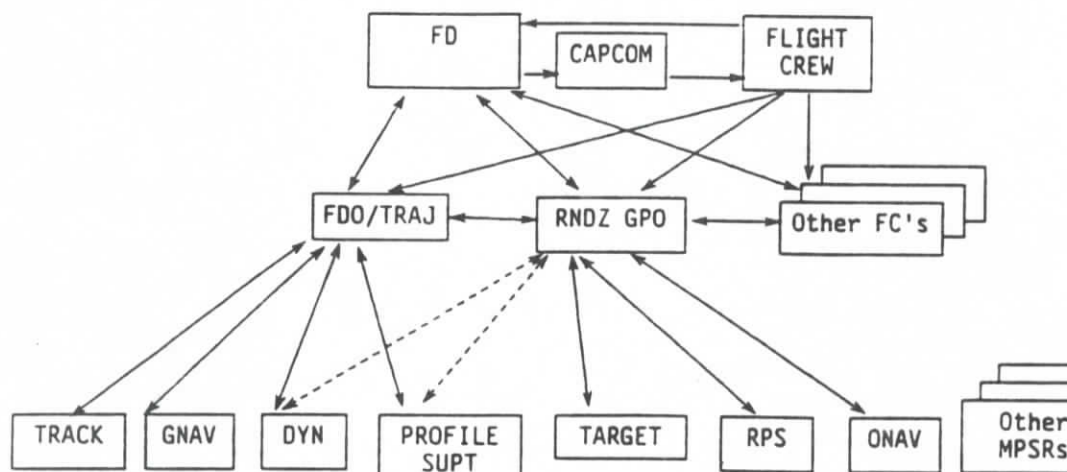

Figure 6-3.- RNDZ team.

In support of MCC monitoring, the RNDZ team uses a specialized set of displays, clocks, and indicators, in particular the MSK 1888 display called "RNDZ PROC" (fig. 6-4). They allow monitoring of: vehicle system status, attitude/errors, active DAP configuration, scratch pad lines, NAV sensor status, performance, readings, and edit status, most REL NAV, UP, and MNVR EXEC parameters, and most relevant switch positions. GMT, MET, PET, post-MC2 ET, and time-to-SR/SS are displayed. There are some parameters not displayed onboard that can be monitored in the MCC (e.g., STRK measured target brightness). Other onboard parameters are not downlisted but are monitored by the MCC during RNDZ phase by using the GNC variable parameter option (currently the SPEC 34 target set number, and the computed T1 TIG to monitor MC2 TIG slip). Still other parameters cannot be observed at all (e.g., PLB CCTV angles during prox ops ranging), and occasional crew readout would facilitate MCC appraisal of mission status. It should be stressed

SECTION 7 TETHERED OPERATIONS

The operation of separate PL's in proximity to the Orbiter has always been a RNDZ/PROX OPS operational concern. In the near future a new class of PL's will appear, those which remain physically attached to the Orbiter by tethers. Although some new flight-dynamics laws come into play, such objects are only a tether-break away from becoming classical PROX OPS subjects and many actually plan to separate rather than return to the Orbiter; furthermore, traditional monitoring and control techniques for RNDZ/PROX OPS have major applications to this new class of PL. Consequently, the flight procedures for tethered objects clearly fall within the purview of this book.

7.1 BACKGROUND

To understand tethered operations, an appreciation of the history, candidate applications, and safety concerns is required.

7.1.1 History

Tethered operations occurred in the Gemini program when the manned Gemini spacecraft was connected to the Agena booster by a 100-foot tether. Gravity gradient and artificial gravity experiments were conducted.

Current projects involve plans for both short (300 feet) tethers (on Hitchhiker G2) and long (10 to 20 n. mi.) tethers (for the Italian "TSS" or "Tethered Satellite System"). An official NASA project envisages systems that can achieve 50 n. mi. (100 km) deployment distances with new tether materials, control laws, and supporting subsystems.

7.1.2 Applications of Space Tethers

Numerous applications have been imagined for tethered objects in space. These include:

Electrodynamic -- A conducting tether moving through Earth magnetosphere generates electrical current (a 5 to 10 n. mi. tether would generate line voltage of 2 to 4 kV), or, inversely, current in a conducting tether generates thrust for orbital adjustment.

Trolling (instruments or test models) -- Instruments are lowered into normally inaccessible (in terms of longterm in situ measurements) regions of the upper atmosphere. Test models of future aerospace planes are lowered into the upper atmosphere for aerodynamic studies. Keels may be lowered into the upper atmosphere for plane changes.

Variable G -- In stable gravity gradient mode, modules moved along tethers can experience a variety of G-forces, which can be tailored to the desired applications. In dynamic, rotating systems, large accelerations can be generated for control, physical processing, or long-term human health applications.

Momentum Transfer -- Objects at the end of tethers can be released, taking momentum from a main object and imparting it to a secondary smaller object for either orbit boost or deboost. The momentum of the larger object can then be made up using high-efficiency low-thrust propulsion systems.

Constellations -- Structures can be established in stable REL positions' tens or even hundreds of miles apart. For operational reasons, specialized modules (such as a docking wharf) can be separated from a main object for operations, and then retrieved, repeatedly.

7.1.3 Safety Considerations

While the theoretical applications appear to be unlimited, the key issue is whether such plans are operationally feasible. That is, can safe procedures (both AUTO and manual) be developed under which such applications can occur?

Key safety issues include (but are not limited to)

- a. System dynamics stability
- b. Tether failure
 - (1) Structural (tether)
 - (2) Attach points
 - (3) Induced (e.g., collision with debris)
- c. Reeling mechanism failure
 - (1) Jamming
 - (2) Power loss
 - (3) Overtorque reel-in
 - (4) Runaway
- d. Deployed-object anomalies
 - (1) In-line thruster fail-off
 - (2) NLOS thruster fail-on
 - (3) Dynamics

- e. Orbiter damage
 - (1) Physical impact (tiles, windows, SSME/OMS/RCS engines)
 - (2) Tether mechanism stow (versus jettison)
 - (3) Mechanical jam (e.g., Ku-band antenna, PLB doors)
- f. Contingency procedures
 - (1) Brake application
 - (2) Motor unpower
 - (3) Tether guillotine
 - (4) Boom jettison
 - (5) Separation maneuvers

Any candidate body of procedures must take into account these and other as yet undefined concerns.

7.1.4 Reference Material

A number of general reference articles are available (from which much of the material in this section has already been directly excerpted), including:

Guidebook for Analysis of Tether Applications, Joseph A. Carroll, contract RH4-394049 with Martin-Marietta (as part of NASA-MSFC contract NAS8-35499, "Study of Selected Tether Applications in Space"), March 1985.

"Controlled Tether Extends Satellite's Orbital Range," Victor Wigotsky, Aerospace America, June 1984, pp. 34-36.

"Tether Propulsion," Ivan Bekey and Paul Penzo, Aerospace America, July 1986, pp. 40-43.

"Tether Applications in Space Transportation", Joseph A. Carroll, Acta Astronautica, 1986, Vol. 13 no. 4, pp. 165-174.

Proceedings of NASA/AIAA/PSN "International Conference on Tethers in Space," September 17-19, 1986.

"Tethers in Space: The Future Nears," William J. Broad, N. Y. Times, January 7, 1986.

"Trolling the Atmosphere," Richard DeMeis, Aerospace America, June 1986, pp. 16-17.

7.2 THEORETICAL CONDITIONS

The statics and dynamics of tethered space systems involve mathematically accurate but intuitively unfamiliar features. A brief summary of the theoretical basis for such features may help in appreciating their operational implications.

7.2.1 Tension

In a weightless condition, tethered objects are unlike objects hung on cables under one g conditions, where the full weight of the object is supported by the cable. In orbit, both tethered objects are nearly in stable ballistic trajectories, and only the difference between such free trajectories and actual tethered trajectories shows up as tether tension.

Consider the example of two equal mass objects tethered 10 miles apart. Their c.m. is in a stable orbit with a known period. For a free-flying object passing 5 miles below this system c.m., relative motion would be approximately 50 miles per REV, or 50 ft/s (in accordance with the "10:1" rule of thumb for ΔH to lateral separation ratios). The lower mass, then, is moving 50 ft/s too slow for a circular orbit at its altitude, but it is still moving at nearly 25,000 ft/s anyway, so the deficit in orbit motion is a very small fraction (several tenths of one percent, in this case), and the weight "hanging" on the tether is a similarly very small fraction of the total one g weight of the lower mass (a half-ton satellite would induce only a few pounds of tether tension). A rule of thumb is that a free-hanging tethered system will experience tension equivalent to 1 percent of the one g weight of the object per 12 n. mi. of length.

Note: If the lower mass, 5 miles below the c.m., were detached, it would act exactly as if a satellite there in circular orbit suddenly performed a -55 ft/s ΔV . Then it would thus fall into an orbit with opposite end about 33 n. mi. lower while the upper mass would rise 33 miles (via the old familiar "2:1 Rule" of ΔV to ΔH ratios). This is approximately the same result discussed under "momentum exchange" applications.

Gravity gradient tension is caused by a combination of gravitational and centrifugal forces (fig. 7-1). One-third of the total force is centrifugal, due to the ROT of the LVLH system in inertial space; two-thirds is gravitational, due to the inverse square diminution of Earth gravitational attraction as distance from Earth increases.

In low Earth orbit, the magnitude of these effects depends on the size of the system. A rule of thumb specifies about 0.12 μg /ft, or 1 μg per 8 feet.

Over about a foot, the gravity gradient forces amount to a tenth of a microgee (essentially undetectable); over the length of the Orbiter (150 feet), the gravity gradient forces amount to about 10 microgees (possibly noticeable); over a tether length of 5 n. mi., gravity gradient forces amount to several thousand microgees. Objects which are located that far from the system c.m. will experience gravity gradient acceleration fields of that size.

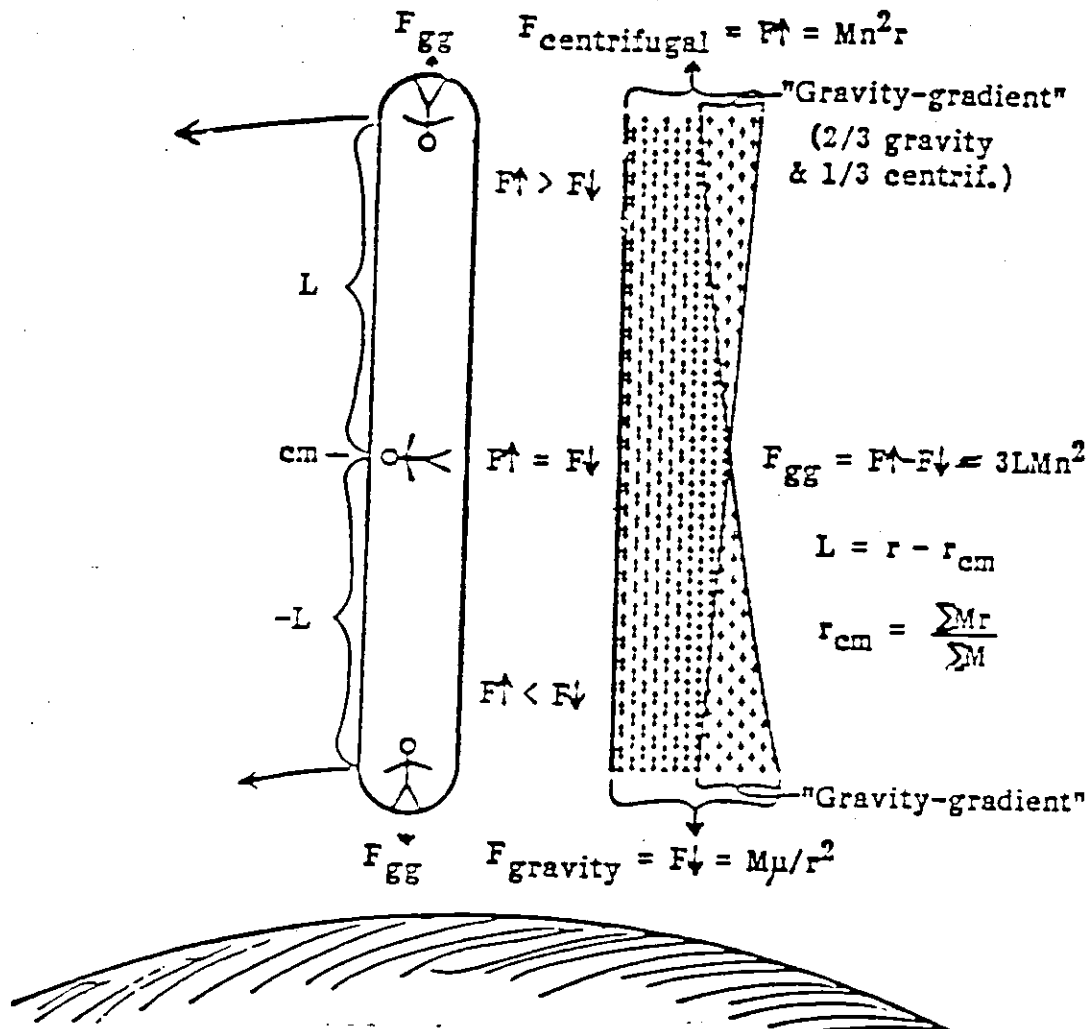

Figure 7-1.- Origin of "gravity-gradient" forces.

Practical considerations help define an Orbiter-satellite range beyond which gravity gradient forces can be relied on to safely maintain tether tension. Inside that range, other techniques (such as in-line thrusters) would be required to maintain tension. For initial TSS-S studies, that range appears to be approximately 4000 feet. For other tethered payloads, analysis may produce a different range.

7.2.2 Motion

The motion of tethered systems has been analytically studied in depth.

Changing the tether length between two end masses induces a system tilt, due to Coriolis forces. This induced tilt sets up a periodic motion called libration. As will be described below, the reverse process is also possible: in-plane libration can be damped by a judicious variation in tether reel in and reel out rates.

Libration is defined as the cyclic swinging motion of a tethered system relative to the local vertical, or the system R-BAR. The following treatment and terminology is adapted from Carroll (1985).

In-plane libration is measured with an angle θ of the tether relative to the system R-BAR. Out-of-plane libration is measured with the angle ϕ , again measured as the tether orientation relative to local vertical. For convenience, these are referred to as θ -libration and ϕ -libration.

In the extreme case, libration becomes spin, as the system begins a centrifugal ROT rather than a periodic back-and-forth swing. Such dynamics have applications both to momentum transfer techniques and potentially to non-thruster retrieval techniques.

Four aspects of libration behavior deserve notice:

First, the restoring forces grow with the tether length, so libration frequencies (at low amplitudes) are independent of tether length. Thus, tether systems tend to librate "solidly," like a dumbbell, rather than with the tether trying to swing faster than the end masses (as can be seen in the chain on a child's swing). For low orbits around Earth, libration periods are roughly an hour (θ -libration period is 0.577 times orbital period; ϕ -libration period is 0.5 times orbital period), and increase if amplitude is very large.

Second, tethered masses would be in free-fall except for the tether, so the sensed acceleration is always along the tether.

Third, the axial force can become negative for extreme swings ($\phi > 60^\circ$, or near ends of retrograde in-plane swings where $\theta > 66^\circ$), and this may cause problems unless the tether is released, or retrieved at an adequate rate to prevent slackness (or if the objects have active in-line thrusters).

Fourth, although theta-libration is not close to resonance with any significant driving forces, phi-libration is in resonance with several, such as out-of-plane components of aerodynamic forces (in nonequatorial orbits that see different air density in northward and southward passes), or electrodynamic forces (if tether currents varying at the orbital frequency are used). There are limits to the effect of such weak but persistent forces, but these limits are, in most cases, quite high. Further, when a system is in an eccentric orbit, variations in orbital rate cause librations which in turn exert periodic torques on an initially uniformly-rotating object, and in highly eccentric orbits this can soon induce tumbling.

Besides libration, other dynamic features of tethered systems are tether oscillations ("longitudinal" or length-wise, and "transverse" or crosswise, both in plane and out of plane), and end mass attitude oscillations (pitch and roll motion is called "pendulous motion," and yaw motion is just spin-around-the-tether axis).

Six control methods have been described in the literature. They are: tension variation via reel commanding; main object thrusting; deployed object thrusters; movable mass on tether; stiff tether and movable boom; aerodynamic effects. Only the first three appear practical in the early years of STS/station tethered operations.

Libration damping is done by paying out the tether when the tension is greater than usual and retrieving it at other times. This absorbs energy from the libration. In-plane libration causes large variations in tension (due to Coriolis effect), so such "yo-yo" maneuvers can damp in-plane librations quickly. Control of out-of-plane libration with this technique is more difficult. Tether oscillations can also be damped by use of this technique. Reversal of these techniques is possible so that libration can be "pumped" rather than "damped."

Although these long-period effects may dominate tethered motion when the satellite is fully or nearly extended, and special control procedures must be defined and validated, during the more dynamic phases (initial deploy and final retrieve), the time period is brief enough that such periodic effects are entirely masked by local Orbiter-specific dynamics.

7.3 TYPICAL HARDWARE

A wide variety of candidate hardware is under development for the various tethered missions now being planned. The following discussion is only meant to describe typical hardware.

7.3.1 Orbiter-Satellite Connection

The Orbiter and the tethered satellite are connected by a physical tether (section 7.3.1.1) and possibly by one or more in-line attenuation mechanisms (section 7.3.1.2).

7.3.1.1 Tether

Both conducting and nonconducting tethers are under development, selected either for pure support or for electromagnetic experimentation.

Candidate tether configurations either have no covering or have jackets of Teflon, Kevlar, or Nomex braid. Diameters range from 0.065 to 0.100 inches. The Kevlar (aramid) tether exhibits a very high strength-to-weight ratio, a wide operating range of -148° to 392° F, and good mechanical fatigue properties.

Typical tether weights run from 2 to 6 lb per kft for breaking strength of 400 to 600 lb.

An attractive material for quick satellite deployments is SPECTRA-1000. Such a tether would be 0.030 inches in diameter, weighing 0.2 lb per kft, with a 150-lb breaking strength. It melts at 300° F and has no long-term resistance to ultraviolet radiation and atomic oxygen erosion, but for short-term missions it provides 10 times the carrying capacity per line weight as does Kevlar.

Two types of tether stretch are of concern: elastic and deformable. Elastic stretch lengthens the tether under tension, but disappears under relaxation; deformable stretch is permanent alteration of line length.

Elastic stretch causes dynamic motion of the satellite, both in attitude and longitudinally along the tether. It damps out tension excursions caused by Orbiter motion (if unintentional excursions, this is a benefit; if deliberate excursions for control, this is a drawback). As a mechanism for energy storage, it can impart energy to the satellite in undesired and unexpected ways.

Deformable stretch is of concern in terms of measured length, as the tether is being retrieved. The "deployed length" parameter computed by the deployer mechanism may reach zero while a significant amount of stretched tether is still deployed. If this parameter is to be used in computations for libration control or as a cue for crew procedures, there must be a means of calibrating it against some other range determinator (e.g., radar or CCTV triangulation) and then entering a corrective offset value.

7.3.1.2 Attenuation Mechanisms

Portions of the Orbiter/satellite connector may be shock attenuation structure, either one-time (stretchable/frangible tether) or cyclic (springy tether). A property known as "lossiness" (where deformation occurs at a cost in work done) would be a useful characteristic of boom-tether-payload correction mechanisms; "lossy" structures could absorb and soften tension jerks.

7.3.2 Deploy-Only Hardware

Simple tether systems which do not envisage retrieval can pay out the tether from the deployed satellite. One such near-term system is the PMG on Hitchhiker G2. The tether is pulled out of a deployer assembly on the satellite as the satellite departs with its own momentum. Any snag will cause the tether/Orbiter attach plug to pull; at the end of the planned deploy, the plug will also nominally pull. Science data is taken only during the reel-out period.

More advanced versions of this system envisage stable stationkeeping at full tether extension. In such cases, the Orbiter/tether connection must be deliberately cut at the end of tethered operations (several REV's). Snagged tether during deploy, or deployment mechanism jam, must still result in immediate Orbiter/tether separation and a subsequent Orbiter/satellite safe separation without Orbiter maneuver.

7.3.3 Deploy/Retrieve Hardware

When tethered objects are to be deployed and then retrieved, much more complex systems are required. These can involve unfurlable boom structures, reels and motors, and corresponding monitor/control mechanisms.

7.3.3.1 Booms

For the TSS, a lattice deployment boom was chosen, rather than a telescoping or furlable design, because of inherently greater strength and damping. This is designed as a jointed non-continuous longeron boom, and is extended and retracted through a motor-driven nut at the canister outlet.

Should the boom and canister assembly need to be jettisoned from its primary support truss, pyro nuts are released and three constant-force linear spring motors give a 60-lb push over 80 inches of travel on tracks in the support truss. There is also a redundant pyro-operated tether cutter for this contingency. A tether cutter is also installed on the upper boom mechanism for simple tether guillotine.

The satellite docking cone at the top of the boom consists of a circular support covered with 0.2-in.-thick Teflon felt, and fastened to a tubular, structurally supported frame. The boom permits docking the satellite at an angle of 20°. The entire upper boom mechanism mounts on a contact ball bearing that allows $\pm 180^\circ$ rotation, powered by a gear motor, to align the aerodynamic boom for satellite reinsertion into the PLB.

7.3.3.2 Reel Motors

The TSS reel drive, which stores the tether, is powered by a brushless, 3-phase, 5-horsepower electrically-commuted samarium cobalt dc motor. The

motor operates over a dynamic range of 10 rpm to 1000 rpm at torques up to 45 ft-lb.

7.3.4 Generic Tethered Object Systems

A generic tethered object may possess a wide variety of operational capabilities, based on different types of hardware.

7.3.4.1 Line Tension Mechanisms

The most straightforward technique for maintaining short-range tether tension is for the tethered object to activate thrusters pointed down the tether. Since the plume is directly into the Orbiter payload bay, most technologies are ruled out on contamination grounds, but nitrogen gas is fully acceptable and has sufficient performance. The TSS-S has two thrusters of 2-newton force (0.45 lb) each. They are controlled over the RF link by crew inputs to a payload-specific SPEC.

Another candidate technique for maintaining satellite tension against a tether is use of another tethered object, a deployed mass at the end of a 5- to 10,000-ft tether which pulls the main payload out (like a drogue chute), and maintains tension during retrieval (fig. 7-2). Postretrieval, this mass is jettisoned. This is the so-called "space anchor."

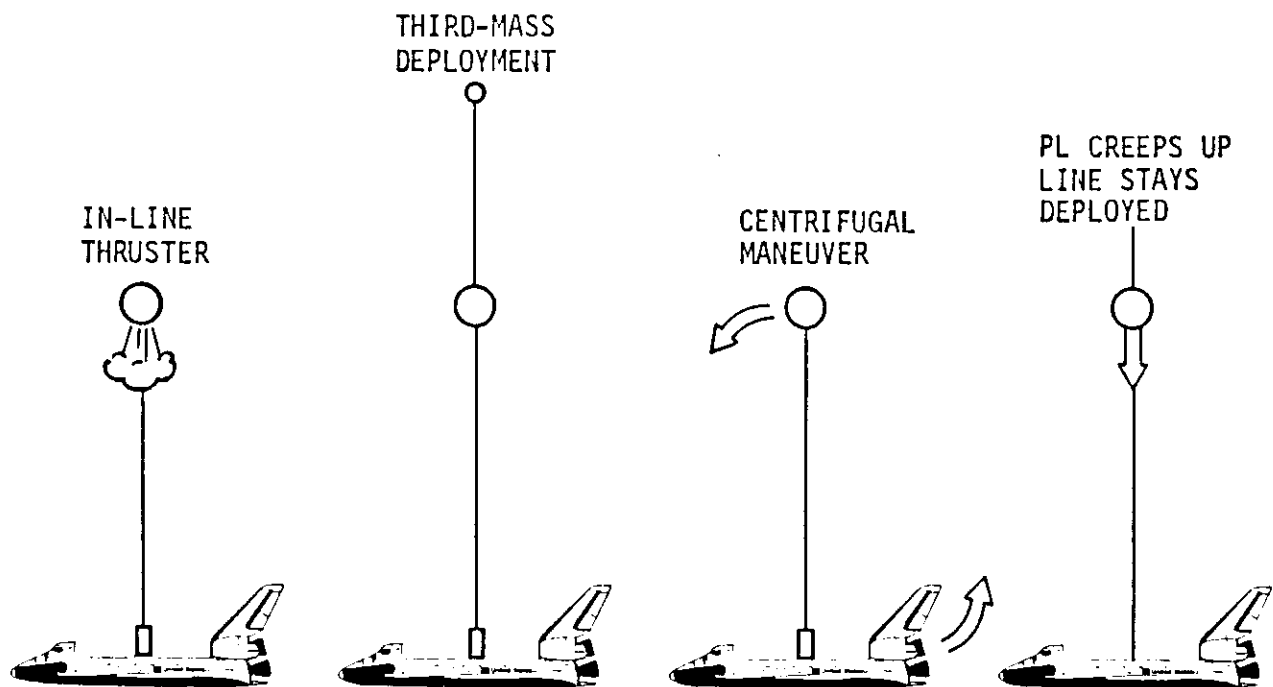

Figure 7-2.- Line-tension techniques.

7.3.4.2 Other Attitude/Translation Capability

Tension on the tether attach point on the satellite can be counted on to maintain satellite roll and pitch angles within small deadbands. However, the tether exerts no force in the satellite yaw axis (roll about the Orbiter-satellite line), so some means of active yaw control may be required both for satellite pointing and to prevent excessive tether twisting.

To assist in maintaining Orbiter-satellite relative stability, a tethered satellite may also possess translation thrusters for both in-plane (parallel to Orbiter X axis) and out-of-plane (parallel to Orbiter Y axis) maneuvers. In the event of significant satellite roll/pitch deviations, however, use of such satellite thrusters can significantly impact tether tension. While translating the satellite is a much more economical technique than translating the Orbiter, there remain operational and training concerns about the practicality of such a technique.

7.3.4.3 Radar/Optical Visibility Enhancement

Due to potential tether-induced radar degradation (in the case of electrically conducting tethers), the placement of radar enhancement devices on tethered objects may be highly desirable. If radar TRK throughout the deployed phase is deemed mandatory, use of an active transponder may be considered.

Visibility of the satellite, especially at night, may be a safety issue for close operations, especially within the range where gravity gradient forces can no longer be relied on to maintain tension. At night and with radar failed, if there are no other sensors capable of verifying safe Orbiter-satellite separation and rates, tether guillotine and Orbiter separation may be the only safe option. Hence, either high-performance reflectors or satellite-mounted lights (even long-period strobes) may be at least highly desirable.

Although volume XIV of the Payload Accommodations Document only specifies PL visibility to 1000 feet, an unresolved issue with tethered systems is whether the tether itself be considered part of the PL. If so, volume XIV lays out the requirement that the first 1000 feet of the deployed tether be visible, no matter how far out the actual satellite is. This issue must be resolved on a case-by-case basis.

Techniques to enhance visibility of the tether itself (particularly the segment closest to the satellite, for several hundred feet, either in entirety or pointwise) may be examined; such visibility may significantly enhance the ease and confidence of crew procedures during initial deploy and final retrieve operations.

7.3.4.4 Reels

Although the most common design involves a tethered satellite attached permanently to the far end of the tether, there are concepts in which the satellite itself may reel in the tether, either to store it onboard or to deploy it out the other end (i.e., the satellite "crawls" up the tether leaving it hanging free beneath it).

7.3.4.5 Grounding Device

For electro-dynamic applications, the electrical circuit must be closed by "grounding" the ends of the tether into the ionosphere, both at the Orbiter end and at the satellite end. This can be done with an electron gun or a hollow cathode.

7.3.5 Typical Tethered Payloads

A wide variety of tethered objects is already under development or advanced design. These are typical:

a. Tethered Satellite System (TSS)

The TSS is a 1100-pound, 5-ft-diameter spacecraft built by Aeritalia in Italy, under management of the Italian Council for National Research.

b. Plasma Motor-Generator (PMG)

Planned for use with the Hitchhiker G2 payload. Details TBS.
Has 200-meter tether, not retrieved.

c. Kinetic Isolation Tether Experiment (KITE)

Involves 1-ton payload (SPARTAN-class or actual modified SPARTAN spacecraft) to range of 1 to 5 kilometers (0.5 to 2.5 n. mi., or 3000 to 15,000 ft), in stable gravity-gradient attitude. In study phase only.

d. Small Expendable Deployment System (SEDS)

This demonstration experiment involves a basketball-size deployer and an 0.030-inch tether, 10 n. mi. long, weighing about 20 lb. The system is designed to deploy a payload of up to 1 to 1-1/2 tons; after deployment, the tether is jettisoned.

7.4 INTERFACE/IMPACTS TO STS

Operating a tethered object from the Orbiter can be expected to have significant impacts on many normal operating procedures, sometimes requiring major procedural changes or additions.

The primary impact of tethered objects will probably be from the enforced attitude holds required during the deployed phase; these attitudes will probably be either -Z toward or away from center of Earth. Impacts may include the following:

7.4.1 DAP

The constant torque from the tether tension can have significant impacts on attitude control, even if the Orbiter is allowed to reach an equilibrium attitude with the deployed tether. The system moments of inertia will be changed in several axes. The TSS-D torque will exert a controlling force in roll, and to a less extent in pitch, while yaw DB must also be maintained. Examination of this issue by appropriate guidance, NAV, and control analysts has not yet been undertaken.

7.4.2 Ku-Band Radar

Testing at White Sands in 1986 indicated that electrically-conducting tethers have a significant negative impact on RR TRK ability (this was anticipated on theoretical grounds). Forward scattering of the radar pulse down the tether seems to sufficiently defocus the pulse so that the return echo is weakened; the effect reduces the apparent radar cross section of the tethered object. This may have impacts for initial RR acquisition during retrieval.

7.4.3 Flight Dynamics

As a tethered satellite object is deployed to great range, the Orbiter/satellite system continues to orbit Earth in a path essentially determined by the c.m. of the whole system. However, both ground and onboard NAV will be TRK the Orbiter only, and can be offset from the true "(whole-system) Orbiter" by a significant amount. For the TSS at 20-mile range, this c.m. offset can amount to several hundred feet, which corresponds to several thousand feet downtrack error per REV. SV management must take this c.m. offset effect into account.

7.4.4 IMU Alignments

Restricted attitudes will require use of TGT's of opportunity. Further complications arise from the specific nature of the required attitude: down-deploys place the -Z STRK toward Earth and up-deploys may still have the satellite continuously in the -Z STRK FOV (at a range of 20 n. mi. the TSS-S

brightness in terms of stellar magnitude should be between 0 and -2, in daylight); in either case, the -Y STRK is pointed nearly horizontal, although there should be a narrow safe-operating range for its use. Two stars of opportunity should be available through the -Y STRK for such alignments.

7.4.5 Microgravity Effects

At maximum extension of a substantially-sized tethered object, significant microgravity acceleration will be experienced in the Orbiter in the +Z ("down") direction. The TSS at 20 n. mi. will move the Orbiter/satellite system c.g. out above the Orbiter by several hundred feet, inducing a microgravity field of several tens of microgees inside the Orbiter. While not immediately noticeable, such a field would cause any free-floating objects to "fall" to the floor within a minute or two (this may impact crew habitability), will cause all fluids to settle, and can induce convective currents in the atmosphere and other fluids (depending on differential heating). This field can last on the order of a full day, under current plans. Proper fluid feed in OMS/RCS, fuel cells, and other systems may be affected; the induced weak convective effects in the cabin atmosphere may impact cooling. As a first approximation, no serious malfunctioning might be expected since the acceleration is in the same direction as during entry and landing; however, the very long time interval of the acceleration may introduce unexpected effects. Serious systems analysis of this issue is yet to be undertaken. It should be noted that such forces already exist within the Orbiter due to its large dimensions (the crew compartment is about 50 feet from the Orbiter c.g.), but the tether-induced forces will be several times as large and in another axis.

7.5 GROUND RULES, ASSUMPTIONS, AND CONSTRAINTS

7.5.1 Dedicated Crew Size - Initial OPS

Analysis by CB indicates that four dedicated crewmembers are needed for initial dynamic tether mission phases: one MS is at the PLT station operating SPEC's; another MS is performing photodocumentation at the aft right station; the PLT is at the aft left station performing the actual flying; the CDR is at the CDR station coordinating, and preparing for contingency operations such as guillotine and separation. Conceivably, a TSS PS could also be present as an observer.

7.5.2 Dedicated Crew Size - Mature OPS

Regular tether operations, once sufficient experience has been accumulated, may be performed with three or even two dedicated crewmembers.

7.6 SPECIAL DISPLAYS/CONTROLS

Unique features of tethered operations require specially-designed monitoring tools and techniques. These can involve standard RNDZ items such as SPEC functions, CCTV systems, and cabin tools such as ranging rulers.

7.6.1 Crew Displays

During 1986 SES TSS runs, a unique pseudo-SPEC function was designed for "TSS Control," and it was arbitrarily designated "SPEC 50"; this number and the entire display definition was unique to the SES. Parameters available on the SPEC 50 display included RR range and range rate, in-plane and out-of-plane angles and angle rates, and NLOS ft/s rates, tether length and length rate (measured by the TSS-D mechanism), etc. The displayed radar range was approximately 75 feet higher than the tether length because of geometric factors. Significant insights were obtained into the desirable features of the real, still-to-be-defined "TSS Control" SPEC. Two displays, one for systems and one for dynamics, were eventually developed (fig. 7-3).

XXXX/XXX/205			TSS DYNAMICS			XX X DDD/HH: MM: SS		
						DDD/HH: MM: SS		
THRUSTER	HI	LO	IP			OP		
+X	1XS	2XS	ANG	±XXX.XXS		±XXX.XXS		
-X	3XS	4XS	RATE-	±X.XXS		±X.XXS		
+Y	5XS	6XS	VEL	±XX.XXS		±XX.XXS		
-Y	7XS	8XS	RADAR			REEL		
INLINE THRUSTERS			RNG	XXXX.XXS		LEN	XXXX.XXS	
+Z	1N	2N	R	±XXX.XXS		RATE	±XXX.XXS	
ON	9XS	11XS	RR	32XS		TEN	XX.XXS	
OFF	10XS	12XS	REF INIT			TSS ATT		
			INRTL	33XS		ATT	RATE	
YAW CONT			LVLH	34XS		R	±XXX.XXS	
+ROT	15XS	HOLD	LVLH	RATE		P	±XXX.XXS	
-ROT	16XS	NULL	35	X.XXX		Y	±XXX.XS	
			FREE	19XS				
VLV	OP	CL	ATT	REF		TANK P XXXXS		
TK ISOL	20XS	21XS	INRTL	36XS		VOLTS XX.XS		
IOP	22XS	23XS	LVLH	37XS				
CDA/IOP	24XS	25XS	REEL			LIGHTS	DOCK RING	
CDA/YAW	26XS	27XS	IN	38XS		ON	41XS ROT+ 43XS	
IL1	28XS	29XS	OUT	39XS		OFF	42X - 44XS	
IL2	30XS	31XS	STOP	40XS		STOP 45XS		
						(XX)		

105890073. ART, 1

Figure 7-3.- Tethered OPS control display.

CAUTION: This is not a draft SPEC and in fact may contain parameters not available for on-board display.

Enough requirements were developed to raise the issue of creating two TSS crew displays, one for TSS-S/D systems and the other devoted to TSS dynamics. The former would include a substantial body of still-undefined TSS-D parameters, as well as TSS-S systems monitoring and reel controls.

The latter would display data needed immediately at the aft crew station by the crewmember performing the flying and would be the basis for design of a generic tether dynamics SPEC for any application to tethered operations.

On the TSS DYNAMICS display, the crew should have the option of entering a length bias to correct for tether stretch during deploy; at a set range measured both by radar and by TSS-S angular size in the CCTV, the measured length should be observed, and the necessary bias consequently computed and entered.

With a correct length and length rate, time-to-berthing should be computed and displayed in MM:SS. This was simulated at the SES by setting a count-down clock based on known run duration, and it was found to be extremely useful during the terminal phase in estimating corrective firings required and in avoiding overcorrection.

TSS-S attitudes must be displayable in an Orbiter relative frame as well as LVLH, so that proper berthing alignment can be noted.

7.6.2 Special CCTV Arrangement

For 1986 SES TSS runs, a special CCTV arrangement specified that two CCTV's be placed on the TSS-D pallet, near the PLB attachment points on the right and left side. Each camera was aligned to look up past the boom tip towards the TSS-S, and the two views were multiplexed onto monitor 1 at the aft crew station to provide a pseudo-stereo representation (fig. 7-4). This technique provided superb cues to TSS-S/boom relative position and rates, especially in the final stages of the retrieval.

7.6.3 Ranging Rulers

The symmetry of the TSS-S lends itself well to use of CCTV image size subtended angle as a backup range determinator, as done on other PROX OPS missions. Traditional "ranging rulers" (which when placed over the max-zoom image of the TSS-S on the aft flight deck monitor provide a usable range indication) have been produced and utilized successfully; a special stereo ranging ruler, used to measure the center-to-center distance on the muxed view, was also tested and proved to be useful in ranges of under 200 feet. Both of these range determinator techniques are highly desirable because of nominal loss of RR range at close ranges and an unpredictable bias on the tether length measurement (as measured by the deployer mechanism) due to tether stretch during the deploy period (at final berthing, the "length" measurement may be reading negative by tens, if not hundreds of feet).

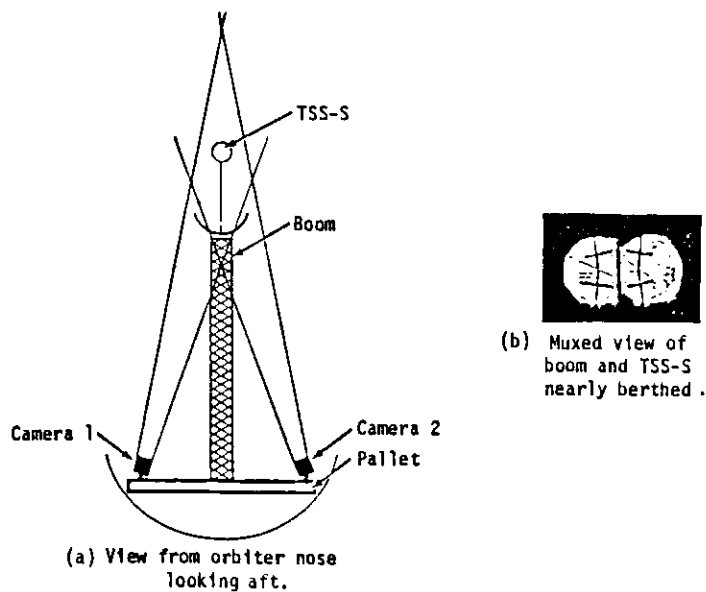

Figure 7-4.- CCTV arrangement/TSS-D boom/pallet.

7.7 CANDIDATE PROCEDURES

Early theoretical considerations and feasibility assessment have generated several candidate procedures for tethered operations. No verified procedures exist for any mission phase at this time.

7.7.1 Deploy

As discussed by Carroll (1985), there are several different theoretical deployment techniques. Two are shown in figure 7-5.

In both cases, the initial deployment is done with thrusting or a large boom.

In the first case (left), the tether is paid out under tension slightly less than the equilibrium tension level for that tether length. The tether is slightly tilted away from vertical during deployment (upper object trailing along V-BAR) and librates slightly after deployment is complete.

In the other case, after the initial near-vertical separation (to about 2 percent of the full tether length), the two end masses are allowed to drift apart in near-free-fall, with very low but controlled tension on the tether. Just under one orbit later, the tether is almost all deployed and the range rate decreases to a minimum due to orbital mechanics effects. Thrusting or tether braking is used to cushion the end of deployment and prevent end mass recoil. Then the tether system begins a large-amplitude prograde swing towards the vertical, during which high tether tension occurs.

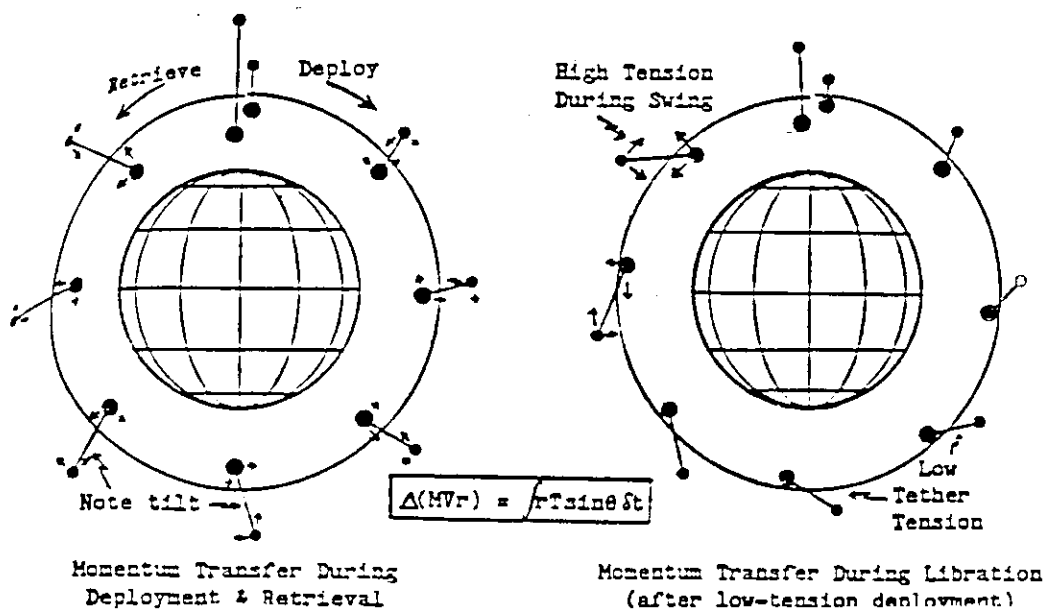

Figure 7-5.- Deployment technique

In both cases, the angular momentum transferred from one mass to the other is simply the integral over time of the radius times the horizontal component of tether tension. In one case, transfer occurs mainly during deployment; in the other case, it occurs mainly during the libration after deployment.

An intermediate strategy, deployment under moderate tension, has also been investigated. However, this technique results in very high deployment velocities and large rotating masses. It also requires powerful brakes and a more massive tether than required by the other two techniques.

Coriolis forces can cause a large bowing of the tether during deployment of light payloads. At low altitudes, aerodynamic drag can have a similar effect.

7.7.2 Stationkeeping

The primary control mechanism for distant tethered objects will probably be reel in/out operations, supplemented by thrusters on the object and on the Orbiter. Secondary effects can be generated by use of the moment arm provided by a long boom (such as the TSS-D).

Details remain undefined until more realistic analysis and simulations are completed.

7.7.3 Nominal Detach

Many interesting applications involve performing a hanging release of a tethered object (fig. 7-6) in order to transfer momentum from a primary body to a smaller one (resulting in transfer to a higher or lower orbit, as desired). The tether (and reel) may either be on the primary body and be retrieved for reuse or on the released body.

For two tethered objects at distance L, release of the tether causes a growing separation. After half an orbit, that separation of orbits reaches a distance of 7 times L (physical separation will be greater since the lower object will also be substantially further ahead due to orbital motion, by about 20 times L).

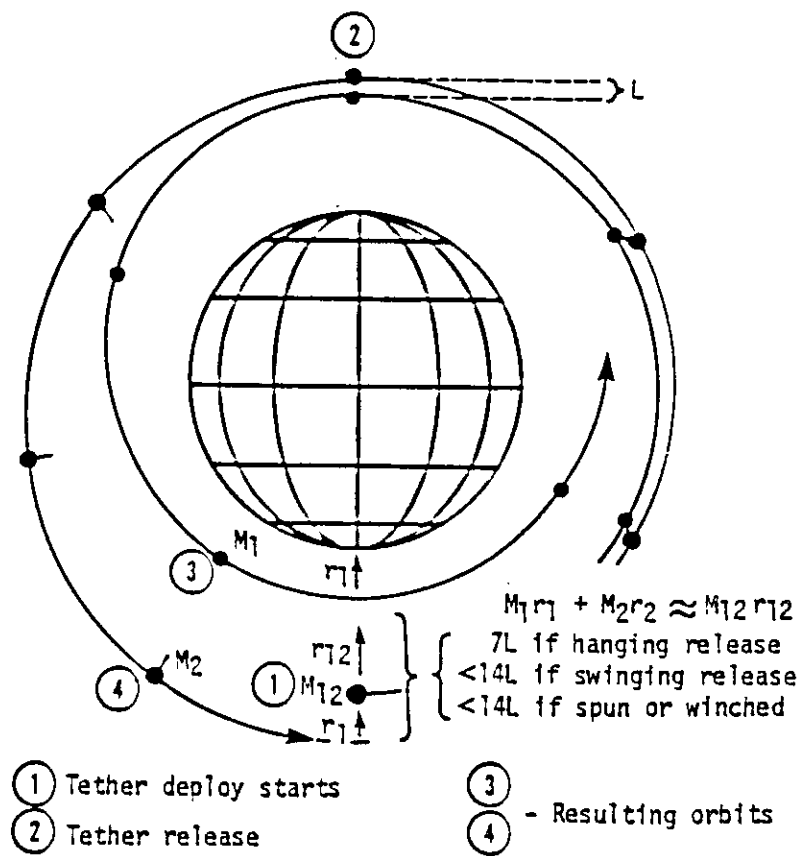

Effects of tether deployment and release

Figure 7-6.- Hanging release.

Under conditions of swinging release (fig. 7-7), that orbit separation can be any value less than 14 L; for spun or winched releases, it can be greater than 14 L.

Carroll (1986) gives an approximation for achievable hanging release ΔV (in LEO, with the deployed object mass much less than the main object mass) as:

$$\Delta V = k V_c \text{SQRT} (\text{tether mass} \times \text{end masses sum} / \text{end masses product})$$

where $V_c = 2300$ ft/s for Kevlar, 3300 to 3800 ft/s for advanced materials
 and $k =$ 1 for spinning operations
 1.15 for hanging releases
 1.2 for swinging releases
 1.4 for winching operations

Note that the ΔV is a function of tether mass, not length (a more massive tether can support more energetic releases). For payloads very light in comparison to launching object, the SQRT reduces to SQRT (tether mass / payload mass). For breaking strength of 10,000 pounds, Kevlar weighs 40 to 100 lb per kft, and Spectra-1000 weighs 12 to 15 lb per kft.

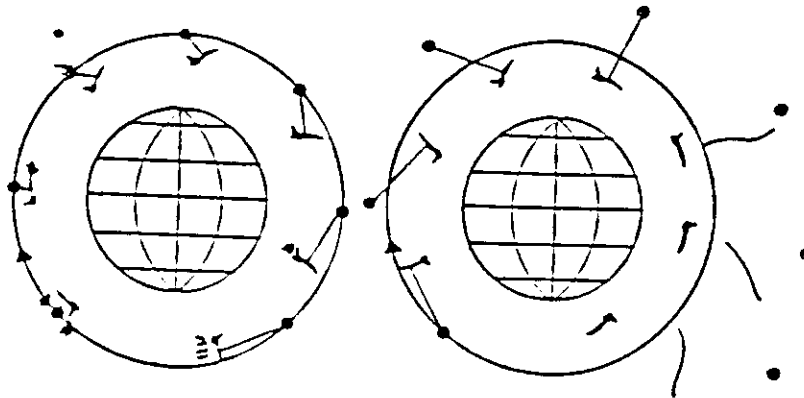

Figure 7-7.- Low-tension deployment, swing and release.

Of course, momentum given to one object is taken from another. If the momentum can later be restored by a high-efficiency propulsion system, this is tolerable. In some cases this may even be useful: if a space station uses a tether to deboost an Orbiter at the end of its resupply mission, space station orbital decay makeup needs and Orbiter deorbit burn propellant needs are both reduced.

7.7.4 Retrieve (Active)

Retrieval of tethered objects is the most difficult phase of tethered operations.

7.7.4.1 Theoretical Basis

The theoretical basis of retrieval stability contains a large, but as yet unvalidated, body of mathematical analysis.

7.7.4.2 Simulator Basis for Procedures

In 1986, a series of TSS retrievals was made on the SES, with variations in Orbiter DB's and in allowable TSS-S out-of-plane and in-plane excursions. A "best technique" was subsequently selected for follow-on contingency runs, but this cannot be construed as being any sort of standard, validated procedure. This technique is offered only as a viable candidate, which may illustrate many of the characteristics the final procedure should be expected to have.

7.7.4.3 Procedure Setup

The DAP was in LVLH, with nominal RNDZ/PROX OPS deadbands (2° NORM, 1° VERN for both DAP A,B), and small translation impulses (0.05 ft/s A, 0.01 ft/s B).

The approach was guided along a funnel with sides proportionately narrowing as tether length decreased: at 500 feet, a 5° dispersion was acceptable in either in plane or out of plane, in the 400's it was 4° , in the 300's it was 3° , and in the 200's it was 2° . The angles and rates of the satellite are observed on SPEC 50.

7.7.4.4 Initial Retrieval

Control can be accomplished by Orbiter translation, performing $\pm X$ and $\pm Y$ burns with the THC to fly the boom tip back towards the satellite image (in the case of the TSS-S, it is also possible to fly the satellite itself by use of its onboard thrusters, but this has not been thoroughly evaluated, and it may be more reasonable to make use of piloting techniques with which the crewmembers are already familiar). Small Orbiter DB's have been (not surprisingly) found to be best for allowing use of this satellite LOS as a cue to corrective maneuvering.

One significant effect of Orbiter RCS cross-coupling has been noted and deserves mention. When observing a target out the overhead window, the crewmember commands RCS translation maneuvers perpendicular to the LOS in order to control Orbiter/target relative position (in a "fly to" mode). However, because translations induce some cross-coupled rotation, the initial LOS motion of the target may be momentarily misleading. This effect is discussed in detail in section 6.2.1.2 and figure 6-7, and accentuates the need for the crewmember to be patient after performing translation pulses, to see the LOS motion after deadbanding, and not be misled by the initial LOS rates (which contain deceptive rotation-induced components). This also underlines the need for tight DB's.

To repeat, these translations are performed to keep the satellite LOS (as displayed on a SPEC) under control in the progressively narrowing funnel. Corrections must be made when the satellite LOS angles exceed the allowable limits; corrections can also be made as it passes through the zero angle(s) to null out the angle rates.

7.7.4.5 Close-in Procedure

Prior to radar losing lock inside 80 to 100 feet, the control scheme must change. Since RR angles are already becoming biased due to the geometric offset of the Ku-band antenna compared to the boom tip, and since RR lock is soon to be lost anyway, it is desirable to switch to another "fly-to" technique. Criteria for translation firings is therefore changed from RR angles to the television monitor, where the multiplexed stereo image of the boom tip is "flown to" a spot directly between the twin images of the satellite. This new piloting technique also appears to be "common sense" with easily understood criteria for corrections.

To prevent automatic deadbanding from unexpectedly disturbing the LOS, at this changeover point, DAP is moded to MAN and RPY to PULSE/PULSE/PULSE (i.e., free drift). During this final phase, the Orbiter attitudes may drift up to 5° from initial, but this should be acceptable.

A typical tension time history is shown in figure 7-8 (two examples). While the in-line thruster constant value is apparent, wide excursions also occur. This includes momentary zero-tension intervals.

7.7.4.6 Alternative Procedures

An alternate control technique during the terminal phase (defined as the close range where RR lock has broken, through contact) is to use vernier attitude control to move the boom tip. There appear to be two arguments against this technique. First, the crewmember is already accustomed to flying by translation and has become well versed in predicting LOS reactions to controllable inputs, so a new control technique would require a new period of adaptation during a very brief and dynamic phase. Secondly, since the boom probably does not extend through the Orbiter c.g., Orbiter rotations (particularly pitch) will induce substantial boom tip translations in the Z axis, complicating the piloting. For this reason, candidate procedures so far use translation control all the way through contact.

7.7.4.7 Failure-Mode Procedures

Several SES runs were made with RR failed, with VRCS failed, or with one of the two TSS-D boom pallet CCTV's failed. Prop usage more than doubled, primarily due to difficulty in correcting subtle angle rate dispersions (in sensor fail cases), or to overcorrections (in VRCS fail case). Higher tether tension excursions and longer periods of zero tension were also experienced. Nevertheless, retrievals seem to have been accomplished successfully.

7.7.4.8 Satellite-in-Motion Procedures

Pendulous motion of the satellite was another area of concern. This consists of the satellite rocking in pitch/roll from the tether attach point. We induced large pitch/roll angle rates, up to 5 to 10 deg/s (any higher, and the tether wrapped around the satellite), and noted how they quickly coupled

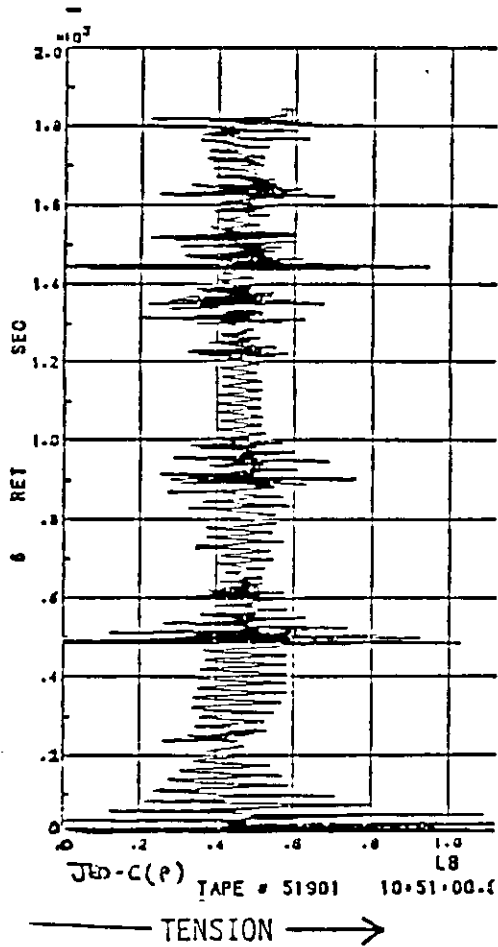
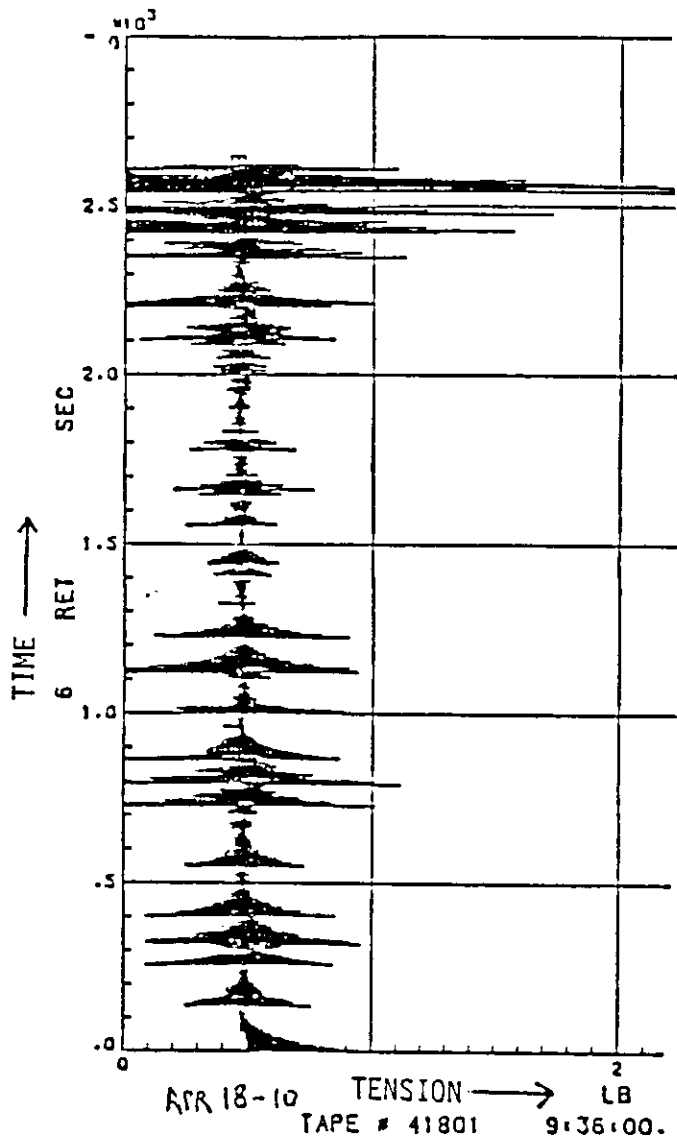

Figure 7-8.- Tension history plots with inlines, various control techniques (illustrates occurrence of zero tension).

into other axes and were continuously excited by subsequent RCS firings. While the rates never damped out, contact with boom tip was usually made well within acceptable angle ranges. Whether the contact range rate was safe could not be determined (this is a hardware issue for the deployer mechanism contractor to judge), but it did not appear to be all that much worse than in nominal cases.

7.7.5 Retrieve (Passive)

Retrieval without in-line thrusters may be performed either entirely without line tension, or with some alternate means of maintaining line tension. Both were performed on the SES in 1986, under many variations. In the absence of vigorous off-line validation, these candidate procedures must be considered very preliminary.

7.7.5.1 No-Tension Retrieval

The no-tension retrieval was performed in several variations, designed to create a known Orbiter/satellite REL position for final approach (and thus allow use of a canned preverified separation maneuver in the event of guillotine). In one, the Orbiter went to inertial hold and performed an inertial flyaround of the satellite until it reached the V-BAR (120° of orbit travel, in about 30 minutes); in another, the Orbiter went only to the satellite R-BAR, in an attempt to use gravity gradient forces to provide a small tension; in another, the approach was made in LVLH mode directly from the initial condition.

In all cases it was found possible to fly the boom tip up to the satellite while monitoring tether slack (comparing RR to tether length) and keeping it small. It was noticed that tether jerks which did occur did not seem to induce worrisome closing rates; instead, due to random satellite attitude, they mostly imparted random attitude rates to the satellite rather than inducing translations.

The major unknown in this class of procedures was how the system would respond at final boom contact. The satellite attitude was essentially random during final approach, although tether jerks tended to pull the attach point toward the center of the visible hemisphere. The SES model was of low fidelity here since it did not simulate "wrap" of the tether around the surface of the satellite; instead, the tether always ran from the attach point straight to the boom, even through the body of the satellite, if the attach point was passing across the hidden hemisphere (the "back side" of the satellite). It is conceivable that with the real hardware the satellite could nestle into the boom tip and then, through a series of final jerks as the tether continues to be reeled in, become properly aligned for latch capture (assuming no snags on satellite structure).

Even so, however, a procedure which allows tether wrap around the satellite appears to be highly undesirable. Since the satellite attitudes and rates go essentially random early in all of these scenarios, and do not appear to be controllable by any crew procedures, this option appears unacceptable.

7.7.5.2 Centrifugal Tension Procedures

The LVLH frame of reference is noninertial. The LVLH is rotating at orbital rate of 4° per minute, or 0.067 deg/s. Under initial conditions for these runs, the Orbiter is moving in a body vector $-X$ direction relative to the Orbiter/TSS system. This system rotation will generate some centrifugal force between the Orbiter and the satellite as they rotate about their mutual center of mass. This induced tension can be enhanced by deliberately creating a higher rotation rate. We chose to rotate in the $-X$ direction (versus $+X$), because we were already moving in that direction and because later control maneuvers induced less cross-coupling.

At a range of 500 to 600 feet, a $-X \Delta V$ of about 0.3 ft/s is performed with THC (monitored on AVG G in SPEC 33), followed by establishment of a -0.150 deg/s pitch rate via RHC input (monitored on OPS 201 display). In the LVLH frame this was one full turn in 40 minutes. The boom tip television image is "flown to" the satellite image using VERN pitch and B NORM out-of-plane translation. DAP is manual, with ROT in DISC-PULSE-DISC (i.e., free in pitch only), and pulse sizes (deg/s) of A NORM 0.1, B NORM 0.04, A VERN 0.01, B VERN 0.002. Turning off in-line thrusters results in the tether elasticity's pulling the satellite inwards, creating a loss of tension for several minutes. However, after a series of gentle jerks, the satellite settles into a reasonable stability with a tension of 20 to 30 percent of that generated by in-line thrusters (several tension history plots are shown in figure 7-9).

If thruster fail is known at long range, and if there is manual control over the reel-in rate, the centrifugal maneuver can be initiated merely by increasing this reel-in rate, without need for thruster firing.

Since this tension is so weak, it can easily be lost entirely by small Orbiter (actually, boom tip) Z translations, even those induced by cross-couplings from translations in other axes or from rotations (translation cross-couplings or just geometric results). Thus, extremely delicate maneuvering is mandatory: pitch in A/MAN/VERN, and translate in B/MAN/NORM with 0.01 ft/s pulses. When maneuvers were made accidentally in higher rates, tension went to zero for long periods and sometimes never restabilized. Several plots of tension-versus-time are shown in figure 7-9.

Using higher rates to create stronger centrifugal force does not solve this problem. The SES reel rate model reacts badly to strong tether tension jerks by slowing or even stopping the reel-in rate. This occurs even if the average centrifugal line tension remains far below the nominal in-line thruster-induced tension, since tension spikes continuously occur due to RCS firings and these short spikes can freeze the reel-in for several seconds or longer. It is an open question whether this model is correct (are the gains simply set too low?), and if the reel-in rate is actually much more robust than a higher system spin rate might be feasible. However, in that case, other limiting factors appear.

As the satellite is reeled in during this 0.15 deg/s system spin rate, angular momentum is transferred into the Orbiter and the spin rate increases. A more important impact on the spin rate is the tendency of the satellite to pull up ($+X$) in the television field of view, requiring more "-pitch" ("pitch up" in $-Z$ mode) to force the boom tip to chase it. This drives the pitch

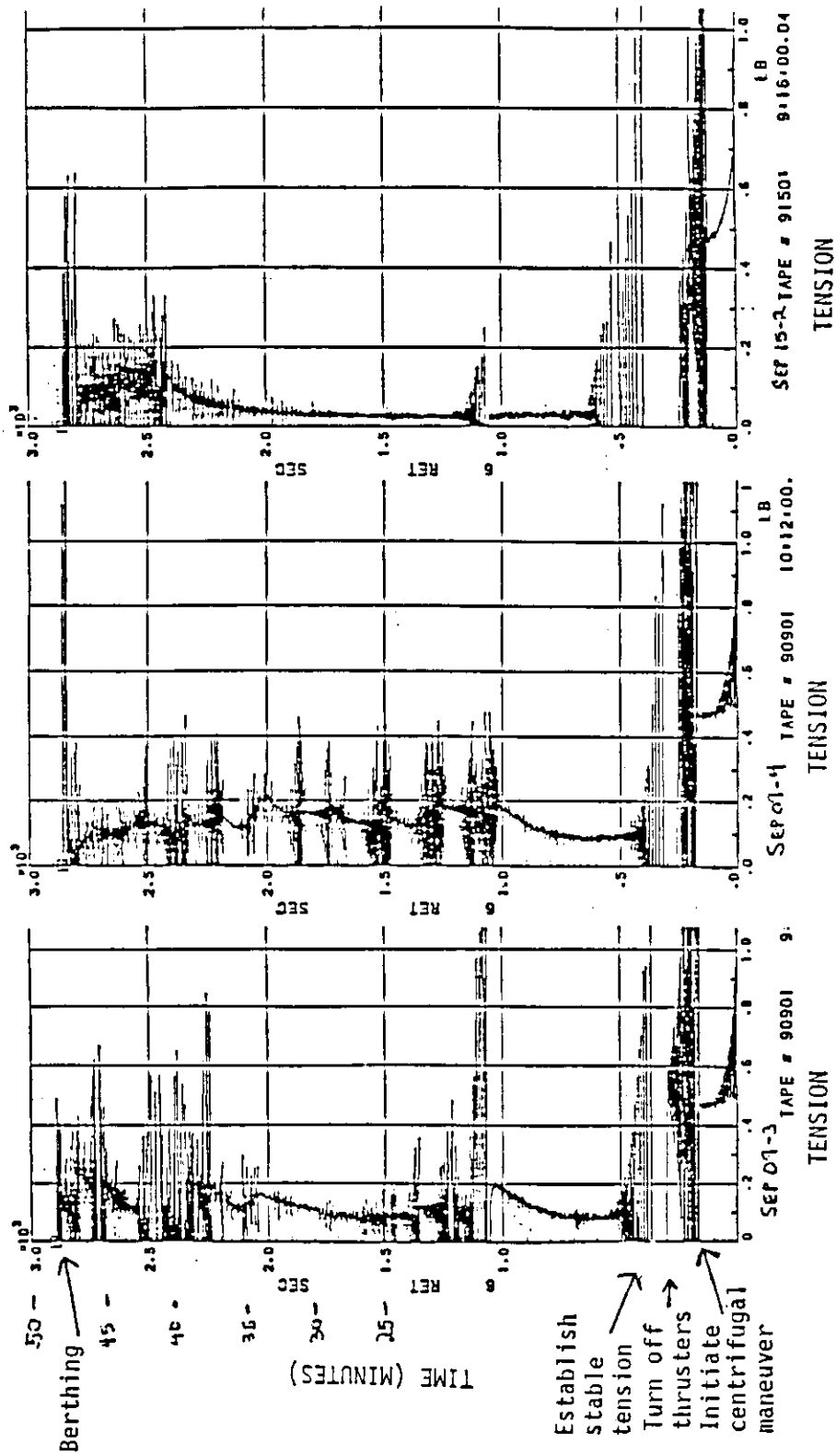

Figure 7-9.- Tension history plots. No in-lines. Centrifugal tension only.

rate from the original -0.150 deg/s to a higher rate (up to -0.400 deg/s), increasing centrifugal force and ultimately causing the satellite reel motor to jam.

To avoid this, a different "fly to" scheme must be used within about 400 feet (when tether centrifugal tension reaches about 35 percent of nominal thruster tension). This is to perform small (0.01 ft/s) +X translations, usually in bursts of 10 or 20 per minute for several minutes (the use of fewer but larger pulses does not work because of the excessive impulsive disturbances of such larger pulses on tether tension). These are sufficiently low and "pure" so as not to induce excessive pitch motion, or in any other way cause loss of the very fragile tension forces (-X pulses, it seems, are too "dirty" in terms of cross-coupling, and they do induce excessive jerks which destroy the constant non-zero tension induced by the system ROT). With such a scheme, if performed patiently and carefully, tension and length rates can both be maintained at reasonable levels throughout this interval. Care must be taken to perform these pulses randomly rather than in a regular pattern, since the longitudinal bobbing resonant frequency of a 300 to 500 foot tether would be on the order of several seconds, and it would not be good if the firings excited that motion.

Once length has dropped below 200 feet, the pitch control option can be resumed. The Orbiter, at its current rotation rate, at this point already possesses enough angular momentum that further reeling in of the satellite does not significantly add to it. These rates may climb to 0.350 to 0.400 deg/s at contact, a high but not unreasonable rate. Meanwhile, induced centrifugal tension drops as the tether length decreases.

The tension maintained constantly on the tether also maintains satellite attitudes to within proper ranges for berthing. This can be crucial to a successful retrieval. During the final few feet (as satellite body radius becomes large in proportion to remaining tether length), tension excursions become high and tension is sporadically lost; however, contact rates and attitudes appear well within acceptable ranges.

7.7.5.3 Open Issues

This passive centrifugal retrieval technique requires substantially more study, both in simulators and analytically. What are visibility considerations (for example, the Sun crossing the FOV at least once)? What are control impacts of finishing retrieval with a pitch rate as high as half a deg/s? What kind of separation maneuvers can be validated for use if a guillotine is required from a random Orbiter/TSS-S pitch orientation? How can this retrieval mode be initiated from any arbitrary range, since the in-line thrusters may fail at any range? These questions were uncovered by the current effort (answers will take substantially more effort); it is prudent to assume that additional questions await discovery.

In conclusion, initial feasibility assessment does suggest that this centrifugal procedure is a viable candidate for consideration in the no-thrusters contingency case, but it can in no way be considered verified since unconsidered factors (or different models) may provide hidden showstoppers.

7.7.6 Reel Stop/Start

The 1986 TSS SES runs indicated that there may be serious problems associated with reel motor brake/jam/lock cases. The TSS-S possesses yaw control thrusters (roll about the axis of the tether), and has $\pm X$ and $\pm Y$ translation thrusters (they work well on the SES; we found no surprises) but it has no roll/pitch attitude control. As long as there is tension on the tether, restoring torques are generated against all roll or pitch dispersions. This feature, this lack of positive roll/pitch attitude control, severely impacted the passive no-tension techniques described above since it led to random satellite attitudes and consequently probable tether wrap; for the motor stop case, it is even worse.

The problem is this: the TSS-S has its initial approach rate of several tenths of a foot per second, and only the weak in-line thruster is repelling it from the Orbiter. From several runs and from back-of-envelope calculations, it is clear that even after reel lock the TSS-S will continue inward (toward the Orbiter) from 20 to 40 seconds, then come to a stop, then fall back out (accelerated by the in-line thrusters) and suddenly run into a jerk when the tether goes taut. At this point, small attitude dispersions which are always present will be translated by the attach-point jerk (a moment arm offset from the satellite c.g.) into roll/pitch rates of up to several deg/s. Even if the rates are low after this first jerk, the second jerk a minute or so later drives them out of control; usually one jerk is enough. Within a minute, the tether is wrapping around the TSS-S.

This could possibly be avoided if the motor stop were extended over a long period of time, say 30 to 60 seconds, while the weak in-line thrusters maintain tension. However, under the current design the reel brake will probably bring the reel to full stop within 5 to 10 seconds, and the TSS-S will then surge upwards in free-flight before falling back against its tether and going into an uncontrolled tumble. Guillotine follows.

[Intuitively there may also be problems with where the slack tether collects during this particular sequence. When the reel-in ceases, the TSS-S and tether will continue towards the Orbiter under their own momentum, and the excess tether immediately above the TSS-D boom may collect at the boom tip and even spill over. The boom is high enough to prevent contact within the PLB unless the slack amounts to more than 100 feet; however, snagging on the outside of the boom tip may occur, especially if the slackened tether forms loops.]

A wide variation of techniques was tried to counter this disastrous consequence of engaging the reel brake. The in-line thruster was cycled on and off to force the TSS-S back against a taut tether; Orbiter +Z translations were used to reduce slack, and -Z translations were made to soften the full-length tautness jerk; centrifugal forces were induced by system ROT's to try to push the bouncing TSS-S against a taut tether. None worked; in all cases, each jerk pulled the TSS-S back inwards in preparation for a subsequent jerk, and no sign of TSS-S angle excursion damping could be detected. This was most likely because the greatest force of the jerks came from the high random attitude rates (which never damped), with random disturbances from variations in absolute Orbiter/TSS-S range.

Even at system spin rates of up to 1.0 deg/s, the bouncing would not damp out. The bouncing was controllable in that the satellite appeared to be bouncing around the radius of the tether, never approaching more than 10 to 20 feet from full extension (and thus not threatening to contact the Orbiter). But TSS-S attitudes were out of control, and tether wrap was almost certainly unavoidable. By the criterion of safe TSS-D retrieval, this situation was absolutely unacceptable and guillotine would be mandatory.

An attempt to spin-stabilize the TSS-S by deliberately inducing a yaw rate in it also seems to be ineffective. Hopefully this would have restrained pitch/yaw excursions and allow the bouncing to damp out. However, the control system as modeled only allowed a ± 5 deg/s rate and this was not enough: angle rates quickly became just as bad as with no "spin-stabilization." Perhaps a TSS-S yaw (spin) rate of 20 to 30 deg/s would be more effective, but it may not be achievable with current TSS control laws. Also, fluid damping in the satellite (e.g., vanes in the N2 tank) may promise sufficient stability.

If the fall-back jerk is not too strong (either at a close range when the closing rate is low, or if the Orbiter performs some -Z in anticipation of the tether going taut), then some control scheme may be effective. Although we were never successful in several runs (some up to a full orbit in duration) in establishing stability (defined as continuous non-zero tension and attach point remaining on visible hemisphere of TSS-S), we cannot rule out the possibility that some technique may be developed. Nevertheless, it looks unlikely.

The implications of this discovery seem to be that it is unacceptable to brake the reel at all, at least during retrievals and at the close ranges we were examining. Any situation requiring braking the reel should be serious enough to accept consequent TSS-S guillotine. This is an extremely severe constraint and needs to be widely discussed in the dynamics and operations groups. Preliminary analysis has suggested that merely unpowering the motor would allow a sufficiently gentle stop for tension to be maintained.

Furthermore, planning must anticipate an unintentional reel jam at ANY range, with subsequent loss of TSS-S attitude control. Procedures must be developed to accommodate such failure modes.

7.7.7 Jettison/Separation

In the tether guillotine case, two features were accentuated. First, the TSS-S becomes a free-flier with an initial closing rate, and secondly, if the in-line thrusters are still firing, they begin to impart an unpredictable ΔV to the TSS-S as the attitude of the satellite wanders out of control. Neither of these features is at all comforting. A prompt and powerful (1 ft/s) Orbiter +Z separation seemed called for (alternately, a strong TSS-S X/Y translation may be initiated before guillotining). Much more PROX OPS and separation analysis and simulations are required here before we can be comfortable about having a reliable procedure.

7.7.8 RNDZ With Tethered Object

There are attractive scenarios which involve a RNDZ (perhaps by the Orbiter or an Orbiter transfer vehicle (OTV) with a tethered object (a docking wharf deployed perhaps from a space station or an Orbiter). These concepts may appear ambitious, but with precise NAV data (e.g., GPS) may actually not be difficult. A sample profile is shown in figure 7-10.

Tethered capture has large benefits in safety (remoteness from primary object) and operations (no plume impingement on primary object; large fuel savings). The main hazard is collision due to undetected NAV errors or tether failure.

The tethered object itself may actually be active and perform the major MNVR's for docking.

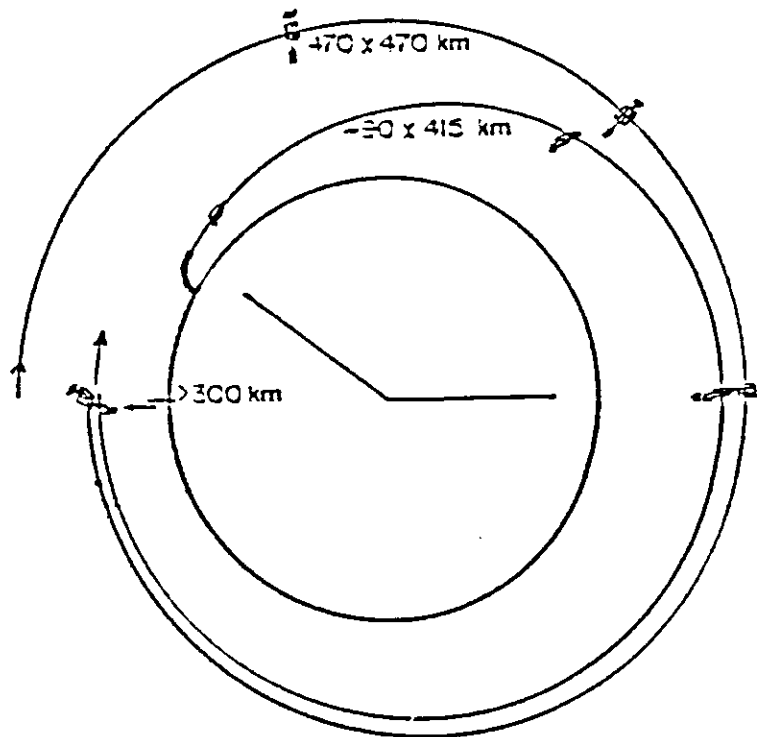

Figure 7-10.- Tether-mediated RNDZ.

Carroll (1986) points out that with experience, much longer tethers might be used to allow vehicle capture at significantly suborbital velocities. This could radically increase PL's delivered to the main object (e.g., a space station facility). Since launch trajectories do not approach the main object, vehicles of uncertain reliability can service the facility and unconventionally boosted PL's can be captured safely.

7.7.9 Loose Tether

7.7.9.1 Jettisoned From Orbiter

Due to the low mass-to-area ratio of typical tether materials, in LEO the tether should depart from the Orbiter extremely rapidly due to differential drag. Natural drag effects dominate all reasonable Orbiter ΔV maneuvers except at very low range.

7.7.9.2 Broken Tether

A loose tether attached to the Orbiter, especially one with a closing velocity induced by continued reel-in (and to a lesser degree by suddenly-released tension), must be of operational concern due to the potential for structural contact.

At very long ranges (> several miles), analysis indicates that differential drag and gravity gradient effects should overcome all reasonable initial closing rates and pull the tether out away from the Orbiter, restoring tautness in a safe and stable configuration.

At medium ranges (1000 feet to several miles) the tether momentum would probably carry it back toward the Orbiter. However, for reasonable return times (several minutes) and stable initial conditions (typical of known deployment/retrieval scenarios), the main segment of the tether will be carried down the V-BAR by Coriolis forces, sufficient to assure Orbiter structure avoidance. If the Orbiter end of the tether is cut in a reasonable reaction time (3 to 5 minutes), the tether segment in this case will entirely miss the Orbiter.

At short ranges (less than 1000 feet from Orbiter to break point) the tether will probably recontact the Orbiter at a speed of 10 to 20 ft/s. Time from break to recontact is on the order of 1 minute.

Since the tether segment is short and light, RCS plume ward-off techniques (perform +Z translation, fly away from tether) appear promising in this case. The technique seems to have the advantage of not being harmful in the event a break is perceived, but does not in fact exist; taking such precautionary steps can be done without impacting successful tethered operations. The tether would become taut again quickly.

7.8 OPEN ISSUES

Through use of the excellent SES model in the 1986 studies, significant new insights into the TSS-S terminal phase retrieval process were gained. Although no operational procedures have yet been designed, much less verified, nevertheless, a number of promising candidate techniques were made available as a starting point for downstream procedures development work.

Deployment jam can cause high stresses and recoil velocities. One proposed fix is to add a section of yieldable tether material which might prevent a fast recoil in this eventuality.

A severed thruster could recoil and foul Orbiter mechanisms. Can the RCS thrusters be used to blow away or deflect a recoiling tether (at low recoil velocities) before it piles up around the Orbiter?