

# Flight Procedures Handbook

Entry

Mission Operations Directorate  
Operations Division

Final, Revision B  
January 23, 1984

**NASA**

National Aeronautics and  
Space Administration

**Lyndon B. Johnson Space Center**  
Houston, Texas

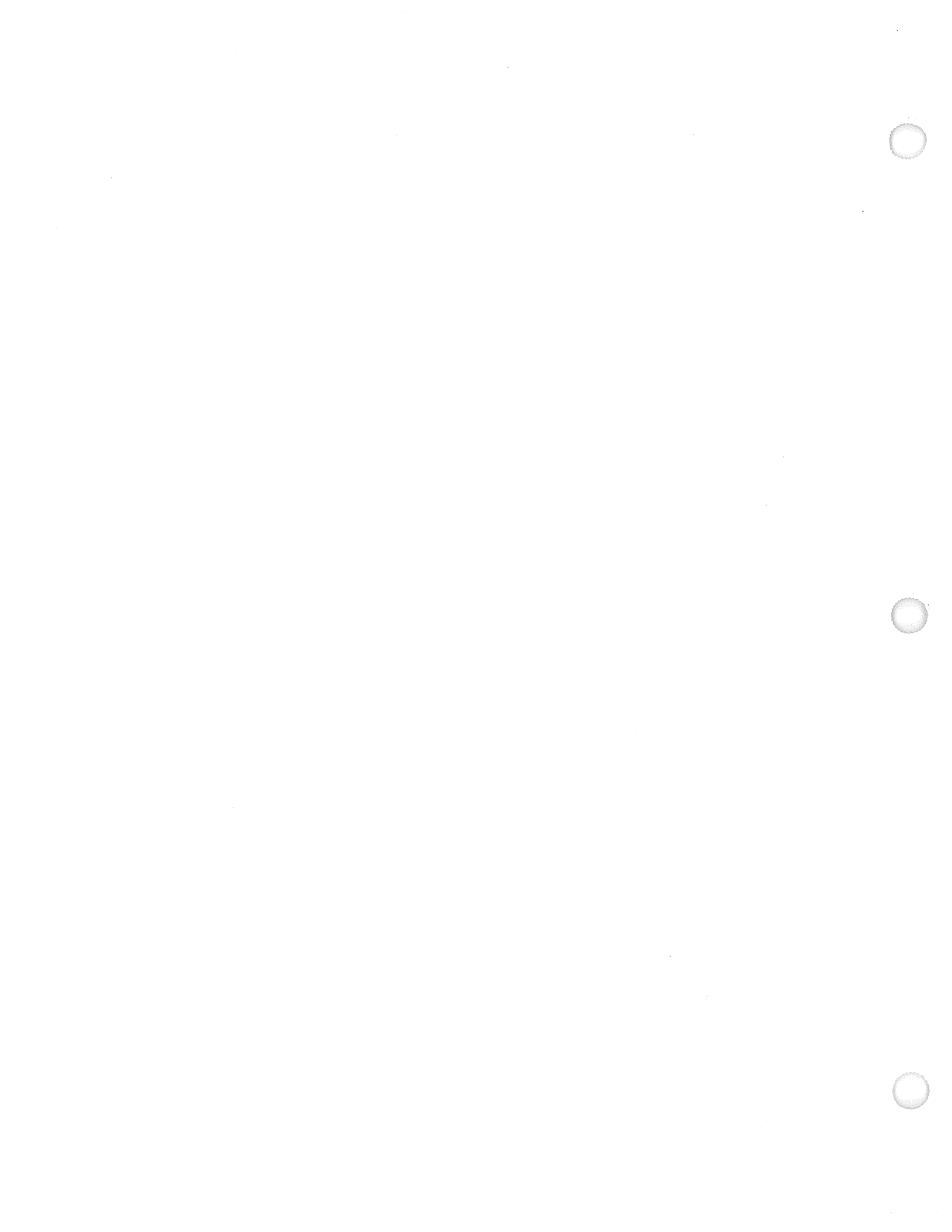

ENTRY FLIGHT PROCEDURES HANDBOOK

FINAL, REV B

MISSIONS OPERATIONS DIRECTORATE

PREPARED BY

*Wm Anderson*

W. M. Anderson  
Ascent/Entry Procedures Section

APPROVED BY

*Gregory C. Hute*

Gregory C. Hute  
Head, Ascent/Entry Procedures Section

*Charles F. Deiterich*

Charles F. Deiterich  
Chief, Operations Branch

NATIONAL AERONAUTICS AND SPACE ADMINISTRATION  
LYNDON B. JOHNSON SPACE CENTER  
HOUSTON, TEXAS



## FLIGHT PROCEDURES HANDBOOK PUBLICATIONS

The following is a list of the Integrated Flight Procedures Handbooks of which this document is a part. These handbooks document integrated and/or flight procedural sequences covering major STS crew activity plan phases.

<u>Title</u>	<u>JSC No.</u>
ASCENT/ABORTS	10559
ENTRY	11542
RENDEZVOUS/ORBITAL NAVIGATION	10589
OMS/RCS	10588
ATTITUDE AND POINTING	10511
STS WORKDAY	10541
SPACELAB ACTIVATION	10545
SPACELAB DEACTIVATION	12803
CREW DATA MANAGEMENT	12985
PROXIMITY OPERATIONS	12802
IMU ALIGNMENT	12842
DEPLOYED PAYLOAD	16191
POSTINSERTION DEORBIT PREPARATION	16219
ASCENT/ORBIT/ENTRY POCKET CHECKLISTS	16873
PAYLOAD ASSIST MODULE-D (PAM-D)	17862



## COMMENTS

It is requested that any organization having comments concerning this document contact W. M. Anderson, Operations Branch, telephone 483-6369.

## ACKNOWLEDGMENT

Major contributions to the Entry Flight Procedures Handbook were made by the following individuals:

Gene Bell  
Ken Patterson  
Holly Barnes  
Mason Lancaster  
Drum Simpson  
Mark Sims





# CONTENTS

Section		Page
1	<u>INTRODUCTION</u> . . . . .	1-1
1.1	<u>PURPOSE</u> . . . . .	1-1
1.2	<u>SCOPE</u> . . . . .	1-1
1.3	<u>ABBREVIATIONS AND ACRONYMS</u> . . . . .	1-2
1.4	<u>SIGN AND SYMBOLS</u> . . . . .	1-5
1.5	<u>TACAN STATIONS</u> . . . . .	1-6
2	<u>ENTRY FLIGHT DESCRIPTIONS</u> . . . . .	2-1
2.1	<u>GENERAL</u> . . . . .	2-1
2.2	<u>DEORBIT BURN OVERVIEW</u> . . . . .	2-1
2.3	<u>ENTRY INTERFACE TO TERMINAL AREA ENERGY MANAGEMENT</u> . . . . .	2-2
2.3.1	<u>Preentry Phase</u> . . . . .	2-4
2.3.2	<u>Temperature Control Phase</u> . . . . .	2-5
2.3.3	<u>Equilibrium Glide Phase</u> . . . . .	2-5
2.3.4	<u>Constant Drag Phase</u> . . . . .	2-5
2.3.5	<u>Transition Phase</u> . . . . .	2-5
2.4	<u>TERMINAL AREA ENERGY MANAGEMENT</u> . . . . .	2-6
2.5	<u>APPROACH AND LANDING</u> . . . . .	2-10
2.6	<u>ENTRY NAVIGATION</u> . . . . .	2-12
3	<u>ASSUMPTIONS, GUIDELINES, AND CONSTRAINTS</u> . . . . .	3-1
3.1	<u>DEORBIT</u> . . . . .	3-1
3.2	<u>OPERATIONAL CONSTRAINTS</u> . . . . .	3-1
3.3	<u>DESCENT PROFILE</u> . . . . .	3-2
3.4	<u>LANDING SITES AND LANDING CONSTRAINTS</u> . . . . .	3-4
4	<u>DEORBIT OPERATIONS</u> . . . . .	4-1
4.1	<u>DEORBIT BURN PROCEDURES</u> . . . . .	4-1
4.1.1	<u>Deorbit Procedures Sequence</u> . . . . .	4-1
4.2	<u>DEORBIT BURN CUE CARDS</u> . . . . .	4-34
4.2.1	<u>Burn Target</u> . . . . .	4-34
4.2.2	<u>RCS Propellant Consumption and Balance</u> . . . . .	4-34
4.2.3	<u>OMS Propellant Balance</u> . . . . .	4-34
4.3	<u>DEORBIT FLIGHT RULES</u> . . . . .	4-34
4.4	<u>PREBURN</u> . . . . .	4-36
4.5	<u>2 ENGINE DEORBIT BURN</u> . . . . .	4-37
4.5.1	<u>Nominal</u> . . . . .	4-37
4.5.2	<u>OMS PRPLT Fail</u> . . . . .	4-40
4.5.3	<u>OMS ENG Fail</u> . . . . .	4-43
4.5.4	<u>RCS Completion</u> . . . . .	4-44
4.6	<u>1 ENG DEORBIT BURN</u> . . . . .	4-55
4.6.1	<u>Planned Procedures</u> . . . . .	4-55
4.6.2	<u>OMS PRPLT Fail</u> . . . . .	4-57
4.6.3	<u>OMS ENG Fail</u> . . . . .	4-57
4.6.4	<u>RCS Completion</u> . . . . .	4-58
4.7	<u>RCS DEORBIT BURN</u> . . . . .	4-59
4.7.1	<u>Preburn</u> . . . . .	4-59
4.7.2	<u>Planned Procedures</u> . . . . .	4-60

Section		Page
4.7.3	<u>OMS PRPLT Fail</u> . . . . .	4-61
4.7.4	<u>OMS PRPLT Low</u> . . . . .	4-63
4.8	<u>UNBALANCED PRPLT DEORBIT BURN</u> . . . . .	4-64
4.8.1	<u>Purpose</u> . . . . .	4-64
4.8.2	<u>Nominal Procedure</u> . . . . .	4-64
4.8.3	<u>OMS PRPLT Fail (Before or During Crossfeeding)</u> . . . . .	4-66
4.8.4	<u>Engine Failure Prior to Crossfeeding</u> . . . . .	4-67
4.8.5	<u>Engine Failure During Crossfeeding</u> . . . . .	4-68
4.9	<u>MIXED XFEED DEORBIT BURN</u> . . . . .	4-68
4.9.1	<u>Purpose</u> . . . . .	4-68
4.9.2	<u>Nominal Procedures</u> . . . . .	4-69
4.9.3	<u>Off-Nominal Procedures</u> . . . . .	4-74
4.10	<u>C.G. CALCULATOR CUE CARD</u> . . . . .	4-79
5	<u>ENTRY OPERATIONS</u> . . . . .	5-1
5.1	<u>CREW ENTRY MONITORING AND CONTROL</u> . . . . .	5-1
5.1.1	<u>Onboard Entry Event Reference</u> . . . . .	5-2
5.1.2	<u>Cockpit CRT Assignments</u> . . . . .	5-2
5.1.3	<u>Dedicated Displays Data Source Management</u> . . . . .	5-5
5.1.4	<u>Entry CRT Trajectory Displays</u> . . . . .	5-6
5.1.5	<u>Entry Sequence of Events</u> . . . . .	5-44
5.1.6	<u>Monitoring ADI Scaled Ay</u> . . . . .	5-163
5.1.7	<u>Entry Flight Control System Downmoding</u> . . . . .	5-166
5.2	<u>GROUND CONTROLLED APPROACH</u> . . . . .	5-178

## SECTION 1 INTRODUCTION

### 1.1 PURPOSE

The purpose of this document is to present Shuttle entry flight procedures with sufficient rationale and supporting information to give the user a good understanding of the crew task for this mission phase. This handbook is intended primarily for use by flight crewmembers and training personnel during follow-on to Shuttle systems training. This publication is written using generic entry data and reflects the results of the STS missions and also includes the essence of decisions of the entry flight techniques panel and techniques developed in simulators.

### 1.2 SCOPE

The Entry Procedures Handbook covers the mission phase as follows:

- o Deorbit burn
- o Entry interface to Terminal Area Energy Management (TAEM) interface
- o TAEM
- o Approach/landing to rollout
- o Post landing through crew egress

For each of the phases listed, this handbook includes a nominal sequence of trajectory and system events and the interrelationship of the crew and the Orbiter entry systems for flying and monitoring the event. It is assumed that the crewmember is already knowledgeable about Shuttle systems. The crew procedures for the entry flight phase may be found in a companion document, Entry Checklist (JSC-12794).

This document is written under the authority vested in the Mission Operations Directorate, Operations Division, for definition, development, validation, and control of all crew procedures for Orbiter operations for NASA manned missions, as specified by Space Shuttle Program Manager Directive 9A, dated September 23, 1974.

### 1.3 ABBREVIATIONS AND ACRONYMS

A/L	Approach and Landing (Autoland)
AA	Accelerometer Assembly
ACN	Ascension Island
ADI	Attitude Direction Indicator
ADS	Air Data System
ADTA	Air Data Transducer Assembly
AGL	Above Ground Level (altitude)
ALTM	Altimeter
AMI	Alpha/Mach Indicator
AOA	Abort-Once-Around
APU	Auxiliary Power Unit
ARS	Atmospheric Revitalization System
ASAP	As Soon As Possible
ATCS	Active Thermal Control Subsystem
ATM	Atmosphere
ATO	Abort-to-Orbit
AVVI	Altitude/Vertical Velocity Indicator
BF	Body Flap
BFS	Backup Flight System
BOB	Best on Best
BRG	Bearing
BU	Backup
C/O	Checkout
	Engine cutoff
C/W	Caution and Warning
CDI	Course Deviation Indicator
CDR	Commander
c.g.	Center of gravity
COAS	Crewmen Optical Alignment Sight
CONUS	Continental United States
CPSS	Critical Phase System Software
CRT	Cathode Ray Tube
CSL	Control Stick Limiter
CSS	Control Stick Steering
$C_L$	Coefficient of Lift
$C_{\ell}$	Rolling Moment Coefficient (lateral coefficient)
$C_{\ell\beta}$	Change of rolling moment with respect to the change in side slip angle
$C_m$	Pitching Moment Coefficient (longitudinal coefficient)
$C_n$	Yawing Moment Coefficient (directional coefficient)
$C_{n\beta}$	Change of yawing moment with respect to the change in the side slip angle
DAP	Digital Autopilot
DDU	Display Driver Unit
DED	Dedicated
DEL	Deorbit, Entry, and Landing
DEU	Display Electronic Unit
DFI	Developmental Flight Instrumentation
DIP	Display Interface Processor

DIR	Direct
DISP	Display (function)
DPS	Data Processing System
DTO	Detailed Test Objective
E/W	Entry-to-Weight Ratio
EAFB	Edwards Air Force Base
EAS	Equivalent Airspeed
ECLSS	Environmental Control and Life Support System
EES	Emergency Ejection Suit
EET	Entry Elapsed Time
EI	Entry Interface
EIT	Entry Interface Time
EOM	End of mission
EPS	Electrical Power System
ETR	Eastern Test Range
EXEC	Execute
FA	Flight Aft-MDM
FB	Feedback
FCS	Flight Control System
FDBK	Feedback
FF	Flight Forward-MDM
FTO	Flight Test Objective
FTR	Flight Test Requirement
FW	Fuel Wasting
FWD	Forward
GCA	Ground Controlled Approach
GDS	Goldstone
GN&C	Guidance, Navigation, and Control
GPC	General Purpose Computer
GRTL	Glide Return to Landing Site
GS	Glide Slope
GSI	Glide Slope Indicator
GWM	Guam
HAC	Heading Alignment Cylinder/Cone/Circle
HRL	Horizontal Reference Line
HSD	Horizontal Situation Display
HSI	Horizontal Situation Indicator
HUD	Head Up Display
HYD	Hydraulic
I/F	Interface
IMU	Inertial Measurement Unit
IPL	Initial Program Load
JSL	Jet Select Logic
KEAS	Knots Equivalent Airspeed
KSC	NASA John F. Kennedy Space Center
L/D	Lift-to-drag

LDG	Landing
LRU	Line Replaceable Unit
LVLH	Local Vertical Local Horizontal
M	Mach
MAN	Manual
MCC	Mission Control Center
MEP	Minimum Entry Point
MET	Mission Elapsed Time
MLS	Microwave Landing System
MM	Major Mode
MPAD	Mission Planning and Analysis Division (JSC)
MPS	Main Propulsion System
MS	Moding Sequencing and Control
MSBLS	Microwave Scan Beam Landing System
MVR	Maneuver
NAVDAD	Navigation-derived Air Data
NEP	Nominal Entry Point
NFW	Nonfuel Wasting
n. mi.	Nautical Mile
NWS	Nose Wheel Steering
OBS	Operational Biomedical System
OFT	Orbital Flight Test
OMS	Orbital Maneuvering System
OPS	Operations
OSOP	Orbiter Systems Operating Procedures
OTT	Optional TAEM Targeting
PAD	Preliminary Advisory Data
PAPI	Precision Approach Path Indicator
PASS	Primary Avionics Software System
pbi	Pushbutton indicator
PCMMU	Pulse Code Modulation Master Unit
PL	Payload
PLT	Pilot
PREL	Preliminary
PRI	Primary
PRL	Priority Rate Limiting
PRO	Proceed
PTI	Programed Test Input
RA	Radar Altimeter
RCS	Reaction Control System
RCVR	Receiver
REL	Relative
rf	Radiofrequency
RGA	Rate Gyro Assembly
RHC	Rotational Hand Control
RM	Redundancy Management
RPTA	Rudder Pedal Transducer Assembly
RTLS	Return to Landing Site

S TRK	Star Tracker
S/W	Software
SB	Speed Brake
SBTC	Speed Brake/Thrust Controller
SEC	Secondary
SIT	Situation
SM	System Management
SPEC	Specialists (function)
SPI	Surface Position Indicator
SS	System Summary
SSME	Space Shuttle Main Engine
STDN	Space Tracking Data Network
STS	Space Transportation System
SV	State Vector
tacan	Tactical Air Navigation
TAEM	Terminal Area Energy Management
TAL	Transatlantic Abort Landing
TBD	To Be Determined
TGT	Target
THC	Translational Hand Controller
TIG	Time of Ignition
TPF	Transfer Phase Final
TPS	Thermal Protection System
TRAJ	Trajectory
TRANS	Transition
TVC	Thrust Vector Control
UHF	Ultrahigh Frequency
UPP	User Parameter Processor
VREL	Relative Velocity
VSD	Vertical Situation Displays
WONG	Weight On Nose Gear
WOW	Weight On Wheels
WOW	Worst On Worst
WP	Way Point
WTR	Western Test Range

#### 1.4 SIGNS AND SYMBOLS

$\alpha$ (alpha)	Angle of attack
$\beta$ (beta)	Angle of side slip
$\gamma$ (gamma)	Flightpath angle
$\delta$ (delta)	Deflection angle
$\phi$ (phi)	Roll angle
$\psi$ (psi)	Azimuth
>	Greater than
<	Less than
=	Equal to
$\geq$	Greater than or equal to
$\leq$	Less than or equal to

≈  
O  
H  
H  
H  
V

Approximately equal to  
Degree  
Altitude  
Vertical velocity  
Vertical acceleration  
Velocity



## SECTION 2 ENTRY FLIGHT DESCRIPTION

### 2.1 GENERAL

The entry phase of a mission comprises those activities that a crew performs to prepare for deorbit, perform the deorbit burn, and fly the Orbiter to the landing field. The phase begins with deorbit preparation checkout procedures in the Deorbit Prep Book approximately 3:30 before the deorbit burn and continues through crew seat ingress. The Entry Checklist procedures begin after seat ingress and continue through the egress of the crew after landing.

### 2.2 DEORBIT BURN OVERVIEW

Following seat ingress activities, the Commander (CDR) and Pilot (PLT) copy updates to the Deorbit, Entry, and Landing (DEL) Preliminary Advisory Data (PAD) and the Orbital Maneuvering System (OMS) PRPLT PAD; the CDR loads the final deorbit target and maneuvers to the deorbit burn attitude. During the remaining half hour before deorbit ignition, the crew configures the Horizontal Situation Displays (HSD), checks the switch positions for an OMS or Reaction Control System (RCS) burn, performs an OMS Thrust Vector Control (TVC) gimbal check, performs the APU PRESTART, and transitions to MM 302. The GO/NO GO for the deorbit burn (and changes to the target or pad data if required) is made during the last Space Tracking Data Network (STDN) pass at Ascension Island (ASN) before the planned time of ignition (TIG). The maneuver to the deorbit burn attitude from the wing glove thermal conditioning 'top-sun' attitude is begun normally at TIG-15 minutes. One Auxiliary Power Unit (APU) will be activated 5 minutes before deorbit ignition. At TIG-2 minutes, the crew exits the Entry Checklist and performs the final preburn steps and the deorbit burn using the deorbit burn and monitor cue cards.

The deorbit burn is planned to be a 2-OMS burn of about 2.5 minutes using PEG 4 guidance and is performed in MM 302. Deorbit can be targeted for 1-OMS deorbit or RCS deorbit before the burn. The capability also exists to downmode or faultdown from 2-OMS to 1-OMS, 1-OMS to RCS, 2-OMS to 1-OMS to RCS to complete the burn if engine failures occur during the burn. Some system failures during the burn will result in the termination of the burn and deorbit completion (shallow target) the next day if the failure occurs above a safe perigee. Completion of the burn using backups of OMS propellant starvation, AFT RCS propellant to the entry redline FWD RCS propellant, prebank capability, and redesignation to Northrup (if targeted for Edwards) will result if the failure occurs below a safe perigee. An OMS propellant failure during the burn will not result in terminating the burn unless the failure occurs at a perigee that is greater than the perigee failure cue for that OMS pod (data from the DEL PAD).

At the completion of the burn, the crew can trim the residual delta velocity (if required) using the Translation Hand Controller (THC). The crew then exits the deorbit burn cue card, returns to the Entry Checklist, and completes the postburn configuration. The CDR then transitions to

MM 303 and maneuvers to the Entry Interface minus 5 minutes (EI-5) attitude. The remaining time before EI-5 is spent performing a forward RCS dump (if required for X c.g. control), starting the remaining APU's, repressing the Space Shuttle Main Engine (SSME) hydraulic system, performing the hydraulic fluid thermal conditioning if required (FTO on STS-2), checking or positioning switches for entry, conferring with the Mission Control Center (MCC) during the Guam (GWM) coverage that begins about EI-7.

### 2.3 ENTRY INTERFACE TO TERMINAL AREA ENERGY MANAGEMENT<sup>1</sup>

The entry phase is initiated by crew action 5 minutes before entry interface (altitude of 400,000 feet) before any aerodynamic forces are sensed and continues to the entry Terminal Area Energy Management (TAEM) interface. The fundamental guidance requirement during entry is to reach the TAEM interface (2500 ft/s, altitude of approximately 82,000 feet) within specified limits on range (about 50 n. mi.) from the selected Heading Alignment Cone (HAC) and with a velocity heading within a few degrees of tangency with the HAC.

During a nominal entry, the Flight Control System (FCS) is in the AUTO mode and then flight crew function is primarily one of monitoring the operation and performance of the guidance, navigation, and control (GN&C) systems. A simplified diagram of entry guidance is shown in figure 2-1.

The entry guidance system controls the entry trajectory by bank angle modulation and reversals while flying a preselected angle of attack versus velocity profile. The alpha profile is designed to be compatible with heating and stability constraints. In addition, angle of attack modulation is used to control drag-to-drag reference under transient conditions such as roll reversals.

Entry range is controlled by drag modulation, based on the predicted range for a selected drag acceleration versus velocity profile. The drag-velocity profile is chosen to conform with several limits, as shown in figure 2-2.

Range predictions are based on solutions of the equations of motion for drag profiles that are constant, linear, or quadratic functions of velocity. The drag-velocity profile is preselected by means of a mission-dependent data load and is adjusted each guidance cycle to null any range error.

The speed brake schedule is a fixed profile independent of the entry guidance. The body flap is positioned by the autopilot so that the trim elevator position is a schedule function of speed and Orbiter c.g. position.

---

<sup>1</sup>Entry aerodynamics response maneuvers are not included in event discussions in this section.

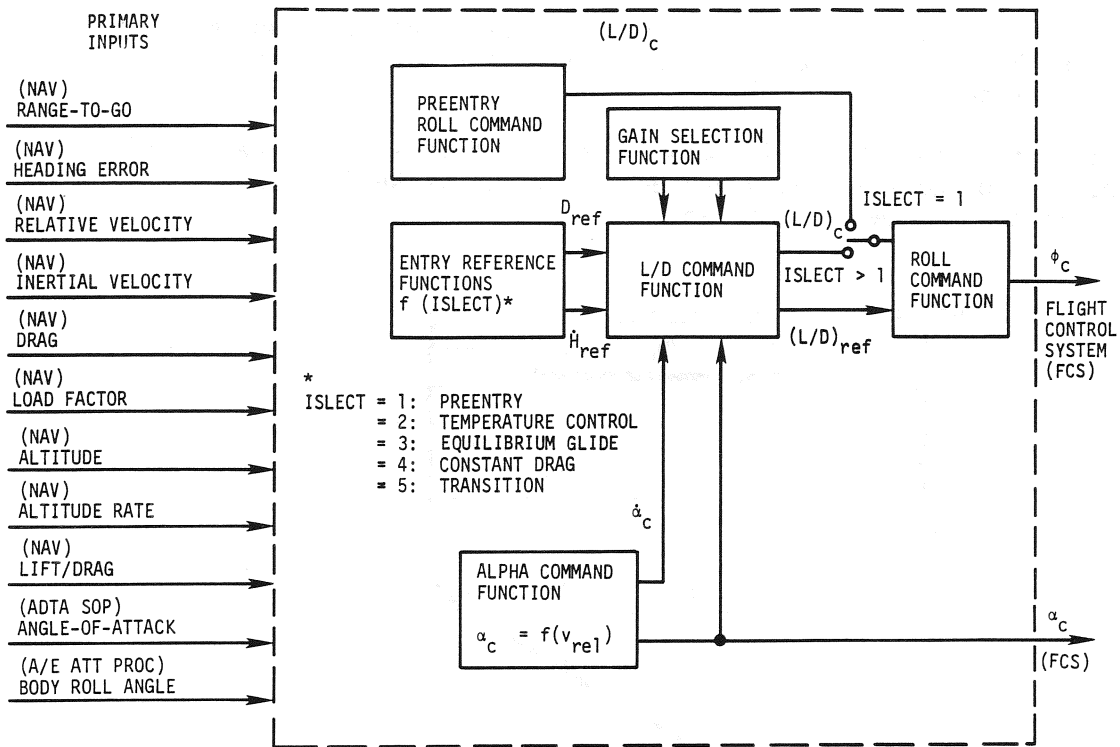

Figure 2-1.- Simplified entry guidance.

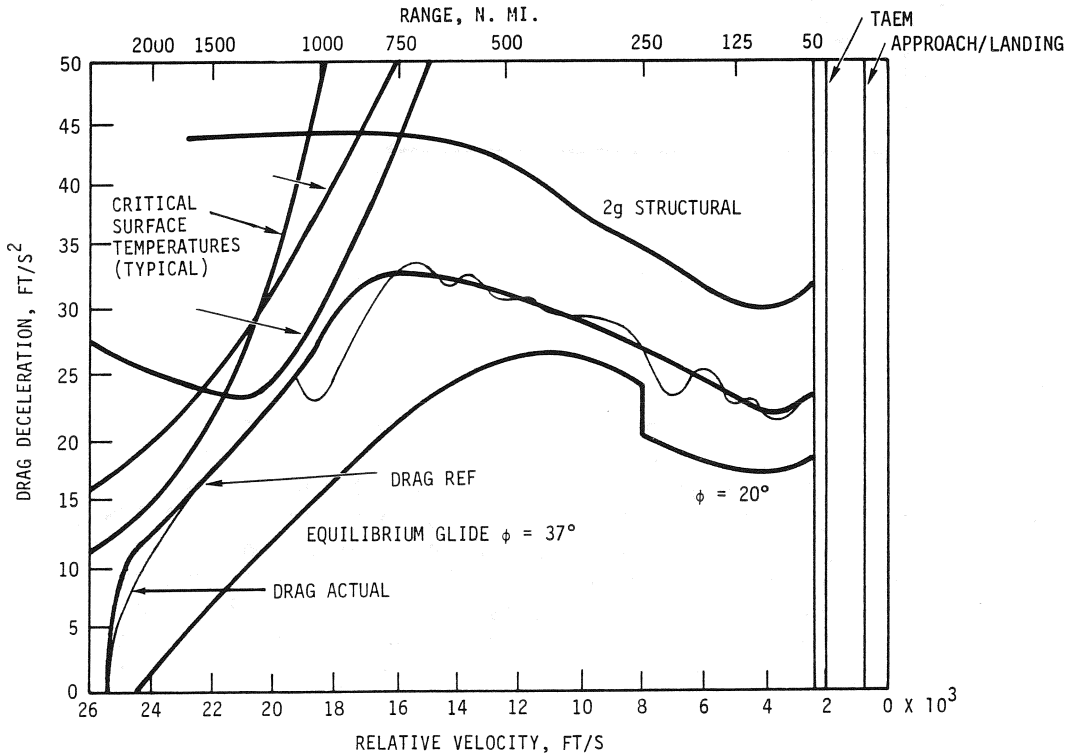

Figure 2-2.- Typical entry corridor and reference profile versus range and velocity.

Drag deceleration is controlled by vertical lift modulation, which is accomplished by changing the magnitude of the bank angle, and crossrange errors are limited by bank angle reversals.

The guidance for the entry major mode consists of five major phases shown in figure 2-3 for nominal entry versus altitude. These five phases are described in the following paragraphs.

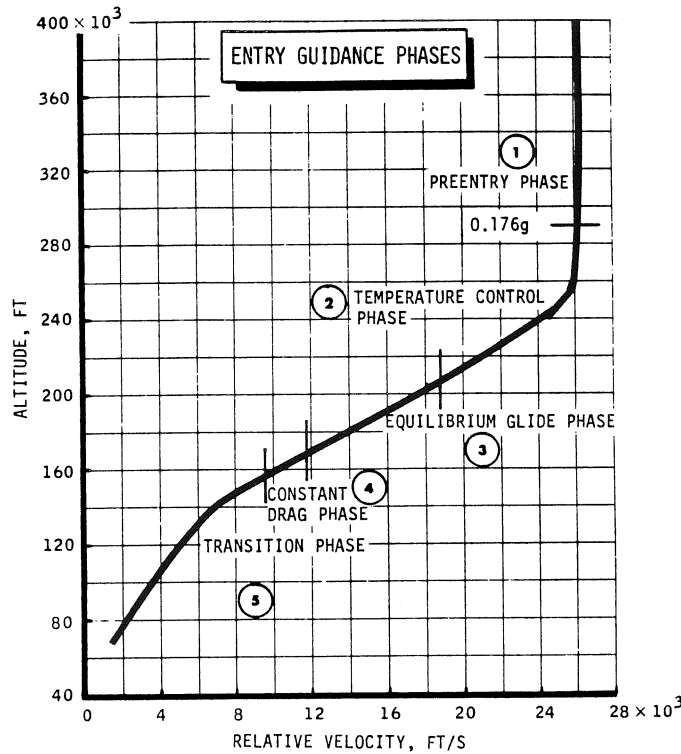

Figure 2-3.- Guidance for nominal entry.

### 2.3.1 Preentry Phase

The preentry phase is an attitude hold mode before atmospheric entry and is an open-loop ranging phase ending at 0.176g (5.66 ft/s<sup>2</sup>). Vehicle attitude is maintained by all RCS jets to hold a constant bank of 0° and 40° angle of attack through the 400,000-foot entry interface. At 0.176g, preentry is terminated and normally the temperature control phase begins. For the extremely short-range case, preentry will be terminated and the constant drag phase begins if the current constant drag level to reach the target is greater than the desired constant drag level. Also, the transition phase will be initiated if relative velocity is greater than transition velocity.

### 2.3.2 Temperature Control Phase

The temperature control phase is entered at 0.176g and is designed to control the entry trajectory through pullout to a temperature profile consistent with the desired total entry profile shape and the required ranging solution. The temperature control phase consists of two quadratic drag-velocity segments that are selected to minimize surface temperatures and maintain adequate dispersion margins. Range predictions are based on the two quadratic segments. The temperature control phase is terminated and nominally the equilibrium glide phase begins when the drag reference profiles for the temperature control phase and equilibrium glide phase converge within limits and velocity is less than an I-loaded value or when the velocity is less than the temperature control/equilibrium glide boundary velocity. For the short-range case, the temperature control phase is terminated and the constant drag phase begins when the constant drag level to reach the target is greater than the desired constant drag level.

### 2.3.3 Equilibrium Glide Phase

The equilibrium glide phase provides a profile that has lifting forces equal to gravitational forces and therefore altitude rate becomes constant. It produces an equilibrium glide trajectory consistent with the ranging solution until the trajectory intersects the constant drag ( $\sim 33 \text{ ft/s}^2$ ) trajectory required to reach the target. The equilibrium glide phase is terminated and nominally the constant drag phase begins when the desired constant drag level is reached. For the long-range case, the equilibrium glide phase transfers directly to the transition phase when the predicted velocity at the intersection of the equilibrium glide and constant drag phases is less than the transition phase initiation velocity.

### 2.3.4 Constant Drag Phase

The constant drag phase provides a profile shape consistent with the control system limits. During this phase, a constant drag level of approximately  $33 \text{ ft/s}^2$  is commanded. Range predictions are based on a constant drag profile. The constant drag phase is terminated and the transition phase begins when relative velocity is less than the transition velocity and the drag reference is less than a predetermined drag level.

### 2.3.5 Transition Phase

The transition phase is based on a linear drag profile (as a function of energy) that is required to null the range errors and is used to steer the Orbiter to the proper TAEM interface conditions. The transition phase logic consists of a linear drag-energy profile selected by ranging requirements. Control is transferred to the TAEM guidance when the TEAM interface criterion (relative velocity < TAEM transition velocity) is met or by crew action (OPS 305 PRO).

## 2.4 TERMINAL AREA ENERGY MANAGEMENT

The TAEM phase of the entry mission phase is from the TAEM interface (approximate altitude of 82,000 feet, VREL 2500 ft/s) to the approach/landing capture zone (approximate altitude of 15,000 feet, 288 knots equivalent airspeed (KEAS)).

Glide range is controlled by flying to a nominal altitude and dynamic pressure reference versus range profile which can be interpreted as an energy over weight versus range profile. A typical TAEM energy plot is shown in figure 2-4. Energy control is achieved by nulling out altitude errors via the normal acceleration command and by nulling out dynamic pressure errors when subsonic via the speed brake deflection command. Additional energy control is achieved by limiting the normal acceleration command based on an energy corridor formulated from a nominal energy versus range profile. Also, the normal acceleration command is constrained by limits based on dynamic pressure to inhibit the vehicle from attaining excessively high dynamic pressures and to optimize the vehicle's lift-to-drag ratio during range 'stretch' maneuvers. If considerable excess energy exists, an S-turn maneuver is executed to dissipate additional energy. If the vehicle is faced with an extreme low-energy situation, the guidance software sends out a message that requests that the crew switch the HAC to the minimum entry point (MEP) HAC location. Crew action is required to achieve relocation of the HAC. At either the nominal or MEP HAC location, the crew can select a straight-in or an overhead HAC for weather avoidance.

The inertial navigation and air data subsystems provide input data to the TAEM guidance software. A groundtrack predictor routine estimates the groundtrack distance to runway threshold. This range prediction is used to determine the altitude, altitude rate, and dynamic pressure references. A simplified diagram of TAEM guidance is shown in figure 2-5.

For all guidance phases (S-turn, acquisition, heading alignment, and pre-final), the normal acceleration command is driven by an error signal based on the reference altitude and altitude rate errors. The speed brake command is generated from the dynamic pressure error during subsonic flight, while during supersonic flight, the speed brake command is a constant angle of deflection.

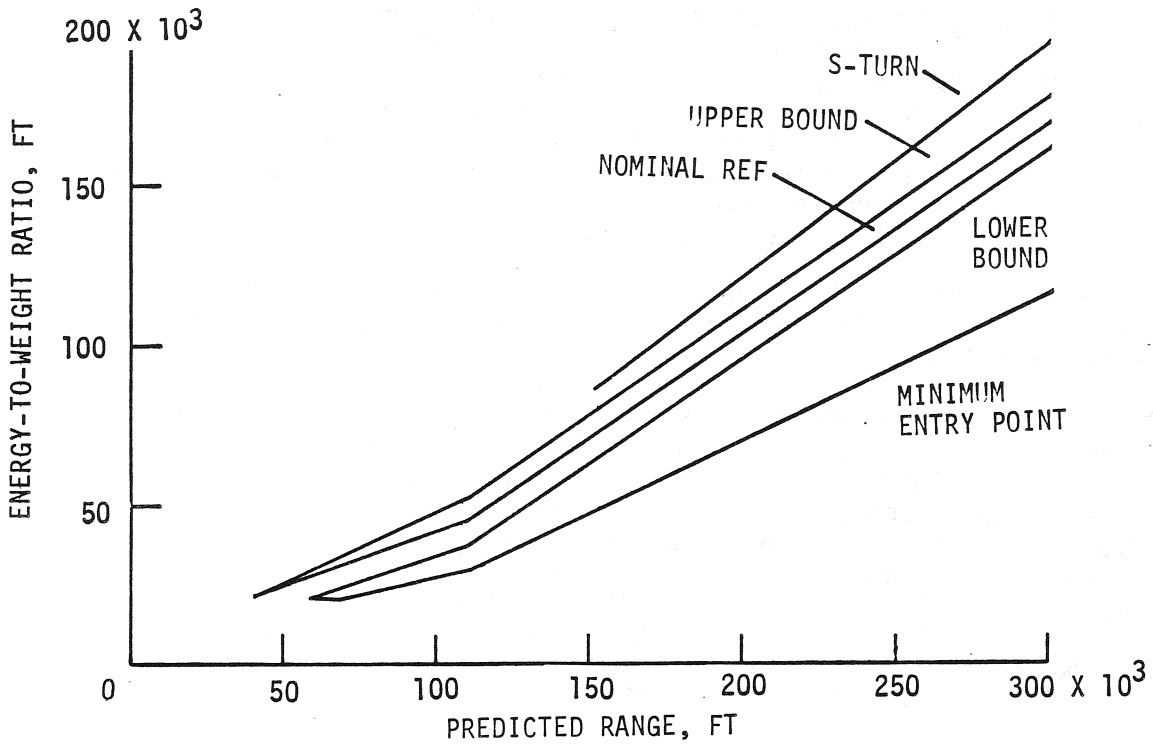

Figure 2-4.- Typical TAEM energy-to-weight ratio.

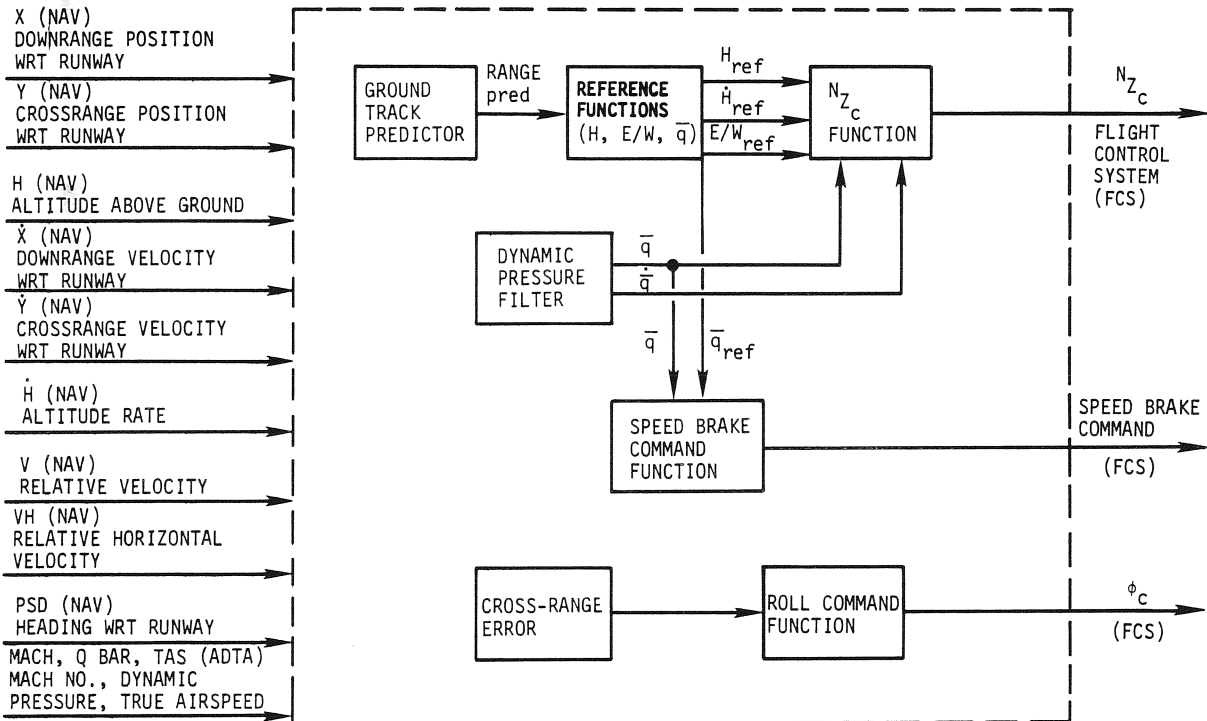

Figure 2-5.- Simplified TAEM guidance.

On the lateral axis, if the guidance is in the S-turn phase, a roll angle command of  $50^{\circ}$  ( $30^{\circ}$  if supersonic) is input to the FCS. If the guidance is in the acquisition phase, a roll angle command is given that is proportional to the Orbiter heading deviation from tangency to the selected HAC; the HAC's are used for a final turn to align the Orbiter to the runway. In the heading alignment phase, the roll angle command is generated to ensure that the Orbiter performs a turn that follows the heading alignment spiral. The spiral is the ground plane projection of the cone.

In the prefinal approach phase, the roll angle command is generated from a linear combination of Orbiter lateral deviation and deviation rate from the runway centerline.

The FCS provides the interface between the guidance system and the Orbiter aerodynamic control surfaces. The inputs from the guidance system to the FCS are (1) normal load factor command, (2) speed brake command, and (3) roll angle command. The commanded load factor is achieved by operating the elevons symmetrically using normal acceleration and pitch rate feedback in the FCS. The speed brake is operated directly by the speed brake servos in the FCS. The roll angle command is achieved by operating the elevons differentially using roll attitude and roll rate feedback in the FCS. The body flap is controlled by the autopilot to maintain elevon trim. Typical flightpath geometry for the TAEM phase is shown in figure 2-6.



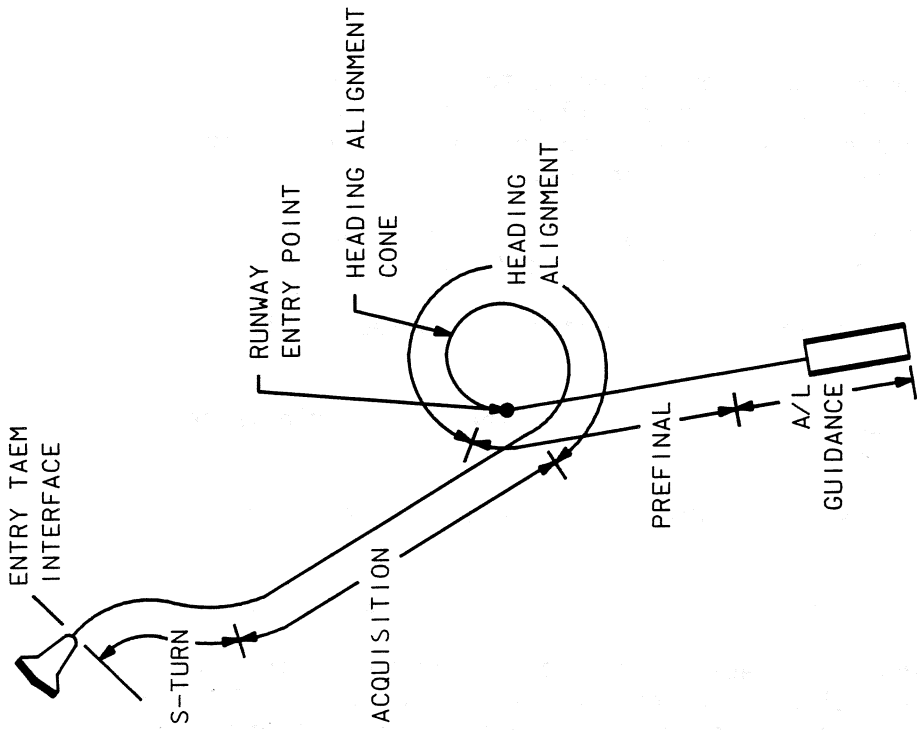

(b) Overhead approach

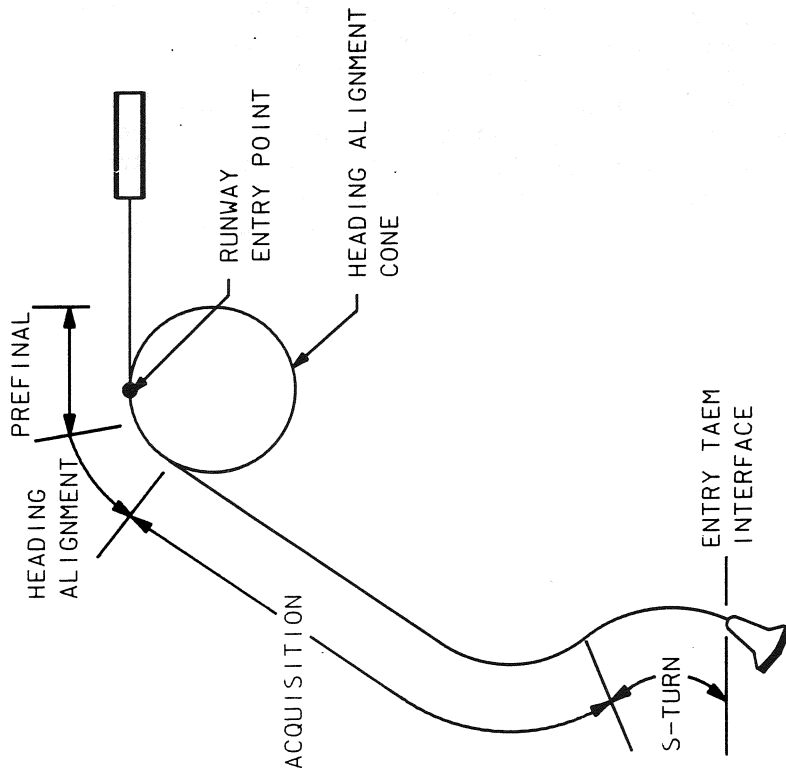

(a) Straight-In approach

Figure 2-6.- TAEM guidance phase and groundtrack geometry.

3137. ART, 2

## 2.5 APPROACH AND LANDING

The approach and landing guidance/control phase takes over with completion of the TAEM guidance/control phase between 10,000 feet and 5000 feet and ends when the vehicle comes to a complete stop on the runway. Approach and landing is divided into five flight phases.

- A. The TRAJECTORY CAPTURE phase starts at the TAEM interface and continues to guidance lockon to the steep glide slope.
- B. In the STEEP GLIDE SLOPE phase, the Orbiter is tracked in elevation and azimuth.
- C. In the FLARE AND SHALLOW GLIDE SLOPE phase, the glide angle is reduced in preparation for landing.
- D. In the FINAL FLARE phase, the sink rate is reduced to near zero for touchdown.

A typical approach and landing trajectory is shown in figure 2-7.

The approach and landing phase begins with the termination of the TAEM phase and ends with wheel stop. The approach/landing guidance automatically acquires and maintains the vehicle on an approach trajectory from TAEM guidance termination to touchdown. Normal acceleration, roll attitude, and speed brake-position commands are issued for the FCS to maintain the specified trajectory while the vehicle is airborne. Yaw rate and wings-level roll-attitude commands are issued during flat-turn, touchdown, and rollout to track the runway centerline. During all phases, the Orbiter state vector is updated by the navigation subsystem. In the approach phase, the state vector computation is augmented by additional information from the microwave landing system data. Autoland guidance commands are issued concurrently with the FCS operating in the Control Stick Steering (CSS) mode in the pitch and/or roll/yaw axes. A simplified diagram of approach/landing guidance is shown in figure 2-8.

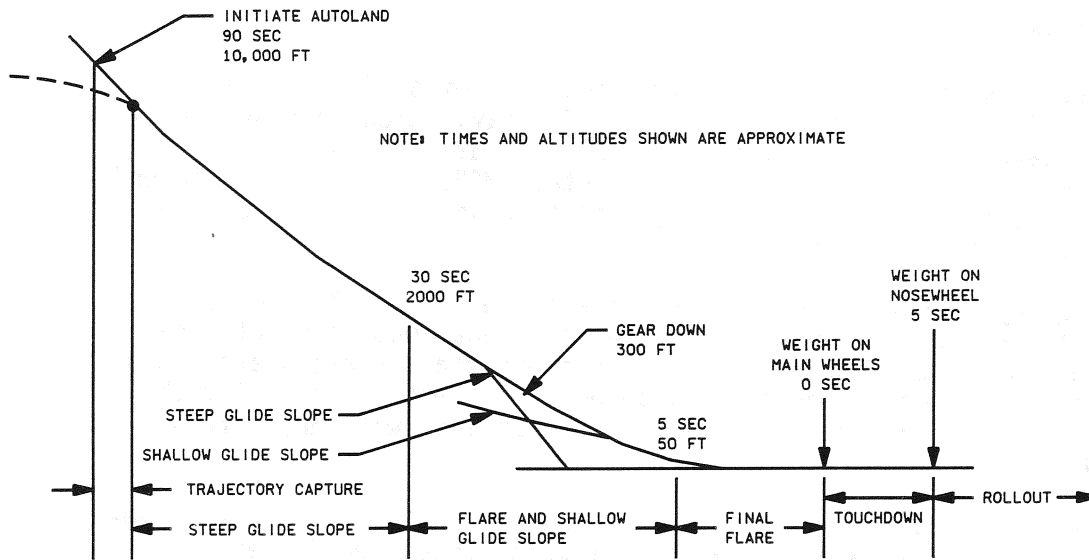

Figure 2-7.- Approach/landing longitudinal trajectory. 3134. ART. 1

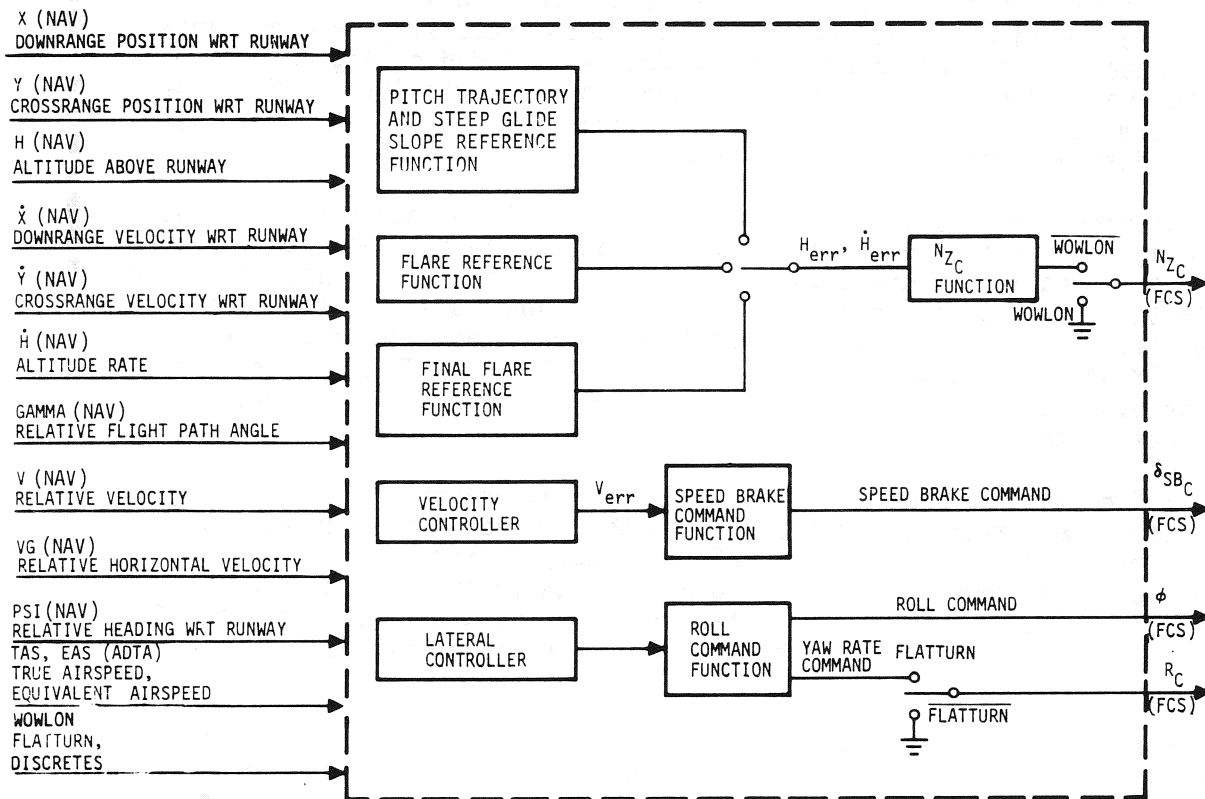

Figure 2-8.- Simplified autoland guidance.

## 2.6 ENTRY NAVIGATION

The navigation system used during entry consists of an Inertial Measurement Unit (IMU) and navigation aid data. The navigation aids available are an air data system, navigation-derived air data (NAVDAD), tacan system, a Microwave Scanning Beam Landing System (MSBLS), a possible ground state vector update based on C-band ground tracking data, altitude updating, and a radar altimeter.

Three IMU's maintain an inertial reference and provide delta velocities ( $\Delta V$ 's) that are used in the state propagation equations to update the estimate of the onboard state. Three different state vectors are propagated until MSBLS measurements are incorporated. After this point the IMU data average midvalues are selected and combined with any external data in NAV filter.

The air data transducer assembly provides barometric altitude, Mach number, dynamic pressure, angle of attack, true airspeed, equivalent airspeed, and pressure altitude rate. These data are available after air data probe deployment, which occurs around Mach 5, and until landing.

The NAVDAD principal software function provides air data parameters based on navigation-supplied data. Navigation-derived air data parameters provided are dynamic pressure, equivalent airspeed, and Mach number. The remaining navigation-derived air data parameters (angle of attack, velocity magnitude, altitude, altitude rate, drag acceleration, and side slip angle) are provided by the navigation, attitude processor, or user parameter processor. Navigation-derived air data are needed during entry as inputs to the guidance, flight control, and dedicated displays. After the crew has manually transferred to the Air Data System (ADS), the navigation-derived data are used as a backup data source.

Tacan provides range and bearing measurements. These data are available beginning at an altitude of about 156,000 feet. The data will be assessed by the crew and the ground-support personnel, and it is estimated that nominally the crew will proceed to accept data incorporation into the state vector before an altitude of 138,000 feet. Ground assessment requires S-band TM and voice communications to be established. Thus, tacan data will be available from this point on until MSBLS acquisition or until 1500 feet if the MSBLS is not available.

The MSBLS provides range, azimuth, and elevation measurements. The range and azimuth measurements are provided by the ground antenna located at the end of the runway and to the left of the runway centerline. Elevation measurements are provided by the ground antenna to the left of the runway centerline and approximately 2000 feet from the runway threshold. MSBLS acquisition is expected to occur at an altitude of approximately 20,000 feet.

The capability to update the onboard state vector after communications blackout with a ground solution of the state corrections is also available. The ground solution of the state corrections or deltas requires that the ground solution of the Orbiter state be converged and the onboard estimate of the state be available on the ground. The ground estimate of

the Orbiter state is derived by processing C-band tracking data. Deltas between the ground-computed state and the onboard state are computed and propagated to a specified future time. These deltas are then uplinked to the Orbiter in runway coordinates. The update to the onboard state is expected (if required) to occur around an altitude of 150,000 feet.

Drag altitude is derived from IMU  $\Delta V$ , a  $C_D$  as a function of Earth-relative velocity curve fit and four-layer approximation of the 1962 Standard Atmosphere. Drag altitude is incorporated when the drag acceleration is greater than  $11 \text{ ft/s}^2$  (altitude of approximately 240,000 feet) and terminated on a navigated altitude of 85,000 feet or when barometric altitude is available, whichever occurs first. Errors are introduced into the drag altitude through platform misalignments, nonstandard atmospheres, and winds. The misalignments cause errors in the  $\Delta V$ 's, which, in turn, are used in the algorithm and cause errors in the drag altitude. Nonstandard atmospheres cause errors in drag altitude because the algorithm assumes the atmosphere is a 1962 Standard Atmosphere. Winds introduce errors because the algorithm requires an estimate of angle of attack to evaluate  $C_D$ . The estimate of angle of attack is derived from the onboard estimate of Earth-relative velocity, which does not include the effects of winds.

Radar altimeter data will be available at an altitude of approximately 5000 feet.

The crew management of the onboard navigation system is contained in section 5.2.



### SECTION 3 ASSUMPTIONS, GUIDELINES, AND CONSTRAINTS

This section presents the generic guidelines and constraints baselined by Level II that are used in generating the entry operational profile. Flight-specific constraints are contained in the Flight Requirements Document for each flight.

#### 3.1 DEORBIT

When selecting the nominal deorbit revolution, the following will be considered:

- o Guidance maneuvers
- o Crew work/rest cycle
- o Landing lighting
- o Postdeorbit communication and tracking
- o Entry Flight Test Objective (FTO) phasing

The deorbit maneuver will nominally be performed using two OMS engines but because of targeting and guidance flexibility, the capability will exist to downmode to a 1-OMS configuration during the burn. Specifically, the TIG and target will be selected so that if one OMS engine fails at TIG (or any time later in the burn), the deorbit maneuver can be successfully completed using the remaining OMS engine. The targeting will be such that the delta velocity ( $\Delta V$ ) used for deorbit is the same whether the maneuver is performed with one or with two OMS engines.

In addition to satisfying the entry velocity, flightpath angle, and range requirements, the deorbit maneuver may include an out-of-plane component to achieve an acceptable Orbiter entry interface c.g. and weight.

#### 3.2 OPERATIONAL CONSTRAINTS

The uncertainties and translation effects of systems venting, aerodynamic drag, and the RCS after initiation of the tracking sequence for deorbit maneuver computation and state vector determination will be minimized consistent with reasonable operations techniques.

Maximum AFT RCS propellant consistent with mission objectives and c.g. considerations will be maintained for descent control. The redline for nominal deorbit will be the amount necessary to accomplish the descent with entry FTO's and process the two AFT RCS failure case without FTO's.

During atmospheric descent, the Orbiter c.g. will be maintained between 65.0 and 67.5 percent in the longitudinal direction and equal to or less than 1.5 inches laterally. These c.g. constraints must be met with allowances for c.g. uncertainties. Postdeorbit forward RCS dumps are allowed for nominal, Abort-Once-Around (AOA), and Abort-to-Orbit (ATO) c.g. control.

The Orbiter entry weight will be minimized by reducing remaining consumables, such as OMS and RCS propellant, consistent with reasonable operations techniques.

### 3.3 DESCENT PROFILE

The environmental model used in determining the nominal descent profile will be the appropriate mean monthly atmospheric model as defined by the Four-D Global Reference Atmospheric Model for orbit inclination  $\leq 57^\circ$ . For larger orbit inclinations, the atmospheric model is TBD. The environmental model for the nominal profile simulation will not include winds.

The descent profile will use standard I-load sets that are designed to accommodate the range of weight and balance data expected on operational flights.

The nominal end of mission (EOM), Transatlantic Abort Landing (TAL), AOA, and ATO have the same angle-of-attack profile during entry as follows.

- o Alpha equals  $40^\circ$  for Eastern Test Range (ETR) returns.
- o Alpha equals TBD for Western Test Range (WTR) returns.
- o An alternate profile for emergency returns will be available.

The entry profile will be shaped to achieve a balance between the Thermal Protection System (TPS) surface and bondline temperatures and Orbiter structural temperatures. This balance will include allowances for aerodynamic heating and trajectory dispersions. Selection of the entry profiles will include consideration of sonic boom ground-level overpressures.

The profiles for EOM, AOA, ATO, TAL, and Glide Return to Landing Site (GRTLs) will be designed for an overhead approach to the runway. Additionally, the nominal descent profile will be designed so that postblack-out runway redesignations and HAC downmoding can be accomplished.



The descent profile will be shaped to conform with the following dynamic pressure constraints (table 3-I).

TABLE 3-I.- DYNAMIC PRESSURE CONSTRAINTS

Mach	Dynamic pressure, psf		Constraint	Comment
	NOM	GRTLS		
M > 5.0	300	(375)	Structural	Constant
5.0 ≥ M ≥ 3.0 (3.2)	342	(375)	Flight control	Constant
(3.2) 3.0 ≥ M ≥ 2.5	342-280	(300)	Guidance/flight control	Linear ramp
2.5 ≥ M ≥ 2.0	280-275	(300)	Guidance/flight control	Linear ramp
2.0 ≥ M ≥ 1.0	275	(320)	Guidance/flight control	Constant
M < 1.0	340	(340)	Guidance	Constant

The minimum dynamic pressure will be restricted to a value that keeps the vehicle's lift/drag (L/D) on the front side of the L/D curve.

The TAEM and Optional TAEM Targeting (OTT) profile will be compatible with manual and automatic modes of operation.

Additionally, this dynamic pressure will allow the TAEM/approach and landing interface constraints to be met in the presence of severe (March Sector 3) headwinds. The energy control will provide conditions suitable for the initiation of a manual approach.

Aero maneuvers will not be executed during the following:

- o Guidance major mode switching
- o Initial bank maneuver to capture the drag profile
- o Bank reversals, including damping of phugoid after completion of the maneuver
- o Aborts (AOA is an exception for auto Programed Test Inputs (PTI's))

The GRTLS angle of attack for the alpha recovery phase will be 50° to optimize the pullout angle of attack and the normal load factor command

for the load relief phase will not exceed 2.2g. The pitch rates during the alpha recovery phase will be limited to 2 deg/s.

The GRTLS profile will be shaped to achieve benign atmospheric entry conditions by minimizing the max q (< 375 psf) and by optimizing the pullout angle of attack experienced during the load relief phase.

Approach and landing is initiated at an altitude of approximately 10,000 feet and 285 KEAS. The steep (outer) glideslope will nominally be 19° with 17° used for the heavy weight vehicle (weight > 220,000 lb). The nominal aimpoint for the outer glideslope will be 7500 feet with 6500 feet used for the high headwind condition (wind velocity (Vw) > 20 knots). The flare to the shallow (inner) glideslope will be initiated at an altitude of 2000 feet. The inner glideslope angle will be 1.5° with a runway aimpoint of 1000 feet. The nominal maingear touchdown point will be between 2500 and 3000 feet. The nominal touchdown speed will be designed to provide a 3- to 5-second margin above tailsrape for worst-on-worst combinations of low-energy dispersions. The body flap will be retracted at an altitude of 10,000 feet. The speed brake will nominally be retracted at an altitude of 2500 feet.

#### 3.4 LANDING SITES AND LANDING CONSTRAINTS

Daylight landings are preferred; however, night landings are acceptable to satisfy mandatory payload requirements or operational considerations. Preferred lighting conditions at landing are as follows.

- o Planned return day and one day flight extension to the prime landing site - land between sunrise and sunset.
- o All other return opportunities - land between 15 minutes prior to sunrise and 15 minutes after sunset. (Ref. PRCBD S21040.)

SECTION 4  
DEORBIT OPERATIONS

4.1 DEORBIT BURN PROCEDURES

4.1.1 Deorbit Procedures Sequence

The sequence of deorbit events referenced to Time of Ignition (TIG) or to Entry Interface (EI) are listed in table 4-I. Each event, discussed on the following pages, lists the event, the onboard cue and/or display for monitoring, the crew action required, and a discussion of the event.

TABLE 4-I.- SEQUENCE OF DEORBIT PROCEDURES

Time (min)	Event	Discussion, page
TIG - 44	Final Deorbit Update/Uplink	4-2
TIG - 24	OMS TVC Gimbal Check	4-7
	APU Prestart	4-8
	Horizontal Situation Configuration	4-9
	OMS (RCS) Burn Preparation	4-10
	Vent Door Close	4-12
TIG - 21	Deorbit Update/Uplink (If Required)	4-13
	GNC OPS 302 PRO	4-14
TIG - 20	GO/NO GO for Deorbit Burn	4-15
TIG - 15	Maneuver to Deorbit Burn Attitude	4-16
TIG - 3	Single APU Start	4-17
	Deorbit Burn	4-18
	OMS (Deorbit Burn) Cutoff	4-19
	OMS/RCS POSTBURN Reconfiguration	4-20
	Postburn Status	4-21
	GNC OPS 303 PRO	4-22
	Maneuver to EI-5 Attitude	4-23
	OMS Gimbal Powerdown	4-24
EI - 10	Forward RCS Dump	4-25
	Entry Switch Check	4-26
EI - 13	Remaining APU's Start	4-27
	SSME Hydraulic System Repressurization	4-28
EI - 11	Hydraulic Fluid Thermal Conditioning	4-29
EI - 20	Burn Report	4-30
	State Vector Change	4-31
	Pin Removal	4-32
	g-Suit Inflation	4-33

<u>EVENT</u>	<u>CUE</u>	<u>DISPLAY</u>
<u>Final Deorbit Update/Uplink</u>	Seat ingress complete MIL AOS	DEORB MNVR COAST

### CREW ACTION

1. UPLINK - ENA (panel C3) to allow uplink (required for OPS 1 and OPS 3).
2. Commander and pilot copy voice updates to the DEL PAD and OMS PRPLT PAD while the ground uplinks PASS and BFS state vectors and targets, and a BFS GYRO/ACCEL (if required) during coverage at MIL and BDA.
3. On MCC GO:  
Execute the LOAD (Item 22) and the TIMER (Item 23) on the DEORB MNVR display.
4. Check PASS and BFS targeting results per DEL PAD.

### DISCUSSION

After seat ingress, a deorbit target (normally for PEG 4 rather than PEG 7) is loaded by keyboard execution of the LOAD item on the DEORBIT MNVR COAST (EXEC) display in MM 301 (or MM 302). The target input parameters can be uplinked from the ground or input to the display by the crew. Execution of the LOAD item effects onboard calculated results of target parameters of inertial attitude, targeted HA and HP, TFF, REI,  $\Delta VTOT$ , body VGOs, and TGO; and provides fly-to ADI error needles for the burn attitude. Execution of the TIMER item starts the CRT timer counting down to the TIG shown on the DEORB MNVR display.

The Deorbit, Entry, and Landing (DEL) PAD (fig. 4-1) is used to validate the uplinked target input by providing expected results of the input. If the results are not satisfactory or the uplink fails, the ground can voice up the entire target input and expected executed results by using the MNVR PAD (fig. 4-2).

The OMS PRPLT PAD (fig. 4-3) provides crossfeed cues in either  $\Delta VTOT$  or percent of OMS quantity, or both, that are applicable to the deorbit burn engine configuration and propellant situation expected at ignition.

A 'reasonable' deorbit target solution can be verified by inspecting the displayed guidance-calculated values of  $\Delta VTOT$ , TGO, and the body VGO's (x, y, z), as follows.

- o For 2 OMS engines burns,  $2 \times TGO$  (sec) is approximately equal to  $\Delta VTOT$  (fps).
- o For 1 OMS engine burns, TGO (sec) is approximately equal to  $\Delta VTOT$  (fps).
- o For RCS burns (four +X jets), TGO (sec) is about 1.7 times  $\Delta VTOT$  (fps).

DISCUSSION - Concluded

- o The nominal deorbit burn  $\Delta V$  requirements (STS-1, Cycle 2) were as follows when the burn was optimized for RCS.

Burn mode	In-plane $\Delta V$ , fps	$\Delta V_{TOT}$ , fps	Total OMS propellant, lb
2 OMS	280.5	292.4	5600
1 OMS	271.9	292.4	5600
+X RCS	268.5	268.5	6035

DEL PAD										
DEORBIT										
BURN ATT:	R				P			Y		
TGT	HA				HP	(	)			
ΔVTOT								.		
TGO								:		
PRPLT					(	)				
BURN CUE CARD:										
TIG SLIP - NO EXEC > TIG +										
STOP/CONTINUE PRPLT FAIL CUES										
L OMS HP										
R OMS HP										
SAFE HP										
PRI HP										
B/U HP										
TOT AFT QTY 1 (%)										
TOT AFT QTY 2 (%)										
FRCS: DUMP TO %								OX		
XCG at M = 3								.		
YCG						(	)	.		
EI-5 MM303										
INRTL ATT	R				P			Y		
(3-25)								L		
MM304 PREBANK (ENT Mmvr Cue Card)								R		
--- AOS								EI -		
--- LOS								EI -		
ALTM SET (3-4)								.		
D=4						:		:		
VREL 1ST REVERSAL										
	L				OVHD			deg	RWY	
	R				STRT					
WINDS:									/	
(ENT Mmvr									/	
Cue Card)									/	
50K									/	
40K									/	
30K									/	
20K									/	
7K									/	
SURFACE									/	
REMARKS:	APU START SEQUENCE <input type="checkbox"/> then <input type="checkbox"/>									

Figure 4-1.- DEL PAD.

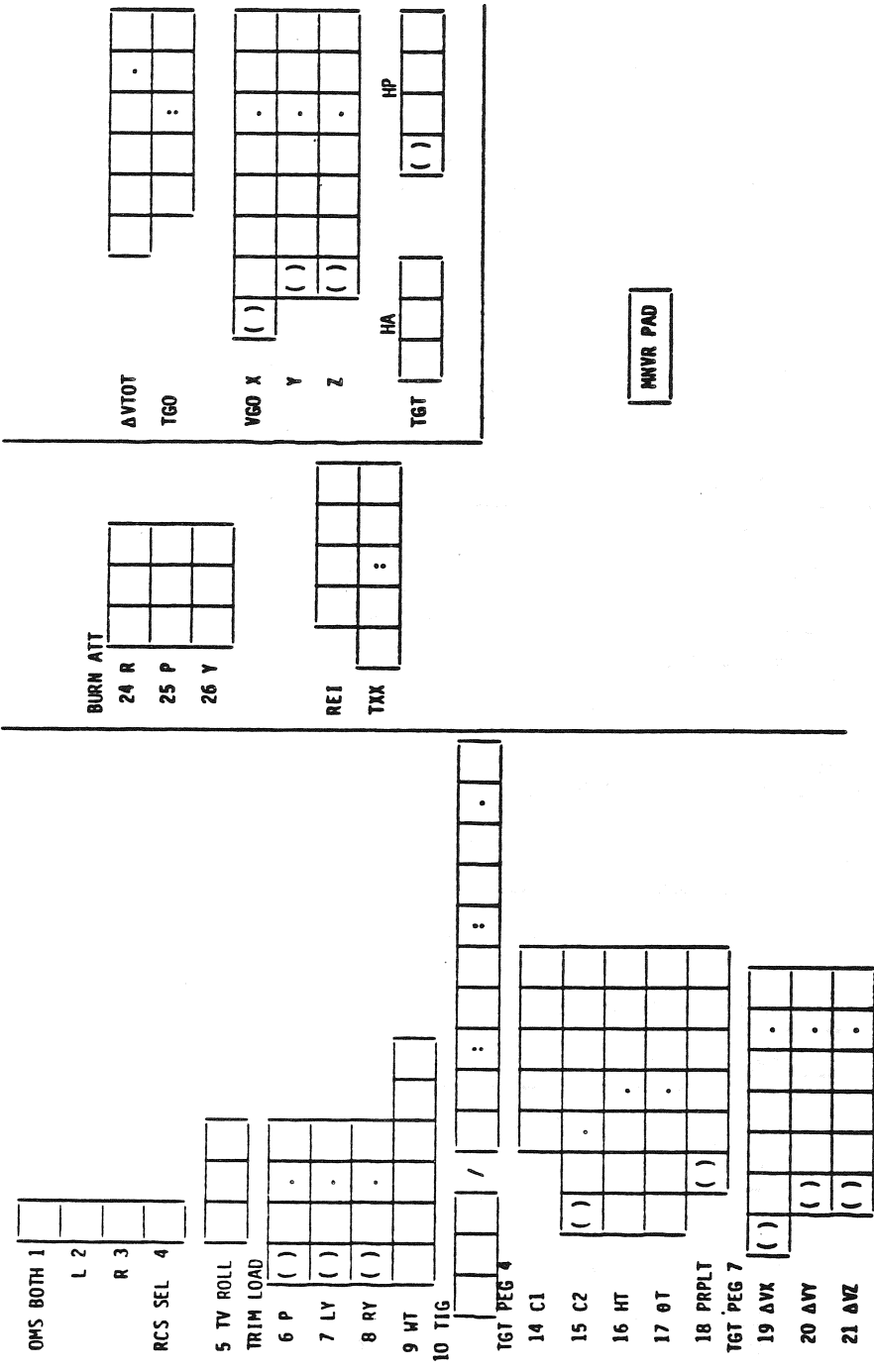

Figure 4-2.- MNVR PAD.

BURN CARD		OMS PRPLT PAD		XFEEED CUE	
DEORBIT BURN (2 ENG)	OMS ENG FAIL	<input type="text"/>	%L	<input type="text"/>	%R
DEORBIT BURN (1 ENG)	OMS XFEEED	<input type="text"/>	ΔVTOT	<input type="text"/>	%
	OMS TK SW	<input type="text"/>	ΔVTOT		
DEORBIT BURN (RCS)	OMS TK SW	<input type="text"/>	ΔVTOT		
	OMS PRPLT LOW	<input type="text"/>	ΔVTOT		
UNBALANCED PRPLT DEORBIT BURN	BEFORE 1 POD FEED				
	OMS ENG FAIL (XFEEED)	<input type="text"/>	ΔVTOT	<input type="text"/>	%L <input type="text"/>
	DURING 1 POD FEED				
	START 1 POD FEED	<input type="text"/>	ΔVTOT	<input type="checkbox"/>	TK ISOLS CL
	OMS ENG FAIL (XFEEED)	<input type="checkbox"/>	TK ISOLS OP	<input type="checkbox"/>	TK ISOLS CL
		<input type="text"/>	ΔVTOT	<input type="text"/>	% <input type="checkbox"/>
AFTER 1 POD FEED	STOP 1 POD FEED	<input type="text"/>	ΔVTOT	<input type="checkbox"/>	TK ISOLS OP
	OMS ENG FAIL (XFEEED)	<input type="text"/>	%L	<input type="text"/>	%R
DEORBIT BURN (MIXED XFEEED)	<input type="checkbox"/>	OMS ENG - ARM/PRESS			
	<input type="text"/>	ΔVTOT: Feed from GOOD POD			
	<input type="checkbox"/>	OMS He PRESS OP			
	<input type="checkbox"/>	TK ISOLS OP			
	<input type="checkbox"/>	OMS He PRESS CL			
	<input type="checkbox"/>	TK ISOLS CL			
	RCS COMPLETION, OMS ENG FAIL:				
	<input type="checkbox"/>	OMS XFEEEDS OP			
	Feed from GOOD POD at	<input type="text"/>	ΔVTOT		
	<input type="checkbox"/>	OMS He PRESS OP			
	<input type="checkbox"/>	TK ISOLS OP			
	<input type="checkbox"/>	XFEEEDS CL			

Figure 4-3.- OMS PRPLT PAD.



EVENT

CUE

DISPLAY

OMS TVC Gimbal Check

DEORB MNVR COAST

CREW ACTION

1. Select SEC L and R gimbal systems (EXEC ITEMS 30 and 31).
2. Perform OMS TVC gimbal check (EXEC ITEM 34).
3. Monitor for down arrows or M's.
4. Select L and R PRI gimbal systems (EXEC ITEMS 28 and 29).
5. Perform OMS TVC gimbal check (EXEC ITEM 34).
6. Monitor for down arrows or M's.
7. Select good gimbal if down arrows or M's.

DISCUSSION

The OMS TVC gimbal check is performed identically for 2 ENG and 1 ENG burns. Although in the 1 ENG burn one OMS engine is not used during the burn, it should be stowed with the good engine after the deorbit burn.

During the gimbal test, the crew can verify indicated motion of the gimbals from displayed values, but they will have to depend on RM to display down arrows to indicate that the proper values of pitch and yaw have not been attained (i.e., gimbal check failed). Usually, the gimbal test will be monitored by the MCC for proper performance. No requirement existed to perform the check over a ground station, but it was scheduled for the ACN pass for STS-1. Since STS-2, the gimbal check has been performed during S-band data coverage.

EVENT

CUE

DISPLAY

APU Prestart

CREW ACTION

1. Check or configure the appropriate switches on panels R2 and R4 so that the APUs can be started with a minimum number of switches.
2. Cycle the APU FUEL TK VLVs.

DISCUSSION

The only switch position in this procedure that is undesirable if the APUs are not started and the deorbit burn is not performed is the HYD MAIN PUMP PRESS LOW. The LOW position draws power and the switch should be returned to NORM if the deorbit burn is going to be accomplished one or more orbits later.

The APU FUEL TK VLVs are cycled to check the ready-to-start talkback before the loss of S-band coverage. The expected talkback is gray when the fuel tank valves are opened. A barberpole talkback indicates that an APU is not ready to start because of pump pressure, H<sub>2</sub>O boiler controller, fuel valves, GG temperature, or turbine speed. Knowledge of a problem may allow the ground to advise the crew of a solution and avoid landing one orbit or one day later than desired.

EVENTCUEDISPLAYHorizontal Situation Configuration

HSD

CREW ACTION

Check the HSD configuration in the PASS and BFS.

DISCUSSION

The Entry Checklist shows a check on display items rather than the previously required 'EXECs' necessary to achieve the desired configuration that was different from some of the currently initialized values. For normal deorbit, these 'EXECs' were performed preburn in the beginning of the Entry Checklist (previously in the PDP); but for AOA deorbit in the Ascent Checklist, the same configuration was desired but required 'EXEC's' postburn only because of the lack of time before the deorbit burn.

ADTA to G&C data are set to INH (inhibit) in the PASS and to AUTO in the BFS. Assuming that the PASS does not fail, the inhibited data will be analyzed during entry before being set to AUTO, and thus, further changes to the BFS HSD would not be required. If the PASS fails before these data have been incorporated, then the BFS HSD should be configured like the PASS rather than the BFS and the inhibited data would then be set to AUTO after analysis as is planned in the PASS.

<u>EVENT</u>	<u>CUE</u>	<u>DISPLAY</u>
<u>OMS (RCS) Burn Preparation</u>	None	Panel talkback

### CREW ACTION

Verify the switch positions on panels 07 and 08 for an OMS deorbit burn or configure the valves on panels 07 and 08 for an RCS deorbit burn.

### DISCUSSION

For the nominal deorbit burn, the OMS propellant is planned to be burned in equal amounts from each OMS pod using both OMS engines. However, possible propellant feed configurations for the propulsive modes are as follows.

2 ENG - Left pod feeds left OMS engine, right pod feeds right OMS engine.

1 ENG - 'Good' OMS engine uses its own propellant initially, then a crossfeed is made during the burn to use the failed engine's propellant. If the 1 OMS engine deorbit burn is a deorbit completion burn following an earlier 'Leaking OMS PRPLT Burn' that was performed to lower the perigee (to approximately 95 n. mi.), the 'good' OMS engine could be started in a mixed XFEED configuration (if necessary for Y c.g. management) and manually reconfigured to complete the deorbit burn on its own propellant, or the engine would use its own propellant for the entire deorbit burn.

RCS - Both left and right aft RCS pods use left OMS propellant initially (arbitrary choice), then right OMS propellant for the second part of the burn.

Unbalanced PRPLT - The burn is started normally and each OMS engine uses propellant from its respective pod for about 10 seconds to establish normal operation. Then both of the engines are supplied by the 'heavy' pod until the imbalance is eliminated, at which time the engines are returned to the normal feed condition to complete the burn. This method would be used if both OMS engines are operable and the postburn Y c.g. would have been too great if the normal 2 ENG burn was used.

Mixed XFEED - If a propellant failure (tank or line) occurs in the oxidizer or fuel system of one pod, that pod's OMS engine is considered failed and the burn is started with the other OMS engine using oxidizer from one pod and fuel from the other. During the burn, the propellant system can be manually reconfigured, if desired, to feed the engine from its own pod so that the Y c.g. is balanced as much as possible.

DISCUSSION - Concluded

Burn preparation procedures require different valve/switch positions depending on whether the burn is planned to be accomplished by 2 ENG, 1 ENG, or RCS. The intent of the deorbit burn preparation is to configure the OMS and RCS plumbing so that the preburn and downmode configurations are as similar as possible and to minimize the steps or number of valves/switches that must be changed when required to downmode or crossfeed OMS propellant during a burn. These steps are shown in the combined use of the deorbit cue cards, which are discussed in detail in section 4.2, DE-ORBIT BURN CUE CARDS.

EVENT

CUE

DISPLAY

Vent Door Close

GNC 51 OVERRIDE

CREW ACTION

The vent doors are closed by the crew's execution of ITEM 23 on the GNC OVERRIDE display. The vent doors are closed for entry except when a leak has occurred in the OMS or RCS propellant tanks or the OMS or RCS helium-pressurization systems.

<u>EVENT</u>	<u>CUE</u>	<u>DISPLAY</u>
<u>Deorbit Update/Uplink</u> <u>(If Required)</u>	ACN AOS at ~TIG-22 (last uplink coverage before deorbit burn)	DEORB MNVR COAST

#### CREW ACTION

1. UPLINK - ENA (panel C3) to allow possible uplink.
2. Commander and pilot copy voice updates to the DEL PAD and OMS PRPLT PAD if changed from the final update, while the ground uplinks PASS and BFS state vectors and targets if a change is required from the final targeting data.
3. On MCC GO:  
Execute the LOAD (ITEM 22) and the TIMER (ITEM 23) on the DEORB MNVR display.

NOTE: The LOAD and TIMER items should be executed to provide the best match of state vector and target even if an uplink is not required to change the target input data.

4. Check PASS and BFS targeting results per DEL PAD.

#### DISCUSSION

MCC changes to the deorbit target from the final uplink/update at MIL/BDA are not expected but the LOAD should be executed as discussed in the preceding note.

<u>EVENT</u>	<u>CUE</u>	<u>DISPLAY</u>
<u>GNC , OPS 302 PRO</u>	CRT	DEORB MNVR COAST

CREW ACTION

GNC , OPS 302 PRO

DISCUSSION

The transition from MM 301 to MM 302 is not time critical except that it must be completed before deorbit TIG because the OMS engine's ignition in OPS 3 occurs in MM 302 only. This necessary transition has been a procedural trap, especially in a simulation environment when several deorbit burns that were initialized in MM 301 were run in a relatively short period of time. The only cue to being in MM 302 other than the '302' at the upper left of the CRT display is that the DEORB MNVR COAST title changes to DEORB MNVR EXEC. This procedural trap should be eliminated by the bold-face 'GNC , OPS 302 PRO' entry in the Entry Checklist and by having a check on MM 302 shown at the top of each Deorbit Burn cue card.



<u>EVENT</u>	<u>CUE</u>	<u>DISPLAY</u>
<u>GO/NO GO for Deorbit Burn</u>	ACN coverage before deorbit burn (TIG-22 to TIG-16)	

CREW ACTION

Agree with MCC on the following:

1. Deorbit target data (DEL PAD)
2. Entry and landing data (DEL PAD)
3. OMS PRPLT XFEED cues (OMS PRPLT PAD)
4. OMS and RCS systems status
5. APU fuel quantity and APU activation times
6. Adjustments to entry procedures as required

DISCUSSION

The GO/NO GO decision for the deorbit burn is expected during the ACN station coverage before deorbit TIG. The remaining time before the deorbit burn is intended for the crew to complete the following procedures or checks that are necessary if the burn is to be performed but would not be appropriate to perform earlier. A last chance for a GO/NO GO decision normally exists at ~TIG-6 at the BOT coverage (UHF) but is a backup only.

1. Maneuver to deorbit burn attitude
2. Copy last OMS PRPLT PAD data on Deorbit Burn cue card
3. APU Start
4. MS seat ingress

<u>EVENT</u>	<u>CUE</u>	<u>DISPLAY</u>
<u>Maneuver to Deorbit Burn Attitude</u>	TIG-15 and final de-orbit target loaded and checked	DEORB MNVR EXEC

### CREW ACTION

At TIG-15, maneuver (manually or automatically) from the top Sun wing glove thermal conditioning altitude to the deorbit burn inertial attitude (shown on the DEORB MNVR display).

### DISCUSSION

Maneuvering to the deorbit burn attitude is accomplished by item execution or by use of the RHC, which currently in the TRANS DAP has modes of AUTO (0.5 deg/s), DISCRETE DETENT (3.5° deadband), DISCRETE RATE (0.5 deg/s), ACCEL, or PULSE (no deadband) during coast in OPS 3 (MM 301 through MM 303). The fly-to error needles will null at the deorbit burn attitude regardless of the position of the ADI ATTITUDE switch, but the attitude shown on the DEORB MNVR display is an inertial attitude that corresponds to the reading on the ADI when the error needles are nulled and the switch is in the INRTL position; i.e., the desired attitude can be attained by nulling the fly-to error needles with the ADI ATTITUDE switch in any of the three positions, but the ADI attitude and the DEORB MNVR display attitude will be the same value only if the switch is in the INRTL position. The OPS 3 RELMATS originally planned for the deorbit burn on STS-1 were meaningful for the deorbit burn attitude, but the decision to maintain a 'STAR BALL' RELMAT and discontinue routinely uplinking relmats left only the unbiased LVLH as a meaningful body-related reference for deorbit.

At one time, the deorbit burn for STS-1 was planned to be a propellant-wasting burn of almost 4 minutes. This amount of propellant wasting was required to meet X c.g. limits for the baselined OMS propellant tank failure loading. Later, the OMS propellant tank failure was ruled out for loading purposes and the baselined STS-1 deorbit burn was planned to be almost in plane. The Cycle 2 nominal deorbit burn was targeted for a 2 OMS burn with 17° wasting (5600 pounds of propellant to be burned of which only about 200 pounds was wasted) for a burn duration of 2 minutes and 26 seconds. Any ΔV shortages resulting from propellant system failures must be solved by alternate means. The nominal STS-2 deorbit was planned to be in plane and still require a forward RCS propellant dump to manage the X c.g. of the Orbiter. As payloads were added, the trend has been to minimize the OMS loading to the extent that RCS deorbit on OMS propellant does not exist, and any desired wasting can be accomplished in plane by adjusting the TIG preburn.

Once the deorbit burn attitude is attained, adjustments to the attitude should be avoided to conserve RCS propellant unless the target input is changed during the ACN coverage. The ADI roll error needle must be nulled immediately before TIG to maintain the preburn calculated inertial attitude during the burn.

<u>EVENT</u>	<u>CUE</u>	<u>DISPLAY</u>
<u>Single APU Start</u>	Deorbit TIG - 3 min	BFS, SM SYS SUMM 2

#### CREW ACTION

Perform APU start

#### DISCUSSION

In early STS-1 planning, the APUs were to be started 3 minutes before deorbit TIG to ensure APU operation before entry. Also, APU operation is necessary for performing the SSME hydraulic system repressurization and the hydraulic fluid thermal conditioning tasks between deorbit cutoff and EI. However, the hydraulic fluid thermal conditioning was deferred to STS-2. The APU fuel budget was a prime concern because early studies showed an insufficient amount of fuel for STS-1. Although the earlier Entry Checklists procedures showed that all three APUs were started at deorbit, TIG-3 minutes, one possible alternative considered was to start two APUs before deorbit TIG and the third APU closer to EI. If the situation required that the APUs be started late, then the most likely time would be at EI-5 minutes.

For STS-1, two APUs were started at TIG-3 and were operated in the depressurized mode until EI-5. After pressurizing the two operating APUs at EI-5, the third APU was started and operated at normal pressure. On STS-2, one APU was started at TIG-3 minutes and the remaining APUs were started at EI-13 minutes and all three were pressurized at that time. This latter method has become the standard.

During the OFT program, the DFI PCM recorders were positioned to continuous record before the APU start because of the requirement to record all APU operations and other entry data post EI.

<u>EVENT</u>	<u>CUE</u>	<u>DISPLAY</u>
<u>Deorbit Burn</u>	EXEC flashes at TIG - 15 sec TIG at 0 on CRT timer	DEORB MNVR EXEC ADI ADI ERROR NEEDLES BFS, GNC SYS SUMM OMS PRESS Pc OMS QTY C&W

### CREW ACTION

1. Perform the deorbit burn using either the Deorbit Burn (2 ENG), the Deorbit Burn (1 ENG), the Deorbit Burn (RCS), the Unbalanced PRPLT Deorbit Burn, or the Deorbit Burn (MIXED XFEED) cue card with the Deorbit Burn Monitor Card.
2. Monitor ADI/ADI error needles for attitude control, OMS gimbal failure, and OMS engine failure.
3. Monitor OMS PRESS Pc (panel F7) and CRT displays for OMS engine failure, OMS system failure, and gimbal failure.

### DISCUSSION

Normally the deorbit burn will be flown in AUTO using both OMS engines. The MANUAL OMS TCV is a proportional 0 to 2 deg/s in all three axes. Attitude deadbands for OMS burns are 5°, 100°, and 100° in roll, pitch, and yaw, respectively, and the rate upper deadband is 2.05 deg/s in all three axes. If the deadband in attitude or rate is exceeded during the burn, the OMS TVC gimbal system will be assisted by the RCS. The OMS engines are gimballed to control the attitude in all three axes for a 2-OMS burn, and the one operating OMS engine is used for pitch and yaw control (roll must be controlled by the RCS) for a 1-OMS burn. For an RCS-only deorbit burn, the attitude deadband in all three axes is 3° (with DAP in discrete) and the burn is flown manually using the RHC for attitude control, and the THC for thrusting with the four +X aft RCS jets.

If an OMS engine fails during the deorbit burn, the OMS ENG switch of the failed engine must be repositioned from ARM/PRESS (or ARM) to OFF to obtain the proper guidance parameters and repositioned ADI error needles for the remaining OMS engine, or for RCS if the second OMS engine fails. OMS propellant crossfeed cues are voiced to the crew before the burn for the configuration in which the burn is started. These cues are given in ΔVTOT or OMS gage percent, or both, depending on the OMS/RCS configuration. For a detailed discussion of the deorbit burn, see section 4.2, DEORBIT BURN CUE CARDS.

<u>EVENT</u>	<u>CUE</u>	<u>DISPLAY</u>
<u>OMS (Deorbit Burn) Cutoff</u>	TGO = 0 ΔVTOT = 0 CUR HP = TGT HP	DEORB MNVR EXEC

### CREW ACTION

1. Position OMS ENG switches to OFF following purge or as backup for OMS engines failing to cut off when commanded or anticipated.
2. Release THC if RCS deorbit burn or RCS completion of deorbit burn.
3. Trim burn residuals to less than 2 fps in each axis for the normal steep target and to less than 0.5 fps for a shallow target.

### DISCUSSION

If the OMS engines cut off normally when the target has been achieved, a sufficient amount of time (usually 2 seconds) is allowed for purge completion before repositioning the OMS ENG switches from ARM/PRESS to OFF. The purge is the normal followup for OMS engines cutoff but the purge would not be mandatory for the deorbit burn because it is the last use of the OMS engines for the mission. Purging is required between burns only if sufficient time has not elapsed since the previous burn.

Positioning the OMS ENG switches to OFF is the backup for failure of the engines to cut off when anticipated; that is, the crew is monitoring the current HP approaching the targeted HP, TGO approaching zero, and ΔVTOT approaching zero. If TGO goes to zero and the OMS engines do not cut off (chamber pressure zero and engine valves closed), the OMS engine switches are repositioned from ARM/PRESS to OFF to stop the overburn.

If cutoff occurs before the required velocity is expended to achieve deorbit targeting and insufficient OMS propellant exists to achieve the ΔVTOT remaining, this UNDERBURN condition can be corrected to some extent by ARCS, FRCS, and the use of prebank from the prebank table that shows the recovery prebank (roll) in degrees versus the magnitude of the UNDERBURN in ΔHP (the current HP minus the targeted HP). If the UNDERBURN magnitude exceeds the RCS and recovery prebank capability, then the landing at EDW can be redesignated to a landing at NOR (with the use of a reduced recovery prebank assuming the redesignation to NOR).

EVENT

CUE

DISPLAY

OMS/RCS Postburn Reconfiguration

Deorbit burn complete and trimmed

CREW ACTION

Reposition or verify the positions of OMS and RCS switches/valves.

DISCUSSION

Following a nominal deorbit burn or a deorbit burn in which engine or propellant systems failures have been encountered, the crew must reposition or verify the positions of the OMS and RCS switches and valves to the desired entry configuration.

To conserve tape (during OFT), the DFI wideband mission recorders were placed in standby following the OMS burn and then to continuous record again before EI, unless there was a recorder requirement for an FTO between the burn and EI. The wideband recorders were required to be in continuous record for OMS engine burns and from EI through rollout for the entry phase.

<u>EVENT</u>	<u>CUE</u>	<u>DISPLAY</u>
<u>Postburn Status</u>	Deorbit burn complete or shut down	DEORB MNVR EXEC ADI

#### CREW ACTION

1. Record either that the deorbit burn was nominal or the  $\Delta$ TIG (the amount of time that OMS ignition was late).
2. Report to MCC as 'BURN REPORT' during upcoming STDN coverage.

#### DISCUSSION

A  $\Delta$ TIG is the only requirement for reporting the burn status, but the crew would likely report any failures that occurred when out-of-station coverage, if the burn was not performed or had been shut down with HP > safe HP, or that an UNDERBURN had occurred. In the event of no OMS ignition or a shutdown with the current HP > safe HP, the crew should return to MM 301 and then confirm the correct configuration of the OMS and RCS with the MCC.

EVENT

GNC , OPS 303 PRO

CUE

Postburn data  
recorded

DISPLAY

DEORB MNVR  
EXEC  
ADI

CREW ACTION

GNC , OPS 303 PRO

DISCUSSION

The transition to MM 303 initiates stowing of the OMS engines (unless the gimbal has been selected OFF) and provides fly-to ADI error needles for the EI-5 minute attitude. The deorbit target data shown on the DEORB MNVR display in MM 301 and MM 302 blank and the I-loaded values of roll, pitch, and yaw that are displayed under BURN ATT are the inertial values equivalent to a 0°, 40°, 0° LVLH MM 304 attitude at EI-5 minutes. These attitudes can be changed directly by the crew through the keyboard but must be supplied by the MCC.



<u>EVENT</u>	<u>CUE</u>	<u>DISPLAY</u>
<u>Maneuver to EI-5 Attitude</u>	MM 303	DEORB MNVR COAST ADI error needles ADI

CREW ACTION

Maneuver to the EI-5 minute attitude using the RHC or by executing the item for an auto maneuver.

DISCUSSION

With the 'GNC, OPS 303 PRO' command, the crew obtains error needles and an inertial attitude on the DEORB MNVR COAST display that is equivalent to a 0°, 40°, 0° (R,P,Y) LVLH attitude in MM 304 at EI-5 minutes. The crew has the capability of an automatic or manual maneuver to this attitude.

The INRTL ADI attitude position is shown in the checklist for maneuvering to the EI-5 attitude and will show values that will be the equivalent of a pitch up of about 135° from a nominal two-engine deorbit burn attitude.

If the crew wishes to verify the approaching 0°, 40°, 0° LVLH attitude at EI-5, they may do so by selecting the LVLH position at, for example, EI-15 and expect a reading of 0°, 359°, 0° on the ball that will pitch at orbital rate into 0°, 40°, 0° at EI-5 and simultaneously serve as an analog clock for the approach to EI-5. A table is provided in the Entry Checklist that shows the time to EI in minutes versus the desired LVLH pitch in degrees.

For an underburn, the inertial values that appear in the BURN ATT fields in MM 303 will be incorrect and the attitude must be adjusted by flying to the LVLH pitch versus Time to EI shown in the table. The prebank required by the UNDERBURN is achieved before EI but after the transition to MM 304.

EVENT

CUE

DISPLAY

OMS Gimbal Powerdown

DEORB MNVR COAST

CREW ACTION

Verify that the OMS engines are in the stow position and then turn off the gimbal power by executing the GMBL OFF Items (32 and 33).

DISCUSSION

The transition to MM 303 commands the OMS engines to their stow positions. To preclude a single-point TVC failure from moving an OMS engine away from the entry stow position during the entry phase, the TVC power is turned off, and the OMS engines will be held in place by the mechanical no-back feature of the gimbal systems. This crew action is a procedural work-around for a flight software DR that will power the TVC off in MM 304 and MM 305.

EVENT

CUE

DISPLAY

Forward RCS Dump

DEORB MNVR COAST

CREW ACTION

Dump a specified amount of FWD RCS propellant, if required, for Orbiter X c.g. control.

DISCUSSION

The amount of propellant to be dumped is determined by the crew (if no comm) using the HP41C calculator, the c.g. wheel (see section 4.10), or read from the DEL PAD if calculated preburn by the MCC. Control of the dump with the four forward yaw jets by the crew is through FWD RCS ARM and DUMP Items (36 and 37) and the OFF Item (38). Because of OV102 RCS tank constraints on helium ingestion, the jets could be on for a maximum of 50 seconds and then were off for 40 seconds before the next ON command.

For OV099, a swirl diffuser was added to the FRCS that enables the FRCS dump to be accomplished in a continuous burn.

EVENT

CUE

DISPLAY

Entry Switch Check

GNC 51 OVERRIDE

CREW ACTION

Check or configure entry related switches in the forward station.

DISCUSSION

The purpose of the Entry Switch Check is to ensure the positions of the most critical forward station switches for entry. Essentially, all of these switches were configured during deorbit preparation Entry Switch Verification at one and a half hours before the deorbit burn, and this final check following the deorbit burn is for only a selected few.

EVENT

CUE

DISPLAY

Remaining APUs Start

BFS, SM SYS SUMM 2

CREW ACTIONS

Start the two APUs at ~EI-13 that were not started before the deorbit burn.

DISCUSSION

The APUs are started using START/RUN or START ORIDE/RUN as required and (for STS-2), if less than three APUs were operating, the HYD FLUID THERMAL CONDITIONING FTO would have been deleted.

EVENTCUEDISPLAY

SSME Hydraulic System  
Repressurization

APUs activated

CREW ACTION

1. Open MPS/TVC ISOL VLV 2.
2. Wait 10 seconds.
3. Close MPS/TVC ISOL VLV 2.
4. Repeat the sequence for MPS/TVC ISOL VLV 3.

DISCUSSION

SSME repressurization is performed to ensure the correct stowing of the main engines for entry. Movement of the engines is not expected when the MPS/TVC VLV SYS 2 and 3 are opened, but opening the valves does ensure that possible voids will be eliminated in the MPS ATVC actuator caused by contraction of the hydraulic fluid that was warmed during the ascent phase and cooled during the on-orbit phase of the mission. Originally, the requirement was to repressurize only the outside main engines on deorbit rehearsal day and make the procedure optional for deorbit day. Repressurizing the outside main engines required cycling of MPS/TVC VLV SYS 2 only. The current method is to repressurize all three main engines on deorbit day only. MPS/TVC isolation valves 2 and 3 will be cycled for 10 seconds each, sequentially, to achieve the repositioning of all three main engines.

At one time the MPS engine power was turned on and the MPS He ISOL B valves were opened for this procedure to prevent the main engine valves from opening when the hydraulic system pressure is applied. The latest procedure has eliminated cycling engine power and the left MPS He ISOL B valve. Opening of the main engine valves would result in contamination during entry.

<u>EVENT</u>	<u>CUE</u>	<u>DISPLAY</u>
<u>Hydraulic Fluid Thermal Conditioning</u>	MCC call HYD MN PUMP PRESS in NORM following de-orbit burn activities	DEORB MNVR COAST BFS, SM THERMAL GNC SYS SUMM 1 SPI

### CREW ACTION

1. Execute SURF DRIVE ON item on DEORB MNVR display.
2. Monitor aerosurface cycling.
3. Execute SURF DRIVE OFF item on DEORB MNVR display when 5 minutes have elapsed.

### DISCUSSION

The thermal conditioning of the hydraulic fluid is accomplished by cycling the aerosurfaces by execution of the SURF DRIVE ON item on the DEORB MNVR COAST display. Motion of the aerosurfaces can be monitored on the GNC SYS SUMM 1 display and the SPI, and actuator temperatures can be monitored on the BFS, SM THERMAL display. Although the expected actuator temperatures did not warrant this fluid thermal conditioning on STS-2, the task was scheduled for a minimum of 5 minutes to collect conditioning performance data in response to FTO 244-1, Hydraulic Fluid Conditioning. The purpose of the test is to validate the technique of using aerosurface cycling to warm hydraulic fluid adequately to provide proper response rates for vehicle control through the entry and landing phases. Since original approval of the DTO for STS-1, the task was dropped from STS-1 and was performed on STS-2. The thermal conditioning task is not performed by the crew unless requested by MCC.

EVENT

Burn Report

See Postburn status discussion, page 4-21.



EVENT

CUE

DISPLAY

State Vector Change

HSD

CREW ACTION

Change the downrange component of the state vector, if required.

DISCUSSION

The downrange effect of the postdeorbit burn state vector can be changed in a short form method by adding a  $\Delta T$  on the HSD in the PASS (Item 18), loading the  $\Delta T$  value (Item 16), and then transferring this altered state vector to the BFS and loading it with the BFS HSD (Items 17 and 16).

EVENT

CUE

DISPLAY

Pin Removal

HSD configuration  
complete

CREW ACTION

Remove and stow the Panel Jettison T-Handle Pin.

DISCUSSION

When OV102 had ejection seats, the seat pin removal procedure was performed before EI, rather than during the more dynamic entry phase, to reduce the necessary action for ejection to the pulling of the D-ring. The procedure has since been reduced to removing and stowing the T-handle pin.

EVENT

CUE

DISPLAY

g-Suit Inflation

CREW ACTION

Load 1.5 so that the proper pressure is available if the crew requires g-suit inflation.

DISCUSSION

Placing the activation valve to ON (if required) pressurizes the g-suit to prevent blood pooling in the lower extremities.

## 4.2 DEORBIT BURN CUE CARDS

Since aerodynamic entry follows irreversibly after deorbit, the deorbit burn must leave the Orbiter in a safe entry configuration. The burn involves three factors.

### 4.2.1 Burn Target

Achieving the proper burn target (position, velocity, and flight path angle) is a goal common to all OMS burns, but for deorbit the consequence of a small error can be a large increase in Orbiter thermal load rather than just an error in the achieved orbit.

### 4.2.2 RCS Propellant Consumption and Balance

The procedures for all OMS burns attempt to save RCS propellant to provide maximum reserve for entry flight control. During the deorbit burn, however, not just the total remaining aft RCS propellant quantity is important, but the net forward-aft balance, because of the effect of the X c.g. on flight control stability. Hence, the usage of OMS propellant, aft RCS and forward RCS propellant must all be considered for their impact on the X c.g.

### 4.2.3 OMS Propellant Balance

The deorbit OMS burn is the final opportunity to correct any sizable Y c.g. offsets. Y c.g. trim is accomplished by altering the amounts of OMS propellant burned from each side, using crossfeeding.

The special deorbit burn requirements in all these three factors lead to more complicated burn procedures and a larger number of cue cards than for other OMS burns.

## 4.3 DEORBIT FLIGHT RULES

The complex deorbit burn requirements are reflected in a number of flight rules covering deorbit burn situations. Flight rule 4-33, on entry planning, contains the criteria used for c.g. planning and for choosing off-nominal deorbit procedures if necessary. It is worth studying this rule in detail to understand the rationale behind many of the deorbit cue card procedures.

A separate cue card (fig. 4-4) containing selected deorbit flight rules is placed above the PLT's ADI prior to the deorbit burn. The four columns at the right show the possible responses to failures. Preignition, a one-orbit, or as much as a 1-day delay is allowed to respond to failures. Of all the pre-TIG failures listed requiring delaying the burn, only the failure of both OMS engines to ignite is listed specifically in the burn cue card, since at TIG the crew will be following this cue card and should

## DEORBIT BURN FLIGHT RULES

ALL VEH/D/BAS

BURN  
CARDS

FAILURE	PRE TIG			POST TIG
	Delay (max)			
	One Orbit	One Day	One Day	Stop Burn, >Safe HP
One-Orbit Late Available	YES	YES	NO	
<b>APU/HYD</b>				
First 2 APUs fail to start.....	..X..	.....	..X	
<b>DPS</b>				
Redun set fail or GPC splits...	.....	..X..	..X..	.....X
1 GPC or FA,FF (except FF4)....	..X			
BFS.....	.....	..X..	..X	
<b>ECLS</b>				
1 Freon Loop.....	..X			
2 Av Bay Fans in Bays 1 or 3...	..X			
2 Av Bay Fans in Bay 2.....	.....	..X..	..X	
<b>ELEC</b>				
2 MN Buses.....	.....	..X..	..X..	.....X
<b>GNC</b>				
IMU Dilemma.....	.....	..X..	..X..	.....X
2 IMUs.....	.....	..X..	..X	
3 ADTAs.....	..X..	.....	..X	
2 AAs, RGAs (If BFS NO GO)....	..X..	.....	..X	
<b>MECH</b>				
Port PLBD Limits.....	.....	..X..	..X	
<b>OMS</b>				
Prplt Tank (DEL PAD/BURN CARD)..	..X..	.....	..X..	.....X
Ignition (neither eng ignites)..	..X..	.....	..X	
Both OMS Eng Fail.....	.....	.....	.....	.....X
Prplt Lk after ACN.....	..perigee adjust			
<b>AFT RCS</b>				
2 jets, same direction, same pod.....	..X			
Prplt Lk after ACN.....	..X..	.....	..X	

Figure 4-4.- Deorbit burn flight rules.

not have to look elsewhere to find the time-critical Auxiliary Power Unit (APU) shutdown instruction.

Part of the deorbit Preliminary Advisory Data (PAD) is a value for 'safe HP'. This is the perigee above which the Orbiter can stay in orbit for ~24 hours and is a decision point for what course of action to take in the event of certain failures (i.e., whether to continue or stop the burn). The reason for having a variable 'safe HP' is that the 'safe' perigee value depends on the apogee (HA), which varies from mission to mission and according to mission phase. Typical values of HA and safe HP are:

HA = 150,	safe HP = 80	(nominal)
HA = 130,	safe HP = 87	(post-OMS 2)
HA = 105,	safe HP = 103	(ATO)

After the burn has started, only four failures are considered serious enough to stop the burn. Of course, if  $HP < \text{safe HP}$ , the burn must be completed in any case because the Orbiter is too low to stay in orbit. The three systems failures (PASS SET FAIL, IMU DLMA, and loss of 2 MN DC BUSES) are listed explicitly in the DEORBIT.BURN MONITOR cue card. The propellant failure burn completion criteria are contained in the gray OMS PRPLT FAIL section of the DEORBIT BURN cue card. Hence, once the burn has started, the crew should never have to refer to the deorbit flight rules cue card. All necessary information for the duration of the burn is contained in the BURN and BURN MONITOR cue cards.

#### 4.4 PREBURN

While the crew has the onboard capability of calculating the Orbiter c.g. and determining how to trim it if necessary during the burn, these calculations will generally be done by the MCC. MCC will advise if one of the special procedures like an unbalanced propellant or a mixed crossfeed burn is necessary.

The ground will also calculate and advise the crew how long ignition can be delayed after TIG and still maintain downmoding capability in achieving the target. This time should be written down by the crew in the space provided on the '-:15' line on whichever DEORBIT BURN cue card is planned to be used.

-:15 EXEC (NO EXEC > TIG + |:|)

One APU is started prior to the deorbit burn. (This is accomplished in the checklist procedures before the crew starts using the cue cards.) If the engines cannot be ignited, the deorbit burn must be delayed; hence, there is an off-nominal gray instruction just below the ':00' line to shut down the APUs if there is no OMS ignition. Normally, only one APU is started before the deorbit burn, but the cue card says 'APUs' to allow for the possibility in an off-nominal situation of having turned on more than one.

\* If no OMS ignition, APUs - SHUT DN \*

Note that if only one engine ignites for a planned two-engine burn, then the burn is continued via the gray OMS ENG FAIL procedure. Also, if both engines fail after having ignited, the burn is continued via the gray RCS completion procedure. The point of the APU shutdown procedure, however, is that the RCS completion procedure is not used if both OMS engines fail to ignite at TIG. The reason for delaying the deorbit burn is to give MCC a chance to recalculate the burn targets and troubleshoot configurations and procedures with the hope of effecting an OMS engine deorbit burn on the next orbit. If an RCS burn is required, the X c.g. calculations must be redone using the reduced Isp of the +X RCS jets compared to the OMS engines, which requires more propellant consumption for a given  $\Delta V$ . Obviously, if the OMS engines fail 10 seconds after TIG, the situation is not much different, even though the cue cards then call for completing the burn. However, the cue cards cannot be optimized for all possible failures. If an OMS engine is bad to start with, the chances are highest that it will fail to ignite properly. If it ignites properly, then its failure probability is probably fairly constant throughout the burn. The cue card procedures recognize these facts and attempt to achieve the best burn results with the most probable failures, avoiding at the same time any catastrophic failure possibilities.

#### 4.5 2 ENG DEORBIT BURN

##### DEORBIT BURN (2 ENG)

##### 4.5.1 Nominal

For a nominal two engine OMS burn (fig. 4-5), the crew does nothing more than configure switches and depress 'EXEC' before ignition and place the OMS engine switches in OFF after cutoff. The  $\Delta V$  (X and Z) residuals are trimmed (if required) with the THC to at least  $< 2$  fps after the OMS engine cutoff.

##### CUTOFF

Trim X,Z residuals  $< 2$  fps ( $< 0.5$  fps if shallow TGT)

Flight rule 4-36 indicates that trimming to 0.5 fps is highly desirable after all deorbit burns to minimize Thermal Protection System (TPS) margins. The deorbit cue cards only specify trimming to  $< 0.5$  fps with a shallow target, because in this case the TPS stress is higher than for a nominal deorbit, and the desirable margin becomes required.

The Deorbit Burn Monitor cue card (fig. 4-6) is included for completeness, but thorough explanations of preburn switch/value configuration, the Deorbit Burn Monitor cue card, and the other OMS burn cue cards can be found in OMS Cue Cards Procedures Rationale, August 1981, by Jeff Hoffman/CB.

```

OVS99/ /MM302 ** /OMS BOTH CNTLR PWR (two) - ON
DEORB/ Enter TGO + 5 sec
BAS 3 /TRIM: P +0.0, LY -5.7, RY +5.7
      /DAP - AUTO(PASS)/DISC ** ADI - LVLH/HI/MED
      L,R OMS He PRESS/VAP ISOL A (two) - OP, then GPC **
      B (two) - GPC **

TIG-2 OMS ENG (two) - ARM/PRESS ** [ ]:[ ]
-:15 EXEC ** (NO EXEC > TIG + [ ]:[ ])
:00 TIG ** (/Pc, ΔVTOT, ENG VLVs; start watch)
      * If no OMS ignition, APUs - SHUT DN

* OMS PRPLT FAIL:
* HP > [ ] [ ] L or [ ] [ ] R (STOP):
* OMS ENG (two) - OFF, APUs - SHUT DN
* Affected OMS TK ISOL (two) - CL
* HP < [ ] [ ] L or [ ] [ ] R (CONTINUE):
* Failed OMS ENG - OFF
* ITEM 18 +Q EXEC
* Affected OMS He PRESS (two) - CL
* TK ISOL (two) - CL
* When Pc < 80%, 2nd OMS ENG - OFF
* Complete RCS (PRPLT FAIL)
* OMS ENG FAIL (CONTINUE BURN):
* Failed ENG - OFF
* OMS XFEED at [ ] [ ] %L [ ] [ ] %R 1/2 of ΔVTOT [ ] [ ]
* at FAIL
* RCS COMPLETION:
* ANY OMS PRPLT FAIL:
* If HP > [ ] [ ] , safe HP: APUs - SHUT DN
* < [ ] [ ] , safe HP: Interconnect to
* good OMS PRPLT
* THC +X (√OMS % vs RCS Burn Time)
* AFT RCS RECONFIG [ ] [ ] %
* THC +X to TGT HP or TOT AFT QTY 1 [ ] [ ] %
* If CUR HP ≤ PRI HP [ ] [ ] , FRCS to PRI Site
* If CUR HP > PRI HP [ ] [ ] and ≤ B/U HP [ ] [ ]
* FRCS TO B/U Site
* If CUR HP > B/U HP [ ] [ ] , THC +X to
* B/U HP [ ] [ ]
* or TOT AFT QTY 2 [ ] [ ] ; FRCS to B/U Site
* MNRV to -X ATT (pitch up at 30/sec to VGOz =
* THC -X (+)1/4 ΔVTOT)
* BOTH OMS ENG FAIL:
* OMS ENG - OFF
* Interconnect OMS to RCS
* THC +X (√OMS % vs RCS Burn Time)
* OMS TK SW
* THC +X (√OMS % vs RCS Burn Time)

CUTOFF ** [ ] [ ]:[ ] [ ]
+:02 OMS ENG(s) - OFF ** (If < 3 IMU, at [ ] [ ]:[ ] [ ] )
      * AFT RCS RECONFIG if INTERCONNECT
      Trim X,Z residuals < 2 fps (< 0.5 fps if shallow)

```

Figure 4-5.- Deorbit burn (2 eng) cue card.





#### 4.5.2 OMS PRPLT Fail

If the OMS propellant system on one side fails, two critical questions must be answered. Is there enough propellant in the other pod to complete the deorbit burn? If so, will burning all this propellant leave the Orbiter with an acceptable c.g.? MCC answers these questions for the crew before the burn by a calculation which takes into account the current and desired c.g., the velocity to be expended during the burn, and the amount of propellant on each side, and yields critical perigee values above which the burn should be stopped and below which it should be continued. These values are read up to the crew before the burn and are entered in the gray OMS PRPLT FAIL section of the DEORBIT BURN cue card.

```
* OMS PRPLT FAIL: *
* * *
* HP > [ 1 | 5 | 0 ] L or [ 1 | 3 | 9 ] R (STOP): *
* * *
* HP < [ 1 | 5 | 0 ] L or [ 1 | 3 | 9 ] R (CONTINUE): *
```

Note that only two values are read up, one for a left pod failure and one for a right pod failure. Four areas are given on the card to write the values, but the values are the same for both entries on a given side. That is, the 'HP >' and 'HP <' criteria for a given side are the same, and the values in the upper two entries are repeated in the spaces directly below. In the example, the HP values indicate that there is more OMS propellant in the right side than the left (fail cues, remember). The loading of more OMS in the right pod is for Y c.g. ballast in this example.

The calculation of these values reflects the philosophy that a deorbit burn should be completed with a propellant failure if possible. The reason for this is that if the burn is terminated prematurely (above a safe HP), MCC may require at least two orbits of tracking data before the Orbiter's new orbit (changed because of the partially completed burn) is known well enough to allow retargeting for another burn to complete the deorbit. By this time, however, the landing site is probably outside the Orbiter's crossrange capability, and the deorbit has to be delayed 24 hours. Usually, continuing with a propellant failure once the burn has started is considered to be more desirable than staying in orbit for another day (weather is a primary example). Obviously, if HP < safe HP, the burn must be completed in any case. But in many cases a burn can be completed even if HP > safe HP, and if so, it should be.

In computing the critical HP values for PRPLT FAIL cues, MCC considers (1) the propellant available in each OMS tank (hence the different HP values for L and R propellant failures), (2) a certain amount of the aft RCS propellant available above the redline that can be burned with the +X RCS jets (how much 'extra' aft RCS propellant can be counted on for the HP calculation has to be decided by the flight controllers), (3) all the Forward RCS (FRCS) propellant available for burning through the -X RCS jets, and (4) ~21 fps available from a 90-degree prebank (redesignating is not used in the HP calculation). The resulting HP value for each side shows the altitude below which enough  $\Delta V$  is available to allow completing the deorbit.

The OMS PRPLT FAIL HP cue is calculated as follows:

$$HP \text{ cue} = HP_i - 2 \left[ \frac{(\Delta V_{IP} - \Delta V_{AVAIL})}{\Delta V_S} \right]$$

where:

- HP cue - the perigee at which deorbit can be completed following an OMS propellant failure
- HP<sub>i</sub> - perigee of orbit before deorbit maneuver
- ΔV<sub>IP</sub> - in plane deorbit ΔV for one OMS engine
- ΔV<sub>AVAIL</sub> - ΔV capability from the OMS pod considered plus auxiliary ΔV from aft RCS, fwd RCS, and prebank

$$\Delta V_S = \frac{\Delta V_{IP}}{HP_i - HP_f} \quad (\text{In plane})$$

$$\Delta V_S = \frac{2 \left[ \frac{\Delta V_{IP} - 0.5\Delta V_W}{HP_i - HP_f} \right]}{\quad} \quad (\text{wasting})$$

where:

- HP<sub>f</sub> - HP of orbit after deorbit maneuver
- ΔV<sub>W</sub> - Total ΔV of wasting deorbit burn

Completing a burn with a propellant failure entails a total use of more propellant from the good side than from the failed side. This causes a Y c.g. shift. The earlier the propellant failure (i.e., the higher HP is at the time of the failure), the greater the Y c.g. shift. This same propellant failure will result in an aft-heavy X c.g. also. MCC will have considered this in the preburn targeting, and any propellant failure below the critical HP value for the failed side should leave the Orbiter with an acceptable c.g. for entry.

If the burn has to be terminated, the cue card indicates that both engines are turned off, the APU's are shut down, and the tank isolation valves on the failed side are closed.

- \* HP >    L or    R (STOP): \*
- \* OMS ENG (two) - OFF, APUs - SHUT DN \*
- \* Affected OMS TK ISOL (two) - CL \*

The OMS XFEED valves are always closed during a normal two-engine burn. The He PRESS/VAP ISOL valve switches are set to 'GPC,' so the GPC closes these as soon as both engines are turned off. Thus there is no reference to either the XFEED or He PRESS/VAP ISOL valves in the two-engine cue card procedures for terminating the burn. At this point, the crew goes back to

the Entry Checklist and enters the indented off-nominal 'Burn Terminated with HP > SAFE HP' section. These steps close the OMS He PRESS/VAP ISOL and XFEED valves and set up the aft RCS to be compatible with the orbit configuration in the Deorbit Preparation checklist. It then advises the crew to consult with MCC at the next STDN regarding a possible 24-hour deorbit delay while MCC recomputes the new orbit (which may require two orbits) and calculates new burn targets.

If the burn is to be continued, then only the engine on the side with the propellant failure is turned off.

\* HP <    | L or    | R (CONTINUE): \*

\* Failed OMS ENG - OFF \*

Guidance, the Orbiter's attitude, and the error needles will reconfigure for a single-engine burn. At this point, there may be insufficient OMS propellant remaining in the good pod to complete the burn, so it is vital to make the best use of what is left. Sometimes, a deorbit burn is targeted to include an out-of-plane component in order to use enough extra OMS propellant to achieve a proper X c.g. for entry. After a propellant failure, all remaining 'good' propellant should be available for in-plane  $\Delta V$ . This situation is achieved via the ITEM 18 +0 EXEC action called for in the cue card, which terminates out-of-plane propellant wasting for the remainder of the burn.

\* ITEM 18 +0 EXEC \*

This action causes retargeting with a resultant change in Orbiter attitude and error needle configuration. This is time-critical and is performed before any OMS valves are reconfigured. Once the crew is satisfied that guidance is properly reconfigured, they should close the He PRESS/VAP ISOL and TK ISOL valves on the failed side.

\* Affected OMS He PRESS (two) - CL \*

\* TK ISOL (two) - CL \*

The GPC will leave both He PRESS/VAP ISOL valves open unless both engines are turned off (this feature is advantageous for crossfeeding in an engine failure situation). After a propellant failure, there will be no cross-feeding from the failed side. Hence, the crew must manually close the He PRESS/VAP ISOL valves on the failed side (CL position).

At this point, the crew must continue to monitor the burn, with the expectation that the remaining tank might be burned dry before  $\Delta VTOT$  reaches zero. The two key cues here are the OMS propellant quantity gauges on panel O3 and the  $P_C$  meters on panel F7. The idea is to burn the tanks as near to empty as possible. However, the fuel and oxidizer tanks will in general not run dry at the same time. It is desirable not to continue operating the engine once the fuel/oxidizer ratio departs from nominal because of possible damage to the engine and the possibility of an explosion. The gauge on panel O3 allows either oxidizer or fuel to be monitored for the OMS system, but not both simultaneously. There is no 'lowest' position for OMS as there is for RCS. After the propellant failure, the PLT should check whether FU or OX is lower on the good side and monitor the

lower quantity, switching back and forth occasionally if time permits. When the level drops to a few percent, the  $P_c$  meter should be watched continuously. As the oxidizer/fuel ratio departs from nominal, the engine performance will start to degrade and the chamber pressure will fall. This is why the cue card calls for  $P_c < 80$  percent as the criterion for turning off the second engine.

\* When  $P_c < 80\%$ , 2nd OMS ENG - OFF \*

If there is still  $\Delta VTOT$  to be burned, the cue card now refers the crew to the PRPLT FAIL subheading of the RCS COMPLETION section of the cue card, which is discussed in section 4.5.4.1 below.

\* Complete RCS (PRPLT FAIL) \*

### 4.5.3 OMS ENG Fail

Directly following this section heading is a (CONTINUE BURN) instruction, which reassures the crew that an engine failure is no reason to terminate the burn, in contrast to some classes of propellant failures (see above).

\* OMS ENG FAIL (CONTINUE BURN): \*  
 \* Failed ENG - OFF \*

Once the failed engine is turned off, guidance will reconfigure for a single-engine burn with a resulting change in Orbiter attitude and error needle configuration. Once the crew is satisfied that this reconfiguration has been successfully accomplished, the next procedure is to start crossfeeding OMS propellant from the other side at the proper time to ensure the expected Y c.g. for entry.

\* OMS XFEED at \_\_\_\_\_ \*  
 \* \*  
 \* [ ] [ ] %L [ ] [ ] %R 1/2 of [ ] [ ] [ ] \*  
 \* \*  $\Delta VTOT$  at FAIL \*

Two cues can be used to determine the proper time: the OMS quantity gages on panel 03 and  $\Delta VTOT$  on the DEORBIT MNVR EXEC display. Of these two,  $\Delta VTOT$  is more precise and is preferred, since for deorbit conditions, each 1 percent of OMS propellant corresponds to a  $\Delta V > 6$  fps (depending on the weight of the Orbiter), and the OMS gaging is considered to be unreliable. To use the  $\Delta VTOT$  cue, the crew must note  $\Delta VTOT$  at the time of the failure. The original plan of the burn was to use equal amounts of propellant from both sides. The crossfeed procedure makes sure that this is still accomplished by dividing equally between the two propellant pods the  $\Delta VTOT$  remaining at the time of the engine failure. The crew will be pretty busy when an engine fails and one technique to save this information so it can be read later is to push the SPEC key on CRT 1 or 2 at the time of the engine failure, which freezes the DEORBIT MNVR EXEC display. Similarly, freezing the BFS GNC SYS SUMM 2 display on CRT 3 allows the failed OMS engine switch to be positioned to OFF and still preserve the engine ball valve condition for failure diagnosis. After monitoring the single-engine

burn reconfiguration, the crew can then read off  $\Delta VTOT$  at their leisure and enter half this value into the space provided on the cue card to use as a crossfeed cue.

The propellant percentage cues (if OMS gaging is valid) are read up to the crew before the burn and will already be on the cue card. They represent MCC's calculation of how much propellant will remain in each side at the completion of the burn. The L and R numbers may not be equal because c.g. management earlier in the flight may have compensated for a Y asymmetry from some other source by burning some extra OMS propellant from one side. Also, different amounts of propellant may be loaded on each side prelaunch to compensate for a dry Orbiter c.g. offset. Suppose that the final propellant amounts are calculated to be 11 percent L and 15 percent R. If the left engine fails, the crew can continue to burn the right side propellant down to 15 percent and then start crossfeeding from the left side. At the end of the burn, the left propellant should be down to 11 percent. If the crew has no  $\Delta VTOT$  cue available for whatever reason, then this quantity gage method can be used to assure an acceptable Y c.g. The  $\pm 1$  percent quantization uncertainty corresponds to a  $\pm 0.06$ -inch Y c.g. uncertainty.

One shortcoming of using the percent cues is that it is not clear whether to use OX or FU quantities. There is no easy answer to this. Normally, the two quantities will be nearly the same. If there is any special reason to use one rather than the other, MCC should advise the crew. Note that if the CRT displays are lost during a burn, the propellant quantities can be used as cues for when to terminate the burn, in addition to using a stopwatch to time the remaining burn.

Now read section 4.5.4.2 below on RCS COMPLETION for OMS ENG FAIL for the continuation of this scenario.

#### 4.5.4 RCS Completion

##### 4.5.4.1 Any OMS PRPLT Fail

Section 4.5.2 explains why the cue card sometimes tells the crew to press on with one engine after a single propellant failure occurs during a two-engine deorbit burn even if  $HP > \text{safe HP}$ . A dual OMS propellant failure or a combined engine/propellant failure requires downmoding to +X RCS jets to complete the burn. RCS jets have a lower Isp than OMS engines, so the critical HP values below which the deorbit burn can be completed with one OMS engine following a single propellant failure are not valid if the remaining propellant must be burned through the +X RCS jets. Because of this uncertainty and because the second failure has reduced the remaining backup capability, the overall safety margin is considered to have been reduced sufficiently below the single OMS completion case that the burn should be terminated if this can be done safely ( $HP > \text{safe HP}$ ).

An extra day in orbit will probably be required, but giving MCC the opportunity to assess the actual propellant situation and retarget for an optimal entry in this case is deemed to be worth the delay. For this reason, the first instruction on entering the RCS COMPLETION, ANY OMS PRPLT FAIL section of the cue card is to shut down the APU if  $HP > \text{safe HP}$ . Both

OMS engines are already shut down, of course. The crew then leaves the cue card and goes to the 'If Burn Terminated with HP > SAFE HP' section of the Entry Checklist.

If HP < safe HP, the burn must be continued.

```

* RCS COMPLETION: *
* ANY OMS PRPLT FAIL: *
* *
* If HP > [ ] [ ] , safe HP: APUs - SHUT DN *
* *
* < [ ] [ ] , safe HP: I'cnect to *
* good OMS PRPLT *
* THC +X (✓OMS % vs RCS Burn Time) *
* AFT RCS RECONFIG *

```

The scenario of section 4.5.2 on OMS PRPLT FAIL ended with burning the remaining propellant tank dry and then moving to the RCS COMPLETION, ANY OMS PRPLT FAIL section of the cue card. In this case, there will be no good OMS propellant on either side because one side is failed and the other side is depleted. The instructions in this section to interconnect (OMS/RCS) to any good OMS PRPLT and burn down to the OMS redline will be skipped and the crew will proceed directly to 'THC +X to TGT HP or TOT AFT QTY 1 [ ] [ ] %.' The only way to get to the interconnect procedures in this section is through combined propellant and engine failures, which leave some good OMS propellant available to burn through the +X RCS jets. These cases are treated first followed by the procedures for completing the burn when no more OMS propellant is available.

4.5.4.1.1 OMS propellant still available on one side: In understanding the actions resulting from the various scenarios described here, it is essential to realize that if a propellant failure on one side occurs it is not permitted to crossfeed propellant from the good side into the engine on the side with the failed propellant system. This is implied by the cue card procedures but is not stated explicitly anywhere. Flight rule 6-18 prohibits crossfeeding from a failed or suspected failed OMS propellant tank but does not address the question of crossfeeding into the engine on the failed propellant side from the good propellant system. The reason for the cue card's procedural restraint against doing this is that if the propellant failure occurs during the burn, it is possible that the engine on that side may ingest He or be damaged in some other way. Because there is no way to be sure the engine is good, it is not used. Furthermore, Redundancy Management (RM) does not allow an engine to be restarted once it has been shut down unless the burn is retargeted and started again. Although retargeting is possible, a minimum of 240 seconds is required before restarting the engine because of OMS hardware limitations. Even if the 30-second minimum for launch aborts was to apply, the uncertainty of having a good OMS engine makes it preferable to use the +X RCS jets if they are available. If a propellant failure (e.g., leak) occurs at some other time during the mission, it is possible that the OMS engine on that side is still good and can be used for future burns. This is something for MCC to determine. The cue cards do not deal with this case.

If a propellant failure occurs on one side and the engine on the other side subsequently fails, then that engine must be turned off. This OMS ENG-OFF instruction could come from the OMS PRPLT FAIL section except that in this case the preceding Pc < 80 percent propellant depletion cue point will not have been reached.

```
* When Pc < 80%, 2nd OMS ENG - OFF      *
* Complete RCS (PRPLT FAIL)              *
```

Alternately, it could be taken from the OMS ENG FAIL section except that the subsequent instruction to crossfeed must then be ignored.

```
* OMS ENG FAIL (CONTINUE BURN):          *
* Failed ENG - OFF                       *
* OMS XFEED AT _____                 *
*                                         *
```

In either case, the crew must then go to the RCS COMPLETION, ANY OMS PRPLT FAIL section, and perform the first instruction after determining that HP < safe HP, and that is to interconnect the +X RCS jets to the good propellant tanks that were feeding the failed engine and that still have usable propellant.

```
* RCS COMPLETION:                        *
* ANY OMS PRPLT FAIL:                    *
* If HP > _____                     *
* < |_____|, safe HP: I'cnect to _____ *
* good OMS PRPLT                         *
```

If the good propellant tanks have already been burned dry, then the crew proceeds directly to 'THC +X to TGT HP or TOT AFT QTY 1 |\_\_\_\_\_| % .' 'AFT RCS RECONFIG' is unnecessary if the crew never interconnects the OMS and RCS in the first place.

```
* RCS COMPLETION:                        *
* ANY OMS PRPLT FAIL:                    *
* If HP > |_____|                       *
* < |_____|, safe HP: I'cnect to _____ *
* good OMS PRPLT                         *
* THC +X (✓OMS % vs RCS Burn Time)      *
* AFT RCS RECONFIG                       *
* THC +X to TGT HP or TOT AFT QTY 1 |_____| % *
```

Another scenario to reach this point is an engine failure occurring before the propellant failure. In this case, the crew will be following the OMS ENG FAIL procedure section of the cue cards. Suppose that the left engine fails. At first, the right engine is burned with right side propellant until the crossfeed ΔVTOT cue point is reached. If the right propellant tank fails before this, then crossfeeding is not performed. The crew might enter the OMS PRPLT FAIL section of the cue card, and the first thing to



do is determine whether HP is low enough to continue the burn. If it is, the next steps in the procedure (ENG-OFF, discontinue propellant wasting, and OMS TK ISOL's-CL) would appear to be valid. However, the second (i.e., left) engine has already failed, and crossfeeding cannot be performed, so the  $P_c < 80$  percent line is skipped over and the crew proceeds to the RCS COMPLETION, ANY OMS PRPLT FAIL section. Now HP must be compared to safe HP to decide whether or not to continue the burn. The L and R critical HP values in the OMS PRPLT FAIL section were, in fact, meant to deal with a single failure only (i.e., the calculation of the cue is based on both OMS engines burning until the PRPLT failure occurs). If a double failure occurs, the crew should stop the burn if  $HP > \text{safe HP}$ . If  $HP < \text{safe HP}$ , an astute crewmember might realize after the second failure that an RCS completion was going to be necessary and save some time and mental effort by going directly to the RCS COMPLETION, ANY OMS PRPLT FAIL section of the cue card without first going through the OMS PRPLT FAIL procedures at the top of the gray off-nominal section. This would result in skipping the ITEM 18 +0 EXEC instruction and the RCS completion would be carried out with propellant wasting still in effect, which could be a bad deal after a propellant failure (if propellant were being wasted). If you are going to be astute, you had better be very astute.

Returning to the postulated scenario, the crew now follows the instruction to interconnect the RCS to any good OMS PRPLT, which in this case is the left side. The remainder of the left OMS propellant will be burned by the +X RCS jets.

Suppose, on the other hand, that after the left engine failure, the burn has progressed to where the right OMS engine is being crossfed from the left propellant pod, and the left propellant system fails. The crew now starts the OMS PRPLT FAIL section. In this case, at least half the burn will already have been completed and HP will be less than the critical value, so the burn will be carried to completion. As before, the first three steps of the procedure are followed but the  $P_c < 80$  percent line is skipped since only one engine was burning. When the RCS COMPLETION, ANY OMS PRPLT FAIL section is entered, the procedure says to interconnect to any good OMS PRPLT, which in this case is the right side. The remainder of the right OMS propellant will be burned by the +X RCS jets.

In any case where OMS propellant is being burned by the +X RCS jets after a propellant failure, the crew has the rather cryptic 'THC +X (OMS percent versus RCS Burn Time)' instruction.

\* THC +X ( $\sqrt{\text{OMS \% vs RCS Burn Time}}$ ) \*

This instruction refers to a table on the 'X' side of the circular slide rule used to compute the Orbiter c.g. This is part of the multiphase cue card kit and is stored in the center console (C6). The OMS gaging has been unreliable so the OMS helium pressure is shown as a backup gaging parameter to determine +X RCS capability in the interconnect mode.

OMS % GAGE	OMS He PRESS*	OMS $\Delta V$	RCS $\Delta V$	RCS BURN MIN:SEC
42	2800	218	182	6:15
40	2710	207	173	5:57
38	2620	195	163	5:36
36	2530	183	153	5:16
34	2450	172	144	4:58
32	2360	161	134	4:37
30	2270	149	125	4:18
28	2180	138	115	3:58
26	2090	126	106	3:40
24	2010	114	96	3:19
22	1920	103	87	3:00
20	1830	92	78	2:42
18	1740	80	68	2:21
16	1650	69	58	2:00
14	1570	57	49	1:42
12	1430	46	39	1:21
10	1390	35	29	1:00
8	1300	23	20	0:42
6	1210	11.8	10	0:21
5	1170	6.1	5.2	0:11

\*He pressure assumes an 80°F tank temp

NOTE: Uses assumed D/O vehicle weight of 230000

With a propellant failure, there is probably insufficient OMS propellant remaining to complete the burn by feeding into the RCS so some RCS propellant has to be used. This should be minimized to save as much RCS propellant as possible for entry. However, burning the OMS tank dry could cause the RCS thrusters to ingest helium, which might prevent completion of the burn even with RCS propellant. This same restriction applies to the OMS engines for most burns (propellant cannot go < 3 percent), but for deorbit it is allowed to burn to propellant exhaustion ( $P_c < 80$  percent) through the OMS engines, since there will be no further requirement for the flight to burn these engines. The point here is that if the +X RCS is being used for deorbit then the 3 percent restriction applies to protect the RCS engines and manifolds. OMS gaging is inoperative once the second OMS engine is shut down. The propellant quantity gages on panel 03 become static and there will be no Caution and Warning (C&W) annunciation of an OMS PRPLT LOW situation, so the crew needs a way to know how long to burn OMS propellant before reconfiguring for AFT RCS; hence the OMS percent versus RCS  $\Delta V$  and RCS burn time table. The table shows OMS percent, the equivalence of He tank pressure, OMS  $\Delta V$ , RCS  $\Delta V$ , and RCS burn time. (The same amount of propellant gives more  $\Delta V$  when burned in an OMS engine than an RCS engine because an OMS engine has a higher Isp.) The 3 percent redline (which allows for trapped propellant and for gaging error) is included in the OMS He PRESS versus  $\Delta V$  numbers.

As an example, suppose  $\Delta V_{TOT} = 68$  fps with only 49 fps of RCS  $\Delta V$  in OMS propellant remaining (as shown by an OMS gage percent of 14 and an OMS

He PRESS of 1570) on the good side when the last OMS engine fails. The OMS % and OMS He PRESS versus RCS  $\Delta V$  and RCS burn time table shows that the 1:42 of RCS burn time that is allowed on the OMS propellant on one side yields 49 fps  $\Delta V$  using the RCS before the redline is reached. Thus, after 1:42, the expected  $\Delta VTOT$  would be  $68 - 49 = 19$  fps. However, the CDR should release the THC on burn time regardless of the  $\Delta V$  expended or remaining because  $\Delta VTOT$  may have increased during +X RCS thrusting.

4.5.4.1.2 No OMS propellant available, AFT RCS RECONFIG: At this point, all scenarios involving propellant failures have arrived at the AFT RCS RECONFIG instruction, and the crew is ready to complete the deorbit burn using RCS propellant. This can get pretty sporty, and it is absolutely essential to understand the various techniques involved and their priorities and constraints to be able to follow the cue card procedures. Flight rule 4-33 D is a complete list of the various targeting and burn execution options in order of priority for deorbit burns when insufficient OMS propellant is available for nominal targeting. Once a burn has reached the AFT RCS RECONFIG stage, however, the options available to the crew are as follows:

- A. Burn aft RCS propellant through the +X RCS jets. This option is limited by the requirement to leave 'enough' aft RCS propellant for Aerojet Digital Autopilot (DAP) RCS control during entry. The amount protected currently to preclude an entry that would encounter a 'no-yaw-jet' region is 1200 pounds at EI. To allow for maneuvers, -X RCS thrusting, and coasting before EI, the 'TOT AFT QTY 1  %' is read to the crew and is used on the cue card to ensure the 1200 pounds (54% total) at EI. 'TOT AFT QTY 2  %' ensures 400 pounds (250 pounds after ejection seats were removed) at EI and no-yaw-jet operation can be expected between  $\bar{q} = 20$  and M7 when the ARCS propellant is used to this lower value.
- B. Burn forward RCS propellant through the -X RCS jets. This involves pitching the Orbiter through nearly  $180^\circ$  between the +X and -X jet firings. Any forward RCS propellant available can be used for deorbit  $\Delta V$  because some of it might have been dumped anyway for X c.g. control after the deorbit burn. The resultant aft c.g. offset from the unused OMS propellant and from burning all the forward propellant should be within the guidelines allowed by flight rule 4-33 D. The amount of FRCS propellant available for use in this manner will vary from mission to mission. MCC supplies the FRCS capability to the crew prior to deorbit as part of the PRI HP and B/U HP values on the DEL PAD. These DEL PAD values are calculated by MCC as follows:

$$PRI\ HP = \Delta HP_{\max\ PB\ to\ EDW} + \Delta HP_{FRCS} + HP_{TGT}$$

$$B/U\ HP = \Delta HP_{90^\circ\ PB\ to\ NOR} + \Delta HP_{FRCS} + HP_{TGT}$$

The PRI HP is the maximum value of CUR HP that can exist such that the primary landing site (EDW) can be attained by using all of the propellant in the FRCS (THC -X) and the maximum allowable prebank (usually  $80^\circ$  to  $90^\circ$ ) to the primary site.



That is, if the TGT HP is attained at an aft quantity that is greater than the TOT AFT QTY 1 cue, the crew obviously would stop thrusting. But, if the QTY 1 level is reached with CUR HP > TGT HP, the crew must then evaluate their capability of making the primary landing site without using additional aft RCS propellant.

\*  
 \* If CUR HP  $\leq$  PRI HP 

--	--

 , FRCS to PRI Site \*

At this point, if CUR HP  $\leq$  PRI HP thrusting is terminated and the FRCS (THC -X) procedure is used to complete the target or if insufficient FRCS propellant, the FRCS is depleted (THC -X) and the remainder of the underburn is absorbed by recovery prebank to the primary site. This situation will leave the crew achieving the primary site with, at worst, giving up PTI's for entry but ensuring an entry without encountering a no-yaw jet region.

If the CUR HP > PRI HP, the crew moves to the next step.

\*  
 \* If CUR HP > PRI HP 

--	--

 and  $\leq$  B/U HP 

--	--

 ,  
 \*  
 \* FRCS TO B/U Site \*

If the CUR HP is between the PRI HP and the B/U HP, this step instructs the crew to stop using the aft RCS propellant beyond the TOT AFT QTY 1 level and proceed to FRCS and prebank techniques. The intent at this point is to give up the primary site for the backup site, if required, rather than use aft RCS propellant past the level that could lead to no-yaw jet operation during entry. However, it should be noted that although the statement is 'FRCS to B/U Site,' the primary site might still be attained because more  $\Delta V$  can probably be obtained from the FRCS than is ensured in the cue calculation, and the closer the CUR HP is to PRI HP before FRCS thrusting, the more likely the primary site can be achieved.

Another possibility after reading AFT QTY 1 is to have CUR HP > B/U HP.

\*  
 \* If CUR HP > B/U HP 

--	--

 , THC +X to 

--	--

  
 \* B/U HP  
 \*  
 \* or TOT AFT QTY 2 

--	--

 ; FRCS to B/U Site \*

In this case, the crew is directed to use aft RCS propellant below the TOT AFT QTY 1 percent but only to the extent necessary to achieve the backup site with the help of FRCS and prebank. Then, even if the CUR HP is still greater than the B/U HP value when the aft RCS propellant quantity has been reduced to equal the TOT AFT QTY 2 (percent), the crew should terminate the use of 'THC +X' (using aft RCS propellant). The TOT AFT QTY 2 (percent) limit should represent the minimum required for flight control during entry and, as such, should be honored even if indications are that a landing at the backup site is in doubt.

Of course, any 'extra' performance from the FRCS might be sufficient to make the backup site and still have aft RCS propellant for entry.

Once the decision is made to burn the -X RCS jets, the  $\Delta VTOT$  must be reduced as soon as possible. PASS closed-loop guidance keeps running during pitcharound (unlike BFS guidance, which goes open-loop when the Orbiter's X-axis passes through  $\sim 90^\circ$  from the desired thrust direction), but the longer the time taken coasting towards EI during pitcharound, the larger the  $\Delta V$  that has to be applied to meet terminal guidance constraints. Hence, the nominal transDAP maneuver rate is replaced by  $30^\circ/\text{sec}$ , achieved by putting the RHC through the soft stop and using the accel mode.

\* MNVR to -X ATT (pitch up at  $30^\circ/\text{sec}$  to  $VGO_z =$  \*  
\* THC -X  $(+1/4 \Delta VTOT)$  \*

This  $30^\circ/\text{sec}$  is considered a compromise between the desire to do a quick pitcharound, the amount of propellant needed to do the maneuver, and flight control stability considerations during the maneuver. The cue for completing the maneuver is  $VGO_z = +1/4 \Delta VTOT$  on the CRT display. In addition to their forward component, the -X RCS jets have a small upward-firing component which causes a pitchdown torque. During the extended -X RCS jet deorbit firing, the pitchdown will be countered by periodic firings of upward-firing aft jets. The net result is a downward (+Z) translation in addition to the commanded -X translation, in a ratio between 1:3 and 1:4. To complete the burn most efficiently, the Orbiter is maneuvered to the attitude where the ratio of  $VGO_x$  and  $VGO_z$  to be burned is approximately equal to the -X and +Z thrusts created by a -X THC deflection after the pitch deadband (of  $-3$  degrees) is attained (shortly after -X thrusting starts), hence the  $VGO_z = +1/4 \Delta VTOT$  cue. Note that if the maneuver starts from a nominal +X RCS burn attitude, the total pitcharound maneuver is  $\sim 165^\circ$ . To facilitate monitoring the maneuver and help in anticipating when to start slowing down (which may not be so easy just using mentally calculated ratios of  $VGO_z$  and  $\Delta VTOT$ ), the crew can select the 'REF' ADI position and hit the ATT REF PBI before starting the maneuver. Then it is easy to monitor how the maneuver is progressing using  $165^\circ$  as the approximate pitch for the -X RCS burn attitude and using the  $VGO_z/\Delta VTOT$  ratios for fine tuning. During the  $\sim 165^\circ$  pitcharound, the  $VGO_x$  portion of  $\Delta VTOT$  will gradually be transferred into  $VGO_z$  and then back into  $VGO_x$  again although with the opposite sign (i.e.,  $VGO_x > 0$  will become  $VGO_x < 0$ ). Note that  $VGO_y$  should be 0 although this is not called for explicitly in the cue card.

The opposite sign of  $VGO_x$  is a cue to another aspect of a -X RCS burn. Guidance is still configured for a +X RCS burn and has no -X RCS capability. The THC must be pulled rather than pushed, which agrees with the minus sign. However, the error needles will be working backwards and will behave as fly from references. The pitch needle will be pegged in any case. In practice, the best way to fly the burn is to start THC -X thrusting with  $VGO_z = +1/4 \Delta VTOT$  and allow the deadband to control the attitude. Soon after the initiation of THC -X, the  $VGO_z/\Delta VTOT$  ratio will go from 1:4 toward 1:3 and stabilize once the  $30^\circ$  pitch deadband has been reached. Any attempt to maintain the 1:4

ratio with the RHC will unnecessarily waste RCS propellant. The discrete rate/attitude hold mode of the DAP should, in fact, hold the Orbiter's attitude to within a  $3^{\circ}$  deadband about the attitude at which the RHC last went into detent. Because of the negative pitch moment of the -X RCS jets, the Orbiter will tend to stay at the negative pitch side of the deadband,  $\sim 3^{\circ}$  low compared to the initial burn attitude. To optimize the burn would require a table of VGOz versus  $\Delta VTOT$  values or more tedious real-time mathematics by the crew. A  $VGOz = +1/4 \Delta VTOT$  approximation is satisfactory. In fact, the required  $\Delta VTOT$  may increase during the pitcharound maneuver so time is important in performing the -X RCS burn. Any propellant saved by fine-tuning the Orbiter's attitude could easily be lost if the -X RCS burn is delayed. Note that during the burn, TGO will be counting down at half real time, since guidance thinks four RCS jets are firing, whereas in reality only two jets are firing.

The cue card does not specify the cutoff criteria to use when following the THC -X instruction. If closed-loop guidance is operating (PASS), VGOx is a valid cutoff cue. In BFS, VGOx is decremented open-loop after pitcharound and may have a smaller absolute magnitude on the CRT than it should have, since the actual  $\Delta V$  required to hit the burn target may increase while the orbiter is coasting, and this is not allowed for in open-loop guidance. In this case,  $\Delta HP = 0$  is a valid cutoff cue. HP should be monitored even if PASS is engaged, both as a confirming cutoff cue and for use later with the prebank table, if necessary.

There is no flight rule against burning the -X RCS jets dry. In fact, the FRCS should be burned until a jet fail message is encountered for this contingency case. Because of the PVT gaging, the fail message should not be expected until the FRCS quantity gages are showing negative values. If after the -X jets are burned dry,  $\Delta HP$  is still  $> 0$ , there are no cue card procedures left. The crew goes back to the Entry Checklist, determines the prebank angle, and gets set for an exciting ride home.

#### 4.5.4.2 Both OMS ENG Fail

This procedure is entered more likely if the second OMS engine fails after the reconfiguration for the first failure is already complete; however, it also applies if both engines were to fail at the same time.

* BOTH OMS ENG FAIL:	*
* OMS ENG - OFF	*

If the two failures have occurred separately, expect another attitude and error needle change as guidance reconfigures from a single-engine to an RCS burn. If both engines fail simultaneously, the RCS reconfiguration will have a lesser effect on attitude or the error needles; however, TGO will nearly quadruple instead of double, which is what usually happens after a two- to one-engine or a one-engine to RCS reconfiguration.

If both engines fail at exactly the same time, then the same argument for determining the proper crossfeed time from  $1/2 \times \Delta VTOT$  at the time of the

failures applies here as it did for the single-engine failure case (4.5.3). Unfortunately, this argument did not apply in some OFT OMS propellant loading and management because OMS propellant was 'borrowed' by the aft RCS on orbit leaving insufficient OMS propellant to complete early OMS engine failures by using equal amounts from each pod with the less efficient RCS jets. Attempting to use equal amounts could have depleted the left (low) side even if enough OMS propellant had been available to complete the burn (counting the ballast in the right pod). The procedure during this era was to use all of the available OMS propellant from the left side and then switch to the right side to complete the burn. This method would minimize the use of the ballast and keep any excess propellant on the right side.

- \* BOTH OMS ENG FAIL: \*
- \* OMS ENG - OFF \*
- \* Interconnect OMS to RCS \*
- \* THC +X (✓OMS % vs RCS Burn Time) \*
- \* OMS TK SW \*
- \* THC +X (✓OMS % vs RCS Burn Time) \*

The current procedure calls for an interconnect to either OMS pod when the second OMS engine fails regardless of the pod levels or which one was being used at the time of the failure. Because the OMS quantity gages do not operate unless an OMS engine is on, the tank switch cue must be determined by using the OMS gage quantity or helium pressure versus RCS Burn Time shown on the c.g. calculator (see section 4.5.4.1.1). The subtraction results in the  $\Delta VTOT$  cue that is used to switch from the left OMS to the right OMS in the interconnect configuration.

If the burn is not completed during the allowable interconnect burn time on the first pod, then the tank switch is made to the other pod. The RCS burn time allowable is checked for the second pod, also, because of the possibility that the amount of OMS propellant in the second pod may be insufficient to complete the remaining  $\Delta V$ . If, in fact, the OMS is depleted after two OMS engine failures and the interconnect of OMS/RCS from both OMS pods, the crew must recognize that this situation is equivalent to an OMS PRPLT failure (because there is insufficient OMS propellant) and proceed to 'AFT RCS RECONFIG' to break the interconnect and get on with the underburn techniques.

As has already been stated, the cue cards are not computers and cannot handle all possible failure scenarios in an optimum fashion. If they are used properly, they will produce acceptable results for all scenarios and near-optimum results for the most likely scenarios.

Information about  $\Delta V$  versus OMS propellant quantity for deorbit is available in tabular form on the c.g. slide rule calculator (see section 4.5.4.1.1) with which the crew should be familiar.

After the burn is complete, the final gray off-nominal instruction, 'AFT RCS RECONFIG if INTERCONNECT,' reconnects the aft RCS jets to the aft RCS propellant.



\* AFT RCS RECONFIG if INTERCONNECT \*  
 Trim X,Z residuals < 2 fps (< 0.5 fps if shallow)

This reconfiguration is done before trimming the residual VGO's. Trimming the residuals while still interconnected to OMS propellant would save a little aft RCS propellant for entry. However, the OMS tanks are not designed to feed more than 1000 pounds under Y and Z accelerations. This is the reason for OMS/RCS quantity gaging on SPEC 23 in OPS 2. This is not available during deorbit; and, in any event, the cue card has to allow for a deorbit when all the interconnect capability has already been used on-orbit. If OMS propellant were fed into the RCS jets in excess of the 1000-pound interconnect capability, helium could be ingested into the aft RCS jets disabling them for entry. Hence, the PLT does the AFT RCS RECONFIG after which the CDR trims the residuals with the THC. These actions must be coordinated so they occur in the proper sequence.

4.6 1 ENG DEORBIT BURN

Much of the explanation of the 2 ENG DEORBIT BURN cue card applies to the other deorbit cue cards as well. This and subsequent sections will cover only the unique aspects of the planned off-nominal burns. The OMS BURN PREP section of the Entry Checklist (TIG-30) is the same for a planned one-engine as for a planned two-engine burn. Remember that for planned off-nominal burns, the 'GPC' position is not used for the He PRESS/VAP ISOL valves.

L,R OMS He PRESS/VAP ISOL A (two) - OP  
 .....Wait 2 sec.....B (two) - OP

4.6.1 Planned Procedures

A one-engine burn (fig. 4-7) is, per se, off-nominal. The planned procedures, given the initial off-nominal configuration, are in the white section of the cue card. Unplanned procedures are in the gray section. The main unique procedure in the planned one-engine burn is crossfeeding at the proper time to balance the propellants remaining on each side for Y c.g. control. Both  $\Delta VTOT$  and percent quantity cues are available.

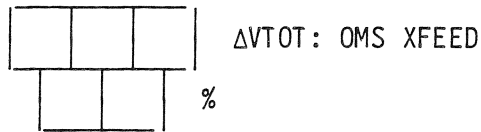

The remarks in section 4.5.3 on the preferability of the  $\Delta VTOT$  cue and OMS gaging reliability apply here also.

HOOK	DEORBIT	HOOK	OV099/
VELCRO	BURN	VELCRO	DEORB/
	(1 ENG)		BAS 3

OV099/ /MM302 \*\* /OMS L or R CNTLR PWR (two) - ON  
 DEORB/ Enter TGO + 10 sec  
 BAS 3 /TRIM: P +0.0, LY +5.2, RY -5.2  
 /DAP - AUTO(PASS)/DISC \*\* ADI - LVLH/HI/MED  
 L,R OMS He PRESS/VAP ISOL A (two) - OP  
 .....Wait 2 sec..... B (two) - OP  
 TIG-2 OMS ENG (good) - ARM/PRESS \*\* [ ]:[ ]  
 -:15 EXEC \*\* (NO EXEC > TIG + [ ]:[ ])  
 :00 TIG \*\* (/Pc, ΔVTOT, ENG VLVs; start watch)  
 \* If NO OMS ignition, APUs - SHUT DN \*

[ ] [ ] [ ] ΔVTOT: OMS XFEED  
 [ ] [ ] %

```

* OMS PRPLT FAIL:
* HP > [ ] [ ] , safe HP (STOP):
* Failed OMS ENG - OFF, APUs - SHUT DN
* Affected OMS He PRESS (two) - CL
* TK ISOL (two) - CL
* HP < [ ] [ ] , safe HP (CONTINUE):
* Failed OMS ENG - OFF
* ITEM 18 +0 EXEC
* Affected OMS He PRESS (two) - CL
* TK ISOL (two) - CL
* XFEED (two) - CL
* Complete RCS (PRPLT FAIL)
* OMS ENG FAIL (CONTINUE BURN):
* Failed ENG - OFF
* Complete RCS (OMS ENG FAIL)
* RCS COMPLETION:
* OMS PRPLT FAIL:
* Interconnect to good OMS PRPLT
* THC +X (/OMS % vs RCS Burn Time)
* AFT RCS RECONFIG
* THC +X to TGT HP or TOT AFT QTY 1 [ ] [ ] %
* If CUR HP ≤ PRI HP [ ] [ ] , FRCS to PRI Site
* If CUR HP > PRI HP [ ] [ ] and ≤ B/U HP [ ] [ ]
* FRCS TO B/U Site
* If CUR HP > B/U HP [ ] [ ] , THC +X to
* B/U HP [ ] [ ]
* or TOT AFT QTY 2 [ ] [ ] ; FRCS to B/U Site
* MNYR to -X AFT (pitch-up at 30/sec to VEOz =
* THC -X (+)1/4 ΔVTOT}
* OMS ENG FAIL:
* Interconnect OMS to RCS
* THC +X, OMS TK SW at [ ] [ ] [ ] ΔVTOT
* THC +X (/OMS % vs RCS Burn Time) [ ] [ ] [ ]
CUTOFF**
+:02 OMS ENG - OFF** (If < 3 IMU, at [ ] [ ] : [ ] [ ] )
* AFT RCS RECONFIG if INTERCONNECT
Trim X,Z residuals < 2 fps (< 0.5 fps if shallow)

```

Figure 4-7.- DEORBIT BURN (1 ENG) Cue Card.

#### 4.6.2 OMS PRPLT Fail

Completing a single-engine deorbit burn after a propellant failure requires burning the OMS propellant (from the good side) through the +X RCS jets. The same reduced Isp and general safety margin considerations apply here as for the RCS COMPLETION: ANY OMS PRPLT FAIL section of the 2 ENG DEORBIT BURN cue card; hence the HP criteria for continuing or terminating the burn is simply > or < safe HP. If the burn is continued, it is with the +X RCS. In any case, the OMS ENG switch is turned OFF.

```
* OMS PRPLT FAIL: *
* HP > [ ][ ], safe HP (STOP): *
* Failed OMS ENG - OFF, APUs - SHUT DN *
* HP < [ ][ ], safe HP (CONTINUE): *
* Failed OMS ENG - OFF *
```

Because the He PRESS/VAP ISOL valves are set to 'OP' rather than 'GPC' as in the two-engine burn, shutting down the OMS engine will not close these valves. Therefore, the one-engine burn cue card contains a 'He PRESS (two) - CL' instruction after a propellant failure even though the OMS ENG switch is already turned off.

```
* OMS PRPLT FAIL: *
* HP > [ ][ ], safe HP (STOP): *
* Failed OMS ENG - OFF, APUs - SHUT DN *
* Affected OMS He PRESS (two) - CL *
* TK ISOL (two) - CL *
```

(The 'TK ISOL (two) - CL' instruction is identical to the 2 ENG BURN cue card and so is not discussed here.)

If the burn is continued after the failure, the cue card shows 'XFEED (two) - CL'.

```
* HP < [ ][ ], safe HP (CONTINUE): *
* Failed OMS ENG - OFF *
* ITEM 18 +0 EXEC *
* Affected OMS He PRESS (two) - CL *
* TK ISOL (two) - CL *
* XFEED (two) - CL *
* Complete RCS (PRPLT FAIL) *
```

This is necessary only if crossfeeding has already been started because the XFEED valves are closed before the beginning of a one-engine burn. Remember that after a propellant failure has occurred, the engine that was connected to the failed side is considered failed. Only the propellant on the good side can be burned through the +X RCS jets.

#### 4.6.3 OMS ENG Fail

Because only one engine was available at the start of the burn, a single-engine failure leads directly to RCS completion of the burn.

- \* OMS ENG FAIL (CONTINUE BURN): \*
- \* Failed ENG - OFF \*
- \* Complete RCS (OMS ENG FAIL) \*

Deorbit targeting by MCC usually allows for a +X RCS completion given the continued availability of all the propellant available before the burn (and assuming there is adequate OMS propellant to perform the deorbit burn  $\Delta V$  with the +X RCS jets).

#### 4.6.4 RCS Completion

##### 4.6.4.1 OMS PRPLT Fail

This section is exactly the same as in the two-engine cue card.

- \* RCS COMPLETION: \*
- \* OMS PRPLT FAIL: \*
- \* Interconnect to good OMS PRPLT \*
- \* THC +X ( $\sqrt{\text{OMS \% vs RCS Burn Time}}$ ) \*
- \* AFT RCS RECONFIG \*
- \* THC +X to TGT HP or TOT AFT QTY 1   % \*
- \* If CUR HP  $\leq$  PRI HP   , FRCS to PRI Site \*
- \* If CUR HP  $>$  PRI HP   and  $\leq$  B/U HP   , \*
- \* FRCS TO B/U Site \*
- \* If CUR HP  $>$  B/U HP   , THC +X to \*
- \* B/U HP   \*
- \* or TOT AFT QTY 2   ; FRCS to B/U Site \*
- \* MNVR to -X ATT (pitch-up at 30/sec to YGOz = \*
- \* THC -X (+)1/4  $\Delta V_{TOT}$  \*

If the propellant failure occurs before crossfeeding begins, then the other side is clearly the good side. Remember that even after crossfeeding has begun from the side opposite the good engine, there is still good propellant remaining on the good engine side. This good propellant would not have been used had the burn proceeded as planned. However, after the propellant failure on the other side, it should be used before the AFT RCS RECONFIG.

After reconfiguring for burning RCS propellant, the priorities for burning aft and forward propellant, prebanking, and retargeting are the same as during a planned two-engine burn.

##### 4.6.4.2 OMS ENG Fail

For a planned two-engine burn, this section is entered after the second engine fails and hence contains the instruction to switch the engine off. For a planned one-engine burn, the engine is switched off as part of the OMS ENG FAIL procedure (section 4.6.3) prior to the RCS completion section.

- \* OMS ENG FAIL (CONTINUE BURN): \*
- \* Failed ENG - OFF \*
- \* Complete RCS (OMS ENG FAIL) \*

The procedure then sends the crew directly to the RCS COMPLETION, OMS ENG FAIL section. The crew should realize as soon as the single engine fails in a planned one-engine burn that the RCS completion is required. However, having an independent OMS ENG FAIL section in the 1 ENG BURN card corresponding to the 2 ENG BURN card helps ensure a proper crew response.

In a planned one-engine burn, the worst case for causing a Y c.g. offset due to the different Isp of the OMS and RCS engines is an engine failure at the halfway point just as crossfeeding is being started. This was discussed for a planned two-engine burn in section 4.5.3. For the two-engine burn, however, it takes two failures to get to this situation whereas a single-engine failure suffices during a planned one-engine burn. For this reason, and also since the OMS TK SW point can be given as part of the PRPLT PAD before the burn, a separate  $\Delta VTOT$  cue is given to avoid the maximum error in the Y c.g. balance for an RCS completion.

* RCS COMPLETION:		*
* OMS ENG FAIL:		*
* Interconnect OMS to RCS		*
* THC +X, OMS TK SW at	→	*
* THC +X (✓OMS % vs RCS Burn Time)		*

--	--	--

}  $\Delta VTOT$

Normally, the RCS  $\Delta VTOT$  cue will be a smaller number than the OMS  $\Delta VTOT$  cue because the RCS burns more propellant for the same  $\Delta V$ . However, the RCS  $\Delta VTOT$  cue could be a larger number if there is insufficient OMS propellant for the  $\Delta V$  required.

Once crossfeeding begins, it is continued until the completion of the burn or until the maximum amount of OMS propellant is used from the pod, as indicated by the 'THC +X (✓OMS % vs RCS Burn Time).' Hence, there is no way to prevent a Y c.g. offset caused by an engine failure after this time (without returning to the original pod). For this reason, the RCS  $\Delta VTOT$  cue is usually calculated for an engine failure halfway between the start of the burn and the planned start of crossfeeding. This is considered to average the failure probability during that part of the burn when something can be done to help the Y c.g. balance. Note that as in the planned 2 ENG BURN cue card, there are no percent cues for RCS completion because OMS propellant gaging is not active unless at least one OMS engine is burning. After the TK SW the RCS burn time capability on the OMS pod is checked to ensure that the interconnect mode is not used too long in trying to complete the burn.

#### 4.7 RCS DEORBIT BURN

##### 4.7.1 Preburn

The Entry Checklist contains a separate indented procedure (TIG-30) to establish the preburn configuration for a planned RCS deorbit. It is arbitrary which OMS propellant side to feed from first. The left side is specified here because English-speaking astronauts usually think from left to right. (It is not known how the Chinese configure their D&C).

#### 4.7.2 Planned Procedures

Once the crew has loaded the deorbit burn target on the DEORB MNVR display for the RCS SEL (+X RCS) option, they will maneuver to the indicated inertial attitude that has been calculated. Venting of the Orbiter can cause the Orbiter to wallow in the  $3.5^\circ$  deadband for some 15 minutes before the burn. The crew should not waste RCS propellant in retweaking the needles just before thrusting (except maybe in roll) because they would needlessly be adjusting to the same reference that had been established previously.

With the onset of THC +X, the crew is instructed to maintain PITCH ATT ERR  $\pm 3^\circ$ .

:00 +X.. (No Deorbit > TIG +  :  )  
Maintain PITCH ATT ERR  $\pm 3^\circ$   
Monitor  $\Delta$ VTOT

The DAP will control to an inertial attitude of  $\pm 3^\circ$  but any misalignment of the thrust vector will be indicated as error on the ADI attitude error needles, which are really thrust vector error indicators. The net thrust of the +X thrusters is above the c.g. causing a small downward pitching moment. If the RCS DAP is controlling the attitude, it will allow a drift down to  $-3^\circ$  (error needle  $+3^\circ$ ), then fire pitch up jets. The upward pitch will decrease due to the +X jets downward pitch moment until the pitch comes back to  $-3^\circ$  causing another RCS pitch up correction.

The proper technique for handling +X RCS burns is to command a manual pitch up maneuver when the pitch error needle reaches  $+3^\circ$ . Hold the RHC out of detente until the needle goes down to  $-3^\circ$  then release the RHC. This resets the RCS phase plane zero point to  $3^\circ$  high. The net error of  $-2^\circ$  to  $-3^\circ$  that the RCS phase plane control will then hold should keep the error needle centered around  $0^\circ$ . Remember, the error needle is still comparing desired to precalculated thrust directions and does not directly show the errors driving the DAP. Hence, the pitch error needle can be showing zero even when the Orbiter is bouncing off the edge of the  $\pm 3^\circ$  DAP deadband.

When using this technique, the pilot will see that the error needle does not hold precisely at  $0^\circ$ , rather it drifts up very slowly. Every minute or more, another RHC positive pitch correction is necessary to bring the error needle back to  $-3^\circ$ .

Starting ~30 seconds before the RCS burn terminates, the pitch error needle starts bouncing around erratically. This is related to the accelerometers being in the nose of the Orbiter rather than at the c.g. The pilot is warned again not to follow the error needles if they become erratic. Hold attitude on the ADI and complete the burn.

Remember that the OMS propellant system is being used, so all the propellant checks that the crew performs during an OMS engine burn should be done here as well.

The RCS BURN Cue Card (fig. 4-8) is a lot less crowded than the OMS engine cards so there is room for the 'Monitor  $\Delta$ VTOT' reminder. This is especially appropriate for an RCS burn because there is no guided cutoff. The burn is terminated by the CDR releasing the THC. The prime cue for this action is  $\Delta$ VTOT. Remember, however, that  $\Delta$ VTOT should always be monitored and, moreover, that there are plenty of other things to monitor during any kind of OMS burn (see section 4 of 'OMS Users' Notes').

The 'crossfeed cue' is  $\Delta$ VTOT.

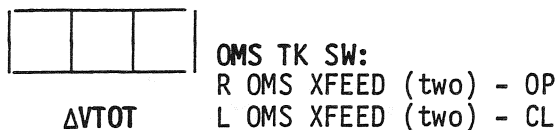

This is not strictly a crossfeed, of course. The RCS is interconnected to the OMS and the interconnect is switched from one OMS pod to the other to access the propellant necessary for the burn and to balance the Y c.g. No direct OMS propellant quantity information is available.

After the burn, reconfigure to burn RCS propellant before trimming out the Y and Z residuals (presumably VGOx will be zero since that is the criterion for stopping the burn). The rationale is the same as in section 4.5.4.2.

CUTOFF VGOx = 0, RELEASE THC \*\*  
 AFT RCS RECONFIG  
 Trim inplane X,Z RESIDUALS < 2 fps  
 (< 0.5 fps if shallow)

#### 4.7.3 OMS PRPLT Fail

The gray OMS PRPLT FAIL section of the RCS DEORBIT BURN cue card contains instructions to follow in the event of a propellant failure.

The equivalent of an OMS engine failure would be a +X RCS jet failure but this is not specified on the RCS DEORBIT BURN cue card. If ample propellant were available, an RCS deorbit would be targeted to withstand one +X jet failure and whether or not to continue the burn with jet failures would be handled by a comment to the DEL PAD for that particular burn. The DEORBIT BURN MONITOR cue card is used for failures as with the OMS BURN cards although there are obviously failures on the Monitor card that apply to OMS engines only.

As in the other deorbit situations, targeting for RCS deorbit assumes that all the preburn propellant can be used, which is no longer valid after a propellant failure. Moreover, an OMS propellant failure occurring while the +X RCS jets are burning OMS propellant may cause damage to the jets rendering them unusable even with aft RCS propellant. It is a bad day if you get a propellant failure after the two OMS engine failures that required the RCS deorbit. If HP > safe HP, stop the burn and regroup. If HP < safe HP, there is no alternative but to press on.

HOOK	DEORBIT	HOOK	OV099/
VELCRO	BURN	VELCRO	DEORB/
	(RCS)		BAS 3

```

√MM302 ..      √RCS SEL   CNTL PWR (two) - ON
√DAP - DISC ..      ADI - LVLH/MED/MED
                    √RCS BURN CONFIG
TIG-2  L,R OMS He PRESS/VAP ISOL A (two) - OP
        .....Wait 2 sec..... B (two) - OP
:00    +X** (No Deorbit > TIG + [ ] : [ ])
        Maintain PITCH ATT ERR +30
        Monitor ΔVTOT

```

ΔVTOT	OMS TK SW:
	R OMS XFEED (two) - OP
	L OMS XFEED (two) - CL

```

* OMS PRPLT FAIL:
* Affected OMS He PRESS (two) - CL
* TK ISOL (two) - CL
* XFEED (two) - CL
*
* HP > [ ] , safe HP (STOP BURN):
* APU's - SHUT DN
*
* HP < [ ] , safe HP (CONTINUE):
* ITEM 18 +0 EXEC

```

```

... If OMS PRPLT LOW .....
Release THC at → [ ] ΔVTOT
Aft RCS RECONFIG
THC +X to TGT HP or TOT AFT QTY 1 [ ] %
If CUR HP ≤ PRI HP [ ] , FRCS to PRI Site
If CUR HP > PRI HP [ ] and ≤ B/U HP [ ] ,
FRCS TO B/U Site
If CUR HP > B/U HP [ ] , THC +X to
B/U HP [ ]
or TOT AFT QTY 2 [ ] ; FRCS to B/U Site
MNVR to -X ATT (pitch up at 30/sec to VGOz =
THC -X (+)1/4 ΔVTOT)

```

```

CUTOFF  VGOx = 0, RELEASE THC **
        AFT RCS RECONFIG
        Trim inplane X,Z RESIDUALS < 2 fps
        (< 0.5 fps if shallow)

```

Figure 4-8.- Deorbit BURN (RCS) cue card.



The cue card does not give any specific instructions on how to continue if this is necessary. Too many different situations are possible to be handled with explicit instructions when the whole general area has such a low probability (three failures). The failure may have occurred before the OMS TK SW in which case the crew can try to switch to the other side. If the failure occurred after the switch, the crew may switch back to the first side to use whatever good propellant remains there. Basically, whatever good OMS propellant is available should be used before reconfiguring to burn aft RCS propellant. If the +X RCS jets are damaged beyond use because of the propellant failure, you have to move down the card to the -X burn completion. At this point you may start wondering what you did to deserve this.

#### 4.7.4 OMS PRPLT Low

MCC will calculate in advance whether enough OMS propellant is available to complete the burn. The  $\Delta VTOT$  'Release THC at

```

... If OMS PRPLT LOW .....
.
.
. Release THC at  $\longrightarrow$     $\Delta VTOT$ 
. AFT RCS RECONFIG
.

```

The PAD value for the THC release  $\Delta VTOT$  cue assumes a nominal RCS burn with an OMS TK SW at the PAD value. If OMS PRPLT is low because of a PRPLT FAIL and the burn has to be continued, this will not be a valid cue. The crew must estimate how much OMS propellant is still available to avoid possibly damaging the +X RCS jets by burning the tanks dry during OMS/RCS interconnect. The only way to do this at this time is to use the OMS percent versus RCS  $\Delta V$ /Burn Time table on the X c.g. calculator cue card. How much information is available or can be reconstructed depends on the details of the failure situation but there is not much else you can do here.

Once the THC is released and the RCS system is configured to burn RCS propellant, the cue card procedures are identical to those in the 2 ENG and 1 ENG DEORBIT BURN cards.

```

.   THC +X to TGT HP or TOT AFT QTY 1   %
.   If CUR HP < PRI HP   , FRCS to PRI Site
.   If CUR HP > PRI HP   and < B/U HP   ,
.   FRCS TO B/U Site
.   If CUR HP > B/U HP   , THC +X to  
.   B/U HP
.   or TOT AFT QTY 2   ; FRCS to B/U Site
.   MNVR to -X ATT (pitch up at 30/sec to VGOz =
.   (+)1/4 ΔVTOT)
.   THC -X
.   . . . . .

```

#### 4.8 UNBALANCED PRPLT DEORBIT BURN

##### 4.8.1 Purpose

This is the longest deorbit cue card (fig. 4-9). The procedure is designed to change the Y c.g. by burning more OMS propellant on one side than the other using OMS crossfeeding during part of the burn to feed propellant from one side to both OMS engines. This procedure would normally be used when, due to operations earlier in the flight, one OMS pod was used more than the other. This is not considered an off-nominal procedure in the sense that a one-engine or RCS deorbit burn because the burn is executed with all components of the OMS system working.

##### 4.8.2 Nominal Procedure

Because both OMS engines are used for this burn, the He PRESS/VAP ISOL A valves are set to 'OP,' then to 'GPC,' and the B valves are set to 'GPC' before the burn as is done in a nominal 2 ENG deorbit burn.

L,R OMS He PRESS/VAP ISOL A (two) - OP then GPC  
 B (two) - GPC

TIG-2

The burn is begun exactly the same as a nominal two-engine deorbit to confirm that both propellant systems and engines are working properly.

At a precalculated ΔVTOT (part of the propellant PAD), the OMS crossfeed valves are opened and the tank isolation valves on the overused side are closed.

			ΔVTOT: Feed 2 ENG from 1 POD
START			OMS XFEED (four) - OP (tb-OP)
			<input type="text"/> TK ISOL (two) - CL (tb-CL)

The PAD includes a little square before 'TK ISOL (two)-CL (tb-CL)' in which to write either an L or R to remind the crew which is the light side. As soon as the proper Y c.g. is achieved, the closed tank isolation valve



is opened and the crossfeed valves are closed. The procedure is similar to crossfeeding in a T-38. The cue for ending crossfeeding is, again, a  $\Delta VTOT$  value from the propellant PAD.

			$\Delta VTOT$ : Return to 2 Eng, 2 POD FLOW				
STOP			<table border="0"> <tr> <td style="border: 1px solid black; padding: 2px;"> </td> <td style="padding-left: 5px;">TK ISOL (two) - OP (tb-OP)</td> </tr> <tr> <td style="border: 1px solid black; padding: 2px;"> </td> <td style="padding-left: 5px;">OMS XFEED (four) - CL (tb-CL)</td> </tr> </table>		TK ISOL (two) - OP (tb-OP)		OMS XFEED (four) - CL (tb-CL)
	TK ISOL (two) - OP (tb-OP)						
	OMS XFEED (four) - CL (tb-CL)						

The same L or R mentioned above is written in here to remind the crew which tank isolation valves to open. This time, however, it should be obvious because only one side is closed.

From this point on, the burn is completed exactly as a nominal two-engine deorbit burn. Inspection of the off-nominal (gray) section taking up most of the second page of this cue card procedure will show that it is identical to the entire gray section of the 2 ENG DEORBIT BURN cue card, so it will not be discussed further. Only the gray sections covering failures prior to the end of crossfeeding will be covered here.

#### 4.8.3 OMS PRPLT Fail (Before or During Crossfeeding)

The reason for doing an unbalanced propellant burn in the first place is to balance the Y c.g. If a propellant failure occurs early in the burn, before the crossfeeding to balance the Y c.g. is complete, then the calculations used to plan the burn are no longer valid and the orbiter may end up with an unacceptable Y c.g. and probably not have enough good propellant remaining for the required  $\Delta V$ . It is safer to stop the burn and let MCC decide how to proceed. If the propellant failure is on the previously underused side, then a mixed crossfeed deorbit burn may be required to balance the Y c.g. (see section 4.9). The burn is planned to begin the feed from one pod procedure early (about 10 seconds after TIG) and hopefully the crossfeeding will be completed while the Orbiter is above the safe HP. Thus, any OMS propellant failure is cause for terminating the burn as indicated by the '(STOP BURN)' instruction.

- |                                       |   |              |
|---------------------------------------|---|--------------|
| * OMS PRPLT FAIL (STOP BURN):         | * |              |
| * OMS ENG (two) - OFF, APUs - SHUT DN | * | Before       |
| * Affected OMS TK ISOL (two) - CL     | * | crossfeeding |
|                                       |   |              |
| * OMS PRPLT FAIL (STOP BURN):         | * |              |
| * OMS ENG (two) - OFF, APUs - SHUT DN | * | During       |
| * Affected OMS TK ISOL (two) - CL     | * | crossfeeding |
| * XFEED (two) - CL                    | * |              |

The only difference between the procedures before and during crossfeeding is that during crossfeeding the XFEED valves are open and hence must be closed in the event of a propellant failure to isolate the failed system. Special circumstances, such as a deorbit burn from a 105 n. mi. orbit (safe HP ~ 103 n. mi.) may possibly allow a propellant failure before or during crossfeeding. There is no reason ever to stop a burn below the safe HP so if the crew has to press on in this case, the cue card procedures for a propellant failure before or during crossfeeding no longer

apply. The procedures for a propellant failure after crossfeeding is completed could be used in this situation and the crew has to accept the resulting Y c.g.

#### 4.8.4 Engine Failure Prior to Crossfeeding

##### 4.8.4.1 OMS ENG Fail

The procedures are similar to the engine failure case during a balanced propellant burn: continue burning the good engine, and switch to crossfeeding propellant from the other side partway through the burn. However, instead of using  $1/2 \times \Delta VTOT$  at the time of engine failure as the crossfeed cue, the crew uses precalculated  $\Delta VTOT$  values.

```

* OMS ENG FAIL (CONTINUE BURN): *
* Failed OMS ENG - OFF *
* OMS XFEED *
* at R ENG FAIL L ENG FAIL *
*  $\Delta VTOT$  [ ] [ ] [ ] [ ] [ ] [ ] *
* [ ] [ ] [ ] [ ] [ ] [ ] *
* [ ] [ ] [ ] [ ] [ ] [ ] *
* [ ] [ ] [ ] [ ] [ ] [ ] *
* [ ] [ ] [ ] [ ] [ ] [ ] *
* [ ] [ ] [ ] [ ] [ ] [ ] *

```

These cues ensure that the proper c.g. will be attained when the burn is complete. Clearly the time of crossfeeding will depend on whether the engine failure occurs on the 'light' or 'heavy' propellant side because it is desired to feed longer from the heavy side. Two sets of  $\Delta VTOT$  and percent quantity crossfeed cues are given; the one on the left is used when the left engine is burning (i.e., the failure is on the right side). Remember that once the gray off-nominal procedures section of the cue card is entered, that section is used for the remainder of the burn.

##### 4.8.4.2 Both OMS ENG Fail

This is a standard RCS completion. Percent quantity is not available with only RCS jets firing so the method of interconnecting to either OMS is used as explained for the balanced Deorbit Burn (2 ENG) cue card (4.5.4.2).

```

* BOTH OMS ENG FAIL (CONTINUE BURN): *
* OMS ENGS - OFF *
* Interconnect OMS to RCS *
* THC +X ( $\checkmark$ OMS % vs RCS Burn Time) *
* OMS TK SW *
* THC +X ( $\checkmark$ OMS % vs RCS Burn Time) *

```

This gray section prior to crossfeeding is complete in itself. At the end of either the OMS ENG FAIL or BOTH OMS ENG FAIL procedure, skip to the CUT-OFF instruction at the end of the second page.

## 4.8.5 Engine Failure during Crossfeeding

### 4.8.5.1 OMS ENG Fail

At this point, both engines are being fed from the heavy pod, with the crossfeed valves open. No matter which engine fails, the other engine will continue to receive propellant. In the nominal procedures, crossfeeding is ended when the proper Y c.g. is obtained and both engines complete the burn from their own pods. However, it is not allowed to feed the one remaining engine in this case from both pods. This could allow propellant to flow from one pod to another through the open crossfeed lines if the propellant pressures differed sufficiently from side to side. Instead, the 'heavy' side propellant is burned for longer than in the nominal case and the burn is then completed with propellant from what was originally the 'light' side. The crossfeed valves remain open for the duration of the burn and only one pod is feeding at any given time. The  $\Delta VTOT$ , percent quantity, and L/R cues are provided in the PAD and are pre-calculated to end up with a balanced c.g.

```
* OMS ENG FAIL (CONTINUE BURN): *
* Failed OMS ENG - OFF *
* * *
* | | TK ISOL (two) - OP at → | | | ΔVTOT *
* | | TK ISOL (two) - CL *
* * *
* * * *
* * * * *
```

### 4.8.5.2 Both OMS ENG Fail

The rationale here is the same as the previously discussed BOTH OMS ENG FAIL case.

```
* BOTH OMS ENG FAIL (CONTINUE BURN): *
* OMS ENGS - OFF *
* Interconnect L OMS to RCS *
* THC +X (✓OMS % vs RCS Burn Time) *
* OMS TK SW *
* THC +X (✓OMS % vs RCS Burn Time) *
```

As with the failures prior to crossfeeding, these procedures go all the way to burn completion. Skip directly to the CUTOFF instruction.

## 4.9 MIXED XFEED DEORBIT BURN

### 4.9.1 Purpose

This is a somewhat involved procedure designed to restore Y c.g. balance in the event of a propellant leak or trapped propellant in either the fuel or oxidizer tank in one OMS pod. It involves feeding fuel from one pod and oxidizer from the other pod for part of the burn. This flow requires nonstandard valve settings that are not available via the normal switches,

hence a GPC read/write procedure is necessary prior to the burn to configure the valves. Note that the mixed crossfeed procedure does not provide any more  $\Delta V$  than would have been available had it not been used. It merely balances the Y c.g.

An example is in order here. Suppose a leak has occurred in the left OMS fuel tank depleting this tank entirely. Suppose further that approximately 50 percent propellant remains in each of the other three tanks and corresponds to a helium pressure of 3700 psi. Fifty percent propellant quantity in one pod gives 299 fps (see OMS He PRESS of 3700 psi on the c.g. calculator cue card), which is close to what is needed for a nominal deorbit. The burn could be carried out feeding all the propellant from the right side, in which case the left oxidizer tank would remain 50 percent full and all three other tanks would be empty following the deorbit burn. This would cause a ~2-inch Y c.g. offset.

With the mixed crossfeed procedure, the burn will be started feeding oxidizer from the left pod and fuel from the right pod. Halfway through the burn, the left pod is closed and oxidizer and fuel are fed from the right side for the rest of the burn. Following the burn, both fuel tanks are empty and both oxidizer tanks are 25 percent full with a balanced Y c.g. As stated above, the mixed crossfeed procedure results in a balanced Y c.g. It does not provide any more  $\Delta V$  for the burn because this is limited by the total amount of fuel available.

OMS/RCS VALVE CONFIG (figs. 4-10 and 4-11) illustrate the OMS tank and valve configurations at the start of this example and at the mid-burn re-configuration point.

#### 4.9.2 Nominal Procedure

Only one engine is used for this procedure. The cue card (fig. 4-12) is written to use the engine on the 'good' propellant side (i.e., the side with both pods intact). If necessary for some special reason, the other engine could be used but this would require that procedural modifications be uplinked to the crew. Prior to the burn, a GPC read/write procedure is carried out. This procedure, 'OMS SSR-1,' is found in section 11 of the 'OV-102 System Malfunction Procedures.' This procedure causes the proper combination of fuel and oxidizer tank valves and crossfeed valves to be open in opposite pods when the TK ISOL and XFEED switches are in the GPC position.

✓L,R OMS TK ISOL (four) - GPC (tb-bp)  
XFEED (four) - GPC (tb-bp)

Note that the XFEED and TK ISOL switches on both L and R sides must be set to 'GPC.' Normally, this would never be done because it would open a path for propellant to flow from one side into the other if a sufficient pressure differential existed. However, the crew has manually closed all the TK ISOL and XFEED valves on the failed propellant tank (left fuel tank, in the example given above) and on the tank that will not be used until part-way through the burn (right oxidizer, in the above example) before going to the GPC position. Thus, no open paths exist between the two pods. The

**OMS/RCS VALVE CONFIG (A)**  
**OMS**

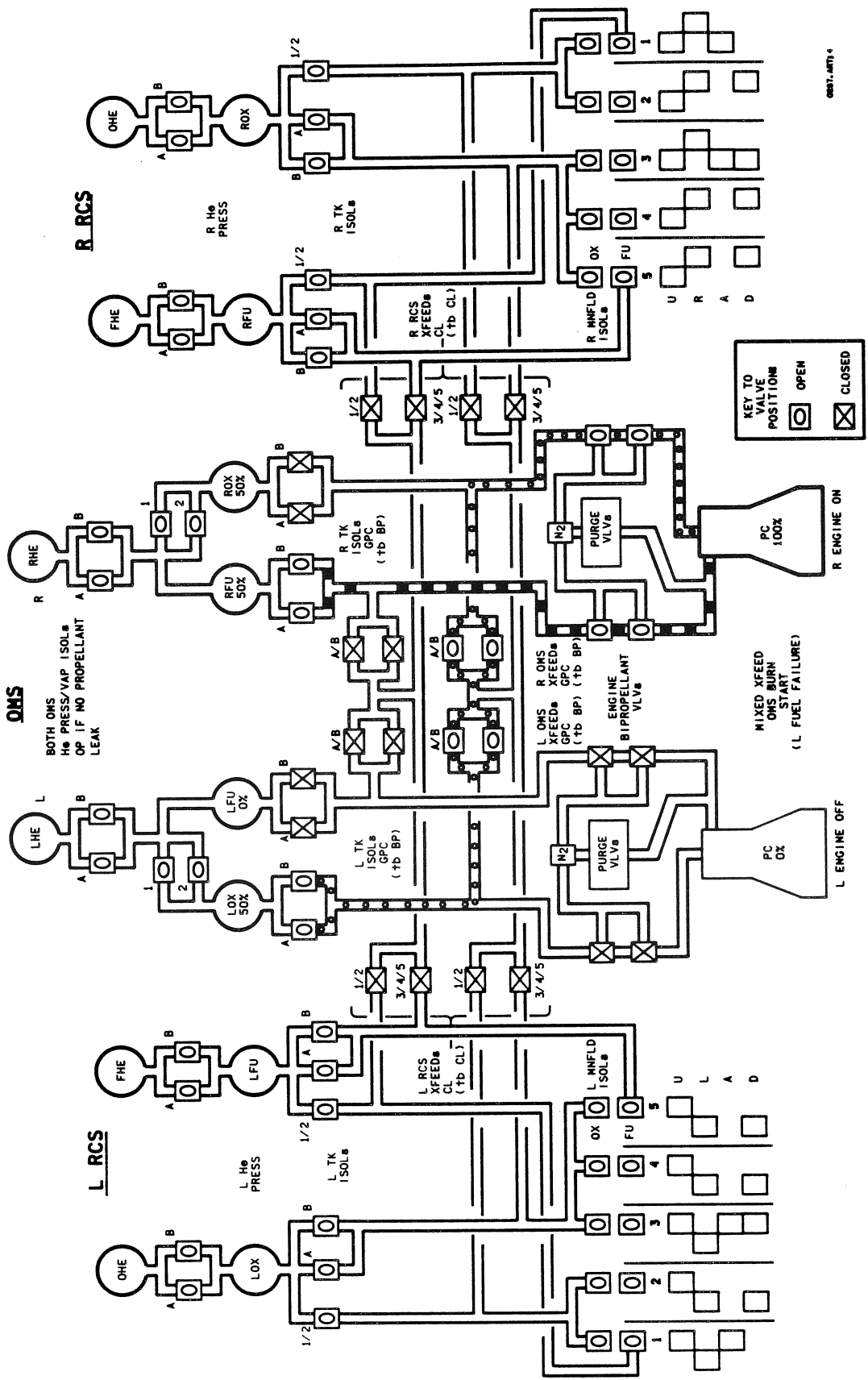

(a) OMS configurations at start of burn.

Figure 4-10.- OMS/RCS valve configuration (A).



OMS/RCS VALVE CONFIG ( B )

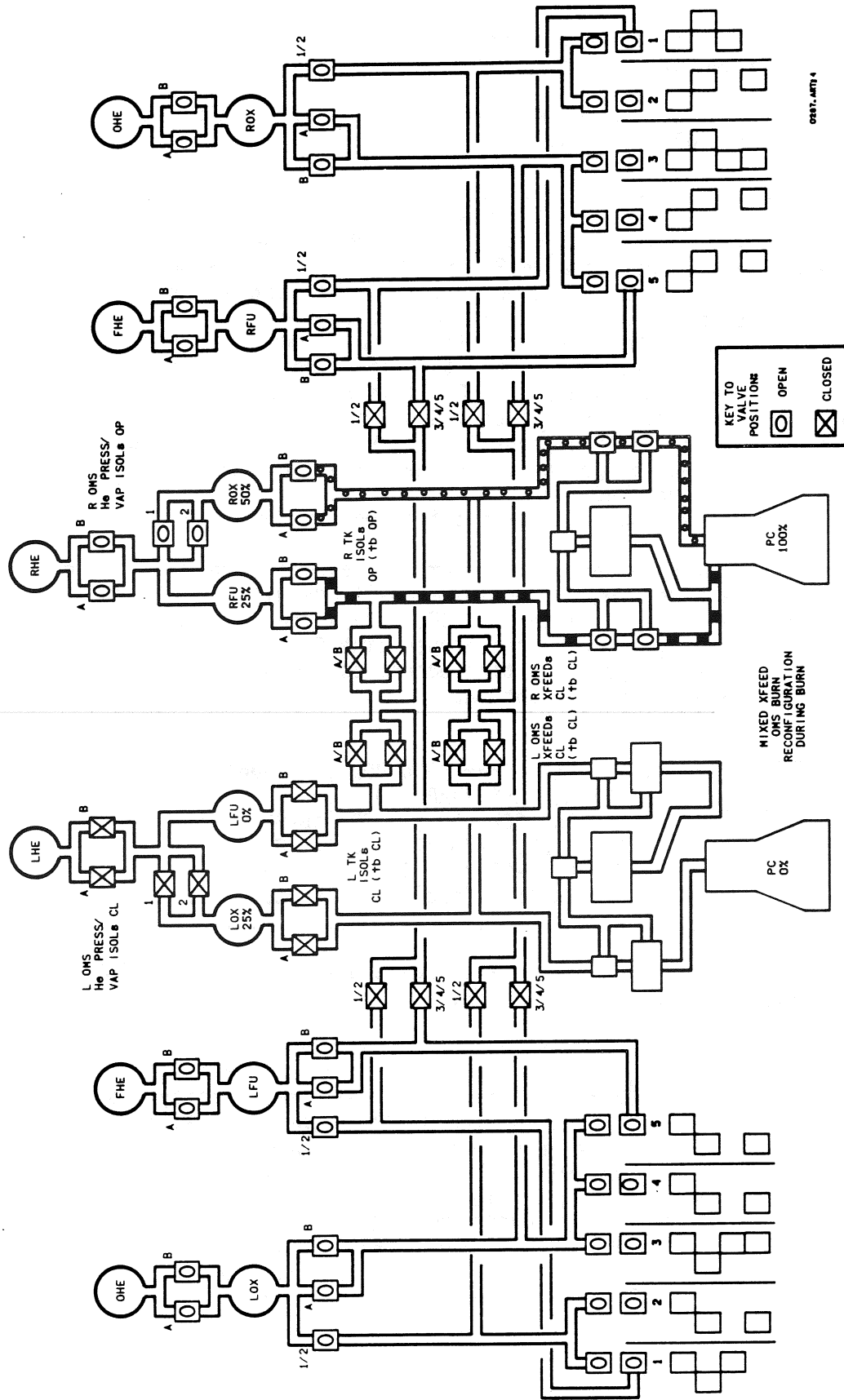

(b) OMS tank and valve mid-burn reconfigurations.

Figure 4-11.- OMS/RCS valve configuration (B).

TK ISOL and XFEED talkbacks are all barberpole, which indicates a mismatch in configuration, caused by the read/write procedure.

The 1 ENG OMS burn procedure of sequentially setting the He PRESS/VAP ISOL A and then B valves to 'OP' is used.

If the He PRESS/VAP ISOL valves on the failed propellant side (left, in the example given above) are opened to pressurize the good tank (left oxidizer), the He may be lost through the leak in the failed tank (left fuel). This means that despite the He PRESS/VAP ISOL valves being open, the left oxidizer tank might still be operating in the blowdown mode. To avoid a tank pressure imbalance that could lead to an improper propellant mixture ratio, the tank on the other side (right fuel) would be operated in blowdown as well, until reconfiguration to both 'good' tanks (on the right side, in the example given above). For this reason, the OMS He PRESS/VAP ISOL valves normally are not opened on either side at the beginning of the burn. However, if the propellant tanks have not yet reached blowdown level (~35 percent propellant), the helium valves may have to be manually cycled to force matched tank pressures between oxidizer and fuel (even though helium is leaking) to obtain sufficient  $\Delta V$  for the burn.

Note that the burn is begun using the off-nominal valve configuration with the altered 'GPC' switch settings. The valve positions will have been checked by MCC prior to deorbit, after the GPC read/write procedure, and the valves are not moved again until the proper time for reconfiguration during the burn. The reconfiguration time occurs at the  $\Delta VTOT$  and percent quantity cues taken from the propellant PAD.

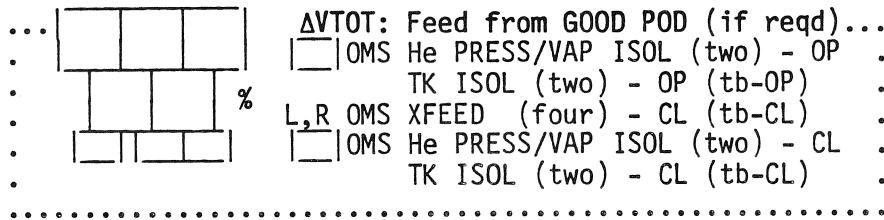

Now that only the good propellant system is being used, the He PRESS/VAP ISOL valves on the good side can be opened.

Note that under the percent quantity cue there are three small squares. The first contains 'L' or 'R,' and the others contain 'OX' or 'FU.' Since only one tank is being used from the 'good' side only one quantity should be monitored. For the reconfiguration, the He PRESS/VAP ISOL valves on the good side (right side, in the above example) are opened, if they were not previously opened during the mixed configuration at the start of the burn. The TK ISOL valves on the good side are opened and all crossfeed valves are closed. Finally, the He PRESS/VAP ISOL and the TK ISOL valves on the bad side are all closed. For all these reconfiguration settings, the hardwired OP and CL switch positions are used because the GPC positions were altered by the read/write procedure. The talkbacks change from barberpole to OP or CL. The rest of the burn is then carried out in this normal single-engine configuration with both propellant tanks on one side feeding the engine on that side.

HOOK  
VELCRO

DEORBIT  
BURN

HOOK  
VELCRO

OV099/  
DEORB/  
BAS

(MIXED XFEED)

MM302 \*\*  $\sqrt$ OMS L or R CNTLR PWR (two) - ON  
Enter TGO + 5 sec  
 $\sqrt$ TRIM: P +0.0, LY +5.2, RY -5.2  
 $\sqrt$ DAP - AUTO(PASS)/DISC \*\* ADI - LVLH/HI/MED  
 $\sqrt$ L,R OMS TK ISOL (four) - GPC (tb-bp)  
XFEED (four) - GPC (tb-bp)  
TIG-2  OMS ENG - ARM/PRESS \*\*  
-:15 EXEC\*\* (NO EXEC > TIG + ||||)  
:00 TIG\*\* (Pc,  $\Delta$ VTOT, ENG VLVs; start watch)  
\* If no OMS ignition, APUs - SHUT DN \*

||||  $\Delta$ VTOT: Feed from GOOD POD .....  
|||| OMS He PRESS/VAP ISOL (two) - OP  
TK ISOL (two) - OP (tb-OP)  
% L,R OMS XFEED (four) - CL (tb-CL)  
|||| OMS He PRESS/VAP ISOL (two) - CL  
TK ISOL (two) - CL (tb-CL)

\* OMS PRPLT FAIL: \*  
\* HP > ||, safe HP (STOP BURN): \*  
\* Failed OMS ENG - OFF, APUs - SHUT DN \*  
\* L,R OMS He PRESS (four) - CL \*  
\* TK ISOL (four) - CL \*  
\* XFEED (four) - CL \*  
\* HP < ||, safe HP (CONTINUE BURN): \*  
\* Failed OMS ENG - OFF \*  
\* ITEM 18 +0 EXEC \*  
\* OMS TK ISOL (four) - CL \*  
\* Complete RCS (PRPLT FAIL) \*  
\* OMS ENG FAIL (CONTINUE BURN): \*  
\* Failed ENG - OFF \*  
\* Complete RCS (OMS ENG FAIL) \*  
\* RCS COMPLETION: \*  
\* OMS PRPLT FAIL: \*  
\* THC +X to TGT HP or TOT AFT QTY 1 || % \*  
\* If CUR HP < PRI HP ||, FRCS to PRI Site \*  
\* If CUR HP > PRI HP || and  $\leq$  B/U HP ||, \*  
\* FRCS TO B/U Site \*  
\* If CUR HP > B/U HP ||, THC +X to \*  
\* B/U HP || \*  
\* or TOT AFT QTY 2 ||; FRCS to B/U Site \*  
\* MNVR to -X ATT (pitch up at 30/sec to VGOz = \*  
\* (+)1/4  $\Delta$ VTOT) \*  
\* THC -X \*  
\* OMS ENG FAIL: \*  
\* || OMS XFEED (two) - OP \*  
\* L,R RCS XFEED (four) - OP \*  
\* TK ISOL (six) - CL \*  
\* THC +X ( $\sqrt$ OMS % vs RCS Burn Time) \*  
\* Feed from GOOD POD at |||  $\Delta$ VTOT \*  
\* || OMS He PRESS/VAP ISOL (two) - OP \*  
\* TK ISOL (two) - OP \*  
\* || XFEED (two) - CL \*  
\* ( $\sqrt$ OMS % vs RCS Burn Time) \*  
CUTOFF \*\*  
+:02 OMS ENG - OFF\*\* (If < 3 IMU, at ||: ||)  
\* AFT RCS RECONFIG if INTERCONNECT \*  
Trim inplane X,Z residuals < 2 fps  
(< 0.5 fps if shallow)

Figure 4-12.- DEORBIT BURN (MIXED FEED) cue card.

### 4.9.3 Off-Nominal Procedures

#### 4.9.3.1 OMS PRPLT Fail

It is a bad day if a second propellant failure occurs on top of the propellant failure that led to the use of this procedure in the first place. As with the other off-nominal burns (one-engine, RCS), the procedure here in the event of a problem during the burn is to shut down if this can be done safely (i.e., HP > safe HP) and allow time for MCC to reconsider the remaining propellant availability.

```
* OMS PRPLT FAIL: *
* HP > [ ][ ], safe HP (STOP BURN): *
* Failed OMS ENG - OFF, APUs - SHUT DN *
* L,R OMS He PRESS (four) - CL *
* TK ISOL (four) - CL *
* XFEED (four) - CL *
```

If the burn is to be continued, the engine is turned off, the OMS tank isolation valves are closed, propellant wasting is terminated, and a normal RCS completion with RCS propellant is carried out.

```
* HP < [ ][ ], safe HP (CONTINUE BURN): *
* Failed OMS ENG - OFF *
* ITEM 18 +0 EXEC *
* OMS TK ISOL (four) - CL *
* Complete RCS (PRPLT FAIL) *
```

The RCS COMPLETION: OMS PRPLT FAIL procedure is the same as for the corresponding sections in other OMS burn procedures following the AFT RCS RECONFIG instruction.

```
* RCS COMPLETION: *
* OMS PRPLT FAIL: *
* THC +X to TGT HP or TOT AFT QTY 1 [ ][ ] % *
* If CUR HP < PRI HP [ ][ ], FRCS to PRI Site *
* If CUR HP > PRI HP [ ][ ] and ≤ B/U HP [ ][ ] , *
* FRCS TO B/U Site *
* If CUR HP > B/U HP [ ][ ] , THC +X to *
* B/U HP [ ][ ] *
* or TOT AFT QTY 2 [ ][ ] ; FRCS to B/U Site *
* MNVR to -X ATT (pitch up at 30°/sec to VGOz = *
* (+)1/4 ΔVTOT) *
* THC -X *
```

The MIXED CROSSFEED DEORBIT BURN cue card is the only one that does not contain an 'AFT RCS RECONFIG' instruction at this point as there is no possibility of interconnecting the RCS to an OMS propellant system. After a propellant failure, there is probably no complete propellant system left. Hence, the RCS is always configured to burn its own propellant and no re-configuration is necessary.

### 4.9.3.2 OMS ENG Fail

The GPC valve configuration is set up for the engine on the good propellant side. If that engine fails, the other engine cannot be used and the burn must be completed using the +X RCS jets.

- \* OMS ENG FAIL (CONTINUE BURN): \*
- \* Failed ENG - OFF \*
- \* Complete RCS (OMS ENG FAIL) \*

OMS propellant can still be used, however, with some additional switch reconfiguration indicated on the second page of the MIXED XFEED cue card.

- \* RCS COMPLETION: \*
- (hinge line)
- \* OMS ENG FAIL: \*
  - \*  OMS XFEED (two) - OP \*
  - \* L,R RCS XFEED (four) - OP \*
  - \* TK ISOL (six) - CL \*
  - \* THC +X ( $\sqrt{\text{OMS \% vs RCS Burn Time}}$ ) \*

If the engine failure occurs while mixed crossfeeding is going on, the OMS XFEED switches on the good propellant side must be changed from GPC to OP (tb changes from BP to OP). In the GPC position, the OMS fuel XFEED valves were all closed. For RCS interconnect, the OMS fuel XFEED valves on the good propellant side must be opened. The RCS XFEED valves are all opened and the RCS TK ISOL valves all closed, as in all interconnect procedures. Once the interconnect is accomplished (PLT call to CDR), the CDR adjusts the attitude with the RHC and starts the +X RCS burn with the THC.

It may be that insufficient propellant remains to complete the burn using the +X RCS jets. This should be checked using the OMS percent versus RCS Burn Time table on the c.g. calculator cue card (see section 4.5.4.1.1) to prevent burning the tanks dry and possibly damaging the +X RCS jets.

The deorbit propellant PAD contains a  $\Delta VTOT$  cue for reconfiguring from mixed crossfeeding to a normal RCS interconnect.

- \* Feed from GOOD POD at     $\Delta VTOT$  \*
- \*  OMS He PRESS/VAP ISOL (two) - OP \*
- \* TK ISOL (two) - OP \*
- \*  XFEED (two) - CL \*
- \* ( $\sqrt{\text{OMS \% vs RCS Burn Time}}$ ) \*

The OMS TK ISOL valves on the good side are changed from GPC to OP (tb from BP to OP), which opens the oxidizer tank isolation valves. The OMS XFEED valves on the bad propellant side are changed from GPC to CL (tb from BP to CL), which isolates the oxidizer tank on the bad side from the RCS interconnect line. Note that in the mixed crossfeed procedure with no OMS engine failure, the TK ISOL and He PRESS/VAP ISOL valves on the bad

side are all closed as part of the midburn reconfiguration. For a +X RCS completion following an OMS engine failure, these valves are not closed until after the burn is finished (part of the postdeorbit switch configuration checks in the Entry Checklist). Closing these switches during the burn adds only a little extra protection against additional failures and is omitted because of the extra workload following an OMS engine failure.

If the OMS engine fails after the midburn reconfiguration, the OMS is in a normal single-engine burn configuration and the nominal RCS interconnect procedure should be used. This is shown on the INTERCONNECT, OMS XFEED, AFT RCS RECONFIG cue card mounted between panels 07 and 08.

The OMS/RCS switch, valve, and tank configurations at the beginning of and at the midburn reconfiguration point of a +X RCS mixed crossfeed burn are shown on OMS/RCS VALVE CONFIG figures (figs. 4-13 and 4-14).

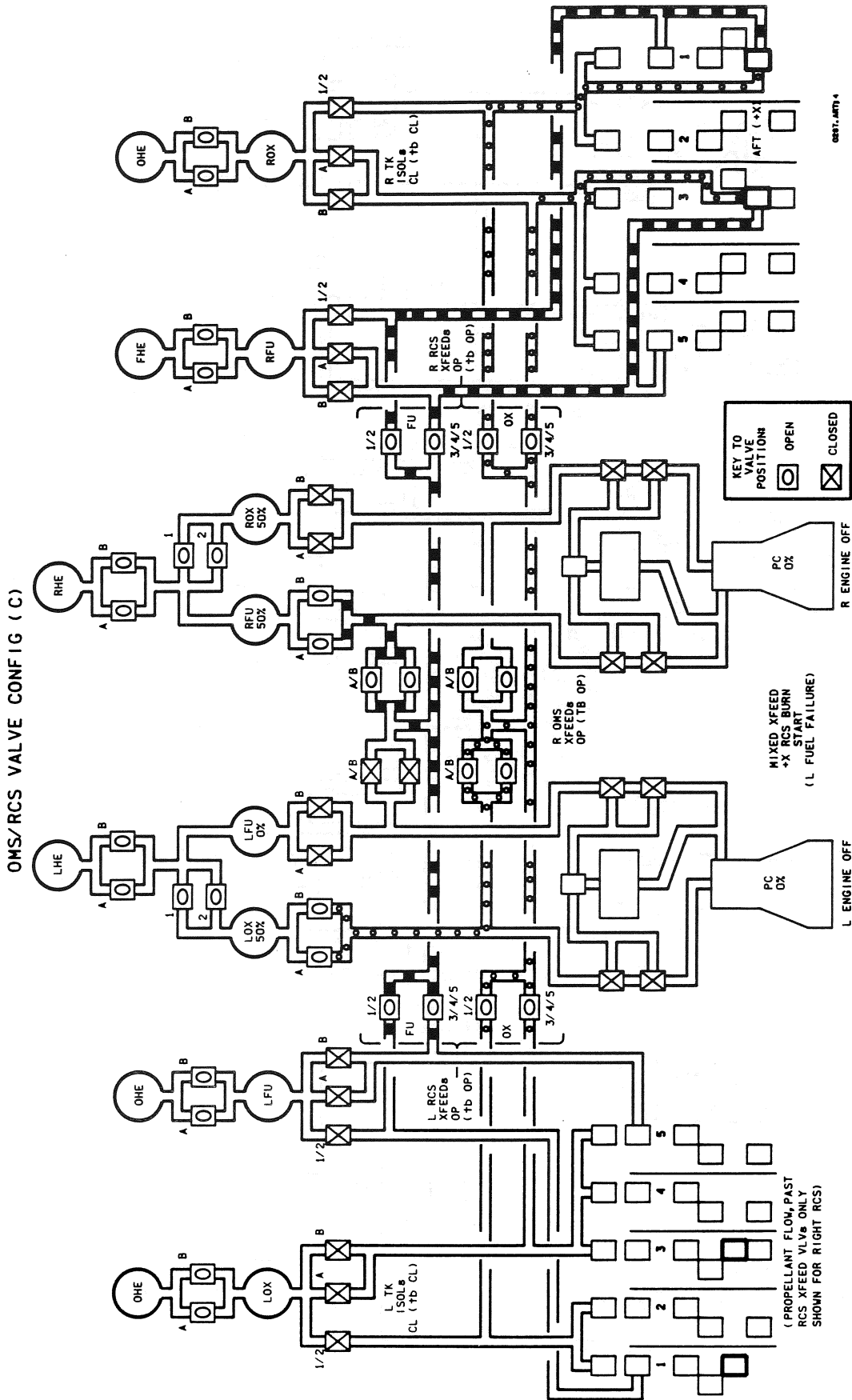

(c) OMS/RCS configurations at start of +X RCS mixed crossfeed burn.  
 Figure 4-13.- OMS/RCS valve configuration (C).

OMS/RCS VALVE CONFIG (D)

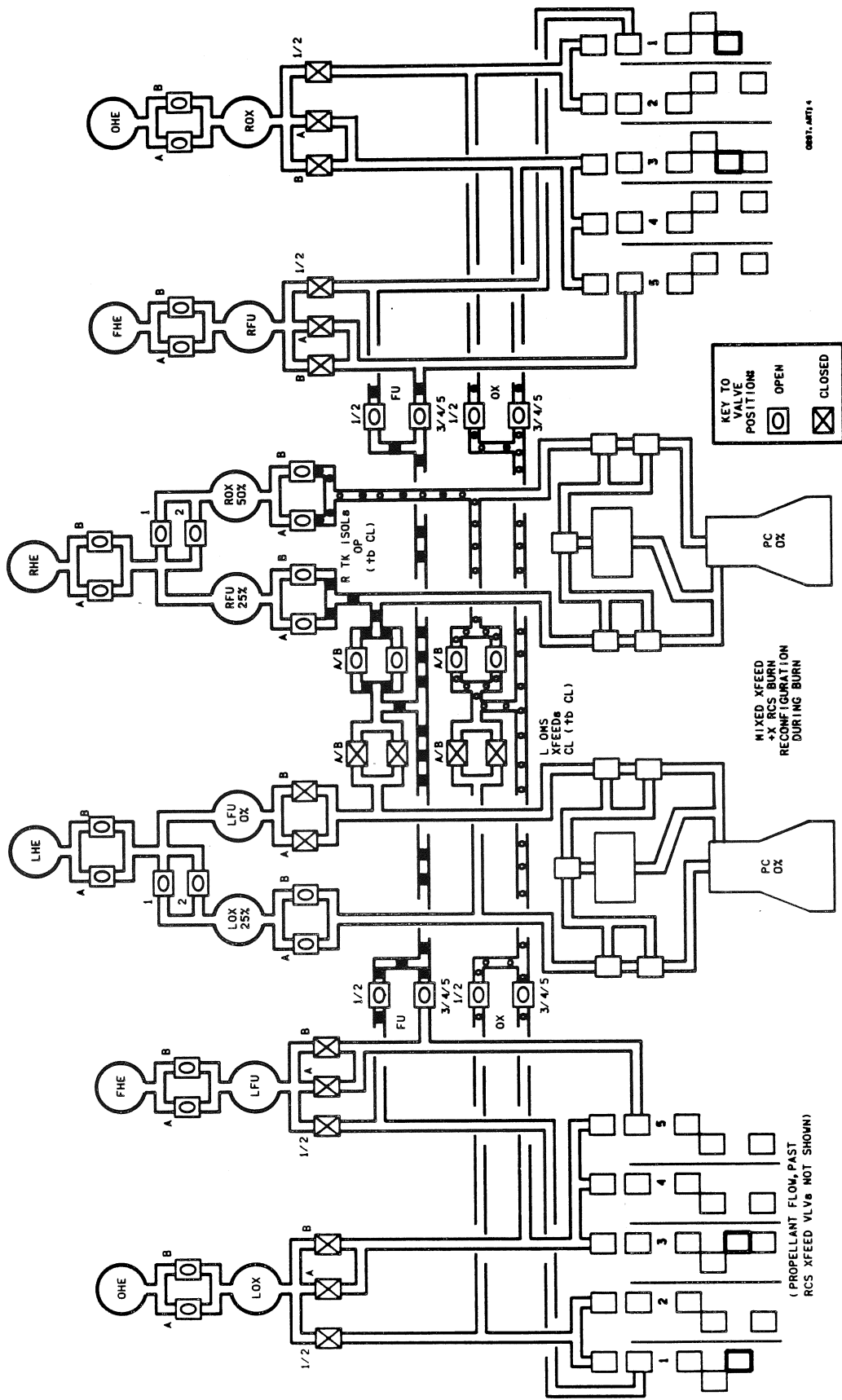

(d) OMS/RCS mid-burn reconfiguration.

Figure 4-14.- OMS/RCS valve configuration (D).



#### 4.10 C.G. CALCULATOR CUE CARD

The capability exists at anytime during the mission for the crew to calculate the current vehicle X and Y center of gravity (c.g.) position using onboard resources. These data are required for onboard c.g. management in the event of a contingency deorbit when ground assistance may be minimal. As will be discussed in section 5, the vehicle X and Y c.g. must be within a predefined envelope during the entry phase to insure controllability and to avoid exceeding thermal constraints.

Two devices are available to the crew for determining onboard c.g.; the HP41C calculator system and the c.g. calculator cue card. Each device can determine the X and Y c.g. to within a few tenths of an inch of the actual c.g. and both devices are acceptable for onboard use depending on crew preference. The following discussion is limited to the c.g. calculator cue card. (For a discussion on the HP41C calculator system, the reader is referred to the HP-41C Flight Procedures Handbook.

General information on the c.g. calculator cue card is as follows:

- o Requirement - For onboard c.g. management in support of critical maneuvers when MCC is not available; i.e., AOA, or contingency deorbit
- o Application - Determine current c.g. (X and Y)  
  
Determine propellant usage by source to move the c.g. from one location to another
- o FDF location - Documented in the Cue Card book  
  
One assembled unit stowed in locker C6
- o Data source - Operational Data Book

The c.g. calculations for onboard use have been simplified by providing a 'dry c.g.' to which the X and Y c.g. offsets due to OMS and RCS propellants can be added to compute the actual c.g. The dry c.g. is the X and Y c.g. of the vehicle minus the effects of the propellant consumables. It includes the weight of the inert Orbiter, the crew, cargo, nonpropulsive consumables, miscellaneous cargo, and nongaged propellants (trapped). The dry c.g. is based on expected nominal consumption of the nonpropulsive consumables. A dry c.g. is provided for several discrete points in the mission and can also be updated by MCC on a daily basis in the event the expenditures of the nonpropulsive consumables deviate from the nominal by an unacceptable amount.

To determine the current c.g., a crewmember notes the remaining propellant quantities on the onboard gages. Using these values on the c.g. calculator cue card, the c.g. offsets can be found. The offsets are then added to the dry c.g. specified for that mission phase to obtain the current c.g.

The X and Y sides of the c.g. calculator cue card are shown in figure 4-15. The X side consists of four circular scales with a common shaft similar to a circular slide rule. The outer scale is graduated from 1085 to 1110 inches and represents the expected range in inches of the X c.g. due to OMS and RCS propellants.

The 'OMS' scale represents the total of the average of the left OMS fuel and oxidizer and the average of the right OMS fuel and oxidizer. For full OMS loading, this scale would be graduated from 0 to 200 percent. Since OMS loading for the earlier missions is less than 100 percent per side, the scale is graduated from 0 to 145 percent.

The circle labeled 'F RCS' and 'A RCS' provides the scales for the aft and forward RCS. As with the OMS, the aft RCS scale is entered using the total of the average right fuel and oxidizer and the average left fuel and oxidizer.

The inner wheel labeled 'PRPLT' converts total OMS in percent to pounds, which is then used as an item entry in the onboard CRT  $\Delta V$  maneuver display. Also provided on the back of the c.g. calculator is the dry X c.g. for discrete mission events. A movable index line (not shown) is provided for scale settings.

The Y side of the calculator consists of five circular scales. Since the OMS and aft RCS tanks are symmetrical to the X axis, there is a circular scale for each tank set (average of fuel and oxidizer). The forward RCS tanks lie on the X axis and have no effect on the 'Y' offsets. The outer scale is graduated  $\pm 0$  to 3 inches in tenths.

### Scaling

Scaling of each of the 'disks' is based on data presented in table 4-II.

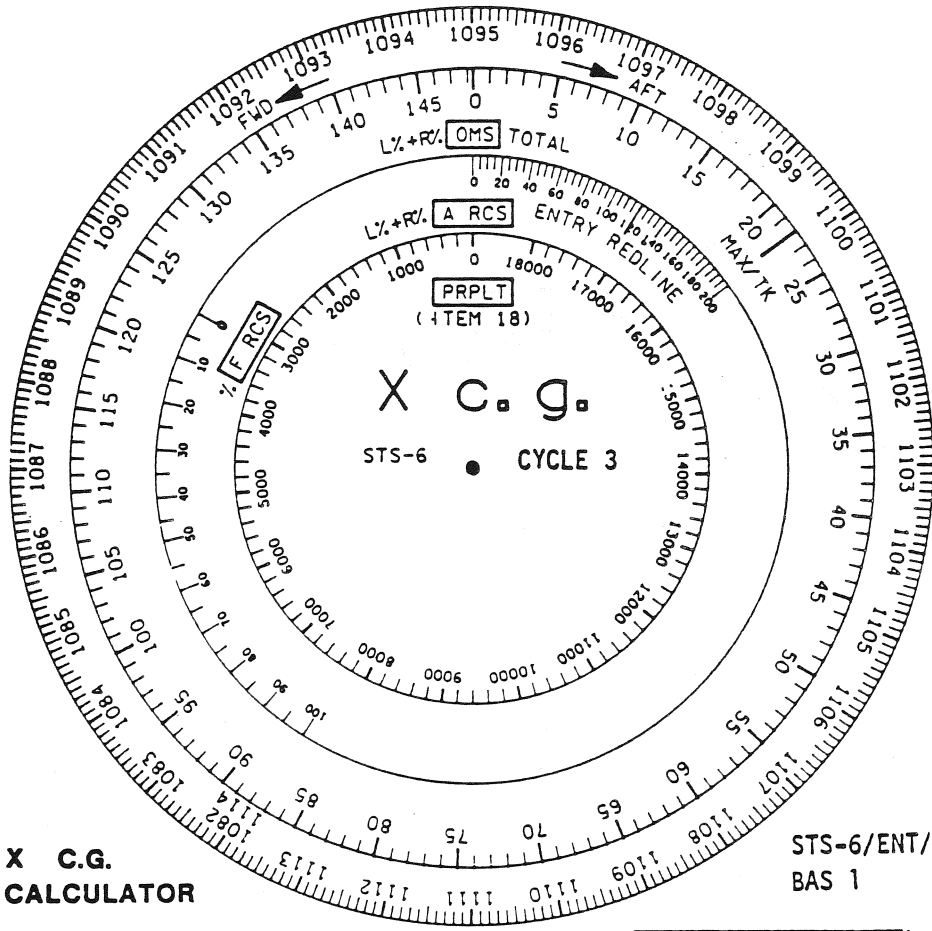

**X C.G.  
CALCULATOR**

STS-6/ENT/  
BAS 1

OMS %	OMS He PRESS*	OMS ΔV	RCS ΔV	RCS BURN MIN:SEC
1972	3	3	3	00:05
2000	12	12	12	00:22
2100	36	31	31	00:57
2200	58	50	50	01:30
2300	80	58	58	02:04
2400	101	86	86	02:36
2500	124	105	105	03:10
2600	145	122	122	03:40
2700	166	140	140	04:13
2800	185	155	155	04:45
2900	170	142	142	05:17
3000	187	157	157	05:47
3100	204	171	171	06:18
3200	221	185	185	06:50
3300	239	199	199	07:21
3400	255	213	213	07:51
3500	266	222	222	08:21
3600	283	236	236	08:53
3700	299	249	249	09:23
3800	315	262	262	09:52
3900	331	276	276	10:22
4000	348	290	290	10:53
4100	363	302	302	11:20

\*Valid one hour after last burn  
OV099/STS-6 OMS gages unreliable,  
use OMS He PRESS for quantity

BASELINE		PL DPY
AOA	1099.0	NO
DAY 1	1099.2	NO
DAY 2	1097.2	YES
DAY 5	1097.9	YES

If TDRS  
not deployed:  
X + 2.1

ΔV CAPABILITY RCS POD	
1% FWD	= 0.9 fps -X
1% AFT	= 0.9 fps +X
OMS	= 20 lbs/fps
OMS	= 6.5/fps/%

(a) X side

Figure 4-15.- The c.g. calculator cue card.

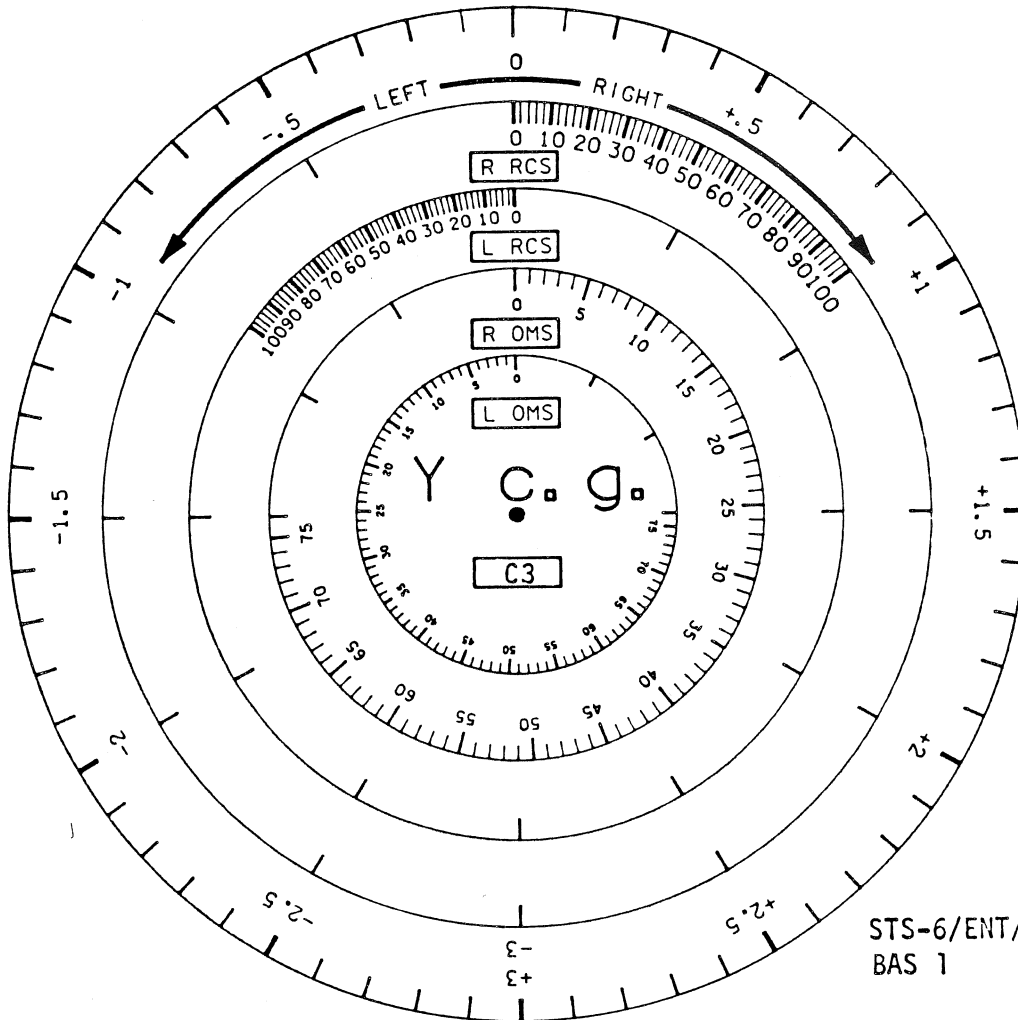

EI cg	DRY Y
AOA	0.4
DAY 1	0.4
DAY 3	0.3
DAY 5	0.3

**Y C.G. CALCULATOR**

(b) Y side

Figure 4-15.- The c.g. calculator cue card.

TABLE 4-II.- SCALING<sup>a</sup>

System		100 percent onboard reading (lbs)	Usable (lbs)	Nonusable (included in 'dry c.g.')(lbs)
OMS (Per side)	OX	8055	7875	80
	FU	4896	4787	43
ARCS (Per side)	OX	1543	1350	193
	FU	956	850	106
FRCS	OX	1603	1350	253
	FU	939	850	139

<sup>a</sup>Scaling is based on the propellant quantities.

- o RCS tank moment arms considered constant
- o OMS tank moment arms are considered constant
- o Pounds per  $\Delta X = 1$  inch
  - FRCS: 264
  - ARCS: 797
  - OMS: 576
- o Pounds per  $\Delta Y = 0.1$  inch
  - ARCS: 237
  - OMS: 217
- o Tank failures (loss of fluid) or tank unbalance (leak or mixture ratio change) requires a bias correction to gage reading to account for FU, OX weight differences (Mixture Ratio = 1.65 Ox/Fuel). Refer to page 4-85.

### Sample Problem

The following sample problem is presented to illustrate the use of the c.g. calculator. Refer to the figures on pages 4-79 through 4-83 for working the following example.

Example: Determine c.g. management for day 3 deorbit,  $\Delta V$  required = 313

Onboard OMS, RCS gage readings:

L OMS avg	36 percent	R ARCS avg	77 percent	FRCS	70 percent
R OMS avg	47 percent	L ARCS avg	75 percent		
	83 percent		152 percent		70 percent

### X c.g.

How to use: To determine current X c.g.

1. Set index to day 3 deorbit dry X c.g. (Assume 1086.4).  
Zero OMS scales to index
2. Set index to OMS remaining (83 percent)
3. Zero ARCS scale to index
4. Set index to ARCS remaining (152 percent)
5. Zero FRCS scale to index
6. Set index to FRCS remaining (70 percent)
7. Read on outer scale under index the current X 'wet' c.g.;  
X current c.g. = 1103.8

To determine propellant usage by source to move the c.g. from one location to another

8. Reset under index the OMS propellant remaining.
9. Determine from table on cue card (page 4-74) the OMS percent to perform  $\Delta V = 313$  fps. Read approximately 52 percent. 83 minus 52 = 31 percent remaining.
10. Reset index to 31 percent on OMS scale. Note c.g. location in relation to '↑' (X c.g. arrows - MNVR or no MNVR).\*
11. Reset current FRCS remaining (70 percent) under index.
12. Note FRCS dump to 0 percent to obtain EI c.g. of 1097.5.

\*NOTE: Must subtract (-2.4) for nominal entry without entry flight test maneuvers; (-3.6 with) to obtain EI c.g.

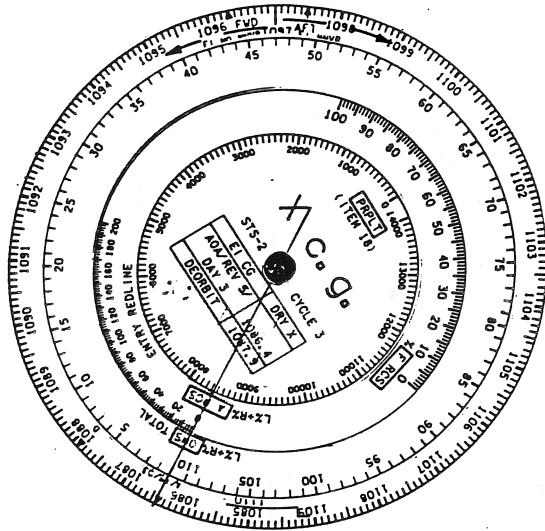

1. Set index to day 3 deorbit dry X c.g. (D3) (1086.4). Zero OMS scale to index

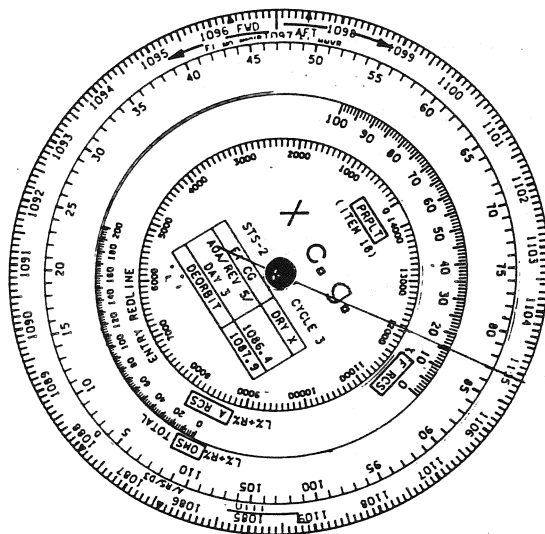

2. Set index to OMS remaining (83 percent)

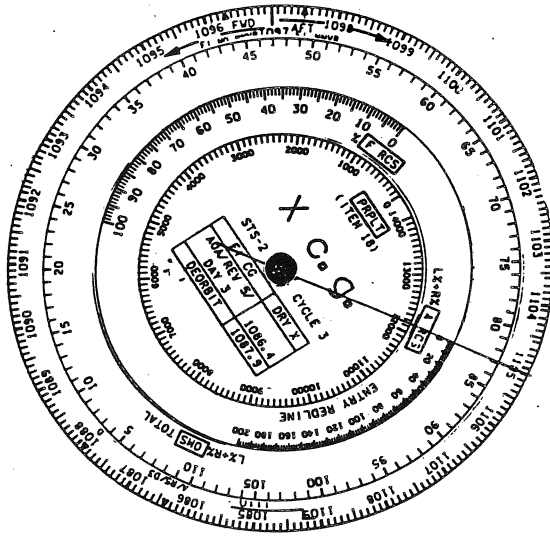

3. Zero ARCS scale to index

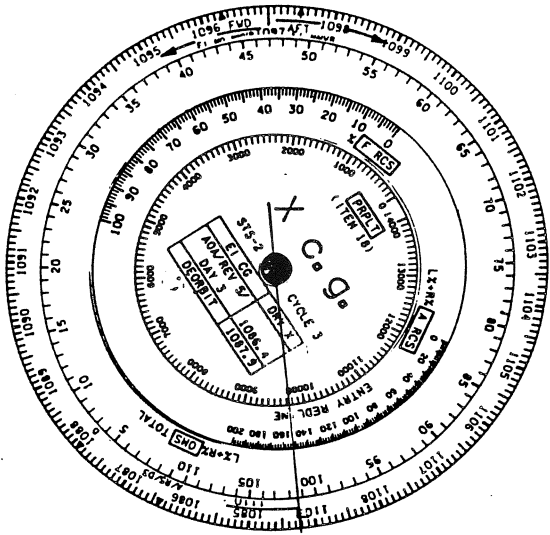

4. Set index to ARCS remaining (152 percent)



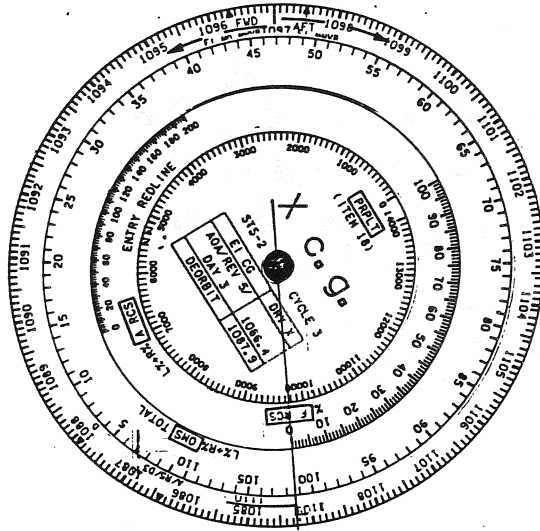

5. Zero FRCS scale to index

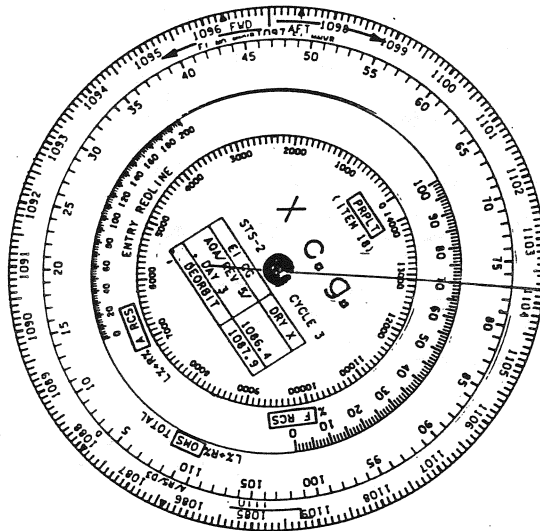

6. Set index to FRCS remaining (70 percent)

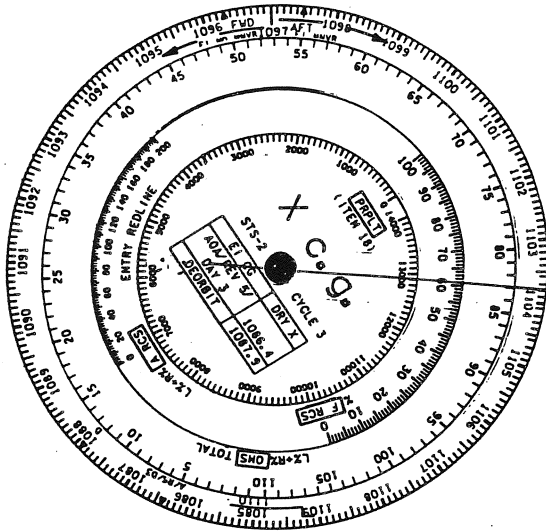

7. Read on outer scale under index the current X 'wet' c.g.
8. Reset under index the OMS propellant remaining

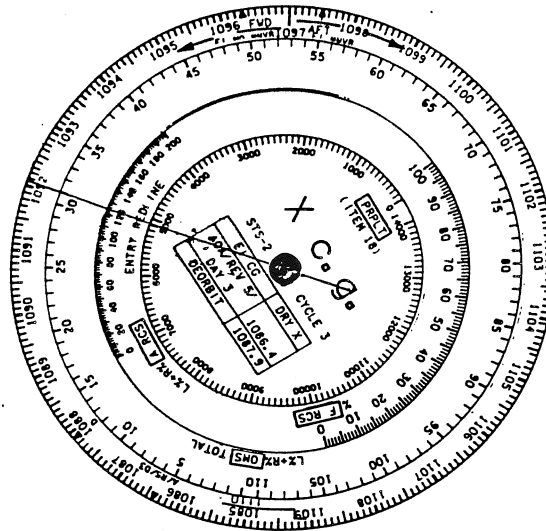

9. Determine from table on cue card the OMS percent to perform a  $\Delta V = 313$  fps. Read approximately 52 percent.  $83$  minus  $52 = 31$  percent remaining OMS propellant
10. Reset index to 31 percent on OMS scale. \*Note c.g. location in relation to '↑'

\*(X c.g. arrows - MNVR or no MNVR).

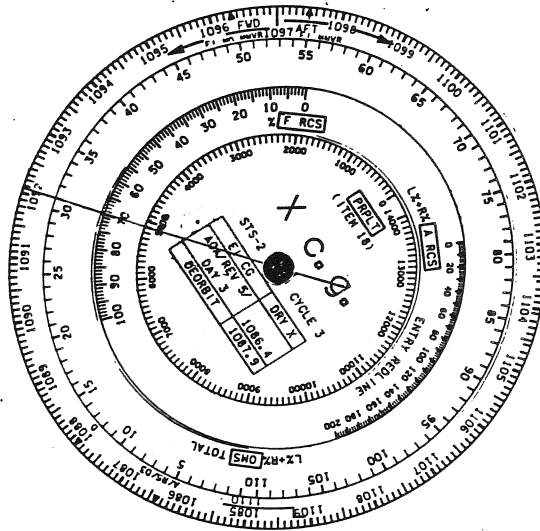

11. Reset current FRCS percent remaining (70 percent) under index

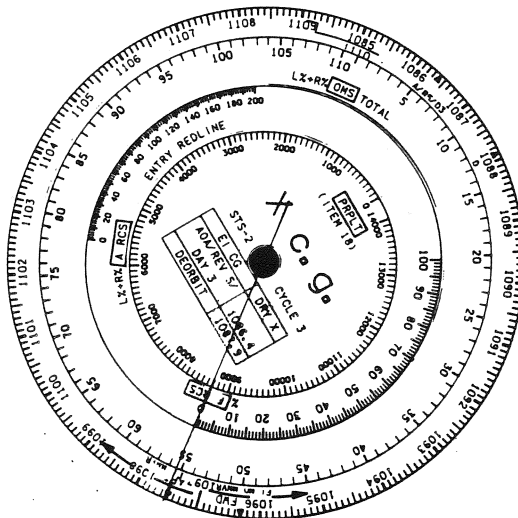

12. Note FRCS dump to 0 percent to obtain EI c.g. of 1097.5\*

\*Compare EI c.g. (calculated) to c.g. envelope to ensure proper X c.g. limits.

### Y c.g.

How to use: To determine current Y c.g. (using same propellant loads from X c.g. example)

1. Set index to (D3) deorbit
2. Zero R RCS scale
3. Set index to R RCS remaining (77 percent)
4. Zero L RCS scale
5. Set index to L RCS remaining (75 percent)
6. Zero R OMS scale
7. Set index to R OMS remaining (47 percent)
8. Zero L OMS scale
9. Set index to L OMS remaining (36 percent)
10. Read on outer scale Y c.g. (0)\*

### PRPLT scale

The innermost scale labeled 'PRPLT' is a quick approximation of OMS propellant (in lbs) to be burned.

How to use: To determine approximate propellant burned (using same PRPLT loads from previous example)

1. Zero PRPLT scale to index prior to performing an OMS burn calculation (0 PRPLT at 83 percent)
2. Move index to reflect the OMS percent used for burn
3. Read the approximate amount of PRPLT burned (6700 PRPLT at 31 percent)

\*Compare EI c.g. (calculated) to c.g. envelope to ensure proper Y c.g. limits.

Bias Connection for Failed or Unbalanced OX, FU Tank (OMS or ARCS)

Since propellant fuel and oxidizer do not weigh the same\*, it is necessary to make a bias connection to the onboard gage reading for an unbalanced or failed tank condition. The following table and example show how this can be done. As a rule of thumb, the 60/40 Ox/Fu ratio can be used onboard to bias the gage readings in lieu of using the table.

Onboard gage percent	Fu	Ox	Use:
100	38	62	Enter appropriate side (wheel) with equivalent Fu or Ox reading
90	35	55	Example: Loss of L OMS Ox tank
80	31	49	<u>L OMS</u> <u>R OMS</u>
70	27	43	Fu 50 percent      Fu 50 percent
60	23	37	Ox 0 percent      Ox 50 percent
50	19	31	Enter wheel with 19 + 50 = 69 percent
40	15	25	Example: Unbalanced ARCS tank
30	11	19	<u>L ARCS</u> <u>R ARCS</u>
20	8	12	Fu 47 percent      Fu 50 percent
10	4	6	Ox 20 percent      Ox 50 percent
0	0	0	Enter wheel with 20 + 10 + 50 = 80 percent

Once you have determined the bias correction for failed or unbalanced Ox or Fu tank, then proceed as normal to calculate X and Y c.g.

*General approximation by weight:	Ox	Fu
	60	40

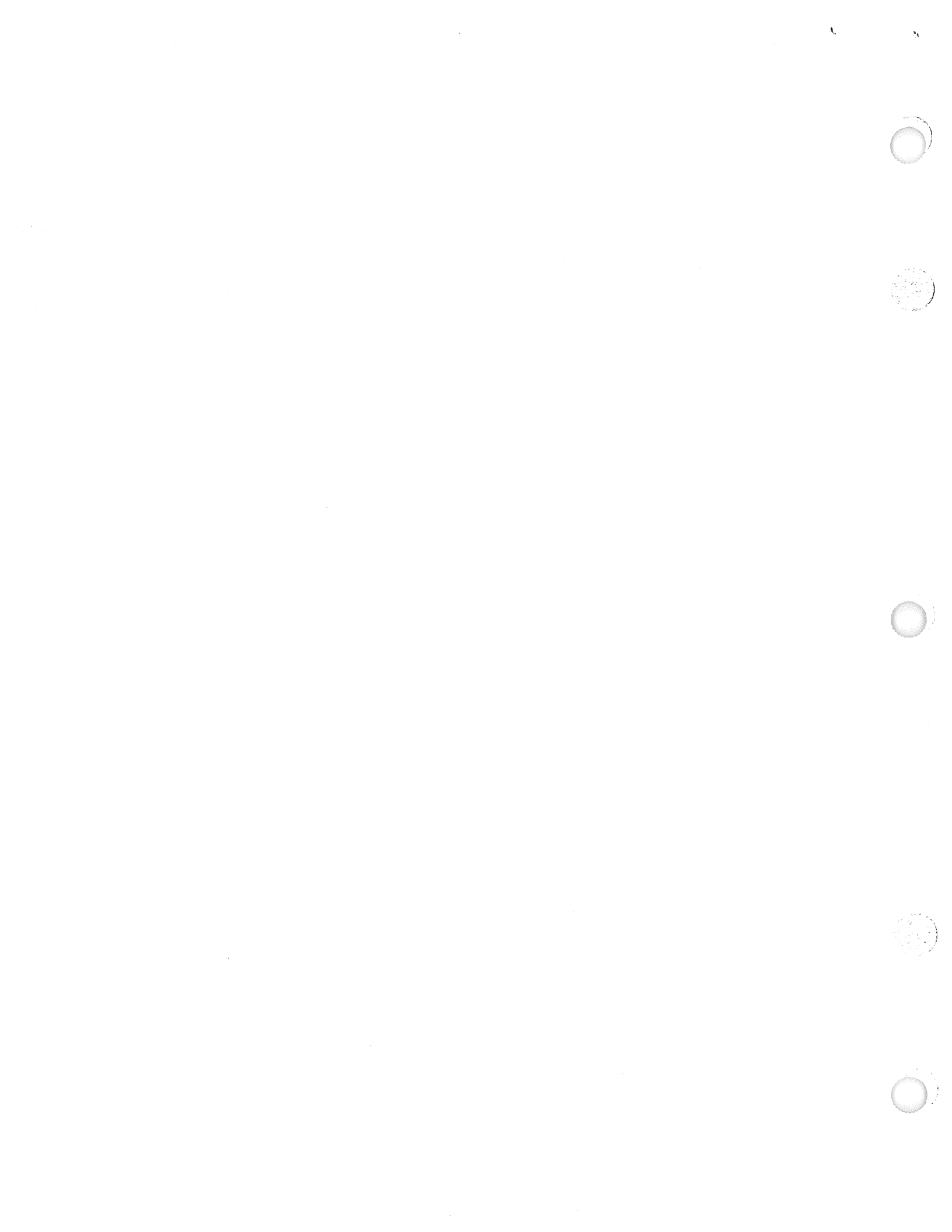

## SECTION 5 ENTRY OPERATIONS

### 5.1 CREW ENTRY MONITORING AND CONTROL

Refer to the attached supplements in the appendix for a discussion of the entry aerodynamics response maneuvers.

The primary crew role during entry is to monitor and control the performance of the navigation, guidance, flight control, and other critical systems so that the Orbiter arrives at TAEM, A&L, and runway interface without violating any constraints. Cockpit dedicated instruments and CRT displays are available that present critical entry parameters for determining vehicle performance and trajectory state. Uplinked advisory data and on-board data cue cards will also be available to assist the crew in the monitoring task. From the available information, the crew assesses the performance of the automatic guidance system and remains alert to take over with manual guidance and control for an off-nominal situation.

Present planning (pending autoland flight assignment) calls for an auto-guidance entry with crew takeover in CSS at Mach 0.95 for a manually controlled landing. However, at any time during entry, conditions could arise that would require crew takeover. Some of the conditions that could cause an off-nominal situation causing crew manual takeover include the following:

- o Navigation errors
- o L/D dispersions
- o Atmosphere variations
- o Winds
- o Deorbit execution errors
- o Unknown GN&C failures or degraded performance

Any of the preceding conditions, if left unchecked, could possibly lead to unrecoverable range control or loss of vehicle control caused by aerovariations other than L/D. Recognition of the off-nominal situation as well as the ability to determine that the GN&C is performing within limits is the primary crew task during entry.

The purpose of this section is to present the crew techniques for monitoring and controlling the integrated entry sequence of events.

A summary listing of the nominal entry sequence of events starting at Entry Interface (EI) minus 5 minutes and continuing through Orbiter rollout is contained in the table in section 5.1.5. For the significant events, data sheets have been prepared that present the following information:

- o Name of the event
- o Best onboard cues and displays for monitoring when the event will occur
- o The VREL, altitude, range to touchdown, and the time the event will occur
- o The crew action associated with the event; i.e., monitor, awareness only, or the procedural step in the Entry Checklist associated with the event

- o A general discussion covering event-related operational data such as configuration changes as a result of the event, ground interface support, procedures rationale, crew techniques for monitoring and controlling the event, major changes in performance capabilities or constraints caused by the event, and any backup procedures associated with the event

A listing of GNC parameters monitored by the crew during entry and the cockpit display that indicates these parameters is shown in table 5-1.

The ensuing discussions are generally limited to actions associated with nominal operations. For discussions of selected off-nominal operations, refer to appendix A.

### 5.1.1 Onboard Entry Event Reference

During entry, the events are keyed in the checklist to the best parameter for monitoring the event rather than to a common base parameter. The following parameters are used in the checklist as event cues:  $\bar{q}$ , EIT, EET, VREL, H, M, drag, and delta azimuth.

Two clock displays are available for crew use as follows.

- o Mission timer (first line on CRT) displays time to TIG and is set during deorbit preparation to show 00:00:00 at TIG, counting up.
- o CRT timer (second line on CRT) is set in MM 301 to count down to 00:00 at TIG, then count up. At the start of MM 303, the same timer is reinitialized to display EIT and counts down to 00:00 at EI, then counts up.

### 5.1.2 Cockpit CRT Assignments

The three CRT displays on the forward panel are configured as follows at entry interface:

- o CRT 1 (left) - ENTRY TRAJ or VERT SIT (PASS)
- o CRT 2 (center) - Assigned to BFS as follows
- o CRT 3 (right) - GNC HORIZ SIT
  - o With CRT 2 Major Function switch in GNC
    - ENTRY TRAJ or VERT SIT with R, P, Y attitude errors digitally displayed for performance comparisons between PASS and BFS
  - o With CRT 2 Major Function switch in SM
    - Primary display is display.
    - Depressing SYS SUMM key calls SM SYS SUMM display.  
Note: Depressing RESUME key restores display.
  - o At VREL ~13,000 ft/s - before tacan acquisition
    - BFC CRT Display switch - OFF (DEU 2 goes to PASS control)
    - Call HORIZ SIT SPEC (SPEC 50 PRO)  
Note: BFC CRT Display switch - ON (DEU 2 reverts to BFS control if required.)



TABLE 5-I.- ENTRY GN&C FLIGHT MONITORING PARAMETERS

Parameter	Availability	
	CRT display <sup>a</sup>	Dedicated display <sup>a</sup>
Acceleration (N <sub>Z</sub> )	F, G	K, R
ADTA H ratio, residual	H	
Aileron position	J	O
Aileron trim	A, B, C, D, E, F, G	O
Alpha actual	A, B, C, D, E, I <sup>b</sup>	N
Alpha commanded	A, B, C, D, E	K
Altitude (NAVDAD or ADTA)	I <sup>b</sup>	M
Altitude (radar)		M
Altitude rate		M
Altitude acceleration		
Altitude rate bias	A, B, C, D, E	
Altitude rate reference	A, B, C, D, E	
Altitude rate guidelines	A, B, C, D, E	
Beta (side slip attitude)		K (until $\bar{q} = 20$ )
Body flap position	J	O
Course deviation		L
Delta azimuth	A, B, C, D, E	L
Drag actual	A, B, C, D, E	N
Drag commanded	A, B, C, D, E	
Drag H ratio, residual	H	
Drag reference	A, B, C, D, E	
Drag reference - phugoid damper	A, B, C, D, E	
Drag guidelines	A, B, C, D, E	
Dynamic pressure	A, B, C, D, E	
Equivalent airspeed		N
Elevon position (left, right, inboard, outboard)	J	O
Energy over weight	F, G	
FCS saturation	J	Q + C&W
Flight profile guidelines	A, B, C, D, E, F, G, H	L
Glide slope deviation		L
Ground speed (post WOW)		
Guidance square	A, B, C, D, E	
Heading (magnetic)		L
Hinge moments	J	
Mach/velocity	I <sup>b</sup>	N
N <sub>y</sub> (lateral acceleration)	A, B, C, D, E, F, G	
N <sub>y</sub> trim	A, B, C, D, E, F, G	
Pitch and roll body attitude error with respect to guidance		K
Pitch rates		K
Pitch attitude with respect to LV/LH		K
Pitch jet firings		Q
Primary bearing		L
Primary miles		L
Radar altitude		M
Roll attitude with respect to LV/LH		K

<sup>a</sup>Display key follows table.

<sup>b</sup>Valid after probe deployment.

TABLE 5-I.- ENTRY GN&C FLIGHT MONITORING PARAMETERS - Concluded

Parameter	Availability	
	CRT display <sup>a</sup>	Dedicated display <sup>a</sup>
Roll commanded	A,B,C,D,E	K
Roll command - phugoid bank scale	A,B,C,D,E	
Roll jet firings		Q
Roll rate		K
Roll reference	A,B,C,D,E	
Roll reversal alert	A,B,C,D,E	
Rudder position	J	O
Rudder trim	A,B,C,D,E,F,G	
Secondary bearing		L
Secondary miles		L
Shuttle symbol	A,B,C,D,E,F,G,H	
Speedbrake actual	F,G,J	O
Speedbrake commanded position	F,G	O,P
Tacan azimuth, range	H	
Tacan ratio, residual, absolute, delta	H	
Theta	F,G	
Yaw jet firings		Q
Yaw rates		K (until $\bar{q} = 20$ )

<sup>a</sup>Display key follows table.  
<sup>b</sup>Valid after probe deployment.

<sup>a</sup>Display key

Code	Display
CRT displays	
A	Entry TRAJ 1
B	Entry TRAJ 2
C	Entry TRAJ 3
D	Entry TRAJ 4
E	Entry TRAJ 5
F	VERT SIT 1
G	VERT SIT 2
H	HORIZ SIT
I	OVERRIDE
J	GNC SYS SUMM 1
Dedicated displays and lights	
K	ADI
L	HSI
M	AVVI
N	AMI
O	SPI
P	Sequence event lights
Q	RCS activity lights
R	g-meter

### 5.1.3 Dedicated Displays Data Source Management

The following table shows the management of the data source switches for the AMI, AVVI and the HSI.

TABLE 5-II.- MANAGEMENT OF DATA SOURCE SWITCHES

Event	L (CDR) <sup>a</sup>			R (PLT) <sup>a</sup>		
	HSI mode	HSI source	Air data	HSI mode	HSI source	Air data
EI	Entry	NAV/1	NAV	Entry	NAV/2	NAV
Tacan lockon					TAC 1,2,3; then NAV	
Deploy ADS						R, L, then NAV
TAEM I/F	(Auto modes to TAEM)			(Auto modes to TAEM)		
ADS accepted						
TAEM/ A/L I/F	(Auto modes to A/L)			(Auto modes to A/L)		
Acquire MLS		MLS/1			MLS/2	

<sup>a</sup>CDR on DATA BUS 3, PLT on DATA BUS 4.

#### 5.1.4 Entry CRT Trajectory Displays

Five entry trajectory CRT displays are available for crew monitoring of each of the four velocity phases of entry guidance: temperature control, equilibrium glide, constant drag, and transition. The information presented on range, velocity, energy-to-weight ratio (E/W), altitude rate reference, and drag reference is based on STS-3 data obtained from the Engineering and Development Directorate as the last I-load update to the entry trajectory CRT displays. It is emphasized that this information will be updated in the future as new I-load updates are made to the displays; however, the basic layout of each display should remain the same. The ENTRY TRAJ 1 display(s) used in section 5.1.4.3: Use of ENTRY TRAJ CRT Displays, and section 5.1.4.4: Phugoid Damper, are STS-1 displays. Before a discussion of each display, from ENTRY TRAJ 1 to VERT SIT 2, a section on mission-independent GN&C information common to all the entry trajectory displays will be presented. Each display will be briefly outlined as to the definition of each of the trajectory guidelines, then a section will follow to discuss use of the displays in monitoring the entry.

The ENTRY TRAJ 1 display shown in figure 5-1 is representative of the common GN&C information cited in the preceding paragraph. Additional information on these CRT displays is also contained in SFOM, Volume 14.

##### 5.1.4.1 Entry CRT Parameters

1. The angle of attack currently being obtained from the ADTA SOP is indicated by the ( $\rightarrow$ ) symbol. The angle of attack scale covers  $25^{\circ}$ . An arrow ( $\rightarrow$ ) is used to indicate the 'canned' alpha schedule based on VREL. It is not the alpha modulation command as displayed on the ADI pitch error needle. The actual  $\alpha$  symbol ( $\triangleright$ ) should nominally follow the commanded  $\rightarrow$  symbol except during roll reversals or whenever a drag error exists. The actual alpha symbol will flash if the difference between actual and 'canned'  $\alpha$  exceeds  $2^{\circ}$ . Nominally this will occur during roll reversals as the alpha modulation limits are greater than  $\pm 2^{\circ}$  from the 'canned' alpha schedule.
2. Drag acceleration in  $\text{ft/s}^2$  is scaled from 0 to  $50 \text{ ft/s}^2$  on the scale opposite the actual/'canned' alpha. The ( $\triangleright$ ) symbol is used to indicate the actual drag acceleration from the entry User Parameter Processor (UPP). The reference/commanded drag from entry guidance is indicated by an arrow ( $\rightarrow$ ). For each phase of entry guidance, reference drag is analytically computed from the reference drag velocity profile as a function of range and  $dR/dD$ . The  $dR/dD$  (derivative of range with respect to drag) is analytically determined by entry guidance. Nominally, the steady-state drag and drag command symbols should also overlay. If the steady-state actual drag differs from commanded drag by more than  $3 \text{ ft/s}^2$ , the crew should take control manually to correct actual drag to reference drag. If either drag symbol reaches the off-scale position, it will remain there and flash. The Flight Rules document contains definitions of current takeover criteria.



6. Digital readout of the GNC dynamic pressure ( $\bar{q}$ , lb/ft<sup>2</sup>) input to the Entry TRAJ Display Module from the ADTA SOP is located under DREF.
7. When the Entry TRAJ displays are driven by the BFS; ADI roll, pitch, and yaw errors (R, P, Y) in degrees are displayed pre-BFS-engage only. These BFS software-computed errors are displayed for comparison with the PASS-driven ADI error needles. The signs of the error values are driven U, D, L, or R to indicate fly-to errors; for example, the action to null U (pitch error) is pitch up. On the PASS Entry TRAJ displays, a digital readout of DELAZ (heading error with respect to the HAC tangency point) in degrees is displayed below the readout of  $\bar{q}$ . (Refer to fig. 5-3.) M-I-L simulations using programmed test inputs have shown the need for an accurate and easily interpretable display of delta azimuth to allow crew phasing of delta maneuvers between entry and roll reversals. The azimuth as read from the HSI cannot be read accurately enough to use for entries that include data maneuvers and possible manually initiated roll reversals.
8. Several trim parameters are digitally displayed on the entry displays to aid the crew in assessing FCS performance and to permit proper manual intervention if required.

$N_y$ , lateral acceleration, comes from the Accelerometer Assembly (AA) lateral acceleration selection filter.  $N_y$  readout is in g's with a range of -0.99 to +0.99g.

$N_y$  TRIM, lateral acceleration trim, comes from the Aerojet DAP yaw channel DRT integrator and is also displayed in g's. Range is -0.99 to +0.99g.

AIL, aileron trim displayed in degrees, comes from the ATRIM function of the Aerojet DAP roll channel, which integrates the aileron trim rate to output a limited aileron trim angle command. For the aileron trim, '+' is represented by 'R' (right), '-' is represented by 'L' (left).

RUD, rudder trim displayed in degrees, comes from the RUD-INT function of the Aerojet DAP yaw channel, which integrates the rudder trim rate to output an integral rudder trim. The direction 'R' (right) and 'L' (left) are driven in front of the trim value.

The following entry guidance parameters are displayed as digital readouts in the lower right-hand corner of each display:  $\dot{H}$  REF in ft/s, which is the guidance-computed reference altitude rate; ROLL REF in degrees, the guidance-computed reference body roll angle; and ROLL CMD in degrees, the guidance-commanded body roll angle.

Item Entry 2, Zero  $\dot{H}$  BIAS, allows the crew to reset the guidance-computed altitude rate correction term to zero. The  $\dot{H}$  BIAS term is zeroed upon each execution of ITEM 2. Additional information concerning the  $\dot{H}$  BIAS function is contained in a dedicated section of this discussion. The  $\dot{H}$  BIAS readout in ft/s is the altitude rate feedback correction term calculated by entry guidance.

The dynamic readout of  $\dot{H}$  REF in ft/s is determined analytically by entry guidance dependent upon whether the vehicle is in the temperature/equilibrium, constant drag, or transition phase of entry. This  $\dot{H}$  REF is calculated as a function of the following parameters: atmospheric density scale height, relative velocity, DREF,  $\dot{D}$ REF,  $C_d$ , and  $\dot{C}_d$ . The  $C_d$  and  $\dot{C}_d$  terms are used to adjust  $\dot{H}$  REF for changes in  $C_d$  along the nominal alpha schedule.

ROLL REF is the reference roll angle (degrees) calculated in the (EGROLCMD) function of entry guidance. Roll reference represents the steady-state roll command for maintaining the desired drag profile. The basic difference between the roll reference readout and the roll command readout is that roll reference is the guidance-calculated reference roll angle, which does not consider the navigation-sensed drag and altitude rate to factor drag error and  $\dot{H}$  error into the calculation of a roll angle. The direction ('R' or 'L') precedes the magnitude of roll.

A parameter status indicator (S) immediately follows the ROLL REF readout to indicate when the reference roll angle from guidance has decreased below a calculated value. This value is  $37^\circ$  down to a relative velocity of 9500 ft/s, where the value becomes  $20^\circ$  to 4000 ft/s and below 4000 ft/s the value is  $-5^\circ$ . (Minus  $5^\circ$  is an I-load value input to delete the caution and warning below 4000 ft/s.) If the ROLL REF value from guidance becomes less than the linear stepped roll versus velocity profile calculated in the Entry DIP, the status indicator will show a down arrow ( $\downarrow$ ) and a Class 3 alert will be triggered.

ROLL CMD is the roll angle (degrees) calculated in the (EGROLCMD) function of Entry Guidance, which goes to the Aerojet DAP. Roll command includes compensation for phugoid oscillations to converge to the reference profile. As was inferred in the discussion of ROLL REF, the ROLL CMD calculation includes corrections for drag error and altitude rate error. ROLL CMD is limited to a maximum of  $70^\circ$  if relative velocity is 8000 ft/s or less to avoid excessive altitude rates in the transition phase of guidance. The direction ('R' or 'L') precedes the magnitude of roll.

A dynamic Shuttle symbol ( $\curvearrowright$ ) represents the current Shuttle X-Y position on the displays. The X-position on all the Entry TRAJ displays represents the current navigation determined range (n. mi.) to WP2 via WP1. This is the same range used by guidance. The Y-position on Entry TRAJ 1, 2, and 3 represents the current vehicle ground relative velocity (ft/s) from navigation. The Y-position of the Shuttle symbol on Entry TRAJ 4 and 5 represents energy over weight (E/W). The Y-axis (velocity or E/W) is a linear scale. The X-axis (range) is a quadratic scale of the form  $C + C1 * R + C2 * R^2$ , where the C's are I-loaded scaling constants and R is the range to WP2.

The Shuttle symbol is replaced every 28.8 seconds on TRAJ 1 and 2 and every 15.36 seconds on TRAJ 3, 4, and 5 by a Shuttle trailer symbol ( $\nabla$ ). A limit of six is set on these trailers. The intent is to give the crew an indication of the trend of the Shuttle trajectory over time against the background lines. The Shuttle symbol will flash to indicate a roll reversal to the crew. Once the limit for the number of trailers has been reached, each succeeding computation of a new trailer causes deletion of the oldest trailer.

A dynamic guidance symbol ( $\square$ ) is plotted on each display to give the crew an indication of a projected range error that is caused by drag being off the drag reference. The X-position of the guidance symbol is calculated in the Entry DIP and is based on a reference range. Reference range equals  $R - DRDD (D - DREF)$ . R is the range to WP2 from navigation (Entry UPP), DRDD is the negative derivative of range WRT drag from entry guidance, and D is drag acceleration from the Entry UPP. DREF is reference drag from guidance. The DRDD is in  $n. mi./ft/s^2$  and is multiplied times drag error in  $ft/s^2$ , so the result is a delta range error that is subtracted from the range to WP2.

A drag error will show on the display as a shift in the guidance symbol. If drag trends lower than drag reference, the guidance symbol will move in front of the Shuttle symbol indicating this as a range difference between the current vehicle position and the guidance symbol range value. Flying a lower drag will result in an overshoot of the target and a requirement for a later high-energy trajectory. As stated earlier, the value for  $|D - DREF|$  at which manual intervention would be required is specified in the Flight Rules. If drag trends higher than drag reference, the guidance symbol will move behind the Shuttle symbol. The Y-position of the guidance symbol is the same as the Y-position of the Shuttle symbol; that is, relative velocity on the first three TRAJ displays, and E/W on the last two TRAJ displays. By observing the movement of the guidance symbol with respect to the Shuttle symbol, the crew can assess how well the vehicle is flying the guidance reference profile (i.e., drag is converging to drag reference). The crew can verify the presence of range error due to drag error by observing the position of the actual drag symbol with respect to the drag command arrow on the drag scale at the left-hand side of the TRAJ display.

On every pass, the guidance symbol X-position is saved for use in computing the guidance trailer symbol ( $\cdot$ ) location. The guidance trailer Y-position is the same as the Shuttle symbol Y-position. The update frequency of these guidance trailers is the same as that for the Shuttle trailers.

The logic for determining when a new display should be called is as follows: The logic checks to see if the Y-position of the Shuttle symbol is below the X-axis of the current graph; if it is, the next display in the OPS sequence is called. The Entry DIP also contains logic to determine the current guidance phase and to call up the appropriate TRAJ display for monitoring guidance. This function ensures compatibility between the TRAJ displays and guidance in the event guidance transits early/late between phases or skips a phase to solve the ranging problem.

#### 5.1.4.2 Entry TRAJ 1 to 5 Background Lines

As discussed in a previous section, the fixed backgrounds of these TRAJ displays are configured for five subphases of entry, are mission dependent, and are designed to allow the crew to monitor the vehicle's progression compared to planned entry profiles. The background information presented as a series of solid and dashed lines is arrived at by mapping the drag-velocity plot into a range-velocity (E/W for TRAJ 4 and 5) plot.



The Entry TRAJ 1 display comes up automatically upon PRO to MM 304 and provides vehicle ranging and entry guidance information to the crew during the thermal region (usually 24,500 to 17,000 ft/s). The range scale axis monitors the vehicle's position usually between 3800 and 800 n. mi. The central plot of this display contains two types of lines: (1) solid lines to represent velocity versus range guidelines, and (2) dashed lines to represent lines of constant drag acceleration. All the succeeding displays are similar in layout.

The five solid guidelines on this display represent (from left to right):

- o First - A thermal boundary representing drag versus velocity values mapped into a velocity versus range plane that defines limiting temperatures (maximum allowable one mission temperature) of the forward chine (CP6 = 2700° F), and elevons (CP4 = 2600° F), between 24,000 ft/s relative velocity and the relative velocity marking the end of thermal region (usually  $\geq$  17,000 ft/s). The thermal line assumes an alpha of 40° F with trimmed elevons and body flap.
- o Second - A guided solution trajectory line halfway between the thermal limit line and the nominal trajectory line.
- o Third - This guideline is a guided solution targeted to a drag value of 33 ft/s<sup>2</sup> and is called the 'nominal' line.
- o Fourth - This line is also a guided solution targeted to a drag of 33 ft/s<sup>2</sup> and is called the ' $\emptyset = 37^\circ$ ' line although bank is not a constant 37°.
- o Fifth - This line is a wings-level, full-lift equilibrium glide boundary and is not a guided solution. Each data point is determined from a distinct guidance solution. The locus of these points is the boundary line. On this boundary line, alpha is 40°. If the shuttle symbol drops below this line, the pilot has no absolute means of verifying that the target can be reached. If drag does not continue to diverge from drag reference, the target should be achievable.

The TRAJ 1 display contains six constant drag (dashed) lines. The number of linear segments of lines (solid and dashed) that can be used on any display is a software constraint (I-load limit). The dashed lines show the drag acceleration required at different combinations of range and relative velocity to acquire a flight profile that will have the correct trajectory shaping and the targeted interface conditions. The solid and dashed lines are mapped into the V-R-D plots using current guidance I-load information from MPAD and off-line computer analysis techniques.

The references to a 'guided solution' profile reflect the E&D computer analysis that used guidance I-loads and equations to obtain range, velocity, and drag data that were mapped as straight-line segments into the display. These guide lines represent what the vehicle would fly using the guidance equations. The  $\emptyset = 37^\circ$  guide line plotted in the drag velocity plane for comparison with the drag versus velocity points corresponding to an actual

$\theta = 37^\circ$  is shown in figure 5-2. Off-line analyses have determined that in the presence of worst-case L/D (minus 3 sigma low)  $\theta = 37^\circ$  is the minimum bank required for the Orbiter to remain within the guidance azimuth dead-band and solve the ranging problem. At slower velocities, below 9500 ft/s, this minimum bank angle is  $20^\circ$ .

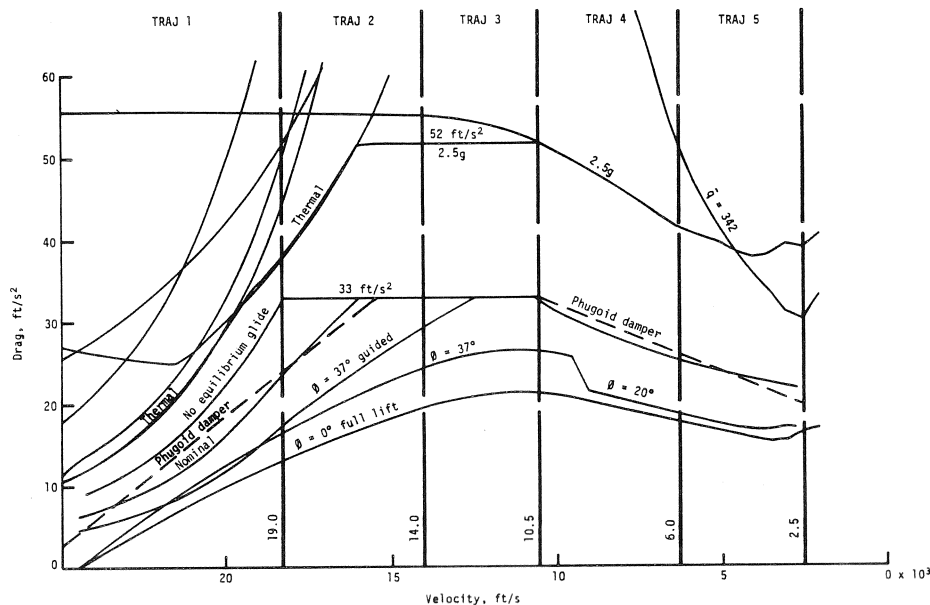

Figure 5-2.- Typical drag versus velocity plot (Cycle 2).

The negative numbers located at the bottom of the display (applies to all TRAJ displays) correspond to the  $\dot{H}$  reference values on the nominal trajectory. As an example, with the Shuttle symbol vertically above the -60 ft/s value on TRAJ 1 and on the 'nominal' line with drag on drag reference, the  $\dot{H}$  should be approximately -60 ft/s. Because the number of values allocated per display for  $\dot{H}$  is also software limited (and to prevent a cluttered display), only a few numbers are used at the bottom of the display as an approximate or 'ballpark' guide for  $\dot{H}$  of the Shuttle as it progresses down the display. The maximum error in navigated displayed altitude rate expected during entry is 43 ft/s. The same source of information also estimates maximum entry range display errors of 8.3 n. mi. and maximum relative velocity display errors of 40 ft/s.

These errors will be less obvious on the earlier TRAJ displays (1 and 2) than they will on the later TRAJ displays (4 and 5) because of the scaling of the range axis. For example, TRAJ 1 covers approximately 2700 n. mi. and TRAJ 4 covers approximately 335 n. mi. in the same scale length. The 8.3-n. mi. range error on TRAJ 1 would be approximately one-fourth of the Shuttle symbol in size, but by TRAJ 4, this error would be two times the

Shuttle symbol size in the range axis and one-half the Shuttle symbol size in the velocity (vertical) direction.

The quadratic scaling of the range axis will also be evident in the relative speed at which the Shuttle symbol traverses the displays. The progress of the Shuttle will appear slower at the top right corner of the TRAJ 1 display because the scale has more miles in the right-hand two-thirds of the scale when compared to the first one-third of the scale length. As the Shuttle moves down, paralleling the guidelines, the range scale covers a decreasing number of miles.

The Entry TRAJ 2 display provides vehicle ranging and entry guidance monitoring information to the crew during the middle velocity (usually 17,000 to 14,000 ft/s) portion of entry. The TRAJ 2 range scale usually covers 1300 to 425 n. mi. This display (fig. 5-3) contains four solid guidelines that are described as follows (from left to right).

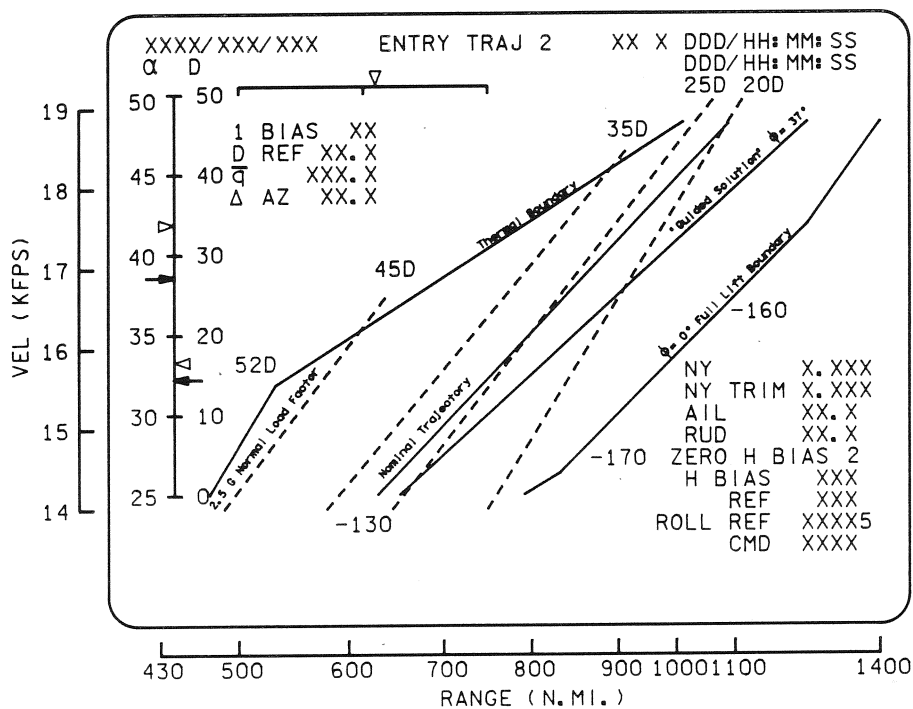

Figure 5-3.- Entry trajectory 2.

- 0 First - A continuation of the thermal boundary as described on TRAJ 1 until the drag acceleration reaches approximately 52 ft/s<sup>2</sup>. This is the limiting amount of drag that autoguidance can fly in the constant drag phase of guidance and still meet transition phase criteria at 10,500 ft/s. A drag acceleration of approximately 52 ft/s<sup>2</sup> represents a 2.5g boundary at 10,500 ft/s.

- o Second - A continuation of the nominal (third) guideline on Entry TRAJ 1 - targeted to a constant drag acceleration value of 33 ft/s<sup>2</sup>.
- o Third - This line is the extension of the  $\theta = 37^\circ$  line discussed on TRAJ 1. This line converges toward the second guideline at the bottom of this display.
- o Fourth - This line is the extension of the full-lift equilibrium glide boundary discussed on TRAJ 1.

Entry TRAJ 2 contains four dashed drag lines that represent increased magnitudes of constant drag over those seen on TRAJ 1. As the vehicle moves closer to the constant drag phase (33 ft/s<sup>2</sup>), these lines of drag acceleration become parallel to the solid lines.

Entry TRAJ 3 provides trajectory and guidance monitoring information to the crew between approximately 14,000 and approximately 10,500 ft/s. This region represents the majority of the constant drag phase of guidance. The range axis usually covers 800 to 315 n. mi. This display (fig. 5-4) contains three solid lines described as follows (from left to right).

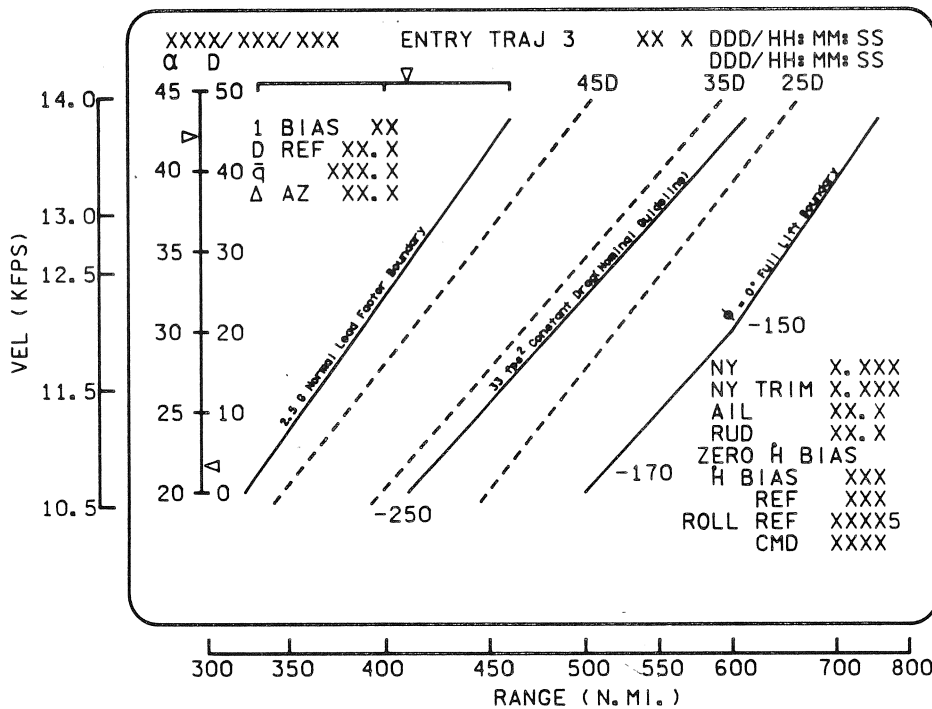

Figure 5-4.- Entry trajectory 3 display (PFS).

- o First - Extension of the zero sigma, 2.5g normal load factor boundary from the TRAJ 2 display.

- o Second - A guideline of range/velocity combinations for a constant drag of 33 ft/s<sup>2</sup>. During constant drag for a nominal trajectory, the vehicle will track down this line.
- o Third - Extension of the full-lift equilibrium glide boundary from TRAJ 2.

The three dashed drag lines indicate parallel lines of constant drag acceleration, which should serve as a reference for the crew to monitor as the vehicle progresses down the 33 ft/s<sup>2</sup> line. The  $\dot{H}$  numbers are determined as discussed on TRAJ 1 and serve as approximate monitoring guides. TRAJ 3 is the last display with relative velocity on the vertical axis. The two subsequent TRAJ displays are configured with E/W on the vertical axis.

The transition phase of guidance usually begins at 10,500 ft/s and Entry TRAJ 4 is the first of two trajectory displays that provide vehicle ranging and guidance monitoring information to the crew in the transition region. Instead of velocity on the vertical axis, energy/weight in units of feet is plotted. The velocity region covered on this display is from 10,500 down to approximately 6000 ft/s. The range scale is approximately 480 on the right to 145 n. mi. on the left of the display. The reason energy was selected as the independent variable during transition is because the flight-path angle magnitude increases and the  $\sin \gamma$  term can no longer be considered negligible in the ranging equation. At the higher velocities, the approximation of  $\cos \gamma = 1$  and  $\sin \gamma = 0$  can be used; but, because  $\gamma$  is increasing during transition, it is mathematically easier to use energy as the independent variable. This display (fig. 5-5) contains three solid lines described as follows (from left to right):

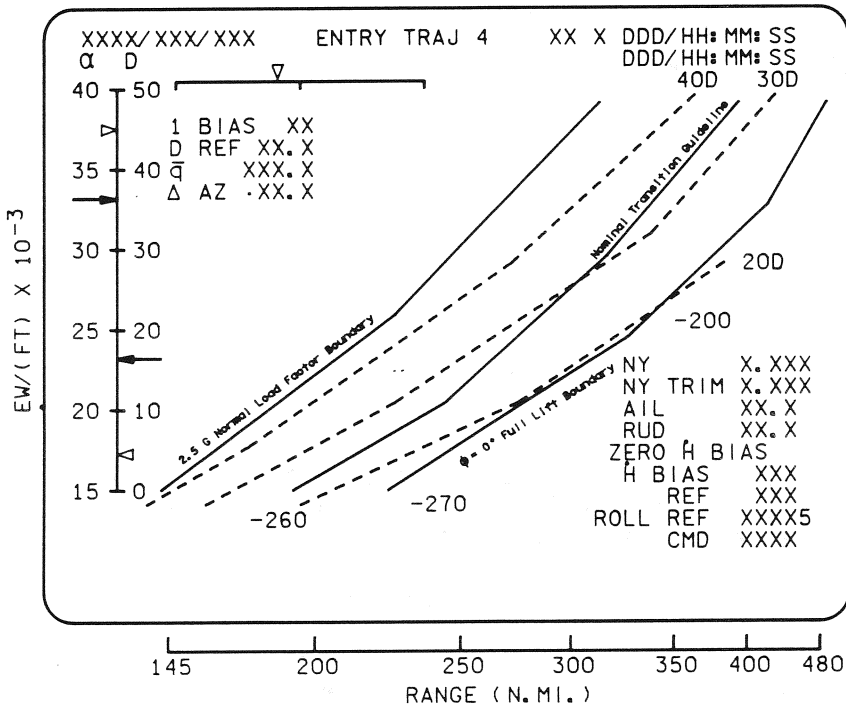

Figure 5-5.- Entry trajectory 4 display (PFS).

- o First - Extension of the zero sigma, 2.5g normal load factor boundary from the TRAJ 3 display
- o Second - A nominal transition profile guideline
- o Third - Extension of the full-lift equilibrium glide boundary from TRAJ 3

The Entry TRAJ 5 display covers the final portion of the transition phase of guidance down to TAEM interface where the vertical situation displays come up. The vertical axis is in E/W as is the TRAJ 4 display. This corresponds to the velocity region from 6000 to 2500 ft/s at TAEM interface. The range axis is scaled from approximately 220 to 55 n. mi. This display (fig. 5-6) contains four solid lines described as follows (from left to right).

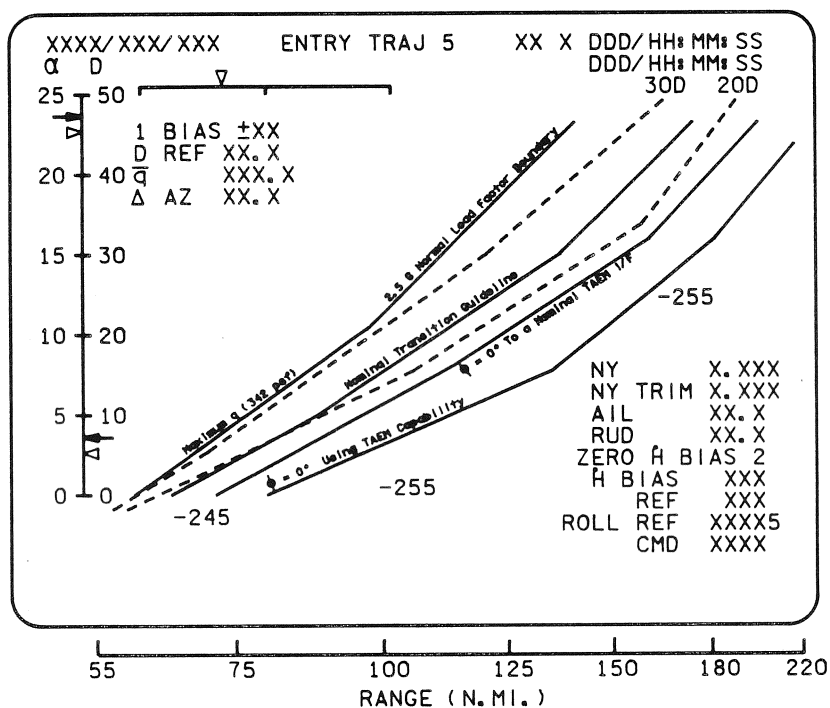

Figure 5-6.- Entry trajectory 5 display (PFS).

- o First - Represents an extension of the zero sigma, 2.5g normal load factor boundary down to a velocity of approximately 5000 ft/s where the line becomes a max  $\bar{q}$  boundary.
- o Second - Extension of the nominal transition profile guideline from the TRAJ 4 display.
- o Third - Represents the extension of the full-lift equilibrium glide boundary, which is targeted to the nominal TAEM interface.

- o Fourth - Also a wings-level line that represents maximum L/D, no wind. This line is not anchored at the nominal TAEM interface. This line represents the vehicle's TAEM ranging capability. If the symbol is below the third guideline, then to make the runway, some TAEM footprint will have to be used.

Two dashed lines of constant drag acceleration are included on this display for crew reference. Further information on the use of these drag lines will be presented later.

This section has presented a summary of the information available to the crew for monitoring the entry portion of the mission from PRO to MM 304 to TAEM interface. In the next section, entry monitoring techniques using the TRAJ 1 display as an illustrative example will be discussed. The vertical situation displays and their use in the TAEM region will be discussed in a subsequent section.

#### 5.1.4.3 Use of Entry TRAJ CRT Displays

In this section, figure 5-7 (Entry TRAJ 1) will be used to illustrate how the information presented on the Entry TRAJ displays can be used for auto-guidance monitoring. Because the five TRAJ displays are basically the same layout and contain the same digital readout information, the monitoring task will be similar on the subsequent TRAJ displays.

The health of the autoguided entry can be considered a function of (1) how well autoguidance is performing in issuing commands to keep drag on drag reference, (2) how well flight control executes the guidance commands to keep drag on drag reference, (3) whether the aerodynamics are within nominal limits so that the vehicle can make the runway, and (4) whether the navigation is accurate enough to support guidance and control.

Entry manual takeover rules/criteria have been proposed (OFT Flight Rules, Final, 03/06/81, Section 4) to allow onboard/MCC decisions in takeover cases. The interpretation of the information on the TRAJ displays will aid the crew in their onboard assessment of when to intervene manually with autoguidance engaged. Nominally at PRO to MM 304, the Entry TRAJ 1 CRT display will come up. This event occurs at EI minus 5 minutes per the Entry Checklist. The Entry Checklist also contains the display to onboard CRT assignments for the nominal entry. At the PRO to MM 304, closed-loop guidance has not yet been activated and the vehicle's position on the CRT is still off scale on the range axis. The range to runway threshold at this point is approximately 5739 n. mi. and the scale limits on the TRAJ 1 display are 3800 n. mi. range and 24,500 ft/s velocity. The Shuttle symbol will be plotted in the upper right corner of the display until the range and velocity can be plotted as an X-Y location. Because this is pre-guidance initiation, the crew can verify that the guidance parameters  $\dot{H}$  BIAS,  $\dot{H}$  REF, and ROLL CMD are zero. ROLL REF will be  $90^\circ$ . The  $\bar{q}$  in the upper left corner should also be zero because the vehicle has not yet started picking up dynamic pressure. The Item Entries (1 and 2) will be discussed separately, as will alpha modulation. The alpha command should be  $40^\circ$ . Values of zero will be displayed in the AIL and RUD slots until the surfaces become active. The NY slot will indicate the lateral acceleration as a g readout. At a  $\bar{q} = 0.5 \text{ lb/ft}^2$ , the auto elevon trim

is active; at  $\bar{q} = 2.0 \text{ lb/ft}^2$ , the elevons and ailerons are active for control (CRT readout). At this point, the Shuttle symbol should now be inside the range axis of TRAJ 1 so that its position is plotted. At  $\bar{q} = 20 \text{ lb/ft}^2$ , the NY trim is active. Procedures for use in monitoring flight control will be discussed in a separate section of this handbook.

The next major event to monitor on the TRAJ 1 display is the initiation of closed-loop guidance, which should nominally occur at a drag acceleration of  $4 \text{ ft/s}^2$ . The crew can note drag by the ( $\Delta$ ) symbol on the drag scale of the CRT. The crew should also see the guidance symbol ( $\square$ ) appear on the display at this time. The guidance CRT parameters discussed earlier will also be active. As the guidance and Shuttle symbols move down the display on the nominal guideline, the trailers will indicate the trend of the trajectory against the background lines. The trend of these trailers should indicate convergence of the guidance symbol and the Shuttle symbol. With the Shuttle symbol on the nominal trajectory line, the DREF interpolated from the dashed lines should correspond to the current commanded DREF and DACT (see fig. 5-7).

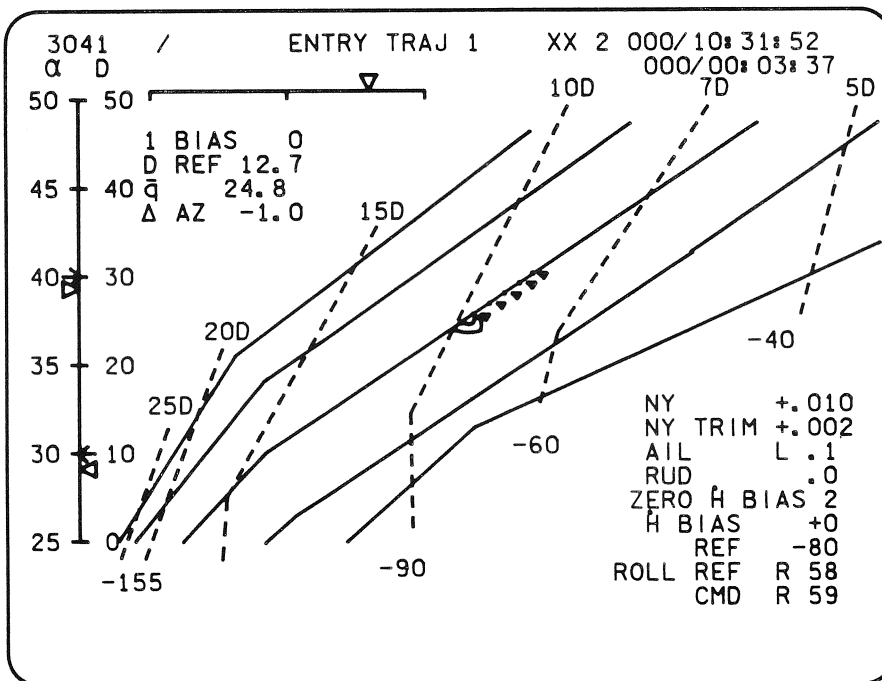

Figure 5-7.- Entry trajectory 1 (typical initial display).

In the illustration, the Shuttle and guidance symbols are overlaid on the  $DREF = 10 \text{ ft/s}^2$  dashed line and the drag command and drag actual symbol reflect this location. The background information shows where the vehicle should be; the drag and drag reference data show where the vehicle actually is. The  $H \text{ REF}$  on the digital readout should be approximately  $-80 \text{ ft/s}$  and increasing. The  $\dot{H}$  at the bottom of the display,  $\dot{H} \text{ REF}$ , and  $\dot{H} \text{ NAV}$  should compare within the  $+3$ -sigma navigation display accuracy limits discussed earlier. Roll command should compare with the bank angle on the ADI.



An approximate number for roll here is R60°. The value for roll reference should also be close to this value, assuming drag errors and  $\dot{H}$  errors are small. Roll reference is the steady-state value of roll command. The roll reference gives the crew an indication of the angle of roll that guidance needs based on reference drag and reference  $\dot{H}$  without errors. The use of roll reference as an indicator of ranging capability available will be discussed later. The crew can use the same kind of checks as discussed previously on each TRAJ display because the same information is available on the subsequent TRAJ displays.

The Flight Rules criterion for CSS takeover for drag error is  $|D - DCMD| > 3 \text{ ft/s}^2$ . There are several indications of an off-nominal drag situation presented on the TRAJ display. Figure 5-8 illustrates how the TRAJ 1 display might look if, while in CSS mode, the drag were to become much larger than drag reference. The ( $\triangleleft$ ) is above the (+) on the drag scale and the guidance square is behind the Shuttle. If this error were allowed to continue, the Shuttle trailers would indicate the vehicle dropping below the nominal guideline toward the 0° bank boundary; that is, the drag error needs to be corrected before the target moves outside the footprint. In this situation, a decrease in bank angle would cause drag to decrease toward drag reference. It is important to keep in mind the roll phugoid sensitivity of the vehicle. As roll changes, so does altitude acceleration. For example, as an approximation, 1° of roll change produces  $0.7 \text{ ft/s}^2 \dot{H}$ . As  $|\text{roll error}|$  increases,  $|\dot{H}|$  increases, which allows a phugoid to develop more quickly.

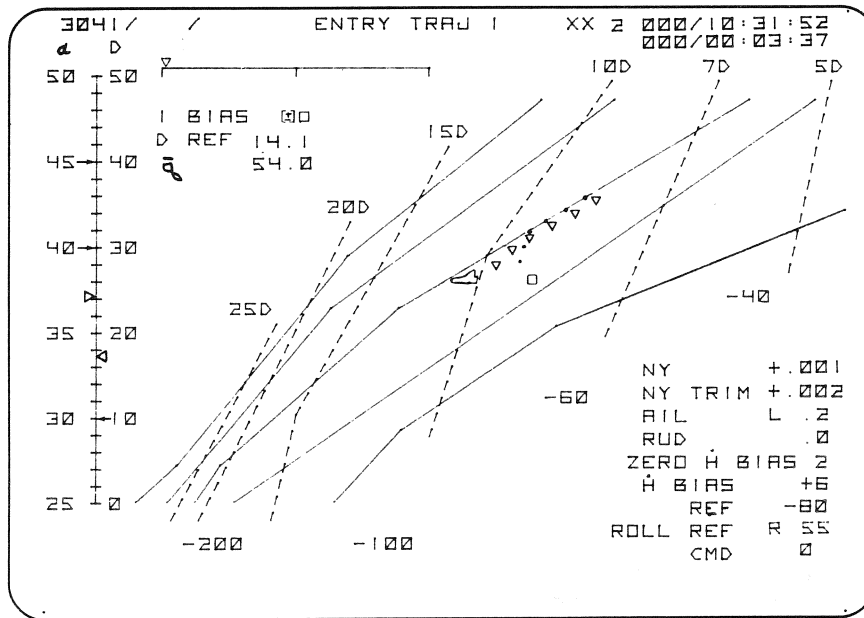

Figure 5-8.- Entry trajectory 1 (drag greater than drag reference).

In the CSS case illustrating the TRAJ 1 display where drag has decreased with respect to drag reference, the indication would be as shown on figure

5-9. The (<) is below the (+) on the drag scale and the guidance square is ahead of the Shuttle symbol. If this error were allowed to continue, the Shuttle trailers would indicate the vehicle moving to the left toward the leftmost constraint boundary. In a manner similar to that described for the high drag situation, an increase in bank in this case would converge drag on drag reference.

If both P and R/Y are in CSS, the task of maintaining drag on drag reference becomes more difficult because of  $\alpha - \theta$  interaction. Oscillations in alpha cause drag transients, which cause roll oscillations. A  $1^\circ$  change in alpha produces a  $1.7\text{-ft/s}^2$  drag change, which is equal to an  $8^\circ$  roll command change.

The third factor mentioned as having an effect on the monitoring of autoguidance was aerodynamic uncertainty. Because this vehicle uses drag modulation for ranging, L/D control is a major factor in the ranging problem. MPAD studies have indicated that autoguidance has the capability to handle L/D dispersions as high as 50 percent high L/D and that with 25 percent low L/D, the autoguidance system can still make a nominal TAEM interface.

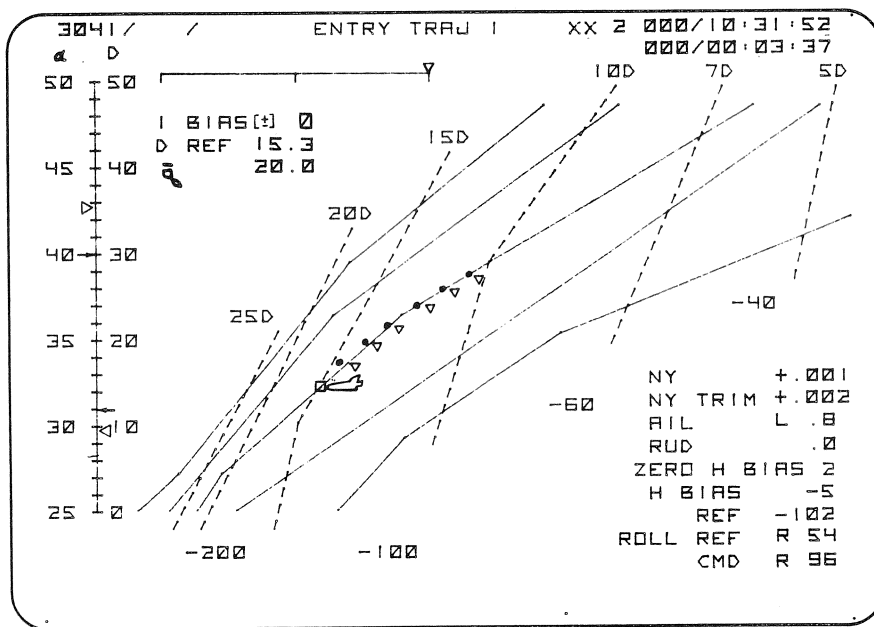

Figure 5-9.- Entry trajectory 1 (drag decreased relative to drag reference).

No specific crew procedures have been developed to date for the high L/D case because of autoguidance capability in handling this type of L/D dispersion.

Although off-line runs indicate the autoguidance can make TAEM interface with 25 percent low L/D, at variations in L/D beyond this value, the miss

distance at TAEM interface increases rapidly. One of the problems in monitoring the guidance for L/D variations is the timely and correct interpretation of clues to a problem with L/D. Low L/D can be detected by the initial entry pitch maneuver and by the trend of ROLL REF as noted on the TRAJ displays.

With an extremely low L/D, the entry guidance will overshoot the initial drag reference (at guidance initiate). The alpha modulation will react to this by pitching down. As was mentioned before, because a low L/D is not the only cause for a pitchdown maneuver, interpretation of the problem cannot be based on just this one clue. Additionally, ROLL REF will show a smaller roll angle than nominally expected. The ROLL REF caution and warning will be set before saturation of roll and angle of attack. Takeover criteria for this situation are discussed in the Flight Rules document. The sequence of events in the extremely low L/D case would be (1) Pitch down to  $37^{\circ}$  alpha at guidance initiate, (2) ROLL REF C&W, either ROLL REF  $< 37^{\circ}$  or ROLL REF  $< 20^{\circ}$ , (3) ROLL REF =  $0^{\circ}$  (saturation of steady-state roll), (4) ROLL CMD =  $0^{\circ}$ , and (5) saturation of alpha at the lower limit.

#### 5.1.4.4 Phugoid Damper

The phugoid damper was incorporated as part of the TRAJ displays to give the crew a 'fly-to' bank angle calculated to avoid phugoid instability and help the crew to control the entry drag/range problem while flying in the CSS mode.

The logic for the phugoid damper is contained in the Entry Display Interface Processor (DIP). A drag versus velocity profile is defined by three linear segmented lines; the associated values that define this profile are I-loaded constants (fig. 5-10).

The D-BASE term is a function of relative velocity and is determined by one of the three linear equations in figure 5-10. The D-BASE term is used in the determination of the DREF value digitally displayed under the Bias Item 1 on the TRAJ displays. With a bias of zero, the D-BASE is the DREF for the phugoid damper, where DREF is defined as  $DREF = D-BASE + Bias-Item$ .

The bias item allows shifting the drag value obtained from the linear drag versus velocity profile. The item entry slot will accept item entries between +10 and -10. The item entry slot will always reflect any current bias value. This bias is initialized to zero at the beginning of MM 304. The phugoid bank scale has a range of  $+20^{\circ}$  on all the TRAJ displays. The phugoid scale and Shuttle symbol will flash to notify the crew of a roll reversal. In addition, when the triangle symbol ( $\nabla$ ) on the phugoid scale reaches the off-scale position, it will remain there and flash.

To determine when to signal a roll reversal, the phugoid bank logic uses DELAZ, the heading error with respect to the HAC tangency point, from navigation (Entry UPP) and YL, the maximum heading error absolute value, from entry guidance. When the DELAZ times the direction of roll becomes equal to or greater than the YL, the logic changes the sign in the roll direction.

Because the YL is a guidance-calculated parameter, alternate techniques may have to be used to determine the appropriate time to make a roll reversal in the remote situation with no guidance at all.

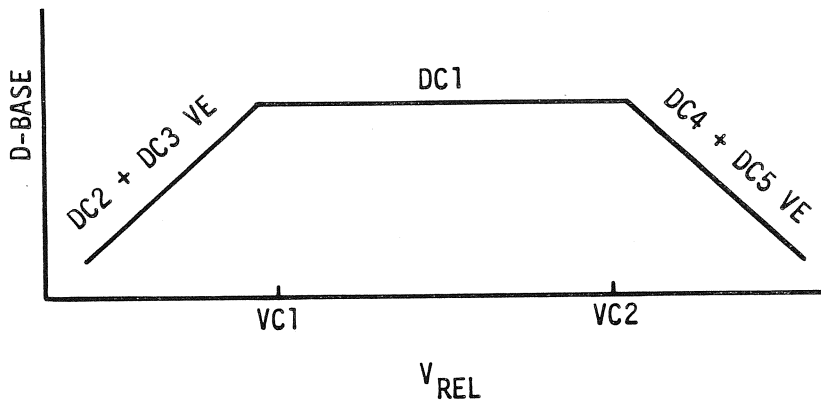

Figure 5-10.- Phugoid damper plot.

#### 5.1.4.5 Use of Phugoid Damper

Although CSS entries are not currently planned and the probability of having to perform one may be low, an emergency deorbit using the phugoid damper could result in the event of certain severe combinations of malfunctions.

At a relative velocity of 26,000 ft/s and in MM 304, the logic for the phugoid damper is initiated. The crew can detect this by the appearance of a roll error bug command on the phugoid bank scale (TRAJ 1). The Item 1 Bias slot will indicate a zero and the DREF digital readout will begin displaying the DREF computed from the linear drag versus velocity segments described earlier.

The procedure for using the phugoid damper with initiation at 26,000 ft/s is to follow the commands after a drag = 4 ft/s<sup>2</sup> (CRT and AMI) has been attained. Before a drag of 4 ft/s<sup>2</sup>, preentry guidance, the bank will be 0° for the nominal deorbit case or an angle determined from the prebank tables based on residual  $\Delta V$  caused by deorbit underburn dispersions. The problem inherent in flying a bank command before a drag of 4 ft/s<sup>2</sup> is that a prebank may be flown unnecessarily and cause detrimental effects to the trajectory.

Preliminary work done in M-I-L simulators indicates that a scan of the dedicated instruments to include  $\dot{H}$  and  $\ddot{H}$  on the AVVI helps in the phugoid control task. Below an altitude of 100,000 feet, the  $\dot{H}$  should be held within -486 ft/s on the AVVI for venting constraints.  $\dot{H}$  can be used to control the  $\ddot{H}$  trend by controlling bank as required to cause  $\ddot{H}$  to be zero at the desired  $\dot{H}$ . As described earlier, the phugoid damper uses navigation and guidance information to determine when a roll reversal is needed and implements a flashing phugoid damper scale and Shuttle symbol as an attention-getting device for the crew. Because the YL deadband comes

from guidance, it is a possible candidate for failure, although considered highly unlikely.

Because the autoguidance landing site coordinates would not be consistent with an emergency deorbit at an arbitrary location and since it is not presently possible to update the landing site coordinates in real time, the procedure to use the phugoid damper following an emergency deorbit would be to fly the phugoid damper (zero bias) commands in the CSS mode.

As discussed previously, the phugoid damper logic was originally set up with Edwards as the target. The azimuth error obtained from navigation is checked against the deadband YL from entry guidance. In the event the phugoid damper is used for an emergency deorbit, a problem exists in the roll reversal notification logic. The roll error bug may peg at the end of the phugoid bank scale and flash indicating the need for a bank reversal. No totally acceptable solution has been found for this very remote problem.

#### 5.1.4.6 $\dot{H}$ Bias Readout

As discussed in a previous section, the  $\dot{H}$  bias term displayed digitally on the Entry TRAJ displays is an  $\dot{H}$  feedback correction term calculated by guidance. Before the addition of alpha modulation to entry guidance, the only means of controlling drag was by roll command to try to keep the Orbiter on a guidance-calculated reference D-V profile. A source of error that can cause a bias in the actual drag flown with respect to the reference drag is an IMU platform misalignment. In the presence of such an IMU error, the  $\dot{H}$  obtained from navigation will cause a stand-off drag error from the DREF versus velocity profile. In the event of a platform misalignment, a drag error will be introduced that will build over time depending on the accuracy of navigation. Because of the possibility of large altitude rate errors in the NAV  $\dot{H}$ , a correction to the altitude rate reference is made based on a feedback in the (D - DREF) error. The method used to correct for such an  $\dot{H}$  error was to subtract its effect over time. The following term was introduced into the (L/D)<sub>CMD</sub> equation:  $\int (D - DREF) dt$ . The (L/D)<sub>CMD</sub> equation that includes this correction term is of the form:

$$(L/D)_{CMD} = (L/D)_{REF} + C16 (D - DREF) + C17 (\dot{H}_{REF} + \Delta\dot{H} - \dot{H})$$

where the  $\Delta\dot{H}$  term is the correction factor based on drag error converted into a  $\Delta\dot{H}$  value. At a relative velocity below 23,000 ft/s, a limited drag error is calculated based on an I-loaded limit that is the maximum delta drag for  $\dot{H}$  feedback. (Minus 2 ft/s<sup>2</sup> <  $\Delta D$  < +2 ft/s<sup>2</sup>.) Because the displayed  $\dot{H}$  bias on the CRT is always an integer value, the crew will not see an  $\dot{H}$  bias value until it has exceeded 1 ft/s.

After the  $\dot{H}$  bias feedback becomes active, guidance makes the following logical checks to see (1) if a roll reversal has occurred, (2) if drag error is converging, or (3) if roll command is saturated. If any of these is true, the  $\dot{H}$  feedback is held constant. Autoguidance continually accounts for the  $\dot{H}$  bias correction factor; however, this factor can also be used to account for the (D - DREF) error introduced by flying in the CSS mode. If in the CSS mode the crew were using the TRAJ display (as

opposed to error needles), the vehicle would probably be flying a drag-velocity profile different from the profile that autoguidance would fly. Drag errors would be accumulated and, because autoguidance is not engaged, these errors would not be accounted for. The H bias readout gives the crew an indication of what these errors are and the Item 2 entry allows the crew to set this error to zero before reengaging autoguidance.

The recommended procedure for using H bias is that, if H bias readout exceeds 30 ft/s while in CSS mode, H bias should be zeroed before returning to AUTO mode. An H bias of approximately 30 ft/s will start causing trajectory effects; this is why it is recommended to zero H bias after flying in CSS and before reengaging auto. The problem associated with reengaging autoguidance with an H bias accumulation greater than 30 ft/s is that autoguidance would offset the trajectory to account for a presumed navigation error when the drag error was caused by the CSS mode.

Unless alpha is saturated, the H bias is not significant ( $H \text{ bias} < 30 \text{ ft/s}$ ). Under certain circumstances, an H bias buildup can be used to signal that a navigation error exists. If the drag is on drag reference and alpha is saturated and a large H bias is noted, a possible cause could be a navigation error. If drag is not on drag reference and alpha is saturated with a large H bias flying CSS, this indicates that the vehicle has not been accurately tracking the trajectory and the Item 2 should be used to zero the H bias ( $> 30 \text{ ft/s}$ ) before reengaging autoguidance. As a rule of thumb, a drag bias of  $1 \text{ ft/s}^2$  is equal to approximately  $40 \text{ ft/s}$  H bias. I-loads limit H bias feedback to be between  $-150$  and  $+150 \text{ ft/s}$ .

#### 5.1.4.7 Vertical Situation Displays

Two Vertical Situation Displays (VSD's) are used to monitor the guidance function in the TAEM region. The VERT SIT 1 display comes up automatically at TAEM interface, when the crew performs an OPS 305 PRO or an OPS 602 PRO; it also comes up automatically at the end of the Z-translation maneuver in the case of a Return to Landing Site (RTLS). This discussion will not address the use of these displays as applied to an RTLS and the reader is referred to the Abort Procedures Handbook. The information contained on the VERT SIT 1 display for crew monitoring is shown in figure 5-11.



The upper line represents an altitude versus range plot to reflect the  $\bar{q}$  limits in autoguidance. The altitude versus range plot was generated by flying wings level at max  $\bar{q}$ . This guideline is based on a speed brake deflection of 65° until Mach 0.90 with full open speed brake (98.6°) below Mach 0.90. The guideline is anchored on VERT SIT 2 at an altitude of 11,000 feet.

4. The middle line represents the nominal altitude versus range profile for end of mission TAEM.
5. The lower guideline represents an altitude versus range plot generated by flying wings level at  $\bar{q}$  min. The speed brake is at 65 percent until Mach 0.90. Below Mach 0.90, the speed brake is set to the FCS minimum value (15 percent until Mach 0.6, then 5 percent below Mach 0.6). The KEAS value corresponds to maximum subsonic L/D, therefore the guideline is not a true maximum L/D line but an approximation. At the peak of the L/D curve the Equivalent Airspeed (EAS) can vary.
6. Each VERT SIT display contains a pitch, or  $\theta$  tape, and an E/W scale on the right-hand side of the display to present E/W and vehicle  $\theta$  limit information to the crew. The intent of this  $\theta$  tape is to provide pitch information to the crew in the event of Air Data System dilemma/failure.

The purpose of the theta limits is to give the crew an indication of approach to vehicle structural and performance limits so that crew takeover may be accomplished if needed. The theta limits were determined by an Engineering & Development (E&D) off-line program that flew a  $\bar{q}$  profile with no errors (i.e., wind, aerovariations). Variations in speed brake deflection, bank angle, and weight were used to define their effects on the profiles. The theta versus VREL data are plotted and a curve fit made to arrive at a set of constants (I-loads) that are used in the VERT SIT DIP to define the  $\phi$  nose-high and  $\phi$  nose-low ticks. The constants (I-loads) that determine the weighting factor associated with bank, SB, and weight, vary, depending on whether  $VREL \leq 900$  ft/s,  $900$  ft/s  $< VREL \leq 1,000$  ft/s,  $1,000$  ft/s  $< VREL \leq 1700$  ft/s, or  $VREL > 1700$  ft/s. These velocity region breakpoints were also determined as part of the E&D off-line analysis. The equation for the nose-high limit is based on no wind, nominal aero, wings-level equilibrium flight at a minimum  $\bar{q}$ . The nose-high tickmark on the theta tape holds approximately maximum L/D. The equation for the theta nose low limit is based on the same no error conditions at the maximum  $\bar{q}$  autoguidance will fly. If the  $\theta$  bug is outside either limit, the procedure is to take CSS (P) and limit pitch CMD to the tickmark. This assumes the limiting occurs only where NAVDAD  $\bar{q}$  accuracy is not acceptable.

Because of a decreased scale distance between the nose-high and nose-low ticks, the motion of the theta bug is erratic at a bank angle greater than 50°. An I-load limits the display of theta on the tape to be at velocities below 1500 ft/s.

In the event of no air data, the Entry Checklist ( $M < 1.5$ ) calls for the crew to check that theta is within the nose HI/LO limits and to fly CSS as required to limit bank to 50°. At Mach 0.90, manual speed brake should be used as required for energy management. In the case



of no wind and no air data, the crew should remain in auto and monitor the theta limits. For a high energy, tailwind situation, onboard EAS will read high. The crew should ensure the theta NOSE LO constraint is maintained and speed brake used at 100 percent as long as needed. If the crew is on the HAC at this point, they know they will be turning into a headwind. Some options (knowing that this situation exists) are to bring in the speed brake early, turn in to the runway early, or plan to hit the HAC high on altitude. For a high-energy case with a headwind, the onboard EAS will read low and NOSE LO tick should be monitored to avoid over  $\bar{q}$  of the vehicle. Speed brakes should be extended to get to nominal energy. In a low-energy case in a headwind, the best the crew can do is fly near maximum L/D (Mach 0.90 - this is near 213 KEAS); but since winds exist, the crew should use the NOSE HI tick. Also on a high-energy case with a tailwind, the NOSE HI tick should be flown with the speed brake retracted below Mach 0.90 until a nominal energy state can be regained. Obviously, below Mach 0.90, chase aircraft airspeed calls would help in energy management.

7. On the energy side of the vertical tape scale, the current vehicle energy/weight, the reference energy, and the guidance energy limits (S-turn and MEP) are displayed. These energy calculations are in units of feet of E/W. The current vehicle energy state (kinetic plus potential) is represented by a triangle symbol; the reference and guidance energy limits are represented by tickmarks. The STN and the MEP energy limits are defined as follows: the STN tick is calculated based on the energy over weight value above which TAEM guidance will initiate an S-turn. The equation used to calculate E/W for S-turn (ES) was derived assuming the vehicle was flying wings level at the TAEM guidance maximum  $\bar{q}$  schedule with the speed brake at 65 percent until Mach 0.95, then speed brake full open. This ES E/W equation represents the closest E/W to an S-turn that the guidance can handle in a straight-in situation and meet the A/L criteria without doing an S-turn. Worst-case winds were used in the analysis to determine the ES equation for guidance. If one looks at a plot of ES versus range to the runway, the slope of the line represents the energy dissipation rate with max  $\bar{q}$  in a tailwind. An iterative computer analysis was used to find the limiting E/W that would allow the vehicle to just make the aim point, utilizing the Minimum Entry Point (MEP) HAC location. The MEP tick is driven based on the E/W for a minimum entry point (EMEP) as calculated by the TAEM guidance. This E/W value, EMEP, considers the vehicle is flying wings level, minimum  $\bar{q}$  with the speed brake at 65 percent until Mach 0.9, where the speed brake is set to zero so as to maximize the range for the EMEP line determination. A 99 percentile headwind (worst month) was used to determine the EMEP E/W versus range to runway. Thus, this EMEP line has some conservatism built in (fig. 5-12). The constants associated with these E/W versus range to runway profiles are included in TAEM guidance as I-load values.

A left pointing arrow ( $\leftarrow$ ) is used to indicate an I-loaded energy level at which a 'straight' approach (as opposed to an 'overhead' approach) should be used. If the current HAC turn angle is greater than  $200^\circ$ , and E/W falls to this level while the range to the runway is greater than 45 n. mi., guidance will generate a class three alarm, calling for a downmode to a straight approach. On SPEC 50, OVHD (Item 6) will flash and an OTT ST IN

message will be given. Forty-five nautical miles was chosen as a minimum range for the approach mode redesignation alarm because changing the approach mode inside this range may result in heading errors that would nullify any potential E/W gains. The approach mode may be changed, however, at any time prior to the prefinal phase by executing item 6 on SPEC 50.

The NOM E/W tick represents EN, the guidance-computed energy over weight reference. This E/W reference is either of two linear segments of E/W versus range to runway. On either side of the reference E/W tick are ticks that define an 'EMAX' and 'EMIN' energy over weight corridor. This corridor is +8000 and -4000 feet of E/W. This EMAX and EMIN E/W corridor is calculated in TAEM guidance down to the prefinal phase of TAEM guidance. The EMAX and EMIN limits are used by the Nz command function of TAEM guidance. The  $\Delta N_z$  command is constrained by energy over weight,  $\bar{q}$ , and absolute  $\Delta N_z$  limits before going to flight control. TAEM guidance will attempt to keep the vehicle inside this EMAX/EMIN corridor. This E/W corridor was devised to protect against degraded navigation altitude, which could drive the E/W off the reference profile. Once outside the E/W corridor, the  $\Delta N_z$  command is being determined to drive the vehicle back inside the E/W limits. The +8000/-4000-foot value was determined from parametric studies starting with 1-sigma navigation filter performance and extending this until TAEM guidance could not reach the A/L criteria. It has been determined that for 3-sigma NAV performance, the E/W should stay within the EMAX, EMIN corridor.

At an altitude of 20,000 feet and below, the energy symbols are no longer driven on the E/W tape. The selection of 20,000 feet was based on engineering judgment because at this altitude the crew will be concentrating on acquisition of the outer glideslope. The current energy indicator, triangular symbol, is programed to flash when the current Shuttle energy over weight exceeds the energy over weight for S-turn and the predicted range is greater than or equal to the S-turn lockout range value (I-load of ~22 n. mi.). The triangular symbol will continue to flash until the current Shuttle energy becomes less than the ES, or S-turn energy over weight. If the current Shuttle energy over weight is high enough so that the Y-position of the triangular current energy symbol is greater than the maximum Y-value of the energy scale, the triangular symbol will remain at this YMAX position until the symbol again is on scale. When the current Shuttle energy over weight becomes equal to or less than the MEP energy over weight, the triangular current energy symbol will flash until the current Shuttle energy becomes greater than the MEP energy-over-weight value. In a similar manner to the YMAX position on the energy scale, if the Y-position of the current Shuttle energy becomes less than the YMIN on the energy scale, the triangular symbol will remain at this YMIN position until the E/W value is within the scale limits. The E/W tape is scaled based on the difference between the energy for S-turn minus the energy for MEP divided by a fixed scale length.

When either VERT SIT 1 or VERT SIT 2 display is driven by the BFS, the ADI errors (in degrees) in roll, pitch, and yaw computed in the BFS Descent-DAP Roll Channel, Descent-DAP Pitch Channel, and Descent-DAP Yaw Channel, respectively, are displayed for comparison with the PASS-driven ADI error needles. These errors and their text labels are driven pre-BFS-engage only. The text labels are U, D, R, and L and indicate fly-to errors.

The BFS VERT SIT 1 has DUMP STOP, Item 1, which provides capability to terminate RTLS RCS +X propellant dump.

The dashed line in the upper left corner of the VERT SIT 1 display represents an alpha transition profile ( $\alpha$  vs M) that is used only in MM 602. The solid line below the dashed line represents the do-not-exceed stability and control boundary for the alpha transition. An Orbiter symbol at a fixed orientation is plotted to indicate the current Mach/alpha location.

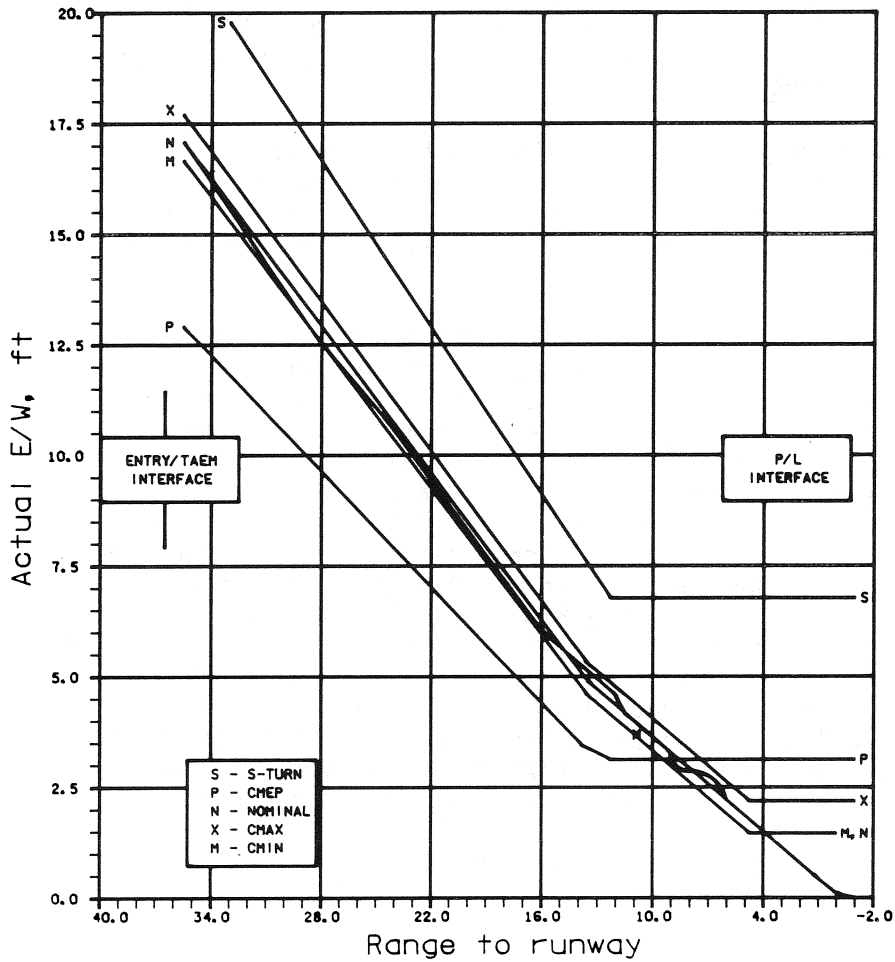

Figure 5-12.- Actual energy over weight during TAEM.

#### 5.1.4.8 Monitoring TAEM with VERT SIT Displays

The VERT SIT 1 display covers the altitude region from 100,000 to 30,000 feet. When the Shuttle symbol is below 30,000 feet, the VERT SIT 2 display is called up. The range used to plot the Shuttle X-position is based on RPRED from guidance (range to the runway threshold via WP 1). The altitude is from the TAEM User Parameter Processor (UPP) and is the altitude of the rear wheels above the runway. The Shuttle symbol is driven to show the current vehicle altitude dissipation rate by the amount of rotation of the Shuttle symbol. An altitude dissipation angle is calculated in the VERT SIT DIP from  $\text{TAN}^{-1} \left( \frac{-\text{HDOT}}{\text{VGND SPEED}} \right)$  where the HDOT term is the estimated

altitude rate from the TAEM UPP and V-GROUNDSPEED is groundspeed from TAEM UPP. The angle is measured from 0° to 360° clockwise where the 0 position equals the Shuttle nose pointing to the top of the CRT. The angle calculated for display purposes is -90° minus the calculated dissipation angle, to give a Shuttle symbol rotation.

In the nominal end-of-mission case at TAEM interface, the Shuttle symbol should appear on the VERT SIT 1 display approximately one quarter the way down from the top of the display. Because the VERT SIT 1 display monitors the majority of the supersonic portion of TAEM guidance and the majority of the energy is kinetic, the E/W scale is of more use/importance to the crew than the altitude versus range lines. The reason for this is that these lines are guidelines determined for the equilibrium flight conditions described in the previous section. These lines do not reflect the current energy state of the vehicle; for this information the crew should monitor the position of the 'bug' on the E/W tape. The altitude versus range lines become more useful on the VERT SIT 2 display after the vehicle reaches subsonic speeds. By monitoring the position of the current E/W triangular symbol inside the  $E_{\text{MAX}}$  and  $E_{\text{MIN}}$  ticks described earlier, the crew can monitor how well autoguidance is handling the energy management problem. While the triangle symbol is inside this E/W corridor, the TAEM guidance  $\Delta N_z$  commands should be following the  $H_{\text{REF}}$  versus range profile.

To understand the E/W corridor between  $E_{\text{MAX}}$  and  $E_{\text{MIN}}$ , one has to look at the way TAEM guidance determines  $\Delta N_z$  command (fig. 5-13).

TAEM guidance computes a  $\Delta N_z$  command based on the H error and  $\dot{H}$  error between the guidance-determined reference values of H and  $\dot{H}$  and the NAV-determined values. This  $\Delta N_z$  command is then limited by six  $\Delta N_z$  limits as shown in figure 5-13 with MIDVALUE selection logic. As was discussed earlier, the E/W corridor was determined through parametric analysis to represent the E/W delta about the reference E/W that could be tolerated due to NAV dispersions and still meet the approach land criteria. The combination of the  $\Delta N_z$  controllers, altitude, energy/weight, dynamic pressure, and absolute is used to obtain the best compromise in handling NAV errors, worst-case aero, and winds.

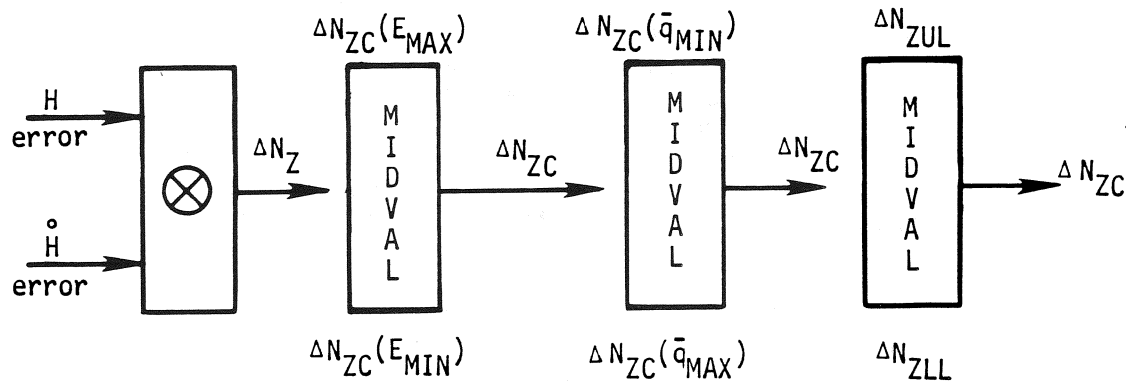

Figure 5-13.- TAEM  $\Delta N_z$  logic.

As an example of how the E/W tape might look in a low-energy autoguided case, assume the vehicle is low on energy/weight, the E/W bug is at MEP point on the E/W tape, and the E/W is converging to the reference E/W. While the E/W is less than the  $E_{MIN}$  limit (tick below the EN tick) the auto  $\Delta N_z$  command is being limited by the  $\Delta N_{zCMD}(E_{MIN})$  and/or  $\Delta N_{zCMD}$

( $Q_{MIN}$ ) limits. As the E/W bug moves inside the E/W corridor on the E/W tape, the  $\Delta N_{zCMD}$  that guidance sends to flight control is based on the H

and  $\dot{H}$  errors from the guidance H versus range profile. In a similar manner, if above the E/W corridor, autoguidance will control the vehicle to get back inside this corridor and fly the reference H versus range profile without being limited by energy or  $\bar{q}$ .

Nominally, the Shuttle symbol will track down the center guideline with the energy bug between the  $E_{MAX}$  and  $E_{MIN}$  tickmarks. The current theta is plotted on the theta tape; but, because its function is limited to the no air data situation discussed previously, it has no significance with good air data. In the event of no air data below Mach 1.5, the crew would be required to monitor this theta scale in situations that could possibly approach vehicle performance and structural limits. The procedure in such a situation if theta were observed to be outside the limits on the tape would be to fly (P) CSS and set  $\phi = \text{limit}$ .

At an altitude of 30,000 feet, the VERT SIT 2 display (fig. 5-14) comes up automatically. This display is also an altitude versus range to the runway plot and covers the lower energy portion of TAEM. The lower limit on the altitude scale is 8000 feet; however, the three guidelines are anchored at  $10,000 \pm 1000$  feet, as described previously. The range axis is scaled from approximately 23 to 4 n. mi. Some overlap exists in range on the first two guidelines from VERT SIT 1 to VERT SIT 2; however, no overlap occurs for the Min  $\bar{q}$  line. The '213 ACCEL' on the min  $\bar{q}$  lines serves as a cue for the crew to accelerate the vehicle for the preflare maneuver.

By the time the VERT SIT 2 display is up, the energy management problem should be one of altitude versus range management (potential energy management). At an altitude of 20,000 feet, the energy/weight display on the right-hand side of the VERT SIT 2 is no longer driven. Nominally, the Shuttle symbol should be tracking the center altitude-range line during this phase. Below Mach 0.9, the speed brake command based on TAEM guidance dynamic pressure error is displayed in percent and above this readout is the speed brake position from the Speed Brake Position Feedback SOP. When TAEM guidance is terminated, the text A/L (autoland) is displayed and flashed. This signals the pilot that the TAEM guidance has delivered the vehicle to the A/L criteria or that the altitude is below 5000 feet where TAEM guidance ends and transitions to autoland. The location of this A/L text is just below the speed brake command readout on the VERT SIT 2. In the BFS display of the text, A/L is not supported.

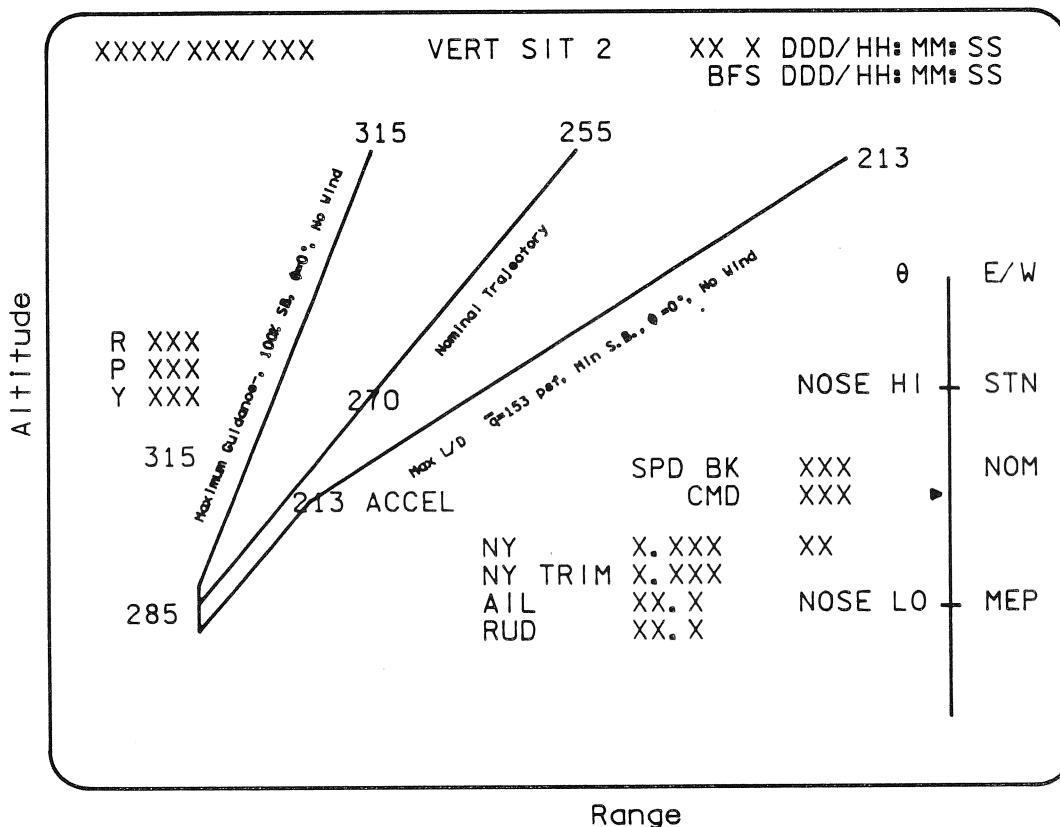

Figure 5-14.- Vertical situation 2 display (PFS/BFS).

#### 5.1.4.9 Horizontal Situation Display - (PFS and BFS)

The HORIZ SIT (SPEC 50) display provides the crew with spacecraft position and heading information with respect to the ground plane, provides readouts and control of navigation parameters and is available in GNC OPS 1, 3, and 6. During entry on STS-2 and subsequent flights, several planned maneuvers will be performed to obtain aerodynamic and structural data.

Control of some of these maneuvers is provided via the PFS HORIZ SIT display. If the BFS is engaged, the maneuvers will not be performed; therefore the BFS HORIZ SIT does not provide the capability to control the Programed Test Inputs (PTI's). The PFS and BFS HORIZ SIT displays shown in figures 5-15 and 5-16 are nearly identical. The few differences are presented as an integral part of this writeup.

1. The graphic portion of the display becomes active when the Orbiter altitude decreases below 200,000 feet. The vehicle position is represented by a fixed Shuttle symbol. The runway and the HAC are dynamically driven to create an out-the-window view for the crew. The view can be visualized as a ground plane projection containing the Shuttle and landing site in a coordinate system fixed to the vehicle. The HORIZ SIT scaling varies so that the groundtrack resolution increases as the vehicle gets closer to the landing area.

The display includes three predictor indicators (small circles) that show the position of the Shuttle relative to the ground at 20, 40, and 60 seconds into the future based on current flight conditions.

2. Item 2 is unique to the Primary HSD and provides the capability to enable or inhibit PTI maneuvers in MM 101, 102, 304, and 305. Execution of Item 2 in any other MM will result in an ILLEGAL ENTRY message.

The display is initialized with PTI's inhibited, indicated by 'INH' displayed next to Item 2. Execution of Item 2 enables the PTI's and displays 'ENA' next to 2. Item 2 acts as a flip-flop, alternately enabling or inhibiting PTI's. The PTI's may also be inhibited manually by establishing the CSS mode in the DAP via the MAN PBI's on the DAP panel, or in OPS 3, by taking the RHC out of detent. In either case, Item 2 is reset to the inhibit state and 'INH' is displayed. The PTI's can then be reenabled only by reestablishing the AUTO mode in the DAP and executing Item 2. The manual inhibits will terminate a PTI maneuver in progress.

The particular PTI maneuver to be performed is indicated by the PTI index, a number from 0 to 25, displayed below Item 2. In OPS 1, the PTI index is initialized to zero indicating a structural PTI, the only type performed in OPS 1. In OPS 3, any one of 25 Aero PTI's may be performed. Consequently, the PTI INDEX will be fixed at zero during OPS 1 and in OPS 3 will range from 1 to 25.

Once enabled, a specific PTI maneuver will be performed as soon as the PTI window (VREL in OPS 1; MACH or q in OPS 3) for that PTI is entered, provided that the systems, guidance, and trajectory constraints are satisfied. In OPS 1, 'PTI' will be displayed oversized and overbright below the PTI INDEX whenever the structural PTI maneuver is in progress. The data field will be blank otherwise. In OPS 3, whenever a PTI window is entered, 'PTI' will be displayed oversized and overbright. If the PTI maneuver is inhibited automatically or manually, 'PTI' will flash throughout the PTI window. While the maneuver is in progress, 'PTI' will not flash. 'PTI' will be blanked and the PTI INDEX incremented when the maneuver is terminated. If no maneuver is performed,

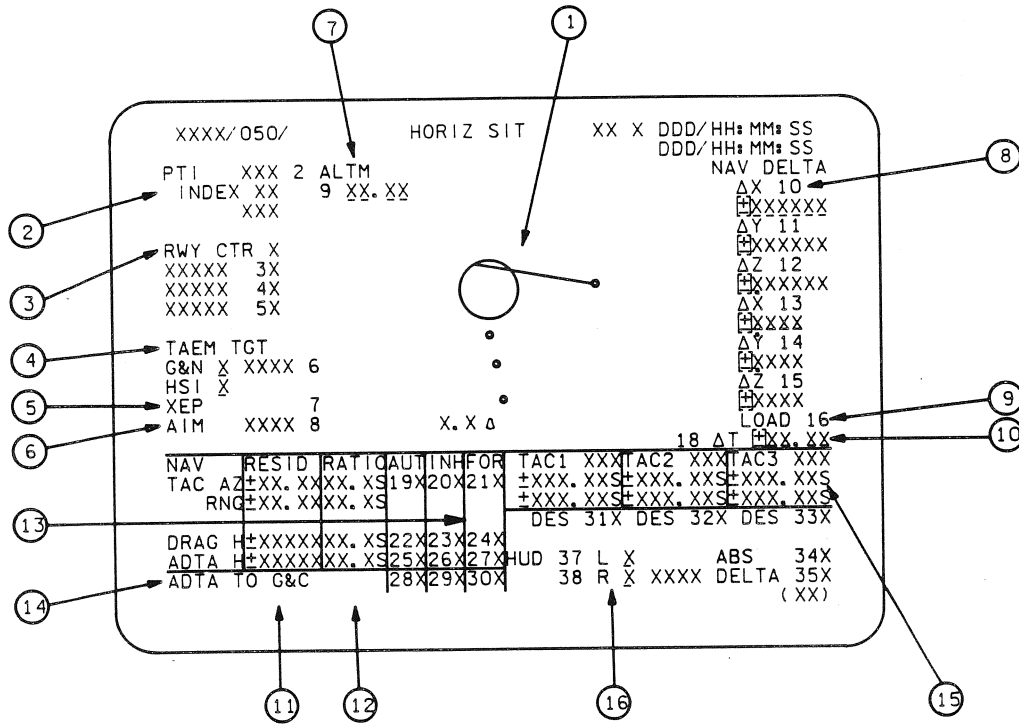

Figure 5-15.- Horizontal situation display (PFS).

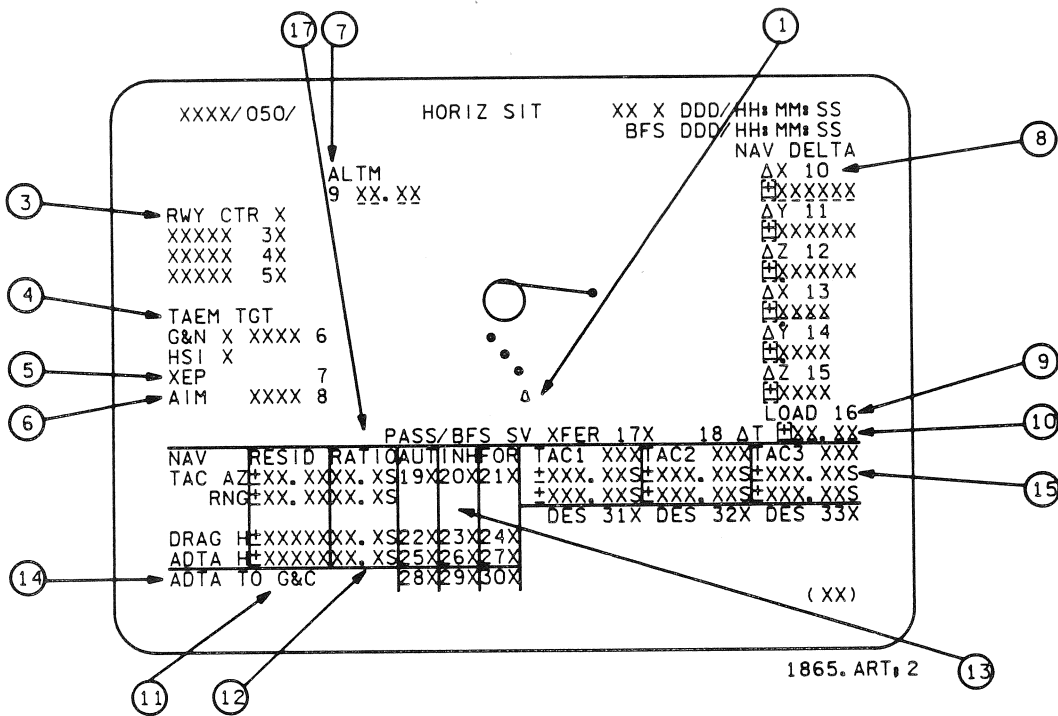

Figure 5-16.- Horizontal situation display (BFS).



this will occur when the window is exited. The PTI INDICATOR will be blanked if a TAL or AOA abort has been declared.

NOTE: Item 1 has been deleted. Any attempt to execute Item 1 will result in an ILLEGAL ENTRY message.

3. The display has a runway designation data field that shall show the designated landing site (RWY). Crew controls shall also be provided to allow the crew to redesignate the intended landing runway; a field shall also be provided to indicate when midpoint targetting is in progress. The primary runway (Item 3), the secondary runway (Item 4), and the alternate runway (Item 5) shall be indicated by displaying the appropriate mnemonic. If the display is called up in MM 301 to 303, an '\*' indicator will be displayed initially by the primary runway (Item 3) and thereafter shall reflect crew inputs. Upon transition to MM 304, the '\*' will be displayed next to the characters CTR (center) to indicate that the target point is midway between the primary and secondary runways. The '\*' will continue to be displayed there until either the velocity is less than an I-loaded value or the crew redesignates the intended landing site by executing any one of Items 3, 4, or 5 (PRI, SEC, ALT). Items 3, 4, 5, and midpoint targetting are mutually exclusive. Once midpoint targetting is terminated, the '\*' will be displayed by the last selected runway.

Midpoint targetting is not available in OPS 1 and 6. The display will be initialized in these OPS with the '\*' displayed by the primary runway (Item 3) and thereafter will reflect crew inputs.

4. Item 6 (G&N) provides the capability to designate the alternate heading alignment circle (HAC) to be used for targetting during entry. Text (OVHD or STRT) is displayed next to Item 6 to indicate whether the approach is to be overhead or straight in. The display is initialized in MM 101 with OVHD selected and will not change unless guidance automatically downmodes to STRT because of insufficient energy or the crew selects the alternate HAC in MM 304, 305, 602, or 603. In addition, indicators are provided for GN&C and the left HSI to identify whether the left (L) or right (R) HAC is the target point. The GN&C and HSI indicators are initialized upon transitioning into MM 304 or 602. Prior to 304 and 602, the fields will be blank. The HAC can be changed when guidance downmodes automatically from OVHD to STRT or when the crew manually selects the alternate HAC via Item 6. If the alternate runway is selected via Item 5, the approach will be reinitialized to OVHD. If an overhead approach has been selected and guidance determines that the energy is too low, a Class 3 message will be generated and OVHD will be flashed on the display. The flashing will be terminated once a straight-in approach is selected, manually or automatically. If guidance downmodes automatically or if the alternate HAC is selected via Item 6, subsequent automatic downmoding is inhibited. Item 6 is legal only in MM 101, 304, 305, 602, and 603.
5. Item 7 is an entry point indicator. Initially, the indicator shall be driven as nominal entry (NEP). Execution of Item 7 (XEP, where the 'X' is dynamic) allows the crew to switch to the minimum entry point (MEP) or from MEP back to NEP as the energy situation dictates.

6. A control is provided to redesignate a glideslope (GLD SLOPE) ground intercept point. The display is initialized with the nominal intercept point selected, indicated by 'NOM' being displayed next to Item 8. Execution of Item 8 (AIM) selects the intercept point closest to the runway for high headwinds. This is indicated by 'CLSE' being displayed next to Item 8. Reexecuting Item 8 reselects the nominal intercept point. It is possible to switch back and forth between the nominal and close intercept points until the TAEM/AUTOLAND interface. Switching the intercept point causes other appropriate values for TAEM geometry parameters to be used. The HAC position shown on the graphics portion of SPEC 50, however, always depicts a HAC location based on the 'NOM' aim point. Therefore when 'CLSE' is selected, the shuttle bug can be expected to fly approximately 1/20 of an inch inside the HSD's HAC depiction.
7. Item 9, the ALTM data field, is used to input the landing site barometric altimeter setting corrected to mean sea level. The display is initialized with this parameter set to 29.92 in. Hg and thereafter shall reflect crew inputs.
8. Items 10 through 15 provide the capability to enter delta position and velocity components in runway coordinates. Only components requiring update need be entered, the remaining components being zeroed.
9. Item 16 (LOAD) provides the capability to execute a delta update to the navigated state of the Orbiter using the data entered in Items 10 through 15. Upon completion of the delta update by NAV, these items and their associated buffer shall be zeroed.
10. Item 18 ( $\Delta T$ ) provides the capability to update state vector downtrack errors by means of adding or subtracting delta time in seconds. The update is performed after a time value is entered via Item 18 ( $\Delta T$ ) and verified, followed by the execution of control Item 16 (LOAD). The delta time display field is zeroed when the display is first called and will be rezeroed upon completion of a delta time update by entry navigation. Item 18 is legal in OPS 3 only. Executing this item in any other OPS will cause an ILLEGAL ENTRY message to be generated.
11. The bottom section of the display allows the crew to manage some of the NAV aid inputs to GN&C. The RESID column contains the residual data value for each component of each data type that is being processed by the NAV filter. The residual is formed in navigation by subtracting the NAV estimate of the data from the selection filter output of the data. It should be noted here that navigation uses the composite data output from the selection filter as inputs to the navigation filter so that no distinctions are made as to the Line Replaceable Unit (LRU) source of the data to the NAV filter. In the two LRU cases, the LRU data are averaged so that the data cannot be distinguished as to LRU source. The residual value gives the crew an indication as to how well the data and the NAV estimate of the data agree. However, these data alone cannot identify whether the data or the NAV estimate of the data is in error.

12. The RATIO column contains numbers called the edit ratios that are the residuals of each data type divided by the maximum allowable residuals. The maximum allowable residual for each type of data is a dynamic number calculated in navigation. It is dependent upon state vector uncertainties and measurement variances and is an estimate of how close navigation thinks the internally generated and externally measured data should compare. If the number in the RATIO column is less than one, the residual edit test performed by navigation on the data is passed, and the data can be subsequently used to update the state vector. If the data fail the residual edit test, the ratio will be displayed as a number equal to or larger than one and will not be used to update the state vector. Thus, the edit ratio and the ratio parameter status indicators give the crew an indication of whether or not a particular data type is being incorporated into the state vector. The residuals and edit ratios are computed by navigation for each NAV cycle and are available for display. When data are not being processed by the RM, the residual and ratio data fields for that parameter will be blanked. A parameter status indicator column to the right of the RATIO will contain a down arrow when the parameter has failed the update edit test. The down arrow will disappear when the edit test is passed by a predefined percentage of 'Good' data. The parameters defining percentage of 'Good' data are I-loaded.
13. There are three filter control options: auto (AUT), inhibit (INH), and force (FOR), which the crew can exercise on three data types: tacan (TAC AZ and RNG), drag altitude (DRAG H), and baro altitude (ADTA H), to update navigation. Items 19, 22, and 25 allow navigation to automatically (AUT) select data to be used if they pass the edit test. Items 20, 23 and 26 (INH) preclude updating the state vector with the RM-selected data, but these data are used to generate the displayed residual and ratio values. Items 21, 24, and 27 (FOR) shall override the edit and force the data to be used to update the state vector if the data are being processed by the NAV filter. Items 19 to 21, 22 to 24, and 25 to 27 are mutually exclusive. An asterisk (\*) appears next to any Item (19 to 27) that has been selected. The display will be initialized with Items 20 (INH), 22 (AUT) and 26 (INH) selected.

The Entry Checklist contains tacan and air data management matrices that show the crew which control options should be selected. The matrices and procedures are discussed later in this section.

14. Items 28 to 30 provide control over the source of air data parameters to guidance and flight control. Item 28 (AUT) provides auto transition from NAV-derived air data to ADTA. Item 29 (INH) inhibits the ADTA data. Item 30 (FOR) forces the use of ADTA data. These items are mutually exclusive. The PFS display will be initialized with Item 29 (INH) selected. The BFS display will be initialized with ITEM 29 (AUT) selected.
15. The tacan channel of the ground station that TAC 1, 2, and 3 is locked onto or is attempting to lock onto is displayed. The PFS HORIZ SIT allows the crew to select via Items 34 or 35 whether the absolute tacan azimuths and ranges or the deltas between the tacan and navigation determined azimuths and ranges to the ground station are displayed. The

BFS HORIZ SIT displays tacan AZ and RNG only in absolute values. Items 34 and 35 are mutually exclusive and an '\*' will be driven next to the item selected. The PFS display will be initialized with Item 35 (DELTA) selected. A parameter status indicator column is provided for the azimuth and range of each tacan. For both PFS and BFS displays, a blank in the column indicates normal operation and a down arrow will be displayed if the parameter is declared failed by RM. The PFS also has the capability to display an 'M' if data are missing or a '?' if a dilemma is declared by RM.

Items 31 to 33 provide the capability for each tacan to be deselected or reselected for use by the Selection Filter. If a tacan is deselected, this will prevent RM from using range and azimuth as inputs to the selection filter. Deselection will be indicated by an asterisk adjacent to the DES item number and down arrows in the range and azimuth parameter status indicator columns. When RM declares either range or azimuth failed on an LRU, a down arrow will be displayed in the parameter status indicator column. In order to reselect and use this parameter again, the LRU has to be deselected and then reselected. The word 'TEST' will be displayed if a self test is being conducted to resolve a dilemma. Tacan self test is only available in the 'GPC' mode.

During MM 301, 302, and 303, the tacan azimuth and range data and the associated parameter status indicators for tacan 1, 2, and 3 will be blanked. When the DELTA values for tacan data have been selected in PFS and a tacan channel selected is invalid, the azimuth and range data fields and associated parameter status indicators for that tacan will also be blanked in MM 304 and 305.

16. Item 37 and 38 provide format selection capability for the left and right HUD's respectively. Crew selection is valid only in MM 304, 305, 602, and 603. Any attempt to select a format in any other major mode shall result in an ILLEGAL ENTRY message and rejection of the input. The HUD's initialize in format 0 (blank) in MM 304 or 602. At transition to MM 305 or 603, the HUD's automatically mode to format 1 (Approach and Land).
17. Item 17 is unique to the BFS HORIZ SIT. It allows the crew to command the BFS to read PFS state information and display the deltas between the PFS and BFS state vectors. Note that the deltas, which are displayed in the data fields for Items 10 to 15, are in UVW coordinates rather than runway coordinates. If Item 16 (LOAD) is then executed, the BFS state vector will be updated by the PFS state vector (subject to BFS current filter cycle time). An asterisk will be displayed next to Item 17 to enable the PFS to BFS state vector update via Item 16. The asterisk is reset when NAV has completed the required state vector update or when the crew reexecutes Item 17, which disables the PFS to BFS state vector update and zeroes the deltas in Items 10 to 15. Item 17 (PASS/BFS SV XFER) does not appear on the PFS display and is illegal in the primary system. Any attempt to execute this item in the PFS will result in an ILLEGAL ENTRY message.

18. The current value of normal acceleration in g's will be displayed adjacent to the Orbiter symbol. This output is unique to the PASS display. The parameters displayed will be total load factor in MM 304 and Nz in 305, 602, and 603. Whenever the normal acceleration exceeds an I-loaded limit, the displayed acceleration data and the Orbiter symbols will flash.
19. On the BFS display, keyboard inputs are not allowed after completion of TAEM guidance and will result in an ILLEGAL ENTRY message on the display (OPS 3 and 6).

#### 5.1.4.10 Override Display (PFS and BFS)

The Override (SPEC 51) displays are available in GNC OPS 1, 3, and 6 and give the crew a capability to manually control events that normally are automatically controlled. The display can also be used to resolve RM dilemmas and provides a manual backup capability for critical switch failures. The PFS and BFS displays are significantly different in content and layout; therefore, they will be described separately.

The PFS display is shown in figure 5-17. Only the functions applicable to entry will be covered.

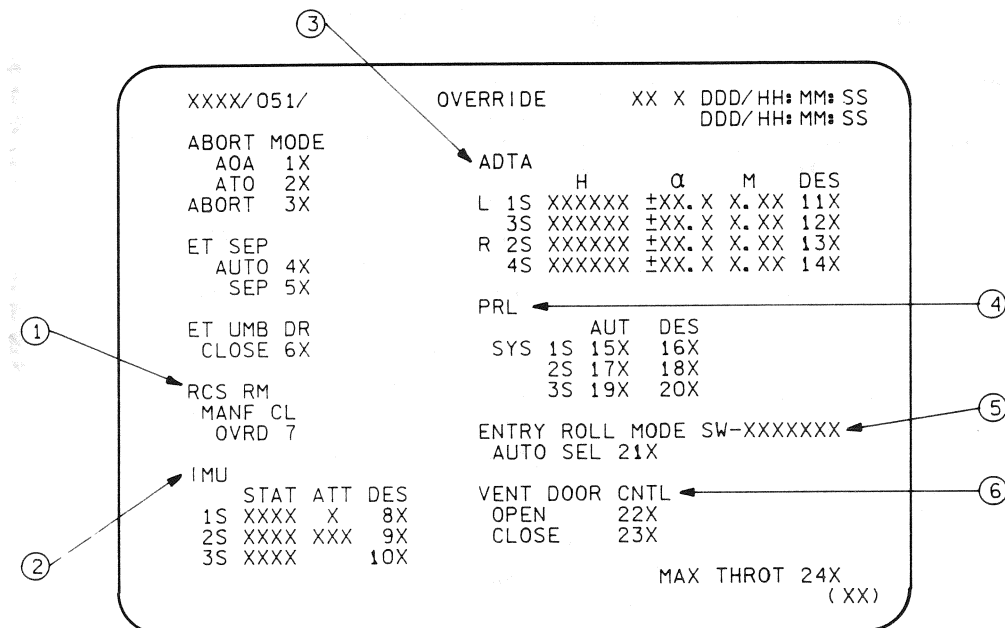

Figure 5-17.- Override display (PFS).

1. Item 7 allows the crew to override an RCS manifold valve microswitch dilemma that has forced RCS RM to set the value status to closed. This dilemma may prevent some good jets from being used and reduce the flight control system capability. Execution of Item 7 causes RCS RM to set the value status to open on any item in dilemma and puts the RCS jets (ones without previous OFF or LK failures that have not been failure overridden) back into the jet availability table.

2. For each of the IMU LRU's, data are displayed cyclically to aid in solving RM dilemmas. A performance monitor column (S) is provided after each LRU ID number that will be blank for normal operation, display a down arrow for an RM declared failure or crew deselection, display a '?' for an RM dilemma, or an 'M' for missing data. The STAT column will either be blank for normal operation or display 'BITE' to indicate a problem detected in the LRU. Two information parameters are displayed in the first two rows of the ATT column. The first indicates by number (1, 2, or 3) which IMU is providing attitude data to the flight control system and the ADI. In the unlikely event that RM determines all IMU attitude is bad, then RGA will be displayed in the second row of the ATT column to indicate that the rate gyro data are being processed and converted for use by the FCS and ADI. The first row will still display the last IMU (1, 2, or 3) that provided good attitude data before the data was determined to be bad. If RGA is displayed during Entry because one IMU is failed and the two remaining are in a dilemma, the crew should deselect the lower number IMU in dilemma. Items 8, 9 and 10 allow the crew to deselect an LRU for use by the IMU selection filter or reselect an LRU that has been declared failed by RM.
3. For each of the four ADTA LRU's, the following data are displayed cyclically to aid in resolving RM dilemmas: ADTA derived altitude in feet, ADTA derived angle of attack in degrees, and ADTA derived Mach number. A performance monitor column (S) adjacent to the LRU ID number will be blank for normal operation, display a down arrow for an RM declared failure or crew deselection, display a '?' for an RM declared dilemma, or display an 'M' for missing data. Items 11, 12, 13, and 14 can be used to deselect or reselect an LRU for use by the ADTA selection filter. These items are legal in MM 304, 305, 602, and 603. Execution of these items in OPS 1, MM 301, 302, 303, or 601 will result in an ILLEGAL ENTRY message. When the air data probes are not deployed, zeros will be displayed in the H,  $\alpha$ , and M columns.
4. Priority Rate Limiting (PRL) reduces the maximum surface rate commands from the aerojet and GRTLS DAP's in the event hydraulic system failures are detected by the hydraulic SOP. Items 15 to 20, two items for each of the three hydraulic systems, allow the crew to manually override or reselect the automatic PRL system management. For example, if the SOP declares hydraulic system 2 failed, it will be visible on the display as a down arrow in the performance monitor column (S) next to the system 2 ID number and PRL will consider that system failed in computing the adjusted surface rate command limits. If by troubleshooting it is determined that hydraulic system 2 is not failed, the crew can force the PRL to consider system 2 as good by executing Item 18 and the maximum surface rate command capability will be restored. The automatic system management can be reselected after selecting the manual override mode of operation by executing the appropriate auto item number. An asterisk is displayed after the item numbers indicating the selected mode. The items for each hydraulic system are mutually exclusive and are initialized in the auto mode. A performance monitor column (S) provided for each hydraulic system will display a blank for normal operation or upmoded manual system operation, a '?' for an RM dilemma, and a down arrow for a failure or downmoded system.

If any of these items are executed in MM 104, 105, 106, 301, 302, or 303, an ILLEGAL ENTRY message will occur.

5. The position of the Entry Roll Mode switch (AUTO, YJET/R or AIL) determined by GNC switch RM is presented on the display. Item 21 allows the crew to select the 'AUTO' position in case the switch fails. When this item is executed, an asterisk will be displayed and the status from GNC switch RM will also read 'AUTO'. The display will be initialized with this item deselected (i.e., no asterisk) and thereafter will reflect crew inputs.
6. Items 22 and 23 allow the crew to issue commands to either open or close all of the vent doors. These items are mutually exclusive. An asterisk shall be driven next to the item currently selected. When the display is initialized, this signal will be set to its last commanded state either by crew entry or via the vent door sequencer. These items will be legal only in OPS 3 and MM 602 and 603. Execution of these items in any other MM will result in an ILLEGAL ENTRY message.

The BFS Override display shown in figure 5-18 allows the crew to deselect IMU's and control vent doors during entry via procedures identical to those used with the PFS display except that the item numbers are different. In addition, if it becomes necessary to change the landing site options from the permission I-loads, this can be done to the PFS in OPS 2; since there is no BFS in OPS 2, the BFS landing site options can be changed in OPS 3 by using the landing site update capability provided by the BFS Override display.

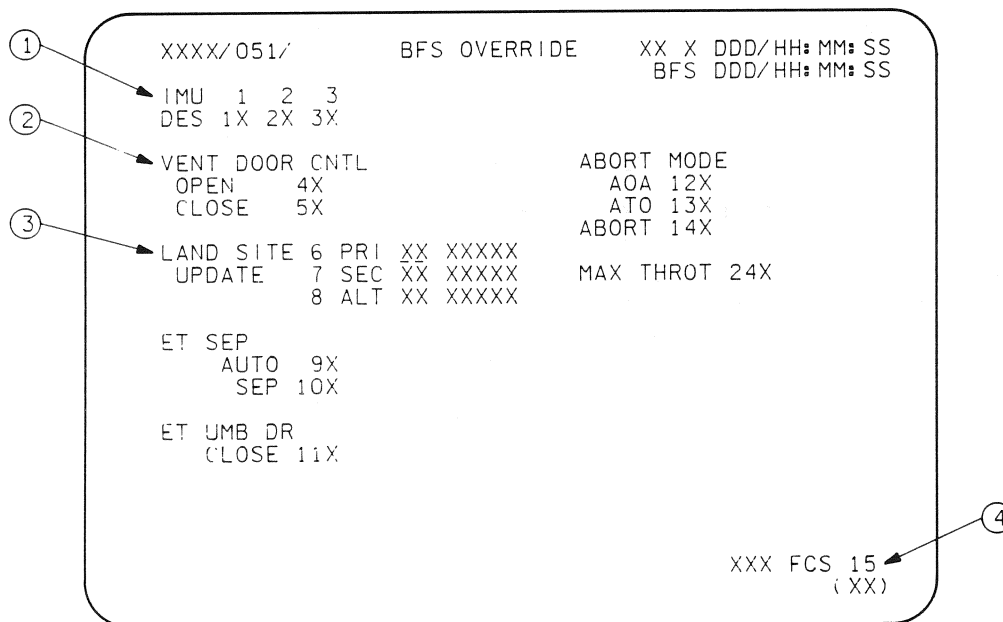

Figure 5-18.- BFS override display (BFS).

1. Items 1, 2, and 3 provide the crew with the capability to select or deselect an IMU LRU for use by the midvalue selection processing of the IMU HIP. Execution of any of these items will cause the associated IMU to be deselected. An asterisk will be displayed beside the item number indicating deselection. The capability exists to reselect an IMU for use in selection processing once it has been deselected. Reselection is accomplished by reexecuting the associated DES item. This action will also cause the asterisk to be blanked. Items 1, 2, and 3 are active in OPS 1, 3, and 6. They are initialized blank and will thereafter reflect the current select/deselect status as modified by crew entry.
2. Items 4 and 5 provide manual capability to command open or closed all of the vent doors. The items are mutually exclusive. An asterisk shall be driven next to the item indicating the current state of the vents as set by crew entry or by the sequencing controller. These items are only functional post-BFS ENGAGE and are legal only in OPS 3 and MM 602 and 603. The asterisk is only driven after BFS ENGAGE. On engage, the display is initialized to reflect the last commanded state of the vents.
3. This display also provides controls for updating the landing sites required for entry.
  - o Items 6, 7, and 8 are used to load landing site ID's contained in the maxitable. On loading the ID's, the data associated with these landing sites shall be transferred to the PRI, SEC, and ALT locations of a minitable. These items are only functional in OPS 3.
  - o In addition to the controls required for loading the minitable, the current status of what landing sites are loaded in the PRI, SEC, and ALT slots is provided.
4. Item 15 allows the crew to alternately command the aerojet DAP to use 'ASC' or 'ENT' FCS parameters. Selection of ENT FCS enables the 'primary' (nominal end-of-mission) elevon schedule and body bending filters. Selection of ASC FCS results in selecting the 'alternate' or 'payload' elevon schedule and body bending filters. Any time an entry is to be performed with an IUS or TDRS in the payload bay, ASC should be selected. (The entry FCS is not certified for flight with the IUS/TDRS if the alternate body bending filters are not selected.) The display is initialized in OPS 3 with ENT parameters if OPS 3 is entered from OPS 2; and with ASC parameters if OPS 3 is entered from OPS 1. Once initialized, the display will reflect crew inputs. Item 15 is legal in OPS 3 only; execution in OPS 1 will result in an ILLEGAL ENTRY message.

#### 5.1.4.11 Entry Controls Display - SPEC 53 (PFS and BFS)

The Entry Controls display (SPEC 53) is available in OPS 3. The Entry Controls display format is shown in figure 5-19.



With the exception of Item 32, all items on this display will not be operable until software release 22 (currently scheduled for STS-15). On implementation of release 22, this display will allow the crew to perform the aerosurface secondary actuator check in OPS 3, control MDM port assignments, and perform AA, RGA, and surface feedback RM. However, only Item 32 is applicable to entry flight procedures and is the only item to be discussed here.

1. Item 32 performs the same function as Item 15 on the BFS Override display (SPEC 51). Please see section 5.1.4.10 for a discussion of this item.

XXXX/053/		ENTRY CONTROLS				XX X	DDD/HH: MM: SS	DDD/HH: MM: SS
SEC	ACT CK		PORT STAT				MDM	PORT
				1	2	3	4	STRING ASSIGN
CH1	1X	L	OB	1	S	S	S	PRI SEC
	2		IB	2	S	S	S	1 22X 23X
	3	R	IB	2	S	S	S	2 24X 25X
	4		OB	4	S	S	S	3 26X 27X
START	5X		RUD	5	S	S	S	4 28X 29X
STOP	6X	SPD	BRK	6	S	S	S	PL 30X 31X
NEG	STIM							
ENA	7X	8	BYPASS		XX			
		9	RESET		XX			
LRU	AA	RGA	SURF	FDBK				
	DES	DES	DES					
1	10X S	14X S	18X S					
2	11X S	15X S	19X S					
3	12X S	16X S	20X S					
4	13X S	17X S	21X S					
								XXX FCS 32
								(XX)

Figure 5-19.- Entry controls (PFS).

### 5.1.5 Entry Sequence of Events

The following table contains a summary listing of the nominal entry events from EI minus 5 minutes to Orbiter rollout and crew egress. This table does not include entry test requirements.

TABLE 5-III.- SUMMARY OF ENTRY EVENTS (TYPICAL)

Time, min:s	Altitude, ft (x10 <sup>3</sup> )	VREL, ft/s (x10 <sup>3</sup> )	Event	Discussion, page
-05:00	548	24.4	Transition to Major Mode 304 Complete pre-EI checklist	5-47
-03:58	517	24.4	Secure FRCS	
00:00	400	24.6	Entry interface	5-51
02:39	322	24.7	Auto elevon trim at $\bar{q} = 0.5$	5-52
03:32	297	24.7	Aerosurface control at $\bar{q} = 2.0$ Potential body flap saturation (M 24.6 to M 22.5)	5-54
04:59	265	24.5	Closed-loop guidance initiated (Drag = 4) Temperature control phase Phugoid damper usable	5-58
05:00	265	24.6	Roll RCS jets deactivated at $\bar{q} = 10$	5-60
05:18	260	24.5	First bank command	5-61
06:10	255	24.3	Maximum surface temperature region (M 19.4 to M 24) Drag profile within 0.5 ft/s <sup>2</sup>	5-64
08:04	248	23.5	Pitch jets deactivated at $\bar{q} = 20$ N <sub>y</sub> trim active at $\bar{q} = 20$	5-67
11:49	234	21.3	Drag H update in NAV filter at Drag = 11; monitor with HSD	5-69
13:40	225	20.4	MPS feedlines pressurized	5-70
13:45	224	19.9	Equilibrium glide phase	5-71
14:17	226	19.4	First bank reversal	5-72
14:42	212	19.0	Landing gear hydraulic isolation valve, system 3, open	5-74
14:42	214	18.9	RCS activity lights reconfiguration at $\bar{q} = 50$ Power up previously powered down LRU's	5-76 5-75
17:47	187	14.5	Constant drag phase	5-77
17:47	187	14.5	Alpha ramps down from 40°	5-78
18:27	180	13.2	Point Pillar C-band AOS (+60 sec)	5-80
18:57	175	12	Radiator flow selected	

TABLE 5-III.- Continued

Time, min:s	Altitude, ft (x10 <sup>3</sup> )	VREL, ft/s (x10 <sup>3</sup> )	Event	Discussion, page
19:20	164	10.5	Call up HSD to monitor tacan AOS	5-81
19:24	167	11.2	Exit L-band blackout	
19:49	162	10.4	Transition phase	5-82
20:03	160	10.0	Speed brake ramp to 100 percent	5-83
20:14	158	9.7	UHF upvoice and downvoice	5-85
20:27	157	9.3	S-band AOS (+30 sec)	5-86
20:41	156	8.9	Earliest opportunity for runway redesignation	5-89
21:34	145	7.5	Earliest opportunity for MCC state vector update	5-90
21:41	144	7.3	First tacan acquisition Tacan two-LRU lockon; EDW selected	5-91
21:50	143	7.2	Check tacan source 1,2,3 on HSI	
22:41	128	6.0	No-comm tacan management	
23:07	120		Call up DPS OVERRIDE display	5-107
		5.0	Deploy ADS probes	5-108
24:24	103	4.0	Speed brake ramp to 65 percent	5-100
24:51	100	3.5	Rudder trim activated	5-102
24:41	100	3.6	Excessive H avoidance	5-101
25:13	89	3.0	Elevon trim position to 0°	5-109
25:20	88		HUD power on	5-110
25:30	85	2.6	Drag H update terminates	
25:30	85	2.6	Flash evaporator OFF	
25:48	81	m=2.54	TAEM interface; HSI select modes to TAEM (AUTO)	5-116
25:40	83	m=2.5	ADTA data into G&C and NAV	5-93
25:55	82	m=2.4	Fuselage vents open Auto aileron trim deactivated	5-126
27:53	51	m=1.0	RCS yaw jets deactivated	5-127
28:17	45	m=0.9	Elevon trim position to 4° DN	5-128
28:03	45	m=0.9	Speed brake modulated for energy control	5-129
28:42	40	m=0.84	HAC tangency (WP 1)	5-130
30:16	20	272	Initiate MLS updating; HSI source to MLS	5-132
31:02	10	285	Track outer glide slope toward aim point	5-134
28:55	15	275	Wind update if required	5-138
30:52	12	283	Approach and landing interface Body flap goes to TRAIL	5-139
31:19	5	286	Arm landing gear	5-142
30:38	5	280	Radar altimeter activated	5-141
31:33	2.5	285	Altimeter check all sources Position speed brake close	5-143

TABLE 5-III.- Concluded

Time, min:s	Altitude, ft (x10 <sup>3</sup> )	VREL, KEAS	Event	Discussion, page
31:47	2	287	Preflare	5-145
32:04	.2	270	Lower landing gear Radar altimeter updating	5-147
32:09	.1	249	Final flare	5-149
32:21	0	195	Touchdown; SB to 100 percent	5-151
32:30	0	165	Slapdown and rollout	5-153
32:40	0	110	Braking on runway	5-156
32:52	0	0	Braking and stop Postlanding checks Establish comm with Convoy 1 ET umbilical door opening RCS, OMS safing Hydraulic load test LRU deactivation DPS transition to OPS 9 BFS to OPS 00 SSME repositioning APU/HYD shutdown Vent door purge positioning Hatch opening by ground support GPC 2, 3, 4 powerdown NH3 deactivation Ground-support personnel ingress Crew egress	5-159
+27				

<u>EVENT</u>	<u>CUE</u>	<u>DISPLAY</u>
<u>Transition to Major Mode 304</u>	EI - 5 min	CRT timer

EIT = -05:00 (min:s)  
VREL =  $24.4 \times 10^3$  (ft/s)  
H =  $548 \times 10^3$  (ft)  
R = 5613 (n. mi.)

CREW ACTION: Perform Pre-EI Checklist

DISCUSSION

Crew transition to OPS 304 has been baselined to occur at EI - 5 minutes. No hardware or software constraints require the GN&C to be configured for MM 304 5 minutes before entry interface is achieved and the time selected is one of crew convenience to provide a margin for start of encounter of atmosphere.

The following GN&C functions are software activated at crew initiation of OPS 304 PRO.

- o Entry guidance is initiated in the preentry phase with a commanded bank angle of  $0^{\circ}$ . At a sensed acceleration of  $5.66 \text{ ft/s}^2$  ( $0.176g$ , Drag  $\sim 4 \text{ ft/s}^2$ ), closed-loop ranging commences.
- o The AEROJET DAP is initialized in AUTO at the current attitude.
- o Subsystem operating programs (SOP) become active for the:
  - o ADTA
  - o Tacan
  - o Body flap slew commands
  - o SBTC - initialized with CDR in control
  - o RPTA
  - o Entry/landing RCS command
  - o Two-axis RHC (pitch and roll)
- o FDI becomes active for the:
  - o ADTA
  - o Tacan
  - o SBTC
  - o RPTA
  - o Body flap command

## DISCUSSION - Continued

- o The ADI becomes a two-axis ball displaying body roll and pitch attitudes with respect to LV/LH regardless of the ADI ATTITUDE switch. The roll and pitch errors each display the body roll and pitch attitude error with respect to entry guidance commands by using the bank guidance error and the angle of attack error. The yaw error needle displays side slip ( $\beta$ ) to a dynamic pressure of 20 lb/ft<sup>2</sup>. Subsequently, the ADI yaw error needle provides side slip information in terms of equivalent yaw jet capability. (Full scale equals 2.5 equivalent yaw jets.) The roll and pitch rate needles display stability roll and body pitch rates using stability roll rate, roll gyro data, and filtered pitch rate. The yaw rate needle displays stability yaw rate. These rates are calculated in the entry flight control system roll, pitch, and yaw channels for display on the ADI.
  - o The HSI, AMI, HUD and the AVVI become active.
  - o NAVDAD becomes active and computes air data parameters ( $\bar{q}$ , Mach, EAS) for the ADTA.
  - o Site lookup is activated to supply other functions with access to the tacan site and landing site tables.
  - o Preland navigation is activated when valid barometric or MLS data are available.
  - o Entry CRT displays become active as described previously in section 5.1.4.
  - o Area navigation that processes data to the two HSI's according to the position of the HSI SELECT switches.
  - o Entry attitude processing.
  - o Landing gear isolation valve hydraulic conditioning initiated at M 19, M 19 + 5 minutes, and M 19 + 10 minutes.
  - o Vent door sequencing initiated at 2400 ft/s.
  - o SPTI SOP.
- The following GN&C functions were initiated by previous modes and are still active during MM 304:
- o Entry user parameter processing.

## DISCUSSION - Continued

- o RCS activity lights. The RCS activity light processing function will perform the processing necessary to drive the roll, pitch, and yaw RCS indicator lights. The RCS lights indicate the presence of an RCS command from the entry FCS to the jet select logic. The RCS light-on times are stretched to allow the pilot time to identify the commanded jets. After the roll and pitch jets have been deactivated, the roll indicator lights are used to indicate that three or four yaw jets have been requested, and the pitch indicator lights are used to indicate elevon rate saturation.
- o IMU inertial processing.
- o Subsystem operating programs for:
  - o RG
  - o AA
  - o Elevon feedback
  - o Rudder feedback
  - o SB feedback
  - o BF feedback
  - o Hydraulic system
  - o MPS TVC command (stow position)
  - o OMS TVC command (entry stow position gimbal activation command)
  - o Selection filtering, which consists of software elements designed to reduce multiple system outputs into one data source for use by application programs
  - o IMU RM
  - o FDIR for the RG's and AA's
  - o FDI for:
    - Elevon position feedback
    - Rudder position feedback
    - SB position feedback
    - BF position feedback
    - RCS RM
    - RCS quantity monitor
    - GAX
    - Deorbit/landing navigation sequencer
    - Entry navigation terminates when valid barometric data are available
    - SPI processing
    - GN&C switch processor
    - Deorbit/landing user parameter sequencer

At transition to MM 304, the elevon trim integrator is initialized to the I-load trim schedule value. The body flap integrator is initialized to a position as a function of vehicle c.g. The surfaces begin driving at transition to these initial positions and remain fixed until  $\bar{q} = 0.5 \text{ lb/ft}^2$ .

## DISCUSSION - Continued

### Effect on Entry of Deorbit Execution Errors

Deorbit execution errors affect:

- o Surface temperatures
- o Backface temperatures
- o Maximum load factor
- o Guidance sequencing
- o Entry maneuver capability

Surface and backface temperatures are affected by range and flight path deviations at EI as follows.

- o Longer range produces higher backface temperatures and lower surface temperatures.
- o Shorter range produces lower backface temperature and higher surface temperatures.
- o Shallow gamma EI produces higher surface and lower backface temperatures.
- o Steeper gamma EI produces both higher surface temperatures and backface temperatures.

Guidance sequencing effects are shown on page 5-58.

### Thermal Effects

Deorbit execution errors can result from an untrimmed underburn or an overburn. (An overburn is considered unlikely and is not discussed.) Prebank can be used to partially compensate for the temperature increase from an underburn due to the shortened EI to landing range. (The shortened range results in increased surface temperatures.) Potential procedures for handling untrimmed underburns include the following.

- o For small underburns, the increase in Orbiter surface temperatures can be accepted.
- o Vary the preentry bank angle (nominally 0°) as a function of the magnitude of the underburn to minimize the surface temperature increase.
- o Change the landing site to a point further downrange (Northrup) when surface temperatures are predicted to reach unacceptable levels.

The matrix in the Entry Checklist indicates the prebank schedule to Edwards and when the crew would redesignate to Northrup for landing.



<u>EVENT</u>	<u>CUE</u>	<u>DISPLAY</u>
<u>Entry Interface</u>	EIT = 00:00	CRT timer

EIT = 00:00 (min:s)  
VREL =  $24.6 \times 10^3$  (ft/s)  
H =  $400 \times 10^3$  (ft)  
R = 4424 (n. mi.)

CREW ACTION: Awareness

DISCUSSION

Entry interface, by definition, occurs at 400,000 feet. Guidance is still in the preentry phase with a nominally commanded bank angle of  $0^\circ$ .  $\dot{H}$  is approximately minus 500 ft/s.

The CRT timer, which has been counting down to display zero at entry interface, starts counting up.

In the AUTO mode, the entry Flight Control System (FCS) will issue commands to the roll, pitch, and yaw RCS jets for rate damping in the attitude hold phase.

<u>EVENT</u>	<u>CUE</u>	<u>DISPLAY</u>
<u>Auto Elevon Trim Activated</u>	$\bar{q} = 0.5 \text{ lb/ft}^2$ Surfaces trim EAS ~12 kn	CRT/ENTRY TRAJ 1 GNC SYS SUMM AMI
EIT = 02:38 (min:s) VREL = $24.7 \times 10^3 \text{ (ft/s)}$ H = $322 \times 10^3 \text{ (ft)}$ R = 3883 (n. mi.)		
<u>CREW ACTION:</u>	Monitor RCS jet firings, $\delta_E$ , $\delta_{\beta F}$ BDY FLP pb - AUTO	

DISCUSSION

Before  $\bar{q} = 0.5 \text{ lb/ft}^2$ , the body flap and elevons remain fixed at the trim schedule positions commanded at the transition to Major Mode 304. At  $\bar{q} = 0.5 \text{ lb/ft}^2$ , the elevons become active in the flight control system auto pitch trim loop. RCS pitch jet commands are integrated in the pitch channel to form elevon trim commands. The body flap channel also receives the elevon trim commands, compares the trim command to the trim schedule, and drives the body flap to maintain the elevons on the trim schedule. By using the elevons and body flap to assist the pitch jets in trimming out pitch rate errors, RCS fuel is conserved. A typical elevon trim schedule is shown in figure 5-20.

NOTE: Other TEST and ALTERNATE elevon and speedbrake schedules may be selected depending on returning a payload and obtaining PTI data.

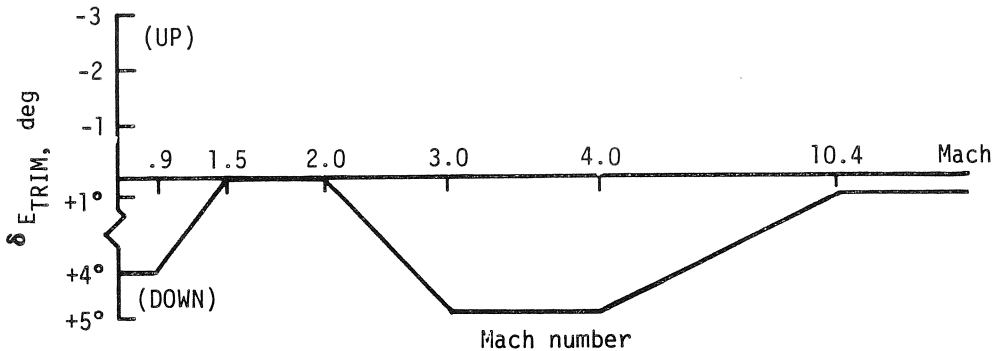

Figure 5-20.- Elevon trim schedule.

However, the elevons may not follow this schedule in this low  $\bar{q}$  region for several reasons. Navigation may not provide a good estimate of  $\bar{q} = 0.5 \text{ lb/ft}^2$ , causing an off-nominal switch to occur. An early switching can cause a mistrim while a late switching can cause higher RCS consumption. In this region, aerovariations in pitching moment because of viscous effects in combination with an aft c.g. can cause the body flap to saturate at the down stop.

## DISCUSSION - Concluded

The primary consideration for elevon trim position down to Mach 12 is a thermal constraint. Surface temperatures begin rising significantly in the 10 to 20 lb/ft<sup>2</sup>  $\bar{q}$  region and remain high until  $\bar{q} \sim 50$  lb/ft<sup>2</sup> and VREL  $\sim 18,000$  ft/s, after which time temperature plots show a decrease in control point temperatures. To prevent overheating, the elevons should be on schedule on attaining  $\bar{q} = 10$  lb/ft<sup>2</sup>.

Manual surface trim is provided by body flap and pitch (elevon) trim switches located on side panels L2 and C3. Surface trim can be commanded in either AUTO or CSS FCS modes.

In the very low dynamic pressure regime, large excursions in elevon trim may be observed, particularly with off-nominal pitching moment variations. Elevon trim deflections are commanded to alleviate pitch jet firings and, because the elevon/body flap trim loop is comparatively slow in this region, the elevon trim may deviate significantly from the trim schedule. The pitch trim limits are  $-33^\circ$  to  $+18^\circ$ , and the roll trim limit is  $\pm 3^\circ$ . Note that if the body flap is in AUTO and the pitch trim is changed from the MM 304 initialization position, the body flap will drive to the stop if required, trying to trim the elevons back to the schedule. At 0.5 psf pressure, the elevons become active for trim through the FCS auto trim loop. As pitch jet firings cause steps in elevon trim, the body flap begins to drive to put the elevons back on the proper schedule. The pitch panel trim could be used to aid in nulling aerodynamic torques prior to  $\bar{q} = 0.5$  psf, but the trim rate is so slow that it is not recommended. For  $\bar{q} > 2$  psf, the panel pitch trim has no recognized utility. Pitch static trim is maintained automatically by the FCS in CSS and AUTO. If a pitch panel trim input is made, the automatic trim will eventually override it.

<u>EVENT</u>	<u>CUE</u>	<u>DISPLAY</u>
<u>Aerosurface Control Activated</u>	$\bar{q} = 2 \text{ lb/ft}^2$	CRT/ENTRY TRAJ 1
EIT = 03:32 (min:s)	$\delta_E$ active	Surface SPI's
VREL = $24.7 \times 10^3$ (ft/s)	$\delta_A$ active	GNC SYS SUMM
H = $297 \times 10^3$ (ft)	EAS ~24 kn	AMI
R = 3670 (n. mi.)		

CREW ACTION: Monitor  $\delta_E$  and  $\delta_A$  surface deflections

### DISCUSSION

AUTO guidance or CSS pitch commands are now sent to Priority Rate Limiting (PRL), commanding the elevons for longitudinal control, rate feedback damping for stability, and automatic trim.

In the AUTO mode the FCS responds to angle of attack commands from entry guidance. These commands are generated within guidance to control drag acceleration variations in bank reversals while maintaining  $\alpha$  within the limits of a desired M- $\alpha$  envelope. If an error exists between the commanded  $\alpha$  and the nav derived  $\alpha$ , the FCS generates a pitch rate in the direction appropriate to null the  $\alpha$  error. The magnitude of the commanded pitch rate is a function of the  $\alpha$  error, limited to  $\pm 2^\circ$  in the pitch axis. The elevon deflections, to produce the required pitch rate commands, are a function of the difference between actual and commanded pitch rate, an integrated surface trim command, and the dynamic pressure. The deflection commands ('forward loop commands') are passed through body bending filters, limited between  $+18^\circ$  and  $-33^\circ$ , and sent to PRL. PRL calculates individual surface panel commands based on the number of hydraulic system failures and the available fluid flow. PRL also sets rate saturation flags if the surface panel commands are being rate limited; i.e., driving at the maximum possible rate of 20 deg/s with two or three APU's operational (13.9 deg/s with one APU). Surface deflections in response to these commands should be visible on the inboard and outboard surface position indicators (SPI's). In AUTO, pitch commands are generally small, 0.5 deg/s or less. RCS pitch jets will fire if the pitch rate error command exceeds 0.25 deg/s. Roll and yaw jets are active to meet roll maneuver acceleration specifications.

In CSS, surface and jet commands are based on pitch rate commands from the pilot's RHC deflection differenced with actual pitch rate feedback, forming a rate error. The pilot can command a pitch rate limited to  $\pm 2.88$  deg/s with the RHC, summed with a  $\pm 1.5$  deg/s rate trim command. Once the rate error between commanded and rate gyro feedback pitch rate is determined, the remainder of the control loop is as in AUTO. The pilot can command higher rates than the AUTO mode; however, actual vehicle initial acceleration remains a function of surface effectiveness in the low  $\bar{q}$  regime and RCS authority. If small residual pitch rates are noted on the ADI, the RHC rate trim can be used to bias the rate command and null the residuals while in CSS.

## DISCUSSION - Continued

The elevons also now respond to aileron commands as generated in the coupled roll and yaw axis channels. Roll maneuvers are commanded by AUTO guidance or RHC inputs in the roll channel. Commanded AUTO roll rates are limited to  $\pm 5$  deg/s about the stability roll axis in the entry flight phase. Based on a commanded roll rate and body yaw rate feedback, the yaw channel computes a yaw rate error signal. This yaw rate signal commands yaw jet firings to achieve the yaw rate required to initiate a bank. The actual yaw rate is sent to the roll channel where a corresponding roll rate for turn coordination is calculated. A roll rate feedback signal is summed with the commanded roll rate to form a body roll rate error command to the roll jets and ailerons. Therefore, in this regime, if a roll is commanded, the following sequence ensues.

- o The yaw jets fire to yaw the vehicle in the direction of the intended roll, inducing a sideslip.
- o As yaw rate builds, aileron commands are generated to produce the roll rate ( $p$ ) required to coordinate the maneuver, damping  $\dot{\beta}$ . Nominal aerodynamics indicates lateral stability ( $-C_{l\beta}$ ); i.e., a negative rolling moment is induced by a positive sideslip angle. The ailerons provide very tight control, and only very small  $\beta$ 's are seen during the roll maneuver.
- o Roll and yaw jet firings and aileron deflections respond to null errors in body roll and yaw rates as required for steady-state turn coordination.
- o Rate damping is performed by the jets and surfaces when the command is zeroed.

An integrator in the roll channel also provides an automatic aileron trim function. From this regime down to Mach 1.25, an aileron is deflected so that the resulting yawing moment will trim out a yawing moment due to sideslip, as might be induced by a lateral c.g. offset or a bent airframe. The pilot can make manual trim inputs to the ailerons via a panel roll trim switch. The aileron trim deflection is limited to  $\pm 3^\circ$ . In response to maneuver commands, trim commands, and rate damping, the aileron command is limited to  $\pm 10^\circ$  in the roll channel. (However, if near the elevon deflection limits,  $10^\circ$  of aileron cannot be obtained.) Using the ailerons for aerodynamic trim alleviates the use of yaw and roll jets for trim, conserving RCS fuel.

The panel roll trim can be used throughout entry. This switch may be used to aid the auto trim to reduce yaw jet activity as follows. If repeated yaw jet firings on the same side are observed, trim away from the firing jet in small steps until the jet activity ceases. For example, if repeated right yaw jet activity is seen with little or no left jet activity, trim to the left with the panel roll trim until the activity ceases or is balanced. Do not attempt to hold the trim switch until the activity ceases or the desired value will

## DISCUSSION - Continued

be overcorrected. This trim procedure should be followed until rudder activation or until aileron trim saturation ( $\pm 30^\circ$ ) occurs. Do not try to trim during bank maneuvers, only during steady state flight.

When the BFS is engaged, the elevator trim is essentially initialized to the present position; however, the aileron and rudder trim integrators are set to zero. The crew should closely monitor aileron trim and yaw jet activity for FCS performance cues as well as for the possibility of a BFS engage case. If in the PASS a large aileron trim is required and the BFS is engaged, manually retrim ASAP to avoid loss of control.

In addition to Y c.g. offsets a bent airframe, aerovariations, and RCS/aero interaction effects may affect the actual aileron trim deflection. Real gas and viscous interaction effects change pitching moment aerocoefficients and, thus, elevon and body flap trim positions. Aileron coefficients and lateral/directional stability coefficients are also a function of elevon trim position, influencing aileron trim deflections. RCS jet firings cause impingement of the plumes on the aerosurfaces and disturb the surrounding airflow. This interaction between plume and flow generates moments different from what might be predicted from system geometry. Flight control characteristics noted from parametric analyses are as follows.

- o Pitch RCS moments are reduced as  $\bar{q}$  increases.
- o Roll due to yaw jets becomes favorable as  $\bar{q}$  increases. At a  $\bar{q}$  of  $0 \text{ lb/ft}^2$ , a plus yaw jet firing, in addition to a yawing moment, produces a  $-13,000 \text{ ft-lb}$  rolling moment. As dynamic pressure increases, the rolling moment produced is positive for a positive yaw jet firing, nominally at about  $6 \text{ lb/ft}^2$ . At  $20 \text{ lb/ft}^2$ , the rolling moment is  $+4,500 \text{ ft-lb}$ . With RCS aero uncertainties applied, however, more rolling moment may result than is required to coordinate a roll maneuver if only one yaw jet is fired. To prevent the possibility of a roll reversal, a minimum of two yaw jets is always commanded.
- o Roll moment due to roll jets decreases significantly as  $\bar{q}$  increases.
- o Yaw RCS moments remain fairly constant throughout the dynamic pressure range for a given number of jet firings. Each jet produces a moment of approximately  $32,000 \text{ ft-lb}$ . The nominal moment is linearly proportional to the number of jets when firing two or more jets. For example, at Mach 10, two jets create a nominal moment of about  $68,000 \text{ ft-lb}$ . (However, if RCS aero uncertainties are applied, depending on specific combinations, that moment varies from  $58,000$  to approximately  $76,000 \text{ ft-lb}$ .)

## DISCUSSION - Concluded

The guidance and control systems are mechanized to minimize the interaction effects as follows.

- o Roll jets are turned off as soon as possible ( $\bar{q} = 10$ ).
- o No guidance roll command until  $\bar{q} > 10$ .
- o A minimum of two yaw jets is always commanded.

Above a dynamic pressure of  $2 \text{ lb/ft}^2$ , the ADI yaw error needle will continue to display the sideslip angle ( $\beta$ ) from ATT PROC to a  $\bar{q}$  of  $20 \text{ lb/ft}^2$ , but  $\beta$  will no longer be used in the FCS calculations of the body yaw rate required for turn coordination. Above a  $\bar{q}$  of  $20 \text{ lb/ft}^2$ , the yaw error needle will display a component of lateral acceleration proportional to  $\beta$  and scaled for ease of monitoring, equivalent to yaw jet authority. This 'scaled  $A_y$ ' or estimated  $\beta$  is discussed further in a subsequent chapter.

<u>EVENT</u>	<u>CUE</u>	<u>DISPLAY</u>
<u>Closed-Loop Guidance Initiated</u>	D = 4 ft/s <sup>2</sup> q̄ = 10 lb/ft <sup>2</sup>	CRT/AMI CRT
EIT = 04:59 (min:s)		
VREL = 24.5 x 10 <sup>3</sup> (ft/s)		
H = 265 x 10 <sup>3</sup> (ft)		
R = 3255 (n. mi.)		

CREW ACTION: Monitor

### DISCUSSION

Closed-loop ranging is initiated at 0.176g total load factor, which is at a drag acceleration of about 4.0 ft/s<sup>2</sup> for nominal L/D and a q̄ of approximately 10 lb/ft<sup>2</sup>, both of which can be monitored on the Entry TRAJ CRT's. The best cue to the crew that closed-loop ranging has commenced is the appearance of the 'square' symbol on the Entry TRAJ 1 display. For each guidance cycle (every 1.92 seconds), entry guidance analytically predicts a reference drag-velocity profile that will satisfy ranging requirements. This drag-velocity profile has been shaped to meet vehicle heating and structural constraints for nominal trajectories plus 3-sigma range dispersions. If, however, these range dispersions are exceeded, the drag-velocity profile will be adjusted in the temperature control and equilibrium glide phases (based on range error) so that nominal constant drag and transition phases can be flown. If a range error still exists in the constant drag phase, the constant drag profile will be adjusted so a nominal transition phase can be flown. Guidance will try to fly a drag-velocity profile that will satisfy ranging requirements regardless of any heating or structural constraints; except, when in the transition phase (VREL < 10,500 ft/s), the drag profile is limited so the vehicle will not exceed 2.2g. To achieve the required vehicle drag so ranging conditions are met, entry guidance uses a combination of bank angle and angle of attack modulation. Because drag changes from bank angle modulations are relatively slow (i.e., increase in bank angle increases H which increases atmospheric density which increases drag), the angle of attack is modulated to achieve the reference drag on the short-period basis and the bank angle is modulated to control drag on the long-period basis. Bank commands are reversed within predetermined delta ψ deadbands to control crossrange errors. Bank angle and angle of attack modulation will be discussed in detail in later sections.

If closed-loop guidance fails to activate, the crew should monitor H and DACT and, as H approaches ~ -200 ft/s, the procedure is to take control in ROLL/YAW 'CSS' and manually bank to ~ 80° bank angle towards WP 1 and converge DACT to DREF. (The first ROLL CMD event contains the drag convergence procedure.) This procedure is only used if autoguidance is known to be failed and the Shuttle symbol is near the nominal trajectory line on the TRAJ 1 display.

Entry closed-loop guidance is nominally initiated in the temperature control phase by the termination of preentry guidance at 0.176g.



DISCUSSION - Concluded

However, depending on the vehicle's energy state, guidance phases can be skipped as shown in the following transition criteria flow diagram.

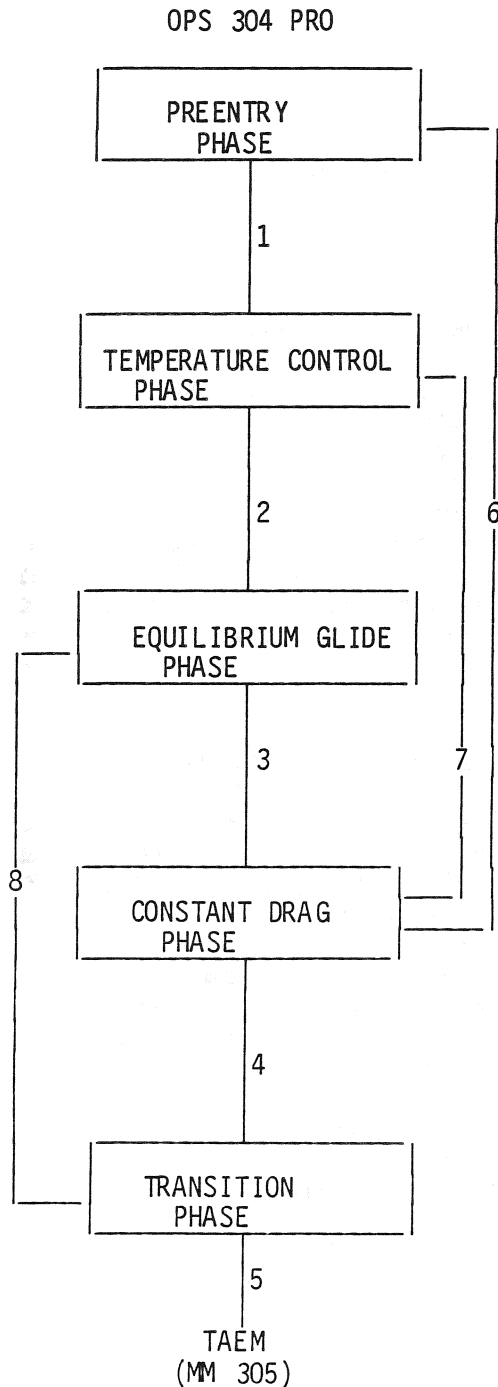

TRANSITION CRITERIA - TYPICAL

1. Total load factor = 0.176g (5.66 ft/s<sup>2</sup>) and criterion 6 is not met.
2. Temperature control and equilibrium glide drag profiles converge at V < 19,000 ft/s.
3. Desired constant drag level (33 ft/s<sup>2</sup>) is reached.
4. V < 10,500 ft/s and drag level < predetermined drag level.
5. V < 2500 ft/s or crew action OPS 305 PRO.
6. Load factor > 0.176g and current constant drag is greater than desired constant drag (short-range case).
7. Desired constant drag is reached and V < 19,000 ft/s or constant drag to reach target > desired constant drag (short-range case).
8. Predicted velocity at criterion V < 10,500 ft/s (very long range entry).

NOTE: The transition flow for different downrange entries is as follows.

- Nominal: 1-2-3-4-5
- Short: 1-7-4-5
- Extremely short: 6-4-5
- Long: 1-2-8-5

<u>EVENT</u>	<u>CUE</u>	<u>DISPLAY</u>
<u>Roll RCS Jets Deactivated</u>	$\bar{q} = 10 \text{ lb/ft}^2$ EAS ~54 kn	CRT/ENTRY TRAJ 1 Roll RCS activity lights AMI
EIT = 05:00 (min:s)		
VREL = $24.6 \times 10^3$ (ft/s)		
H = $265 \times 10^3$ (ft)		
R = 3320 (n. mi.)		

CREW ACTION: None. RCS activity lights should not indicate further roll jet firing.

### DISCUSSION

As dynamic pressure builds, aileron effectiveness increases until sufficient control authority is available without assistance from RCS roll jets. As previously mentioned, the roll moment due to roll jets decreases significantly as  $\bar{q}$  increases toward  $20 \text{ lb/ft}^2$ . RCS jet interactions can cause the moment produced by roll jet firings to change sign between  $4$  and  $20 \text{ lb/ft}^2$ , depending on the number of jets fired, but the aileron moments are powerful enough to overcome these jet interaction moments. Continuation of roll jet firings above  $\bar{q} = 10 \text{ lb/ft}^2$  would only result in somewhat excessive RCS fuel consumption. The FCS ROLL channel terminates roll jet commands above  $10 \text{ lb/ft}^2$ ; thus, if an adequate determination of dynamic pressure is made by NAV, the jets should not continue to fire in a questionable aerodynamic region.

Above  $10 \text{ lb/ft}^2$ , if the ENTRY MODE switch is in the AUTO position, forward loop commands will now be sent from AUTO or the RHC to the ailerons. (At dynamic pressures between  $2$  and  $10 \text{ lb/ft}^2$ , aileron commands are based on yaw and roll rate feedback terms only.) The forward loop commands an initial aileron deflection opposite to the normal command for roll to allow the aileron adverse yawing moment to assist the yaw jets in producing the moments necessary to initiate the roll maneuver sequence. Therefore, if the pilot commands a right roll maneuver, an initial left aileron spike may be observed on the SPI's in conjunction with the yaw jet firings. As the roll is established, the ailerons deflect to damp  $\beta$  and provide the body roll rate to coordinate the stability roll. This initial aileron spike will occur with a roll command initiated between a  $\bar{q}$  of  $10 \text{ lb/ft}^2$  and Mach 3.8. Larger aileron spikes in response to roll commands may be seen (and felt) if the ENTRY MODE switch is in the 'NO YJET' position, as the gain on the aileron command is much higher. Further discussion on NO YJET procedures is contained in the 'Entry Flight Control System Downmoding' section.

<u>EVENT</u>	<u>CUE</u>	<u>DISPLAY</u>
<u>First Bank Command</u>	$\dot{D} = 5.1 \text{ ft/s}^2$ $\dot{H} = 227 \text{ ft/s}$	CRT/ENTRY TRAJ 1 AVVI
EIT = 05:18 (min:s)		
VREL = $24.5 \times 10^3$ (ft/s)		
H = $260 \times 10^3$ (ft)		
R = 3180 (n. mi.)		

CREW ACTION: Monitor

### DISCUSSION

The first bank command is issued by guidance when vehicle drag and  $\dot{H}$  reach a certain delta compared to the trajectory referenced drag and  $\dot{H}$ . This will nominally occur at Drag = 5.1 and  $\dot{H} = -227 \text{ ft/s}$ , which can be monitored by the crew on the Entry TRAJ 1 display and the AVVI. The first bank command will always be toward the landing site.

Under nominal conditions, this first bank command is very soon after closed-loop guidance is activated (guidance activated at  $q = 10 \text{ lb/ft}^2$  and first bank command is a  $q \sim 12 \text{ lb/ft}^2$ ). If for some reason the vehicle does not bank,  $\dot{H}$  will become positive and enter the atmosphere with lift vector up and will cause the vehicle to 'skip out' (i.e., positive  $\dot{H}$  will occur and the vehicle will reenter further down range). The crew should therefore monitor the initial  $\phi$  command at guidance activation and should monitor drag during the pullout to make sure it converges with DREF. If actual drag does not converge to reference drag within  $2 \text{ ft/s}^2$ , the crew should take over in ROLL/YAW CSS and adjust bank angle to converge actual drag with DREF.

To converge DACT with DREF manually, a good instrument cross-check of DACT, DREF,  $\phi$ ,  $\dot{H}$ , and H should be developed. A decrease in  $\phi$  will decrease DACT and an increase in  $\phi$  will increase DACT, but  $\dot{H}$  and H must be used to control the rate of change due to the lags between  $\Delta\phi$  and DACT. Small  $\Delta\phi$  changes are quickly reflected in  $\dot{H}$ ; by cross-referencing  $\dot{H}$  with  $\dot{H}$  and  $\phi$ , an  $\dot{H}$  can be obtained that will place the vehicle at the proper drag level (the desired  $\dot{H}$  to fly is interpolated from the Entry TRAJ display). As a rule of thumb, changes in H should be kept small and the H needle should never be pegged. When in trouble (phugoid), bank to make  $\dot{H} = 0$ . The procedure and flying techniques to perform this are as follows.

- o Maintain DACT  $\sim$  DREF by changing bank angle to change  $\dot{H}$  to change  $\dot{H}$  to change DACT. For example, if DACT is less than DREF, the pilot should check to see if the present trend is toward convergence. If not, he should increase bank angle which will increase the magnitude of  $\dot{H}$  ( $\dot{H}$  should never exceed  $-400 \text{ ft/s}$ ). Finally, he should decrease bank angle to converge  $\dot{H}$  to  $\dot{H}_{REF}$  as DACT converges to DREF. After drag error is nulled, he should return FCS ROLL/YAW to AUTO.

## DISCUSSION - Continued

- o If guidance is suspect, he should continue to fly ROLL/YAW CSS and after the drag error is nulled, attempt to establish an  $\dot{H}$  and  $\dot{H}$  that will slowly trim DACT to keep pace with DREF.

If guidance fails, the crew could take over in P, R, Y CSS and fly a manual entry using the DREF and  $\dot{H}$  REF information on the ENTRY TRAJ displays. The main objective is to keep actual vehicle drag equal to DREF (interpolated from the Shuttle symbol's position between dashed drag lines on the CRT display). The actual vehicle drag is controlled by changes in bank angle  $\phi$  and by  $\alpha$  modulation. Bank angle changes are long-term effects as a change in  $\phi$  changes the vehicle lift in the vertical plane that determines the rate at which the vehicle sinks into the Earth's atmosphere; i.e., the faster the vehicle sinks into the atmosphere (denser air), the faster the drag builds up. This is a slow process, however, due to lags between  $\Delta\phi \rightarrow H \rightarrow \dot{H} \rightarrow D$  change. Changes in  $\alpha$ , on the other hand, are short-term effects on vehicle drag because as  $\alpha$  is changed, the drag coefficient is changed, which has an immediate effect on vehicle drag. The procedure and flying techniques to keep DACT = DREF are as follows.

- o Fly scheduled  $\alpha$  first (CRT or cue card). Do not modulate  $\alpha$  outside the guidance limits.
- o Bank as required to maintain  $\dot{H} \sim \dot{H}$  REF ( $\dot{H}$  for nominal entry is displayed at bottom of CRT TRAJ display). This  $\dot{H}$  number may have to be biased if flying off-nominal trajectories. These  $\dot{H}$  numbers are only used as a gauge for converging and maintaining the drag profile.
- o Perform bank reversals at approximately 5 deg/s ramp  $\alpha$  2° high when  $\phi$  passes through 0° (this helps keep DACT closer to DREF). RHC to detent as  $H$  goes to 0, then shallow bank as required to converge on  $\dot{H}$  that will keep DACT  $\sim$  DREF (use  $H$  to converge on the proper  $\dot{H}$ ).
- o Fine tune  $\alpha$  and  $\phi$  to keep DACT = DREF (using  $\alpha$  modulation to fine tune drag profile will conserve RCS fuel if  $\bar{q} > 20$ ).

### Notes of interest:

- o If flying at drag values that are greater than the DREF values along the top line of TRAJ 1 display, the one time reuse TPS temperature will be exceeded.
- o For nominal trajectories between M 22 and M 10,  $\phi = 60^\circ \pm 5^\circ$  (excluding bank reversals).
- o When in a phugoid, adjust  $\phi$  to make  $\ddot{H} = 0$ .
- o Don't peg the  $\dot{H}$  needle.

## DISCUSSION - Concluded

An early bank command is an indication of higher than nominal L/D or a shallower than nominal  $\gamma$ . A late bank command is an indication of lower than nominal energy and may be due to a low L/D or a steeper than nominal  $\gamma$  or a longer than nominal range to go. With the addition of  $\alpha$  modulation, the low L/D case can also be detected by observing  $\alpha$  after drag equals DREF. (Alpha modulation is activated when  $DACT > DREF$  or  $VREL < 23,000$  ft/s, whichever is first.) If the vehicle has lower than nominal L/D, drag will equal DREF sooner than nominal and  $\alpha$  will ramp down to its limit of  $37^\circ$ , as discussed in the section on first bank reversal at EIT = 14:17.

<u>EVENT</u>	<u>CUE</u>	<u>DISPLAY</u>
<u>Maximum Surface Temperature Region</u>	16 < M < 23	AMI CRT/ENTRY TRAJ 1

EIT = 06:10 (min:s)  
VREL =  $24.0 \times 10^3$  (ft/s)  
H =  $255 \times 10^3$  (ft)  
R = 3800 (n. mi.)

CREW ACTION: Monitor drag-velocity profile

DISCUSSION

In the Mach region, 16 < M < 23, maximum surface temperatures are generated on the Orbiter. These temperatures are a function of the reference drag profile, ranging target, mass properties, elevon schedule, and aerovariations. The critical surfaces in this Mach regime include the nose cap, wing leading edge, forward chine, body flap, elevons, and OMS pods.

Using the OFT 40° alpha profile, the body flap and elevons can be expected to reach temperatures between 2000° F and 2400° F. The nose cap, wing leading edge, and forward chine should be as listed, ±2 percent.

Component	Temperature, °F
Nose cap	2550
Wing leading edge	2710
Forward chine	2520

As of March 1983, the 3-sigma temperature limits for these surfaces are as follows.

Component	Temperature, °F
Nose cap (CP1)	2558
Wing leading edge (CP3)	2840
Forward chine (CP6)	2595
Elevons (CP4)	2531
Body Flap (CP2)	2396

## DISCUSSION - Concluded

A drag-velocity profile is designed for each mission so that it falls between a profile that would generate the most limiting surface temperatures and a profile that defines the 'full-lift equilibrium glide' boundary. This limiting drag-velocity envelope is subject to change from mission to mission as a function of guidance I-loads, mass properties, and aero uncertainties.

A drag-velocity profile that (1) would generate the Thermal Protection System (TPS) material limiting temperatures, (2) would generate the 3-sigma value of these temperatures, and (3) is a 'nominal' trajectory as shown in figure 5-21.

If the generated surface temperature exceeds the material limits of the TPS, tile distortion and shrinkage will occur leading to still higher surface and structural temperatures.

For a nominal trajectory, the maximum generated backface temperature after on-orbit cooldown is 313<sup>o</sup> F and the maximum tolerable temperature limit is 3500<sup>o</sup> F.

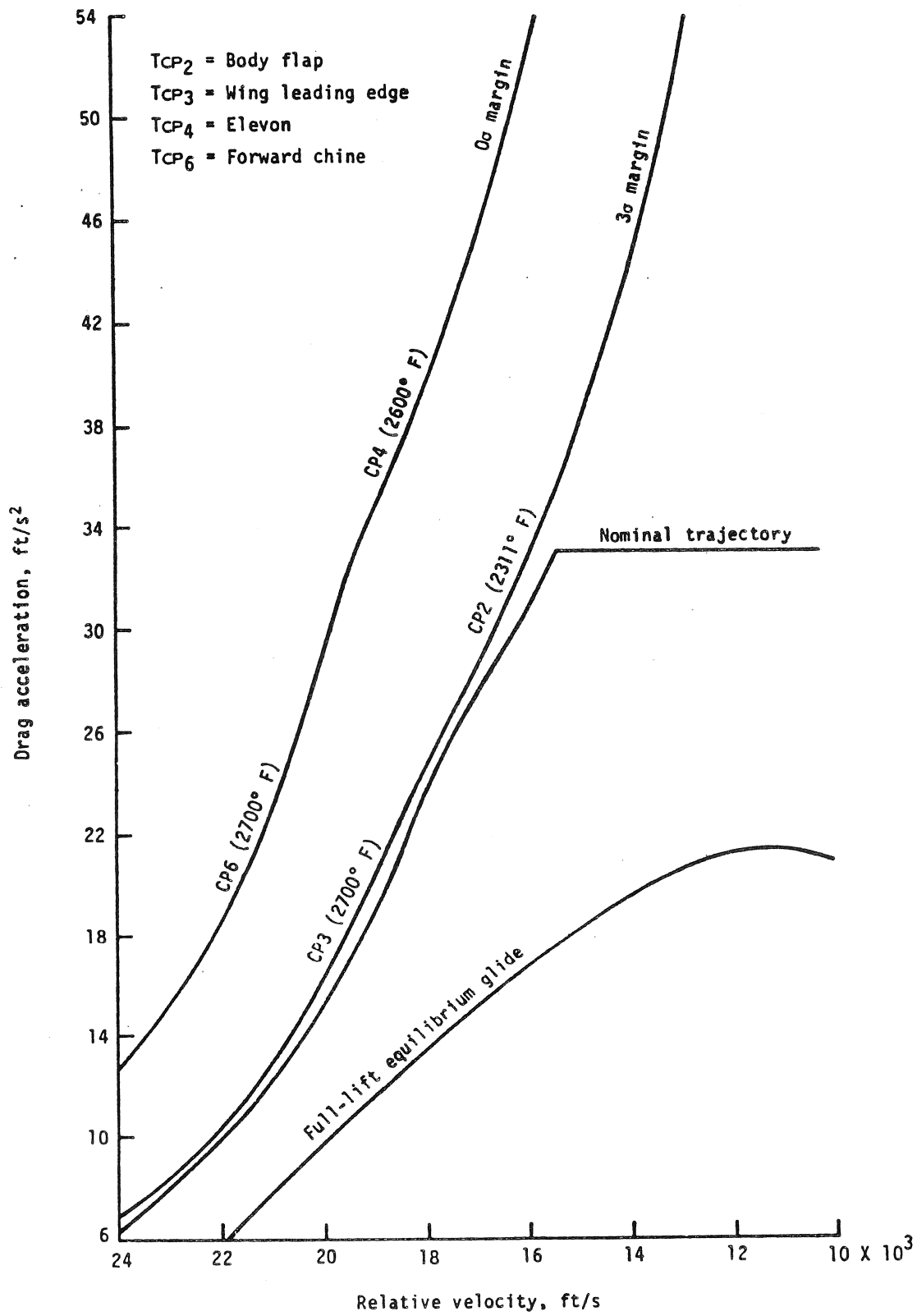

Figure 5-21.- Temperature margin boundaries.



<u>EVENT</u>	<u>CUE</u>	<u>DISPLAY</u>
<u>Pitch RCS Jets Deactivated</u>	$\bar{q} = 20 \text{ lb/ft}^2$ EAS ~77 kn	CRT/ENTRY TRAJ 1 Pitch RCS activity lights AMI
EIT = 08:04 (min:s)		
VREL = $23.5 \times 10^3$ (ft/s)		
H = $248 \times 10^3$ (ft)		
R = 2604 (n. mi.)		

CREW ACTION: None; crew awareness. RCS pitch jet activity lights should not indicate further jet firings.

### DISCUSSION

Based on a NAV-derived dynamic pressure of  $20 \text{ lb/ft}^2$ , the entry FCS undergoes a number of configuration changes.

#### Pitch channel:

- o Commands to the pitch jets for maneuver execution and trim are terminated.
- o Elevon trim is no longer based on an integral of the elevon deflection commands. Elevon position, compensated for speed brake deflection, is passed through a first order lag filter to form the trim command. The panel trim command is also summed with the position feedback and passed through the filter. The total filtered trim command is sent to the body flap channel and is also added to the elevon pitch rate error command.

#### Yaw channel:

- o The sideslip angle,  $\beta$ , from ATT PROC is no longer sent to the ADI. The ADI yaw error needle displays an accelerometer feedback  $A_y$ , compensated for aileron deflection, rudder deflection, yaw jet firings, and yaw rate. This resultant lateral acceleration is scaled as a function of angle of attack and sent to the Flight Director for display. Full scale ( $\pm$ ) deflection of the lowest error needle is comparable to the authority of  $\pm 2.5$  jets; that is, if in flight the needle should deflect full scale, 2.5 yaw jets firing would be required to counteract the torque due to sideslip. If yaw rate/sideslip does not continue to diverge, 2.5 jets may be required for trim if the aileron trim integrator is saturated. Controllability will be marginal. Monitoring  $A_y$  during roll maneuvers gives the pilot an indication of flight control system performance. Manual takeover may be required if the AUTO system does not constrain  $A_y$  within the authority of two yaw jets, particularly in roll reversals. A more detailed discussion of scaled  $A_y$  is contained in section 5.1.6 with interpretation of the displays and recommended pilot actions.
- o At dynamic pressures of  $20 \text{ lb/ft}^2$  and greater, lateral acceleration ( $N_y$ ) feedback is included in the yaw rate error commanding

## DISCUSSION - Concluded

the yaw jet firings. This loop was added to ensure tighter control of sideslip angles, generated especially in bank maneuvers in the presence of aerovariations and angle of attack errors.

- o The yaw panel trim switch commands are integrated and bias the  $N_y$  accelerometer feedback. The value of this integrator is displayed on the TRAJ series CRT displays as NYTRIM. The actual feedback, which NYTRIM is summed with, is displayed as NY.
- o At  $\bar{q} \geq 20$  lb/ft<sup>2</sup>, the number of yaw jets available per side for control increases from two to four.

### Roll channel:

- o At dynamic pressures of 20 lb/ft<sup>2</sup> and greater, lateral acceleration ( $N_y$ ) feedback is also used to calculate a component, as a function of angle of attack, of the total roll rate feedback term. The error between the roll rate feedback term and the AUTO or RHC roll rate command is converted to an aileron surface deflection command. The roll maneuver initiation sequence remains as previously described at  $\bar{q} \geq 10$  lb/ft<sup>2</sup>.

<u>EVENT</u>	<u>CUE</u>	<u>DISPLAY</u>
<u>Drag H Update in NAV Filter Initiated</u>	D = 11 ft/s <sup>2</sup>	ENTRY TRAJ CRT AMI HSD
EIT = 11:49 (min:s)		
VREL = 21.3 x 10 <sup>3</sup> (ft/s)		
H = 234 x 10 <sup>3</sup> (ft)		
R = 1713 (n. mi.)		

CREW ACTION: Check drag H on HSD

DISCUSSION

The drag altitude computation and NAV filter update are initiated when the onboard sensed acceleration reaches 11 ft/s<sup>2</sup>. Simply stated, the drag altitude is calculated by using the relationship between drag and air density to estimate altitude. (Drag is determined from the IMU's and air density from an onboard atmospheric model in software.) Using the model of air density versus altitude, the altitude can be deduced from the air density, which is deduced from drag acceleration. The HSD RESID and DRAG altitude ratio data displays will change from blank to computed values. The drag altitude edit threshold will be set at 80,000 feet. If the ratio is less than 1, the NAV filter state vector will be automatically updated. If the ratio is greater than 1, the crew has two options.

1. The NAV filter can be forced to use the data in updating the state vector (ITEM 22 EXEC).
2. The NAV filter can be left to choose whether or not to update based on the edit routine.

If the NAV filter is forced to update with inaccurate data or if the update is not initiated because of bad drag altitude data, the state vector probably will be so much in error that a GCA will be required. The crew should anticipate this change and be prepared to follow direction when postblackout communications are restored.

The present crew procedure is always to force the NAV filter to use the data since they are assumed to be more accurate than H calculated from IMU's.

Drag altitude computations terminates at VREL <2500 ft/s or until H <85200 feet.

<u>EVENT</u>	<u>CUE</u>	<u>DISPLAY</u>
<u>Pressurize MPS Feedlines</u>	H = 225,000 ft	AVVI

EIT = 13:40 (min:s)  
VREL =  $20.4 \times 10^3$  (ft/s)  
H =  $225 \times 10^3$  (ft)  
R = 1430 (n. mi.)

CREW ACTION: None

DISCUSSION

MPS feedline pressurization with helium pressurant is initiated by the GPC's at an altitude of 225,000 feet. The feedline repressurization is delayed as late as possible during entry to avoid depletion through leakage of the helium pressurant gas but, at the same time, it must occur above the significant atmosphere of 200,000 feet to prevent contamination or corrosion. Ground monitoring will confirm that the event occurred. The crew backup action to the GPC sequence is to manually open the pneumatic valve and the He isolation valve on R1.

<u>EVENT</u>	<u>CUE</u>	<u>DISPLAY</u>
<u>Equilibrium Glide Phase</u>	V = 19,929 ft/s	AMI

EIT = 13:45 (min:s)  
VREL =  $19.9 \times 10^3$  (ft/s)  
H =  $224 \times 10^3$  (ft)  
R = 1328 (n. mi.)

CREW ACTION: Monitor

DISCUSSION

The equilibrium glide phase is one of the five guidance phases and nominally starts at a relative velocity of 19,929 ft/s. During this guidance phase, VREL = 19,929 to 14,493 ft/s, the vehicle  $\dot{H}$  will be fairly constant at approximately minus 150 ft/s. This guidance phase is called equilibrium glide because it is based on a drag-velocity profile that has the fundamental form of equilibrium glide flight. (Equilibrium glide flight is defined as flight in which the flightpath angle remains constant.) Equilibrium glide flight provides a convenient interface between the rapidly increasing drag level from the temperature control phase and the constant drag level of the constant drag phase. The crew probably will not notice when they are in the equilibrium glide phase. If they happen to be looking at the Entry TRAJ display, they would see the DRAG REF and 'square' symbol jump on the CRT when the equilibrium glide phase is initiated. The equilibrium glide phase will be automatically bypassed in short downrange cases if the desired constant drag is reached before VREL < 19,000 ft/s or if the constant drag value required to reach the target is greater than the desired constant drag called for in the constant drag phase.

EVENT

CUE

DISPLAY

First Bank Reversal

$\Delta = 10.5^\circ$

HSI  
ENTRY CRT

EIT = 14:17 (min:s)  
VREL ~  $19.4 \times 10^3$  (ft/s)  
H =  $226 \times 10^3$  (ft)  
R = 1224 (n. mi.)

CREW ACTION: Monitor

DISCUSSION

The first bank reversal is issued by guidance when the azimuth error is  $\pm 10.5^\circ$ . Bank reversals thereafter are issued when the azimuth error is  $\pm 17.5^\circ$  down to Mach 4. At Mach 4, the azimuth error is ramped to  $\pm 10^\circ$  as shown in figure 5-22.

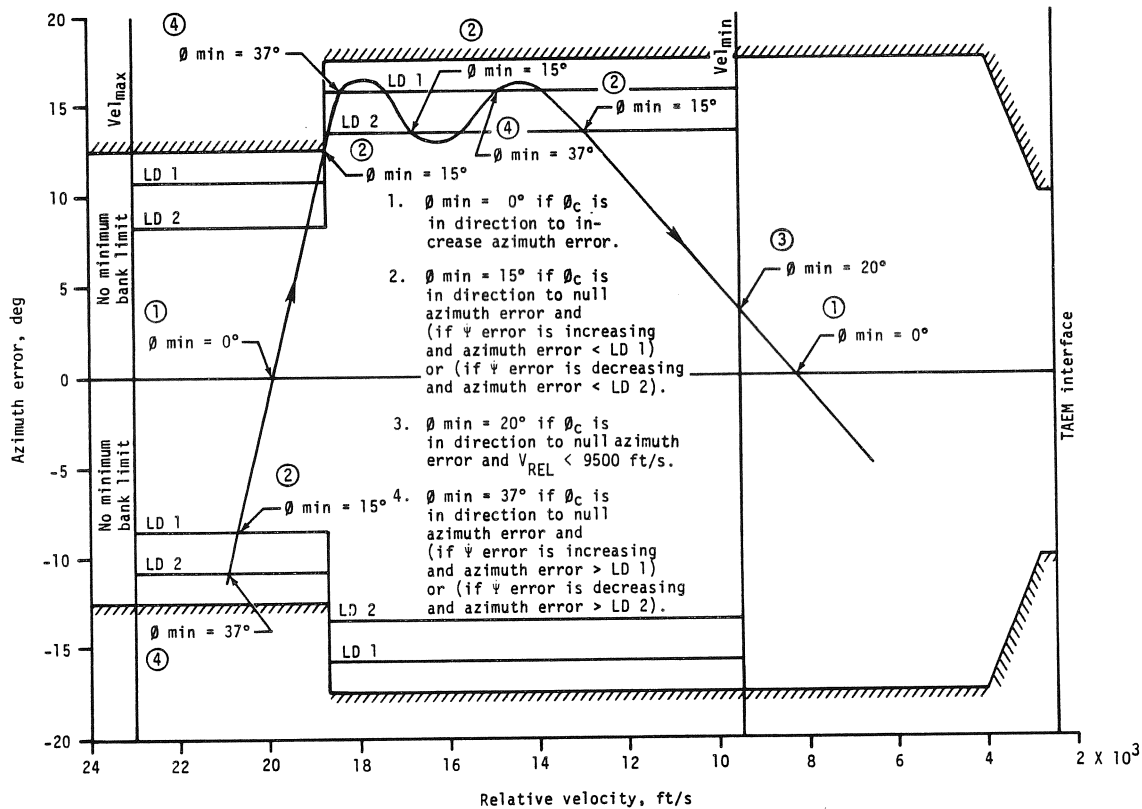

Figure 5-22.- Azimuth error versus relative velocity plot.

Bank reversals are performed to null crossrange errors; and, if the reversals failed to occur within the specified deadbands, serious ranging problems would result.

## DISCUSSION - Concluded

The crew can monitor when bank reversals should occur by a digital readout of 'Delta Azimuth' displayed on the ENTRY TRAJ displays and by observing azimuth error on HSI (difference between the primary bearing pointer and LUBBER LINE). The Shuttle symbol on the display will also flash when the azimuth error limits are reached. Nominally, the vehicle will bank to an angle greater than it had been holding before the reversal. The increased  $\phi$  is necessary to converge back to the drag profile as vehicle drag was reduced (less  $\dot{H}$ ) while rolling through wings level. Also with the addition  $\alpha$  modulation,  $\alpha$  will increase about  $2^\circ$  while rolling through wings level to help keep vehicle drag on DREF. The greater  $\phi$  will shallow out and  $\alpha$  will ramp back to the 'canned'  $\alpha$  - VREL profile as drag converges back to DREF. After drag converges, ROLREF on the Entry TRAJ display should be continually monitored because ROLREF is an indicator of the vehicle's energy reserve. (The larger the ROLREF number, the more energy in reserve.)

For extremely long range entries or low L/D cases, autoguidance has minimum  $\phi$  limits to ensure that crossrange conditions are met while still trying to satisfy total energy conditions. These limits are a function of VREL, azimuth direction, and azimuth error as shown in figure 5-22. Basically, if azimuth error is increasing (i.e., the Orbiter is banked to head away from WP 1), the minimum  $\phi$  command is  $0^\circ$ . If VREL is less than 9500 ft/s and azimuth error is decreasing, the minimum  $\phi$  command is  $20^\circ$ . If VREL is greater than 9500 ft/s and the azimuth error is decreasing (banked toward WP 1), the minimum  $\phi$  command is  $37^\circ$  if azimuth error is  $>13.5^\circ$ , and  $15^\circ$  if azimuth error is  $<13.5^\circ$ .

<u>EVENT</u>	<u>CUE</u>	<u>DISPLAY</u>
<u>Landing Gear Hydraulic Isolation Valve, System 3, Open</u>	V = 19,000 ft/s	AMI

EIT = 14:42 (min:s)  
V =  $19.0 \times 10^3$  (ft/s)  
H =  $212 \times 10^3$  (ft)  
R = 1118 (n. mi.)

CREW ACTION: Monitor

DISCUSSION

At a velocity of 19,000 ft/s, the GPC issues a command to the hydraulic system 3 landing gear isolation valve to drive the valve to the 'open' position. Subsequently, hydraulic systems 2 and 1 landing gear isolation valves are opened at VREL of 19,000 ft/s plus 10 minutes and VREL of 19,000 ft/s plus 13 minutes 5 seconds respectively. Two seconds after each valve is automatically opened, the sequence terminates the open command and the valve remains latched open. The valves are opened in a timed sequence to ensure proper heating of the hydraulic fluids and hardware components in the landing gear arms before initiation of the landing gear extend commands.

MCC will monitor the automatic sequence operation by noting that the three landing gear isolation valves have opened. The backup action for the crew in the event of a malfunction in the auto sequence is to open the valves manually using the switches on panel R4.



<u>EVENT</u>	<u>CUE</u>	<u>DISPLAY</u>
<u>Power Up Previously Powered Down LRU's</u>	V = 15,000 ft/s	CRT

EIT =  
VREL =  $15.0 \times 10^3$  (ft/s)  
H =  
R =

CREW ACTION: If MLS, CRTX - I/O RESET, EXEC power up LRU's

DISCUSSION

For several cooling systems failures, all navigation sensor's (tacan, MLS, Radar Altimeter) are powered off to avoid the heat load they would otherwise generate. Analysis has shown that the loads are acceptable from V = 15,000 ft/s until postlanding powerdown. If using MLS, powerup requires an I/O RESET, EXEC to incorporate the data that would otherwise not be sent through the MDM's.

Additionally and for the same reasons, flight controller and instrument power is off and may at this time be powered on.

<u>EVENT</u>	<u>CUE</u>	<u>DISPLAY</u>
<u>RCS Activity Lights Reconfiguration</u> EIT = 14:42 (min:s) VREL = $18.9 \times 10^3$ (ft/s) H = $214 \times 10^3$ (ft) R = 1500 (n. mi.)	$\bar{q} = 50 \text{ lb/ft}^2$ EAS ~121 kn	CRT/ENTRY RCS activity lights

CREW ACTION: None; crew awareness

DISCUSSION

At a dynamic pressure of  $50 \text{ lb/ft}^2$ , the roll and pitch RCS activity lights are processed by software functions to indicate the flight control system workload to the pilot. Both left and right sides of the ROLL light will illuminate simultaneously if more than two YAW jets are commanded on by the FCS. Note that the lights indicate commands from the FCS to the Jet Select Logic (JSL), not actual jet firings. Additionally, the minimum on-time for a yaw RCS jet to fire is presently 80 milliseconds in this regime, so the commands to the light have been lengthened to allow the pilot time to identify the light flash. The minimum light on-time is 200 milliseconds in this regime, or 80 milliseconds plus a constant of 120 milliseconds. When the minimum jet on-time is increased below 125,000 feet to 320 milliseconds, the minimum light on-time is 440 milliseconds.

Both halves of the PITCH light will illuminate if PRL issues a flag for elevon rate saturation; i.e., either left or right elevon is driving at 20 deg/s or greater with three or two APU's; 13.9 deg/s with one APU operating.

<u>EVENT</u>	<u>CUE</u>	<u>DISPLAY</u>
<u>Constant Drag Phase</u>	V = 14,493 ft/s D = 33 ft/s <sup>2</sup>	AMI AMI/ENTRY TRAJ 2,3 CRT displays
EIT = 17:47 (min:s)		
VREL = 14.5 x 10 <sup>3</sup> (ft/s)		
H = 187 x 10 <sup>3</sup> (ft)		
R = 645 (n. mi.)		

CREW ACTION: Monitor

### DISCUSSION

On the nominal entry profile, the constant drag guidance phase is entered at a vehicle velocity of approximately 14,500 ft/s. In this phase, range predictions are based on a constant drag profile until the transition phase is entered at VREL = 10,445 ft/s. The constant drag phase provides a profile shape that is acceptable to thermal, vehicle performance, and flight control system limits. The crew can monitor this phase by observing a buildup in vehicle drag (AMI and Entry CRT display) to a level of approximately 33 ft/s<sup>2</sup>. This drag value will remain constant until VREL = 10,445 ft/s where it will start ramping down when the transition phase is entered. The phugoid problem is more severe if roll reversals are performed during the constant drag phase because of the higher drag levels. Under nominal conditions, this phase starts when the Shuttle symbol intersects the 33-ft/s constant drag nominal trajectory guideline on the Entry TRAJ 2 CRT display and continues through the Entry TRAJ 3 CRT display. For off-nominal cases, if the ranging problem has not been satisfied by the start of the constant drag phase, the constant drag profile will be adjusted (based on range error) so that a nominal transition phase can be flown. (For extremely short-range cases, the DREF value to fly may be much greater than the nominal 33 ft/s<sup>2</sup>. For extremely long-range cases, this guidance phase will be automatically bypassed if the predicted velocity at end of the equilibrium glide phase is less than 10,400 ft/s.)

<u>EVENT</u>	<u>CUE</u>	<u>DISPLAY</u>
<u>Alpha Ramps Down from 40°</u>	V ~ 14,500 ft/s	AMI ENTRY TRAJ CRT
EIT = 17:47 (min:s)		
VREL = 14.5 x 10 <sup>3</sup> (ft/s)		
H = 187 x 10 <sup>3</sup> (ft)		
R = 645 (n. mi.)		

CREW ACTION: Monitor

DISCUSSION

During the entry flight phase,  $\alpha$  follows a velocity profile that initially is constant at 40°. At VREL ~ 14,500 ft/s, it starts ramping down until it reaches ~ 13° at the TAEM interface. This velocity/ $\alpha$  profile was selected mainly to satisfy thermal constraints but it also satisfies crossrange and flight control system requirements. This profile flies the Orbiter on the back side of the L/D curve until about Mach 4. On later operational flights, the velocity/ $\alpha$  profile will go to a 38°/28° profile, which has greater crossrange capability. The crew can monitor  $\alpha$  via the AMI or Entry CRT display. The pitch command needle on the ADI displays  $\alpha$  error ( $\alpha - \alpha_{CMD}$ ). With the addition of  $\alpha$  modulation to entry guidance,  $\alpha_{CMD}$  can vary from the canned velocity profile plus or minus several degrees as shown in figure 5-23. Autoguidance modulates  $\alpha$  within the limits shown as required to keep actual drag the same as DREF. When the pitch command needle on the ADI is nulled, the  $\alpha$  modulation activity can be monitored by comparing the actual  $\alpha$  ( $\triangleleft$ ) and the canned profile  $\alpha$  (+) displayed on the Entry TRAJ CRT. When the actual  $\alpha$  ( $\triangleleft$ ) is different from the canned  $\alpha$  (+) by more than 2°, the actual  $\alpha$  symbol ( $\triangleleft$ ) flashes. This will occur on nominal entries during roll reversals as  $\alpha$  modulation increases  $\alpha$  more than 2° above the canned profile to keep drag on DREF. The crew's only indication of  $\alpha$  exceeding its limits are from monitoring  $\alpha$  and comparing it to the limits on the  $\alpha$  cue card. If these limits are exceeded or if  $|\alpha - \alpha_{CMD}|$  is greater than 1° under steady state conditions, the crew should take over in CSS and null the  $\alpha$  error.

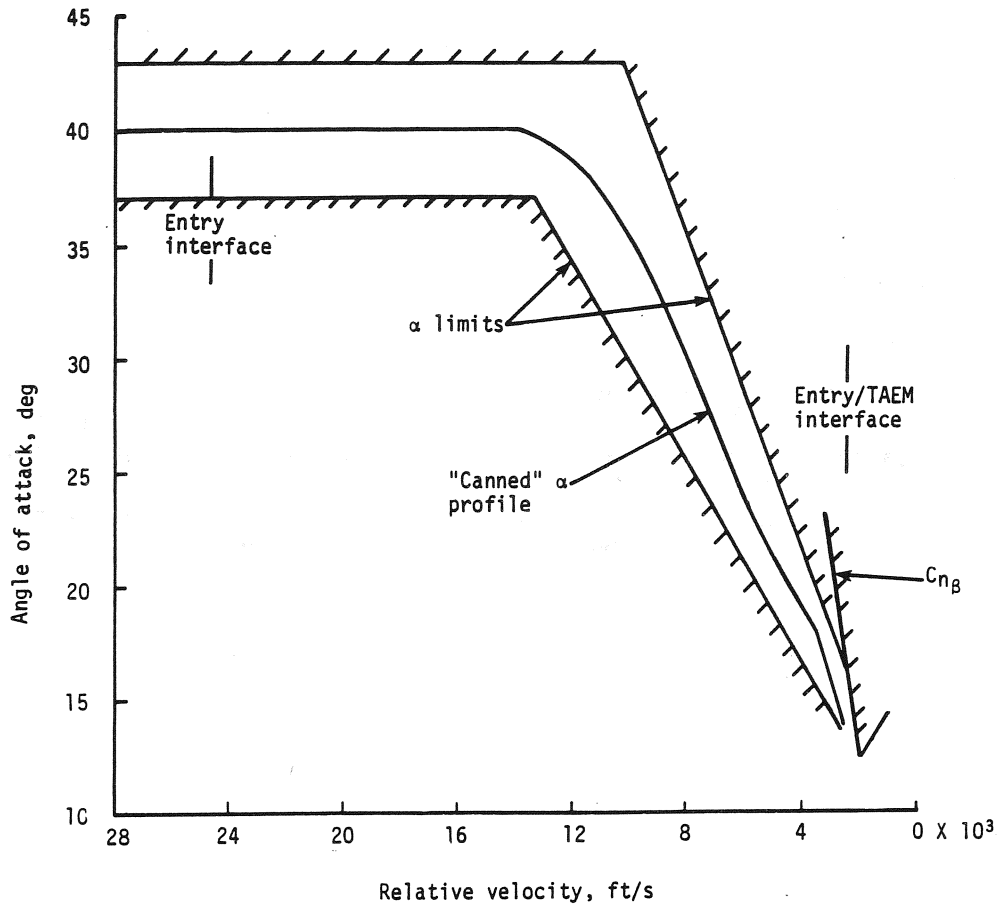

Figure 5-23.- Entry angle of attack profile.

<u>EVENT</u>	<u>CUE</u>	<u>DISPLAY</u>
<u>Point Pillar C-Band AOS</u>	EIT = 18:27	CRT timer

EIT = 18:27 (min:s)  
VREL =  $13.2 \times 10^3$  (ft/s)  
H =  $180 \times 10^3$  (ft)  
R = 558 (n. mi.)

CREW ACTION: Awareness

DISCUSSION

C-band is used by ground radar stations for skin tracking. At the time C-band acquisition occurs during entry, the Orbiter is in the communications blackout phase; therefore, the crew does not receive immediate confirmation of skin tracking. No crew actions are required. On the nominal trajectory, the ground will have had about 1 minute of skin tracking before S-band acquisition.

<u>EVENT</u>	<u>CUE</u>	<u>DISPLAY</u>
<u>Call Up HSD to Monitor Tacan AOS</u>	EIT = 19:20 V ~ 10,500 ft/s	CRT timer AMI
EIT = 19:20 (min:s)		
VREL = $10.5 \times 10^3$ (ft/s)		
H = $164 \times 10^3$ (ft)		
R = 385 (n. mi.)		

CREW ACTION: BFS CRT DISPLAY - OFF  
GNC - SPEC 50 PRO

DISCUSSION

The HSD is called up by the pilot for tacan and navigation management on CRT 3 before first tacan acquisition. Previously the BFS entry displays on CRT 3 had been used for monitoring the BFS/PASS attitude error readouts for statusing the health of the BFS in the event of takeover.

The PASS HSD comes up with the following navigation ITEMS inhibited.

ITEM 20: TAC AZ and RNG  
ITEM 25: ADTA H  
ITEM 28: ADTA G&C

Page 5-88 explains in detail how the tacans are managed.

<u>EVENT</u>	<u>CUE</u>	<u>DISPLAY</u>
<u>Transition Phase</u>	V = 10,400 ft/s	AMI

EIT = 19:49 (min:s)  
VREL =  $10.4 \times 10^3$  (ft/s)  
H =  $162 \times 10^3$  (ft)  
R = 395 (n. mi.)

CREW ACTION: Monitor

DISCUSSION

The transition phase starts at approximately 10,400 ft/s and terminates at TAEM interface velocity VREL = 2487 ft/s. During this phase, a linear drag profile is used as the reference profile shape. Ranging is accomplished by changing the slope of the drag profile as a function of the range error. As in previous phases, a reference drag level (DREF), altitude rate reference (HREF), and L/D reference are computed. Also, to ensure that excessive aerodynamic loads and descent rates are not encountered, DREF is limited to a premission load-factor limit (currently 2.2g) and the bank angle command limited to 70° (Mach 8) as an additional protection against excessive descent. ROLREF is left about 62° at the start of transition and one or two bank reversals can be expected before TAEM.

Nominal data for the transition phase are as follows.

Event	EIT, hr:min	VREL, ft/s	DREF, ft/s <sup>2</sup>	HREF, ft/s	ROLREF deg
Start	19:49	10,462	33	-255	-62
End	25:48	2,487	20	-260	-21



<u>EVENT</u>	<u>CUE</u>	<u>DISPLAY</u>
<u>Speed Brake Ramp to 100 percent</u>	M = 10 Speed brake ramp	AMI $\delta_{SB}$ SPI GNC SYS SUMM
EIT = 20:03 (min:s)		
VREL = $10 \times 10^3$ (ft/s)		
H = $160 \times 10^3$ (ft)		
R = 362 (n. mi.)		

CREW ACTION: Monitor surface command and surface deflection on speed brake SPI.

DISCUSSION

When in the AUTO mode, the speed brake follows a deflection schedule based on Mach number. Before Mach 10, the speed brake channel sends a command of  $-9^\circ$  to Priority Rate Limiting (PRL) to ensure that the surfaces are thermally sealed. The following schedule (fig. 5-24) is representative for  $M < 10$ .

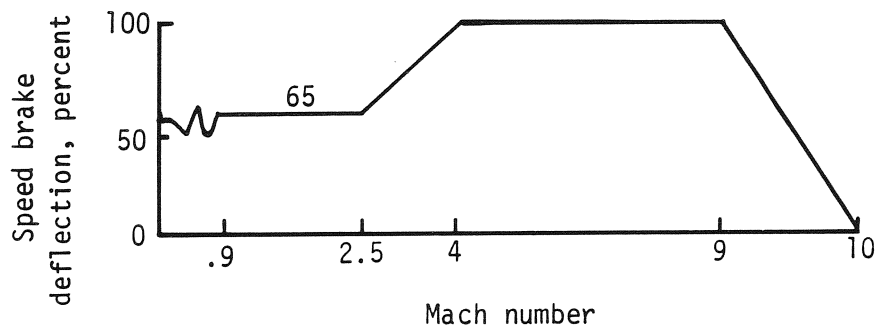

Figure 5-24.- Speed brake schedule.

In the Mach 10 to 3.0 regime, the full deflection of the speed brake produces a nose-up pitching moment, which allows a counteracting down elevon trim position of  $+5^\circ$ . The down elevon trim position is required for  $-C_{n\delta_a}$  (negative yawing moment due to aileron deflection)

necessary to trim out yaw moments resulting from lateral c.g. offsets or a bent airframe. The speed brake position is crossfed to the elevon pitch channel to calculate an elevon trim contribution.

If the speed brake does not follow the cited schedule within 10 percent, the CONFIG event sequence light will illuminate. The crew can take manual control by depressing the takeover button on the SBTC handle and commanding the appropriate surface deflection. If desired, the AUTO SPEED BRAKE pbi can then be depressed to put the speed brake back in the AUTO mode. The speed brake opening rate is 6.1 deg/s (Hinge Reference Line); and the closure rate is 10.86 deg/s until the softstop at  $12^\circ$ , at which point the closure rate decreases to 1 deg/s. After the speed brakes are opened at M 10, a

DISCUSSION - Concluded

minimum speed brake position limit of 15° is required for directional stability down to Mach 0.6. (Until subsonic, the speed brake has little effect on the vehicle's L/D or glide capability.) After Mach 0.6 for final approach and touchdown, the minimum speed brake deflection remains at 15° to prevent damage to the rudder conical seal from rudder/speed brake hinge interference due to a design/manufacturing error in OV099. At WOWLON, a software event flag indicating touchdown on main gear, the speed brake minimum deflection is 25°. These limits are imposed in the FCS speed brake channel.

<u>EVENT</u>	<u>CUE</u>	<u>DISPLAY</u>
<u>UHF Upvoice and Downvoice</u>	Voice	N/A

EIT = 20:14 (min:s)  
VREL =  $9.7 \times 10^3$  (ft/s)  
H =  $158 \times 10^3$  (ft)  
R = 359 (n. mi.)

CREW ACTION: Awareness, uhf communications check.

DISCUSSION

UHF provides a backup to S-band for communications and is used in case of S-band failure. As soon as practical after emerging from blackout, the crew may perform a uhf two-way voice check with the MCC by using the uhf transceiver relaying to MCC through a UHF ground station.

The main UHF controls are located on overhead panel 06. Circuit breakers on panel R15 (UHF MNA and UHF MNC) must be closed for uhf activation. Two frequencies, 259.7 and 296.8 MHz, are available for normal transmission and receiving, and emergency uhf communications are available on the guard frequency, 243.0 MHz.

<u>EVENT</u>	<u>CUE</u>	<u>DISPLAY</u>
<u>S-Band AOS</u>	MCC call	HSD

EIT = 20:27 (min:s)  
VREL =  $9.3 \times 10^3$  (ft/s)  
H =  $157 \times 10^3$  (ft)  
R = 340 (n. mi.)

CREW ACTION: Manage NAV filter, respond to ground directions

DISCUSSION

No communications will exist between the Orbiter and ground from before entry interface to S-band acquisition. During this time, navigation may degrade. A combined effort between crew and ground is required to recognize and resolve the discrepancy as soon as possible.

Preentry, the tacan A-I-F is set to INHIBIT, BARO to INHIBIT and DRAG H to AUTO. Although communications are expected to be reestablished before two tacan lockons, the crew will monitor and control the NAV filter via the HSD in case communications are delayed or communications failure occurs. Per the entry cue cards, crew management of the tacans is as follows:

With COMM

If tacans lock on before normal communications are established with MCC, the crew will leave the tacan A-I-F in INHIBIT until communications are established, but no later than VREL = 6000 ft/s.

If the ratio  $< 1$  and if MCC concurs that the tacan data are good, the crew will put the tacan A-I-F to AUTO (Item 19 on HSD). MCC typically has approximately 1.5 minutes of C-band radar skin tracking before S-band AOS so, as soon as communications are acquired, the state vector from skin tracking is compared with onboard NAV and tacan data.

DISCUSSION - Continued

If the ratio is < 1 and MCC sees that the tacans will degrade the NAV state, then the crew will be told to leave the tacans in INHIBIT.

TACAN MGMT

	RATIO < 1	RATIO > 1	ONE TACAN LOCKED	NO LOCK
PRE-COMM	INH	INH	INH	INH
COMM OK	MCC: AUTO or INH (if TACAN will degrade NAV state)	MCC: INH (+Δ STATE or FORCE or ZERO Δ STATE or CHG TACAN CH	MCC: DESELECT MISSING TACAN(S) then- AUTO	MCC: TACAN MODE (three) - GPC MCC call at 118,000 ft

NO COMM TACAN MGMT

V = 6K

* * * * * * * * * * * *	RATIO < 1	RATIO > 1		ONE TACAN LOCKED	NO LOCK	* * * * * * * * * * * *
		TROUBLESHOOT		BELOW V = 5.5K	BELOW V = 5.5K	
		IF BAD TACAN	IF BAD NAV STATE	DESELECT MISSING TACANS,	TAC (three) GPC	
	AUTO	AUTO	If 1st acq-FORCE If not - ZERO Δ STATE	then - AUTO		

If the ratio > 1 and MCC determines that tacan data are bad, they will update the state vector. If the tacan data are good and the onboard NAV state is determined bad they will either have the crew 'FORCE' in tacan data or they will send up a delta state vector update. If for any reason it is necessary for MCC to voice an update to the onboard state vector, the crew will manually enter the data on the HSD. The manual entry requires approximately 3 minutes. If it is not determined that the tacan ground station is bad, the crew will change tacan channels (two ground stations are always available near the landing site) by changing the tacan rotary switches from T/R to GPC.

## DISCUSSION - Continued

If for some reason after initial acquisition the tacan ratio has increased to  $> 1$ , then MCC might have the crew perform a zero  $\Delta$  state update (Item 16) that would reinitialize the covariance matrix and hopefully bring the ratio  $< 1$ .

If only one tacan is locked on and MCC determines that they would like to update NAV from a single tacan, the crew will prime select by deselecting the other two tacans (breaks the two-lock requirement).

For the no-lock case: If there has been no lock by VREL = 5500 ft/s, MCC will have the crew select a different tacan channel by going to 'GPC'. If there is still no tacan lockon, the crew may select the lower antennas (auto antenna selection may have failed).

No comm case: If there has been no comm by VREL = 6000 ft/s and the tacan ratio is  $< 1$ , the crew will put the tacan A-I-F to 'AUTO'.

If the ratio is  $> 1$ , the crew will have to do some troubleshooting to determine whether the problem is with the tacans or in the NAV state. First check IMU status. If the IMU's were at the two level and/or they required several updates prior to entry, the crew might suspect the onboard NAV. Also observe the tacan AZ and RNG behavior on the HSD and HSI using the HSI SELECT SOURCE switches. If it was erratic (best observed in the absolute mode), the crew would suspect the tacans. Finally, select the other tacan station at the landing site and if the ratio decreased to  $< 1$ , then the ground station was bad. If the ratio stayed  $> 1$  and the tacan data were steady with at least 2 LRU's locked ON, then the NAV state is probably bad. After troubleshooting, if the tacan was determined to be bad, the crew will place the A-I-F to AUTO and let RM inhibit the bad tacan data (if the tacan later becomes good, the data will automatically be taken into NAV). If the NAV state was determined to be bad and no tacan processing has taken place, the crew will then 'FORCE' in the data (Item 21). If this was not the first acquisition, i.e., tacan A-I-F was in AUTO and NAV processing of tacan data had occurred, then the crew would open up the covariance matrix by doing a zero  $\Delta$  state update that would reduce the ratio to  $< 1$  and allow processing.

For the no comm, one tacan lockon case, the crew would wait until VREL = 5500 ft/s before they prime selected. This allows the maximum time for two tacan lockon but still gets the NAV state updated by a single tacan before the critical FCS mark region.

<u>EVENT</u>	<u>CUE</u>	<u>DISPLAY</u>
<u>Runway Redesignation</u>	Communications	HSD

EIT = 20:41 (min:s)  
VREL =  $8.9 \times 10^3$  (ft/s)  
H =  $156 \times 10^3$  (ft)  
R = 318 (n. mi.)

CREW ACTION: Awareness

DISCUSSION

A capability exists via HSD item entries to reselect the Orbiter landing runway. During entry, navigation errors or aerodynamic dispersions could bias the trajectory or wind conditions could change enough that redesignation would be preferred. Although this redesignation during entry between runways can be accomplished by item number on the HSD, it should not be performed without MCC concurrence. Studies have shown that for low-energy cases it may be better to delay redesignation until TAEM. Regardless, the most accurate trajectory, guidance, and navigation assessment cannot be made until C-band radar tracking data and S-band telemetry data have been analyzed and postblackout communications have been established between the Orbiter crew and ground-support personnel.

<u>EVENT</u>	<u>CUE</u>	<u>DISPLAY</u>
<u>Earliest Opportunity for MCC State Vector Update</u>	S-band commun- ications	HSD

EIT = 21:34 (min:s)  
VREL =  $7.5 \times 10^3$  (ft/s)  
H =  $145 \times 10^3$  (ft)  
R = 251 (n. mi.)

CREW ACTION: Awareness

DISCUSSION

A high-speed ground processor computes delta state vector updates from available radar tracking data and Orbiter S-band telemetry data. Position and velocity components in a runway coordinate system are time correlated and compared. If the deltas exceed Flight Rules limits, then a delta state vector update is prepared. The onboard NAV state can be corrected by a direct uplink command or the MCC can read the deltas for the crew to input manually via keyboard entry to the HORIZ SIT CRT display.

The ground delta state processor can evaluate the NAV errors in approximately 45 seconds. Additional time is required to implement the corrections; therefore, the current delta state is propagated ahead to provide an accurate update at the time of incorporation. For example, assume that at  $T = 0$ , a 90,000-foot downrange position error and a 100-ft/s downrange velocity error exist. If the state vector update is incorporated at  $T = 60$  seconds, then the velocity update is -100 ft/s and the position update is -96,000 feet. (IMU acceleration errors are considered as negligible for the propagation interval.)

The crew will probably be informed that a delta state vector update is being prepared if NAV errors exceed Flight Rules limits. They will be requested to engage CSS if significant transients are predicted to occur with the auto flight control system selected when the delta state update is incorporated, and to inhibit external NAV aids to NAV.



<u>EVENT</u>	<u>CUE</u>	<u>DISPLAY</u>
<u>First Tacan Acquisition</u>	Tacan range and bearing data appear	HSD
EIT = 21:41 (min:s)		
VREL ~ $7.3 \times 10^3$ (ft/s)		
H ~ $144 \times 10^3$ (ft)		
R ~ 242 (n. mi.)		

CREW ACTION: Monitor

DISCUSSION

Tacan acquisition and operation are completely automatic under nominal conditions. The crew is provided with the necessary controls and displays to evaluate the tacan system performance and to take over manually if required. The tacan scheme is based on common channel operation of the three onboard LRU's; i.e., all LRU's tuned to a common ground station. Because the three tacan LRU's have different antenna locations, they will not all lock on at the same time. Other factors that affect tacan lockon are vehicle bank angle and ground station location. All three LRU's are manually tuned in the T/R mode. At MM 304, the onboard LRU's will start searching for range and bearing lock. They will interrogate with the lower and upper antennas approximately 12 seconds each until a range lock is acquired. After an LRU has a range lockon, that LRU will stay on the antenna (upper or lower) that has acquired the lockon. In order for NAV to process RNG or bearing, each component must separately satisfy a two-lock requirement. As soon as an LRU acquires AZ/RNG data, those data are displayed on the HSD for the LRU; however, the RESID and RATIO column for the AZ/RNG data will still be blank until the two lock and acquisition filter requirements are satisfied (10 consecutive lockons required for RNG if  $M > 7.6$ , 5 if  $M < 7.6$ , and 12 consecutive lockons required for BRG). The acquisition filter guarantees that there is a steady lockon before the data can be used. Since RM operates at 1 Hz, there will be 10 to 12 seconds before data will appear in the RESID, RATIO column. Once lockon is lost, the acquisition filter cycle starts all over again. The two-lock range requirement, however, goes away after about 30 seconds of initial NAV processing (depends on size of covariance matrix; if the crew performs a zero delta site update, the two-lock RNG requirement is reinstated). The two BRG lock requirement never goes away. Typically, two LRU's have locked on in both RNG and BRG at approximately 150,000 - 145,000 feet.

Because BRG data are not reliable when flying over a station, there is a 'cone of confusion' check ( $35^\circ$  from horizontal,  $110^\circ$  cone) where no BRG data will be processed. The accuracy of position of the cone is a function of state vector accuracy. The crewmen can determine presence of the cone by observing that AZ data have been and are being displayed for the LRU's, but the AZ RESID/RATIO data are blank. While in the cone, RNG data are still used to update NAV (the RNG RESID/RATIO data are displayed). One should not initially process tacan data (AUTO or force) while in the cone because the resulting NAV errors may be large and loss of control has resulted in simulations.

DISCUSSION - Concluded

If BRG data from an LRU differ from the others by 60 or more for 10 consecutive cycles, the BRG data from that LRU will be deselected and a '↓' will appear by that parameter. If range data from an LRU differ from the others by 3000 feet for five consecutive cycles, the range data from the LRU will be deselected and a '↓' will appear by that parameter.

If there are three LRU's available, RM will MVS by parameter. At the two-LRU level, RM will take the average by parameter and will use data if only one LRU is available (may have to prime select to break two-lock requirement). If there is a dilemma, no data are used. Operation in the T/R mode precludes self test. In the 'GPC' mode, there is an automatic self test when in a dilemma. After steady lockon has been achieved, a postselection filter will prevent any sudden data changes from being processed (if there is a change in BRG of 4.50 or change in RNG of 10,000 feet in one cycle, the filter will inhibit the data).

Management of the tacans is discussed in detail in the section on S-band AOS, page 5-86.

<u>EVENT</u>	<u>CUE</u>	<u>DISPLAY</u>
<u>ADTA Data into G&amp;C and NAV</u>	M = 5.0	AMI, AVVI SPEC 051 SPEC 050
EIT =		
M > 5.0		
H >		
R >		

CREW ACTION: Monitor ADS DATA upon MCC call  
 Incorporate ADTA-H (Item 25, SPEC 050)  
 and ADTA-G&C (Item 28)

DISCUSSION

At EI - 5 minutes when the crew PRO's into MM 304, ADTA-H and ADTA to G&C comes up in INHIBIT. MCC monitors the ADTA data after the probes are fully deployed at M = 5.0. If the data look good, MCC will have the crew put ADTA-H and ADTA to G&C into AUTO before M = 2.5 allowing barometric altitude to update the NAV and ADS parameters to be used by G&C. In any case, ADTA data will not update NAV or GNC until M 2.5. DRAG-H will continue to update NAV until M = 2.5. If the ADTA data will degrade the NAV state, the MCC will advise the crew to leave ADTA in INHIBIT. In the no comm case, the crew will determine whether the data look good or not (via SPEC 51) and if the ratio is less than 1, they will select AUTO. If the ratio is greater than 1 and tacan data have been satisfactory, they may leave ADTA in INHIBIT. If there has been no tacan updating and the ADTA data appear erratic, the crew will select AUTO and let the RM system perform its data edit function. If the ADTA data are steady, they should select FORCE and after the ratio is less than 1, select AUTO.

NOTE: In the BFS, ADTA-H is left in INHIBIT to keep the BFS state isolated from external measurements (tacan and ADTA). However, the ADTA to G&C is left in AUTO in case the crew must quickly downmode to the BFS, thus air data will be available for flight control. The ADS parameters used by G&C are shown in table 5-V.

DISCUSSION - Continued

TABLE 5-V.- ADS PARAMETERS

(a) Used by flight control

Parameter	Use
Angle of attack, $\alpha$	Compute stability axis rates for lateral channel Lateral axis turn coordination term
Dynamic pressure, $\bar{q}$	Gain scheduling for all channels
Mach number, M	Gain scheduling for all channels Switching logic to inhibit yaw jets
True airspeed, TAS	Lateral axis turn coordination terms Longitudinal axis gain on Nz command

(b) Used by guidance

$\bar{q}$	TAEM normal acceleration limits TAEM speed brake control
M	TAEM bank angle command limits Initiation of TAEM active speed brake modulation
TAS	TAEM S-turn gain compensation Autoland acceleration command calculation during flare to shallow glide slope
EAS	Approach/land speed brake control

The preceding ADS parameters are automatically input into G&C provided:

- o A probe is deployed.
- o VREL < 2500 ft/s.
- o No dilemma exists.
- o A-I-F is in either AUTO or FORCE (FORCE < 2500 ft/s).

## DISCUSSION - Continued

Pressure altitude (ADTA-H) is used by NAV provided:

- o A probe is deployed.
- o A-I-F is in FORCE.
- o No dilemma exists.
- o Not in Mach jump region ( $1.1 \leq M \leq 1.6$ ).
- o A-I-F is in 'AUTO' with ratio  $< 1$  and VREL  $< 2500$  ft/s or AIF = Force and Vrel  $< 2500$  ft/s.

After ADS probe deployment at VREL = 5000 ft/s, the 'L' and 'R' positions of the Air Data switch will display ADS probe-sensed parameters on the AMI and AVVI, with the exception that Alt Accel (H) on the AVVI and 'ACCEL' on the AMI will always display NAV data. This allows the crew to check good deployment of the probes by moving the ADS switch 'R,' then 'L.' In the event of an ADTA failure or dilemma, the override display available (as per SPEC 51) can be used to determine actual ADTA output. This output can be used to determine which appropriate reconfiguration option should be executed.

As the probes go subsonic, measured static pressure error is approximately 50 percent. If this static pressure were used in the ADS SOP, an altitude error of approximately 17 percent and Mach error of approximately 25 percent would result. A Mach jump region ( $1.1 \leq M \leq 1.6$ ) has been set up to ensure coverage of this phenomenon. During flight through this Mach jump region, the FCS and guidance continue to use data from total pressure for  $\bar{q}$  and M and upper and lower pressure for angle of attack. Measured static pressure from the probes is not used as a primary input to the air data SOP in the Mach jump region; instead, a static pressure estimated from NAV altitude is used in the air data SOP for computation of parameters used by the FCS and guidance. NAV does not process ADTA-H in the Mach jump region.

Should the ADS data be bad or a dilemma exist, the FCS will use default  $\bar{q}$  and  $\alpha$  data, and NAVDAD will provide EAS, TAS, and M. Guidance will continue to use the  $\bar{q}$  from NAVDAD for speed brake commands in this case. A summary depicting the conditions under which the various air data sets (navigation derived, probe sensed, Mach jump, and default) can be invoked is provided in table 5-VI. For the cases in which the output states to 'Freeze Air Data,' this means that the output remains unchanged from its previous cycle.

TABLE 5-VI.- AIR DATA MODING AND OUTPUTS

(a) ADTA GMC

⑤ MACH REGION	PROBE RH STATUS	MODING CONDITION		OUTPUTS TO GC (α, H, Q, EAS, TAS)
		HORIZ SIT ADTA TO GMC	ADTA RH STATUS	
N O M I N A L	O N E O R B O T H	①	N/A	AIR DATA DERIVED FROM NAVIGATION
			0. K.	AIR DATA DERIVED FROM PROBE SENSED PRESSURES
			DG FAILURE OR DILEMMA ③	AIR DATA DERIVED FROM MACH JUMP PRESSURES
			DG FAILURE ③	AIR DATA DERIVED FROM PROBE SENSED PRESSURES
F A I L U R E	D E P L O Y E D	A U T / F O R	DILEMMA ③	AIR DATA DERIVED FROM NAVIGATION
			DG FAILURE ③	FREEZE AIR DATA BASED ON MACH JUMP PROCESSING
			DILEMMA	DEFAULT AIR DATA AND DEFAULT FLAG TO GUIDANCE
			DG FAILURE ③	FREEZE AIR DATA DERIVED FROM PROBE SENSED PRESSURES
C R E W	B O T H N O T D E P L O Y E D ②	①	N/A	AIR DATA DERIVED FROM NAVIGATION
			N/A	DEFAULT AIR DATA AND DEFAULT FLAG TO GUIDANCE
C R E W O R R M	B O T H N O T D E P L O Y E D ②	N/A	N/A	AIR DATA DERIVED FROM NAVIGATION
			N/A	DEFAULT AIR DATA AND DEFAULT FLAG TO GUIDANCE

(b) ADTA H

⑤ MACH REGION	PROBE RH STATUS	MODING CONDITION		OUTOUT TO NAVIGATION (MPC.)
		ADTA RH STATUS	ADTA RH STATUS	
N O M I N A L	O N E O R B O T H	0. K.	N/A	AIR DATA DERIVED FROM PROBE SENSED PRESSURES
			DG FAILURE ③	AIR DATA DERIVED FROM PROBE SENSED PRESSURES AND INDICATION OF MACH JUMP ⑥
			DILEMMA	AIR DATA DERIVED FROM PROBE SENSED PRESSURES
			DG FAILURE ③	FREEZE AIR DATA DERIVED FROM PROBE SENSED PRESSURES AND SET ALT DG AND HJ FLGS FALSE.
F A I L U R E	D E P L O Y E D	0.2 ≤ M ≤ 2.5	DILEMMA	FREEZE AIR DATA DERIVED FROM PROBE SENSED PRESSURES AND SET INDICATION OF ALT DG FAILURE
			DG FAILURE ③	FREEZE AIR DATA DERIVED FROM PROBE SENSED PRESSURES AND SET INDICATION OF ALT DG FAILURE ③
C R E W O R R M	B O T H N O T D E P L O Y E D ②	N/A	N/A	FREEZE AIR DATA DERIVED FROM PROBE SENSED PRESSURES AND SET INDICATION OF ALT DG FAILURE ③
			N/A	FREEZE AIR DATA DERIVED FROM PROBE SENSED PRESSURES AND SET INDICATION OF ALT DG FAILURE ③

NOTES

1. ONLY CREW CAN INVOKE AUT FOR COMMAND, SOFTWARE IS INITIALIZED TO INH
2. IF BOTH PROBES FAIL AFTER AT LEAST ONE PROBE WAS DEPLOYED, A DILEMMA IS DECLARED
3. THREE CONSECUTIVE DG FAILURES WILL RESULT IN A DILEMMA
4. IF A PROBE WAS NEVER DEPLOYED, MPC IS INITIALIZED TO 90,000 FT WITH AN ALT DG FAILURE INDICATION
5. ADTA AIR DATA CALCULATIONS LIMITED AT M = 3.5
6. P-static FDIR NOT PERFORMED DURING MACH JUMP

DISCUSSION - Continued

The AMI and AVVI display sources of data for the three positions of the Air Data switch are summarized in table 5-VII.

TABLE 5-VII.- DISPLAY DATA SOURCES

(a) AMI

Parameter	$\alpha$		M/vel		EAS		ACCEL <sup>a</sup>	
Switch position	NAV <sup>b</sup>	L/R	NAV <sup>b</sup>	L/R	NAV <sup>b</sup>	L/R	NAV	L/R
Mach region $M \geq 2.5$	N	ADS	N	ADS	N	ADS	N	N
$2.5 > M \geq 1.5$	ADS	ADS	ADS	ADS	ADS	ADS	--	--
$1.1 < M < 1.6$ (Mach jump)	ADS	ADS	ADS <sup>c</sup>	ADS	ADS <sup>c</sup>	ADS	--	--
$1.5 > M \geq 0.2$	ADS	ADS	ADS	ADS	ADS	ADS	--	--

<sup>a</sup>During MM 305, ACCEL will be driven to zero.

<sup>b</sup>Whenever either air data source select switch is in the NAV position, the air data parameters displayed on the AMI display reflect whatever air data parameters (NAV derived or ADS) are being used by G&C.

<sup>c</sup>In the Mach jump region, limited actual  $P_{static}$  is used to calculate Mach and EAS for display.

(b) AVVI

Parameter	Altitude rate, $\dot{H}$		Altitude, H		ALT ACCEL, $\ddot{H}$	
Switch position	NAV	L/R	NAV	L/R	NAV	L/R
Mach region $3.5 > M \geq 2.5$	N	ADS	N	ADS	N	N
$2.5 > M \geq 1.5$	N	ADS	N	ADS	N	N
$1.1 < M < 1.6$ (Mach jump)	N	ADS	N	ADS	N	N
$1.5 > M \geq 0.2$	N	ADS	N	ADS	N	N

DISCUSSION - Continued

Onboard Management of ADS

Onboard management of the auto transition of the ADS parameters into G&C is through the following portion of the HORIZ SIT display.

NAV	RESID	RATIO	AUT	INH	FOR
TAC AZ	± X X . X X	X . X S	1 9 X	2 0 X	2 1 X
RNG	± X X . X X	X . X S			
DRA G H	± X X X X X	X . X S	2 2 X	2 3 X	2 4 X
ADTA H	± X X X X X	X . X S	2 5 X	2 6 X	2 7 X
ADTA T O G & C			2 8 X	2 9 X	3 0 X

G&C switch

- AUTO - Air data sent to users if probes are deployed and several conditions are satisfied. If conditions not satisfied, NAVDAD or default parameters are sent to the users.
- INHIBIT - Inhibits the ADS data and enables either default NAV or NAV-derived data.
- FORCE - Air data sent to users if probes are deployed and no RM dilemma exists. If RM dilemma exists, NAVDAD or default parameters are sent to users.  
(NAVDAD if VREL > 1,500 ft/s, default if VREL < 1,500 ft/s)

NAV switch

- AUTO - Uses air data altitude in filter if probes are deployed, data good, and NAV edit satisfied.
- INHIBIT - Inhibits air data altitude from filter.
- FORCE - Overrides the edit and forces the data to be used to update the state vector if the data are being processed by the NAV filter.

The RESID column contains the residual data value for each component of each data type that is being processed by the NAV filter. The residual is formed in navigation by subtracting the NAV estimate of the data from the selection filter output of the data. It should be noted here that navigation uses the composite data output from the selection filter as inputs to the navigation filter so that no distinctions are made as to the LRU source of the data to the NAV filter. The residual value gives the crew an indication as to how well the data and the NAV estimate of the data agree. However, these data alone cannot identify whether the data or the NAV estimate of the data is in error.



DISCUSSION - Concluded

The RATIO column contains the edit ratio computed in navigation as the ratio of the data residual to the maximum allowable residual. If this ratio is less than 1, the residual edit test performed by navigation on the data is passed, and the data are subsequently used to update the state vector. If the data fail the residual edit test, the ratio will be displayed as a number equal to or larger than 1 and will not be used to update the state vector. Thus, the edit ratio and the ratio status indicators give the crew an indication as to whether a particular data type is being incorporated into the state vector. The residuals and edit ratios are computed by navigation for each NAV cycle and are available to display. A status column to the right of the RATIO will contain a down arrow (↓) if A-I-F is in AUTO when the parameter has failed the update edit test three out of four measurements. The down arrow will disappear when a certain percentage (I-loaded) of the data points passes the edit test.

<u>EVENT</u>	<u>CUE</u>	<u>DISPLAY</u>
<u>Speed Brake Ramp to 65 percent</u>	M = 4.0 Speed brake ramp	AMI $\delta_{SB}$ SPI GNC SYS SUMM
EIT = 24:24 (min:s)		
VREL = $4.0 \times 10^3$ (ft/s)		
H = $103 \times 10^3$ (ft)		
R = 103 (n. mi.)		

CREW ACTION: Monitor surface command and deflection on speed brake SPI

### DISCUSSION

AUTO speed brake commands should begin closing the speed brake from 100 percent at Mach 4.0 to 65 percent at Mach 2.5. Again, the event sequence CONFIG light should indicate if the speed brake is not on schedule. A number of trade-offs have to be considered for speed brake deflection in this regime. The trimmed down elevon is still required for adverse yaw ( $-C_{n\delta_A}$ ) in this regime, hence the need

for the speed brake-induced pitch-up moment. Angle of attack has ramped down to about  $20^\circ$  at Mach 4.5, so the vertical tail will be less blanked by the forebody. However, with full speed brake deflection, shock wave formations limit rudder effectiveness. Thus, the speed brake is pulled in to 65 percent to allow an increase in rudder effectiveness. Maximum speed brake deflection rates are to be calculated as functions of available fluid flow and are not necessarily constant in the adaptive Priority Rate Limiting (PRL) logic. Finally, as rudder and speed brake effectiveness increases with decreasing angle of attack and Mach number, so does the capability of the speed brake to affect the Orbiter range potential. Above Mach 1, speed brake deflection does not appreciably affect L/D; it functions primarily for longitudinal trim and directional stability. Below Mach 0.95, TAEM and AUTOLAND guidance command the speed brake for energy control.

<u>EVENT</u>	<u>CUE</u>	<u>DISPLAY</u>
<u>Excessive <math>\dot{H}</math> Avoidance</u>	M = 3.68	AVVI

EIT = 24:41 (min:s)  
M = 3.68  
H =  $100 \times 10^3$  (ft)  
R = 92 (n. mi.)

CREW ACTION: Monitor AVVI

DISCUSSION

Sink rates in excess of -486 ft/s should be avoided below 100,000 feet so that adequate fuselage venting may occur. Venting of the Orbiter cavities to accommodate the rapid differential pressure rise may not be fast enough at  $\dot{H}$  of -486 ft/s to prevent structural failure. The crew procedure would be to fly R/Y - CSS and shallow vehicle bank angle to reduce sink rate, then R/Y - AUTO.

EVENTCUEDISPLAY

Rudder Trim Activated  
 FCS Roll/Yaw Phasing

M = 3.5  
 Rudder  
 active

AMI  
 $\delta_R$  SPI  
 CRT/ENTRY TRAJ 5

EIT = 24:51 (min:s)  
 VREL =  $3.5 \times 10^3$  (ft/s)  
 H =  $97.6 \times 10^3$  (ft)  
 R = 86.6 (n. mi.)

CREW ACTION: Monitor rudder deflection for trim on CRT display and rudder responding to FCS maneuver commands on SPI

DISCUSSION

The Mach 5 to 2.0 regime is critical for vehicle stability. The air-flow is changing from a Newtonian flow to a more conventional flow, and the FCS is most sensitive in this region to aerovariations. Reduction of surface effectiveness due to aeroelasticity is most pronounced in the Mach 2.0 region, particularly at high dynamic pressure. Pitch trim deflections must be maintained to ensure sufficient lateral control surface effectiveness with aerovariations. Off-nominal trim positions, a slow body flap drive rate, yaw jet failures, and angle of attack errors in conjunction with aerovariations are the primary factors that may render control extremely marginal in this regime.

At Mach 3.8, a gain in the roll channel, scheduled with Mach number, transitions the ailerons from primarily yaw inducing and  $\dot{\beta}$  damping devices to more conventional roll control effectors. As Mach decreases, ailerons become more effective in roll, with the associated yawing moment becoming proverse near Mach 1.5. The transition of roll control methods is normally phased between Mach 3.8 and Mach 1.0 if the Entry Mode switch is in the AUTO position.

Additionally, the FCS is undergoing a lateral-directional trim reconfiguration in this region. Throughout early entry, as previously discussed, the ailerons are used to damp  $\dot{\beta}$  and trim moments induced by lateral c.g. offsets and a bent airframe. If aerodynamic performance is as 'nominally' predicted, a +1.5 inch Y c.g. offset will result in approximately  $-0.6^\circ$  aileron trim deflection. However, if surface effectiveness is reduced as a result of aerovariations or of the elevons being up off the trim schedule, the yawing moment produced by an aileron deflection ( $C_{n\delta_a}$ , negative desired) can be dim-

inished to zero or even change sign (proverse yaw) prematurely. The sensitivity of adverse yaw to elevon trim deflection and angles of attack in this Mach regimes shown in figure 5-26. (Data plots are excerpted from the Orbiter Aerodynamic Design Data Book, June 1976.) The 3-sigma variation on  $C_{n\delta_a}$  is  $\pm 0.00032$  which, if added to a value from

## DISCUSSION - Continued

graph of  $\sim -0.0003$  for an  $\alpha \sim 18.5^\circ$  and  $\delta_E = +2.5^\circ$ , can be seen to diminish the yawing moment due to aileron to nearly zero. If the elevon is up further off the trim schedule, this effect is more pronounced and  $C_{n\delta_a}$  may reverse sign. If the moment does change sign,

the ailerons may be commanded in the wrong direction for lateral trim, out toward trim limits  $\pm 3^\circ$ , depending on the following summation of coefficients, which determines aileron trim:

$$\delta_{ATRIM} = \frac{\Delta y}{b} \frac{(C_N C_{n\beta} + C_A C_{l\beta})}{(C_{l\beta} C_{n\delta_A} - C_{n\beta} C_{l\delta_A})}$$

As a result, the yaw jets will be required for trim also, causing excessive RCS fuel usage. Particularly, if two yaw jets per pod have failed, sufficient control authority for maneuvers may not be available. However, by Mach 7 to 6, the pilot can obtain some indication that aileron effectiveness is diminishing by observing an increase in yaw jet firing on one side and increasing aileron trim. If the aileron trim saturates ( $\pm 3^\circ$ ), drive the elevons down by moving the body flap up. This increases aileron trim effectiveness. If  $5 > M > 3.5$  and the jet duty cycle continues to increase and approaches 100 percent, increase alpha as required ( $\sim 3^\circ$ ) to increase the elevon effectiveness for trim. This procedure is very effective for the GRTLS high  $\bar{q}$  environment if a tendency to roll off is encountered. After the rudder is active, return the body flap to the AUTO mode. (Refer to the 'TRIM/ OSC' Cue Card reprinted in the Flight Data File Cue Card Book.)

To reduce the dependence on yaw jets for stability, the FCS generates rudder commands at Mach 3.5 based on commanded roll rate and corresponding yaw rate, the yaw rate required for turn coordination, and lateral acceleration feedback to control  $\beta$ . (Max rudder trim deflection is  $\pm 6^\circ$ .) The maximum rudder deflection rate is  $\pm 14$  deg/s without hydraulic system failures or excessive hinge moments. In response to maneuver commands, the maximum rudder deflection is limited in the yaw channel to  $\pm 24.1^\circ$  in flight until WOWLON because of rudder/speed brake hinge interference with large rudder and small speed brake deflections. At WOWLON, the rudder maximum deflection limit is increased to  $\pm 27.1^\circ$ , as the speed brake should procedurally be opening to 100 percent. A basic ground rule assumes that the rudder effectiveness derivatives ( $C_{l\delta_r}$  and  $C_{n\delta_r}$ ) will never change sign,

although aerovariations may cause them to diminish to near zero.

DISCUSSION - Continued

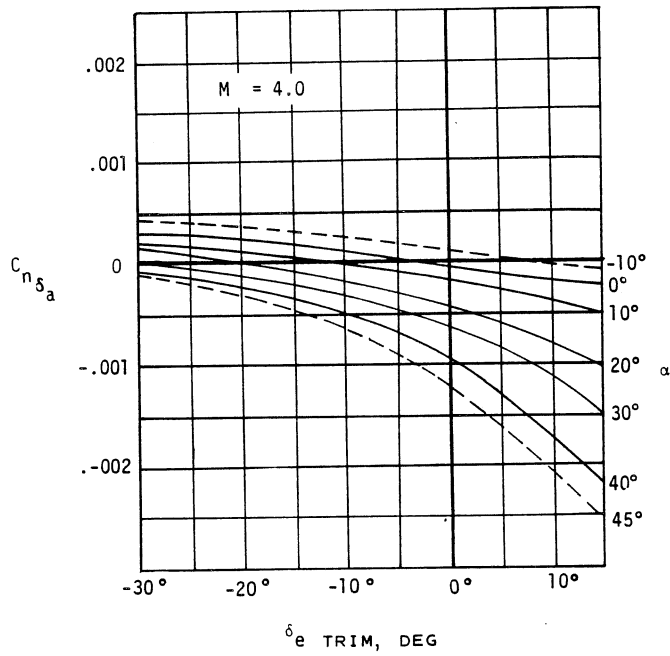

(a) Yawing.

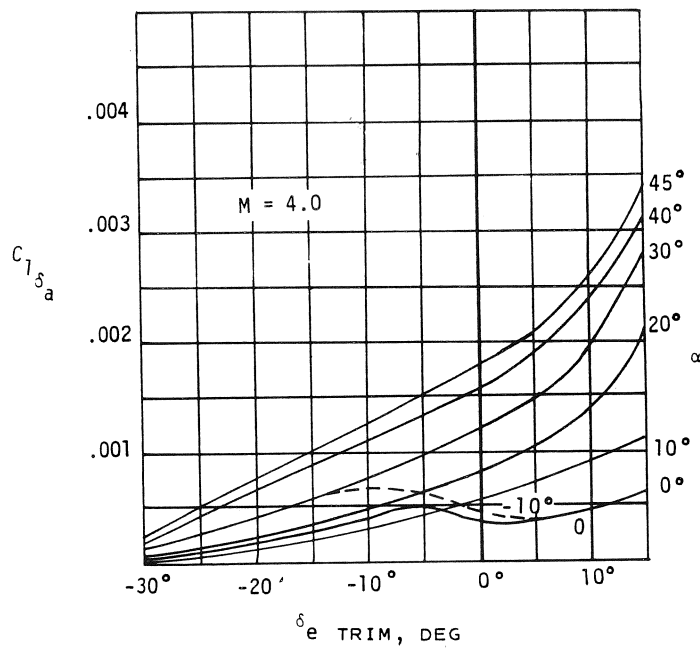

(b) Rolling.

Figure 5-25.- Aileron movement derivations.

## DISCUSSION - Continued

Because of the uncertainties involved in determining which control surfaces are most affected, the FCS uses a combination of both rudder and aileron for trim below Mach 3.5. There exists the potential for an aileron-rudder trim force fight, even with nominal aero, below Mach 3.5. Usually this is of concern only when rolling and yawing moments from a large Y c.g. offset and bent airframe must be balanced by aileron, rudder, and  $\beta$  combinations. The FCS trim solution is stable in most cases. If variations result in the ratios of  $\Delta C_{\ell}/\Delta C_{\eta}$  due to the rudder and aileron being nearly equal, the trim logic can drive the aileron and rudder trim commands to the limits in seeking a trim solution from an infinite number of combinations of  $\beta$ , aileron, rudder, and ultimately, yaw jets. In the cockpit, an aileron-rudder trim force fight is evidenced by the CRT trim readouts indicating both trims on the SAME side; e.g., 'AIL TRIM L2.4' and 'RUD TRIM L4.3'. As in this case, if the AIL TRIM is greater than  $10^\circ$ , the pilot should manually drive the AIL TRIM to zero with the roll panel trim switch and maintain zero aileron trim until the force fight tendencies have diminished; i.e., the M,  $\alpha$  and elevon trim conditions have changed, influencing the trim requirements. The trim logic may reestablish a force fight even after the aileron trim has once been zeroed manually. The combination of ineffective surfaces, a trim force fight, and high dynamic pressure may allow the development of moments and rates too large for the remaining yaw jets to counter, resulting in a divergent rolloff in a roll reversal.

For these reasons, it is highly desirable not to stress the system further by imposing a roll maneuver on large trim requirements. The current entry trajectory results in a guidance roll command at ~ Mach 3.8 that should be closely monitored. The optimum elevon and speed brake schedules have been devised to seek a positive (down) elevon trim position to Mach 3.0 for aileron trim effectiveness; however, some test schedules do not follow this desirable rule.

The pilot must perform all roll trimming manually below Mach 1.25 via the panel trim switch if in CSS ROLL/YAW. Below Mach 1.25, the forward loop aileron command is integrated through an automatic trim loop if in AUTO ROLL/YAW. No automatic aileron trim is provided below Mach 1.25 if in CSS ROLL/YAW. If manual trim is not accomplished, achievable roll rates and damping may be diminished in the presence of some aerovariation cases.

In the event of a PASS to BFS switchover, the aileron and rudder trim integrators will be reinitialized to zero. This may result in a moderate roll transient until appropriate RHC and trim commands can be applied. The following procedures should minimize both vehicle upsets and RCS fuel expended during the subsequent automatic retrimming.

DISCUSSION - Concluded

A. BFS engagements in nonmaneuvering flight:

Manually trim aileron to last remembered value. If uncertain of aileron trim prior to BFS engagement, manually beep trim 'away from yaw jet lights' until activity diminishes.

B. BFS engagements during rolling maneuver above M 3.5:

Apply RHC lateral input as required to reestablish roll rate. If certain of previous aileron trim, manually set trim to pre-engagement value. If uncertain of previous trim, do nothing until rolling maneuver is completed, unless:

- RCS fuel considerations do not allow luxury of an extra 100 pounds of fuel to retrim during the maneuver. In this case, manually trim 'away from the yaw jet light' to diminish its activity.
- Unable to reestablish an adequate roll rate. In this case, trim away from the desired direction of roll. Confirm that this is in the same direction as trimming 'away from the yaw jet light'.

C. BFS engagements during rolling maneuvers below M 3.5:

Allow rudder trim to take care of the out-of-trim transient. Yaw jet activity will diminish considerably when the trim condition is approached, assuming the bank attitude has been stabilized. Monitor for the possible aileron-rudder force fight.



<u>EVENT</u>	<u>CUE</u>	<u>DISPLAY</u>
<u>Call Up DPS OVERRIDE Display</u>	V = 5000 ft/s	AMI

EIT = 23:07 (min:s)  
VREL =  $5.0 \times 10^3$  (ft/s)  
H =  $120 \times 10^3$  (ft)  
R = (n.mi.)

CREW ACTION: SPEC 51 PRO: GNC 51 OVERRIDE

DISCUSSION

The OVERRIDE display is called up by the pilot on CRT 2 before ADS deployment. The display is used to monitor the following ADTA derived data: Altitude (ft),  $\alpha$  (deg), and Mach number. The display is used to give the crew the capability to deselect or reselect an ADTA to resolve an RM dilemma or to force RM to consider a previously deselected LRU. The display can also be used to determine if a probe is deployed or not. For example, if a probe is not deployed,  $\alpha$  and M data will be zero.

<u>EVENT</u>	<u>CUE</u>	<u>DISPLAY</u>
<u>Deploy ADS Probes</u>	V = 5000 ft/s	AMI

EIT = 23:07 (min:s)  
VREL =  $5.0 \times 10^3$  (ft/s)  
H =  $120 \times 10^3$  (ft)  
R = 140 (n. mi.)

CREW ACTION: AIR DATA PROBE (two) - 'Deploy'  
AIR DATA R, L - then NAV

### DISCUSSION

The ADS probes are deployed at VREL = 5000 ft/s by crew actuation of the two Air Data Probe switches on panel C3. A probe can be extended by one motor only but the time is increased from 15 to 30 seconds. The static pressure ports on each probe are used to obtain pressure altitude; the total pressure port is used to obtain dynamic pressure and Mach number; and the upper and lower pressure ports are used to determine Orbiter angle of attack. By selecting the Air Data switch from NAV to R to L, the probe data can be compared to NAV data by monitoring the altitude and EAS on the AMI and AVVI. The crew should compare ADS data to NAV-derived air data by calling up SPEC 051 where ADS M,  $\alpha$ , H from the left and right ADTA's are digitally displayed. After the ADS is checked to verify probe deployment and good data, the Air Data switch is returned to NAV so NAV-derived air data will be displayed during the  $1.1 < M < 1.6$  Mach jump region.

The ADS probe heaters will be used if flight through visible moisture is anticipated.

<u>EVENT</u>	<u>CUE</u>	<u>DISPLAY</u>
<u>Elevon Trim 0°</u>	M = 3.0	AMI δ <sub>E</sub> SPI GNC SYS SUMM
EIT = 25:13 (min:s)		
VREL = 3.0 x 10 <sup>3</sup> (ft/s)		
H = 89 x 10 <sup>3</sup> (ft)		
R = 71 (n. mi.)		

CREW ACTION: Verify elevon trim ramping up to 0°  
 Monitor vehicle dynamic performance

- o Body and stability rates on ADI
- o Elevon, aileron, body flap, and speed brake trim positions
- o Yaw RCS activity
- o Dynamic pressure/airspeed
- o Normal acceleration
- o Angle of attack
- o Scaled A<sub>y</sub>

### DISCUSSION

The representative elevon trim schedule will maintain 5° of trim until Mach 3.0 and then ramp to 0° at Mach 2 to improve performance with aerovariations. The elevons are also moved up to take advantage of aileron-induced proverse yaw in roll maneuvers and to allow a higher body flap trim position that relieves hinge moments. It is also in this region that air data parameters must be incorporated into flight control and guidance. Air data errors in  $\bar{q}$  are sensitive to flight control cause many FCS gains are scheduled for surface commands as functions of  $\bar{q}$ . These concerns emphasize the importance of the elevons following the trim schedule in this region.

In the pitch channel, normal acceleration commands ( $\Delta N_z$  commands) are received from TAEM guidance on initialization at a VREL of 2500 ft/s. The commands in g's are converted into the appropriate body pitch rate commands. Although AUTO guidance commands are limited, the pilot in CSS may drive angle of attack and normal acceleration, as dynamic pressure builds, to the limits of controllability and structural integrity.

<u>EVENT</u>	<u>CUE</u>	<u>DISPLAY</u>
<u>HUD Power On</u>	M = 2.7	AMI HUD

EIT = 25:20 (min:s)  
VREL =  $2.7 \times 10^3$  (ft/s)  
H =  $88 \times 10^3$  (ft)  
R = 61 (n. mi.)

CREW ACTION: Power up the L and R HUD

DISCUSSION

The HUD power switches, located adjacent to each PDU, provide power (MAIN A - CDR and MAIN C - PLT) to operate the HUD's through the control busses (CNTL AB2 - CDR and CNTL BC1 - PLT).

A three-position MODE switch is located on the front of the PDU. The switch positions are up TEST, center NORM, and down DCLT, (declutter). The DCLT position is a momentary spring-loaded position.

In the NORM position, automatic sequencing of formats and symbology is provided. The up TEST position forces up a test display, consisting of a rotating pattern of lines and circles, for a period of 5 seconds. At the end of the 5-second display, the test lines and circles will remain stationary in the FOV as long as the MODE switch is in the TEST position (fig. 5-26D). Repositioning the switch to normal will resume the interrupted format. Selection of the momentary DCLT position initiates a symbol blanking routine described in figure 5-27.

A two-position AUTO BRT ON/OFF switch provides the capability to select manual brightness control (OFF) or automatic brightness control (ABC) (ON). With ABC OFF, symbology intensity is adjusted with the rotary BRT control adjacent to the ABC switch. With ABC ON, the rotary BRT control selects a contrast level, which is then automatically maintained relative to the ambient light level.

The HUD format, as shown in figure 5-28 will automatically be displayed at TAEM interface, (MM 305 and MM 603). The format can also be called up in MM 304 or MM 602 by item entry on the SPEC 50 display. (Item 37 + 1 for the CDR; item 38 + 1 for the PLT).

There are four annunciator windows, displaying cues/alerts, within the HUD-FOV, as shown in figure 5-29. Window number 1 is reserved for landing gear cueing, window number 3 displays guidance mode. Windows 2 and 4 display three alerts to the crew:

DISCUSSION - Continued

HUD CUE/ALERT

COMMENT

CSS	CSS control in all axis
MLSNV	Navigation is not processing MLS data
B/F	Body flap is not in trail

A maximum of two mnemonics can be displayed in window 2 at any time. CSS and MLSNV have priority. If B/F is occupying the second field in window 2 and the CSS or MLSNV cue/alert is triggered, with the window full, then B/F will be put on hold to make room for the priority cue/alert.

A cue/alert that persists beyond the 5-second time in window 2 will be transferred to window 4.

NOTE: All mnemonics appearing in window 2 flash; all mnemonics in window 4 are steady.

Declutter: The HUD declutter switch will selectively remove different symbols from the display. Successive selections of the declutter mode (maximum of three) will serially remove display elements in accordance with the following programmed logic:

- The first activation removes the runway symbology.
- The second activation removes the airspeed and altitude tapes, (replacing them with digital values) and the horizon/pitch attitude scales, but leaves the horizon line when within FOV.
- The third declutter level removes all symbology except for the boresight.
- A fourth declutter attempt will return the HUD to its original form and with all symbols displayed.

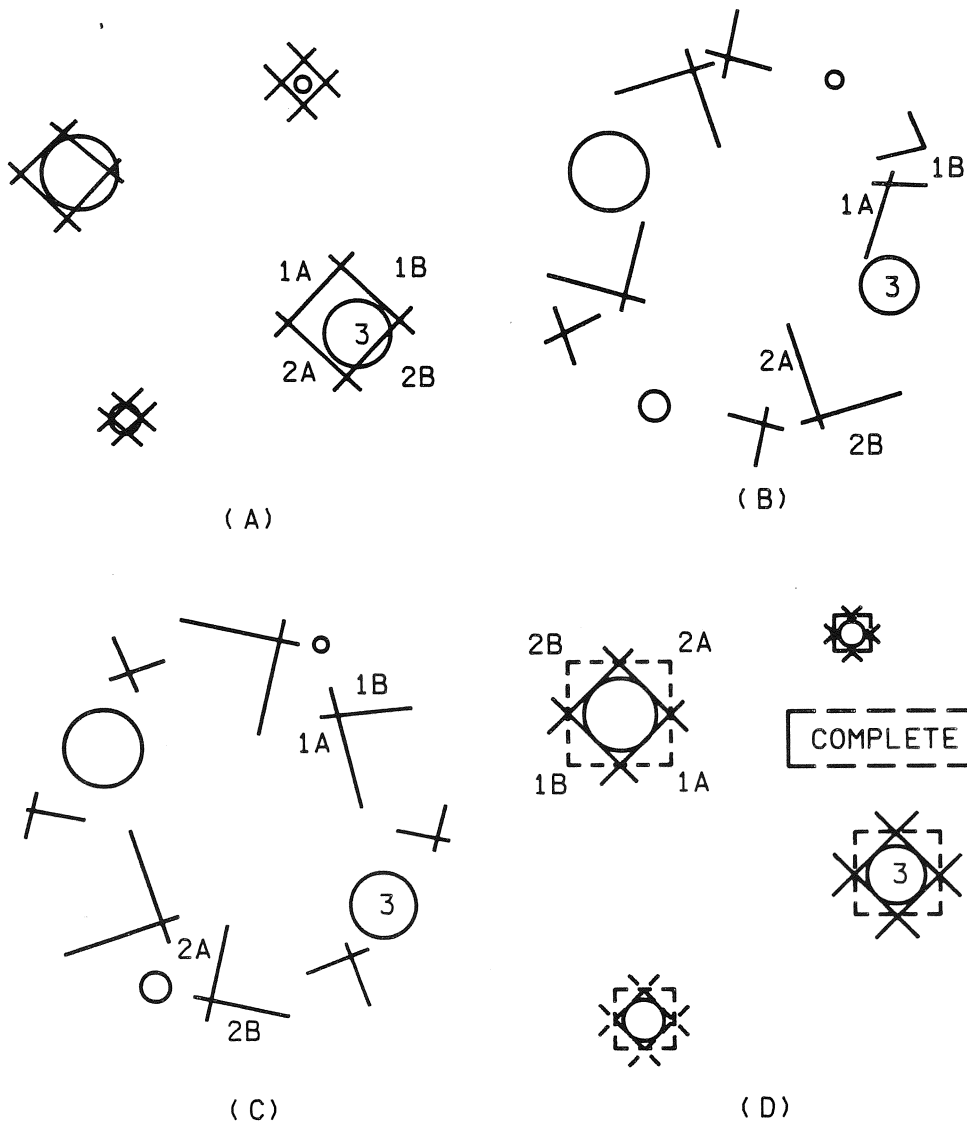

**NOTE:** Dashed lines and labels are not on actual display. they are shown here to help one follow the movement of the symbols.

Figure 5-26.-

3142. ART, 2

APPROACH AND LAND DISPLAY  
(DECLUTTER LEVEL 1)

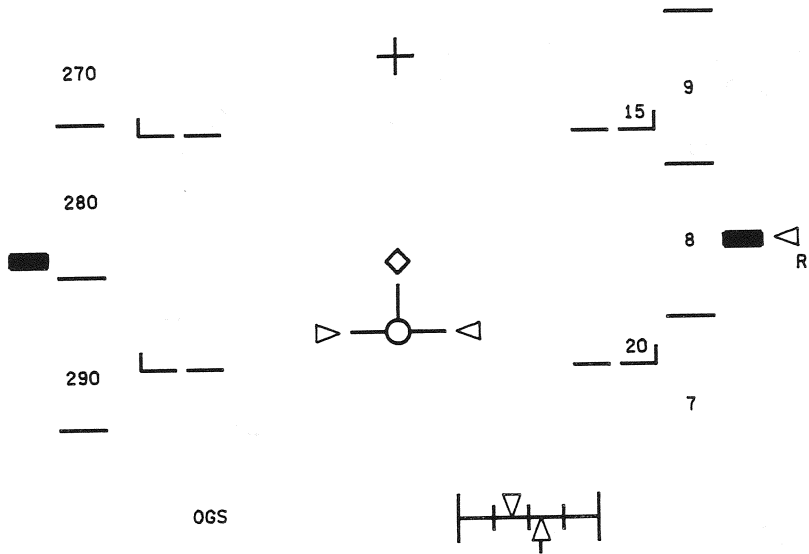

APPROACH AND LAND DISPLAY  
(DECLUTTER LEVEL 2)

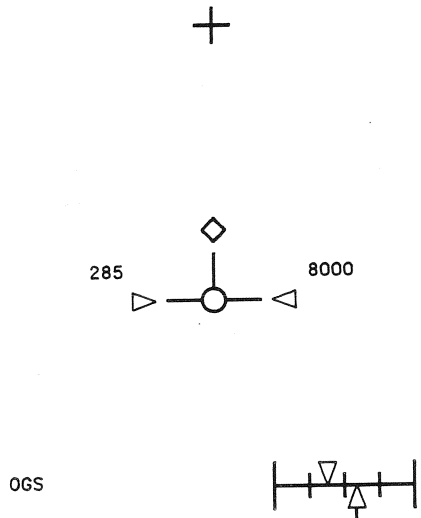

NOTE: HORIZON IS DISPLAYED WHEN  
IN THE HUD FOV.

APPROACH AND LAND DISPLAY  
(DECLUTTER LEVEL 3)



Figure 5-27.-

5-113

3144. ART, 3

## HUD Symbology Description

The HUD format in figure 5-28 will automatically be displayed at TAEM interface (MM 305 and MM 603) if the HUD power switch is on. The format can also be called up in MM 304 or MM 602 by item entry on the SPEC 50 display (item 37 + 1 for the CDR HUD; item 38 + 1 for the PLT HUD). Detailed explanations of each symbol are on the following pages.

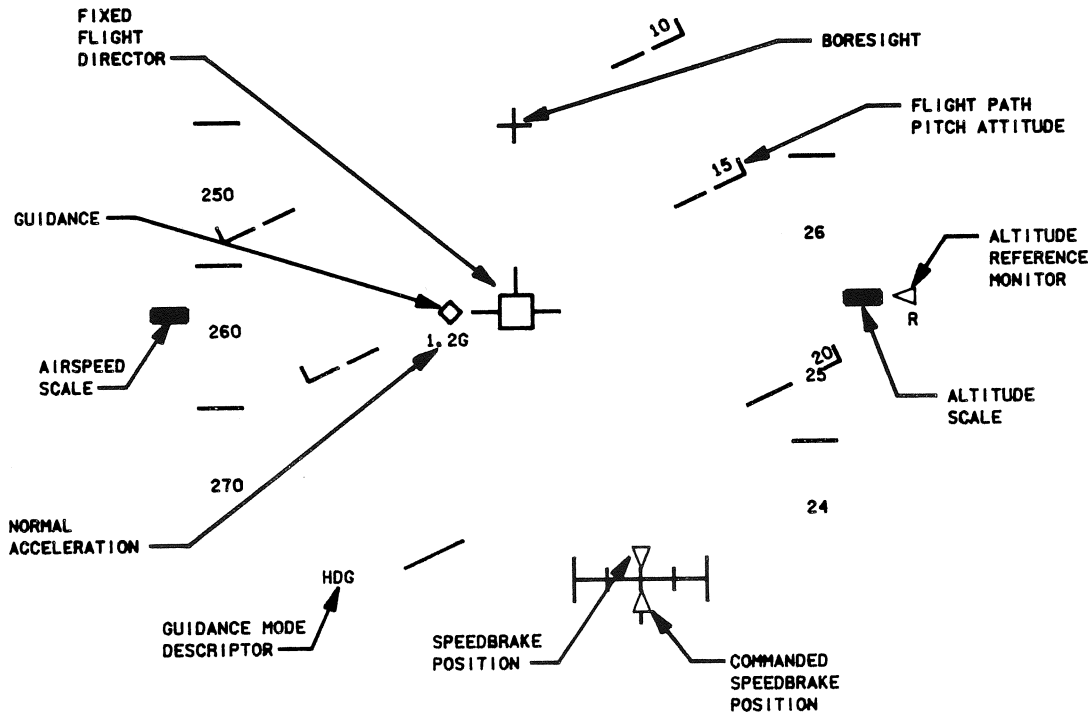

3143. ART, 3

Figure 5-28.- Approach and land display (TAEM heading phase).



## Cues/Alerts

The cues/alerts are displayed in three different 'windows' with a fourth 'window' serving as a summary line. Each 'window' is a reserved field for the cue/alert; however, there are no visible lines defining the window and if no mnemonic is being displayed, the field will be blank. The windows are numbered 1 through 4. Their relative position in the display is shown in figure 5-29.

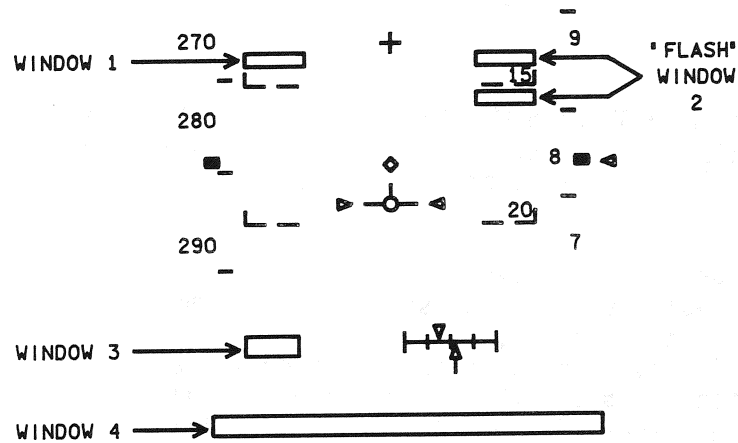

Figure 5-29.-

3145. ART, 1

<u>EVENT</u>	<u>CUE</u>	<u>DISPLAY</u>
<u>TAEM Interface</u>	M = 2.5	AMI VERT SIT HUD
EIT = 25:48 (min:s)		
VREL = $2.49 \times 10^3$ (ft/s)		
H = $81 \times 10^3$ (ft)		
R = 58.7 (n. mi.)		

CREW ACTION: Monitor Transition

DISCUSSION

Transition to MM 305 from MM 304 is automatic when TAEM interface is achieved (VREL = <2500 ft/s). TAEM can also be called up by OPS 305 PRO. The following GN&C software modules are initiated at transition to MM 305:

- o TAEM user parameter processing, which propagates the state vector forward as well as providing specifically computed parameters for guidance, flight control, displays, and other users
- o VERT SIT display processing as described in section 5.1.4.7
- o MLS operating program, which determines the elevation angle, azimuth, and range of the MLS ground transmitters and processes the raw data to other users
- o MLS fault detection
- o TAEM guidance
- o HUD approach and land format processing

The following GN&C software modules are terminated at TAEM transition

- o MM 305:
  - o Entry guidance
  - o Entry user parameter processing
  - o Entry display processing

The other GN&C software modules listed for MM 304 remain in operation for MM 305.

TAEM guidance provides for automatic control as follows:

- o Crossrange errors controlled by bank angle commands
- o Vertical flight path errors controlled by normal acceleration commands ( $N_z$ )
- o Energy management in TAEM accomplished through various combinations of the following:
  - S-turns
  - Energy dump maneuver
  - Pull-up maneuver
  - Nominal to minimum entry point HAC location
  - Overhead to straight-in approach
  - Speed brake modulation < 0.9 Mach
  - HAC spiral radius adjustment

## DISCUSSION - Continued

TAEM guidance controls glide range by tracking and flying three profiles simultaneously: altitude versus range, dynamic pressure versus range, and specific energy versus range. The outputs of TAEM guidance, Nz command, roll command, and speed brake command, are functions of errors from the above profiles. Therefore, the validity of these commands depend upon the accuracy of NAV and air data, i.e., guidance is only as good as the NAV state. In addition, range to the runway can be varied by moving the Heading Alignment Cone (HAC) using items 6 and 7 on Spec 50 display. Item 6 allows selection of 'OVHD' (overhead approach) or 'STRT' (straight-in approach). This item simply allows the pilot to put the HAC on either side of the runway centerline. Item 7 allows the pilot to move the HAC closer to the approach end of the runway. The choices for this item are 'NEP' (nominal energy HAC position) or 'MEP' (minimum energy HAC position). These approach modes will be discussed later.

The TAEM guidance scheme is broken up into phases. The S-turn phase dissipates energy by turning away from the HAC until the energy state is sufficiently close to normal. This phase is normally bypassed and will be discussed in more detail later. TAEM is initialized at Mach 2.5 in the acquisition phase, which turns the vehicle toward the HAC tangent point (Way Point 1). The heading alignment phase is initialized at the HAC tangency point, and follows the HAC until the Orbiter is near the runway centerline where the prefinal phase leaves the HAC and aligns the Orbiter on the runway centerline. Prefinal transitions to Approach and Land Guidance (A/L) when the A/L tolerances are met, and altitude is below 10,000 feet, or under any conditions when altitude is less than 5000 feet.

### Output Commands

NZ CMD: The normal acceleration command is primarily a function of altitude error and altitude rate error. But, as suggested in the first paragraph, the Nz command function combines energy and dynamic pressure filters to maintain energy and  $\bar{q}$  profiles as closely as possible. The following is a diagram of the Nz command logic.

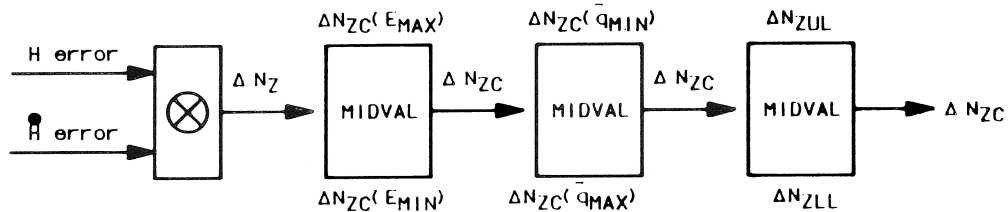

Figure 5-30.- TAEM  $\Delta N_7$  logic.

3151. ART. 2

## DISCUSSION - Continued

A  $\Delta N_z$  command is calculated as a function of altitude and altitude rate error.  $\Delta N_z$  command limits are calculated based on minimum and maximum allowable  $\bar{q}$ . The calculated  $\Delta N_z$  command is limited as necessary to fall within these limits. If guidance is not in the prefinal phase, the  $\Delta N_z$  command is then limited as necessary so that the upper and lower energy limits are not violated. A third filter is implemented so that the  $\Delta N_z$  command does not exceed  $\pm 0.5g$ .

This scheme works well with accurate air data. However, if the air data is in default (ADTA DILEMMA) and  $M < 1.5$ , the  $\bar{q}$  input to the  $N_z$  command function is a canned function of  $V_{rel}$ . Therefore, when air data are not going to guidance, and  $M < 1.5$ , the pilot should be in CSS and fly the theta limits on the Vert Sit display in order to prevent exceeding  $\bar{q}$  limits and a resulting loss of vehicle control.

**BANK COMMAND:** TAEM  $\phi$  command and  $\phi$  limits are phase dependent. In the acquisition phase,  $\phi$  cmd is a function of heading error from the HAC tangency point. The  $\phi$  limit for this phase is  $50^\circ$ . In the heading alignment phase,  $\phi$  cmd is a function of radius error from the HAC, and  $\phi$  limit is  $60^\circ$ . However, if the radius error exceeds 7000 feet, the  $\phi$  cmd logic and limits will be the same as it was for the acquisition phase. If the radius error is  $< 7000$  feet while in the heading alignment phase, then  $\phi$  cmd will always be in the direction of the HAC spiral. In other words, the Orbiter will not bank right while attempting to fly a left-hand HAC, and vice versa. During the prefinal phase,  $\phi$  cmd is a function of lateral error and lateral error rate from the runway center-line.  $\phi$  limit is a function of  $\phi$  cmd. See figure 5-31.

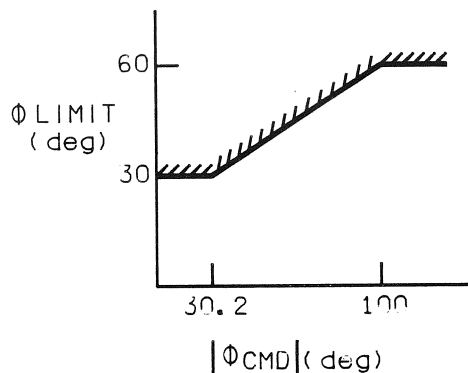

Figure 5-31.- Prefinal  $\phi$  limit versus  $\phi$  cmd.

If the vehicle is flying supersonic, then the  $\phi$  limit is  $30^\circ$ . The limit is ramped during the transition from supersonic to subsonic (fig. 5-32). But if air data are default, then the supersonic limits are not applicable, and guidance refers to the phase dependent limits.

## DISCUSSION - Continued

During the S-turn phase,  $\phi$  cmd by guidance is always  $50^\circ$ , subsonic or supersonic in a direction which tends to unwind the HAC. But, if an S-turn occurs, it is almost always in the supersonic regime, and the actual bank angle will not exceed the  $30^\circ$  supersonic limit, and the command needles will be centered.

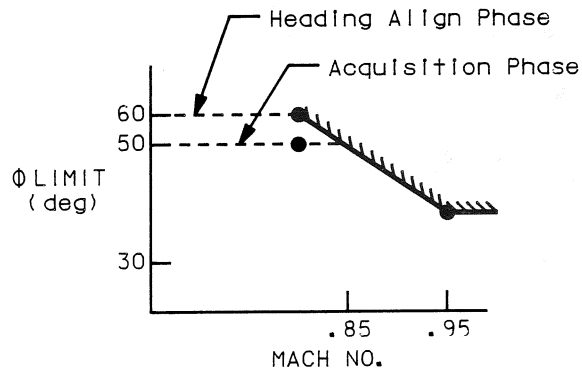

Figure 5-32.- Transonic limit.

SPEEDBRAKE COMMAND: The speed brake command follows an I-loaded schedule while in the supersonic flight regime. In the subsonic regime, the speed brake is used only to help control the  $\bar{q}$  profile. However, the speed-brake upper limit is a function of E/W error. As E/W falls below nominal, the speed brake upper limit is ramped down, until E/W reaches 7000 feet below nominal, where the upper limit is then set to  $0^\circ$ , or full closed. In the S-turn phase, if subsonic, speed brake command is set to full open.

## Energy Management Features

OVHD/STRT LOGIC: As mentioned earlier, Item 6 on Spec 50 can be used to toggle between an 'OVHD' or 'STRT' approach. In a STRT approach, the HAC will always be on the same side of the extended runway centerline as the Orbiter. Therefore, if the Orbiter should cross the centerline for some reason, the HAC would switch sides. This can be monitored on the Horizontal Sit Display (HSD). The OVHD HAC will not change its location relative to the runway centerline once it has been selected. Whenever an Item 6 execution changes the approach mode to OVHD, or when the software initializes in MM 304, the logic checks to determine which side of the extended runway centerline the Orbiter is on. It then places the OVHD HAC on the opposite side of the centerline. The OVHD HAC remains in this location, even if the Orbiter should cross the extended runway centerline during entry, unless the approach mode is toggled via item 6.

DISCUSSION - Continued

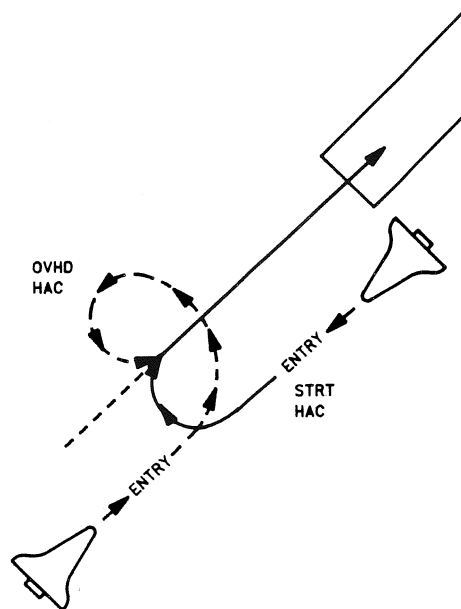

Figure 5-33

If in an OVHD approach with the HAC turn angle  $>200^\circ$ , and the energy level in TAEM falls below a predetermined level, the crew will receive an 'OTT ST IN' message. This is guidance calling for a downmode from OVHD approach to the STRT approach. The amount of range which can be saved with such a toggle depends upon the HAC turn angle,  $\psi$ . For example, if the HAC turn angle is currently  $270^\circ$  with an OVHD approach, a downmode to STRT could save about 13 n. mi. in range. Similarly, if  $\psi = 360^\circ$ , range saved 20 n. mi., and if  $\psi = 180^\circ$ , range saved = 10 n. mi.

The approach mode is initialized to OVHD in MM 304. The left or right turn results from the approach mode and geometry. For example, in the situation shown in the above figure, an OVHD approach results in a left turn, and a STRT approach results in a right turn.

The approach mode for the secondary runway will be the same as that for the primary runway. However, selecting the alternate runway will re-initialize the approach mode to OVHD.

Once range to go is less than 45 n. mi. a switch in the approach mode is not recommended. The heading error generated by a downmode while in close range could nullify any energy gains that may have been realized.

DISCUSSION - Continued

NEP/MEP Logic

Item 7 allows the pilot to switch the HAC position alternately between MEP and NEP points. The software initializes with NEP selected, as this is the preferred approach mode. Refer to figure 5-34 for a side and top view of the NEP and MEP HAC locations.

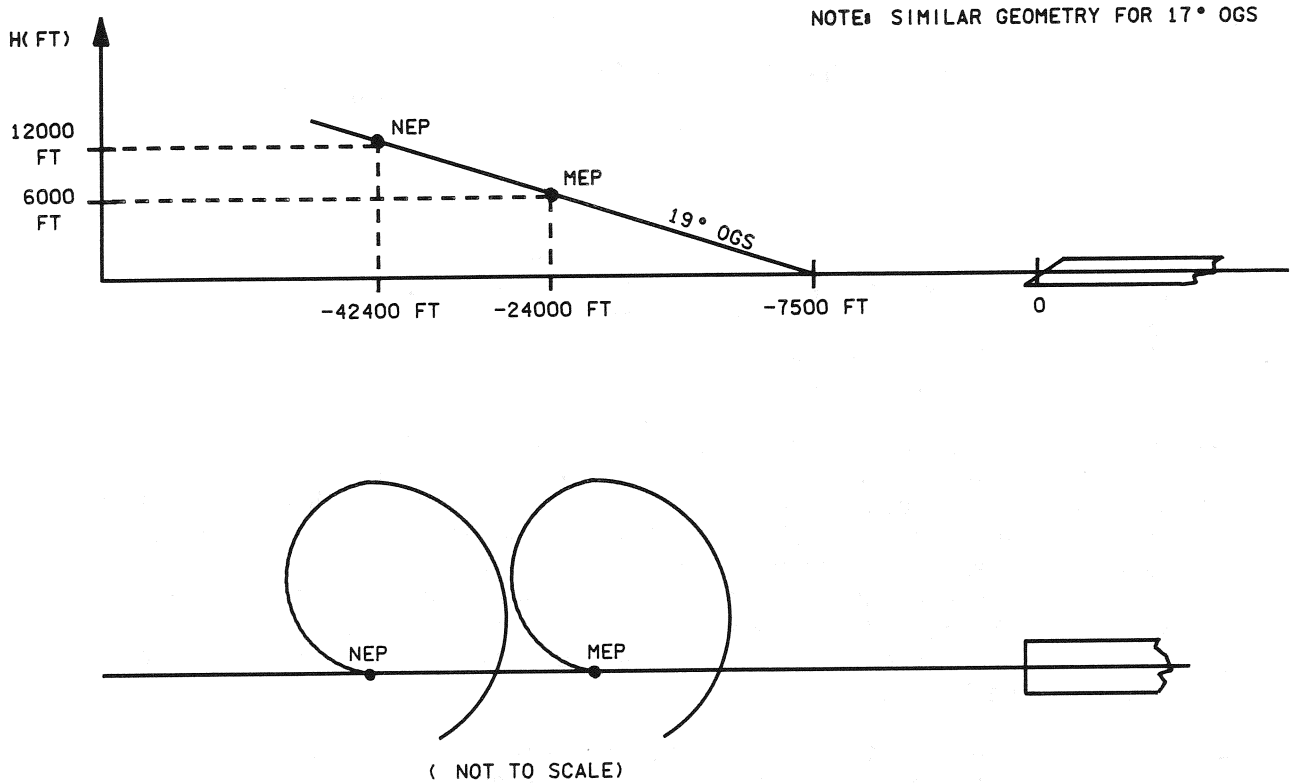

Figure 5-34.- NEP/MEP geometry.

3149. ART# 3

If the energy state falls below a predetermined level, which is lower than the level for an OVHD alert, the crew receives an MEP alert which consists of an 'SW TO MEP' message. As in the OVHD versus STRT approach, the range saved by the downmode depends upon the approach geometry. Obviously, no energy can be gained by the switch if the HAC turn angle is 0°. A maximum range of approximately 6 n. mi. may be eliminated by switching to MEP if the HAC turn angle is 180°.

As with the OVHD/STRT option, switches to NEP or MEP should be done as early as possible. Because of the software structure, there is a chance, although only slight, that guidance can become unusable if the switch is made once the HAC has been acquired.

## DISCUSSION - Continued

### S-Turn Logic

Guidance will enter the S-turn phase if the energy state is greater than a predetermined value, the HAC turn angle is less than  $200^{\circ}$ , and range to go is greater than approximately 25 n. mi. During the S-turn phase, guidance calls for a constant  $50^{\circ}$  bank in a direction which tends to unwind the HAC. However, this bank is usually limited to  $30^{\circ}$  though, since the S-turn is most likely to occur in the supersonic regime.

The S-turn is terminated when  $E/W = \text{ENERGY nominal} + 10,000$  feet. This energy level, and hence the S-turn termination, can be predicted by monitoring the E/W scale on the Vert Sit display.

### Energy Dump Logic

On a trajectory with a HAC turn angle exceeding  $315^{\circ}$ , the range to go at HAC intercept will be greater than approximately 22 n. mi. If nominal energy,  $\bar{q}$ , and altitude is achieved at this range, the Orbiter would be supersonic. Obviously, because of performance and  $\phi$  limits, the Orbiter should be subsonic at HAC intercept.

Therefore, if the predicted range to go at HAC intercept is greater than a predetermined value, the nominal energy over weight level is lowered. To make the vehicle acquire the HAC at an energy level which will correspond to a subsonic velocity. This energy dump can be detected for large HAC turn angles. When the Nz channel recognizes that the Orbiter is above the desired energy over weight corridor, it commands a gradual pitch down to get inside the corridor. Sometimes this pitch maneuver is limited by max  $\bar{q}$ . If the energy dump is severe, the nominal energy corridor on the E/W scale of the Vert Sit display will appear close to the MEP tic.

At a predetermined point in the trajectory ( $E/W = 85,000$  feet), if the predicted range to go at HAC intercept is greater than the predetermined value mentioned above, then the max  $\bar{q}$  limit is biased downward. The amount of bias depends on E/W error as well as predicted range to go at HAC intercept. If max  $\bar{q}$  is ramped down enough, the result would be a pull up (recall Nz channel must stay within  $\bar{q}$  limits) which would reduce the dynamic pressure and Mach number. Again, the goal is to acquire the HAC subsonically.

This logic does not represent a pure maneuver like the S-turn. It does represent an E/W and  $\bar{q}$  profile adjustment. Any maneuvers noticed are simply the Nz channel reacting to this adjustment.



## DISCUSSION - Continued

### Spiral Turn Radius Modulation

In the heading alignment phase, the HAC radius may be adjusted if the vehicle is below the nominal glideslope. At 6000 feet below the reference altitude with 270° or more of the turn to go, dropping to 2000 feet below the reference altitude with 90° of the turn to go, HAC shrinking is triggered. This situation is normally associated with the following conditions:

- o High HAC approach speed
- o Low or below glideslope
- o Tailwinds approaching the HAC

Under these conditions, the pilot should consider flying the vehicle in manual (CSS) mode using the following technique.

### Manual HAC Procedures

Under lightweight EOM conditions, with extreme tailwinds ( 150 kts) approaching the HAC, it may be desirable to fly the vehicle around the HAC in manual (CSS) mode.

Using the following procedures, and accepting small deviations from the HSD depiction of the HAC, the normal load factor should remain below 2.0g.

1. Retract speedbrakes and fly  $\geq$  one dot deflection high (2,500 feet) on the HSI glideslope indicator.
2. Lead the turn (initiate when 20-second predictor is tangent to HAC).
3. Maintain 220 to 240 KEAS (caution, watch angle of attack); use a  $\theta$  of  $-10^\circ$  to  $-15^\circ$ . (With a low EAS, it is almost impossible to require more than 2.0g to stay on HAC.)
4. At 100° to 120° turn-to-go, lower the nose as necessary to acquire the glideslope. Use manual speed brake to control EAS.

The primary factors that influence the shape of the trajectory during the TAEM phase are:

- o Aerodynamic maneuver capability
- o Compartment venting
- o Allowances for dispersions and winds
- o Sonic boom overpressures
- o Flight control considerations

DISCUSSION - Continued

Crew concerns from TAEM interface to landing can be summarized as follows:

- o Not exceeding critical flight control and structural limits ( $\bar{q}$ ,  $N_z$ ,  $\beta$ ,  $\phi$ ,  $\alpha$ ).
- o Getting timely and accurate navigation data.
- o Maintaining energy over weight (E/W) within limits required to achieve A&L interface.
- o Keeping critical systems running well.
- o Keeping pace with the increasing workload, because events are beginning to accelerate with less time available for corrections.

Display Modes in TAEM

The TAEM position is automatically selected to enable the HSI to be used for monitoring TAEM guidance. (The HSI MODE switch determines the display mode independent of the actual flight regime.) The HSI function, as described in table 5-VIII, is driven by area navigation and does not reflect the spiral logic. The HSI uses a circle with a 15,500-foot radius. In cases where the HAC shrinks, the HSI pointers and range will be in error. However, this should be negligible for the last 180° of the HAC turn angle. The vehicle glide range is controlled by flying nominal altitude versus range and dynamic pressure versus range profiles. These can be interpreted as E/W versus range profiles. The lower left window of the HUD (window 3) will display the appropriate phase descriptor as: S-TRN, ACQ, HDG, and PRFNL for S-turn, acquisition, heading alignment, and pre-final phases, respectively. Using these cues, the crew should be aware of the following guidance limits.

<u>Phase</u>	<u><math>N_z</math></u>	<u>Bank</u>
ACQ	± 0.5g	50°
S-TRN	± 0.5g	30° M > 1 50° M < 1
HDG	± 0.5g	60°
PRFNL	+1.5 to -0.75g	30°

As each phase is flown, the phase name and  $N_z$  may be read on the HUD. Normal acceleration is displayed below and outboard of the left wing of the velocity vector. Leading zero's are displayed when the g is less than unity. The symbol digits will flash when the  $N_z$  exceeds the I-loaded limit. This g readout automatically blanks when guidance modes to pre-final phase.

DISCUSSION - Concluded

TABLE 5-VIII.- HSI OUTPUT INFORMATION IN TAEM AND A/L MODES

HSI output identity							
Display mode	Primary bearing	Primary miles	Secondary bearing	Secondary miles	Course deviation (CDI)	Glidescope deviation (GSI)	Compass card (heading)
TAEM	Bearing to WP 1 on selected HAC for primary runway	Horizontal distance to WP 2 on primary runway via WP 1 for EP selected (LSB = 0.1 n. mi.)	Bearing to center of selected HAC for primary runway	Horizontal distance to center of selected HAC for primary runway (LSB = 0.1 n. mi.)	Deviation from extended runway centerline (full scale = $\pm 10^\circ$ )	Deviation from TAEM reference altitude (full scale = $\pm 5000$ ft)	Magnetic heading of body X-axis
A/L	Bearing to WP 2 at primary runway	Horizontal distance to WP 2 on primary runway (LSB = 0.1 n. mi.)	Bearing to WP 2 at primary runway (same as primary bearing)	Horizontal distance to WP 2 on primary runway (same as primary miles) (LSB = 0.1 n. mi.)	Deviation from extended runway centerline (full scale = $\pm 2.50$ )	Deviation from steep glide path; not computed for altitude less than prescribed value (full scale = $\pm 1000$ ft)	Magnetic heading of body X-axis

<u>EVENT</u>	<u>CUE</u>	<u>DISPLAY</u>
<u>Fuselage Vents Open</u>	M = 2.4	AMI SPEC 051

EIT = 25:55 (min:s)  
V =  $2.4 \times 10^3$  (ft/s)  
H =  $82 \times 10^3$  (ft)  
R = 58 (n. mi.)

CREW ACTION: Monitor

DISCUSSION

Opening of fuselage vents is initiated automatically by the GPC at a velocity of 2400 ft/s, which corresponds to an altitude of 82,000 feet. No cockpit indication is given that the vents have opened and the crew will have to rely on the MCC for confirmation that the vents have opened. Door opening time is normally 5 seconds (two motors) or 10 seconds (one motor).

Nine of 18 doors should be open for adequate venting. The time from nominal opening at 82,000 to 70,000 feet is 48 seconds; to 58,000 feet is 84 seconds. The MCC will advise what action the crew should take if any of the vents fail to open. In the event the MCC confirms that the vents failed to open at the desired time or altitude, the crew can manually command all vent doors open through the use of the VENT DOOR CNTL on the OVERRIDE CRT display.

<u>EVENT</u>	<u>CUE</u>	<u>DISPLAY</u>
<u>RCS Yaw Jets Deactivated</u>	M = 1.0	AMI/HUD RCS jet activity lights
EIT = 27:53 (min:s)		
M = 1.0		
H = 51.4 x 10 <sup>3</sup> (ft)		
R = 26.7 (n. mi.)		

CREW ACTION: None; crew awareness. No shutoff procedure is used.

DISCUSSION

The entry FCS retains the use of the yaw jets to augment the rudder for directional control down to Mach 1.0. At that velocity, the FCS is reconfigured to cease sending firing commands to the Jet Select Logic (JSL). If the use of the jets is terminated before Mach 1.0, as might occur with NAV errors in M and  $\bar{q}$ , some combinations of aerovariations render roll control very marginal. Loss of control may not occur, but the oscillatory roll rates may temporarily prohibit trajectory ranging control. In these cases, a low  $\bar{q}$  trajectory, wings level at 200 KEAS tracking toward Way Point 1, maximizes retaining control while minimizing altitude loss until subsonic, where maneuvering to the runway is improved. Even with jets, roll control may be marginal in the presence of variations, particularly if the vehicle is mistrimmed.

<u>EVENT</u>	<u>CUE</u>	<u>DISPLAY</u>
<u>Elevon Trim Position to +4° Down</u>	M = 0.95	AMI/HUD δE SP GNC SYS SUMM
EIT = 28:17 (min:s) M = 0.95 H = 45.8 x 10 <sup>3</sup> (ft) R = 23.3 (n. mi.)		
<u>CREW ACTION:</u>	Monitor elevon trim ramp down to +4° and corresponding body flap trim change	

### DISCUSSION

The elevons are trimmed down in this region to reduce hinge moments. Generally, hinge moments on the inboard elevons exceed outboard elevon hinge moments, principally because the inboard surface area is approximately twice that of the outboard. Also, in the Mach 1.4 to 0.9 region, the inboard hinge moments increase at a faster rate, resulting in positive inboard hinge moments and negative outboard hinge moments. As the elevon trim ramps down, both inboard and outboard moments tend toward zero. As the body flap drives up to maintain pitch trim, its hinge moments decrease toward zero.

The elevon should reach the +4° trim position by Mach 0.9. This slow trim change is partially limited by the slow body flap drive rate to trim in the AUTO BODY FLAP mode. With three operational hydraulic systems, the body flap will only move about 3 deg/s (1 deg/s per hydraulic system). If tolerances for air loads are considered, the drive rate may vary from 1-1/2 to 4-1/2 deg/s.

In OPS 3, a Caution and Warning light will alert the pilot to high hinge moments. The alert is based on exceeding 80 percent of the 3000 lb/in<sup>2</sup> maximum pressure in the actuator primary piston. This alert is in OPS 3 only - in PASS and BFS software - not in OPS 6.

<u>EVENT</u>	<u>CUE</u>	<u>DISPLAY</u>
<u>Speed Brake Modulated for Energy Control</u>	M = 0.95	AMI/HUD

EIT = 28:03 (min:s)  
M = 0.9  
H ≈ 45 x 10<sup>3</sup> (ft)  
R ≈ 24 (n. mi.)

CREW ACTION: Awareness

DISCUSSION

TAEM guidance uses the speed brake to fly the dynamic pressure versus range profile below Mach 0.95. Energy control is achieved by modulating drag through speed brake deflection commands to null out the dynamic pressure error.

The speed brake commanded by guidance can be monitored by the crew on the HUD, or on the VERT SIT display on CRT 1, on the lower right-hand side of the display. On both the VERT SIT 1 and 2 displays, the actual speed brake position from the speed brake position feedback SOP and the commanded speed brake position from guidance is displayed in percent. The actual speed brake position and command (0 to 100 percent) may also be monitored on the SPI on panel F7.

HUD PROCEDURES

The bottom of the HUD-FOV has a horizontal scale with two opposing pointers. The upper pointer indicates actual position and the lower arrow indicates speed brake command. From M = 10 to M = 0.9 a speed brake position difference greater than 10 percent from auto command will cause the speed brake position pointer to flash. At Mach > 0.6 and above, the speed brakes augment lateral stability and they cannot close to less than 15° (AUTO or CSS).

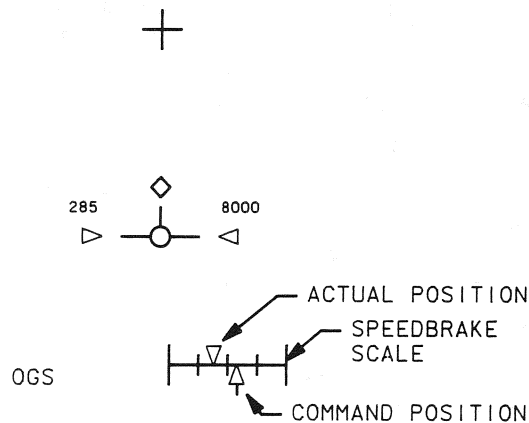

3153. ART, 3

Figure 5-35.-

<u>EVENT</u>	<u>CUE</u>	<u>DISPLAY</u>
<u>HAC Tangency (WP 1)</u>	HSI 1 bearing pointer on nose	HSI/HUD
EIT = 28:42 (min:s)	HSI 2 bearing	
M = 0.84	pointer near wingtip	
H $\approx 40 \times 10^3$ (ft)		
R $\approx 20$ (n. mi.)		

CREW ACTION: Monitor HAC acquisition. Place HSI mode to APPROACH when CDI shows within  $2.5^\circ$  of runway centerline (full scale).

### DISCUSSION

The software will cycle the HSI display mode from ENTRY to TAEM to APPROACH automatically if the mode switch (F6 and F8) is left on the ENTRY position. At Way Point 1 (WP 1), the primary bearing pointer will point to the Orbiter nose while the secondary bearing pointer will be near the wingtip position and point to the center of the selected HAC. The secondary DME at WP 1 should be approximately 3.3 n. mi. and the primary DME will indicate the horizontal distance around the HAC arc to WP 2 on the runway (table 4.2-VII). HAC tangency may also be observed on the HSD (CRT 3). The Orbiter symbol will be on the heading alignment cylinder with dynamic position indicators giving the Orbiter position 20, 40, and 60 seconds in the future.

Prior to TAEM-prefinal, the HUD has a flight director symbol, ( $\square$ ), fixed in the center of the field of view. This symbol can be used together with the guidance diamond ( $\diamond$ ), to null out any guidance command errors. (The guidance diamond depicts the direction to which the Orbiter must be flown to satisfy the GPC-derived guidance solution. The diamond represents the intersection of the guidance needles on the ADI.)

At TAEM prefinal the flight director symbol ( $\square$ ) automatically releases and begins moving in the field of view as a velocity vector ( $\circ$ ). A line of sight projection from the pilot's eye, through the velocity vector symbol, depicts the instantaneous flight-path of the Orbiter. Precise adjustments in flight path can be accomplished as required by overlaying the velocity vector symbol on the desired aim point.

At HAC tangency as noted above, the crew may expect the TAEM guidance to transition from the acquisition phase to the alignment phase. The crew should be aware that in the heading alignment phase the guidance can command a bank angle to  $60^\circ$  as opposed to  $50^\circ$  in the acquisition phase.

As the Orbiter flies around the HAC, the CDI will come off full-scale deflection when the Orbiter is within  $15^\circ$  (second dot on CDI is  $10^\circ$ ) of the extended runway centerline with the switch position in the ENTRY or TAEM position. At an altitude below (12,018 feet for NOM end of mission) the HSI modes automatically to APPROACH mode



## DISCUSSION - Concluded

and displays the information identified in table 4.2-VII. Although the HSI changes automatically from TAEM to APPROACH modes with the mode switch left in the ENTRY position, if the display mode selection switch is moved manually from the TAEM setting to the APPROACH switch setting, the autoland display computations will be performed. To prevent a possible transient in the Glide Slope Indicator (GSI), the crew should manually move the HSI mode switch to the APPROACH position when the deviation from the extended runway centerline is  $2.5^{\circ}$  on the CDI. In the APPROACH display mode, the second dot represents  $2.5^{\circ}$ . The rationale for this recommended procedure is that in the TAEM mode when the Orbiter passes the point where the two HAC's are tangent and at an altitude above ALT LAND (ft), the range predictor in the TAEM mode calculates another turn around the HAC. The increased range from this calculation causes the GSI to show the vehicle low on the glide slope and when the altitude does decrease below ALT LAND (ft) the GSI indicates the correct position on the glide slope.

NOTE: If the manual switch to Approach position is not made a glitch on range and glide path on the HSI and GSI may be observed for only 2-4 seconds. This assumes  $\dot{H}$  is approximately -150 fps and H error is not excessive.

During the transition from the heading alignment cone to the steep outer glide slope, the crew can use the CDI and the GSI to monitor the prefinal phase of TAEM guidance which positions the vehicle at the TAEM-Approach/Land interface. The parameters presented on the HSI provide the pilot with the minimum G&N information needed to monitor the turn to final. The pilot can use the HSI to verify bearing and distance to the field. In addition, the pilot may verify the airspeed to be approximately 240 KEAS at HAC tangency and increasing to approximately 285 KEAS as the vehicle reaches runway centerline near OGS intercept.

### HUD Procedures

The lower left window (number 3) of the HUD will display the various phases, as the approach progresses, as (CAPT-OGS-FLARE-FNLFL) for capture, outer glide slope, preflare, and final flare, respectively.

<u>EVENT</u>	<u>CUE</u>	<u>DISPLAY</u>
<u>Initiate MLS Updating</u>	Tacan RESID and RATIO data disappear BRG and GS flags disappear	HSD/HSI/HUD
EIT = 30:16 (min:s) V = 272 (KEAS) H = 20.0 x 10 <sup>3</sup> (ft) R = 9 (n. mi.)		
<u>CREW ACTION:</u>	Monitor MLS acquisition, change HSI source switches on panels F6 and F8 to MLS	

### DISCUSSION

The MLS hardware limitations for range, elevation, and azimuth are 20 n. mi., 29<sup>0</sup> from horizon, and ±13.5<sup>0</sup> from runway centerline, respectively. A software lockout inhibits processing MLS data until range equals 15 n. mi. Several cues are available for crew use in verifying that MLS has been acquired and is being processed, as follows:

1. Tacan RESID and RATIO data on the HSD will go blank.
2. The missing data 'M' flags will disappear from SYSTEM SUMMARY 1 display.
3. Guidance-commanded steering bars on the ADI will jump because of the difference in altitude detected by the MLS versus air data system.
4. Bearing, range, and glide slope flags will disappear from the HSI provided the HSI data source was selected to MLS before MLS acquisition.

The crew should change HSI source switches to MLS after acquisition. It is possible to select any of the three MLS LRU's to drive the HSI in the same manner as it is possible to select any of the three tacan LRU's.

MLS-derived altitude should be much more accurate than barometric altitude. If the Orbiter flight control system was in AUTO mode at time of MLS acquisition, it is possible that a sudden guidance command change would be followed to correct the discrepancy between actual and desired trajectories. All three channels (azimuth, elevation, and distance) of the MLS data can be used until the range reduces to 3350 feet beyond the runway threshold on the nominal trajectory. At this point, the Orbiter flies past the elevation antenna. The azimuth and distance data are continually used through rollout.

In the absence of MLS data, the NAV filter will update the state vector with tacan data, but only down to 1500 feet.

Circuit breakers and power switches for the three MLS receiver/transmitters are located on panels 014, 015, 016, and 08.

## HUD PROCEDURES

From an altitude of 12,000 feet and below, nav is continuously checked for the use of MLS data. If MLS data are not available for a period in excess of 6 seconds, having once been acquired, the MLSNV alert will be displayed on the HUD window 2.

NOTE: This alert is not displayed head-down. Under these conditions, unless the vehicle is at a very low altitude (less than 100 feet), it may be prudent to consider manual control, (engage CSS).

<u>EVENT</u>	<u>CUE</u>	<u>DISPLAY</u>
<u>Track Outer Glide Slope</u> <u>Toward Aim Point</u>	G/S indicator Visual ground marker PAPI lights HUD OGS symbols	ADI/HUD GSI VERT SIT 2

EIT = 31:02 (min/s)  
V = 285 (KEAS)  
H  $\approx$   $9 \times 10^3$  (ft)  
R  $\approx$  6 (n. mi.)

CREW ACTION: Monitor autoland capture; flashing A/L on VERT SIT 2  
Monitor error needle on ADI centered and PAPI lights show two red and two white.  
Monitor 'OGS' on HUD.

### DISCUSSION

By 10,000 feet above the ground the TAEM guidance should switch to the approach and landing (A/L) guidance phase (Major Mode 305). The transition from TAEM prefinal guidance to A/L guidance is based on a logical check of altitude error, lateral position error, dynamic pressure error, and flight path angle error. The cockpit indication that the logic conditions mentioned above have been met is a flashing 'A/L' displayed on the VERT SIT 1 display. This should normally occur at 10,000 feet above ground. Other instrument indications and independent ground located glide slope indications available will also be discussed herein.

The outer glide slope is designed to be as shallow as possible while providing the lowest descent rate and the least demanding maneuver in making a transition to a  $1.5^\circ$  shallow glide slope. Yet, to be steep enough to maintain sufficient speed brake reserves to cope with varying winds and trajectory dispersions. Because outer glide slope angles are a function of vehicle weight and airspeed, winds, and TAEM trajectory dispersions, a pitch angle,  $\theta$ , to be flown on the HUD/ADI will be determined by the pilot as he compares the vehicle velocity vector with the ground aim point and PAPI light configurations. When the Orbiter is tracking on the projected runway centerline and is on glide slope, all ADI and HSI needles (CDI and GSI) should be centered.

The outer glide slope angle is  $19^\circ$  and reference speed on the OGS is 285 KEAS. The lower the gamma, the less sensitive the preflare to touchdown profile is to execution errors. This OGS angle is panned to be compatible with manual control of the Orbiter. Some factors affecting the selection of the steep OGS angle for the Orbiter are discussed in section 4.2 of this handbook.

## DISCUSSION - Concluded

Prior to A/L interface, the crew will be given a landing winds update if required. Before this update, the ground controllers will be able to assess any wind or density altitude effects on touchdown conditions and make the crew aware of these effects. The ground can also factor in the effects of any weight or known L/D variations on touchdown conditions if necessary. Air density determines true airspeed corresponding to the constant equivalent airspeed on the steep OGS. Temperature increases or decreases change the air density at preflare, which changes the true airspeed and therefore groundspeed.

The headwind/tailwind component of wind is the other major atmospheric effect on the vehicle's approach and landing performance. On the outer glide slope, the speed brake will be modulated by auto-guidance. Speed brake modulation is used to maintain the reference equivalent airspeed on the outer glide slope. With a headwind on the 19° outer glide slope, the speed brake deflection required to hold the reference equivalent airspeed will be less than the speed brake deflection required on the 19° outer glide slope with no wind. The stronger the headwinds, the slower the touchdown velocity; or, if equivalent airspeed is held constant, then the touchdown range will be short by  $\Delta X$  distance.

The commander can estimate his position on the outer glide slope by using the Precision Approach Path Indicator (PAPI) light located at an X runway distance of -7,500 feet at the OGS aimpoint. These lights (four) are set at vertical angles (left to right) of 22°, 20°, 18°, 16° about the reference angle on the OGS such that the pilot should see two red and two white lights when he is on the desired outer glide slope. Refer to figure 4.1-27 as a visual aid for the following explanation of the PAPI array. Should the vehicle go high on the glide slope (>19°), the PAPI array will show one red and three white lights. More red lights are seen as the vehicle drops low on the glide slope. The visibility of these lights is a function of the atmosphere and the brightness of the background at the landing site, but they are usually useful for information by 10,000 feet above ground. The PAPI lights are narrow beam lights and give a sharp transition between the red and white portions of the beam. Because the PAPI lights are highly directional, narrow beam, the pilot should use the triangle shape of the OGS aimpoint marker to locate the OGS aimpoint during the turn to final approach. The PAPI lights are designed to give primarily vertical plane information.

EOM, TAL, AOA, and RTLS landing weights in excess of 220,000 pounds will use a 17° OGS angle. Under these approach conditions the PAPI's will indicate three reds with one white when the vehicle is on the glide slope, two reds and two whites when high, and four reds when low. The weight dependent glide slope angle is selected on the first pass through entry navigation when the appropriate HAC's are selected.

HUD PROCEDURES

The outer glideslope symbols provide flight path angle reference information for OGS acquisition and tracking. The relative position of the OGS indicies in the FOV is a function of vehicle weight and selected glidepath angle (I-load).

The HUD runway symbology, including OGS and IGS aim points, and extended centerline appear in the HUD FOV, one on one with the real world, whenever that scene is within the HUD FOV. The runway symbol accurately depicts the selected runway length up to a maximum of 15,000 feet. Assuming no nav state error, the HUD runway threshold symbol will overlies the actual runway threshold. The runway symbol width is a constant 300 feet regardless of actual runway width. Runway symbol will depict actual runway length up to a maximum of 15,000 feet.

NOTE: Any observed position deltas between the HUD runway symbology and the real world scene are indications of Shuttle nav state errors.

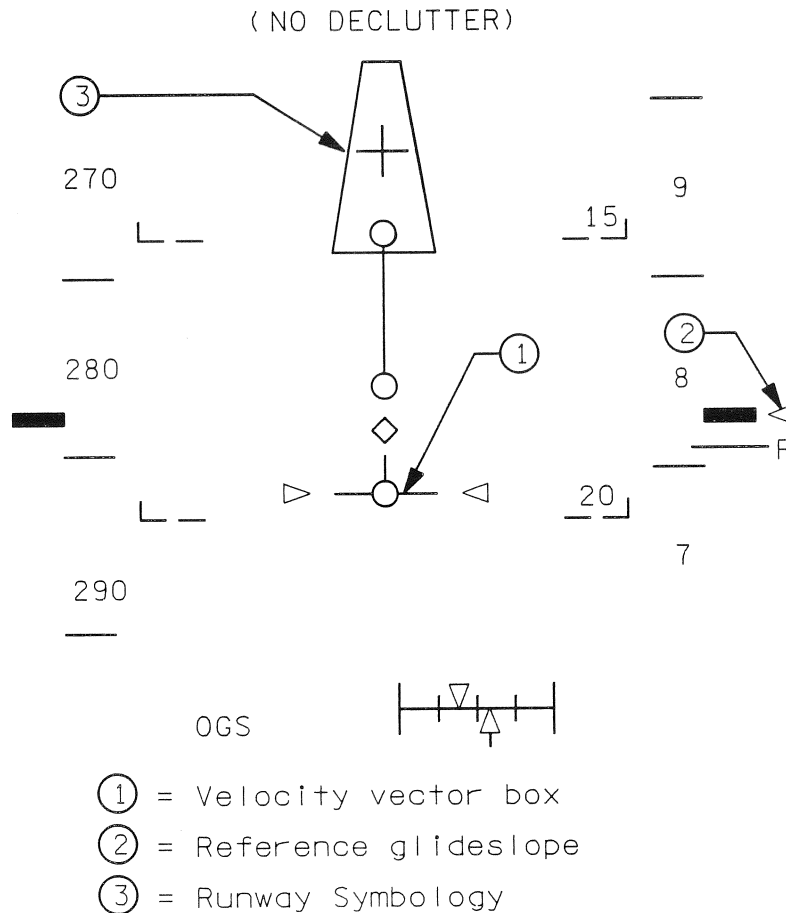
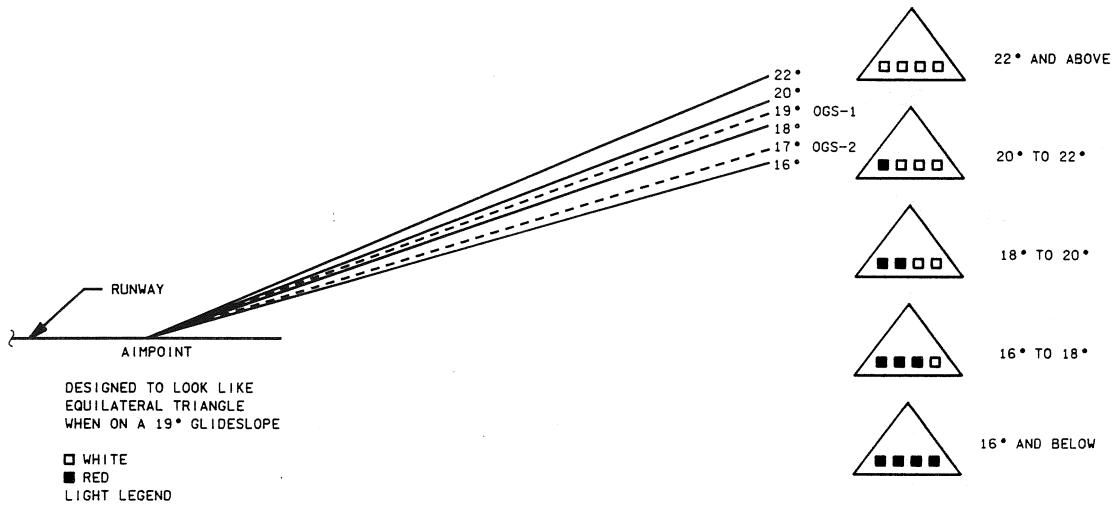
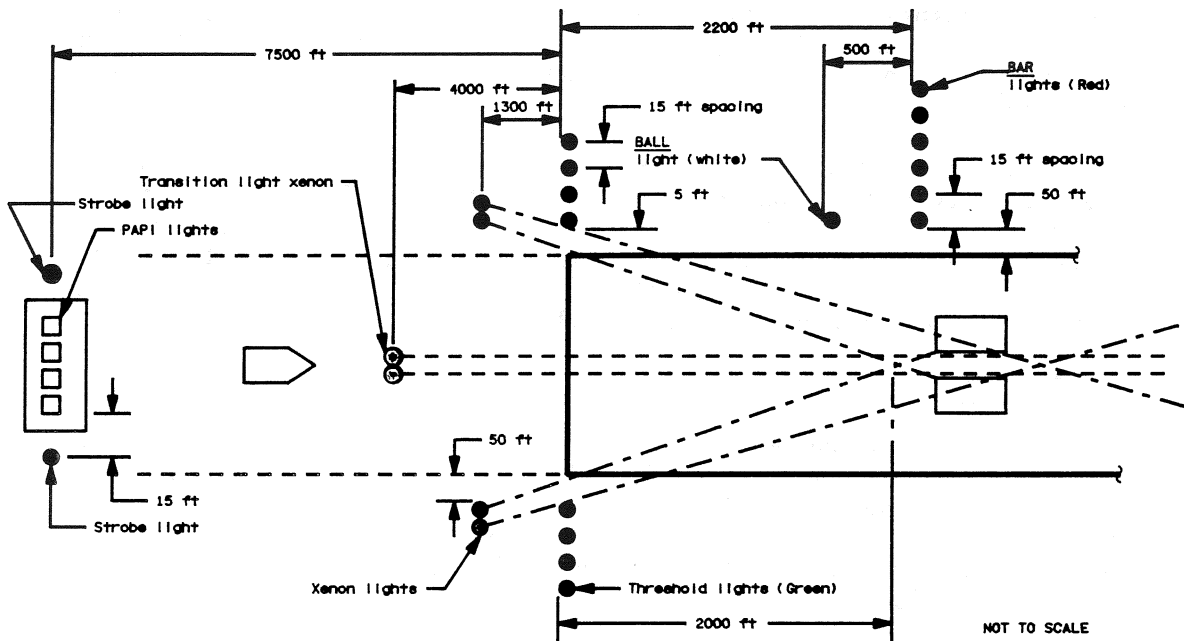

Figure 5-36.-Approach and land display.



0675. ART. 6

Figure 5-37.- Illustrative example of PAPI system geometry for a 19° OGS.



NOTES: UNLESS OTHERWISE SPECIFIED,

1. INNER ZENON LITES BORESITED TO Q OF RUNWAY AT THE 2000 FT MARK.
2. OUTER ZENON LITES BORESITED TO OPPOSITE END OF RUNWAY (15000 FT MARK).
3. PLACE ORANGE PAVEMENT REFLECTORS ON EITHER SIDE OF RUNWAY STARTING AT THE 3000 FT MARK FROM THE THRESHOLD SPACED EVERY 100 FT TO THE 15,000 FT MARK.

1899. ART. 6

Figure 5-38.- Typical runway lighting configuration.

<u>EVENT</u>	<u>CUE</u>	<u>DISPLAY</u>
<u>Wind Update if Required</u>	Call from ground	HUD

EIT = 29:55 (min:s)  
V = 275 (KEAS)  
H ~ 15 X 10<sup>3</sup> (ft)  
R = 7 (n. mi.)

CREW ACTION: Awareness

DISCUSSION

If necessary, the crew will be advised of changes in the latest wind information, which may cause a change in energy management between approach and land interface and touchdown.

The winds during the Orbiter trajectory from preflare to touchdown can cause a decrease in the energy reserve available to the pilot. The winds discussed here are not necessarily surface winds, but rather the effective steady state wind that would produce the same change in vehicle performance as the wind under consideration. As an example, a strong shear produces a significant change in touchdown airspeed because above it the vehicle will have an airspeed determined by its inertial velocity and the windspeed, but just below the shear the inertial velocity is essentially unchanged and the drop in windspeed will cause a drop in airspeed. These effects are not completely predictable, but it is important to have an option in the form of a second aim point to diminish the effects of a bad wind situation.

Should the MCC computed touchdown prediction, based on current winds, place the vehicle touchdown point at less than 1000 feet past the runway threshold, the high wind or CLSE glide slope will be recommended. The crew may reselect to the close-in glide slope by 'Item 8 Execute' on Vert Sit 2. This glide slope is 1000 feet closer to the runway threshold than the nominal glide slope.

HUD PROCEDURES

When a large crab angle exists, as a result of strong crosswinds, the velocity vector symbol may be forced to the limits of the TFOV. At this point further lateral travel will be restricted and an 'X' will be superimposed on the velocity vector symbol (~~✱~~). The 'X' will remain superimposed on the symbol until the side-slip angle or velocity which forced the symbol out to the TFOV limits is reduced.

The CDR or PLT can cage the velocity vector symbol, laterally in the center of both PDU's by pushing either of the ATT-REF pushbuttons. Pushing either ATT-REF pushbutton a second time will return the symbols to a true velocity vector indicator. This feature is intended to ensure uncluttered guidance, digital airspeed, and digital altitude information during crosswind approaches when declutter level 2 is not selected.



<u>EVENT</u>	<u>CUE</u>	<u>DISPLAY</u>
<u>Approach and Landing Interface</u>	'A/L' appears on VERT SIT 2	VERT SIT 2
EIT = 30:52 (min:s)	'CAPT' on HUD	HUD
V = 283 (KEAS)		
H = $10 \times 10^3$ (ft)		
R = 4.9 (n. mi.)		

CREW ACTION: Monitor

DISCUSSION

Transition to A/L GN&C is automatic between 10K and 5K upon satisfying the A/L interface. The cues that TAEM guidance has terminated and A/L guidance has been initiated are the A/L symbol that appears on VERT SIT 2, and CAPT mode appears in HUD window 3.

The following GN&C software modules are initiated.

- o A/L guidance.
- o A/L user parameter processing.
- o Landing subsystem operating program provides discrete signals for user functions to configure G&C for landing (MLG touchdown imminent, MLG has occurred, NLG touchdown has occurred, load relief, load balance, and nosewheel steering).

The following GN&C software modules are terminated.

- o TAEM user parameter processing
- o TAEM guidance
- o Landing gear valve control (at MLG touchdown)
- o Vent control sequence (at NLG touchdown)

On the first pass through A/L guidance, the body flap will be commanded to trail. Between 5000 feet and touchdown, if the body flap is not within 5 percent of trail, an alert will flash in HUD window 2. Should this appear, the body flap should be manually selected to the trail position.

BFS does not have A/L guidance nor does it process MLS data for NAV or crew displays.

To Be Supplied

5-140

<u>EVENT</u>	<u>CUE</u>	<u>DISPLAY</u>
<u>Radar Altimeter Activated</u>	H = 5000 ft	AVVI HUD

EIT = 30:38 (min:s)  
 VREL = 280 (KEAS)  
 H = 5000 (ft)  
 R = 3 (n. mi.)

CREW ACTION: Monitor AVVI and HUD

DISCUSSION

Altitude data provided by the radar altimeter are displayed on the HUD and AVVI. During final approach, the pilot will monitor altitude and confirm that the commander has initiated preflare at 2000 feet. Crosschecks between barometric and radar altimeter data should be made.

Circuit breakers and power switches for the two radar altimeters are located on panels 014, 015, and 08. An LRU select switch is adjacent to the commanders and pilots AVVI (panels F6 and F8).

The scale on the AVVI is from 0 to 9000 feet. Before radar altimeter lockon, the AVVI scale will be parked at 8192 feet. Signal lockon may occur as high as 5476 feet; thus, the crew can expect to see a jump on the AVVI when the radar altimeter is activated.

CAUTION: Rough or hilly terrain under the Shuttle approach path will cause erratic readings on the radar altitude.

HUD PROCEDURES

Radar altitude is displayed on the right-hand side of the HUD. Altitude is read off the scale, at the 'tick' mark (—R). Differences between radar altitude and nav altitude are readily apparent by an indicated delta between the radar (—R) and nav (■) indicies. HUD radar altitude information depends on the position of the RADAR ALTM switch (1 or 2) on F6/F8.

<u>EVENT</u>	<u>CUE</u>	<u>DISPLAY</u>
<u>Arm Landing Gear</u>	H = 4000 ft	AVVI HUD
EIT = 31:19 (min:s)		
V = 286 (KEAS)		
H = 4000 (ft)		
R = 3.5 (n. mi.)		

CREW ACTION: LANDING GEAR pbi - ARM  
Verify light (F6, F8)

#### DISCUSSION

When the landing gear ARM pushbutton indicator on panel F6 or F8 is depressed, power is provided to the DN pbi circuits from main buses A, B, and C. The contacts of the relays provide power to illuminate the ARM lights, close the landing gear retract/circulation valve, and close the landing gear redundant shutoff valve.

#### HUD PROCEDURES

At approximately 3800 feet a set of flare reference indicies, identical in size and shape to the OGS reference indicies, will appear in the bottom of the HUD. These indicies will move up the display, merging with the OGS indicies to become a single set at preflare.

<u>EVENT</u>	<u>CUE</u>	<u>DISPLAY</u>
<u>Speed Brake Closed</u>	H = 2500 ft	AVVI RDR ALT HUD
EIT = 31:33 (min:s) V = 285 (KEAS) H = 2500 (ft) R = 2 (n. mi.)		
<u>CREW ACTION:</u> CDR - position speed brake to close (CSS) Monitor (AUTO)		

DISCUSSION

Autoland guidance will command the speed brake (nominally approximately 55 percent) to maintain an airspeed of approximately 285 KEAS, on the outer glide slope.

HUD PROCEDURES

At the bottom of the FOV, the speed brake command and actual position are indicated by an arrow and index pointer, respectively. The scale indicates fully closed on the left (0 percent), and a fully open on the right (98.6 percent), divided into four 25 percent increments. Below 500 feet to touchdown, less than  $-0.5^{\circ}$  or more than  $+5.5^{\circ}$  from command will cause position pointer to flash.

Autoguidance logic for speed brake retraction functions is as follows: at 4000 feet the logic checks the amount of speed brake deflection, if it is equal to or less than  $40^{\circ}$  the logic will retract the SB. If the SB deflection exceeds  $40^{\circ}$ , the test will continue through 2500 feet. At 2500 feet the test for speed brake deflection changes to equal to or less than  $85^{\circ}$  for retraction. At 2000 feet, if the speed brake has not retracted, it is frozen at the current setting throughout preflare, and any remaining speed brake deflection retracted at 1000 feet. At touchdown, (WOWLON) the speed brake is commanded to 100 percent open ( $98.6^{\circ}$ ).

The crew may verify that the speed brakes are closed by reference to the SPI on panel F7 for an indication of both speed brake position and command in percent. With the speed brake positioned to close, the actual speed brake position is limited to 15 percent by software. In addition, the VERT SIT display on CRT 1 and HUD will show the commanded and actual speed brake positions in percent.

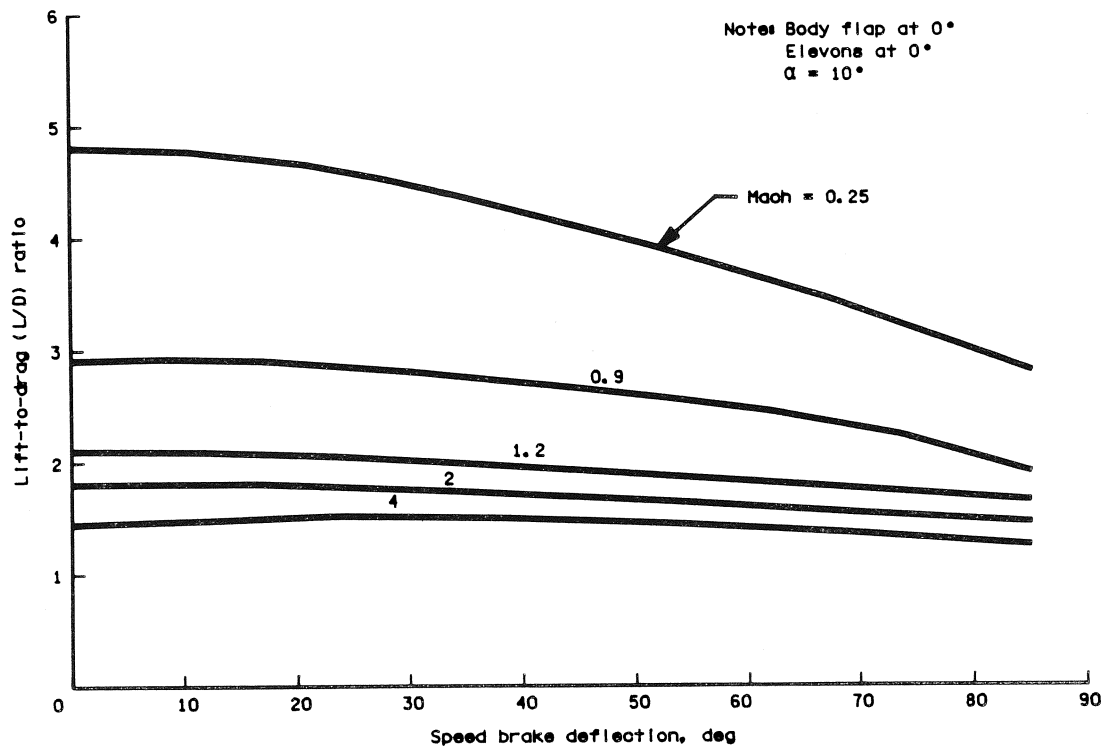

Figure 5-39.- L/D ratio vs. speed brake deflection.

2534. ART. 3

<u>EVENT</u>	<u>CUE</u>	<u>DISPLAY</u>
<u>Preflare</u>	H = 2000 ft	RDR ALT HUD
EIT = 31:47 (min:s)		
V = 287 (KEAS)		
H = 2000 (ft)		
R = 12,312 (ft)		

CREW ACTION: Perform preflare

### DISCUSSION

The preflare maneuver is the transition between the outer and inner glide slopes. If the outer glide slope angle is varied, then either the initialization of preflare or the g-level of preflare pullup must be varied. An airspeed should be maintained to yield a velocity at the preflare point that provides approximately 5 seconds of flight time on the inner glide slope and meets the touchdown conditions. The length of time on the inner glide slope is very important because it allows the commander time to make corrections and establish a controlled approach to the runway. An inner glide slope time of less than 5 seconds between the completion of the preflare and the beginning of the final flare seriously degrades the pilot's ability to make any corrections and prepare for landing.

Under nominal conditions at a vehicle weight of 205,000 pounds, an outer glide slope of  $-19^{\circ}$  and a preflare entry airspeed of approximately 287 KEAS, the vehicle will lose approximately 1800 feet in the transition to the shallow glidepath. The amount of altitude lost in the preflare is affected by several parameters: vehicle weight, flightpath angle, preflare entry airspeed, and the  $\phi N_z$  used in the preflare maneuver. Analytical studies have shown that the minimum acceptable preflare velocity is 240 to 250 KEAS. A preflare trajectory envelope is used rather than a flightpath that must be followed exactly. This envelope is bounded on the lower limit by the  $N_z$  maximum g-load used in the preflare pullup and by an upper limit defined by airspeed loss. A possible problem associated with delaying the preflare and pulling more than 2g's is that this action may bring the pullout close to the ground. In pulling the desired g-load, a pilot may end up pulling excessive g's to correct a real or assumed error.

For the case of the 205,000-pound vehicle on a  $-19^{\circ}$  steep glide slope, the pitch attitude on the ADI just before the preflare maneuver will be approximately  $-14^{\circ}$ . Analysis comparing the previously baselined  $-20^{\circ}$  outer glide slope with the  $-19^{\circ}$  outer glide slope shows that the preflare sensitivity to initiation time decreases with the shallower flightpath angle and lower glide slope speed. The minimum preflare altitude decreases with the shallower flightpath angle also. Basically this means to the crew that the preflare maneuver is less sensitive to execution errors and this should make the manual flare-to-landing task easier.

## DISCUSSION - Concluded

At the completion of the preflare maneuver on the reference 1.5° inner glide slope, the angle of attack should be approximately +8° at an airspeed of approximately 275 KEAS. The pitch rate required in the preflare is a function of initial  $\gamma$ , airspeed, and initiation altitude. If the commander flies the preflare so as to reach the end of the maneuver about 100 feet above the ground at 250 KEAS, he will have approximately 15 seconds on the shallow final approach during which time he can correct lateral errors and prepare for touchdown.

## HUD PROCEDURES

As the two sets of indicies (OGS and flare) merge into a single set the indicies display the required preflare flightpath angle for the flare maneuver. By maintaining the velocity vector wings precisely in line with the flare indicies throughout the flare process, the desired profile will be tracked. At final flare, the flare indicies will automatically blank from the HUD-FOV.



<u>EVENT</u>	<u>CUE</u>	<u>DISPLAY</u>
<u>Lower Landing Gear</u>	275 KEAS	AMI/HUD

EIT = 32:04 (min:s)  
V = 275 (KEAS)  
H = 300 (ft)

CREW ACTION: Landing Gear PBI - 'DN'  
Verify light (F6 and F8)  
Landing Gear tb (3) - Down

DISCUSSION

The crew should reach 275 KEAS near the end of the preflare maneuver. As the commander stabilizes the Orbiter on the short inner glide slope, at 300 feet he should command gear extension. The PLT will press the Landing Gear pbi 'DN' and report gear deployed. The landing gear may be deployed from either the pilot's (F8) or commander's (F6) console. Activation of the DN pushbutton indicator opens the landing gear control valve and allows hydraulic pressure to the nose gear uplock and strut actuator, nosewheel steering, and the main landing gear uplocks and strut actuators. The 'DN' pbi also provides power for the landing gear Pyro Initiator Controller (PIC) 1 and 2 firing circuits. The contacts of the relays provide power to illuminate the 'DN' light (F6 and F8) and power the circuits 1 and 2 of the right main gear, left main gear, and nose gear (PIC) backup uplock release 1 and 2. The 'DN' gear light indicates that at least one relay has latched. The purpose of the (PIC) uplock release actuators is to release the gear uplock hook if the uplock release hydraulic actuator fails to do so 1 second after gear deployment is requested. Additionally, the nose gear is aided in extension in extension by a PYRO actuator that applies a force to the nose gear strut. The booster actuator PIC's (two redundant PIC's) will fire approximately 2 seconds after gear extension is requested. The landing gear talkbacks (F6 and F8) will be barberpole until the circuit breakers are activated before reentry. When the gear uplock proximity sensor indicates the uplock is released, the talkback transfers from 'UP' to barberpole, indicating the gear is in transit or a loss of input signal. When the gear downlock proximity sensor indicates the gear is down and locked, the talkback transfers from barberpole to 'DN'.

Some landing gear reference data/operating limitations are:

- o Gear extension time . . . . . 6 to 8 (10 max) sec
- o Maximum deployment velocity . . . . . 300 kt
- o Maximum allowable main gear  
sink rate at normal landing  
weight, no x wind . . . . . 8 ft/s

The nose and main gears should extend to the down and locked position without hydraulic power assist demonstrating a free-fall capability.

## HUD PROCEDURES

At airspeeds less than 300 KEAS and altitudes less than 300 feet, a gear lowering cue 'GEAR' will flash in the upper left (no. 1) window on the HUD. Flashing will continue until the gear has been released.

Upon release, '/GR//' is displayed while the gear is in transit. 'GR-DN' is displayed when all three gears are down and locked. All gear symbology is blanked from the HUD upon touchdown.

<u>EVENT</u>	<u>CUE</u>	<u>DISPLAY</u>
<u>Final Flare</u>	H < 80 ft Ball/Bar	RDR ALT AVVI HUD
EIT = 32:09 (min:s)		
V = 249 (KEAS)		
H < 80 (ft)		
R = 1651 (ft)		
<u>CREW ACTION:</u>		
CDR - Fly final flare		
PLT - Call altitude from AVVI		
Call airspeed from AMI		

### DISCUSSION

The final flare should be a smooth increase in pitch attitude started at an altitude high enough to allow the pilot to predict a safe landing. The angle of the inner glide slope establishes the severity of the flare. This trajectory does not require a large maneuver to land. The aerodynamic data indicate relatively strong ground effects, and the Orbiter displays a large change in lift with elevon deflections. The pilot should anticipate the effect of ground effects as the altitude decreases through 50 feet in the flare. The net effect of the cushion of air underneath the vehicle in ground effect is an increase in lift of the vehicle with increase in force as it approaches the ground. The increase in lift as the Orbiter approaches the ground will cause a nose-up pitching moment, which may increase the chance for a pilot to overcontrol and 'balloon' the vehicle. To minimize this risk, large control inputs close to the ground and 'grease job' landings should be avoided, because both increase the chance of a balloon. The 1.5° reference inner glide slope requires less flare because the descent rate on that glide slope is acceptable for landing at normal landing weights. The reference sink rate is approximately 3 ft/s and should not be more than 8.0 ft/s. The final flare sets the sink rate and angle of attack for touchdown. The reference angle of attack for touchdown is approximately 8°, not to exceed approximately 14.7°. Establishment of the desired angle of attack in the flare is important for several reasons. At an  $\alpha$  of approximately 12°, (L/D) max is reached. Increasing  $\alpha$  further will place the vehicle on the 'backside' of the L/D curve. In this region, drag is increasing and velocity is decreasing. This combination of forces presents an undesirable condition if the vehicle is flying above the runway too high to make a controllable touchdown. Flying angle of attack will aid in maintaining airspeed. If for example airspeed is allowed to build up to and through the flare, this excess speed will not be easily dissipated because of the reduction of drag due to ground effect. Low speed ground approach and landing data derived from STS-1 flight data indicate in free air (prior to gear down and height/span value greater than 1.5) that the axial force ( $C_A$ ) and drag coefficient ( $C_D$ ) should be reduced by -0.0040. Lift coefficient is unchanged. The speedbrake was found to be more effective in drag at deflections above 25 degrees. Once in ground effects the contribution to the coefficient of normal force due to ground effect ( $C_{NGE}$ ) was found to be additive, which improves lift. The

DISCUSSION - Continued

contribution to the coefficient of axial force due to ground effect ( $\phi C_{A_{GE}}$ ) was found to be subtractive, which reduces drag. The combination of improved lift and reduced drag in ground effect give the vehicle increased L/D performance near the ground and may increase any tendency to 'float'. The following figures are illustrative examples of the relationship of  $C_L$  and  $C_D$  in and out of ground effect. For a  $C_L > 0.5$ , the coefficient of drag,  $C_D$ , is lower in ground effect compared to the free-stream value as shown in figure 5-40.

At high angles of attack,  $C_{\eta_B}$  decreases toward neutral stability as indicated in figure 5-41. This decrease in directional control is due to the blanking effect of the wing on the vertical tail at the high angle of attack. Thus, especially in a crosswind condition, high angles of attack ( $\alpha > 15^\circ$ ) should be avoided.

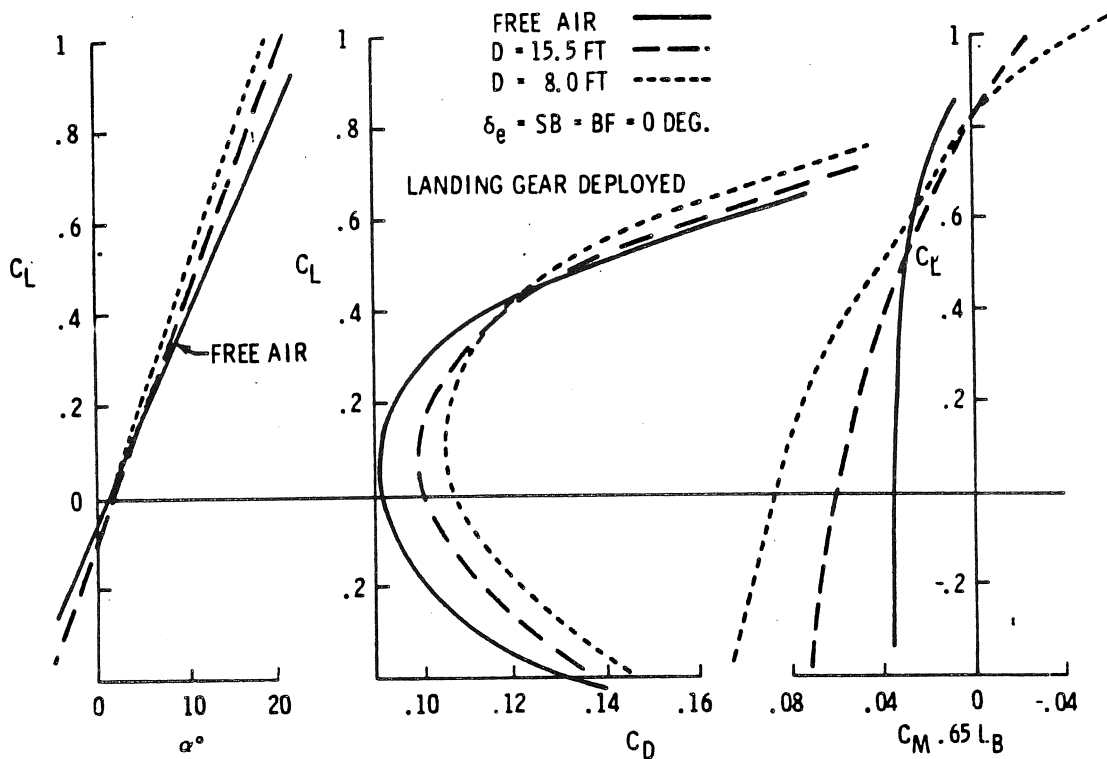

Figure 5-40.- Orbiter ground effects.

HUD PROCEDURES

The velocity vector symbol may be used to assist in setting up a smooth touchdown. By placing the upperlimb of the velocity vector tangent to and just below the horizon line, as the vehicle crosses the threshold, it should produce a touchdown sink of less than  $2 \text{ ft/s}^2$ .

<u>EVENT</u>	<u>CUE</u>	<u>DISPLAY</u>
<u>Touchdown</u>	Physiological V ~ 195 KEAS	AMI HUD
EIT = 32:21 (min:s)		
V ~ 195 (KEAS)		
H = 0		
R ~ 3000 (ft)		

CREW ACTION: CDR - Position speed brake to 100 percent  
SRB SEP - MAN/AUTO and PBI - PUSH

### DISCUSSION

As the Orbiter approaches touchdown, it is carrying an energy reserve that will provide the capability to continue flying the vehicle for approximately 5 seconds after the normal touchdown speed. This reserve amounts to approximately 25 KEAS. The purpose of this reserve is to allow the commander to null errors caused by gusts, turbulence, or other factors. If excess speed is carried through the flare, this energy will either be dissipated in a longer float distance or be absorbed by the main gear and tires and brakes at touchdown.

For a 214,000-pound Orbiter, the maximum allowable sink rate for the main gear is 8.4 ft/s. This sink rate is a function of the vehicle gross weight and cross-wind conditions. The worst case for limiting sink rate is a heavy vehicle (240,000 pounds) in a 20-knot crosswind. The reference sink rate at touchdown is approximately 3.0 ft/s.

The preferred technique for landing the Orbiter is to fly to the standard equivalent airspeed (~195 KEAS) and let touchdown range vary, as opposed to a 'spot'-type landing in which the airspeed is allowed to vary and a control input has to be made to put the Orbiter down on a certain spot. The difficulty associated with the latter type of touchdown is due to the negative flightpath response of the Orbiter to elevator inputs. If, as the vehicle nears the ground, it is carrying too high a sink rate, back stick input will move the elevons up, decrease lift, and result in an even higher sink rate at touchdown. In a situation in which the flightpath has leveled out, a forward stick input to put the vehicle on the runway causes an increased balloon together with a lower angle of attack.

This situation causes a higher sink rate to occur later and also leads to a firm touchdown. It was observed that any pitch oscillation, although small, if on the upswing at touchdown would combine an increasing angle of attack and the rebound force of the landing gear struts resulting in a skip. Although a mild skip may be of no great concern, in the presence of other perturbations, such as gusts, crosswinds, or turbulence, it could invite control inputs that may result in some of the undesirable vehicle responses discussed previously.

## DISCUSSION - Concluded

The touchdown attitude is restricted by the angle of attack at which either the body flap or elevons will scrape. The worst condition for scrape occurs when the landing gear struts are fully compressed with the tires flattened. Conditions for scrape will also be dependent upon the respective deflections of the body flap and elevons at touchdown. Under nominal landing conditions, the body flap will be in trail and elevon deflection will be approximately  $+10^\circ$ . For a 207,000-pound Orbiter, scrape speed would be approximately 156 KEAS. This compares to a nominal touchdown speed of 195 KEAS. Tail-scrape velocity is a function of vehicle weight, vehicle c.g. location, elevon and body flap positions, and angle of attack at touchdown.

Checklist procedure calls for the crew to place the SRB-SEP switch (C3) to MAN/AUTO, and then to push the SRB-SEP pbi at main gear contact. The purpose of this is to provide a manual backup for the weight-on-wheels (WOW) signal in the landing SOP. The software logic incorporated as part of the Landing SOP will nominally automatically move the elevons for load relief, set the nosewheel groundspeed enable discrete, and latch a flat-turn command (auto landing). If this load relief logic is not incorporated, the pilot will have to push the stick forward at nosewheel contact to keep the elevons down to  $+10^\circ$  to unload the tires.

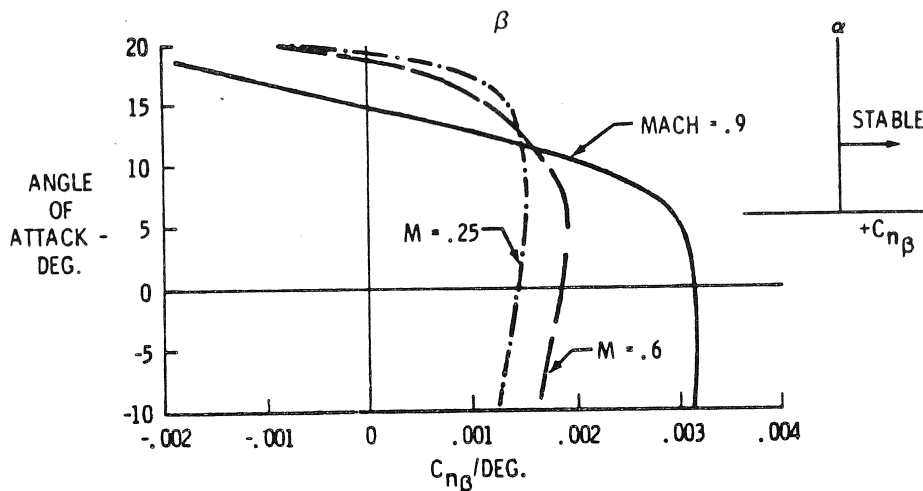

Figure 5-41.- Orbiter directional stability.

<u>EVENT</u>	<u>CUE</u>	<u>DISPLAY</u>
<u>Slapdown and Rollout</u>	EAS = 180 KT	AMI HUD
EIT = 32:30 (min:s)		
V = 180 kt		
H = 0		
R = 5680 (ft)		

CREW ACTION: At 180 kt derotate per schedule

DISCUSSION

The slapdown and rollout portion of the Orbiter landing profile has become a critical flight phase involving precise crew control for several reasons. The pilot is forced into a trade-off between maximum main gear and nose gear loads, braking, and rollout distance. The problem encountered is that what alleviates one area of concern tends to worsen another area. The stopping problem is a trade-off between brake reuse and runway remaining. The problem associated with strut/tire loading is caused by a combination of increasing vehicle weight and an aerodynamic loading force transmitted to the struts and tires when the Orbiter is in a three-point attitude rolling down the runway. With all three gears on the runway, the Orbiter has a negative angle of attack ( $\sim -3.5^\circ$ ) and this nose-low attitude adds to the weight on the gear because of aerodynamic loading. Analysis has shown that peak loads occur just before or as the nose gear touches. The derotation technique has to be a compromise maneuver to try to satisfy the constraints already discussed.

Because maximum main gear loads occur near nosewheel contact, derotation is not started until the velocity has been reduced to a value that will not result in excessive aerodynamic loading. At an airspeed of 180 KEAS the nose should be lowered with the rate a function of gross weight. At light EOM weights auto guidance will lower the nose at  $-1$  deg/s until theta is less than  $+2^\circ$  then it increases the rate to  $-4$  deg/s at  $-3^\circ$  theta: at heavy weights, the  $-1$  deg/s rate is maintained until  $+3^\circ$  theta then ramped to  $-6$  deg/s at  $-3^\circ$  theta. The vehicle should follow a similar profile in manual (CSS) mode.

Results of tire load alleviation studies indicate that the position of the elevons at nosegear touchdown has a large effect on the gear loading. For example, at a groundspeed of approximately 160 knots and a 210,000-pound vehicle with a 50/50 strut load distribution, the increase in load between  $5^\circ$  down elevon and  $5^\circ$  up elevon is approximately 20,000 pounds. The elevon effect becomes even more significant at higher groundspeeds. The 228-knot qualification speed at 240,000 pounds abort weight assumes the elevator is commanded to  $+10^\circ$  down at 2 seconds after nosewheel contact.

## DISCUSSION - Concluded

During the rollout phase of the landing, rudder is used as the primary mode of directional control (Nosewheel Steering in the OFF position, which allows the nosewheel to caster). Differential braking may be used when necessary, however, subsequent rollout and braking time should be kept to a minimum. Nosewheel steering DIRECT mode and GPC are the first and second backups. By ensuring that the Nosewheel Steering switch is in the OFF position, the crew can avoid two situations that have been identified as potentially hazardous: (1) No nosewheel steering command when needed or (2) an incorrect nosewheel steering command due to an error in the software-generated command. Because both of these situations require a software interface, the NWS switch would have to be in DIRECT or GPC. The crew may select the mode of operation for nosewheel steering using the NWS switch on panel L2.

Below approximately 100 knots, the rudder effectiveness diminishes. The following NWS switch positions are available.

- OFF - No nosewheel steering commands are accepted. The nosewheel casters. Steering is via differential braking.
- DIRECT - The nosewheel is directed by manual commands using rudder pedals and NWS command transducer.
- GPC - Steering can be accomplished using the rudder pedals or by the autoland system. The type of nosewheel steering (through RPTA's or totally automatic through the GPC) is dependent on the Roll/Yaw mode selected on panel(s) F2/F4. If AUTO pbi is selected and the NWS switch is in GPC, steering is automatic. If CSS pbi is selected, and the NWS switch is in GPC, the crew must input commands to the steering box using rudder pedals.

A nosewheel steering fail light (panel F2) indicates the status of the NWS system. When the FAIL light is illuminated, NWS is disabled and other methods of steering must be used.

The NWS Fail light will be activated during rollout if a failure is sensed by one or more of the following detectors and the NWS switch is in DIRECT or GPC.

- o Low hydraulic pressure
- o Open or short in servo control valve
- o Open or short in the NWS command transducer
- o Open or short in the position transducer
- o Loss of steering control box power
- o Broken linkage (command transducer)
- o Hard-over condition



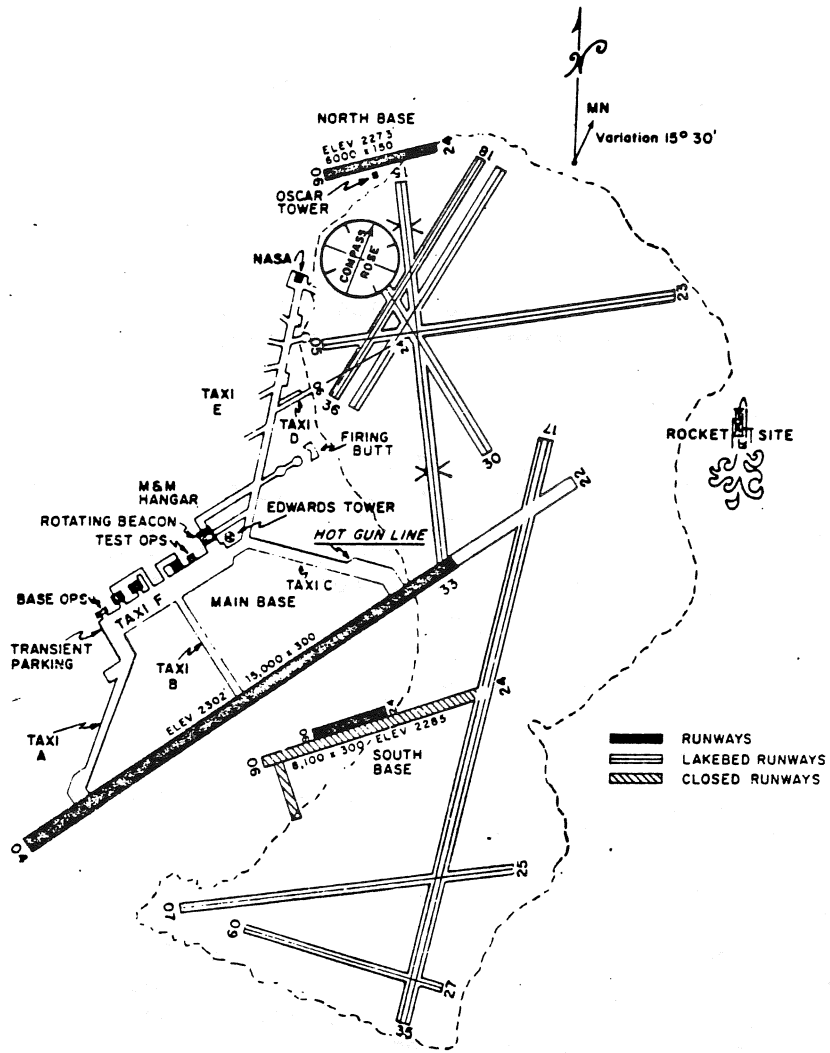

Figure 5-42.- Edwards runway complex.

<u>EVENT</u>	<u>CUE</u>	<u>DISPLAY</u>
<u>Braking on Runway</u>	EAS < 140 KEAS	AMI HUD

EIT = 32:40 (min:s)  
V = <140 knots  
H = 0  
R = <5000 (ft)

CREW ACTION: Below 140 knots, apply light to moderate wheel brakes for energy management (approx. 6-10 ft/s<sup>2</sup>)

#### HUD PROCEDURES

A deceleration rate symbol, consisting of a vertical scale on the right side of the FOV, with two opposed pointers, will show the commanded and actual deceleration rate. The scale is marked in four equal increments with zero at the bottom and 16 ft/s<sup>2</sup> at the top. The arrow indicator on the right shows commanded deceleration, and the pointer on the left, actual deceleration.

The commanded deceleration rate (arrow on right of FOV) displays the rate necessary to stop within 1000 feet of the runway end, for the selected runway.

NOTE: The commanded deceleration rate assumes that the vehicle navigation state is accurate.

#### SHORT FIELD LANDING PROCEDURES

A short field landing nomographs (as shown in fig. 5-43) has been developed to enable the crew to manually preset the speed brake, depending upon conditions, to a value which should produce a 195-KEAS touchdown at 1500 feet past the threshold. A decal (fig. 5-43), adjacent to the speed brake handle (SBTC) facilitates an accurate setting of the deflection determined from the nomograph. This placard assumes a nominal braking deceleration level of 7.5 ft/s<sup>2</sup> initiated at 140 knots ground speed.

#### Braking

Braking is initiated through toe pressure deflection of the rudder pedals. Braking signals from the CDR's and/or PLT's brake transducers are input into the brake/anti-skid system where a logic circuit which gives preference to the pedal signal commanding the greater pressure. The brakes may be operated with or without the anti-skid system support. The anti-skid system provides touchdown, locked wheel, and wheel skid protection for the four main wheels. The anti-skid (located on panel L2) has the following functions.

SHORT FIELD LANDING PROCEDURES - Continued

ON - Applies power to the driver circuits that power the anti-skid portion of the brake/skid control boxes.

OFF - Removes power from the antiskid driver circuits; powers the antiskid fail light (panel F4).

This switch is set to the ON position in the Postdeorbit Burn Checklist.

The ANTISKID FAIL light will be activated if the ANTISKID switch is in the OFF position and the BRAKE MN A, B, and C power switches (O14, O15, O16) are ON, or if one of the following anomalies in the antiskid system is detected by brake failure detection system.

- o Wheel speed sensor fault
- o Skid control test circuit input or regulated power loss
- o Servo valve fault

If the brakes are activated without antiskid (i.e., ANTISKID switch-OFF), the antiskid light will be ON. Nominally, the ANTISKID switch will be ON during landing. Whenever the ANTISKID switch is ON, touchdown protection prevents brake application until main gear touchdown.

Current braking limits for reuse are 36.5 million foot-pounds, and 'abort stop' limits of 55 million foot pounds, per brake. The individual brake energy absorbed will vary with their use as follows:

- Required differential braking for directional control in crosswinds
- The 'right drift' characteristic which is a byproduct of the bias ply construction of the tires
- Differential tire-pressures
- New versus used tires (used tires have a larger outside diameter)
- Differential nose tire load with bank angle ( $\phi$ ).
- Relationship of the vehicle runway path to the normal runway crown

General guidelines for optimum use of the brakes, with a minimum of heat build-up prior to stopping include:

- Delay brake application as long as feasible following touchdown
- Once braking has commenced, bring the vehicle to a stop without delay to minimize heat soak effects.

## SHORT FIELD LANDING PROCEDURES - Concluded

### Nominal Braking (Assumes 15,000 feet available)

- Delay any braking until at mid-field
- After mid-field and  $V_{GND} < 140$  knots, brake moderately hard until wheel stop (6 to 10  $\text{ft/s}^2$ )
- If at 5000 feet to go,  $V_{GND}$  is still  $> 140$  knots use maximum braking until stopped

### Abort Braking

- Delay braking, if possible, until 5000 feet to go
- At 5000 feet to go:
  - $V_{GND} > 140$  knots use maximum braking until stopped
  - $V_{GND} < 140$  knots use moderate braking (approx. 6 to 10  $\text{ft/s}^2$ )

These braking procedures will provide an adequate margin for stopping, including an allowance for differential braking, while minimizing the likelihood of brake damage or failure.

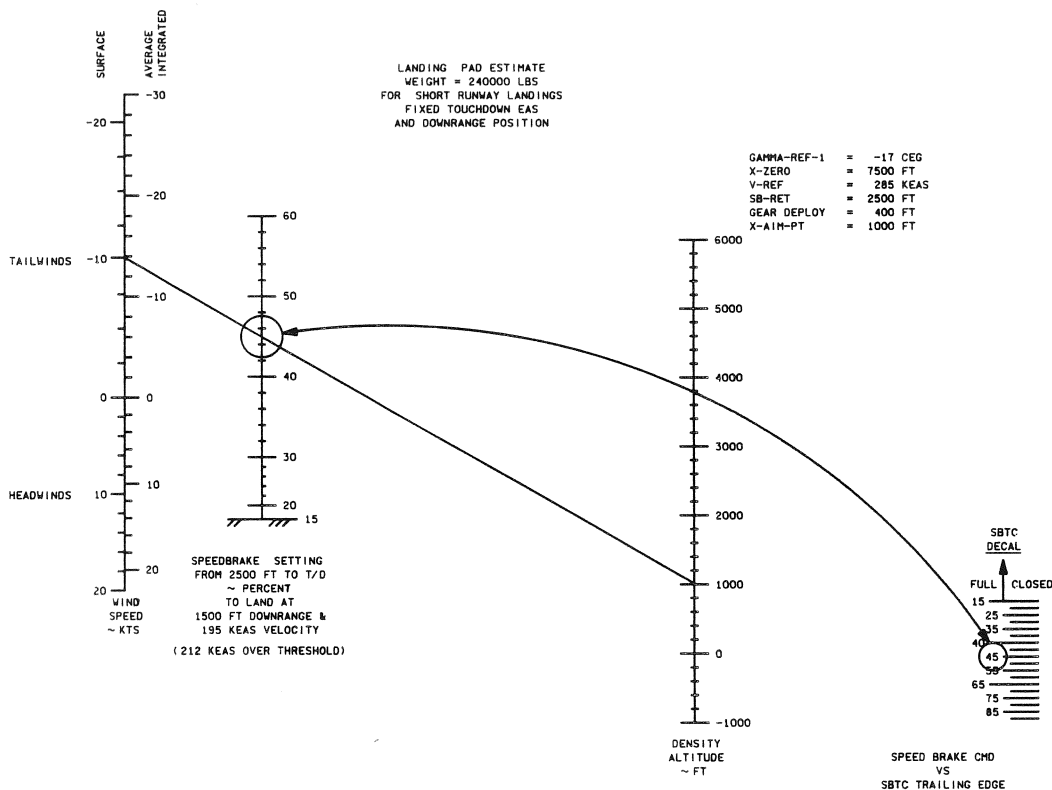

Figure 5-43.- Landing pad estimate.

EVENT

CUE

DISPLAY

Postlanding

CREW ACTION:

DISCUSSION

The postlanding phase for the prime crew begins at wheels stop and ends with crew egress. There are three postlanding options available to the crew:

- o Orbiter powerdown
- o Extended powerup
- o Contingency Landing Site (CLS)

The exact option will depend on the landing site and the availability of a convoy to support any required postlanding power and cooling operations.

Regardless of the option, the checklist is structured to permit branching to the desired option after the accomplishment of Orbiter safing and turnaround support activities.

The postlanding procedures flow and available options are shown in figures 5- and 5- and are described in the following paragraphs.

Postlanding

- o Initial cleanup checks include installing the panel jettison pin and powering down the HUD (thermal consideration).
- o ET umbilical doors are opened to vent any accumulated hydrogen (RTLS, TAL concern) as well as to facilitate turnaround.
- o OMS/RCS safing electrically and mechanically secures each system to prevent inadvertent firings and allows for thermal expansion.
- o The hydraulic load test checks each hydraulic pump for the next flight, eliminating the requirement for a 'hot firing' during turnaround.
- o NH<sub>3</sub> activation for internal cooling is a real-time call dependent on the EVAP OUT temperature.
- o OPS 9 transition brings up the Test Control Supervision (TCS) displays that are required for execution of the SSME repositioning and the vent door positioning.
- o SSME repositioning places the main engine bells in the 'rain-drain' position (down XX<sup>0</sup>).

- o The Pressure Control System (PCS) is deactivated by closing the N<sub>2</sub> and O<sub>2</sub> supply lines external to the cabin so there is no chance of leakage into the cabin after crew egress.
- o Vent door purge positioning configures the vent valves for N<sub>2</sub> purge of the payload bay by the convoy purge cart.
- o Further crew activities are now based on the landing field support facilities.

#### Powerdown Option

- o The five GPC's are placed in the HALT position for subsequent powerdown so that nonvolatile memory is protected.
- o Hatch opening is performed by the ground-support crew.
- o The Orbiter powerdown is accomplished by disconnecting the fuel cells from the main buses and removing the essential bus source from the fuel cells.

#### Extended Powerup Option

- o Since the Orbiter will remain powered up all unnecessary electrical equipment is powered OFF to reduce equipment wear and to reduce ground-supplied electrical and cooling requirements.
- o After crew egress, Ground Support Personnel (GSP) come aboard to perform required housekeeping activities until the Orbiter is powered down.

#### CLS

- o Cabin pressure equalization is required for landings at NOR if the cabin pressure is > 15.1 psi (prevents overloading the hatch latching mechanism).
- o Hatch opening is performed by the crew. Egress is via the egress bar.

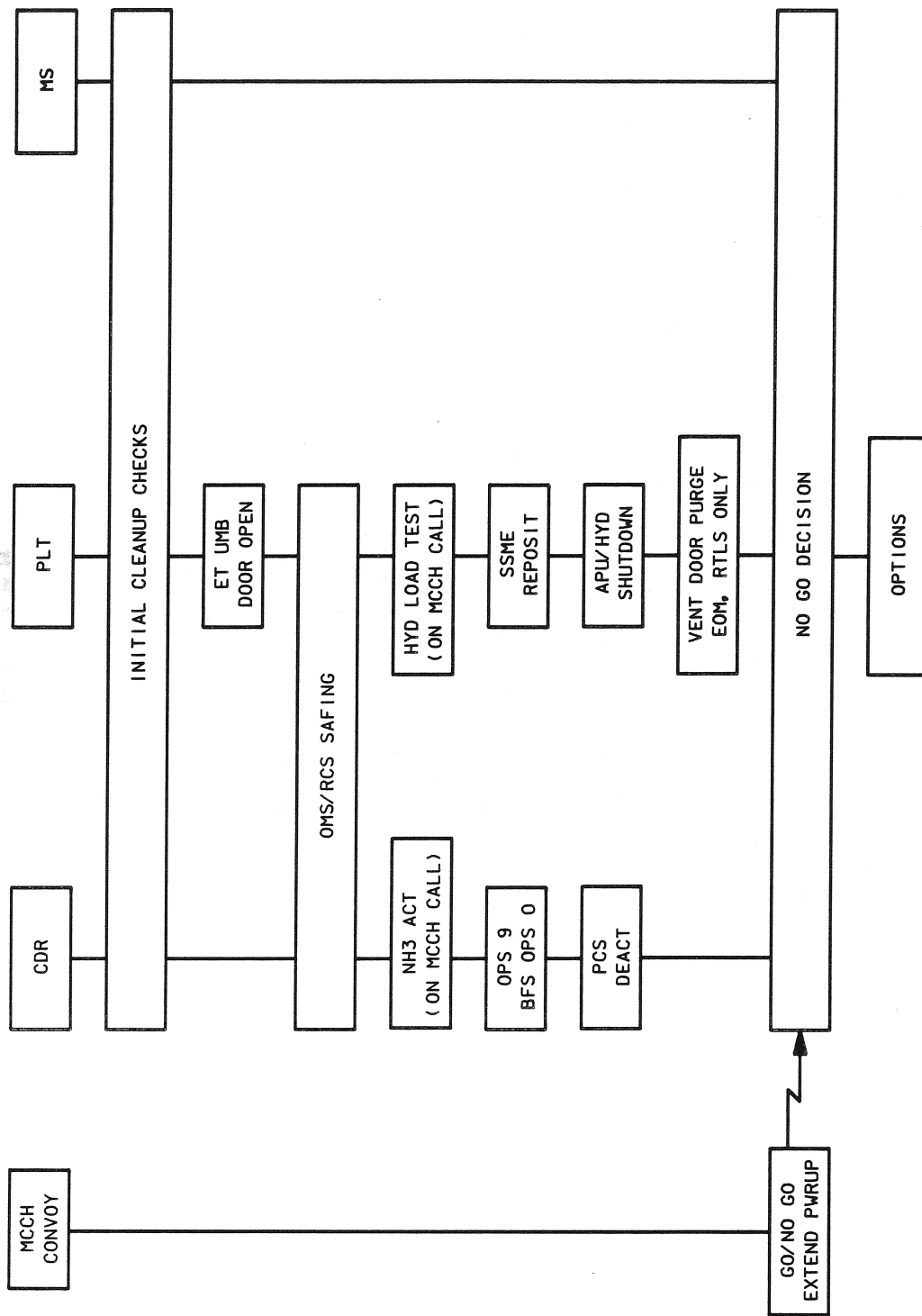

Figure 5-44.- Postlanding procedure flow.

3155. ART, 2

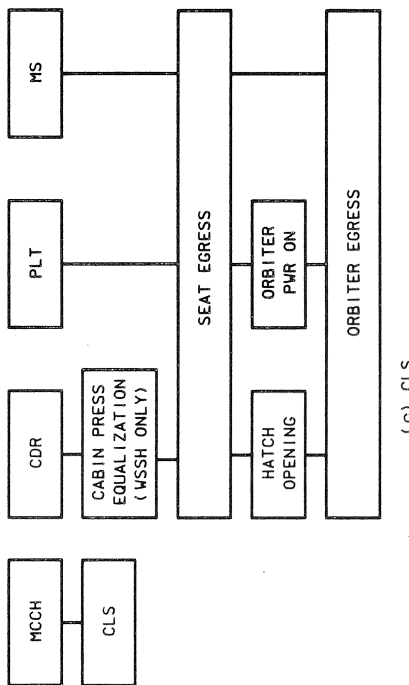
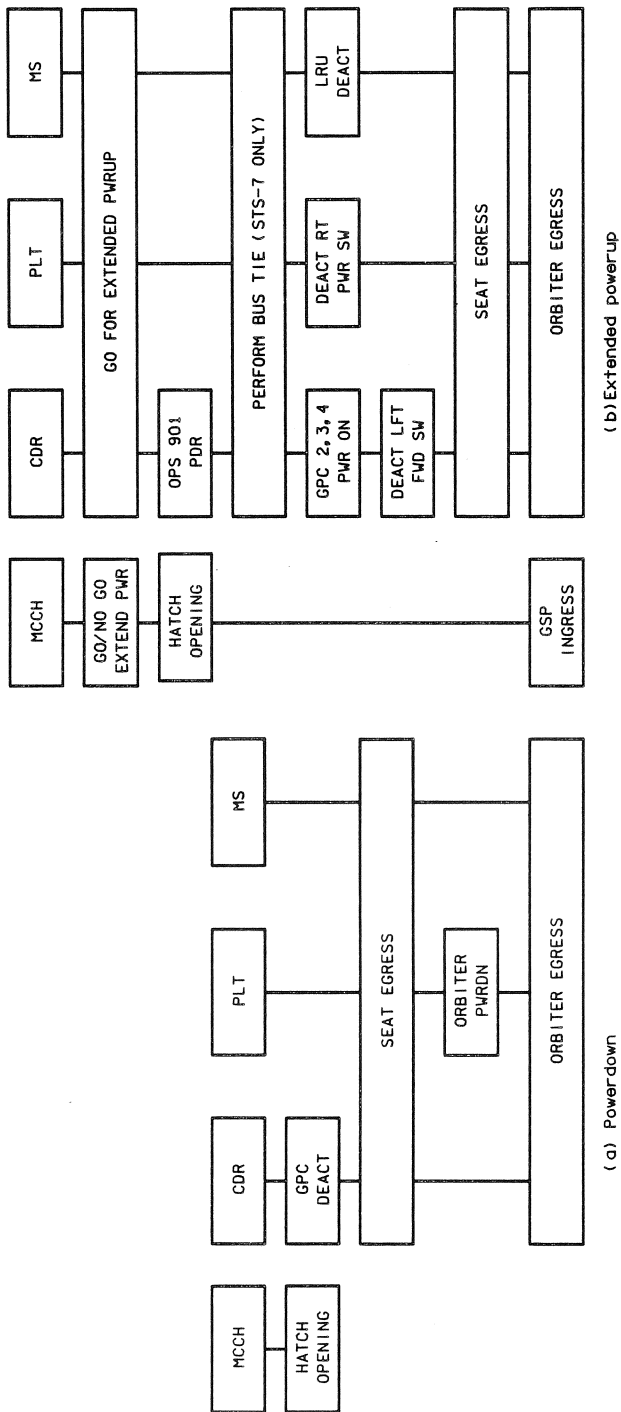

Figure 5-45.- Options procedures flow.



### 5.1.6 Monitoring ADI Scaled Ay

The purpose of this section is to review the mechanization and recommended use of the scaled Ay displayed on the yaw steering needle during entry or GRTLS when dynamic pressure ( $\bar{q}$ ) is greater than 20 psf.

#### Background

Early in the Orbiter FCS development phase, environmental sideslip ( $\beta$ ) was always displayed to the pilot in simulations and was found to be an extremely valuable tool for assessing FCS performance. It had to be remembered, however, how much sideslip could be tolerated as a function of Mach,  $\bar{q}$ , and angle of attack ( $\alpha$ ). As actual  $\beta$  was not available on the Orbiter, a suitable approximation was sought for a pilot display. It was deemed highly desirable to make the display independent of Mach,  $\bar{q}$ , and  $\alpha$ , if possible. This led to the present software (S/W) implementation.

#### Mechanization

The sensed lateral acceleration Ay is the basis for the display calculations, because lateral acceleration is directly proportional to sideslip. To isolate that portion of the acceleration due only to the sideslip, the sensed acceleration is corrected for yaw jet firing, yaw acceleration at the accelerometer location, and for aileron and rudder deflection at the lower Mach numbers where their effects are significant. This corrected acceleration is then scaled as a function of alpha for display.

The scale factor was arrived at by calculating the lateral acceleration caused by a sideslip angle that would be just balanced by the torque due to 2.5 yaw jets. The choice of 2.5 jets was made so that each unit on the display scale could equate to 0.5 yaw jet. The scale factor thus chosen was independent of  $\bar{q}$  and dependent only on the  $C_{y\beta}/C_{n\beta}$  ratio. These

ratios were calculated from the aero tables and plotted as a function of Mach and alpha. It was observed that if an alpha profile reasonably close to nominal was maintained, the Mach dependence could be eliminated. A curve fit was made for the ratios as a function of alpha and used in the S/W scaling module.

#### Accuracy

With nominal aero, the display is fairly accurate down to an alpha of 10 degrees. At lower alphas, the display accurately depicts sideslip trends and relative magnitudes, but no longer bears a proper relationship to yaw jet authority. In the presence of aero variations, the display can be in error by up to a factor of two, but is biased toward the conservative side; i.e., it can underestimate by approximately 30 percent, but can overestimate by up to 100 percent. In summary, the display gives a good estimate of sideslip in terms of yaw jet authority for  $\bar{q} > 20$  psf and  $\alpha > 10$  degrees in entry.

## Use of the Display

The display is very useful in assessing trim because the direction and relative magnitude of the sideslip can be seen. If no yaw jets are firing, the direction and magnitude of the needle deflection will indicate the relative size of the y c.g. offset and/or bent airframe ( $C_{n_0}$  and  $C_{l_0}$ ).

Remember that the display shows sideslip in terms of yaw jet authority. For example, suppose that at Mach 20 the vehicle is trimmed with  $2^\circ$  of aileron and 0.5 yaw jet (one unit) of scaled  $A_y$ . What should be deduced from this is that the yawing moment generated by the sideslip would require 0.5 yaw jet to counteract it. It does not indicate that if the aileron were trimmed to zero the 0.5 yaw jet would trim the vehicle. It is obvious that those factors that produce yawing moments (aileron, rudder, sideslip, bent airframe, CG offset) also produce rolling moments and satisfactory trim is achieved when rolling and yawing moments are balanced. Typically, during an entry, scaled  $A_y$  will rarely exceed 0.5 jet steady state even in the presence of an offset CG, bent airframe, and aero variations.

Note that the scaled  $A_y$  needle can be full scale and operation will be normal as long as the vehicle is trimmed and there is adequate yaw jet authority remaining. This will typically occur during the transient that accompanies an abrupt maneuver and is no cause for alarm. Because  $C_{n\beta_{dyn}}$  is positive throughout the flight envelope (except for a small low subsonic region at high alpha with adverse aerovariations), large sideslips will cause the vehicle to roll in a direction to reduce the sideslip. On the other hand, with reduced yaw authority (such as loss of two yaw jets per side) the scaled  $A_y$  can be centered during a roll maneuver and loss of control can occur if an abrupt input is made to stop the maneuver. This is particularly true with alpha errors that reduce the effectiveness of  $C_{n\beta_{dyn}}$ . It cannot be emphasized too strongly the importance of smooth slow inputs, especially with reduced control authority.

The scaled  $A_y$  is perhaps most useful in maneuvers. For example, suppose the vehicle has lost two yaw jets per side and is executing a bank reversal. If it is noted on the display that during the steady state roll maneuver the scaled  $A_y$  approaches a two yaw jet delta from the quiescent trim position, then loss of control may be imminent. Such a scenario accompanies a large alpha error case and checklist actions should be taken as soon as possible. Before each maneuver, it is important to note the scaled  $A_y$  trim and monitor it during the maneuver.

Scaled  $A_y$  is also useful in assessing FCS performance during oscillations. The relative magnitude and frequency of any lateral/directional oscillation can be seen on the scaled  $A_y$  needle and a qualitative evaluation of how hard the FCS is working can be made. This data is useful in deciding whether crew intervention in the GN&C system will be required.

## Summary

The scaled  $A_y$  display provides information that is useful in assessing FCS performance. One should keep in mind, however, its limitations. If properly interpreted, it can provide more insight into control margins than a simple estimate of sideslip. Briefly,

- o When no yaw jets are firing and not maneuvering, the magnitude of the scaled  $A_y$  can provide insight into the Orbiter trim conditions - Y CG,  $C_{n_0}$ ,  $C_{l_0}$ .
- o During steady state roll maneuvers, the scaled  $A_y$  can indicate the sign and relative magnitude of  $\alpha$  errors.
- o The relative magnitude and frequency of any scaled  $A_y$  oscillation provides a useful qualitative insight into how hard the FCS is working in the roll/yaw axes.
- o The position of the scaled  $A_y$  needle in steady state non-maneuvering flight must be the null position from which to assess FCS performance in maneuvering flight.
- o The scaled  $A_y$  is not an absolute indicator of flight margins.

### 5.1.7 Entry Flight Control System Downmoding

During the initial stage of the Orbital Flight Test program, the crew was provided with a capability to affect or alter the Entry FCS gains and control laws during flight. The desire for this capability was based upon scenarios observed during the development and stress testing of the control system, during which the sensitivity of the control system performance to off-nominal conditions was demonstrated. Although the system has been tuned to be tolerant of many of the preflight uncertainties, still flight test data are insufficient to verify system performance in several areas, such as: bending instabilities, large aerodynamic coefficient errors associated with different angle of attack profiles, angle of attack errors, anomalous RCS system malfunctions requiring minimum RCS fuel consumption, or control surface rate limiting. Some of the original downmoding capability has been 'I-loaded out' in the flight software; however, the crew still has the capability to reduce the gains on the surface commands and to fly in a mode without firing the yaw jets. These functions are provided on the ENTRY MODE switch, located on the CDR's panel L2, as shown in figure.

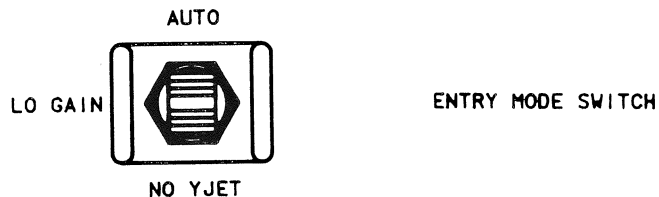

#### AUTO

This position is the normal switch position and may be verified and selected on the CONTROLS display, SPEC 52. In this position the FCS accomplishes the nominal moding and gain scheduling within the control laws. The position is recognized in either AUTO or CSS in the pitch or roll/yaw axes.

#### LO GAIN

This position is also selectable in either AUTO or CSS in the pitch and roll/yaw axes. If selected, the gains scheduled as functions of Mach, angle of attack, and dynamic pressure on the rate error commands in each channel will be reduced by a factor of 0.5. This action could be invoked to counter over-gained system response, i.e., high frequency oscillations, usually in the roll/yaw channels, but possibly cross-coupling into the pitch axis as well. Reducing the gains should allow an improvement in damping. If large amplitude, diverging rates are induced, as might be encountered in a large signal instability, the LO FWD gain may retard the vehicle accelerations, allowing recovery. Also, if only one APU/hydraulic system remains for control, low pitch and roll/yaw gains may potentially prevent RHC commands from causing surface rate saturation in high  $\bar{q}$  conditions. Note also that the gain reduction applies to the surfaces only, not on the jet command loops.

## NO YJET

If RCS fuel reserves are marginal, it is desirable to conserve available supplies for use in the flight regimes below Mach 7, where additional control authority may be required for trim and maneuvers. Aerovariation combinations may critically reduce surface effectiveness, forcing a dependence on the RCS for stability. The NO YJET position eliminates yaw rate error commands to the yaw jets. Roll maneuver initiation and rate damping are provided only by ailerons and, below Mach 3.5, rudder. In early entry, aileron deflections produce an adverse yawing moment overpowering the initial rolling moment, inducing a sideslip angle. As  $\beta$  increases, the vehicle rolls in the opposite direction. Taking advantage of this powerful adverse yaw and subsequent roll opposite to the command, the FCS in this 'direct aileron control' mode commands an initial roll input in a direction opposite to the desired roll. For example, a pilot desires a roll to the right. For a right RHC command, the aileron initially deflects left. The vehicle initially rolls left with an increasing left  $\beta$ . The roll direction will reverse to the right, and  $\beta$  will decrease slightly. In this case since the yaw jets are not available for roll initiation and  $\beta$  damping, the ailerons have a much larger gain on the roll command. This mode is planned only for use down to approximately Mach 7, where the nominal FCS configuration would be reselected. The aileron/rudder provides roll/yaw rate feedback stabilization in the same manner as the nominal system, although  $\beta$  damping is not as tight without the RCS. At low dynamic pressure damping is poor ( $\bar{q} < 20$  psf). If necessary procedures have been developed to complete the entry, once the first bank command is established, without further use of the yaw jets. Selection of NO YJET will downmode the ROLL/YAW axis from AUTO to CSS. The PITCH axis may remain in AUTO.

### 5.1.7.1 Off Nominal Control Procedures

Section 10 of the Entry Checklist offers basic guidelines in troubleshooting control anomalies as observed by the crew and the responsive actions. These actions are summarized in the checklist and cue cards entitled 'TRIM/ OSC' and 'RCS CRITICAL ENTRY'. The basic problem areas covered are symptomatic of design problems encountered during the development of the Entry Flight Control System, and include the following:

- Aileron trim saturation
- Angle of attack errors
- Roll/yaw oscillations including rudder and/or yaw jet limit cycles
- Bending instabilities
- RCS critical entries

Recognition of symptomatic cues may result in actions ranging from changing body flap position to using alternate control modes and pilot techniques. Therefore, based on recent experience, it is appropriate to emphasize certain points as they apply to specific pilot techniques. Yaw jet activity should be monitored closely throughout the entry, because it is the key to assessing how well the vehicle is trimmed, RCS propellant consumption, and the degree of stress to which the G&C is subject. The scaled  $A_y$  should be checked periodically and noted prior to each bank reversal so that shifts from static trim can be assessed. Aileron trim must be monitored occa-

sionally above Mach 10 and frequently below Mach 10. From rudder activation until subsonic flight, rudder and aileron trim must both be closely monitored. During all bank reversals yaw jet activity, scaled  $A_y$  shift, and roll rates should be monitored closely to allow early detection of alpha errors or other symptoms of FCS stress.

The following paragraphs provide the rationale for the cue card procedures and expand upon the required pilot techniques.

#### Dynamic oscillatory problems (TRIM/OSC cue card)

High Frequency Roll/Yaw Oscillation: The Orbiter FCS is high gained to obtain overall best system performance in the presence of aero variations. Because of this, it is possible, with a certain combination of shifts in the aero coefficients, for the FCS to experience high frequency oscillations with a period less than 1.5 seconds. If the oscillation is large enough, it can cause a yaw jet limit cycle and excessive RCS consumption. If this occurs, select ROLL/YAW CSS and ENTRY MODE-LO GAIN. This halves the pitch and roll/yaw axes forward loop gains and will stop the oscillation. When in a lower Mach,  $\alpha$ ,  $\bar{q}$  regime or subsonic, nominal gains may be reselected.

Large Deflection Rudder Limit Cycle: This oscillation occurs with the same type combination of coefficients as in the previous case, but the significant factor here is a rudder limit cycle which may be divergent if not stopped. The rudder limit cycle may be caused by making a large roll RHC input to start a maneuver and then reversing the input rapidly. Because of the low rudder rate limit and high systems gains, a large signal instability can be triggered. The obvious solution is to always make smooth inputs and avoid abrupt reversals of commands. If in AUTO, guidance input reversals acquiring the HAC in TAEM could also potentially start such an oscillation. The recommended crew action to stop the oscillation is the same as before. Select ROLL/YAW CSS and ENTRY MODE-LO GAIN if the oscillations do not damp within two or three cycles. Nominal gains may be restored after the oscillation stops.

Bending Instability: The FCS includes bending filters in all axes that protect the FCS from coupling with the structure in a resonant oscillation by providing appropriate gain and phase margins. If the bending filter constants should be in error, it could be possible to excite a bending instability. This is also of concern when returning certain types of payloads, such as the IUS, when soft cradle mounted in the payload bay. The symptoms would be very high frequency oscillation ( $\tau < 0.5$  sec) most likely accompanied by airframe vibration caused by the rapid oscillation of the aerosurfaces. The oscillations might be seen on the ADI rate needles and perhaps the SPI. It might also be possible to have a yaw jet limit cycle accompanying the oscillations. Any bending instability should be stopped ASAP to avoid the potential of catastrophic failures or excessive APU or RCS propellant depletion.

If a bending instability is encountered, immediately lower the gains by selecting PITCH and ROLL/YAW CSS followed by ENTRY MODE-LO GAIN. Also verify on the ENTRY CONTROLS display, SPEC 53, that the appropriate body bending filters and elevon schedule have been selected. Item 32 should

### TRIM/OSC

#### JETS OPPOSE ROLL, INCR RATE DURING ROLL REVERSAL (Alpha Error)

1. R/Y - CSS,  $\text{DECR } \dot{\phi} \text{ CMD} \leq 5^\circ/\text{sec}$
2. When  $\phi = \phi_{\text{CMD}}$ :  
R/Y - CSS or AUTO

:::V:  
:H:E:  
:O:L:  
:O:C:  
:K:R:  
:::O:

#### AIL TRIM SAT ( $\pm 3^\circ$ )

POSSIBLE ROLL - OFF:

1. BF - UP to lower ELEV until  $M < 2$ ;  
then BF - AUTO
2. Incr  $\alpha$  to  $\alpha$  limit as reqd, until  
RUD TRIM act

#### HIGH FREQ ROLL/YAW OSC

( $\tau < 1.5$  sec & yaw jet limit cycle)

1. R/Y - CSS
2. ENTRY MODE - LO GAIN (if reqd)

#### LARGE DEFLECTION RUD LIMIT CYCLE

1. R/Y - CSS
2. ENTRY MODE - LO GAIN (if reqd)

#### HIGH FREQ SURFACE OSC OR SURFACE/JET LIMIT CYCLE

1. P,R/Y - CSS
2. ENTRY MODE sw - LO GAIN

If IUS returning:

1. 2: GNC 53 ENTRY CONTROLS  
ITEM 32 - ASC
2. 3: BFS, GNC 51 OVERRIDE  
ITEM 15 - ASC

3. After OSC stops:  
ENTRY MODE sw - AUTO  
P,R/Y - AUTO

:::V:  
:H:E:  
:O:L:  
:O:C:  
:K:R:  
:::O:

STS-11/A,E/FIN

read 'ASC' if returning with an IUS payload or executing a GRTLS. The oscillations should immediately stop.

Alpha Errors: The flight control system uses alpha to compute stability axis roll and yaw rates and, then coordinate the yaw/roll axes to provide pure stability axis roll maneuvers. During a roll maneuver, the sensed yaw rate (corrected for vehicle turn) is multiplied by  $\cot \alpha$  to generate the proper aileron command to coordinate the roll ( $p = r \cot \alpha$ ). If alpha is in error then, obviously, the roll/yaw ratio will not be proper to coordinate a roll maneuver. If the alpha error is large enough, it can cause serious FCS problems, especially if yaw control authority is reduced (yaw jet failures).

To better understand the problem, consider first the case where the alpha used by flight control is less than the actual alpha. Since  $\cot \alpha$  increases as alpha decreases, the aileron command ( $r \cot \alpha$ ) issued in a roll maneuver will provide a body roll rate too large for the body yaw rate. This results in shifting the sideslip in a direction to oppose the commanded roll. The actual stability roll rate achieved may be smaller than commanded rate. If the alpha error is in the opposite direction, i.e., FCS alpha greater than actual alpha, then the roll command for a sensed yaw rate during a roll maneuver will be too small and cause the sideslip to shift in a direction to aid the roll maneuver. The actual stability roll rate may be greater than commanded and the jets will oppose the roll. Since  $\beta \neq 0$ ,  $\beta$  may build to the limit of the yaw jet authority to oppose or retrim  $\beta$  to zero after the maneuver.

Alpha errors may be caused by navigation errors, but performance estimates predict  $3\sigma$  errors no greater than 0.5 deg. An error of this size causes little or no FCS problem. The largest potential source of alpha errors is the wind. High level winds can be of such a magnitude to cause alpha errors of the order of 2-3 degrees. In banking away from a strong crosswind, the actual alpha will be greater than that used by the FCS. The converse is true if banking into the wind. From the previous discussion, it is seen that if rolling with the wind to the bottom of the vehicle, sideslip will shift to oppose the roll, and the jets will fire to aid the roll. If rolling with the wind on top of the vehicle, the sideslip will shift to aid the roll, and the jets will oppose the roll. The latter is the worst for controllability, especially with reduced authority such as with jet failures. Large roll overshoots are seen with poor damping. Loss of control can occur with unfavorable aero variations.

There are then, two cases to consider, a bank reversal from top wind to bottom wind, and vice versa. In the first case, after the roll rate is essentially established, it will be seen that the sideslip has shifted to aid the roll rate, and yaw jets will be firing to oppose the roll. Roll rate may be greater than commanded. As the bank angle approaches wings level, the jet firings will cease, the sideslip will shift toward the static trim, and the roll rate will approach the commanded rate. As the bank angle increases in the new direction, the sideslip will shift to oppose the roll rate, the jets will fire to aid the roll rate, and the roll rate may be less than commanded. There is no problem controlling this case.

On the other hand, if rolling from bottom wind into top wind, the opposite symptoms are seen. Initially, the sideslip shift will be to oppose the roll rate, the jets will aid, and the rate may be less than commanded. As the vehicle passes wings level, the jet firings will cease as sideslip returns to trim. As bank increases in the new direction, the sideslip shifts to aid the roll rate, jets oppose the roll, and the roll rate may be greater than commanded. If yaw jet authority is reduced, this case may be difficult to control.

If the symptoms for rolling from a bottom wind into a top wind are present, it is recommended that the roll be completed in CSS, while slowing the rate. As soon as the bank maneuver is completed and the guidance transients are damped, the AUTO mode may then be reselected. The procedures are strongly recommended for cases of reduced jet authority.



Aileron Trim Saturation: There are two basic reasons for the aileron trim to be at the limit of  $30^\circ$ . The trim integrator is limiting the trim deflection, although more aileron is required (possibly due to a y.c.g. offset larger than 3 inches or ineffective ailerons as a result of aero variations). Or, because of a combination of aero variations, Mach regime, and elevon trim position, the sign of the aileron trim has reversed from the sign currently held in the integrator. Whatever the reason, the implications are serious, if it becomes necessary to use yaw jets for trim, dramatically increasing fuel consumption. Therefore, it is highly desirable to maintain the elevons in the optimum position for lateral trim. The most critical trim region encompasses Mach 5 to 3.5, and the elevons are normally scheduled down to ensure  $-C_{NSA}$  until the rudder becomes active.

The body flap may be driven to the uplimit to improve aileron coefficients with down elevon. At Mach 2 the body flap is returned to the AUTO mode, since the body flap is usually saturated up at this Mach number. Increasing  $\alpha$  also improves the lateral trim and stability equations ( $C_{NB_{DYN}}$ ),

and has been demonstrated to be the fastest technique for stopping a divergent roll-off tendency. After the rudder is active, the rudder trim should assume the trim function, and the aileron trim integrator should begin to decrement.

#### RCS critical entry

The following pilot procedures have proven effective on the SMS and are probably applicable to flight. These procedures assume a critically low RCS quantity and were developed for flight in the lower Mach regimes without relying on RCS. The actual decision process that dictates the use of these procedures will not be discussed in this section, although some thoughts on use of any remaining RCS below Mach 7 will be given.

The data base that supports these techniques comes from SMS/SPS experience with the following aero variation sets: 2, 9, 11, 12, 19, 20, and 23. The procedures are based on a strategy which will handle all tested cases satisfactorily, i.e., they are intended to be universal, not optimal.

#### MM 304 through initial bank maneuver.

After transition to MM 304, select AUTO in the pitch axis and CSS in the roll/yaw axis. If there is no prebank where tight roll control is required, do not make roll inputs until bank angle error reaches 30 degrees. Make small constant inputs to establish low rates for the correction to the desired bank angle. This avoids transients and fuel-using overshoots. If a prebank is required, the prebank angle must be tightly controlled at the expense of RCS fuel. Once guidance is active, it is important to follow the bank commands closely to protect thermal limits and preserve ranging.

The initial guidance commanded bank maneuver could be made in the NO YJET mode but at these low dynamic pressures, the control is very loose and large beta excursions are seen. The slow, loose control response can give some difficulty in maintaining tight drag control which is essential to preserve ranging and avoid thermal problems. Hence, CSS is recommended for the initial bank maneuver. If the NO YJET mode must be used, greater

anticipation is required when approaching the desired bank angle. Best results can be attained by slowing the roll rate to 2 deg/sec at 30 degrees from the roll command called for on the TRAJ display.

Theoretically, a few pounds might be saved by leaving the pitch axis in CSS and letting alpha drift between 35 and 45 degrees. However, aerodynamic torque can cause the rate error deadband to be exceeded causing frequent pitch jet firings. Numerous pitch inputs are required to maintain alpha control and no significant savings over AUTO can be realized. Prior to  $\bar{q} = 2$  psf, elevon trim could be used to counteract the aerodynamic torque. The trim rate is so slow, however, that it is easy to get out of phase and use more RCS fuel than if trimming had not been attempted. The same holds true for trim with body flap. Aero variations can also make trim techniques difficult for this region. Consequently, it is recommended that the pitch axis stay in AUTO. The few pounds saved by perfect trimming is not worth the risk of excessive usage caused by imperfect trimming.

#### Initial bank maneuver to M7

After reaching the initial bank angle, the NO YJET mode flies well and may be used until either Mach 7, or aileron trim saturates, or roll rate oscillations exceed 5 deg/sec. Except for bank reversals, all roll inputs should be kept small. Make the input, watch scaled  $A_y$  and the roll rate needle. Patience is required. The vehicle is fairly slow to respond at low dynamic pressures, but with a little practice precise roll control is relatively easy. You must also anticipate when to remove the input. Inputs should be made and removed slowly and smoothly. Additionally, the inputs should be held constant to avoid generation of oscillations. When an input is made, a slight roll in the opposite direction will be initially observed, followed by roll in the desired direction. When the input is removed, initially you will see an increase in roll rate followed by damping to zero rate. Small bank angle changes can often be made by putting in a roll pulse. When the rate damps out, you will have made a small net bank angle change in the direction of the input. Do not continually go in and out of detent, as it is easy to get out of phase with the reverse roll. Hold the roll error to zero to minimize pitch/roll interaction. This is important so that full alpha modulation capability is available for bank reversals.

To make bank reversals, apply the roll input slowly and smoothly until the desired roll rate is achieved. Slightly more lead than in CSS will be needed to stop the roll reversal, since the response of the vehicle is slightly slower than in CSS, and the roll rate will initially increase. Concentrate on normal phugoid damping techniques to aid the guidance. Keep the roll rate high in the lift vector up regime. Don't let altitude acceleration ( $\dot{H}$ ) exceed 10 ft/sec<sup>2</sup>. Monitor altitude rate reference ( $\dot{H}$  ref) and roll command on the trajectory display to aid in the phugoid damping. Use the MED error scale for the bank reversal and return to LOW when the phugoid is damped. Use the HIGH scale on the rate needles, since desired rate is near full scale in the LOW scale.

The system response improves as Mach decreases toward Mach 10. Below that region performance may begin to degrade. In the event roll oscillations occur and approach a rate amplitude of 5 deg/sec (not likely), return to

CSS to provide roll damping. If RCS fuel available is marginal, only remain in CSS for roll reversals. Otherwise, attempt to minimize  $\dot{q}$  and RHC roll inputs in the presence of roll oscillations in the NO YJET mode. The oscillations are aggravated by the high aileron gain used in the NO YJET mode unbalancing the roll/yaw ratio in the FCS. With the cases seen thus far, flight can always be safely made to Mach 7 using these techniques.

In this region aileron trim may be required if a roll-off tendency is observed. Using panel roll trim, trim away from the RHC command input to stop the roll-off. This is the same rule as for trimming out the yaw jet activity lights, i.e., 'trim away from the light'.

#### Flight M7 - M3.5

If flight in the NO YJET Mode must be continued below Mach 7, continue to use the same techniques. If oscillations are present, avoid rapid RHC inputs, as they serve to aggravate the oscillations. Try to make small steady inputs until the desired bank angle is achieved. If the aileron trim saturates and roll-off or divergence tendencies are noted, increase alpha slightly, being careful not to exceed the alpha limits. This will increase trim effectiveness. If in GRTLS, pay even closer attention to alpha control, as the lower alpha boundary is a hard boundary. If in a nominal entry, and the body flap is not saturated, it may be moved up to drive the elevon trim down to gain some more aileron trim effectiveness.

In those cases where roll oscillations are present, the oscillations usually increase in magnitude between Mach 6 and Mach 3.5. By controlling the average bank angle, rather than fighting the oscillations, best control margins can be maintained and adequate footprint preserved.

#### Flight M3.5 to TD

After the rudder activation transients, return to CSS ROLL/YAW. Below Mach 3.5 the NO YJET mode gain on the ailerons is still negative and too large for this Mach regime in which the nominal FCS is blending in proverse aileron for roll control. If aero variations are producing large roll/yaw oscillations and ineffective ailerons, the rudder may be used for primary roll control, until the ailerons become more effective. Rudder pedal inputs should be made smoothly and held steady as erratic inputs will excite oscillations. Because of the slow rudder action, do not attempt to damp oscillations with it. Remember that the rudder pedals command lateral acceleration and not rudder position. Immediately after rudder activation, start beeping out the aileron trim as seen on the TRAJ display and maintain near zero until  $M < 1.25$ . This is especially important if the rudder and aileron initially trim to the same side. (With roll/yaw CSS, any aileron trim by the integrator at  $M 1.25$  will be held unless manually retrimmed.) Reduce the bank angle to less than 30 degrees and head for WP1. Keep wings level after reaching the azimuth to WP1. Prior to reaching  $M 2.5$  (TAEM interface) select CSS in pitch and fly the high side of the alpha corridor decreasing EAS to ~200 KEAS. The vehicle is easier to control with lower dynamic pressure. Do not neglect keeping the aileron trim near zero. It must be frequently monitored. As Mach approaches 2.0 the ailerons should be more effective for roll control. If positive roll response to a small RHC roll input is obtained, the CSS mode is effective

and the guidance commands may be reacquired. If roll response to the RHC input is extremely sluggish, generates large  $A_y$  deflections, is in a direction opposite to the command, or is otherwise unsatisfactory, cease RHC inputs and attempt to maintain near wings level attitude with rudder pedal commands in the R/Y CSS mode. A few tenths of Mach decrease will rapidly improve RHC roll response, so make another small RHC input at a lower Mach number.

With the oscillatory cases, it is possible for the oscillations to become severe again after rudder activation. In this region, control can be such that just keeping the vehicle upright and  $\bar{q}$  low is the best strategy. If control appears solid, banks less than 30 degrees may be made safely in the direction of the guidance commands.

In this flight regime ( $M \sim 3.5$ ), beta is not as tightly controlled without the yaw jets, particularly in the presence of off-nominal aero. This can cause the ADTA RM to put air data into dilemma, causing a reversion to NAV DAD and default gains. If this occurs  $M < 2$ , care must be exercised when flying near the high alpha limit, as an alpha error could cause the vehicle to enter the pitchup region. If a dilemma occurs, it should be resolved as soon as possible. One might consider deselecting one probe in this region to avoid the RM dilemma.

#### Flight below Mach 7 with some RCS remaining

The decision that leads to the employment of the RCS critical procedures below Mach 7 can only be based on the circumstances that caused the low RCS fuel state, e.g., low state at EI, leak, excessive usage, etc. The following considerations are also offered. The NO YJET mode flies well between Mach 7 and rudder activation at Mach 3.5 except for the oscillation cases which are not likely. Those are still flyable by controlling average bank angle rather than trying to tightly control bank. Below Mach 4.5, maneuvers can be difficult to make in the NO YJET mode, hence, the recommendation to keep the vehicle near wings level and avoid maneuvers. Maintaining bank angles less than 30 degrees is fairly easy down to Mach 3.5. Below Mach 3.5, controlling bank with the rudder pedals is a fairly easy task in most cases. In all the cases seen, control is not lost abruptly, but a slow build up in oscillations or a tendency to roll-off is seen. The characteristics listed above should be considered in selecting a realtime strategy for best utilizing RCS fuel below Mach 7 in a fuel critical situation.

#### 5.1.7.2 Entry RCS Monitoring

To aid in detecting abnormal RCS propellant consumption and forecast fuel critical situations, the RCS redline cue card was developed.

The indicated regions were developed to provide the following guidelines for recommended actions.

- a) An EXPECTED USAGE RATE line is provided for information. This line reflects the consumption rate for an AUTO run including PTI maneuvers, and is the anticipated baseline for the Entry (flight specific data).
- b) The redline (converted to percent) at Mach 7 is extended upwards to the end of the first roll at a slope paralleling the observed usage rate of the first five flights. If fuel state falls below this line, it should be anticipated that the RCS redline will be tripped before Mach = 7, if expected consumption rates prevail. The redline is a function of fuel requirements specified for either forward or aft X c.g.s.
- c) Below Mach 7, the use of some of the 400-pound pad is allowed before downmoding to NO YJET is recommended. The slope of the NO YJET line is equivalent to the worst aero variations case propellant usage and terminates with 10 percent remaining at M3.5. The dashed line slope reflects the flight average usage observed, Mach 7 to 1.

For the discussion of specific RCS procedures associated with the cue card, it is convenient to think of the plot in terms of 6 regions. These regions are defined by the EXPECTED USAGE RATE line, the redline and the line for average usage below M = 7. Figure 5-46 shows the RCS cue card split into procedural regions.

Region I - This is the normal operating region. The entry should proceed in the AUTO mode, unless handling considerations dictate CSS takeover.

Region II - If below the observed flight rate slope at Entry Interface, lateral CSS should be engaged and roll inputs minimized prior to closed loop guidance in order to conserve fuel.

Region III - This region presents a real-time decision which must be made on the basis of what put the vehicle into a low fuel state. (Either the entry was started low on fuel or consumption has been running at an excessive rate.) The alternatives are:

- a) Continue in AUTO. If the vehicle fuel state was simply low to start with, and consumption rates appear normal, it might be possible to track near the upper line of the NO YJET OPTION region, without invoking NO YJET. The intent is to preserve the 20 percent remaining for flight below Mach 7, since most critical trim and control problems are encountered at the lower Mach numbers. If nominal aero and nominal consumption rates are encountered, it may not be necessary to downmode.
- b) If fuel state is obviously diverging downward from the average usage rate line, downmode to CSS with NO YJET lateral control immediately. The NO YJET mode handling qualities (i.e., maneuver acceleration and rate damping) are best between Mach 20 and 7.

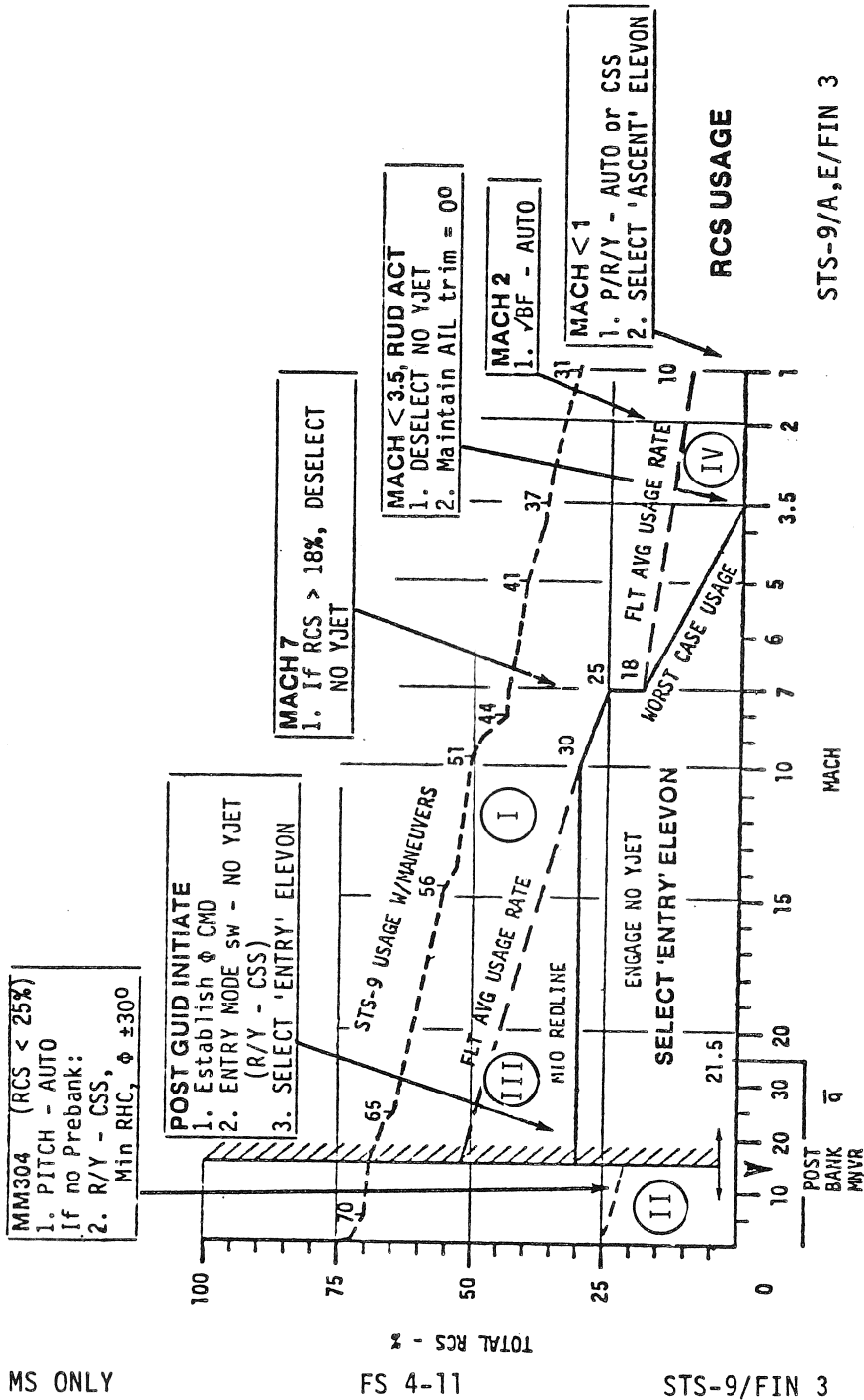

Figure 5-46.-

MS ONLY

FS 4-11

STS-9/FIN 3

So, if use of this mode is under consideration, it is preferable to engage as early as possible. To allow the CDR to determine the time of NO YJET selection, based on vehicle handling and remaining RCS quantities, the area above the 20 percent redline has been designated as an area of potential NO YJET selection. If the total RCS remaining is greater than 20 percent and less than the average usage rate line, NO YJET may be engaged, until Mach decreases sufficiently to put the quantity vs. Mach across the average usage rate guideline, whereupon NO YJET may be deselected. Or, elect to remain in NO YJET until Mach 7, using the extra fuel (between current state and the redline) as an additional buffer below Mach 7.

If the total RCS remaining is 20 percent or less, downmode to lateral CSS with NO YJET. Pitch channel remains in AUTO. Use yaw RCS augmentation only if required for maintaining control or performing bank maneuvers. In such cases, reestablish the NO YJET configuration as soon as vehicle control has been positively regained.

Region IV - This region would normally be entered from the redline or from region III. The vehicle would already be in the NO YJET mode. Delay in turning yaw-jets back on below Mach 7 can be tolerated as long as vehicle handling remains satisfactory. Once yaw-jets are reactivated, fly roll reversals in lateral CSS, AUTO pitch control. The following guidelines should be applied if no YJET is required below Mach 7:

- a) limit roll rates to 5°/sec
- b) start lead for roll termination as vehicle rolls thru  $\theta = 30^\circ$  in commanded direction
- c) stop bank angle at  $\theta = 60^\circ$ , then capture roll command.

As always the aileron and rudder trim should be closely monitored for evidence of a force fight below Mach 3.5.

The CSS mode without the yaw jets flies fairly well, after the rudder is active. However, the NO YJET mode is unstable in the regime; the aileron gain is excessive and of the reverse sign of normal roll control. Therefore, regardless of the remaining RCS fuel available, ROLL/YAW-CSS will be reselected at Mach 3.5. If roll oscillations are prevalent or ailerons seem at first ineffective (poor roll response), roll control at bank angles less than  $\pm 30^\circ$  can be accomplished with the rudder pedals. As Mach decreases, aileron effectiveness will improve rapidly, to near nominal response.

Some simulation results currently indicate the 1/4 Hz oscillation phenomena to be divergent without RCS augmentation. However, much speculation still surrounds this phenomena. Some indications are that an RHC input may interrupt the oscillation.

The body flap may have been manually driven UP to improve aileron trim effectiveness during higher Mach region. Normally, the AUTO commands have the surface saturated UP in this region to attempt to keep the elevons on the trim schedule, so the BF mode can be returned to AUTO below Mach 2.

## 5.2 GROUND CONTROLLED APPROACH

Ground Controlled Approach (GCA) techniques have been developed, and are available, to control the Orbiter's trajectory from post-blackout to a point where the crew can take over visually and compute the landing unassisted.

This procedure should be considered an emergency alternative only, and control should be quickly returned to autoguidance if and when conditions permit.

During entry, should autoguidance fail or allow the Orbiter to stray outside the desired footprint pending a navigational update, a GCA will be performed.

The controller's responsibility will be to provide the crew with the necessary roll, heading, airspeed, and speed brake information while the crew maintains the Orbiter within the required,  $g$ ,  $\bar{q}$ , and  $\dot{h}$  limits.

The GCA controller uses a series of dynamic plot boards, with latitude vs longitude and altitude vs longitude, incorporating increasing resolution scales, to compare actual and nominal trajectories along with range and velocity data.

GCA becomes available as an option at S-band acquisition, nominally at a velocity of approximately 10,000 ft/s.

C-band tracking data will provide GCA with an estimate of the Orbiter state vector approximately one minute before communications are restored with the crew. During this brief interval, the Orbiter trajectory will be assessed and compared with predetermined criteria for initiating a GCA.

It should be noted that late S-band acquisition severely compromises GCA's ability to manage Orbiter energy. Nominally, a reliable GCA footprint capability of  $\pm 150$  n. mi. downrange and  $\pm 100$  n. mi. crossrange is feasible.

The GCA can be divided into three phases:

1. High Velocity Phase (M10-M3)
2. Thermal Area Phase (M 3-M.9)
3. Final Approach Phase

The criteria for electing to use the GCA option depends upon autoguidance's ability to achieve a nominal trajectory by Mach 5. For example, at Mach 10 a GCA will become desirable if the downrange NAV uncertainty is greater than 63 n. mi., or if the range to landing is shorter than nominal by more than 125 n. mi. In the former case, a GCA would be performed until NAV could be updated. In the later case, a GCA would be



performed until the projected landing target was converged within the autoguidance footprint.

In all cases, roll modulation will be used to maintain the range/velocity schedule down to approximately 3,000 ft/s. (Between 5,000 ft/s and 3,000 ft/s it is desirable to maintain a constant roll angle to avoid FCS problems should two yaw jets fail.)

In the high velocity phase the controller will provide roll magnitude information to control drag and roll direction information to control cross-range error.

To ease pilot workload it is recommended that the crew fly with the roll/yaw axis in CSS and the speed brake, body flap, and pitch axis in AUTO.

In the terminal area phase, below Mach 3, control of the Orbiter reverts to the more conventional technique of heading controlling desired ground-track and airspeed controlling energy. The controller determines the ranging potential from an altitude vs. velocity plot, compares it with the range-to-go from the desired groundtrack, and derives the appropriate energy management and airspeed.

The recommended crew action is to fly heading and airspeed information with all axes in the CSS mode with the speed brake in auto until Mach 0.9. (If energy is low, the speed brake may be manually closed to extend the range.) Turns should be made using  $40^\circ$  roll angle and  $\bar{q}$  controlled by modulating  $\alpha$ .

In the terminal area phase, an attempt will be made to position the Orbiter over the field at Mach 0.9 to enable a left-hand turn to a final approach of 15,000 ft at 7 n. mi. A decision will be made to fly a left-hand turn to final, or a minimum ground track turn to final, based upon the Orbiter's energy state.

The final approach phase is basically the traditional GCA final. Heading information is given to acquire and maintain the runway centerline and position information given relative to the glideslope. The crew should use the speed brake to control the air speed.

The two extremely high and low energy cases will require slightly different control techniques. In the low energy case (greater than 100 n. mi. dispersion at 10,000 ft/s or a very low Orbiter L/D), the roll angle should be kept to a minimum and used only as necessary to continue directly to the field.

In the high energy case, roll angles of  $70^\circ$  and more may be necessary to control the trajectory using azimuth offsets and a roll reversal towards a spiral that terminates with runway alignment. The roll reversal timing is critical. The controller will use turn radius templates to determine when the last reversal should take place and evaluate the merits of landing at the prime runway.

With the high roll angles used to control drag, the crew must carefully monitor the  $g$ ,  $\bar{q}$ , and  $h$  limits.

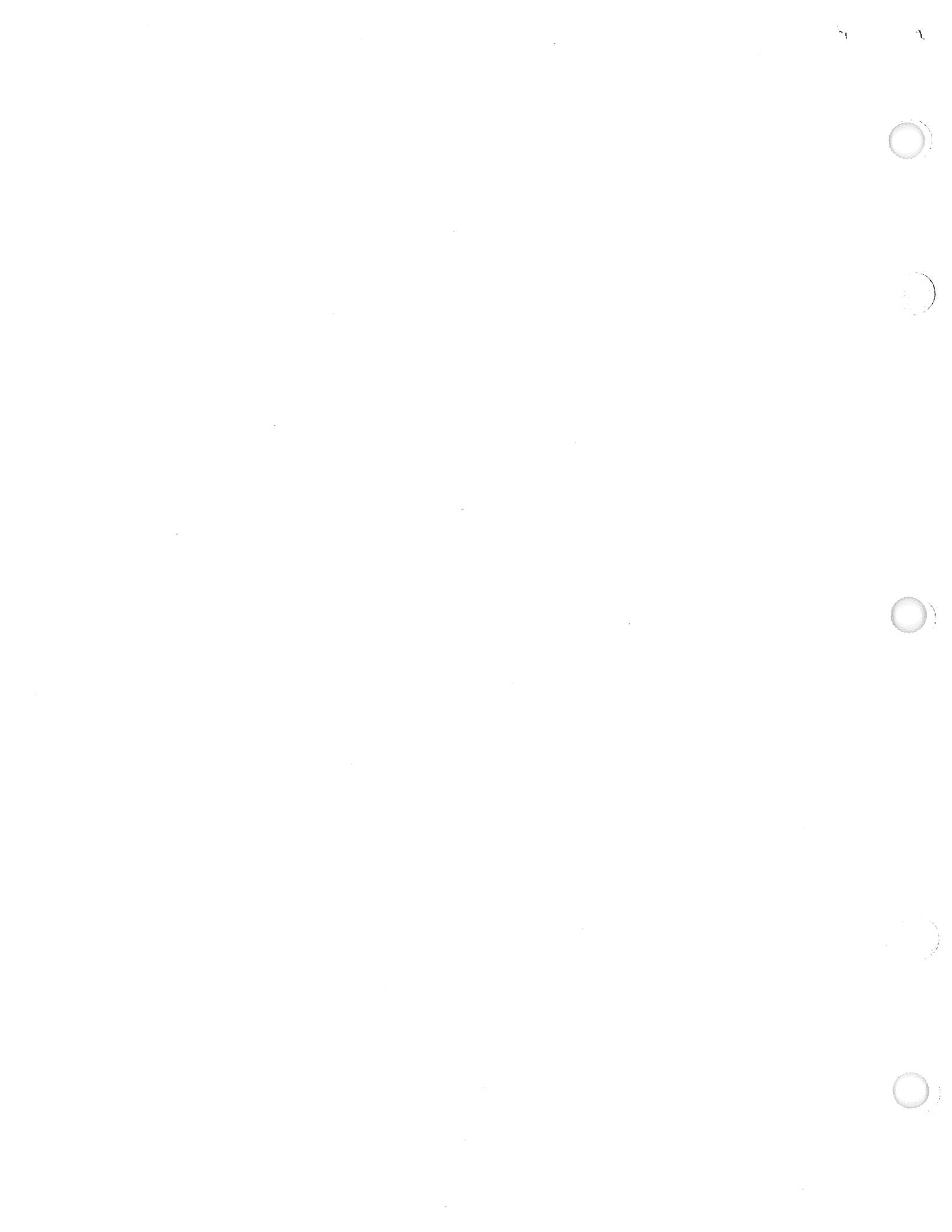

APPENDIX  
OPERATIONAL SUPPLEMENTS

This section is intended to be a collection of crew technique discussions, memos, and related data pertaining to entry topics that are not discussed with the sequence of events. As new discussions are developed, they will be issued as updates for inclusion in this section.

<u>Entry topics</u>	<u>Page</u>
FLYING WITH DEFAULT AIR DATA . . . . .	A-2
RUNWAY REDESIGNATIONS . . . . .	A-4
LRU DILEMMAS . . . . .	A-5
NIGHT LANDINGS . . . . .	A-6
OFF-NOMINAL AERODYNAMICS . . . . .	A-9
STABILITY AND CONTROL FLIGHT TEST PLAN . . . . .	A-12

## FLYING WITH DEFAULT AIR DATA

In the absence of air data below Mach 1.5, the Orbiter Navigation-Derived Air Data (NAVDAD) may be in error enough to cause Flight Control System (FCS) instabilities or loss of control. To protect against this contingency, in PASS only, Default Air Data exists. It provides a constant angle of attack of  $7.5^\circ$  and  $\bar{q}$  between 100 and 265 psf scheduled as a non-linear table lookup function of VREL. Using Default Air Data, Terminal Area Energy Management (TAEM) guidance does not sense changes in real-world  $\bar{q}$  and will unwittingly allow unreasonable  $\bar{q}$ , while correcting to its H versus range or Energy-to-Weight Ratio (E/W) versus range profile, and loss of control may occur. Always fly Default Air Data in Control Stick Steering (CSS) monitoring  $\theta$  limits on the VERT SIT displays.

### Background

When the Air Data System (ADS) is inoperative, the  $\bar{q}$  and angle of attack (alpha) are derived by the navigation system using numerical integration methods to determine the Earth relative speed. This procedure is accurate and adequate to the point where winds have a significant effect on the parameters. For velocity relative to the speed of sound (MACH) numbers above 1.5,  $\bar{q}$  is derived from drag acceleration data and a curvefit function of the coefficient of drag ( $C_D$ ) that is based on an alpha versus velocity nominal profile. The value of  $\bar{q}$  delivered by the navigation system has been found to be sufficiently accurate for  $M > 1.5$ . Therefore, above  $M = 1.5$ ,  $\bar{q}$  limiting is provided by guidance using this  $\bar{q}$  determined by  $C_D$ . Below  $M = 1.5$ ,  $\bar{q}$  is determined by a default schedule based on the Monte Carlo results using 3- $\sigma$  dispersions. Because the navigation derived data are Earth relative and do not take into account the presence of winds, the displayed alpha can be as much as  $16^\circ$  in error below  $M = 1.5$ . In addition, the  $\bar{q}$  used to command speed brake (SB) deflection is calculated from the equation:  $\bar{q} = 1/2 \rho V^2$ , where  $\rho$  is determined from the navigated value of altitude. Since below  $M 0.9$ , the SB is driven by this erroneous  $\bar{q}$ , this results in nonoptimum operation of the SB's for  $\bar{q}$  control. Thus  $\bar{q}$  can be as much as 175 pounds per square feet (psf) in error below  $M = 1.5$ ; hence, the onboard displayed values of  $\bar{q}$  and alpha cannot be used for pitch control in the absence of air data. In addition, computed  $\alpha$  to limit  $\bar{q}$  cannot be used because it is with respect to the Earth relative velocity and not with respect to the wind.

A procedure called theta limits, which is independent of the air data, was developed to allow the pilot, using an onboard CRT display, to manually control the pitch attitude (theta) to keep the actual pitch angle between the nose-high (maximum theta) and nose-low (minimum theta) constraints. Theta is the angle between the Orbiter X axis and the local horizontal plane with the nose-down attitude being defined as a negative theta. The maximum theta limit corresponds to the minimum  $\bar{q}$  that can be flown and still remain near the peak of the lift/drag (L/D) curve. The minimum theta corresponds to the maximum  $\bar{q}$  limit set for flight control system performance. The theta limits procedure is not used for  $M > 1.5$  for two reasons. First,  $\bar{q}$  based on  $C_D$  is accurate enough for guidance to protect the vehicle from violating any constraints and second, theta limits are

based on steady-state flight conditions and do not allow enough flexibility to overcome possible transients at entry-TAEM interface. It is necessary to ignore theta limits at some prescribed altitude to allow preparation for the flare maneuver just prior to landing. The currently recommended altitude is 5000 feet. Note that once the Orbiter is below an altitude of 10,000 feet, greater emphasis is placed on maintaining the glideslope and using theta limits as a guide to setting the SB as well as preventing  $\bar{q}$  constraint violations. The primary goal of theta limits is to provide an independent means of controlling pitch and preventing the vehicle limits from being surpassed even in the presence of worst-case winds. The purpose of this internal note is to discuss how these theta limits were derived and to present results from performance analysis cases.

The theta limits procedure is a very useful technique for  $\bar{q}$  limiting when air data is not available. However, it does require proper training to derive the maximum benefits. The procedure does have drawbacks at high bank angles but using a fixed theta during this period solves the problem. The following recommended procedures are a result of analysis.

- A. For MACH greater than 1.5, guidance should be used with normal  $\bar{q}$  limiting using a  $\bar{q}$  determined by a navigationally derived air data curvefit based on  $C_D$ . This allows greater flexibility to overcome transients at entry-TAEM interface. The  $C_D$  curvefit for  $\bar{q}$  is adequate if alpha is not too far from nominal.
- B. Theta limits should be adhered to for VREL < 1500 fps and altitude > 5000 feet or until the glideslope is achieved (below an altitude of 10,000 feet).
- C. For a high-energy situation (above the glideslope) and on the minimum theta limit with the pitch error needle indicating pitchdown and the needle not moving up adequately, the SB's should be opened more (if  $M \leq 0.9$ ).
- D. When flying minimum theta below VREL = 900 fps, the SB's should be fully open (100 percent).
- E. For a low-energy situation (below glideslope) and on the maximum theta limit with the pitch error needle indicating pitchup and the needle not moving down adequately, the SB's should be closed more (if  $M \leq 0.9$ ).
- F. When flying the pitch error needle and nominal energy (on the glideslope), if theta decreases significantly toward minimum theta limit, the SB's should be opened more. If theta increases significantly toward the maximum theta limit, the SB's should be closed more.
- G. Bank as necessary up to  $50^\circ$ . As an option, go to a theta of  $-12^\circ$  with closed SB's during high banks.
- H. In a tailwind case and approaching a headwind, keep altitude and energy high.

## RUNWAY REDESIGNATIONS

For various reasons, it becomes desirable to redesignate to a runway different from that selected by default in OPS 3. This is accomplished using Item numbers 3, 4, and 5 on the Horizontal Sit display. Redesignation from the default selection is most often accomplished before the deorbit burn and no further changes occur. If performed in atmospheric flight, CSS P/Y/R should be employed before EXEC to avoid a transient. After re-centering the guidance needles, AUTO may be engaged.

Redesignations to other runways in the same landing area (EDW, for example) will always be resolved to equilibrium flight without any uncomfortable energy penalties if accomplished prior to Mach 5.0.

## LRU DILEMMAS

There are no special procedures for flying in the presence of LRU dilemmas except for those in ADTA below Mach 1.5. ADTA dilemma is the same as no ADTA's and below Mach 1.5 the Orbiter should be flown in CSS, both axes, monitoring limits. (See Flying with Default Air Data in this appendix.)

## NIGHT LANDINGS

While no special procedures are required to perform a night landing, several ground-based aids are available to the pilot as follows (fig. A-1).

### Precision Approach Path Indicator (PAPI)

PAPI units should be used in night operations as in daylight with no change in configuration other than lowering the intensity to a more comfortable level.

### Strobe Lights

A pair of strobe lights are located at the PAPI site and are oriented so they are visible while the vehicle is on the Heading Alignment Circle (HAC). They disappear at approximately the same point that the PAPI's become visible. The strobes are provided to give the pilot knowledge of the outer glideslope aimpoint position before PAPI acquisition.

### Approach/Transition Light

On runways equipped with an approach-light system, that system will be used. If approach lights are unavailable (e.g., a lakebed), a pair of xenon floodlights will be used. These floodlights are located on the extended runway centerline 4000 feet before the threshold and are aimed directly down the centerline. The approach/transition lights provide azimuth guidance to assist the pilot in final runway alignment.

### Ball/Bar

The ball/bar unit is used at night as in daylight with only a variation in intensity to provide a more comfortable setting.

### Xenon Floodlights

Two pair of xenon floodlights provide general area lighting. They are located 50 feet from either side of the runway edge and 1300 feet before the threshold. One light on each side is concentrated on the touchdown zone; the other pair is aimed at the opposite end of the runway. Light from these units is sufficient to provide the pilot with the necessary cues to successfully perform the final flare/touchdown maneuver.

### Threshold Lights

On runways equipped with threshold lights, these lights will be turned on. If no threshold lights are available, a portable set will be used. (Note: Portable threshold lights are not visible until approximately preflare.) Threshold lights indicate the exact location of the physical beginning of the runway.



### Edge Lights/Reflectors

On runways so equipped, the standard edge lights will be used. If edge lights are unavailable, reflectors similar to those used in highway construction will be placed along both sides of the runway 200 feet apart. These reflectors use available xenon light to provide azimuth guidance during rollout. (Note: Reflectors are not visible until an altitude of approximately 1000 feet.)

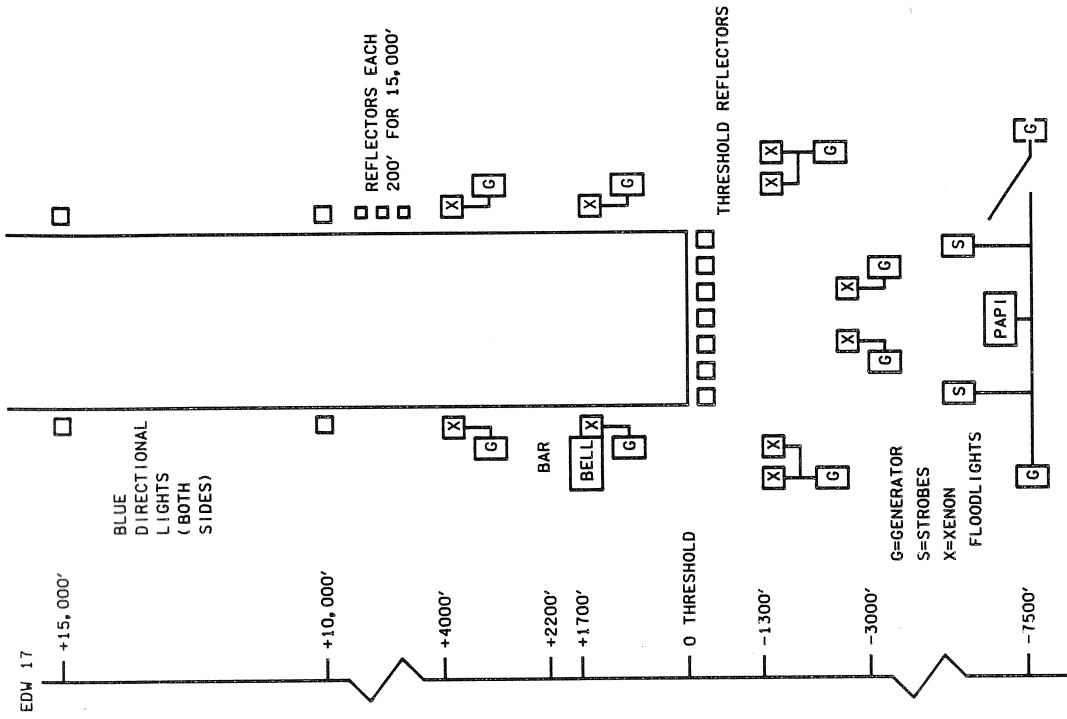

3220, ART# 2

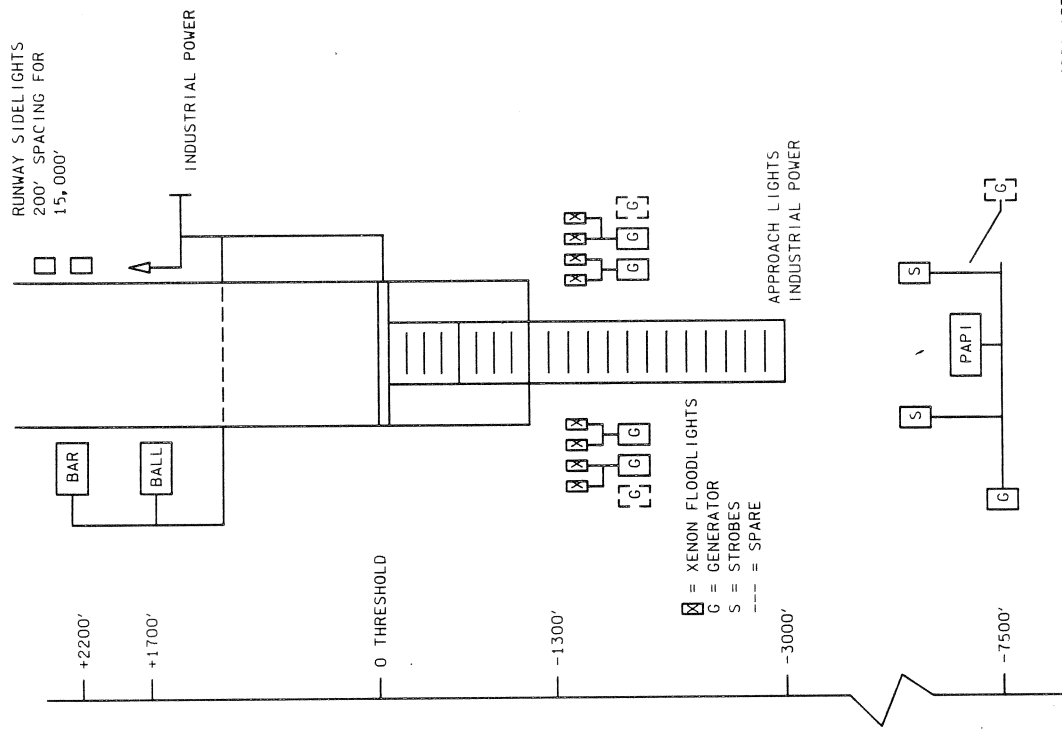

3221, ART# 2

Figure A-1.- Night landing aids configuration.

## OFF-NOMINAL AERODYNAMICS

The purpose of this section is to briefly explain how the uncertainties (off-nominal) in aerodynamics affect entry.

In a conventional aircraft, program flight 'worthiness' is demonstrated by incremental expansion of the flight envelope. This is not feasible with the Shuttle. Preflight characteristics must be based on aerodynamic data derived from ground test and analysis. Allowances have been made in the Flight Control System (FCS) design for aerodynamic characteristics with uncertainties added to the basic aero base and will be discussed later.

There are two types of uncertainties: tolerances and variations. Tolerances are the errors between different wind tunnel tests, models, and test organizations. They are usually small and will not be discussed in this article. Variations are the differences between actual flight and predicted aerodynamics as a function of Mach number. However, a set of variations for the Shuttle program had to be established prior to STS-1. The most reasonable approach to develop these variations was to analyze the wind tunnel results to flight test differences of past aircraft programs. The flight data base was limited by restricting the comparison to vehicles geometrically similar to the Orbiter; a very subjective process. Therefore, a team of aerodynamicists from the Air Force Flight Test Center, NASA Dryden Flight Research Facility, Johnson Space Center, and Rockwell International was formed to analyze and reach a consensus on variations. For the formal entry verification, the decision was made to use the 3-sigma (Statistical Standard deviation) correlated variations. A total of 10 lateral-directional and 3 longitudinal coefficients was defined for application of entry uncertainty FCS verification.

### Variation Sizes

Flight data were limited to lower Mach numbers and angle of attack. In Mach regions where flight data were unavailable, variations were obtained by multiplying wind tunnel uncertainties by a safety factor. These sizes will be modified accordingly following the stability and control flight test results. (See Stability and Control Flight Test Plan in this appendix for the method used to define the coefficients.)

A typical vector diagram of the aero and jet coefficients for the roll and yaw axes is shown in figure A-2. (This figure is for illustrative purposes only.) The uncertainties and coefficients will vary with Mach number and other flight conditions. The X-axis represents the yawing moment coefficient,  $C_n$ , while the Y-axis represents the rolling moment coefficient,  $C_l$ . The vectors represent the nominal aerodynamics. The variations are represented by the boxes and ellipses. The rectangular variations were used in the FCS development and the ellipses are the correlated variations. In most cases, the rectangular variations are approximately 20 percent worse than the elliptical variations depending on the location on the aerodynamic vector position.

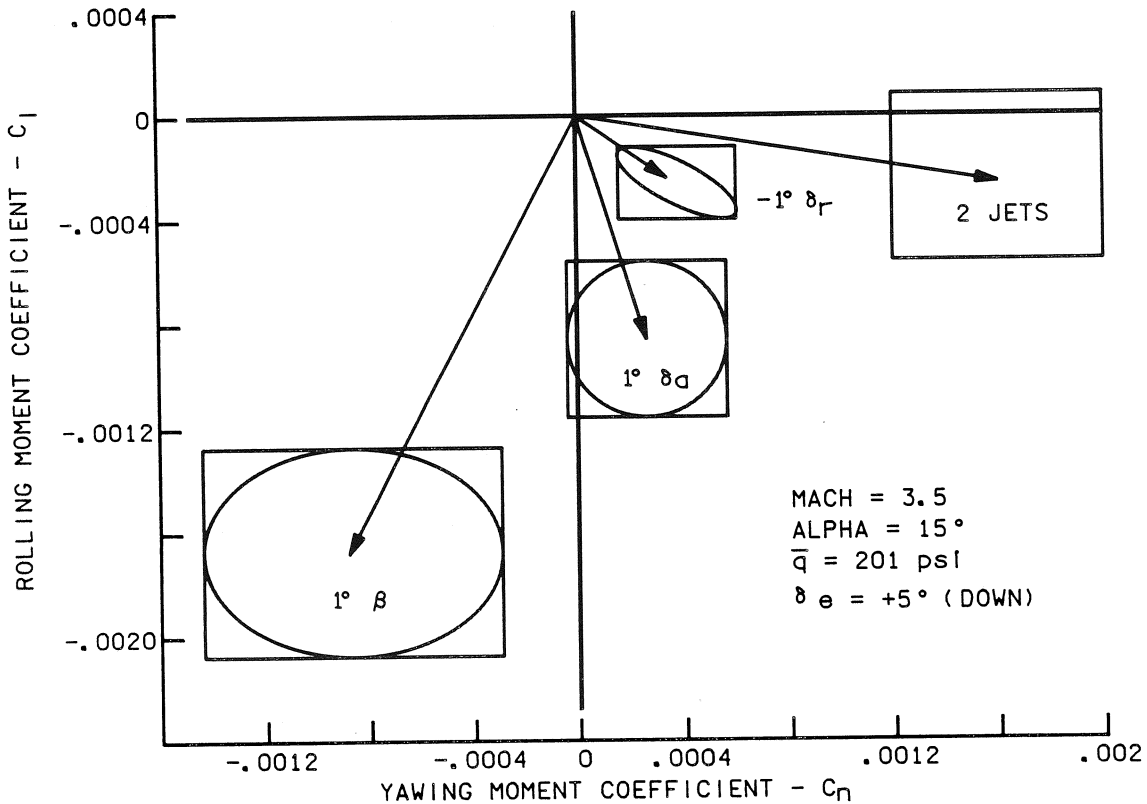

Figure A-2.- Vector diagram of aerodynamic coefficients showing uncertainties.

Physical Description of the Vector Diagram (Off-Nominal)

In figure A-2,  $1^\circ \beta$  with nominal aero will produce approximately  $-0.0008 C_n$  and  $-0.0018 C_l$ . If the system has more or less than  $1^\circ \beta$ , the vector is extended or shortened to the appropriate amount along with the yawing and rolling moment coefficients. This is also representative of the other vectors. If the system has off-nominal aerodynamics, the rolling and yawing moment coefficients will vary accordingly. A 3-sigma variation on the  $\beta$  coefficient, with a change in magnitude and shift in direction of the vector, will give the rectangular boundary. This shift will cause the system to behave differently from the nominal case. If the different vectors move off-nominal in certain locations, this can represent high or low aerodynamic control gains. In other cases, it can represent minimum or maximum aero surface controllability (coalignment of effector vectors,  $\delta_a$ ,  $\delta_r$ ) or even lateral trim problems caused by coalignment of  $\beta$  and  $\delta_a$  vectors. Once the rudder becomes active, currently Mach 3.5, and if aileron vector coaligns with the rudder vector, an aileron-rudder force fight can occur. In this situation, the crew will need to manually trim the vehicle.

The motion associated with the different off-nominal aero sets can cause (1) low-damped oscillations in roll, (2) less stable  $C_{n\beta}$  dynamic causing

rapid oscillations in the lateral-directional axes, (3) large aileron-rudder trim positions to trim small Y c.g. offsets. Under severe conditions, these off-nominal cases can cause divergence. However, the FCS was designed to handle operational aerodynamic uncertainties along with the following various stress conditions:

- o Winds, discrete gust, turbulence, shear
- o Atmospheric variations
- o Uncertainties, bent airframe/Y c.g. offsets
- o Reaction control jet failures (2)

For the control specialist, the military specification levels are as follows:

- o Level 1
  - o Stability margin - 6 db, 30° phase
  - o Cooper Harper pilot rating of 3 or less
- o Level 2
  - o Stability margin - 4 db, 20° phase
  - o Cooper Harper pilot rating of 6 or less

## STABILITY AND CONTROL FLIGHT TEST PLAN

The purpose of this section is to describe the flight test program and how the data are used to reduce the uncertainty boundary about the preflight aerodynamic coefficients.

Orbiter testing is more expensive than flying other aircraft and therefore it is essential to reduce testing to a minimum. However, the operational limits must be expanded to include payloads that will make the Shuttle more cost effective. The payloads may cause the center of gravity to shift aft or forward and the Shuttle will have to accommodate this shift within a certain boundary. Since the Shuttle glides from 400,000 feet at Mach 25 to touchdown in a time span of 35 minutes, only one test maneuver at a given flight condition can be executed on one flight.

Because of limited testing while obtaining the maximum amount of information, the locations of the test maneuvers were based on extensive Shuttle testing, potential control problems, and flight anomalies. A plan was devised that would provide data with a minimum amount of testing. To optimize maneuver responses, Programed Test Inputs (PTI's) were designed to pulse the control effectors (surfaces and jets) through onboard software. On flights 2 through 4, the PTI's were initiated by the crew by entering keystrokes at the computer keyboard. On flights 5 through 17, the PTI's will be completely automatic. On the average, there are 8 to 10 PTI maneuvers per flight. If certain PTI's are missed during a flight, these PTI's will be executed on another flight. This may increase the number of flights required to ensure valid data. More than one data point is necessary to reduce the aero uncertainties about the variable at a particular Mach number.

To provide high quality sensor data during these maneuvers, an instrumentation package was carried onboard.

### Flight Data Extraction

The flight test data were extracted from flight-measured translational accelerations, rotational rates, angle of sideslip, and bank angle through the use of a modified maximum likelihood estimator, MMLE3; a computer program developed at NASA Dryden Flight Research Facility. This digital computer program has been well demonstrated in flight test analyses of other aircraft.

For a given maneuver, MMLE outputs a linear estimate of the lateral-directional or longitudinal derivatives as well as an estimate of the relative uncertainty of the extracted derivative. Experience from previous flight test programs indicate that a multiplier of 10 on the uncertainty is the most representative of the Shuttle flight uncertainties.

The results of MMLE3 on the lateral-directional derivative CLLB (rolling moment coefficient due to sideslip) are shown in figure A-3.

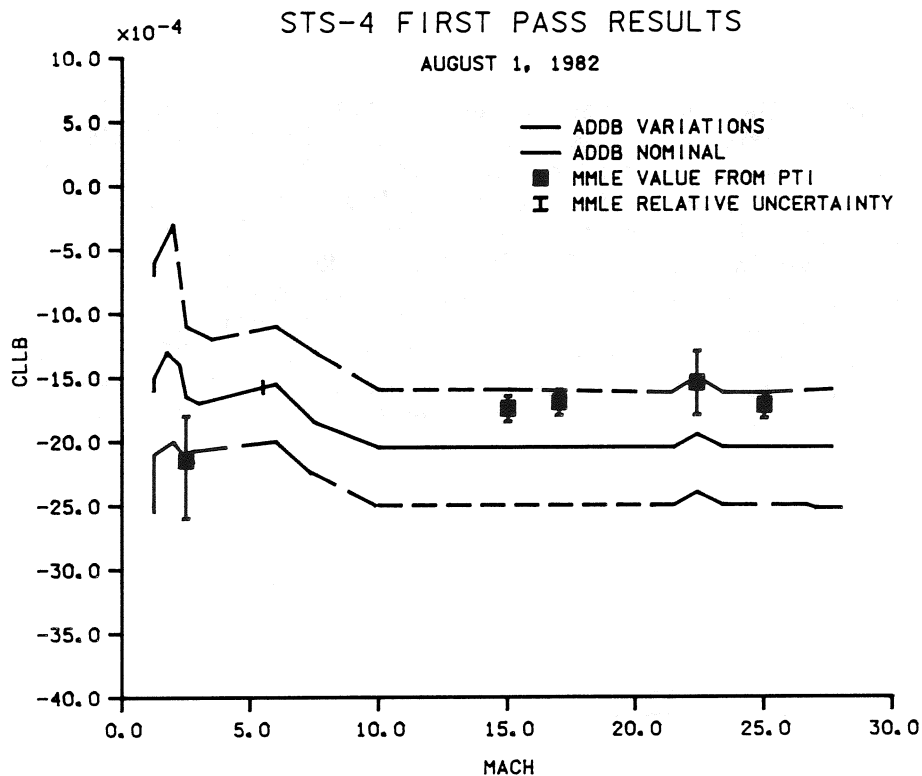

Figure A-3.- CLLB versus Mach.

The solid line is the aero data book predicted nominal CLLB values versus Mach. The dashed lines represent the aero design data book variations about the nominal CLLB. The data points are MMLE extraction values of CLLB from the PTI maneuvers during STS-4 entry. The band attached to the estimation value is the uncertainty multiplied by 10; a qualitative measure of the uncertainty in the estimation. Large bounds indicate a lower relative confidence in the results. An analyst would conclude from figure A-3 that MMLE did a better job of predicting CLLB for the PTI's at Mach 25, 17, and 15 than for the PTI's at Mach 22 and 2.5. By the end of the aerodynamic flight test program, the uncertainties about the coefficients will be reduced.

#### Automatic PTI Design (STS-5 and Beyond)

The crew involvement in the maneuvers is primarily a monitoring function. The software automatically executes the predefined maneuvers within specified windows located at different Mach regions of entry by data requirements. The software logic avoids executing maneuvers close to bank reversals and when the body rates are above certain limits. At the present time, the constraints are roll rate less than 1.5 deg/s, pitch rate less than 0.5 deg/s, yaw rate less than 0.5 deg/s, and altitude acceleration less than 4 ft/s/s. The crew can quickly stop the maneuver sequence by moving the stick or selecting the control stick steering (CSS). However, if the vehicle is executing a PTI, the consensus from the designers is to wait until the maneuver is completed before going to CSS. The inputs are made through the flight control system at the point where the surface deflection is commanded. The signal is added to the current command. The

surface rate command is then processed through a maximum rate limiter. An integrator converts the rate to an amplitude signal. The PTI signals can be sent to the elevons, aileron, rudder, and jets. A typical PTI doublet is shown in figure A-4. The doublets are strung together in combinations to provide various inputs to the control effectors. A typical time response to a PTI is shown in figure A-5. The amplitude and time widths vary from one PTI doublet to another. All the PTI maneuvers are safety verified on several simulators before each flight. The verification process consists of doubling both the amplitudes and times of the PTI inputs using stressed flight conditions. These conditions consist of at least worst aero variation sets, offset center of gravity, jet failures, and angle-of-attack errors.

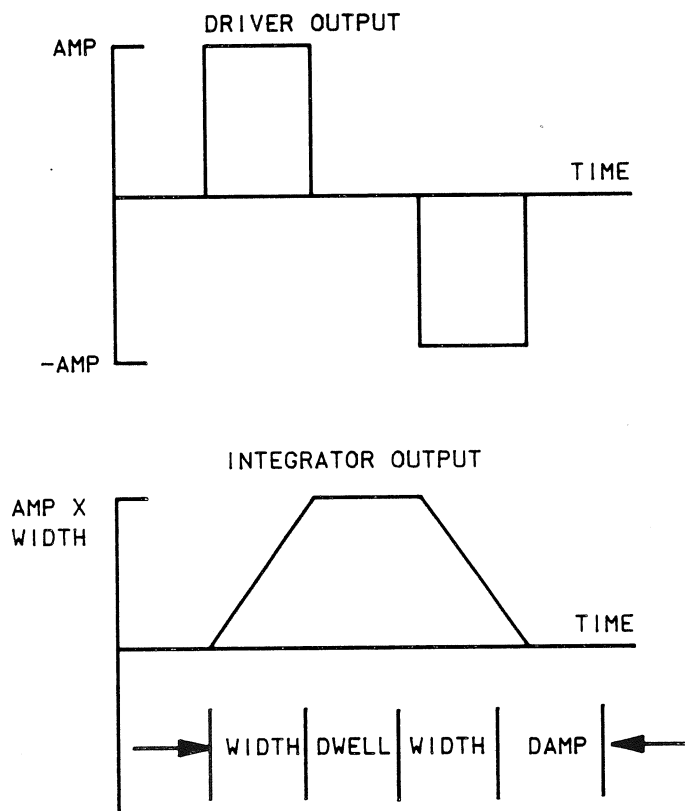

Figure A-4.- Typical auto PTI output.



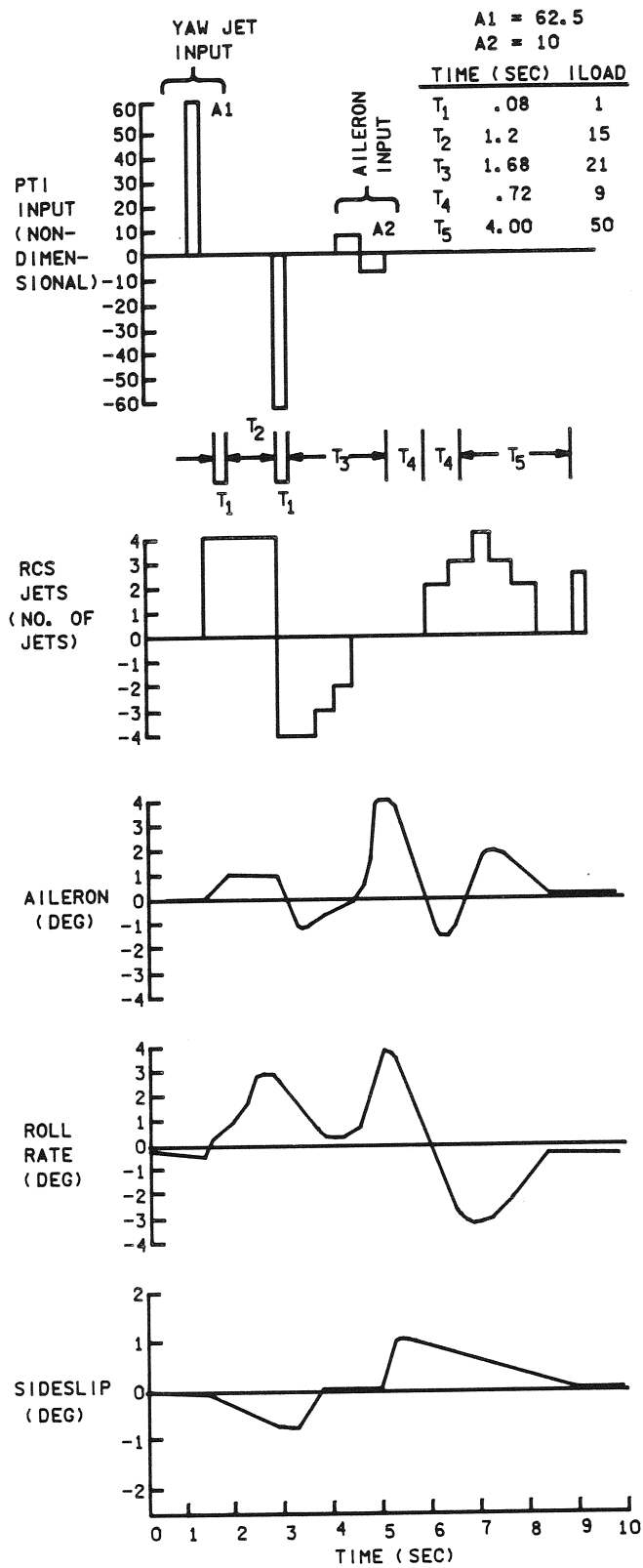

Figure A-5.- Automatic PTI (Mach 5.8).

