

# Flight Procedures Handbook

---

Entry

Mission Operations Directorate  
Operations Division

Final, Rev D  
July 1995



National Aeronautics  
and Space Administration

Lyndon B. Johnson Space Center  
Houston, Texas

## SECTION 1 INTRODUCTION

### 1.1 PURPOSE

The purpose of this document is to present shuttle entry flight procedures with sufficient rationale and supporting information to give the user a good understanding of the crew task for this mission phase. This handbook is intended primarily for use by flight crewmembers and training personnel during follow-on to shuttle systems training.

### 1.2 SCOPE

The Entry Procedures Handbook covers the mission phase as follows:

- Deorbit burn
- Entry interface (EI) to terminal area energy management (TAEM) interface
- TAEM

For each of the phases listed, this handbook includes a nominal sequence of trajectory and system events and the interrelationship of the crew and the orbiter entry systems for flying and monitoring the event. To avoid duplication, approach and landing (A/L) to rollout and postlanding phases are not covered in this handbook. The Approach/Landing Flight Procedures Handbook (JSC-23266) provides detailed information on these final flight phases. It is assumed that the crewmember is already knowledgeable about shuttle systems. The crew procedures for the entry flight phase may be found in a companion document, Entry Checklist (JSC-48019).

This document is written under the authority vested in the Mission Operations Directorate, Operations Division, for definition, development, validation, and control of all crew procedures for orbiter operations for NASA manned missions, as specified by Space Shuttle Program Manager Directive 9A, dated September 23, 1974.

### 1.3 ABBREVIATIONS AND ACRONYMS

|       |                                      |
|-------|--------------------------------------|
| A/L   | approach and landing                 |
| AA    | accelerometer assembly               |
| ACN   | Ascension Island                     |
| ADI   | attitude direction indicator         |
| ADS   | air data system                      |
| ADTA  | air data transducer assembly         |
| AFO   | abort from orbit                     |
| AGL   | above ground level (altitude)        |
| ALTM  | altimeter                            |
| AMI   | alpha/mach indicator                 |
| AOA   | abort-once-around                    |
| AOS   | acquisition of signal                |
| APILS | aimpoint identification light system |
| APU   | auxiliary power unit                 |

|              |  |
|--------------|--|
| ARCS         | aft reaction control system  |
| ARS          | atmospheric revitalization system  |
| ATCS         | active thermal control subsystem   |
| ATM          | atmosphere   |
| ATO          | abort-to-orbit   |
| AVVI         | altitude/vertical velocity indicator                                     |
| BDA          | Bermuda  |
| BFS          | backup flight system   |
| BOB          | best on best   |
| $C_D$        | drag coefficient   |
| $C_L$        | coefficient of lift  |
| $C_l$        | rolling moment coefficient (lateral coefficient)                         |
| $C_{l\beta}$ | change of rolling moment with respect to the change in sideslip angle    |
| $C_m$        | pitching moment coefficient (longitudinal coefficient)                   |
| $C_n$        | yawing moment coefficient (directional coefficient)                      |
| $C_{n\beta}$ | change of yawing moment with respect to the change in the sideslip angle |
| c.g.         | center of gravity  |
| C/O          | checkout   |
|              | engine cutoff  |
| C/W or C&W   | caution and warning  |
| CAPS         | crew altitude protection system  |
| CES          | crew escape system   |
| CDI          | course deviation indicator   |
| CDR          | commander  |
| CLS          | contingency landing site   |
| CRT          | cathode ray tube   |
| CSS          | control stick steering   |
| DAP          | digital autopilot  |
| DDU          | display driver unit  |
| DED          | dedicated  |
| DEL          | deorbit, entry, and landing  |
| DEU          | display electronic unit  |
| DFI          | development flight instrumentation                                       |
| DIP          | display interface processor  |
| DIR          | direct   |
| DISP         | display (function)   |
| DME          | distance measuring equipment   |
| DPS          | data processing system   |
| DTO          | detailed test objective  |
| E&D          | engineering and development  |
| E/W          | energy-to-weight ratio   |
| EAFB         | Edwards Air Force Base   |
| EAS          | equivalent airspeed  |
| ECLSS        | environmental control and life support system                            |
| EET          | entry elapsed time   |

|       |   |
|-------|---|
| EI    | entry interface                                 |
| EIT   | entry interface time                            |
| EOM   | end of mission                                  |
| EPS   | electrical power system                         |
| ET    | external tank                                   |
| ETR   | Eastern test range                              |
| EXEC  | execute   |
| FA    | flight aft-MDM                                  |
| FB    | feedback  |
| FCS   | flight control system                           |
| FDBK  | feedback  |
| FDIR  | fault detection, isolation, and reconfiguration |
| FF    | flight forward-MDM                              |
| FOV   | field of view                                   |
| FRCS  | forward reaction control system                 |
| FTO   | flight test objective                           |
| FTR   | flight test requirement                         |
| FW    | fuel wasting                                    |
| FWD   | forward   |
| G     | gravity   |
| G&C   | guidance and control                            |
| G&N   | guidance and navigation                         |
| GCA   | ground controlled approach                      |
| GG    | gas generator                                   |
| GN&C  | guidance, navigation, and control               |
| GPC   | general purpose computer                        |
| GRTLS | glide return to launch site                     |
| GS    | glide slope                                     |
| GSI   | glide slope indicator                           |
| GSP   | ground support personnel                        |
| GWM   | Guam  |
| HAC   | heading alignment cylinder/cone/circle          |
| HRL   | horizontal reference line                       |
| HSD   | horizontal situation display                    |
| HSI   | horizontal situation indicator                  |
| HUD   | head up display                                 |
| HYD   | hydraulic                                       |
| I/F   | interface                                       |
| IGS   | inner glide slope                               |
| IMU   | inertial measurement unit                       |
| IPL   | initial program load                            |
| JSL   | jet select logic                                |
| KEAS  | knots equivalent airspeed                       |
| KSC   | John F. Kennedy Space Center                    |

|        |  |
|--------|--|
| L/D    | lift-to-drag ratio                           |
| LDG    | landing                                      |
| LRU    | line replaceable unit                        |
| LVLH   | local vertical local horizontal              |
| M      | Mach   |
| MAN    | manual                                       |
| MCC    | Mission Control Center                       |
| MDM    | multiplexer/demultiplexer                    |
| MEP    | minimum entry point                          |
| MET    | mission elapsed time                         |
| MIL    | Merritt Island                               |
| MLG    | main landing gear                            |
| MLS    | microwave landing system                     |
| MM     | major mode                                   |
| MPAD   | Mission Planning and Analysis Division (JSC) |
| MPS    | main propulsion system                       |
| MSC    | moding sequencing and control                |
| MSBLS  | microwave scan beam landing system           |
| MNVR   | maneuver                                     |
| n. mi. | nautical mile                                |
| NAVDAD | navigation-derived air data                  |
| NEP    | nominal entry point                          |
| NFW    | nonfuel wasting                              |
| NLG    | nose landing gear                            |
| NWS    | nose wheel steering                          |
| NYJ    | no yaw jet                                   |
| OBS    | operational biomedical system                |
| OFT    | orbital flight test                          |
| OGS    | outer glide slope                            |
| OMS    | orbital maneuvering system                   |
| OPS    | operations                                   |
| OSOP   | orbiter systems operating procedures         |
| OTT    | optional TAEM targeting                      |
| PAD    | preliminary advisory data                    |
| PAPI   | precision approach path indicator            |
| PASS   | primary avionics software system             |
| pb     | pushbutton                                   |
| pbi    | pushbutton indicator                         |
| PCMMU  | pulse code modulation master unit            |
| PCS    | pressure control system                      |
| PEG    | powered explicit guidance                    |
| PFS    | primary flight system                        |
| PIC    | pyro initiator controller                    |
| PL     | payload                                      |
| PLT    | pilot  |
| PREL   | preliminary                                  |

|       |                                   |
|-------|-----------------------------------|
| PRI   | primary                           |
| PRL   | priority rate limiting            |
| PRO   | proceed                           |
| PTI   | programmed test input             |
| RA    | radar altimeter                   |
| RCS   | reaction control system           |
| RCVR  | receiver                          |
| REG   | regulator                         |
| REI   | range from entry interface        |
| REL   | relative                          |
| RF    | radio frequency                   |
| RG    | rate gyro                         |
| RGA   | rate gyro assembly                |
| RHC   | rotational hand controller        |
| RM    | redundancy management             |
| RPTA  | rudder pedal transducer assembly  |
| RTLS  | return to launch site             |
| S/W   | software                          |
| SBTC  | speedbrake/thrust controller      |
| SEC   | secondary                         |
| SIT   | situation                         |
| SM    | system management                 |
| SOP   | subsystem operating program       |
| SPEC  | specialists (function)            |
| SPI   | surface position indicator        |
| SPTI  | structural programmed test inputs |
| SRB   | solid rocket booster              |
| SS    | system summary                    |
| SSME  | space shuttle main engine         |
| STDN  | space tracking data network       |
| STRK  | star tracker                      |
| STS   | space transportation system       |
| SV    | state vector                      |
| TACAN | tactical air navigation           |
| TAEM  | terminal area energy management   |
| TAL   | transoceanic abort landing        |
| TAS   | true airspeed                     |
| tb    | talkback                          |
| TBD   | to be determined                  |
| TCS   | test control supervision          |
| TDRS  | tracking and data relay satellite |
| TFF   | time to free fall                 |
| TFOV  | total field of view               |
| TGO   | time to go                        |
| TGT   | target                            |
| THC   | translational hand controller     |
| TIG   | time of ignition                  |

|       |                            |
|-------|----------------------------|
| TPF   | transfer phase final       |
| TPS   | thermal protection system  |
| TRAJ  | trajectory                 |
| TRANS | transition                 |
| TVC   | thrust vector control      |
| UHF   | ultrahigh frequency        |
| UPP   | user parameter processor   |
| VREL  | relative velocity          |
| VSD   | vertical situation display |
| WONG  | weight on nose gear        |
| WOW   | weight on wheels           |
| WP    | way point                  |
| WTR   | western test range         |

#### 1.4 SIGNS AND SYMBOLS

|                  |                          |
|------------------|--------------------------|
| $\alpha$ (alpha) | angle of attack          |
| $\beta$ (beta)   | angle of side slip       |
| $\gamma$ (gamma) | flightpath angle         |
| $\delta$ (delta) | deflection angle         |
| $\phi$ (phi)     | roll angle               |
| $\psi$ (psi)     | azimuth                  |
| >                | greater than             |
| <                | less than                |
| =                | equal to                 |
| $\geq$           | greater than or equal to |
| $\leq$           | less than or equal to    |
| $\approx$        | approximately equal to   |
| $^{\circ}$       | degree                   |
| H                | altitude                 |
| $\dot{H}$        | altitude rate            |
| $\ddot{H}$       | altitude acceleration    |
| V                | velocity                 |

## SECTION 2

### ENTRY FLIGHT DESCRIPTION

#### 2.1 GENERAL

The entry phase of a mission comprises those activities that a crew performs to prepare for deorbit, perform the deorbit burn, and fly the orbiter to the landing field. The phase begins with deorbit preparation checkout procedures in the Deorbit Prep Book approximately 4 hours before the deorbit burn and continues through crew seat ingress. The Entry Checklist procedures begin after seat ingress and continue through the egress of the crew after landing.

#### 2.2 DEORBIT BURN OVERVIEW

Following seat ingress activities, the commander (CDR) and pilot (PLT) copy updates to the deorbit, entry, and landing (DEL) preliminary advisory data (PAD) and the orbital maneuvering system (OMS) propellant (PRPLT) PAD. The CDR checks and loads the final deorbit targets previously uplinked by the MCC. During the remaining half hour before deorbit ignition, the crew configures the horizontal situation display (HSD), checks the switch positions for an OMS or reaction control system (RCS) burn, performs an OMS thrust vector control (TVC) gimbal check, performs the auxiliary power unit (APU) PRESTART, and transitions to major mode (MM) 302. The GO/NO-GO for the deorbit burn is given at time of ignition minus 25 minutes (TIG - 25). The maneuver to the deorbit burn attitude is done normally at TIG - 15. One APU is activated 5 minutes before deorbit ignition. At TIG - 2, the crew performs the final preburn steps and the deorbit burn using the deorbit burn and monitor cue cards.

The deorbit burn is planned to be a two-OMS burn of about 2.5 minutes using powered explicit guidance (PEG) 4 guidance and is performed in MM 302. PEG 4 guidance can also be targeted for a one-OMS deorbit or an RCS deorbit burn. The capability also exists during the burn, to downmode or faultdown from two-OMS to one-OMS, one-OMS to RCS, or two-OMS to one-OMS to RCS to complete the burn if engine failures occur. Some system failures during the burn result in the termination of the burn and deorbit might be postponed until the next day or the next rev. If a failure occurs below a safe perigee, the following capabilities may be used to achieve a successful deorbit: aft RCS propellant, FWD RCS propellant, prebank, and underburn landing site redesignation.

At the completion of the burn, the crew can trim the residual delta velocity (if required) using the translational hand controller (THC). The crew then performs the OMS/RCS postburn reconfiguration. The CDR transitions to MM 303 and initiates the auto maneuver to the entry interface minus 5 minutes (EI -5) attitude.

The remaining time before EI - 5 is spent performing a forward RCS dump (if required for X center of gravity (c.g.) control), starting the remaining APU's, repressing the space shuttle main engine (SSME) hydraulic system, performing the hydraulic fluid thermal conditioning if required, checking or positioning switches for entry, and conferring with the Mission Control Center (MCC).



## 2.3 ENTRY INTERFACE TO TERMINAL AREA ENERGY MANAGEMENT<sup>1</sup>

The entry phase is initiated by crew action 5 minutes before EI (altitude of 400,000 ft) and continues to the entry TAEM interface. The fundamental guidance requirement during entry is to reach the TAEM interface (2500 ft/s, altitude of approximately 82,000 ft) within specified limits on range (about 50 nautical miles (n. mi.)) from the selected heading alignment cone (HAC) and with a velocity heading within a few degrees of tangency with the HAC.

During a nominal entry, the flight control system (FCS) is in the AUTO mode and the flight crew function is primarily one of monitoring the operation and performance of the guidance, navigation, and control (GN&C) systems. A simplified diagram of entry guidance is shown in figure 2-1.

The entry guidance system controls the entry trajectory by bank angle commands while flying a predesigned angle of attack ( $\alpha$ ) versus velocity profile. The  $\alpha$  profile is designed to be compatible with heating and stability constraints. In addition,  $\alpha$  modulation is used to control drag-to-drag reference under transient conditions such as roll reversals.

Entry range is controlled by drag modulation, based on the predicted range for a selected drag acceleration versus velocity profile. The drag-velocity profile is chosen to conform with several limits, as shown in figure 2-2.

Range predictions are based on solutions of the equations of motion for drag profiles that are constant, linear, or quadratic functions of velocity. The drag-velocity profile is preselected by means of a mission-dependent data load and is adjusted each guidance cycle to null any range error.

The speedbrake schedule is a fixed profile independent of the entry guidance. The body flap is positioned by the autopilot so that the trim elevon position is a schedule function of speed and orbiter c.g. position.

---

<sup>1</sup>Entry aerodynamics response maneuvers are not included in event discussions in this section.

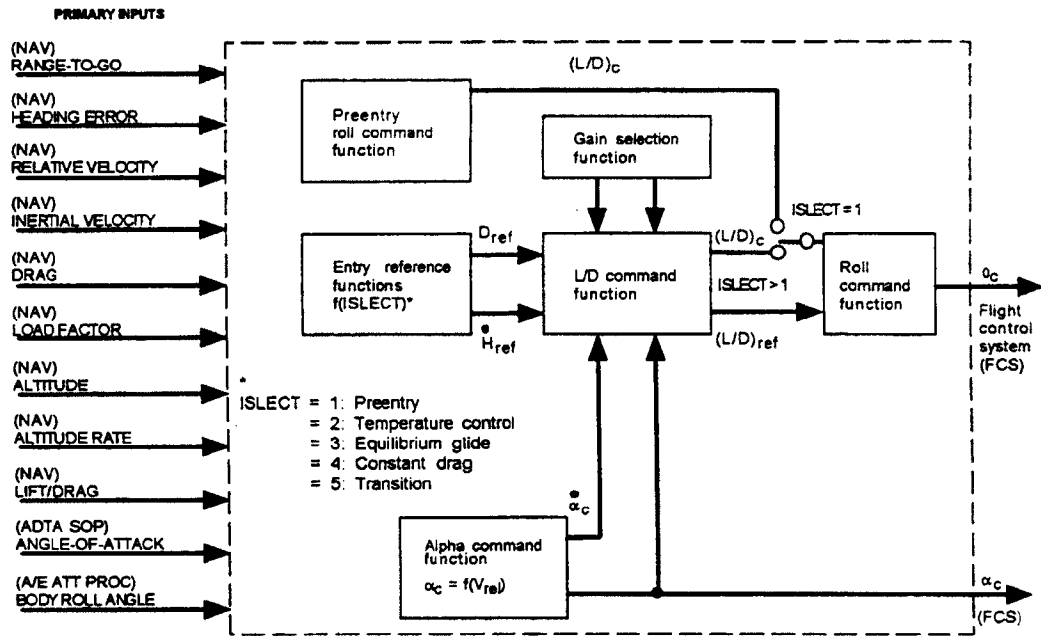

L11542\_012

Figure 2-1. Simplified entry guidance

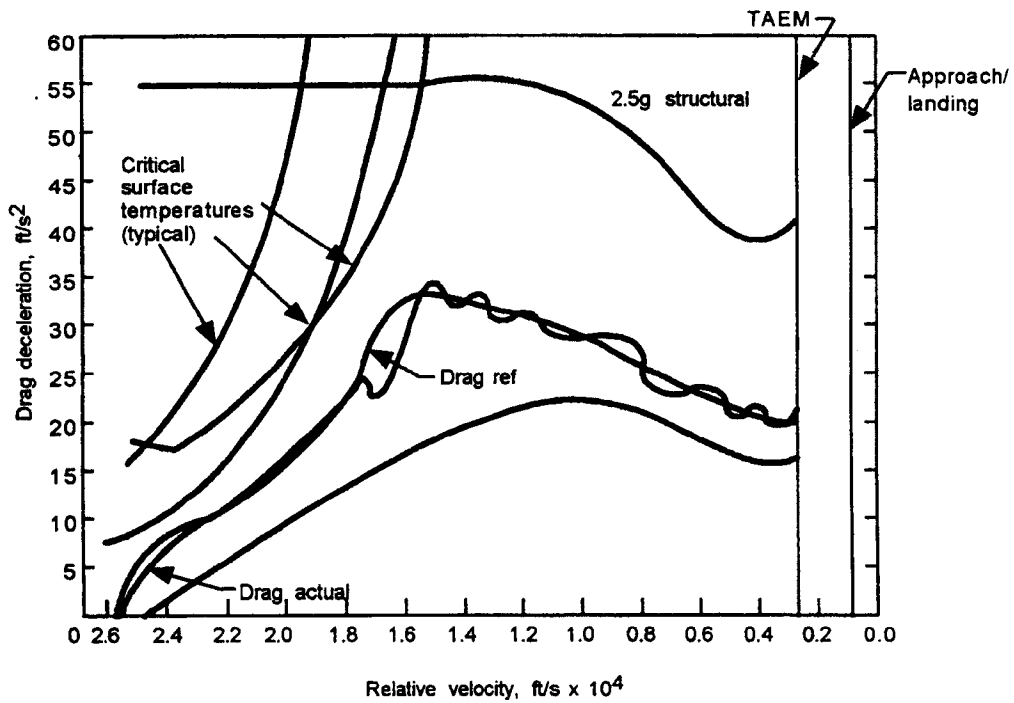

L11542\_000

Figure 2-2. Typical entry corridor and reference profile versus range and velocity

Drag deceleration is controlled by the vertical component of lift modulation, which is accomplished by changing the magnitude of the bank angle; crossrange errors are limited by bank angle reversals.

Entry guidance consists of five major phases for nominal entry versus altitude shown in figure 2-3. These five phases are described in the paragraphs following the figure.

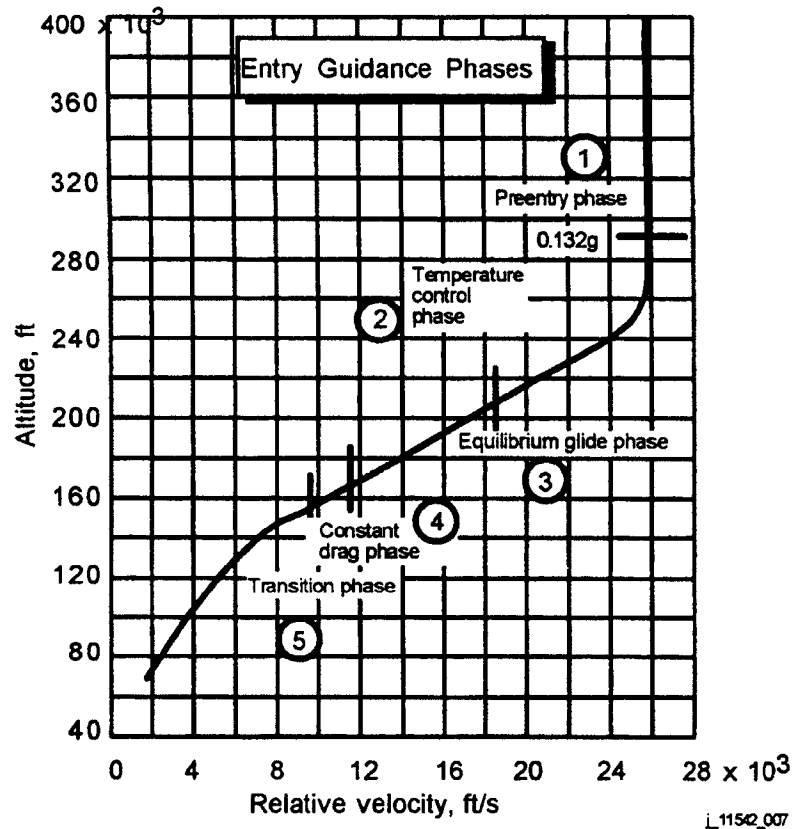

**Figure 2-3. Guidance for nominal entry**

### 2.3.1 Preentry Phase

The preentry phase is an attitude hold mode before atmospheric entry and is an open-loop ranging phase ending at 0.132g (4.25 ft/s<sup>2</sup>). Vehicle attitude is maintained by all RCS jets to hold a constant bank of 0° and 40° angle of attack through EI. At 0.132g, preentry is terminated and normally the temperature control phase begins. For the extremely short-range case, preentry will be terminated and the constant drag phase begins if the current constant drag level to reach the target is greater than the desired constant drag level. If the extremely short-range case is such that the relative velocity of the orbiter is less than an I-loaded transition phase velocity at 0.132g, the transition phase is initiated.

### **2.3.2 Temperature Control Phase**

The temperature control phase is entered at 0.132g and is designed to control the entry trajectory through pullout to a temperature profile consistent with the desired total entry profile shape and the required ranging solution. The temperature control phase consists of two quadratic drag-velocity segments that are selected to minimize surface temperatures and maintain adequate dispersion margins. Range predictions are based on the two quadratic segments. The temperature control phase is terminated and nominally the equilibrium glide phase begins when the drag reference profiles for the temperature control phase and equilibrium glide phase converge within limits and velocity is less than an I-loaded value or when the velocity is less than the temperature control/equilibrium glide boundary velocity. For the short-range case, the temperature control phase is terminated and the constant drag phase begins when the constant drag level to reach the target is greater than the desired constant drag level.

### **2.3.3 Equilibrium Glide Phase**

The equilibrium glide phase provides a profile that has lifting forces equal to gravitational forces and therefore altitude rate becomes constant. It produces an equilibrium glide trajectory consistent with the ranging solution until the trajectory intersects the constant drag ( $\sim 33 \text{ ft/s}^2$ ) trajectory required to reach the target. The equilibrium glide phase is terminated and nominally the constant drag phase begins when the desired constant drag level is reached. For the long-range case, the equilibrium glide phase transfers directly to the transition phase when the predicted velocity at the intersection of the equilibrium glide and constant drag phases is less than the transition phase initiation velocity.

### **2.3.4 Constant Drag Phase**

The constant drag phase provides a profile shape consistent with the control system limits. During this phase, a constant drag level of approximately  $33 \text{ ft/s}^2$  is commanded. Range predictions are based on a constant drag profile. The constant drag phase is terminated and the transition phase begins when relative velocity is less than the transition velocity and the drag reference is less than a predetermined drag level.

### **2.3.5 Transition Phase**

The transition phase is based on a linear drag profile (as a function of energy) that is required to null the range errors and is used to steer the orbiter to the proper TAEM interface conditions. The transition phase logic consists of a linear drag-energy profile selected by ranging requirements. Control is transferred to the TAEM guidance when the TAEM interface criterion (relative velocity < TAEM transition velocity) is met or by crew action (OPS 305 PRO).

## 2.4 TERMINAL AREA ENERGY MANAGEMENT

The TAEM phase is from the TAEM interface (approximate altitude of 82,000 ft, VREL 2500 ft/s) to the A/L capture zone (approximate altitude of 10,000 ft, 288 knots equivalent airspeed (KEAS)).

Glide range is controlled by flying to a nominal altitude and dynamic pressure reference versus range profile which can be interpreted as an energy over weight versus range profile. A typical TAEM energy plot is shown in figure 2-4. Energy control is achieved by nulling altitude errors via the normal acceleration command and by nulling dynamic pressure errors when subsonic via the speedbrake deflection command. Additional energy control is achieved by limiting the normal acceleration command based on an energy corridor formulated from a nominal energy versus range profile. Also, the normal acceleration command is constrained by limits based on dynamic pressure to inhibit the vehicle from attaining excessively high dynamic pressures and to optimize the vehicle's lift-to-drag ratio during range 'stretch' maneuvers. If considerable excess energy exists, an S-turn maneuver is executed to dissipate additional energy. If the vehicle is faced with an extreme low-energy situation, the guidance software sends a message requesting the minimum entry point (MEP) HAC location. The crew can select the straight-in HAC configuration to compensate for low energy and if further action is required, the crew can select the MEP configuration.

The inertial navigation and air data subsystems provide input data to the TAEM guidance software. A groundtrack predictor routine estimates the groundtrack distance to runway threshold. This range prediction is used to determine the altitude, altitude rate, and dynamic pressure references. A simplified diagram of TAEM guidance is shown in figure 2-5.

For all TAEM guidance phases (S-turn, acquisition, heading alignment, and prefinal), the normal acceleration command is driven by an error signal based on the reference altitude and altitude rate errors. The speedbrake command is generated from the dynamic pressure error during subsonic flight, while during supersonic flight the speedbrake command is a constant angle of deflection.

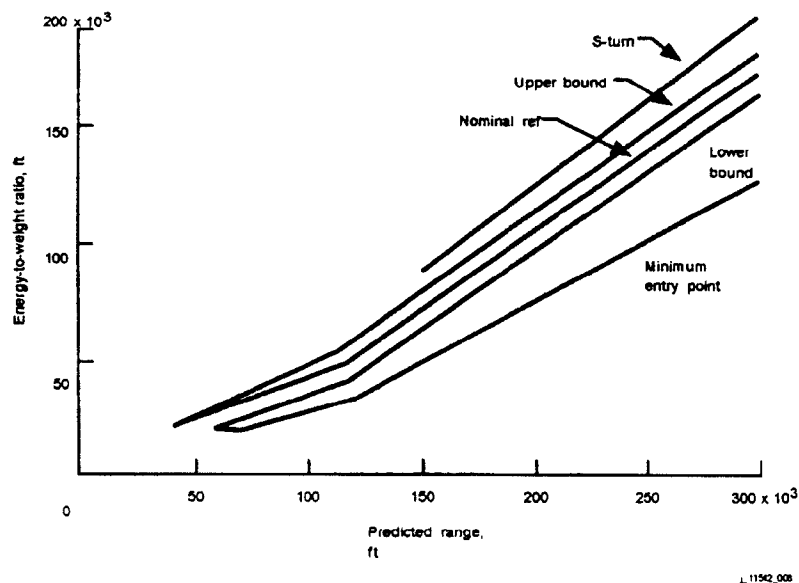
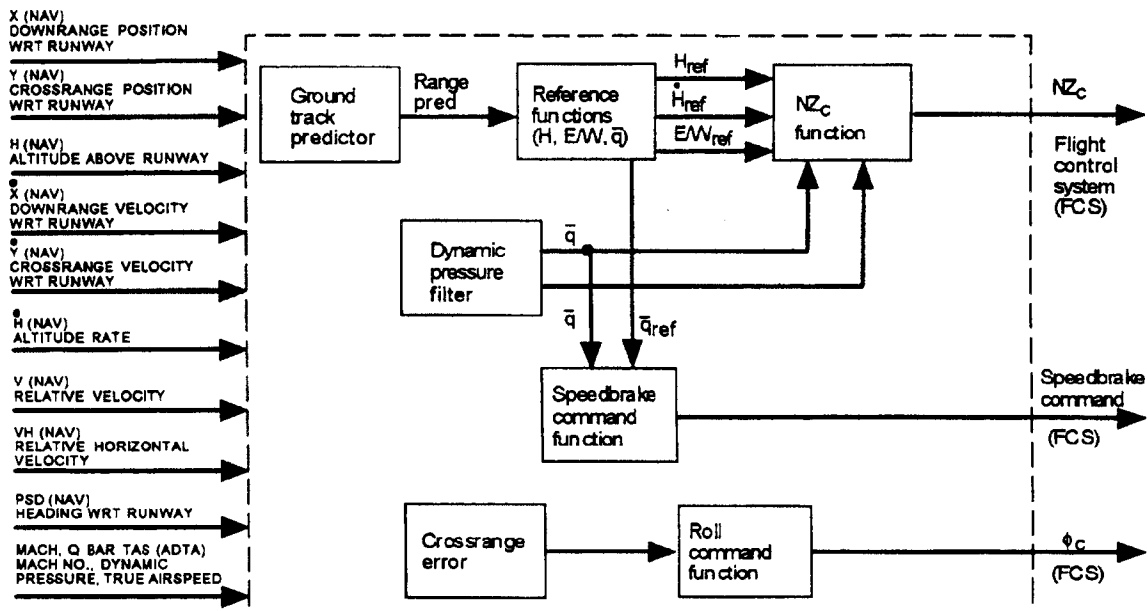

Figure 2-4. Typical TAEM energy-to-weight ratio



L 11542\_009

**Figure 2-5 Simplified TAEM guidance**

On the lateral axis, if the guidance is in the S-turn phase, a roll angle command of  $50^\circ$  ( $30^\circ$  if supersonic) is input to the FCS. If the guidance is in the acquisition phase, a roll angle command is given that is proportional to the orbiter heading deviation from tangency to the selected HAC; the HAC's are used for a final turn to align the orbiter to the runway. In the heading alignment phase, the roll angle command is generated to ensure that the orbiter performs a turn that follows the heading alignment spiral. The spiral is the ground plan projection of the cone.

In the prefinal approach phase, the roll angle command is generated from a linear combination of orbiter lateral deviation and deviation rate from the runway centerline.

The FCS provides the interface between the guidance system and the orbiter aerodynamic control surfaces. The inputs from the guidance system to the FCS are (1) normal load factor command, (2) speedbrake command, and (3) roll angle command. The commanded load factor is achieved by operating the elevons symmetrically using normal acceleration and pitch rate feedback in the FCS. The speedbrake is operated directly by the speedbrake servos in the FCS. The roll angle command is achieved by operating the elevons differentially using roll attitude and roll rate feedback in the FCS. The body flap is controlled by the autopilot to maintain elevon trim. Typical flightpath geometry for the TAEM phase is shown in figure 2-6.

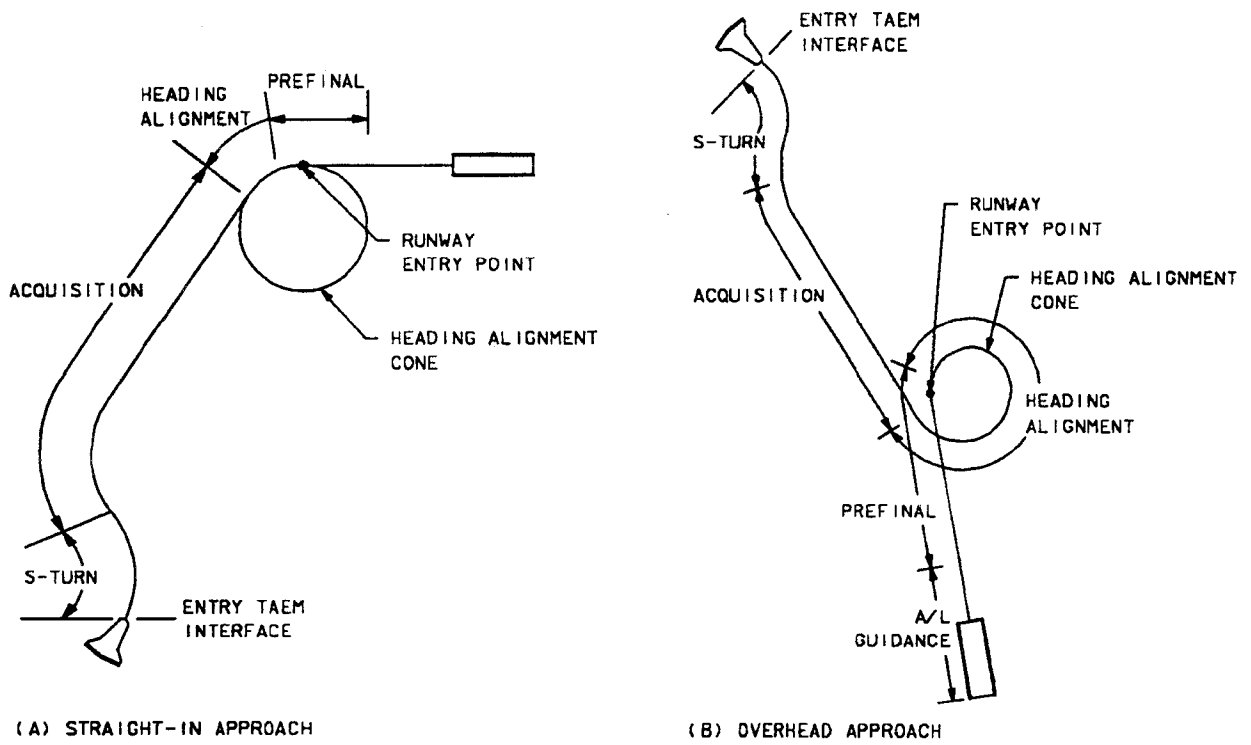

115420206. ART, 1

**Figure 2-6. TAEM guidance phase and groundtrack geometry**

## 2.5 APPROACH AND LANDING

The A/L guidance/control phase begins with completion of the TAEM guidance/control phase between 10,000 and 5000 ft and ends when the vehicle comes to a complete stop on the runway. A/L is divided into five flight phases.

- A. The TRAJECTORY CAPTURE phase starts at the A/L interface and continues to guidance lockon to the steep glide slope.
- B. In the STEEP GLIDE SLOPE phase, the orbiter is tracked in elevation and azimuth.
- C. In the FLARE AND SHALLOW GLIDE SLOPE phase, the glide angle is reduced in preparation for landing.
- D. In the FINAL FLARE phase, the sink rate is reduced to near zero for touchdown.

A typical A/L trajectory is shown in figure 2-7.

The A/L guidance automatically acquires and maintains the vehicle on an approach trajectory from TAEM guidance termination to touchdown. Normal acceleration, roll attitude, and speedbrake-position commands are issued for the FCS to maintain the specified trajectory while the vehicle is airborne. Yaw rate and wings-level roll-attitude commands are issued during flat-turn, touchdown, and rollout to track the runway centerline. During all phases, the orbiter state vector is updated by the navigation subsystem. In the approach phase, the state vector computation is augmented by additional information from the microwave landing system (MLS) data. Autoland guidance commands are issued concurrently with the FCS operating in the control stick steering (CSS) mode. A simplified diagram of A/L guidance is shown in figure 2-8.

This flight phase is discussed in detail in the Approach and Landing Flight Procedures Handbook.



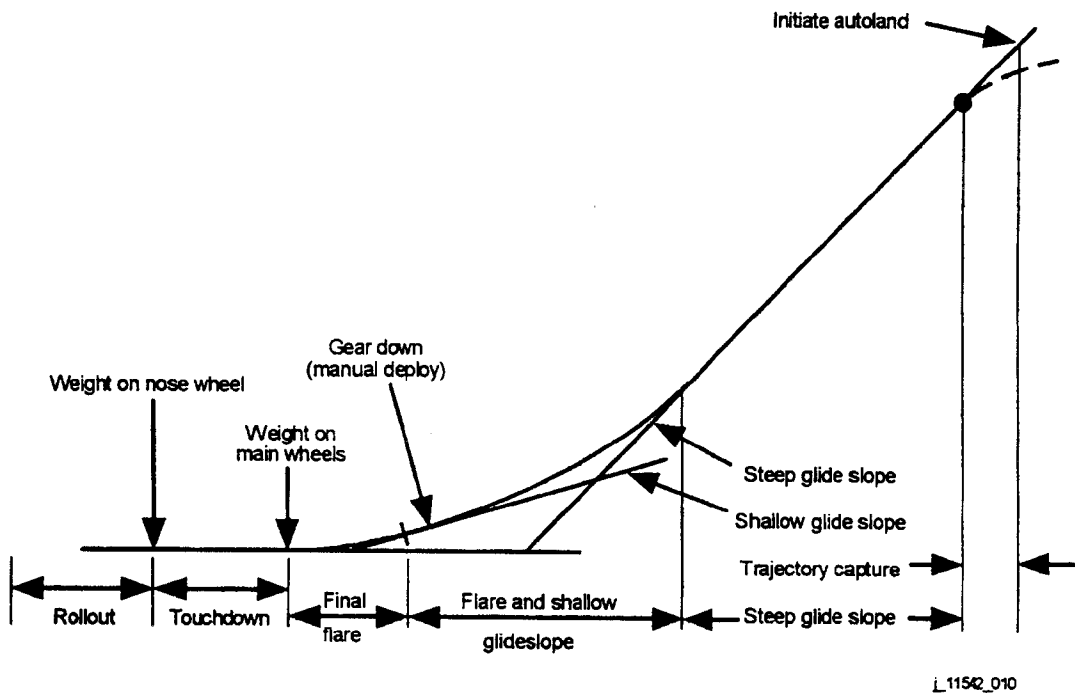

Figure 2-7. A/L longitudinal trajectory

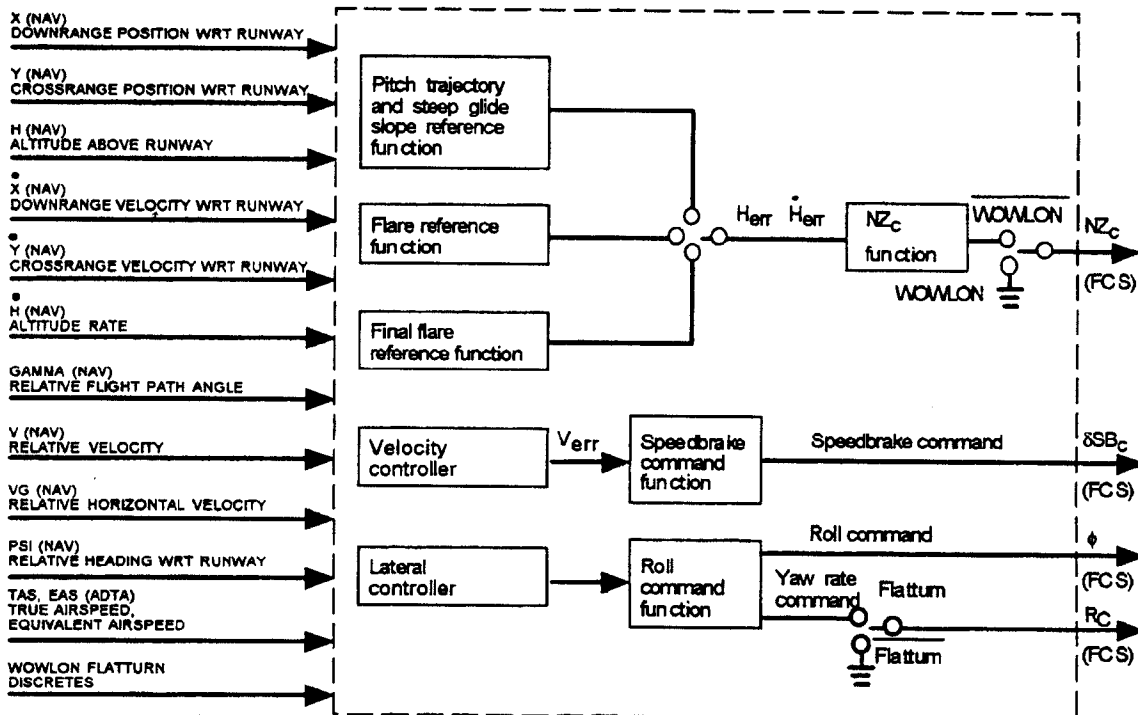

Figure 2-8. Simplified autoland guidance

## 2.6 ENTRY NAVIGATION

The entry navigation system combines inertial measurement unit (IMU) data with navigation aid data to cyclically update the vehicle state vector. The available navigation aids are drag altitude, tactical navigation system (TACAN), air data system (ADS), and microwave scanning beam landing system (MSBLS) or MLS.

Three IMU's maintain an inertial reference and provide sensed delta velocities that are used in the state vector propagation equations. A Kalman filter is used to blend the IMU delta velocities with incoming sensor data to produce the optimum state vector update.

The first sensor update to navigation (NAV) is by the drag altitude measurement. Given the IMU delta velocity measurements, the drag equation, and an assumed atmosphere, an altitude measurement can be derived and incorporated into the nav state at a time when no other external sensor data are available. Drag altitude is incorporated at a drag (deceleration) level of  $11 \text{ ft/s}^2$  (around 240,000 ft altitude) and is terminated at a navigated altitude of 85,000 ft or upon incorporation of ADS to nav. Drag altitude is considered an approximation at best and is subject to the following errors. Drag altitude uses the 1976 Standard Atmosphere model in its algorithm and any deviation to the assumed conditions can cause measurement errors. IMU platform misalignments can also cause altitude measurement errors by producing inaccurate delta velocity measurements.

TACAN provides range and bearing measurements. The nav system locks on to the first bits of TACAN data at an altitude of around 156,000 ft. TACAN data are assessed by the crew and the MCC prior to incorporating the data into the nav state. MCC assessment requires that S-band radar tracking and voice communication is established. TACAN has been traditionally incorporated into the nav state prior to 130,000 ft and is available until MSBLS acquisition or until 1500 ft when MSBLS is not available.

The ADS provides barometric altitude updates to the nav state beginning at Mach 2.5 and is available until MSBLS acquisition or until 500 ft when MSBLS is not available. ADS also provides Mach number, dynamic pressure, angle of attack, true airspeed, equivalent airspeed, and pressure altitude rate to the Guidance and Control software from Mach 2.5 until touchdown. The ADS measurements are assessed by the crew and the MCC prior to incorporation. ADS probes are deployed at Mach 5 and assessments can be made at any time following probe deployment; however, the data will not be used until Mach 2.5. The nav system does not accept ADS measurements during the Mach jump region (Mach 1.6 to 1.1) due to subsonic transition airflow transients at the probes.

And finally, MSBLS provides range, azimuth, and elevation measurements from about 20,000 ft until touchdown. MSBLS measurements are highly accurate and are heavily weighted in the nav Kalman filter.

The capability to update the onboard state vector with the ground-minus-onboard state vector deltas is also available. This capability requires that the ground solution of the vehicle state vector be converged and the onboard state vector be available to the ground via telemetry. Deltas between the ground-computed state vector and the onboard state vector are

propagated to a specified future time. These deltas are then uplinked to the vehicle in runway coordinates to correct the current onboard state.

Crew management of the onboard navigation system is contained in section 5.2 of this handbook.

## SECTION 3 ASSUMPTIONS, GUIDELINES, AND CONSTRAINTS

This section presents the generic guidelines and constraints baselined by Level II that are used in generating the entry operational profile. Flight-specific constraints are contained in the Flight Requirements Document for each flight.

### 3.1 DEORBIT

When selecting the nominal deorbit revolution, the following are considered:

- Guidance maneuvers
- Crew work/rest cycle
- Landing lighting
- Postdeorbit communication and tracking
- Entry flight test objective (FTO) phasing

The deorbit maneuver is nominally performed using two OMS engines, but because of targeting and guidance flexibility, the capability exists to downmode to a one-OMS configuration during the burn. Specifically, the TIG and target are selected so that if one OMS engine fails at TIG (or any time later in the burn), the deorbit maneuver can be successfully completed using the remaining OMS engine. The targeting is such that the delta velocity ( $\Delta V$ ) used for deorbit is the same whether the maneuver is performed with one or with two OMS engines.

In addition to satisfying the entry velocity, flightpath angle, and range requirements, the deorbit maneuver may include an out-of-plane component to achieve an acceptable orbiter E1 c.g. and weight.

### 3.2 OPERATIONAL CONSTRAINTS

Maximum aft RCS propellant consistent with mission objectives and c.g. considerations is maintained for descent control. The redline for nominal deorbit is the amount necessary to accomplish the descent and the greater of either waveoff or 1-day extension of programmed test inputs (PTI's).

During atmospheric descent, the orbiter c.g. is maintained between 1076.7 and 1109 inches (65.0 and 67.5 percent) in the longitudinal direction and equal to or less than 1.5 inches laterally. These c.g. constraints must be met with allowances for c.g. uncertainties. Postdeorbit forward RCS dumps are allowed for nominal, abort-once-around (AOA), and abort-to-orbit (ATO) c.g. control.

The orbiter entry weight is minimized by reducing remaining consumables, such as OMS and RCS propellant, consistent with reasonable operations techniques.

### 3.3 DESCENT PROFILE

The environmental model used in determining the nominal descent profile is the appropriate mean monthly atmospheric model as defined by the Four-D Global Reference Atmospheric Model for orbit inclination  $\leq 57^\circ$ . The environmental model for the nominal profile simulation does not include winds.

The descent profile uses standard I-load sets that are designed to accommodate the range of weight and balance data expected on operation flights.

For nominal end of mission (EOM), transoceanic abort landing (TAL), AOA, and ATO, the angle-of-attack profile during entry is the same. Alpha is held at  $40^\circ$  until around Mach 14, then it is ramped down to be  $12^\circ$  to  $15^\circ$  at TAEM interface.

The entry profile is shaped to achieve a balance between the thermal protection system (TPS) surface and bondline temperatures and orbiter structural temperatures. This balance includes allowances for aerodynamic heating and trajectory dispersions. Selection of the entry profiles includes consideration of sonic boom ground-level overpressures.

The profiles for EOM, AOA, ATO, TAL, and glide return to launch site (GRTLS) are designed for an overhead approach to the runway. Additionally, the nominal descent profile is designed so that runway redesignations and HAC downmoding can be accomplished.

The descent profile is shaped to conform with the following dynamic pressure constraints (table 3-1).

**Table 3-1. Dynamic pressure constraints**

| Mach                        | Dynamic pressure<br>psf |       | Constraint     | Comment  |
|-----------------------------|-------------------------|-------|----------------|----------|
|                             | NOM                     | GRTLS |                |          |
| $M > 5.0$                   | 300                     | (375) | Structural     | Constant |
| $5.0 \geq M \geq 2.5$       | 342                     | (375) | Flight control | Constant |
| (3.2) $2.5 \geq M \geq 1.0$ | 300                     | (300) | Guidance       | Constant |
| $M < 1.0$                   | 340                     | (340) | Guidance       | Constant |

The minimum dynamic pressure is restricted to a value that keeps the vehicle's lift/drag (L/D) on the front side of the L/D curve.

Additionally, this dynamic pressure allows the TAEM/A/L interface constraints to be met even in severe (March sector 3) headwinds. The energy control provides conditions suitable for the initiation of a manual approach.

Aeromaneuvers are not executed during the following conditions:

- Guidance MM switching
- Initial bank maneuver to capture the drag profile
- Bank reversals, including damping of phugoid after completion of the maneuver
- Aborts (AOA is an exception for auto PTI's)

The GRTLS angle of attack for the alpha recovery phase is 50° to optimize the pullout angle of attack, and the normal load factor command for the load relief phase will not exceed 2.2g. The pitch rates during the alpha recovery phase are limited to 2 deg/sec.

The GRTLS profile is shaped to achieve benign atmospheric entry conditions by minimizing the max  $q$  (<375 psf) and by optimizing the pullout angle of attack experienced during the load relief phase.

A/L is initiated at an altitude of approximately 10,000 ft and 285 KEAS. The steep (outer) glide slope is nominally 20°, with 18° used for the heavy weight vehicle (weight >220,000 lb). The nominal aim point for the outer glide slope will be 7500 ft. When touchdown using the nominal aim point is predicted to be less than 1000 ft down the runway, the close-in aim point is selected which is 6500 ft behind the runway threshold. The flare to the shallow (inner) glide slope is initiated at an altitude of 2000 ft. The inner glide slope angle is 1.5°, with a runway aim point of 1000 ft. The nominal main gear touchdown point is between 2500 and 3000 ft. The nominal touchdown speed is designed to provide a 3- to 5-second margin above tailscrape for worst-on-worst combinations of low-energy dispersion. The body flap is retracted at an altitude of 10,000 ft. The speedbrake will make corrections at 3000 ft and 500 ft to make the planned touchdown point.

### 3.4 LANDING SITES AND LANDING CONSTRAINTS

Daylight landings are preferred; however, night landings are acceptable to satisfy mandatory payload requirements or operational considerations. Preferred lighting conditions at landing are as follows:

- Planned return day and 1-day flight extension to the prime landing site - land between sunrise and sunset.
- All other return opportunities - land between 15 minutes prior to sunrise and 15 minutes after sunset (ref. PRCBD S21040).

## SECTION 4 DEORBIT OPERATIONS

### 4.1 DEORBIT BURN EVENTS

#### 4.1.1 Deorbit Procedures Sequence

The sequence of deorbit events referenced to TIG or to EI is listed in table 4-1. Each event listed in the table is discussed at length in the following pages. Each page includes an event name and onboard cue, the proper crew display for monitoring the event, the crew action required, and a discussion of the event.

*Table 4-1. Sequence of deorbit events*

| Time (min)         | Event   | Discussion,<br>page      |                  |
|--------------------|---|--------------------------|------------------|
| TIG - 46           | Final Deorbit Update/Uplink                     | 4-2                      |                  |
|                    | SEL Atmosphere                                  | 4-7                      |                  |
|                    | OMS TVC Gimbal Check                            | 4-8                      |                  |
|                    | APU Prestart                                    | 4-9                      |                  |
|                    | Horizontal Situation Configuration              | 4-10                     |                  |
| TIG - 25           | OMS (RCS) Burn Preparation                      | 4-11                     |                  |
|                    | Vent Door Close                                 | 4-12                     |                  |
|                    | Deorbit Update/Uplink (if required)             | 4-13                     |                  |
|                    | GNC OPS 302 PRO                                 | 4-14                     |                  |
| TIG - 15           | GO/NO-GO for Deorbit Burn                       | 4-15                     |                  |
|                    | Maneuver to Deorbit Burn Attitude               | 4-16                     |                  |
| TIG - 5            | Single APU Start                                | 4-17                     |                  |
|                    | Deorbit Burn                                    | 4-18                     |                  |
|                    | OMS (Deorbit Burn) Cutoff                       | 4-19                     |                  |
|                    | OMS/RCS Postburn Reconfiguration                | 4-20                     |                  |
|                    | Underburn                                       | 4-21                     |                  |
|                    | Postburn Status                                 | 4-22                     |                  |
|                    | GNC, OPS 303 PRO                                | 4-23                     |                  |
|                    | Maneuver to EI - 5 Attitude                     | 4-24                     |                  |
|                    | OMS Gimbal Powerdown                            | 4-25                     |                  |
|                    | EI - 20   | Secondary Actuator Check | 4-26             |
|                    |   | EI - 18                  | Forward RCS Dump |
| Entry Switch Check | 4-30  |                          |                  |
| EI - 13            | Remaining APU's Start                           | 4-31                     |                  |
|                    | SSME Hydraulic System Repressurization          | 4-32                     |                  |
| EI - 11            | Hydraulic Fluid Thermal Conditioning (MCC call) | 4-33                     |                  |
|                    | Burn Report                                     | 4-34                     |                  |
|                    | State Vector Change                             | 4-35                     |                  |
|                    | G-Suit Inflation                                | 4-36                     |                  |

| <u>EVENT</u>                       | <u>CUE</u>                       | <u>DISPLAY</u>   |
|------------------------------------|----------------------------------|------------------|
| <u>Final Deorbit Update/Uplink</u> | Seat ingress complete<br>MIL AOS | DEORB MNVR COAST |

### CREW ACTION

1. UPLINK - ENA (panel C3) to allow uplink (required for OPS 1 and OPS 3).
2. Commander and pilot copy voice updates to the DEL PAD and OMS PRPLT PAD while the ground uplinks primary avionic software system (PASS) and backup flight system (BFS) state vectors and targets, and a BFS GYRO/ACCEL (if required) during coverage at Merritt Island (MIL) and Bermuda (BDA).
3. On MCC GO:  
Execute the LOAD (item 22) and the TIMER (item 23) on the deorbit maneuver (DEORB MNVR) display.
4. Check PASS/BFS targeting results per MNVR PAD.

### DISCUSSION

After seat ingress, a deorbit target (normally for PEG 4 rather than PEG 7) is loaded by keyboard execution of the LOAD item on the DEORBIT MNVR COAST (EXEC) display in MM 301 (or MM 302). The target input parameters can be uplinked from the ground or input to the display by the crew. Execution of the LOAD item affects onboard calculated results of target parameters of inertial attitude, targeted apogee altitude (HA) and perigee altitude (HP), time to free fall (TFF), range from entry interface (REI),  $\Delta VTOT$ , body velocity remaining (VGOs), and time to go (TGO) and provides fly-to attitude direction indicator (ADI) error needles for the burn attitude. Execution of the TIMER item starts the CRT timer counting down to the TIG shown on the DEORB MNVR display.

The DEORB MNVR PAD (figure 4-1) is used to validate the uplinked target input by providing expected results of the input.

The OMS PRPLT PAD (figure 4-2) provides crossfeed cues in either  $\Delta VTOT$  or percent of OMS quantity, or both, that are applicable to the deorbit burn engine configuration and propellant situation expected at ignition.

The DEL PAD (figure 4-3) provides cues to the crew on whether to stop or continue the deorbit burn and when to expect entry events.

A 'reasonable' deorbit target solution can be verified by inspecting the displayed guidance-calculated values of  $\Delta VTOT$ , TGO, and the body VGO's (x, y, z), as follows.

- For two OMS engines burns,  $2 \times TGO$  (sec) is approximately equal to  $\Delta VTOT$  (fps)
- For one OMS engine burn, TGO (sec) is approximately equal to  $\Delta VTOT$  (fps)



**DEORBIT MNVR PAD**

**OMS BOTH** 1

L 2

R 3

**RCS SEL** 4

**TV ROLL** 5

**TRIM LOAD**

P 6  ( )  .

LY 7  ( )  .

RY 8  ( )  .

WT 9

TIG 10   /   :   :   .

**TGT PEG4**

C1 14

C2 15  ( )  .

HT 16    .

GT 17    .

PRFLT 18  ( )

**BURN ATT**

R 24

P 25

Y 26

REI

TXX   :

$\Delta$ VTOT    .

TGO   :

VGO X  ( )   .

VGO Y  ( )   .

VGO Z  ( )   .

HA   HP

TGT   ( )

NOTES

**RCS ICNCT:**

L OMS → RCS

R OMS → RCS

NONE

Figure 4-1. MNVR PAD

| BURN CARD                              | OMS PRPLT PAD   |
|--|---|
| DEORBIT<br>BURN<br>(2 ENG)             | OMS ENG FAIL:<br>XFEED QTY CUE <input type="text"/> <input type="text"/> %L <input type="text"/> <input type="text"/> %R  |
| DEORBIT<br>BURN<br>(1 ENG)             | OMS XFEED RETURN at ΔVTOT = <input type="text"/> <input type="text"/> <input type="text"/><br>or <input type="text"/> <input type="text"/> at <input type="text"/> <input type="text"/> %   |
| DEORBIT<br>BURN<br>(RCS)               | RCS I'CNCT TK SW at ΔVTOT = <input type="text"/> <input type="text"/> <input type="text"/><br>OMS PRPLT LOW: ΔVTOT = <input type="text"/> <input type="text"/> <input type="text"/>   |
| UNBALANCED<br>PRPLT<br>DEORBIT<br>BURN | INITIAL CONFIG: <input type="checkbox"/> TK ISOLs - CL<br>While feeding 2 OMS from 1 POD:<br>OMS PRPLT FAIL:<br>Interconnect <input type="checkbox"/> OMS to RCS<br>THC + X for <input type="text"/> : <input type="text"/> <input type="text"/><br>If <input type="checkbox"/> (XFEED) ENG '↓'<br>If <input type="checkbox"/> (STRAIGHT FEED) ENG '↓'<br>OMS ENG FAIL:<br>At ΔVTOT = <input type="text"/> <input type="text"/> <input type="text"/><br>or <input type="text"/> <input type="text"/> at <input type="text"/> <input type="text"/> %<br><input type="checkbox"/> TK ISOL (two) - OP<br><input type="checkbox"/> TK ISOL (two) - CL<br>Return to 2 ENG, 2 POD FLOW:<br>At ΔVTOT = <input type="text"/> <input type="text"/> <input type="text"/> <input type="checkbox"/> TKISOLs - OP<br>OMS ENG FAIL: (XFEED CUE)<br>OMS QTY <input type="text"/> <input type="text"/> %L or <input type="text"/> <input type="text"/> %R |
| DEORBIT<br>BURN<br>(MIXED<br>XFEED)    | FEED FROM GOOD POD:<br>At ΔVTOT = <input type="text"/> <input type="text"/> <input type="text"/><br>or <input type="text"/> <input type="text"/> at <input type="text"/> <input type="text"/> %<br><input type="checkbox"/> OMS He PRESS (two) - OP<br><input type="checkbox"/> TK ISOL (two) - OP<br><input type="checkbox"/> XFEED (two) - OP<br>Secure <input type="checkbox"/> OMS<br>OMS PRPLT LOW:<br>AFT RCS RECONFIG at ΔVTOT = <input type="text"/> <input type="text"/> <input type="text"/><br>OMS ENG FAIL:<br><input type="checkbox"/> OMS He PRESS (two) - OP<br><input type="checkbox"/> TK ISOL (two) - OP<br><input type="checkbox"/> OMS XFEED (two) - CL   |

2-2

ENT/ALL/GEN D

Figure 4-2. OMS PRPLT PAD



- For RCS burns (four +X jets), TGO (sec) is about 1.7 times  $\Delta VTOT$  (fps)
- The nominal deorbit burn  $\Delta V$  requirements (STS-1, Cycle 2) were as follows when the burn was optimized for RCS

| Burn mode | In-plane $\Delta V$ ,<br>fps | $\Delta VTOT$ ,<br>fps | Total OMS<br>propellant, lb |
|-----------|------------------------------|------------------------|-----------------------------|
| 2 OMS     | 280.5                        | 292.4                  | 5600                        |
| 1 OMS     | 271.9                        | 292.4                  | 5600                        |
| +X RCS    | 268.5                        | 268.5                  | 6035                        |

EVENT

CUE

DISPLAY

SEL Atmosphere

OVERRIDE

CREW ACTION

Select the atmosphere for drag processing according to the inclination of the flight and the month of the year for the entry.

**G51**

**SEL ATMOSPHERE:**

incl ≤ 50° ITEM 22 EXEC

incl > 50° SEL ITEM NR (table)

| Hemi      | Jan | Feb | Mar | Apr | May | Jun | Jul | Aug | Sep | Oct | Nov | Dec |
|-----------|-----|-----|-----|-----|-----|-----|-----|-----|-----|-----|-----|-----|
| N<br>Desc | 23  | 23  | 23  | 23  | 22  | 24  | 24  | 24  | 22  | 23  | 23  | 23  |
| S Asc     | 24  | 24  | 22  | 23  | 23  | 23  | 23  | 23  | 23  | 23  | 22  | 24  |
| N Asc     | 22  |     |     |     |     |     |     |     |     |     |     |     |
| S<br>Desc |     |     |     |     |     |     |     |     |     |     |     |     |

DISCUSSION

The OVERRIDE display is initialized with item 22 (NOM atmosphere) selected, so crew action is not required unless the inclination is greater than 50°.

If the inclination is greater than 50° the crew must select item 23 (for 'cold' atmosphere) or item 24 (for 'hot' atmosphere) according to the above table that is shown in the Entry Checklist.

The 'HEMI' column of the table contains choices of N, S, Asc and Desc. The 'N' or 'S' refers to the hemisphere in which the landing site is located, thus for orbiter operations the choice has always been 'N' because all landing sites (EDW, NOR, and KSC) have been in the northern hemisphere. The 'Asc' or 'Desc' choice is made based on the approach to the landing site following the deorbit burn; i.e., 'Asc' would be a landing site approach from south to north and 'Desc' would be an approach from north to south.

EVENTCUEDISPLAYOMS TVC Gimbal Check

DEORB MNVR COAST

CREW ACTION

1. Select SEC L and R gimbal systems (EXEC ITEMS 30 and 31).
2. Perform OMS TVC gimbal check (EXEC ITEM 34).
3. Monitor for down arrows or M's.
4. Select L and R PRI gimbal systems (EXEC ITEMS 28 and 29).
5. Perform OMS TVC gimbal check (EXEC ITEM 34).
6. Monitor for down arrows or M's.
7. Select good gimbal if down arrows or M's.

DISCUSSION

The OMS TVC gimbal check is performed identically for 2 ENG and 1 ENG burns.

During the gimbal test, the crew can verify indicated motion of the gimbals from displayed values, but they have to depend on RM down arrows to indicate if proper pitch and yaw values have not been attained (i.e., gimbal check failed). Usually, the gimbal test is monitored by the MCC for proper performance. The gimbal check is performed during S-band data coverage.

EVENTCUEDISPLAYAPU PrestartCREW ACTION

1. Check or configure the appropriate switches on panels R2 and R4 so that the APU's can be started with a minimum number of switches.
2. Cycle the APU FUEL TK VLV's.

DISCUSSION

The only switch position in this procedure that is undesirable if the APU's are not started and the deorbit burn is not performed is the HYD MAIN PUMP PRESS LOW. The LOW position draws power and the switch should be returned to NORM if the deorbit burn is going to be accomplished one or more orbits later.

The APU FUEL TK VLV's are cycled to check the ready-to-start talkback before the loss of S-band coverage. The expected talkback is gray when the fuel tank valves are opened. A barberpole talkback indicates that an APU is not ready to start because of pump pressure, H2O boiler controller, fuel valves, gas generator (GG) temperature, or turbine speed. Knowledge of a problem may allow the ground to advise the crew of a solution and avoid landing one orbit or 1 day later than desired.

| <u>EVENT</u>                              | <u>CUE</u> | <u>DISPLAY</u> |
|---|------------|----------------|
| <u>Horizontal Situation Configuration</u> | HSD        |                |

#### CREW ACTION

Check the HSD configuration in the PASS and BFS.

#### DISCUSSION

The Horizontal Situation Configuration has the crew check the item entries on SPEC 50 to ensure that it is properly configured. Provisions are made for off-nominal X c.g. or BFS engage.

Air data transducer assembly (ADTA) data to guidance and control (G&C) are initialized to inhibit (INH) in the PASS and to AUTO in the BFS. The inhibited ADTA data are analyzed during entry before being set to AUTO in the PASS. Changes to the BFS HSD during entry are required to keep it consistent with the PASS. If the PASS fails before ADTA data have been incorporated, the BFS HSD should be configured like the PASS and the inhibited ADTA data set to AUTO after analysis.

A check of the appropriate elevon and filter schedule on SPEC 51 (OVERRIDE) is also provided for both PASS and BFS. Should an off-nominal c.g. be encountered due to a returning payload, the appropriate body-bending filter may also be selected on SPEC 51 at this time. The AUTO elevon schedule is nominally selected, while the fixed elevon schedule may be selected for entry detailed test objective (DTO) purposes.



| <u>EVENT</u>                      | <u>CUE</u> | <u>DISPLAY</u> |
|-----------------------------------|------------|----------------|
| <u>OMS (RCS) Burn Preparation</u> | None       | Panel talkback |

### CREW ACTION

Verify the switch positions on panels 07 and 08 for an OMS deorbit burn or configure the valves on panels 07 and 08 for an RCS deorbit burn.

### DISCUSSION

For the nominal deorbit burn, the OMS propellant is planned to be burned in equal amounts from each OMS pod using both OMS engines. However, possible propellant feed configurations for the propulsive modes are as follows:

- 2 ENG - Left pod feeds left OMS engine; right pod feeds right OMS engine.
- 1 ENG - 'Good' OMS engine uses the failed engine's propellant initially via a crossfeed, then is reconfigured back to straightfeed during the burn to use its own propellant.
- RCS - Both left and right aft RCS pods use left OMS propellant initially (arbitrary choice), then right OMS propellant for the second part of the burn.

Unbalanced PRPLT - The burn is started with both of the engines being supplied by the 'heavy' pod. When the imbalance is eliminated, the engines are returned to the normal feed condition to complete the burn. This method would be used if both OMS engines are operable and the postburn Y c.g. would have been too great if the normal 2 ENG burn was used.

Mixed XFEED - If a propellant failure (tank or line) occurs in the oxidizer or fuel system of one pod, that pod's OMS engine is considered failed and the burn is started with the other OMS engine, using oxidizer from one pod and fuel from the other. During the burn, the propellant system can be manually reconfigured, if desired, to feed the engine from its own pod so that the Y c.g. is balanced as much as possible.

Burn preparation procedures require different valve/switch positions depending on whether the burn is planned to be accomplished by 2 ENG, 1 ENG, or RCS. The intent of the deorbit burn preparation is to configure the OMS and RCS plumbing so that the preburn and downmode configurations are as similar as possible and to minimize the number of valves/switches that must be changed when required to downmode or crossfeed during a burn. These steps are shown in the combined use of the deorbit cue cards, which are discussed in detail in section 4.3, DEORBIT BURN CUE CARDS.

EVENTCUEDISPLAYVent Door Close

TIG - 25

The vent doors are closed by the crew's execution of item 44 on the GNC OVERRIDE display. The vent doors are closed for entry except when a leak has occurred in the OMS or RCS propellant tanks or the OMS or RCS helium-pressurization systems.

| <u>EVENT</u>                                  | <u>CUE</u>  | <u>DISPLAY</u>   |
|---|---|------------------|
| <u>Deorbit Update/Uplink</u><br>(If Required) | ACN AOS at ~TIG - 25<br>(last uplink coverage<br>before deorbit burn) | DEORB MNVR COAST |

CREW ACTION

1. UPLINK - ENA (panel C3) to allow possible uplink.
2. Commander and pilot copy voice updates to the DEL PAD and OMS PRPLT PAD if changed from the final update, while the ground uplinks PASS and BFS state vectors and targets if a change is required from the final targeting data.
3. On MCC GO:  
Execute the LOAD (item 22) and the TIMER (item 23) on the DEORB MNVR display.

Note: The LOAD and TIMER items should be executed after each new state vector uplink or after each new guidance target uplink to provide the best match of state vector and target.

4. Check PASS and BFS targeting results per MNVR PAD.

DISCUSSION

MCC changes to the deorbit target from the final uplink/update are not expected, but the LOAD should be executed as discussed in the preceding note.

EVENT

CUE

DISPLAY

GNC, OPS 302 PRO

CRT

DEORB MNVR COAST

CREW ACTION

GNC, OPS 302 PRO

DISCUSSION

The transition from MM 301 to MM 302 is not time critical except that it must be completed before deorbit TIG because the OMS engine's ignition in OPS 3 occurs in MM 302 only.

EVENTCUEDISPLAYGO/NO-GO for Deorbit BurnACN coverage before  
deorbit burn  
(TIG - 22 to TIG - 16)CREW ACTION

Agree with MCC on the following:

1. Deorbit target data (MNVR PAD)
2. Entry and landing data (DEL PAD)
3. OMS PRPLT XFEED cues (OMS PRPLT PAD)
4. OMS and RCS systems status
5. APU fuel quantity and APU activation times
6. Adjustments to entry procedures as required

DISCUSSION

The GO/NO-GO decision for the deorbit burn is expected about 20 minutes before deorbit TIG.

| <u>EVENT</u>                             | <u>CUE</u>   | <u>DISPLAY</u>    |
|--|--|-------------------|
| <u>Maneuver to Deorbit Burn Attitude</u> | TIG - 15 and final deorbit target loaded and checked | DEORBIT MNVR EXEC |

CREW ACTION

At TIG - 15, maneuver from the IMU align attitude to the deorbit burn inertial attitude (shown on the DEORB MNVR display). For flights not requiring a thermal or other special attitude before deorbit, the deorbit burn attitude may be achieved much earlier if the attitude provides sufficient communications through tracking and data relay satellite (TDRS) E and TDRS W.

Maneuvering to the deorbit burn attitude is accomplished by item execution or by use of the rotational hand controller (RHC). The fly-to error needles null at the deorbit burn attitude regardless of the position of the ADI ATTITUDE switch. The attitude shown on the DEORB MNVR display is inertial attitude.

The proper burn attitude can also be determined by looking at the ADI in local vertical/local horizontal (LVLH). Roll is 0°; yaw is 0° for a two-OMS or RCS burn and  $\pm 12^\circ$  for a one-OMS burn; pitch is approximately  $180^\circ \pm 20^\circ$ .

Finally, the proper burn attitude can be confirmed by looking on the VGO parameter on the Deorbit Maneuver Exec display.

The following table shows the approximate fractions of the total  $\Delta V$  that should be present for each component of VGO for all possible burns.

|                  | 2 OMS     | L/R OMS   | +XRCS     | -XRCS     |
|------------------|-----------|-----------|-----------|-----------|
| VGO <sub>x</sub> | +1        | +1        | +1        | -1        |
| VGO <sub>y</sub> | 0         | $\pm 1/5$ | 0         | 0         |
| VGO <sub>z</sub> | $\pm 1/4$ | $\pm 1/4$ | $\pm 1/6$ | $\pm 1/3$ |

Once the deorbit burn attitude is attained, adjustments to the attitude should be avoided to conserve RCS propellant unless the target input is changed.

EVENTCUEDISPLAYSingle APU Start

Deorbit TIG - 5

BFS, SM SYS SUMM 2

CREW ACTION

Perform APU start

DISCUSSION

One APU is started at TIG - 5 and left in low pressure. The remaining APU's are started at EI - 13, at which time all three are taken to high pressure. The APU starting sequence is provided to the crew on the DEL PAD.

| <u>EVENT</u>        | <u>CUE</u>                      | <u>DISPLAY</u>   |
|---------------------|---------------------------------|--|
| <u>Deorbit Burn</u> | EXEC flashes<br>at TIG - 15 sec | DEORB MNVR EXEC<br>ADI   |
|                     | TIG at 0 on<br>CRT timer        | ADI ERROR NEEDLES<br>BFS, GNC SYS SUMM<br>OMS PRESS Pc<br>OMS QTY<br>C&W |

### CREW ACTION

1. Perform the deorbit burn using either the Deorbit Burn (2 ENG), the Deorbit Burn (1 ENG), the Deorbit Burn (RCS), the Unbalanced PRPLT Deorbit Burn, or the Deorbit Burn (MIXED XFEED) cue card with the Deorbit Burn Monitor Card.
2. Monitor ADI/ADI error needles for attitude control, OMS gimbal failure, and OMS engine failure.
3. Monitor OMS PRESS Pc (panel F7) and CRT displays for OMS engine failure, OMS system failure, and gimbal failure.

### DISCUSSION

Normally the deorbit burn is flown in AUTO using both OMS engines. The MANUAL OMS TVC is a proportional 0 to 2 deg/sec in all three axes. Attitude deadbands for OMS burns are 5°, 100°, and 100° in roll, pitch, and yaw, respectively. The rate upper deadband is 2.05 deg/sec in all three axes. If the deadband in attitude or rate is exceeded during the burn, the OMS TVC gimbal system will be assisted by the RCS. For a two-OMS burn, the OMS engines are gimballed to control the attitude in all three axes. For a one-OMS burn, the one operating OMS engine is used for pitch and yaw control, and roll must be controlled by the RCS. For an RCS burn, the attitude deadband in all three axes is 3° (with digital autopilot (DAP) in discrete). The RCS burn is flown manually using the RHC for attitude control and the THC for thrusting with the four +X aft RCS jets.

If an OMS engine fails during the deorbit burn, the OMS ENG switch of the failed engine must be repositioned from ARM/PRESS (or ARM) to OFF. The failed engine must be taken to OFF to obtain the proper guidance parameters and to reposition the ADI error needles for the remaining OMS engine or for the RCS engines if the second OMS engine fails. OMS propellant crossfeed cues are voiced to the crew before the burn for the configuration in which the burn is started. These cues are given in  $\Delta$ VTOT or OMS gauge percent, or both, depending on the OMS/RCS configuration. For a detailed discussion of the deorbit burn, see section 4.3, DEORBIT BURN CUE CARDS.



| <u>EVENT</u>                     | <u>CUE</u>                                      | <u>DISPLAY</u>  |
|----------------------------------|---|-----------------|
| <u>OMS (Deorbit Burn) Cutoff</u> | TGO = 0<br>$\Delta$ VTOT = 0<br>CUR HP = TGT HP | DEORB MNVR EXEC |

CREW ACTION

1. Position OMS ENG switches to OFF following purge or as backup for OMS engines failing to cut off when commanded or anticipated.
2. Release THC if RCS deorbit burn or RCS completion of deorbit burn.
3. Trim burn residuals to less than 2 fps in each axis for the normal steep target and to less than 0.5 fps for a shallow target.

DISCUSSION

If the OMS engines cut off normally when the target has been achieved, a sufficient amount of time (usually 2 seconds) is allowed for purge completion before repositioning the OMS ENG switches from ARM/PRESS to OFF. The purge is the normal followup for OMS engines cutoff. Purging is mandatory between burns only if sufficient time has not elapsed since the previous burn.

Positioning the OMS ENG switches to OFF is the backup for failure of the engines to cut off when anticipated. The crew will be monitoring the current HP approaching the targeted HP, TGO approaching zero, and  $\Delta$ VTOT approaching zero. If TGO goes to zero and the OMS engines do not cut off (chamber pressure zero and engine valves closed), the OMS engine switches are repositioned from ARM/PRESS to OFF to stop the overburn.

If cutoff occurs prematurely and insufficient OMS propellant exists to achieve the  $\Delta$ VTOT remaining, an underburn condition will result. This underburn condition can be corrected to some extent by aft reaction control system (ARCS), forward reaction control system (FRCS), and the use of prebank from the prebank table. For more information, see the underburn discussion in this section.

EVENTOMS/RCS PostburnCUEReconfiguration  
complete and trimmedDISPLAYCREW ACTION

Reposition or verify the positions of OMS and RCS switches/valves.

DISCUSSION

Following a nominal deorbit burn or a deorbit burn in which engine or propellant systems failures have been encountered, the crew must reposition or verify the positions of the OMS and RCS switches and valves to the desired entry configuration.

| <u>EVENT</u>     | <u>CUE</u>   | <u>DISPLAY</u>                      |
|------------------|--|-------------------------------------|
| <u>Underburn</u> | DELTA V remaining<br>and TGT HP not<br>equal to CUR HP | DEORB MNVR EXEC<br>DEORB MNVR COAST |

### CREW ACTION

Determine the delta HP by subtracting the TGT HP from the CUR HP on the DEORB MNVR display and use this delta HP value in the PREBANK TABLE to find the magnitude of the recovery prebank. For deorbit burns to Edwards, the option of redesignating to Northrup may be available. Redesignating to Northrup will require less prebank.

### DISCUSSION

The UNDERBURN backout box in the Entry Checklist is provided to determine the magnitude of the recovery prebank necessary to establish the proper trajectory to the intended landing site. Prebank (either planned or unplanned) is the roll or bank angle that is manually implemented in MM 304 before EI and is held until closed loop guidance. This prebank does not change the REI because this range was established at EI when the prebank becomes effective. The prebank does, however, 'slice' the orbiter through the atmosphere at a steeper angle to attain the proper trajectory for the intended landing site. The penalty for the use of prebank is increased orbiter surface temperatures.

Recovery prebank is used when the deorbit underburn results in an REI that is smaller than it would have been with a complete burn; that is, EI (400,000-ft altitude) will be reached later and closer to the landing site than was predicted. A planned or targeted prebank is used when insufficient OMS propellant exists to plan a steep deorbit target (zero prebank) and prebank can be used to compensate for the delta velocity shortage. The burn can be targeted to any prebank; i.e., less steep or more shallow, but the standard shallow target is for a 90° prebank. In this case a 90° prebank would be required following a perfect burn completion, and any underburn would require additional banking, or recovery prebank, and would be greater than 90° for an underburn of the 90° shallow target.

The crew can see the planned REI on the DEORB MNVR display after the deorbit target is loaded (ITEM 22 EXEC). Following an incomplete burn, the transition to MM 303 provides the resulting (postburn) REI. If the MM 303 REI is less than the preburn REI, then a recovery prebank would be desired. However, if the MM 303 REI is greater than the preburn REI, a recovery prebank makes the situation worse because the range is already too long and the effect of the prebank would make the range even longer (although REI would not increase, the orbiter would be lower sooner and thus turn a low energy situation into an even lower energy situation).

Recovery prebank as an underburn procedural backup tool is available for the normal EOM deorbit situation, but an example of when not to use recovery prebank is for a direct insertion systems AOA (i.e., OMS 1 is not performed). In this case the existing perigee is changed only slightly or not at all and the OMS 2 deorbit burn is essentially radial (instead of retrograde) to rotate the orbit so that the perigee is moved from its current location to the landing site.

EVENTCUEDISPLAYPostburn StatusDeorbit burn  
complete or  
shutdownDEORB MNVR EXEC  
ADICREW ACTION

1. Record either that the deorbit burn was nominal or the  $\Delta$ TIG (the amount of time that OMS ignition was late).
2. Report to MCC as 'BURN REPORT' during upcoming COMM coverage (if no COMM at burn cutoff).

DISCUSSION

In the event of no OMS ignition or a shutdown with the current HP > safe HP, the crew should return to MM 301 and then confirm the correct configuration of the OMS and RCS with the MCC.

EVENTGNC, OPS 303 PROCUEPostburn data  
recordedDISPLAYDEORB MNVR  
EXEC  
ADICREW ACTION

The transition to MM 303 initiates stowing of the OMS engines (unless the gimbal has been selected OFF). The deorbit target data shown on the DEORB MNVR display in MM 301 and MM 302 blank. The crew then verifies the uplinked values of roll, pitch, and yaw that are displayed under BURN DATA. These are the inertial values equivalent to a 0°, 40°, 0° LVLH MM 304 attitude at EI - 5. These attitudes can be changed directly by the crew through the keyboard but are supplied by uplink or the DEL PAD.

| <u>EVENT</u>                       | <u>CUE</u> | <u>DISPLAY</u>                               |
|------------------------------------|------------|--|
| <u>Maneuver to EI - 5 Attitude</u> | MM 303     | DEORB MNVR COAST<br>ADI error needles<br>ADI |

CREW ACTION

Maneuver to the EI - 5 attitude using the RHC or by executing the item for an auto maneuver.

DISCUSSION

With good inertial roll, pitch, and yaw values, the crew obtains error needles and an inertial attitude on the DEORB MNVR COAST display that is equivalent to a 0°, 40°, 0° (R, P, Y) LVLH attitude in MM 304 at EI - 5. The crew has the capability of an automatic or manual maneuver to this attitude.

The INRTL ADI attitude position is shown in the DEL PAD for maneuvering to the EI - 5 attitude and shows values that are the equivalent of a pitch up of about 135° from a nominal two-engine deorbit burn attitude.

If the crew wishes to verify that the vehicle is approaching the EI - 5 attitude, they may consult the table provided in the Entry Checklist that shows the time to EI in minutes versus the desired LVLH pitch in degrees.

For an underburn, the inertial values that appear in the BURN ATT fields in MM 303 will be incorrect and the attitude must be adjusted by flying to the LVLH pitch versus time to EI shown in the table. Any prebank required by the underburn is achieved before EI but after the transition to MM 304.

EVENTCUEDISPLAYOMS Gimbal Powerdown

DEORB MNVR COAST

CREW ACTION

Verify that the OMS engines are in the stow position and then turn off the gimbal power by executing the GMBL OFF Items (32 and 33).

DISCUSSION

The transition to MM 303 commands the OMS engines to their stow positions. To preclude a single-point TVC failure from moving an OMS engine away from the entry stow position during the entry phase, the TVC power is turned off, and the OMS engines are held in place by the mechanical no-back feature of the gimbal systems.

| <u>EVENT</u>                    | <u>CUE</u> | <u>DISPLAY</u>                            |
|---------------------------------|------------|---|
| <u>Secondary Actuator Check</u> | EI - 20    | DEORB MNVR COAST<br>GNC 53 Entry Controls |

### CREW ACTION

This checkout is normally performed in OPS 8 on the day prior to the planned entry, but the OPS 3 capability allows the opportunity to accomplish part I of the checkout if it was not previously performed on orbit. The crew is expected to perform the following checks and item entries.

### DISCUSSION

The primary purpose of the SECONDARY ACTUATOR CHECK procedure (figure 4-4) is to verify the functional integrity of the ASA's and the aerosurface actuators. This test verifies the proper operation of all the fault detection and isolation circuitry inside the ASA's as well as detecting any problems with the driver circuitry or actuator hardware.

This procedure might be used if an emergency abort-from-orbit (AFO) were performed prior to the scheduled FCS checkout time. This procedure is also used if any APU failed during ascent and the only FCS checkout performed on orbit was the circ pump option of the FCS checkout. Performing the secondary actuator check with an APU provides a more thorough check of all the ASA and the hydraulic system components.

The OPS 3 option for performing the secondary actuator check uses a single APU operating at normal hydraulic pressure (3000 psi). The CONTROLS display (SPEC 53) is used for the setup and execution of this test. The test is performed after the deorbit burn during MM 303 at EI - 20 minutes. The difference between the secondary actuator check in OPS 3 and OPS 8 is that only the positive polarity is used in biasing each FCS channel's drivers in order to save time during the entry coast phase. Additionally, the aerosurface drive test that is normally used to warm up the hydraulic fluid prior to the OPS 8 checkout is not available in OPS 3. Instead, a similar aerosurface slew capability, SURF DRIVE TEST (normally for hydraulic thermal conditioning), is commanded from the GNC DEORB MNVR COAST display. An explanation of each of the steps in the OPS 3 secondary actuator check is as follows:

- Item 1 - Performed in MM 303 at  $\approx$  EI - 20 minutes if this check has not previously been performed or if only the circ pump option has been performed on orbit.
- Item 2 - If a port on an actuator does not bypass automatically when a biased driver command is sent out on that channel, there is a problem with either the fault detection circuitry on that channel or the driver command (null driver) being sent out on that channel. If the failure is a null driver (Crit 1/R2) the port bypasses when the crew performs the manual bypass command. If the port does not bypass when the crew sends out the manual bypass command, the original problem was not a null driver but a problem with the fault isolation circuitry. If this is the case, the crew can reselect the affected port, since the driver commanding that channel is good and can be used effectively for aerosurface control.



- Item 3 - Crew takes the APU that is normally in low pressure (900 psi) until EI - 13 to norm pressure (3000 psi) for the duration of this test. If the APU is not in norm press, the hydraulic pressure will not be above the 2200 psi required to bypass a port.
- Item 4 - The elevon drivers on the selected channel are biased by 6°, which causes a force fight between the channels that will generate enough secondary delta pressure to cause the biased channel to bypass. The crew must ensure that the elevons are less than 6° from the hardstops or a valid check cannot be performed. If the elevons are closed more than 6° from the hardstop, the crew initiates a SURF DRIVE ON to position the elevons inside the required deadband (+12° to -27°), and then performs a SURF DRIVE OFF.
- Item 5 - The crew chooses the positive polarity for the stimulus check. Only the positive polarity is checked in order to save time (positive and negative polarity checked in OPS 8).
- Item 6 - The crew ensures that the FCS channels are in AUTO to allow automatic bypassing of the ports being checked.
- Item 7 - The crew initiates the check on channel 1. Execution of the check (CHECK START) induces biases to the drivers of 6° for the elevons, 12° for the rudder, and 24° for the speedbrake. The execution of this test causes all the aerosurface ports on channel 1 to bypass.
- Item 8 - The crew checks on CONTROLS (SPEC 53) to ensure that all the ports have bypassed, then issues the STOP command for the actuator check.
- Item 9 - The crew then resets all the ports on FCS channel 1 by taking the channel to OVERRIDE and back to AUTO.
- Item 10 - The positive stimulus check is then repeated for FCS channels 2, 3, and 4.

|                          |                        |
|--------------------------|------------------------|
| 1: GNC 53 ENTRY CONTROLS | 2: BFS, GNC SYS SUMM 2 |
| 3: GNC DEORB MNVR COAST  |                        |

EI-20 C **SECONDARY ACTUATOR CHECK** (If not previously performed and time permits)

**NOTE**

If port does not bypass during check, bypass affected port after check:

SEC ACT BYPASS - ITEM 8 +XX EXEC

If affected port still does not bypass:

SEC ACT RESET - ITEM 9 +XX EXEC

- R2 a. HYD MN PUMP PRESS (one) - NORM
- F7 b. √SPI: If all elevon posns not within +12° to -27°, then:
- CRT3 SURF DRIVE ON, ITEM 39 EXEC (\*)  
Stop drive test when all posns within limits:  
SURF DRIVE OFF, ITEM 40 EXEC (\*)
- CRT1 c. √POS STIM ENA, ITEM 7 - (no \*)
- C3 d. √FCS CH 1,2,3,4 - AUTO
- CRT1 e. SEC ACT CK, CH 1 - ITEM 1 EXEC (\*)  
CK START - ITEM 5 EXEC (\*)
- f. √All CH 1 ports bypass, '↓'  
STOP - ITEM 6 EXEC (\*)
- C3 g. FCS CH 1 - ORIDE
- CRT1 √All CH 1 PORTS RESET, no '↓'  
FCS CH 1 - AUTO
- h. Repeat steps e thru g for CH 2,3,4

3-35

ENT/ALL/GEN D

**Figure 4-4. SECONDARY ACTUATOR CHECK procedure**

EVENTCUEDISPLAYForward RCS Dump

EI - 18

DEORB MNVR COAST

CREW ACTION

Dump a specified amount of FWD RCS propellant, if required, for orbiter X c.g. control.

DISCUSSION

The amount of propellant to be dumped is determined by the crew (if no COMM) using the HP41C calculator, the c.g. wheel (see sec. 4.4), or the DEL PAD (if calculated preburn by the MCC). Control of the dump with the four forward yaw jets by the crew is through FWD RCS ARM and DUMP items (36 and 37) and the OFF item (38).

EVENTCUEDISPLAYEntry Switch Check

GNC 51 OVERRIDE

CREW ACTION

Check or configure entry-related switches in the forward station.

DISCUSSION

The purpose of the Entry Switch Check is to ensure the positions of the most critical forward station switches for entry. Essentially, all these switches were configured during deorbit preparation Entry Switch Verification at 1.5 hours before the deorbit burn.

| <u>EVENT</u>                 | <u>CUE</u> | <u>DISPLAY</u>     |
|------------------------------|------------|--------------------|
| <u>Remaining APU's Start</u> | EI - 13    | BFS, SM SYS SUMM 2 |

#### CREW ACTION

Start the two APU's at ~EI - 13 that were not started before the deorbit burn.

#### DISCUSSION

The remaining APU's are started and all three hydraulic systems are taken from low to normal pressure. SSME hydraulic repressurization is then done. If less than three APU's are running, the hydraulic pressure is kept at low pressure and the SSME hydraulic repress is delayed until EI - 6.

EVENTCUEDISPLAY

SSME Hydraulic System  
Repressurization

APU's activated

CREW ACTION

1. Open MPS/TVC ISOL VLV 2.
2. Wait 10 seconds.
3. Close MPS/TVC ISOL VLV 2.
4. Repeat the sequence for MPS/TVC ISOL VLV 1.

DISCUSSION

SSME repressurization is performed to ensure the correct stowing of the main engines for entry. Movement of the engines is not expected when the MPS/TVC VLV SYS 2 and 1 are opened, but opening the valves does ensure that possible voids caused by contraction of the hydraulic fluid that was warmed during the ascent phase and cooled during the on-orbit phase of the mission are eliminated in the MPS ATVC actuator. MPS/TVC isolation valves 2 and 1 will be cycled for 10 seconds each, sequentially, to achieve the repositioning of all three main engines.

EVENT

Hydraulic Fluid Thermal  
Conditioning (MCC CALL)

CUE

MCC CALL  
HYD MN PUMP  
PRESS in NORM  
following deorbit  
burn activities

DISPLAY

DEORB MNVR COAST  
BFS, SM THERMAL  
GNC SYS SUMM 1  
SPI

CREW ACTION

1. Execute SURF DRIVE ON item on DEORB MNVR display.
2. Monitor aerosurface cycling.
3. Execute SURF DRIVE OFF item on DEORB MNVR display when 5 minutes have elapsed.

DISCUSSION

The thermal conditioning of the hydraulic fluid is accomplished by cycling the aerosurfaces. Execution of the SURF DRIVE ON item on the DEORB MNVR COAST display cycles the aerosurfaces. Motion of the aerosurfaces can be monitored on the GNC SYS SUMM 1 display and the surface position indicator (SPI). Actuator temperatures can be monitored on the BFS SM THERMAL display. The thermal conditioning task is not performed by the crew unless requested by MCC.

EVENT

Burn Report

See postburn status discussion, page 4-22.



EVENTCUEDISPLAYState Vector Change

HSD

CREW ACTION

Change the downrange component of the state vector, if required.

DISCUSSION

If sufficient tracking exists near EI, the downrange component of the vehicle state vector can be corrected (if required) by adding a  $\Delta T$  to the time tag of the state vector. The HSD in the PASS (item 18), loading the  $\Delta T$  value (item 16), and then transferring this altered state vector to the BFS and loading it with the BFS HSD (items 17 and 16).

The MCC computes the  $\Delta T$  value and voices it to the crew. The crew enters the  $\Delta T$  value into the PASS HSD via item 18 and incorporates the change into the onboard state vector with LOAD item 16. The new state vector may then be transferred to the BFS using the BFS HSD, items 17 and 16.

EVENTCUEDISPLAYG-Suit InflationCREW ACTION

Load 1.5 so that the proper pressure is available if the crew requires g-suit inflation.

DISCUSSION

Turning the activation valve three turns clockwise (if required) pressurizes the g-suit to prevent blood pooling in the lower extremities.

## 4.2 DEORBIT FLIGHT RULES

The complex deorbit burn requirements are reflected in a number of flight rules covering deorbit burn situations. Flight rule 4-72, on entry planning, contains the criteria used for c.g. planning and for choosing off-nominal deorbit procedures if necessary. It is worth studying this rule in detail to understand the rationale behind many of the deorbit cue card procedures.

A separate cue card (figures 4-5 and 4-6) containing selected deorbit flight rules is placed above the PLT's ADI prior to the deorbit burn. The three columns on the right side of the card show the possible responses to failures. Preignition, a one-orbit, or a 1-day delay is allowed to respond to failures.

Part of the deorbit PAD is a value for 'safe HP'. This is the perigee above which the orbiter can stay in orbit for ~24 hours and is a decision point for what course of action to take in the event of certain failures (i.e., whether to continue or stop the burn). The reason for having a variable 'safe HP' is that the 'safe' perigee value depends on the apogee (HA), which varies from mission to mission and according to mission phase. Typical values of HA and safe HP are:

|                         |              |
|-------------------------|--------------|
| HA = 150, safe HP = 80  | (nominal)    |
| HA = 130, safe HP = 87  | (post-OMS 2) |
| HA = 105, safe HP = 103 | (ATO)        |

After the burn has started, only a few failures are considered serious enough to stop the burn. Of course, if  $HP < \text{safe HP}$ , the burn must be completed in any case because the orbiter is too low to stay in orbit. Once the burn has started, the crew should not have to refer to the deorbit flight rules cue card. All necessary information for the duration of the burn is contained in the BURN and BURN MONITOR cue cards.

TOP

**DEORBIT BURN FLIGHT RULES  
ONE-ORBIT LATE AVAILABLE**

| FAILURE  | PRE TIG        |         | POST TIG             |
|--|----------------|---------|----------------------|
|  | Delay (max)    |         | Stop Burn, > Safe HP |
|  | One Orbit      | One Day |                      |
| <b>APU/HYD</b>                                     |                |         |                      |
| 1 No APU operating .....                           | X              |         |                      |
| <b>LDG/DECEL</b>                                   |                |         |                      |
| 2 NWS (KSC) .....                                  | X              |         |                      |
| <b>DPS</b>   |                |         |                      |
| 3 RDNT fail, 4-Way or 2-2 Split .....              |                | X       | X                    |
| 4 1 GPC .....                                      | X              |         |                      |
| 5 2 GPCs (and spare available) .....               |                | X       |                      |
| 6 BFS .....  |                | X       |                      |
| 7 GPC BITE (Multiple GPCs) .....                   |                | X       |                      |
| <b>ECLS</b>  |                |         |                      |
| 8 2 Av Bay Fans in Bay 3 .....                     | X              |         |                      |
| 9 2 Av Bay Fans in Bay 1 or 2 .....                |                | X       |                      |
| <b>ELEC</b>  |                |         |                      |
| 10 H2 Manf or TK leak (not in depleted tk(s) ..... | X              |         |                      |
| 11 2 MN Buses .....                                |                | X       | X                    |
| 12 CNTL CA1 (No BFS Engage in GPC 3/5) .....       |                | X       |                      |
| 13 Multi $\phi$ AC BUS (unshorted) .....           | X              |         |                      |
| <b>GNC</b>   |                |         |                      |
| 14 IMU Dilemma .....                               |                | X       | X                    |
| 15 RHC Dilemma .....                               | X              |         |                      |
| 16 2 IMUs .....                                    |                | X       |                      |
| 17 3 ADTAs .....                                   | X              |         |                      |
| 18 2 ADTAs, AAs, RGAs, FCS (LKBD not avail) .....  | X              |         |                      |
| <b>OMS</b>   |                |         |                      |
| 19 Prplt Tank .....                                | X              |         | X ①                  |
| 20 Ignition (neither eng ignites) .....            | X              |         |                      |
| 21 Both OMS Eng fail .....                         |                |         | X ②                  |
| 22 Prplt Lk after LAST LOS .....                   | perigee adjust |         |                      |
| <b>AFT RCS</b>                                     |                |         |                      |
| 23 2 jets, same direction, same pod .....          | X              |         |                      |
| 24 Prplt Lk after LAST LOS .....                   | X              |         |                      |
| 25 1 AFT RCS PROP TK fail .....                    | X              |         |                      |
| <b>COMM</b>  |                |         |                      |
| 26 MCC GO for DEORBIT not rcvd .....               |                | X       |                      |

① Stop Burn > OMS PRPLT FAIL HP (Ref: DEL PAD/BURN Card)

② Stop Burn > OMS ENG FAIL HP (Ref: DEL PAD/BURN Card)

ENT-1a/D/F

CC 8-2 (FQ)

**Figure 4-5. DEORBIT BURN FLIGHT RULES ONE-ORBIT LATE AVAILABLE**

TOP

BACK OF 'DEORBIT FLIGHT RULES'  
 DEORBIT BURN FLIGHT RULES  
 ONE-ORBIT LATE NOT AVAILABLE

|    | FAILURE   | PRE TIG                | POST TIG             |
|----|---|------------------------|----------------------|
|    |   | Delay (max)<br>One Day | Stop Burn, > Safe HP |
|    | <b>APU/HYD</b>                                  |                        |                      |
| 1  | No APU operating .....                          | X                      |                      |
|    | <b>LDG/DECEL</b>                                |                        |                      |
| 2  | NWS (KSC) .....                                 | X                      |                      |
|    | <b>DPS</b>                                      |                        |                      |
| 3  | RDNT fail, 4-Way or 2-2 Split .....             | X                      | X                    |
| 4  | 1 GPC .....                                     | X                      |                      |
| 5  | 2 GPCs (and spare available) .....              | X                      |                      |
| 6  | BFS .....                                       | X                      |                      |
| 7  | GPC BITE (Multiple GPCs) .....                  | X                      |                      |
|    | <b>ECLS</b>                                     |                        |                      |
| 8  | 2 Av Bay Fans in Bay 3 .....                    | X                      |                      |
| 9  | 2 Av Bay Fans in Bay 1 or 2 .....               | X                      |                      |
|    | <b>ELEC</b>                                     |                        |                      |
| 10 | H2 Manf or TK leak (not in depleted tk(s) ..... | X                      |                      |
| 11 | 2 MN Buses .....                                | X                      | X                    |
| 12 | CNTL CA1 (No BFS Engage in GPC 3/5) .....       | X                      |                      |
| 13 | Multi $\phi$ AC BUS (unshorted) .....           | X                      |                      |
|    | <b>GNC</b>                                      |                        |                      |
| 14 | IMU Dilemma .....                               | X                      | X                    |
| 15 | RHC Dilemma .....                               | X                      |                      |
| 16 | 2 IMUs .....                                    | X                      |                      |
| 17 | 3 ADTAs .....                                   | X                      |                      |
| 18 | 2 ADTAs, AAs, RGAs, FCS (LKBD not avail) .....  | X                      |                      |
|    | <b>OMS</b>                                      |                        |                      |
| 19 | Prplt Tank .....                                | X                      | X ①                  |
| 20 | Ignition (neither eng ignites) .....            | X                      |                      |
| 21 | Both OMS Eng fail .....                         |                        | X ②                  |
| 22 | Prplt Lk after LAST LOS .....                   | perigee adjust         |                      |
|    | <b>AFT RCS</b>                                  |                        |                      |
| 23 | 2 jets, same direction, same pod .....          | X                      |                      |
| 24 | Prplt Lk after LAST LOS .....                   | X                      |                      |
| 25 | 1 AFT RCS PROP TK FAIL .....                    | X                      |                      |
|    | <b>COMM</b>                                     |                        |                      |
| 26 | MCC GO for DEORBIT not rcvd .....               | X                      |                      |

① Stop Burn > OMS PRPLT FAIL HP (Ref: DEL PAD/BURN Card)

② Stop Burn > OMS ENG FAIL HP (Ref: DEL PAD/BURN Card)

ENT-1b/D/F

CC 8-3 (FQ)

Figure 4-6. DEORBIT BURN FLIGHT RULES ONE-ORBIT LATE NOT AVAILABLE

### 4.3 DEORBIT BURN CUE CARDS

Since aerodynamic entry follows irreversibly after deorbit, the deorbit burn must leave the orbiter in a safe entry configuration. The burn involves three factors; burn target, RCS propellant consumption and balance, and OMS propellant balance. Achieving the proper burn target (position, velocity, and flightpath angle) is a goal common to all OMS burns, but for deorbit the consequence of a small error can be a large increase in orbiter thermal load rather than just an error in the achieved orbit.

The procedures for all OMS burns attempt to save RCS propellant to provide maximum reserve for entry flight control. However, the net forward-aft balance is just as important because of the effect of the X c.g. on flight control stability. Hence, the usage of OMS, aft RCS, and forward RCS propellant must all be considered for their impact on the X c.g.

The deorbit OMS burn is the final opportunity to correct any sizable Y c.g. offsets. Y c.g. trim is accomplished by altering the amounts of OMS propellant burned from each side (crossfeeding). While the crew has the onboard capability of calculating the orbiter c.g. and determining how to trim it if necessary during the burn, these calculations are generally done by the MCC. MCC advises if an unbalanced propellant or a mixed crossfeed burn is necessary.

Each of the five deorbit burn cue cards is discussed in the following sections beginning with the DEORBIT BURN (2 ENG) card. The DEORBIT BURN (1 ENG) card is then discussed, followed by the DEORBIT BURN (RCS), UNBALANCED PRPLT DEORBIT BURN, and DEORBIT BURN (MIXED XFEED) cue cards.

#### 4.3.1 2 ENG DEORBIT BURN

This section presents the preburn, nominal burn, and failure procedures associated with the DEORBIT BURN (2 ENG) cue card (figure 4-7).

**DEORBIT BURN (2 ENG)**

- √ MM302    √ OMS BOTH  
Enter TGO + 5 sec
- √ TRIM per MNVR PAD or P+0.0, LY-5.7, RY+5.7  
L,R OMS He PRESS/VAP ISOL A(two) - GPC  
B(two) - OP
- √ DAP - AUTO(PASS)/DISC  
ADI - LVLH(REF)/HI/MED  
FLT CNTLR PWR (two) - ON

**TIG-2 OMS ENG (two) - ARM/PRESS**

- :15 EXEC (NO EXEC > TIG +  : )
- :15 If OMS AFT QTY < 11%, THC +X to OMS IGN + 1 sec
- :00 TIG Start watch (√ Pc, DVTOT, ENG VLVs)  
If no OMS ignition: APUs - SHUT DN

**\* OMS PRPLT FAIL:**

- \* Failed OMS ENG - OFF
- \* STOP BURN:
- \* Good OMS ENG - OFF
- \* APUs - SHUT DN
- \* L OMS                      R OMS                      APU - SHUT DN
- \* FAIL HP                    FAIL HP                    Secure aff OMS
- \*                      -----

- \* CONTINUE BURN:
- \* ITEM 18 + 0 EXEC
- \* Secure aff OMS
- \* When good OMS Pc < 80,
- \* good OMS ENG - OFF
- \* √ ADI - LVLH, center needles
- \* RCS COMPLETION

**\* OMS ENG FAIL:**

- \* Failed OMS ENG - OFF
- \* OMS XFEED at 1/2 ΔVTOT at fail
- \* or OMS QTY  %L or  %R

**\* 2nd OMS FAIL (ENG or PRPLT):**

- \* Failed OMS ENG - OFF
- \* If PRPLT FAIL:
- \* Secure aff OMS
- \* ITEM 18 + 0 EXEC
- \* Both                      Either
- \* ENG FAIL                    PRPLT FAIL                    STOP BURN:
- \* HP                            (SAFE) HP                    APU - SHUT DN
- \*                      -----

- \* CONTINUE BURN
- \* √ ADI - LVLH, center needles
- \* Interconnect good OMS to RCS
- \* THC +X (√ OMS% vs RCS Burn Time)
- \* RCS I'CNCT TK SW (N/A PRPLT FAIL)
- \* THC +X (√ OMS% vs RCS Burn Time)
- \* AFT RCS RECONFIG
- \* RCS COMPLETION

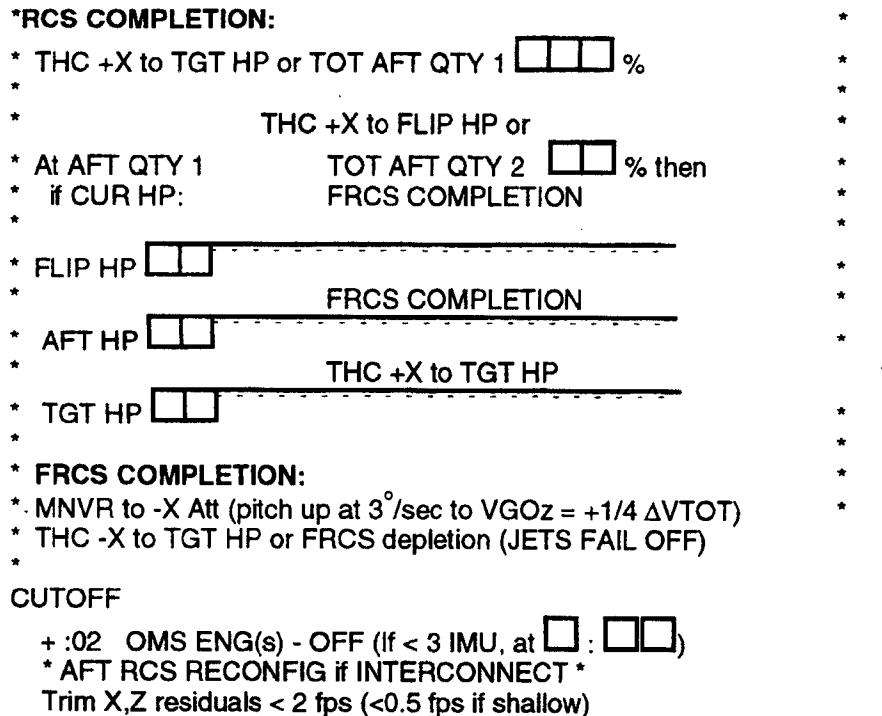

*Figure 4-7. DEORBIT BURN (2 ENG) cue card*

**4.3.1.1 Preburn**

Upon entering the DEORBIT BURN cue card (figure 4-7), several checks and switch configurations are made. Since the burn can only be executed in major mode 302, the crew ensures the correct major mode. They also verify that both OMS engines are selected and that the proper trim angles are entered on the MNVR display. Flight-specific OMS engine trim values are read up to the crew from the Deorbit MNVR PAD and uplinked as part of the deorbit targets. If specific numbers are not available, the crew can enter the generic numbers specified on the cue card.

An IMU failure during the deorbit burn that affects the navigation state may result in a premature cutoff or a prolonged burn. For a premature cutoff, the crew would complete the burn using RCS +X jets per the deorbit burn monitor card. For a prolonged burn, the crew adds 5 seconds to the computed time of the burn (TGO) and records that value in the boxes at the bottom of the card.

**CUTOFF**

+ :02 OMS ENG(s) - OFF (If < 3 IMU, at  : )

If the burn is continuing past this TGO + 5 seconds, the crew should terminate the burn by turning off both OMS engines.

The He PRESS/VAP ISOL switches are configured to provide pressurization to the propellant tanks. The ADI is set to LVLH or REF based on crew preference. The DAP is set to auto, and



both flight controller power switches are turned on in preparation for the possibility of needing manual control. At TIG - 2 minutes the OMS engine switches are moved to the ARM/PRESS position to allow the software to command the engines on.

At TIG - 15 seconds the burn is enabled. The ground will calculate and advise the crew how long ignition can be delayed after TIG and still maintain downmoding capability in achieving the target, typically 5:00 for an OMS burn and 2:00 for an RCS burn. This time is provided on the DEL PAD and should be written in the space provided on the '-:15' line on the DEORBIT BURN cue card.

-:15 EXEC (NO EXEC > TIG +  :  )  
 -:15 If OMS AFT QTY < 11%, THC +X to OMS IGN + 1 sec

Also at TIG - 15 seconds, a propellant settling burn is started if the OMS quantity is less than 11%. The +X burn is required to move the OMS propellant to the aft in preparation for engine ignition.

One APU is started prior to the deorbit burn. This procedure is accomplished in the checklist procedures before the crew starts using the cue cards. If the OMS engines cannot be ignited, the deorbit burn must be delayed; hence, there is an instruction just below the ':00' line to shut down the APU's if there is no OMS ignition. Normally, only one APU is started before the deorbit burn, but the cue card says 'APU's' to allow for the possibility in an off-nominal situation of having turned on more than one.

If no OMS ignition, APU's - SHUT DN

If only one engine ignites for a planned two-engine burn, the burn is continued via the OMS ENG FAIL procedure. If both engines fail after having ignited, the burn is continued via the 2nd OMS FAIL procedure. If both OMS engines fail to ignite at TIG, the APU shutdown procedure is done.

The reason for a failure-related deorbit burn delay is to give MCC a chance to recalculate the burn targets and troubleshoot configurations and procedures with the hope of effecting an OMS engine deorbit burn on the next orbit. If an RCS burn is required, the X c.g. calculations must be redone using the reduced Isp of the +X RCS jets compared to the OMS engines. More propellant consumption for a given  $\Delta V$  is required for an RCS burn. Obviously, if the OMS engines fail immediately after TIG, the situation is not much different from an OMS failure to ignite. If an OMS engine is bad, the chances are highest that it will fail to ignite properly. If it ignites properly, its failure probability is fairly constant throughout the burn.

#### 4.3.1.2 Nominal Burn Procedures

At TIG, the crew starts a timer and verifies OMS ignition by checking the OMS chamber pressure increases to approximately 104 percent, and the four OMS engine valves increase to approximately 100 percent. During the burn, the crew monitors  $\Delta VTOT$ , TGO, and orbiter weight decreasing and good attitude control on the ADI.

Two seconds after the engines shut down, the OMS engine switches are turned off. The 2-second delay allows time for a nitrogen purge of the engines. The VGO (X and Z) residuals are trimmed (if required) with the THC to < 2 fps after the OMS engine cutoff.

**CUTOFF**

Trim X, Z residuals < 2 fps (< 0.5 fps if shallow)

Flight rule 4-77 indicates that trimming to 2 fps is acceptable after nominal deorbit burns. The deorbit cue cards specify trimming to <0.5 fps only with a shallow target, because in this case the orbiter state at closed loop guidance initiate is more sensitive to velocity errors than for a nominal deorbit, and the desirable margin becomes required.

The deorbit burn monitor cue card (figure 4-8) is included for completeness, but thorough explanations of this cue card can be found in the All Vehicle Flight Procedures Handbook, APCL/OPCL/EPCL Pocket Checklist and Cue Cards with Rationale.

TOP



**DEORBIT  
BURN  
MONITOR**

|  |  |
|--|--|
| <b>OMS Pc LOW</b><br>OMS ↓ and<br>ENG VLV 1 or 2 < 70%                                 | OMS ENG FAIL   |
| OMS ↓ and<br>ENG VLV 1 and 2 > 70%<br>and FU and OX TK P < 185<br>(System In Blowdown) | Burn to Pc = 72%<br>then OMS PRPLT FAIL  |
| OX IN P > 227  | OMS ENG FAIL   |
| P ≤ 227  | OMS PRPLT FAIL   |
| No OMS ↓   | SENSOR FAIL  |
| <b>OMS TEMP L R</b><br>FU IN P ≥ 225 225   | OMS ENG FAIL   |
| P ≤ 205 211  | OMS PRPLT FAIL   |
| P 206-224 212-224  | SENSOR FAIL  |
| <b>OMS OX/FU TK P</b>  |  |
| OX & FU LOW  | He PRESS/VAP ISOL (two) -- OP<br>Burn to OMS ↓, then OMS<br>PRPLT FAIL   |
| OX LOW   |  |
| FU LOW   | He PRESS/VAP ISOL (two) -- CL<br>Burn to OMS ↓, then OMS<br>PRPLT FAIL   |
| OX & FU HIGH   | Cycle He to maint OMS TK P 234-284<br>Cycle He A(B) to isolate failed leg  |
| <b>OMS GMBL</b> 1st FAIL   | Select SEC GMBL (twice)  |
| 2nd FAIL   | If control problems or<br>high RCS fuel usage:<br>All OMS ENG -- OFF<br>XFEED if AVTOT > 20  |
| <b>RDNT FAIL, 4-WAY OR 2-2<br/>SPLIT</b>   |  |
| OX Safe HP:  |  |
| IMU DLMA HP > <input type="checkbox"/>   | Stop burn, APUs - SHUT DN  |
| OX HP < <input type="checkbox"/>   | Continue burn:<br>PASS SET FAIL only - BFS engage<br>PASS SET SPLIT only - ✓MCC<br>on Restring<br>IMU DLMA - Post OMS cutoff,<br>decel IMU with 'ACC' > 0.03<br>+X on watch (AOA) or +X to<br>TGT HP (EOM) |
| <b>2 MN DC BUSES</b>   |  |
| <b>GPC1(4)</b>   | GPC1(4) MODE - STBY,HALT<br>FF1(4) - OFF,ON<br>L(R) OMS GMBLs - sel SEC  |
| <b>FA1(4)</b>  | L(R) OMS GMBLs - sel SEC   |

ENT-2a/65/A,O,D,E/A

FS CC 8-23 (FQ)

Figure 4-8. DEORBIT BURN MONITOR cue card

**4.3.1.3 OMS PRPLT FAIL**

If the OMS propellant system on one side fails, two critical questions must be answered. Is there enough propellant in the other pod to complete the deorbit burn? If so, will burning all this propellant leave the orbiter with an acceptable c.g.? MCC answers these questions for the crew before the burn by a calculation which takes into account the current and desired c.g., the velocity to be expended during the burn, and the amount of propellant on each side and yields critical perigee values above which the burn should be stopped and below which it should be continued. These values are read up to the crew before the burn and are entered in the OMS PRPLT FAIL section of the DEORBIT BURN cue card.

```

*   OMS PRPLT FAIL:                               *
*   Failed OMS ENG - OFF                           *
*                                                    *
*   L OMS          R OMS                          *
*   FAIL HP        FAIL HP                         *
*   [ ] [ ] [ ]   [ ] [ ] [ ] _____          *

```

When a propellant failure occurs, the first step is to turn off the failed OMS engine as soon as possible. If a fuel restriction caused the OMS propellant failure, there is significant hazard with continuing to burn that engine. Chamber burnthrough may occur due to inadequate chamber cooling. The next step is to compare the current HP to the HP values entered in the box for the failed side. If the current HP is greater than or equal to the OMS fail HP, the procedures above the horizontal double line should be performed. Similarly, the procedure below the double line is performed if the current HP is less than the OMS fail HP. In general, one side of the double line is dashed to indicate that if the current HP equals the OMS fail HP, the action on that side of the double line should be performed.

A deorbit burn should be completed with a propellant failure, if possible. If the burn is terminated prematurely (above a safe HP), MCC may require at least two orbits of tracking data before the orbiter's new orbit (changed by the partial burn) is known well enough to allow retargeting for another burn. By this time, the landing site is probably outside the orbiter's crossrange capability and the deorbit has to be delayed 24 hours. Continuing with a propellant failure once the burn has started is considered to be more desirable than staying in orbit for another day (weather is a primary example). Obviously, if  $HP < \text{safe HP}$ , the burn must be completed in any case.

In computing the critical HP values for PRPLT FAIL cues, the MCC considers (1) the propellant available in each OMS tank, (2) the available aft RCS propellant (above a redline amount required for entry), (3) the FRCS propellant, and (4) the deceleration which can be achieved from orbiter prebank. The resulting HP value for each side shows the altitude below which enough  $\Delta V$  is available to allow completing the deorbit to the primary landing site. The OMS FAIL HP cue is read up to the crew from the DEL PAD.

Completing a burn with a propellant failure entails a total use of more propellant from the good side than from the failed side. This causes a Y c.g. shift. The earlier the propellant failure (i.e., the higher HP is at the time of the failure), the greater the Y c.g. shift. This same propellant failure results in an aft-heavy X c.g. MCC has considered this in the preburn targeting, and any propellant failure below the critical HP value for the failed side should leave the orbiter with an acceptable c.g. for entry.

If the burn is to be terminated, the cue card indicates that subsequent to turning off the failed engine, the good engine is turned off, the APU's are shut down, and the failed OMS is secured via the EPCL procedures.

|   |                    |   |
|---|--------------------|---|
| * | STOP BURN:         | * |
| * | Good OMS ENG - OFF | * |
| * | APU's - SHUT DN    | * |
| * | Secure aff OMS     | * |

At this point, the crew goes back to the Entry Checklist and enters the indented off-nominal 'Burn Terminated with HP > SAFE HP' section. These steps close the OMS He PRESS/VAP ISOL and XFEED valves and set up the aft RCS to be compatible with the orbit configuration in the Deorbit Preparation Checklist. It then advises the crew to consult with MCC regarding a possible 24-hour deorbit delay while MCC recomputes the new orbit (which may require two orbits) and calculates new burn targets.

If the burn is to be continued, then only the engine on the side with the propellant failure is turned off.

|   |                              |   |
|---|------------------------------|---|
| * | CONTINUE BURN:               | * |
| * | ITEM 18 + 0 EXEC             | * |
| * | Secure aff OMS               | * |
| * | When good OMS $P_c < 80$ ,   | * |
| * | good OMS ENG - OFF           | * |
| * | √ ADI - LVLH, center needles | * |
| * | RCS COMPLETION               | * |

The orbiter attitude and the ADI error needles are reconfigured for a single-engine burn. The deorbit burn is often targeted to include an out-of-plane component in order to use enough extra OMS propellant to achieve a proper X c.g. for entry. After a propellant failure, all remaining 'good' propellant must be made available for in-plane  $\Delta V$ . The out-of-plane propellant wasting is terminated for the remainder of the burn via the ITEM 18 + 0 EXEC action.

This time-critical action causes retargeting and is performed before any OMS valves are reconfigured. Once the crew is satisfied that guidance is properly reconfigured, they should secure the affected OMS valves on the failed side.

At this point, the crew must continue to monitor the burn, since the remaining tank might be depleted before  $\Delta VTOT$  reaches zero. The two key cues here are the OMS propellant quantity gauges on panel 03 and the  $P_c$  meter on panel F7. After the propellant failure, the PLT should check whether FU or OX is lower on the good side and monitor the lower quantity, switching back and forth occasionally if time permits. When the level drops to a few percent, the  $P_c$  meter should be watched continuously. As the oxidizer/fuel ratio departs from nominal, the engine performance will start to degrade and the chamber pressure will fall. Once  $P_c < 80$  percent, the engine should be shut down to avoid damage.

If there is still  $\Delta VTOT$  to be burned, the vehicle should be maneuvered back in-plane, since it is currently in a single-engine trim configuration, by centering the ADI error needles. This maneuver puts the vehicle in the correct attitude for the +X RCS COMPLETION. The cue card now refers the crew to the RCS COMPLETION heading of the cue card, which is

discussed in section 4.3.1.5. Since all available OMS propellant has been used, any remaining  $\Delta V$  will utilize RCS propellant through the 4 +X jets.

#### 4.3.1.4 OMS ENG FAIL

When one OMS engine fails, the crew will always continue the burn, since all the OMS propellant is still available.

|   |   |   |
|---|---|---|
| * | <b>OMS ENG FAIL:</b>  | * |
| * | Failed OMS ENG - OFF  | * |
| * | OMS XFEED at 1/2 $\Delta VTOT$ at fail <input type="text"/> <input type="text"/> <input type="text"/>   | * |
| * | or OMS QTY <input type="text"/> <input type="text"/> %L or <input type="text"/> <input type="text"/> %R | * |

Once the failed engine is turned off, guidance reconfigures for a single-engine burn with a resulting change in orbiter attitude and error needle configuration. Once the crew is satisfied that this reconfiguration has been successfully accomplished, the next procedure is to start crossfeeding OMS propellant from the other side at the proper time to ensure a good Y c.g. for entry.

Two cues can be used to determine the proper time to perform the crossfeed: the OMS quantity gauges on panel O3 and  $\Delta VTOT$  on the DEORBIT MNVR EXEC display. Of these two,  $\Delta VTOT$  is more precise and is preferred. For deorbit conditions, each 1 percent of OMS propellant corresponds to a  $\Delta V$  of approximately 6 fps (depending on the weight of the orbiter). To use the  $\Delta VTOT$  cue, the crew must note  $\Delta VTOT$  at the time of the failure. The original plan of the burn was probably to use equal amounts of propellant from both sides. The crossfeed procedure makes sure that this is still accomplished by dividing equally between the two propellant pods the  $\Delta VTOT$  remaining at the time of the engine failure.

The propellant percentage cues (if OMS gauging is valid) are read to the crew from the PRPLT PAD before the burn. They represent MCC's calculation of how much propellant will remain in each side at the completion of the burn. The L and R numbers may not be equal because c.g. management earlier in the flight may have compensated for a Y-axis asymmetry by burning extra OMS propellant from one side. Also, different amounts of propellant may be loaded on each side prelaunch to compensate for a dry orbiter c.g. offset. Suppose that the final propellant amounts are calculated to be 11 percent L and 15 percent R. If the left engine fails, the crew can continue to burn the right side propellant down to 15 percent and then start crossfeeding from the left side. At the end of the burn, the left propellant should be down to 11 percent. If the crew has no  $\Delta VTOT$  cue available for whatever reason, then this quantity gauge method can be used to ensure an acceptable Y c.g. The  $\pm$  percent quantization uncertainty corresponds to a  $\pm 0.06$ -inch Y c.g. uncertainty.

One shortcoming of using the percent cues is that it is not always clear whether to use OX or FU quantities. The lower of the two quantities should be used. If there is any special reason to use one rather than the other, MCC should advise the crew. Note that if the CRT displays are lost during a burn, the propellant quantities can be used as cues for when to terminate the burn, although the total burn time is preferred.

**4.3.1.5 2nd OMS FAIL (ENG or PRPLT)**

This section of the cue card covers the dual failure procedures. By combining all the dual failure procedures in a separate section, the procedures for single failures are more straightforward. In addition, the two engine failure procedures are similar to the one propellant and one engine failure procedures. This section of the cue card covers three failure scenarios:

- a. Propellant failure on one side, followed by an engine failure on the other side
- b. Engine failure followed by a propellant failure
- c. Engine failure followed by the failure of the other engine

```

*          2nd OMS FAIL (ENG or PRPLT):          *
*          Failed OMS ENG - OFF                   *
*          If PRPLT FAIL:                         *
*          Secure aft OMS                         *
*          ITEM 18 + 0 EXEC                       *
*
*          Both          Either                    *
*          ENG FAIL    PRPLT FAIL                *
*          HP          (SAFE) HP                 *
*          [ ][ ]     [ ]-----                *
*
*
*
*

```

When a second failure occurs, the first step is to turn off the failed OMS engine. Guidance reconfigures the orbiter's attitude and the ADI error needles for an RCS completion burn. If the second failure is a propellant failure, the affected OMS is secured and the propellant-wasting value is zeroed via the ITEM 18 + 0 EXEC action. After a propellant failure, all remaining 'good' propellant must be made available for in-plane ΔV.

Next, the current HP should be compared to the HP value entered in the box for Both ENG FAIL HP or Either PRPLT FAIL HP. If both failures were engine failures, Both ENG FAIL HP is used to determine whether to continue or stop the deorbit burn. If deorbit wave-off capability exists, this number is set equal to SAFE HP. If deorbit must be done on this opportunity, Both ENG FAIL HP is the point at which the burn can be completed with the +X RCS thrusters using OMS propellant. If either failure was a propellant failure, SAFE HP is used to determine whether to continue or stop the burn.

If the current HP is greater than or equal to the applicable fail HP, the procedures above the horizontal double line should be performed. These procedures are to stop the burn and shut down any running APU's. Similarly, the procedure below the double line is performed if the current HP is less than the applicable fail HP. These procedures are described for the specific failure scenario in the the following paragraphs.

- \* STOP BURN: \*
- \* APU's - SHUT DN \*
- \* CONTINUE BURN: \*
- \* √ ADI - LVLH, center needles \*
- \* Interconnect good OMS to RCS \*
- \* THC +X (Ck OMS% vs RCS Burn Time) \*
- \* RCS I'CNCT TK SW (N/A PRPLT FAIL) \*
- \* THC +X (Ck OMS% vs RCS Burn Time) \*
- \* AFT RCS RECONFIG \*
- \* RCS COMPLETION \*

a. Propellant Failure on One Side Followed by an Engine Failure on the Other Side

In this scenario the deorbit burn will be continued if the current HP is less than SAFE HP. Note that for a propellant failure, the OMS engine feeding off that propellant is also considered failed and will not be reused. Therefore, no useable OMS engines remain and the only useful OMS propellant is from the side with the failed engine.

Once the crew determines that the burn is to be continued, the first step is to check that the ADI is in LVLH and to center the error needles. The remaining good OMS propellant tanks that were feeding the failed engine and still have usable propellant are then interconnected to the RCS. If the good propellant tanks have already been depleted, the crew proceeds directly to the RCS COMPLETION section of the cue card. AFT RCS RECONFIG is unnecessary if the crew never interconnects the OMS and RCS.

Once interconnected, the crew can begin to THC +X for a given time. In this configuration, OMS quantity gauging will not update, so the RCS burn time must be calculated from the table on the 'X' side of the circular slide rule used to compute the orbiter c.g. The OMS helium pressure is shown as a backup gauging parameter to determine RCS burn time.



| <b>X C.G. CALCULATOR</b> |                      |                                  |                                  |                         |
|--------------------------|----------------------|----------------------------------|----------------------------------|-------------------------|
| <b>OMS % GAUGE</b>       | <b>OMS He PRESS*</b> | <b>OMS <math>\Delta V</math></b> | <b>RCS <math>\Delta V</math></b> | <b>RCS BURN MIN:SEC</b> |
| 50                       | 3230                 | 297                              | 246                              | 7:13                    |
| 40                       | 2830                 | 233                              | 193                              | 5:39                    |
| 38                       | 2750                 | 220                              | 183                              | 5:21                    |
| 36                       | 2670                 | 207                              | 172                              | 5:02                    |
| 34                       | 2590                 | 194                              | 162                              | 4:43                    |
| 32                       | 2510                 | 181                              | 151                              | 4:24                    |
| 30                       | 2430                 | 168                              | 140                              | 4:05                    |
| 28                       | 2350                 | 155                              | 130                              | 3:47                    |
| 26                       | 2270                 | 142                              | 119                              | 3:28                    |
| 24                       | 2190                 | 129                              | 108                              | 3:09                    |
| 22                       | 2110                 | 116                              | 98                               | 2:50                    |
| 20                       | 2030                 | 103                              | 87                               | 2:32                    |
| 18                       | 1950                 | 90                               | 76                               | 2:13                    |
| 16                       | 1870                 | 77                               | 65                               | 1:54                    |
| 14                       | 1790                 | 64                               | 54                               | 1:34                    |
| 12                       | 1710                 | 51                               | 43                               | 1:15                    |
| 10                       | 1630                 | 38                               | 32                               | 0:56                    |
| 8                        | 1550                 | 25                               | 21                               | 0:36                    |
| 6                        | 1470                 | 12                               | 10                               | 0:17                    |
| 5                        | 1430                 | 5                                | 4                                | 0:07                    |

As an example, suppose  $\Delta VTOT = 68$  fps with only 54 fps of RCS  $\Delta V$  in OMS propellant remaining (as shown by an OMS gauge percent of 14 and an OMS He PRESS of 1790) on the good side when the last OMS engine fails. The OMS % and OMS He PRESS versus RCS  $\Delta V$  and RCS BURN timetable shows that the 1:34 of RCS burn time that is allowed on the OMS propellant on one side yields 54 fps  $\Delta V$  using the RCS before the redline is reached. Thus, after 1:34, the expected  $\Delta VTOT$  would be  $68 - 54 = 14$  fps. However, the CDR should release the THC on burn time regardless of the  $\Delta V$  expended or remaining, because the  $\Delta VTOT$  required may have increased during the time to configure the interconnect, and the given  $\Delta V$  is just an estimate.

#### b. Engine Failure Followed by a Propellant Failure

In this scenario the deorbit burn will be continued if the current HP is less than SAFE HP. Note that for a propellant failure, the OMS engine feeding off that propellant is also considered failed and will not be reused. Therefore, no useable OMS engines remain, and the only useful OMS propellant is from the side with the failed engine.

Suppose that the left engine fails. At first, the right engine is burned with right side propellant until the crossfeed  $\Delta VTOT$  cue point is reached. If the right propellant tank fails before this, crossfeeding is not performed. The crew enters the 2nd OMS FAIL section of the cue card and determines whether the current HP is less than SAFE HP.

If below safe HP, the crew follows the instruction to interconnect the RCS to the good OMS PRPLT, which in this case is the left side. The remainder of the left OMS propellant will be burned by the +X RCS jets. The burn time for this +X burn is calculated by using the OMS gauge quantity or helium pressure versus RCS Burn Time shown on the c.g. calculator cue card.

Suppose, on the other hand, that after the left engine failure, the burn has progressed to where the right OMS engine is being crossfed from the left propellant pod, and the left propellant system fails. The crew enters the 2nd OMS FAIL section. In this case, at least half the burn has already been completed and current HP is probably less than SAFE HP, so the burn will be carried to completion. The procedure says to interconnect to the good OMS PRPLT, which in this case is the right side. However, the right side has probably been depleted already. In this case the crew would enter the RCS COMPLETION procedure. Any  $\Delta V$  remaining for the deorbit burn will come from RCS propellant through the +X RCS jets.

#### c. Engine Failure Followed by the Failure of the Other Engine

In this scenario the deorbit burn will be continued if the current HP is less than both ENG FAIL HP. Entering this procedure is more likely if the second OMS engine fails after the reconfiguration for the first failure is already complete; however, it also applies if both engines were to fail at the same time.

If the two failures have occurred separately, expect another attitude and error needle change as guidance reconfigures from a single-engine to an RCS burn. If both engines fail simultaneously, the RCS reconfiguration has a lesser affect on attitude or the error needles; however, TGO will nearly quadruple. TGO usually doubles after a two- to one-engine or a one-engine to RCS reconfiguration.

If both engines fail at exactly the same time, the same argument for determining the proper crossfeed time from  $1/2 \times \Delta VTOT$  at the time of the failures applies here as it did for the single-engine failure case (sec. 4.3.1.4).

The current procedure calls for an interconnect to either OMS pod when the second OMS engine fails regardless of the pod levels or which one was being used at the time of the failure. Because the OMS quantity gauges do not operate unless an OMS engine is on, the tank-switch cue must be determined by using the OMS gauge quantity or helium pressure versus RCS Burn Time shown on the c.g. calculator.

The RCS burn time allowable is also checked for the second pod because of the possibility that the amount of OMS propellant in the second pod may be insufficient to complete the remaining  $\Delta V$ . If the OMS is depleted after the interconnect of OMS/RCS from both OMS pods, the crew must recognize that there is insufficient OMS propellant and proceed to 'AFT RCS RECONFIG' to break the interconnect and complete the burn with the RCS COMPLETION procedure.

It is important to remember that the cue cards cannot handle all possible failure scenarios in an optimum fashion. If they are used properly, they produce acceptable results for all scenarios.

#### 4.3.1.6 RCS COMPLETION

At this point, all scenarios involving propellant failures have arrived at the RCS COMPLETION instruction, and the crew is ready to complete the deorbit burn using RCS propellant. Once a burn has reached this point, the options available to the crew are as follows:

- A. Burn aft RCS propellant through the +X RCS jets. This option is limited by the requirement to leave enough aft RCS propellant for aerojet DAP RCS control during entry. TOT AFT QTY 1 is the amount protected to preclude an entry that would require no-yaw-jet operation. It is a function of X c.g. and varies from 1430 to 1630 lb at EI. TOT AFT QTY 1 allows for maneuvers, -X RCS attitude control, coasting before EI, and enough prop for the entire entry. TOT AFT QTY 2 ensures 146 lb of prop at EI and requires a no-yaw-jet entry after  $q_{bar} = 20$  (flightpath angle capture). Both of these values are read up to the crew from the DEL PAD prior to the burn.
- B. Burn forward RCS propellant through the -X RCS jets. This involves pitching the orbiter through about  $165^\circ$  from the +X to the -X jet attitude. Once at attitude, the -X jets are burned until the FRCS prop is depleted and forward RCS jets fail off. All forward RCS propellant can be used for deorbit  $\Delta V$  because it is often dumped after the deorbit burn. The resultant aft c.g. offset from the unused OMS propellant and from burning all the forward propellant should be within the guidelines allowed by flight rule 4-72 D.
- C. Prebank the orbiter prior to EI. Prebank decreases the vertical component of the lift vector and causes a steeper trajectory early in the entry, increasing drag to dissipate  $\Delta V$  faster. Following the OMS/RCS POSTBURN RECONFIGURATION, the Entry Checklist contains a table showing prebank angle vs.  $\Delta HP$  (CUR HP - TGT HP) for use after all thrusting is completed. This procedure would be used only if insufficient propellant was available to burn all the required  $\Delta V$ .
- D. Redesignate the field from Edwards to Northrup. The maximum allowable prebank is limited by orbiter thermal constraints (primarily the wing chine). If prebanking cannot safely dissipate enough  $\Delta V$  to get down to Edwards, the orbiter can extend its entry trajectory to Northrup, allowing more time to dissipate  $\Delta V$  and reducing the surface heating load (but increasing the back face temperatures). The first row of the prebank table in the Entry Checklist shows those values of  $\Delta HP$  which can be handled for an Edwards landing. For larger  $\Delta HP$  remaining after all thrusting is completed, the second row shows prebanks required for Northrup. For landings at KSC there is no backup site available.

With these options explained, it is now possible to work through the cue card instructions following RCS COMPLETION.

- \* **RCS COMPLETION:** \*
- \* THC +X to TGT HP or TOT AFT QTY 1  % \*
- \* \*
- \* At AFT QTY 1 if CUR HP: THC +X to FLIP HP or \*
- \* TOT AFT QTY 2  % then \*
- \* FRCS COMPLETION \*
- \* \*
- \* FLIP HP  FRCS COMPLETION \*
- \* \*
- \* AFT HP  THC +X to TGT HP \*
- \* \*
- \* TGT HP  \*
- \* \*
- \* **FRCS COMPLETION:** \*
- \* MNVR to -X Att (pitch up at 3 deg/sec to VGOz = +1/4 ΔVTOT) \*
- \* THC -X to TGT HP or FRCS depletion (JETS FAIL OFF) \*

When the crew has used all the available OMS propellant and reconfigured for aft RCS jets, the next step in completing the burn is to use excess aft RCS propellant (THC +X) until the burn target is achieved (CUR HP = TGT HP) or until the aft RCS propellant is reduced to TOT AFT QTY 1. The RCS quantities can be read on the BFS SYS SUMM 2 display and on the quantity gauges on panel O3 if 'RCS' is selected.

If the TGT HP is achieved, the crew obviously would release the THC. But if the TOT AFT QTY 1 level is reached with CUR HP > TGT HP, the crew must then evaluate their capability of making the primary landing site without using additional aft RCS propellant.

If the current HP is greater than FLIP HP, the crew should continue to THC +X until reaching FLIP HP or TOT AFT QTY 2, whichever comes first. At this point the FRCS COMPLETION procedure is used to complete the burn. The TOT AFT QTY 2 limit should represent the minimum RCS propellant required for flight control during entry and, as such, should be honored even if indications are that a landing at the primary site is in doubt. FLIP HP is the HP at which the entry can be completed with forward RCS and prebank to the primary or secondary site.

If the current HP is less than or equal to FLIP HP but greater than AFT HP, +X thrusting is terminated and the FRCS COMPLETION procedure is used to complete the burn. If insufficient forward RCS propellant exists to deliver the desired ΔV, the forward RCS is depleted and the remainder of the underburn is absorbed by recovery prebank to the primary site or backup site if appropriate.

If the current HP is less than or equal to AFT HP, the crew should continue to THC +X until reaching the TGT HP. The AFT HP value is the maximum HP at which the burn may be completed on ARCS using the aft RCS propellant that was reserved for the fast flip maneuver, FRCS attitude hold, and prebank maneuver.

Once the decision is made to burn the -X RCS jets, the  $\Delta VTOT$  must be reduced as soon as possible. PASS closed-loop guidance keeps running during pitcharound (unlike BFS guidance, which goes open loop when the orbiter's X-axis passes through  $90^\circ$  from the desired thrust direction), but the longer the time taken coasting toward EI during pitcharound, the larger the  $\Delta V$  that has to be applied to meet terminal guidance constraints. Hence, the nominal trans-DAP maneuver rate of 0.5 deg/sec is replaced by 3 deg/sec, achieved by putting the RHC through the soft stop and using the accel mode.

This 3 deg/sec is considered a compromise between the desire to do a quick pitcharound, the amount of propellant needed to do the maneuver, and flight control stability considerations during the maneuver. The cue for completing the maneuver is  $VGOz = +1/4 \Delta VTOT$  on the CRT display. In addition to their -X component, the -X RCS jets have a small upward-firing (-Z) component that causes a pitchdown moment. During the extended -X RCS jet deorbit firing, the pitchdown is countered by periodic firings of upward-firing aft jets. The net result is a downward (+Z) translation in addition to the commanded -X translation, in a ratio between 1:3 and 1:4. To complete the burn most efficiently, the orbiter is maneuvered to the attitude where the ratio of  $VGOx$  and  $VGOz$  to be burned is approximately equal to the -X and +Z thrusts created by a -X THC deflection (after the pitch deadband of  $3^\circ$  is attained), hence the  $VGOz = +1/4 \Delta VTOT$  cue. Once the burn has started, the ratio of  $VGOz$  will increase to  $+1/3 \Delta VTOT$  due to the small upward-firing (-Z) component of the -X jets.

If the maneuver starts from a nominal +X RCS burn attitude, the total pitcharound maneuver is approximately  $165^\circ$ . To facilitate monitoring the maneuver and to help in anticipating when to start slowing down (which may not be so easy just using mentally calculated ratios of  $VGOz$  and  $\Delta VTOT$ ), the crew can select the 'REF' ADI position and hit the ATT REF PBI before starting the maneuver. Then it is easy to monitor how the maneuver is progressing using  $165^\circ$  as the approximate pitch for the -X RCS burn attitude and using the  $VGOz/\Delta VTOT$  ratios for fine tuning. During the  $165^\circ$  pitcharound, the  $VGOx$  portion of  $\Delta VTOT$  is gradually transferred into  $VGOz$  and then back into  $VGOx$  again, although with the opposite sign (i.e.,  $VGOx > 0$  becomes  $VGOx < 0$ ). Note that  $VGOy$  should be 0, although this is not called for explicitly in the cue card.

The opposite sign of  $VGOx$  is a cue to another aspect of a -X RCS burn. Guidance is still configured for a +X RCS burn and has no -X RCS capability. The THC must be pulled rather than pushed, which agrees with the minus sign. However, the error needles are working backwards and will behave as fly from references. The pitch needle is pegged in any case. In practice, the best way to fly the burn is to start THC -X thrusting with  $VGOz = +1/4 \Delta VTOT$  and allow the deadband to control the attitude. Soon after the initiation of THC -X, the  $VGOz/\Delta VTOT$  ratio will go from 1:4 toward 1:3 and will stabilize once the  $3^\circ$  pitch deadband has been reached. Any attempt to maintain the 1:4 ratio with the RHC will unnecessarily waste RCS propellant. The discrete rate/attitude hold mode of the DAP should, in fact, hold the orbiter attitude to within a  $3^\circ$  deadband about the attitude at which the RHC last went into detent. Because of the negative pitch moment of the -X RCS jets, the orbiter will tend to stay at the negative pitch side of the deadband, approximately  $3^\circ$  low compared to the initial burn attitude. To optimize the burn would require a table of  $VGOz$  versus  $\Delta VTOT$  values or more tedious real-time mathematics by the crew. A  $VGOz = +1/4 \Delta VTOT$  approximation is satisfactory. In fact, the required  $\Delta VTOT$  may increase during the pitcharound maneuver, so time is important in performing the -X RCS burn. Any propellant saved by fine-tuning the orbiter attitude could easily be lost if the -X RCS burn is delayed. Note that during the burn,

TGO will be counting down at half real time, since guidance thinks four RCS jets are firing, whereas in reality only two jets are firing.

The cue card specifies the cutoff criteria to use when following the THC -X instruction as TGT HP. If closed-loop guidance is operating (PASS), VGOx is also a valid cutoff cue. In the BFS, VGOx is decremented open-loop after pitcharound and may have a smaller absolute magnitude on the CRT than it should have. The actual  $\Delta V$  required to hit the burn target may increase while the orbiter is coasting, and this is not considered by open-loop guidance. So in the BFS, TGT HP is the valid cutoff cue.

There is no flight rule against burning the -X RCS jets dry. In fact, the FRCS should be burned until jet fail messages are encountered for this contingency case. Because of the PVT gauging, the fail message should not be expected until the FRCS quantity gauges are showing negative values. If after the -X jets are burned dry,  $\Delta HP$  is still  $> 0$ , there are no cue card procedures left. The crew goes back to the Entry Checklist, determines the prebank angle, and gets set for an exciting ride home.

#### 4.3.2 1 ENG DEORBIT BURN

This section presents the nominal burn and failure procedures associated with the DEORBIT BURN (1 ENG) cue card (figure 4-9). Much of the explanation of the DEORBIT BURN (2 ENG) cue card applies to the other deorbit cue cards as well. This and subsequent sections will cover only the unique aspects of the planned off-nominal burns. Note that the OMS BURN PREP section of the Entry Checklist has the crew crossfeed the failed engine's propellant to the good engine.

##### 4.3.2.1 Nominal Procedures

The main unique procedure in the 1 engine deorbit burn is starting the burn with the failed OMS engine propellant crossfed to the good OMS engine. During the burn a return to straight feed must be done at the proper time to balance the propellants remaining on each side for Y c.g. control. Both  $\Delta VTOT$  and percent quantity cues are available. The percent quantity cue includes the side to be monitored (L or R), the propellant to be monitored (FU or OX), and the percent quantity to return to straight feed.

OMS XFEED RETURN at  $\Delta VTOT = \begin{array}{|c|c|c|} \hline \square & \square & \square \\ \hline \end{array}$   
 or  $\begin{array}{|c|c|} \hline \square & \square \\ \hline \end{array}$  at  $\begin{array}{|c|c|} \hline \square & \square \\ \hline \end{array} \%$   
 L,R OMS TK ISOL (four) - OP  
 XFEED (four) - CL

The OMS switch throws required to reconfigure from crossfeed to return to normal are also included on the cue card.

TOP  
BACK OF 'DEORBIT BURN (2 ENG)'

**DEORBIT  
BURN (1 ENG)**

✓MM302    ✓OMS L or R  
 ✓OMS BURN CONFIG (L or R XFEED)  
 Enter TGO + 10 sec  
 ✓TRIM per MNVR PAD or P +0.0, LY +5.2, RY -5.2  
 L,R OMS He PRESS/VAP ISOL A (two) - OP  
 ..... Wait 2 sec ..... B (two) - OP  
 ✓DAP - AUTO(PASS)/DISC  
 ADI - LVLH(REF)/HI/MED  
 FLT CNTLR PWR (two) - ON  
 TIG-2    Good OMS ENG - ARM/PRESS  :   )  
 - :15 EXEC (NO EXEC > TIG +  :  )  
 - :15 If OMS AFT QTY < 11%, THC +X to OMS IGN + 1 sec  
 :00 TIG Start watch (✓Pc, ΔVTOT, ENG VLVs)  
 \* If no OMS ignition: APUs - SHUT DN \*  
 OMS XFEED RETURN at ΔVTOT =      
 or   at   %  
 L,R OMS TK ISOL (four) - OP  
 XFEED (four) - CL

**\* OMS PRPLT FAIL:**  
 OMS ENG - OFF

STOP BURN:  
 APUs - SHUT DN  
 Secure aft OMS

SAFE    
 HP

CONTINUE BURN:  
 Secure aft OMS  
 ITEM 18 +0 EXEC  
 ✓ADI - LVLH, center needles  
 Interconnect good OMS to RCS  
 THC +X(✓OMS% vs RCS Burn Time)  
 AFT RCS RECONFIG  
 RCS COMPLETION

**\* OMS ENG FAIL:**  
 OMS ENG - OFF

STOP BURN:  
 APUs - SHUT DN

ENG FAIL     
 HP

CONTINUE BURN:  
 ✓ADI - LVLH, center needles  
 Interconnect OMS to RCS  
 THC +X(✓OMS% vs RCS Burn Time)  
 RCS I'CNCT TK SW  
 THC +X(✓OMS% vs RCS Burn Time)  
 AFT RCS RECONFIG  
 RCS COMPLETION

**\* RCS +X JET FAIL OFF:**

STOP BURN:  
 APUs - SHUT DN

SAFE    
 HP

CONTINUE BURN:  
 ITEM 18 +0 EXEC  
 [G23] Resel jets

ENT-4b/D/G

HINGE

CC 8-10 (FQ)

Figure 4-9. DEORBIT BURN (1 ENG) cue card

#### 4.3.2.2 OMS PRPLT FAIL

When a propellant failure occurs, the first step is to turn off the failed OMS engine as soon as possible to avoid any additional problems. The next step is to compare the current HP to the safe HP value entered on the cue card. If the current HP is greater than or equal to safe HP, the burn is terminated. This entails shutting down the APU's and securing the affected OMS.

If the current HP is less than safe HP, the burn must be continued. Remember that after a propellant failure has occurred, the engine is considered failed. The burn must be continued using only the propellant on the good side burned through the +X RCS jets.

|   |                                |   |
|---|--------------------------------|---|
| * | CONTINUE BURN:                 | * |
| * | Secure aff OMS                 | * |
| * | ITEM 18 + 0 EXEC               | * |
| * | √ADI - LVLH, center needles    | * |
| * | interconnect good OMS to RCS   | * |
| * | THC +X(√OMS% vs RCS BURN TIME) | * |
| * | AFT RCS RECONFIG               | * |
| * | RCS COMPLETION                 | * |

If the burn is continued, the crew should secure the OMS on the side with the failed propellant. After a propellant failure, all remaining 'good' propellant must be made available for in-plane  $\Delta V$ . The out-of-plane propellant wasting is terminated for the remainder of the burn via the ITEM 18 + 0 EXEC action. The crew should position the ADI in the LVLH position and center the ADI error needles. Guidance will reconfigure the orbiter's attitude and the ADI error needles for an RCS burn.

If the propellant failure occurred after return to straight feed, the propellant remaining on the other side is the good side. This good propellant would not have been used had the burn proceeded as planned. If any useable propellant remains, it is interconnected to the RCS. If no propellant is remaining on the good side, the crew would jump to the RCS COMPLETION section of the cue card.

When a propellant failure occurs while in the crossfeed configuration, the propellant on the straight feed side is the good side. In this case the good OMS is interconnected to the RCS, and the remainder of the OMS propellant is burned through the +X RCS jets. In any case, once the OMS is interconnected to the RCS, the burn time for the +X burn is calculated by using the OMS gauge quantity or helium pressure versus RCS Burn Time on the c.g. calculator cue card.

Once all available OMS propellant has been depleted, the aft RCS is reconfigured to use RCS propellant. If target HP is still not achieved, the crew proceeds to the RCS COMPLETION section of the cue card. Any remaining  $\Delta V$  for the deorbit burn will come from RCS propellant through the +X RCS jets.



#### 4.3.2.3 OMS ENG FAIL

Because only one engine was available at the start of the burn, a single engine failure leads directly to completion of the burn using any remaining OMS propellant through the +X RCS jets. The OMS engine fail procedures are very similar to the OMS propellant fail procedures just described. When an engine failure occurs, the first step is to turn off the failed OMS engine as soon as possible.

The next step is to compare the current HP to the engine fail HP value entered on the cue card. If the current HP is greater than or equal to the engine fail HP, the burn is terminated and the APU's are shut down. If the burn is to be continued, the crew should position the ADI in the LVLH position and center the ADI error needles. Guidance will reconfigure the orbiter attitude and the ADI error needles for an RCS burn.

The procedure calls for an interconnect to either OMS pod when the second OMS engine fails, regardless of the pod levels or which one was being used at the time of the failure. Because the OMS quantity gauges do not operate unless an OMS engine is on, the tank-switch cue must be determined by using the OMS gauge quantity or helium pressure versus RCS Burn Time shown on the c.g. calculator. Once the first tank burn time is completed, an RCS interconnect tank switch is done. The RCS burn time for the second pod is also checked because of the possibility that the amount of OMS propellant in the second pod may be insufficient to complete the remaining  $\Delta V$ . If the OMS is depleted from both pods and target HP is still not achieved, the crew should proceed to 'AFT RCS RECONFIG' to break the interconnect and complete the burn with the RCS COMPLETION procedure.

#### 4.3.2.4 RCS +X JET FAIL OFF

These procedures are analogous to the OMS ENG FAIL procedures and are used only if the crew has already downmoded to using OMS propellant through the RCS +X jets. If a +X jet fails off, the burn is terminated if HP is greater than safe HP, because enough propellant may not be available to complete the burn with 3 +X jets. If the burn is continued, propellant wasting is zeroed to utilize all available propellant for in-plane  $\Delta V$ . The failed +X jet is then reselected in hopes that it will restart and be useable for the remainder of the burn.

```

* RCS +X JET FAIL OFF: *
*   STOP BURN: *
*   APU's - SHUT DN *
*   SAFE HP  _____ *
*   CONTINUE BURN: *
*   ITEM 18 + 0 EXEC *
*   G23 Resel jets *

```

### 4.3.3 RCS DEORBIT BURN

This section presents the nominal burn and failure procedures associated with the DEORBIT BURN (RCS) cue card (figure 4-10). Note that the OMS BURN PREP section of the Entry Checklist has a separate procedure to establish the preburn configuration for a planned RCS deorbit. Though it is arbitrary which OMS propellant side to feed from first, the procedures have the crew always start with the left side for consistency.

## DEORBIT BURN (RCS)

TOP



- ✓MM302 ✓RCS SEL
- ✓RCS BURN CONFIG (L OMS I'CNCT)
- L,R OMS H<sub>0</sub> PRESS/VAP ISOLA (two) - OP
- ..... Wait 2 sec ..... B (two) - OP
- ✓DAP - INRTL/DISC
- ADI - LVLH(REF)/MED/MED
- FLT CNTLR PWR (two) - ON

TIG    THC +X (No deorbit > TIG +  :  )  
 Maintain PITCH ATT ERR ± 3°  
 Monitor ΔVTOT:  
     RCS I'CNCT TK SW at ΔVTOT =   
     R OMS XFEED (two) - OP  
     L OMS XFEED (two) - CL

· OMS PRPLT LOW ·  
 · AFT RCS RECONFIG AT ΔVTOT =  ·  
 · RCS COMPLETION ·

• **OMS PRPLT FAIL (MULTIPLE JETS FAIL OFF):**

Secure aff OMS

STOP BURN:  
 APU<sub>s</sub> - SHUT DN

---

CONTINUE BURN:  
 ITEM 18 +0 EXEC  
 (G23) Resel jets  
 Interconnect good OMS to RCS  
 THC +X (✓OMS% vs RCS Burn Time)  
 AFT RCS RECONFIG  
 RCS COMPLETION

• **RCS +X JET FAIL OFF:**

STOP BURN:  
 APU<sub>s</sub> - SHUT DN

---

CONTINUE BURN:  
 ITEM 18 +0 EXEC  
 (G23) Resel jets

ENT-3a/D/I



CC 8-4 (FQ)

*Figure 4-10. DEORBIT Burn (RCS) cue card*

TOP  
HINGED AT BOTTOM OF  
'DEORBIT BURN (RCS)'  
HINGE

• **RCS COMPLETION:**  
 • THC +X to TGT HP or TOT AFT QTY 1   %  
 •  
 • At AFT QTY 1                      THC +X to FLIP HP or  
 • if CUR HP:                      TOT AFT QTY 2   % then  
 •                                      FRCS COMPLETION  
 •  
 • FLIP   -----  
 • HP                                      FRCS COMPLETION  
 •  
 • AFT   -----  
 • HP                                      THC +X to TGT HP  
 •  
 • TGT   -----  
 • HP  
 •  
 • **FRCS COMPLETION:**  
 • MNVR to -X Att (pitch up at 3°/sec to VGOz = +1/4 ΔVTOT)  
 • THC -X to TGT HP or FRCS depletion (JETS FAIL OFF)

CUTOFF VGOx = 0, release THC  
 AFT RCS RECONFIG  
 Trim Inplane X,Z residuals < 2 fps (< 0.5 if shallow)

ENT-3aa/D/H

CC 8-5 (FQ)

Figure 4-10. Concluded

#### 4.3.3.1 Nominal Procedures

Once the crew has loaded the deorbit burn target on the DEORB MNVR display for the RCS SEL (+X RCS) option, they will maneuver to the indicated inertial attitude that has been calculated. Venting of the orbiter can cause the orbiter to wallow in the 3.5° deadband for some 15 minutes before the burn. The crew should not waste RCS propellant in retweaking the needles before thrusting (except maybe in roll) because they would needlessly be adjusting to the same reference that had been established previously.

With the onset of THC +X, the crew is instructed to maintain PITCH ATT ERR  $\pm 3^\circ$ . The DAP controls to an inertial attitude of  $\pm 3^\circ$ , but any misalignment of the thrust vector is indicated as error on the ADI attitude error needles, which are really thrust vector error indicators. The net thrust of the +X thrusters is above the c.g., causing a small downward pitching moment. If the RCS DAP is controlling the attitude, it will allow a drift down to  $-3^\circ$  (error needle up  $3^\circ$ ) and will then fire pitchup jets to correct the attitude and stay within the deadband. The corrected pitch decreases again due to the +X jets downward pitch moment until the pitch comes back to  $-3^\circ$  causing another RCS pitchup correction.

The proper technique for handling +X RCS burns is to command a manual pitchup maneuver when the pitch error needle reaches  $+3^\circ$  (up). Hold the RHC out of detent until the needle goes to  $-3^\circ$  (down), then release the RHC. This resets the RCS phase plane zero point to  $3^\circ$  high. The net error of  $-2^\circ$  to  $-3^\circ$  that the RCS phase plane control then holds should keep the error needle centered around  $0^\circ$ . Remember, the error needle is still comparing desired to precalculated thrust directions and does not directly show the errors driving the DAP. Hence, the pitch error needle can be showing zero even when the orbiter is bouncing off the edge of the  $\pm 3^\circ$  DAP deadband.

When using this technique, the pilot may see that the error needle does not hold precisely at  $0^\circ$ ; it may instead drift up very slowly. RHC pitchup corrections are necessary to bring the error needle back to  $-3^\circ$  (down).

Approximately 30 seconds before the RCS burn terminates, the pitch error needle may begin to bounce around erratically. This is related to the accelerometers' being in the nose of the orbiter rather than at the c.g. The pilot is warned not to follow the error needles if they become erratic. Hold attitude on the ADI and complete the burn based on  $VGO_x = 0$ .

Remember that the OMS propellant system is being used, so all the propellant checks that the crew performs during an OMS engine burn should be done here as well.

The tank switch cue is  $\Delta VTOT$ .

Monitor  $\Delta VTOT$ :

RCS I'CNCT TK SW at  $\Delta VTOT = \square \square \square$   
 R OMS XFEED (two) - OP  
 L OMS XFEED (two) - OP

This is not strictly a crossfeed, of course. The RCS is interconnected to the OMS, and the interconnect is switched from one OMS pod to the other to access the propellant necessary

for the burn and to balance the Y c.g. No direct OMS propellant quantity information is available.

After the burn, reconfigure to burn RCS propellant before trimming out the Y and Z residuals (presumably VGOx will be zero since that is the criterion for stopping the burn). The rationale is the same as the 2 engine deorbit burn.

The OMS PRPLT LOW  $\Delta VTOT$  is given to the crew preburn via the PRPLT PAD if there is not enough OMS propellant to complete the burn. When the burn reaches the  $\Delta VTOT$  given, a reconfiguration to utilize RCS propellant will be done and the burn completed with RCS propellant.

#### **4.3.3.2 OMS PRPLT FAIL**

The OMS PRPLT FAIL section of the cue card contains procedures to follow in the event of a propellant failure. The basic cue that a propellant failure has occurred is when multiple jets fail off or  $\Delta VTOT$  does not decrement.

As in the other deorbit situations, targeting for RCS deorbit assumes that all the preburn propellant can be used, which is no longer valid after a propellant failure. Moreover, an OMS propellant failure occurring while the +X RCS jets are burning OMS propellant may cause damage to the jets, rendering them unusable even with aft RCS propellant. It is a bad day if you get a propellant failure after the two OMS engine failures that required the RCS deorbit. If  $HP > \text{safe HP}$ , stop the burn and shut down the APU's. If  $HP < \text{safe HP}$ , there is no alternative but to press on.

If the burn is continued, propellant wasting is zeroed to utilize all available propellant for in-plane  $\Delta V$ . The failed +X jet is then reselected in the hope that it will restart and be useable for the remainder of the burn. If the propellant failure occurs before the RCS interconnect tank switch, the RCS is interconnected to the remaining good OMS pod and the burn is continued. The RCS burn is time for the second pod is checked because of the possibility that the amount of OMS propellant in the second pod may be insufficient to complete the remaining  $\Delta V$ . If all useable OMS propellant is depleted from the good pod and target HP is still not achieved, the crew should proceed to AFT RCS RECONFIG to break the interconnect and complete the burn with the RCS COMPLETION procedure. If the propellant failure occurs after the RCS interconnect tank switch, no useable OMS propellant remains. The only option is for the crew to perform the AFT RCS RECONFIG and complete the burn with the RCS COMPLETION procedure. Once the RCS system is configured to burn RCS propellant, the cue card procedures are identical to those in the 2 ENG DEORBIT BURN cards.

#### **4.3.4 UNBALANCED PRPLT DEORBIT BURN**

This is the longest deorbit cue card (figure 4-11) and is used when one OMS pod is significantly heavier than the other. The procedure is designed to change the Y c.g. by burning more OMS propellant on the heavy side. The burn is started with the propellant from the heavy side feeding both OMS engines. Straight feed is configured during the burn when the Y c.g. is balanced. The burn is then completed in the normal configuration. This is not considered an off-nominal procedure because the burn is executed with all components of the OMS system working.





TOP  
 BACK OF 'UNBALANCED PRPLT DEORBIT BURN'  
 DEORBIT  
 BURN  
 (MIXED  
 XFEED)

✓MM302 ✓OMS L(R) or RCS  
 Enter TGO + 10 sec  
 ✓L,R OMS TK ISOL (four) - GPC  
   ✓XFEED (four) - GPC  
 ✓tb config from table (OMS SSR-1)  
 ✓DAP - AUTO(PASS)/DISC  
 ADI - LVLH(REF)/HI/MED  
 FLT CNTLR PWR (two) - ON  
 Man repress to maintain good OMS Tk Ps > 234 psi (simo)  
 If OMS BURN INITIATION:  
   ✓TRIM per MNVR PAD or: P +0.0, LY +5.2, RY -5.2  
 TIG-2: Good OMS ENG - ARM/PRESS  
   - :15 EXEC (No EXEC > TIG +  :  )  
   - :15 If OMS AFT QTY < 11%, THC +X to OMS IGN + 1 sec  
   :00 TIG Start watch (✓Pc, ΔVTOT, ENG VLVs)  
     \* If no OMS ignition, APUs - SHUT DN \*  
 If RCS BURN INITIATION:  
   Man repress L,R OMS > L,R RCS TK Ps  
   L,R RCS XFEED (four) - OP  
     TK ISOL (sb) - CL  
   :00 THC +X (No Deorbit > TIG +  :  )  
     Maintain PITCH ATT ERR ± 3°

FEED FROM GOOD POD:  
   at ΔVTOT =     
 or  at   %  
 OMS He PRESS/VAP ISOL (two) - OP  
   TK ISOL (two) - OP (tb-OP)  
   XFEED (two) - OP (tb-OP)  
 SECURE  OMS

• OMS PRPLT LOW  
 • AFT RCS RECONFIG at ΔVTOT =     
 • RCS COMPLETION

----- ENT-5b/D/G -----  
 HINGE  
 CC 8-14 (FQ)

Figure 4-11. Continued

TOP  
 HINGED AT BOTTOM OF  
 'DEORBIT BURN (1 ENG)'  
 HINGE

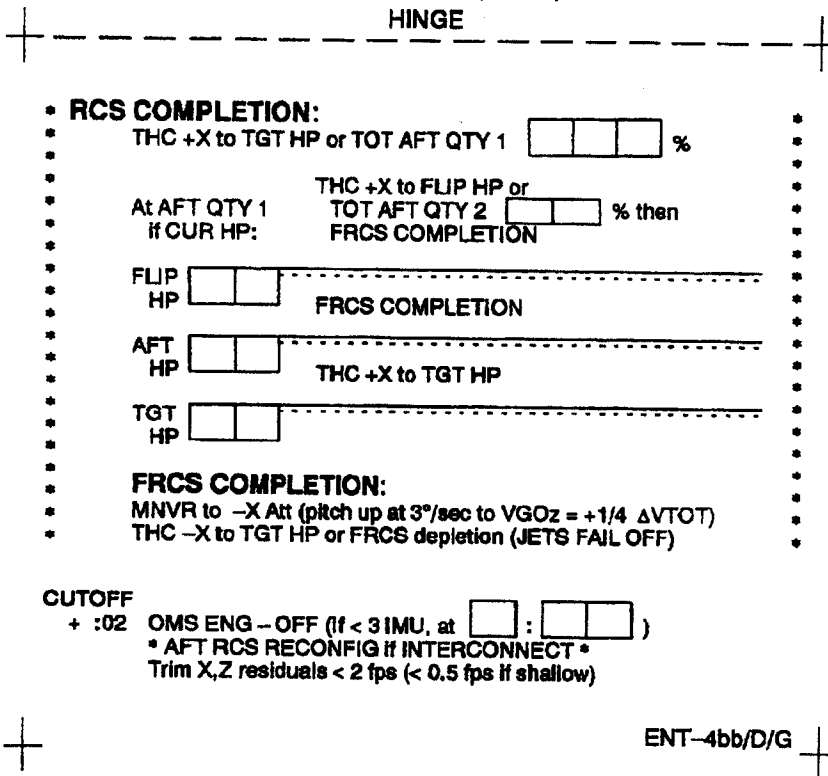

CC 8-11 (FQ)

Figure 4-11. Continued

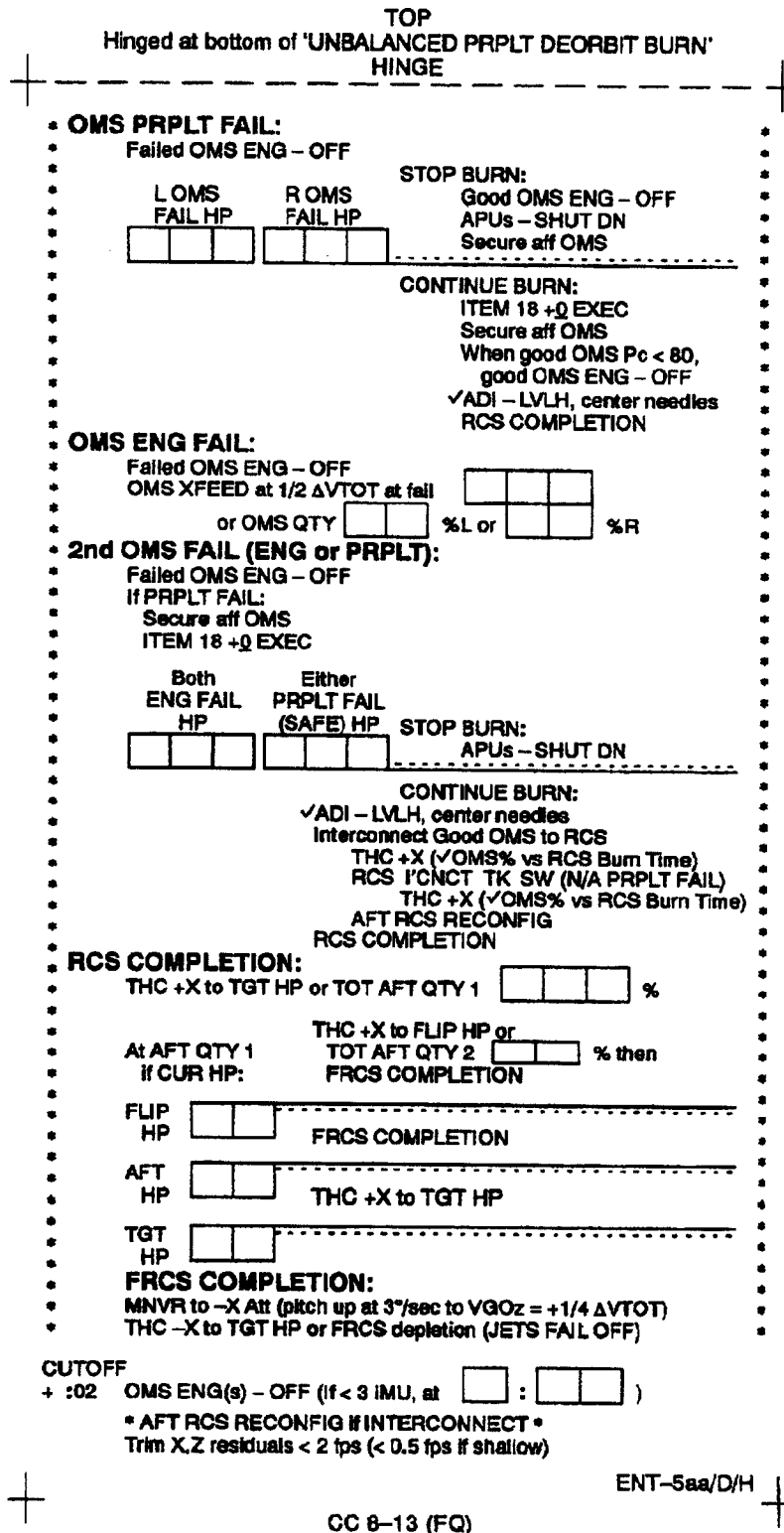

Figure 4-11. Concluded

#### 4.3.4.1 Nominal Procedure

Prior to burn start, the OMS valves are configured such that the heavy OMS pod is feeding both OMS engines. The tank isolation valves on the light side are closed and all the OMS crossfeed valves are opened. The PAD includes a block before OMS TK ISOL (two) - CL (tb-CL) in which to write either an L or R to remind the crew which is the light side.

OMS TK ISOL(two) - CL (tb-CL)  
L,R OMS XFEED(four) - OP (tb-OP)

As soon as the proper Y c.g. is achieved, straight feed is configured by opening the tank isolation valves and closing all crossfeed valves. The cue for ending crossfeeding is a  $\Delta VTOT$  value from the propellant PAD. L or R is also written in this TK ISOL block to remind the crew which tank isolation valves to open.

Return to 2 ENG, 2 POD FLOW at  $\Delta VTOT$ :   
 OMS TK ISOL (two) - OP (tb-OP)  
L,R OMS XFEED (four) - CL (tb-CL)

From this point on, the burn is completed exactly as a nominal two-engine deorbit burn. Inspection of the off-nominal section taking up the second page of this cue card procedure shows that it is identical to the off-nominal section of the 2 ENG DEORBIT BURN cue card. For simplicity, only the off-nominal sections covering failures during the crossfeed are discussed in the following sections.

#### 4.3.4.2 OMS PRPLT Fail During Crossfeeding

Since one OMS pod is feeding both OMS engines, a propellant failure may fail both OMS engines. If any propellant failure occurs above safe HP, the burn is stopped, the APU's are shut down, and the affected OMS pod is secured. Below safe HP the burn must be continued.

After a propellant failure, all remaining propellant should be used for in-plane  $\Delta V$ . The out-of-plane propellant wasting is terminated for the remainder of the burn via the ITEM 18 + 0 EXEC action. Depending on where the propellant failure occurs, one or both OMS engines may fail. The deorbit maneuver display will indicate which engines have failed by a down arrow. If both OMS engines fail, the blockage is above the crossfeed tee. Therefore, the propellant that was feeding the engines is unuseable and the burn must be completed with RCS +X jets. The good OMS propellant is connected to the RCS jets and a +X translation is done. In this case, the good OMS would be the side that was not used to start the burn (the light side). Since the correct pod and the amount of propellant on the light side are known in advance, the cue card has blocks for an L or R and the time available to burn the RCS jets with the OMS prop. These values are entered from the propellant PAD prior to burn start.

- \* ITEM 18 + 0 EXEC \*
- \* If Both ENGS ↓: \*
- \*     Secure aff OMS \*
- \*     √ ADI - LVLH, center needles \*
- \*     Interconnect  OMS to RCS \*
- \*     THC +X for  :  \*
- \*     AFT RCS RECONFIG \*
- \* RCS COMPLETION \*

A propellant blockage that occurs in the crossfeed line will fail the crossfed engine without failing the straightfed engine. In this case, the crew must continue to monitor the burn with one engine. As the oxidizer/fuel ratio departs from nominal, the engine performance will start to degrade and the chamber pressure will fall. This is why the cue card calls for Pc < 80 percent as the criterion for turning off the second engine. Since the blockage is in the crossfeed line, there is no way to get the propellant from the once light side to the RCS jets. If there is still ΔVTOT to be burned, the cue card now refers the crew to the RCS COMPLETION heading of the cue card, which is discussed in section 4.3.1.5.

A propellant blockage that occurs in the straightfed engine without affecting the crossfed engine is downstream of the crossfeed tee. This is equivalent to an OMS engine failure and is handled by that procedure.

**4.3.4.3 OMS ENG Fail During Crossfeeding**

At this point, both engines are being fed from the heavy pod, with the crossfeed valves open. No matter which engine fails, the other engine continues to receive propellant. In the nominal procedures, crossfeeding is ended when the proper Y c.g. is obtained and both engines complete the burn from their own pods. However, it is not allowed to feed the one remaining engine in this case from both pods. This could allow propellant to flow from one pod to another through the open crossfeed lines if the propellant pressures differed sufficiently from side to side. Instead, the 'heavy' side propellant is burned longer than in the nominal case and the burn is then completed with propellant from what was originally the 'light' side. The crossfeed valves remain open for the duration of the burn, and only one pod is feeding at any given time. The ΔVTOT, percent quantity, and L/R cues for the tank switch are provided in the PAD and are precalculated to end up with a balanced c.g.

- \* OMS ENG FAIL(CONTINUE BURN): \*
- \* Failed OMS ENG - OFF \*
- \*     at ΔVTOT =  \*
- \*     or   at  % \*
- \*      TK ISOL(two) - OP \*
- \*      TK ISOL(two) - CL \*

#### 4.3.5 DEORBIT BURN (MIXED XFEED)

This is a somewhat involved procedure designed to restore Y c.g. balance in the event of a propellant leak or trapped propellant in either the fuel or oxidizer tank in one OMS pod. It involves feeding fuel from one pod and oxidizer from the other pod for part of the burn. This flow requires nonstandard valve settings that are not available via the normal switches; hence, a GPC read/write procedure is necessary prior to the burn to configure the valves. Note that the mixed crossfeed procedure does not provide any more  $\Delta V$  than would have been available had it not been used. It merely balances the Y c.g.

As an example, suppose a leak has occurred in the left OMS fuel tank depleting this tank entirely. Suppose further that approximately 50 percent propellant remains in each of the other three tanks and corresponds to a helium pressure of 3230 psi. Fifty percent propellant quantity in one pod gives 297 fps (see OMS He PRESS of 3230 psi on the c.g. calculator cue card), which is close to what is needed for a nominal deorbit. The burn could be carried out feeding all the propellant from the right side, in which case the left oxidizer tank would remain 50 percent full and all three other tanks would be empty following the deorbit burn. This would cause an approximately 2- to 3-inch Y c.g. offset.

With the mixed crossfeed procedure, the burn is fed oxidizer from the left pod and fuel from the right pod. Halfway through the burn, the left pod is closed, and oxidizer and fuel are fed from the right side for the rest of the burn. Following the burn, both fuel tanks are empty and both oxidizer tanks are 25 percent full with a balanced Y c.g. As stated above, the mixed crossfeed procedure results in a balanced Y c.g. It does not provide any more DV for the burn because this is limited by the total amount of fuel available.

OMS/RCS VALVE CONFIG (figures 4-12 and 4-13) illustrate the OMS tank and valve configurations at the start of this example and at the midburn reconfiguration point.

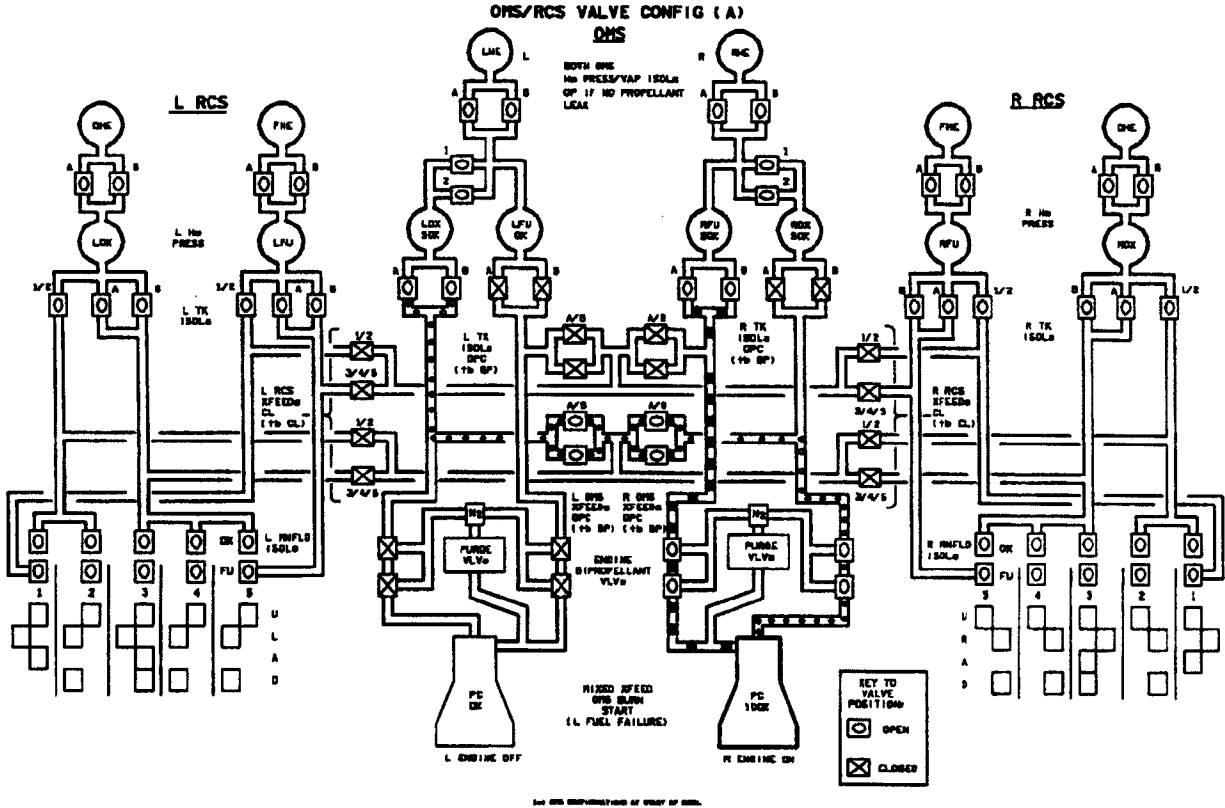

Figure 4-12. OMS/RCS valve configuration (A)

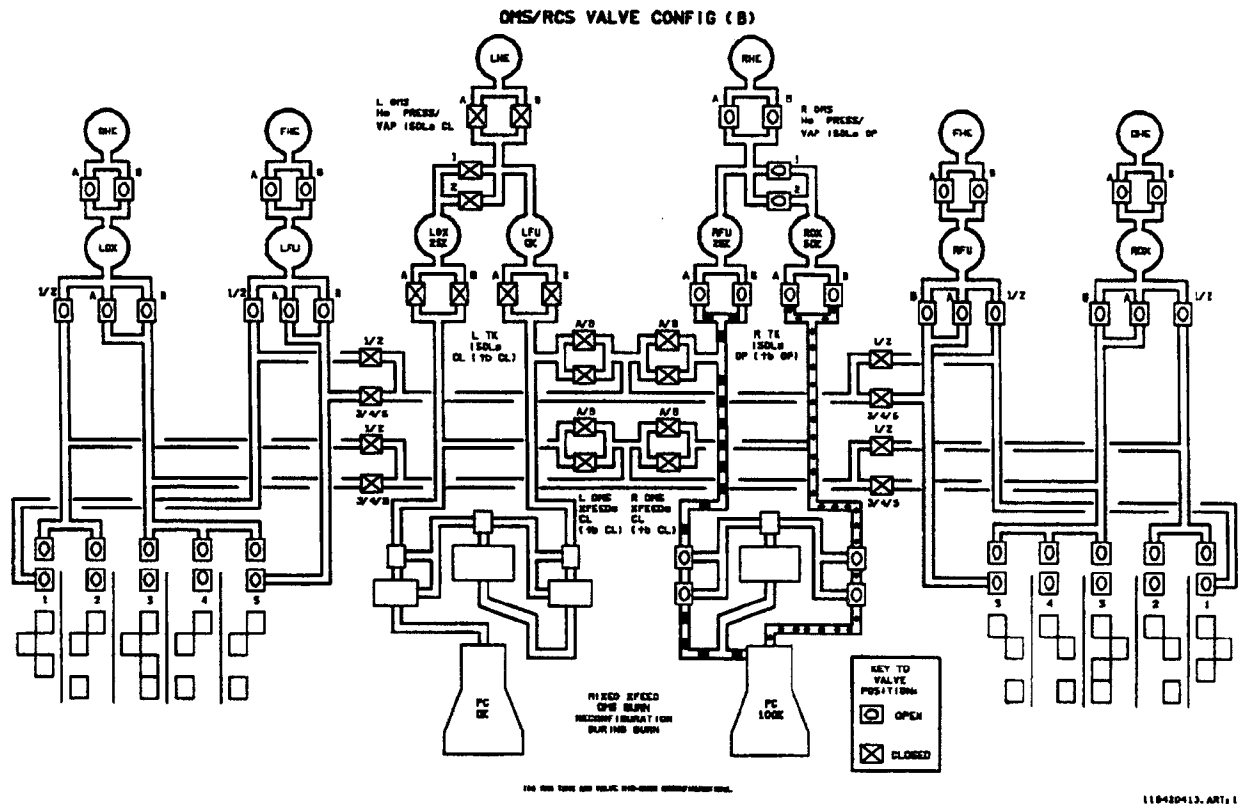

Figure 4-13. OMS/RCS valve configuration (B)



#### 4.3.5.1 Nominal Procedure

The cue card (figure 4-14) is written to use the OMS engine on the 'good' propellant side (i.e., the side with both pods intact) or +X RCS jets. If necessary for some special reason, the other engine could be used, but this would require that procedural modifications be uplinked to the crew. Prior to the burn, a GPC read/write procedure is carried out. This procedure, 'OMS SSR-1,' is found in section 11 of the 'Malfunction Procedures.' This procedure causes the proper combination of fuel and oxidizer tank valves and crossfeed valves to be open in opposite pods when the TK ISOL and XFEED switches are in the GPC position.

Note that the XFEED and TK ISOL switches on both L and R sides must be set to 'GPC.' Normally, this would never be done because it could allow a path for propellant to flow from one side into the other if a sufficient pressure differential existed. However, the crew has manually closed all the TK ISOL and XFEED valves on the failed propellant tank (left fuel tank, in the example given above) and on the tank that will not be used until partway through the burn (right oxidizer, in the above example) before going to the GPC position. Thus, no open paths exist between the two pods. The TK ISOL and XFEED talkbacks are all barberpole, which indicates a mismatch in configuration, caused by the read/write procedure.

If an OMS engine is used, the burn is begun using the off-nominal valve configuration with the altered 'GPC' switch settings. The valve positions are checked by MCC prior to deorbit, after the GPC read/write procedure, and the valves are not moved again until the proper time for reconfiguration during the burn.

If the +X RCS jets are used, an OMS/RCS interconnect must be done. Prior to interconnecting, the OMS tank is manually repressurized to a pressure greater than the RCS tanks. This prevents the flow of RCS propellant to the OMS tanks while doing the interconnect. The interconnect is done by opening the RCS XFEED valves and closing the RCS TK ISOL valves. At TIG, the +X is initiated and manual pitch control is maintained using the techniques described in the RCS DEORBIT BURN section (section 4.3.3.1). The crossfeed must be done at the proper time to balance the propellants remaining on each side for Y c.g. control. For an RCS burn the DVTOT cue is used.

For the reconfiguration, the He Press/VAP ISOL valves on the good side (right side, in the above example) are opened if they were not previously opened during the mixed configuration at the start of the burn. The TK ISOL valves and XFEED on the good side are opened. Finally, the OMS pod on the bad side is secured by closing the He PRESS/VAP ISOL and the TK ISOL valves. For all these reconfiguration settings, the hardwired OP and CL switch positions are used because the GPC positions were altered by the read/write procedure. The talkbacks change from barberpole to OP or CL. The rest of the burn is then carried out in the normal single-engine configuration with both propellant tanks on one side feeding the engine on that side.

**DEORBIT BURN (MIXED XFEED)**



✓MM302    ✓OMS L(R) or RCS  
 Enter TGO + 10 sec  
 ✓L,R OMS TK ISOL (four) – GPC  
     ✓XFEED (four) – GPC  
 ✓tb config from table (OMS SSR-1)  
 ✓DAP – AUTO(PASS)/DISC  
 ADI – LVLH(REF)/HI/MED  
 FLT CNTLR PWR (two) – ON  
 Man repress to maintain good OMS Tk Ps > 234 psi (simo)  
 If OMS BURN INITIATION:  
     ✓TRIM per MNVR PAD or: P +0.0, LY +5.2, RY -5.2  
 TIG-2:    Good OMS ENG – ARM/PRESS  
     - :15 EXEC            (No EXEC > TIG +  :  )  
     - :15 If OMS AFT QTY < 11%, THC +X to OMS IGN + 1 sec  
     :00 TIG    Start watch (✓Pc, ΔVTOT, ENG VLVs)  
         \* If no OMS Ignition, APUs – SHUT DN \*  
 If RCS BURN INITIATION:  
     Man repress L,R OMS > L,R RCS TK Ps  
     L,R RCS XFEED (four) – OP  
     TK ISOL (sb) – CL  
     :00 THC +X (No Deorbit > TIG +  :  )  
     Maintain PITCH ATT ERR ± 3°  
  
 FEED FROM GOOD POD:  
      at ΔVTOT =     
 or  
      at  %  
      OMS He PRESS/VAP ISOL (two) – OP  
     TK ISOL (two)                    – OP (tb-OP)  
     XFEED (two)                      – OP (tb-OP)  
     SECURE  OMS  
  
 : OMS PRPLT LOW :  
 : AFT RCS RECONFIG at ΔVTOT =    :  
 : RCS COMPLETION :



**Figure 4-14. DEORBIT BURN MIXED XFEED cue card**

TOP  
Hinged at bottom of 'DEORBIT BURN (MIXED XFEED)'  
HINGE

**OMS PRPLT FAIL:**  
OMS ENG - OFF

STOP BURN:  
APUs - SHUT DN  
Secure L,R OMS

SAFE     
HP

CONTINUE BURN:  
Secure L,R OMS  
ITEM 18 +Q EXEC  
✓ADI - LVLH, center needles  
RCS COMPLETION

---

**OMS ENG FAIL:**  
OMS ENG - OFF

STOP BURN:  
APUs - SHUT DN

ENG     
FAIL  
HP

CONTINUE BURN:  
Man repress L,R OMS > L,R RCS TK Ps  
FEED FROM GOOD POD:

OMS HE PRESS/VAP ISOL  
(two) - OP  
TK ISOL (two) - OP

OMS XFEED (two) - CL  
L,R RCS XFEED (four) - OP  
TK ISOL (six) - CL

✓ADI - LVLH, center needles  
THC +X (✓Lowest OMS % vs  
RCS Burn Time)  
AFT RCS RECONFIG  
RCS COMPLETION

---

**RCS +X JET FAIL OFF:**

STOP BURN:  
APUs - SHUT DN

SAFE     
HP

CONTINUE BURN:  
ITEM 18 +Q EXEC  
G23 Raset jet

---

**RCS COMPLETION:**

THC +X to TGT HP or TOT AFT QTY 1    %  
At AFT QTY 1  
if CUR HP: THC +X to FLIP HP or  
TOT AFT QTY 2   % then  
FRCS COMPLETION

---

FLIP    
HP FRCS COMPLETION

---

AFT    
HP THC +X to TGT HP

---

TGT    
HP

---

**FRCS COMPLETION:**  
MNVR to -X Att (pitch up at 3°/sec to VGOz = +1/4 ΔVTOT)  
THC -X to TGT HP or FRCS depletion (JETS FAIL OFF)

CUTOFF VGOx = 0, Release THC  
+ :02 OMS ENG(s) - OFF (if < 3 IMU, at  :   )

\* AFT RCS RECONFIG if INTERCONNECT \*  
Trim X,Z residuals < 2 fps (< 0.5 fps if shallow)

ENT-5bb/D/F

CC 8-15 (FQ)

Figure 4-14. Concluded

#### 4.3.5.2 OMS PROPELLANT FAIL

It is a bad day if a second propellant failure occurs on top of the propellant failure that led to the use of this procedure in the first place. As with the other off-nominal burns (one-engine, RCS), the procedure here, in the event of a problem during the burn, is to shut down if this can be done safely (i.e., HP > safe HP) and allow time for MCC to reconsider the remaining propellant availability.

If the burn is to be continued, the engine is turned off, propellant wasting is terminated, both OMS tanks are secured, and a normal RCS completion with RCS propellant is carried out.

The MIXED CROSSFEED DEORBIT BURN cue card is the only card that does not contain an 'AFT RCS RECONFIG' instruction at this point, as there is no possibility of interconnecting the RCS to an OMS propellant system. After a propellant failure, there is probably no complete propellant system left. Hence, the RCS is always configured to burn its own propellant and no reconfiguration is necessary.

#### 4.3.5.3 OMS ENG FAIL

The GPC valve configuration is set up for the engine on the good propellant side. If that engine fails, the other engine cannot be used and the burn must be completed using the +X RCS jets. OMS propellant can still be used, however, with some additional switch reconfiguration indicated on the second page of the MIXED XFEED cue card.

The RCS is interconnected to feed from the good OMS pod only (right side, in the example above). The HE PRESS/VAP ISOL valves and the TK ISOL valves are opened. The OMS XFEED switches on the bad propellant side are closed to isolate the bad propellant side from the RCS interconnect line. The RCS XFEED valves are all opened and the RCS TK ISOL valves are all closed, as in all interconnect procedures. Once the interconnect is accomplished (PLT call to CDR), the CDR adjusts the attitude with the RHC and starts the +X RCS burn with the THC.

It may be that insufficient propellant remains to complete the burn using the +X RCS jets. This should be checked using the OMS percent versus RCS Burn Time table on the C.G. CALCULATOR cue card (see sect. 4.3.1.5) to prevent burning the tanks dry and possibly damaging the +X RCS jets.

The OMS/RCS switch, valve, and tank configurations at the beginning and at the midburn reconfiguration point of a +X RCS mixed crossfeed burn are shown in OMS/RCS VALVE CONFIG figures (figures 4-15 and 4-16).

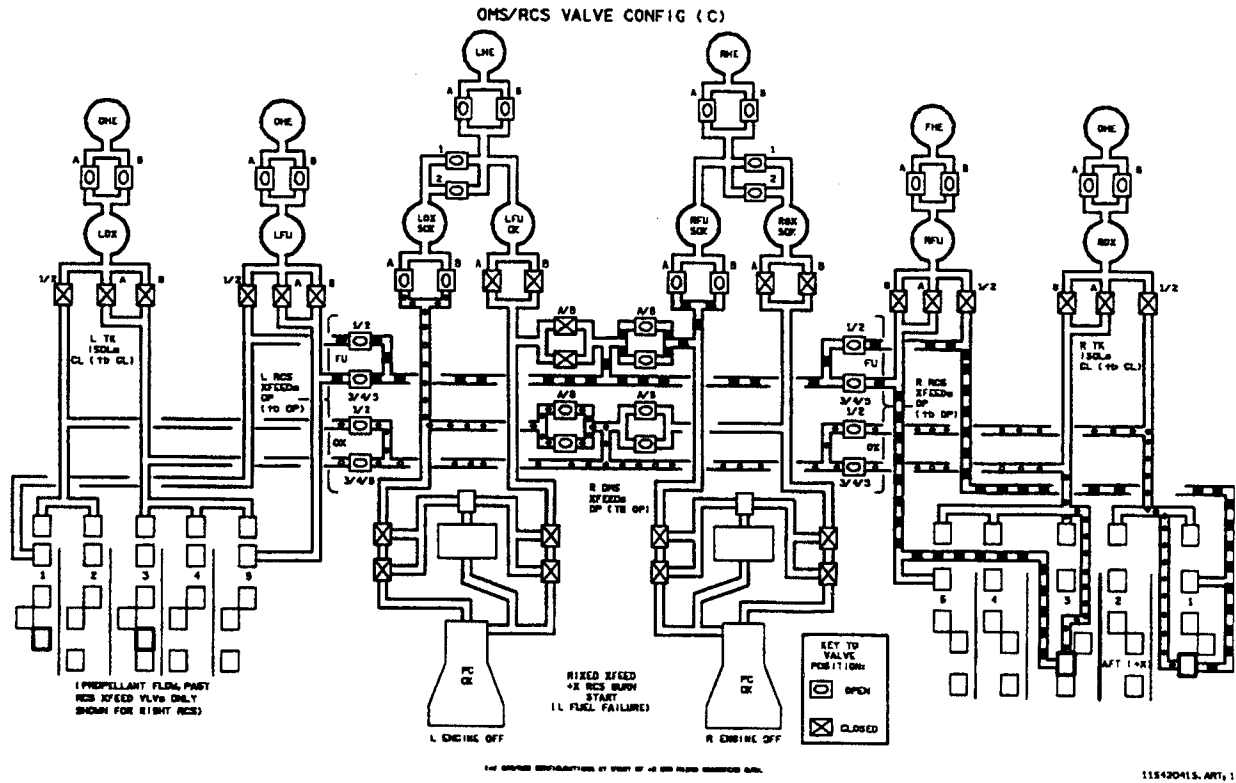

**Figure 4-15. OMS/RCS valve configuration (C)**

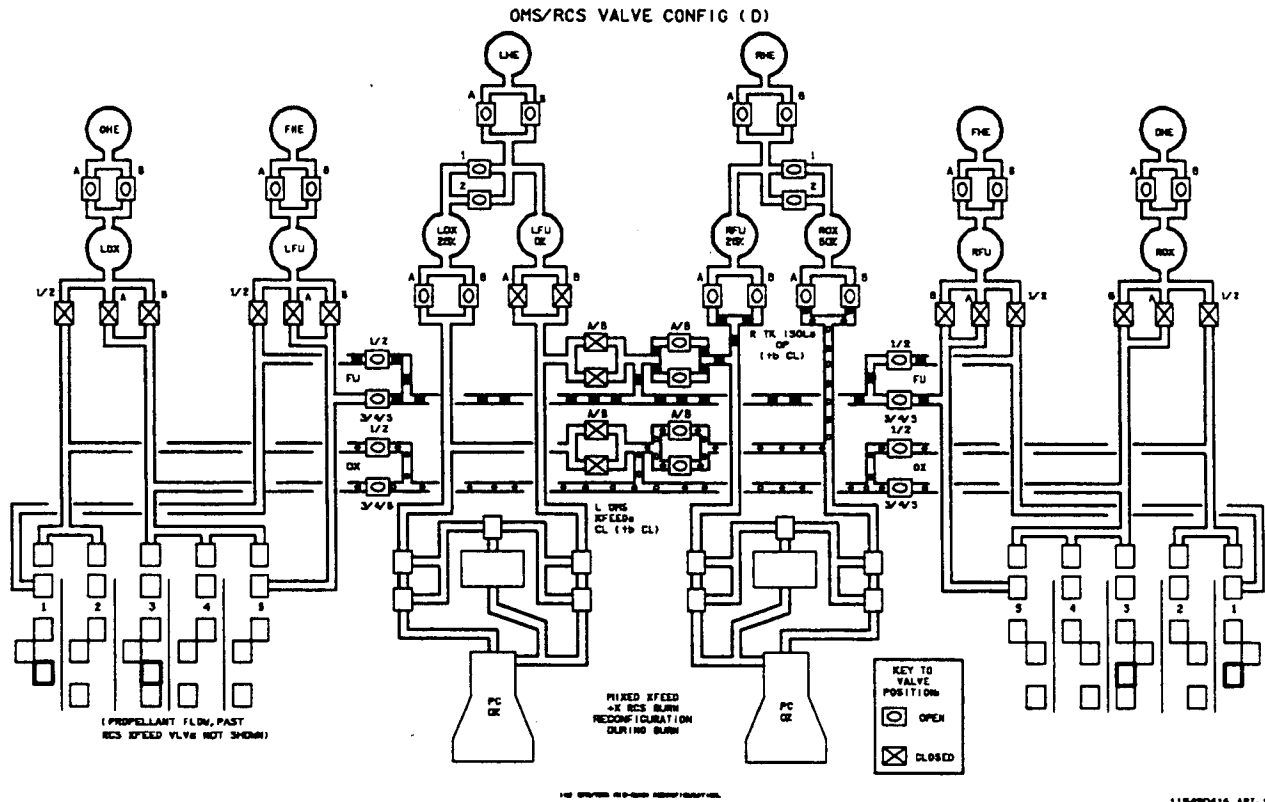

Figure 4-16. OMS/RCS valve configuration (D)

#### 4.4 OMS/RCS RULES OF THUMB

Below are several helpful bits of information for crewmembers and MCC to know. These data are taken from notes to an SMS Deorbit Burn training class.

##### Rules of thumb

- 1% of OMS = 6 fps  $\Delta V$
- 1% of RCS ~ 1 fps  $\Delta V$
- 1% of RCS = 22 lb of propellant
- 1% of OMS = 130 lb of propellant
- VGO decrements            2 fps for two-OMS burn  
   1 fps for one-OMS burn  
   0.6 fps for RCS burn
- Perigee decrements    2 fps  $\Delta V$  ~ 1 NM  $\Delta HP$
- Do not change items 1, 2, 3, or 4 on MNVR EXEC display during a burn:  
Item 1, 2, or 3 - Illegal entry  
Item 4 - Lose targets

## SECTION 5 ENTRY OPERATIONS

### 5.1 CREW ENTRY MONITORING AND CONTROL

Refer to the attached supplements in the appendix for discussion of the entry aerodynamics response maneuvers.

The crew's primary role during entry is to monitor and control the performance of navigation, guidance, flight control, and other critical systems so that the orbiter arrives at TAEM, A/L, and runway interface without violating any constraints. Cockpit dedicated instruments and CRT displays are available that present critical entry parameters for determining vehicle performance and trajectory state. Uplinked advisory data and onboard data cue cards are available to assist the crew in the monitoring task. From the available information, the crew assesses the performance of the automatic guidance system and remains alert to take over with manual guidance and control for an off-nominal situation.

Present planning (pending autoland flight assignment) calls for an autoguidance entry with crew takeover in CSS at Mach 0.95 for a manually controlled landing. However, at any time during entry, conditions could arise that would require crew takeover. Some of the conditions that could cause an off-nominal situation necessitating manual takeover by the orbiter crew include the following:

- Navigation errors
- L/D dispersions
- Atmosphere variations
- Winds
- Off-nominal deorbit burn
- GN&C failures or degraded performance
- Low aft RCS propellant

Any of the preceding conditions, if left unchecked, could possibly lead to unrecoverable range control or loss of vehicle control. Recognition of the off-nominal situation, as well as the ability to determine that the GN&C is performing within limits, is the primary crew task during entry.

A listing of GN&C parameters monitored by the crew during entry and the cockpit display that indicates these parameters is shown in table 5-I.

A summary listing of the nominal entry sequence of events starting at EI - 5 and continuing through orbiter rollout is contained in table 5-III.



For the significant events, section 5.1.5 presents the following information:

- Name of the event
- Best onboard cues and displays for monitoring when the event will occur
- The VREL, altitude, range to touchdown, and the time at which the event will occur
- The crew action associated with the event; i.e., monitor, awareness only, or the procedural step in the Entry Checklist associated with the event
- A general discussion covering event-related operational data such as configuration changes as a result of the event, ground interface support, procedures rationale, crew techniques for monitoring and controlling the event, major changes in performance capabilities or constraints caused by the event, and any backup procedures associated with the event

The ensuing discussions are generally limited to actions associated with nominal operations. For discussions of selected off-nominal operations, refer to appendix A.

### 5.1.1 Onboard Entry Event Reference

During entry, the events are keyed in the checklist to the best parameter for monitoring the event rather than to a common base parameter. The following parameters are used in the checklist as event cues:  $\bar{q}$ , EIT, EET, VREL, H, M, drag, and delta azimuth.

Two clock displays are available for crew use as follows:

- Mission timer (first line on CRT) displays mission elapsed time (00:00:00:00) from lift-off.
- CRT timer (second line on CRT) is set in MM 301 to count down to 00:00:00:00 at TIG, then count up. At the start of MM 303, the same timer is initialized again to display entry interface time (EIT) and counts down to 00:00 at EI, then counts up.

Table 5-1. Entry GN&amp;C flight monitoring parameters

| Parameter   | Availability             |                                |
|---|--------------------------|--------------------------------|
|   | CRT display <sup>a</sup> | Dedicated display <sup>a</sup> |
| Acceleration (N <sub>z</sub> )                              | F,G                      | K,R,S                          |
| ADTA H ratio, residual                                      | H                        |                                |
| Aileron position  | J                        | O                              |
| Aileron trim  | A,B,C,D,E,F,G            | O                              |
| Alpha actual  | A,B,C,D,E,I <sup>b</sup> | N                              |
| Alpha commanded   | A,B,C,D,E                | K                              |
| Altitude (NAVDAD or ADTA)                                   | I <sup>p</sup>           | M,S                            |
| Altitude (radar)  |                          | M,S                            |
| Altitude rate   |                          | M                              |
| Altitude acceleration                                       |                          | M                              |
| Altitude rate bias  | A,B,C,D,E                |                                |
| Altitude rate reference                                     | A,B,C,D,E                |                                |
| Altitude rate guidelines                                    | A,B,C,D,E                |                                |
| Beta (side slip attitude)                                   |                          | K (until $\bar{q} = 20$ )      |
| Body flap position  | J                        | O                              |
| Course deviation  |                          | L                              |
| Delta azimuth   | A,B,C,D,E                | L                              |
| Drag actual   | A,B,C,D,E                | N                              |
| Drag commanded  | A,B,C,D,E                |                                |
| Drag H ratio, residual                                      | H                        |                                |
| Drag reference  | A,B,C,D,E                |                                |
| Drag reference - phugoid damper                             | A,B,C,D,E                |                                |
| Drag guidelines   | A,B,C,D,E                |                                |
| Dynamic pressure  | A,B,C,D,E                |                                |
| Equivalent airspeed   |                          | N                              |
| Elevon position (left, right, inboard, outboard)            | J                        | O                              |
| Energy over weight  | F,G                      |                                |
| FCS saturation  | J                        | Q + C&W                        |
| Flight profile guidelines                                   | A,B,C,D,E,F,G,H          | L,S                            |
| Glide slope deviation                                       |                          | L,S                            |
| Ground speed (post weight-on-wheels (WOW))                  | A,B,C,D,E                |                                |
| Guidance square   |                          | L                              |
| Heading (magnetic)  | J                        |                                |
| Hinge moments   | I <sup>p</sup>           | N,S                            |
| Mach/velocity   | A,B,C,D,E,F,G            |                                |
| NY (lateral acceleration)                                   | A,B,C,D,E,F,G            |                                |
| NY trim   |                          |                                |
| Pitch and roll body attitude error with respect to guidance |                          |                                |
| Pitch rates   |                          |                                |
| Pitch attitude with respect to LVLH                         |                          |                                |
| Pitch jet firings   |                          |                                |
| Primary bearing   |                          | L                              |
| Primary miles   |                          | L                              |
| Radar altitude  |                          | M                              |
| Roll attitude with respect to LVLH                          |                          | K                              |

<sup>a</sup>Display key follows table.

<sup>b</sup>Valid after probe deployment.

| Parameter                              | Availability             |                                |
|--|--------------------------|--------------------------------|
|  | CRT Display <sup>a</sup> | Dedicated display <sup>a</sup> |
| Roll commanded                         | A,B,C,D,E                | K                              |
| Roll command - phugoid bank scale      | A,B,C,D,E                |                                |
| Roll jet firings                       |                          | Q                              |
| Roll rate                              |                          | Q                              |
| Roll reference                         | A,B,C,D,E                |                                |
| Roll reversal alert                    | A,B,C,D,E                |                                |
| Rudder position                        | J                        | O                              |
| Rudder trim                            | A,B,C,D,E,F,G            |                                |
| Secondary bearing                      |                          | L                              |
| Secondary miles                        |                          | L                              |
| Shuttle symbol                         | A,B,C,D,E,F,G,H          |                                |
| Speedbrake actual                      | F,G,J                    | O,S                            |
| Speedbrake commanded position          | F,G                      | O,P,S                          |
| TACAN azimuth, range                   | H                        |                                |
| TACAN ratio, residual, absolute, delta | G,H                      |                                |
| Theta                                  |                          |                                |
| Yaw jet firings                        |                          | Q                              |
| Yaw rates                              |                          | K (until $\bar{q} = 20$ )      |

| Code |                               | Display               |
|------|-------------------------------|-----------------------|
|      | CRT displays                  |                       |
| A    |                               | ENTRY TRAJ 1          |
| B    |                               | ENTRY TRAJ 2          |
| C    |                               | ENTRY TRAJ 3          |
| D    |                               | ENTRY TRAJ 4          |
| E    |                               | ENTRY TRAJ 5          |
| F    |                               | VERT SIT 1            |
| G    |                               | VERT SIT 2            |
| H    |                               | HORIZ SIT             |
| I    |                               | OVERRIDE              |
| J    |                               | GNC SYS SUMM 1        |
|      | Dedicated displays and lights |                       |
| K    |                               | ADI                   |
| L    |                               | HSI                   |
| M    |                               | AVVI                  |
| N    |                               | AMI                   |
| O    |                               | SPI                   |
| P    |                               | Sequence event lights |
| Q    |                               | RCS activity lights   |
| R    |                               | G-meter               |
| S    |                               | Heads up display      |

<sup>a</sup> Display key follows table.

### 5.1.2 Cockpit CRT Assignments

The three CRT displays on the forward panel are configured at EI as follows:

- CRT 1 (left) - ENTRY TRAJ 1 or VERT SIT (PASS)
- CRT 2 (right) - GNC HORIZ SIT or OVERRIDE
- CRT 3 (center) - Assigned to BFS as follows:
  - With CRT 3 Major Function switch in GNC
    - ENTRY TRAJ or VERT SIT with R, P, Y attitude errors digitally displayed for performance comparisons between PASS and BFS
  - With CRT 3 Major Function switch in SM
    - Primary display is Thermal display.
    - Depressing SYS SUMM KEY calls SM SYS SUMM display.

### 5.1.3 Dedicated Displays Data Source Management

Table 5-II shows the management of the data source switches for the alpha/Mach indicator (AMI), altitude/vertical velocity indicator (AVVI), and the horizontal situation indicator (HSI).

*Table 5-II. Management of data source switches*

| Event        | L (CDR)*             |            |          | R (PLT)*             |            |                  |
|--------------|----------------------|------------|----------|----------------------|------------|------------------|
|              | HSI mode             | HSI source | Air data | HSI mode             | HSI source | Air data         |
| EI           | Entry                | NAV        | NAV      | Entry                | NAV        | NAV              |
| TACAN lockon | ↓                    |            |          | ↓                    |            | ↓                |
| Deploy ADS   | ↓                    |            |          | ↓                    |            | R, L, then NAV** |
| TAEM I/F     | (Auto modes to TAEM) |            |          | (Auto modes to TAEM) |            | NAV              |
| ADS accepted | ↓                    |            |          | ↓                    |            |                  |
| TAEM/ A/L IF | (Auto modes to A/L)  |            |          | (Auto modes to A/L)  |            |                  |
| Acquire MLS  | (Auto modes to MLS)  | ↓          | ↓        | (Auto modes to MLS)  | ↓          | ↓                |

\*CDR on DATA BUS 3, PLT on data bus 4.

\*\*During entry, the AMI and AVVI data source is either NAV or the ADS (left probe or right probe) depending on the position of the air data source switch. The pilot will use this switch to compare the left and right ADS's and to see how air data compares to navigation computations prior to incorporating air data into NAV or GN&C.

### 5.1.4 Entry CRT Trajectory Displays

Five entry trajectory CRT displays are available for crew monitoring of each of the four velocity phases of closed loop entry guidance: temperature control, equilibrium glide, constant drag, and transition. The information presented on range, velocity, energy-to-weight (E/W) ratio, altitude rate reference, and drag reference is based on flight data obtained from the Engineering Directorate as of the last I-load update to the ENTRY TRAJ CRT displays. This information will be updated in the future as new I-load updates are made to the displays; however, the basic layout of each display should remain the same.

A brief definition of the trajectory guidelines residing on each of the trajectory displays (ENTRY TRAJ 1 through 5) is presented, followed by a discussion of the crew's use of these displays to monitor the entry. The Vertical Situation, Horizontal Situation, Override, and Entry Controls displays are covered in a similar manner to complete the section. Additional information on all CRT displays can be obtained from the Data Processing System (DPS) Dictionary (JSC-48017).

#### 5.1.4.1 Entry CRT Parameters

Prior to beginning the discussions of each display, some mission-independent GN&C parameters common to all the entry trajectory displays should be defined. The ENTRY TRAJ 1 display, shown in figure 5-1, is representative of the common format among the entry trajectory displays. The following GN&C parameter discussion references the ENTRY TRAJ 1 display.

1. The angle of attack currently being obtained from NAV or the ADTA subsystem operating program (SOP) is indicated by the ( $\triangleright$ ) symbol. The angle of attack scale covers  $25^\circ$ . An arrow ( $\rightarrow$ ) is used to indicate the 'canned' alpha ( $\alpha$ ) schedule based on VREL. The actual symbol ( $\triangleright$ ) should follow the nominal command ( $\rightarrow$ ) symbol except during roll reversals or whenever a drag error exists. The actual alpha symbol will flash if the difference between actual and canned  $\alpha$  exceeds  $2^\circ$ . Nominally this will occur during roll reversals as the alpha modulation limits are greater than  $\pm 2^\circ$  from the canned alpha schedule.
2. Drag acceleration in  $\text{ft/s}^2$  is scaled from 0 to  $50 \text{ ft/s}^2$  on the scale opposite the actual/canned alpha. The ( $\triangleleft$ ) symbol is used to indicate the actual drag acceleration from the entry user parameter processor (UPP). The reference/commanded drag from entry guidance is indicated by an ( $\leftarrow$ ). For each phase of entry guidance, reference drag is analytically computed from the reference drag velocity profile as a function of range and derivative of range with respect to drag ( $dR/dD$ ). The  $dR/dD$  is analytically determined by entry guidance. Nominally, the steady-state drag and drag command symbols should also overlay. If either drag symbol reaches the off-scale position, it remains there and flashes.

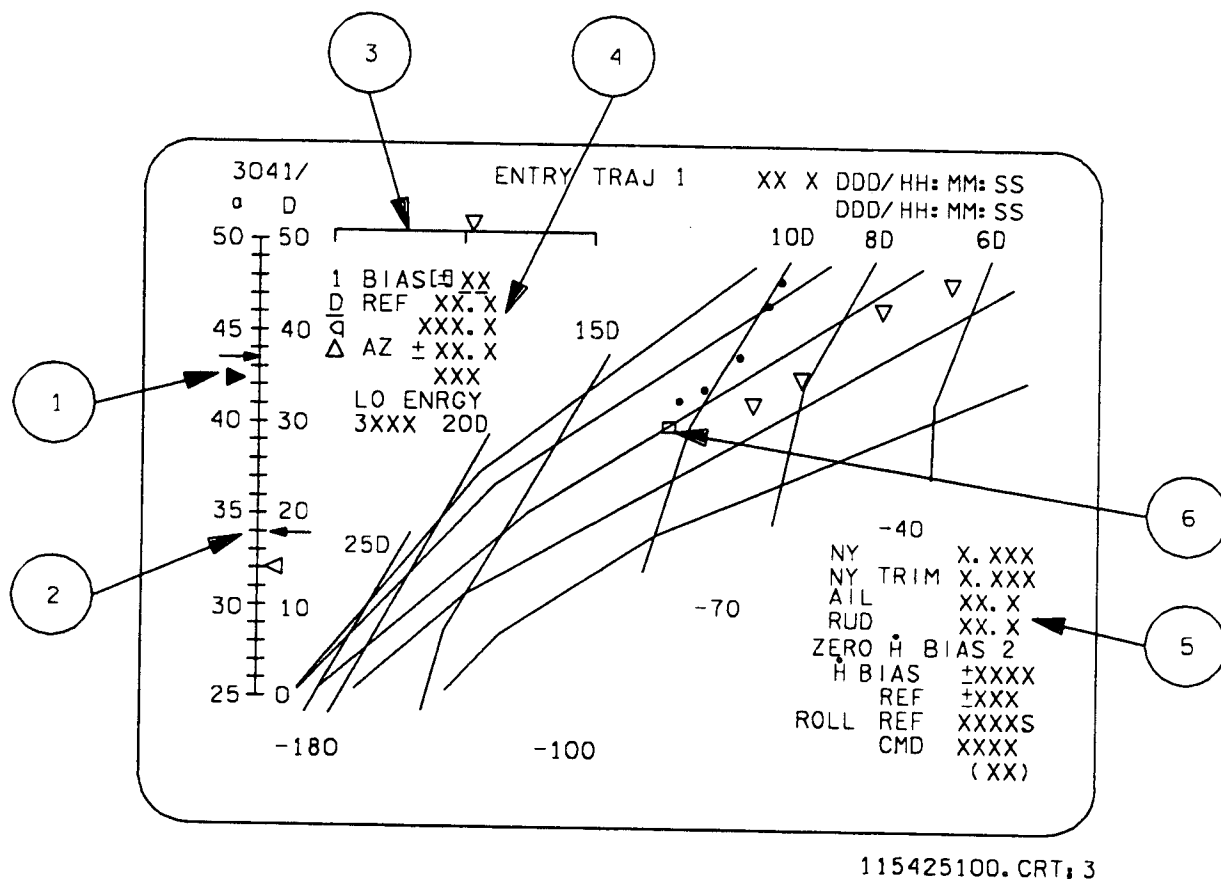

**Figure 5-1. ENTRY TRAJ 1 (representative) display**

3. A phugoid bank scale is displayed in the upper left corner of the display. The symbol ( $\nabla$ ) driven by roll error calculated by the entry display interface processor (DIP) is based on achieving a biased reference drag. The entry DIP calculations are completely independent with respect to the entry guidance ranging calculations. BFS stows the phugoid damper ( $\nabla$ ) until closed-loop guidance is initiated. In PASS, the phugoid damper jumps from side-to-side of the phugoid damper scale prior to guidance initiation. Additional information concerning this phugoid damper is presented in section 5.1.4.4.
4. The item entry 1 allows an entry from the crew to bias the entry DIP reference drag for the phugoid damper. In BFS, item 1 BIAS responds to PASS inputs (digital keyboard (DK) listen) as well as BFS inputs. Bias values between +10 to -10 ft/s<sup>2</sup> can be entered. Under certain situations, restrictions are placed on the maximum bias that can be used. These cases are discussed later. The data entry slot always reflects the current value of the bias and is initialized as zero at the beginning of MM 304.

DREF, located immediately below the item 1 BIAS, displays the value for DREF calculated by the entry DIP. For the phugoid damper, DREF is defined as equal to D-BASE + BIAS. D-BASE is determined from an I-loaded linear drag versus velocity profile and the bias is from the crew entry function defined earlier.

Digital readout of the GNC dynamic pressure ( $\bar{q}$ , lb/ft<sup>2</sup>) input to the ENTRY TRAJ display module from the NAV or ADTA SOP is located under DREF.

The BFS ENTRY TRAJ displays the BFS ADI roll, pitch, and yaw (R, P, Y) errors in degrees pre-BFS engage only. These BFS software-computed errors are displayed for comparison with the PASS-driven ADI error needles. Preengage, the digital BFS ADI errors on VERT SIT may differ from the values observed on the PASS driven dedicated ADI display by as much as 12°. This anomaly has been attributed to the asynchronous BFS/PASS execution and sequencing, slight NAV differences between PASS and BFS, and different values for HDOT Bias (item 2). The general trend observed is a bias of about 7° between PASS and BFS commanded Roll. The signs of the error values are driven U, D, L, or R to indicate fly-to error; for example, the action to null U (pitch error) is pitch up.

On the PASS ENTRY TRAJ displays, a digital readout of DELAZ (heading error with respect to the HAC tangency point) in degrees is displayed below the readout of  $\bar{q}$ . (Refer to figure 5-3.) M-I-L simulations using programmed test inputs have shown the need for an accurate and easily interpretable display of delta azimuth to allow crew phasing of delta maneuvers between entry and roll reversals. The azimuth as read from the HSI cannot be read accurately enough to use for entries that include data maneuvers and possible manually initiated roll reversals.

Item 3 enables low-energy guidance. This item is initially inhibited and may be enabled only by crew item entry. Low-energy guidance is operationally used only for entries following a TAL abort. However, the software does not preclude it from being used any time in OPS 304. Reference the Ascent/Aborts Flight Procedure Handbook for more details on the TAL low-energy guidance.

5. Several trim parameters are digitally displayed on the entry displays to aid the crew in assessing FCS performance and to permit proper manual intervention if required.

Lateral acceleration (NY) comes from the accelerometer assembly (AA) lateral acceleration selection filter. NY readout is in g with a range of -0.99g to +0.99g.

Lateral acceleration trim (NY TRIM) comes from the aerojet digital autopilot (DAP) yaw channel design reference timeline (DRT) integrator and is also displayed in g. Range is -0.99g to +0.99g.

Aileron trim displayed in degrees (AIL) comes from the ATRIM function of the aerojet DAP roll channel, which integrates the aileron trim rate to output a limited aileron trim angle command. For the aileron trim, '+' is represented by 'R' (right), '-' is represented by 'L' (left).

Rudder trim displayed in degrees (RUD) comes from the RUD\_INT function of the aerojet DAP yaw channel, which integrates the rudder trim rate to output an integral rudder trim. The directions 'R' and 'L' are driven in front of the trim value.

The following entry guidance parameters are displayed as digital readouts in the lower right-hand corner of each display: H REF in ft/s, the guidance-computed reference altitude rate; ROLL REF in degrees, the guidance-computed reference body roll angle; and ROLL CMD in degrees, the guidance-commanded body roll angle.

Item entry 2, ZERO  $\dot{H}$  BIAS, allows the crew to reset the guidance-computed altitude rate correction term to zero. The  $\dot{H}$  BIAS term is zeroed upon each execution of item 2. Additional information concerning the  $\dot{H}$  BIAS function is contained in a dedicated section of this discussion. The  $\dot{H}$  BIAS readout in ft/s is the altitude rate feedback correction term calculated by entry guidance.

The dynamic readout of  $\dot{H}$  REF in ft/s is determined analytically by entry guidance dependent upon whether the vehicle is in the temperature control, equilibrium glide, constant drag, or transition phase of entry. This  $\dot{H}$  REF is calculated as a function of the following parameters: atmospheric density scale height, relative velocity, DREF, DREF, and  $C_d$  along the nominal alpha schedule. For the pilot,  $\dot{H}$  REF should equal  $\dot{H}$  DOT from the AVVI if on the nominal trajectory.

ROLL REF is the reference roll angle (degrees) calculated in the EGROLCMD function of entry guidance. Roll reference represents the steady-state roll command for maintaining the desired drag profile. The basic difference between the roll reference readout and the roll command readout is that roll reference is the guidance-calculated reference roll angle, which does not consider the navigation-sensed drag and altitude rate. Therefore, drag error and  $\dot{H}$  error are not factored into the calculation of the reference roll angle. The direction ('R' or 'L') precedes the magnitude of roll. For the pilot, ROLL REF is the roll command to meet the required range. It is uncompensated for errors and unconstrained for crossrange requirements.

A parameter status indicator (S) immediately follows the ROLL REF readout to indicate when the reference roll angle from guidance has decreased below a calculated value. This value is  $37^\circ$  down to a relative velocity of 9500 ft/s. The value becomes  $20^\circ$  between 9000 and 4000 ft/s, and below 4000 ft/s the value is  $-5^\circ$  ( $-5^\circ$  is an I-load value input to delete the C&W below 4000 ft/s). If the ROLL REF value from guidance becomes less than the linear-stepped roll versus velocity profile calculated in the entry DIP, the status indicator shows a down arrow ( $\downarrow$ ), and a class 3 alert is triggered. A ROLL REF alert means that guidance is having difficulty solving the downrange and crossrange requirements simultaneously. Manual control may be required.

ROLL CMD is the roll angle (degrees) calculated in the EGROLCMD function of entry guidance, which goes to the aerojet DAP. Roll command includes compensation for phugoid oscillations to converge to the reference profile. As was inferred in the discussion of ROLL REF, the ROLL CMD calculation includes corrections for drag error and altitude rate error. ROLL CMD is limited to a maximum of  $70^\circ$  if relative velocity is 8000 ft/s or less to avoid excessive altitude rates in the transition phase of guidance. The direction (R or L) precedes the magnitude of roll.

6. A dynamic shuttle symbol (  ) represents the current shuttle X-Y position on the displays. The X-position on all the ENTRY TRAJ displays represents the current navigation determined range (n. mi.) to way point (WP) 2 via WP 1. This is the same range used by guidance. The Y-position on ENTRY TRAJ 1, 2, and 3 represents the current vehicle ground relative velocity (ft/s) from navigation. The Y-position of the shuttle symbol on ENTRY TRAJ 4 and 5 represents E/W. The Y-axis (velocity or E/W) is a linear scale. The X-axis (range) is a quadratic scale of the form  $C + C1 * R + C2 * R^2$ , where C's are I-loaded scaling constants and R is the range to WP 2. The shuttle symbol is replaced every 28.8 seconds on ENTRY TRAJ 1 and 2 and every 15.36 seconds on ENTRY TRAJ



3, 4, and 5 by a shuttle trailer symbol ( $\nabla$ ). A limit of six is set on these trailers. The intent is to give the crew an indication of the trend of the shuttle trajectory over time against the background lines. The shuttle symbol flashes to indicate a roll reversal to the crew. Once the limit for the number of trailers has been reached, each succeeding computation of a new trailer causes deletion of the oldest trailer.

A dynamic guidance symbol ( $\square$ ) is plotted on each display to give the crew an indication of a projected range error that is caused by drag being off the drag reference. The X-position of the guidance symbol is calculated in the Entry DIP and is based on a reference range. Reference range equals  $R - DRDD$  (D-DREF). R is the range to WP 2 from navigation (entry UPP), DRDD is the negative derivative of range WRT drag from entry guidance, and D is drag acceleration from the entry UPP. DREF is reference drag from guidance. The DRDD is in n. mi./(ft/s) and is multiplied times drag error in ft/s<sup>2</sup>, so the result is a delta range error that is subtracted from the range to WP 2.

A drag error shows on the display as a shift in the guidance symbol. If drag trends lower than drag reference, the guidance symbol moves in front of the shuttle symbol indicating this as a range difference between the current vehicle position and the guidance symbol range value. Flying a lower drag results in an overshoot of the target and a requirement for a later high-energy trajectory. If drag trends higher than drag reference, the guidance symbol moves behind the shuttle symbol. The Y-position of the guidance symbol is the same as the Y-position of the shuttle symbol (relative velocity on the first three ENTRY TRAJ displays, and E/W on the last two ENTRY TRAJ displays). By observing the movement of the guidance symbol with respect to the shuttle symbol, the crew can assess how well the vehicle is flying the guidance reference profile (i.e., drag is converging to drag reference). The crew can verify the presence of range error due to drag error by observing the position of the actual drag symbol with respect to the drag command arrow on the drag scale at the left-hand side of the ENTRY TRAJ display. Taking manual control of the vehicle must be considered upon encountering a drag error (i.e., the shuttle symbol diverging from the nominal trajectory line).

On every pass, the guidance symbol X-position is saved for use in computing the guidance trailer symbol ( $\bullet$ ) location. The guidance trailer Y-position is the same as the shuttle symbol Y-position. The update frequency of these guidance trailers is the same as that for the shuttle trailers.

The logic for determining when a new display should be called up is as follows: The logic checks to see if the Y-position of the shuttle symbol is below the X-axis of the current graph; if it is, the next display in the OPS sequence is called. The entry DIP also contains logic to determine the current guidance phase and to call up the appropriate ENTRY TRAJ display for monitoring guidance in the event guidance transits early/late between phases or skips a phase to solve a ranging problem.

### 5.1.4.2 ENTRY TRAJ 1 to 5 Background Lines

As discussed in a previous section, the fixed backgrounds of these TRAJ displays are configured for five subphases of entry and are designed to allow the crew to monitor the vehicle's progression compared to planned entry profiles. The background information presented as a series of solid and dashed lines is arrived at by mapping the drag-velocity plot into a range-velocity (E/W for ENTRY TRAJ 4 and 5) plot (figure 5-2).

The ENTRY TRAJ 1 display comes up automatically upon PRO to MM 304 and provides vehicle ranging and entry guidance information to the crew during the thermal region (usually 24,500 to 17,000 ft/s). The range scale axis monitors the vehicle's position usually between 3800 and 800 n. mi. The central plot of this display contains two types of lines: (1) solid lines to represent velocity versus range guidelines and (2) dashed lines to represent lines of constant drag acceleration. All the succeeding displays are similar in layout.

The five solid guidelines on this display represent (from left to right)

- First - A thermal boundary representing drag versus velocity values mapped into a velocity versus range plane that defines limiting temperatures (maximum allowable one mission temperature) of the forward chine (CP6 = 2700° F) and elevons (CP4 = 2600° F) between 24,000 ft/s relative velocity and the relative velocity marking the end of thermal region (usually 18,000 ft/s). The thermal line assumes an alpha of 40° with trimmed elevons and body flap.
- Second - A guided solution trajectory line halfway between the thermal limit line and the nominal trajectory line.
- Third - A guided solution targeted to a drag value of 33 ft/s<sup>2</sup> and is called the 'nominal' line.
- Fourth - A guided solution targeted to a drag of 33 ft/s<sup>2</sup> and is called the ' $\phi = 37^\circ$ ' line although bank angle is not a constant 37°.
- Fifth - A wings-level, full-lift equilibrium glide boundary and is not a guided solution. Each data point is determined from a distinct guidance solution. The locus of these points is the boundary line. On this boundary line, alpha is 40°. If the shuttle symbol drops below this line, the crew has no absolute means of verifying that the target can be reached.

If drag does not continue to diverge from drag reference, the target should be achievable.

The ENTRY TRAJ 1 display contains six constant drag (dashed) lines. The number of linear segments of lines (solid and dashed) that can be used on any display is a software constraint (I-load limit). The dashed lines show the drag acceleration required at different combinations of range and relative velocity to acquire a flight profile that will have the correct trajectory shaping and the targeted interface conditions. The solid and dashed lines are mapped into the V-R-D plots using current guidance I-load information and off-line computer analysis techniques.

The references to a 'guided solution' profile reflect the engineering and development (E&D) computer analysis that used guidance I-loads and equations to obtain range, velocity, and drag data that were mapped as straight-line segments into the display. These guidelines represent what the vehicle would fly using the guidance equations. The  $\phi = 37^\circ$  guideline plotted in the drag velocity plane for comparison with the drag versus velocity points corresponding to an actual  $\phi = 37^\circ$  is shown in figure 5-2. Off-line analyses have determined that in the presence of worst-case L/D (minus 3 sigma low)  $\phi = 37^\circ$  is the minimum bank required for the orbiter to remain within the guidance azimuth deadband and solve the ranging problem. At slower velocities, below 9500 ft/s, this minimum bank angle is  $20^\circ$ .

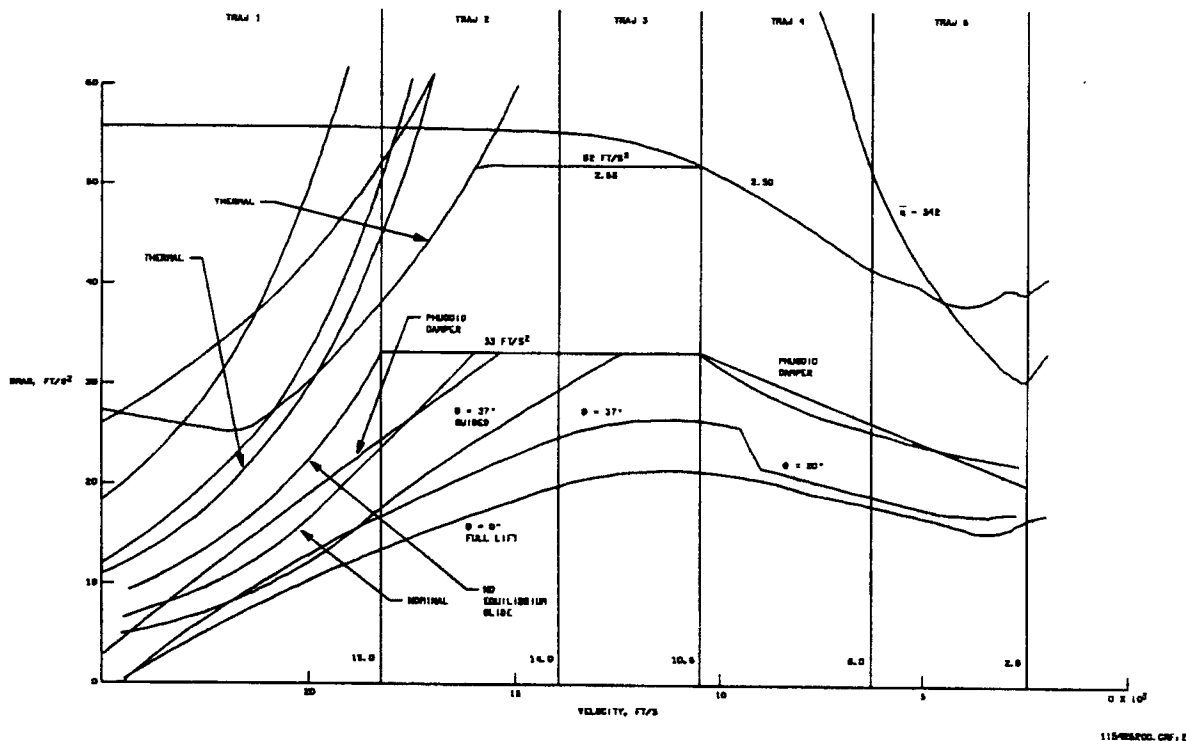

**Figure 5-2. Typical drag versus velocity plot (cycle 2)**

The negative numbers located at the bottom of the display (applies to all ENTRY TRAJ displays) correspond to the  $\dot{H}$  reference values on the nominal trajectory. As an example, with the shuttle symbol vertically above the -70 ft/s value on ENTRY TRAJ 1 and on the 'nominal' line with drag on drag reference, the  $\dot{H}$  should be approximately -70 ft/s. Because the number of values allocated per display for  $\dot{H}$  is also software limited (and to prevent a cluttered display), only a few numbers are used at the bottom of the display as an approximate or 'ballpark' guide for  $\dot{H}$  of the shuttle as it progresses down the display. The maximum error in navigated displayed altitude rate expected during entry is 43 ft/s. The same source of information also estimates maximum entry range display errors of 8.3 n. mi. and maximum relative velocity display errors of 40 ft/s.

These errors are less obvious on the earlier ENTRY TRAJ displays (1 and 2) than on the later ENTRY TRAJ displays (4 and 5) because of the scaling of the range axis. For example, ENTRY TRAJ 1 covers approximately 2700 n. mi. and ENTRY TRAJ 4 covers approximately 335 n. mi. in the same scale length. The 8.3 n. mi. range error on ENTRY TRAJ 1 would be

approximately one-fourth of the shuttle symbol in size, but by ENTRY TRAJ 4, this error would be twice the shuttle symbol size in the range axis and one-half of the shuttle symbol size in the velocity (vertical) direction.

The quadratic scaling of the range axis is also evident in the relative speed at which the shuttle symbol traverses the displays. The progress of the shuttle appears slower at the top right corner of the ENTRY TRAJ 1 display because the scale has more miles in the right-hand two-thirds of the scale when compared to the first one-third of the scale length. As the shuttle moves down, paralleling the guidelines, the range scale covers a decreasing number of miles.

The ENTRY TRAJ 2 display provides vehicle ranging and entry guidance monitoring information to the crew during the middle velocity (usually 17,000 to 14,000 ft/s) portion of entry. The ENTRY TRAJ 2 range scale usually covers 1300 to 425 n. mi. This display (figure 5-3) contains four solid guidelines that are described below (from left to right).

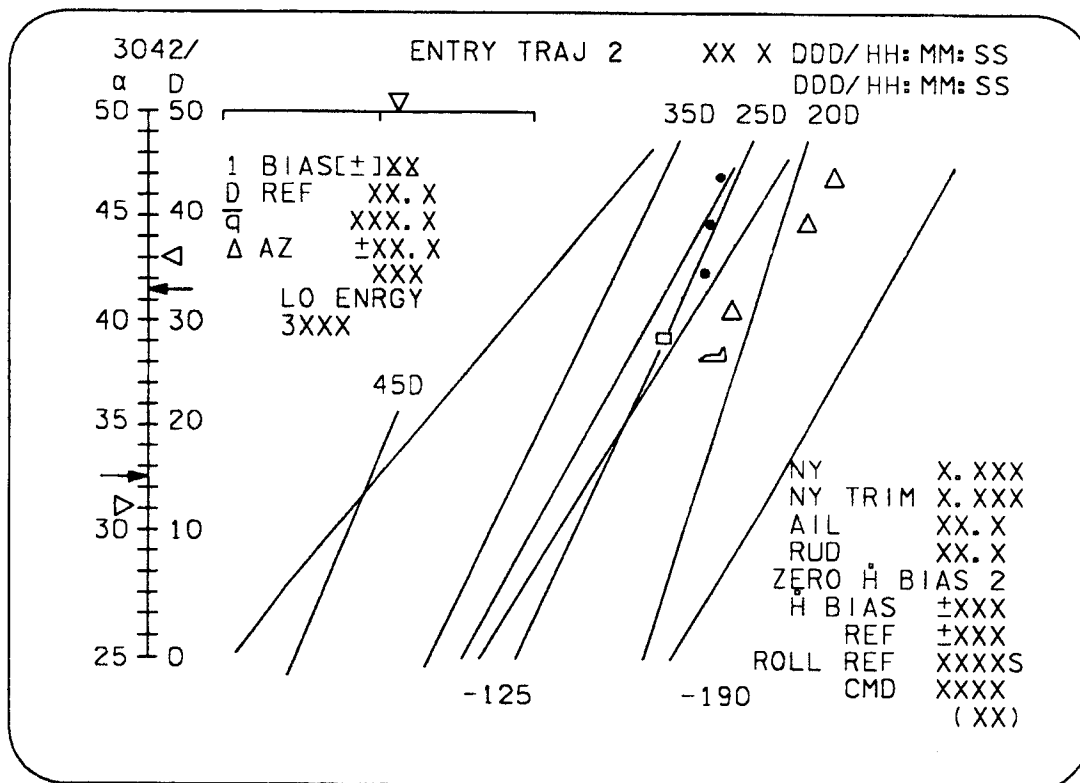

115420503. CRT; 5

**Figure 5-3. ENTRY TRAJ 2 display**

- First - A continuation of the thermal boundary as described on ENTRY TRAJ 1 until the drag acceleration reaches approximately 52 ft/s<sup>2</sup>. This is the limiting amount of drag that autoguidance can fly in the constant drag phase of guidance and still meet transition phase criteria at 10,500 ft/s. A drag acceleration of approximately 52 ft/s<sup>2</sup> represents a 2.5g boundary at 10,500 ft/s.
- Second - A continuation of the nominal (third) guideline on ENTRY TRAJ 1 - targeted to a constant drag acceleration value of 33 ft/s<sup>2</sup>.

- Third - This line is the extension of the  $\phi = 37^\circ$  line discussed on ENTRY TRAJ 1. This line converges toward the second guideline at the bottom of this display.
- Fourth - This line is the extension of the full-lift equilibrium glide boundary discussed on ENTRY TRAJ 1.

ENTRY TRAJ 2 contains four dashed drag lines that represent increased magnitudes of constant drag over those seen on ENTRY TRAJ 1. As the vehicle moves closer to the constant drag phase (33 ft/s<sup>2</sup>), these lines of drag acceleration become parallel to the solid lines.

ENTRY TRAJ 3 provides trajectory and guidance monitoring information to the crew between approximately 14,000 and approximately 10,500 ft/s. This region represents the majority of the constant drag phase of guidance. The range axis usually covers 800 to 315 n. mi. This display (figure 5-4) contains three solid lines from left to right which are described below.

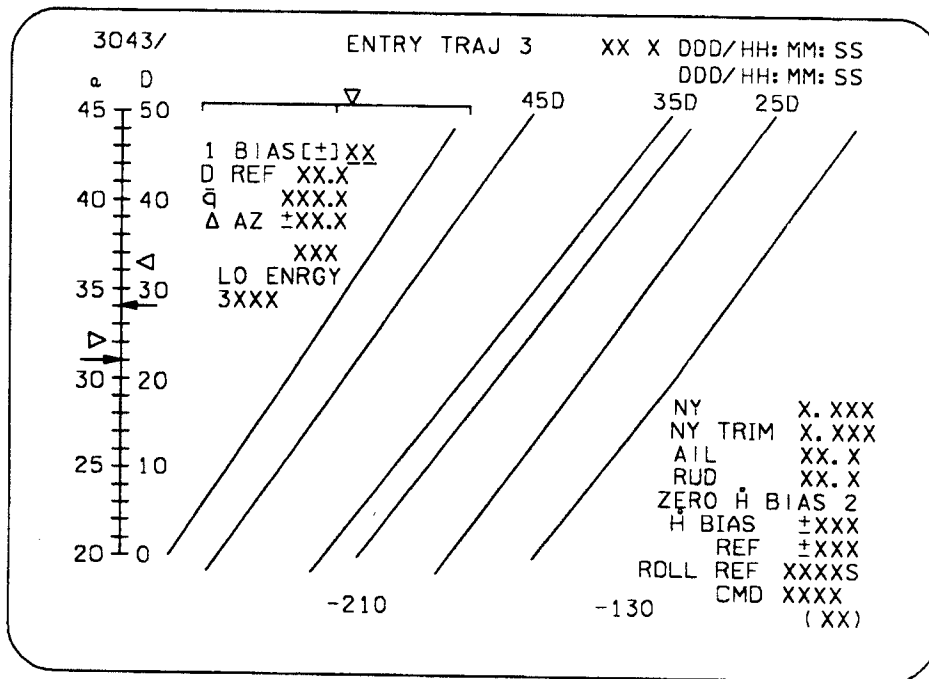

115420504. CRT; 1

**Figure 5-4. ENTRY TRAJ 3 display (PFS)**

- First - Extension of the zero sigma, 2.5g normal load factor boundary from the ENTRY TRAJ 2 display.
- Second - Guideline of range/velocity combinations for a constant drag of 33 ft/s<sup>2</sup>. During constant drag for a nominal trajectory, the vehicle will track down this line.
- Third - Extension of the full-lift equilibrium glide boundary from ENTRY TRAJ 2.

The three dashed drag lines indicate parallel lines of constant drag acceleration, which should serve as a reference for the crew to monitor as the vehicle progresses down the 33-ft/s<sup>2</sup> line. The H numbers are determined as discussed on ENTRY TRAJ 1 and serve as approximate

monitoring guides. ENTRY TRAJ 3 is the last display with relative velocity on the vertical axis. The two subsequent ENTRY TRAJ displays are configured with E/W on the vertical axis.

The transition phase of guidance usually begins at 10,500 ft/s and ENTRY TRAJ 4 is the first of two trajectory displays that provide vehicle ranging and guidance monitoring information to the crew in the transition region. Instead of velocity on the vertical axis, E/W in units of feet is plotted. The velocity region covered on this display is from 10,500 down to approximately 6000 ft/s. The range scale is approximately 480 on the right to 145 n. mi. on the left of the display. The reason energy was selected as the independent variable during transition is because the flightpath angle magnitude increases and the  $\sin \gamma$  term can no longer be considered negligible in the ranging equation. At the higher velocities, the approximation of  $\cos \gamma = 1$  and  $\sin \gamma = 0$  can be used; but, because  $\gamma$  is increasing during transition, it is mathematically easier to use energy as the independent variable. This display (figure 5-5) contains three solid lines from left to right, which are described as follows:

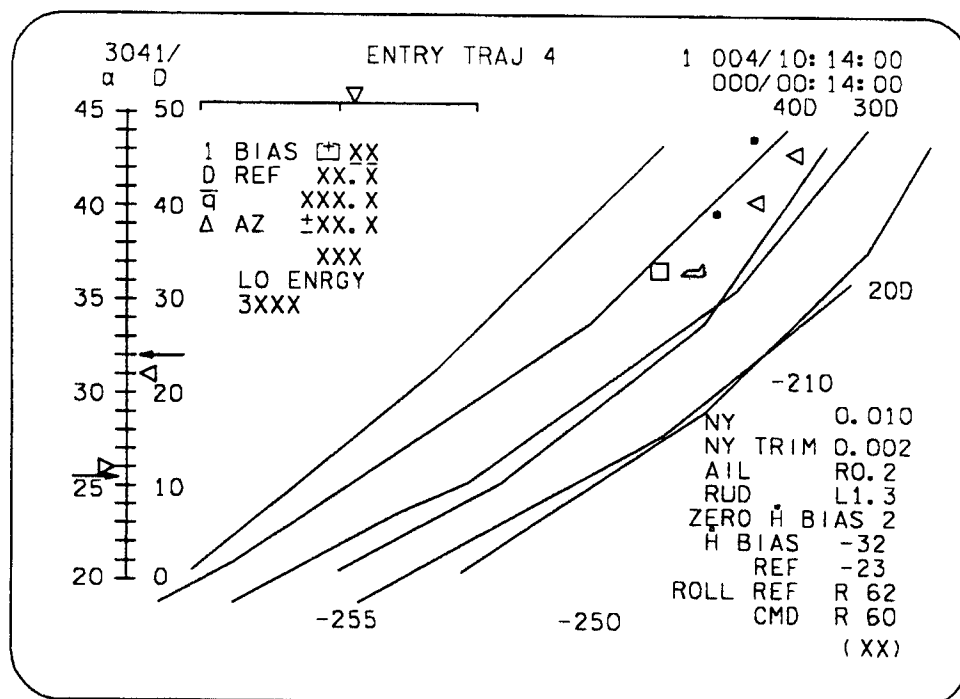

115420505. CRT; 1

**Figure 5-5. ENTRY TRAJ 4 display (PFS)**

- First - Extension of the zero sigma, 2.5g normal load factor boundary from the ENTRY TRAJ 3 display
- Second - Nominal transition profile guideline
- Third - Extension of the full-lift equilibrium glide boundary from ENTRY TRAJ 3

The ENTRY TRAJ 5 display covers the final portion of the transition phase of guidance down to TAEM interface where the vertical situation displays (VSD's) come up. The vertical axis is in E/W as is the ENTRY TRAJ 4 display. This corresponds to the velocity region from 6000 to

2500 ft/s at TAEM interface. The range axis is scaled from approximately 220 to 55 n. mi. This display (figure 5-6) contains four solid lines described from left to right as follows:

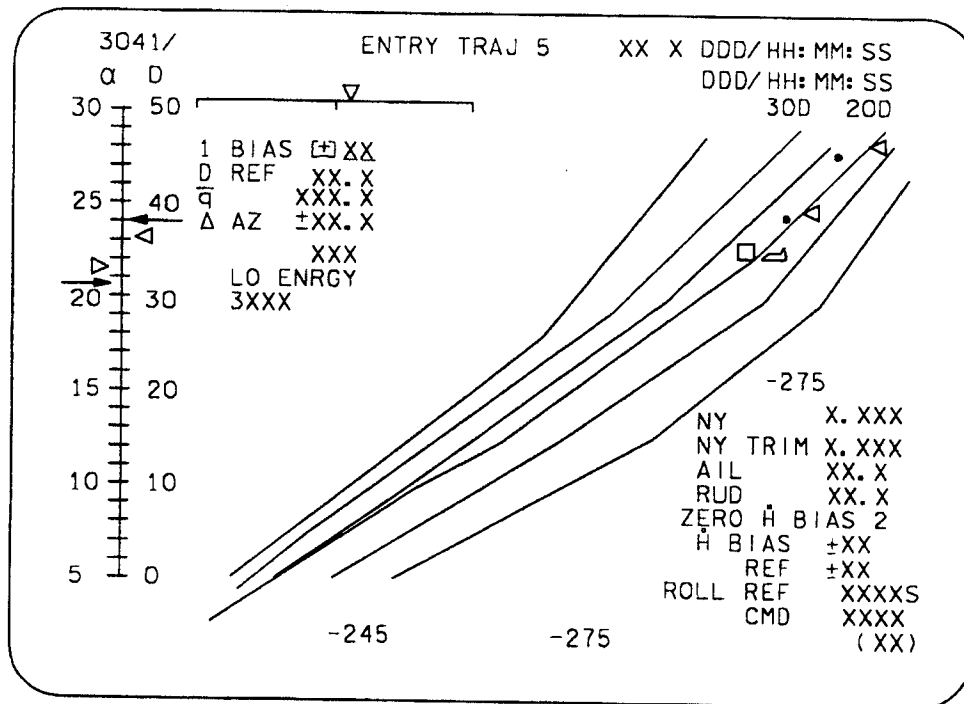

115420506. CRT; 1

**Figure 5-6. ENTRY TRAJ 5 display (PFS)**

- First - Represents an extension of the zero  $\sigma$ , 2.5g normal load factor boundary down to a velocity of approximately 5000 ft/s where the line becomes a max  $\bar{q}$  boundary.
- Second - Extension of the nominal transition profile guideline from the ENTRY TRAJ 4 display.
- Third - Represents the extension of the full-lift equilibrium glide boundary, which is targeted to the nominal TAEM interface.
- Fourth - Also a wings-level line that represents maximum L/D, no wind. This line is not anchored at the nominal TAEM interface. This line represents the vehicle's TAEM ranging capability. If the symbol is below the third guideline, then to make the runway, some TAEM footprint will have to be used.

Two dashed lines of constant drag acceleration are included on this display for crew reference. Further information on the use of these drag lines is presented later.

This section has presented a summary of the information available to the crew for monitoring the entry position of the mission from PRO to MM 304 to TAEM interface. In the next section, entry monitoring techniques using the ENTRY TRAJ 1 display as an illustrative example are discussed. The vertical situation displays and their use in the TAEM region are discussed in a subsequent section.

### 5.1.4.3 Use of ENTRY TRAJ CRT Displays

In this section figure 5-7 (ENTRY TRAJ 1) is used to illustrate how the information presented on the ENTRY TRAJ displays can be used for autoguidance monitoring. Because the five TRAJ displays are basically the same layout and contain the same digital readout information, the monitoring task is similar on the subsequent TRAJ displays.

The health of the autoguided entry can be considered a function of (1) how well autoguidance is performing in issuing commands to keep drag on drag reference, (2) how well flight control executes the guidance commands to keep drag on drag reference, (3) whether the aerodynamics are within nominal limits so that the vehicle can make the runway, and (4) whether the navigation is accurate enough to support guidance and control.

Entry manual takeover rules/criteria are listed in chapter 4 of the Space Shuttle Operational Flight Rules, which allow onboard/MCC decisions in takeover cases. The interpretation of the information on the TRAJ displays aids the crew in their onboard assessment of when to intervene manually. At PRO to MM 304, the ENTRY TRAJ 1 CRT display comes up. This event occurs at EI minus 5 minutes per the Entry Checklist. The Entry Checklist also contains the onboard CRT assignments for the nominal entry. At the PRO to MM 304, closed-loop guidance has not yet been initiated and the vehicle's position on the CRT is still off scale on the range axis. The range to runway threshold at this point is approximately 5739 n. mi. and the scale limits on the ENTRY TRAJ 1 display are 3800 n. mi. range and 24,500 ft/s velocity. The shuttle symbol is plotted in the upper right corner of the display until the range and velocity can be plotted as an X-Y location. Because this is preguidance initiation, the crew can verify that the guidance parameters  $\dot{H}$  BIAS,  $\dot{H}$  REF, and ROLL CMD are zero. ROLL REF should be 90°. The  $\bar{q}$  in the upper left corner should also be zero because the vehicle has not yet started picking up dynamic pressure. The item entries (1 and 2) will be discussed separately, as will  $\alpha$  modulation. The  $\alpha$  command should be 40°.

Values of zero are displayed in the AIL and RUD slots until the surfaces become active. The NY slot indicates the lateral acceleration as a g readout. At a  $\bar{q} = 0.5$  lb/ft<sup>2</sup>, the auto elevon trim is active; at  $\bar{q} = 2.0$  lb/ft<sup>2</sup>, the elevons and ailerons are active for control (CRT readout). At this point, the shuttle symbol should be inside the range axis of ENTRY TRAJ 1 so that its position is plotted. At  $\bar{q} = 20$  lb/ft<sup>2</sup>, the NY trim is active. Procedures for use in monitoring flight control are discussed in a separate section of this handbook.

The next major event to monitor on the TRAJ 1 display is the initiation of closed-loop guidance, which should nominally occur at a drag acceleration of 3 ft/s<sup>2</sup> or  $\bar{q} \sim 8$ . The crew can note drag by the ( $\triangleleft$ ) symbol on the drag scale of the CRT. The crew should also see the guidance symbol ( $\square$ ) appear on the display at this time. The guidance CRT parameters discussed earlier will also be active. As the guidance and shuttle symbols move down the display on the nominal guideline, the trailers indicate the trend of the trajectory against the background lines. The trend of these trailers should indicate convergence of the guidance symbol and the shuttle symbol. With the shuttle symbol on the nominal trajectory line, the DREF interpolated from the dashed lines should correspond to the current command DREF and DACT (figure 5-7).



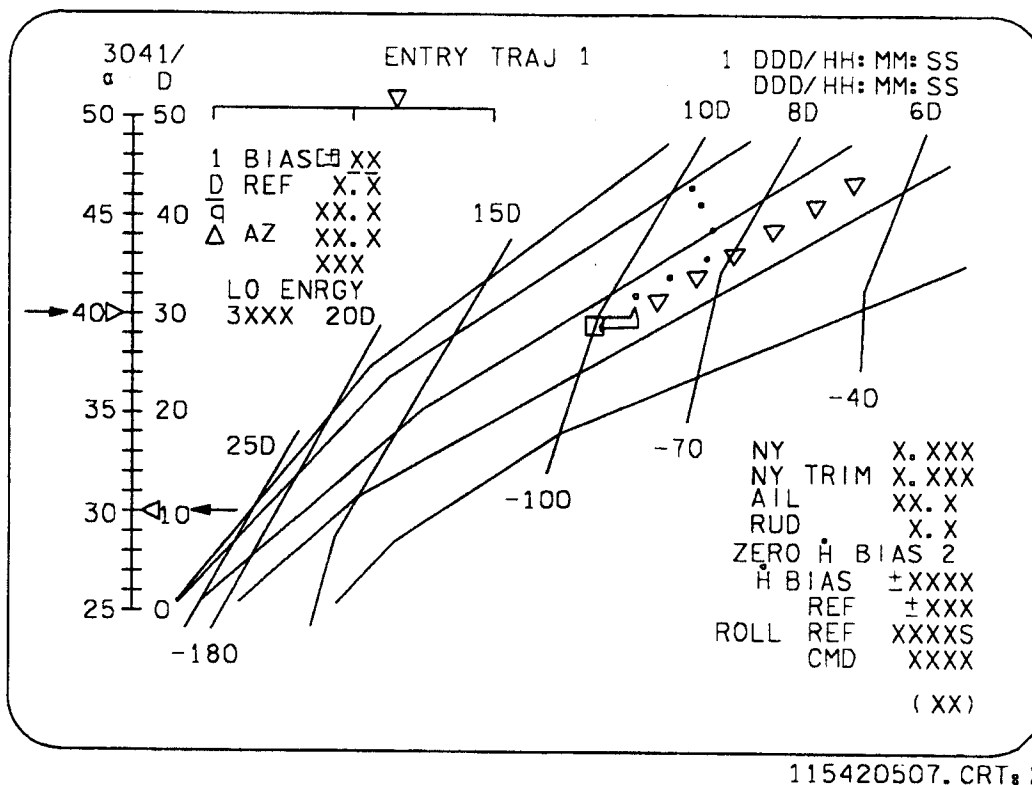

Figure 5-7. ENTRY TRAJ 1 (typical initial display)

In the illustration, the shuttle and guidance symbols are overlaid on the  $DREF = 10 \text{ ft/s}^2$  dashed line, and the drag command and drag actual symbol reflect this location. The background information shows where the vehicle should be; the drag and drag reference data show where the vehicle actually is. The  $\dot{H}$  REF on the digital readout should be approximately  $-80 \text{ ft/s}$  and increasing. The  $\dot{H}$  at the bottom of the display,  $\dot{H}$  REF, and  $\dot{H}$  NAV should compare within the +3-sigma navigation display accuracy limits discussed earlier. Roll command should compare with the bank angle on the ADI.

An approximate number for roll here is  $R60^\circ$ . The value for roll reference should also be close to this value, assuming drag errors and  $\dot{H}$  errors are small. Roll reference is the steady-state value of roll command. The roll reference gives the crew an indication of the angle of roll that guidance needs based on reference drag and reference  $\dot{H}$  without errors. The use of roll reference as an indicator of ranging capability available is discussed later. The crew can use the same kind of checks as discussed previously on each TRAJ display because the same information is available on the subsequent TRAJ displays.

There are several indications of an off-nominal drag situation presented on the TRAJ display. Figure 5-8 illustrates how the ENTRY TRAJ 1 display might look if, while in CSS mode, the drag were to become much larger than drag reference. The ( $\triangleleft$ ) is above the ( $\leftarrow$ ) on the drag scale and the guidance square is behind the shuttle. If this error were allowed to continue, the shuttle trailers would indicate the vehicle dropping below the nominal guideline toward the  $0^\circ$  bank boundary; that is, the drag error needs to be corrected before the target moves outside the footprint. In this situation, a decrease in bank angle would cause drag to decrease toward drag reference. It is important to keep in mind the roll phugoid sensitivity of the vehicle. As

roll changes, so does altitude acceleration. For example, as an approximation,  $1^\circ$  of roll change produces  $0.7 \text{ ft/s}^2 \text{ H}$ . As  $|\text{roll error}|$  increases,  $|\dot{H} \text{ error}|$  increases, allowing a phugoid to develop more quickly.

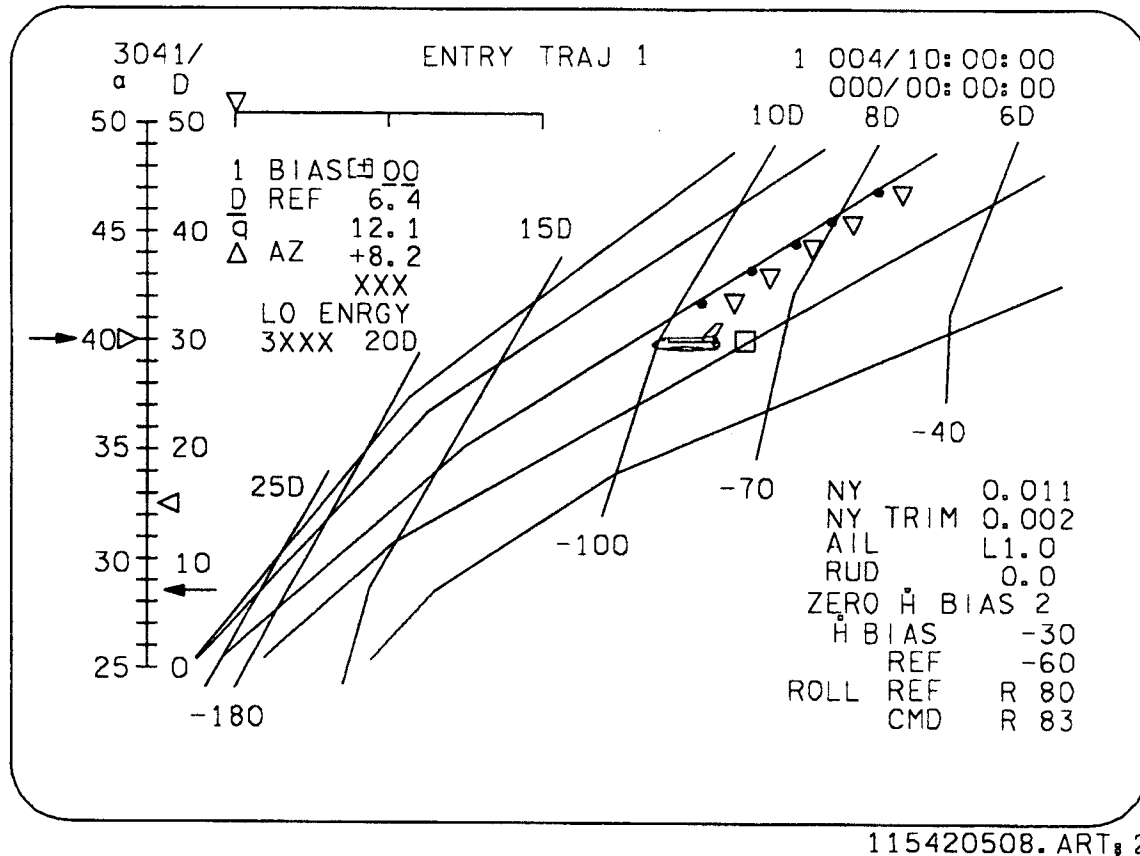
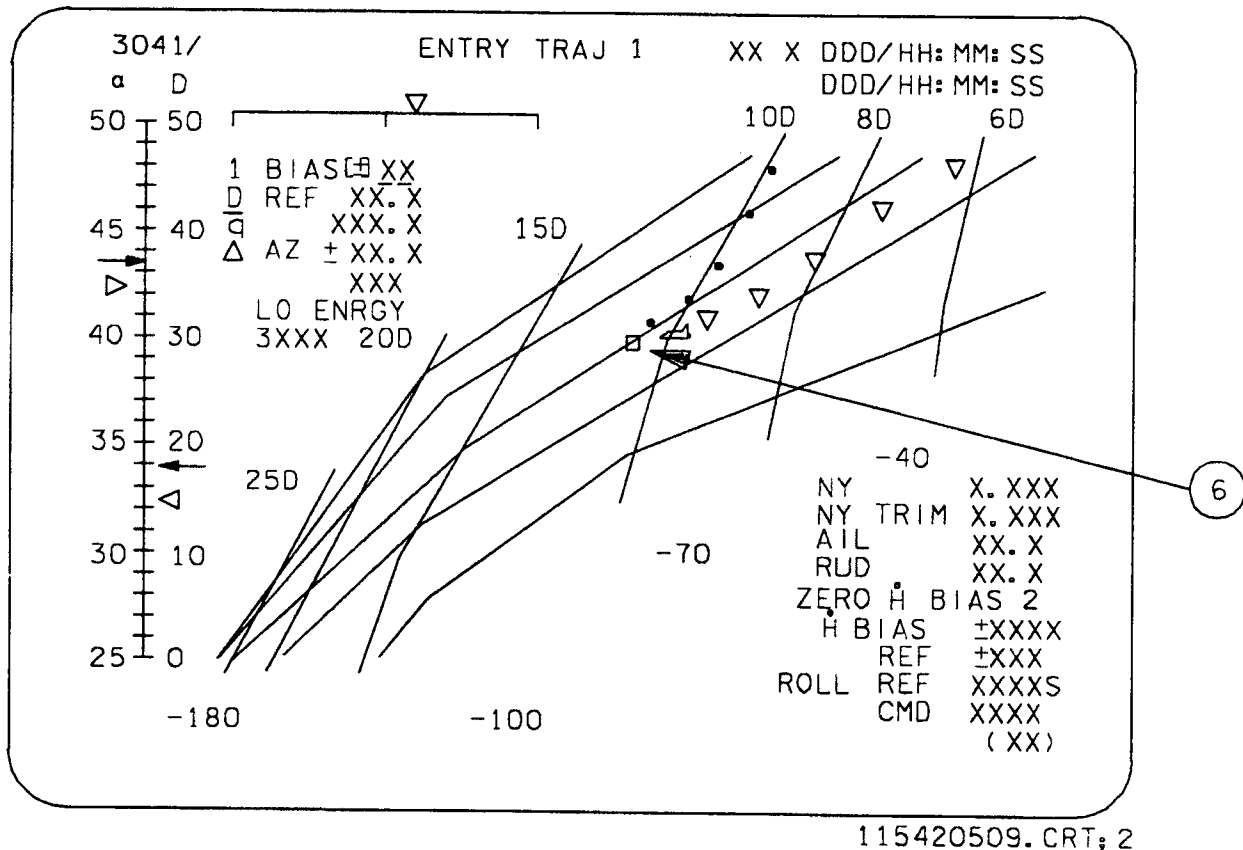

**Figure 5-8. ENTRY TRAJ 1 (drag greater than drag reference)**

In the CSS case illustrating the ENTRY TRAJ 1 display where drag has decreased with respect to drag reference, the indication would be as shown on figure 5-9. The ( $\triangleleft$ ) is below the ( $\leftarrow$ ) on the drag scale and the guidance square is ahead of the shuttle symbol. If this error were allowed to continue, the shuttle trailers would indicate the vehicle moving to the left toward the leftmost constraint boundary. In a manner similar to that described for the high drag situation, an increase in bank in this case would converge drag on drag reference.

If both P and R/Y are in CSS, the task of maintaining drag on drag reference becomes more difficult because of  $\alpha - \phi$  interaction. Oscillations in alpha cause drag transients, which cause roll oscillations. A  $1^\circ$  change in alpha produces a  $1.7\text{-ft/s}^2$  drag change, which is equal to an  $8^\circ$  roll command change.

The third factor mentioned as having an effect on the monitoring of autoguidance was aerodynamic uncertainty. Because this vehicle uses drag modulation for ranging, L/D control is a major factor in the ranging problem. Studies have indicated that autoguidance has the capability to handle L/D dispersions as high as 50 percent high L/D and as low as 25 percent low L/D, and still make a nominal TAEM interface.



**Figure 5-9. Entry TRAJ 1 (drag decreased relative to drag reference)**

No specific crew procedures have been developed to date for the high L/D case because of autoguidance capability in handling this type of L/D dispersion.

Although off-line runs indicate the autoguidance can make TAEM interface with 25 percent low L/D, at variations in L/D beyond this value the miss distance at TAEM interface increases rapidly. One of the problems in monitoring the guidance for L/D variations is the timely and correct interpretation of clues to a problem with L/D. Low L/D can be detected by the initial entry pitch maneuver and by the trend of ROLL REF as noted on the trajectory displays.

With an extremely low L/D, the entry guidance overshoots the initial drag reference (at guidance initiate). The alpha modulation reacts to this by pitching down. As was mentioned before, because a low L/D is not the only cause for a pitchdown maneuver, interpretation of the problem cannot be based on just this one clue. Additionally, ROLL REF C&W is set before saturation of roll and angle of attack. The sequence of events in the extremely low L/D case would be (1) pitch down to 37° alpha at guidance initiate, (2) ROLL REF C&W, either ROLL REF < 37° or ROLL REF < 20°, (3) ROLL REF = 0° (saturation of steady-state roll), (4) ROLL CMD = 0°, and (5) saturation of alpha at the lower limit.

#### 5.1.4.4 Phugoid Damper

The phugoid damper was incorporated as part of the TRAJ displays to give the crew a 'fly-to' bank angle calculated to avoid phugoid instability and help the crew to control the entry drag/range problem while flying in the CSS mode.

The logic for the phugoid damper is contained in the entry DIP. A drag versus velocity profile is defined by three linear segmented lines; the associated values that define this profile are I-loaded constants (figure 5-10).

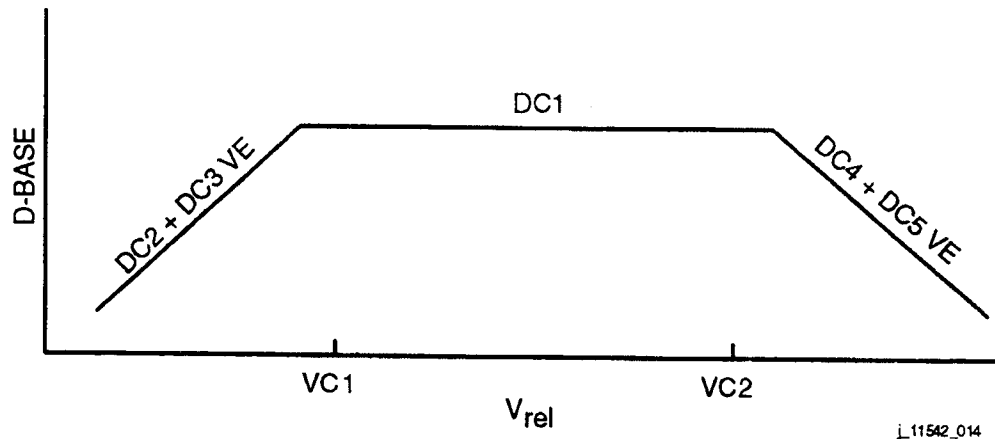

**Figure 5-10. Phugoid damper plot**

The D-BASE term is a function of relative velocity and is determined by one of the three linear equations in figure 5-10. The D-BASE term is used in the determination of the DREF value digitally displayed under the bias item 1 on the ENTRY TRAJ displays. With a bias of zero, the D-BASE is the DREF for the phugoid damper, where DREF is defined as  $DREF = D-BASE + \text{bias item}$ .

The bias item allows shifting of the drag value obtained from the linear drag versus velocity profile. The item entry slot accepts item entries between +10 and -10. The item entry slot always reflects any current bias value. This bias is initialized to zero at the beginning of MM 304. The phugoid bank scale has a range of  $\pm 20^\circ$  on all the ENTRY TRAJ displays. The phugoid scale and shuttle symbol flashes to notify the crew of a roll reversal. In addition, when the triangle symbol ( $\nabla$ ) on the phugoid scale reaches the off-scale position, it remains there and flashes.

To determine when to signal a roll reversal, the phugoid bank logic uses DELAZ, the heading error with respect to the HAC tangency point, from navigation (entry UPP) and YL, the maximum heading error absolute value, from entry guidance. When the DELAZ times the direction of roll becomes equal to or greater than the YL, the logic changes the sign in the roll direction. This logic is in contrast to that of autoguidance where, when the current-cycle DELAZ times the sign of commanded roll of the previous cycle becomes equal to or greater than the YL, the logic changes the sign of commanded roll, and a bank reversal is initiated. If the orbiter is in CSS, only then is the product for comparison to YL the current DELAZ times the sign of current actual roll, as in the logic of the phugoid damper.

Because the YL is a guidance-calculated parameter, alternate techniques may have to be used to determine the appropriate time to make a roll reversal in the remote situation with no guidance at all.

#### 5.1.4.5 Use of Phugoid Damper

Although CSS entries are not currently planned and the probability of having to perform one is low, an emergency deorbit using the phugoid damper could result, in the event of certain severe combinations of malfunctions.

At a drag equal to  $3 \text{ ft/s}^2$  or  $\bar{q}$  bar equal to approximately  $8 \text{ lb/ft}^2$ , the logic for the phugoid damper is initiated. The crew can detect this by the appearance of a roll error bug command on the BFS TRAJ 1 phugoid bank scale and by the appearance of the guidance symbol ( $\square$ ) in PASS TRAJ 1. The item 1 bias slot indicates a zero and the DREF digital readout begins displaying the DREF computed from the linear drag versus velocity segments described earlier.

The procedure for using the phugoid damper is to follow the commands after a drag =  $3 \text{ ft/s}^2$  (CRT and AMI) has been attained. Before a drag of  $3 \text{ ft/s}^2$ , preentry guidance, the bank is  $0^\circ$  for the nominal deorbit case or an angle determined from the prebank tables based on residual  $\Delta V$  caused by deorbit underbum dispersions.

Preliminary work done in M-I-L simulators indicates that a scan of the dedicated instruments to include H and  $\dot{H}$  on the AVVI helps in the phugoid control task. Below an altitude of 100,000 ft, the  $\dot{H}$  should be held to less than  $-486 \text{ ft/s}$  on the AVVI for venting constraints.  $\dot{H}$  can be used to control the H trend by controlling bank, as required, to cause  $\dot{H}$  to be zero at the desired H. As described earlier, the phugoid damper uses navigation and guidance information to determine when a roll reversal is needed and implements a flashing phugoid damper scale and shuttle symbol as an attention-getting device for the crew. Because the YL deadband comes from guidance, it is a possible candidate for failure, although considered highly unlikely. The procedure to use the phugoid damper following an emergency deorbit would be to fly the phugoid damper (ZERO BIAS) commands in the CSS mode.

#### 5.1.4.6 $\dot{H}$ Bias Readout

As discussed in a previous section, the  $\dot{H}$  bias term displayed digitally on the ENTRY TRAJ displays is an  $\dot{H}$  feedback correction term calculated by guidance. Before the addition of alpha modulation to entry guidance, the only means of controlling drag was by roll command to try to keep the orbiter on a guidance-calculated reference D-V profile. A source of error that can cause a bias in the actual drag flown with respect to the reference drag is an IMU platform misalignment. In the presence of such an IMU error, the  $\dot{H}$  obtained from navigation will cause a standoff drag error from the DREF versus velocity profile. In the event of a platform misalignment, a drag error is introduced that builds over time, depending on the accuracy of navigation. Because of the possibility of large altitude rate errors in the NAV  $\dot{H}$ , a correction to the altitude rate reference is made based on a feedback in the (D - DREF) error. The method used to correct for such an  $\dot{H}$  error is to subtract its effect over time. The following term was introduced into the (L/D) CMD equation:  $\int (D - DREF) dt$ . The (L/D) CMD equation that includes this correction term is of the form:

$$(L/D) \text{ CMD} = (L/D)_{\text{REF}} + C_{16} (D - D_{\text{REF}}) + C_{17} (\dot{H}_{\text{REF}} + \Delta\dot{H} - \dot{H})$$

where the  $\Delta\dot{H}$  term is the correction factor based on drag error converted into a  $\Delta\dot{H}$  value. At a relative velocity below 23,000 ft/s, a limited drag error is calculated based on an I-loaded limit that is the maximum delta drag for H feedback ( $-2 \text{ ft/s}^2 < \Delta D < +2 \text{ ft/s}^2$ ). Because the displayed  $\dot{H}$  bias on the CRT is always an integer value, the crew will not see an  $\dot{H}$  bias value until it has exceeded 1 ft/s.

After the  $\dot{H}$  bias feedback becomes active, guidance makes the following logical checks to see (1) if a roll reversal has occurred, (2) if drag error is converging, or (3) if roll command is saturated. If any of these is true, the  $\dot{H}$  feedback is held constant. Autoguidance continually accounts for the  $\dot{H}$  bias correction factor; however, this factor can also be used to account for the  $(D - D_{\text{REF}})$  error introduced by flying in the CSS mode. If the crew were flying in CSS and using the TRAJ display (as opposed to error needles), the vehicle would probably be flying a drag-velocity profile different from the profile that autoguidance would fly. Drag errors would be accumulated, and because autoguidance is not engaged, these errors would not be accounted for. The  $\dot{H}$  bias readout gives the crew an indication of what these errors are and the item 2 entry allows the crew to set this error to zero before reengaging autoguidance.

The recommended procedure for using  $\dot{H}$  bias is that if  $\dot{H}$  bias readout exceeds 30 ft/s while in CSS mode,  $\dot{H}$  bias should be zeroed before returning to AUTO mode. An  $\dot{H}$  bias of approximately 30 ft/s will start causing trajectory effects; this is why it is recommended to zero  $\dot{H}$  bias after flying in CSS and before reengaging auto. The problem associated with reengaging autoguidance with an  $\dot{H}$  bias accumulation greater than 30 ft/s is that autoguidance would offset the trajectory to account for a presumed navigation error when the drag error was caused by the CSS mode.

Unless alpha is saturated, the  $\dot{H}$  bias is not significant ( $\dot{H}$  bias  $< 30 \text{ ft/s}$ ). Under certain circumstances, an  $\dot{H}$  bias buildup can be used to signal that a navigation error exists. If the drag is on drag reference, alpha is saturated, and a large  $\dot{H}$  bias is noted, a possible cause could be a navigational error. If drag is not on drag reference and alpha is saturated with a large  $\dot{H}$  bias flying CSS, this indicates that the vehicle has not been accurately tracking the trajectory and the item 2 should be used to zero the  $\dot{H}$  bias ( $> 30 \text{ ft/s}$ ) before reengaging autoguidance. As a rule of thumb, a drag bias of  $1 \text{ ft/s}^2$  is equal to approximately 40 ft/s  $\dot{H}$  bias. I-loads limit  $\dot{H}$  bias feedback to between -150 and +150 ft/s.

### 5.1.4.7 Vertical Situation Displays

Two VSD's are used to monitor the guidance function in the TAEM region. The VERT SIT 1 display comes up automatically at TAEM interface when the crew performs an OPS 305 PRO or an OPS 602 PRO. It also comes up automatically at the end of the Z-translation maneuver in the case of a return to launch site (RTL). This discussion does not address the use of these displays as applied to an RTL and the reader is referred to the Ascent Abort Flight Procedures Handbook. The information contained on the VERT SIT 1 display for crew monitoring is shown in figure 5-11.

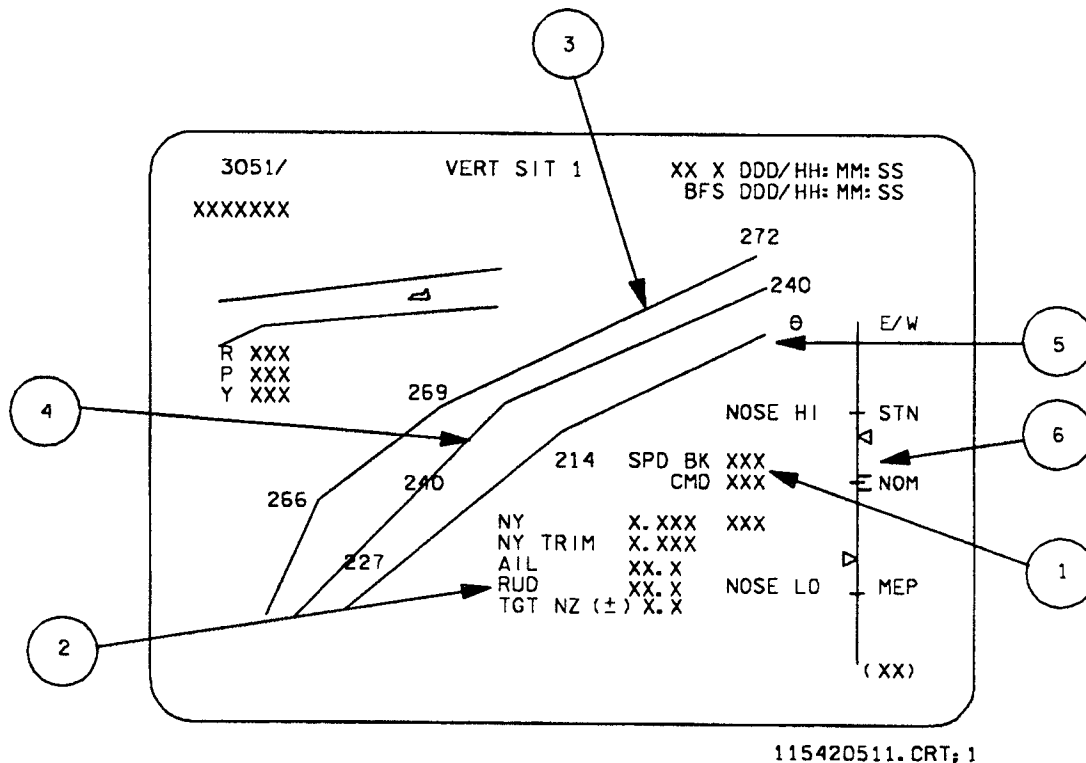

**Figure 5-11. VERT SIT 1 display (PFS/BFS)**

1. On each VERT SIT display, the auto speedbrake command (percent) from either TAEM or A/L (depending on guidance) and the speedbrake position from the speedbrake position feedback SOP are displayed.
2. The following digital readout information is included on the VERT SIT 1 and VERT SIT 2 displays: aileron trim, rudder trim, lateral acceleration, and lateral acceleration trim. The aileron trim (degrees) is from the roll channel of the aerojet DAP. The rudder trim (degrees) is from the yaw channel of the aerojet DAP. The lateral acceleration, NY, comes from the AA lateral acceleration selection filter. NY readout is in g. NY trim comes from a yaw channel integrator and is also displayed in g. The readouts are the same format as that outlined in the discussion on the ENTRY TRAJ displays. In the GRTL S case, the aileron trim, rudder trim, and NY trim readouts are from the GRTL S DAP.
3. Each VSD contains three altitude versus range (RPRED) lines. The VERT SIT 1 range scale runs from 70 n. mi. on the right to 10 n. mi. on the left. The altitude (vertical) scale

runs from 100,000 ft at the top to 30,000 ft at the bottom. The altitude versus range lines are defined as follows:

The upper line represents an altitude versus range plot to reflect the  $\bar{q}$  limits in auto-guidance. The altitude versus range plot was generated by flying wings level at max  $\bar{q}$ . This guideline is based on a speedbrake deflection of  $65^\circ$  until Mach 0.90 with full open speedbrake ( $98.6^\circ$ ) below Mach 0.90. The guideline is anchored on VERT SIT 2 at an altitude of 11,000 ft.

4. The middle line represents the nominal altitude versus range profile for end of mission TAEM.
5. The lower guideline represents an altitude versus range plot generated by flying wings level at  $\bar{q}$  min. The speedbrake is at 65 percent until Mach 0.90. Below Mach 0.90, the speedbrake is set to the FCS minimum value of 15 percent. The KEAS value corresponds to maximum subsonic L/D, therefore the guideline is not a true maximum L/D line but an approximation. At the peak of the L/D curve the equivalent airspeed (EAS) can vary.
6. Each VERT SIT display contains a pitch, or  $\theta$  tape, and an EW scale on the right-hand side of the display to present E/W and vehicle  $\theta$  limit information to the crew. The intent of this  $\theta$  tape is to provide pitch information to the crew in the event of an ADS dilemma/failure.

The purpose of the theta limits is to give the crew an indication of approach to vehicle structural and performance limits so that crew takeover may be accomplished if needed. The threat limits were determined by an E&D off-line program that flew a  $\bar{q}$  profile with no errors (i.e., wind, aerovariations). Variations in speedbrake deflection, bank angle, and weight were used to define their effects on the profiles. The theta versus VREL data are plotted and a curve fit made to arrive at a set of constants (I-loads) that are used in the VERT SIT DIP to define the  $\theta$  NOSE HI and  $\theta$  NOSE LO ticks. The I-loads that determine the weighting factor associated with bank, speedbrake, and weight vary, depending on whether  $VREL \leq 900$  ft/s,  $900$  ft/s  $< VREL \leq 1000$  ft/s,  $1000$  ft/s  $< VREL \leq 1700$  ft/s, or  $VREL > 1700$  ft/s. These velocity region breakpoints were also determined as part of the E&D off-line analysis. The equation for the nose-high limit is based on no wind, nominal aero, wings-level equilibrium flight at minimum  $\bar{q}$ . The nose-high tickmark on the theta tape holds approximately maximum L/D. The equation for the theta nose low limit is based on the same no-error conditions at the maximum  $\bar{q}$  that autoguidance will fly. If the  $\theta$  bug is outside either limit, and air data is not incorporated, the procedure is to take CSS (P) and limit pitch CMD to the tickmark.

Because of a decreased scale distance between the nose-high and nose-low ticks, the motion of the theta bug is erratic at a bank angle greater than  $50^\circ$ . An I-load limits the display of theta on the tape to velocities below 1500 ft/s.

In the event of no air data, the Entry Checklist ( $M < 2.0$ ) calls for the crew to check that theta is within the nose HI/LO limits and to fly CSS, as required, to limit bank to  $50^\circ$ . At Mach 0.90 manual speedbrake should be used, as required, for energy management.



When flying theta limits, guidance should be followed until either the nose HI or nose LO limit is reached. A high energy case has the crew flying at the nose LO  $\theta$  limit. At Mach 0.90 the speedbrake should be set to full open until nominal energy is achieved. A low energy case will have the crew flying the nose HI  $\theta$  limit and at Mach 0.90, the speedbrake should be manually retracted until a nominal energy state is regained.

Displayed on the energy side of the vertical tape scale, the current vehicle E/W, the reference energy, and the guidance energy limits (S-turn and MEP) are displayed. These energy calculations are in units of feet of E/W. The current vehicle energy state (kinetic plus potential) is represented by a triangle symbol. The reference and guidance energy limits are represented by tickmarks.

The STN and MEP energy limits are defined as follows: The STN tick is calculated based on the E/W value above which TAEM guidance will initiate an S-turn. The equation used to calculate E/W for S-turn (ES) was derived assuming the vehicle was flying wings-level at the TAEM guidance maximum  $\bar{q}$  schedule with the speedbrake at 65 percent until Mach 0.95, then speedbrake full open.

This ES E/W equation represents the closest E/W to an S-turn that the guidance can handle in a straight-in situation and meet the A/L criteria without doing an S-turn. Worst-case winds were used in the analysis to determine the ES equation for guidance. If one looks at a plot of ES versus range to the runway, the slope of the line represents the energy dissipation rate with max  $\bar{q}$  in a tailwind.

An iterative computer analysis was used to find the limiting E/W that would allow the vehicle to just make the aimpoint, utilizing the MEP HAC location. The MEP tick is driven based on the E/W for a minimum entry point (EMEP) as calculated by the TAEM guidance. This E/W value, EMEP, considers the vehicle is flying wings-level, minimum  $q$  with the speedbrake at 65 percent until Mach 0.9, where the speedbrake is set to zero to maximize the range for the EMEP line determination. A 99-percentile headwind (worst month) was used to determine the EMEP E/W versus range to runway. Thus, this EMEP line has some conservatism built in, as seen in figure 5-12. The constants associated with these E/W versus range to runway profiles are included in TAEM guidance as I-load values.

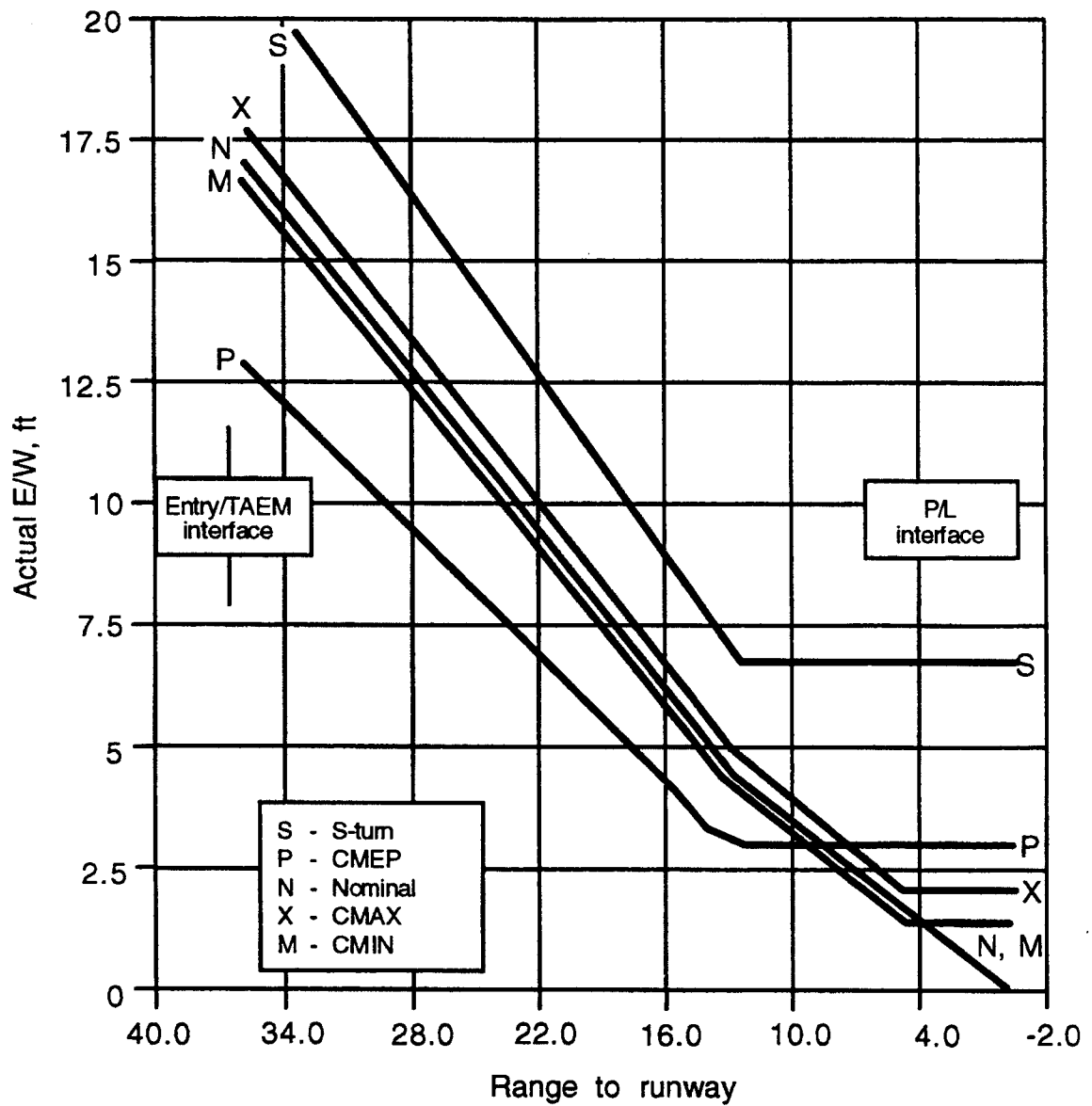

L11542\_015

Figure 5-12. Actual energy over weight during TAEM

A left pointing arrow ( $\leftarrow$ ) is used to indicate an I-loaded energy level at which a 'straight' approach (as opposed to an 'overhead' approach) should be used. If the current HAC turn angle is greater than  $200^\circ$ , and E/W falls to this level while the range to the runway is greater than 45 n. mi., guidance will generate a class 3 alarm, calling for a downmode to a straight approach. On SPEC 50, OVHD (item 6) will flash and an OTT ST IN message will be given. Forty-five n. mi. was chosen as a minimum range for the approach mode redesignation alarm because changing the approach mode inside this range may result in heading errors that would nullify any potential E/W gains. The approach mode may be changed, however, at any time prior to the prefinal phase by executing item 6 on SPEC 50.

The NOM E/W tick represents EN, the guidance-computed E/W reference. This E/W reference is either of two linear segments of E/W versus range to runway. On either side of the reference E/W tick are ticks that define an 'E<sub>MAX</sub>' and 'E<sub>MIN</sub>' E/W corridor. This corridor is +8000 and -4000 ft of E/W. This E<sub>MAX</sub> and E<sub>MIN</sub> E/W corridor is calculated in TAEM guidance down to prefinal phase of TAEM guidance. The E<sub>MAX</sub> and E<sub>MIN</sub> limits are used by the N<sub>Z</sub> command function of TAEM guidance. The N<sub>Z</sub> command is constrained by E/W,  $\bar{q}$ , and absolute N<sub>Z</sub> limits before going to flight control. TAEM guidance attempts to keep the vehicle inside this E<sub>MAX</sub>/E<sub>MIN</sub> corridor. This E/W corridor was devised to protect against degraded navigation altitude, which could drive the E/W off the reference profile. Once outside the E/W corridor, the N<sub>Z</sub> command is being determined to drive the vehicle back inside the E/W limits. The +8000/-4000 ft value was determined from parametric studies starting with 1-sigma navigation filter performance and extending this until TAEM guidance could not reach the A/L criteria. It has been determined that for 3-sigma NAV performance, the E/W should stay within the E<sub>MAX</sub>, E<sub>MIN</sub> corridor.

At an altitude of 20,000 ft or less, the energy symbols are no longer driven on the E/W tape. The selection of 20,000 ft was based on engineering judgment because at this altitude the crew is concentrating on acquisition of the outer glide slope (OGS). The current energy indicator, a triangular symbol, is programmed to flash when the current shuttle E/W exceeds the ES and the predicted range is greater than or equal to the S-turn lockout range value (I-load of ~22 n. mi.). The triangular symbol continues to flash until the current shuttle energy becomes less than the ES, or S-turn E/W. If the current shuttle E/W is high enough so that the Y-position of the triangular current energy symbol is greater than the maximum Y-value of the energy scale, the triangular symbol remains at this Y<sub>MAX</sub> position until the symbol again is on scale. When the current shuttle E/W becomes equal to or less than the MEP E/W, the triangular current energy symbol flashes until the current shuttle energy becomes greater than the MEP E/W value. In a similar manner to the MAX position on the energy scale, if the Y-position of the current shuttle energy becomes less than the Y<sub>MIN</sub> on the energy scale, the triangular symbol will remain at this Y<sub>MIN</sub> position until the E/W value is within the scale limits. The E/W tape is scaled based on the difference between the energy for S-turn minus the energy for MEP divided by a fixed scale length.

When either VERT SIT 1 or VERT SIT 2 display is driven by the BFS, the ADI errors (in degrees) in roll, pitch, and yaw computed in the BFS descent-DAP roll channel, descent-DAP pitch channel, and descent-DAP yaw channel, respectively, are displayed for comparison with the PASS-driven ADI error needles. These errors and their text labels are driven pre-BFS - engage only. The text labels are U, D, R, and L and indicate fly-to errors.

The dashed line in the upper left corner of the VERT SIT 1 display represents an alpha transition profile ( $\alpha$  as opposed to M) that is used only in MM 602. The solid line below the dashed

line represents the do-not-exceed stability and control boundary for the alpha transition. An orbiter symbol at a fixed orientation is plotted to indicate the current Mach/alpha location.

The pilot should fly an  $\alpha$  profile that keeps the shuttle symbol in the dashed line and not let the symbol get below the bottom line. Maximum alpha limits are not depicted and the crew has to use the entry alpha cue card to determine the maximum alpha.

#### 5.1.4.8 Monitoring TAEM with VERT SIT Displays

The VERT SIT 1 display covers the altitude region from 100,000 to 30,000 ft. When the shuttle symbol is below 30,000 ft, the VERT SIT 2 display is called up. The range used to plot the shuttle X-position is based on RPRED from guidance (range to the runway threshold via WP 1). The altitude is from the TAEM UPP and is the altitude of the rear wheels above the runway. The shuttle symbol is driven to show the current vehicle altitude dissipation rate by the amount of rotation of the shuttle symbol. An altitude dissipation angle is calculated in the VERT SIT DIP from ARCTAN ( $-\text{HDOT}/\text{VGND SPEED}$ ) where the HDOT term is the estimated altitude rate from the TAEM UPP and V-GROUNDSPED is groundspeed from TAEM UPP. The angle is measured from  $0^\circ$  to  $360^\circ$  clockwise where the  $0^\circ$  position equals the shuttle nose pointing to the top of the CRT. The angle calculated for display purposes is  $-90^\circ$  minus the calculated dissipation angle, to give a shuttle symbol rotation.

In the nominal EOM case at TAEM interface, the shuttle symbol should appear on the VERT SIT 1 display approximately one quarter of the way down from the top of the display. Because the VERT SIT 1 display monitors the majority of the supersonic portion of TAEM guidance and the majority of the energy is kinetic, the E/W scale is of more use/importance to the crew than the altitude versus range lines. The reason for this is that these lines are guidelines determined for the equilibrium flight conditions described in the previous section. These lines do not reflect the current energy state of the vehicle; for this information the crew should monitor the position of the bug on the E/W tape. The altitude versus range lines become more useful on the VERT SIT 2 display after the vehicle reaches subsonic speeds. By monitoring the position of the current E/W triangular symbol inside the  $E_{\text{MAX}}$  and  $E_{\text{MIN}}$  ticks described earlier, the crew can monitor how well autoguidance is handling the energy management problem.

While the triangle symbol is inside the E/W corridor, the TAEM guidance  $\Delta N_z$  commands should be following the  $H_{\text{REF}}$  versus range profile.

To understand the E/W corridor between  $E_{\text{MAX}}$  and  $E_{\text{MIN}}$ , one has to look at the way TAEM guidance determines  $\Delta N_z$  command.

TAEM guidance computes a  $\Delta N_z$  command based on the H error and  $\dot{H}$  error between the guidance-determined reference values of  $\dot{H}$  and H and the NAV-determined values. This  $\Delta N_z$  command is then limited by six  $\Delta N_z$  limits, as shown in figure 5-13, with MIDVALUE selection logic. As was discussed earlier, the E/W corridor was determined through parametric analysis to represent the E/W delta about the reference E/W that could be tolerated due to NAV dispersions and still meet the A/L criteria. The combination of the  $\Delta N_z$  controllers, altitude, E/W, dynamic pressure, and absolute  $\Delta N_z$  is used to obtain the best compromise in handling NAV errors, worst-case aero, and winds.

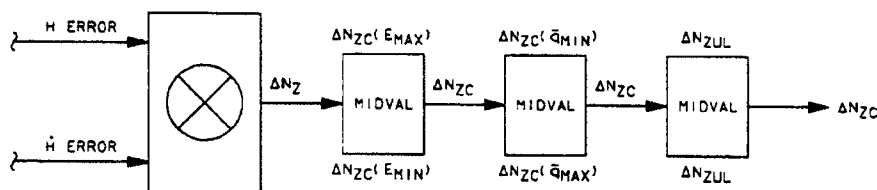

115425290. ART 1

**Figure 5-13. TAEM  $\Delta N_Z$  logic**

As an example of how the E/W tape might look in a low-energy autoguided case, assume the vehicle is low on E/W, the E/W bug is at MEP point on the E/W tape, and the E/W is converging to the reference E/W. While the E/W is less than the  $E_{MIN}$  limit (tick below the EN tick), the auto  $\Delta N_Z$  command is being limited by the  $\Delta N_{ZCMD}(E_{MIN})$  and/or  $\Delta N_{ZCMD}(Q_{MIN})$  limits.

As the E/W bug moves inside the E/W corridor on the E/W tape, the  $\Delta N_{ZCMD}$  that guidance sends to flight control is based on the H and  $\dot{H}$  errors from the guidance H versus range profile. In a similar manner, if above the E/W corridor, autoguidance controls the vehicle to get back inside this corridor and fly the reference H versus range profile while being limited by energy or  $\bar{q}$ .

Nominally, the shuttle symbol tracks down the center guideline with the energy bug between the  $E_{MAX}$  and  $E_{MIN}$  tickmarks. The current theta is plotted on the theta tape; but, because its function is limited to the no air data situation discussed previously, it has no significance with good air data. In the event of no air data below Mach 1.5, the crew would be required to monitor this theta scale in situations that could possibly approach vehicle performance and structural limits. The procedure in such a situation if theta were observed to be outside the limits on the tape would be to fly (P) CSS and set  $\theta = \text{limit}$ .

At an altitude of 30,000 ft, the VERT SIT 2 display seen in figure 5-14 comes up automatically. This display is also an altitude versus range to the runway plot and covers the lower energy portion of TAEM. The lower limit on the altitude scale is 8000 ft. However, the three guidelines are anchored at  $10,000 \pm 1000$  ft, as described previously. The range axis is scaled from approximately 23 to 4 n. mi. Some overlap exists in range on the first two guidelines from VERT SIT 1 to VERT SIT 2; however, no overlap occurs for the min  $\bar{q}$  line. The '214 ACCEL' on the min  $\bar{q}$  line serves as a cue for the crew to accelerate the vehicle for the preflare maneuver.

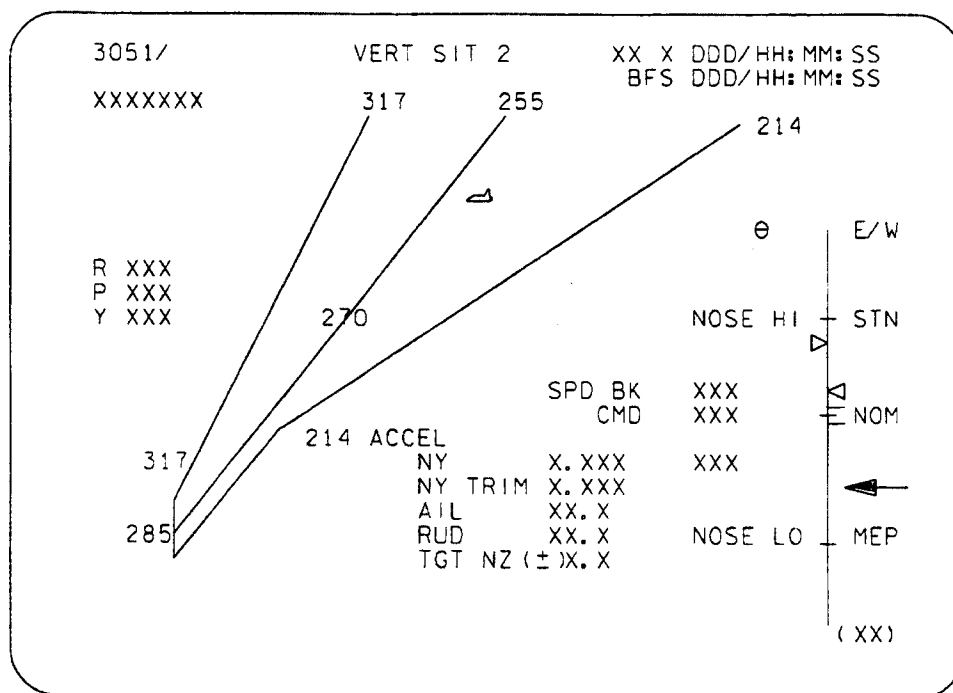

11542005. CRT: 2

**Figure 5-14. VERT SIT 2 display (PFS/BFS)**

By the time the VERT SIT 2 display is up, the energy management problem should be one of altitude versus range management (potential energy management). At an altitude of 20,000 ft, the E/W display on the right-hand side of the VERT SIT 2 is no longer driven. Nominally, the shuttle symbol should be tracking the center altitude-range line during this phase. Below Mach 0.9, the speedbrake command based on TAEM guidance dynamic pressure error is displayed in percent and above this readout is the speedbrake position from the speedbrake position feedback SOP. When TAEM guidance is terminated, the text A/L (autoland) is displayed and flashed. This signals the pilot that the TAEM guidance has delivered the vehicle to the A/L criteria or that the altitude is below 5000 ft, where TAEM guidance ends and transitions to autoland. The location of this A/L text is just below the speedbrake command readout on the VERT SIT 2. In the BFS display of the text, A/L is not supported.

#### 5.1.4.9 Horizontal Situation Display - (PFS and BFS)

The HORIZ SIT (SPEC 50) display provides the crew with spacecraft position and heading information with respect to the ground plane, provides readouts and control of navigation parameters, and is available in GNC OPS 1, 3, and 6. Control of planned aerodynamic maneuvers to obtain aerodynamic and structural data PTI's is provided via the PFS HORIZ SIT display. If the BFS is engaged, the maneuvers will not be performed; therefore, the BFS HORIZ SIT does not provide the capability to control the PTI's. The PFS and BFS HORIZ SIT displays shown in figures 5-15 and 5-16 are nearly identical. The few differences are pointed out in the following parameter descriptions.

1. The graphic portion of the display becomes active when the orbiter altitude decreases below 200,000 ft. The vehicle position is represented by a fixed shuttle symbol. The runway and the HAC are dynamically driven to create an out-the-window view for the crew. The view can be visualized as a ground plane projection containing the shuttle and landing site in a coordinate system fixed to the vehicle. The HORIZ SIT scaling varies so that the groundtrack resolution increases as the vehicle gets closer to the landing area.

The display includes three predictor indicators (small circles) that show the position of the shuttle relative to the ground at 20, 40, and 60 seconds into the future based on current flight conditions.

2. Item 1 is unique to the primary HSD and provides the capability to enable or inhibit PTI maneuvers in MM 101, 102, 304, and 305. Execution of item 1 in any other MM results in an ILLEGAL ENTRY message.

The display is initialized with PTI's inhibited, indicated by 'INH' displayed next to item 1. Execution of item 1 enables the PTI's and displays 'ENA' next to 1. Item 1 acts as a flip-flop, alternately enabling or inhibiting PTI's. The PTI's may also be inhibited manually by establishing the CSS mode in the DAP via the pushbutton indicators (pbi's) on panels F2 and F4 or by taking the RHC out of detent. In either case, item 2 is reset to the inhibit state and 'INH' is displayed. The PTI's can then be reenabled only by reestablishing the AUTO mode in the DAP and executing item 1. The manual inhibits terminate a PTI maneuver in progress.

The particular PTI maneuver to be performed is indicated by the PTI index, a number from 0 to 25, displayed below item 1. In OPS 1, the PTI index is initialized to zero indicating a structural PTI, the only type performed in OPS 1. In OPS 3, any one of 25 aero PTI's may be performed. Consequently, the PTI index will be fixed at zero during OPS 1 and in OPS 3 will range from 1 to 25.

Once enabled, a specific PTI maneuver is performed as soon as the PTI window (VREL in OPS 1; MACH or  $\bar{q}$  in OPS 3) for that PTI is entered, provided that the systems, guidance, and trajectory constraints are satisfied. In OPS 1, 'PTI' is displayed oversized and overbright below the PTI index whenever the structural PTI maneuver is in progress. The data field is blank otherwise. In OPS 3, whenever a PTI window is entered, 'PTI' is displayed oversized and overbright.

If the PTI maneuver is inhibited automatically or manually, 'PTI' flashes throughout the PTI window. While the maneuver is in progress, 'PTI' does not flash. 'PTI' is blanked and the PTI index incremented when the maneuver is terminated; if no maneuver is performed, this occurs when the window is exited. The PTI INDICATOR is blanked if a TAL or AOA abort has been declared.

3. The display has a runway designation data field that shows the designated landing site (RWY). Item 41 followed by an index number (a.k.a. area number) is used by the crew to provide the GNC software with geodetic data for the desired landing site. The primary runway (item 3), the secondary runway (item 4), and the primary or secondary TACAN (item 5) from the landing site area selected by item 41 shall be indicated by displaying the appropriate mnemonic. If the display is called up in MM 301 to 303, an '\*' indicator is displayed initially by the primary runway (item 3) and thereafter shall reflect crew inputs. Items 3 and 4 are mutually exclusive.

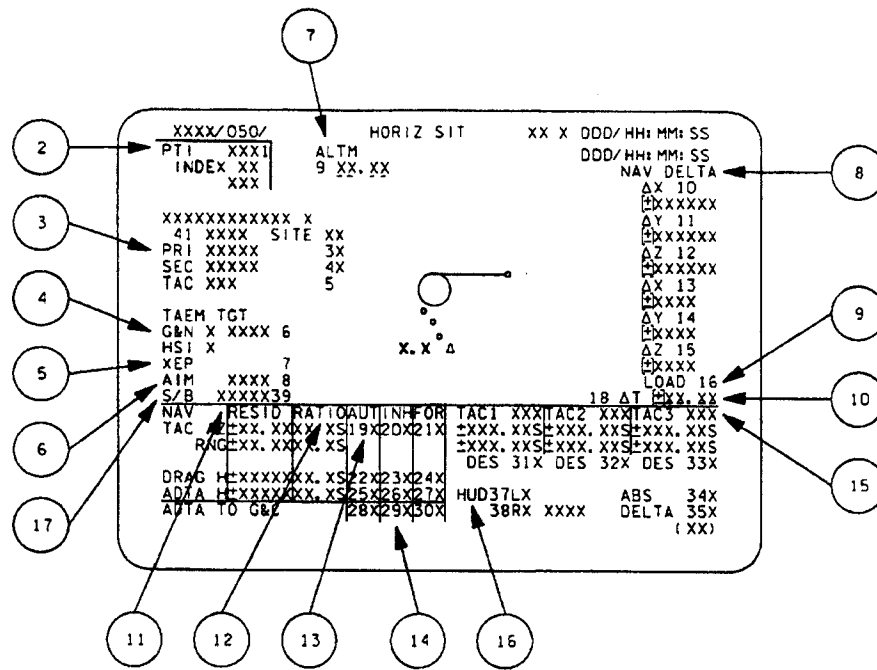

11542004. CRT, 2

Figure 5-15. HORIZ SIT display (PFS)

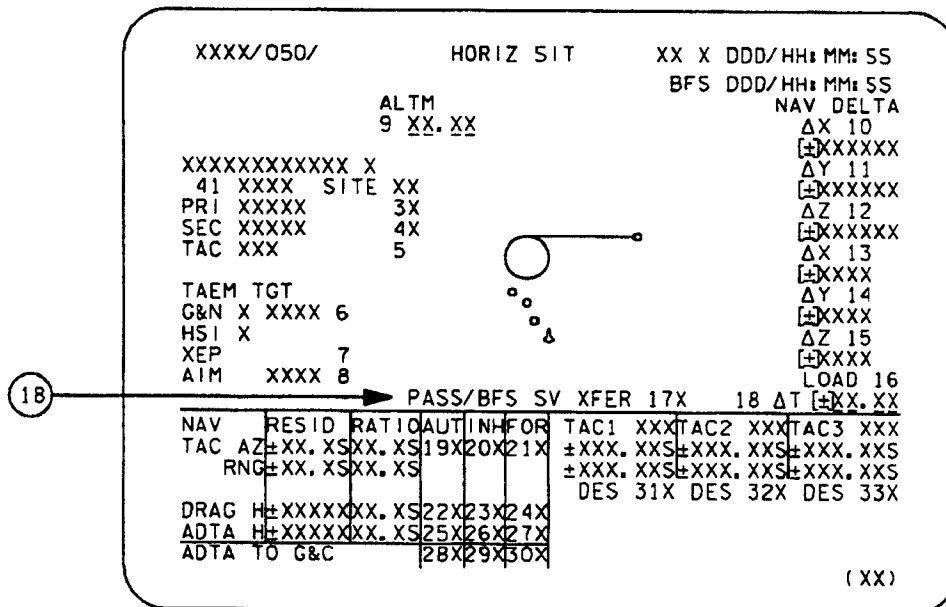

115420516. CRT, 1

Figure 5-16. HORIZ SIT display (BFS)



4. Item 6 (G&N) provides the capability to designate the alternate HAC to be used for targeting during entry. Text (OVHD or STRT) is displayed next to item 6 to indicate whether the approach is to be overhead or straight in. The display is initialized in MM 101 with OVHD selected and does not change unless the crew selects the alternate HAC in MM 304, 305, 602, or 603. In addition, indicators are provided for GN&C and the left HSI to identify whether the L or R HAC is the target point. The GN&C and HSI indicators are initialized upon transitioning into MM 304 or 602. Prior to 304 and 602, the fields are blank. The HAC can be changed when the crew manually selects the alternate HAC via item 6. If the alternate runway is selected via item 5, the approach is reinitialized to OVHD. If an overhead approach has been selected and guidance determines that the energy is too low, a class 3 message is generated and OVHD is flashed on the display. The flashing is terminated once a straight-in approach is selected. Item 6 is legal only in MM 101, 304, 305, 602, and 603.
5. Item 7 is an entry point indicator. Initially, the indicator shall be driven as nominal entry point (NEP). Execution of item 7 (XEP, where the 'X' is dynamic) allows the crew to switch to the MEP or from MEP back to NEP as the energy situation dictates.
6. A control is provided to redesignate a glide slope ground intercept point. The display is initialized with the nominal intercept point selected, indicated by 'NOM' being displayed next to item 8. Execution of item 8 (AIM) selects the intercept point closest to the runway for high headwinds. This is indicated by 'CLSE' being displayed next to item 8. Reexecuting item 8 reselects the nominal intercept point. It is possible to switch back and forth between the nominal and close intercept points until the TAEM/autoland interface. Switching the intercept point causes other appropriate values of TAEM geometry parameters to be used. The HAC position shown on the graphics portion of SPEC 50, however, always depicts a HAC location based on the NOM aimpoint. Therefore when CLSE is selected, the shuttle bug can be expected to fly approximately 1/20 of an inch inside the HSD HAC depiction.
7. Item 9, the ALTM data field, is used to input the landing site barometric altimeter setting corrected to mean sea level. The display is initialized with this parameter set to 29.92 in Hg and thereafter shall reflect crew inputs.
8. Items 10 through 15 provide the capability to enter delta position and velocity components in runway coordinates. Only components requiring update need be entered, the remaining components being zeroed.
9. Item 16 (LOAD) provides the capability to execute a delta update to the navigated state of the orbiter, using the data entered in items 10 through 15. Upon completion of the delta update by NAV, these items and their associated buffer shall be zeroed.
10. Item 18 ( $\Delta T$ ) provides the capability to update state vector downtrack errors by means of adding or subtracting delta time in seconds. The update is performed after a time value is entered via item 18 ( $\Delta T$ ) and verified, followed by the execution of control item 16 (LOAD). The delta time display field is zeroed when the display is first called and is rezeroed upon completion of a delta time update by entry navigation. Item 18 is legal in OPS 3 only. Executing this item in any other OPS causes an ILLEGAL ENTRY message to be generated.

11. The bottom section of the display allows the crew to manage some of the NAVAID inputs to GN&C. The RESID column contains data value for each component of each data type that is being processed by the NAV filter. The residual is formed in navigation by subtracting the NAV estimate of the data from the selection filter output of the data. It should be noted here that navigation uses the composite data output from the selection filter as inputs to the navigation filter so that no distinctions are made as to the line replaceable unit (LRU) source of the data to the NAV filter. In the two LRU cases, the LRU data are averaged so that the data cannot be distinguished as to LRU source. The residual value gives the crew an indication as to how well the data and the NAV estimate of the data agree. However, these data alone cannot identify whether the data or the NAV estimate of the data is in error.
12. The RATIO column contains numbers called the edit ratios that are the residuals of each data type divided by the maximum allowable residuals. The maximum allowable residual for each type of data is a dynamic number calculated in navigation. This number is dependent upon state vector uncertainties and measurement variances. It is an estimate of how closely navigation thinks the internally generated and externally measured data should compare. If the number in the ratio column is less than 1, the residual edit test performed by navigation on the data is passed, and the data can be used subsequently to update the state vector. If these data fail the residual edit test, the ratio is displayed as a number equal to or larger than 1 and is not used to update the state vector. Thus, the edit ratio and the ratio parameter status indicators give the crew an indication of whether or not a particular data type is being incorporated into the state vector. The residuals and edit ratios are computed by navigation for each NAV cycle and are available for display. When data are not being processed by the RM, the residual and ratio data fields for that parameter are blanked. A parameter status indicator column to the right of the RATIO will contain a down arrow when the parameter has failed the update edit test. The down arrow disappears when the edit test is passed by a predefined percentage of 'good' data. The parameters defining percentage of good data are I-loaded.
13. There are three filter control options: auto (AUT), inhibit (INH), and force (FOR), which the crew can exercise on three data types: TACAN (TAC AZ and RNG), drag altitude (DRAG H), and baro altitude (ADTA H), to update navigation. Items 19, 22, and 25 (AUT) allow navigation to automatically select data to be used if they pass the edit test. Items 20, 23, and 26 (INH) preclude updating the state vector with the RM-selected data, but these data are used to generate the displayed residual and ratio values. Items 21, 24, and 27 (FOR) shall override the edit and force the data to be used to update the state vector if the data are being processed by the NAV filter. Items 19 to 21, 22 to 24, and 25 to 27 are mutually exclusive. An asterisk (\*) appears next to any item (19 to 27) that has been selected. The display is initialized with items 20 (INH), 22 (AUT), and 26 (INH) selected.

The Entry Checklist contains TACAN and air data management matrices that show the crew which control options should be selected. The matrices and procedures are discussed later in this section.

14. Items 28 to 30 provide control over the source of air data parameters to guidance and flight control. Item 28 (AUT) provides auto transition from NAV-derived air data to ADTA. Item 29 (INH) inhibits the ADTA data. Item 30 (FOR) forces the use of ADTA data. These items are mutually exclusive. The PFS display is initialized with item 29 (INH) selected. The BFS display is initialized with item 29 (AUT) selected.

15. The TACAN channel of the ground station that TAC 1, 2, and 3 is locked onto, or is attempting to lock onto, is displayed. The PFS HORIZ SIT allows the crew to select via items 34 or 35 whether the absolute TACAN azimuths and ranges or the deltas between the TACAN and navigation determined azimuths and ranges to the ground station are displayed. The BFS HORIZ SIT display indicates TACAN AZ and RNG in absolute values only. Items 34 and 35 are mutually exclusive and an '\*' is driven next to the item selected. The PFS display is initialized with item 35 (DELTA) selected. A parameter status indicator column is provided for the azimuth and range of each TACAN. For both PFS and BFS displays, a blank in the column indicates normal operation and a down arrow will be displayed if the parameter is declared failed by RM. The PFS also has the capability to display an 'M' if data are missing or a '?' if a dilemma is declared by RM.

Items 31 to 33 provide the capability for each TACAN to be deselected or reselected for use by the selection filter. If a TACAN is deselected, this prevents RM from using range and azimuth as inputs to the selection filter. Deselection is indicated by an asterisk adjacent to the DES item number and down arrows in the range and azimuth parameter status indicator columns. When RM declares either range or azimuth failed on an LRU, a down arrow is displayed in the parameter status indicator column. In order to reselect and use this parameter again, the LRU has to be deselected and then reselected. The word 'TEST' is displayed if a self-test is being conducted to resolve a dilemma. TACAN self-test is available only in the 'GPC' mode.

During MM 301, 302, and 303, the TACAN azimuth and range data and the associated parameter status indicators for TACAN 1, 2, and 3 are blanked. When the DELTA values for TACAN data have been selected in PFS and a TACAN channel selected is invalid, the azimuth and range data fields and associated parameter status indicators for that TACAN are also blanked in MM 304 and 305.

16. Items 37 and 38 provide format selection capability for the left and right head up displays (HUD's) respectively. Crew selection is valid only in MM 304, 305, 602, and 603. Any attempt to select a format in any other major mode shall result in an ILLEGAL ENTRY message and rejection of the input. The HUD's initialize in format 0 (blank) in MM 304 or 602. At transition to MM 305 or 603, the HUD's automatically mode to format 1 (A/L).
17. Item 39 (S/B) provides the capability to select one of two modes of speedbrake control logic during OPS 3 and 6. (Use of a short speedbrake gives a touchdown point 1000 ft shorter than the nominal speedbrake. The short speedbrake was designed for use on the shorter TAL runways.) Upon transition to MM 601 or MM 301, if a TAL abort has not been declared, the display is initialized to the nominal mode, displaying the text 'NOM' to the left of the item number. In MM 301, if a TAL abort has been declared, the display is initialized to the short field mode. Subsequent executions of item 30 alternate the choice between NOM and SHORT modes. The SHORT field mode is indicated by displaying the 'SHORT' double overbright. Execution of item 39 is legal down to the transition to the A/L guidance phase. An 'ILLEGAL ENTRY' message results if item 39 is executed either after the A/L Guidance transition, or anytime during OPS 1.
18. Item 17 is unique to the BFS HORIZ SIT. It allows the crew to command the BFS to read PFS state information and display the deltas between the PFS and BFS state vectors. Note that the deltas, which are displayed in the data fields for items 10 to 15, are in runway coordinates rather than the UVW coordinates. If item 16 (LOAD) is then executed,

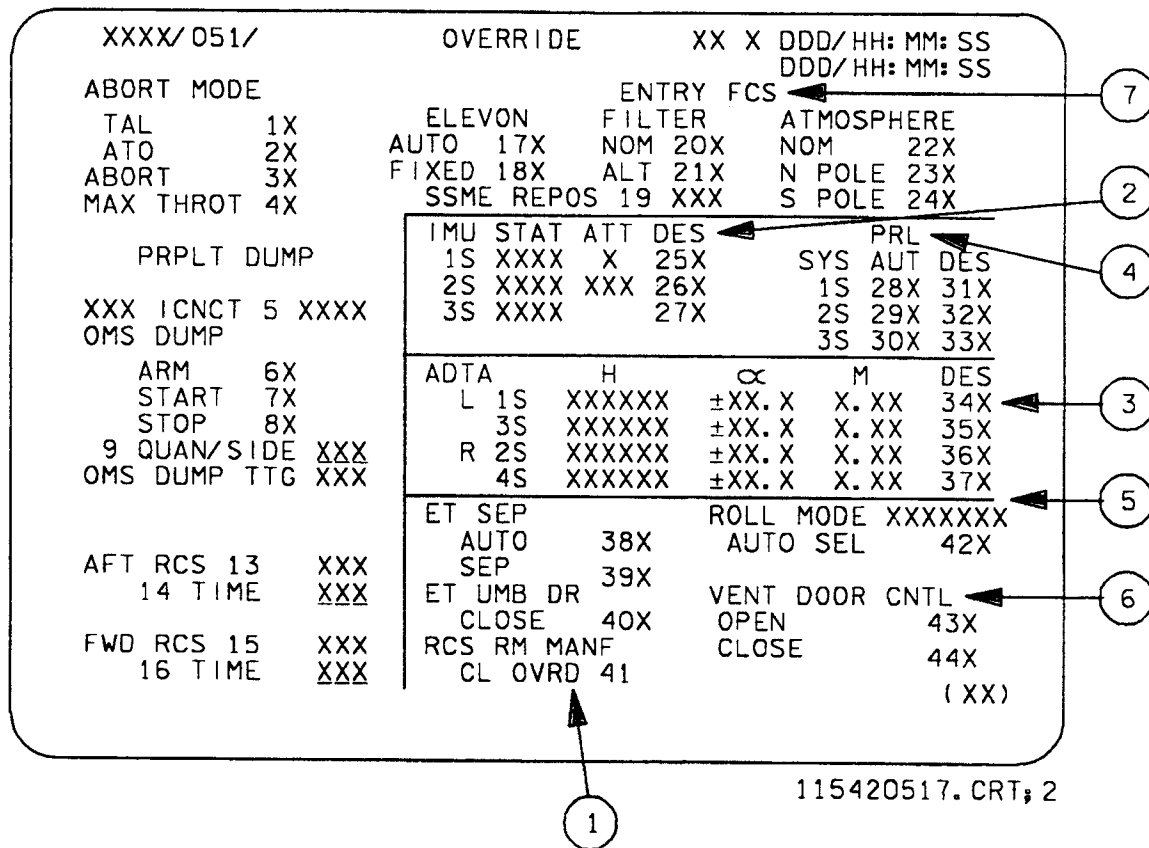

**Figure 5-17. OVERRIDE display (PFS)**

- Item 41 allows the crew to override an RCS manifold valve microswitch dilemma that has forced RCS RM to set the valve status to closed. This dilemma may prevent some good jets from being used and reduce the FCS capability. Execution of item 41 causes RCS RM to set the valve status to open on any item in dilemma and puts the RCS jets (ones without previous OFF or LK failures that have not been overridden) back into the jet availability table.
- For each of the IMU LRU's, data are displayed cyclically to aid in solving RM dilemmas. A performance monitor column (S) is provided after each LRU ID number that is blank for normal operation, displays a down arrow for an RM declared failure or crew deselection, and displays a '?' for an RM dilemma or an 'M' for missing data. The STAT column is either blank for normal operation or displays 'BITE' to indicate a problem detected in the LRU. Two information parameters are displayed in the first two rows of the ATT column. The first indicates by number (1, 2, or 3) which IMU is providing attitude data to the FCS and the ADI. In the unlikely event that RM determines all IMU attitude is bad, then rate gyro assembly (RGA) is displayed in the second row of the ATT column to indicate that the rate gyro data are being reprocessed and converted for use by the FCS and ADI. The first row still displays the last IMU (1, 2, or 3) that provided good attitude data before the data were determined to be bad. If RGA is displayed during entry because one IMU is failed and the two remaining are in a dilemma, the crew should deselect the lower number IMU in dilemma. Items 25, 26, and 27 allow the crew to deselect an LRU for use by the IMU selection filter or reselect an LRU that has been declared failed by RM.

3. For each of the four ADTA LRU's, the following data are displayed cyclically to aid in resolving RM dilemmas: ADTA derived altitude in feet, ADTA derived angle of attack in degrees, and ADTA derived Mach number. A performance monitor column (S) adjacent to the LRU ID number is blank for normal operation, displays a down arrow for an RM declared failure or crew deselection, and displays a '?' for an RM dilemma or an 'M' for missing data. Items 34, 35, 36, and 37 can be used to deselect or reselect an LRU for use by the ADTA selection filter. These items are legal in MM 304, 305, 602, and 603. Execution of these items in OPS 1 and in MM 301, 302, 303, or 601 will result in an ILLEGAL ENTRY message. When the air data probes are not deployed, zeros are displayed in the H,  $\alpha$ , and M columns.
4. Priority rate limiting (PRL) reduces the maximum surface rate commands from the aerojet and GRTLs DAP's in the event hydraulic system failures are detected by the hydraulic SOP. Items 28 to 33, two items for each of the three hydraulic systems, allow the crew to manually override or reselect the automatic PRL system management. For example, if the SOP declares hydraulic system 2 failed, it is visible on the display as a down arrow in the performance monitor column (S) next to the system 2 ID number, and PRL will consider that system failed in computing the adjusted surface rate command limits. If by troubleshooting it is determined that hydraulic system 2 is not failed, the crew can force the PRL to consider system 2 as good by executing item 18, and the maximum surface rate command capability will be restored. The automatic system management can be reselected after selecting the manual override mode of operation by executing the appropriate auto item number. An asterisk is displayed after the item numbers, indicating the selected mode. The items for each hydraulic system are mutually exclusive and are initialized in the auto mode. A performance monitor column (S) provided for each hydraulic system displays a blank for normal operation or upmoded manual system operation, a '?' for an RM dilemma, and a down arrow for a failure or downmoded system. If any of these items are executed in MM 104, 105, 106, 301, 302, or 303, an ILLEGAL ENTRY message will occur.
5. The position of the entry mode switch (AUTO, No Y JET, or LO GAIN) determined by GNC switch RM is presented on the display. Item 42 allows the crew to select the 'AUTO' position in case the switch fails. When this item is executed, an asterisk will be displayed and the status from GNC switch RM will also read 'AUTO.' The display will be initialized with this item deselected (i.e., no asterisk) and thereafter will reflect crew inputs.
6. Items 43 and 44 allow the crew to issue commands to either open or close all the vent doors. These items are mutually exclusive. An asterisk shall be driven next to the item currently selected. When the display is initialized, this signal will be set to its last commanded state either by crew entry or via the vent door sequencer.
7. The crew can change the entry FCS through items 17, 18, and 20 through 24. A detailed listing may be found in the DPS dictionary.

The BFS OVERRIDE display is shown in figure 5-18.

```

XXXX/051/                OVERRIDE                XX X DDD/HH: MM: SS
                                     BFS DDD/HH: MM: SS
ABORT MODE                ENTRY FCS
TAL           1X          ELEVON   FILTER     ATMOSPHERE
ATO           2X          AUTO    17X     NOM     20X     NOM     22X
ABORT        3X          FIXED   18X     ALT    21X     N POLE  23X
MAX THROT   4X          SSME   REPOS  19 XXX  S POLE  24X

PRPLT DUMP                IMU DES ATT          AA   RGA   SURF
1  25X  X  LRU DES     DES     DES
XXX ICNCT 5 XXXX         2  26X          1  31X  35X  39X
OMS DUMP                 3  27X          2  32X  36X  40X
ARM           6X          3  33X  37X  41X
START        7X          4  34X  38X  42X
STOP         8X
9 QUAN/SIDE  XXX
OMS DUMP TTG XXX        ET SEP          VENT DOOR CNTL
AFT RCS 13   XXX        AUTO    28X      OPEN      43X
14 TIME     XXX        SEP     29X      CLOSE     44X
FWD RCS 15   XXX        ET UMB DR
16 TIME     XXX        CLOSE  30X

                                     ( XX )

```

11542518C.CRT; 1

**Figure 5-18. BFS OVERRIDE display**

The BFS OVERRIDE display is similar to the PFS OVERRIDE display with the following exceptions:

- There is no ADTA data.
- There is no roll mode switch override capability.
- There is no PRL override capability.
- There is no RCS manifold dilemma override capability.

### 5.1.5 Entry Sequence of Events

The following table contains a summary listing of the nominal entry events from EI - 5 to orbiter rollout and crew egress. These numbers are from STS-26 and provide a good general overview of events sequence.

**Table 5-III. Summary of entry events (STS-26)**

| EI time,<br>min:sec | Altitude,<br>kft | VREL,<br>kfps | Event  | Page |
|---------------------|------------------|---------------|--|------|
| -05:00              | 567              | 24.2          | Transition to MM 304   | 5-46 |
|                     |                  |               | Complete pre-EI checklist  |      |
| -03:00              | 501              | 24.3          | Secure FRCS  | 5-50 |
| 00:00               | 400              | 24.4          | Entry Interface  |      |
| 02:18               | 330              | 24.5          | Auto Elevon Trim activation ( $\bar{q} = 0.5$ )                  | 5-51 |
| 02:38               | 320              | 24.5          | Enter communication blackout                                     | 5-53 |
| 03:24               | 298              | 24.5          | Aerosurface Control activated (at $\bar{q} = 2$ )                |      |
|                     |                  |               | Potential body flap saturation<br>(Mach 24.6 to Mach 22.5)       | 5-57 |
| 04:36               | 270              | 24.4          | Temperature Control phase  |      |
| 04:51               | 267              | 24.4          | Closed-Loop Guidance initiated (drag = 3)                        | 5-60 |
|                     |                  |               | If prebank, roll to wings level<br>Phugoid damper usable         |      |
| 04:52               | 265              | 24.4          | Roll RCS Jets deactivated (at $\bar{q} = 10$ )                   | 5-61 |
| 04:59               | 263              | 24.4          | First nonzero bank command                                       | 5-64 |
| 06:00               | 255              | 24.0          | Maximum surface temperature region<br>(Mach 24.0 to Mach 19.4)   | 5-67 |
|                     |                  |               | Drag profile within 0.5 ft/s <sup>2</sup>                        |      |
| 07:15               | 248              | 23.5          | Ny Trim active (at $\bar{q} = 20$ ) 4 yaw jets available         | 5-69 |
| 09:49               | 238              | 22.1          | Drag H update to NAV initiated (drag = 11; monitor)<br>with HSD) | 5-70 |
| 11:51               | 228              | 20.6          | Pitch jets deactivated at $\bar{q} = 40$                         |      |
| 12:25               | 224              | 20.0          | MPS LO2 Fill and Drain Valves open                               | 5-71 |
| 13:02               | 219              | 19.1          | RCS Activity Lights reconfigure ( $\bar{q} = 50$ )               | 5-72 |
| 14:14               | 210              | 17.9          | Equilibrium Glide phase  | 5-73 |
| 15:35               | 196              | 15.7          | First bank reversal  | 5-75 |
| 15:50               | 193              | 15.3          | Constant Drag phase  | 5-76 |
| 16:00               | 190              | 15.0          | Power up previously powered down LRU's                           | 5-77 |
| 17:14               | 182              | 12.5          | Exit S-band communication blackout                               |      |
| 17:23               | 181              | 12.2          | Alpha ramps down from 40°  | 5-79 |
| 17:30               | 180              | 12.0          | Point Pillar C-band AOS<br>Radiator flow selected                | 5-80 |
| 17:48               | 177              | 11.4          | Exit L-band communication blackout                               |      |
| 18:10               | 175              | 10.5          | Call up HSD to monitor TACAN AOS                                 | 5-81 |
| 18:20               | 171              | 10.4          | Transition phase   | 5-82 |
| 18:33               | 168              | 10.0          | Speedbrake ramp to 81 percent                                    | 5-84 |
| 18:38               | 167              | 9.8           | UHF Upvoice and Downvoice  |      |

Table 5-III. Concluded

| El time,<br>min:sec | Altitude,<br>kft | VREL,<br>kfps | Event   | Page  |
|---------------------|------------------|---------------|---|-------|
| 19:36               | 156              | 8.1           | S-band AOS  | 5-85  |
| 19:51               | 153              | 7.7           | Runway redesignation                                | 5-87  |
|                     |                  |               | Called by MCC at earliest opportunity               |       |
| 20:10               | 150              | 7.2           | First TACAN acquisition                             | 5-88  |
| 20:15               | 147              | 7.0           | MCC directs take TACAN to NAV                       |       |
| 20:38               | 142              | 6.5           | Earliest Opportunity for MCC State Vector Update    | 5-92  |
| 21:01               | 135              | 6.0           | No Comm TACAN Management                            |       |
| 21:52               | 122              | 5.0           | Ammonia boiler activated                            |       |
|                     |                  |               | Rudder active                                       | 5-93  |
|                     |                  |               | Deploy ADS Probes                                   | 5-94  |
|                     |                  |               | FCS Roll/Yaw phasing                                | 5-95  |
| 22:43               | 107              | 4.0           | Excessive H avoidance                               | 5-97  |
| 23:05               | 102              | 3.5           | ADTA to AUTO for G&C and Nav                        | 5-98  |
| 23:27               | 96               | 3.2           | Speedbrake ramp to 65 percent                       | 5-105 |
| 23:39               | 93               | 3.0           | Elevon Trim 0°                                      | 5-106 |
| 23:54               | 89               | 2.7           | HUD Power on  | 5-107 |
| 24:09               | 85               | 2.5           | TAEM Interface                                      | 5-113 |
|                     |                  |               | ADTA data processing to NAV and G&C                 |       |
| 24:20               | 83               | 2.4           | Fuselage Vents open                                 | 5-124 |
| 25:50               | 60               | 1.2           | Auto aileron trim deactivated in CSS                |       |
| 26:21               | 50               | 0.9           | RCS Yaw Jets deactivated (Mach 1.0)                 | 5-125 |
| 26:27               | 48               | 0.9           | Speedbrake modulated for Energy Control (Mach 0.95) | 5-126 |
|                     |                  |               | Elevon Trim Position to 4° down                     | 5-128 |
| 27:00               | 40               | 0.8           | HAC Tangency (WP 1)                                 | 5-129 |
|                     |                  |               | LG extend isol vlv opens                            |       |
| 28:42               | 17               | 0.6           | Initiate MLS updating                               | 5-131 |
| 28:50               | 15               | 0.6           | Track OGS toward aim point                          | 5-132 |
| 29:09               | 10               | 0.6           | Approach and Landing Interface                      | 5-137 |
|                     |                  |               | Body flap goes to trail                             |       |

Each event listed in the table is discussed at length in the following pages (same order as the table). Each page includes an event name and onboard cue, the proper crew display for monitoring the event, the crew action required, and a detailed discussion of the event.



| <u>EVENT</u>                     | <u>CUE</u> | <u>DISPLAY</u> |
|----------------------------------|------------|----------------|
| <u>Transition to MM 304</u>      | EI - 5     | CRT timer      |
| EIT = -05:00 (min:s)             |            |                |
| VREL = $24.2 \times 10^3$ (ft/s) |            |                |
| H = $567 \times 10^3$ (ft)       |            |                |
| R = 5290 (n. mi.)                |            |                |

### CREW ACTION

Perform pre-EI checklist

### DISCUSSION

Crew transition to OPS 304 has been baselined to occur at EI - 5; however, no hardware or software constraints require the GN&C to be in MM 304 at this time. The time selected is based on crew convenience and provides a sufficient margin until the initial encounter of atmosphere.

The following GN&C functions are software activated at crew initiation of OPS 304 PRO:

- Entry guidance is initiated in the preentry phase with a commanded bank angle of 0°. At a sensed acceleration of 4.2 ft/s<sup>2</sup> (0.132g, drag ~3 ft/s<sup>2</sup>), closed-loop ranging commences.
- If AOA-shallow or deorbit underburn, the crew should roll into the appropriate prebank. For an AOA-shallow, the prebank is a planned 90°. For a deorbit underburn, the prebank is a function of the underburn. A table is provided in the Entry Checklist to provide the crewmembers with required prebank values. The bank is toward the primary bearing pointer on the HSI at a rate of 1 deg/sec.
- The aerojet DAP is initialized in AUTO at the current attitude.
- SOP's become active for the
  - ADTA
  - TACAN
  - Body flap slew commands
  - SBTC - initialized with CDR in control
  - RPTA
  - Entry/landing RCS command
  - Two-axis RHC (pitch and roll)
- FDI becomes active for the
  - ADTA
  - TACAN
  - SBTC
  - RPTA
  - Body flap command
- MPS vacuum inerting is activated.

- The ADI becomes a two-axis ball displaying topodetic roll and pitch attitudes with respect to LVLH regardless of the ADI ATTITUDE switch. Each roll and pitch error displays the roll and angle-of-attack or normal acceleration error with respect to entry guidance commands by using the bank guidance error and the angle of attack error. The yaw error needle displays sideslip ( $\beta$ ) to a dynamic pressure of 20 lb/ft<sup>2</sup>. Subsequently, the ADI yaw error needle provides sideslip information in terms of equivalent yaw jet capability. (Full scale equals 2.5 equivalent yaw jets.) The roll and pitch rate needles display stability roll and body pitch rates using stability roll rate, roll gyro data, and filtered pitch rate. The yaw rate needle displays stability yaw rate. These rates are calculated for the entry flight control system roll, pitch, and yaw channels for display on the ADI.
- The HSI, AMI, and AVVI become active, and the HUD is available.
- NAVDAD becomes active and computes air data parameters ( $\bar{q}$ , Mach, EAS) for the ADTA.
- Site lookup is activated to supply other functions with access to the TACAN site and landing site tables.
- Preland NAV is activated when MLS data are available.
- Entry CRT displays become active as described previously in section 5.1.4.
- Area navigation is activated. Area Nav processes data to the two HSI's according to the position of the HSI SELECT switches.
- Entry attitude processing occurs.
- Vent door sequencing is initiated at 2400 ft/s.
- Structural programmed test inputs (SPTI) SOP is activated.

The following GN&C functions were initiated by previous modes and are still active during MM 304.

- Entry user parameter processing.
- RCS activity lights. The RCS activity light processing function will perform the processing necessary to drive the roll, pitch, and yaw RCS indicator lights. The RCS lights indicate the presence of an RCS command from the aerojet DAP to the jet select logic (JSL). The RCS light-on times are stretched to allow the pilot time to identify the commanded jets. After the roll and pitch jets have been deactivated, the roll indicator lights are used to indicate that three or four yaw jets have been requested, and the pitch indicator lights are used to indicate elevon rate saturation.

- IMU inertial processing.
- Subsystem operating programs for
  - RGA
  - Accelerometer assembly (AA)
  - Elevon feedback
  - Rudder feedback
  - Speedbrake feedback
  - Body flap feedback
  - Hydraulic system
  - MPS TVC command (stow position)
  - OMS TVC command (entry stow position gimbal activation command)
  - Selection filtering, which consists of software elements designed to reduce multiple system outputs into one data source for use by application programs
  - IMU RM
  - Fault detection, isolation, and reconfiguration (FDIR) for the rate gyro's (RG's) and AA's
  - FDI for:
    - Elevon position feedback
    - Rudder position feedback
    - Speedbrake position feedback
    - Body flap position feedback
    - RCS RM
    - RCS quantity monitor
    - Deorbit/landing navigation sequencer
    - Entry navigation terminates when valid barometric data are available
    - SPI processing
    - GN&C switch processor
    - Deorbit/landing user parameter sequencer

At transition to MM 304, the elevon trim integrator is initialized to the I-load trim schedule value. The body flap integrator is initialized to a position as a function of vehicle c.g. The surfaces begin driving at transition to these initial positions and remain fixed until  $\bar{q} = 0.5 \text{ lb/ft}^2$ .

#### Effect on Entry of Deorbit Execution Errors

Deorbit execution errors affect

- Surface temperatures
- Backface temperatures
- Maximum load factor
- Guidance sequencing
- Entry maneuver capability

Surface and backface temperatures are affected by range and flightpath deviations at EI, as follows:

- A longer range produces higher backface temperatures and lower surface temperatures.
- A shorter range produces lower backface temperatures and higher surface temperatures.
- A shallower gamma EI produces higher surface and lower backface temperatures.
- A steeper gamma EI produces both higher surface temperatures and backface temperatures.

Guidance sequencing effects are shown on page 5-56.

### Thermal Effects

Deorbit execution errors can result from an untrimmed underburn or an overburn. (An overburn is considered unlikely and is not discussed.) Prebank can be used to partially compensate for the temperature increase from an underburn due to the shortened EI-to-landing range. (The shortened range results in increased surface temperatures). Potential procedures for untrimmed underburns include the following:

- For small underburns, the increase in orbiter surface temperatures can be accepted.
- Vary the preentry bank angle (nominally 0°) as a function of the magnitude of the underburn to minimize the surface temperature increase.
- Change the landing site to a point further downrange (Northrup) when surface temperatures are predicted to reach unacceptable levels.

The matrix in the Entry Checklist indicates the prebank schedule to Edwards and Northrup.

| <u>EVENT</u>                     | <u>CUE</u>  | <u>DISPLAY</u> |
|----------------------------------|-------------|----------------|
| <u>Entry Interface</u>           | EIT = 00:00 | CRT timer      |
| EIT = 00:00 (min:s)              |             |                |
| VREL = $24.4 \times 10^3$ (ft/s) |             |                |
| H = $400 \times 10^3$ (ft)       |             |                |
| R = 4108 (n. mi.)                |             |                |

### CREW ACTION

Awareness

### DISCUSSION

EI, by definition, occurs at 400,000 ft. Guidance is still in the preentry phase with a nominally commanded bank angle of  $0^\circ$  and a commanded pitch attitude of  $40^\circ$  angle of attack.  $\dot{H}$  is approximately -500 ft/s.

The CRT timer, which has been counting down to display zero at EI, starts counting up.

In the AUTO mode, the aerojet DAP issues commands to the roll, pitch, and yaw RCS jets for rate damping in the attitude hold phase.

| <u>EVENT</u>                             | <u>CUE</u>  | <u>DISPLAY</u>                            |
|--|---|---|
| <u>Auto Elevon Trim Activation</u>       | $\bar{q} = 0.5 \text{ lb/ft}^2$<br>Aerosurface trim<br>EAS $\approx 12 \text{ knots}$ | CRT/ENTRY TRAJ 1<br>GNC SYS SUMM 1<br>AMI |
| EIT = 2:18 (min:s)                       |   |   |
| VREL = $24.5 \times 10^3 \text{ (ft/s)}$ |   |   |
| H = $330 \times 10^3 \text{ (ft)}$       |   |   |
| R = 3565 (n. mi.)                        |   |   |

CREW ACTION

Monitor RCS jet firings  
Elevon deflection ( $\delta_E$ )  
Body flap deflection ( $\delta_{BF}$ )

DISCUSSION

Upon transition to MM 304, the elevons and body flap are commanded to the initial trim positions as specified by the auto or fixed schedule. This position will typically be between  $+7^\circ$  (down) to  $-3^\circ$  (up), regardless of whether the fixed or auto schedule is selected.

The elevons will remain at this initial trim position (not be used for flight control purposes), until a  $\bar{q}$  value of  $0.5 \text{ lb/ft}^2$ . At a  $\bar{q}$  of  $0.5 \text{ lb/ft}^2$ , the elevons and body flap begin to be 'phased in' with the pitch RCS jets to maintain the pitch attitude deadband. This 'phasing in' of the aer-surfaces is accomplished by activating the auto pitch trim loop in the aerojet DAP.

This pitch trim loop drives the elevons in the direction required to take out the rate induced by pitch jet firings as the orbiter attitude bounces between deadband limits. The overall effect of this trimming is a long period oscillation of the body flap and elevons. Since the body flap and elevons do not have adequate control authority at this low  $\bar{q}$ , the pitch jets fire when the deadband is reached (reverses the oscillation direction) (figure 5-19). Eventually, the elevons and body flap gain more control authority (with increasing Q), and the oscillation is damped out. By  $\bar{q} = 40 \text{ lb/ft}^2$ , the control authority of the elevons is enough to allow the pitch jets to be turned off.

The only crew task required during this timeframe is to monitor the position of the body flap to ensure that it is not trimmed full up or full down. A full up or full down (saturated) body flap is a concern due to thermal issues in the  $\bar{q} = 10 \text{ to } 20 \text{ lb/ft}^2$  region. It is important to remember that this saturation can only occur when the fixed schedule is selected, since the 'smart' body flap software has I-loaded trim positions for the body flap and elevons that specifically avoid the thermal regions of concern.

If the body flap is saturated full up or full down, the crew can manually position it to trail ( $0^\circ$ ) using the manual body flap switches on L2 or C3. This action should only be taken when flying the fixed elevon schedule.

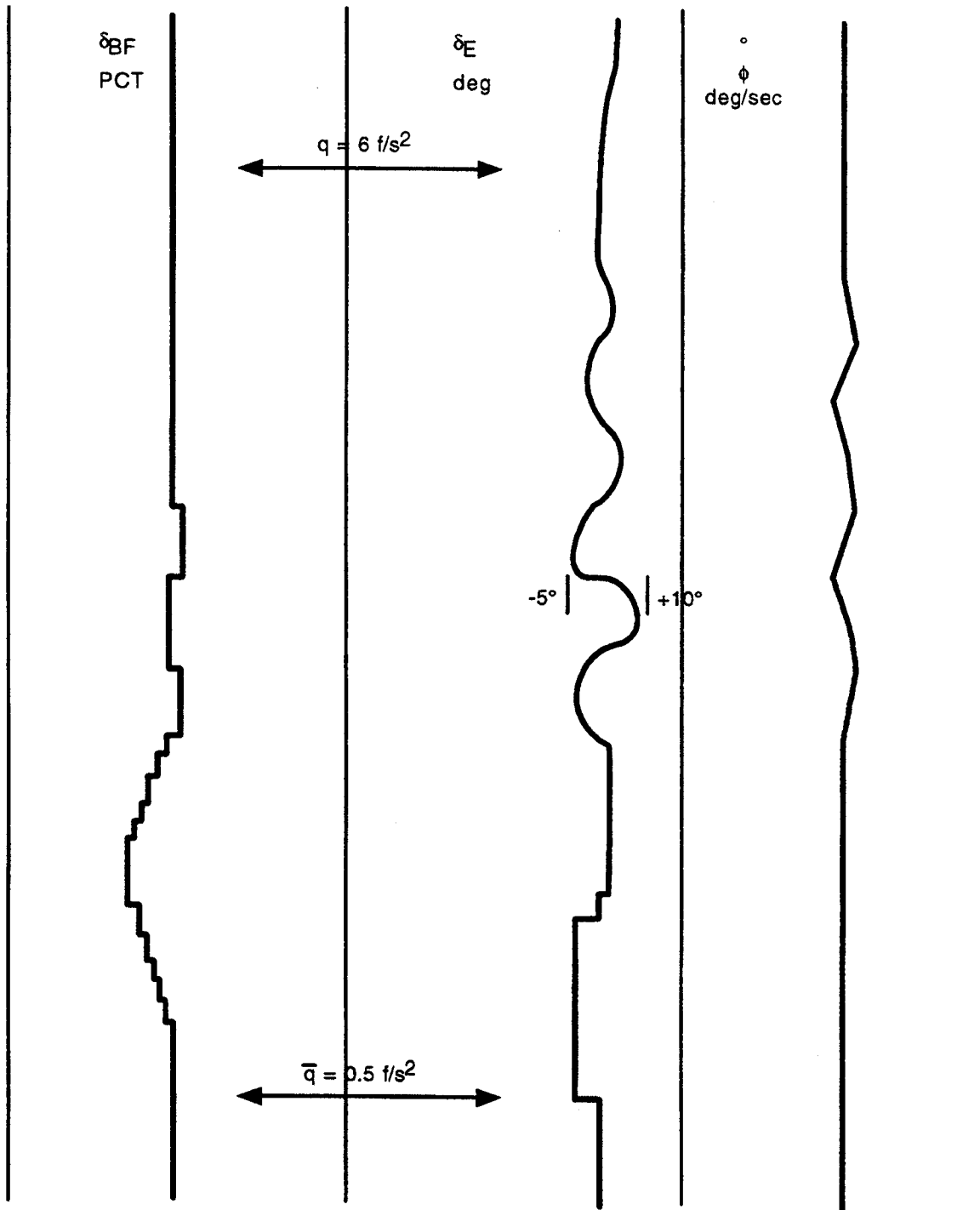

L11542\_003

Figure 5-19. Aerosurface trim activation at low qbar

| <u>EVENT</u>                         | <u>CUE</u>                    | <u>DISPLAY</u>   |
|--------------------------------------|-------------------------------|------------------|
| <u>Aerosurface Control Activated</u> | $\bar{q} = 2 \text{ lb/ft}^2$ | CRT/ENTRY TRAJ 1 |
| EIT = 3:24 (min:s)                   | $\delta_E$ active             | Surface SPI's    |
| VREL = $24.5 \times 10^3$ (ft/s)     | $\delta_A$ active             | GNC SYS SUMM     |
| H = $298 \times 10^3$ (ft)           | EAS~24 kn                     | AMI              |
| R = 3303 (n. mi.)                    |                               |                  |

### CREW ACTION

Monitor  $\delta_E$  and  $\delta_A$  surface deflections

### DISCUSSION

AUTO guidance or CSS pitch commands are now sent to PRL, commanding the elevons for longitudinal control, rate feedback damping for stability, and automatic trim.

In the AUTO mode, the DAP responds to angle-of-attack commands from entry guidance. These commands are generated within guidance to control drag acceleration variations in bank reversals while maintaining  $\alpha$  within the limits of a desired  $M - \alpha$  envelope. If an error exists between the commanded  $\alpha$  and the NAV-derived  $\alpha$ , the DAP generates a pitch rate in the direction appropriate to the  $\alpha$  error. The magnitude of the commanded pitch rate is a function of the  $\alpha$  error. The elevon deflections, to produce the required pitch rate commands, are a function of the difference between actual and commanded pitch rate, an integrated surface trim command, and the dynamic pressure. The deflection commands (i.e., 'forward loop commands') are passed through body bending filters, limited to between  $+18^\circ$  and  $-33^\circ$ , and sent to PRL. PRL calculates individual surface panel commands based on the number of hydraulic system failures and the available fluid flow. PRL also sets rate saturation flags if the surface panel commands are being rate limited; i.e., driving at the maximum possible rate of 20 deg/sec with two or three APU's operational (13.9 deg/sec with one APU). Surface deflections in response to these commands should be visible on the inboard and outboard SPI's. In AUTO, pitch commands are generally small, 0.5 deg/sec or less. RCS pitch jets fire if the pitch rate error command exceeds 0.25 deg/sec. Roll and yaw jets are active to meet roll maneuver acceleration specifications.

In CSS, surface and jet commands are based on pitch rate commands from the pilot's RHC deflection biased with actual pitch rate feedback, forming a rate error. The pilot can command a pitch rate limited to  $\pm 2.88$  deg/sec with the RHC, summed with a  $\pm 1.5$  sec deg/sec rate trim command. Once the rate error between commanded and rate gyro feedback pitch rate is determined, the remainder of the control loop is as in AUTO. The pilot can command higher rates than the AUTO mode; however, actual vehicle initial acceleration remains a function of surface effectiveness in the low  $\bar{q}$  regime and RCS authority. If small residual pitch rates are noted on the ADI when the RHC is in detent, the RHC rate trim can be used to bias the rate command and null the residuals while in CSS. This procedure is considered of very low utility.

The elevons now respond to aileron commands as generated in the coupled roll and yaw axis channels. Roll maneuvers are commanded by AUTO guidance or RHC inputs in the roll channel. Commanded AUTO roll rates are limited to  $\pm 5$  deg/sec about the stability roll axis in the



entry flight phase. Based on a commanded roll rate and body yaw rate feedback, the yaw channel computes a yaw rate error signal. This yaw rate signal commands yaw jet firings to achieve the yaw rate required to initiate a bank. The actual yaw rate is sent to the roll channel where a corresponding roll rate for turn coordination is calculated. A roll rate feedback signal is summed with the commanded roll rate to form a body roll rate error command to the roll jets and ailerons. Therefore, in this regime, if a roll is commanded, the following sequence ensues:

- The yaw jets fire to yaw the vehicle in the direction of the intended roll, inducing a sideslip ( $\beta$ ).
- As yaw rate builds, aileron commands are generated to produce the roll rate ( $p$ ) required to coordinate the maneuver. Damping  $\beta$  nominal aerodynamics indicates lateral stability ( $-C_{\ell\beta}$ ); i.e., a negative rolling moment is induced by a positive sideslip angle. The ailerons provide very tight control, and only very small  $\beta$ 's are seen during the roll maneuver.
- Roll and yaw jet firings and aileron deflections respond to null errors in body roll and yaw rates as required for steady-state turn coordination.
- Rate damping is performed by the jets and surfaces when the command is zeroed.

An integrator in the roll channel also provides an automatic aileron trim function. From this regime down to Mach 1.25 (if in CSS), an aileron is deflected so that the resulting yawing moment will trim out a yawing moment due to sideslip, as might be induced by a lateral c.g. offset or a bent airframe. The pilot can make manual trim inputs to the ailerons via a panel roll trim switch. The aileron trim deflection is limited to  $\pm 3^\circ$ . In response to maneuver commands, trim commands, and rate damping, the aileron command is limited to  $\pm 10^\circ$  in the roll channel. (However, if near the elevon deflection limits,  $10^\circ$  of aileron cannot be obtained.) Using the ailerons for aerodynamic trim alleviates the use of yaw and roll jets for trim, conserving RCS fuel.

The panel roll trim can be used throughout entry. This switch may be used to aid the AUTO trim to reduce yaw jet activity as follows: If repeated yaw jet firings on the same side are observed, trim away from the firing jet in small steps until the jet activity ceases. For example, if repeated right yaw jet activity is seen with little or no left jet activity, trim to the left with the panel roll trim until the activity ceases or is balanced. Do not attempt to hold the trim switch until the activity ceases or the desired value will be overcorrected. This trim procedure should be followed until rudder activation or until aileron trim saturation ( $\pm 3^\circ$ ) occurs. Do not try to trim during bank maneuvers, only during steady state flight.

When the BFS is engaged, the elevator trim is essentially initialized to the present position; however, the aileron and rudder trim integrators are set to zero. The crew should closely monitor aileron trim and yaw jet activity for FCS performance cues as well as for the possibility of a BFS engage case. If in the PASS a large aileron trim is required and the BFS is engaged, manually retrim as soon as possible to avoid excessive RCS prop usage, loss of control.

In addition to Y c.g. offsets a bent airframe, aerovariations, and RCS/aerointeraction effects may affect the actual aileron trim deflection. Real gas and viscous interaction effects change pitching moment aerocoefficients, and thus, elevon and body flap trim positions. Aileron coefficients and lateral/directional stability coefficients are also a function of elevon trim position, influencing aileron trim deflections. RCS jet firings cause impingement of the plumes on the

aerosurfaces and disturb the surrounding airflow. This interaction between plume and flow generates moments different from what might be predicted from system geometry. Flight control characteristics noted from parametric analyses are as follows:

- Pitch RCS moments are reduced as  $\bar{q}$  increases.
- Roll due to yaw jets becomes favorable as  $\bar{q}$  increases. At a  $\bar{q}$  of 0 lb/ft<sup>2</sup>, a plus yaw jet firing in addition to a yawing moment produces a -13,000 ft-lb rolling moment. As dynamic pressure increases, the rolling moment produced is positive for a positive yaw jet firing, nominally at about 6 lb/ft<sup>2</sup>. At 20 lb/ft<sup>2</sup>, the rolling moment is +4,500 ft-lb. With RCS aero uncertainties applied, however, more rolling moment may result than is required to coordinate a roll maneuver if only one yaw jet is fired. To prevent the possibility of a roll reversal, a minimum of two yaw jets is always commanded.
- Roll moment due to roll jets decreases significantly as  $\bar{q}$  increases.
- Yaw RCS moments remain fairly constant throughout the dynamic pressure range for a given number of jet firings. Each jet produces a moment of approximately 32,000 ft-lb. The nominal moment is linearly proportional to the number of jets when firing two or more jets. For example, at Mach 10, two jets create a nominal moment of about 68,000 ft-lb. It should be noted that if RCS aero uncertainties are applied, depending on specific combinations, that moment varies from 58,000 to approximately 76,000 ft-lb.

The G&C systems are mechanized to minimize the interaction effects as follows:

- Roll jets are turned off as soon as possible ( $\bar{q} = 10$ ).
- No guidance roll command until  $\bar{q} > 10$ .
- A minimum of two yaw jets is always commanded.

Above a dynamic pressure of 2 lb/ft<sup>2</sup>, the ADI yaw error needle continues to display the sideslip angle ( $\beta$ ) from ATT PROC to a  $\bar{q}$  of 20 lb/ft<sup>2</sup>, but  $\beta$  is no longer used in the FCS calculations of the body yaw rate required for turn coordination. Above a  $\bar{q}$  of 20 lb/ft<sup>2</sup>, the yaw error needle displays a component of lateral acceleration proportional to  $\beta$  and scaled for ease of monitoring, equivalent to yaw jet authority. This 'scaled  $A_y$ ' or estimated  $\beta$  is discussed further in a subsequent section.

| <u>EVENT</u>                          | <u>CUE</u>   | <u>DISPLAY</u> |
|---------------------------------------|--|----------------|
| <u>Closed-Loop Guidance Initiated</u> | $\Delta = 3 \text{ ft/s}^2$<br>$\bar{q} = 8 \text{ lb/ft}^2$ | CRT/AMI<br>CRT |
| EIT = 4:51 (min:s)                    |  |                |
| VREL = $24.4 \times 10^3$ (ft/s)      |  |                |
| H = $267 \times 10^3$ (ft)            |  |                |
| R = 3000 (n. mi.)                     |  |                |

CREW ACTION

Monitor

DISCUSSION

Closed-loop ranging is initiated at 0.132g total load factor, which is at a drag acceleration of about  $3 \text{ ft/s}^2$  for nominal L/D and a  $\bar{q}$  of approximately  $8 \text{ lb/ft}^2$ , both of which can be monitored on the ENTRY TRAJ CRT's. The best cue to the crew that closed-loop ranging has commenced is the appearance of the 'square' symbol on the ENTRY TRAJ 1 display. For each guidance cycle (every 1.92 sec), entry guidance analytically predicts a reference drag-velocity profile that satisfies ranging requirements. This drag-velocity profile has been shaped to meet vehicle heating and structural constraints for nominal trajectories plus 3-sigma range dispersions. If, however, these range dispersions are exceeded, the drag-velocity profile is adjusted in the temperature control and equilibrium glide phases (based on range error) so that nominal constant drag and transition phases can be flown. If a range error still exists in the constant drag phase, the constant drag profile is adjusted so a nominal transition phase can be flown. Guidance tries to fly a drag-velocity profile that satisfies ranging requirements regardless of any heating or structural constraints, except when, in the transition phase ( $VREL < 10,500 \text{ ft/s}$ ), the drag profile is limited so the vehicle will not exceed 2.5g. To achieve the required vehicle drag so that ranging conditions are met, entry guidance uses a combination of bank angle and angle of attack modulation. Because drag changes from bank angle modulations are relatively slow (i.e., increase in bank angle increases H, which increases atmospheric density, which increases drag), the angle of attack is modulated to achieve the reference drag on the short-period basis and the bank angle is modulated to control drag on the long-period basis. Bank commands are reversed within predetermined delta azimuth deadbands to control crossrange errors. Bank angle and angle of attack modulation are discussed in detail in later sections.

If closed-loop guidance fails to activate, the crew should monitor H and DACT, and as H approaches  $-200 \text{ ft/s}$ , the procedure is to take control in ROLL/YAW 'CSS' and manually bank to  $\sim 80^\circ$  towards WP 1 and converge DACT to DREF. The first ROLL CMD event contains the drag convergence procedure. This procedure is only used if autoguidance is known to be failed and the shuttle symbol is near the nominal trajectory line on the ENTRY TRAJ 1 display.

Entry closed-loop guidance is nominally initiated in the temperature control phase by the termination of preentry guidance at 0.132g.

If in prebank for an AOA-shallow or a deorbit underburn, at closed-loop guidance initiate, the CDR should start a 3 deg/sec roll rate back toward wings level ( $\phi = 0$ ). Depending on a

number of factors, the orbiter may actually get to zero bank angle and the CDR can mode the autopilot back to AUTO. However, during the rollout to wings-level, it is likely that the first nonzero bank command starts and the CDR modifies the bank angle as necessary to go to that bank command. The CDR can then mode the autopilot to AUTO. Depending on the energy state of the vehicle, guidance phases can be skipped, as shown in the transition criteria flow diagram.

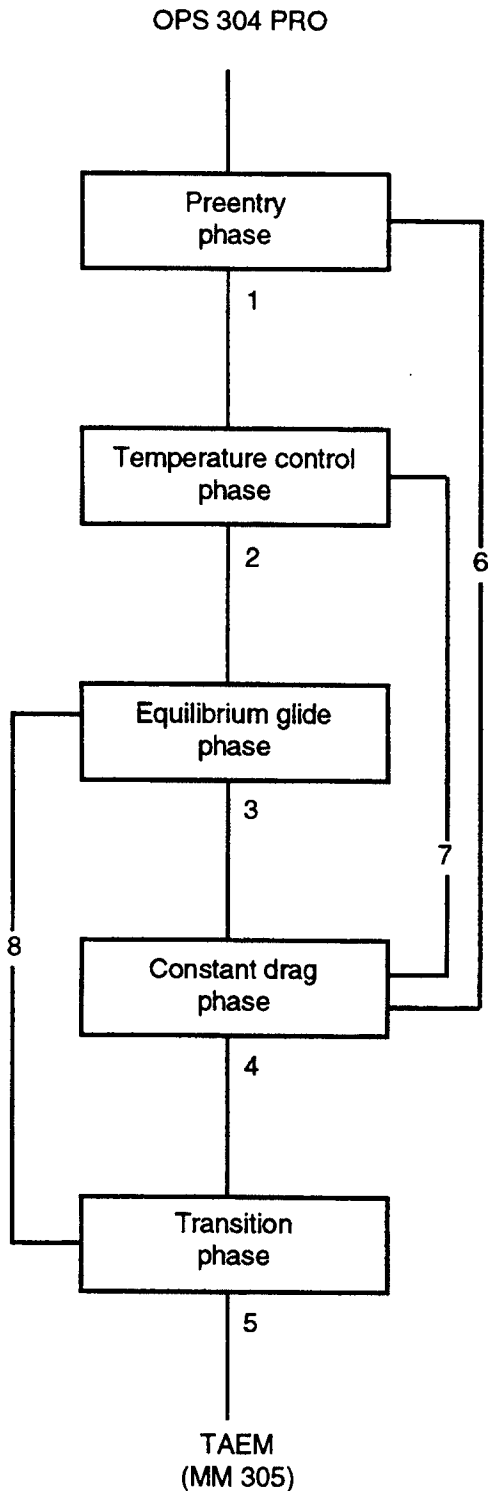

TRANSITION CRITERIA - TYPICAL

1. Total load factor = 0.132g (4.2 ft/s<sup>2</sup>) and criterion 6 is not met.
2. Temperature control and equilibrium glide drag profiles converge at V < 9000 ft/s.
3. Desired constant drag level (33 ft/s<sup>2</sup>) is reached.
4. V < 10,500 ft/s and drag level < predetermined drag level.
5. V < 2500 ft/s or crew action OPS 305 PRO.
6. Load factor > 0.132g and current constant drag is greater than desired constant drag (short-range case).
7. Desired constant drag is reached and V < 10,000 ft/s or constant drag to reach target is greater than desired constant drag (short-range case).
8. Predicted velocity at criterion V < 10,000 ft/s (very long range entry).

Note: The transition flow for different downrange entries is as follows:

- Nominal: 1-2-3-4-5
- Short: 1-7-4-5
- Extremely short: 6-4-5
- Long: 1-2-8-5

| <u>EVENT</u>  | <u>CUE</u>                                  | <u>DISPLAY</u>                                  |
|---|---|---|
| <u>Roll RCS Jets Deactivated</u>  | $\bar{q} = 10 \text{ lb/ft}^2$<br>EAS-54 kn | CRT/ENTRY TRAJ 1<br>Roll RCS activity<br>lights |
| EIT = 4:52 (min:s)<br>VREL = $24.4 \times 10^3 \text{ (ft/s)}$<br>H = $265 \times 10^3 \text{ (ft)}$<br>R = 2960 (n. mi.) | AMI   |   |

CREW ACTION

None. RCS activity lights should not indicate further roll jet firing.

DISCUSSION

As dynamic pressure builds, aileron effectiveness increases until sufficient control authority is available without assistance from RCS roll jets. As previously mentioned, the roll moment due to roll jet decreases significantly as  $\bar{q}$  increases toward 20 lb/ft<sup>2</sup>. RCS jets interactions can cause the moment produced by roll jet firings to change sign between 4 and 20 lb/ft<sup>2</sup>, depending on the number of jets fired, but the aileron moments are powerful enough to overcome these jet interaction moments. Continuation of roll jet firings above  $\bar{q} = 10 \text{ lb/ft}^2$  would only result in somewhat excessive RCS fuel consumption. The DAP ROLL channel terminates roll jet commands above 10 lb/ft<sup>2</sup>; thus, if an adequate determination of dynamic pressure is made by NAV, the jets should not continue to fire in a questionable aerodynamic region.

Above 10 lb/ft<sup>2</sup>, if the ENTRY MODE switch is in the AUTO position, forward loop commands are now sent from AUTO or the RHC to the ailerons. (At dynamic pressures between 2 and 10 lb/ft<sup>2</sup>, aileron commands are based on yaw and roll rate feedback terms only.) The forward loop commands an initial aileron deflection opposite to the normal command for roll to allow the aileron adverse yawing moment to assist the yaw jets in producing the moments necessary to initiate the roll maneuver sequence. Therefore, if the pilot commands a right roll maneuver, an initial left aileron spike may be observed on the SPI's in conjunction with the yaw jet firings. As the roll is established, the ailerons deflect to damp  $\beta$  and provide the body roll rate to coordinate the stability roll. This initial aileron spike occurs with a roll command initiated between a  $\bar{q}$  of 10 lb/ft<sup>2</sup> and Mach 3.8. Larger aileron spikes in response to roll commands may be seen (and felt) if the ENTRY MODE switch is in the 'NO YJET' position, as the gain on the aileron command is initially much higher. Further discussion of NO YJET procedures is contained in the 'Entry DAP Downmoding' section.

| <u>EVENT</u>                             | <u>CUE</u>  | <u>DISPLAY</u>           |
|--|---|--------------------------|
| <u>First Nonzero Bank Command</u>        | $\Delta = 5.1 \text{ ft/s}^2$<br>$H = 227 \text{ ft/s}$ | CRT/ENTRY TRAJ 1<br>AVVI |
| EIT = 4:59 (min:s)                       |   |                          |
| VREL = $24.4 \times 10^3 \text{ (ft/s)}$ |   |                          |
| H = $263 \times 10^3 \text{ (ft)}$       |   |                          |
| R = 2929 (n. mi.)                        |   |                          |

### CREW ACTION

Monitor

### DISCUSSION

The first nonzero bank command is issued by guidance when vehicle drag and  $\dot{H}$  reach a certain delta compared to the trajectory referenced drag and  $\dot{H}$ . This nominally occurs at drag = 5.1 and  $H = -227 \text{ ft/s}$ , which can be monitored by the crew on the ENTRY TRAJ 1 display and the AVVI. The first nonzero bank command is always toward the landing site.

Under nominal conditions, this first nonzero bank command is very soon after closed-loop guidance is activated (guidance activated at  $\bar{q} = 10 \text{ lb/ft}^2$  and first bank command is at  $\bar{q} \sim 12 \text{ lb/ft}^2$ ). If for some reason the vehicle does not bank,  $\dot{H}$  becomes positive and enters the atmosphere with the lift vector up and causes the vehicle to 'skip out' (i.e., positive  $\dot{H}$  occurs and the vehicle reenters further down range). The crew should therefore monitor the initial  $\phi$  command at guidance activation and should monitor drag during the pullout to make sure it converges with DREF. If actual drag does not converge to reference drag, the crew should take over in ROLL/YAW CSS and adjust bank angle to converge actual drag with DREF.

To converge DACT with DREF manually, a good instrument cross-check of DACT, DREF,  $\phi$ ,  $\dot{H}$ , and  $\ddot{H}$  should be developed. A decrease in  $\phi$  decreases DACT and an increase in  $\phi$  increases DACT, but  $\dot{H}$  and  $\ddot{H}$  must be used to control the rate of change due to the lags between  $\Delta\phi$  and DACT. Small  $\Delta\phi$  changes are quickly reflected in  $\ddot{H}$ ; by cross-referencing  $\ddot{H}$  with  $\dot{H}$  and  $\phi$ , an  $\dot{H}$  can be obtained that places the vehicle at the proper drag level (the desired  $\dot{H}$  to fly is interpolated from the ENTRY TRAJ display). As a rule of thumb, changes in  $\ddot{H}$  should be kept small and the  $\ddot{H}$  needle should never be pegged. When in trouble (phugoid), bank to make  $\ddot{H} = 0$ . The procedure and flying techniques to perform this are as follows.

- Maintain DACT ~ DREF by changing bank angle to change  $\dot{H}$ , which changes  $\ddot{H}$ , and therefore changes DACT. For example, if DACT is less than DREF, the pilot should check to see if the present trend is toward convergence. If not, he should increase bank angle which increases the magnitude of  $\dot{H}$  ( $\dot{H}$  should never exceed  $-400 \text{ ft/s}$ ). Finally, the pilot should decrease bank angle to converge  $H$  to  $-\dot{H}_{REF}$  as DACT converges to DREF. After drag error is nulled, he should return DAP ROLL/YAW to AUTO.

- If guidance is suspect, he should continue to fly ROLL/YAW CSS. After the drag error is nulled, he should attempt to establish an  $\dot{H}$  and  $\ddot{H}$  that slowly trims DACT to keep pace with DREF.

If guidance fails, the crew could take over in P, R, Y CSS and fly a manual entry using the DREF and H REF information on the ENTRY TRAJ displays. The main objective is to keep actual vehicle drag equal to DREF (interpolated from the shuttle symbol's position between dashed drag lines on the CRT display). The actual vehicle drag is controlled by changes in bank angle  $\phi$  and by  $\alpha$  modulation. Bank angle changes are long-term effects, as a change in  $\phi$  changes the vehicle lift in the vertical plane that determines the rate at which the vehicle sinks into the Earth's atmosphere; i.e., the faster the vehicle sinks into the atmosphere (denser air), the faster the drag builds up. This is a slow process, however, due to lags between  $\Delta\phi \rightarrow \dot{H} \rightarrow \ddot{H} \rightarrow \Delta$  change. Changes in  $\alpha$ , on the other hand, are short-term effects on vehicle drag because as  $\alpha$  is changed, the drag coefficient is changed, which has an immediate effect on vehicle drag. The procedure and flying techniques to keep DACT = DREF are as follows:

- Fly scheduled  $\alpha$  first (CRT or cue card). Do not modulate  $\alpha$  outside the guidance limits.
- Bank as required to maintain  $\dot{H} \sim \dot{H}$  REF ( $\dot{H}$  for nominal entry is displayed at bottom of CRT TRAJ display). These  $\dot{H}$  numbers may have to be biased if flying off-nominal trajectories. These  $\dot{H}$  numbers are used only as a gauge for converging and maintaining the drag profile.
- Perform bank reversals at approximately 5 deg/sec roll rate with  $\alpha$  2° high when  $\phi$  passes through 0°. (This helps keep DACT closer to DREF.) RHC to detent as  $\dot{H}$  goes through 0, then shallow bank as required to converge on  $\dot{H}$  that will keep DACT  $\phi$  DREF (use  $\dot{H}$  to converge on the proper  $\dot{H}$ ).
- Fine tune  $\alpha$  and  $\phi$  to keep DACT = DREF (using  $\alpha$  modulation to fine tune drag profile will conserve RCS fuel if  $\bar{q} > 20$  lb/ft<sup>2</sup>).

Notes of interest are as follows:

- If flying at drag values that are greater than the DREF values along the top line of the ENTRY TRAJ 1 display, the one time reuse TPS temperature will be exceeded.
- For nominal trajectories between Mach 22.0 and Mach 10.0,  $\phi = 60^\circ \pm 5^\circ$  (excluding bank reversals).
- When in a phugoid, adjust  $\phi$  to make  $\ddot{H} = 0$ .
- Do not peg the  $\dot{H}$  needle.

An early nonzero bank command is an indication of higher than nominal L/D or a shallower than nominal  $\gamma$ . A late bank command is an indication of lower than nominal energy and may be due to a low L/D or a steeper than nominal  $\gamma$  or a longer than nominal range to go. With the addition of  $\alpha$  modulation, the low L/D case can also be detected by observing  $\alpha$  after drag equals DREF. (Alpha modulation is activated when DACT  $\geq$  DREF or VREL  $<$  23,000 ft/s, whichever is first.) If the vehicle has lower than nominal L/D, drag will equal DREF sooner than nominal and  $\alpha$  will ramp down to its limit of 37°, as discussed in the section on first bank reversal at EIT = 14:17.



| <u>EVENT</u>                              | <u>CUE</u>  | <u>DISPLAY</u>          |
|---|-------------|-------------------------|
| <u>Maximum Surface Temperature Region</u> | 16 < M < 23 | AMI<br>CRT/ENTRY TRAJ 1 |
| EIT = 6:00 (min:s)                        |             |                         |
| VREL = 24.0 x 10 <sup>3</sup> (ft/s)      |             |                         |
| H = 255 x 10 <sup>3</sup> (ft)            |             |                         |
| R = 2700 (n. mi.)                         |             |                         |

CREW ACTION

Monitor drag-velocity profile

DISCUSSION

In the Mach region 16 < M < 23, maximum surface temperatures are generated on the orbiter. These temperatures are a function of the reference drag profile, ranging target, mass properties, elevon schedule, and aerovarations. The critical surfaces in this Mach regime include the nose cap, wing leading edge, forward chine, body flap, elevons, and OMS pods.

Using the 40° alpha profile, the body flap and elevons can be expected to reach temperatures ranging from 2000° and 2400° F. The nose cap, wing leading edge, and forward chine should be as listed, ±2 percent.

| Component         | Temperature (°F) |
|-------------------|------------------|
| Nose cap          | 2550             |
| Wing leading edge | 2710             |
| Forward chine     | 2520             |

As of March 1983, the 3-sigma temperature limits for these surfaces are as follows:

| Component               | Temperature (°F) |
|-------------------------|------------------|
| Nose cap (CP1)          | 2558             |
| Wing leading edge (CP3) | 2840             |
| Forward chine (CP6)     | 2595             |
| Elevons (CP4)           | 2531             |
| Body flap (CP2)         | 2396             |

A drag-velocity profile is designed for each mission so that it falls between a profile that would generate the most limiting surface temperatures and a profile that defines the 'full-lift

equilibrium glide' boundary. This limiting drag-velocity envelope is subject to change from mission to mission as a function of guidance l-loads, mass properties, and aero uncertainties.

A drag-velocity profile that would generate the TPS material limiting temperatures would generate the 3-sigma value of these temperatures and is a 'nominal' trajectory, as shown in figure 5-20.

If the generated surface temperature exceeds the material limits of the TPS, tile distortion and shrinkage occur, leading to still higher surface and structural temperatures.

For a nominal trajectory, the maximum generated backface temperature after on-orbit cool-down is 313° F and the maximum tolerable temperature limit is 3500° F.

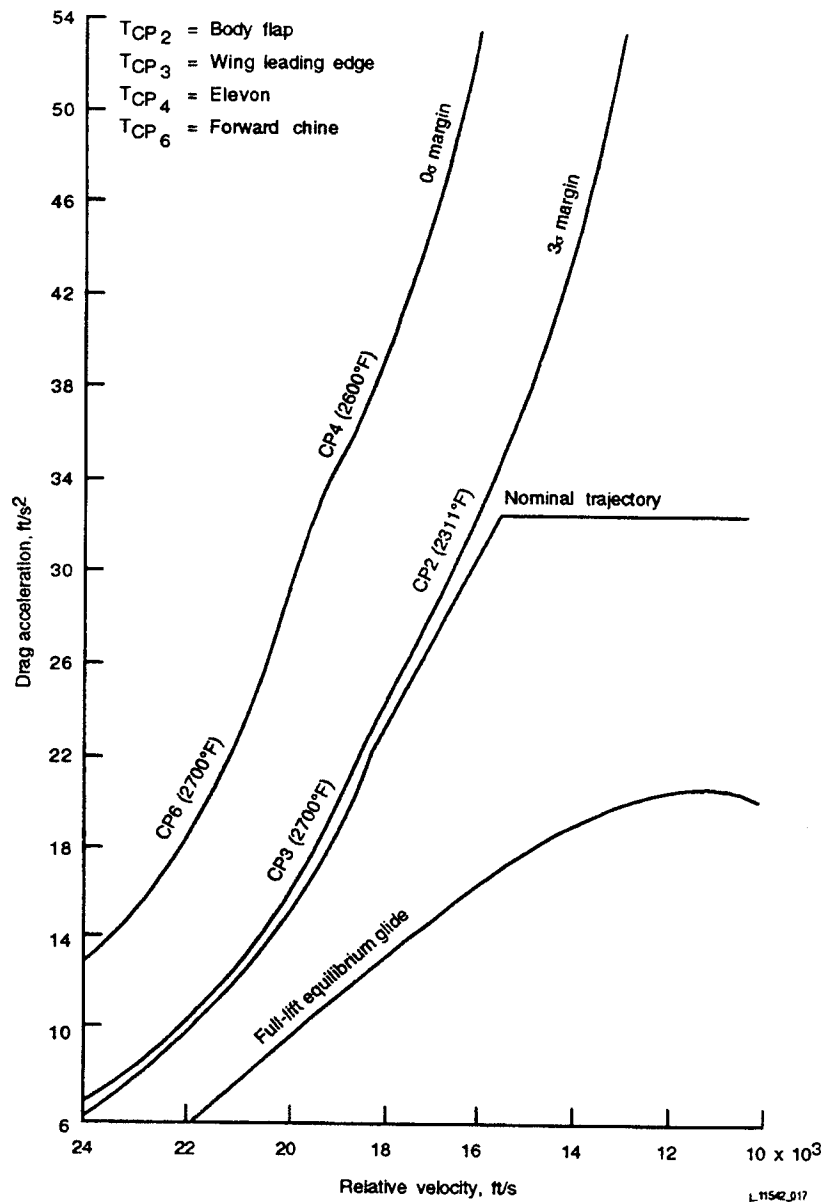

Figure 5-20. Temperature margin boundaries

| <u>EVENT</u>                             | <u>CUE</u>                                   | <u>DISPLAY</u>  |
|--|--|---|
| <u>Ny Trim Active</u>                    | $\bar{q} = 20 \text{ lb/ft}^2$<br>EAS ~77 kn | CRT/ENTRY TRAJ 1<br>Pitch RCS activity<br>lights<br>AMI |
| EIT = 7:15 (min:s)                       |  |   |
| VREL = $23.5 \times 10^3 \text{ (ft/s)}$ |  |   |
| H = $248 \times 10^3 \text{ (ft)}$       |  |   |
| R = 2400 (n. mi.)                        |  |   |

CREW ACTION

None; crew awareness

DISCUSSION

Based on a NAV-derived dynamic pressure of  $20 \text{ lb/ft}^2$ , the entry DAP undergoes a number of configuration changes.

## Pitch channel

- Elevon trim is no longer based on an integral of the elevon deflection commands. Elevon position, compensated for speedbrake deflection, is passed through a first-order lag filter to form the trim command. The panel trim command is also summed with the position feedback and passed through the filter. The total filtered trim command is sent to the body flap channel and is also added to the elevon pitch rate error command.

## Yaw channel

- The sideslip angle,  $\beta$ , from ATT PROC is no longer sent to the ADI. The ADI yaw error needle displays an accelerometer feedback  $A_y$ , compensated for aileron deflection, rudder deflection, yaw jet firings, and yaw rate. This resultant lateral acceleration is scaled as a function of angle of attack and sent to the flight director for display. Full scale ( $\pm$ ) deflection of the lowest error needle is comparable to the authority of  $\pm 2.5$  jets; that is, if in flight the needle should deflect full scale, 2.5 yaw jets firing would be required to counteract the torque due to sideslip. If yaw rate/sideslip does not continue to diverge, 2.5 jets may be required for trim if the aileron trim integrator is saturated. Controllability will be marginal. Monitoring  $A_y$  during roll maneuvers gives the pilot an indication of flight control system performance. Manual takeover may be required if the AUTO system does not constrain  $A_y$  within the authority of two yaw jets, particularly in roll reversals. A more detailed discussion of scaled  $A_y$  is contained in section 5.1.6 with interpretation of the displays and recommended pilot actions.
- At dynamic pressures of  $20 \text{ lb/ft}^2$  and greater, lateral acceleration (NY) feedback is included in the yaw rate error commanding the yaw jet firings. This loop was added to ensure tighter control of sideslip angles, generated especially in bank maneuvers in the presence of aerovariations and angle-of-attack errors.
- The yaw panel trim switch commands are integrated and bias the NY accelerometer feedback. The value of this integrator is displayed on the ENTRY TRAJ series CRT displays as NYTRIM. The actual feedback with which NYTRIM is summed is displayed as NY.

- At  $\bar{q} \geq 20$  lb/ft<sup>2</sup>, the number of yaw jets available per side for control increases from two to four.

#### Roll channel

- At dynamic pressures of 20 lb/ft<sup>2</sup> and greater, NY feedback is also used to calculate a component, as a function of angle of attack, of the total roll rate feedback term. The error between the roll rate feedback term and the AUTO or RHC roll rate command is converted to an aileron surface deflection command. The roll maneuver initiation sequence remains as previously described at  $\bar{q} \geq 10$  lb/ft<sup>2</sup>.

Later, at  $\bar{q} = 40$  lb/ft<sup>2</sup>, commands to the pitch jets for maneuver execution and trim are terminated. Pitch control is now via elevons, and pitch trim is via the body flap. (The body flap will drive to return the elevons to the elevon schedule.)

| <u>EVENT</u>                                 | <u>CUE</u>                   | <u>DISPLAY</u>                  |
|--|------------------------------|---------------------------------|
| <u>Drag H Update in NAV Filter Initiated</u> | $\Delta = 11 \text{ ft/s}^2$ | ENTRY TRAJ<br>CRT<br>AMI<br>HSD |
| EIT = 9:49 (min:s)                           |                              |                                 |
| VREL = $22.1 \times 10^3$ (ft/s)             |                              |                                 |
| H = $238 \times 10^3$ (ft)                   |                              |                                 |
| R = 1834 (n. mi.)                            |                              |                                 |

CREW ACTION

Check drag H on HSD

DISCUSSION

The drag altitude computation and NAV filter update are initiated when the onboard sensed acceleration reaches  $11 \text{ ft/s}^2$ . Simply stated, the drag altitude is calculated by using the relationship between drag and air density to estimate altitude. (Drag is determined from the IMU's and air density from an onboard atmospheric model in the software.) Using the model of air density versus altitude, the altitude can be deduced from the air density, which is deduced from drag acceleration. On the HSD, the DRAG H RESID and RATIO parameters will change from blank to computed values. The drag altitude edit threshold is about 80,000 ft. If the ratio is less than 1, the NAV filter state vector is automatically updated. If the ratio is greater than 1, the crew has two options.

1. The NAV filter can be forced to use the data in updating the state vector (ITEM 22 EXEC).
2. The NAV filter can be left to choose whether or not to update based on the edit routine.

If the NAV filter is forced to update with inaccurate data or if the update is not initiated because of bad drag altitude data, the state vector probably will be so much in error that a ground controlled approach (GCA) will be required. The crew should anticipate this change and be prepared to follow direction when postblackout communications are restored.

The present crew procedure is always to force the NAV filter to use drag altitude data, since it is assumed to be more accurate than H calculated from IMU's.

Drag altitude computations terminate at ADTA processing (VREL  $\geq 2500$  f/s) or  $H < 85,200$  ft, whichever occurs first.

| <u>EVENT</u>                              | <u>CUE</u>       | <u>DISPLAY</u> |
|---|------------------|----------------|
| <u>MPS L02 Fill and Drain Valves Open</u> | VREL = 20,000 ft | AMI            |
| EIT = 12:25 (min:s)                       |                  |                |
| VREL = 20.0 x 10 <sup>3</sup> (ft/s)      |                  |                |
| H = 224 x 10 <sup>3</sup> (ft)            |                  |                |
| R = 1380 (n. mi.)                         |                  |                |

CREW ACTION

None

DISCUSSION

LH<sub>2</sub> inerting, through the fill/drain valves and prevalues, is initiated at the transition to MM 304. LO<sub>2</sub> inerting is delayed until Mach 20.0 when the aerosurfaces have enough control authority to override the thrust generated by escaping LO<sub>2</sub>. The OPS 3 inerting is designed primarily for a TAL where substantial propellant residues are likely due to an abbreviated MPS dump. The helium system is also configured in preparation for the purge and repressurization at this time.

When VREL = 5300 ft/s, the LH<sub>2</sub> and LO<sub>2</sub> outboard fill/drain valves and the LO<sub>2</sub> prevalues are closed to terminate inerting. Also, MPS helium is used to pressurize the propellant lines and accomplish an H<sub>2</sub> purge. The LH<sub>2</sub> and LO<sub>2</sub> propellant lines are pressurized to prevent atmospheric contamination, eliminating the need for a lengthy cleanup prior to the next flight. The two OMS pods, the LH<sub>2</sub> ET umbilical cavity, and the aft compartment are purged of any potentially explosive H<sub>2</sub> that may have accumulated during the flight. The purge continues through landing.

| <u>EVENT</u>   | <u>CUE</u>                                    | <u>DISPLAY</u>                   |
|--|---|----------------------------------|
| <u>RCS Activity Lights</u><br><u>Reconfiguration</u> | $\bar{q} = 50 \text{ lb/ft}^2$<br>EAS ~121 kn | CRT/ENTRY<br>RCS activity lights |
| EIT = 13:02 (min:s)                                  |   |                                  |
| VREL = $19.1 \times 10^3 \text{ (ft/s)}$             |   |                                  |
| H = $219 \times 10^3 \text{ (ft)}$                   |   |                                  |
| R = 1200 (n. mi.)                                    |   |                                  |

CREW ACTION

None; crew awareness

DISCUSSION

At a dynamic pressure of 50 lb/ft<sup>2</sup>, the roll and pitch RCS activity lights are processed by software functions to indicate the FCS workload to the pilot. Both left and right sides of the ROLL light illuminate simultaneously if more than two yaw jets are commanded on by the FCS. Note that the lights indicate commands from the FCS to the JSL, not actual jet firings. Additionally, the minimum on-time for a yaw RCS jet to fire is presently 80 milliseconds in this regime, so the commands to the light have been lengthened to allow the pilot adequate time to identify the light flash. The minimum light on-time is 200 milliseconds in this regime, or 80 milliseconds plus a constant of 120 milliseconds. When the minimum jet-on time is increased below 125,000 ft to 320 milliseconds, the minimum light on-time is 440 milliseconds.

Both halves of the PITCH light illuminate if PRL issues a flag for elevon rate saturation; i.e., either left or right elevon is driving at 13.9 deg/sec with one APU operating, and 20 deg/sec or greater with two or three APU's operating.

| <u>EVENT</u>                     | <u>CUE</u>      | <u>DISPLAY</u> |
|----------------------------------|-----------------|----------------|
| <u>Equilibrium Glide Phase</u>   | V = 17,913 ft/s | AMI            |
| EIT = 14:14 (min:s)              |                 |                |
| VREL = $17.9 \times 10^3$ (ft/s) |                 |                |
| H = $210 \times 10^3$ (ft)       |                 |                |
| R = 961 (n. mi.)                 |                 |                |

CREW ACTION

Monitor

DISCUSSION

The equilibrium glide phase is one of five guidance phases and nominally starts at a relative velocity of less than 19,929 ft/s. During this guidance phase, VREL = 19,929 to 14,493 ft/s and the vehicle H fairly constant at approximately -150 ft/s. This guidance phase is called equilibrium glide because it is based on a drag-velocity profile that has the fundamental form of equilibrium glide flight. (Equilibrium glide flight is defined as flight in which the flightpath angle remains constant.) Equilibrium glide flight provides a convenient interface between the rapidly increasing drag level from the temperature control phase and the constant drag level of the constant drag phase. The crew probably will not notice when they are in the equilibrium glide phase. If they happen to be looking at the ENTRY TRAJ display, they will see the DRAG REF and 'square' symbol jump on the CRT when the equilibrium glide phase is initiated. The equilibrium glide phase will be automatically bypassed in short downrange cases if the desired constant drag is reached before  $VREL < 10,000$  ft/s or if the constant drag value required to reach the target is greater than the desired constant drag called for in the constant drag phase.



| <u>EVENT</u>               | <u>CUE</u>            | <u>DISPLAY</u>   |
|----------------------------|-----------------------|------------------|
| <u>First Bank Reversal</u> | $\Delta = 10.5^\circ$ | HSI<br>ENTRY CRT |

EIT = 15:35 (min:s)  
VREL =  $15.7 \times 10^3$  (ft/s)  
H =  $196 \times 10^3$  (ft)  
R = 741 (n. mi.)

CREW ACTION

Monitor

DISCUSSION

The first bank reversal is issued by guidance when the azimuth error is  $\pm 10.5^\circ$ . Bank reversals, to Mach 4.0, are thereafter issued when the azimuth error is  $\pm 17.5^\circ$ . At Mach 4.0, the azimuth error is ramped to  $\pm 10^\circ$ , as shown in figure 5-21.

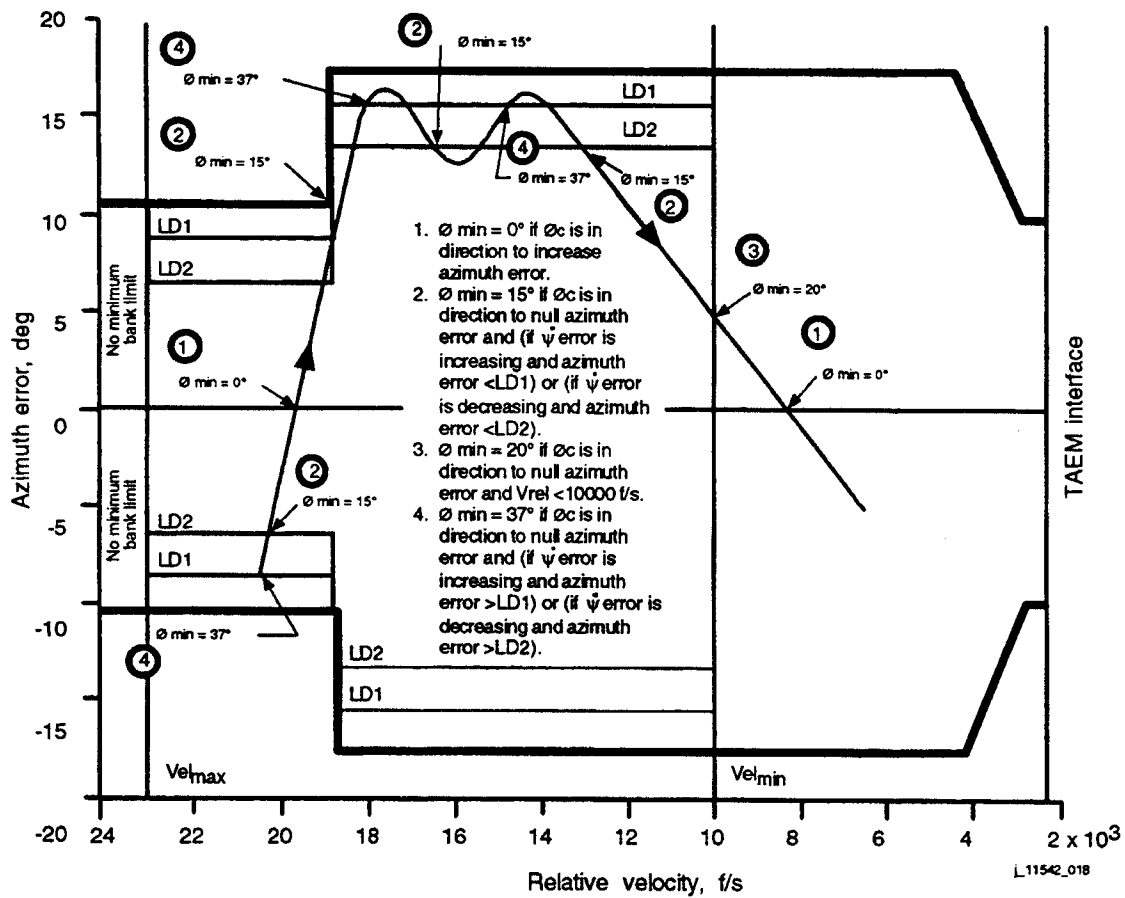

**Figure 5-21. Azimuth error versus relative velocity plot**

Bank reversals are performed to null crossrange errors. If the reversals fail to occur within the specified deadbands, then serious ranging problems result.

Bank reversal initiating logic operates differently depending on whether Roll/Yaw CSS is engaged. When flight control is in auto and the current cycle DELAZ times the sign of commanded roll of the previous cycle becomes equal to or greater than YL (DELAZ deadband), the logic changes the sign of commanded roll and a bank reversal is initiated. For the first roll reversal, the DELAZ deadband is then expanded to 17.5°. If Roll/Yaw is in CSS, the logic works the same as it did in OI-21; i.e., the product for comparison to YL is the current DELAZ times the sign of current roll attitude and the DELAZ deadband is not expanded until the vehicle rolls through wings level. The addition of the Roll/Yaw CSS check was made to simplify the code and eliminate many anomalies associated with the roll reversal logic, while still providing the capability for guidance to 'follow' manual roll reversals. For example, a phenomenon termed 'ROLCMD sign bounce' is eliminated in OI-22 when flight control is in auto. This phenomenon can now only occur if Roll/Yaw is in CSS. It has been demonstrated in simulations that if

1. Guidance is in CSS, and
2. The sign of commanded roll has just changed (a bank reversal has started), and
3. While azimuth error still exceeds the azimuth error limit, an event occurs that causes the azimuth error to jump to the inside of the azimuth error limit (e.g., runway centerline crossing causing HAC redesignation, or a navigation update),

then the sign of commanded roll changes again, and another bank reversal is initiated, regardless of the fact that this reaction makes azimuth error tend toward the limit it just encountered. If, shortly thereafter, the orbiter rolls through wings-level due to its momentum, then the relationship among the involved parameters is altered to cause yet another bank reversal initiation. It has been shown that three bank command reversals can be induced within the span of 14 seconds of elapsed time. However, the worst physical effect demonstrated to date has been a minor perturbation in actual roll. Nevertheless, the phenomenon will not occur when in autoguidance.

Even though many anomalies associated with the roll reversal logic were eliminated with OI-22, the Roll/Yaw CSS check can result in an unexpected roll command sign change. If Roll/Yaw CSS is engaged after the first roll reversal is initiated but prior to wings level, guidance will 'abort' the roll reversal and continue flying to the expanded, 17.5° deadband. If the crew inadvertently engages Roll/Yaw CSS after the first roll reversal has started but prior to wings level, the recommended action is to finish the initial roll reversal in CSS and return to auto flight control after wings level. However, if the crew does not realize they are in this region and simply returns to auto, performing the first roll reversal at 17.5° is not a safety or performance issue. Manually completing the roll reversal at 10.5° keeps the trajectory timeline closer to nominal. This information is documented in the User Note 108586 included in the OI-22 Program Notes. Note that the BFS roll reversal logic was not changed in OI-22, so the BFS will not abort the roll reversal in this scenario.

The crew can monitor when bank reversals should occur by a digital readout of 'Delta Azimuth' displayed on the ENTRY TRAJ displays and by observing azimuth error on the HSI (difference between the primary bearing pointer and LUBBER LINE). Also, the shuttle symbol and the phugoid damper scale on the ENTRY TRAJ display flash when the azimuth error limits are

reached and the signs of current bank angle and DELAZ are the same. Nominally, the vehicle banks to an angle greater than it had been holding before the reversal. The increased  $\phi$  is necessary to converge back to the drag profile as vehicle drag was reduced (less  $\dot{H}$ ) while rolling through wings level. Also with the addition of  $\alpha$  modulation,  $\alpha$  increases about  $2^\circ$  while rolling through wings-level to help keep vehicle drag on DREF. The greater  $\phi$  shallows out and  $\alpha$  ramps back to the 'canned'  $\alpha$  - VREL profile as drag converges back to DREF. After drag converges, ROLREF on the ENTRY TRAJ display should be continually monitored because ROLREF is an indicator of the vehicle's energy reserve. (The larger the ROLREF number, the more energy in reserve.)

For extremely long-range entries or low L/D cases, autoguidance has minimum  $\phi$  limits to ensure that crossrange conditions are met while still trying to satisfy total energy conditions. These limits are a function of VREL, azimuth direction, and azimuth error, as was shown in figure 5-21. Basically, if azimuth error is increasing (i.e., the orbiter is banked to head away from WP 1), the minimum  $\phi$  command is  $0^\circ$ . If VREL is less than 10,000 ft/s and azimuth error is decreasing, the minimum  $\phi$  command is  $20^\circ$ . If VREL is greater than 10,000 ft/s and the azimuth error is decreasing (banked toward WP 1), the minimum  $\phi$  command is  $37^\circ$  if azimuth error is  $>13.5^\circ$ , and  $15^\circ$  if azimuth error is  $<13.5^\circ$ .

EVENTCUEDISPLAYConstant Drag Phase

V = 14,493 ft/s

AMI

 $\Delta = 33 \text{ ft/s}^2$ 

ENTRY TRAJ 2, 3

EIT = 15:50 (min:s)

VREL =  $15.3 \times 10^3$  (ft/s)H =  $193 \times 10^3$  (ft)

R = 702 (n. mi.)

CREW ACTION

Monitor

DISCUSSION

On the nominal entry profile, the constant drag guidance phase is entered at a vehicle velocity of approximately 14,500 ft/s. In this phase, range predictions are based on a constant drag profile until the transition phase is entered at VREL = 10,445 ft/s. The constant drag phase provides a profile shape that is acceptable to thermal constraints, vehicle performance, and FCS limits. The crew can monitor this phase by observing a buildup in vehicle drag (AMI and entry CRT display) to a level of approximately 33 ft/s<sup>2</sup>. This drag value remains constant until VREL = 10,445 ft/s, where it starts ramping down when the transition phase is entered. The phugoid problem is more severe if roll reversals are performed during the constant drag phase because of the higher drag levels. Under nominal conditions, this phase starts when the shuttle symbol intersects the 33-ft/s constant drag nominal trajectory guideline on the ENTRY TRAJ 2 CRT display and continues through the ENTRY TRAJ 3 CRT display. For off-nominal cases, if the ranging problem has not been satisfied by the start of the constant drag phase, the constant drag profile is adjusted (based on range error) so that a nominal transition phase can be flown. For extremely short-range cases, the DREF value to fly may be much greater than the nominal 33 ft/s<sup>2</sup>. For extremely long-range cases, this guidance phase is automatically bypassed if the predicted velocity at end of the equilibrium glide phase is less than 10,400 ft/s.

| <u>EVENT</u>                                      | <u>CUE</u>      | <u>DISPLAY</u> |
|---|-----------------|----------------|
| <u>Power Up Previously Powered<br/>Down LRU's</u> | V = 15,000 ft/s | CRT            |
| EIT = 16:00 (min:s)                               |                 |                |
| VREL = $15.0 \times 10^3$ (ft/s)                  |                 |                |
| H = $190 \times 10^3$ (ft)                        |                 |                |
| R = 680 (n. mi.)                                  |                 |                |

CREW ACTION

If MLS, CRTX - I/O RESET EXEC power up LRU's

DISCUSSION

For several cooling systems failures, all navigation sensors (TACAN, MLS, radar altimeter) are powered off to avoid the heat load they would otherwise generate. Analysis has shown that some of the LRU's can be powered up and the loads are acceptable from V = 15,000 ft/s until postlanding powerdown. If using MLS, powerup requires an I/O RESET EXEC to incorporate the data that would otherwise not be sent through the MDM's.

For the same reasons, flight controller and instrument power is off and may at this time be powered on.

EVENTCUEDISPLAYAlpha Ramps Down From 40°

V ~ 12,200 ft/s

AMI  
ENTRY TRAJ CRT

EIT = 17:23 (min:s)  
 VREL =  $12.2 \times 10^3$  (ft/s)  
 H =  $181 \times 10^3$  (ft)  
 R = 496 (n. mi.)

CREW ACTION

Monitor

DISCUSSION

During the entry flight phase, a follows a velocity profile that initially is constant at 40°. At VREL ~14,500 ft/s, it starts ramping down until it reaches ~13° at the TAEM interface. This velocity/ $\alpha$  profile was selected mainly to satisfy thermal constraints but it also satisfies cross-range and FCS requirements. This profile flies the orbiter on the back side of the L/D curve until about Mach 4.0. The crew can monitor  $\alpha$  via the AMI or Entry CRT display. The pitch command needle on the ADI displays  $\alpha$  error ( $\alpha - \alpha_{CMD}$ ). With the addition of  $\alpha$  modulation to entry guidance,  $\alpha_{CMD}$  can vary from the canned velocity profile plus or minus several degrees, as shown in figure 5-22. Autoguidance modulates  $\alpha$  within the limits shown, as required, to keep actual drag the same as DREF. When the pitch command needle on the ADI is nulled, the  $\alpha$  modulation activity can be monitored by comparing the actual  $\alpha$  ( $\triangleleft$ ) and the canned profile  $\alpha$  ( $\leftarrow$ ) displayed on the ENTRY TRAJ CRT. When the actual  $\alpha$  ( $\triangleleft$ ) is different from the canned  $\alpha$  ( $\leftarrow$ ) by more than 2°, the actual  $\alpha$  symbol ( $\triangleright$ ) flashes. This will occur on the ENTRY TRAJ CRT. When the actual  $\alpha$  ( $\triangleright$ ) is different from the canned  $\alpha$  by comparing the actual  $\alpha$  ( $\triangleleft$ ) and the canned profile  $\alpha$  ( $\leftarrow$ ) displayed on nominal entries during roll reversals as  $\alpha$  modulation increases  $\alpha$  more than 2° above the canned profile to keep drag on DREF. The crew's only indication of  $\alpha$  exceeding its limits is from monitoring  $\alpha$  and comparing it to the limits on the  $\alpha$  cue card.

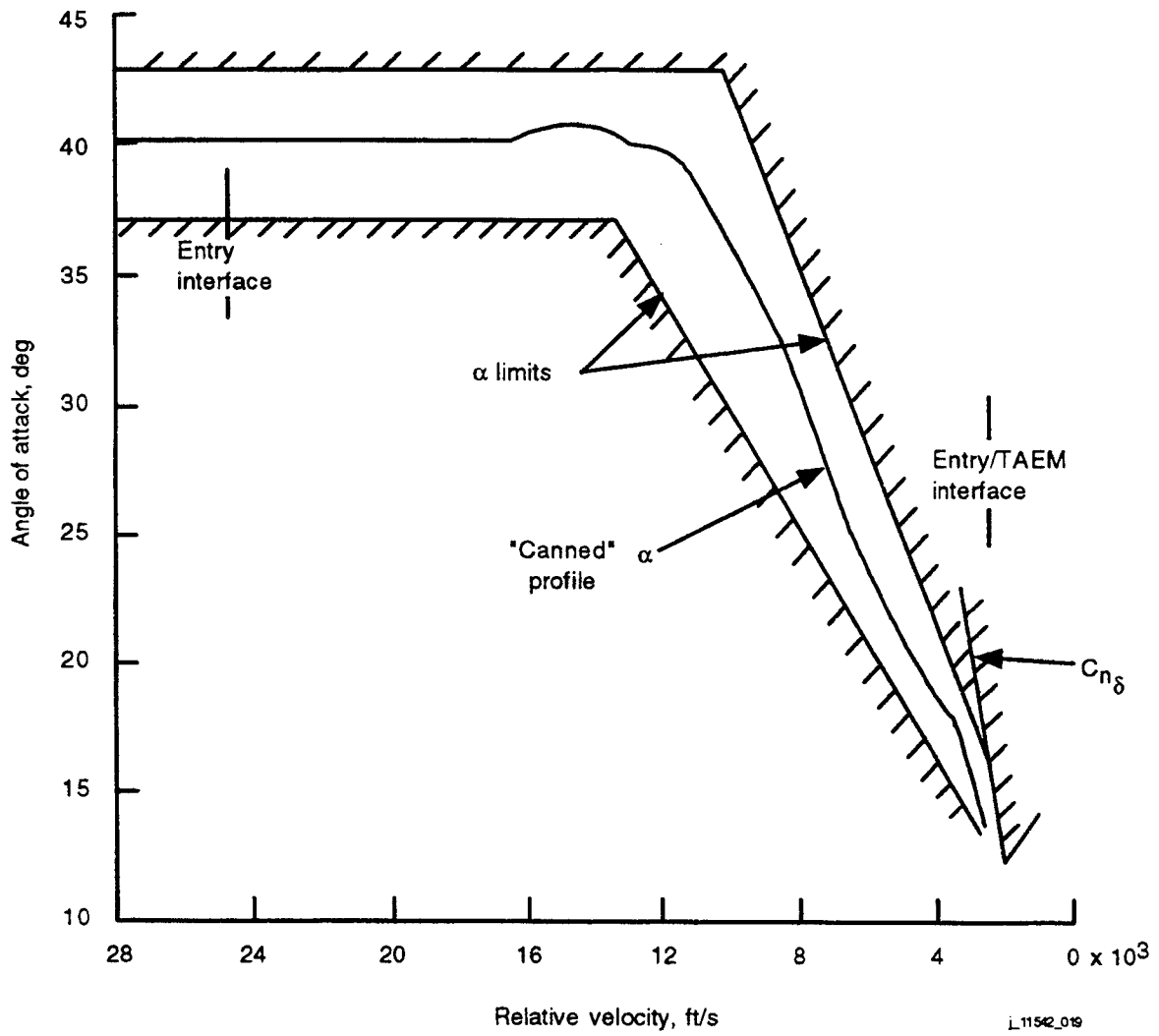

Figure 5-22. Entry angle-of-attack profile

EVENTCUEDISPLAYPoint Pillar C-Band AOS

EIT = 17:30

CRT timer

EIT = 17:30 (min:s)  
VREL =  $12.0 \times 10^3$  (ft/s)  
H =  $180 \times 10^3$  (ft)  
R = 482 (n. mi.)

CREW ACTION

Awareness

DISCUSSION

C-band is used by ground radar stations for skin tracking. At the time C-band acquisition occurs during entry, the orbiter is in the communications blackout phase; therefore, the crew does not receive immediate confirmation of skin tracking. No crew actions are required. On the nominal trajectory, the ground will have had about 1 minute of skin tracking before S-band acquisition.



EVENTCUEDISPLAY

Call Up HSD to Monitor  
TACAN AOS

EIT = 18:10  
V ~ 10,500 ft/s

CRT timer  
AMI

EIT = 18:10 (min:s)  
VREL =  $10.5 \times 10^3$  (ft/s)  
H =  $175 \times 10^3$  (ft)  
R = 420 (n. mi.)

CREW ACTION

GNC - SPEC 50 PRO

DISCUSSION

The HSD is called up by the pilot for TACAN and navigation management on CRT 2 before first TACAN acquisition.

The PASS HSD comes up with the following navigation items inhibited.

Item 20: TAC AZ and RNG

Item 26: ADTA H

Item 29: ADTA G&C

Greater detail with regard to the management of TACAN is found beginning on page 5-83.

| <u>EVENT</u>                     | <u>CUE</u>      | <u>DISPLAY</u> |
|----------------------------------|-----------------|----------------|
| <u>Transition Phase</u>          | V = 10,400 ft/s | AMI            |
| EIT = 18:20 (min:s)              |                 |                |
| VREL = $10.4 \times 10^3$ (ft/s) |                 |                |
| H = $171 \times 10^3$ (ft)       |                 |                |
| R = 392 (n. mi.)                 |                 |                |

CREW ACTION

Monitor

DISCUSSION

The transition phase starts at approximately 10,400 ft/s and terminates at TAEM interface velocity VREL = 2487 ft/s. During this phase, a linear drag profile is used as the reference profile shape. Ranging is accomplished by changing the slope of the drag profile as a function of the range error. As in previous phases, a reference drag level (DREF), altitude rate reference (HREF), and L/D reference are computed. Also, to ensure that excessive aerodynamic loads and descent rates are not encountered, DREF is limited to a premission load-factor limit and the bank angle command is limited to 70° (Mach 8.0) as an additional protection against excessive descent. ROLREF is left about 62° at the start of transition and one or two bank reversals can be expected before TAEM.

Nominal data for the transition phase are as follows:

| Event | EIT<br>hr:min | VREL<br>ft/s | DREF<br>ft/s <sup>2</sup> | HREF<br>ft/s | ROLREF<br>deg |
|-------|---------------|--------------|---------------------------|--------------|---------------|
| Start | 18:20         | 10,462       | 33                        | -255         | -62           |
| End   | 24:10         | 2,487        | 20                        | -260         | -21           |

| <u>EVENT</u>                         | <u>CUE</u>                | <u>DISPLAY</u>                           |
|--------------------------------------|---------------------------|--|
| <u>Speedbrake Ramp to 81 Percent</u> | M = 10<br>Speedbrake ramp | AMI<br>$\delta_{SB}$ SPI<br>GNC SYS SUMM |

EIT = 18:33 (min:s)  
VREL =  $10 \times 10^3$  (ft/s)  
H =  $168 \times 10^3$  (ft)  
R = 370 (n. mi.)

### CREW ACTION

Monitor surface command and surface deflection on speedbrake SPI

### DISCUSSION

When in the AUTO mode, the speedbrake follows a deflection schedule based on Mach number. Before Mach 10.0, the speedbrake channel sends a command of  $-9^\circ$  to PRL to ensure that the surfaces are thermally sealed. The following speedbrake schedule found in figure 5-23 is representative for  $M < 10$ .

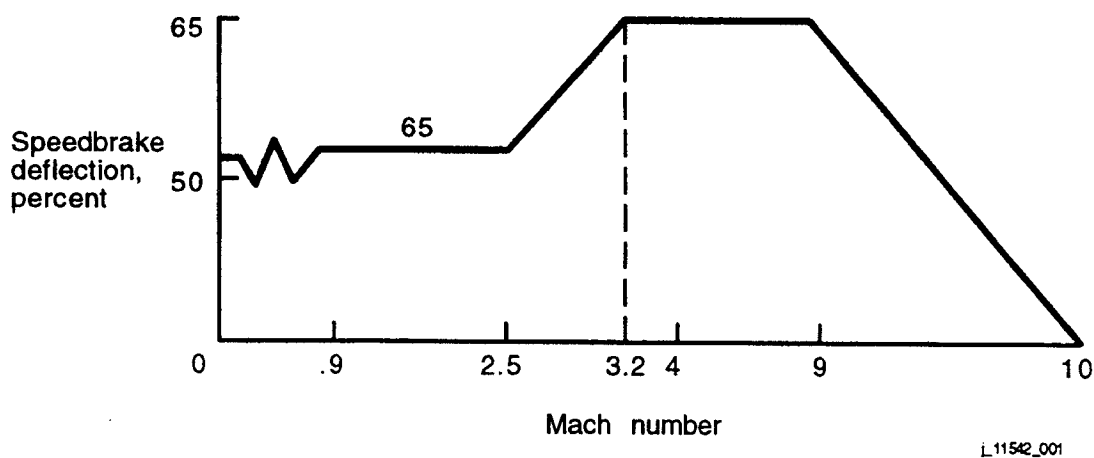

**Figure 5-23. Speedbrake schedule**

In the Mach 10.0 to 3.0 regime, the full deflection of the speedbrake produces a nose-up pitching moment, which allows a counteracting down elevon trim position of  $+5^\circ$ . The down elevon trim position is required for  $-C_{n\delta_a}$  (negative yawing moment due to aileron deflection) necessary to trim out yaw moments resulting from lateral c.g. offsets or a bent airframe. The speedbrake position is crossed to the elevon pitch channel to calculate an elevon trim contribution.

If the speedbrake does not follow the cited schedule within 20 percent, the SPD BRK C&W message is annunciated supersonic. The crew can take manual control by depressing the takeover button on the SBTC handle and commanding the appropriate surface deflection.

If desired, the AUTO SPEEDBRAKE pbi can then be depressed to put the speedbrake back in the AUTO mode. The speedbrake opening rate is 6.1 deg/sec (hinge reference line); and the closure rate is 10.86 deg/sec until the softstop at 12°, at which point the closure rate decreases to 1 deg/sec. After the speedbrakes are opened at M = 10, a minimum speedbrake position limit of 15° is required for directional stability down to Mach 0.6. Until subsonic, the speedbrake has little effect on the vehicle's L/D or glide capability. After Mach 0.6 for final approach and touchdown, the minimum speedbrake deflection remains at 15° to prevent damage to the rudder conical seal from rudder/speedbrake hinge interference. At WOWLON, a software event flag indicating touchdown on main gear, the speedbrake is commanded to 100 percent open to aid in a controlled derotation. These limits are imposed in the FCS speedbrake channel.

#### WARNING

It is possible for one of the two rudder/speedbrake panel output shafts to fail and, therefore, only one of the speedbrake panels would extend. Unfortunately, the rudder and speedbrake transducers, which provide data to the system summary display and the SPI, are located on the output shaft of the rudder and speedbrake gearboxes far upstream of the two rudder/speedbrake panel output shafts. Therefore, with a rudder/speedbrake panel shaft failure, the indications to the crew on the displays and SPI would appear normal. But by Mach 8.5, with only one panel deployed, the airloads would start to build on that panel. Aileron trim would probably saturate and yaw jets would start firing to maintain control. By Mach 4.5, yaw jet firings would be continuous and loss of control may occur at Mach 3.0. If the crew sees this signature (aileron saturation and continuous yaw jet firings), they should retract the speedbrake. If the problem was caused by a panel shaft failure, retracting the speedbrake should remedy the problem except for the most forward c.g. cases.

| <u>EVENT</u>                     | <u>CUE</u> | <u>DISPLAY</u> |
|----------------------------------|------------|----------------|
| <u>UHF Upvoice and Downvoice</u> | Voice      | N/A            |
| EIT = 18:38 (min:s)              |            |                |
| VREL = $9.8 \times 10^3$ (ft/s)  |            |                |
| H = $167 \times 10^3$ (ft)       |            |                |
| R = 363 (n. mi.)                 |            |                |

CREW ACTION

Awareness, ultrahigh frequency (UHF) communications check

DISCUSSION

UHF provides a backup to S-band for communications and is used in case of S-band failure. As soon as practical after emerging from blackout, the crew may perform a UHF two-way voice check with the MCC by using the UHF transceiver, relaying to MCC through a UHF ground station.

The main UHF controls are located on overhead panel 06. Circuit breakers on panel R15 (UHF MNA and UHF MNC) must be closed for UHF activation. Note that only R15 MNA powers the SPLX power amp. Two frequencies, 259.7 and 296.8 MHz, are available for normal transmission and receiving, and emergency UHF communications are available on the guard frequency, 243.0 MHz. UHF maximum range to about 350 miles with power amp, 90 miles without power amp.

EVENTCUEDISPLAYS-band AOS

MCC call

HSD

EIT = 19:36 (min:s)  
VREL =  $8.1 \times 10^3$  (ft/s)  
H =  $156 \times 10^3$  (ft)  
R = 280 (n. mi.)

CREW ACTION

Manage NAV filter, respond to ground directions

DISCUSSION

No communications exist between the orbiter and ground before EI to S-band acquisition, unless TDRS is functional. During this time, navigation may degrade. A combined effort between crew and ground is required to recognize and resolve the discrepancy as soon as possible.

| <u>EVENT</u>                    | <u>CUE</u>     | <u>DISPLAY</u> |
|---------------------------------|----------------|----------------|
| <u>Runway Redesignation</u>     | Communications | HSD            |
| EIT = 19:51 (min:s)             |                |                |
| VREL = $7.7 \times 10^3$ (ft/s) |                |                |
| H = $153 \times 10^3$ (ft)      |                |                |
| R = 250 (n. mi.)                |                |                |

CREW ACTION

Awareness

DISCUSSION

A capability exists via HSD item entries to reselect the orbiter landing runway. During entry some navigation errors or aerodynamic dispersions could bias the trajectory, or wind conditions could change enough that redesignation would be preferred. Although this redesignation during entry between runways can be accomplished by item entry on the HSD, it should not be performed without MCC concurrence. Studies have shown that for low-energy cases it may be better to delay redesignation until TAEM. Regardless, the most accurate trajectory, guidance, and navigation assessment cannot be made until C-band radar tracking data and S-band telemetry data have been analyzed and postblackout communications have been established between the orbiter crew and ground-support personnel.

| <u>EVENT</u>                    | <u>CUE</u>                          | <u>DISPLAY</u> |
|---------------------------------|-------------------------------------|----------------|
| <u>First TACAN Acquisition</u>  | TACAN range and bearing data appear | HSD            |
| EIT = 20:10 (min:s)             |                                     |                |
| VREL = $7.2 \times 10^3$ (ft/s) |                                     |                |
| H = $150 \times 10^3$ (ft)      |                                     |                |
| R = 239 (n. mi.)                |                                     |                |

### CREW ACTION

Incorporate TACAN data via CRT input

### DISCUSSION

TACAN acquisition is automatic under nominal conditions. Onboard displays provide the crew with TACAN data residuals and ratios to evaluate the TACAN system performance. Additional TACAN data evaluation is done by the MCC with the use of ground tracking compares.

The TACAN scheme is based on common channel operation of the three onboard LRU's (i.e., all LRU's are tuned to a common ground station.) Because the three TACAN LRU's have different antenna locations, they do not all lock on at the same time. Other factors that affect TACAN lockon are vehicle bank angle and groundstation location. At MM 304, the onboard LRU's start searching for range and bearing lock. They interrogate with the lower and upper antennas approximately 12 seconds each until a range lock is acquired. After an LRU has a range lockon, that LRU stays on the antenna (upper and lower) that has acquired the lockon.

In order for NAV to process range or bearing, each component must separately satisfy a two-lock requirement. In addition, the acquisition filter requires that bearing be locked on for at least 12 consecutive TACAN RM cycles and that range be locked on for at least 10 consecutive cycles (if velocity is less than Mach 7.5, range must be locked on for 5 cycles). TACAN data are displayed on the HSD the instant it is acquired by the antennas; however, residuals and ratios are not available until the two-lock and the acquisition filter requirements are satisfied. Since TACAN RM operates at 1 Hz, there are 10 to 12 seconds between receiving data and displaying residuals and ratios. Once lockon is lost, the acquisition filter cycle starts over again. The two-lock range requirement goes away after about 30 seconds of initial NAV processing but is reinstated following a zero delta NAV state update. The two-bearing lock requirement never goes away. Typically, at least two LRU's have locked on in both range and bearing at approximately 150,000 to 140,000 ft. The NAV incorporates TACAN data when placed in AUTO by the crew via an item 19 on SPEC 50.

Because bearing data are not reliable when flying over a station, there is a 'cone of confusion' check ( $35^\circ$  from horizontal,  $110^\circ$  cone) where no BRG data will be processed. The accuracy of position of the cone is a function of state vector accuracy. The crewmember can determine presence of the cone by observing that AZ data has been and is being displayed on the HSD, but the AZ RESID/RATIO data are blank. While in the cone, range data are still used to update NAV (the RNG RESID/RATIO data are displayed). One should not initially process TACAN data (AUTO or force) while in the cone because the resulting NAV errors may be large and in simulations, loss of control has resulted.



If bearing data from an LRU differ from the others by 6° or more for 10 consecutive cycles, the bearing data from that LRU are deselected and a '↓' appears by that parameter. If range data from an LRU differs from the others by 3000 ft for five consecutive cycles, the range data from the LRU are deselected and a '↓' appears by that parameter.

If there are three LRU's available, RM mid-value-selects each parameter. At the two-LRU level, RM takes the average of each parameter. If only one LRU is available (may have to prime select to break two-lock requirement) the data from that LRU will be used. If there is a dilemma, no data are used, RM places each available TACAN in 'Self-Test' to attempt to solve the dilemma. Operation in the transmit/receive (T/R) mode precludes self-test. After steady lockon has been achieved, a postselection filter prevents any sudden data changes from being processed (if there is a change in BRG of 4.5° or change in RNG of 10,000 ft in one cycle, the filter inhibits the data).

**TACAN Management**

Preentry, the TACAN A-I-F is set to INHIBIT, BARO to INHIBIT, and DRAG H to AUTO. Although communications are expected to be reestablished before two TACAN lockons, the crew monitors and controls the NAV filter via the HSD in case communications are delayed or communications failure occurs. Per the entry cue cards, crew management of the TACAN's is as follows:

**With COMM**

If TACAN's lock on before normal communications are established with MCC, the crew leaves the TACAN A-I-F in INHIBIT until communications are established, but no later than VREL = 6000 ft/s.

If the ratio <1 and if MCC concurs that the TACAN data are good, the crew puts the TACAN A-I-F to AUTO (item 19 on HSD). MCC typically has approximately 1.5 minutes of C-band radar skin tracking before S-band AOS, so as soon as communications are acquired, the state vector from skin tracking is compared with onboard NAV and TACAN data.

If the ratio is <1 and MCC sees that the TACAN's degrade the NAV state, then the crew is told to leave the TACAN's in INHIBIT.

TACAN MGMT

|          | RATIO < 1  | RATIO > 1   | ONE TACAN LOCKED                                | NO LOCK                        |
|----------|--|---|---|--------------------------------|
| PRE-COMM | INH  | INH   | INH   | INH                            |
| COMM OK  | MCC:<br>AUTO<br>or<br>INH (if TACAN will<br>degrade NAV state) | MCC:<br>INH (+Δ STATE)<br>or<br>FORCE<br>or<br>ZERO Δ STATE<br>or<br>CHG TACAN CH | MCC:<br>DESELECT MISSING<br>TACANS, then - AUTO | MCC:<br>Select secondary TACAN |

## NO COMM TACAN MGMT

V = 6K

| RATIO < 1 | RATIO > 1    |   | ONE TACAN LOCKED  | NO LOCK                                  |
|-----------|--------------|---|---|--|
| AUTO      | TROUBLESHOOT |   | BELOW V = 5.5K<br>DESELECT MISSING<br>TACANS, then - AUTO | BELOW V = 5.5K<br>Select secondary TACAN |
|           | IF BAD TACAN | IF BAD NAV STATE                              |   |  |
|           | AUTO         | If first acq - FORCE<br>If not - ZERO Δ STATE |   |  |

If the ratio >1 and MCC determines that TACAN data are bad, MCC updates the state vector. If the TACAN data are good and the onboard NAV state is determined bad, MCC either has the crew 'FORCE' TACAN data or update the state vector. If for any reason it is necessary for MCC to voice an update to the onboard state vector, the crew manually enters the data on the HSD. The manual entry requires approximately 3 minutes. If it is not determined that the TACAN groundstation is bad, the crew changes TACAN channels (two groundstations are always available near the landing site) by selecting the backup TACAN station on the HORIZ SIT display.

If for some reason after initial acquisition the TACAN ratio has increased to >1, then the MCC might have the crew perform a zero Δ state update (item 16) that would reinitialize the covariance matrix and hopefully bring the ratio <1.

If only one TACAN is locked on and MCC determines that they would like to update NAV from a single TACAN, the crew primes select by deselecting the other two TACAN's (breaks the two-lock requirement).

For the no-lock case - If there has been no lock by VREL = 5500 ft/s, MCC will have the crew select a different TACAN channel. If there is still no TACAN lockon, the crew may select the lower antennas (auto antenna selection may have failed).

No COMM case - If there has been no COMM by VREL = 6000 ft/s and the TACAN ratio is <1, the crew puts the TACAN A-I-F to 'AUTO.'

If the ratio is >1, the crew has to do some troubleshooting to determine whether the problem is with the TACAN's or in the NAV state. First check IMU status. If the IMU's are at the two level and/or they required several updates prior to entry, the crew might suspect the onboard NAV. Also observe the TACAN AZ and RNG behavior on the HSD and HSI using the HSI SELECT SOURCE switches. If it is erratic (best observed in the absolute mode), the crew will suspect the TACAN's. Finally, select the other TACAN station at the landing site and if the ratio decreased to <1, then the groundstation was bad. If the ratio stayed >1 and the TACAN data are steady with at least two LRU's locked ON, then the NAV state is probably bad. After troubleshooting, if the TACAN is determined to be bad, the crew places the A-I-F to AUTO and lets RM inhibit the bad TACAN data (if the TACAN later becomes good, the data automatically are taken into NAV). If the NAV state is determined to be bad and no TACAN processing has taken place, the crew will then 'FORCE' the data (item 21). If this was not the first acquisition (i.e., TACAN A-I-F was in AUTO and NAV processing of TACAN data had occurred), then the crew would open up the covariance matrix by doing a zero Δ state update that would reduce the ratio to <1 and allow processing.

For the no COMM, one TACAN lockon case, the crew would wait until VREL = 5500 ft/s before they prime select. This allows the maximum time for two TACAN lockon but still gets the NAV state updated by a single TACAN before the critical FCS Mach region.

| <u>EVENT</u>  | <u>CUE</u>            | <u>DISPLAY</u> |
|---|-----------------------|----------------|
| <u>Earliest Opportunity for<br/>MCC State Vector Update</u> | S-band communications | HSD            |
| EIT = 20:38 (min:s)   |                       |                |
| VREL = $6.5 \times 10^3$ (ft/s)                             |                       |                |
| H = $142 \times 10^3$ (ft)                                  |                       |                |
| R = 190 (n. mi.)  |                       |                |

### CREW ACTION

Awareness

### DISCUSSION

Upon acquisition of the shuttle by at least two stateside radar tracking sources, the ground navigation state vector propagation filter is declared GO. The propagated ground state (position and velocity components) is time-correlated and compared to the onboard navigation state vector (acquired via telemetry) to assess the deltas. If the deltas exceed flight rule limits and the ground filter is still GO, a delta NAV state vector is prepared to correct the onboard state.

Given COMM, the crew is informed when a delta NAV state vector correction is required. Prior to preparing the delta state command, the crew must take all external NAV sensors (excluding MLS) to inhibit. This is done so that the MCC delta state processor may propagate both the onboard and the ground state vector out to a specified time in the future (30 seconds) without sensors contributing inputs to the onboard state which are not modeled by the ground. A delta state between the ground and onboard vector is then built to reflect what the deltas are at that future time. The theory is that the delta state gets onboard at about the same time for which the deltas were computed.

A second crew action is to take CSS prior to receiving the delta state. This eliminates any transients that could occur in AUTO due to the sudden change in the NAV state.

With the delta state command now prepared and the crew in CSS, the MCC uplinks the command directly to the software if possible. If uplink capability is not available, the MCC can read the delta state values to the crew for manual input into the HSD.

A second delta state capability is available to the MCC that allows only the position components of the onboard vector to be corrected. This position only delta state does not require the crew to inhibit sensors, and CSS is necessary only below Mach 5. This update is less complex for both the crew and the MCC, since the ground delta state processor need not deal with velocity differences; however, the cases are few and far between in which the onboard position vector requires correction and the velocity vector does not.

EVENTCUEDISPLAYRudder Active

M = 5.0

SPI, VERT SIT

EIT = 21:52 (min:s)  
VREL =  $5.0 \times 10^3$  (ft/s)  
H =  $122 \times 10^3$  (ft)  
R = 141 (n. mi.)

CREW ACTION

Monitor SPI and VERT SIT to check the rudder active

DISCUSSION

At Mach 5.0, the rudder becomes active for control and trim. The crew can monitor the rudder on the SPI, VERT SIT, or GNC SYS SUMM 1 display. Once the rudder becomes active, aileron trim and rudder trim should be monitored on the VERT SIT display. (The SPI should not be used, since it shows both trim and command positions.) Should the aileron trim be in excess of  $1^\circ$  with the rudder active, the crew should enable panel trim and use the roll panel trim to reduce aileron trim to less than  $1^\circ$ . This allows the rudder to do most of the lateral/directional trim and frees the aileron for control.

| <u>EVENT</u>                    | <u>CUE</u>    | <u>DISPLAY</u> |
|---------------------------------|---------------|----------------|
| <u>Deploy ADS Probes</u>        | V = 5000 ft/s | AMI            |
| EIT = 21:52 (min:s)             |               |                |
| VREL = $5.0 \times 10^3$ (ft/s) |               |                |
| H = $122 \times 10^3$ (ft)      |               |                |
| R = 141 (n. mi.)                |               |                |

CREW ACTION

AIR DATA PROBE (two) - 'Deploy'

DISCUSSION

The ADS probes are deployed at VREL = 5000 ft/s by crew actuation of the two air data probe switches on panel C3. A probe can be extended by one motor only with the time needed to do so doubled from 15 to 30 seconds. The static pressure ports on each probe are used to obtain pressure altitude; the total pressure port is used to obtain dynamic pressure and Mach number, and the upper and lower pressure ports are used to determine orbiter angle of attack.

The ADS probe heaters are used if flight through visible moisture is anticipated.

The OVERRIDE display is called up by the pilot on CRT 2 after ADS deployment. The display is used to monitor the following ADTA-derived data: Altitude (ft),  $\alpha$  (deg), and Mach number. The display is used to give the crew the capability to deselect or reselect an ADTA to resolve an RM dilemma or to force RM to consider a previously deselected LRU. The display can also be used to determine if a probe is deployed or not. For example, if a probe is not deployed,  $\alpha$  and M data are zero.

| <u>EVENT</u>                    | <u>CUE</u> | <u>DISPLAY</u> |
|---------------------------------|------------|----------------|
| <u>FCS Roll/Yaw Phasing</u>     | M = 5.0    | AMI            |
| EIT = 21:52 (min:s)             |            |                |
| VREL = $5.0 \times 10^3$ (ft/s) |            |                |
| H = $122 \times 10^3$ (ft)      |            |                |
| R = 141 (n. mi.)                |            |                |

### CREW ACTION

Monitor rudder deflection for trim on CRT display and rudder responding to FCS maneuver commands on SPI

### DISCUSSION

The Mach 5.0 to 2.0 regime is critical for vehicle stability. The airflow is changing from a Newtonian flow to a more conventional flow, and the FCS is most sensitive in this region to aerovariations. Reduction of surface effectiveness due to aeroelasticity is most pronounced in the Mach 2.0 region, particularly at high dynamic pressure. Pitch trim deflections must be maintained to ensure sufficient lateral control surface effectiveness with aerovariations. Off-nominal trim positions, a slow body flap drive rate, yaw jet failures, and angle-of-attack errors in conjunction with aerovariations are the primary factors that may render control extremely marginal in this regime.

At Mach 3.8 a gain in the roll channel, scheduled with Mach number, transitions the ailerons from primarily yaw inducing and  $\beta$  damping devices to more conventional roll control effectors. As Mach decreases, ailerons become more effective in roll, with the associated yawing moment becoming proverse near Mach 1.5. The transition of roll control methods is normally phased between Mach 3.8 and Mach 1.0.

To reduce the dependence on yaw jets for stability, the FCS generates rudder commands at Mach 5.0 based on commanded roll rate and corresponding yaw rate, the yaw rate required for turn coordination and lateral acceleration feedback to control  $\beta$ . (Maximum rudder trim deflection is  $\pm 6^\circ$ .) The maximum rudder deflection rate is  $\pm 14$  deg/sec without hydraulic system failures or excessive hinge moments. In response to maneuver commands, the maximum rudder deflection is limited in the yaw channel to  $\pm 24.1^\circ$  in flight until WOWLON because of rudder/speedbrake-hinge interference with large rudder and small speedbrake deflections. At WOWLON, the rudder maximum deflection limit is increased to  $\pm 27.1^\circ$ , as the speedbrake should procedurally be opening to 100 percent. A basic ground rule assumes that the rudder effectiveness derivatives ( $c_{l\delta_y}$  and  $c_{n\delta_y}$ ) never change sign, although aerovariations may cause them to diminish to near zero.

The pilot must perform all roll trimming manually below Mach 1.25 via the panel trim switch if in CSS ROLL/YAW. Below Mach 1.25, the forward loop aileron command is integrated through an automatic trim loop if in AUTO ROLL/YAW. No automatic aileron trim is provided below Mach 1.25 if in CSS ROLL/YAW. If manual trim is not accomplished, achievable roll rates and damping may be diminished in the presence of some aerovariation cases.

In the event of a PASS to BFS switchover, the aileron and rudder trim integrators are reinitialized to zero. This may result in a moderate roll transient until appropriate RHC and trim commands can be applied. The following procedures should minimize both vehicle upsets and RCS fuel expended during the subsequent automatic retrimming.

A. BFS engagements in nonmaneuvering flight

Manually trim aileron to last remembered value. If uncertain of aileron trim prior to BFS engagement, manually keep trim 'away from yaw jet lights' until activity diminishes.

B. BFS engagements during rolling maneuver above Mach 5.0

Apply RHC lateral input, as required, to reestablish roll rate. If certain of previous aileron trim, manually set trim to preengagement value. If uncertain of previous trim, do nothing until rolling maneuver is completed, unless

- RCS fuel considerations do not allow luxury of an extra 100 lb of fuel to retrim during the maneuver. In this case, manually trim 'away from the yaw jet light' to diminish its activity.
- Unable to reestablish an adequate roll rate. In this case, trim away from the desired direction of roll. Confirm that this is in the same direction as trimming 'away from the yaw jet lights.'

C. BFS engagements during rolling maneuvers below Mach 5.0

Allow rudder trim to take care of the out-of-trim transient. Yaw jet activity will diminish considerably when the trim condition is approached, assuming the bank attitude has been stabilized. Monitor aileron and rudder trim.



| <u>EVENT</u>                    | <u>CUE</u> | <u>DISPLAY</u> |
|---------------------------------|------------|----------------|
| <u>Excessive H Avoidance</u>    | M = 4.0    | AVVI           |
| EIT = 22:43 (min:s)             |            |                |
| VREL = $4.0 \times 10^3$ (ft/s) |            |                |
| H = $107 \times 10^3$ (ft)      |            |                |
| R = 104 (n. mi.)                |            |                |

CREW ACTION

Monitor AVVI

DISCUSSION

Sink rates in excess of -486 ft/s should be avoided below 100,000 ft so that adequate fuselage venting may occur. Venting of the orbiter cavities to accommodate the rapid differential pressure rise may not be fast enough at an H of -486 ft/s to prevent structural failure. The crew procedure would be to fly R/Y - CSS and shallow vehicle bank angle to reduce sink rate, then R/Y - AUTO.

| <u>EVENT</u>                          | <u>CUE</u>   | <u>DISPLAY</u>                    |
|---------------------------------------|--------------|-----------------------------------|
| <u>ADTA Data Into G&amp;C and NAV</u> | $M \leq 3.5$ | AMI, AVVI<br>SPEC 051<br>SPEC 050 |
| EIT = 23:05 (min:s)                   |              |                                   |
| VREL = $3.5 \times 10^3$ (ft/s)       |              |                                   |
| H = $102 \times 10^3$ (ft)            |              |                                   |
| R = 91 (n. mi.)                       |              |                                   |

CREW ACTION

Monitor ADS DATA upon MCC call  
 Incorporate ADTA-H (Item 25, SPEC 050) and ADTA-G&C (Item 28)

DISCUSSION

At EI - 5 when the crew PRO's into MM 304, ADTA-H and ADTA to G&C comes up in INHIBIT. MCC monitors the ADTA data after the probes are fully deployed at Mach 5.0. If the data look good, MCC has the crew put ADTA-H and ADTA to G&C into AUTO before Mach 2.5, allowing barometric altitude to update the NAV and ADS parameters to be used by G&C. In any case, ADTA data do not update NAV or GNC until Mach 2.5. DRAG-H will continue to update NAV until Mach 2.5. If the ADTA data degrade the NAV state, the MCC advises the crew to leave ADTA in INHIBIT. In the no COMM case, the crew determines whether the data look good or not (via SPEC 51) and if the ratio is less than 1, select AUTO. If the ratio is greater than 1 and TACAN data have been satisfactory, they may leave ADTA in INHIBIT. If there has been no TACAN updating and the ADTA data appear erratic, the crew selects AUTO and lets the RM system perform its data edit function. If the ADTA data are steady, they should select FORCE. After the ratio has become less than 1, select AUTO.

Table 5-IV. ADS parameters used by G&amp;C

| Parameter                   | Use   |
|-----------------------------|---|
| Used by flight control      |   |
| Angle of attack, $\alpha$   | Compute stability axis rates for lateral channel<br>Lateral axis turn coordination                                |
| Dynamic pressure, $\bar{q}$ | Gain scheduling for all channels  |
| Mach number (M)             | Gain scheduling for all channels<br>Switching logic to inhibit yaw jets   |
| True airspeed, TAS          | Lateral axis turn coordination terms<br>Longitudinal axis gain on Nz command                                      |
| Used by guidance            |   |
| $\bar{q}$                   | TAEM normal acceleration limits<br>TAEM speedbrake control  |
| M                           | TAEM bank angle command limits<br>Initiation of TAEM active speedbrake modulation                                 |
| TAS                         | TAEM S-turn gain compensation<br>Autoland acceleration command calculation<br>during flare to shallow glide slope |
| EAS                         | A/L speedbrake control  |

The preceding ADS parameters are automatically input into G&C, provided

- A probe is deployed.
- VREL < 2500 ft/s.
- No dilemma exists.
- A-I-F is in either AUTO or FORCE (FORCE <2500 ft/s)

Pressure altitude (ADTA-H) is used by NAV provided that

- A probe is deployed.
- No dilemma exists.
- The orbiter is not in Mach jump region ( $1.1 \leq M \leq 1.6$ ).
- A-I-F is in 'AUTO' with ratio <1 and VREL <2500 ft/s or A-I-F = Force and VREL <2500 ft/s.

After ADS probe deployment at VREL = 5000 ft/s, the 'L' and 'R' positions of the air data switch display ADS probe-sensed parameters on the AMI and AVVI, with the exception that Alt Accel ( $\dot{H}$ ) on the AVVI and 'ACCEL' on the AMI always displays NAV data. This allows the crew to check good deployment of the probes by moving the ADS switch to 'R,' then 'L.' In the event of an ADTA failure or dilemma, the OVERRIDE display (SPEC 51) can be used to determine

actual ADTA output. This output can be used to determine which appropriate reconfiguration option should be executed.

As the probes go subsonic, measured static pressure error is approximately 50 percent. If this static pressure were used in the ADS SOP, an altitude error of approximately 17 percent and Mach error of approximately 25 percent would result. A Mach jump region ( $1.1 \leq M \leq 1.6$ ) has been set up to ensure coverage of this phenomenon. During flight through this Mach jump region, the FCS and guidance continue to use data from total pressure for  $\bar{q}$  and M, and upper and lower pressure for angle of attack. Measured static pressure from the probes is not used as a primary input to the air data SOP in the Mach jump region; instead, a static pressure estimated from NAV altitude is used in the air data SOP for computation of parameters used by the FCS and guidance. NAV does not process ADTA-H in the Mach jump region.

Should the ADS data be bad or a dilemma exist, the FCS uses default  $\bar{q}$  and  $\alpha$  data, and NAVDAD will provide EAS, true airspeed (TAS), and M. Guidance continues to use the  $\bar{q}$  from NAVDAD for speedbrake commands in this case. A summary depicting the conditions under which the various air data sets (navigation derived, probe sensed, Mach jump, and default) can be invoked is provided in table 5-V. For the cases in which the output states to 'FREEZE AIR DATA,' this means that the output remains unchanged from its previous cycle.

**Table 5-V. Air data moding and outputs**

| (a) ADTA QBC |                      |                         |                | (b) ADTA H       |                |                |   |
|--------------|----------------------|-------------------------|----------------|------------------|----------------|----------------|---|
| MACH REGION  | MODING CONDITION     |                         | ADTA HP STATUS | MODING CONDITION |                | ADTA HP STATUS | OUTPUT TO NAVIGATION (NPC)                    |
|              | PROBE HP STATUS      | HORIZ SIT "ADTA TO QBC" |                | PROBE HP STATUS  | ADTA HP STATUS |                |   |
| NOMINAL      | ONE OR BOTH DEPLOYED | INH                     | N/A            | D.K.             | D.K.           | D.K.           | AIR DATA DERIVED FROM NAVIGATION              |
|              |                      |                         |                |                  |                |                | AIR DATA DERIVED FROM PROBE SENSED PRESSURES  |
|              |                      |                         |                |                  |                |                | AIR DATA DERIVED FROM MACH JUMP PRESSURES     |
|              |                      |                         |                |                  |                |                | AIR DATA DERIVED FROM PROBE SENSED PRESSURES  |
| FAILURE      | ONE OR BOTH DEPLOYED | AUT/FOR                 | N/A            | D.K.             | D.K.           | D.K.           | DC FAILURE OR DILEMMA                         |
|              |                      |                         |                |                  |                |                | AIR DATA DERIVED FROM NAVIGATION              |
|              |                      |                         |                |                  |                |                | DC FAILURE                                    |
|              |                      |                         |                |                  |                |                | FREEZE AIR DATA BASED ON MACH JUMP PROCESSING |
|              |                      |                         |                |                  |                |                | DILEMMA                                       |
| DC FAILURE   |                      |                         |                |                  |                |                |   |
| CREW         | BOTH NOT DEPLOYED    | INH                     | N/A            | D.K.             | D.K.           | D.K.           | AIR DATA DERIVED FROM NAVIGATION              |
|              |                      |                         |                |                  |                |                | DEFAULT AIR DATA AND DEFAULT FLAG TO GUIDANCE |
| CREW OR HP   | BOTH NOT DEPLOYED    | N/A                     | N/A            | D.K.             | D.K.           | D.K.           | AIR DATA DERIVED FROM NAVIGATION              |
|              |                      |                         |                |                  |                |                | DEFAULT AIR DATA AND DEFAULT FLAG TO GUIDANCE |

| MACH REGION | MODING CONDITION     |                         | ADTA HP STATUS | MODING CONDITION |                | ADTA HP STATUS | OUTPUT TO NAVIGATION (NPC)                    |
|-------------|----------------------|-------------------------|----------------|------------------|----------------|----------------|---|
|             | PROBE HP STATUS      | HORIZ SIT "ADTA TO QBC" |                | PROBE HP STATUS  | ADTA HP STATUS |                |   |
| NOMINAL     | ONE OR BOTH DEPLOYED | INH                     | N/A            | D.K.             | D.K.           | D.K.           | AIR DATA DERIVED FROM NAVIGATION              |
|             |                      |                         |                |                  |                |                | AIR DATA DERIVED FROM PROBE SENSED PRESSURES  |
|             |                      |                         |                |                  |                |                | AIR DATA DERIVED FROM MACH JUMP PRESSURES     |
|             |                      |                         |                |                  |                |                | AIR DATA DERIVED FROM PROBE SENSED PRESSURES  |
| FAILURE     | ONE OR BOTH DEPLOYED | AUT/FOR                 | N/A            | D.K.             | D.K.           | D.K.           | DC FAILURE OR DILEMMA                         |
|             |                      |                         |                |                  |                |                | AIR DATA DERIVED FROM NAVIGATION              |
|             |                      |                         |                |                  |                |                | DC FAILURE                                    |
|             |                      |                         |                |                  |                |                | FREEZE AIR DATA BASED ON MACH JUMP PROCESSING |
|             |                      |                         |                |                  |                |                | DILEMMA                                       |
| DC FAILURE  |                      |                         |                |                  |                |                |   |
| CREW        | BOTH NOT DEPLOYED    | INH                     | N/A            | D.K.             | D.K.           | D.K.           | AIR DATA DERIVED FROM NAVIGATION              |
|             |                      |                         |                |                  |                |                | DEFAULT AIR DATA AND DEFAULT FLAG TO GUIDANCE |
| CREW OR HP  | BOTH NOT DEPLOYED    | N/A                     | N/A            | D.K.             | D.K.           | D.K.           | AIR DATA DERIVED FROM NAVIGATION              |
|             |                      |                         |                |                  |                |                | DEFAULT AIR DATA AND DEFAULT FLAG TO GUIDANCE |

- NOTES**
1. ONLY CREW CAN INVOKE AUT FOR COMMAND. SOFTWARE IS INITIALIZED TO INH
  2. IF BOTH PROBES FAIL AFTER AT LEAST ONE PROBE WAS DEPLOYED, A DILEMMA IS DECLARED
  3. THREE CONSECUTIVE DO FAILURES WILL RESULT IN A DILEMMA
  4. IF A PROBE WAS NEVER DEPLOYED, NPC IS INITIALIZED TO 30,000 FT WITH AN ALT DO FAILURE INDICATION
  5. ADTA AIR DATA CALCULATIONS LIMITED AT M = 3.5
  6. *P* static FBIR NOT PERFORMED DURING MACH JUMP

050V

The sources of AMI and AVVI display data for the three positions of the air data switch are summarized in table 5-VI.

**Table 5-VI. Display data sources**

**(a) AMI**

| Parameter                            | $\alpha$         |     | M/vel            |     | EAS              |     | ACCEL <sup>a</sup> |     |
|--------------------------------------|------------------|-----|------------------|-----|------------------|-----|--------------------|-----|
|                                      | NAV <sup>b</sup> | L/R | NAV <sup>b</sup> | L/R | NAV <sup>b</sup> | L/R | NAV <sup>b</sup>   | L/R |
| Switch position                      |                  |     |                  |     |                  |     |                    |     |
| Mach region                          |                  |     |                  |     |                  |     |                    |     |
| $M \geq 2.5$                         | N                | ADS | N                | ADS | N                | ADS | N                  | N   |
| $2.5 > M \geq 1.5$                   | ADS              | ADS | ADS              | ADS | ADS              | ADS | --                 | --  |
| $1.1 \leq M \leq 1.6$<br>(Mach jump) | ADS              | ADS | ADS <sup>c</sup> | ADS | ADS <sup>c</sup> | ADS | --                 | --  |
| $1.5 > M \geq 0.2$                   | ADS              | ADS | ADS              | ADS | ADS              | ADS | --                 | --  |

<sup>a</sup>During MM 305, ACCEL is driven to zero.

<sup>b</sup>Whenever either air data source select switch is in the NAV position, the air data parameters displayed on the AMI display reflect whatever air data parameters (NAV-derived or ADS) are being used by G&C.

<sup>c</sup>In the Mach jump region, limited actual  $P_{static}$  is used to calculate Mach and EAS for display.

**(b) AVVI**

| Parameter                            | Altitude rate, $\dot{H}$ |     | Altitude, H |     | Altitude accel, $\ddot{H}$ |     |
|--------------------------------------|--------------------------|-----|-------------|-----|----------------------------|-----|
|                                      | NAV <sup>b</sup>         | L/R | NAV         | L/R | NAV                        | L/R |
| Switch position                      |                          |     |             |     |                            |     |
| Mach region                          |                          |     |             |     |                            |     |
| $3.5 > M \geq 2.5$                   | N                        | ADS | N           | ADS | N                          | N   |
| $2.5 > M \geq 1.5$                   | N                        | ADS | N           | ADS | N                          | N   |
| $1.1 \leq M \leq 1.6$<br>(Mach jump) | N                        | ADS | N           | ADS | N                          | N   |
| $1.5 > M \geq 0.2$                   | N                        | ADS | N           | ADS | N                          | N   |

<sup>b</sup>Whenever either air data source select switch is in the NAV position, the air data parameters displayed on the AMI display reflect whatever air data parameters (NAV-derived or ADS) are being used by G&C.

## Onboard Management of ADS

Onboard management of the ADS is done with the HORIZ SIT display.

| NAV     | RESID     | RATIO | AUT | INH | FOR |
|---------|-----------|-------|-----|-----|-----|
| TAC     | AZ±XX.XX  | X.XS  | 19X | 20X | 21X |
|         | RNG±XX.XX | X.XS  |     |     |     |
| DRAG    | H±XXXXX   | X.XS  | 22X | 23X | 24X |
| ADTA    | H±XXXXX   | X.XS  | 25X | 26X | 27X |
| ADTA TO | G&C       |       | 28X | 29X | 30X |

### G&C switch

**AUTO** - Air data sent to users if probes are deployed and several conditions are satisfied. If conditions are not satisfied, NAVDAD or default parameters are sent to the users.

**INHIBIT** - Inhibits the ADS data and enables either default NAV or NAV-derived data.

**FORCE** - Air data sent to users if probes are deployed and no RM dilemma exists. If RM dilemma exists, NAVDAD or default parameters are sent to users. (NAVDAD if VREL >1500 ft/s, default if VREL <1500 ft/s)

### NAV switch

**AUTO** - Uses air data altitude in filter if probes are deployed, data are good, and NAV edit satisfied.

**INHIBIT** - Inhibits air data altitude from filter.

**FORCE** - Overrides the edit and forces the data to be used to update the state vector if the data are being processed by the NAV filter.

The RESID column contains the residual data value for each component of each data type that is being processed by the NAV filter. The residual is formed in navigation by subtracting the NAV estimate of the data from the selection filter output of the data. It should be noted here that navigation uses the composite data output from the selection filter as inputs to the navigation filter so that no distinctions are made as to the LRU source of the data to the NAV filter. The residual value gives the crew an indication as to how well the data and the NAV estimate of the data agree. However, these data alone cannot identify whether the data or the NAV estimate of the data is in error.

The RATIO column contains the edit ratio computed in navigation as the ratio of the data residual to the maximum allowable residual. If this ratio is less than 1, the residual edit test performed by navigation on the data is passed, and the data subsequently used to update the state vector. If the data fail the residual edit test, the ratio is displayed as a number equal to or larger than 1 and is not used to update the state vector. Thus, the edit ratio and the ratio status indicators give the crew an indication as to whether a particular data type is being

incorporated into the state vector. The residuals and edit ratios are computed by navigation for each NAV cycle and are available to display. A status column to the right of RATIO contains a down arrow (↓) if A-I-F is in AUTO when the parameter has failed the update edit test on three out of four measurements. The down arrow disappears when a certain percentage (I-loaded) of the data points have passed the edit test.

| <u>EVENT</u>                         | <u>CUE</u>                    | <u>DISPLAY</u>                           |
|--------------------------------------|-------------------------------|--|
| <u>Speedbrake Ramp to 65 Percent</u> | M = 3.2<br>Speedbrake<br>ramp | AMI<br>$\delta_{SB}$ SPI<br>GNC SYS SUMM |
| EIT = 23:27 (min:s)                  |                               |  |
| VREL = $3.2 \times 10^3$ (ft/s)      |                               |  |
| H = $96 \times 10^3$ (ft)            |                               |  |
| R = 79 (n. mi.)                      |                               |  |

CREW ACTION

Monitor surface command and deflection on speedbrake SPI

DISCUSSION

AUTO speedbrake commands should begin closing the speedbrake from 81 percent at Mach 3.2 to reach 65 percent at Mach 2.5. Crew awareness of the speedbrake closure is essential since C/W does not announce a failed open speedbrake.

A number of tradeoffs have to be considered for speedbrake deflection in this regime. The trimmed down elevon is still required for adverse yaw ( $-C_{n\delta_A}$ ) in this regime, hence the need for the speedbrake-induced pitch-up moment. Angle of attack has ramped down to about  $20^\circ$  at Mach 4.5, so the vertical tail will be less banked by the forebody. However, with full speedbrake deflection, shock wave formations limit rudder effectiveness. Thus, the speedbrake is pulled in to 65 percent to allow an increase in rudder effectiveness. Maximum speedbrake deflection rates are to be calculated as functions of available fluid flow and are not necessarily constant in the adaptive PRL logic. Finally, as rudder and speedbrake effectiveness increase with decreasing angle of attack and Mach number, so does the capability of the speedbrake to affect the orbiter range potential. Above Mach 1.0, speedbrake deflection does not appreciably affect L/D; it functions primarily for longitudinal trim and directional stability. Below Mach 0.95, TAEM and autoland guidance command the speedbrake for energy control.



| <u>EVENT</u>                        | <u>CUE</u>   | <u>DISPLAY</u>            |
|-------------------------------------|--------------|---------------------------|
| <u>Elevon Trim 0°</u>               | M = 3.0      | AMI<br>δ <sub>E</sub> SPI |
| EIT = 23:39 (min:s)                 | GNC SYS SUMM |                           |
| VREL = 3.0 x 10 <sup>3</sup> (ft/s) |              |                           |
| H = 93 x 10 <sup>3</sup> (ft)       |              |                           |
| R = 73 (n. mi.)                     |              |                           |

### CREW ACTION

Verify elevon trim ramping up to 0°  
Monitor vehicle dynamic performance

- Body and stability rates on ADI
- Elevon, aileron, body flap, and speedbrake trim positions
- Yaw RCS activity
- Dynamic pressure/airspeed
- Normal acceleration
- Angle of attack
- Scaled  $A_y$

### DISCUSSION

The representative elevon trim schedule maintains 5° of trim until Mach 3.0 and then ramps to 0° at Mach 2.0 to improve performance with aerovariations. The elevons are also moved up to take advantage of aileron-induced proverse yaw in roll maneuvers and to allow a higher body flap trim position that relieves hinge moments. It is also in this region that air data parameters must be incorporated into flight control and guidance. Air data errors in  $\bar{q}$  are sensitive to flight control because many FCS gains are scheduled for surface commands as functions of  $\bar{q}$ . These concerns emphasize the importance of the elevons following the trim schedule in this region.

| <u>EVENT</u>                    | <u>CUE</u> | <u>DISPLAY</u> |
|---------------------------------|------------|----------------|
| <u>HUD Power On</u>             | M = 2.7    | AMI<br>HUD     |
| EIT = 23:54 (min:s)             |            |                |
| VREL = $2.7 \times 10^3$ (ft/s) |            |                |
| H = $89 \times 10^3$ (ft)       |            |                |
| R = 66 (n. mi.)                 |            |                |

### CREW ACTION

Power up the L and R HUD

### DISCUSSION

The HUD power switches, located adjacent to each PDU, provide power (MAIN A - CDR and MAIN C - PLT) to operate the HUD's through the control buses (CNTL AB2 - CDR and CNTL BC1 - PLT).

A three-position MODE switch is located on the front of the PDU. The switch positions are up for TEST, center for NORM, and down for declutter (DCLT). The DCLT position is a momentary, spring-loaded position.

In the NORM position, automatic sequencing of formats and symbology is provided. The TEST position forces up a test display, consisting of a rotating pattern of lines and circles, for a period of 5 seconds. At the end of the 5-second display, the test lines and circles remain stationary in the field of view (FOV) as long as the MODE switch is in the TEST position (figure 5-24). Repositioning the switch to NORM resumes the interrupted format. Selection of the momentary DCLT position initiates a symbol blanking routine described in figure 5-25.

A three-position MAN DAY/AUTO/NIGHT switch provides the capability to select manual brightness control or automatic brightness control. With manual control (day or night), symbology intensity is adjusted with the rotary BRT control adjacent to the switch. With AUTO, the rotary BRT control selects a contrast level, which is then automatically maintained relative to the ambient light level.

The HUD format, as shown in figure 5-26, automatically displays at TAEM interface (MM 305 and MM 603). The format can also be changed by item entry on the SPEC 50 display (item 37 for the CDR; item 38 for the PLT).

There are four annunciator windows displaying cues/alerts within the HUD/FOV. These are shown in figure 5-27. Window 1 is reserved for landing gear cueing; window 3 displays guidance mode. Windows 2 and 4 display three alerts to the crew.

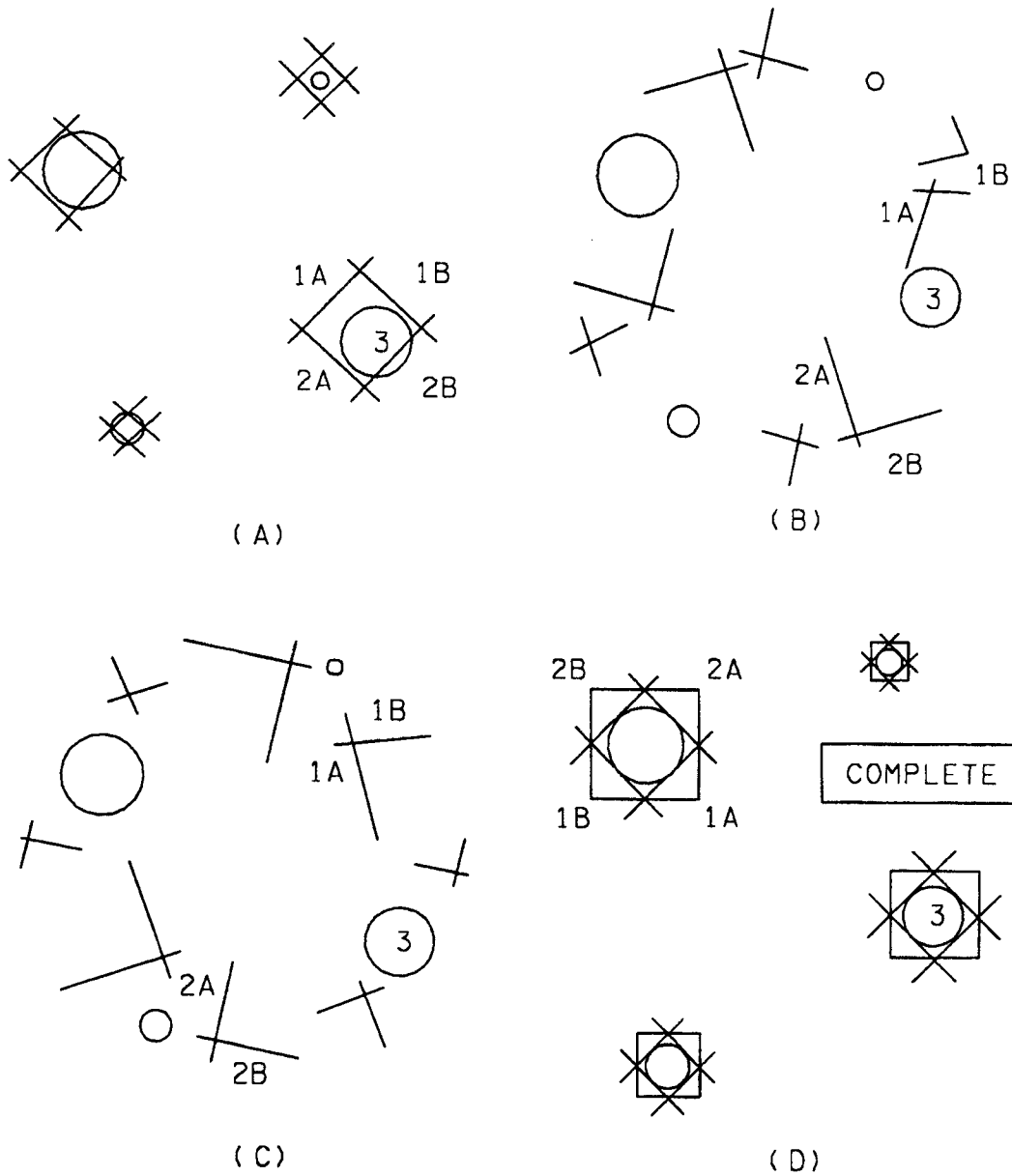

NOTE: Dashed lines and labels are not on actual display. They are shown here to help one follow the movement of the symbols.

115420525. ART; 1

**Figure 5-24. Test display (automatic sequencing)**

APPROACH AND LAND DISPLAY  
(DECLUTTER LEVEL 1)

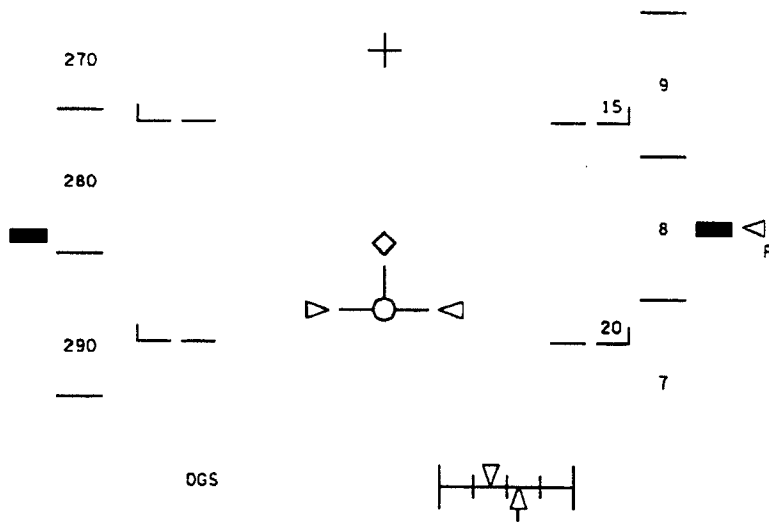

APPROACH AND LAND DISPLAY  
(DECLUTTER LEVEL 2)

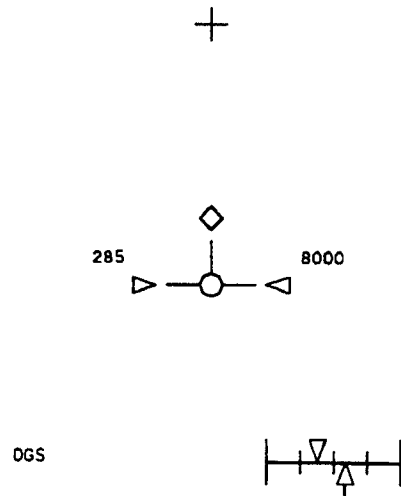

NOTE: HORIZON IS DISPLAYED WHEN  
IN THE HUD FOV.

APPROACH AND LAND DISPLAY  
(DECLUTTER LEVEL 3)



115420026. ART, 1

**Figure 5-25. Approach and landing display (declutter levels)**

HUD Symbology Description

The HUD format in figure 5-26 automatically displays if the HUD power switch is on. The format can also be changed by item entry on the SPEC 50 display (item 37 for the CDR HUD; item 38 for the PLT HUD). Detailed explanations of each symbol are on the following pages.

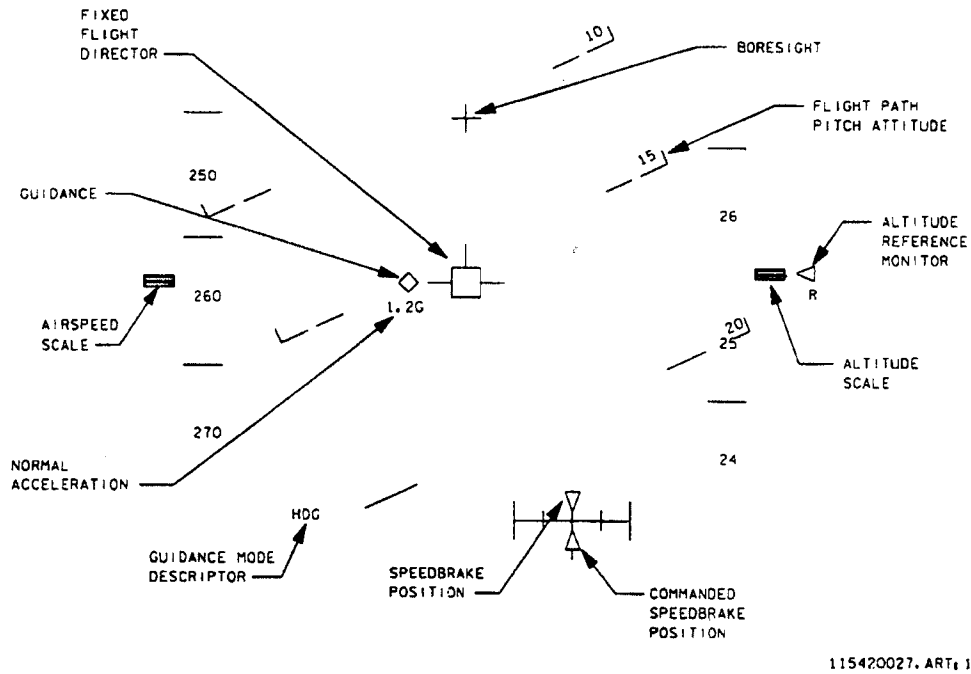

**Figure 5-26. Approach and land display (TAEM heading phase)**

HUD CUE/ALERT

COMMENT

CSS  
MLSNV  
B/F

CSS control in all axes  
Navigation is not processing MLS data  
Body flap is not in trail

A maximum of two mnemonics can be displayed in window 2 at any time. CSS and MLSNV have priority. If the body flap is occupying the second field in window 2 and the CSS or MLSNV cue/alert is triggered with the window full, then it is put on hold to make room for the priority cue/alert.

A cue/alert that persists beyond the 5-second time in window 2 is transferred to window 4.

Note: All mnemonics appearing in window 2 flash; all mnemonics in window 4 are steady.

Declutter

The HUD declutter switch selectively removes different symbols from the display. Successive selections of the declutter mode (maximum of three) serially removes display elements in accordance with the following programmed logic:

- The first activation removes the runway symbology.
- The second activation removes the airspeed and altitude tapes (replacing them with digital values) and the horizon/pitch attitude scales, but leaves the horizon line when within FOV.
- The third declutter level removes all symbology except for the boresight.
- A fourth declutter attempt returns the HUD to its original form with all symbols displayed.

Cues/Alerts

The cues/alerts are displayed in three different 'windows' with a fourth window serving as a summary line. Each window is a reserved field for the cue/alert; however, there are no visible lines defining the window and if no mnemonic is being displayed, the field is blank. The windows are numbered 1 through 4. Their relative positions in the display are shown in figure 5-27.

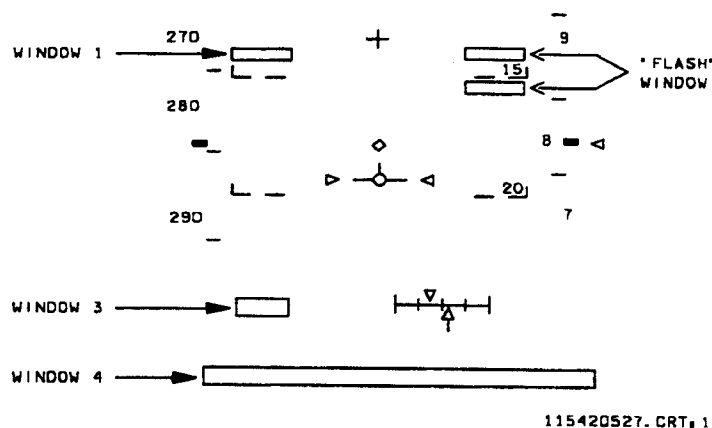

115420527. CRT, 1

**Figure 5-27. Cue/alert windows**

| <u>EVENT</u>                    | <u>CUE</u> | <u>DISPLAY</u>  |
|---------------------------------|------------|-----------------|
| <u>TAEM Interface</u>           | M = 2.5    | AMI<br>VERT SIT |
| EIT = 24:09 (min:s)             | HUD        |                 |
| VREL = $2.5 \times 10^3$ (ft/s) |            |                 |
| H = $85 \times 10^3$ (ft)       |            |                 |
| R = 60 (n. mi.)                 |            |                 |

### CREW ACTION

Monitor transition

### DISCUSSION

Transition to MM 305 from MM 304 is automatic when TAEM interface is achieved (VREL <2500 ft/s). TAEM can also be called up by OPS 305 PRO. The following GN&C software modules are initiated at transition to MM 305:

- TAEM user parameter processing, which propagates the state vector forward as well as providing specifically computed parameters for guidance, flight control, displays, and other users
- VERT SIT display processing, as described in section 5.1.4.7
- MLS operating program, which determines the elevation angle, azimuth, and range of the MLS ground transmitters and processes the raw data to other users
- MLS fault detection
- TAEM guidance
- HUD approach and land format processing

The following GN&C software modules are terminated at TAEM transition:

- MM 305
  - Entry guidance
  - Entry user parameter processing
  - Entry display processing

The other GN&C software modules listed for MM 304 remain in operation for MM 305.

TAEM guidance provides for automatic control as follows:

- Crossrange errors controlled by bank angle commands
- Vertical flight path errors controlled by normal acceleration commands ( $N_z$ )
- Energy management in TAEM accomplished through various combinations of the following:

- S-turns
- Energy dump maneuver
- Pull-up maneuver
- Nominal to minimum entry point HAC location
- Overhead to straight-in approach
- Speedbrake modulation <0.9 M
- HAC spiral radius adjustment

TAEM guidance controls glide range by tracking and flying three profiles simultaneously: altitude versus range, dynamic pressure versus range, and specific energy versus range. The outputs of TAEM guidance,  $N_z$  command, roll command, and speedbrake command are functions of errors from the above profiles. Therefore, the validity of these commands depends upon the accuracy of NAV and air data; i.e., guidance is only as good as the NAV state. In addition, range to the runway can be varied by moving the HAC, using items 6 and 7 on SPEC 50 display. Item 6 allows selection of 'OVHD' (overhead approach) or 'STRT' (straight-in approach). This item simply allows the pilot to put the HAC on either side of the runway centerline. Item 7 allows the pilot to move the HAC closer to the approach end of the runway. The choices for this item are NEP (nominal entry HAC position) or MEP (minimum entry HAC position). These approach modes are discussed later.

The TAEM guidance scheme is broken up into phases. The S-turn phase dissipates energy by turning away from the HAC until the energy state is sufficiently close to normal. This phase is normally bypassed and is discussed in more detail later. TAEM is initialized at Mach 2.5 in the acquisition phase, which turns the vehicle toward the HAC tangent point (WP 1). The heading alignment phase is initialized at the HAC tangency point and follows the HAC until the orbiter is near the runway centerline where the prefinal phase leaves the HAC and aligns the orbiter on the runway centerline. Prefinal transitions to A/L guidance when the A/L tolerances are met and altitude is below 10,000 ft, or under any conditions when altitude is less than 5000 ft.

### Output Commands

$N_z$  Command - In the pitch channel, normal acceleration commands ( $\Delta N_z$  commands) are received from TAEM guidance on initialization at a VREL of 2500 ft/s. The commands in g are converted into the appropriate body pitch rate commands. Although AUTO guidance commands are limited, the pilot in CSS may drive the angle of attack and normal acceleration, as dynamic pressure builds, to the limits of controllability and structural integrity.

The normal acceleration command is primarily a function of altitude error and altitude rate error. But, as suggested in the first paragraph, the  $N_z$  command function combines energy and dynamic pressure filters to maintain energy and  $\bar{q}$  profiles as closely as possible. The following is a diagram of the  $N_z$  command logic (figure 5-28).



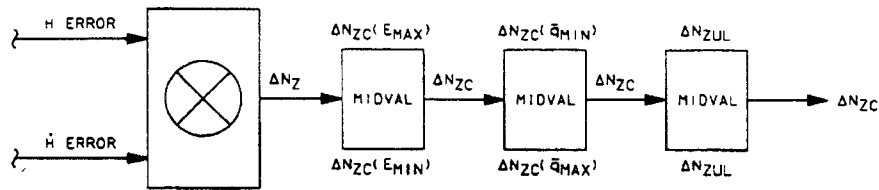

115425290. ART, 1

**Figure 5-28. TAEM DNZ logic**

A  $\Delta N_z$  command is calculated as a function of altitude and altitude rate error.  $\Delta N_z$  command limits are calculated based on minimum and maximum allowable  $\bar{q}$ . The calculated  $\Delta N_z$  command is limited as necessary to fall within these limits. If guidance is not in the prefinal phase, the  $\Delta N_z$  command is then limited, as necessary, so that the upper and lower energy limits are not violated. A third filter is implemented so that the  $\Delta N_z$  command does not exceed  $\pm 0.5g$ .

This scheme works well with accurate air data. However, if the air data is in default (ADTA DILEMMA) and  $M < 1.5$ , the  $\bar{q}$  input to the  $N_z$  command function is a canned function of VREL. Therefore, when air data are not going to guidance, and  $M < 1.5$ , the pilot should be in CSS and fly the theta limits on the VERT SIT display in order to prevent exceeding  $\bar{q}$  limits and a resulting loss of vehicle control.

**Bank Command** - TAEM  $\phi$  command and  $\phi$  limits are phase dependent. In the acquisition phase,  $\phi$  CMD is a function of heading error from the HAC tangency point. The  $\phi$  limit for this phase is  $50^\circ$ . In the heading alignment phase,  $\phi$  CMD is a function of radius error from the HAC, and  $\phi$  limit is  $60^\circ$ . However, if the radius error exceeds 7000 ft, the  $\phi$  CMD logic and limits are the same as for the acquisition phase. If the radius error is  $< 7000$  ft while in the heading alignment phase, then  $\phi$  CMD is always in the direction of the HAC spiral. In other words, the orbiter does not bank right while attempting to fly a left-hand HAC, and vice versa. During the prefinal phase,  $\phi$  CMD is a function of lateral error and lateral error rate from the runway centerline. The  $\phi$  limit is a function of  $\phi$  CMD (figure 5-29).

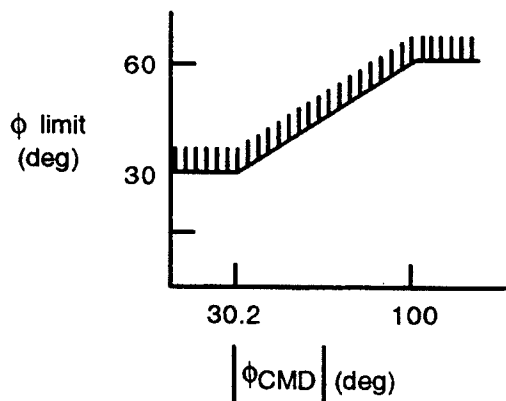

L11542\_013

**Figure 5-29. Prefinal  $\phi$  limit versus  $\phi$  CMD**

If the vehicle is flying supersonic, then the  $\phi$  limit is  $30^\circ$ . The limit is ramped during the transition from supersonic to subsonic (figure 5-30). However, if air data are default, then the supersonic limits are not applicable, and guidance refers to the phase dependent limits.

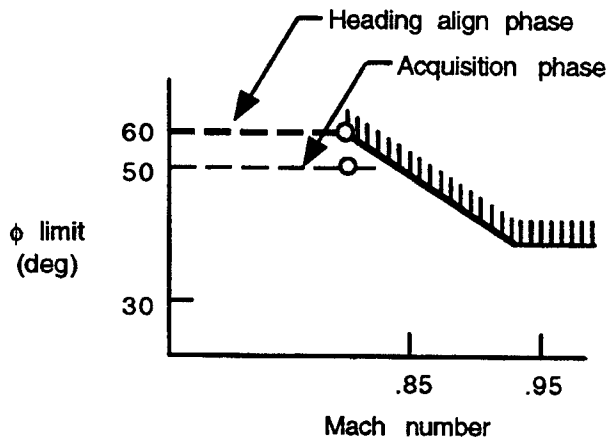

L11542\_002

**Figure 5-30. Transonic limit**

During the S-turn phase,  $\phi$  CMD by guidance is always  $50^\circ$ , subsonic or supersonic in a direction which tends to unwind the HAC. If an S-turn does occur, it is usually in the supersonic regime; the actual bank angle does not exceed the  $30^\circ$  supersonic limit, and the command needles are centered.

**Speedbrake Command** - The speedbrake command follows an I-loaded schedule while in the supersonic flight regime. At MM304 transition the speedbrake is fully closed. The speedbrake is commanded to 81 percent at Mach 10, and 66 percent at Mach 3.2. At Mach 0.95 speedbrake modulation begins. The subsonic speedbrake command is a nominal command plus proportional terms based on energy, energy rate, and dynamic pressure errors. A blending function is used to allow for an altitude dependent, linear transition from an energy and energy rate derived command to a solely dynamic pressure error derived command. From Mach 0.95 to 15,000 ft altitude, the speedbrake command is a function of energy and energy rate. From 15,000 ft to 10,000 ft, dynamic pressure error is also taken into account. Below 10,000 ft, only dynamic pressure error is used to compute the speedbrake command, to provide equivalence

with the A/L speedbrake command. In the S-turn phase, if subsonic, the speedbrake command is set to full open.

Display Modes in TAEM

The TAEM mode is automatically selected to enable the HSI to be used for monitoring TAEM guidance. (The HSI MODE switch determines the display mode either automatically, depending on flight regime, or manually via switch throws.) The HSI function, as described in table 5-VII, is driven by area navigation and does not reflect the spiral logic. The HSI uses a circle with a 15,500-ft radius. In cases where the HAC shrinks, the HSI pointers and range will be in error. However, this should be negligible for the last 180° of the HAC turn angle. The vehicle glide range is controlled by flying nominal altitude versus range and dynamic pressure versus range profiles. These can be interpreted as E/W versus range profiles. The lower left window of the HUD (window 3) displays the appropriate phase descriptor as: S-TRN, ACQ, HDG, and PRFNL for S-turn, acquisition, heading alignment, and prefinal phases, respectively. Using these cues, the crew should be aware of the following guidance limits.

| Phase | N <sub>z</sub> ,g | Bank, deg            |
|-------|-------------------|----------------------|
| ACQ   | ± 0.5g            | 50                   |
| S-TRN | ± 0.5g            | 30 M > 1<br>50 M < 1 |
| HDG   | ± 0.5g            | 60                   |
| PRFNL | +1.5 to -0.75g    | 30                   |

As each phase is flown, the phase name and N<sub>z</sub> may be read on the HUD. Normal acceleration is displayed below and outboard of the left wing of the velocity vector. Leading zeros are displayed when the g is less than unity. The symbol digits flash when the N<sub>z</sub> exceeds the I-loaded limit. This g readout automatically blanks when guidance modes to prefinal phase.

**Table 5-VII. HSI output information in TAEM and A/L modes**  
**HSI output identity**

| Display mode | Primary bearing                                   | Primary miles   | Secondary bearing  | Secondary miles   | Course deviation (CDI)   | Glide slope deviation (GSI)   | Compass card (heading)          |
|--------------|---|---|--|---|--|---|---------------------------------|
| TAEM         | Bearing to WP1 on selected HAC for primary runway | Horizontal distance to WP2 on primary runway via WP1 for EP selected (LSB = 0.1 n. mi.) | Bearing to center of selected HAC for primary runway       | Horizontal distance to center of selected HAC for primary runway (LSB = 0.1 n. mi.)     | Deviation from extended runway centerline (full scale = ±10)   | Deviation from TAEM reference altitude (full scale = ±5000 ft)  | Magnetic heading of body X-axis |
| A/L          | Bearing to WP2 at primary runway                  | Horizontal distance to WP2 on primary runway (LSB = 0.1 n. mi.)                         | Bearing to WP2 at primary runway (same as primary bearing) | Horizontal distance to WP2 on primary runway (same as primary miles) (LSB = 0.1 n. mi.) | Deviation from extended runway centerline (full scale = +2.5°) | Deviation from steep glide path; not computed for altitude less than prescribed value (full scale = ±1000 ft) | Magnetic heading of body X-axis |

EIT = 28:17

| <u>EVENT</u>                 | <u>CUE</u> | <u>DISPLAY</u>  |
|------------------------------|------------|-----------------|
| <u>Fuselage Vents Open</u>   | M = 2.4    | AMI<br>SPEC 051 |
| EIT = 24:20 (min:s)          |            |                 |
| V = $2.4 \times 10^3$ (ft/s) |            |                 |
| H = $83 \times 10^3$ (ft)    |            |                 |
| R = 58 (n. mi.)              |            |                 |

### CREW ACTION

Monitor

### DISCUSSION

Opening of fuselage vents is initiated automatically by the GPC at a velocity of 2400 ft/s, which corresponds to an altitude of 82,000 ft. No cockpit indication is given that the vents have opened and the crew has to rely on the MCC for confirmation that the vents have opened. Door opening time is normally 5 seconds (two motors) or 10 seconds (one motor).

At least 9 of 18 doors should be open for adequate venting. The time from nominal opening at 82,000 to 70,000 ft is 48 seconds, to 58,000 ft is 84 seconds. The MCC advises what action the crew should take if any of the vents fail to open. In the event the MCC confirms that the vents failed to open at the desired time or altitude, the crew can manually command all vent doors open through the use of the VENT DOOR CNTL on the OVERRIDE CRT display.

| <u>EVENT</u>                    | <u>CUE</u> | <u>DISPLAY</u>              |
|---------------------------------|------------|-----------------------------|
| <u>RCS Yaw Jets Deactivated</u> | M = 1.0    | AMI/HUD<br>RCS jet activity |
| EIT = 26:21 (min:s)             | lights     |                             |
| M = 1.0                         |            |                             |
| H = 50.0 x 10 <sup>3</sup> (ft) |            |                             |
| R = 25.1 (n. mi.)               |            |                             |

CREW ACTION

None; crew awareness. No shutoff procedure is used.

DISCUSSION

The entry DAP retains the use of the yaw jets to augment the rudder for directional control down to Mach 1.0. At that velocity, the FCS is reconfigured to cease sending firing commands to the JSL. If the use of the jets is terminated before Mach 1.0, as might occur with NAV errors in M and  $\bar{q}$ , some combinations of aerovariations render roll control very marginal. Loss of control may not occur, but the oscillatory roll rates may temporarily prohibit trajectory ranging control. In these cases, a low  $\bar{q}$  trajectory and wings level at 200 KEAS, tracking toward WP 1 maximizes retaining control and minimizes altitude loss until subsonic, where maneuvering to the runway is improved. Even with jets, roll control may be marginal in the presence of variations, particularly if the vehicle is mistrimmed.

| <u>EVENT</u>                                   | <u>CUE</u> | <u>DISPLAY</u>               |
|--|------------|------------------------------|
| <u>Speedbrake Modulated for Energy Control</u> | M = 0.95   | AMI/HUD<br>VERT SIT 2<br>SPI |
| EIT = 26:27 (min:s)                            |            |                              |
| M = 0.9  |            |                              |
| H ≅ 48 x 10 <sup>3</sup> (ft)                  |            |                              |
| R ≅ 24 (n. mi.)                                |            |                              |

CREW ACTION

Awareness

DISCUSSION

The TAEM guidance subsonic speedbrake command is a nominal command plus proportional terms based on energy, energy rate, and dynamic pressure errors. A blending function is used to allow for an altitude-dependent, linear transition from an energy and energy-rate-derived command to a solely dynamic pressure error derived command. From Mach 0.95 to 15,000 ft altitude, the speedbrake command is a function of energy and energy rate. From 15,000 ft to 10,000 ft, dynamic pressure error is also taken into account. Below 10,000 ft, only dynamic pressure error is used to compute the speedbrake command, to provide equivalence with the A/L speedbrake command. In the S-turn phase, if subsonic, the speedbrake command is set to full open.

The speedbrake command can be monitored by the crew on the HUD, on the VERT SIT display, or on the SPI on panel F7. On both the VERT SIT 1 and 2 displays, the actual and commanded speedbrake positions are displayed in percent.

It is possible for the speedbrake to either fail to open or fail to close. The fail to open can occur at Mach 10 when the speedbrake is commanded from closed to 81 percent. The fail to close can occur at Mach 3.2 or subsonic when the speedbrake is commanded from 81 percent to more closed.

In the speedbrake fail to open scenario, the problem is the lack of drag on the OGS and inner glide slope (IGS). The procedure is to deploy the landing gear once below Mach 0.95. Deployed gear has approximately the same drag as 50 percent speedbrake, which is less drag than usual for the OGS and more drag than usual for the IGS. To avoid a low energy situation while on the IGS, the close-in aim point is selected to achieve a nominal touchdown.

If the speedbrake is stuck open, the orbiter has too much drag for both the OGS and IGS. A normal approach will result in the orbiter landing short. The procedure for a stuck open speedbrake is to fly the HAC approximately one or two dots high on the GSI (2500 to 5000 ft above normal glide slope). The approach to final is done with a 21° OGS (25° if < 220 klbs) to a 4000 ft aim point. The 4000 ft aim point is visualized by the crew as the point halfway between the threshold and the nominal aimpoint at 7500 ft.

The complete stuck speedbrake procedures as follows:

| Stuck speedbrake setting, percent | TAEM                                       | A/L                                      | Aimpoint |
|-----------------------------------|--|--|----------|
| > 60                              | Fly 1-2 dots high on GSI throughout TAEM   | <220 klbs: 25° OGS<br><220 KLBS: 21° OGS | 4000 ft  |
| 40 - 60                           | Auto P,R/Y                                 | Fly needles                              | Close-in |
| 30 - 40                           | Fly 1-2 dots low on GSI Keep EAS < 300 kts | 15° OGS                                  | Close-in |
| < 30                              | Auto P, R/Y<br>At M < 0.95, deploy gear    | Fly needles                              | Close-in |

**HUD PROCEDURES**

The bottom of the HUD FOV has a horizontal scale with two opposing pointers. The upper pointer indicates actual position and the lower arrow indicates speedbrake command (figure 5-31). From Mach 10.0 to Mach 0.9, a speedbrake position difference greater than 20 percent from auto command causes the speedbrake position pointer to flash. At Mach >0.6 and above, the speedbrakes augment lateral stability and they cannot close to less than 15° (AUTO or CSS).

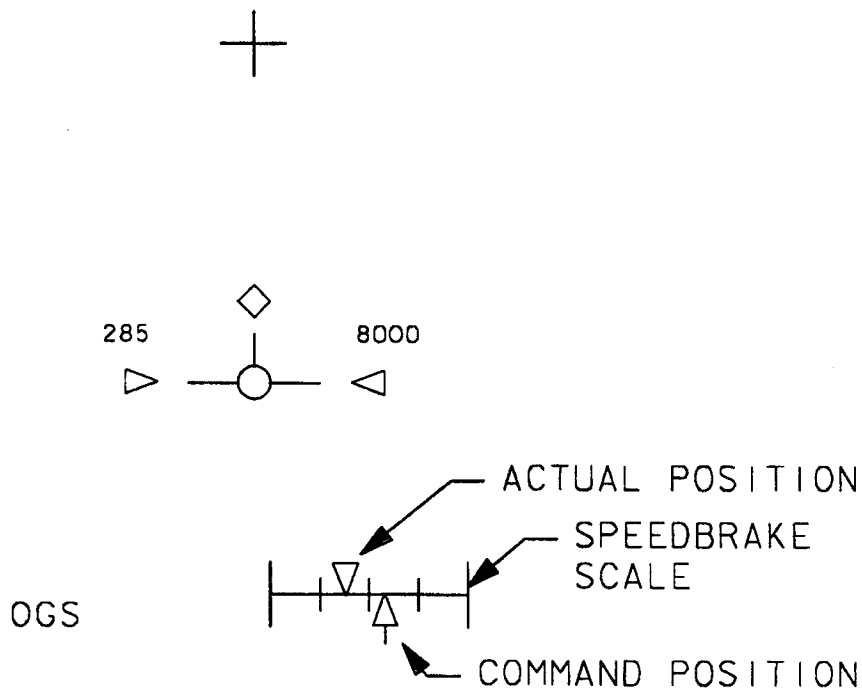

115420531. ART; 1

**Figure 5-31 HUD speedbrake presentation**

| <u>EVENT</u>                            | <u>CUE</u>   | <u>DISPLAY</u>   |
|---|--------------|------------------|
| <u>Elevon Trim Position to +4° Down</u> | M = 0.95     | AMI/HUD<br>δE SP |
| EIT = 26:27 (min:s)                     | GNC SYS SUMM |                  |
| M = 0.95                                |              |                  |
| H = 48.0 x 10 <sup>3</sup> (ft)         |              |                  |
| R = 24.0 (n. mi.)                       |              |                  |

CREW ACTION:

Monitor elevon trim ramp down to +4° and corresponding body flap trim change

DISCUSSION

The elevons are trimmed down in this region to reduce hinge moments. Generally, hinge moments on the inboard elevons exceed outboard elevon hinge moments, principally because the inboard surface area is approximately twice that of the outboard surface. Also, in the  $1.4 < M < 0.9$  region, the inboard hinge moments increase at a faster rate, resulting in positive inboard hinge moments and negative outboard hinge moments. As the elevon trim ramps down, both inboard and outboard moments tend toward zero. As the body flap drives up to maintain pitch trim, its hinge moments decrease toward zero.

The elevon should reach the +4° trim position by Mach 0.9. This slow trim change is partially limited by the slow body flap drive rate to trim in the AUTO BODY FLAP mode. With three operational hydraulic systems, the body flap will move only about 3 deg/sec (1 deg/sec per hydraulic system). If tolerances for air loads are considered, the drive rate may vary from 1.5 to 4.5 deg/sec.

In OPS 3 a C&W light alerts the pilot to high hinge moments. The alert is based on exceeding 80 percent of the 3000 lb/in<sup>2</sup> maximum pressure in the actuator primary piston. This alert is in OPS 3 only (in PASS and BFS software), not in OPS 6.



| <u>EVENT</u>                        | <u>CUE</u>                       | <u>DISPLAY</u> |
|-------------------------------------|----------------------------------|----------------|
| <u>HAC Tangency (WP 1)</u>          | HSI 1 bearing pointer<br>on nose | HSI/HUD        |
| EIT = 27:00 (min:s)                 | HSI 2 bearing pointer            |                |
| M = 0.82                            | near wingtip                     |                |
| H $\cong$ 40 x 10 <sup>3</sup> (ft) |                                  |                |
| R $\cong$ 20 (n. mi.)               |                                  |                |

### CREW ACTION

Monitor HAC acquisition

### DISCUSSION

The software cycles the HSI display mode from ENTRY to TAEM to APPROACH automatically if the mode switch (F6 and F8) is left on the ENTRY position. At WP 1, the primary bearing pointer points to the orbiter nose while the secondary bearing pointer is near the wingtip position and points to the center of the selected HAC. The secondary distance measuring equipment (DME) at WP 1 should be approximately 3.3 n. mi. and the primary DME indicates the horizontal distance around the HAC arc to WP 2 on the runway (table 4.2-VII). HAC tangency may also be observed on the HSD (CRT 3). The orbiter symbol is on the heading alignment cylinder, with dynamic position indicators giving the orbiter position 20, 40, and 60 seconds in the future.

Prior to TAEM prefinal, the HUD has a flight director symbol ( $\ominus$ ) fixed in the center of the FOV. This symbol can be used together with the guidance diamond ( $\diamond$ ) to null out any guidance command errors. The guidance diamond depicts the direction to which the orbiter must be flown to satisfy the GPC-derived guidance solution. The diamond represents the intersection of the guidance needles on the ADI.

At TAEM prefinal the flight director symbol ( $\ominus$ ) automatically releases and begins moving in the FOV as a velocity vector ( $\rightarrow$ ). A line of sight projection from the pilot's eye, through the velocity vector symbol, depicts the instantaneous flightpath of the orbiter. Precise adjustments in flightpath can be accomplished, as required, by overlaying the velocity vector symbol on the desired aim point.

At HAC tangency, as noted above, the crew may expect the TAEM guidance to transition from the acquisition phase to the alignment phase. The crew should be aware that in the heading alignment phase the guidance can command a bank angle to 60°, as opposed to 50° in the acquisition phase.

As the orbiter flies around the HAC, the course deviation indicator (CDI) comes off full-scale deflection when the orbiter is within 15° (second dot on CDI is 10°) of the extended runway centerline with the switch position in the ENTRY or TAEM position. At an altitude below 12,018 ft (from NOM end of mission) the HSI modes automatically to APPROACH mode and displays the information identified in table 4.2-VII.

During the transition from the HAC to the steep OGS, the crew can use the CDI and the GSI to monitor the prefinal phase of TAEM guidance which positions the vehicle at the TAEM-A/L

interface. The parameters presented on the HSI provide the pilot with the minimum guidance and navigation (G&N) information needed to monitor the turn to final. The pilot can use the HSI to verify bearing and distance to the field. In addition, the pilot may verify the airspeed to be approximately 240 KEAS at HAC tangency and increasing to approximately 290 KEAS as the vehicle reaches runway centerline near OGS intercept.

### HUD PROCEDURES

The lower left window (no. 3) of the HUD displays the various phases, the approach progresses, (CAPT-OGS-FLARE-FNLFL) to capture, OGS, preflare, and final flare, respectively.

| <u>EVENT</u>                 | <u>CUE</u>   | <u>DISPLAY</u> |
|------------------------------|--|----------------|
| <u>Initiate MLS Updating</u> | TACAN RESID and RATIO<br>data disappear<br>BRG and GS flags<br>disappear | HSD/HSI/HUD    |
| EIT = 28:42 (min:s)          |  |                |
| V = 282 (KEAS)               |  |                |
| H = $17.2 \times 10^3$ (ft)  |  |                |
| R = 9 (n. mi.)               |  |                |

CREW ACTION

Monitor MLS acquisition

DISCUSSION

The MLS hardware limitations for range, elevation, and azimuth are 20 n. mi., 29° from horizon, and  $\pm 13.5^\circ$  from runway centerline, respectively. A software lockout inhibits processing MLS data until range equals 15 n. mi. Several cues are available for crew use in verifying that MLS has been acquired and is being processed, as follows:

- TACAN RESID and RATIO data on the HSD go blank.
- The missing data 'M' flags disappear from SYSTEM SUMMARY 1 display.
- Guidance-commanded steering bars on the ADI jump because of the difference in altitude detected by the MLS versus ADS.

MLS-derived altitude should be much more accurate than barometric altitude. If the orbiter FCS was in AUTO mode at time of MLS acquisition, it is possible that a sudden guidance command change will be followed to correct the discrepancy between actual and desired trajectories. All three channels (azimuth, elevation, and distance) of the MLS data can be used until the range reduces to 3350 ft beyond the runway threshold on the nominal trajectory. At this point, the orbiter flies past the elevation antenna. The azimuth and distance data are continually used through rollout.

In the absence of MLS data, the NAV filter updates the state vector with TACAN data, but only down to 1500 ft.

Circuit breakers and power switches for the three MLS receiver/transmitters are located on panels 014, 015, 016, and 08.

HUD PROCEDURES

From an altitude of 12,000 ft and below, NAV is continuously checked for the use of MLS data. If MLS data are not available for a period in excess of 6 seconds, when acquired, the MLSNV alert is displayed on the HUD window 2.

| <u>EVENT</u>                    | <u>CUE</u>           | <u>DISPLAY</u> |
|---------------------------------|----------------------|----------------|
| <u>Track OGS</u>                | GS indicator         | ADI/HUD        |
| <u>Toward Aim Point</u>         | Visual ground marker | GSI            |
| PAPI lights                     | VERT SIT 2           |                |
| EIT = 28:50 (min:s)             | HUD OGS symbols      |                |
| V = 284 (KEAS)                  |                      |                |
| H = 15.7 x 10 <sup>3</sup> (ft) |                      |                |
| R = 8 (n. mi.)                  |                      |                |

### CREW ACTION

Monitor flashing A/L on VERT SIT 2

Monitor error needle on ADI centered and PAPI lights show two red and two white

Monitor 'OGS' on HUD

### DISCUSSION

By 10,000 ft AGL, the TAEM guidance should switch to the A/L guidance phase (MM 305). The transition from TAEM prefinal guidance to A/L guidance is based on a logical check of altitude error, lateral position error, dynamic pressure error, and flightpath angle error. The cockpit indication that the logic conditions mentioned above have been met is a flashing 'A/L' displayed on the VERT SIT 1 display. This should normally occur at 10,000 ft above ground. Other instrument indications and independent ground-located glide slope indication available are also discussed later.

The OGS is designed to be as shallow as possible, providing the lowest descent rate and the least demanding maneuver in making a transition to a 1.5° shallow glide slope, yet also steep enough to maintain sufficient speedbrake reserves to cope with varying winds and trajectory dispersions. Because OGS angles are a function of vehicle weight and airspeed, winds, and TAEM trajectory dispersions, the PLT determines a pitch angle,  $\theta$ , to be flown on the HUD/ADI as he compares the vehicle velocity vector with the ground aim point and PAPI light configurations. When the orbiter is tracking on the projected runway centerline and is on glide slope, all ADI and HSI needles (CDI and GSI) should be centered.

| <u>EVENT</u>                          | <u>CUE</u>                                   | <u>DISPLAY</u>    |
|---------------------------------------|--|-------------------|
| <u>Approach and Landing Interface</u> | 'A/L' appears on VERT SIT 2<br>'CAPT' on HUD | VERT SIT 2<br>HUD |

EIT = 29:09 (min:s)  
 V = 292 (KEAS)  
 H = 12.0 x 10<sup>3</sup> (ft)  
 R = 5.8 (n. mi.)

### CREW ACTION

Monitor

### DISCUSSION

Transition to A/L GN&C is automatic between 10k and 5k upon satisfying the A/L interface. The cues that TAEM guidance has terminated and A/L guidance has been initiated are the A/L symbol that appears on the VERT SIT 2 and the CAPT mode that appears in HUD window 3.

The following GN&C software modules are initiated:

- A/L guidance
- A/L user parameter processing
- Landing SOP provides discrete signals for user functions to configure G&C for landing (main landing gear (MLG)) touchdown imminent; MLG has occurred; nose landing gear (NLG) touchdown has occurred, load relief, load balance, and nosewheel steering (NWS)

The following GN&C software modules are terminated:

- TAEM user parameter processing
- TAEM guidance
- Landing gear valve control (at MLG touchdown)
- Vent control sequence (at NLG touchdown)

On the first pass through A/L guidance, the body flap is commanded to trail. Between 5000 ft and touchdown, if the body flap is not within 5 percent of trail, an alert flashes in HUD window 2. Should this alert appear, the body flap should be manually selected to the trail position.

BFS does not have A/L guidance nor does it process MLS data for NAV or crew displays.

| <u>EVENT</u>        | <u>CUE</u>                  | <u>DISPLAY</u>  |
|---------------------|-----------------------------|-----------------|
| <u>Final Flare</u>  | H < 80 ft<br>Bal/Bar<br>HUD | RDR ALT<br>AVVI |
| EIT = 30:16 (min:s) |                             |                 |
| VREL = 234 (KEAS)   |                             |                 |
| H = 55 (ft AGL)     |                             |                 |
| R = 1324 (ft)       |                             |                 |

CREW ACTION

CDR - Fly final flare  
 PLT - Call altitude from AVVI  
 Call airspeed from AMI

DISCUSSION

The final flare should be a smooth increase in pitch attitude started at an altitude high enough to allow the CDR to predict a safe landing. The angle of the IGS establishes the severity of the flare. This trajectory does not require a large maneuver to land. The aerodynamic data indicate relatively strong ground effects, and the orbiter displays a large change in lift with elevon deflections. The CDR should anticipate ground effects as the altitude decreases through 50 ft in the flare. The cushion of air underneath the vehicle in ground effect produces an increase in lift as the vehicle approaches the ground. The increase in lift causes a nose-up pitching moment which may increase the chance for a CDR to overcontrol and 'balloon' the vehicle. To minimize this risk, large control inputs close to the ground and 'grease job' landings should be avoided because both increase the chance of a balloon. The 1.5° reference IGS requires less flare because the descent rate on that glide slope is acceptable for landing at normal landing weights. The reference sink rate is approximately 3 ft/s and should not be more than 8.0 ft/s. The final flare sets the sink rate and angle of attack for touchdown. The reference angle of attack for touchdown is approximately 8°, not to exceed approximately 14.7°. Establishment of the desired angle of attack in the flare is important for several reasons. At an  $\alpha$  of approximately 12°, L/D maximum is reached. Increasing  $\alpha$  further places the vehicle on the 'backside' of the L/D curve. In this region, drag is increasing and velocity is decreasing. This combination of forces presents an undesirable condition if the vehicle is flying above the runway too high to make a controllable touchdown. Flying angle of attack aids in maintaining airspeed. If, for example, airspeed is allowed to build up to and through the flare, this excess speed does not easily dissipate because of the reduction of drag due to ground effect. Low speed ground A/L data derived from STS-1 flight data indicate that in free air (prior to gear down and height/span value greater than 1.5) the axial force ( $C_A$ ) and drag coefficient ( $C_D$ ) should be reduced by -0.0040. Lift coefficient is unchanged. The speedbrake was found to be more effective in drag at deflections above 25°. Once in ground effects, the contribution to the coefficient of normal force due to ground effect ( $C_{N_{GE}}$ ) was found to be additive, which improves lift. The contribution to the coefficient of axial force to ground effect ( $\phi C_{A_{GE}}$ ) was found to be subtractive, which reduces drag. The combination of improved lift and drag in ground effect gives the vehicle increased L/D performance near the ground and may increase any tendency to 'float.'

## 5.1.6 Energy Management Features

### OVHD/STRT Logic

Item 6 on SPEC 50 can be used to toggle between an 'OVHD' or 'STRT' approach. In a STRT approach, the HAC is always on the same side of the extended runway centerline as the orbiter. In a OVHD approach, the HAC and the orbiter are always on the opposite sides of the extended runway centerline. The software initializes in MM304 to an OVHD HAC. The logic checks to determine which side of the extended runway centerline the orbiter is on and selects the proper HAC and turn direction. Whenever an item 6 changes the approach mode or whenever the orbiter crosses the runway centerline, the HAC automatically switches to the other side of the runway. This automatic switch occurs until an I-loaded velocity (currently Mach 9) is reached.

If in an OVHD approach with the HAC turn angle  $>200^\circ$ , the energy level in TAEM falls below a predetermined level, the crew receives an 'OTT ST IN' message. This is guidance calling for a downmode from OVHD approach to the STRT approach. The amount of range which can be saved with such a toggle depends upon the HAC turn angle,  $\psi$ . For example, if the HAC turn angle is currently  $270^\circ$  with an OVHD approach, a downmode to STRT could save about 13 n. mi. in range. Similarly, if  $\psi = 360^\circ$ , range saved is 20 n. mi.

The approach mode is initialized to OVHD in MM 304. The left or right turn results from the approach mode and geometry. For example, in the situation shown in the figure 5-32, an OVHD approach results in a left turn, and a STRT approach results in a right turn.

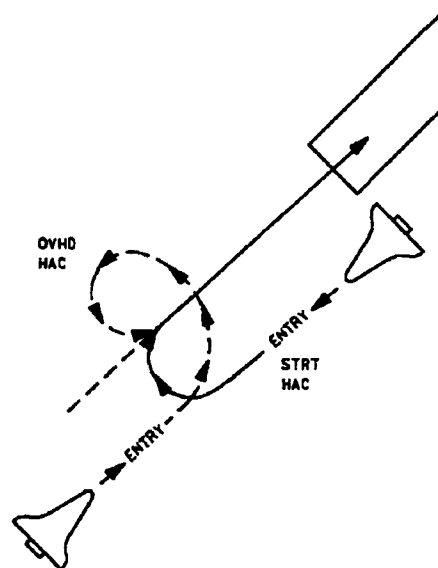

115420032. ART, 1

**Figure 5-32. Heading alignment circle entry**

The approach mode for the secondary runway is the same as that for the primary runway. However, selecting the alternate runway reinitializes the approach mode to OVHD.

Once range-to-go is less than 45 n. mi., a switch in the approach mode is not recommended. The heading error generated by a downmode while in close range could nullify any energy gains that may have been realized.

### NEP/MEP logic

Item 7 allows the pilot to switch the HAC position alternately between MEP and NEP points. The software initializes with NEP selected, as this is the preferred approach mode. Refer to figure 5-33 for a side and top view of the NEP and MEP HAC locations.

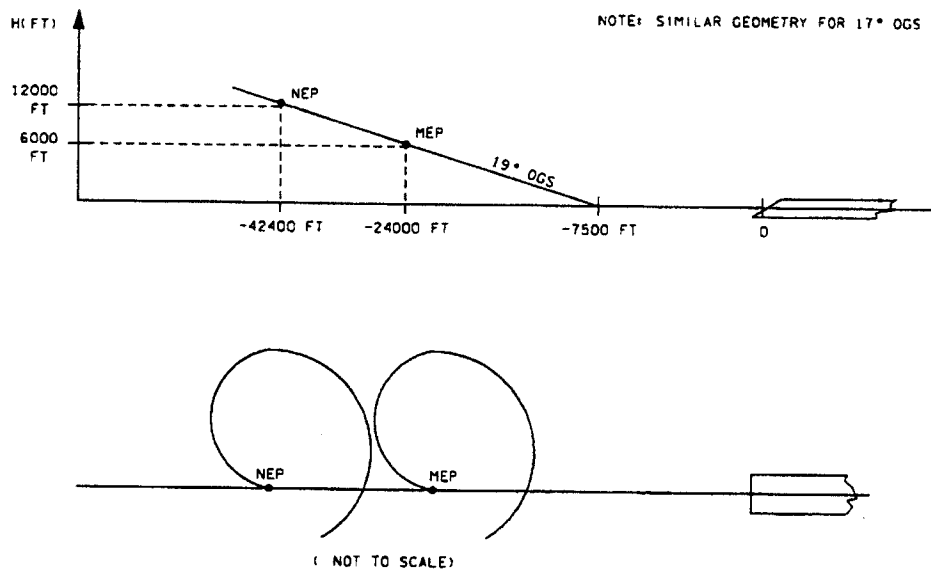

115420033. ART. 1

**Figure 5-33. NEP/MEP geometry**



If the energy state falls below a predetermined level, which is lower than the level for an OVHD alert, the crew receives an MEP alert consisting of an 'SW TO MEP' message. As in the OVHD versus STRT approach, the range saved by the downmode depends upon the approach geometry. Obviously, no energy can be gained by the switch if the HAC turn angle is  $0^\circ$ . A maximum range of approximately 6 n. mi. may be eliminated by switching to MEP if the HAC turn angle is  $180^\circ$ .

As with the OVHD/STRT option, switches to NEP or MEP should be done as early as possible. Because of the software structure, there is a slight chance that guidance can become unusable if the switch is made once the HAC has been acquired.

### S-Turn Logic

Guidance enters the S-turn phase if the energy state is greater than a predetermined value, the HAC turn angle is less than  $200^\circ$ , and range-to-go is greater than approximately 25 n. mi. During the S-turn phase, guidance calls for a constant  $50^\circ$  bank in a direction which tends to unwind the HAC.

Since the S-turn is most likely to occur in the supersonic regime, this bank is usually limited to  $30^\circ$ .

The S-turn is terminated when  $E/W = \text{ENERGY nominal} + 10,000 \text{ ft}$ . This energy level, and hence the S-turn termination, can be predicted by monitoring the E/W scale on the VSD.

### Energy Dump Logic

On a trajectory with an HAC turn angle exceeding  $315^\circ$ , the range-to-go at HAC intercept is greater than approximately 22 n. mi. If nominal energy,  $\bar{q}$ , and altitude are achieved at this range, the orbiter will be supersonic. Obviously, because of performance and  $\phi$  limits, the orbiter should be subsonic at HAC intercept.

If the predicted range-to-go at HAC intercept is greater than a predetermined value, the nominal energy-over-weight level is lowered to make the vehicle acquire the HAC at an energy level that corresponds to a subsonic velocity. This energy dump can be detected for large HAC turn angles. When the  $N_z$  channel recognizes that the orbiter is above the desired E/W, it commands a gradual pitchdown to get inside the corridor. Sometimes this pitch maneuver is limited by  $\max \bar{q}$ . If the energy dump is severe, the nominal energy corridor on the E/W scale of the VSD appears close to the MEP tick.

At a predetermined point in the trajectory ( $E/W = 85,000 \text{ ft}$ ), if the predicted range-to-go at HAC intercept is greater than the predetermined value mentioned above, then the  $\max \bar{q}$  limit is biased downward. The amount of bias depends on E/W error as well as predicted range-to-go at HAC intercept. If  $\max \bar{q}$  is ramped down enough, the result would be a pullup (recall  $N_z$  channel must stay within  $\bar{q}$  limits), which would reduce the dynamic pressure and Mach number. Again, the goal is to acquire the HAC subsonic.

This logic does not represent a pure maneuver like the S-turn. It does represent an E/W and  $\bar{q}$  profile adjustment. Any maneuvers noticed are simply the  $N_z$  channel reacting to this adjustment.

### Spiral Turn Radius Modulation

In the heading alignment phase, the HAC radius may be adjusted if the vehicle is below the nominal glide slope. At 6000 ft below the reference altitude with 270° or more of the turn to go, dropping to 2000 ft below the reference altitude with 90° of the turn to go, HAC shrinking is triggered. This situation is normally associated with the following conditions:

- High HAC approach speed
- Low energy or below glide slope
- Tailwinds approaching the HAC

Under these conditions, the pilot should consider flying the vehicle in manual (CSS) mode using the following technique.

### Manual HAC Procedure

The manual HAC procedure allows the pilot to conserve energy when flying into known low energy, high wind conditions on the HAC. Guidance has no knowledge of the winds, so energy loss is reduced by flying higher than guidance is commanding. The lateral groundtrack remains approximately the same as that commanded by guidance. The procedure should only be used when necessary, as recommended in the MCC by the Flight Dynamics Officer (FDO). Use of the procedure when it is not required will cause a high energy condition, but will not cause significant adverse effects on the trajectory.

The criteria used to determine the requirement for the manual HAC procedure are documented in Flight Rule 4-75. The technique will be recommended if the transition to approach and landing guidance (assuming auto flight control) is predicted to occur between 6K and 9K ft altitude, and other available runways and/or the straight-in approach will not provide transition above 9K ft. If none of the options meet the 6K ft constraint then the site is NO-GO, requiring a 1-day waveoff or selection of a secondary landing site.

The recommendation will be provided by the FDO at the time the DEL PAD is read up. Upper level wind persistence is usually quite good, so a possible requirement for manual techniques can be apparent using data from the L-11 hour balloon. If time permits, the manual techniques will be flown in the SMS in order to evaluate the flight conditions and provide additional piloting information (ref. Flight Control Operations Handbook, section 2.10).

The procedure is as follows:

1. CSS at Mach 0.95, leave speedbrake in AUTO.
2. Fly 220-230 KEAS, expect to get two or more dots high on the glideslope indicator.
3. Use the 20-, 40-, and 60-second predictors on SPEC 50, the Horizontal Situation Display (HSD), to initiate the turn and to modulate bank on the HAC. Maintain the low airspeed and keep the predictors on the HAC.
4. At 120° turn-to-go, transition back to the guidance commands.

Note: It is important to maintain the low airspeed, especially when transitioning from a head/tail wind to a crosswind, or vice versa. For example, when coming off of a tailwind into a crosswind, a rapid buildup in  $N_z$  can occur if a nose-up pitch is not made to hold the low EAS.

### 5.1.7 Monitoring ADI Scaled $A_y$

The purpose of this section is to review the mechanization and recommended use of the scaled  $A_y$  displayed on the yaw steering needle during entry or GRTLs when  $\bar{q}$  is greater than 20 lb/ft<sup>2</sup>.

#### Background

Early in the orbiter FCS development phase, environmental sideslip ( $\beta$ ) was always displayed to the PLT in simulations and was found to be an extremely valuable tool for assessing FCS performance. It had to be remembered, however, how much sideslip could be tolerated as a function of Mach,  $\bar{q}$ , and  $\alpha$ . As actual  $\beta$  was not available on the orbiter, a suitable approximation was sought for a PLT display. It was deemed highly desirable to make the display independent of Mach,  $\bar{q}$ , and  $\alpha$ , if possible. This led to the present S/W implementation.

#### Mechanization

The sensed lateral acceleration  $A_y$  is the basis for the display calculations because lateral acceleration is directly proportional to sideslip. To isolate that portion of the acceleration due only to the sideslip, the sensed acceleration is corrected for yaw jet firing, yaw acceleration at the accelerometer location, and for aileron and rudder deflection at the lower Mach numbers where their effects are significant. This corrected acceleration is then scaled as a function of alpha for display.

The scale factor was arrived at by calculating the lateral acceleration caused by a sideslip angle that would be just balanced by the torque due to 2.5 yaw jets. The choice of 2.5 jets was made so that each unit on the display scale could equate to 0.5 yaw jets. The scale factor thus chosen was independent of  $\bar{q}$  and dependent only on the  $C_{Y\beta}/C_{n\beta}$  ratio. These ratios were calculated from the aero tables and plotted as a function of Mach and  $\alpha$ . It was observed that if an alpha profile reasonably close to nominal was maintained, the Mach dependence could be eliminated. A curve fit was made for the ratios as a function of  $\alpha$  and used in the S/W scaling module.

#### Accuracy

With nominal aero, the display is fairly accurate down to an alpha of 10°. At lower alphas, the display accurately depicts sideslip trends and relative magnitudes, but no longer bears a proper relationship to yaw jet authority. In the presence of aerovariations, the display can be in error by up to a factor of two, but is biased toward the conservative side; i.e., it can underestimate by approximately 30 percent, but can overestimate by up to 100 percent. In summary, the display gives a good estimate of sideslip in terms of yaw jet authority for  $\bar{q} > 20$  lb/ft<sup>2</sup> and  $\alpha > 10^\circ$  in entry.

## Use of the Display

The display is very useful in assessing trim because the direction and relative magnitude of the sideslip can be seen. If no yaw jets are firing, the direction and magnitude of the needle deflection indicates the relative size of the Y c.g. offset and/or bent airframe ( $C_{N0}$  and  $C_{l0}$ ).

Remember that the display shows sideslip in terms of yaw jet authority. For example, suppose that at Mach 20.0 the vehicle is trimmed with  $2^\circ$  of aileron and 0.5 yaw jet (one unit) of scaled  $A_y$ . What should be deduced from this is that the yawing moment generated by the sideslip would require 0.5 yaw jet to counteract it. It does not indicate that if the ailerons were trimmed to zero the 0.5 yaw jet would trim the vehicle. It is obvious that those factors that produce yawing moments (aileron, rudder, sideslip, bent airframe, c.g. offset) also produce rolling moments, and satisfactory trim is achieved when rolling and yawing moments are balanced. Typically, during an entry, scaled  $A_y$  will rarely exceed 0.5 jet steady state, even in the presence of an offset c.g., bent airframe, and aerovariations.

Note that the scaled  $A_y$  needle can be full scale and operation is normal as long as the vehicle is trimmed and there is adequate yaw jet authority remaining. This typically occurs during the transient that accompanies an abrupt maneuver and is no cause for alarm. Because  $C_{n\beta_{dyn}}$  is positive throughout the flight envelope (except for a small low subsonic region at high alpha with adverse aerovariations), large sideslips will cause the vehicle to roll in a direction to reduce the sideslip. On the other hand, with reduced yaw authority (such as loss of two yaw jets per side) the scaled  $A_y$  can be centered during a roll maneuver and loss of control can occur if an abrupt input is made to stop the maneuver. This is particularly true with alpha errors that reduce the effectiveness of  $C_{n\beta_{dyn}}$ . The importance of smooth, slow inputs, especially with reduced control authority cannot be emphasized too strongly.

The scaled  $A_y$  is perhaps most useful in maneuvers. For example, suppose the vehicle has lost two yaw jets per side and is executing a bank reversal. If it is noted on the display that during the steady state roll maneuver the scaled  $A_y$  approaches a two yaw jet delta from the quiescent trim position, then loss of control may be imminent. Such a scenario accompanies a large alpha error case and checklist actions should be taken as soon as possible. Before each maneuver, it is important to note the scaled  $A_y$  trim and monitor it during the maneuver.

Scaled  $A_y$  is also useful in assessing FCS performance during oscillations. The relative magnitude and frequency of any lateral/directional oscillation can be seen on the scaled  $A_y$  needle, and a qualitative evaluation of how hard the FCS is working can be made. These data are useful in deciding whether crew intervention in the GN&C system is required.

## Summary

The scaled  $A_y$  display provides information that is useful in assessing FCS performance. One should keep in mind, however, its limitations.

If properly interpreted, the  $A_y$  display can provide more insight into control margins than a simple estimate of sideslip, as stated in the following:

- When no yaw jets are firing and the orbiter is not maneuvering, the magnitude of the scaled  $A_y$  can provide insight into the orbiter trim conditions - Y CG,  $C_{N0}$ ,  $C_{l0}$ .

- During steady state roll maneuvers, the scaled  $A_y$  can indicate the sign and relative magnitude of  $\alpha$  errors.
- The relative magnitude and frequency of any scaled  $A_y$  oscillation provides a useful qualitative insight into how hard the FCS is working in the roll/yaw axes.
- The position of the scaled  $A_y$  needle in steady-state nonmaneuvering flight must be the quiescent trim position from which to assess FCS performance in maneuvering flight.
- The scaled  $A_y$  is not an absolute indicator of flight margins.

### **5.1.8 Entry FCS Downmoding**

During the initial stage of the orbital flight test program, the crew was provided with a capability to affect or alter the Entry FCS gains and control laws during flight. The desire for this capability was based upon scenarios observed during the development and stress testing of the control system, during which the sensitivity of the control system performance to off-nominal conditions was demonstrated. Although the system has been tuned to be tolerant of many of the preflight uncertainties, flight test data are insufficient to verify system performance in several areas, such as bending instabilities, large aerodynamic coefficient errors associated with different angle of attack profiles, angle of attack errors, anomalous RCS system malfunctions requiring minimum RCS fuel consumption, and control surface rate limiting. Some of the original downmoding capability has been 'I-loaded out' in the flight software; however, the crew still has the capability to reduce the gains on the surface commands and to fly in a mode without firing the yaw jets. These functions are provided on the ENTRY MODE switch, located on the CDR's panel L2, as shown below.

AUTO

This position is the normal switch position and may be verified and selected on the OVER-RIDE display, SPEC 51. In this position the FCS accomplishes the nominal moding and gain scheduling within the control laws. The position is recognized in either AUTO or CSS in the pitch or roll/yaw axes.

LO GAIN

This position is also selectable in either AUTO or CSS in the pitch and roll/yaw axes. If selected, the gains scheduled as functions of Mach, angle of attack, and dynamic pressure on the rate error commands in each channel will be reduced by a factor of 0.5. This action could be invoked to counter over-gained system response; i.e., high-frequency oscillations, usually in the roll/yaw channels, but possibly cross-coupling into the pitch axis as well. Reducing the gains should allow an improvement in damping. If large amplitude, diverging rates are induced, as might be encountered in a large signal instability, the LO GAIN may retard the vehicle accelerations, allowing recovery. Also, if only one APU/hydraulic system remains for control, low pitch and roll/yaw gains may potentially prevent RHC commands from causing surface rate saturation in high  $\bar{q}$  conditions. Note also that the gain reduction applies to the surfaces only, not on the jet command loops.

NO YJET

If RCS fuel reserves are marginal, it is desirable to conserve available supplies for use in the flight regimes below Mach 7.0, where additional control authority may be required for trim and maneuvers. Aerovariation combinations may critically reduce surface effectiveness, forcing a dependence on the RCS for stability. The NO YJET position eliminates yaw rate error commands to the yaw jets. Roll maneuver initiation and rate damping are provided only by ailerons, and below Mach 5.0, rudder. In early entry, aileron deflections produce an adverse yawing moment, overpowering the initial rolling moment and inducing a sideslip angle. As  $\beta$  increases, the vehicle rolls in the opposite direction. Taking advantage of this powerful adverse yaw and subsequent roll opposite to the command, the FCS in this 'direct aileron control' mode commands an initial roll input in a direction opposite to the desired roll. For example, a pilot desires a roll to the right. For a right RHC command, the aileron initially deflects left. The vehicle initially rolls left with an increasing left  $\beta$ . The roll direction reverses to the right, and  $\beta$  decreases slightly. In this case, since the yaw jets are not available for roll initiation and  $\beta$  damping, the ailerons have a much larger gain on the roll command. This mode is planned only for emergency use. The aileron/rudder provides roll/yaw rate feedback stabilization in the same manner as the nominal system, although  $\beta$  damping is not as tight without the RCS. At low dynamic pressure damping is poor ( $\bar{q} < 20 \text{ lb/ft}^2$ ). Procedures have been developed to complete the entry, if necessary, once the first bank command is established, without further use of the yaw jets. Selection of NO YJET downmodes the ROLL/YAW axis from AUTO to CSS. The PITCH axis may remain in AUTO.

### 5.1.9 Off-Nominal Control Procedures

The Entry Checklist offers basic guidelines in troubleshooting control anomalies as observed by the crew and gives the responsive actions. These actions are summarized in the checklist and cue cards entitled 'TRIM/OSC' (figure 5-35) and 'RCS CRITICAL ENTRY'. The basic problem areas covered are symptomatic of design problems encountered during the development of the entry flight control system and include the following:

- Roll/yaw oscillations, including rudder and/or yaw jet limit cycles
- Angle of attack errors
- Aileron trim saturation
- RCS critical entries

Recognition of symptomatic cues may result in actions ranging from changing body flap position to using alternate control modes and pilot techniques. Therefore, based on recent experience, it is appropriate to emphasize certain points as they apply to specific pilot techniques. Yaw jet activity should be monitored closely throughout the entry, because it is the key to assessing how well the vehicle is trimmed, RCS propellant consumption, and the degree of stress to which the G&C is subject. The scaled  $A_y$  should be checked periodically and noted prior to each bank reversal so that shifts from static trim can be assessed. Aileron trim must be monitored occasionally above Mach 12.0 and frequently below Mach 12.0. From rudder activation until subsonic flight, rudder and aileron trim must both be monitored. During all bank reversals yaw jet activity, scaled  $A_y$  shift and roll rates should be monitored to allow early detection of alpha errors or other symptoms of FCS stress.

## TRIM/OSC

|  |   |
|--|---|
| <b>AIL TRIM SAT (<math>\pm 3^\circ</math>)</b> |   |
| 1. BF - MAN: raise to 0% .....                 | 1 |
| 2. M12 to M8: fly alpha lower limit .....      | 2 |
| M8 to M6: fly alpha = 30 deg                   |   |
| M6 to M5: fly alpha upper limit                |   |
| 3. M < 5: maintain aileron trim < 1 deg .....  | 3 |
| TRIM RHC/PNL - ENA                             |   |
| TRIM ROLL - away from indicated trim           |   |
| until < 1 deg                                  |   |
| 4. M2: BF - AUTO .....                         | 4 |
| <br>   |   |
| <b>HIGH FREQ OSC OR SURFACE/JET</b>            |   |
| <b>LIMIT CYCLE</b>                             |   |
| 1. If returning payload > 10k lb .....         | 1 |
| 2: GNC 51 OVERRIDE                             |   |
| √ALT FILTER - ITEM 21                          |   |
| 3: BFS, GNC 51 OVERRIDE                        |   |
| √ALT FILTER - ITEM 21                          |   |
| 2. P, R/Y - CSS .....                          | 2 |
| 3. If osc/cycle continues: .....               | 3 |
| ENTRY MODE - LO GAIN                           |   |
| 4. After osc/cycle stops: .....                | 4 |
| ENTRY MODE - AUTO                              |   |
| P, R/Y - AUTO                                  |   |

*Figure 5-34. TRIM OSC cue card*

The following paragraphs provide the rationale for the cue card procedures and expand upon the required pilot techniques.

#### 5.1.9.1 High-Frequency Oscillations or Aerosurface/RCS Jet Limit Cycles

This procedure is used if the shuttle is oscillating about any or all axes at a high frequency, if opposing jets are alternating firings at a high rate, or if an aerosurface is moving back and forth at a rapid rate. This could be caused by an improperly selected body bending filter, improper commands from the AUTO flight control system, or flight control gains set too high.

1. Check that the proper bending filter is selected for the payload being returned. If the payload is greater than 10k lb, the ALT filter is optimum. Otherwise, the NOM filter should be used. These steps are checks only, because they are called out in the nominal preburn procedures.
2. Select CSS flight control system.
3. Select LO GAIN to cut all aerojet DAP commands in half; take care of any flight control gain that is set too high.
4. Depending on the severity of the situation, perform all three steps without delay between steps. Do one step and wait to see if that stops the oscillations or limit cycle before going



to the next step. If the oscillations stop, AUTO can be reselected for ENTRY MODE and flight control. There is a good chance that the oscillations will not return.

The FCS includes bending filters in all axes that protect the FCS from coupling with the structure in a resonant oscillation by providing appropriate gain and phase margins. If the bending filter constants should be in error, it could be possible to excite a bending instability. This is also of concern when returning certain types of payloads, such as the IUS, when soft-cradle mounted in the payload bay. The symptoms would be very-high-frequency oscillation ( $\tau < 0.5$  sec) most likely accompanied by airframe vibration caused by the rapid oscillation of the aerosurfaces. The oscillations might be seen on the ADI rate needles and perhaps the SPI. It might also be possible to have a yaw jet limit cycle accompanying the oscillations. Any bending instability should be stopped ASAP to avoid the potential of catastrophic failures or excessive APU or RCS propellant depletion.

Verify on the OVERRIDE display, SPEC 51, that the appropriate body bending filters have been selected. The oscillations should stop immediately.

### 5.1.9.2 Angle-of-Attack Errors

The FCS uses  $\alpha$  to compute stability axis roll and yaw rates and then coordinate the yaw/roll axes to provide pure stability axis roll maneuvers. During a roll maneuver, the sensed yaw rate (corrected for vehicle turn) is multiplied by  $\cot \alpha$  to generate the proper aileron command to coordinate the roll ( $p = r \cot \alpha$ ). If  $\alpha$  is in error, the roll/yaw ratio will obviously not be proper to coordinate a roll maneuver. If the alpha error is large enough, it can cause serious FCS problems, especially if yaw control authority is reduced (yaw jet failures).

To better understand the problem, consider first the case where the alpha used by flight control is less than the actual alpha. Since  $\cot \alpha$  increases as alpha decreases, the aileron command ( $r \cot \alpha$ ) issued in a roll maneuver provides a body roll rate too large for the body yaw rate. This results in shifting the sideslip in a direction to oppose the commanded roll. The actual stability roll rate achieved may be smaller than the commanded rate. If the alpha error is in the opposite direction; i.e., FCS alpha greater than actual alpha, then the roll command for a sensed yaw rate during a roll maneuver will be too small and cause the sideslip to shift in a direction to aid the roll maneuver. The actual stability roll rate may be greater than commanded and the jets will oppose the roll. Since  $\beta \neq 0$ ,  $\beta$  may build to the limit of the yaw jet authority to oppose or retrim  $\beta$  to zero after the maneuver.

Alpha errors may be caused by navigation errors, but performance estimates predict  $3\sigma$  errors no greater than  $0.5^\circ$ . An error of this size causes little or no FCS problem. The largest potential source of alpha errors is the wind. High level winds can be of such a magnitude as to cause alpha errors of the order of  $2^\circ$  to  $3^\circ$ . In banking away from a strong crosswind, the actual alpha will be greater than that used by the FCS. The converse is true if banking into the wind. From the previous discussion, it is seen that if rolling with the wind to the bottom of the vehicle, sideslip will shift to oppose the roll, and the jets fire to aid the roll. If rolling with the wind on top of the vehicle, the sideslip shifts to aid the roll, and the jets will oppose the roll. The latter is worse for controllability, especially with reduced authority such as with jet failures. Large roll overshoots are seen with poor damping. Loss of control can occur with unfavorable aerovariations.

There are then two cases to consider, a bank reversal from top wind to bottom wind and vice versa. In the first case, after the roll rate is essentially established, it will be seen that the sideslip has shifted to aid the roll rate, and yaw jets will be firing to oppose the roll. Roll rate may be greater than commanded. As the bank angle approaches wings-level, the jet firings cease, the sideslip shifts toward the static trim, and the roll rate approaches the commanded rate. As the bank angle increases in the new direction, the sideslip shifts to oppose the roll rate; the jets fire to aid the roll rate, and the roll rate may be less than commanded. There is no problem controlling this case.

On the other hand, if rolling from bottom wind into top wind the opposite symptoms are seen. Initially, the sideslip shift is to oppose the roll rate, the jets will aid, and the rate may be less than commanded. As the vehicle passes wings-level, the jet firings cease as sideslip returns to trim. As bank increases in the new direction, the sideslip shifts to aid the roll rate; jets oppose the roll, and the roll rate may be greater than commanded. If yaw jet authority is reduced, this case may be difficult to control.

If the symptoms for rolling from a bottom wind into a top wind are present, it is recommended that the roll be completed in CSS while slowing the rate. As soon as the bank maneuver is completed and the guidance transients are damped, the AUTO mode may then be reselected. The procedures are strongly recommended for cases of reduced jet authority.

### 5.1.9.3 Aileron Trim Saturation

There are two basic reasons for the aileron trim to be at the limit of  $3^\circ$ . The trim integrator is limiting the trim deflection, although more aileron is required (possibly due to a Y c.g. offset larger than 3 in. or ineffective ailerons as a result of aerovariations or because of a combination of aerovariations, Mach regime, and elevon trim position); the sign of the aileron trim has reversed from the sign currently held in the integrator. Whatever the reason, the implications are serious if it becomes necessary to use yaw jets for trim, dramatically increasing fuel consumption. Therefore, it is highly desirable to maintain the elevons in the optimum position for lateral trim. The most critical trim region encompasses Mach 12.0 to 5.0, and the elevons are normally scheduled down to ensure  $(-C_{N\delta A})$  until the rudder becomes active. The body flap may be driven to the up limit to improve aileron coefficients with down elevon. At Mach 2 the body flap is returned to the AUTO mode, since the body flap is usually saturated up at this Mach number. Decreasing or increasing  $\alpha$  (depending on Mach) also improves the lateral trim and stability equations  $(C_{N\delta_{DYN}})$ , and has been demonstrated to be the fastest technique for stopping a divergent roll-off tendency. After the rudder is active, the rudder trim should assume the trim function, and the aileron trim integrator should begin to decrement. Once the rudder is active, if aileron trim is greater than  $1^\circ$ , the crew should enable panel trim and use roll panel trim to manually trim the ailerons to less than  $1^\circ$ .

1. The body flap is raised manually to the full up position (0%) to create a nose up pitching moment, which causes the elevons to move down further into the airstream and increases aileron effectiveness.
2. Flying this modified alpha schedule between Mach 12 and Mach 5 maximizes control authority.
3. At Mach 5 the rudder becomes active. To speed up the process by which the rudder takes over trim, manually drive the aileron trim to a value less than  $1^\circ$  using the roll panel trim

switch (L2 or C3) with the associated trim enabled on the 'eyebrow' panel. For example, if there is full left aileron trim, which would show up as 'AIL L3.0' on the VERT SIT or ENTRY TRAJ display, it would be necessary to manually trim right until aileron trim was approximately zero. Depending on the severity of the case, this step may be required several times. By performing this step, roll control is maximized and the possibility of an aileron-rudder force fight is eliminated.

4. At Mach 2, take the body flap to AUTO so it can position the elevons to prevent the high hinge moments that occur around Mach 1.

5.1.9.4 RCS CRITICAL ENTRY

The RCS CRITICAL ENTRY cue card (figure 5-35) is used to provide the crew with procedures for flying the vehicle at low RCS propellant quantities throughout the entry flight profile. The five sections (blocks) of the card tell the crew when propellant quantities require selection of the NO YAW JET (NYJ) DAP mode and when to secure from the NYJ DAP mode for divergent control situations. The card also provides insight into when sufficient propellant quantity remains to secure from the NYJ DAP mode and return to the baseline DAP.

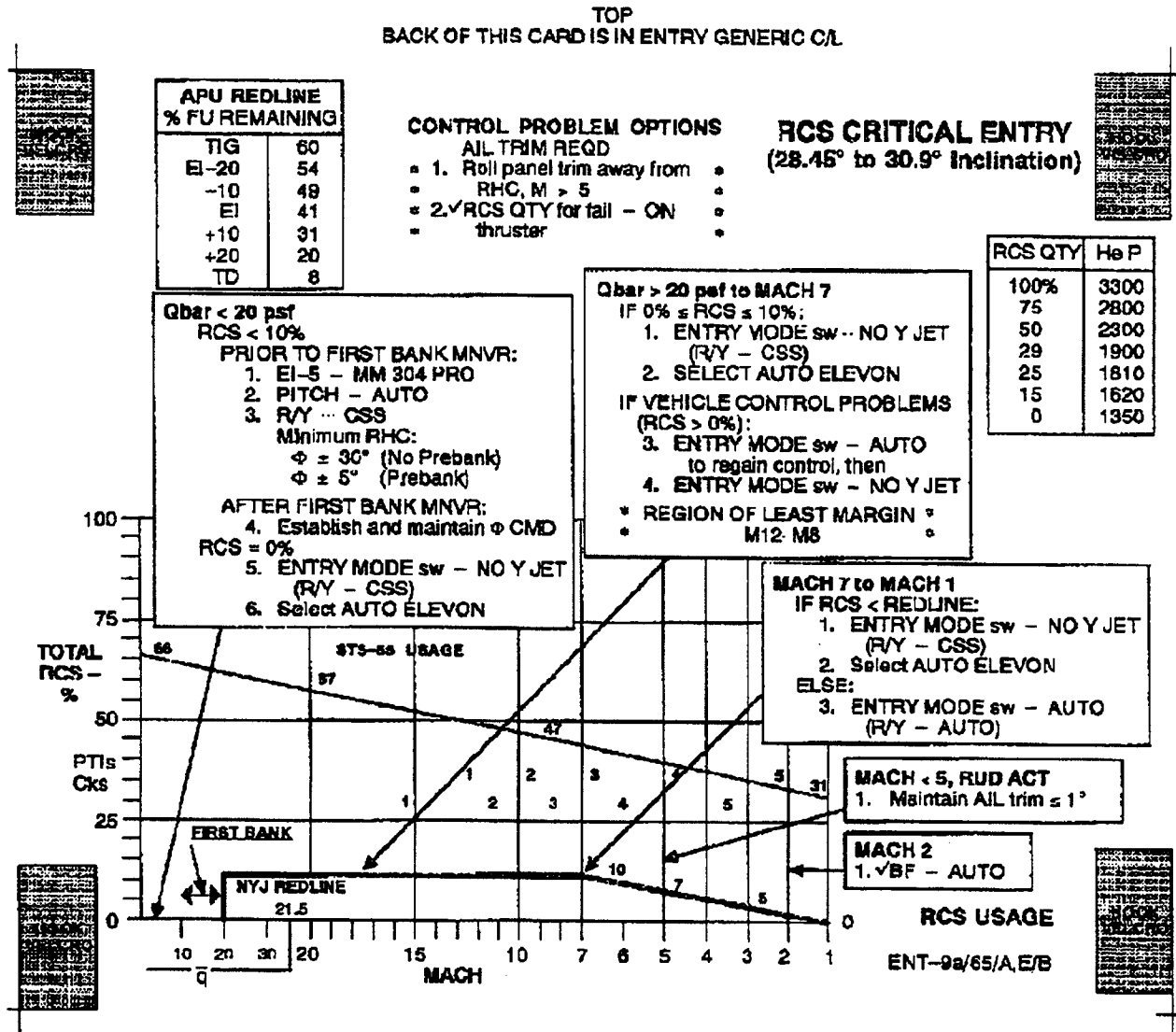

Figure 5-35. RCS CRITICAL ENTRY cue card

1. MM 304 to Qbar  $\geq 20$  psf

Specifically, block 1 of the card provides procedures for cases when there is less than 10 percent RCS quantity prior to the first bank maneuver (at Qbar 10 - 20 psf). For this case, the crew should pro to MM 304 at the nominal EI - 5 minutes to allow the entry guidance software to begin processing. To minimize RCS usage during this time, CSS in the

### 3. Mach 7 to Mach 1

Block 3 of the card covers when to secure the Mach 7 to Mach 1 flight region from the NYJ mode format. From actual flight data, 10 percent (the NYJ limit from Qbar 20 to Mach 7) was actually 2 to 3 percent more total propellant than was required to fly from Mach 7 to Mach 1. Therefore, if the crew has 10 percent total RCS propellant quantity remaining at Mach 7, the prudent action is to secure from NYJ at Mach 7 and fly the baseline DAP for the remainder of entry. Additional RCS propellant usage points were derived from flight data at Mach 5 and Mach 3. The nominal RCS usage line was then extended down to Mach 1. Block 3 states that if the actual RCS quantity exceeds the nominal RCS usage line at any time from Mach 7 to Mach 1, the crew should secure from the NYJ flight control mode back to the baseline DAP. If the RCS quantity subsequently goes to 0 due to higher than nominal usage from poor aerodynamic conditions (body-bending, poor control surface response, wind and density shears), the NYJ mode should be reselected.

### 4. Mach 5 - Rudder Activation

Block 4 was retained from the previous RCS CRITICAL ENTRY cue card to remind the crew that lateral/directional stability should improve at Mach 5, when the rudder becomes active. After the rudder is active, the aileron deflection should be trimmed to less than 1° to reduce rudder/aileron force flight potential.

### 5. Body Flap Monitoring

Block 5 was also retained from the previous RCS CRITICAL ENTRY cue card to remind the crew to put the body flap in AUTO at Mach 2. Mach 2 is typically where the elevons transition from an adverse to a proverse FCS, so it is critical to have the body flap in AUTO to keep the elevons trimmed on schedule. To increase aileron control authority at higher Mach numbers, it may be ground call to take the body flap to manual and drive it full up, thereby lowering the elevons farther down into the airstream and increasing control authority. Since the flight control gains for NYJ and the baseline DAP become very similar around Mach 2, the body flap can be taken back to AUTO to assist in keeping the elevons on schedule. The body flap should also be in AUTO to allow movement to the trail position at TAEM end (OGSe).

### 6. Expected Usage Line

A flight-specific expected usage line is provided for information. This line reflects the consumption rate for an AUTO DAP run, including PTI maneuvers, and is the anticipated baseline for the entry.

Note: This line assumes a starting propellant quantity. The actual starting point for the propellant quantity is most likely on the actual entry day. Therefore, this line is useful only as a tool for determining propellant consumption rate.

## 5.2 GROUND CONTROLLED APPROACH

GCA techniques have been developed and are available, to control the orbiter trajectory from postblackout to a point where the crew can take over visually and compute the landing unassisted.

This procedure should be considered an emergency alternative only and control should be quickly returned to autoguidance if and when conditions permit.

During entry, should autoguidance fail or allow the orbiter to stray outside the desired footprint pending a navigational update, a GCA is performed.

The controller's responsibility is to provide the crew with the necessary roll, heading, airspeed, and speedbrake information while the crew maintains the orbiter within the required  $g$ ,  $\bar{q}$ , and  $\dot{H}$  limits.

The GCA controller uses a series of dynamic plot boards, with latitude vs. longitude and altitude vs. longitude, incorporating increasing resolution scales, to compare actual and nominal trajectories along with range and velocity data.

GCA becomes available as an option at S-band acquisition, nominally at a velocity of approximately 10,000 ft/s.

C-band tracking data provide GCA with an estimate of the orbiter state vector. The orbiter trajectory is assessed and compared with predetermined criteria for initiating a GCA.

It should be noted that late S-band acquisition severely compromises GCA's ability to manage orbiter energy. Nominally, a reliable GCA footprint capability of  $\pm 150$  n. mi. downrange and  $\pm 100$  n. mi. crossrange is feasible.

The GCA can be divided into three phases:

1. High velocity phase (Mach 10.0 - Mach 3.0)
2. Terminal area phase (Mach 3.0 - Mach 0.9)
3. Final approach phase

The criteria for electing to use the GCA option depends upon autoguidance ability to achieve a nominal trajectory by Mach 5.0. For example, at Mach 10.0 a GCA becomes desirable if the downrange NAV uncertainty is greater than 63 n. mi. or if the range to landing is shorter than nominal by more than 125 n. mi. In the former case, a GCA would be performed until NAV could be updated. In the latter case, a GCA would be performed until the projected landing target was converged within the autoguidance footprint.

In all cases, roll modulation is used to maintain the range/velocity schedule down to approximately 3000 ft/s. (Between 5000 ft/s and 3000 ft/s it is desirable to maintain a constant roll angle to avoid FCS problems should two yaw jets fail.)

In the high velocity phase the controller provides roll magnitude information to control drag and roll direction information to control crossrange error.

To ease pilot workload it is recommended that the crew fly with the roll/yaw axis in CSS and the speedbrake, body flap, and pitch axis in AUTO.

In the terminal area phase, below Mach 3.0, control of the orbiter reverts to the more conventional technique of heading controlling desired groundtrack and airspeed controlling energy. The controller determines the ranging potential from an altitude vs. velocity plot, compares it with the range-to-go from the desired groundtrack, and derives the appropriate energy management and airspeed.

The recommended crew action is to fly heading and airspeed information with all axes in the CSS mode and the speedbrake in AUTO until Mach 0.9. (If energy is low, the speedbrake may be manually closed to extend the range.) Turns should be made using 40° roll angle and  $\bar{q}$  controlled by modulating  $\alpha$ .

In the terminal area phase, an attempt is made to position the orbiter over the field at Mach 0.9 to enable a left-hand turn to a final approach of 15,000 ft at 7 n. mi. A decision is made to fly a left-hand turn to final, or a minimum ground track turn to final, based upon the orbiter energy state.

The final approach phase is basically the traditional GCA final. Heading information is given to acquire and maintain the runway centerline and position information given relative to the glide slope. The crew should use the speedbrake to control the airspeed.

The two extremely high and low energy cases require slightly different control techniques. In the low energy case (greater than 100 n. mi. dispersion at 10,000 ft/s or a very low orbiter L/D), the roll angle should be kept to a minimum and used only as necessary to continue directly to the field.

In the high energy case, roll angles of 70° and more may be necessary to control the trajectory using azimuth offsets and a roll reversal towards a spiral that terminates with runway alignment. The roll reversal timing is critical. The controller uses turn radius templates to determine when the last reversal should take place and evaluate the merits of landing at the prime runway.

With the high roll angles used to control drag, the crew must carefully monitor the  $g$ ,  $\bar{q}$ , and H limits.

## APPENDIX A OPERATIONAL SUPPLEMENTS

This section is a collection of crew technique discussions, memos, and related data pertaining to entry topics that are not discussed with the sequence of events. As new discussions are developed, they will be issued as updates for inclusion in this section.

| <u>Entry topics</u>                    | <u>Page</u> |
|--|-------------|
| FLYING WITH DEFAULT AIR DATA           | A-2         |
| OFF-NOMINAL AERODYNAMICS               | A-4         |
| STABILITY AND CONTROL FLIGHT TEST PLAN | A-7         |



## FLYING WITH DEFAULT AIR DATA

In the absence of air data below Mach 1.5, the orbiter NAVDAD may be in error enough to cause FCS instabilities or loss of control. To protect against this contingency, default air data exists in PASS only. It provides a constant angle of attack of  $7.5^\circ$  and  $q$  between 100 and 265 psf scheduled as a nonlinear table lookup function of VREL. Using default air data, TAEM guidance does not sense changes in real-world  $\bar{q}$  and will unwittingly allow unreasonable  $\bar{q}$  while correcting to its H versus range or E/W versus range profile, and loss of control may occur. Always fly default air data in CSS, monitoring  $\theta$  limits on the VERT SIT displays.

### Background

When the ADS is inoperative, the  $\bar{q}$  and angle of attack (alpha) are derived by the navigation system, using numerical integration methods to determine the Earth relative speed. This procedure is accurate and adequate to the point where winds have a significant effect on the parameters. For velocity relative to Mach numbers above 1.5,  $\bar{q}$  is derived from drag acceleration data and a curvefit function of the  $C_D$  that is based on an alpha versus velocity nominal profile. The value of  $\bar{q}$  delivered by the navigation system has been found to be sufficiently accurate for  $M > 1.5$ . Therefore, above  $M = 1.5$ ,  $\bar{q}$  limiting is provided by guidance, using this  $\bar{q}$  determined by  $C_D$ . Below  $M = 1.5$ ,  $\bar{q}$  is determined by a default schedule based on the Monte Carlo results, using  $3\sigma$  dispersions. Because the navigation-derived data are Earth relative and do not take into account the presence of winds, the displayed alpha can be as much as  $16^\circ$  in error below  $M = 1.5$ . In addition, the  $\bar{q}$  used to command speedbrake deflection is calculated from the equation:  $\bar{q} = 1/2 \rho V^2$ , where  $\rho$  is determined from the navigated value of altitude. Since below  $M 0.9$ , the speedbrake is driven by this erroneous  $\bar{q}$ , this results in nonoptimum operation of the speedbrakes for  $\bar{q}$  control. Thus  $\bar{q}$  can be as much as 175 lb/ft<sup>2</sup> in error below  $M = 1.5$ ; hence, the onboard displayed values of  $\bar{q}$  and alpha cannot be used for pitch control in the absence of air data. In addition, computed  $\alpha$  to limit  $\bar{q}$  cannot be used because it is with respect to the Earth relative velocity and not with respect to the wind.

A procedure called theta limits, which is independent of the air data, was developed to allow the pilot, using an onboard CRT display, to manually control the pitch attitude (theta) to keep the actual pitch angle between the nose-high (maximum theta) and nose-low (minimum theta) constraints. Theta is the angle between the orbiter X axis and the local horizontal plane with the nose-down attitude being defined as a negative theta. The maximum theta limit corresponds to the minimum  $\bar{q}$  that can be flown and still remain near the peak of the L/D curve. The minimum theta corresponds to the maximum  $\bar{q}$  limit set for flight control system performance. The theta limits procedure is not used for  $M > 1.5$  for two reasons. First,  $\bar{q}$  based on  $C_D$  is accurate enough for guidance to protect the vehicle from violating any constraints and second, theta limits are based on steady-state flight conditions and do not allow enough flexibility to overcome possible transients at entry-TAEM interface. It is necessary to ignore theta limits at some prescribed altitude to allow preparation for the flare maneuver just prior to landing. The currently recommended altitude is 5000 feet. Note that once the orbiter is below an altitude of 10,000 feet, greater emphasis is placed on maintaining the glide slope and using theta limits as a guide to setting the speedbrake as well as preventing  $\bar{q}$  constraint violations. The primary goal of theta limits is to provide an independent means of controlling pitch and preventing the vehicle limits from being surpassed even in the presence of worst-case winds. The purpose of this internal note is to discuss how these theta limits were derived and to present results from performance analysis cases.

The theta limits procedure is a very useful technique for limiting  $\bar{q}$  when air data are not available. However, it does require proper training to derive the maximum benefits. The procedure has drawbacks at high bank angles but using a fixed theta during this period solves the problem. The following recommended procedures are a result of analysis.

- A. For Mach greater than 1.5, guidance should be used with normal  $\bar{q}$  limiting using a  $\bar{q}$  determined by a navigationally derived air data curvefit based on  $C_D$ . This allows greater flexibility to overcome transients at entry-TAEM interface. The  $C_D$  curvefit for  $\bar{q}$  is adequate if alpha is not too far from nominal.
- B. Theta limits should be adhered to for VREL < 1500 fps and altitude > 5000 feet or until the glide slope is achieved (below an altitude of 10,000 feet).
- C. For a high-energy situation (above the glide slope) and on the minimum theta limit with the pitch error needle indicating pitchdown and the needle not moving up adequately, the speedbrakes should be opened more (if  $M \leq 0.9$ ).
- D. For a low-energy situation (below glide slope) and on the maximum theta limit with the pitch error needle indicating pitchup and the needle not moving down adequately, the speedbrakes should be closed more (if  $M \leq 0.9$ ).
- E. When flying the pitch error needle and nominal energy (on the glide slope), if theta decreases significantly toward the maximum theta limit, the speedbrakes should be closed more.
- F. Bank as necessary up to  $50^\circ$ . As an option, go to a theta of  $-12^\circ$  with closed speedbrakes during high banks.
- G. In a tailwind case and approaching a headwind, keep altitude and energy high.

## OFF-NOMINAL AERODYNAMICS

The purpose of this section is to briefly explain how the uncertainties (off-nominal) in aerodynamics affect entry.

In a conventional aircraft, program flight 'worthiness' is demonstrated by incremental expansion of the flight envelope. This is not feasible with the shuttle. Preflight characteristics must be based on aerodynamic data derived from ground test and analysis. Allowances have been made in the FCS design for aerodynamic characteristics with uncertainties added to the basic aero base and are discussed later.

There are two types of uncertainties, tolerances and variations. Tolerances are the errors between different wind tunnel tests, models, and test organizations. They are usually small and are not discussed in this article. Variations are the differences between actual flight and predicted aerodynamics as a function of Mach number. However, a set of variations for the shuttle program had to be established prior to STS-1. The most reasonable approach to develop these variations was to compare the wind tunnel results to flight test differences of past aircraft programs. The flight data base was limited by restricting the comparison to vehicles geometrically similar to the orbiter, a very subjective process. Therefore, a team of aerodynamicists from the Air Force Flight Test Center, NASA Dryden Flight Research Facility, Johnson Space Center, and Rockwell International was formed to analyze and reach a consensus on variations. For the formal entry verification, the decision was made to use the  $3\text{-}\sigma$  (statistical standard deviation) correlated variations. A total of 10 lateral-directional and 3 longitudinal coefficients was defined for application of entry uncertainty FCS verification.

### Variation Sizes

Flight data were limited to lower Mach numbers and angle of attack. In Mach regions where flight data were unavailable, variations were obtained by multiplying wind tunnel uncertainties by a safety factor. These sizes are modified accordingly following the stability and control flight test results. (See Stability and Control Flight Test Plan in this appendix for the method used to define the coefficients.)

A typical vector diagram of the aero and jet coefficients for the roll and yaw axes is shown in figure A-1. (This figure is for illustrative purposes only.) The uncertainties and coefficients vary with Mach number and other flight conditions. The X-axis represents the yawing moment coefficient,  $C_n$ , while the Y-axis represents the following moment coefficient,  $C_\ell$ . The vectors represent the nominal aerodynamics. The variations are represented by the boxes and ellipses. The rectangular variations were used in the FCS development and the ellipses are the correlated variations. In most cases, the rectangular variations are approximately 20 percent worse than the elliptical variations, depending on the location on the aerodynamic vector position.

Physical Description of the Vector Diagram (Off-Nominal)

In figure A-1,  $1^\circ \beta$  with nominal aero produces approximately  $-0.0008 C_n$  and  $-0.0018 C_l$ . If the system has more or less than  $1^\circ \beta$ , the vector is extended or shortened to the appropriate amount along with the yawing and following moment coefficients. This is also representative of the other vectors. If the system has off-nominal aerodynamics, the rolling and yawing moment coefficients vary accordingly. A  $3\sigma$  variation on the  $\beta$  coefficient, with a change in magnitude and shift in direction of the vector, will give the rectangular boundary. This shift causes the system to behave differently from the nominal case. If the different vectors move off-nominal in certain locations, this can represent high or low aerodynamic control gains. In other cases, it can represent minimum or maximum aerosurface controllability (coalignment of effector vectors,  $\delta_a$ ,  $\delta_r$ ) or even lateral trim problems caused by coalignment of  $\beta$  and  $\delta_a$  vectors. Once the rudder becomes active, currently Mach 5, and if aileron vector coaligns with the rudder vector, aileron-rudder force flight might occur. In this situation, the crew needs to manually trim the vehicle.

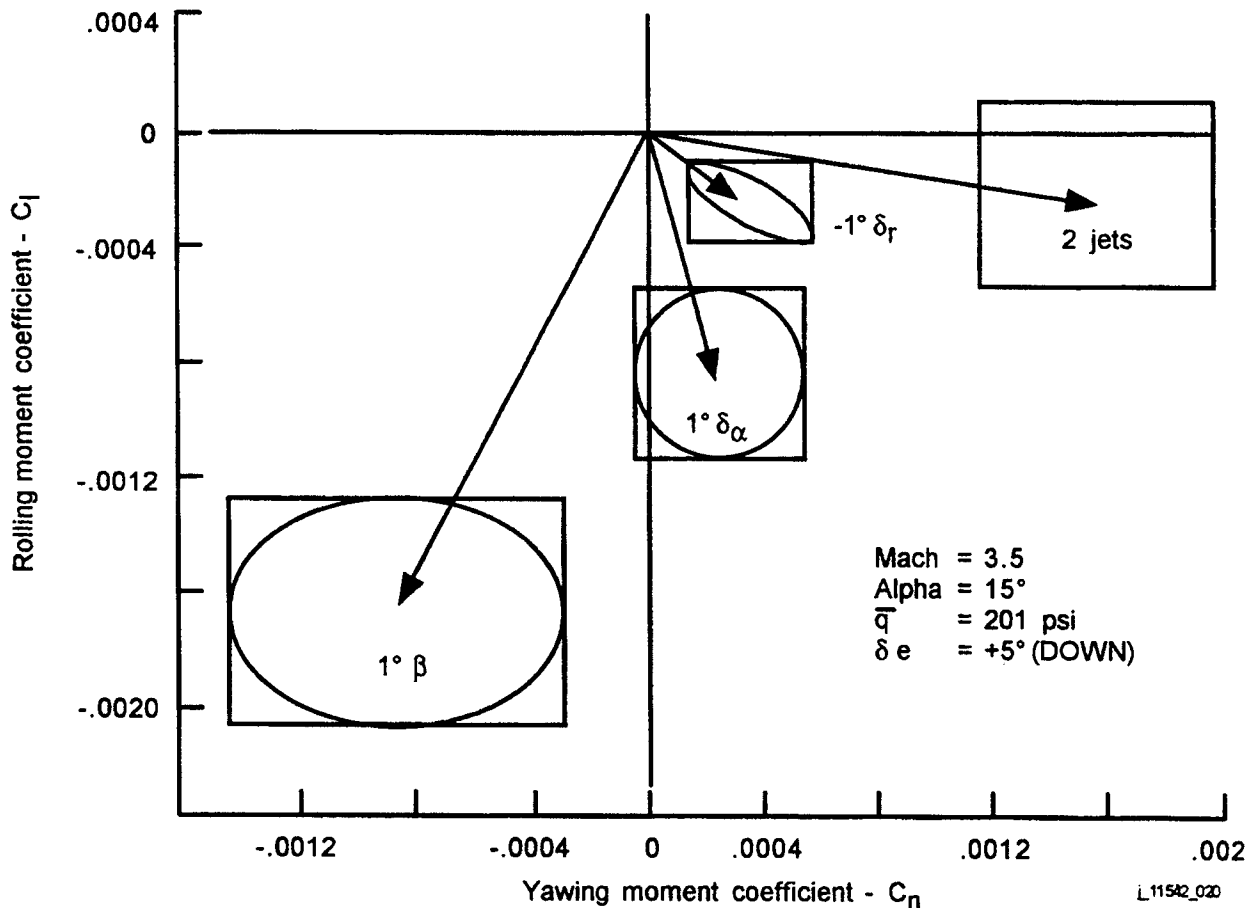

**Figure A-1. Vector diagram of aerodynamic coefficients showing uncertainties**

The motion associated with the different off-nominal aerosets can cause (1) low-damped oscillations in roll, (2) less stable  $C_{N\beta}$  dynamic, causing rapid oscillations in the lateral-directional axes, (3) large aileron-rudder trim positions to trim small Y c.g. offsets. Under severe conditions, these off-nominal cases can cause divergence. However, the FCS was designed to handle operational aerodynamic uncertainties along with the following various stress conditions:

- Winds, discrete gust, turbulence, shear
- Atmospheric variations
- Uncertainties, bent airframe/Y c.g. offsets
- Reaction control jet failures (two)

For the control specialist, the military specification levels are as follows:

- Level 1
  - Stability margin - 5 dB, 30° phase
  - Cooper Harper pilot rating of 3 or less
- Level 2
  - Stability margin - 4 dB, 20°
  - Cooper Harper pilot rating of 6 or less

## STABILITY AND CONTROL FLIGHT TEST PLAN

The purpose of this section is to describe the flight test program and how the data are used to reduce the uncertainty boundary about the preflight aerodynamic coefficients.

Orbiter testing is more expensive than flying other aircraft and therefore it is essential to reduce testing to a minimum. However, the operational limits must be expanded to include payloads that will make the shuttle more cost effective. The payloads may cause the center of gravity to shift aft or forward and the shuttle will have to accommodate this shift within a certain boundary. Since the shuttle glides from 400,000 feet at Mach 25 to touchdown in a time span of 35 minutes, only one test maneuver at a given flight condition can be executed on one flight.

Because of limited testing while obtaining the maximum amount of information, the locations of the test maneuvers were based on extensive shuttle testing, potential control problems, and flight anomalies. A plan was devised that would provide data with a minimum amount of testing. To optimize maneuver responses, PTI's were designed to pulse the control effectors (surfaces and jets) through onboard software. On flights 2 through 4, the PTI's were initiated by the crew by entering keystrokes at the computer keyboard. On subsequent flights, the PTI's are completely automatic. On the average, there are 8 to 10 PTI maneuvers per flight. If certain PTI's are missed during a flight, these PTI's are executed on another flight. This may increase the number of flights required to ensure valid data. More than one data point is necessary to reduce the aerouncertainties about the variable at a particular Mach number.

To provide high quality sensor data during these maneuvers, an instrumentation package was carried onboard.

### Flight Data Extraction

The flight test data were extracted from flight-measured translational accelerations, rotational rates, angle of sideslip, and bank angle through the use of a modified maximum likelihood estimator, MMLE3, a computer program developed at NASA Dryden Flight Research Facility. This digital computer program has been well demonstrated in flight test analyses of other aircraft.

For a given maneuver, MMLE outputs a linear estimate of the lateral-directional or longitudinal derivatives as well as an estimate of the relative uncertainty of the extracted derivative. Experience from previous flight test programs indicates that a multiplier of 10 on the uncertainty is the most representative of the shuttle flight uncertainties.

The results of MMLE3 on the lateral-directional derivative CLLB (rolling moment coefficient due to sideslip) are shown in figure A-2.

command is then processed through a maximum rate limiter. An integrator converts the rate to an amplitude signal. The PTI signals can be sent to the elevons, aileron, rudder, and jets. A typical PTI doublet is shown in figure A-3. The doublets are strung together in combinations to provide various inputs to the control effectors. A typical time response to a PTI is shown in figure A-4. The amplitude and time widths vary from one PTI doublet to another. All the PTI maneuvers are safety verified on several simulators before each flight. The verification process consists of doubling both the amplitudes and times of the PTI inputs, using stressed flight conditions. These conditions consists of at least worst aerovariation sets, offset center of gravity, jet failures, and angle-of-attack errors.

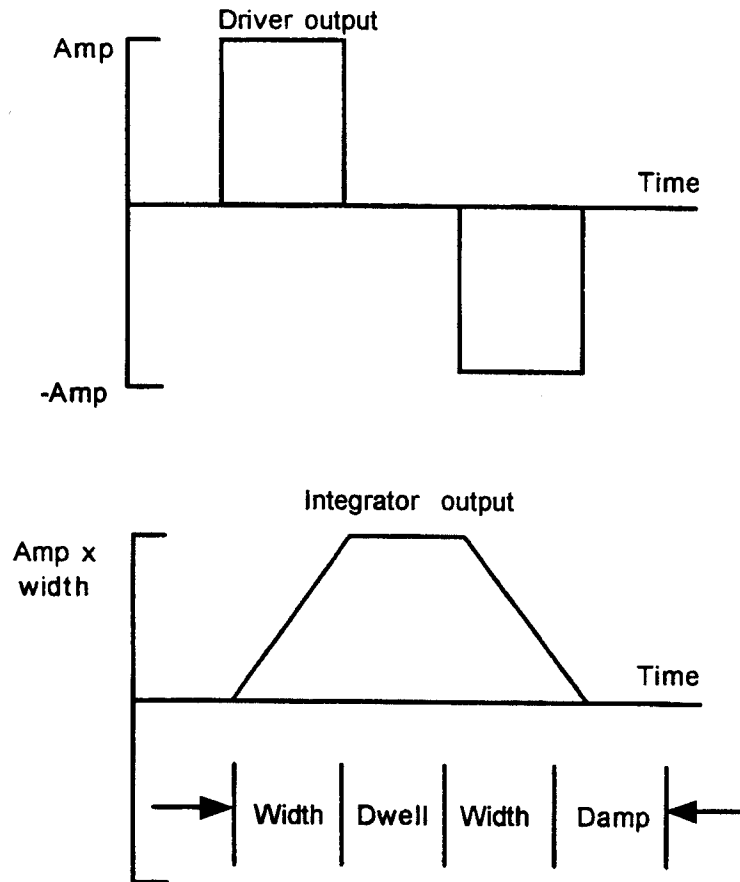

L11542\_022

**Figure A-3. Typical auto PTI output**

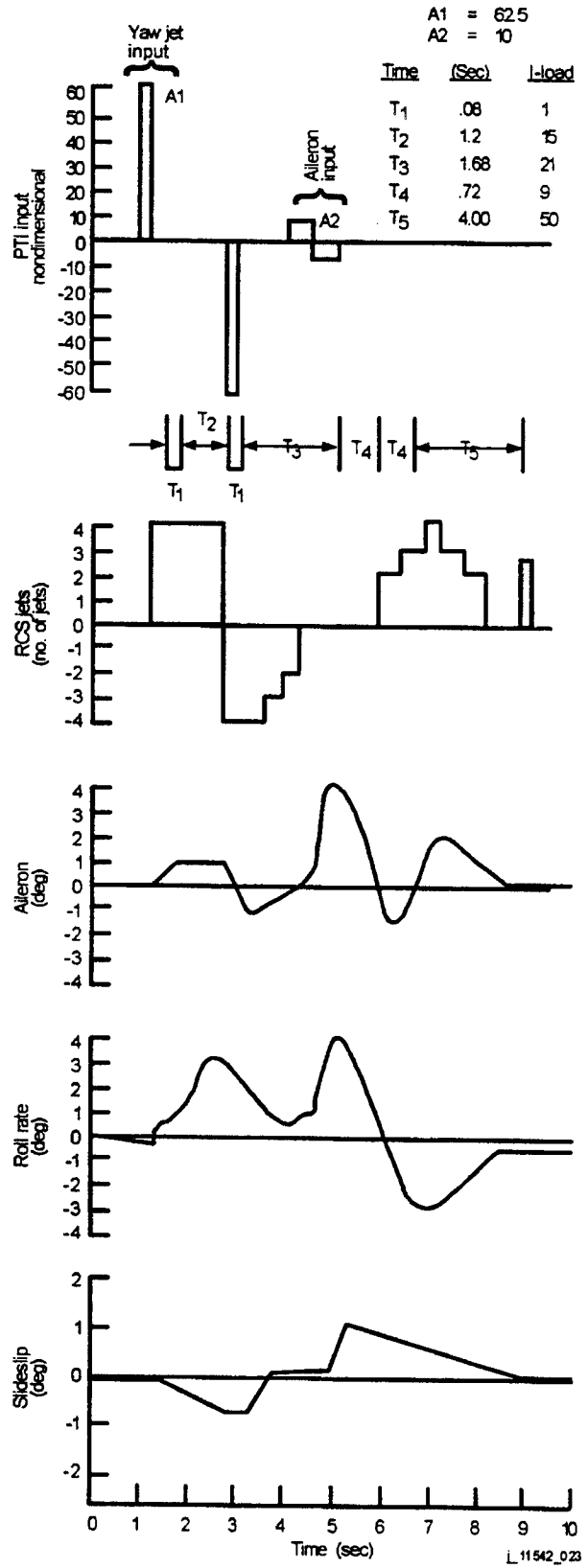

**Figure A-4. Automatic PTI (Mach 5.8)**