

# OFT Shuttle Flight Operations Manual

Vol 4 A - Audio System and UHF

Flight Operations Directorate  
Crew Training and Procedures Division

Preliminary

May 1978

LYNDON B. JOHNSON SPACE CENTER LIBRARY  
HOUSTON, TEXAS 77058

**NASA**

National Aeronautics and  
Space Administration

Lyndon B. Johnson Space Center  
Houston, Texas

4A-AUD

4A-AUD  
JSC-12770

FLIGHT OPERATIONS DIRECTORATE  
Preliminary  
OFT SHUTTLE FLIGHT OPERATIONS MANUAL  
Volume 4A Audio System and UHF

May 1978

PREPARED BY FLIGHT TRAINING BRANCH

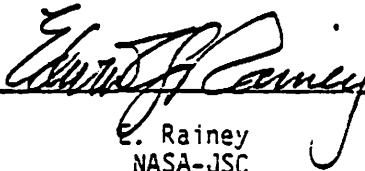
  
E. Rainey  
NASA-JSC

Approved By:

---

R. L. Myers  
Head, Ground Systems Section

  
for C. R. Lewis  
Chief, Flight Training Branch

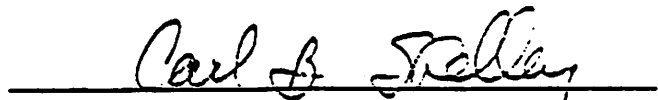
  
for J. W. Bilodeau  
Chief, Crew Training and Procedures Division

NATIONAL AERONAUTICS AND SPACE ADMINISTRATION  
LYNDON B. JOHNSON SPACE CENTER  
HOUSTON, TEXAS

This page intentionally left blank.

## TABLE OF CONTENTS

SECTION		PAGE
1	<u>INTRODUCTION</u> . . . . .	1-1
2	<u>AUDIO SYSTEM INTERFACES</u> . . . . .	2-1
3	<u>FUNCTIONAL DESCRIPTION</u> . . . . .	3-1
3.1	<u>AUDIO DISTRIBUTION SYSTEM (ADS)</u> . . . . .	3-1
3.1.1	Audio Central Control Unit (ACCU) . . . . .	3-2
3.1.2	Audio Center Switch . . . . .	3-2
3.1.3	Audio Terminal Unit (ATU) . . . . .	3-2
	A. ATU Control Knob . . . . .	3-7
	B. ATU Power Switch . . . . .	3-7
	C. Page Switch . . . . .	3-12
	D. Channel Control Switches . . . . .	3-12
	E. Channel Volume Control . . . . .	3-13
	F. XMIT/ICOM Mode Selection . . . . .	3-13
	G. VOX Sensitivity Control . . . . .	3-13
	H. Master (Speaker) Volume Control . . . . .	3-14
	I. TACAN Selection . . . . .	3-14
3.1.4	SMU Operation . . . . .	3-14
3.1.5	Audio Center . . . . .	3-15
	A. UHF Access . . . . .	3-15
	B. Electrical Interface Capability . . . . .	3-15
	C. Voice Recorder Selection . . . . .	3-15
3.1.6	CCU/EMU Outlets and Power Switches . . . . .	3-15
3.1.7	Headset Interface Unit (HIU) . . . . .	3-19
3.1.8	Headset Helmet Cables . . . . .	3-19
3.1.9	Circuit Breakers . . . . .	3-19
3.1.10	Launch Umbilical Interface . . . . .	3-22
3.2	<u>UHF SYSTEM</u> . . . . .	3-22
	A. UHF Control . . . . .	3-22
	B. UHF Access . . . . .	3-23
	C. UHF Transceiver . . . . .	3-23
3.3	<u>POWER DISTRIBUTION</u> . . . . .	3-23
3.4	<u>CIRCUITRY SCHEMATICS LIST</u> . . . . .	3-23

## TABLES

TABLE		PAGE
3-1	BUS POWER DISTRIBUTION . . . . .	3-31

## FIGURES

FIGURE		PAGE
1-1	ADS block diagram and subsystem interface . . . . .	1-2
3-1	Flight station audio panels . . . . .	3-3
3-2	Aft station audio panels . . . . .	3-4
3-3	Mid deck audio panels . . . . .	3-5
3-4	Audio center switch (ACCU control) . . . . .	3-6
3-5	Left (CDR) and right (PLT) ATU's . . . . .	3-8
3-6	MS, PS, and OS ATU's . . . . .	3-9
3-7	Mid deck CCU and mid deck SMU ATU's . . . . .	3-10
3-8	Airlock ATU . . . . .	3-11
3-9	Audio center panel . . . . .	3-16
3-10A	MS, OS CCU controls . . . . .	3-17
3-10B	RT (PLT) CCU control . . . . .	3-17
3-10C	SMU (typical) . . . . .	3-17
3-11	Airlock CCU and EMU controls . . . . .	3-18
3-12	Headset interface unit (HIU) . . . . .	3-20
3-13	ADS circuit breakers . . . . .	3-21
3-14	UHF controls . . . . .	3-24
3-15	ATU circuitry . . . . .	3-25
3-16	ATU XMIT/ICOM MODE circuitry . . . . .	3-25
3-17	ATU control transfer . . . . .	3-27
3-18	SMU circuitry . . . . .	3-28
3-19	UHF and audio center circuitry . . . . .	3-29
3-20	ACCU circuitry . . . . .	3-30

## PREFACE

The SFOM material covers the operation of the Audio Distribution System (ADS). The material is operationally oriented, covering switch and knob functions of the ADS components which enable crewmembers to communicate with one another and with sources external to the Orbiter. Detail of coverage goes to the level of basic circuitry diagrams to show generally what happens electrically when a switch/knob position is activated. Brief, general coverage is given to the Audio Central Control Unit, Crewman Communication Umbilicals (CCU) and Jacks, EVA Maneuvering Units (EMU) and Jacks, Headset Interface Units (HIU), Circuit Breakers, and the Launch Umbilical. Specific, relatively detailed coverage is given to the Audio Terminal Units (ATU), Speaker Microphone Unit (SMU), Audio Center, and the UHF system.

SECTION 1  
INTRODUCTION

The audio system includes internal communications and the various methods of interfacing with transmission and reception of external signals. Access to and operation of the UHF transceiver is also covered in this SFOM.

# ADS BLOCK DIAGRAM & SUBSYSTEM INTERFACE

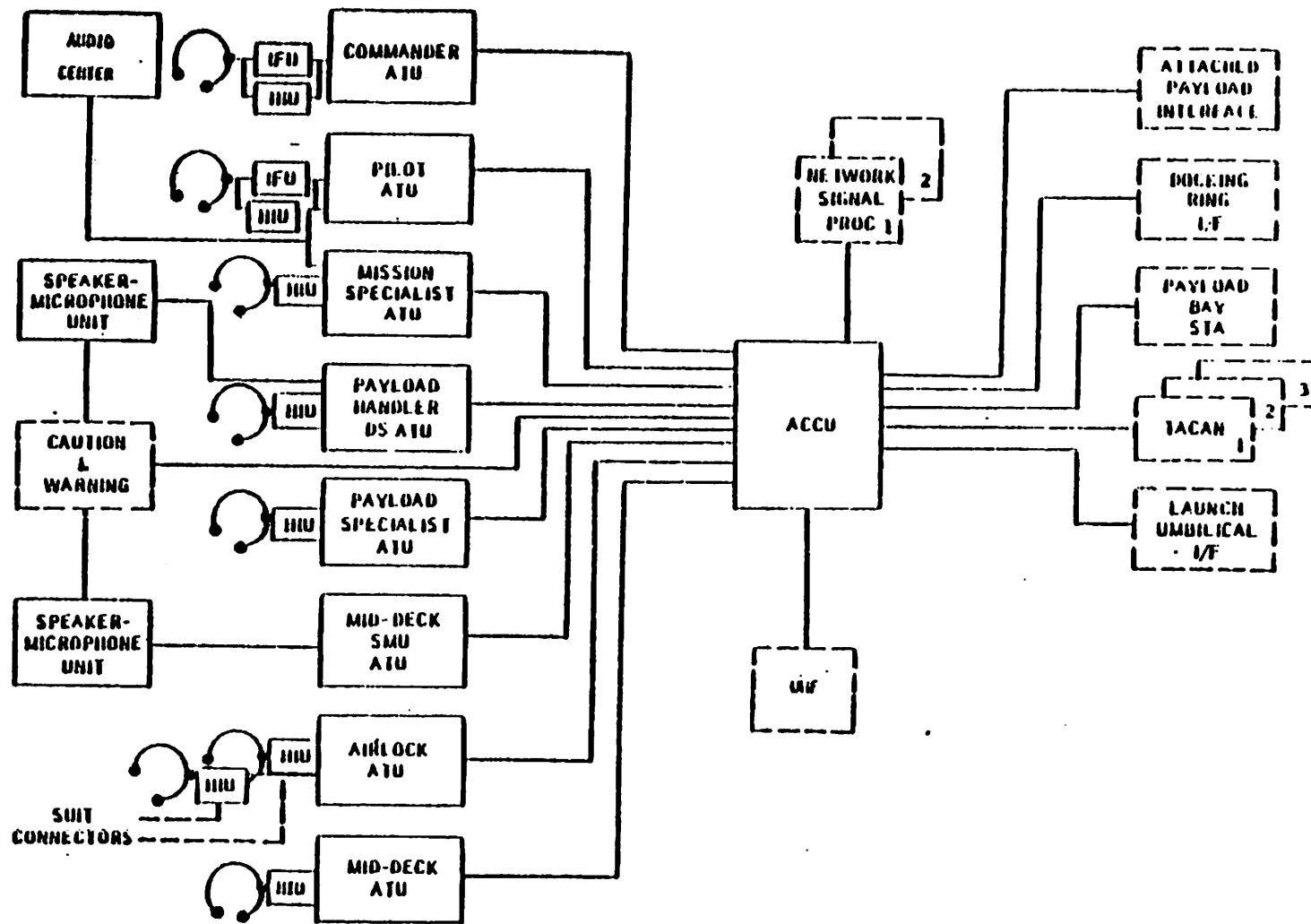

1-2

Figure 1-1.- ADS block diagram & subsystem interface.

1-1-100



SECTION 2  
AUDIO SYSTEM INTERFACES

The audio system interfaces with the caution and warning (C/W) system for reception of C/W (tone) signals, with the UHF and S-band systems for transmission and reception of external signals (air to air and air to ground), and with the three TACAN sets for receiver selection and signal monitoring. The Network Signal Processor (NSP) supplies S-band (and, when installed, Ku-band) signals to the audio system for transmission and/or reception at the various crew stations. The Docking Ring (DR), Attached Payload (Spacelab), Payload Bay, Launch Umbilical, and the NSP (OPS) recorder all have electrical interface with the audio system for transmission and/or reception of signals.

SECTION 3  
FUNCTIONAL DESCRIPTION

### 3.1 AUDIO DISTRIBUTION SYSTEM (ADS)

The Audio Distribution System (ADS) is a digital system which greatly reduces the number of wires necessary to carry electronic signals between system components. Electronic impulses can be given identifying characteristics and sorted into groups of signals. The coded impulses are called 'bits' of information and are generated by the particular position of each switch on the various control panels. Several bits can be reduced in number by a multiplexer to a particular identifying impulse. Bit groups from several sources are reduced so that a large number of signals can be sent along a single wire. Up to 128 bits of information can be encoded by the Audio Terminal Unit (ATU) into a serial data word and sent along one wire to a decoder in the Audio Central Control Unit (ACCU) where the bits are identified and separated by their original characteristics. Audio signals are then distributed by the ACCU to the appropriate ADS components. There are no digital voice signals in the ADS - only digital enable signals. All ADS voice signals are analog (audio).

The (ADS) is comprised of the following major components:

- A. Audio Central Control Unit (ACCU) - the "switchboard" of the audio system.
- B. Audio Terminal Unit (ATU) - audio control panels at the various crew stations.
- C. Speaker Microphone Unit (SMU) - a hard-mounted, combination speaker and microphone.
- D. Audio Center - control center for UHF, external vehicle/payload bay interface, and the NSP recorder.
- E. Crewman's Communication Umbilical (CCU) - headset/helmet cable.
- F. Crewman's Communication Umbilical Jack - plug for CCU.
- G. EVA Mobility Unit (EMU) - Maneuvering Unit for EVA.
- H. EVA Mobility Unit Jack - plug for EMU cable.
- I. Headset Interface Units (HIU) - hand held (or attachable) mic switch.
- J. Headset/Helmet Cables - transmission wires from HIU to headset/helmet.
- K. Circuit Breakers.
- L. Launch Umbilical Interface - intercom ground connection through launch pad umbilical.

Equipment location at the three crew stations is shown in Figures 3-1, 3-2, and 3-3.

**3.1.1 Audio Central Control Unit (ACCU).**- The ACCU, the heart of the audio system, is located in the mid deck forward avionics bay. It is not serviceable inflight. The purpose of the ACCU is to identify, switch, and distribute signals between the various ADS components. Both digital and audio signals are received and processed by the ACCU, but the ACCU transmits only audio signals.

The ACCU receives 28-v power from the ESS 2 CA DC Bus or the MN C DC Bus. The ESS 2 CA Bus is the primary power source for the ACCU. In the event of loss of ESS 2 CA Bus power, changeover to secondary, MN C Bus power must be manually accomplished with the AUDIO CENTER switch located on the center console. ACCU power is selected between buses or turned off with the three-position AUDIO CENTER switch.

**3.1.2 Audio Center Switch.**- Power to the ACCU is controlled by a three-position toggle switch on the center console (Figures 3-1 and 3-4). The switch is labeled 1, 2, and OFF. Position 1 selects ESS 2 CA Bus power for primary control of the ADS through the ACCU. Position 2 selects MN C Bus power for secondary control of the ADS. The OFF position blocks power from the ACCU.

#### NOTE

If the AUDIO CENTER switch is OFF, all normal audio functions will be inoperative. However, the CDR and the PLT will be able to communicate with headsets via sidetone if one of their ATU's is in the alternate position and the other ATU is in NORMAL. The volume level will be slightly reduced. No other stations have this feature.

**3.1.3 Audio Terminal Unit (ATU).**- The eight ATU's onboard are audio control panels and are used to select access and control volume to various audio signals (Figures 3-5, 3-6, 3-7, 3-8). There is an ATU at each crew station, two at mid deck, and one in the airlock to control signals to headsets (or helmets) via CCU/EMU outlets. The Orbit Station (OS) and mid deck each have an ATU to control signals through an SMU located at each of these stations. The OS ATU can control signals either to an SMU or to a headset/helmet through a CCU. Signals to or from ATU's are processed by the ACCU. The VOX Sensitivity, ATU control and Master Volume are controlled by circuitry within the ATU. All other knobs or switches on the face of the ATU send digital enable signals to the ACCU (except the "AUD" function of the ATU power switch which supplies power to the ATU circuits).



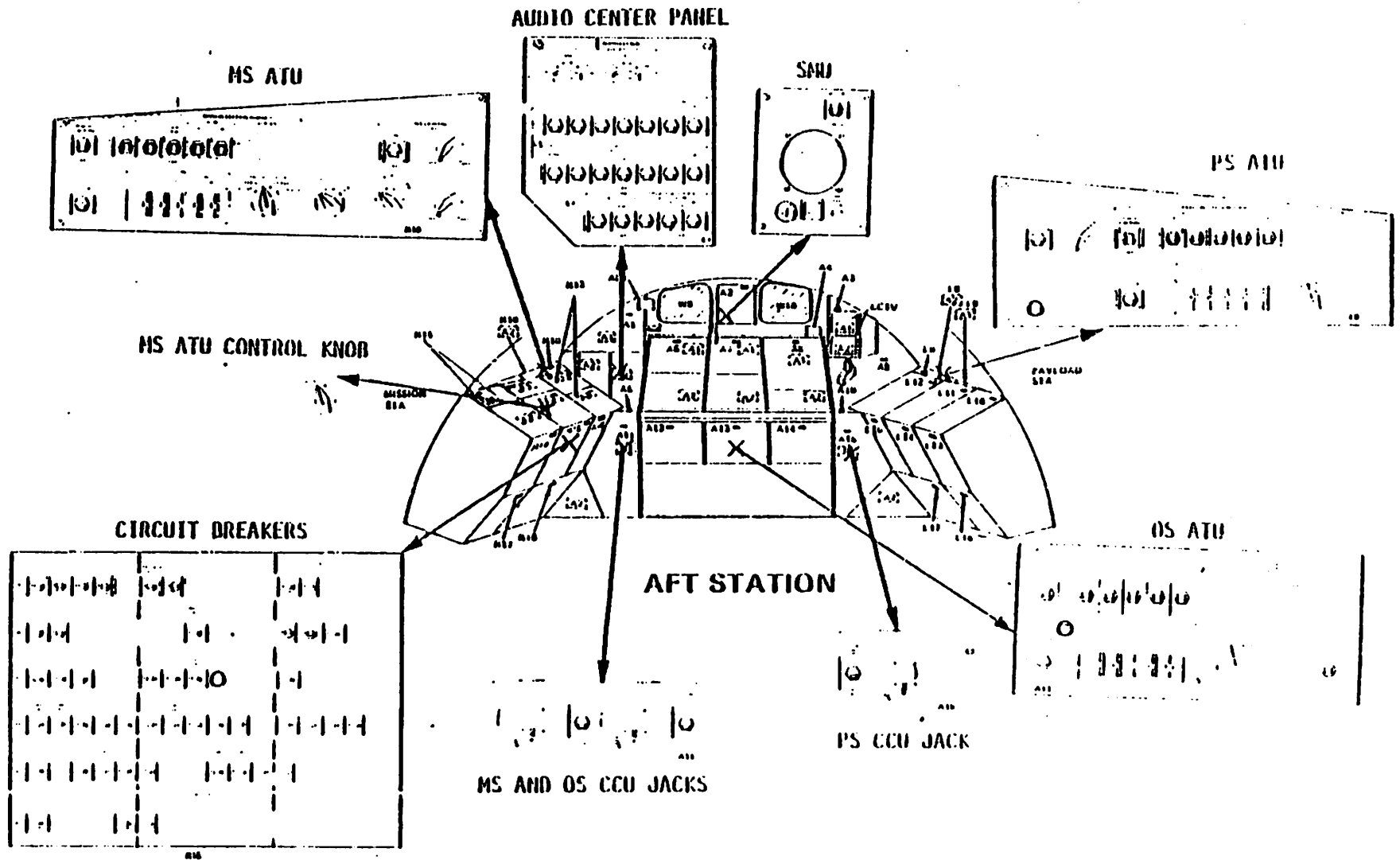

3-4

Figure 3-2.- Aft station audio panels.

3-5

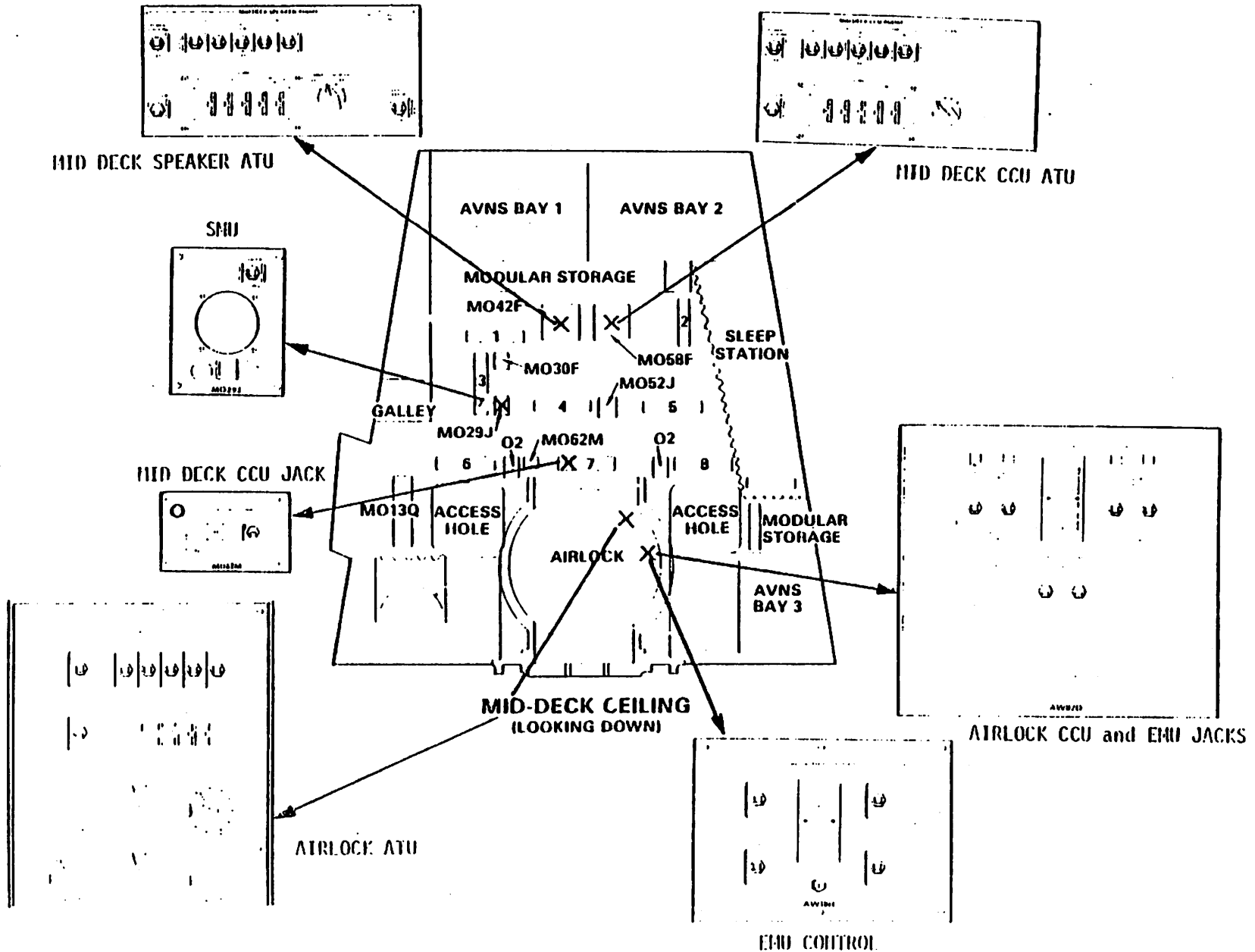

Figure 3-3.- Mid deck audio panels.

3-5

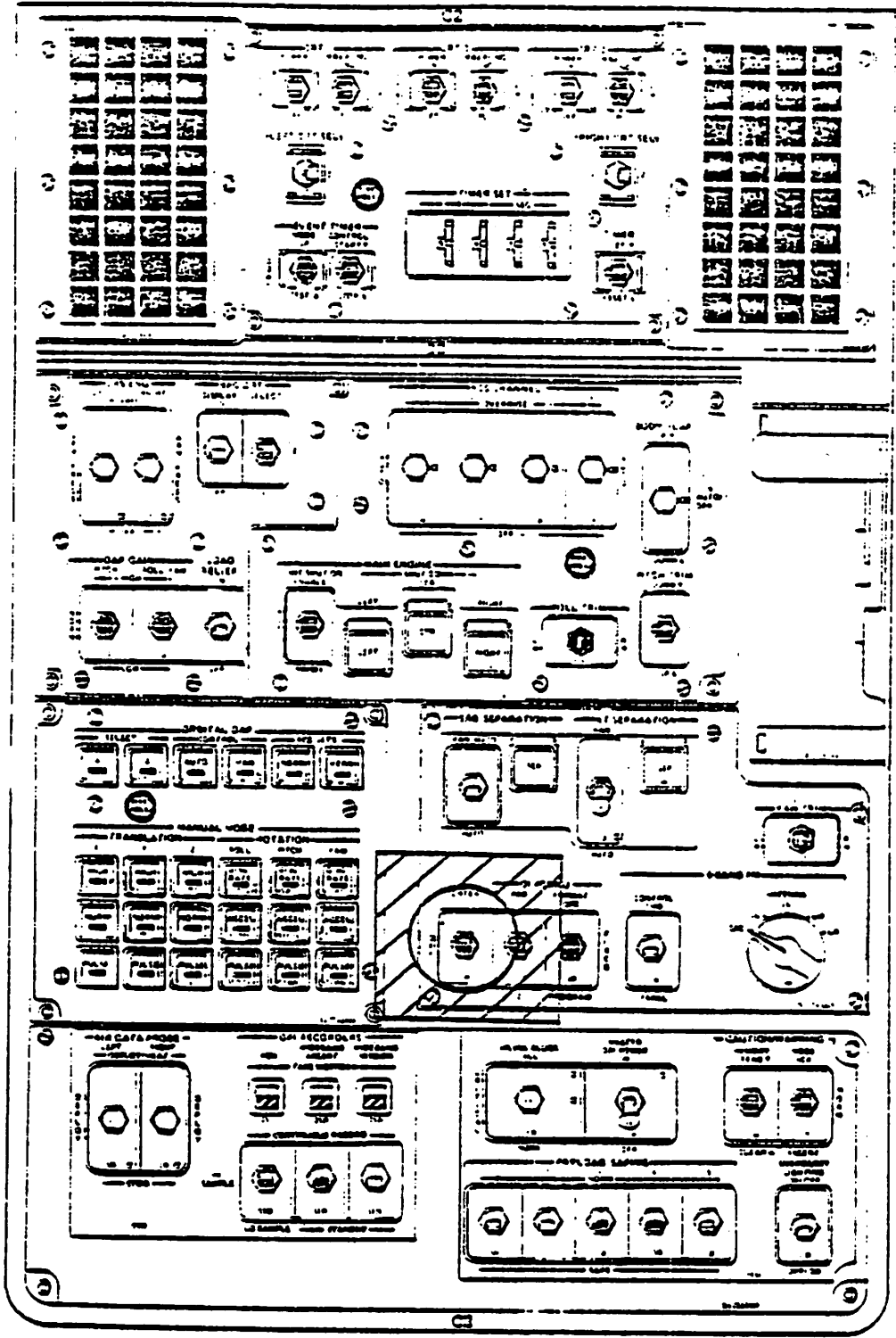

Figure 3-4.- Audio center switch (ACCU control).

A. ATU Control Knob (Redundancy Protection)

Four ATU's have a redundancy feature in which control of a particular panel may be switched to another ATU (Figures 3-5, 3-8). The left, commander's (CDR), may be switched to the right, pilot's (PLT) ATU. The right (PLT) ATU control may be switched to the left (CDR). The MS ATU control may be switched to the PS ATU, and the airlock control may be switched to the mid deck. Control of these latter two ATU's is not reversible as with the PLT and CDR ATU's. Airlock CCU/EMU 1 control is switched to the mid deck CCU ATU, and airlock CCU/EMU 2 control is switched to the mid deck SMU ATU. Both functions are switched with the single control knob on the airlock ATU.

The CDR, PLT, and the airlock control knobs are located on the respective ATU panel. The control knob for the MS ATU is located below the CRT 4 keyboard, which is below and left of the MS ATU.

In the NORM position, control of the ATU is with the panel to which the knob belongs. The other position of the knob indicates the ATU to which control can be transferred.

NOTE

With ATU control selected to the redundant ATU, the MASTER VOL on both ATU's will be operational. With an HIU in use, the HIU volume control is in series with its own ATU volume control.

The ATU control knob changes all ATU functions to the alternate ATU except the master volume control. Redundancy protection is for use in the event of failure or malfunction of any of the four ATU's that have an ATU control knob. After switching to the alternate ATU, it is recommended that the Audio Power switch for the malfunctioning ATU be turned OFF.

It is possible, although not recommended, for the CDR and PLT ATU control knobs both to be simultaneously switched to the alternate position. With both ATU's functioning, the CDR will have control of the PLT ATU, and the PLT will have control of the CDR ATU (except, in both cases, for master volume control).

B. ATU Power Switch

Each ATU has its own three-position power switch to control all signals to or from the ATU. The switch positions are labeled AUD/TONE, AUD, and OFF (Figures 3-5, 3-6, 3-7, 3-8).



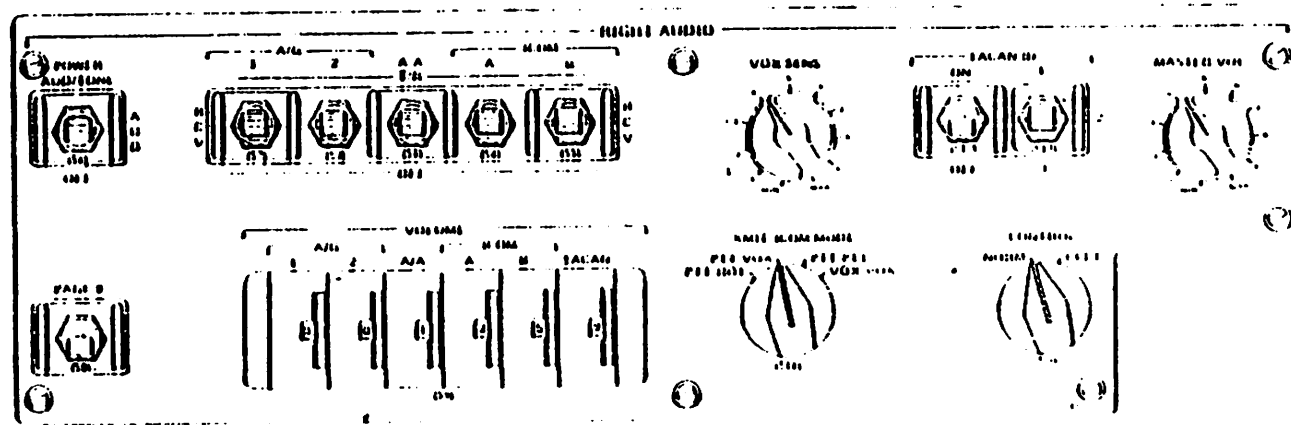
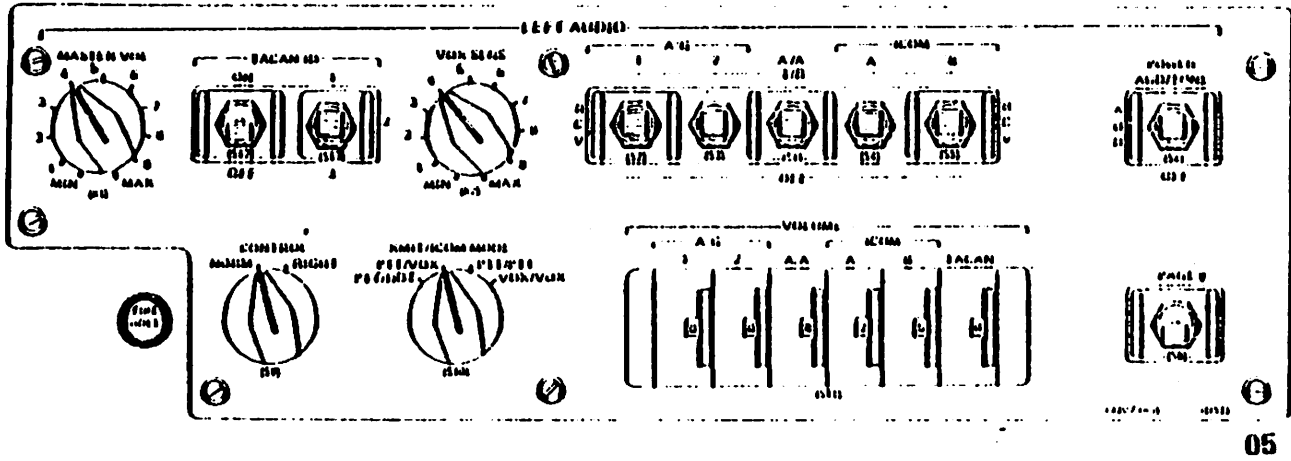

Figure 3-5.- Left (CDR) and right (PLT) ATU's.

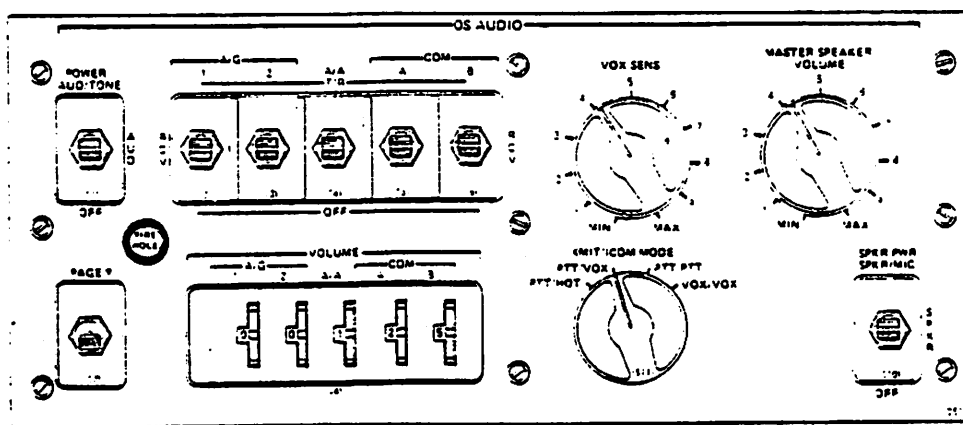
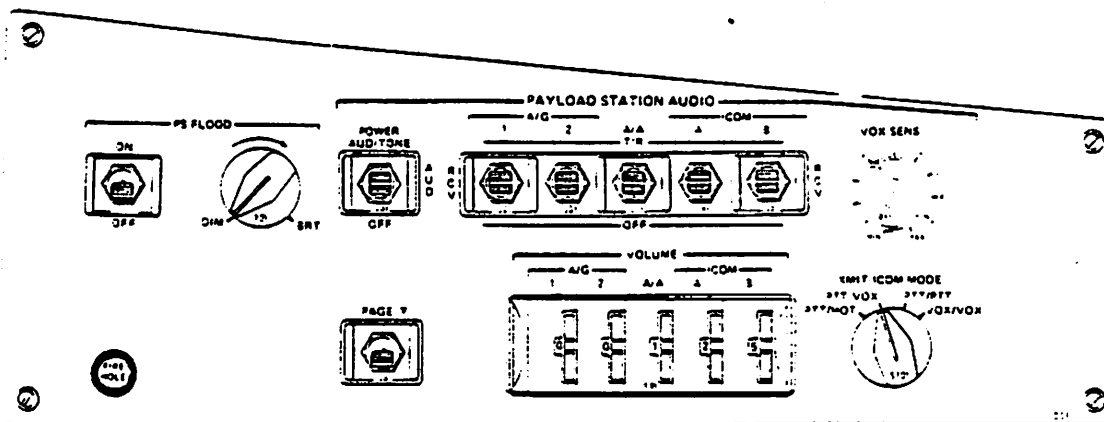
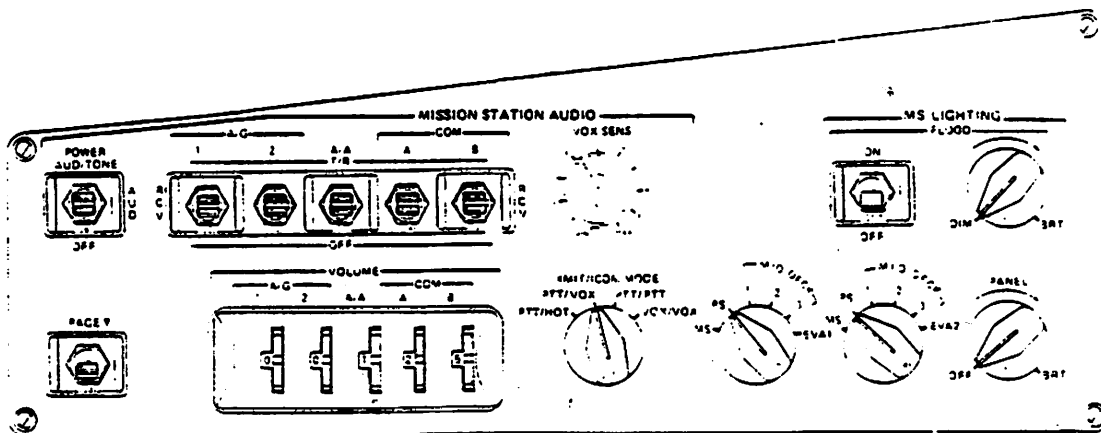

Figure 3-6.- MS, PS, and OS ATU's.

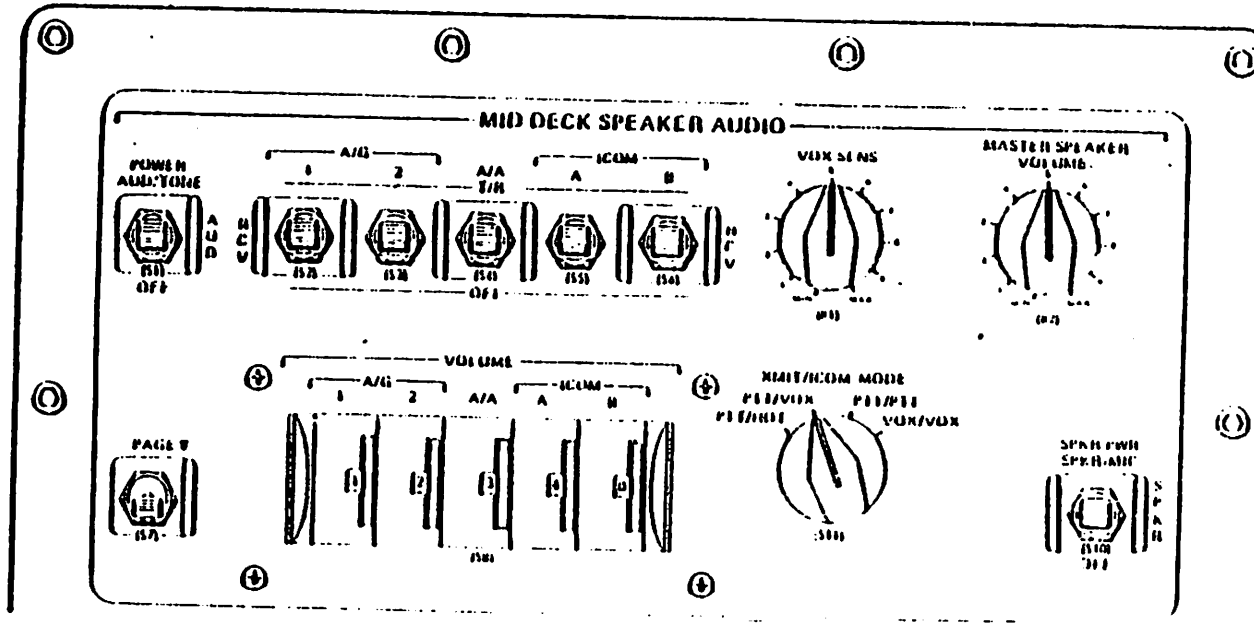
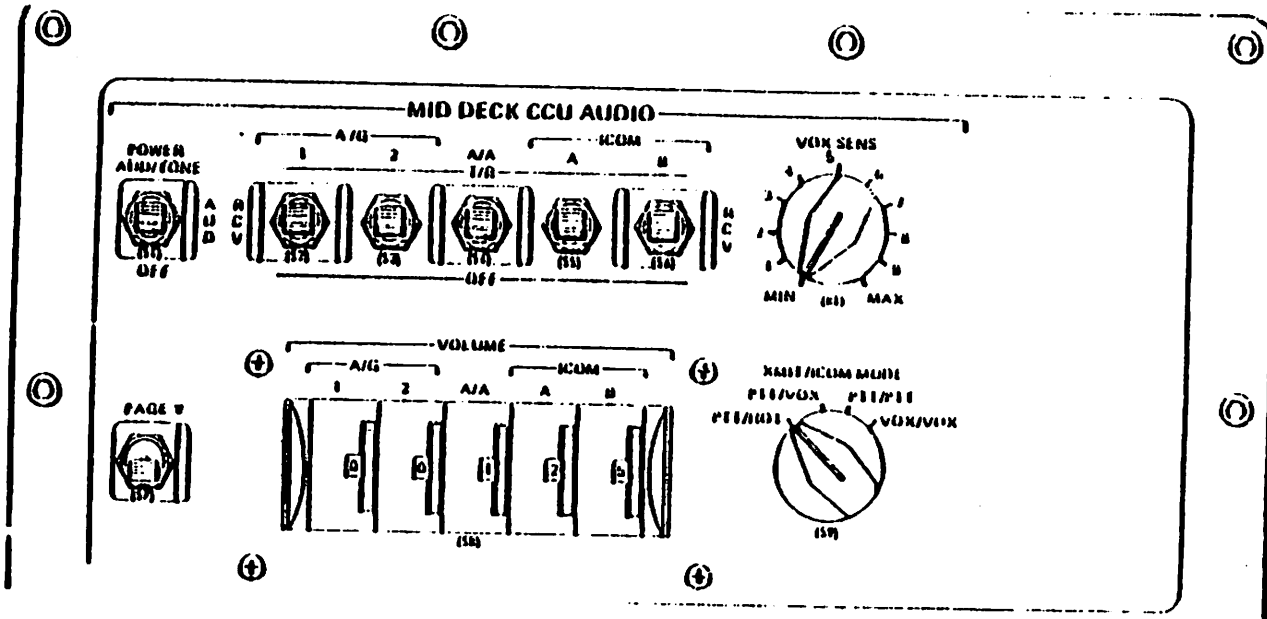

Figure 3-7.- Mid deck CCU and mid deck SMU AU's.

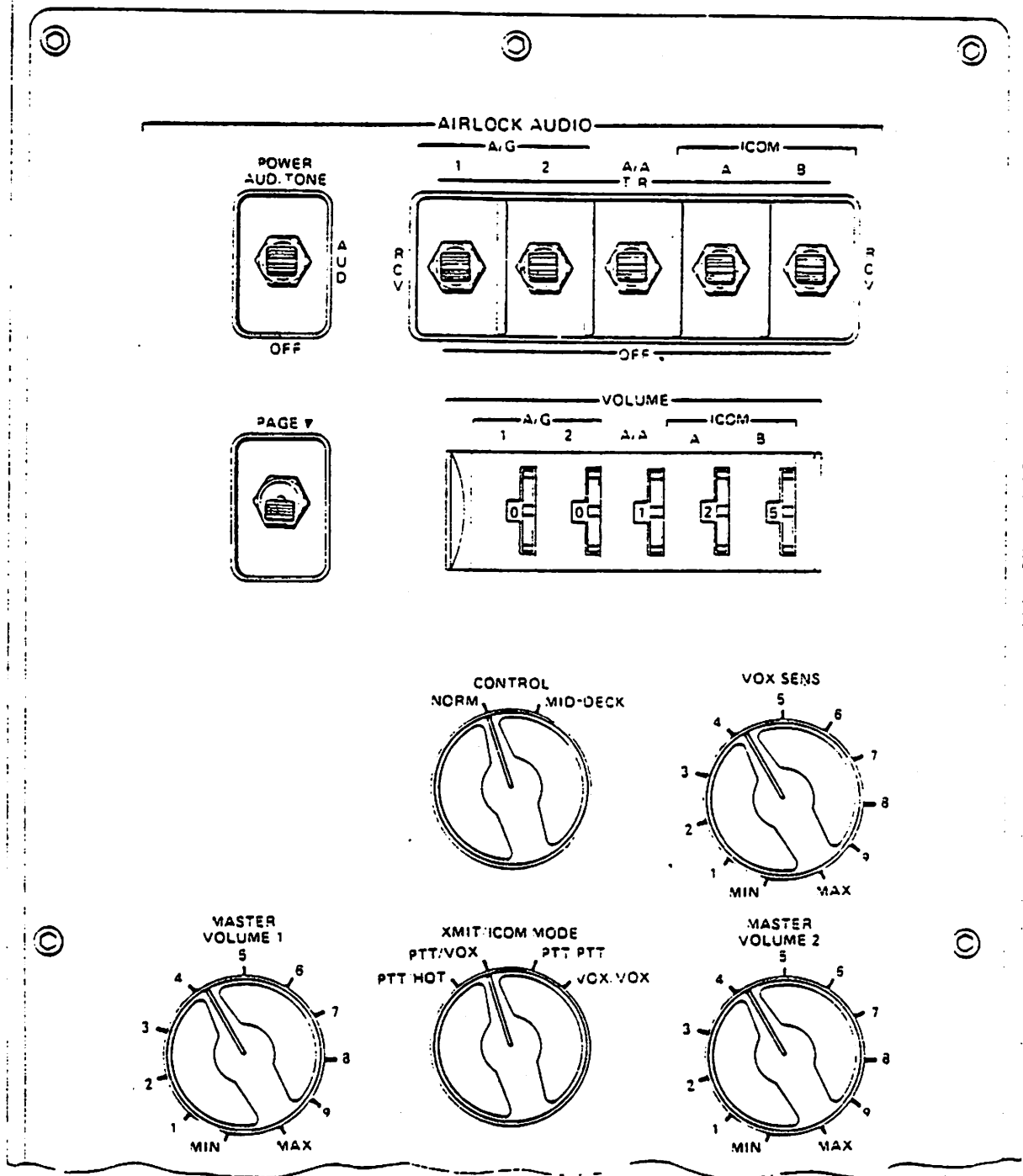

Figure 3-3.- Airlock ATU.

In the AUD/TONE position, all available functions of the ATU are armed, and transmission and reception may be made through the ATU, depending upon the position of other switches on the ATU. Caution and Warning (C/W, tone) digital enable signals are sent to the ACCU to allow C/W audio to reach the ATU, thence to a CCU Jack or an SMU. The AUD position has the same functions as AUD/TONE except that C/W signals are blocked from the ATU. The OFF position snuffs off power to the ATU power supply, which powers the ATU amplifiers.

NOTE

Siren (AP) and Klaxon (Fire) C/W signals go directly to an SMU even with the SMU and/or ATU power off.

C. Page Switch

Each ATU has a two-position, spring-loaded-off paging switch which must be held in the PAGE position to activate the circuit (Figure 3-5, 3-6, 3-7, 3-8). When activated, the switch enables the ATU to transmit to all other ATU's, the EVA transceiver, the attached payload circuit, and the docking ring circuit. Any number of stations may simultaneously use the paging circuit, and the circuit may be used regardless of the position of the various individual (channel) control switches (see paragraph D).

D. Channel Control Switches

On all ATU's, the two air to ground (A/G) channels, the air to air channel (A/A), and the two intercom (ICOM A and B) channels have individual three-position control switches for selecting access to particular channels for transmission or reception (Figures 3-5, 3-6, 3-7, 3-8).

The switch positions are T/R, RCY, and OFF. The T/R position permits transmission or reception over the selected channel. The RCY position deactivates transmission capability on the selected channel, and permits reception only of signals. The OFF position deactivates transmission and reception on the selected channel.

These control switches do not turn on any transmitter or receiver, but are used to allow access to a transmitter or receiver. For early OFT flights, only S-band and UHF will be used for external communications. Any ATU has the capability to transmit or receive S-band signals on AG1 or AG2 channels if the S-band is on. Any ATU can transmit or receive UHF signals on AA, AG1, or AG2 channels if the UHF is on and properly selected (see UHF section).

NOTE

It is possible to simultaneously transmit or receive UHF and S-band on either AG1 or AG2 channels, depending upon various switch positions.

### E. Channel Volume Control

Each of the individual channel control switches has a thumb-wheel volume control (Figures 3-5, 3-6, 3-7, 3-8) which permits adjustment of signal intensity on the related channel. The thumb wheels are labeled from zero (lowest volume) to nine (highest volume), and cover a range of approximately 27 db in 3 db increments. There is also a volume control wheel for TACAN signals on the PLT and CDR ATU's.

### F. XMIT/ICOM Mode Selection

The XMIT/ICOM MODE knob (Figures, 3-5, 3-6, 3-7, 3-8) controls the selection of transmission capability in four combinations of external/intercom transmissions. The four knob positions are labeled PTT/HOT, PTT/VOX, PTT/PTT, and VOX/VOX. In each case, the first set of initials indicates the method of external transmission activation, and the second set indicates the method of intercom activation.

1. PTT/HOT: External transmissions are made through push-to-talk (PTT) activation of an RHC (CDR or PLT station), an HIU (any CCU station ATU, or an SMU (OS or mid deck). In this mode HOT MIC is activated and the intercom is continuously live from the selected station. HIU or SMU XMIT must be keyed to enable external transmissions.
2. PTT/VOX: External transmissions are made by the XMIT function of an HIU or SMU, or RHC PTT. Intercom signals are voice activated (VOX). HOT MIC is more sensitive than VOX and will pick up more extraneous noise. VOX requires a higher decibel level to be activated than HOT MIC.
3. PTT/PTT: Access to external and intercom channels is through the PTT feature of an RHC, an HIU, or an SMU. The RHC PTT will activate any external and intercom channels selected.
4. VOX/VOX: Access to external and intercom channels is voice activated.

#### NOTE

The XMIT position of an HIU or SMU will activate selected external and intercom channels, but the ICOM position of an HIU or an SMU will activate only selected intercom channels. RHC PTT will activate any PTT function selected by the XMIT/ICOM mode knob and selected on the individual channel control switches.

### G. VOX Sensitivity Control

The loudness of the signal required to activate the VOX feature is regulated by the VOX sensitivity knob. The MAX (10dbm+3,-0db) setting requires a higher decibel level to activate the circuit than does the MIN (-17dbm+0,-3db).

## H. Master (Speaker) Volume Control

Volume control of all incoming signals to earphones (or speaker) is adjusted with the MASTER VOL knob (Figures 3-5, 3-6, 3-7, 3-8). The master volume control acts in series with the volume control wheels for the individual channels (AG1 and 2, A/A, ICOM A and B, and TACAN). Master volume knobs are located on the CDR, PLT, and airlock CCU ATU's, and on the OS and mid deck SMU ATU's. There are two master volume knobs on the airlock ATU (Figure 3-8). These knobs are labeled 1 and 2 and they control volume to the respective CCU/SMU outlets in the airlock. The knobs are labeled from 1 (minimum volume) to 9 (maximum volume) and have a 54-db range.

## I. TACAN Selection

The CDR and PLT ATU are the only two ATU's at which access to TACAN signals can be controlled. There are two TACAN switches (Figure 3-3). The two-position ON-OFF switch either allows reception of TACAN signals (ON) or blocks incoming TACAN signals (OFF). The other switch, which is three-position and labeled 1, 2, and 3, allows selection of the particular TACAN set to be monitored. There is no transmission capability over the TACAN channels.

3.1.4 SMU Operation.- Two ATU's, the OS AUDIO and the MID DECK SPEAKER AUDIO panels, control operation of the SMU located at the respective stations. In addition to the features of the other ATU's, the SMU ATU's have a three-position power switch labeled OFF, SPKR, and SPKR/MIC. In the OFF position, no signals go through the ATU. In the SPKR position, the SMU operates as a speaker only. In the SPKR/MIC position, the SMU can be used as either a speaker or a microphone. There are two SMU's on board (Figure 3-10-C). One is located at operations station (OS) on the panel between the two aft viewing windows, and the other is in the mid deck ceiling. Both units operate identically. The power switch for the SMU is located on the associated ATU (Figures 3-6, 3-7). Signals to or from the SMU are selected on the related ATU. A three-position, spring-loaded off switch on the face of the SMU operates in conjunction with the PTT functions of the ATU. The positions are: XMIT, for access to external transmissions; ICOM, for internal communications; and the unlabeled off (center) position which blocks outgoing PTT signals from the SMU. The XMIT position will send signals over selected intercom circuits and to any external transmitters selected by the SMU ATU. The ICOM position excludes signals to external transmitters and allows signals to be sent over the selected ICOM channel(s) (A and/or B). Keying the ICOM or XMIT switch will override the speaker, except for caution and warning (C/W) emergency signals. In the VOX mode, the first signal to activate the circuit, either MIC or SPEAKER, will have priority, except over C/W emergency signals. The MIC KEY light is a two-position adjustable intensity light that operates in conjunction with SMU transmissions. The intensity of the top half of the light (MIC) is adjustable by the MIC LEVEL knob; the brighter the light, the louder the signal. The bottom half of the light (KEY) will illuminate when a PTT function is selected and the circuit is keyed. Siren ( $\Delta P$ ) and Klaxon (Fire) C/W tones go directly to the speakers, even if the speaker power switch is off.

3.1.5 Audio Center.- The audio center panel (Figure 3-9) is located at the OS station and has three functions: (1) UHF control, (2) electrical interface capability with external vehicles and the payload bay, and (3) NSP recorder (OPS recorder) selection. All functions on the audio center panel use 28-Vdc power, and the switches on the audio panel send digital impulses to the ACCU to enable the selected function.

Both the PLT ATU and the MS ATU supply power to the Audio Center Panel to generate simultaneous data streams to the ACCU to enable the various functions. When the ACCU is operating on primary (ESS 2 CA) power, the MS data stream is used, and the PLT data stream is available as backup. When the ACCU is operating on secondary (MN C) power, the PLT data stream is used, and the MS data stream is available as backup. In either case, if the primary data stream becomes unreliable, switching to the backup data stream is automatic through diodes in the ACCU.

A. UHF Access

See Section 3-10.

B. Electrical Interface Capability

Provisions for communicating with the docking ring, the Spacelab, and the payload bay are controlled by the audio center panel. Sets of ON-OFF toggle switches labeled DOCKING RING, SPACELAB, and PL BAY OUTLETS electrically connect the particular function to the ADS. The DOCKING RING and SPACELAB each have seven switches to enable the following functions: A/A, A/G1, A/G2, ICOM A, ICOM B, PAGE, and TONE (C/W). The PL BAY OUTLETS sub-panel has two ON-OFF switches, one for ICOM A and one for ICOM B, to enable the respective intercom function.

C. Voice Recorder Selector

The two rotary knobs, labeled VOICE RECORD SELECT, control various audio signals to be sent to the NSP recorder (also called the OPS recorder) via the NSP. AG1, AG2, A/A, ICOM A, or ICOM B audio can be sent to either recorder. Any two signals may be recorded at the same time, one on Channel 1 and the other on Channel 2. Either, or both channels may be turned off. Signals going to the recorder cannot be monitored by the crew.

3.1.6 CCU/EMU Outlets and Power Switches.- The outlets provide electrical connection to headset/helmet cables, and have an ON-OFF toggle switch at each outlet to control electrical power to the respective cables (See Figures 3-1, 3-2, 3-3, 3-10A, 3-10B, 3-11).



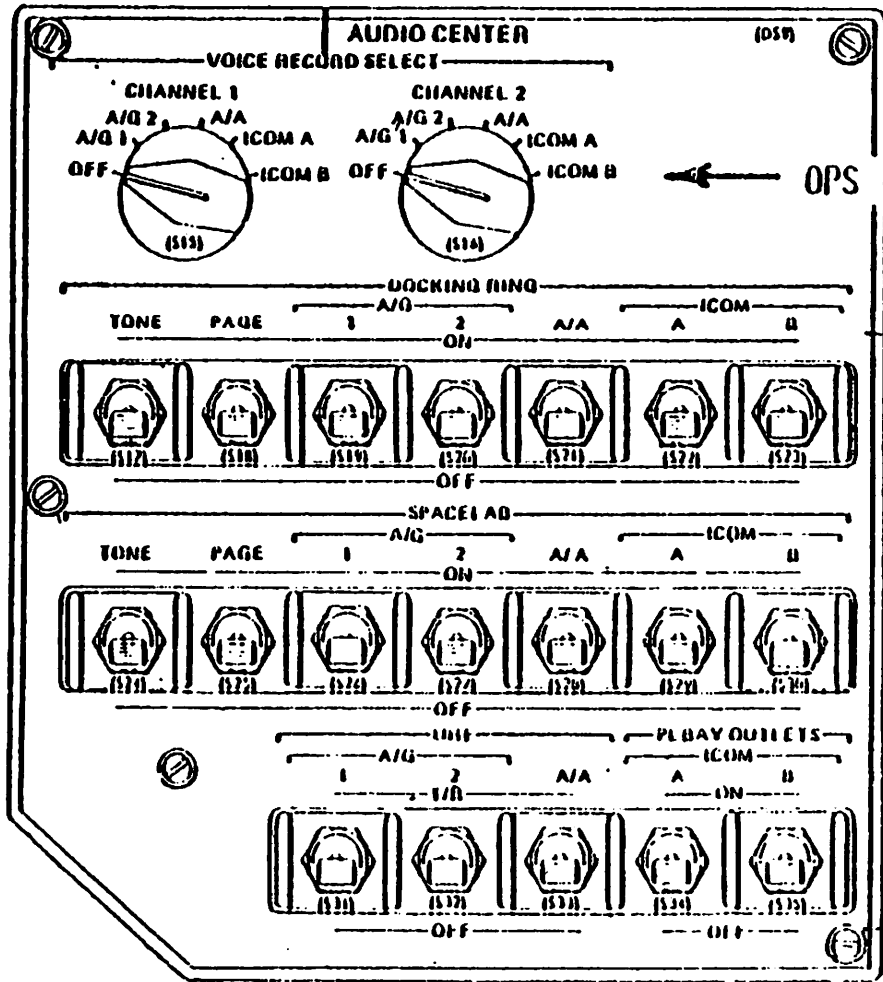

OPS (NSP) RECORDER KNOBS

CHANNEL ENABLE SWITCHES  
(FOR DOCKING RING, SPACE LAB,  
UIIF AND PAYLOAD BAY)

Figure 3-9.- Audio center panel.

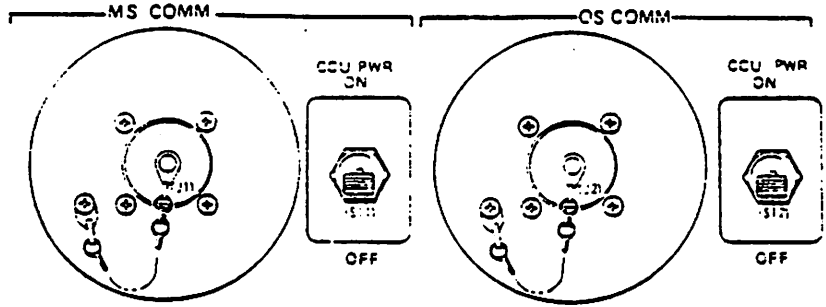

A.

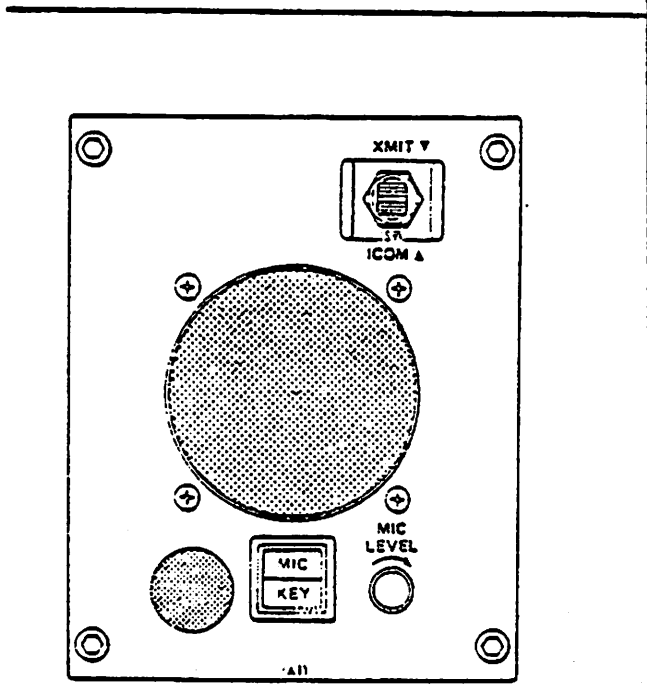

C

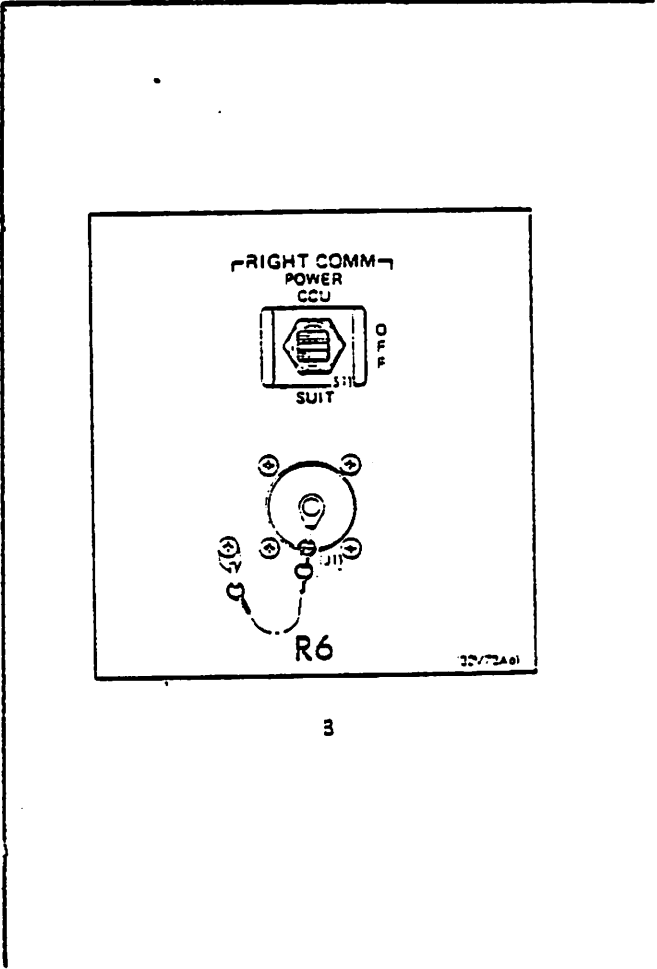

B

Figure 3-10.- A. MS, OS CCU controls.  
 B. RT(PLT) CCU control.  
 C. SMU (typical).

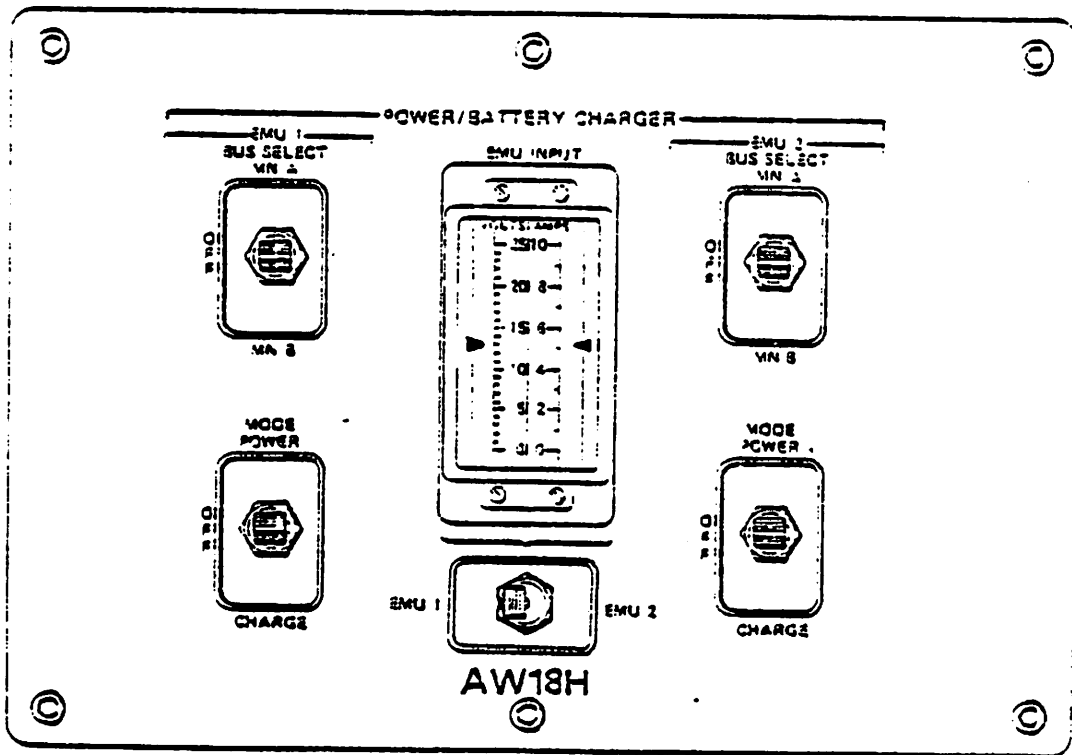
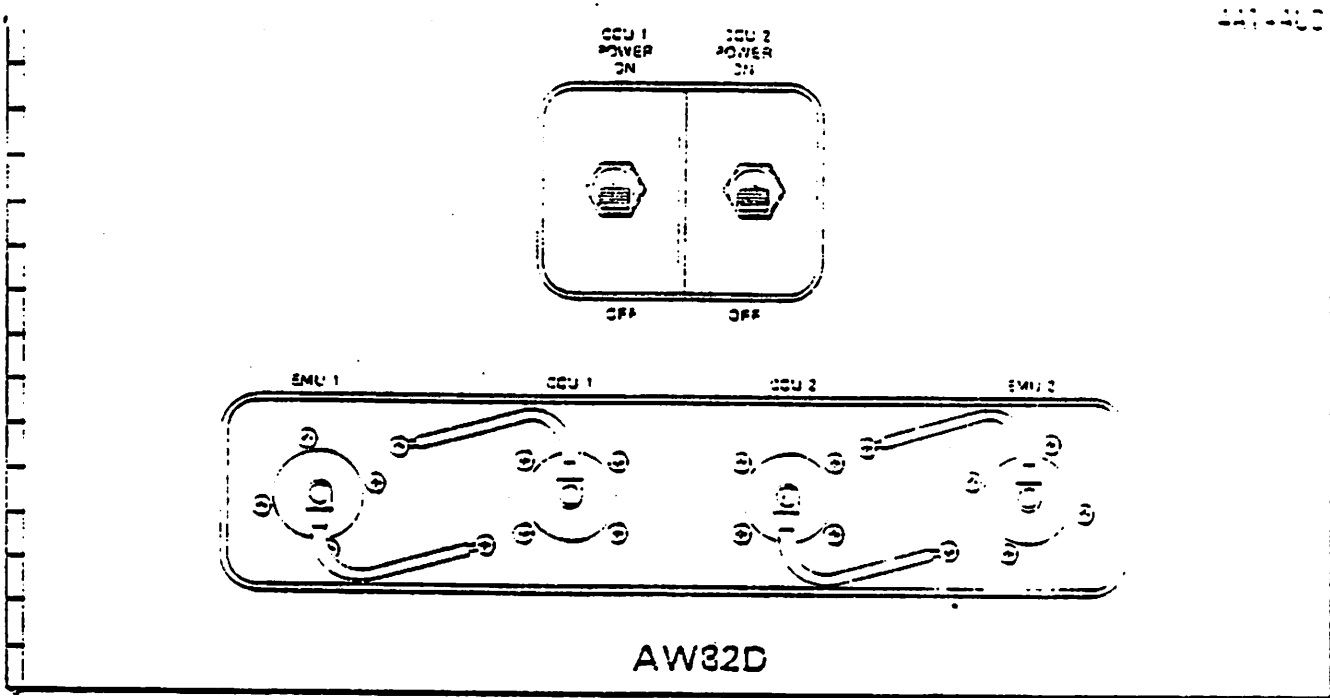

Figure 3-11.- Airlock CCU and EMU controls.

## NOTE

It is recommended that the switch be turned off prior to connecting or disconnecting CCU/EMU leads to prevent the possibility of electrical arc between the lead and the outlet.

Only MIC signals are affected by the position of the CCU/EMU switch. With the switch OFF (and the HIU/HELMET leads plugged in), signal reception will be normal, but transmissions will be blocked.

The CDR and PLT stations each have three-position CCU switches labeled CCU, OFF, and SUIT (Figure 3-10-3). The CCU position permits power flow to an HIU. The OFF position blocks MIC power from either an HIU or a helmet/suit, and the SUIT position permits power to reach the suit microphone. All other CCU's are two-position ON-OFF switches labeled CCU and OFF, and the switch functions are the same as with the PLT and CDR's switches.

The EMU control toggle switches are located in the airlock, below the EMU outlets, on the panel labeled POWER/BATTERY CHARGER (Figure 3-11). The individual three-position switches are labeled EMU 1, EMU 2, and BUS SELECT. Each switch provides the capability of selecting Main A or Main B DC power for the EMU, or of turning power on/off to the EMU.

3.1.7 Headset Interface Unit (HIU).- The HIU is a portable mic switch which is part of a CCU (Figure 3-12). The HIU has a clip for attaching to an individual's flight suit. The unit has a rocker-type three-position switch and a volume control knob. The switch positions are XMIT, ICOM, and an unlabeled, spring-loaded off, center position. The XMIT position allows access to intercom and external circuits, while the ICOM position is for intercom only. The volume control knob acts in series with the volume controls on the associated ATU. See note in Section 3.3.A.

3.1.8 Headset/Helmet Cables.- These are the electrical leads that plug into a CCU/EMU Jack to electrically connect a headset/helmet to the ADS. The leads from the headset/helmet to the HIU are 24 in. long. The leads from the HIU to the CCU/EMU Jacks are 48 in. long and any number may be connected in series.

3.1.9 Circuit Breakers.- The circuit breaker panel, located at lower MS, contains pull-type circuit breakers for all audio system components (Figure 3-13). The MS/OS ATU's and the PS/airlock ATU's are each controlled by a single breaker. The ACCU power CB's are labeled AUD CTR 1 and AUD CTR 2. The AUD CTR 1 CB controls ESS 2CA (primary) power to the 1 position of the AUDIO center switch on the center console. The AUD CTR 2 CB controls MN C (secondary) power to the 2 position of the AUDIO CENTER switch.

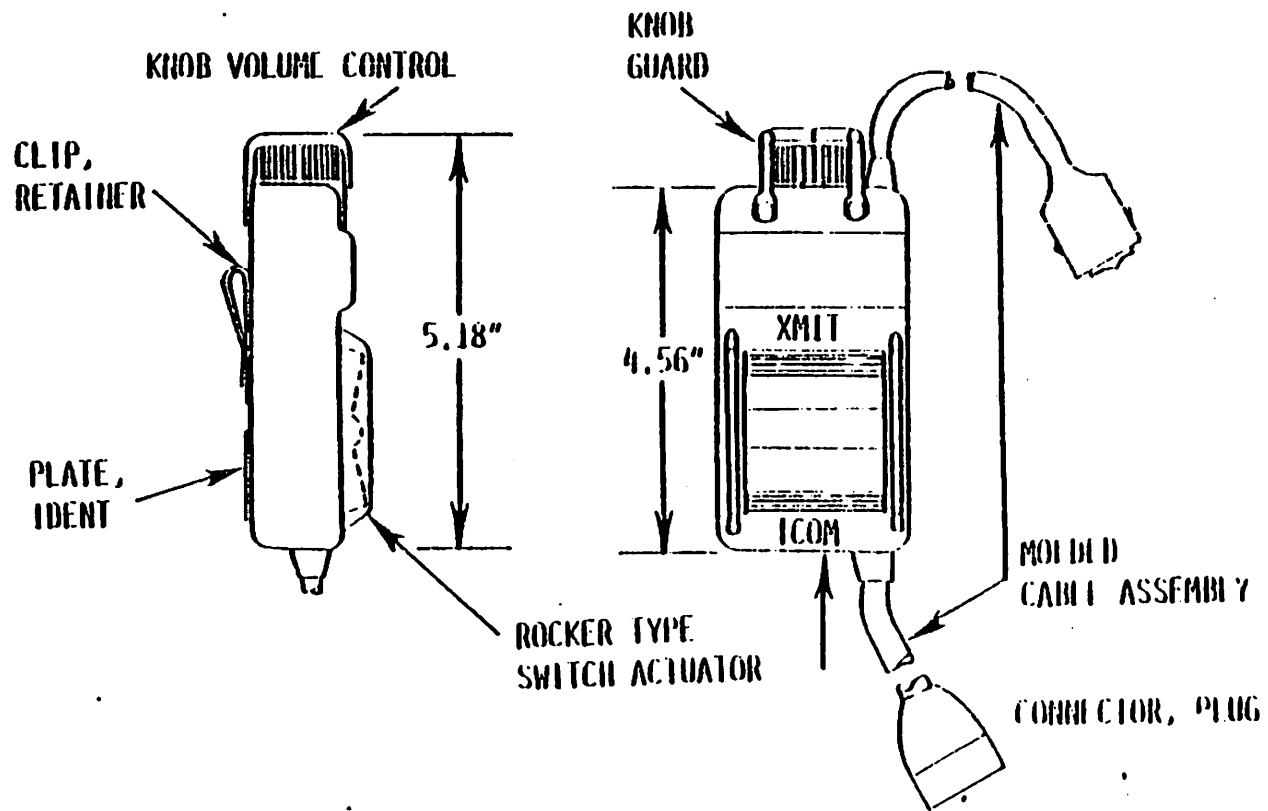

Figure 3-12.- Headset interface unit (HIU).



3.2.10 Launch Umbilical Interface. - The ACCU contains circuitry that activates signals from the Launch Umbilical connection ICCM A and B channels. Any crew station -TU can then be configured to transmit and/or receive ICCM signals from the ground via the umbilical. Only ICCM signals will be processed through the umbilical.

## 3.2 UHF SYSTEM

### A. UHF Control

Control of UHF external transmission is accomplished through the UHF mode knob on the CDR's overhead panel (Figure 3-14). Three two-position toggle switches, labeled XMIT FREQ, ANTENNA, and SQUELCH, are on the same panel, and perform the following functions:

1. XMIT FREQ - permits selection of one of two UHF frequencies, 296.8 MHz or 259.7 MHz, for external transmissions. These two frequencies, as well as UHF guard (243.0 MHz), are pre-set in the UHF transmitter and cannot be altered by the crew.
2. ANTENNA - permits selection of either the external (EXT) antenna on the outside lower fuselage, or the airlock (airlock) antenna located in the forward cargo bay.
3. SQUELCH - permits selection (ON) or deselection (OFF) of UHF squelch.

The five-position rotary UHF mode knob permits selection of various modes of UHF transmissions, and activates power to the UHF transceiver. The knob controls 28-Vdc power from the PLT's ATU (ESS 29C) and the MS ATU (MN 3) to the audio center UHF switches (see UHF access section) and to the transceiver. Should either ATU become inoperative, the changeover to the other ATU is automatically dioded in the ACCU. The knob labels and functions are as follows:

1. EVA - external transmissions are made on the frequency selected by the XMIT FREQ toggle switch, and reception is on the other UHF frequency.
2. OFF - power is blocked from the UHF control switches on the AUDIO CENTER panel at the OS station, which, through the PLT or MS ATU, send digital UHF enable signals to the ACCU to activate the transceiver.
3. SIMPLEX - UHF transmissions and receptions are made on the frequency selected by the XMIT/FREQ toggle.
4. SIMPLEX + G RCY - same as SIMPLEX, except that reception of UHF guard (243.0 MHz) is possible.
5. G T/R - UHF transmissions and receptions are made on guard frequency.

### 3. UHF Access

Access to transmission and reception of UHF signals is controlled by three two-position toggle switches located on the bottom of the audio center panel at the OS station (Figure 3-14). The switches are labeled T/R, for transmission and reception, and OFF, for blocking UHF signals to or from the UHF transceiver. There is a switch for both of the A/G channels and the A/A channel. Power (28 Vdc) to the switches is controlled by the rotary UHF mode knob on the CDR's overhead panel.

Digital signals are sent from the switches to the ACCU to enable the selected function, and to enable power to the transceiver.

#### NOTE

If all three of these switches are in the OFF position, UHF operation will not be possible.

### C. UHF Transceiver

The UHF transceiver is an AR - 150 (V)SS "off-the-shelf" military unit modified for use in OFT. The set is powered, through circuit breakers, by 28-Vdc power from the MN A Bus. Within the main UHF transceiver is a separate guard transceiver for transmitting or receiving on UHF guard (243.0 Mhz).

### 3.3 POWER DISTRIBUTION

The ADS is powered, in various redundant combinations, by the A, B, C 28-V Main DC Buses, the ESS 1 BC Bus (CDR ATU), and the ESS 2 CA Bus (PLT ATU). Table I shows which components are powered by which buses.

### 3.4 CIRCUITRY SCHEMATICS

- A. Figure 3-15 - ATU Circuitry
- B. Figure 3-16 - ATU XMIT/ICOM MODE Circuitry
- C. Figure 3-17 - ATU Control Transfer
- D. Figure 3-18 - SMU Circuitry
- E. Figure 3-19 - UHF and AUDIO CENTER Circuitry
- F. Figure 3-20 - ACCU Circuitry



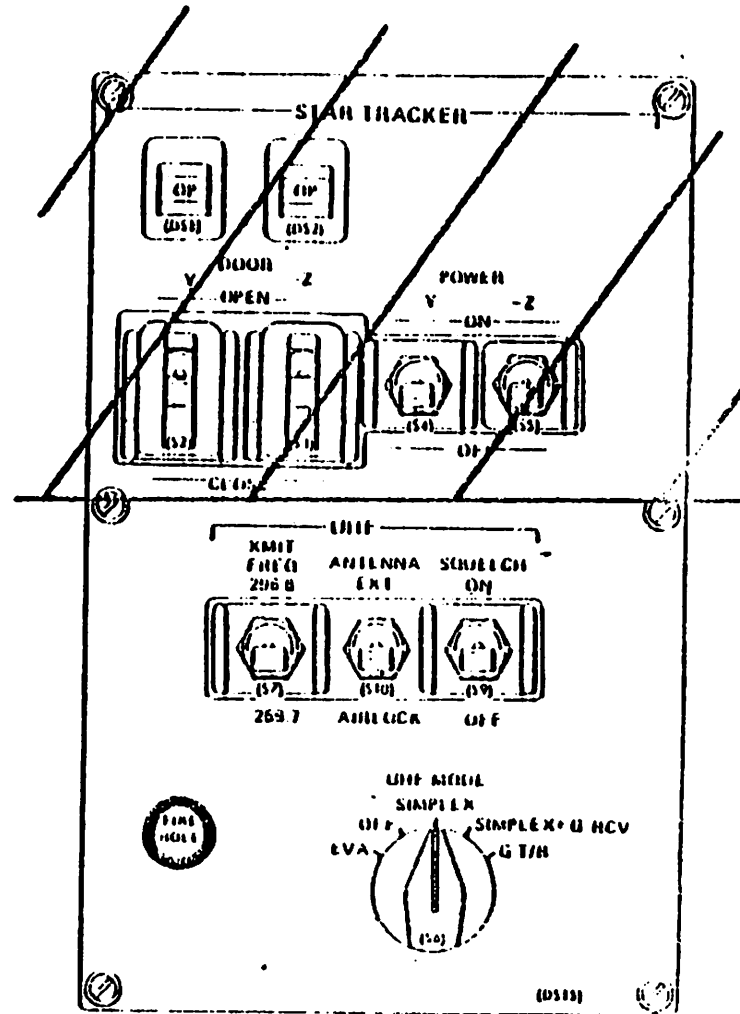
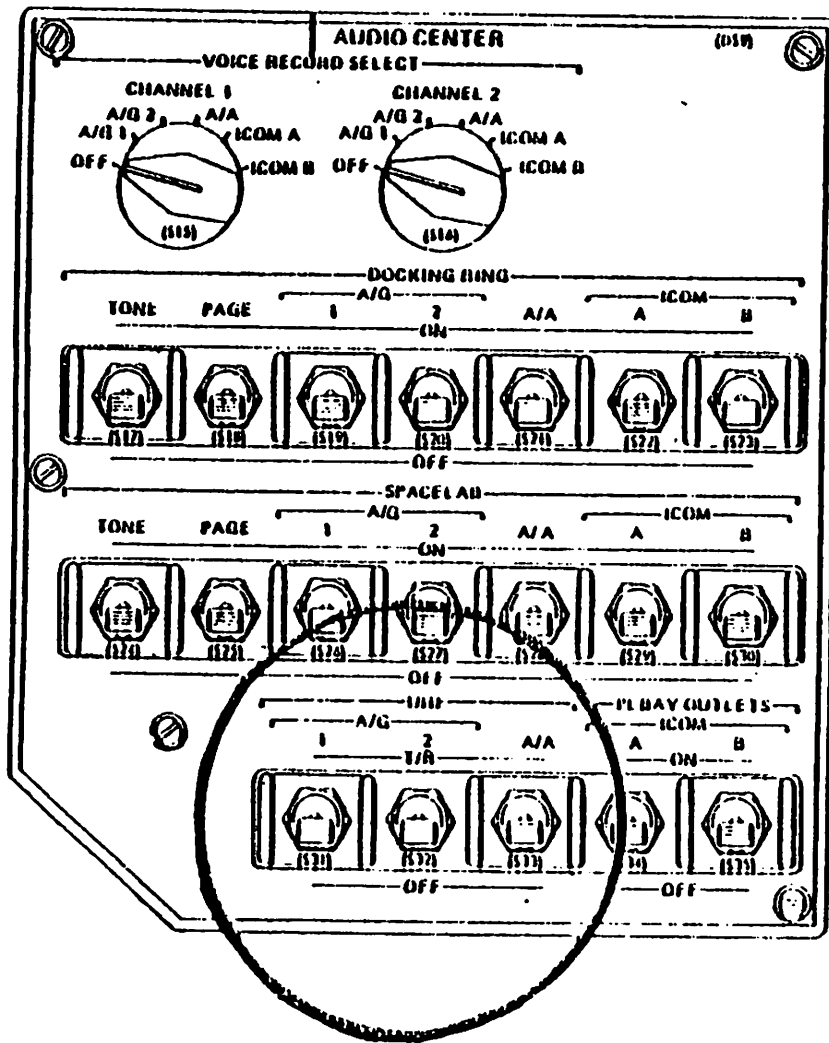

3-24

Figure 3-14.- UHF controls.

3-1-60

# ATU CIRCUITRY

ESS 0 DC: 400  
 ESS 2 CA: P10  
 M A : 15/20C, 200 OHM 500  
 M B : 10/10 0.015 SP/500  
 M C : PS, 10/10/10

P. 1. P1000  
 AUDIO (ANALOG, VOICE)  
 DIGITAL SIGNALS

3-25

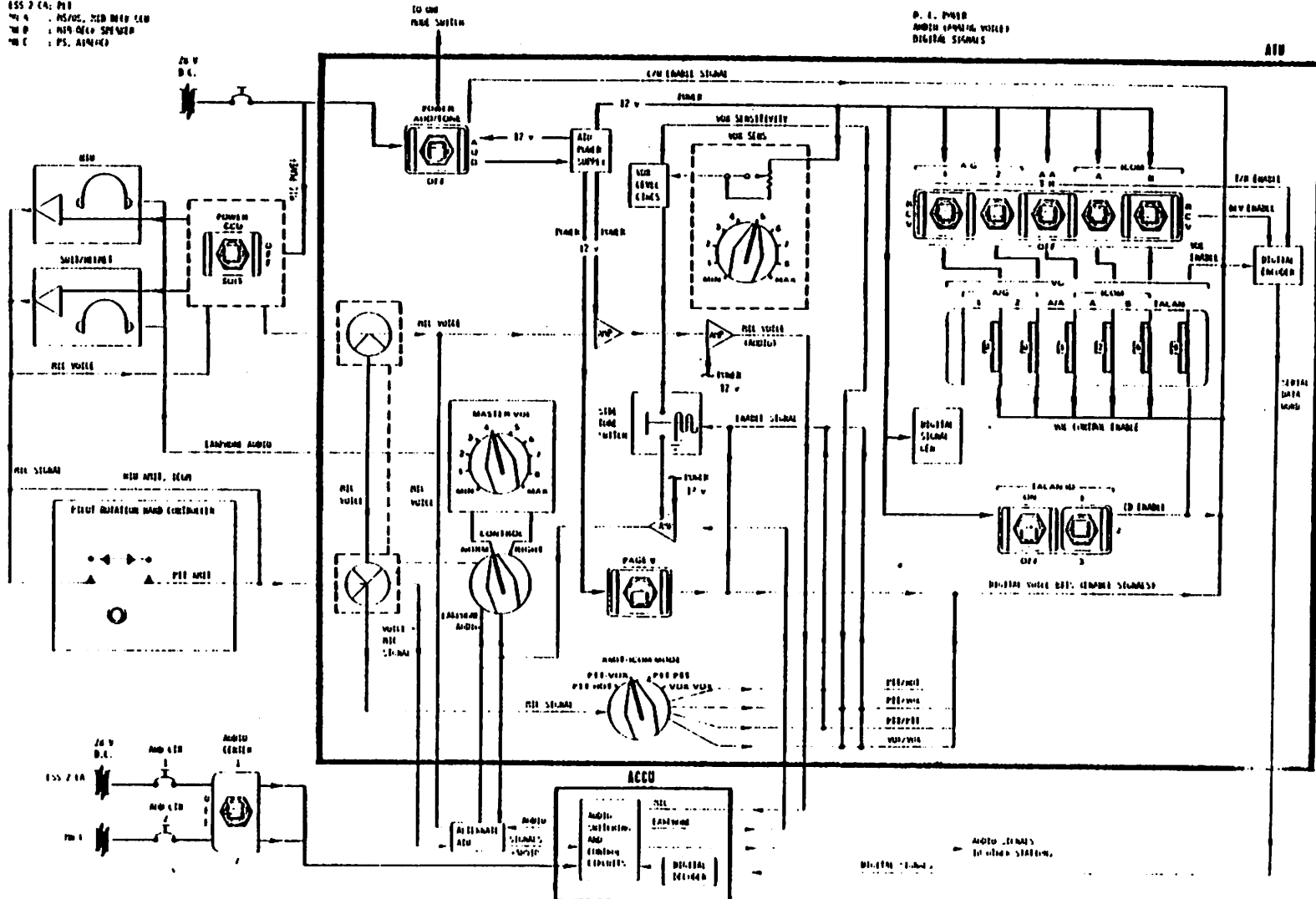

4A1-AUD

Figure 3-15.- ATU Circuitry.



# ATU CONTROL TRANSFER

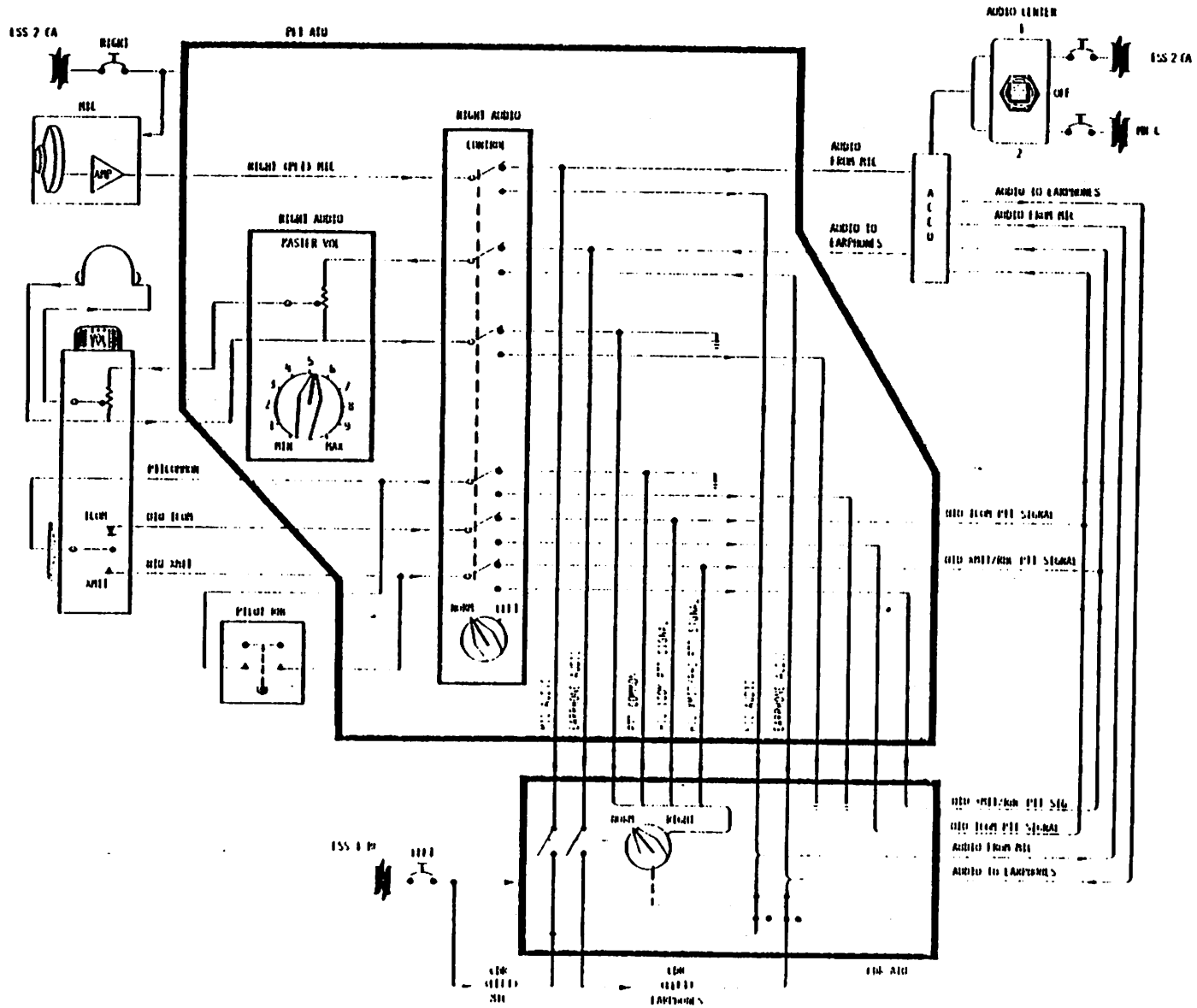

3-27

4A1-AUD

# SMU CIRCUITRY

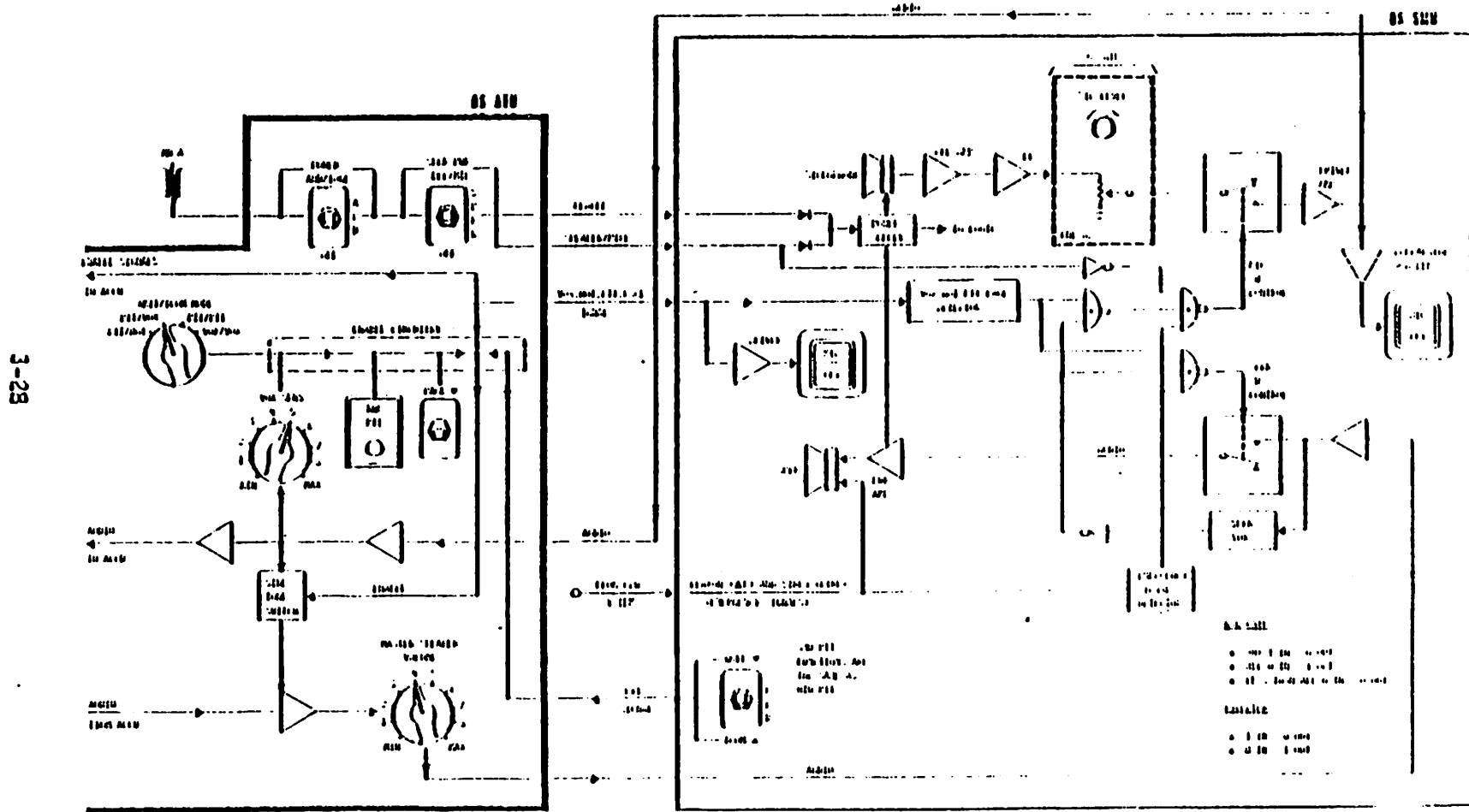
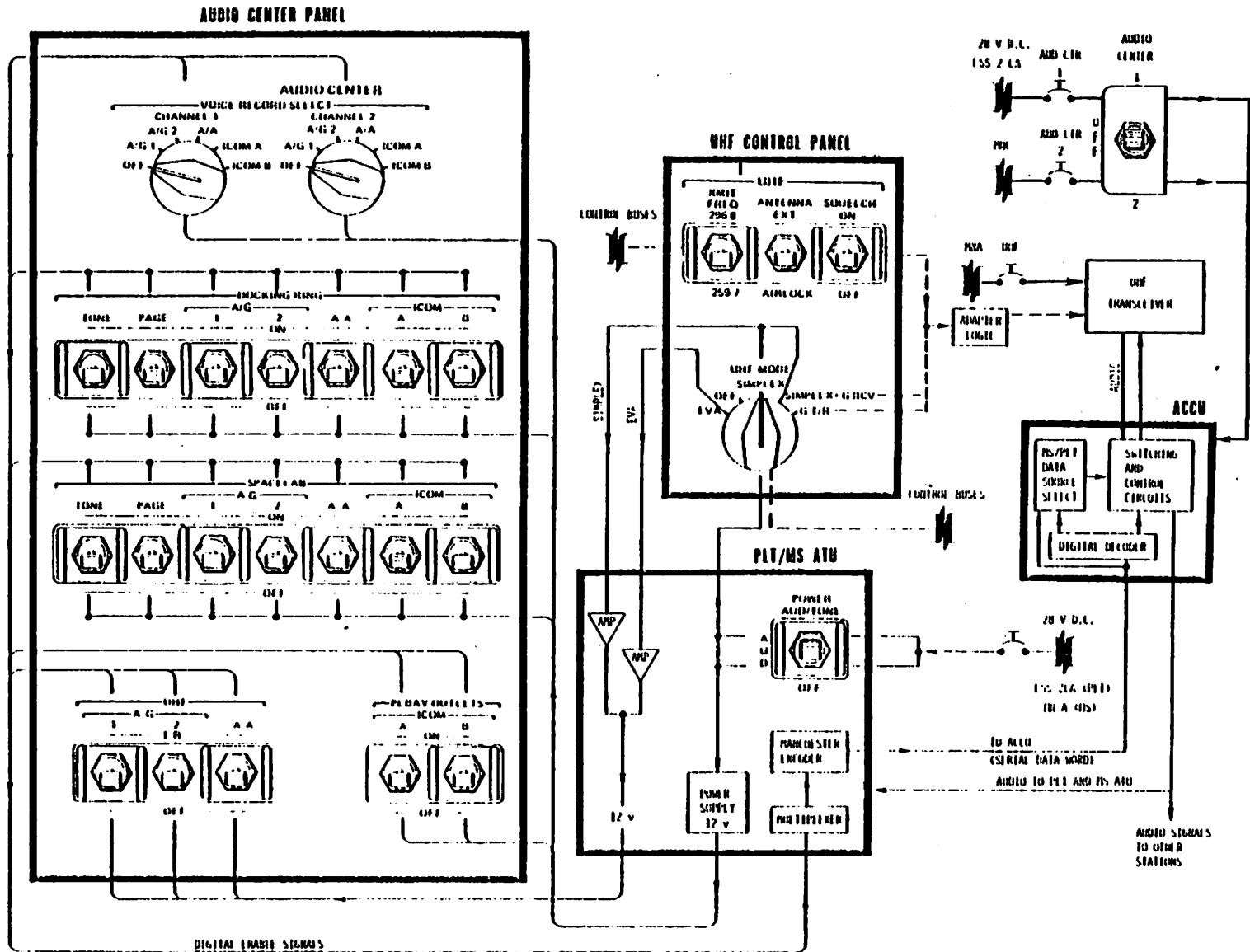

Figure 3-18.- SMU Circuitry.

14-1-10

# UHF AND AUDIO CENTER

3-29



4A1-ADD

Figure 3-19.- UHF and Audio Center Circuitry.



STATION	UNIT	BUSES				
		MNA	MNB	MNC	ESS 1 3C	ESS 2 CA
FLIGHT DECK	LEFT (CDR) ATU				X	
	RIGHT (PLT) ATU					X
	UHF (SELECT)		X			
	AUDIO CENTER SWITCH (ACCU POWR)			BKUP		X
AFT STATION	MS ATU	X				
	OS CCU/SPEAKER ATU	X				
	PS ATU			X		
	AUDIO CENTER PANEL (INCL. UHF CONTROL)	X				X
MID DECK/AIRLOCK	MID DECK CCU ATU	X				
	MID DECK SPEAKER ATU		X			
	AIRLOCK ATU			X		
FWD EQUIP BAY	ACCU			BKUP		X
	UHF TRANSCVR	X				

TABLE 3-I.- BUS POWER DISTRIBUTION



