

STS-1 Operational Flight Profile

(NASA-TM-81098) STS-1 OPERATIONAL FLIGHT
PROFILE. VOLUME 6: ABORT ANALYSIS (NASA)
624 p MC A99/M A01 CSCL 22A

N80-27413

Unclas
G3/16 24461

Volume VI Abort Analysis - Cycle 3

Mission Planning and Analysis Division

June 1980

NASA

National Aeronautics and
Space Administration

Lyndon B. Johnson Space Center
Houston, Texas

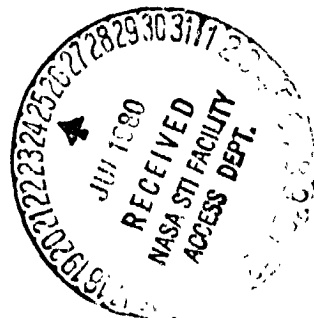

78-FM-51
Vol. VI, Rev. 1

SHUTTLE PROGRAM

STS-1 OPERATIONAL FLIGHT PROFILE
ABORT ANALYSIS - CYCLE 3

By Flight Analysis Branch

Approved: Morris V. Jenkins
Morris V. Jenkins, Chief
Flight Analysis Branch

Approved: Ronald L. Berry
Ronald L. Berry, Chief
Mission Planning and Analysis Division

Mission Planning and Analysis Division
National Aeronautics and Space Administration
Lyndon B. Johnson Space Center
Houston, Texas
June 1980

FOREWORD

The orbital flight test (OFT) phase of the Space Shuttle Program consists of five orbital flights beginning in March 1980 and continuing through 1981. The major purpose of the OFT program is to demonstrate and verify Shuttle systems and flight capabilities by satisfying the Space Shuttle Program Office (SSPO) OFT requirements.

This document (Volume VI), presents the Space Transportation System (STS) operational flight profile (OFF) for the abort analysis data (cycle 3).

All STS-1 OFF documents for cycle 3 and their scheduled distribution dates are listed in the following table.

STS-1 OFF DOCUMENT PUBLICATION SCHEDULE

Document	Scheduled distribution date
Volume I - Groundrules and Constraints, Rev. 2	September 1979 (A)
Volume II - Profile Summary, Rev. 1	April 1980 (A)
Volume III - Ascent, Rev. 1	May 1980 (P)
Volume IV - Onorbit, Rev. 1	November 1979 (A)
Volume V - Descent, Rev. 1	May 1980 (P)
Volume VI - Abort, Rev. 1	June 1980 (P)
Volume VII - OMS and RCS Consumables Analysis, Rev. 1	February 1980 (A)
Volume VIII - Nonpropulsive Consumables Analysis, Rev. 1	February 1980 (A)

ACKNOWLEDGMENTS

The following NASA and McDonnell Douglas Technical Services Co. (MDTSCO) individuals have contributed to this document. Questions concerning any section of this document should be referred to the designated individuals.

Overall	Mack Henderson (NASA/FM4) Lyle Winans (MDTSCO)
SSME-Out in First Stage	Steve Zabal (MDTSCO) Dave Stanton (MDTSCO)
PRTLS	Don Simpson (MDTSCO) Jerry Garner (MDTSCO)
GRTLS	Jim West (NASA/FM4) Hector Garcia (NASA/FM4) Dick Moore (NASA/FM4) Randy Waibel (MDTSCO) Carl Lauritzen (MDTSCO)
AOA/Powered Flight	Don Hull (MDTSCO) Paul Dowty (MDTSCO) Charlie Mallini (MDTSCO)
AOA/Entry	Dan Payne (NASA/FM4) Dick Moore (NASA/FM4) Ken Strong (MDTSCO)
ATO/Powered Flight	Don Hull (MDTSCO) Paul Dowty (MDTSCO) Charlie Mallini (MDTSCO)
ATO/Deorbit	Dallas Ives (NASA/FM4)
ATO/Entry	Dan Payne (NASA/FM4) Dick Moore (NASA/FM4)
SRB and ET Separation and Disposal	Bob Prah1 (NASA/FM4) Joe Nolley (NASA/FM4) Richard Seale (MDTSCO) John Lo (MDTSCO) Rick Sykes (MDTSCO) Pat Swain (MDTSCO)
Ground Monitoring	Lee Norbraten (NASA/FM4) Jim Joyner (MDTSCO)
Onboard Monitoring	Mack Henderson (NASA/FM4) Hector Garcia (NASA/FM4)

78FM51:VI

Abort Issues

Mack Henderson (NASA/FM4)

Abort Dispersions

Glenn Venables (MDTSCO)

Mel Loether (MDTSCO)

CONTENTS

Section		Page
1.0	<u>INTRODUCTION</u>	1-1
2.0	<u>FLIGHT DESCRIPTION</u>	2-1
3.0	<u>ABORT ANALYSIS SUMMARY</u>	3-1
4.0	<u>STS-1 OFF FLIGHT DESIGN GROUNDRULES AND CONSTRAINTS</u>	4-1
4.1	GENERAL	4-1
4.2	NOMINAL ASCENT	4-2
4.2.1	<u>General</u>	4-2
4.2.2	<u>Space Shuttle Main Engine (SSME) Constraints</u>	4-5
4.3	SEPARATION	4-5
4.3.1	Orbiter-ET/SRB	4-5
4.3.2	Orbiter/ET	4-5
4.4	ORBITAL OPERATIONS	4-6
4.5	ORBITAL MANEUVERING SYSTEM	4-7
4.6	REACTION CONTROL SYSTEM	4-7
4.7	AUXILIARY POWER UNIT, ELECTRICAL POWER SYSTEM, AND ENVIRONMENTAL CONTROL LIFE SUPPORT SYSTEM	4-8
4.8	DESCENT - DEORBIT	4-9
4.9	DESCENT - ENTRY THROUGH ROLLOUT	4-9
4.10	ABORTS	4-12
4.10.1	<u>General</u>	4-12
4.10.2	<u>RTLS</u>	4-13
4.10.3	<u>PRTLs</u>	4-15
4.10.4	<u>RTLS Orbiter/ET Separation</u>	4-15
4.10.5	<u>GRTLs</u>	4-16
4.10.6	<u>AOA/ATO</u>	4-17
4.10.7	<u>Contingency Abort</u>	4-18
5.0	<u>INITIALIZATION INFORMATION</u>	5-1
5.1	ASCENT	5-1
5.2	DESCENT	5-1

Section	Page
6.0	<u>ABORT CAPABILITY</u> 6-1
6.1	SSME OUT IN FIRST STAGE 6-1
6.2	RTLS 6-2
6.2.1	<u>PRTLS</u> 6-3
6.2.2	<u>GRTLS Overview</u> 6-4
6.3	AOA 6-14
6.3.1	<u>Powered Flight</u> 6-14
6.3.2	<u>AOA Descent</u> 6-14
6.4	ATO 6-16
6.4.1	<u>Powered Flight</u> 6-16
6.4.2	<u>Deleted</u> 6-16
7.0	<u>SRB AND ET SEPARATION AND DISPOSAL</u> 7-1
7.1	SEPARATION 7-1
7.1.1	<u>SRB Separation</u> 7-1
7.1.2	<u>ET Separation</u> 7-2
7.2	SRB AND ET DISPOSAL 7-6
7.2.1	<u>SRB Disposal</u> 7-6
7.2.2	<u>ET Disposal</u> 7-7
8.0	<u>ABORT MONITORING</u> 8-1
8.1	GROUND MONITORING 8-1
8.1.1	<u>ARD Monitoring</u> 8-1
8.1.2	<u>Flight Dynamics Trajectory Displays</u> 8-1
8.1.3	<u>Console Charts</u> 8-2
8.1.4	<u>AME</u> 8-2
8.2	ONBOARD MONITORING 8-3
8.2.1	<u>Powered Flight Monitoring</u> 8-3
8.2.2	<u>Descent Monitoring</u> 8-5
9.0	<u>ABORT INITIALIZATION LOAD FOR ONBOARD COMPUTER</u> 9-1
10.0	<u>ABORT ISSUES</u> 10-1
10.1	GENERAL 10-1

Section		Page
10.2	RTLS	10-1
10.3	AOA/ATO	10-2
11.0	<u>REFERENCES</u>	11-1
APPENDIX A	- POWERED FLIGHT DISPERSION ANALYSIS	A-1

TABLES

Table		Page
5.1-I	RTLS INITIALIZATION CONDITIONS AT NOMINAL SRB STAGING . . .	5-2
5.1-II	INITIALIZATION INFORMATION FOR AOA AND ATO POWERED FLIGHT ANALYSIS	5-3
5.2-I	GRTLS APRIL GLOBAL ATMOSPHERE DEVIATIONS FROM 1962 STANDARD ATMOSPHERE	5-5
5.2-II	GRTLS APRIL GLOBAL REFERENCE ATMOSPHERE DATA	5-6
5.2-III	AOA APRIL GLOBAL REFERENCE ATMOSPHERE DATA	5-7
5.2-IV	AOA APRIL REFERENCE ATMOSPHERE DEVIATIONS FROM 1962 STANDARD ATMOSPHERE	5-8
6.1-I	MISSION DEPENDENT FIRST-STAGE ENGINE-OUT GUIDANCE AND CONTROL I-LOADS	6-17
6.1-II	STS-1 FIRST-STAGE NOMINAL AND ENGINE-OUT I-LOADS	
	(a) Guidance attitude commands	6-18
	(b) Flight control system reference steering tables . . .	6-19
6.2.1-I	WEIGHT DEVELOPMENT FOR STS-1 RTLS ABORTS	
	(a) PPD target weights	6-20
	(b) Last RTLS MECU weight	6-21
6.2.1-II	PRTLS KEY EVENT PARAMETERS FOR ABORTS DURING STS-1 ASCENT .	6-22
6.2.1-III	PRTLS RADAR SUMMARY	6-24
6.2.2-I	SEPARATION STATE VECTOR INITIAL CONDITIONS	
	(a) Last RTLS (GRTLS-1)	6-25
	(b) Lift-off RLTS (GRTLS-2)	6-26
	(c) 3-SSME RTLS (GRTLS-3)	6-27
6.2.2-II	GRTLS/TAEM INITIATE CONDITIONS	
	(a) Last RTLS (GRTLS-1)	6-28
	(b) Lift-off RTLS (GRTLS-2)	6-29
	(c) 3-SSME RTLS (GRTLS-3)	6-30

Table	Page	
6.2.2-III	TAEM/APPROACH AND LANDING INTERFACE CONDITIONS	
	(a) Last RTLS (GRTLS-1)	6-31
	(b) Lift-off RTLS (GRTLS-2)	6-32
	(c) 3-SSME RTLS (GRTLS-3)	6-33
6.2.2-IV	SEQUENCE OF EVENTS FOR GRTLS-1, LAST RTLS INITIATED AT 272.5 SECONDS	
	(a) ET separation to MM603	6-34
	(b) MM603 to approach and landing interface	6-34
	(c) Approach and landing interface to main gear landing	6-34
6.2.2-V	SEQUENCE OF EVENTS FOR GRTLS-2 LIFT-OFF RTLS INITIATED AT 150 SECONDS	
	(a) ET separation to MM603	6-35
	(b) MM603 to approach and landing	6-35
	(c) Approach and landing interface to main gear landing	6-35
6.2.2-VI	SEQUENCE OF EVENTS FOR GRTLS-3, 3-SSME RTLS INITIATED AT 260 SECONDS	
	(a) ET separation to MM603	6-36
	(b) MM603 to approach and landing interface	6-36
	(c) Approach and landing interface to main gear landing	6-36
6.3.1-I	SEQUENCE OF EVENTS FOR MAXIMUM UNDERSPEED AOA	6-37
6.3.1-II	SEQUENCE OF EVENTS FOR AOA AFTER NOMINAL OMS-1	6-38
6.3.1-III	AOA PLOTTED PARAMETERS	6-39
6.3.1-IV	AOS-LUS TIMES	6-40
6.3.1-V	EARLIEST AOA MECO STATE	6-41
6.3.1-VI	EARLIEST AOA OMS-1 TIG STATE	6-43
6.3.1-VII	EARLIEST AOA OMS-1 BURNOUT STATE	6-45
6.3.1-VIII	EARLIEST AOA OMS-2 TIG STATE	6-47
6.3.1-IX	EARLIEST AOA OMS-2 BURNOUT STATE	6-49
6.3.1-X	EARLIEST AOA ENTRY INTERFACE -5 MINUTES STATE	6-51

Table	Page
6.3.1-XI EARLIEST ACA ENTRY INTERFACE STATE	6-53
6.3.1-XII AOA AFTER NOMINAL OMS-1, OMS-2 TIG STATE	6-55
6.3.1-XIII AOA AFTER NOMINAL OMS-1, OMS-2 BURNOUT STATE	6-57
6.3.1-XIV AOA AFTER NOMINAL OMS-1 ENTRY INTERFACE -5 MINUTES STATE	6-59
6.3.1-XV AOA AFTER NOMINAL OMS-1 ENTRY INTERFACE STATE	6-61
6.3.2-I SEQUENCE OF EVENTS FOR STS-1 (CYCLE 3)	
(a) Entry guidance initiate to TAEM interface	6-63
(b) TAEM interface to approach a landing interface	6-64
(c) Approach and landing interface to main gear touchdown	6-64
6.3.2-II STS-1 CYCLE 3 EARLIEST AOA MASS PROPERTIES	6-65
6.3.2-III ENTRY PARAMETERS	
(a) Entry interface minus 5 minutes	6-66
(b) Entry interface	6-67
6.3.2-IV ENTRY/TAEM INTERFACE CONDITIONS	6-68
6.3.2-V TAEM/A&L INTERFACE CONDITIONS	6-69
6.3.2-VI EARLIEST AOA THERMAL PROTECTION SUMMARY	6-70
6.3.2-VII COMPARISON OF EOM AND AOA THERMAL ENVIRONMENT (6-DOF SIMULATION)	6-71
6.3.2-VIII C-BAND AND S-BAND COMMUNICATION SEQUENCE OF EVENTS	6-72
6.3.2-IX S-BAND AND C-BAND STATION LOCATIONS	6-73
6.4.1-I SEQUENCE OF EVENTS FOR MAXIMUM UNDERSPEED ATO	6-74
6.4.1-II ATO PLOTTED PARAMETERS	6-75
6.4.1-III ATO MECO STATE	6-76
6.4.1-IV ATO OMS-1 TIG STATE	6-78
6.4.1-V ATO OMS-2 TIG STATE	6-80
6.4.1-VI ATO OMS-1 BURNOUT STATE	6-82
6.4.1-VII ATO OMS-2 BURNOUT STATE	6-84

Table	Page	
7.1.2-I	RTLS ORBITER/ET AUTO SEPARATION CRITERIA	7-10
7.2.1-I	SRB DISPOSAL SEQUENCE OF EVENTS, AND STS-1 EARLIEST RTLS	7-11
7.2.1-II	NOMINAL IMPACT POINT LOCATION OF EACH SRB ELEMENT AND STS-1 EARLIEST RTLS	7-12
7.2.1-III	SRB DISPOSAL SEQUENCE OF EVENTS, STS-1 NOMINAL, ATO, AOA, AND LATEST RTLS	7-13
7.2.1-IV	NOMINAL IMPACT POINT LOCATION OF EACH SRB ELEMENT, STS-1 NOMINAL, AOA, ATO, AND LATEST RTLS	7-14
7.2.2-I	STS-1 ET DISPERSION, EARLIEST PTM (3 σ LOW PERFORMANCE) . .	7-15
7.2.2-II	STS-1 ET DISPERSION, EARLIEST PTM (NOMINAL PERFORMANCE) . .	7-16
7.2.2-III	STS-1 ET DISPERSION, GUIDED MECO (NOMINAL PROFILE)	7-17
7.2.2-IV	STS-1 ET DISPERSION, 50/50 PTM	7-18
7.2.2-V	STS-1 ET DISPERSION, FINE COUNTDOWN (SSME-1 OUT)	7-19
7.2.2-VI	STS-1 ET DISPERSION, FINE COUNTDOWN (2 or 3 SSME-OUT) . . .	7-20
8.1.1-I	ARD/EP MONITORING CHARACTERISTICS	8-7
8.1.1-II	ARD NOMINAL-DAY BOUNDARIES	8-10
8.2.1-I	OMS-1/-2 TARGET CHECKLIST FOR STS-1	8-11
9-I	STS-1 ASCENT GUIDANCE T-LOADS	9-2
9-II	DEFINITION OF AUTOLAND GUIDANCE CONSTANTS	
	(a) Entry (G4.8)	9-17
	(b) TAEM (4.9)	9-24
	(c) Autoland (G4.10)	9-31
9-III	DEFINITION OF GRTLS TAEM GUIDANCE CONSTANTS	
	(a) G4.204	9-36
	(b) G4.234)	9-46

FIGURES

Figure		Page
5.2-1	Percent deviations from 1962 Standard Atmosphere for April, KSC global	5-9
5.2-2	Mean April global reference atmosphere	5-10
6.0-1	Types of intact abort	6-86
6.0-2	Abort mode capability during STS-1 ascent	6-87
6.1-1	Engine-out design procedure block diagram	6-88
6.1-2	Engine-out design procedure for pitch	6-89
6.1-3	STS-1 engine out $\bar{q} \cdot \alpha$ results for April mean wind	6-90
6.1-4	STS-1 variation of $\max \bar{q}$ with engine-out time April mean wind	6-91
6.1-5	STS-1 variation of SRB separation conditions with engine-out time	6-92
6.1-6	SSME-2 failing at lift-off trajectory parameter time histories	
	(a) Inertial flightpath angle	6-93
	(b) Earth-relative flightpath angle	6-93
	(c) Inertial flight azimuth	6-94
	(d) Earth-relative flight azimuth	6-94
	(e) Indicated Earth-relative velocity	6-95
	(f) Navigation Earth-relative velocity	6-95
	(g) SVDS Earth-relative velocity	6-95
	(h) Dynamic pressure	6-96
	(i) Mach number	6-96
	(j) Geodetic altitude	6-96
	(k) Sideslip	6-97
	(l) Angle of attack	6-97
	(m) Lateral aerodynamic load	6-98
	(n) Normal aerodynamic load	6-98
	(o) Actual body rate vector from SVDS environment	6-99
	(p) SSME actual pitch gimbal deflection wrt null axis (positive down)	6-100
	(q) SSME actual yaw gimbal deflection wrt null axis (positive left)	6-101
	(r) SRB actual right (rock) gimbal deflections (positive inward)	6-102
	(s) SRB actual left (tilt) gimbal deflections (positive inward)	6-103

Figure		Page
6.1-7	SSME-2 failing at 46 seconds trajectory parameter time histories	
	(a) Inertial flightpath angle	6-104
	(b) Earth-relative flightpath angle	6-104
	(c) Inertial flight azimuth	6-105
	(d) Earth-relative flight azimuth	6-105
	(e) Indicated Earth-relative velocity	6-106
	(f) Navigation Earth-relative velocity	6-106
	(g) SVDS Earth-relative velocity	6-106
	(h) Dynamic pressure	6-107
	(i) Mach number	6-107
	(j) Geodetic altitude	6-107
	(k) Sideslip	6-108
	(l) Angle of attack	6-108
	(m) Lateral aerodynamic load	6-109
	(n) Normal aerodynamic load	6-109
	(o) Actual body rate vector from SVDS environment	6-110
	(p) SSME actual pitch gimbal deflection wrt null axis (positive down)	6-111
	(q) SSME actual yaw gimbal deflection wrt null axis (positive left)	6-112
	(r) SRB actual right (rock) gimbal deflections (positive inward)	6-113
	(s) SRB actual left (tilt) gimbal deflections (positive inward)	6-114
6.2-1	Typical RTLS profile	6-115
6.2.1-1	OMS pre-MECO propellant dump timeline for RTLS on STS-1	6-116
6.2.1-2	PRTLS fuel dissipation thrust attitude	6-117
6.2.1-3	PRTLS target lines for STS-1	6-118
6.2.1-4	PRTLS trajectory data for SSME-1 out at lift-off RTLS selected at 150 seconds	
	(a) Altitude versus time	6-119
	(b) Altitude versus range	6-119
	(c) Latitude versus longitude	6-120
	(d) Relative velocity versus time	6-120
	(e) Relative flightpath angle versus time	6-121
	(f) Dynamic pressure versus time	6-121
	(g) Angle of attack versus time	6-122
	(h) Angle of sideslip versus time	6-122
	(i) Roll angle versus time	6-123
	(j) Pitch angle versus time	6-123
	(k) Yaw angle versus time	6-123

Figure

	Page
(l) Pitch rate versus time	6-124
(m) Yaw rate versus time	6-124
(n) Roll rate versus time	6-124
(o) Angle of attack versus time in pitchdown and mated coast	6-125
(p) Pitch rate versus time during turnaround	6-125
(q) Pitch rate versus time in pitchdown and mated coast	6-125
(r) Time-to-go versus time	6-126
(s) Command throttle versus time	6-126
(t) Thrust acceleration versus time	6-127
(u) Weight versus time	6-127
(v) Roll error versus time	6-128
(w) Pitch error versus time	6-128
(x) Yaw error versus time	6-128
(y) Roll rate command versus time	6-129
(z) Pitch rate command versus time	6-129
(aa) Yaw rate command versus time	6-129
(bb) SSME-1 pitch deflection versus time	6-130
(cc) SSME-1 yaw deflection versus time	6-130
(dd) SSME-2 pitch deflection versus time	6-131
(ee) SSME-2 yaw deflection versus time	6-131
(ff) SSME-3 pitch deflection versus time	6-132
(gg) SSME-3 yaw deflection versus time	6-132

6.2.1-5

PRTLs trajectory data for SSME 2 out at 262.5
seconds, RTLS selected at 272.5 seconds

(a) Altitude versus time	6-133
(b) Altitude versus range	6-133
(c) Latitude versus longitude	6-134
(d) Relative velocity versus time	6-134
(e) Relative flightpath angle versus time	6-135
(f) Dynamic pressure versus time	6-135
(g) Angle of attack versus time	6-136
(h) Angle of sideslip versus time	6-136
(i) Roll angle versus time	6-137
(j) Pitch angle versus time	6-137
(k) Yaw angle versus time	6-137
(l) Pitch rate versus time	6-138
(m) Yaw rate versus time	6-138
(n) Roll rate versus time	6-138
(o) Angle of attack versus time in pitchdown and mated coast	6-139
(p) Pitch rate versus time during turnaround	6-139
(q) Pitch rate versus time in pitchdown and mated coast	6-139
(r) Time-to-go versus time	6-140
(s) Command throttle versus time	6-140
(t) Thrust acceleration versus time	6-141

Figure

Page

(u)	Weight versus time	6-141
(v)	Roll error versus time	6-142
(w)	Pitch error versus time	6-142
(x)	Yaw error versus time	6-142
(y)	Roll rate command versus time	6-143
(z)	Pitch rate command versus time	6-143
(aa)	Yaw rate command versus time	6-143
(bb)	SSME-1 pitch deflection versus time	6-144
(cc)	SSME-1 yaw deflection versus time	6-144
(dd)	SSME-2 pitch deflection versus time	6-145
(ee)	SSME-2 yaw deflection versus time	6-145
(ff)	SSME-3 pitch deflection versus time	6-146
(gg)	SSME-3 yaw deflection versus time	6-146

6.2.1-6

PRTL5 trajectory data for a 3-SSME R5LS selected
at 260 seconds

(a)	Altitude versus time	6-147
(b)	Altitude versus range	6-147
(c)	Latitude versus longitude	6-148
(d)	Relative velocity versus time	6-148
(e)	Relative flightpath angle versus time	6-149
(f)	Dynamic pressure versus time	6-149
(g)	Angle of attack versus time	6-150
(h)	Angle of sideslip versus time	6-150
(i)	Roll angle versus time	6-151
(j)	Pitch angle versus time	6-151
(k)	Yaw angle versus time	6-151
(l)	Pitch rate versus time	6-152
(m)	Yaw rate versus time	6-152
(n)	Roll rate versus time	6-152
(o)	Angle of attack versus time in pitchdown and mated coast	6-153
(p)	Pitch rate versus time during turnaround	6-153
(q)	Pitch rate versus time in pitchdown and mated coast	6-153
(r)	Time to go versus time	6-154
(s)	Command throttle versus time	6-154
(t)	Thrust acceleration versus time	6-155
(u)	Weight versus time	6-155
(v)	Roll error versus time	6-156
(w)	Pitch error versus time	6-156
(x)	Yaw error versus time	6-156
(y)	Roll rate command versus time	6-157
(z)	Pitch rate command versus time	6-157
(aa)	Yaw rate command versus time	6-157
(bb)	SSME-1 pitch deflection versus time	6-158
(cc)	SSME-1 yaw deflection versus time	6-158
(dd)	SSME-2 pitch deflection versus time	6-159
(ee)	SSME-2 yaw deflection versus time	6-159

Figure	Page
(ff) SSME-3 pitch deflection versus time	6-160
(gg) SSME-3 yaw deflection versus time	6-160
6.2.1-7 Envelope of PRTLS trajectories	6-161
6.2.2-1 STS-1 GRTLS Orbiter/ET separation target line and performance boundaries	5-162
6.2.2-2 GRTLS profile	6-163
6.2.2-3 Alpha recovery, NZ hold, and alpha transition phases . .	6-164
6.2.2-4 GRTLS TAEM energy/weight versus range profiles for STS-1	6-165
6.2.2-5 GRTLS approach and landing profile	6-166
6.2.2-6 GRTLS from RTLS 1 - last RTLS initiated at 272.5 seconds - STS-1 ascent, ET separation to landing at KSC runway 15	
(a) Groundtrack	6-167
(b) Altitude versus range-to-runway threshold	6-168
(c) Relative velocity versus range-to-runway threshold .	6-169
(d) Altitude versus relative velocity	6-170
(e) Altitude and altitude reference versus range-to- runway threshold	6-171
(f) Angle of attack versus relative velocity	6-172
(g) Roll angle and azimuth error versus relative velocity	6-173
(h) Body attitude rates versus velocity	6-174
(i) Relative flightpath angle versus relative velocity .	6-175
(j) Altitude rate versus relative velocity	6-176
(k) Load factor components versus relative velocity . .	6-177
(l) Pilot station loads versus relative velocity	6-178
(m) Dynamic pressure versus relative velocity	6-179
(n) Drag acceleration versus relative velocity	6-180
(o) Sideslip angle and rudder deflection versus relative velocity	6-181
(p) Elevator and aileron deflections versus relative velocity	6-182
(q) Right and left elevator deflections versus relative velocity	6-183
(r) Body-flap and speedbrake deflections versus relative velocity	6-184
(s) Elevon panel hinge moments versus relative velocity	6-185
(t) Body-flap, rudder, and speedbrake hinge moments versus relative velocity	6-186
(u) Local horizontal angles versus relative velocity . .	6-187

Figure		Page
	(v) Relative velocity time history	6-188
	(w) Geodetic altitude time history	6-189
	(x) Range-to-runway threshold time history	6-190
	(y) Merritt Island tracking time history	6-191
	(z) New Smyrna Beach tracking time history	6-192
6.2.2-7	RTLS 1 - TAEM interface (MM603) to landing at KSC runway 15	
	(a) Altitude versus range-to-runway threshold	6-193
	(b) Angle of attack, pitch angle, and flightpath angle versus range-to-runway threshold	6-194
	(c) Heading, actual, and commanded roll angle versus range-to-runway threshold	6-195
	(d) Altitude rate and equivalent airspeed versus range-to-runway threshold	6-196
	(e) True airspeed, relative velocity and Mach number versus range-to-runway threshold	6-197
	(f) Actual and commanded normal load factor versus range-to-runway threshold	6-198
	(g) Sideslip angle and lateral load factor versus range-to-runway threshold	6-199
	(h) Body attitude rates versus range-to-runway threshold	6-200
	(i) Aileron, elevator, and body-flap position versus range-to-runway threshold	6-201
	(j) Speedbrake and rudder position versus range-to- runway threshold	6-202
6.2.2-8	RTLS 1 - approach and landing interface to touchdown at KSC runway 15	6-203
6.2.2-9	RTLS 1 - 24 000-foot X-range from runway threshold to touchdown at KSC runway 15	
	(a) Flightpath angle, pitch angle, and angle of attack versus X-runway position	6-204
	(b) True airspeed, relative velocity, and dynamic pressure versus X-runway position	6-205
	(c) Reference and gear altitude versus X-runway position	6-206
	(d) Body attitude rates versus X-runway position	6-207
	(e) Aileron, elevator, and body-flap position versus X-runway position	6-208
	(f) Speedbrake and rudder position versus X-runway position	6-209
6.2.2-10	STS-1 GRTLS operational flight profile perspective	6-210

Figure		Page
6.2.2-11	GRTLS from RTLS 2 - RTLS 1 engine-out at lift-off, RTLS at 150 seconds, STS-1 ascent, ET separation to landing at KSC runway 15	
	(a) Groundtrack	6-211
	(b) Altitude versus range-to-runway threshold	6-212
	(c) Relative velocity versus range-to-runway threshold	6-213
	(d) Angle of attack versus relative velocity	6-214
	(e) Roll angle and azimuth error versus relative velocity	6-215
	(f) Body attitude rates versus velocity	6-216
	(g) Relative flightpath angle versus relative velocity	6-217
	(h) Load factor components versus relative velocity	6-218
	(i) Pilot station loads versus relative velocity	6-219
	(j) Dynamic pressure versus relative velocity	6-220
	(k) Sideslip angle and rudder deflection versus relative velocity	6-221
	(l) Elevator and aileron deflections versus relative velocity	6-222
	(m) Right and left elevator deflections versus relative velocity	6-223
	(n) Body-flap and speedbrake deflection versus relative velocity	6-224
	(o) Elevon panel hinge moments versus relative velocity	6-225
	(p) Body-flap, rudder, and speedbrake hinge moments versus relative velocity	6-226
	(q) Relative velocity time history	6-227
	(r) Geodetic altitude time history	6-228
	(s) Range-to-runway threshold time history	6-229
	(t) Merritt Island tracking time history	6-230
	(u) New Smyrna Beach tracking time history	6-231
6.3.1-1	STS-1, cycle 3 ascent groundtrack and post-MECO communication coverage for downrange aborts	6-232
6.3.1-2	Maximum underspeed earliest AOA - second stage	
	(a) Inertial azimuth	6-233
	(b) Inertial flightpath angle	6-233
	(c) Inertial velocity	6-233
	(d) Mach number	6-234
	(e) Sideslip angle	6-234
	(f) Angle of attack	6-234
	(g) Geodetic altitude	6-235
	(h) Inclination	6-235
	(i) Sensed acceleration	6-235

Figure		Page
6.3.1-3	Maximum underspeed earliest AOA - MECO to EI	
	(a) Inertial azimuth	6-236
	(b) Inertial flightpath angle	6-236
	(c) Inertial velocity	6-236
	(d) Geodetic altitude	6-237
	(e) Longitude	6-237
	(f) Geodetic latitude	6-237
	(g) True anomaly	6-238
	(h) Perigee altitude	6-238
	(i) Apogee altitude	6-238
6.3.1-4	AOA after nominal ascent and nominal OMS-1 - MECO to EI	
	(a) Inertial azimuth	6-239
	(b) Inertial flightpath angle	6-239
	(c) Inertial velocity	6-239
	(d) Geodetic altitude	6-240
	(e) Longitude	6-240
	(f) Geodetic latitude	6-240
	(g) True anomaly	6-241
	(h) Perigee altitude	6-241
	(i) Apogee altitude	6-241
6.3.2-1	STS-1, cycle 3 AOA target lines	6-242
6.3.2-2	Surface temperature critical control points and various panel locations	6-243
6.3.2-3	Entry drag acceleration corridor and flight profile during atmospheric descent	6-244
6.3.2-4	Lift/drag reference, actual and commanded angle of attack during atmospheric descent	6-245
6.3.2-5	Elevator, body-flap, and speedbrake deflection versus time from entry interface	6-246
6.3.2-6	Geodetic altitude versus range-to-runway threshold	6-247
6.3.2-7	Delta azimuth, actual, and commanded roll angles during atmospheric descent	6-248
6.3.2-8	Geodetic altitude during atmospheric descent	6-249
6.3.2-9	Range-to-runway threshold during atmospheric descent	6-250
6.3.2-10	Dynamic pressure during atmospheric descent	6-251

Figure		Page
6.3.2-11	X, Y, and Z body axis and total load factor during atmospheric descent	6-252
6.3.2-12	Altitude versus time from entry interface	6-253
6.3.2-13	Range-to-runway threshold versus time from entry interface	6-254
6.3.2-14	Relative velocity versus time from entry interface	6-255
6.3.2-15	Control point temperatures versus relative velocity	6-256
6.3.2-16	Reference heat rate versus relative velocity	6-257
6.3.2-17	TAEM dynamic pressure corridor	6-258
6.3.2-18	TAEM angle-of-attack corridor	6-259
6.3.2-19	Altitude and altitude reference of gear above landing site during TAEM	6-260
6.3.2-20	Altitude rate and altitude rate reference during TAEM	6-261
6.3.2-21	Earliest AOA groundtrack	6-262
6.3.2-22	AOA, TAEM, approach and landing groundtrack	6-263
6.4.1-1	Maximum underspeed earliest ATO - MECO to OMS-2 cutoff + 60 seconds	
	(a) Inertial azimuth	6-264
	(b) Inertial flightpath angle	6-264
	(c) Inertial velocity	6-264
	(d) Geodetic altitude	6-265
	(e) Longitude	6-265
	(f) Geodetic latitude	6-265
	(g) True anomaly	6-266
	(h) Perigee altitude	6-266
	(i) Apogee altitude	6-266
7.1.1-1	SRB separation sequence	7-21
7.1.1-2	Latest RTLS, AOA, and ATO SRB separation trajectories	
	(a) Bottom view	7-22
	(b) Side view	7-23
	(c) Front view	7-24
7.1.2-1	RTLS ET separation concept	7-25

Figure		Page
7.1.2-2	ET separation timeline - RTLS	7-26
7.1.2-3	RTLS Orbiter/ET separation boundaries	7-27
7.1.2-4	RTLS Orbiter/ET separation boundary comparisons illustrating effects of propellant dynamics and dispersed aerodynamics	7-28
7.1.2-5	RTLS STS-1 Orbiter/ET separation trajectories	7-29
7.1.2-6	RTLS Orbiter and ET nose displacement from mated position and attitude parameters for a 1-SSME failure at 262.5 seconds MET (RTLS at 272.5 seconds)	7-30
7.1.2-7	RTLS Orbiter and ET nose displacement from mated position and attitude parameters for a 2-SSME failure at lift-off (RTLS at 150 seconds)	7-31
7.1.2-8	RTLS Orbiter and ET nose displacement from mated position and attitude parameters for a 3-SSME RTLS at 260 seconds	7-32
7.1.2-9	ET separation timeline - NOM/AOA/ATO	7-33
7.1.2-10	AOA and ATO Orbiter/ET relative motion for the separation maneuver	
	(a) Vertical and horizontal	7-34
	(b) Vertical and lateral displacement	7-35
7.2.1-1	Composite SRB impact footprints, STS-1 earliest RTLS . .	7-36
7.2.1-2	Composite SRB impact footprints, STS-1 AOA, ATO, and latest RTLS	7-37
7.2.1-3	STS-1 SRB impact corridor for nominal, RTLS, AOA, and ATO missions	7-38
7.2.2-1	STS-1 ET disposal abort regions	7-39
7.2.2-2	STS-1 RTLS ET footprint	7-40
7.2.2-3	STS-1 RTLS ET and SRB impact footprint corridors	7-41
7.2.2-4	STS-1 AOA/ATO press to MECO contingency ET impact footprints	7-42
7.2.2-5	STS-1 AOA/ATO guided MECO ET impact footprints	7-43

Figure		Page
7.2.2-6	STS-1 AOA/ATO fine countdown contingency ET impact footprints	7-44
8.1.1-1	Delta velocity margin number 1 - Nom/AOA/RTLS	8-12
8.1.1-2	Delta velocity margin number 2 - Nom/ATO/AOA	8-13
8.1.1-3	Abort region determinator	8-14
8.1.2-1	Inertial velocity and inertial flightpath angle at 125 000 feet	
	(a) Nominal/ATO/AOA	8-15
	(b) RTLS	8-16
8.1.2-2	Inertial flightpath angle versus velocity	8-17
8.1.2-3	Out-of-plane monitor	8-18
8.1.2-4	Altitude versus downrange distance	8-19
8.1.2-5	Altitude versus relative velocity - nominal	8-20
8.1.2-6	Altitude versus relative velocity - RTLS	8-21
8.1.2-7	Velocity monitor	8-22
8.1.3-1	STS-1 ascent/abort MECO zoning	8-23
8.1.3-2	ARD PEG error messages	8-24
8.1.3-3	Launch hold MPS propellant usage	8-25
8.1.4-1	AME downmoding for STS-1	8-26
8.1.4-2	AME primary display	8-27
8.1.4-3	AME secondary display	8-28
8.2-1	Attitude Director Indicator (ADI)	8-29
8.2-2	Horizontal Situation Indicator (HSI)	8-30
8.2.1-1	XXXXX TRAJ generic display with mission-dependent constants	8-31
8.2.1-2	ASCENT TRAJ 1 generic display with mission-dependent constants (BFS)	8-32

Figure		Page
8.2.1-3	ASCENT TRAJ 2 generic display with mission-dependent constants (BFS)	8-33
8.2.1-4	RTLS TRAJ 2 generic display with mission-dependent constants (BFS)	8-34
8.2.1-5	CONTINGENCY ABORT generic display	8-35
8.2.1-6	XXXXX MNVR XXXXX generic display	8-36
8.2.2-1	VERT SIT 1 generic display with mission-dependent constants	8-37
8.2.2-2	VERT SIT 2 generic display with mission-dependent constants	8-38
8.2.2-3	HORIZ SIT generic display	8-39

ACRONYMS AND SYMBOLS

ACIP	aerodynamics coefficients identification package
A&L	approach and landing
AM	actual mode
AME	abort maneuver evaluator
AOA	abort once around
AOS	acquisition of signal
APU	auxiliary power unit
ARD	abort region determinator
ARS	atmospheric revitalization system
ATO	abort to orbit
AZI	inertial azimuth
BFS	backup flight system
BRM	baseline reference mission
BSM	booster separation motor
CPU	computer processing unit
CR	change request
CRT	cathode ray tube
CSS	control stick steering
DFI	development flight instrumentation
DOF	degrees of freedom
EAFB	Edwards Air Force Base
EAS	equivalent air speed
EI	entry interface
EOM	end of mission
EOW	energy over weight

EP	event predictor
EPS	electrical power system
ERA-75	EAFB Reference Atmosphere 1975
ET	external tank
EVA	extravehicular activity
FDO	flight dynamics officer
EAS	equivalent airspeed
FCP	fuel cell powerplant
FPR	flight performance reserve
FSSR	functional subsystem software requirements
GET	ground elapsed time
GMT	Greenwich mean time
GPC	general purpose computer
GRTLS	glide return-to-launch site
GSE	ground support equipment
GSTDN	ground spaceflight tracking and data network
h	altitude
HAC	heading alignment circle
HDA	geodetic altitude
HM	hypothetical mode
HRSI	high-temperature reusable surface insulation
IECM	induced environment contamination monitor
IGS	inner glideslope
IMU	inertial measurement unit
KEAS	knots equivalent airspeed
KSC	Kennedy Space Center

LATC	geocentric latitude
LATD	geodetic latitude
LH2	liquid hydrogen
LOS	loss of signal
LOX	liquid oxygen
LRSI	low-temperature surface insulator
MAX q	maximum dynamic pressure
MECO	main engine cutoff
MET	mission elapsed time
MPS	main propulsion system
MSBLS	microwave scanning beam landing system
NZ	normal load factor
OEX	Orbiter experiments
OPF	operational flight profile
OFT	operational flight test
OGS	outer glideslope
OMS	orbital maneuvering system
Pc	chamber pressure
PIC	pyrotechnic initiation controllers
PLBD	payload bay doors
PPD	powered pitchdown
PRTLS	powered return-to-launch site
PSIE	relative azimuth
PTC	passive thermal control
PTM	press to MECO
\dot{Q}	maximum heat rate

\bar{q}	dynamic pressure
$\bar{q} \cdot \alpha$	product of dynamic pressure and angle of attack
$\bar{q} \cdot \beta$	product of dynamic pressure and sideslip angle
RCC	reinforced carbon carbon
RCS	reaction control system
RPL	rated power level
RTLS	return-to-launch site
SAR	single axis rotation
SILTS	Shuttle infrared leeside temperature sensing
SRB	solid rocket booster
SSME	Space Shuttle main engine
Tacan	tactical air navigation
TAEM	terminal area energy management
TBF2	maximum structural bondline (backface) temperature margin on panel 2
TBS	to be supplied
TPS	thermal protection system
TIG	time of ignition
T_1	maximum temperature on control point 1 (nose)
T_2	maximum temperature on control point 2 (body flap)
T_3	maximum temperature on control point 3 (wing leading edge)
T_4	maximum temperature on control 4 (elevon)
T_6	maximum temperature on control point 6 (RCC HRSI)
V_PYR_SW	relative velocity magnitude used to inhibit guidance from switching to alternate attitude commands
V_i	inertial velocity
V_e	relative velocity

1.0 INTRODUCTION

The STS-1 flight activities described in this document reflect the trajectory, consumable, crew activity, and flight requirement baselines as of September 1, 1979. Changes that occur after this date and that affect the STS-1 baseline profile described in this document will be reflected in revisions to be published in 1980.

This document defines the abort analysis for the cycle 3 OFP for STS-1 (vol. VI) and supersedes the abort analysis presented in the OFP (ref. 1). This document contains the flight description, abort analysis summary, flight design groundrules and constraints, initialization information, general abort description and results, abort SRB and ET separation and disposal results, abort monitoring displays and discussion on both ground (MCC) and onboard trajectory monitoring, abort initialization load summary for the onboard computer, list of the key abort issues, and abort powered flight dispersion analysis.

2.0 FLIGHT DESCRIPTION

The STS-1 will be a 54.5-hour flight launched from Kennedy Space Center (KSC) on March 31, 1980 at 11:30 Greenwich Mean Time (GMT). The flight test will be achieved in a 150-n. mi. circular orbit with a 40.3-degree inclination. This orbit will be achieved by two orbital maneuvering system (OMS) maneuvers, OMS-1 (ground elapsed time (GET) = 00:10:34) and OMS-2 (GET = 00:45:50). The OMS-1 maneuver will occur shortly after external tank (ET) separation with the OMS-2 maneuver occurring at the apogee of the orbit resulting from OMS-1. The payload bay doors will be opened as early as possible on day 1. The Orbiter will be placed in a Z-axis (payload bay down) local vertical (Z-LV) attitude for most of the STS-1 flight. This attitude will be maintained unless other requirements (flight test requirements, inertial measurement unit alignment, etc.) preclude Z-LV attitude. Two orbital OMS maneuvers will be performed during the flight to satisfy flight test objectives. The OMS-3 maneuver (delta-V = 30 fps) will be performed following the deorbit rehearsal on day 2 at GET = 30:59:44. The OMS-4 maneuver (delta-V = 30 fps) will be performed approximately 30 minutes after the OMS-3 maneuver at GET = 31:29:44. Both of these OMS maneuvers will be performed out of plane with the Orbiter remaining in a 150-n. mi. circular orbit. Deorbit (GET = 53:31:04) will occur on April 2, 1980. Nominal landing will occur on runway 23 during a descending pass (orbit 37) to Edwards Air Force Base (EAFB). The GET for the nominal landing will be 54:30:44 (10:01 a.m. Pacific Standard Time (PST)).

3.0 ABORT ANALYSIS SUMMARY

This volume (vol. VI) of the OFP contains a brief description and a summary of the results from the abort analysis performed on STS-1 for cycle 3. Trajectory data for discrete intact abort cases are presented for each abort mode and correspond to the detailed trajectory tapes released for the cycle 3 data base. Note that the only difference between the abort once around (AOA) and abort to orbit (ATO) pre-MECO (main engine cutoff) trajectories is the amount of underspeed at MECO.

Some of the significant differences between this analysis and that performed on cycle 2 (ref. 1) include the following:

A 3000-pound MPS propellant manager's margin is held in reserve for abort planning to protect against unknowns and growth uncertainties.

At least 10 seconds for decision time are assumed between the time a Space Shuttle main engine (SSME) fails and the time the actual abort selection is made onboard.

The return-to-launch site (RTLS) powered flight turnaround pitch maneuver rate has been increased to 10 deg/sec.

The RTLS pre-MECO RCS propellant dump burn has been deleted to avoid potential reaction control system (RCS) propellant fuel problems (gas ingestion) during mated coast control. This dump will now be performed after ET separation during the glide phase to satisfy Orbiter center of gravity (c.g.) and RCS propellant tank landing constraints.

Sufficient main propulsion system (MPS) propellant allowances are maintained for a 5-minute launch hold and a 95-percent launch wind dispersion in determining the earliest engine-out time for the press-to-MECO boundary.

OMS propellant is used as ballast for Y c.g. offset for AOA/ATO.

The minimum geodetic altitude between OMS-1 and OMS-2 burns is constrained to be above 55 n. mi. for AOA and ATO to avoid excessive drag.

Orbiter angle-of-attack management to reduce drag is required when performing an AOA shallow abort from large MECO underspeeds to avoid catastrophic orbit decay between the OMS-1 and OMS-2 maneuvers.

The abort mode selector will be used pre-OMS-1 to automatically engage the proper abort OMS-1 target set (ATO engages the common AOA/ATO OMS-1 target and AOA engages the AOA OMS-1 shallow target). After performing a common OMS-1 to engage the AOA OMS-2 target, the crew will PRO to OPS-3 and then manually key in the target from an onboard checklist. Selecting AOA on the abort mode selector post-OMS-1 (only after performing an AOA OMS-1 burn) would automatically engage the AOA OMS-2 shallow target. This switch set-up allows automatic target selection for the more probable and time-critical abort paths.

78FM51:VI

To gain additional performance for AOA and ATO, the forward RCS propellant can be dumped (burned) to eliminate the OMS propellant X c.g. ballast requirement.

The AOA entry and landing has been changed back to Northrup Strip, Holloman AFB.

Though some abort issues are in work, abort analyses to date show that a continuous intact abort capability exists during the STS-1 ascent. Contingency abort analysis remains outstanding but will be incorporated later when the studies are finalized.

4.0 STS-1 OFF FLIGHT DESIGN GROUNDRULES AND CONSTRAINTS

The following groundrules and constraints were obtained from volume I (ref. 2) and were used in the generation of cycle 3 of the OFF for STS-1.

4.1 GENERAL

- 4.1.1 Trajectory techniques will provide maximum vehicle subsystem margins from design specifications when possible. Priorities and trade analyses will determine the best compromise when conflicts exist.
- 4.1.2 The launch date is March 31, 1980 at 11:30:00 GMT (6:30 a.m. EST).
- 4.1.3 The nominal orbit is 150/150 nautical miles.
- 4.1.4 The nominal inclination is 40.3 degrees. This inclination will provide an ET groundtrack that, for excessive MECO overspeeds, passes to the south of King Island and north of the Furneaux Group off the southern coast of Australia.
- 4.1.5 Nominal and abort to orbit (ATO) landings will be on Rogers Lakebed runway 23 at EAFB. Abort-once-around (AOA) landing will be on runway 17 at Northrup strip. Landing for glide return to launch site (GRTLS) will be on runway 15 at KSC. Because of the high probability of landing on either runway 15 or 33 for RTLS, OFT performance assessment will be based on the capability to achieve either runway for RTLS. Nominal and abort landing site locations are given in appendix A.
- 4.1.6 Standard GSTDN contact data will be provided for selected stations depending on the mission phase. Table II of appendix A establishes the AOS/LOS computational requirements for each phase. Minimum elevation may be computed assuming zero degree or 3 degrees maximum elevation with no masking. However, normally all AOS/LOS is computed assuming zero degree elevation with masking and keyholes considered. Exclusion of a site from table II, appendix A does not preclude it from being used in the tracking network.
- 4.1.7 All landings (nominal, abort, and contingency) except AOA will be no earlier than 30 minutes after sunrise and no later than 30 minutes before sunset. AOA landings may be as early as sunrise. It is desirable that nominal landing at EAFB occur prior to 10:00 a.m. local time.
- 4.1.8 A 1-hour launch window (as a minimum) will be provided.
- 4.1.9 There is no ontime launch requirement.
- 4.1.10 There are to be two crewmen. Crew provisions will be loaded for 5 days.
- 4.1.11 The planned flight duration will be approximately 54 hours.

- 4.1.12 There will be landing opportunities at EAFB on at least four orbits each day.
- 4.1.13 The payload will include the development flight instrumentation (DFI), the induced environment contamination monitor (IECM), the aerodynamic coefficients identification package (ACIP), and the Orbiter experiments (OEX) tape recorder. Mass properties for total payload weight are given in appendix A.
- 4.1.14 The payload bay doors (PLBD) are to be opened as soon as operationally practicable after OMS-2. However, the contingency capability will exist to leave the PLBD closed for up to 8 hours following OMS-2.
- 4.1.15 (Deleted)
- 4.1.16 All nominal deorbit opportunities will be planned such that the entry crossrange is ≤ 550 nautical miles; however, a crossrange of ≤ 690 nautical miles is acceptable for AOA and contingency cases.
- 4.1.17 (Deleted)
- 4.1.18 Reaction control system (RCS) backup deorbit capability is required. For this contingency, propellant from both OMS pods is assumed to be available.
- 4.1.19 The deorbit targeting will be biased to accommodate the designated backup deorbit propulsion mode.
- 4.1.20 Aerodynamic data, atmosphere and wind models, I-load values, software baseline (including implemented CR's), engine data, assumed constants, geodetic locations for TACAN/MSBLS/launch and landing sites and mass properties data for the nominal, RTLS, ATO, and AOA analysis are specified in appendix A. The limitations and constraints defined in volume I and volume II of the SODB (JSC-08934) will be adhered to in the design of the nominal and abort OFF profile except as defined in appendix B. (See 4.1.21.)
- 4.1.21 Appendix B summarizes the groundrules and constraints that deviate either from reference 2 or from reference 3 of this document.

4.2 NOMINAL ASCENT

4.2.1 General

- 4.2.1.1 (Deleted. Moved to appendix A.)
- 4.2.1.2 The first-stage pitch and yaw attitude profiles will be biased for the steady-state mean vector wind for the month of April. Fifty-percentile groundwinds will be used during the early launch time period and smoothly transitioned into in-flight steady-state winds.

- 4.2.1.3 The boost phase pitchover maneuver will be initiated through open-loop attitude steering when the Orbiter relative velocity reaches a magnitude which corresponds to a vertical rise of 365 feet, which includes dispersions.
- 4.2.1.4 The undispersed Q_{max} used for ascent shaping will be no greater than 580 psf. Launch opportunities and lift-off wind conditions will comply with the allowed max dispersed Q constraint of 660 psf.
- 4.2.1.5 The solid rocket booster (SRB) impact ellipse will not be west of a line connecting the following points (including dispersions):
- $$\phi = 30.00^\circ \text{ N}, \quad \lambda = 80.310^\circ \text{ W and}$$
- $$\phi = 31.44^\circ \text{ N}, \quad \lambda = 79.895^\circ \text{ W}$$
- 4.2.1.6 The SRB descent dispersion will use the same in-flight winds as the ascent.
- 4.2.1.7 At lift-off, the Space Shuttle main engines (SSME's) will be at 100-percent thrust rated power level (RPL).
- 4.2.1.8 The SSME's will be throttled during the first stage for max q control.
- 4.2.1.9 The main engine cutoff (MECO) conditions will be consistent with the external tank (ET) impact constraints enumerated below:
- a. Planned ET impact locations for nominal cutoff, including dispersions, will be no closer than 200 nautical miles to land masses in the Indian Ocean.
 - b. MECO and ET separation will be within GSTDN coverage.
 - c. MECO target conditions (r, v, γ, Ω, i) will be the same for normal ascent, AOA, and ATO.
 - radius = 21 290 308 feet (60 nautical miles altitude)
 - inertial velocity = 25 668 fps
 - biased inertial flightpath angle = 0.526 degrees
 - ascending node = optimum in-plane
 - inclination = 40.3 degrees
- 4.2.1.10 (Deleted)
- 4.2.1.10-a T_{fail} is a direct controlling parameter of the earliest time that a downrange intact abort resulting from one SSME out is possible. For nominal and abort shaping purposes, T_{fail} shall be set at 260 seconds (approximate RTLS abort mode boundary).

- 4.2.1.11 The ascent trajectory will be shaped for an acceptable propellant margin for nominal, intact aborts, and contingency abort, respectively.
- 4.2.1.12 A single OMS engine failure will not preclude nominal orbit insertion.
- 4.2.1.13.a As a minimum, communications (voice, command, and telemetry) above masking for a nominal mission are required through tracking station BDA through OMS-1 ignition + 5 seconds.
- 4.2.1.13.b For nominal, AOA, and ATO, the OMS-1 time of ignition (TIG) shall occur no earlier than 103.5 seconds from Orbiter/ET structural release. The OMS-1 TIG = 120 seconds will include a nominal 16.5 seconds from MECO to structural release to accommodate tail-off, damp rates, and preparation for separation and 103.5 seconds for tracking, ground evaluation, and appropriate action prior to OMS-1 ignition.
- 4.2.1.14 The OMS-1 maneuver will provide an orbit with a nominal 150-nautical mile apogee. The OMS-2 cutoff will result in a nominal 150-nautical mile circular orbit.
- 4.2.1.15 Deleted. Moved to appendix A.
- 4.2.1.16 The FPR allowance for the nominal mission will accommodate the occurrence of both 3-sigma low SSME and SRB performance (10 600 pounds propellant).
- 4.2.1.17 From T-9 minutes to T-1 minute 57 seconds, propellant capability for a 5-minute launch hold is available. A 5-minute hold after auxiliary power unit (APU) startup at T-5 will preclude a 24-hour recycle.
- 4.2.1.18 All four nominal SSME throttle change commands provided by the first-stage guidance principal function are available for OFT mission planning.
- 4.2.1.19 Nominally, the Shuttle vehicle will fly a $+2.0^\circ$ angle of attack and a 0.0° sideslip profile after the q_α and q_β constraint region.
- 4.2.1.20 Nominal SSME and SRB performance will be used for planning purposes.
- 4.2.1.21 The vehicle will be oriented on the pad with the -Z body axis (tail) pointed south.
- 4.2.1.22 During the first orbit, S-band telemetry, voice, and uplink communication coverage for a duration of 3 minutes is required at Madrid for ≥ 1 -degree elevation.
- 4.2.1.23 The ascent steering will be limited until GET = 150 seconds and altitude is greater than 200 000 feet to avoid post-SRB separation heating problems (total delt. angle of attack less than 5 degrees from a $+2$ -degree angle of attack and zero-degree sideslip angle).

4.2.2 Space Shuttle Main Engine (SSME) Constraints

- 4.2.2.1 The general purpose computers (GPC's) will issue the same thrust command to each SSME controller; i.e., no differential throttling.
- 4.2.2.2 The SSME's must be reduced to and operated at minimum power level for at least 6 seconds before MECO.
- 4.2.2.3 For flight design analysis, the SSME power levels are assumed to be:
 - Minimum throttle = 65 percent
 - Maximum throttle = 100 percent (nominal and aborts)

4.3 SEPARATION

The following groundrules and constraints will apply for nominal, ATO, AOA, RTLS, and contingency abort mission.

4.3.1 Orbiter-ET/SRB

- 4.3.1.1 The dynamic pressure at SRB separation will not exceed 75 psf and the pitch and yaw angles of attack will not exceed ± 15 degrees. Body rates at separation will not exceed the following: $p \pm 5$ deg/sec; $q \pm 2$ deg/sec; $r \pm 2$ deg/sec.
- 4.3.1.2 Orbiter/ET three-axis attitude hold will be maintained for 4 seconds after SRB staging to prevent recontact.
- 4.3.1.3 The time from SRB separation cue (primary or backup) to separation command will be approximately 6 seconds.

4.3.2 Orbiter/ET

- 4.3.2.1 The Orbiter will perform a -Z axis translational maneuver from the ET. The RCS translational delta-V will be at least 4.0 fps.
- 4.3.2.2 (Deleted)
- 4.3.2.3 Separation (nominal, ATO, and AOA) will occur at MECO inertial attitude. Measured attitude rates must be ≤ 0.5 deg/sec in all axes.
- 4.3.2.4 The Orbiter will perform a Y body axis translational maneuver. This maneuver will be executed following the completion of the RCS -Z body axis translational maneuver and the correction of attitude errors to within the acceptable deadband. If at ET separation the configuration is within the deadband, then the maneuver will be in the direction of the +Y body axis. If at ET separation the configuration is outside the deadband then for positive roll the translational maneuver shall be in

the -Y body direction and if the roll angle is negative then the translational maneuver shall be in the +Y body direction. The RCS translational delta-V will be for a duration of 24 seconds (~4 fps).

4.4 ORBITAL OPERATIONS

- 4.4.1 It is planned that a minimum of two 3-minute STDN passes above masking be available on each of the first three orbits and at least one 2-minute STDN pass above masking be available for each orbit.
- 4.4.2 The nominal mission orbital altitude will be 150 nautical miles circular to maximize the onorbit GSTDN coverage without jeopardizing the RCS deorbit capability or the post-MECO tracking requirement.
- 4.4.3 An inertial measurement unit (IMU) alignment will be required within 1.5 orbits before each major onorbit translation maneuver.
- 4.4.4 All three IMU's and all five GPC's will be on during the entire flight.
- 4.4.5 The onorbit attitude timeline and predeorbit thermal conditioning will be designed to provide thermal protection systems (TPS) backface temperature and Orbiter structural temperature gradients within defined limits during entry.
- 4.4.6 During the approximate 4-hour period before deorbit, the navigation requirements are as follows:
 - a. Three tracking passes (at least 30 minutes apart) >2 minutes above a 10-degree elevation
 - b. A primary uplink pass (at least 30 minutes after last tracking pass) ≥ 1 minute above a 5-degree elevation
 - c. After the primary uplink pass, a backup uplink pass at least 20 minutes before deorbit
- 4.4.7 The uncertainties and translation effects of systems venting, aerodynamic drag, and the RCS after initiation of the tracking sequence for deorbit maneuver computation and state vector determination will be minimized consistent with reasonable operations techniques.
- 4.4.8 The Orbiter will be placed in the Z-LV attitude (payload bay to Earth) for thermal control rather than the passive thermal control (PTC) attitude for nominal STS-1 flight.
- 4.4.9 A two-engine OMS maneuver and a minimum delta-V single-engine OMS maneuver will be scheduled after the deorbit rehearsal on day 2.

4.5 ORBITAL MANEUVERING SYSTEM

- 4.5.1 Delta-V requirements >6 fps for +X translation (using two OMS engines) or >3 fps for +X translation (using one OMS engine) will be performed with the OMS.
- 4.5.2 Maneuver computations will be based on nominal engine performance.
- 4.5.3 All normal OMS maneuvers >6 fps will be performed with two engines. (Deorbit targeting will be biased to protect against one-engine out.)
- 4.5.4 It is desirable to plan all OMS maneuvers to occur within GSTDN coverage.
- 4.5.5 The interconnect will be used only for contingency conditions. However, the crossfeed will be used during nominal onorbit system tests.
- 4.5.6 An OMS engine failure will require that the propellant in the failed pod be used in equal amounts with the operating pod.
- 4.5.7 Propellant in the OMS retention tanks will be available to the RCS engines for all onorbit conditions.
- 4.5.8 Loss of both OMS engines will require that the RCS deorbit propellant be obtained from both OMS tanks.
- 4.5.9 Sufficient OMS/RCS propellant will be provided to allow deorbit to a minimum delta-V entry target line if the propellant in one OMS tank is unavailable for use.
- 4.5.10 Where possible OMS propellants will be used as a ballasting agent for longitudinal and lateral c.g. requirements.

4.6 REACTION CONTROL SYSTEM

- 4.6.1 Unless otherwise specified, exoatmospheric attitude maneuvers will be budgeted at 0.5 deg/sec except for time-critical maneuvers, which will be budgeted at 1.0 deg/sec.
- 4.6.2 RCS propellant tanks will be loaded full for both the fore and aft systems.
- 4.6.3 Nominal and contingency RCS entry control allowance will be available in either aft RCS pod. However, maximum aft RCS propellant, consistent with mission objectives and c.g. considerations, will be maintained for entry-through-landing control.
- 4.6.4 Maneuver computations will be based on nominal engine performance.
- 4.6.5 For nominal mission operation, maximum steady-state firing duration will be 150 seconds for forward thrusters and 150 seconds for aft thrusters.

For contingency mission operation, the maximum steady-state firing will be 5 0 seconds for aft thrusters.

4.7 AUXILIARY POWER UNIT, ELECTRICAL POWER SYSTEM, AND ENVIRONMENTAL CONTROL LIFE SUPPORT SYSTEM

- 4.7.1 All nonpropulsive consumable tanks will be assumed to be fully loaded except the potable and wastewater tanks. The potable and wastewater tanks will be offloaded to allow for storage of prelaunch fuel cell powerplant (FCP) product water, atmospheric revitalization system (ARS) condensate, and crew waste products.
- 4.7.2 Four potable water tanks will be available for nominal onorbit cooling using the flash evaporator with PLBD closed. Two additional potable water tanks and the wastewater tank can be used for additional cooling.
- 4.7.3 The APU's will be assumed to be turned on 5 minutes before deorbit ignition and will remain on throughout landing and rollout.
- 4.7.4 (Deleted)
- 4.7.5 For nonpropulsive consumables budgeting, the following contingencies will be considered:
 - a. A 24-hour hold without reservice.
 - b. The worst case of the following:
 - (1) Cabin puncture
 - (2) One extravehicular activity (EVA)
 - (3) Last deorbit opportunity on mission extension day
 - (4) One cabin repressurization
 - (5) Deorbit one rev late
- 4.7.6 The electrical power system (EPS) analysis is based on the Orbiter electrical equipment utilization baseline.
- 4.7.7 The flash evaporators (hi-load and topping) will be turned on during ascent at 140 000 feet and will be turned off during descent at 100 000 feet. The ammonia boiler will be turned on at 100 000 feet during descent and will maintain cooling until ground support equipment (GSE) connect.

4.8 DESCENT - DEORBIT

- 4.8.1 The IMU alignment will be designed to minimize the IMU misalignment at the entry interface. To maintain system performance margins, the maximum platform misalignment at entry interface will be 950 arc-seconds. For a contingency where degraded system performance margins are necessary during entry, the maximum IMU misalignment at entry interface will be 1900 arc-seconds.
- 4.8.2 The deorbit maneuver will nominally be performed using two OMS engines, but due to targeting and guidance flexibility, the capability will exist to downmode to other thruster configurations during the burn. Specifically, the TIG and targets will be selected so that if one OMS engine fails at TIG, or any time later in the burn, the deorbit maneuver can be successfully completed using the remaining OMS engine. Furthermore, if the other OMS engine should also fail at the same time or at any time after the first failure, the deorbit maneuver could still be successfully completed using the +X RCS engines.
- 4.8.3 Propellant-critical contingency deorbit will be based on a shallower-than-nominal targeting criteria to provide the best compromise between deorbit capability, RCS propellant availability for attitude control during atmospheric descent, and entry thermal environment.
- 4.8.4 Between the termination of the deorbit maneuver (except ATO) and entry interface for two OMS, one OMS, and RCS modes that result from the triple downmoding operation, a minimum free-fall time of 15 minutes is required for entry preparation.
- 4.8.5 In addition to satisfying the entry velocity, flightpath angle, and range requirements, the deorbit maneuver will include an out-of-plane component to achieve an acceptable Orbiter entry interface center of gravity and weight.
- 4.8.6 The Orbiter entry weight will be minimized by reducing remaining consumables, such as OMS and forward and aft RCS propellant, etc., consistent with reasonable operations techniques.
- 4.8.7 When selecting the nominal deorbit revolution, it is highly desirable to have communication with and tracking of the spacecraft postdeorbit.
- 4.8.8 During descent, the Orbiter shall operate within the limits established in Structural Flight Restrictions for Orbital Flight Test Program (SD78-SH-0121).

4.9 DESCENT - ENTRY THROUGH ROLLOUT

- 4.9.1 The environment model used for computing the nominal OFF will be a mean monthly atmospheric model for the planned entry date as defined by the Four-D Global Reference Atmospheric Model. The environment model for the nominal profile simulation will not include winds.

- 4.9.2 The entry profile will be shaped to achieve a balance between the TPS surface and bondline temperatures and Orbiter structural temperatures such that the TPS performance during entry is optimized. This balance will include allowances for aerodynamic heating and trajectory dispersions.
- 4.9.3 (Deleted)
- 4.9.4 Entry-through-landing profiles will conform to control surface hinge moment limits, aerodynamic load limits, actuator rate limits, and structural load limits. For actual Orbiter weights for nominal end of mission, the structural load limits are +0.3 to 2g normal load factor between a Mach no. of 5.0 and an Earth relative speed of 24 000 fps and -0.3 to 2.0g normal load factor for a Mach no. ≤ 5 .
- 4.9.5 Optimization of the entry profiles will include consideration of sonic boom ground-level overpressures.
- 4.9.6 Nominal entry profiles will be targeted so that post-blackout target changes are not required. However, the profiles will be shaped to maximize post-blackout redesignation capability.
- 4.9.7 At entry interface, the nominal Orbiter longitudinal c.g. will be 66.70 percent and the lateral c.g. displacement will be 0.0. The nominal vertical c.g. will be 375 ± 3 inches.
- 4.9.8 The terminal area energy management (TAEM) guidance reference dynamic pressure will be based on the concept of flying directly to the heading alignment circle without employing an S-turn in tailwind conditions.
- Additionally, this dynamic pressure will allow the TAEM/approach and landing interface constraints to be met in the presence of severe headwinds. The energy control will provide conditions suitable for the initiation of a manual approach.
- 4.9.9 The TAEM profile will be compatible with manual and automatic modes of operation.
- 4.9.10 The max q will be limited to 300 psf for a Mach number >5 and to 342 psf for a Mach number <5 . The dynamic pressure on the nominal profile will be less than 240 psf for a Mach number >5 and less than 300 psf for a Mach number <5 . During the terminal area maneuvers for a Mach number <2.5 , the minimum dynamic pressure will be restricted to a value that keeps the vehicle's lift/drag (L/D) on the front side of the L/D curve. Therefore, the minimum dynamic pressure is a function of Orbiter weight and varies from 133 to 161 psf as the Orbiter weight varies from 181 000 to 218 000 pounds.
- 4.9.11 To conform to compartment venting constraints, the maximum descent rate and dynamic pressure will be 400 fps and 300 psf, respectively, in the transonic region. In addition, the minimum dynamic pressure on the nominal profile will be 150 psf in this flight region.

- 4.9.12.a The approach and landing profile will be shaped with a modified autoland guidance to approximate the manually flown flightpath. An autoland I-load that approximates the manual profile will be loaded onboard.
- 4.9.12.b The approach and landing profile will be optimized for the STS-1 Orbiter weight with the steep glideslope as shallow as possible, consistent with dispersion margin requirements. The steep and shallow glideslopes will be 20 degrees and 1.5 degrees, respectively.
- 4.9.13 Two steep glideslope intercept points will be used to accommodate winds on the final approach. The objective for one set will be to accommodate 20-percent tailwinds to 60-percent headwinds and the second will be to accommodate 40-percent to 100-percent headwinds.
- 4.9.14 After the first flare, at least 5 seconds of flying time will be provided between the time the pitch rate is less than 0.5 deg/sec and the initiation of final flare.
- 4.9.15 An energy reserve equivalent to approximately 4 seconds of flight time at nominal main-gear touchdown will be provided for the range of wind conditions used to design the approach and landing profile.
- 4.9.16 The normal load factor during the pullup from the steep glideslope to the shallow glideslope will be designed for an average value of less than 1.5g's.
- 4.9.17 The landing-gear deployment will be initiated at an equivalent airspeed (EAS) such that deployment will be completed 5 seconds prior to main-gear touchdown, with 9.4 seconds allowed for worst case gear deployment time.
- 4.9.18 The body flap will be retracted to zero degree at approach and landing initiation and will remain in this position through rollout.
- 4.9.19 The nominal descent rate at main-gear touchdown will be approximately 2 fps.
- 4.9.20 Nominal touchdown speed will provide adequate pitch margins for structural clearance. The maximum groundspeed at main-gear touchdown will not exceed 218 knots. The nominal speed will be targeted for approximately 185 knots.
- 4.9.21 The nominal landing point will be selected to optimize MSBLS coverage and ensure that the main-gear touchdown is beyond the runway threshold in the presence of dispersions. The shallow glideslope aimpoint will be 1500 feet beyond the runway threshold for all landing sites for all nominal and abort conditions. Nominal main-gear touchdown will be approximately 2500 feet downrange from the runway threshold.
- 4.9.22 After touchdown, the derotation and load relief technique will limit the main-gear tire loads to less than 100 000 pounds per tire. In

determining tire loads, a 60/40 percent proportioning of strut loads will be used, thus the maximum allowable strut load will be 166 667 pounds. After main-gear touchdown, the speedbrake will be commanded to 50% HRL (49.3°), and a pitch angle of 6 degrees will be held until the EAS has decreased to 165 knots. Then derotation at a pitch rate of approximately 3 deg/sec will be used to lower the nose gear to the runway. The elevons will be lowered to 10 degrees down deflection after nose-gear contact.

- 4.9.23 The pitch rate at nose gear contact will not exceed 9.4 deg/sec (11 ft/sec at the nose gear). The nominal rate will be approximately 3 deg/sec (3.5 ft/sec at the nose gear). The total radial load (steady state plus dynamic) on the nose-gear tires will be less than 45 000 pounds per tire.
- 4.9.24 Three seconds after nose-gear contact, moderate braking will be initiated to stop the Orbiter without exceeding the 36×10^6 ft-lb brake energy reuse limit.
- 4.9.25 Nosewheel steering will not be engaged until the groundspeed is less than 110 knots.
- 4.9.26 The profile will be designed for a left-hand turn on the final approach.

4.10 ABORTS

4.10.1 General

- 4.10.1.1 At all points on the ascent profile, the Orbiter with one SSME out will have RTLS or AOA/ATO capability, allowing for 3 σ low performance (SRB's and SSME's), plus 95 percent abort wind dispersions, and 5-minute launch hold.
- 4.10.1.2 Based on ground advice, the crew will manually select the abort mode. A 10-second delay from the abort condition to initiation of the abort sequence will be provided to allow for the abort mode decision process and abort selection.
- 4.10.1.3 (Deleted)
- 4.10.1.4 If a single SSME-out failure occurs during powered ascent, the remaining two SSME's will be automatically advanced to 100 percent, except during the throttledown-for-cutoff sequence.
- 4.10.1.5 Provided intact abort capability exists throughout launch, ascent shaping will include a three-SSME-out capability from lift-off to SRB staging plus 30 seconds.
- 4.10.1.6 For all RTLS, the pre-MECO OMS and RCS burn/dump sequence shall primarily be designed to achieve the desired orbiter c.g. For all downrange

intact aborts, AOA/ATO, performance critical aborts, and time critical aborts there shall be no pre-MECO burn/dump OMS/RCS propellant sequences.

- 4.10.1.7 The required c.g.'s for atmospheric descent resulting from aborts will be the same as for the nominal end of mission. Longitudinal c.g. = 66.7 percent, lateral c.g. = 0 inches, and vertical c.g. = 375 ± 3 inches.
- 4.10.1.8 The Orbiter weight for ATO, AOA, and RTLS atmospheric descent shall be minimized within systems and operational constraints and Orbiter performance capability.
- 4.10.1.9 Flight safety and systems performance margins will not be compromised during aborts to achieve flight test objectives.
- 4.10.1.10 (Deleted)
- 4.10.1.11 The nominal end of mission, ATO, and AOA have the same angle-of-attack profile during entry.
- 4.10.1.12 (Deleted)
- 4.10.1.13 For time-critical aborts from orbit, the gas generator (GG) cooler must be utilized if deorbit occurs less than 3 hours from APU shutdown. APU restart must occur within 120 seconds after GG cooler is used. It should be recognized that this is a one time only operation and should restart not take place in the prescribed time (2 minutes) then the full 3-hour cool down will be required.
- 4.10.1.14 Downrange aborts will incorporate a post-MECO forward RCS dump that significantly decreases the OMS ballast requirements.
- 4.10.1.15 To avoid contingency ditch, the shallow target line will be used for AOA. The perigee resulting from the OMS-1 burn shall be no lower than 55 nautical miles, and the AOA shallow targets will accommodate this constraint.

4.10.2 RTLS

- 4.10.2.1 The RTLS profile is shaped for benign maneuver rates, minimum loads, and maximum control margins.
- 4.10.2.2 OMS/RCS/MPS propellant burns or dumps are designed to achieve the required Orbiter entry longitudinal c.g. specifications and minimize the entry weight. Pre-MECO OMS/RCS burn schedules are planned for completion at least 6 seconds prior to the powered pitchdown maneuver for the latest RTLS abort. Post-MECO MPS LH₂ dump and LO₂ vent will not be initiated until after the RTLS ET separation maneuver and will be terminated by 100 000 feet altitude.

- 4.10.2.3 MECO target conditions (range velocity) are selected to maximize glide ranging potential and will be based on the Orbiter maneuver capability to achieve the target in the presence of dispersions.
- 4.10.2.4 For RTLS, the ET impact ellipse will be no closer than 25 nautical miles to any landmass. No ET impact will be allowed west of a line connecting the following points (including dispersions):
- | | |
|-------------------------|--------------------------|
| $\phi_d = 30.000$ deg N | $\lambda = 80.310$ deg W |
| $\phi_d = 31.440$ deg N | $\lambda = 79.895$ deg W |
- 4.10.2.5 Automatic guidance is the primary mode for RTLS. However, the profile will be shaped for benign flight conditions to enhance manual takeover if required.
- 4.10.2.6 Single RCS jet failures will not preclude a successful RTLS. This includes failures during the second stage c.g. management, ET separation, and GRTLS. RCS-to-RCS crossfeed will not be considered during mated coast and ET separation.
- 4.10.2.7 The SRB's will not impact west of a line connecting the following points:
- | | |
|--------------------------|----------------------------|
| $\phi_D = 30^\circ$ N | $\lambda = 80.31^\circ$ W |
| $\phi_D = 31.44^\circ$ N | $\lambda = 79.895^\circ$ W |
- (including dispersions)
- 4.10.2.8 First-Stage SSME-Out
- a. The engine-out steering will be the same as nominal for:
 - (1) Vertical rise
 - (2) Mach numbers between 1.05 and 1.6 to maintain structural margins in the event of an engine out during max q
 - (3) The time after 15 seconds prior to normal SRB separation to ensure steady-state conditions at dispersed separation conditions
 - b. The rate of change of pitch attitude between engine-out and nominal steering after Mach 1.6 will prevent q_a from going below -4100 psf degrees.
 - c. The maximum delta pitch attitude will be 5 degrees.
 - d. Engine-out steering is designed to center the trajectory in the squatcheloid at $M = 1.05$, approximately.
 - e. Only one engine-out is considered.

f. The alternate SRB trim gibal tables allow the SSME's to remain in their null position in mean wind conditions.

4.10.2.9 The last RTLS abort will be determined as the last time an SSME can fail and still make a guided MECO allowing for -3σ ascent FPR (6000 pounds), 5 minute launch hold, and 95 percentile adverse winds (includes the 10 seconds abort mode decision delay).

4.10.3 PRTLS

4.10.3.1 The abort steering will be limited in the same manner as nominal ascent to avoid post-SRB separation heating problems.

4.10.3.2 The pitcharound pitch rate will be commanded to 10 deg/sec.

4.10.3.3 Postpitcharound SSME throttle will be 95 percent with throttle for weight control and weight target set for 1-percent MPS remaining at MECO for early aborts (prior to V_LATE). For late aborts (after V_LATE), postpitcharound SSME throttle will vary from 95 percent up to a maximum of 100 percent for the last abort point and with only 3σ FPR remaining. For three SSME aborts, the throttle will be 67 percent prepitcharound and 70 percent postpitcharound with a maximum of 3 percent MPS remaining at MECO.

4.10.3.4 Powered pitchdown will be extended to approximately 20 seconds. Then the pitchdown rate and acceleration commands will be selected for slosh control. The SSME's will be throttled to 65 percent, and at least 5 seconds of flight will be provided at final attitude and rate commands prior to MECO.

4.10.4 RTLS Orbiter/ET Separation

4.10.4.1 MECO target conditions will be adjusted to achieve (1) Five psf separation dynamic pressure without dispersions, (2) Less than 3 percent MPS propellant excess remaining in the ET at separation, and (3) A flightpath angle of zero degree at ET separation.

4.10.4.2 The ET separation attitude and rate nominal target conditions are listed below. These conditions have an acceptable envelope for separation design being defined by the tolerances about the nominal target conditions.

a. Angle of attack = $-4^\circ \pm 2^\circ$

b. Sideslip angle = $0^\circ \pm 2^\circ$

c. Roll angle = no constraint

d. Pitch rate = $-0.25^\circ/\text{sec} \pm 0.5^\circ/\text{sec}$

- e. Yaw rate = $0^\circ/\text{sec} \pm 0.5^\circ/\text{sec}$
- f. Roll rate = $0^\circ/\text{sec} \pm 1.25^\circ/\text{sec}$

4.10.4.3 ET separation will occur 12.5 seconds after the MECO command. ET separation is followed by a -Z translation maneuver that is terminated when at least 10 seconds have elapsed since separation and when the angle of attack α is greater than 10 degrees. ET separation will be automatically inhibited for up to 6 seconds if any of the following attitude or rate inhibits are exceeded.

- a. Angle of attack: -4° $\begin{matrix} +2^\circ \\ -85^\circ \end{matrix}$
- b. Angle of sideslip: $0^\circ \pm 2^\circ$
- c. Roll angle: no inhibit
- d. Pitch rate: $-.25 \text{ deg/sec}$ $\begin{matrix} +0.5 \text{ deg/sec} \\ -4.75 \text{ deg/sec} \end{matrix}$
- e. Yaw rate: $0 \text{ deg/sec} \pm 0.5 \text{ deg/sec}$
- f. Roll rate: $0 \text{ deg/sec} \pm 5 \text{ deg/sec}$

4.10.5 GRTLS

4.10.5.1 The GRTLS profile will be shaped to achieve benign atmospheric entry conditions by minimizing the max q (<400 psf) and by optimizing the pullout angle of attack experienced during the load relief phase.

4.10.5.2 The Orbiter attitude and rates at the end of the -Z RCS separation burn phase will be within the RCS-aero surface recovery limits. The GRTLS attitude and attitude rate control requirements at the end of the -Z translational burn phase are as follows:

<u>Axis</u>	<u>Angle</u>	<u>Angle limit</u>	<u>Rate</u>
Roll	Roll	$-30^\circ \leq \phi \leq 30^\circ$	$-2^\circ/\text{sec} \leq p \leq 2^\circ/\text{sec}$
Pitch	Angle of attack	$\alpha = 20^\circ \pm 10^\circ$	$2^\circ \pm 1^\circ/\text{sec}$
Yaw	Angle of sideslip	$-3^\circ \leq \beta \leq 3^\circ$	$-1^\circ/\text{sec} \leq r \leq 1^\circ/\text{sec}$

4.10.5.3 The angle of attack for the alpha recovery phase will be 50 degrees to optimize the pullout angle of attack, and the N_z command for the N_z hold phase will be 2.0g's to provide an approximate 0.5g margin from the design limit.

4.10.5.4 (Deleted)

- 4.10.5.5 Orbiter maneuver pitch rates during the alpha recovery phase will be limited to 2 deg/sec.
- 4.10.5.6 The environment model used for computing the nominal OFP will be a mean monthly atmospheric model for the planned entry date as defined by the Four-D Global Reference Atmospheric Model. The environment model for the nominal profile simulation will not include winds.
- 4.10.5.7 All approach and landing groundrules and constraints for the nominal entry apply to GRTLS. All entry groundrules except 4.9.1, 4.9.2, and 4.9.10 apply to GRTLS. Entry rule 4.9.4 applies with the exception that the maximum load factor will be 2.5g's for GRTLS. Entry rule 4.9.8 is applicable except that an S-turn is incorporated in the nominal profile to cover dispersion during open-loop guidance phases.

4.10.6 AOA/ATO

- 4.10.6.1 For AOA/ATO, continuous S-band telemetry and voice communication coverage are required for ascent through MECO plus 2 minutes.
- 4.10.6.2 The AOA/ATO guided MECO conditions will provide ET impact locations no closer than 200 nautical miles (including dispersions) to landmasses in the Indian Ocean.
- 4.10.6.3 For Orbiter/ET separation, all groundrules and constraints that apply to the nominal mission also apply to AOA and ATO.
- 4.10.6.4 For ATO, the intermediate orbit will be targeted for the circular orbit, which results in the minimum post-MECO ΔV requirements for a full duration alternate mission. For STS-1, this has been determined to be a 105-nautical mile orbit.
- 4.10.6.5 (Deleted)
- 4.10.6.6 For AOA and ATO, the post-MECO OMS/RCS maneuvers will satisfy specific velocity, flightpath angle, and range requirements at entry interface, and also achieve an acceptable Orbiter weight and longitudinal c.g.
- 4.10.6.7 (Deleted)
- 4.10.6.8 For nominal planning purposes, the downrange abort mode boundary is the earliest time at which a single SSME failure can occur with a successful AOA to the nominal AOA target line, assuming:
 - a. A 5-minute launch hold
 - b. A 95-percent abort wind dispersion allowance
 - c. Abort mode decision delay does not apply to downrange abort mode
 - d. No pre-MECO OMS/RCS burns
 - e. Managers margin (3000 pounds MPS)
 - f. A -3σ abort ascent performance
 - g. A -3σ OMS dispersion allowance

- h. An 80-fps navigation dispersion allowance
- i. A 2-minute OMS-1 TIG delay (i.e., optimized for MECO plus 4 minutes)
- j. Common OMS-1 targets for AOA/ATO (apogee restriction of 105 n. mi.)
- k. A 1500-pound forward RCS dump between OMS-1 and OMS-2 to maintain x and y c.g. at entry interface while lowering entry weight and providing additional OMS for performance.

4.10.6.9 For an AOA the APU's will be on from prelaunch through MPS dump. One APU will be shut down and the remaining two put in depress mode until entry interface -5 minutes. The shutdown APU will then be restarted at entry interface -5 minutes by operating the gas generator (GG) cooler. Restart must occur within 120 seconds after GG cooler operation and the systems will remain on through stoproll.

4.10.6.10 All descent-deorbit and descent-entry through rollout groundrules and constraints will be used for AOA Entry Profiles, except that the balance between surface and bondline temperatures will be biased to maintain the surface temperatures at the expense of higher bondline temperatures.

4.10.7 Contingency Abort

4.10.7.1 General

4.10.7.1.1 Unrelated failures beyond those causing the contingency situation will not be addressed.

4.10.7.1.2 SRB and ET impact ellipses should not be closer than 25 nautical miles to any land mass, whenever possible.

4.10.7.1.3 If two SSME's fail, the throttle of the remaining SSME is to be set to 100 percent (the maximum setting recommended to ensure continued operation).

4.10.7.1.4 Maximum loads and load factors during contingency aborts could stress the Orbiter to the structural load limit; i.e., operational but not reusable.

4.10.7.1.5 Contingency abort analyses shall be based on nominal aerodynamic data and nominal aerodynamic heating.

4.10.7.2 First Stage

4.10.7.2.1 Contingency abort trajectory design will endeavor to maintain structural loads within ultimate values (factor of safety = 1.0) for failure of two or three SSME's at any time.

- 4.10.7.2.2 Should more than one SSME shutdown occur in the first stage and providing the roll program has been completed, control stick steering (CSS) mode should be selected and followed by a "hands-off" procedure that allows auto-load relief to ensure load limiting and the required low \bar{q} during control of SRB tail-off.
- 4.10.7.2.3 The ejection seats will not be used above 75 000 feet. (Other constraints on seat usage may evolve through analysis of, especially, heat or radiation from SRB and/or SSME plumes, if these are a problem.)
- 4.10.7.2.4 One-sigma rather than three-sigma SRB tail-off thrust mismatch will be used.
- 4.10.7.3 (Deleted)
 - 4.10.7.3.1 (Moved to 4.10.7.2.4)
 - 4.10.7.3.2 (Deleted)
- 4.10.7.4 Second Stage
 - 4.10.7.4.1 Manual control is the primary mode following the loss of two or three SSME's.
 - 4.10.7.4.2 Single engine burns will be used to minimize the maximum entry dynamic pressure. Nominal and intact abort OFT trajectories that exceed the 800 psf boundary defined in terms of instantaneous apogee altitude and velocity may have a contingency abort gap for failure of all three SSME's.
 - 4.10.7.4.3 If two SSME's fail or are shut down, the Orbiter/ET will be manually controlled (aided by autopilot RCS roll control using OMS propellant) to a canned attitude sequence, as a function of initial conditions, to achieve a MECO where a safe ET separation and Orbiter entry can be achieved.
 - 4.10.7.4.4 Maneuver rates under single SSME control will be limited to 5 deg/sec in pitch and roll and 1 deg/sec in yaw.
 - 4.10.7.4.5 Pre-MECO dumping of OMS propellant is performed by burning the OMS and aft RCS engines. These burns are initiated by item entry and can be terminated at propellant depletion, MECO, or item entry. The burns will automatically be reinitiated post-MECO (MM 602 only) if burn/dump and terminated automatically (propellant depletion or g's) or manually by item entry.

4.10.7.5 ET Separation

ET separation for 2 SSME failures will utilize the fast separation sequence (3 seconds, MM 601). The ET separation for 3 SSME failures will utilize the nominal sequence (16 seconds) when in MM 103 and the RTLS (12 seconds) or fast separation (3 seconds) when in MM 601. Dynamic pressure will be less than or equal to 2 psf and attitude and attitude rates are the same as nominal. ET propellant remaining up to 100 percent is acceptable for separation.

4.10.7.6 Descent - Recovery, Load Relief, and Glide

- 4.10.7.6.1 An RTLS abort must be selected in order to provide the necessary software for recovery, load relief, and glide. If initiated from an ATO or AOA mission, the RTLS mode must be selected after the post ET separation -Z translation maneuver phase and before OMS-1 ignition.
- 4.10.7.6.2 Recovery angle of attack (currently 50 degrees) shall be selected to minimize the maximum entry dynamic pressure and to allow adequate control.
- 4.10.7.6.3 The load relief phase normal acceleration (N_z) command will not violate the maximum structural load that the Orbiter can endure and continue to function until ditching/ejection. The maximum load currently being used is 635 075 pounds for a factor of safety = 1.0.
- 4.10.7.6.4 If required, an OMS/RCS burn schedule is planned to dump propellants to achieve an acceptable entry longitudinal c.g. and to minimize Orbiter entry weight.
- 4.10.7.6.5 (Deleted)
- 4.10.7.6.6 RCS burns using OMS propellant must be terminated before a normal acceleration of 0.05g. OMS burns can be continued to depletion, and RCS (4 + X) burns using RCS propellant must be terminated before entry redlines are violated.
- 4.10.7.6.7 MPS onorbit LOX dump will be initiated at post-MECO OMS ignition and will be stopped at OMS cutoff and then switched to the RTLS MPS dump/vent sequence.
- 4.10.7.6.8 The Orbiter will be manually flown to a benign glide profile after pullout.

4.10.7.7 Post-MECO

If an ATO has been selected pre-MECO and another SSME fails, an AOA may be selected via the abort switch after the post-ET separation -Z translation maneuver phase and prior to the first OMS burn for intact abort capability and quick return. (This capability is highly

78FM51:VI

dependent on the timing of the engine failures.) To facilitate downrange ditching, in some cases, RTL5 must be selected no later than OMS-1 ignition.

5.0 INITIALIZATION INFORMATION

Basically, the abort analysis initialization data are consistent with that used for the ascent and entry analysis contained in volumes III and V, respectively. Some of the more significant abort unique initialization information is provided as follows.

5.1 ASCENT

The powered flight abort trajectory profiles were generated using a 6-degree-of-freedom (DOF) version of the space vehicle dynamics simulation (SVDS) program. A spline-fit algorithm of the 1963 Patrick AFB atmosphere was modeled during ascent, and the vehicle mass properties are consistent with reference 3. The nominal aerodynamics used for the powered RTLS simulation were obtained from reference 4.

The SRB staging conditions used are presented in table 5.1-I. A summary of the AOA/ATO initialization data is shown in table 5.1-II. Additional initialization ascent abort constants are presented in section 10.0 as part of the onboard computer I-loads list.

5.2 DESCENT

The descent abort trajectory profiles were generated using a 6-DOF version of the SVDS program (ref. 5). The profiles are based on zero winds, and the aerodynamic data are defined in the April 1979 update to the Aerodynamic Design Data Book (ref. 6). All Orbiter weight and balance data utilized are documented in reference 2.

Additional assumptions are summarized by abort type as follows:

- a. GRTLS: The atmospheric model used is the April mean monthly atmospheric model for KSC extracted from the Four-D Global Reference Atmospheric Model (ref. 7). The April KSC atmosphere is presented in table 5.2-I and a comparison to the 1962 Standard Atmosphere is presented in figure 5.2-1 and table 5.2-II. The guidance, navigation, and control flight software functionally simulates the IBM May 21, 1979 delivery.
- b. AOA: The AOA descent profiles simulation models are identical to those used for the nominal end-of-mission descent profile documented in reference 5-4, with one exception. The atmospheric model used is the April mean monthly atmospheric model for AOA to Northrup Strip and is presented in table 5.2-III. A comparison to the 1962 Standard Atmosphere is presented in figure 5.2-2 and table 5.2-IV.
- c. ATO: The ATO descent profile simulation models are identical to those used for the nominal end-of-mission descent profile documented in reference 8.

TABLE 5.1-I.- RTLS INITIALIZATION CONDITIONS AT NOMINAL SRB STAGING

Parameter	Value
Position	
Geodetic latitude, deg	28.815467
Longitude, deg	-80.195386
Altitude, ft	167 273.59
Velocity	
Earth-relative velocity magnitude, fps	4 186.7626
Earth-relative flightpath angle, deg	34.866909
Earth-relative azimuth, deg	59.457601
Aerodynamic angles	
Alpha, deg	0.55094343
Beta, deg	-.21154258
Bank, deg	-179.72672
Body rates	
Roll rate, deg/sec	-2.3262762E-1
Pitch rate, deg/sec	-8.8501452E-2
Yaw rate, deg/sec	-1.0378046E-1
Total weight, lb	1.4681100E6
Time from L/O, sec	131.44

TABLE 5.1-II.- INITIALIZATION INFORMATION FOR AOA AND ATO
POWERED FLIGHT ANALYSIS

Parameter	Value
SRB ignition time, GMT	March 31, 1980; 11:30:00
Launch site location	
Longitude, deg	-80.604128
Latitude (geodetic), deg	28.608419
Altitude (to c.g.), ft	183.74927
Landing site location for AOA (NOR)	
Longitude, deg	-106.417381
Latitude (geodetic), deg	32.960354
Altitude, ft	3 771
Landing site location for ATO (EAFB)	
Longitude, deg	-117.843134
Latitude (geodetic), deg	34.9019
Altitude, ft	2 089
L/O weight (at SRB ignition), lb	4 449 964.9
MPS propellant	
At SRB ignition, lb	1 564 823
KSC launch hold, lb	160
Fuel bias, lb	700
-3 σ FPR, lb	5 644
Mean FPR, lb	717
Residuals (upper failure), lb	5 068
95 percent winds, lb	1 271
MPS usable at SRB ignition, lb	1 551 263
MPS used SRB ignition to L/O, lb	8 759
MPS usable at L/O, lb	1 542 504
Pre-MECO OMS/RCS burns, lb	0
Post-MECO OMS	
Loaded, lb	18 000
AOA	
Nav dispersions, lb	1 600
Ballast (including trapped and FPR), lb	1 100
ATO	
Nav dispersions, lb	800
Ballast (including trapped and FPR), lb	1 100

TABLE 5.1-II.- Concluded

Parameter	Value	
Parallel 4 + X RCS burn during OMS-1 for AOA and ATO	0	
Atmosphere 1963 Patrick AFB spline-fit algorithm		
Transformation matrix from mean of 1950 to ideal platform for vehicle 1		
0.16142387+00	-0.86322585+00	0.47831313+00
.46277395+00	-.36186815+00	-.80925378+00
.87165508+00	.35198374+00	.34106428+00

TABLE 5.2-I.- GRTLS APRIL GLOBAL ATMOSPHERE DEVIATIONS
FROM 1962 STANDARD ATMOSPHERE

NO. OF ATMOSPHERIC ELEMENTS	ALTITUDE ABOVE M.S.L. FEET	PRESSURE, PSF	DENSITY SLUGS/FT ³	TEMPERATURE DEG RANKINE
1	.39698162+06	.55159797-04	.41239354-10	.70979900+03
2	.39941995+06	.64642188-04	.52287537-10	.65976467+03
3	.38385827+06	.76749276-04	.67122580-10	.61197175+03
4	.37729655+06	.92451146-04	.86860018-10	.56697617+03
5	.37073491+06	.11580523-03	.11925583-09	.52762189+03
6	.36417323+06	.14424325-03	.16150293-09	.48826761+03
7	.35761155+06	.18497390-03	.22420839-09	.45379472+03
8	.35104987+06	.24457943-03	.31907587-09	.42420322+03
9	.34448819+06	.32180640-03	.45408385-09	.39461172+03
10	.33792651+06	.45023499-03	.66742719-09	.37774732+03
11	.33136483+06	.62864201-03	.98100617-09	.36088292+03
12	.32480315+06	.88619073-03	.14359117-08	.34986387+03
13	.31824147+06	.12630835-02	.20930130-08	.34469017+03
14	.31167979+06	.17997587-02	.30508165-08	.33951647+03
15	.30511811+06	.25806745-02	.43747613-08	.34091395+03
16	.29855643+06	.37003036-02	.62732504-08	.34231142+03
17	.29199475+06	.53156706-02	.89673229-08	.34433829+03
18	.28543307+06	.74566499-02	.12408316-07	.34929158+03
19	.27887139+06	.10457935-01	.17169704-07	.35424847+03
20	.27230971+06	.14629621-01	.23779504-07	.35826746+03
21	.26574803+06	.20461049-01	.32956389-07	.36226730+03
22	.25918635+06	.28414835-01	.45199890-07	.36734742+03
23	.25262467+06	.39177309-01	.61347390-07	.37350864+03
24	.24606299+06	.54000621-01	.83162861-07	.37977388+03
25	.23950131+06	.73838204-01	.11133946-06	.38747407+03
26	.23293963+06	.10092636+00	.14906259-06	.39518587+03
27	.22637795+06	.13660497+00	.19706773-06	.40388979+03
28	.21981627+06	.18297966+00	.25717674-06	.41344650+03
29	.21325459+06	.24485561+00	.33549750-06	.42286666+03
30	.20669291+06	.32375925+00	.43489352-06	.43187000+03
31	.20013123+06	.42790277+00	.56373613-06	.44087671+03
32	.19356955+06	.56011551+00	.72153590-06	.45131914+03
33	.18700787+06	.72600128+00	.91186227-06	.46320178+03
34	.18044619+06	.94040873+00	.11523912-05	.47509109+03
35	.17388451+06	.12083449+01	.14601540-05	.48110661+03
36	.16732283+06	.15536524+01	.18591339-05	.48646661+03
37	.16076115+06	.19441613+01	.23814530-05	.48749737+03
38	.15419947+06	.25532947+01	.30110299-05	.48487640+03
39	.14763779+06	.32691717+01	.39489042-05	.48226244+03
40	.14107612+06	.42263104+01	.51907740-05	.47372836+03
41	.13451444+06	.54638481+01	.68634184-05	.46384993+03
42	.12795276+06	.70938516+01	.90811070-05	.45527503+03
43	.12139108+06	.92494000+01	.12037791-04	.44794411+03
44	.11482940+06	.12055245+02	.15906184-04	.44055890+03
45	.10826772+06	.15958153+02	.21477479-04	.43322064+03
46	.10170604+06	.21115932+02	.28308194-04	.42583242+03
47	.95144356+05	.28310647+02	.39519651-04	.41748783+03
48	.88582677+05	.38457272+02	.54874715-04	.40822779+03
49	.82020997+05	.52213586+02	.76195875-04	.39896774+03
50	.75459317+05	.71219328+02	.10619077-03	.39069883+03
51	.68897638+05	.97951601+02	.14937560-03	.38190333+03
52	.62335958+05	.11602944+03	.17890818-03	.37322728+03
53	.55774278+05	.13643080+03	.21197433-03	.37353520+03
54	.49212598+05	.16095851+03	.25172841-03	.37228941+03
55	.42650918+05	.18987490+03	.29901914-03	.36931942+03
56	.36089239+05	.22443868+03	.35367711-03	.36974199+03
57	.29527559+05	.26470948+03	.41120884-03	.37456978+03
58	.22965879+05	.31162710+03	.47849665-03	.37941661+03
59	.16404199+05	.36602045+03	.55500629-03	.38414080+03
60	.09842519+05	.43018500+03	.64200345-03	.39021054+03
61	.03280839+05	.50739975+03	.72675933-03	.40268394+03
62	.00000000+05	.58738617+03	.81911432-03	.41507563+03
63	.29527559+05	.67398926+03	.91741618-03	.42795684+03
64	.26464199+05	.76116719+03	.10290381-02	.44111297+03
65	.22965879+05	.85004191+03	.11414371-02	.45436778+03
66	.19685019+05	.10171131+04	.12674512-02	.46752911+03
67	.16404199+05	.11569551+04	.14070495-02	.47900651+03
68	.13123360+05	.13133437+04	.15610256-02	.49008329+03
69	.9845197+04	.14811871+04	.17290114-02	.50096696+03
70	.61616798+04	.16786214+04	.19142012-02	.51092719+03
71	.33006399+04	.18907711+04	.21190159-02	.51970902+03
72	.49299860+04	.21221413+04	.23420975-02	.52766133+03

TABLE 5.2-II.- GRtls APRIL GLOBAL REFERENCE ATMOSPHERE DATA

NO. OF ATMOSPHERIC ELEMENTS	ALTITUDE ABOVE M. S. L. FEET	PRESSURE DEVIATIONS FROM 1962 STANDARD, PERCENT	DENSITY DEVIATIONS FROM 1962 STANDARD, PERCENT	TEMPERATURE DEVIATIONS FROM 1962 STANDARD, PERCENT
1	.39698162+06	.14476659+02	.65713406+00	.70991314+01
2	.39041995+06	.11883123+02	-.19532509+01	.76675797+01
3	.38305827+06	.94836761+01	-.18391586+01	.55220340+01
4	.37729659+06	.73793368+01	-.18338443+01	.36858208+01
5	.37073491+06	.80050390+01	-.12002513+00	.27749178+01
6	.36417323+06	.63324664+01	-.44307702+00	.18036726+01
7	.35761155+06	.59592553+01	.14468909+01	-.13365316+00
8	.35104987+06	.76421728+01	.65824979+01	-.31107684+01
9	.34448819+06	.76103600+01	.10554275+02	-.62731811+01
10	.33792651+06	.13016041+02	.16802657+02	-.64973657+01
11	.33136483+06	.16900213+02	.21547415+02	-.66891095+01
12	.32480315+06	.20424364+02	.25187067+02	-.61777271+01
13	.31824147+06	.24162419+02	.28186087+02	-.49070853+01
14	.31167979+06	.26706974+02	.29835904+02	-.35241494+01
15	.30511811+06	.28746495+02	.27885712+02	-.08436554+01
16	.29855643+06	.29344570+02	.24424824+02	.35686225+01
17	.29199475+06	.28828909+02	.21302104+02	.58948553+01
18	.28543307+06	.25081537+02	.16175116+02	.74181475+01
19	.27887139	.21392230+02	.11239330+02	.89425471+01
20	.27230971+06	.17482749+02	.65845919+01	.10178513+02
21	.26574803+06	.13648981+02	.21710539+01	.11408589+02
22	.25918635+06	.93502209+01	-.82736538+00	.10596038+02
23	.25262467+06	.58297754+01	-.15210601+01	.78864238+01
24	.24606299+06	.38233729+01	-.11240674+01	.54145212+01
25	.23950131+06	.23455480+01	-.83907861+00	.35092545+01
26	.23293963+06	.20573816+01	.49551612+00	.17427195+01
27	.22637795+06	.18953115+01	.15580809+01	.34407679+00
28	.21981627+06	.17201851+01	.22344185+01	-.75735269+00
29	.21325459+06	.24247267+01	.37543503+01	-.18203862+01
30	.20669291+06	.28287578+01	.54632822+01	-.29114447+01
31	.20013123+06	.40446264+01	.74907710+01	-.34979465+01
32	.19356955+06	.47836090+01	.74880158+01	-.27168661+01
33	.18700787+06	.48929090+01	.65106986+01	.16543575+01
34	.18044619+06	.53226454+01	.59095967+01	-.62279894+00
35	.17388451+06	.52809479+01	.60079637+01	-.83296271+00
36	.16732283+06	.55799912+01	.56474702+01	-.14438171+00
37	.16076115+06	.56948901+01	.55495531+01	.67199811+01
38	.15419947+06	.55252736+01	.56051003+01	-.11432536+00
39	.14763779+06	.49813193+01	.34593520+01	.14230923+01
40	.14107612+06	.48744491+01	.30509908+01	.17558746+01
41	.13451444+06	.41721387+01	.23346577+01	.18055061+01
42	.12795276+06	.32948917+01	.11523774+01	.21596572+01
43	.12139108+06	.22195674+01	-.50859646+00	.28123779+01
44	.11482940+06	.45512024+00	-.28396828+01	.34846379+01
45	.10826772+06	-.42052040+00	-.43590240+01	.42022794+01
46	.10170604+06	-.19614021+01	-.56583884+01	.39885873+01
47	.95144356+05	-.25102541+01	-.51763501+01	.28465059+01
48	.88582677+05	-.20549555+01	-.34758486+01	.14572256+01
49	.82020997+05	-.19309276+01	-.20355629+01	.43640137+01
50	.75459317+05	-.16402421+01	-.50844758+00	-.11441474+01
51	.68897638+05	-.82452134+00	.16730243+01	-.24875023+01
52	.65616798+05	.47378451+00	.34872865+01	-.29855413+01
53	.62335958+05	.10025040+01	.50249182+01	-.37481844+01
54	.59055118+05	.18702706+01	.66653447+01	-.45338319+01
55	.55774278+05	.27291106+01	.85128955+01	-.52954263+01
56	.52493438+05	.37993696+01	.94002112+01	-.51870669+01
57	.49212598+05	.46444461+01	.89484025+01	-.39490770+01
58	.45931758+05	.52956579+01	.82044029+01	-.27077425+01
59	.42650918+05	.57029693+01	.72879821+01	-.14947799+01
60	.39370079+05	.61751250+01	.61155214+01	.61683510+01
61	.36089239+05	.59689921+01	.26688894+01	.32014015+01
62	.32808399+05	.54785649+01	.21100927+01	.32902184+01
63	.29527559+05	.47724739+01	.10009361+01	.34914908+01
64	.26246719+05	.42323003+01	.40906755+00	.37454812+01
65	.22965879+05	.36968252+01	-.29500594+00	.40076213+01
66	.19685039+05	.31586160+01	-.10491202+01	.42344221+01
67	.16404199+05	.24919743+01	-.15444118+01	.40829869+01
68	.13123300+05	.19828270+01	-.17954251+01	.30533348+01
69	.98425197+04	.15139808+01	-.20017081+01	.35940633+01
70	.65016798+04	.10959776+01	-.19200671+01	.31596529+01
71	.32208399+04	.72783610+00	-.1700767+01	.25124059+01
72	.40990996+02	.46116454+00	-.13241621+01	.18070948+01

ORIGINAL PAGE
OF POOR QUALITY

TABLE 5.2-III.- AOA APRIL GLOBAL REFERENCE ATMOSPHERE DATA

NO. OF ATMOSPHERIC ELEMENTS	ALTITUDE ABOVE 1960 FISCHER ELLIPSOID.FT	PRESSURE.PSF	DENSITY SLUGS/FT ³	TEMPERATURE DEG RANKINE
1	.39999714+06	.49762714-04	.37320281-10	.70495312+03
2	.39337964+06	.58385253-04	.47222698-10	.65742826+03
3	.38672319+06	.69454192-04	.60759024-10	.61154286+03
4	.38003023+06	.83916427-04	.79540288-10	.56795327+03
5	.37414591+06	.10248204-03	.10366472-05	.53531010+03
6	.36739129+06	.13157501-03	.14302854-09	.50164194+03
7	.36060764+06	.16802581-03	.19800973-09	.46825712+03
8	.35379802+06	.23245953-03	.28890619-09	.44478802+03
9	.34782114+06	.30673552-03	.40220677-09	.42400036+03
10	.34097330+06	.42924319-03	.59346886-09	.40462831+03
11	.33411282+06	.61261492-03	.88517382-09	.38947417+03
12	.32810567+06	.83461363-03	.12656655-08	.37000948+03
13	.32124513+06	.11934135-02	.18450386-08	.36772757+03
14	.31440381+06	.17042337-02	.27062878-08	.35991447+03
15	.30844912+06	.23210484-02	.37297154-08	.35748941+03
16	.30170521+06	.32889791-02	.52968460-08	.35873109+03
17	.29506452+06	.46334831-02	.74914256-08	.36004673+03
18	.28857921+06	.63711338-02	.10258830-07	.36144827+03
19	.28155587+06	.89924748-02	.14423151-07	.36283001+03
20	.27565941+06	.12037819-01	.19338401-07	.36235942+03
21	.26894478+06	.16810555-01	.27194153-07	.36028264+03
22	.26225318+06	.23441399-01	.38210931-07	.35794313+03
23	.25567814+06	.32571792-01	.52956603-07	.35927141+03
24	.24911847+06	.45279007-01	.73398046-07	.35890655+03
25	.24255701+06	.62947627-01	.10048112-06	.36148581+03
26	.23593437+06	.87869812-01	.13527816-06	.37786757+03
27	.22949678+06	.12017319+00	.17907046-06	.39020561+03
28	.22278329+06	.16270069+00	.23435409-06	.40316966+03
29	.21633886+06	.21653177+00	.30367565-06	.41378054+03
30	.20981392+06	.28634544+00	.39133020-06	.42486467+03
31	.20321423+06	.37669874+00	.50282795-06	.43594383+03
32	.19660145+06	.49444332+00	.64584537-06	.44655926+03
33	.19017999+06	.63516035+00	.80769659-06	.45851914+03
34	.18356068+06	.82085939+00	.10167475-05	.47062521+03
35	.17687179+06	.10606442+01	.12888446-05	.47941517+03
36	.17042352+06	.13547441+01	.16253983-05	.48509669+03
37	.16367078+06	.17581579+01	.20933807-05	.48873618+03
38	.15719134+06	.22473917+01	.26945057-05	.48550817+03
39	.15055757+06	.28894009+01	.34891086-05	.48215616+03
40	.14431533+06	.36690141+01	.44741560-05	.47746795+03
41	.13757418+06	.47831742+01	.59705735-05	.46664936+03
42	.13097095+06	.61992037+01	.79170820-05	.45171537+03
43	.12466502+06	.80037494+01	.10381988-04	.44938249+03
44	.11769719+06	.10607999+02	.14005516-04	.44163435+03
45	.11113513+06	.13959334+02	.18740237-04	.441423064+03
46	.10470086+06	.18400699+02	.25114462-04	.42683678+03
47	.98203218+05	.24348809+02	.33805803-04	.41931408+03
48	.91681241+05	.33066763+02	.46900211-04	.41052578+03
49	.84919898+05	.45393925+02	.65851957-04	.40148608+03
50	.78509817+05	.61389293+02	.90059220-04	.39362980+03
51	.71962734+05	.84080838+02	.12642075-03	.38739433+03
52	.65419333+05	.11595228+03	.17671562-03	.38233991+03
53	.61839163+05	.13755374+03	.21051429-03	.38082504+03
54	.58925070+05	.15959525+03	.24505172-03	.37949626+03
55	.55613208+05	.18798808+03	.28978031-03	.37798547+03
56	.52099634+05	.22365837+03	.34632685-03	.37631170+03
57	.49014915+05	.26065929+03	.40083813-03	.37855664+03
58	.45761393+05	.30994518+03	.46729421-03	.38111054+03
59	.42338742+05	.36171502+03	.54848154-03	.38121221+03
60	.39207036+05	.42145835+03	.63385257-03	.38729874+03
61	.35820609+05	.49592296+03	.72540931-03	.38803754+03
62	.32534808+05	.57727486+03	.82273532-03	.40873356+02
63	.29274112+05	.66961497+03	.92759044-03	.42049868+02
64	.26035289+05	.77157121+03	.10354745-02	.43412727+02
65	.22731246+05	.88772346+03	.11544477-02	.44798758+02
66	.19335133+05	.10209237+04	.12868710-02	.46221271+02
67	.16064831+05	.11639417+04	.14263509-02	.47539985+02
68	.12861937+05	.13182140+04	.15734594-02	.48902779+02
69	.95804851+04	.14911581+04	.17386494-02	.49968907+02
70	.62916816+04	.16838374+04	.19297809-02	.50837636+02
71	.37865753+04	.18438474+04	.20861393-02	.51496091+02
72	.37865753+04	.18438474+04	.20861393-02	.51496091+02

TABLE 5.2-IV.- AOA APRIL REFERENCE ATMOSPHERE DEVIATIONS FROM

1962 STANDARD ATMOSPHERE

NO. OF ATMOSPHERIC ELEMENTS	ALTITUDE ABOVE 1960 FISCHER ELLIPSOID, FT	PRESSURE		DENSITY		TEMPERATURE	
		DEVIATIONS FROM 1962 STANDARD, PERCENT	DEVIATIONS FROM 1962 STANDARD, PERCENT	DEVIATIONS FROM 1962 STANDARD, PERCENT	DEVIATIONS FROM 1962 STANDARD, PERCENT		
1	.39999714+06	.11619461+02	.32052390+01	.16371883+01			
2	.39337964+06	.98636080+01	.12539531+01	.47703127+01			
3	.38672319+06	.79574882+01	.96997293+00	.28992989+01			
4	.38003023+06	.63470872+01	.65528353+00	.13006043+01			
5	.37414591+06	.7322085+01	.97722097+00	.84965244+00			
6	.36739129+06	.90831226+01	.27515352+01	.10959506+01			
7	.36060764+06	.86992717+01	.24993295+01	.13791079+01			
8	.35379802+06	.14397534+02	.97482491+01	.59691658-03			
9	.34782114+06	.18100895+02	.15180468+02	.12392229+01			
10	.34097330+06	.23288615+02	.21286215+02	.17711813+01			
11	.33411282+06	.29388048+02	.26984432+02	.11474147+01			
12	.32810567+06	.33011334+02	.30261447+02	.55645074+00			
13	.32124513+06	.36221827+02	.32998702+02	.12367207+00			
14	.31440381+06	.37988537+02	.34144986+02	.10098380+01			
15	.30844912+06	.38107181+02	.32127379+02	.31186055+01			
16	.30170521+06	.36561242+02	.26752481+02	.68685586+01			
17	.29506452+06	.33379941+02	.20364389+02	.10725694+02			
18	.28857921+06	.27497249+02	.14586254+02	.11570194+02			
19	.28155587+06	.21354414+02	.86393354+01	.11600093+02			
20	.27565941+06	.16676206+02	.46178182+01	.11436919+02			
21	.26894478+06	.11746035+02	.89652414+00	.10798244+02			
22	.26225318+06	.69816438+01	.25412352+01	.99376963+01			
23	.25567814+06	.35526256+01	.18409741+01	.54779386+01			
24	.24911847+06	.18217388+01	.21335044+00	.14385525+01			
25	.24255701+06	.14564383+01	.22392817+01	.89679455+00			
26	.23593437+06	.24628298+01	.34299977+01	.10792070+01			
27	.22949678+06	.34503526+01	.47303617+01	.13951202+01			
28	.22278329+06	.31798220+01	.46505784+01	.17201998+01			
29	.21633886+06	.34115105+01	.55701039+01	.24277129+01			
30	.20981392+06	.35617114+01	.64321191+01	.30226395+01			
31	.20321423+06	.37481538+01	.75176791+01	.36178211+01			
32	.19660145+06	.43599042+01	.77864915+01	.30605349+01			
33	.19017999+06	.39281670+01	.60692914+01	.19297856+01			
34	.18356068+06	.36990394+01	.46616361+01	.80036186+00			
35	.17687179+06	.35578014+01	.40956547+01	.52060040+00			
36	.17042352+06	.35297742+01	.38696021+01	.42558106+00			
37	.16367078+06	.40449065+01	.35933405+01	.32148634+00			
38	.15719134+06	.40456251+01	.43145375+01	.34105666+00			
39	.15055757+06	.38798971+01	.33344192+01	.46044908+00			
40	.14431533+06	.34748681+01	.18970807+01	.14890628+01			
41	.13757418+06	.31945870+01	.17621574+01	.13914366+01			
42	.13097695+06	.22851896+01	.96226801+00	.13315992+01			
43	.12466502+06	.15836305+01	.33195385+00	.19790862+01			
44	.11769719+06	.87856880-01	.24477614+01	.26867630+01			
45	.11113513+06	.10721788+01	.42294657+01	.33611946+01			
46	.10470086+06	.21747259+01	.57772346+01	.38213711+01			
47	.98203218+05	.35867052+01	.63473259+01	.28750038+01			
48	.91681241+05	.28565671+01	.44409935+01	.16027598+01			
49	.84919898+05	.24201530+01	.27240062+01	.27838601+00			
50	.78509817+05	.21526568+01	.13431976+01	.81945590+00			
51	.71962734+05	.15343479+01	.60759708-01	.15055401+01			
52	.65419333+05	.53557256+00	.14710479+01	.19565748+01			
53	.61939163+05	.78555476-01	.23621061+01	.23450298+01			
54	.58925070+05	.38161603+00	.31723481+01	.26957789+01			
55	.55613208+05	.92808574+00	.41410438+01	.30731913+01			
56	.52099634+05	.15086607+01	.52446611+01	.34972676+01			
57	.49014915+05	.20734771+01	.50704204+01	.28497971+01			
58	.45761393+05	.25310004+01	.48325243+01	.21928469+01			
59	.42338742+05	.29102421+01	.44552209+01	.14764582+01			
60	.39207636+05	.32152652+01	.39079716+01	.68505887+00			
61	.35820609+05	.31992389+01	.14179047+01	.17616234+01			
62	.32534808+05	.29852639+01	.14870494+01	.14664315+01			
63	.29274112+05	.29081440+01	.14055835+01	.14667534+01			
64	.26015289+05	.26638237+01	.73239198+00	.19222258+01			
65	.22731246+05	.23709871+01	.19614843-01	.23515442+01			
66	.19335133+05	.20268680+01	.71167126+00	.27637903+01			
67	.16064831+05	.16995648+01	.12914258+01	.30287777+01			
68	.12861937+05	.13059994+01	.18583827+01	.32141000+01			
69	.95884851+04	.82338515+00	.22385309+01	.31367793+01			
70	.82916816+04	.38070580+00	.20082128+01	.24457422+01			
71	.37865753+04	.84634933-01	.18110757+01	.19383600+01			
72	.37865753+04	.84634933-01	.18110757+01	.19383600+01			

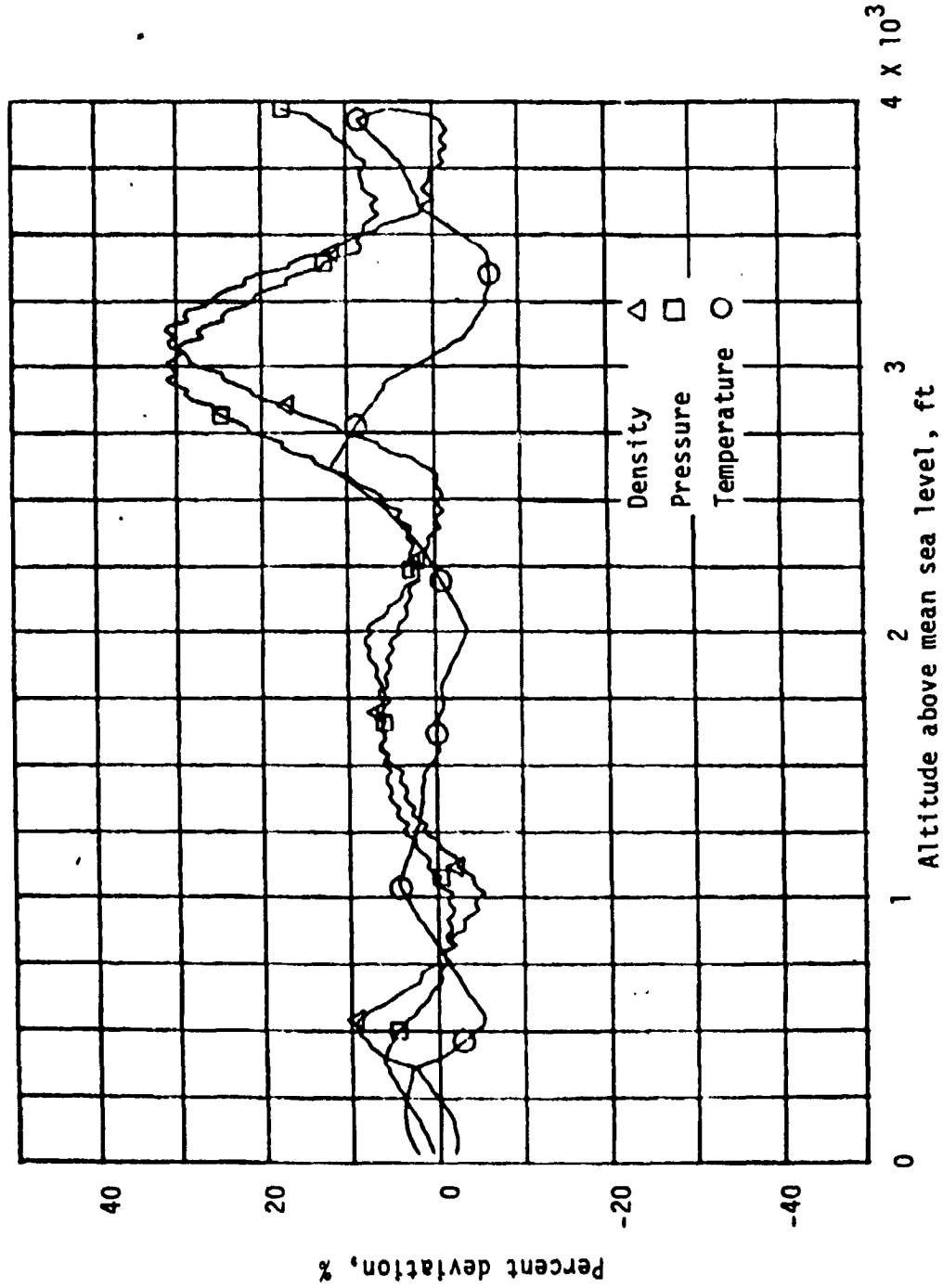
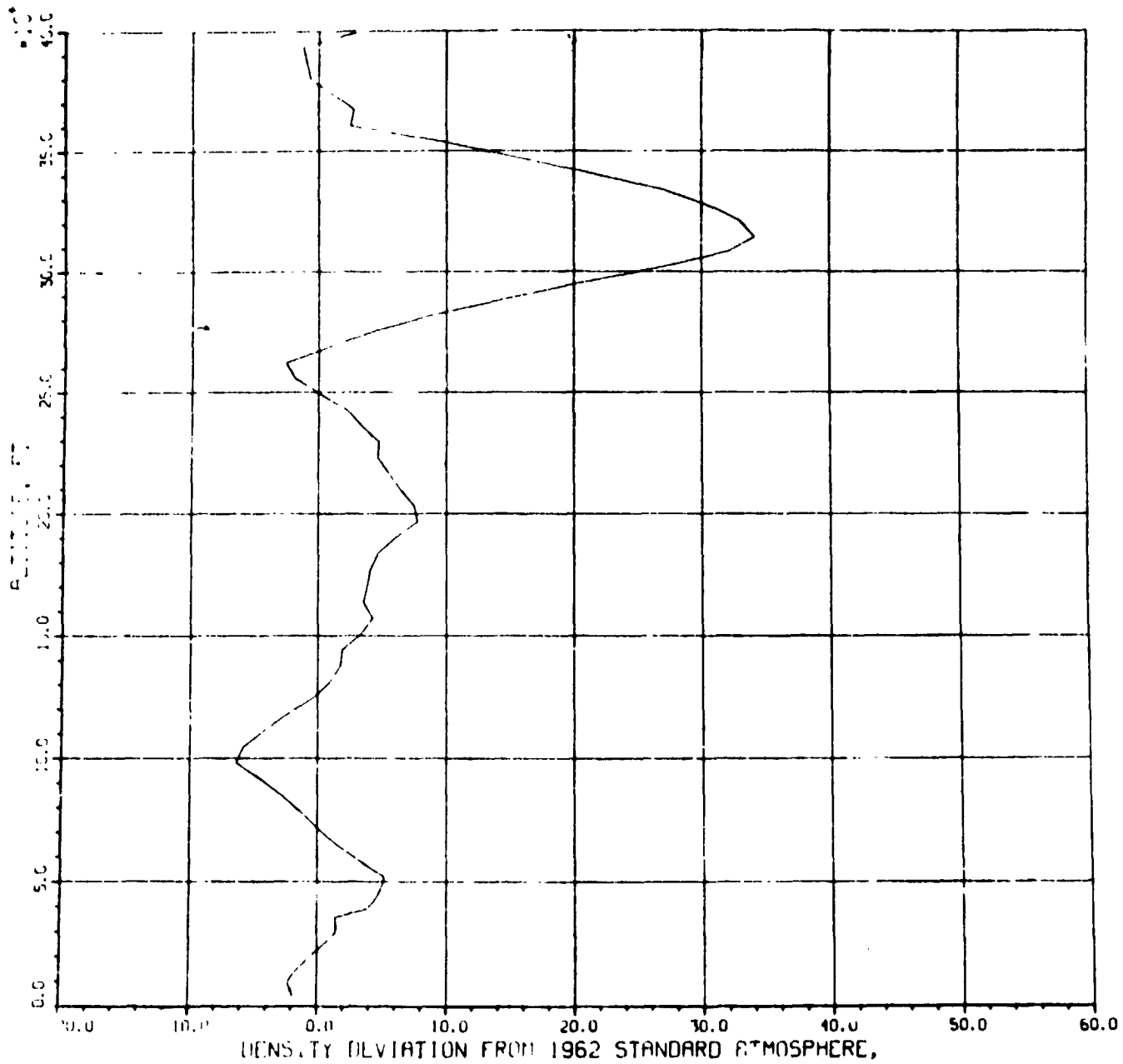

Figure 5.2-1.- Percent deviations from 1962 Standard Atmosphere for April, KSC global.



MEAN APRIL GLOBAL REFERENCE ATMOSPHERE

Figure 5.2-2.

6.0 ABORT CAPABILITY

This section contains a general discussion of the Shuttle intact abort capabilities for the STS-1 launch. Specifically, it documents selected abort cases that have been supplied to IBM as OFF trajectory tapes for onboard software verification.

Basically, three intact abort modes will be available during ascent if an abort is required (fig. 6.0-1). These modes, RTLS, AOA, and ATO are designed to provide continuous intact abort capability from lift-off to insertion. Intact abort capability will provide a route for safe return of the crew, Orbiter, and payload to a planned landing site. The primary requirement for an intact abort capability is to provide protection against the loss of a single SSME or a single OMS engine. This inherent (designed-in) capability does provide protection for other failures that require an immediate return and for some cases (AOA and ATO) protection against the loss of both an SSME and an OMS engine. The abort mode capability during ascent is summarized in figure 6.0-2 for the STS-1 mission.

6.1 SSME OUT IN FIRST STAGE

First-stage engine-out steering consists of alternate mission-dependent I-load tables for guidance attitude commands, flight control load relief and SRB trim gimbal schedules, and a relative velocity magnitude beyond which the alternate attitudes will not be selected. Table 6.1-I shows the alternate table requirements based on which engine goes out as specified in the current guidance and flight control system functional subsystem software requirements (FSSR's), respectively (refs. 9 and 10). The engine-out steering I-loads are designed to meet two objectives:

- a. Maintain structural margins in the region of maximum dynamic pressure (max \bar{q})
- b. Provide SRB separation conditions that meet separation criteria and thermal constraints

These objectives are to be met while adhering to the following groundrules and constraints:

- a. The engine-out steering will be the same as nominal for
 - (1) Vertical rise
 - (2) Mach numbers between 0.9 and 1.6 to maintain structural margins in the event of an engine-out during max \bar{q} .
 - (3) After 15 seconds prior to normal SRB separation to ensure steady-state conditions at dispersed separation conditions.
- b. The rate of change of pitch attitude between engine-out and nominal steering after $M = 1.6$ will prevent $\dot{q} \cdot \alpha$ from going below -4100 psf degrees.

- c. The maximum delta pitch attitude will be 5 degrees.
- d. Engine-out steering prior to $\max \bar{q}$ must center the trajectory in the squatcheloid at Mach 1.05.
- e. Only one engine-out is considered.
- f. The alternate SRB trim gimbal tables retrim the Shuttle with the two operating SSME'S in their null positions.
- g. The alternate NZ tables compensate for the failed SSME ΔNZ , and the SRB retrim ΔNZ .

The following assumptions are made to simplify the design procedure.

- a. The mean wind conditions will place the trajectory in the center of the squatcheloid for each engine-out.
- b. Engine-out squatcheloids are smaller than those for no failure.
- c. Maintaining a 5° cone about $+2^\circ$ angle of attack and zero sideslip at SRB separation will provide acceptable thermal conditions.

The design procedure works backwards from SRB separation to vertical rise. The design between $\max \bar{q}$ and SRB staging provides the desired staging and thermal conditions. The design prior to $\max \bar{q}$ provides the desired loads margins. The detailed steps of the procedure are shown in figure 6.1-1. Also, figure 6.1-2 clarifies some of the steps of the procedure in terms of pitch attitude.

The resultant engine-out I-loads for the STS-1 cycle 3 mission are shown in table 6.1-II for the first-stage guidance attitude commands and flight control system reference steering tables. Because STS-1, as currently designed, has benign SRB separation conditions, no post- $\max \bar{q}$ lofting is required. The nominal yaw attitude profile was used to maintain the desired $\bar{q} \cdot \beta$ during the $\max \bar{q}$ region.

Performance data showing trends in $\bar{q} \cdot \alpha$, $\max \bar{q}$, and SRB separation conditions for various engine-out cases are shown in figures 6.1-3 through 6.1-5. Plots of trajectory parameter time histories for SSME 2 failure at lift-off and 46 seconds from SRB ignition command are presented in figures 6.1-6(a) through (s) and figures 6.1-7(a) through (s), respectively.

6.2 RTLS

The RTLS abort is the intact abort mode that provides a suborbital return capability of the Orbiter, crew, and payload directly to the KSC Shuttle landing field within approximately 22 minutes after lift-off for aborts initiated during the first 262.5 seconds of ascent. RTLS was basically designed to protect against loss of thrust of a single SSME, but its inherent capabilities also provide a three-SSME return capability for time-critical failures requiring an immediate return early in ascent. A typical RTLS profile and its associated flight phases are presented pictorially on figure 6.2-1.

6.2.1 PRTLS

The powered RTLS (PRTL)S is that portion of RTLS with the SSME's burning and characteristically begins when the abort is initiated and terminates at MECO. Although an RTLS abort might be required for a failure in the first stage, the actual RTLS sequence and guidance would not be initiated until after SRB jettison. At powered pitcharound, a fixed OMS burn sequence is executed to dump excess OMS propellant for entry c.g. management (fig. 6.2.1-1).

The PRTL)S flight phases are shown on figure 6.2-1 in relationship to the RTLS profile. The first PRTL)S phase is the propellant dissipation phase. This phase is designed to continue powered flight downrange without violating poststaging heating constraints and to loft the Orbiter/ET configuration to a suitable altitude, dependent on abort time, to perform the pitcharound maneuver. To accomplish this after the heating region ($t = 150$ seconds or $h = 200K$ feet), a constant thrust attitude is selected based on the velocity at the engine-out or the corresponding staging velocity if the engine went out during the first stage (fig. 6.2.1-2). This phase is not used for late RTLS aborts ($t > 254$ seconds) and pitcharound would be performed immediately. Except for the latter, pitcharound is delayed until the MPS propellant remaining is sufficient to achieve the required RTLS MECC targets.

The pitcharound maneuver is essentially an in-plane pitch maneuver (excluding yaw steering effects) at approximately 10 deg/sec to orient the Orbiter/ET configuration in a heads-up attitude, pointing back toward the launch site (retrograde). Once the pitcharound has occurred, flyback guidance will be initiated to null off the downrange velocity and add sufficient uprange velocity for the Orbiter return. During this phase, the vehicle will be explicitly targeting to the altitude, flightpath angle, and range-velocity line. Also, active SSME throttling will be performed to make final adjustments to the MPS propellant remaining to allow for a satisfactory ET separation (<2 percent excess MPS propellant remaining in the ET).

The final PRTL)S phase is the powered pitchdown (PPD) phase. This phase starts approximately 20 seconds prior to MECO when closed-loop guidance is terminated. PPD takes the mated vehicle from a relatively high angle of attack to the required separation attitude ($\alpha = -4^\circ$). MECO will then be performed when the desired cutoff velocity has been achieved based on the MECO range-velocity line (fig. 6.2.1-3). The cutoff velocity is adjusted by guidance to compensate for flightpath angle errors built up during the pitchdown maneuver.

Several PRTL)S trajectories have been generated for STS-1. These are an SSME-out at lift-off, 60 seconds, SRB staging, 150 seconds, 200 seconds, 254 seconds, and the last RTLS time of 262.5 seconds; also, a three-SSME case initiated at 260 seconds was run and a three-SSME case initiated at 260 seconds with an SSME failure at 100 seconds prior to pitchdown. These trajectories should be representative of the powered flight phase for any RTLS abort during OFT-1 ascent. A representative PRTL)S weight breakdown (consistent with ref. 3) used for these runs is shown in table 6.2.1-I(a) and 6.2.1-I(b). General trajectory information for

abort cases of SSME-out at lift-off, last RTLS, and 3 SSME RTLS selected at 260 seconds is presented on figures 6.2.1-4(a) through 6.2.1-6(gg) from SRB separation to ET separation. Some of the key event parameters for the collective PRTLS runs are summarized in table 6.2.1-II.

The simulations used to generate these data had the following constraints:

- a. All simulations terminated at ET separation.
- b. All the OFT-1 guidelines and constraints were followed.
- c. All inputs to the software were from the cycle 3 I-load delivery.

Additional data for the cases of an SSME failing at lift-off, latest RTLS and 3 SSME RTLS selected at 260 seconds, are available on standard trajectory tapes. Users interested in these tapes can contact the Flight Analysis Branch, Mission Planning and Analysis Division, Johnson Space Center for additional information. A summary plot of the PRTLS trajectory profiles is shown on figure 6.2.1-7 indicating the fan of possible RTLS abort trajectories for STS-1. A PRTLS radar summary is presented in table 6.2.1-III for the early and late RTLS abort cases.

6.2.2 GRTLS Overview

The GRTLS atmospheric flight returns the Orbiter, crew, and payload (intact) to the designated RFLS abort runway at the launch site. This flight phase begins at the end of the Orbiter/ET -Z RCS translational separation burn and terminates at landing. The GRTLS phase is designed (1) to maximize the range flown during atmospheric descent while limiting the aerodynamic loads experienced by shaping the angle-of-attack and bank-angle histories that enhance the FCS performance margins, and (2) to maximize maneuver margins that compensate for navigation uncertainties, effects of unfavorable aerodynamics, atmosphere, and winds.

The basic GRTLS profile shaping problem is the result of the requirement to separate the Orbiter from the ET at low dynamic pressure (<10 psf), which ensures adequate separation clearances. At this dynamic pressure the Orbiter has insufficient aerodynamic lift for equilibrium flight; therefore, the Orbiter accelerates to a high descent rate until the dynamic pressure increases sufficiently to allow an arresting of the descent rate. Very high descent rates are reached before an effective aerodynamic recovery can be accomplished; therefore, high aerodynamic and structural loads occur prior to stabilizing the trajectory. The severity of these high loads depends on the speed, dynamic pressure, flightpath angle at separation, Orbiter weight, and the angle of attack flown during initial entry into the atmosphere (alpha recovery angle).

A high angle of attack is maintained during the initial entry into the atmosphere until the normal load factor exceeds 1.65g's. This initial angle of attack is maintained as long as possible to arrest the descent rate, and when the normal load factor approaches the desired limit, the angle of attack is reduced at a rate designed to maintain a constant normal load factor (N_z) as the Orbiter descends through the atmosphere and attains equilibrium flight conditions. The initial angle of attack and the normal load limit for this load relief maneuver

are determined by a trade-off between structural and flight control considerations and trajectory performance requirements.

During the critical alpha recovery and load relief flight phases, no steering or ranging is performed. Closed-loop guidance does not begin until the alpha transition phase.

After the Orbiter pulls out of the initial dive into the atmosphere and achieves near-equilibrium flight, a flight profile similar to the terminal area energy management (TAEM) profile for normal entry flight is established. A transition flight phase is necessary to smoothly match the angle-of-attack profile at the end of the load relief phase to the angle of attack required to optimize the remainder of the flight profile. The transition angle-of-attack reference profile is maintained until Mach 3.2 where angle-of-attack modulation is introduced for range control. The capability exists during alpha transition to dissipate excess energy by use of an S-turn maneuver if required. At Mach 3.2, the Orbiter initiates a guidance mode similar to the TAEM guidance for normal entry. During this period, trajectory control is accomplished by angle-of-attack modulation to control the altitude/energy-range profile with speedbrake modulation introduced at Mach 0.9 for dynamic pressure control. Natural trajectory control is achieved by bank-angle modulation that steers the Orbiter to the heading alignment circle (HAC) and then along the HAC. This flight mode is maintained until the approach and landing interface conditions are achieved. The Orbiter then follows an approach and landing profile similar to the nominal end-of-mission approach and lands on the selected abort runway.

For STS-1, the GRTLS landings will be at the Kennedy Space Center (KSC). Although an April launch is unlikely, ground-level winds may require a landing on runway 33; therefore, performance assessment must be based on the capability to achieve either runway 15 or 33 at KSC for GRTLS. The prevailing winds and the desire to make a left turn onto final approach dictate runway 15 as the primary runway.

Furthermore, it is important that the Orbiter c.g. is within acceptable limits during the atmospheric phase of the GRTLS flight and that the Orbiter weight during this flight phase is minimized. For cycle 3, these two objectives are aided by both a pre-MECO OMS and RCS dump sequence during PRTLS and a post-MECO dump of the trapped MPS propellants initiated after the termination of the Orbiter/ET -Z RCS translational separation burn. To eliminate potential fire or explosive hazards, this MPS dump is scheduled to terminate prior to reaching a 100 000-foot altitude.

PRTLS targeting criteria at the GRTLS interface are discussed in section 6.2.2.1. The GRTLS guidance and profile shaping considerations are discussed in sections 6.2.2.2 and 6.2.2.3. Section 6.2.2.4 contains the GRTLS trajectory profiles from the PRTLS trajectories generated for STS-1. Profile data for the GRTLS, resulting from a one SSME-out at 262 seconds and a one SSME-out at lift-off, is also presented in section 6.2.2.4.

6.2.2.1 GRTLS Targeting Criteria

The PRTLS is targeted for a range/velocity (RV) target line at MECO that is based on the capability of the Orbiter to reach the abort landing site from Orbiter/ET separation conditions and requires an S-turn for the nominal profile. At ET separation, the Orbiter is also targeted for a horizontal flight condition; i.e., zero descent rate and an altitude designed to achieve the low dynamic pressure required by ET separation.

The target altitude is based on the maximum expected velocity at separation to ensure that the maximum separation dynamic pressure criteria are always satisfied. For STS-1, the nominal dynamic pressure requirement at separation is 5 psf, which results in a separation altitude of 224 000 feet for an April 1980 launch.

The positioning of the RV target line is accomplished as follows:

- a. The maximum range from which the Orbiter can reach the runway is determined for several different ET separation speeds. These speeds are chosen to include the expected variation in PRTLS MECO velocities. A maximum-range flight profile is considered a limiting case if the Orbiter reaches the approach-and-landing steep glide slope at an altitude of 10 000 feet above-ground level while flying at the minimum dynamic pressure or maximum lift to drag (L/D) angle of attack. A line drawn in the RV plane defined by the locus of these maximum range points represents the low energy, undispersed GRTLS ranging capability boundary.
- b. The minimum range, or high energy line in the RV plane is determined for the same variation in MECO speeds. Two criteria for high energy limit case acceptability are used. If either the Orbiter's specific energy versus range-to-go profile touches the minimum entry point reference line, or if the Orbiter flies so far over the runway centerline that it must fly more than a 45° arc around the western heading alignment circle, then the maximum energy case has been exceeded.
- c. The undispersed RV ranging capability footprint is reduced by moving the maximum range line toward the runway and the minimum range line away from the runway. Range increments used for this purpose are derived by taking a root-sum-square of all the increments resulting from dispersions that can affect GRTLS ranging capability such as aerocoefficient uncertainties, winds, atmospheric density variations, and navigation errors. The aerocoefficient uncertainties and winds are the largest of these dispersion effects.
- d. The nominal target line can now be positioned, after considering the three-sigma PRTLS dispersions at MECO and the effects target position may have on GRTLS constraints; e.g., the dynamic pressure/angle of attack/Mach stability boundary. Location of the RV target line also determines whether or not an S-turn is required for energy dissipation in the nominal case.

The minimum angle-of-attack constraints necessary to assure lateral/directional trim and $C_{n\delta}$ dynamic stability, require S-turns within approximately 5 n. mi. of the dispersed low energy footprint edge. By designing an

RV target for moderate S-turns, the angle-of-attack/dynamic pressure constraints based upon C_{ng} dynamic are more likely to be avoided and the dynamic pressure is controlled with less difficulty (after the pullout peak) in dispersed conditions. For STS-1 cycle 3, the RV target line is placed relatively close (within 10 n. mi.) to the dispersed low-energy boundary so that only moderate S-turns are experienced for the nominal profile.

The GRTLS range capability for STS-1 is presented in figure 6.2.2-1 with and without the effects of dispersions. The STS-1 Orbiter/ET separation RV target line is also presented in this figure. This target line is situated between the maximum and minimum range lines, with the difference between the target and the limiting range lines representing maneuver margins.

The target range (fig. 6.2.2-1) is the predicted range from the Orbiter/ET separation to the tangency point on the heading alignment circle (HAC), plus the path length around the HAC and along the final approach to the runway threshold. This target range is applicable for a landing on either runway 15 or 33 at KSC because the approach azimuth at ET separation is approximately 90° to the runway for STS-1.

6.2.2.2 GRTLS Guidance

The GRTLS profile (fig. 6.2.2-2) consists of eight flight phases that correspond to the guidance modes (ref. 11) used during GRTLS. Seven of these phases are contained within the GRTLS TAEM guidance, which guides the Orbiter through all of the GRTLS flight phases from the end of the Orbiter/ET -Z RCS translational separation burn to the approach and landing interface on final approach. The final phase is the approach and landing phase. The first three phases of the GRTLS TAEM guidance are unique to RTLS and the last four phases are identical to those of the TAEM guidance for normal entry. The first three phases of the GRTLS TAEM guidance are (1) the alpha recovery, (2) the N_z hold or load relief, and (3) the alpha transition (fig. 6.2.2-3). The first two phases are required to stabilize the trajectory following Orbiter/ET separation. The alpha transition phase can incorporate an S-turn if required by the Orbiter's energy state. The remaining four phases of the GRTLS TAEM guidance are (1) S-turn, (2) acquisition, (3) heading alignment, (4) and prefinal. They accomplish the necessary ranging and are identical to the phases of the TAEM guidance used for normal entry with two exceptions: (1) the energy per unit weight, altitude, and dynamic pressure references are extended to higher speeds to allow closed-loop ranging to begin as early as possible, and (2) by providing greater energy control, the bank angle limit during S-turn is increased from 30° to 45° . Note that an S-turn initiated during the alpha transition phase may continue into the S-turn phase.

- a. Alpha recovery phase - The alpha recovery phase (phase 6) begins at the end of the Orbiter/ET -Z RCS translational separation burn and maneuvers the Orbiter attitude from the low angle of attack required for separation to the high angle of attack and a lift vector-up bank attitude in preparation for atmospheric flight. This attitude is maintained until the normal load factor increases to within 0.35g's of the constant normal acceleration value of the N_z hold phase.

The value of the angle of attack during the alpha recovery phase influences both the subsequent aerodynamic loads experienced by the Orbiter and the minimum angle of attack experienced during the N_z hold phase. This recovery angle of attack also influences the Orbiter's range potential. Therefore, this angle of attack is determined for each flight by a trade-off between Orbiter structural and flight control considerations and trajectory range performance requirements. The higher this initial angle of attack, the lower the maximum dynamic pressure and the higher the minimum angle of attack experienced during the N_z hold phase. Both of these results are desirable for structural and flight control stability considerations. However, a higher initial angle of attack decreases the maximum range capability and also increases the postpullout phugoid motion, thus reducing the latest time for an RTLS abort and introducing long-period trajectory transients. For STS-1, the constant angle of attack for the alpha recovery phase is 50° . This results in minimizing the peak dynamic pressure and maximizing the minimum angle of attack during the N_z hold phase.

Attitude control during this phase is accomplished by both sets of aft RCS thrusters and by aerodynamic surface effectors. Use of the aft roll and pitch RCS thrusters is terminated when dynamic pressures of 10 psf and 20 psf, respectively, are reached. The aft yaw jets, used as the primary mode for lateral control during low dynamic pressure, remain available to assist the ailerons and rudder for lateral control until Mach 1.0, using the GRTLS attitude control logic defined in reference 12.

The elevons and body flap are activated at the end of the separation burn. The GRTLS FCS schedules the elevons and controls the body flap to null the elevator trim command. When a dynamic pressure of 20 psf is reached, the speedbrake is ramped from 0 to 98.6° relative to the hingeline to enhance lateral stability.

The recovery angle of attack is maintained until the normal force N_z increases to within 0.35g's of the desired N_z (2.0g's) during the N_z hold phase. Switching to the N_z hold phase prior to reaching the desired N_z provides for a smooth transition into the N_z hold phase with minimum N_z overshoot. For STS-1, switching from the alpha recovery phase to the N_z hold phase occurs when N_z reaches 1.65g's.

- b. N_z hold phase - The N_z hold phase (phase 5) maintains the normal load factor to the predetermined 2-g value by reducing the angle of attack. To minimize aerodynamics loads, the Orbiter is maintained in a lift vector up attitude during this phase. For STS-1, the commanded N_z for this phase is a constant 2g's, allowing a 0.5-g margin from the structural design limit.

The primary concerns during this phase are to maintain structurally acceptable aerodynamic loads and to achieve a pullout angle of attack that is within the alpha/Mach dynamic pressure constraint flight corridor required for adequate Orbiter lateral control. No maneuvers (heading correction, S-turns, ranging, etc.) that could induce subsequent higher aerodynamic loads and unfavorable flight conditions, are performed during this phase. After reducing the descent rate to 250 ft/sec the guidance switches to the alpha

transition phase provided the angle of attack is higher than the angle-of-attack/Mach reference profile. If the angle of attack is below the reference at this point, the load relief maneuver is continued until the optimum angle-of-attack profile is reached, and then the guidance switches to the alpha transition phase.

- c. Alpha transition phase - The objective of the alpha transition phase (phase 4) is to transfer the Orbiter from the N_z hold phase to the subsequent closed loop guidance phases. During this phase, the guidance commands a predetermined open loop angle-of-attack profile and a bank angle designed to direct the velocity vector toward the nearest HAC or initiate an S-turn if called for by the energy state. If the angle of attack is above the reference alpha/Mach profile when phase 4 is initiated, a rate of 1.0 deg/sec pitchdown is commanded until the angle-of-attack profile is smoothly merged with the alpha/Mach reference profile.

Because the alpha recovery and the N_z hold phases are both open loop with regard to energy management, and sufficient energy must be available to cope with open-loop energy losses from headwinds and unfavorable L/D variations, GRTLS is intentionally targeted to produce an excess energy state at the initiation of active ranging in the nominal no-wind case. Therefore, an S-turn is normally initiated (and terminated) during the alpha transition phase. The alpha transition phase is terminated at Mach 3.2, and complete closed-loop TAEM guidance begins.

- d. S-turns - An S-turn (phase 4 or phase zero) is used to dissipate excess energy by changing the groundtrack to increase the range to be flown when angle-of-attack modulation is insufficient for range control. Since GRTLS is intentionally targeted to produce an excess energy state at nominal pullout conditions an S-turn is needed for a nominal no-wind GRTLS.

While performing an S-turn, the guidance commands a bank angle of 45° to establish the S-turn energy dissipation maneuver. The direction in which the S-turn is made depends on the Orbiter heading and on which side of the runway centerline the Orbiter is located. If the S-turn is performed during the alpha transition phase (phase 4), the guidance commands the predetermined open-loop, angle-of-attack profile. If the S-turn continues below Mach 3.2 (phase zero), ΔN_z is commanded to achieve the altitude, dynamic pressure, and energy reference profiles. Termination of the S-turn phase occurs when the energy/weight (E/W) becomes less than the S-turn termination E/W limit and switching to the acquisition phase occurs. The GRTLS TAEM E/W versus range profiles for STS-1 are shown in figure 6.2.2.4.

- e. Acquisition phase - During the acquisition phase (phase 1), the altitude and energy profiles are controlled by angle-of-attack modulation and the dynamic pressure is controlled by speedbrake modulation when the Mach number is less than 0.9. Dynamic pressure is indirectly controlled above Mach = 0.9 by selecting the altitude versus range reference profile to achieve a particular dynamic pressure profile. Trajectory control is achieved by nulling out altitude and altitude rate errors via the normal acceleration ΔN_z command. The ΔN_z command is restricted by constraint control laws that are functions of specific energy, angle of attack, and dynamic pressure. Finally,

the ΔN_z command issued by the guidance is constrained to be within $-0.5g$ to $0.75g$.

During this phase, the roll angle is commanded to steer the Orbiter toward a tangent to the nearest HAC. The roll angle command in this phase is proportional to the Orbiter heading deviation from the tangency to the nearest HAC.

Checking the criteria for switching to the heading alignment phase (phase 2) occurs when the Orbiter approaches within 22 000 feet of the center of HAC, which has a radius of 20 000 feet and is located approximately 6.50 n. mi. from the runway threshold. A switch to the heading alignment phase occurs when either the Orbiter is within 2000 feet of the tangency point on the HAC or within 20 200 feet of the center of HAC. For STS-1 GRTLS conditions, the switch to phase 2 occurs around 23 100 feet altitude and approximately 11.7 n. mi. from the runway threshold.

- f. Heading alignment phase - The heading alignment phase (phase 2) commands a roll angle to assure that the Orbiter performs a turn, which follows the HAC while the angle of attack is commanded to maintain the reference altitude-range profile.

The Orbiter remains in this phase, gliding around the HAC until it gets within 4000 feet of the intersection of the HAC and the runway centerline. This occurs when approximately 10° of turn around the HAC remain. The guidance then switches to the prefinal phase (phase 3) approximately 7.1 n. mi. from the runway threshold at approximately 13 200 feet altitude.

- g. Prefinal phase - In the prefinal phase, the bank command is generated from a linear combination of the Orbiter's lateral deviation and deviation rate from the runway centerline. The Orbiter remains on the nominal altitude-range profile that takes the Orbiter from its present glideslope to the autoland outer glideslope (20° for STS-1) by angle-of-attack modulation generated from N_z commands. During this phase, the TAEM/autoland transition logic is executed to determine when the switch to the autoland guidance should occur. This is an automatic transfer, and an indicator that transfer has occurred is displayed to the crew.

The autoland guidance is initiated when the altitude is less than 10 000 feet and crossrange displacement from the runway centerline, dynamic pressure, and glideslope are within acceptable tolerances. At an altitude of 10 000 feet, transfer occurs if the Orbiter is within 1000 feet of the desired reference altitude, within 1000 feet from the runway centerline, within 4° of the desired outer glideslope (20° for STS-1), and within 24 psf of the desired dynamic pressure (265 psf for STS-1). These tolerances (except the dynamic pressure) decrease linearly with altitude until an altitude of 5000 feet is reached. At this point the Orbiter has to be within 50 feet of the desired outer glideslope, and within 24 psf from the desired dynamic pressure for transfer to occur. If the tolerances are not met by the time the Orbiter reaches an altitude of 5000 feet, the guidance mode transfer occurs automatically and an indicator is displayed to the crew. Nominally, the

TAEM/autoland interface conditions are met by an altitude of 10 000 feet with a range of 34 000 feet from the threshold.

6.2.2.3 GRTLS approach and landing

Approach and landing for STS-1 will be flown manually but autoland guidance modified to approximate manually flown profiles was used to generate trajectory data presented in this document. This guidance incorporates four phases: the trajectory capture, steep glideslope, flare and shallow glideslope, and final flare phases. These phases are shown on the geometric altitude-range profile presented in figure 6.2.2-5.

The approach and landing phase consists of a steep (20° for STS-1) outer glideslope followed by a flare and a shallow (1.5° for STS-1) inner glideslope followed by a final flare before touchdown. The 20° glideslope is designed to provide equilibrium flight with approximately 60 percent speedbrake deployment with a speed of 280 knots equivalent airspeed (KEAS) corresponding to approximately 265 psf dynamic pressure. This configuration for the 20° outer glideslope permits sufficient speedbrake modulation to compensate for design headwinds, aerovariations, and TAEM/autoland interface dispersions. The 1.5° inner glideslope is designed to provide at least 5 seconds of shallow glideslope flight time. A desired landing speed of 185 KEAS is designed to provide 4 seconds of flight time margin in the presence of worst-case conditions.

The approach and landing phase begins when the TAEM/autoland guidance interface conditions are met. The trajectory capture phase computes normal acceleration commands to guide the Orbiter from the TAEM/autoland interface conditions to the 20° outer glideslope trajectory. This phase is usually very short (approximately 2 to 3 seconds) because the prefinal phase of TAEM guidance usually leaves the Orbiter near the steep glideslope. During the steep glideslope phase, normal acceleration commands are computed to guide the Orbiter along the desired glideslope. The desired dynamic pressure is maintained during this phase by speedbrake modulation. The Orbiter remains on the outer glideslope trajectory until the initiation of the flare and shallow glideslope phase. The body flap is retracted to 0° at approach and landing initiation. The speedbrake is retracted at an altitude of 2500 feet.

For STS-1, manual initiation of the flare and shallow glideslope phase begins at an altitude of 1850 feet. The phase begins with a constant N_z pullup and then transitions to the 1.5° inner glideslope using an exponential flare. This inner glideslope is designed to minimize the sink rate when close to the ground and to require only a small final flare prior to touchdown and still provide adequate ground clearance while on final approach. The landing gear deployment is delayed until airspeed decreases below 270 KEAS.

Checking for the final flare phase initiation begins at an altitude of 50 feet. The exact altitude (h) of the final flare is determined as a function of the altitude rate (\dot{h}). For STS-1, switching occurs at an altitude of approximately 50 feet. If phase switching has not occurred by a 30-foot altitude, the guidance switches to the final flare phase regardless of the altitude rate. In this

phase, the normal acceleration commands are computed to reduce the descent rate to approximately 3 fps at Orbiter touchdown.

The GRTLS autoland guidance is designed such that two sets of approach and landing phase geometric parameter I-load values are available for selection, depending on landing site wind conditions. Each set of parameters is designed to meet a given range of wind conditions possibly encountered for that particular flight. One set is designed for zero to 50 percent of worst-case wind conditions and one set for winds higher than 50 percent. Each set is designed such that the final approach and landing phase will always be approximately the same from an operational viewpoint.

6.2.2.4 GRTLS Trajectory Profiles

The STS-1 GRTLS profiles have been simulated and analyzed. These profiles begin at Orbiter/ET separation. The -Z RCS translational separation burn was simulated. The trajectory profiles presented are simulations of GRTLS for the following abort conditions: (1) engine-out at 262.5 seconds flight time with the RTLS initiated 10 seconds later, (2) engine-out at lift-off with the RTLS initiated at 150 seconds flight time, and (3) 3-SSME RTLS initiated at 260 seconds flight time. For identification of the tables and plots that follow, these profiles are referred to as (1) last RTLS (GRTLS-1), (2) lift-off RTLS (GRTLS-2), (3) 3-SSME RTLS (GRTLS-3), respectively, and are presented in this order.

The initial ET/separation conditions of the profiles shown in table 6.2.2-I varied from a velocity of 6100 fps to 6541 fps with ranges to runway 15 at KSC of 226.9 n. mi. to 243.7 n. mi., respectively. The GRTLS trajectory profile and the aerodynamic loads experienced were similar for all these initial separation conditions. For example, the peak dynamic pressure experienced during the load relief phase ranged from 298 psf to 259 psf. All cases initiated with an azimuth error less than 1.0° to the tangency on the HAC.

Altitude at initiation of the separation sequence ranged from 221 532 feet to 225 045 feet. The conditions at the initiation of the closed loop GRTLS/TAEM ranging (major mode 603) are shown on table 6.2.2-II. The range at initiation of the acquisition phase was from 76.9 n. mi. to 78.2 n. mi. and altitude varied from 91 082 to 92 086 feet at the given predicted ranges all profiles were within 1200 feet of the reference altitude profiles at this point. Dynamic pressure varied from 235.5 to 249.7 psf, compared to a reference dynamic pressure of 210 psf. These conditions are a result of the transition angle-of-attack schedule chosen and termination of the S-turn before acquisition phase initiation. Angle of attack at this point ranged from 13.9° to 14.05° . The center of the angle-of-attack corridor is 14° . The azimuth to the HAC tangency point ranged from -12.43° to -20.04° . The variation is because of the length and time of completion of the S-turn.

The conditions at approach and landing interface are shown on table 6.2.2-III for the three trajectory profiles. All three trajectories initiated the autoland guidance by passing the 10 000-foot limit and meeting all the additional criteria at this point. Flightpath angle was within 0.3° of the 20° outerglide slope and altitude was within 120 feet of the reference profile. The

trajectory profiles initiated the approach and landing at the nominal 280 KEAS (265 psf dynamic pressure) and maintained speedbrake between a 55° and 60° deflection. Retraction of the speedbrake was initiated at a 2500-foot altitude for all three trajectories. The landing gear deployment cue (270 KEAS) was reached at a gear altitude of 225 to 230 feet and the gear was fully deployed by an altitude of 65 feet. Preflare was completed in an altitude range of 155 to 160 feet and the final flare was initiated at altitudes ranging from 45 to 50 feet.

Touchdown occurred from 2537 to 2586 feet from the runway threshold. Relative velocity at touchdown was approximately 189 knots for all three trajectory profiles. Equivalent airspeed at touchdown was approximately 188 knots (120 psf dynamic pressure) and sink rate was 2 fps. Angle of attack at touchdown varied from 9.4° to 9.6°.

The time and conditions at other significant events during the GRTLS trajectory profiles are given in tables 6.2.2-IV to 6.2.2-VII (sequence of events). These tables are compiled for the open-loop GRTLS, closed-loop ranging, and approach and landing portions of the trajectory profiles.

Since the GRTLS trajectory profiles and aerodynamic loads experienced were similar for all three RTLS aborts, detailed data for only the last RTLS (GRTLS-1) profile are presented in figures 6.2.2-6 through 6.2.2-10. Figure 6.2.2-10 displays the GRTLS STS-1 OFP in a perspective view. Selected trajectory data for the lift-off RTLS (GRTLS-2) are presented in figure 6.2.2-11. Tracking data for both profiles for stations at Merritt Island and New Smyrna Beach are also included.

6.3 AOA

6.3.1 Powered Flight

This section presents tabulated and plotted trajectory data for selected AOA aborts. Two cases are considered: maximum underspeed (earliest) AOA, SSME number 3 failure at 262 sec with a 410 fps underspeed at MECO, and an AOA selected after nominal OMS-1 from a no SSME-out nominal MECO. The two cases represent the most performance critical AOA (maximum underspeed at MECO) and an AOA selected for a quick return due to a time-critical situation. A sequence of events summary is presented in table 6.3.1-I for Case 1 and in table 6.3.1-II for Case 2.

The plots are divided into two regions, SRB staging to MECO and MECO-to-entry interface. All are plotted versus time in seconds from lift-off. The plotted parameters were chosen to indicate performance and to provide a definition of the trajectory. The tabulated data describe specific events such as OMS burns and entry interface. The parameters plotted for the pre- and post-MECO regions of the trajectory are presented in table 6.3.1-III.

Ground communication AOS and LOS are presented in table 6.3.1-IV. These data are for Case 1 maximum underspeed of 410 fps with SSME number 3 failure at 262 seconds. AOS and LOS GET were generated using the SVDS RADAR postprocessor with terrain masking. A typical groundtrack with relative locations of OMS-1, OMS-2, and post-MECO communication coverage is shown in figure 6.3.1-1 for these two AOA cases. The trajectory plots are shown in figures 6.3.1-2 through 6.3.1-4 and the tabulated events are given in tables 6.3.1-V through 6.3.1-XV.

No data are presented for Case 2 until after the OMS-1 burn because it performs nominally from lift-off through the OMS-1 burn. Because current crew procedures prohibit the selection of an AOA or ATO pre-MECO, the first- and second-stage trajectories for an SSME-out at 262 seconds are identical for AOA and ATO except that MECO occurs at a slightly greater underspeed for AOA. Therefore, the SRB staging to MECO plots presented in this section are not repeated for ATO (sec. 6.4).

6.3.2 AOA Descent

The prime AOA landing site for the STS-1 OFP is runway 17 at Northrup Strip. The AOA crossrange to Northrup Strip is 316 n. mi. and the crossrange capability for AOA is 700 n. mi., which includes a 95-n. mi. allowance for dispersions. The entry weight and longitudinal c.g. at entry interface for AOA profiles presented are 192 023 pounds and 66.7 percent, respectively. Control of the c.g. is a requirement.

Descent Profile Design

The AOA profile shaping reflects the nominal descent profile design presented in reference 8. All flight software I-loads are identical to those used in the nominal descent profile, and are presented in section 9.0. Targeting at entry

interface for the AOA profiles was adjusted from the nominal descent targeting to establish a 3σ margin above the equilibrium glide boundary in the drag acceleration/velocity plane, to ensure adequate maneuver capability. The resulting nominal AOA target line is presented in figure 6.3.2-1. This, and the added Orbiter entry weight for the AOA profiles, resulted in slightly higher maximum surface temperatures.

A contingency target line, also in figure 6.3.2-1, can be a backup target line in case of limited OMS-1 or -2 performance or some other contingency that limits the abort performance available. The contingency target line used a preentry roll attitude of 90° and gives similar temperatures on the Orbiter as the EOM contingency line.

The Orbiter thermal control points and panels are identified in figure 6.3.2-2.

AOA trajectories - one AOA descent trajectory, the earliest SSME-out AOA is documented as follows:

Earliest SSME-Out AOA

The entry interface conditions are a 4258-n. mi. range from the runway threshold, and the inertial velocity and flightpath angle are 25 611 fps and -0.8971° , respectively. A summary of the event times and trajectory data, including the TPS environment and groundtrack, is found in figures 6.3.2-1 through 6.3.2-22 and in tables 6.3.2-I through 6.3.2-IX.

6.4 ATO

6.4.1 Powered Flight

This section presents tabulated and plotted trajectory data for a maximum underspeed (earliest) ATO abort with SSME number 3 failure at 262 seconds and with a 375 fps underspeed at MECO. A sequence of events summary is presented in table 6.4.1-I.

The plotted parameters were chosen to indicate performance and provide a definition of the trajectory. The tabulated data describe specific events such as the MECO state and OMS burns. Because current crew procedures prohibit the selection of an AOA or ATO pre-MECO, the second-stage trajectories for an SSME-out 262 seconds are identical for an AOA and ATO except that MECO occurs at a slightly smaller underspeed for ATO. Thus, no ATO SRB staging to MECO plots are presented in this section but are provided in the AOA section, 6.3. The parameters plotted for the post-MECO region of the trajectory are presented in table 6.4.1-II. The trajectory plots are shown in figures 6.4.1-1 and the tabulated events are given in tables 6.4.1-III through 6.4.1-VII.

A typical groundtrack with relative locations of OMS-1, OMS-2, and post-MECO communication coverage is shown in figure 6.3.1-1 for this earliest ATO.

After orbit has been achieved for an ATO situation, an alternate mission is flown in which the orbit is raised to as near nominal as available propellant allows. No deorbit data are included in this document because deorbit will be a function of that final orbit. In the earliest ATO situation, a 105-n. mi. circular orbit is achieved, and approximately 245 fps are required for that deorbit.

6.4.2 Deleted

TABLE 6.1-I.- MISSION DEPENDENT FIRST-STAGE ENGINE-OUT
GUIDANCE AND CONTROL I-LOADS

Guidance

Attitude commands

*Relative velocity	SSME 1 out pitch attitude	SSME 2, 3, out pitch attitude	V PYR switch
30	30	30	1

Flight control

*Relative velocity	SSME 1 out SRB trim	SSME 2, 3, SRB trim	SSME 1 out NZREF	SSME 2, 3, out NZREF
20	20	20	20	20

SSME 2 out NYREF	SSME 3 out NYREF
1	1

TOTALS - 143

*Same as nominal

TABLE 6.1-II.- STS-1 FIRST-STAGE NOMINAL AND ENGINE-OUT I-LOADS

(a) Guidance attitude commands

VE, fps	Pitch, deg			Yaw, deg	Roll, deg
	Nominal	SSME 1 out	SSME 2,3 out	Nominal	Nominal
0.0	90	90.0	90.0	0.0	0.0
107.18	74.24	73.50	74.55	67.18	180.0
364.29	74.24	73.50	74.55	67.18	180.0
368.02	74.14	73.50	74.52	67.10	180.0
479.35	73.03	73.57	73.68	65.16	180.0
676.34	70.30	73.70	72.20	62.73	180.0
782.68	69.06	71.36	70.47	61.76	180.0
939.99	67.91	67.91	67.91	60.46	180.0
975.41	67.62	67.62	67.62	60.12	180.0
1090.43	65.98	65.98	65.98	58.67	180.0
1212.31	64.40	64.40	64.40	57.40	180.0
1320.54	63.53	63.53	63.53	56.44	180.0
1384.72	62.93	62.93	62.93	55.98	180.0
1481.62	61.74	61.74	61.74	55.66	180.0
1575.53	60.23	60.23	60.23	55.98	180.0
1669.92	58.54	58.54	58.54	56.59	
1928.98	53.40	53.40	53.40	58.22	
2070.02	50.51	50.51	50.51	58.96	
2167.55	48.53	48.53	48.53	59.24	
2366.77	46.34	46.34	64.34	59.49	
2484.87	45.21	45.21	45.21	59.53	
2665.70	43.65	43.65	43.65	59.49	
2833.37	42.34	42.34	42.34	59.42	
2923.22	41.73	41.73	41.73	59.54	
3167.98	40.06	40.06	40.06	59.40	
3500.48	37.88	37.88	37.88	59.14	
3750.96	36.32	36.32	36.32	59.09	
4003.96	34.79	34.79	34.79	59.16	
4102.24	33.87	33.87	33.87	59.21	
4300.0	31.58	31.58	31.58	59.45	

VFYRSW = 1000. fps

TABLE 6.1-II.- Concluded

(b) Flight control system reference steering tables

Nominal			SSME 1 out		SSME 2 or 3 out	
VE, fps	SRB trim, deg	N _z , g	SRB trim, deg	N _z , g	SRB trim, deg	N _z , g
0	-0.613	-0.0590	-0.0644	-0.0307	-0.1299	-0.0406
167.76	-.598	-.0590	-.0264	-.0249	-.0919	-.0341
269.53	-.672	-.0538	-.0842	-.0213	-.1436	-.0304
417.79	-.721	-.0649	-.2111	-.0475	-.2730	-.0420
779.16	-1.394	-.1414	-.6500	-.1330	-.7400	-.1350
877.32	-1.543	-.1683	-.7800	-.1375	-.8600	-.1480
939.99	-1.453	-.1817	-.9000	-.1400	-.9000	-.1550
1006.20	-.519	-.1485	-.2763	-.1450	-.2977	-.1620
1110.17	.586	-.1566	+.7030	-.1547	+.6482	-.1692
1151.33	.388	-.1668	+.5864	-.1596	+.5267	-.1732
1208.91	.318	-.1651	+.5119	-.1535	+.4500	-.1664
1296.92	-.292	-.2173	+.5504	-.1582	+.4920	-.1697
1606.40	.057	-.1739	+.8980	-.1350	+.8382	-.1461
1951.98	.300	-.1090	+.9894	-.0780	+.9452	-.0911
2167.55	.373	-.0803	+.9981	-.0494	+.9633	-.0642
2417.08	.606	-.0950	+1.1690	-.0560	+1.1497	-.0725
2833.37	.616	-.1090	+1.1556	-.0619	+1.1554	-.0806
3058.84	.590	-.1173	+1.1556	-.0651	+1.1554	-.0844
3787.75	.588	-.1351	+1.1556	-.0651	+1.1554	-.0844
4300.0	.588	-.1351	+1.1556	-.0651	+1.1554	-.0844

N_ynominal, 1 out = 0.0gN_y2out = -0.008gN_y3out = +0.008g

SSME trim = -2.90 deg

TABLE 6.2.1-I.- WEIGHT DEVELOPMENT FOR STS-1 RTLS ABORTS

(a) PPD target weights

Configuration	Weight, lb
Orbiter without consumables	169 712
Nonpropulsive consumables	5 123
MPS propellant FPR	5 387
OMS propellant loaded	18 000
Aft RCS propellant loaded	5 031
Forward RCS propellant loaded	<u>2 477</u>
Orbiter minus cargo	205 730
Cargo module total	<u>10 175</u>
Total Orbiter weight	215 905
ET inert	<u>79 343</u>
Total ORB/ET mated vehicle	295 248
OMS burned pre-MECO	-15 439
RCS burned pre-MECO	<u>0</u>
ORB/ET minus OMS/RCS dumped	279 809
MPS propellant remaining in ET for 2 SSME RTLS	<u>27 000</u>
Desired 2 SSME PPD weight target	334 809
Desired 2 SSME RTLS MECO weight	306 809
MPS propellant requirement for 3 SSME RTLS	<u>-2 500</u>
Desired 3 SSME RTLS PPD weight target	344 814
Desired 3 SSME RTLS MECO weight	304 309

TABLE 6.2.1-I.- Concluded

(b) Last RTLS MECO weight

Configuration	Weight, lb
ORB/ET minus OMS dumped	279 809
Fuel bias	934
ET residuals	5 068
Abort FPR	6 029
Launch hold and winds	1 887
Manager's margin	<u>3 000</u>
Total last RTLS MECO weight	296 727

TABLE 6.2.1-II.- PRTLS KEY EVENT PARAMETERS FOR ABORTS DURING STS-1 ASCENT

Case	Time, sec	Velocity, fps	Flightpath angle, deg	Altitude, ft	Range, n. mi.	Dynamic pressure, psf	Angle of attack, deg	Weight, lb
SRB staging								
#1EO ^a at lift-off	131.44	3354.1	35.48	143 294.0	35.8	26.53	-4.71	586 453
#2EO at 60 sec	131.44	3664.6	34.57	156 980.0	38.1	18.20	-3.34	1 539 763
#2EU at SRB sep	131.44	4186.8	34.87	167 274.0	39.7	16.24	+0.55	1 468 110
#2EO at 150 sec	131.44	4186.8	34.87	167 274.0	39.7	16.24	+0.55	1 468 110
#2EO at 200 sec	131.44	4186.8	34.87	167 274.0	39.7	16.24	+0.55	1 468 110
#2EO at 254 sec	131.44	4186.8	34.87	167 274.0	39.7	16.24	+0.55	1 468 110
#2EO at 262.5 sec	131.44	4186.8	34.87	167 274.0	39.7	16.24	+0.55	1 468 110
3 SSME at 260 sec	131.44	4186.8	34.87	167 274.0	39.7	16.24	+0.55	1 468 110
3 SSME at 260 sec	131.44	4186.8	34.87	167 274.0	39.7	16.24	+0.55	1 468 110
#2EO at 100 sec to PPD								
Abort initiation								
#1EO at lift-off	150.00	3382.5	28.98	176 680.0	43.6	7.49	-3.48	1 548 097
#2EO at 60 sec	150.00	3707.0	28.80	192 947.0	47.0	4.94	-2.90	1 501 407
#2EO at SRB sep	150.00	4255.5	29.87	209 258.7	49.8	3.51	-7.66	1 428 688
#2EO at 150 sec	160.00	4517.0	27.12	231 669.1	56.2	1.58	-11.32	1 368 848
#2EO at 200 sec	210.00	5624.7	16.29	324 765.0	94.2	0.02	-15.41	1 233 913
#2EO at 254 sec	264.00	7256.4	9.54	402 442.1	149.2	0.00	-9.53	1 066 627
#2EO at 262.5 sec	272.50	7564.4	8.56	412 997.0	159.4	0.00	-2.27	1 040 298
3 SSME at 260 sec	260.00	7240.7	10.22	397 585.4	144.7	0.03	-8.58	1 069 757
3 SSME at 260 sec	260.00	7240.7	10.22	397 585.4	144.7	0.00	-8.58	1 069 757
#2EO at 100 sec to PPD								
Pitcharound								
#1EO at lift-off	462.96	4910.9	-1.61	286 311.0	240.8	0.13	-68.15	901 764
#2EO at 60 sec	403.44	5554.8	0.48	358 889.0	224.5	0.00	-55.22	977 985
#2EO at SRB sep	338.16	6282.4	3.64	420 160.0	198.2	0.00	-38.57	1 040 072
#2EO at 150 sec	325.12	6454.2	4.62	427 014.0	193.3	0.00	-35.18	1 047 822
#2EO at 200 sec	290.64	6877.3	6.63	418 624.0	175.2	0.00	-25.65	1 067 377
#2EO at 254 sec	264.00	7256.4	9.54	402 442.0	149.2	0.00	-9.53	1 066 627
#2EO at 262.5 sec	272.50	7564.4	8.56	412 997.0	159.4	0.00	-0.27	1 040 298
3 SSME at 260 sec	260.00	7240.7	10.22	397 585.0	144.7	0.00	-8.58	1 069 757
3 SSME at 260 sec	260.00	7240.7	10.22	397 585.0	144.7	0.00	-8.58	1 069 757
#2EO at 100 sec to PPD								
Powered pitchdown								
#1EO at lift-off	754.80	5413.5	8.90	205 127.9	273.3	6.92	39.33	333 095
#2EO at 60 sec	733.20	5452.8	9.81	204 743.2	275.2	7.13	50.25	332 407
#2EO at SRB sep	696.56	5387.9	9.79	204 640.1	271.9	6.99	53.62	332 682
#2EO at 150 sec	686.32	5386.2	9.79	204 653.9	271.8	6.98	53.84	332 616
#2EO at 200 sec	660.72	5314.3	9.81	204 766.9	267.3	6.77	54.56	332 434
#2EO at 254 sec	628.40	5131.3	9.80	201 716.6	256.8	6.33	56.12	332 115

^aEO = Engine-out.

TABLE 6.2.1-II.- Concluded

Case	Time, sec	Velocity, fps	Flightpath angle, deg	Altitude, ft	Range, n. mi.	Dynamic pressure, psf	Angle of attack, deg	Weight, lb
Powered pitchdown (Cont'd)								
#2EO at 262.5 sec	611.30	5286.9	9.81	204 800.9	266.0	6.69	55.22	325 239
3 SSME at 260 sec	506.80	4579.4	9.92	204 587.6	253.9	5.07	56.82	350 054
3 SSME at 260 sec	611.92	5012.5	9.80	204 643.9	249.4	6.06	54.72	340 141
#2EO at 100 sec to PPD								
MECO commanded								
#1EO at lift-off	773.95	6495.1	3.74	218 771.1	255.0	5.77	-2.98	306 681
#2EO at 60 sec	752.32	6492.1	4.34	220 381.6	256.9	5.39	-3.34	305 979
#2EO at SRB sep	715.85	6426.7	4.43	220 473.3	253.6	5.26	-3.28	305 967
#2EO at 150 sec	705.45	5416.5	4.54	220 473.8	253.6	5.25	-3.28	306 064
#2EO at 200 sec	679.88	6344.2	4.53	220 462.8	249.3	5.13	-3.27	305 848
#2EO at 254 sec	647.77	6170.3	4.40	220 103.1	239.2	4.93	-3.25	306 124
#2EO at 262.5 sec	629.39	6292.4	5.27	220 365.6	249.2	5.07	-3.13	299 633
3 SSME at 200 sec	626.19	6089.2	4.65	220 001.8	237.4	4.82	-3.33	310 910
3 SSME at 200 sec	631.76	6066.9	3.98	219 716.6	231.8	4.84	-3.44	312 317
#2EO at 100 sec to PPD								
EI separation								
#1EO at lift-off	784.95	6541.5	.21	221 533.6	241.2	5.22	-4.00	305 352
#2EO at 60 sec	765.22	6533.3	.75	223 943.8	243.1	4.71	-4.00	304 650
#2EO at SRB sep	728.75	6467.7	.80	224 099.8	243.0	4.58	-4.00	4 637
#2EO at 150 sec	718.35	6456.7	.91	224 248.6	240.1	4.54	-4.00	404 735
#2EO at 200 sec	692.77	6384.8	.86	224 145.6	235.9	4.46	-4.00	304 519
#2EO at 254 sec	660.67	6212.3	.61	223 416.8	226.1	4.35	-4.00	304 794
#2EO at 262.5 sec	642.29	6329.3	1.57	225 047.0	235.9	4.22	-4.00	298 303
3 SSME at 260 sec	639.09	6160.1	0.79	223 555.8	224.5	4.26	-4.00	308 916
3 SSME at 260 sec	644.66	6110.9	0.12	222 350.6	218.9	4.41	-4.00	310 988
#2EO at 100 sec to PPD								

TABLE 6.2.1-III.- PRTLS RADAR SUMMARY

Site/ID	EO @ lift-off RTLS				Last RTLS			
	e, deg	Rs, n. mi.	Y, deg		e, deg	Rs, n. mi.	Y, deg	
Merritt Island/MLL	SRB staging	27.5	55.4	SRB staging	40.3	32.3	54.9	
	ET separation	235.3	61.1	ET separation	7.1	230.9	58.0	
Greenbelt/ETC	AOS, 293.68 sec	578.9	190.2	AOS, 206.00 sec	0	595.8	192.7	
	LOS, 621.68 sec	494.1	171.0	Los, 556.02 sec	0	483.2	173.6	
Bermuda/BDA	AOS, None			AOS, 288.82 sec	0	693.0	261.8	
	LOS, None			LOS, 495.54 sec	0	565.1	265.1	
Wallops/MLP	AoS, 235.44 sec	552.7	201.4	AOS, 185.52 sec	0	561.4	202.4	
	ET separation	453.5	187.8	ET separation	1.0	445.8	189.2	
Ponce de Leon/PDL	SRB staging	37.9	117.7	SRB staging	34.2	40.0	111.5	
	ET separation	231.3	69.5	ET separation	7.4	225.1	66.5	

TABLE 6.2.2-I.- SEPARATION STATE VECTOR INITIAL CONDITIONS

(a) Last RTLS (GRTLS-1)

PARAMETER	VALUE
GET.HR:MIN:SEC	6:10:42.29
GRTLS WEIGHT.LB	196888.
INERTIAL VELOCITY.FPS	5171.
INERTIAL FLIGHT PATH ANGLE.DEG	1.9186
INERTIAL HEADING FROM NORTH.DEG	-122.6253
LONGITUDE.DEG E	76.917J
GEODETTIC LATITUDE.DEG NORTH	30.5017
GEOCENTRIC LATITUDE.DEG NORTH	30.3337
ALTITUDE OF C.G. ABOVE THE FISCHER ELLIPSOID.FT	22J045.
ORBITAL INCLINATION.DEG	40.3
RANGE TO RUNWAY THRESHOLD. N.MI.	238.
DYNAMIC PRESSURE.PSF	4.1

Table 6.2.2-I.- Continued
 (b) Lift-off RTLS (GRTLS-2)

PARAMETER	VALUE
GET.HR:MIN:SEC	0:13: 6.8E
GRTLS WEIGHT.LB	196888.
INERTIAL VELOCITY.FPS	5337.
INERTIAL FLIGHT PATH ANGLE.DEG2608
INERTIAL HEADING FROM NORTH.DEG	-118.1982
LONGITUDE.DEG E	76.7255
GEODETTIC LATITUDE.DEG NORTH	30.3499
GEOCENTRIC LATITUDE.DEG NORTH	30.1824
ALTITUDE OF C.G. ABOVE THE FISCHER ELLIPSOID.FT	221532.
ORBITAL INCLINATION.DEG	40.3
RANGE TO RUNWAY THRESHOLD, N.MI.	244.
DYNAMIC PRESSURE.PSF	5.1

TABLE 6.2.2-I.- Concluded

(c) 3-SSME RTLS (GRTLS-3)

PARAMETER	VALUE
GET.HR:MIN:SEC	0:10:39.09
GRTLS WEIGHT.LB	196888.
INERTIAL VELOCITY.FPS	4988.
INERTIAL FLIGHT PATH ANGLE.DEG9700
INERTIAL HEADING FROM NORTH.DEG	-121.7790
LONGITUDE.DEG E	77.1028
GEODETTIC LATITUDE.DEG NORTH	30.3962
GEOCENTRIC LATITUDE.DEG NORTH	30.2286
ALTITUDE OF C.G. ABOVE THE FISCHER ELLIPSOID.FT	223555.
ORBITAL INCLINATION.DEG	40.3
RANGE TO RUNWAY THRESHOLD. N.MI.	227.
DYNAMIC PRESSURE.PSF	4.2

TABLE 6.2.2-II.- GRTLS/TAEM INITIATE CONDITIONS

(a) Last RTLS (GRTLS-1)

PARAMETER	VALUE
GET.HR:MN:SEC	0:13:54.29
TIME FROM ET SEPARATION,MIN:SEC . .	0:03:12.00
GRTLS WEIGHT,LB	19687.8
RELATIVE VELOCITY,FPS	3179.4
RELATIVE FLIGHT PATH ANGLE,DEG . .	-2.8712
RELATIVE HEADING FROM NORTH,DEG . .	-102.0052
GEODETTIC LATITUDE,DEG N	29.3722
GEOCENTRIC LATITUDE,DEG N	29.2080
LONGITUDE,DEG E	79.7176
ALTITUDE OF C.G. ABOVE FISCHER ELLIPSOID,FT	91100.9
ALTITUDE OF C.G. ABOVE RUNWAY,FT . .	61569.1
MACH NUMBER	3.19
ANGLE OF ATTACK,DEG	14.04
DYNAMIC PRESSURE,PSF	241.7
RANGE TO RUNWAY THRESHOLD, N.MI. . .	73.9
DELTA AZIMUTH TO HAC,DEG	-20.64

TABLE 6.2.2-II.- Continued

(b) Lift-off RTLS (GRTLS-2)

PARAMETER	VALUE
GET.HR:MIN:SEC	0:16:22.21
TIME FROM ET SEPARATION,MIN:SEC . .	0:03:15.36
GRTLS WEIGHT,LB	196887.8
RELATIVE VELOCITY,FPS	3175.1
RELATIVE FLIGHT PATH ANGLE,DEG . .	-4.1888
RELATIVE HEADING FROM NORTH,DEG . .	-107.8634
GEODETTIC LATITUDE,DEG N	29.3558
GEOCENTRIC LATITUDE,DEG N	29.1917
LONGITUDE,DEG E	79.6677
ALTITUDE OF C.G. ABOVE FISCHER ELLIPSOID,FT	90396.4
ALTITUDE OF C.G. ABOVE RUNWAY,FT . .	91082.1
MACH NUMBER	3.19
ANGLE OF ATTACK,DEG	13.90
DYNAMIC PRESSURE,PSF	249.7
RANGE TO RUNWAY THRESHOLD, N.MI. . . .	78.2
DELTA AZIMUTH TO MAC,DEG	-12.43

TABLE 6.2.2-II.- Concluded

(c) 3-SSME RTLS (GRTLS-3)

PARAMETER	VALUE
GET.HR:MM:SEC	0:13:41.01
TIME FROM ET SEPARATION.MIN:SEC . .	0:03: 1.92
GRTLS WEIGHT.LB	196887.8
RELATIVE VELOCITY.FPS	3179.6
RELATIVE FLIGHT PATH ANGLE.DEG . .	-2.7578
RELATIVE HEADING FROM NORTH.DEG . .	-103.8495
GEODEIC LATITUDE.DEG N	29.3732
GE CENTRIC LATITUDE.DEG N	29.2090
LONGITUDE .DEG E	79.7161
ALTITUDE OF C.G. ABOVE FISCHER ELLIPSOID.FT	91627.5
ALTITUDE OF C.G. ABOVE RUNWAY.FT . .	92085.9
MACH NUMBER	3.19
ANGLE OF ATTACK.DEG	14.05
DYNAMIC PRESSURE.PSF	235.5
RANGE TO RUNWAY THRESHOLD. N.MI. . .	77.2
DELTA AZIMUTH TO MAC.DEG	-18.39

TABLE 6.2.2-III.- TAEM/APPROACH AND LANDING INTERFACE CONDITIONS

(a) Last RTLS (GRTLS-1)

PARAMETER	VALUE
GET.HR:MM:SEC	0:19:32.21
TIME FROM ET SEPARATION.MIN:SEC . .	0:08:49.92
RELATIVE VELOCITY.FPS	555.6
RELATIVE FLIGHT PATH ANGLE.DEG . .	-20.1952
RELATIVE HEADING FROM NORTH.DEG . .	150.7802
LONGITUDE.DEG E	30.7586
GEOETIC LATITUDE.DEG N	28.7134
GEOCENTRIC LATITUDE.DEG N	28.5518
ALTITUDE OF C.G. ABOVE FISCHER ELLIPSOID.FT	9799.6
ALTITUDE OF C.G. ABOVE RUNWAY.FT . .	10005.0
RANGE TO RUNWAY THRESHOLD. N.MI. . . .	-33832.8

TABLE 6.2.2-III.- Continued

(b) Lift-off RTLS (GRTLS-2)

PARAMETER	VALUE
GET.HR:MN:SEC	0:22: 4.45
TIME FROM ET SEPARATION.MIN:SEC . .	0:08:57.60
RELATIVE VELOCITY.FPS	554.4
RELATIVE FLIGHT PATH ANGLE.DEG . .	-20.1738
RELATIVE HEADING FROM NORTH.DEG . .	150.7309
LONGITUDE .DEG E	80.7579
GEODEYIC LATITUDE.DEG N	28.7124
GEOCENTRIC LATITUDE.DEG N	28.5505
ALTITUDE OF C.G. ABOVE FISCHER ELLIPSOID.FT	9636.1
ALTITUDE OF C.G. ABOVE RUNWAY.FT . .	9883.5
RANGE TO RUNWAY THRESHOLD. N.MI. . .	-33517.3

TABLE 6.2.2-III.- Concluded

(c) 3-SSME RTLS (GRTLS-3)

PARAMETER	VALUE
GET.HR:MN:SEC	0:19:18.45
TIME FROM ET SEPARATION,MIN:SEC . .	0:08:39.36
RELATIVE VELOCITY,FPS	554.7
RELATIVE FLIGHT PATH ANGLE,DEG . .	-20.3018
RELATIVE HEADING FROM NORTH,DEG . .	150.8347
LONGITUDE,DEG E	-0.7579
GEODETTIC LATITUDE,DEG N	28.7124
GEOCENTRIC LATITUDE,DEG N	28.5505
ALTITUDE OF C.G. ABOVE FISCHER ELLIPSOID,FT	9046.6
ALTITUDE OF C.G. ABOVE RUNWAY,FT . .	9938.7
RANGE TO RUNWAY THRESHOLD, N.MI. . . .	-33644.4

TABLE 6.3.1-1.- SEQUENCE OF EVENTS FOR MAXIMUM UNDERSPEED AOA

Event	Time, day : hr:min:sec	Total weight, lb	Geodetic altitude, ft	Inertial velocity, fps	Inertial flightpath angle, deg	HA x HP, n. mi.
SSME-3 out	0:0:4:20.44	1068394.	398155.	8435.5	8.748	68.4 x - 3267.
3g boundary	NA					
MECO	0:0:10:25.2	311411.	388014.	25258.	.351	61.7 x - 181.5
ET separation/-Z RCS burn	0:0:10:43.1	215494.	390362.	25255.	.317	61.7 x - 181.5
Start 24-sec +Y separation maneuver	0:0:10:50.3	215344.	391611.	25255.	.288	61.7 x - 181.1
OMS-1 ign/LOX vent	0:0:12:26.68	215143.	401044.	25245.	.051	61.7 x - 181.0
End LOX vent	0:0:14:23.5	205984.	399362.	25468.	-.158	61.7 x - 69.0
Begin LH2 vent	0:0:14:33.1	205614.	398750.	25486.	-.166	61.8 x - 59.7
End LH2 vent	0:0:15:19.5	203526.	395519.	25578.	-.186	62.1 x - 13.7
OMS-1 cutoff	0:0:17:14.5	199203.	387849.	25799.	-.092	104.6 x 58.3
Trans to OPS-3	0:0:38:14.5	199203.	451672.	25692.	.327	98.8 x 57.6
OMS-2 ignition	0:0:54:41.9	199158.	602507.	25526.	.182	98.6 x 57.3
OMS-2 cutoff	0:0:56:8.4	195928.	613993.	25366.	.288	99.3 x - 22.8
Entry interface	0:1:15:38.8	195887.	400000.	25610.	-.898	99.1 x - 23.2

(SAME AS NOMINAL SEQUENCE OF EVENTS)

TABLE 6.3.1-II.- SEQUENCE OF EVENTS FOR AOA AFTER NOMINAL OMS-1

Event	Time, day : hr:min:sec	Total weight, lb	Geodetic altitude, ft	Inertial velocity, fps	Inertial flightpath angle, deg	HA x HP, n. mi.
SRB ignition to end LH ₂ vent						
Transition to OPS-3	0:0:33:24.4	206001.	798578.	25372.3	.615742	150.2 x 57.5
OMS-2 ignition	0:0:49:59.5	205879.	921312.	25236.6	-.172377	150.2 x 57.4
OMS-2 cutoff	0:0:55:15.1	193886.	900383.	25169.8	-.296744	146.5 x 7.7
Entry interface	0:1:16:12.1	193788.	400000.	25751.8	-1.101265	146.2 x 7.5

(SAME AS NOMINAL SEQUENCE OF EVENTS)

TABLE 6.3.1-III.- AOA PLOTTED PARAMETERS

Event	Parameter
Pre-MECO	Sensed acceleration Altitude Inertial velocity Inertial flightpath angle Mach number Angle of attack Angle of sideslip Inclination
Post-MECO	Inertial velocity Inertial flightpath angle Altitude Latitude Longitude Apogee altitude Perigee altitude

TABLE 6.3.1-IV.- AOS-LOS TIMES

Comm site	AOS, sec	LOS, sec
Merrit Island	0.0	544.0
Bermuda	289.0	767.0
Madrid	1181.0	1487.0
Indian Ocean	2216.0	2580.0
Orrora	3584.0	3965.0

TABLE 6.3.1-V.- EARLIEST AOA MECO STATE

Parameter	Value	Unit
GMT	42 029.6	sec
GET	629.6	sec
Orbital parameters		
Apogee altitude	61.74	n. mi.
Perigee altitude	-181.52	n. mi.
True anomaly	170.5	deg
Argument of perigee	-106.4	deg
Semimajor axis	20 567 850.	ft
Eccentricity	.035676	ND
Guidance parameters		
Velocity to go	--	fps
Time to go	--	sec
Velocity-to-go LVLH		
VGOX	--	fps
VGOY	--	fps
VGOZ	--	fps
Trajectory parameters		
Inertial velocity	25 258.0	fps
Inertial flightpath angle	.350565	deg
Geodetic altitude	388 014.	ft
Geodetic latitude	35.7448	deg
Longitude	-63.7765	deg
Inertial azimuth	69.6563	deg
Weight	311 021.	lb

TABLE 6.3.1-V.- Concluded

Parameter	Value	Unit
Attitude parameters		
ADI inertial		
Roll	180.3	deg
Pitch	163.1	deg
Yaw	2.6	deg
ADI reference		
Roll	178.0	deg
Pitch	338.3	deg
Yaw	354.8	deg
ADI LVLH		
Roll	191.8	deg
Pitch	334.7	deg
Yaw	0.0	deg

TABLE 6.3.1-VI.- EARLIEST AOA OMS-1 TIG STATE

Parameter	Value	Unit
GMT	42 146.7	sec
GET	746.7	sec
Orbital parameters		
Apogee altitude	61.66	n. mi.
Perigee altitude	-181.01	n. mi.
True anomaly	178.6	deg
Argument of perigee	-106.6	deg
Semimajor axis	20 566 660.	ft
Eccentricity	.035676	ND
Guidance parameters		
Velocity to go	543.80	fps
Time to go	289.6	sec
Velocity-to-go LVLH		
VGOX	543.3	fps
VGOY	0.0	fps
VGOZ	24.0	fps
Trajectory parameters		
Inertial velocity	25 244.7	fps
Inertial flightpath angle	.051200	deg
Geodetic altitude	401 044.	ft
Geodetic latitude	38.1476	deg
Longitude	-54.7956	deg
Inertial azimuth	75.3362	deg
Weight	215 143.	lb

TABLE 6.3.1-VI.- Concluded

Parameter	Value	Unit
Attitude parameters		
ADI inertial		
Roll	185.3	deg
Pitch	137.3	deg
Yaw	358.8	deg
ADI reference		
Roll	101.6	deg
Pitch	129.5	deg
Yaw	6.2	deg
ADI LVLH		
Roll	185.3	deg
Pitch	338.6	deg
Yaw	358.9	deg

TABLE 6.3.1-VII.- EARLIEST AOA OMS-1 BURNOUT STATE

Parameter	Value	Unit
GMT	42 434.5	sec
GET	1 034.5	sec
Orbital parameters		
Apogee altitude	104.57	n. mi.
Perigee altitude	58.33	n. mi.
True anomaly	345.8	deg
Argument of perigee	106.0	deg
Semimajor axis	21 421 025	ft
Eccentricity	.006587	ND
Guidance parameters		
Velocity to go	0.1	fps
Time to go	0.0	sec
Velocity-to-go LVLH		
VGOX	0.1	fps
VGOY	0.0	fps
VGOZ	0.0	fps
Trajectory parameters		
Inertial velocity	25 798.9	fps
Inertial flightpath angle	-.092076	deg
Geodetic altitude	387 849.	ft
Geodetic latitude	40.4539	deg
Longitude	-30.6056	deg
Inertial azimuth	91.5493	deg
Weight	19 9203.	lb

TABLE 6.3.1-VII.- Concluded

Parameter	Value	Unit
Attitude parameters		
ADI inertial		
Roll	185.4	deg
Pitch	140.8	deg
Yaw	358.5	deg
ADI reference		
Roll	101.6	deg
Pitch	129.5	deg
Yaw	2.8	deg
ADI LVLH		
Roll	185.4	deg
Pitch	1.7	deg
Yaw	358.6	deg

TABLE 6.3.1-VIII.- EARLIEST AOA OMS-2 TIG STATE

Parameter	Value	Unit
GMT	44 681.9	sec
GET	3 281.9	sec
Orbital parameters		
Apogee altitude	98.64	n. mi.
Perigee altitude	57.27	n. mi.
True anomaly	145.7	deg
Argument of perigee	101.1	deg
Semimajor axis	21 404 359	ft
Eccentricity	.005613	ND
Guidance parameters		
Velocity to go	164.5	fps
Time to go	84.5	sec
Velocity-to-go LVLH		
VGOX	-141.6	fps
VGOY	0.0	fps
VGOZ	-83.7	fps
Trajectory parameters		
Inertial velocity	25 526.2	fps
Inertial flightpath angle	.182140	deg
Geodetic altitude	602 507.	ft
Geodetic latitude	-36.6512	deg
Longitude	108.103	deg
Inertial azimuth	108.482	deg
Weight	199 158.	-b

TABLE 6.3.1-VIII.- Concluded

Parameter	Value	Unit
Attitude parameters		
ADI inertial		
Roll	358.1	deg
Pitch	151.8	deg
Yaw	359.4	deg
ADI reference		
Roll	274.1	deg
Pitch	131.6	deg
Yaw	351.9	deg
ADI LVLH		
Roll	358.1	deg
Pitch	167.6	deg
Yaw	359.4	deg

TABLE 6.3.1-IX.- EARLIEST AOA OMS-2 BURNOUT STATE

Parameter	Value	Unit
GMT	44 768.4	sec
GET	3 368.4	sec
Orbital parameters		
Apogee altitude	99.28	n. mi.
Perigee altitude	-22.79	n. mi.
True anomaly	163.4	deg
Argument of perigee	89.2	deg
Semimajor axis	21 161 575.	ft
Eccentricity	.0173495	ND
Guidance parameters		
Velocity to go	0.5	fps
Time to go	.0	sec
Velocity-to-go LVLH		
VGOX	-.5	fps
VGOY	.0	fps
VGOZ	-.2	fps
Trajectory parameters		
Inertial velocity	25 366.6	fps
Inertial flightpath angle	.288523	deg
Geodetic altitude	613 993.	ft
Geodetic latitude	-38.3053	deg
Longitude	114.815	deg
Inertial azimuth	104.186	deg
Weight	195 928.	lb

TABLE 6.3.1-IX.- Concluded

Parameter	Value	Unit
Attitude parameters		
ADI inertial		
Roll	357.8	deg
Pitch	149.8	deg
Yaw	359.3	deg
ADI reference		
Roll	273.8	deg
Pitch	131.3	deg
Yaw	354.0	deg
ADI LVLH		
Roll	357.8	deg
Pitch	171.3	deg
Yaw	359.3	deg

TABLE 6.3.1-X.- EARLIEST AOA ENTRY INTERFACE
-5 MINUTES STATE

Parameter	Value	Unit
GMT	45 653.3	sec
GET	4 253.3	sec
Orbital parameters		
Apogee altitude	99.29	n. mi.
Perigee altitude	-22.77	n. mi.
True anomaly	223.7	deg
Argument of perigee	88.9	deg
Semimajor axis	21 171 616.	ft
Eccentricity	.0169785	ND
Guidance parameters		
Velocity to go	--	fps
Time to go	--	sec
Velocity-to-go LVLH		
VGOX	--	fps
VGOY	--	fps
VGOZ	--	fps
Trajectory parameters		
Inertial velocity	25 474.1	fps
Inertial flightpath angle	-.680471	deg
Geodetic altitude	518758.	ft
Geodetic latitude	-28.6018	deg
Longitude	-176.415	deg
Inertial azimuth	60.1340	deg
Weight	195 887.	lb

TABLE 6.3.1-X.- Concluded

Parameter	Value	Unit
Attitude parameters		
ADI inertial		
Roll	1.3	deg
Pitch	318.4	deg
Yaw	2.2	deg
ADI reference		
Roll	85.0	deg
Pitch	308.6	deg
Yaw	354.9	deg
ADI LVLH		
Roll	1.3	deg
Pitch	22.8	deg
Yaw	--	deg

TABLE 6.3.1-XI.- EARLIEST AOA ENTRY INTERFACE STATE

Parameter	Value	Unit
GMT	45 958.8	sec
JET	4 558.8	sec
Orbital parameters		
Apogee altitude	99.14	n. mi.
Perigee altitude	-23.16	n. mi.
True anomaly	246.2	deg
Argument of perigee	87.3	deg
Semimajor axis	21 179 526.	ft
Eccentricity	.017017	ND
Guidance parameters		
Velocity to go	--	fps
Time to go	--	sec
Velocity-to-go LVLH		
VGOX	--	fps
VGOY	--	fps
VGOZ	--	fps
Trajectory parameters		
Inertial velocity	25 610.1	fps
Inertial flightpath angle	0.898124	deg
Geodetic altitude	400 000.	ft
Geodetic latitude	-16.8792	deg
Longitude	-158.833	deg
Inertial azimuth	52.7702	deg
Weight	195 887.	lb

TABLE 6.3.1-XI.- Concluded

Parameter	Value	Unit
Attitude parameters		
ADI inertial		
Roll	1.3	deg
Pitch	39.4	deg
Yaw	2.2	deg
ADI reference		
Roll	85.0	deg
Pitch	308.6	deg
Yaw	354.9	deg
ADI LVLH		
Roll	1.3	deg
Pitch	22.8	deg
Yaw	2.3	deg

TABLE 6.3.1-XII.- AOA AFTER NOMINAL OMS-1,
OMS-2 TIG STATE

Parameter	Value	Unit
GMT	44 399.9	sec
GET	2 999.9	sec
Orbital parameters		
Apogee altitude	150.19	n. mi.
Perigee altitude	57.37	n. mi.
True anomaly	193.60	deg
Argument of perigee	34.25	deg
Semimajor axis	21 566 232.	ft
Eccentricity	.012634	ND
Guidance parameters		
Velocity to go	604.82	fps
Time to go	314.6	sec
Velocity-to-go LVLH		
VGOX	-86.22	fps
VGOY	-588.70	fps
VGOZ	-108.68	fps
Trajectory parameters		
Inertial velocity	25 236.6	fps
Inertial flightpath angle	-.172377	deg
Geodetic altitude	921 312.	ft
Geodetic latitude	-28.8189	deg
Longitude	88.7818	deg
Inertial azimuth	119.654	deg
Weight	205 879.	lb

TABLE 6.3.1-XII.- Concluded

Parameter	Value	Unit
Attitude parameters		
ADI inertial		
Roll	356.8	deg
Pitch	187.9	deg
Yaw	281.4	deg
ADI reference		
Roll	15.5	deg
Pitch	21.8	deg
Yaw	273.5	deg
ADI LVLH		
Roll	356.9	deg
Pitch	184.8	deg
Yaw	281.4	deg

TABLE 6.3.1.- XIII.- AOA AFTER NOMINAL OMS-1,
OMS-2 BURNOUT STATE

Parameter	Value	Unit
GMT	44 715.1	sec
GET	3 315.1	sec
Orbital parameters		
Apogee altitude	146.48	n. mi.
Perigee altitude	7.69	n. mi.
True anomaly	195.1	deg
Argument of perigee	55.0	deg
Semimajor axis	21 397 621.	ft
Eccentricity	.019542	ND
Guidance parameters		
Velocity to go	0.84	fps
Time to go	0.0	sec
Velocity-to-go LVLH		
VGOX	0.01	fps
VGOY	0.04	fps
VGOZ	0.0	fps
Trajectory parameters		
Inertial velocity	25 169.8	fps
Inertial flightpath angle	-.296744	deg
Geodetic altitude	900 383.	ft
Geodetic latitude	-37.0153	deg
Longitude	110.376	deg
Inertial azimuth	105.726	deg
Weight	193 886.	lb

TABLE 6.3.1-XIII.- Concluded

Parameter	Value	Unit
Attitude parameters		
ADI inertial		
Roll	34.9	deg
Pitch	226.5	deg
Yaw	277.9	deg
ADI reference		
Roll	103.8	deg
Pitch	110.3	deg
Yaw	276.3	deg
ADI LVLH		
Roll	43.8	deg
Pitch	253.0	deg
Yaw	277.2	deg

TABLE 6.3.1-XIV.- AOA AFTER NOMINAL OMS-1 ENTRY
INTERFACE -5 MINUTES STATE

Parameter	Value	Unit
GMT	45 673.2	sec
GET	4 273.2	sec
Orbital parameters		
Apogee altitude	146.51	n. mi.
Perigee altitude	7.73	n. mi.
True anomaly	260.4	deg
Argument of perigee	54.0	deg
Semimajor axis	21 407 728.	ft
Eccentricity	.019386	ND
Guidance parameters		
Velocity to go	--	fps
Time to go	--	sec
Velocity-to-go LVLH		
VGOX	--	fps
VGOY	--	fps
VGOZ	--	fps
Trajectory parameters		
Inertial velocity	25 568.8	fps
Inertial flightpath angle	-1.09909	deg
Geodetic altitude	55 8264.	ft
Geodetic latitude	-27.2636	deg
Longitude	-176.791	deg
Inertial azimuth	59.9134	deg
Weight	193 788.	lb

TABLE 6.3.1-XIV. - Concluded

Parameter	Value	Unit
Attitude parameters		
ADI inertial		
Roll	2.9	deg
Pitch	315.7	deg
Yaw	357.3	deg
ADI reference		
Roll	8.6	deg
Pitch	131.0	deg
Yaw	3.1	deg
ADI LVLH		
Roll	3.8	deg
Pitch	0.3	deg
Yaw	358.4	deg

TABLE 6.3.1-XV.- AOA AFTER NOMINAL OMS-1
ENTRY INTERFACE STATE

Parameter	Value	Unit
GMT	45 972.1	sec
GET	4 572.1	sec
Orbital parameters		
Apogee altitude	146.23	n. mi.
Perigee altitude	7.51	n. mi.
True anomaly	281.9	deg
Argument of perigee	53.1	deg
Semimajor axis	21 415 506.	ft
Eccentricity	.019724	N
Guidance parameters		
Velocity to go	--	fps
Time to go	--	sec
Velocity-to-go LVLH		
VGOX	--	fps
VGOY	--	fps
VGOZ	--	fps
Trajectory parameters		
Inertial velocity	25 751.8	fps
Inertial flightpath angle	-1.10127	deg
Geodetic altitude	400 000.	ft
Geodetic latitude	-15.7751	deg
Longitude	-159.667	deg
Inertial azimuth	53.1095	deg
Weight	193 788.	lb

TABLE 6.3.1-XV.- Concluded

Parameter	Value	Unit
Attitude parameters		
ADI inertial		
Roll	2.9	deg
Pitch	315.7	deg
Yaw	357.3	deg
ADI reference		
Roll	8.6	deg
Pitch	131.0	deg
Yaw	3.1	deg
ADI LVLH		
Roll	3.8	deg
Pitch	0.3	deg
Yaw	358.4	deg

TABLE 6.3.2-1.- SEQUENCE OF EVENTS FOR STS-1(CYCLE 3)
(a) Entry guidance initiate to TAEM interface

EVENT	EVENT TIME (GMT) HR MM SEC	EVENT TIME (GMT) HR MM SEC	EVENT TIME (GMT) HR MM SEC	EVENT TIME WRT ENTRY INTERFACE HR MM SEC	GEODETTIC ALTITUDE FT	RANGE TO RUNWAY THRESHOLD N M	REL VEL FPS	REL HEADING DEG	RELATIVE FLT PATH ANGLE DEG	LONGITUDE DEG	GEODETTIC LATITUDE DEG	MACH NUMBER	ANGLE OF ATTACK DEG	DYNAMIC PRESSURE LB/FT ²
INITIATE ENTRY GUIDANCE MAJOR MODE 304	1 10 53 28	12 40 53 24	10 18 11 38	0 05 8 24	518756	5444 1 24292	58 520	- 714	178 41 W	28 60 S	11 23	28 11	00	
ENTRY INTERFACE	1 18 59 52	12 45 59 52	10 21 17 62	0 00 00	349789	4256 2 24443	50 648	- 840	156 79 W	18 55 S	18 45	28 54	01	
ACTIVATE ELEVONS AND BODY FLAP	1 18 53 76	12 48 53 76	10 24 11 88	0 02 54 24	322789	3970 0 24520	48 399	-1 008	149 84 W	9 32 S	25 99	40 52	50	
ENTER COMMUNICATION BLACKOUT	1 18 48	12 49 48	10 24 18 58	0 03 06	319781	3547 3 24532	48 332	-1 008	149 51 W	9 02 S	26 13	40 84	60	
AEROSURFACE CONTROL ACTIVATED	1 18 51 84	12 49 51 84	10 25 9 84	0 03 52 32	247148	3342 3 24575	47 839	- 874	146 98 W	6 74 S	26 39	40 90	2 00	
DEACTIVATE RCS ROLL THRUSTERS	1 21 20 18	12 51 20 18	10 26 38 36	0 05 20 84	264464	2993 4 24290	47 415	- 818	142 63 W	2 77 S	26 27	40 32	10 06	
INITIATE TEMPERATURE CONTROL PHASE	1 21 21 12	12 51 21 12	10 26 39 22	0 05 21 60	264208	2985 9 24396	47 412	- 810	142 58 W	2 73 S	26 27	40 12	10 18	
FIRST NON ZERO ROLL COMMAND	1 21 34 56	12 51 34 56	10 26 52 88	0 05 36 04	280980	2933 1 24332	47 378	- 484	141 93 W	2 12 S	26 23	40 78	11 84	
DEACTIVATE RCS PITCH THRUSTERS	1 23 45 12	12 53 45 12	10 29 3 22	0 07 48 80	248184	2428 1 2350	45 884	- 150	135 78 W	3 72 N	25 31	40 11	20 01	
INITIATE DRAG UPDATING IN NAVIGATION FILTER	1 27 00	12 57 00	10 32 18 10	0 11 48	237417	1715 8 21718	42 924	- 251	127 33 W	12 33 N	22 90	39 58	29 83	
INITIATE EQUILIBRIUM GLIDE PHASE	1 29 17 28	12 59 17 28	10 34 35 38	0 13 17 76	224120	1246 4 1982	40 503	- 474	121 98 W	18 18 N	20 31	39 64	43 74	
FIRST ROLL REVERSAL	1 21 36 96	13 01 36 96	10 36 58 06	0 15 37 44	200183	830 7 16876	32 580	- 770	117 40 W	23 74 N	16 16	39 48	79 30	
INITIATE CONSTANT DRAG PHASE	1 32 4 32	13 02 4 32	10 37 22 42	0 16 4 80	197953	795 0 16017	33 910	.038	116 67 W	24 78 N	15 50	40 38	78 18	
INITIATE ANGLE OF ATTACK TRANSITION	1 32 51 36	13 02 51 36	10 38 8 48	0 16 51 84	180232	641 9 14499	39 608	- 787	116 38 W	26 33 N	13 82	40 90	84 18	
SCOTT PEAK C BAND AOS (0 DEG ELEV +05SEC)	1 33 26 38	13 03 26 38	10 38 47 38	0 17 29 76	164027	585 4 13263	44 617	- 875	114 10 W	27 40 N	12 49	39 98	87 41	
FT HUACHUCA C-BAND AOS (0 DEG ELEV +05SEC)	1 33 30 34	13 03 30 34	10 38 48 34	0 17 30 72	183857	855 4 13231	44 798	- 884	114 28 W	27 42 N	12 45	39 97	87 87	
MT LEMMON C-BAND AOS (0 DEG ELEV +05SEC)	1 33 48 60	13 03 48 60	10 39 3 70	0 17 48 08	180929	842 2 12732	48 877	- 899	112 84 W	27 60 N	11 93	39 47	89 88	
EXIT S BAND COMMUNICATIONS BLACKOUT	1 33 54 72	13 03 54 72	10 39 12 82	0 17 55 20	179110	903 1 12435	48 314	-1 026	112 96 W	28 01 N	11 82	39 18	81 43	
EXIT L BAND COMMUNICATIONS BLACKOUT	1 34 28 80	13 04 28 80	10 39 46 80	0 18 28 28	171981	438 0 11323	53 712	- 1 185	112 61 W	28 71 N	10 50	37 88	87 83	
INITIATE SPEEDBRAKE DEPLOYMENT TO 100%	1 34 44 84	13 04 44 84	10 40 2 74	0 18 48 12	188448	408 3 10805	56 475	-1 318	112 17 W	28 98 N	10 00	37 14	101 46	
INITIATE TRANSITION PHASE	1 34 55 20	13 04 55 20	10 40 13 30	0 18 59 58	165919	388 5 10460	58 448	-1 439	111 87 W	29 14 N	9 66	36 58	104 84	
WHITE SANDS C BAND AOS (0 DEG ELEV +05SEC)	1 35 1 92	13 05 1 92	10 40 20 02	0 19 2 40	164228	378 9 10241	59 740	-1 492	111 69 W	29 24 N	9 45	36 14	106 75	
EXIT UHF COMMUNICATIONS BLACKOUT	1 35 18 24	13 05 18 24	10 40 36 34	0 19 18 72	160611	281 3 9725	62 609	-1 216	111 24 W	29 48 N	8 99	34 27	110 74	
TULA PEAK S BAND AOS (CLEAR WASKAZO SEC)	1 35 21 12	13 05 21 12	10 40 39 22	0 19 21 80	160090	348 3 9638	63 190	-1 203	111 17 W	29 49 N	8 91	34 08	111 10	
WILCO SITE C BAND AOS (0 DEG ELEV +05SEC)	1 35 22 56	13 05 22 56	10 40 40 56	0 19 22 04	159787	345 4 9594	63 426	- 1 204	111 13 W	29 51 N	8 87	33 80	111 27	
WHITE SANDS C BAND AOS (0 DEG ELEV +05SEC)	1 35 28 80	13 05 28 80	10 40 46 80	0 19 28 28	158592	338 8 9410	64 664	-1 259	110 98 W	29 58 N	8 70	33 38	112 14	
PHILIPS HILL C BAND AOS (0 DEG ELEV +05SEC)	1 35 32 16	13 05 32 16	10 40 50 26	0 19 32 64	157827	331 1 9311	65 348	-1 303	110 87 W	29 62 N	8 67	33 21	112 68	
EARLIEST OPPORTUNITY FOR RUNWAY DESIGNATION	1 35 36 00	13 05 36 00	10 40 54 10	0 19 36 48	157 40	326 8 9159	66 147	- 1 388	110 77 W	29 68 N	8 52	33 02	113 41	
INITIATE TACAN ACQUISITION REGION UPDATING (2 LRU LOCK ON) TUS SELECTED	1 36 25 44	13 06 25 44	10 41 43 54	0 20 25 92	148912	280 2 7824	80 520	-2 128	109 58 W	30 4 N	7 28	31 47	112 81	
EARLIEST OPPORTUNITY FOR MCC STATE UPDATE (TULA PEAK AOS+87 SEC)	1 36 28 38	13 06 28 38	10 41 46 42	0 20 28 00	148182	257 8 7748	88 884	-2 174	109 52 W	30 17 N	7 21	31 08	114 27	
AMMONIA BOILER ACTIVATED	1 37 53 76	13 07 53 76	10 42 1 88	0 21 54 24	124810	186 1 5710	41 275	- 2 787	108 11 W	31 13 N	5 49	23 44	188 18	
INITIATE TACAN NAVIGATION REGION UPDATING CUS SELECTED	1 38 17 76	13 08 17 76	10 42 38 86	0 22 18 24	118713	144 5 5188	24 604	- 3 854	107 85 W	31 42 N	5 03	21 88	178 88	
CUS TACAN ELEVATION GREATER THAN 48 DEG	1 38 32 16	13 08 32 16	10 42 50 26	0 22 32 64	115044	132 0 4883	20 246	-3 141	107 73 W	31 58 N	4 75	21 00	186 28	
INITIATE RUDDER TRIM AND SPEEDBRAKE RETRACTION TO 65%	1 39 12 48	13 09 12 48	10 44 30 58	0 23 12 98	108364	103 9 4054	24 742	- 3 128	107 48 W	32 03 N	1 50	18 80	189 70	
DMN TACAN SELECTED	1 39 14 88	13 09 14 88	10 44 32 38	0 23 15 26	108018	102 7 4007	25 678	- 3 288	107 47 W	32 05 N	3 95	18 65	189 25	
DMN TACAN ELEVATION GREATER THAN 48 DEG	1 39 14 88	13 09 14 88	10 44 32 38	0 23 15 26	108018	102 7 4007	25 678	- 3 288	107 47 W	32 05 N	3 95	18 65	189 25	
INITIATE AIR DATA SYSTEMS PROBE DEPLOYMENT	1 39 40 32	13 09 40 32	10 44 58 42	0 23 40 80	100484	87 9 3524	38 614	- 4 567	107 31 W	32 27 N	3 50	18 21	191 11	
UHF EJECTION CAPABILITY	1 39 42 24	13 09 42 24	10 45 0 34	0 23 42 72	99950	88 9 3489	37 490	- 4 673	107 30 W	32 27 N	3 47	18 11	191 11	
MT LEMMON C BAND LOS (3 DEG ELEVATION)	1 39 54 72	13 09 54 72	10 45 12 82	0 23 56 20	98395	78 9 3264	40 808	- 5 263	107 21 W	32 38 N	3 24	18 01	191 11	
SCOTT PEAK C BAND LOS (3 DEG ELEVATION)	1 40 11 04	13 10 11 04	10 45 28 14	0 24 11 92	91988	71 7 3975	50 321	- 5 828	107 08 W	32 47 N	3 00	6 33	206 80	
FT HUACHUCA C BAND LOS (3 DEG ELEVATION)	1 40 18 80	13 10 18 80	10 45 34 90	0 24 17 28	89888	68 8 3878	52 651	- 5 988	107 08 W	32 50 N	2 50	15 88	210 20	

TABLE 6.3.2-II.- STS-1 CYCLE 3 EARLIEST AOA MASS PROPERTIES

ORBITER AT ENTRY INTERFACE

MASS PROPERTIES

WEIGHT AND C. G.		MOMENT OF INERTIA (SF2)		PRODUCT OF INERTIA (SF2)	
WEIGHT	102022.8 (LB)				
X	1098.6 (IN)	IXX	848723.3	IXY	-1969.4
Y	.2 (IN)	IYY	6666495.7	IXZ	164456.5
Z	373.7 (IN)	IZZ	6937777.2	IYZ	849.3
X CG IN PERCENT BODY LENGTH =		66.7			

ORBITER AT TAEM INTERFACE

MASS PROPERTIES

WEIGHT AND C. G.		MOMENT OF INERTIA (SF2)		PRODUCT OF INERTIA (SF2)	
WEIGHT	101090.7 (LB)				
X	1097.5 (IN)	IXX	845085.3	IXY	-1720.6
Y	.2 (IN)	IYY	6657252.9	IXZ	160184.5
Z	373.3 (IN)	IZZ	6921743.3	IYZ	842.1
X CG IN PERCENT BODY LENGTH =		66.6			

ORBITER AT LANDING GEAR DOWN

MASS PROPERTIES

WEIGHT AND C. G.		MOMENT OF INERTIA (SF2)		PRODUCT OF INERTIA (SF2)	
WEIGHT	101055.4 (LB)				
X	1098.6 (IN)	IXX	868714.7	IXY	-1774.9
Y	.2 (IN)	IYY	6663246.6	IXZ	160164.1
Z	371.0 (IN)	IZZ	6916056.4	IYZ	827.1
X CG IN PERCENT BODY LENGTH =		66.7			

TABLE 6.3.2.-III.- ENTRY PARAMETERS
(a) Entry interface minus 5 minutes

PARAMETER	ENTRY INTERFACE MINUS 5 MINUTES
GET.HR.MN:SEC	1:10:53.28
INERTIAL VELOCITY.FPS	25474.
INERTIAL FLIGHT PATH ANGLE.DEG	- .6805
INERTIAL HEADING FROM NORTH.DEG	60.1340
LONGITUDE.DEG E	-176.4148
GEODEIC LATITUDE.DEG NORTH	-28.6018
GEOCENTRIC LATITUDE.DEG NORTH	-28.4403
ALTITUDE OF C.G. ABOVE THE FISCHER ELLIPSOID.FT	518756.
ORBITAL INCLINATION.DEG	40.3
ENTRY RANGE.N.MI.	5449.
WEIGHT.LB	192023.

TABLE 6.3.2-III.- ENTRY PARAMETERS

(b) Entry interface

Parameter	Value
<u>Initial conditions</u>	
GET, hr:min:sec	1:15:59.52
Entry weight, lb	192 023.
Inertial velocity, FPS	25 611.
Inertial flightpath angle, deg	-.8971
Inertial heading from N, deg	52.7577
Longitude, deg E	-158.7935
Geodetic Latitude, deg N	-16.8481
Geocentric latitude, deg N	-16.7417
Altitude of c.g. above the Fischer ellipsoid, ft	399 799.
Orbital inclination, deg	40.3
Entry range, n. mi.	4 258
<u>Target (runway threshold)</u>	
Longitude, deg W	106.417381
Geodetic latitude, deg N	32.960354
Geodetic altitude, ft	3771
True heading, deg	187.24

TABLE 6.3.2.-IV.- ENTRY/TAEM INTERFACE CONDITIONS

PARAMETER	VALUE
GET.HR:MN:SEC	1:40:38.88
TIME FROM ENTRY INTERFACE,MIN:SEC .	3:24:39.36
TAEM WEIGHT,LB	192022.8
RELATIVE VELOCITY,FPS	2497.9
RELATIVE FLIGHT PATH ANGLE,DEG . . .	-5.9998
RELATIVE HEADING FROM NORTH,DEG . .	63.2702
LONGITUDE,DEG W	-106.8874
GEODEIC LATITUDE,DEG NORTH	32.5856
GEOCENTRIC LATITUDE,DEG NORTH	32.4113
ALTITUDE OF C.G. ABOVE FISCHER ELLIPSOID,FT	83495.8
ALTITUDE OF C.G. ABOVE RUNWAY,FT . .	79917.6
MACH NUMBER	2.55
ANGLE OF ATTACK,DEG	14.02
DYNAMIC PRESSURE,PSF	218.6
DOWNRANGE TO RUNWAY THRESHOLD,NM . .	58.9
DELTA AZIMUTH TO HAC,DEG	14.14

TABLE 6.3.2.-V.- TAEM/A&L INTERFACE CONDITIONS

PARAMETER	VALUE
GET.HR.MN.SEC	1:45:45.12
TIME FROM ENTRY INTERFACE.MIN:SEC .	0:29:45.60
RELATIVE VELOCITY.FPS	592.6
RELATIVE FLIGHT PATH ANGLE.DEG . .	-19.9075
RELATIVE HEADING FROM NORTH.DEG . .	-172.4744
LONGITUDE.DEG W	-106.4033
GEODEIC LATITUDE.DEG N	33.0525
GEOCENTRIC LATITUDE.DEG N	32.8769
ALTITUDE OF C.G. ABOVE FISCHER ELLIPSOID.FT	13785.0
ALTITUDE OF C.G. ABOVE RUNWAY.FT .	9998.6
DOWNRANGE TO RUNWAY THRESHOLD.FT .	-33836.0

TABLE 6.3.2-VI.- EARLIEST AOA THERMAL PROTECTION SUMMARY

PANEL NO.	PANEL AREA (FT) ²	MAXIMUM HEATING RATE BTU/(FT) ² /SEC	MAXIMUM SURFACE TEMPERATURE DEG F	SURFACE INSULATION TYPE	TOTAL HEAT LOAD BTU/(FT) ²	STRUCTURAL TEMPERATURE MARGIN, DEG F
1	24.00	22.58	2267.07	RCC	18525.25	*****
2	362.00	11.77	1862.50	HRSI	9766.71	33.68
3	113.00	9.92	1765.23	HRSI	8214.17	26.27
4	446.00	9.23	1725.36	HRSI	7603.07	23.46
5	559.00	6.73	1559.51	HRSI	5660.99	24.94
6	403.00	4.70	1404.97	HRSI	4296.32	23.61
7	158.00	11.28	1837.68	RCC	10204.55	*****
8	435.00	13.39	1938.32	HRSI	12686.14	30.77
9	412.00	11.04	1825.32	HRSI	9828.21	30.24
10	641.00	18.40	2136.79	HRSI	8350.66	.90
11	165.00	22.43	2268.65	HRSI	9265.99	13.09
12	360.00	9.82	1759.22	HRSI	4478.86	16.77
13	275.00	2.97	1185.81	HRSI	2456.50	38.88
14	473.00	2.05	1039.82	LRSI	1719.97	34.65
15	1631.00	.22	393.76	LRSI	182.88	*****
16	764.00	.10	241.49	LRSI	75.15	*****
17	114.00	.50	595.17	LRSI	273.35	*****
18	631.00	.38	525.01	LRSI	255.59	*****
19	155.00	7.65	1625.02	HRSI	4341.65	72.56
20	673.00	1.74	980.10	LRSI	1568.85	36.86
21	242.00	1.08	818.44	LRSI	670.85	40.94
22	610.00	.77	713.67	LRSI	655.28	33.08
23	1132.00	.42	549.20	LRSI	349.25	*****
24	372.00	.45	567.18	LRSI	374.04	33.54
25	82.00	30.96	2497.41	HRSI	13633.20	18.22

TABLE 6.3.2-VII.- COMPARISON OF EOM AND AOA
THERMAL ENVIRONMENT (6-DOF SIMULATION)

<u>Parameter symbol</u>	<u>Unit</u>	<u>EOM</u>	<u>AOA earliest</u>
CP1	°F	2529	2541
CP2	°F	2158	2186
CP3	°F	2685	2696
CP4	°F	2366	2415
CP6	°F	2488	2502
\dot{Q}	Btu/ft ² /sec	61.38	62.28
QL	Btu/ft ²	53731	51505
T _{BF2} (margin)	°F	25.05	33.68

TABLE 6.3.2-IX. - S-BAND AND C-BAND STATION LOCATIONS

RADAR SITE	NAME	DESCRIPTION	LONGITUDE .DEG +EAST, -WEST	LATITUDE .DEG +NORTH, -SOUTH	ALTITUDE .FT	TERRAIN MASKING	MINIMUM ELEV. DEG
1	FTM	FT HUACHUCA	-110.371	31.571	4802.700	0	.000
2	WSP	PHILIPS HILL	-106.132	33.445	5191.000	0	.000
3	SPK	SCOTT PEAK	-110.438	31.557	5818.000	0	.000
4	WHS	WHITE SANDS	-106.370	32.358	3906.000	0	.000
5	WSS	WHITE SANDS	-106.659	33.814	5025.100	0	.000
6	MTL	MT LERMON	-110.789	32.442	9036.000	0	.000
7	WSW	WILDE SITE	-106.159	33.096	4039.000	0	.000
8	TUL	TULA PEAK	-106.139	33.027	4232.000	1	-1.200

• ABOVE 1960 FISCHER ELLIPSOID

TABLE 6.4.1-1.- SEQUENCE OF EVENTS FOR MAXIMUM UNDERSPEED ATO

Event	Time, day hr:min:sec	Total weight, lb	Geodetic altitude, ft	Inertial velocity, fps	Inertial flightpath angle, deg	HA x HP, n. ml.
SSME-3 out 3-g boundary	0:0:4:20.44 NA	1068394.	398155.	8435.	8.748	68.4 x -3267.
MEO	0:0:10:28.8	310657.	387885.	25293.	.365	62.0 x -164.4
ET separation/ -Z RCS burn	0:0:10:43.7	215498.	390582.	25290.	.331	62.0 x -164.3
Start 24-sec Y separation maneuver	0:0:10:52.1	215335.	391960.	25289.	.302	61.9 x -163.9
OMS-1 IGM/LOX vent	0:0:12:27.3	215137.	402337.	25278.	.084	61.9 x -163.8
End LOX vent	0:0:14:24.1	205978.	402267.	25499.	-.129	62.0 x -51.0
Begin LH ₂ vent	0:0:14:33.7	205608.	401807.	25518.	-.138	62.1 x -41.6
End LH ₂ vent	0:0:15:20.1	203521.	399113.	25609.	-.159	62.6 x 4.67
OMS-1 cutoff	0:0:16:56.5	199868.	393423.	25795.	-.097	105.1 x 59.2
OMS-2 ignition	0:1:3:48.9	199868.	639308.	25490.	-.001	100.7 x 58.4
OMS-2 cutoff	0:1:4:34.2	198216.	638448.	25575.	+.001	105.0 x 100.7

(SAME AS NOMINAL SEQUENCE OF EVENTS)

TABLE 6.4.1-II.- ATO PLOTTED PARAMETERS

Event	Parameter
Post-MECO	Inertial velocity Inertial flightpath angle Altitude Latitude Longitude Apogee altitude Perigee altitude

TABLE 6.4.1-III.- ATO MECO STATE

Parameter	Value	Unit
GMT	42 028.8	sec
GET	628.8	sec
Orbital parameters		
Apogee altitude	62.04	n. mi.
Perigee altitude	-164.36	n. mi.
True anomaly	169.2	deg
Argument of perigee	-105.2	deg
Semimajor axis	20 620 958.	ft
Eccentricity	.033057	ND
Guidance parameters		
Velocity to go	--	fps
Time to go	--	sec
Velocity-to-go LVLH		
VGOX	--	fps
VGOY	--	fps
VGOZ	--	fps
Trajectory parameters		
Inertial velocity	25 293.0	fps
Inertial flightpath angle	.365409	deg
Geodetic altitude	387 884.6	ft
Geodetic latitude	35.7260	deg
Longitude	-63.8351	deg
Inertial azimuth	69.6187	deg
Weight	310 267.	lb

TABLE 6.4.1-III.- Concluded

Parameter	Value	Unit
Attitude parameters		
ADI inertial		
Roll	180.3	deg
Pitch	163.9	deg
Yaw	2.6	deg
ADI reference		
Roll	170.0	deg
Pitch	339.1	deg
Yaw	354.7	deg
ADI LVLH		
Roll	191.7	deg
Pitch	335.4	deg
Yaw	0.0	deg

TABLE 6.4.1-IV.- ATO OMS-1 TIG STATE

Parameter	Value	Unit
GMT	42 147.3	sec
GET	747.3	sec
Orbital parameters		
Apogee altitude	61.94	n. mi.
Perigee altitude	-163.76	n. mi.
True anomaly	177.5	deg
Argument of perigee	-105.5	deg
Semimajor axis	20 619 942.	ft
Eccentricity	.033082	ND
Guidance parameters		
Velocity to go	506.7	fps
Time to go	270.3	sec
Velocity-to-go LVLH		
VGOX	504.0	fps
VGOY	.08	fps
VGOZ	52.3	fps
Trajectory parameters		
Inertial velocity	25 278.1	fps
Inertial flightpath angle	.084175	deg
Geodetic altitude	402 337.	ft
Geodetic latitude	38.1616	deg
Longitude	-54.7315	deg
Inertial azimuth	75.3759	deg
Weight	215 137.	lb

TABLE 6.4.1-IV.- Concluded

Parameter	Value	Unit
Attitude parameters		
ADI inertial		
Roll	181.5	deg
Pitch	138.1	deg
Yaw	355.6	deg
ADI reference		
Roll	176.0	deg
Pitch	312.6	deg
Yaw	349.5	deg
ADI LVLH		
Roll	181.5	deg
Pitch	339.3	deg
Yaw	355.6	deg

TABLE 6.4.1-V.- ATO OMS-2 TIG STATE

Parameter	Value	Unit
GMT	45 228.9	sec
GET	3 828.9	sec
Orbital parameters		
Apogee altitude	100.65	n. mi.
Perigee altitude	58.40	n. mi.
True anomaly	180.2	deg
Argument of perigee	103.7	deg
Semimajor axis	21 411 196.	ft
Eccentricity	.005891	ND
Guidance parameters		
Velocity to go	84.3	fps
Time to go	43.7	sec
Velocity-to-go LVLH		
VGOX	84.3	fps
VGOY	0.0	fps
VGOZ	-2.1	fps
Trajectory parameters		
Inertial velocity	25 489.9	fps
Inertial flightpath angle	-.001454	deg
Geodetic altitude	639308.	ft
Geodetic latitude	-39.0627	deg
Longitude	153.111	deg
Inertial azimuth	78.4544	deg
Weight	199 868.	lb

TABLE 6.4.1-V.- Concluded

Parameter	Value	Unit
Attitude parameters		
ADI inertial		
Roll	176.6	deg
Pitch	287.8	deg
Yaw	359.5	deg
ADI reference		
Roll	184.4	deg
Pitch	103.0	deg
Yaw	2.0	deg
ADI LVLH		
Roll	176.7	deg
Pitch	340.7	deg
Yaw	359.6	deg

TABLE 6.4.1-VI.- ATO OMS-1 BURNOUT STATE

Parameter	Value	Unit
GMT	42 416.5	sec
GET	1 016.5	sec
Orbital parameters		
Apogee altitude	105.06	n. mi.
Perigee altitude	59.16	n. mi.
True anomaly	344.8	deg
Argument of perigee	105.8	deg
Semimajor axis	21 424 999.	ft
Eccentricity	.006538	ND
Guidance parameters		
Velocity to go	.31	fps
Time to go	0.0	sec
Velocity-to-go LVLH		
VGOX	-.22	fps
VGOY	0.0	fps
VGOZ	.05	fps
Trajectory parameters		
Inertial velocity	25 794.6	fps
Inertial flightpath angle	-.097400	deg
Geodetic altitude	393 423.	ft
Geodetic latitude	40.4765	deg
Longitude	-32.1333	deg
Inertial azimuth	90.5095	deg
Weight	199 912	lb

TABLE 6.4.1-VI.- Concluded

Parameter	Value	Unit
Attitude parameters		
ADI inertial		
Roll	181.5	deg
Pitch	133.2	deg
Yaw	359.5	deg
ADI reference		
Roll	175.5	deg
Pitch	308.1	deg
Yaw	353.9	deg
ADI LVLH		
Roll	181.5	deg
Pitch	352.8	deg
Yaw	359.6	deg

TABLE 6.4.1-VII.- ATO OMS-2 BURNOUT STATE

Parameter	Value	Unit
GMT	45 274.2	sec
GET	3 874.2	sec
Orbital parameters		
Apogee altitude	105.02	n. mi.
Perigee altitude	100.70	n. mi.
True anomaly	191.9	deg
Argument of perigee	-74.9	deg
Semimajor axis	21 552 985	ft
Eccentricity	+.0007	ND
Guidance parameters		
Velocity to go	.07	fps
Time to go	0.0	sec
Velocity-to-go LVLH		
VGOX	.04	fps
VGOY	.05	fps
VGOZ	.03	fps
Trajectory parameters		
Inertial velocity	25 574.6	fps
Inertial flightpath angle	.001398	deg
Geodetic altitude	638 448.	ft
Geodetic latitude	-38.3826	deg
Longitude	156.760	deg
Inertial azimuth	76.0579	deg
Weight	198 216.	lb

TABLE 6.4.1-VII.- Concluded

Parameter	Value	Unit
Attitude parameters		
ADI inertial		
Roll	176.6	deg
Pitch	289.0	deg
Yaw	1.9	deg
ADI reference		
Roll	184.4	deg
Pitch	103.8	deg
Yaw	4.6	deg
ADI LVLH		
Roll	176.7	deg
Pitch	344.8	deg
Yaw	2.0	deg

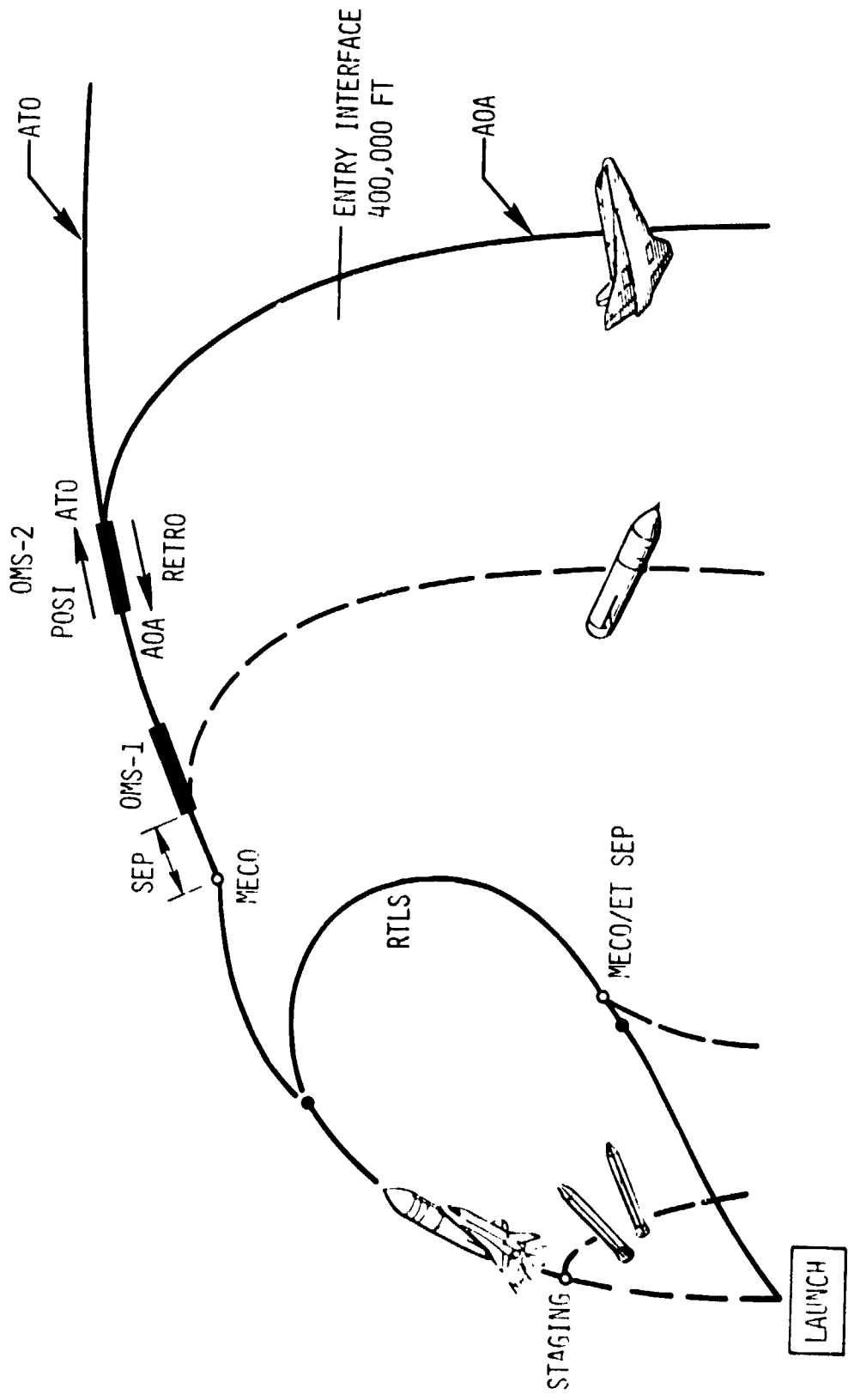

Figure 6.0-1.- Types of intact abort.

ABORT CAPABILITY*

● LAST RTLS:

- 5 MIN LAUNCH HOLD = 160 LBS
- LAUNCH WINDS = 1271 LBS
- MEAN + 3σ FPR = 6485 LBS
- 3000 LB MANAGERS MARGIN
- 10 SEC DECISION LAG

● PRESS TO MECO:

- 5 MIN LAUNCH HOLD = 160 LBS
- 95% LAUNCH WIND DISPERSION ALLOWANCES = 1271 LBS
- STEEP TARGET LINE FOR AOA
- 3000 LB MANAGERS MARGIN
- -3σ ABORT ASCENT PERFORMANCE (MEAN + 3σ = 6361 LBS)
- THE UNDERSPEED AT MECO ON A 3σ BAD DAY FOR MAINSTAGE PROPULSION IS LIMITED BY POST MECO OMS ΔV AVAILABLE EXCLUDING:
 - OMS 1
 - OMS 2
 - BALLAST (Y C.G.) ≠
 - OMS 3σ RESERVES
 - 80 FT/SEC NAV ALLOWANCE
 - 2 MIN OMS-1 TIG DELAY
 - COMMON AOA AND ATO
 - OMS-1 TARGETS

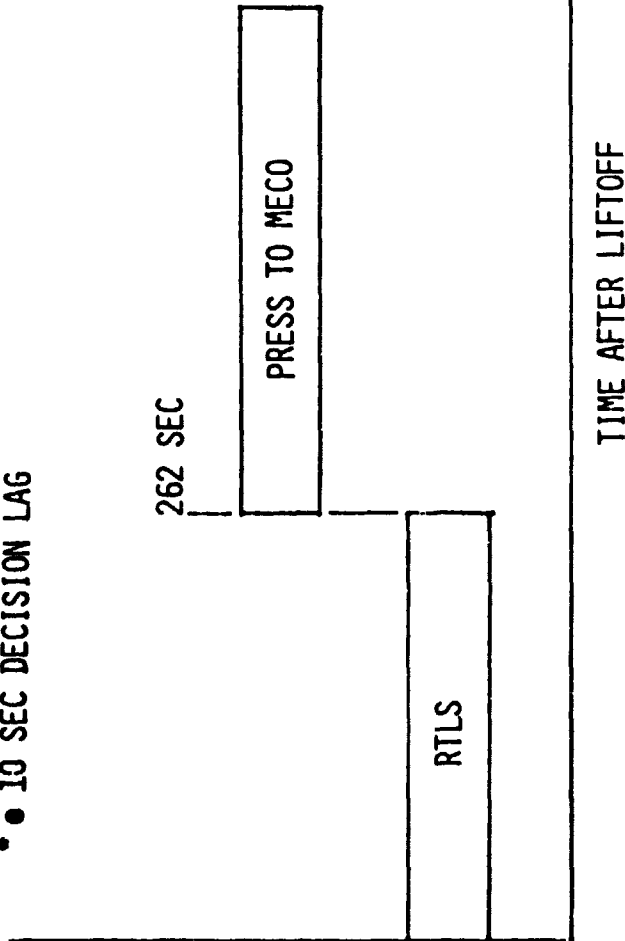

✓ NOTE: ABORT CAPABILITY SHOWN FOR NOMINAL MISSION PLANNING ONLY
 ✓ FORWARD RCS PROPELLANT IS DUMPED TO ELIMINATE OMS BALLAST FOR X C.G.

Figure 6.0-2.- Abort mode capability during STS-1 ascent.

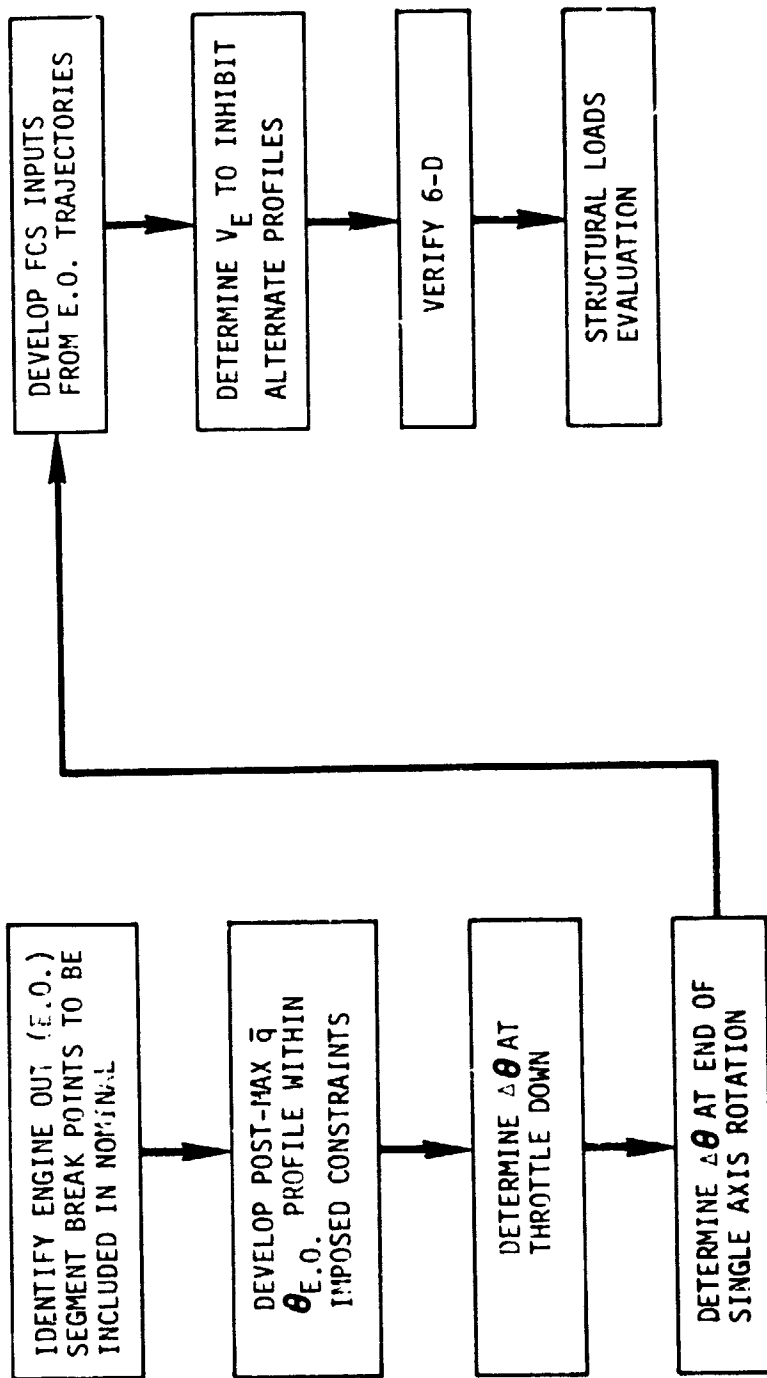

Figure 6.1-1.- Engine-out design procedure block diagram.

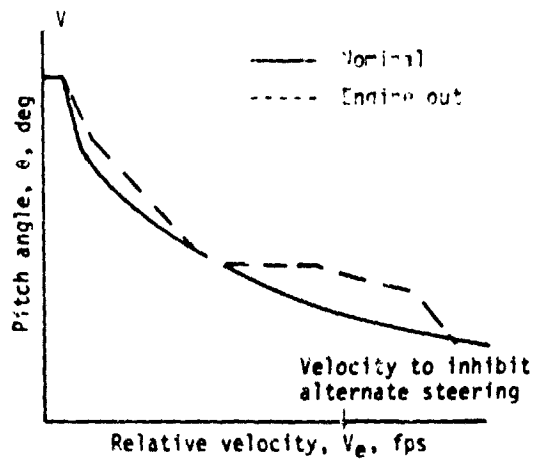
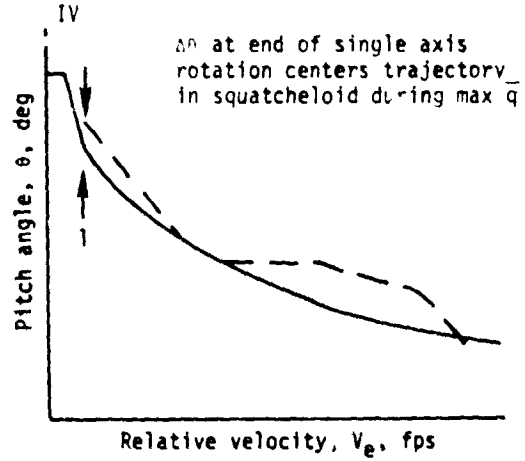
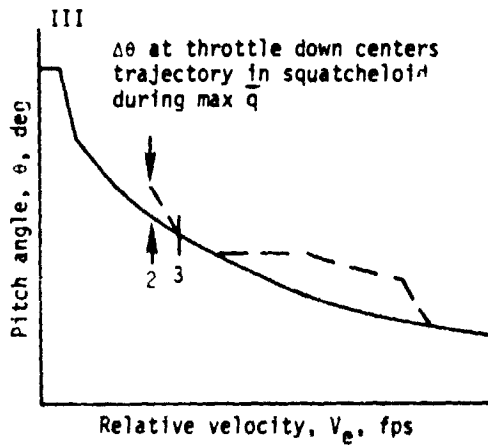
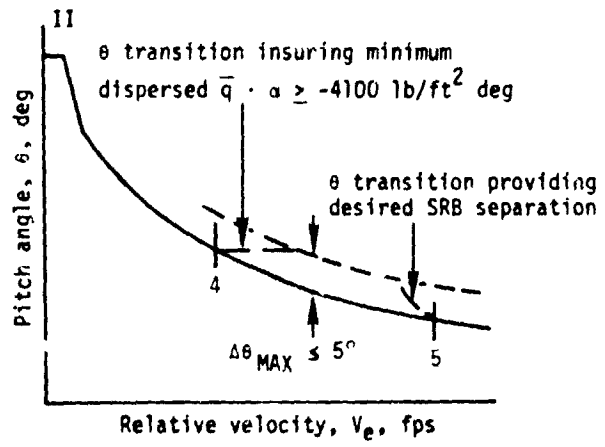
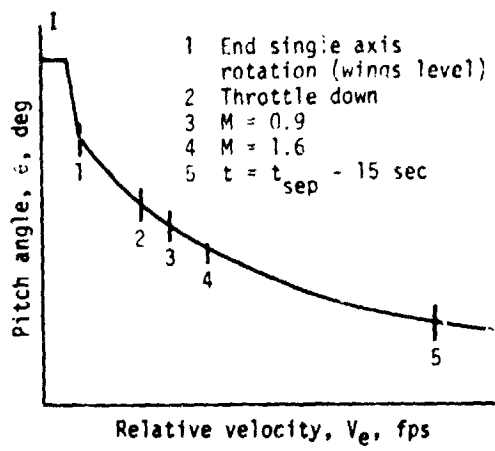

Figure 6.1-2.- Engine-out design procedure for pitch.

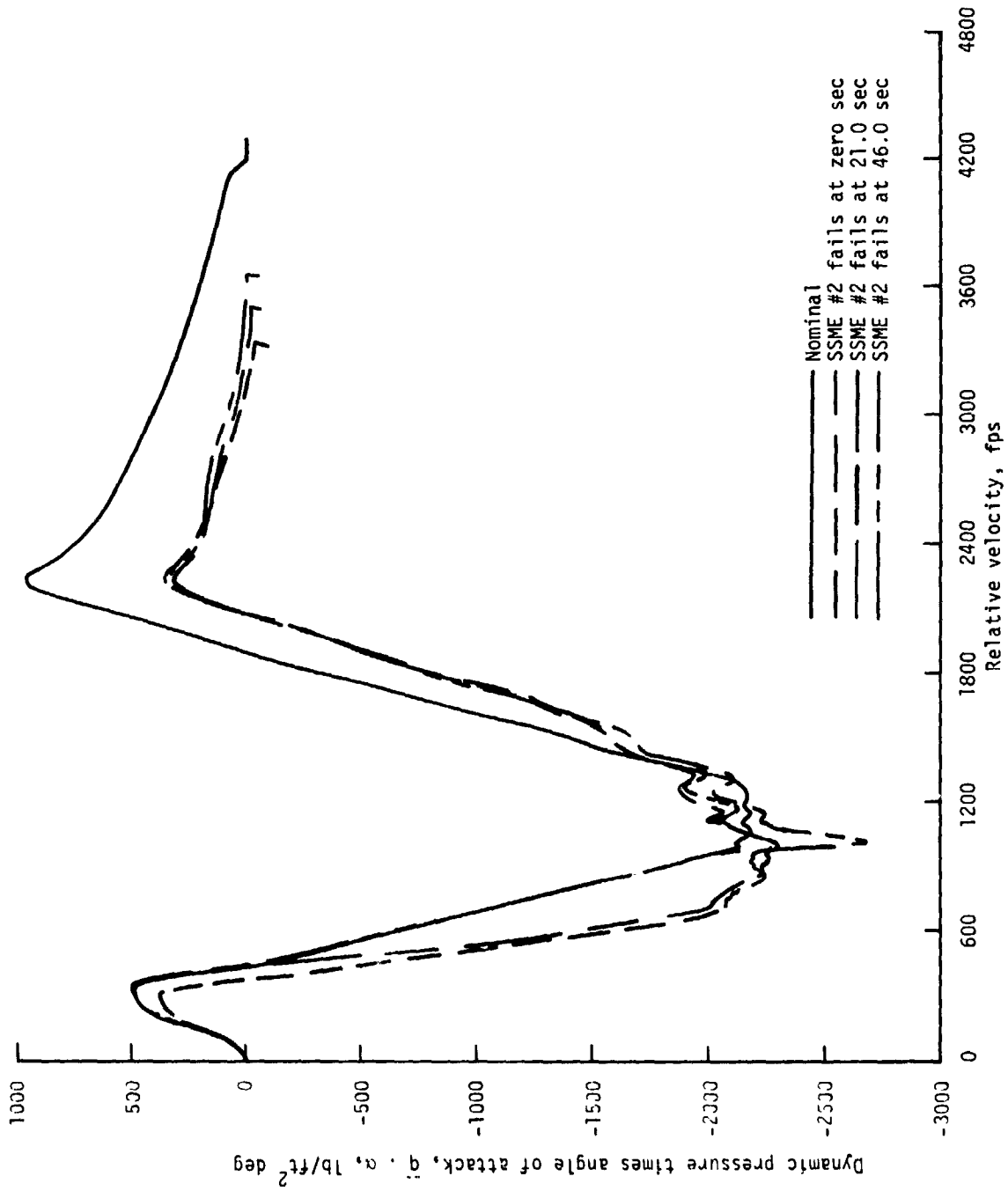

Figure 6.1-3.- STS-1 engine out $\bar{q} \cdot \alpha$ results for April mean wind.

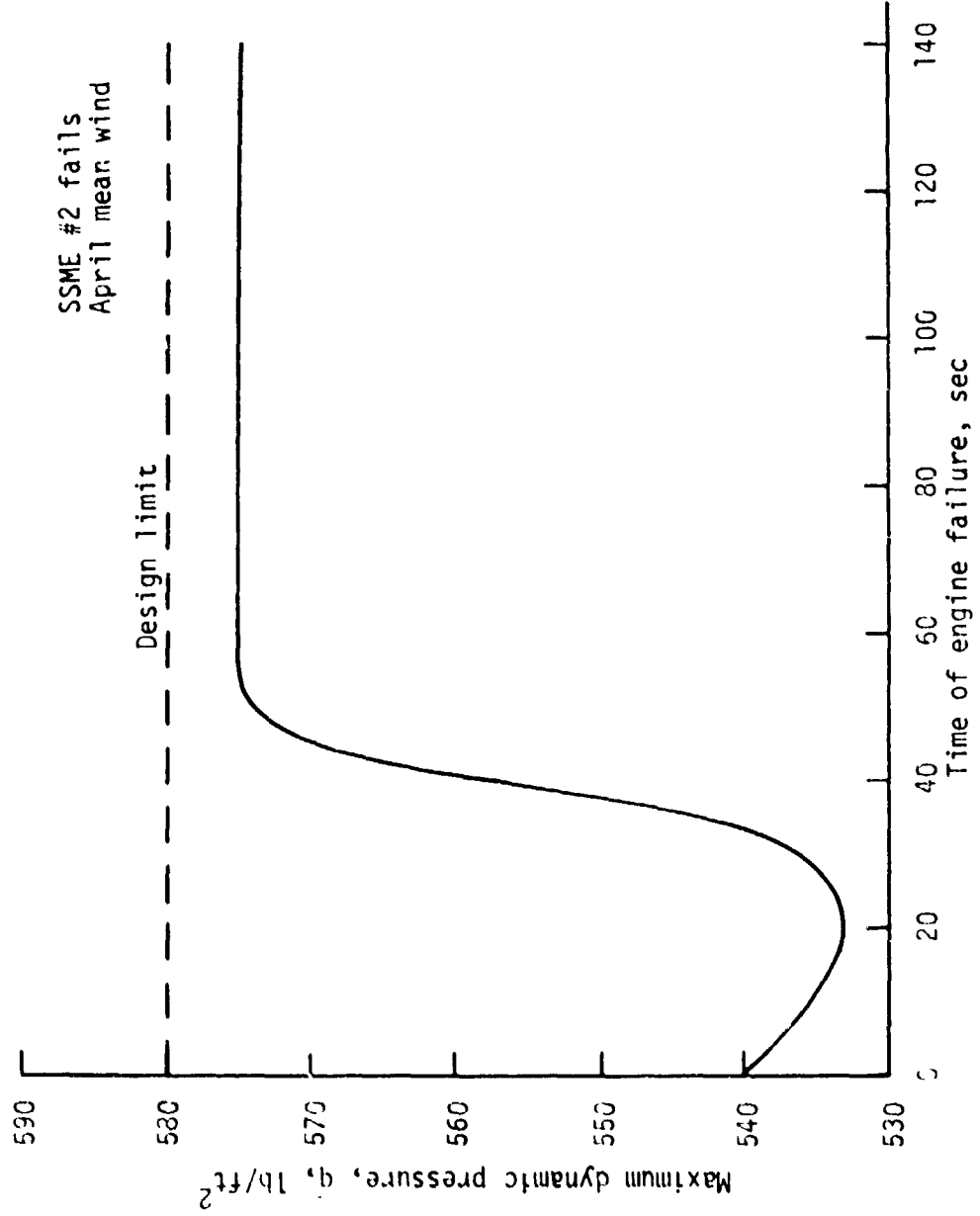

Figure 6.1-4.- STS-1 variation of max \bar{q} with engine-out time April mean wind.

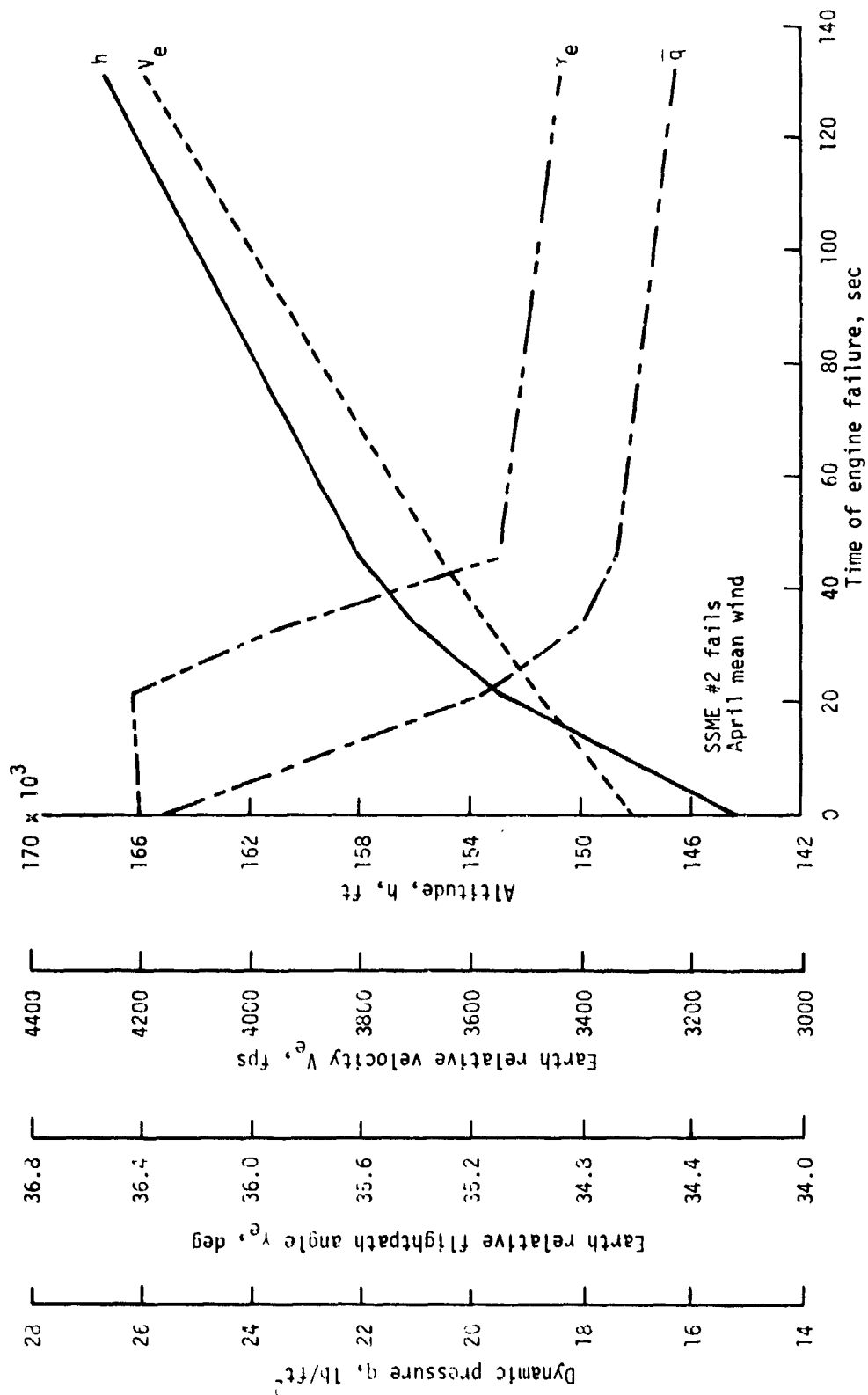

Figure 6.1-5.- STS-1 variation of SRB separation conditions with engine-out time.

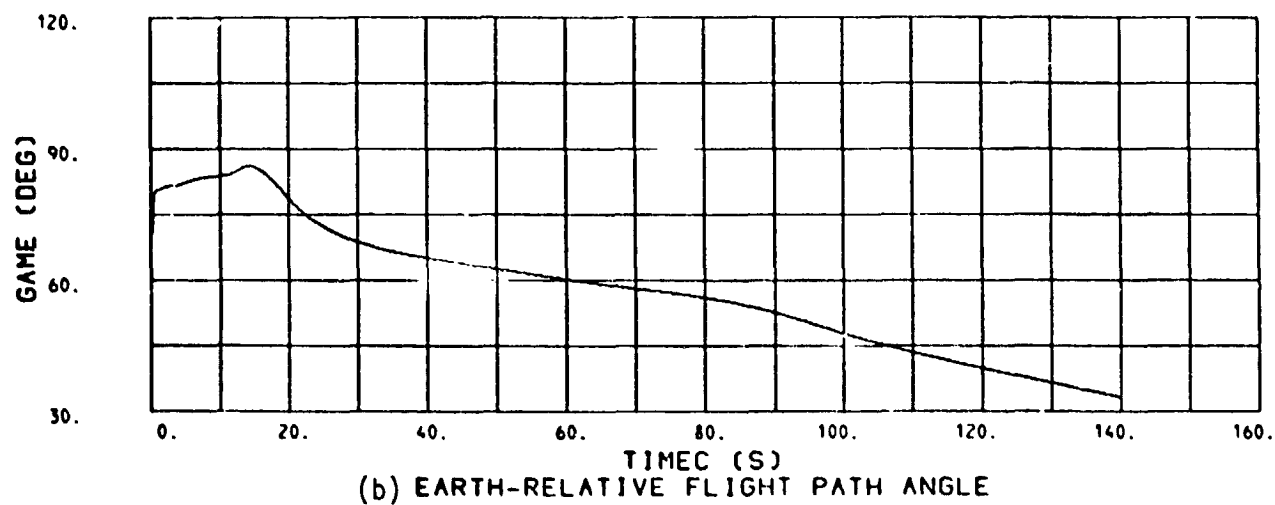
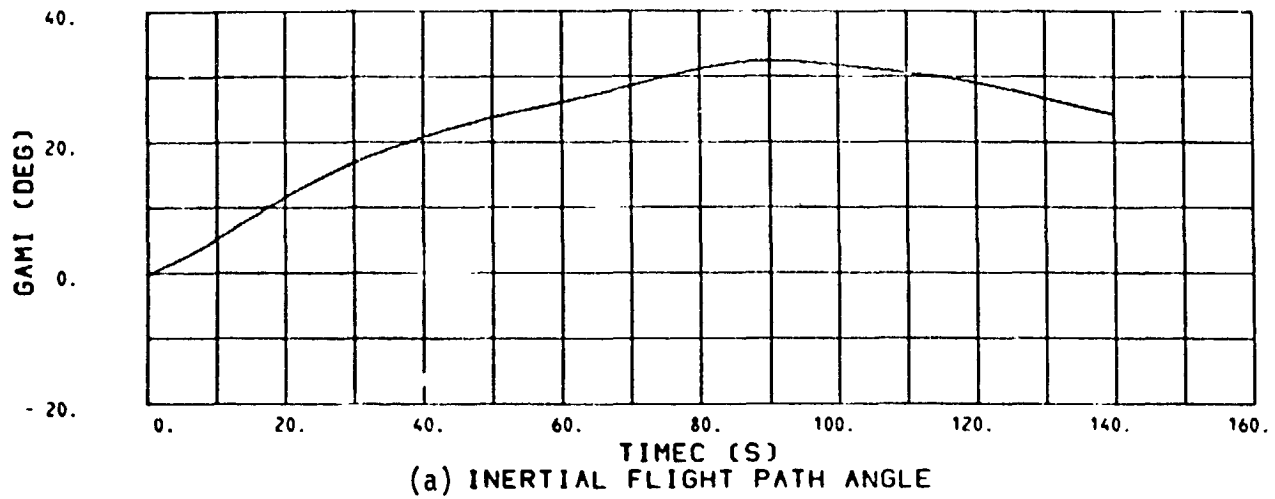
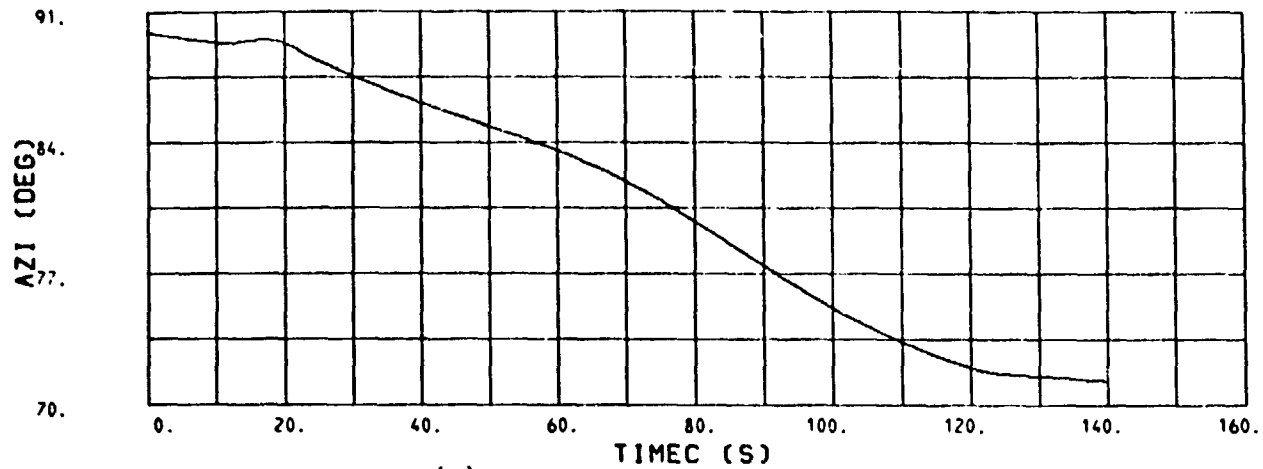
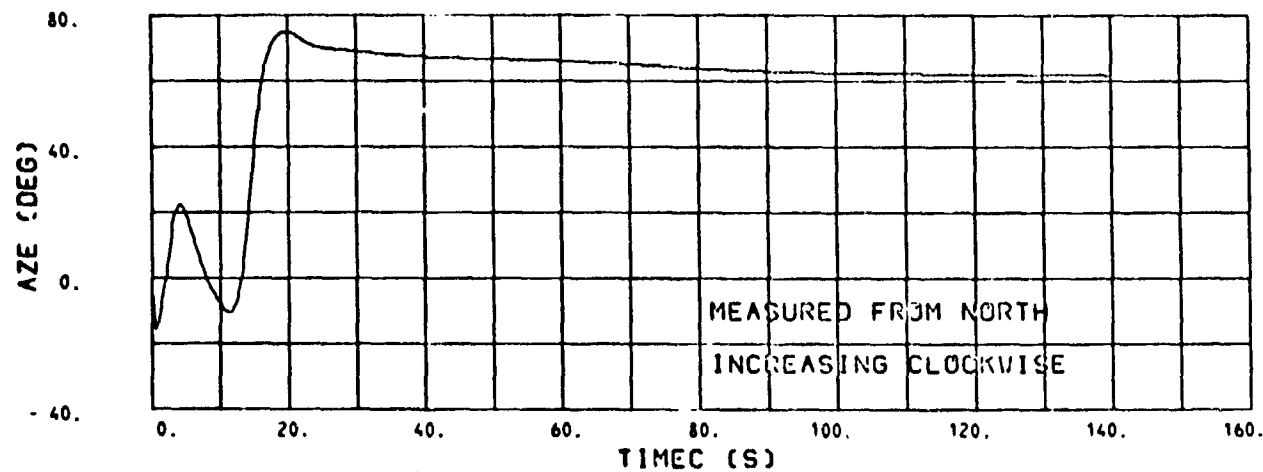

Figure 6.1-6.- SSME number 2 failing at lift-off trajectory parameter time histories.



(c) INERTIAL FLIGHT AZIMUTH



(d) EARTH-RELATIVE FLIGHT AZIMUTH

MEASURED FROM NORTH
INCREASING CLOCKWISE

Figure 6.1-6.- Continued.

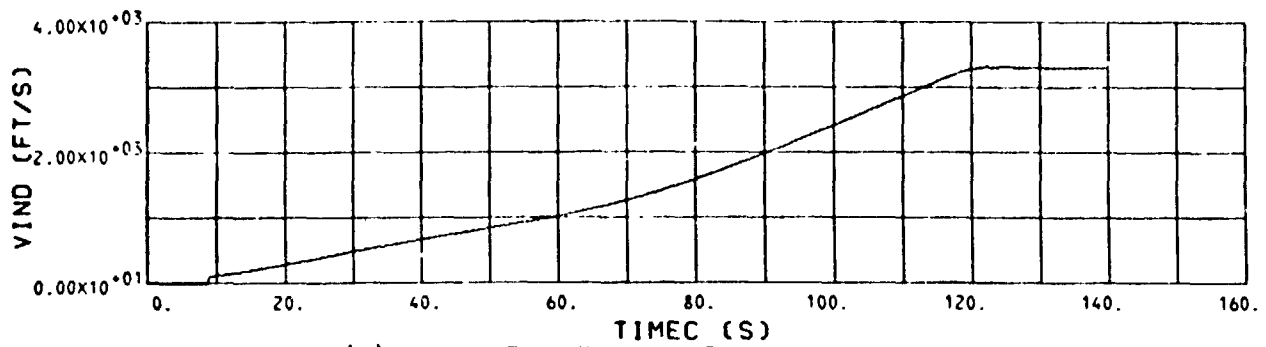

(e) INDICATED EARTH-RELATIVE VELOCITY

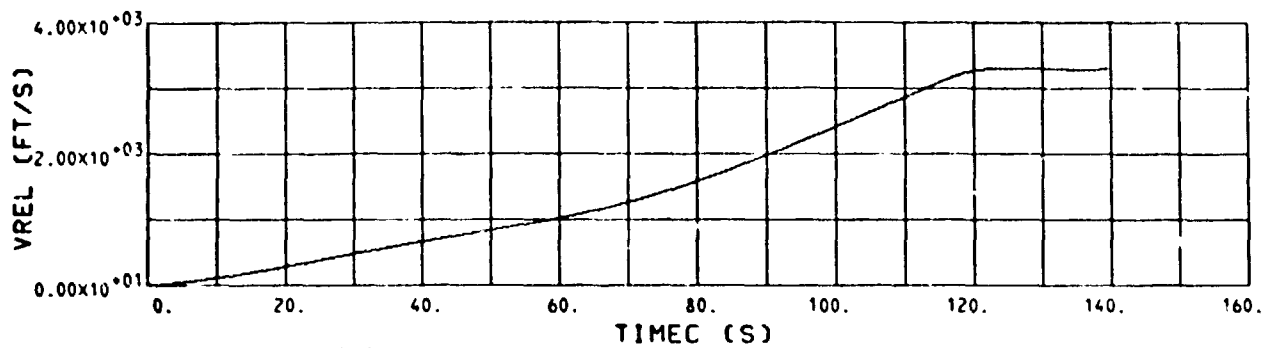

(f) NAVIGATION EARTH-RELATIVE VELOCITY

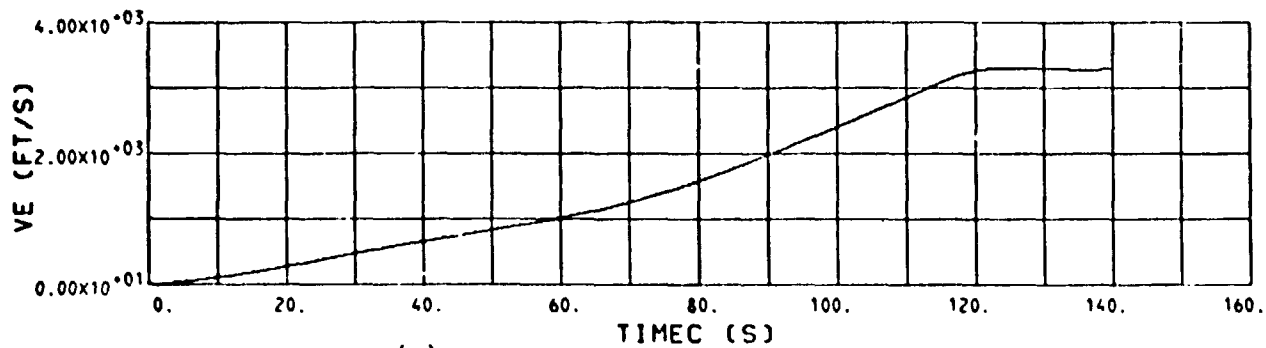

(g) SVDS EARTH RELATIVE VELOCITY

Figure 6.1-6.- Continued.

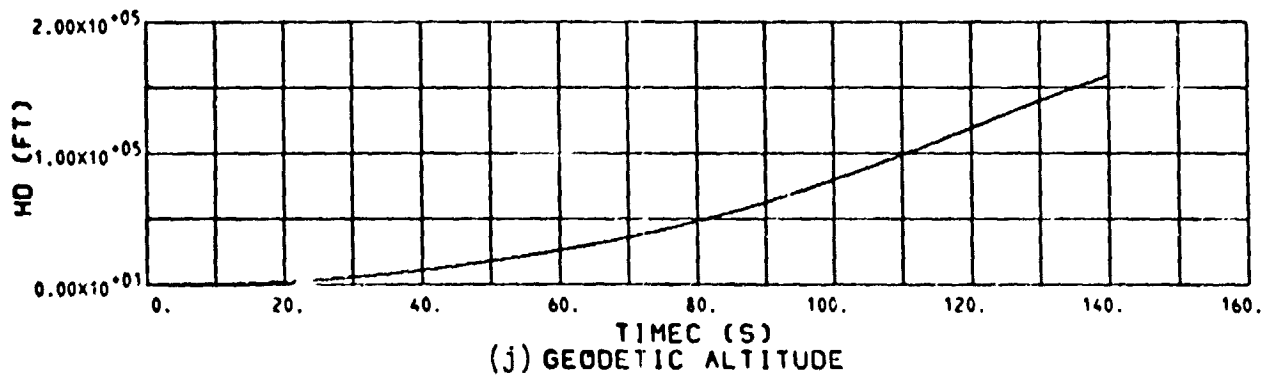
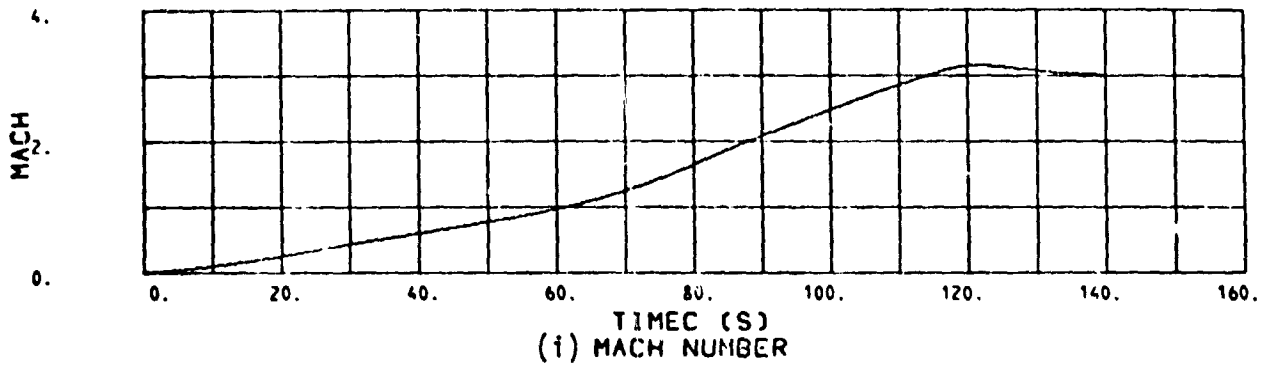
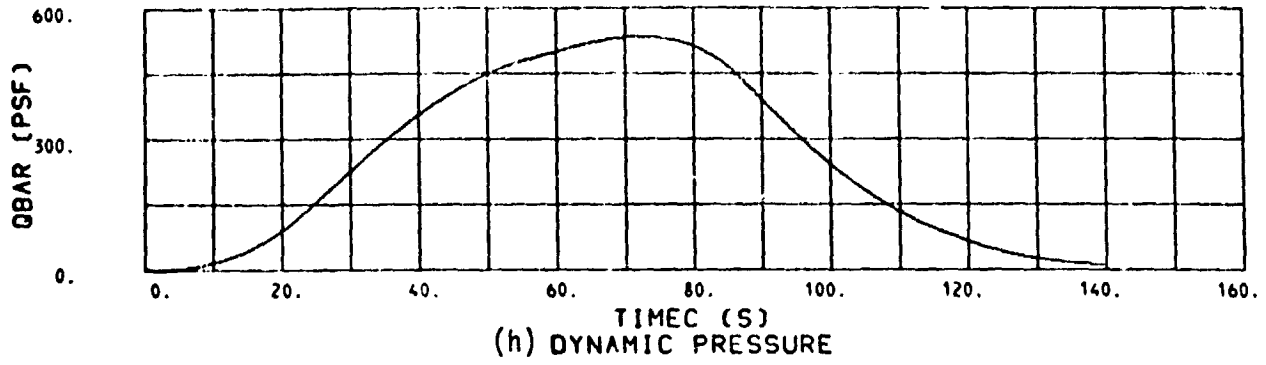

Figure 6.1-6.- Continued.

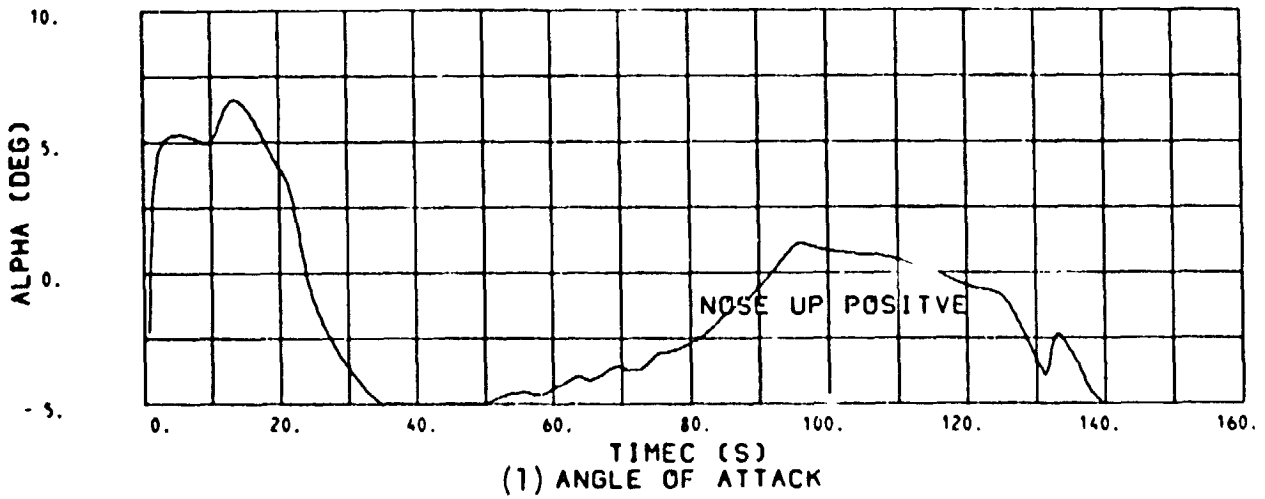
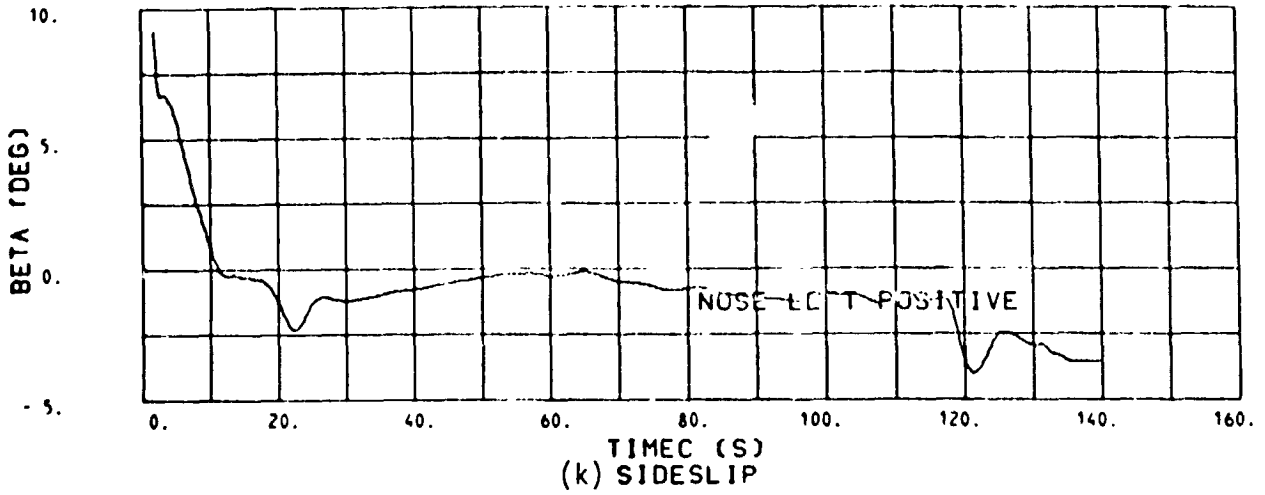

Figure 6.1-6.- Continued.

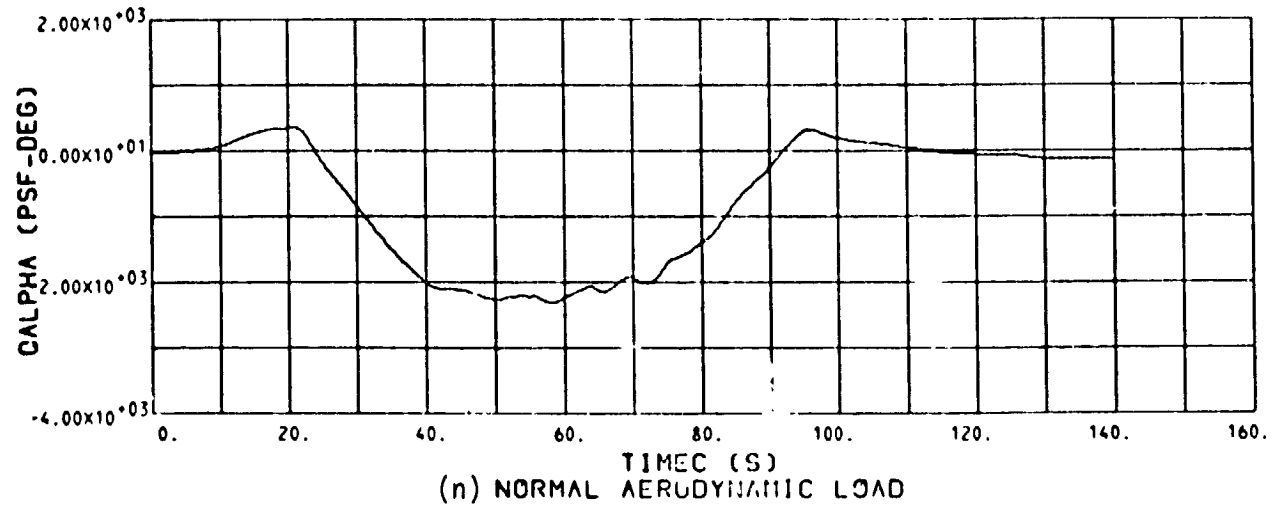
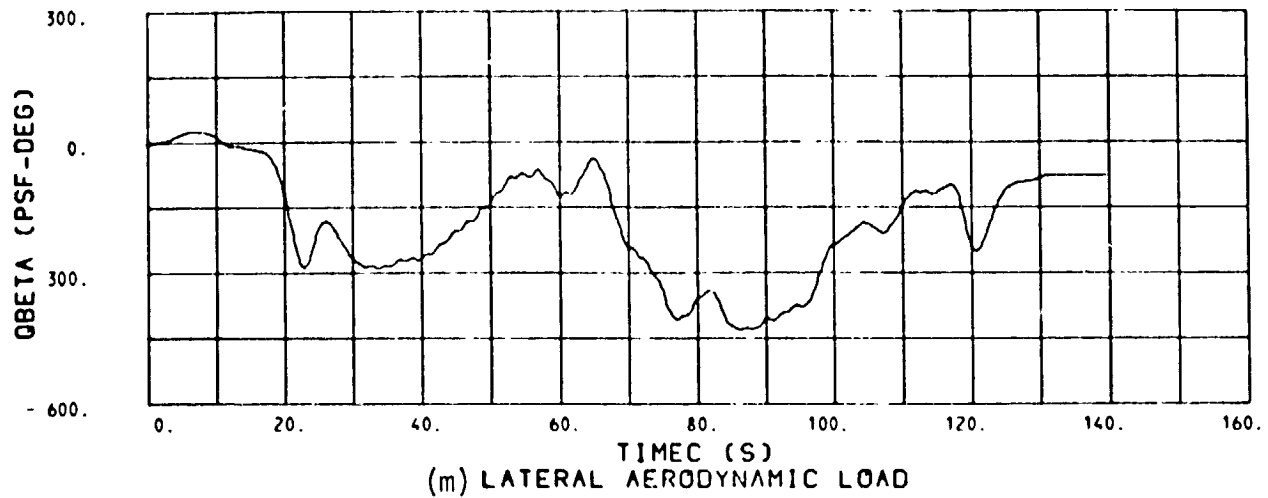
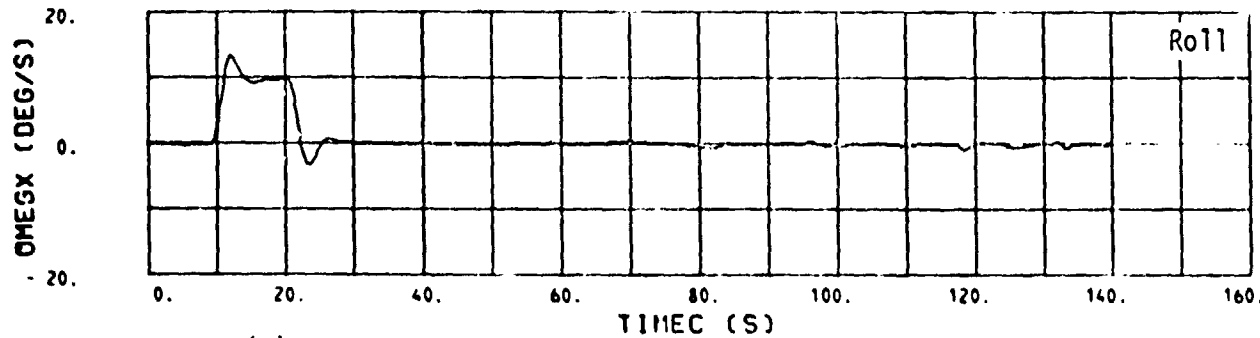
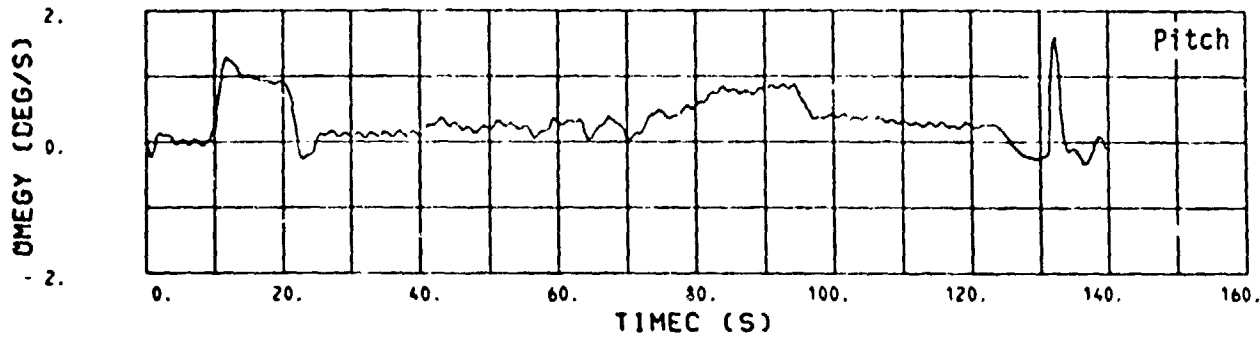
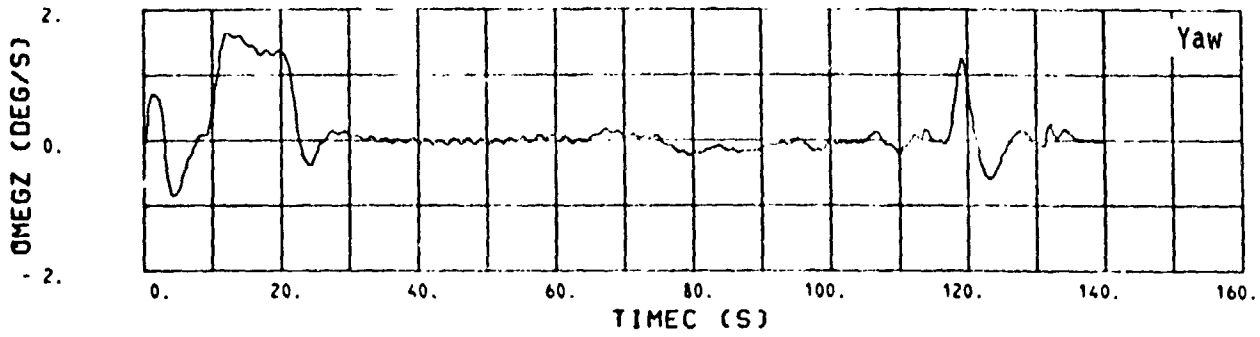
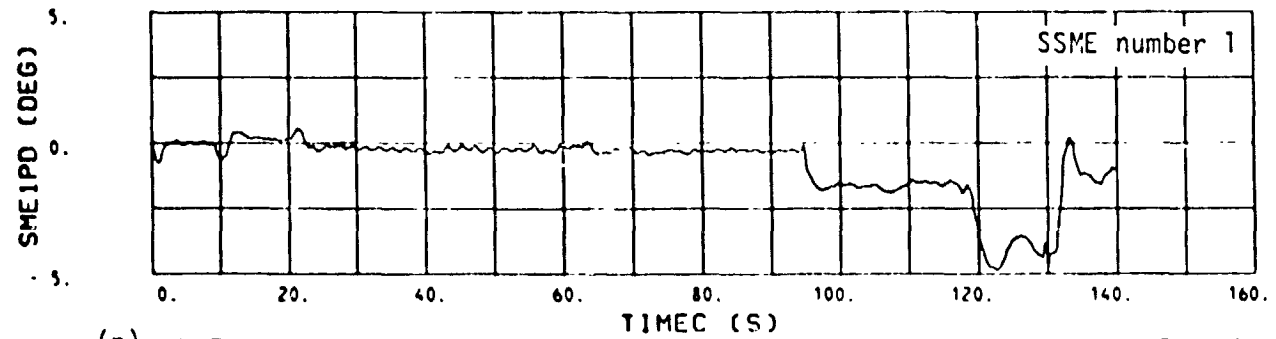
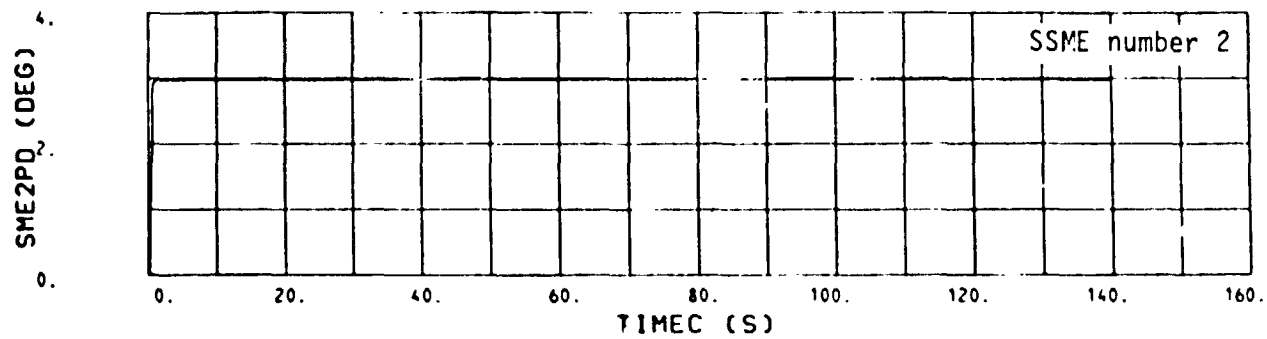
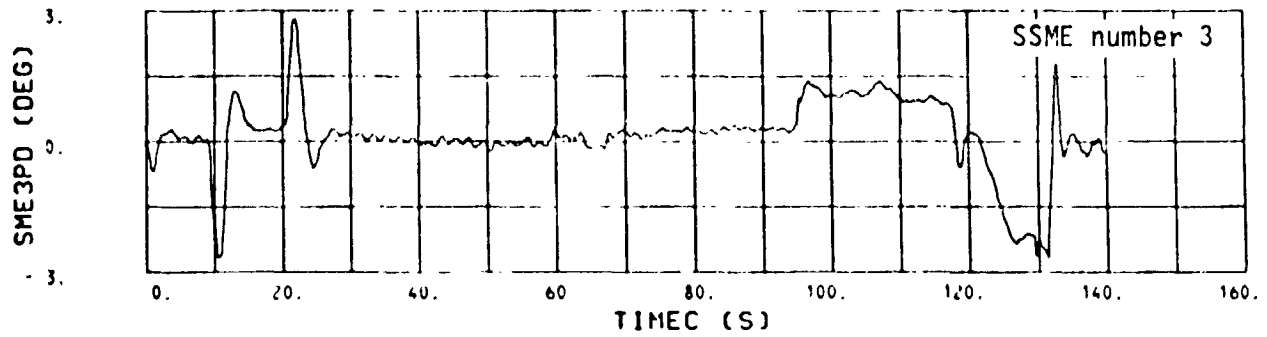

Figure 6.1-6.- Continued.



(o) ACTUAL BODY RATE VECTOR FROM SVDS ENVIRONMENT

Figure 6.1-6.- Continued.



(P) SSME ACTUAL PITCH GIMBAL DEFLECTION WRT NULL AXIS (POS. DOWN)

Figure 6.1-6.- Continued.

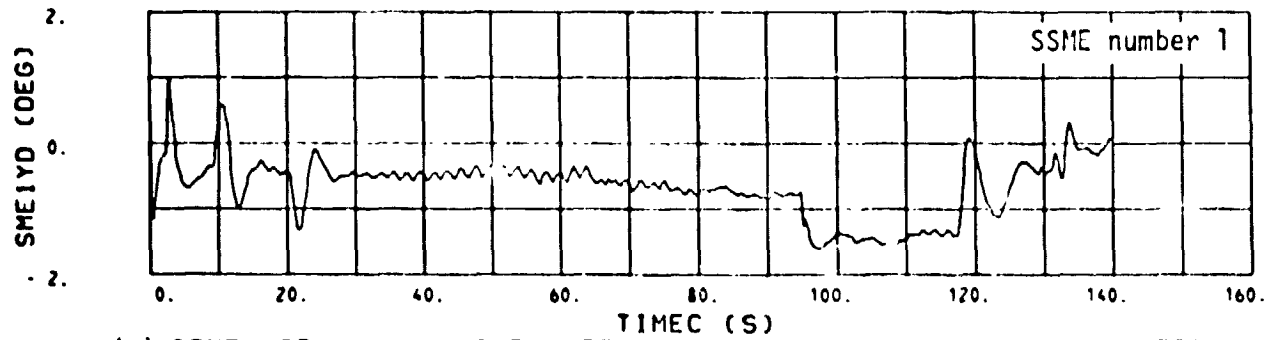
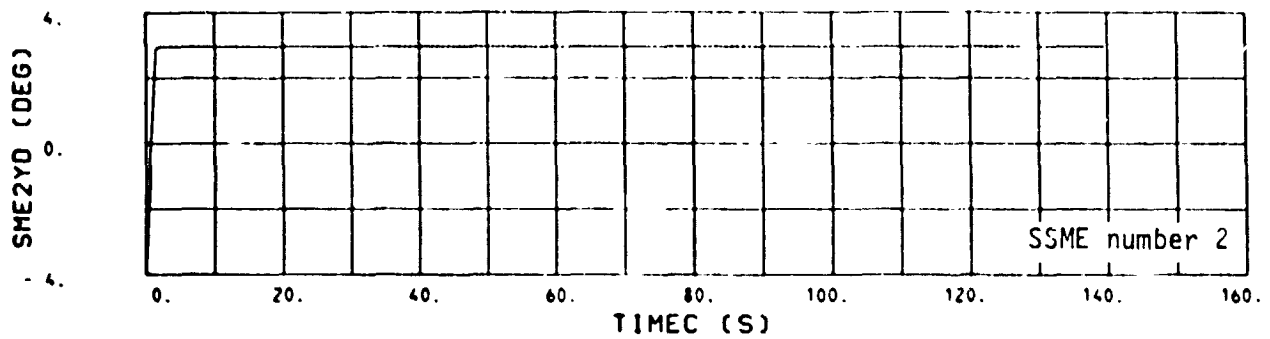
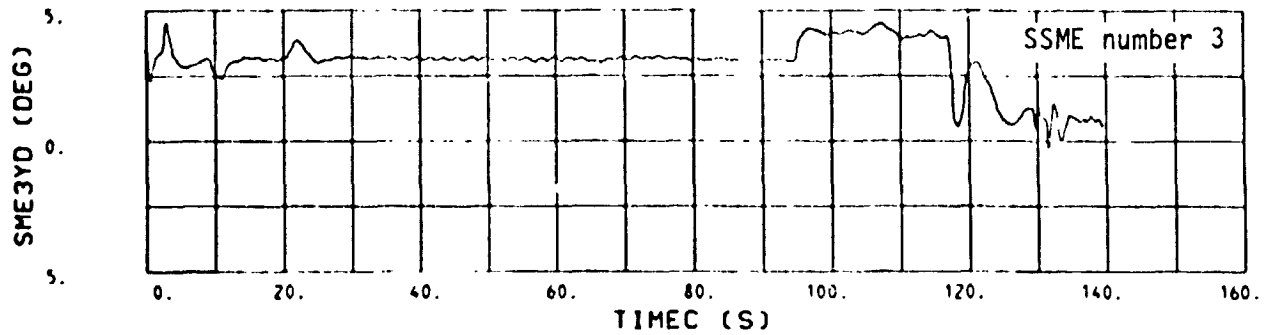

(q) SSME ACTUAL YAW GIMBAL DEFLECTION WRT NULL AXIS (POS. LEFT)

Figure 6.1-6.- Continued.

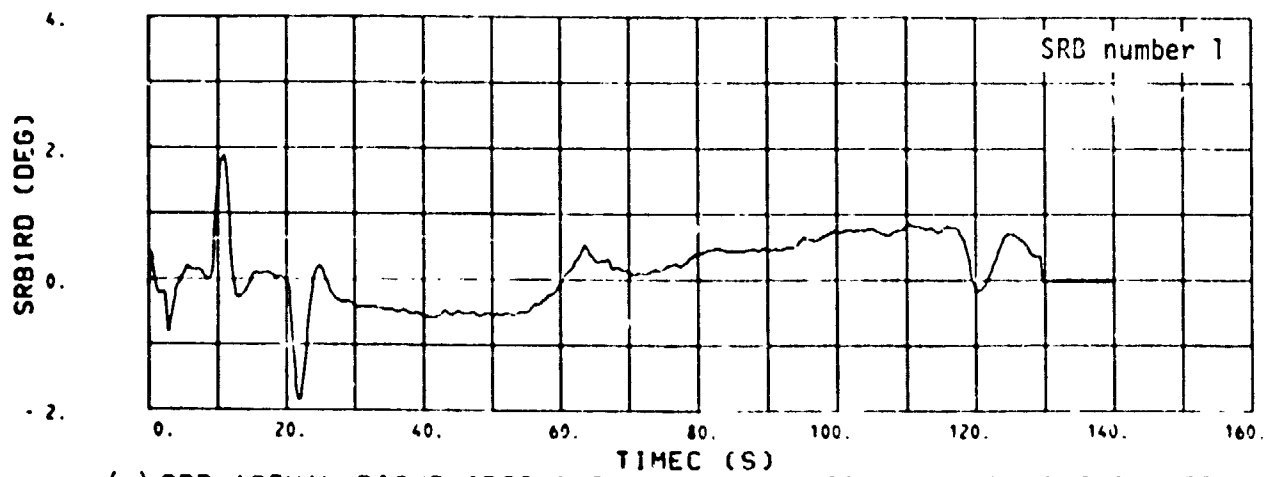
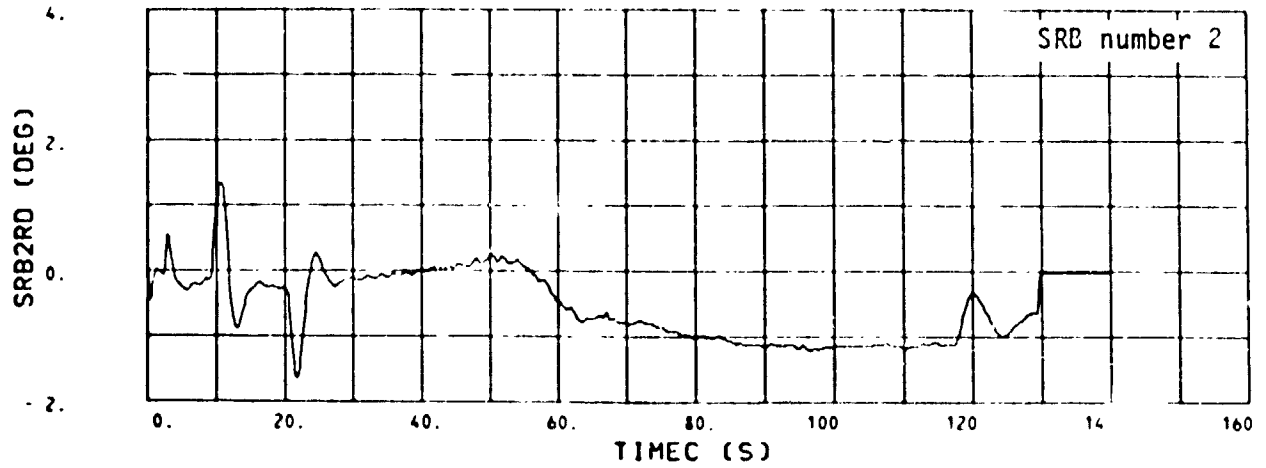

(r) SRB ACTUAL RIGHT (ROCK) GIMBAL DEFLECTIONS (POSITIVE INWARD)

Figure 6.1-6.- Continued.

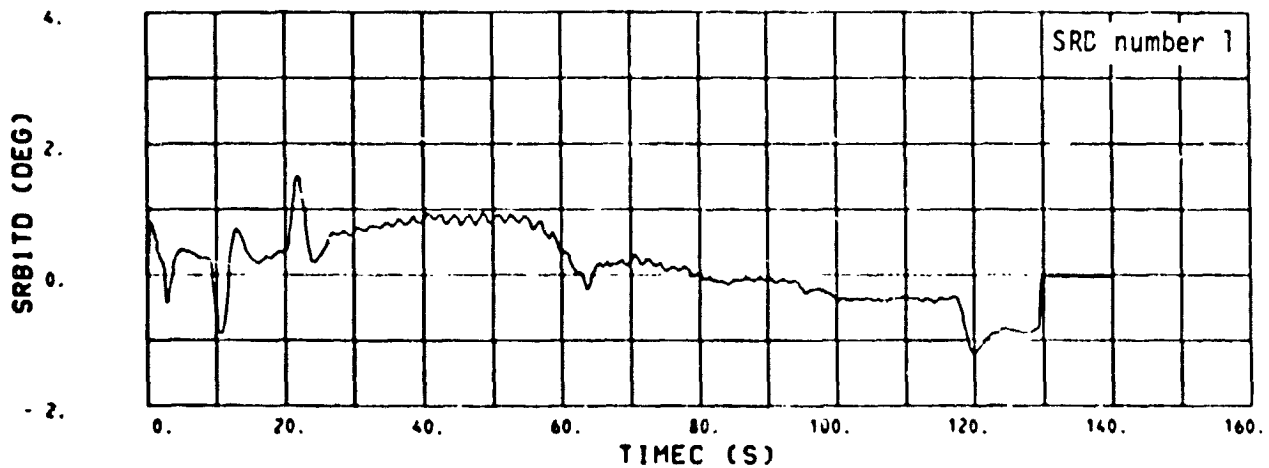
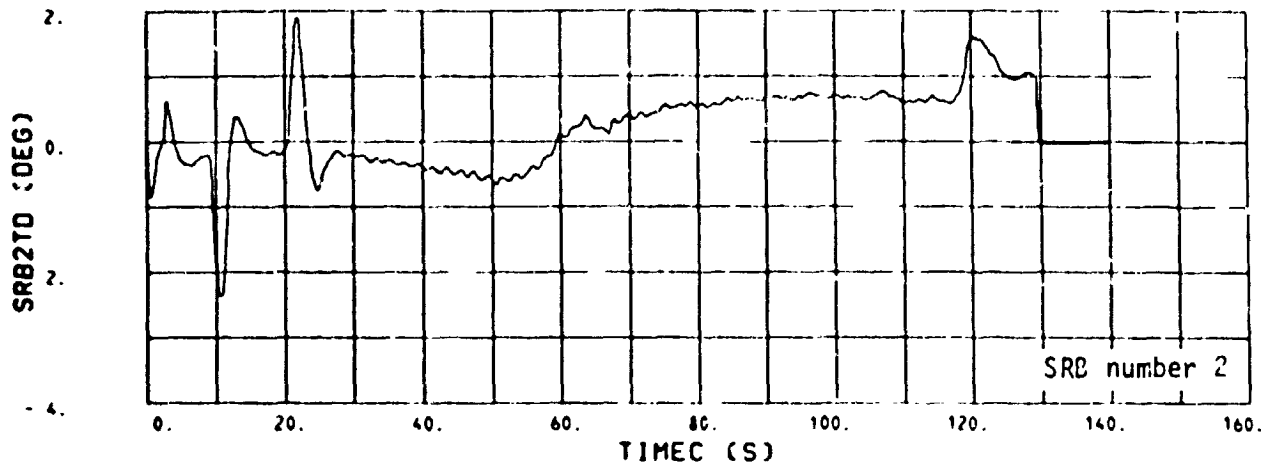

(s) SRB ACTUAL LEFT (TILT) GIMBAL DEFLECTIONS (POSITIVE INWARD)

Figure 6.1-6.- Concluded.

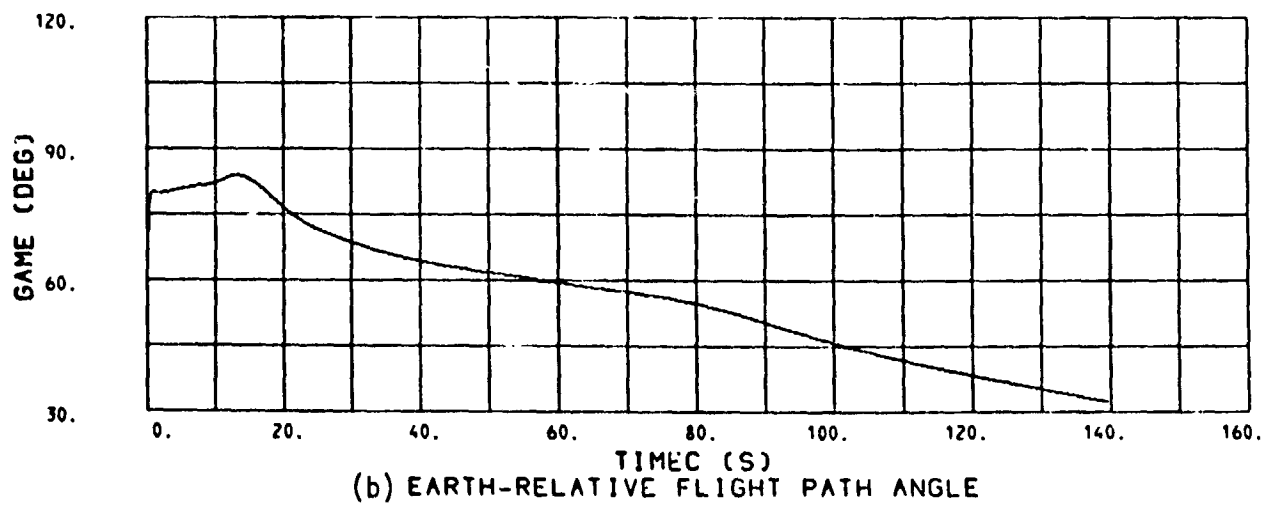
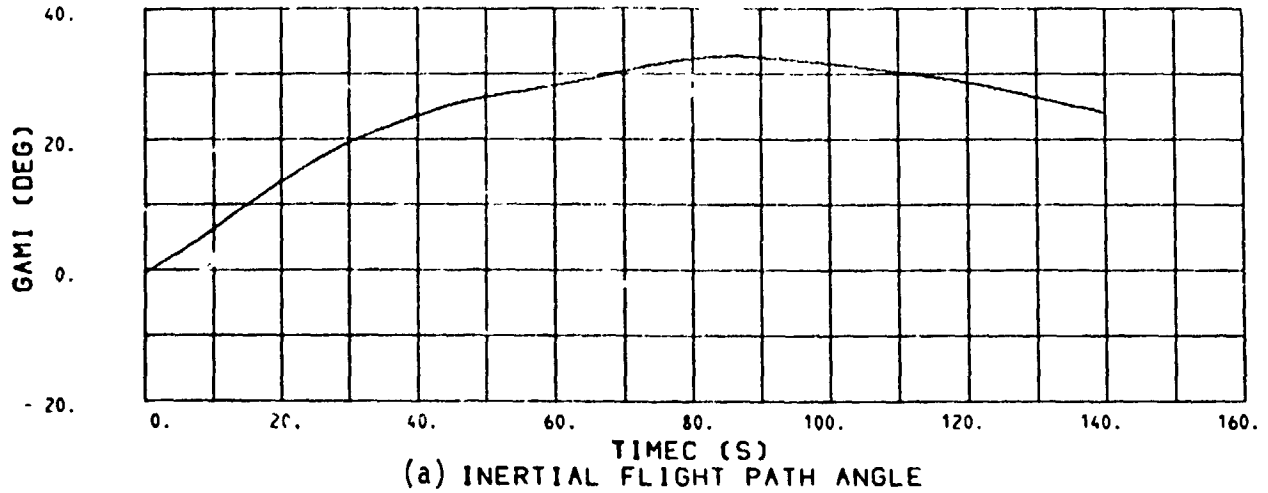

Figure 6.1-7.- SSME number 2 failing at 46 seconds trajectory parameter time histories.

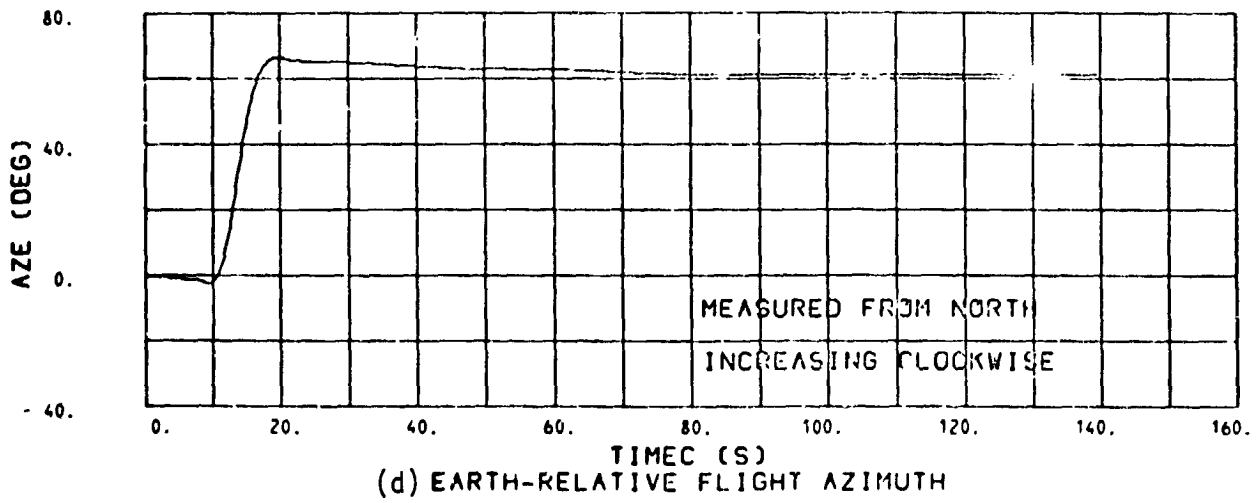
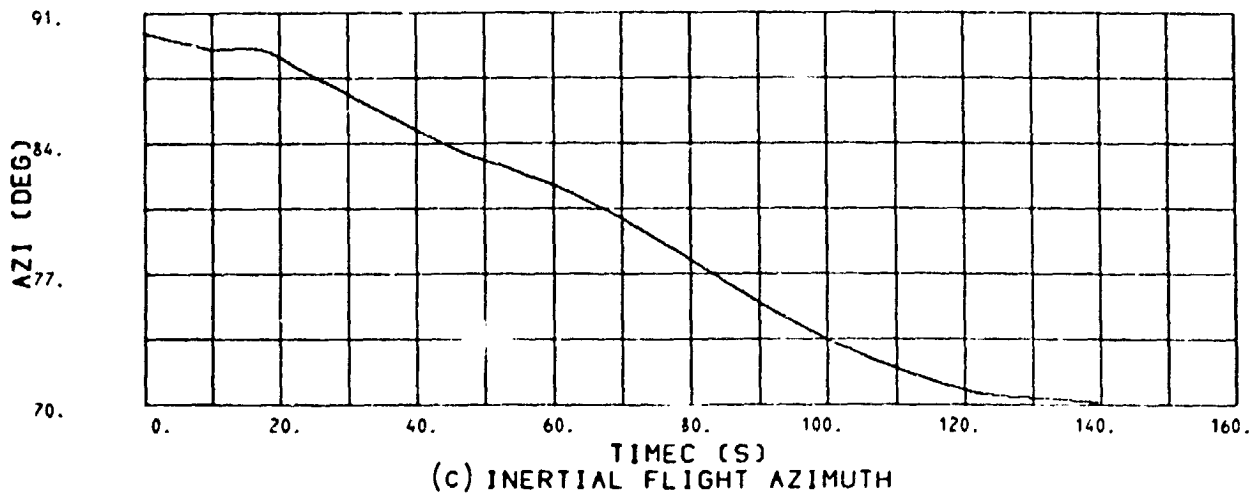
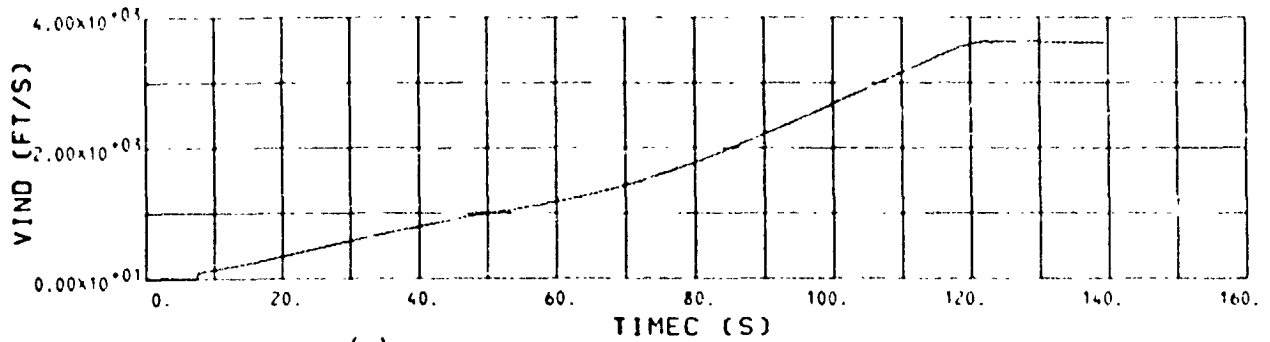
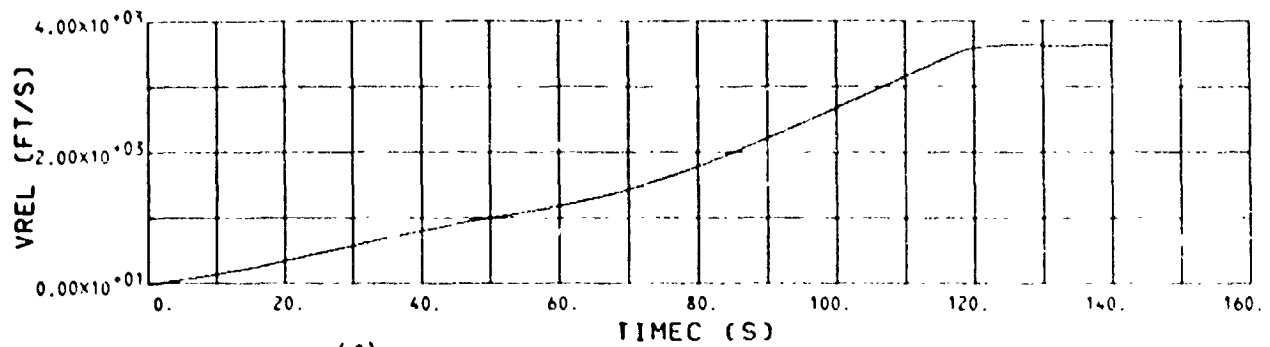

Figure 6.1-7.- Continued.



(e) INDICATED EARTH-RELATIVE VELOCITY



(f) NAVIGATION EARTH-RELATIVE VELOCITY

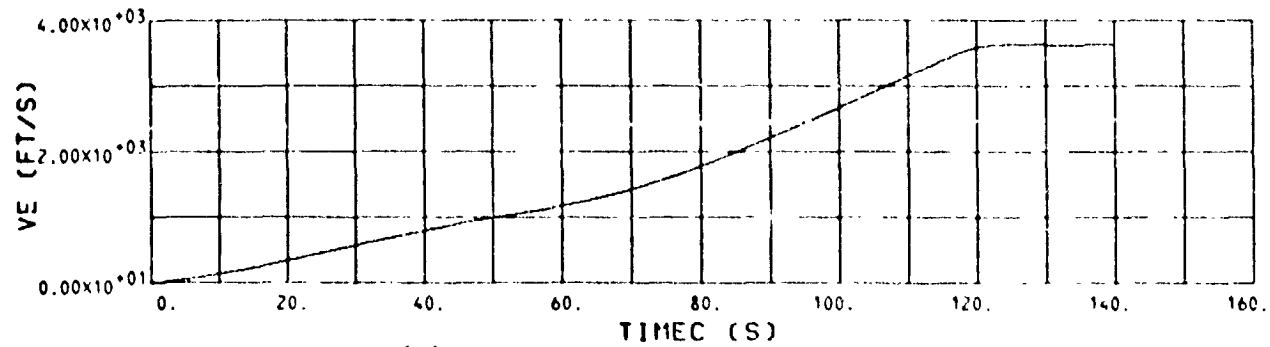

(g) SVDS EARTH RELATIVE VELOCITY

Figure 6.1-7.- Continued.

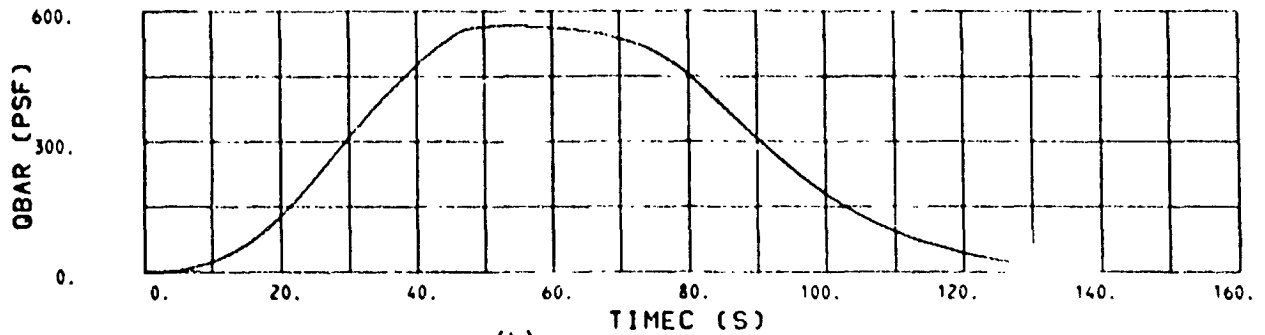

(h) DYNAMIC PRESSURE

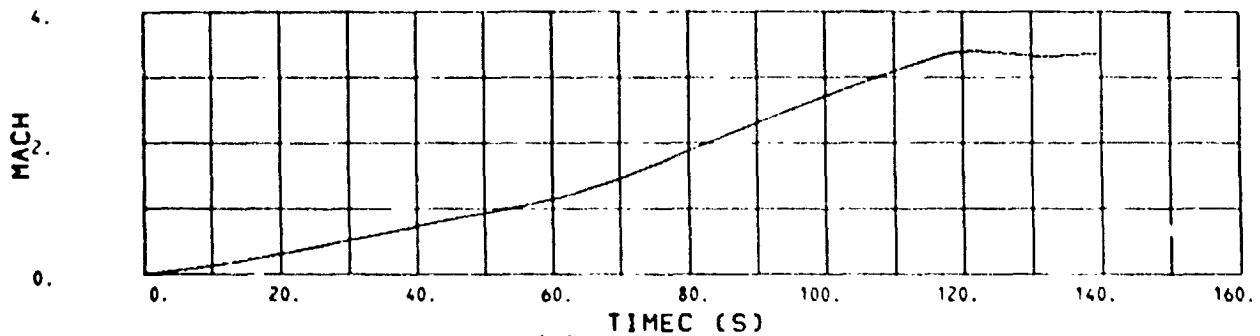

(i) MACH NUMBER

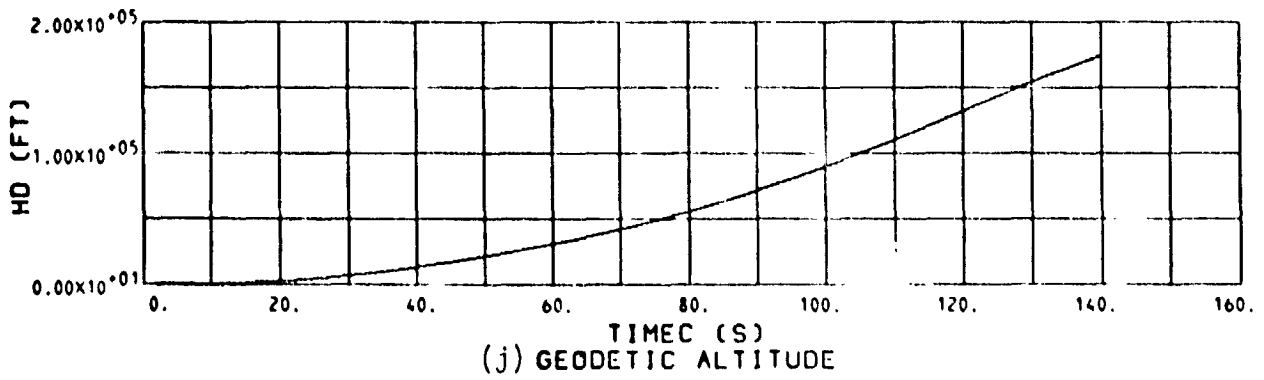

(j) GEODETIC ALTITUDE

Figure 6.1-7.- Continued.

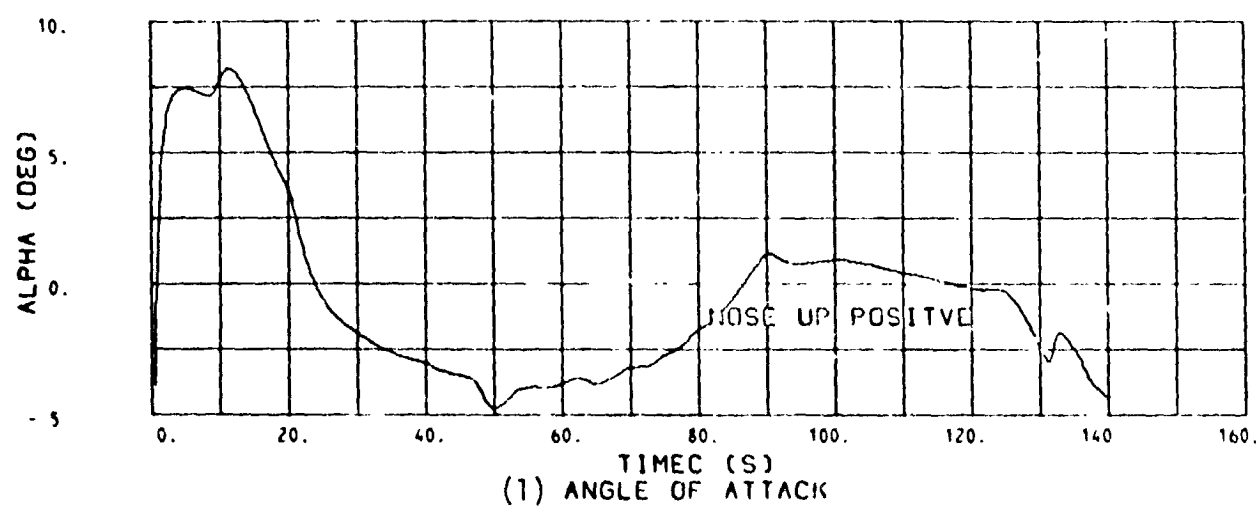
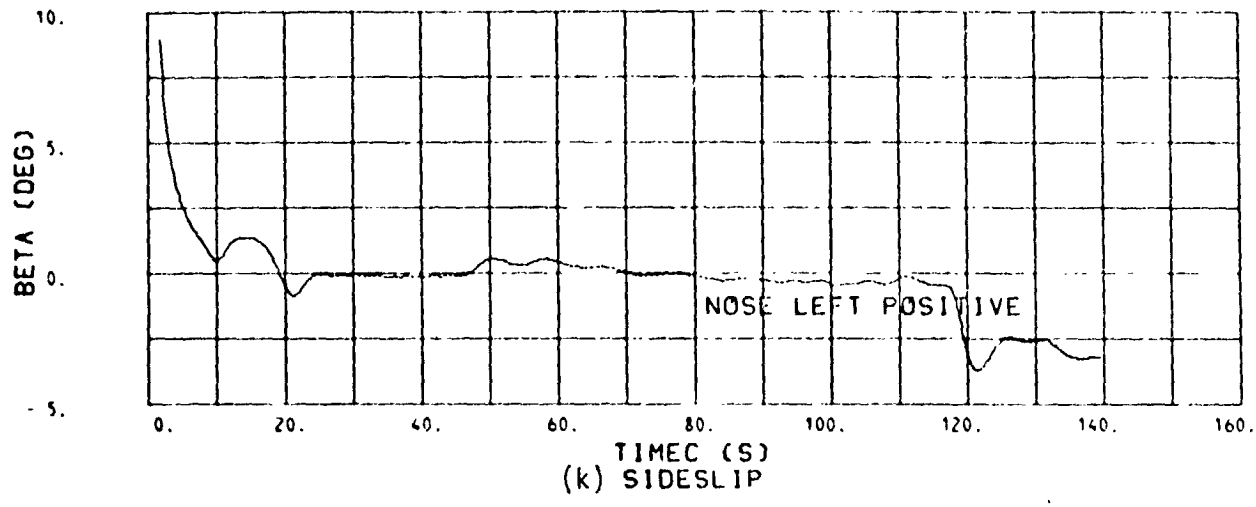

Figure 6.1-7.- Continued.

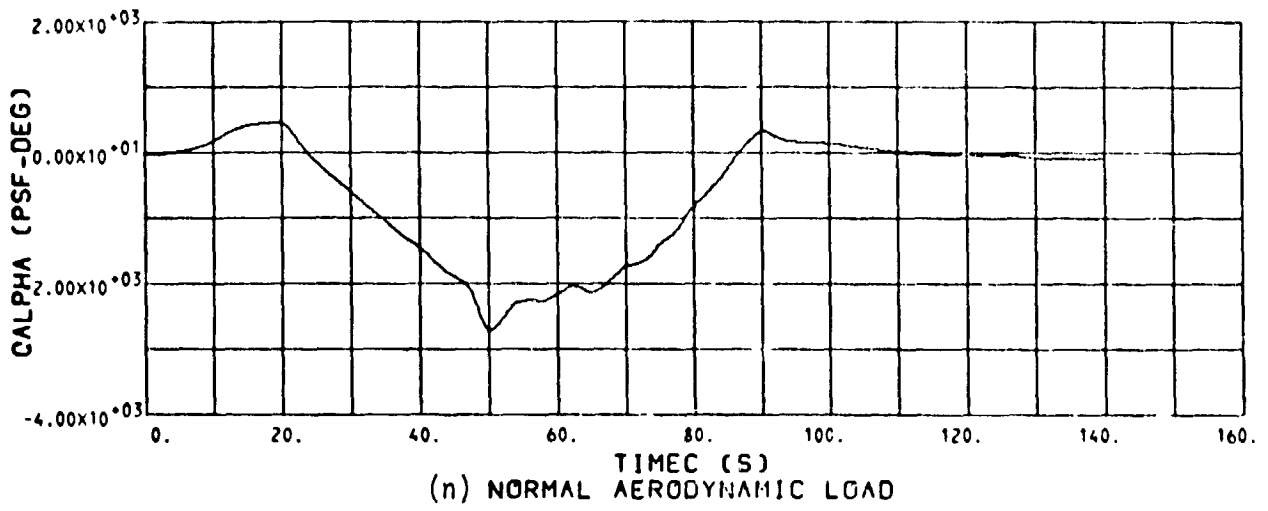
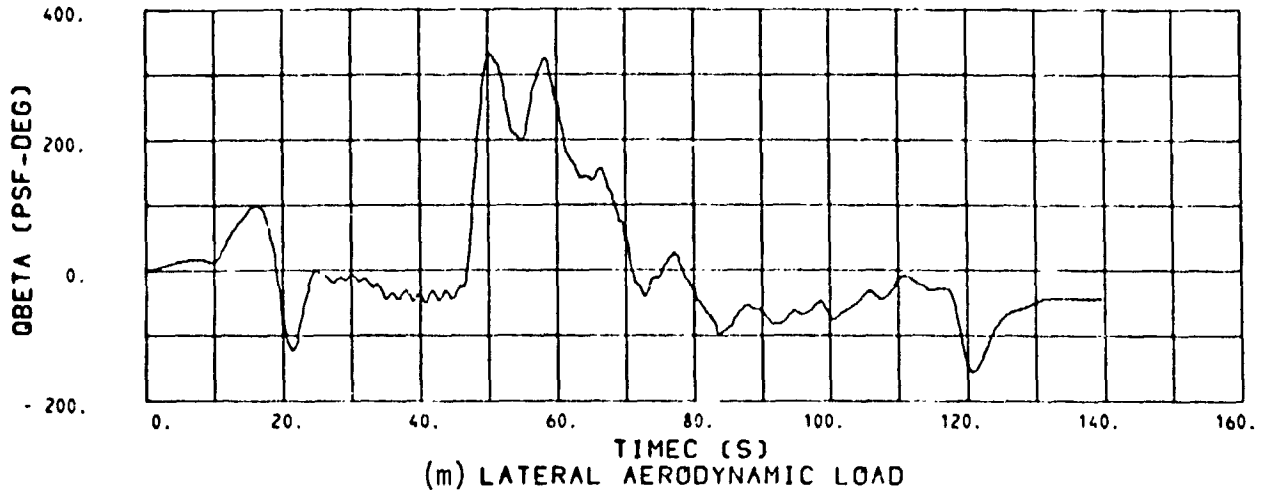
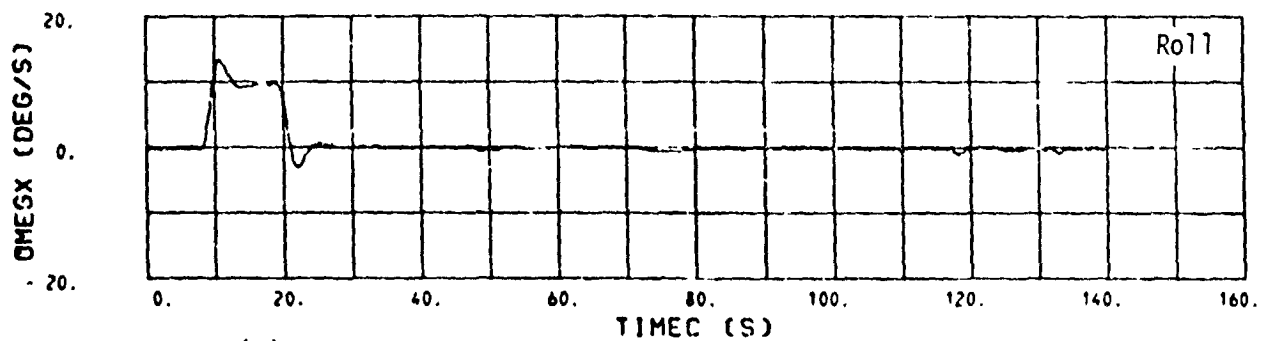
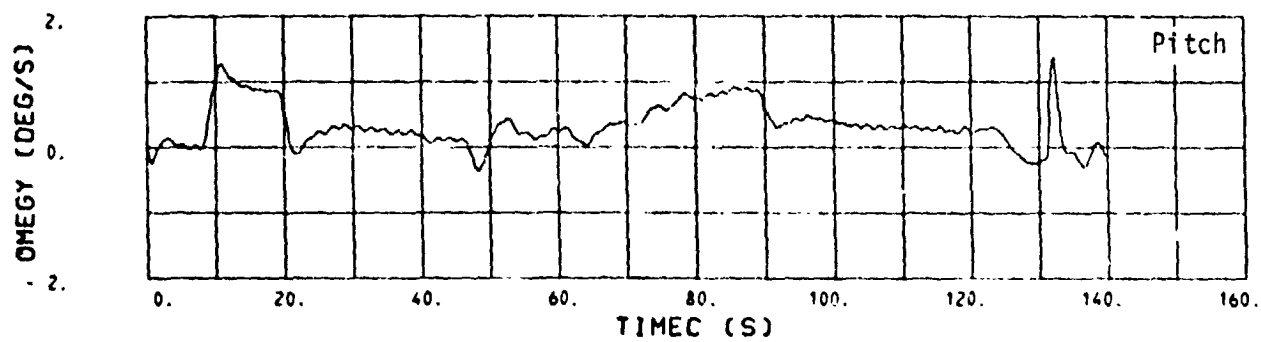
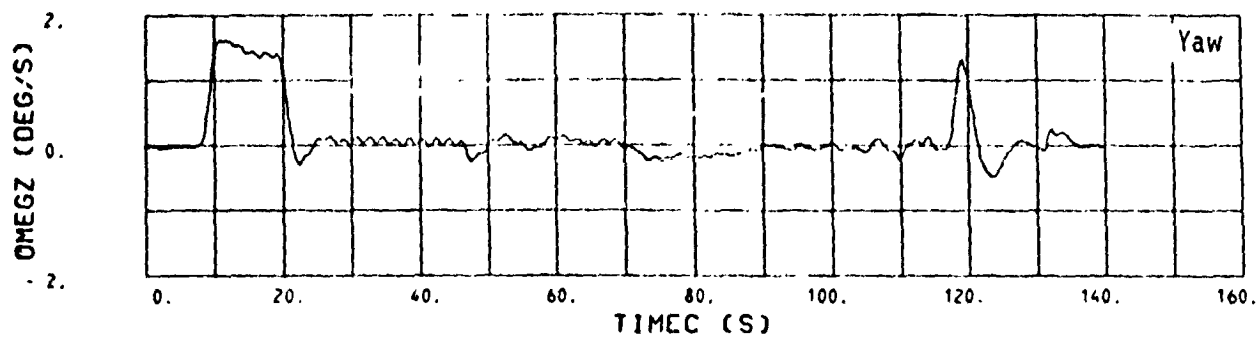
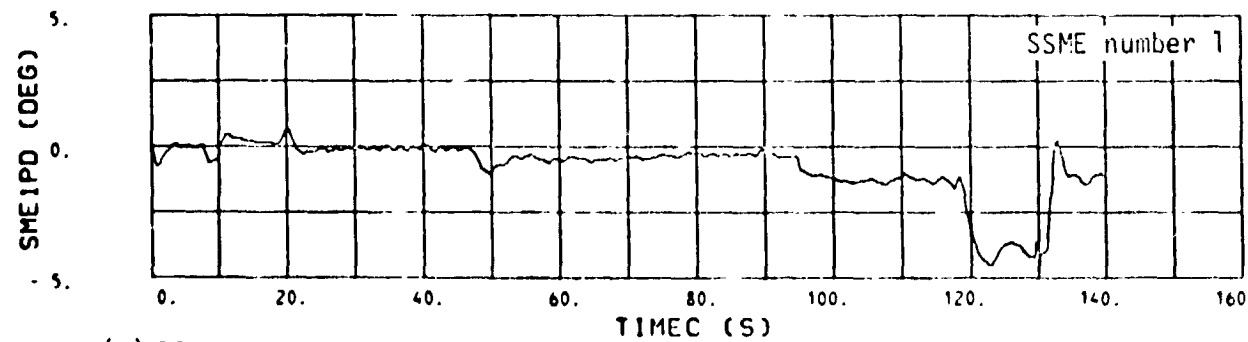
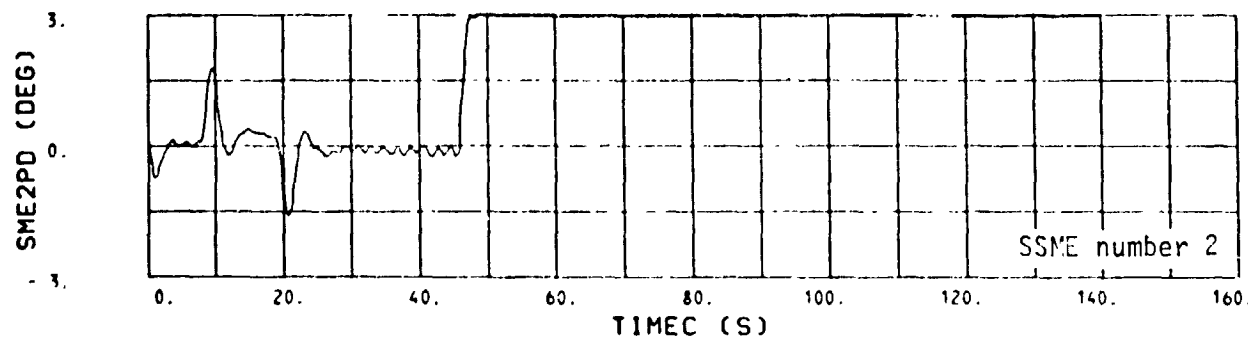
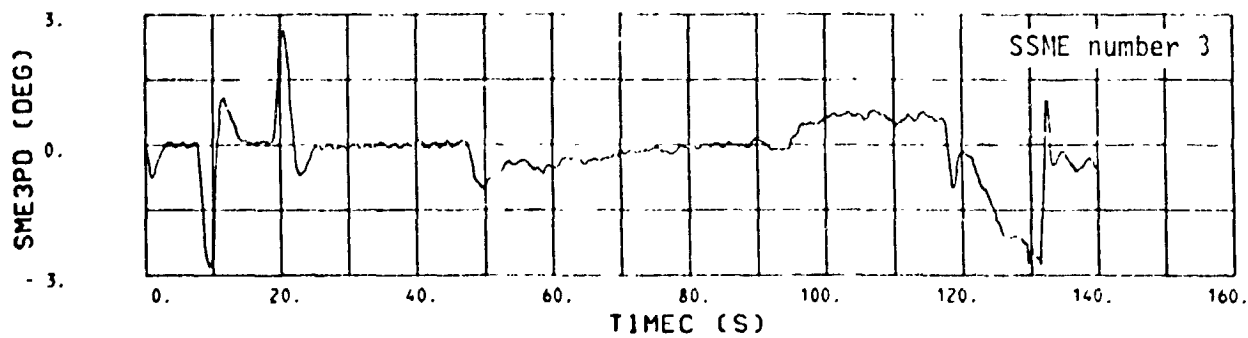

Figure 6.1-7.- Continued.



(o) ACTUAL BODY RATE VECTOR FROM SVDS ENVIRONMENT

Figure 6.1-7.- Continued.



(p) SSME ACTUAL PITCH GIMBAL DEFLECTION WRT NULL AXIS (POS. DOWN)

Figure 6.1-7.- Continued.

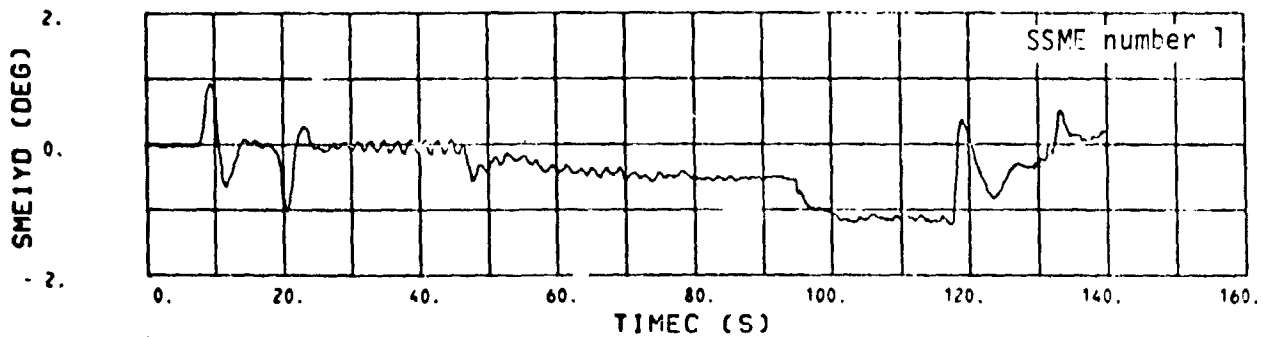
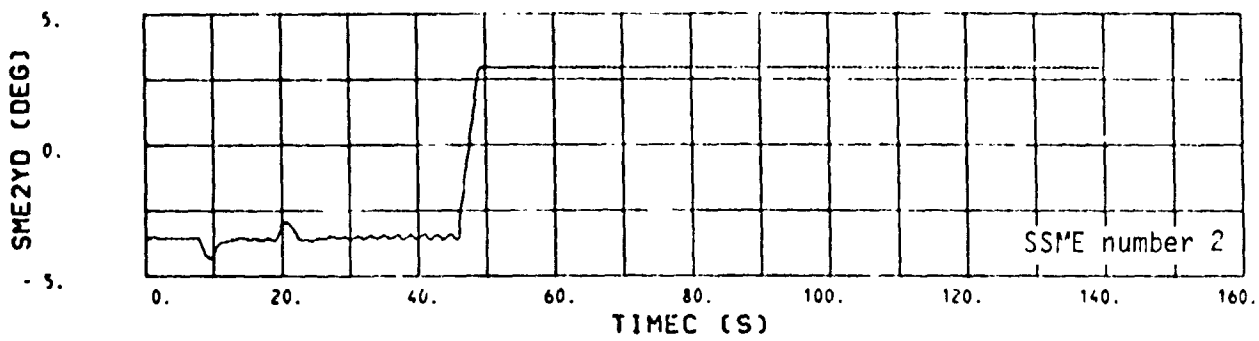
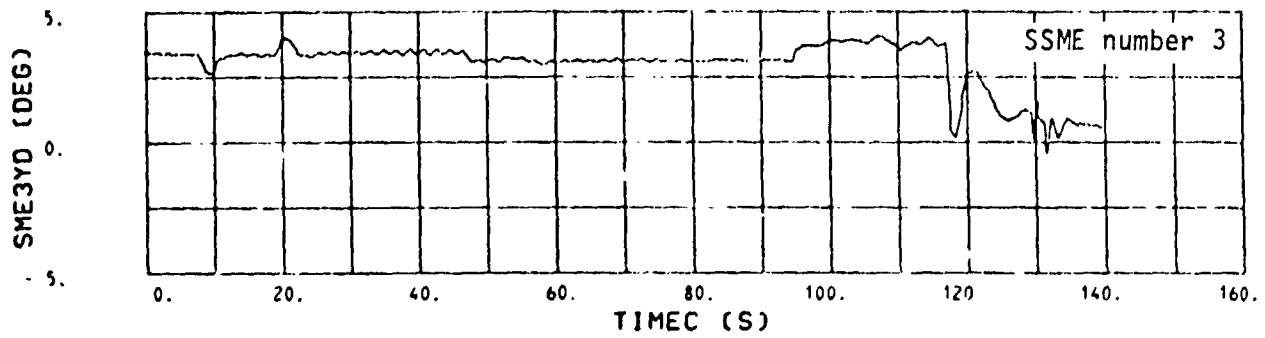

(q) SSME ACTUAL YAW GIMBAL DEFLECTION WRT NULL AXIS (POS. LEFT)

Figure 6.1-7.- Continued.

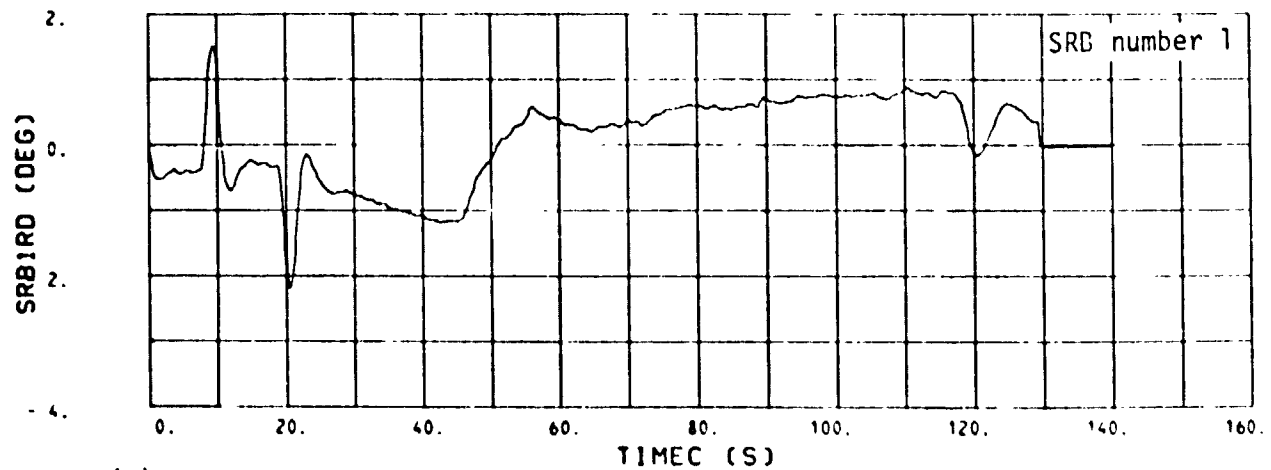
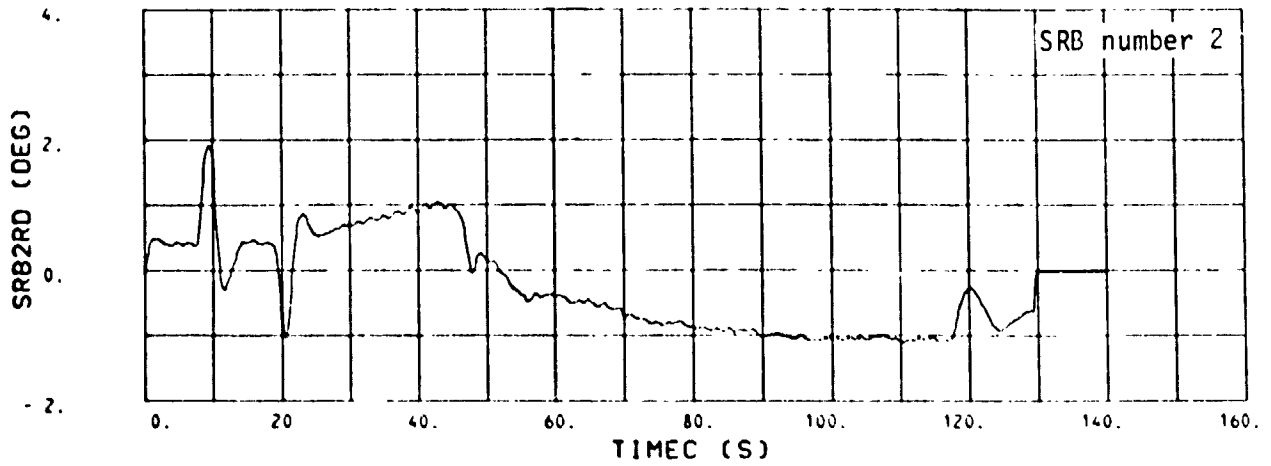

(r) SRB ACTUAL RIGHT (ROCK) GIRDAL DEFLECTIONS (POSITIVE INWARD)

Figure 6.1-7.- Continued.

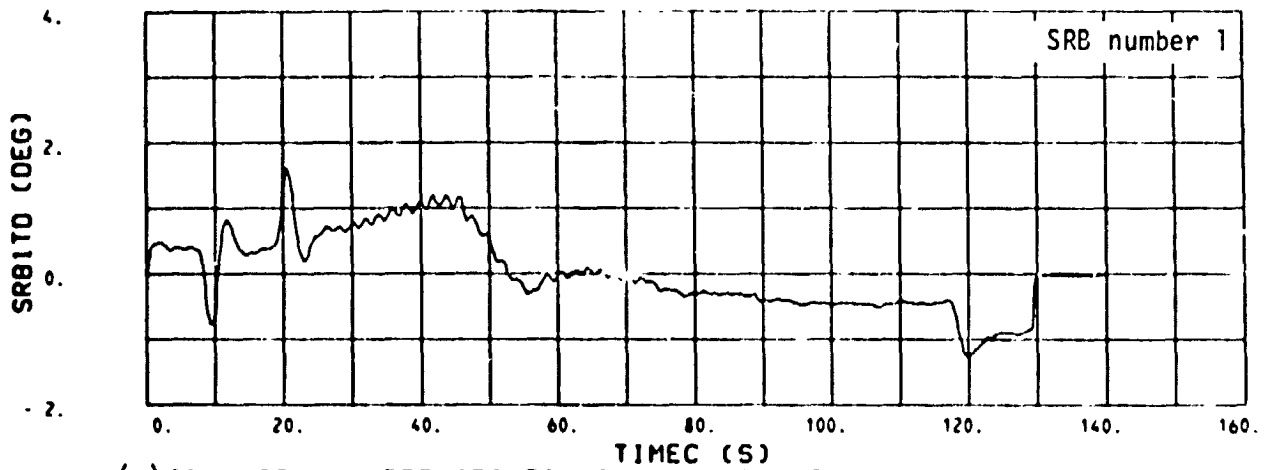
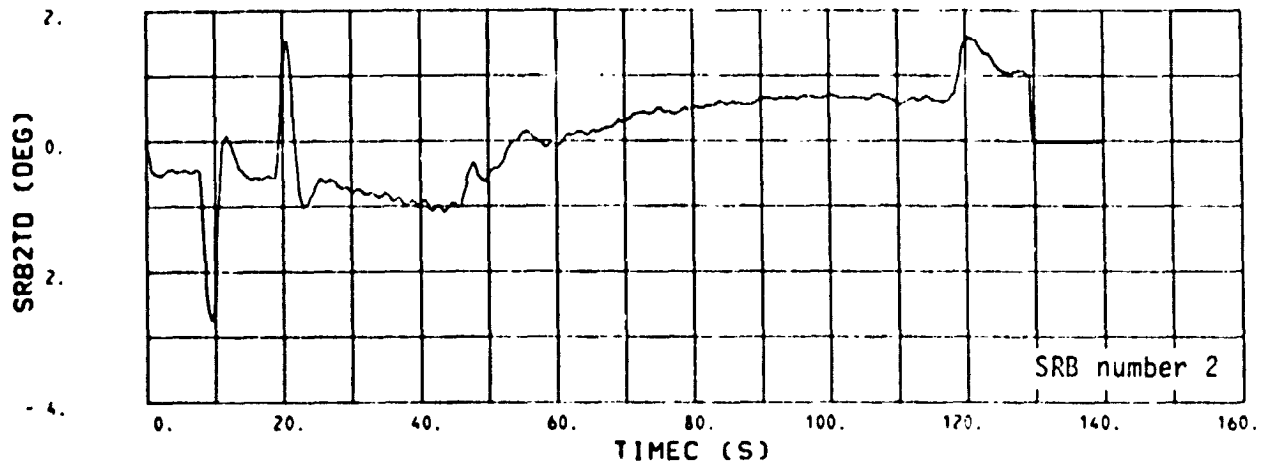

(s) SRB ACTUAL LEFT (TILT) GIMBAL DEFLECTIONS (POSITIVE INWARD)

Figure 6.1-7.- Concluded.

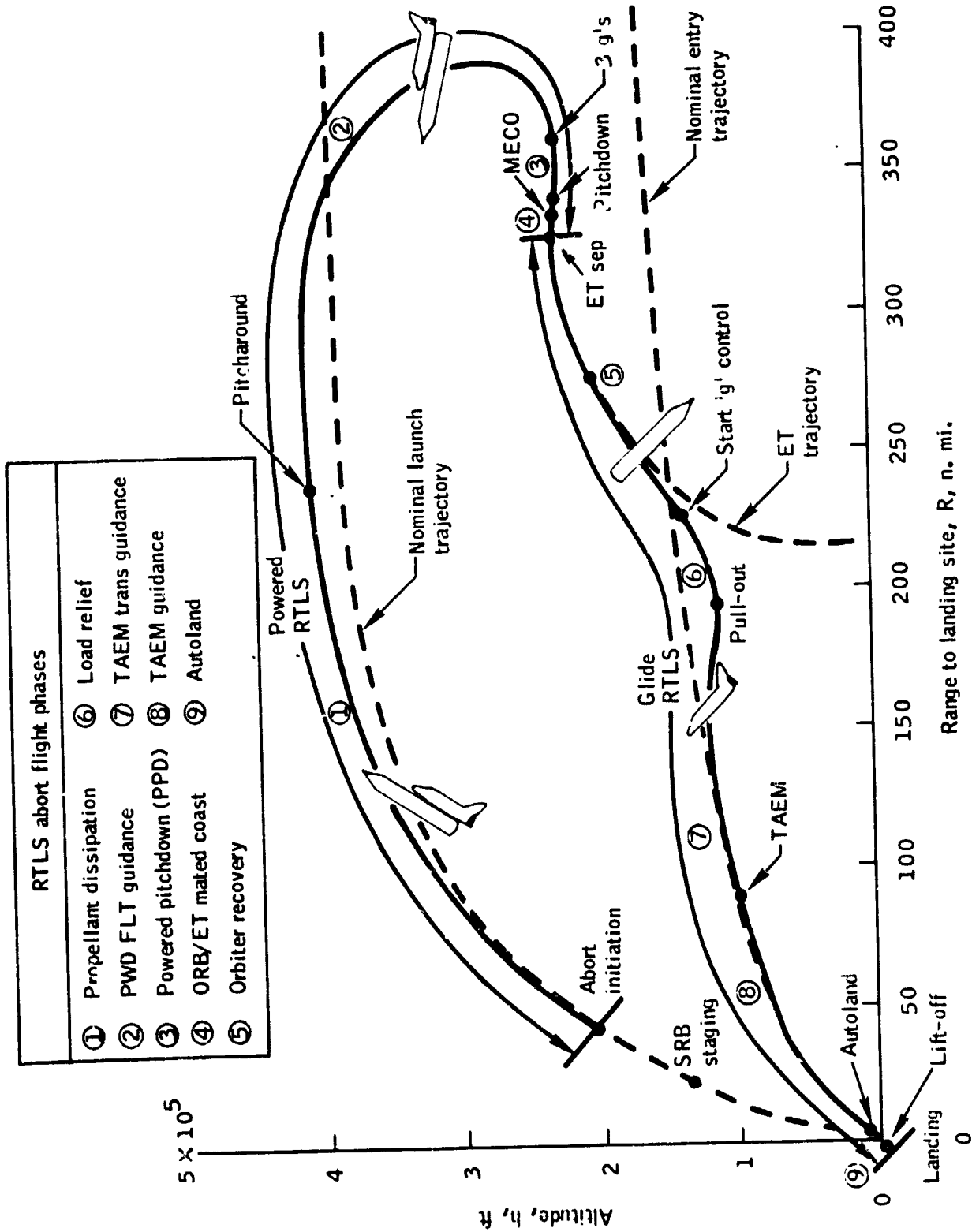

Figure 6.2-1.- Typical RTLS profile.

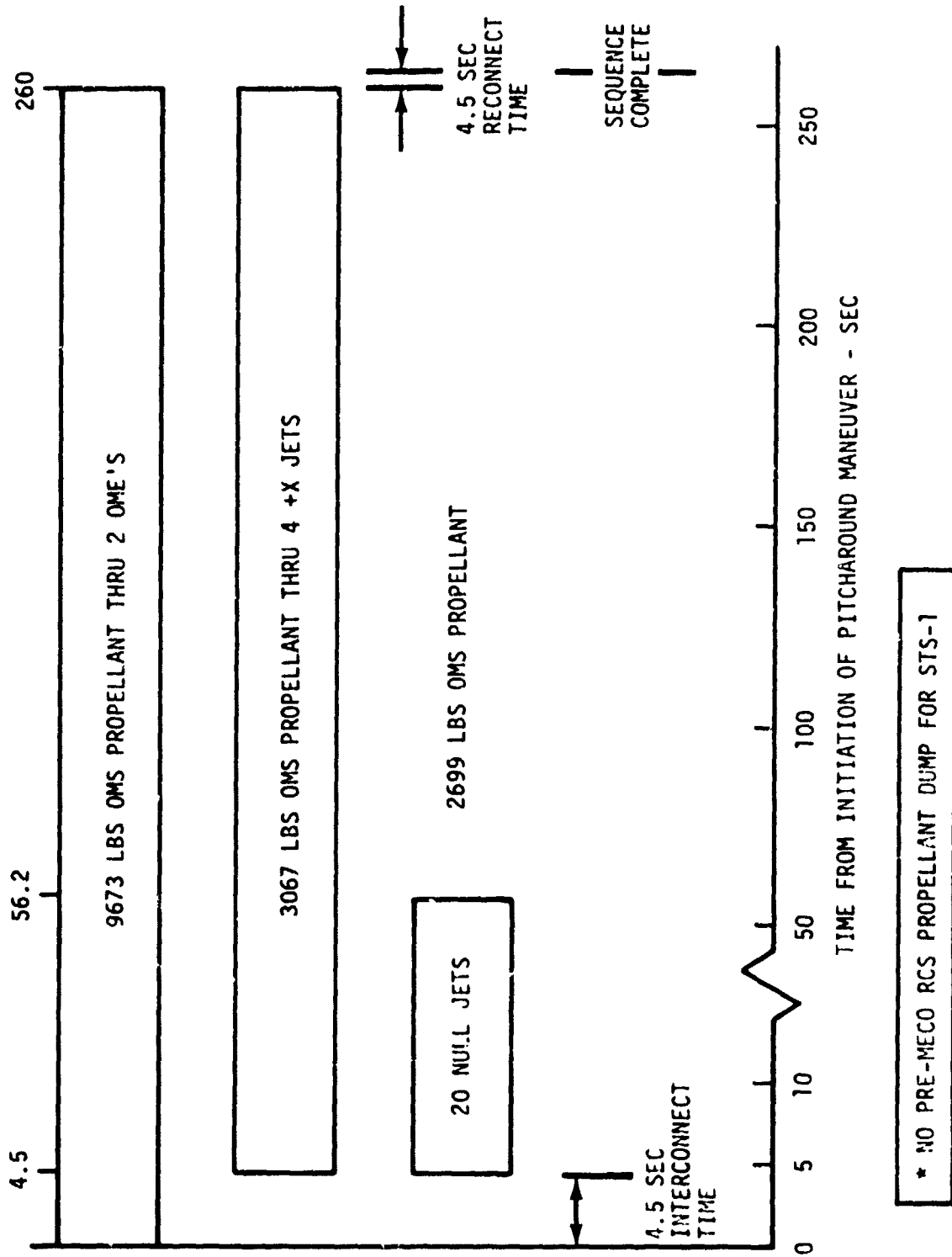

Figure 6.2.1-1.- OMS pre-MECO propellant dump timeline for RTLs on STS-1.

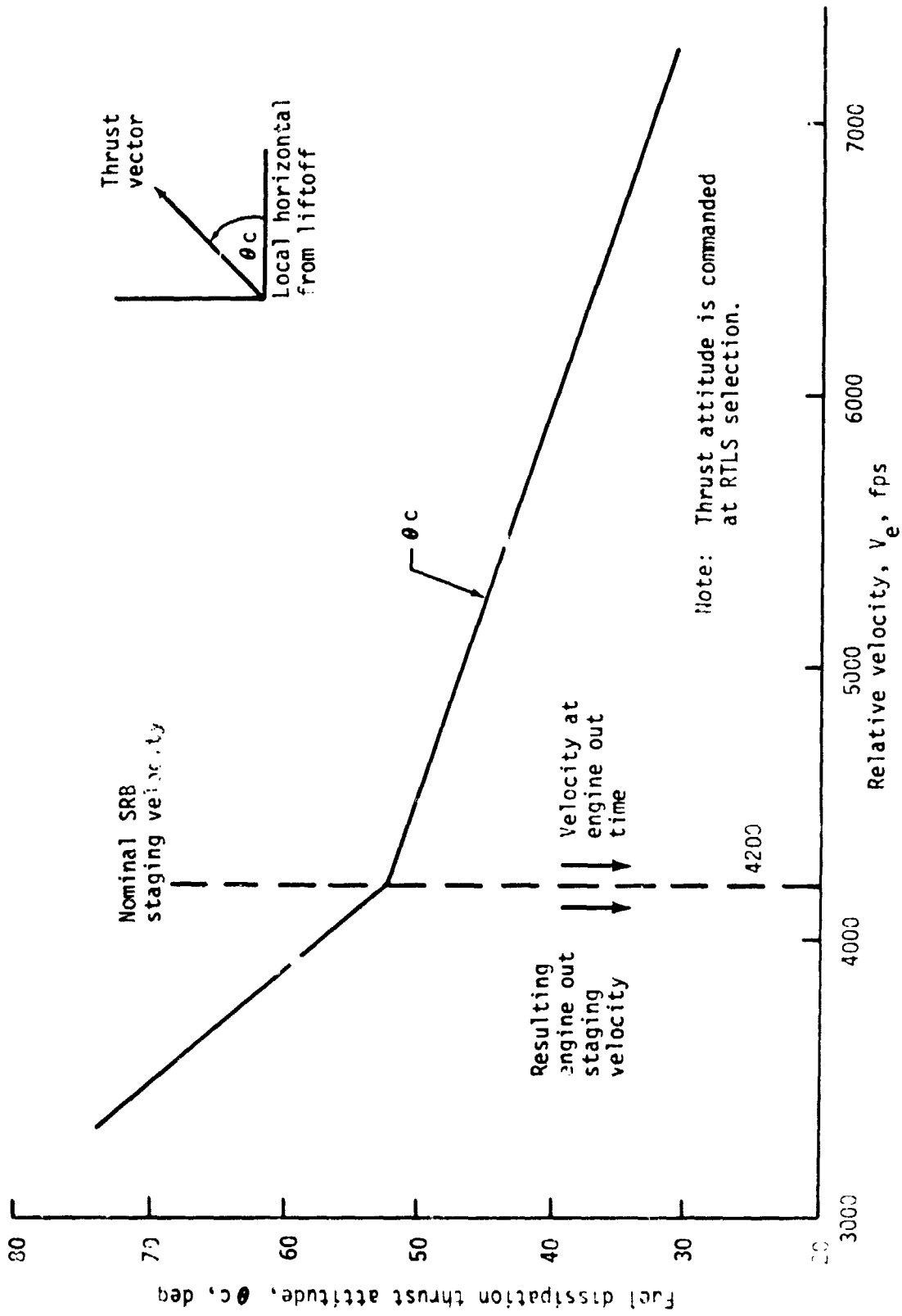

Figure 6.2.1-2.- PRTLS fuel dissipation thrust attitude.

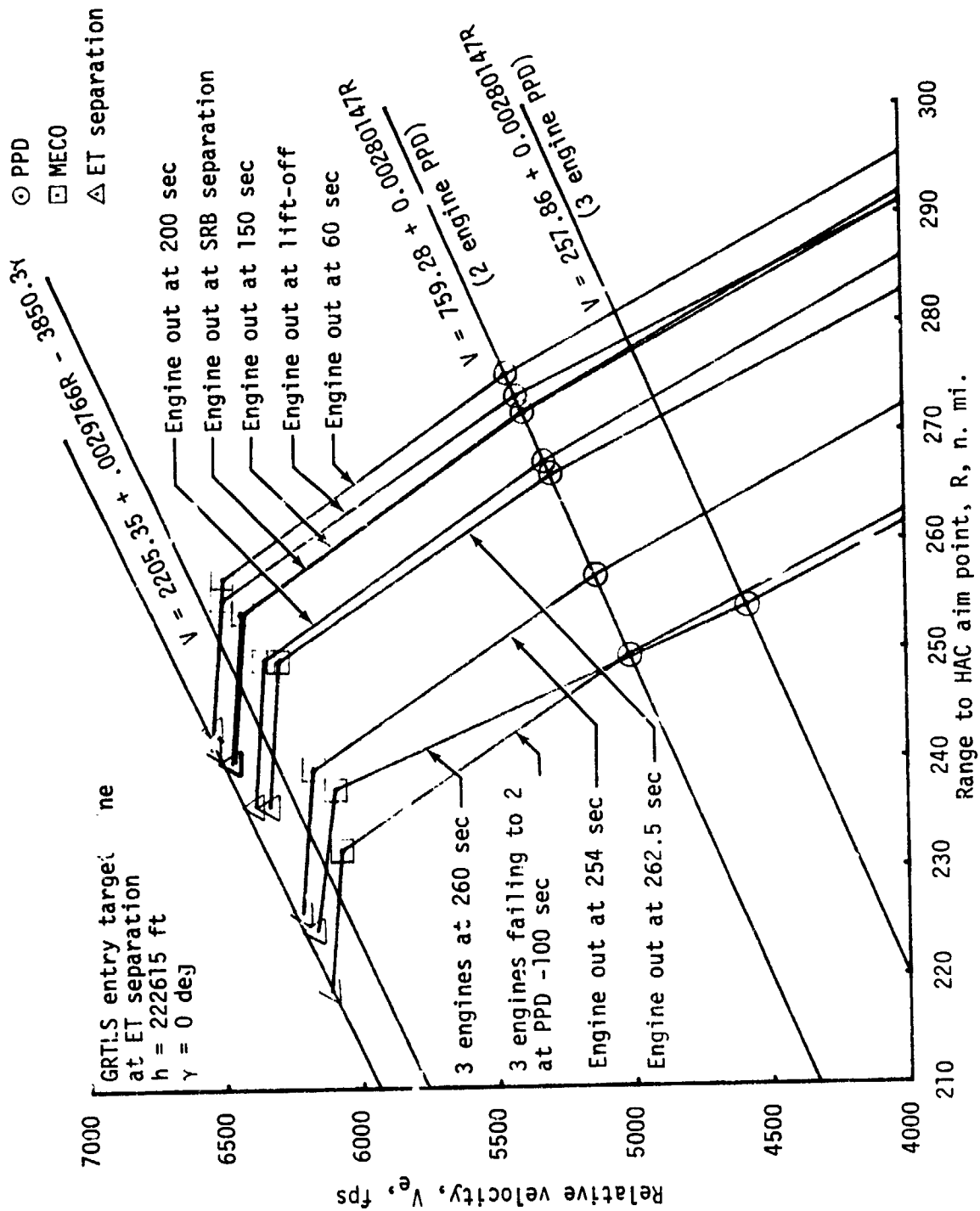
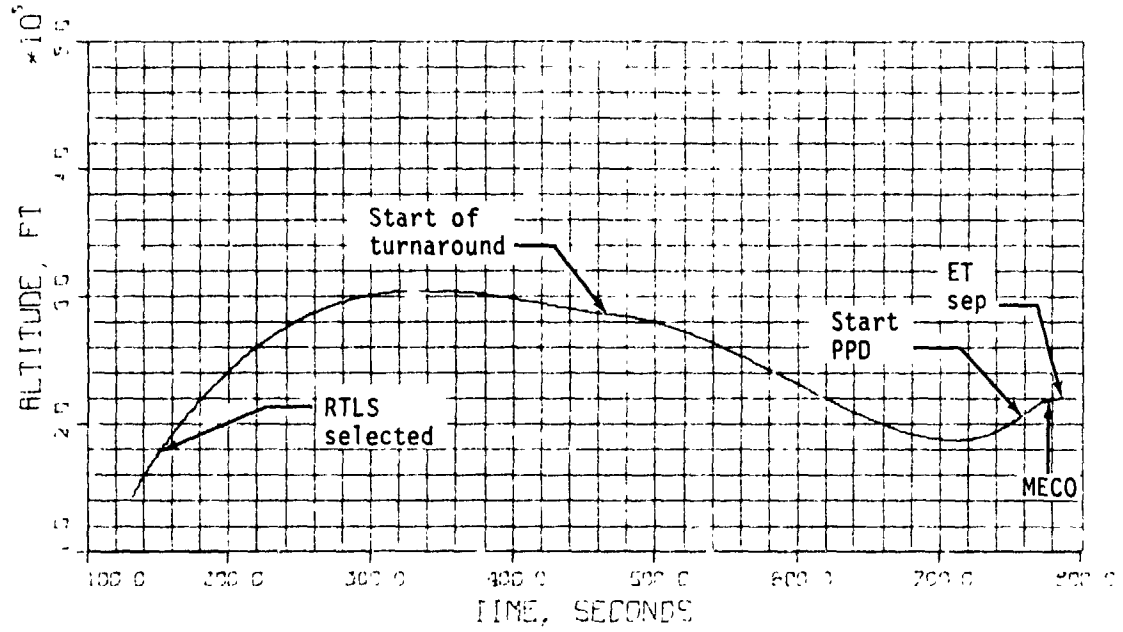
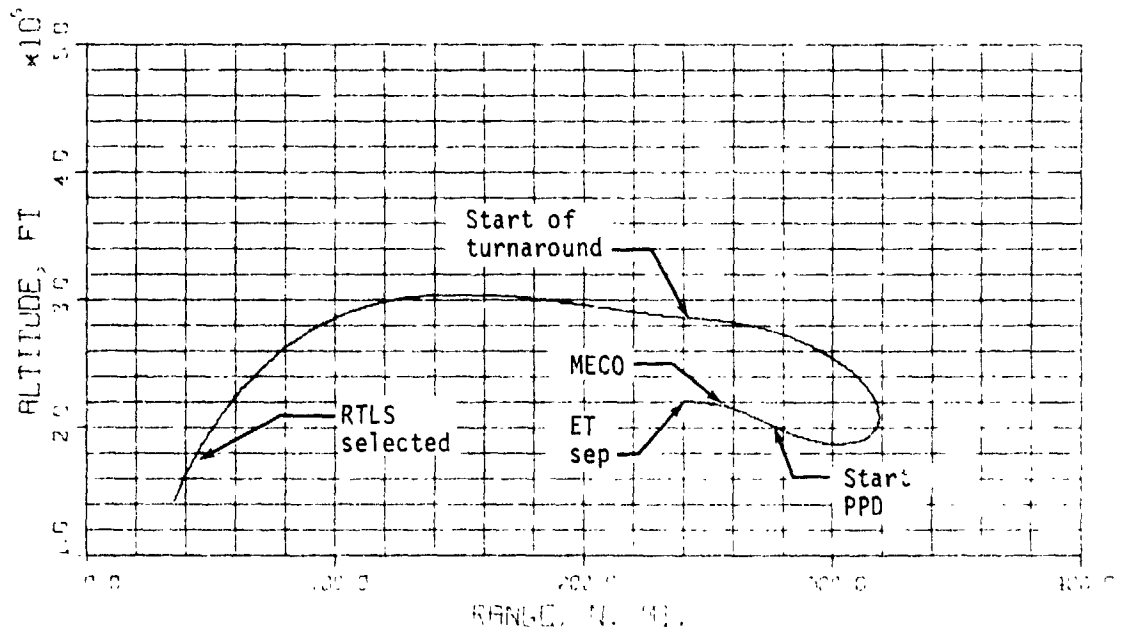

Figure 6.2.1-3.- PRTLS target lines for STS-1.



(a) Altitude versus time.



(b) Altitude versus range.

Figure 6.2.1-4.- PRTLs trajectory data for SSME #1 out at lift-off, RTLS selected at 150 seconds.

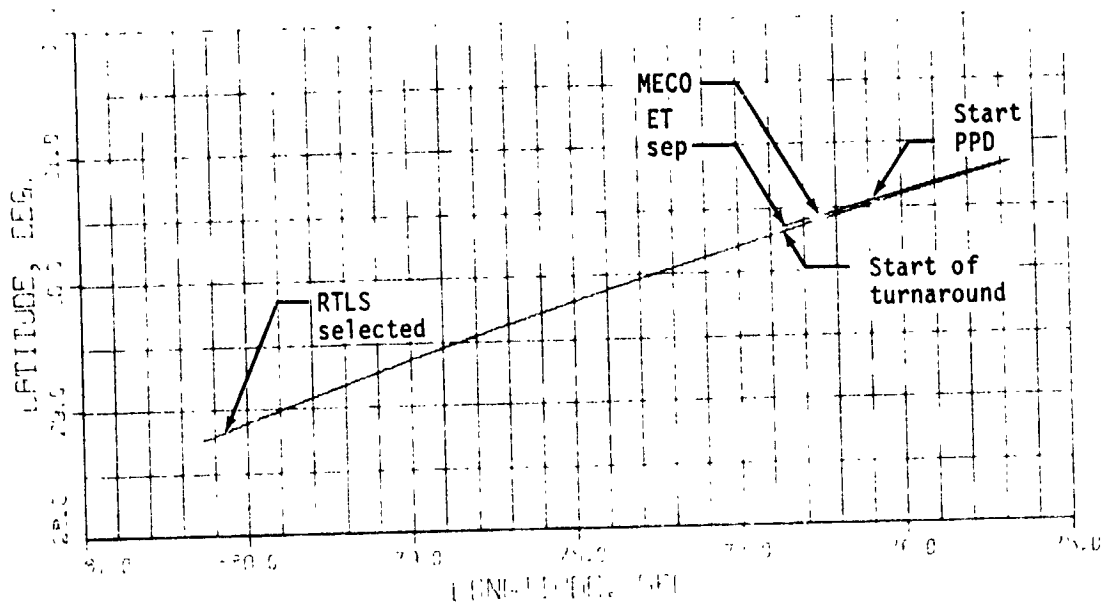

(c) Latitude versus longitude.

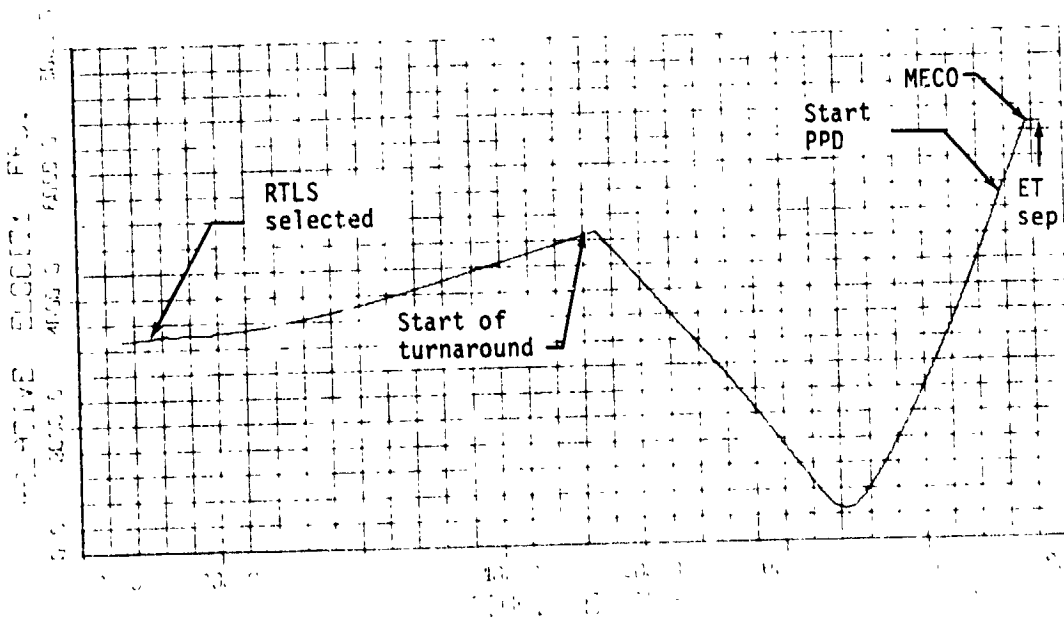

(d) Relative velocity versus time.

Figure 6.2.1-4.- Continued.

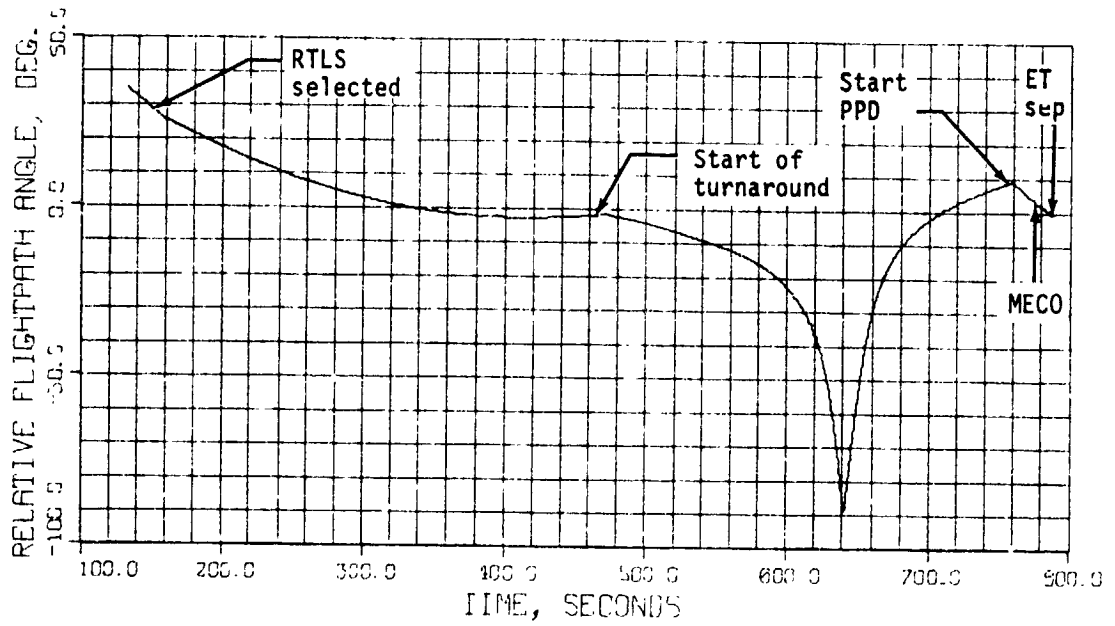

(e) Relative flightpath angle versus time.

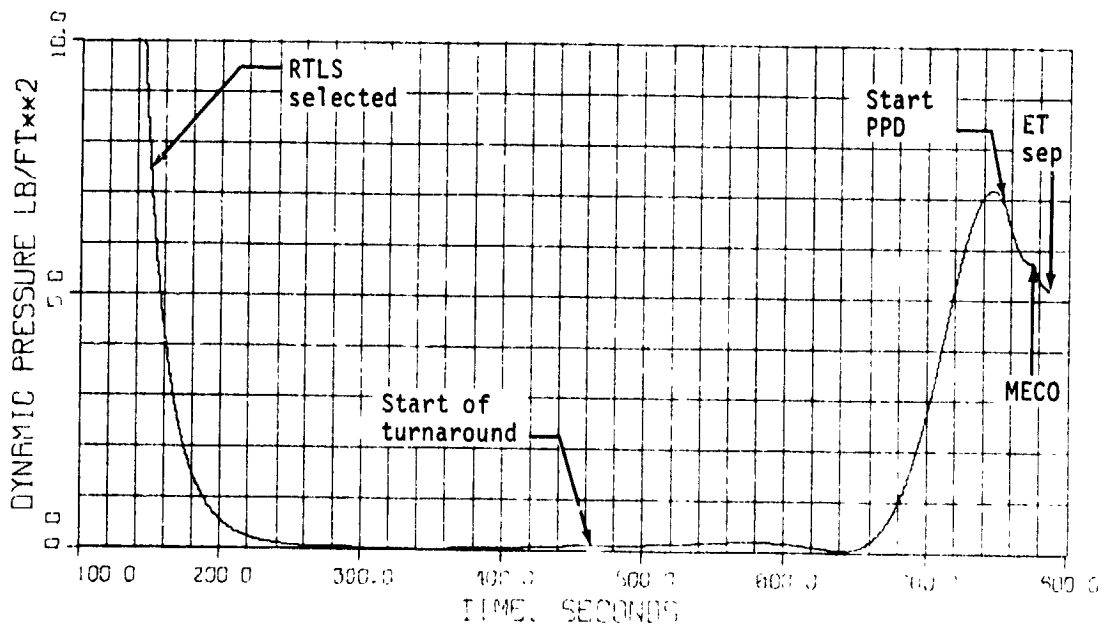

(f) Dynamic pressure versus time.

Figure 6.2.1-4.- Continued.

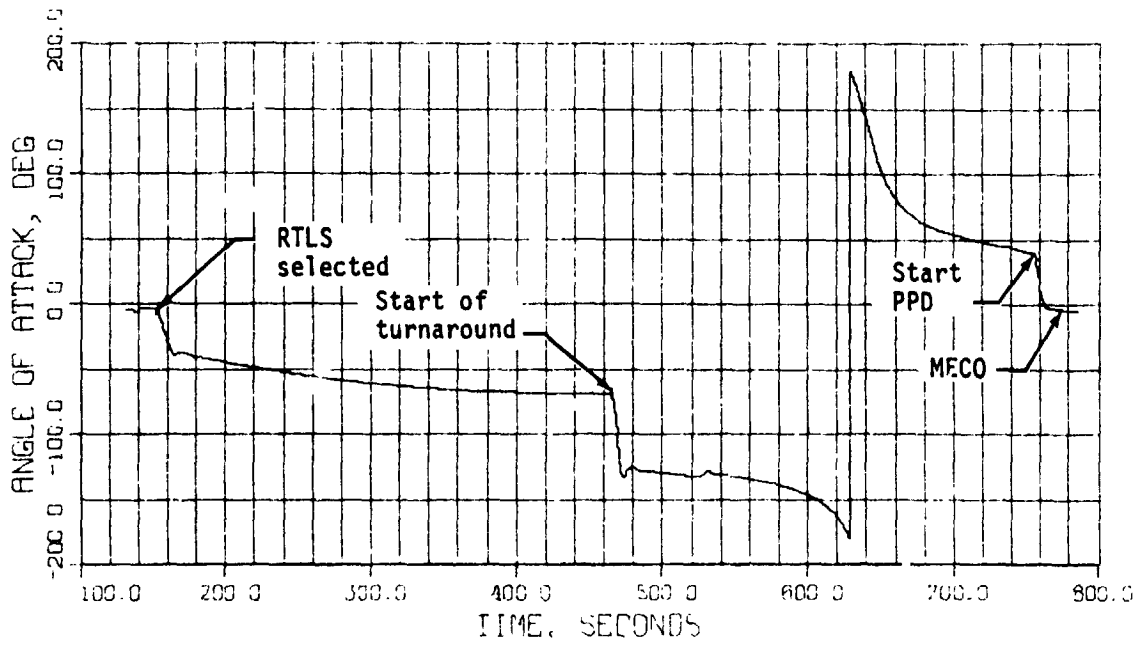

(g) Angle of attack versus time.

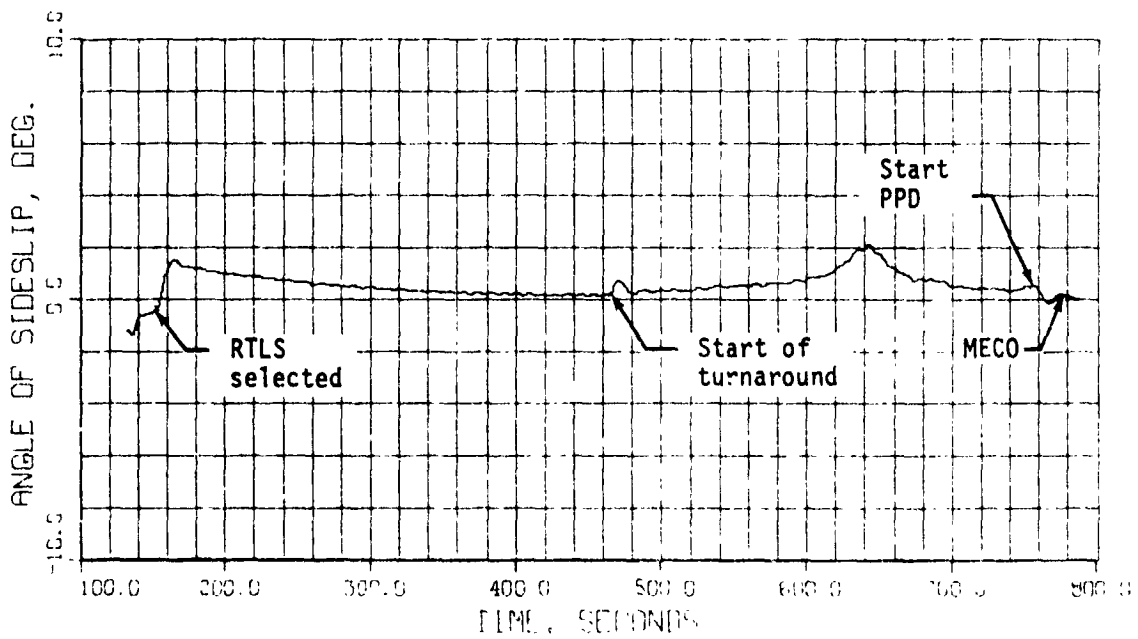

(h) Angle of sideslip versus time.

Figure 6.2.1-4.- Continued.

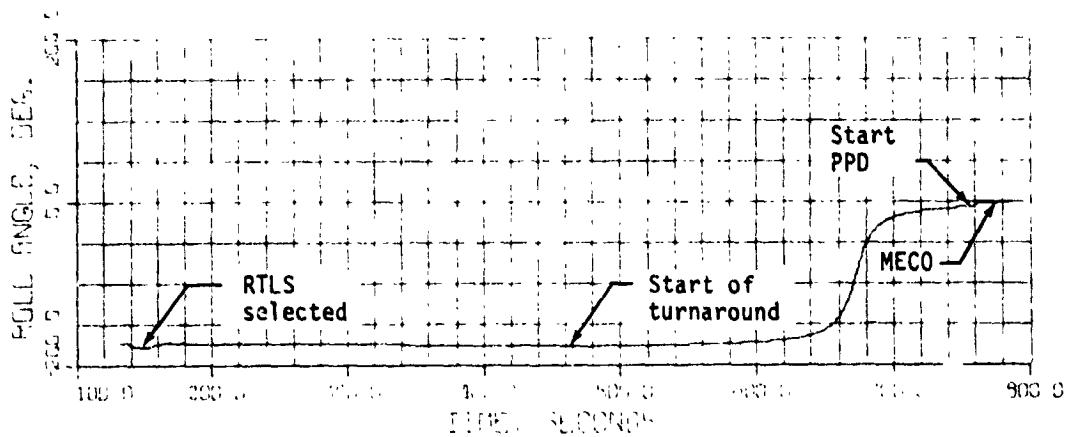

(i) Roll angle versus time.

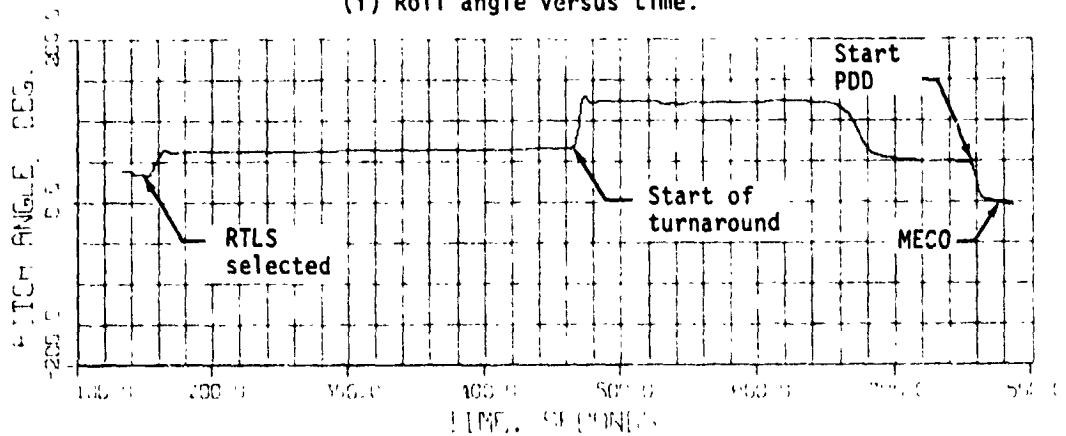

(j) Pitch angle versus time.

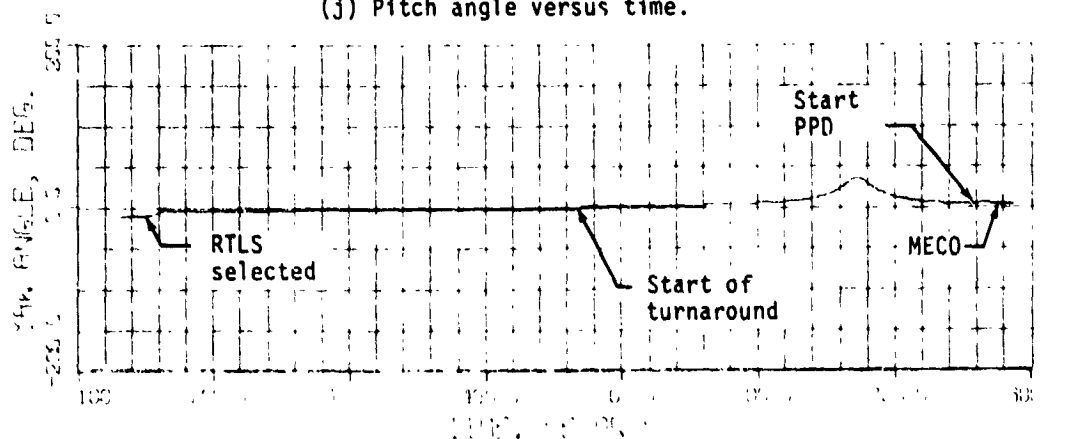

(k) Yaw angle versus time.

Figure 6.2.1-4.- Continued.

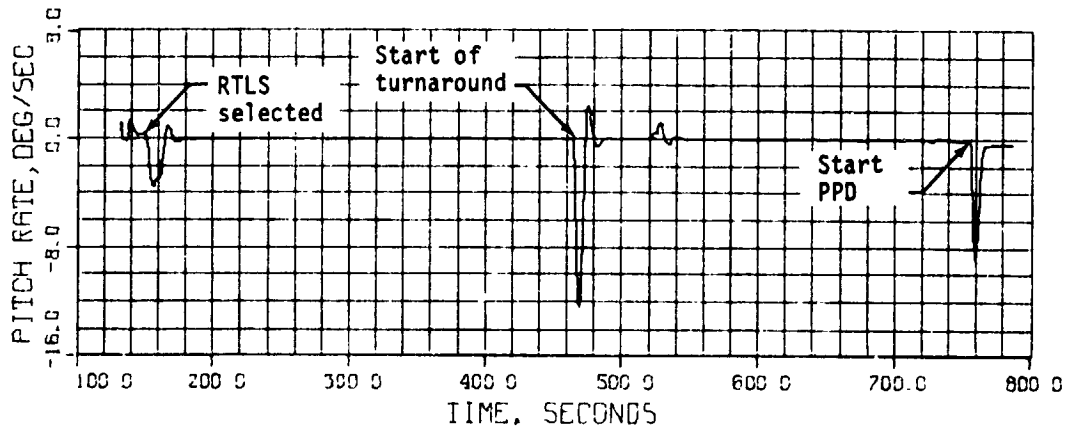

(l) Pitch rate versus time.

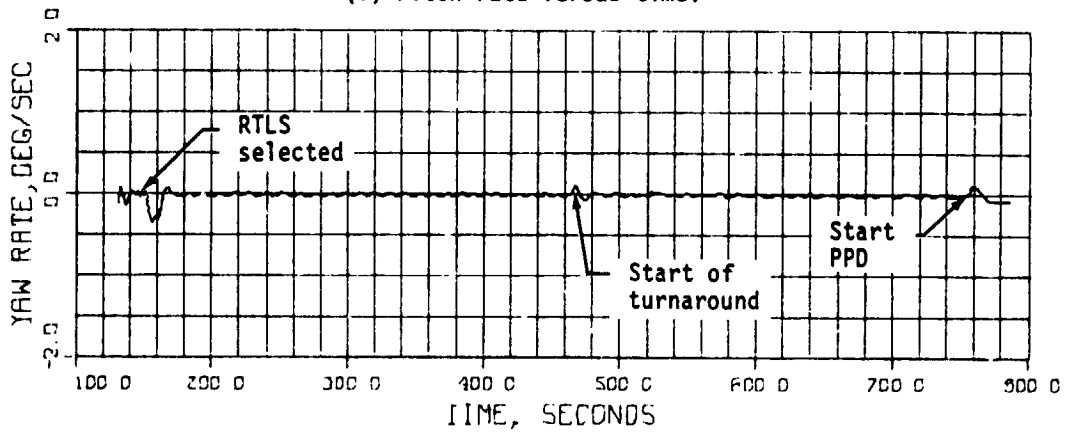

(m) Yaw rate versus time.

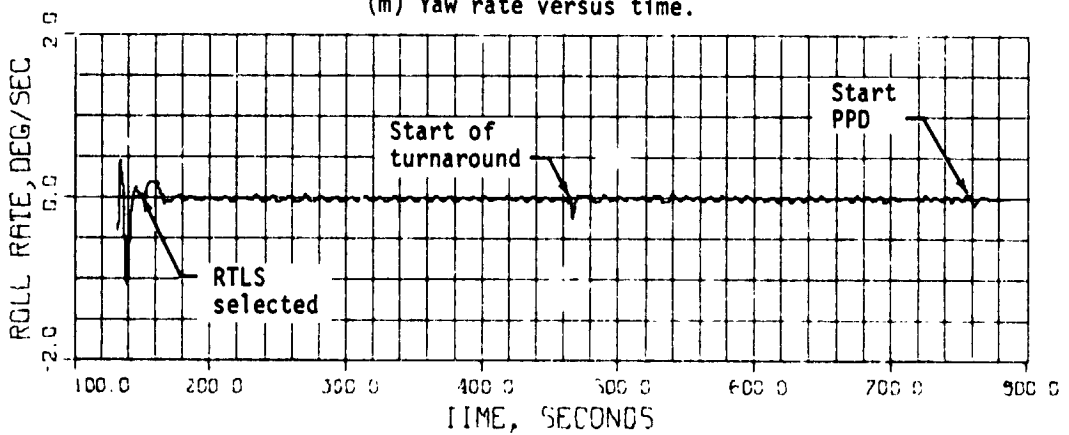

(n) Roll rate versus time.

Figure 6.2.1-4.- Continued.

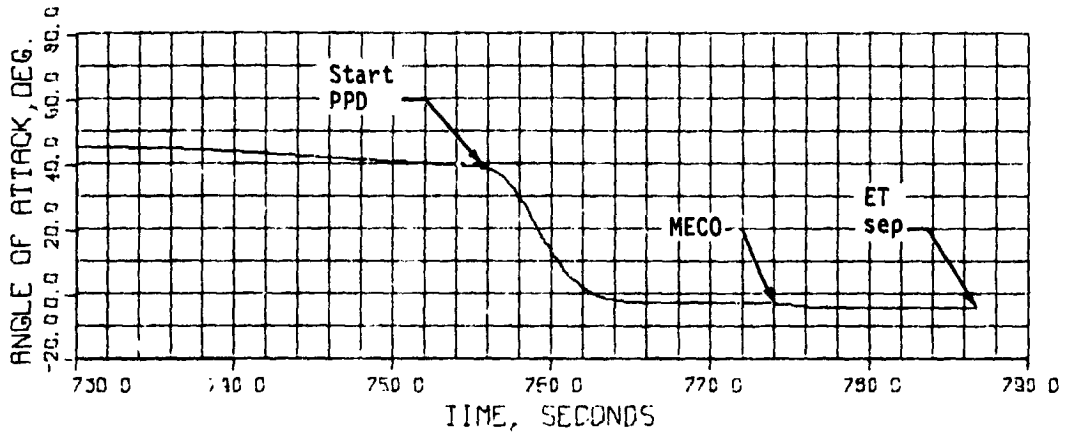

(o) Angle of attack versus time in pitchdown and mated coast.

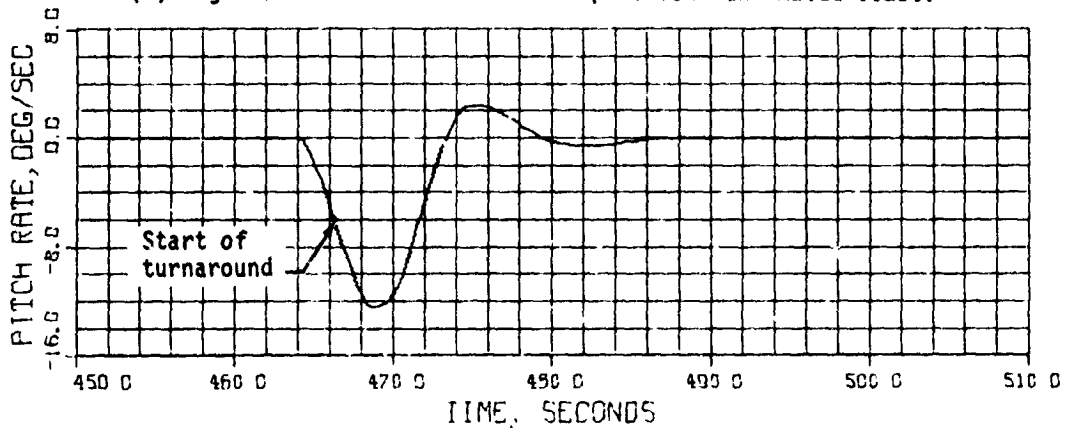

(p) Pitch rate versus time during turnaround.

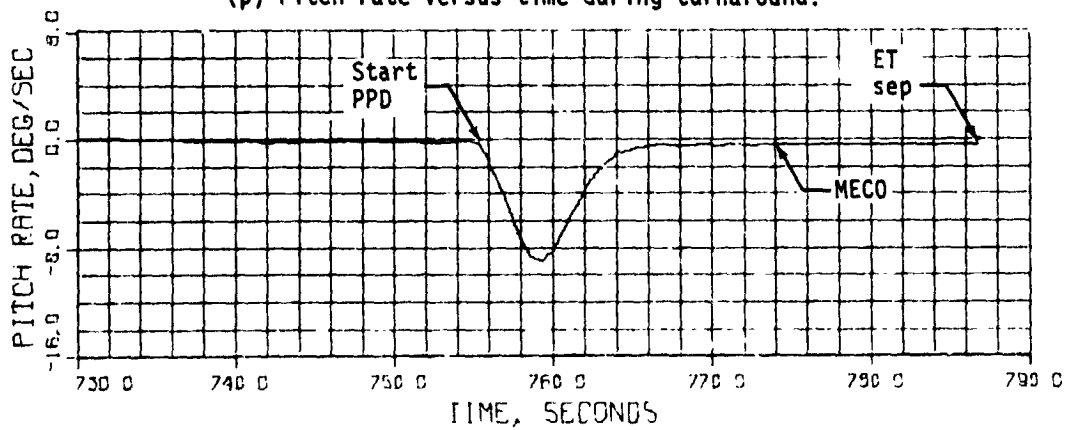

(q) Pitch rate versus time in pitchdown and mated coast.

Figure 6.2.1-4.- Continued.

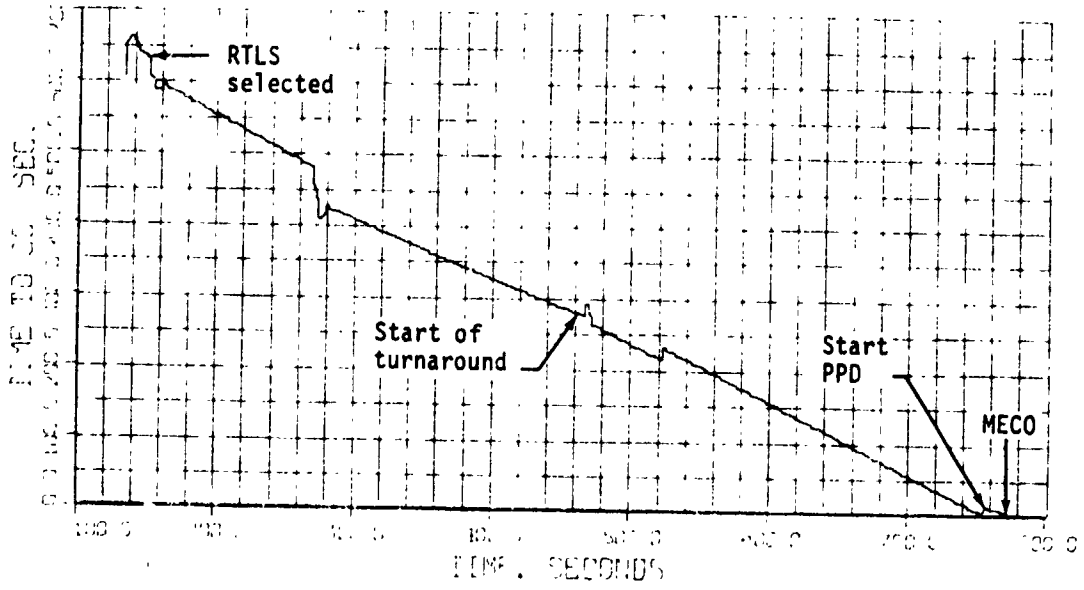

(r) Time to go versus time.

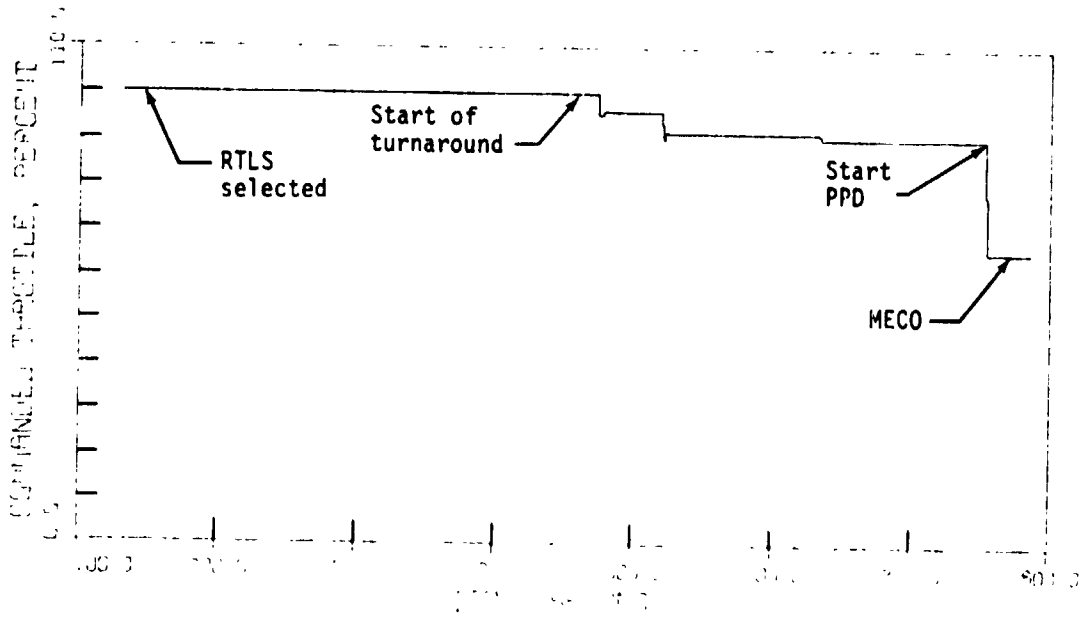

(s) Command throttle versus time.

Figure 6.2.1-4.- Continued.

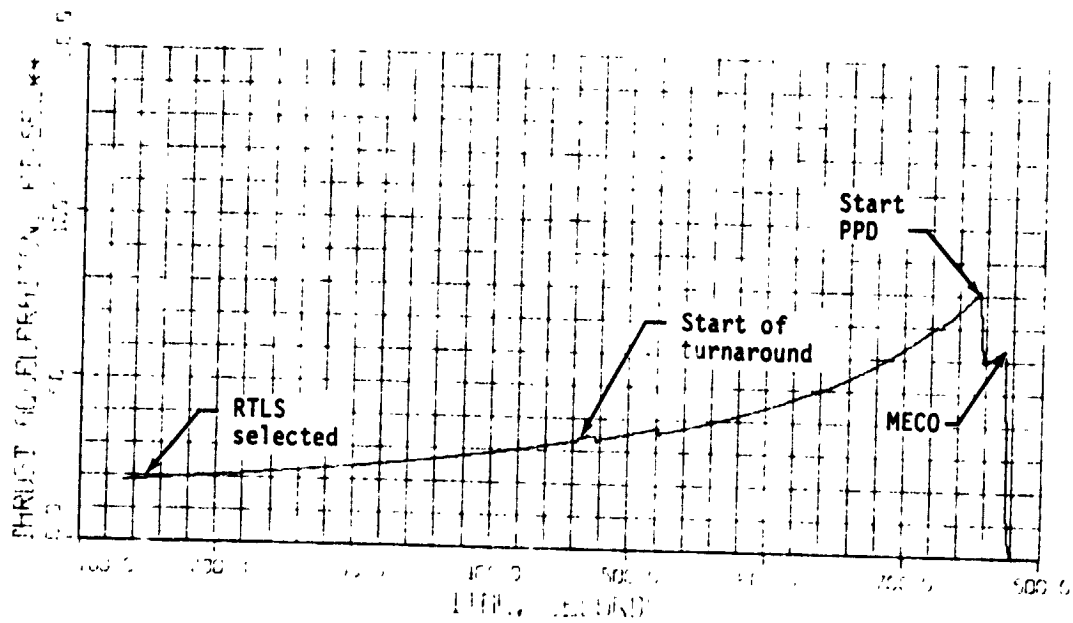

(t) Thrust acceleration versus time.

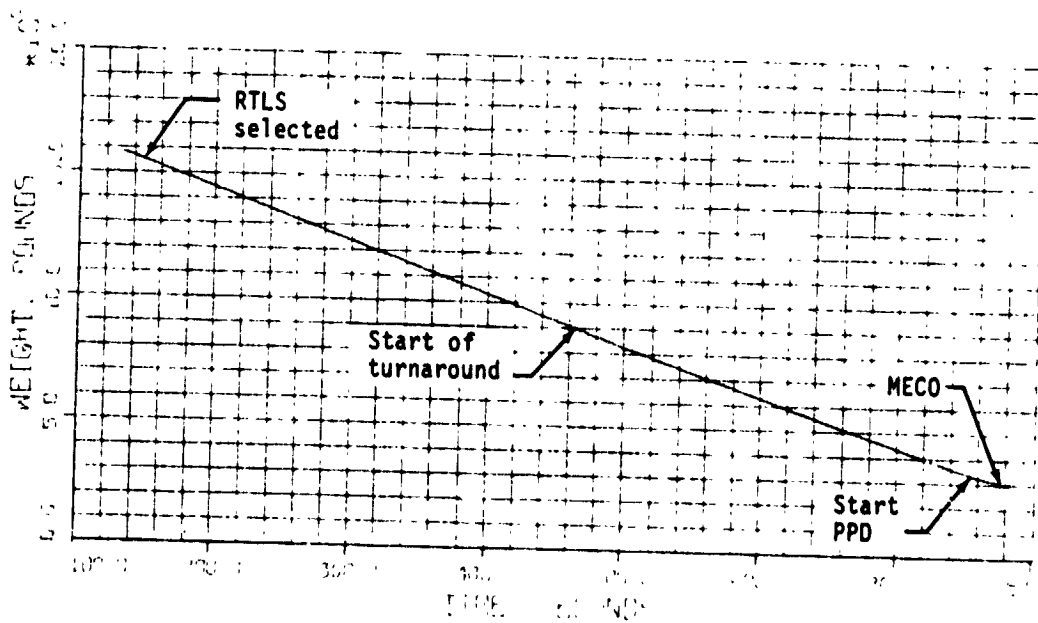

(u) Weight versus time.

Figure 6.2.1-4.- Continued.

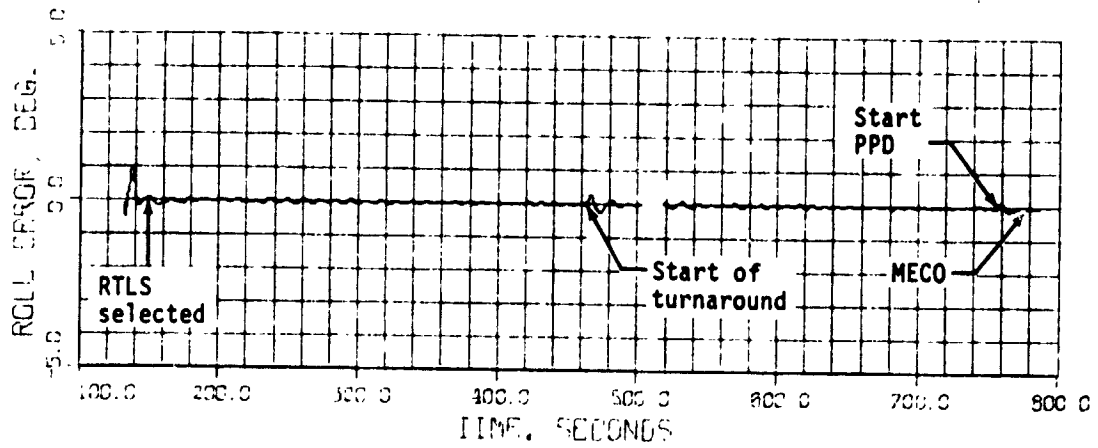

(v) Roll error versus time.

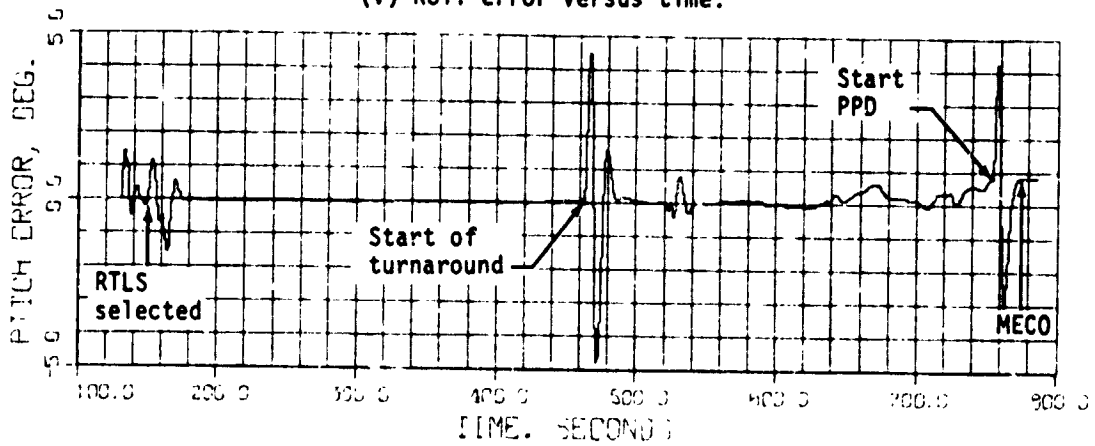

(w) Pitch error versus time.

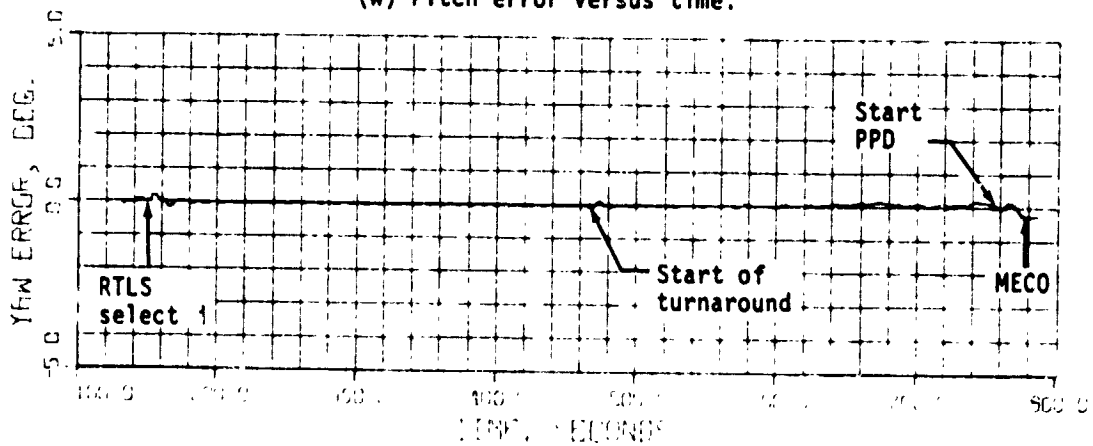

(x) Yaw error versus time.

Figure 6.2.1-4.- Continued.

ORIGINAL PAGE IS
OF POOR QUALITY

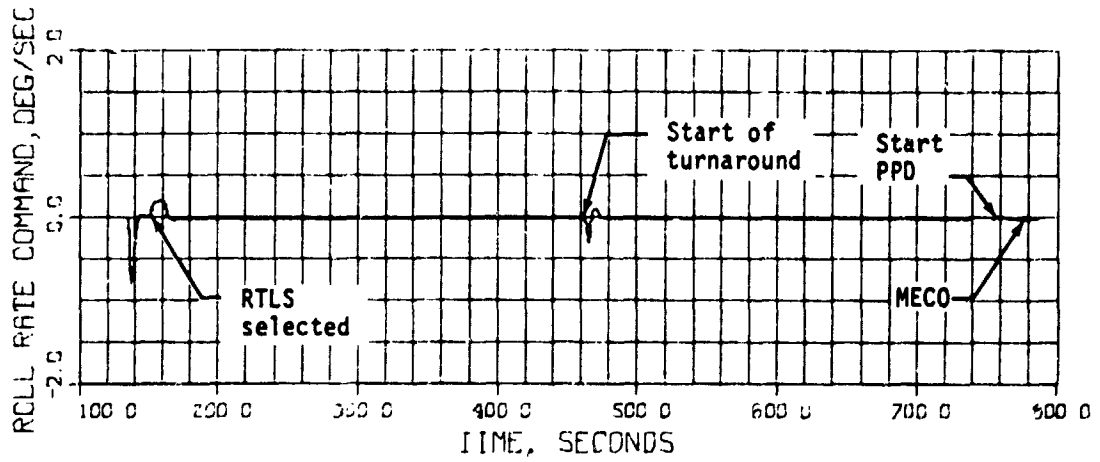

(y) Roll rate command versus time.

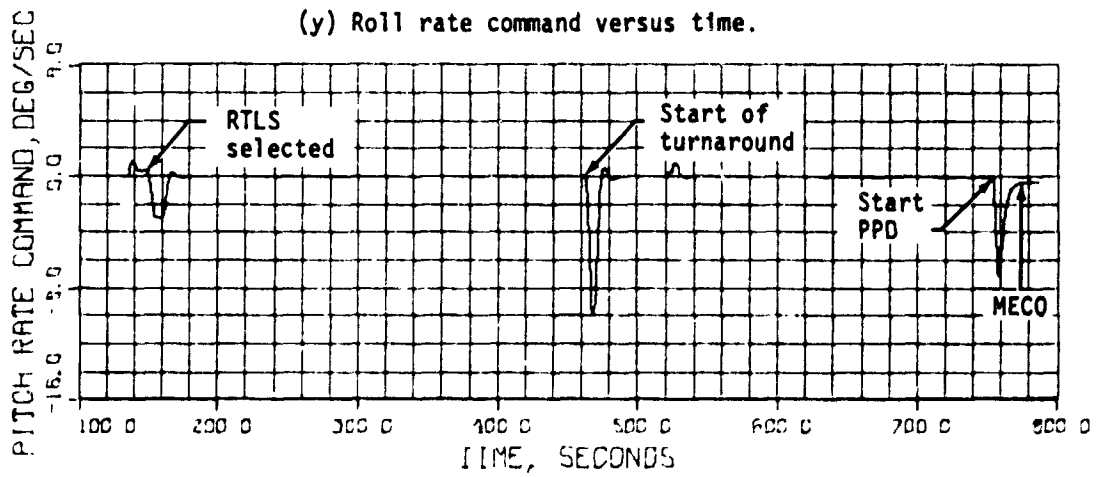

(z) Pitch rate command versus time.

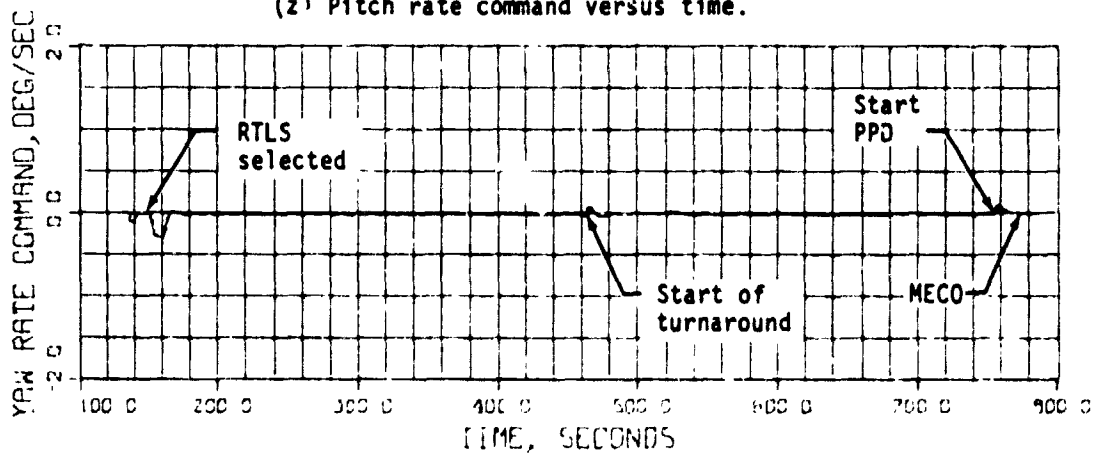

(aa) Yaw rate command versus time.

Figure 6.2.1-4.- Continued.

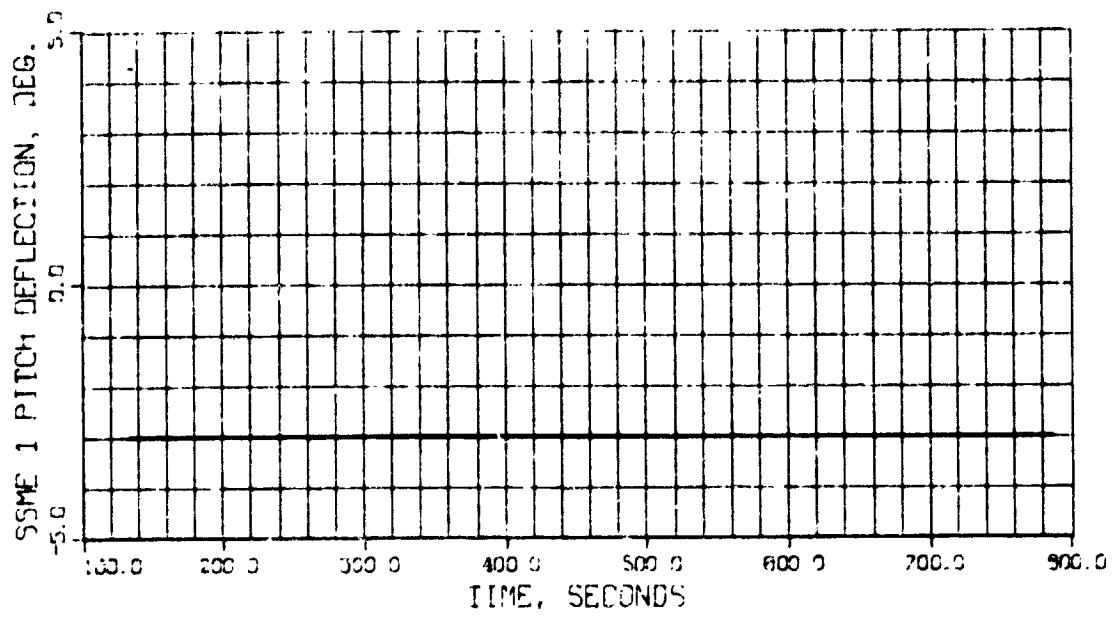

(bb) SSME 1 pitch deflection versus time.

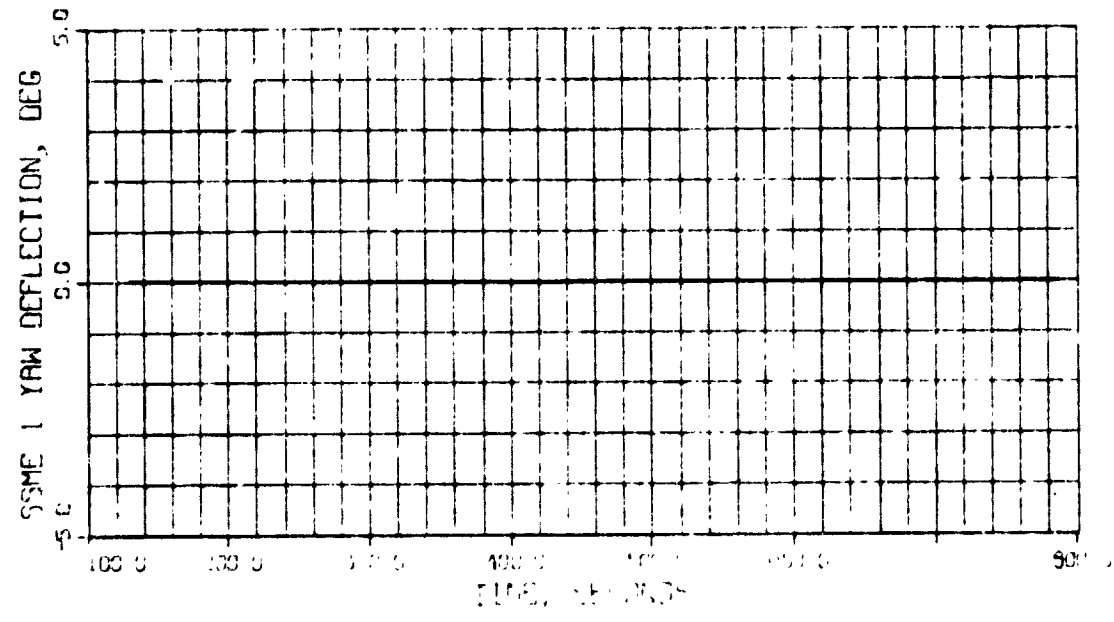

(cc) SSME 1 yaw deflection versus time.

Figure 6.2.1-4.- Continued.

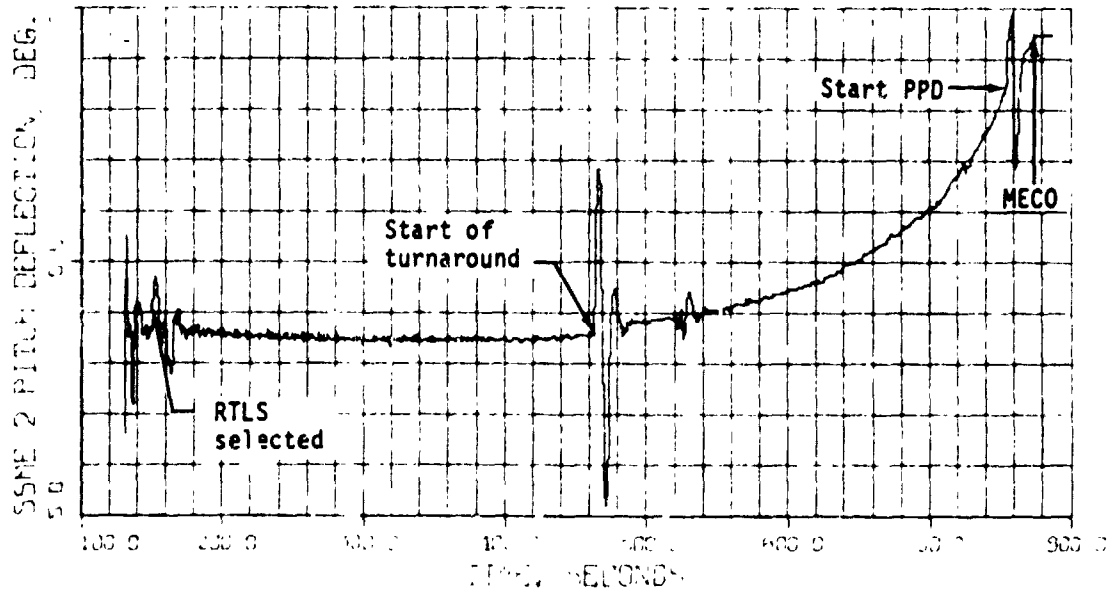

(dc) SSME 2 pitch deflection versus time.

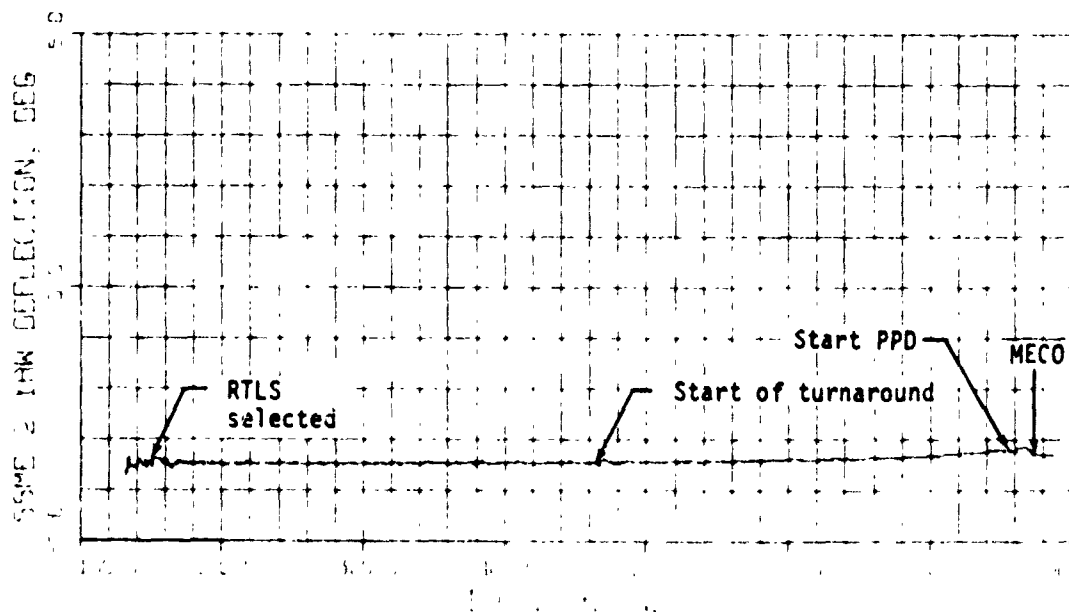

(ee) SSME 2 yaw deflection versus time.

Figure 6.2.1-4.- Continued.

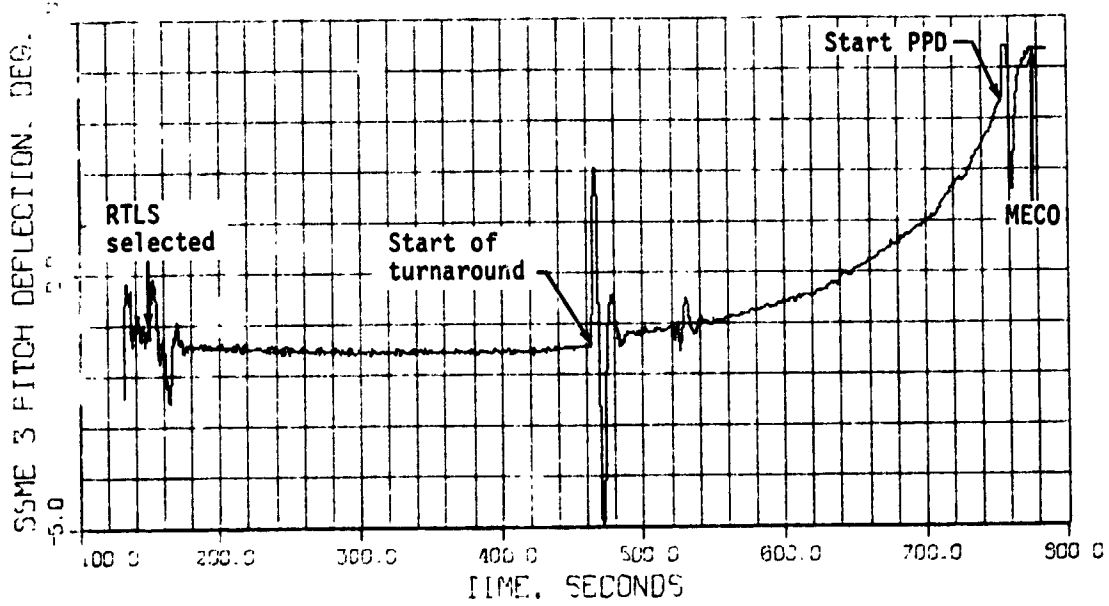

(ff) SSME 3 pitch deflection versus time.

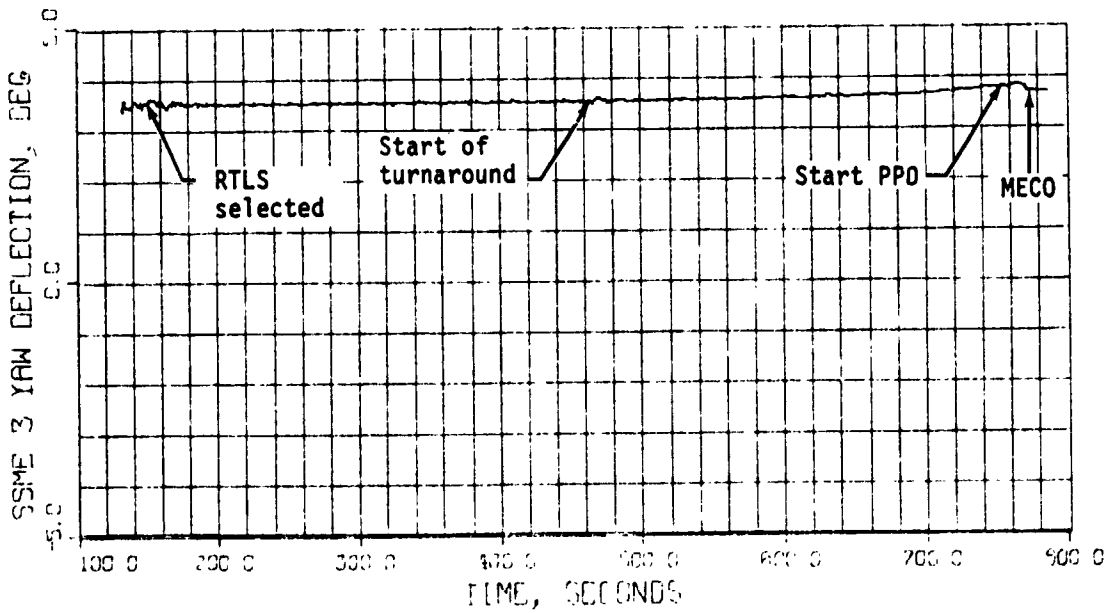

(gg) SSME 3 yaw deflection versus time.

Figure 6.2.1-4.- Concluded.

C-3

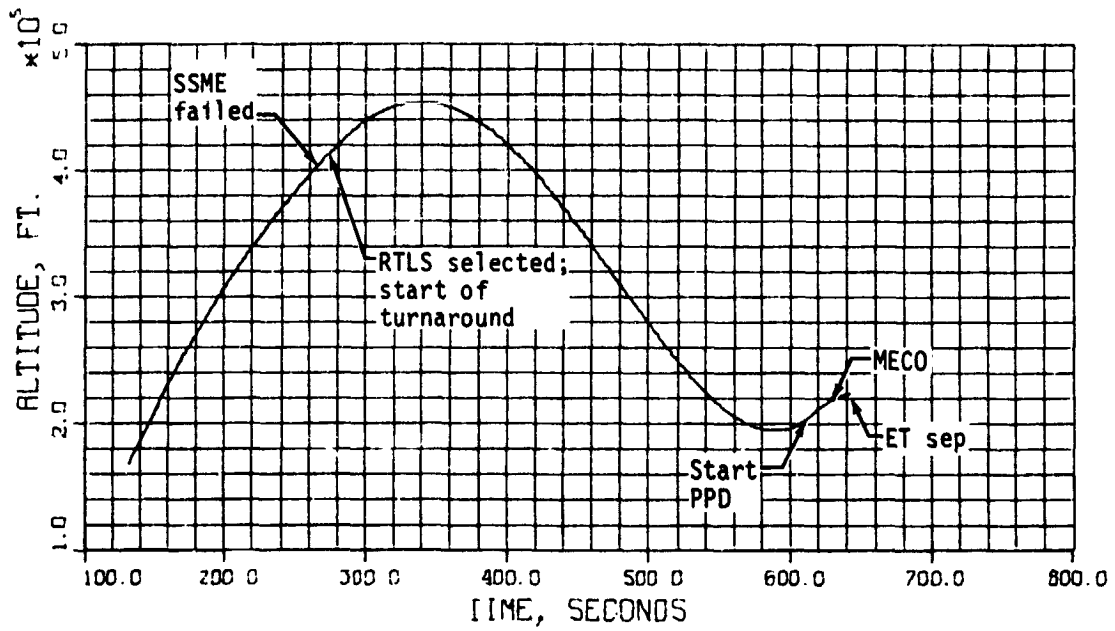

(a) Altitude versus time.

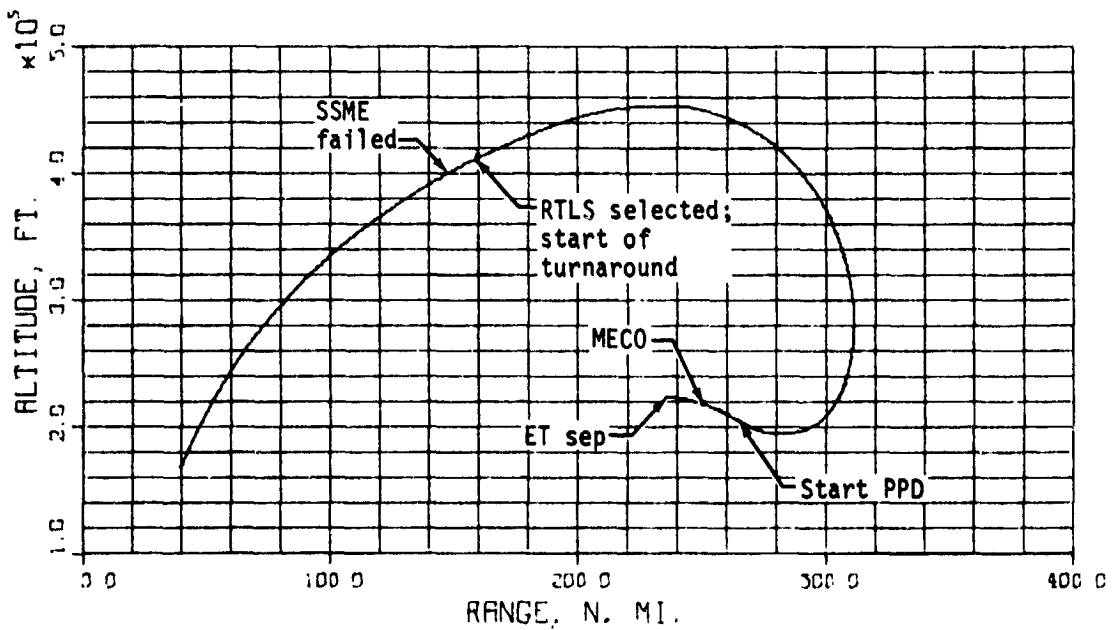

(b) Altitude versus range.

Figure 6.2.1-5.- PRTLs trajectory data for SSME #2 out at 262.5 seconds, RTLs selected at 272.5 seconds.

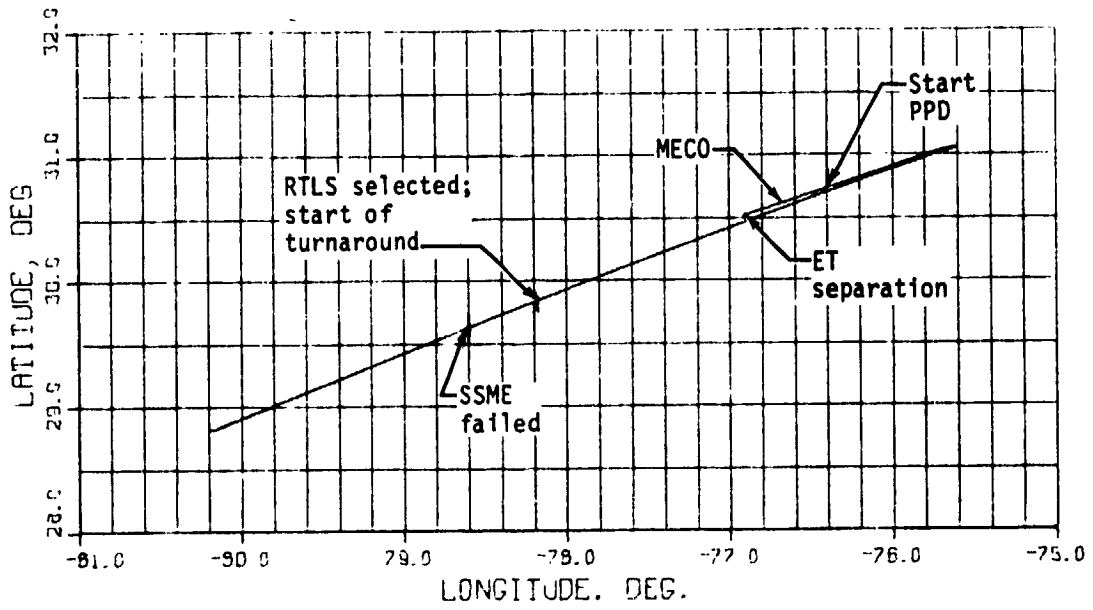

(c) Latitude versus longitude.

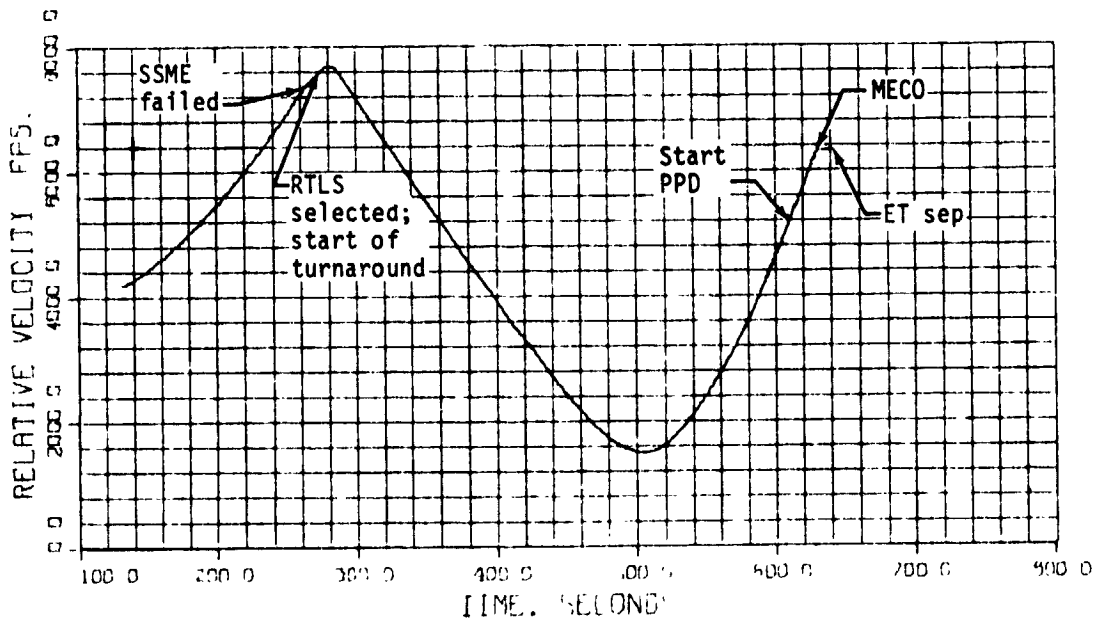

(d) Relative velocity versus time.

Figure 6.2.1-5.- Continued.

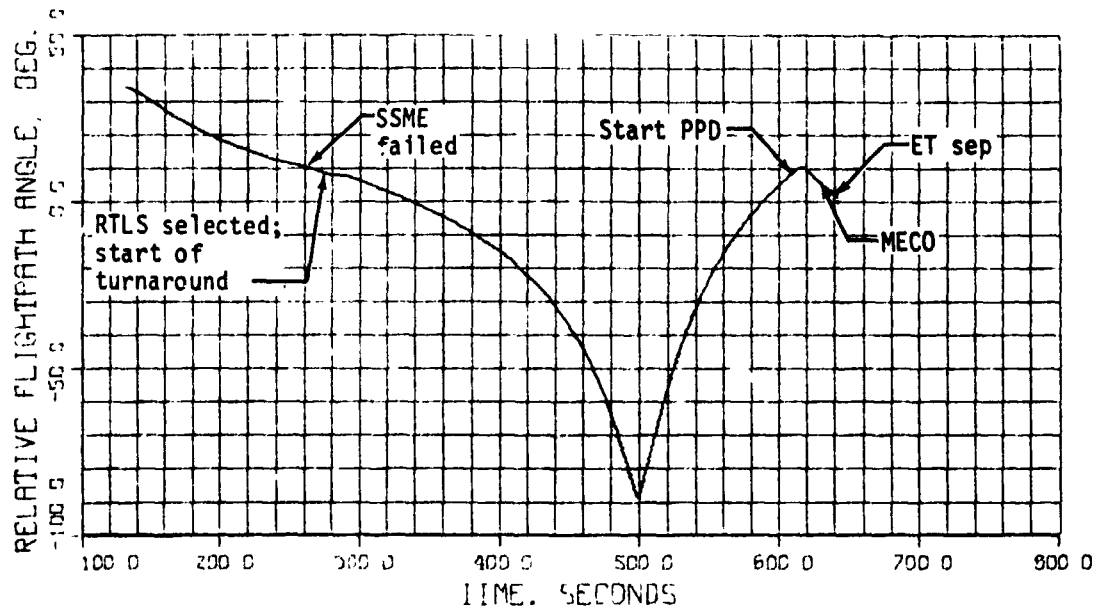

(e) Relative flightpath angle versus time.

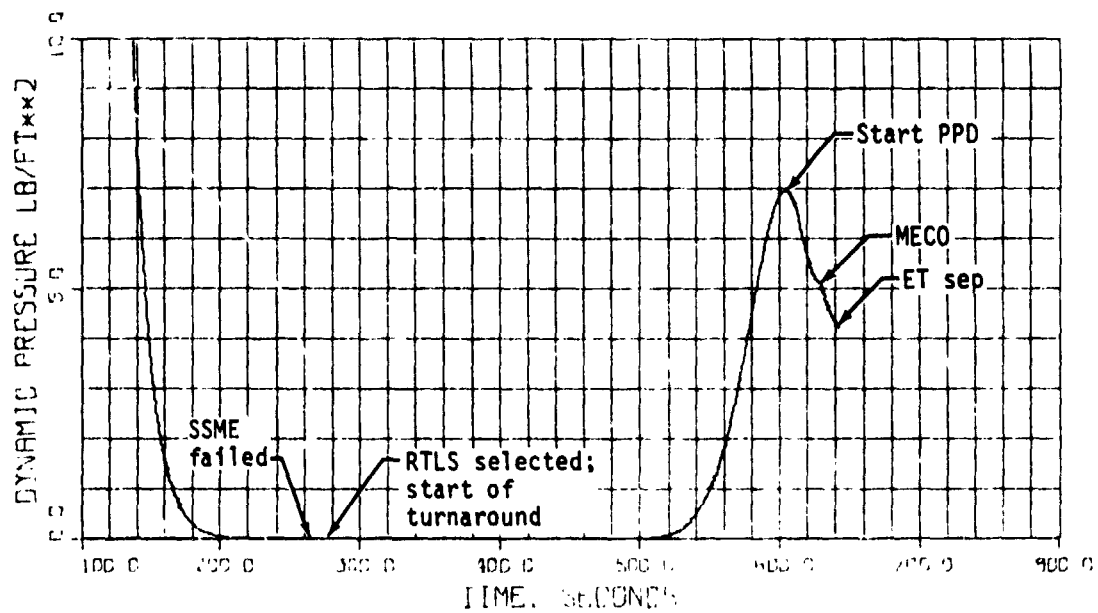

(f) Dynamic pressure versus time.

Figure 6.2.1-5.- Continued.

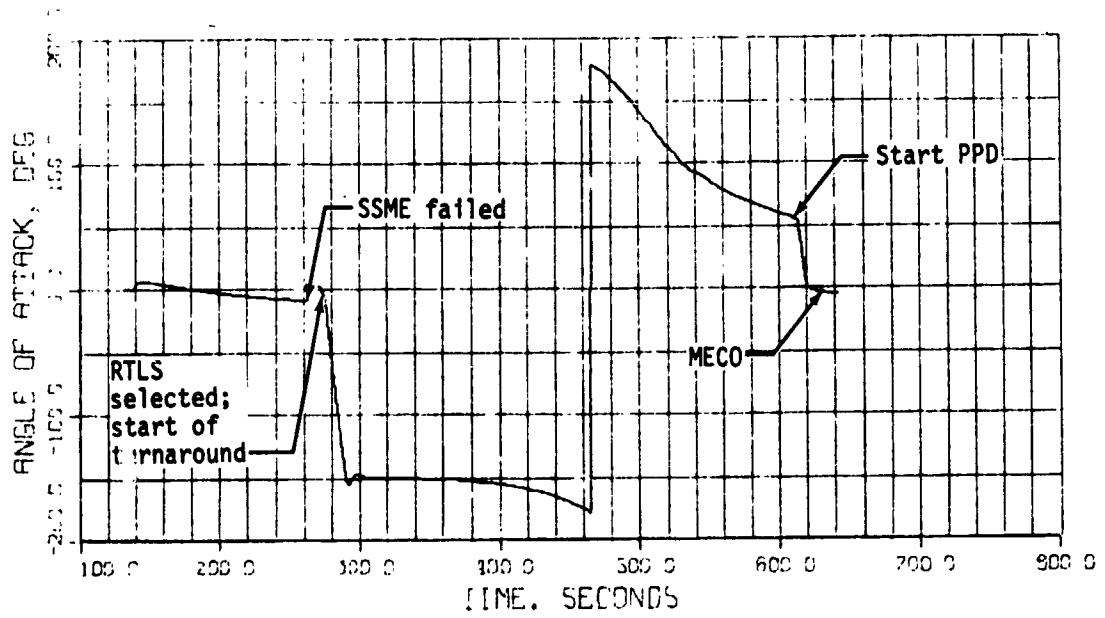

(g) Angle of attack versus time.

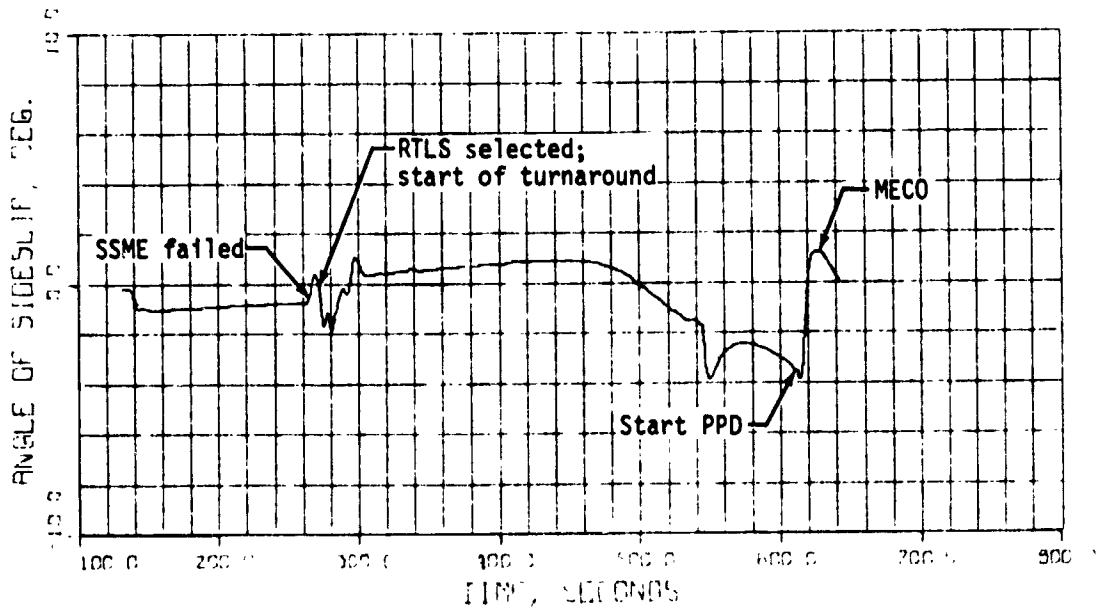

(h) Angle of sideslip versus time.

Figure 6.2.1.-5.- Continued.

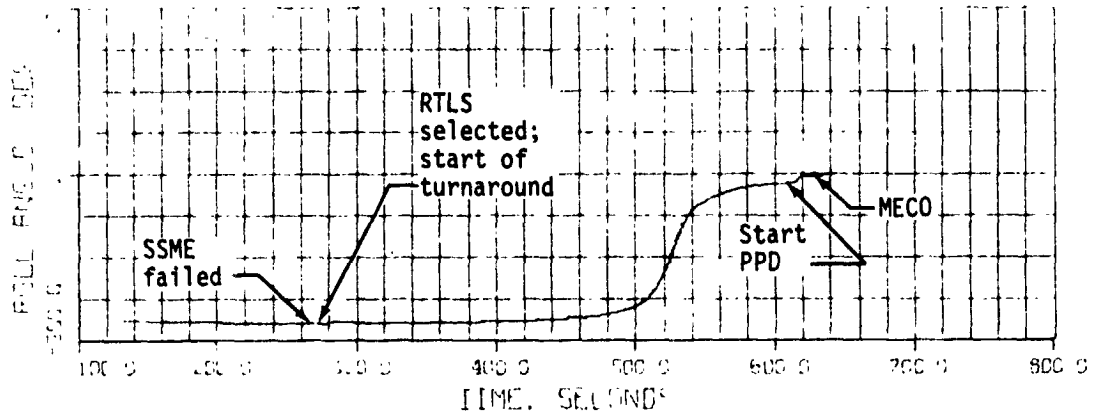

(i) Roll angle versus time.

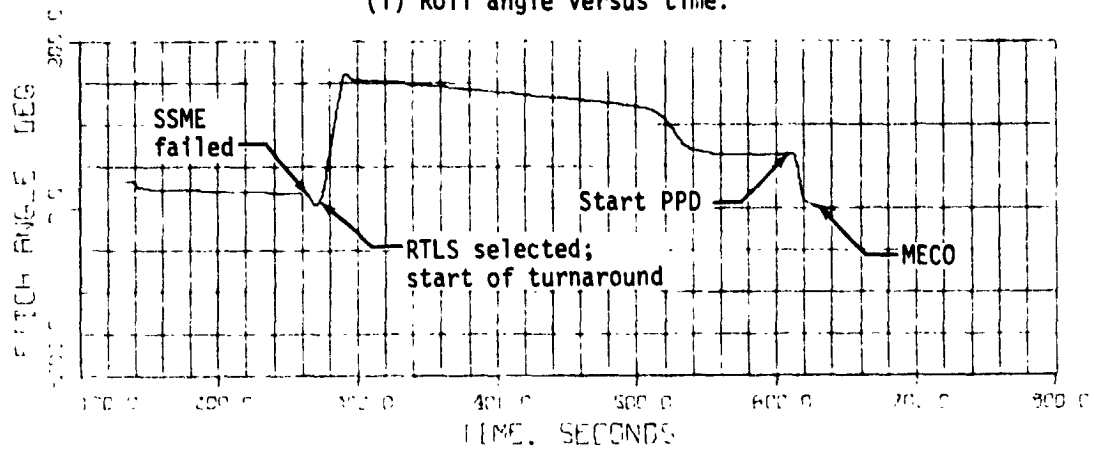

(j) Pitch angle versus time.

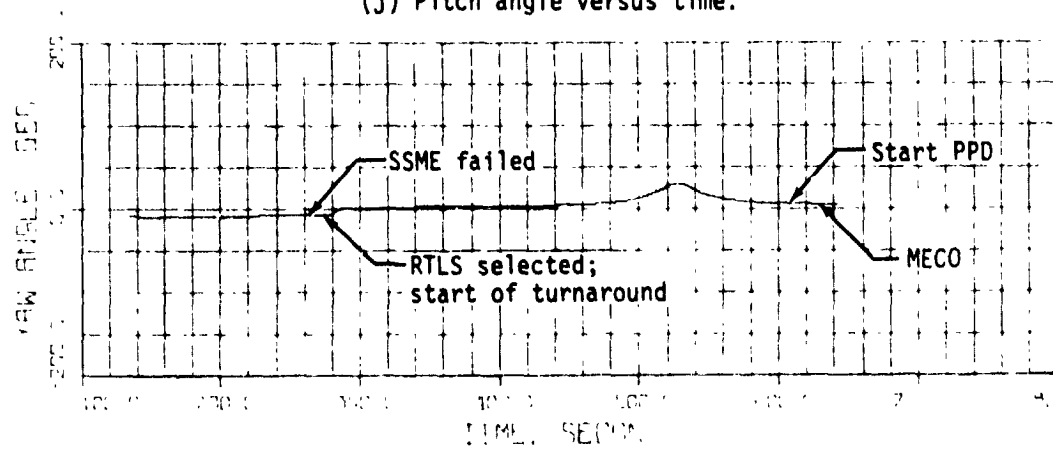

(k) Yaw angle versus time.

Figure 6.2.1-5.- Continued.

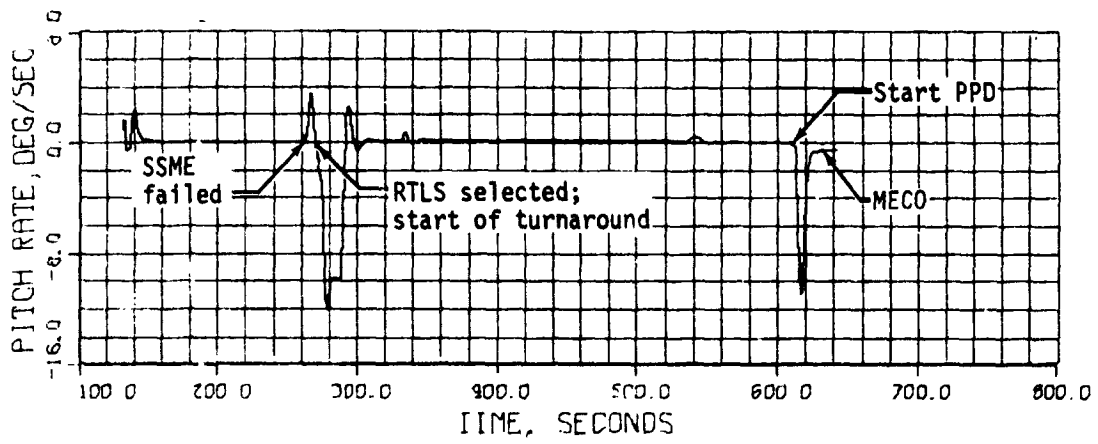

(l) Pitch rate versus time.

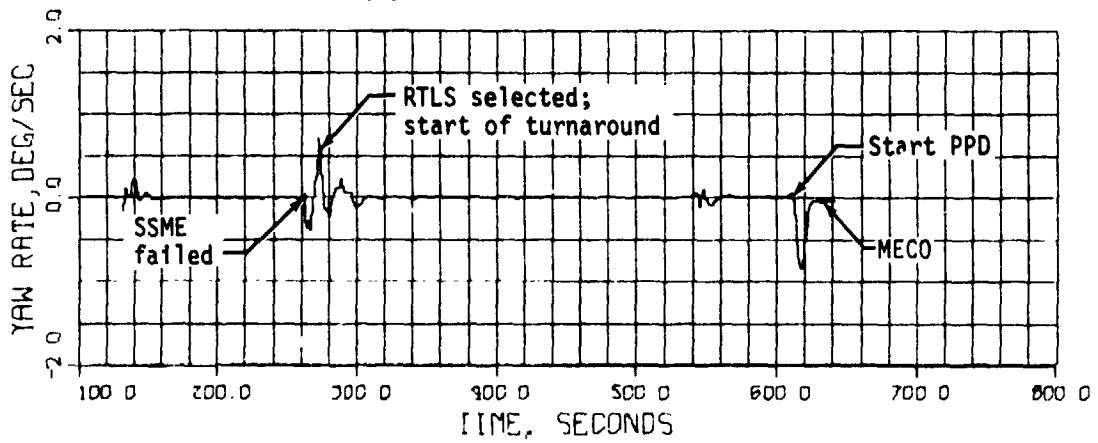

(m) Yaw rate versus time.

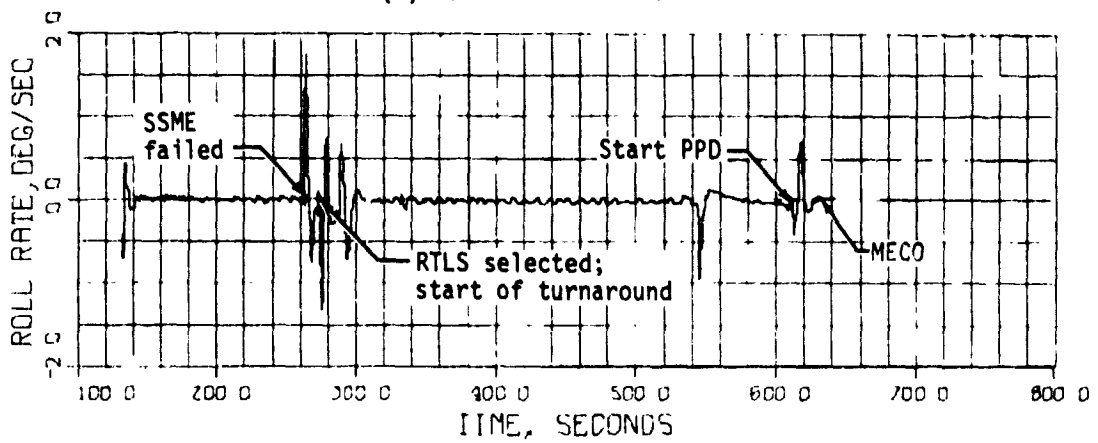

(n) Roll rate versus time.

Figure 6.2.1-5.- Continued.

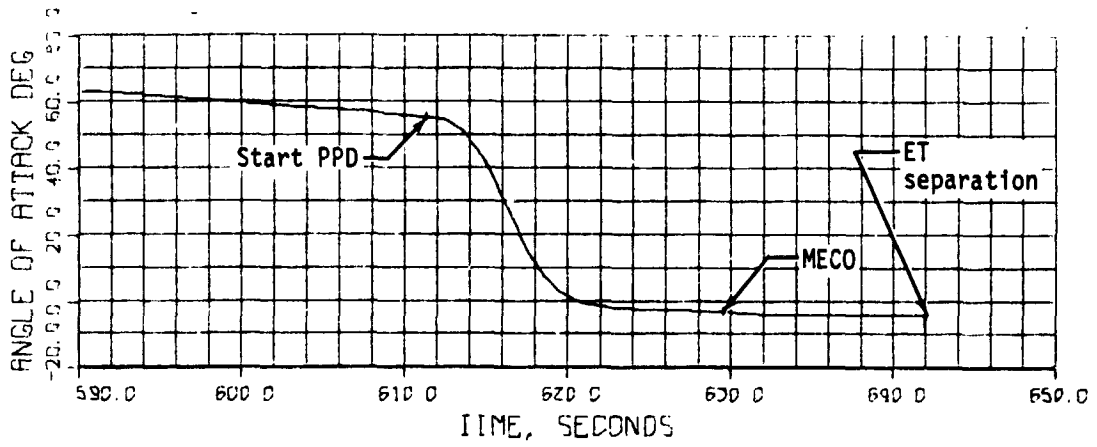

(o) Angle of attack versus time in pitchdown and mated coast.

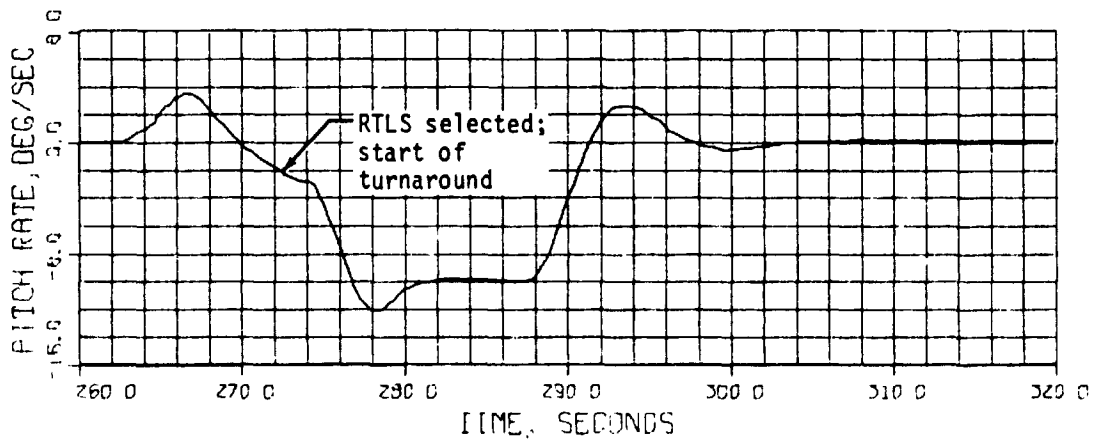

(p) Pitch rate versus time during turnaround.

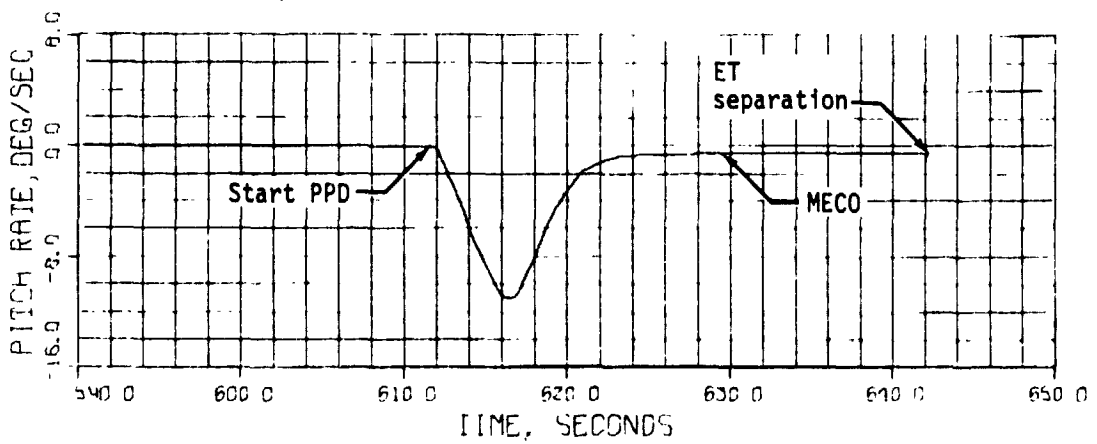

(q) Pitch rate versus time in pitchdown and mated coast.

Figure 6.2.1-5.- Continued.

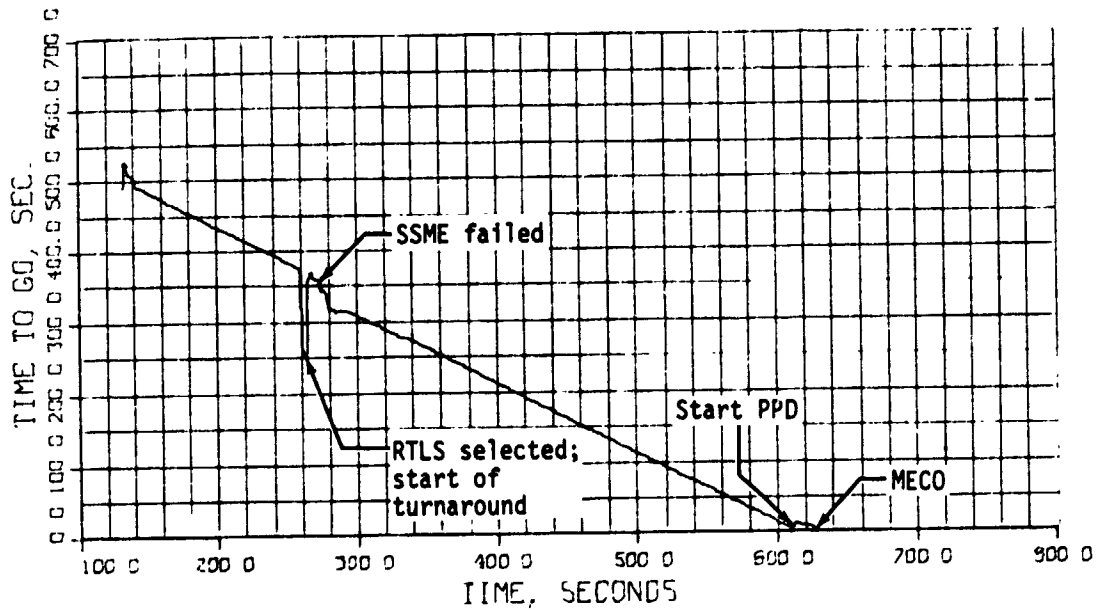

(r) Time to go versus time.

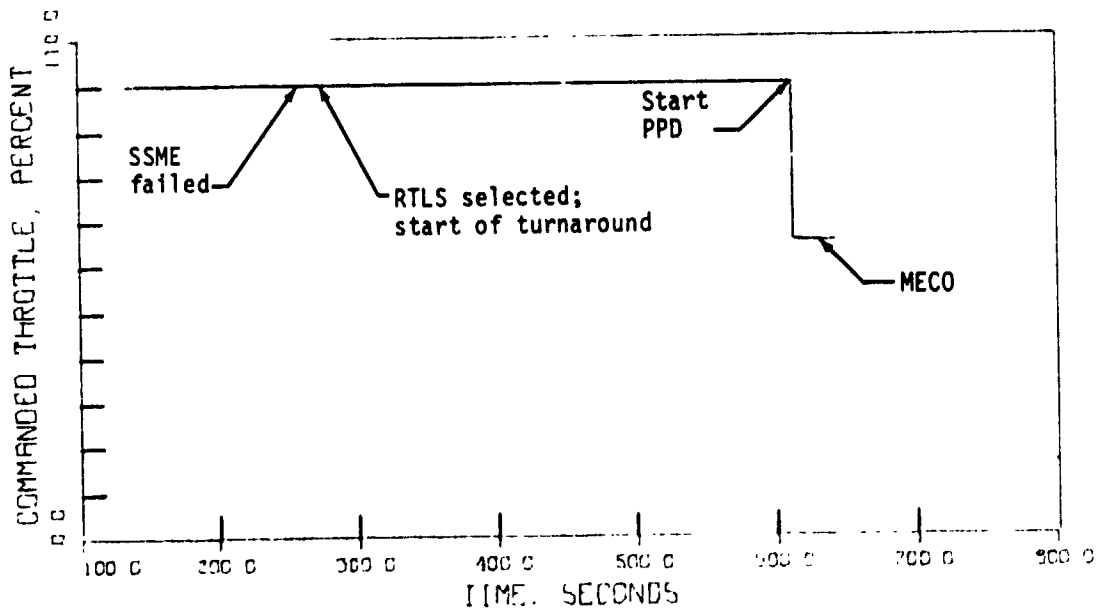

(s) Command throttle versus time.

Figure 6.2.1-5.- Continued.

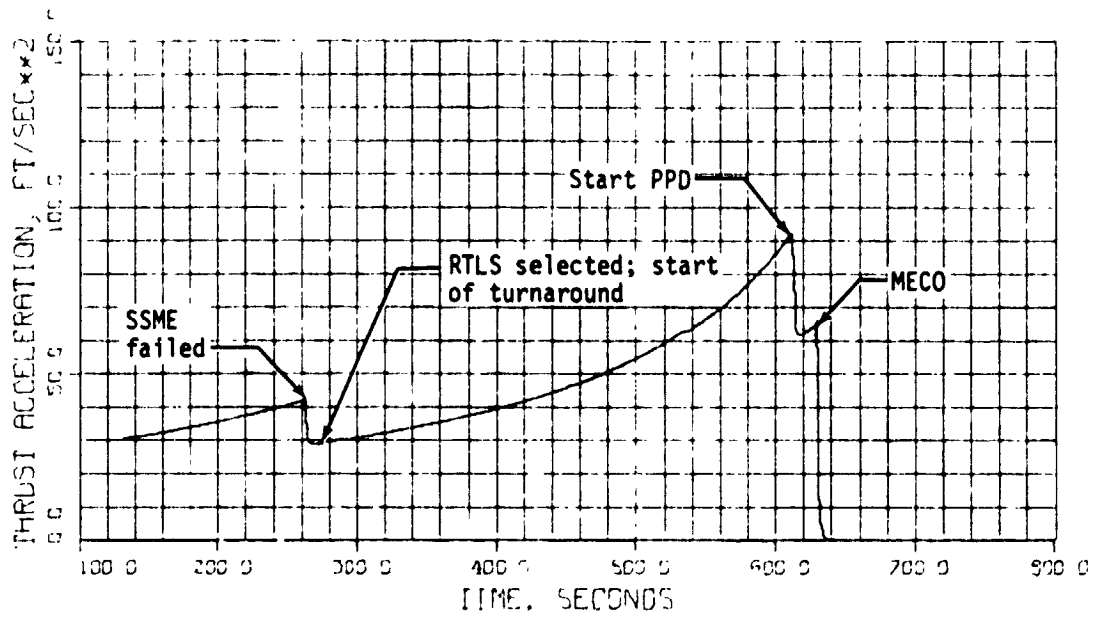

(t) Thrust acceleration versus time.

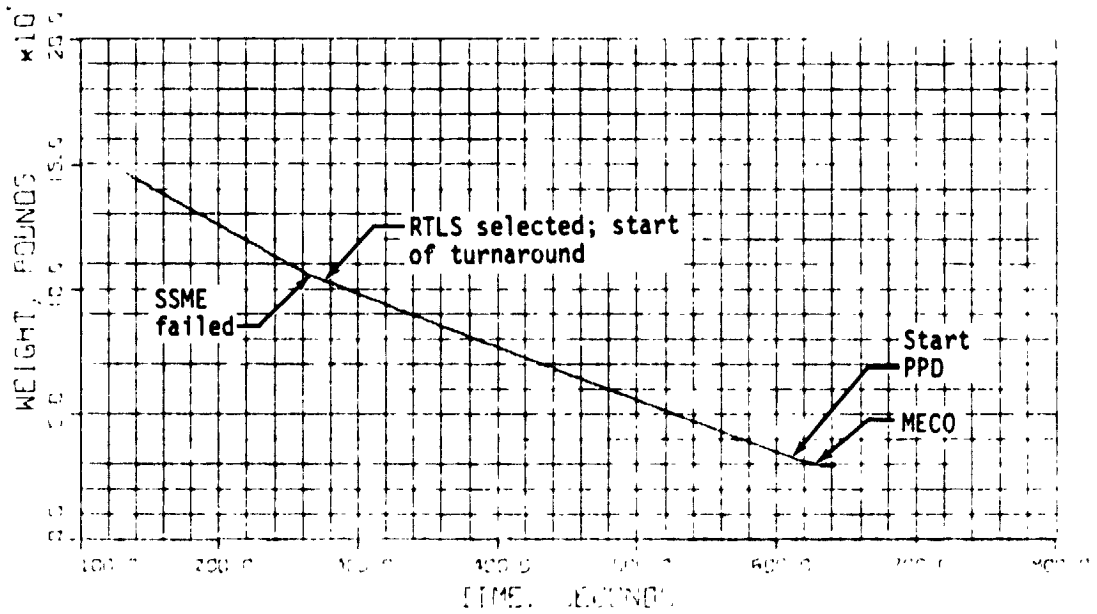

(u) Weight versus time.

Figure 6.2.1-5.- Continued.

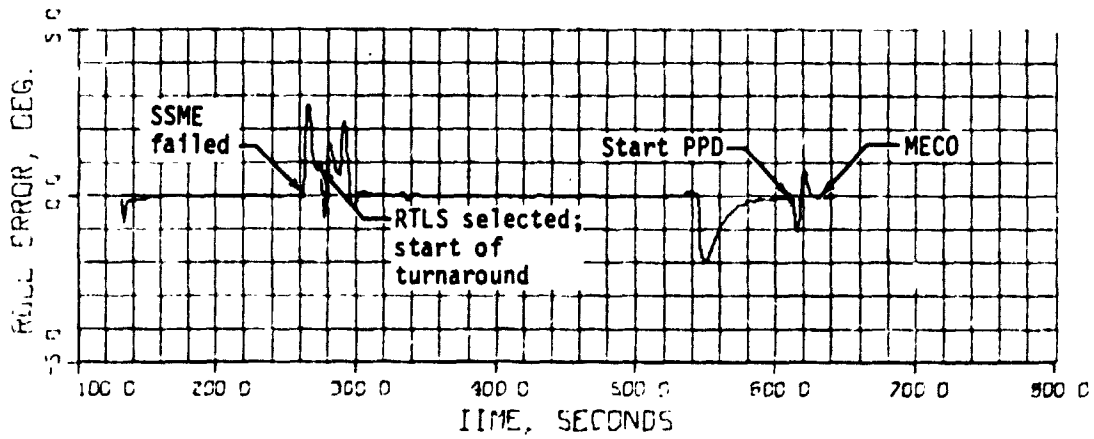

(v) Roll error versus time.

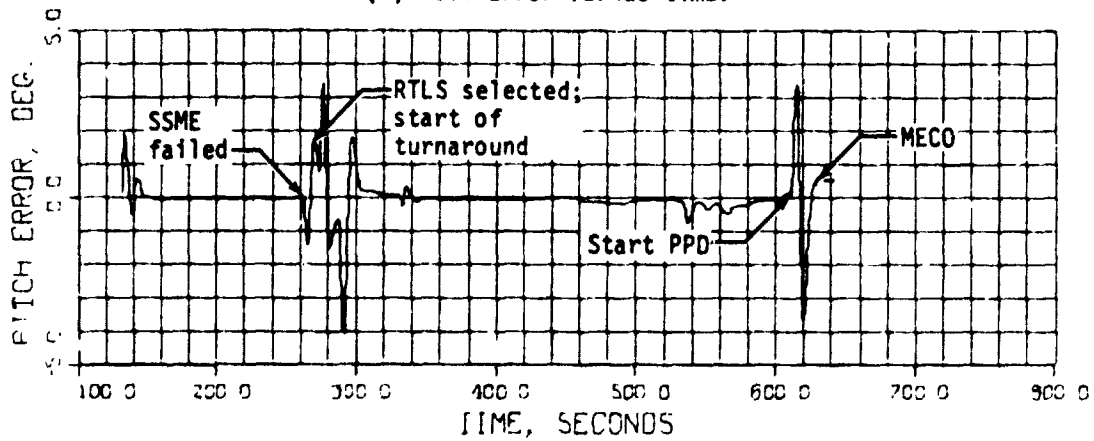

(w) Pitch error versus time.

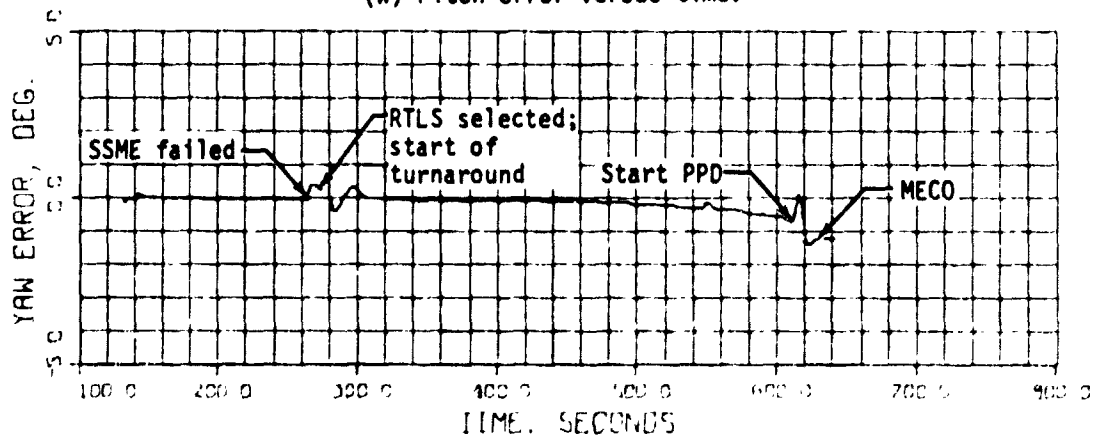

(x) Yaw error versus time.

Figure 6.2.1-5.- Continued.

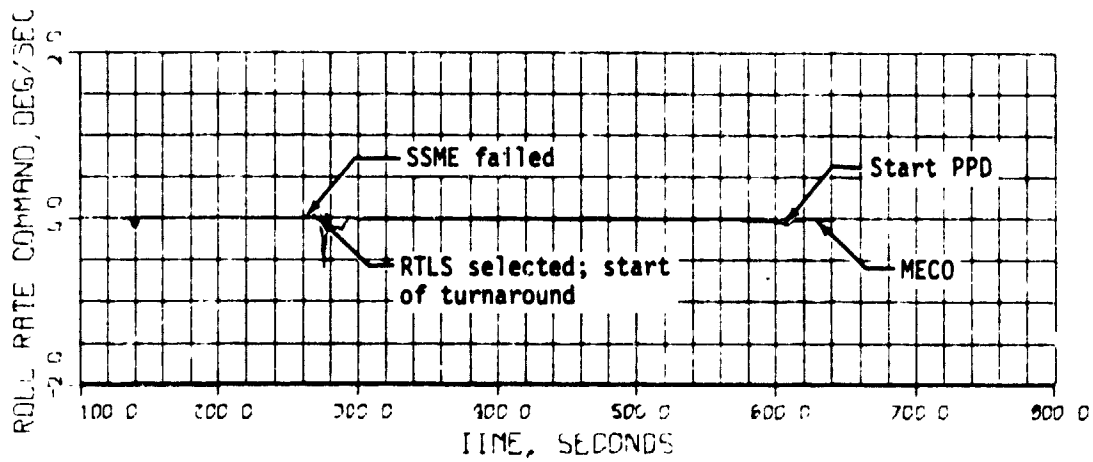

(y) Roll rate command versus time.

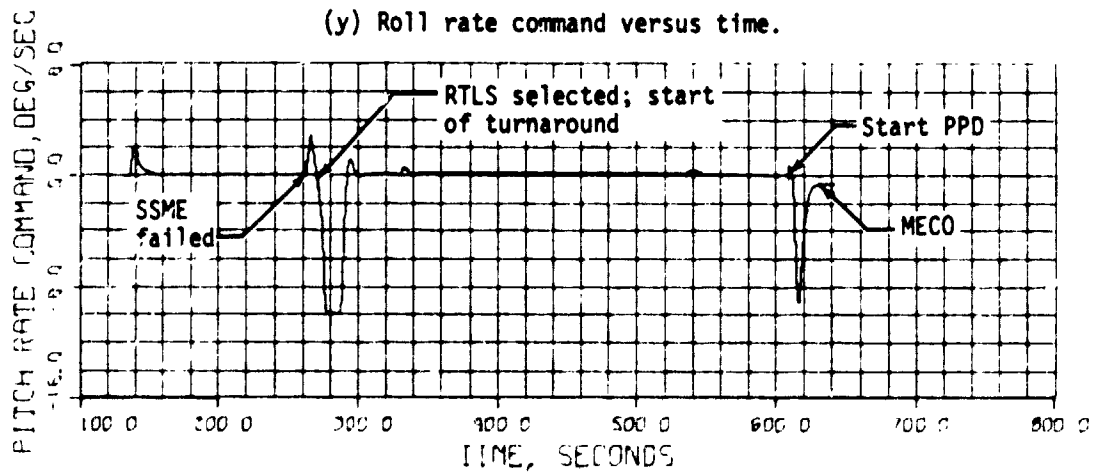

(z) Pitch rate command versus time.

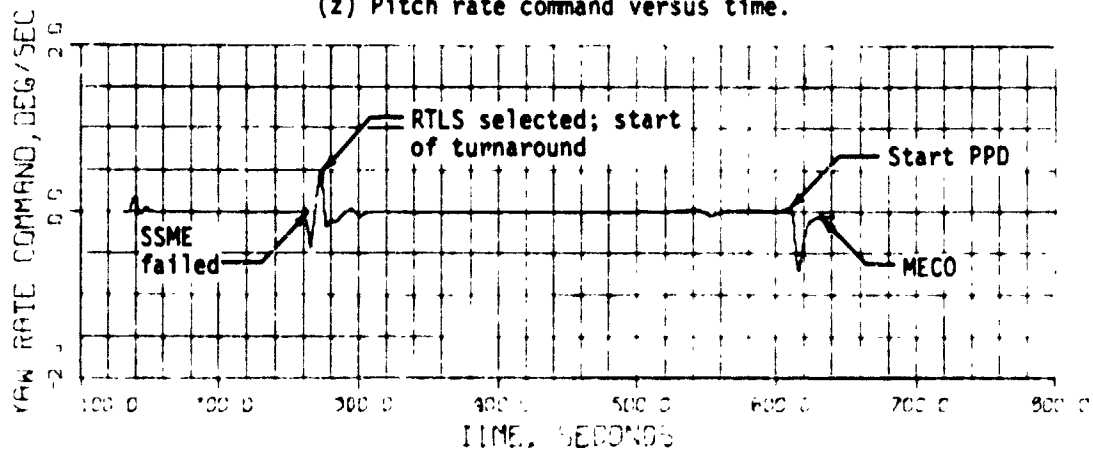

(aa) Yaw rate command versus time.

Figure 6.2.1-5.- Continued.

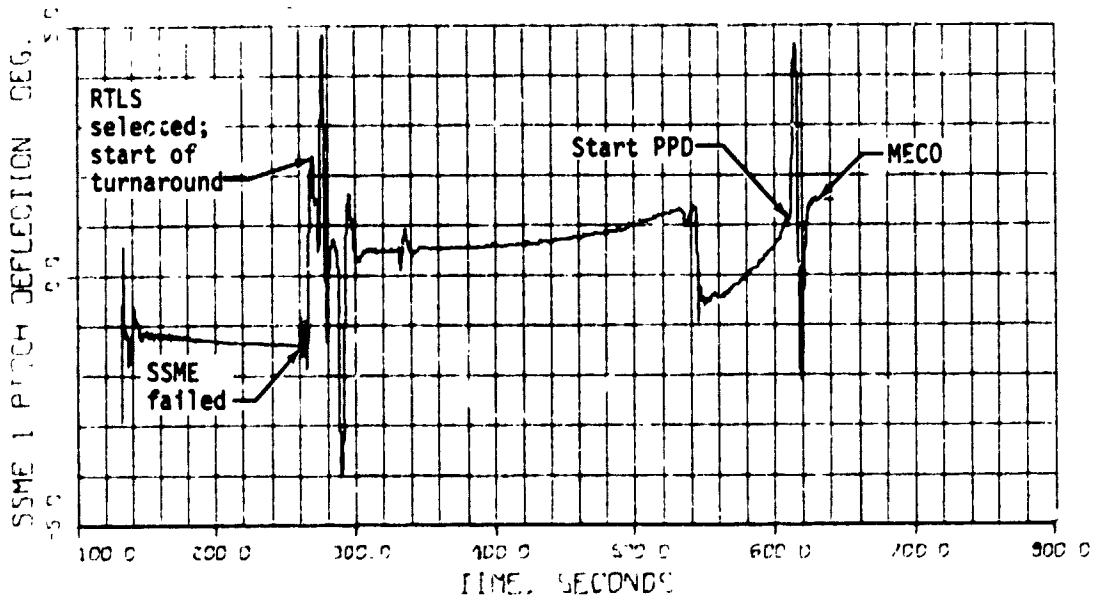

(bb) SSME 1 pitch deflection versus time.

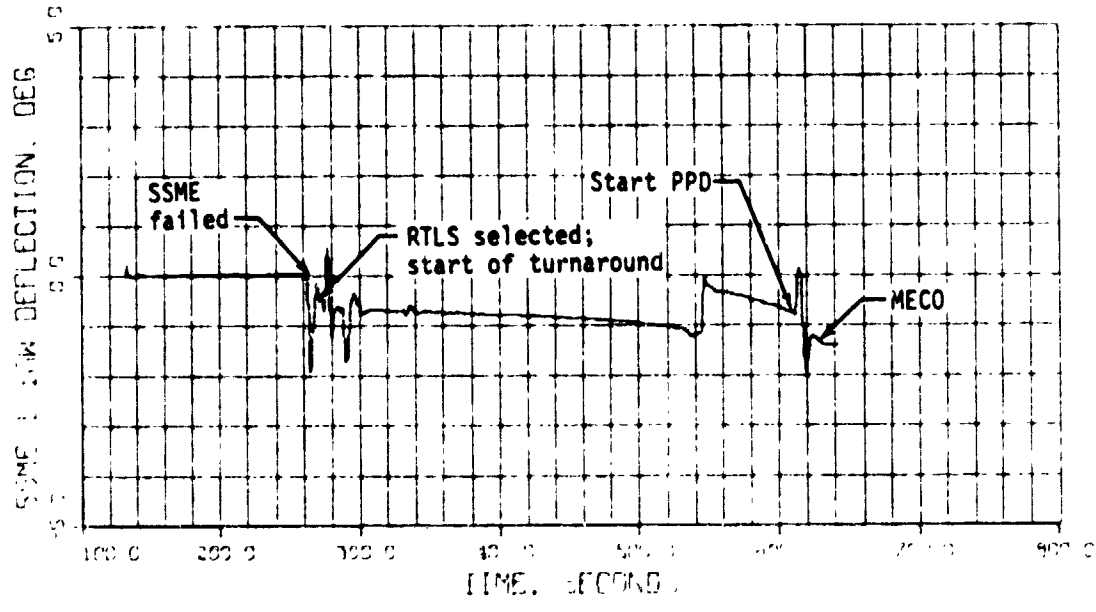

(cc) SSME 1 yaw deflection versus time.

Figure 6.2.1-5.- Continued.

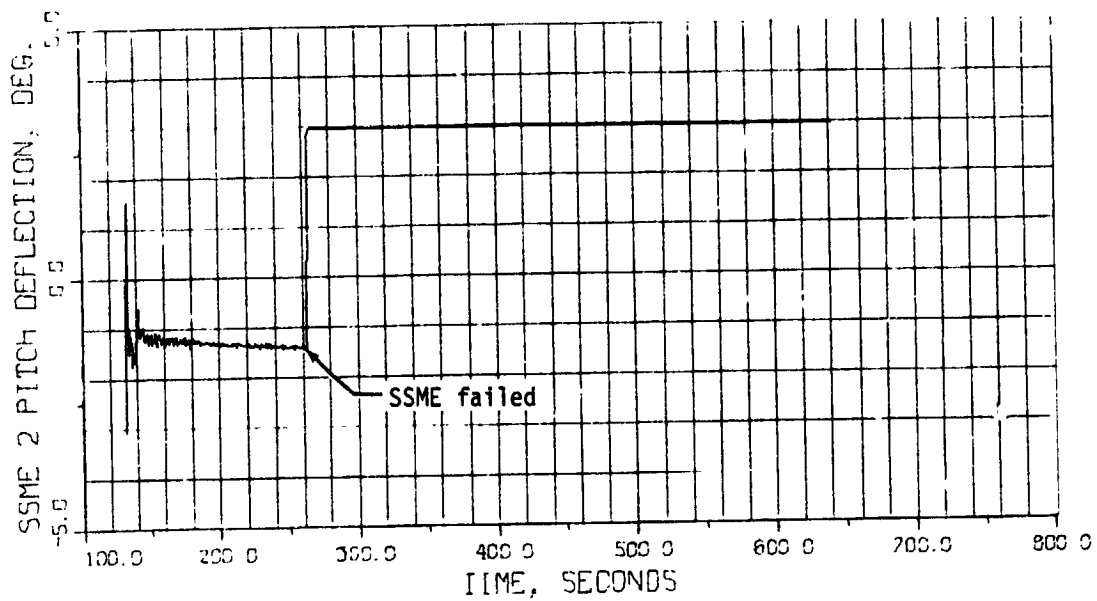

(dd) SSME 2 pitch deflection versus time.

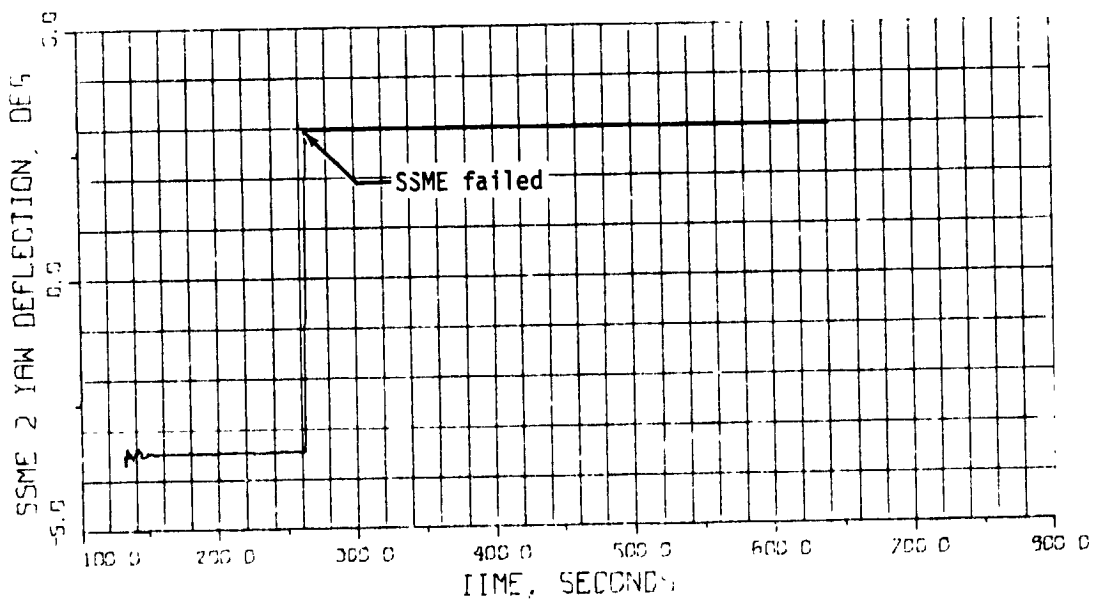

(ee) SSME 2 yaw deflection versus time.

Figure 6.2.1-5.- Continued.

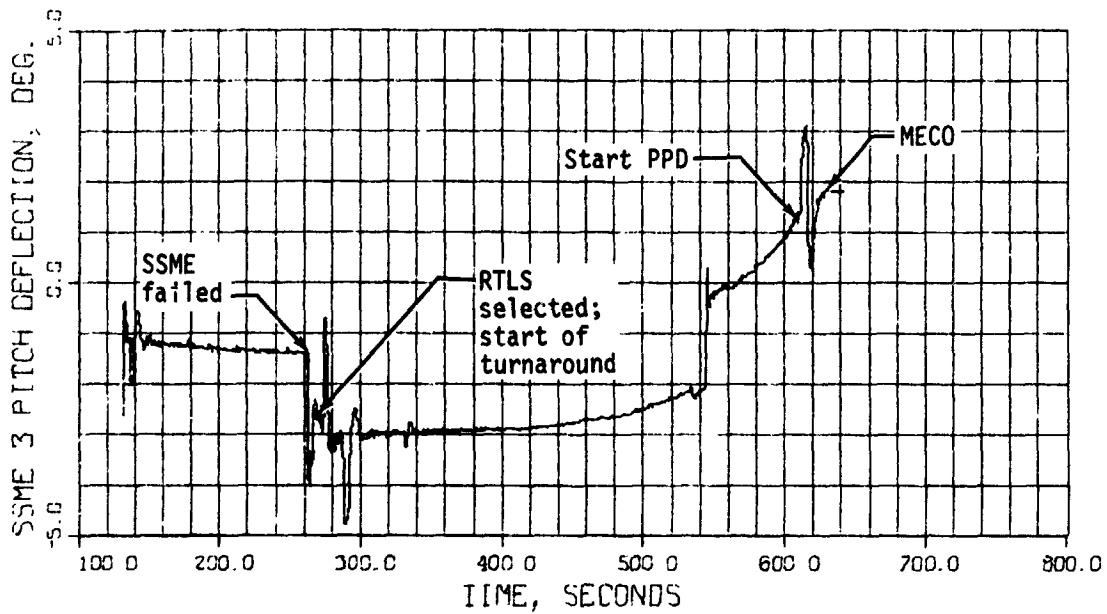

(ff) SSME 3 pitch deflection versus time.

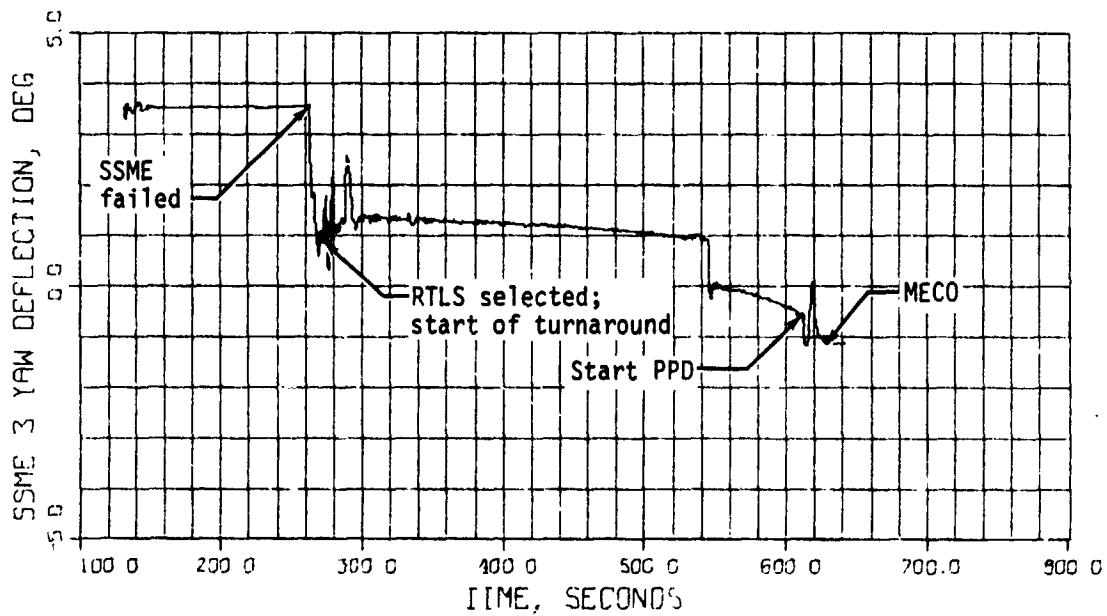

(gg) SSME 3 yaw deflection versus time.

Figure 6.2.1-5.- Concluded.

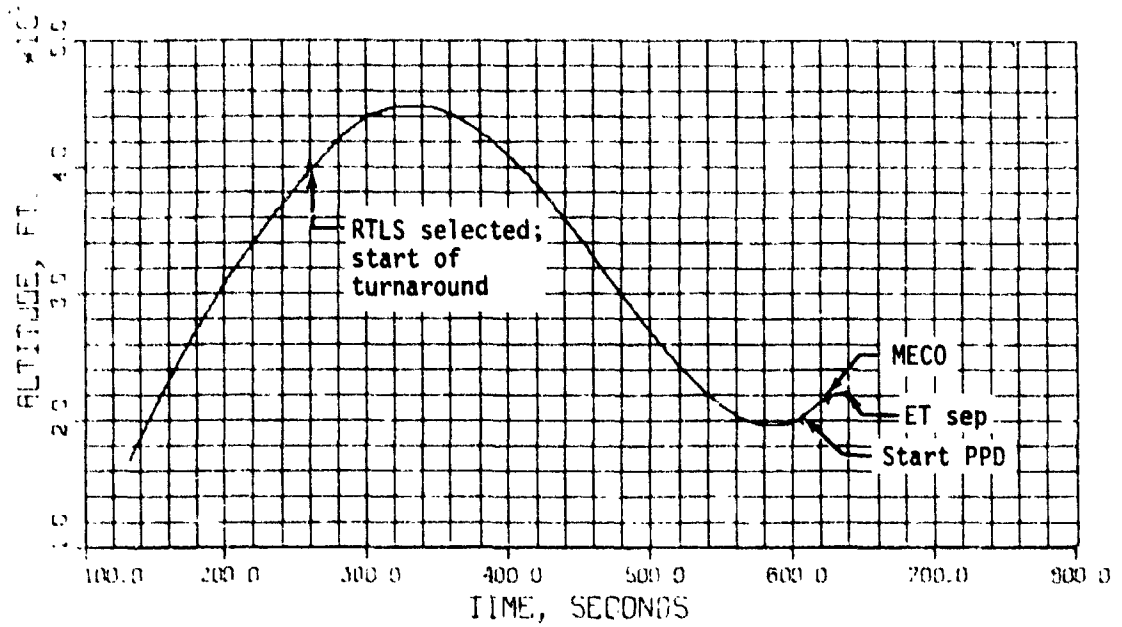

(a) Altitude versus time.

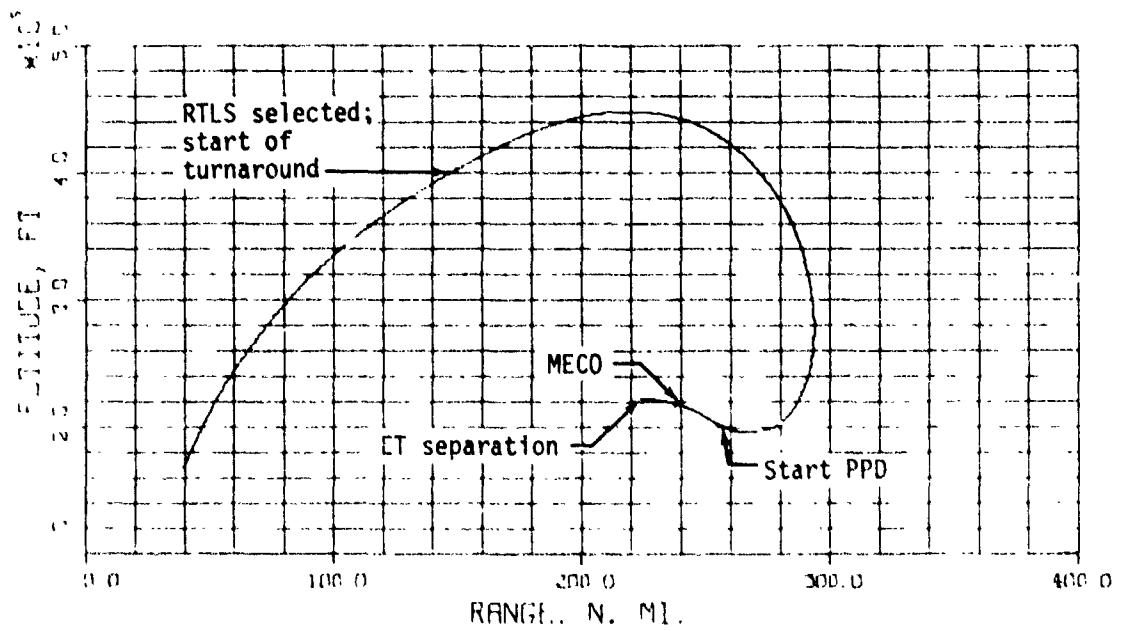

(b) Altitude versus range.

Figure 6.2.1-6.- PRTLs trajectory data for a 3-SSME
RTLs selected at 260 seconds.

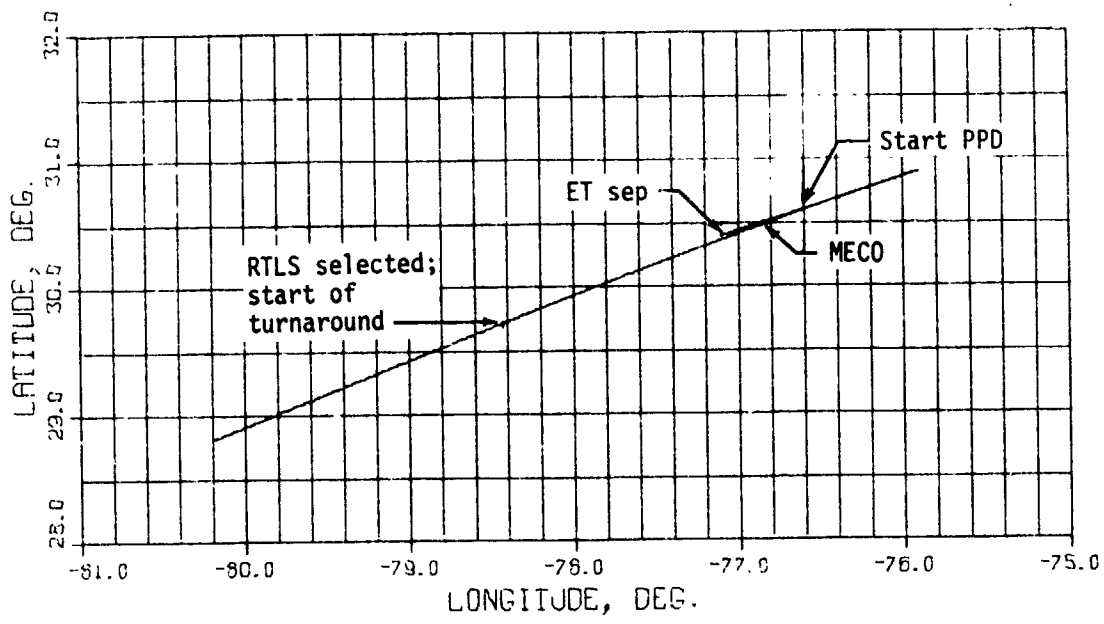

(c) Latitude versus longitude.

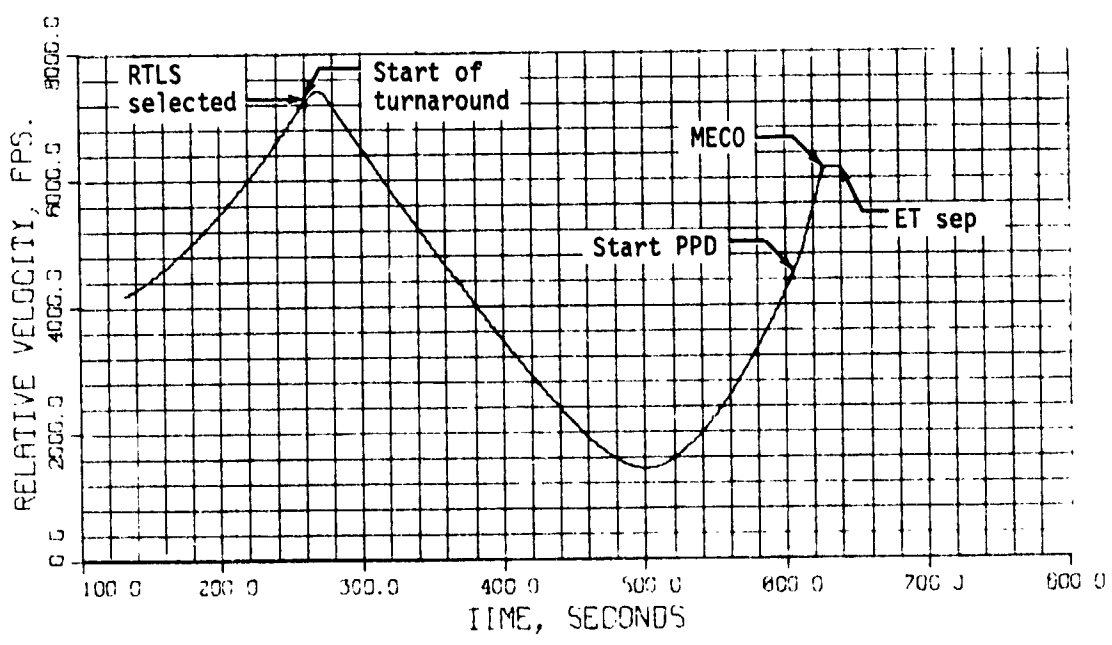

(d) Relative velocity versus time.

Figure 6.2.1-6.- Continued.

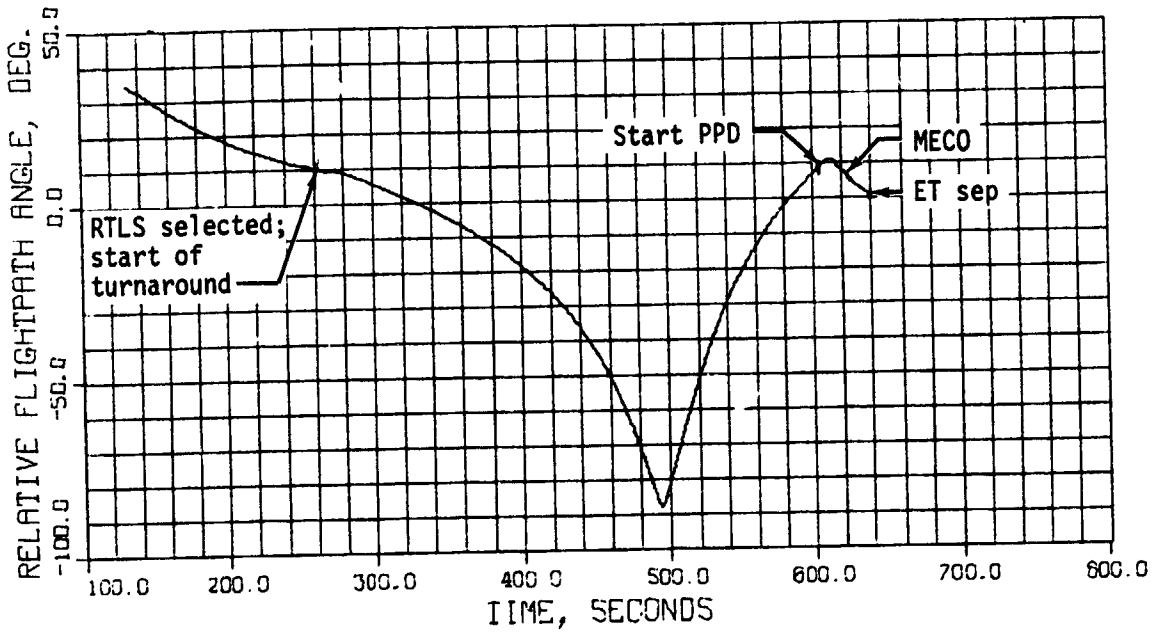

(e) Relative flightpath angle versus time.

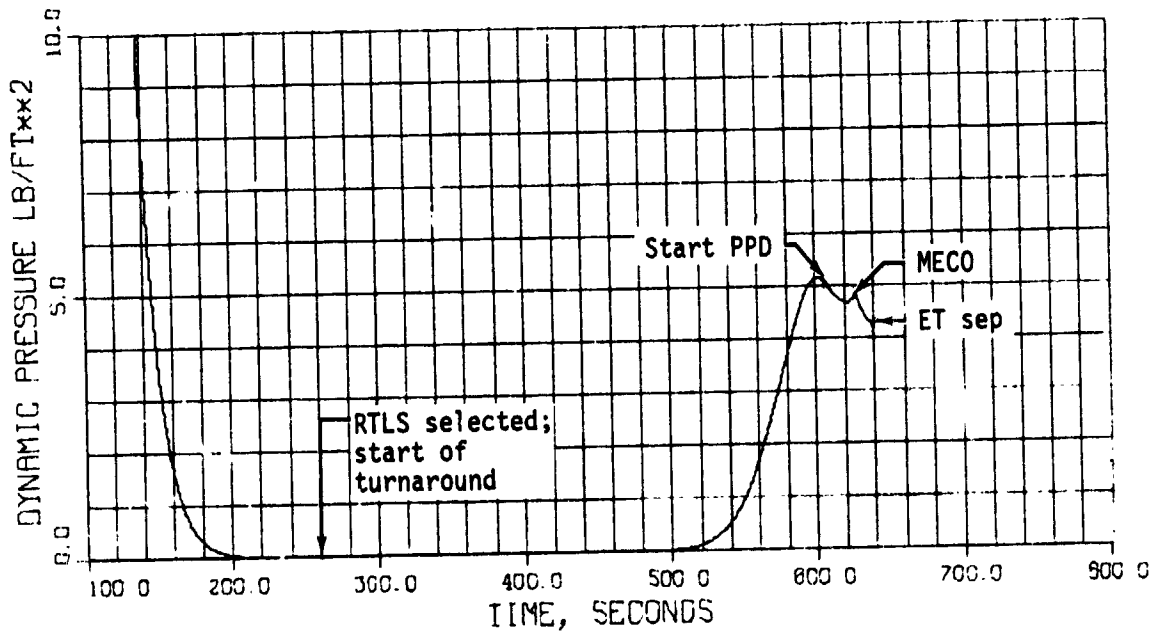

(f) Dynamic pressure versus time.

Figure 6.2.1-6.- Continued.

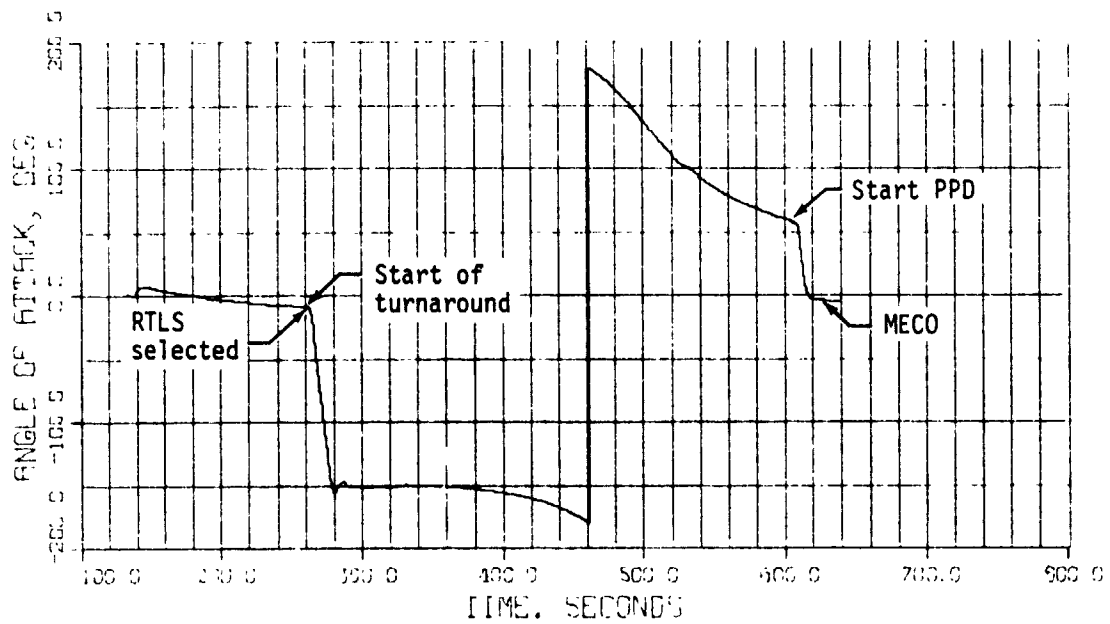

(g) Angle of attack versus time.

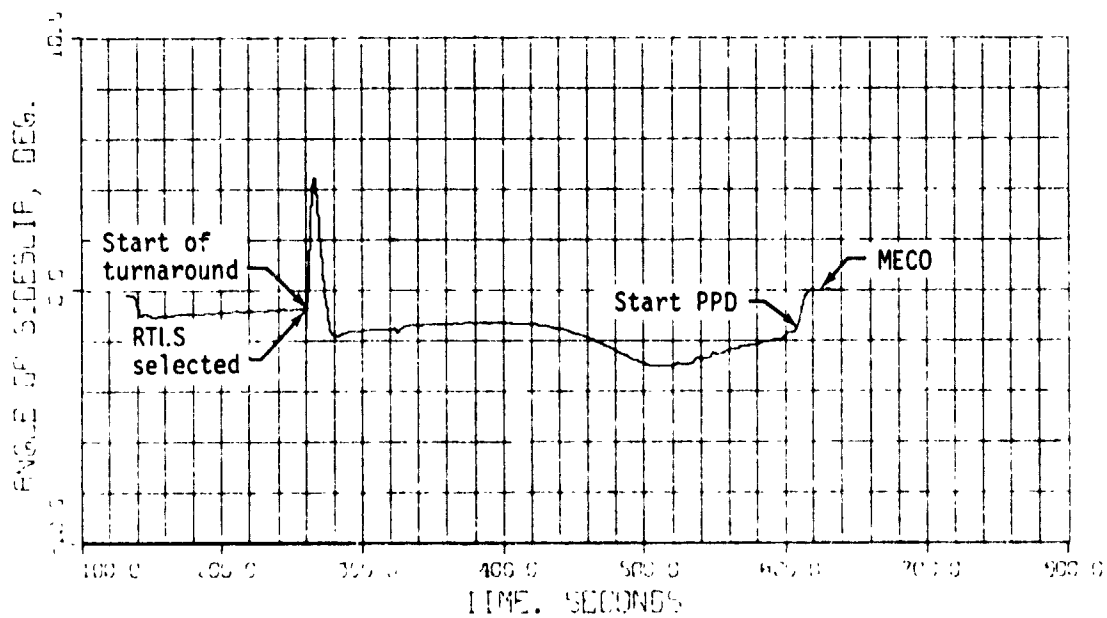

(h) Angle of sideslip versus time.

Figure 6.2.1-6.- Continued.

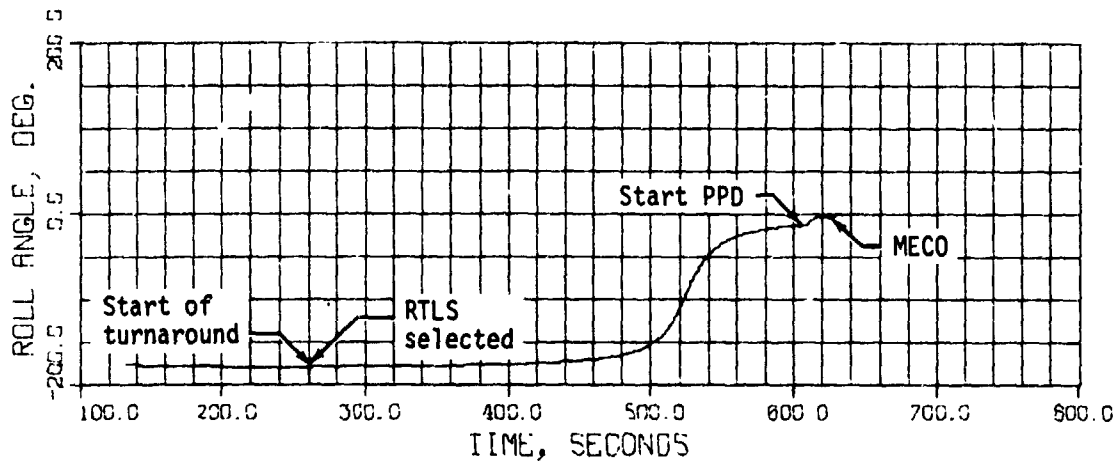

(i) Roll angle versus time.

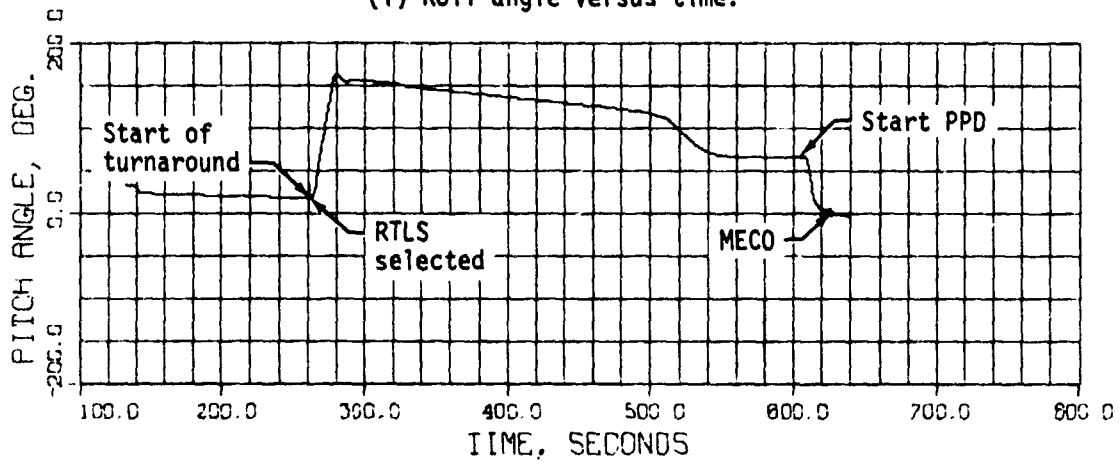

(j) Pitch angle versus time.

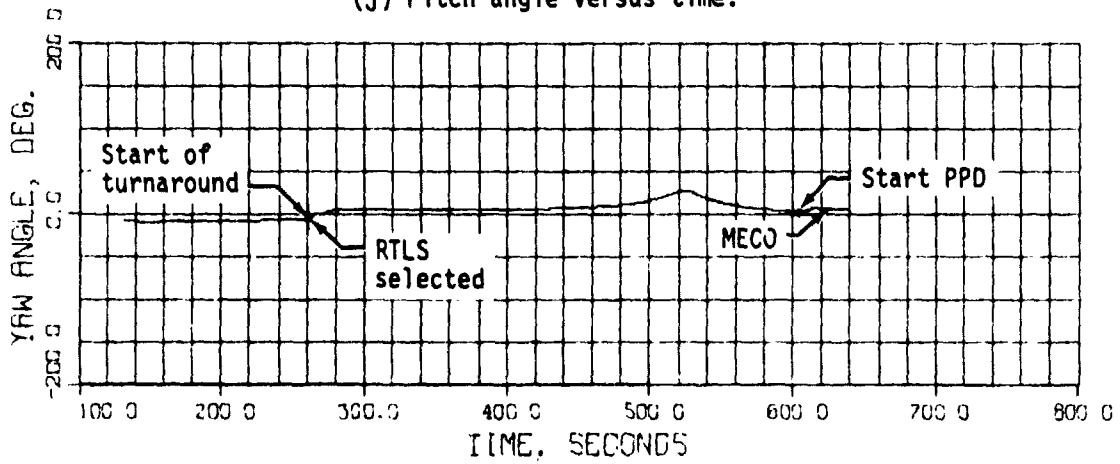

(k) Yaw angle versus time.

Figure 6.2.1-6.- Continued.

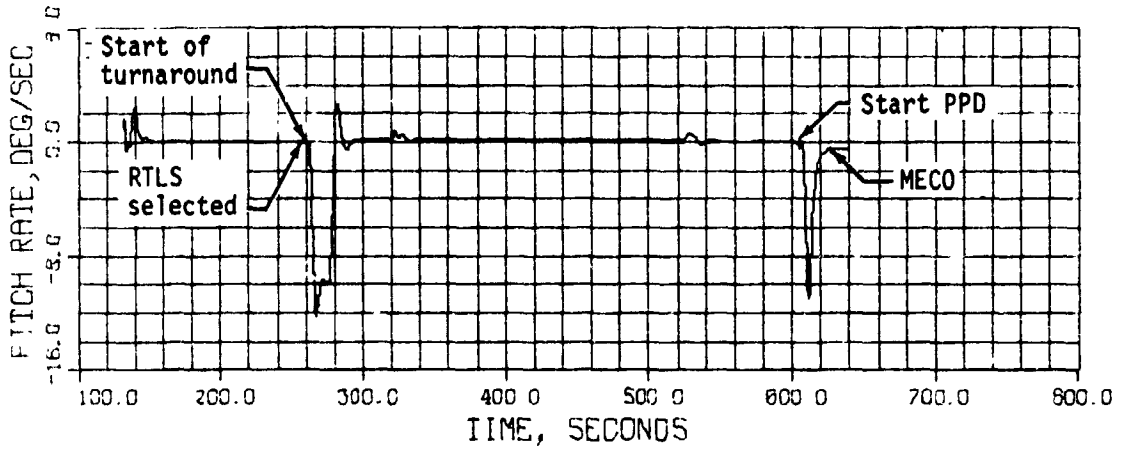

(l) Pitch rate versus time.

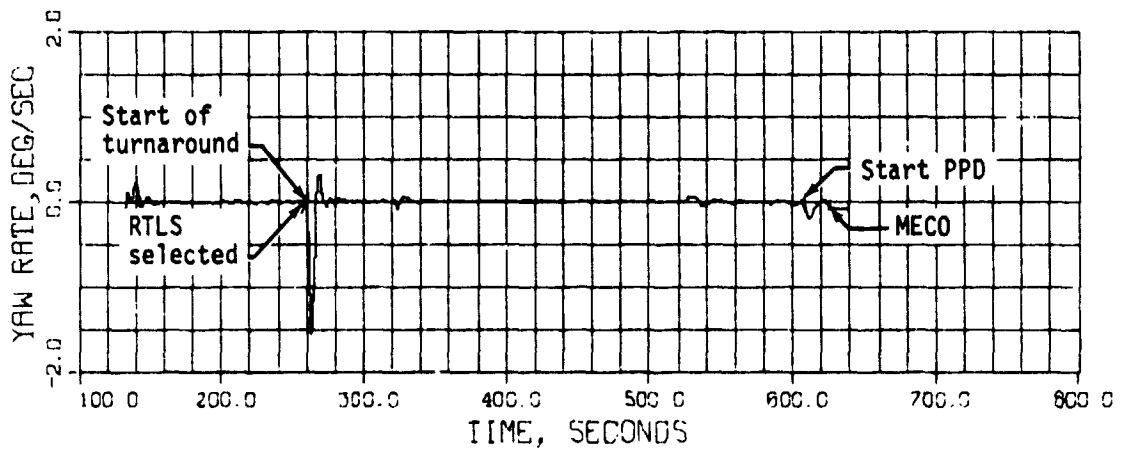

(m) Yaw rate versus time.

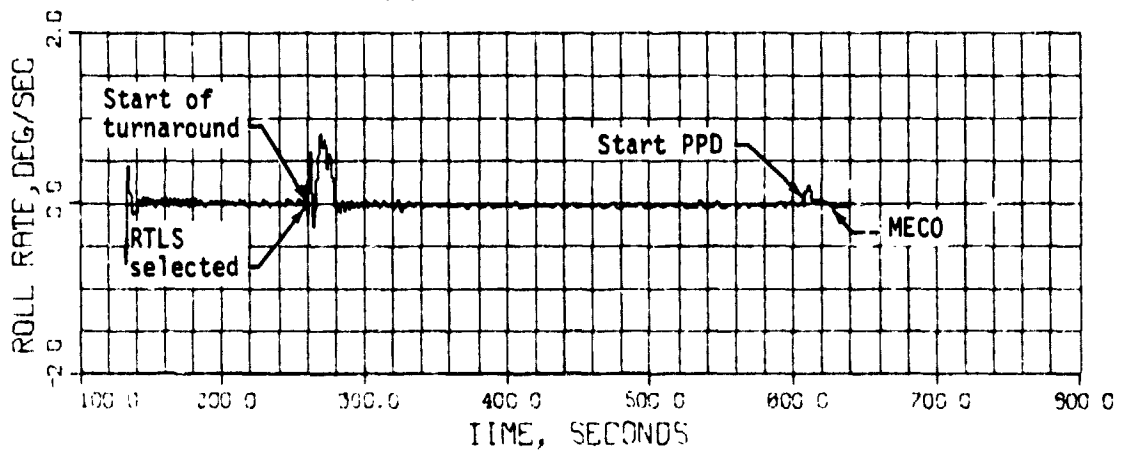

(n) Roll rate versus time.

Figure 6.2.1-6.- Continued.

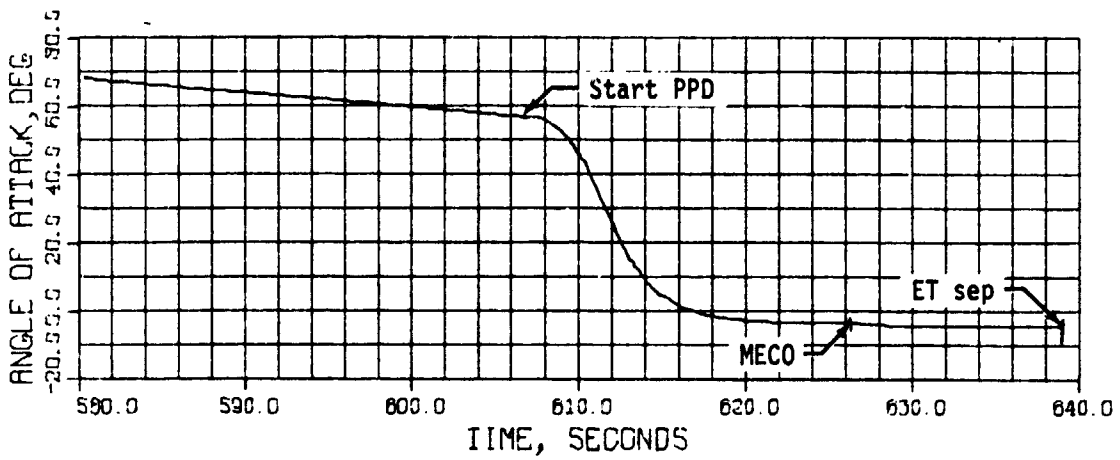

(o) Angle of attack versus time in pitchdown and mated coast.

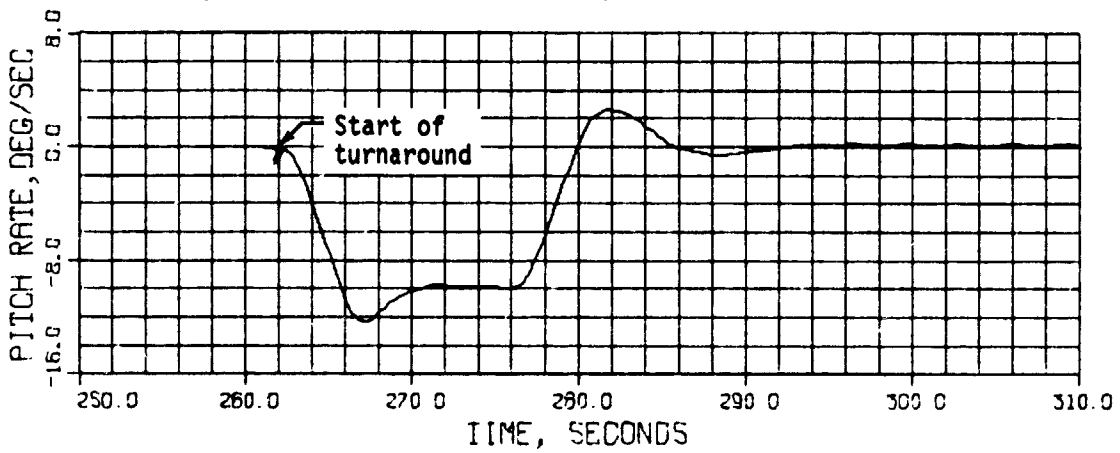

(p) Pitch rate versus time during turnaround.

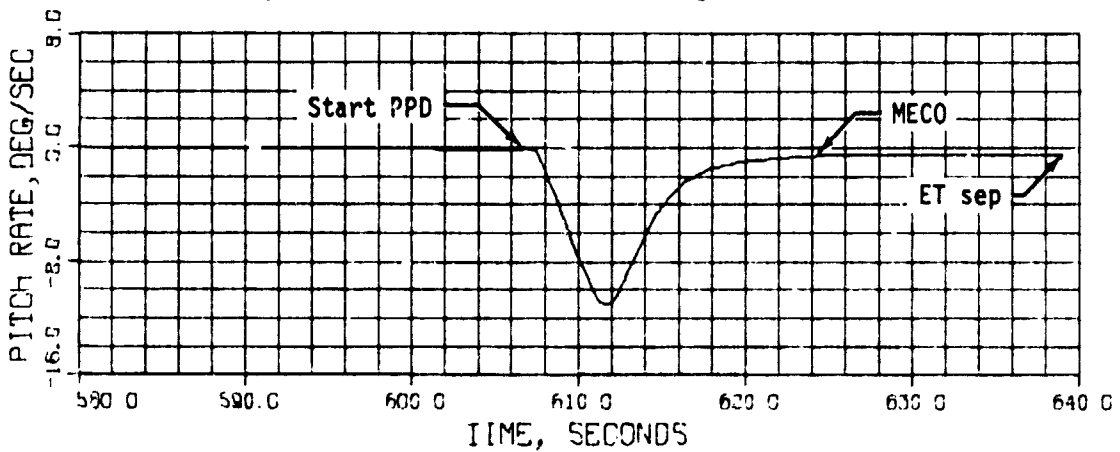

(q) Pitch rate versus time in pitchdown and mated coast.

Figure 6.2.1-6.- Continued.

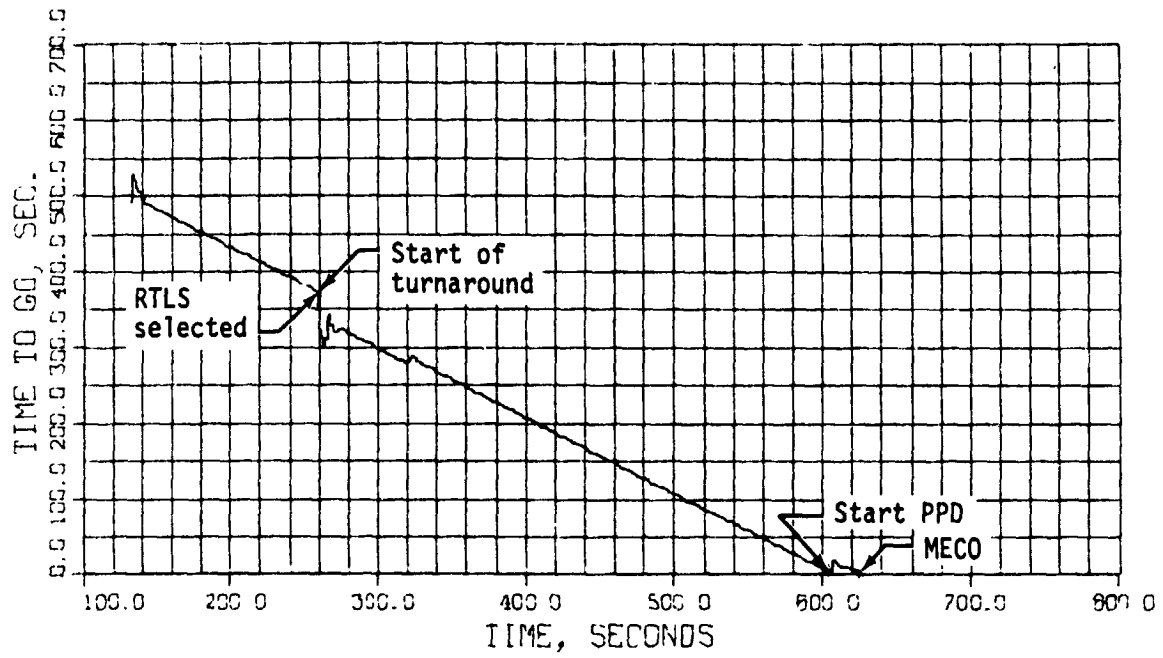

(r) Time to go versus time.

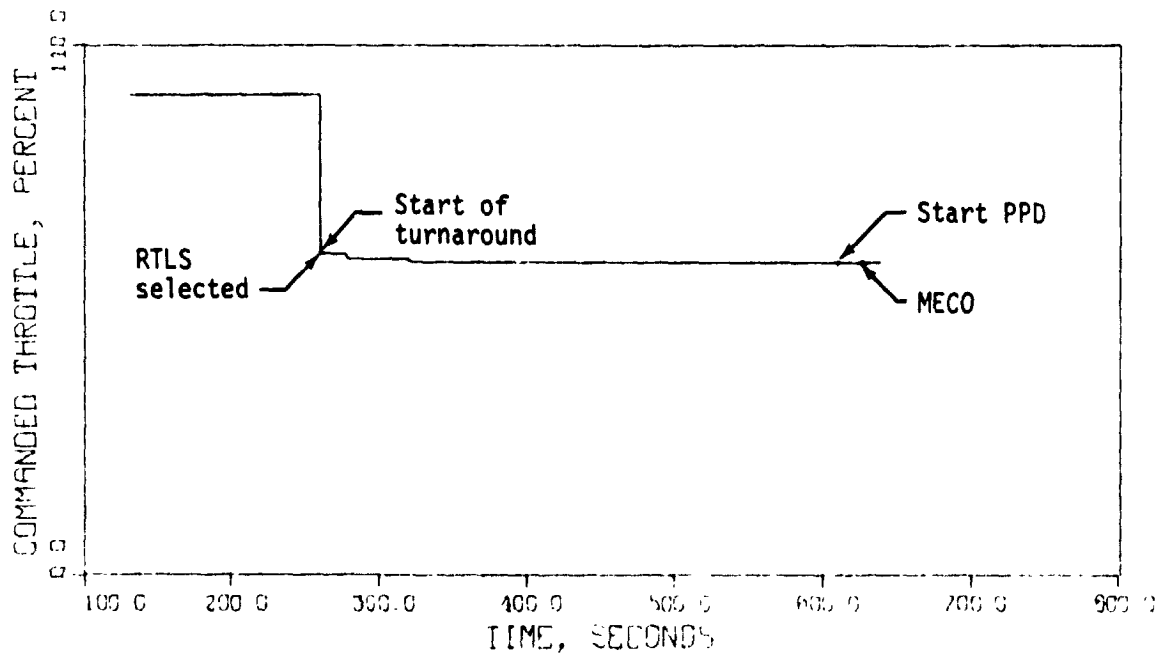

(s) Command throttle versus time.

Figure 6.2.1-6.- Continued.

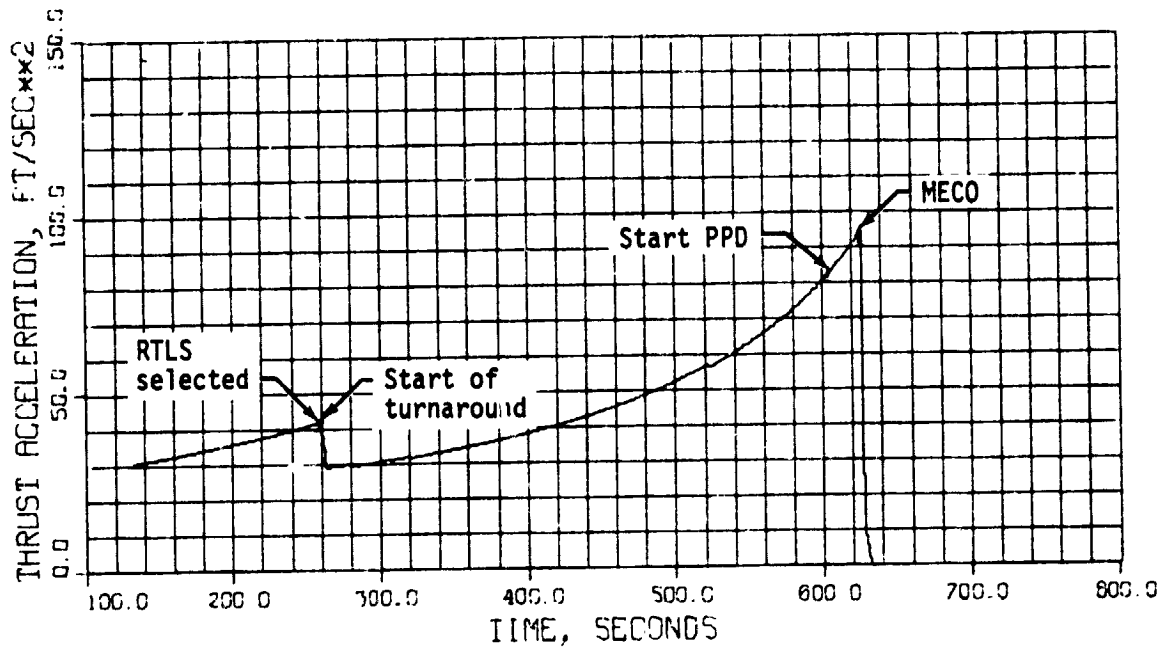

(t) Thrust acceleration versus time.

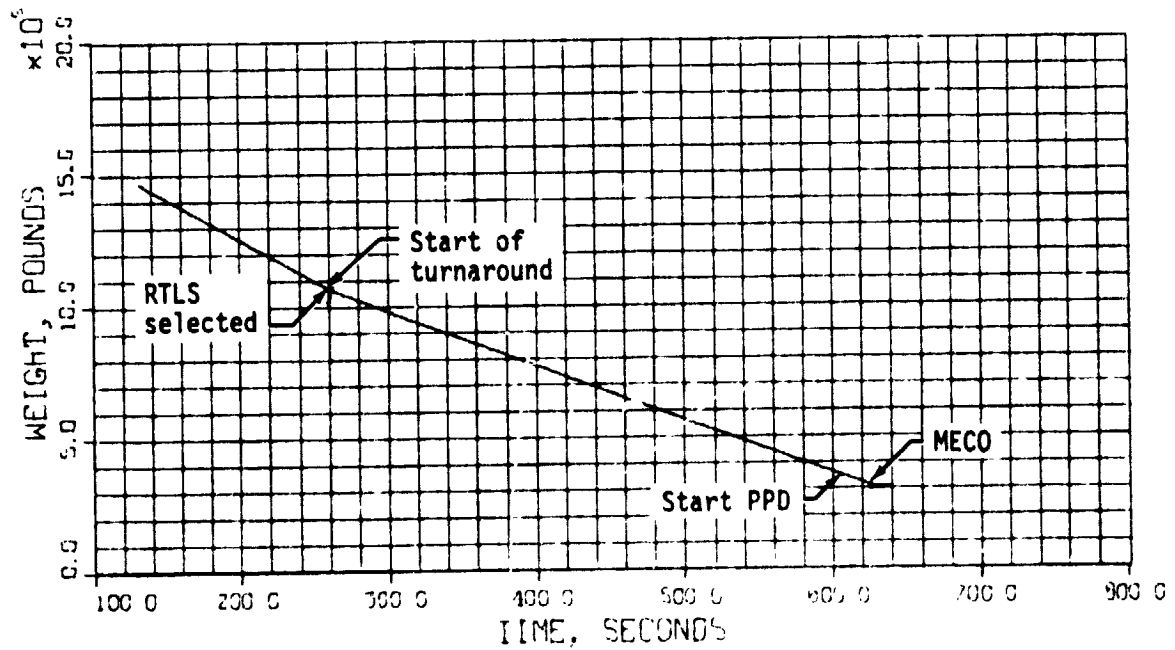

(u) Weight versus time.

Figure 6.2.1-6.- Continued.

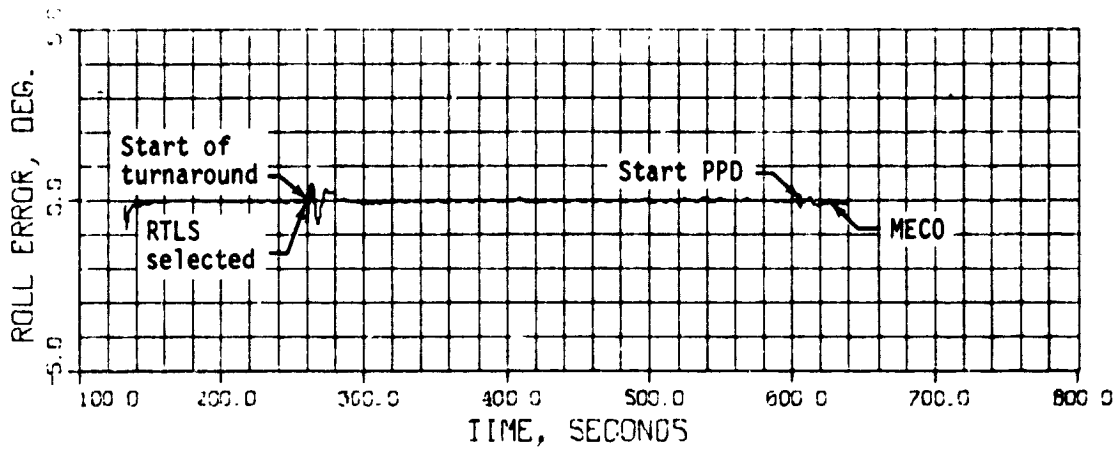

(v) Roll error versus time.

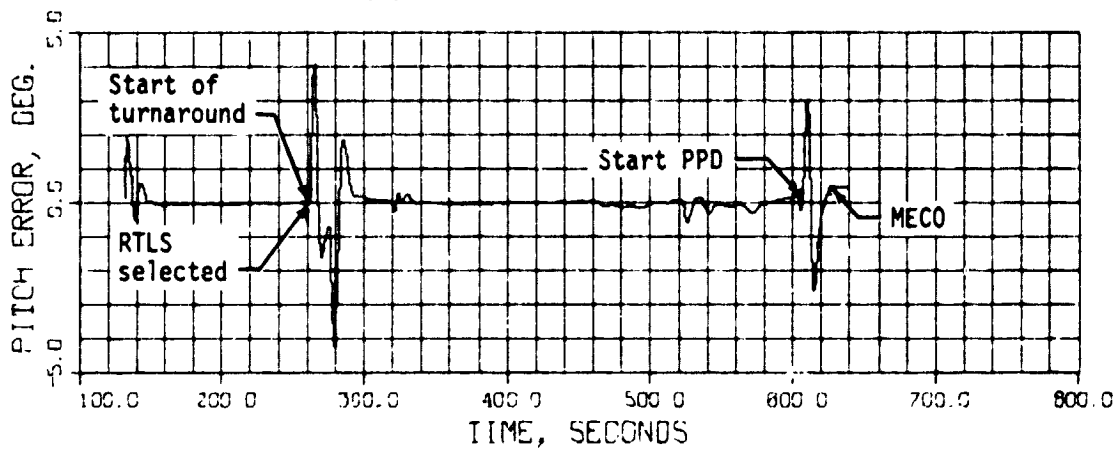

(w) Pitch error versus time.

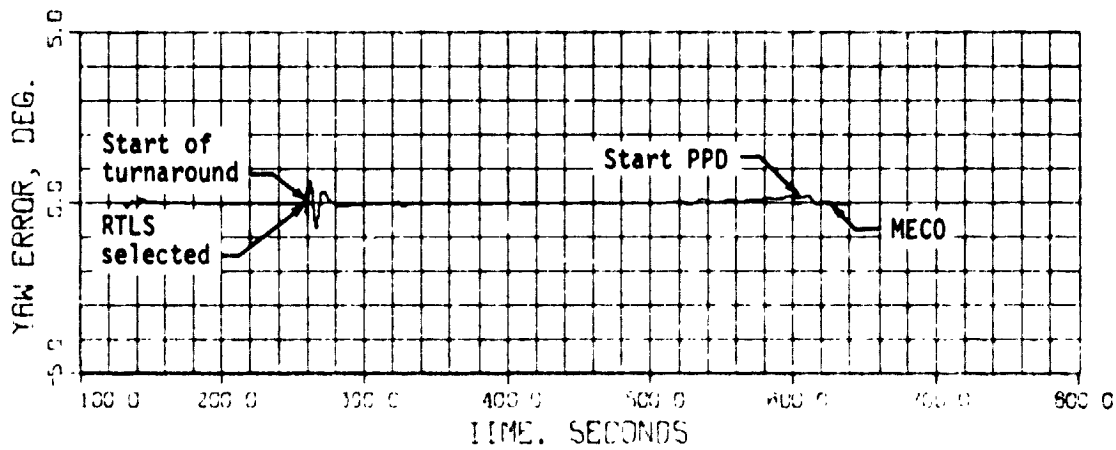

(x) Yaw error versus time.

Figure 6.2.1-6.- Continued.

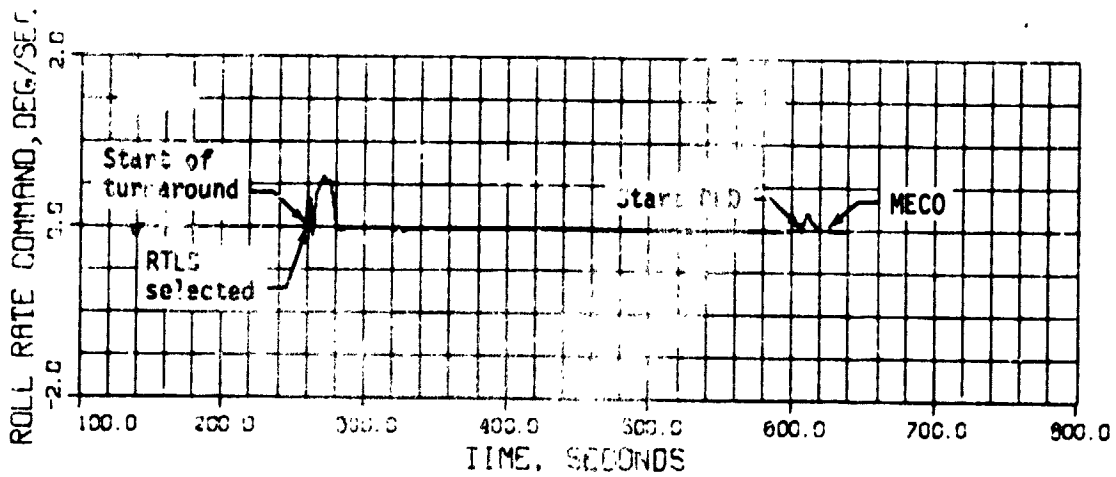

(y) Roll rate command versus time.

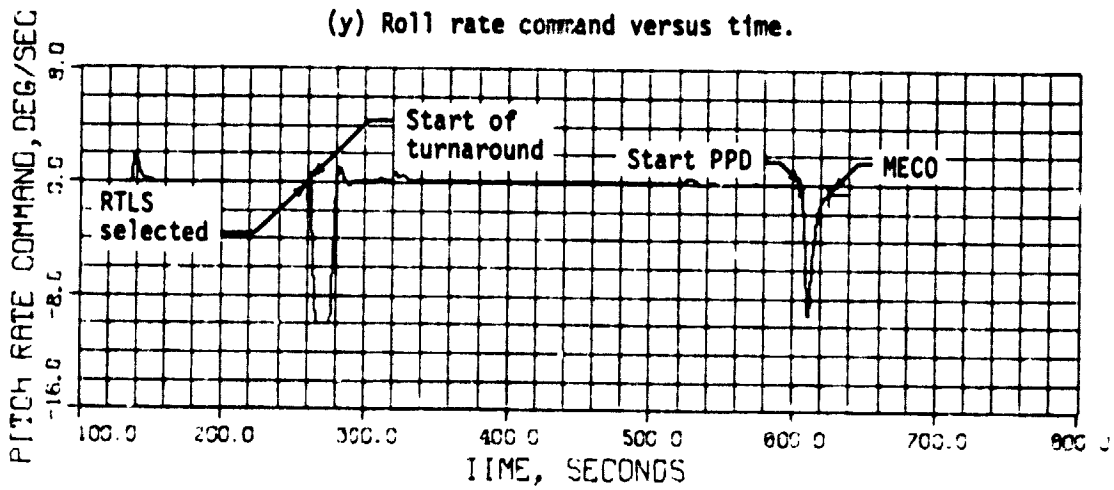

(z) Pitch rate command versus time.

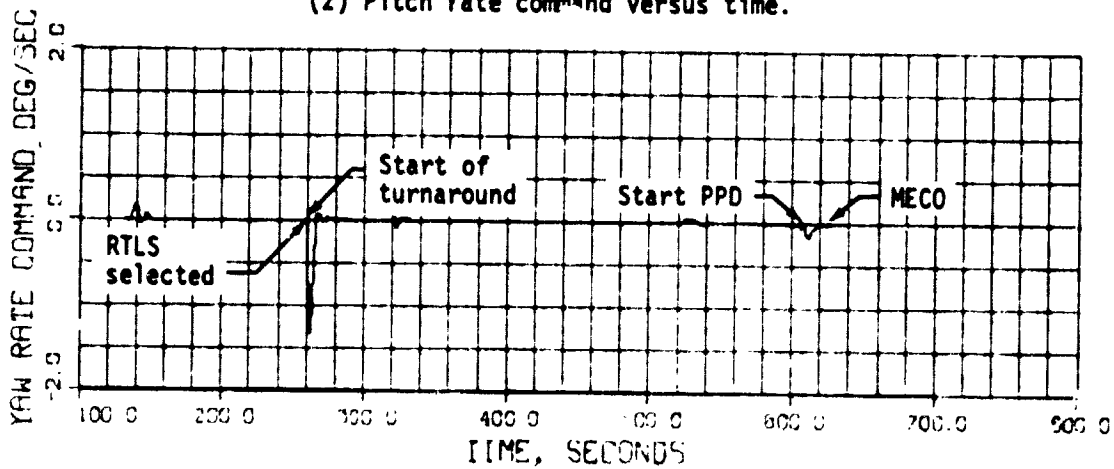

(aa) Yaw rate command versus time.

Figure 6.2.1-6.- Continued.

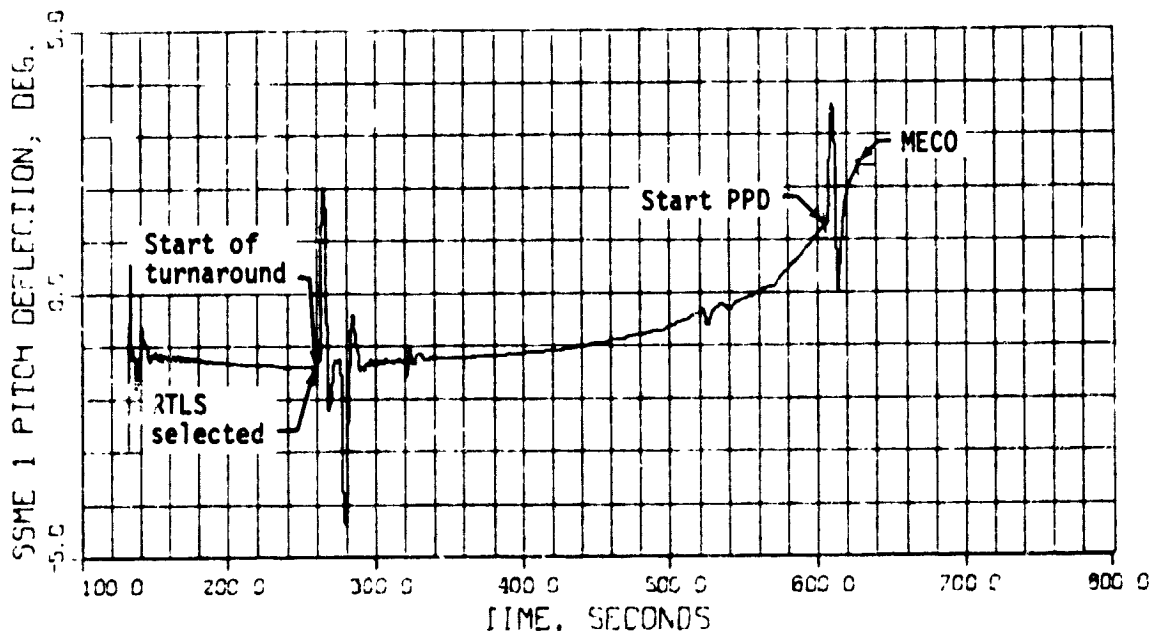

(bb) SSME 1 pitch deflection versus time.

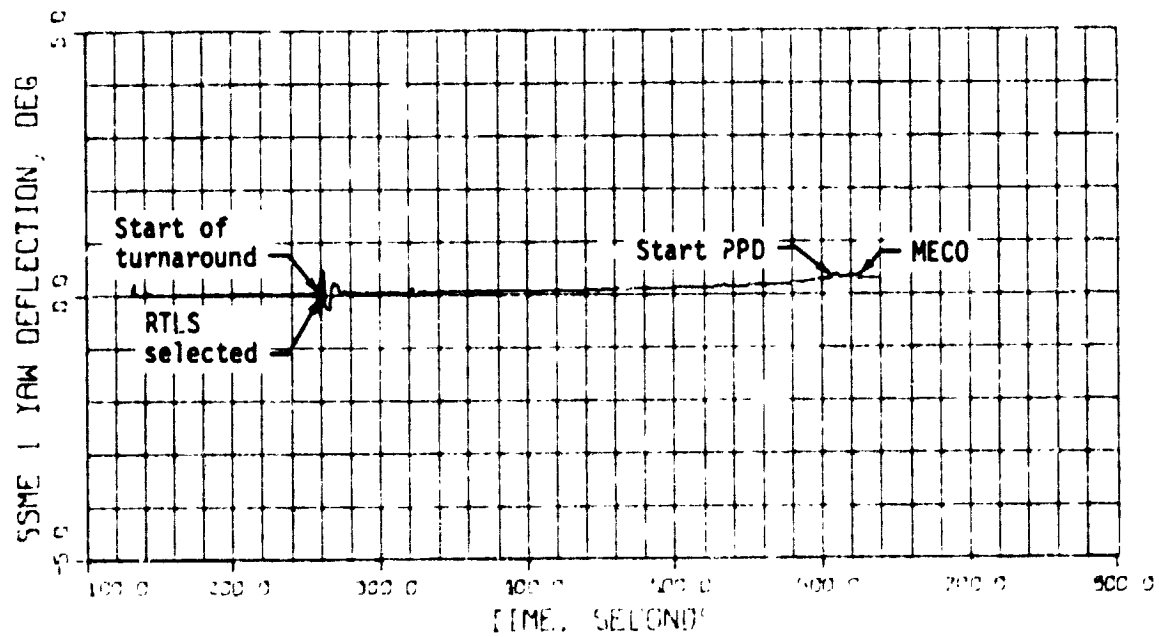

(cc) SSME 1 yaw deflection versus time.

Figure 6.2.1-6.- Continued.

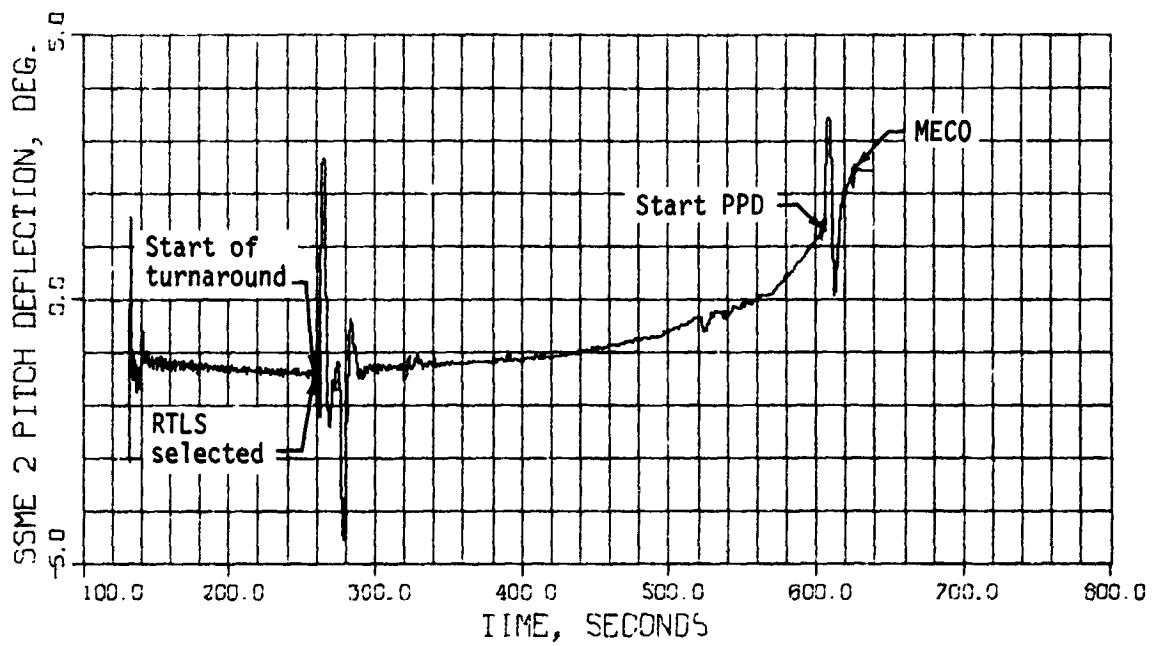

(dd) SSME 2 pitch deflection versus time.

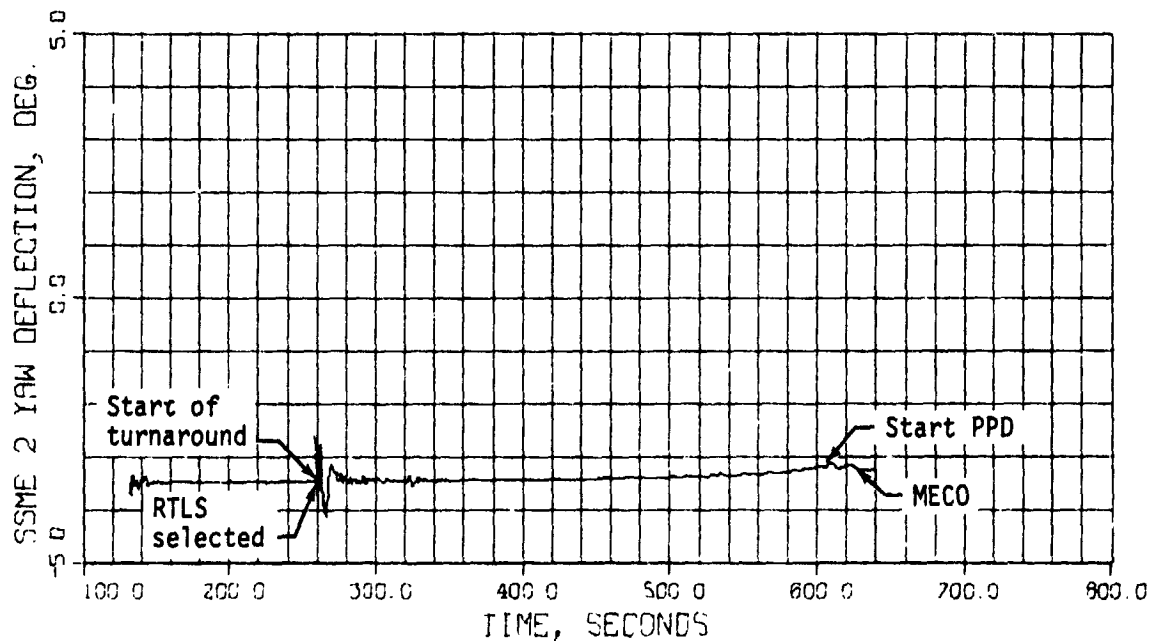

(ee) SSME 2 yaw deflection versus time.

Figure 6.2.1-6.- Continued.

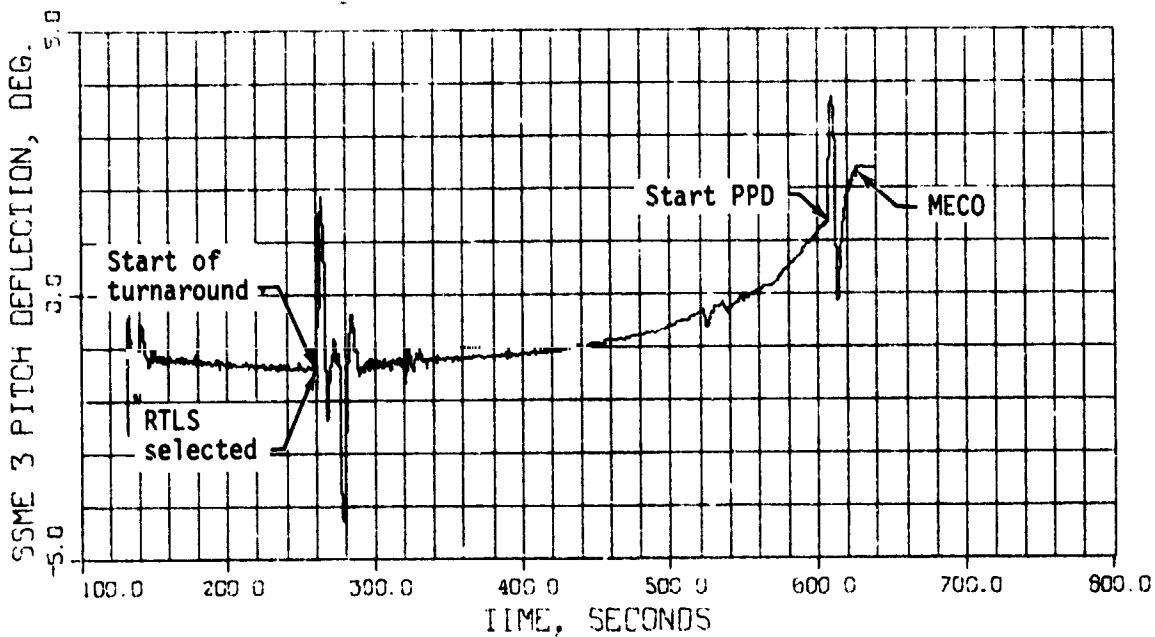

(ff) SSME 3 pitch deflection versus time.

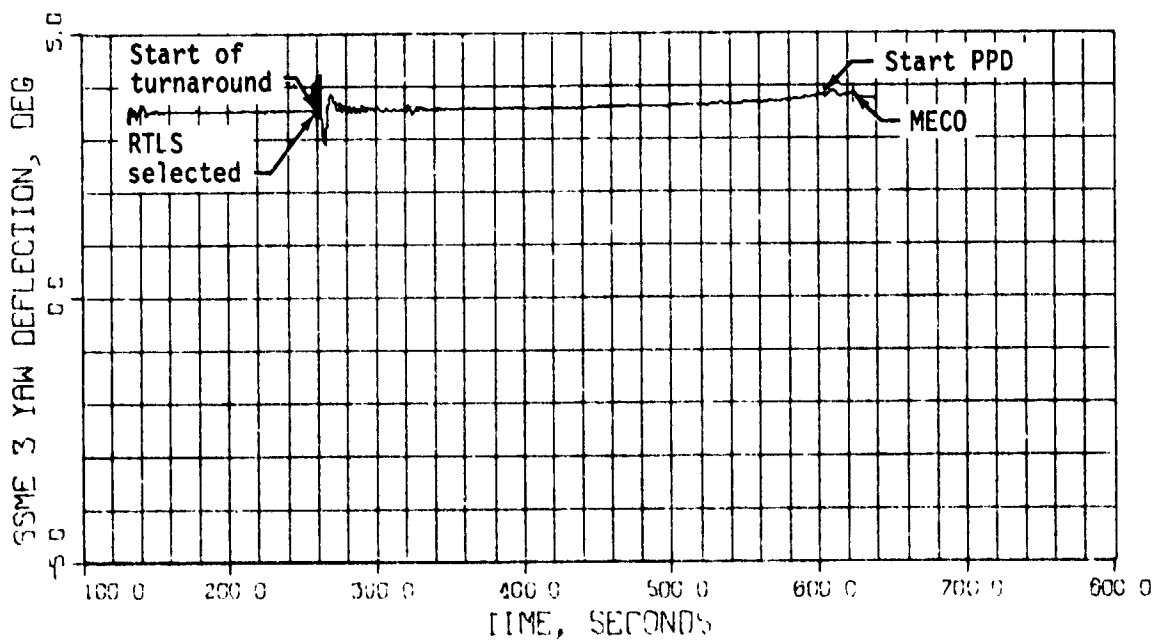

(gg) SSME 3 yaw deflection versus time.

Figure 6.2.1-6.- Concluded.

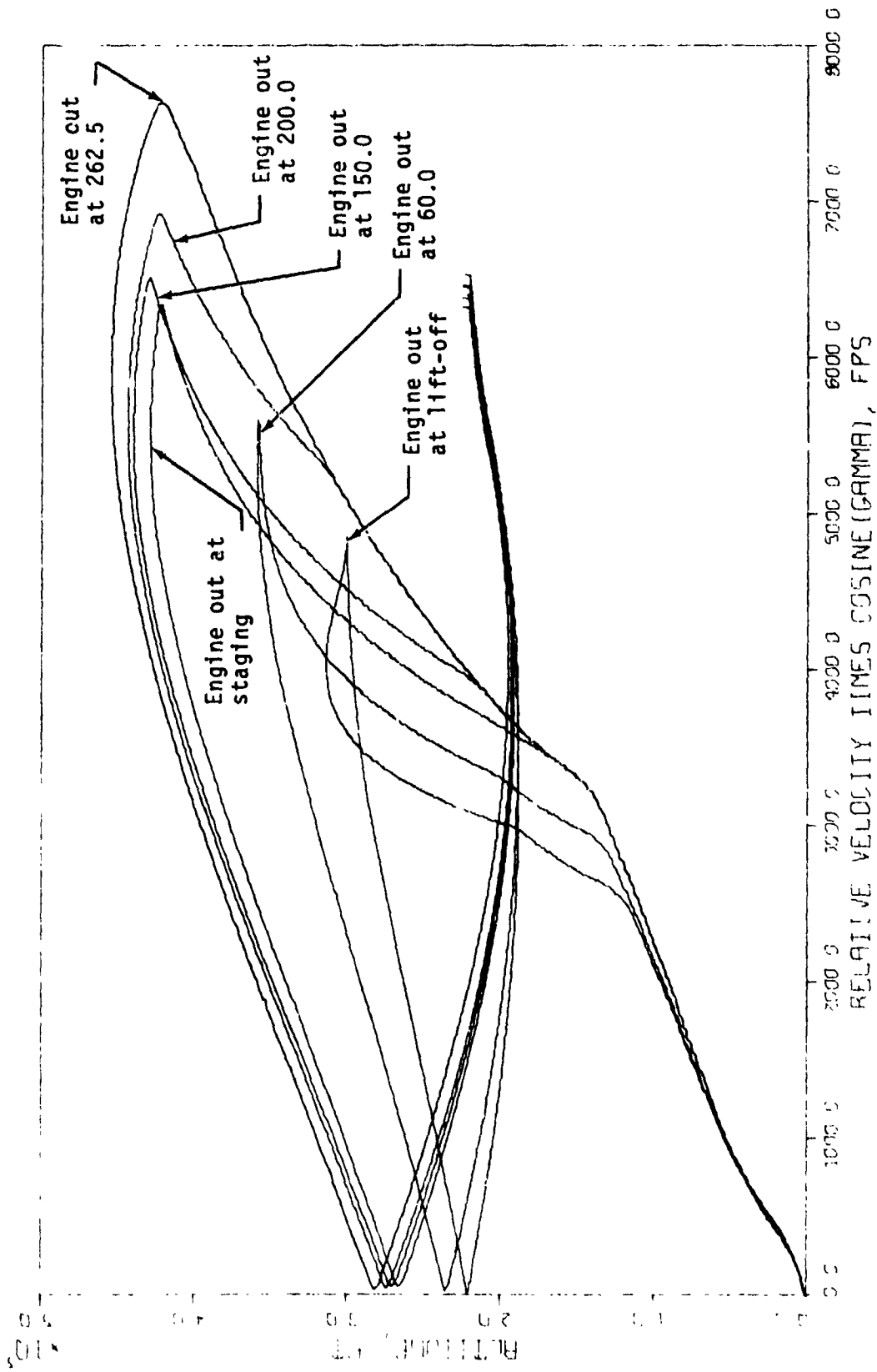

Figure 6.2.1-7.- Envelope of PTRLs trajectories.

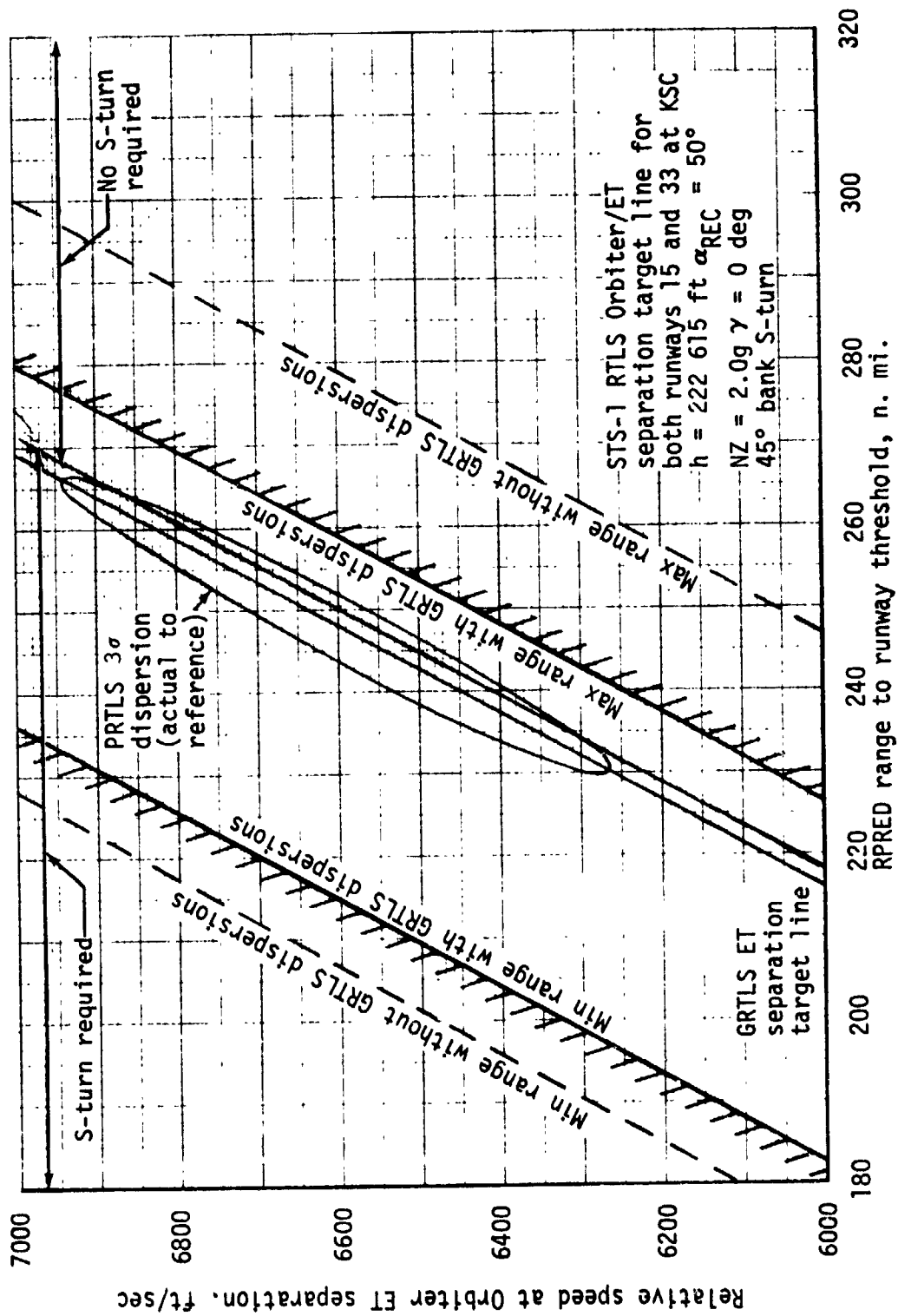

Figure 6.2.2-1.- STS-1 GRTLS Orbiter/ET separation target line and performance boundaries.

ALTITUDE PROFILE

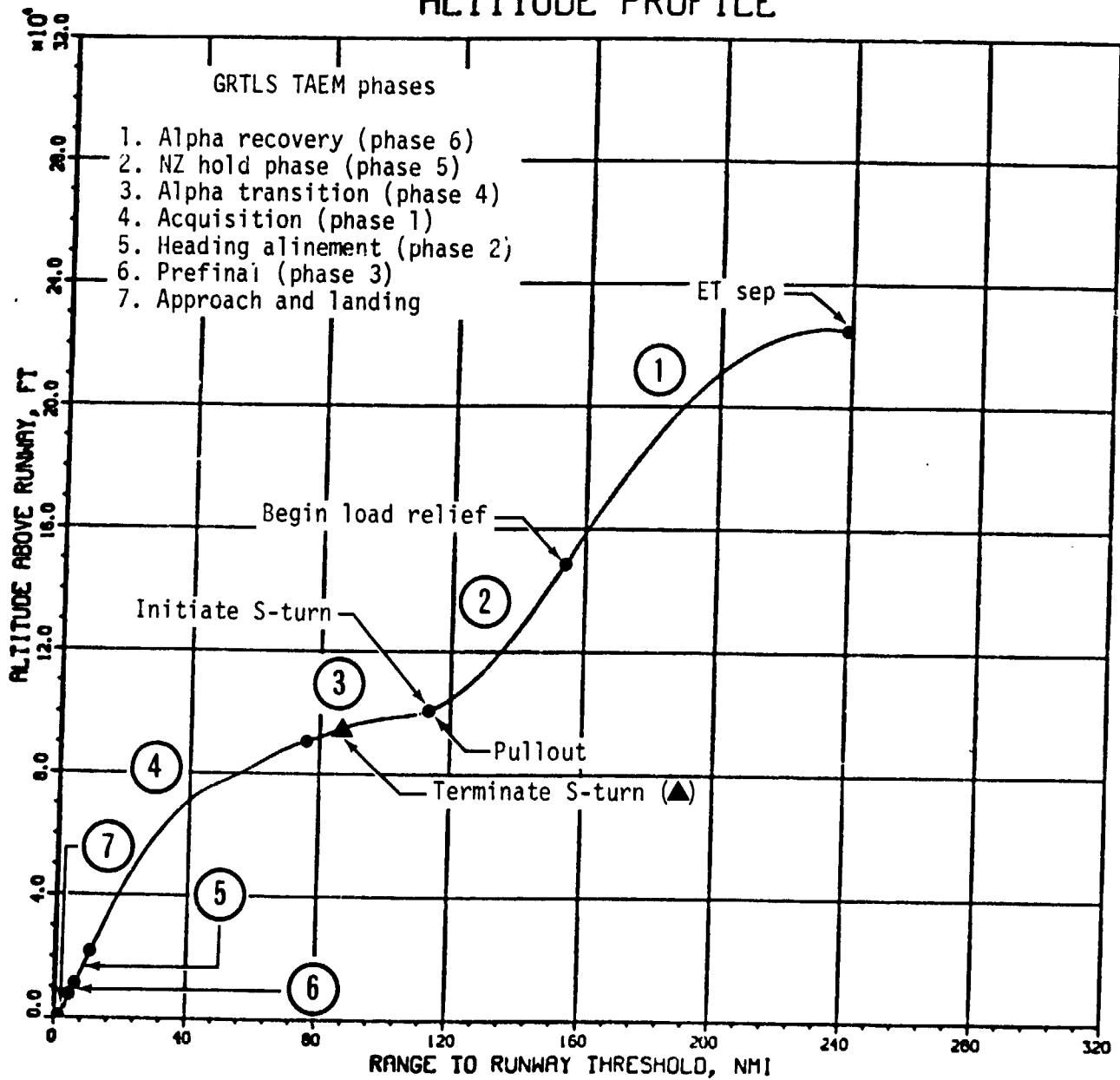

Figure 6.2.2-2.- GRTLS profile.

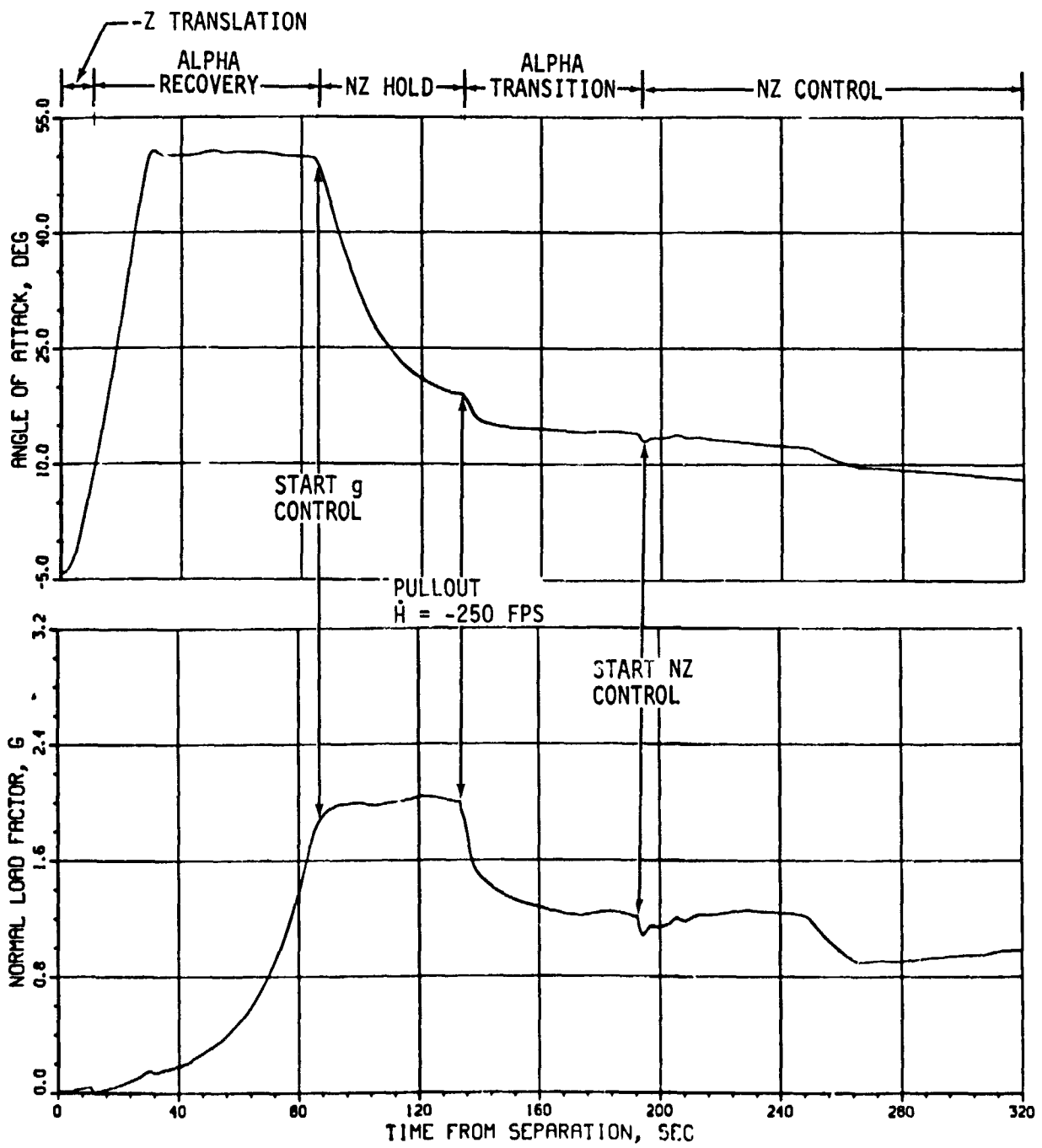

Figure 6.2.2-3.- Alpha recovery, NZ hold and alpha transition phases.

ENERGY CORRIDOR

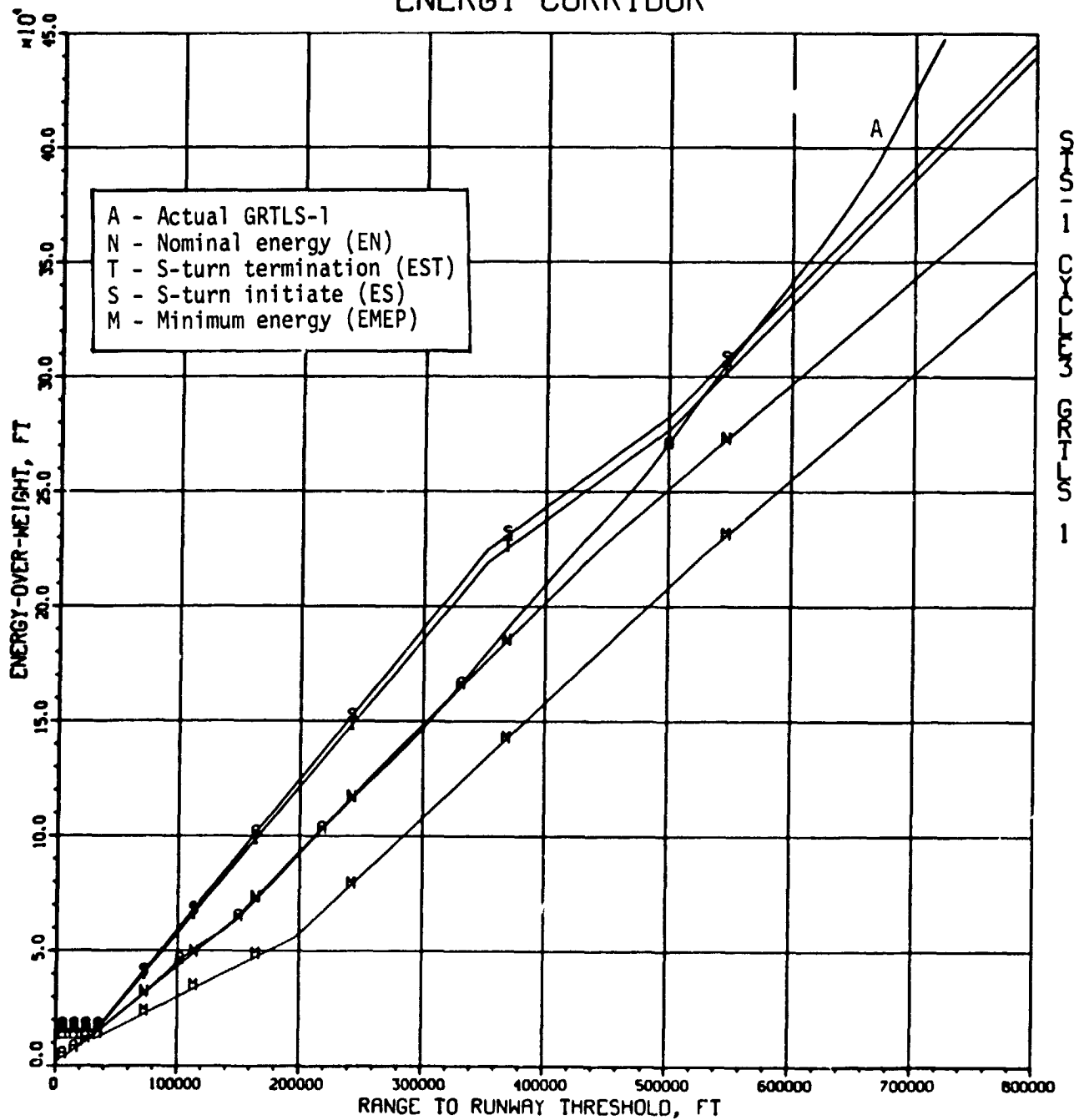

Figure 6.2.2-4.- GRTLS TAEM energy/weight versus range profiles for STS-1.

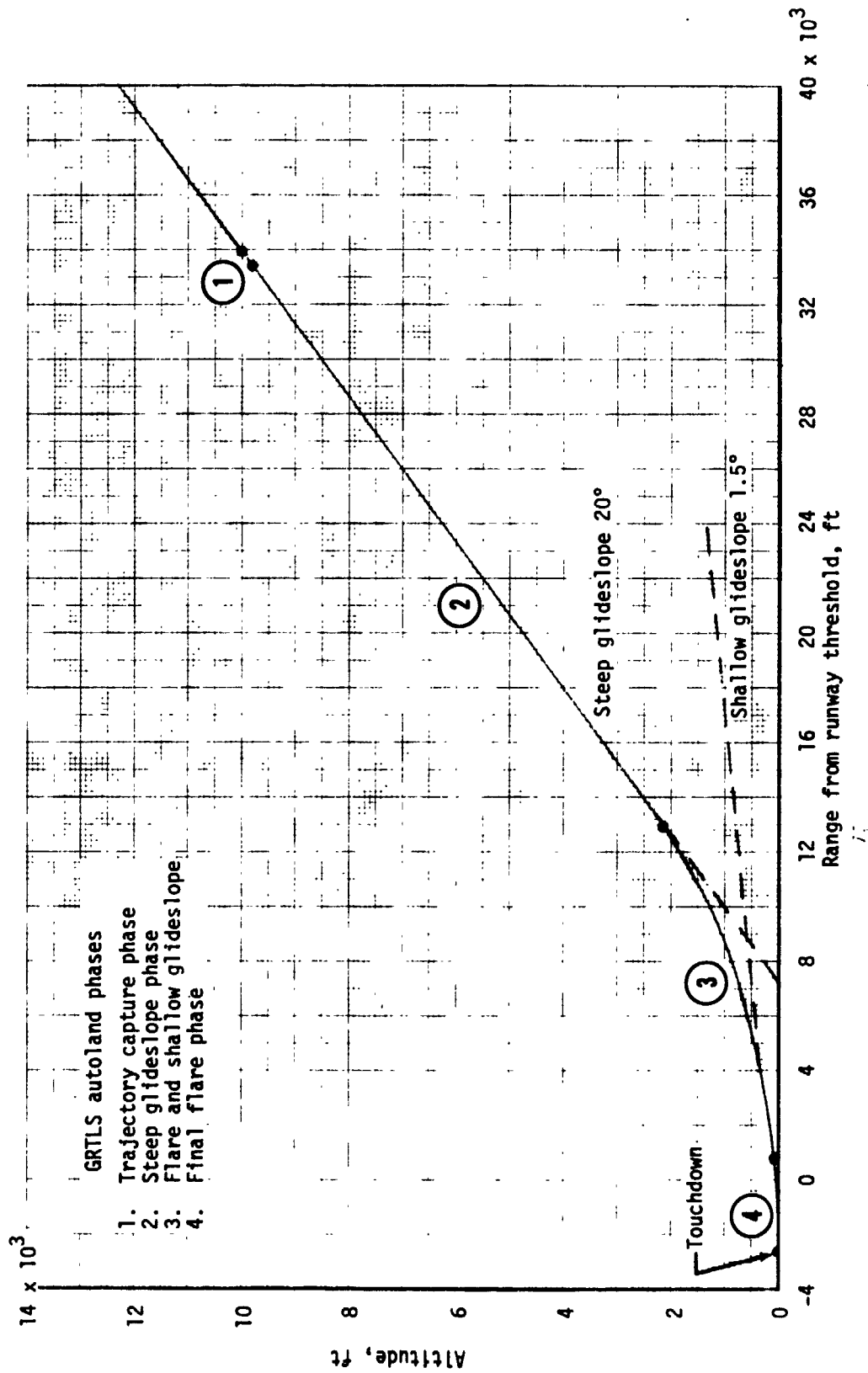
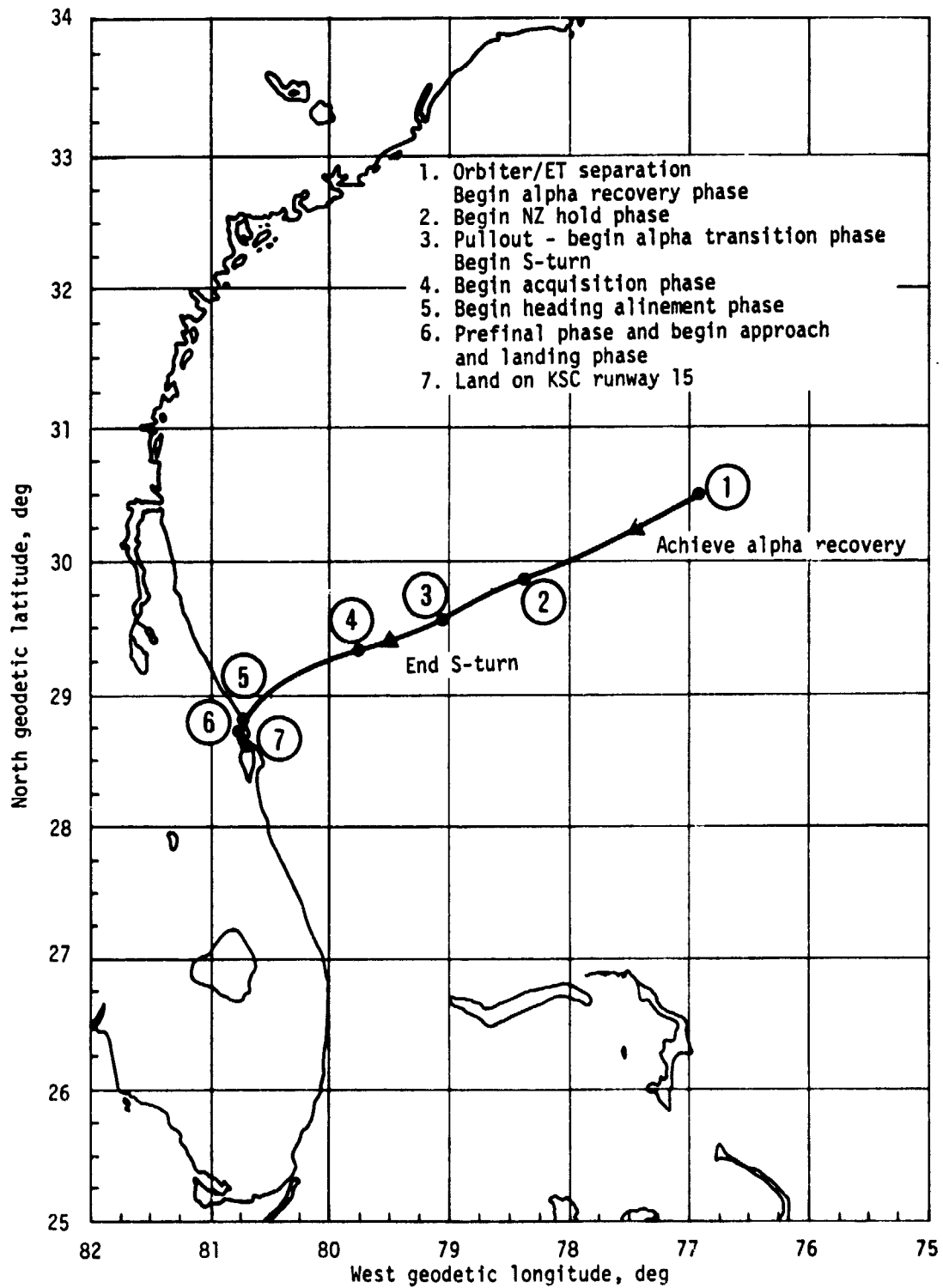

Figure 6.2.2-5.- GRTLS approach and landing profile.



(a) Groundtrack.

Figure 6.2.2-6.- GRTLS from RTLS number 1 - last RTLS initiated at 272.5 seconds - STS-1 ascent, ET separation to landing at KSC runway 15.

ALTITUDE PROFILE

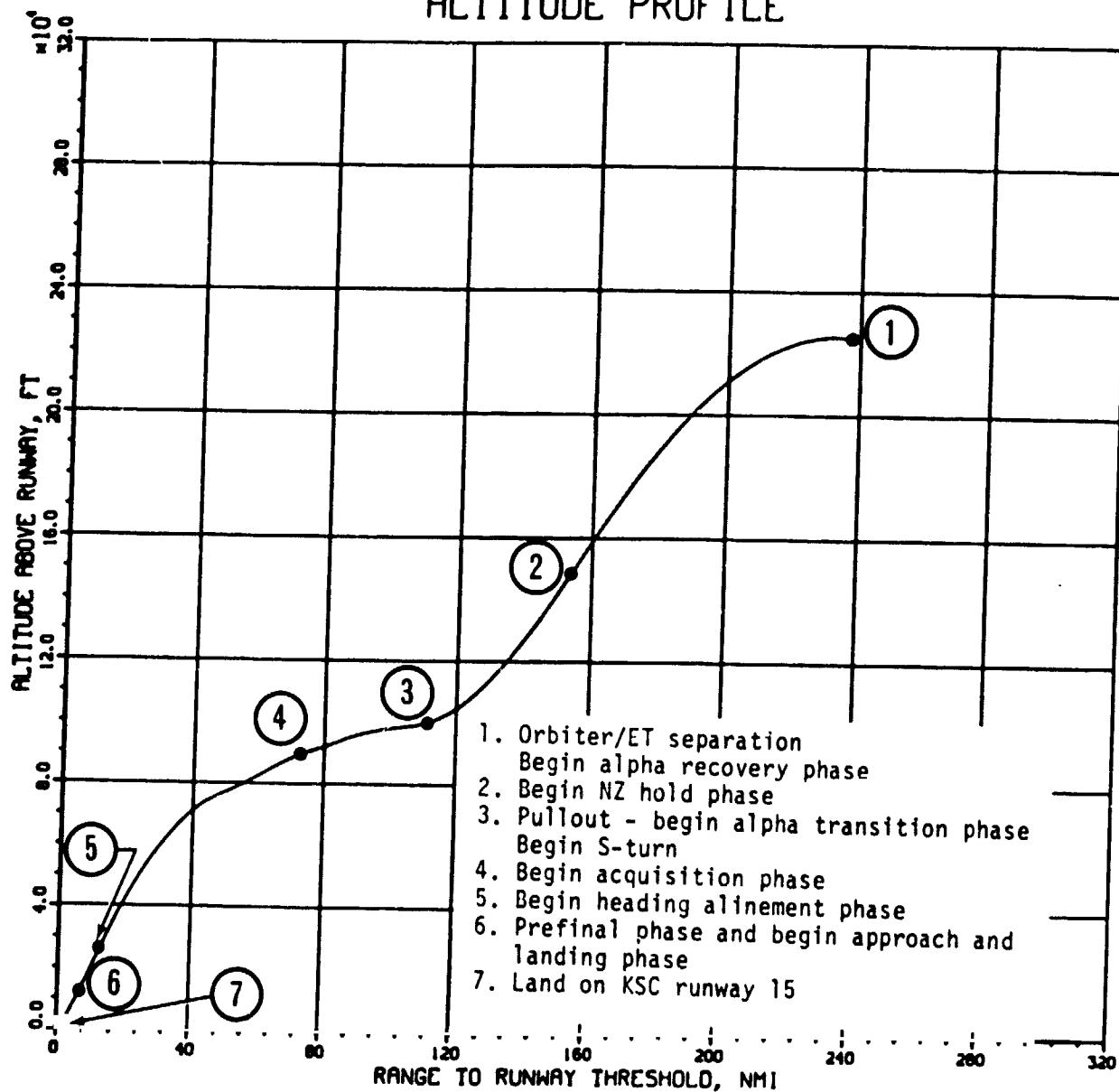

(b) Altitude versus range to runway threshold.

Figure 6.2.2-6.- Continued.

VELOCITY PROFILE

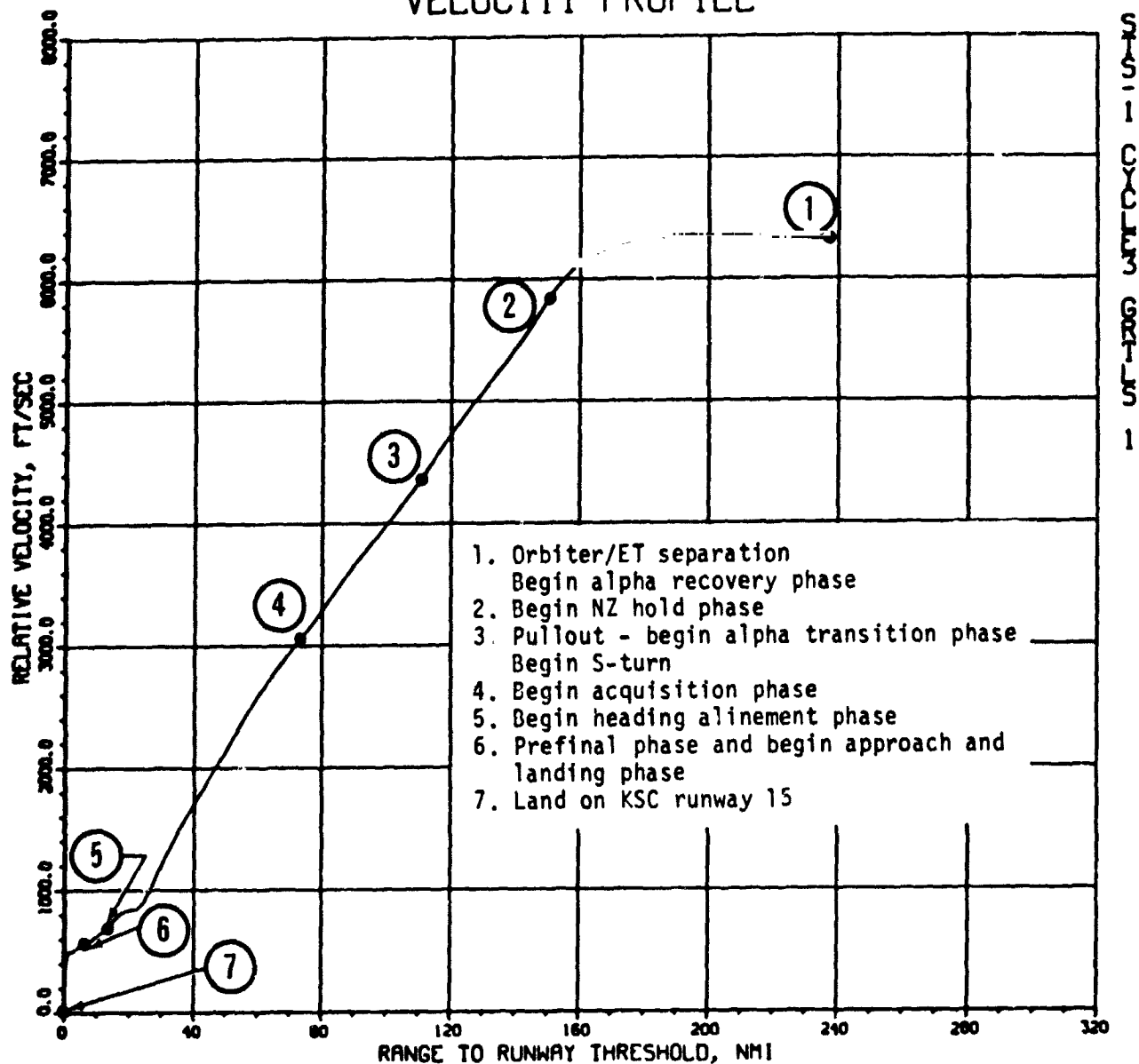

(c) Relative velocity versus range to runway threshold.

Figure 6.2.2-6.- Continued.

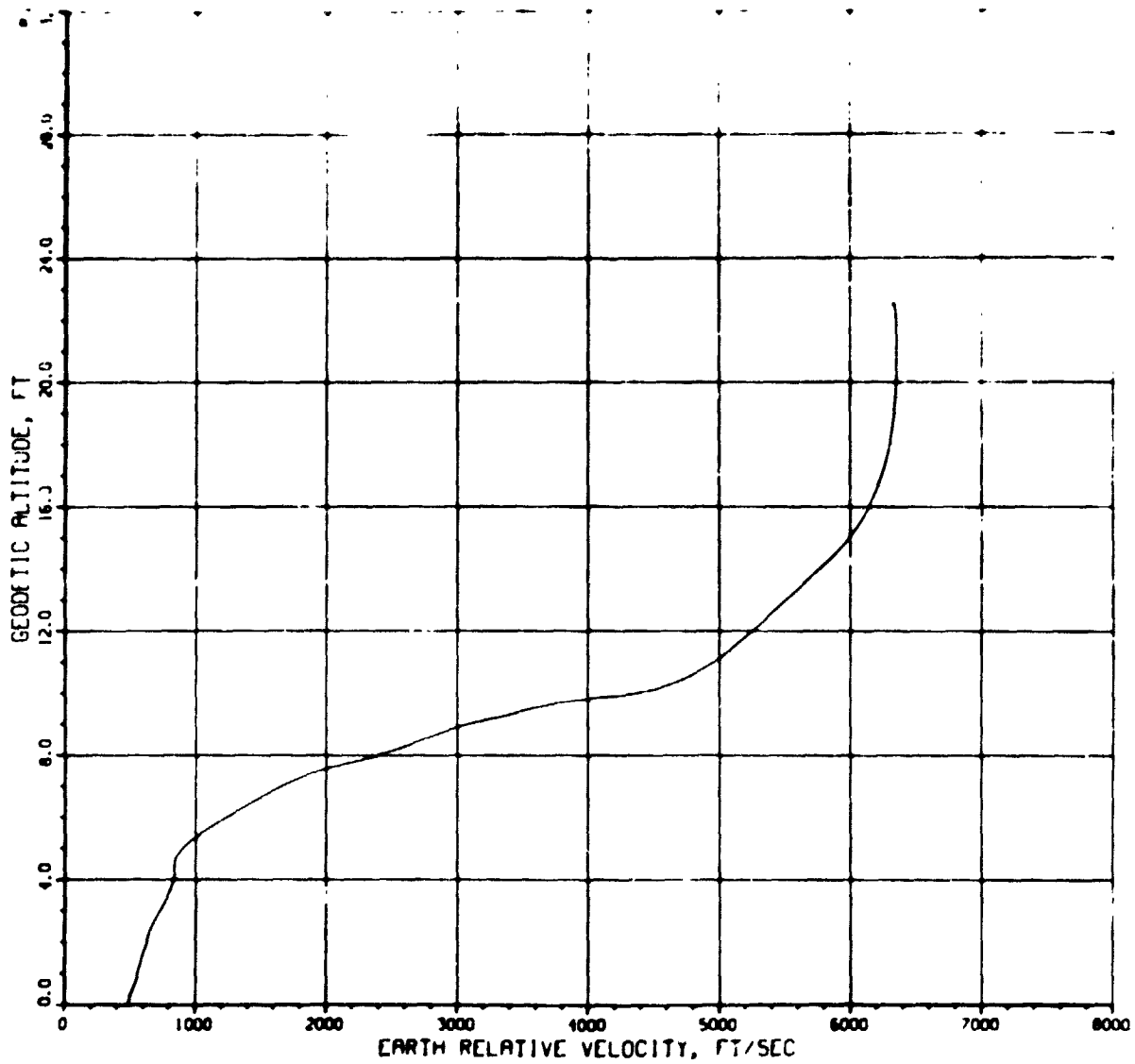

(d) Altitude versus relative velocity.

Figure 6.2.2-6.- Continued.

ALTITUDE PROFILE

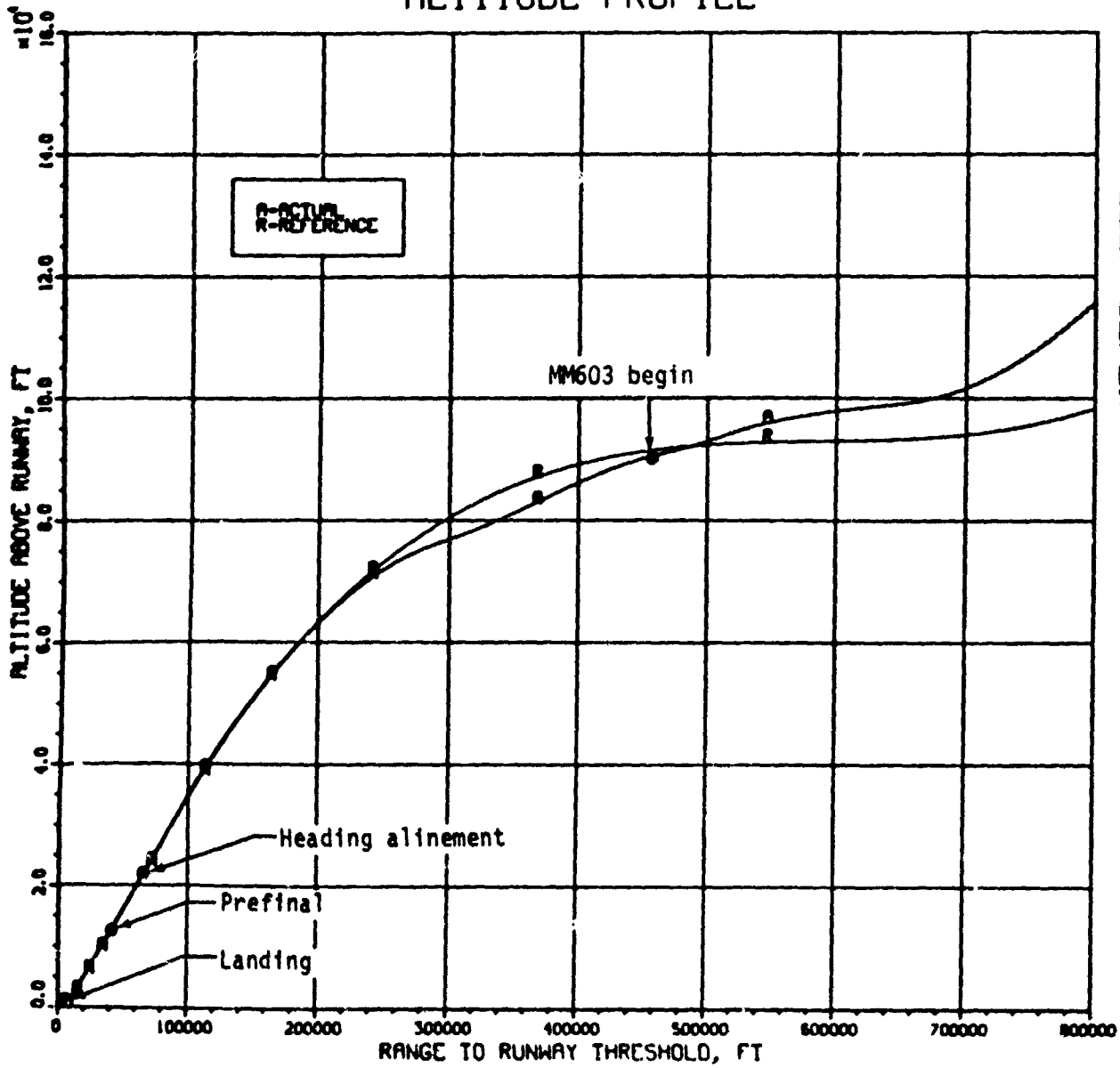

(e) Altitude and altitude reference versus range to runway threshold.

Figure 6.2.2-6.- Continued.

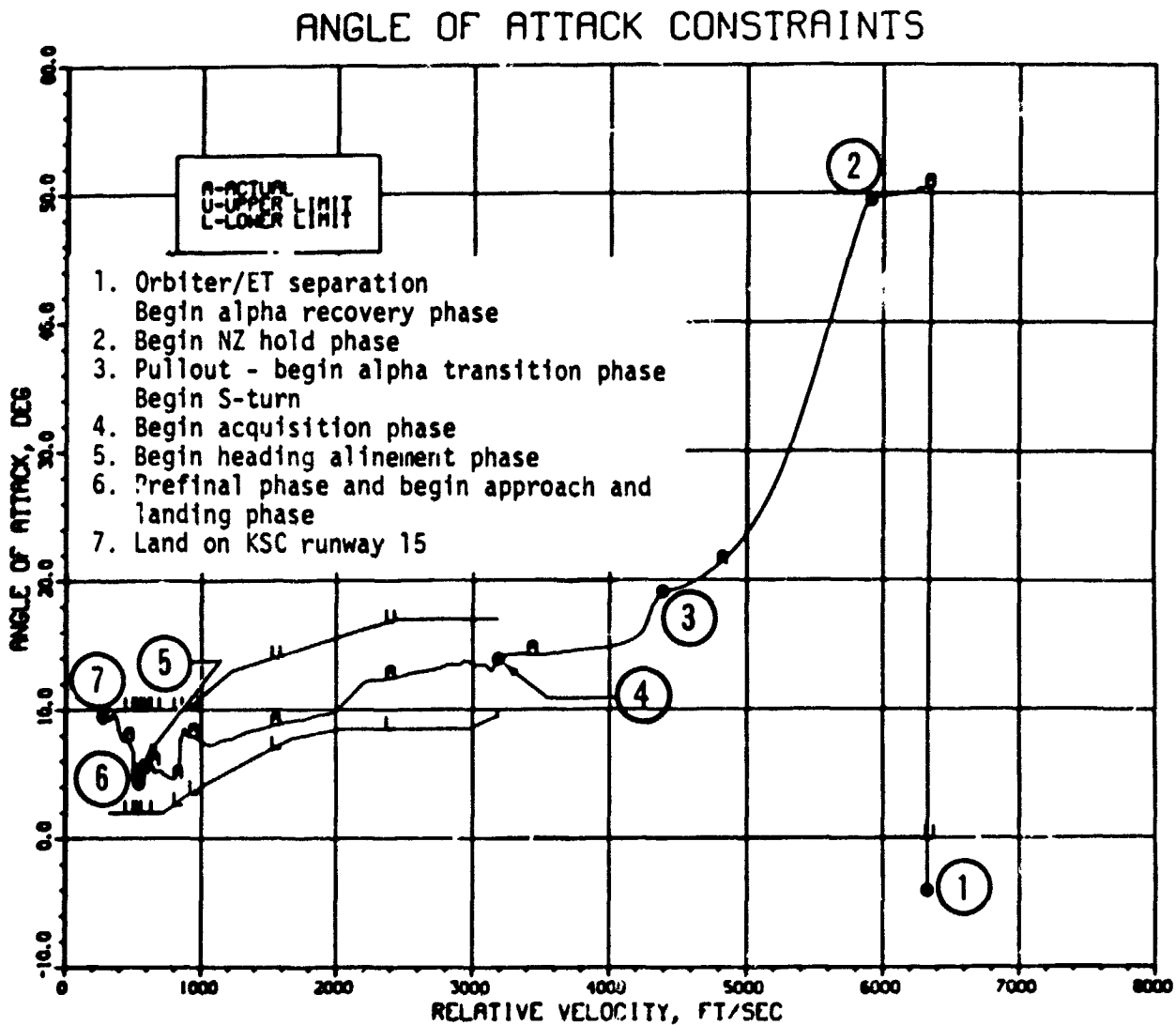

(f) Angle of attack versus relative velocity.

Figure 6.2.2-6.- Continued.

AZIMUTH ERROR AND ROLL ANGLE

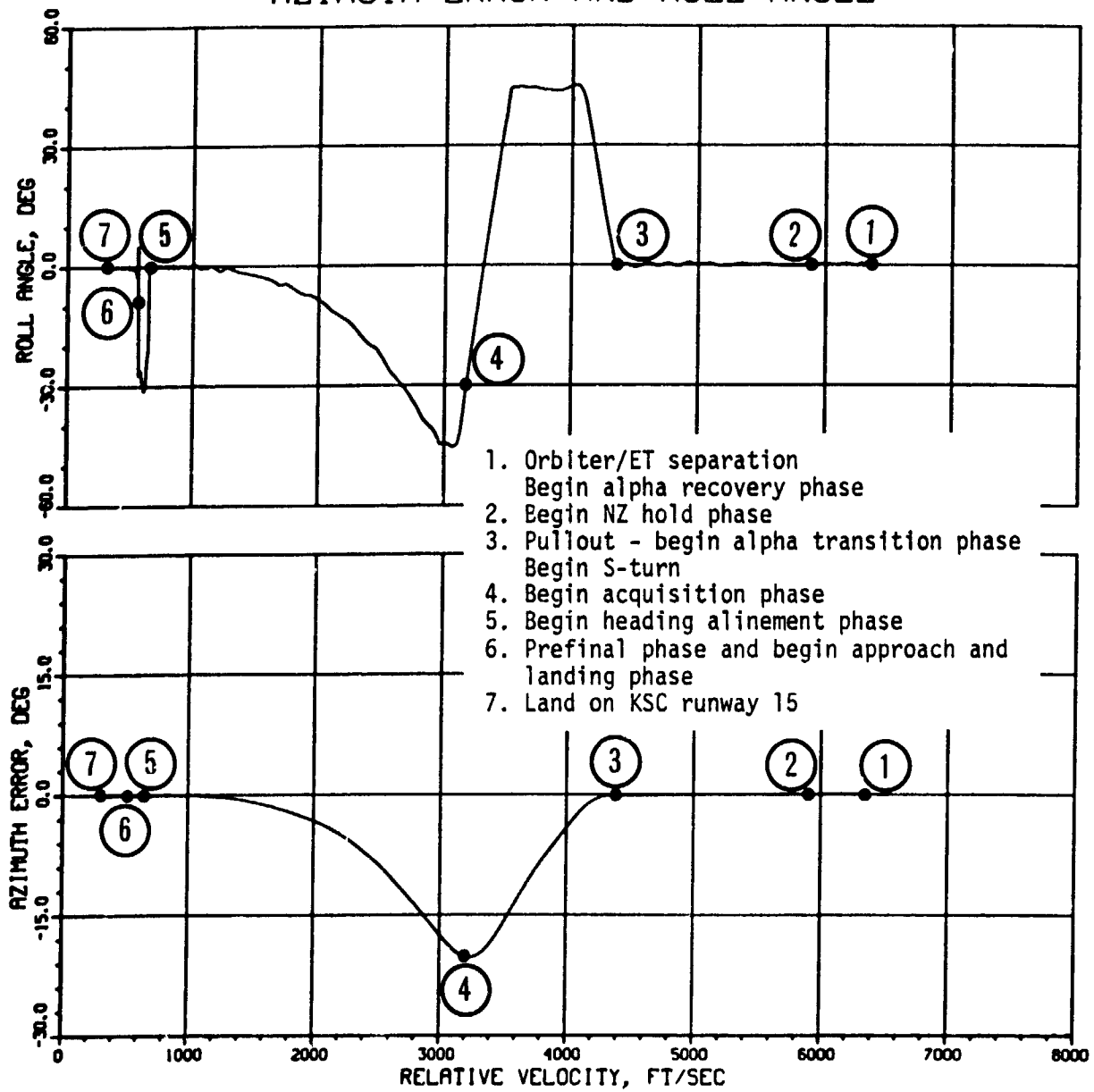

(g) Roll angle and azimuth error versus relative velocity.

Figure 6.2.2-6.- Continued.

BODY ATTITUDE RATES

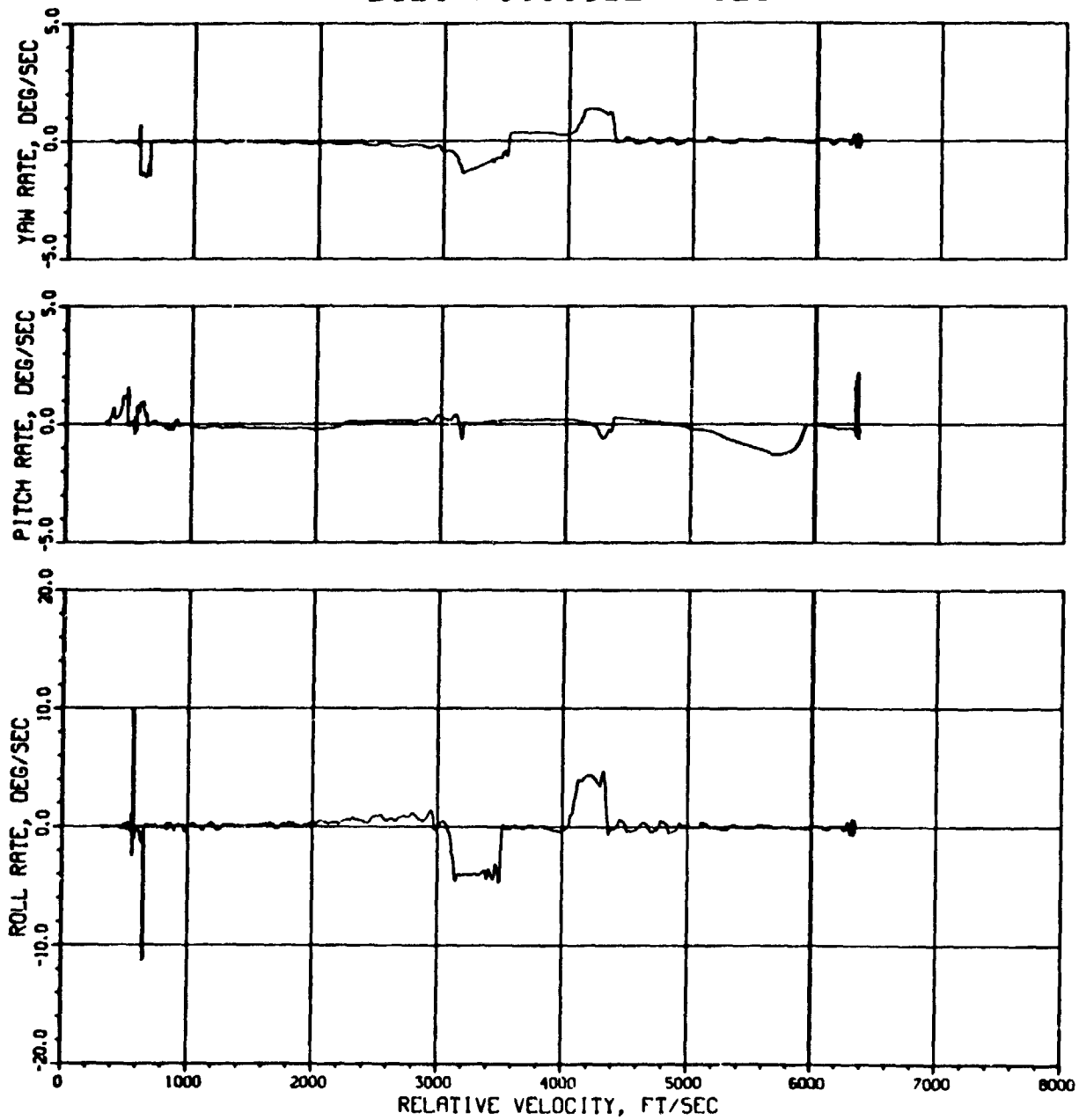

(h) Body attitude rates versus velocity.

Figure 6.2.2-6.- Continued.

FLIGHT PATH ANGLE

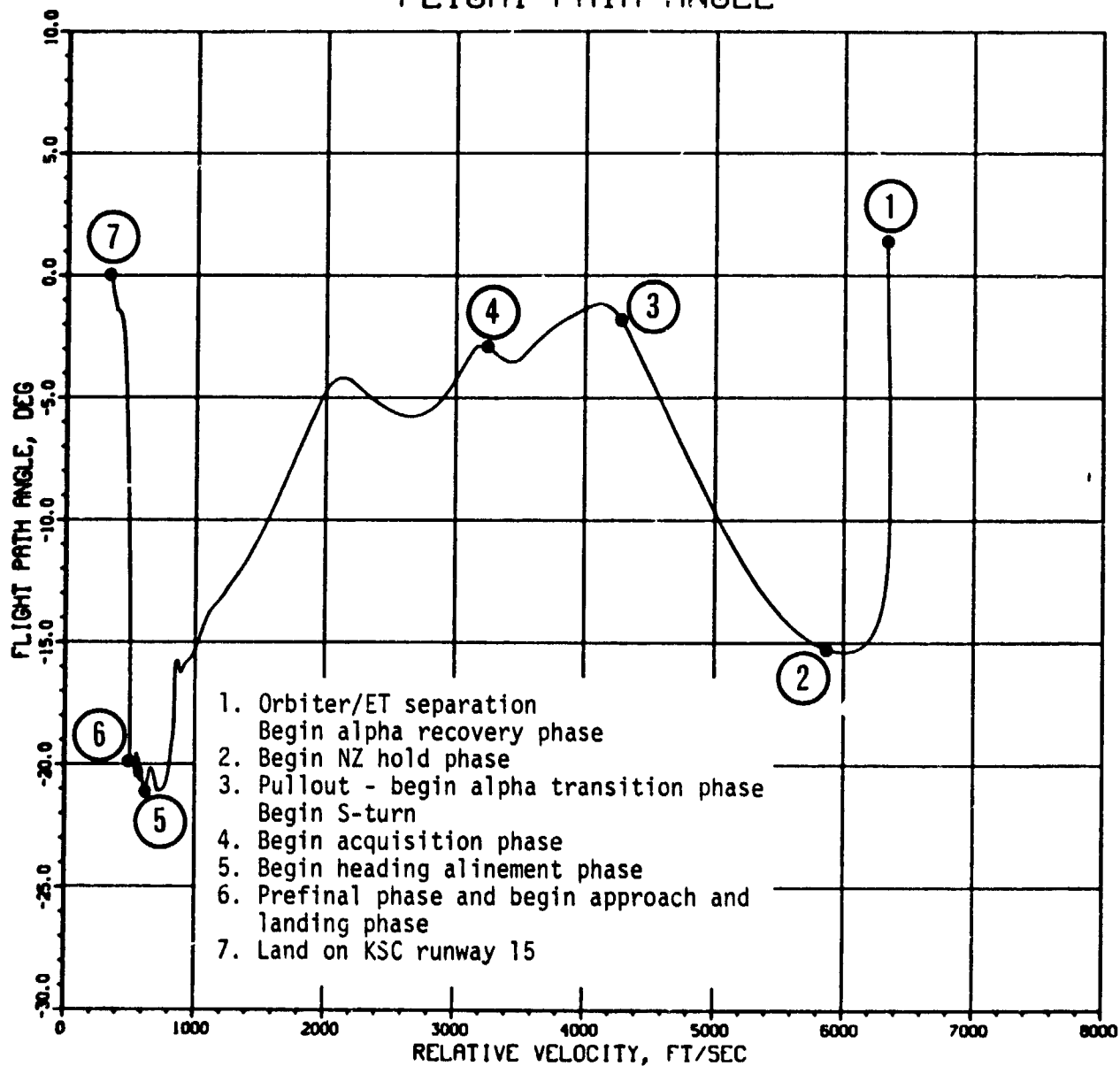

(i) Relative flightpath angle versus relative velocity.

Figure 6.2.2-6.- Continued.

ALTITUDE RATE

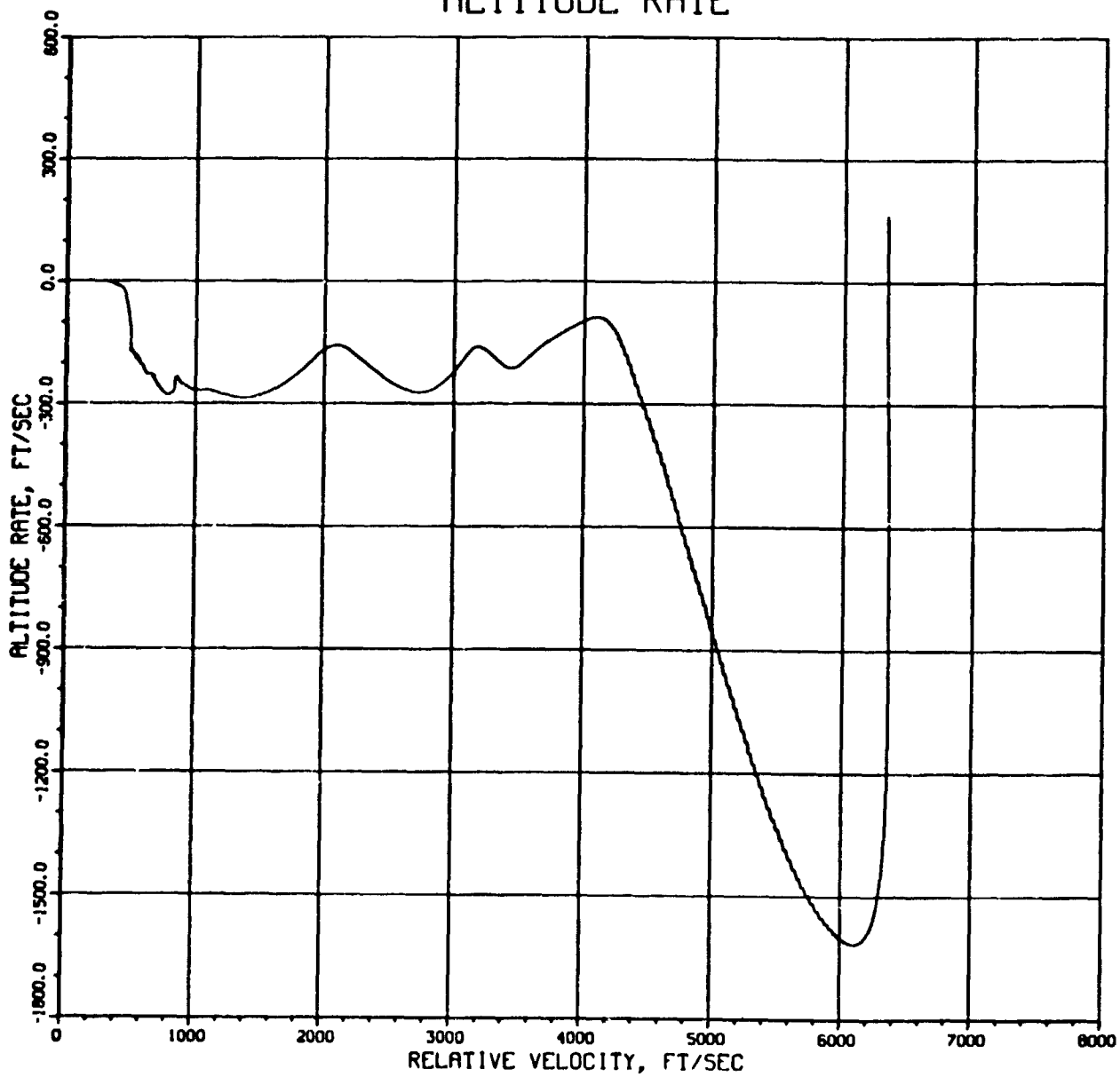

SK-1-10000-1

(j) Altitude rate versus relative velocity.

Figure 6.2.2-6.- Continued.

LOAD FACTOR COMPONENTS

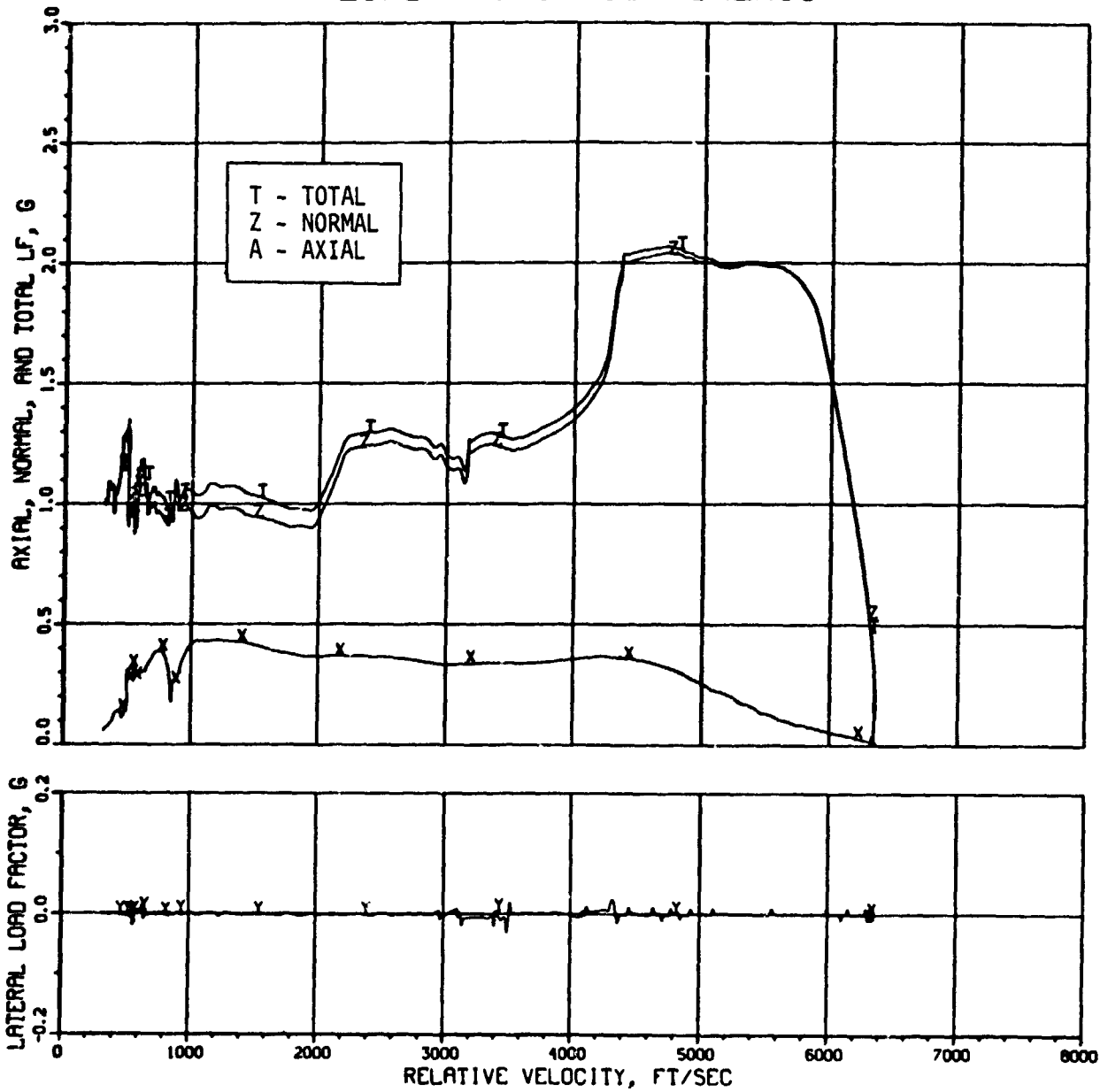

(k) Load factor components versus relative velocity.

Figure 6.2.2-6.- Continued.

PILOT STATION LOADS

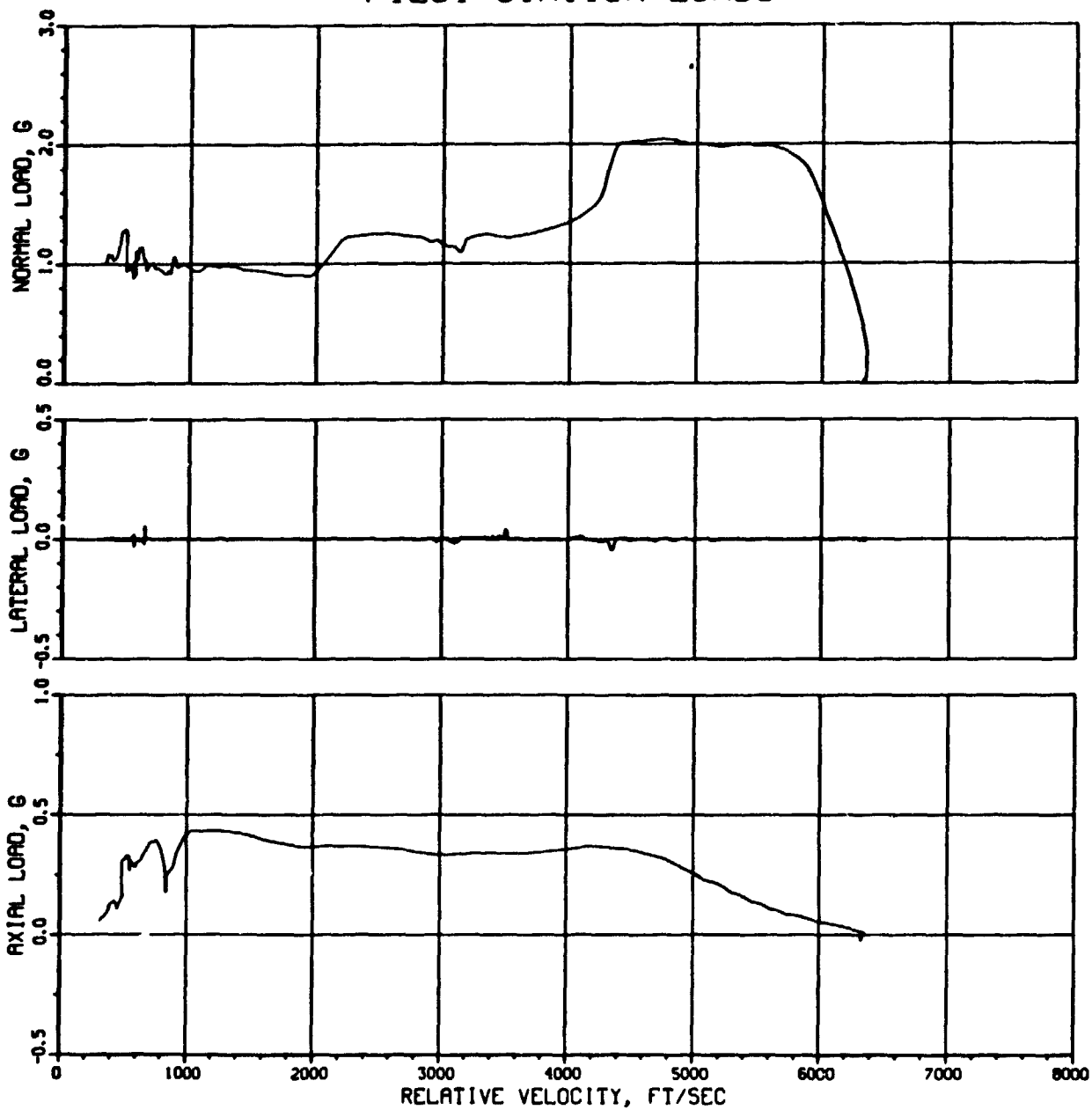

SHS 1 15163 SAFETY CYCLES 1

(1) Pilot station loads versus relative velocity.

Figure 6.2.2-6.- Continued.

DYNAMIC PRESSURE CONSTRAINTS

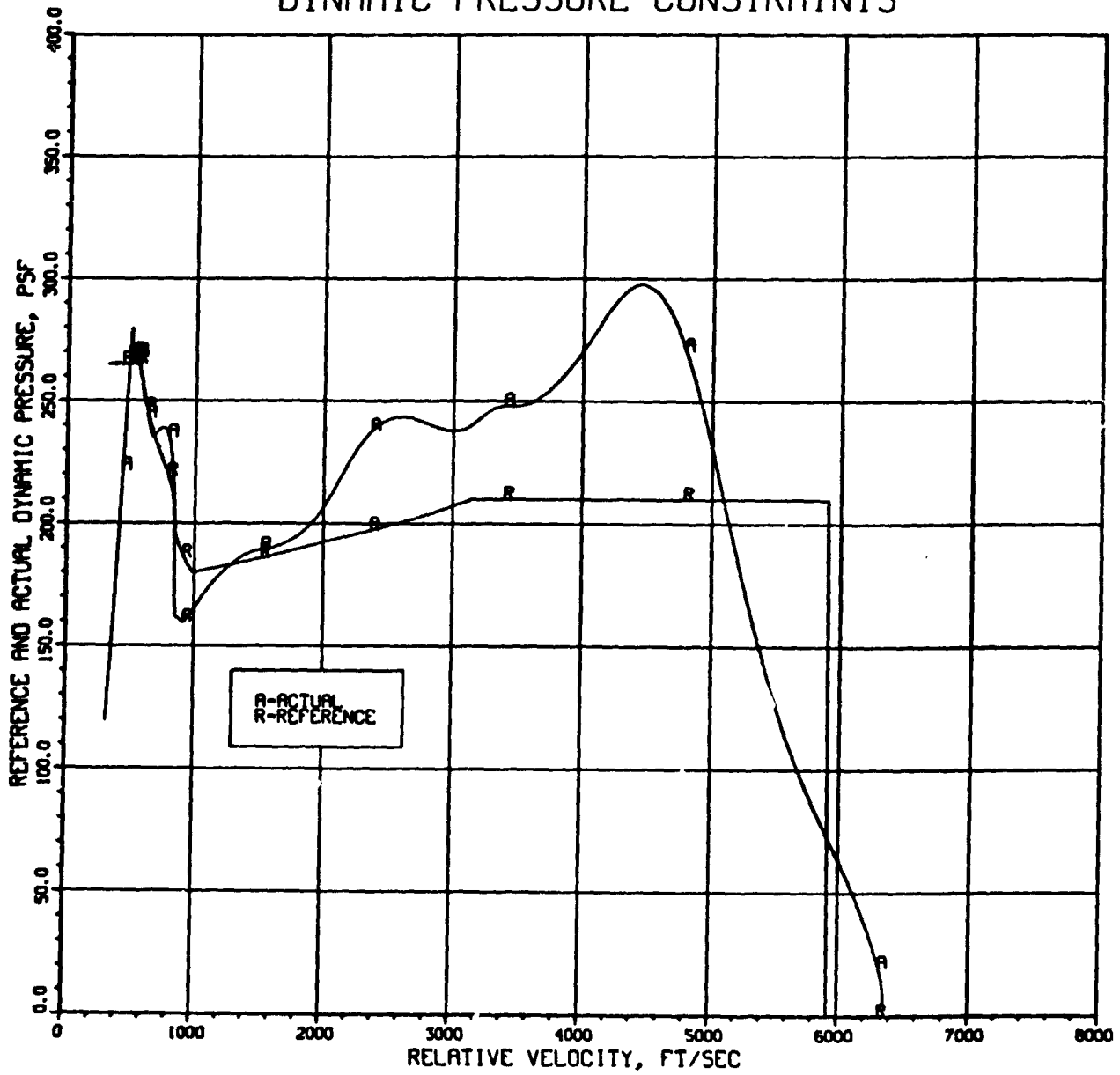

(m) Dynamic pressure versus relative velocity.

Figure 6.2.2-6.- Continued.

DRAG ACCELERATION

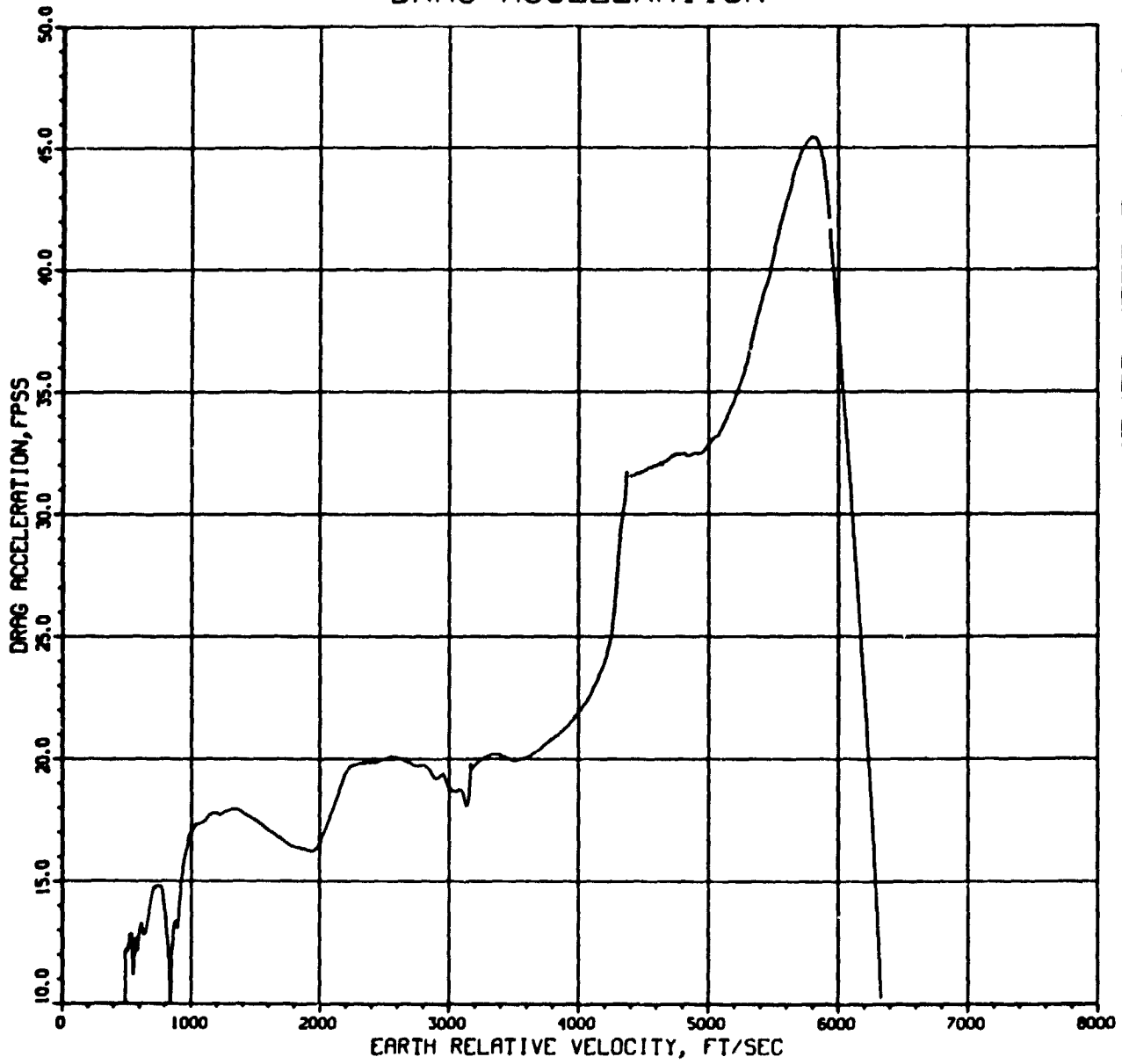

(n) Drag acceleration versus relative velocity.

Figure 6.2.2-6.- Continued.

LATERAL CONTROL

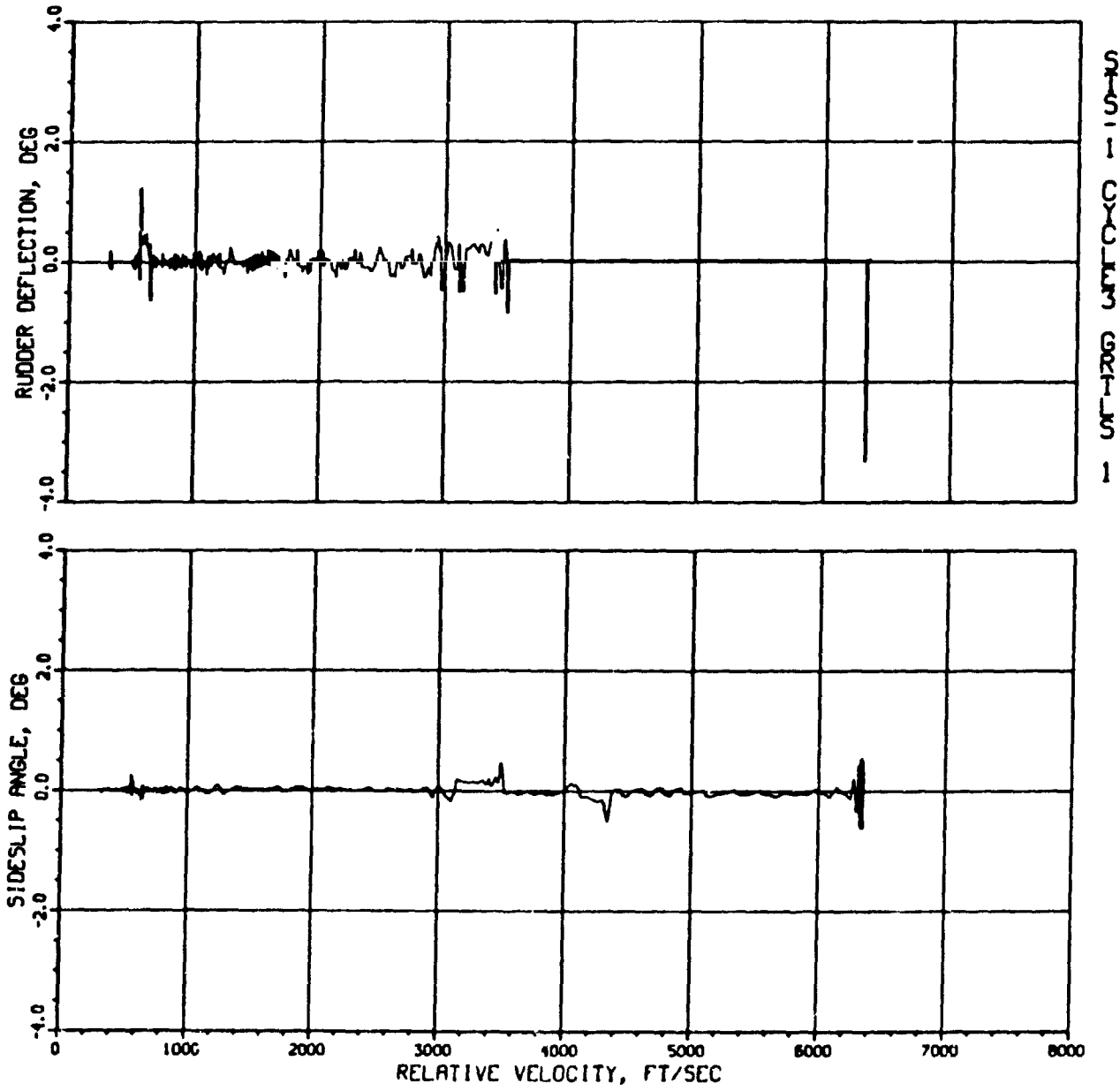

(o) Sideslip angle and rudder deflection versus relative velocity.

Figure 6.2.2-6.- Continued.

CONTROL SURFACE DEFLECTIONS

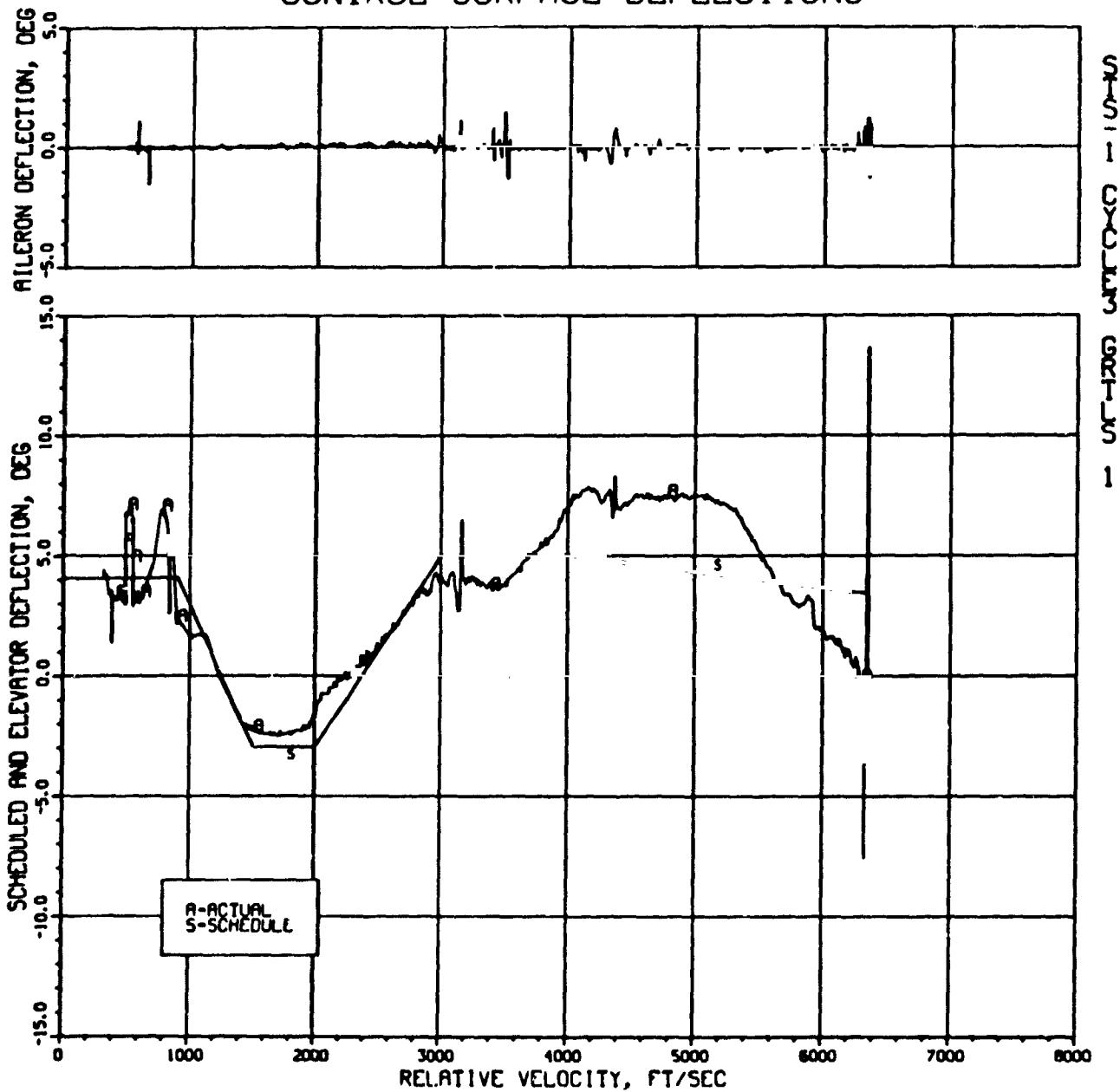

(p) Elevator and aileron deflections versus relative velocity.

Figure 6.2.2-6.- Continued.

ELEVATOR DEFLECTIONS

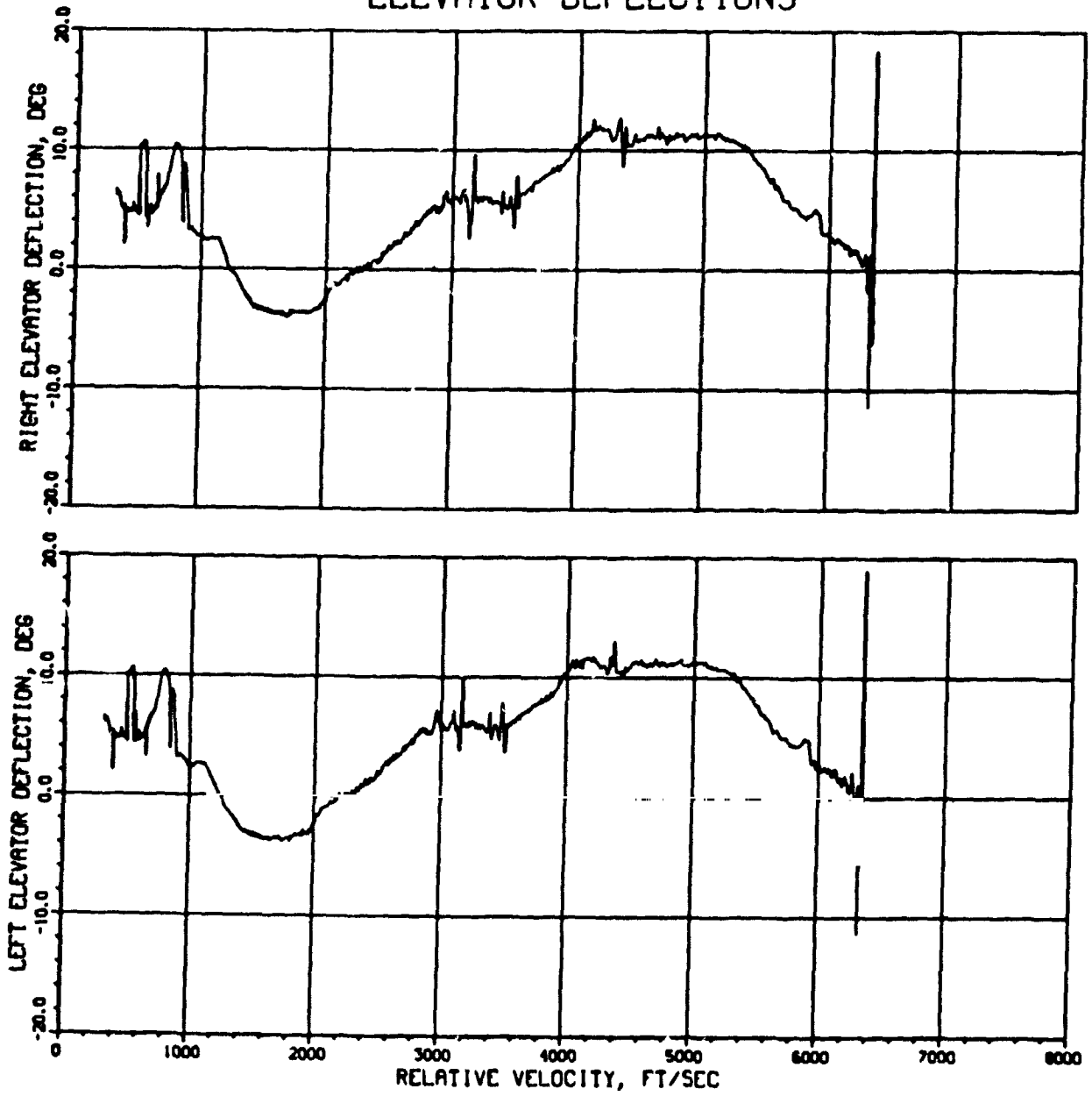

(q) Right and left elevator deflections versus relative velocity.

Figure 6.2.2-6.- Continued.

CONTROL SURFACE DEFLECTIONS

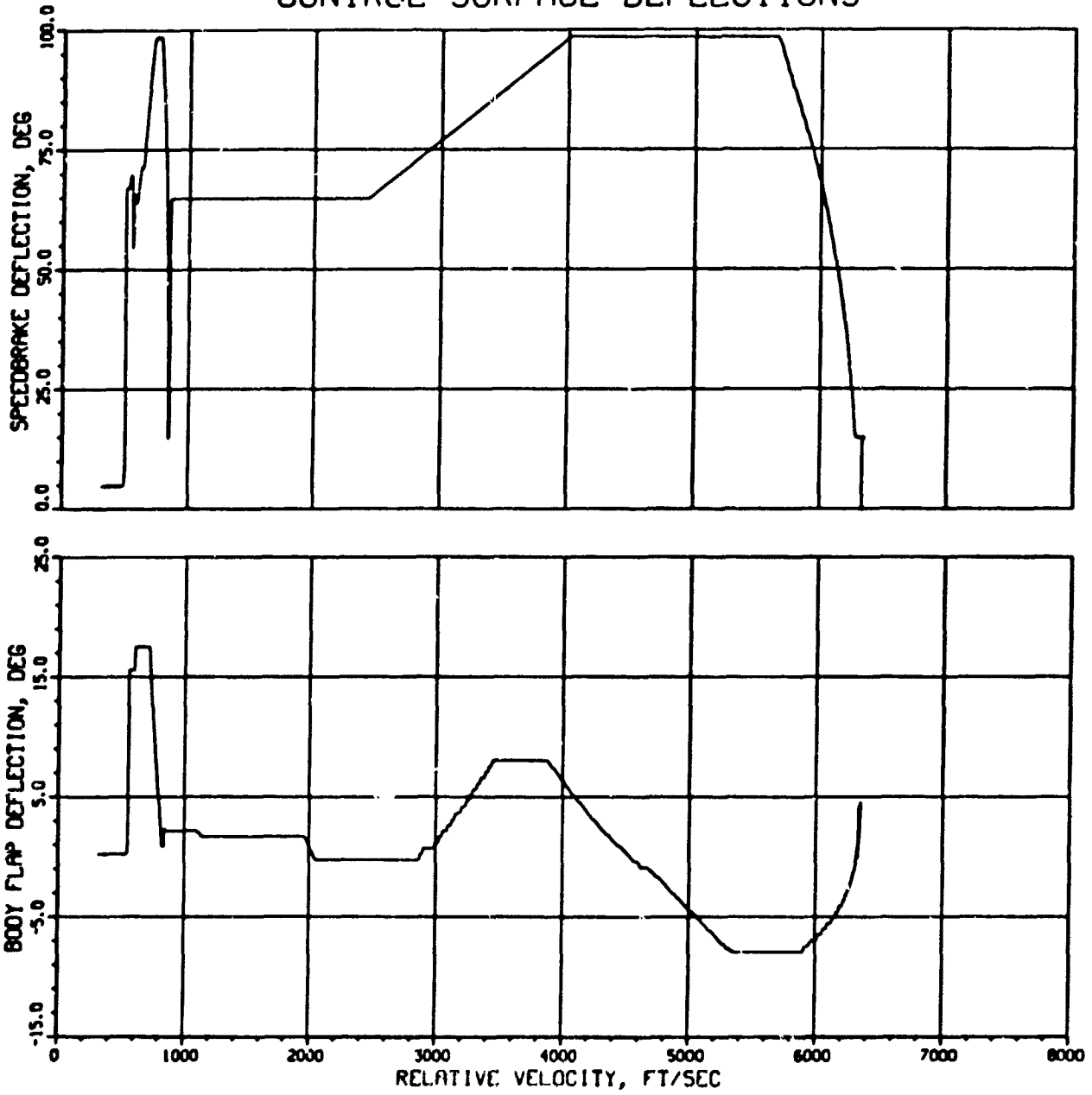

(r) Body flap and speedbrake deflections versus relative velocity.

Figure 6.2.2-6.- Continued.

ELEVON PANEL HINGE MOMENTS

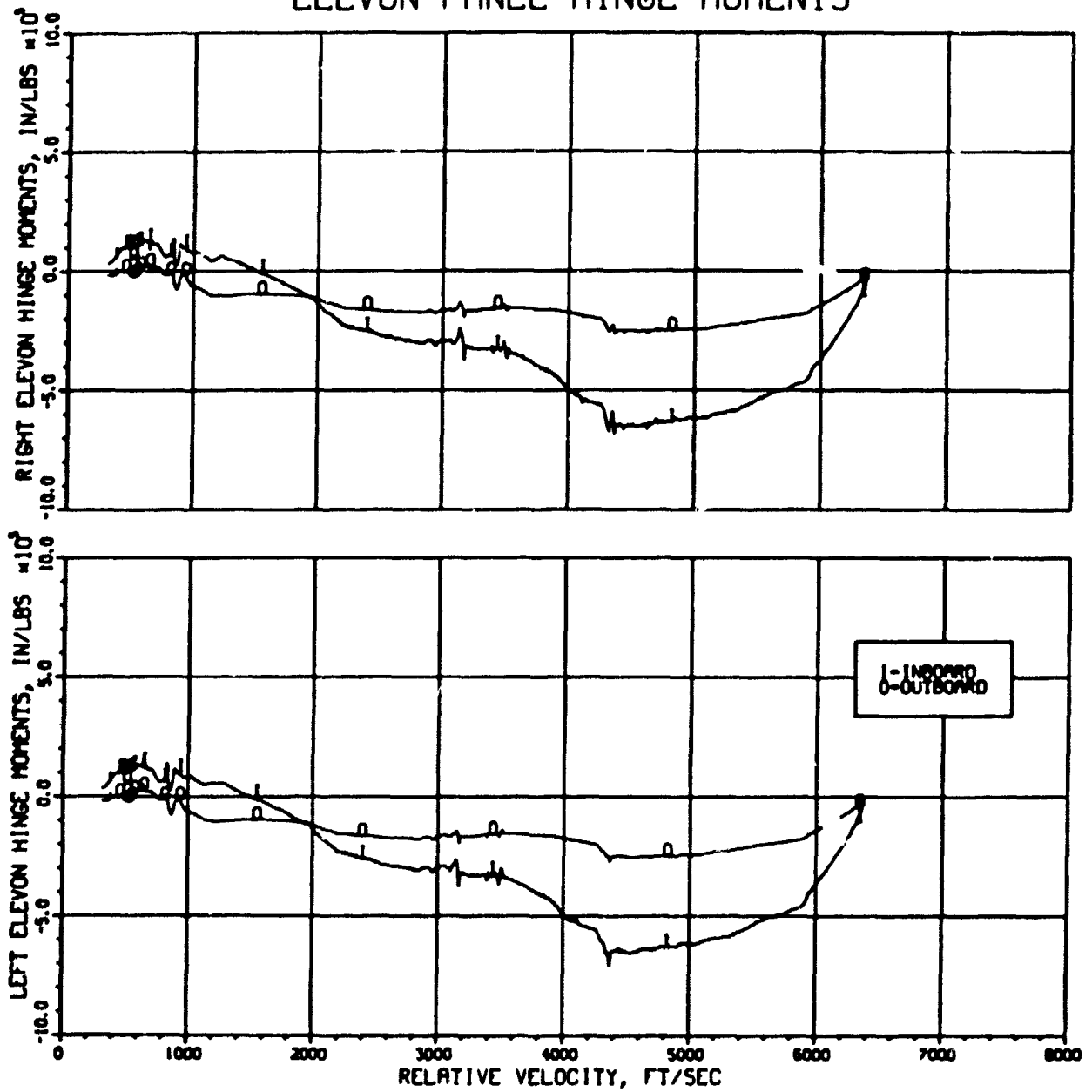

(s) Elevon panel hinge moments versus relative velocity.

Figure 6.2.2-6.- Continued.

CONTROL SURFACE HINGE MOMENTS

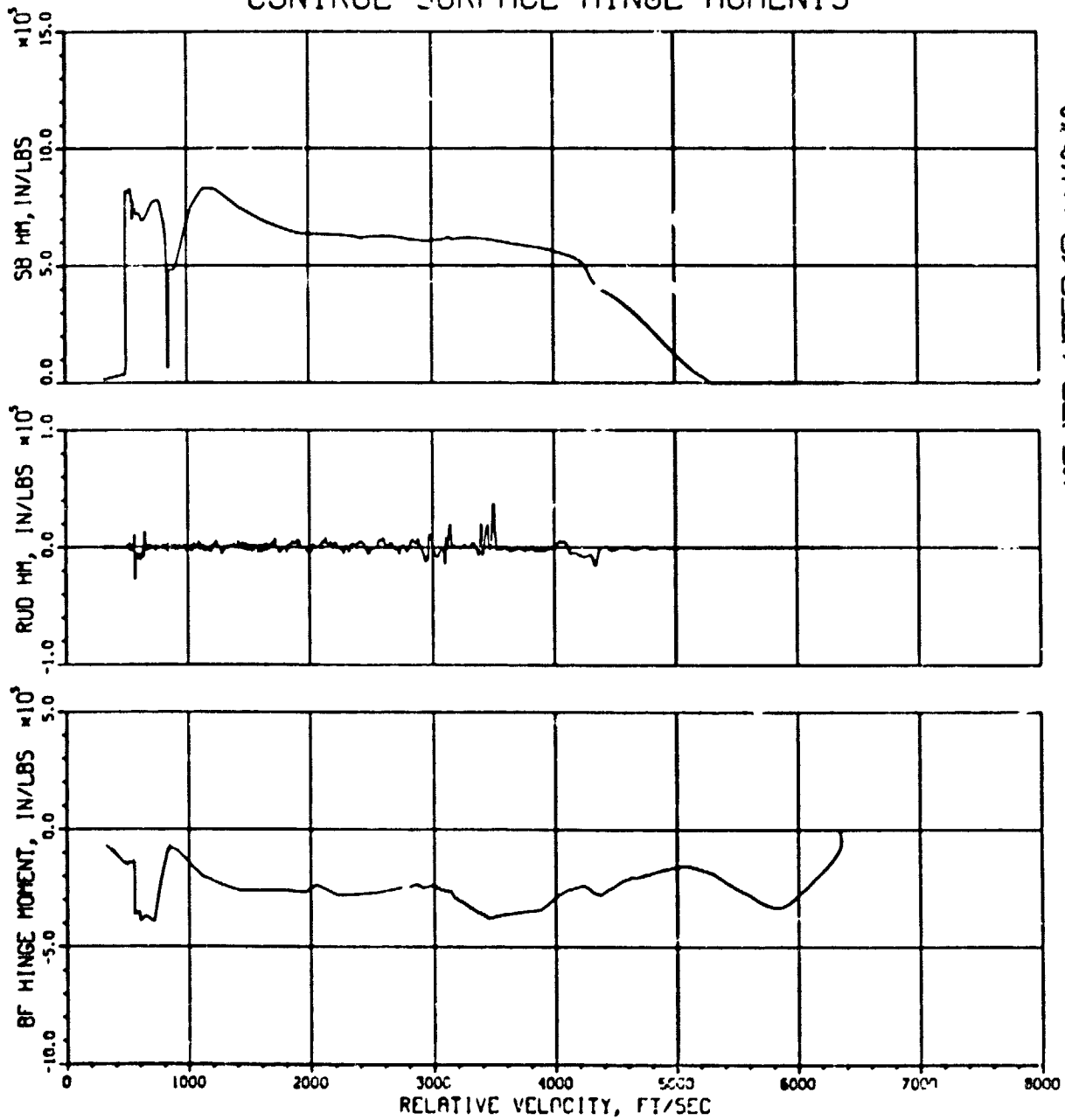

(t) Body flap, rudder, and speedbrake hinge moments versus relative velocity.

Figure 6.2.2-6.- Continued.

LOCAL HORIZONTAL ANGLES

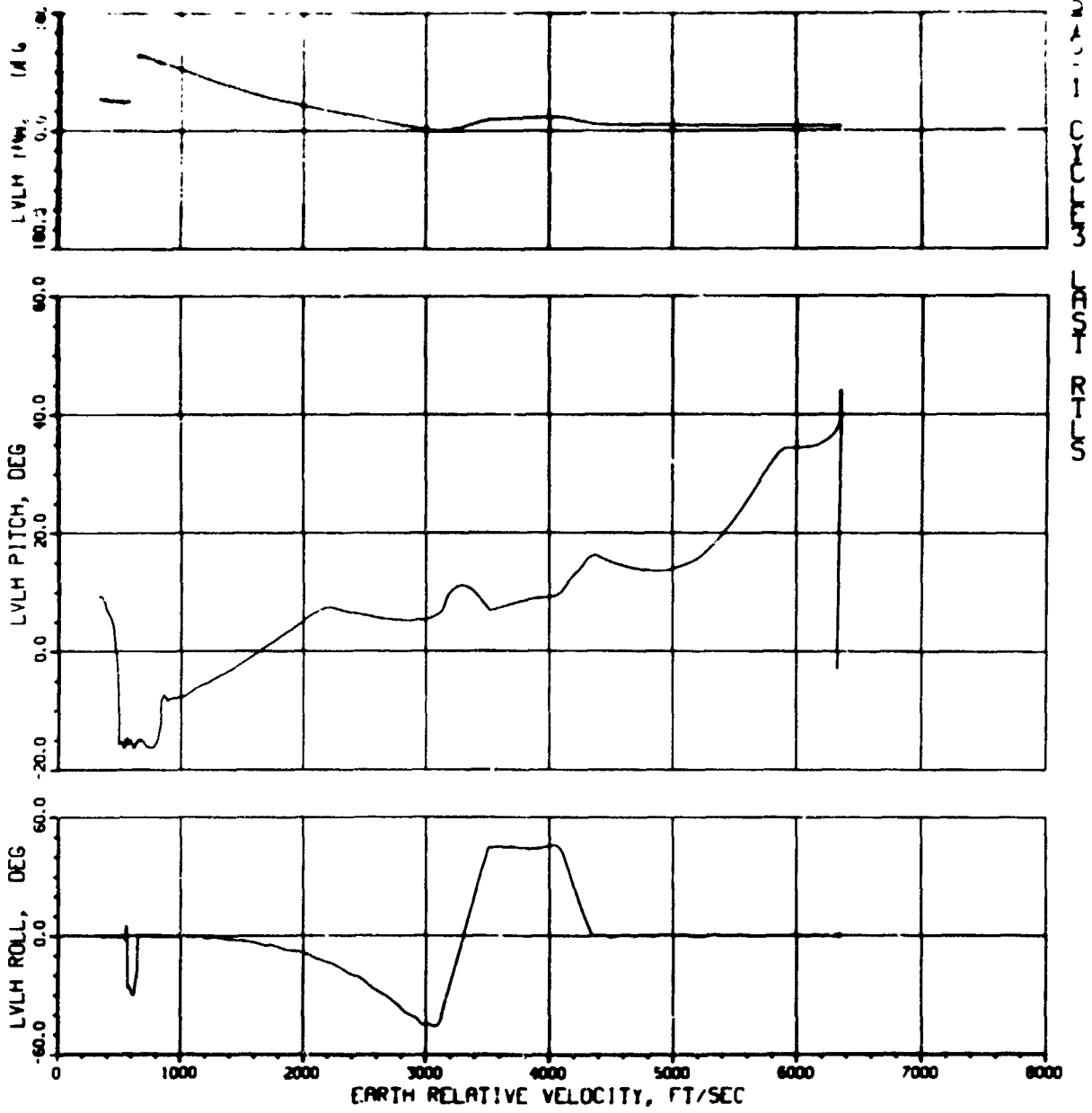

(u) Local horizontal angles versus relative velocity.

Figure 6.2.2-6.- Continued.

VELOCITY HISTORY

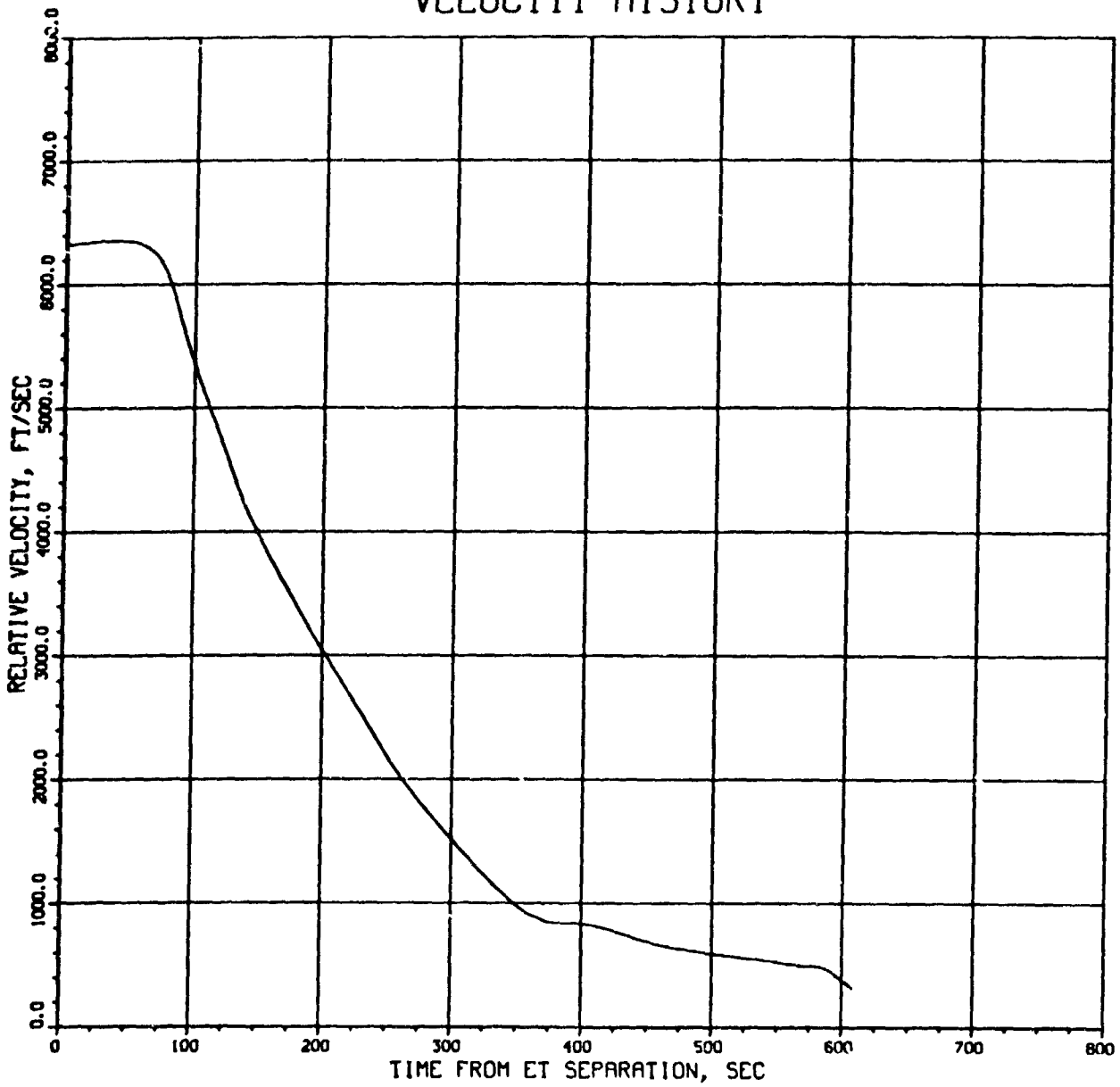

(v) Relative velocity time history.

Figure 6.2.2-6.- Continued.

ALTITUDE PROFILE

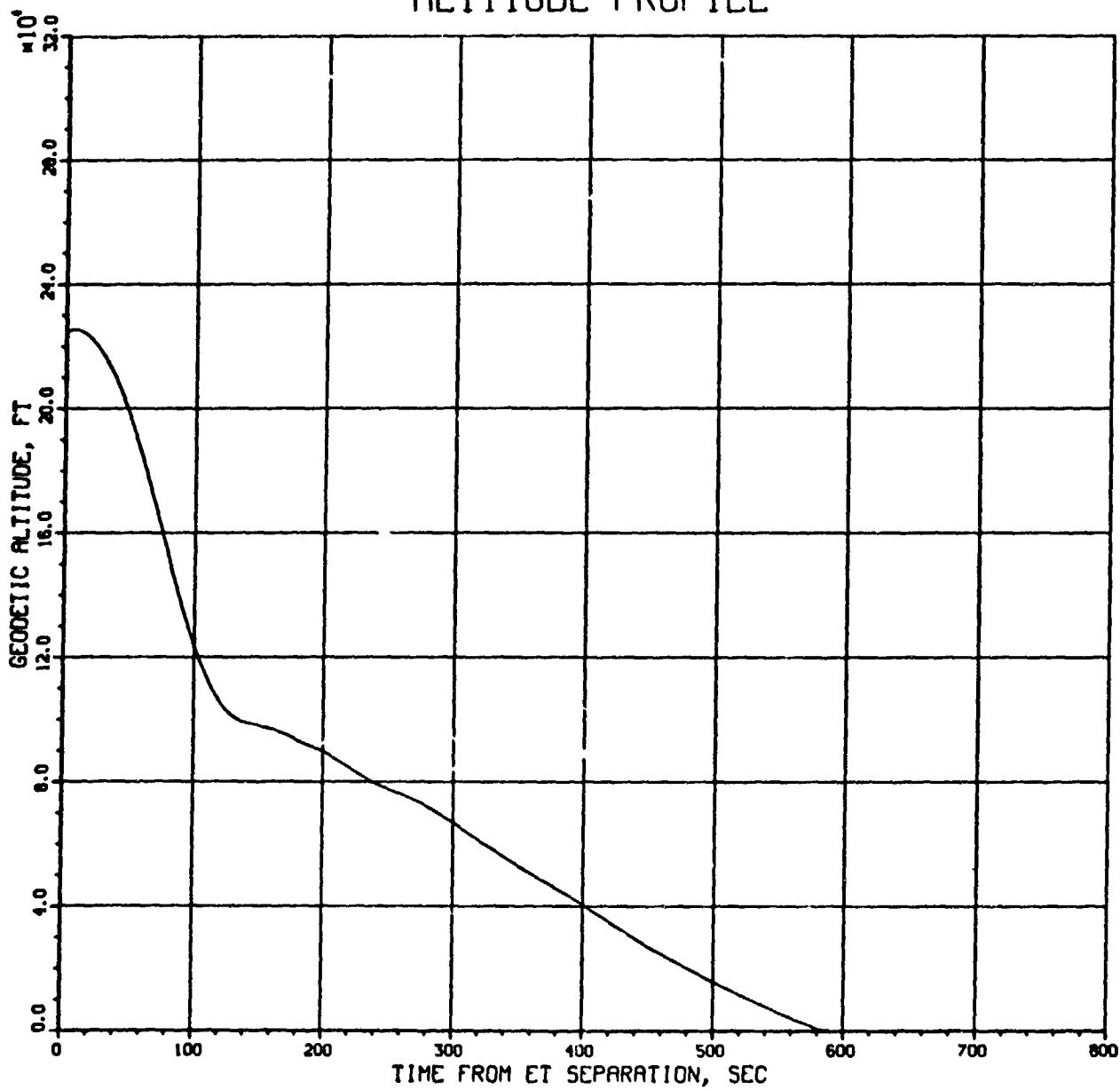

(w) Geodetic altitude time history.

Figure 6.2.2-6.- Continued.

RANGE TO RUNWAY THRESHOLD

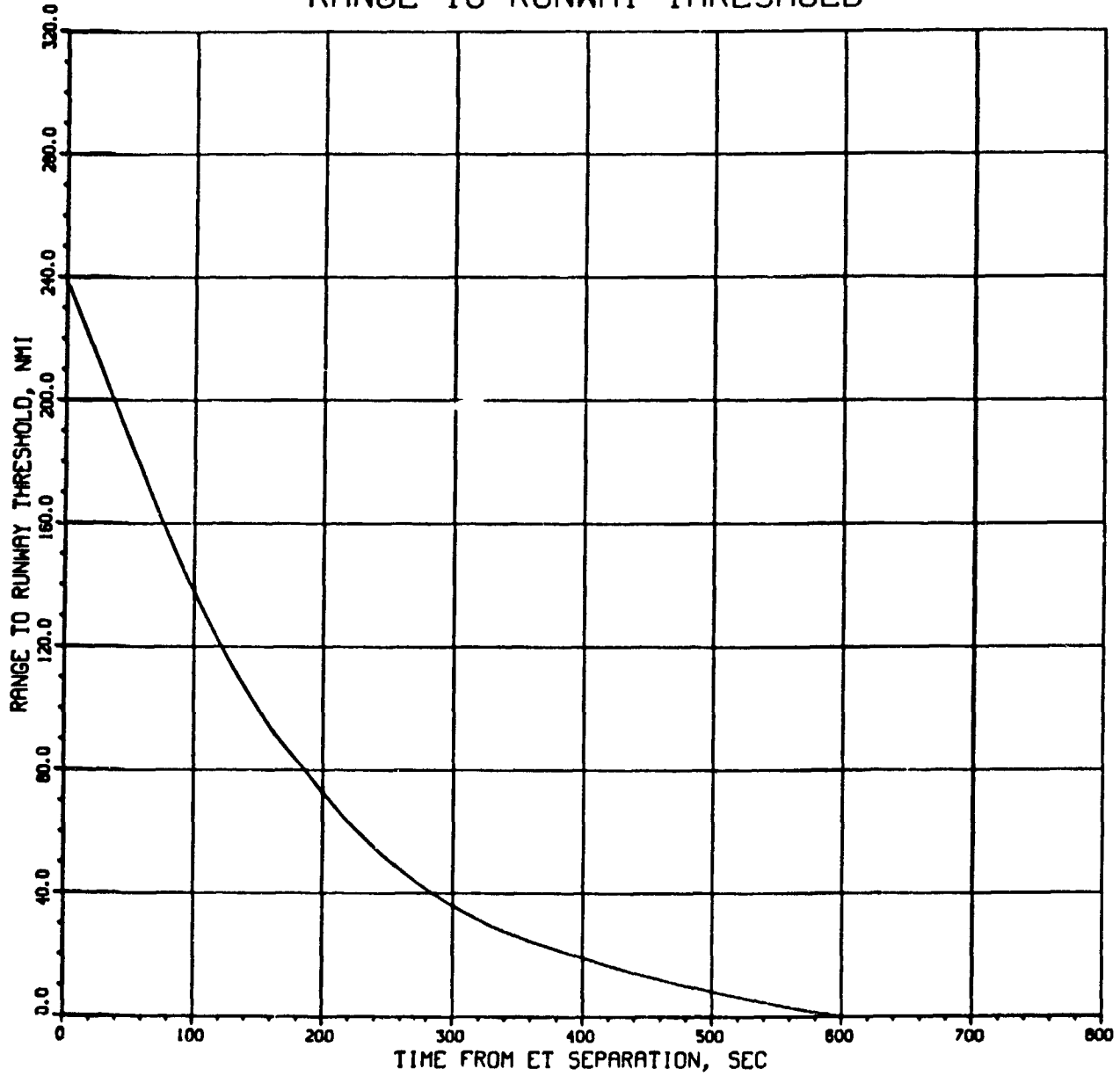

(x) Range to runway threshold time history.

Figure 6.2.2-6.- Continued.

MERRITT IS. TRACKING DATA

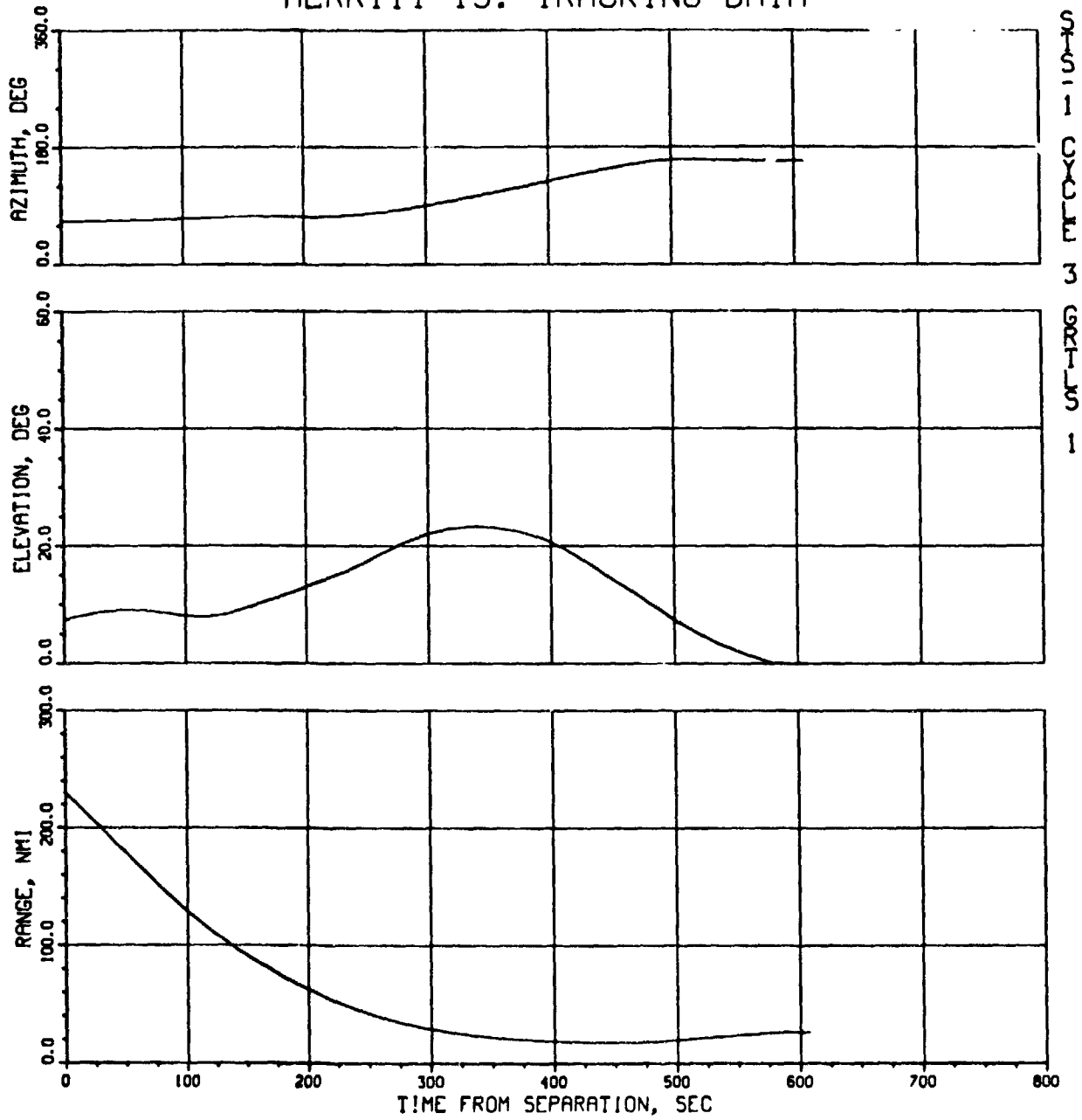

(y) Merritt Island tracking time history.

Figure 6.2.2-6.- Continued.

NEW SMYRNA TRACKING DATA

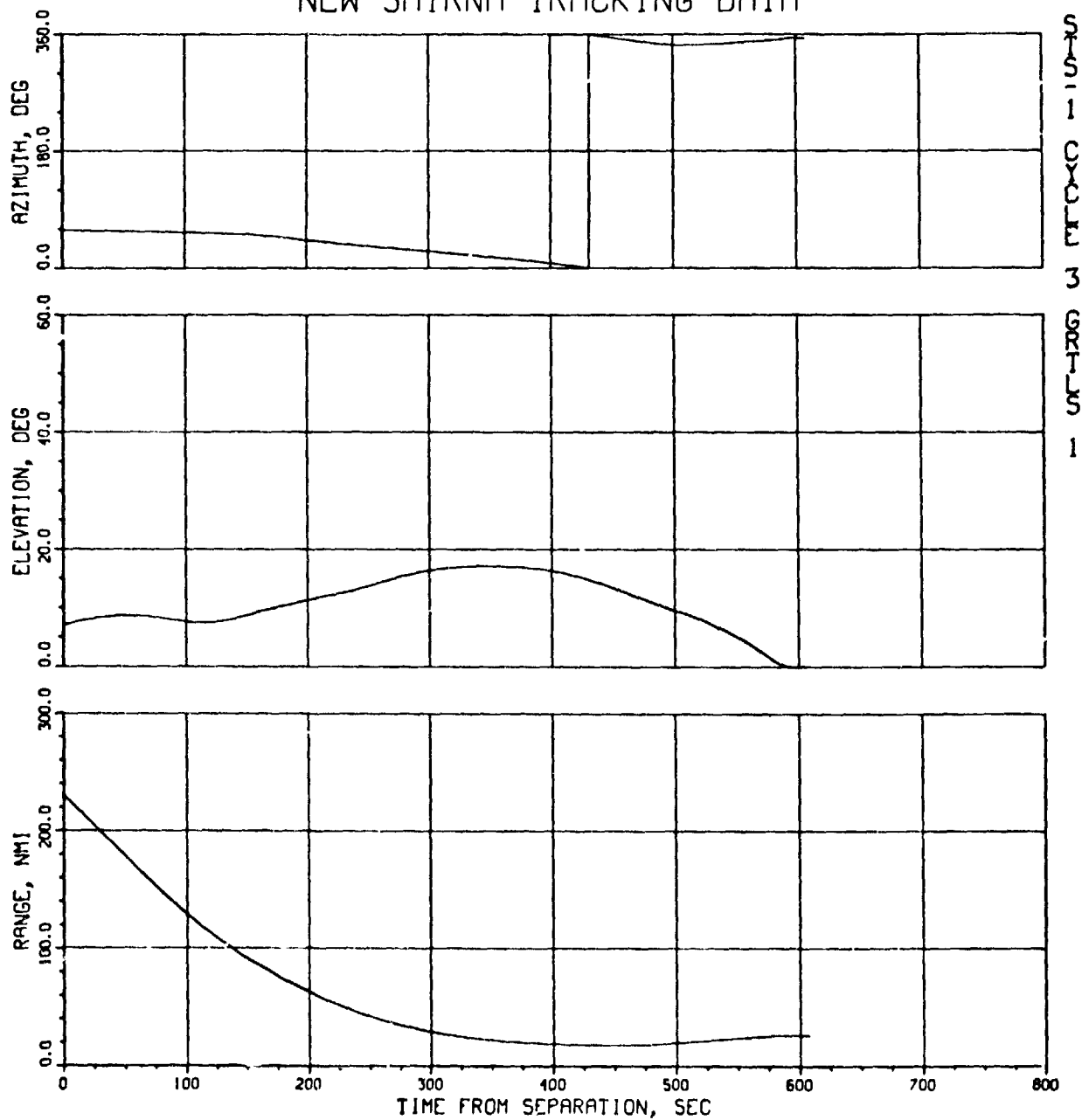

(z) New Smyrna Beach tracking time history.

Figure 6.2.2-6.- Concluded.

ALTITUDE PROFILE

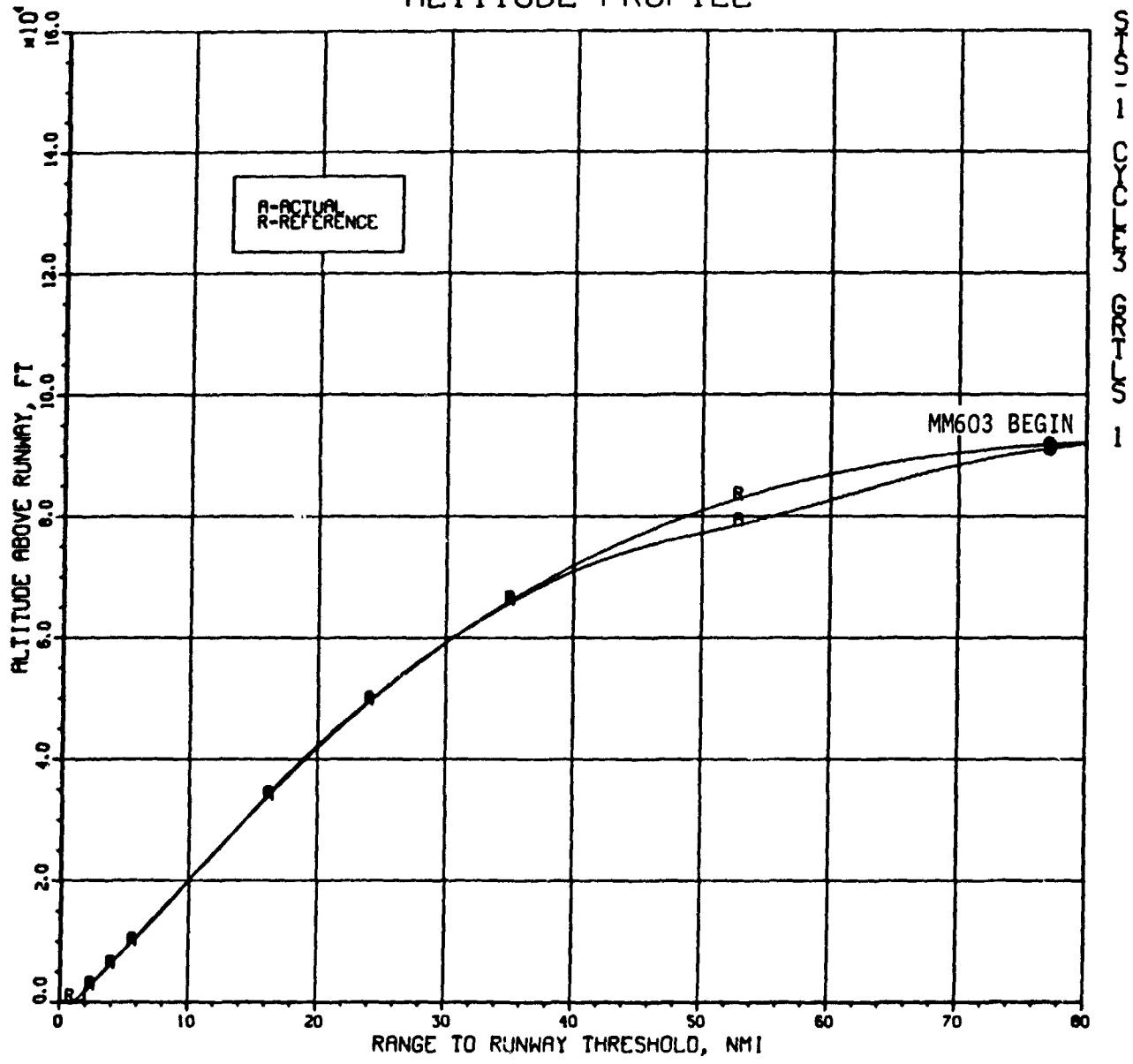

(a) Altitude versus range to runway threshold.

Figure 6.2.2-7.- RTLS no. 1 - TAEM interface (MM603) to landing at KSC runway 15.

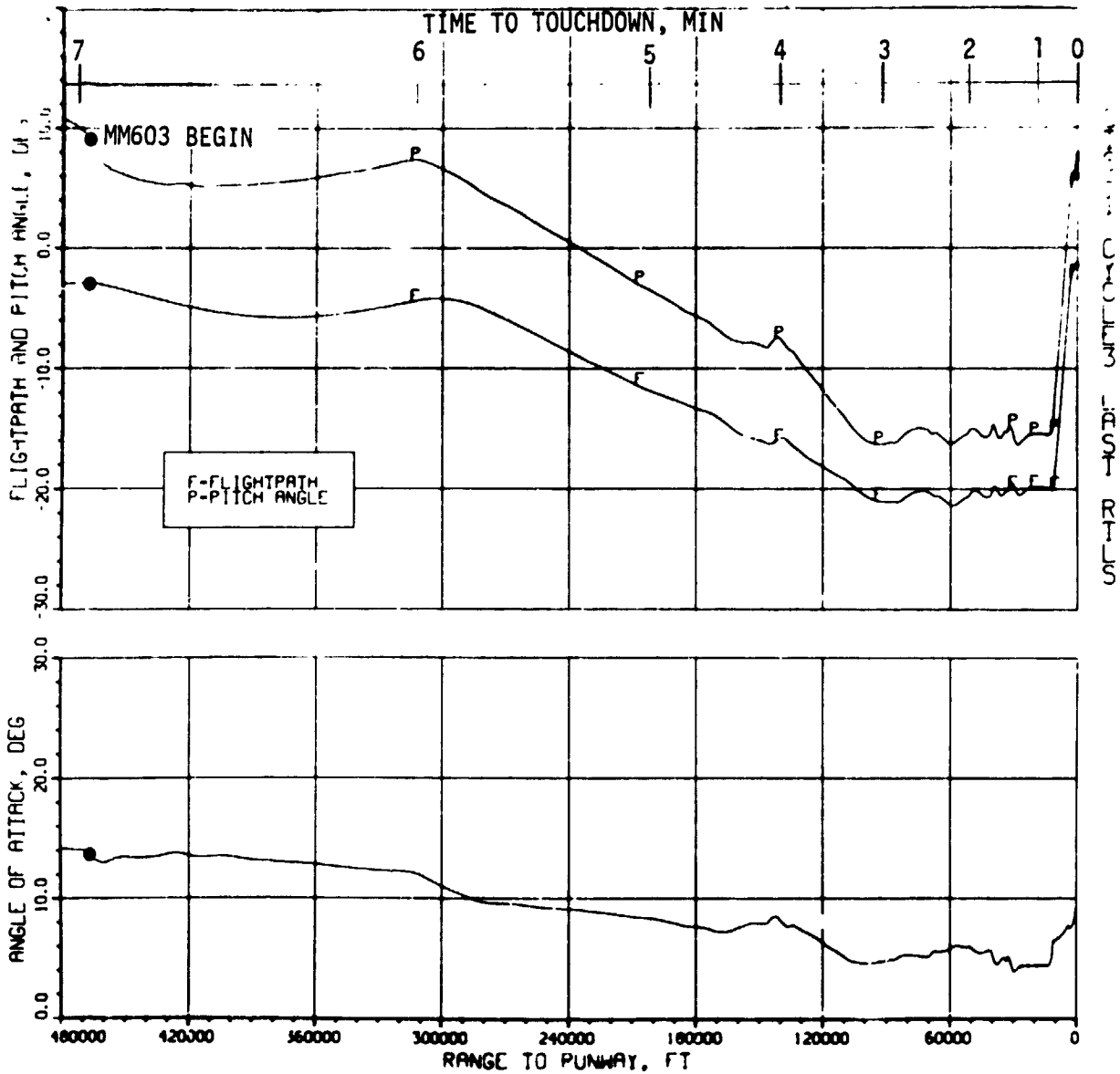

(b) Angle of attack, pitch angle and flightpath angle versus range to runway threshold.

Figure 6.2.2-7.- Continued.

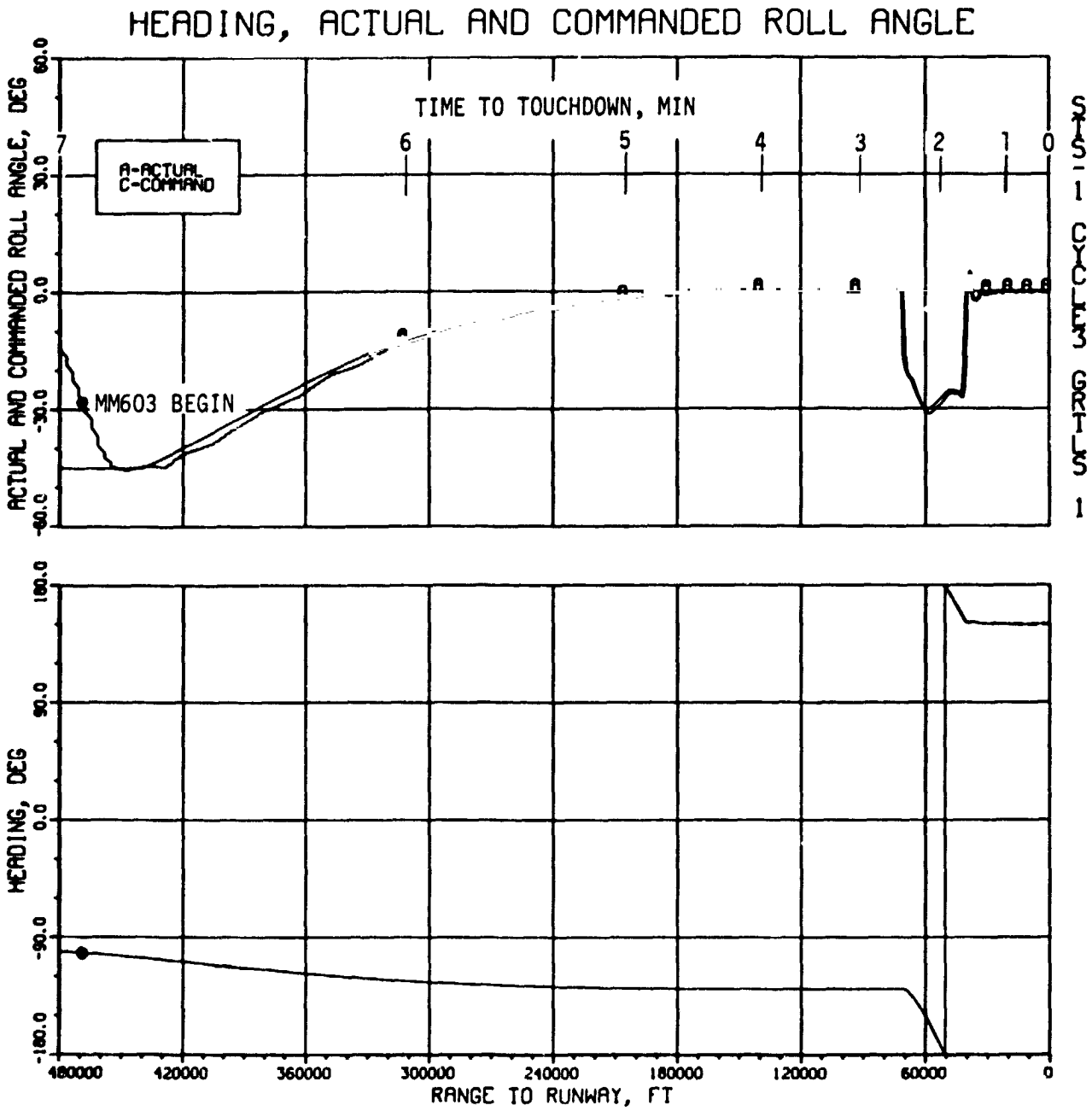

(c) Heading, actual, and commanded roll angle versus range to runway threshold.

Figure 6.2.2-7.- Continued.

ALTITUDE RATE AND EQUIVALENT AIRSPEED

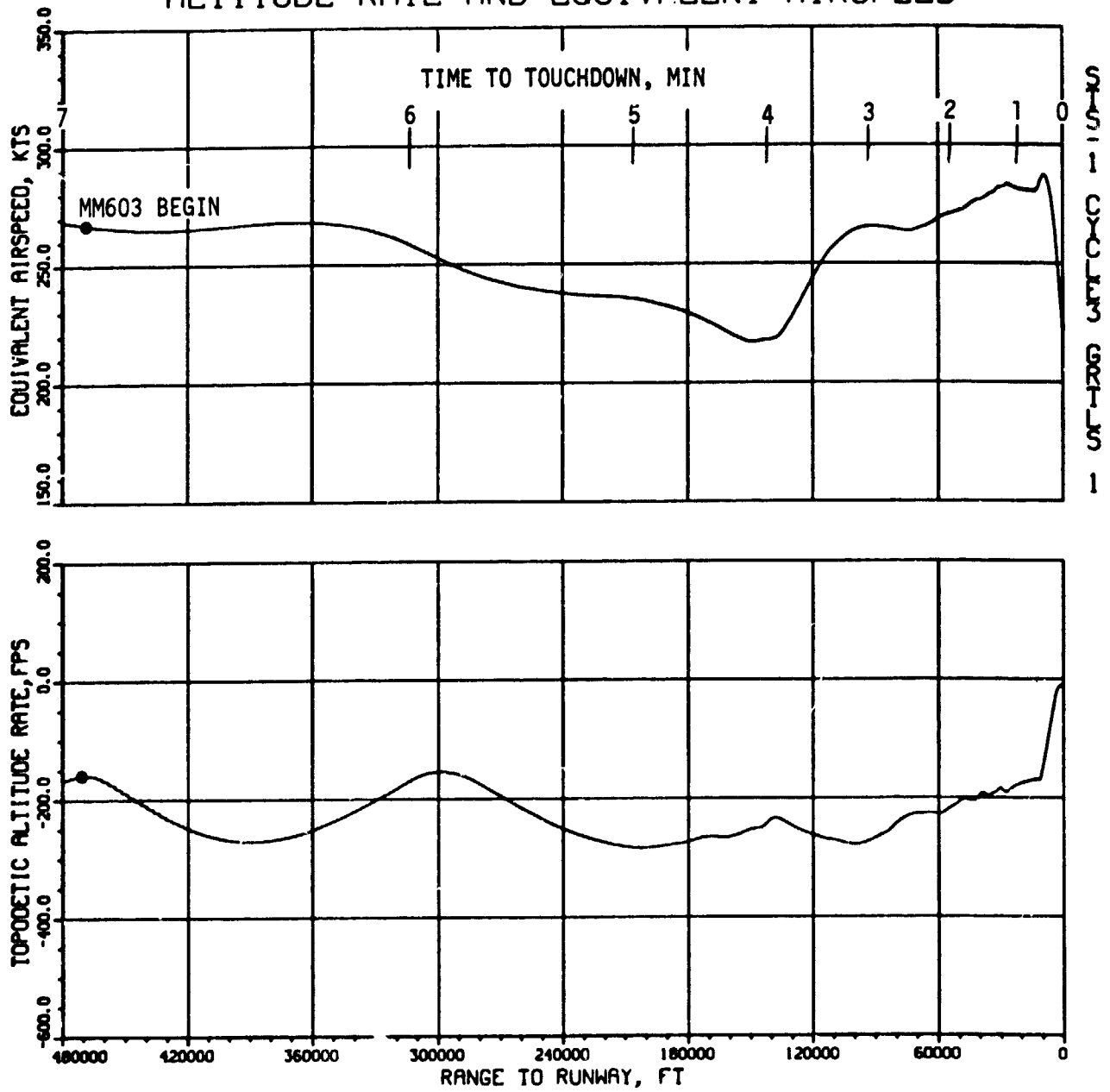

(d) Altitude rate and equivalent airspeed versus range to runway threshold.

Figure 6.2.2-7.- Continued.

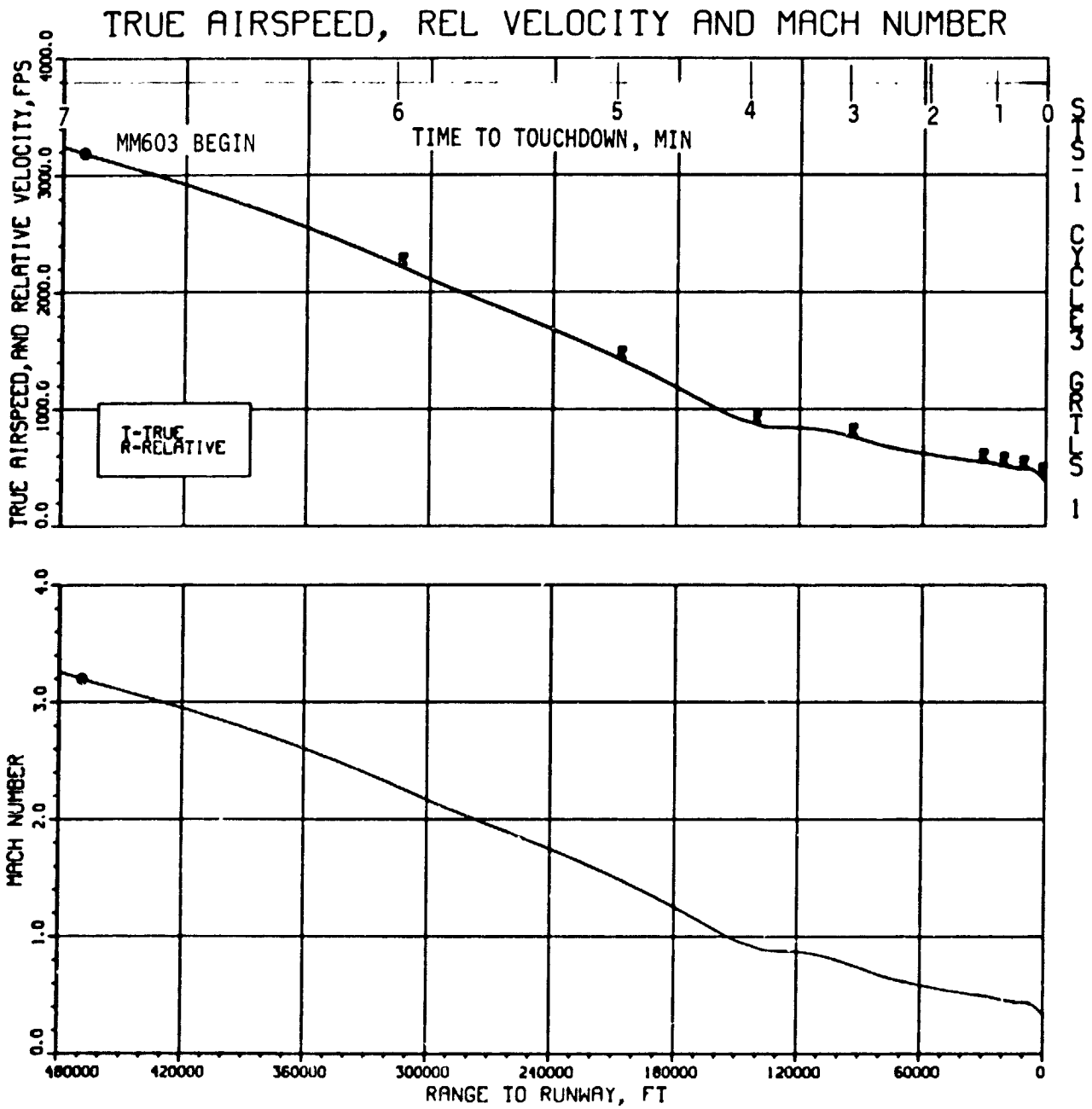

(e) True airspeed, relative velocity and mach number versus range to runway threshold.

Figure 6.2.2-7.- Continued.

ACTUAL AND COMMANDED NORMAL LOAD FACTOR

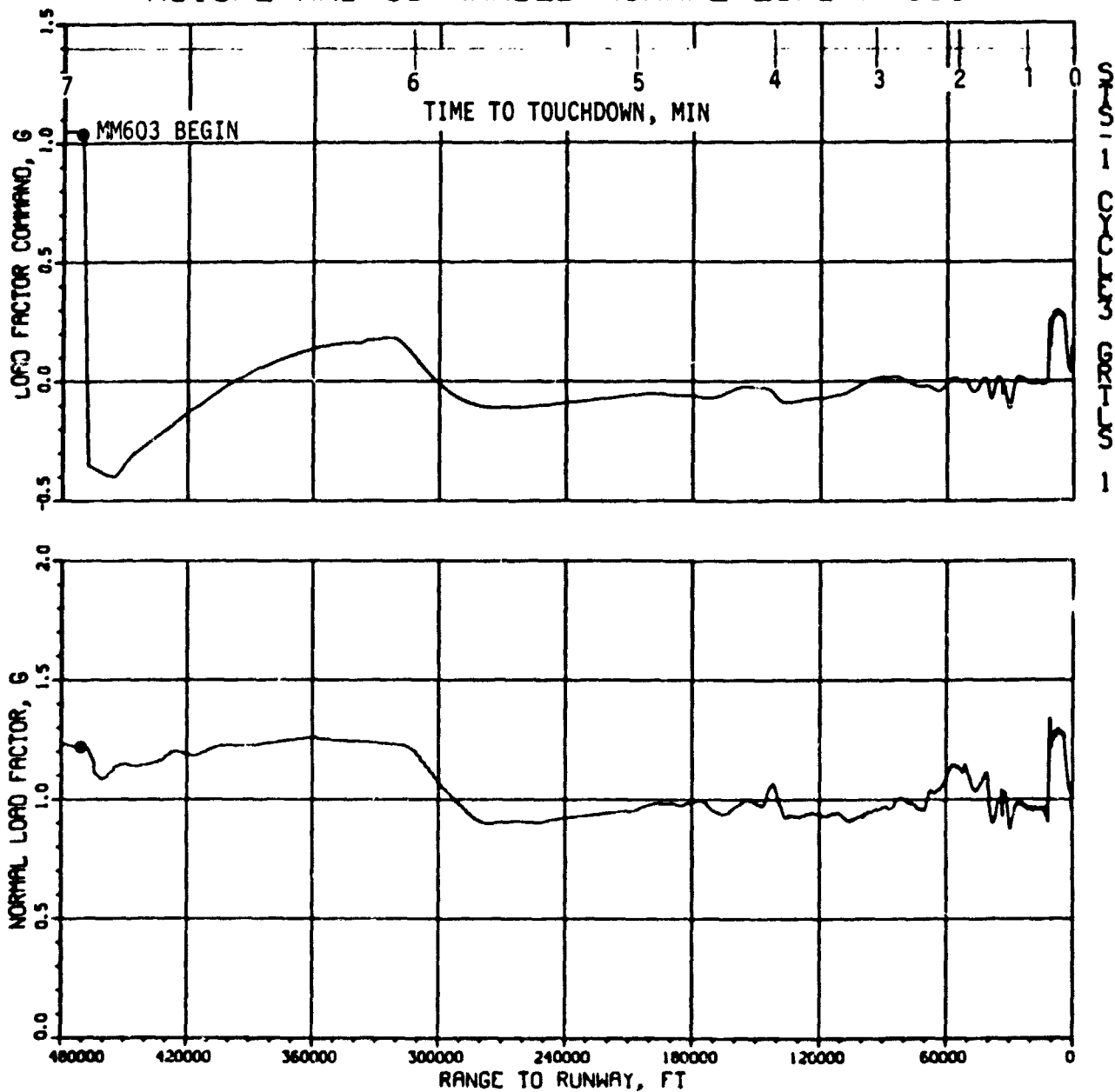

(f) Actual and commanded normal load factor versus range to runway threshold.

Figure 6.2.2-7.- Continued.

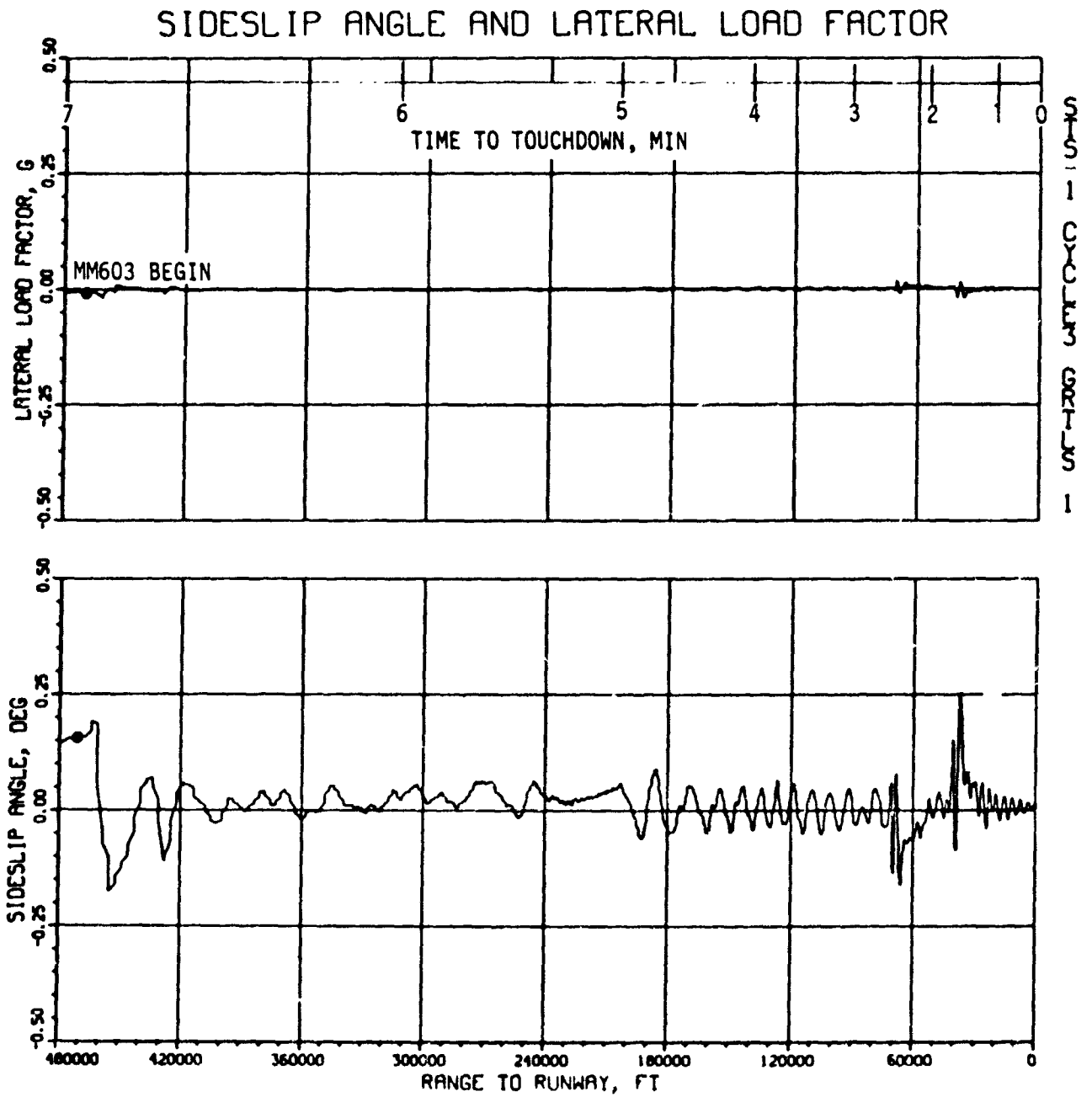

(g) Sideslip angle and lateral load factor versus range to runway threshold.

Figure 6.2.2-7.- Continued.

BODY ATTITUDE RATES

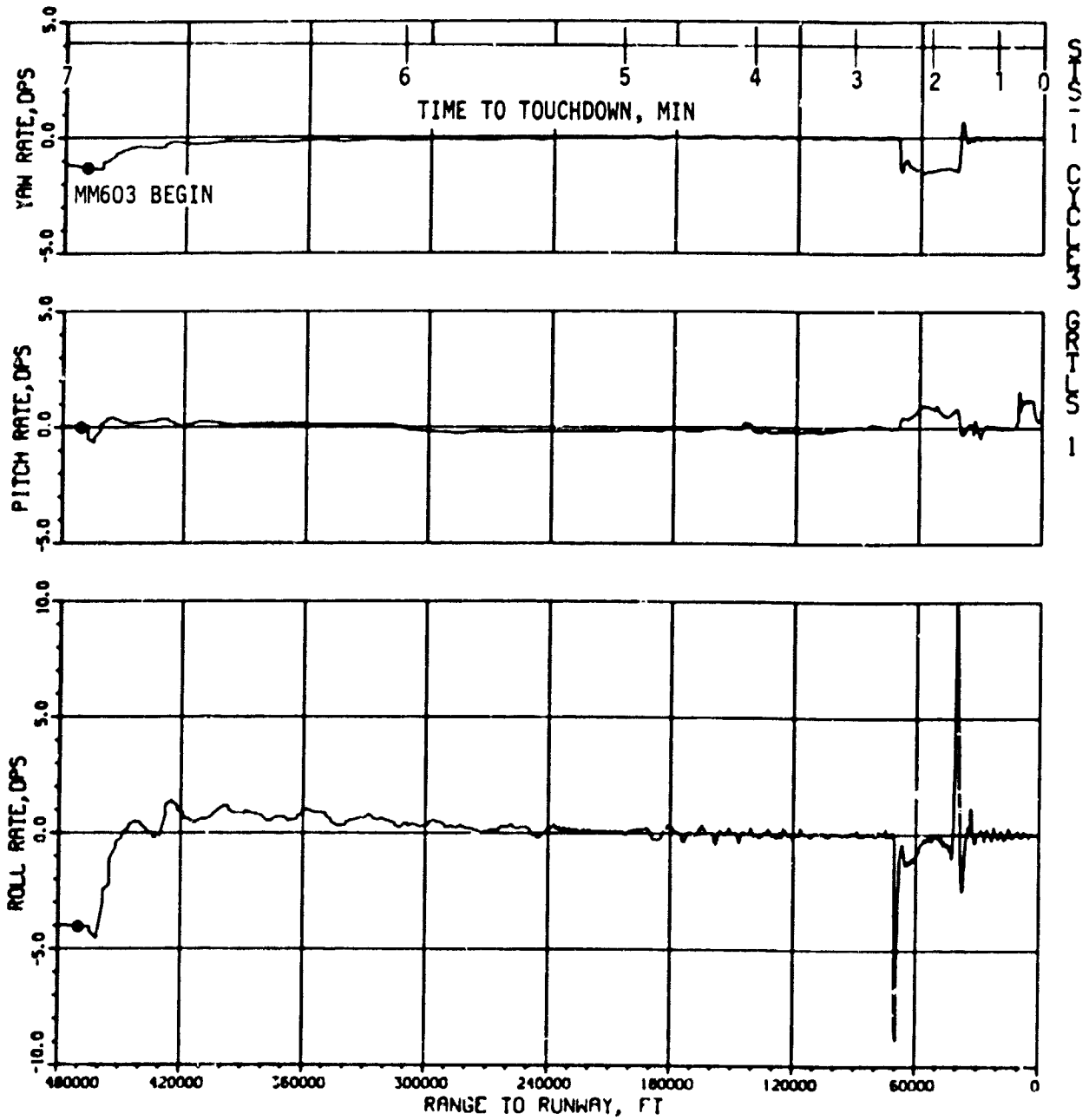

(h) Body attitude rates versus range to runway threshold.

Figure 6.2.2-7.- Continued.

AILERON, ELEVATOR AND BODY FLAP POSITION

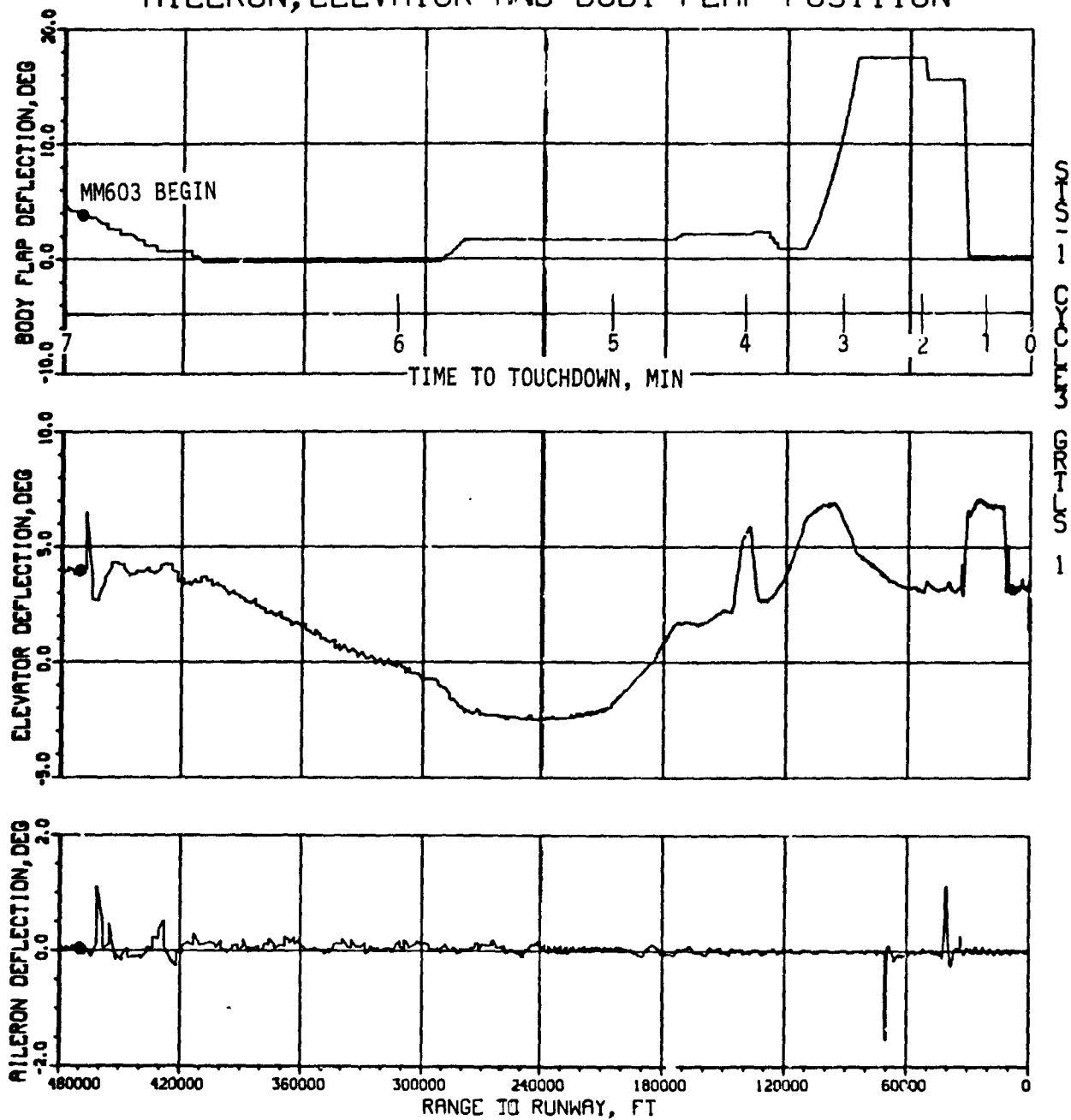

(i) Aileron, elevator, and body flap position versus range to runway threshold.

Figure 6.2.2-7.- Continued.

SPEEDBRAKE AND RUDDER POSITION

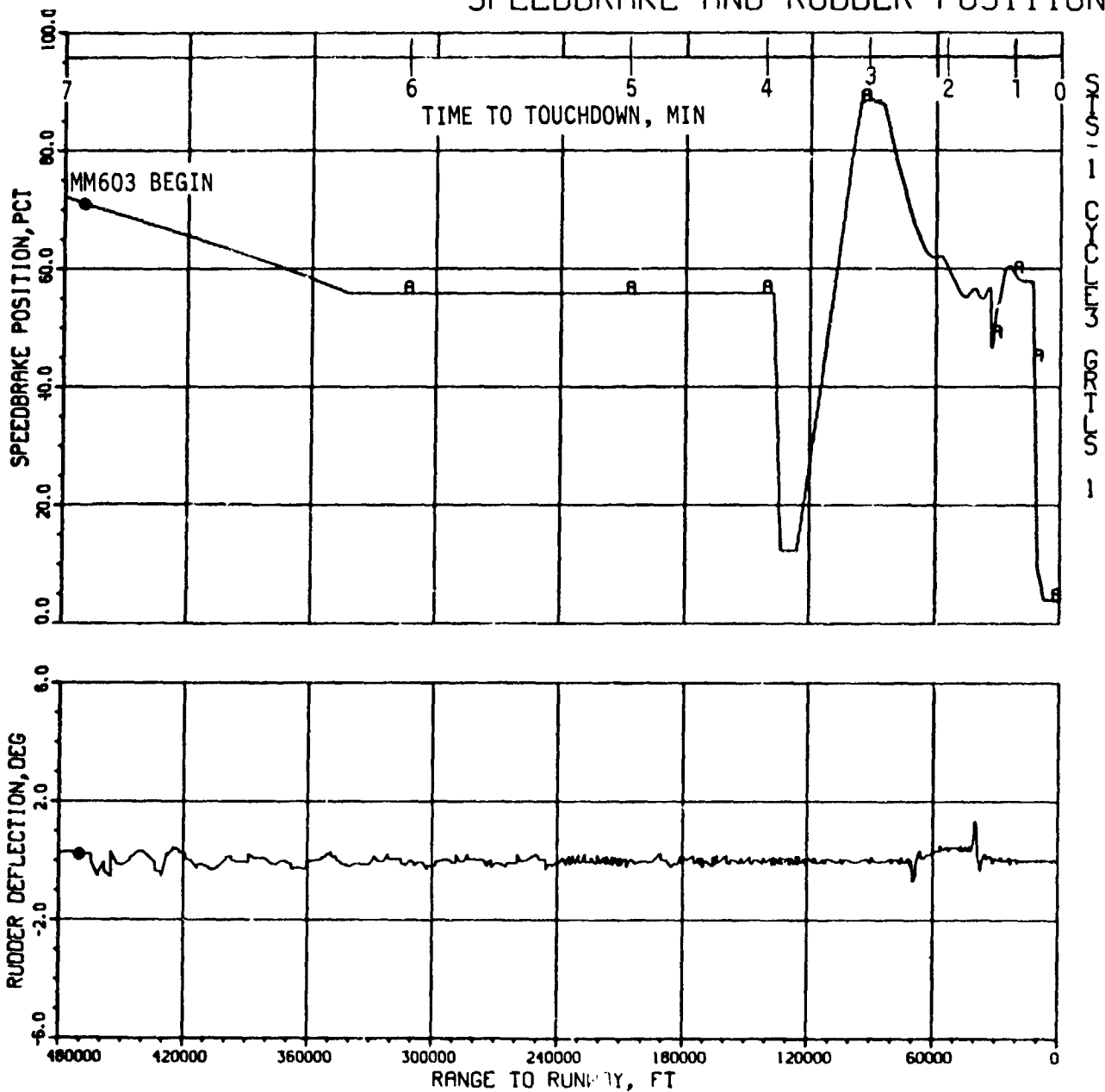

(j) Speedbrake and rudder position versus range to runway threshold.

Figure 6.2.2-7.- Concluded.

GEAR ALT, FLIGHTPATH AND LOAD FACTOR VS RANGE

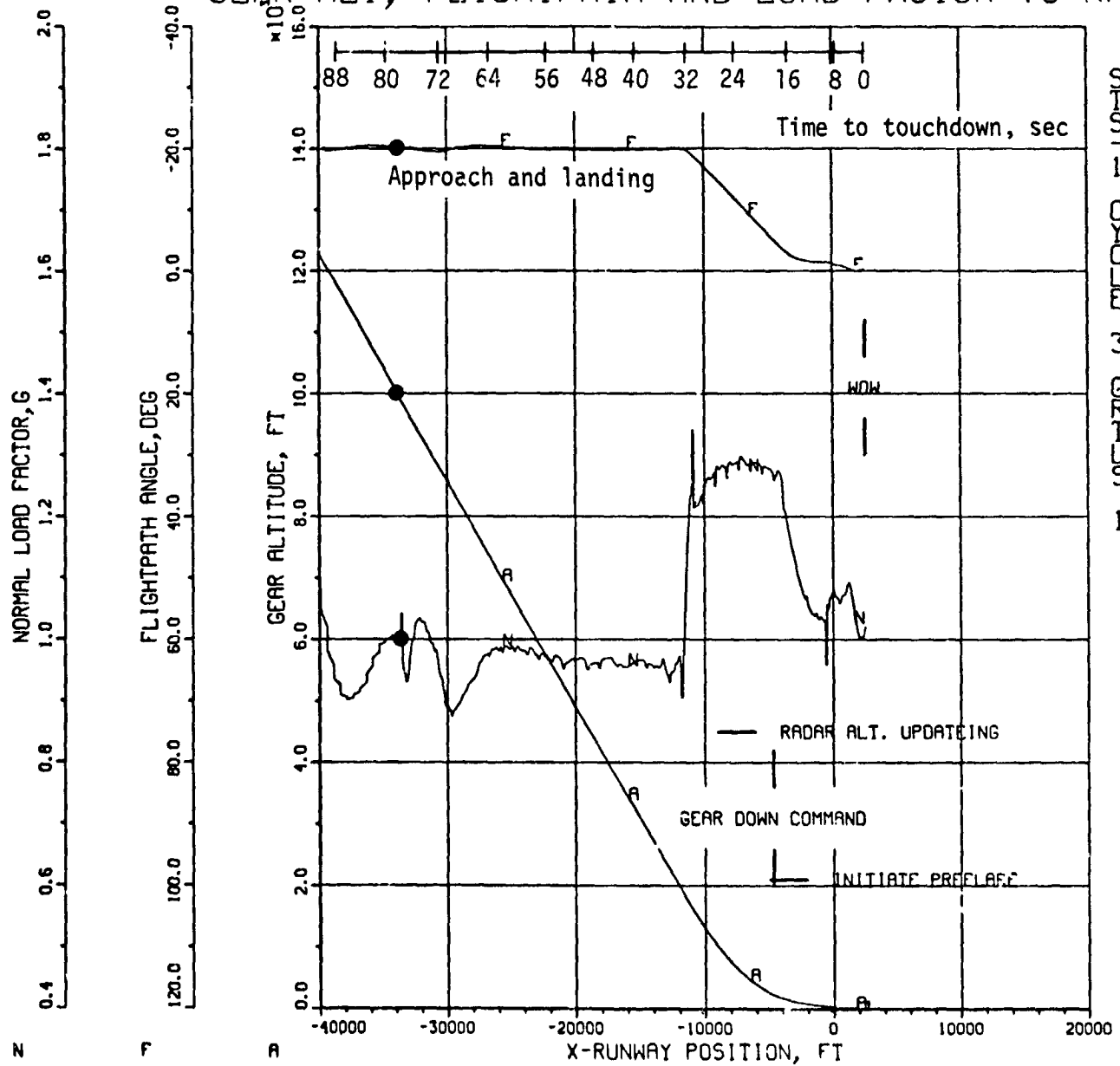
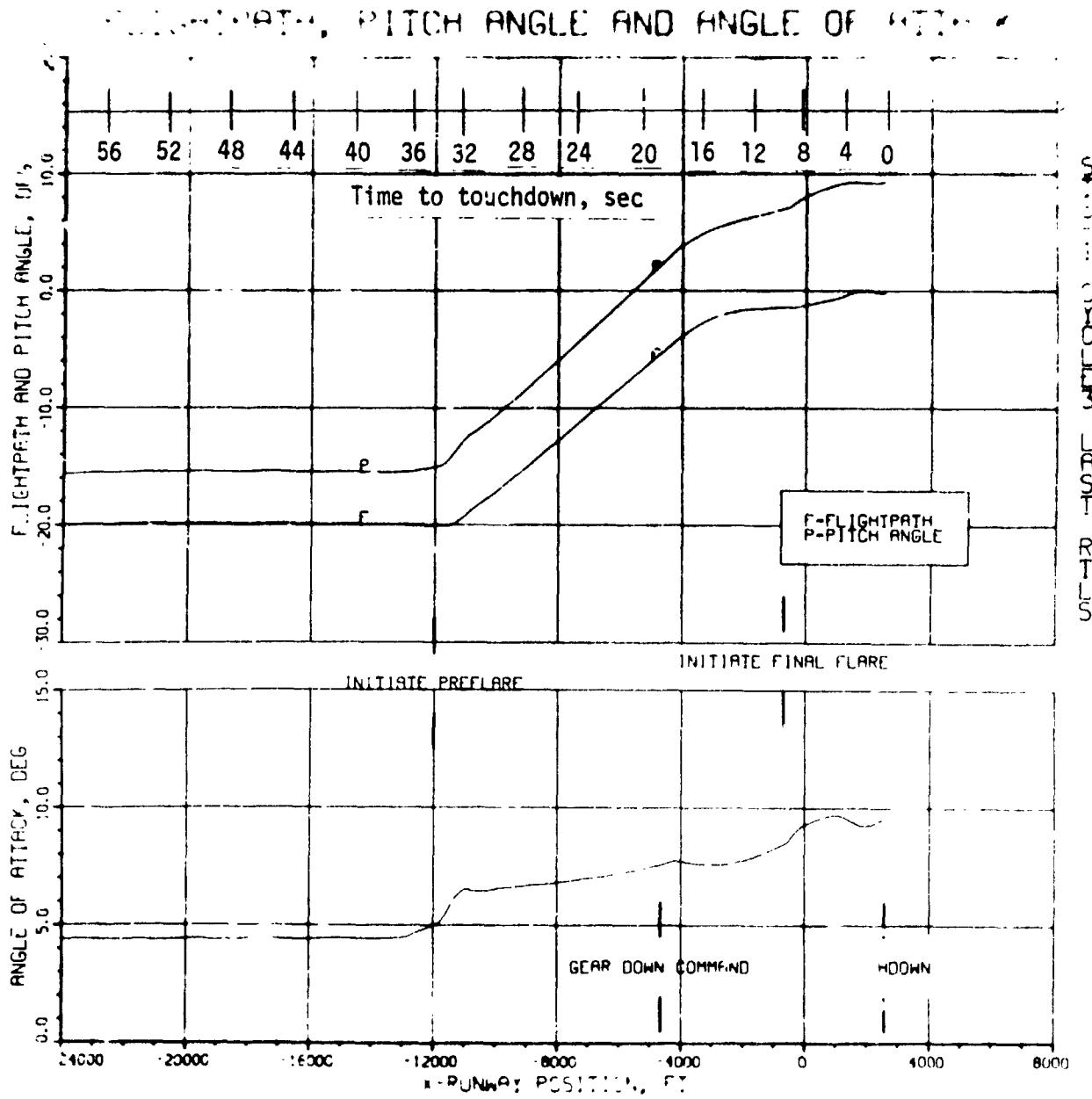
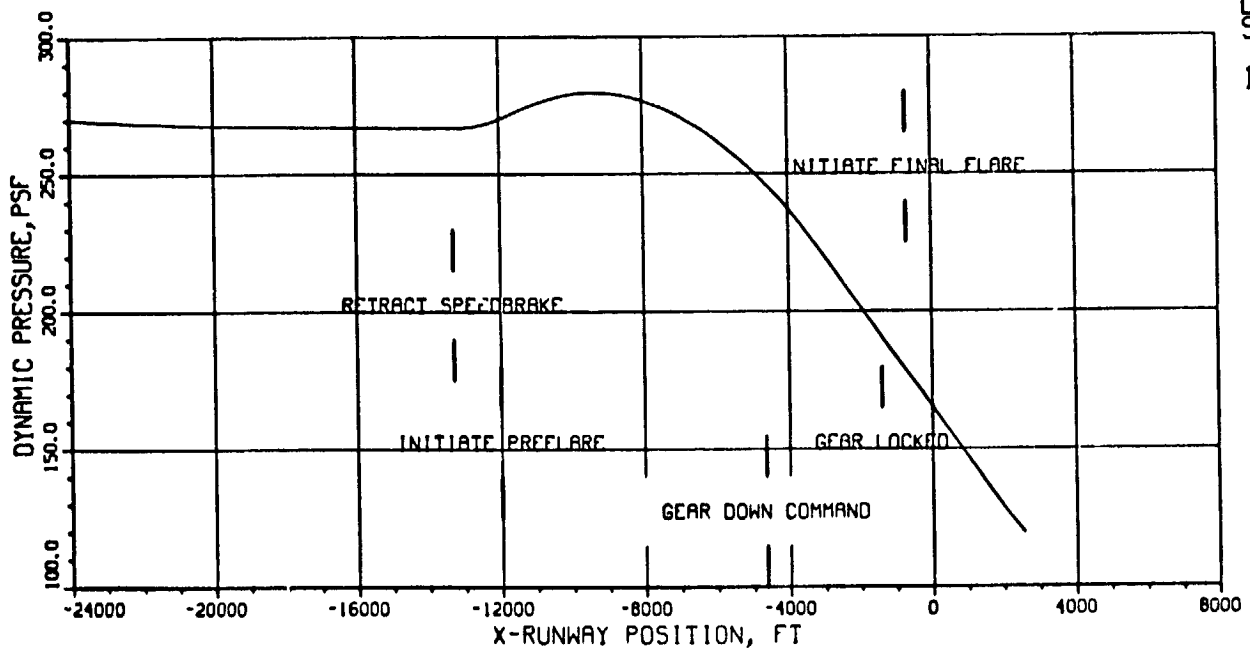
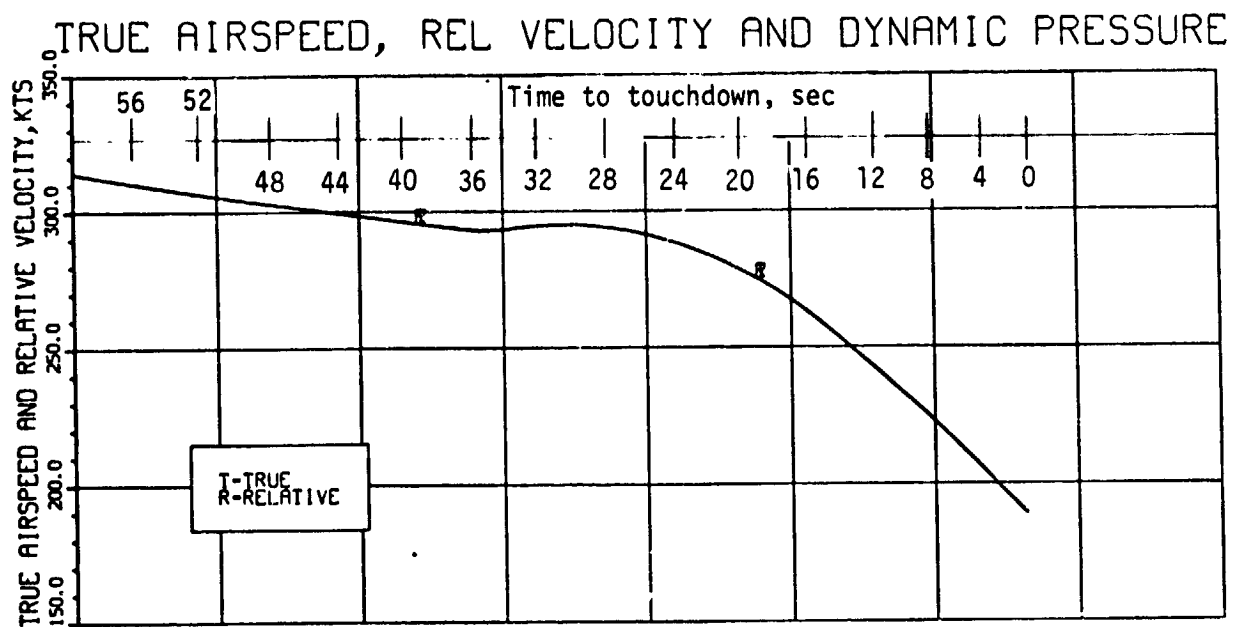

Figure 6.2.2-8.- RTLS no. 1 - approach and landing interface to touchdown at KSC runway 15.



(a) Flightpath angle, pitch angle, and angle of attack versus X-runway position.

Figure 6.2.2-9.- RTLS no. 1 - 24 000 ft X-range from runway threshold to touchdown at KSC runway 15.



S-11 CYCLES 3 GRT-15 1

(b) True airspeed, relative velocity, and dynamic pressure versus X-runway position.

Figure 6.2.2-9.- Continued.

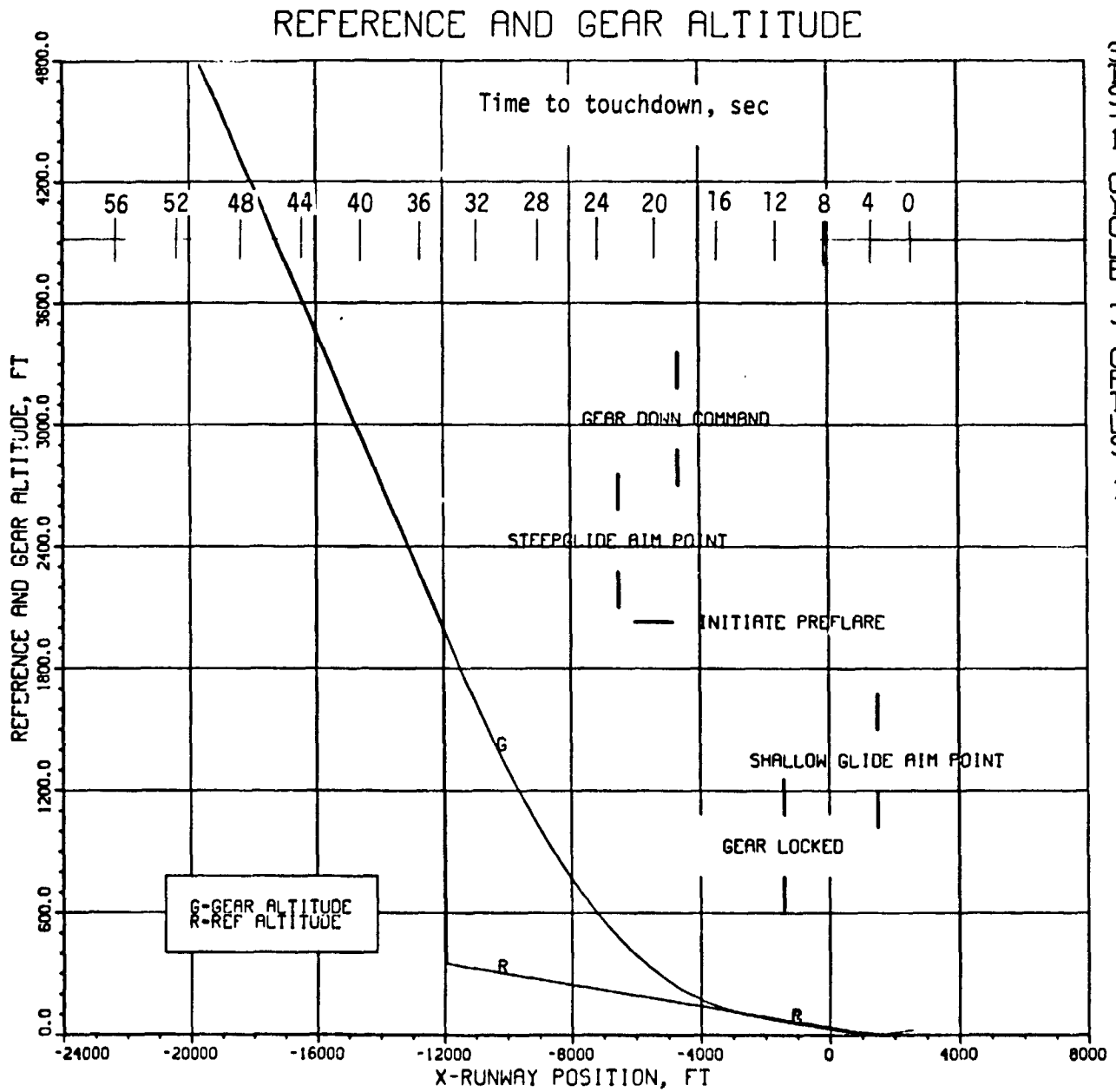

S-151 C-103 3 G-151 1

(c) Reference and gear altitude versus x-runway position.

Figure 6.2.2-9.- Continued.

BODY ATTITUDE RATES

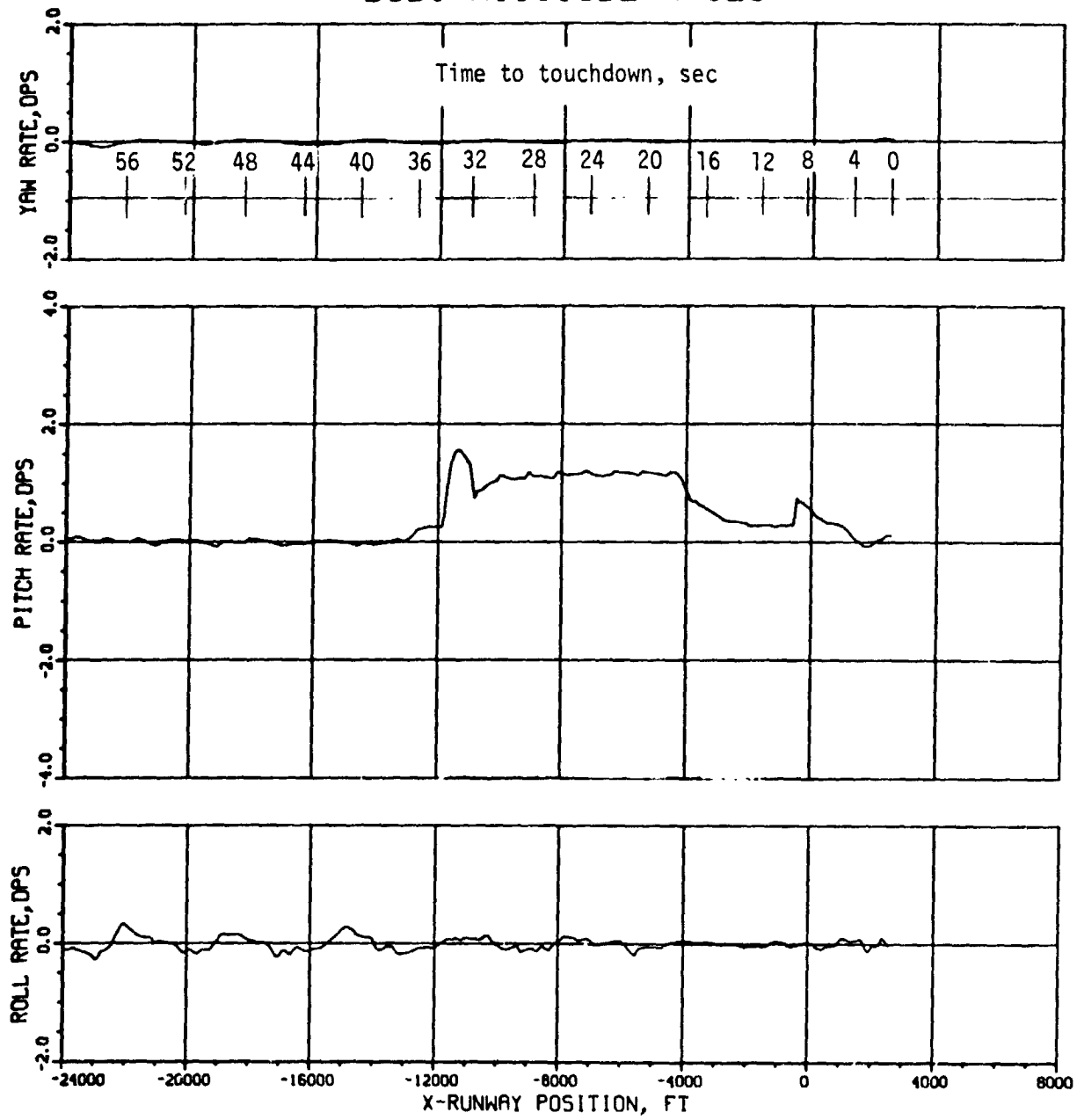

(d) Body attitude rates versus X-runway position.

Figure 6.2.2-9.- Continued.

AILERON, ELEVATOR AND BODY FLAP POSITION

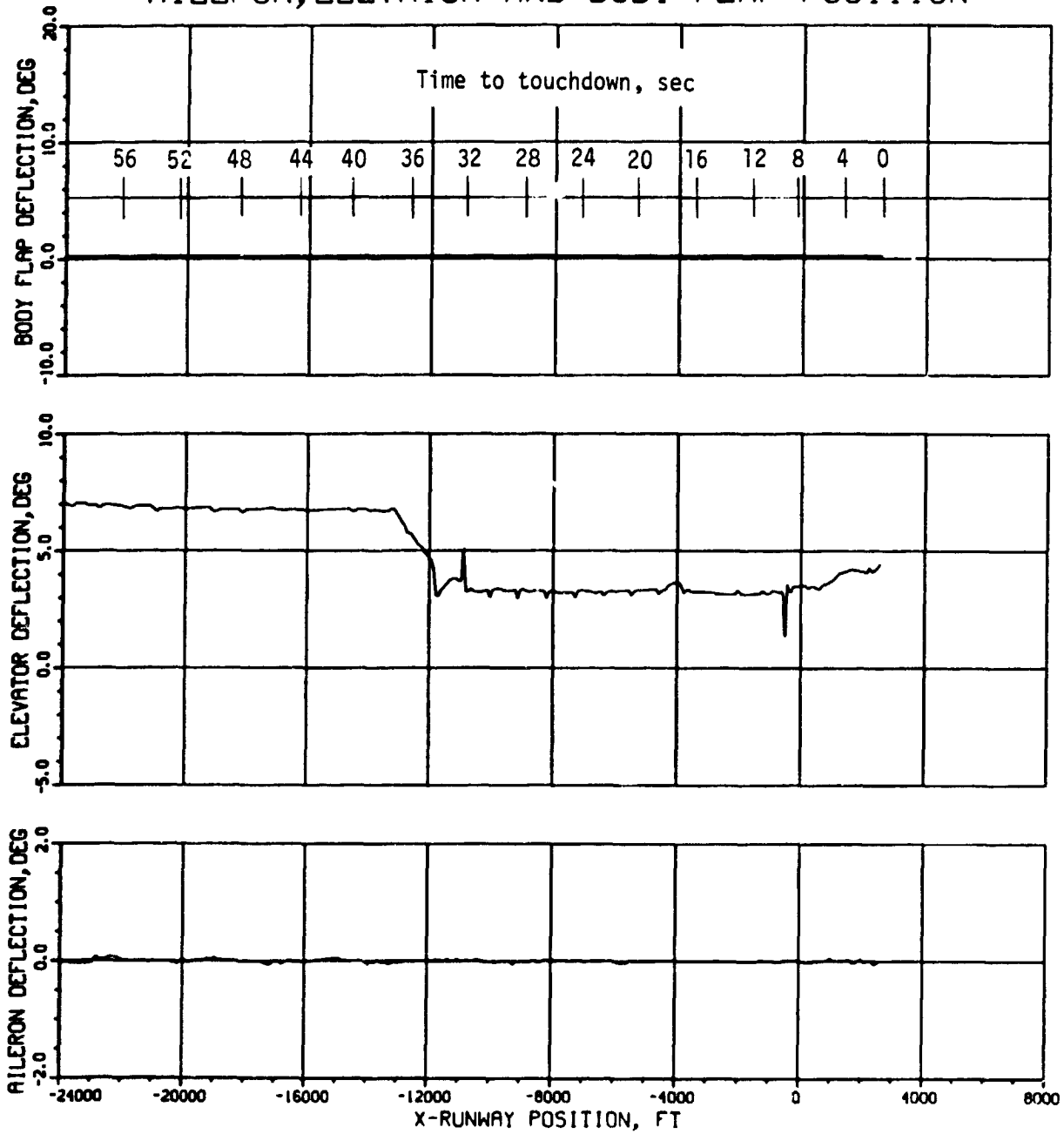

SHEET 3 OF 3

(e) Aileron, elevator, and body flap position versus X-runway position.

Figure 6.2.2-9.- Continued.

SPEEDBRAKE AND RUDDER POSITION

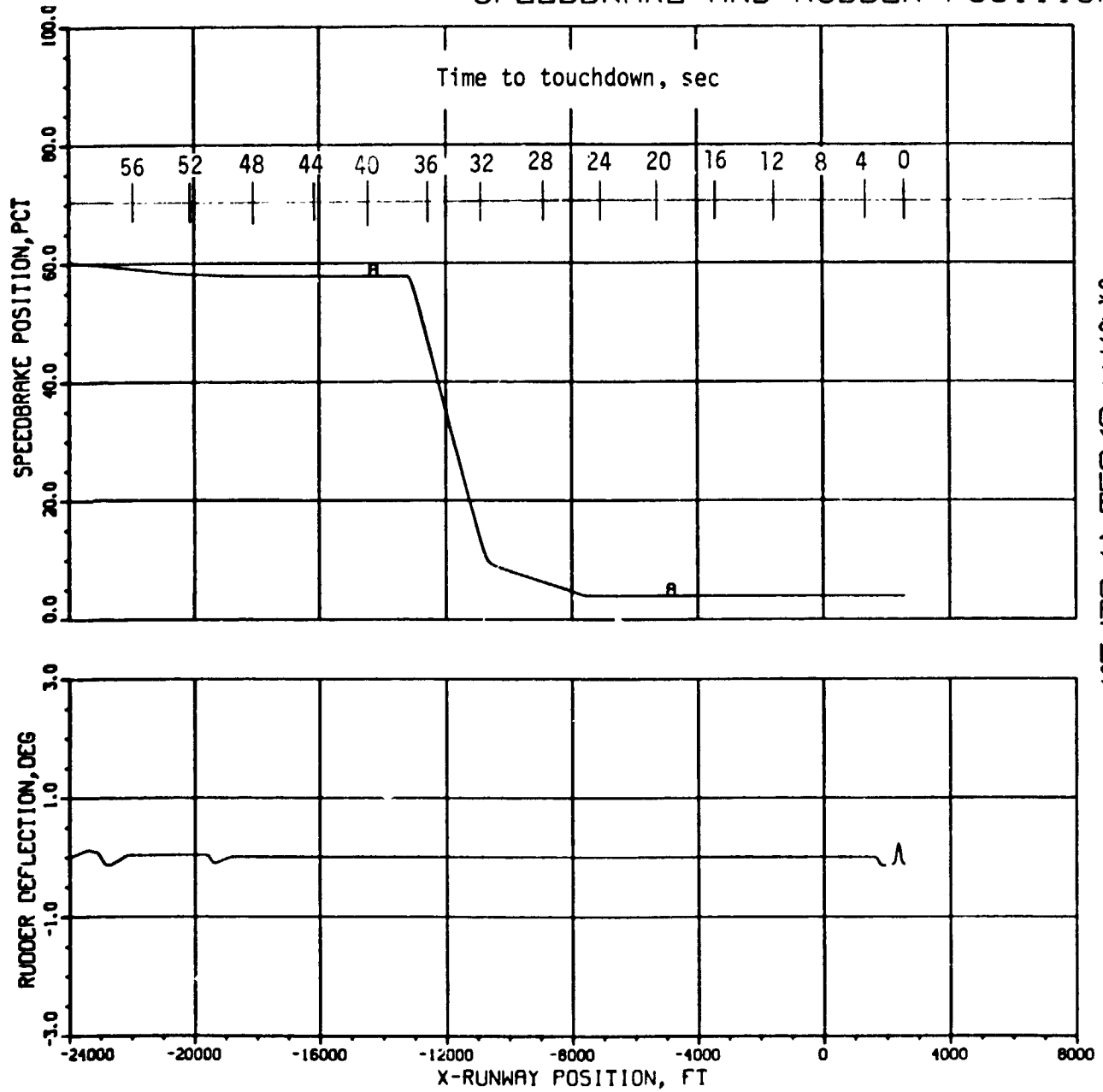

(f) Speed brake and rudder position versus X-runway position.

Figure 6.2.2-9.- Concluded.

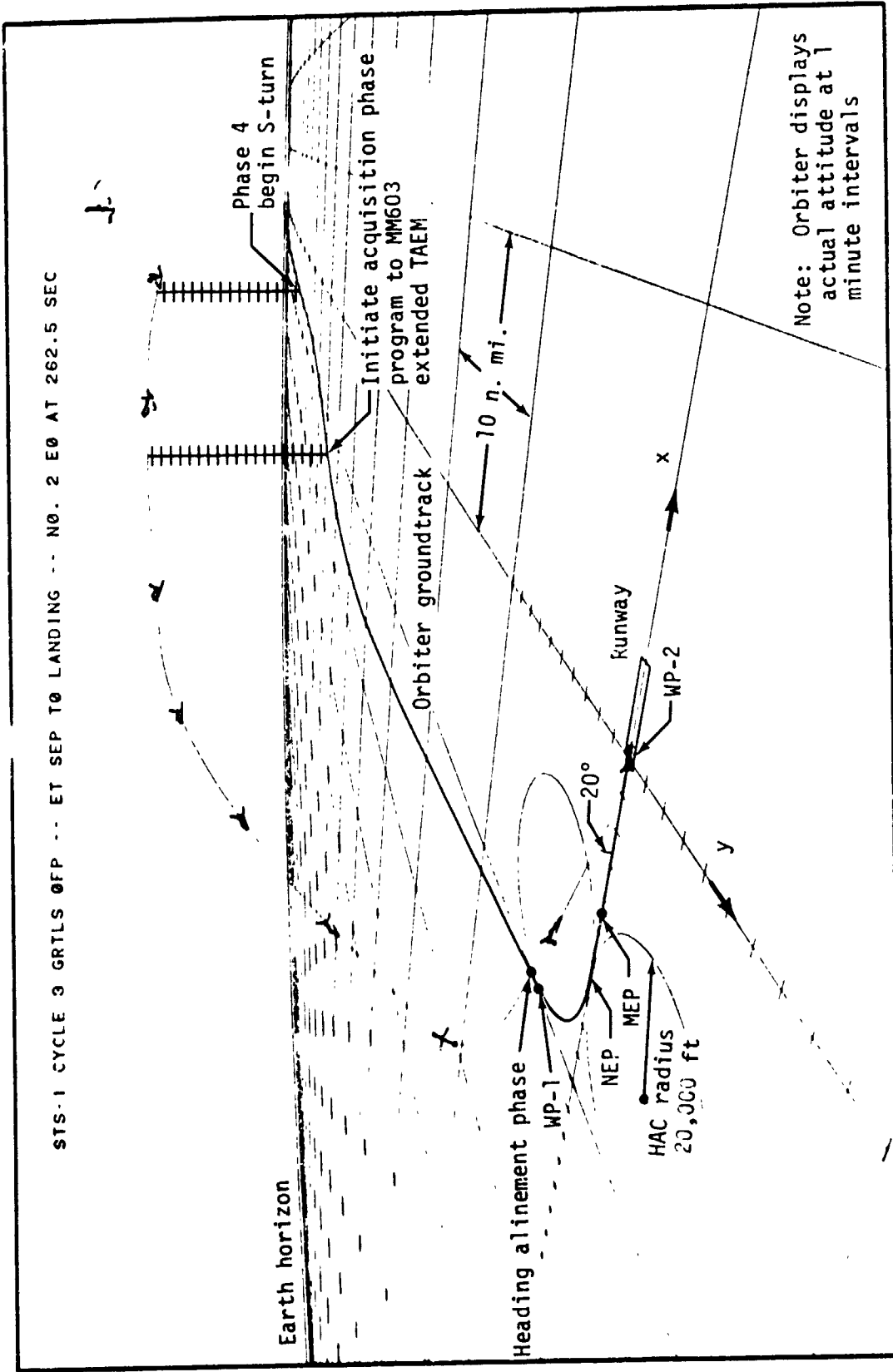
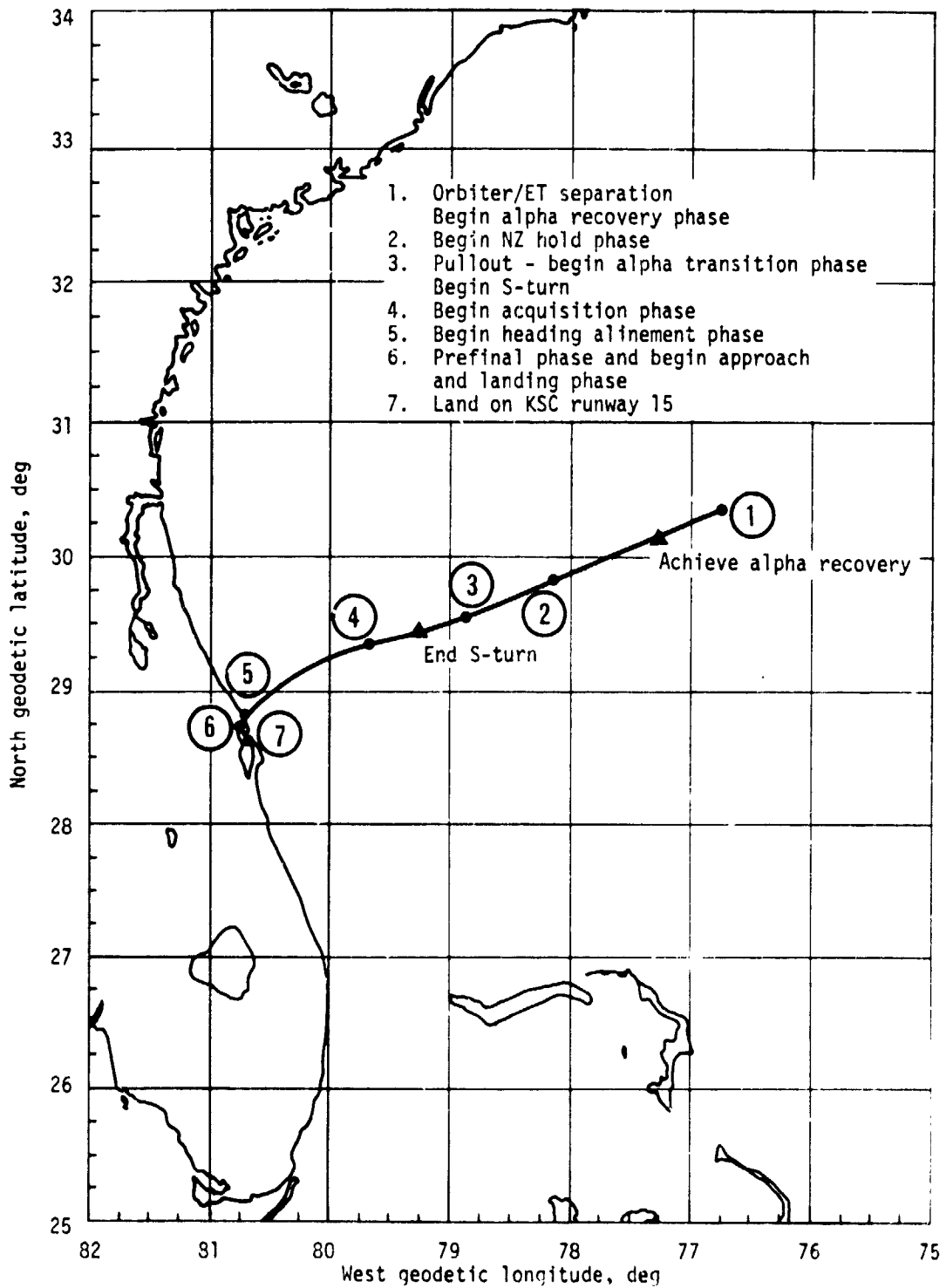

Figure 6.2.2-10.- STS-1 GRTLS operational flight profile perspective.



(a) Groundtrack.

Figure 6.2.2-11.- GRTLS from RTLS number 2 - number 1 engine-out at liftoff, RTLS at 150 seconds, STS-1 ascent, ET separation to landing at KSC runway 15.

ALTITUDE PROFILE

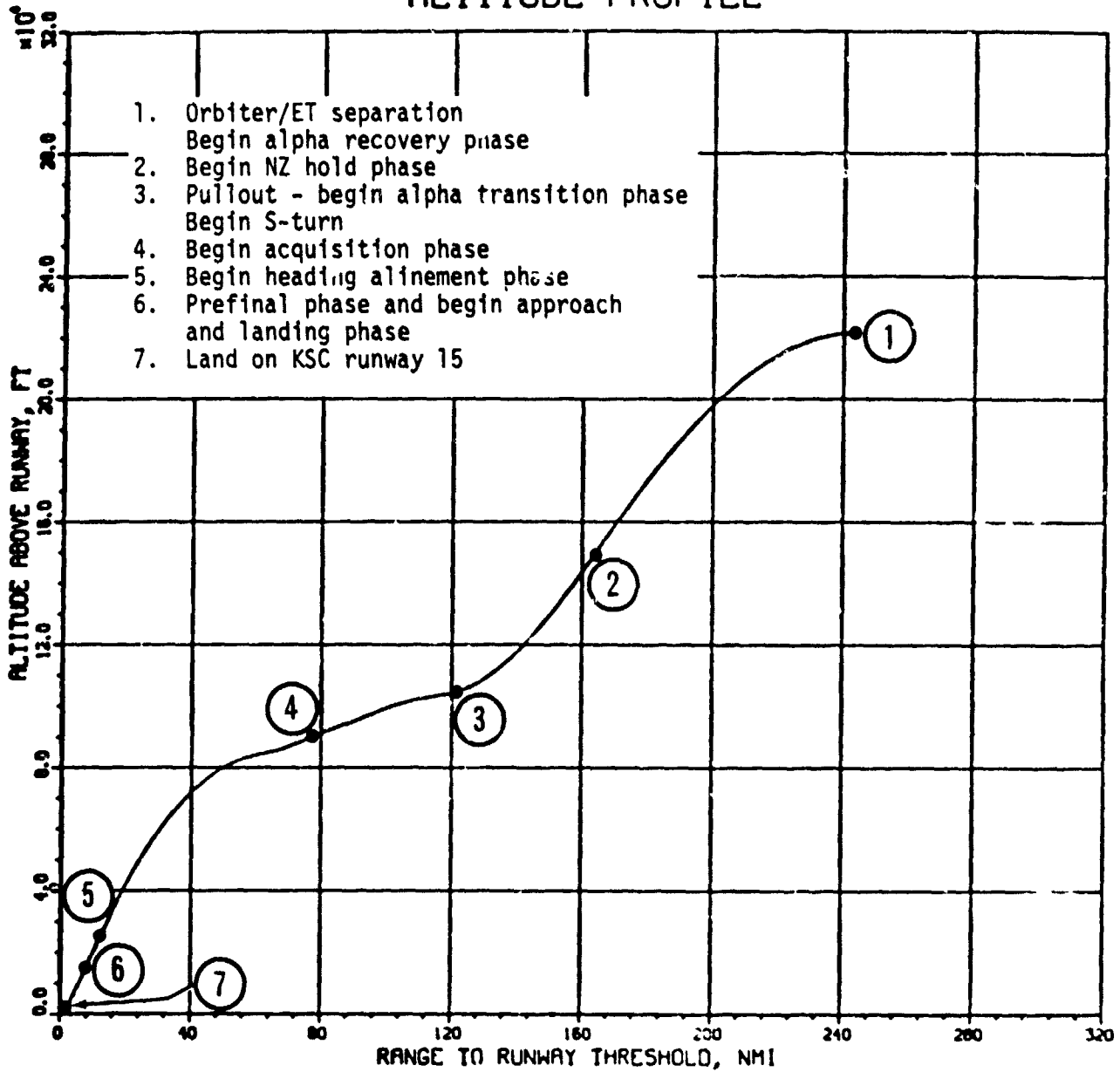

(b) Altitude versus range to runway threshold.

Figure 6.2.2-11.- Continued.

VELOCITY PROFILE

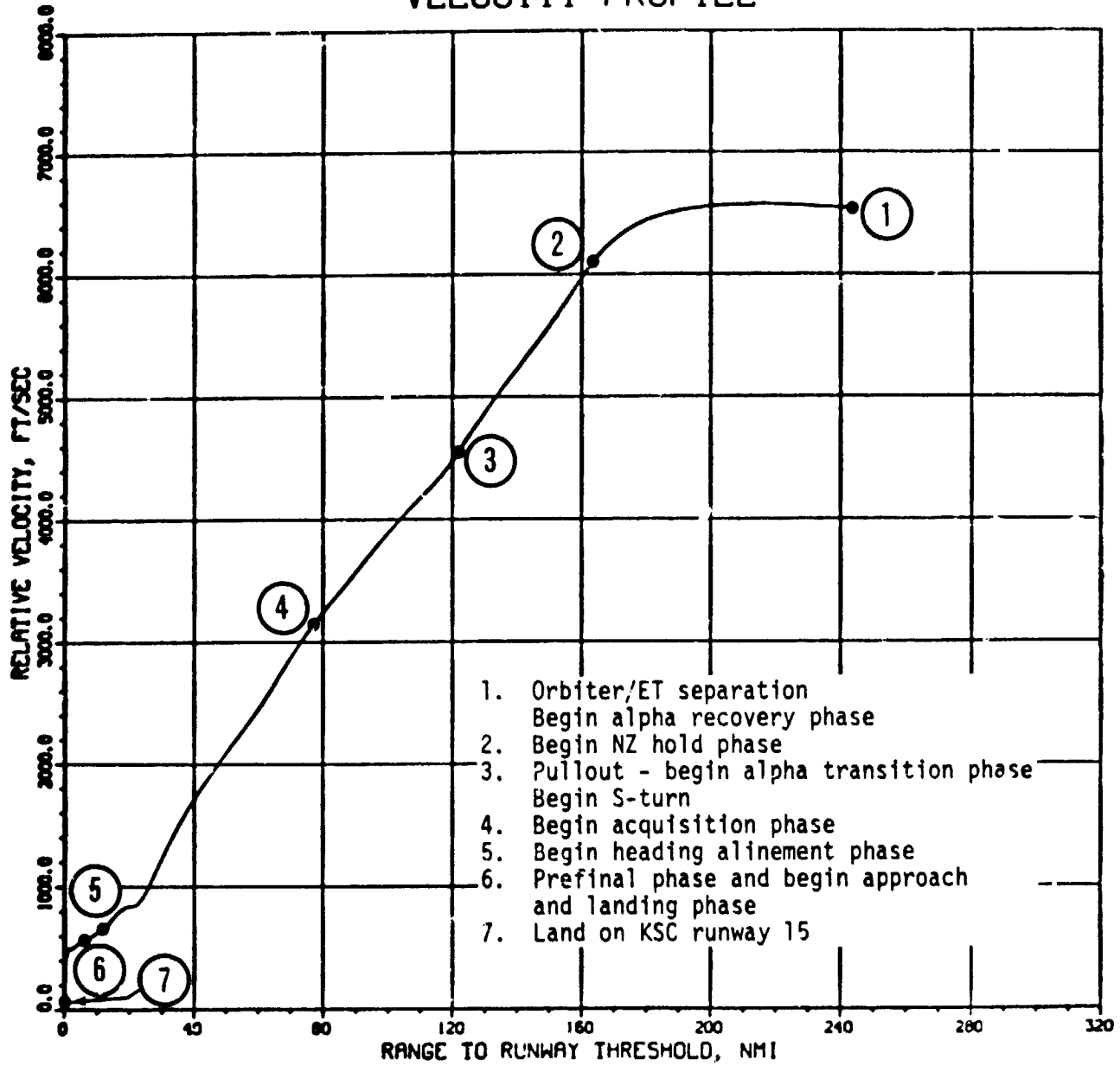

S S 1 C O E F 3 1 3 6 5 2

(c) Relative velocity versus range to runway threshold.

Figure 6.2.2-11.- Continued.

ANGLE OF ATTACK CONSTRAINTS

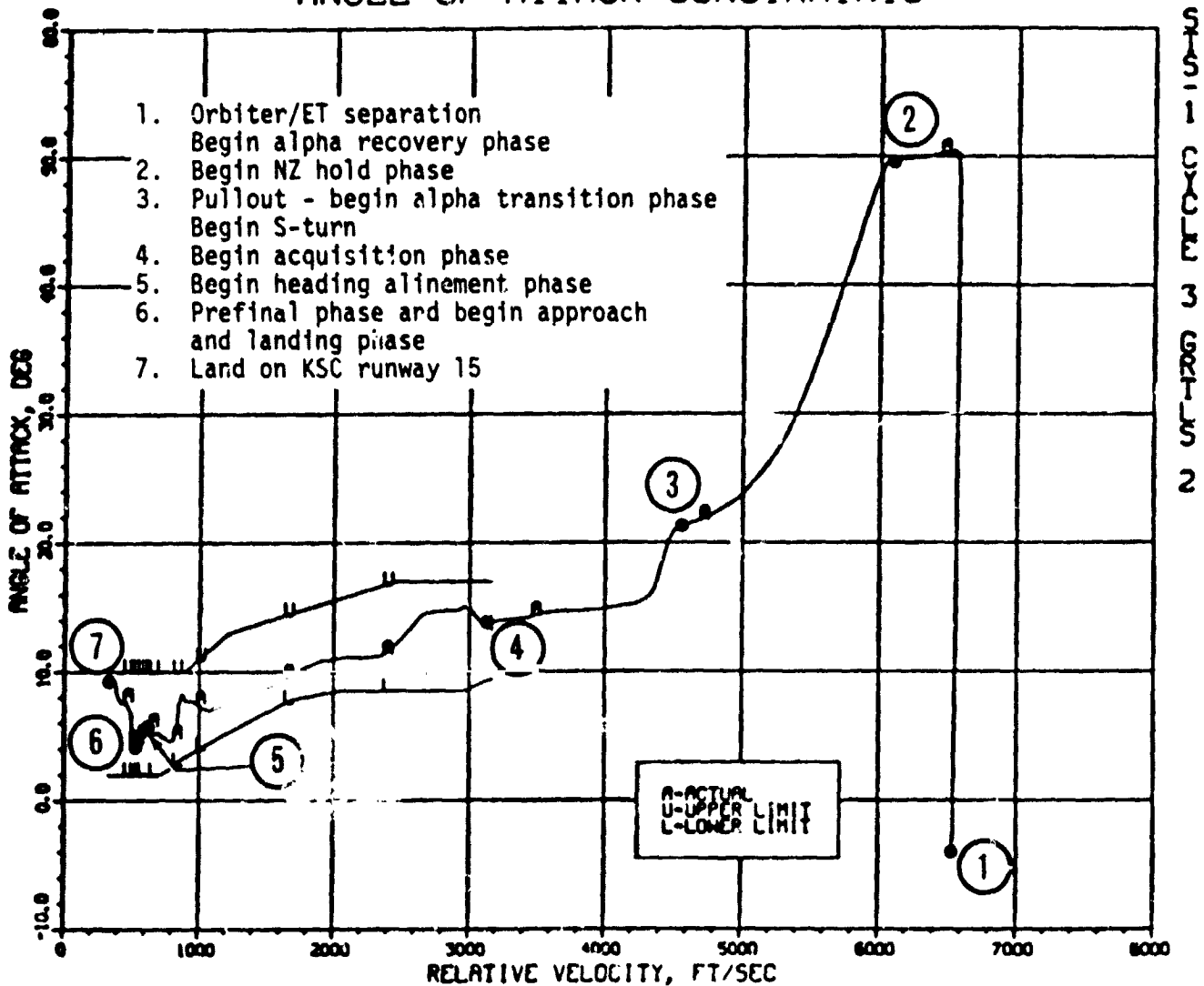

(d) Angle of attack versus relative velocity.

Figure 6.2.2-11.- Continued.

VELOCITY PROFILE

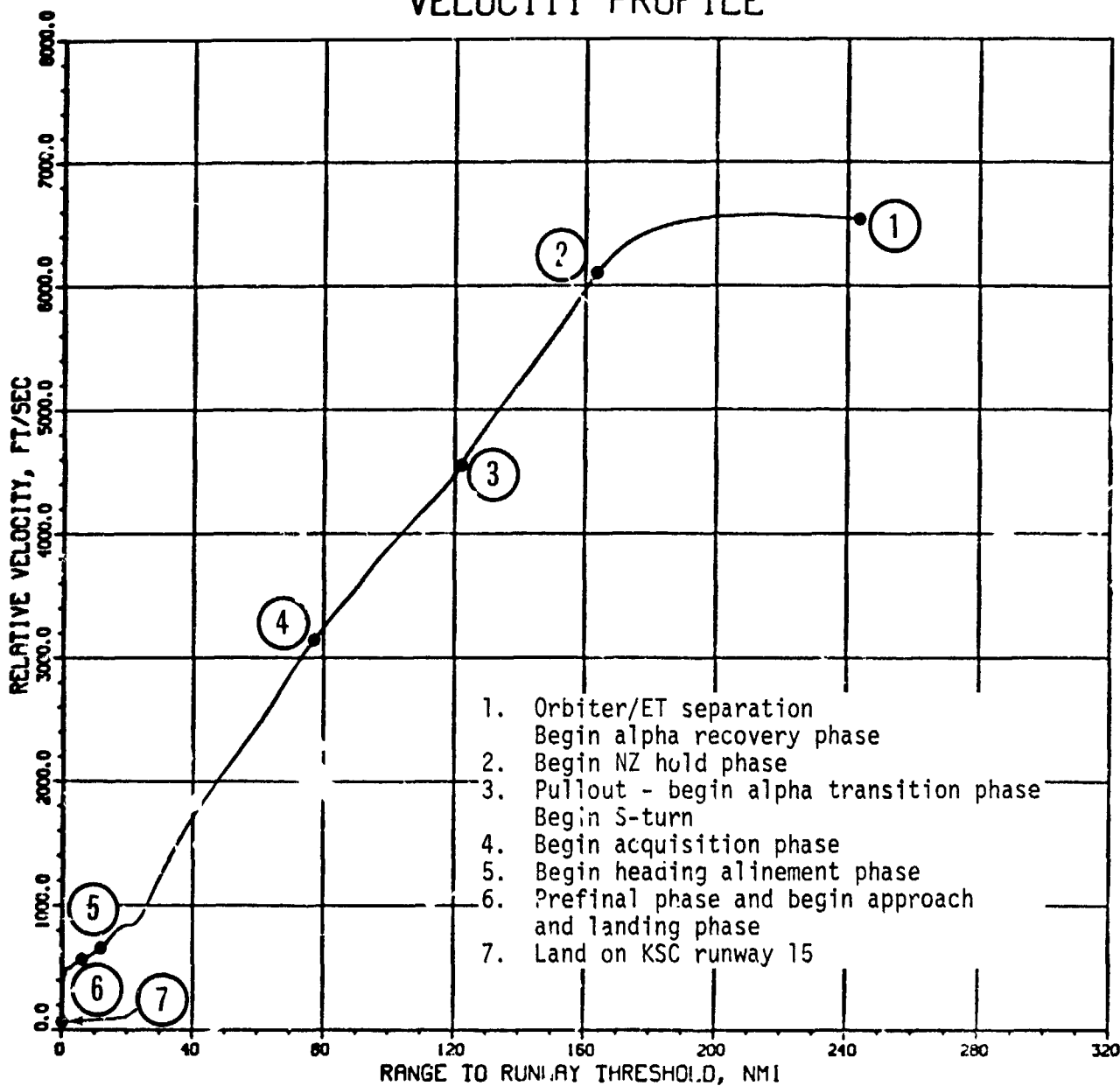

(c) Relative velocity versus range to runway threshold.

Figure 6.2.2-11.- Continued.

ANGLE OF ATTACK CONSTRAINTS

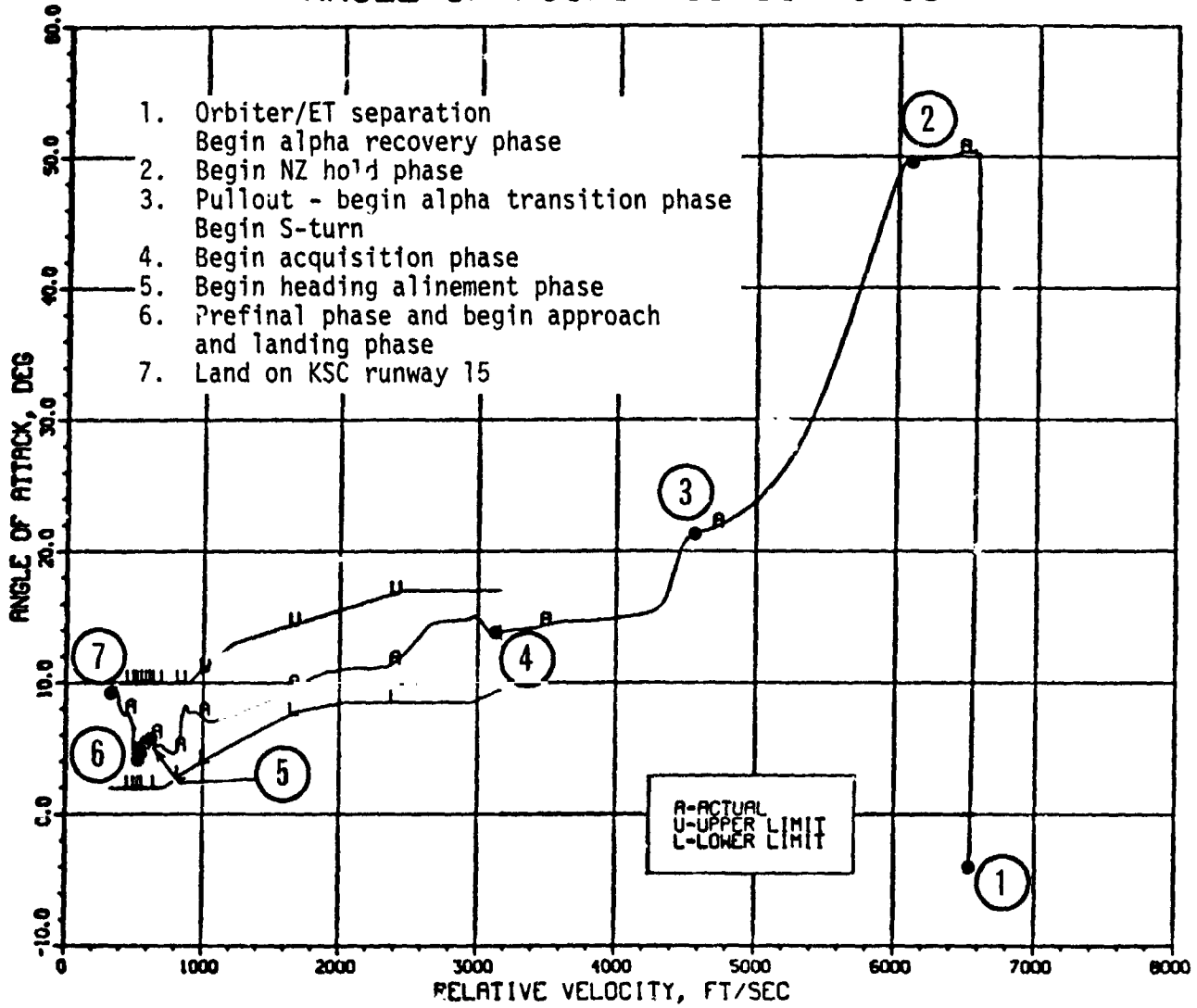

(d) Angle of attack versus relative velocity.

Figure 6.2.2-11.- Continued.

AZIMUTH ERROR AND ROLL ANGLE

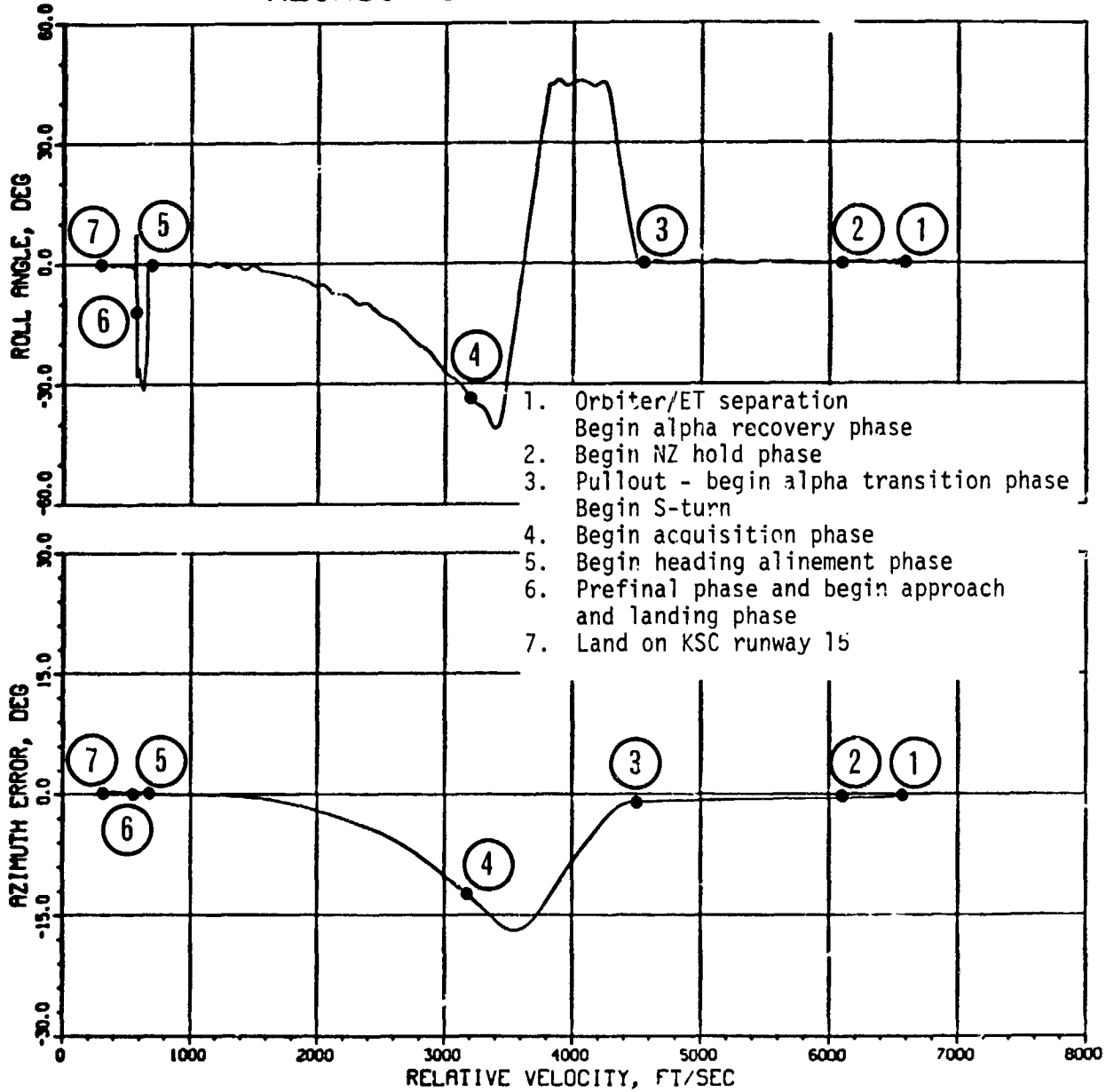

(e) Roll angle and azimuth error versus relative velocity.

Figure 6.2.2-11.- Continued.

BODY ATTITUDE RATES

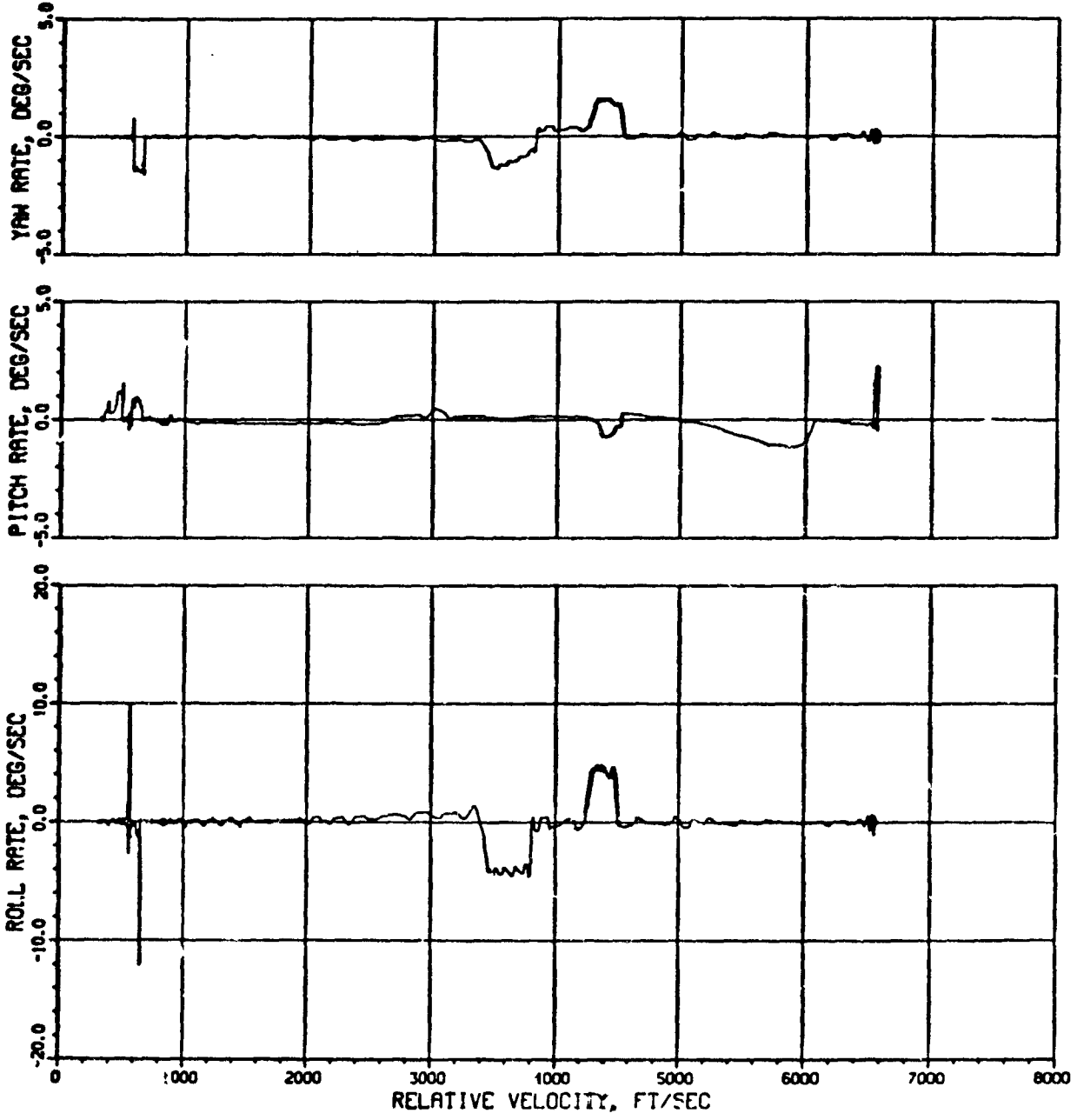

(f) Body attitude rates versus velocity.

Figure 6.2.2-11.- Continued.

FLIGHT PATH ANGLE

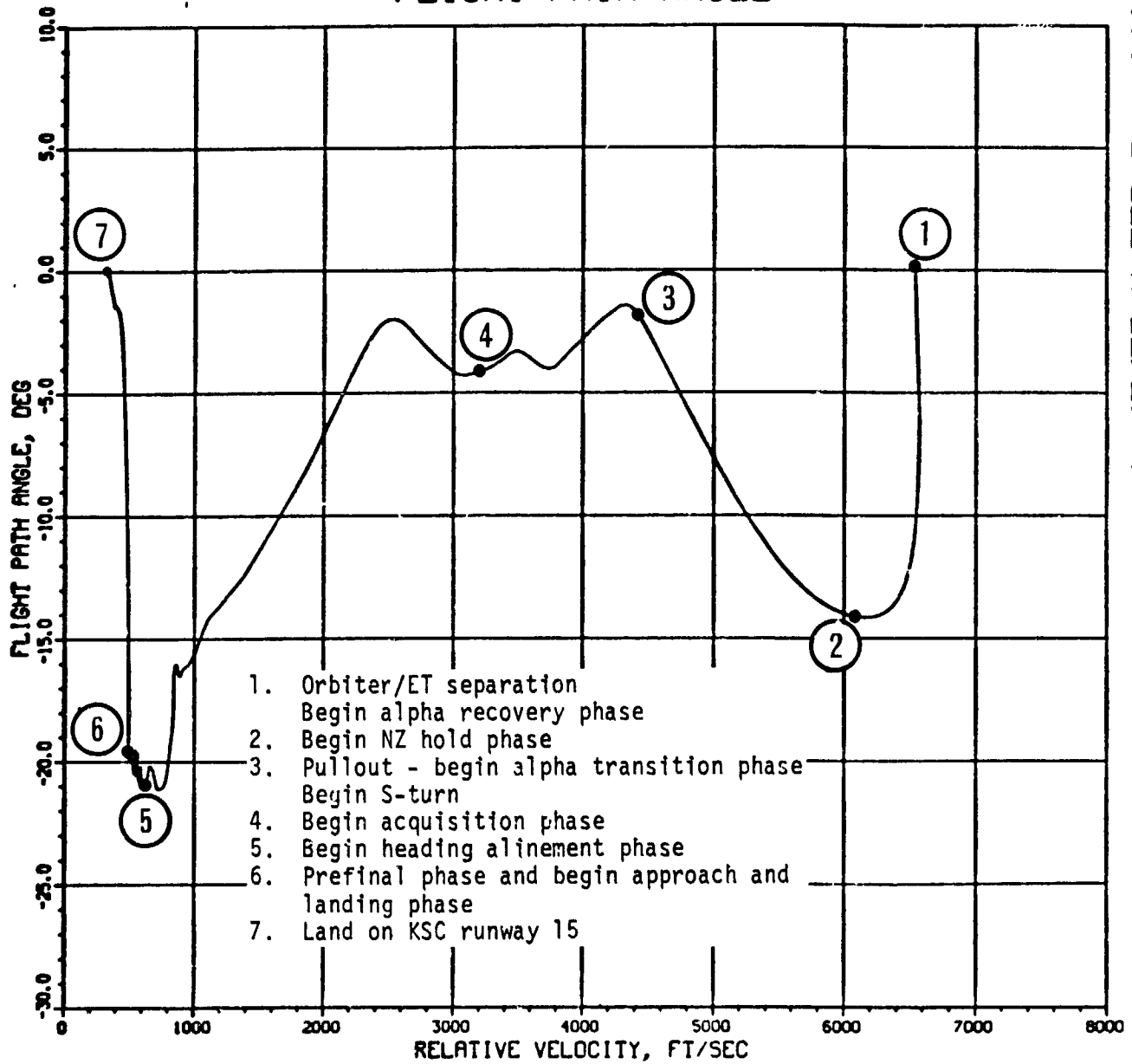

(g) Relative flightpath angle versus relative velocity.

Figure 6.2.2-11.- Continued.

LOAD FACTOR COMPONENTS

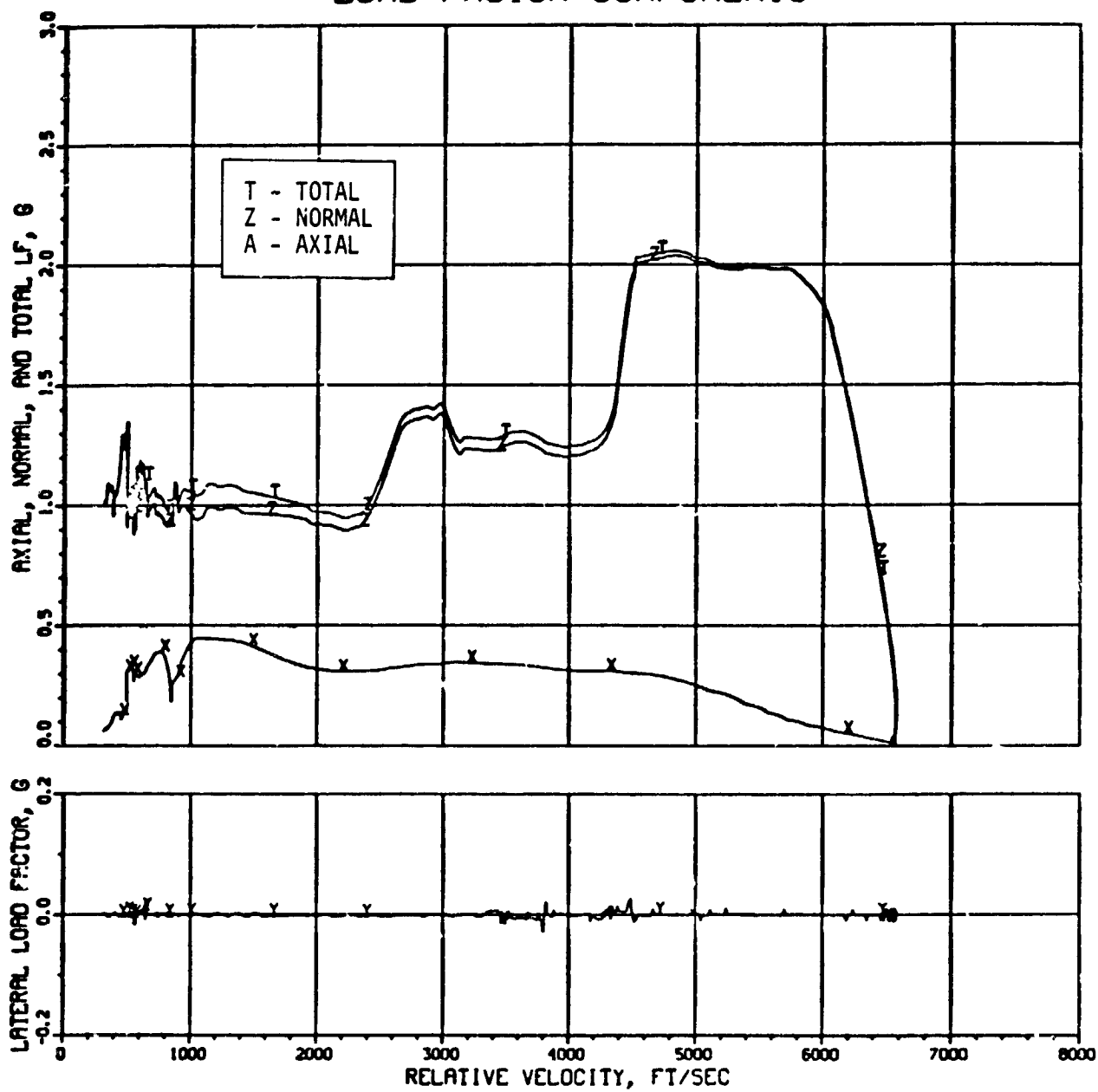

(h) Load factor components versus relative velocity.

Figure 6.2.2-11.- Continued.

PILOT STATION LOADS

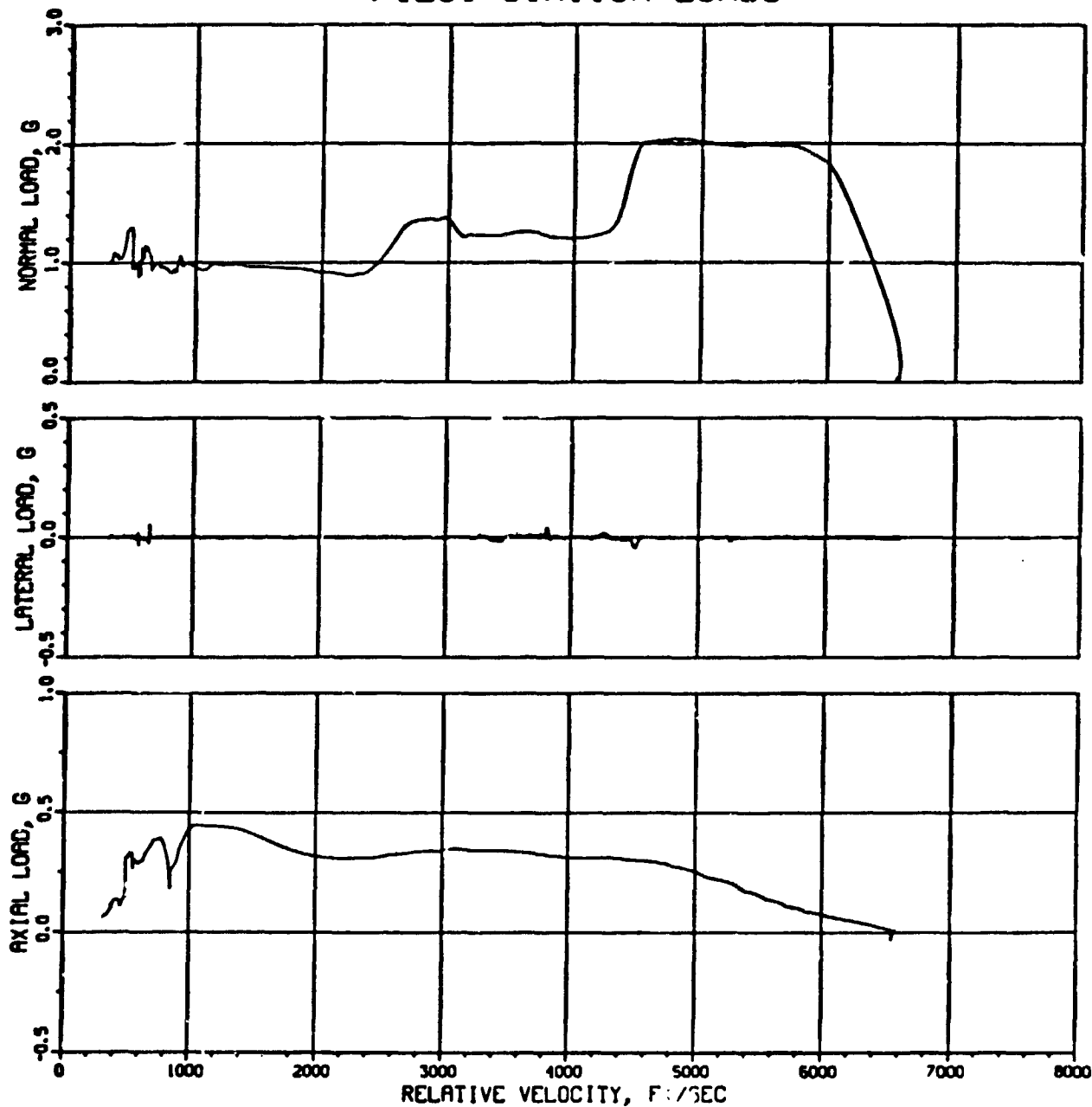

2 58-1306 3 115-15

(i) Pilot station loads versus relative velocity.

Figure 6.2.2-11.- Continued.

DYNAMIC PRESSURE CONSTRAINTS

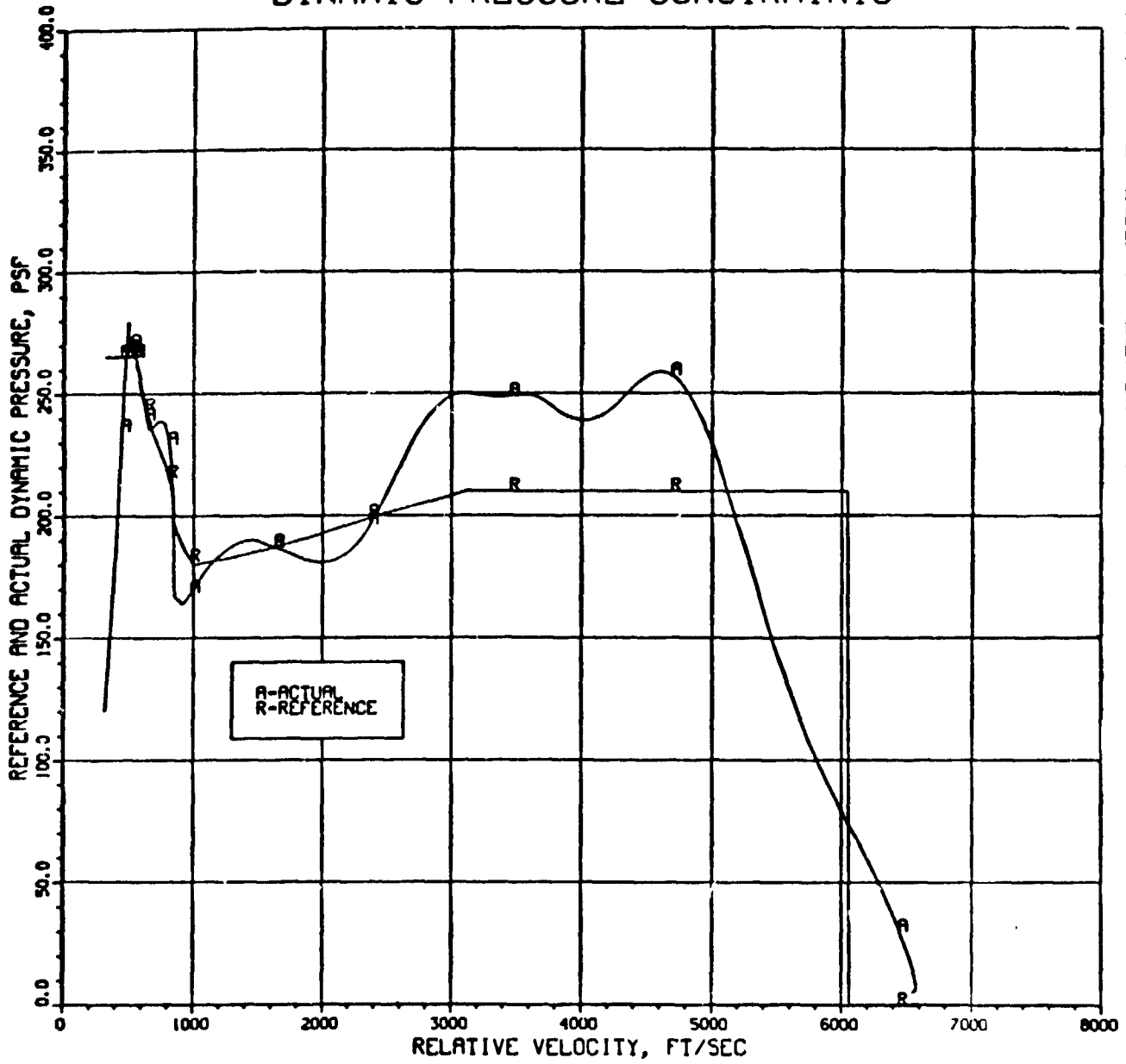

(j) Dynamic pressure versus relative velocity.

Figure 6.2.2-11.- Continued.

LATERAL CONTROL

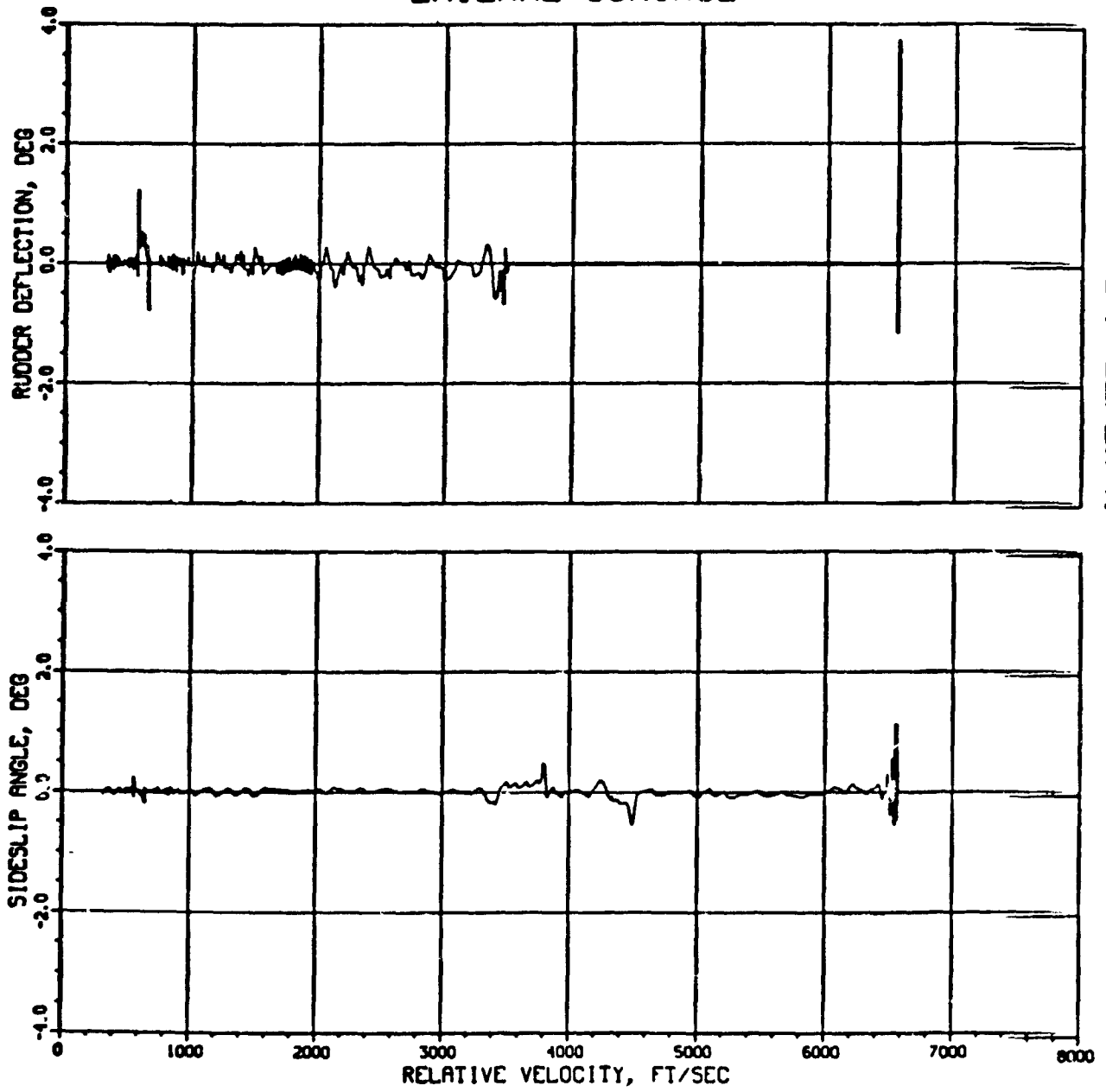

(k) Sideslip angle and rudder deflection versus relative velocity.

Figure 6.2.2-11.- Continued.

CONTROL SURFACE DEFLECTIONS

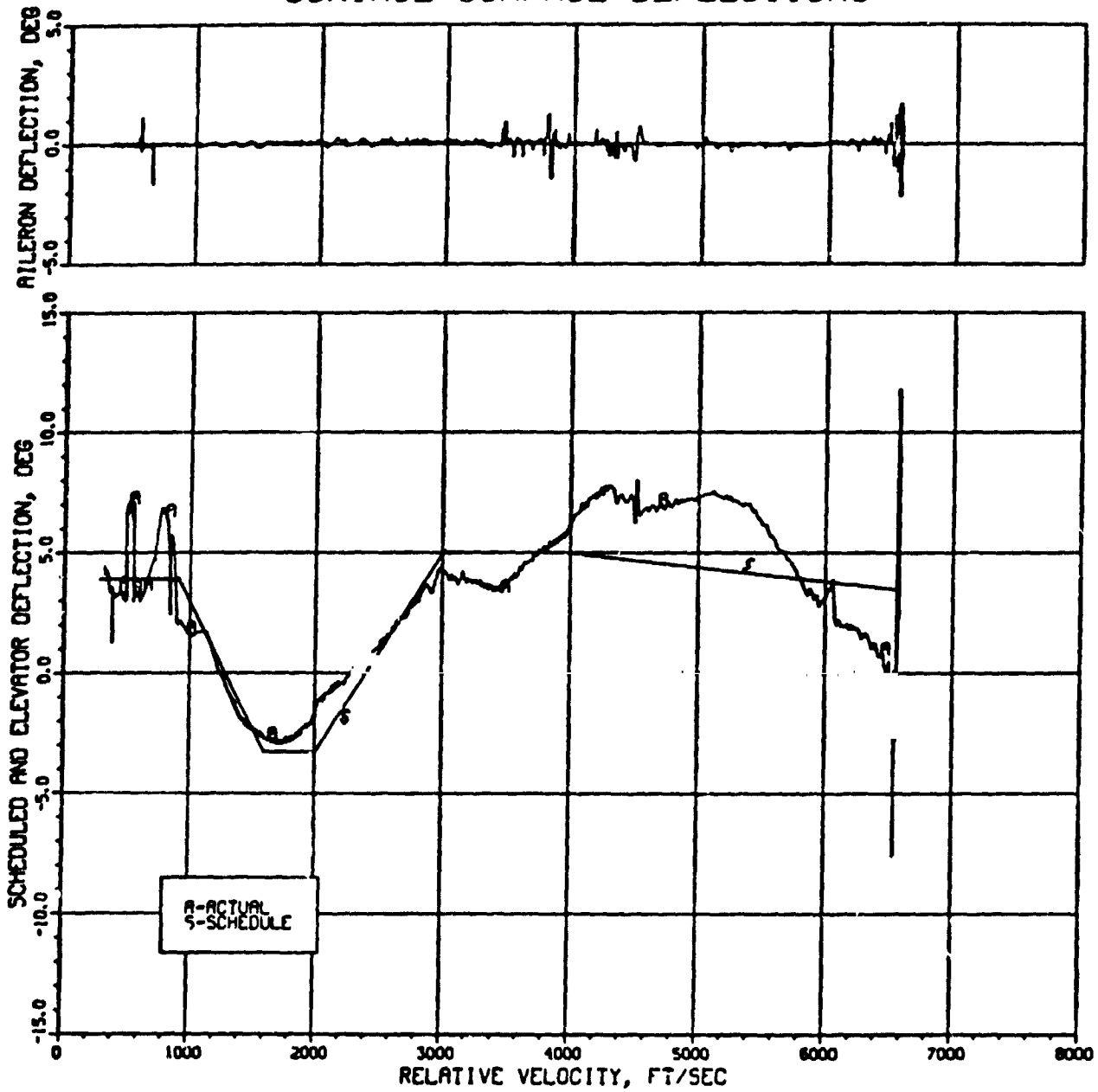

SKS-1
CXC-1
E-3
GRT-5
2

(1) Elevator and aileron deflections versus relative velocity.

Figure 6.2.2-11.- Continued.

ELEVATOR DEFLECTIONS

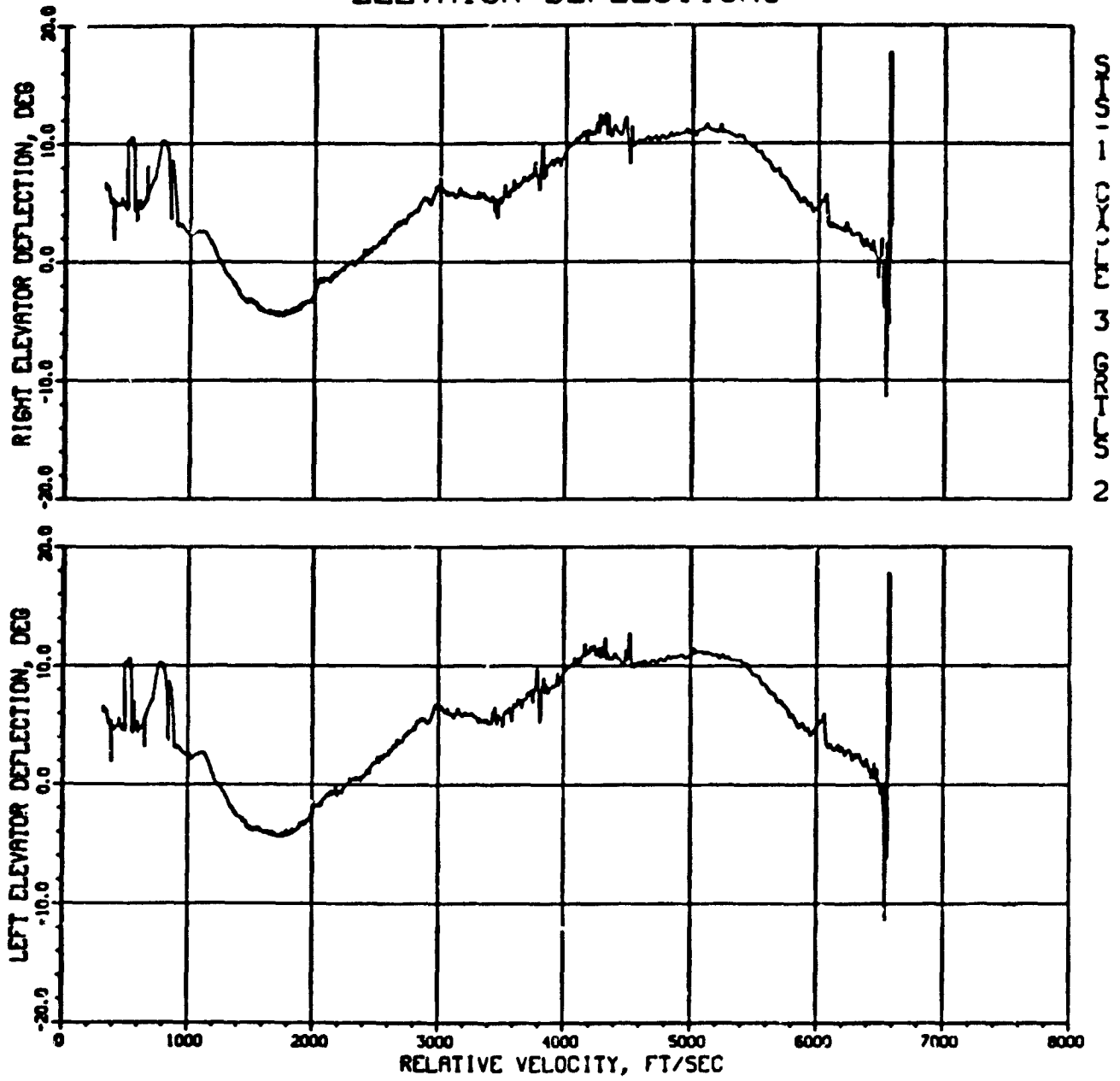

(m) Right and left elevator deflections versus relative velocity.

Figure 6.2.2-11.- Continued.

CONTROL SURFACE DEFLECTIONS

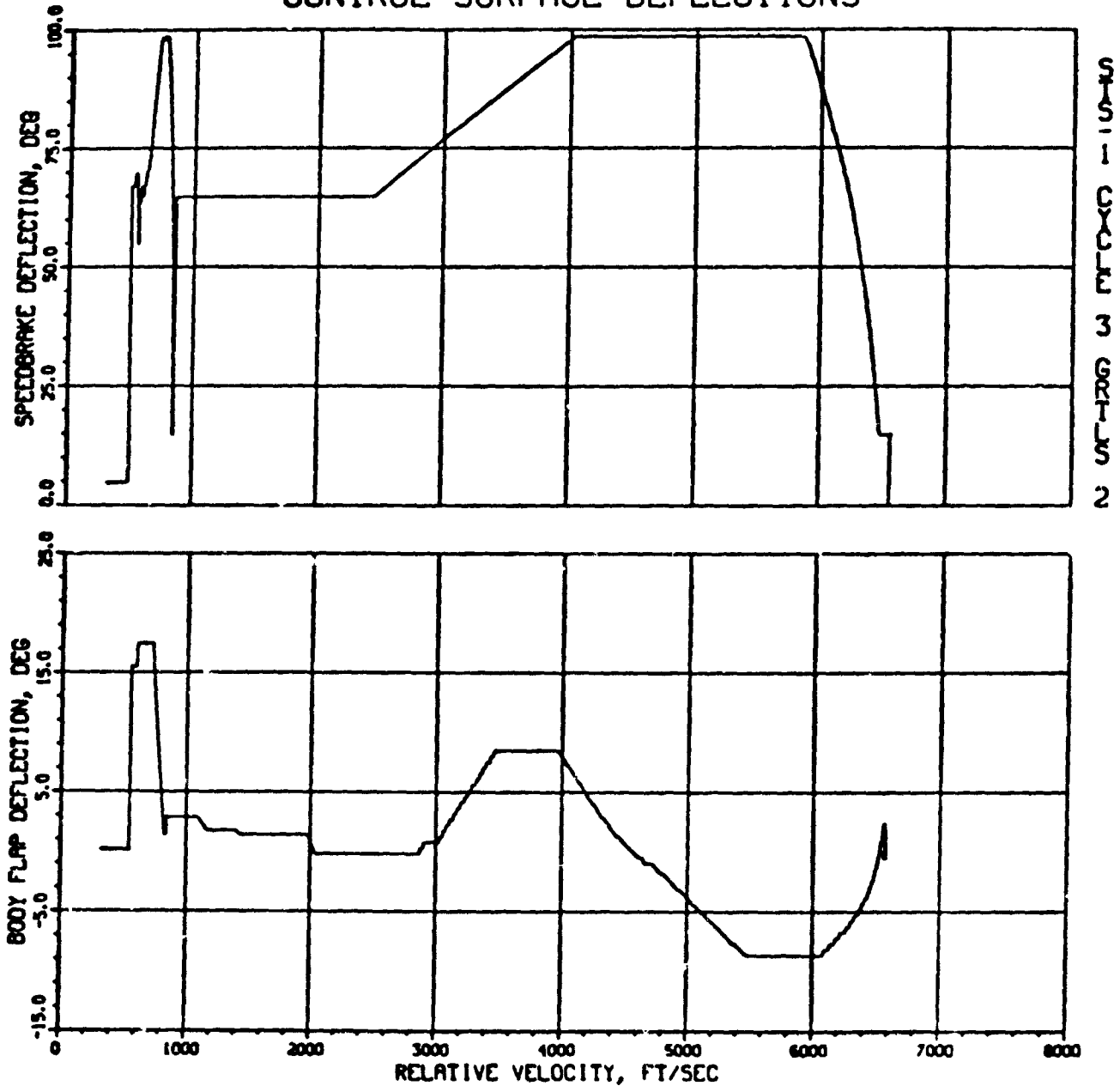

(n) Body flap and speedbrake deflection versus relative velocity.

Figure 6.2.2-11.- Continued.

ELEVON PANEL HINGE MOMENTS

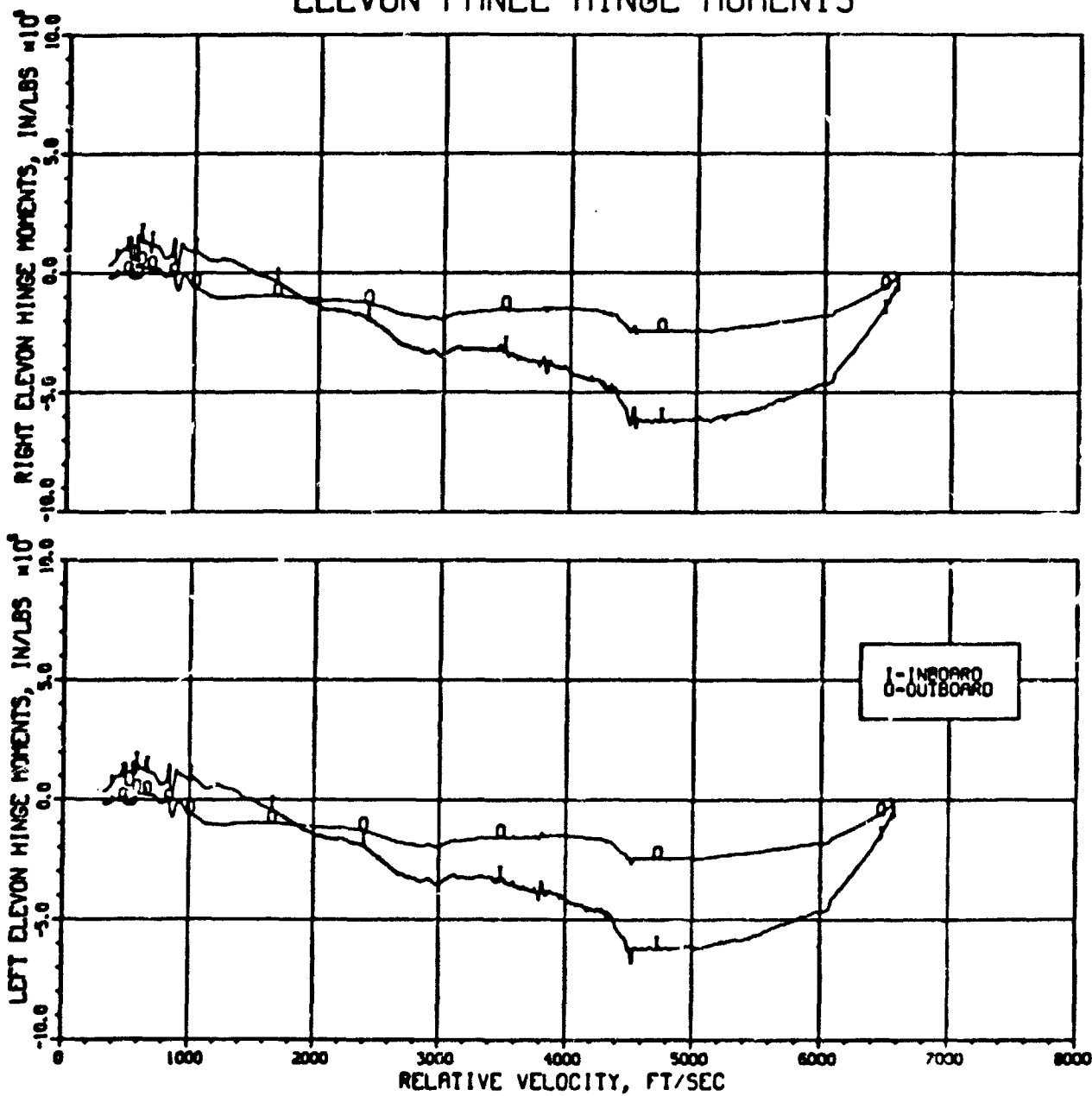

(o) Elevon panel hinge moments versus relative velocity.

Figure 6.2.2-11.- Continued.

CONTROL SURFACE HINGE MOMENTS

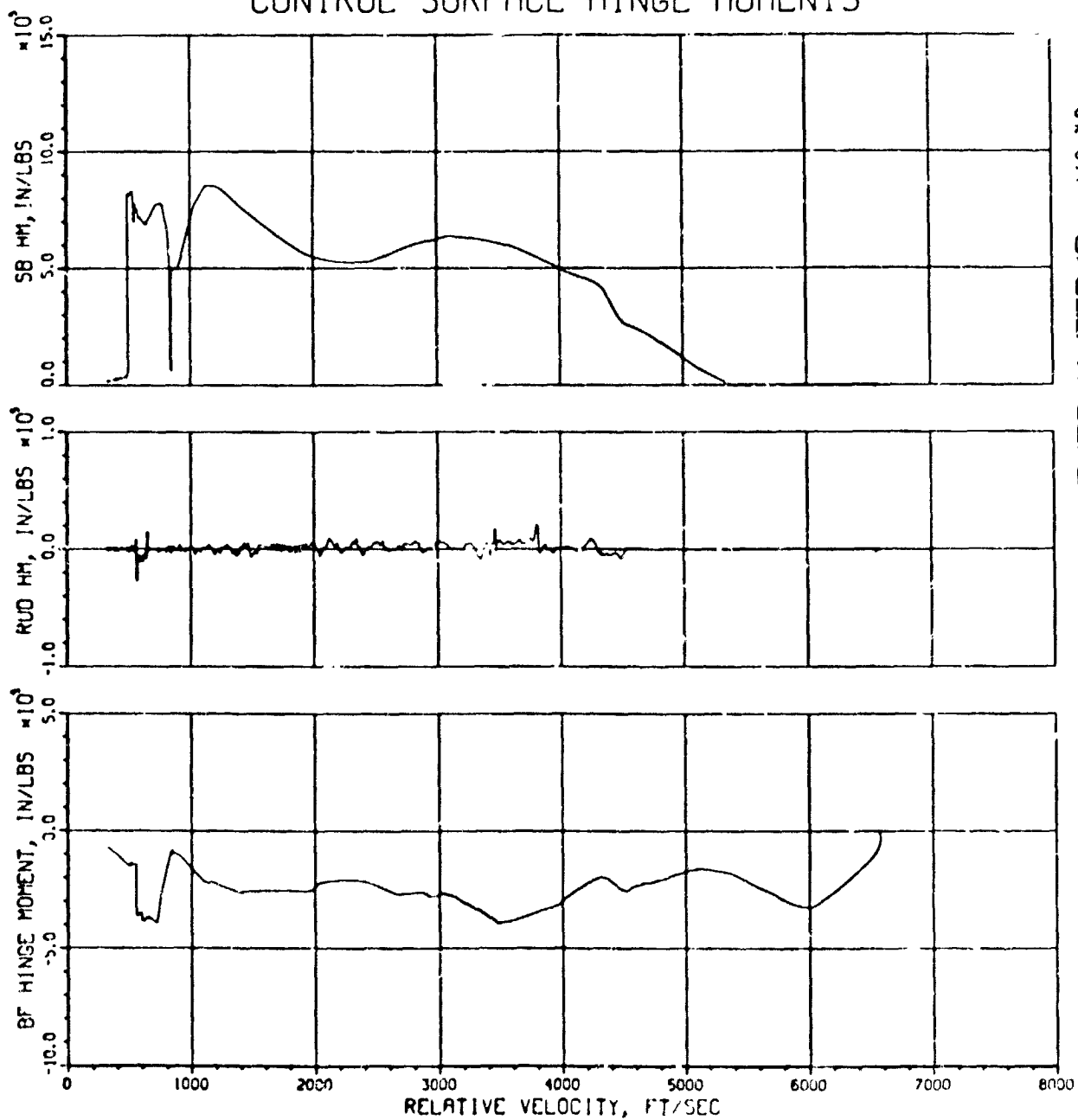

2 3 4 5 6 7 8 9 10 11 12 13 14 15 16 17 18 19 20

(p) Bodyflap, rudder, and speedbrake hinge moments versus relative velocity.

Figure 6.2.2-11.- Continued.

VELOCITY HISTORY

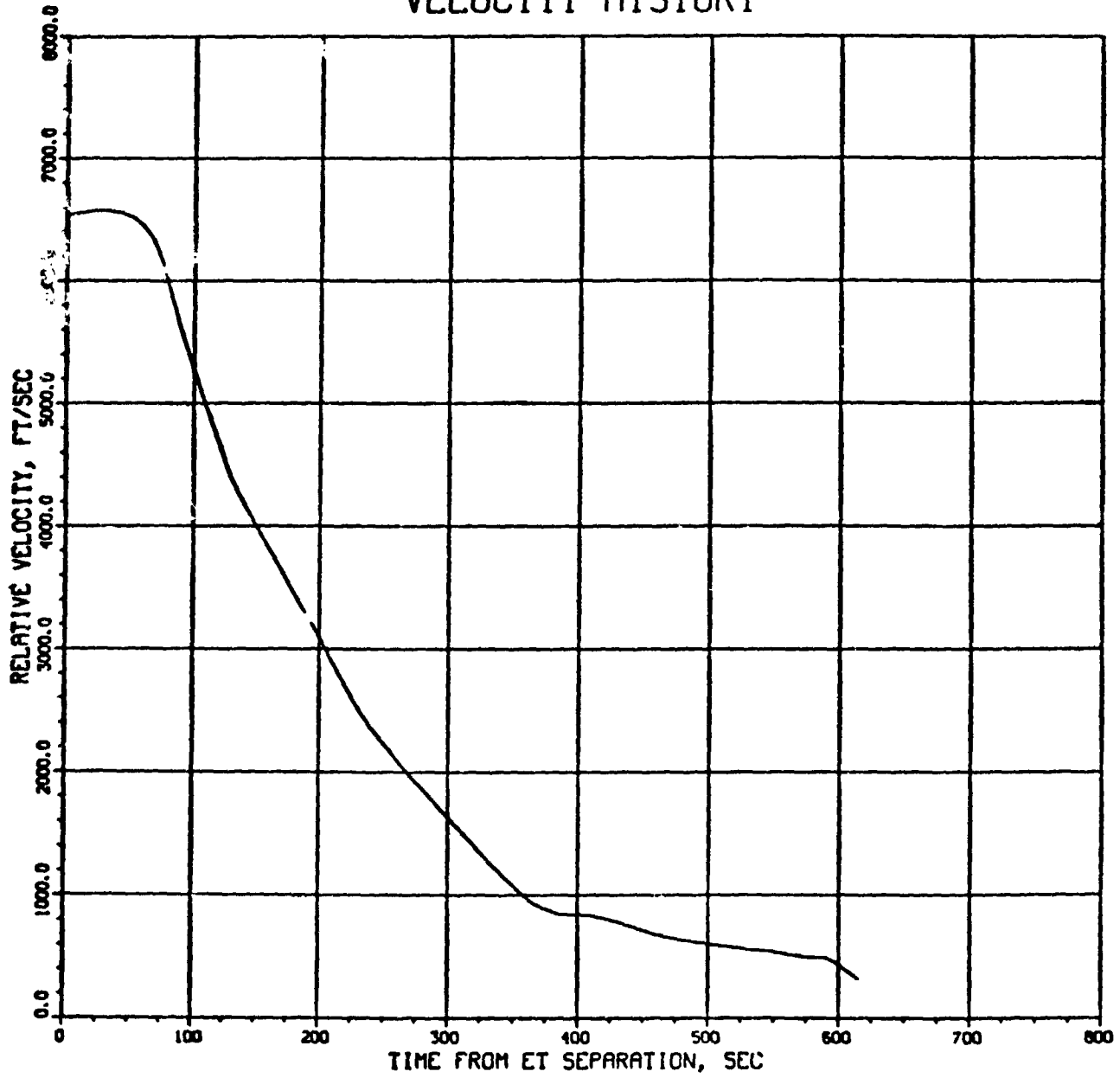

2 501-1200 3 11515

(q) Relative velocity time history.

Figure 6.2.2-11.- Continued.

ALTITUDE PROFILE

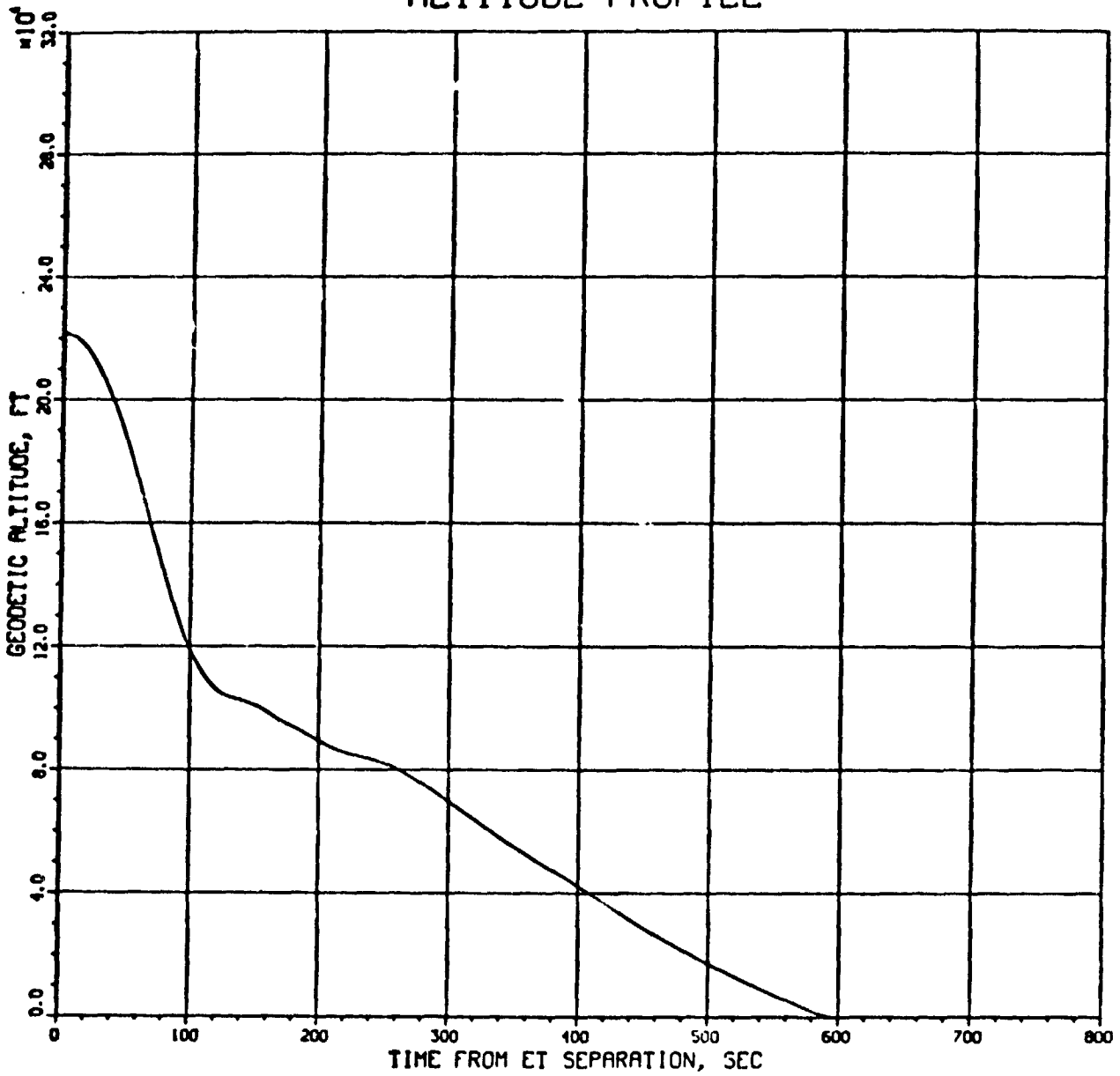

(r) Geodetic altitude time history.

Figure 6.2.2-11.- Continued.

RANGE TO RUNWAY THRESHOLD

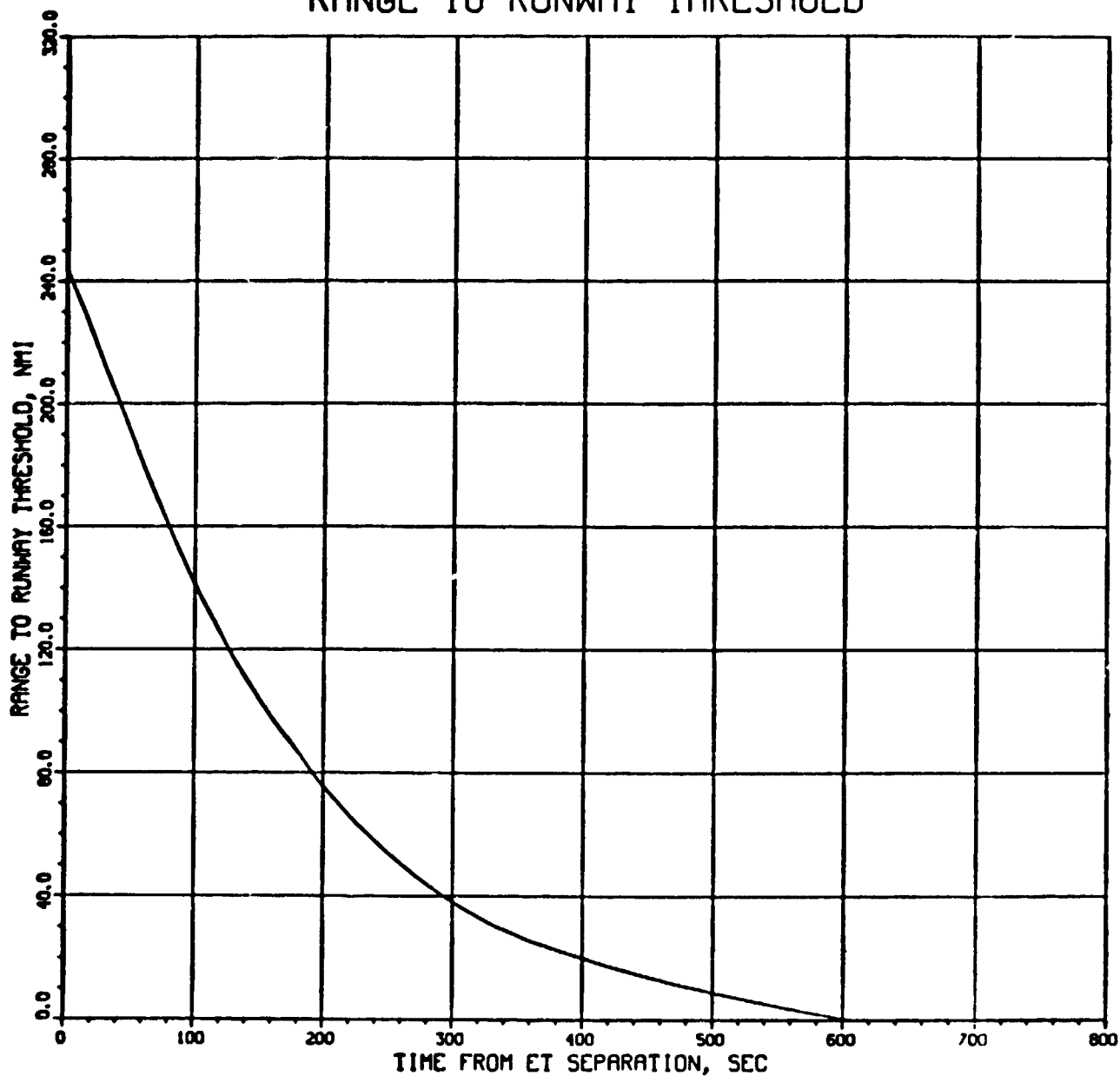

2 511306 3 11515

(s) Range to runway threshold time history.

Figure 6.2.2-11.- Continued.

MERRITT IS. TRACKING DATA

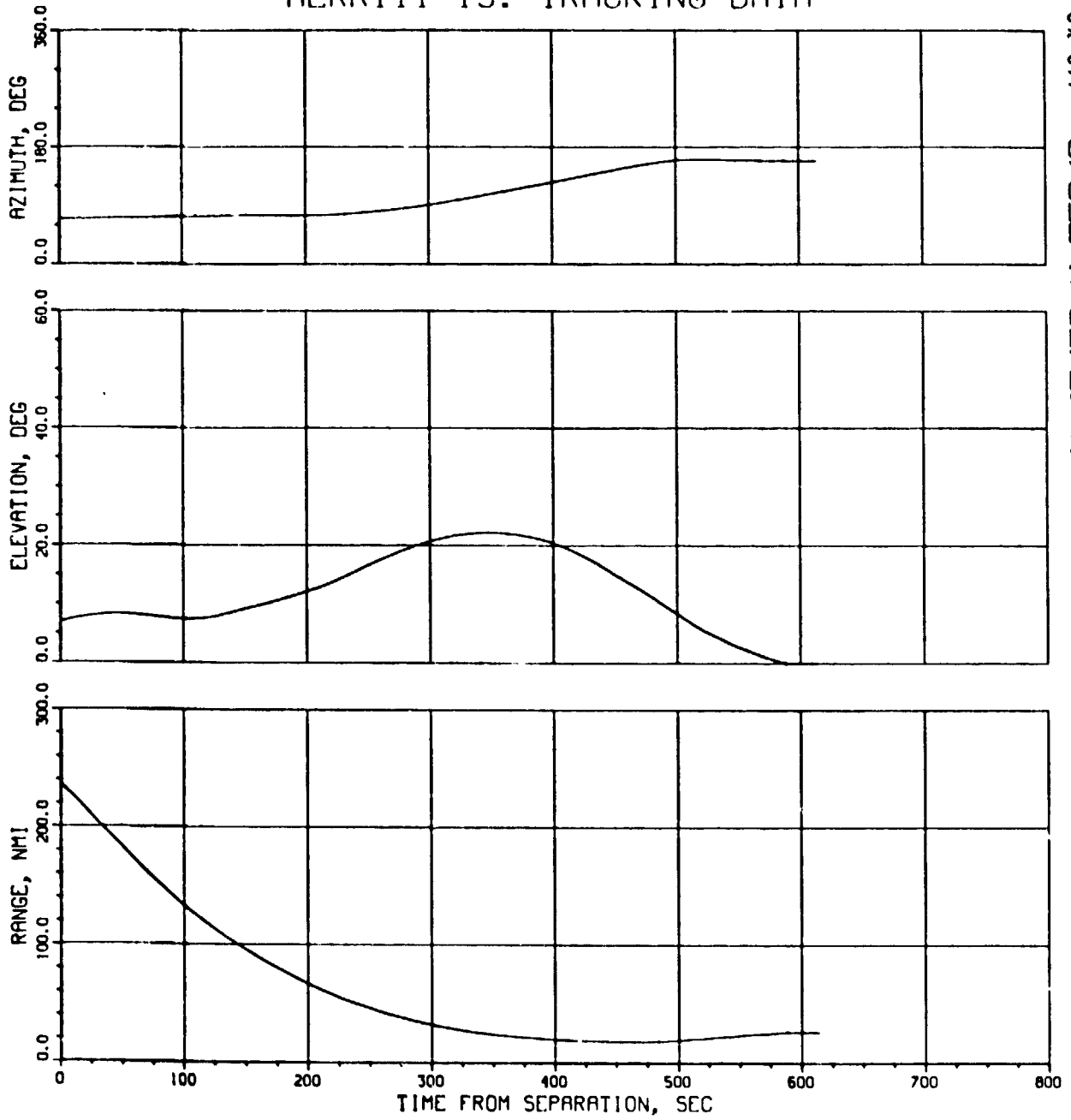

151103
 25136
 3
 4

(t) Merritt Island tracking time history.

Figure 6.2.2-11.- Continued.

NEW SMYRNA TRACKING DATA

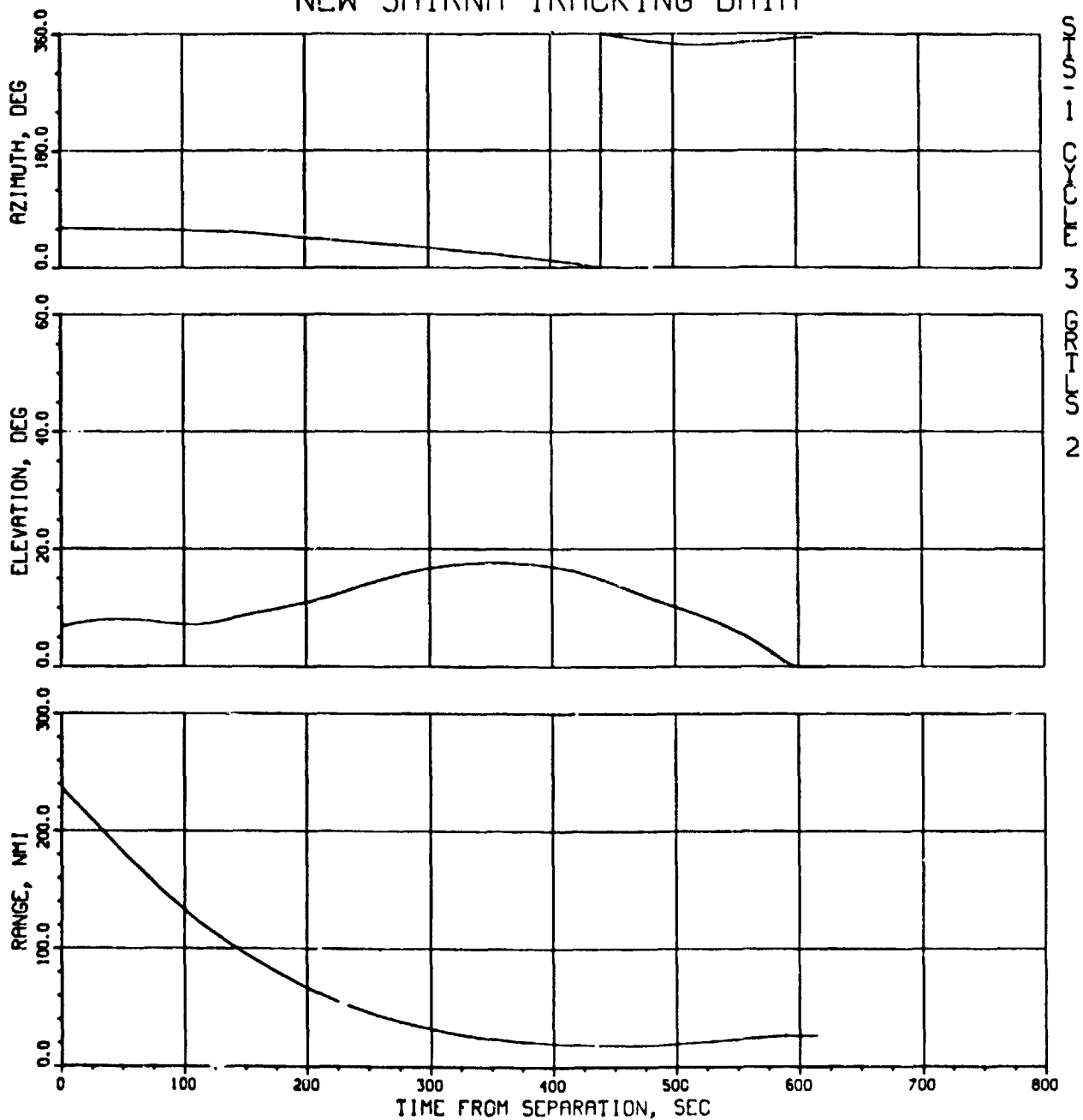

SHS-1 CONTROL 3 501-15-15

(u) New Smyrna Beach tracking time history.

Figure 6.2.2-11.- Concluded.

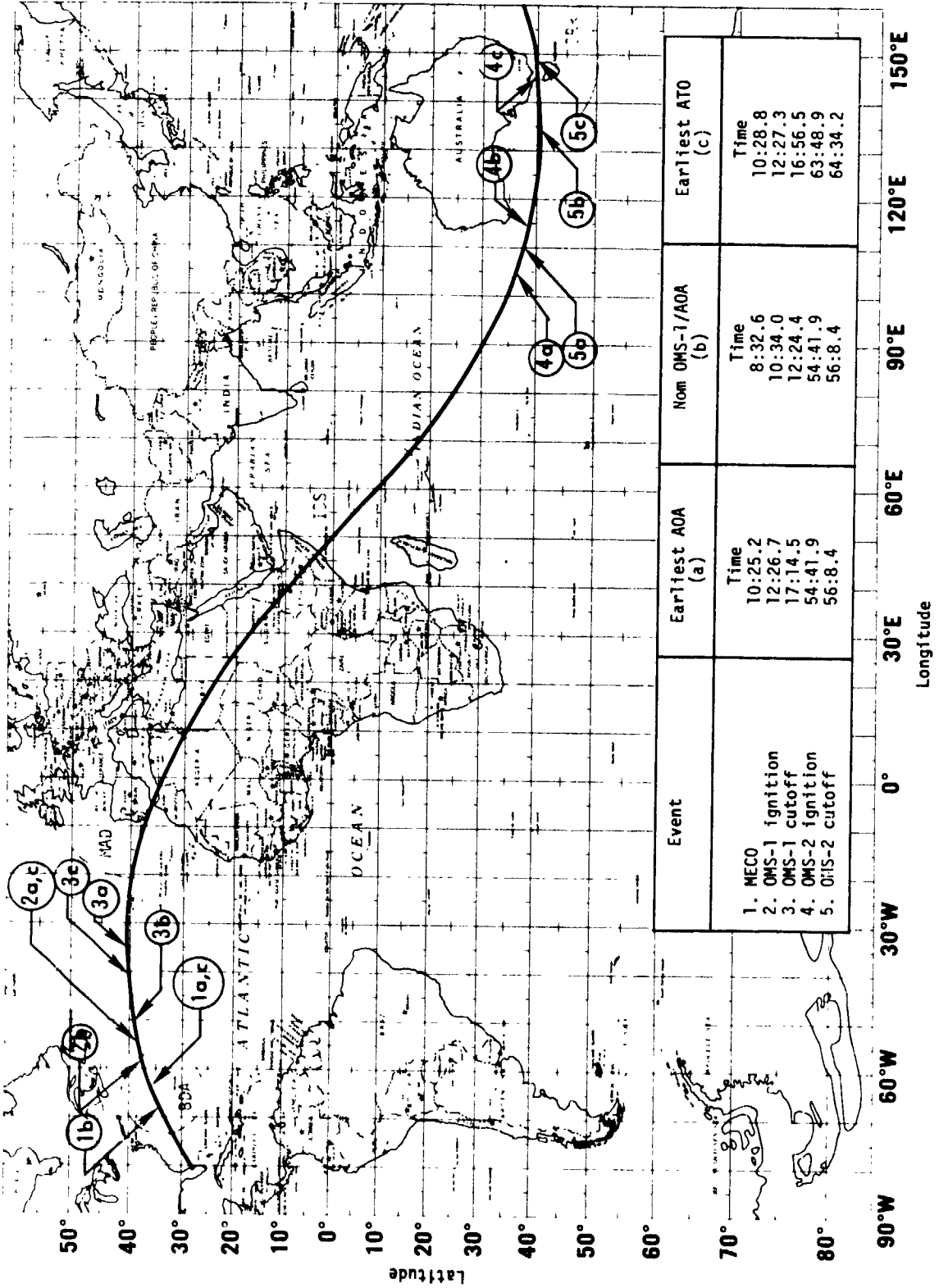
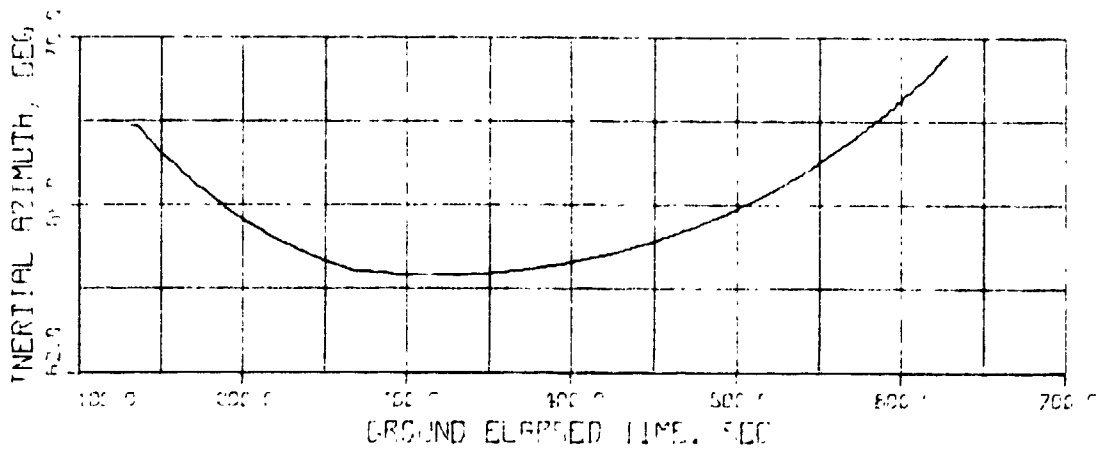
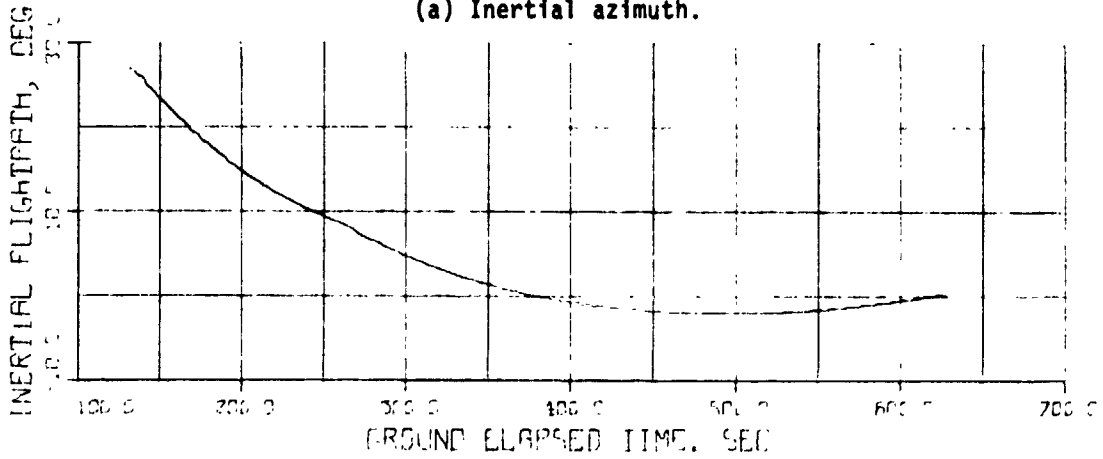

Figure 6.3.1-1.- STS-1 cycle 3 ascent groundtrack and post-MECO communication coverage for downrange aborts.



(a) Inertial azimuth.



(b) Inertial flightpath angle.

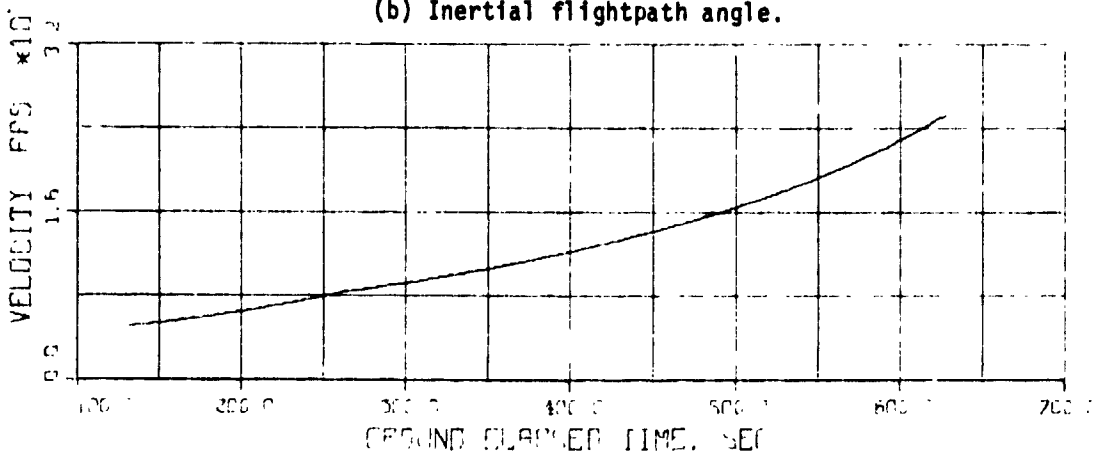

(c) Inertial velocity.

Figure 6.3.1-2.- Maximum underspeed earliest AOA - second stage.

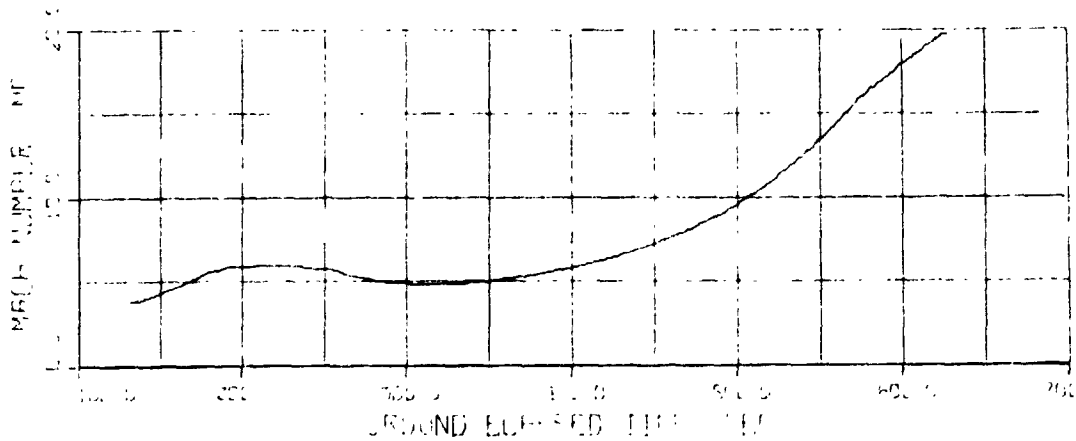

(d) Mach number.

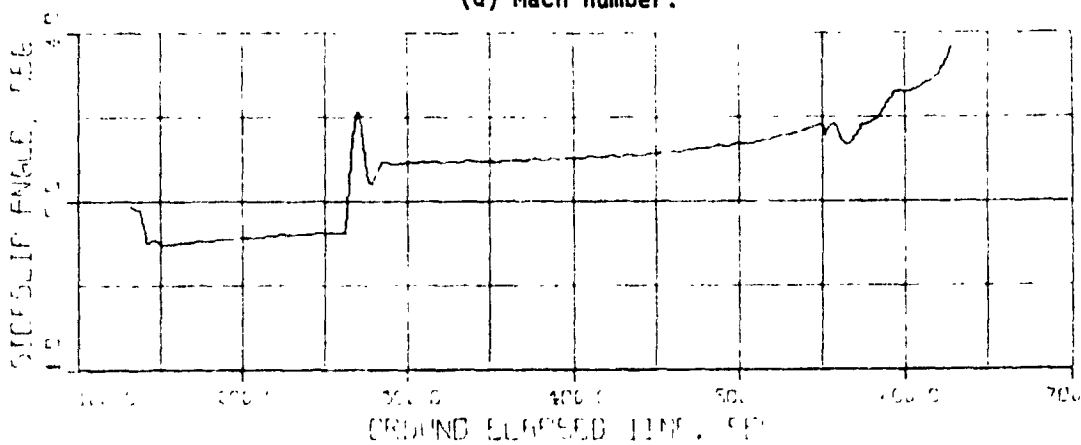

(e) Sideslip angle.

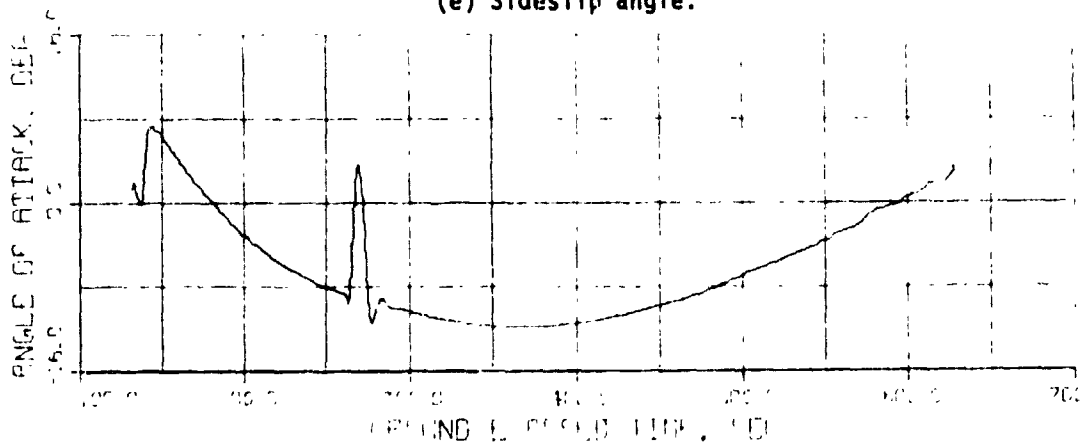

(f) Angle of attack.

Figure 6.3.1-2.- Continued.

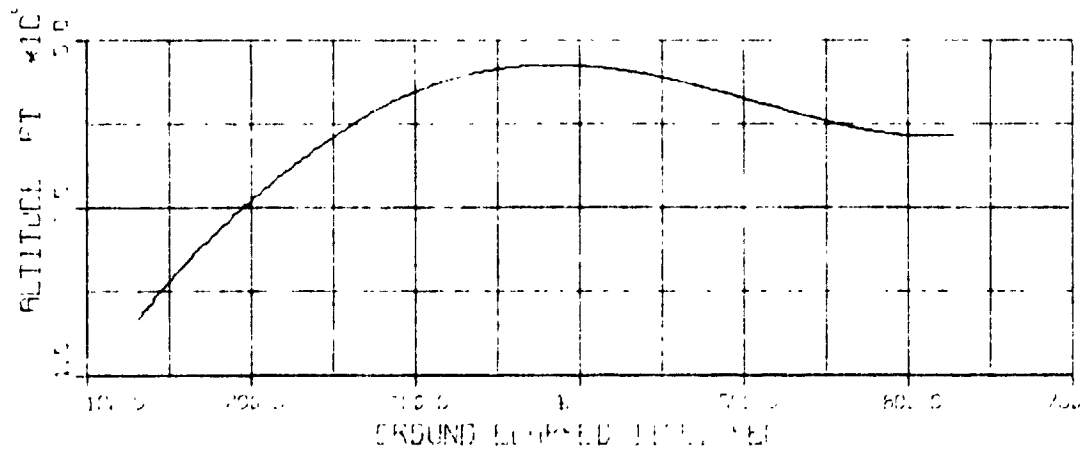

(g) Geodetic Altitude.

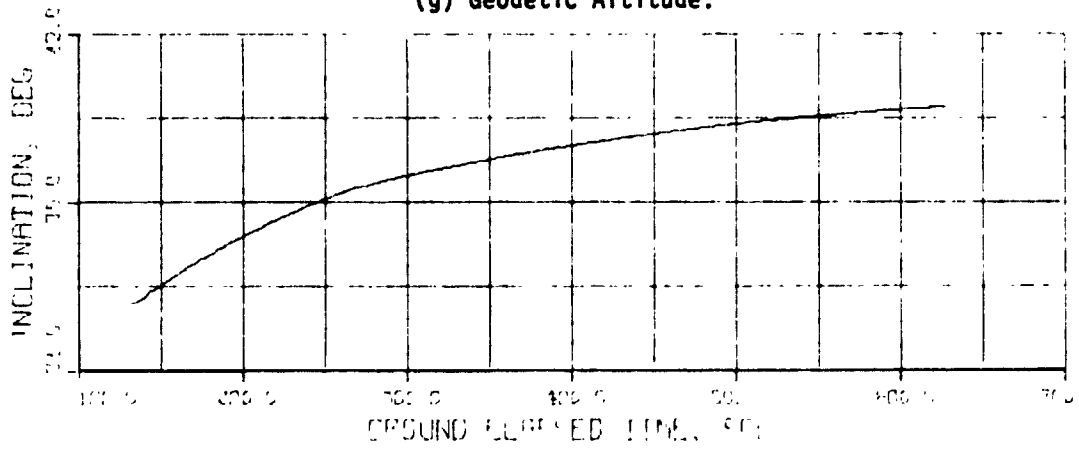

(h) Inclination.

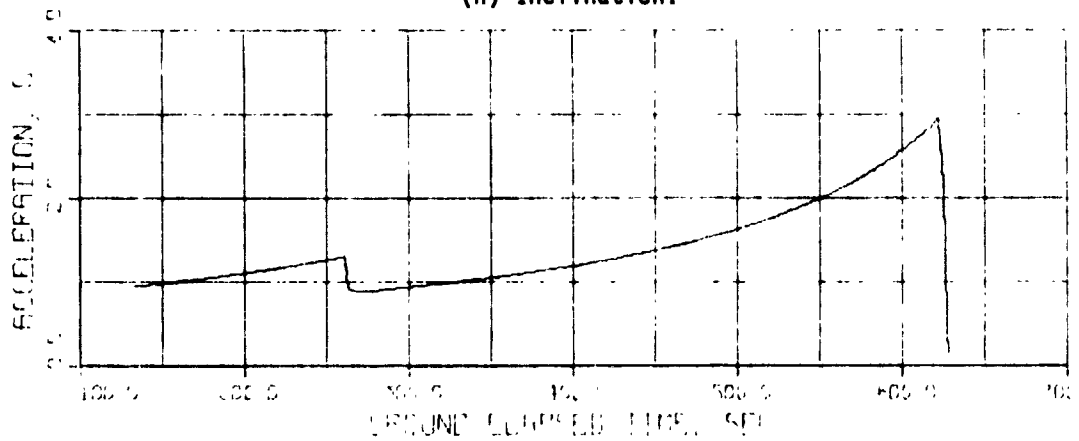

(i) Sensed acceleration.

Figure 6.3.1-2.- Concluded.

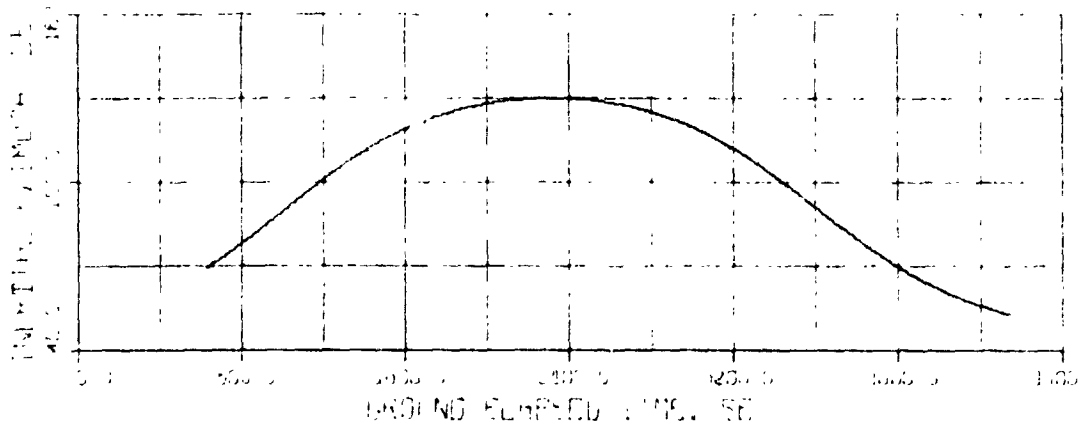

(a) Inertial azimuth.

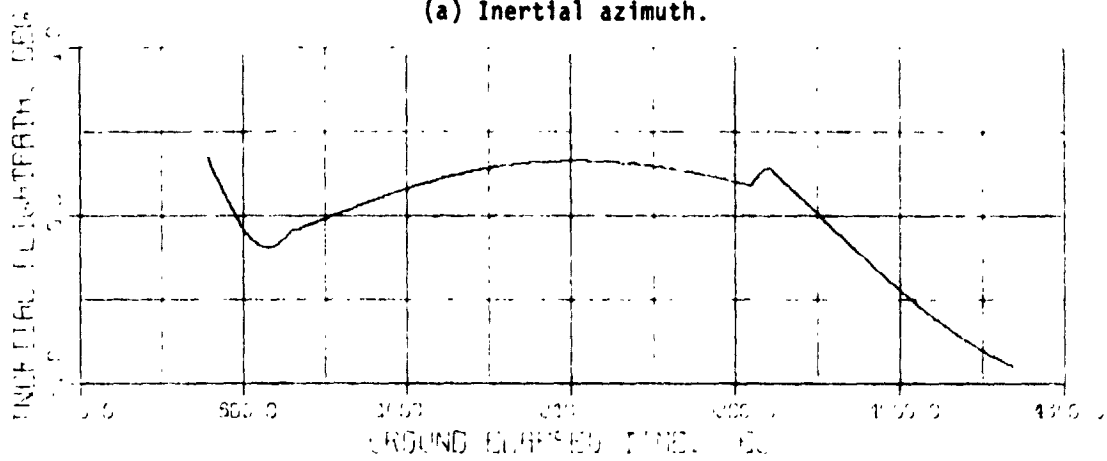

(b) Inertial flightpath angle.

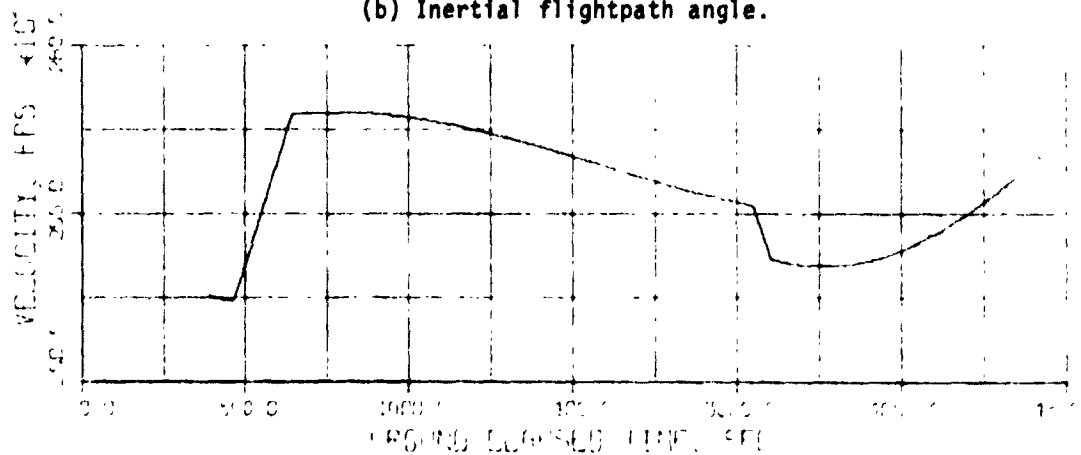

(c) Inertial velocity.

Figure 6.3.1-3.- Maximum underspeed earliest ACA - MECO to EI.

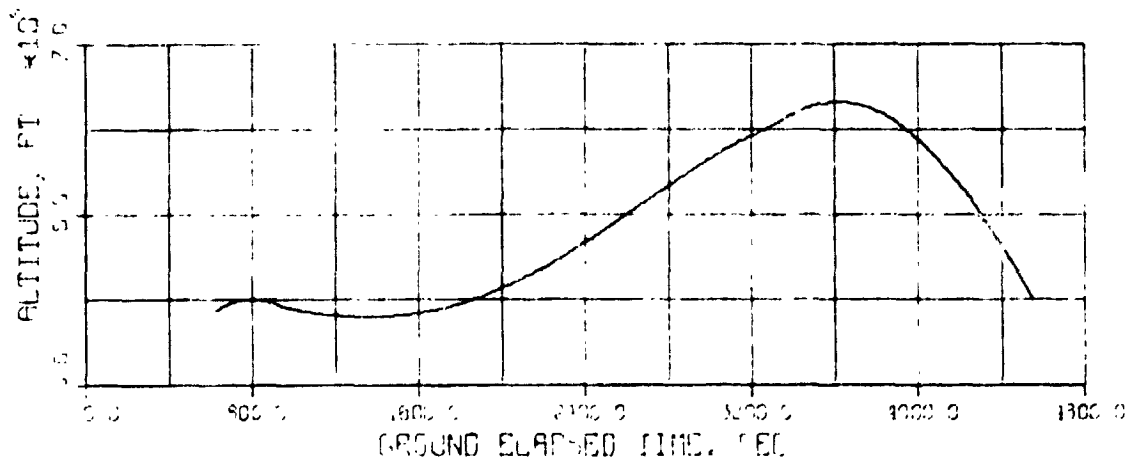

(d) Geodetic altitude.

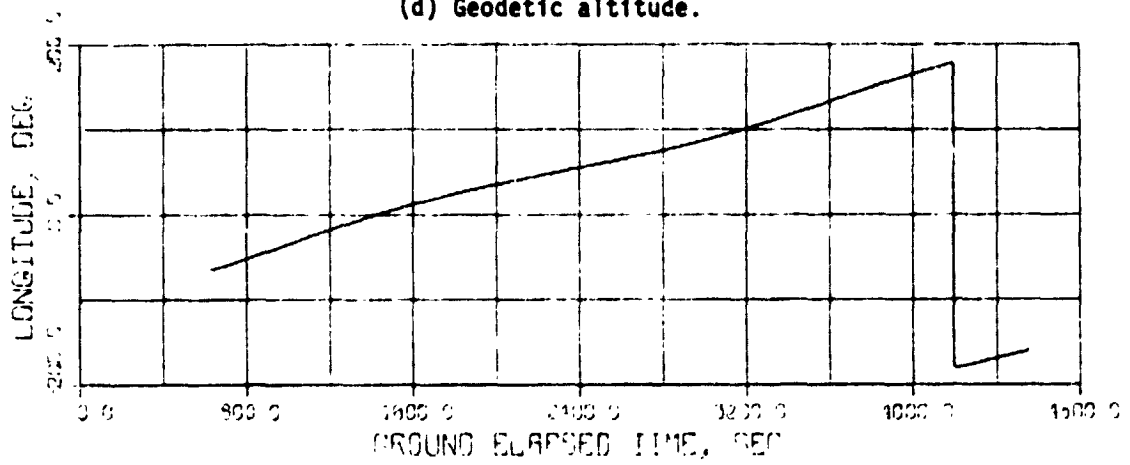

(e) Longitude.

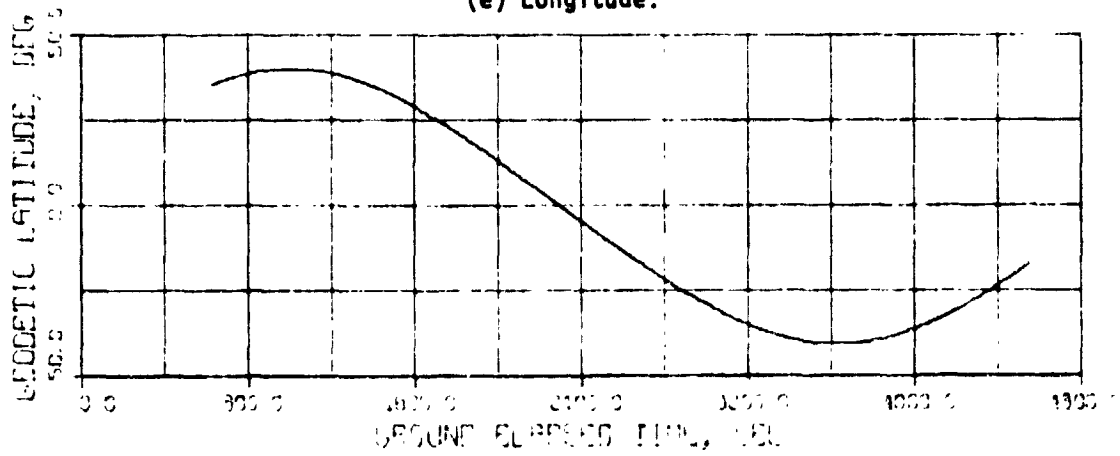

(f) Geodetic latitude.

Figure 6.3.1-3.- Continued.

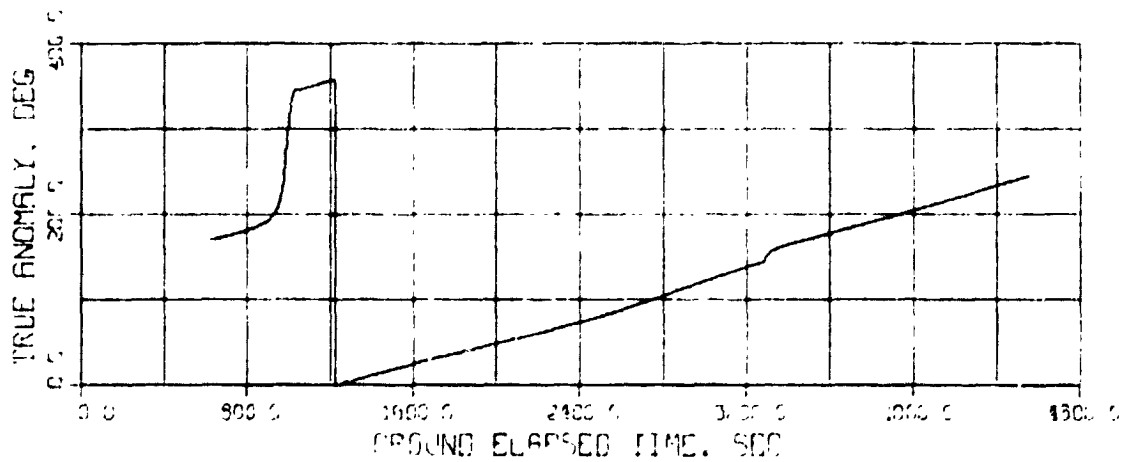

(g) True anomaly.

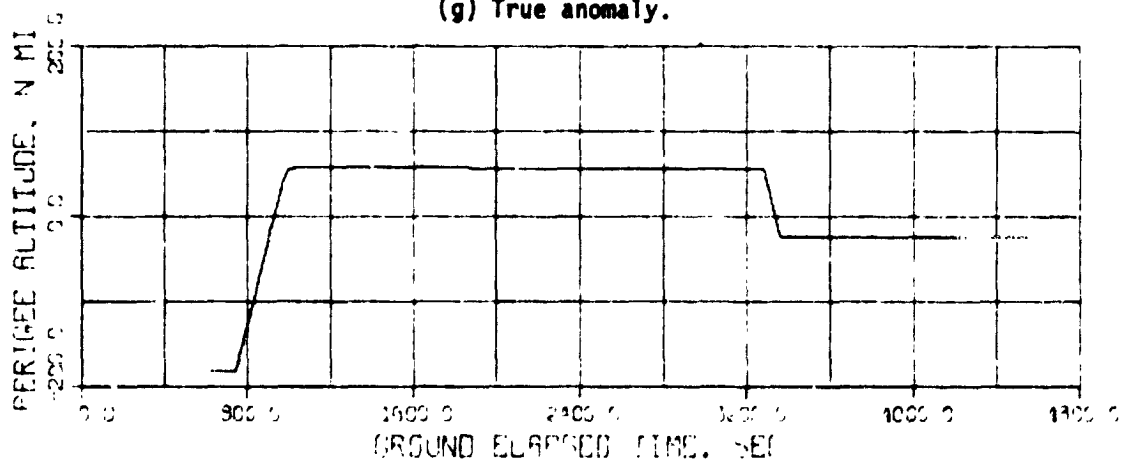

(h) Perigee altitude.

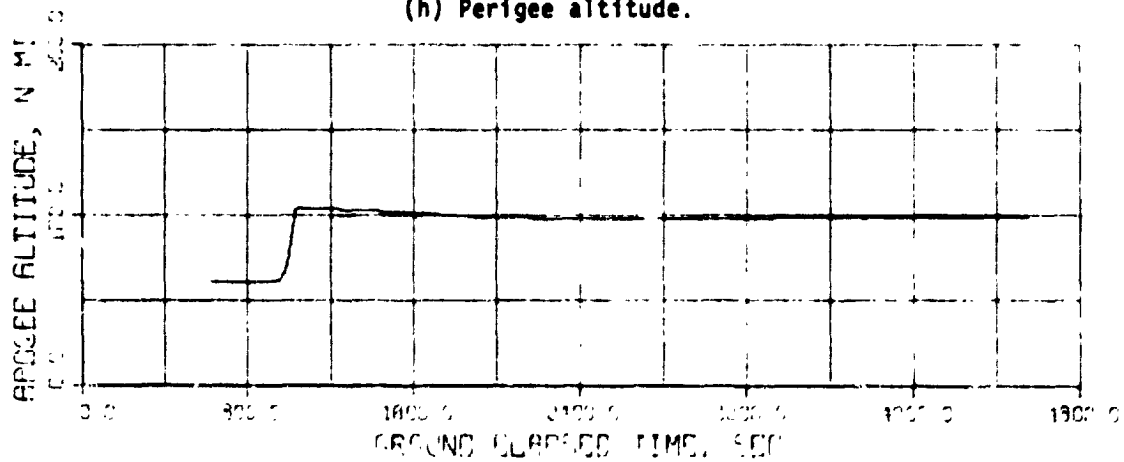

(i) Apogee altitude.

Figure 6.3.1-3.- Concluded.

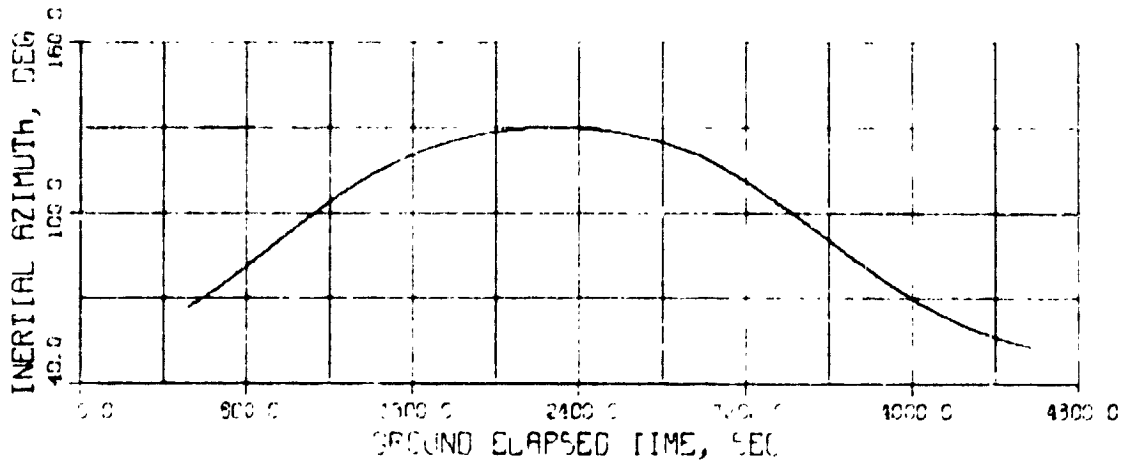

(a) Inertial azimuth.

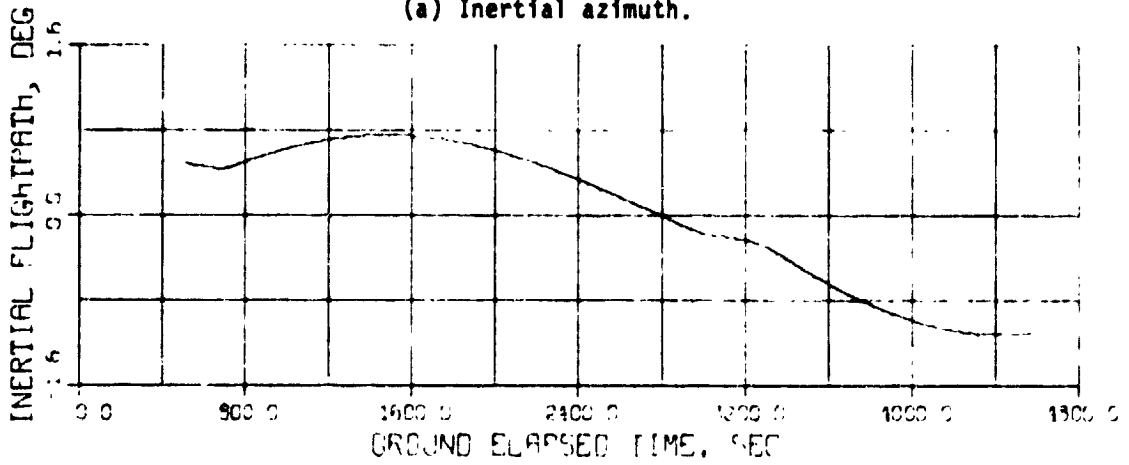

(b) Inertial flightpath angle.

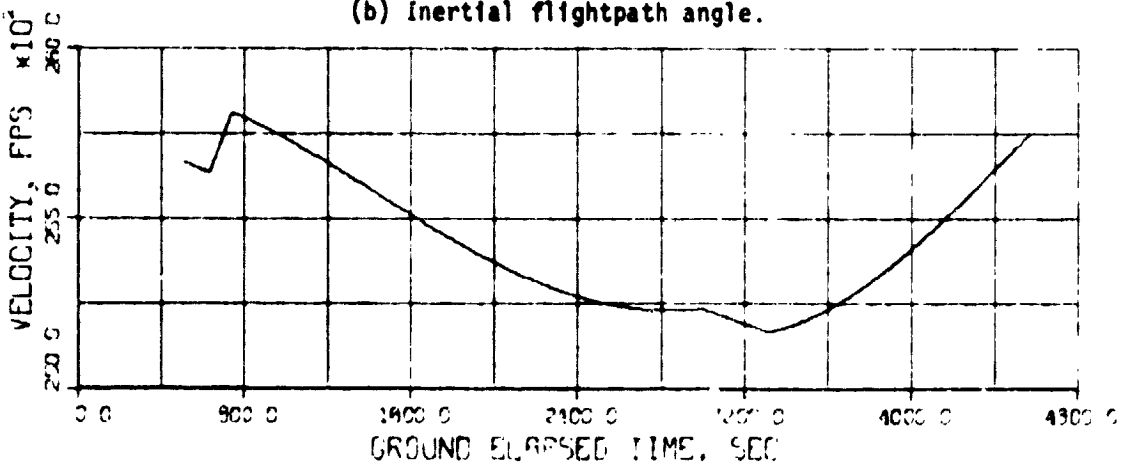

(c) Inertial velocity.

Figure 6.3.1-4.- AOA after nominal ascent and nominal O/S-1 - MECO to EI.

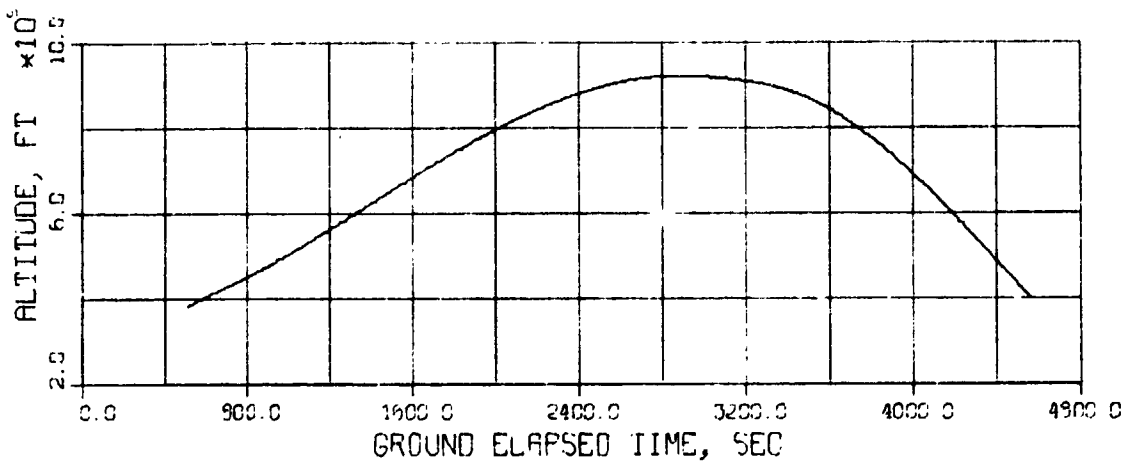

(d) Geodetic altitude.

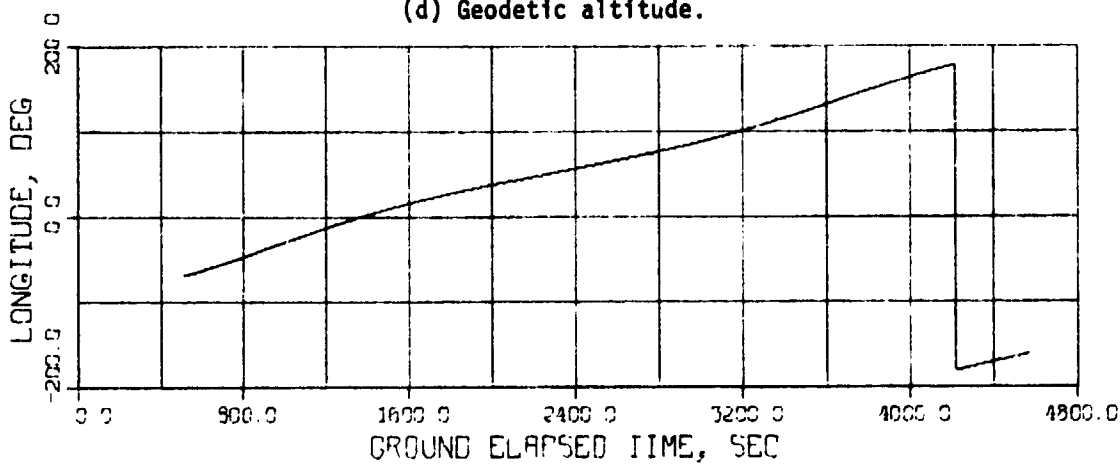

(e) Longitude.

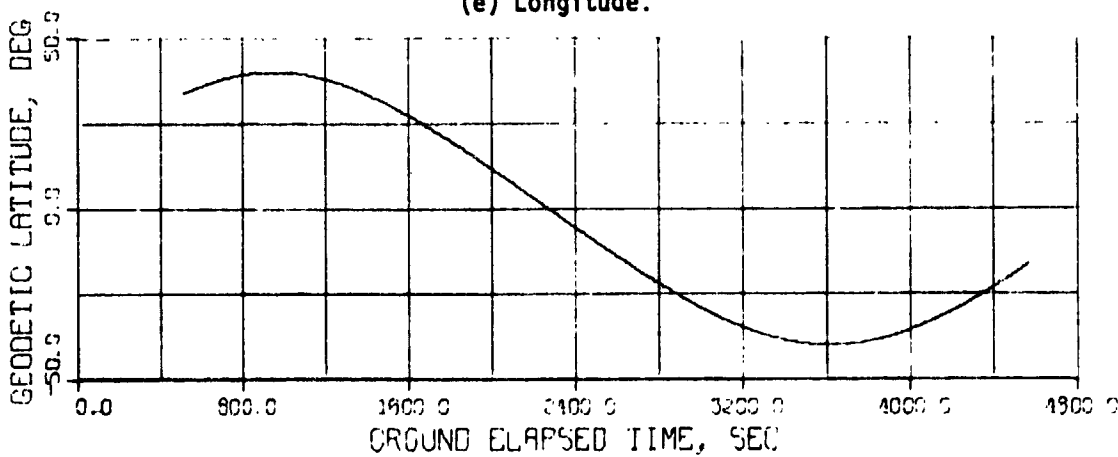

(f) Geodetic latitude.

Figure 6.3.1-4.- Continued.

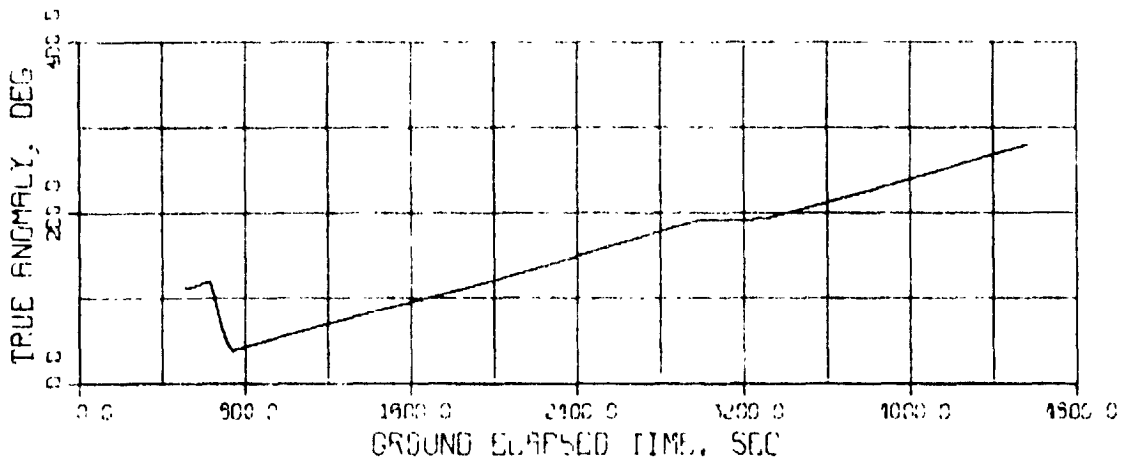

(g) True anomaly.

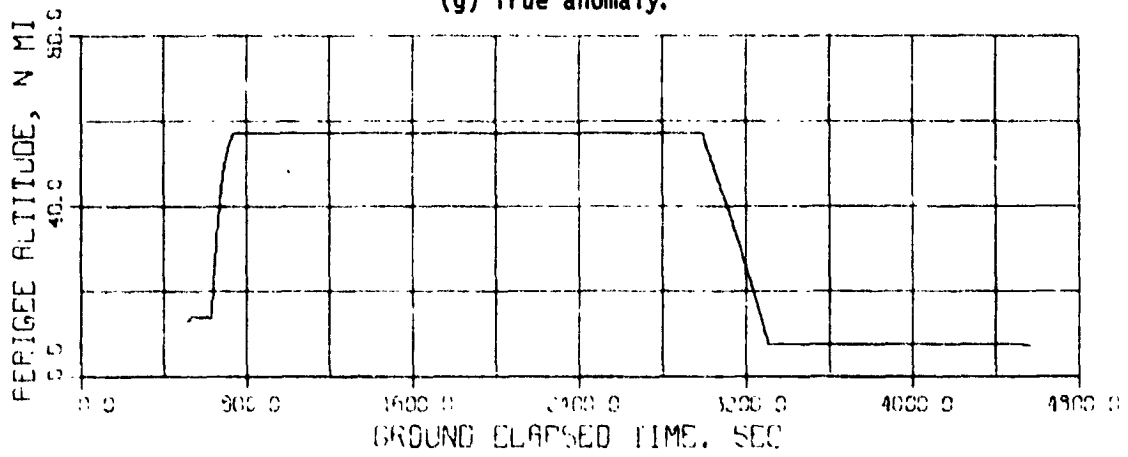

(h) Perigee altitude.

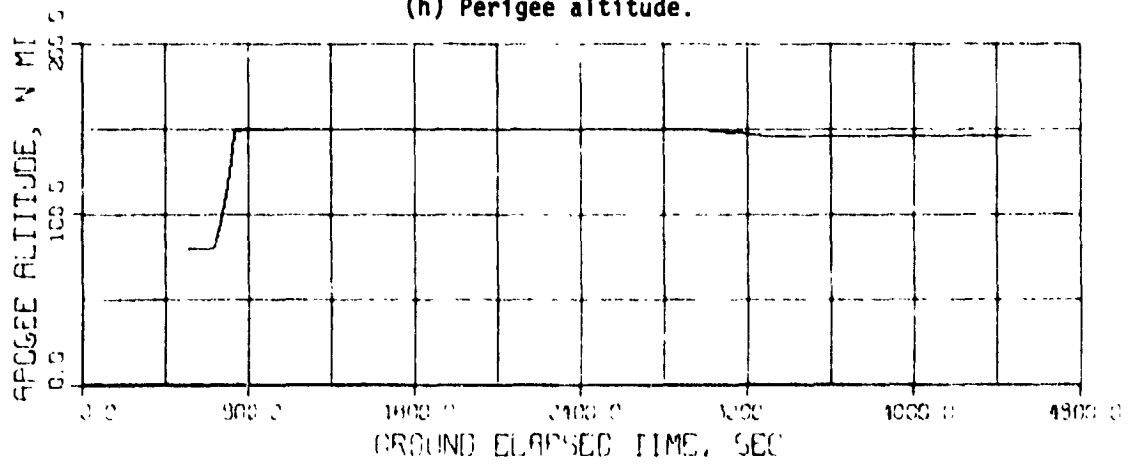

(i) Apogee altitude.

Figure 6.3.1-4.- Concluded.

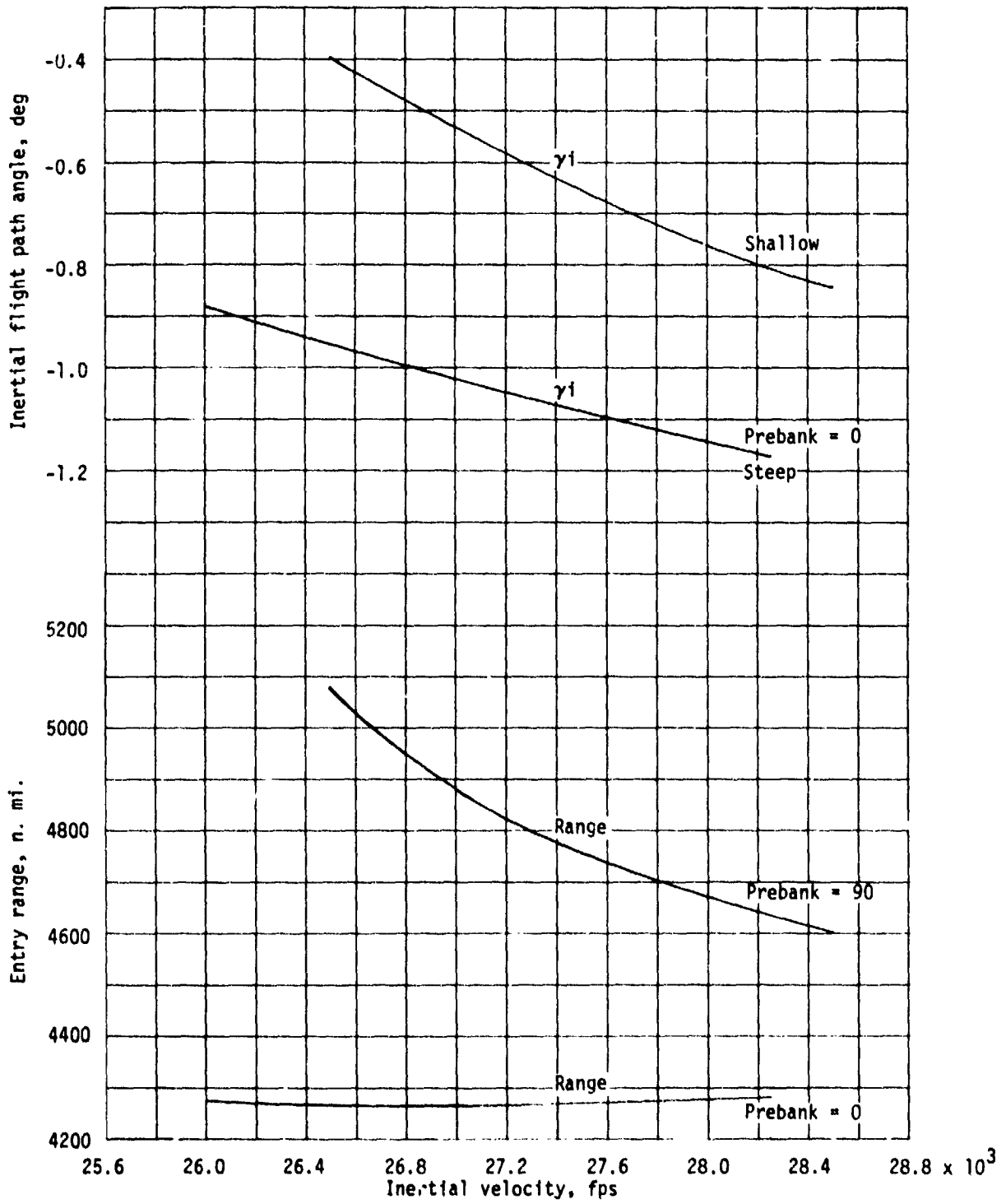

Figure 6.3.2-1.- STS-1 cycle 3 AOA target lines.

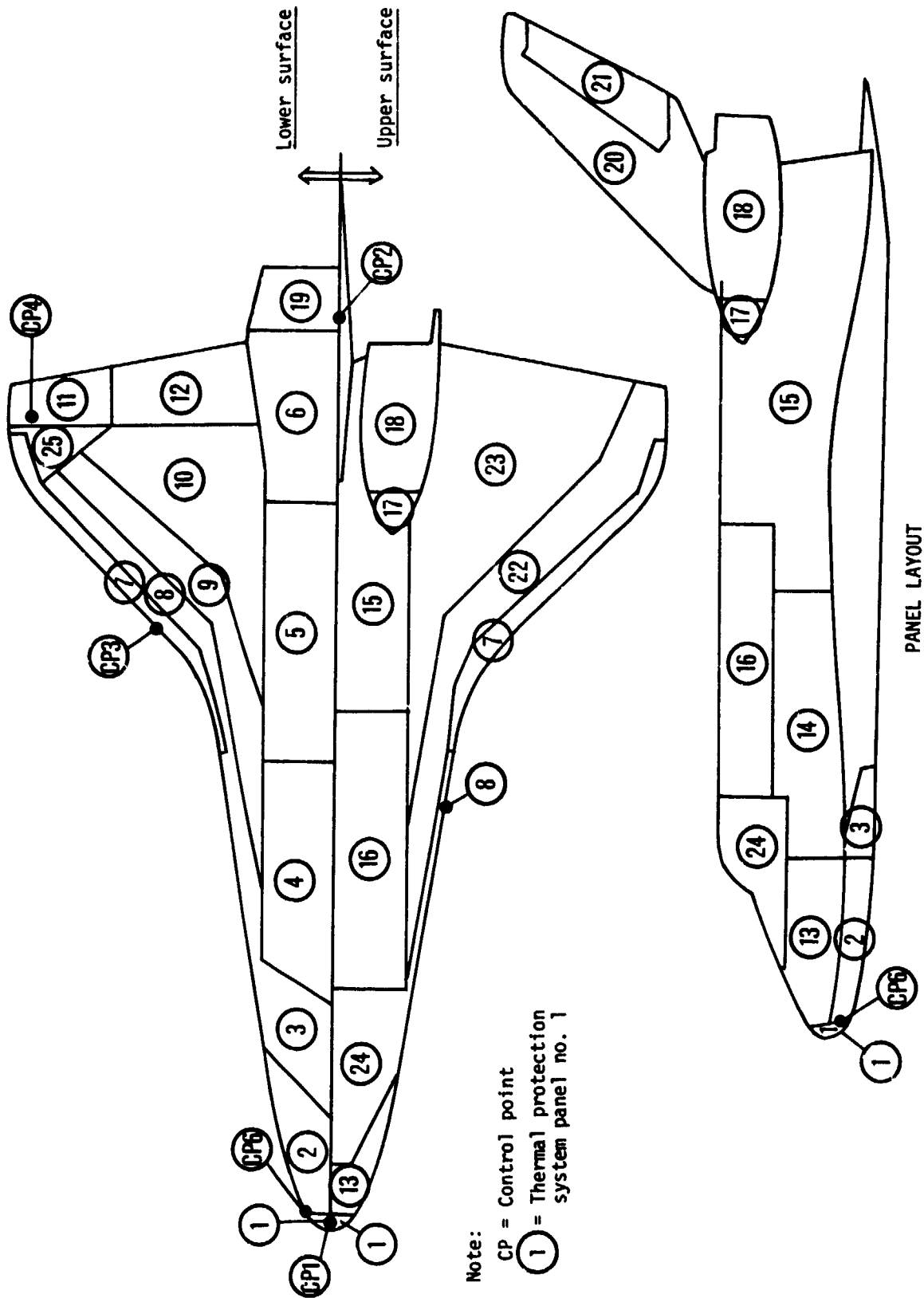
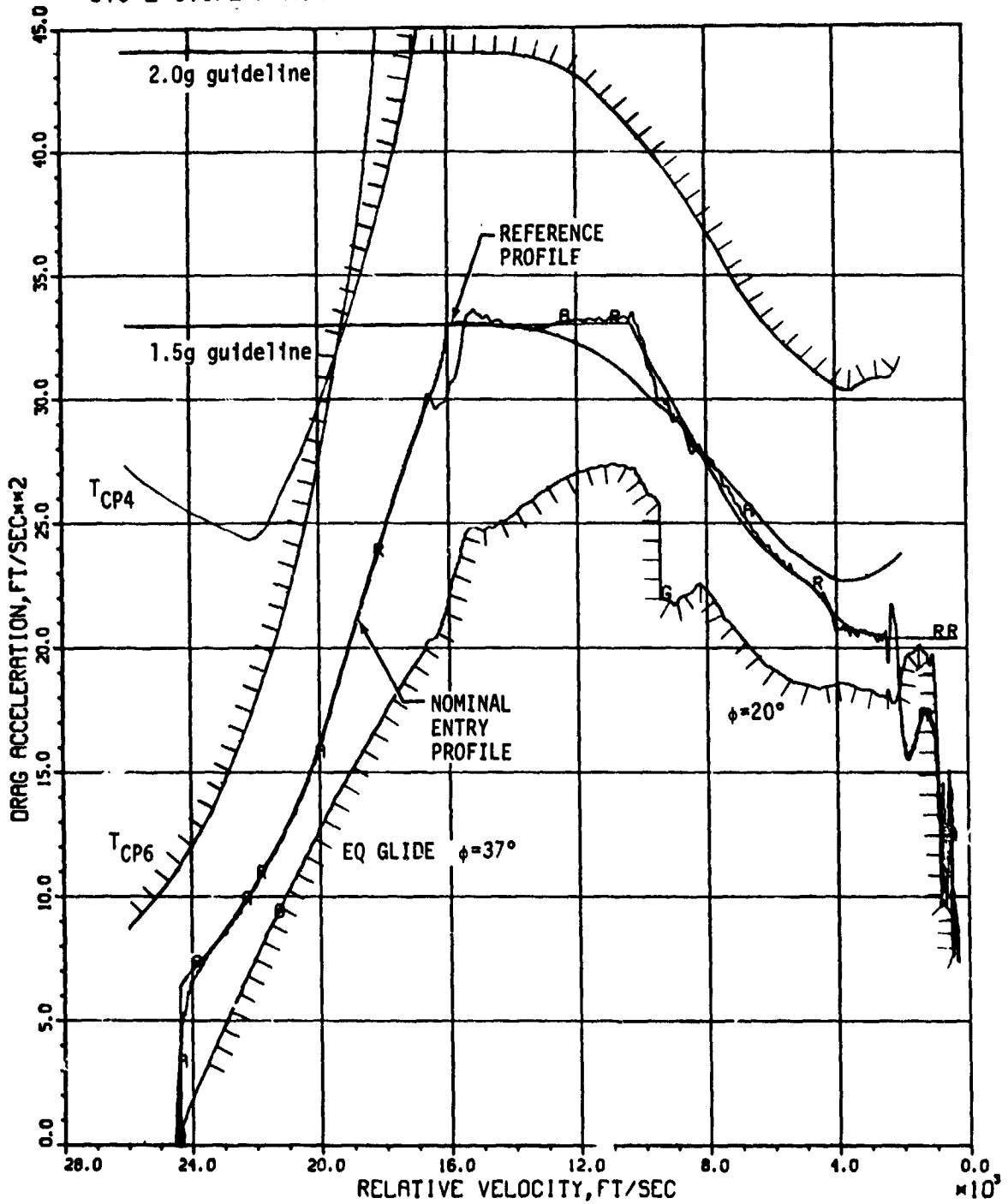

Figure 6.3.2-2.- Surface-temperature critical control points and various panel locations.

STS-1 CYCLE 3 AOA



ENTRY DRAG ACCELERATION CORRIDOR AND FLIGHT PROFILE DURING ATMOSPHERIC DESCENT

Figure 6.3.2-3.

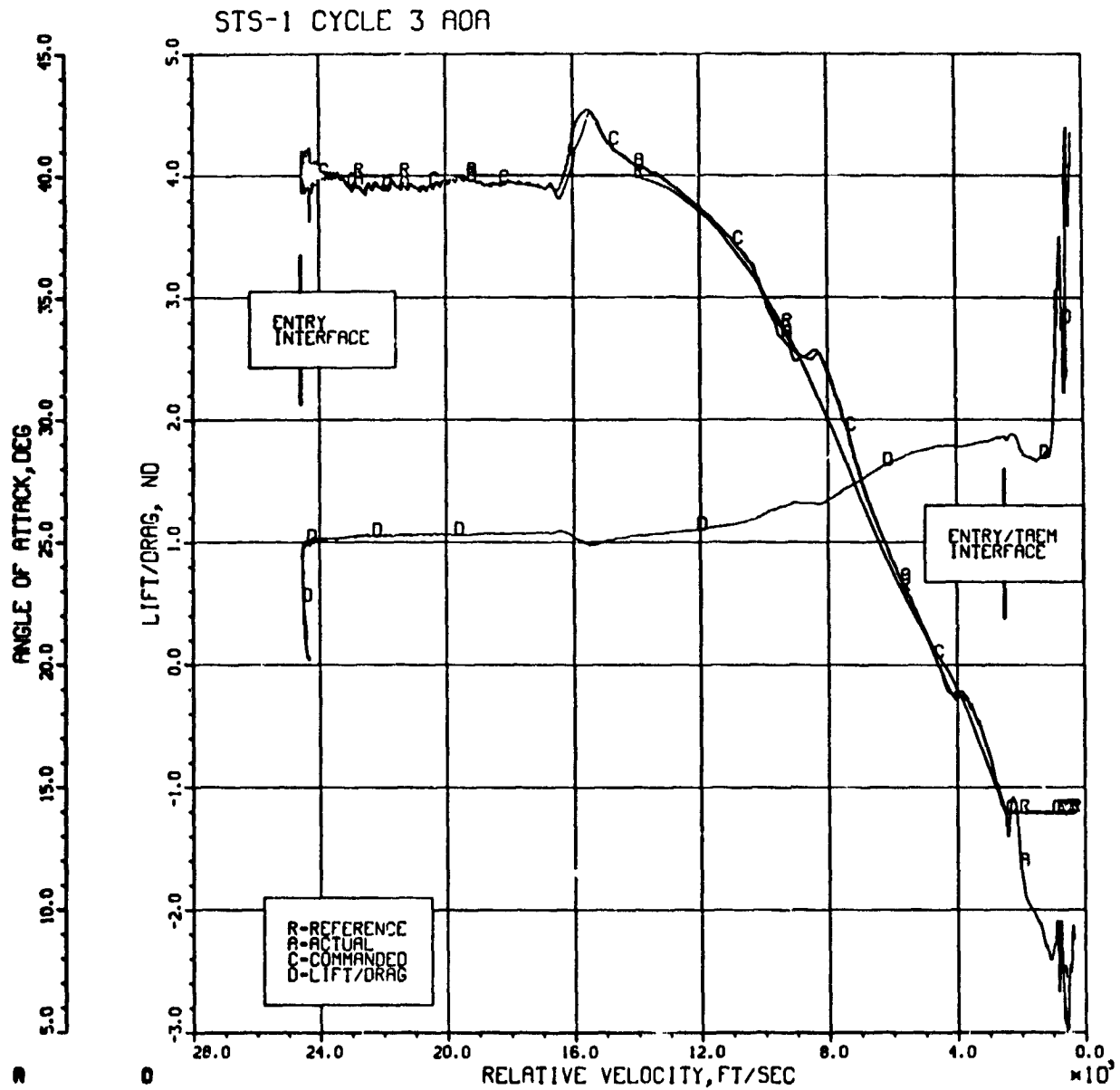
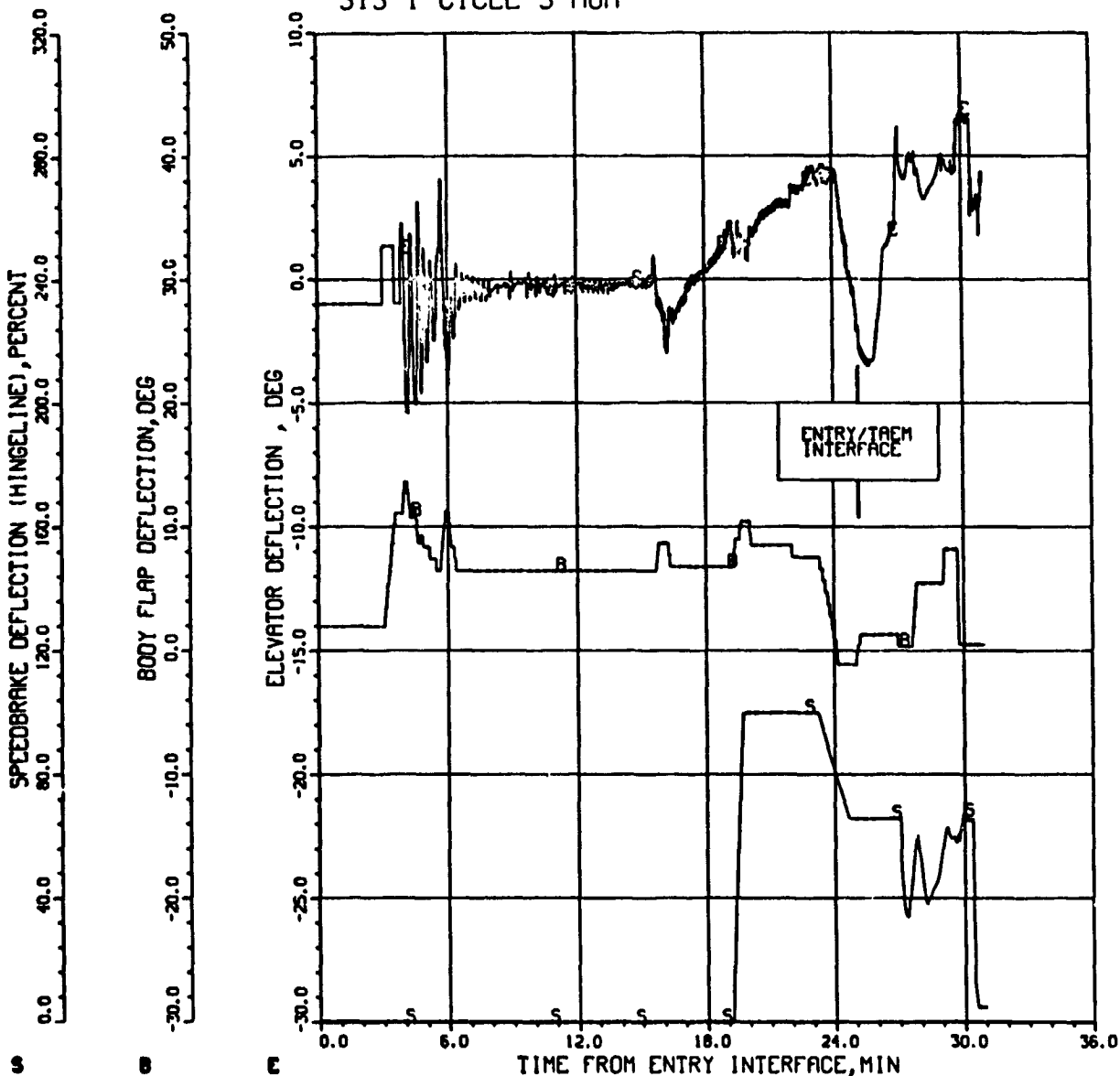

Figure 6.3.2-4.

STS-1 CYCLE 3 AOA



ELEVATOR, BODY FLAP, AND SPEEDBRAKE DEFLECTION VS. TIME FROM ENTRY INTERFACE

Figure 6.3.2-5.

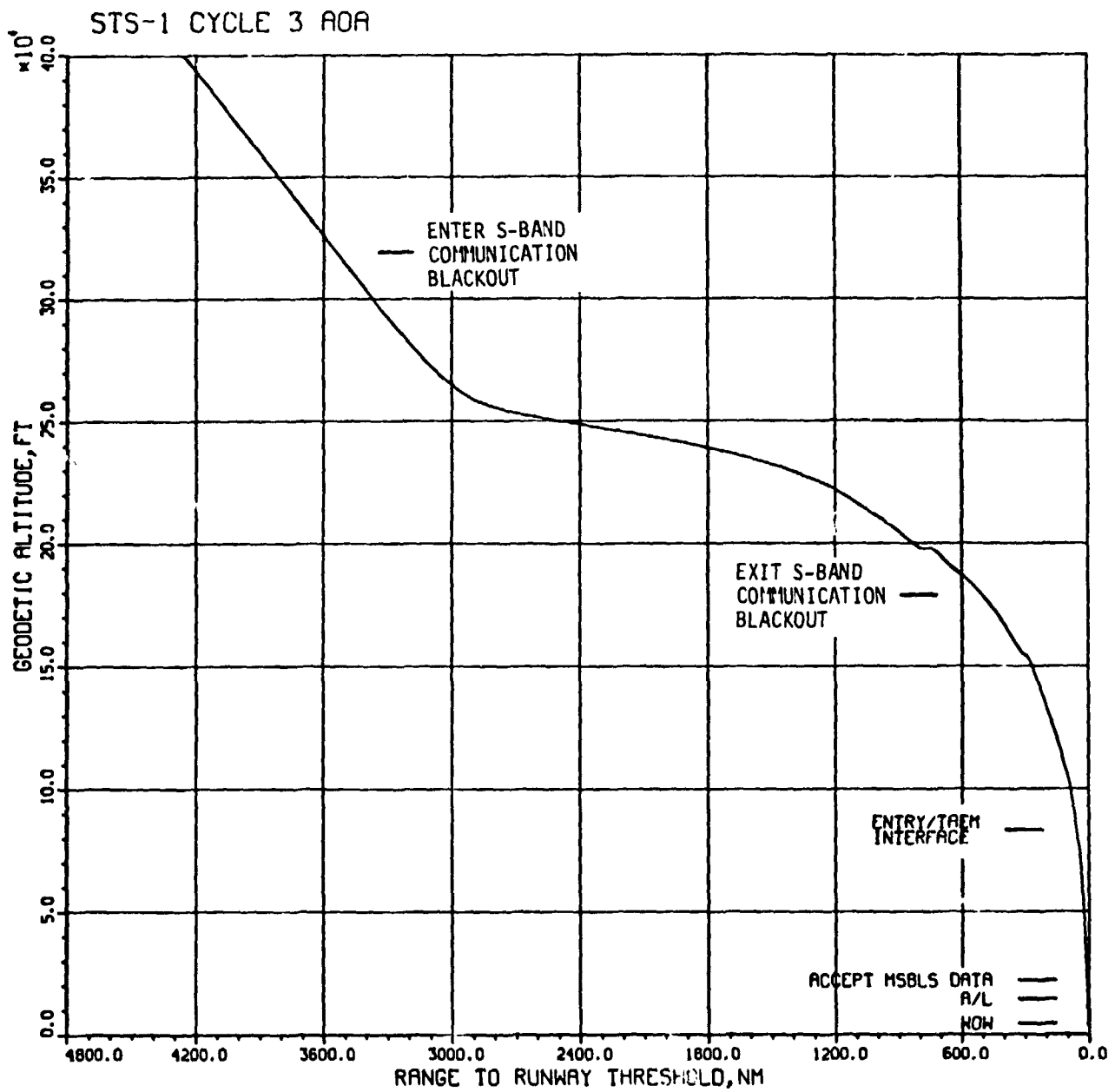

GEODETIC ALTITUDE VS. RANGE TO RUNWAY THRESHOLD

Figure 6.3.2-6.

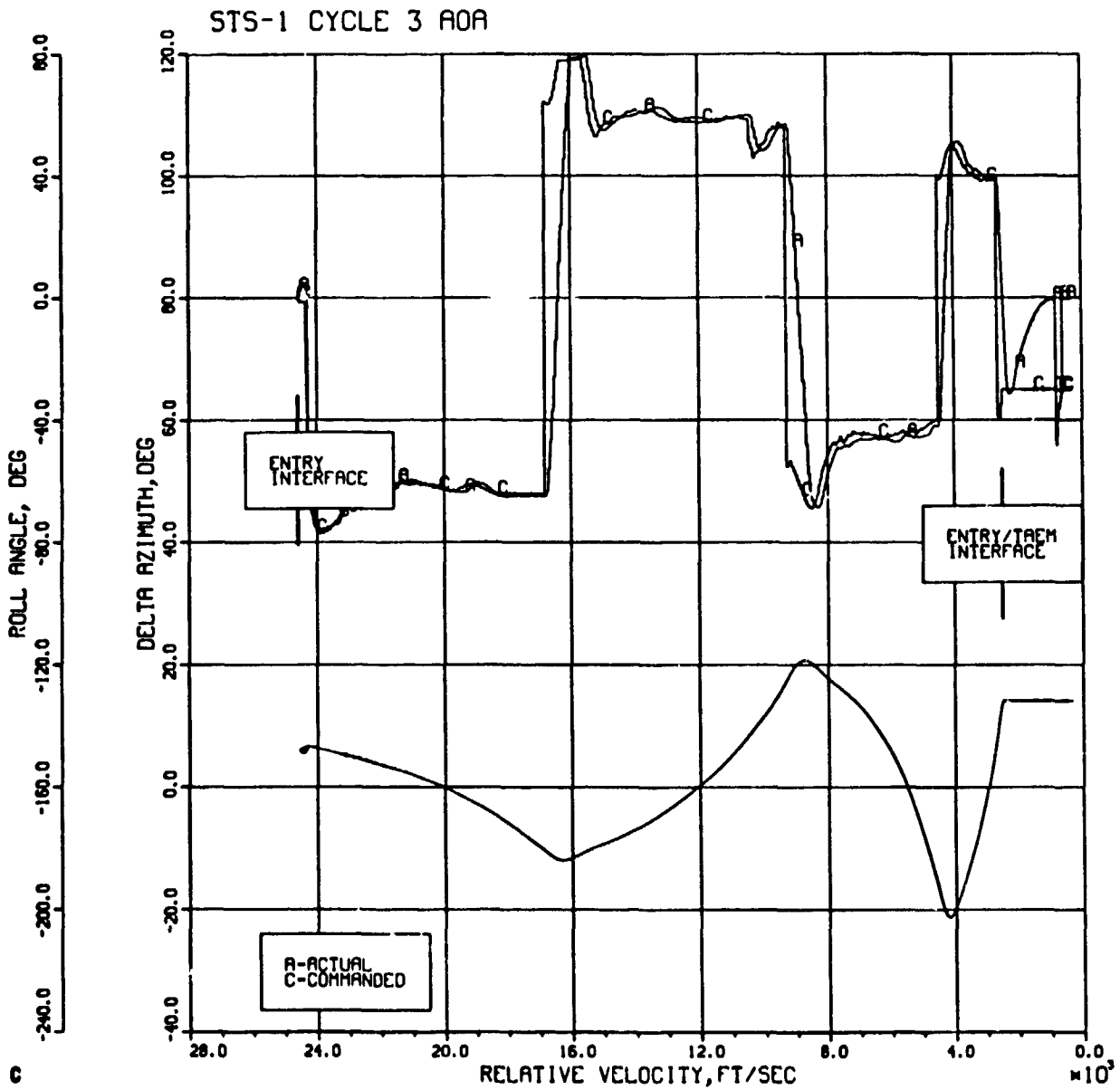

DELTA AZIMUTH, ACTUAL AND COMMANDED
ROLL ANGLES DURING ATMOSPHERIC DESCENT

Figure 6.3.2-7.

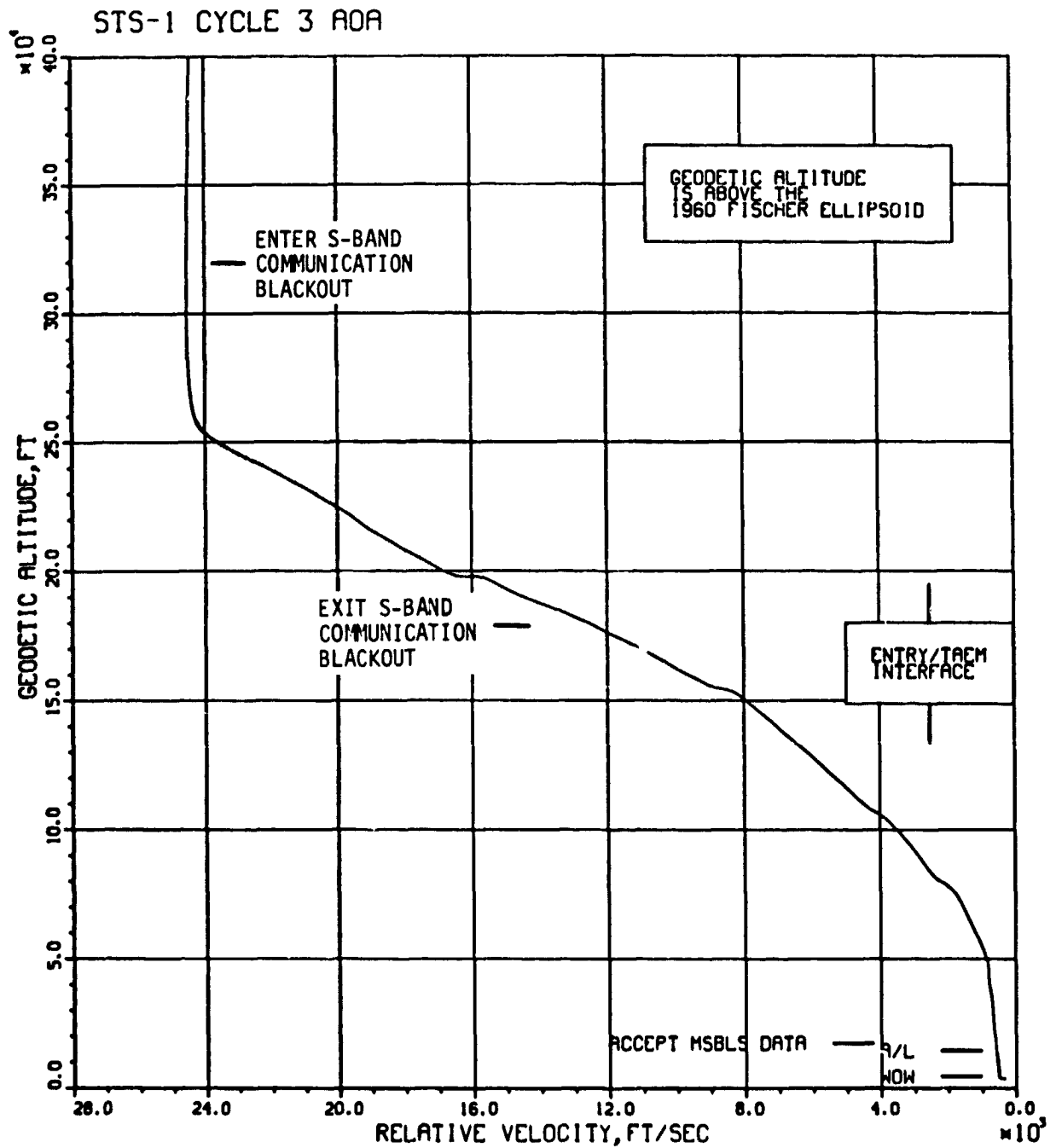

GEODETTIC ALTITUDE DURING ATMOSPHERIC DESCENT

Figure 6.3.2-8.

STS-1 CYCLE 3 AOA

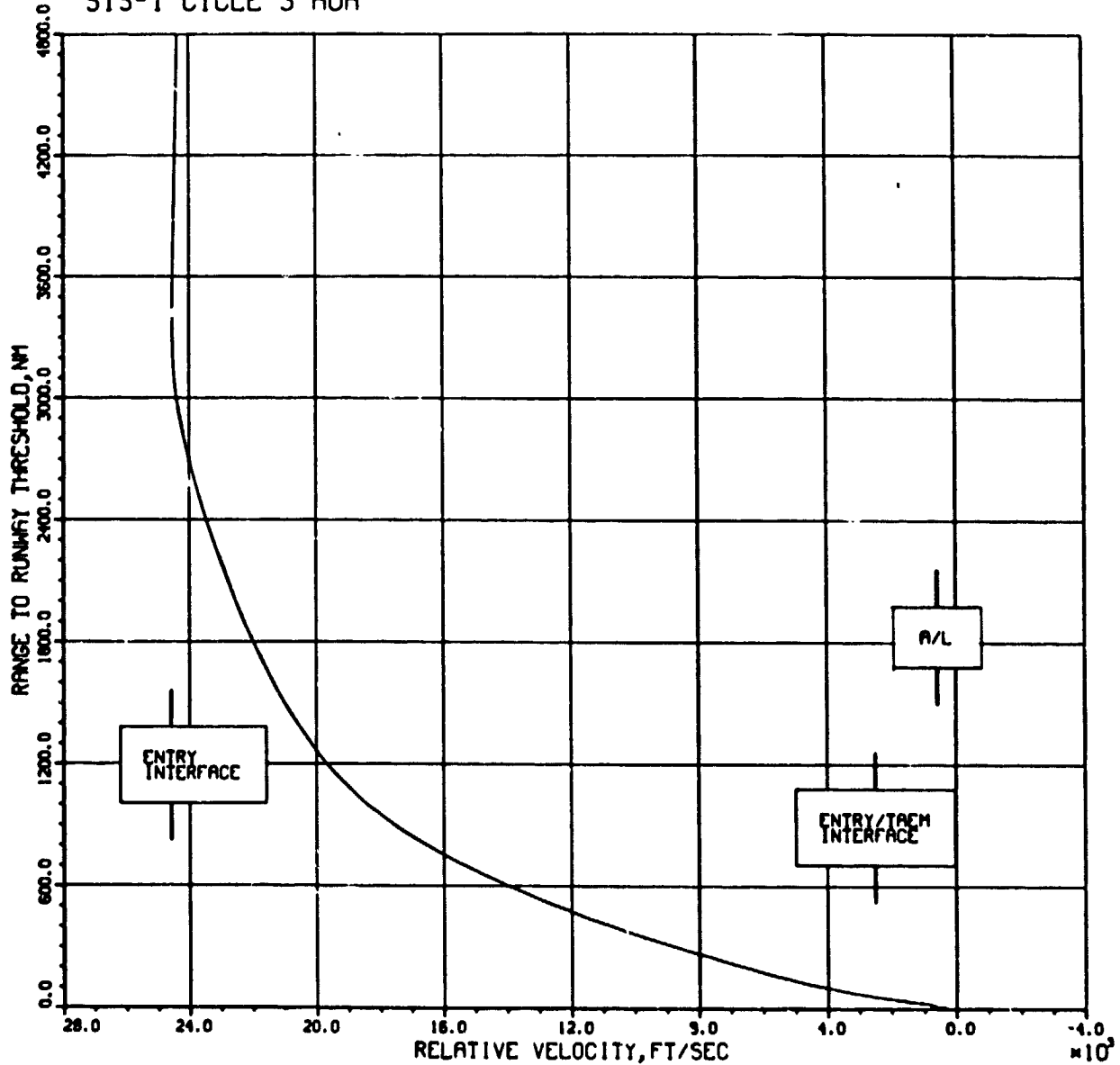

RANGE TO RUNWAY THRESHOLD
DURING ATMOSPHERIC DESCENT

Figure 6.3.2-9.

STS-1 CYCLE 3 AOA

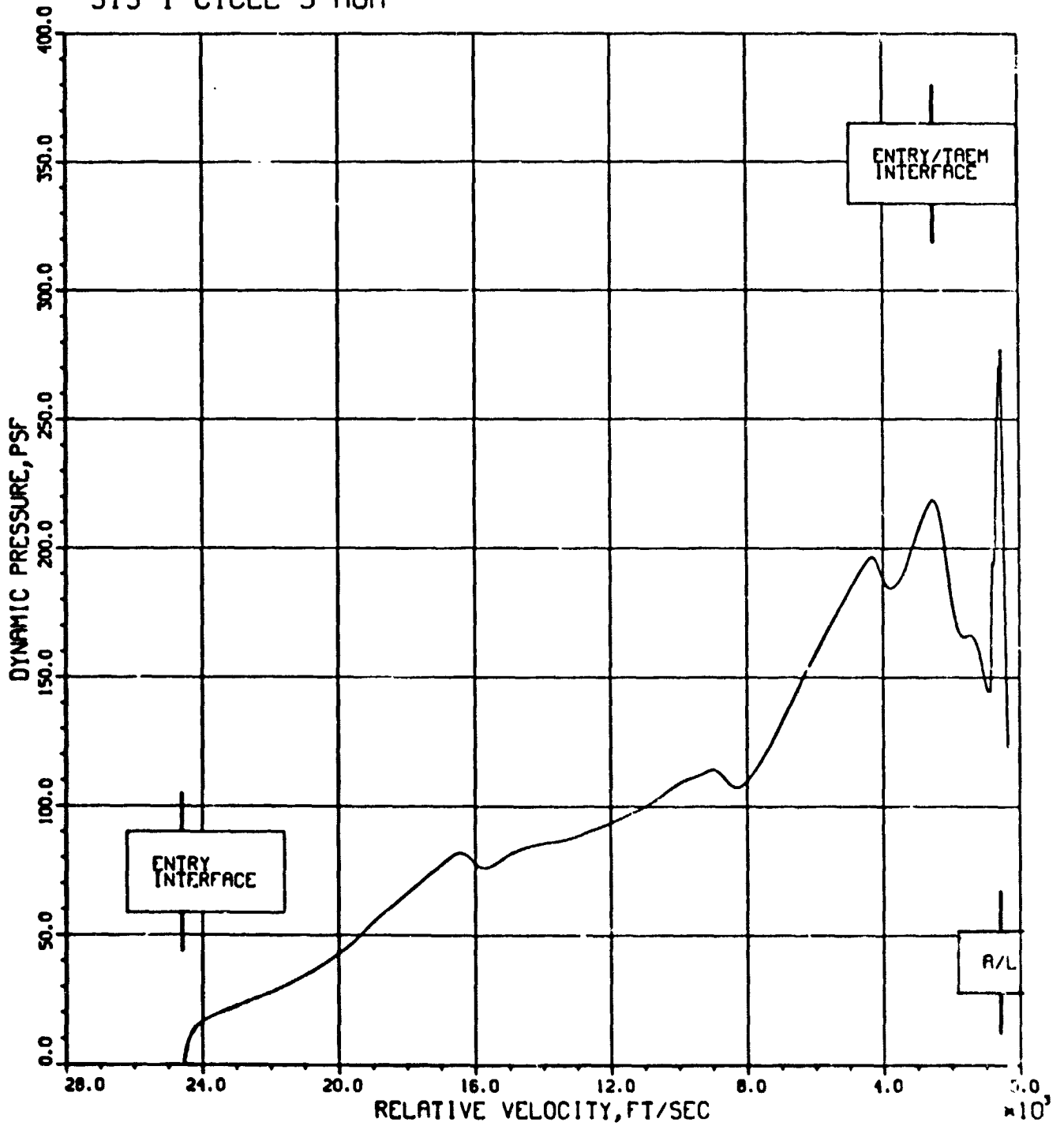

DYNAMIC PRESSURE DURING ATMOSPHERIC DESCENT

Figure 6.3.2-10.

STS-1 CYCLE 3 ROA

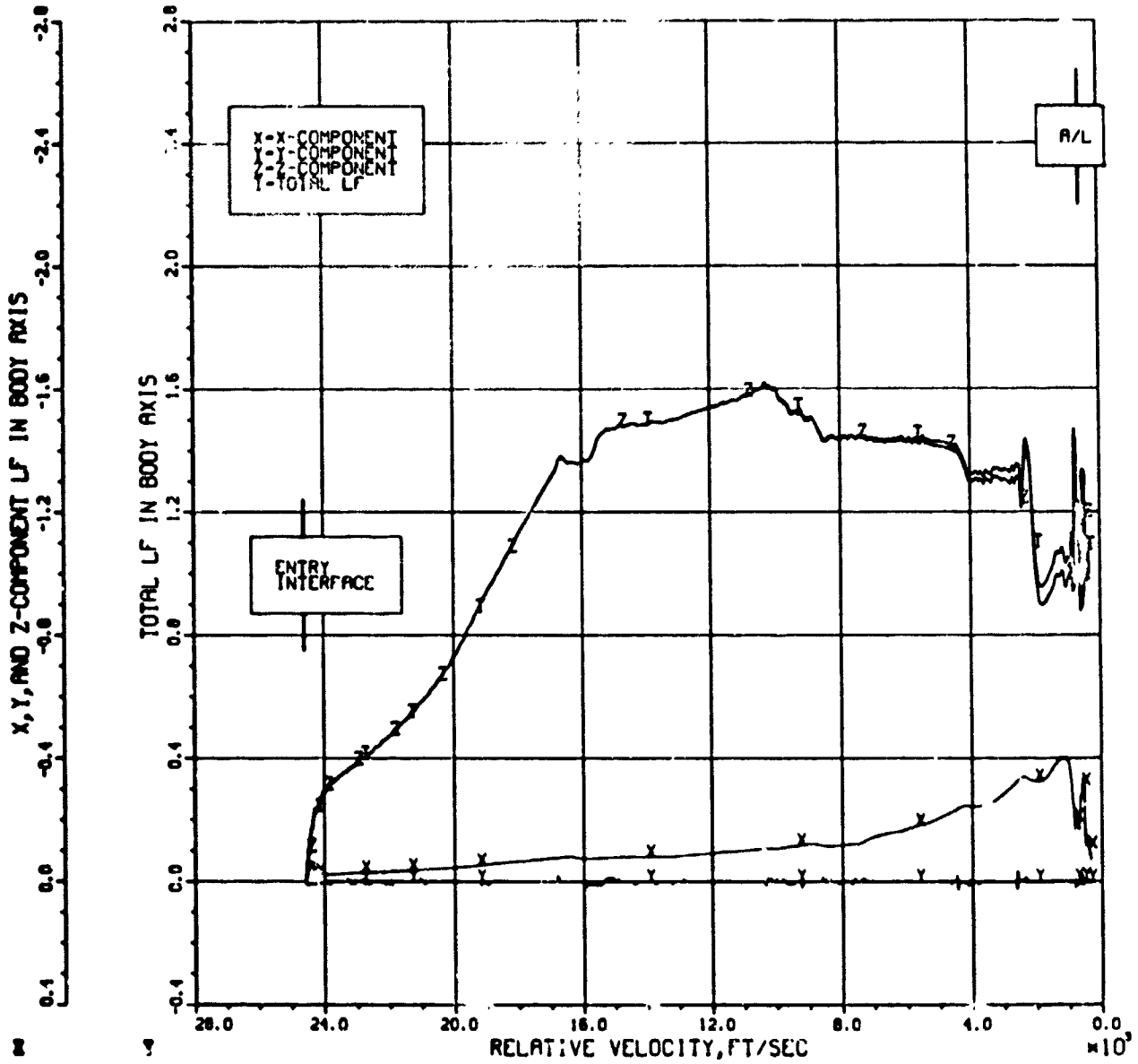

X, Y, AND Z-BODY AXIS AND TOTAL LOAD FACTOR DURING ATMOSPHERIC DESCENT

Figure 6.3.2-11.

STS-1 CYCLE 3 AOA

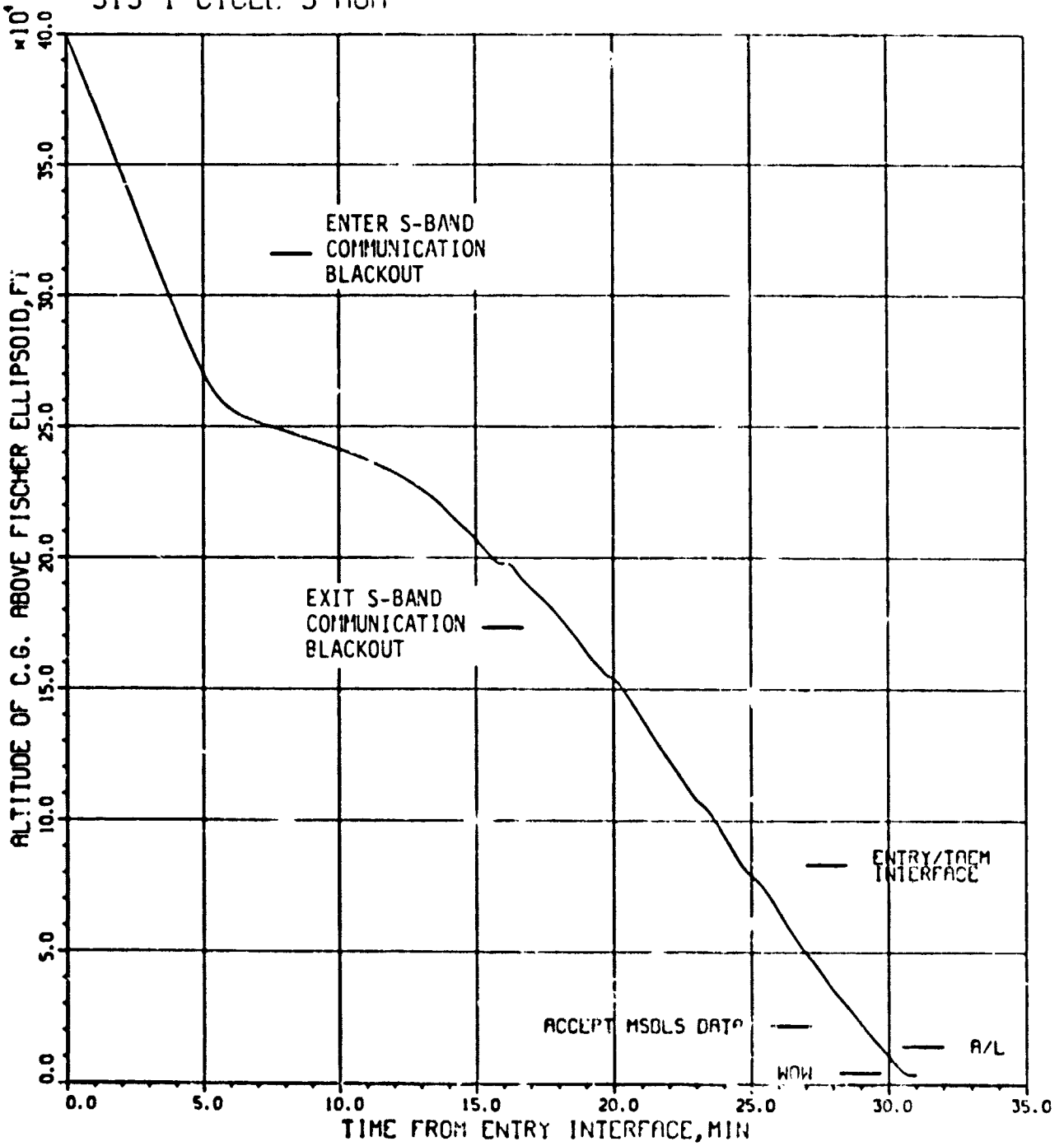

ALTITUDE VS. TIME FROM ENTRY INTERFACE

Figure 6.3.2-12.

STS-1 CYCLE 3 AOA

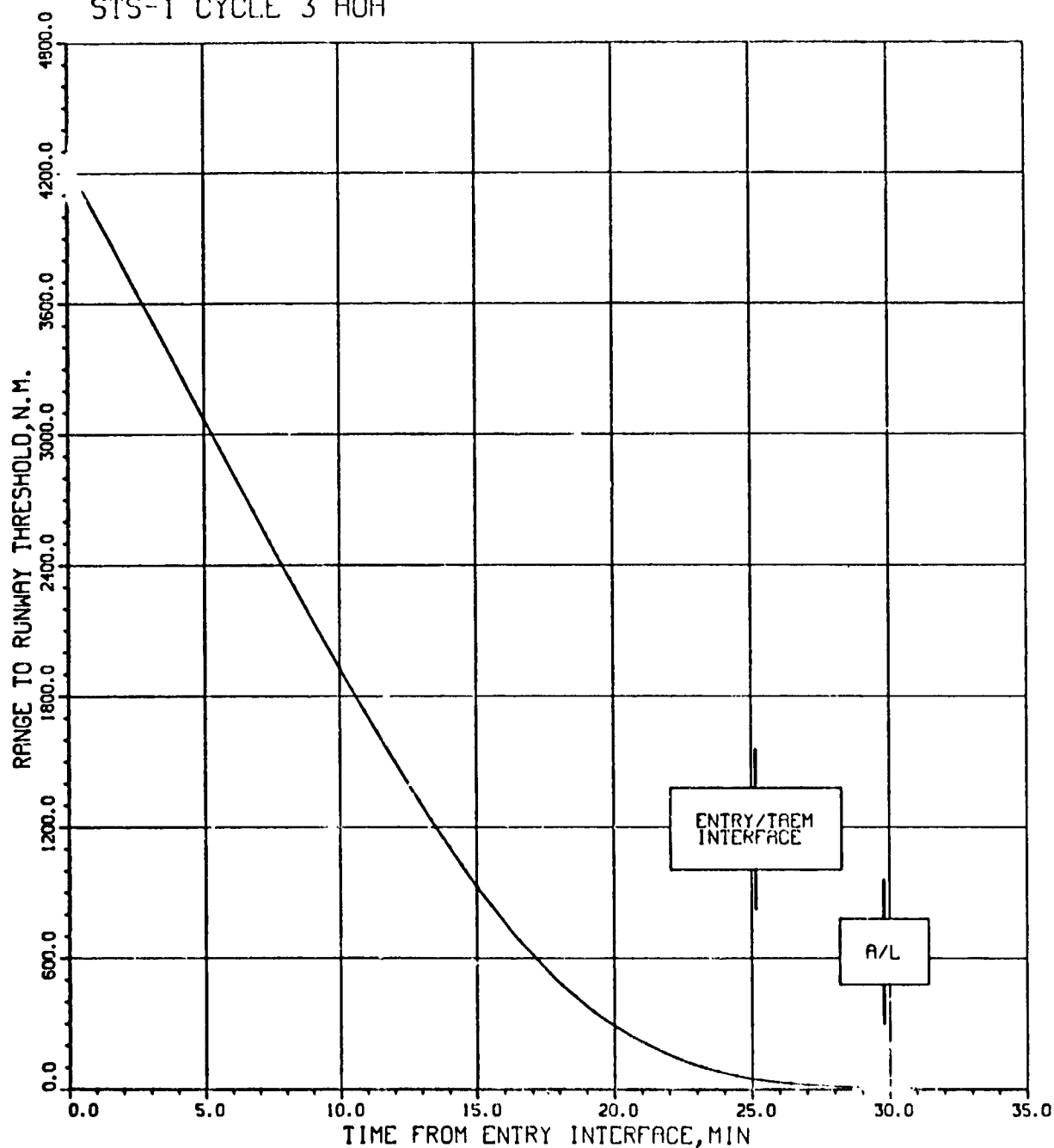

RANGE-TO-RUNWAY THRESHOLD VS.
TIME FROM ENTRY INTERFACE

Figure 6.3.2-13.

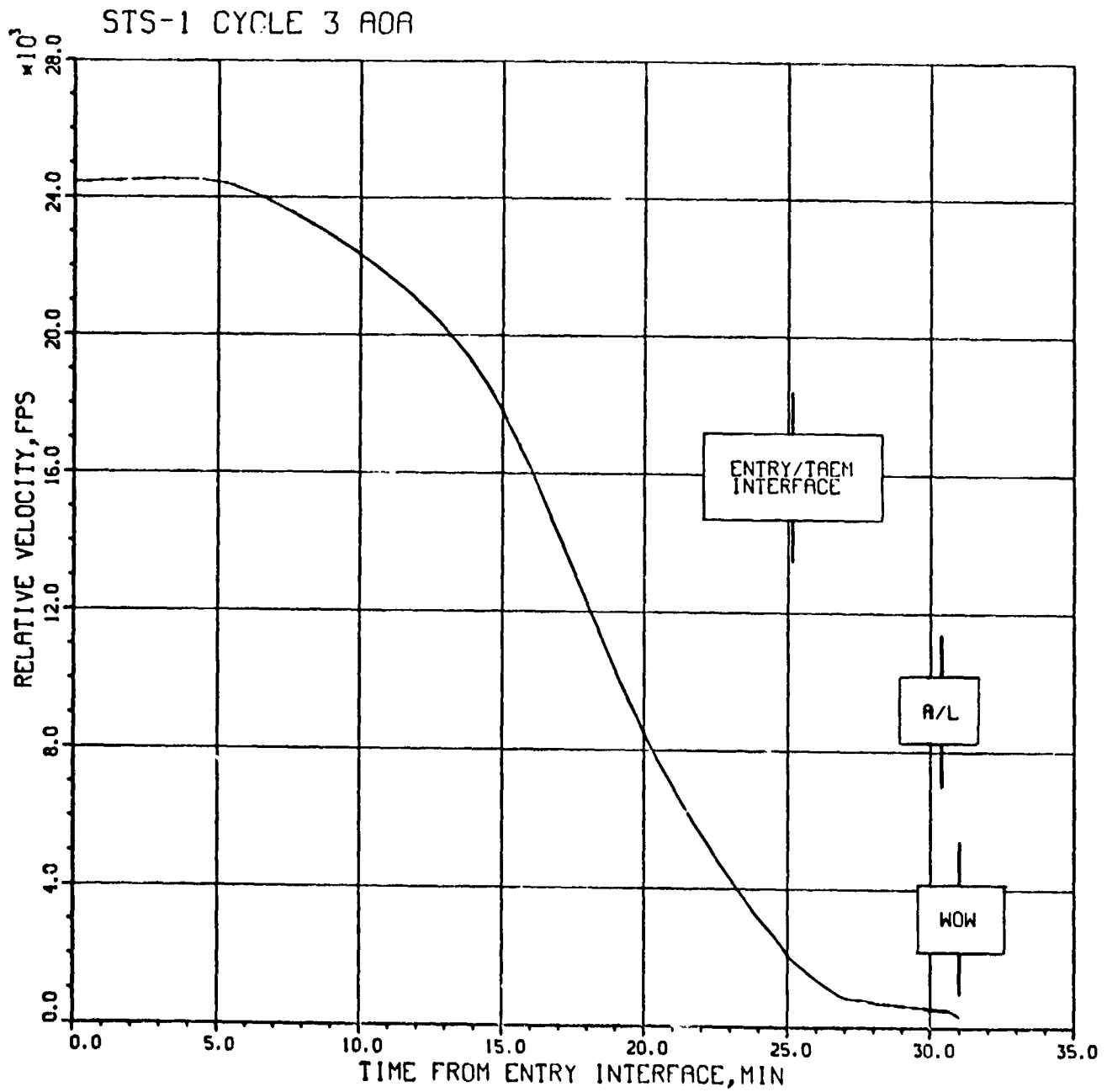

RELATIVE VELOCITY VS. TIME FROM ENTRY INTERFACE

Figure 6.3.2-14.

STS-1 CYCLE 3 AOA

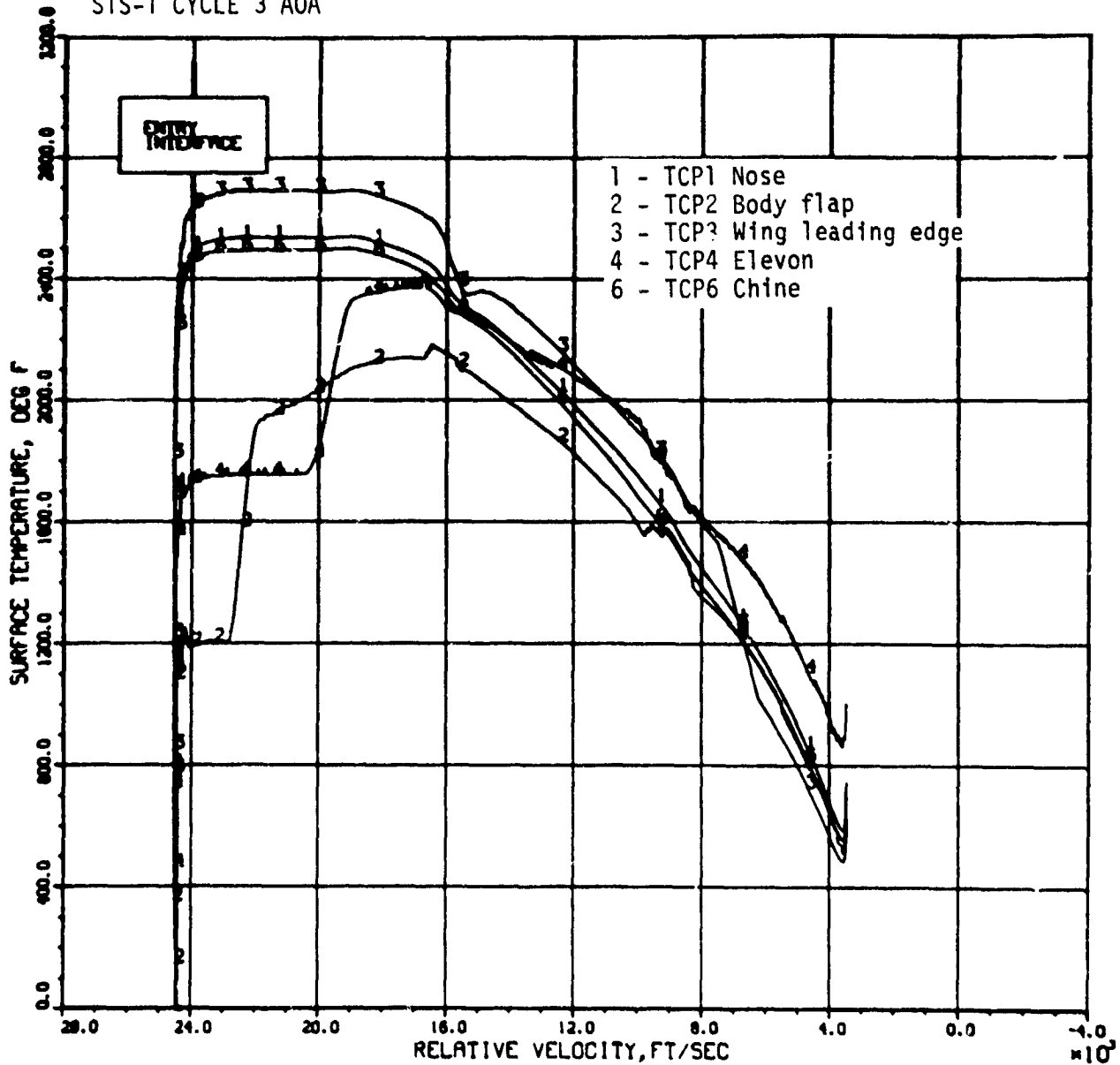

CONTROL POINT TEMPERATURES
VS. RELATIVE VELOCITY

Figure 6.3.2-15.

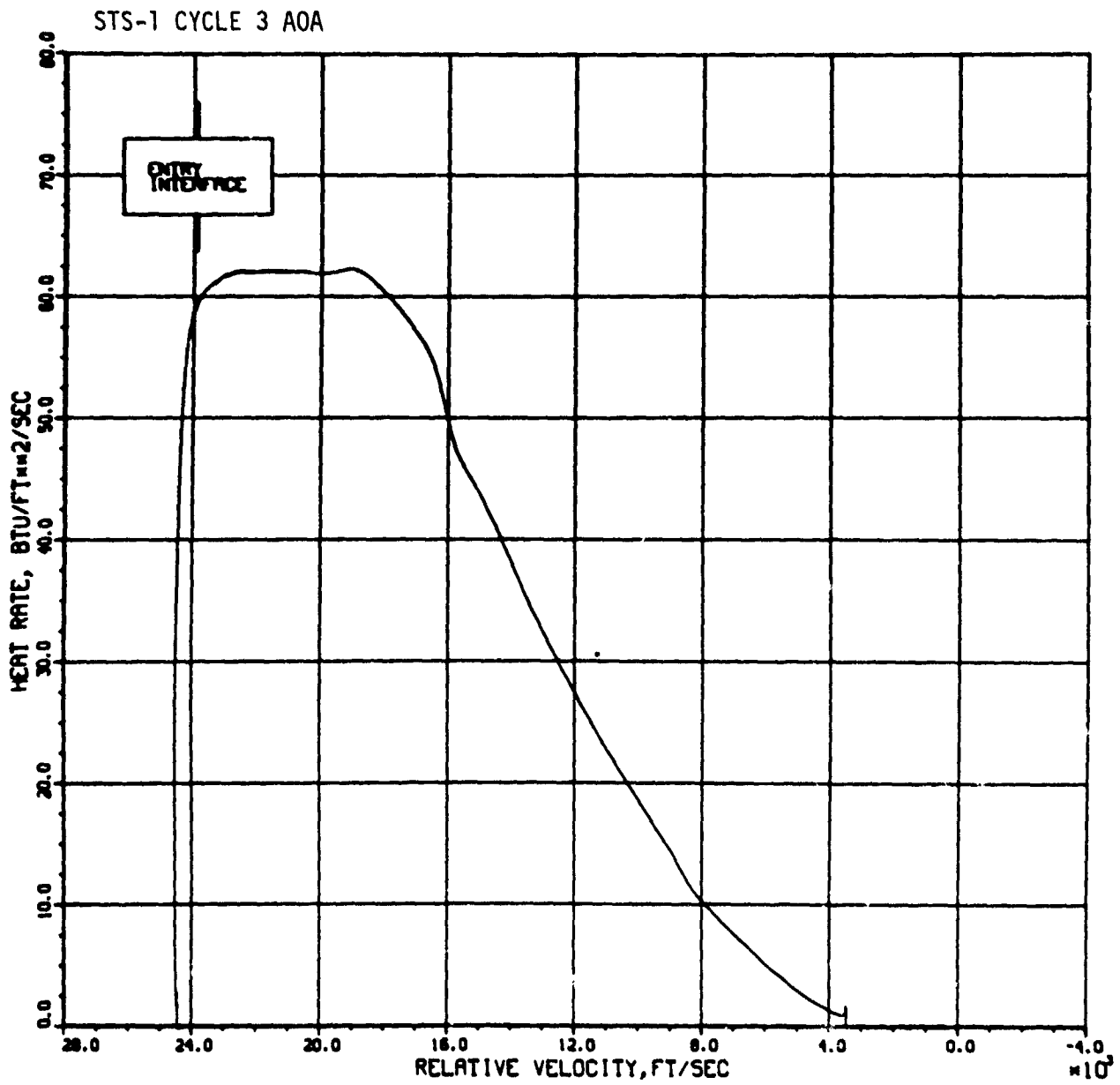

REFERENCE HEAT RATE VS.
RELATIVE VELOCITY

Figure 6.3.2-16.

STS-1 CYCLE 3 AOA

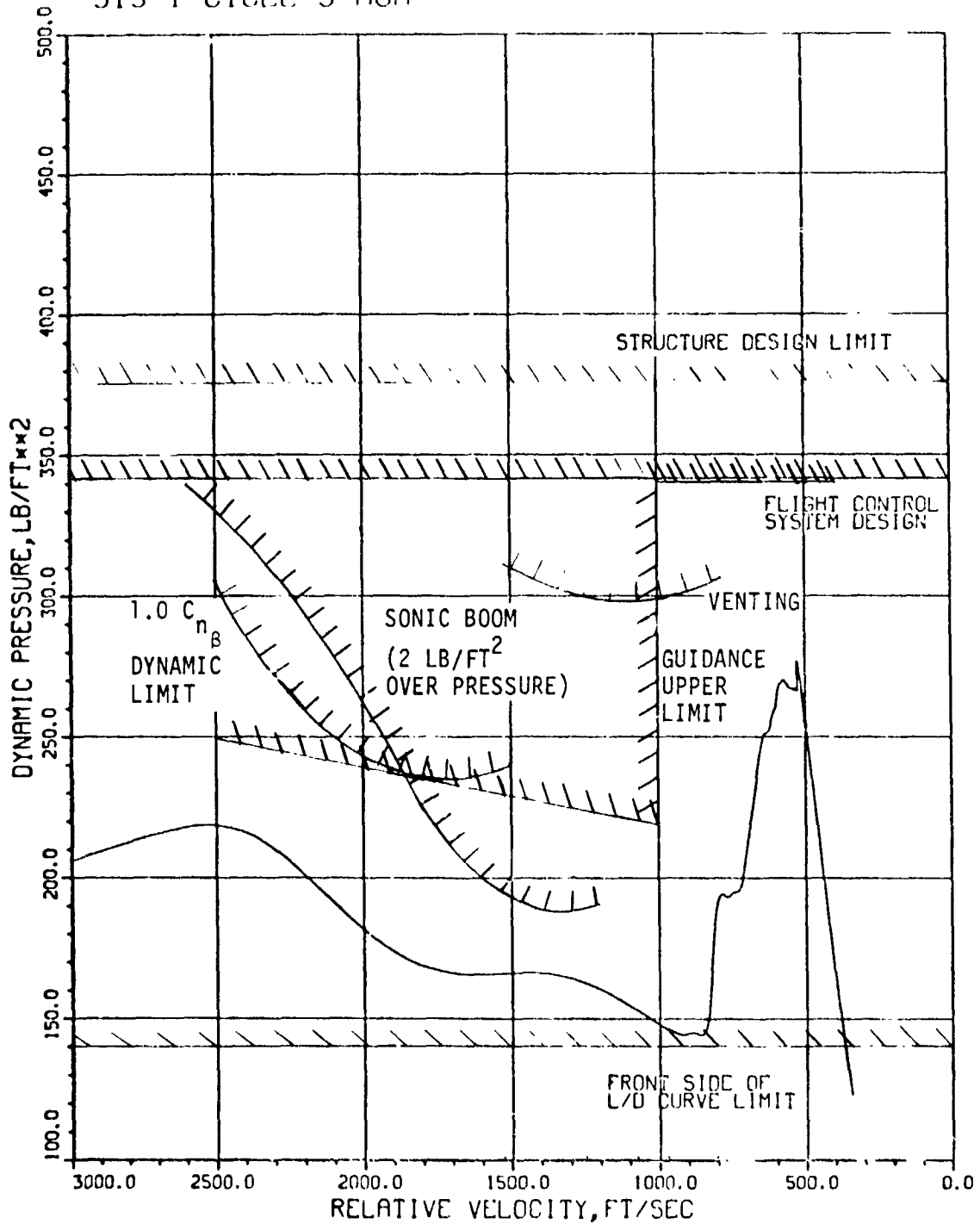

TAEM DYNAMIC PRESSURE CORRIDOR

Figure 6.3.2-17.-

STS-1 CYCLE 3 AOA

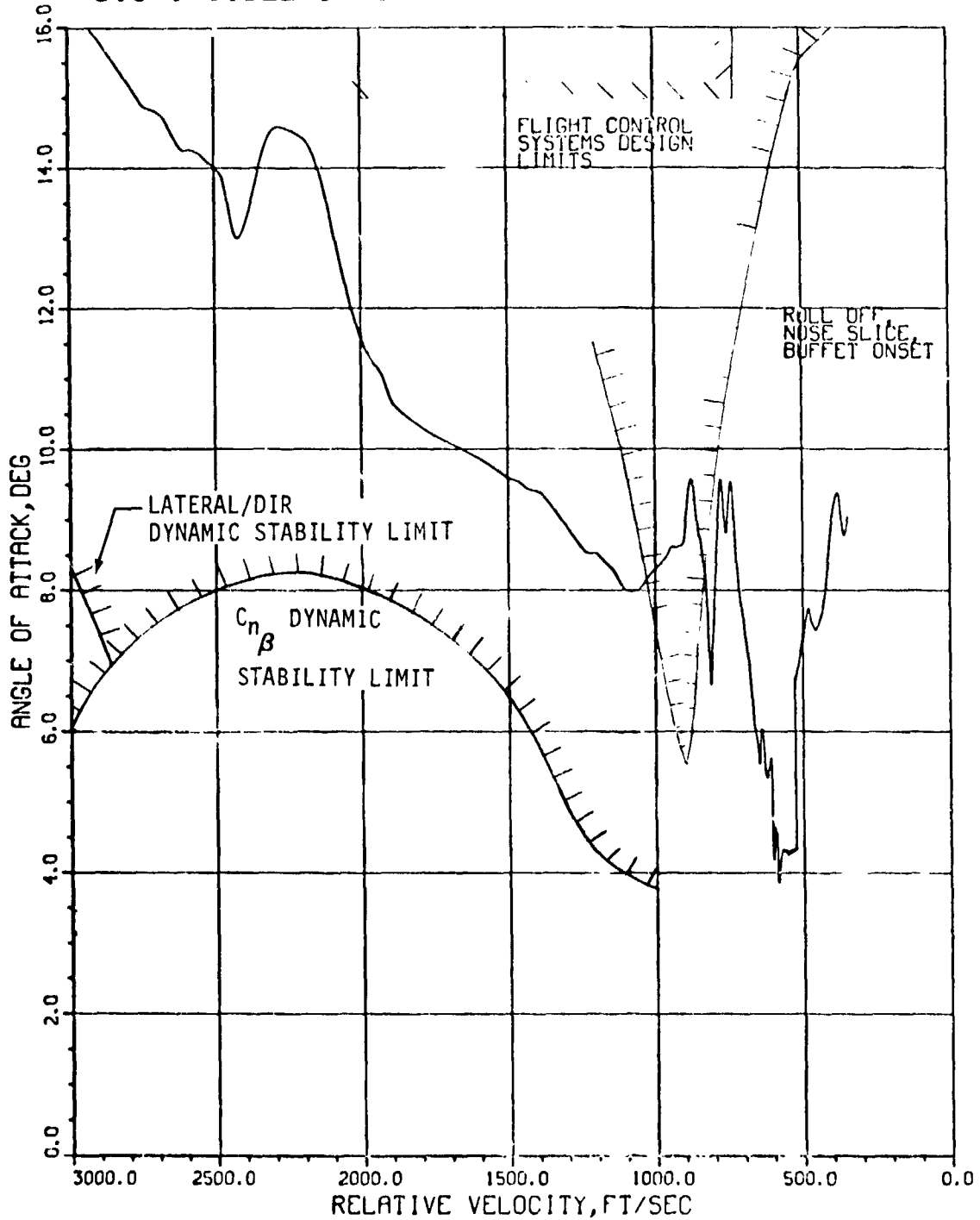

TAEM ANGLE-OF-ATTACK CORRIDOR

Figure 6.3.2-18.

STS-1 CYCLE 3 AOA

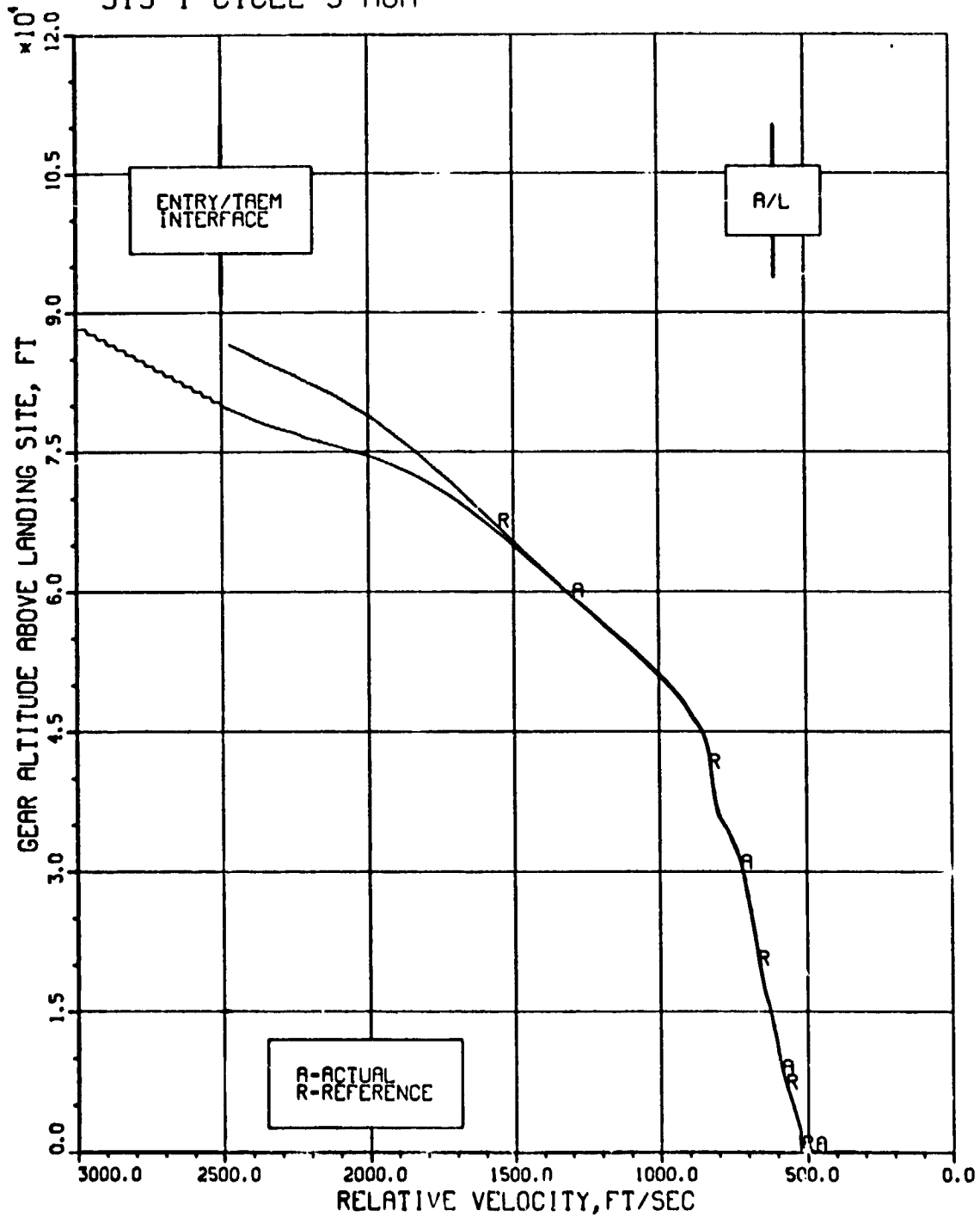

ALTITUDE AND ALTITUDE REFERENCE OF GEAR ABOVE LANDING SITE DURING TAEM

Figure 6.3.2-19.

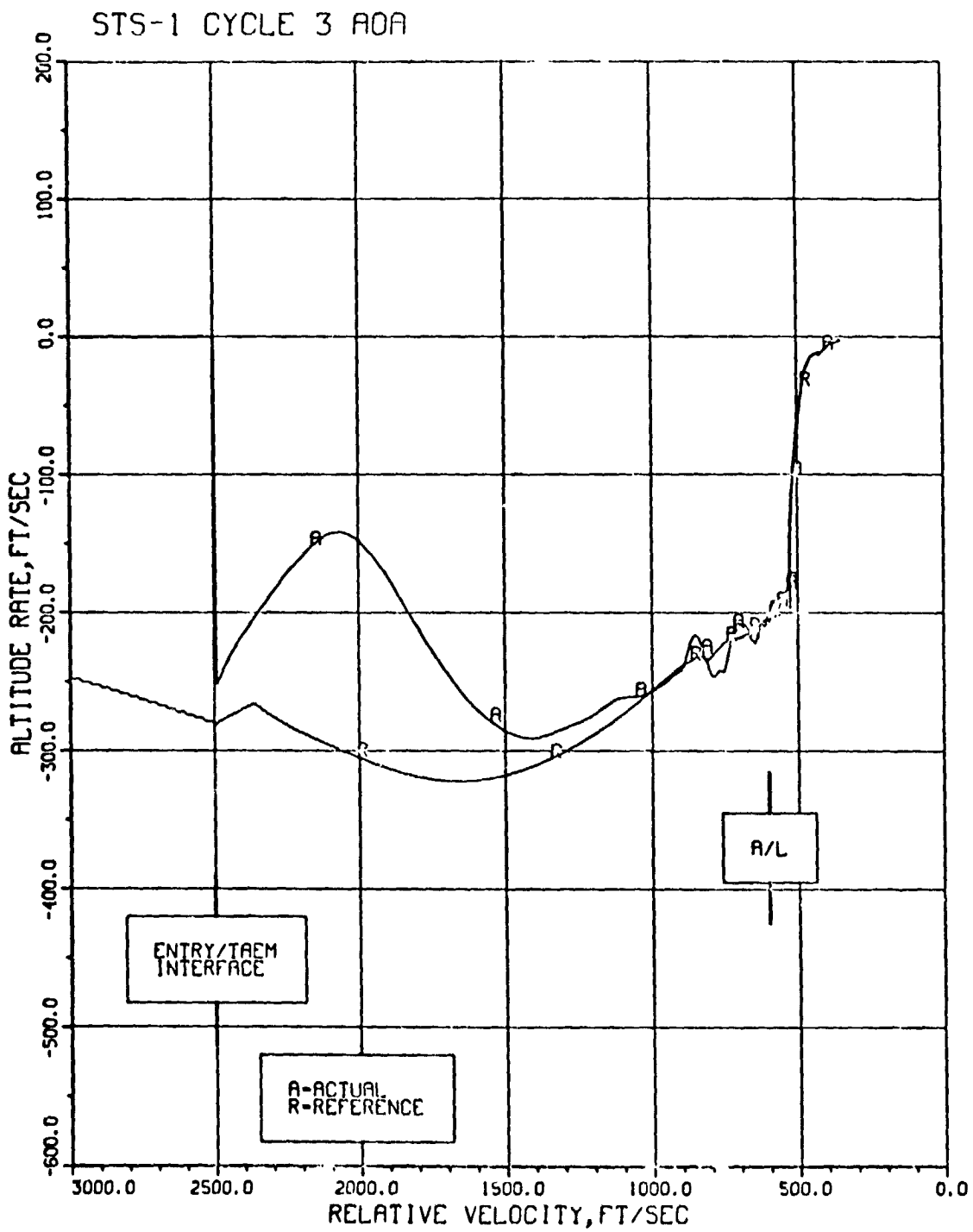

ALTITUDE RATE AND ALTITUDE RATE REFERENCE DURING TAEM

Figure 6.3.2-20.

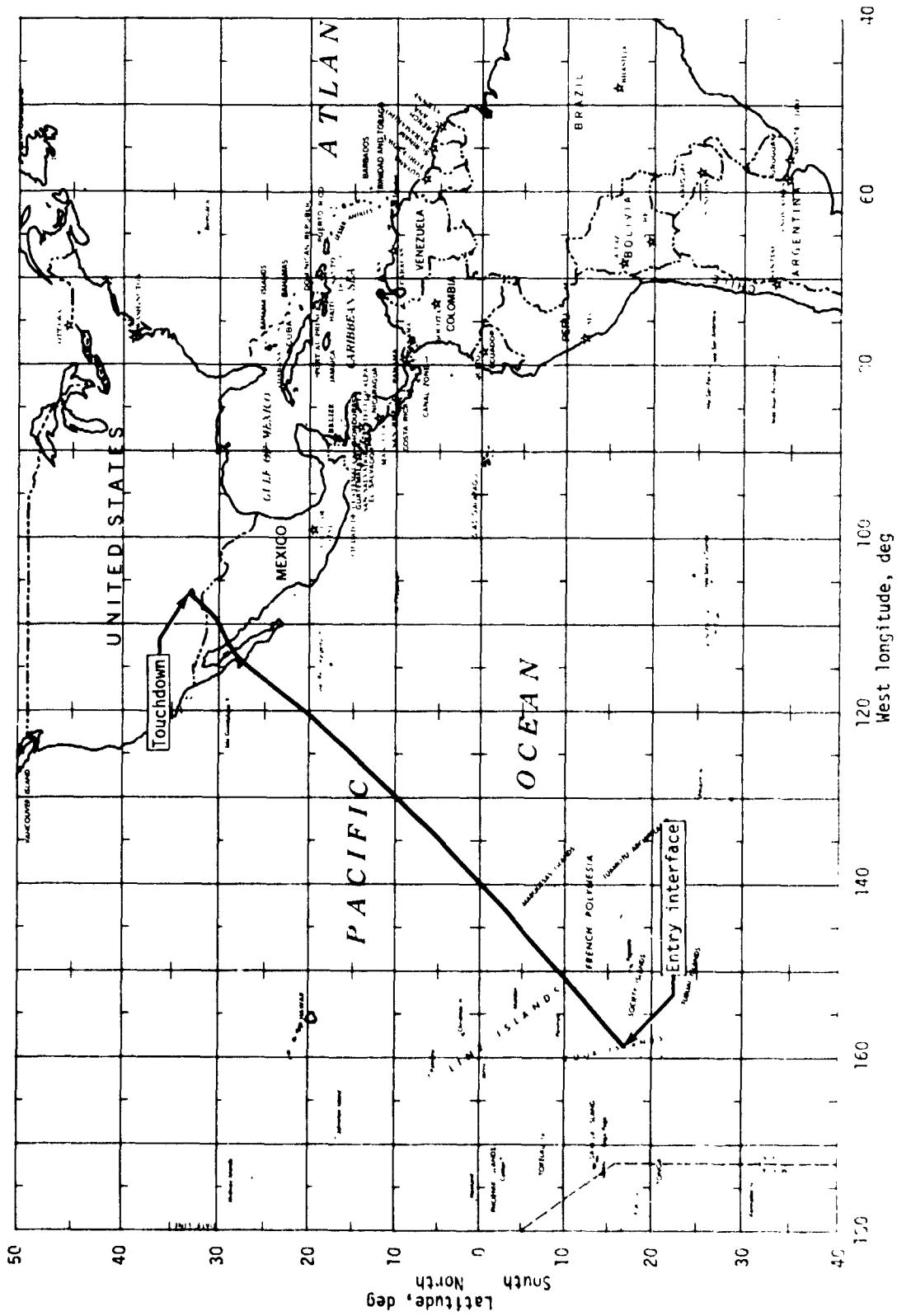

Figure 6.3.2-21.- Earliest ACA groundtrack.

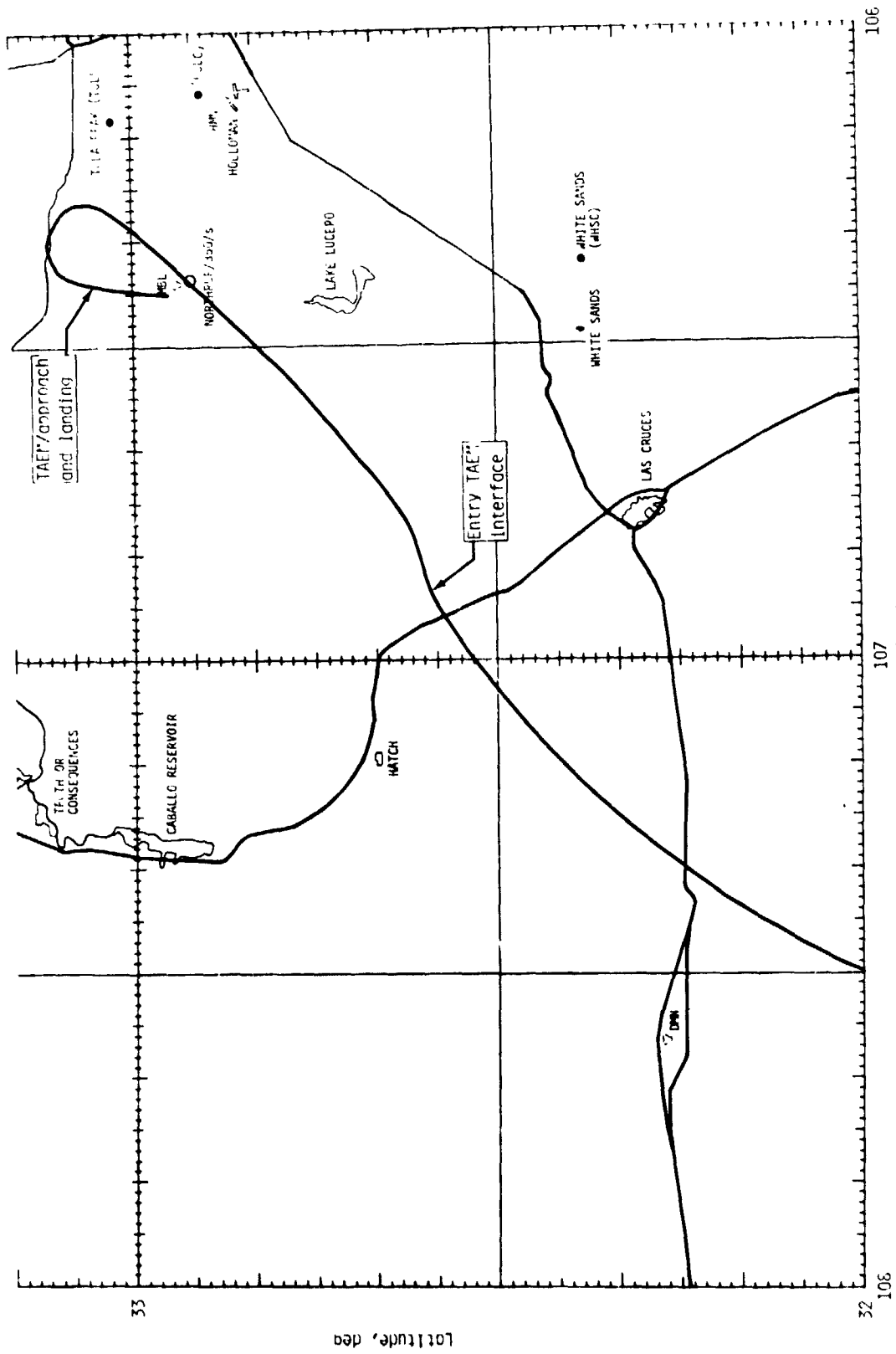
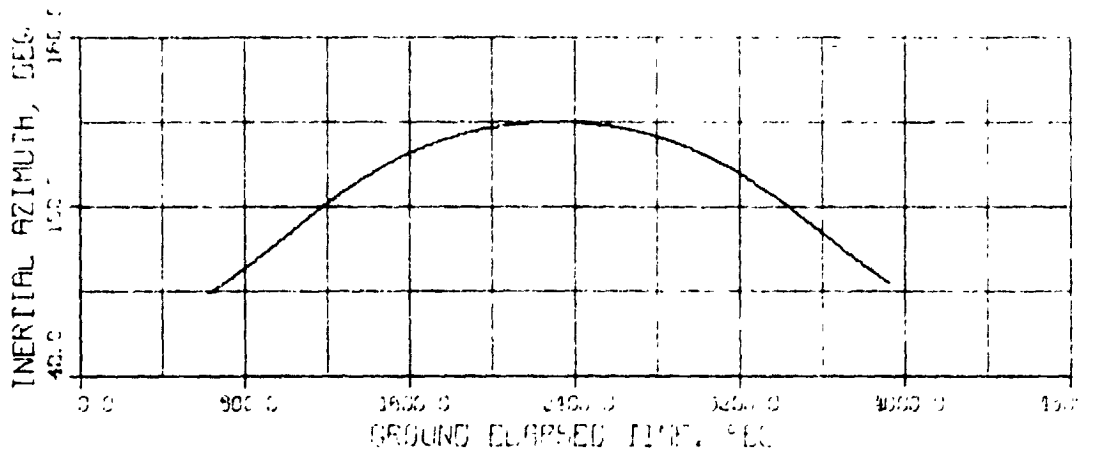
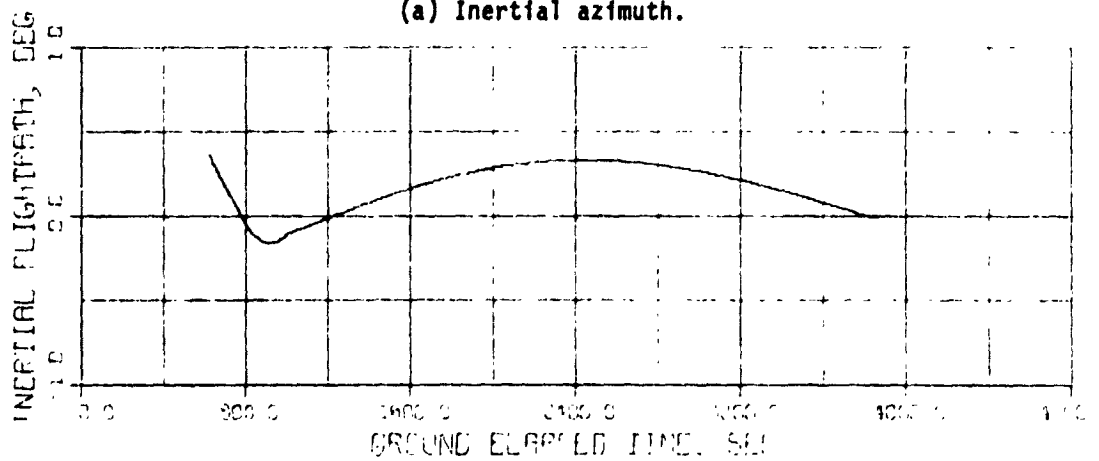

Figure 5.3.2-22.- AOA TAEI, approach and landing area.



(a) Inertial azimuth.



(b) Inertial flightpath angle.

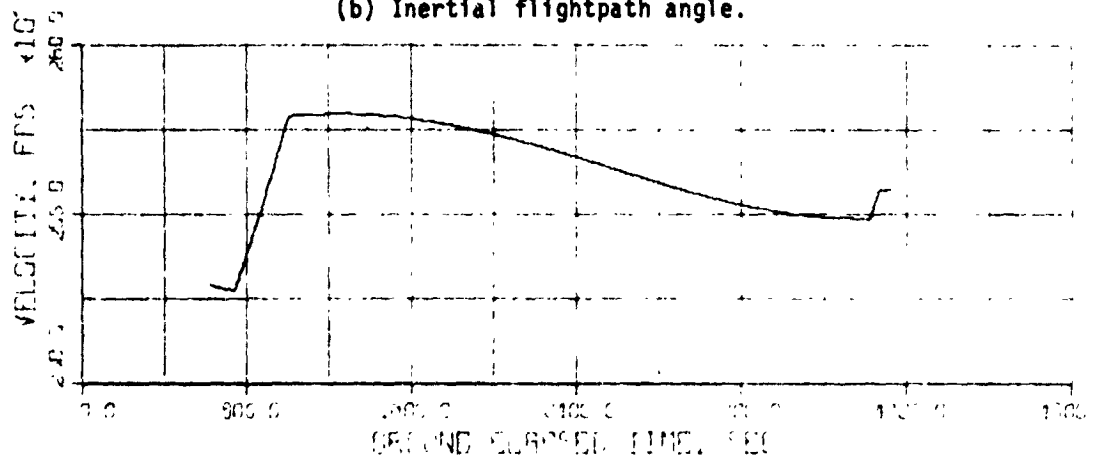

(c) Inertial velocity.

Figure 6.4.1-1.- Maximum underspeed earliest ATO - MECO to OMS-2 cutoff + 60 sec.

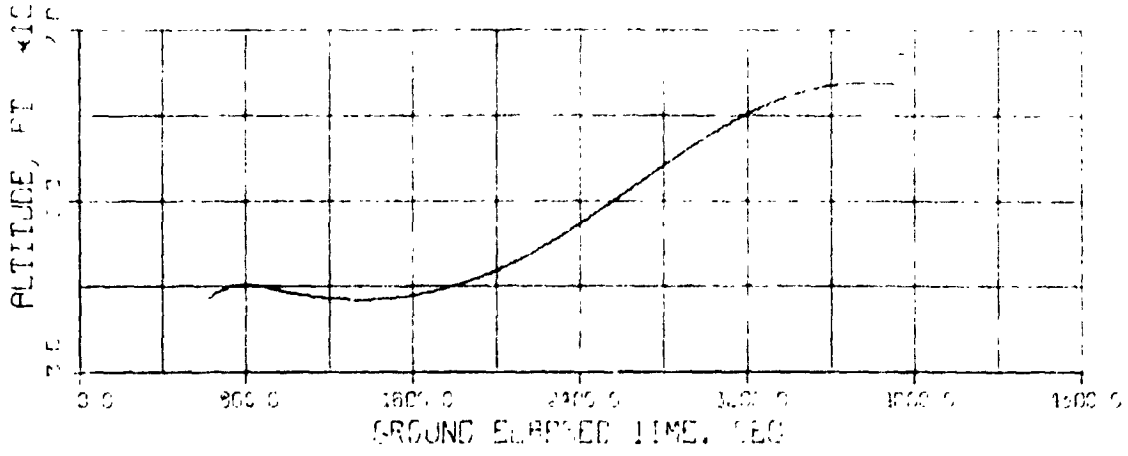

(d) Geodetic altitude.

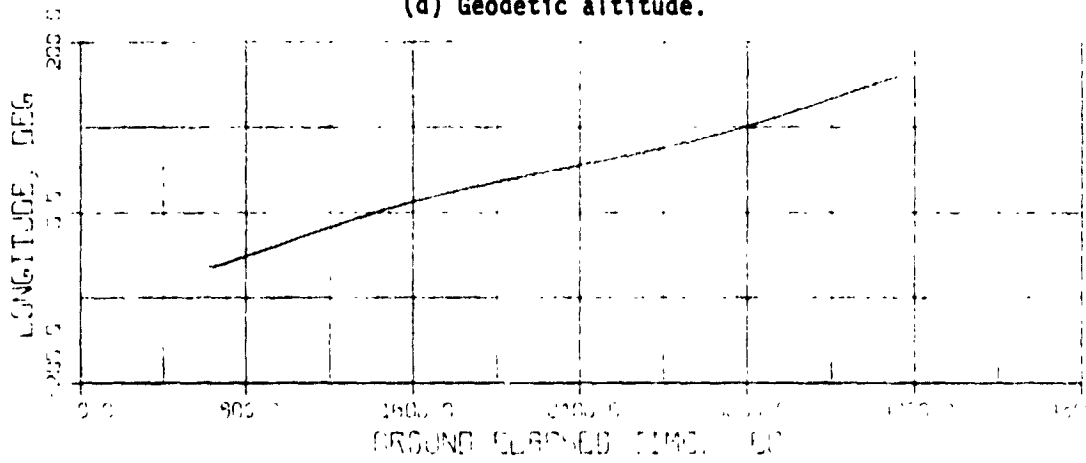

(e) Longitude.

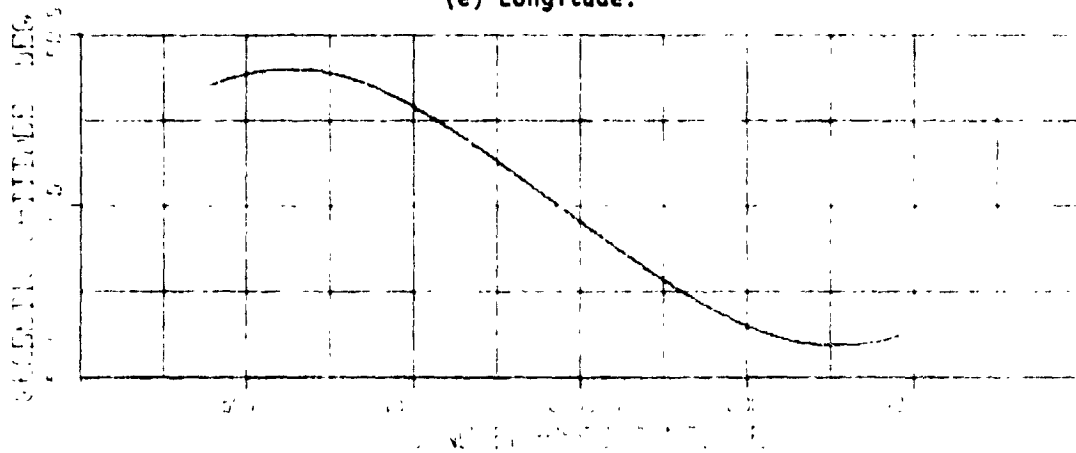

(f) Geodetic latitude.

Figure 6.4.1-1.- Continued.

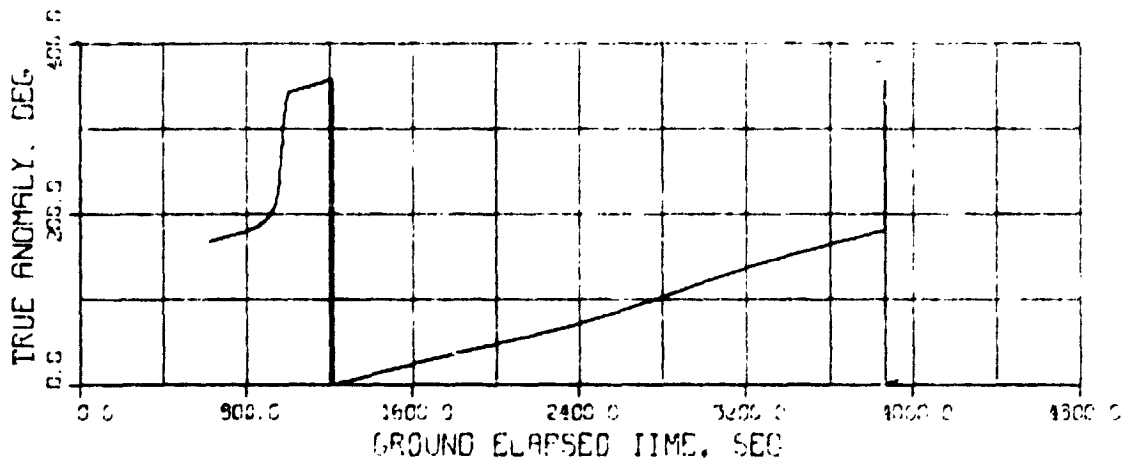

(g) True anomaly.

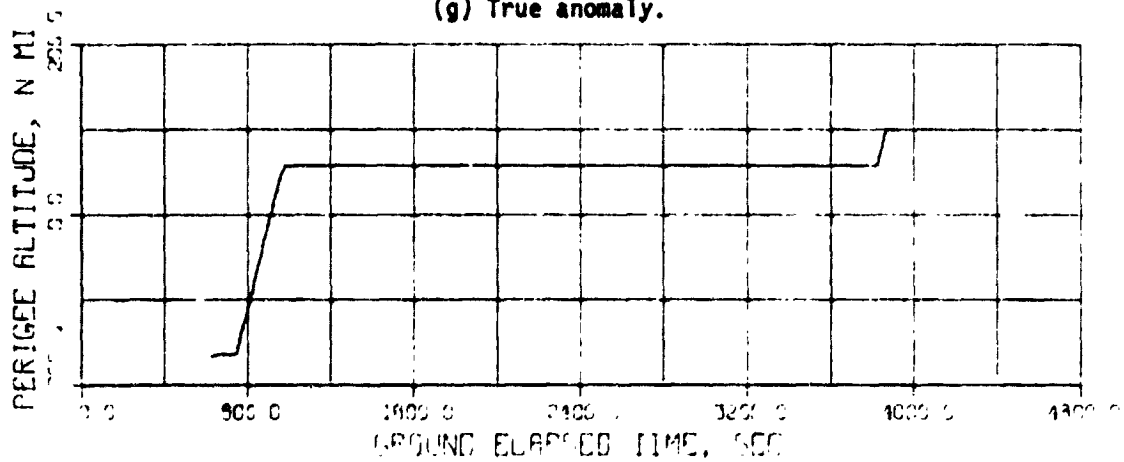

(h) Perigee altitude.

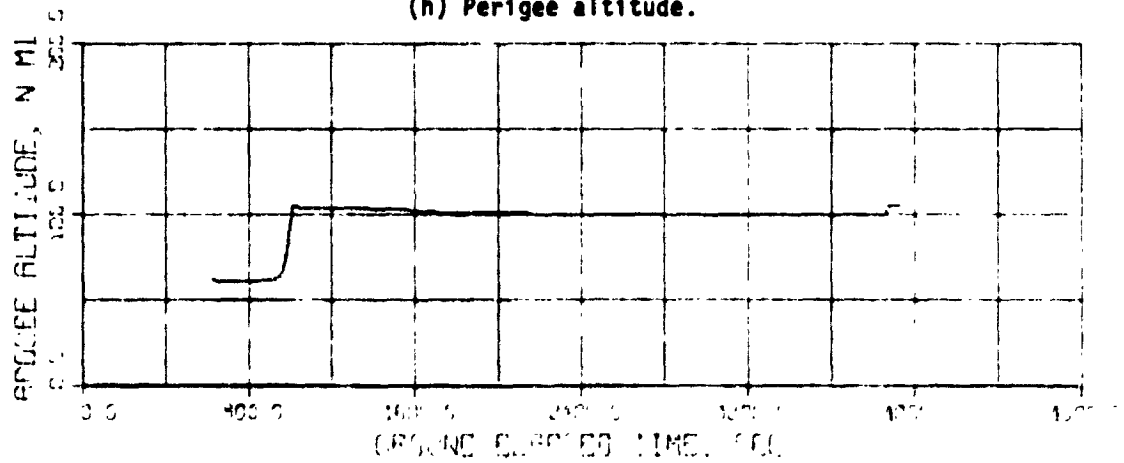

(i) Apogee altitude.

Figure 6.4.1-1.- Concluded.

7.0 SRB AND ET SEPARATION AND DISPOSAL

7.1 SEPARATION

SRB separation for all missions occurs at approximately 131.52 seconds after SRB ignition and always after SRB burnout. The separation system provides safe separation for staging conditions within specified limits and is affected by eight booster separation motors (BSM's) per SRB.

RTLS, AOA, and ATO Orbiter/ET separations are initiated at MECO command. Orbiter separation from the ET for all abort modes is accomplished by firing the RCS thrusters in a four-forward/six-aft combination to obtain Orbiter translation. The RTLS separation occurs at flight conditions from which the Orbiter can make a safe entry and unpowered glide to landing site.

7.1.1 SRB Separation

SRB separation for aborts (RTLS, AOA, and ATO) is like the nominal SRB separation and can only occur after SRB burnout. The SRB separation normally occurs at 131.52 seconds after SRB ignition for the nominal, RTLS, AOA, and ATO missions. The SRB separation sequence is initiated and controlled by the Orbiter. The primary cue for initiation of the separation sequence is the SRB headend chamber pressure, and the backup cue is time elapsed from the command of SRB ignition. Each SRB furnishes redundant chamber pressure signals to the Orbiter during SRB thrust tail-off. Normally, the separation sequence is initiated when the indicated chamber pressure on both SRB's (P_{c4} and P_{c5}) is ≤ 50 psia. The chamber pressure measurements are accurate to ± 20 psia. As a backup, the sequence is initiated on a time (133.0 seconds) that will assure that the chamber pressure of both SRB's is ≤ 50 psia.

The separation is completely automatic but could be inhibited (auto inhibit) if the test on the dynamic pressure limit or the rate inhibit inequality test is failed. SRB separation auto inhibit criteria considered in the separation inhibit test are presented in a listing on the following page.

Commands to null the SRB thrust vector control actuators and to initiate the second-stage flight control system configuration are issued 1.7 seconds before the separation command to ensure that the null has adequate time to be achieved. The command-to-arm separation pyrotechnic initiation controllers (PIC's) is also issued at this time. Commands to separate the SRB's and to initiate a three-axis attitude control are issued 6 seconds after sequence initiation (to assure that the thrust of each SRB is ≤ 60 000 pounds). The attitude hold is terminated 4.0 seconds after the separation command.

The separation is affected by eight BSM's per SRB. Four BSM's are mounted forward in the nose frustum, and four are mounted aft in the SRB skirt. The BSM's nominally burn for 0.68 second with a thrust of 21 700 pounds each.

The SRB separation sequence is shown in figure 7.1.1-1. Separation trajectory data are presented in figure 7.1.1-2 for a normal SRB separation and are applicable to all aborts initiated after SRB staging. For early aborts, one SSME out in first stage, SRB separation occurs in a different environment and with different separation initial conditions (dynamic pressure, angle of attack, sideslip angle, and body angular rates) than the nominal SRB separation but exhibits the same trend.

The separation system provides a safe separation for staging conditions that satisfy the dynamic pressure and rate inhibit inequality tests that are based on the following parameters.

P	- Selected RGA roll rate		
Q	- Selected RGA pitch rate		
R	- Selected RGA yaw rate		
QBAR	- Derived ascent dynamic pressure		
		<u>I-load parameter, value</u>	
AP	- Roll rate limit slope	AP,	0.0
AQ	- Pitch rate limit slope	AQ,	0.0
AR	- Yaw rate limit slope	AR,	0.0
BP	- Roll rate limit constant	BP,	5.0
BQ	- Pitch rate limit constant	BQ,	2.0
BR	- Yaw rate limit constant	BR,	2.0
DPL	- Dynamic pressure limit	DPL,	55.0

Note: Dynamic pressure and rate inhibit inequality tests are as follows -

if $Q \text{ BAR} > \text{DPL}$

or if $|P| > AP (QBAR) + BP$

or if $|Q| > AQ (QBAR) + BQ$

or if $|R| > AR (QBAR) + BR$, then inhibit separation

If an SRB separation is inhibited, the length of the delay will be a variable. Separation will occur when staging conditions are within specified limits or the crew elects to perform manual separation.

7.1.2 ET Separation

RTLS, AOA, and ATO ET separations that occur after MECO are controlled by the Orbiter and may be initiated in either an automatic or manual mode. The ET separation sequence begins at the MECO-confirmed command and is complete after the function of closing and latching the umbilical doors for the RTLS and at the termination of the feedline disconnect valve close commands for the nominal, AOA, or ATO. Events are timed within the ET separation sequence so that each function is accomplished within the appropriate timing constraints.

Status checks and tests are performed prior to separation to assure that Orbiter/ET separation can be conducted safely. For any abort, the ET tumble system is activated 7.2 seconds after the sequence is initiated. Unless the mode of separation is manual, the Orbiter and ET structurally separate following a 13.8-second mated coast for the RTLS and following a 18.0-second mated coast for the AOA or ATO. The RCS thrusters are fired in a minus-Z four-forward/six-aft combination for Orbiter translation from the ET.

7.1.2.1 RTLS Orbiter/ET Separation

The Orbiter/ET separation is designed for flight conditions that allow Orbiter entry/recovery to occur within acceptable control and load boundaries and assure unpowered glide range to reach the landing site. Separation capability is provided for the range of Orbiter weights and c.g. locations from 65 to 68 percent of body length and for as much as 3-percent MPS excess propellant remaining in the ET at separation. The separation functions required for Orbiter/ET separation are initiated and controlled by the Orbiter. The RTLS ET separation concept is presented in figure 7.1.2-1. The RTLS ET separation time line is presented in figure 7.1.2-2.

The separation sequence has several major functions and is initiated at the MECO-confirmed command. First, it determines the mode of separation; i.e., automatic or manual. It then commands the prevalves to close, arms and fires the ET tumble system, commands the disconnect valves closed, arms the umbilical plate unlatch PIC's, gimbals the SSME nozzles to the stow position, deadfaces the Orbiter/ET interface, and unlatches and retracts the umbilical plates. Each of these functions is accomplished within the appropriate time constraints. The sequence then arms the structural separation PIC's and performs some limit tests on body rates and angles before continuing with an automatic separation. RTLS Orbiter/ET automatic separation criteria that must be met before automatic separation can occur are presented in table 7.1.2-1.

In the automatic mode, if any of the requirements-tests are not satisfied, the separation is inhibited and can occur only if the criteria for separation are met or if at least 19.8 seconds have elapsed since MECO command (6 seconds after auto inhibit check).

In the manual mode, the separation functions halt and will resume only if the ET SEP INITIATE pushbutton has been depressed or the auto position of the auto/manual separation switch is selected.

When conditions for either the automatic or manual mode are satisfied, the structural separation PIC's are fired. The RCS thrusters are fired in a minus-Z four-forward/six-aft combination for 10 seconds. Following the first 5 seconds and for the remainder of the translation burn (5 seconds), attitude and rate control are obtained by activation/deactivation of selected RCS jets and rudder deflection. The sequence then performs the function of closing and latching the umbilical doors at which time the separation sequence is terminated.

The RTLS Orbiter/ET separation is planned to occur with an initial pitch rate of -0.25 deg./sec and an initial angle of attack of -4.0 degrees. The RTLS

Orbiter/ET separation boundaries for the STS-1 mission are presented in figure 7.1.2-3. Without considering the effects of propellant dynamics or dispersed aerodynamics, safe separation can be accomplished for ranges of initial pitch rate and angle of attack to the left of the dynamic pressure boundaries of 5 and 7 lb/ft², and the capability increases with decreasing dynamic pressure.

Effects of propellant dynamics and dispersed aerodynamics are illustrated in figure 7.1.2-4. The effect of propellant dynamics plus dispersed aerodynamics is for a dynamic pressure of 7 lb/ft² and 2 percent movable propellant case. The effect of dispersed aerodynamics alone is for a dynamic pressure of 7 lb/ft². The comparison shows that the trend is for the safe separation boundary to narrow when propellant dynamic effects and dispersed aerodynamic effects are included.

A pictorial separation of the Orbiter from the ET in the pitch plane representative of a separation for the STS-1 mission is presented in figure 7.1.2-5. Separation characteristics are presented for the following three RTLS Orbiter/ET separation cases:

- a. No. 1 SSME - failure at 262.5 seconds MET (RTLS at 272.5 seconds)
- b. No. 2 SSME - failure at lift-off (RTLS at 150.0 seconds)
- c. Three SSME RTLS at 260 seconds

Data for these 3 cases are presented in figures 7.1.2-6 through 7.1.2-8. Displacement from the mated position of the nose of the Orbiter from the nose of the ET (ΔX and ΔZ versus time) and the angle of attack for each vehicle (α_{orb} and α_{et} versus time) are presented for each case. The average relative displacement at the end of the 10-second -Z translation for the three cases is approximately $\Delta X = 700$ inches (58 feet) and $\Delta Z = 1460$ inches (121 feet) as the ET moves below and behind the Orbiter. The angle of attack for the two vehicles is diverging as they move apart.

7.1.2.2 AOA and ATO Orbiter/ET Separation

AOA and ATO use the same Orbiter/ET separation sequence as nominal ascent. The Orbiter/ET separation sequence, controlled by the Orbiter, is initiated at the MECO-confirmed command when all SSME engine chamber pressures are below 30 percent. The mode of separation may be automatic or manual. In the auto mode, separation takes place if (1) the body rate limit is not exceeded in any axis and (2) the propellant feed umbilical disconnect valves are closed. If these two requirements for auto separation are not met, they may be manually bypassed. Separation may then be initiated by placing the auto/manual switch in the manual position and depressing the separation push button. The ET separation timeline applicable to the nominal, AOA, and ATO missions is presented in figure 7.1.2-9.

After initiation of the separation sequence, there is a mated coast with issuance of a series of commands and status checks. The ET tumble system is activated 7.7 seconds after the MECO-command. Rate damping and attitude hold after SSME thrust tail-off is performed with the TRANS DAP using forward and aft RCS

systems. A snapshot of the body attitude is taken at initiation of the TRANS DAP. The attitude deadbands (roll, pitch, and yaw) are set to ± 5.0 deg/axis. Body rates (roll, pitch, and yaw) for attitude rate control are ± 0.3 deg/sec/axis.

The Orbiter structurally releases the ET at MECO-confirmed +17 seconds. RCS jet firing is initiated 0.16 second prior to structural release to assure a positive separation rate between the Orbiter and ET and to preclude possible damage at the forward attach strut. Maximum time delay from the first to the last structural release is not greater than 0.02 second. The Orbiter performs a high-mode RCS $-Z$ translation for a translational $\Delta V_{-Z \text{ body}} \geq 4.0$ fps, which is then followed approximately 2.0 seconds later by a $+Y$ translation for a $\Delta V_{+Y \text{ body}}$ of 4.0 fps.

Four forward and six aft RCS jets are used to achieve the translational ΔV_{-Z} of 4.0 fps. Thrust duration for the nominal $-Z$ translation is approximately 5.3 seconds.

An attitude deadband of ± 3.0 deg/axis and rate deadband of ± 0.3 deg/sec/axis are maintained during the maneuver. The $-Z$ translation assures Orbiter clearance from the arc of a rotating ET.

Approximately 2.0 seconds following the $-Z$ translation, a $+Y$ translational maneuver is executed for a $\Delta V_{+Y \text{ body}}$ of 4.0 fps. Two-side firing RCS jets (one

forward and one aft) are used to perform the $+Y$ translation and thrust duration is for 24 seconds. An attitude deadband of ± 3.5 deg/axis and rate deadband of ± 0.3 deg/sec/axis are maintained during the maneuver. The $+Y$ translation places the Orbiter out of plane from the ET to a more preferred relative position for performing the OMS-1 burn.

The Orbiter continues to coast away from the ET to obtain additional vertical and horizontal clearance prior to OMS-1 ignition. During the coast period, the Orbiter maneuvers at 1.0 deg/sec to the OMS-1 burn attitude. The Orbiter is aligned to the burn attitude when ignition occurs at MECO command +17.4 seconds.

Relative motion between the Orbiter and ET from structural separation through 10 seconds of the OMS burn is presented in a target-centered curvilinear coordinate system in figure 7.1.2-10. No recontact problems exist at separation or during the following maneuver for the AOA or ATO Orbiter/ET separation.

7.2 SRB AND ET DISPOSAL

After staging, the SRB elements will impact in the Atlantic Ocean in a region between 83.1 n. mi. downrange from the launch pad, for an engine-out on the pad RTLS abort, and 141.4 n. mi. downrange for the nominal, ATO, and AOA aborts.

The ET disposal area for an RTLS abort will be in a region between approximately 94 and 135 n. mi. from the launch pad. This area overlaps the SRB impact corridor. For AOA or ATO missions, the ET will impact in the Indian Ocean if a guided MECO is achieved. For press-to-MECO conditions where MECO underspeeds result, the ET impact area ranges from the Atlantic Ocean, across the African continent, to the Indian Ocean.

7.2.1 SRB Disposal

The left and right SRB's are jettisoned after burnout (lift-off + 131.4 seconds nominally) on tumbling free-fall trajectories. At 78.5 seconds after separation (nominal apogee), the nozzle extension on each SRB is jettisoned. During the descending portion of the trajectory, the SRB's achieve a nose-up trim condition. At an altitude of 17 000 feet, the nose cap on each SRB is jettisoned, beginning the parachute deployment sequence. This culminates at 7000 feet with the deployment of three main parachutes on each SRB. The nozzle extension and frustum impact such that their three-sigma footprints lie mostly within that of the SRB. The nozzle extension impacts five n. mi. uprange and approximately half of its footprint lies within that of the SRB. The SRB impact areas defined for the nominal mission apply for all AOA and ATO aborts as well as for all RTLS aborts occurring after SRB separation. Only engine failures between lift-off and SRB cutoff affect the footprint, shifting the footprint in an uprange direction.

7.2.1.1 SRB Disposal for Engine-Out Off the Pad RTLS Abort

The abort mission which causes maximum uprange shift in the SRB impact point is SSME 2 failure at lift-off. Table 7.2.1-I presents the sequence of significant events for this trajectory. The right SRB impacts in the Atlantic Ocean 280.6 seconds after separation, 91.9 n. mi. from the launch site. The left SRB impacts approximately 0.4 n. mi. SSE of the right SRB, 280.6 seconds after separation. This also occurs 91.9 n. mi. from the launch site. Impact points for both SRB's and all jettisoned components are summarized in table 7.2.1-II. Figure 7.2.1-1 shows the composite footprint containing all elements of both SRB's. The composite footprint is 13.5 n. mi. long and 8.8 n. mi. wide.

7.2.1.2 SRB Disposal for AOA, ATO, and Latest RTLS

The nominal mission results in SRB impact points further from the launch site than engine-out RTLS aborts occurring before nominal SRB separation. For late RTLS, and for all AOA and ATO aborts, the SRB impact footprint is unchanged from the nominal. Table 7.2.1-III presents the sequence of significant events for this trajectory. The right SRB impacts in the Atlantic Ocean 311.3 seconds

after separation 136.9 n. mi. from the launch site. The left SRB impacts approximately 0.5 n. mi. SSE of the right SRB, 311.3 seconds after separation. This is also 136.9 n. mi. from the launch site. Impact points for both SRB's and all jettisoned components are summarized in table 7.2.1-IV. Figure 7.2.1-2 shows the composite footprint containing all elements of both SRB's. The composite footprint is 13.3 n. mi. long and 9.9 n. mi. wide. Figure 7.2.1-3 illustrates the location and size of the impact corridor for the STS-1 mission. The engine-out RTLS and nominal footprints define the extremes of this corridor that measures 58.3 n. mi. long and 9.9 n. mi. wide. For the nominal, AOA, ATO, and RTLS profiles there is a 99.73-percent probability that the SRB elements will land within this corridor.

7.2.2 ET Disposal

For ET disposal analysis ascent aborts are divided into four regions as shown in figure 7.2.2-1. The RTLS abort region for ET disposal is the same as that for ascent design. The AOA/ATO abort region is divided into three subregions. The first is the press-to-MECO (PTM) contingency abort region with an SSME failure between the earliest PTM time (262.5 seconds GET) and the 50/50 PTM time (293.5 seconds GET). For this region there is less than a 50-percent chance of achieving a guided MECO. In most cases an underspeed exists at MECO.

The second region is the guided MECO abort region, which extends from the 50/50 PTM time to MECO minus 15 seconds (503.3 seconds GET). If an SSME fails during this time, the probability of achieving a guided MECO is greater than 50 percent.

The last region is the fine countdown contingency abort region with an SSME failure between MECO minus 15 seconds and nominal MECO (518.3 seconds GET). When an engine failure occurs, excursions in the flightpath angle result. Normally, the guidance corrects these errors, and the target flightpath angle is reached. However, if an engine fails during the last 15 seconds prior to MECO, the guidance does not have time to correct the excursions. Maximum excursions in flightpath angle occur when an engine fails at the start of the fine countdown region (MECO -10 seconds) during which time no flightpath angle corrections are made. If SSME-1 fails at this time, the flightpath angle at MECO is 0.29 degrees instead of the target of 0.5 degree. If SSME-2 or 3 fails, the MECO flightpath angle is 0.6 degree. These excursions in MECO flightpath angle cause large shifts in the ET impact footprint position.

The following sections present the ET impact areas for each of the four ET disposal abort regions.

7.2.2.1 ET Disposal for RTLS Aborts

The Orbiter/ET separation occurs 12.5 seconds after MECO, and the ET is jettisoned on a suborbital trajectory that results in an impact location in the Atlantic Ocean. Trajectory errors, attitude errors, atmosphere and drag uncertainties, and wind effects result in an ET impact footprint uprange and downrange of the impact point. Figure 7.2.2-2 presents the size and shape of the ET impact footprint for any given RTLS profile.

For the STS-1 mission, RTLS ET separation velocities will range from approximately 6160 to 6653 fps (Earth relative). Separation will occur downrange from the RTLS landing site along the groundtrack from approximately 212 to 236 n. mi. from the launch pad.

Twelve RTLS profiles from the earliest to latest RTLS were examined, and the following six define the extremes of the impact area:

- a. SSME-2 out at lift-off, RTLS selected at 150.0 seconds GET, ET impact at latitude 29.60° N and longitude 78.54° W.
- b. SSME-1 out at 60.0 seconds GET, RTLS selected at 150.0 seconds GET, ET impact at latitude 29.74° N and longitude 78.41° W.
- c. SSME-2 out at 60.0 seconds GET, RTLS selected at 150.0 seconds GET, ET impact at latitude 29.65° N and longitude 78.48° W.
- d. SSME-1 out at 254.0 seconds GET. RTLS selected at 264.0 seconds GET, ET impact at latitude 29.73° N and longitude 78.73° W.
- e. SSME-1 out at 262.5 seconds GET, RTLS selected at 272.5 seconds GET, ET impact at latitude 29.76° N and longitude 78.65° W.
- f. No engines out, RTLS selected at 260.0 seconds GET, ET impact is latitude 29.70° N and longitude 78.77° W.

All other RTLS ET trajectories examined impact between these six impact points.

Figure 7.2.2-3 shows the STS-1 RTLS impact footprint corridor for the ET and SRB's. The ET corridor is 63.4 n. mi. long and 23.2 n. mi. wide. Approximately half of the SRB corridor lies within the ET corridor. Figure 7.2.2-3 shows that the ET footprint will not violate the constraint of not impacting closer than 25 n. mi. from a landmass. Also, this figure shows that the ET footprint will not violate the constraint of impacting west of a line connecting the following two points:

latitude 30.000° N	longitude 80.310° W
latitude 31.440° N	longitude 79.895° W

The SRB's impact at 443 seconds GET for the nominal profile and 412 seconds GET for the early RTLS profile. The latest ET impact time for the RTLS abort profiles considered is 9.5 minutes after the SRB nominal impact at 1011 seconds GET.

7.2.2.2 ET Disposal for AOA/ATO Aborts

The Orbiter/ET separation occurs 16.5 seconds after MECO, and the ET is jettisoned on a suborbital trajectory. The MECO target conditions for an STS-1 nominal, ATO, or AOA profile are as follows:

Altitude = 60 n. mi. (referenced to the equatorial radius)

$$V_I = 25\ 668\ \text{fps}$$

$$Y_I = 0.5\ \text{degree}$$

Insertion, drag, and atmospheric and rotational lifting effect uncertainties, together with the estimate of breakup debris scatter during entry, results in an ET impact dispersion footprint both uprange and downrange from the theoretical intact impact point.

ET PTM Contingency Aborts - For the earliest PTM profile (an SSME at 262.5 seconds GET), MECO occurs with an underspeed of 410 fps for three-sigma low performance, an underspeed of 56 fps for nominal performance, and achieves a nominal guided MECO for one-sigma high performance. Tables 7.2.2-I and 7.2.2-II give the MECO conditions, intact impact locations, and the contributions of the various errors to the footprint for the first two earliest PTM profiles. Figure 7.2.2-4 presents the ET groundtrack and dispersion footprint area for this abort region. The uprange footprint boundary is latitude 36.9° N and longitude 6.8° W. The downrange footprint boundary, represented by the nominal ET impact footprint, is latitude 35.9° S and longitude 106.6° E. The crossrange boundary is ± 0.5 degree wide.

ET Guided MECO Aborts - For the 50/50 PTM profile (a 50-percent chance that a guided MECO will be achieved with an SSME out at 293.5 seconds GET), the ET intact impact location is latitude 32.8° S and longitude 97.2° E in the Indian Ocean. For an SSME out at 15 seconds prior to MECO (503.3 seconds GET), the ET intact impact location is latitude 31.2° S and longitude 93.7° E. Tables 7.2.2-III and 7.2.2-IV give the MECO conditions, intact impact locations, and the contributions of the various errors to the footprint for both profiles. Figure 7.2.2-5 presents the ET groundtrack and dispersion footprint area for this abort region. The uprange footprint boundary is latitude 21.9° S and longitude 77.9° E. The downrange footprint boundary is latitude 37.3° S and longitude 111.4° E. The crossrange boundary is ± 0.5 degree in width.

ET Fine Countdown Contingency Aborts - An SSME failure at 10 seconds prior to MECO produces deviations of MECO flightpath angle of $+0.1$ or -0.21 degree from nominal MECO target because of the freezing of guidance at this time. Tables 7.2.2-V and 7.2.2-VI give the MECO conditions, intact impact locations, and the contributions of various errors to the footprint for these two profiles. Figure 7.2.2-6 presents the ET groundtrack and dispersion footprint area for this abort region. The uprange footprint boundary is latitude 9.3° S and longitude 62.0° E. The downrange footprint boundary is latitude 36.6° S and longitude 108.9° E. The crossrange boundary is ± 0.5 degree wide.

TABLE 7.1.2-1.- RTLS ORBITER/ET
AUTO SEPARATION CRITERIA

Parameter	Unit
Roll rate, P	0.0 \pm 5.0 deg/sec
Pitch rate, Q	-0.25 + 0.5 deg/sec -4.75 deg/sec
Yaw rate, R	0.0 \pm 0.5 deg/sec
Angle of attack, α	-4.0 + 2 deg - 85 deg
Sideslip angle, β	0.0 \pm 2.0 deg
Roll angle, ϕ	no inhibit

TABLE 7.2.1-I.- SRB DISPOSAL SEQUENCE OF EVENTS AND STS-1 EARLIEST RTLS

Event	Time	Altitude
SRB separation (lift-off + 131.5 sec)	0.0	142 662
Terminate separation motor burn	2.0	146 508
Jettison nozzle extension	78.5	198 856
Jettison nose cap and deploy pilot chute	203.4	17 000
Deploy drogue chute	204.4	16 506
Jettison frustum and deploy 3 main parachutes	226.9	7 000
SRB impact	280.7	0
Nose cap impact	322.9	0
Nozzle extension impact	323.7	0
Frustum impact	369.1	0

TABLE 7.2.1-II.- NOMINAL IMPACT POINT LOCATION OF EACH
SRB ELEMENT AND STS-1 EARLIEST RTLS

Element	Geodetic latitude, deg	Longitude, deg	DR ^a , n. mi.	CR ^a , n. mi.
Left SRB	29.296	-79.044	--	--
Left SRB nozzle extension	29.253	-79.127	-5.1	0.4
Left SRB nose cap	29.295	-79.043	0.0	.1
Left SRB frustum	29.297	-78.043	.1	0.0
Right SRB	29.302	-79.047	--	--
Right SRB nozzle extension	29.258	-79.130	-5.1	.4
Right SRB nose cap	29.301	-79.046	0.0	.0
Right SRB frustum	29.302	-79.046	.1	0.0

^aDR and CR are the relative downrange and crossrange distances from the impact point of the SRB to those of its components.

TABLE 7.2.1-III.- SRB DISPOSAL SEQUENCE OF EVENTS, STS-1
 NOMINAL, ATO, AOA, AND LATEST RTLS

Event	Time	Altitude
SRB separation (lift-off + 131.4 sec)	0.0	167 274
Terminate separation motor burn	2.0	172 037
Jettison nozzle extension	78.5	261 770
Jettison nose cap and deploy pilot chute	233.8	17 000
Deploy drogue chute	234.8	16 508
Jettison frustum and deploy 3 main parachutes	257.5	7 000
SRB impact	311.3	0
Nose cap impact	353.3	0
Nozzle extension impact	358.3	0
Frustum impact	399.7	0

TABLE 7.2.1-IV.- NOMINAL IMPACT POINT LOCATION OF EACH SRB ELEMENT, STS-1
 NOMINAL, AOA, ATO, AND LATEST RTLS

Element	Geodetic latitude, deg	Longitude, deg	DRA, n. mi.	CRA, n. mi.
Left SRB	29.732	-78.337	--	--
Left SRB nozzle extension	29.682	-78.426	-5.6	0.4
Left SRB nose cap	29.731	-78.337	-.1	0.1
Left SRB frustum	29.733	-78.336	.1	0.0
Right SRB	29.739	-78.341	--	--
Right SRB nozzle extension	29.688	-78.430	-5.6	0.4
Right SRB nose cap	29.738	-78.342	-.1	0.1
Right SRB frustum	29.740	-78.340	.1	0.0

^aDR and CR are the relative downrange and crossrange distances from the impact point of the SRB to those of its components.

TABLE 7.2.2-1.- STS-1 ET DISPERSION, EARLIEST PTM (3 σ LOW PERFORMANCE)

SSME cutoff conditions:
 Flightpath angle = 0.35 $^\circ$
 Velocity = 25 258 fps
 Altitude = 59.7 n. mi.
 Inclination = 40.3 $^\circ$
 Range = 942 n. mi.
 Latitude = 35.5 $^\circ$ N
 Longitude = 64.0 $^\circ$ W
 ET weight = 85 017 lb

Impact point:
 Latitude = 35.1 $^\circ$ N
 Longitude = 0.2 $^\circ$ W
 Surface range from pad = 4021 n. mi.
 LH₂ rupture altitude = 343 000 ft
 LOX rupture altitude = 260 000 ft
 Breakup altitude = 195 000 ft

Error source	3 σ error	Downrange, n. mi.	Upr. nge, n. mi.	Crossrange, n. mi.
Separation altitude	\pm 2678 ft	25	25	0
Separation velocity	\pm 10.66 fps	40	39	0
Separation flightpath angle	\pm 0.021 deg	38	38	0
Drag	\pm Tolerances	10	11	0
Atmosphere	3 σ Dense/thin	45	68	1
Weight	\pm 10 000 lb	19	22	0
Azimuth	\pm 0.071 deg	0	0	3
Trajectory dispersion 3 σ RSS		79	94	3
Rotational lifting effect (3 σ)		182	138	6
Debris scatter		95	190	15
Total footprint with debris scatter (3 σ)		290	361	22

TABLE 7.2.1-II.- STS-1 ET DISPERSION, EARLIEST PTM (NOMINAL PERFORMANCE)

SSME cutoff conditions:
 Flightpath angle = 0.4°
 Velocity = 25 612 fps
 Altitude = 59.9 n. mi.
 Inclination = 40.3°
 Range = 966 n. mi.
 Latitude = 35.6° N
 Longitude = 63.6° W
 ET weight = 85 071 lb

Impact point:
 Latitude = 8.7° S
 Longitude = 61.1° E
 Surface range from pad = 8349 n. mi.
 LH2 rupture altitude = 343 000 ft
 LOX rupture altitude = 260 000 ft
 Breakup altitude = 195 000 ft

Error source	3σ Error	Downrange, n. mi.	Uprange, n. mi.	Crossrange, n. mi.
Separation altitude	±2678 ft	100	99	0
Separation velocity	±10.66 fps	367	329	1
Separation flightpath angle	±0.02 deg	99	103	0
Drag	±Tolerances	53	75	0
Atmosphere	3σ Dense/thin	122	190	0
Weight	±10 000 lb	50	58	0
Azimuth	±0.071 deg	0	0	3
Trajectory dispersion 3σ RSS		417	417	3
Rotational lifting effect (3σ)		309	392	11
Debris scatter		95	190	15
Total footprint with debris scatter (3σ)		582	810	27

TABLE 7.2.2-III.- STS-1 ET DISPERSION, GUIDED MECO (NOMINAL PROFILE)

SSME cutoff conditions:
 Flightpath angle = 0.5°
 Velocity = 25 668 fps
 Altitude = 60 n. mi.
 Inclination = 40.3°
 Range = 739 n. mi.
 Latitude = 34.1° N
 Longitude = 67.8° W
 ET weight = 101 902 lb

Impact point:
 Latitude = 31.2° S
 Longitude = 93.7° E
 Surface range from pad = 8349 n. mi.
 LH₂ rupture altitude = 343 000 ft
 LOX rupture altitude = 260 000 ft
 Breakup altitude = 195 000 ft

Error source	3σ Error	Downrange, n. mi.	Uprange, n. mi.	Crossrange, n. mi.
Separation altitude	+1923 ft	109	108	1
Separation velocity	±10.73 fps	626	562	11
Separation flightpath angle	+0.022 deg	63	70	1
Drag	+Tolerances	79	124	1
Atmosphere	3σ Dense/thin	163	256	2
Weight	+10 000 lb	55	63	1
Azimuth	+0.109 deg	1	1	1
Trajectory dispersion 3σ RSS		666	646	11
Rotational lifting effect (3σ)		289	413	9
Debris scatter		95	190	15
Total footprint with debris scatter (3σ)		745	1059	29

TABLE 7.2.2-IV.- STS-1 ET DISPERSION, 50/50 PTM

SSME cutoff conditions:
 Flightpath angle = 0.5°
 Velocity = 25 668 fps
 Altitude = 60.1 n. mi.
 Inclination = 40.3°
 Range = 969 n. mi.
 Latitude = 35.6° N
 Longitude = 63.5° W
 ET weight = 85 071 lb

Impact point:
 Latitude = 32.8° S
 Longitude = 97.2° E
 Surface range from pad = 10 543 n. mi.
 LH₂ rupture altitude = 343 000 ft
 LOX rupture altitude = 260 000 ft
 Breakup altitude = 195 000 ft

Error source	3σ Error	Downrange, n. mi.	Uprange, n. mi.	Crossrange, n. mi.
Separation altitude	+2678 ft	155	153	2
Separation velocity	+10.66 fps	626	577	11
Separation flightpath angle	+0.021 deg	63	69	1
Drag	+Tolerance	88	138	2
Atmosphere	3σ Dense/thin	171	269	3
Weight	+10 000 lb	55	75	1
Azimuth	+0.071 deg	0	0	0
Trajectory dispersion 3σ RSS		681	677	12
Rotational lifting effect (3σ)		95	190	12
Debris scatter		95	190	15
Total footprint with debris scatter (3σ)		790	1088	32

TABLE 7.2.2-V.- STS-1 ET DISPERSION, FINE COUNTDOWN (SSME-1 OUT)

SSME cutoff conditions:
 Flightpath angle = 0.29°
 Velocity = 25 668 fps
 Altitude = 60 n. mi.
 Inclination = 40.3°
 Range = 739 n. mi.
 Latitude = 34.1° N
 Longitude = 67.8° W
 ET weight = 101 902 lb

Impact point:
 Latitude = 21.7° S
 Longitude = 77.5° E
 Surface range from pad = 9561 n. mi.
 LH2 rupture altitude = 343 000 ft
 LOX rupture = titude = 260 000 ft
 Breakup altitude = 195 000 ft

Error source	3σ Error	Downrange, n. mi.	Uprange, n. mi.	Crossrange, n. mi.
Separation altitude	±1923 ft	146	143	1
Separation velocity	±10.73 fps	796	657	11
Separation flightpath angle	±0.022 deg	160	174	1
Drag	±Tolerance	125	182	1
Atmosphere	3σ Dense/thin	246	377	2
Weight	±10 000 lb	92	93	1
Azimuth	±0.109 deg	1	1	3
Trajectory dispersion 3σ RSS		874	816	12
Rotational: lifting effect (3σ)		521	510	10
Debris scatter		95	190	15
Total footprint with debris scatter (3σ)		1127	1219	30

TABLE 7.2.2-VI.- STS-1 ET DISPERSION, FINE COUNTDOWN (2 or 3 SSME-OUT)

SSME cutoff conditions:
 Flightpath angle = 0.60°
 Velocity = 25 668 fps
 Altitude = 60 n. mi.
 Inclination = 40.3°
 Range = 739 n. mi.
 Latitude = 34.1° N
 Longitude = 67.8° W
 ET weight = 101 902 lb

Impact point:
 Latitude = 33.0° S
 Longitude = 97.9° E
 Surface range from pad = 10 543 n. mi.
 LH₂ rupture altitude = 343 000 ft
 LOX rupture altitude = 260 000 ft
 Breakup altitude = 195 000 ft

Error source	3σ Error	Downrange, n. mi.	Uprange, n. mi.	Crossrange, n. mi.
Separation altitude	±1923 ft	93	92	1
Separation velocity	±10.73 fps	537	506	9
Separation flightpath angle	±0.022 deg	37	42	0
Drag	±Tolerance	60	95	1
Atmosphere	3σ Dense/thin	132	208	2
Weight	±10 000 lb	45	51	1
Azimuth	±0.109 deg	0	0	0
Trajectory dispersion 3σ RSS		567	567	9
Rotational lifting effect (3σ)		194	391	8
Debris scatter		95	190	15
Total footprint with debris scatter (3σ)		617	963	27

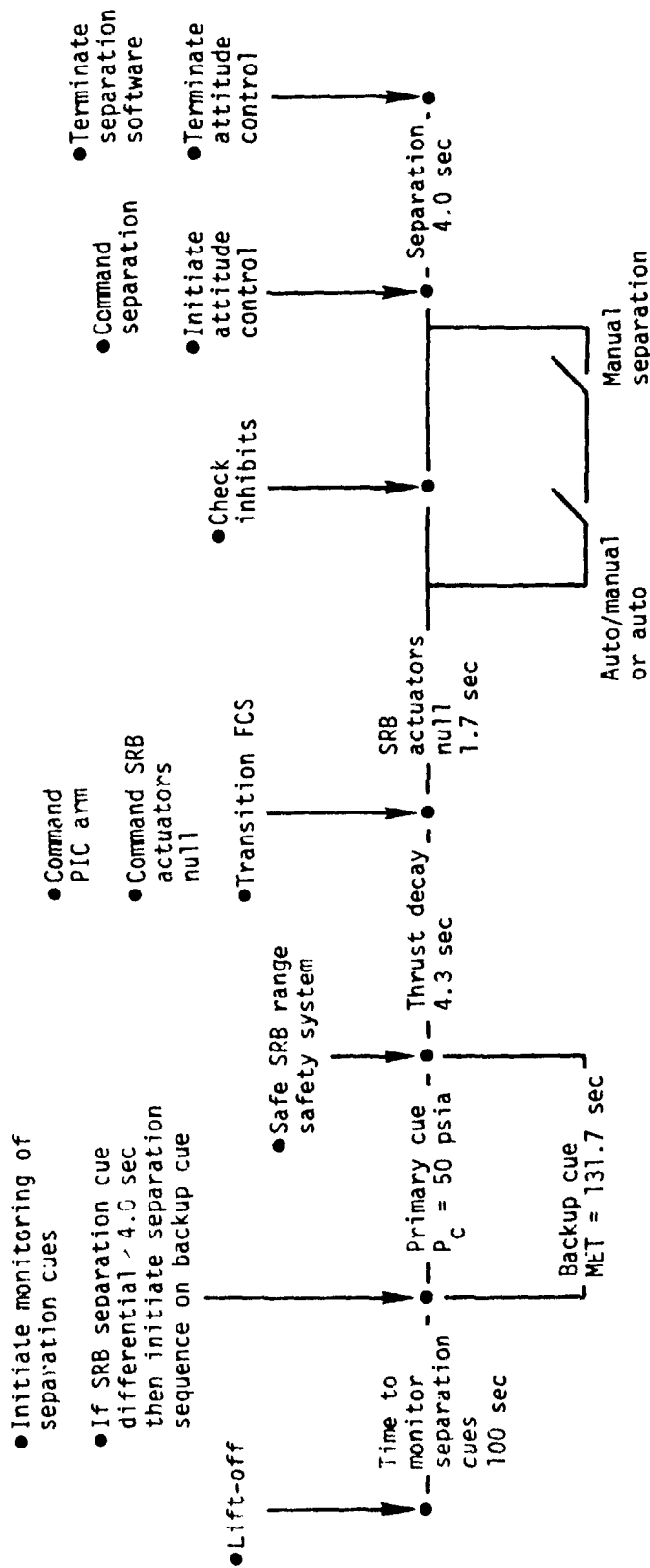

• Sequence resides in redundant flight computer set

• Separation inhibit a function of body rates and dynamic pressure

Figure 7.1.1-1.- SRB separation sequence.

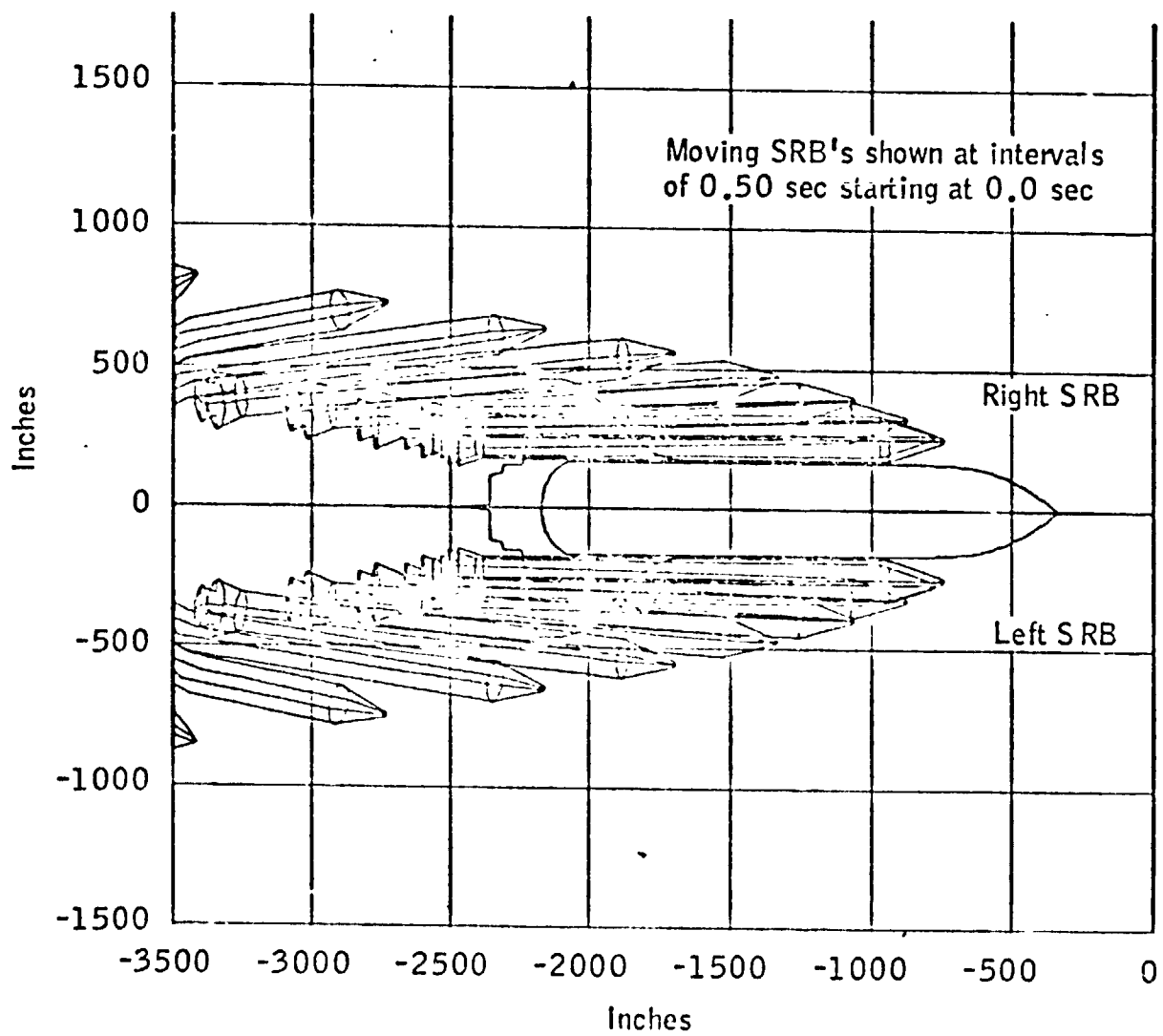

(a) Bottom view.

Figure 7.1.1-2.- Latest RTLS, AOA and ATO SRB separation trajectories.

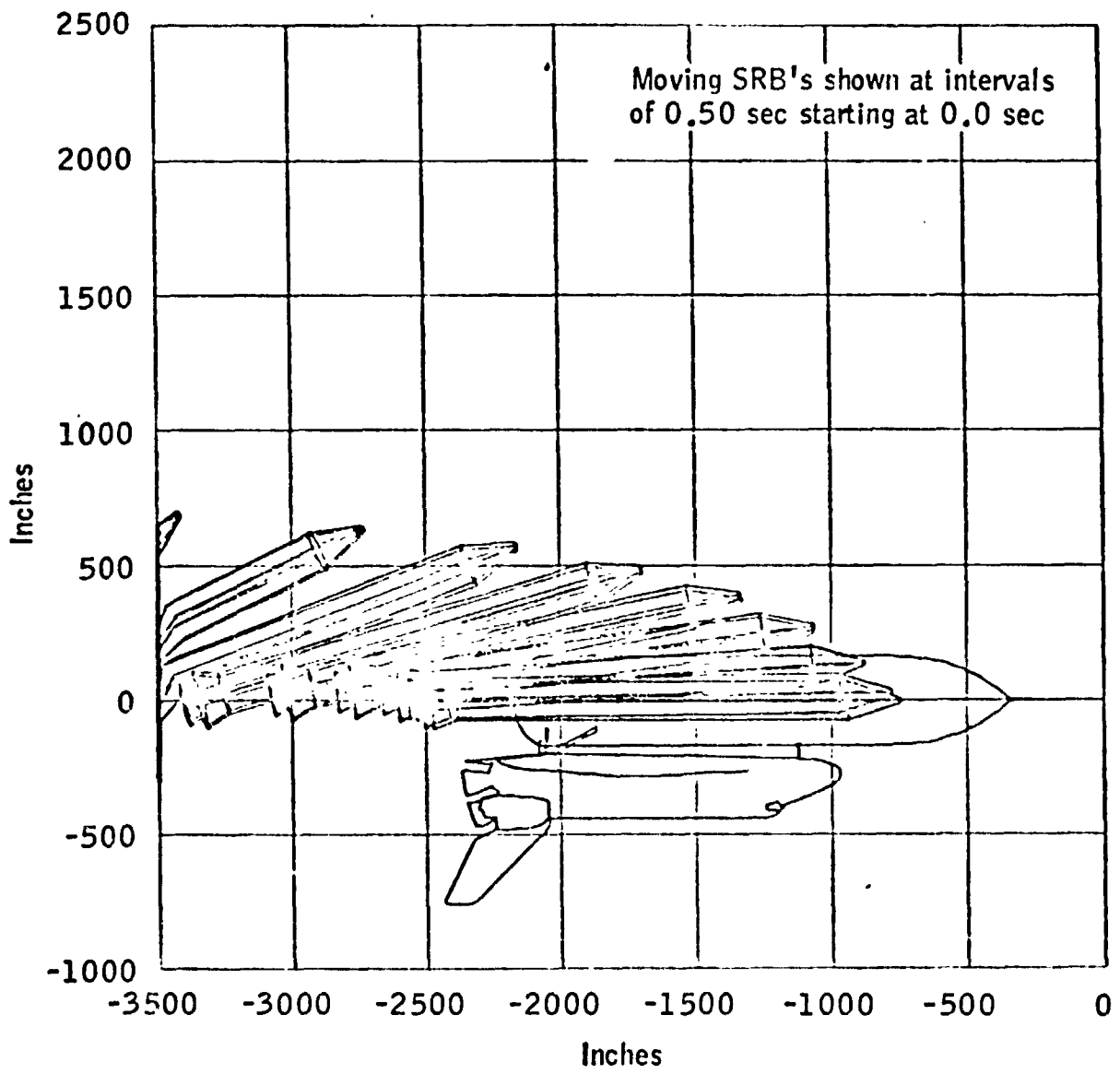

(b) Side view.

Figure 7.1.1-2.- Continued.

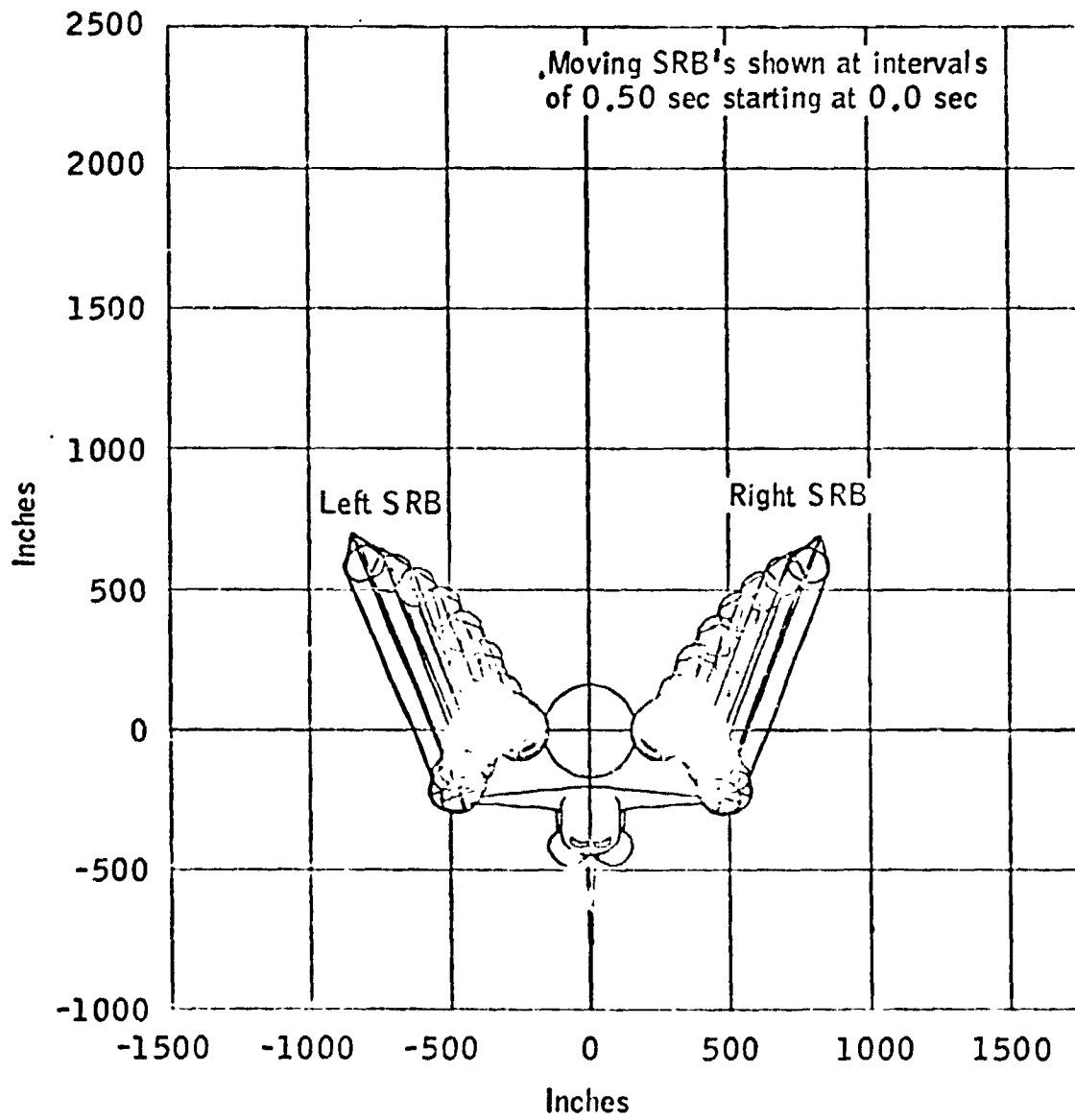

(c) Front view.

Figure 7.1.1-2.- Concluded.

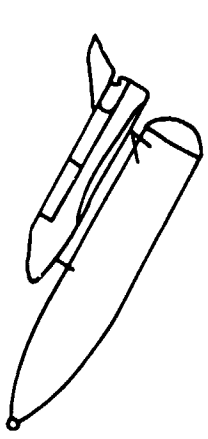

- Initiate pitch down
- SSME TVC
- $\alpha \sim 30 - 40^\circ$



- Coast
- RCS control
- $\alpha \sim \sim 4^\circ$
- $\dot{\theta} \sim \sim .25^\circ/\text{sec}$

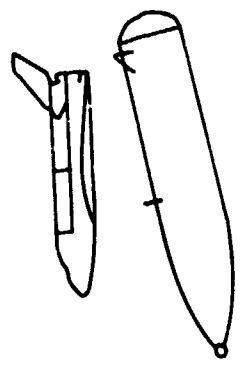

- Release
- Fwd/aft RCS translation & control

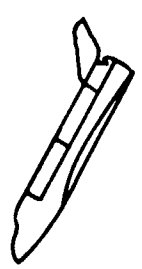

- Orbiter pull up
- RCS control
- $\alpha \sim 40 - 50^\circ$

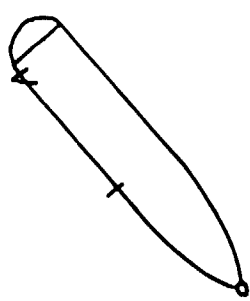

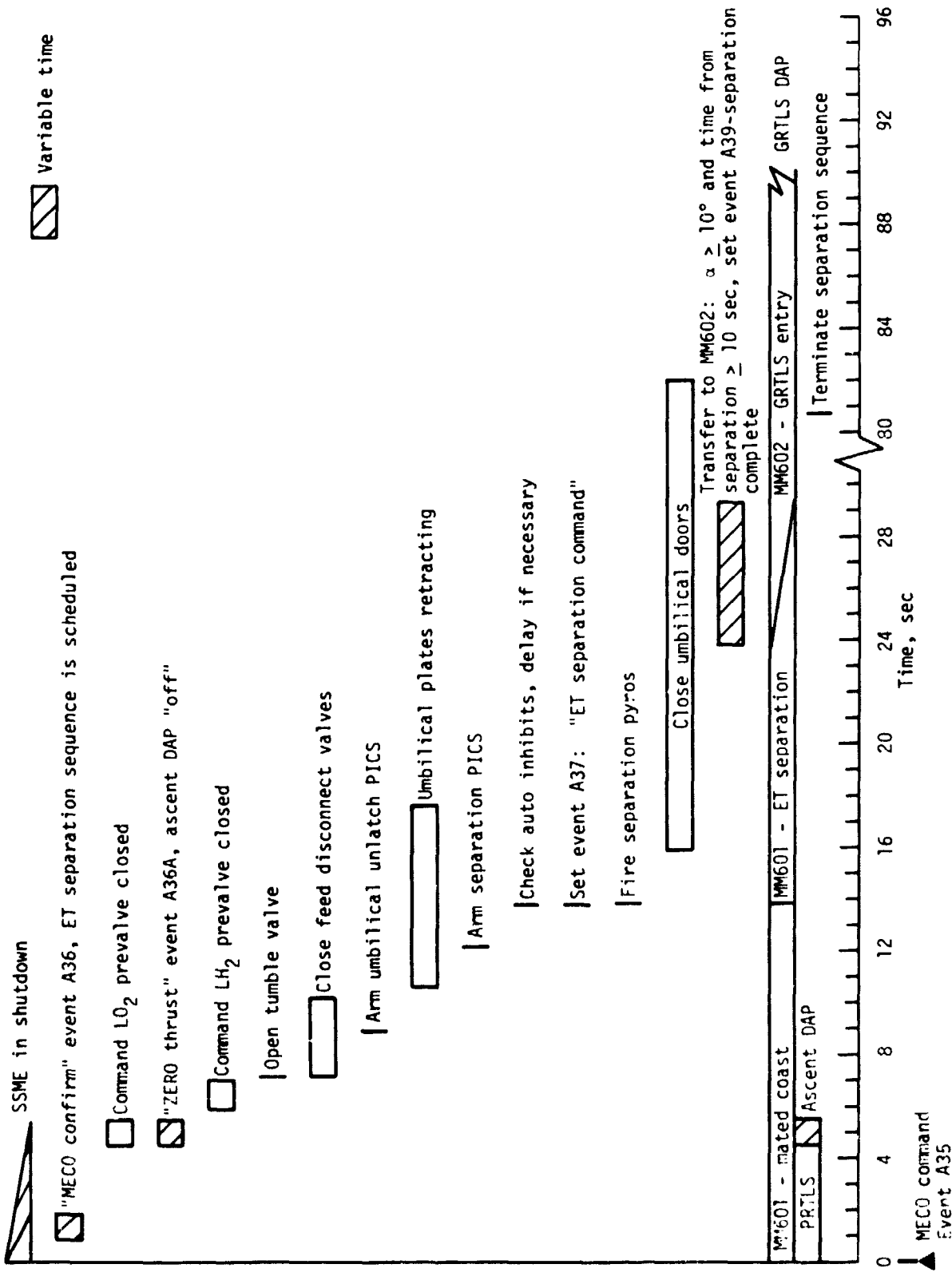

Figure 7.1.2-2.- ET separation timeline - RTLS.

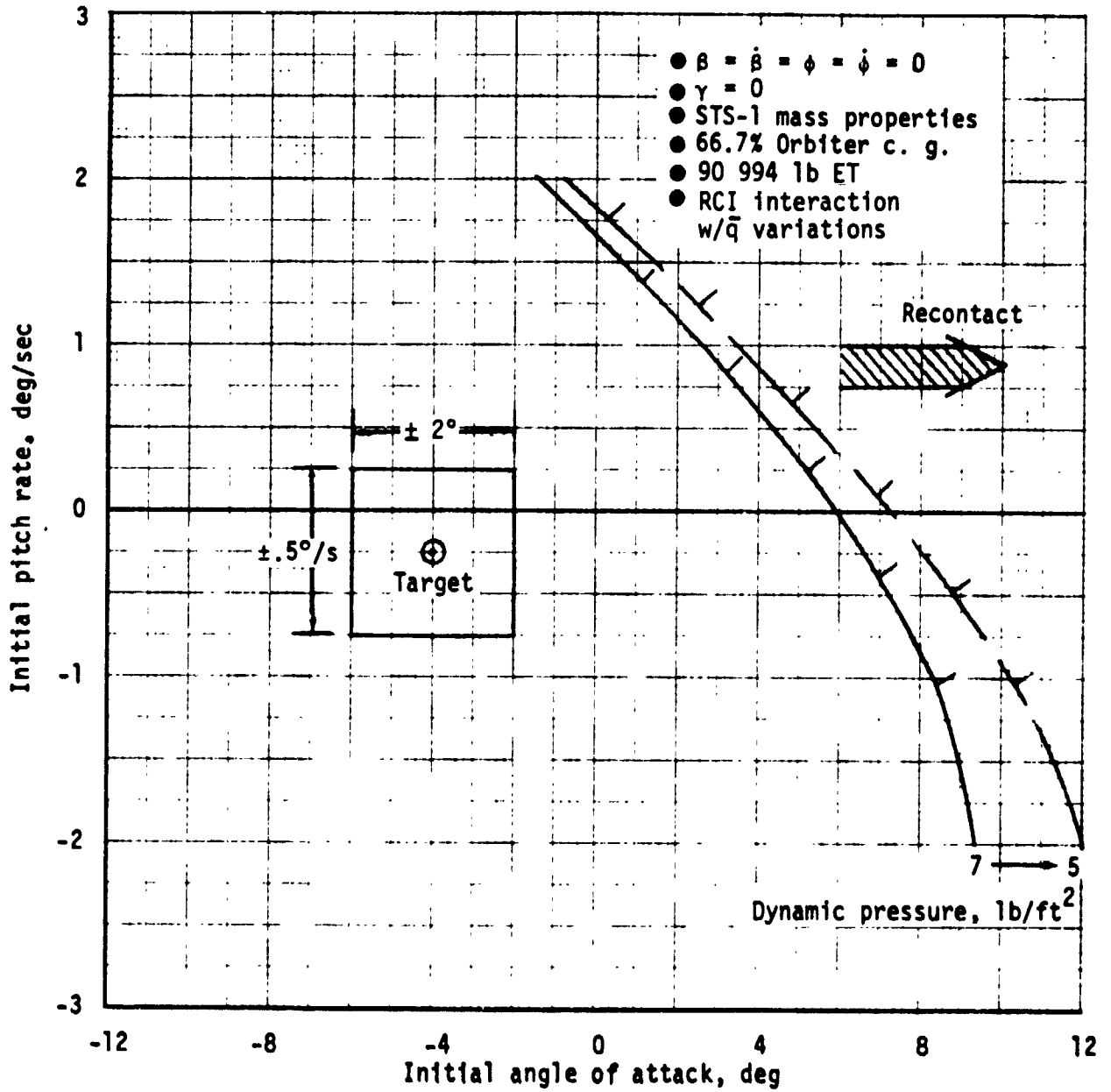

Figure 7.1.2-3.- RTLS Orbiter/ET separation boundaries.

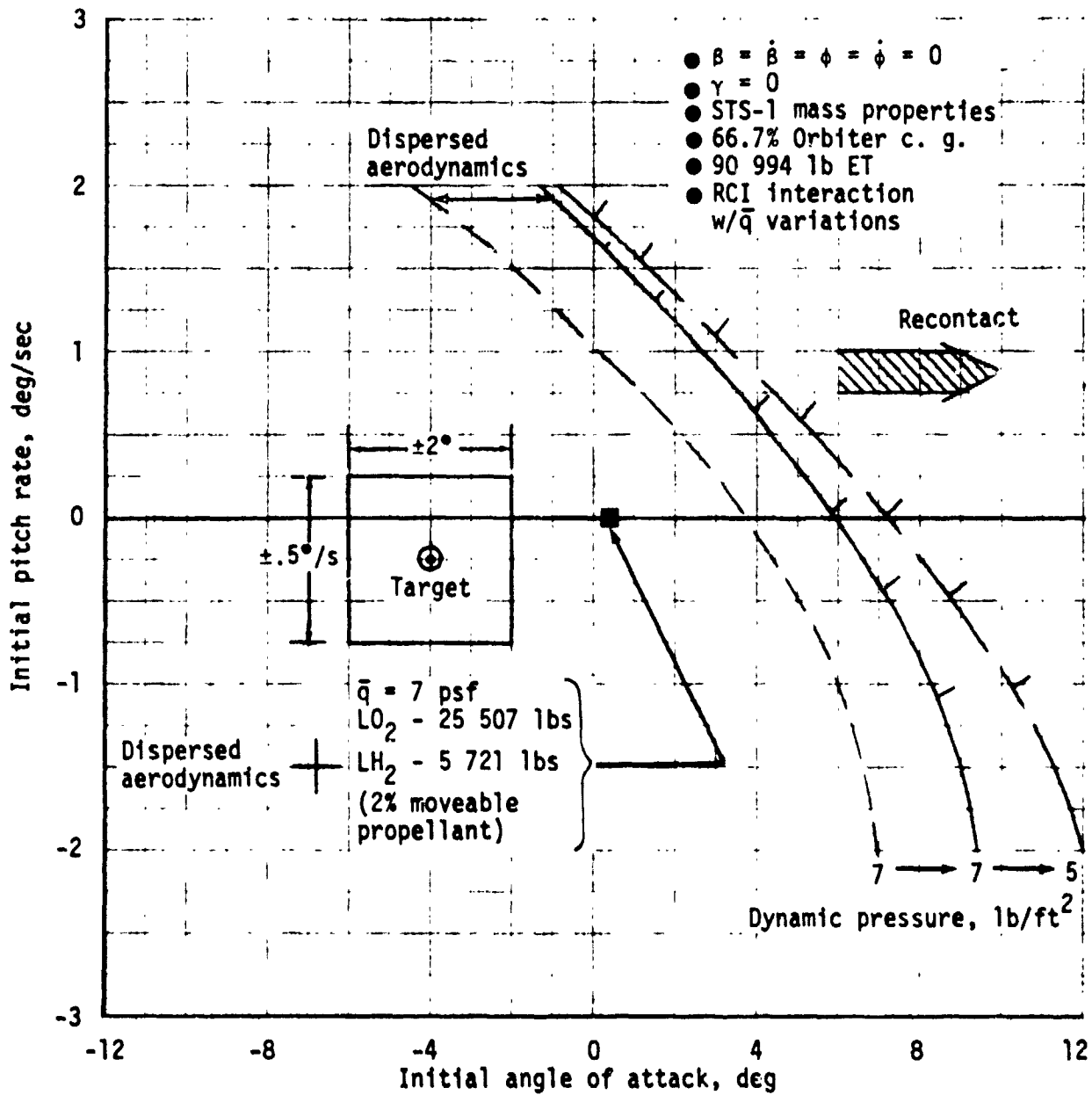

Figure 7.1.2-4.- RTLS Orbiter/ET separation boundary comparisons illustrating effects of propellant dynamics and dispersed aerodynamics.

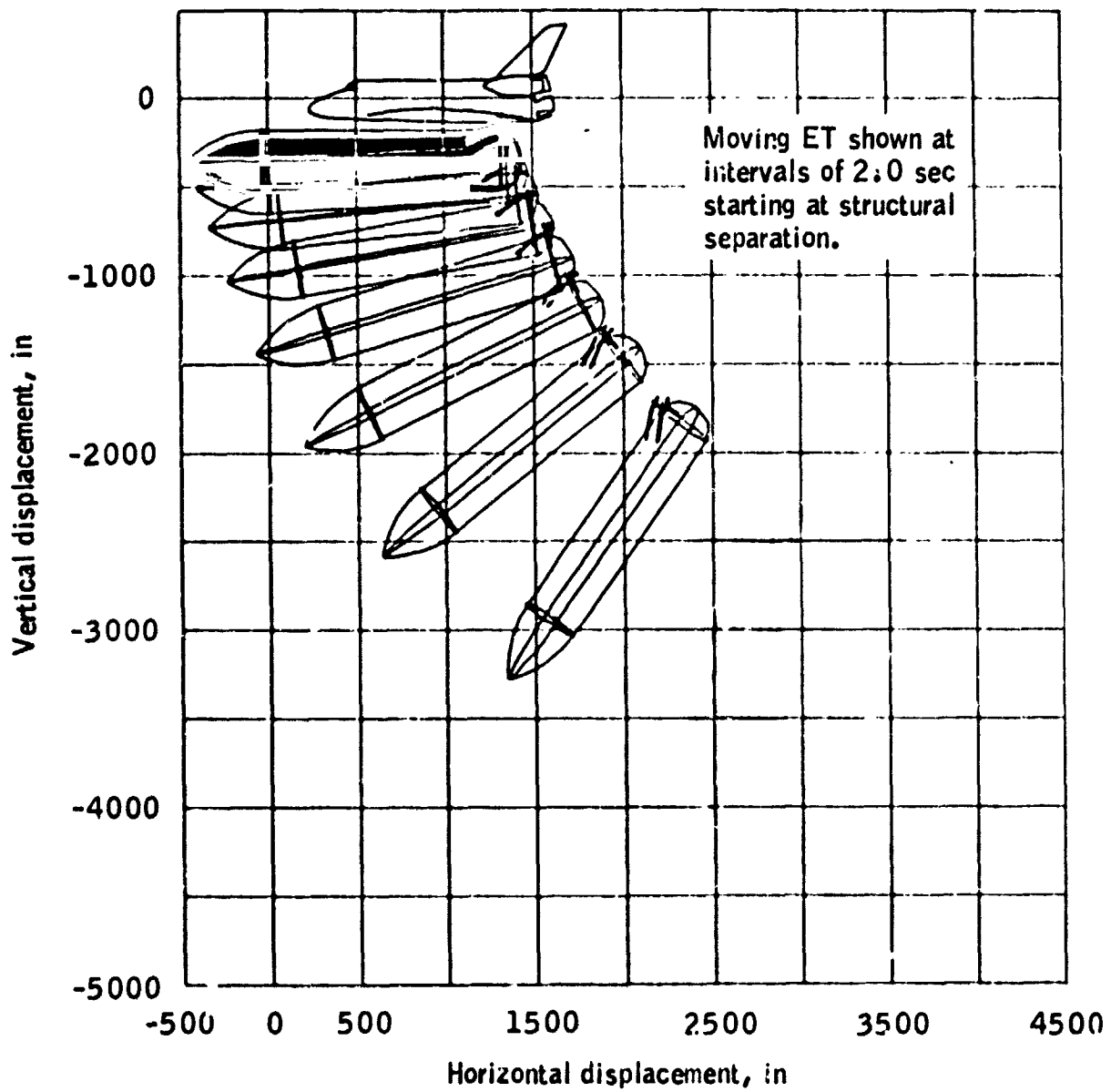

Figure 7.i.2-5.- RTLS STS-1 Orbiter/ET separation trajectories.

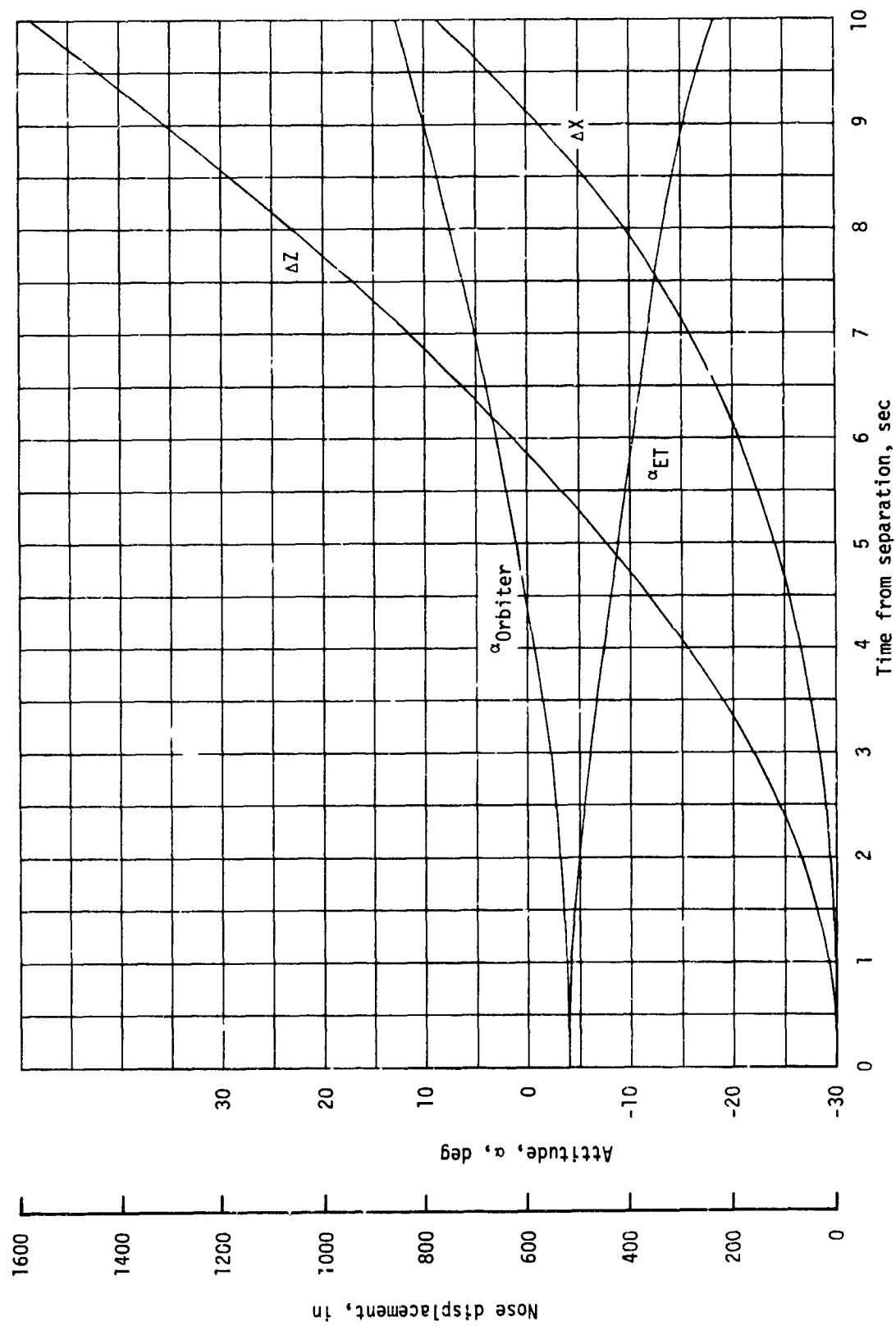

Figure 7.1.2-6.- RTLS Orbiter and ET nose displacement from mated position and attitude parameters for number one SSME-failure at 262.5 seconds MET (RTLS at 272.5 seconds).

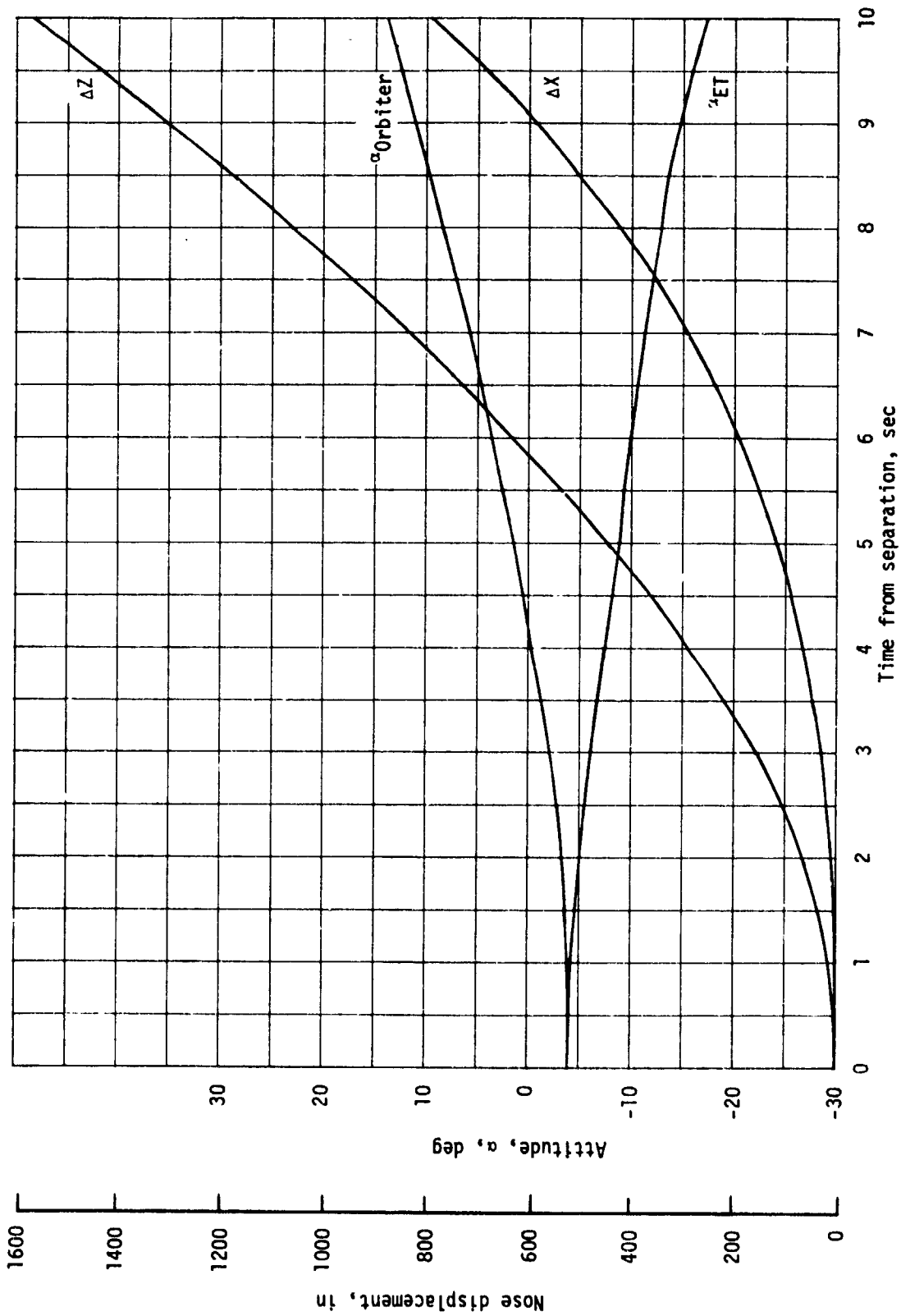

Figure 7.1.2-7.- RTLS Orbiter and ET nose displacement from mated position and attitude parameters for number two SSME-failure at lift-off (RTLS at 150.0 seconds).

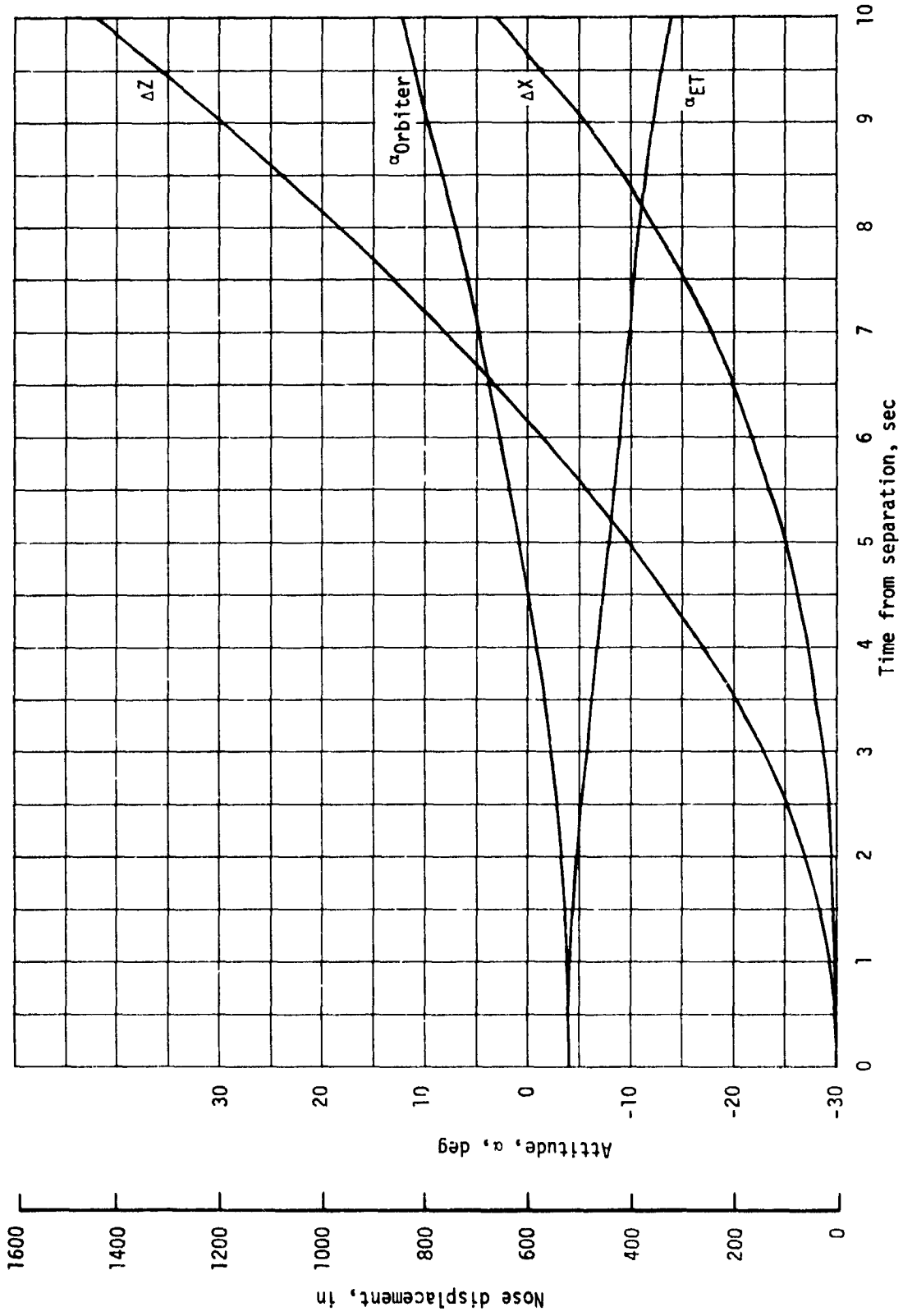
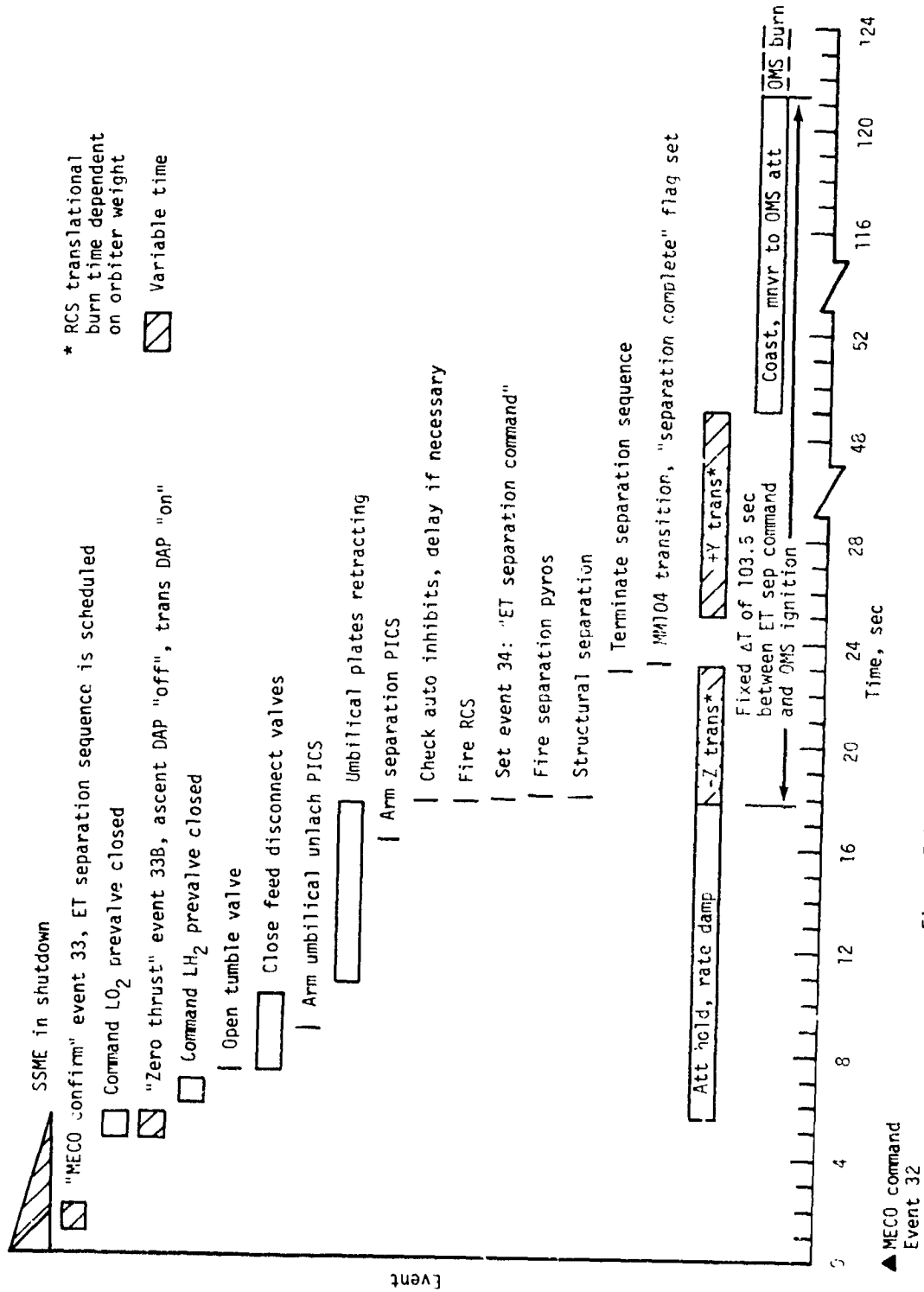

Figure 7.1.2-8.- RTLS Orbiter and ET nose displacement from mated position and attitude parameters for a three SSME RTLS at 260 seconds.



* RCS translational burn time dependent on orbiter weight

□ Variable time

Figure 7.1.2-9.- ET separation time line - NOM/ADA/ATO.

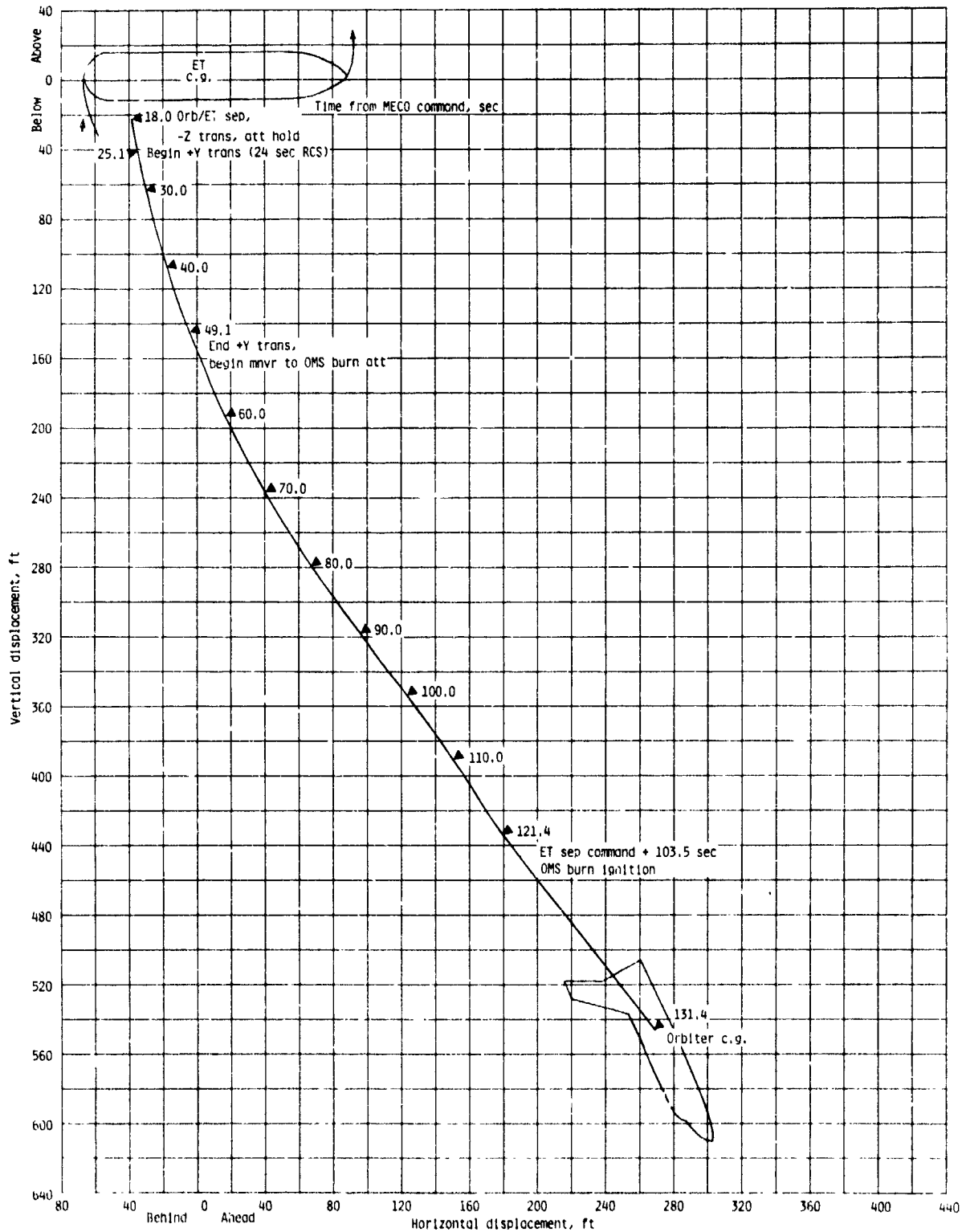

a. Vertical and horizontal displacement.

Figure 7.1.2-10.- AOA and ATP Orbiter/ET relative motion for the separation maneuver

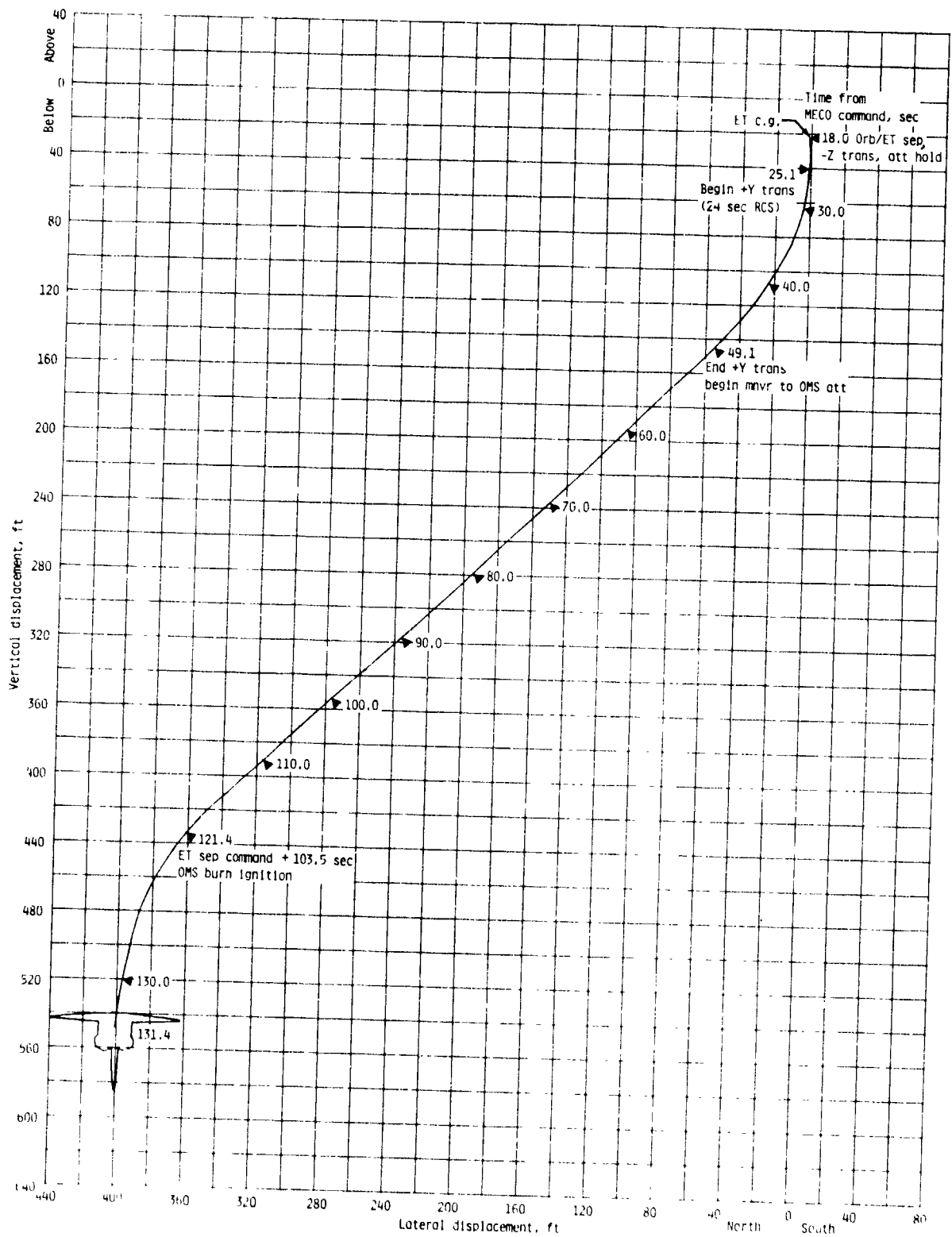

b. Vertical and lateral displacement.

Figure 7.1.2.10.- Concluded.

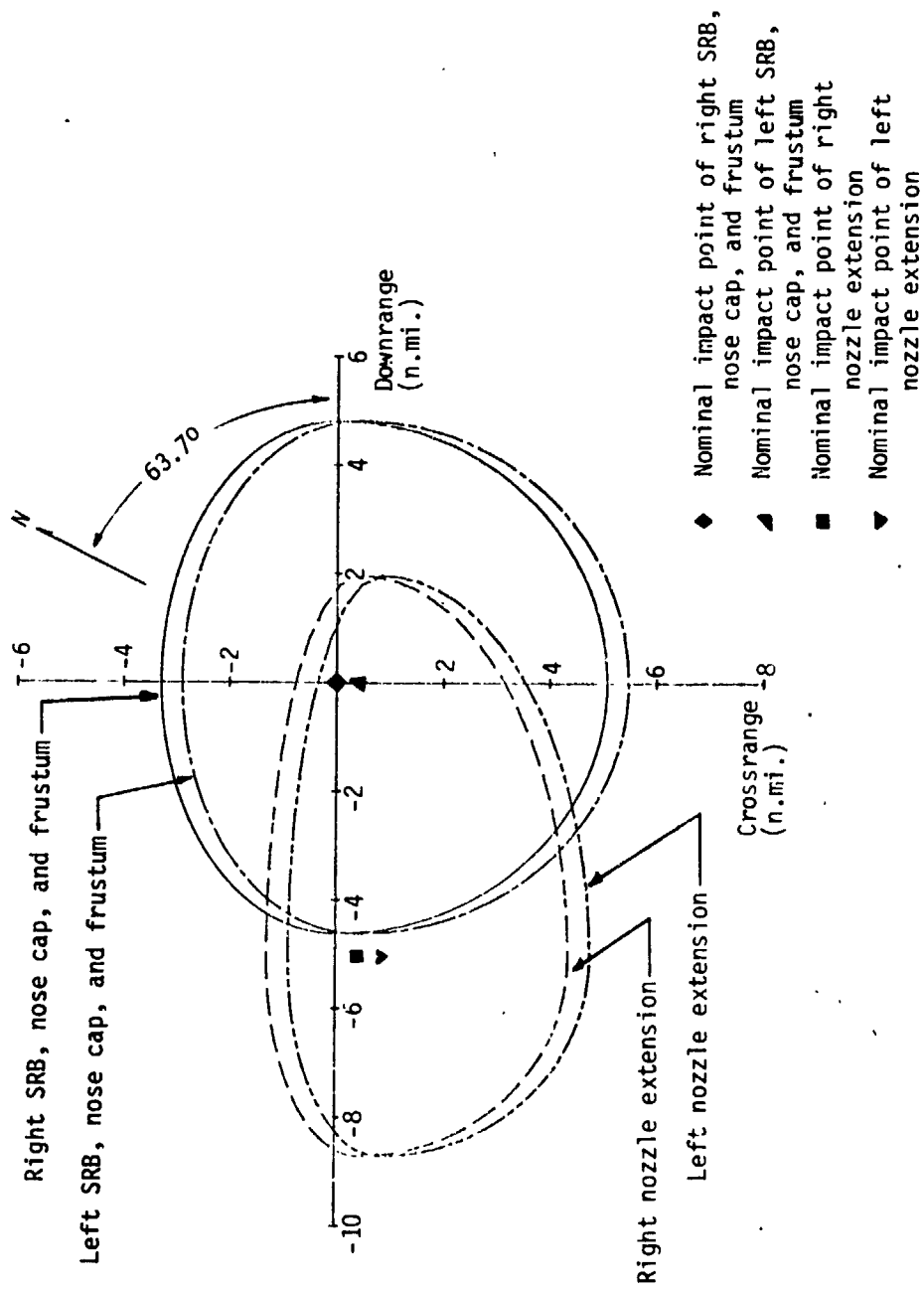

Figure 7.2.1-1.- Composite SRB impact footprint, STS-1 earliest RTLS.

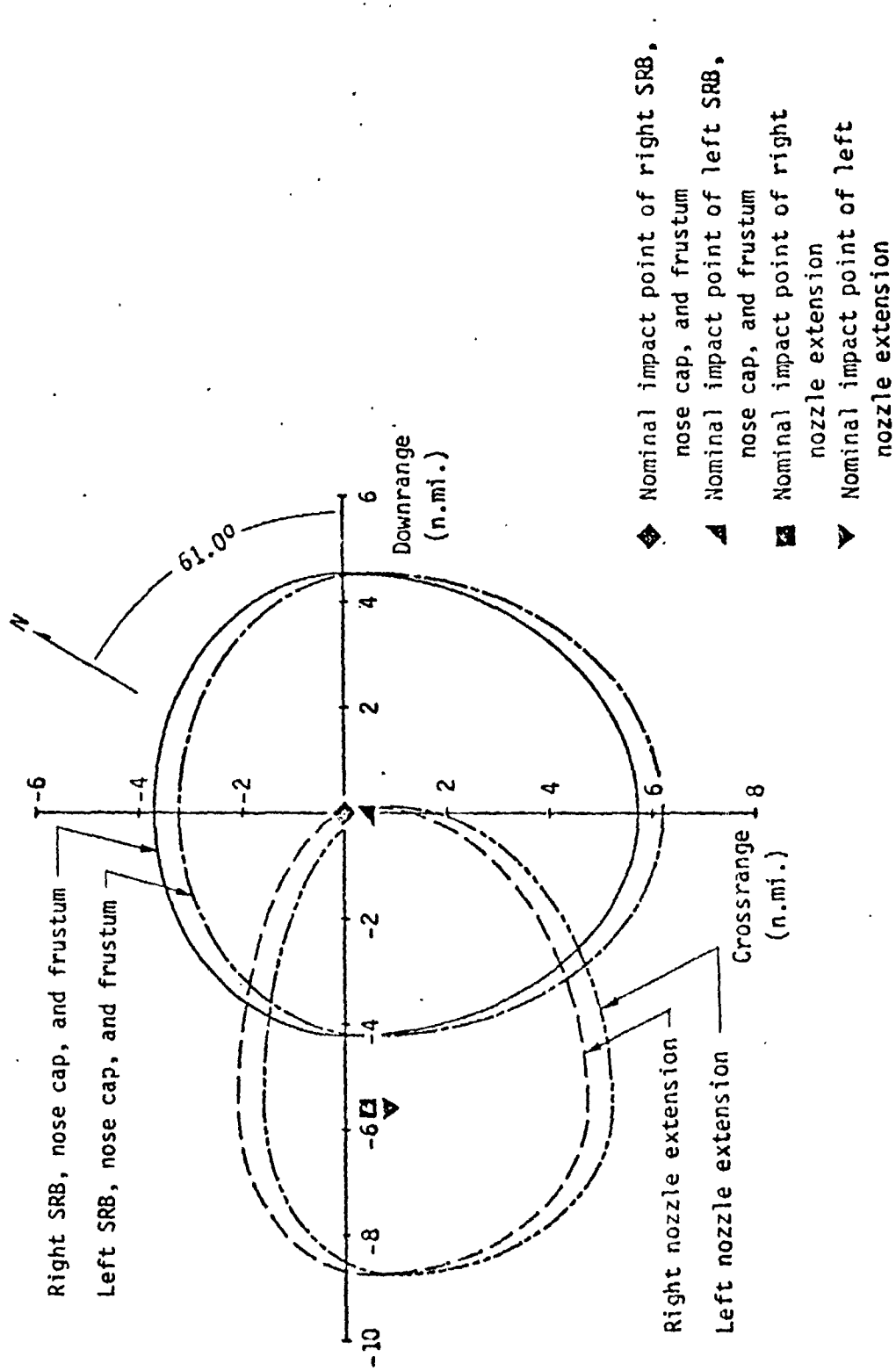
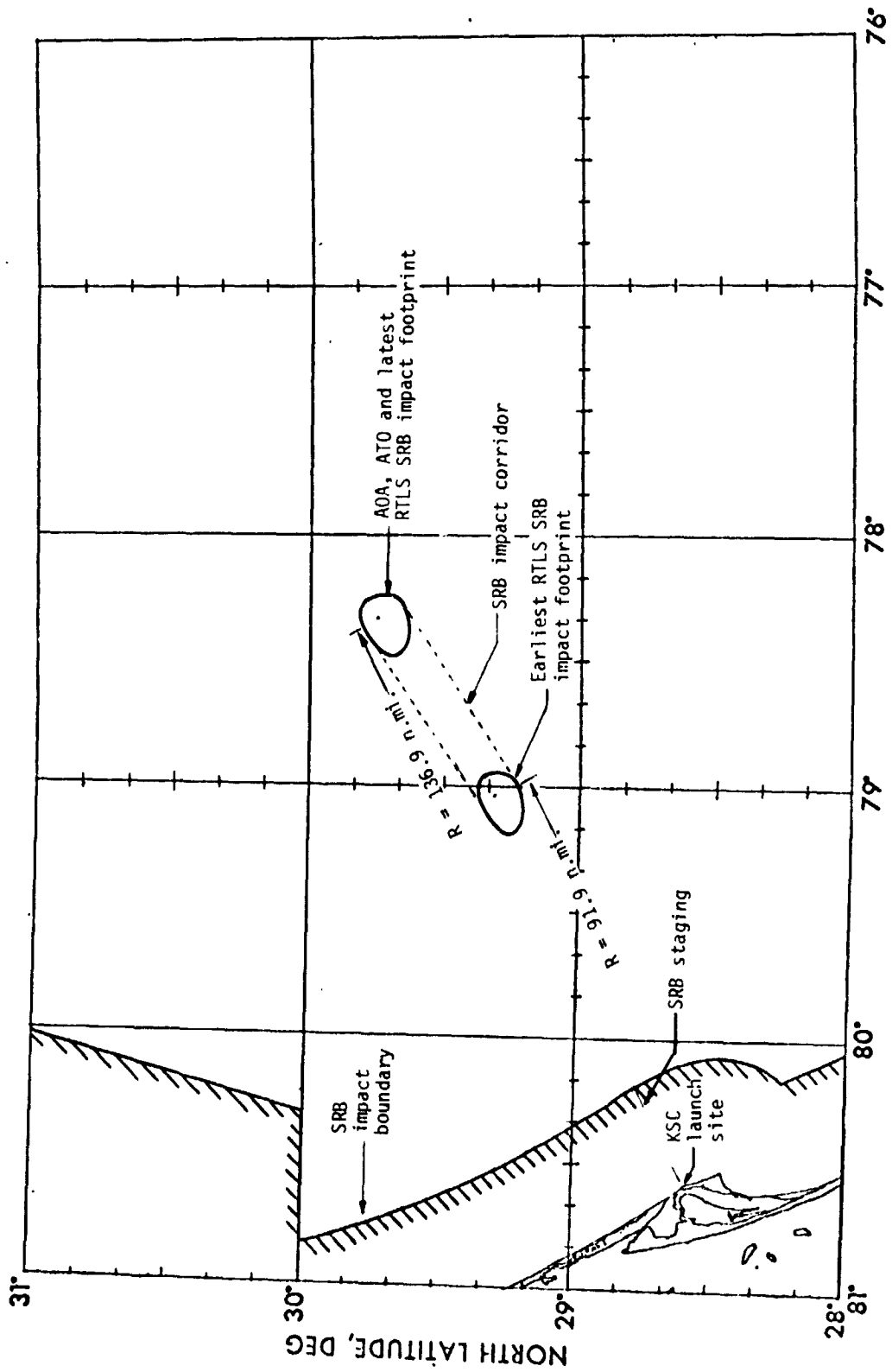

Figure 7.2.1-2. - Composite SRB impact footprint, STS-1 AOA, ATO, and latest RTLS.



WEST LONGITUDE, DEG

Figure 7.2.1-3. - STS-1 SRB impact corridor for nominal, RTLS, AOA, and ATO missions.

ET DISPOSAL ABORT REGIONS

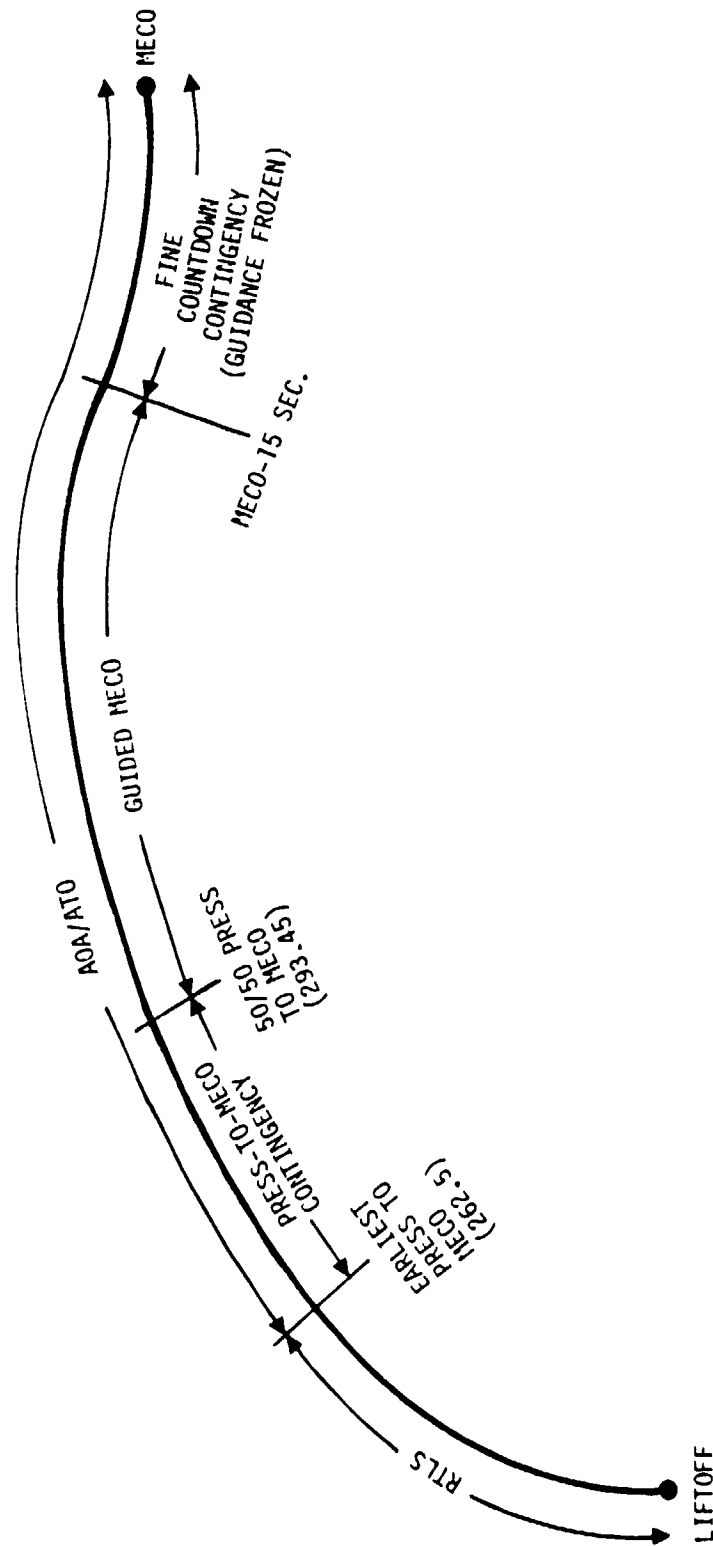
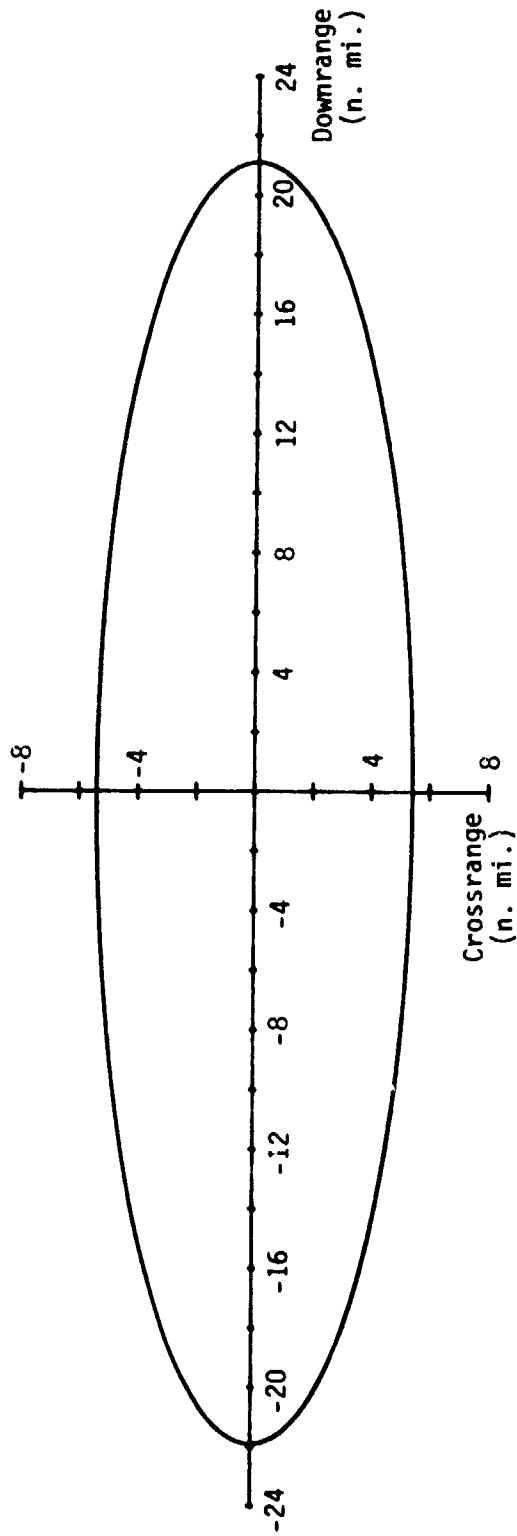

Figure 7.2.2-1.- STS-1 ET disposal abort regions.



RTLS ET footprint:
 downrange = 21.1 n. mi.
 uprange = 21.9 n. mi.
 crossrange = 5.4 n. mi.

Figure 7.2.2.2.- STS-1 RTLS ET footprint.

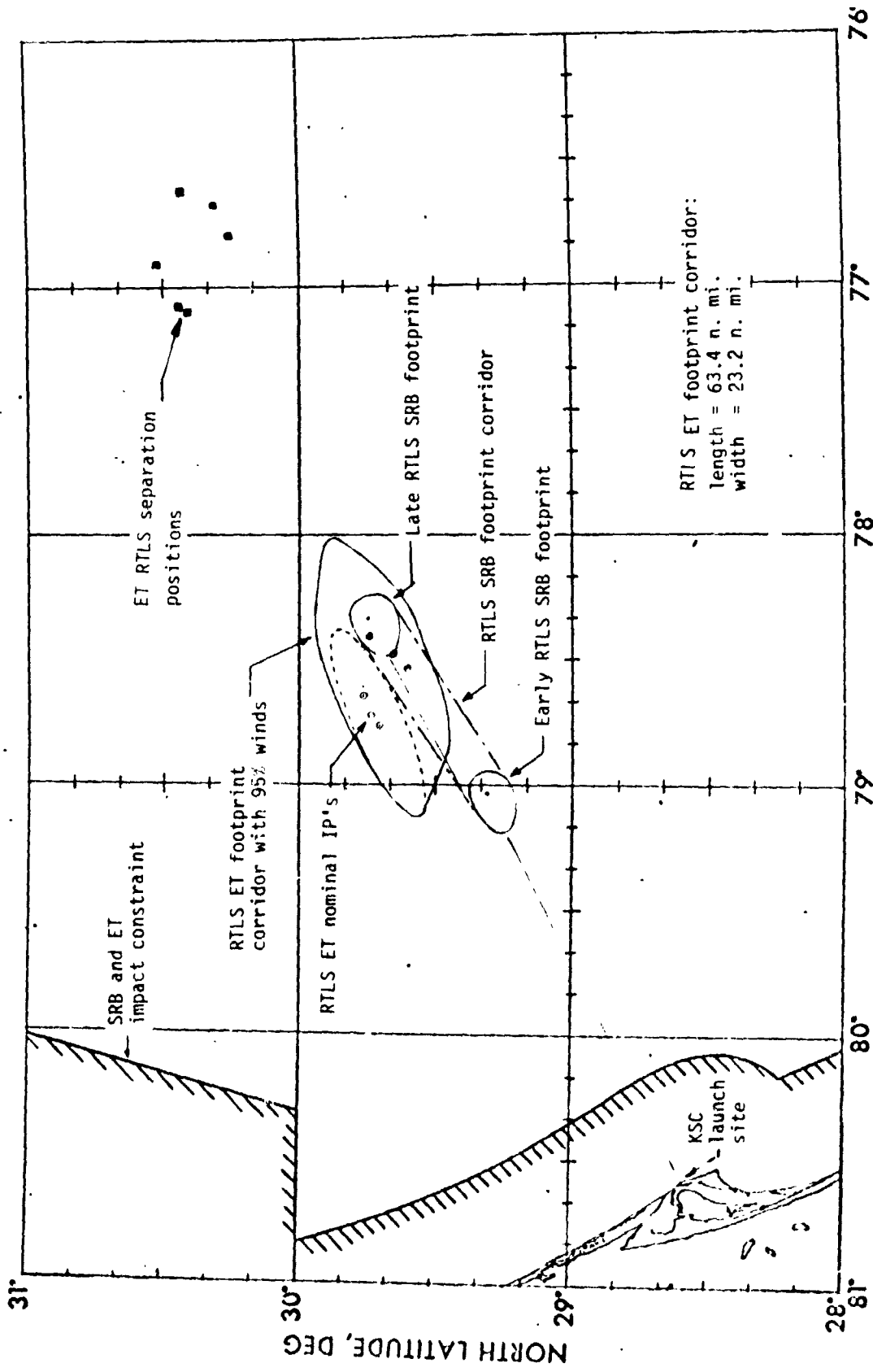

Figure 7.2.2-3.- STS-1 RTLS ET and SRB impact footprint corridors.

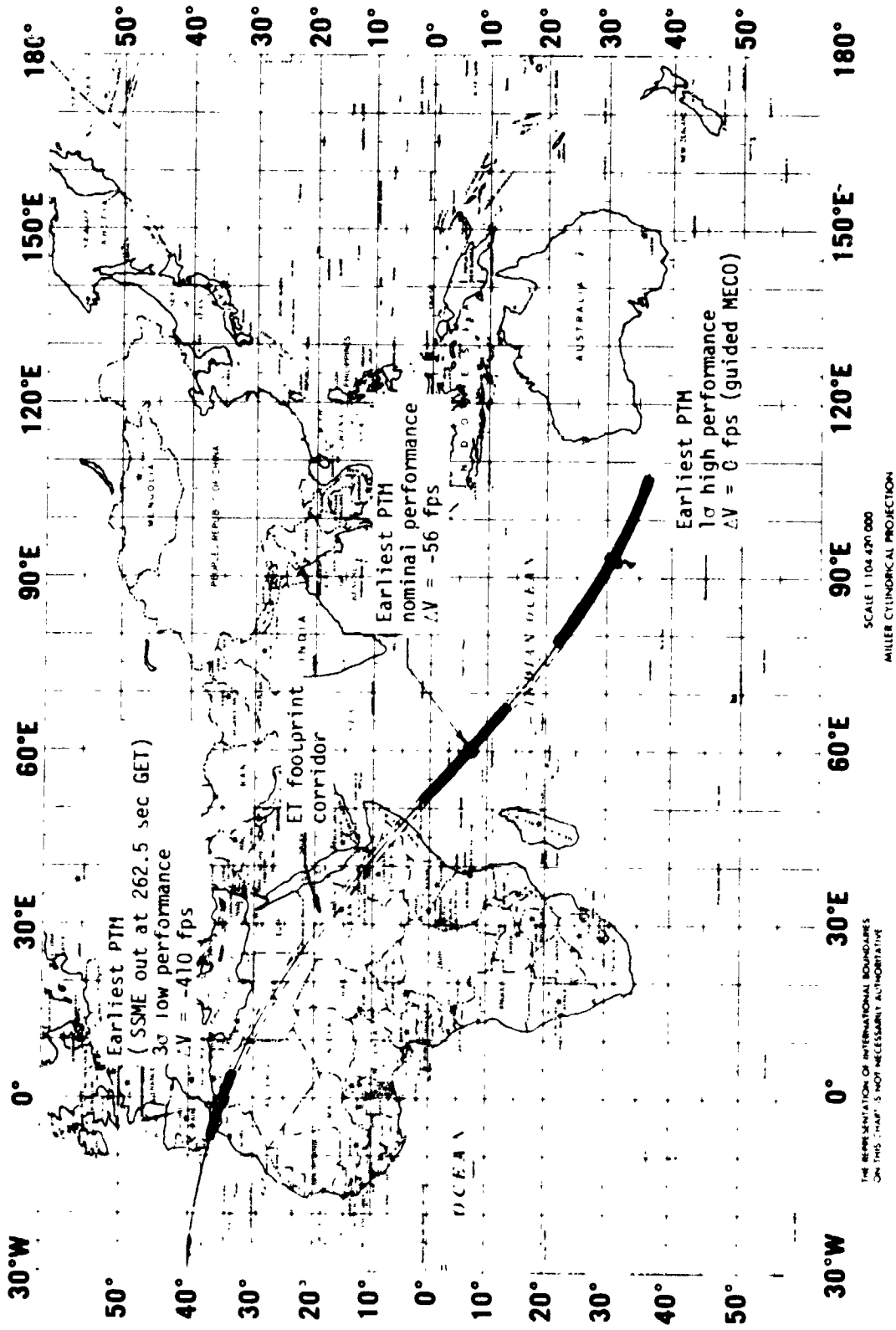

Figure 7.2.2-4.- STS-1 AOA/ATO Press to MECO contingency ET impact footprints.

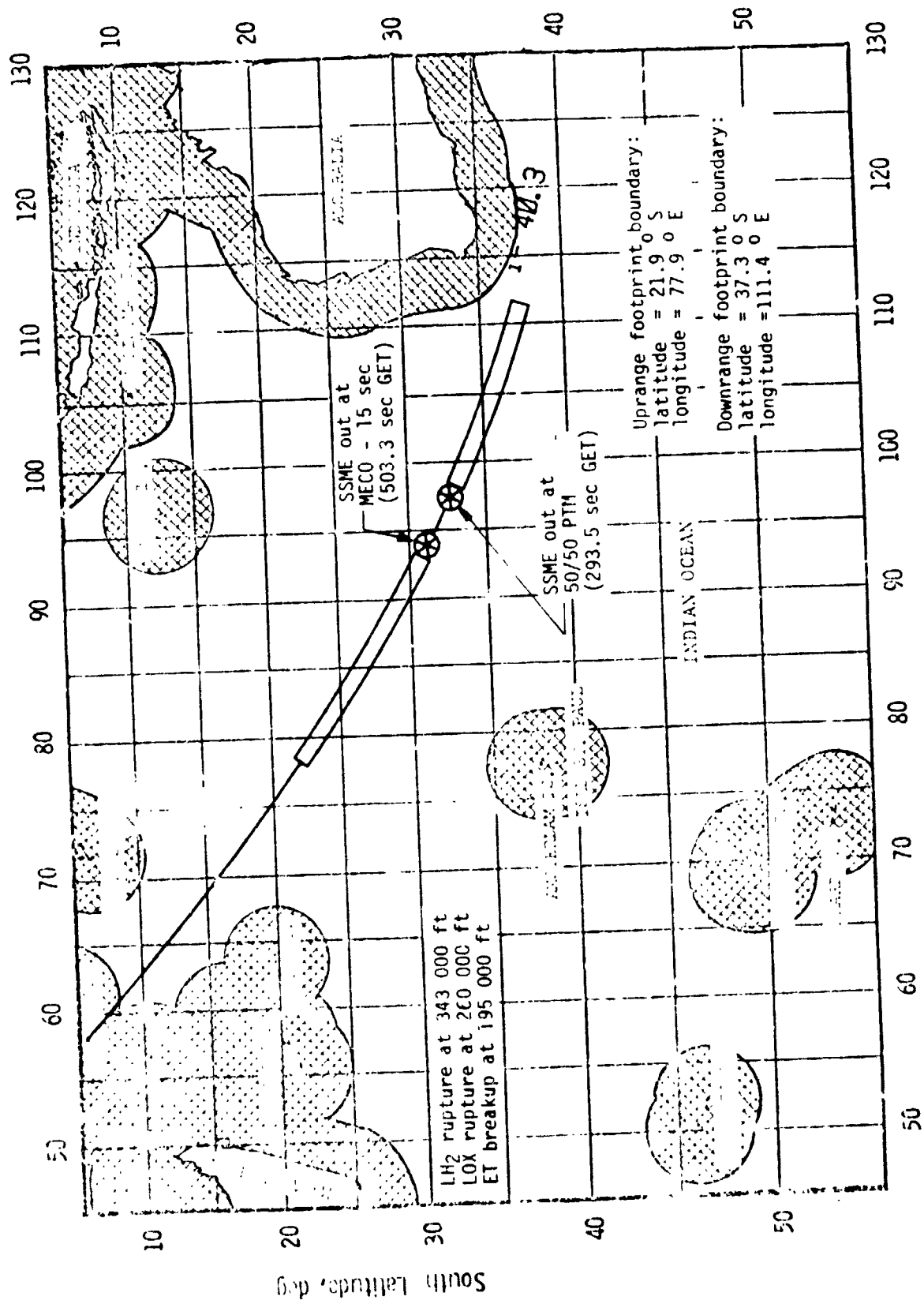

Figure 7.2.2-5.- STS-1 AOA/ATO guided MECO ET impact footprints.

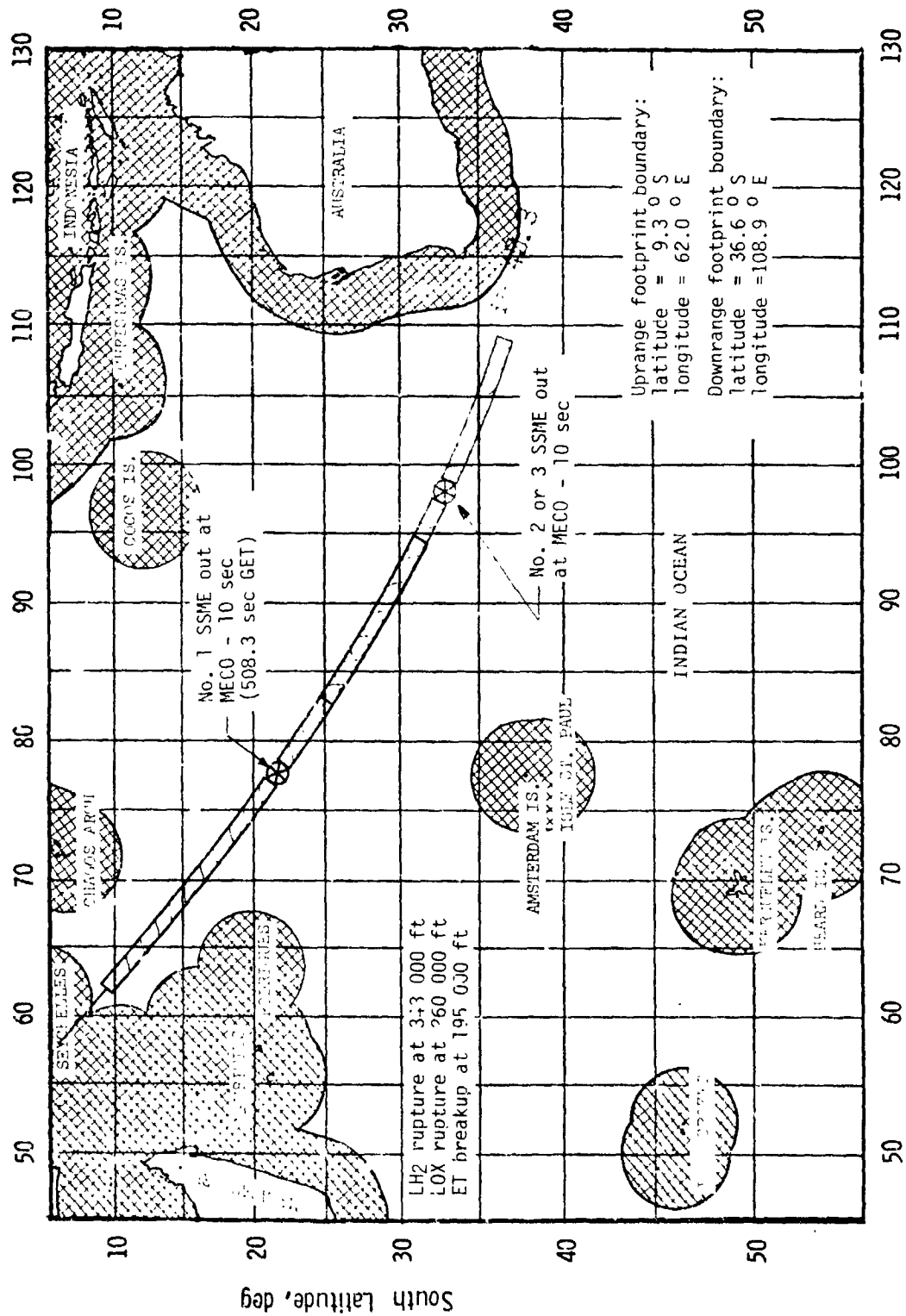

Figure 7.2.2-6.- STS-1 AOA/ATO fine countdown contingency ET impact footprints.

3.0 ABORT MONITORING

8.1 GROUND MONITORING

Ground controllers are responsible for monitoring the launch trajectory during the Shuttle ascent phase. Primary ground tasks associated with launch monitoring are to determine trajectory limit violations, abort mode decisions, the go/no-go orbit insertion status, and real-time post-MECO maneuver planning, if required. The abort region determinator (ARD), a real-time cyclic processor, will be used by the ground for pre-MECO abort mode decisions and trajectory performance limit violations. In addition, planned launch profiles and trajectory limits are plotted on flight dynamics displays and will be used by the ground controllers for other trajectory limit violations. The abort maneuver evaluator, a post-MECO demand/response processor, will be used by the ground for the go/no-go insertion status and to compute alternate OMS/RCS post-MECO maneuvers if required.

8.1.1 ARD Monitoring

ARD real-time monitoring data are displayed in the MCC in both digital and analog format. Figures 8.1.1-1 and 8.1.1-2 summarize the ARD analog displays that will be used to evaluate ascent performance trends and characteristics. Figure 8.1.1-3 defines the ARD digital display that will provide the margin granularity and supporting information required for launch monitoring. Real-time data for these displays will be generated by the ARD processor based on the premission initialization data of reference 13 and cyclic updates based on the Shuttle state vector from either telemetry or ground radar. These ARD displays are updated at 6-second intervals from lift-off to MECO with these real-time data.

Table 8.1.1-I defines the premission reference margins, trajectory performance limits, and supporting data that will be used in ARD ascent/abort monitoring. Note that the most important of these are plotted as background data on the MCC displays in figures 8.1.1-1 and 8.1.1-2. These plots will provide rapid and accurate determination of abort capability and ascent performance status from real-time ARD data.

Table 8.1.1-II summarizes ARD premission reference abort boundaries defined by the reference margins and the limits of table 8.1.1-I and figure 8.1.1-1 and 8.1.1-2. These data assume nominal ascent performance, on-time launch, and mean launch winds. Real-time deviation of ARD monitoring data and these boundaries will result from nonmean winds, launch hold, and/or off-nominal ascent performance from any component.

8.1.2 Flight Dynamics Trajectory Displays

Figures 8.1.2-1 through 8.1.2-7 summarize additional flight dynamics plotboard and CRT displays that will be used for STS-1 ascent/abort monitoring in conjunction with the ARD. Important applications of these analogs include RTLS abort

support, contingency abort region determination and monitoring, and ascent/abort protection for onboard navigation problems.

8.1.3 Console Charts

Console charts will be used as an additional monitoring tool for selected functions in the MCC. Figure 8.1.3-1 defines a permission reference chart that will be used in evaluating the STS-1 MECO. Real-time MECO data will be plotted on this MECO zoning chart as a routine SSR function. This chart assumes that there are no significant positional deviations associated with the MECO state. Note that the performance limits of this chart are sized to complete OMS-2 on a three-sigma bad day with only the normal OMS c.g. ballast allotments remaining.

Figure 8.1.3-2 summarizes the meaning of MCC ARD error messages that may be experienced. Figure 8.1.3-2 summarizes MCC adjustment required for launch holds.

Remaining console charts for STS-1 have not been completed as yet and are not included in this document.

8.1.4 AME

The abort maneuver evaluator (AME) will be used by the ground post-MECO to recommend the highest available nominal or abort mode that can be achieved taking into account the current trajectory, navigation, and available propellant, and assuming fixed PEG-4 targets for OMS-1 and OMS-2.

The AME begins processing at approximately 60 seconds after MECO on the receipt of a converged ground estimate of the vehicle state. If this ground estimate is selected as the best source over the onboard state estimate, it is retained for an eventual nav update after OMS-1 at Madrid.

AME first investigates the nominal or abort mode that was suggested by the ARD or by the flight controller, to determine if sufficient ΔV exists to accomplish the selected mode. If not, and if the ground was selected as the best nav source, the nav update is moved prior to OMS-1 at Bermuda, and the case is reevaluated. If the early nav update fails to produce an acceptable solution, successive lower abort modes are investigated until an acceptable solution is found.

The downmoding sequence that is assumed in the AME for STS-1 is as follows: NOM, ATO, AOA steep, AOA shallow, and ditch (see fig. 8.1.4-1). (Although ditch mode is supported by the AME, it is not an approved procedure for STS-1.) The flight controller will have the solution of the highest available mode displayed on the AME primary display (fig. 8.1.4-2). The AME secondary display (fig. 8.1.4-3) will present the solution for the next lower mode that is available. These displays will be available in time for the flight controller to make an abort recommendation to the crew at MECO + 90 seconds.

8.2 ONBOARD MONITORING

This section contains a description of the onboard trajectory displays and a brief discussion on how these displays can be used to perform the onboard abort trajectory monitoring tasks. The onboard trajectory displays are made up of prescribed trajectory profiles, mode boundary tic marks, and various alpha/numeric parameters that can be used along with real-time indicators of current and projected conditions displayed on any one of the three CRT's available for crew monitoring. Characteristically, these displays are used for general trajectory and guidance monitoring, manual takeover assessment, and manual guidance reference in conjunction with the attitudes, attitude rates, and attitude errors displayed on the ADI and HSI (figs. 8.2-1 and 8.2-2). These displays can also be used to replace normal ground calls in the event of ground communications loss. The displays are subdivided into powered and entry flight regimes and are discussed below.

8.2.1 Powered Flight Monitoring

The onboard displays available for trajectory monitoring during ascent and abort powered flight are shown on figures 8.2.1-1 through 8.2.1-6.

The first display (fig. 8.2.1-1) shows a portion of the nominal ascent trajectory and the expected envelope of RTLS trajectories bounded by an early (engine out at lift-off) and a late (engine out at last RTLS time with 5-second decision delay) RTLS trajectory. This display will be used to monitor normal ascent in the RTLS region and to monitor an RTLS abort if it occurs. The display will be the prime onboard tool along with the ADI and HSI to provide steering commands should manual takeover be required for an RTLS abort. The crew would match current trajectory indicators and/or predictors to preflight scribes on the display to execute the powered RTLS maneuvers.

Similar displays exist for ascent and abort trajectory monitoring for the first-stage, second-stage, and RTLS flight regions and are shown on figures 8.2.1-2, 8.2.1-3, and 8.2.1-4, respectively. These displays are available for crew monitoring but are driven by the backup flight system (BFS) and should only be used when acceptable agreement between the primary and backup systems exists. As indicated on the first display, these displays are primarily used for trajectory monitoring but are available for manual steering cues in the event that manual takeover is required.

Another significant feature of these displays are the GO and RTLS tic marks along the nominal ascent trajectory (figs. 8.2.1-1 and 8.2.1-3). The GO tic marks represent the first time a single SSME can fail, and the remaining performance exists to achieve an AOA with 3-sigma bad performance. The second tic mark (RTLS) represents the last time an SSME can fail, and the capability exists to achieve an RTLS MECO with 3-sigma bad performance. These tic marks can be used in place of normal ground calls in the event of voice communications loss during ascent. Additional conservatism is used in placing these ties on the display to accommodate launch hold, winds, decision delays, and other dispersions such that continuous RTLS and AOA capability exists for a three-sigma performing vehicle should the crew use these tic marks to select the abort mode after an

SSME failed. Note again that this procedure would only be recommended when communications are lost because these calls normally come from the ground mission control center (MCC), which can accommodate for the actual vehicle state, whatever it may be, and therefore are more accurate than the onboard cues.

A special onboard contingency abort display is shown in figure 8.2.1-5. This display shows the boundaries that subdivide the contingency abort regions in second-stage flight in terms of instantaneous apogee altitude and apogee velocity. This display will be the crew's primary source for determining which contingency abort mode procedure to use should two SSME's fail during nominal second stage of during an intact abort powered flight. The vertical boundary on the right indicates when the capability exist (indicator crossing left to right) to continue normal ascent (auto guidance) with a single SSME and achieve a MECO that ensures a contingency downrange ditch entry of less than 2750° F aerosurface normal heating. The boundary on the left indicates when, during an RTLS abort, a time-critical separation is required (indicator crossing right to left) following the loss of a second SSME. Note that the capability to automatically continue an RTLS abort with a single SSME does not exist until powered pitchdown conditions are achieved. Two SSME's out in all other regions of this display result in the crew following a checklist null H-dot procedure in an attempt to achieve a MECO condition resulting in an ET separation of less than 2 psf dynamic pressure and a contingency downrange ditch entry of less than 800 psf dynamic pressure. This display also will indicate when the contingency propellant dump is in progress. This dump is initiated by an item enter.

The final powered flight trajectory display (fig. 8.2.1-6) shows the various OMS maneuver parameters. This display is the primary tool for monitoring the various OMS maneuvers. It displays the OMS burn conditions accepted by the onboard computer, which include: burn attitude, ignition time, burn target parameters, and required burn ΔV 's. This display is available prior to all OMS burns and requires a manual initialization within 5 seconds of ignition before the onboard computer will execute the maneuver. Therefore, the crew has visibility into the selected burn parameters prior to the burn and may option to change any of these before executing the maneuver.

Normally, these type changes will not be required, but should some abort condition exist because of an underspeed/overspeed at MECO or some time-critical situation, the crew has the option to change the targets for the given situation. A list of the various OMS-1 and OMS-2 target options is shown on table 8.2.1-1. The option selected will normally be recommended by the ground, but the crew has a similar list in their checklist onboard. Note that generally these targets are automatically selected by the onboard computer for both the nominal and abort cases; however, should large off-nominal conditions exist, the crew would have to manually key in a new target set. Other features of this maneuver display are monitoring the automatic maneuver once initiated, giving cues for manual takeover, providing manual guidance references, and listing the postburn residuals.

8.2.2 Descent Monitoring

The onboard trajectory displays for an AOA entry are essentially the same as for the nominal end-of-mission. There are several displays used during GRTLS for trajectory and guidance monitoring.

During the alpha recovery and load relief phases, the alpha/Mach indicator (AMI), the normal accelerometer (ACCEL), and the altitude/vertical velocity indicator (AAVI) displays will be used to monitor the Orbiter's pitch up to a 50-degree angle of attack and the subsequent buildup of normal load. During the load relief, the AVVI is used to monitor the pullout when the altitude rate increases above -250 fps.

After pullout, the vertical situation-1 display (VERT SIT-1) (fig. 8.2.2-1), is used to monitor the energy/weight (E/W) on the lower right-hand side and the angle-of-attack on the Mach-alpha displayed on the upper left-hand side. The dashed line represents the alpha profile that the guidance is trying to fly during the alpha transition phase. The solid line represents a manual takeover line should the angle of attack fall below this line. The energy dissipation during an S-turn can be monitored with this display.

After the Orbiter's energy state falls within the altitude and range limits of the VERT SIT scales and the Orbiter's velocity falls below Mach 3.2 the three altitude/range profiles shown can be used to monitor the Orbiter's energy dissipation rate. The upper line represents a maximum energy dissipation rate, the lower line represents a minimum energy dissipation rate, while the middle line represents the reference energy dissipation profile.

The vertical situation 2 (VERT SIT 2) display (fig. 8.2.2-2) replaces the VERT SIT 1 when the altitude drops below 30 000 feet. This display is used to monitor both the energy dissipation and altitude.

When the Orbiter gets close to the landing field, the horizontal situation display (HSD) (fig. 8.2.2-3) and the horizontal situation indicator (HSI) (fig. 8.2-2) can be used to monitor the Orbiter's position relative to the landing site and navigation points. The glideslope pointer (GSI) on the right side of HSI will display the displacement of the vehicle above or below the reference glideslope, and the course deviation indicator (CDI) on the HSI indicates out-of-plane angle.

With the help of the onboard displays mentioned above, and the attitude director indicator (ADI) (fig. 8.2-1), the crew can fly a manual (CSS) GRTLS. Immediately after separation, the pilot pitches up at 2 deg/sec and monitors angle of attack on the AMI. When angle of attack reaches 45°, he starts trimming alpha to 50 degrees and starts monitoring the normal load in fps^2 on the AMI and also g's on the ACCEL display. When the normal load approaches 50 fps^2 (1.65g's), the pilot starts a pitchdown to keep the normal load at 2g's. He then monitors the angle of attack and the altitude rate (H-DOT) on the AVVI to keep alpha above 20° at pullout (H-DOT > -250 fps for cycle 3.)

After pullout, the pilot checks the E/W on the VERT SIT 1. If the E/W indicator is above the STN line (initiate S-turn line), he banks to 45° at a rate of 5 deg/sec away from the runway. He continues this S-turn until the E/W indicator drops below the STN line. He immediately reverses bank to 45° , and he levels out when headed toward waypoint 1. During the S-turn, the pilot controls pitch by flying the Shuttle symbol on the Mach-alpha reference dotted line displayed on the upper left-hand side of the VERT SIT 1.

Below Mach = 3.2, and when the Orbiter's energy state falls within the altitude/range profiles on the VERT SIT 1, the pilot flies the heading to waypoint 1 shown by the primary pointer on the HSI and maintains the E/W indicator on the nominal mark on the VERT SIT 1 by pitching down to increase equivalent airspeed (EAS) to decrease E/W with respect to the nominal reference or by pitching up to decrease EAS to increase E/W. Once the E/W indicator is on the nominal mark, the pilot will fly toward the nominal reference line. When the Orbiter speed drops below Mach = 0.9, the pilot will fly along the nominal altitude reference line and will take over manual speedbrake control to maintain the recommended EAS shown on the VERT SIT 2 altitude reference line.

When the secondary pointer is about 90° away from the primary pointer on the HSI, the heading alignment turn is started by the pilot. All this time, he has been keeping an eye on the GSI so as not to get too far off the outer glideslope. The pilot should now be within visual sight of the runway and should retract the body flap and maintain the outer glideslope. He should maintain the reference velocity of 280 knots EAS by modulating the speedbrake until the altitude decreases to 2500 feet when the speedbrake is retracted. The pilot will execute the preflare maneuver of $1.4g$'s at an altitude of 2000 feet above the runway. When the velocity decreases to 270 knots EAS, the landing gear is deployed. This should occur at an altitude slightly above 200 feet above the runway and landing should occur approximately 3200 feet past the runway threshold at an airspeed of 185 knots EAS at a sink rate of approximately 3 fps.

TABLE 8.1.1-I.- ARD/EP MONITORING CHARACTERISTICS

Parameter	Description	Value
ARD reference margins		
Δ VNOM AM L/O	Permission reference AM margin at lift-off	1425 fps
Δ VNOM MPS AM STG	Permission reference AM margin at staging	1009 fps
Δ VAOA HM STG	Permission reference HM margin at staging	-1849 fps
Δ VNOM MPS AM TFAIL	Permission reference AM margin at TFALL	817 fps
Δ VRTL5 HM TFALL	Permission reference RTL5 HM margin at TFALL	1587 fps
Δ VRTL5 FLYBACK	Normal flyback AM Δ V for RTL5 selected before 4:00	767 fps
Δ VLAST RTL5 FLYBACK	Normal flyback AM Δ V for latest RTL5 case	363 fps

TABLE 8.1.1-I.- Continued

Parameter	Description	Value
ARD/EP monitoring limits		
$\Delta V2SSME$ RTLS LIMIT	Last RTLS limit for 10-second decision delay and 5-second data lag	1241 fps
$\Delta V3SSME$ RTLS LIMIT	Last 3-SSME RTLS limit for 10-second decision delay and 5-second data lag	1616 fps
$\Delta VCE/O$ ZERO MARGIN LIMIT	Zero margin limit for center SSME failure	-21 fps
$\Delta VSE/O$ ZERO MARGIN LIMIT	Zero margin limit for side (either left or right) SSME failure	0 fps
$\Delta VABORT$ GAP LIMIT	Reference AOA HM margin limit (at last RTLS) defining RTLS/AOA abort gap	-26 fps
$\Delta V15SECOND$ GAP LIMIT	Reference AOA HM margin limit (at last RTLS) defining 15-second RTLS/AOA abort gap	-109 fps
$\Delta VAOA$ SHALLOW ABORT GAP	AOA HM margin limit (at last RTLS) defining RTLS/AOA - shallow abort gap	-286 fps
$\Delta VSINGLE$ SSME COMPLETION LIMIT	Margin limit defining single SSME AOA intact completion capability	-192 fps
$\Delta TTURN$ LIMIT	Longest delay after EP T TURN for successful manual pitcharound	20 sec
$\Delta VRESERVES$	ARD MPS reserves not considered usable in AOA/ATO margins	234 fps

TABLE 8.1.1-I.- Concluded

Parameter	Description	Value
ARD/EP monitoring limits - Concluded		
Δ VRTLS FLYBACK WEIGHT CONSTRAINT	Upper limit on RTLS flyback AM Δ V for safe ET separation	2100 fps
Δ VOMS TANK LEAK	Defines ARD Δ V limit required in MCC calls for leaking OMS tank: <ul style="list-style-type: none"> o Press-to-MECO o Single SSME 	+417 fps +225 fps
Δ TOMS TANK LEAK	Nominal day ARD boundary shift due to leaking OMS tank <ul style="list-style-type: none"> o Press-to-MECO o Single SSME 	57 sec 16 sec
Δ WOMS SINGLF SSME ROLL CONTROL	OMS fuel adjustment for single-SSME roll control: <ul style="list-style-type: none"> o Minimum adjustment o Auto guidance/convergent flight control o Manual guidance or flight control problems 	300 lbs 3 lb/sec 22 lb/sec
ARD/trajectory key events		
TFAIL	Time to discontinue trajectory lofting	4:20 min:sec
Δ VHM I/C	Inertial velocity limit for first ARD HM single SSME completion support	12 000 fps
TMSTG	SRB staging	2:07 min

TABLE 8.1.1-II.- ARD NOMINAL-DAY BOUNDARIES

Boundary	Side SSME failure	Top SSME failure
50/50 guided MECO probability	4:15	4:13
Earliest AOA	4:00	3:58
Earliest ATO	3:55	3:53
Earliest mission completion (50/50 probability)	4:08	4:07
Latest RTLS ^a	4:23	4:22
Single SSME completion	6:52	6:52

^aIncludes 5-second data delay and 10-second decision time.

TABLE 8.2.1-1.- OMS-1/-2 TARGET CHECKLIST FOR STS-1

Options	MECO state	OMS-1 targets	OMS-1 Tig/Δv	OMS-2 targets	Resultant mission	Applications (post-MECO system failure)
1	Nominal (0 < USPD < 80)	Nominal onboard	MECO + 2	Nominal onboard	Nominal 150 circ	Pre-OMS 1: no failure Post-OMS 1: 1 OMS prop tank, 1 or 2 OMS He tanks
2	Nominal (0 < USPD < 80)	Nominal checklist	MECO + 12	Nominal procedure	Nominal 150 circ	Slip to Madrid for comm. coverage
3	Underspeed (80 < USPD < 415)	ATO onboard	MECO + 2	ATO onboard	Nominal > 105 < 150 circ	Pre-OMS 1: no failure Post-OMS 1: 1 or 2 OMS He tanks Post-OMS 1: 1 OMS He tank
4	Underspeed (80 < USPD < 512)	ATO onboard	MECO + 2	AOA checklist	AOA	Pre-OMS 1: no failure, time critical return Post-OMS 1: 1 OMS prop tank, 1 or 2 OMS He tanks 2, OMS engines Pre-OMS 1: time-critical return, 1 OMS He tanks Post-OMS 1: 1 OMS prop tank, 2 OMS engines
5	Underspeed (80 < USPD < 555)	ATO onboard	MECO + 2	AOA shallow checklist	AOA shallow	Pre-OMS 1: no failure, time critical return, 2 OMS engines Post-OMS 1: 1 OMS prop tank, 1 or 2 OMS He tanks, 2 OMS engines
6	Underspeed (512 < USPD < 623)	AOA shallow onboard	MECO + 2	AOA shallow onboard	AOA shallow	Pre-OMS 1: 2 OMS He tanks, 1 OMS prop tank or 1 OMS He tank for USPD > 300 fps
7	Nominal (0 < USPD < 80)	ATO onboard	MECO + 12	ATO procedure (checklist)	ATO 4 rev	Pre-OMS 1: 1 OMS prop tank or 1 OMS He tank with delayed OMS 1
8	Nominal (0 < USPD < 80)	ATO onboard	MECO + 12	AOA checklist	AOA	Pre-OMS 1: 1 OMS prop tank, 2 OMS engines
9	Nominal (0 < USPD < 80)	AOA shallow checklist	MECO + 12	AOA shallow checklist	AOA shallow	Pre-OMS 1: 2 OMS He tanks with delayed OMS 1
10	Nominal (0 < USPD < 30)	Nominal onboard	MECO + 2	AOA onboard	AOA	Pre-OMS 1: time critical return, 2 OMS engines Post-OMS 1: 2 OMS engines
11	Nominal (0 < USPD < 80)	Nominal onboard	MECO + 2	AOA shallow checklist	AOA shallow	Pre-OMS 1: 2 OMS He tanks
12	Nominal (0 < USPD < 80)	Nominal checklist	MECO + 12	AOA checklist	AOA	Pre-OMS 1: Slip to Madrid for comm. coverage Post-OMS 1: 2 OMS engines

USPD = Under-speed velocity at MECO fps.

DELTA V MARG NO. 1 < NOM/FDA/RTLS > MSK 0437

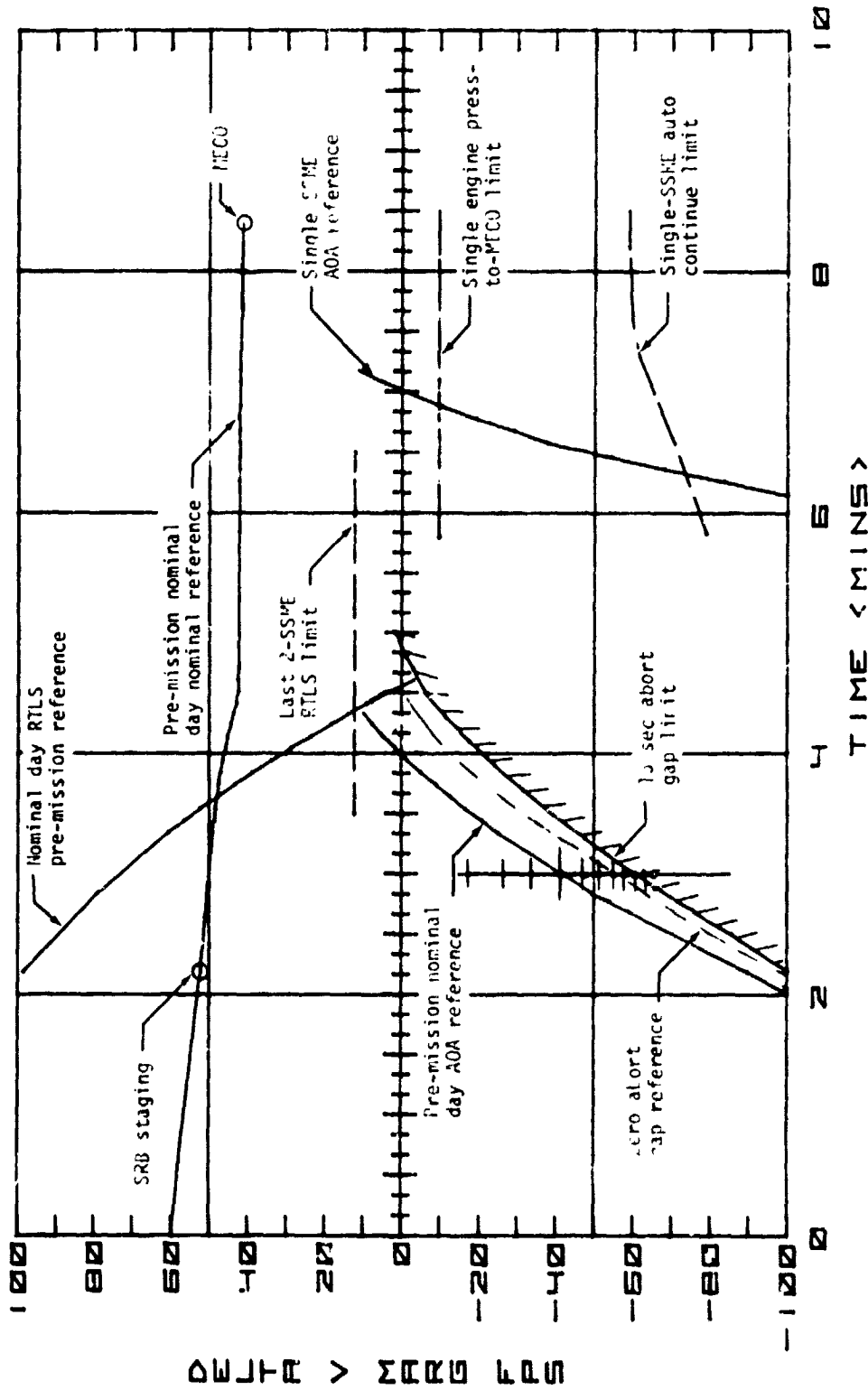

Figure 8.1.1-1.- Delta velocity margin number 1 (4/AOA/RTLS).

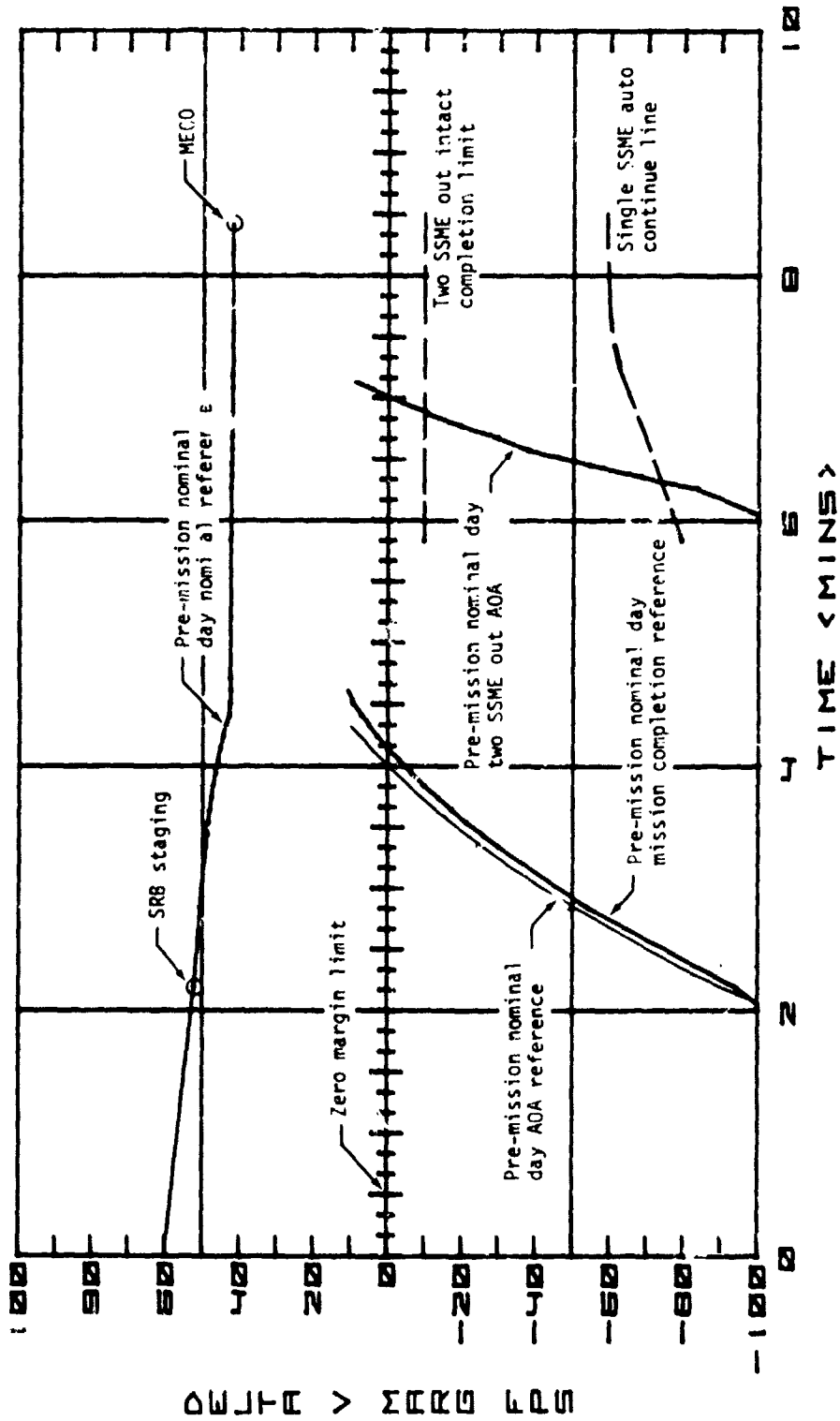

Figure 8.1.1-2.- Delta velocity margin number 2 - NOM/ATO/AOA.

0434 05
 ABORT REGION DETERMINATOR
 PET+00:00 ARD PET+00:00 SS 0000 000 GMT L/O 00:00:00:00 HYP MODE
 ACTUAL MODE

THROTTLE ARD PRI BFS CMD 000 000 000 LEFT 000 000 000 CENTER 000 000 000 RIGHT 000 000 000 THROTTLE LEFT 000 CENTER 000 RIGHT 000	ABORT MASS 00000000 0000 TGD 00:00 MASS CYCLE +00:00	REGION MPROP XOMS Σ 000000000000000000000000 NOM +000000 +00000 +000000 000000000000000000000000 RTLS +000000 +000000 000000000000000000000000 AOA +000000 +00000 +000000 000000000000000000000000 ATO +000000 +00000 +000000	REGION MPROP XOMS Σ 000000000000000000000000 NOM +000000 +00000 +000000 000000000000000000000000 RTLS +000000 +000000 000000000000000000000000 AOA +000000 +00000 +000000 000000000000000000000000 ATO +000000 +00000 +000000
EVENT ARD PRI BFS TGO +00:00 00:00 00:00 MECO +00:00 00:00 00:00 TLEO +00:00 00:00 00:00 TCEO +00:00 00:00 00:00 TREQ 00:00 00:00 00:00 VMEO 00000 00000 00000 PRPLT OMS RCS CURRENT WT LBS 00000 00000 VEH 00000000 ΔV 00000 00000 ETP 00000000	RTLS EVENT PREDICTION 0DISS 00.0 TMECO +00:00 ΔT TO TURN +00:00 RMECO 000.0 PET TURN +00:00 YMECO 0000.0 ΔT END TURN +00:00 YMECO 0.0 Δθ PITCH 000.0 PPD % 00.0 PPD ANG 00.0	RTLS EVENT PREDICTION 0DISS 00.0 TMECO +00:00 ΔT TO TURN +00:00 RMECO 000.0 PET TURN +00:00 YMECO 0000.0 ΔT END TURN +00:00 YMECO 0.0 Δθ PITCH 000.0 PPD % 00.0 PPD ANG 00.0	RTLS EVENT PREDICTION 0DISS 00.0 TMECO +00:00 ΔT TO TURN +00:00 RMECO 000.0 PET TURN +00:00 YMECO 0000.0 ΔT END TURN +00:00 YMECO 0.0 Δθ PITCH 000.0 PPD % 00.0 PPD ANG 00.0

Figure 8.1.1-3.- Abort region determinator.

C-5

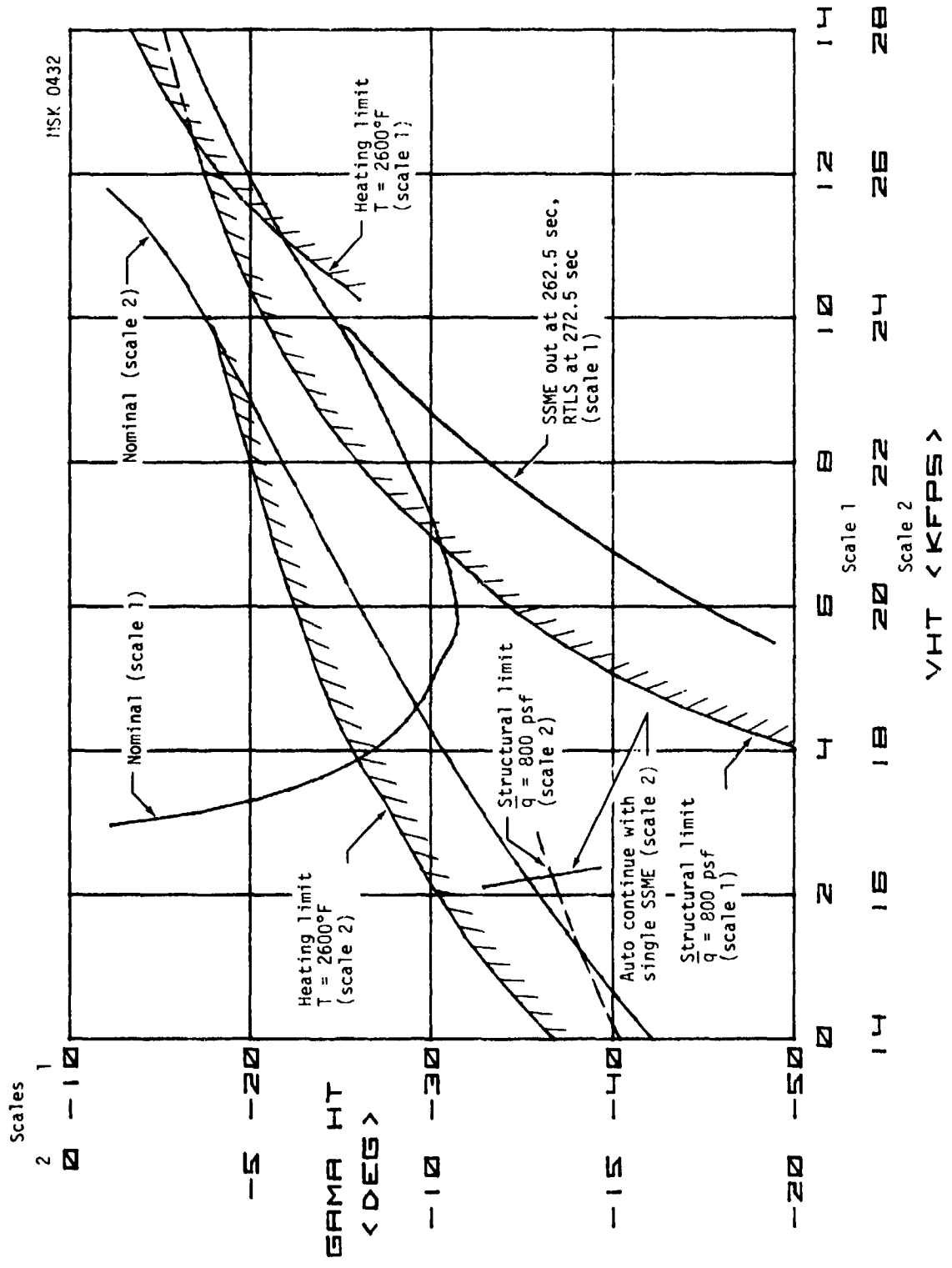

(a) Nominal/ATO/AOA.

Figure 8.1.2-1.- Inertial velocity and inertial flight path angle at 125 000 feet.

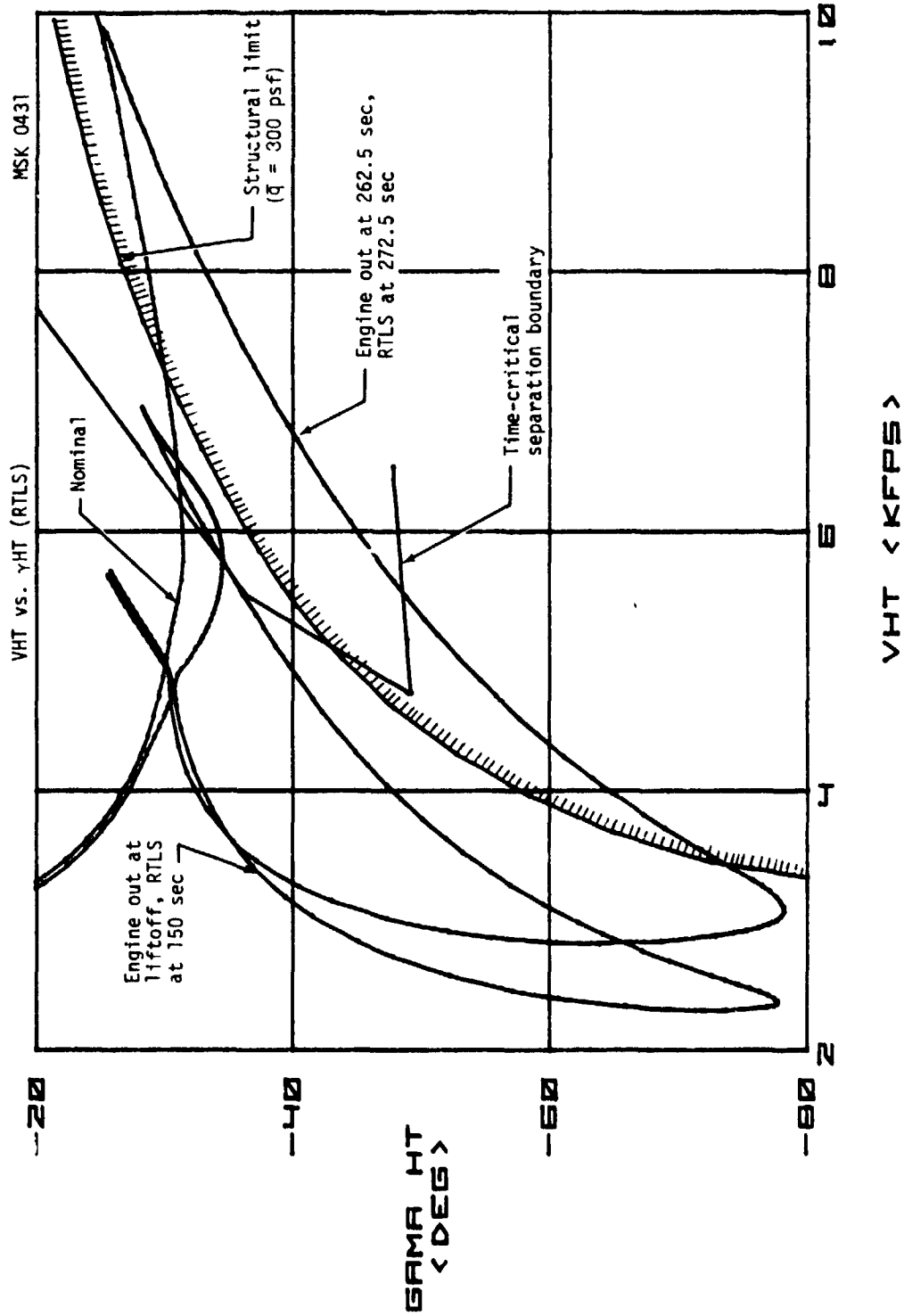

(b) RTLS.

Figure 8.1.2-1.- Concluded.

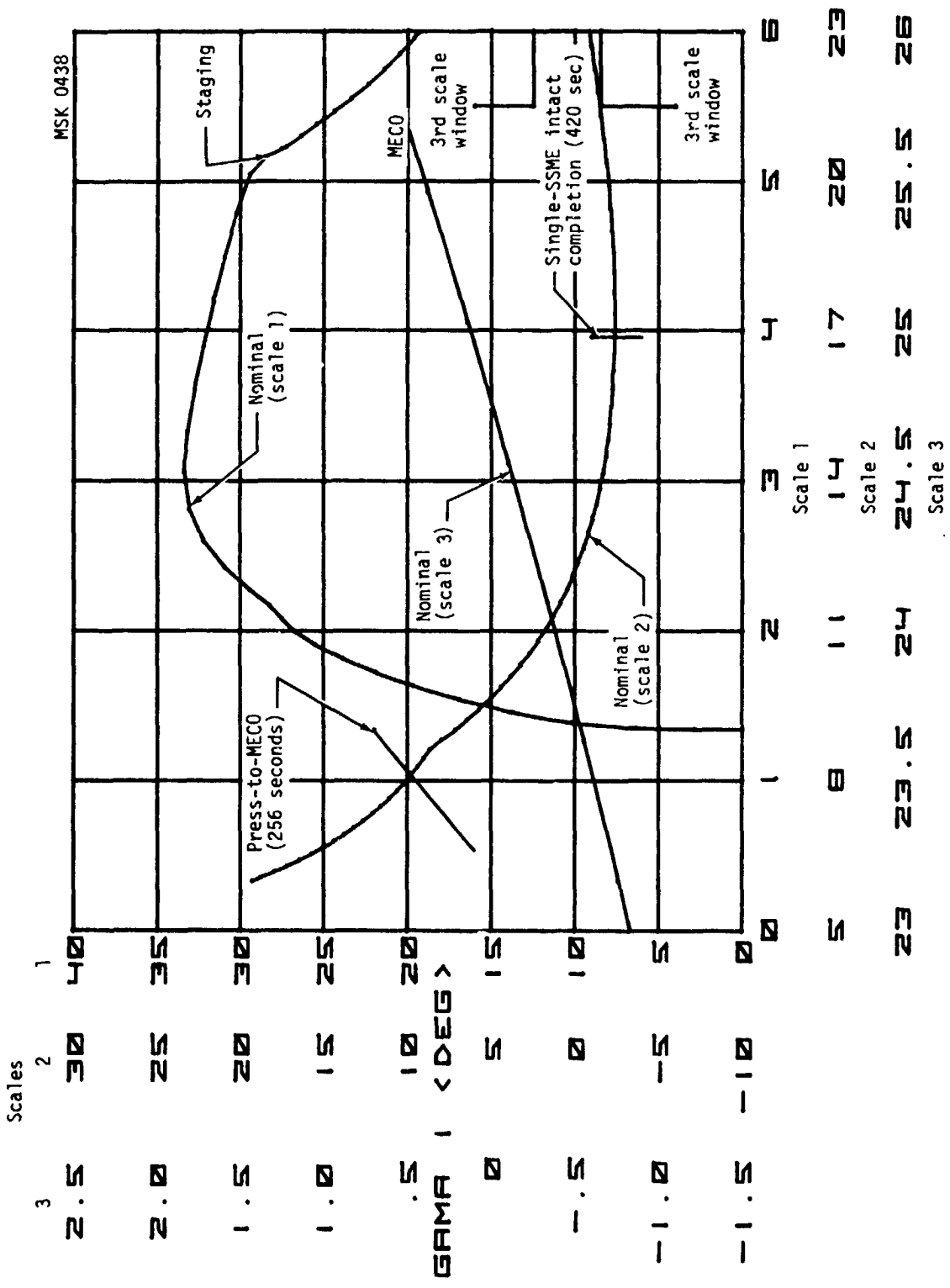
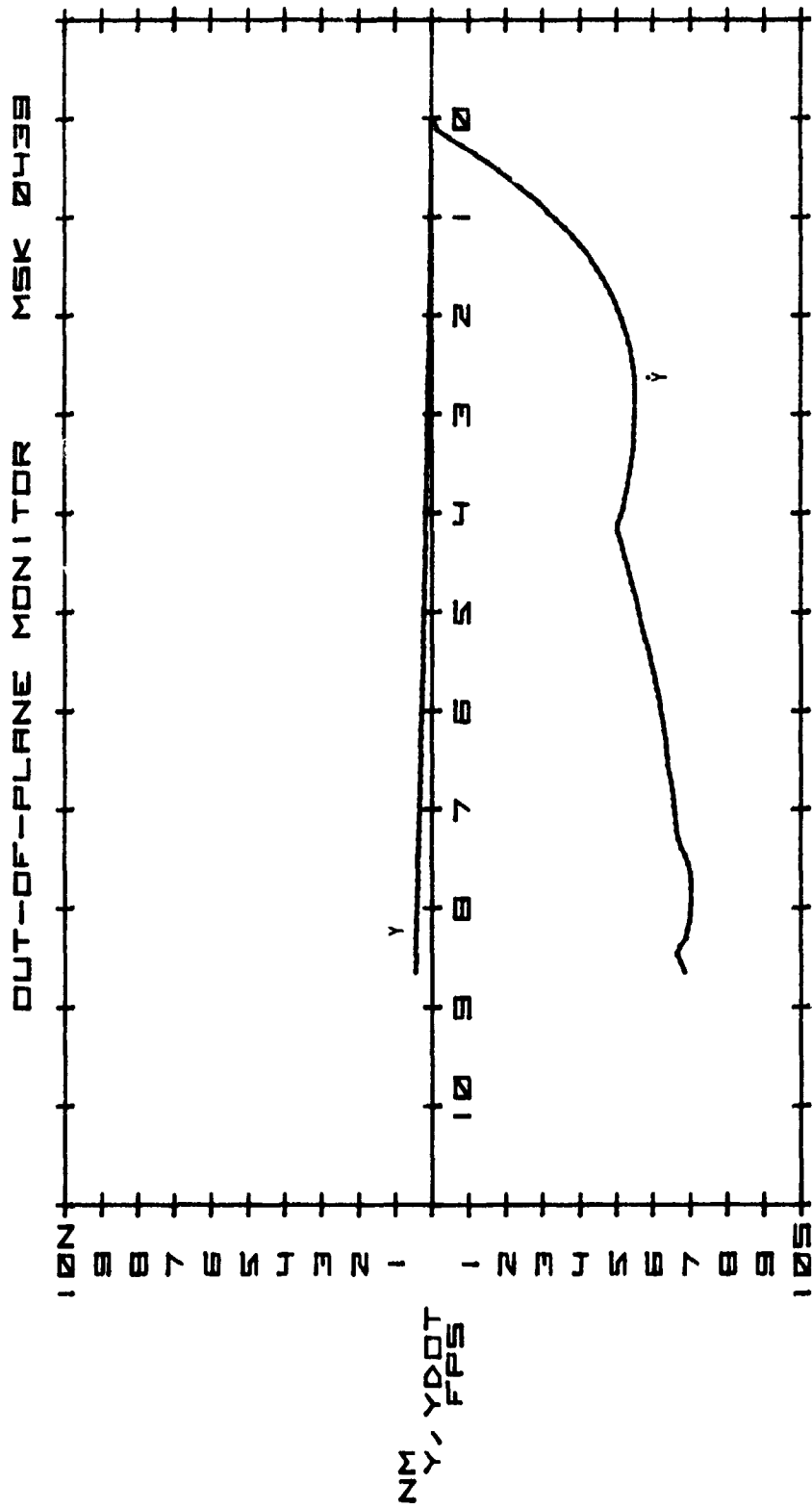

Figure 8.1.2-2.- Inertial flightpath angle versus velocity.



TSD < MINUTES >

Figure 8.1.2-3.- Out-of-plane monitor.

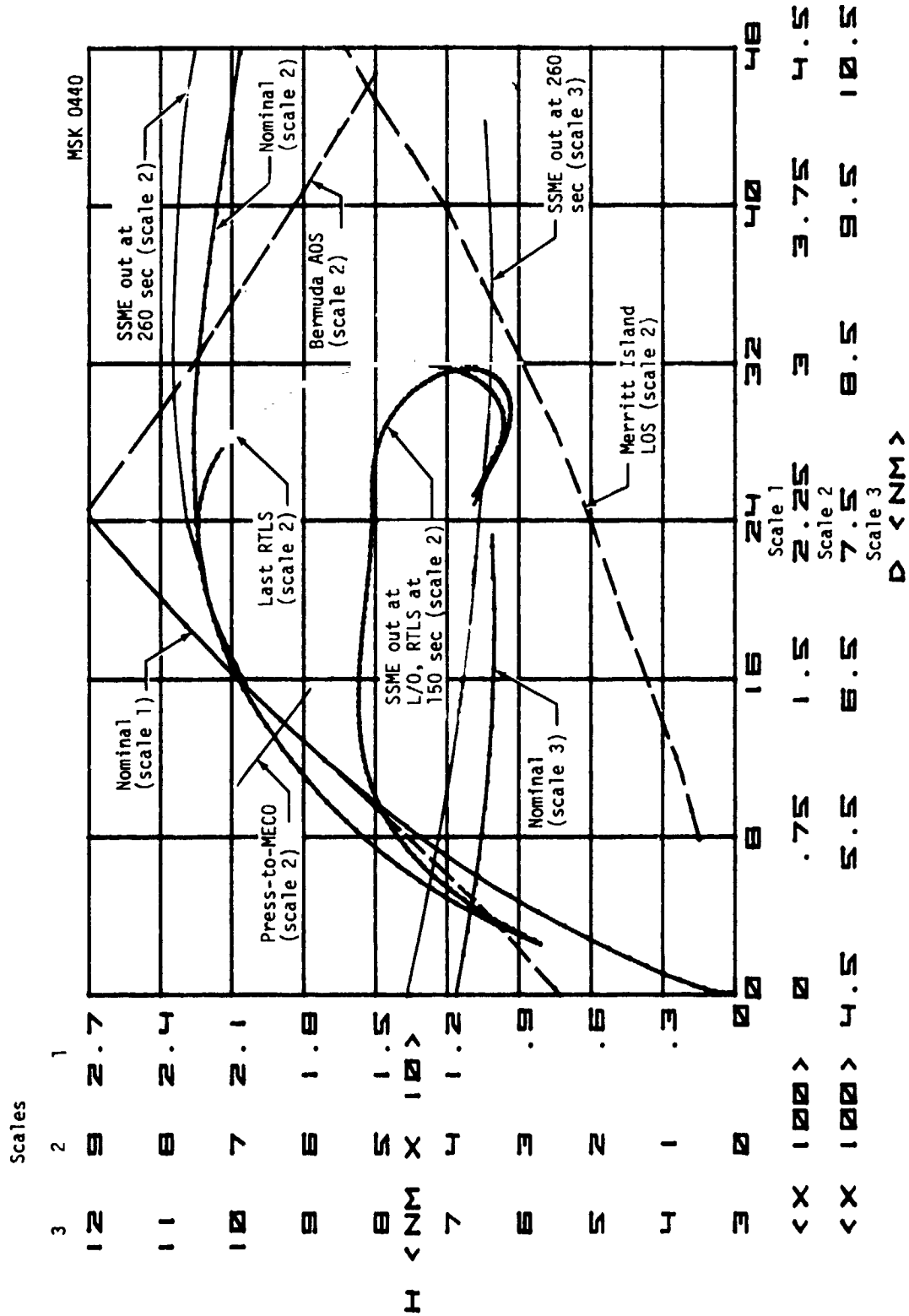

Figure 8.1.2-4.- Altitude versus downrange distance.

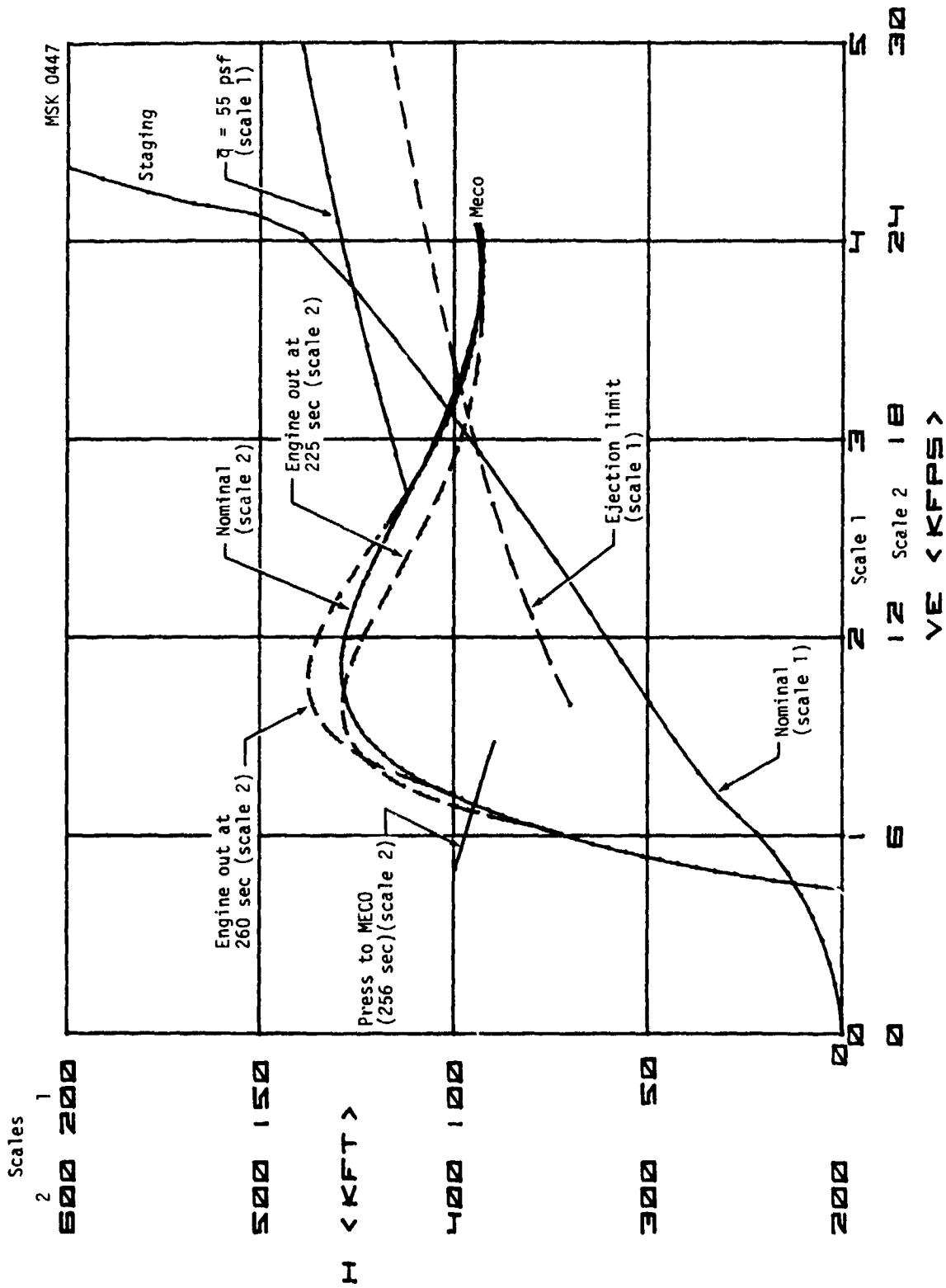

Figure 8.1.2-5.- Altitude versus relative velocity - nominal.

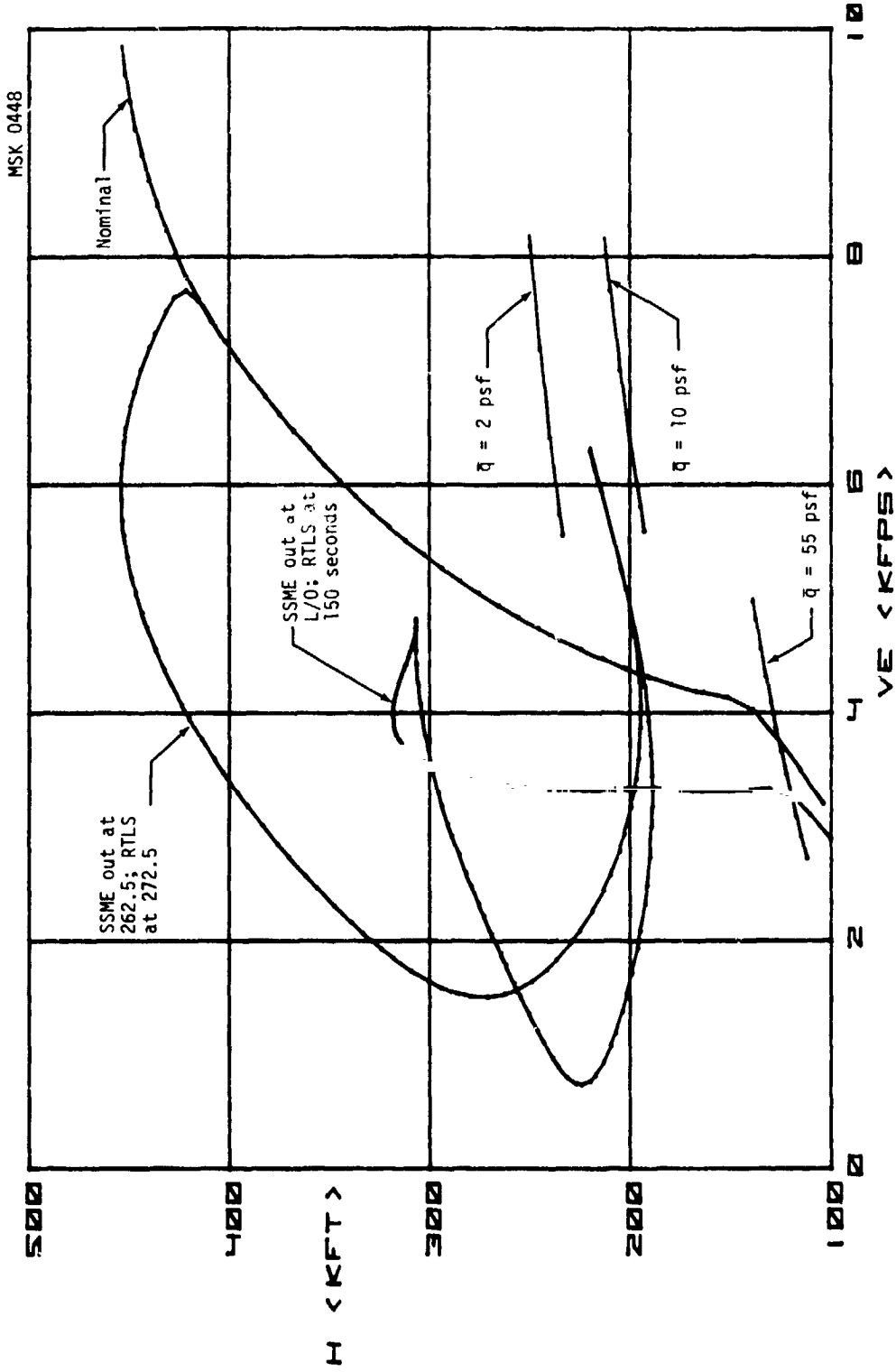

Figure 8.1.2-6.- Altitude versus relative velocity - RTLS.

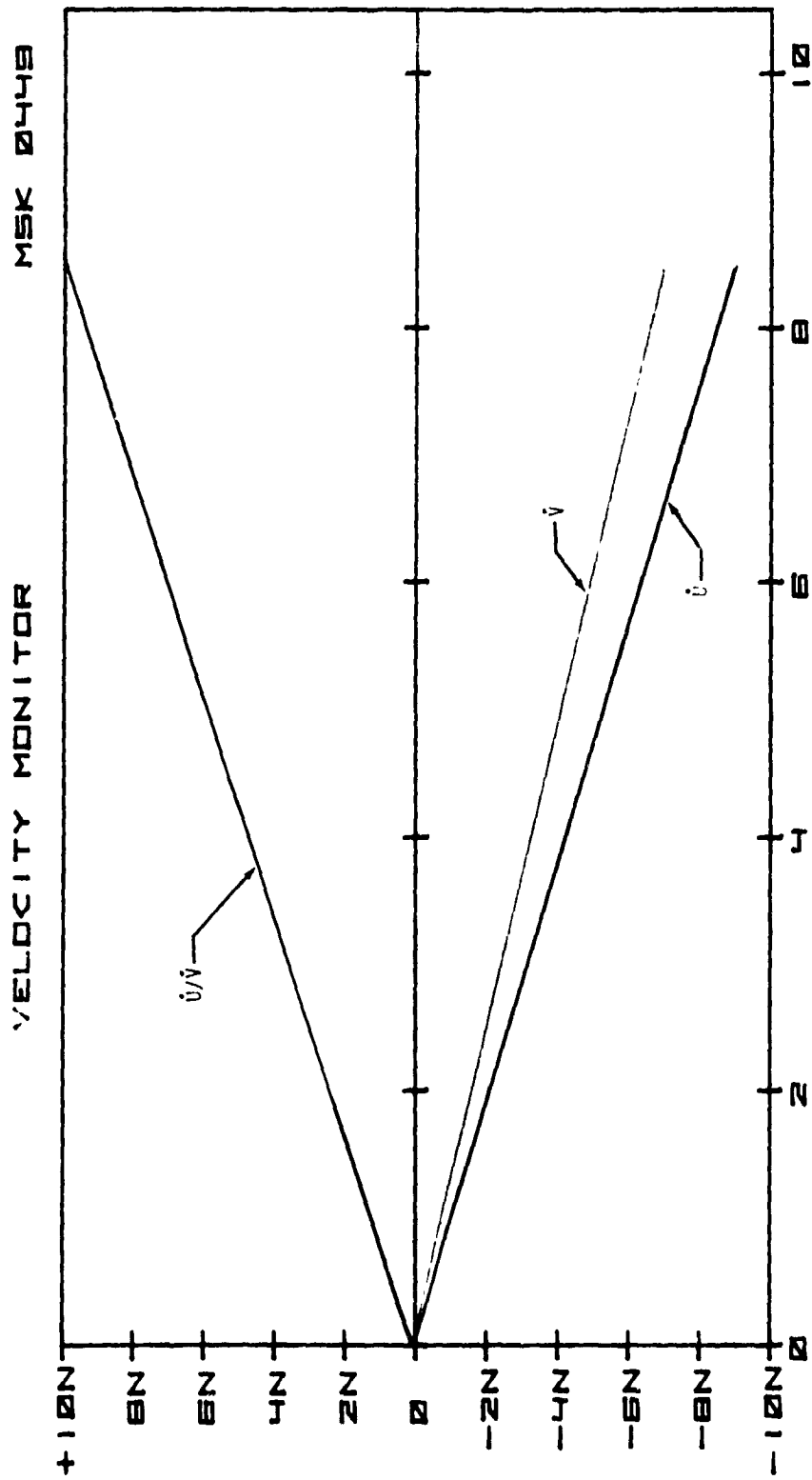

Figure 8.1.2-7.- Velocity monitor.

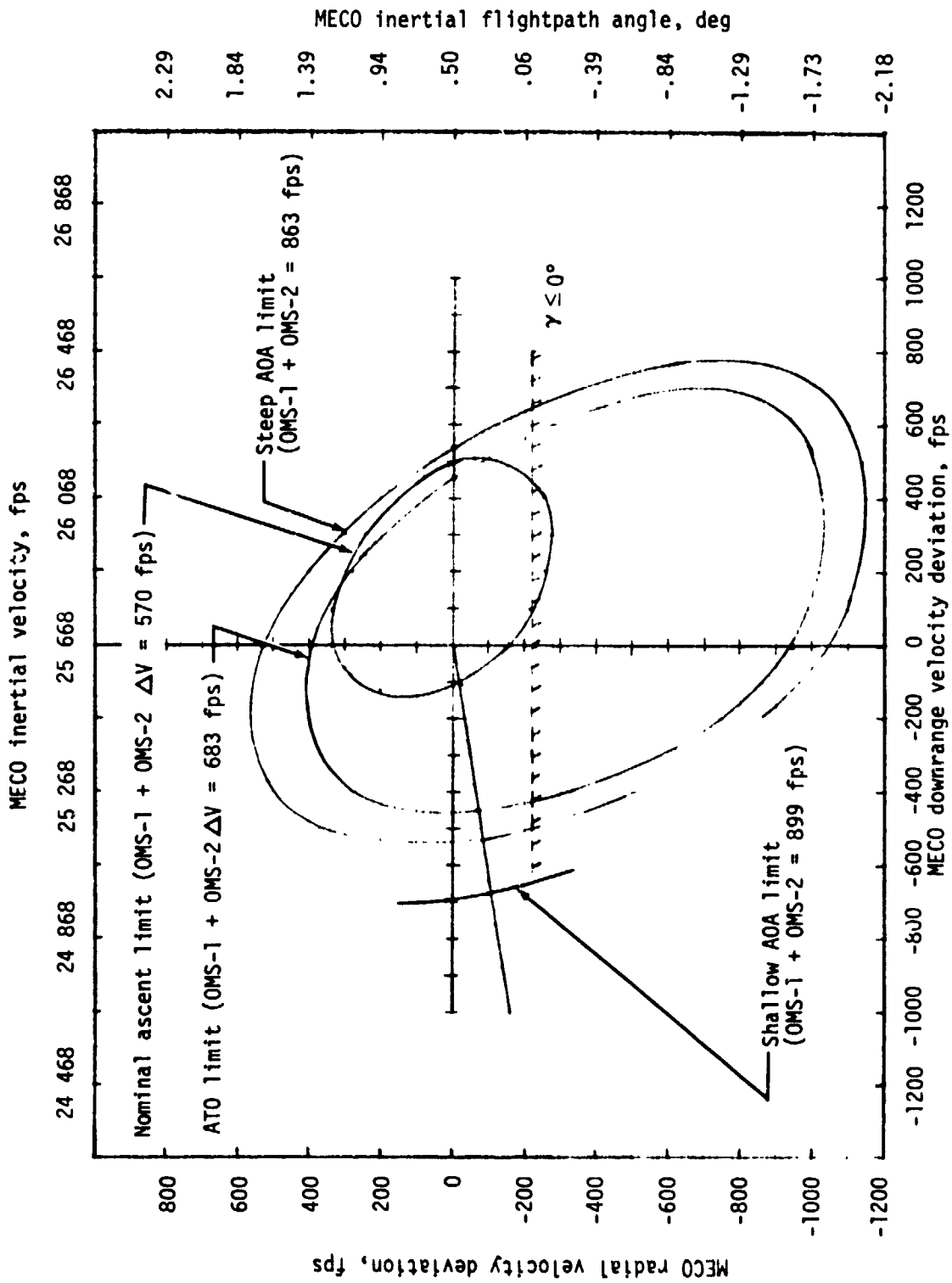

Figure 8.1.3-1.- STS-1 ascent/abort MECO zoning.

MX TURN RATE-NEW SOL

Indicates that the solution requires an excessive thrust rotation (57.3 degrees or more) and that the small angle approximations used in the solution are invalid. Even though the new solution is displayed, PEC output in this case is suspect since the thrust angle has been artificially limited to one radian. This message will be routinely displayed early in ascent for all HM modes and again following entry of the HM second-engine-out MED and is not necessarily indicative of any ARD processing problems.

MX ITER-OLD SOL

Guidance equations have been cycled 25 times without achieving a converged solution. Since convergence is normally achieved in 5 to 10 cycles, this is usually indicative of severe difficulties in either the current performance or targetting regime (e.g., too close to the landing site for RTLS, single-SSME HM comps initiated too early, etc.) ARD display is not updated in this case but, instead, retains the last valid solution for this mode. This message will normally be output in early ascent for PTLs and is not here a cause for concern. Any other occurrence of this message, however, is probably indicative of a serious ARD processing difficulty.

VGO=0-OLD SOL!

Means that PEG processing has been terminated for the identified mode because the magnitude of the velocity required to achieve the targets was identically equal to zero (to 16 decimal places). There are no identifiable occurrences of this message. Note that the ARD display has not been updated and retains data for this mode from the last valid solution.

VGO, MX TURN THROTTLE ON

This message indicates that velocity-to-be-gained-by-thrust was exceeded 75 000 FPS. during the process of PEG iteration for the indicated mode. ARD display for this mode has not been updated this cycle and retains data from the last valid mode solution. Error condition is most often a result of very low thrust-to-weight ratio and is most likely the effect of an erroneous zero MED throttle entry.

GENERAL NOTES:

- 1) ARD error messages are displayed immediately above the solution to which they apply (i.e., AOA, ATO, RTLS, or NOM AM or HM) on the ARD Digital Display (MSK 0434).
- 2) Error processing and error message provisions affect only the current ARD display cycle. Normal ARD cycling and display updates every six seconds are not affected by these.

Figure 8.1.3-2.- ARD PEG error messages.

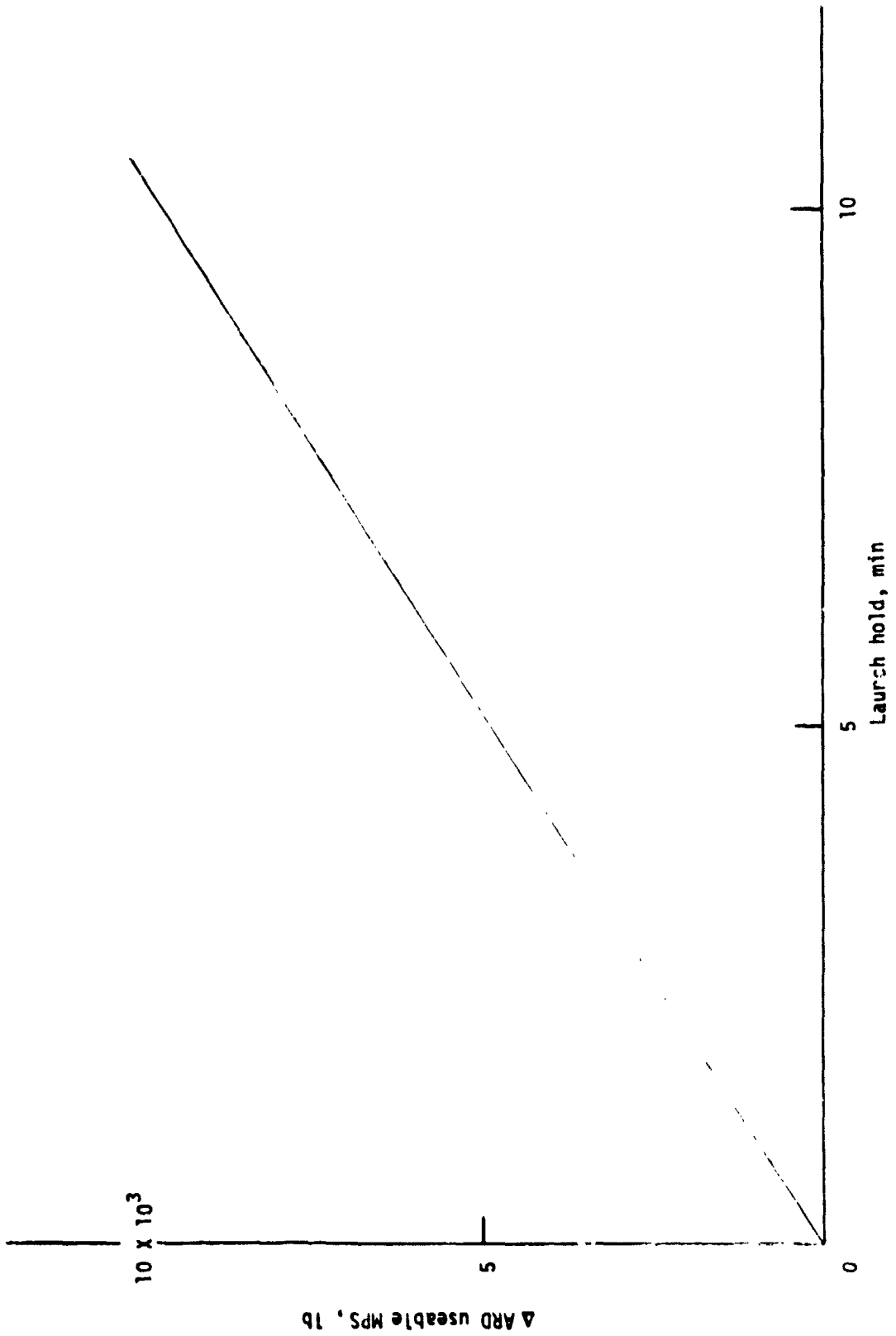

Figure 8.1.3-3.- Launch hold MPS propellant usage.

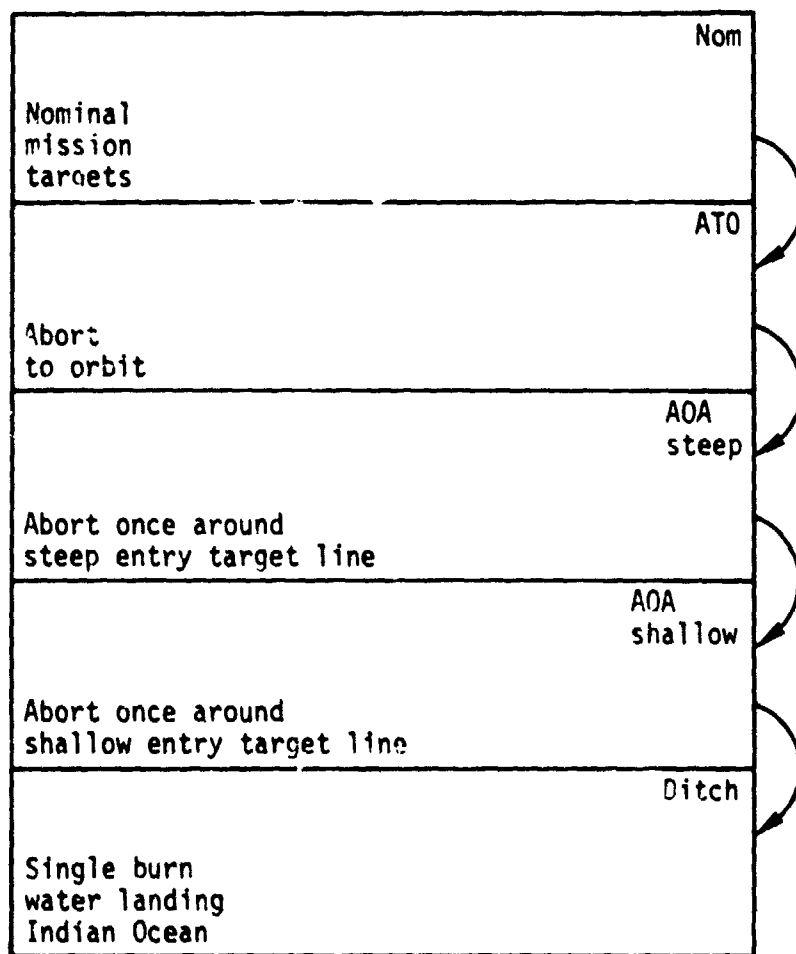

Figure 8.1.4-1.- AME downmoding for STS-1.

AME PRIMARY

0435 03

```

PET+000:00:00.0 GMT 000:00:00.0 GMT L/O 000:00:00.00
000000000000000000000000000000000000000000000000
MECOET+00:00 EOM ΔV 0000.0 TMVECT ID 0000000000
MODE 0000 ACH 0 SEL SPCE 0000 EPHVECT ID 0000000000
MP ON+000 OFF+000 TLM GRND 000 TLM OB 000 TGT 000
    
```

ΔV Pass 0000.0 OPTION 00 00000 ΔV FAIL 0000.0
 0000000000 000 0000000000

FIRST BURN

```

OMS-1
GMT+00:00:00.00 ΔVX ±0000.0
PET+00:00:00.00 ΔVY ±0000.0
C1 000000 ΔVZ ±0000.0
C2 +.00000 THRUSTER 000
HT 000.0 ΔVT ±0000.0
θ 000.0 ΔtB +00:00.0
PRPLT +00000 ΔtRCS +00:00.0
ULL+000 ULL+000
TVR 000.0
Ha 000.0 Hp 000.0
ADI R P Y RELMAT
INTRL 000.0 000.0 000.0 0000000
LVLH 000.0 000.0 000.0 SN 00000
WI 000000.0
ΔVOMS 0000.0
ΔVRCS 0000.0
WF 000000.0
    
```

SECOND/ONLY BURN

```

OMS-2
GMT+00:00:00.00 ΔVX ±0000.0
PET+00:00:00.00 ΔVY ±0000.0
C1 000000 ΔVZ ±0000.0
C2 +.00000 THRUSTER 000
HT 000.0 ΔVT ±0000.0
θ 000.0 ΔtB +00:00.0
PRPLT +00000 ΔtRCS +00:00.0
ULL+000 ULL+000
TVR 000.0
Ha 000.0 Hp 000.0
ADI R P Y RELMAT
INTRL 000.0 000.0 000.0 0000000
LVLH 000.0 000.0 000.0 SN 00000
WI 000000.0
ΔVOMS ±0000.0
ΔVRCS ±0000.0
WF 000000.0
    
```

```

Ha 000.0 Hp 000.0 Tff +00:00
ADI R P Y RELMAT VEI 00000.0
INTRL 000.0 000.0 000.0 0000000 YEI ±0.00
LVLH 000.0 000.0 000.0 SN 00000
WI 000000.0
ΔVOMS ±0000.0
ΔVRCS ±0000.0
WF 000000.0
    
```

Figure 8.1.4-2.- AME primary display.

AME SECONDARY

3436 93

```

RET+000:00:00:00 GMT 000:00:00:00 W GMT L/O 000:00:00:00 000000000000000000000000000000
00000000000000000000000000000000000000000000000000000000000000000000000000000000
MODEY+00:00:00 ECM 1 0000.0 INJECT ID 0000000000
MODE 0000 0000 0000 SEL SPCE 0000 EPHVECT ID 0000000000
MP ON+0000 OFF 0000 TLM GRND 0000 TLM DB 000 TGT 0000
    
```

FIRST BURN

SECOND/ONLY BURN

```

ΔV PASS 0000.0 ΔV PASS 0000.0
0000000000 000 0000000000 000
ΔV1 10000.0 ΔV1 10000.0
ΔV2 1000.0 ΔV2 1000.0
THRUSTER 000 THRUSTER 000
ΔVT 10000.0 ΔVT 10000.0
Δ+8 100:00.0 Δ+8 100:00.0
Δ+RCS 100:00.0 Δ+RCS 100:00.0
ULL+00 ULL+00
TVP 000.0 TVP 000.0
    
```

```

DMS-1
GMT+00:00:00:00 ΔV1 10000.0
RET+00:00:00:00 ΔV2 1000.0
C1 000000 THRUSTER 000
C2 +.000000 ΔVT 10000.0
HT 000.0 Δ+8 100:00.0
SY 000.0 Δ+RCS 100:00.0
PPPLT +000000 ULL+00
TVP 000.0
    
```

```

HA 000.0 Hf 000.0
ADI P P PELMNT Y PELMNT
INRTL 000.0 000.0 000.0 000.0 000.0 00000000
LVLH 000.0 000.0 000.0 000.0 000.0 000000
WI 000000.0 WI 000000.0
WF 0000000.0 WF 0000000.0
Tff +00:00
YEI 000000
TEI 100.00
    
```

```

HA 000.0 Hf 000.0
ADI P P PELMNT Y PELMNT
INRTL 000.0 000.0 000.0 000.0 000.0 00000000
LVLH 000.0 000.0 000.0 000.0 000.0 000000
WI 000000.0 WI 000000.0
WF 0000000.0 WF 0000000.0
Tff +00:00
YEI 000000
TEI 100.00
    
```

Figure 8.1.4-3.- AME secondary display.

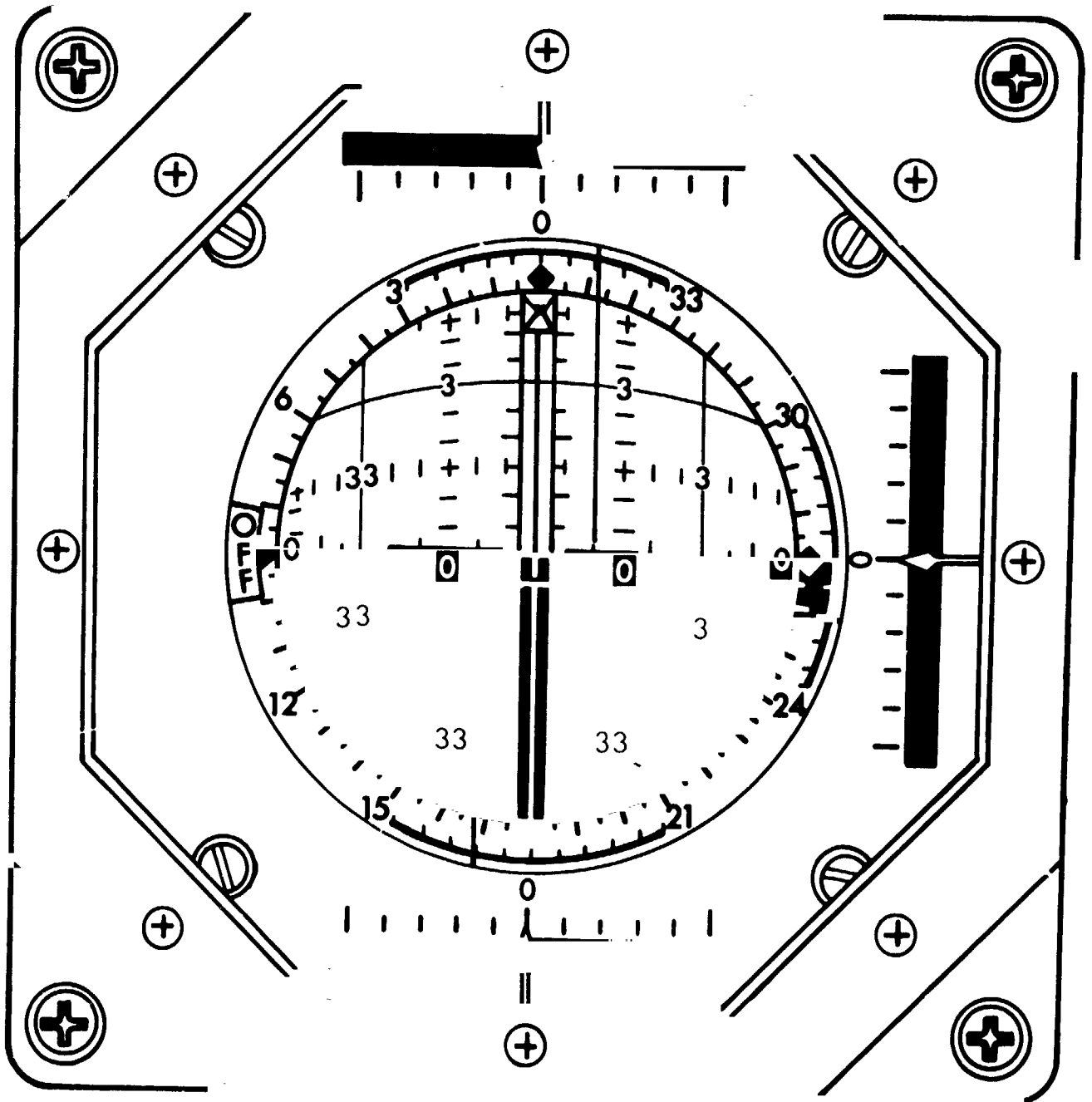

Figure 8.2-1.- Attitude Director Indicator (ADI).

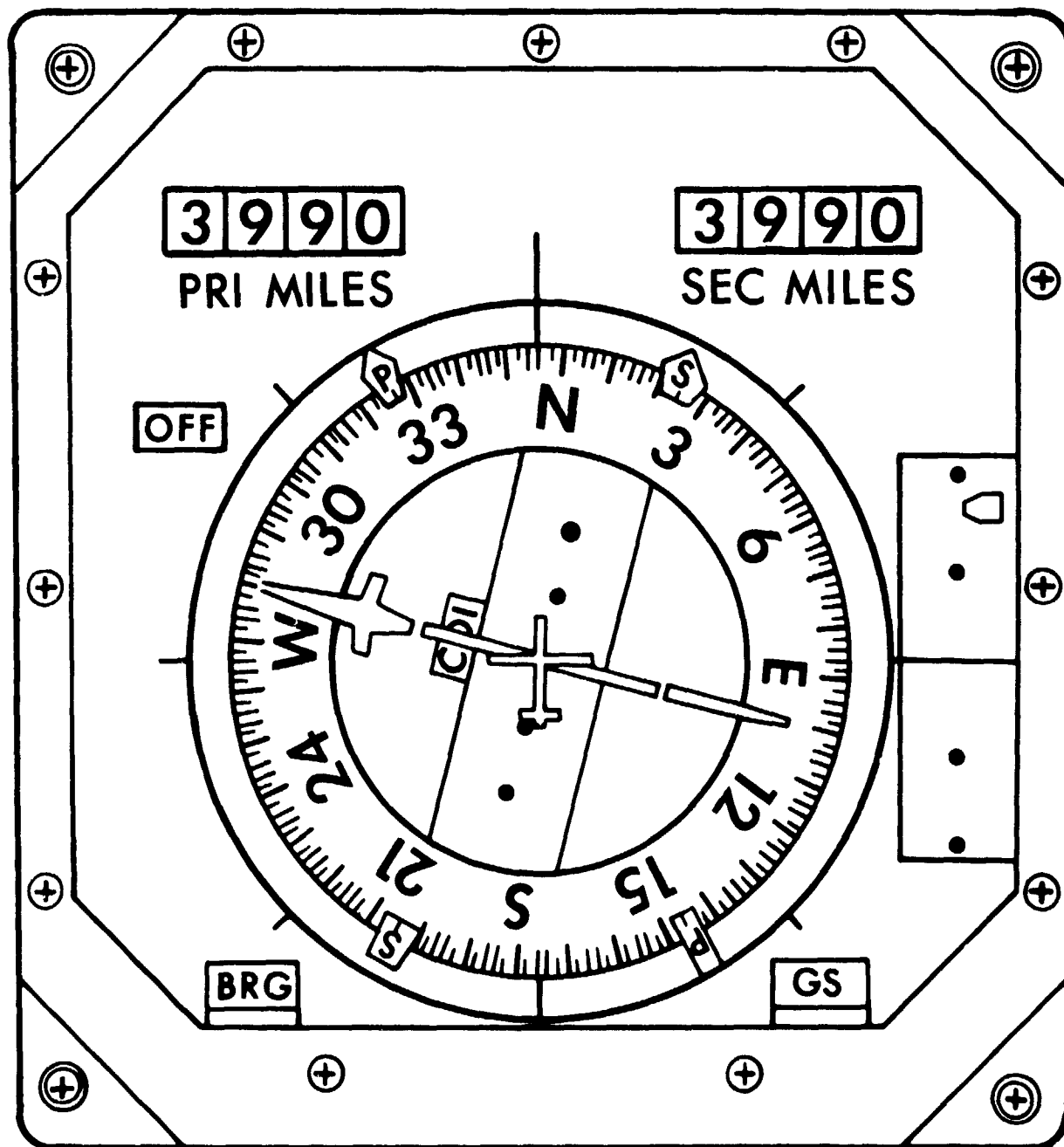

Figure 8.2-2.- Horizontal Situation Indicator (HSI)

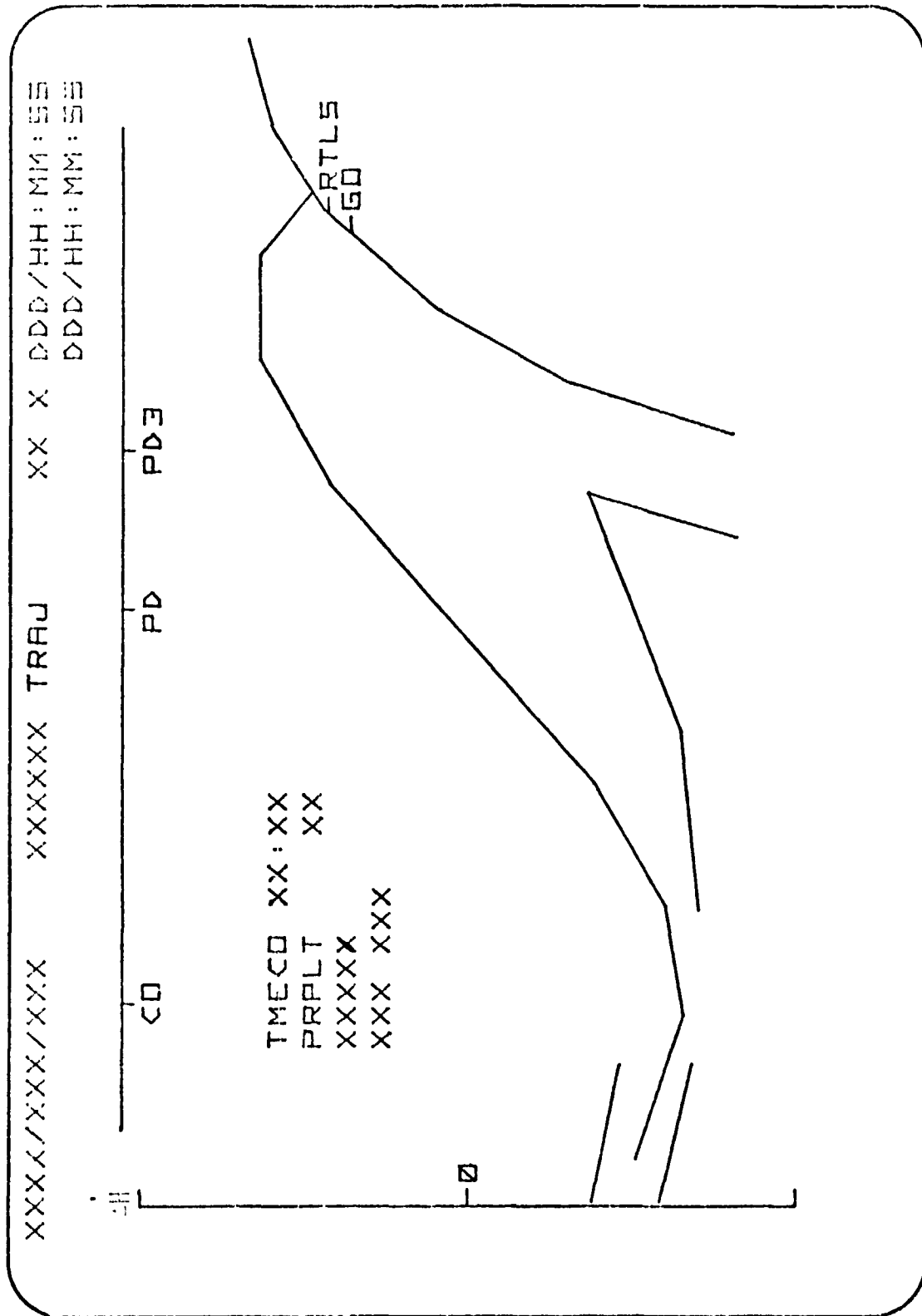

Figure J.2.1-1.- XXXXX TRAJ generic display with mission-dependent constants.

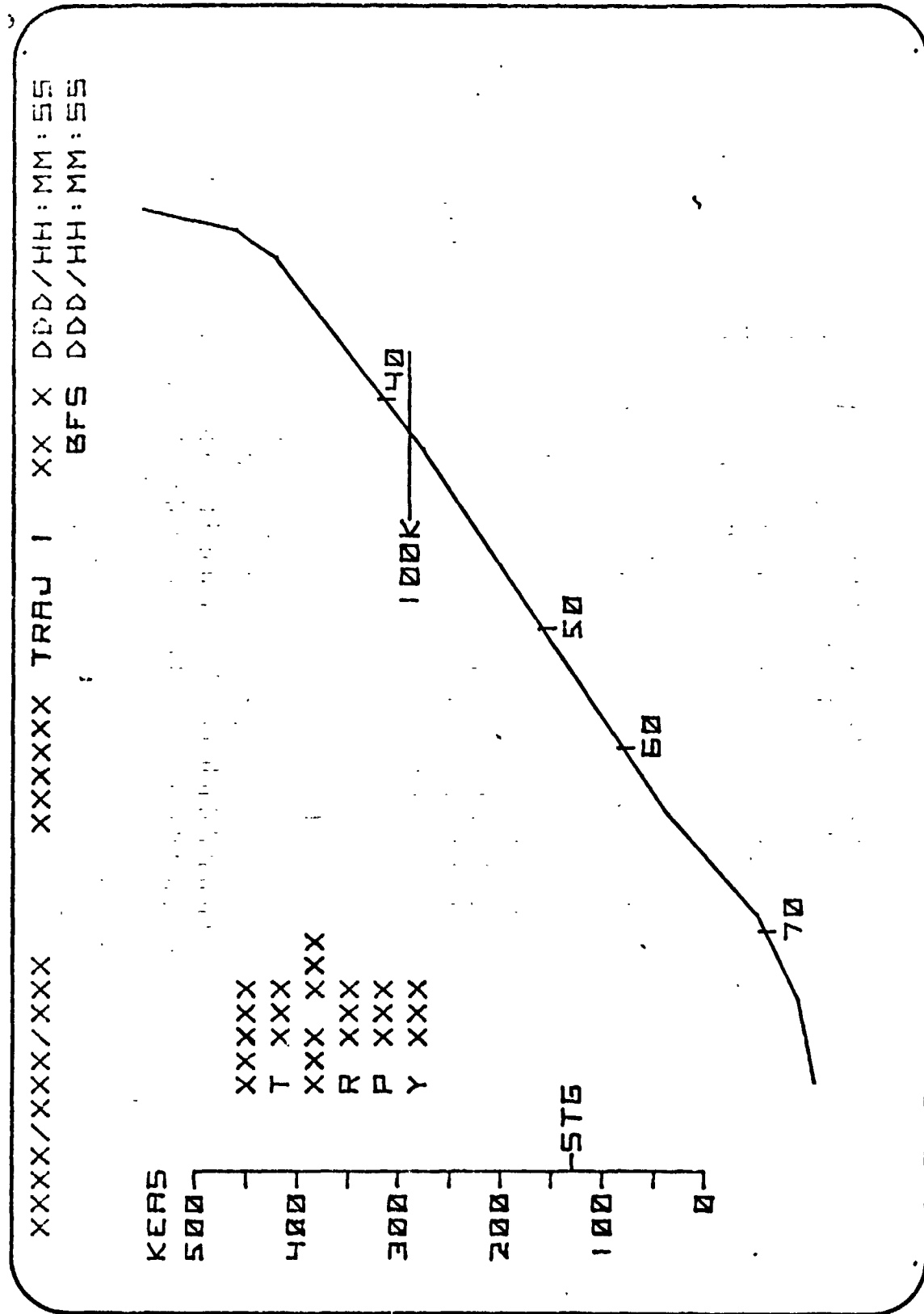

Figure 3.2.1-2.- ASCENT TRAJ 1 generic display with mission-dependent constants (BFS).

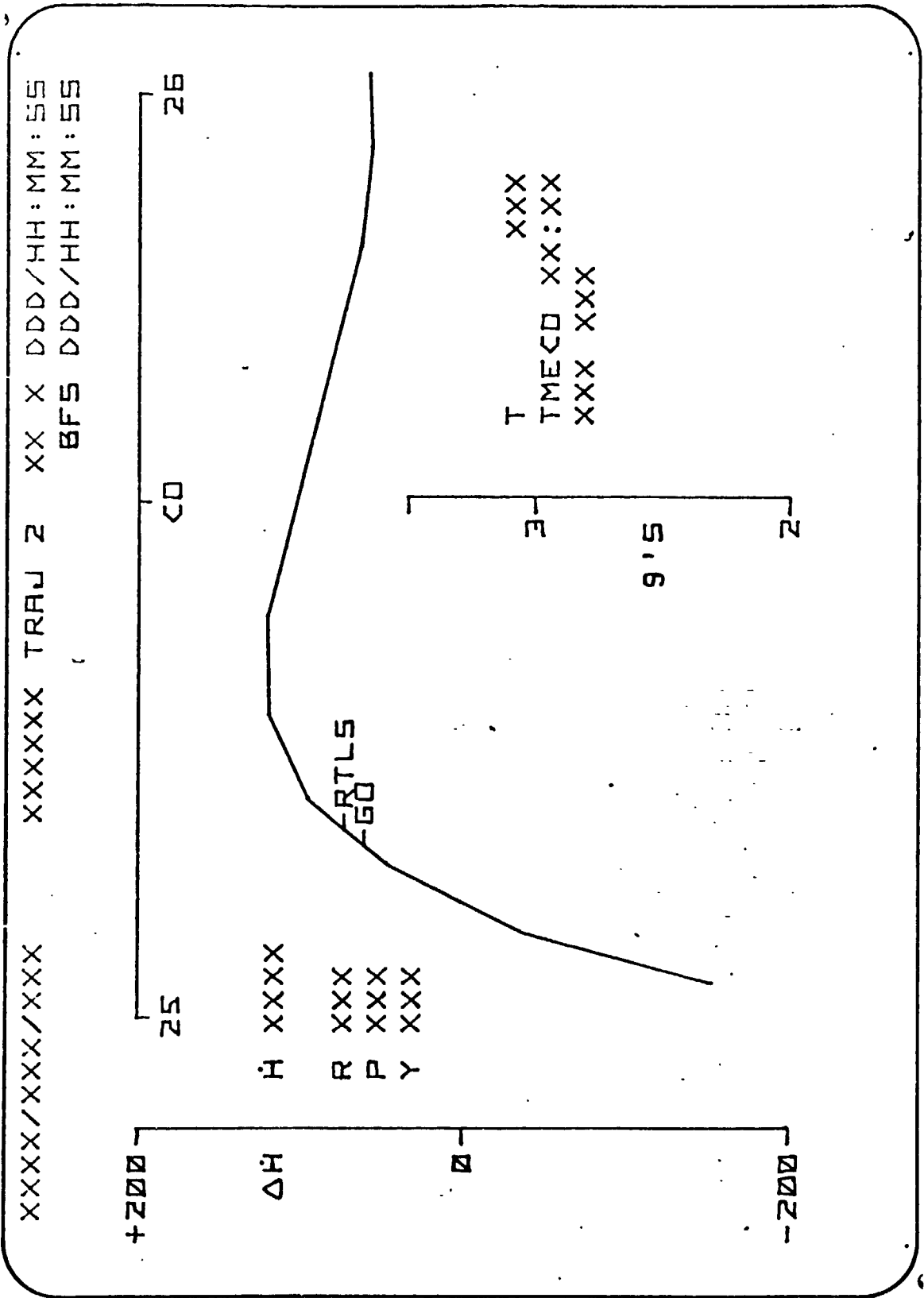

Figure 8.2.1-3.- ASCENT TRAJ 2 generic display with mission-dependent constants (BFS).

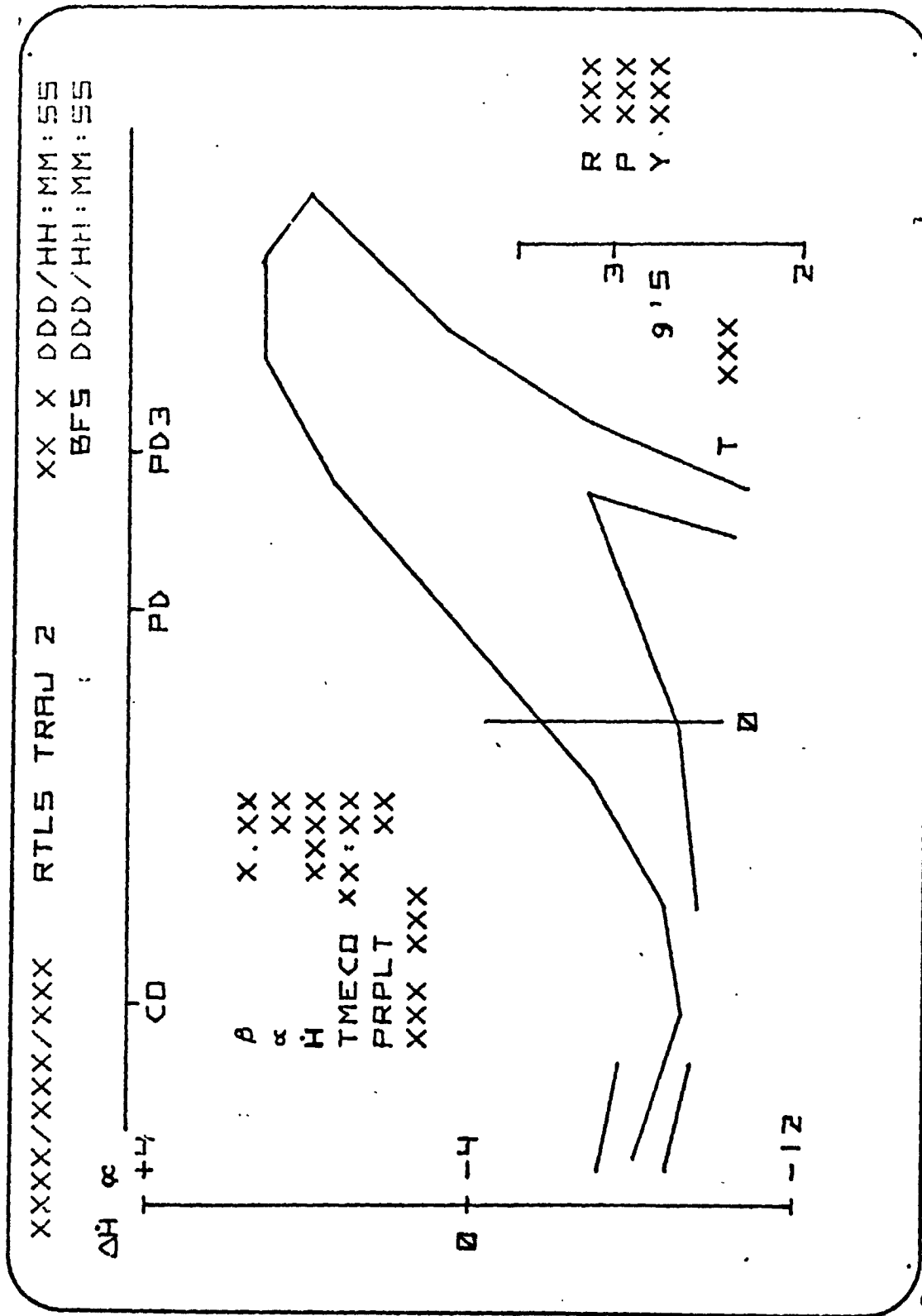

Figure 8.2.1-4.- RTLS TRAJ 2 generic display with mission-dependent constants (BFS).

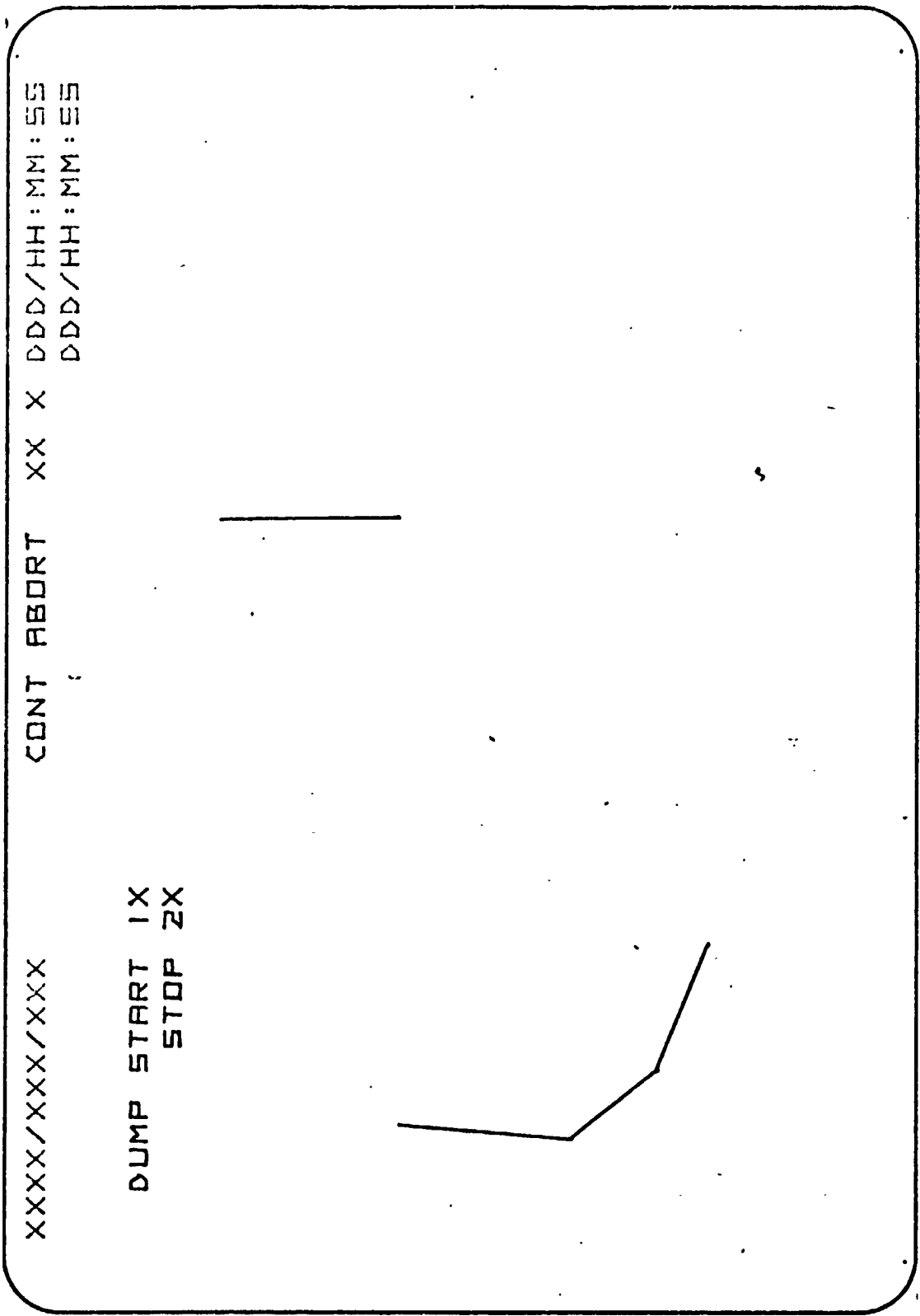

Figure 8.2.1-5.- CONTINGENCY ABORT generic display.

```

XXXXXXXX/XXX  XXXXX MNVR XXXXX XX X DDD/HH:MM:SS
GMBL CK 1X  L R  DDD/HH:MM:SS
P ±X.XS ±X.XS  TRIM L 12 [±]X.X
Y ±X.XS ±X.XS  P Y 13 [±]X.X 14 [±]X.X
SEL
PRI 2X 5X  ENG SEL OMS
SEC 3X 6X  OMS BOTH 15X PURGE ENA 19X
OFF 4X 7X  L 16XS
BURN ATT 8 R XX
9 P XXX
10 Y XXX

HA HP
TGT XXX ±XXX
CUR XXX ±XXX
TXX XX:XX
REI XXXX
ΔVTOT XXXX.X
TGO XX:XX
VGO X ±XXXXX.XX
Y ±XXXX.XX
Z ±XXXX.XX

F RCS ARM 24X
DUMP 25X
OFF 26X

TARGET
27 TIG XX/XX:XX.X 36 ΔVX [±]XXX.X
31 C1 XXXXX 37 ΔVY [±]XXX.X
32 C2 [±]XXX.X 38 ΔVZ [±]XXX.X
33 HT XXX.XXX
34 T XXX.XXX
35 PRPLT [±]XXX.XX

XXXXX 39 ST CRT TMR 40
(XX)

```

Figure 8.2.1-6.- XXXXX MNVR XXXXX generic display.

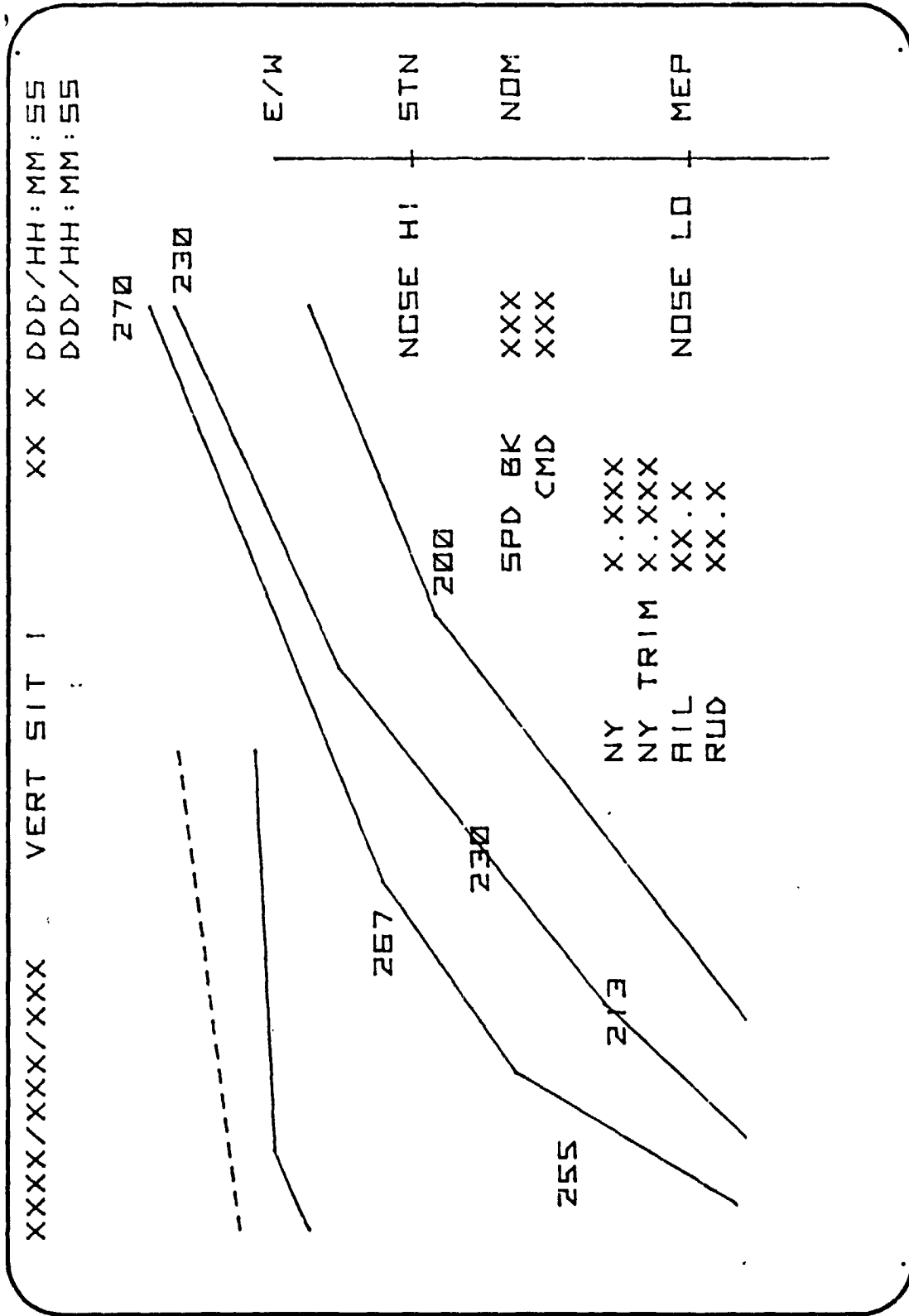

Figure 8.2.2-1.- VERT SIT 1 generic display with mission-dependent constants.

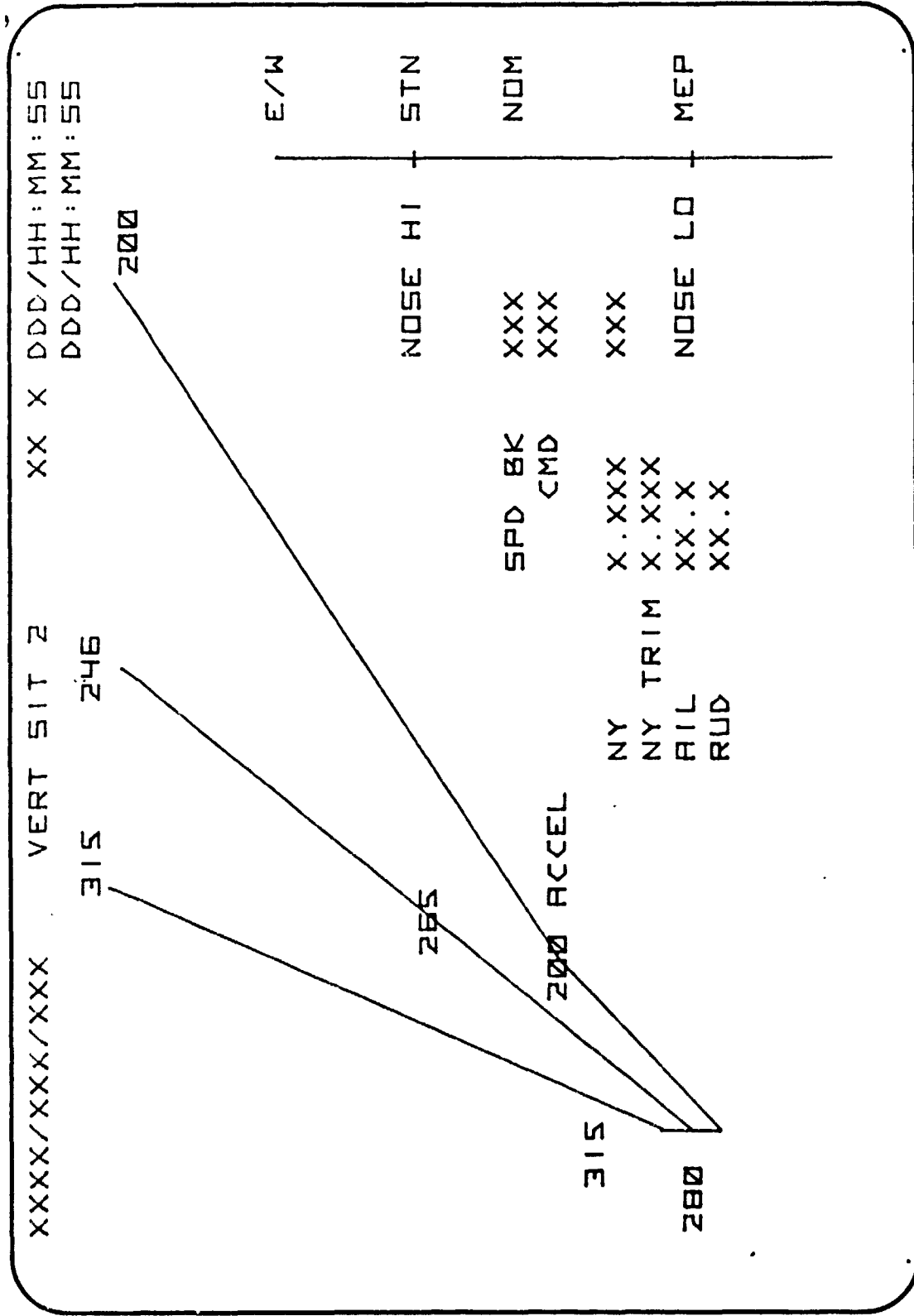
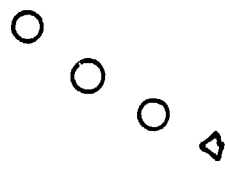
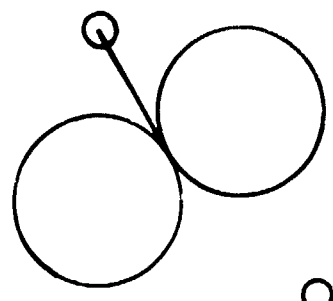

Figure 3.2.2-2.- VERT SIT 2 generic display with mission-dependent constants.

XXXX/XXXX/XXX HORIZ SIT XX X DDD/HH:MM:SS
 ALTM BFS DDD/HH:MM:SS
 1 XX.XX NAV DELTA
 ΔX 3
 [+]XXXXXΔ
 LY 9
 RWY XX 2X [±]XXXXXX
 ΔZ 10
 [±]XXXXXX
 ΔX 1'
 GLO SLOPE [±]XXXXX
 LO WND 5X ΔY 12
 HI WND 6X [±]XXXXX
 ΔZ 13
 XEP SW 7 [±]XXXXX
 LOAD 14



	PASS/BFS	SV	XFER	15X	16	AT	17	18	19	20	21	22	23	24	25	26	27	28	29	30	31	32	33	34	35	36	37	38	39	40		
NAV	RESID	RATIO	AUT	TIN	HFOR	TACT	XXXX	TAC2	XXXX	TAC3	XXXX																					
TAC	AZ ±XX.XXX	X.XS	17X	18X	19X	±XXX.XXS	±XXX.XXS	±XXX.XXS	±XXX.XXS	±XXX.XXS	±XXX.XXS	±XXX.XXS	±XXX.XXS	±XXX.XXS	±XXX.XXS	±XXX.XXS	±XXX.XXS	±XXX.XXS	±XXX.XXS	±XXX.XXS	±XXX.XXS	±XXX.XXS	±XXX.XXS	±XXX.XXS	±XXX.XXS	±XXX.XXS	±XXX.XXS	±XXX.XXS	±XXX.XXS	±XXX.XXS	±XXX.XXS	
	RNG ±XX.XXX	X.XS																														
DRAG	H ±XXX	XXX	X.XS	20X	21X	22X																										
ADTA	H ±XXX	XXX	X.XS	23X	24X	25X																										
ADTA	TO G&C			26X	27X	28X	VENT	DOOR	OP	37X	CL	38X																				

Figure 8.2.2-3.- HORIZ SIT generic display.

9.0 ABORT INITIALIZATION LOAD FOR ONBOARD COMPUTER

This section contains the onboard computer initialization data set (I-load) that was used for generating the abort trajectories for this analysis cycle. The ascent I-loads are presented in tables 9-I. The abort unique I-loads are superscripted for easy identification. The I-loads used for AOA descent (table 9-II) are identical to those for nominal end-of-mission descent and are documented in STS-1 OFP deorbit-through-landing profile document (vol. V, cycle 3). The I-loads specifically for the RTLS entry are shown in table 9-III. The abort unique I-loads are superscripted for easy identification. The I-loads used for AOA descent, (table 9-II) are identical to those for nominal end-of-mission descent and are documented in STS-1 OFP deorbit-through-landing profile document (Vol. V, cycle 3). The I-loads specifically for the RTLS entry are shown in table 9-III.

TABLE 9-I.- STS-1 ASCENT GUIDANCE I-LOADS

Symbol	Value	Unit	Type	Prec	FSSR reference	Definition
K_CMD	100	pct	I-2	SP	4.2.2	Commanded SSME throttle setting
MDOT_SSME	32.0915	slug sec	F-2	SP	4.2.2, 4.8.7	Nominal SSME mass flow rate
M	57818.891	slug	F-1	SP	4.1, 4.2.2	Estimated mass of Orbiter with external tank
DT_LAG	0.16	sec	F-2	SP	4.2.3	Time bias applied to attitude commands to account for transport lag
PPOLY _I (30)	0.0 107.18 364.29 368.02 479.35 676.34 782.68 939.99 975.41 1090.43 1212.31 1320.54 1384.72 1481.62 1575.53 1669.92 1928.98 2070.02 2167.55 2366.77 2484.87 2665.70 2833.37 2923.22 3167.98 3500.48 3750.96 4003.96 4102.24 4300.00	fps	F-1	SP	4.1, 4.2.3	Segment start values for independent value of pitch and yaw polynomials
PSI _{I,L} (30)	.00000 .30182 .30182 .30144 .29223 .28076	n.d.	F-1	SP	4.1, 4.2.3	Segment start values for dependent values of yaw polynomial (nominal and all eng/out)

TABLE 9-i.- Continued

Symbol	Value	Unit	Type	Prec	FSSR reference	Definition
PSI ₁ (30) (Cont'd.)	0.27620					
	.27710					
	.26851					
	.25174					
	.25583					
	.25137					
	.24924					
	.24775					
	.24924					
	.25206					
	.25964					
	.26309					
	.26440					
	.26557					
	.25575					
	.26557					
	.26524					
	.25580					
	.26515					
	.26393					
	.26370					
	.25402					
	.26426					
	.26539					
	THI ₁ (30,3)	.41421	n.d.	F-1	SP	4.1, 4.2.3
.33576						
.33576						
.33227						
.32950						
.31674						
.31080						
.30530						
.30332						
.29612						
.28864						
.28453						
.28170						
.27610						
.26903						
.26112						
.23734						
.22403						
.21497						
.20500						
.19987						
.19280						
.18687						
.18412						

TABLE 9-I.- Continued

Symbol	Value	Unit	Type	Prec	PSSR reference	Definition
THEI 1,1(30,3) (Cont'd)	5.17660					
	.16680					
	.15982					
	.15298					
	.14887					
	.13867					
	.41421					
	.33217					
	.33217					
	.33217					
	.33251					
	.33314					
	.32184					
	.30530					
.30392						
.29612						
.28864						
.28453						
.28173						
.27610						
.26903						
.26113						
.23731						
.22402						
.21497						
.20500						
.19387						
.19280						
.18687						
.18412						
.17660						
.16680						
.15982						
.15298						
.14887						
.13867						
THEI 1,3(30,3)	.41421					
	.33217					
	.33217					
	.33217					
	.33304					
	.32589					
	.31756					
	.30530					
	.30392					
	.29612					
	.28864					
	.28453					
	.28173					
	.27610					

ORIGINAL PAGE IS
OF POOR QUALITY

TABLE 9-I.- Continued

Symbol	Value	Unit	Type	Prec	FSSR reference	Definition
THET _I (30,3) (Cont'd)	0.28170 .27610 .26903 .26113 .23731 .22403 .21497 .20500 .19987 .19280 .18687 .18412 .17660 .16680 .15982 .15298 .14887 .13867					
PHI _I (15)	.0000 1.0000 1.0000 1.0000 1.0000 1.0000 1.0000 1.0000 1.0000 1.0000 1.0000 1.0000 1.0000 1.0000 1.0000 1.0000 1.0000	n.d.	F-1	SP	4.1, 4.2.3	Segment start values for dependent value of roll polynomial
QPOLY _J (4)	100.0 938.1425 1209.4828 5000.0	fps	F-1	SP	4.1, 4.2.4	Tabular values of independent variable for boost throttling
THROT _J (4)	100 65 100 100	pct	I-1	SP	4.1, 4.2.4	Tabular values for boost throttling
I_RTLS_AOA	260.0	sec	F-1	SP	4.2, 4.3.1 4.8.1	Mission elapsed time defining RTLS/AOA mode boundary

TABLE 9-I.- Continued

Symbol	Value	Unit	Type	Prec	FSSR reference	Definition
MASS_LOW_LEVEL	9327.69	slug	F-1	SP	4.2, 4.3.1, 4.4, 4.6.1	Value of mass for enabling MFS low-level sensing
MASS_SSME_TRIM	14558.137	slug	F-1	SP	4.2, 4.3.1, 4.4, 4.6.1	Value of mass for TVC retrim
MASS_MIN	4500.0	slug	F-2	SP	4.8.1	Value of minimum predicted burnout mass to allow steering in MM103
MASS_TERM_GUID	14258.	slug	F-2	SP	4.3.1	Value of mass to inhibit auto guidance
GAMD_NOM	0.00872665	rad	F-1	SP	4.3.2	Nominal ascent terminal flight/path angle constraint
RD_NOM	21290308.	ft	F-1	DP	4.3.2	Nominal ascent terminal radius constraint
VD_NOM	25668.0	fps	F-1	SP	4.3.2	Desired inertial velocity magnitude at nominal MECO
K_2STG_NOM	100	pct	I-2	SP	4.3.2	Nominal SSME throttle setting after RTLS/AOA mode boundary
NMAX	1	n.d.	I-2	SP	4.3.3	Maximum number of PEG iterations
TGO_FCD	10.0	sec	F-2	SP	4.3.3	Value of TGO to initiate fine countdown for second stage
PHI_CMD	3.141593	rad	F-1	SP	4.3.2	Commanded roll angle
PHI_2STG	3.141593	rad	F-1	SP	4.3.3, 4.6.3	Desired roll command for second stage
V_REF_PHI	5700.	fps	F-1	SP	4.3.3, 4.6.3	Switch velocity for roll command
TGO_MIN	6.0	sec	F-2	SP	4.4.3, 4.7.4	Value of TGO when active guidance is inhibited during OMS maneuvers
TGO_BIAS	0.205	sec	F-2	SP	4.4.3	Cutoff time bias
NMAX_BURN	1	n.d.	I-2	SP	4.4.3	Maximum number of PEG iterations
V_ME_GGSA	25668.	fps	F-2	SP	4.5.2, 4.5.3	Relative velocity magnitude at SSME failure time

AOA or ATO unique I-load

TABLE 9-I.- Continued

Symbol	Value	Unit	Type	Prec	FSSR reference	Definition
RD_AOA_ATO ^a	21290308	ft	F-1	UP	4.5.2	AOA/ATO MECO terminal radius constraint
VD_AOA_ATO ^a	25668.0	fps	F-1	SP	4.5.2	AOA/ATO MECO terminal velocity constraint
GAMD_AOA_ATO ^a	0.00916043	rad	F-1	SP	4.5.2	AOA/ATO MECO terminal flightpath angle constraint
V_AOA_MECO ^a	0.0	fps	F-1	SP	4.5.2	AOA velocity criterion for switching MECO constraint
I_ATO_MECO ^a	0.0	fps	F-1	SP	4.5.2	ATC velocity criterion for switching MECO constraints
V_EI_Sw ^a	0.0	fps	F-1	SP	4.5.3	AOA velocity criterion for switching from shallow to steep entry interface target constraints
V_LINA	0.0	fps	F-1	SP	4.5.3	ATO velocity criterion for defining pre-MECO and post-MECO OMS and RCS burn requirements
V_ZERO ^a	1.0	fps	F-1	UP	4.5.3	ATO velocity criterion for defining pre-MECO OMS and RCS burn requirements
V_RCS_ADJ ^a	0.0	fps	F-1	SP	4.5.3	ATO bias velocity for the pre-MECO OMS burn computation when the parallel RCS is not burned during OMS-1
EPS_K2 ^a	100.0	n.d.	F-2	SP	4.5.3	Minimum tolerance value for K2
MASS_ORB	5500.157736	slug	F-1	SP	4.5.4, 4.5.5, 4.7.3	Mass of Orbiter at lift-off (not to include MPS vent mass)
MASS_OMS_INIT ^a	507.552	slug	F-1	SP	4.5.4	Mass of usable OMS propellant loaded minus the OMS propellant set aside for DT_TOL
MASS_CO_CNT ^a	0.0	slug	F-2	SP	4.5.4	Mass of OMS propellant to be reserved for c.g. control

^aAOA or ATO unique load

TABLE 9-1.- Continued

Symbol	Value	Unit	Type	Prec	FSSR reference	Definition
DV_RQDb	0.0 0.0 0.0	fps	F-1	SP	4.5.4	Sum of OMS-1 and OMS-2 delta velocity expected (3)a
DV_TOLb	1000.0	fps	F-2	SP	4.5.4	Delta velocity tolerance for OMS-1 and OMS-2 default targeting decision
VDIAGb	25668.0	fps	F-1	SP	4.5.4, 4.8.1, 4.8.5	Desired MECO velocity
HTGT_AOA_OMS1b	577231. 577231. 577231. 577231.	ft	F-1	SP	4.5.4	Target altitude referenced to Earth equatorial radius for OMS-1 (4)a
HTGT_AOA_OMS2b	400000. 400000. 400000.	ft	F-1	SP	4.5.4	Target altitude referenced to Fischer ellipsoid for OMS2 (7)a
HTGT_AOA_OMS2b	400000. 400000. 400000.					
THETA_AOA_OMS1b	4.18879 4.18879 4.18879	rad	F-1	SP	4.5.4	Target inplane downrange angle from launch site for OMS-1 (4)a
THETA_AOA_OMS2b	4.82879 4.82879 4.82879 4.82879 4.82879 5.030859	rad	F-1	SP	4.5.4	Target inplane downrange angle from launch site for OMS-2 (7)a
G_2_FPS2	32.17405	lb slug or fps ²	F-3	SP	4.5.4, 4.7.3, 4.7.8	Mass-to-weight conversion factor
C1_AOA_OMS1b	0.0 0.0 0.0	fps	F-1	SP	4.5.4	Target intercept of the vertical velocity vs. horizontal velocity relationship: - OMS-1 (4)a

aNumber of uses required.
bAOA and FPS unique I-load.

TABLE 9-1.- Continued

Symbol	Value	Unit	Type	Prec	FSSR reference	Definition
C1_AOA_OMS2 ^b	18881. 18882. 18883. 18884. 18885. 18886. 14766.	fps	F-1	SP	4.5.4	- OMS-1 (7) ^a
C2_AOA_OMS1 ^b	0.0 0.0 0.0 0.0	n.d.	F-1	SP	4.5.4	Target slope of the vertical velocity vs. horizontal velocity relationship: - OMS-1 (4) ^a
C2_AOA_OMS2 ^b	- .743938 - .743938 - .743938 - .743938 - .743938 - .592389	n.d.	F-1	SP	4.5.4	- OMS-2 (7) ^a
DTIG_AOA_OMS1 ^b	103.5	sec	F-1	SP	4.5.4	Time of ignition referenced to ET separation: - OMS-1 (1) ^a
DTIG_AOA_OMS2 ^b	2414.1 2414.1 2414.1 2414.1 2414.1 2415.95	sec	F-1	SP	4.5.4	- OMS-2 (7) ^a
SFUELD ^b	+1	n.d.	I-1	SP	4.5.4	Fuel wasting flag: 0 - no fuel wasting + - left/right thrusting to use excess propellant
FT_OMS	6000.0	lbf	F-2	SP	4.5.4, 4.8.1, 4.8.7, 4.8.10	Nominal OMS thrust scaling factor
MDOT_OMS	0.5954205	slug/sec	F-2	SP	4.5.4, 4.5.5, 4.8.1, 4.8.7	Nominal OMS mass flow rate

^aNumber of values required.
^bAOA and ATO unique I-load.

TABLE 9-I.- Continued

Symbol	Value	Unit	Type	Prec	FSSR reference	Definition
MDOT_RCS	0.10655714	slug sec	F-2	SP	4.5.4, 4.5.5, 4.8.7	Nominal RCS mass flow rate
NMAX_DIP	10	n.d.	I-2	SP	4.5.4, 4.7.8	Maximum PEG cycles
DT_AOA_PRED ^b	10.0	sec	F-2	SP	4.5.4	Desired A/E PREC PRED step size
THETA_LS_REF ^b	.447404	rad	F-1	SP	4.5.4	Reference central angle between launch site
ORB_RATE ^b	0.001195301	rad/sec	F-1	SP	4.5.4	Circular orbit rate
HTGT_ATO_OMS1 ^b	644100.	ft	F-1	SP	4.5.5	Target altitude referenced to Earth equatorial radius: - OMS-1 (1) ^a
HTGT_ATO_OMS2 ^b	641600. 643000.	ft	F-1	SP	4.5.5	- OMS-2 (2) ^a
THETA_ATO_OMS1 ^b	4.18879	rad	F-1	SP	4.5.5	Target inplane downrange angle from launch site: - OMS-1 (1) ^a
THETA_ATO_OMS2 ^b	7.31293 6.10342	rad	F-1	SP	4.5.5	- OMS-2 (2) ^a
DTIG_ATO_OMS1 ^b	103.5	sec	F-1	SP	4.5.5	Time of ignition referenced to ET separation: - OMS-1 (1) ^a
DTIG_ATO_OMS2 ^b	3185.1 2145.9	sec	F-1	SP	4.5.5	- OMS-2 (2) ^a
C1_ATO_OMS1 ^b	0.0	fps	F-1	SP	4.5.5	Target intercept of the vertical velocity vs. horizontal velocity relationship: - OMS-1 (1) ^a
C1_ATO_OMS2 ^b	0.0 0.0	fps	F-1	SP	4.5.5	- OMS-2 (2) ^a

^aNumber of values required.
^bAOA and ATO unique I-load.

TABLE 9-I.- Continued

Symbol	Value	Unit	Type	Prec	FSSR reference	Definition
C2_ATO_OMS1 ^b	0.0	n.d.	F-1	SP	4.5.5	Target slope of the vertical velocity vs. horizontal velocity relationship: - OMS-1 (1) ^a
C2_ATO_OMS2 ^b	0.0 0.0	n.d.	F-1	SP	4.5.5	- OMS-2 (2) ^a
DT_FCD	0.32	sec	F-2	SP	4.6.1, 4.8.5	Planned guidance cycle time for fine countdown and powered pitchdown task
RD_RTLS ^c	21111960.	ft	F-1	DP	4.6.2	RTLS position target vector magnitude
K_2ENGC	95.0	pct	F-2	SP	4.6.2	Initial value of K for two-engine RTLS
K_3ENGC	70.0	pct	F-2	SP	4.6.2	Initial value of K for three-engine RTLS
DT_TURN ^c	17.0	sec	F-2	SP	4.6.3, 4.6.4	Length of turnaround
DTHETA_LIM ^c	0.17453293	rad sec	F-2	SP	4.6.3	Maximum angular velocity
DTHETA_RATE ^c	0.0436332	rad sec ²	F-2	SP	4.6.3	Maximum angular acceleration
M_BIAS ^c	97.0	slug	F-2	SP	4.6.3	Mass bias for turnaround
DT_PITCH ^c	20.0	sec	F-2	SP	4.6.3, 4.6.4	Nominal time of powered pitchdown
TGO_PPDC	6.0	sec	F-2	SP	4.6.4	TGO to initiate fine countdown for RTLS
DK_ROUND ^c	0.75	pct	F-2	SP	4.6.4	Difference needed to update SSME throttle command
ALPHA_PPDC	-0.0698132	rad	F-2	SP	4.6.5	Desired angle of attack at end of PPD
ALPHA_Z ^c	0.87266	rad	F-1	SP	4.6.5	Angle-of-attack command after ET separation

^aNumber of values required.
^bAOA and ATO unique I-load.
^cRTLS unique I-load.

TABLE 9-1.- Continued

Symbol	Value	Unit	Type	Prec	FSSR reference	Definition
RMIN	65	pot	I-2	SP	4.6.5, 4.8.1, 4.8.3, 4.8.5	Minimum throttle setting of SSME
AZ0	1.1686725	rad	F-1	SP	4.6.6	RTLS azimuth
THETA_0 ^b	2.68532	rad	F-1	SP	4.6.6	
THETA_1 ^b	-4.22323x10 ⁻⁴	rad·sec ft	F-1	SP	4.6.6	Coefficients for calculating fuel dissipation thrust attitude
THETA_2 ^b	1.41238	rad	F-1	SP	4.6.6	
THETA_3 ^b	-1.21243x10 ⁻⁴	rad·sec ft	F-1	SP	4.6.6	
V_SWITCH ^b	4200.0	fps	F-1	SP	4.6.6	Fuel dissipation thrust attitude switch velocity
THETA_FB ^b	2.40855	rad	F-1	SP	4.6.6	Flyback thrust direction
V_RTLS_CNIG ^b	2500.0	fps	F-1	SP	4.6.7	RTLS contingency decision velocity
HTGI_OMS	906560. 953950.	ft	F-1	3P	4.7.3	Target altitude magnitude (2) ^a
THETA_OMS	2.808498 5.0614548	rad	F-1	SP	4.7.3	Target Earth central angle from launch site (2) ^a
C1_OMS	0.0 22.0	fps	F-1	SP	4.7.3	Intercept of target line (2) ^a
C2_OMS	0.0 0.0	n.d.	F-1	SP	4.7.3	Slope of target line (2) ^a
DTIG_OMS	109.0 2108.0	sec	F-1	SP	4.7.3	Time interval between time of ET separation and OMS-1 and OMS-2 ignition
OMS1_IVR_ROLL	3.14159265	rad	F-1	SP	4.7.3	Thrust vector roll angle desired at ignition for OMS-1
OMS2_IVR_ROLL	3.14159265	rad	F-1	SP	4.7.3	Thrust vector roll angle desired at ignition for OMS-2

^aNumber of values required.
^bRTLS unique I-load.

TABLE 9-1.- Continued

Symbol	Value	Unit	Type	Prec	FSSR reference	Definition
MM_PER_FT	1.6457885×10^{-4}	$\frac{\text{n. mi.}}{\text{ft}}$	F-3	SP	4.7.3, 4.7.8, 4.7.9	Conversion factor for feet to n. mi.
RAD_PER_DEG	0.017453292	$\frac{\text{rad}}{\text{deg}}$	F-3	SP	4.7.3, 4.7.8, 4.8.10	Conversion factor for degrees to radians
THRUST_BODY_RCS_X	0.9848078 0.0 0.1736482	n.d.	F-2	3P	4.7.8, 4.8.10	Unit body thrust vector for the 4 + X RCS propulsive system in body coordinates
DT_MIN	2.0	sec	F-2	SP	4.7.8	Time interval stepsize to be used by A/E PREC PRED function to predict current state to ignition state
Q_M50_ADI_S	.51065244 .77263467 .37672637 .018627466	n.d.	F-1	SP	4.7.8	ADI to M50 quaternion
DTHMAX	25.0	sec	F-2	SP	4.7.8, 4.8.1	Maximum integration time step for gravity prediction
EARTH_MU	$1.407645794 \times 10^{16}$	$\frac{\text{ft}^3}{\text{sec}^2}$	F-3	DP	4.8.1, 4.8.4, 4.8.8, 4.7.9	Earth's gravitational constant
J2_GRAV	1.0826283×10^{-3}	n.d.	F-3	SP	4.7.9	Earth's second gravitational constant (J_2)
RE	20925705.0	ft	F-3	DP	4.7.9, 4.8.6	Mean equatorial radius of Earth
EARTH_POLE	$-.28322844 \times 10^{-2}$ $-.5027996 \times 10^{-4}$.9999959878	n.d.	F-1	DP	4.7.9, 4.8.1	Unit North Pole vector in M50
DELT_H_CIRC	30380.0	ft	F-2	SP	4.7.9	Maximum difference between apogee and perigee for orbit to be considered circular
PI	3.14159265	n.d.	F-3	SP	4.7.9, 4.8.4	Ratio of the circumference of a circle to the diameter

TABLE 9-I.- Continued

Symbol	Value	Unit	Type	Prec	FSSR reference	Definition
AL	95.5	fps ²	F-2	SP	4.8.1, 4.8.3	Specific force limit during SSME maneuvers
DTMIN	2.0	sec	F-2	SP	4.8.1	Minimum integration time step for gravity prediction
DTMD	40.0	sec	F-2	SP	4.8.1	TGO remaining to release all position constraints
EPSTGO	0.04	n.d.	F-2	SP	4.8.1	PFC convergence criterion for inhibiting steering output
ETB	5.0	sec	F-2	SP	4.8.1	Minimum TB(N-1) in computation of TGO
GAMB	0.00872665	rad	F-1	SP	4.8.1	Desired MECO flight path angle
IID_EF	.56778345 -.30977246 -.76266833	n.d.	F-1	DP	4.2, 4.3, 4.8.1	Unit vector normal to desired trajectory plane in Earth-fixed coordinates (+X through Greenwich, +Z through North Pole)
KLAWDIZ	1.0	n.d.	F-2	SP	4.8.1	Turning rate scale factor used for convergence criterion for VHISS
AIA ^b	759.28 0.00280147 257.96 0.00280147	fps or sec ⁻¹	F-1	SP	4.8.1	Coefficients used to define MECO-20 range/velocity constraint line for RTLS: (4)a VDMAG = (AIA-1 + AIA)/THETA IA = 2 for two-engine RTLS IA = 4 for three-engine RTLS
KMAX	100	pcr	I-2	SP	4.8.1, 4.8.3, 4.8.9, 4.8.2	Maximum throttle setting of SSME
RTEF ^b	2892016.3 -15136530.0 9995881.7	ft	F-2	DP	4.8.1,	Landing site target in Earth-fixed coordinates
DTHROTB	120.0	sec	F-2	SP	4.8.1	Burn time remaining before g-limiting to inhibit fuel depletion throttling

^aNumber of values required.
^bRTLS unique ID#.

TABLE 9-I.- Continued

Symbol	Value	Unit	Type	Prec	FSSR reference	Definition
N	3	n.d.	I-2	SP	4.8.1	Number of thrust phases for second stage
MSEC	10	n.d.	I-2	SP	4.8.1	Number of integration time steps for gravity predictions
PHIMAX	1.0	rad	F-2	SP	4.8.1	Maximum JOL/LANEMAG to be used
RDMAG	21290308	ft	F-1	DP	4.8.1	MECO radius
RHMAG	1.0	n.d.	F-2	SP	4.8.1	Scalar damp-ing factor applied to VMISS to correct VDU
M ² D ₁ ^b	10406.17	slug	F-1	SP	4.8.1	Desired PPD mass for two-engine RTLS
MEOD ₂ ^b	10717.13	slug	F-1	SP	4.8.1	Desired PPD mass for three-engine RTLS
EARTH_ROT ₂	7.2921151x10 ⁻⁵	rad/sec	F-3	DP	4.8.1	Earth equatorial rotation rate
TCO_IA ^b	60.0	sec	F-2	SP	4.8.1	Minimum TCO for selecting RTLS constraint line
GAM _J ^b	0.171918 0.153588 0.169820	rad	F-1	SP	4.8.1	Desired flightpath angle for RTLS at start of PPD (3) ^a
ENG_TURN_PRED ^b	500000.0	ft	F-2	SP	4.8.1	Range to begin turnaround prediction
EPS_X	0.02	n.d.	F-2	SP	4.8.2	Criterion for rejecting the estimate of the thrust
A ₅ ^b	2205.35	fps	F-1	SP	4.6.5	RTLS MECO relative velocity coefficient
A ₆ ^b	0.00297660	sec ⁻¹	F-1	SP	4.8.5	RTLS MECO relative velocity coefficient
A ₇ ^b	3850.3	ft/rad·sec	F-1	SP	4.8.5	RTLS MECO relative velocity coefficient
FT_SSME	470000.0	lbf	F-2	SP	4.8.7	Nominal SSME thrust

^aNumber of values required.
^bRTLS unique i-load.

TABLE 9-I.- Concluded

Symbol	Value	Unit	Type	Prec	FSSR reference	Definition
FT_RCS	877.2	lbf	F-2	SP	4.8.7, 4.8.10	Nominal RCS thrust
V_LATE_RTLS ^b	7260.0	fps	F-1	SP	4.8.8	Relative velocity magnitude for latest RTLS
V_PYR_SW	1000.0	fps	F-1	SP	4.1, 4.8.9	Maximum velocity for changing pitch/yaw profile in first stage
PITCH_BIAS	0.276053	rad	F-2	SP	4.8.10	Constant bias term to convert OMS engine electrical null pitch trim angles to the body axis reference
YAW_BIAS	0.113446	rad	F-2	SP	4.8.10	Constant bias term to convert OMS engine electrical yaw trim angles to the body axis reference

^bRTLS unique I-load.

TABLE 9-II.- DEFINITION OF GUIDANCE CONSTANTS

(a) Entry(G4.E)

MSID # V97U	SM	SYMBOL	DESCRIPTION	MC	VALUE	UNITS	MISSION DEPENDENT CONSTANT
0495C	C	ACLAM1	MAXIMUM ALPHA COMMAND INTERCEPT CONSTANT	03	.75000000+01	DEG	D
0496C	C	ACLAM2	MAXIMUM ALPHA COMMAND SLOPE CONSTANT	03	.35000000-02	DEG-S/FT	D
0497C	C	ACLIM1	MINIMUM ALPHA COMMAND UPPER LIMIT INTERCEPT	03	.37000000+02	DEG	D
0498C	C	ACLIM2	MINIMUM ALPHA COMMAND UPPER LIMIT SLOPE	03	.00000000	DEG-S/FT	D
0499C	C	ACLIM3	MINIMUM ALPHA COMMAND LOWER LIMIT INTERCEPT	03	.76F66670+01	DEG	D
0500C	C	ACLIM4	MINIMUM ALPHA COMMAND LOWER LIMIT SLOPE	03	.22333330-02	DEG-S/FT	D
0606C	C	ACN1	TIME CONSTANT FOR H DOT FEEDBACK	03	.50000000+02	S	D
0607C	C	AK	FACTOR IN DD/DV FOR TEMPERATURE CONTROL GUIDANCE USED TO DEFINE C23	03	-.43127770+01	ND	M
0608C	C	AK1	FACTOR IN DD/DV FOR TEMPERATURE CONTROL GUIDANCE USED TO DEFINE C23	03	-.41766250+01	ND	M
0609C	C	ALFM	DESIRED CONSTANT DRAG LEVEL	03	.33000000+02	FT/SEC**2	M
0610C	C	ALIM	MAXIMUM SENSED ACCELERATION IN TRANSITION	03	.70840000+02	FT/SEC**2	D
0611C	C	ALMN1	MAXIMUM L/D COMMAND OUTSIDE OF HEADING ERROR DEADBAND	03	.79863550+00	ND	D
0612C	C	ALMN2	MAXIMUM L/D COMMAND INSIDE OF HEADING ERROR DEADBAND	03	.96592580+00	ND	D
0613C	C	ALMN3	MAXIMUM L/D COMMAND BELOW VELMAX	03	.93969000+00	ND	D
0614C	C	ALMN4	MAXIMUM L/D COMMAND ABOVE VELMAX	03	.10000000+01	ND	D
0642C	C	ASTART	SENSED ACCELERATION TO ENTER PHASE 2	03	.56600000+01	FT/SEC**2	D
0643C	C	CALPO(1)	ALPCMD CONSTANT TERM IN VC	03	.54245050+01	DEG	M
0644C	C	CALPO(2)	ALPCMD CONSTANT TERM IN VE	03	.54245050+01	DEG	M
0645C	C	CALPO(3)	ALPCMD CONSTANT TERM IN VE	03	-.42778000+01	DEG	M

TABLE 9-II.- Continued
(a) Continued

MSID # V37U	SW	SYMBOL	DESCRIPTION	MC	VALUE	UNITS	MISSION DEPENDENT CONSTANT
0046C	C	CALPO(4)	ALPCMD CONSTANT TERM IN VE	03	.16398000+02	DEG	M
0047C	C	CALPO(5)	ALPCMD CONSTANT TERM IN VE	03	.44760000+01	DEG	M
0048C	C	CALPO(6)	ALPCMD CONSTANT TERM IN VE	03	-.99339000+01	DEG	M
0049C	C	CALPO(7)	ALPCMD CONSTANT TERM IN VE	03	.40000000+02	DEG	M
0479C	C	CALPO(6)	ALPCMD CONSTANT TERM IN VE	03	.40000000+02	DEG	M
0480C	C	CALPO(9)	ALPCMD CONSTANT TERM IN VE	03	.40000000+02	DEG	M
0481C	C	CALPO(10)	ALPCMD CONSTANT TERM IN VE	03	.40000000+02	DEG	M
0050C	C	CALP1(1)	ALPCMD RATE TERM IN VE	03	.34301980-02	DEG-SEC/FT	M
0051C	C	CALP1(2)	ALPCMD RATE TERM IN VE	03	.34301980-02	DEG-SEC/FT	M
0052C	C	CALP1(3)	ALPCMD RATE TERM IN VE	03	.88750020-02	DEG-SEC/FT	M
0053C	C	CALP1(4)	ALPCMD RATE TERM IN VE	03	-.31431090-03	DEG-SEC/FT	M
0054C	C	CALP1(5)	ALPCMD RATE TERM IN VE	03	.31875000-02	DEG-SEC/FT	M
0055C	C	CALP1(6)	ALPCMD RATE TERM IN VE	03	.68874360-02	DEG-SEC/FT	M
0056C	C	CALP1(7)	ALPCMD RATE TERM IN VE	03	.00000000	DEG-SEC/FT	M
0482C	C	CALP(8)	ALPCMD RATE TERM IN VE	03	.00000000	DEG-SEC/FT	M
0483C	C	CALP1(9)	ALPCMD RATE TERM IN VE	03	.00000000	DEG-SEC/FT	M
0484C	C	CALP1(10)	ALPCMD RATE TERM IN VE	03	.00000000	DEG-SEC/FT	M
0057C	C	CALP2(1)	ALPCMD QUADRATIC TERM IN VE	03	.00000000	DEG(S/FT)**2	M
0058C	C	CALP2(2)	ALPCMD QUADRATIC TERM IN VE	03	.00000000	DEG(S/FT)**2	M
0059C	C	CALP2(3)	ALPCMD QUADRATIC TERM IN VE	03	-.76388910-06	DEG(S/TT)**2	M
0060C	C	CALP2(4)	ALPCMD QUADRATIC TERM IN VE	03	.25714550-06	DEG(S/FT)**2	M
0061C	C	CALP2(5)	ALPCMD QUADRATIC TERM IN VE	03	.00000000	DEG(S/FT)**2	M
0062C	C	CALP2(6)	ALPCMD QUADRATIC TERM IN VE	03	-.23745780-06	DEG(S/FT)**2	M
0063C	C	CALP2(7)	ALPCMD QUADRATIC TERM IN VE	03	.00000000	DEG(S/FT)**2	M
0485C	C	CALP2(8)	ALPCMD QUADRATIC TERM IN VE	03	.00000000	DEG(S/FT)**2	M

TABLE 9-II.- Continued
(a) Continued

MSID # V97U	SN	SYMBOL	DESCRIPTION	MC	VALUE	UNITS	MISSION DEPENDENT CONSTANT
0486C	C	CALP2(9)	ALPCMD QUADRATIC TERM IN VE	03	.00000000	DEG(S/FT)**2	M
0487C	C	CALP2(10)	ALPCMD QUADRATIC TERM IN VE	03	.00000000	DEG(S/FT)**2	M
0064C	C	CDD0T1	CD VELOCITY COEFFICIENT	03	.15000000+04	FT/S	D
0065C	C	CDD0T2	CD VELOCITY COEFFICIENT	03	.20000000+04	FT/S	D
0066C	C	CDD0T3	CD VELOCITY COEFFICIENT	03	.18000000+00	ND	D
0067C	C	CDD0T4	CD ALPHA COEFFICIENT	03	.78300000-01	ND	D
0068C	C	CDD0T5	CD ALPHA COEFFICIENT	03	-.81650000-02	1/DEG	D
0069C	C	CDD0T6	CD ALPHA COEFFICIENT	03	.68330000-03	1/DEG**2	D
0070C	C	CDD0T7	CD COEFFICIENT	03	.90000000-04	S/FT	D
0071C	C	CDD0T8	CD COEFFICIENT	03	.13666000-02	1/DEG**2	D
0072C	C	CDD0T9	CD COEFFICIENT	03	-.81650000-02	1/DEG	D
0501C	C	CRDEAF	GAIN ON ROLL BIAS	03	.40000000+01	ND	D
0078C	C	CT16(1)	C16 COEFFICIENT	03	.13540000+00	S**2/FT	D
0079C	C	CT16(2)	C16 POWER COEFFICIENT	03	-.10000000+00	ND	D
0080C	C	CT16(3)	GAIN ON C16 ERROR TERM	03	.60000000-02	S**4/FT**2	D
0083C	C	CT17(1)	C17 COEFFICIENT	03	.15370000-01	S/FT	D
0084C	C	CT17(2)	C17 POWER COEFFICIENT	03	-.58146000+00	ND	D
0502C	C	C17MP	MULTIPLICATION FACTOR ON C17 FOR ALPHA MODULATION	03	.75000000+00	ND	D
0081C	C	CT16MN	MINIMUM VALUE OF C16	03	.25000000-01	S**2/FT	D
0082C	C	CT16MX	MAXIMUM VALUE OF C16	03	.35000000+00	S**2/FT	D
0085C	C	CT17MN	MINIMUM VALUE OF C17	03	.25000000-02	S/FT	D
0086C	C	CT17MX	MAXIMUM VALUE OF C17	03	.14000000-01	S/FT	D
0503C	C	CT17M2	VALUE OF CT17MN FOR ALPHA MODULATION	03	.13300000-02	S/FT	D

TABLE 9-II.- Continued

(a) Continued

MSID # V97U	SW	SYMBOL	DESCRIPTION	MC	VALUE	UNITS	MISSION DEPENDENT CONSTANT
0109C	C	CYO	CONSTANT TERM IN HEADING ERROR DEADBAND	03	-.13090000+00	RAC	D
0110C	C	CY1	SLOPE OF HEADING ERROR DEADBAND WRT VE	03	.10908300-03	RAD-S/FT	D
0506C	C	C21	C20 CONSTANT VALUE	03	.60000000-01	1/DEG	M
0507C	C	C22	C20 CONSTANT VALUE LINEAR TERM	03	-.10000000-02	1/DEG	M
0508C	C	C23	C20 LINEAR TERM	03	.42500000-05	S/FT-DEG	M
0509C	C	C24	C20 CONSTANT VALUE	03	.10000000-01	1/DEG	M
0510C	C	C25	C20 CONSTANT VALUE IN LINEAR TERM	03	.10000000-01	1/DEG	M
0511C	C	C26	C20 LINEAR VALUE	03	.00000000	S/FT-DEG	M
0512C	C	C27	C20 CONSTANT VALUE	03	.00000000	1/DEG	M
0111C	C	DDLIM	MAXIMUM DELTA DRAG FOR MDOT FEEDBACK	03	.20000000+01	FT/S**2	D
0534C	C	DDMIN	MAXIMUM DRAG ERROR	03	.15000000+00	FT/S**2	D
0118C	C	DELV	PHASE TRANSFER VELOCITY BIAS	03	.23000000+04	FT/S	D
0121C	C	DF	FINAL DRAG VALUE IN TRANSITION PHASE	03	.20800310+02	FT/S**2	M
0141C	C	D230	INITIAL VALUE OF D23	03	.19380000+02	FT/S**2	M
0477C	C	DLRDTM	MAXIMUM VALUE OF DLRDOT	03	.15000000+03	FT/S	D
0504C	C	DLALLM	MAXIMUM ALPHA CONSTANT	03	.43000000+02	DEG	D
0505C	C	DALPLM	LIMIT VALUE FOR DLAPLM	03	.20000000+01	DEG	D
0128C	C	DRDDL	MINIMUM VALUE OF DRDD	03	-.15000000+01	NM-S**2/FT	D
0140C	C	DT2MIN	MINIMUM VALUE OF T2DOT	03	.80000000-02	FT/S**3	D
0160C	C	EEF4	FINAL REFERENCE ENERGY LEVEL IN TRANSITION PHASE	03	.20000000+07	(FT/S)**2	M
0227C	C	ETRAN	ENERGY LEVEL AT START OF TRANSITION	03	.59984730+08	(FT/S)**2	M
0228C	C	E1	MINIMUM VALUE OF DREFF AND DREFF-DF IN TRANSITION PHASE	03	.10000000-01	FT/S**2	D

TABLE 9-II.- Continued

(a) Continued

MSID # V97U	SW	SYMBOL	DESCRIPTION	MC	VALUE	UNITS	MISSION DEPENDENT CONSTANT
0259C	C	GS1	FACTOR IN SMOOTHING ROLL COMMAND	03	.00000000	1/S	M
0260C	C	GS2	FACTOR IN SMOOTHING ROLL COMMAND	03	.10000000-03	1/S	M
0261C	C	GS3	FACTOR IN SMOOTHING ROLL COMMAND	03	.00000000	1/S	M
0262C	C	GS4	FACTOR IN SMOOTHING ROLL COMMAND	03	.00000000	1/S	M
0293C	C	HSMIN	MINIMUM VALUE OF SCALE HEIGHT	03	.20500000+05	FT	D
0294C	C	HSO1	SCALE HEIGHT CONSTANT TERM	03	.18075000+05	FT	D
0295C	C	HSO2	SCALE HEIGHT CONSTANT TERM	03	.27000000+05	FT	D
0296C	C	HSO3	SCALE HEIGHT CONSTANT TERM	03	.45563500+05	FT	D
0297C	C	HS11	SCALE HEIGHT SLOPE WRT VE	03	.72500000+00	S	D
0298C	C	HS13	SCALE HEIGHT SLOPE WRT VE	03	-.94450000+00	S	D
0316C	C	LODMIN	MINIMUM L/D RATIO	03	.50000000+00	ND	D
0321C	C	NALP	NUMBER OF ALPCMD VELOCITY SEGMENT BOUNDARIES	03	.90000000+01	RD	D
0349C	C	PREBNK	PREENTRY BANK ANGLE COMMAND	03	.00000000	DEG	M
0535C	C	RDMAX	MAXIMUM ROLL BIAS	03	.12000000+02	DEG	D
0470C	C	RLMC1	MAXIMUM VALUE OF RLM	03	.70000000+02	DEG	D
0471C	C	RLMC2	COEFFICIENT IN FIRST RLM SEGMENT	03	.70000000+02	DEG	D
0472C	C	RLMC3	COEFFICIENT IN FIRST RLM SEGMENT	03	.00000000	DEG-S/FT	D
0473C	C	RLMC4	COEFFICIENT IN SECOND RLM SEGMENT	03	-.37000000+03	DEG	D
0474C	C	RLMC5	COEFFICIENT IN SECOND RLM SEGMENT	03	.16000000+00	DEG-S/FT	D
0475C	C	RLMC6	MINIMUM VALUE OF RLM	03	.30000000+02	DEG	D
0392C	C	RPT1	RANGE BIAS TERM	03	.29440000+02	NM	M
0421C	C	VA	INITIAL VELOCITY FOR TEMPER- ATURE QUADRATIC, DD/DV=0	03	.23163700+05	FT/S	M
0513C	C	VALMOD	VELOCITY TO START ALPHA MODULATION FOR NON-CONVERGENCE	03	.23000000+05	FT/S	M

TABLE 9-II.- Continued
(a) Continued

MS10 # V97U	SW	SYMBOL	DESCRIPTION	MC	VALUE	UNITS	MISSION DEPENDENT CONSTANT
0422C	C	VALP(1)	ALPCMD VS VE BOUNDARY	03	.28500000+04	FT/S	M
0423C	C	VALP(2)	ALPCMD VS VE BOUNDARY	03	.35638700+04	FT/S	M
0424C	C	VALP(3)	ALPCMD VS VE BOUNDARY	03	.45000000+04	FT/S	M
0425C	C	VALP(4)	ALPCMD VS VE BOUNDARY	03	.68090000+04	FT/S	M
0426C	C	VALP(5)	ALPCMD VS VE BOUNDARY	03	.77894000+04	FT/S	M
0427C	C	VALP(6)	ALPCMD VS VE BOUNDARY	03	.14500000+05	FT/S	M
0488C	C	VALP(7)	ALPCMD VS VE BOUNDARY	03	.14500000+05	FT/S	M
0489C	C	VALP(8)	ALPCMD VS VE BOUNDARY	03	.14500000+05	FT/S	M
0490C	C	VALP(9)	ALPCMD VS VE BOUNDARY	03	.14500000+05	FT/S	M
0428C	C	VA1	BOUNDARY VELOCITY BETWEEN QUADRATIC SEGMENTS IN TEMPERATURE CONTROL PHASE	03		FT/S	M
0429C	C	VA2	INITIAL VELOCITY FOR TEMPERATURE QUADRATIC. DD/DV=0	03	.27197460+05	FT/S	M
0430C	C	VB1	HEAT RATE-EQUILIBRIUM GLIDE PHASF BOUNDARY VELOCITY	03	.19000000+05	FT/S	M
0432C	C	VC16	VELOCITY TO START C16 DRAG ERROR TERM	03	.23000000+05	FT/S	D
0514C	C	VC20	C20 VELOCITY BREAKPOINT	03	.25000000+04	FT/S	M
0433C	C	VELMN	MAXIMUM VELOCITY FOR LIMITING LMN BY ALMN3	03	.95000000+04	FT/S	D
0434C	C	VEROLC	MAXIMUM VELOCITY FOR LIMITING BANK ANGLE COMMAND	03	.80000000+04	FT/S	D
0435C	C	VMS1	SCALE HEIGHT VS VE BOUNDARY	03	.12310340+05	FT/S	D
0436C	C	VMS2	SCALE HEIGHT VS VE BOUNDARY	03	.19675500+05	FT/S	D
0515C	C	VNOALP	VELOCITY TO START ALPHA MODULATION	03	.25000000+05	FT/S	M
0437C	C	VQ	PREDICTED END VELOCITY FOR CONSTANT DRAG PHASE	03	.50000000+04	FT/S	M

TABLE 9-II.- Continued

(a) Concluded

MSIO # V97U	SW	SYMBOL	DESCRIPTION	MC	VALUE	UNITS	MISSION DEPENDENT CONSTANT
0438C	C	VRDT	VELOCITY TO START HDOT FEEDBACK	03	.23000000+05	FT/S	D
0476C	C	VRLMC	VELOCITY IN TRANSITION MAXIMUM ROLL COMMAND DETERMINATION	03	.27500000+04	FT/S	D
0439C	C	VSAT	LOCAL CIRCULAR ORBIT VELOCITY	03	.25766200+05	FT/S	D
0440C	C	VS1	REFERENCE VELOCITY FOR EQUILIBRIUM GLIDE	03	.23271870+05	FT/S	M
0420C	C	V TAEM	REFERENCE VELOCITY AT ENTRY- TAEM INTERFACE	03	.25000000+04	FT/S	D
0441C	C	VTRAN	NOMINAL VELOCITY AT START OF TRANSITION PHASE	03	.10500000+05	FT/S	M
0442C	C	VYLMAX	MINIMUM VELOCITY FOR LIMITING LMN BY ALMN4	03	.23000000+05	FT/S	D
0465C	C	YLMIN	YL BIAS USED IN TEST FOR LMN.	03	.30000000-01	RAD	D
0466C	C	YLMN2	MINIMUM YL BIAS	03	.70000000-01	RAD	D
0467C	C	Y1	MAXIMUM HEADING ERROR DEADBAND FOR INITIAL BANK MANEUVER	03	.18325960+00	RAD	D
0468C	C	Y2	MINIMUM HEADING ERROR DEADBAND	03	.17453290+00	RAD	D
0478C	C	Y3	MAXIMUM HEADING ERROR DEADBAND	03	.30543260+00	RAD	D
0469C	C	ZK1	GAIN FOR H DOT FEEDBACK	03	.60000000+00	S	D

TABLE 9-II.- Continued

(b) TAEM(G4.9)

MSID # V97U	SW	SYMBOL	DESCRIPTION	MC	VALUE	UNITS	MISSION DEPENDENT CONSTANT
0073C	P	CDEOD	CONSTANT GAIN USED TO COMPUTE OBD (= EXP (-0.4 DTG))	03	.68113130+00	ND	D
0075C	P	CPMIN	MINIMUM VALUE OF COSPHI	03	.70700000+00	ND	D
0076C	P	CODG	CONSTANT GAIN USED TO COMPUTE OBD (= 1 - CDEOD)	03	.31886860+00	ND	D
0077C	P	COG	CONSTANT GAIN USED TO COMPUTE OBARD AND DNZCD (= 11 - EXP (-0.08 DTG))/DTG)	03	.55839580+00	1/S	D
0103C	P	CUBIC C3(1)	COEFFICIENT USED TO COMPUTE	03	-.36411680-06	1/FT	M
0104C	P	CUBIC C3(2)	HREF AND DHDRF	03	-.36411690-06	1/FT	M
0105C	P	CUBIC C4(1)	COEFFICIENT USED TO COMPUTE	03	-.94810260-13	FT**2	M
0106C	P	CUBIC C4(2)	HREF AND DHDRF	03	-.94810260-13	FT**2	M
0113C	P	DEL H1	ALTITUDE ERROR COEFFICIENT	03	.19000000+00	ND	D
0114C	P	DEL H2	ALTITUDE ERROR COEFFICIENT	03	.90000000+03	FT	D
0115C	P	DEL R EMAX(1)	DELTA RANGE USED TO COMPUTE	03	.54000000+05	FT	M
0116C	P	DEL R EMAX(2)	EMAX	03	.54000000+05	FT	M
0123C	P	DNZCG	GAIN USED TO COMPUTE DNZC	03	.10000000-01	G-S/FT	D
0124C	P	DNZLC1	PHASES 0.1. AND 2 LOWER NZC LIMIT	03	-.50000000+00	G	D
0125C	P	DNZLC2	PHASE 3 LOWER NZC LIMIT	03	-.75000000+00	G	D
0126C	P	DNZUC1	PHASES 0.1. AND 2 UPPER NZC LIMIT	03	.50000000+00	G	D
0127C	P	DNZUC2	PHASE 3 UPPER NZC LIMIT	03	.15000000+01	G	D
0131C	P	DS8CM	MACH VALUE TO INITIATE SPEEDBRAKE MODULATION	03	.90000000+00	ND	D
0132C	P	DS8IL	LIMIT ON INTEGRAL COMPONENT OF SPEEDBRAKE COMMAND	03	.20000000+02	DEG	D
0133C	P	DS8LIM	MAXIMUM VALUE FOR SPEEDBRAKE COMMAND	03	.98600000+02	DEG	D

TABLE 9-II.- Continued

(b) Continued

MSID #	SW	SYMBOL	DESCRIPTION	MC	VALUE	UNITS	MISSION DEPENDENT CONSTANT
V97J							
0134C	P	DSBNO	NOMINAL SPEEDBRAKE COMMAND VALUE	03	.65000000+02	DEG	D
0135C	P	DSBSUP	MACH DSBCM SPEEDBRAKE COMMAND	03	.65000000+02	DEG	D
0136C	P	DSMPY	DELTA RANGE VALUE USED TO COMPUTE SHPLYK	03	.40000000+04	FT	D
0142C	P	EDEL1	CONSTANT USED IN DETERMINATION OF EMAX	03	.10000000+01	ND	M
0143C	P	EDEL2	CONSTANT USED IN DETERMINATION OF EMAX	03	.10000000+01	ND	M
0144C	P	EDELN(1)	DELTA ENERGY OVER WEIGHT USED TO COMPUTE EMAX AND EMIN	03	.40000000+04	FT	M
0145C	P	EDELN(2)	DELTA ENERGY OVER WEIGHT USED TO COMPUTE EMAX AND EMIN	03	.40000000+04	FT	M
0146C	P	EDRS(1)	SLOPE OF ES WITH RANGE	03	.60894920+00	ND	M
0150C	P	EDRS(2)	SLOPE OF ES WITH RANGE	03	.60894920+00	ND	M
0161C	P	EMEP C1 (1.1)	CONSTANT ENERGY OVER WEIGHT USED TO COMPUTE EMEP	03	-.37137970+03	FT	M
0162C	P	EMEP C1 (1.2)	CONSTANT ENERGY OVER WEIGHT USED TO COMPUTE EMEP	03	.14604870+05	FT	M
0164C	P	EMEP C1 (2.1)	SLOPE OF EMEP WITH RANGE	03	-.37137970+03	FT	M
0165C	P	EMEP C1 (2.2)	SLOPE OF EMEP WITH RANGE	03	.14604870+05	FT	M
0167C	P	EMEP C2 (1.1)	SLOPE OF EMEP WITH RANGE	03	.41682740+00	ND	M
0168C	P	EMEP C2 (1.2)	SLOPE OF EMEP WITH RANGE	03	.28211870+00	ND	M
0170C	P	EMEP C2 (2.1)	SLOPE OF EMEP WITH RANGE	03	.41682740+00	ND	M
0171C	P	EMEP C2 (2.2)	SLOPE OF EMEP WITH RANGE	03	.28211870+00	ND	M
0173C	P	EN C1 (1.1)	CONSTANT ENERGY OVER WEIGHT USED TO COMPUTE EN	03	-.25423950+03	FT	M
0174C	P	EN C1 (1.2)	CONSTANT ENERGY OVER WEIGHT USED TO COMPUTE EN	03	.17645340+05	FT	M
0177C	P	EN C1 (2.1)	SLOPE OF EN WITH RANGE	03	-.25423950+03	FT	M
0178C	P	EN C1 (2.2)	SLOPE OF EN WITH RANGE	03	.17645340+05	FT	M
0181C	P	EN C2 (1.1)	SLOPE OF EN WITH RANGE	03	.55002750+00	ND	M
0182C	P	EN C2 (1.2)	SLOPE OF EN WITH RANGE	03	.38902400+00	ND	M

TABLE 9-II.- Continued

(b) Continued

MSID # V97U	SW	SYMBOL	DESCRIPTION	MC	VALUE	UNITS	MISSION DEPENDENT CONSTANT
0185C.	P	EN C2 (2.1)	SLOPE OF EN WITH RANGE	03	.55002750+00	ND	M
0186C	P	EN C2 (2.2)	SLOPE OF EN WITH RANGE	03	.38502400+00	ND	M
0199C.	P	EOW SPT(1)	RANGE USED FOR IEL SELECTION	03	.11771800+06	FT	M
0200C	P	EOW SPT(2)	RANGE USED FOR IEL SELECTION	03	.11771800+06	FT	M
0219C.	P	ES1(1)	CONSTANT ENERGY OVER WEIGHT	03	.90000000+05	FT	M
0223C	P	ES1(2)	USED TO COMPUTE ES	03	.90000000+05	FT	M
0230C	P	GAMMA-COEF1	FLIGHTPATH ERROR COEFFICIENT	03	.70000000-03	DEG/FT	D
0231C	P	GAMMA-COEF2	FLIGHTPATH ERROR COEFFICIENT	03	.30000000+01	DEG	D
0232C	P	GAMMA ERR TRAN	FLIGHTPATH ERROR BAND	03	.40000000+01	DEG	D
0236C	P	GAMSGS(1)	STEEP GLIDESLOPE ANGLE	03	-.20000000+02	DEG	M
0237C	P	GAMSGS(2)	STEEP GLIDESLOPE ANGLE	03	-.20000000+02	DEG	M
0238C	P	GDMC	CONSTANT USED TO COMPUTE GDM	03	.20000000+01	ND	D
0239C	P	GDMLL	LOWER LIMIT ON GDM	03	.30000000+00	ND	D
0240C	P	GDMH	SLOPE OF GDM WITH ALTITUDE	03	.70000000-04	1/FT	D
0241C	P	GDMUL	UPPER LIMIT ON GDM	03	.10000000+01	ND	D
0242C	P	GEMDLL	GAIN USED TO COMPUTE EOWNZLL	03	.10000000-01	G-S/FT	D
0243C	P	GEMDUL	GAIN USED TO COMPUTE EOWNZUL	03	.10000000-01	G-S/FT	D
0244C	P	GELL	GAIN USED TO COMPUTE EOWNZLL	03	.10000000+00	1/S	D
0245C	P	GEUL	GAIN USED TO COMPUTE EOWNZUL	03	.10000000+00	1/S	D
C246C	P	GPHI	GAIN ON HEADING ERROR FOR PHASE 1 ROLL COMMAND	03	.25000000+01	ND	D
0247C	P	GR	GAIN ON RADIAL ERROR FOR PHASE 2 ROLL COMMAND	03	.20000000-01	DEG/FT	D
0253C	P	GRDOT	GAIN ON RADIAL RATE ERROR FOR PHASE 2 ROLL COMMAND	03	.20000000+00	DEG-S/FT	D
0257C	P	GSBE	SPEEDBRAKE PROPORTIONAL GAIN ON QBER	03	.15000000+01	DEG/PSF	D

TABLE 9-11.- Continued

(b) Continued

MSID # V97U	SM	SYMBOL	DESCRIPTION	MC	VALUE	UNITS	MISSION DEPENDENT CONSTANT
0268C	P	G5B1	SPEEDBRAKE INTEGRAL GAIN ON OBERR	03	.10000000+00	DEC/S-PSF	D
0263C	P	GY	PHASE 3 LATERAL ERROR GAIN	03	.50000000-01	DEG/FT	D
0264C	P	GYDOT	PHASE 3 LATERAL RATE ERROR GAIN	03	.60000000+00	DEG-S/FT	D
0267C	P	H ERR TRAN	ALTITUDE ERROR BOUND FOR TRANSI- TION TO AUTOLAND	03	.10000000+04	FT	D
0279C	P	H REF1	ALTITUDE REFERENCE FOR TRANSI- TION TO AUTOLAND	03	.10000000+05	FT	D
0280C	P	H REF2	ALTITUDE REFERENCE FOR TRANSI- TION TO AUTOLAND	03	.50000000+04	FT	D
0287C.	P	MALI(1)	ALTITUDE USED TO COMPUTE XALI AND MREF	03	.10018000+05	FT	M
0288C	P	MALI(2)		03	.10018000+05	FT	M
0290C	P	MOREGG	GAIN ON MERROR TO COMPUTE DNZC	03	.10000000+00	1/S	D
0291C.	P	MFTC(1)	ALTITUDE USED TO COMPUTE XFTC	03	.12018000+05	FT	M
0292C	P	MFTC(2)	ALTITUDE USED TO COMPUTE XFTC	03	.12018000+05	FT	M
0319C	P	MXOBT	CONSTANT USED TO COMPUTE OBLL = (140./190000 PSF/LB M)	03	.23707160-01	PSF/SLUGS	M
0327C.	P	PBGC(1)	LOWER LIMIT ON DMDRRF =	03	.11259530+00	ND	M
0328C	P	PBGC(2)	(TAN (6.2 DTR). TAN (6.2DTR))	03	.11259530+00	ND	M
0333C.	P	PBRCO(1)	RANGE BREAKPOINT FOR OBREF	03	.12200000+06	FT	M
0334C	P	PBRCO(2)	RANGE BREAKPOINT FOR OBREF	03	.12200000+06	FT	M
0339C.	P	PBMC(1)	ALTITUDE REFERENCE FOR RPRED = PBRC	03	.84821290+05	FT	M
0330C	P	PBMC(2)		03	.84821290+05	FT	M
0331C.	P	PBRC(1)	MAXIMUM RANGE FOR CUBIC	03	.30810950+06	FT	M
0332C	P	PBRC(2)	ALTITUDE REFERENCE	03	.30810950+06	FT	M
0335C	P	PHAVGC	CONSTANT USED TO COMPUTE PHAVG	03	.63330000+02	DEG	D
0336C	P	PHAVGLL	LOWER LIMIT ON PHAVG	03	.30000000+02	DEG	D
0337C	P	PHAVGS	SLOPE OF PHAVG WITH MACH	03	.13330000+02	DEG	D

TABLE 9-II.- Continued

(b) Continued

MSID # V97U	SM	SYMBOL	DESCRIPTION	MC	VALUE	UNITS	MISSION DEPENDENT CONSTANT
0338C	P	PHAVGUL	UPPER LIMIT ON PHAVG	03	.50000000+02	DEG	D
0342C	P	PHILMSUP	SUPERSONIC ROLL COMMAND LIMIT	03	.30000000+02	DEG	D
0343C	P	PHILMD	5 TURN ROLL COMMAND LIMIT	03	.50000000+02	DEG	D
0344C	P	PHILM1	ACQUISITION ROLL COMMAND LIMIT	03	.50000000+02	DEG	D
0345C	P	PHILM2	HEADING ALIGNMENT ROLL COMMAND LIMIT	03	.60000000+02	DEG	D
0346C	P	PHILM3	PREFINAL ROLL COMMAND LIMIT	03	.30000000+02	DEG	D
0347C	P	PHIM	MACH VALUE FOR PHILIMIT TEST	03	.10000000+01	ND	D
0348C	P	PHIP2C	NOMINAL ROLL COMMAND DURING PHASE 2	03	.30000000+02	DEG	D
0351C	P	P2TRNC1	CONSTANT USED IN PHASE 2 INITIATION TEST	03	.11000000+01	ND	D
0352C	P	P2TRNC2	CONSTANT USED IN PHASE 2 INITIATION TEST	03	.10100000+01	ND	D
0353C	P	OB ERROR1	DYNAMIC PRESSURE ERROR BOUND FOR TRANSITION TO AUTOLAND	03	.10000000+01	PSF	D
0354C	P	OB ERROR2	DYNAMIC PRESSURE ERROR BOUND FOR TRANSITION TO AUTOLAND	03	.24000000+02	PSF	D
0355C	P	OBARDL	LIMIT ON OBARD	03	.20000000+02	PSF/S	D
0356C	P	OB C1(1)	SLOPE OF OBREF WITH DRPRED	03	.58095650-03	PSF/FT	M
0357C	P	OB C1(2)	PBRCO	03	.58695650-03	PSF/FT	M
0358C	P	OB C2(1)	SLOPE OF OBREF WITH DRPRED	03	-.10316950-02	PSF/FT	M
0359C	P	OB C2(2)	PBRCO	03	-.10316950 02	PSF/FT	M
0360C	P	OBG1	GAIN USED TO COMPUTE OBZLL AND OBZUL	03	.10000000+00	1/S	D
0361C	P	OBG2	GAIN USED TO COMPUTE OBZLL AND OBZUL	03	.12500000+00	S-G/PSF	D
0366C	P	OBMXS	SLOPE OF OBMANZ WITH MACH OBM2	03	.20000000+02	PSF	D

TABLE 9-II.- Continued

(b) Continued

MSID # V97U	SB	SYMBOL	DESCRIPTION	MC	VALUE	UNITS	MISSION DEPENDENT CONSTANT
0367C	P	OBMK1	CONSTANT USED TO COMPUTE OBMKXZ	03	.24000000+03	PSF	D
0368C	P	OBMK2	CONSTANT USED TO COMPUTE OBMKXZ	03	.22000000+03	PSF	D
0369C	P	OBMK3	CONSTANT USED TO COMPUTE OBVKXZ	03	.25000000+03	PSF	D
0371C	P	OBM1	MACH BREAKPOINT FOR COMPUTING OBMKXZ	03	.10000000+01	ND	D
0372C	P	OBM2	MACH BREAKPOINT FOR COMPUTING OBMKXZ	03	.10000000+01	ND	D
0373C	P	OBRL1(1)	OBREF LOWER LIMIT	03	.15300000+03	PSF	M
0374C	P	OBRL1(2)	OBREF LOWER LIMIT	03	.15300000+03	PSF	M
0375C	P	OBRL1(1)	OBREF MIDDLE LIMIT	03	.18000000+03	PSF	M
0376C	P	OBRL1(2)	OBREF MIDDLE LIMIT	03	.18000000+03	PSF	M
0377C	P	OBRL1(1)	OBREF UPPER LIMIT	03	.26543000+03	PSF	M
0378C	P	OBRL1(2)	OBREF UPPER LIMIT	03	.26543000+03	PSF	M
0384C	P	OBRLM	LIMIT ON RERRC	03	.50000000+03	DEG	D
0385C	P	RFIC	POLL FADER TIME CONSTANT	03	.50000000+01	S	D
0387C	P	RMINST(1)	MINIMUM RANGE TO INITIATE S TURN PHASE	03	.1220460+06	FT	M
0388C	P	RMINST(2)	CONSTANT RANGE USED IN COM-	03	.1220460+06	FT	M
0389C	P	RN1(1)	PUTING EN. EMEP. AND EMAX	03	.65428860+04	FT	M
0390C	P	RN1(2)	CONSTANT USED IN PHASE2 INITIATION TEST	03	.65428860+04	FT	M
0393C	P	RTBIAS	MAC RADIUS	03	.30000000+04	FT	D
0394C	P	RTURN	TANGENT OF A/L STEEP GLIDESLOPE	03	.20000000+05	FT	D
0414C	P	TGGS(1)	TANGENT OF A/L STEEP GLIDESLOPE	03	.36397000+00	ND	M
0415C	P	TGGS(2)	TANGENT OF A/L STEEP GLIDESLOPE	03	.36397000+00	ND	M

TABLE 9-II.- Continued

(b) Concluded

MSID # V97U	SW	SYMBOL	DESCRIPTION	MC	VALUE	UNITS	MISSION DEPENDENT CONSTANT
0431C	P	VCO	CONSTANT USED TO COMPUTE GCONT (=RTD G/GQN. WHERE GON = GON (GCS))	03	.10000000+21	FT/SEC	D
0536C	P	V DEF	NAV/DAD/DEFAULT QBAR SWITCH ON VELOCITY	03	.00000000	FT/SEC	M
0444C	P	WT GS1	WEIGHT USED FOR IGS SELECTION	03	.65270000+04	SLUGS	M
0456C.	P	XA(1)	STEEP GLIDESLOPE GROUND	03	-.65000000+04	FT	M
0457C	P	XA(2)	INTERCEPT	03	-.55000000+04	FT	M
0459C	P	Y ERROR	CROSSRANGE ERROR BOUND FOR AUTOLAND INITIATION WHEN H> H REF 1	03	.10000000+04	FT	D
0462C	P	Y RANGE1	COEFFICIENT ON H USED TO COMPUTE CROSSRANGE ERROR BOUND WHEN H< H REF 1	03	.18000000+00	ND	D
0463C	P	Y RANGE2	CONSTANT USED TO COMPUTE CROSSRANGE ERROR BOUND WHEN H< H REF 1	03	.80000000+03	FT	D
0464C	P	YERRLM	LIMIT ON YERRC	03	.12000000+03	DEG	D

TABLE 9-II.- Continued
(c) AutoLand(G4.10)

MS10 # V97U	SW	SYMBOL	DESCRIPTION	MC	VALUE	UNITS	MISSION DEPENDENT CONSTANT
0004C	P	A 3	FINAL FLARE FILTER CONSTANT	03	.10000000+02	1/S	D
0000C	P	A INT	CROSSRANGE ERROR INTEGRATOR GAIN	03	.00000000	DEG-S/FT	D
0001C	P	A SBF	SPEEDBRAKE COMMAND FILTER CONSTANT	03	.50000000+00	1/S	D
0002C	P	A 13	AIRSPEED FILTER CONSTANT	03	.10000000+01	1/S	D
0003C	P	A 14	SPEED CONTROL FILTER CONSTANT	03	.10000000+01	1/S	D
0005C	P	A 40	OPEN LOOP FILTER CONSTANT	03	.13330000+01	1/S	D
0117C	P	DELTA SB	SPEEDBRAKE THRESHOLD ANGLE FACTOR	03	.28000000+01	DEG	D
0128C.	P	DSBC TD(1)	SPEEDBRAKE ANGLE AT TD	03	.00000000	DEG	D
0130C	P	DSBC TD(2)	SPEEDBRAKE ANGLE AT TD	03	.00000000	DEG	D
0229C	P	GAMMA CAPTURE	MAXIMUM GAMMA ERROR TO ENGAGE STEEP GLIDESLOPE	03	.20000000+01	DEG	D
0233C.	P	GAMMA REF 1(1)	STEEP GLIDESLOPE FLIGHTPATH REFERENCE	03	-.20000000+02	DEG	M
0234C	P	GAMMA REF 1(2)	REFERENCE	03	-.20000000+02	DEG	M
0235C	P	GAMMA REF 2	SHALLOW GLIDESLOPE FLIGHTPATH REFERENCE	03	-.15000000+01	DEG	M
0265C	P	H CLOOP	ALTITUDE AT WHICH START CLOSED LOOP PULLUP	03	.17000000+04	FT	M
0266C	P	H DECAY	EXPONENTIAL CAPTURE ALTITUDE REFERENCE	03	.29000000+02	FT	M
0268C	P	H ERROR CAPTURE	MAXIMUM ALTITUDE ERROR TO ENGAGE STEEP GLIDESLOPE	03	.50000000+02	FT	D
0269C	P	H ERROR MAX	MAXIMUM ALTITUDE ERROR	03	.30000000+03	FT	D
0270C	P	H FF	ALTITUDE TO START CHECKING FINAL FLARE ALTITUDE	03	.80000000+02	FT	D
0271C	P	H FLARE	FLARE ALTITUDE	03	.20000000+04	FT	M
0272C	P	H INTMX	ALTITUDE ERROR INTEGRATOR MAXIMUM	03	.50000000+02	FT	D

TABLE 9-II.- Continued

(c) Continued

MSID # V97U	SW	SYMBOL	DESCRIPTION	MC	VALUE	UNITS	MISSION DEPENDENT CONSTANT
0273C.	P	H K (1.1)	CONSTANT G CIRCLE CENTER	03	.26320000+05	FT	M
0274C.	P	H K (1.2)	ALTITUDE	03	.26796000+05	FT	M
0275C.	P	H K (2.1)		03	.26320000+05	FT	M
0276C	P	H K (2.2)		03	.26796000+05	FT	M
0277C	P	H MIN	MINIMUM ALTITUDE FOR FINAL FLARE	03	.30000000+02	FT	D
0278C	P	H NO ACC	ALTITUDE FOR ZERO ACCELERATION	03	.20000000+01	FT	D
0281C.	P	H SBR TABLE(1)	TABLE OF SPEEDBRAKE RETRACT	03	.25000000+04	FT	M
0282C.	P	H SBR TABLE(2)	ALTITUDES	03	.25000000+04	FT	M
0283C	P	H SBR TABLE(3)		03	.10000000+04	FT	M
0284C	F	H TD1 DOT	TOUCHDOWN ALTITUDE RATE	03	.90000000+01	FT/S	D
0285C	P	H TD2 DOT	CLOSED-LOOP TOUCHDOWN ALTITUDE RATE	03	-.30000000+01	FT/S	D
0296C	P	H WL	ALTITUDE REFERENCE FOR LIMITER	03	.75000000+04	FT	D
0492C	P	INT RET BF	INITIAL RETRACT BODY FLAP FLAG	03	.10000000+01	ND	M
0301C	P	K H SGS	ALTITUDE ERROR GAIN. SGS	03	.24000000-02	G/FT	D
0299C	P	K FLR	FEED-FORWARD GAIN, F-F	03	.25000000-01	G-S**2/FT	D
0300C	P	K H FSGS	ALTITUDE ERROR GAIN. FSGS	03	.24000000-02	G/FT	D
0302C	P	K H TC	ALTITUDE ERROR GAIN. TC. SGS	03	.24000000-02	G/FT	D
0303C	P	K HDOT FF	VERTICAL VELOCITY GAIN. FF	03	.12000000-01	G-S/FT	D
0304C	P	K HDOT FSGS	VERTICAL VELOCITY GAIN. FSGS	03	.12000000-01	G-S/FT	D
0305C	P	K HDOT SGS	VERTICAL VELOCITY GAIN. SGS	03	.12000000-01	G-S/FT	D
0306C	P	K HDOT TC	VERTICAL VELOCITY GAIN. TC	03	.12000000-01	G-S/FT	D
0307C	P	K HINT1	INTEGRATOR GAIN. SGS	03	.12000000-03	G/FT-S	D
0308C	P	K IFLR	INTEGRATOR GAIN. FF	03	.00000000	1/S	D
0309C	P	K INT FSGS	INTEGRAL GAIN. FSGS	03	.50000000-01	1/S	D

TABLE 9-II.- Continued

(c) Continued

MSID # V97U	SW	SYMBOL	DESCRIPTION	MC	VALUE	UNITS	MISSION DEPENDENT CONSTANT
0310C	P	K R1	YAW RATE COMMAND GAIN. FLAT TURN	03	.25000000+00	1/S	D
0311C	P	K R2	YAW RATE COMMAND GAIN. TOUCHDOWN	03	.50000000+00	1/S	D
0312C	P	K SB	SPEEDBRAKE GAIN	03	.20000000+01	DEG-S/FT	D
0313C	P	K SBI	SPEEDBRAKE INTEGRAL GAIN	03	.10000000+00	DEG/FT	D
0315C	P	K Y1	CROSSRANGE ERROR INTEGRATOR -GAIN	03	.70000000-01	DEG/FT	D
0314C	P	M YDOT	CROSSRANGE RATE GAIN	03	.10000000+02	S	D
0320C	P	N FADER	ROLL FADER CONSTANT	03	.00000000	ND	D
0322C	P	NSB	MAXIMUM VALUE OF ISB	03	.30000000+01	ND	D
0323C	P	NZC LIM	MAX-G LIMIT FOR NZC	03	.10000000+01	G	D
0339C	P	PHI M1	MAXIMUM ROLL ATTITUDE COMMAND	03	.45000000+02	DEG	D
0340C	P	PHI M2	MAXIMUM ROLL ATTITUDE COMMAND	03	.20000000+02	DEG	D
0341C	P	PHI M3	MAXIMUM ROLL ATTITUDE COMMAND	03	.45000000+02	DEG	D
0326C	P	P MODE INITIAL	INITIAL PITCH SUBPHASE INDICATOR	03	.10000000+01	ND	D
0350C	P	PSI CAP	MAXIMUM HEADING ERROR (RC)	03	.20000000+01	DEG	D
0379C.	P	R (1.1)	CONSTANT G CIRCLE RADIUS	03	.26200000+05	FT	M
0380C.	P	R (1.2)	CONSTANT G CIRCLE RADIUS	03	.26707000+05	FT	M
0381C.	P	R (2.1)	CONSTANT G CIRCLE RADIUS	03	.28200000+05	FT	M
0382C	P	R (2.2)	CONSTANT G CIRCLE RADIUS	03	.26707000+05	FT	M
0396C	P	S6 RATE	SPEEDBRAKE RETRACT RATE	03	.11000000+02	DEG/S	D
0397C	P	S8 REF	SPEEDBRAKE REFERENCE	03	.55000000+02	DEG	D
0398C.	P	S8F TABLE(1)	TABLE OF REFERENCE SPEEDBRAKE	03	.25000000+02	DEG	M
0399C.	P	S8F TABLE(2)	POSITIONS FOR RETRACTION ALTITUDE	03	.75000000+02	DEG	M

TABLE 9-II.- Continued

(c) Continued

MSID # V97U	SW	SYMBOL	DESCRIPTION	MC	VALUE	UNITS	MISSION DEPENDENT CONSTANT
0400C	P	SBF TABLE(3)	POSITIONS FOR RETRACTION ALTITUDE	03	.98600000+02	DEG	M
0402C	P	SIGMA(1)	EXPONENTIAL DISTANCE	03	.85000000+03	FT	M
0403C	P	SIGMA(2)	EXPONENTIAL DISTANCE	03	.85000000+03	FT	M
0409C	P	T O	MINIMUM TIME WITH BOUNDED ERRORS FOR TRANSITION TO STEEP GLIDESLOPE PHASE	03	.40000000+01	S	D
0410C	P	TAU GAMMA	TIME CONSTANT. FSGS	03	.20000000+01	S	D
0411C	P	TAU TD	TIME CONSTANT. FSGS	03	.60000000+01	S	D
0412C	P	TAU TD1	TIME CONSTANT. FF	03	.50000000+01	S	D
0413C	P	TAU TD2	TIME CONSTANT. FF	03	.50000000+01	S	D
0416C	P	TO LAT	MINIMUM TIME WITH BOUNDED ERROR TO ENGAGE LATERAL TRACK	03	.40000000+01	S	D
0417C	P	V LIMIT	MAXIMUM ERROR VELOCITY LIMIT	03	.10000000+02	FT/S	D
0418C	P	V REF(1)	REFERENCE AIRSPEED	03	.47300000+03	FT/S	M
0419C	P	V REF(2)	REFERENCE AIRSPEED	03	.47300000+03	FT/S	M
0444C	P	WT GS1	WEIGHT FOR GLIDESLOPE SELECTION	03	.65270000+04	SLUGS	M
0445C	P	X AIM PT	AIM POINT X-DISTANCE	03	.15000000+04	FT	M
0446C	P	X EXP (1.1)	EXPONENTIAL CAPTURE X DISTANCE	03	-.37840000+04	FT	M
0447C	P	X EXP (1.2)	EXPONENTIAL CAPTURE X DISTANCE	03	-.26460000+04	FT	M
0448C	P	X EXP (2.1)	EXPONENTIAL CAPTURE X DISTANCE	03	-.37840000+04	FT	M
0449C	P	X EXP (2.2)	EXPONENTIAL CAPTURE X DISTANCE	03	-.26760000+04	FT	M
0450C	P	X K (1.1)	CONSTANT G CIRCLE CENTER RANGE	03	-.22090000+04	FT	M
0451C	P	X K (1.2)	CONSTANT G CIRCLE CENTER RANGE	03	-.10360000+04	FT	M
0452C	P	X K (2.1)	CONSTANT G CIRCLE CENTER RANGE	03	-.22090000+04	FT	M
0453C	P	X K (2.2)	CONSTANT G CIRCLE CENTER RANGE	03	-.10360000+04	FT	M

TABLE 9-II.- Concluded
(c) Concluded

19

MSID # V97U	SW	SYMBOL	DESCRIPTION	MC	VALUE	UNITS	MISSION DEPENDENT CONSTANT
0454C.	P	X ZERO(1)	STEEP GLIDESLOPE INTERCEPT	03	.65000000+04	FT	M
0455C	P	X ZERO(2)	STEEP GLIDESLOPE INTERCEPT	03	.55000000+04	FT	M
0460C	P	Y IN LIM	CROSSRANGE ERROR INTEGRATION LIMIT	03	.50000000+02	FT	D
0458C	P	Y CAP	LATERAL CAPTURE DISTANCE (RC)	03	.50000000+02	FT	D
0461C	P	Y LIMIT	CROSSRANGE ERROR LIMIT	03	.10000000+04	FT	D

TABLE 9-II.- DEFINITION OF GRTLS TAEM GUIDANCE CONSTANTS

(a) G4.204

MSID # V97U	SW	SYMBOL	DESCRIPTION	MC	VALUE	UNITS	MISSION DEPENDENT CONSTANT
0015C	P	ALPC1	MACH BREAKPOINT COMPUTING ALPUL	01	.13000000+01	ND	D
0026C	P	ALPC2	SLOPE OF ALPUL WITH MACH	01	.85714287+01	DEG	D
0031C	P	ALPC3	CONSTANT USED TO COMPUTE ALPUL	01	.18571430+01	DEG	D
0032C	P	ALPC4	LOWER LIMIT FOR COMPUTING ALPUL	01	.10000000+02	DEG	D
0033C	P	ALPC5	UPPER LIMIT FOR COMPUTING ALPUL	01	.13000000+02	DEG	D
0034C	P	ALPC6	SLOPE OF ALPUL WITH MACH	01	.33333330+01	DEG	D
0035C	P	ALPC7	CONSTANT USED TO COMPUTE ALPUL	01	.86666670+01	DEG	D
0036C	P	ALPC8	LOWER LIMIT FOR COMPUTING ALPUL	01	.13000000+02	DEG	D
0037C	P	ALPC9	UPPER LIMIT FOR COMPUTING ALPUL	01	.17000000+02	DEG	D
0016C	P	ALPC10	MACH BREAKPOINT COMPUTING ALPLL	01	.17500000+01	ND	D
0017C	P	ALPC11	SLOPE OF ALPLL WITH MACH	01	.55238100+0*	DEG	D
0018C	P	ALPC12	CONSTANT USED TO COMPUTE ALPLL	01	-.18666670+01	DEG	D
0019C	P	ALPC13	LOWER LIMIT FOR COMPUTING ALPLL	01	.20000000+01	DEG	D
0020C	P	ALPC14	UPPER LIMIT FOR COMPUTING ALPLL	01	.78000000+01	DEG	D
0021C	P	ALPC15	MACH BREAKPOINT COMPUTING ALPLL	01	.30000000+01	ND	D
0022C	P	ALPC16	SLOPE OF ALPLL WITH MACH	01	.20000000+01	DEG	D
0023C	P	ALPC17	CONSTANT USED TO COMPUTE ALPLL	01	.43000000+01	DEG	D
0024C	P	ALPC18	LOWER LIMIT FOR COMPUTING ALPLL	01	.78000000+01	DEG	D
0025C	P	ALPC19	UPPER LIMIT FOR COMPUTING ALPLL	01	.85000000+01	DEG	D
0027C	P	ALPC20	SLOPE OF ALPLL WITH MACH	01	.50000000+01	DEG	D
0028C	P	ALPC21	CONSTANT USED TO COMPUTE ALPLL	01	-.65000000+01	DEG	D
0029C	P	ALPC22	LOWER LIMIT FOR COMPUTING ALPLL	01	.85000000+01	DEG	D
0030C	P	ALPC23	UPPER LIMIT FOR COMPUTING ALPLL	01	.11000000+02	DEG	D
0038C	P	ALPG1	GAIN TO COMPUTE ALPNZLL & ALPNZUL	01	.25000000+01	1/S	D
0039C	P	ALPG2	GAIN TO COMPUTE ALPNZLL & ALPNZUL	01	.50000000-0:	DEG	M

TABLE 9-III.- Continued

(a) Continued

MSID # V97U	SW	SYMBOL	DESCRIPTION	MC	VALUE	UNITS	MISSION DEPENDENT CONSTANT
0040C	P	ALPREC	RECOVERY ANGLE OF ATTACK	01	.5000000+02	G-S/DEG	D
0041C	P	ALPSW	ANGLE OF ATTACK CONSTANT FOR TRANSITION TO PHASE 5	01	.4500000+02	DEG	M
0073C	P	CDEOD	CONST GAIN USED TO COMPUTE QBD (= EXP (-0.4 DTG))	01	.68113140+00	ND	D
0075C	P	CPMIN	MINIMUM VALUE OF COSPHI	01	.7070000+00	ND	D
0076C	P	COOG	CONST GAIN USED TO COMPUTE QBD (= 1 - CDEOD)	01	.31888860+00	ND	D
0077C	P	COG	CONSTANT GAIN USED TO COMPUTE QBD AND DNZCD (= (1 - EXP (- 0.08 DTG)) / DTG)	01	.55839580+00	1/S	D
0087C.	P	CUBC1(1.1)	CUBIC ALTITUDE REF CONSTANT	01	.70180000+04	FT	M
0088C	P	CUBC1(1.2)	CUBIC ALTITUDE REF CONSTANT	01	.50130000+05	FT	M
0091C.	P	CUBC2(1.1)	CUBIC ALTITUDE REF CONSTANT	01	.36397020+00	ND	M
0092C	P	CUBC2(1.2)	CUBIC ALTITUDE REF CONSTANT	01	.28674540+00	ND	M
0095C.	P	CUBC3(1.1)	CUBIC ALTITUDE REF CONSTANT	01	.33858480-06	1/FT	M
0096C	P	CUBC3(1.2)	CUBIC ALTITUDE REF CONSTANT	01	-.64653470-06	1/FT	M
0099C.	P	CUBC4(1.1)	CUBIC ALTITUDE REF CONSTANT	01	-.35597540-11	FT**2	M
0100C	P	CUBC4(1.2)	CUBIC ALTITUDE REF CONSTANT	01	.49136690-12	FT**2	M
0107C	P	CUBRC(1)	RANGE BREAKPOINT FOR CUBIC SELECTION	01	.12246000+06	FT	M
G113C	P	DEL M1	ALTITUDE ERROR COEFFICIENT	01	.19000000+00	ND	D
0114C	P	DEL F2	ALTITUDE ERROR COEFFICIENT	01	.90000000+03	FT	D
0115C	P	DEL R EMAX(1)	DELTA RANGE TO COMPUTE EMAX	01	.91543400+05	FT	M
0119C	P	DEL15B	SPEEDBRAKE COMMAND INCREMENT FOR PHASES 5 AND 6	01	.31250000+01	DEG	M
0122C	P	DNZCDL	LIMIT ON DNZCD	01	.10000000+00	G/S	D
0123C	P	DNZCG	GAIN USED TO COMPUTE DNZC	01	.10000000-01	G-S/FT	D

TABLE 9-III.- Continued

(a) Continued

MSID # V97U	SM	SYMBOL	DESCRIPTION	MC	VALUE	UNITS	MISSION DEPENDENT CONSTANT
0124C	P	DNZLC1	PHASES 0.1, AND 2 LOWER NZC LIMIT	01	-.50000000+00	G	D
0125C	P	DNZLC2	PHASE 3 LOWER NZC LIMIT	01	-.75000000+00	G	D
0126C	P	DNZUC1	PHASES 0.1, AND 2 UPPER NZC LIMIT	01	.75000000+00	G	D
0127C	P	DNZUC2	PHASE 3 UPPER NZC LIMIT	01	.15000000+01	G	D
0131C	P	DSBCM	MACH VALUE TO INITIATE SPEEDBRAKE MODULATION	01	.90000000+00	ND	D
0132C	P	DSBIL	LIMIT ON INTEGRAL COMPONENT OF SPEEDBRAKE COMMAND	01	.20000000+02	DEG	D
0133C	P	DSBLIM	MAXIMUM VALUE FOR SPEEDBRAKE COMMAND	01	.98600000+02	DEG	D
0134C	P	DSBNOM	NOMINAL SPEEDBRAKE COMMAND VALUE	01	.65000000+02	DEG	D
0135C	P	DSBSUP	MACH DSBCM SPEEDBRAKE COMMAND	01	.98600000+02	DEG	M
0136C	P	DSMPLY	DELTA RANGE VALUE USED TO COMPUTE SMPLYK	01	.40000000+04	FT	D
0142C	P	EDELCL	CONSTANT USED IN DETERMINATION OF EMAX	01	.10000000+01	ND	M
0143C	P	EDELCL2	CONSTANT USED IN DETERMINATION OF EMAX	01	.10000000+01	ND	M
0144C	P	EDELNZ(1)	DELTA ENERGY OVER WEIGHT USED TO COMPUTE EMAX AND EMIN	01	.40000000+04	FT	M
0147C	P	EDRS(1.1)	SLOPE OF ES WITH RANGE	01	.54708500+00	ND	M
0148C	P	EDRS(1.2)	SLOPE OF ES WITH RANGE	01	.39070800+00	ND	M
0149C	P	EDRS(1.3)	SLOPE OF ES WITH RANGE	01	.65609800+00	ND	M
0154C	P	EDRST(1.1)	SLOPE OF EST WITH RANGE	01	.54708500+00	ND	M
0155C	P	EDRST(1.2)	SLOPE OF EST WITH RANGE	01	.39070800+00	ND	M
0156C	P	EDRST(1.3)	SLOPE OF EST WITH RANGE	01	.64015000+00	ND	M

TABLE 9-III.- Continued

(a) Continued

MSID #	SW	SYMBOL	DESCRIPTION	MC	VALUE	UNITS	MISSION DEPENDENT CONSTANT
0161C.	P	EMEP C1(1.1)	CONSTANT ENERGY OVER WEIGHT USED TO COMPUTE EMEP	01	-.90000000+04	FT	M
0162C.	P	EMEP C1(1.2)		01	-.29766000+05	FT	M
0163C	P	EMEP C1(1.3)		01	.10000000+05	FT	M
0167C.	P	EMEP C2(1.1)	SLOPE OF EMEP WITH RANGE	01	.46000000+00	ND	M
0168C.	P	EMEP C2(1.2)	SLOPE OF EMEP WITH RANGE	01	.50153200+00	ND	M
0169C	P	EMEP C2(1.3)	SLOPE OF EMEP WITH RANGE	01	.26899330+00	ND	M
0173C.	P	EN C1(1.1)	CONSTANT ENERGY OVER WEIGHT USED TO COMPUTE EN	01	.33274000+05	FT	M
0174C.	P	EN C1(1.2)		01	.23810000+04	FT	M
0175C.	P	EN C1(1.3)		01	-.52660000+04	FT	M
0176C	P	EN C1(1.4)		01	.11385000+05	FT	M
0181C.	P	EN C2(1.1)	SLOPE OF EN WITH RANGE	01	.45888800+00	ND	M
0182C.	P	EN C2(1.2)	SLOPE OF EN WITH RANGE	01	.53221400+00	ND	M
0183C.	P	EN C2(1.3)	SLOPE OF EN WITH RANGE	01	.56371200+00	ND	M
0184C	P	EN C2(1.4)	SLOPE OF EN WITH RANGE	01	.42777300+00	ND	M
0189C	P	EW MP1(1)	RANGE FOR IEM SELECTION	01	.50000000+06	FT	M
0191C	P	EW MP2(1)	RANGE FOR IEM SELECTION	C1	.17100800+06	FT	M
0193C	P	EW NP1(1)	RANGE FOR IEL SELECTION	01	.42131000+06	FT	M
0195C	P	EW NP2(1)	RANGE FOR IEL SELECTION	01	.24278000+06	FT	M
0197C	P	EW NP3(1)	RANGE FOR IEL SELECTION	01	.12248800+06	FT	M
0201C	P	EW SP1(1)	RANGE FOR IES SELECTION	01	.47740500+06	FT	M
0203C	P	EW SP2(1)	RANGE FOR IES SELECTION	01	.32662500+06	FT	M
0205C	P	EW STP1(1)	RANGE FOR IEST SELECTION	01	.47740500+06	FT	M
0207C	P	EW STP2(1)	RANGE FOR IEST SELECTION	01	.32662500+06	FT	M
0209C	P	EWL1(1)	MAXIMUM ENERGY OVER WEIGHT AT WHICH AN S-TURN CAN OCCUR	01	.00000000	FT	M
0211C	P	EWL2(1)	MAXIMUM ENERGY OVER WEIGHT AT WHICH THE IEP ALERT CAN BE ISSUED	01	.62000000+06	FT	M

TABLE 9-III.- Continued
(a) Continued

MSID # V97U	SW	SYMBOL	DESCRIPTION	MC	VALUE	UNITS	MISSION DEPENDENT CONSTANT
0213C.	P	EST1(1,1)	CONSTANT ENERGY OVER WEIGHT	01	.16818800+05	FT	M
0214C.	P	EST1(1,2)	USED TO COMPUTE EST	01	.91473900+05	FT	M
0215C	P	EST1(1,3)		01	.10000000+05	FT	M
0220C.	P	ES1(1,1)	CONSTANT ENERGY OVER WEIGHT	01	.22448730+05	FT	M
0221C.	P	ES1(1,2)	USED TO COMPUTE ES	01	.97103890+05	FT	M
0222C	P	ES1(1,3)		01	.10421000+05	FT	M
0230C	P	GAMMA-COEF1	FLIGHTPATH ERROR COEFFICIENT	01	.70000000-03	DEG/FT	D
0231C	P	GAMMA-COEF2	FLIGHTPATH ERROR COEFFICIENT	01	.30000000+01	DEG	D
0232C	P	GAMMA ERR TRAN	FLIGHTPATH ERROR BAND	01	.40000000+01	DEG	D
0236C	P	GAMSGS(1)	STEEP GLIDESLOPE ANGLE	01	-.20000000+02	DEG	M
0238C	P	GDHC	CONSTANT USED TO COMPUTE GDH	01	.20000000+01	ND	D
0239C	P	GDHLL	LOWER LIMIT ON GDH	01	.30000000+00	ND	D
0240C	P	GDHS	SLOPE OF GDH WITH ALTITUDE	01	.70000000-04	1/FT	D
0241C	P	GDHUL	UPPER LIMIT ON GDH	01	.10000000+01	ND	D
0242C	P	GEHLL	GAIN USED TO COMPUTE EOWNZLL	01	.10000000-01	G-S/FT	D
0243C	P	GEMDUL	GAIN USED TO COMPUTE EOWNZUL	01	.10000000-01	G-S/FT	D
0244C	P	GELL	GAIN USED TO COMPUTE EOWNZLL	01	.10000000+00	1/S	D
0245C	P	GELUL	GAIN USED TO COMPUTE EOWNZUL	01	.10000000+00	1/S	D
0246C	P	GPHI	GAIN ON HEADING ERROR FOR PHASE 1 ROLL COMMAND	01	.25000000+01	ND	D
0247C	P	GR	GAIN ON RADIAL ERROR FOR PHASE 2 ROLL COMMAND	01	.20000000-01	DEG/FT	D
0248C	P	GRAL	ANGLE OF ATTACK COMMAND RATE LIMIT	01	.10000000+01	DEG/S	D
0249C	P	GRALPI	CONSTANT ANGLE OF ATTACK USED TO COMPUTE GRALPR	01	.91304350+01	DEG	M
0250C	P	GRALPL	MINIMUM VALUE FOR GRALPR	01	.14000000+02	DEG	M

TABLE 9-III.- Continued

(a) Continued

MSID #	SW	SYMBOL	DESCRIPTION	MC	VALUE	UNITS	MISSION DEPENDENT CONSTANT
V97U							
0251C	P	GRALPS	SLOPE OF GRALPR WITH MACH NUMBER	01	.15217390+01	DEG	M
0252C	P	GRALPU	MAXIMUM VALUE FOR GRALPR	01	.17500000+02	DFG	M
0253C	P	GRDOT	GAIN ON RADIAL RATE ERROR FOR PHASE 2 ROLL COMMAND	01	.20000000+00	DEG-S/FT	D
0254C	P	GRNZC1	DESIRED NORMAL ACCELERATION FOR NZ-HOLD PHASE	01	.10000000+01	G	M
0255C	P	GRSBL1	MAX VAL OF DSBC AT FOR PHASES 5 & 6	01	.98600000+02	DEG	M
0256C	P	GRSBL2	MAX VALUE OF DSBC AT FOR SCHEDULED MINIMUM SPEEDBRAKE COMMAND	01	.65000000+02	DEG	M
0257C	P	GSBE	SPEEDBRAKE PROPORTIONAL GAIN ON DBERR	01	.15000000+01	DEG/PSF	D
0258C	P	GSBI	SPEEDBRAKE INTEGRAL GAIN ON DBERR	01	.10000000+00	DEG/S-PSF	D
0263C	P	GY	PHASE 3 LATERAL ERROR GAIN	01	.50000000-01	DEG/FT	D
0264C	P	GYDOT	PHASE 3 LATERAL RATE ERROR GAIN	01	.60000000+00	DEG-S/FT	D
0267C	P	M ERR TRAN	ALTITUDE ERROR BOUND FOR TRANSITION TO AUTOLAND	01	.10000000+04	FT	D
(V96U) 8305C	P	M MIN 3	MINIMUM ALTITUDE FOR PREFINAL INITIATION	01	.70000000+04	FT	D
0279C	P	M REF1	ALTITUDE REFERENCE FOR TRANSITION TO AUTOLAND	01	.10000000+05	FT	D
0280C	P	M REF2	ALTITUDE REFERENCE FOR TRANSITION TO AUTOLAND	01	.50000000+04	FT	D
0289C	P	MDCLM	MAXIMUM VALUE OF HEADCR	01	.00000000	DEG	D
0290C	P	MDREGG	GAIN ON MERROR TO COMPUTE DNZC	01	.10000000+00	1/S	D
(V96U) 7792C	P	MDTRN	ALTITUDE RATE AT WHICH PHASE 5 TO PHASE 4 TRANSITION OCCURS	01	-.25000000+03	FT/SEC	M
0291C	P	MFYC(1)	ALTITUDE USED TO COMPUTE MFTC	01	.12018000+05	FT	M
(V96U) 7786C	P	MACHSBI	MACH VALUE TO INITIATE SPEEDBRAKE SCHEDULE	01	.40000000+01	ND	D

TABLE 9-III.- Continued

(a) Continued

MSID #	SW	SYMBOL	DESCRIPTION	MC	VALUE	UNITS	MISSION DEPENDENT CONSTANT
(V96U) 7784C	P	MACHSBI	CONSTANT FOR MACH SCHEDULED SPEEDBRAKE COMMAND	01	.90000000+01	ND	D
(V96U) 7785C	P	MACHSBS	SLOPE FOR MACH SCHEDULED SPEEDBRAKE COMMAND	01	-.22400000+02	DEG	M
0317C	P	MSW1	M/N MACH AT WHICH PHASE 4 TO PHASE 1 TRANSITION OCCURS	01	-.32000000+01	ND	D
0318C	P	MSW2	MAX MACH AT WHICH NZ SWITCHING CRITERIA FOR PHASE 4 TO PHASE 1 IS INITIATED	01	.32000000+01	ND	D
(V96U) 1897C	P	MSW3	MAXIMUM MACH AT WHICH AN S-TURN CAN OCCUR	01	.70000000+01	ND	D
0319C	P	MXORWT	CONSTANT USED TO COMPUTE OBLI	01	.21036940-01	PSF/SLUG	M
0324C	P	NZSW1	NZ LEVEL AT WHICH PHASE 5 TO PHASE 4 TRANSITION OCCURS	01	.16500000+01	G	M
0325C	P	NZSW2	NZ ERROR TOLERANCE FOR PHASE 4 TO PHASE 1 TRANSITION	01	.10000000-00	G	M
0333C	P	PBRCO(1)	RANGE BREAKPOINT FOR OBREF	01	.13280000+06	FT	M
0335C	P	PHAVGC	CONSTANT USED TO COMPUTE PHAVG	01	.63333000+02	DEG	D
0336C	P	PHAVGLL	LOWER LIMIT ON PHAVG	01	.30000000+02	DEG	D
0337C	P	PHAVGS	SLOPE OF PHAVG WITH MACH	01	.13333330+02	DEG	D
0338C	P	PHAVGUL	UPPER LIMIT ON PHAVG	01	.45000000+02	DEG	D
0342C	P	PHILMSUP	SUPERSONIC ROLL COMMAND LIMIT	01	.45000000+02	DEG	D
0343C	P	PHILMO	S-TURN ROLL COMMAND LIMIT	01	.45000000+02	DEG	D
0344C	P	PHILM1	ACQUISITION ROLL COMMAND LIMIT	01	.45000000+02	DEG	D
0345C	P	PHILM2	HEADING ALIGNMENT ROLL COMMAND LIMIT	01	.50000000+02	DEG	D
0346C	P	PHILM3	PREFINAL ROLL COMMAND LIMIT	01	.30000000+02	DEG	D
0347C	P	PHIM	MACH VALUE FOR PHILIMIT TEST	01	.10000000+01	ND	D
0348C	P	PHIP2C	NOMINAL ROLL COMMAND DURING PHASE 2	01	.30000000+02	DEG	D

TABLE 9-III.- Continued
(a) Continued

MSID # V97U	SW	SYMBOL	DESCRIPTION	MC	VALUE	UNITS	MISSION DEPENDENT CONSTANT
0351C	P	P2TRNC1	CONSTANT USED IN PHASE 2 INITIATION TEST	01	.11000000+01	NO	D
0352C	P	P2TRNC2	CONSTANT USED IN PHASE 2 INITIATION TEST	01	.10100000+01	NO	D
0353C	P	OB ERROR1	DYNAMIC PRESSURE ERROR BOUND FOR TRANSITION TO AUTOLAND	01	-.10000000+01	PSF	D
0354C	P	OB ERROR2	DYNAMIC PRESSURE ERROR BOUND FOR TRANSITION TO AUTOLAND	01	.24000000+02	PSF	D
0355C	P	OBARDL	LIMIT ON OBARD	01	.10000000+04	PSF/S	D
0356C	P	OBG1(1)	SLOPE OF OBREF WITH DRPRED	01	.00360660-04	PSF/FT	M
0358C	P	OBG2(1)	SLOPE OF OBREF WITH DRPRED	01	-.00147740-03	PSF/FT	M
0360C	P	OBG1	GAIN USED TO COMPUTE OBNZLL AND OBNZUL	01	.10000000+00	1/S	D
0362C	P	OBG2C1	SLOPE OF OBG2 WITH MACH	01	.250000+00	S-G/PSF	D
0363C	P	OBG2C2	CONSTANT USED TO COMPUTE OBG2	01	-.12500000+00	S-G/PSF	D
0364C	P	OBG2LL	MINIMUM VALUE OF OBG2	01	.12500000+00	S-G/PSF	D
0365C	P	OBG2UL	MAXIMUM VALUE OF OBG2	01	.25000000+00	S-G/PSF	D
0366C	P	OBMXS	SLOPE OF OBMXZ WITH MACH OBM2	01	.20000000+02	PSF	D
0367C	P	OBMX1	CONSTANT USED TO COMPUTE OBMXZ	01	.34000000+03	PSF	D
0368C	P	OBMX2	CONSTANT USED TO COMPUTE OBMXZ	01	.22000000+03	PSF	D
0369C	P	OBMX3	CONSTANT USED TO COMPUTE OBMXZ	01	.25000000+03	PSF	D
0370C	P	OBMX4	CONSTANT FOR COMPUTING OBMXZ	01	.30000000+03	PSF	D
0371C	P	OBM1	MACH BREAKPOINT FOR COMPUTING OBMXZ	01	.10000000+01	NO	D
0372C	P	OBM2	MACH BREAKPOINT FOR COMPUTING OBMXZ	01	.10000000+01	NO	D

TABLE 9-III.- Continued

(a) Continued

MSID # V97U	SW	SYMBOL	DESCRIPTION	MC	VALUE	UNITS	MISSION DEPENDENT CONSTANT
0373C	P	OBRL(1)	OBREF LOWER LIMIT	01	.18000000+03	PSF	M
0375C	P	OBRL(1)	OBREF MIDDLE LIMIT	01	.21000000+03	PSF	M
0377C	P	OBRL(1)	OBREF UPPER LIMIT	01	.27050000+03	PSF	M
0384C	P	RERLM	LIMIT ON RERRC	01	.50000000+02	DEG	D
0385C	P	RFTC	ROLL FADER TIME CONSTANT	01	.50000000+01	S	D
0387C	P	RMINST(1)	MINIMUM RANGE TO INITIATE S-TURN PHASE	01	.12220460+08	FT	M
0389C	P	RN1(1)	CONSTANT RANGE USED IN COMPUTING EN. EMEP. AND EMAX	01	.03000000	FT	M
0391C	P	ROLLRT	MAXIMUM SUPERSONIC ROLL RATE	01	.50000000+01	DEG/S	D
0393C	P	RTBIAS	CONSTANT USED IN PHASE2 INITIATION TEST	01	.30000000+04	FT	D
0394C	P	RTURN	HAC RADIUS	01	.20000000+05	FT	D
0401C	P	SBQ	DYNAMIC PRESSURE FOR SPEEDBRAKE OPENING	01	.20000000+02	PSF	D
0404C	P	SMNZC1	INITIAL VALUE OF SMNZ1	01	.12500000+00	G	M
0405C	P	SMNZC2	INITIAL VALUE OF SMNZ2	01	.25800000+00	G	M
0406C	P	SMNZC3	COEFFICIENT USED TO COMPUTE SMNZ1	01	.80000000+00	ND	M
0407C	P	SMNZC4	CONSTANT NORMAL ACCELERATION USED TO COMPUTE SMNZ2	01	.80000000-02	G	M
0408C	P	SMNZ2L	MINIMUM VALUE OF SMNZ2	01	-.50000000-01	G	M
0431C	P	VCO	CONSTANT USED TO COMPUTE GCOMT (=RTD G/GON. WHERE GON = GON (GCS))	01	.54870000+03	FT/SEC	D
0536C	P	V DEF	NAV/DAD/DEFAULT QBAR SWITCH ON VELOCITY	01	.15000000+04	FT/SEC	M
0443C	P	WEIGHT RTLS	ORBITER MASS	01	.61194800+04	SLUGS	M
0444C	P	WT GS1	WEIGHT USED FOR IGS SELECTION	01	.65270000+04	SLUGS	M
0456C	P	XA(1)	STEEP GLIDESLOPE GROUND	01	-.65000000+04	FT	M
0457C	P	XA(2)	INTERCEPT	01	-.65000000+04	FT	M

TABLE 9-III.- Continued

(a) Concluded

MSID # V97U	SM	SYMBOL	DESCRIPTION	MC	VALUE	UNITS	MISSION DEPENDENT CONSTANT
0459C	P	Y ERROR	CROSSRANGE ERROR BOUND FOR AUTOLAND INITIATION WHEN H> H REF 1	C1	.10000000+04	FT	D
0462C	P	Y RANGE1	COEFFICIENT ON H USED TO COMPUTE CROSSRANGE ERROR BOUND WHEN H< H REF 1	O1	.18000000+00	ND	D
0463C	P	Y RANGE2	CONSTANT USED TO COMPUTE CROSSRANGE ERROR BOUND WHEN H< H REF 1	O1	.80000000-03	FT	D
0464C	P	YERRLM	LIMIT ON YERRC	O1	.12000000+03	DEG	D

TABLE 9-III.- Continued

(b) G4.234

MSJD # V97U	SW	SYMBOL	DESCRIPTION	MC	VALUE	UNITS	MISSION DEPENDENT CONSTANT
0004C	P	A 3	FINAL FLARE FILTER CONSTANT	01	.10000000+02	1/S	D
0000C	P	A INT	CROSSRANGE ERROR INTEGRATOR GAIN	01	.00000000	DEG-S/FT	D
0001C	P	A SBF	SPEEDBRAKE COMMAND FILTER CONSTANT	01	.50000000+00	S**2	D
0002C	P	A 13	AIRSPD FILTER CONSTANT	01	.10000000-01	1/S	D
0003C	P	A 14	SPEED CONTROL FILTER CONSTANT	01	.10000000-01	1/S	D
0005C	P	A 40	OPEN LOOP FILTER CONSTANT	01	.13333000-01	1/S	D
0117C	P	DELTA SB	SPEEDBRAKE THRESHOLD ANGLE FACTOR	01	.28000000+01	DEG	D
0129C.	P	DSBC TD(1)	SPEEDBRAKE ANGLE AT TD	01	.00000000	DEG	D
0130C	P	DSBC TD(2)		01	.00000000	DEG	D
0229C	P	GAMMA CAPTURE	MAXIMUM GAMMA ERROR TO ENGAGE STEEP GLIDESLOPE	01	.20000000-01	DEG	D
0233C.	P	GAMMA REF 1(1)	STEEP GLIDESLOPE FLIGHTPATH REFERENCE	01	-.20000000+02	DEG	M
0234C	P	GAMMA REF 1(2)		01	-.20000000+02	DEG	M
0235C	P	GAMMA REF 2	SHALLOW GLIDESLOPE FLIGHTPATH REFERENCE	01	-.15000000+01	DEG	M
0265C	P	H CLOOP	ALTITUDE AT WHICH START CLOSED LOOP PULLUP	01	.17000000+04	FT	M
0266C	P	H DECAY	EXPONENTIAL CAPTURE ALTITUDE REFERENCE	01	.29000000+02	FT	M
0268C	P	H ERROR CAPTURE	MAXIMUM ALTITUDE ERROR TO ENGAGE STEEP GLIDESLOPE	01	.50000000+02	FT	D
0269C	P	H ERROR MAX	MAXIMUM ALTITUDE ERROR	01	.30000000+03	FT	D
0270C	P	H FF	ALTITUDE TO START CHECKING FINAL FLARE ALTITUDE	01	.80000000+02	FT	D
0271C	P	H FLARE	FLARE ALTITUDE	01	.20000000+04	FT	M
0272C	P	H INTMAX	ALTITUDE ERROR INTEGRATOR MAXIMUM	01	.60000000+02	FT	D

TABLE 9-III.- Continued

(b) Continued

MSID # V97U	SW	SYMBOL	DESCRIPTION	MC	VALUE	UNITS	MISSION DEPENDENT CONSTANT
0273C.	P	H K (1.1)	CONSTANT G CIRCLE CENTER	01	.26320000+05	FT	M
0274C.	P	H K (1.2)	ALTITUDE	01	.26796000+05	FT	M
0275C.	P	H K (2.1)		01	.26320000+05	FT	M
0276C	P	H K (2.2)		01	.26796000+05	FT	M
0277C	P	H MIN	MINIMUM ALTITUDE FOR FINAL FLARE	01	.30000000+02	FT	D
0278C	P	H NO ACC	ALTITUDE FOR ZERO ACCELERATION	01	.20000000+01	FT	D
0281C.	P	H SBR TABLE(1)	TABLE OF SPEEDBRAKE RETRACT	01	.25000000+04	FT	M
0282C.	P	H SBR TABLE(2)	ALTITUDES	01	.25000000+04	FT	M
0283C	P	H SBR TABLE(3)		01	.10000000+04	FT	M
0284C	P	H TD, DOT	TOUCHDOWN ALTITUDE RATE	01	.90000000+01	FT/S	D
0285C	P	H TD2 DOT	CLOSED-LOOP TOUCHDOWN ALTITUDE RATE	01	-.30000000+01	FT/S	D
0286C	P	H WL	ALTITUDE REFERENCE FOR LIMITER	01	.75000000+04	FT	D
0492C	P	INT RET BF	INITIAL RETRACT BODY FLAP FLAG	01	.10000000+01	ND	M
0301C	P	K H SGS	ALTITUDE ERROR GAIN, SGS	01	.24000000-02	G/FT	D
0299C	P	K FLR	FEED-FORWARD GAIN, F-F	01	.25000000-01	G-S**2/FT	D
0300C	P	K H FSGS	ALTITUDE ERROR GAIN, FSGS	01	.24000000-02	G/FT	D
0302C	P	K H TC	ALTITUDE ERROR GAIN, TC, SGS	01	.24000000-02	G/FT	D
0303C	P	K HDOT FF	VERTICAL VELOCITY GAIN, FF	01	.12000000-01	G-S/FT	D
0304C	P	K HDOT FSGS	VERTICAL VELOCITY GAIN, FSGS	01	.12000000-01	G-S/FT	D
0305C	P	K HDOT SGS	VERTICAL VELOCITY GAIN, SGS	01	.12000000-01	G-S/FT	D
0306C	P	K HDOT TC	VERTICAL VELOCITY GAIN, TC	01	.12000000-01	G-S/FT	D
0307C	P	K HINT1	INTEGRATOR GAIN, SGS	01	.12000000-03	G/FT-S	D
0308C	P	K IFLR	INTEGRATOR GAIN, FF	01	.00000000	1/S	D
0309C	P	K INT FSGS	INTEGRAL GAIN, FSGS	01	.50000000-01	1/S	D

TABLE 9-III.- Continued

(b) Continued

MSID #	SW	SYMBOL	DESCRIPTION	MC	VALUE	UNITS	MISSION DEPENDENT CONSTANT
V97U							
0310C	P	K R1	YAW RATE COMMAND GAIN. FLAT TURN	01	.25000000+00	1/S	D
0311C	P	K R2	YAW RATE COMMAND GAIN. TOUCHDOWN	01	.50000000+00	1/S	D
0312C	P	K SB	SPEEDBRAKE GAIN	01	.20000000+01	DEG-S/FT	D
0313C	P	K SBI	SPEEDBRAKE INTEGRAL GAIN	01	.10000000+00	DEG/FT	D
0315C	P	K Y1	CROSSRANGE ERROR INTEGRATOR GAIN	01	.70000000-01	DEG/FT	D
0314C	P	K YDOT	CROSSRANGE RATE GAIN	01	.10000000+02	S	D
0320C	P	N FADER	ROLL FADER CONSTANT	01	.00000000	ND	D
0322C	P	NSB	MAXIMUM VALUE OF ISB	01	.30000000+01	ND	D
0323C	P	NZC LIM	MAX-G LIMIT FOR NZC	01	.10000000+01	G	D
0339C	P	PHI M1	MAXIMUM ROLL ATTITUDE COMMAND	01	.45000000+02	DEG	D
0340C	P	PHI M2	MAXIMUM ROLL ATTITUDE COMMAND	01	.20000000+02	DEG	D
0341C	P	PHI M3	MAXIMUM ROLL ATTITUDE COMMAND	01	.45000000+02	DEG	D
0326C	P	P MODE INITIAL	INITIAL PITCH SUBPHASE INDICATOR	01	.10000000+01	ND	D
0350C	P	PSI CAP	MAXIMUM HEADING ERROR (RC)	01	.20000000+01	DEG	D
0379C.	P	R (1.1)	CONSTANT G CIRCLE RADIUS	01	.26200000+05	FT	M
0380C.	P	R (1.2)		01	.26707000+05	FT	M
0381C.	P	R (2.1)		01	.26200000+05	FT	M
0382C	P	R (2.2)		01	.26707000+05	FT	M
0396C	P	SB RATE	SPEEDBRAKE RETRACT RATE	01	.11000000+02	DEG/S	D
0397C	P	SB REF	SPEEDBRAKE REFERENCE	01	.55000000+02	DEG	D
0398C.	P	SBF TABLE(1)	TABLE OF REFERENCE SPEEDBRAKE	01	.25000000+02	DEG	M

TABLE 9-III.- Continued

(b) Continued

MSID #	SW	SYMBOL	DESCRIPTION	MC	VALUE	UNITS	MISSION DEPENDENT CONSTANT
0399C.	P	SFB TABLE(2)	POSITIONS FOR RETRACTION	01	.78000000+02	DEG	M
0400C	P	SFB TABLE(3)	ALTITUDE	01	.98600000+02	DEG	M
0402C.	P	SIGMA(1)	EXPONENTIAL DISTANCE	01	.85000000+03	FT	M
0403C	P	SIGMA(2)		01	.85000000+03	FT	M
0409C	P	T Q	MINIMUM TIME WITH BOUNDED ERRORS FOR TRANSITION TO STEEP GLIDESLOPE PHASE	01	.40000000+01	S	D
0410C	P	TAU GAMMA	TIME CONSTANT, FSGS	01	.20000000+01	S	D
0411C	P	TAU TD	TIME CONSTANT, FSGS	01	.60000000+01	S	D
0412C	P	TAU TD1	TIME CONSTANT, FF	01	.50000000+01	S	D
0413C	P	TAU TD2	TIME CONSTANT, FF	01	.50000000+01	S	D
0416C	P	TO LAT	MINIMUM TIME WITH BOUNDED ERROR TO ENGAGE LATERAL TRACK	01	.40000000+01	S	D
0417C	P	V LIMIT	MAXIMUM ERROR VELOCITY LIMIT	01	.10000000+02	FT/S	D
0418C.	P	V REF(1)	REFERENCE AIRSPEED	01	.47300000+03	FT/S	K
0419C	P	V REF(2)		01	.47300000+03	FT/S	M
0444C	P	WT GS1	WEIGHT FOR GLIDESLOPE SELECTION	01	.65270000+04	SLUGS	M
0443C	P	WEIGHT RTLS	ORBITER MASS	01	.61194800+04	SLUGS	M
0445C	P	X AIM PT	AIM POINT X-DISTANCE	01	.15000000+04	FT	M
0446C.	P	X EXP (1.1)	EXPONENTIAL CAPTURE	01	-.37840000+04	FT	M
0447C.	P	X EXP (1.2)	X DISTANCE	01	-.26460000+04	FT	M
0448C.	P	X EXP (2.1)		01	-.37840000+04	FT	M
0449C	P	X EXP (2.2)		01	-.26460000+04	FT	M
0450C.	P	X K (1.1)	CONSTANT G CIRCLE CENTER RANGE	01	-.22090000+04	FT	M
0451C.	P	X K (1.2)		01	-.10360000+04	FT	M
0452C.	P	X K (2.1)		01	-.22090000+04	FT	M

TABLE 9-III.- Concluded

(b) Concluded

MSIO #	SW	SYMBOL	DESCRIPTION	MC	VALUE	UNITS	MISSION DEPENDENT CONSTANT
0453C	P	X K (2.2)		01	-.10360000+04	FT	M
0454C	P	X ZERO(1)	STEEP GLIDESLOPE INTERCEPT	01	.65000000+04	FT	M
0455C	P	X ZERO(2)		01	.55000000+04	FT	M
0460C	P	Y IN LIM	CROSSRANGE ERROR INTEGRATION LIMIT	01	.50000000+02	FT	D
0458C	P	Y CAP	LATERAL CAPTURE DISTANCE (RC)	01	.50000000+02	FT	D
0461C	P	Y LIMIT	CROSSRANGE ERROR LIMIT	01	.10000000+04	FT	D

10.0 ABORT ISSUES

This section lists some of the key abort issues at cycle 3 publication for the STS-1 OFP. Some of the issues shown are significant omissions, corrections, or updates that will be reflected in future revisions.

10.1 GENERAL

- a. The plan is to use 2σ instead of 3σ bad performance for press to MECO performance estimates on future updates.
- b. The plan is to use compatible RTLS and AOA wind and performance estimates for defining the abort mode boundary on future updates.
- c. Contingency abort analysis is in work and will be added in a later document revision.
- d. OFT ejection seat analysis being performed by Rockwell/Space Division. (refs. 14 and 15).
- e. A fast separation sequence has been baselined for Orbiter separation during the first stage. No abort analyses are currently planned to demonstrate safe recovery beyond the implementation of the fast separation sequence.
- f. No trajectories have been generated for stuck SSME throttles. However, the basic capability to evaluate abort margins for stuck throttles exists at real time in the ground software.
- g. Range safety (i.e., ET impact) implications of the current press to MECO abort philosophy are unresolved.
- h. Abort gap rules and limits for SSME stuck throttle and thrust limiting cases are currently undefined.
- i. The ARD loading and limits for SSME thrust limiting are to be established.
- j. A new null H-DOT contingency abort single SSME pitchdown sequence has been defined for future updates.
- k. Variable I_y could be considered for STS-1 if ascent performance estimates continue to degrade such to effect continuous intact abort capability.

10.2 RTLS

- a. The 65-percent minimum SSME throttle requirement results in a slight over g (3.05) at MECO with 2 percent MPS propellant remaining for the three SSME RTLS abort cases. This constitutes a minor degradation of the normal safety factor of 1.4.

- b. The 100-percent maximum SSME throttle requirement results in a significantly lower altitude ($\Delta H > 100\ 000$ ft) at pitcharound for the engine-out at lift-off abort case. This unavoidably results in noncommon RTLS profiles for different abort times, complicating training somewhat.
- c. An aft RCS propellant dump was assumed to occur post-MECO for this cycle, however it is not reflected in the RTLS targets. This dump has just recently been baselined out and will not be used in future revisions.
- d. GRTLS cycle 3 V/R targeting produces moderate S-turns in nominal cases. Flight control stability considerations and crew preferences may require targeting farther away from the runway (close to max range footprint boundary) to eliminate S-turning profiles.
- e. Changes in flight control $\bar{Q}/\alpha/m$ stability boundary definitions may alter minimum alpha and max \bar{Q} limits in GRTLS guidance. Such changes could also modify the E/R S-turn action lines and/or require extending the alpha transition phase to M 2.5.
- f. Elimination of the post sep RCS thrust/dump assumed load factor/touchdown altitude rate restrictions for STS-1. If these structural constraints are changed, then the need for an RCS dump may have to be reexamined.
- g. The GRTLS flight control system is still being modified and possible effects on flight profile design must be investigated.

10.3 AOA/ATO

- a. The AOA trajectory data presented reflect the AOA landing at Northrup Strip. Should Northrup Strip have bad weather on the day of launch, an alternate mission will be designed with yaw steering in second stage so that an AOA can land at EAFB. This alternate AOA to EAFB has not yet been generated for cycle 3.
- b. Neither onorbit vents (APU and water evaporator) nor RCS attitude control perturbations during coasts were simulated in the trajectories presented.
- c. The navigation system simulation used one IMU platform instead of three platforms with mid-value selection redundancy management. All accelerations sensed by the IMU were incorporated into the state vector. The navigation drag model in the flight software was not employed.
- d. The trajectories do not reflect actual vehicle attitude timelines. Angle-of-attack (alpha) management will be utilized with MECO underspeeds greater than 300 fps in order to minimize the effects of drag after the OMS-1 burn. A minimum of two reorientations is required to maintain alpha between $\pm 20^\circ$.
- e. Display adequacy to fly AOA without guidance-driven needles is unconfirmed.

- f. For planning purposes, the OMS propellant reserves are based on the following assumptions:
1. OMS propellant reserved for a 2-minute TIG delay will be deleted for future updates.
 2. The proper amount of forward RCS propellant will be dumped between OMS-1 and OMS-2 so that there is never a requirement to reserve OMS propellant for X c.g. management.
 3. A 570-pound OMS propellant is reserved for Y c.g. management.
 4. Future updates will assume that there is no aft RCS propellant usable for propulsive ΔV .
 5. OMS propellant reserved for the 80 fps navigation dispersion allowance is inadequate to cover a broken navigation system unless a state vector update is performed prior to Bermuda LOS.
 6. Earliest ATO trajectory for future updates will assume deorbit to the steep entry line rather than the shallow entry line.
- g. The current onorbit MPS propellant dump sequence is being revised from 116 sec LOX and 47 sec LH₂ sequence used for the analysis presented.
- h. The NAV-drag model parameters do not provide satisfactory results for the low altitudes achieved for MECO underspeed AOA and ATO. These parameters are being redesigned for low altitudes.
- i. The feasibility of performing an AOA or ATO from large MECO underspeeds is being studied with a complete dispersion analysis. This analysis includes the effects of aerodynamic uncertainties, density, variations, vent uncertainties, and three-sigma IMU performance.
- j. No MPS propellant slosh was simulated post-MECO.
- k. These trajectories did not execute a forward RCS propellant dump.
1. The cycle 3 constraint for common AOA and ATO OMS-1 targets may be removed in future updates if ascent performance penalties compromise allowable abort mode overlap.
- m. AOA and ATO OMS-1 targets will be designed to produce a geodetic altitude greater than 55 n. mi. between OMS-1 and OMS-2 for future updates.

11.0 REFERENCES

1. Flight Analysis Branch: STS-1 Operational Flight Profile, Abort Analysis - Cycle 2, JSC IN 78-FM-51, Vol. VI, JSC-14483, May 1979.
2. STS-1 Operational Flight Profile, Volume I, Groundrules and Constraints - Cycle 3. JSC-14483, Sept. 1979.
3. Shuttle Operational Data Book. Vol. II - Mass Properties, Amend. 31, JSC-08934, Feb. 7, 1980.
4. Mated Vehicle/Aerodynamic Design Data Book, Vol. II: Rockwell Document SD 72-SH-0060-2K, July 1979.
5. Software Development Branch: Space Vehicle Dynamics Simulation (SVDS) Program Description, Rev. 1, JSC IN 76-FM-26, Nov. 30, 1976.
6. Rockwell International: Aerodynamic Design Data Book - Vol. I, Orbiter Vehicle, Rev. K, SD 72-SH-0060-K, Nov. 1977 with June 1978 update.
7. Justus, C. G.; Woodrum, A. W.; Roper, R. G.; and Smith, O. E.: Four-D Global Reference Atmosphere. NASA TMX-64872, 1976.
8. STS-1 Operational Flight Profile, Vol. V, Descent - Cycle 3. JSC-14483 May 1980.
9. Space Shuttle Orbital Flight Test Level C Functional Subsystem Software Requirements; Guidance, Navigation, and Control; Part A; Guidance - Ascent/RTLS. SD 76-SH-0002D, May 1, 1978.
10. Space Shuttle Orbital Flight Test Level C Functional Subsystem Software Requirements; Guidance, Navigation, and Control; Part C; Flight Control - Ascent Flight Phase. SD 76-SH-0008B, April 21, 1978.
11. Space Shuttle Orbital Flight Test Level C Functional Subsystem Software Requirements Document: Guidance, Navigation, and Control; Part A: Guidance - RTLS TAEM. SD76-SH-0001C, Dec. 15, 1978.
12. Space Shuttle Orbital Flight Test Level C Functional Subsystem Software Requirements: Guidance, Navigation and Control; Part C: Flight Control, Vol. 3, Ascent (GRTLS). SD76-SH-0008, May 1979.
13. STS-1 Cycle 3 MCC Data Base. MDTSCO TM 1.4-TM-D1232-130, Jan. 4, 1980.
14. Engineering Analysis Report Crew Escape System Installation Crew Provisions and Accomodations, SOD 79-0190, Oct. 24, 1979.
15. Engineering Analysis Report Crew Escape System Installation Crew Provisions and Accomodations, SOD 79-0190, Addendum I, Nov. 29, 1979.

APPENDIX A

POWERED FLIGHT DISPERSION ANALYSIS

CONTENTS

Section		Page
A1.0	<u>SUMMARY</u>	A-12
A2.0	<u>INTRODUCTION</u>	A-13
A3.0	<u>METHODOLOGY</u>	A-15
A3.1	DISPERSION SIMULATION TECHNIQUES	A-15
A3.2	MODEL DESCRIPTION	A-15
A3.3	ERROR SOURCES, SYMBOLS, AND DEFINITIONS	A-16
A4.0	<u>RESULTS</u>	A-17
A4.1	POWERED RETURN-TO-LAUNCH SITE	A-18
A4.1.1	<u>Trajectory Description</u>	A-18
A4.1.2	<u>Error Contribution Data</u>	A-19
A4.1.3	<u>RSS Summary Data</u>	A-19
A4.1.4	<u>Covariance and Correlation Matrix Data</u>	A-19
A4.1.5	<u>Conclusions</u>	A-19
A4.2	ABORT ONCE AROUND	A-20
A4.2.1	<u>Trajectory Description</u>	A-21
A4.2.2	<u>Error Contribution Data</u>	A-21
A4.2.3	<u>RSS Summary Data</u>	A-22
A4.2.4	<u>Covariance and Correlation Matrix Data</u>	A-22
A4.2.5	<u>Conclusions</u>	A-22
A4.3	ABORT TO ORBIT	A-22
A4.3.1	<u>Trajectory Description</u>	A-23
A4.3.2	<u>Error Contribution Data</u>	A-23
A4.3.3	<u>RSS Summary Data</u>	A-23
A4.3.4	<u>Covariance and Correlation Matrix Data</u>	A-24
A4.3.5	<u>Conclusions</u>	A-24
A5.0	<u>REFERENCES</u>	A-25

THIS PAGE IS BLANK NOT FILMED

TABLES

Table		Page
A3.3-I	ERROR SOURCE DEFINITIONS	A-26
A4.0-I	PARAMETER DEFINITIONS FOR RSS DATA TABLES	A-28
A4.0-II	DEFINITION OF COVARIANCE AND CORRELATION MATRIX ELEMENTS	A-30
A4.1.1-I	PRTL5 EVENT TIMELINE	A-31
A4.1.2-I	PRTL5 RSS DATA AT SRB SEPARATION FOR SSME-OUT AT LIFT-OFF	
	(a) Actual minus nominal state parameters	A-33
	(b) Navigated minus actual state parameters	A-35
	(c) Actual minus nominal vehicle parameters	A-37
A4.1.2-II	PRTL5 RSS DATA AT SRB SEPARATION FOR NOMINAL FIRST STAGE	
	(a) Actual minus nominal state parameters	A-39
	(b) Navigated minus actual state parameters	A-41
	(c) Actual minus nominal vehicle parameters	A-43
A4.1.2-III	PRTL5 RSS DATA AT ET SEPARATION FOR SSME-OUT AT LIFT-OFF	
	(a) Actual minus nominal state parameters	A-45
	(b) Navigated minus actual state parameters	A-47
	(c) Actual minus nominal vehicle parameters	A-49
A4.1.2-IV	PRTL5 RSS DATA AT ET SEPARATION FOR SSME-OUT AT SRB SEPARATION	
	(a) Actual minus nominal state parameters	A-51
	(b) Navigated minus actual state parameters	A-53
	(c) Actual minus nominal vehicle parameters	A-55
A4.1.2-V	PRTL5 RSS DATA AT ET SEPARATION FOR LAST TWO-ENGINE RTLS	
	(a) Actual minus nominal state parameters	A-57
	(b) Navigated minus actual state parameters	A-59
	(c) Actual minus nominal vehicle parameters	A-61
A4.1.2-VI	PRTL5 RSS DATA AT ET SEPARATION FOR LAST THREE-ENGINE RTLS	
	(a) Actual minus nominal state parameters	A-63
	(b) Navigated minus actual state parameters	A-65
	(c) Actual minus nominal vehicle parameters	A-67

Table	Page
A4.1.3-I	PRTL5 RSS SUMMARY OF UVW STATE PARAMETERS
	(a) Actual minus nominal A-69
	(b) Navigated minus actual A-71
A4.1.3-II	PRTL5 RSS SUMMARY OF TRAJECTORY PARAMETERS
	(a) Actual minus nominal A-73
	(b) Navigated minus actual A-75
A4.1.3-III	PRTL5 PSS SUMMARY OF VEHICLE PARAMETERS A-77
A4.1.4-I	PRTL5 MATRICES AT SRB SEPARATION FOR SSME-OUT AT LIFT-OFF
	(a) Covariance matrix A-79
	(b) Correlation matrix A-80
A4.1.4-II	PRTL5 MATRICES AT SRB SEPARATION FOR NOMINAL IN FIRST STAGE
	(a) Covariance matrix A-81
	(b) Correlation matrix A-82
A4.1.4-III	PRTL5 MATRICES AT ET SEPARATION FOR SSME-OUT AT LIFT-OFF
	(a) Covariance matrix A-83
	(b) Correlation matrix A-84
A4.1.4-IV	PRTL5 MATRICES AT ET SEPARATION FOR SSME-OUT AT SRB SEPARATION
	(a) Covariance matrix A-85
	(b) Correlation matrix A-86
A4.1.4-V	PRTL5 MATRICES AT ET SEPARATION FOR LAST TWO-ENGINE RTLS
	(a) Covariance matrix A-87
	(b) Correlation matrix A-88
A4.1.4-VI	PRTL5 MATRICES AT ET SEPARATION FOR LAST THREE-ENGINE RTLS
	(a) Covariance matrix A-89
	(b) Correlation matrix A-90
A4.2.1-I	AOA EVENT TIMELINE A-91

Table	Page
A4.2.2-I	AOA RSS DATA AT MECO
	(a) Actual minus nominal state parameters A-92
	(b) Navigated minus actual state parameters A-93
	(c) Actual minus nominal vehicle parameters A-94
	(d) Actual minus nominal orbital parameters A-95
A4.2.2-II	AOA RSS DATA AT O: 3-1 CUTOFF
	(a) Actual minus nominal state parameters A-96
	(b) Navigated minus actual state parameters A-97
	(c) Actual minus nominal vehicle parameters A-98
	(d) Actual minus nominal orbital parameters A-99
A4.2.2-III	AOA RSS DATA AT OMS-2 CUTOFF
	(a) Actual minus nominal state parameters A-100
	(b) Navigated minus actual state parameters A-101
	(c) Actual minus nominal vehicle parameters A-102
	(d) Actual minus nominal orbital parameters A-103
A4.2.2-IV	AOA RSS DATA AT ENTRY INTERFACE MINUS 5 MINUTES
	(a) Actual minus nominal state parameters A-104
	(b) Navigated minus actual state parameters A-105
	(c) Actual minus nominal vehicle parameters A-106
	(d) Actual minus nominal orbital parameters A-107
A4.2.2-V	AOA RSS DATA AT ENTRY INTERFACE
	(a) Actual minus nominal state parameters A-108
	(b) Navigated minus actual state parameters A-109
	(c) Actual minus nominal vehicle parameters A-110
	(d) Actual minus nominal orbital parameters A-111
A4.2.3-I	AOA RSS SUMMARY OF UVW STATE PARAMETERS
	(a) Actual minus nominal A-112
	(b) Navigated minus actual A-113
A4.2.3-II	AOA RSS SUMMARY OF TRAJECTORY PARAMETERS
	(a) Actual minus nominal A-114
	(b) Navigated minus actual A-115
A4.2.3-III	AOA RSS SUMMARY OF VEHICLE PARAMETERS A-116
A4.2.3-IV	AOA RSS SUMMARY OF ORBITAL PARAMETERS A-117

Table	Page
A4.2.4-I	AOA MATRICES AT MECO
	(a) Covariance matrix A-118
	(b) Correlation matrix A-119
A4.2.4-II	AOA MATRICES AT OMS-2 CUTOFF
	(a) Covariance matrix A-120
	(b) Correlation matrix A-121
A4.2.4-III	AOA MATRICES AT ENTRY INTERFACE MINUS 5 MINUTES
	(a) Covariance matrix A-122
	(b) Correlation matrix A-123
A4.2.4-IV	AOA MATRICES AT ENTRY INTERFACE
	(a) Covariance matrix A-124
	(b) Correlation matrix A-125
A4.3.1-I	ATO EVENT TIMELINE A-126
A4.3.2-I	ATO RSS DATA AT MECO
	(a) Actual minus nominal state parameters A-127
	(b) Navigated minus actual state parameters A-128
	(c) Actual minus nominal vehicle parameters A-129
	(d) Actual minus nominal orbital parameters A-130
A4.3.2-II	ATO RSS DATA AT OMS-1 CUTOFF
	(a) Actual minus nominal state parameters A-131
	(b) Navigated minus actual state parameters A-132
	(c) Actual minus nominal vehicle parameters A-133
	(d) Actual minus nominal orbital parameters A-134
A4.3.2-III	ATO RSS DATA AT OMS-2 CUTOFF
	(a) Actual minus nominal state parameters A-135
	(b) Navigated minus actual state parameters A-136
	(c) Actual minus nominal vehicle parameters A-137
	(d) Actual minus nominal orbital parameters A-138
A4.3.2-IV	ATO RSS DATA AT NOMINAL OMS-2 CUTOFF PLUS 1 MINUTE
	(a) Actual minus nominal state parameters A-139
	(b) Navigated minus actual state parameters A-140
	(c) Actual minus nominal vehicle parameters A-141
	(d) Actual minus nominal orbital parameters A-142

Table	Page
A4.3.3-I	ATO RSS SUMMARY OF UVW STATE PARAMETERS
	(a) Actual minus nominal A-143
	(b) Navigated minus actual A-144
A4.3.3-II	ATO RSS SUMMARY OF TRAJECTORY PARAMETERS
	(a) Actual minus nominal A-145
	(b) Navigated minus actual A-146
A4.3.3-III	ATO RSS SUMMARY OF VEHICLE PARAMETERS A-147
A4.3.3-IV	ATO RSS SUMMARY OF ORBITAL PARAMETERS A-148
A4.3.4-I	ATO MATRICES AT MECO
	(a) Covariance matrix A-149
	(b) Correlation matrix A-150
A4.3.4-II	ATO MATRICES AT OMS-2 CUTOFF
	(a) Covariance matrix A-151
	(b) Correlation matrix A-152
A4.3.4-III	ATO MATRICES AT OMS-2 CUTOFF PLUS 1 MINUTE
	(a) Covariance matrix A-153
	(b) Correlation matrix A-154

FIGURES

Figure		Page
A3.1-1	Local horizontal (UVW) coordinate system	A-155
A4.0-1	Illustration of velocity errors in UVW and trajectory coordinates	A-156
A4.2-1	Illustration of trajectory errors at entry interface	A-157
A4.4-1	Effect of engine-out time on MECO underspeed	A-158

ACRONYMS AND SYMBOLS

AOA	abort once around
ATO	abort to orbit
DOF	degree of freedom
EI	entry interface (400 000-feet altitude)
ET	external tank
GET	ground elapsed time
GRTLS	glide return-to-launch site
HA	apogee altitude
H-DOT	altitude rate error
HP	perigee altitude
IMU	inertial measurement unit
Isp	specific impulse
LHS	local horizontal coordinate system
MECO	main engine cutoff
MPS	main propulsion system
OMS	orbital maneuvering system
OMS-1	first OMS maneuver (burn)
OMS-2	second OMS maneuver (burn)
PRTLS	powered return-to-launch site
RCS	reaction control system
RSS	root-sum-square
RTLS	return-to-launch site
RV	range velocity
RVY	range-velocity-gamma
SEP	separation

SRB	solid rocket booster
SSME	Space Shuttle main engine
STS	Space Transportation System
SVDS	space vehicle dynamics simulation
U-DOT	radial velocity error
UVW	local horizontal coordinate system

APPENDIX A

POWERED FLIGHT DISPERSION ANALYSIS

A1.0 SUMMARY

This appendix provides a linear dispersion analysis for each of the STS-1 intact abort modes: (1) powered return-to-launch site (PRTLS) from lift-off through external tank (ET) separation, (2) abort once around (AOA) from lift-off to entry interface (EI), and (3) abort to orbit (ATO) from lift-off through the OMS-2 circularization burn. This analysis assumes the guidelines and Cycle 3 I-load data consistent with the STS-1 Abort Plan. Small differences exist between the abort trajectories used for the dispersion analysis and the baseline abort cases, but the dispersion results are directly applicable to the baseline abort cases. The results from this analysis include three-sigma dispersions in the actual state and three-sigma uncertainties in the navigated state. The significant error sources are identified, and covariance and correlation matrices are provided at major events. PRTLS results are presented for the following four cases: main engine failure at lift-off, main engine failure at solid rocket booster (SRB) separation, main engine failure at 262.5 seconds (latest two-engine return-to-launch site (RTLS)), and a three-engine RTLS at 262.5 seconds. AOA results are presented for the case with a main engine cutoff (MECO) underspeed of 410 fps (earliest AOA steep), and ATO results are presented for the case with a MECO underspeed of 375 fps (earliest ATO).

A2.0 INTRODUCTION

Dispersion analyses of the intact abort modes have been performed to determine state vector and performance dispersions (or variations) that result from uncertainties in the platform, vehicle, and environmental parameters. These uncertainties are of an assumed known magnitude and probability distribution. The dispersions are determined at major mission events and fixed times from lift-off using the linear root-sum-square (RSS) procedure. The dispersion results are used to evaluate the capability of the vehicle to satisfy mission constraints and requirements with a three-sigma level of confidence. A description of the various types of dispersion results is provided in the paragraphs below.

A principal result from a dispersion analysis is a measure of the dispersion in the actual state. That is, how much does the actual position and velocity differ from the premission nominal at a given time or event occurrence in the trajectory? These variations in the actual state are expressed as three-sigma values for each component of position and velocity. A three-sigma value may be expressed as a probability associated with a normal distribution; i.e., in vehicle flight there is a 99.73-percent probability that the actual state dispersion will be within the three-sigma bounds. Actual state dispersions are important in answering questions related to SRB and ET footprints, staging and separation studies, and whether or not all constraints have been satisfied, communication and telemetry acquisition and loss of signal, achieving the desired final orbit within specified limits for rendezvous or payload release, ability of the vehicle to correct for known dispersions and still achieve final target conditions, and verification that the flight software can handle dispersions without stability or convergence problems.

Another principal result from a dispersion analysis is a measure of the errors or uncertainties in the navigated state. That is, how much does the navigated position and velocity differ from the actual position and velocity at a given time or event occurrence in the trajectory? Or simply, how well does the vehicle "know" where it is? Uncertainties in the navigated state are also expressed as three-sigma values for each component of position and velocity. Navigated state uncertainties are important in answering questions related to: time history of navigation errors and whether they converge or diverge, necessity and criterion for ground updates of the navigated state, and the ability of the vehicle to satisfy all constraints when navigation errors are present.

A third result of a dispersion analysis is defining dispersions in the final vehicle characteristics such as total vehicle weight and propellant weight. These characteristics are important in determining the flight performance reserve and in answering vehicle performance questions such as the ability of the vehicle to fly with off-nominal weights and engine performance and still achieve final target conditions.

Another result is to identify those error sources that have the greatest effect on the final mission parameters of interest. For example, dispersions in the actual state typically result from variations in the vehicle performance parameters such as thrust and weight and from errors in the inertial measurement unit (IMU). The largest navigation errors typically result from errors in the IMU such as platform misalignments and accelerometer biases.

Finally, covariance and correlation matrices are provided at selected times or events in the trajectory. A covariance matrix contains the statistics of the vehicle actual state dispersions and the vehicle navigated state uncertainty at a particular point of interest. The various components of the position and velocity are assumed to be normally distributed. Because they are correlated, it is necessary to represent them in matrix form. The covariance matrix then represents the statistics of a random vector with a multidimensional normal distribution. Other parameters may be included in the covariance matrix such as time, vehicle weight, and IMU error parameters. Covariance matrices are often used to initialize another dispersion study where the state vector statistics are advanced to some later point in time. A correlation matrix, computed from the elements of the covariance matrix, defines the simple linear correlation between any two parameters in the matrix. The correlation indicates the degree of linear relationship between two parameters. It measures how well a straight line equation explains the relationship between the parameters.

A3.0 METHODOLOGY

A3.1 DISPERSION SIMULATION TECHNIQUES

A dispersion analysis is based on a nominal or reference trajectory generated without including any of the uncertainties. Performance optimum first-stage steering commands and second-stage guidance inputs are defined by the I-load data. Because perturbations are unplanned occurrences, the same I-load data are used in simulating trajectories with perturbations.

The perturbation simulations in this analysis are determined by independently simulating three-sigma values of the indicated uncertainties. That is, a complete trajectory simulation is developed using only one error source. The dispersion results from these independent simulations are then statistically correlated at each time or event slice by: (1) an RSS process, (2) determining a covariance matrix indicative of all error sources, and (3) using the elements of the covariance matrix to compute a correlation matrix.

Inherent in the RSS method are the following assumptions:

- a. The perturbations are statistically independent; that is, the occurrence of one perturbation will not affect the probability of a second perturbation.
- b. A perturbation and its associated flight dispersions are linearly related.
- c. The perturbations are assumed normally distributed about their statistical mean.

Figure A3.1-1 contains the definition of a local horizontal coordinate system (LHS, UVW). The RSS data and covariance matrices indicate state vector dispersions in the LHS. Because the LHS is determined from the nominal state, a different LHS is determined at each time or event for which RSS or covariance data are required.

A3.2 MODEL DESCRIPTION

This dispersion analysis assumes the guidelines and cycle 3 I-load data consistent with the STS-1 Abort Plan (see main text). Detailed descriptions of the nominal abort trajectories may also be found in the STS-1 Abort Plan. A description of the dispersion analysis model is summarized below:

- a. Dispersion analysis simulations are generated using the cycle 3 file version of the space vehicle dynamics simulation (SVDS) program operating in a three degrees-of-freedom (DOF) flight simulation mode.
- b. The three-IMU platform with midvalue select is represented as a single IMU. The initial IMU orientation is defined by the alignment specified in reference 1. The platform alignment errors at lift-off reflect the nominal alignment schedule (platform release 30 minutes before lift-off, gyrocompass completed 40 minutes before lift-off).

- c. The acceleration threshold used by the navigation software is reset from zero to 1000 micro-g at the completion of the main propulsion system (MPS) dump. Accelerometer data below this threshold are not incorporated by navigation.
- d. There is no onorbit drag model in either the navigation or the environment.
- e. Reaction control system (RCS) activity for vehicle attitude control is not modeled.
- f. The MPS propellant dumps are simulated; no other vents are modeled.

A3.3 ERROR SOURCES, SYMBOLS, AND DEFINITIONS

A list of the error sources and their three-sigma values is given in table A3.3-I. Included in table A3.3-I are symbols used in the RSS data tables to identify dispersions resulting from the error sources. The references for the various error sources are also noted in table A3.3-I. It should be noted that the hot atmosphere was analyzed but was not included in the RSS results inasmuch as the cold atmosphere produced larger dispersions. The following error sources were not included in the analysis: atmospheric winds, aerodynamics, thrust misalignments, and orbital maneuvering system (OMS) thrust and specific impulse (Isp) errors.

A4.0 RESULTS

The dispersion analysis results are presented in separate sections for the PRTLS, AOA, and ATO abort modes.

Three-sigma dispersions in the actual state and three-sigma uncertainties in the navigated state, including covariance and correlation matrices, are provided for each abort mode. In addition, the significant error sources are identified.

Dispersion data are provided at selected event and time slices for each abort trajectory. An event is defined as a fixed occurrence (sensed by attaining a given target value) and may have a time-from-lift-off dispersion associated with it. Typical events include SRB staging, ET separation, and the completion of powered flight segments such as MECO, OMS-1 cutoff, and OMS-2 cutoff. A time slice is indicative of a fixed time from lift-off where the fixed time is often referenced to the nominal trajectory. For example, a time slice might be defined as 30 seconds after the time of nominal MECO. All dispersion data are then computed at that fixed time from lift-off.

Each event and time slice has its own LHS or UVW system for the calculation of state vector dispersions. The UVW system is always defined using the nominal abort state at the event or time slice of interest. It is important to note the distinction between a radial velocity error (U-DOT) in the UVW system and an altitude rate error (H-DOT) in the current local horizontal system (fig. A4.0-1). A U-DOT error is computed in a fixed UVW coordinate system defined by the nominal state vector. In this system, a downrange position error will also result in a U-DOT error, but an H-DOT error is computed using two distinct coordinate systems: a local horizontal system defined by the nominal state vector, and a local horizontal system defined by the errored state vector. Thus, a downrange position error rotates the local horizontal such that an H-DOT error will not correspond to a U-DOT error. Only when there is no position error will an H-DOT error equal a U-DOT error.

The RSS technique is the method used in this analysis to statistically combine dispersions in the flight parameters to determine the three-sigma limits in the significant parameters. In actual vehicle flight, there is a 99.73-percent probability that the value of the parameter will be inside the three-sigma bounds (the RSS value) if all assumptions required for this method are valid. RSS data tables are included in the results to indicate parameter dispersions for each individual error source and the three-sigma RSS of all the error sources. Parameter names used in the RSS data tables are defined in table A4.0-1. Because all error sources are assumed to be normally distributed, the RSS data are computed without regard to sign. Actual state dispersions are computed as the actual state of the perturbed abort trajectory minus the actual state of the nominal abort trajectory. Navigation uncertainties are computed as the navigated state of the perturbed abort trajectory minus the actual state of the perturbed abort trajectory.

Covariance and correlation matrix data are presented at selected event and time slices for each abort trajectory. The covariance matrix represents a multivariate normal distribution of one-sigma dispersions in the actual state, uncertainty in the navigated state, and dispersions in vehicle weight. The matrices

also include terms for accelerometer biases and platform misalignment angles. Although three-sigma values of the error sources are used in the trajectory simulations, the dispersions are adjusted to a one-sigma level for determining the covariance matrices. Table A4.0-II contains a definition of the symbols used to identify the elements of a covariance matrix. Because a covariance matrix is symmetrical, only the lower triangle is given. Each diagonal element of the matrix represents the linear covariance between the "row" parameter and the "column" parameter. The covariance measures how two parameters, X and Y, tend to vary together. The covariance will be positive if both parameters are at the same time greater than or less than their respective means; negative if one parameter is greater than its mean while the other parameter is less than its mean, and zero if X and Y are independent.

The correlation matrix measures the linear interdependence between any two parameters appearing in the covariance matrix. It has an identical format to the covariance matrix. Each element of the correlation matrix has values between -1 and +1: -1 denotes perfect negative or inverse correlation, 0 denotes statistical independence, and +1 denotes perfect positive correlation.

A4.1 POWERED RETURN-TO-LAUNCH SITE

A4.1.1 Trajectory Description

Because there is a wide range of possible PRTLS trajectories, the dispersion analysis was performed for four separate cases, each having its own nominal trajectory.

- a. Engine-out at lift-off, RTLS selected at 150 seconds
- b. Engine-out at SRB separation, RTLS selected at 150 seconds
- c. Engine-out at 262.5 seconds, RTLS selected at 272.5 seconds
- d. Three-engine RTLS selected at 262.5 seconds

Each of the above cases was selected for a particular reason. The engine-out at lift-off case was chosen because it has the longest powered flight time, so platform errors have the longest time to accumulate. The case with an engine-out at SRB separation was chosen because at ET separation it has the greatest velocity and range to the landing site (highest point of arrival on the range-velocity (RV) target line). The case with an engine-out at 262.5 seconds was chosen because it corresponds to the latest possible two-engine RTLS and it is performance critical. Lastly, the three-engine RTLS at 262.5 seconds was chosen because at ET separation it has the lowest velocity and range (lowest point of arrival on the RV target line).

An event timeline is provided in table 4.1.1-1 for the four nominal PRTLS trajectories. Dispersion data were computed at the following six event slices:

- a. SRB separation
- b. RTLS selection
- c. End of powered pitcharound
- d. Start of powered pitchdown
- e. MECO commanded
- f. ET separation

The PRTLS dispersion results are shown in an Earth-relative system.

A4.1.2 Error Contribution Data

The contributions of each error source to the total RSS values can be seen at SRB separation in tables 4.1.2-I and 4.1.2-II for the cases with an engine-out at lift-off and the cases with no engine-out in first stage (i.e., nominal). The same data are shown at ET separation in tables 4.1.2-III through 4.1.2-VI for each of the PRTLS cases. The actual state dispersions are shown in the (a) tables and the navigated state uncertainties are shown in the (b) tables. The (c) tables contain actual dispersions in other trajectory parameters, as well as dispersions in time, vehicle weight, and ET propellant weight.

A4.1.3 RSS Summary Data

Summary tables of the three-sigma RSS errors are included to allow comparison among the PRTLS cases at each of the six event slices. Table A4.1.3-I summarizes the three-sigma values of the UVW state parameters, table A4.1.3-II summarizes the trajectory state parameters, and table A4.1.3-III summarizes the vehicle parameters. The actual state dispersions are shown in the (a) tables and the navigated state uncertainties are shown in the (b) tables.

A4.1.4 Covariance and Correlation Matrix Data

Covariance and correlation matrices are provided at SRB separation in tables A4.1.4-I and A4.1.4-II. The matrices are provided at ET separation in tables A4.1.4-III through A4.1.4-VI for the four cases. The (a) tables provide the covariance matrices, and the (b) tables provide the correlation matrices.

A4.1.5 Conclusions

The final assessment of the PRTLS dispersion analysis comes after using the data to determine the effects of dispersions on SRB disposal, ET disposal, and Orbiter glide return-to-launch site (GRTLS) trajectories. Once these effects are known, the capability of the vehicle to satisfy mission constraints and achieve target conditions may be evaluated. The purpose of the conclusions

below is to highlight areas where dispersions have been of special concern. Significant items have been identified where possible, and an attempt has been made to explain the physical interpretation of the results.

For the PRTLs with Space Shuttle main engine (SSME) failure at lift-off, the first-stage open-loop guidance flies an attitude profile specifically designed for the engine-out case. This profile maintains acceptable load margins in the maximum dynamic pressure region, acceptable aerodynamic heating margins near staging, and acceptable SRB staging conditions. The net effect of the engine failure is that dispersions in the actual state at SRB separation are different from the dispersions for the nominal no engine-out case. The engine failure case shows smaller position dispersions and larger velocity dispersions.

The dispersions at the completion of the powered pitcharound are not significant because this marks the beginning of a closed-loop guidance phase that will compensate for the dispersions. One should note that the time at the completion of the powered pitcharound is sensitive to vehicle performance. The time dispersions result from both the time at which the pitcharound is initiated and the time spent in the pitcharound. For a low performing vehicle with a slower velocity, the pitcharound will be initiated later in time. The time spent in the pitcharound varies with the pitcharound angle computed by guidance, and the pitcharound angle depends on the guidance solution for the amount of velocity wasting required.

At the start of powered pitchdown, guidance satisfies its target conditions for radius magnitude, velocity magnitude (a function of range), flightpath angle, heading, and mass. Closed-loop guidance ends just prior to the start of powered pitchdown, and the powered pitchdown is flown open loop with MECO occurring when the velocity achieves the cutoff velocity from the MECO range-velocity-gamma (RVY) line. The RVY line is designed to provide an equal opportunity of achieving the runway from any point on the line. The nominal point of arrival on the line is a function of the engine-out time and/or the time at which the RTLS is selected. The actual state dispersions at MECO and ET separation that are shown in the RSS tables are largely variations in the point of arrival on the RVY line, and they do not reflect variations in the glide-ranging capability. The navigation errors, however, do represent a miss in the RVY target line, and these errors must be absorbed by the GRTLs trajectory. The navigation errors are comparable for the four PRTLs cases, but largest for the engine-out at lift-off case because it has the longest flight time.

A4.2 ABORT ONCE AROUND

The primary purpose of the AOA dispersion analysis is to define the actual state dispersions and navigated state uncertainties at entry interface (E1). These errors are a direct result of navigation performance. The vehicle performance variations have a minimal effect on entry errors because they are compensated for by closed-loop guidance. Consequently, the performance errors are ignored for this analysis.

A4.2.1 Trajectory Description

The AOA trajectory used to define the nominal was the earliest AOA case with a MECO underspeed of 410 fps. This case was defined by first assuming an engine-out at 260 seconds with nominal performance, a guided MECO, and no underspeed. Then, a case with an engine-out at 224.4 seconds with nominal performance was found to arrive at MECO with a propellant depletion cutoff and a 410 fps underspeed. Thus, all of the dispersed cases for the AOA analysis assumes an engine-out at 224.4 seconds with a propellant depletion cutoff.

An event timeline is provided in table A4.2.1-I for the nominal AOA trajectory (no dispersions present). Dispersion data were computed at the following nine event and time slices:

- a. SRB separation (event)
- b. MECO (event)
- c. Nominal MECO + 1 minute (fixed time)
- d. OMS-1 cutoff (event)
- e. Nominal OMS-1 cutoff + 6 minutes (fixed time)
- f. OMS-2 ignition (event)
- g. OMS-2 cutoff (event)
- h. EI - 5 minutes (fixed time)
- i. EI (event)

The event slice at entry interface is taken at the time when the actual state from each perturbed trajectory reaches 400 000 feet. At this time, the navigated state is at some other altitude. Figure A4.2-1 illustrates how the trajectory errors are computed at EI.

A4.2.2 Error Contribution Data

The contributions of each source to the total RSS values are given at MECO, OMS-1 cutoff, OMS-2 cutoff, EI minus 5 minutes, and EI in tables A4.2.2-I through A4.2.2-V, respectively. The actual state dispersions in the state parameters are shown in the (a) tables and the navigated state uncertainties in the state parameters are shown in the (b) tables. The (c) tables present the actual dispersions in the vehicle parameters, and the (d) tables present the actual dispersions in the orbital parameters, which include apogee altitude (HA), perigee altitude (HP), period, inclination, longitude of the ascending node, argument of perigee, true anomaly, and eccentricity.

A4.2.3 RSS Summary Data

Summary tables of the three-sigma RSS errors at all of the event and time slices are presented in tables A4.2.3-I through A4.2.3-IV. The UVW state errors are shown in table A4.2.3-I, the trajectory parameter errors in table A4.2.3-II, the vehicle parameter errors in table A4.2.3-III, and the orbital parameter errors in table A4.2.3-IV. The (a) tables contain the actual state dispersions and the (b) tables contain the navigated state uncertainties.

A4.2.4 Covariance and Correlation Matrix Data

Covariance and correlation matrices are provided at MECO in tables A4.2.4-I(a) and (b). Terms have been included in the matrix for time from lift-off, accelerometer biases, and platform misalignment angles. The corresponding matrices are also provided at OMS-2 cutoff, E1 minus 5 minutes, and E1 in tables A4.2.4-II through A4.2.4-IV, respectively.

A4.2.5 Conclusions

The final assessment of the AOA dispersion analysis comes after using the data to determine the effects of dispersions on the subsequent entry. Once these effects are known, the capability of the vehicle to satisfy mission constraints and achieve target conditions may be evaluated. The purpose of the conclusions below is to highlight areas where dispersions have been of special concern. Significant items have been identified where possible, and an attempt has been made to explain the physical interpretation of the results.

The actual state dispersions are equivalent to the navigation uncertainties since only the LMJ error source was included in the AOA analysis. The navigation uncertainties are larger for the AOA MECO than for the nominal MECO because the AOA flight time is longer. With the long OMS-1 burn, the navigation errors increase from MECO to OMS-1 cutoff. From OMS-1 cutoff to OMS-2 ignition, the navigation uncertainty grows significantly because of the propagation of the OMS-1 cutoff errors. By E1 the navigation uncertainty ellipsoid maps into a large downrange dispersion in the actual state. The actual state dispersion is quoted for a fixed altitude, so a small altitude error results in a large downrange dispersion because of the shallow flightpath angle (fig. A4.2-1).

4.3 ABORT TO ORBIT

The purpose of the ATO dispersion analysis is to define the final orbit insertion accuracy that results from plus or minus three-sigma navigation performance. Because the vehicle performance variations are compensated for by closed-loop guidance, they have a minimal effect on the insertion accuracy, and hence are ignored for this analysis. Another reason for ignoring the performance errors is that certain combinations of performance variations are necessary to obtain the MECO underspeed velocities where an ATO would be selected.

4.3.1 Trajectory Description

The ATO trajectory used to define the nominal was the earliest ATO with a MECO underspeed of 375 fps. This case was defined by first assuming an engine-out at 260 seconds with nominal performance, guided MECO, and no underspeed. Then a case with an engine-out at 227.1 seconds with nominal performance was found to arrive at MECO with a propellant depletion cutoff and 375 fps underspeed. Thus, all of the dispersed cases for the ATO analysis assume an engine-out at 227.1 seconds with a propellant depletion cutoff.

An event timeline is provided in table A4.3.1-I for the nominal ATO trajectory (no dispersions present). Dispersion data were computed at the following eight event and time slices:

- a. SRE separation (event)
- b. MECO (event)
- c. Nominal MECO + 1 minute (fixed time)
- d. OMS-1 cutoff (event)
- e. Nominal OMS-1 cutoff + 5 minutes (fixed time)
- f. OMS-2 ignition (event)
- g. OMS-2 cutoff (event)
- h. Nominal OMS-2 cutoff + 1 minute (fixed time)

A4.3.2 Error Contribution Data

The contributions of each error source to the total RSS values are given at MECO, OMS-1 cutoff, OMS-2 cutoff, and nominal OMS-2 cutoff + 1 minute in tables A4.3.2-I through A4.3.2-IV, respectively. The actual state dispersions in the state parameters are shown in the (a) tables and the navigated state uncertainties in the state parameters are shown in the (b) tables. The (c) tables present the actual dispersions in the vehicle parameters and the (d) tables present the actual dispersions in the orbital parameters. The dispersions in the argument of perigee and true anomaly after OMS-2 cutoff are large as a result of the near-circular orbit.

A4.3.3 RSS Summary Data

Summary tables of the three-sigma RSS errors at all of the event and time slices are presented in tables A4.3.3-I through A4.3.3-IV. The UVW state errors are shown in table A4.3.3-I, the trajectory parameter errors are shown in table 4.3.3-II, the vehicle parameter errors are shown in table A4.3.3-III, and the

orbital parameter errors are shown in table A4.3.3-IV. The (a) tables contain the actual state dispersions and the (b) tables contain the navigated state uncertainties.

A4.3.4 Covariance and Correlation Matrix Data

Covariance and correlation matrices are provided at MECO in tables A4.3.4-I(a) and (b). The matrices are also provided at OMS-2 cutoff and OMS-2 cutoff + 1 minute in tables A4.3.4-II and A4.3.4-III.

A4.3.5 Conclusions

The final assessment of the ATO dispersion analysis comes after using the data to determine the effects of dispersions on the subsequent deorbit and entry. Once these effects are known, the capability of the vehicle to satisfy mission constraints and achieve target conditions may be evaluated. The purpose of the conclusions below is to highlight areas where dispersions have been of special concern. Significant items have been identified where possible, and an attempt has been made to explain the physical interpretation of the results.

Concluding remarks for the earliest ATO are similar to those for the earliest AOA trajectory. From lift-off to MECO, the ATO and AOA trajectories are similar except for the MECO underspeeds. This is because both target for the same MECO conditions and the ATO arrives at MECO earlier than the AOA. At OMS-1 cutoff, the navigation uncertainty is slightly smaller for the ATO than the AOA because the OMS-1 burn time is less for the ATO.

From OMS-1 cutoff to OMS-2 ignition, the navigation uncertainty grows during the long propagation of the OMS-1 cutoff errors.

After the OMS-2 circularization burn, dispersions in the orbital parameters become more meaningful than dispersions in the state vector components. The three-sigma dispersions in apogee altitude and perigee altitude have a small effect on the delta velocity required for the deorbit burn. It should be noted that for a circular orbit, large dispersions are present in the argument of perigee and true anomaly because the line of apsides rotates with a small perturbation in flightpath angle. The navigation error after the OMS-2 burn is of little consequence because it is planned to update the navigated state prior to the deorbit burn.

A5.0 BIBLIOGRAPHY

1. Thibodeau, Joseph R., III: Prelaunch IMU Alinements for OFT. JSC Memorandum FM83(78-134), May 8, 1978.
2. Requirements/Definition Document, Guidance and Navigation. Rockwell International SD-72-SH-0105-1, May 16, 1975.
3. Thibodeau, Joseph R., III: Prelaunch IMU Alinement Errors. JSC Memorandum FM83(78-24), February 22, 1978.
4. CDR Mission I Flight Performance Reserve for Winter (February) Launch. Rockwell International Internal Letter SAS/MR&I 77-116, June 22, 1977.
5. SRB Systems Performance and Design Data. MSFC Document SE-019-125-2H, June 24, 1977.
6. Shuttle Operational Data Book. Volume I, Amendment 84, JSC-08934, Aug. 1, 1979.
7. Shuttle Operational Data Book. Volume II, Amendment 31, JSC-08934, Feb. 7, 1980.
8. Terrestrial Environment (Climatic) Criteria Guidelines for Use in Aerospace Vehicle Development, 1973 Version. NASA TMX-b4757, March 1974.
9. Space Shuttle Flight and Ground System Specification, Level II Program Definition and Requirements. JSC-07700, Volume X, Revision C, April 27, 1978.

TABLE A3.3-I.- ERROR SOURCE DEFINITIONS

Error source symbols	Definition	3-sigma values	Reference	Units
PLATFORM ALINE	Initial platform misalignment azimuth tilt, roll	276.50 78.60	3	arc sec arc sec
DRIFT PIAS	Free gyro bias	.045	2	deg/hr
G-SENS IA DRIFT	Gyro input axis acceleration sensitive drift	.075	2	deg/hr/g
G-SENS OA DRIFT	Gyro output axis acceleration sensitive drift	.075	2	deg/hr/g
G-SENS-SQ DRIFT	Gyro acceleration squared sensitive drift	.075	2	deg/hr/g**2
ACCEL BIAS	Accelerometer bias	150.000	2	micro-g
ACCEL SCALE FAC	Accelerometer scale factor	120.000	2	ppm
ACCEL IA ALINE	Accelerometer input axis misalignment			
- TOWARD SA	- Toward spin axis	45.000	2	arc sec
- TOWARD OA	- Toward output axis	45.000		arc sec
CG	Center of gravity - X component	.083	4	ft
	Y component	.043		ft
	Z component	.250		ft
WEB ACT	Web action time	4.900	5,6	percent
S ISP	SRB specific impulse	- .500	5,6	percent
S PROP	SRB propellant loading	- .210	5,7	percent
S INERT	SRB inert weight	.850 (3083.000)	5,7	percent (lb)

TABLE A3.3-I.- Concluded

Error source symbols	Definition	3-sigma values	Reference	Units
O THRST	Orbiter thrust	- 6000.000 (-10392.000)	4,6	lb/eng (lb/3 eng)
O ISP	Orbiter specific impulse	- 2.300 (-1.328)	4,6	sec/1 eng (sec/3 eng)
O INERT	Orbiter inert weight	.100 (185.000)	4,7	percent, (lb)
ET INERT	External tank inert weight	.250 (198.000)	4,7	percent (lb)
ET OXID	External tank oxidizer loading	0.54 (7376.)	4,7	percent (lb)
ET FUEL	External tank fuel loading	0.69 (1569.)	4,7	percent (lb)
MIX RATIO	SSME mixture ratio	1.0 (0.03464)	7	percent/1 eng (percent/3 eng) (gr/3 eng)
ATMOSPHERE -COLD	63 Patrick Cold Atmosphere		8	

TABLE A4.0-I.- PARAMETER DEFINITIONS FOR RSS DATA TABLES

Name	Definition	Units
State Parameters		
U	Radial position component in the LHS	ft
V	Downrange position component in the LHS	ft
W	Crossrange position component in the LHS	ft
U-DOT	Radial velocity component in the LHS	fps
V-DOT	Downrange velocity component in the LHS	fps
W-DOT	Crossrange velocity component in the LHS	fps
ALTITUDE	Inertial position vector magnitude	ft
SPEED	Inertial velocity vector magnitude	fps
H-DOT	Inertial altitude rate (velocity x sin γ)	fps
DR-DOT	Inertial downrange rate (velocity x cos γ)	fps
GAMMA	Inertial flightpath angle (γ)	fps
Vehicle Parameters		
LATD	Geodetic latitude	deg
LONG	Longitude	deg
AZIM	Inertial azimuth	deg
RANGE	Surface range from launch site	n. mi.
TIME	Elapsed time	sec
WEIGHT	Total vehicle weight	lb
PROP	SSME propellant for events through MECO, OMS propellant for events post-MECO	lb
OXID	MPS oxidizer remaining	lb
FUEL	MPS fuel remaining	lb

TABLE A4.0-I.- Concluded

Name	Definition	Units
Orbital Parameters		
HA	Apogee altitude	n. mi.
HP	Perigee altitude	n. mi.
PERIOD	Orbital period	sec
INCLIN	Inclination	deg
ASC NOD	Longitude of ascending node	deg
ARG PER	Argument of perigee	deg
TRU ANOM	True anomaly	deg
SMAJ AXIS	Semimajor axis	n. mi.
ECCENT	Orbital eccentricity	nd

TABLE A4.0-II.- DEFINITION OF COVARIANCE AND
CORRELATION MATRIX ELEMENTS

<u>Matrix element</u>	<u>Definition</u>	<u>Units</u>
U ACT ^a	Actual position dispersion minus radial	ft
V ACT	Actual position dispersion minus downrange	ft
W ACT	Actual position dispersion minus crossrange	ft
U-DOT ACT	Actual velocity dispersion minus radial	fps
V-DOT ACT	Actual velocity dispersion minus downrange	fps
W-DOT ACT	Actual velocity dispersion minus crossrange	fps
U NAV ^b	Navigated position uncertainty minus radial	ft
V NAV	Navigated position uncertainty minus downrange	ft
W NAV	Navigated position uncertainty minus crossrange	ft
U-DOT NAV	Navigated velocity uncertainty minus radial	fps
V-DOT NAV	Navigated velocity uncertainty minus downrange	fps
W-DOT NAV	Navigated velocity uncertainty minus crossrange	fps
WT	Total vehicle weight	lb
TIME	Time from lift-off	sec
X ACC BIAS	Platform X accelerometer bias	fps ²
Y ACC BIAS	Platform Y accelerometer bias	fps ²
Z ACC BIAS	Platform Z accelerometer bias	fps ²
X MISALIGN	Misalinement about platform X-axis	rad
Y MISALIGN	Misalinement about platform Y-axis	rad
Z MISALIGN	Misalinement about platform Z-axis	rad

^aThe actual state dispersion is computed by constructing a UVW system defined by the nominal actual state at the event/time slice of interest. Then,

$$\text{Actual dispersion} = (\text{Perturbed actual state in UVW}) \text{ minus} \\ (\text{Nominal actual state in UVW})$$

^bThe navigated state uncertainty is computed by constructing a UVW system defined by the nominal navigated state at the event/time slice of interest. Then,

$$\text{Navigated uncertainty} = (\text{Perturbed navigated state in UVW}) \text{ minus} \\ (\text{Perturbed actual state in UVW})$$

TABLE A4.1.1-1.- PRTLS EVENT TIMELINE

Event/case	Time, sec	Total weight, lb	Geodetic altitude, ft	Earth- relative velocity, ft	Earth- relative flightpath angle, deg	Range, n. mi.
SRB separation						
E O at lift-off	131.7	1 960 279	138 988	3277.2	34.96	20.2
E O at SRB sep	131.7	1 830 427	165 271	4205.9	33.76	25.6
E O at 262.5 sec	131.7	1 830 427	165 271	4209.9	33.76	25.6
3 engines at 262.5 sec	131.7	1 830 427	165 271	4209.9	33.76	25.6
HTLS selection						
E O at lift-off	150.0	1 559 706	170 855	3291.5	28.99	25.5
E O at SRB sep	150.0	1 420 132	206 439	4376.6	28.88	36.6
E O at 262.5 sec	272.5	1 040 586	404 775	7599.5	8.32	148.7
3 engines at 262.5 sec	262.5	1 062 360	392 986	7588.7	9.65	150.8
Pitcharound completed						
E O at lift-off	487.9	861 252	259 614	4494.2	-2.36	234.9
E O at SRB sep	338.2	1 030 572	413 620	6161.7	3.29	192.1
E O at 262.5 sec	289.8	1 903 594	423 228	7511.4	7.51	169.8
3 engines at 262.5 sec	283.6	1 015 636	418 616	7383.6	8.61	162.0
Powered pitchover						
E O at lift-off	761.0	334 447	204 755	5311.4	9.75	254.8
E O at SP, sep	694.5	336 120	204 546	5370.8	9.77	258.0
E O at 262.5 sec	611.4	325 434	204 559	5313.1	9.73	255.9
3 engines at 262.5 sec	594.8	345 095	204 540	4678.2	9.91	247.3
MECU command						
E O at lift-off	780.7	307 302	219 068	6416.2	3.32	236.2
E O at SRB sep	713.1	310 271	220 146	6383.4	4.93	240.4
E O at 262.5 sec	628.6	300 938	219 857	6291.0	5.96	239.8
3 engines at 262.5 sec	613.0	308 367	220 099	6125.6	5.86	231.6

TABLE A4.1.1-I.- Concluded

Event/case	Time, sec	Total weight, lb	Geodetic altitude, ft	Earth- relative velocity, ft	Earth- relative flightpath angle, deg	Range, n. mi.
ET separation						
E 0 at lift-off	793.6	305 973	221 070	6464.5	-0.31	222.6
E 0 at SRB sep	726.0	308 942	224 445	6420.2	1.28	226.9
E 0 at 262.5 sec	641.5	299 609	225 517	6322.8	2.26	226.5
3 engines at 262.5 sec	625.9	306 373	225 376	6188.7	2.02	218.7

TABLE AN.1.2-1.- PRTLS PSS DATA AT SPB SEP FOR SSMC-OUT AT LIFTOFF

(A) ACTUAL MINUS NOMINAL STATE PARAMETERS

	U (FT)	Y (FT)	W (FT)	U-DOT (FPS)	V-DOT (FPS)	W-DOT (FPS)	ALTITUDE (FT)	SPEED (FPS)	M-DOT (FPS)	DP-DOT (FPS)	GAMMA (DEG)
PLATEFORM ALINE											
AZIMUTH	0.	0.	-0.	-0.	-0.	-0.	0.	-0.	-0.	-0.	-0.000
TILT	0.	-0.	-0.	-0.	-0.	-0.	0.	-0.	-0.	-0.	-0.000
ROLL	-0.	-0.	-0.	-0.	-0.	-0.	-0.	-0.	-0.	-0.	-0.000
DRIFT BIAS											
X	0.	0.	0.	-0.	-0.	-0.	0.	-0.	-0.	-0.	-0.000
Y	-0.	-0.	0.	-0.	-0.	-0.	0.	-0.	-0.	-0.	-0.000
Z	0.	0.	0.	-0.	-0.	-0.	0.	-0.	-0.	-0.	-0.000
G-SENS 1A DRIFT											
X	0.	0.	0.	-0.	-0.	-0.	0.	-0.	-0.	-0.	-0.000
Y	-0.	-0.	0.	-0.	-0.	-0.	0.	-0.	-0.	-0.	-0.000
Z	0.	0.	0.	-0.	-0.	-0.	0.	-0.	-0.	-0.	-0.000
G-SENS 0A DRIFT											
X	0.	0.	0.	-0.	-0.	-0.	0.	-0.	-0.	-0.	-0.000
Y	-0.	-0.	0.	-0.	-0.	-0.	0.	-0.	-0.	-0.	-0.000
Z	0.	0.	0.	-0.	-0.	-0.	0.	-0.	-0.	-0.	-0.000
0-SQ SEN DRIFT											
X	0.	0.	0.	-0.	-0.	-0.	0.	-0.	-0.	-0.	-0.000
Y	0.	0.	0.	-0.	-0.	-0.	0.	-0.	-0.	-0.	-0.000
Z	0.	0.	0.	-0.	-0.	-0.	0.	-0.	-0.	-0.	-0.000
ACCEL BIAS											
X	0.	-0.	-0.	-0.	-0.	-0.	0.	-0.	-0.	-0.	-0.000
Y	-0.	-0.	0.	-0.	-0.	-0.	0.	-0.	-0.	-0.	-0.000
Z	-0.	-0.	0.	-0.	-0.	-0.	0.	-0.	-0.	-0.	-0.000
ACCEL SCALE FAC											
X	0.	-0.	-0.	-0.	-0.	-0.	0.	-0.	-0.	-0.	-0.000
Y	-0.	-0.	0.	-0.	-0.	-0.	0.	-0.	-0.	-0.	-0.000
Z	-0.	-0.	0.	-0.	-0.	-0.	0.	-0.	-0.	-0.	-0.000
ACCEL 1A ALINE											
- OA											
X	-0.	-0.	0.	-0.	-0.	-0.	0.	-0.	-0.	-0.	-0.000
Y	-0.	-0.	0.	-0.	-0.	-0.	0.	-0.	-0.	-0.	-0.000
Z	-0.	-0.	0.	-0.	-0.	-0.	0.	-0.	-0.	-0.	-0.000
ACCEL 1A ALINE											
- SA											
X	-0.	-0.	0.	-0.	-0.	-0.	0.	-0.	-0.	-0.	-0.000
Y	-0.	-0.	0.	-0.	-0.	-0.	0.	-0.	-0.	-0.	-0.000
Z	-0.	-0.	0.	-0.	-0.	-0.	0.	-0.	-0.	-0.	-0.000

TABLE AN-1.2-1.- PPTLS RSS DATA AT SRB SEP FOR SSME-OUT AT LIFTOFF
(CONTINUED)

(A) ACTUAL MINUS NOMINAL STATE PARAMETERS

	U (FT)	V (FT)	W (FT)	U-DOT (FPS)	V-DOT (FPS)	M-DOT (FPS)	ALTITUDE (FT)	SPEED (FPS)	M-DOT (FPS)	DR-DOT (FPS)	GAMMA (DEG)
CO	0.	0.	0.	0.	0.	0.	0.	0.	0.	0.	0.
X	0.	0.	0.	0.	0.	0.	0.	0.	0.	0.	0.
Y	0.	0.	0.	0.	0.	0.	0.	0.	0.	0.	0.
Z	0.	0.	0.	0.	0.	0.	0.	0.	0.	0.	0.
PERFORMANCE											
MEB ACT	-1816.	5819.	-4204.	-56.1	-101.5	-1.2	-1015.	-115.3	-55.5	-181.9	-.233
S ISP	-1288.	-1868.	-19.	-13.5	-38.1	-.3	-1288.	-38.8	-13.8	-37.9	-.184
S PROP	-332.	-480.	-6.	-4.0	-10.6	-.1	-332.	-11.0	-4.1	-10.6	-.047
S IMERT	-256.	-349.	-7.	-3.6	-8.2	-.1	-256.	-8.7	-3.6	-8.1	-.038
O IMERT	-431.	-530.	-13.	-7.1	-12.3	-.0	-431.	-14.2	-7.2	-12.3	-.029
O ISP	25.	36.	1.	.6	1.0	0.	25.	1.1	.6	1.0	-.002
O IMERT	-15.	-21.	0.	-.2	-.5	0.	-15.	-.5	-.2	-.5	-.002
ET IMERT	-16.	-22.	-1.	-.2	-.5	0.	-16.	-.6	-.2	-.5	-.002
ET OXID	-813.	-871.	-9.	-8.5	-19.7	-.1	-812.	-21.0	-8.7	-19.6	-.072
ET FUEL	-130.	-178.	-4.	-1.8	-4.1	0.	-130.	-4.4	-1.8	-4.1	-.015
MIX RATIO	0.	0.	0.	0.	0.	0.	0.	0.	0.	0.	0.
ATMOSPHERE											
COLD	250.	778.	-7.	5.2	21.6	-.4	249.	20.7	5.3	21.6	-.139
3-SIGMA RSS *	1074.	5542.	4204.	50.3	113.8	1.3	1873.	126.9	58.8	114.1	-.342

TABLE A4.1.2-1.- PRILS RSS DATA AT SRB SEP FOR SSMC-OUT AT LIFTOFF

(B) NAVIGATED MINUS ACTUAL STATE PARAMETERS

	U (FT)	V (FT)	W (FT)	U-DOT (FPS)	V-DOT (FPS)	W-DOT (FPS)	ALTITUDE (FT)	SPEED (FPS)	M-DOT (FPS)	DR-DOT (FPS)	GAMMA (DEG)
PLATFORM ALINE											
AZIMUTH	7.	-24.	-205.	.2	-4	-4.2	7.	-2	.1	-3	.006
TILT	-25.	86.	128.	-6	1.3	1.9	-25.	.7	-6	1.3	-.021
ROLL	39.	-134.	86.	.8	-2.0	1.3	39.	-1.1	.8	-2.0	.031
DRIFT BIAS											
X	0.	-0.	-2.	-0	-0	.0	0.	-0	-0	-0	.000
Y	-1.	3.	4.	-0	0	.1	-1.	0	-0	0	-.001
Z	2.	-4.	2.	-0	-1	.1	2.	-1	-0	-1	-.001
0-SENS IA DRIFT											
X	1.	-1.	-5.	.0	0	-1	1.	0	0	0	-.000
Y	-1.	2.	3.	-0	0	-1	-1.	0	-0	0	-.001
Z	1.	-1.	1.	.0	-1	.0	1.	-0	0	-1	-.001
0-SENS OA DRIFT											
X	-0.	0.	-1.	-0	-0	.0	0.	-0	-0	-0	.000
Y	-2.	8.	8.	-1	1	.2	-3.	1	-1	1	-.002
Z	1.	-2.	2.	.0	-1	.1	1.	-1	-0	-1	-.001
0-SO SEM DRIFT											
X	-0.	0.	-2.	-0	-0	-1	0.	-0	-0	-0	.000
Y	0.	0.	1.	0	0	1	1.	0	0	0	-.000
Z	1.	-1.	1.	.0	-1	-1	1.	-1	-0	-1	-.001
ACCEL BIAS											
X	41.	-3.	2.	.6	-1	.0	41.	.3	.8	-1	.009
Y	4.	35.	-22.	.1	.5	-3	4.	.4	.1	.5	-.004
Z	1.	23.	36.	.0	.3	.3	1.	.3	.0	.3	-.003
ACCEL SCALE FAC											
X	48.	-4.	2.	.7	-1	.0	48.	.3	.7	-1	.010
Y	1.	14.	-9.	.0	.2	-2	1.	.2	.0	.2	-.002
Z	-0.	5.	7.	.0	.1	.2	0.	.1	.0	.1	-.001
ACCEL IA ALINE											
-OA	30.	-2.	1.	.6	-0	.0	30.	.3	.6	-0	.009
X	1.	12.	-8.	.0	.2	-2	1.	.2	.0	.2	-.002
Y	1.	48.	74.	.0	.7	1.1	1.	.6	.0	.7	-.007
Z											
ACCEL IA ALINE											
-SA	15.	-1.	1.	.3	-0	.0	15.	.2	.3	-0	.005
X	8.	74.	-47.	.1	1.0	-7	8.	.9	.1	1.0	-.008
Y	1.	16.	26.	.0	.4	.5	1.	.3	.0	.4	-.003
Z											

TABLE A4.1.2-1.- PARTS RSS DATA AT SRB SEP FOR SSME-OUT AT LIFTOFF
(CONTINUED)

(B) NAVIGATED MINUS ACTUAL STATE PARAMETERS											
	U (FT)	V (FT)	W (FT)	U-DOT (FPS)	V-DOT (FPS)	M-DOT (FPS)	ALTITUDE (FT)	SPEED (FPS)	M-DOT (FPS)	DR-DOT (FPS)	GAMMA (DEG)
CO	0.	0.	0.	0.	0.	0.	0.	0.	0.	0.	0.000
X	0.	0.	0.	0.	0.	0.	0.	0.	0.	0.	0.000
Y	0.	0.	0.	0.	0.	0.	0.	0.	0.	0.	0.000
Z	0.	0.	0.	0.	0.	0.	0.	0.	0.	0.	0.000
PERFORMANCE											
MEB ACT	3.	3.	1.	0.	0.	0.	3.	1.0	0.	0.	0.000
S ISP	1.	-1.	-0.	-0.	-0.	-0.	1.	-0.	-0.	-0.	-0.000
S PROP	1.	0.	1.	-0.	-0.	-0.	1.	-0.	-0.	-0.	-0.000
S INERT	1.	-0.	0.	0.	0.	0.	1.	0.	0.	0.	-0.000
D THRST	-0.	-1.	1.	-0.	-0.	-1.	-0.	-0.	-0.	-0.	-0.000
O ISP	1.	-0.	0.	-0.	-0.	-0.	1.	-0.	-0.	-0.	0.000
O INERT	0.	0.	1.	-0.	-0.	-0.	1.	-0.	-0.	-0.	0.000
ET INERT	-1.	-0.	0.	-0.	-0.	1.	-1.	-0.	-0.	-0.	0.000
ET OXID	1.	-0.	0.	-0.	-0.	0.	1.	-0.	-0.	-0.	-0.000
ET FUEL	0.	-0.	0.	-0.	-0.	0.	0.	-0.	-0.	-0.	0.000
MIX RATIO	0.	0.	0.	0.	0.	0.	0.	0.	0.	0.	0.000
ATMOSPHERE											
COLD	-0.	-0.	-0.	-0.	-0.	-0.	-0.	-0.	-0.	-0.	-0.000
3-SIGMA RSS	86.	190.	277.	1.6	2.9	5.0	87.	2.2	1.6	2.9	0.044

TABLE A4.1.2-1.- PRTLS RSS DATA AT SRB SEP FOR SSME-OUT AT LIFTOFF

(C) ACTUAL MINUS NOMINAL VEHICLE PARAMETERS

	LATD (DEG)	LONG (DEG)	AZIM (DEG)	RANGE (NM)	TIME (SEC)	WEIGHT (LBS)	PROP (LBS)	OXID (LBS)	FUEL (LRS)
PLATFORM ALINE									
AZIMUTH	.000	.000	.000	.00	.00	0.	0.	0.	0.
TILT	-.000	-.000	-.000	.00	.00	-0.	-0.	-0.	-0.
ROLL	.000	.000	.000	.00	.00	0.	0.	0.	0.
DRIFT BIAS									
X	.000	.000	.000	.00	.00	0.	0.	0.	0.
Y	.000	.000	.000	.00	.00	0.	0.	0.	0.
Z	.000	.000	.000	.00	.00	0.	0.	0.	0.
0-SENS 1A DRIFT									
X	.000	.000	.000	.00	.00	0.	0.	0.	0.
Y	.000	.000	.000	.00	.00	0.	0.	0.	0.
Z	.000	.000	.000	.00	.00	0.	0.	0.	0.
0-SENS 0A DRIFT									
X	.000	.000	.000	.00	.00	0.	0.	0.	0.
Y	.000	.000	.000	.00	.00	0.	0.	0.	0.
Z	.000	.000	.000	.00	.00	0.	0.	0.	0.
0-SO SEN DRIFT									
X	.000	.000	.000	.00	.00	0.	0.	0.	0.
Y	.000	.000	.000	.00	.00	0.	0.	0.	0.
Z	.000	.000	.000	.00	.00	0.	0.	0.	0.
ACCEL BIAS									
X	-.000	.000	-.000	.00	.00	-0.	-0.	-0.	-0.
Y	.000	.000	-.000	.00	.00	-0.	-0.	-0.	-0.
Z	.000	.000	-.000	.00	.00	-0.	-0.	-0.	-0.
ACCEL SCALE FAC									
X	-.000	.000	-.000	.00	.00	-0.	-0.	-0.	-0.
Y	.000	.000	-.000	.00	.00	-0.	-0.	-0.	-0.
Z	.000	.000	-.000	.00	.00	-0.	-0.	-0.	-0.
ACCEL 1A ALINE									
-0A									
X	.000	.000	-.000	.00	.00	-0.	-0.	-0.	-0.
Y	.000	.000	-.000	.00	.00	0.	0.	0.	0.
Z	.000	.000	-.000	.00	.00	-0.	-0.	-0.	-0.
ACCEL 1A ALINE									
-SA									
X	.000	.000	.000	.00	.00	-0.	-0.	-0.	-0.
Y	-.000	-.000	-.000	.00	.00	-0.	-0.	-0.	-0.
Z	.000	.000	.000	.00	.00	0.	0.	0.	0.

TABLE AN-1.2-1.- PRTLS RSS DATA AT SRB SEP FOR SSME-OUT AT LIFTOFF
(CONTINUED)

(C) ACTUAL MINUS NOMINAL VEHICLE PARAMETERS										
	LATD (DEG)	LONG (DEG)	AZIM (DEG)	RANGE (NMI)	TIME (SEC)	WEIGHT (LBS)	PROP (LBS)	OXID (LBS)	FUEL (LBS)	
CO										
X	.000	.000	.000	.00	.00	0.	0.	0.	0.	
Y	.000	.000	.000	.00	.00	0.	0.	0.	0.	
Z	.000	.000	.000	.00	.00	0.	0.	0.	0.	
PERFORMANCE										
WEB ACT	.003	.005	.284	-.31	5.92	-12417.	-12431.	-10655.	-1776.	
S ISP	.003	.005	.099	-.31	.00	.93	.93	.00	.13.	
S PROP	.001	.001	.028	-.08	.00	.16	.16	.11.	.13.	
S INERT	.000	.001	.021	-.06	.00	3070.	.13.	.11.	.2.	
O THRST	.001	.001	.031	-.09	.00	1905.	1905.	1633.	272.	
O ISP	.000	.000	.003	.01	.00	.771.	.771.	.661.	.110.	
O INERT	.000	.000	.001	-.00	.00	184.	.1.	.1.	.0.	
ET INERT	.000	.000	.001	-.00	.00	197.	.1.	.1.	.0.	
ET OXID	.001	.002	.051	-.14	.00	7342.	7342.	7347.	.5.	
ET FUEL	.000	.000	.011	-.03	.00	1563.	1563.	1568.	.5.	
MIX RATIO	.000	.000	.000	.00	.00	.0.	.0.	.185.	.185.	
ATMOSPHERE										
COLD	.001	.002	-.048	.13	.00	-143.	-143.	-123.	-20.	
3-SIGMA RSS	.004	.008	.312	.48	5.92	14977.	14667.	13064.	2394.	

TABLE AN.1.2-11.- PRTLS RSS DATA AT SRB SEP FOR NOMINAL FIRST STAGE

(A) ACTUAL MINUS NOMINAL STATE PARAMETERS

	U (FT)	V (FT)	W (FT)	U-DOT (FPS)	V-DOT (FPS)	W-DOT (FPS)	ALTITUDE (FT)	SPEED (FPS)	H-DOT (FPS)	DR-DOT (FPS)	GAMMA (DEG)
PLATFORM ALINE											
AZIMUTH	0.	0.	0.	-0.	-0.	-0.	0.	-0.	-0.	-0.	-0.000
TILT	0.	0.	0.	-0.	-0.	-0.	0.	-0.	-0.	-0.	-0.000
ROLL	-0.	0.	0.	-0.	-0.	-0.	-0.	-0.	-0.	-0.	-0.000
DRIFT BIAS											
X	-0.	-0.	0.	-0.	-0.	-0.	0.	-0.	-0.	-0.	-0.000
Y	0.	0.	0.	-0.	-0.	-0.	0.	-0.	-0.	-0.	-0.000
Z	0.	0.	0.	-0.	-0.	-0.	0.	-0.	-0.	-0.	-0.000
0-SEMS 1A DRIFT											
X	-0.	-0.	0.	-0.	-0.	-0.	0.	-0.	-0.	-0.	-0.000
Y	0.	0.	0.	-0.	-0.	-0.	0.	-0.	-0.	-0.	-0.000
Z	0.	0.	0.	-0.	-0.	-0.	0.	-0.	-0.	-0.	-0.000
0-SEMS 0A DRIFT											
X	0.	0.	0.	-0.	-0.	-0.	0.	-0.	-0.	-0.	-0.000
Y	0.	0.	0.	-0.	-0.	-0.	0.	-0.	-0.	-0.	-0.000
Z	0.	0.	0.	-0.	-0.	-0.	0.	-0.	-0.	-0.	-0.000
0-50 SEN DRIFT											
X	-0.	-0.	0.	-0.	-0.	-0.	0.	-0.	-0.	-0.	-0.000
Y	0.	0.	0.	-0.	-0.	-0.	0.	-0.	-0.	-0.	-0.000
Z	0.	0.	0.	-0.	-0.	-0.	0.	-0.	-0.	-0.	-0.000
ACCEL BIAS											
X	0.	-0.	-0.	-0.	-0.	-0.	0.	-0.	-0.	-0.	-0.000
Y	-0.	-0.	0.	-0.	-0.	-0.	0.	-0.	-0.	-0.	-0.000
Z	-0.	-0.	0.	-0.	-0.	-0.	0.	-0.	-0.	-0.	-0.000
ACCEL SCALE FAC											
X	0.	0.	0.	-0.	-0.	-0.	0.	-0.	-0.	-0.	-0.000
Y	0.	0.	0.	-0.	-0.	-0.	0.	-0.	-0.	-0.	-0.000
Z	0.	0.	0.	-0.	-0.	-0.	0.	-0.	-0.	-0.	-0.000
ACCEL 1A ALINE											
-0A	-0.	-0.	0.	-0.	-0.	-0.	0.	-0.	-0.	-0.	-0.000
X	-0.	-0.	0.	-0.	-0.	-0.	0.	-0.	-0.	-0.	-0.000
Y	-0.	-0.	0.	-0.	-0.	-0.	0.	-0.	-0.	-0.	-0.000
Z	-0.	-0.	0.	-0.	-0.	-0.	0.	-0.	-0.	-0.	-0.000
ACCEL 1A ALINE											
-SA	-0.	-0.	0.	-0.	-0.	-0.	0.	-0.	-0.	-0.	-0.000
X	-0.	-0.	0.	-0.	-0.	-0.	0.	-0.	-0.	-0.	-0.000
Y	-0.	-0.	0.	-0.	-0.	-0.	0.	-0.	-0.	-0.	-0.000
Z	-0.	-0.	0.	-0.	-0.	-0.	0.	-0.	-0.	-0.	-0.000

TABLE A-1.1.2-11.- PRTLS RSS DATA AT SRB SEP FOR NOMINAL FIRST STAGE
(CONTINUED)

(A) ACTUAL MINUS NOMINAL STATE PARAMETERS

	U (FT)	V (FT)	W (FT)	U-DOT (FPS)	V-DOT (FPS)	W-DOT (FPS)	ALTITUDE (FT)	SPEED (FPS)	M-DOT (FPS)	DR-DOT (FPS)	GAMMA (DEG)
CG	0.	0.	0.	0.	0.	0.	0.	0.	0.	0.	0.000
X	0.	0.	0.	0.	0.	0.	0.	0.	0.	0.	0.000
Y	0.	0.	0.	0.	0.	0.	0.	0.	0.	0.	0.000
Z	0.	0.	0.	0.	0.	0.	0.	0.	0.	0.	0.000
PERFORMANCE											
WEB ACT	1959.	8572.	-4108.	-29.4	-42.3	.7	1961.	-51.5	-28.0	-43.2	.010
S ISP	-1222.	-1953.	-7.	-11.3	-39.6	.1	-1221.	-39.2	-11.6	-39.4	.168
S PROP	-301.	-492.	-2.	-3.3	-10.8	.1	-301.	-10.8	-3.4	-10.7	.043
S INERT	-269.	-411.	-4.	-3.7	-9.7	0.	-269.	-10.1	-3.7	-9.7	.031
O IMPST	-638.	-809.	-30.	-10.2	-20.1	-0.0	-638.	-22.4	-10.3	-20.0	.035
O ISP	41.	64.	0.	.9	1.9	0.	41.	2.1	.9	1.9	-.004
O INERT	-16.	-25.	0.	-.2	-.5	0.	-16.	-.6	-.2	-.6	.002
ET INERT	-17.	-26.	0.	-.2	-.6	0.	-17.	-.6	-.2	-.6	.002
ET OXID	-643.	-982.	-10.	-8.8	-23.2	.1	-643.	-24.1	-8.9	-23.1	.074
ET FUEL	-137.	-210.	-2.	-1.9	-4.9	0.	-137.	-5.1	-1.9	-4.9	.016
MIX RATIO	0.	0.	0.	0.	0.	0.	0.	0.	0.	0.	0.000
ATMOSPHERE											
COLD	318.	829.	-19.	5.7	20.2	-.3	318.	20.0	5.8	20.1	-.086
3-SIGMA RSS -	2536.	6948.	4108.	35.1	70.3	.8	2538.	77.0	34.2	70.7	.213

TABLE AN-1.2-11.- PRTLS RSS DATA AT SRB SEP FOR NOMINAL FIRST STAGE

(B) NAVIGATED MINUS ACTUAL STATE PARAMETERS

	U (FT)	V (FT)	W (FT)	U-DOY (FPS)	V-DOY (FPS)	W-DOY (FPS)	ALTIITUDE (FT)	SPEED (FPS)	M-DOY (FPS)	DR-DOY (FPS)	GAMMA (DEG)
PLATFORM ALINE											
AZIMUTH	9.	-24.	-252.	.2	-3	-5.4	9.	-2	-2	-3	-.005
TILT	-32.	93.	135.	-7	1.4	2.0	-32.	.7	-7	1.4	-.018
ROLL	48.	-140.	92.	1.1	-2.1	1.3	48.	-1.1	1.1	-2.0	.027
DRIFT BIAS											
X	1.	-0.	-3.	.0	-0	-1.1	1.	-0	-0	-0	-.000
Y	-1.	2.	4.	-0	-0	.1	-1.	-0	-0	-0	-.001
Z	2.	-3.	2.	.1	-1	.0	1.	-0	.1	-1	-.001
G-SENS IA DRIFT											
X	0.	-0.	-7.	-0	-0	-2	0.	-0	-0	-0	-.000
Y	-1.	2.	3.	-0	-0	.1	-1.	-0	-0	-0	-.001
Z	1.	-1.	1.	.0	-0	.0	1.	-0	.0	-0	-.001
G-SENS OA DRIFT											
X	-0.	-0.	-1.	-0	-0	-0	0.	-0	-0	-0	-.000
Y	-4.	7.	9.	-1	-1	.2	-4.	-0	-1	-1	-.002
Z	2.	-3.	2.	.1	-1	.0	1.	-0	.1	-1	-.001
G-SO SEN DRIFT											
X	1.	0.	-4.	-0	-0	-1	1.	-0	-0	-0	-.000
Y	-1.	1.	2.	-1	-0	.0	-1.	-0	-1	-0	-.001
Z	1.	-2.	1.	-0	-1	.0	1.	-0	.0	-1	-.001
ACCEL BIAS											
X	41.	-3.	-2.	.0	-1	.0	41.	3	-6	-1	-.007
Y	4.	35.	-23.	.1	.6	-4	4.	5	-1	-6	-.003
Z	0.	23.	35.	.0	.3	.5	1.	3	.0	-3	-.002
ACCEL SCALE FAC											
X	52.	-4.	2.	.7	-1	.0	52.	3	7	-1	-.008
Y	1.	17.	-11.	.0	.3	-2	1.	3	0	3	-.002
Z	-0.	5.	9.	.0	.1	.2	0.	.1	.0	.1	-.001
ACCEL IA ALINE											
-GA											
X	38.	-3.	1.	.0	-1	.0	38.	.4	-0	-1	-.009
Y	1.	16.	-10.	.0	.4	-2	1.	.3	-0	.4	-.002
Z	1.	52.	78.	.0	.7	1.1	1.	.6	.0	.7	-.005
ACCEL IA ALINE											
-SA											
X	19.	-2.	1.	.4	-0	.0	19.	2	.4	-0	-.005
Y	0.	70.	-51.	-1	1.2	-8	0.	1.0	-1	1.1	-.007
Z	0.	20.	31.	.0	.4	.7	1.	.4	.0	.4	-.003

TABLE AN-1.2-11.- PRTLS RSS DATA AT SRB SEP FOR NOMINAL FIRST STAGE
(CONTINUED)

(B) NAVIGATED MINUS ACTUAL STATE PARAMETERS

	U (FT)	V (FT)	W (FT)	U-DOT (FPS)	V-DOT (FPS)	W-DOT (FPS)	ALTIITUDE (FT)	SPEED (FPS)	M-DOT (FPS)	DR-DOT (FPS)	GAMMA (DEG)
CG											
X	0.	0.	0.	0.	0.	0.	0.	0.	0.	0.	0.000
Y	0.	0.	0.	0.	0.	0.	0.	0.	0.	0.	0.000
Z	0.	0.	0.	0.	0.	0.	0.	0.	0.	0.	0.000
PERFORMANCE											
MEB ACT	2.	4.	0.	.5	.9	.0	3.	1.1	.5	.9	-.001
S ISP	-1.	-0.	1.	-0.	-0.	0.	-1.	-0.	-0.	-0.	-.000
S PROP	1.	0.	-0.	-0.	0.	0.	1.	-0.	-0.	0.	-.001
S INERT	-1.	-0.	-0.	-0.	-0.	0.	-1.	-0.	-0.	-0.	-.000
O THRST	-1.	-1.	-0.	-0.	0.	0.	-1.	-0.	-0.	-0.	-.000
O ISP	0.	0.	-1.	0.	0.	0.	0.	0.	0.	0.	-.000
O INERT	0.	1.	0.	-0.	0.	0.	1.	0.	-0.	0.	-.000
ET INERT	-0.	0.	0.	0.	0.	0.	-0.	0.	0.	0.	-.000
ET OXID	1.	-0.	1.	-0.	-0.	0.	1.	-0.	-0.	-0.	-.000
ET FUEL	0.	-0.	-1.	0.	0.	0.	0.	0.	0.	0.	-.000
MIX RATIO	0.	0.	0.	-0.	0.	-0.	0.	0.	0.	0.	-.000
ATMOSPHERE											
COLD	-0.	-0.	-0.	-0.	0.	0.	0.	0.	-0.	0.	-.001
3-SIGMA RSS	98.	201.	320.	1.0	3.1	6.1	98.	2.3	1.9	3.1	.038

TABLE A-1.1.2-11.- PTTLS RSS DATA AT SRB SEP FOR NOMINAL FIRST STAGE

(C) ACTUAL MINUS NOMINAL VEHICLE PARAMETERS

	LATD (DEG)	LONG (DEG)	AZIM (DEG)	RANGE (MM)	TIME (SEC)	WEIGHT (LBS)	PROP (LBS)	OXID (LBS)	FUEL (LBS)
PLATFORM ALINE									
AZIMUTH	.000	.000	.000	.00	.00	0.	0.	0.	0.
TILT	.000	.000	.000	.00	.00	0.	0.	0.	0.
ROLL	.000	.000	.000	.00	.00	0.	0.	0.	0.
DRIFT BIAS									
X	.000	.000	.000	.00	.00	0.	0.	0.	0.
Y	.000	.000	.000	.00	.00	0.	0.	0.	0.
Z	.000	.000	.000	.00	.00	0.	0.	0.	0.
0-SENS 1A DRIFT									
X	.000	.000	.000	.00	.00	0.	0.	0.	0.
Y	.000	.000	.000	.00	.00	0.	0.	0.	0.
Z	.000	.000	.000	.00	.00	0.	0.	0.	0.
0-SENS 0A DRIFT									
X	.000	.000	.000	.00	.00	0.	0.	0.	0.
Y	.000	.000	.000	.00	.00	0.	0.	0.	0.
Z	.000	.000	.000	.00	.00	0.	0.	0.	0.
0-SQ SEC. DRIFT									
X	.000	.000	.000	.00	.00	0.	0.	0.	0.
Y	.000	.000	.000	.00	.00	0.	0.	0.	0.
Z	.000	.000	.000	.00	.00	0.	0.	0.	0.
ACCEL BIAS									
X	.000	.000	.000	.00	.00	0.	0.	0.	0.
Y	.000	.000	.000	.00	.00	0.	0.	0.	0.
Z	.000	.000	.000	.00	.00	0.	0.	0.	0.
ACCEL SCALE FAC									
X	.000	.000	.000	.00	.00	0.	0.	0.	0.
Y	.000	.000	.000	.00	.00	0.	0.	0.	0.
Z	.000	.000	.000	.00	.00	0.	0.	0.	0.
ACCEL 1A ALINE									
-0A	.000	.000	.000	.00	.00	0.	0.	0.	0.
X	.000	.000	.000	.00	.00	0.	0.	0.	0.
Y	.000	.000	.000	.00	.00	0.	0.	0.	0.
Z	.000	.000	.000	.00	.00	0.	0.	0.	0.
ACCEL 1A ALINE									
-5A	.000	.000	.000	.00	.00	0.	0.	0.	0.
X	.000	.000	.000	.00	.00	0.	0.	0.	0.
Y	.000	.000	.000	.00	.00	0.	0.	0.	0.
Z	.000	.000	.000	.00	.00	0.	0.	0.	0.

TABLE AN-1.2-11.- PRTLS RSS DATA AT SRB SEP FOR NOMINAL FIRST STAGE
(CONTINUED)

(C) ACTUAL MINUS NOMINAL VEHICLE PARAMETERS										
	LATD (DEG)	LONG (DEG)	AZIM (DEG)	RANGE (MM)	TIME (SEC)	WEIGHT (LBS)	PROP (LBS)	OYD (LBS)	FUEL (LBS)	
CG										
X	.000	.000	.000	.00	.00	0.	0.	0.	0.	0.
Y	.000	.000	.000	.00	.00	0.	0.	0.	0.	0.
Z	.000	.000	.000	.00	.00	0.	0.	0.	0.	0.
PERFORMANCE										
HEB ACT	.002	.005	.074	.20	5.92	-17804.	-17890.	-15341.	-2557.	
S ISP	.003	.005	.067	.32	.00	1.	1.	1.	0.	
S PROP	.001	.001	.010	.00	.00	10.	10.	0.	1.	
S INERT	.001	.001	.018	.07	.00	3067.	3067.	3.	1.	
O THRST	.001	.002	.035	.13	.00	2092.	2092.	2479.	413.	
O ISP	.000	.000	.003	.01	.00	-1153.	-1153.	-909.	-165.	
O INERT	.000	.000	.001	.00	.00	185.	0.	0.	0.	
ET INERT	.000	.000	.001	.00	.00	198.	0.	0.	0.	
ET OYD	.001	.003	.030	.16	.00	7385.	7385.	7384.	1.	
ET FUEL	.001	.001	.000	.03	.00	1571.	1571.	1571.	1560.	
MIX RATIO	.000	.000	.000	.00	.00	0.	0.	-675.	0.	
ATMOSPHERE										
COLD	.001	.002	.031	.14	.00	-142.	-142.	-122.	0.	
3-SIGMA RSS	.004	.008	.110	.50	5.92	10904.	10673.	17236.	3745	

TABLE AG.1.2-III.- PRILS BSS DATA AT ET SEP FOR SRE-OUT AT LIFTOFF

(A) ACTUAL MINUS NOMINAL STATE PARAMETERS

	U (FT)	V (FT)	W (FT)	U-DOT (FPS)	V-DOT (FPS)	W-DOT (FPS)	U-DOT (FPS)	V-DOT (FPS)	W-DOT (FPS)	ALITUDE (FT)	SPEED (FPS)	M-DOT (FPS)	DR-DOT (FPS)	AMMA (E-7)
PLATFORM ALIGN														
ALZIMUTH	-55.	-64.	-1109.	5.4	-5.3	-4.2	-5.3	5.3	5.3	-34.	-5.3	5.3	-5.3	-.47
Y	389.	-497.	1397.	2.8	8.4	13.7	8.4	8.4	2.8	349.	8.4	2.8	8.4	-.57
ROLL	-684.	-5427.	339.	-5.3	10.2	6.7	10.2	-6.4	-6.4	-483.	10.2	-6.4	10.2	-1.56
BRIEF BIAS														
X	6.	13.	41.	-.2	-.1	-.4	-.1	-.1	-.1	6.	-.1	-.2	-.1	-.002
Y	-73.	156.	284.	-1.8	1.9	2.8	1.9	1.9	-1.8	-73.	1.9	-1.8	1.9	-.016
Z	189.	-283.	126.	3.7	-4.0	1.2	-4.0	-4.0	3.7	150.	-4.0	3.7	-4.0	-.036
G-SERIES IA BRIEF														
X	-2.	-16.	34.	-.0	-.0	1.3	-.0	-.0	-.0	-1.	-.0	-.0	-.0	-.000
Y	-8.	73.	139.	-.8	1.0	1.1	1.0	1.0	-.8	-.8.	1.0	-.8	1.0	-.007
Z	7.	-31.	30.	1.0	-.9	-.2	-.9	-.9	7.	7.	-.9	1.0	-.9	-.009
G-SERIES OA BRIEF														
X	1.	-2.	-16.	-.2	-.2	-.2	-.2	-.2	1.	1.	-.2	-.2	-.2	-.002
Y	-107.	228.	449.	-3.7	3.7	4.4	3.7	3.7	-107.	-107.	3.7	-3.4	3.7	-.032
Z	31.	-97.	64.	2.1	-2.0	-.4	-2.0	-.4	31.	31.	-2.0	2.1	-2.0	-.018
G-SERIES SER BRIEF														
X	7.	3.	-34.	-.6	-.5	-.3	-.5	-.5	7.	7.	-.5	-.4	-.5	-.005
Y	-17.	23.	71.	-.6	-.7	-.7	-.7	-.7	-16.	-16.	-.7	-.6	-.7	-.015
Z	8.	-87.	33.	1.6	-1.3	-.2	-1.3	-.2	8.	8.	-1.6	1.6	-1.5	-.014
ACCEL BIAS														
X	-1323.	268.	10.	6.7	-6.6	-2.9	-6.6	-2.9	-1323.	-1323.	-6.0	6.4	-6.0	-.042
Y	-625.	592.	-294.	-6.6	7.0	-2.5	7.0	-2.5	-625.	-625.	7.0	-6.4	7.0	-.057
Z	124.	-371.	598.	11.5	-1.9	6.3	-1.9	6.3	124.	124.	-1.9	11.3	-1.9	-.100
ACCEL SCALE FAC														
X	-1234.	520.	105.	-.5	1.2	-.4	1.2	-.4	-1234.	-1234.	-1.2	-.5	-1.2	-.013
Y	-515.	-48.	-27.	-2.4	1.8	-.0	1.8	-.0	-515.	-515.	1.9	-2.4	1.8	-.022
Z	-26.	-87.	33.	-.7	-.5	-.1	-.5	-.1	-26.	-26.	-.5	-.7	-.5	-.006
ACCEL TR ALTIME														
X	-640.	172.	87.	-.1	1.0	-.2	1.0	-.2	-640.	-640.	-1.0	-.0	-1.0	-.000
Y	-97.	-170.	-8.	-2.1	1.3	-.1	1.3	-.1	-97.	-97.	1.6	-2.1	1.3	-.019
Z	82.	-569.	879.	10.8	-.2	7.2	-.2	7.2	82.	82.	-.2	10.6	-.2	-.094
ACCEL TA ALTIME														
X	-295.	62.	36.	-.4	-.1	-.1	-.1	-.1	-295.	-295.	-.1	-.4	-.1	-.004
Y	-354.	-220.	-473.	4.2	6.1	-6.7	6.1	-6.7	-354.	-354.	6.0	4.2	6.1	-.037
Z	-99.	-120.	180.	-3.6	2.7	-.9	-3.6	-.9	-99.	-99.	2.7	-3.6	2.7	-.030

TABLE A4.1.2-III.- PRTL5 RSS DATA AT ET SEP FOR SSME-OUT AT LIFT-OFF

(A) Actual minus nominal state parameters											
	U (FT)	V (FT)	W (FT)	U-BOOT (FPS)	V-BOOT (FPS)	W-BOOT (FPS)	ALTYTUDE (FT)	SPEED (FPS)	H-BOOT (FPS)	DR-BOOT (FPS)	ZAMMA (DEG)
CG	0.	0.	0.	0.	0.	0.	0.	0.	0.	0.	0.000
X	0.	0.	0.	0.	0.	0.	0.	0.	0.	0.	0.000
Y	0.	0.	0.	0.	0.	0.	0.	0.	0.	0.	0.000
Z	0.	0.	0.	0.	0.	0.	0.	0.	0.	0.	0.000
PERFORMANCE											
WBS ACT	156.	91286.	5141.	10.4	-374.2	-31.7	354.	-374.1	37.0	-374.1	.330
S ISP	-216.	19710.	890.	-10.0	-63.0	-3.1	-206.	-62.9	-4.0	-63.0	-.039
S PROP	197.	3759.	113.	11.8	-19.9	-2.1	198.	-19.9	13.0	-19.9	.114
S INERT	25.	1036.	-753.	3.3	2.3	-2.2	25.	2.3	3.7	2.3	.033
O THRST	-1333.	-7923.	-2172.	-69.2	56.3	27.0	-1331.	57.0	-71.7	56.3	-.627
O ISP	181.	522.	-228.	18.1	-8.2	-6.4	182.	-8.2	14.2	-8.2	.126
O INERT	173.	-400.	-76.	9.8	-3.4	-4.	173.	-3.3	9.7	-3.4	.086
ET INERT	163.	-387.	-72.	8.9	-3.0	-4.	163.	-3.0	8.8	-3.0	.078
ET OXID	-454.	1954.	-683.	-25.0	1.1	10.6	-433.	1.3	-24.4	1.1	-.216
ET FUEL	33.	601.	-218.	2.3	-6.1	-1.	34.	-6.1	2.4	-6.1	-.021
MIX RATIO	1.	4.	1.	-0.	0.	0.	1.	0.	-0.	0.	-.000
ATMOSPHERE											
COLD	79.	-8033.	-159.	1.9	30.8	.9	81.	30.7	-6	30.7	-.004
3-SIGMA RSS =	2701.	94254.	4225.	81.4	328.1	47.8	2717.	328.2	90.2	328.0	.794

TABLE 1A.1.2-III.- PARTS RSS DATA AT ET SEP FOR SSME-GUT AT LIFTOFF

(B) NAVIGATED MINUS ACTUAL STATE PARAMETERS

	U (FT)	V (FT)	W (FT)	U-DOT (FPS)	V-DOT (FPS)	W-DOT (FPS)	ALTITUDE (FT)	SPEED (FPS)	M-DOT (FPS)	DR-DOT (FPS)	GAMMA (DEG)
PLATFORM ALINE											
221MOUTH	136.	390.	2894.	-2	1.2	-5.8	156.	1.2	-1	1.2	-0.01
TILT	-310.	-1754.	-2992.	.9	-4.0	-7.3	-310.	-4.1	.3	-4.1	.003
ROLL	365.	3086.	-1728.	-2.1	6.9	-4.1	364.	6.9	-1.2	6.9	-0.010
DRIFT BIAS											
X	-2.	23.	-32.	-1	-1	-1.1	-2.	-1	-1	-1	-0.01
Y	51.	-247.	-453.	.7	-1.2	-1.9	51.	-1.0	.6	-1.0	.004
Z	-96.	880.	-254.	-1.3	1.7	-1.0	-96.	1.7	-1.1	1.7	-0.010
G-SENS IA DRIFT											
X	1.	35.	-16.	-1	-2	-1.7	0.	-2	-1	-2	-0.01
Y	-10.	-136.	-238.	0	-3	-4	-10.	-3	-0	-3	-0.00
Z	17.	113.	-64.	0	2	-2	17.	2	.1	2	.001
G-SENS OA DRIFT											
X	6.	7.	33.	0	0	-1	4.	0	0	0	.000
Y	57.	-617.	-755.	1.1	-1.6	-3.1	57.	-1.6	1.0	-1.6	.008
Z	10.	239.	-137.	-1	.6	-3	9.	.6	-0	.6	-0.00
G-SENS SEM DRIFT											
X	3.	12.	76.	0	0	0	3.	0	0	0	.000
Y	8.	-61.	-112.	2	-3	-3	7.	-3	-2	-3	.002
Z	25.	140.	-81.	1	.3	-1	24.	.3	.1	.3	.001
ACCEL BIAS											
X	1740.	258.	-75.	3.1	.7	-2	1739.	.7	5.1	.7	.046
Y	316.	-1196.	488.	1.0	-2.7	1.6	316.	-2.7	.6	-2.7	.006
Z	82.	-690.	-1221.	.3	-1.6	-2.8	82.	-1.6	.0	-1.6	.000
ACCEL SCALE FAC											
X	1375.	197.	-60.	4.1	.6	-2	1374.	.5	4.1	.6	.037
Y	64.	-206.	118.	0	.3	-2	64.	.3	0	.3	.000
Z	10.	-67.	-85.	-0	.2	.3	10.	.2	-0	.2	.000
ACCEL IA ALINE											
- OA											
X	654.	84.	-24.	.3	-1	-0	653.	-1	.3	-1	.002
Y	50.	-152.	67.	-0	.3	-3	50.	.3	-1	.3	.001
Z	111.	-972.	-1724.	.3	-2.4	-4.1	110.	-2.4	.0	-2.4	.000
ACCEL IA ALINE											
- SA											
X	284.	35.	-9.	-1	-1	0	285.	-1	-1	-1	.001
Y	446.	-1488.	968.	1.3	-4.0	2.4	446.	-4.0	.9	-4.0	.008
Z	29.	-217.	-364.	0	.3	.6	28.	.3	-0	.3	.000

TABLE A4.1.2-III.- Concluded

(B) Navigated minus actual state parameters

	U (FT)	V (FT)	W (FT)	U-DOT (FPS)	V-DOT (FPS)	W-DOT (FPS)	ALTITUDE (FT)	SPEED (FPS)	H-DOT (FPS)	DR-DOT (FPS)	GAMMA (DEG)
CG											
X	0.	0.	0.	0.	0.	0.	0.	0.	0.	0.	.000
Y	0.	0.	0.	0.	0.	0.	0.	0.	0.	0.	.000
Z	0.	0.	0.	0.	0.	0.	0.	0.	0.	0.	.000
PERFORMANCE											
WEB ACT	6.	2.	-1.	0.	0.	0.	0.	0.	0.	0.	-.000
S ISP	2.	4.	1.	-0.	-0.	-0.	2.	-0.	-0.	-0.	-.000
S PROP	3.	-7.	-2.	-0.	-0.	-0.	3.	-0.	-0.	-0.	-.000
S INERT	3.	-2.	0.	-0.	-0.	-0.	4.	-0.	-0.	-0.	.000
O THRST	-4.	5.	2.	-0.	-0.	-0.	-4.	-0.	-0.	-0.	.000
O ISP	3.	2.	-1.	-0.	-0.	-0.	3.	-0.	-0.	-0.	-.000
O INERT	4.	-3.	0.	-0.	-0.	-0.	1.	-0.	-0.	-0.	.000
ET INERT	-2.	1.	1.	-0.	-0.	-0.	-3.	-0.	-0.	-0.	.000
ET OXID	3.	2.	0.	-0.	-0.	-0.	0.	-0.	-0.	-0.	.000
ET FUEL	3.	-7.	-0.	-0.	-0.	-0.	4.	-0.	-0.	-0.	.000
MIX RATIO	-0.	1.	-0.	-0.	-0.	-0.	-1.	-0.	-0.	-0.	-.000
ATMOSPHERE											
COLD	5.	-0.	1.	-0.	-0.	-0.	5.	-0.	0.	-0.	.000
3-SIGMA BSS =	2433.	4365.	5226.	7.6	10.3	12.5	2452.	10.3	7.0	10.3	.062

TABLE AA.1.2-III.- PRTLS RSS DATA AT ET SEP FOR SSME-OUT AT LIFTOFF

(C) ACTUAL MINUS NOMINAL VEHICLE PARAMETERS

	LATD (DEG)	LONG (DEG)	AZIM (DEG)	RANGE (MM)	TIME (SEC)	WEIGHT (LBS)	PROP (LBS)	OXID (LBS)	FUEL (LBS)
PLATFORM ALINE									
AZIMUTH	.003	-.001	.039	.04	-.08	111	111	95	14.
TILT	-.003	.003	-.137	.05	.08	-229	-229	-196	-33.
ROLL	.003	.018	-.054	.90	-1.62	72	72	62	10.
DRIFT BIAS									
X	-.000	.000	-.009	-.00	-.00	3	3	2	0.
Y	-.001	-.000	-.028	-.03	.02	-27	-27	-23	-4.
Z	-.000	.001	-.016	.05	-.05	65	65	56	9.
G-SENS IA DRIFT									
X	-.000	.000	-.014	.00	.00	-3	-3	-2	-0.
Y	-.000	-.000	-.011	-.02	.02	-20	-20	-17	-3.
Z	-.000	.000	-.003	.01	-.01	20	20	17	3.
G-SENS OA DRIFT									
X	.000	-.000	.001	.00	-.00	3	3	3	0.
Y	-.001	-.000	-.046	-.05	.05	-61	-61	-52	-9.
Z	-.000	.000	-.006	.02	-.03	40	40	34	6.
G-SQ SEN DRIFT									
X	.000	-.000	.002	.00	-.01	9	9	8	1.
Y	-.000	-.000	-.007	-.01	.01	-13	-13	-11	-2.
Z	-.000	.000	-.003	.01	-.02	33	33	28	5.
ACCEL BIAS									
X	-.000	.004	.024	.14	-.03	32	32	27	5.
Y	.000	-.002	-.035	-.17	.09	-163	-163	-140	-23.
Z	-.001	.003	-.030	.10	-.05	-21	-21	-18	-3.
ACCEL SCALE FAC									
X	-.001	-.001	.003	-.08	-.03	40	40	34	6.
Y	.000	-.000	.002	.00	.04	-51	-51	-44	-7.
Z	-.000	.000	-.000	.00	.01	-16	-16	-14	-2.
ACCEL IA ALINE									
-OA									
X	-.000	-.000	.001	-.03	.00	-0	-0	-0	-0.
Y	-.000	-.000	-.000	.01	.03	-41	-41	-35	-9.
Z	-.002	.003	-.074	.00	-.04	-74	-74	-63	-11.
ACCEL IA ALINE									
-SA									
X	-.000	-.000	.001	-.01	.01	-14	-14	-12	-2.
Y	-.001	-.000	-.037	.03	.05	-195	-195	-167	-28.
Z	-.000	.000	-.006	.01	.05	-72	-72	-62	-10.

TABLE AA.1.2-III.- PARTS RSS DATA AT ET SEP FOR SSME-OUT AT LIFTOFF
(CONTINUED)

(C) ACTUAL MINUS NOMINAL VEHICLE PARAMETERS										
	LATD (DEG)	LONG (DEG)	AZIM (DEG)	RANGE (NM)	TIME (SEC)	WEIGHT (LBS)	PROP (LBS)	OXID (LBS)	FUEL (LBS)	
C6										
X	.000	.000	.000	.00	.00	0.	0.	0.	0.	0.
Y	.000	.000	.000	.00	.00	0.	0.	0.	0.	0.
Z	.000	.000	.000	.00	.00	0.	0.	0.	0.	0.
PERFORMANCE										
WED ACT	-.113	-.237	-.171	-14.95	.34	574.	-775.	-664.	-111.	
S ISP	-.024	-.038	-.072	-3.32	.54	-261.	-261.	-223.	-37.	
S PROP	-.004	-.009	-.006	-.31	.51	41.	9.	8.	1.	
S IMERT	.001	.004	.024	.22	-2.00	222.	322.	190.	32.	
O THRST	.014	.002	-.214	.43	4.43	-343.	-343.	-293.	-49.	
O ISP	-.000	.006	.042	.29	-1.92	-1446.	-1446.	-1240.	-207.	
O IMERT	.001	.001	-.001	.07	.02	123.	-62.	-53.	-9.	
ET IMERT	.001	.001	-.001	.04	.00	114.	-82.	-70.	-12.	
ET OXID	-.000	-.016	-.118	-.77	2.36	1153.	1158.	2346.	-882.	
ET FUEL	-.000	-.001	-.006	-.03	-.34	278.	288.	-1098.	1386.	
MIX RATIO	-.000	-.000	.000	.00	.00	-1.	-1.	-1084.	1082.	
ATMOSPHERE										
COLD	.009	.023	.039	1.33	-1.10	-128.	-128.	-110.	-18.	
J-SIGMA RSS =										
	.117	.266	.372	13.44	6.12	2072.	2132.	2977.	1986.	

TABLE AN.1.2-1V.- PRTLS RSS DATA AT ET SEP FOR SSME-OUT AT SRB SEP

(A) ACTUAL MINUS NOMINAL STATE PARAMETERS

	U (FT)	V (FT)	W (FT)	U-DOT (FPS)	V-DOT (FPS)	W-DOT (FPS)	ALTITUDE (FT)	SPEED (FPS)	M-DOT (FPS)	OR-DOT (FPS)	QAHMA (DEG)
PLATFORM ALINE											
AZIMUTH	-422.	649.	-1240.	-23.0	14.9	12.8	-422.	14.4	-22.5	14.9	-203
TILT	109.	1244.	1634.	-18.1	22.3	12.9	109.	21.9	-17.7	22.3	-162
ROLL	-407.	-58.	986.	1.0	-13.8	5.2	-407.	-13.8	1.0	-13.8	.011
DRIFT BIAS											
X	4.	2.	55.	-1.0	0	0.9	4.	0	-1.0	0	-0.000
Y	-72.	87.	223.	-1.2	1.2	2.2	-72.	1.1	-1.1	1.2	-0.002
Z	124.	-223.	114.	2.2	-2.4	1.0	124.	-2.4	2.1	-2.4	-0.019
0-SENS IA DRIFT											
X	5.	-42.	38.	0.3	-1.5	1.2	5.	-1.5	0.3	-1.5	-0.003
Y	-1.	65.	128.	-1.1	1.2	0.9	-1.	1.2	-1.1	1.2	-0.010
Z	-16.	-39.	34.	0.7	-0.8	0.1	-15.	-0.8	0.7	-0.8	-0.008
0-SENS OA DRIFT											
X	8.	1.	-21.	-1.3	0.2	-1.1	8.	0.2	-1.3	0.2	-0.003
Y	-77.	171.	375.	-2.5	2.6	3.6	-76.	2.6	-2.4	2.6	-0.022
Z	4.	-83.	71.	1.3	-1.5	0.2	4.	-1.5	1.3	-1.5	-0.012
0-SO SEN DRIFT											
X	-6.	15.	-43.	-1.2	0.2	-1.1	-6.	0.2	-1.2	0.2	-0.002
Y	-23.	20.	105.	-1.5	0.4	1.0	-22.	0.4	-1.5	0.4	-0.004
Z	-17.	-45.	47.	0.9	-1.0	0.1	-17.	-1.0	0.9	-1.0	-0.008
ACCEL BIAS											
X	-1624.	1199.	177.	-17.9	3.6	0.8	-1624.	3.2	-17.5	3.6	-0.157
Y	-400.	1406.	-248.	-14.7	17.0	-1.1	-399.	16.7	-14.3	17.0	-0.131
Z	-153.	316.	663.	-5.2	5.4	4.7	-153.	5.3	-5.1	5.4	-0.047
ACCEL SCALE FAC											
X	-1355.	1876.	236.	-24.1	13.0	1.3	-1355.	12.5	-23.5	13.0	-0.212
Y	-96.	17.	-59.	-2.3	1.8	0.2	-96.	1.7	-2.3	1.8	-0.021
Z	-22.	-1.	41.	0.7	0.6	-1.1	-22.	0.6	0.7	0.6	-0.007
ACCEL IA ALINE											
-DA											
X	-817.	263.	61.	-1.9	-1.1	-1.1	-816.	-1.1	-1.1	-1.1	-0.007
Y	-82.	-47.	-48.	-1.7	1.0	0.3	-81.	1.0	-1.7	1.0	-0.015
Z	-226.	1211.	1005.	-13.6	18.2	7.6	-226.	18.0	-13.2	18.2	-0.121
ACCEL IA ALINE											
-SA											
X	-292.	166.	37.	-1.9	0.1	-0.0	-291.	0.1	-1.9	0.1	-0.008
Y	-575.	1656.	-367.	-19.1	21.4	-2.0	-575.	21.0	-18.6	21.4	-0.170
Z	-71.	-57.	185.	-2.2	1.6	0.4	-71.	1.5	-2.2	1.6	-0.020

TABLE AN.1.2-IV.- PRILS RSS DATA AT ET SEP FOR SSME-OUT AT SRB SEP
(CONTINUED)

(A) ACTUAL MINUS NOMINAL STATE PARAMETERS

	U (FT)	V (FT)	W (FT)	U-DOT (FPS)	V-DOT (FPS)	W-DOT (FPS)	ALTITUDE (FT)	SPEED (FPS)	M-DOT (FPS)	DR-DOT (FPS)	QAMMA (DEG)
CG X	0.	0.	0.	0.	0.	0.	0.	0.	0.	0.	0.000
CG Y	0.	0.	0.	0.	0.	0.	0.	0.	0.	0.	0.000
CG Z	0.	0.	0.	0.	0.	0.	0.	0.	0.	0.	0.000
PERFORMANCE											
MEB ACT	-543.	31333.	6214.	-36.8	-81.7	-22.9	-518.	-82.4	-27.4	-81.8	-.231
S ISP	-21.	8388.	839.	-6.8	-10.9	-3.1	-20.	-11.1	-4.9	-11.0	-.041
S PROP	-180.	2696.	-223.	-11.8	5.8	-1.8	-180.	5.5	-11.0	5.7	-.099
J INERT	-5.	2066.	-334.	-2.0	2.1	-2.3	-4.	2.0	-1.3	2.1	-.012
O THRST	-259.	-3596.	1113.	-24.9	17.2	9.7	-259.	18.6	-26.0	17.2	-.235
O ISP	-179.	4908.	574.	-11.6	-3.9	-1.5	-179.	-4.1	-10.1	-3.9	-.089
O INERT	-182.	1119.	144.	-14.9	12.3	1.1	-182.	12.0	-14.6	12.3	-.132
ET INERT	-172.	1183.	151.	-19.6	12.7	1.2	-172.	12.4	-15.2	12.7	-.138
ET OXID	-461.	-864.	1054.	-31.1	13.2	6.3	-460.	12.6	-31.4	13.2	-.282
ET FUEL	-1.	246.	260.	-5.1	9.4	1.2	-1.	5.3	-5.1	9.4	-.046
MIX RATIO	-2.	12.	-0.	-1.2	.2	-0.	-1.	.2	-1.2	.2	-.002
ATMOSPHERE											
COLD	-61.	-617.	-502.	-4.4	10.0	-1.	-60.	9.9	-4.6	10.0	-.043
3-SIGMA RSS	2571.	33024.	7032.	79.8	99.6	31.3	2565.	99.5	74.9	99.7	.672

TABLE A4.1.2-1V.- PRTLS RSS DATA AT ET SEP FOR SSME-OUT AT SRB SEP

(B) NAVIGATED MINUS ACTUAL STATE PARAMETERS

	U (FT)	V (FT)	W (FT)	U-DOT (FPS)	V-DOT (FPS)	W-DOT (FPS)	ALTITUDE (FT)	SPEED (FPS)	H-DOT (FPS)	DR-DOT (FPS)	GAHNA (DEG)
PLATFORM ALINE											
AZIMU:M	132.	305.	2750.	-2	1.1	-6.0	132.	1.1	-1	1.1	-.001
TILT	-326.	-1470.	-2930.	.8	-3.8	-8.9	-326.	-3.7	.3	-3.8	-.004
ROLL	421.	2627.	-1453.	-2.0	8.5	-3.9	421.	8.5	-1.2	8.5	-.012
DRIFT BIAS											
X	-3.	18.	-70.	-1.1	.1	-1.0	-3.	.1	-1	.1	-.001
Y	59.	-177.	-336.	.6	-8.0	-1.6	59.	-8.0	.6	-8	-.005
Z	-110.	318.	-184.	-1.2	1.4	-.9	-110.	1.4	-1.1	1.4	-.010
0-SENS IA DRIFT											
X	-5.	26.	-36.	-1.1	.1	-1.5	-5.	.1	-1	.1	-.001
Y	-17.	-113.	-197.	.0	-2	-.5	-17.	-2	-0	-2	-.000
Z	29.	103.	-54.	.0	.2	-.1	29.	.2	.1	.2	-.000
0-SENS OA DRIFT											
X	4.	6.	40.	-1.0	.0	.1	4.	.0	-0	.0	-.000
Y	51.	-309.	-570.	.9	-1.3	-2.7	50.	-1.3	.8	-1.3	-.007
Z	31.	206.	-113.	-1.1	.5	-.3	30.	.5	-0	.5	-.000
0-SQ SEN DRIFT											
X	6.	11.	85.	-1.0	.1	.0	6.	.1	.0	.1	-.000
Y	14.	-87.	-161.	.3	-4	-.8	13.	-4	-2	-4	-.002
Z	36.	140.	-77.	.0	.3	-.2	35.	.3	.1	.3	-.001
ACCEL BIAS											
X	1421.	213.	-61.	4.4	.8	-1.2	1421.	.7	4.5	.8	.040
Y	253.	-1014.	579.	.9	-2.8	1.5	252.	-2.6	.5	-2.6	-.005
Z	82.	-580.	-1040.	.2	-1.5	-2.7	82.	-1.5	.0	-1.5	-.001
ACCEL SCALE FAC											
X	1124.	168.	-97.	3.6	.5	-.2	1124.	.6	3.6	.5	.032
Y	53.	-196.	108.	.8	4	-2.2	53.	4	-0	4	-.000
Z	9.	-46.	-84.	.8	.2	.3	9.	.2	-0	.2	-.000
ACCEL IA ALINE											
-0A	885.	78.	-22.	.1	-1	.0	885.	-1	-2	-1	-.001
X	48.	-151.	86.	-1	.8	-.3	47.	.8	-1	.8	-.001
Y	89.	-889.	-1460.	.3	-2.2	-3.8	88.	-2.2	.0	-2.2	-.001
Z											
ACCEL IA ALINE											
-5A	278.	32.	-10.	-1	-1	.0	278.	-1	-2	-1	-.002
X	360.	-1424.	812.	1.2	-3.8	2.2	360.	-3.8	.8	-3.8	-.008
Y	24.	-202.	-362.	-0	.4	.7	24.	.4	-1	.4	-.001
Z											

TABLE AN.1.2-1V.- PRTLS RSS DATA AT ET SEP FOR SSME-OUT AT SRB SEP
(CONTINUED)

(B) NAVIGATED MINUS ACTUAL STATE PARAMETERS											
	U (FT)	V (FT)	W (FT)	U-DOT (FPS)	V-DOT (FPS)	W-DOT (FPS)	ALTITUDE (FT)	SPEED (FPS)	M-DOT (FPS)	DR-DOT (FPS)	GAMMA (DEG)
CO	0.	0.	0.	0.	0.	0.	0.	0.	0.	0.	0.000
X	0.	0.	0.	0.	0.	0.	0.	0.	0.	0.	0.000
Y	0.	0.	0.	0.	0.	0.	0.	0.	0.	0.	0.000
Z	0.	0.	0.	0.	0.	0.	0.	0.	0.	0.	0.000
PERFORMANCE											
MEB ACT	9.	-4.	-1.	-0.0	-0.0	-0.0	9.	0.	-0.0	-0.0	-0.000
S ISP	-3.	1.	-1.	-0.0	-0.0	-0.0	-3.	-0.0	-0.0	-0.0	-0.000
S PROP	4.	0.	1.	-0.0	-0.0	-0.0	3.	0.	-0.0	0.	-0.000
S INERT	0.	3.	1.	-0.0	-0.0	-0.0	0.	-0.0	-0.0	-0.0	-0.000
O THRST	-6.	12.	2.	-0.0	-0.0	-0.0	-6.	-0.0	-0.0	-0.0	-0.000
O ISP	2.	4.	1.	-0.0	-0.0	-0.0	2.	0.	-0.0	0.	-0.000
O INERT	4.	3.	0.	-0.0	-0.0	-0.0	4.	-0.0	-0.0	0.	-0.000
ET INERT	2.	5.	0.	-0.0	-0.0	-0.0	2.	0.	-0.0	0.	-0.000
ET OXID	1.	3.	-0.	-0.0	-0.0	-0.0	0.	0.	-0.0	0.	-0.000
ET FUEL	3.	10.	2.	-0.0	-0.0	-0.0	3.	0.	0.	0.	-0.000
MIX RATIO	-1.	-1.	1.	-0.0	-0.0	-0.0	-1.	0.	0.	0.	-0.000
ATMOSPHERE											
COLD	1.	11.	2.	-0.0	-0.0	-0.0	1.	0.	-0.0	0.	-0.000

3-SIGMA RSS =	2064.	3703.	4585.	6.5	6.6	12.0	2063.	9.6	6.1	9.0	.055

TABLE A4.1.2-IV.- PRTLS RSS DATA AT ET SEP FOR SSME-OUT AT SRB SEP

(C) ACTUAL MINUS NOMINAL VEHICLE PARAMETERS

	LATO (DEG)	LONG (DEG)	AZIM (DEG)	RANGE (NM)	TIME (SEC)	WEIGHT (LBS)	PROP (LBS)	OXID (LBS)	FUEL (LBS)
PLATFORM ALINE									
AZIMUTH	.001	-.007	.006	-.31	.25	-245.	-245.	-210.	-35.
TILT	-.005	-.003	-.116	-.27	.29	-385.	-385.	-330.	-55.
ROLL	-.002	.002	-.071	.02	-.11	236.	236.	202.	34.
DRIFT BIAS									
X	-.000	.000	-.010	-.00	.00	-2.	-2.	-1.	0.
Y	-.001	.000	-.022	-.02	.01	-8.	-8.	-7.	-1.
Z	-.000	.001	-.013	.04	-.02	26.	26.	22.	4.
0-SENS 1A DRIFT									
X	-.000	.000	-.013	.01	-.01	0.	0.	7.	1.
Y	-.000	-.000	-.008	-.01	.01	-18.	-18.	-18.	-3.
Z	-.000	.000	-.001	.01	-.01	13.	13.	11.	2.
0-SENS 0A DRIFT									
X	.000	-.000	.002	-.00	.00	-2.	-2.	-2.	0.
Y	-.001	-.000	-.036	-.04	.02	-28.	-28.	-24.	-4.
Z	-.000	.000	-.004	.02	-.02	22.	22.	19.	3.
0-SQ SEN DRIFT									
X	.000	-.000	.002	-.00	.00	-4.	-4.	-3.	-1.
Y	-.000	.000	-.010	-.00	.00	-1.	-1.	0.	0.
Z	-.000	.000	-.002	.01	-.01	16.	16.	14.	2.
ACCEL BIAS									
X	-.002	-.004	-.004	-.21	.07	-1.	-1.	-1.	0.
Y	-.001	-.005	.029	-.27	.24	-327.	-327.	-280.	-47.
Z	-.002	-.000	-.046	-.07	.07	-81.	-81.	-78.	-13.
ACCEL SCALE FAC									
X	-.003	-.006	-.002	-.35	.21	-195.	-195.	-167.	-20.
Y	.000	-.000	-.000	-.01	.03	-35.	-35.	-30.	-5.
Z	-.000	.000	.001	-.00	.01	-13.	-13.	-11.	-2.
ACCEL 1A ALINE									
- 0A									
X	-.000	-.001	.001	-.04	.01	-11.	-11.	-9.	-2.
Y	.000	.000	-.002	.00	.02	-22.	-22.	-19.	-3.
Z	-.004	-.003	-.066	-.25	.23	-316.	-316.	-271.	-45.
ACCEL 1A ALINE									
- SA									
X	-.000	-.000	.000	-.03	.02	-21.	-21.	-18.	-3.
Y	-.001	-.006	.042	-.32	.30	-405.	-405.	-347.	-58.
Z	-.000	.000	-.003	.00	.02	-28.	-28.	-24.	-4.

TABLE AN-1.1.2-IV.- PARTS RSS DATA AT ET SEP FOR SSME-OUT AT SRB SEP
(CONTINUED)

(C) ACTUAL MINUS NOMINAL VEHICLE PARAMETERS

	LATD (DEG)	LONG (DEG)	AZIM (DEG)	RANGE (NM)	TIME (SEC)	WEIGHT (LBS)	PROP (LBS)	OXID (LBS)	FUEL (LBS)
CO									
X	.000	.000	.000	.00	.00	0.	0.	0.	0.
Y	.000	.000	.000	.00	.00	0.	0.	0.	0.
Z	.000	.000	.000	.00	.00	0.	0.	0.	0.
PERFORMANCE									
HEB ACT	.049	.009	.107	-5.46	1.04	-276.	-276.	-237.	-39.
S ISP	.009	.017	.010	-1.01	-.23	134.	134.	115.	19.
S PROP	.002	.002	.021	-.16	-1.40	-205.	-205.	-244.	-41.
S INERT	.001	.000	.024	-.03	-1.55	-247.	-247.	-212.	-35.
O THRST	.001	.008	-.079	-.34	4.70	107.	107.	91.	15.
O ISP	.007	.015	-.008	-.07	.35	-2028.	-2028.	-1739.	-290.
O INERT	.002	.004	-.001	-.24	.27	-182.	-182.	-314.	-52.
ET INERT	.002	.004	-.001	-.25	.20	-301.	-301.	-327.	-54.
ET OXID	.001	.010	-.051	-.52	3.34	1207.	1207.	2157.	-870.
ET FUEL	.001	.004	-.008	-.19	.76	193.	193.	-1179.	1372.
MIX RATIO	.000	.000	.001	-.00	.00	-2.	-2.	-1082.	1080.
ATMOSPHERE									
COLD	.002	.005	.013	.30	-1.00	-260.	-260.	-223.	-37.
3-SIOWA RSS *	.052	.004	.228	5.73	0.53	2022.	2003.	3344.	1078.

TABLE AN.1.1-2-V.- PRILS RSS DATA AT ET SEP FOR LAST TWO-ENGINE RTLS

(A) ACTUAL MINUS NOMINAL STATE PARAMETERS

	U (FT)	V (FT)	W (FT)	U-DOT (FPS)	V-DOT (FPS)	W-DOT (FPS)	ALTI.UDE (FT)	SPEED (FPS)	W-DOT (FPS)	DR-DOT (FPS)	GAMMA (DEG)
PLATFORM ALINE											
AZIMUTH	-111.	-105.	-2551.	1.4	-2.5	6.1	-111.	-2.3	1.4	-2.3	-0.13
TILT	634.	153.	1487.	15.0	-3	6.2	634.	.3	15.0	-3	.143
ROLL	-346.	-812.	1040.	2.5	-6.2	4.3	-346.	-8.1	2.2	-6.2	.022
DRIFT BIAS											
X	0.	0.	22.	.2	-.2	1.0	0.	-.2	.2	-.2	-.002
Y	-46.	106.	166.	-.5	.7	1.5	-45.	.6	-.5	.7	-.005
Z	81.	-161.	94.	1.2	-1.4	.8	81.	-1.3	1.1	-1.4	-.011
G-SEMS IA DRIFT											
X	4.	-10.	-29.	.1	-.2	1.4	4.	-.1	.1	-.2	-.001
Y	31.	67.	103.	.2	.1	.4	31.	.2	.2	.1	-.002
Z	-22.	-35.	37.	.1	-.3	.1	-22.	-.3	.1	-.3	-.001
G-SEMS OA DRIFT											
X	-3.	19.	-37.	-.3	.3	-.1	-3.	.3	-.3	.3	-.003
Y	-21.	178.	296.	-.8	1.3	2.4	-20.	1.3	1.3	1.3	-.008
Z	-30.	-88.	69.	.3	-.6	.2	-30.	-.6	.3	-.6	-.008
G-SO SEM DRIFT											
X	0.	-1.	-83.	.3	-.2	.1	0.	-.2	.3	-.2	-.003
Y	-36.	76.	123.	-.5	.6	1.1	-36.	.6	-.5	.6	-.005
Z	-31.	-64.	50.	.0	-.3	.1	-31.	-.3	.0	-.3	-.000
ACCEL BIAS											
X	-1071.	-148.	64.	-3.0	-.7	.1	-1071.	-.8	-3.0	-.7	-.035
Y	81.	-137.	-438.	14.0	-1.1	-3.0	81.	-5.	14.0	-1.1	.127
Z	243.	-364.	560.	16.0	-3.3	1.8	243.	-2.7	15.9	-3.3	.145
ACCEL SCALE FAC											
X	-844.	-125.	47.	-3.1	-.9	.1	-844.	-.6	-3.1	-.9	-.028
Y	-50.	-21.	-110.	-.7	.7	.4	-50.	.7	-.7	.7	-.007
Z	-12.	-12.	82.	-.4	.4	-.3	-12.	.4	-.4	.4	-.003
ACCEL IA ALINE											
-SA	-226.	-726.	-27.	15.0	-4.0	-1.2	-225.	-4.2	14.7	-4.0	.135
X	-60.	-52.	-188.	-1.0	1.0	.6	-60.	.8	-1.1	1.0	-.010
Y	201.	-232.	853.	14.6	-1.4	3.3	201.	-.8	14.5	-1.4	.132
ACCEL IA ALINE											
-SA	31.	-684.	-55.	16.4	-5.4	-1.4	32.	-4.8	16.2	-5.4	.149
X	-21.	34.	-599.	11.9	1.3	-3.6	-21.	1.8	11.9	1.3	.107
Y	-46.	-41.	314.	-1.3	1.3	-.5	-46.	1.3	-1.3	1.3	-.013

TABLE AN-1.2-V-1 - PRILS RSS DATA AT ET SEP FOR LAST TWO-ENGINE RILS
(CONTINUED)

(A) ACTUAL MINUS NOMINAL STATE PARAMETERS

CO	U (FT)	V (FT)	W (FT)	U-DOT (FPS)	V-DOT (FPS)	W-DOT (FPS)	ALTITUDE (FT)	SPEED (FPS)	M-DOT (FPS)	DR-DOT (FPS)	DAMMA (DEG)
PERFORMANCE											
W/B ACT	-446	43698	6908	-38.5	-120.5	-88.1	-400	-121.2	-25.7	-120.3	-.193
S ISP	186	17206	-38	-5.1	-53.0	-9.4	13	-53.2	.0	-53.2	.020
S PROP	149	3851	-122	13.0	-22.4	-2.7	186	-22.4	14.2	-23.5	.137
S INERT	-41	3506	-118	11.0	-21.2	-2.5	149	-20.8	12.0	-21.3	.117
O THRST	138	16678	2641	-20.7	-57.0	-3.2	-34	-57.7	-15.8	-57.2	-.124
O ISP	255	-782	-780	12.0	2.2	.4	138	2.6	11.8	2.2	.106
O INERT	246	2	-21	13.1	-5.5	-1.1	255	-4.9	13.1	-5.5	.121
ET INERT	-265	-2	-24	12.9	-5.7	-1.2	246	-5.2	12.9	-5.7	.119
ET OXID	256	14953	1499	-29.4	-37.1	-1.7	-259	-38.2	-24.9	-37.3	-.213
ET FULL	2	2629	239	11.1	-14.6	-1.6	256	-14.2	11.2	-14.7	.113
MIX RATIO				.0	-.0	-.0	2	-.0	.0	-.0	.000
ATMOSPHERE											
COLD	147	-8718	-10	8.5	25.1	2.0	149	25.5	8.8	25.3	.053
3-SIGMA RSS	1771	53106	8403	73.3	154.9	88.2	1758	155.8	84.1	155.0	.563

TABLE AN-1.2-V.- PRILS RSS DATA AT ET SEP FOR LAST TWO-ENGINE RTLS

(B) NAVIGATED MINUS ACTUAL STATE PARAMETERS

	U (FT)	V (FT)	W (FT)	U-DOT (FPS)	V-DOT (FPS)	W-DOT (FPS)	ALTITUDE (FT)	SPEED (FPS)	M-DOT (FPS)	DR-DOT (FPS)	GAMMA (DEG)
PLATFORM ALINE											
AZIMUTH	120.	243.	2549.	-1.3	1.1	-6.2	120.	1.1	-2	1.1	-.002
TILT	-329.	-1277.	-1949.	1.0	-3.7	-6.2	-329.	-3.7	0	-3.7	-.007
ROLL	400.	2047.	-1254.	-1.9	5.0	-3.9	400.	5.7	-1.3	5.0	-.014
DRIFT BIAS											
X	-5.	10.	-60.	-1.1	-1	-1.0	-5.	-1	-1	-1	-.001
Y	49.	-120.	-219.	0	-7	-1.3	49.	-7	-7	-7	-.006
Z	-80.	207.	-132.	-1.0	1.1	-1.0	-80.	1.1	-5	1.1	-.009
G-SENS IA DRIFT											
X	-2.	10.	11.	-1.1	-1	-1.4	-2.	-1	-1	-1	-.001
Y	-30.	-80.	-136.	-0	-2	-3	-29.	-2	-0	-2	-.009
Z	20.	70.	-47.	1.1	-1	-1.1	20.	1	1	1	-.001
G-SENS OA DRIFT											
X	2.	3.	41.	0	0	0	2.	0	0	0	-.000
Y	23.	-23.	-303.	0	-1.2	-2.1	23.	-1.1	0	-1.2	-.008
Z	37.	145.	-80.	0	-1.3	-1.2	36.	1.3	1	1.3	-.000
G-SENS SEM DRIFT											
X	0.	0.	81.	0	0	0	0.	0	0	0	-.000
Y	30.	-94.	-163.	5	-5	-1.0	30.	-5	5	-5	-.005
Z	34.	105.	-62.	0	-2	-1.1	34.	2	1	1.2	-.001
ACCEL BIAS											
X	1077.	162.	-48.	3.7	5	-2	1077.	7	3.7	5	-.034
Y	103.	-706.	496.	7	-2.3	1.5	103.	-2.3	5	-2.3	-.005
Z	50.	-486.	-800.	2	-1.5	-2.4	50.	-1.5	1	-1.5	-.001
ACCEL SCALE FAC											
X	054.	120.	-37.	3.0	0	-2	054.	5	3.1	0	-.020
Y	44.	-189.	100.	0	0	-2	43.	0	0	0	-.001
Z	4.	-53.	-86.	0	-2	-3	0.	2	-0	-2	-.000
ACCEL IA ALINE											
-OA											
X	400.	60.	-20.	-1	-1	0	400.	-1	-0	-1	-.000
Y	42.	-149.	100.	-0	0	-0	42.	0	-1	0	-.001
Z	73.	-600.	-1127.	3	-2.2	-3.5	73.	-2.2	1	-2.2	-.002
ACCEL IA ALINE											
-SA											
X	263.	36.	-0.	-3	-1	0	263.	-1	-3	-1	-.002
Y	263.	-1107.	600.	1.1	-3.2	2.2	263.	-3.2	7	-3.2	-.000
Z	24.	-191.	-314.	0	0	-0	23.	0	-0	0	-.001

TABLE AN.1.2-V.- PRTLS RSS DATA AT ET SEP FOR LAST TWO-ENGINE RPLS
(CONTINUED)

(B) NAVIGATED MINUS ACTUAL STATE PARAMETERS												
	U (FT)	V (FT)	W (FT)	U-DOT (FPS)	V-DOT (FPS)	W-DOT (FPS)	ALTITUDE (FT)	SPEED (FPS)	H-DOT (FPS)	DP-DOT (FPS)	GAMMA (DEG)	
CG	0.	0.	0.	0.	0.	0.	0.	0.	0.	0.	0.	0.000
X	0.	0.	0.	0.	0.	0.	0.	0.	0.	0.	0.	0.000
Y	0.	0.	0.	0.	0.	0.	0.	0.	0.	0.	0.	0.000
Z	0.	0.	0.	0.	0.	0.	0.	0.	0.	0.	0.	0.000
PERFORMANCE												
MEB ACT	6.	1.	1.	0.	0.	0.	6.	0.	0.	0.	0.	0.000
S ISP	-5.	2.	0.	0.	0.	0.	-4.	0.	0.	0.	0.	-0.000
S PROP	-2.	-1.	-1.	0.	0.	0.	-2.	0.	0.	0.	0.	-0.000
S INERT	-1.	-2.	-1.	0.	0.	0.	-1.	0.	0.	0.	0.	-0.000
O THRST	-4.	6.	1.	0.	0.	0.	-4.	0.	0.	0.	0.	-0.000
O ISP	0.	4.	2.	0.	0.	0.	0.	0.	0.	0.	0.	0.000
O INERT	1.	2.	0.	0.	0.	0.	1.	0.	0.	0.	0.	0.000
ET INERT	-0.	1.	2.	0.	0.	0.	-0.	0.	0.	0.	0.	0.000
ET OXID	-3.	6.	0.	0.	0.	0.	-3.	0.	0.	0.	0.	0.000
ET FUEL	1.	8.	2.	0.	0.	0.	1.	0.	0.	0.	0.	0.000
MIX RATIO	-1.	-1.	-0.	0.	0.	0.	-1.	0.	0.	0.	0.	0.000
ATMOSPHERE												
COLD	-2.	8.	2.	0.	0.	0.	-3.	0.	0.	0.	0.	-0.000
3-SIGMA RSS	1622.	2960.	3857.	5.6	8.8	11.3	1621.	8.7	5.3	8.8	0.049	

TABLE A4.1.2-V.- PRTLS RSS DATA AT ET SEP FOR LAST TWO-ENGINE RTLS

(C) ACTUAL MINUS NOMINAL VEHICLE PARAMETERS

	LATD (DEG)	LONG (DEG)	AZIM (DEG)	RANGE (NM)	TIME (SEC)	WEIGHT (LBS)	PROP (LBS)	OXID (LBS)	FUEL (LBS)
PLATFORM ALINE									
AZIMUTH	.006	-.003	-.073	.04	-.02	28.	28.	24.	4.
TILT	-.004	.002	-.068	-.03	-.06	-34.	-34.	-29.	-5.
ROLL	-.001	.004	-.053	.14	.00	-0.	-0.	-0.	-0.
DRIFT BIAS									
X	-.000	.000	-.011	.00	-.00	3.	3.	3.	0.
Y	-.001	-.000	-.015	-.02	.00	-1.	-1.	-1.	-0.
Z	-.000	.001	-.011	.03	-.01	8.	8.	7.	1.
G-SENS 1A DRIFT									
X	.000	-.000	-.019	.00	-.00	1.	1.	1.	0.
Y	-.000	-.000	-.004	-.01	-.00	0.	0.	0.	0.
Z	-.000	.000	-.001	.01	-.00	1.	1.	1.	0.
G-SENS 0A DRIFT									
X	.000	-.000	.001	-.00	.01	-7.	-7.	-6.	-1.
Y	-.001	-.000	-.025	-.03	.00	-5.	-5.	-4.	-1.
Z	-.000	.000	-.003	.01	-.00	4.	4.	3.	1.
G-50 SEC. DRIFT									
X	.000	-.000	-.001	.00	-.00	3.	3.	2.	0.
Y	-.000	-.000	-.012	-.01	.00	-3.	-3.	-2.	-0.
Z	-.000	.000	-.002	.01	.00	-1.	-1.	-1.	-0.
ACCEL BIAS									
X	.000	.000	-.001	.02	.01	-8.	-8.	-7.	-1.
Y	.001	-.000	.031	.03	-.03	-75.	-75.	-64.	-11.
Z	-.001	.002	-.021	.07	-.06	-35.	-35.	-30.	-5.
ACCEL SCALE FAC									
X	.000	.000	-.001	.02	.00	-5.	-5.	-4.	-1.
Y	.000	-.000	-.003	.00	.01	-18.	-18.	-16.	-3.
Z	-.000	.000	-.004	-.00	.01	-8.	-8.	-8.	-1.
ACCEL 1A ALINE									
- OA									
X	.001	.002	.009	.13	-.04	-56.	-56.	-48.	-8.
Y	.000	-.000	-.005	.01	.02	-24.	-24.	-20.	-3.
Z	-.002	.002	-.037	.04	-.04	-67.	-67.	-58.	-10.
ACCEL 1A ALINE									
- SA									
X	.001	.002	.009	.12	-.06	-29.	-29.	-25.	-4.
Y	.001	-.001	.041	.00	-.01	-107.	-108.	-92.	-15.
Z	-.001	.000	.008	.00	.02	-27.	-27.	-23.	-4.

TABLE AN.1.2-V.- PPILS RSS DATA AT ET SEP FOR LAST TWO-ENGINE RTLS
(CONTINUED)

(C) ACTUAL MINUS NOMINAL VEHICLE PARAMETERS

	LATD (DEG)	LONG (DEG)	AZIM (DEG)	RANGE (NM)	TIME (SEC)	WEIGHT (LBS)	PROP (LBS)	OXID (LBS)	FUEL (LBS)
CG									
X	.000	.000	.000	.00	.00	0.	0.	0.	0.
Y	.000	.000	.000	.00	.00	0.	0.	0.	0.
Z	.000	.000	.000	.00	.00	0.	0.	0.	0.
PERFORMANCE									
HEB PCT	-.070	-.108	-.764	-6.92	-1.29	3228.	3228.	2767.	461.
S ISP	-.021	-.044	-.051	-2.61	-1.01	2049.	2049.	1757.	203.
S PROP	-.004	-.009	-.007	-.55	-.41	681.	681.	563.	97.
S INERT	-.004	-.008	-.006	-.50	-.38	630.	630.	540.	90.
O THRST	-.027	-.060	-.067	-3.47	3.92	3503.	3503.	3003.	500.
O ISP	-.003	-.007	-.008	.40	-1.43	-1668.	-1668.	-1430.	-238.
O INERT	-.000	-.000	-.006	.00	-.01	90.	-95.	-81.	-14.
ET INERT	-.000	-.000	-.006	.00	-.02	104.	-94.	-81.	-13.
ET OXID	-.022	-.048	-.055	-2.81	1.97	3587.	3587.	4128.	-541.
ET FUEL	-.004	-.002	-.005	-.49	-.32	788.	788.	-669.	1457.
MIX RATIO	-.000	-.000	.000	.00	-.00	1.	1.	-1087.	1087.
ATMOSPHERE									
COLD	.011	.023	.026	1.34	.43	-1070.	-1070.	-917.	-153.
3-SIGMA RSS =	.062	.142	.783	8.80	4.96	6724.	6724.	6479.	2061.

TABLE AN.1.2-VI.- PRTL5 RSS DATA AT ET SEP FOR LAST THREE-ENGINE RTLS

(A) ACTUAL MINUS NOMINAL STATE PARAMETERS

	U (FT)	V (FT)	W (FT)	U-DOT (FPS)	V-DOT (FPS)	W-DOT (FPS)	ALTITUDE (FT)	SPEED (FPS)	H-DOT (FPS)	DR-DOT (FPS)	GAMMA (DEG)
PLATFORM ALINE											
AZIRUTH	-432.	604.	-2276.	-15.9	0.6	3.4	-432.	0.0	-15.7	0.5	-1.48
TILT	220.	500.	1442.	-5.5	9.2	7.8	220.	9.0	-5.3	9.2	-0.52
ROLL	-616.	-408.	1010.	-10.1	-1.0	3.2	-616.	-2.2	-10.3	-1.0	-0.94
DRIFT BIAS											
X	-0.	18.	26.	-2	.3	.9	-1.	.3	-2	.3	-.002
Y	-45.	104.	154.	-9	1.2	1.4	-46.	1.2	-9	1.2	-.009
Z	71.	-118.	87.	.7	-9	.0	71.	-9	.7	-9	.007
G-SENS IA DRIFT											
X	0.	17.	-26.	-2	.3	1.1	1.	.3	-2	.3	-.002
Y	16.	56.	97.	-5	.7	.4	16.	.7	-5	.7	-.005
Z	-24.	-42.	34.	.1	-4	.1	-24.	-4	.1	-4	.001
G-SENS OA DRIFT											
X	-5.	23.	-33.	-4	.5	-1	-5.	.4	-4	.5	-.004
Y	-24.	143.	270.	-1.2	1.7	2.2	-24.	1.6	-1.2	1.7	-.011
Z	-28.	-74.	65.	.4	-9	.2	-29.	-9	.4	-9	.004
O-SO SEM DRIFT											
X	-5.	1.	-66.	-1	-1	1	-5.	-1	-1	-1	-.001
Y	-36.	48.	112.	-3	.3	1.1	-36.	.3	-3	.3	-.003
Z	-19.	-52.	48.	.3	-8	.2	-19.	-8	.3	-8	.003
ACCEL BIAS											
X	-1047.	-210.	29.	-5.3	1.2	-1	-1047.	1.0	-5.4	1.2	-.050
Y	-315.	1017.	-329.	-14.4	22.6	-2.2	-315.	22.0	-14.1	22.5	-.137
Z	-146.	45.	580.	-5.1	6.0	3.2	-146.	5.0	-5.0	6.0	-.049
ACCEL SCALE FAC											
X	-835.	-217.	18.	-4.5	.9	.2	-835.	.8	-4.5	.9	-.042
Y	-102.	-112.	-132.	-2.9	2.8	.4	-102.	2.7	-2.9	2.8	-.028
Z	-30.	-58.	67.	-1.1	1.1	-2	-30.	1.1	-1.1	1.1	-.011
ACCEL IA ALINE											
-OA											
X	-596.	549.	63.	-12.6	18.2	-6	-596.	17.8	-12.5	18.2	-.121
Y	-101.	-143.	-133.	-3.1	3.0	.5	-101.	2.9	-3.2	3.0	-.030
Z	-189.	931.	887.	-12.9	21.3	4.1	-189.	20.8	-12.6	21.3	-.123
ACCEL 1A ALINE											
-SA											
X	-330.	-159.	-5.	-4.1	3.7	-0	-330.	3.6	-4.2	3.7	-.040
Y	-447.	708.	-534.	-14.2	19.7	-2.7	-447.	19.2	-14.0	19.7	-.136
Z	-89.	-173.	245.	-3.3	3.4	-2	-89.	3.3	-3.4	3.4	-.032

TABLE 44.1.2-VI.- PRTLS RSS DATA AT ET SEP FOR LAST THREE-ENGINE RTLS
(CONTINUED)

(A) ACTUAL MINUS NOMINAL STATE PARAMETERS

	U (FT)	V (FT)	W (FT)	U-DOT (FPS)	V-DOT (FPS)	M-DOT (FPS)	ALTITUDE (FT)	SPEED (FPS)	H-DOT (FPS)	DR-DOT (FPS)	GAMMA (DEG)
CG											
X	0.	0.	0.	0	0	0	0.	0	0	0	0.000
Y	0.	0.	0.	0	0	0	0.	0	0	0	0.000
Z	0.	0.	0.	0	0	0	0.	0	0	0	0.000
PERFORMANCE											
WEB ACT	-511.	20846.	7534.	-24.1	-83.8	-12.3	-499.	-84.5	-18.1	-83.9	-142
S ISP	-145.	1885.	-1284.	-9.2	10.3	3.8	-145.	9.9	-8.6	10.2	-0.083
S PROP	-90.	4829.	1736.	-5.9	-15.6	.5	-90.	-15.8	-4.5	-15.7	-0.36
S INERT	-170.	4355.	1739.	-10.0	-10.8	.7	-170.	-11.2	-8.7	-10.9	-0.77
O THRST	-202.	-5989.	2851.	-18.9	14.8	6.4	-200.	14.1	-20.6	14.8	-1.95
O ISP	-216.	-800.	-849.	-7.7	19.0	1.9	-216.	18.7	-8.0	19.0	-0.80
O INERT	-34.	651.	95.	-2.2	1.7	-6	-34.	-8	-2.1	-7	-0.17
ET INERT	-36.	692.	100.	-2.3	1.8	-.7	-36.	-9	-2.1	-8	-0.20
ET OXID	-225.	-1874.	960.	-16.3	12.4	2.3	-225.	11.8	-16.8	12.4	-1.59
ET FUEL	-49.	2684.	1919.	-4.1	-12.9	1.1	-49.	-13.0	-3.3	-12.9	-0.66
MIX RATIO	-3.	14.	1.	-1.4	.3	-0	-3.	.3	-1.4	.3	-0.004
ATMOSPHERE											
COLD	-330.	-4839.	1603.	-17.6	16.8	16.3	-329.	16.2	-19.0	16.8	-181
3-SIGMA RSS	1959.	23573.	9525.	55.3	102.9	24.8	1956.	102.8	53.5	103.1	.500

TABLE AN.1.2-VI.- PRILS RSS DATA AT ET SEP FOR LAST THREE-ENGINE RTLS

(B) NAVIGATED MINUS ACTUAL STATE PARAMETERS

	U (FT)	V (FT)	W (FT)	U-DOT (FPS)	V-DOT (FPS)	W-DOT (FPS)	ALITUDE (FT)	SPEED (FPS)	M-DOT (FPS)	DR-DOT (FPS)	GAMMA (DEG)
PLATFORM ALINE											
AZIMUTH	125.	183.	2450.	-2	1.0	-6.1	125.	1.0	-1	1.0	-.002
TILT	-311.	-1158.	-1906.	.9	-3.4	-6.1	-310.	-3.4	.6	-3.4	-.006
ROLL	395.	1998.	-1133.	-1.9	5.8	-3.6	394.	5.7	-1.3	5.8	-.014
DRIFT BIAS											
X	1.	12.	-53.	-.0	.1	-.9	1.	.1	-.0	.1	-.000
Y	44.	-110.	-207.	.6	-.6	-1.3	44.	.6	-.5	.6	-.005
Z	-71.	198.	-115.	-1.0	1.1	-.7	-71.	1.0	-.9	1.1	-.009
G-SENS IA DRIFT											
X	0.	14.	-3.	-.1	.1	-1.3	0.	.1	-.1	.1	-.001
Y	-23.	-78.	-129.	-.0	-.2	-.3	-23.	-.2	-.0	-.2	-.000
Z	30.	74.	-39.	.1	.1	-.1	29.	.1	.1	.1	-.001
G-SENS OA DRIFT											
X	3.	2.	38.	.0	-.0	.0	3.	-.0	.0	-.0	-.000
Y	28.	-207.	-364.	.8	-1.1	-2.0	20.	-1.0	.7	-1.1	-.007
Z	38.	139.	-77.	.0	.3	-.2	38.	.3	.1	.3	-.000
G-50 SEN DRIFT											
X	6.	8.	69.	.0	.0	-.1	6.	.0	.0	.0	-.000
Y	39.	-82.	-154.	.5	-.5	-1.0	38.	-.5	.4	-.5	-.004
Z	28.	103.	-57.	.0	.2	-.2	28.	.2	.1	.2	-.001
ACCEL BIAS											
X	1025.	154.	-43.	3.6	.5	-.2	1025.	.6	3.6	.5	.034
Y	175.	-763.	448.	.7	-2.3	1.4	175.	-2.3	.5	-2.3	-.005
Z	48.	-448.	-779.	.2	-1.4	-2.4	46.	-1.4	.0	-1.4	-.001
ACCEL SCALE FAC											
X	816.	124.	-33.	3.0	.4	-.1	816.	.5	3.0	.4	.028
Y	46.	-167.	99.	.0	-.3	-.2	45.	.3	-.0	.3	-.001
Z	10.	-46.	-83.	-.0	.2	-.3	10.	-.2	-.0	-.2	-.000
ACCEL IA ALINE											
- GA											
X	474.	66.	-18.	-.1	-.1	.0	474.	-.1	-.1	-.1	-.001
Y	40.	-151.	89.	-.0	.5	-.3	40.	.5	-.1	.5	-.001
Z	65.	-630.	-1101.	.3	-2.1	-3.5	65.	-2.1	.1	-2.1	-.002
ACCEL IA ALINE											
- SA											
X	248.	32.	-9.	-.2	-.1	.0	248.	-.1	-.2	-.1	-.002
Y	249.	-1076.	633.	1.0	-3.4	2.0	249.	-3.4	.7	-3.4	-.007
Z	22.	-177.	-311.	.0	.4	-.7	22.	.4	-.0	.4	-.001

TABLE A4.1.2-VI.- PRTLS RSS DATA AT ET SEP FOR LAST THREE-ENGINE RTLS
(CONTINUED)

(B) NAVIGATED MINUS ACTUAL STATE PARAMETERS												
	U (FT)	V (FT)	W (FT)	U-DOT (FPS)	V-DOT (FPS)	M-DOT (FPS)	ALTITUDE (FT)	SPEED (FPS)	M-DOT (FPS)	DR-DOT (FPS)	GAMMA (DEG)	
CG	0.	0.	0.	0.	0.	0.	0.	0.	0.	0.	0.000	
X	0.	0.	0.	0.	0.	0.	0.	0.	0.	0.	0.000	
Y	0.	0.	0.	0.	0.	0.	0.	0.	0.	0.	0.000	
Z	0.	0.	0.	0.	0.	0.	0.	0.	0.	0.	0.000	
PERFORMANCE												
WEB ACT	7.	-12.	-0.	0.	0.	0.	7.	0.	0.	0.	0.000	
S ISP	2.	-12.	-0.	0.	0.	0.	2.	0.	0.	0.	0.000	
S PROP	2.	6.	-1.	0.	0.	0.	2.	0.	0.	0.	0.000	
S INERT	-1.	7.	1.	0.	0.	0.	-1.	0.	0.	0.	0.000	
O THRST	0.	0.	1.	0.	0.	0.	0.	0.	0.	0.	0.000	
O ISP	0.	3.	-1.	0.	0.	0.	0.	0.	0.	0.	0.000	
O INERT	3.	1.	2.	0.	0.	0.	3.	0.	0.	0.	0.000	
ET INERT	1.	-1.	1.	0.	0.	0.	1.	0.	0.	0.	0.000	
ET OXID	1.	0.	-1.	0.	0.	0.	1.	0.	0.	0.	0.000	
ET FUEL	1.	6.	1.	0.	0.	0.	1.	0.	0.	0.	0.000	
MIX RATIO	0.	0.	-0.	0.	0.	0.	1.	0.	0.	0.	0.000	
ATMOSPHERE												
COLD	2.	-6.	1.	0.	0.	0.	2.	0.	0.	0.	0.000	
3-SIGMA RSS =	1545.	2823.	3703.	5.5	8.6	11.0	1545.	8.5	5.2	8.6	.049	

TABLE AW.1.2-VI.- PRTL RSS DATA AT ET SEP FOR LAST THREE-ENGINE RTLS

(C) ACTUAL MINUS NOMINAL VEHICLE PARAMETERS

	LATD (DEG)	LONG (DEG)	AZIM (DEG)	RANGE (NM)	TIME (SEC)	WEIGHT (LBS)	PROP (LBS)	OXID (LBS)	FUEL (LBS)
PLATFORM ALINE									
AZIMUTH	.005	-.005	-.031	-.08	.04	-78.	-78.	-67.	-11.
TILT	-.004	.000	-.077	-.11	.05	-91.	-91.	-78.	-13.
ROLL	-.002	.002	-.037	.05	.00	8.	8.	6.	1.
DRIFT BIAS									
X	-.000	-.000	-.010	-.00	.00	-6.	-6.	-5.	-1.
Y	-.000	-.000	-.014	-.02	.01	-11.	-11.	-9.	-2.
Z	-.000	-.000	-.010	.02	.00	-0.	-0.	-0.	-0.
G-SENS 1A DRIFT									
X	-.000	-.000	-.013	-.00	.00	-6.	-6.	-5.	-1.
Y	-.000	-.000	-.004	-.01	.00	-8.	-8.	-7.	-1.
Z	-.000	-.000	-.002	.01	-.00	5.	5.	4.	1.
O-SENS 0A DRIFT									
X	-.000	-.000	.002	-.00	.00	-7.	-7.	-6.	-1.
Y	-.001	-.000	-.023	-.03	.01	-11.	-11.	-9.	-2.
Z	-.000	-.000	-.003	.01	-.01	11.	11.	9.	2.
O-SQ SE.: DRIFT									
X	-.000	-.000	-.001	.00	-.00	2.	2.	2.	0.
Y	-.000	-.000	-.012	-.01	-.00	2.	2.	2.	0.
Z	-.000	-.000	-.002	.01	-.00	5.	5.	5.	1.
ACCEL BIAS									
X	-.000	-.001	.001	.03	.02	-32.	-32.	-28.	-5.
Y	-.000	-.004	.051	-.20	.21	-416.	-416.	-357.	-59.
Z	-.001	.000	-.028	-.02	.04	-86.	-86.	-74.	-12.
ACCEL SCALE FAC									
X	-.000	-.001	-.000	.03	.01	-20.	-20.	-17.	-3.
Y	-.000	-.000	-.001	.02	.02	-42.	-42.	-36.	-6.
Z	-.000	-.000	.004	.01	.01	-17.	-17.	-15.	-2.
ACCEL 1A ALINE									
-OA									
X	-.001	-.002	.029	-.13	.19	-392.	-392.	-336.	-56.
Y	-.000	-.000	-.002	.02	.02	-46.	-46.	-40.	-7.
Z	-.003	-.002	-.021	-.20	.20	-398.	-398.	-341.	-57.
ACCEL 1A ALINE									
-SA									
X	-.000	-.000	-.005	.02	.04	-80.	-80.	-69.	-11.
Y	-.001	-.003	.054	-.14	.17	-333.	-333.	-286.	-48.
Z	-.000	-.001	.007	.02	.03	-53.	-53.	-45.	-8.

TABLE AN-1.2-VI.- PRTLS RSS DATA AT ET SEP FOR LAST THREE-ENGINE RTLS
(CONTINUED)

(C) ACTUAL MINUS NOMINAL VEHICLE PARAMETERS

CG	LATD (DEG)	LONG (DEG)	AZIM (DEG)	RANGE (NM)	TIME (SEC)	WEIGHT (LBS)	PROP (LBS)	OXID (LBS)	FUEL (LBS)
X	.000	.000	.000	.00	.00	0.	0.	0.	0.
Y	.000	.000	.000	.00	.00	0.	0.	0.	0.
Z	.000	.000	.000	.00	.00	0.	0.	0.	0.
PERFORMANCE									
HEB ACT	-.042	-.080	-.001	-4.84	7.19	-245.	-245.	-210.	-35.
S ISP	-.001	.003	-.035	1.19	-2.53	238.	238.	204.	34.
S PROP	-.010	-.020	-.033	-1.21	2.15	-435.	-435.	-373.	-62.
S INERT	-.009	-.019	-.023	-1.14	2.19	-521.	-521.	-447.	-74.
O THRST	-.000	-.003	-.040	-1.12	5.60	375.	375.	322.	54.
O ISP	.003	.006	.004	.38	-1.26	-1885.	-1885.	-1616.	-269.
O INERT	-.001	-.002	.005	-.12	.04	95.	-90.	-77.	-13.
ET INERT	-.001	-.002	.006	-.12	.05	102.	-96.	-82.	-14.
ET OXID	-.000	-.001	-.006	-.06	1.87	1204.	1204.	2086.	882.
ET FUEL	-.008	-.017	-.033	-.98	2.77	-192.	-192.	-1509.	1317.
MIX RATIO	-.000	-.000	-.001	-.00	.00	-5.	-5.	-1086.	1092.
ATMOSPHERE									
COLD	.002	-.005	-.153	-.17	4.95	-628.	-628.	-538.	-90.

B-SIGMA RSS	.046	.087	.216	5.25	11.67	2609.	2609.	3423.	1947.

TABLE A4.1.3-I.- PRTLS RSS SUMMARY OF UVW STATE PARAMETERS

(a) Actual minus nominal
(Actual perturbed minus actual nominal)

Event/case	Time, sec	U, ft	V, ft	W, ft	U-DOT, fps	V-DOT, fps	W-DOT, fps
SRB separation							
E O at lift-off	5.92	1 874	5 542	4 204	59.3	113.8	1.3
E O at SRB sep	5.92	2 536	8 948	4 108	35.1	70.3	.8
E O at 262.5 sec	5.92	2 536	8 948	4 108	35.1	70.3	.8
3 engines at 262.5 sec	5.92	2 536	8 948	4 108	35.1	70.3	.8
RTLS selection							
E O at lift-off (GET = 150 sec)	0.00	11 579	20 206	242	44.7	176.5	.9
E O at SRB sep (GET = 150 sec)	.00	11 520	21 824	73	47.7	197.0	3.2
E O at 262.5 sec							
(GET = 272.5 sec)	.00	6 722	47 869	775	60.6	249.4	12.0
3 engines at 262.5 sec	.00	7 522	45 188	726	55.9	243.5	11.1
(GET = 262.5 sec)							
Pitcharound completed							
E O at lift-off	45.07	21 625	116 434	23 806	279.5	502.7	12.4
E O at SRB sep	11.99	8 184	35 014	10 280	69.0	159.9	20.9
E O at 262.5 sec	3.84	3 098	23 206	2 879	9.1	199.1	55.9
3 engines at 262.5 sec	11.52	7 517	61 487	7 368	236.4	334.4	23.4
Powered pitchdown							
E O at lift-off	5.60	2 286	105 446	8 151	73.9	285.2	34.3
E O at SRB sep	5.97	2 078	34 090	7 393	31.9	102.6	25.7
E O at 262.5 sec	4.63	1 488	56 478	10 343	36.8	143.1	37.7
3 engines at 262.5 sec	11.28	1 510	26 339	9 265	29.4	100.8	15.4
MEOO commanded							
E O at lift-off	6.12	2 422	98 362	6 626	81.6	329.1	47.1
E O at SRB sep	6.53	2 069	33 902	7 169	80.0	104.8	31.2
E O at 262.5 sec	4.96	1 557	55 504	9 418	72.5	147.4	85.3
3 engines at 262.5 sec	11.67	1 587	24 797	9 578	53.4	98.2	24.5

TABLE A4.1.3-I.- Continued

(a) Concluded

(Actual perturbed minus actual nominal)

Event/case	Time, sec	U, ft	V, ft	W, ft	U-DOT, fps	V-DOT, fps	W-DOT, fps
ET separation							
E O at lift-off	6.12	2701	94 254	6225	81.4	328.1	47.8
E O at SRB sep	6.53	2571	33 024	7032	79.8	99.6	31.3
E O at 262.5 sec	4.96	1771	53 106	8403	73.3	154.9	89.2
3 engines at 262.5 sec	11.67	1959	23 573	9525	55.3	102.9	24.8

TABLE A4.1.3-I.- Continued
 (b) Navigated minus actual
 {Navigated perturbed minus actual perturbed}

Event/case	Time, sec	U, ft	V, ft	W, ft	U-DOT, fps	V-DOT, fps	W-DOT, fps
SRB separation							
E O at lift-off	5.92	86	190	277	1.6	2.9	5.0
E O at SRB sep	5.92	98	201	320	1.9	3.1	6.1
E O at 262.5 sec	5.92	98	201	320	1.9	3.1	5.1
3 engines at 262.5 sec	5.92	98	201	320	1.9	3.1	5.1
RTLS selection							
E O at lift-off (GET = 150 sec)	0.00	116	241	368	1.7	2.9	5.3
E O at SRB sep (GET = 150 sec)	.00	132	257	432	2.1	3.1	6.6
E O at 262.5 sec (GET = 262.5 sec)	.00	481	733	1548	3.9	4.5	11.8
3 engines at 262.5 sec (GET = 262.5 sec)	.00	449	689	1437	3.8	4.5	11.5
Pitcharound completed							
E O at lift-off	45.07	1026	1830	2932	4.0	6.7	9.9
E O at SRB sep	11.99	652	1021	2063	3.6	5.0	10.5
E O at 262.5 sec	3.84	548	816	1759	3.9	4.7	11.8
3 engines at 262.5 sec	11.52	526	786	1685	3.8	4.6	11.7
Powered pitchdown							
E O at lift-off	5.97	2259	4054	5046	6.8	10.3	11.6
E O at SRB sep	4.63	1910	3412	4449	6.1	9.6	11.1
E O at 262.5 sec	11.28	1512	2706	3781	5.2	8.7	10.3
3 engines at 262.5 sec	11.28	1436	2568	3619	4.9	8.5	9.7
MECO commanded							
E O at lift-off	5.60	2374	4255	5156	7.2	10.3	12.5
E O at SRB sep	6.53	1999	3589	4530	6.4	9.7	11.9
E O at 262.5 sec	4.96	1574	2850	3825	5.5	8.9	11.2
3 engines at 262.5 sec	11.67	1497	2719	3672	5.3	8.6	10.9

TABLE A4.1.3-I.- Concluded

(b) Concluded

(Navigated perturbed minus actual perturbed)

Event/case	Time, sec	U, ft	V, ft	W, ft	U-DOT, fps	V-DOT, fps	W-DOT, fps
ET separation							
E O at lift-off	6.12	2453	4385	5228	7.4	10.3	12.5
E O at SRB sep	6.53	2064	3703	4585	6.5	9.6	12.0
E O at 262.5 sec	4.96	1622	2960	3857	5.6	8.8	11.3
3 engines at 262.5 sec	11.67	1545	2823	3703	5.5	8.6	11.0

TABLE A4.1.3-II.- PRTLS RSS SUMMARY OF TRAJECTORY PARAMETERS

(a) Actual minus nominal
(actual perturbed minus actual nominal)

event/case	Time, sec	Altitude, ft	Velocity magnitude, fps	Altitude rate, fps	Downrange rate, fps	Flightpath angle, deg
SRE separation						
E O at lift-off	5.92	1 873	126.9	58.8	114.1	0.342
E O at SRB sep	5.92	2 538	77.0	34.2	70.7	.213
E O at 262.5 sec	5.92	2 538	77.0	34.2	70.7	.213
3 engines at 262.5 sec	5.92	2 538	77.0	34.2	70.7	.213
KILLS selection						
E O at lift-off (GET = 150 sec)	0.00	11 570	137.4	42.7	175.0	2.068
E O at SRB sep (GET = 150 sec)	.00	11 509	154.1	44.7	194.8	1.594
E O at 262.5 sec (GET = 262.5 sec)	.00	6 676	238.1	44.4	247.0	.605
3 engines at 262 sec (GET = 262.5 sec)	.00	7 480	230.6	41.	240.9	.638
Pitcharound completed						
E O at lift-off	45.07	21 656	504.9	301.5	503.1	3.973
E O at SRB sep	11.99	8 182	162.6	66.5	160.1	.561
E O at 262.5 sec	3.84	3 092	196.5	7.5	197.9	.189
3 engines at 262.5 sec	11.52	7 569	363.0	216.6	336.8	1.329
Powered pitchdown						
E O at lift-off	5.60	2 248	293.4	49.3	289.4	.074
E O at SRB sep	5.97	2 077	106.2	25.1	103.9	.137
E O at 262.5 sec	4.63	1 492	146.8	26.5	145.3	.179
3 engines at 262.5 sec	11.28	1 510	104.1	25.0	101.7	.138
MECO commanded						
E O at lift-off	6.12	2 398	327.1	91.2	330.9	.933
E O at SRB sep	6.53	2 066	103.9	75.5	105.4	.696
E O at 262.5 sec	4.96	1 556	150.9	62.4	148.6	.518
3 engines at 262.5 sec	11.67	1 581	98.1	51.5	98.8	.496

TABLE A4.1.3-II.- Continued

(a) Concluded

(Actual perturbed minus actual nominal)

Event/case	Time, sec	Altitude, ft	Velocity magnitude, fps	Altitude rate, fps	Downrange rate, fps	Flightpath angle, deg
ET separation						
E O at lift-off	6.12	2717	328.2	90.2	328.0	0.794
E O at SRB sep	6.53	2565	99.5	74.9	99.7	.672
E O at 262.5 sec	4.96	1755	155.9	64.1	155.0	.563
3 engines at 262.5 sec	11.67	1956	102.8	53.5	103.1	.500

TABLE A4.1.3-II.- Continued

(b) Navigated minus actual

(Navigated perturbed minus actual perturbed)

Event/case	Time, sec	Altitude, ft	Velocity magnitude, fps	Altitude rate, fps	Downrange rate, fps	Flightpath angle, deg
SRB separation						
E O at lift-off	5.92	87	2.2	1.6	2.9	0.044
E O at SRB sep	5.92	98	2.3	1.9	3.1	.038
E O at 262.5 sec	5.92	98	2.3	1.9	3.1	.038
3 engines at 262.5 sec	5.92	98	2.3	1.9	3.1	.038
RFLS selection						
E O at lift-off (GET = 150 sec)	0.00	116	2.2	1.7	2.9	.044
E O at SRB sep (GET = 150 sec)	.00	132	2.3	2.1	3.1	.038
E O at 262.5 sec (GET = 262.5 sec)	.00	481	4.2	3.7	4.5	.031
3 engines at 262.5 sec (GET = 262.5 sec)	.00	448	4.1	3.7	4.4	.032
Pitcharound completed						
E O at lift-off	45.07	1026	6.7	3.9	6.7	.049
E O at SRB sep	11.95	652	4.9	3.5	5.0	.034
E O at 262.5 sec	3.84	548	4.4	3.7	4.6	.031
3 engines at 262.5 sec	11.52	526	4.3	3.7	4.6	.032
Poweru pitchdown						
E O at lift-off	5.60	2258	9.9	6.6	10.2	.075
E O at SRB sep	5.97	1910	9.2	5.8	9.5	.067
E O at 262.5 sec	4.63	1512	8.3	5.0	8.6	.059
3 engines at 262.5 sec	11.28	1437	8.1	4.8	8.4	.064
MECO commandea						
E O at lift-off	6.12	2374	10.2	6.8	10.3	.062
E O at SRB sep	6.53	1999	9.4	6.1	9.6	.056
E O at 262.5 sec	4.96	1574	8.6	5.2	8.8	.051
3 engines at 262.5 sec	11.67	1497	8.4	5.1	8.5	.050

TABLE A4.1.3-II.- Concluded

(b) Concluded

(Navigated perturbed minus actual perturbed)

Event/case	Time, sec	Altitude, ft	Velocity magnitude, fps	Altitude rate, fps	Downrange rate, fps	Flightpath angle, deg
EI separation						
EO at lift-off	6.12	2452	10.3	7.0	10.3	0.062
EO at SRB sep	6.53	2063	9.6	6.1	9.6	.055
EO at 262.5 sec	4.96	1621	8.7	5.3	8.8	.049
3 engines at 262.5 sec	11.67	1545	8.5	5.2	8.6	.049

TABLE A4.1.3-III.- PRTLS RSS SUMMARY OF VEHICLE PARAMETERS

(Actual perturbed minus actual nominal)

Event/case	Time, sec	Latitude, deg	Longitude, deg	Azimuth, deg	Range, n. mi.	Weight, lb	Propellant, lb
SRB separation							
E O at lift-off	5.92	0.004	0.008	0.312	0.49	14 977	14 667
E O at SRB sep	5.92	.004	.008	.119	.50	19 904	19 673
E O at 262.5 sec	5.92	.004	.008	.119	.50	19 904	19 673
3 engines at 262.5 sec	5.92	.004	.008	.117	.50	19 904	19 673
RTLS selection							
E O at lift-off (GET = 150 sec)	0.00	.028	.054	.389	3.31	7 877	7 872
E O at SRB sep (GET = 150 sec)	.00	.030	.058	.320	3.57	8 333	8 329
E O at 262.5 sec (GET = 262.5 sec)	.00	.063	.129	.059	7.75	9 974	9 970
3 engines at 262.5 sec (GET = 262.5 sec)	.00	.060	.122	.061	7.30	9 866	9 863
Pitcharound completed							
E O at lift-off	45.07	.077	.193	.549	11.02	94 687	94 550
E O at SRB sep	11.99	.023	.068	.282	3.78	26 463	26 299
E O at 262.5 sec	3.84	.035	.071	.425	4.24	12 591	12 602
3 engines at 262.5 sec	11.52	.066	.133	.378	7.99	18 788	18 267
Powered pitchdown							
E O at lift-off	5.60	.131	.298	.548	17.29	2 305	2 524
E O at SRB sep	5.97	.053	.094	.237	5.74	2 755	2 742
E O at 262.5 sec	4.63	.090	.149	.304	9.30	7 179	7 191
3 engines at 262.5 sec	11.28	.049	.092	.294	5.56	2 688	2 675
MECO commanded							
E O at lift-off	6.12	.122	.278	.378	16.12	2 069	2 129
E O at SRB sep	6.53	.053	.097	.227	5.89	2 619	2 659
E O at 262.5 sec	4.96	.087	.147	.756	9.13	6 724	6 724
3 engines at 262.5 sec	11.67	.047	.090	.216	5.43	2 606	2 606

TABLE A4.1.3-III.- Concluded
 (Actual perturbed minus actual nominal)

Event/case	Time, sec	Latitude, deg	Longitude, deg	Azimuth, deg	Range, n. mi.	Weight, lb	Propellant, lb
ET separation							
E O at lift-off	6.12	0.117	0.266	0.372	15.44	2072	2132
E O at SRB sep	6.53	.052	.094	.228	5.73	2622	2663
E O at 262.5 sec	4.96	.082	.142	.783	8.80	6724	6724
3 engines at 262.5 sec	11.67	.046	.087	.216	5.25	2609	2609

TABLE A4.1.4-1.- PRTLS MATRICES AT SRB SEPARATION FOR SSME-OUT AT LIFT-OFF

(A) Covariance matrix.

	U ACT	V ACT	W ACT	U-DOT ACT	V-DOT ACT	W-DOT ACT	U MAY
U ACT	3.9005189+05	4.1658231+06					
V ACT	-2.4312417+05	-1.9525371+06					
W ACT	3.3763667+05	2.459133+04					
U-DOT ACT	9.4506880+03	-3.0819157+04					
V-DOT ACT	1.9794856+04	-9.931394+04					
W-DOT ACT	3.8413987+03	-9.3315672+03					
U MAY	-4.7176723+02	1.4304617+03					
V MAY	-1.1810200+02	2.0421641+03					
W MAY	-1.9430774+02	7.8959578+02					
U-DOT MAY	-6.2282016+01	3.7570466+02					
V-DOT MAY	-7.9236642+01	4.9071255+02					
W-DOT MAY	-3.1719827+01	1.2952354+02					
WT	7.0853570+05	-8.7758724+06					
TIME	-6.4842421+02	3.7298024+03					
X ACC BIAS	1.1789119+05	-6.3654827+05					
Y ACC BIAS	-1.9645835+07	-1.3724824+05					
Z ACC BIAS	-1.1340477+07	-7.8439564+06					
X MISALIGN	1.5789684+08	7.0893639+06					
Y MISALIGN	9.2682527+06	-3.4980464+06					
Z MISALIGN	-2.5052420+04	4.1279913+07					
U ACT							
V ACT							
W ACT							
U-DOT ACT							
V-DOT ACT							
W-DOT ACT							
U MAY							
V MAY							
W MAY							
WT							
TIME							
X ACC BIAS							
Y ACC BIAS							
Z ACC BIAS							
X MISALIGN							
Y MISALIGN							
Z MISALIGN							
U ACT							
V ACT							
W ACT							
U-DOT ACT							
V-DOT ACT							
W-DOT ACT							
U MAY							
V MAY							
W MAY							
WT							
TIME							
X ACC BIAS							
Y ACC BIAS							
Z ACC BIAS							
X MISALIGN							
Y MISALIGN							
Z MISALIGN							

ORIGINAL PAGE IS
OF POOR QUALITY

TABLE A4.1.4-I.- Concluded
(B) Correlation matrix

	U ACT	V ACT	W ACT	U-DOT ACT	V-DOT ACT	W-DOT ACT	U MAY
U ACT	1.0000000+00						
V ACT	-1.9072777-01	1.0000000+00					
W ACT	8.6733567-01	-8.6733567-01	1.0000000+00				
U-DOT ACT	7.7692731-01	-7.5968445-01	9.8243014-01	1.0000000+00			
V-DOT ACT	8.5007989-01	-6.5130227-01	9.4191554-01	9.8593504-01	1.0000000+00		
W-DOT ACT	8.4822774-01	-6.6513027-01	9.4678576-01	9.833712-01	9.8593504-01	1.0000000+00	
U MAY	-2.6205901-02	2.4313942-02	-3.2312284-02	-3.2942268-02	-3.2980906-02	-3.3072233-02	1.0000000+00
V MAY	-3.0091047-03	1.5921312-02	-1.4592154-02	-1.5253941-02	-1.5377765-02	-1.5377765-02	-4.1174973-01
W MAY	-3.3866888-03	4.1837630-03	-6.7575753-03	-5.5553048-03	-4.7537774-03	-4.7756441-03	-1.0563340-01
U-DOT MAY	-1.8184566-01	3.3404727-01	-3.5186190-01	3.3315625-01	3.1293356-01	3.1511535-01	9.2579273-01
V-DOT MAY	-1.3151876-01	2.4922612-01	-2.6002722-01	-2.4518174-01	-2.2943365-01	-2.3121599-01	3.8986859-01
W-DOT MAY	-3.0040375-02	3.8185632-02	-4.4564371-02	-4.2834835-02	-4.1242833-02	-4.1666124-02	-1.0294017-01
TIME	2.2723230-01	-8.6128224-01	7.8929194-01	6.8348886-01	6.2131337-01	6.2819036-01	-1.9890036-02
X ACC BIAS	-5.4232587-01	9.2604580-01	-9.9153866-01	9.4771981-01	-8.9101793-01	-8.9759461-01	3.4030453-02
Y ACC BIAS	1.7684227-04	-1.23295485-05	-2.90942787-05	2.0543623-05	-2.3618853-06	-6.647428-06	4.7964055-01
Z ACC BIAS	-1.9753003-07	-4.1806330-06	2.9094898-04	1.5410537-05	-1.8352699-04	4.6785175-06	4.5208785-02
X MISALIGN	-1.1287430-07	-2.3889332-06	1.4623656-04	8.322160-04	-1.3145805-04	2.9993101-06	7.4452591-03
Y MISALIGN	3.6350684-08	1.1920018-06	-8.2956745-07	-4.8964781-06	2.4813228-07	-1.1623636-06	7.7511943-02
Z MISALIGN	1.1433402-04	-1.3204328-05	-2.8717780-05	2.0675663-05	-2.3830039-06	6.0147784-06	-2.8861352-01
TIME	-3.1292411-05	1.5777305-06	-3.6276892-05	-3.6118955-05	1.8501288-06	-1.0602324-05	4.4609778-01

	V MAY	W MAY	U-DOT MAY	V-DOT MAY	W-DOT MAY	WT	TIME
V MAY	1.0000000+00						
W MAY	-6.5830472-02	1.0000000+00					
U-DOT MAY	-4.8195629-01	-1.2749861-01	1.0000000+00				
V-DOT MAY	9.6284097-01	-8.9315712-02	-3.7431538-01	1.0000000+00			
W-DOT MAY	-2.8819061-02	9.2453748-01	-1.591778-01	-8.8468114-02	1.0000000+00		
WT	-1.3575317-02	-3.2138836-03	3.0214669-01	-3.2733337-01	-3.3397073-02	1.0000000+00	
TIME	1.4962525-02	6.8646644-03	3.5633267-01	2.0400773-01	3.3640276-02	-0.2912993-01	1.0000000+00
X ACC BIAS	-1.7939670-02	6.1788346-03	3.7431284-01	-1.034845-02	3.3094958-03	-1.5432344-04	0.0000000
Z ACC BIAS	2.0129162-01	-5.7824420-02	3.2125319-02	1.86337430-01	-4.3894478-02	-1.6433944-04	0.0000000
X MISALIGN	8.7325452-02	1.4090114-01	3.9128191-03	8.6733567-02	1.1616882-01	-1.6433944-04	0.0000000
Y MISALIGN	6.0794444-02	-7.4463742-01	8.7914662-02	1.3729310-01	-8.3271063-01	-1.6433944-04	0.0000000
Z MISALIGN	3.2785748-01	5.0307302-01	-3.6435541-01	3.2239642-01	4.14093978-01	-1.6433944-04	0.0000000
TIME	-7.7298529-01	2.2162335-01	5.6770272-01	-7.4864046-01	1.6213350-01	1.6337751-04	0.0000000

	X ACC BIAS	Y ACC BIAS	Z ACC BIAS	X MISALIGN	Y MISALIGN	Z MISALIGN
X ACC BIAS	1.0000000+00					
Y ACC BIAS	0.0000000	1.0000000+00				
Z ACC BIAS	0.0000000	0.0000000	1.0000000+00			
X MISALIGN	0.0000000	0.0000000	0.0000000	1.0000000+00		
Y MISALIGN	0.0000000	0.0000000	0.0000000	0.0000000	1.0000000+00	
Z MISALIGN	0.0000000	0.0000000	0.0000000	0.0000000	0.0000000	1.0000000+00

TABLE A4.1.4-II.- PRTLS MATRICES AT SRB SEPARATION FOR NOMINAL FIRST STAGE

(A) Covariance matrix

	U ACT	V ACT	M ACT	U-DOT ACT	V-DOT ACT	M-DOT ACT	U MAV
U ACT	7.1484021+03						
V ACT	9.0728820+06						
M ACT	2.4248452+01						
U-DOT ACT	-2.7318657+06						
V-DOT ACT	-2.5143408+04						
M-DOT ACT	2.8664178+02						
U MAV	2.8664178+02						
V MAV	1.0207076+03						
M MAV	5.8566355+01						
U-DOT MAV	1.2071683+02						
V-DOT MAV	1.0833308+02						
M-DOT MAV	3.2950784+01						
TIME	-4.7520074+06						
X ACC BIAS	1.2883160+03						
Y ACC BIAS	-8.2174905+08						
Z ACC BIAS	-3.1087453+08						
X MISALION	7.8171136+09						
Y MISALION	2.3310657+06						
Z MISALION	-1.1815324+05						
U ACT							
V ACT							
M ACT							
U-DOT ACT							
V-DOT ACT							
M-DOT ACT							
U MAV							
V MAV							
M MAV							
U-DOT MAV							
V-DOT MAV							
M-DOT MAV							
TIME							
X ACC BIAS							
Y ACC BIAS							
Z ACC BIAS							
X MISALION							
Y MISALION							
Z MISALION							
U ACT							
V ACT							
M ACT							
U-DOT ACT							
V-DOT ACT							
M-DOT ACT							
U MAV							
V MAV							
M MAV							
U-DOT MAV							
V-DOT MAV							
M-DOT MAV							
TIME							
X ACC BIAS							
Y ACC BIAS							
Z ACC BIAS							
X MISALION							
Y MISALION							
Z MISALION							
U ACT							
V ACT							
M ACT							
U-DOT ACT							
V-DOT ACT							
M-DOT ACT							
U MAV							
V MAV							
M MAV							
U-DOT MAV							
V-DOT MAV							
M-DOT MAV							
TIME							
X ACC BIAS							
Y ACC BIAS							
Z ACC BIAS							
X MISALION							
Y MISALION							
Z MISALION							

TABLE A4.1.4-II.- Concluded
(B) Correlation matrix

	U ACT	V ACT	M ACT	U-DOT ACT	V-DOT ACT	M-DOT ACT	U MAY
U ACT	1.000000+00						
V ACT	0.126597-01	1.000000+00					
M ACT	-0.762065-01	-0.174511-01	1.000000+00				
U-DOT ACT	3.2161367-01	-0.7491423-01	0.0745043-01	1.000000+00			
V-DOT ACT	3.0151635-02	-3.6243108-01	7.0227809-01	9.2411001-01	1.000000+00		
M-DOT ACT	1.0777607-01	-2.0030745-01	0.5203921-01	0.9890927-01	0.6933706-03	1.000000+00	
U MAY	2.0368607-02	2.1226652-02	-2.3019915-02	-1.0745187-02	-1.1242702-02	-0.003713-03	1.000000+00
V MAY	1.0103620-02	2.1226652-02	-2.1008298-02	-1.0745187-02	-2.3974938-03	-2.3210154-03	-4.0601843-01
M MAY	0.9019607-04	1.5444512-03	-2.2026109-03	-2.2755428-03	-1.0390944-01	-1.4756121-01	-1.1609925-01
U-DOT MAY	2.2165975-01	2.7112701-01	-2.7636255-01	-2.3317378-01	-1.0390944-01	-1.4756121-01	0.4700142-01
V-DOT MAY	2.233540-01	2.768854-01	-2.8064309-01	-2.4128071-01	-1.0701641-01	-1.5215129-01	-4.2100830-01
M-DOT MAY	1.0159162-02	2.4067874-02	-2.4731132-02	-2.1052003-02	-1.4911619-02	-1.3536883-02	-1.1268766-01
TIME	0.8714348-01	0.2530520-01	0.5771842-01	0.0374665-01	3.4354160-01	2.0143432-01	-2.1989786-02
X ACC BIAS	7.7217805-01	0.6311430-01	-0.9061595-01	-0.4415391-01	-5.9916046-01	-5.4303958-01	2.4751455-02
Y ACC BIAS	1.1006506-04	-1.5091170-06	-1.7030010-06	4.1019008-05	0.9135047-06	2.0951749-05	4.1457948-01
Z ACC BIAS	-4.5712564-08	-7.0471958-07	1.0507366-06	2.0041302-05	4.0520338-06	1.0907446-05	3.8729330-02
X MISALION	-2.2056202-08	-3.0235979-07	9.2036032-07	1.9937402-05	2.2907607-06	9.2002029-06	4.5334726-03
Y MISALION	2.0107003-08	3.3630084-07	-4.6571152-07	-7.5266540-06	-2.2074400-06	-4.0556452-06	0.9492446-02
Z MISALION	2.2043359-03	3.1631455-06	3.6310372-05	3.0105269-05	5.9143399-06	2.0405056-05	-3.2667448-01
	-1.0053825-04	2.3219707-06	0.3534532-07	-0.1407443-03	-1.13328750-05	-4.0035328-05	4.0000000
V MAY	1.000000+00						
M MAY	-4.5348254-02	1.000000+00					
U-DOT MAY	5.204670-01	-1.3723907-01	1.000000+00				
V-DOT MAY	0.5083910-01	-1.1077016-01	-2.293502-01	1.000000+00			
M-DOT MAY	-3.3203064-02	0.0559172-01	-1.2655924-01	-1.0709333-01	1.000000+00		
TIME	-2.0274000-02	-1.4204504-03	-2.5536776-01	-2.3735756-01	1.000000+00		
X ACC BIAS	1.500147-02	2.0426077-03	2.7996221-01	2.0604650-01	-2.2414926-02	1.000000+00	1.000000+00
Y ACC BIAS	-1.6436003-02	5.3913094-02	3.2149234-01	-1.7341502-02	2.4968662-02	-0.9052639-01	0.000000
Z ACC BIAS	0.9075733-02	-9.1915020-02	3.1539857-02	1.0144777-01	-4.0311561-02	-1.5700590-06	0.000000
X MISALION	0.2731003-02	1.105243-01	1.0266203-03	0.2709008-02	0.1634509-07	-7.0502990-07	0.000000
Y MISALION	3.5066121-31	-7.0091817-01	1.0431075-01	1.0055585-01	-0.7768049-01	0.2309345-07	0.000000
Z MISALION	-7.9511447-01	4.20021-01	-3.0471860-01	3.3934472-01	3.4030246-01	-1.5204329-06	0.000000
		2.1765791-01	9.6605046-01	-7.0377020-01	1.0777264-01	3.0750232-06	0.000000
X ACC BIAS	1.000000+00						
Y ACC BIAS	0.000000	1.000000+00					
Z ACC BIAS	0.000000	0.000000	1.000000+00				
X MISALION	0.000000	0.000000	0.000000	1.000000+00			
Y MISALION	0.000000	0.000000	0.000000	0.000000	1.000000+00		
Z MISALION	0.000000	0.000000	0.000000	0.000000	0.000000	1.000000+00	

TABLE A4.1.4-III.- PRTLS MATRICES AT ET SEPARATION FOR SSME-OUT AT LIFT-OFF

(A) Covariance matrix

	U ACT	V ACT	M ACT	U-DOT ACT	V-DOT ACT	M-DOT ACT	U MAY
U ACT	0.1044313+05						
V ACT	2.2430783+06	9.6819917+08					
M ACT	2.5163330+05	-4.4862982+07					
U-DOT ACT	1.3265182+04	-3.4331027+06	3.2054720+06				
V-DOT ACT	-1.2958004+04	-3.4331027+06	6.6566820+03				
M-DOT ACT	-2.6453376+03	2.8537309+04	-1.5048177+05	7.5414148+02			
U MAY	-4.0502118+05	7.9038977+04	-1.2318665+03	-1.0049803+02	1.2102457+04	1.0037396+02	6.6831731+05
V MAY	-1.9712158+05	-9.9310712+05	-5.1206266+04	-7.6230647+02	-7.1984228+00	-1.0026383+03	1.3194618+05
M MAY	-8.4930887+04	9.7901593+05	3.0856064+05	-3.4749408+03	-2.0407027+03	-1.7090852+03	7.2953077+04
U-DOT MAY	-1.4308181+03	1.4085405+03	4.0574843+01	3.1547588+03	6.0441585+03	-9.7833713+03	1.6309571+03
V-DOT MAY	-4.0630975+02	-2.1778310+03	8.0394400+02	-8.5362250+00	-3.1464841+00	-1.4512395+00	1.6309571+03
M-DOT MAY	-1.8733762+02	2.3886953+03	-1.9151544+03	-1.0024662+01	-9.8471305+00	-3.9514855+00	2.4013309+02
TIME	-5.8172827+02	3.8684924+06	3.3621524+05	-1.0854924+03	-2.0316391+04	-1.9554888+01	-3.1922507+00
X ACC BIAS	-8.1801393+01	1.3050881+03	-9.5873785+02	-4.5151399+01	1.4415992+01	1.093169+01	6.0626908+03
Y ACC BIAS	-2.2785813+01	1.4259643+01	-9.4025955+03	-2.5422704+03	-3.3139830+03	-1.2138026+03	-2.7074476+02
Z ACC BIAS	8.6608150+02	2.9977065+01	-1.8894748+01	-3.5253515+03	4.0411830+03	-1.7677816+03	9.3281839+01
X MISALIGN	-5.1285382+03	-2.7219534+01	3.5001126+01	6.1261015+03	-7.6010932+04	2.3147050+03	1.6945004+01
Y MISALIGN	9.7893838+03	-1.5504150+03	8.7803673+02	-4.3432400+05	8.4149441+04	-4.8415728+04	4.4236721+02
Z MISALIGN	-1.7736597+02	-1.5526802+01	3.2322816+02	-1.6683011+04	3.9878787+04	2.5974787+04	-1.0192576+02
							1.3430789+02

	U-DOT MAY	V-DOT MAY	M-DOT MAY	U MISALIGN	V MISALIGN	Z MISALIGN	TIME
U-DOT MAY	5.8793154+00						
V-DOT MAY	-2.7905503+00	1.1683239+01					
M-DOT MAY	-3.8359638+01	5.0580523+01	1.7418605+01				
TIME	-6.5226737+01	-1.3322641+00	3.6121558+02	4.7888000+05			4.1551813+00
X ACC BIAS	2.4711605+01	-1.3322641+00	9.1844225+01	3.6259815+02			-5.370247+04
Y ACC BIAS	2.7243209+03	3.0668978+04	-1.2315113+04	1.7078449+02			4.9175450+05
Z ACC BIAS	4.9355575+04	-1.390073+03	9.984781+04	-8.7320151+02			-2.4240434+05
X MISALIGN	1.2882452+04	-1.0262371+03	-1.4320504+03	1.3338002+02			-1.2190079+05
Y MISALIGN	-3.9188078+05	7.6528771+05	-9.5727602+04	1.6435331+02			5.2712417+06
Z MISALIGN	8.9335039+05	-2.7988066+04	-4.2289076+04	-1.2245587+02			-6.9235181+05
	-1.8352978+04	3.0125517+04	-2.1881030+04	4.0403772+03			

	X ACC BIAS	Y ACC BIAS	Z ACC BIAS	X MISALIGN	Y MISALIGN	Z MISALIGN
X ACC BIAS	2.5879158+06					
Y ACC BIAS	0.0000000	2.5879158+06				
Z ACC BIAS	0.0000000	0.0000000	2.5879158+06			
X MISALIGN	0.0000000	0.0000000	0.0000000	2.9478275+08		
Y MISALIGN	0.0000000	0.0000000	0.0000000	0.0000000	1.9732189+08	
Z MISALIGN	0.0000000	0.0000000	0.0000000	0.0000000	0.0000000	

TABLE A4.1.4-III.- Concluded
(B) Correlation matrix

	U ACT	Y ACT	M ACT	U-DOT ACT	Y-DOT ACT	M-DOT ACT	U MAY
U ACT	1.000000+00						
Y ACT	7.9261249-02	1.000000+00					
M ACT	1.5612000-01	-7.9804696-01	1.000000+00				
U-DOT ACT	5.3540714-01	2.3173142-01	1.3538983-01	1.000000+00			
Y-DOT ACT	-1.3084188-01	-9.9272232-01	7.6401366-01	-3.3265524-01	1.000000+00		
M-DOT ACT	-2.0490637-01	-8.0018324-02	-6.6711389-02	-0.5268493-01	-6.3354748-03	1.000000+00	
U MAY	-0.2200732-01	3.0755070-03	3.4905312-02	3.1955634-02	-1.257181-02	-1.1901462-01	1.000000+00
Y MAY	-1.4089313-01	-2.1408005-02	-1.1879800-01	-2.3092124-02	-3.1745531-02	-1.120108-01	1.000000+00
M MAY	-5.4311452-02	1.7994864-02	-5.571744-01	4.7377960-02	-1.1795678-02	-5.4697263-01	5.1562708-02
U-DOT MAY	-6.5540097-01	1.8452889-02	9.3404289-33	4.7377960-02	-1.2690413-02	-5.8030731-02	8.2732803-01
Y-DOT MAY	-1.3204268-01	-2.6269369-02	-8.669579-02	-8.6940684-02	-1.2690413-02	-1.1200851-01	-8.5936767-02
M-DOT MAY	-4.4590710-02	1.0267701-02	-2.5630670-01	-8.7465474-02	-1.4393330-02	-4.5430184-01	-9.3561883-04
TIME	-3.0068133-02	2.7021863-01	-2.7191328-01	-5.7234687-02	-2.7330177-01	1.4745092-01	1.0738240-02
X ACC BIAS	-3.1708339-01	2.0318973-02	-2.6269928-01	-0.0658437-01	6.4285050-02	6.7034134-01	-1.6247820-01
Y ACC BIAS	-5.6401860-01	2.0197549-03	-3.2645754-03	5.7614587-02	-1.8725717-02	-7.3156905-02	7.0929866-01
Z ACC BIAS	-1.5731694-01	5.8277764-03	-6.5602451-02	-7.978850-02	2.263472-02	-1.0644565-01	1.2884774-01
X MISALIGN	-4.5932927-02	-5.3824819-03	1.2132370-01	1.3867088-01	-4.2950138-03	-1.5156330-01	3.3836843-02
Y MISALIGN	-1.2333978-02	-1.0118877-03	-1.9437982-01	0.3378982-02	-1.6387806-02	-1.0179894-01	5.3769895-02
Z MISALIGN	6.3336158-02	-2.8725869-04	2.8583778-01	-9.2116278-03	3.8994136-02	4.1201282-01	-7.2617545-02
	-1.4025598-01	-3.5161885-02	1.2892143-01	-4.3628772-02	2.5876397-02	1.7928613-01	1.1895601-01

	U-DOT MAY	Y-DOT MAY	M-DOT MAY	MT	TIME
U-DOT MAY	1.000000+00				
Y-DOT MAY	1.3922207-02	1.000000+00			
M-DOT MAY	3.3670133-01	3.5458429-02	1.000000+00		
MT	5.0814546-02	1.5301847-01	6.9789849-03	1.000000+00	
TIME	4.5101359-01	1.9121136-01	1.0772176-01	2.5756522-01	1.000000+00
X ACC BIAS	5.6624475-02	-1.3416833-02	-1.0342421-02	1.000000+00	
Y ACC BIAS	9.8333308-02	6.9842508-01	5.3773378-02	-1.0342421-02	1.000000+00
Z ACC BIAS	-1.9355513-02	1.9514131-01	-2.5293397-01	-1.0342421-02	1.000000+00
X MISALIGN	5.6355882-02	1.2655734-01	-1.8228545-01	-2.1323927-01	1.000000+00
Y MISALIGN	-2.5295527-01	3.3282679-02	1.0228545-01	-4.0540401-02	1.000000+00
Z MISALIGN	1.0307975-01	-2.2046554-01	-0.0423235-02	4.7894859-01	1.000000+00
	1.5117189-01	5.2011519-01	2.0617686-01	6.2742894-01	1.000000+00
	-4.2793321-01	-5.0431274-01	-3.0395801-01	3.7893338-01	1.000000+00
	6.2207227-01	-3.7332109-01	-3.0395801-01	4.1847916-02	1.000000+00

	X ACC BIAS	Y ACC BIAS	Z ACC BIAS	X MISALIGN	Y MISALIGN	Z MISALIGN
X ACC BIAS	1.000000+00					
Y ACC BIAS	0.0002008	1.000000+00				
Z ACC BIAS	0.0000000	0.0000000	1.000000+00			
X MISALIGN	0.0000000	0.0000000	0.0000000	1.000000+00		
Y MISALIGN	0.0000000	0.0000000	0.0000000	0.0000000	1.000000+00	
Z MISALIGN	0.0000000	0.0000000	0.0000000	0.0000000	0.0000000	1.000000+00

TABLE A4.1.4-IV.- PRTLS MATRICES AT ET SEPARATION FOR SSME-OUT AT SRB SEPARATION

(A) Covariance matrix

	U ACT	V ACT	M ACT	U-DOT ACT	V-DOT ACT	M-DOT ACT	U MAY
U ACT	7.3426674+05						
V ACT	-2.7760777+02	1.24415132+08					
M ACT	-2.3655570+05	9.7643212+08					
U-DOT ACT	-1.5248304+05	-1.0733674+04	2.2579368+06				
V-DOT ACT	-1.8477674+03	-2.9067676+05	-2.3473501+04	8.1684049+02			
M-DOT ACT	3.7308081+02	-5.1323076+04	1.0878330+03	-4.8842800+01	1.1504332+03		
U MAY	-5.4730087+05	5.8176952+05	-2.6475488+04	-6.9783693+03	1.6263201+02	5.8989256+01	4.7331150+05
V MAY	-5.1264050+04	-6.7568976+05	-1.4022450+05	7.8981338+03	-2.4161404+03	-2.2523152+02	1.4294617+05
M MAY	-8.5678137+04	7.1110773+04	-1.3417254+06	-2.2807249+03	-1.4279593+04	-5.5055338+02	5.8000219+04
U-DOT MAY	-1.3760827+03	1.7548317+03	-1.3482617+01	-2.3737440+01	1.6678273+01	-8.4545069+02	1.1259816+03
V-DOT MAY	-3.8201341+01	-1.8768091+03	-2.0420678+02	2.3357333+01	-3.8887951+01	-9.3788419+01	3.8493386+02
M-DOT MAY	3.8255773+02	-2.0702700+03	-1.5619482+03	2.3368444+01	-2.1852474+01	-1.3363245+00	-2.9892326+01
TIME	8.0428400+04	-2.6190834+06	1.1761606+03	3.7266990+03	2.5418525+02	1.113717+03	3.4393338+04
X ACC BIAS	-8.7108163+01	3.4215922+03	1.9786425+03	-3.3517038+03	-1.6549458+00	4.6771536+00	4.6936954+01
Y ACC BIAS	-2.1438781+01	7.3632153+01	2.0827123+02	-5.5527777+03	2.4024525+03	1.1778335+04	7.8201197+01
Z ACC BIAS	-8.2540356+02	2.2443692+01	-2.0859638+01	-7.8577969+03	9.0224594+03	-1.5073638+03	1.3548111+01
X MISALIGN	8.5749377+04	6.7580785+02	2.0658006+01	-3.3827133+03	3.1251807+03	2.2344003+03	3.3288370+02
Y MISALIGN	-1.4958814+02	-1.4068444+03	7.8401121+02	-8.5822857+04	2.2129129+03	-9.9739398+05	-1.9480765+02
Z MISALIGN			4.4074804+02	6.8151821+05	-5.5213182+04	2.9614722+04	1.1090185+02
						2.9614722+04	1.5625345+02

	U-DOT MAY	V-DOT MAY	M-DOT MAY	Y MISALIGN	Z MISALIGN	TIME
V MAY	1.5535756+06					
M MAY	-1.8608589+05					
U-DOT MAY	-8.7856743+02	2.3051797+06				
V-DOT MAY	3.8840715+03	4.7521673+01	4.5298829+00			
M-DOT MAY	-2.4910406+02	1.7630844+02	-2.3645818+00			
TIME	-2.5768247+05	-2.2107515+03	4.0946247+01	1.0273730+01		
X ACC BIAS	-1.6265768+02	-2.4024129+04	-2.4232757+02	3.6160378+01	1.5923658+01	7.6408533+05
Y ACC BIAS	-5.037742+01	4.4151036+02	2.1211523+01	-4.5724180+01	-3.2152290+01	4.6485370+02
Z ACC BIAS	-3.6819231+01	3.6356350+01	2.3610108+03	2.8265162+04	-1.1423355+04	-5.5299081+04
X MISALIGN	8.7821570+02	-5.2308340+01	4.2010610+04	-1.3103880+03	9.3017624+04	-1.7527498+01
Y MISALIGN	-8.7931336+07	4.0054423+01	-4.7115187+05	-8.2948157+04	-1.3578444+03	-8.8719738+02
Z MISALIGN	1.8338237+01	-1.2265528+01	7.2484644+05	-2.4986254+04	-9.6759309+04	-3.6211735+02
		-7.5400140+02	-8.5908440+05	2.8147340+04	-3.8407226+04	-1.7227047+02
					-2.0267384+04	1.0366552+02

X ACC BIAS	Y ACC BIAS	Z ACC BIAS	X MISALIGN	Y MISALIGN	Z MISALIGN
2.5879156+06					
8.0000000	2.5879156+06				
8.0000000	0.0000000	8.0000000	2.1082071+07		
8.0000000	0.0000000	0.0000000	0.0000000	8.0000000	
8.0000000	0.0000000	0.0000000	0.0000000	0.0000000	2.7717131+08
8.0000000	0.0000000	0.0000000	0.0000000	0.0000000	1.8178875+08

TABLE A4.1.4-IV.- Concluded
(B) Correlation matrix

	U ACT	V ACT	M ACT	U-DOT ACT	V-DOT ACT	M-DOT ACT	U MAY
U ACT	1.000000+00						
V ACT	-2.903312E-01	1.000000+00					
M ACT	-1.037172E-01	5.025712E-01	1.000000+00				
U-DOT ACT	6.047022E-01	-4.742505E-01	-4.742505E-01	1.000000+00			
V-DOT ACT	-6.357473E-02	5.195671E-01	-4.405651E-01	-5.477971E-02	1.000000+00		
M-DOT ACT	5.650915E-02	-5.990017E-01	1.644302E-01	3.505101E-03	6.242335E-01	1.000000+00	
U MAY	-4.750760E-02	4.060000E-02	7.561028E-02	3.039133E-01	-3.377003E-01	-1.800000+00	1.000000+00
V MAY	-6.505254E-02	4.199002E-03	-7.488893E-02	2.410490E-01	1.641743E-02	-4.791067E-02	-1.666609E-01
M MAY	-1.394514E-02	7.392056E-02	-5.081054E-01	5.714373E-02	-2.310334E-01	-5.695354E-01	5.361221E-02
U-DOT MAY	1.127563E-01	-4.651230E-02	-4.239554E-02	2.771900E-01	-3.577011E-01	-2.420795E-02	7.089019E-01
V-DOT MAY	1.073704E-01	-2.686219E-01	-2.604000E-01	2.704346E-01	-1.555431E-01	-5.600000E-01	1.302020E-01
M-DOT MAY	-6.319123E-01	3.617565E-02	6.052333E-01	-5.060370E-01	0.573135E-03	1.653106E-01	-1.031550E-02
TIME	-1.534538E-01	4.100314E-02	-0.633430E-02	1.192532E-02	3.680100E-02	2.790027E-01	-5.085414E-02
X ACC BIAS	-5.052431E-01	4.100314E-02	-0.633430E-02	1.192532E-02	3.680100E-02	2.790027E-01	-5.085414E-02
Z ACC BIAS	-5.052431E-01	4.100314E-02	-0.633430E-02	1.192532E-02	3.680100E-02	2.790027E-01	-5.085414E-02
X MISALIGN	-1.591050E-01	4.384366E-02	1.392610E-01	-6.594517E-02	1.421015E-01	-2.262220E-02	6.109955E-02
Z MISALIGN	3.031532E-03	-9.109366E-04	2.110426E-01	-1.983270E-01	1.956652E-01	4.584015E-01	-0.002503E-02
Y ACC BIAS	-1.260916E-01	1.000000+00					1.040344E-01
Z ACC BIAS	-1.260916E-01	1.000000+00					1.040344E-01
X MISALIGN	1.000000+00						
Y MISALIGN	1.000000+00						
Z MISALIGN	1.000000+00						
U-DOT MAY	1.000000+00						
V-DOT MAY	1.000000+00						
M-DOT MAY	1.000000+00						
TIME	1.000000+00						
X ACC BIAS	1.000000+00						
Z ACC BIAS	1.000000+00						
X MISALIGN	1.000000+00						
Z MISALIGN	1.000000+00						

	U-DOT MAY	V-DOT MAY	M-DOT MAY	Y MISALIGN	Z MISALIGN
U-DOT MAY	1.000000+00				
V-DOT MAY	1.000000+00				
M-DOT MAY	1.000000+00				
TIME	1.000000+00				
X ACC BIAS	1.000000+00				
Z ACC BIAS	1.000000+00				
X MISALIGN	1.000000+00				
Z MISALIGN	1.000000+00				

	U-DOT MAY	V-DOT MAY	M-DOT MAY	Y MISALIGN	Z MISALIGN
U-DOT MAY	1.000000+00				
V-DOT MAY	1.000000+00				
M-DOT MAY	1.000000+00				
TIME	1.000000+00				
X ACC BIAS	1.000000+00				
Z ACC BIAS	1.000000+00				
X MISALIGN	1.000000+00				
Z MISALIGN	1.000000+00				

TABLE A4.1.4-V.- PRTLS MATRICES AT ET SEPARATION FOR LAST TWO-ENGINE RTLS

(A) Covariance matrix

	U ACT	V ACT	W ACT	U-DOT ACT	V-DOT ACT	W-DOT ACT	U MAV
U ACT	3.4834581+05						
V ACT	-2.5549132+04	3.1073978+08					
W ACT	-7.5003374+03	3.3890877+06	2.4273927+06				
U-DOT ACT	6.8919091+03	-2.7037447+05	-5.9059753+03	5.6780790+02			
V-DOT ACT	6.9202931+03	-9.5290802+05	-1.4783025+04	6.9367025+02	2.9283468+03		
W-DOT ACT	3.8769807+03	3.2586784+05	-1.5717794+04	7.7737111+02	9.8233995+02	5.9778975+02	
U MAV	-2.5863117+05	-1.3008634+05	-3.1000914+04	9.0851862+02	-8.3004340+02	-1.1644310+02	2.9219456+03
V MAV	-2.4933001+05	-1.9430293+05	-1.8032452+05	-6.6714670+03	-1.3214356+03	5.1391038+02	1.2389639+05
W MAV	-1.2597358+05	-2.585923+05	-1.4452432+06	-4.0316773+03	7.7617511+02	-1.3272792+03	4.1010078+04
U-DOT MAV	-5.8401105+02	2.3789867+02	5.2258322+01	6.9511718+01	1.0024084+00	-7.5988752+01	6.4169056+02
V-DOT MAV	-7.1078946+02	-3.8068274+02	-1.9088070+02	-2.1601273+01	-3.4044921+00	1.6339131+01	3.0346207+02
W-DOT MAV	-2.7330177+03	2.8342742+02	-5.3724682+02	-1.5147057+01	5.1212472+00	-1.5380369+01	-6.0301620+01
U MAV	-2.7330177+03	3.4265848+07	3.3811941+05	-3.3898615+04	-1.0365417+05	-2.2190132+04	-1.1075442+04
V MAV	-6.1088058+01	1.8844075+03	4.0193815+01	-1.1973049+01	-3.9080423+00	1.2486891+01	5.1843040+00
W MAV	-5.7437192+01	-7.4750102+02	4.2983637+02	-2.0762003+03	-3.1921655+04	7.6595591+05	5.7771877+01
Z ACC BIAS	4.8812288+02	-9.9825121+02	-2.2492243+01	7.5195174+03	-7.5485990+04	-1.5048294+03	9.8365572+02
Z ACC BIAS	1.5004288+01	3.2046917+01	8.5591899+03	8.5591899+03	-1.908942+03	1.0449598+03	2.4862132+02
Z MISALIGN	-1.4297707+02	-3.9356808+02	-3.7556223+01	2.2830373+04	-2.2830373+04	9.9897581+04	1.8965793+02
Z MISALIGN	2.4984850+02	2.2117824+02	7.2443144+02	4.2822214+04	7.4430489+03	3.5725492+04	-1.1951975+02
Z MISALIGN	-1.3105180+02	-3.5000071+02	6.9292519+02	1.1914903+04	-2.5572529+04	2.2313255+04	1.5829816+02
U MAV	9.9951925+05						
V MAV	1.4989606+05	1.6274777+08					
W-DOT MAV	-7.0024514+02	6.5933493+00	3.4253241+00				
V-DOT MAV	2.8203835+03	1.2949421+02	-2.1433043+00				
W-DOT MAV	-2.8410278+02	1.7635353+03	5.3571432+01	5.5658090+00			
U MAV	3.8918775+04	1.0421199+04	-2.4680134+01	5.7004733+01	1.2710099+01		
V MAV	2.0587604+01	1.2008832+01	-1.0382671+02	1.1634722+02	-3.4533944+01	5.0242845+06	2.7354739+00
W MAV	8.3503637+02	-3.607073+02	1.9814388+03	2.3405943+04	-1.2377816+04	-4.2563520+03	3.1319922+06
Z ACC BIAS	-3.8837472+01	3.1249140+01	3.4024239+04	-1.1500844+03	9.1455308+04	-4.0251014+02	-1.5951338+05
Z ACC BIAS	-3.1335864+01	-3.9547094+01	1.0622385+04	-9.3425443+04	-1.1858942+03	-1.8818638+02	-3.1869942+05
Z MISALIGN	7.9639054+02	3.6984799+01	-5.1152124+05	4.3940078+03	-9.8172240+04	4.2413233+03	-3.1513904+06
Z MISALIGN	-7.3998822+02	-8.9969400+02	7.9688645+05	-2.4008270+04	-3.2744493+04	-1.6398202+03	-2.4028076+04
Z MISALIGN	8.1873573+02	-6.4257175+02	-8.9957903+05	2.3991977+04	-1.9901624+04	9.3980494+05	-6.7823535+08
Z ACC BIAS							
Z ACC BIAS	2.5879156+04						
Z ACC BIAS	0.0000000	2.5879156+04					
Z ACC BIAS	0.0000000	0.0000000	2.5879156+04				
Z MISALIGN	0.0000000	0.0000000	0.0000000	2.0844598+07			
Z MISALIGN	0.0000000	0.0000000	0.0000000	0.0000000	2.4340024+08		
Z MISALIGN	0.0000000	0.0000000	0.0000000	0.0000000	0.0000000	1.3464184+08	

TABLE A4.1.4-V.- Concluded
(B) Correlation matrix

	U ACT	V ACT	W ACT	U-DOT ACT	V-DOT ACT	W-DOT ACT	U NAV
U ACT	1.0000000+00						
V ACT	-2.824609-01	1.0000000+00					
W ACT	-7.8826502-03	1.9165358-01	1.0000000+00				
U-DOT ACT	6.9001092-01	-6.3552339-01	-1.5521884-01	1.0000000+00			
V-DOT ACT	2.1666835-01	-9.8632654-01	-1.7475050-01	5.1793005-01	1.0000000+00		
W-DOT ACT	2.5879992-01	-7.6742287-01	-3.7724237-01	4.7547737-01	7.4087742-01	1.0000000+00	
U NAV	-8.1063815-01	-1.4308600-02	-3.6348815-02	7.0537279-02	-2.9059873-02	-8.3720705-03	0.000000+00
V NAV	-6.2253355-01	-1.0997998-02	-1.7493337-01	-2.6003334-01	-2.0422559-02	2.1026175-02	2.292932-01
W NAV	-1.6848725-01	-1.1287206-03	-7.2187277-01	-1.7425938-01	1.1742377-02	-4.8965192-02	5.9466941-02
U-DOT NAV	-5.3645983-01	7.1998034-03	1.7994888-02	1.5761249-02	1.0008814-02	-1.6732884-02	6.6160513-01
V-DOT NAV	-4.1147092-01	-7.2855251-03	-8.1563355-02	-3.0972705-02	-2.1695962-02	2.2833444-03	1.9188324-01
W-DOT NAV	-1.0365390-01	6.2113873-03	-8.9818812-02	-1.0855300-01	-2.5405330-02	-1.6687503-01	-2.7691517-02
U ACC BIAS	-2.0657966-01	8.5626166-01	9.6131975-02	-6.2464003-01	-6.5456813-01	-9.0450771-01	-9.141591-02
V ACC BIAS	-4.2090256-02	6.3817390-02	1.5488146-01	-3.0384056-01	6.6010991-02	3.0879280-01	-5.7994709-03
W ACC BIAS	-6.0492340-01	-2.6026670-03	1.7014109-02	-5.8160983-02	-3.0669022-03	1.9473104-03	6.6433827-01
U MISALIGN	5.1408667-02	-3.4737350-03	-8.9103052-02	1.9615330-01	-8.6712168-03	-3.8310239-02	3.331407-01
V MISALIGN	1.3696000-01	-5.5559875-03	1.2495391-01	2.2327377-01	-1.9515060-02	2.7075963-02	3.0894815-02
W MISALIGN	-6.0492284-02	-7.2818136-03	-5.2422277-01	2.0984866-02	-9.2428179-03	8.9491352-02	7.0849993-02
U-DOT NAV	2.6082579-01	7.6333680-03	2.8526729-01	1.6256794-01	6.9748630-03	9.0158804-02	-1.1622744-01
V-DOT NAV	-1.6252520-01	-1.4349814-02	2.2993833-01	3.6599063-02	-3.4591766-02	6.7399945-02	2.1405379-01

	U-DOT NAV	V-DOT NAV	W-DOT NAV	U MISALIGN	V MISALIGN	W MISALIGN	Z MISALIGN
U-DOT NAV	1.0000000+00						
V-DOT NAV	-3.7844580-01	1.0000000+00					
W-DOT NAV	9.8389204-01	3.9736325-02	1.0000000+00				
U MISALIGN	-7.02263274-02	2.8228672-01	-3.5369782-02	1.0000000+00			
V MISALIGN	1.7402364-02	3.7143233-03	-5.9513832-03	1.7735181-02	1.0000000+00		
W MISALIGN	1.2450706-02	5.6915038-03	-3.3918016-03	1.6164722-02	1.1036193-02	1.0000000+00	
X ACC BIAS	5.1920008-02	-1.7549950-02	6.0351028-01	5.0562272-02	-2.0435939-02	4.8050444-01	1.000000+00
Y ACC BIAS	-2.4147953-01	1.5228627-01	1.7427797-01	-2.4426593-01	1.5081212-01	-1.1502176-03	1.000000+00
Z ACC BIAS	-1.9483683-01	-1.9270048-01	3.5694429-02	-1.9842935-01	-1.9535654-01	-5.2180000-03	1.000000+00
U MISALIGN	1.7467522-01	6.3489822-01	-6.0536330-02	3.2890500-02	-5.7261744-01	6.1444174-01	4.1729814-01
V MISALIGN	-4.5605910-01	-4.3648023-01	2.6530016-01	-5.0559689-01	-5.3522509-01	-6.3076159-03	-9.9516161-01
W MISALIGN	5.9943713-01	-3.6868916-01	-3.5578199-01	6.0003602-01	-3.8644300-01	1.1089943-04	-2.6742958-04

	U ACC BIAS	V ACC BIAS	W ACC BIAS	U MISALIGN	V MISALIGN	W MISALIGN	Z MISALIGN
U ACC BIAS	1.0000000+00						
V ACC BIAS	0.00000000	1.0000000+00					
W ACC BIAS	0.00000000	0.00000000	1.0000000+00				
U MISALIGN	0.00000000	0.00000000	0.00000000	1.0000000+00			
V MISALIGN	0.00000000	0.00000000	0.00000000	0.00000000	1.0000000+00		
W MISALIGN	0.00000000	0.00000000	0.00000000	0.00000000	0.00000000	1.0000000+00	

ORIGINAL PAGE IS
OF POOR QUALITY

TABLE A4.1.4-VI.- PRTLS MATRICES AT ET SEPARATION FOR LAST THREE-ENGINE RTLS

(A) Covariance matrix

	U ACT	V ACT	W ACT	U-DOT ACT	V-DOT ACT	M-DOT ACT	U I-V
U ACT	4.2644088+05						
V ACT	-1.1014271+06	6.4759510+07					
W ACT	-4.0044327+05	1.0504152+07	7.0618216+06				
U-DOT ACT	8.4402863+03	-4.8704460+04	-2.3740600+04				
V-DOT ACT	-7.8110252+02	-2.3412787+05	-4.7160517+04				
W-DOT ACT	-2.9135331+02	1.2039904+04	6.3126398+03				
U MAY	-2.9960409+05	1.2930779+07	-3.4993805+04	1.2033188+03	3.9401702+01	4.2751483+01	2.6513360+05
V MAY	-1.0780455+05	-4.0971259+05	-1.1094587+05	-2.0759728+03	-7.4861285+03	-3.0941221+02	1.1312308+05
W MAY	-7.3839043+04	1.0082658+04	-1.2830530+06	-1.3849825+03	4.2809929+02	-2.3544119+03	6.1203630+04
U-DOT MAY	-8.1880255+02	2.1430243+02	-4.2788839+00	-4.8110062+00	6.1048788+00	5.0789890+01	4.1203381+02
V-DOT MAY	4.9471951+02	-1.2980421+03	-6.8007896+01	8.7351398+00	-2.4813924+01	1.2050776+01	-4.8119764+02
W-DOT MAY	1.3235057+05	-1.8612877+02	-5.2157024+02	1.9027818+01	-2.2631188+01	-1.2050776+01	-4.4748880+01
TIME	-8.0831743+02	1.1874158+06	9.3375988+03	-4.8442656+01	-2.5778092+03	0.8312041+02	-4.7401883+04
X ACC BIAS	-5.6120705+01	-1.1011550+01	2.8055400+02	-2.8657332+03	8.8785834+04	-2.4801155+03	5.4950812+01
Y ACC BIAS	-1.8006804+01	5.2268300+01	-2.3563304+01	-7.6705336+03	1.1808959+02	0.9943705+00	3.0723846+01
Z ACC BIAS	-6.4318584+02	5.7434733+02	2.9596629+01	-2.7204151+03	3.3876339+03	1.3489618+03	2.4604479+02
X MISALIGN	7.4627584+03	3.4664583+02	6.8144749+02	-2.3559588+03	1.3543400+03	4.0591275+04	1.858252+02
Y MISALIGN	-2.4780342+02	-1.3589305+02	4.3382997+02	-2.8102311+04	4.9337962+04	3.7213813+04	-1.1386250+02
Z MISALIGN				-4.2363970+04	-8.84454781+05	1.42033573+04	1.5318597+02
U MAY	9.0432624+05						
V MAY	1.1992720+05	1.5044722+06					
W MAY	-6.4784678+02	1.7717382+01	3.2581191+00				
U-DOT MAY	2.6234283+03	9.5950598+01	-2.0428235+00				
V-DOT MAY	-2.0827748+02	-1.0587002+03	2.8393444+01				
W-DOT MAY	1.1838483+05	-1.0273377+03	-1.0038587+02	8.1472638+00	1.3483317+01	7.5843412+05	1.5133375+01
TIME	-8.2554480+01	2.5509424+00	6.1288534 J2	3.6232772+01	1.1002744+02	-1.8848956+02	8.5750202+06
X ACC BIAS	-7.9690248+02	-3.2159267+02	3.1647335+04	-2.0420708+02	-8.5170712+02	-1.7339807+02	1.1067749+04
Y ACC BIAS	-3.7985027+01	2.8395916+01	3.3647335+04	2.2407222+04	8.7246517+05	-2.2307725+01	2.2967635+05
Z ACC BIAS	-2.8487580+01	3.8862019+01	8.8983371+05	-1.1846873+03	8.5400073+04	-4.8375804+02	8.5941551+06
X MISALIGN	6.4938889+02	3.5864843+01	-3.7531275+05	-8.7570777+04	-1.1820714+03	-4.2584981+03	2.1085359+06
Y MISALIGN	-8.7059318+02	-8.8042888+02	7.3140527+05	-2.9727378+05	-9.5828058+04	-4.2584981+03	8.0083906+08
Z MISALIGN	-8.0591152+02	-5.84244301+02	-8.9667001+05	2.2408888+04	-1.8400178+04	2.4381809+04	
X ACC BIAS	2.5879156+06						
Y ACC BIAS	0.0000000	2.5879156+06					
Z ACC BIAS	0.0000000	0.0000000	2.5879156+06				
X MISALIGN	0.0000000	0.0000000	0.0000000	2.0788105+07			
Y MISALIGN	0.0000000	0.0000000	0.0000000	0.0000000	2.5872149+08		
Z MISALIGN	0.0000000	0.0000000	0.0000000	0.0000000	0.0000000	1.84980329+08	

TABLE A4.1.4-VI.- Concluded
(B) Correlation matrix

	U ACT	V ACT	M ACT	U-DOT ACT	Y-DOT ACT	M-DOT ACT	U MAY
U ACT	1.000000+00						
V ACT	-2.095999+01	1.000000+00					
M ACT	-2.387371+01	4.811903+01	1.000000+00				
U-DOT ACT	7.044808+01	-3.183239+01	-5.278488+01	1.000000+00			
V-DOT ACT	-3.445275+02	-8.380129+01	-5.111822+01	-4.137342+02	1.000000+00		
M-DOT ACT	-6.823571+02	-2.288208+01	-3.033147+01	-3.188717+01	1.735780+01	1.000000+00	
U MAY	-8.931084+01	-3.120817+03	-2.557445+02	-3.316450+01	1.200529+01	-1.177829+01	1.020000+00
V MAY	-1.735952+01	-5.353834+02	-4.390321+02	-1.898288+01	-2.270898+01	4.978218+02	2.310232+01
M MAY	-8.218503+02	-1.021487+03	-3.957086+01	-7.843017+02	1.003314+02	-2.835728+01	6.527814+02
U-DOT MAY	-5.251319+01	1.473782+02	8.828914+04	-1.453132+01	9.744878+02	-4.383073+02	8.587252+01
V-DOT MAY	-1.231857+01	-5.653428+02	-8.880515+03	1.887974+01	-2.504826+01	2.898506+02	-1.913257+01
M-DOT MAY	1.887804+01	-2.093478+02	-5.345178+02	2.824348+01	-6.908195+02	-9.022607+01	-2.368742+02
TIME	2.330272+01	-1.710838+01	-1.183759+02	2.381147+01	-4.537514+02	8.495603+02	-1.058470+01
X ACC BIAS	-3.181856+01	4.373743+01	9.032648+01	-6.508908+01	-4.401346+02	3.923300+01	1.933813+02
Y ACC BIAS	-5.342130+01	-8.505926+03	8.562803+03	-9.709226+02	1.195482+02	-4.633987+03	6.033855+01
Z ACC BIAS	-1.609359+01	4.037490+02	-5.512483+02	-2.998286+01	2.132478+01	-2.357937+01	1.135825+01
X MISALOM	-7.444339+02	4.432818+03	6.923729+02	-8.218914+02	8.085358+02	1.282472+01	2.970348+02
Y MISALOM	-2.159724+01	1.432818+02	-2.882418+01	-2.815801+01	8.354331+02	1.374753+01	7.914841+02
Z MISALOM	7.091072+02	2.678849+02	1.581203+01	-9.504150+02	8.818133+02	3.531634+01	-1.368710+01
X MISALOM	-2.781735+01	-1.240027+02	1.255932+01	-1.898038+01	-1.450035+02	1.709997+01	2.187382+01

	Y MAY	M MAY	U-DOT MAY	Y-DOT MAY	M-DOT MAY	MT	TIME
Y MAY	1.000000+00						
M MAY	1.028155+01	1.000000+00					
U-DOT MAY	-3.775933+01	8.004925+03	1.000000+00				
V-DOT MAY	-5.864805+02	2.748828+02	-3.966202+01	1.000000+00			
M-DOT MAY	1.431358+01	-9.360206+01	8.398418+02	3.456983+02	1.000000+00		
TIME	-1.690393+02	5.348144+04	8.730943+03	-1.839870+02	-5.952438+03	1.000000+00	
X ACC BIAS	5.209158+02	-1.829765+02	8.687228+01	4.878857+02	-1.848883+02	-1.230382+02	1.808800+00
Y ACC BIAS	-2.482891+01	1.438143+01	1.138051+01	-2.536919+01	1.444533+01	-5.311888+02	1.370280+03
Z ACC BIAS	-1.862164+01	-1.969510+01	3.065442+02	-1.907121+01	-2.001166+01	-3.314597+02	1.768346+02
X MISALOM	1.497428+01	8.411743+01	-4.568917+02	2.283885+02	-5.723278+01	-2.984672+02	3.670814+03
Y MISALOM	-4.375650+01	-4.453984+01	2.515097+01	-4.820692+01	-5.480971+01	-3.038204+02	3.363250+03
Z MISALOM	8.232325+01	-3.502904+01	-3.654338+01	8.208927+01	-3.685097+01	2.081681+03	1.665192+04

	X ACC BIAS	Y ACC BIAS	Z ACC BIAS	X MISALOM	Y MISALOM	Z MISALOM
X ACC BIAS	1.000000+00					
Y ACC BIAS	0.000000	1.000000+00				
Z ACC BIAS	0.000000	0.000000	1.000000+00			
X MISALOM	0.000000	0.000000	0.000000	1.000000+00		
Y MISALOM	0.000000	0.000000	0.000000	0.000000	1.000000+00	
Z MISALOM	0.000000	0.000000	0.000000	0.000000	0.000000	1.000000+00

TABLE A4.2.1-I.- AOA EVENT TIMELINE

Event/case	Time, sec	Total weight, lb	Geodetic altitude, ft	Inertial velocity, fps	Inertial flightpath angle, deg	HA x HP, n. mi.
SRB ignition	0.0	4 449 965	-23	1 341	0.00	--
SRB separation	131.7	1 830 427	165 271	5 260	26.41	39.4 x -3447.3
MECO	644.9	310 980	386 950	24 876	.33	60.6 x -365.3
OMS-1 ignition	770.6	215 999	404 537	25 239	.11	62.3 x -182.3
OMS-1 cutoff	1061.1	199 971	394 300	25 795	-.08	105.3 x 59.5
OMS-2 ignition	3299.1	199 971	633 559	25 505	.23	105.3 x 59.5
OMS-2 cutoff	3383.0	1967 56	644 059	25 347	.22	103.1 x -18.0
Entry interface - 5 min	4273.0	196 756	521 573	25 468	-.73	103.1 x -18.4
Entry interface	4573.1	196 756	400 000	25 626	-.92	103.1 x -18.4

TABLE AN.2-2-1. - AOA RSS DATA AT MECO
(A) ACTUAL MINUS NOMINAL STATE PARAMETERS

	U (FT)	V (FT)	W (FT)	U-DOT (FPS)	V-DOT (FPS)	W-DOT (FPS)	ALTITUDE (FT)	SPEED (FPS)	M-DOT (FPS)	DR-DOT (FPS)	GAMMA (DEG)
PLATFORM ALINE											
AZIMUTH	-410.	-61.	8382.	-1.7	-3	33.0	-416.	-3	-1.8	-2	-004
TILT	1013.	-789.	-1577.	4.4	-3.1	-2.8	1013.	-3.1	3.5	-3.1	.008
ROLL	-1412.	1277.	-1164.	-6.4	4.9	-2.4	-1412.	4.8	-4.9	4.8	-011
DRIFT BIAS											
X	-20.	1.	345.	-1	-0	2.2	-20.	-0	-1	-0	-000
Y	164.	-110.	-118.	1.1	-6	-2	164.	-6	1.0	-6	-002
Z	-234.	171.	-96.	-1.7	.9	-3.3	-234.	.9	-1.5	.9	-003
0-SEMS IA DRIFT											
X	-28.	-1.	535.	-2	-0	2.7	-28.	-0	-2	-0	-000
Y	220.	-144.	-136.	1.6	-8	-2	220.	-8	1.5	-8	-003
Z	-194.	135.	-70.	-1.5	.8	-2	-193.	.8	-1.4	.8	-003
0-SEMS OA DRIFT											
X	-15.	-1.	278.	-1	-0	2.0	-15.	-0	-1	-0	-000
Y	254.	-186.	-226.	1.4	-9	-5	254.	-9	1.2	-9	-003
Z	-307.	219.	-115.	-2.4	1.2	-3.3	-307.	1.2	-2.1	1.2	-005
0-S0 SEN DRIFT											
X	-25.	2.	418.	-1	-0	2.1	-25.	-0	-1	-0	-000
Y	133.	-87.	-76.	1.1	-5	-1	133.	-5	1.0	-5	-002
Z	-167.	133.	-73.	-1.0	.6	-2	-167.	.6	-8	.6	-002
ACCEL BIAS											
X	-1039.	977.	-50.	-4.2	3.3	-2	-1039.	3.3	-3.1	3.3	-007
Y	-350.	309.	522.	-2.1	1.0	1.6	-349.	1.0	-1.7	1.0	-004
Z	-165.	202.	-808.	-1.1	.7	-2.5	-165.	.7	-1.9	.7	-002
ACCEL SCALE FAC											
X	-782.	707.	-32.	-2.2	2.1	-1	-701.	2.1	-1.4	2.1	-003
Y	-227.	192.	343.	-1.5	.7	1.3	-226.	.7	-1.2	.7	-003
Z	-66.	80.	-339.	-1.5	.3	-1.4	-66.	.3	-1.4	.3	-001
ACCEL 1A ALINE											
-OA											
X	-1228.	1106.	-59.	-5.8	4.0	-2	-1228.	4.0	-4.5	4.0	-010
Y	-261.	219.	399.	-1.7	.8	1.6	-260.	.8	-1.5	.8	-003
Z	-193.	236.	-941.	-1.2	.8	-1.7	-193.	.7	-1.9	.8	-002
ACCEL 1A ALINE											
-SA											
X	-774.	689.	-38.	-3.8	2.5	-2	-773.	2.5	-2.9	2.5	-007
Y	-417.	373.	608.	-2.1	1.2	1.1	-417.	1.2	-1.7	1.2	-004
Z	-193.	229.	-968.	-1.4	.8	-3.7	-193.	.8	-1.2	.8	-003
3-SIGMA RSS *	2787.	2464.	8854.	13.1	9.0	34.0	2787.	8.9	10.3	9.0	.024

TABLE AN-2-2-1. - AOA RSS DATA AT MECO
 (B) NAVIGATED MINUS ACTUAL STATE PARAMETERS

	U (FT)	V (FT)	W (FT)	U-DOT (FPS)	V-DOT (FPS)	W-DOT (FPS)	M-DOT (FPS)	ALTITUDE (FT)	SPEED (FPS)	M-DOT (FPS)	DR-DOT (FPS)	GAMMA (DEG)
PLATFORM ALINE												
AZIMUTH	420.	-212.	-8428.	2.0	-2.2	-32.0	1.7	418.	-2.2	1.7	-3.3	.004
TILT	-1028.	1526.	1576.	-5.1	3.7	2.5	-3.2	-1019.	3.7	-3.2	3.7	-.007
ROLL	1422.	-2299.	1163.	7.2	-5.6	2.2	4.4	1422.	-5.5	4.4	-5.6	.010
DRIFT BIAS												
X	20.	-1.	-350.	.1	0	-2.1	.1	20.	0	.1	0	.000
Y	-187.	152.	116.	-1.2	.6	.2	-1.0	-187.	.6	-1.0	.6	-.002
Z	238.	-226.	96.	1.7	-.9	.3	1.4	238.	-.9	1.4	-.9	.003
0-SENS IA DRIFT												
X	20.	-5.	-549.	.1	0	-2.8	.1	20.	0	.1	0	.000
Y	-224.	189.	134.	-1.7	.6	.2	-1.5	-224.	.6	-1.5	.6	-.003
Z	198.	-178.	78.	1.6	-.8	.2	1.4	197.	-.7	1.4	-.8	.003
G-SENS OA DRIFT												
X	15.	-2.	-283.	.1	0	-1.9	.1	15.	0	.1	0	.000
Y	-256.	265.	225.	-1.5	.9	.4	-1.1	-256.	.9	-1.1	.9	-.003
Z	314.	-278.	115.	2.5	-1.2	.3	2.1	314.	-1.2	2.1	-1.2	.005
G-SQ SEN DRIFT												
X	24.	-4.	-421.	.1	0	-2.1	.1	24.	0	.1	0	.000
Y	-136.	111.	74.	-1.2	.5	.1	-1.0	-136.	.5	-1.0	.5	-.002
Z	188.	-170.	73.	1.0	-.6	.2	.8	188.	-.6	.8	-.6	.002
ACCEL BIAS												
X	1045.	-389.	50.	3.6	-1.2	.2	3.1	1045.	-1.1	3.1	-1.1	.007
Y	356.	788.	-524.	1.2	2.2	-1.5	2.1	356.	2.2	2.1	2.2	.005
Z	169.	508.	809.	.5	1.5	2.4	1.1	169.	1.5	1.1	1.5	.003
ACCEL SCALE FAC												
X	704.	-957.	31.	1.7	-1.5	.1	1.4	704.	-1.5	1.4	-1.5	.003
Y	232.	408.	-345.	1.0	1.8	-1.3	1.6	231.	1.8	1.6	1.8	.003
Z	88.	212.	341.	.3	.8	1.3	.6	88.	.8	.6	.8	.001
ACCEL IA ALINE												
-OA												
X	1239.	-464.	59.	5.1	-1.8	.2	4.5	1239.	-1.7	4.5	-1.8	.010
Y	267.	566.	-401.	1.1	2.2	-1.6	1.8	267.	2.2	1.8	2.2	.004
Z	196.	581.	939.	.4	1.0	1.6	1.1	196.	1.0	1.1	1.0	.003
ACCEL IA ALINE												
-SA												
X	781.	-293.	38.	3.3	-1.2	.2	3.0	781.	-1.1	3.0	-1.2	.007
Y	422.	854.	-607.	.9	1.4	-1.0	2.0	421.	1.5	2.0	1.4	.004
Z	199.	601.	973.	.8	2.2	3.7	1.5	199.	2.2	1.5	2.2	.003
3-SIGMA RSS	2810.	3366.	8899.	12.6	8.9	32.9	10.4	2810.	8.9	10.4	8.9	.024

TABLE AN.2.2-1. - ADA RSS DATA AT MECO

(C) ACTUAL MINUS NOMINAL VEHICLE PARAMETERS

	LATD (DEG)	LONG (DEG)	AZIM (DEG)	RANGE (NM)	TIME (SEC)	WEIGHT (LBS)	PROP (LBS)	OXID (LBS)	FUEL (LBS)
PLATFORM ALINE									
AZIMUTH	.021	-.010	-.080	.03	.00	0.	0.	0.	0.
TILT	-.005	-.001	.006	-.13	-.00	0.	0.	0.	0.
ROLL	-.002	.005	.008	.20	-.00	0.	0.	0.	0.
DRIFT BIAS									
X	.001	-.000	-.005	.00	.00	0.	0.	0.	0.
Y	-.000	-.000	.000	-.02	-.00	0.	0.	0.	0.
Z	-.000	.001	.001	.03	-.00	0.	0.	0.	0.
G-SENS 1A DRIFT									
X	.001	-.001	-.006	.00	.00	0.	0.	0.	0.
Y	-.000	-.000	.000	-.02	-.00	0.	0.	0.	0.
Z	-.000	.001	.001	.02	-.00	0.	0.	0.	0.
G-SENS 0A DRIFT									
X	.001	-.000	-.005	.00	.00	0.	0.	0.	0.
Y	-.001	-.000	.001	-.03	-.00	0.	0.	0.	0.
Z	-.000	.001	.001	.04	-.00	0.	0.	0.	0.
O-SO SEM DRIFT									
X	.001	-.000	-.005	.00	.00	0.	0.	0.	0.
Y	-.000	-.000	.000	-.01	-.00	0.	0.	0.	0.
Z	-.000	.000	.001	.02	-.00	0.	0.	0.	0.
ACCEL BIAS									
X	.001	.003	.002	.16	-.00	0.	0.	0.	0.
Y	.002	.000	-.003	.05	-.00	0.	0.	0.	0.
Z	-.002	.002	.006	.03	-.00	0.	0.	0.	0.
ACCEL SCALE FAC									
X	.001	.002	.001	.11	-.00	0.	0.	0.	0.
Y	.001	.000	-.003	.03	-.00	0.	0.	0.	0.
Z	-.001	.001	.003	.01	-.00	0.	0.	0.	0.
ACCEL 1A ALINE									
-0A									
X	.001	.004	.003	.18	-.00	0.	0.	0.	0.
Y	.001	.000	-.004	.04	-.00	0.	0.	0.	0.
Z	-.002	.002	.004	.03	-.00	0.	0.	0.	0.
ACCEL 1A ALINE									
-5A									
X	.001	.002	.002	.11	-.00	0.	0.	0.	0.
Y	.002	.000	-.002	.06	-.00	0.	0.	0.	0.
Z	-.002	.002	.010	.03	-.00	0.	0.	0.	0.
3-SIGMA RSS *	.022	.013	.083	.40	.00	0.	0.	0.	0.

TABLE AN.2.2-1. - AOA RSS DATA AT MECO

(D) ACTUAL MINUS NOMINAL ORBITAL PARAMETERS

	MA (MM)	MP (MM)	PERIOD (SEC)	INCLIN (DEG)	ASC NOD (DEG)	ARG PER (DEG)	TRU ANOM (DEG)	SHAJ AXS (MM)	ECCENT (IND)
PLATFORM ALINE									
AZIMUTH	-.12	-.25	-.41	-.928	.0887	-.19	.12	-.19	.00002
TILT	.25	-1.18	-1.01	-.085	-.058	.15	-.15	-.48	.00021
ROLL	-.34	1.88	1.68	-.052	-.054	-.19	.20	-.77	-.00034
DRIFT BIAS									
X	-.01	-.01	-.02	-.030	.0062	-.01	.01	-.01	.00000
Y	-.05	-.25	-.21	-.005	-.005	.05	-.05	-.18	.00005
Z	-.07	-.38	.33	-.005	-.007	-.07	.07	-.15	-.00007
0-SEMS IA DRIFT									
X	-.01	-.02	-.03	-.039	.0074	-.02	.01	-.01	.00000
Y	-.07	-.34	-.29	-.006	-.005	.07	-.07	-.13	.00006
Z	-.07	-.33	.28	-.004	-.005	-.07	.07	-.13	-.00006
0-SEMS OA DRIFT									
X	-.01	-.01	-.02	-.026	.0057	-.01	.01	-.01	.00000
Y	-.07	-.34	-.30	-.018	-.010	.05	-.05	-.13	.00006
Z	-.10	-.51	.44	-.008	-.008	-.10	.10	-.28	-.00009
0-SO SEN DRIFT									
X	-.01	-.01	-.02	.0031	-.0060	-.01	.01	-.01	.00000
Y	-.05	-.21	-.18	-.003	-.002	.05	-.05	-.08	.00004
Z	-.05	-.25	.22	-.004	-.005	-.04	.04	-.10	-.00004
ACCEL BIAS									
X	-.24	1.23	1.08	-.0003	-.0004	-.12	.12	.49	-.00022
Y	-.18	.40	.32	-.029	-.042	-.08	.08	.15	-.00007
Z	-.05	-.28	.25	-.004	-.0063	-.03	.04	.12	-.00005
ACCEL SCALE FAC									
X	-.14	-.74	.65	-.0001	-.0002	-.04	.04	.30	-.00013
Y	-.07	-.27	.22	.0022	-.0036	-.06	.06	.10	-.00005
Z	-.02	-.12	.11	-.0022	-.0037	-.02	.02	.05	-.00002
ACCEL IA ALINE									
OA									
X	-.31	1.53	1.34	-.0004	-.0006	-.19	.19	.81	-.00028
Y	-.08	.31	.25	-.026	-.045	-.08	.07	.11	-.00008
Z	-.05	-.31	.28	-.0040	-.0037	-.04	.04	.13	-.00005
ACCEL IA ALINE									
SA									
X	-.28	.88	.86	-.0003	-.0004	-.12	.13	.39	-.00018
Y	-.11	.46	.38	-.026	-.025	-.08	.08	.17	-.00009
Z	-.06	-.35	.32	-.0060	-.010	-.04	.05	.14	-.00008
3-SIGMA RSS -	.70	3.48	3.07	.0548	.0912	.47	.45	1.40	.00063

TABLE AN-2.2-11. - AOA RSS DATA AT OMS-1 CUTOFF

(A) ACTUAL MINUS NOMINAL STATE PARAMETERS

	U (FT)	V (FT)	W (FT)	U-DOT (FPS)	V-DOT (FPS)	W-DOT (FPS)	ALTIITUDE (FT)	SPEED (FPS)	W-DOT (FPS)	DR-DOT (FPS)	GAMMA (DEG)
PLATFORM ALINE											
AZIMUTH	-1187.	7740.	20440.	-10.9	1.1	24.7	-1175.	1.1	-1.5	1.1	-.003
TILT	1827.	-11238.	-2475.	13.5	-4.6	-1.4	1030.	-4.6	-.1	-4.6	-.000
ROLL	-2460.	14408.	-1982.	-17.0	6.7	-1.4	-2455.	6.7	.4	6.7	-.001
DRIFT BIAS											
X	-76.	72.	1159.	-2	-1	1.8	-76.	1.1	-1.1	1.1	-.000
Y	468.	-430.	-188.	9	-1.0	-1	468.	-1.0	.4	-1.0	-.001
Z	-864.	431.	-192.	-1.2	1.4	-2	-864.	1.4	-7	1.4	-.001
0-SENS IA DRIFT											
X	-89.	617.	1524.	-9	-1	2.1	-84.	1.1	-2	1.1	-.000
Y	671.	-321.	-208.	1.1	-1.3	-1	671.	-1.3	.7	-1.3	-.002
Z	-618.	615.	-144.	-1.5	1.3	-1	-617.	1.3	-7	1.3	-.002
0-SENS OA DRIFT											
X	-67.	242.	1023.	-4	-8	1.6	-67.	0	-1	0	-.000
Y	503.	-778.	-378.	1.3	-1.3	-3	503.	-1.3	.4	-1.3	-.001
Z	-953.	831.	-230.	-2.8	1.9	-2	-953.	1.9	-1.0	1.9	-.002
0-SQ SEN DRIFT											
X	-82.	418.	1213.	-8	-1	1.7	-82.	1.1	-1	1.1	-.000
Y	449.	-116.	-105.	7	-8	-0	449.	-8	.5	-8	-.001
Z	-394.	397.	-143.	-8	-9	-1	-394.	9	-3	9	-.001
ACCEL BIAS											
X	-1894.	-15897.	-109.	16.2	3.3	-2	-1878.	3.3	-3.1	3.3	-.007
Y	-1264.	-57130.	1162.	63.7	-1.8	2.0	-1167.	-1.8	-9.5	-1.8	-.012
Z	-658.	-38415.	-1768.	43.1	-1.4	-2.8	-623.	-1.4	-3.4	-1.4	-.008
ACCEL SCALE FAC											
X	-1052.	-20762.	-57.	23.8	9	-0	-1041.	9	-1.3	9	-.003
Y	-862.	-34670.	834.	38.5	-1.0	1.1	-834.	-1.0	-3.5	-1.0	-.008
Z	-289.	-15203.	-846.	17.0	-5	-1.0	-283.	-5	-1.4	-5	-.003
ACCEL IA ALINE											
- OA											
X	-2553.	-26971.	-132.	28.4	3.5	-1	-2536.	3.4	-3.3	3.4	-.007
Y	-1025.	-41772.	989.	46.5	-1.2	1.3	-984.	-1.2	-4.1	-1.2	-.009
Z	-882.	-23183.	-1585.	25.8	-4	-8	-590.	-4	-2.2	-4	-.005
ACCEL IA ALINE											
- SA											
X	-1648.	-16600.	-99.	18.0	2.3	-1	-1641.	2.3	-2.1	2.2	-.005
Y	-1158.	-35233.	981.	39.2	-4	7	-1128.	-4	-3.5	-4	-.008
Z	-838.	-42784.	-2328.	47.8	-1.4	-2.7	-795.	-1.4	-3.9	-1.4	-.009
3-SIGMA RSS -											
	5875.	116663.	21210.	130.3	10.9	25.6	5814.	11.0	11.8	11.0	-.026

TABLE 44.2-2-11. - AOA RSS DATA AT OMS-1 CUTOFF
 (8) NAVIGATED MINUS ACTUAL STATE PARAMETERS

	U (FT)	V (FT)	W (FT)	U-DOOT (FPS)	V-DOOT (FPS)	M-DOOT (FPS)	ALTIUDE (FT)	SPEED (FPS)	M-DOOT (FPS)	DR-DOOT (FPS)	OAMMA (DEG)
PLATFORM ALINE											
AZIMUTH	1102.	-842.	-2032.	2.5	-1.0	-23.9	1091.	-1.0	1.5	-1.0	.003
TILT	-1696.	3991.	2372.	-4.0	4.5	1.2	-1690.	4.5	.0	4.5	.000
ROLL	2291.	-5860.	1876.	0.7	-0.5	1.2	2207.	-0.5	-4	-0.5	-.001
DRIFT BIAS											
X	75.	-36.	-1102.	.2	-.1	-1.0	75.	-.1	.1	-.1	.000
Y	-471.	043.	101.	-1.2	.0	.0	-471.	.0	-.5	.0	-.001
Z	000.	-047.	175.	1.0	-1.4	.1	007.	-1.4	.0	-1.4	-.001
O-SENS IA DRIFT											
X	90.	-51.	-1510.	.2	-.1	-2.0	00.	-.1	.1	-.1	.000
Y	-004.	000.	100.	-1.0	1.3	.0	-004.	1.3	-.7	1.3	-.002
Z	026.	-010.	123.	1.7	-1.3	.1	025.	-1.3	.7	-1.3	-.002
O-SENS OA DRIFT											
X	04.	-32.	-1040.	.2	-.1	-1.0	04.	-.1	.1	-.1	.000
Y	-075.	020.	347.	-1.5	1.2	.2	-075.	1.2	-.4	1.2	-.001
Z	071.	-1202.	206.	2.0	-2.0	.1	071.	-2.0	1.0	-2.0	-.002
O-50 SEN DRIFT											
X	77.	-43.	-1101.	.2	-.1	-1.0	77.	-.1	.1	-.1	.000
Y	-402.	090.	70.	-1.2	.0	-.1	-402.	.0	-.0	.0	-.001
Z	309.	-021.	137.	1.0	-.0	.1	309.	-.0	-.2	-.0	-.001
ACCEL BIAS											
X	2300.	-2131.	1111.	5.5	-3.7	-.2	2311.	-3.7	3.0	-3.7	.007
Y	1776.	005.	-1175.	3.0	1.2	-1.0	1773.	1.2	5.1	1.2	.011
Z	1017.	702.	1027.	2.3	.0	2.0	1015.	.0	3.2	.0	.007
ACCEL SCALE FAC											
X	1241.	-1077.	40.	2.4	-1.3	.0	1242.	-1.3	1.1	-1.3	.003
Y	1227.	009.	-015.	2.4	.5	-1.0	1225.	.5	3.2	.5	.007
Z	456.	349.	029.	.0	.3	1.0	456.	.3	1.3	.3	.003
ACCEL IA ALINE											
-0A											
X	2032.	-2032.	141.	0.3	-3.0	-.2	2036.	-3.0	3.1	-3.0	.007
Y	1456.	027.	-070.	2.0	.7	-1.2	1454.	.7	3.9	.7	.009
Z	052.	000.	1447.	1.3	-.0	.0	051.	-.0	2.0	-.0	.004
ACCEL IA ALINE											
-SA											
X	1023.	-1703.	91.	4.0	-2.5	.1	1024.	-2.5	2.0	-2.5	.004
Y	1522.	727.	-032.	2.4	-.1	-.5	1521.	-.1	3.3	-.1	.007
Z	1276.	003.	2299.	2.5	.0	2.7	1273.	.0	3.0	.0	.008
3-SIGMA RSS	0591.	0705.	20005.	15.4	10.0	24.7	0509.	10.0	11.0	10.0	.024

TABLE AN.2.2-11. - AGA RSS DATA AT OMS-1 CUTOFF

(C) ACTUAL MINUS NOMINAL VEHICLE PARAMETERS

	LATD (DEG)	LONG (DEG)	AZIM (DEG)	RANGE (MM)	TIME (SEC)	WEIGHT (LBS)	PROP (LBS)	OXID (LBS)	FUEL (LBS)
PLATFORM ALINE									
AZIMUTH	-.024	-.028	-.036	1.38	.28	-11.	0.	0.	0.
YAW	-.006	-.039	-.023	-1.77	-.32	12.	0.	0.	0.
ROLL	-.007	-.049	-.036	2.24	.38	-14.	0.	0.	0.
DRIFT BIAS									
X	-.003	-.000	-.004	.02	.00	0.	0.	0.	0.
Y	-.000	-.002	-.001	-.07	.01	0.	0.	0.	0.
Z	-.001	-.002	-.001	.07	-.02	1.	0.	0.	0.
0-SENS 1A DRIFT									
X	-.004	-.002	-.003	.11	.02	-1.	0.	0.	0.
Y	-.001	-.001	-.001	-.05	.02	-1.	0.	0.	0.
Z	-.000	-.002	-.002	.10	-.01	0.	0.	0.	0.
0-SENS 0A DRIFT									
X	-.003	-.001	-.003	.04	.01	0.	0.	0.	0.
Y	-.001	-.003	-.001	-.13	.00	0.	0.	0.	0.
Z	-.001	-.003	-.002	.14	-.02	1.	0.	0.	0.
0-50 SEN DRIFT									
X	-.003	-.002	-.003	.00	.01	-1.	0.	0.	0.
Y	-.000	-.000	-.000	-.02	.02	-1.	0.	0.	0.
Z	-.000	-.001	-.001	.08	-.01	0.	0.	0.	0.
ACCEL BIAS									
X	-.001	-.003	-.036	-2.43	-1.75	29.	0.	0.	0.
Y	-.009	-.102	-.134	-0.70	-2.26	97.	0.	0.	0.
Z	-.001	-.128	-.001	-5.02	-1.52	50.	0.	0.	0.
ACCEL SCALE FAC									
X	-.002	-.070	-.047	3.10	-.00	34.	0.	0.	0.
Y	-.000	-.116	-.001	-0.32	-1.30	23.	0.	0.	0.
Z	-.001	-.001	-.032	-2.34	-.60	23.	0.	0.	0.
ACCEL 1A ALINE									
X	-.002	-.000	-.001	-4.12	-1.20	40.	0.	0.	0.
Y	-.007	-.140	-.000	-0.42	-1.66	84.	0.	0.	0.
Z	-.002	-.070	-.051	-3.57	-.03	30.	0.	0.	0.
ACCEL 1A ALINE									
X	-.001	-.005	-.030	-2.54	-.74	20.	0.	0.	0.
Y	-.006	-.110	-.002	-5.40	-1.42	54.	0.	0.	0.
Z	-.002	-.144	-.002	-0.50	-1.89	65.	0.	0.	0.
3-SIGMA RSS	-.057	-.302	-.267	17.93	4.60	170.	0.	0.	0.

TABLE 24.2.P-11. - 40A RSS DATA AT GMS-1 CUTOFF

(B) ACTUAL MINUS NOMINAL ORBITAL PARAMETERS

	MA (MM)	MP (MM)	PERIOD (SEC)	INCLIN (DEG)	ASC NOD (DEG)	ARG PER (DEG)	TRU ANOM (DEG)	SHAJ AXS (MM)	ECCENT (ML)
PLATFORM ALINE									
AZIMUTH	-10	-23	-16	-920	-0005	30	-42	-00	-00004
TILT	-1.02	-20	-1.91	-0053	-0033	97	-50	-07	-00027
ROLL	2.64	-35	2.33	-0051	-0031	-05	00	1.04	-00040
DRIFT BIAS									
X	00	-02	-02	-0020	-0003	04	-05	-01	-00000
Y	-21	00	-25	-0005	-0003	-04	04	-11	-00006
Z	-45	-12	-37	-0005	-0006	07	-07	-17	-00000
0-SENS 1A DRIFT									
X	-01	-02	-03	-0030	-0074	05	-05	-02	-00010
Y	-23	-12	-34	-0006	-0003	-00	00	-15	-00004
Z	-08	-12	-32	-0004	-0005	10	-10	-14	-00007
0-SENS 0A DRIFT									
X	-01	-01	-03	-0025	-0050	03	-04	-01	-00000
Y	-01	-10	-35	-0010	-0009	-02	-02	-16	-00007
Z	-02	-10	-50	-0006	-0007	14	-13	-22	-00011
0-50 SEN DRIFT									
X	01	-02	-01	-0031	-0060	04	-04	-01	-00000
Y	-20	-00	-21	-0003	-0001	-00	00	-00	-00005
Z	-20	-07	-23	-0004	-0004	-00	00	-10	-00015
ACCEL BIAS									
X	-01	-00	-00	-0003	-0005	04	-00	-25	-00010
Y	-1.30	-30	-2.02	-0020	-0072	2.13	-2.20	-01	-00010
Z	-06	-22	-1.33	-0045	-0100	1.34	-1.93	-00	-00010
ACCEL SCALE FAC									
X	-01	-21	-22	-0002	-0001	35	-41	-10	-00003
Y	-06	-25	-1.25	-0021	-0030	1.32	-1.41	-57	-00000
Z	-30	-00	-34	-0022	-0037	04	-50	-24	-00004
ACCEL 1A ALINE									
X	-73	-00	-24	-0003	-0003	72	-70	-11	-00017
Y	-1.02	-32	-1.50	-0020	-0040	1.50	-1.50	-07	-00010
Z	-45	-17	-70	-0040	-0034	70	-05	-31	-00004
ACCEL 1A ALINE									
X	40	-32	-17	-0003	-0003	40	-31	00	-00011
Y	-07	-30	-1.11	-0026	-0025	1.27	-1.34	-50	-00005
Z	-1.04	-28	-1.40	-0000	-0007	1.52	-1.02	-00	-00011
3-SIGMA RSS	4.25	1.21	4.70	0.046	0.016	4.23	4.54	2.14	0.0065

TABLE AN.2.2-111. -- ADA RSS DATA AT OMS-2 CUTOFF

(A) ACTUAL MINUS NOMINAL STATE PARAMETERS

	U (FT)	V (FT)	W (FT)	U-DOT (FPS)	V-DOT (FPS)	W-DOT (FPS)	ALTITUDE (FT)	SPEED (FPS)	M-DOT (FPS)	DR-DOT (FPS)	GAMMA (DEG)
PLATFORM ALIGN											
AZIMUTH	-124	8026	-12430	-8.7	-1.1	-31.2	-149	-1.7	1.7	-1.1	.004
TILT	-940	1990	1000	-15.5	0.0	0.0	-9597	0.0	-2.6	3.0	-.008
ROLL	14370	-17816	1506	24.3	-13.6	1.3	14586	-13.5	3.0	-13.5	.008
DRIFT BIAS											
X	-51	804	-995	-8	.1	-2.1	-51	.1	.2	.1	.008
Y	-1040	531	211	-1.6	1.5	.2	-1040	1.5	-1.6	1.5	-.002
Z	2376	625	100	.7	-2.2	.3	2376	-2.2	1.4	-2.2	.003
G-SENS IA DRIFT											
X	-124	1700	-804	-1.0	.1	-2.5	-123	.1	.3	.1	.001
Y	-2104	-1	230	-1.3	2.1	.1	-2104	2.1	-1.3	2.1	-.003
Z	2052	1271	140	-.2	-1.0	.1	2052	-1.0	1.3	-1.0	.003
G-SENS OA DRIFT											
X	-90	1000	-456	-1.7	.0	-1.0	-87	.0	.2	.0	.008
Y	-2271	1700	330	-2.0	2.1	.3	-2271	2.1	-2.0	2.1	-.002
Z	3195	1100	150	.0	-3.0	.1	3194	-3.0	2.0	-3.0	.004
G-SENS SEM DRIFT											
X	-34	1445	-610	-1.0	.0	-2.0	-34	.0	.1	.0	.000
Y	-1360	-420	93	-.4	1.3	-.1	-1360	1.3	-.4	1.3	-.002
Z	1523	324	190	.4	-1.4	.3	1522	-1.4	.4	-1.4	.002
ACCEL BIAS											
X	3003	14320	92	-12.3	-0.1	.0	3007	-4.2	4.0	-4.2	.010
Y	-1050	4104	-502	-40.3	0.7	-.5	-10010	0.6	2.7	0.6	.008
Z	-7233	22330	873	-24.0	0.7	3.4	-7222	0.0	1.5	0.0	.003
ACCEL SCALE FAC											
X	-440	16420	90	-17.7	-0	1.3	-433	-1.1	1.0	-1.1	.004
Y	-6036	34010	-955	-30.0	5.7	1.0	-6009	5.6	2.0	5.6	.005
Z	-2075	13037	950	-19.5	2.5	2.3	-2070	2.5	.0	2.5	.001
ACCEL IA ALIGN											
-04											
X	2076	23010	150	-23.0	-3.3	2.2	2050	-3.3	4.3	-3.4	.010
Y	-7000	30750	-541	-44.6	0.0	1.1	-7071	6.7	2.3	6.7	.005
Z	-3005	22106	1213	-24.5	2.0	2.0	-3594	2.0	1.0	2.0	.004
ACCEL IA ALIGN											
-54											
X	1020	13071	124	-13.0	-2.0	1.3	1025	-2.1	2.7	-2.1	.006
Y	-5574	33000	-702	-37.5	4.7	1.4	-5547	4.6	4.6	4.6	.005
Z	-7046	37274	1404	-42.3	7.0	0.1	-7016	0.0	1.0	0.0	.007
3-STORA RSS	27599	90750	13003	111.3	25.2	32.0	27551	24.9	10.7	24.9	.024

TABLE AN-2.2-111. - 404 BSS DATA AT OMS-2 CUTOFF

10' NAVIGATED MINUS ACTUAL STATE PARAMETERS

	U (FT)	V (FT)	W (FT)	M-DOY (FPS)	Y-DOY (FPS)	M-DOY (FPS)	ALTITUDE (FT)	SPEED (FPS)	M-DOY (FPS)	DR-DOY (FPS)	GAUSS (GCO)
PLATFORM ALINE											
AZIMUTH	42	-7395	12355			30.3	30	2	-1.6	2	-004
PITCH	6222	-1022	133		-0.0	-2.1	6222	-0.0	2.6	-0.0	-000
ROLL	-10652	-1070	-223		3.6	-1.0	-14064	13.5	-3.5	13.5	-000
DRIFT BIAS											
X	52	-667	602		-1.1	2.9	52	-1.1	-1.2	-1.1	-000
Y	1016	173	-149		-1.9	-1.1	1016	-1.9	1.0	-1.9	-002
Z	-2420	72	-133		2.3	-1.2	-2420	2.3	-1.0	2.3	-003
0-SENS IA DRIFT											
X	-15	-600	600		0	2.9	-14	0	-1.1	0	-000
Y	2123	671	-100		-2.0	-1.1	2123	-2.0	1.3	-2.0	-003
Z	-2063	-942	-90		1.0	-1.1	-2063	1.0	-1.3	1.0	-003
0-SENS OA DRIFT											
X	55	-623	620		0	2.0	55	0	-1.1	0	-000
Y	2126	-620	-277		-1.6	-1.3	2126	-2.0	1.0	-2.0	-002
Z	-3221	-379	-152		1.3	-1.2	-3220	3.0	-1.0	3.0	-004
0-SENS SB DRIFT											
X	83	-667	674		-1.1	2.6	83	-1.1	-1.1	-1.1	-000
Y	1342	750	-93		-1.3	-1.0	1342	-1.3	1.0	-1.3	-002
Z	-1500	661	-90		1.5	-1.1	-1500	1.5	-1.7	1.5	-002
ACCEL BIAS											
X	-933	-630	-30		9.4	-1.1	-932	9.2	-0.7	9.2	-011
Y	10050	-3605	605		-0.5	1.0	10050	-0.0	-0.0	-0.0	-007
Z	-23648	-23648	-864		26.2	-3.0	-23648	-0.7	-1.7	-0.6	-004
ACCEL SCALE FAC											
X	-1	-7100	-10		7.0	-1.0	-1	2	-1.3	-2	-003
Y	6293	-22000	501		24.2	1.2	6293	-0.4	-1.0	-0.3	-004
Z	2010	-9500	-902		10.6	-2.6	2010	-2.5	-1.7	-2.5	-002
ACCEL IA ALINE											
X	-3167	-11000	-50		0.0	-1.2	-3170	3.4	-0.2	3.4	-000
Y	7653	-26701	650		20.3	-0.7	7650	-0.6	-0.6	-0.6	-005
Z	3176	-12500	-1119		13.4	-2.0	3173	-2.7	-1.3	-2.7	-003
ACCEL IA DRIFT											
X	-1073	-7045	-31		6.6	2.1	-1072	2.1	-2.7	2.1	-000
Y	5205	-21050	706		22.0	-4.4	5182	-4.4	-2.2	-4.4	-005
Z	6070	-2040	-1361		20.3	-7.1	6050	-7.0	-1.0	-7.0	-004
3-SIGMA BSS	27510	72430	12007		70.0	25.2	27403	25.0	10.6	25.0	-024

TABLE 14.2.2. - AOA RSS DATA AT OMS-2 CUTOFF

(C) ACTUAL MINUS NOMINAL VEHICLE PARAMETERS									
	LATD (DEG)	LONG (DEG)	AZIM (DEG)	RANGE (NM)	TIME ECI	HEIGHT (LBS)	WOP (LBS)	OXID (LBS)	FUEL (LBS)
PLATFORM ALINE									
AZIMUTH	-.038	.018	.059	-1.88	.06	-13.	0.	0.	0.
TILT	-.002	.037	-.029	-1.54	.04	9.	0.	0.	0.
ROLL	.016	-.056	.032	2.73	-.04	-11.	0.	0.	0.
DRIFT BIAS									
X	-.002	.002	.004	-.13	.00	0.	0.	0.	0.
Y	-.000	.002	-.002	-.07	.02	-1.	0.	0.	0.
Z	.000	.002	-.002	-.06	.02	0.	0.	0.	0.
0-SENS 1A DRIFT									
X	-.003	.005	.002	-.31	.03	-2.	0.	0.	0.
Y	-.001	.000	-.000	.01	.02	-1.	0.	0.	0.
Z	-.000	.004	-.003	-.18	.03	-1.	0.	0.	0.
0-SENS 0A DRIFT									
X	-.002	.005	.001	-.26	.04	-2.	0.	0.	0.
Y	-.000	.006	-.004	-.24	.03	-2.	0.	0.	0.
Z	-.000	.004	-.003	-.17	.02	0.	0.	0.	0.
0-SO SEM DRIFT									
X	-.003	.004	.002	-.25	.03	-2.	0.	0.	0.
Y	-.001	-.001	.001	.07	.01	-1.	0.	0.	0.
Z	.000	.001	-.001	-.03	.03	-1.	0.	0.	0.
ACCEL BIAS									
X	-.009	.046	-.030	-2.12	.21	19.	0.	0.	0.
Y	-.029	.135	-.083	-6.28	.16	79.	0.	0.	0.
Z	-.012	.074	-.053	-3.33	-.03	59.	0.	0.	0.
ACCEL SCALE FAC									
X	-.016	.053	-.036	-2.42	.30	21.	0.	0.	0.
Y	-.023	.109	-.071	-5.08	.41	2.	0.	0.	0.
Z	-.007	.045	-.033	-2.00	.15	17.	0.	0.	0.
ACCEL 1A ALINE									
-0A									
X	-.015	.077	-.053	-3.52	.41	29.	0.	0.	0.
Y	-.027	.128	-.083	-5.94	.48	44.	0.	0.	0.
Z	-.011	.072	-.052	-3.23	.31	22.	0.	0.	0.
ACCEL 1A ALINE									
-SA									
X	-.009	.045	-.031	-2.05	.22	19.	0.	0.	0.
Y	-.024	.109	-.071	-5.07	.42	36.	0.	0.	0.
Z	-.020	.122	-.090	-5.47	.41	48.	0.	0.	0.
3-SIGMA RSS	.075	.322	.224	14.93	1.11	140.	0.	0.	0.

TABLE A4.2.2-111. - AOA RSS DATA AT OMS-2 CUTOFF

(D) ACTUAL MINUS NOMINAL ORBITAL PARAMETERS

	MA (MM)	MP (MM)	PERIOD (SEC)	INCLIN (DEG)	ASC MOD (DEG)	ARD PER (DEG)	TPU ANOM (DEG)	SHAJ AXS (MM)	ECCENT (MD)
PLATFORM ALINE									
AZIMUTH	.03	-.16	-.16	.0526	.0887	.16	-.20	-.08	.00003
TILT	-1.84	.28	-1.51	-.0059	-.0068	-.12	-.15	-.68	-.00027
ROLL	2.48	-.3	2.35	-.0048	-.0023	.14	-.19	1.06	.00040
DRIFT BIAS									
X	-.00	.00	.00	.0030	.0064	.02	-.02	-.00	-.00000
Y	-.30	.07	-.26	-.0006	-.0003	-.09	-.09	-.12	-.00005
Z	.43	-.09	.37	-.0007	-.0009	.14	-.13	.17	.00007
0-SENS IA DRIFT									
X	-.01	-.02	-.03	.0037	.0074	.04	-.04	-.01	.00030
Y	-.39	.10	-.33	-.0006	.0000	-.12	-.12	-.15	-.00007
Z	.37	-.09	.32	-.0005	-.0003	.12	-.12	.14	.00000
0-SENS OA DRIFT									
X	-.01	-.03	-.04	.0025	.0059	.02	-.02	-.02	.00000
Y	-.39	.07	-.36	-.0011	-.0006	-.06	-.07	-.16	-.00007
Z	.58	-.15	.47	-.0005	-.0003	.19	-.18	.21	.00010
0-SQ SEN DRIFT									
X	-.00	-.01	-.02	.0029	.0059	.01	-.01	-.01	.00000
Y	-.25	.06	-.22	-.0001	.0006	-.09	-.09	-.10	-.00004
Z	.27	-.06	.23	-.0006	-.0007	.07	-.07	.11	.00005
ACCEL BIAS									
X	.79	-.45	.37	-.0006	-.0018	.51	-.47	.17	.00018
Y	-1.67	-.10	-1.97	.0018	.0009	.64	-.53	-.89	-.00022
Z	-1.13	.03	-1.22	-.0045	-.0103	.39	-.32	.55	-.00016
ACCEL SCALE FAC									
X	-.02	-.30	-.36	-.0011	-.0044	.23	-.18	-.16	.00004
Y	-1.01	-.21	-1.35	.0005	-.0039	.45	-.35	-.61	-.00011
Z	-.45	-.05	-.55	-.0029	-.0068	.16	-.11	.25	-.00006
ACCEL IA ALINE									
-OA									
X	.59	-.54	.06	-.0018	-.0070	.51	-.44	.02	.00016
Y	-1.21	-.21	-1.58	.0006	-.0045	.51	-.40	-.72	-.00014
Z	-.54	-.24	-.86	-.0050	-.0083	.31	-.24	-.39	-.00004
ACCEL IA ALINE									
-SA									
X	.79	-.27	.14	-.0012	-.0043	.32	-.28	.06	.00008
Y	-.93	-.26	-1.21	.0008	-.0055	.47	-.37	-.55	-.00008
Z	-1.74	-.14	-1.53	-.0079	-.0186	.43	-.32	-.69	-.00015
3-SIGMA RSS *	4.2	1.10	4.85	.0549	.0939	1.55	1.31	2.19	.00069

TABLE AN-2.2-IV. - ADA RSS DATA AT ENTRY INTERFACE MINUS 5 MINUTES
(A) ACTUAL MINUS NOMINAL STATE PARAMETERS

	U (FT)	V (FT)	W (FT)	U-DOF (FPS)	V-DOF (FPS)	M-DOF (FPS)	ALTITUDE (FT)	SPEED (FPS)	M-DOF (FPS)	DR-DOF (FPS)	OSRMA (DOE)
PLATFORM ALINE											
AZIMUTH	876.	5998.	-29020.	-6.5	-1.6	-2.5	897.	-1.5	.6	-1.5	.001
TILT	-8204.	28119.	3019.	-29.3	7.8	.8	-8885.	8.2	4.1	8.2	.009
ROLL	13302.	-43965.	1693.	46.8	-11.6	-1.1	13347.	-12.1	-6.2	-12.2	-.014
DRIFT BIAS											
X	52.	830.	-1858.	.6	-.1	-.4	92.	-.1	.1	-.1	.000
Y	-1889.	3639.	222.	-3.9	1.8	-.1	-1889.	1.8	.5	1.9	.001
Z	2775.	-5152.	340.	5.5	-2.8	.0	2776.	-2.7	-.6	-2.7	-.001
0-SENS IA DRIFT											
X	113.	865.	-2233.	-.8	-.2	-.4	113.	-.2	-.2	-.2	.000
Y	-2505.	4343.	175.	-4.3	2.4	-.2	-2505.	2.5	.6	2.5	.002
Z	2412.	-4003.	172.	4.2	-2.3	-.1	2412.	-2.4	-.5	-2.4	-.001
0-SENS OA DRIFT											
X	23.	664.	-1639.	-.7	-.1	-.5	24.	-.1	.1	-.1	.000
Y	-2275.	5419.	397.	-5.6	2.1	-.2	-2274.	2.1	.9	2.1	.002
Z	3733.	-6471.	183.	6.8	-3.6	-.1	3733.	-3.7	-.9	-3.7	-.002
0-SENS SEN DRIFT											
X	7.	874.	-1760.	-.8	-.1	-.3	7.	-.9	.0	-.0	.000
Y	-1882.	2487.	-61.	-2.7	1.6	-.2	-1881.	1.7	.3	1.7	.001
Z	1867.	-3643.	275.	3.8	-1.6	.0	1867.	-1.6	-.5	-1.6	-.001
ACCEL BIAS											
X	5980.	-1882.	453.	1.6	-6.5	.2	5980.	-6.6	-.6	-6.6	-.002
Y	-6232.	52980.	-875.	-56.3	3.4	.4	-6166.	4.2	6.8	4.2	.015
Z	-4290.	34447.	2811.	-36.4	2.6	.8	-4262.	3.1	4.6	3.2	.010
ACCEL SCALE FAC											
X	548.	7810.	1088.	-5.0	-1.4	1.6	549.	-1.3	.3	-1.3	.0
Y	-3835.	32568.	480.	-34.7	1.6	1.0	-3810.	2.1	4.8	2.1	.004
Z	-1778.	13917.	1910.	-14.9	1.0	.5	-1773.	1.2	1.7	1.2	.004
ACCEL IA ALINE											
-OA	4799.	4753.	1621.	-6.1	-5.8	.9	4799.	-5.7	-.5	-5.7	-.001
X	-4437.	38931.	531.	-41.6	2.1	1.2	-4402.	2.7	4.7	2.7	.011
Y	-1770.	16629.	2716.	-20.1	.4	-.2	-1761.	.7	2.1	.7	.005
ACCEL IA ALINE											
-SA	3196.	2850.	1026.	-3.5	-3.7	.5	3197.	-3.6	-.2	-3.6	-.000
X	-2650.	29997.	836.	-32.2	.7	1.4	-2628.	1.1	3.5	1.2	.008
Y	-4907.	38522.	5179.	-41.3	2.8	1.5	-4872.	3.3	4.6	3.4	.010
Z	22408.	111878.	30356.	118.9	13.2	4.2	22383.	20.1	14.3	20.3	.033

TABLE AN-2.2-IV. - ADA RSS DATA AT ENTRY INTERFACE MINUS 5 MINUTES
 (8) NAVIGATED MINUS ACTUAL STATE PARAMETERS

	U (FT)	V (FT)	W (FT)	U-DOT (FPS)	V-DOT (FPS)	W-DOT (FPS)	ALTITUDE (FT)	SPEED (FPS)	H-DOT (FPS)	DR-DOT (FPS)	QAMMA (DEG)
PLATFORM ALINE											
AZIMUTH	-1008.	-5922.	29332.	6.5	1.5	2.1	-1026.	1.5	-6	1.5	-.001
TILT	8872.	-27484.	-2481.	28.5	-7.8	.9	8863.	-8.2	-4.2	-8.2	-.010
ROLL	-13267.	43355.	-2081.	-45.2	11.6	.7	-13329.	12.1	6.3	12.2	.015
DRIFT BIAS											
X	-82.	-634.	1796.	6	-1.1	.4	-82.	.1	-1.1	-1.1	-.000
Y	1882.	-3388.	-156.	3.6	-1.8	.1	1883.	-1.9	-1.9	-1.9	-.001
Z	-2767.	5292.	-201.	-5.6	2.6	.1	-2770.	2.7	.7	2.7	-.002
O-SENS IA DRIFT											
X	-128.	-452.	2244.	.5	.2	.3	-128.	.1	-1.1	.1	-.000
Y	2509.	-4028.	-155.	4.2	-2.4	.1	2510.	-2.5	-1.6	-2.5	-.001
Z	-2404.	4086.	-135.	-4.3	2.3	.0	-2406.	2.4	.6	2.4	.001
O-SENS OA DRIFT											
X	-31.	-597.	1100.	.7	.1	.4	-31.	.1	-1.1	.1	-.000
Y	2251.	-4936.	-350.	5.1	-2.1	.1	2252.	-2.2	-1.8	-2.2	-.002
Z	-3737.	6472.	-223.	-6.8	3.6	.1	-3740.	3.7	.9	3.7	.002
O-SO SEM DRIFT											
X	-7.	-689.	1805.	.8	.1	.3	-7.	.1	-1.1	.1	-.000
Y	1671.	-2317.	-54.	2.5	-1.6	.1	1671.	-1.7	-1.7	-1.7	-.001
Z	-1679.	3910.	-145.	-4.1	1.5	.0	-1680.	1.6	.5	1.6	.001
ACCEL BIAS											
X	-8263.	4147.	-113.	-2.9	10.2	-1.1	-8264.	10.3	2.1	10.3	-.005
Y	4211.	-52165.	720.	50.3	-2.8	-1.9	4165.	-2.5	-11.7	-3.6	-.026
Z	3059.	-34334.	-1255.	33.0	-2.4	2.1	3044.	-2.9	-7.8	-3.0	-.018
ACCEL SCALE FAC											
X	-756.	-5876.	-24.	6.8	1.2	-1.0	-754.	1.2	-2	1.2	-.000
Y	3553.	-30707.	1167.	32.8	-1.8	.0	3540.	-2.2	-3.7	-2.2	-.008
Z	1782.	-13767.	-1145.	14.7	-1.0	-1.1	1782.	-1.2	-1.7	-1.2	-.004
ACCEL IA ALINE											
OA											
X	-5018.	-2888.	185.	3.8	5.8	-1.0	-5017.	5.6	.4	5.6	-.001
Y	4354.	-37389.	1397.	39.9	-2.2	-1.0	4334.	-2.7	-4.6	-2.8	-.010
Z	1510.	-16558.	-1543.	17.6	-1.5	.5	1508.	-1.8	-2.1	-1.8	-.005
ACCEL IA ALINE											
SA											
X	-3200.	-2218.	-135.	2.9	3.6	-1.0	-3199.	3.6	.5	3.6	.001
Y	2562.	-27644.	1014.	29.6	-1.8	-1.4	2552.	-1.3	-3.2	-1.3	-.007
Z	4925.	-38079.	-3202.	40.7	-2.8	-1.3	4904.	-3.3	-4.6	-3.4	-.010
3-SIGMA RSS	21768.	108695.	29128.	111.8	20.6	3.9	21782.	21.4	18.4	21.6	.042

TABLE AN.2.2-IV. -- AOA RSS DATA AT ENTRY INTERFACE MINUS 5 MINUTES

(C) ACTUAL MINUS NOMINAL VEHICLE PARAMETERS										
	LATD (DEG)	LONG (DEG)	AZIM (DEG)	RANGE (NM)	TIME (SEC)	WEIGHT (LBS)	PROP (LBS)	OXID (LBS)	FUEL (LBS)	
PLATFORM ALINE										
AZIMUTH	-.059	.000	-.022	-1.50	.00	-13.	0.	0.	0.	
TILT	-.045	.070	-.032	-4.43	.00	9.	0.	0.	0.	
ROLL	-.055	-.110	.059	7.04	.00	-11.	0.	0.	0.	
DRIFT BIAS										
X	-.003	.004	-.001	-.14	.00	0.	0.	0.	0.	
Y	-.005	-.009	-.004	-.50	.00	-1.	0.	0.	0.	
Z	-.006	-.014	.007	.83	.00	0.	0.	0.	0.	
0-SENS IA DRIFT										
X	-.004	.006	-.002	-.10	.00	-2.	0.	0.	0.	
Y	-.006	.011	-.005	-.69	.00	-1.	0.	0.	0.	
Z	-.005	-.011	.005	.64	.00	-1.	0.	0.	0.	
0-SENS OA DRIFT										
X	-.003	.004	-.001	-.14	.00	-2.	0.	0.	0.	
Y	-.006	.014	-.006	-.66	.00	-2.	0.	0.	0.	
Z	-.008	-.017	.008	1.04	.00	0.	0.	0.	0.	
0-50 SEM DRIFT										
X	-.003	.004	-.001	-.14	.00	-2.	0.	0.	0.	
Y	-.003	.007	-.003	-.40	.00	-1.	0.	0.	0.	
Z	-.004	-.010	.005	.50	.00	-1.	0.	0.	0.	
ACCEL BIAS										
X	-.001	-.006	.002	.31	.00	10.	0.	0.	0.	
Y	-.009	.141	-.008	-0.46	.00	70.	0.	0.	0.	
Z	-.053	-.006	-.043	-5.44	.00	50.	0.	0.	0.	
ACCEL SCALE FAC										
X	.013	.010	-.010	-1.23	.00	21.	0.	0.	0.	
Y	.045	.005	-.043	-5.19	.00	35.	0.	0.	0.	
Z	.023	.034	-.017	-2.10	.00	17.	0.	0.	0.	
ACCEL 1A ALINE										
- OA										
X	.010	.016	-.007	-.73	.00	29.	0.	0.	0.	
Y	.053	.102	-.051	-6.20	.00	44.	0.	0.	0.	
Z	.031	.045	-.022	-2.92	.00	22.	0.	0.	0.	
ACCEL 1A ALINE										
- SA										
X	.006	.006	-.004	-.44	.00	19.	0.	0.	0.	
Y	.042	.078	-.040	-4.77	.00	46.	0.	0.	0.	
Z	.024	.034	-.048	-6.05	.00	40.	0.	0.	0.	
3-SIGMA RSS *	.170	.205	.144	17.01	.00	140.	0.	0.	0.	

TABLE AN.2.2-1V. - 40A RSS DATA AT ENTRY INTERFACE MINUS 5 MINUTES

(O) ACTUAL MINUS NOMINAL ORBITAL PARAMETERS									
	MA (MM)	MP (MM)	PERIOD (SEC)	INCLIN (DEG)	ASC MOD (DEG)	ARO PER (DEG)	TRU ANOM (DEG)	SMAJ AXS (MM)	ECCENT (MD)
PLATFORM ALINE									
AZIMUTH	-.03	-.16	-.16	-.0526	-.0000	-.10	-.23	-.00	-.00003
TILT	-1.54	-.28	-1.51	-.0068	-.0070	-.14	-.22	-.07	-.00027
ROLL	2.98	-.37	2.35	-.0049	-.0021	.17	-.28	1.05	-.00040
DRIFT BIAS									
X	-.00	.00	-.00	-.0029	-.0084	.02	-.02	-.00	-.00000
Y	-.30	-.07	-.26	-.0006	-.0003	-.09	-.10	-.11	-.00005
Z	-.93	-.09	.37	-.0007	-.0009	.14	-.16	.17	-.00007
O-SENS 1A DRIFT									
X	-.01	-.02	-.03	-.0037	-.0074	.04	-.04	-.01	-.00000
Y	-.39	-.10	-.33	-.0006	-.0000	-.13	.14	-.15	-.00007
Z	-.37	-.09	.32	-.0005	-.0002	.13	-.14	.14	-.00006
O-SENS 0A DRIFT									
X	-.01	-.03	-.04	-.0025	-.0059	.02	-.02	-.02	-.00000
Y	-.39	-.07	-.36	-.0011	-.0007	-.07	.08	-.16	-.00007
Z	-.59	-.15	.47	-.0005	-.0002	.20	-.21	.21	-.00010
O-SO SEN DRIFT									
X	-.00	-.01	-.02	-.0029	-.0050	.01	-.01	-.01	-.00000
Y	-.25	-.06	-.22	-.0001	-.0006	-.10	.10	-.10	-.00004
Z	-.27	-.06	.23	-.0006	-.0007	.07	-.08	.10	-.00005
ACCEL BIAS									
X	-.79	-.45	-.37	-.0006	-.0017	.53	-.53	.17	-.00017
Y	-1.67	-.18	-1.97	-.0019	-.0009	.63	-.49	-.87	-.00023
Z	-1.13	-.03	-1.22	-.0044	-.0104	.38	-.20	-.54	-.00017
ACCEL SCALE FAC									
X	-.02	-.30	-.36	-.0011	-.0043	.23	-.21	-.16	-.00004
Y	-1.01	-.21	-1.35	-.0006	-.0038	.44	-.35	-.60	-.00012
Z	-.45	-.05	-.55	-.0029	-.0069	.15	-.11	-.25	-.00006
ACCEL 1A ALINE									
-SA									
X	-.59	-.54	-.06	-.001P	-.0069	.53	-.51	.03	-.00016
Y	-1.21	-.21	-1.58	-.0007	-.0045	.51	-.40	-.70	-.00014
Z	-.54	-.24	-.06	-.0050	-.0002	.30	-.25	-.38	-.00004
ACCEL 1A ALINE									
-SA									
X	-.39	-.27	-.14	-.0012	-.0043	.33	-.32	.06	-.00009
Y	-.83	-.26	-1.21	-.0010	-.0055	.47	-.30	-.54	-.00008
Z	-1.24	-.14	-1.53	-.0077	-.0106	.43	-.31	-.68	-.00016
J-SIGMA RSS									
	4.52	1.10	4.05	.0540	-.0339	1.56	1.39	2.16	.00070

TABLE AN.2.2-V. - AOA RSS DATA AT ENTRY INTERFACE

(A) ACTUAL MINUS NOMINAL STATE PARAMETERS

	U (FT)	V (FT)	W (FT)	U-DOT (FPS)	V-DOT (FPS)	W-DOT (FPS)	M-DOT (FPS)	ALTITUDE (FT)	SPEED (FPS)	M-DOT (FPS)	DR-DOT (FPS)	QAHMA (DEG)
PLATFORM ALINE												
AZIMUTH	-332.	82425.	-27864.	-89.7	-1.8	10.1	10.1	-154.	-3	-6	-3	-.001
PITCH	-4348.	-889722.	2663.	501.9	.8	-2.2	-2.2	-403.	-2.2	9.4	-2.1	-.021
ROLL	-7575.	587857.	1257.	-728.4	-18.1	-1.2	-1.2	530.	3.5	-13.9	3.3	-.031
DRIFT BIAS												
X	128.	577.	-1889.	-1.8	-2.2	.4	.4	128.	-8	8	-8	-.000
Y	-311.	-83812.	188.	114.2	1.2	-3	-3	-188.	-4	1.7	-3	-.004
Z	-382.	148731.	387.	-171.7	-2.7	-1	-1	182.	.5	-2.5	.5	-.006
0-SENS IA DRIFT												
X	158.	748.	-2208.	-7.8	-3	.8	.8	158.	-1	8	-1	-.000
Y	-823.	-112248.	188.	137.1	1.6	-3	-3	-328.	-5	2.3	-4	-.005
Z	-842.	130821.	133.	-158.5	-2.4	-1	-1	-40.	.4	-2.2	.4	-.005
0-SENS OA DRIFT												
X	35.	815.	-1874.	-7.7	-1.1	.2	.2	35.	-1	8	-1	-.000
Y	-804.	-87037.	317.	118.8	1.3	-4	-4	-283.	-5	2.3	-5	-.005
Z	-889.	188882.	141.	-258.4	-4.8	-8	-8	139.	.7	-3.4	.6	-.008
0-50 SEM DRIFT												
X	8.	654.	-1748.	-7.8	-1.1	.4	.4	8.	-8	8	-8	-.000
Y	-159.	-84868.	-104.	115.6	1.1	-2	-2	92.	-3	1.5	-3	-.003
Z	-282.	88388.	246.	-110.3	-1.9	-1	-1	-70.	.3	-1.6	.3	-.004
ACCEL BIAS												
X	-2278.	322511.	475.	-322.8	-8.7	.2	.2	188.	.4	-5.3	.3	-.012
Y	-1113.	-130525.	-548.	237.7	-4	.4	.4	-282.	-2	8.7	-3.0	-.019
Z	-882.	-123832.	2953.	154.8	.3	-8	-8	-322.	-1.8	8.1	-1.8	-.014
ACCEL SCALE FAC												
X	-178.	48522.	1184.	-58.8	-1.4	.1	.1	-124.	-8	-6	-8	-.001
Y	-487.	-113673.	782.	141.5	-3	.8	.8	-184.	-2	4.9	-2.1	-.011
Z	-383.	-48788.	1842.	81.8	.3	-4	-4	-245.	-8	2.3	-8	-.005
ACCEL IA ALINE												
-OA												
X	-1858.	247354.	1777.	-381.7	-8.8	.3	.3	385.	-1	-4.5	-2	-.010
Y	-727.	-127588.	818.	158.2	-2	.7	.7	-345.	-2.5	8.0	-2.5	-.013
Z	-288.	-41328.	2595.	51.8	-4	-1.8	-1.8	-228.	-1.4	2.3	-1.4	-.005
ACCEL IA ALINE												
-SA												
X	-778.	183888.	1114.	-223.8	-4.2	.2	.2	15.	.1	-2.8	.1	-.008
Y	-188.	-87887.	1088.	85.8	-7	1.8	1.8	-88.	-2.8	3.8	-1.8	-.008
Z	-828.	-158488.	5288.	188.8	.2	-8	-8	-348.	-2.4	8.3	-2.3	-.014
3-SIGMA RSS	9403.	978888.	29241.	1188.8	22.8	18.7	18.7	1215.	7.6	24.9	7.2	.055

TABLE AN-2-2-V. - ADA RSS DATA AT ENTRY INTERFACE
(B) NAVIGATED MINUS ACTUAL STATE PARAMETERS

	U (FT)	V (FT)	W (FT)	U-DOY (FPS)	V-DOY (FPS)	W-DOY (FPS)	M-DOY (FPS)	ALTITUDE (FT)	SPEED (FPS)	M-DOY (FPS)	DR-DOY (FPS)	GAMMA (DEG)
PLATFORM ALINE												
AZIMUTH	-1198.	-5049.	27119.	6.1	1.0	-10.1	-1.7	-1105.	1.7	-1.1	1.7	-0.00
TILT	8993.	-22359.	-2093.	32.0	-6.5	1.0	-6.6	7430.	-6.6	-5.0	-0.7	-0.13
ROLL	-12508.	50945.	-1713.	-53.0	6.4	1.6	9.2	-18000.	9.2	0.0	9.3	-0.20
ORIFT BIAS												
X	-112.	-557.	1794.	0	-2	-4	-7.0	-111.	-7.0	-0	-0	-0.00
Y	1600.	-4540.	-120.	4.5	-1.5	.1	-1.0	1070.	-1.0	-0	-1.6	-0.02
Z	-2558.	8972.	-171.	-7.1	2.0	.1	2.3	-2449.	2.3	1.3	2.3	-0.03
0-SEMS IA DRIFT												
X	-197.	-353.	2107.	.4	.2	-0.6	-0	-146.	-0	0	-0	-0.00
Y	2256.	-9580.	-115.	5.5	-2.1	.2	-2.0	2242.	-2.0	-1.3	-2.0	-0.03
Z	-2217.	5583.	-113.	-5.5	2.0	.1	2.4	-2131.	2.4	1.1	2.4	-0.03
0-SEMS OA DRIFT												
X	-91.	-559.	1719.	.7	-1	-3	-0	-40.	-0	-0	-0	-0.00
Y	1932.	-6273.	-208.	8.2	-1.7	.3	-1.0	1943.	-1.0	-1.4	-1.7	-0.03
Z	-3455.	8766.	-107.	-8.7	2.9	.2	3.3	-3303.	3.3	1.0	3.3	-0.04
0-SQ SEM DRIFT												
X	-22.	-661.	1775.	0	.1	-0.5	-1.1	-22.	-1.1	-0	-1	-0.00
Y	1934.	-3365.	-31.	3.3	-1.4	.1	-1.7	1912.	-1.7	-0.7	-1.7	-0.02
Z	-1515.	4093.	-125.	-5.0	1.2	.1	1.5	-1459.	1.5	0	1.5	-0.02
ACCEL BIAS												
X	-5943.	9380.	-120.	-4.0	0.0	0	10.3	-4774.	10.3	7.5	10.4	-0.17
Y	86.	-3156.	31.	51.1	1.4	-2.0	1.1	564.	1.1	-12.0	0	-0.26
Z	391.	-35250.	-402.	33.0	.7	3.0	0	577.	0	-0.0	0	-0.020
ACCEL SCALE FAC												
X	-751.	-5234.	-21.	6.6	1.9	0	1.9	-743.	1.9	0.2	1.5	-0.01
Y	2314.	-32096.	1095.	39.0	-0	-0.5	-1.0	2486.	-1.0	-3.5	-1.1	-0.08
Z	1203.	-14921.	-1100.	15.0	-0.3	.4	-0.3	1203.	-0.3	-1.7	-0.3	-0.04
ACCEL IA ALINE												
- OA												
X	-4698.	532.	-104.	1.9	5.0	0	4.9	-4586.	4.9	2.3	5.0	-0.05
Y	2705.	-39090.	1320.	42.6	-0	-0	-0	3005.	-0	-4.5	-0	-0.10
Z	809.	-17043.	-1308.	10.6	.4	1.1	.3	913.	.3	-1.9	.3	-0.04
ACCEL IA ALINE												
- SA												
X	-3010.	-27.	-137.	1.4	3.2	0	3.5	-2030.	3.5	1.3	3.5	-0.03
Y	1557.	-20477.	334.	31.4	-2	-0	-2	1840.	-2	-2.9	-2	-0.06
Z	3269.	-46142.	-3095.	43.6	-1.3	1.0	-1.5	3543.	-1.5	-4.7	-1.6	-0.10
3-SIGMA RSS	18207.	116680.	27012.	120.6	10.0	11.0	17.0	17243.	17.0	22.3	10.1	.050

TABLE AV-2.2-V. - ADA RSS DATA AT ENTRY INTERFACE
(C) ACTUAL MINUS NOMINAL VEHICLE PARAMETERS

	LATD (DEG)	LONG (DEG)	AZIM (DEG)	RANGE (NM)	TIME (SEC)	HEIGHT (LBS)	PROP (LBS)	OXID (LBS)	FUEL (LBS)
PLATFORM ALINE									
ALMUTN	.855	.184	-.081	-11.31	2.55	-13.	0.	0.	0.
TILT	-.855	-.846	.277	61.65	-17.14	0.	0.	0.	0.
ROLL	.955	1.198	-.383	-88.87	24.78	-11.	0.	0.	0.
DRIFT BIAS									
X	.009	.028	-.087	-1.28	.29	0.	0.	0.	0.
Y	-.152	-.184	.082	14.23	-3.84	-1.	0.	0.	0.
Z	.225	.284	-.088	-20.88	5.84	0.	0.	0.	0.
0-SENS IA DRIFT									
X	.012	.025	-.089	-1.58	.36	-2.	0.	0.	0.
Y	-.282	-.857	.082	18.84	-5.87	-1.	0.	0.	0.
Z	.188	.248	-.077	-18.23	4.88	-1.	0.	0.	0.
0-SENS OA DRIFT									
X	.001	.008	-.003	-.45	.08	-2.	0.	0.	0.
Y	-.174	-.222	.071	18.28	-4.45	-2.	0.	0.	0.
Z	.381	.588	-.118	-27.84	7.52	0.	0.	0.	0.
0-S8 SEN DRIFT									
X	-.002	.006	-.003	-.23	.02	-2.	0.	0.	0.
Y	-.148	-.177	.056	13.81	-3.48	-1.	0.	0.	0.
Z	.132	.188	-.052	-12.21	3.32	-1.	0.	0.	0.
ACCEL BIAS									
X	.518	.843	-.188	-47.34	12.38	18.	0.	0.	0.
Y	-.318	-.382	.128	28.85	-8.78	78.	0.	0.	0.
Z	-.213	-.278	.081	28.28	-8.88	58.	0.	0.	0.
ACCEL SCALE FAC									
X	.084	.078	-.024	-5.83	1.28	21.	0.	0.	0.
Y	-.181	-.228	.073	18.83	-5.78	38.	0.	0.	0.
Z	-.085	-.127	.041	8.18	-2.85	17.	0.	0.	0.
ACCEL IA ALINE									
- OA									
X	.418	.523	-.183	-38.88	8.84	28.	0.	0.	0.
Y	-.225	-.285	.088	28.82	-7.83	44.	0.	0.	0.
Z	-.078	-.118	.038	7.63	-2.78	22.	0.	0.	0.
ACCEL IA ALINE									
- SA									
X	.285	.357	-.111	-28.31	8.72	18.	0.	0.	0.
Y	-.188	-.138	.043	18.18	-3.87	38.	0.	0.	0.
Z	-.283	-.352	.115	25.48	-8.15	48.	0.	0.	0.
3-SIGMA RSS									
	1.581	2.088	.832	187.31	41.48	148.	0.	0.	0.

TABLE AN-2.2-V. - AOA RSS DATA AT ENTRY INTERFACE

(D) ACTUAL MINUS NOMINAL ORBITAL PARAMETERS

	MA (MM)	MP (MM)	PERIOD (SEC)	INCLIN (DEG)	ASC MOD (DEG)	ARG PER (DEG)	TRU ANOM (DEG)	SMAJ AXS (MM)	ECCENT (MD)
PLATFORM ALINE									
AZIMUTH	-.03	-.16	-.16	-.027	-.007	.16	-.04	-.08	-.0003
TILT	-1.04	-.20	-1.51	-.0076	-.003	-.07	-1.01	-.75	-.00028
ROLL	2.40	-.37	2.35	-.0039	-.0036	.00	1.40	1.16	-.00042
DRIFT BIAS									
X	-.00	.00	.00	-.0030	-.0004	.02	-.00	.00	-.00000
Y	-.30	.07	-.26	-.0000	-.0002	-.00	-.17	-.13	-.00005
Z	.43	-.09	.37	-.0005	-.0011	.12	.25	.10	-.00000
0-SENS IA DRIFT									
X	-.01	-.01	-.03	-.0037	-.0074	.03	-.01	-.01	-.00000
Y	-.30	.10	-.33	-.0000	-.0002	-.11	-.23	-.17	-.00107
Z	.37	-.00	.32	-.0003	-.0004	.11	.22	.10	-.00007
0-SENS OA DRIFT									
X	-.01	-.03	-.04	-.0025	-.0039	.02	-.02	-.02	-.00000
Y	-.30	.07	-.30	-.0012	-.0005	-.05	-.24	-.10	-.00007
Z	.00	-.15	.07	-.0002	-.0005	.17	.33	.24	-.00011
0-SENS SEN DRIFT									
X	-.00	-.01	-.02	-.0020	-.0030	.01	-.01	-.01	-.00000
Y	-.25	.00	-.22	-.0003	-.0007	-.00	-.15	-.11	-.00005
Z	.27	-.00	.23	-.0005	-.0000	.00	.10	.12	-.00005
ACCEL BIAS									
X	.70	-.45	.37	-.0001	-.0021	.12	.30	.22	-.00010
Y	-1.07	-.10	-1.07	-.0015	-.0013	.02	-1.10	-.02	-.00024
Z	-1.13	.03	-1.21	-.0007	-.0101	.40	-.75	-.57	-.00017
ACCEL SCALE FAC									
X	-.02	-.30	-.30	-.0011	-.0043	.23	-.12	-.15	-.00004
Y	-1.01	-.21	-1.35	-.0004	-.0030	.40	-.70	-.03	-.00012
Z	-.45	-.05	-.05	-.0030	-.0007	.10	-.32	-.20	-.00000
ACCEL IA ALINE									
-0A									
X	.50	-.54	.00	-.0014	-.0072	.49	.20	.07	-.00010
Y	-1.21	-.21	-1.50	-.0004	-.0041	.33	-.00	-.74	-.00015
Z	-.54	-.24	-.00	-.0051	-.0001	.31	-.45	-.40	-.00005
ACCEL OA ALINE									
-5A									
X	.30	-.27	.14	-.0000	-.0045	.30	.10	.00	-.00010
Y	-.03	-.20	-1.21	-.0000	-.0033	.40	-.00	-.50	-.00000
Z	-1.24	-.14	-1.53	-.0001	-.0103	.45	-.00	-.72	-.00017
3-SIGMA RSS	4.52	1.10	4.05	.0550	.0037	1.54	2.05	2.32	.00073

TABLE A4.2.3-I.- :0A RSS SUMMARY OF UVW STATE PARAMETERS
 (a) Actual minus nominal
 (Actual perturbed minus actual nominal)

Event/case	U, ft	V, ft	W, ft	U-DOT, fps	V-DOT, fps	W-DOT, fps
SRB separation	1	0	0	0.0	0.0	0.0
MECO	2 787	2 464	8 854	13.1	9.0	34.0
OMS-1 cutoff	5 875	116 663	21 210	130.3	10.9	25.6
OMS-2 ignition	27 502	68 267	10 098	76.6	25.1	33.9
OMS-2 cutoff	27 599	99 758	13 003	111.3	25.2	32.9
Entry interface	9 403	978 006	29 241	1198.8	22.6	10.7
<u>Fixed time slice</u>						
Nominal MECO + 1 min (GET = 725 sec)	3 501	3 449	11 353	13.0	9.9	32.9
Nominal OMS-1 cutoff + 6 min (GET = 1440 sec)	9 003	41 628	28 359	54.9	10.8	11.7
Entry interface - 5 min (GET = 4273 sec)	22 408	111 878	30 356	118.9	19.2	4.2

TABLE A4.2.3-I.- Concluded

(b) Navigated minus actual

(Navigated perturbed minus actual perturbed)

Event/case	U, ft	V, ft	W, ft	U-DOT, fps	V-DOT, fps	W-DOT, fps
SRB separation	98	200	321	1.9	3.0	6.1
MECO	2 810	3 366	8 899	12.6	8.9	32.9
OMS-1 cutoff	6 591	8 785	20 885	15.4	10.8	24.7
OMS-2 ignition	27 372	68 661	16 141	76.6	24.8	32.9
OMS-2 cutoff	27 516	72 430	12 897	79.9	25.2	31.3
Entry interface	18 207	116 696	27 812	120.6	16.0	11.6
<u>Fixed time slice</u>						
Nominal MECO + 1 min (GET = 725 sec)	3 548	4 197	11 318	12.8	9.3	31.9
Nominal OMS-1 cutoff + 6 min (GET = 1440 sec)	9 954	15 066	27 726	20.1	11.3	11.1
Entry interface - 5 min (GET = 4273 sec)	21 768	108 695	29 128	111.8	20.6	3.9

TABLE A4.2.3-II.- AOA RSS SUMMARY OF TRAJECTORY PARAMETERS

(a) Actual minus nominal
(Actual perturbed minus actual nominal)

Event/case	Altitude, ft	Velocity magnitude, fps	Altitude rate, fps	Downrange rate, fps	Flightpath angle, fps
SRB separation	1	0.0	0.0	0.0	0.000
MECO	2 787	8.9	10.3	9.0	.024
O/S-1 cutoff	5 814	11.0	11.8	11.0	.026
O/S-2 ignition	27 476	24.9	10.6	24.9	.024
O/S-2 cutoff	27 551	24.9	10.7	24.9	.024
Entry interface	1 215	7.6	24.9	7.2	.055
<u>Fixed time slice</u>					
Nominal MECO + 1 min (GET = 725 sec)	3 500	9.8	9.1	9.9	.021
Nominal O/S-1 cutoff + 6 min (GET = 1440 sec)	8 992	10.7	13.9	10.7	.031
Entry interface - 5 min (GET = 4273 sec)	22 383	20.1	14.3	20.3	.033

TABLE A4.2.3-II.- Concluded
 (b) Navigated minus actual
 (Navigated perturbed minus actual perturbed)

Event slice	Altitude, ft	Velocity magnitude, fps	Altitude rate, fps	Downrange rate, fps	Flightpath angle, fps
SRB separation	98	2.4	1.8	3.0	0.028
MECO	2 810	8.9	10.4	8.9	.024
OMS-1 cutoff	6 589	10.8	11.0	10.8	.024
OMS-2 ignition	27 361	24.6	11.0	24.6	.025
OMS-2 cutoff	27 493	25.0	10.6	25.0	.024
Entry interface	17 243	17.8	22.3	18.1	.050
<u>Fixed time slice</u>					
Nominal MECO + 1 min (GET = 725 sec)	3 547	9.3	10.0	9.3	.023
Nominal OMS-1 cutoff + 6 min (GET = 1440 sec)	9 950	11.3	13.7	11.3	.030
Entry interface - 5 min (GET = 4273 sec)	21 782	21.4	18.4	21.6	.042

TABLE A4.2.3-III.- AOA RSS SUMMARY OF VEHICLE PARAMETERS
 (Actual perturbed minus actual nominal)

Event slice	Latitude, deg	Longitude, deg	Azimuth, deg	Range, n. mi.	Time, sec	Weight, lb	Propellant, lb
SRB separation	0.000	0.000	0.000	0.000	0.000	0	0
MECO	.022	.013	.083	.40	.00	0	0
OMS-1 cutoff	.057	.332	.267	17.93	4.68	179	0
OMS-2 ignition	.066	.214	.145	9.73	.15	179	0
OMS-2 cutoff	.075	.322	.224	14.93	1.11	140	0
Entry interface	1.581	2.006	.632	147.31	41.49	140	0
<u>Fixed time slice</u>							
Nominal MECO + 1 min (GET = 725 sec)	.029	.016	.082	.56	.00	0	0
Nominal OMS-1 cutoff + 5 min (GET = 1440 sec)	.071	.062	.026	2.59	.00	179	0
Entry interface - 5 min (GET = 4273 sec)	.170	.295	.144	a17.81	.00	140	0

aRange dispersion is computed referenced to Northrup Strip.

TABLE A4.2.3-IV.- AOA RSS SUMMARY OF ORBITAL PARAMETERS
 (Actual perturbed minus actual nominal)

Event/case	Apogee, n. mi.	Perigee, n. mi.	Period, sec	Inclination, deg	Longitude of ascending node, deg	Argument of perigee, deg	True anomaly, deg	Semi- major axis, n. mi.
SRB separation	0.00	0.00	0.00	0.0000	0.0000	0.00	0.00	0.00
MECO	.70	3.48	3.07	.0548	.0912	.47	.45	1.40
OMS-1 cutoff	4.25	1.21	4.79	.0546	.0916	4.23	4.54	2.14
OMS-2 ignition	4.25	1.21	4.79	.0547	.0917	4.40	4.23	2.15
OMS-2 cutoff	4.52	1.10	4.85	.0549	.0939	1.55	1.31	2.19
Entry interface	4.52	1.10	4.85	.0550	.0937	1.54	2.95	2.32
<u>Fixed time slice</u>								
Nominal MECO + 1 min (GET = 725 sec)	.69	3.48	3.08	.0548	.0913	.47	.46	1.41
Nominal OMS-1 cutoff + 6 min (GET = 1440 sec)	4.25	1.21	4.79	.0546	.0916	4.00	3.99	2.14
Entry interface - 5 min (GET = 4273 sec)	4.52	1.10	4.85	.0548	.0939	1.56	1.39	2.16

TABLE A4.2.4-I.- ADA MATRICES AT MECO
(A) Covariance matrix

	U ACT	V ACT	M ACT	U-DOT ACT	V-DOT ACT	M-DOT ACT	U MAY
U ACT	0.6325872+05	6.7477463+05	0.7059190+06	1.9159365+01	9.0818361+00	1.2053251+02	0.7759550+05
V ACT	-7.4053854+05	-1.0975156+05	-1.5232390+02	-1.2074805+01	-1.6734253+00	1.4526317+03	-6.0447340+05
M ACT	-3.0268730+05	-3.4581361+03	-4.1075487+02	-5.0150700+00	-2.7714209+03	-7.2029053+02	-3.8590057+05
U-DOT ACT	-2.7480223+03	2.4603048+03	3.3115243+00	-4.0385559+03	2.6718975+02	-3.3292703+04	3.8256657+03
V-DOT ACT	-1.4479486+03	-4.1916955+02	3.0.37477+05	2.5570318+03	4.2080980+02	6.7560033+00	-1.6169810+03
M-DOT ACT	-8.7038945+05	7.594687+05	-1.9831956+05	1.5033197+03	1.2102119+01	-8.4203789+01	-1.3085600+03
U MAY	6.0153837+05	4.5947224+05	-8.7753406+06	-1.8033561+01	1.6751583+00	-1.2445810+02	-7.7722462+00
V MAY	3.8470659+05	1.1022325+05	1.7788155+03	6.9493755+00	-5.3170839+00	1.8422135+02	2.2714036+04
M MAY	-3.7929730+03	3.2317036+03	-2.5810701+02	5.5331850+00	1.6751583+00	-1.8422135+02	-2.2714036+04
U-DOT MAY	1.6089221+03	1.3458958+03	-3.2033822+04	3.6817453+02	-2.3910391+02	2.7098014+05	5.6045655+01
V-DOT MAY	1.3843845+03	4.2010727+02	-3.1107376+00	-1.7818416+07	5.6783798+09	0.7675622+04	1.9084787+01
M-DOT MAY	7.6941722+00	-1.4224959+00	5.3991471+03	-2.2665829+03	1.7507717+03	-8.0787351+05	9.0368782+02
TIME	-5.5718316+01	5.2395967+01	-2.6649790+02	-1.1084329+01	5.5419712+04	-1.3202515+03	6.3715570+02
X ACC BIAS	-1.0746298+01	1.6588475+01	2.9010056+01	-6.1079335+04	3.6354386+04	5.0405315+03	-5.8442279+02
Y ACC BIAS	-8.0328900+02	1.0822147+01	-4.3311321+01	-2.8708746+04	-1.0221244+05	-1.3581586+04	7.6931497+02
Z ACC BIAS	6.3431457+02	-9.5951733+03	1.2699948+00	2.8708746+04	-1.0221244+05	-1.3581586+04	-1.1943265+04
X MISALIGN	5.7889016+02	-4.3559001+02	-7.7076724+02	-3.9418151+04	2.6945432+04	-1.1943265+04	
Y MISALIGN	-7.8178046+02	6.5853437+02	-5.5570865+02				
Z MISALIGN							
U MAY	1.2586280+06	0.7990174+06	1.7651510+01	0.8645470+00	1.2052074+02	2.2379557+04	7.3729704+10
V MAY	-2.0002109+05	-1.7881550+03	-0.4100924+00	-6.4539740+03	-2.7037597+05	1.5563435+07	-1.2573407+08
M MAY	3.2590211+03	3.2505905+04	-2.7936365+02	-4.2827022+05	0.5614003+05	-6.2839843+06	-0.1822712+09
U-DOT MAY	-2.4827894+00	3.1471421+00	-5.4478780+02	1.9301892+05	-8.0759457+04	-2.0946614+06	-4.0911336+09
V-DOT MAY	-1.9336386+02	-2.0861073+01	2.6816428+02	1.9038099+03	1.1582069+03	-1.2086445+03	-1.4321198+09
M-DOT MAY	3.9548070+01	2.8086785+01	6.3282892+04	7.8349328+04	-3.5419052+05	-4.8856965+03	-9.6908557+10
TIME	3.1791456+02	1.2771757+00	3.0011506+04	2.1279502+04	1.2238159+04	-2.1806819+07	2.0582078+09
X ACC BIAS	-3.1791456+02	7.6895167+02	-3.2390859+04	-2.9875278+04	1.1103538+04	-3.4976668+07	
Y ACC BIAS	-1.1240241+01	5.5508906+02	4.3031819+04				
Z ACC BIAS							
X MISALIGN							
Y MISALIGN							
Z MISALIGN							
X ACC BIAS	2.5879156+06	2.5879156+06	0.0000000	2.0721087+07	0.0000000	3.1285213+08	2.8075743+08
Y ACC BIAS	0.0000000	0.0000000	0.0000000	0.0000000	0.0000000	0.0000000	
Z ACC BIAS	0.0000000	0.0000000	0.0000000	0.0000000	0.0000000	0.0000000	
X MISALIGN	0.0000000	0.0000000	0.0000000	0.0000000	0.0000000	0.0000000	
Y MISALIGN	0.0000000	0.0000000	0.0000000	0.0000000	0.0000000	0.0000000	
Z MISALIGN	0.0000000	0.0000000	0.0000000	0.0000000	0.0000000	0.0000000	

TABLE A4.2.4-I.- Concluded
(B) Correlation matrix

	U ACT	V ACT	M ACT	U-DOT ACT	V-DOT ACT	M-DOT ACT	U MAY
U ACT	1.000000+00						
V ACT	-0.007632-01	1.000000+00					
M ACT	-1.395617E-01	-4.527143-02	1.000000+00				
U-DOT ACT	0.842338-01	-0.619714-01	-1.170184-01	1.000000+00			
V-DOT ACT	-1.374588-01	-9.539342E-01	-9.709320-01	-9.709320-01	1.000000+00		
M-DOT ACT	-9.999906-01	-4.500946E-02	9.897246E-01	-1.172003-01	-4.697934E-02	1.000000+00	
U MAY	5.770900-01	9.807811-01	1.308468E-01	9.042414E-01	9.816765-01	1.307734E-01	1.000000+00
V MAY	1.395886E-01	-5.419800-01	-6.007887-02	5.207247-01	-5.802842-01	-5.725975E-02	-5.751502E-01
M MAY	9.716894-01	9.363995-01	9.999983-01	1.179422E-01	4.708249E-02	-0.899778-01	-1.388708E-01
U-DOT MAY	9.016158-01	5.502931E-01	-2.937409E-02	9.805351E-01	9.621550E-01	1.418378E-01	9.720058E-01
V-DOT MAY	1.357235-01	4.658428-02	9.807142E-01	1.151501E-01	-5.925955E-01	-2.494754E-02	-5.797275E-01
M-DOT MAY	5.535612E-01	-5.708461E-01	7.045804E-02	5.038022E-01	-5.303040E-01	9.806672E-01	-1.350261E-01
TIME	0.364806E-03	-6.377394E-02	6.737470E-02	-1.499232E-03	6.993109E-05	8.825749E-02	-8.929874E-03
X ACC BIAS	-3.727798E-01	3.965002E-01	-5.613215E-03	-3.218973E-01	3.631961E-01	-4.429572E-03	3.718944E-01
Y ACC BIAS	-1.254209E-01	1.253194E-01	5.899727E-02	-1.574182E-01	1.143147E-01	4.807256E-02	1.266383E-01
Z ACC BIAS	-5.909389E-02	0.189530E-02	9.126142E-02	-0.674411E-02	7.500919E-02	-7.238947E-02	5.997804E-02
X MISALIGN	-1.499781E-01	-2.432345E-02	9.453424E-01	-1.340503E-01	-2.931889E-02	9.787053E-01	1.494142E-01
Y MISALIGN	3.523150E-01	-2.997981E-01	-1.476544E-01	3.809889E-01	-3.507980E-01	-6.772636E-02	-3.527840E-01
Z MISALIGN	-4.803208E-01	4.784465E-01	-1.123762E-01	-5.374665E-01	5.336207E-01	-6.207108E-02	4.801075E-01

	Y MAY	M MAY	U-DOT MAY	V-DOT MAY	M-DOT MAY	WT	TIME
Y MAY	1.000000+00						
M MAY	6.010491E-02	1.000000+00					
U-DOT MAY	-6.697637E-01	-1.434819E-01	1.000000+00				
V-DOT MAY	9.756630E-01	2.937320E-02	-6.723285E-01	1.000000+00			
M-DOT MAY	5.891414E-02	7.889800E-01	-1.035104E-01	2.849313E-02	1.000000+00		
TIME	-1.479331E-01	7.092078E-02	-4.444810E-01	-1.449016E-01	-1.000000+00		
X ACC BIAS	-6.347538E-01	-6.763731E-02	1.698963E-01	-5.297468E-01	0.990308E-02	1.000000+00	1.000000+00
Y ACC BIAS	-1.156804E-01	5.619643E-03	2.016810E-01	-1.291542E-01	4.667737E-03	0.000000	0.000000
Z ACC BIAS	2.181298E-01	-5.865594E-02	9.384593E-02	2.410314E-01	-4.572855E-02	-3.481533E-01	0.000000
X MISALIGN	1.485548E-01	9.096012E-02	4.316879E-02	1.635066E-01	7.286519E-02	-8.703882E-02	0.000000
Y MISALIGN	-6.225230E-02	-9.458609E-01	1.569244E-01	-2.613378E-02	-9.776833E-01	0.000000	0.000000
Z MISALIGN	3.948774E-01	1.465589E-01	-4.358748E-01	4.040782E-01	6.302540E-02	0.000000	0.000000
	-5.879450E-01	1.116811E-01	6.112700E-01	-5.886300E-01	6.036217E-02	0.880000	0.000000

	X ACC BIAS	Y ACC BIAS	Z ACC BIAS	X MISALIGN	Y MISALIGN	Z MISALIGN
X ACC BIAS	1.000000+00					
Y ACC BIAS	0.0002070	1.000000+00				
Z ACC BIAS	0.000000	0.000000	1.000000+00			
X MISALIGN	0.000000	0.000000	0.000000	1.000000+00		
Y MISALIGN	0.000000	0.000000	0.000000	0.000000	1.000000+00	
Z MISALIGN	0.000000	0.000000	0.000000	0.000000	0.000000	1.000000+00

TABLE A4.2.4-II.- AOA MATRICES AT OMS-2 CUTOFF
(A) Covariance matrix

	U ACT	V ACT	M ACT	U-DOT ACT	V-DOT ACT	M-DOT ACT	U MAY
U ACT	8.4632408+07						
V ACT	-2.1817785+06	1.1957297+08					
M ACT	-5.1805194+04	-9.3391929+06	1.8785988+07				
U-DOT ACT	7.7050857+04	1.8959720+05	3.5085172+02	1.3753989+03	7.0345943+01	1.1993237+02	0.4122643+07
M-DOT ACT	1.1107617+04	3.6623576+04	4.6374947+04	-4.4392662+01	7.6877351+04	1.1246260+04	1.7176234+08
U MAY	-8.4324133+07	2.1379814+08	2.2603797+05	0.7953522+05	-7.5298523+05	-2.0502444+04	2.3329357+05
V MAY	1.7447842+08	-7.8634424+08	8.3712327+06	1.2436574+04	5.2266113+01	-4.5861412+04	2.0543332+05
M MAY	-4.3050071+05	1.2587529+07	-1.8625018+07	-9.6323541+02	1.6397743+02	-2.5111820+01	-7.6560877+04
U-DOT MAY	-2.6812962+05	8.5366292+05	-7.8867005+03	2.2540347+02	-7.0418170+01	-1.0388008+01	-6.0395147+02
M-DOT MAY	7.7076140+04	-1.8758012+05	-4.4852367+02	-2.5054912+01	8.7897661+01	-1.1232989+02	2.8781605+05
MT	-2.8238721+05	2.5817828+04	2.4310814+04	-1.6054082+03	2.5459367+02	1.3745962+02	1.4074014+03
TIME	-1.4905455+03	1.4482048+06	-4.1546345+01	-1.5028071+01	1.2131846+00	5.3647646+01	-2.1624191+00
X ACC BIAS	2.1405984+00	7.6893483+00	4.9149022+02	-6.5783454+03	-2.2046266+03	3.1490193+04	3.9572306+00
Y ACC BIAS	-5.8181956+00	2.2314968+01	-3.0146173+01	-2.4811646+02	5.2129038+03	-2.6046330+04	5.8761339+00
Z ACC BIAS	-3.8787064+00	1.1978019+01	4.6814122+01	-1.3291063+02	3.5706500+03	1.8320327+03	3.9572306+00
Y MISALIGN	-3.0828360+02	1.4370114+00	-1.9226037+00	-1.4179958+03	-7.2019268+06	-4.9134214+03	1.1961737+02
V MISALIGN	-6.6212670+01	5.2092844+01	1.1434212+01	-8.7160732+04	8.2012728+04	1.3415548+04	6.5699402+01
Z MISALIGN	9.4652752+01	-6.3665880+01	8.9054013+02	1.1005590+03	-8.8250942+04	8.9466075+05	-9.5525479+01

	U-DOT MAY	V-DOT MAY	M-DOT MAY	Y MISALIGN	Z MISALIGN
U-DOT MAY	7.0984002+02	7.0531195+01	1.0895753+02	2.1812554+03	1.3787073+01
V-DOT MAY	-1.8333382+02	1.1637961+00	-5.7814757+01	1.2720271+01	1.1468271+04
M-DOT MAY	1.9930045+01	-2.5392136+02	1.6043882+01	4.2135162+02	8.5095620+05
MT	1.1578678+03	-1.1714389+00	-2.2570992+05	3.1630435+02	-3.6896256+05
TIME	7.3534806+00	2.2334053+03	-9.8256483+04	-1.9529816+03	9.8343329+06
Y ACC BIAS	2.8731034+03	-5.3526261+03	-3.6172075+03	4.7756989+03	2.3257744+04
Z ACC BIAS	1.4031319+02	1.3351091+03	1.858629+05	-1.0615377+04	1.6824953+06
Y MISALIGN	-4.6340424+01	6.7417667+04	8.9092485+04	-1.0187722+04	-5.1975787+04
Z MISALIGN	-1.1212292+03	-1.1212292+03	8.9092485+04	8.9816274+07	8.6868527+08

TABLE A4.2.4-II.- Concluded
(6) Correlation matrix

	U ACT	V ACT	M ACT	U-DOT ACT	V-DOT ACT	M-DOT ACT	U NAV
U ACT	1.0000000+00						
V ACT	-7.1647958-01	1.0000000+00					
M ACT	-1.2942240-03	-0.4799138-02	1.0000000+00				
U-DOT ACT	-7.6506949-01	9.9766650-01	5.5181756-02	1.0000000+00			
V-DOT ACT	-8.9859549-01	6.7981055-01	9.6513586-03	-7.3150819-01	1.0000000+00		
M-DOT ACT	-1.1025145-01	1.0056991-01	8.7701128-01	-1.0930213-01	1.1192246-01	1.0000000+00	
U NAV	-0.9937177-01	7.8180798-01	5.6860321-03	-7.5097768-01	9.9936106-01	1.1180530-01	1.0000000+00
V NAV	7.0555453-01	-0.7947010-01	7.9997561-02	9.8259597-01	-7.5549736-01	-1.1180530-01	-7.7586547-01
M NAV	-1.0085178-02	8.8955521-01	-8.8955521-01	-7.8003932-02	1.4495418-03	-9.7411284-01	5.9166587-03
U-DOT NAV	-8.4915174-01	8.6356654-01	-8.7169434-01	-7.7485018-01	8.2331265-01	-9.9371126-01	8.4068284-01
V-DOT NAV	9.8781055-01	-8.7169434-01	-1.2319990-02	7.2369511-01	-9.9371126-01	1.0044505-02	-9.9913214-01
M-DOT NAV	7.8381813-04	7.4784177-02	9.9097867-01	-6.4751421-02	1.0044505-02	-9.8310843-01	6.3112648-03
TIME	-6.8051351-01	9.3250725-01	-1.2800857-01	-8.2686798-01	3.9005805-01	1.3189305-01	6.7190101-01
X ACC BIAS	1.4466815-01	8.9002180-01	1.4363448-01	-8.7317762-01	3.9005805-01	1.3189305-01	4.1135104-01
Y ACC BIAS	-3.9313722-01	4.1715420-01	-4.3235600-02	-1.1026233-01	-1.6339584-01	-1.7878965-02	-1.4655760-01
Z ACC BIAS	-2.6208580-01	2.3393111-01	6.7140750-02	-4.1587822-01	3.8633830-01	-1.4789385-02	3.9825402-01
X MISALIGN	-6.5022224-03	8.3852391-02	-8.6224130-01	-2.2277598-01	-1.8661301-03	2.8463830-01	2.6820066-01
Y MISALIGN	-2.4915699-01	5.2272836-02	8.8026431-02	-7.4642044-02	2.4870832-01	-8.7053365-01	2.5305651-03
Z MISALIGN	3.49886699-01	-6.4960749-02	6.9711853-02	1.0068295-01	-3.5700031-01	2.7717812-02	2.3901628-01

	Y MAY	M MAY	U-DOT MAY	V-DOT MAY	M-DOT MAY	WT	TIME
Y MAY	1.0000000+00						
M MAY	-1.0113865-01	1.0000000+00					
U-DOT MAY	-8.9379402-01	8.8506265-02	1.0000000+00				
V-DOT MAY	7.5097295-01	1.5421999-03	-8.1935429-01	1.0000000+00			
M-DOT MAY	-8.4073507-02	9.8249845-01	7.1698640-02	-1.3281803-02	1.0000000+00		
TIME	-7.0550307-01	5.0182411-02	9.3855601-01	-6.4737419-01	-1.1885507-01	1.0000000+00	
X ACC BIAS	-1.1788884-01	-2.8612383-03	7.4305204-01	-3.7922121-01	4.6559386-02	1.0000000+00	1.0000000+00
Y ACC BIAS	-5.0952767-01	5.3080899-02	6.7034128-02	1.6531104-01	-4.3527320-03	7.3324586-01	1.9192408-01
Z ACC BIAS	-3.2638871-01	-6.7006203-02	5.0653723-01	-3.9618798-01	5.8540567-02	5.6081077-01	1.4240940-01
X MISALIGN	-9.5188612-02	8.8509019-01	3.2733171-01	-2.6773660-01	9.5962830-02	4.2099491-01	-5.1705568-02
Y MISALIGN	-4.8211012-02	-7.9361867-02	8.2667940-02	4.2928877-03	8.8815229-01	-8.1138060-02	5.1372554-02
Z MISALIGN	9.3138581-02	-6.3084339-02	-1.4278460-01	3.5893097-01	-3.3549132-02	1.6618395-02	3.8151488-02
X ACC BIAS	1.0000000+00						
Y ACC BIAS	0.0000000	1.0000000+00					
Z ACC BIAS	0.0000000	0.0000000	1.0000000+00				
X MISALIGN	0.0000000	0.0000000	0.0000000	1.0000000+00			
Y MISALIGN	0.0000000	0.0000000	0.0000000	0.0000000	1.0000000+00		
Z MISALIGN	0.0000000	0.0000000	0.0000000	0.0000000	0.0000000	1.0000000+00	

TABLE A4.2.4-III.- AOA MATRICES AT ENTRY INTERFACE MINUS FIVE MINUTES
(A) Covariance matrix

	U ACT	V ACT	W ACT	U-DOT ACT	V-DOT ACT	W-DOT ACT	U MAY
U ACT	9.5791082+07						
V ACT	-2.2080544+06	1.3907379+09					
W ACT	-7.2806340+06	-2.7050272+07	1.0238406+08				
U-DOT ACT	2.3233312+05	-1.4773374+04	2.8865147+04	1.5695985+03			
V-DOT ACT	-4.6188841+04	1.4675075+05	6.3920528+03	-1.5329890+02	4.0802086+01	1.9621139+00	
W-DOT ACT	-3.3522350+03	2.8913918+04	9.6731798+03	-3.0850224+01	1.6925562+00	3.0934435+03	5.2650212+07
U MAY	-5.3894864+07	2.0232422+08	6.9853666+06	-2.1250248+05	4.5329227+04	-2.7522264+04	-2.0044926+08
V MAY	2.1852968+08	-1.3500283+09	-2.5294681+07	1.4334537+06	-4.4718978+05	-7.9724453+03	-3.2362367+06
W MAY	3.1566747+05	1.6200170+07	-9.7069848+07	-1.4754408+04	4.9087350+03	2.8900567+01	-4.7623666+04
U-DOT MAY	-2.2160372+05	-1.5866566+06	-6.1548345+03	1.5188463+02	-4.3155481+01	-1.8349082+00	-7.7911041+02
V-DOT MAY	4.8227478+04	-1.5226087+05	-6.0348901+03	-5.1270708+03	6.4530098+01	-8.4136999+01	1.2407262+05
W-DOT MAY	-1.5323350+05	1.5137894+06	1.1110185+05	-1.6177214+03	8.4590000+00	4.3735251+01	0.0000000
TIME	0.0000000	0.0000000	0.0000000	0.0000000	0.0000000	0.0000000	0.0000000
X ACC BIAS	3.2067391+00	-1.0089747+00	2.4270616+01	0.6790451+04	-3.5094363+03	9.1264781+05	-3.3585747+00
Y ACC BIAS	-3.3410102+00	2.8409798+01	-3.6169893+01	-3.0173457+02	1.8082205+03	2.1467301+04	2.2581826+00
Z ACC BIAS	-2.3004545+00	1.8471731+01	1.5608017+00	-1.9512205+02	1.4078475+03	4.3625728+04	1.6404523+00
X MISALIGN	1.5682504+01	0.8804450+01	-4.5908103+00	-1.0664663+03	-2.5232983+04	-4.3067422+04	-1.6101676+01
Y MISALIGN	-7.0878965+01	-1.8147124+00	1.5945933+01	-1.9019813+03	8.4638073+04	-5.2877325+04	7.0725062+01
Z MISALIGN	1.0871682+00	-2.6674271+00	1.1663030+01	2.8033809+03	-9.1572601+04	-5.3893931+05	-1.00449082+00

	Y MAY	M MAY	U-DOT MAY	V-DOT MAY	W-DOT MAY	MT	TIME
Y MAY	1.3127409+09						
M MAY	-1.5737250+07	9.4269455+07					
U-DOT MAY	1.3488135+06	1.7341732+04	1.3890707+03				
V-DOT MAY	1.4650846+05	4.7284949+03	-1.4891736+02	4.7872746+01			
W-DOT MAY	4.8466601+03	6.1430118+03	-4.6446022+00	-5.3091186+01	1.6652175+00	2.1812554+03	0.0000000
TIME	-1.4561845+06	-5.1032600+04	1.4898800+03	0.0000000	-9.5534006+00	0.0000000	0.0000000
X ACC BIAS	0.0000000	0.0000000	0.0000000	0.0000000	0.0000000	0.0000000	0.0000000
Y ACC BIAS	2.239190+00	-6.8425705+02	-1.5280720+03	5.487822+03	-2.8141583+05	1.0253368+02	0.0000000
Z ACC BIAS	-2.737218+01	3.8587422+01	2.6980736+02	-1.5065302+03	-1.0363138+03	4.2135162+02	0.0000000
X MISALIGN	-1.8411201+01	-6.7289959+01	1.7699919+02	-1.3040820+03	1.1228129+03	3.1630435+02	0.0000000
Y MISALIGN	-9.7402489+01	4.4836199+00	1.0573544+03	2.4577086+04	3.7153729+04	-1.9541588+03	0.0000000
Z MISALIGN	-1.7427882+00	-1.3136905+01	1.8163574+03	-6.5127458+04	9.2744332+05	2.1121825+04	0.0000000
TIME	2.8592112+00	-1.1834654+01	-2.7823388+03	9.1173727+04	3.8501185+05	-5.2254478+04	0.0000000

	X ACC BIAS	Y ACC BIAS	Z ACC BIAS	X MISALIGN	Y MISALIGN	Z MISALIGN
X ACC BIAS	2.5879156+06					
Y ACC BIAS	0.0000000	2.5879156+06				
Z ACC BIAS	0.0000000	0.0000000	2.5879156+06			
X MISALIGN	0.0000000	0.0000000	0.0000000	3.0157272+07		
Y MISALIGN	0.0000000	0.0000000	0.0000000	0.0000000	1.2578079+07	
Z MISALIGN	0.0000000	0.0000000	0.0000000	0.0000000	0.0000000	1.2683274+07

TABLE A4.2.4-III.- Concluded
(B) Correlation matrix

	U ACT	V ACT	M ACT	U-DOT ACT	V-DOT ACT	M-DOT ACT	U MAY
U ACT	1.000000+00						
V ACT	-7.5237660-01	1.000000+00					
M ACT	7.1712249-02	7.1712249-02	1.000000+00				
U-DOT ACT	-9.6464325-02	-0.0000219-01	-7.2002013-02	1.000000+00			
V-DOT ACT	-9.6000500-01	6.1605977-01	6.0574485-01	6.0574485-01	1.000000+00		
M-DOT ACT	-3.2039011-01	3.5159151-01	6.8240185-01	5.5606926-01	1.0016547-01	1.000000+00	
U MAY	-9.0440872-01	7.4706620-01	6.5142150-02	-7.3985793-01	9.7709597-01	3.8337003-01	1.000000+00
V MAY	-9.074326-01	-9.9815066-01	-8.0995937-02	9.8050727-01	-6.3590479-01	-5.8229119-01	-7.6245619-01
M MAY	4.3527322-02	4.4741591-02	-9.0805954-01	-4.5611021-02	-7.9140550-02	5.0655043-01	-4.5936164-02
U-DOT MAY	-9.4321000-01	9.9910469-01	6.0855654-02	9.9894076-01	6.2445500-01	5.5339251-01	7.6149580-01
V-DOT MAY	9.4100100-01	-9.6772842-01	-8.0657491-02	5.5772431-01	-8.0471401-01	-1.7011652-01	-9.5661677-01
M-DOT MAY	9.4274468-02	-9.9556306-02	-4.6218090-01	1.0026263-01	-8.1905771-02	-4.6545756-01	-9.3207680-02
U	-4.3026210-01	0.6913063-01	2.3509950-01	-0.7426351-01	2.1650677-01	6.0052206-01	3.6611930-01
V	0.000000	0.000000	0.000000	0.000000	0.000000	0.000000	0.000000
M	2.6607307-01	-1.6010310-02	1.4010409-02	1.3617230-02	-3.4152382-01	4.8501024-02	-2.8772652-01
X ACC BIAS	-2.7011495-01	4.7355479-01	-2.2220811-02	-4.7341407-01	1.7596059-01	9.5266515-02	1.9345677-01
Y ACC BIAS	-1.0145030-01	3.0780015-01	6.5986280-02	-3.0614210-01	1.3700593-01	1.9360000-01	1.4053620-01
Z ACC BIAS	3.0257257-02	4.0265194-02	-8.2618470-01	-4.9016570-02	-7.2107430-02	-5.9807450-01	-4.0400710-02
X MISALIGN	-2.6784150-01	1.3720755-01	4.4435144-02	-1.3536010-01	2.0531632-01	-1.9402051-01	2.7403125-01
Y MISALIGN	3.0473567-01	-2.0400570-01	3.2000301-02	2.0190534-01	-4.0004225-01	-1.0069786-01	-3.0515655-01
Z MISALIGN							
TIME							

	U-DOT MAY	V-DOT MAY	X MISALIGN	Y MISALIGN	Z MISALIGN	TIME
U-DOT MAY	1.000000+00					
V-DOT MAY	-4.7923080-02	1.000000+00				
X MISALIGN	-5.0236919-01	6.3784997-02	1.000000+00			
Y MISALIGN	-9.6571919-02	-1.5850548-01	0.000000	1.000000+00		
Z MISALIGN	0.5992527-01	0.000000	0.000000	-1.5851459-01	0.000000	
TIME	0.000000	0.000000	0.000000	0.000000	0.000000	1.000000+00
X ACC BIAS	3.0155172-02	-3.0606712-03	-2.5492960-02	4.9719602-01	-1.3561810-02	1.3647032-01
Y ACC BIAS	-6.7992135-01	2.4705212-03	4.000419-01	-1.3646822-01	-4.9031670-01	5.6081077-01
Z ACC BIAS	-3.1507667-01	-4.1000962-02	2.452123-01	-1.1015309-01	5.4007491-01	7.2099491-01
X MISALIGN	-4.0002010-02	0.4090564-01	5.1660947-02	6.520361-02	5.2420910-01	-7.6122209-02
Y MISALIGN	-1.3582600-01	3.0150515-02	1.3741431-01	-2.1705305-01	1.1531340-01	1.2751047-02
Z MISALIGN	2.0041422-01	-3.4770664-02	-2.1306343-01	3.7816468-01	0.5129770-02	-3.1923691-02
TIME						

	X ACC BIAS	Y ACC BIAS	Z ACC BIAS	X MISALIGN	Y MISALIGN	Z MISALIGN
X ACC BIAS	1.000000+00					
Y ACC BIAS	0.000000	1.000000+00				
Z ACC BIAS	0.000000	0.000000	1.000000+00			
X MISALIGN	0.000000	0.000000	0.000000	1.000000+00		
Y MISALIGN	0.000000	0.000000	0.000000	0.000000	1.000000+00	
Z MISALIGN	0.000000	0.000000	0.000000	0.000000	0.000000	1.000000+00
TIME						

TABLE A4.2.4-IV.- ADA MATRICES AT ENTRY INTERFACE
(A) Covariance matrix

	U ACT	V ACT	M ACT	U-DOT ACT	V-DOT ACT	M-DOT ACT	U MAY
U ACT	9.0233304+06						3.6833329+07
V ACT	-3.6646730+06	1.0627730+11					-1.8160791+03
M ACT	-2.6647452+06	-1.5629526+08	9.5084184+07				-9.9577422+03
U-DOT ACT	4.5035796+04	-1.3026584+08	4.0865007+05	1.5867843+05			-2.9534310+06
V-DOT ACT	1.8636238+04	-2.8799552+08	9.2874543+02	2.5036899+03	5.688518+01		1.5980301+05
M-DOT ACT	1.7619816+03	1.4368754+05	-3.3398883+02	-1.7408659+02	-7.346251+01	1.2777729+01	-2.8042167+04
U MAY	-0.6723158+06	-1.8172880+08	3.1868084+06	2.3485577+06	3.9975986+04	-1.0160791+03	3.6833329+07
V MAY	-1.0237487+07	9.3669501+09	-3.5383180+07	-1.1552509+07	-1.1866877+03	-9.9577422+03	-1.5755937+08
M MAY	1.0988311+06	2.4444784+08	0.8752800+07	3.0214112+05	2.2056893+03	3.2480403+04	-2.9534310+06
U-DOT MAY	-5.0375144+03	9.3433289+06	3.6226214+04	1.1528099+04	1.1458886+02	7.7805974+08	1.5980301+05
V-DOT MAY	-1.9141918+03	1.5621743+08	4.5442720+03	1.8352756+03	-3.2594499+01	3.3205812+08	-2.8042167+04
M-DOT MAY	-1.9141918+03	0.8654148+04	3.4651420+04	7.2690817+01	-7.2623856+01	3.2957834+01	5.8755964+02
TIME	-1.4108463+04	4.1125010+06	1.1624561+05	5.1576537+03	-3.3500433+01	-1.1080134+01	4.108862+04
X ACC BIAS	-1.2221525+00	1.7524112+05	-2.5473282+01	-2.1871283+01	0.3077031+01	4.9797682+08	-8.0435907+04
Z ACC BIAS	-5.9681933+01	-1.0216894+02	-2.8940289+01	1.2745337+01	-2.0448804+04	1.2242007+04	-2.7841378+08
X MISALIGN	-3.656278+01	-8.6493711+01	1.5835279+08	0.3031247+02	1.6780224+04	2.2852731+04	5.1725766+02
Z MISALIGN	-2.4560302+01	1.2364594+01	-4.4332128+00	-1.4943539+02	-2.9886707+04	1.5698295+03	-1.7914773+01
X MISALIGN	-3.8940405+01	4.8597840+01	9.4499938+02	-5.8428409+02	-1.2306000+03	-1.4624036+04	6.0332225+01
Z MISALIGN							-9.5696237+01

	Y MAY	M MAY	U-DOT MAY	V-DOT MAY	M-DOT MAY	HT	TIME
Y MAY	1.5131842+09						
M MAY	-1.0862543+07	9.5845528+07	1.6149873+03	2.2377983+01	1.4888856+01	2.1812554+03	1.9128360+02
U-DOT MAY	1.3784897+04	-7.2458829+01	-1.2445509+01	-2.1682055+00	1.3435878+01	-2.3253627+02	6.6364402+03
V-DOT MAY	7.7355051+04	3.2557502+04	1.5501844+03	3.6831303+01	-1.7113030+00	1.0253368+02	-5.2011425+03
M-DOT MAY	-1.4888835+06	-5.0006634+04	-4.3336360+02	0.4888818+01	7.2488850+06	4.2135182+02	-2.5794810+03
TIME	4.3164347+05	8.3274531+03	-2.1228330+03	5.2617584+03	-1.5391875+03	3.1830435+02	-1.2811425+03
X ACC BIAS	5.0300809+00	-6.4118451+02	2.7428085+02	7.5600488+04	-1.8297560+03	-1.9545559+03	4.1884305+04
Z ACC BIAS	-2.8504252+01	1.6827450+02	-2.7428085+02	3.8032395+04	-1.5694038+03	2.0410776+04	-1.4284543+03
X MISALIGN	-1.8882428+01	-2.1336242+01	1.8025829+02	9.9508901+04	-3.5807314+04	-5.0342456+04	1.9872814+03
Z MISALIGN	-8.3469073+01	4.3150329+00	9.9508901+04	-3.5807314+04	0.0448748+05	-5.2351316+04	
X MISALIGN	-2.1845382+00	-1.8866591+01	-2.1935837+03	-5.9880377+04			
Z MISALIGN	-3.3820463+00	-0.9456799+02	-3.3865336+03	6.2228486+04			
X ACC BIAS	2.5878158+06						
Z ACC BIAS	9.0000000	2.5878158+06					
X MISALIGN	9.0000000	9.0000000	3.1558418+07				
Z MISALIGN	9.0000000	9.0000000	9.0000000	0.0000000	1.3968663+07	1.3712300+07	
X MISALIGN	9.0000000	9.0000000	9.0000000	9.0000000	9.0000000	9.0000000	
Z MISALIGN	9.0000000	9.0000000	9.0000000	9.0000000	9.0000000	9.0000000	

TABLE A4.2.4-IV.- Concluded
(B) Correlation matrix

	U ACT	V ACT	M ACT	U-DOT ACT	V-DOT ACT	M-DOT ACT	U MAY
U ACT	1.000000+00						
V ACT	-3.315801-01	1.000000+00					
M ACT	-1.1527616-01	1.1524350-01	1.000000+00				
U-DOT ACT	3.4997424-01	-0.320079-01	1.254559-02	1.000000+00			
V-DOT ACT	7.0010226-01	1.5181245-01	-0.5082832-01	0.3071981-01	1.000000+00		
M-DOT ACT	4.5581388-01	0.5581378-01	0.7850361-02	1.2167358-01	-2.7248622-02	1.000000+00	
U MAY	-0.3976358-02	7.3065783-01	-3.3323503-02	9.0846384-01	0.7329366-01	-0.3711729-02	1.000000+00
V MAY	6.5233578-02	0.2533746-02	9.5219226-01	-6.1559631-02	-4.0455528-01	-4.2847682-02	-6.6756827-01
M MAY	7.4775257-02	7.1317328-01	9.244008-02	7.1787135-01	3.1544533-02	9.0012033-01	5.2492057-02
U-DOT MAY	-3.4862916-01	0.6498114-01	-6.7518981-02	0.6215885-01	3.7807881-01	5.4182855-02	6.5521105-01
V-DOT MAY	-1.5820506-01	4.6214708-02	9.2127619-01	4.7140781-02	-0.1123909-01	1.7437993-01	0.6735959-01
M-DOT MAY	-2.1843384-01	-2.7818177-01	2.5535944-01	2.7638038-01	-0.9162622-02	-6.3038861-01	2.5089382-02
TIME	-3.2756338-01	9.9431115-01	-1.1301798-01	3.8488433-01	-0.6368942-02	1.5586871-01	1.5586871-01
X ACC BIAS	-2.4230339-01	3.2978616-01	1.6245781-02	3.2778788-01	-3.8418211-01	1.0873168-01	-9.8038151-01
Y ACC BIAS	-1.1838881-01	-1.9488392-01	-1.6456749-02	1.9876888-01	-1.6858832-02	3.9748789-02	-2.7695963-01
Z ACC BIAS	-7.2515127-02	1.2661727-01	1.0089821-01	1.2015456-01	-1.3244782-02	-5.5141382-02	5.2979793-03
X MISALIGN	-1.8532188-02	6.7515244-02	-0.0963559-01	-6.6569183-02	7.6498477-02	7.0175025-01	-5.2544882-02
Y MISALIGN	-2.0872545-01	-2.8112742-01	3.7398018-02	2.8046787-01	9.1603371-02	-1.9498825-01	2.6606142-01
Z MISALIGN	-3.3558757-01	4.0257883-01	2.6328633-02	-4.0156683-01	-4.4081584-01	-4.288713-02	-4.2581228-01
U ACT							
V ACT							
M ACT							
U-DOT ACT							
V-DOT ACT							
M-DOT ACT							
U MAY							
V MAY							
M MAY							
U-DOT MAY							
V-DOT MAY							
M-DOT MAY							
TIME							
X ACC BIAS							
Y ACC BIAS							
Z ACC BIAS							
X MISALIGN							
Y MISALIGN							
Z MISALIGN							

	U-DOT MAY	V-DOT MAY	M-DOT MAY	U MAY	V MAY	M MAY	TIME
U-DOT MAY	1.000000+00						
V-DOT MAY	-1.0547513-01	1.000000+00					
M-DOT MAY	1.4723488-01	0.262717-01	1.000000+00				
U MAY	0.2983881-01	0.2983881-01	0.2983881-01	1.000000+00			
V MAY	0.4950801-02	6.4950801-02	7.797434-01	0.4950801-02	1.000000+00		
M MAY	-0.2993331-03	-3.2828088-02	-7.797434-01	0.1399548-01	0.1399548-01	1.000000+00	
U-DOT MAY	1.1280831-03	4.2417688-01	4.2417688-01	0.1949885-02	1.1677136-03	1.3847832-01	1.000000+00
V-DOT MAY	-1.4440334-02	-7.7877805-01	-7.7877805-01	4.6966171-02	-2.4794573-01	5.6881877-01	-2.3378018-01
M-DOT MAY	0.2854249-01	4.4077784-02	4.4077784-02	0.6237155-02	-7.2396412-01	4.2099491-01	-1.6088986-01
U MAY	-3.1658714-02	1.4608878-01	1.4608878-01	-2.0124888-01	7.1731851-02	1.1896428-02	-2.7845325-01
V MAY	-2.0971882-02	-2.2824234-01	-2.2824234-01	3.1341874-01	6.3287849-02	-3.0270472-02	3.0003471-01
X ACC BIAS							
Y ACC BIAS							
Z ACC BIAS							
X MISALIGN							
Y MISALIGN							
Z MISALIGN							

	Y ACC BIAS	Z ACC BIAS	X MISALIGN	Y MISALIGN	Z MISALIGN
Y ACC BIAS	1.000000+00				
Z ACC BIAS	0.000000	1.000000+00			
X MISALIGN	0.000000	0.000000	1.000000+00		
Y MISALIGN	0.000000	0.000000	0.000000	1.000000+00	
Z MISALIGN	0.000000	0.000000	0.000000	0.000000	1.000000+00

TABLE A4.3.1-I.- ATO EVENT TIMELINE

Event	Time, sec	Total weight, lb	Geodetic altitude, ft	Inertial velocity, ft	Inertial flightpath angle, deg	HA x HP, n. mi.
SRB ignition	0.0	4 449 965	-23	1 341	0.00	--
SRB separation	131.7	1 830 427	165 271	5 260	26.41	39.4 x -3447.3
MECO	648.5	302 912	387 990	25 293	.45	62.8 x -165.0
OMS-1 ignition	770.0	215 999	405 712	25 273	.13	62.6 x -165.0
OMS-1 cutoff	1041.6	200 693	399 329	25 790.	-.09	105.3 x 60.2
OMS-2 ignition	3851.6	200 693	667 531	25 468.	-.02	105.3 x 60.3
OMS-2 cutoff	3896.0	199 093	666 805	25 550.	-.00	106.5 x 105.3

TABLE AN.3.2-1. - ATO GSS DATA AT MECO
 (A) ACTUAL MINUS NOMINAL STATE PARAMETERS

	U (FT)	V (FT)	W (FT)	U-DOT (FPS)	V-DOT (FPS)	W-DOT (FPS)	ALTITUDE (FT)	SPEED (FPS)	M-DOT (FPS)	DR-DOT (FPS)	GAMMA (DEG)
PLATFORM ALIGN											
AZIMUTH	-421.	-88.	8488.	-1.8	-3.3	32.8	-418.	-3.3	-1.8	-2	-004
PITCH	1818.	-788.	-1573.	4.4	-3.1	-2.8	1818.	-3.1	3.8	-3.1	-000
ROLL	-1818.	1274.	-1181.	-8.3	4.8	-2.4	-1418.	4.8	-4.8	4.8	-011
DRIFT BIAS											
X	-28.	2.	348.	-1.1	-0.8	2.1	-28.	-1.1	-1.1	-0	-008
Y	188.	-111.	-118.	1.2	-0.8	-1.2	188.	-0.8	1.2	-0	-002
Z	-238.	171.	-85.	-1.8	-0.8	-3.3	-238.	-0.8	-1.8	-0	-003
0-SENS IA DRIFT											
X	-29.	-1.	537.	-1.1	-0.8	2.8	-29.	-1.1	-1.1	-0	-008
Y	221.	-148.	-138.	1.8	-0.8	-2.2	221.	-0.8	1.8	-0	-003
Z	-188.	138.	-87.	-1.8	-0.8	-2.2	-188.	-0.8	-1.8	-0	-003
0-SENS OA DRIFT											
X	-18.	-1.	281.	-1.1	-0.8	1.8	-18.	-1.1	-1.1	-0	-008
Y	288.	-187.	-222.	1.4	-0.8	-1.4	288.	-0.8	1.4	-0	-003
Z	-313.	221.	-114.	-2.4	-0.8	-3.3	-313.	-0.8	-2.4	-0	-005
0-SENS OB DRIFT											
X	-28.	-1.	421.	-1.1	-0.8	2.1	-28.	-1.1	-1.1	-0	-008
Y	138.	-88.	-74.	1.1	-0.8	-1.1	138.	-0.8	1.1	-0	-002
Z	-188.	132.	-73.	-1.8	-0.8	-2.2	-188.	-0.8	-1.8	-0	-002
ACCEL BIAS											
X	-1828.	888.	-48.	-4.2	3.2	-1.1	-1838.	3.2	-3.8	3.2	-007
Y	388.	-388.	521.	-2.8	1.8	1.8	388.	-1.8	-1.7	1.8	-004
Z	-188.	281.	-887.	-1.1	-1.7	-2.8	-188.	-1.7	-1.8	-0	-002
ACCEL SCALE FAC											
X	-788.	781.	-31.	-2.2	2.1	-1.1	-788.	2.8	-1.8	2.8	-003
Y	-227.	188.	348.	-1.4	-1.7	1.3	-227.	-1.7	-1.2	-0	-003
Z	-87.	88.	-348.	-1.8	-1.3	-1.8	-87.	-1.3	-1.4	-0	-001
ACCEL IA ALIGN											
X	-1231.	1182.	-88.	-3.8	4.8	-1.2	-1231.	4.8	-4.8	4.8	-018
Y	-282.	218.	388.	-1.7	-0.8	1.8	-282.	-0.8	-1.8	-0	-003
Z	-188.	238.	-838.	-1.2	-0.8	-1.7	-188.	-0.8	-1.8	-0	-002
ACCEL IA ALIGN											
X	-777.	688.	-37.	-3.7	2.8	-1.1	-777.	2.8	-2.8	2.8	-007
Y	-417.	378.	888.	-2.1	-1.2	1.1	-417.	-1.2	-1.7	-0	-004
Z	-188.	228.	-878.	-1.4	-0.8	-3.7	-188.	-0.8	-1.4	-0	-003
3-SIGMA GSS	2788.	2438.	8878.	13.8	8.8	33.8	2788.	8.8	18.3	8.8	-823

TABLE AN.3.2-1. - 410 RSS DATA AT RECO

(C) NAVIGATED MINUS ACTUAL STATE PARAMETERS

	U (FT)	V (FT)	W (FT)	U-DOT (FPS)	V-DOT (FPS)	W-DOT (FPS)	ALTITUDE (FT)	SPEED (FPS)	M-DOT (FPS)	OR-DOT (FPS)	GAMMA (DEG)
PLATFORM ALIGN											
AZIMUTH	422.	-212.	-8455.	2.0	-3.3	-32.0	420.	-3.3	1.7	-3.3	.004
PITCH	-1023.	1325.	1570.	-5.0	3.7	2.5	-1023.	3.7	-3.2	3.7	-.007
ROLL	1927.	-2206.	1150.	7.2	-5.6	2.2	1427.	-5.5	4.5	-5.5	.010
DRIFT BIAS											
X	20.	-0.	-352.	-1.1	0	-2.1	20.	0	-1.1	0	.000
Y	-160.	150.	110.	-1.2	0	1.1	-170.	0	-1.0	0	-.002
Z	230.	-220.	00.	1.7	-0.0	0.2	230.	-0.0	1.4	-0.0	-.003
0-SENS 1A DRIFT											
X	20.	-4.	-542.	-2	0	-2.0	20.	0	-2	0	.000
Y	-223.	181.	133.	-1.7	0	1.1	-223.	0	-1.5	0	-.003
Z	200.	-160.	87.	1.6	-0.0	0.2	200.	-0.7	1.4	-0.0	-.003
0-SENS 0A DRIFT											
X	10.	1.	-207.	-1.1	-0.0	-2.0	10.	-0.0	-1.1	-0.0	.000
Y	-230.	265.	223.	-1.4	0	0.4	-230.	0	-1.1	0	-.003
Z	310.	-270.	113.	2.5	-1.2	0.3	310.	-1.2	2.1	-1.2	-.005
0-SENS 0B DRIFT											
X	23.	-3.	-425.	-2	-0	-2.1	23.	-0	-1	-0	.000
Y	-130.	112.	72.	-1.1	0	0	-130.	0	-1.0	0	-.002
Z	170.	-160.	73.	1.0	-0.0	0.2	160.	-0.6	0	-0.6	-.002
ACCEL BIAS											
X	1043.	-300.	49.	3.6	-1.2	0.1	1042.	-1.2	3.1	-1.2	.007
Y	357.	737.	-523.	1.2	2.1	-1.5	357.	2.1	2.1	2.1	.005
Z	160.	500.	007.	0.6	1.4	2.4	160.	1.4	1.2	1.4	.003
ACCEL SCALE FAC											
X	702.	-250.	30.	1.7	-0.5	0	701.	-0.5	1.4	-0.5	.003
Y	233.	400.	-347.	1.0	1.0	-1.3	232.	1.0	1.5	1.0	.003
Z	70.	212.	341.	0.3	0	1.3	70.	0	0	0	.001
ACCEL 1A ALIGN											
X	1241.	-907.	50.	5.1	-1.0	0.2	1241.	-1.0	4.5	-1.0	.010
Y	260.	507.	-402.	1.2	2.2	-1.6	260.	2.2	1.0	2.2	.001
Z	100.	370.	035.	0.5	1.0	1.6	100.	1.0	1.1	1.0	.003
ACCEL 1B ALIGN											
X	704.	-205.	36.	3.3	-1.2	0.1	704.	-1.2	3.0	-1.2	.007
Y	421.	051.	-005.	1.0	1.4	-1.0	421.	1.4	2.0	1.4	.004
Z	202.	002.	075.	0	2.2	3.6	202.	2.2	1.5	2.2	.003
3-SIGMA RSS	2017.	3303.	0022.	12.7	0.0	33.0	2017.	6.0	10.4	0.0	.024

TABLE AN.3.2-1. - ATO RSS DATA AT MECO
 (C) ACTUAL MINUS NOMINAL VEHICLE PARAMETERS

	LATD (DEG)	LONG (DEG)	AZIM (DEG)	RANGE (NMI)	TIME (SEC)	WEIGHT (LBS)	PROP (LBS)	OXID (LBS)	FUEL (LBS)
PLATFORM ALINE									
AZIMUTH	.021	-.010	-.080	.03	.00	0.	0.	0.	0.
TILT	-.005	-.001	.005	-.13	.00	-0.	-0.	-0.	-0.
ROLL	-.002	.005	.008	.20	.00	0.	0.	0.	0.
DRIFT BIAS									
X	.001	-.000	-.005	.00	.00	0.	0.	0.	0.
Y	-.000	-.000	.000	-.02	.00	-0.	-0.	-0.	-0.
Z	-.000	.001	.001	.03	.00	0.	0.	0.	0.
0-SENS IA DRIFT									
X	.001	-.001	-.005	.00	.00	0.	0.	0.	0.
Y	-.000	-.000	.000	-.02	.00	-0.	-0.	-0.	-0.
Z	-.000	.001	.001	.02	.00	0.	0.	0.	0.
0-SENS OA DRIFT									
X	.001	-.000	-.005	.00	.00	0.	0.	0.	0.
Y	-.001	-.000	.001	-.03	.00	-0.	-0.	-0.	-0.
Z	-.000	.001	.001	.04	.00	0.	0.	0.	0.
0-50 SEN DRIFT									
X	.001	-.000	-.005	.00	.00	0.	0.	0.	0.
Y	-.000	-.000	.000	-.01	.00	-0.	-0.	-0.	-0.
Z	-.000	.000	.001	.02	.00	0.	0.	0.	0.
ACCEL BIAS									
X	.001	.003	.002	.18	.00	-0.	-0.	-0.	-0.
Y	.002	.000	-.003	.05	.00	-0.	-0.	-0.	-0.
Z	-.002	.002	.006	.03	.00	-0.	-0.	-0.	-0.
ACCEL SCALE FAC									
X	.001	.002	.001	.11	.00	-0.	-0.	-0.	-0.
Y	.001	.000	-.003	.03	.00	-0.	-0.	-0.	-0.
Z	-.001	.001	.004	.01	.00	0.	0.	0.	0.
ACCEL IA ALINE									
- OA									
X	.001	.003	.003	.18	.00	-0.	-0.	-0.	-0.
Y	.001	.000	-.004	.04	.00	-0.	-0.	-0.	-0.
Z	-.002	.002	.005	.03	.00	-0.	-0.	-0.	-0.
ACCEL IA ALINE									
- SA									
X	.001	.002	.002	.11	.00	-0.	-0.	-0.	-0.
Y	.002	.000	-.002	.06	.00	-0.	-0.	-0.	-0.
Z	-.002	.002	.010	.03	.00	-0.	-0.	-0.	-0.

3-SIGMA RSS =	.022	.013	.083	.40	.00	0.	0.	0.	0.

TABLE A4.3.2-1. - ATD RSS DATA AT MECO

(01) ACTUAL MINUS NOMINAL ORBITAL PARAMETERS

	MA (MM)	MP (MM)	PERIOD (SEC)	IMCLIM (DEG)	ASC MOD (DEG)	ARG PER (DEG)	TRU ANOM (DEG)	SHAJ AXS (MM)	ECCENT (ND)
PLATFORM ALINE									
AZIMUTH	-.13	-.25	-.41	-.0527	-.0894	-.20	.13	-.19	-.0002
TILTY	-.26	-1.17	-1.00	-.0065	-.0058	.16	-.15	-.46	-.0021
ROLL	-.35	1.08	1.67	-.0052	-.0054	-.19	.20	.76	-.00034
DRIFT BIAS									
X	-.01	-.01	-.02	-.0029	.0061	-.01	.01	-.01	-.00000
Y	-.05	-.25	-.21	-.0005	-.0006	.05	-.05	-.10	-.00005
Z	-.08	.38	.33	-.0005	-.0008	-.07	.07	.15	-.00007
0-SEMS IA DRIFT									
X	-.01	-.02	-.03	-.0039	.0073	-.02	.01	-.01	-.00000
Y	-.08	-.35	-.29	-.0006	-.0005	.07	-.07	-.13	-.00006
Z	-.07	.33	.28	-.0004	-.0008	-.07	.07	.13	-.00006
0-SEMS OA DRIFT									
X	-.01	-.01	-.02	-.0026	.0056	-.01	.01	-.01	-.00000
Y	-.07	-.35	-.30	-.0010	-.0010	.06	-.06	-.14	-.00008
Z	-.11	.52	.45	-.0006	-.0009	-.11	.11	.20	-.00009
0-SO SEM DRIFT									
X	-.01	-.01	-.02	-.0031	-.0059	-.01	.01	-.01	-.00000
Y	-.05	-.22	-.18	-.0003	-.0002	.05	-.05	-.08	-.00004
Z	-.05	.25	.22	-.0004	-.0006	-.04	.04	.10	-.00004
ACCEL BIAS									
X	-.24	1.22	1.06	-.0003	-.0004	-.12	.12	.49	-.00022
Y	-.10	.40	.32	-.0028	.0041	-.09	.08	.15	-.00007
Z	-.05	-.28	.25	-.0044	-.0063	-.04	.04	.12	-.00005
ACCEL SCALE FAC									
X	-.15	.74	.65	-.0001	-.0001	-.04	.04	.30	-.00013
Y	-.07	.27	.22	-.0021	.0036	-.06	.06	.10	-.00005
Z	-.02	.12	.11	-.0022	-.0038	-.02	.02	.05	-.00002
ACCEL IA ALINE									
- OA									
X	-.31	1.53	1.33	-.0004	-.0007	-.19	.20	.61	-.00028
Y	-.08	.31	.25	-.0026	.0044	-.08	.07	.11	-.00006
Z	-.06	.31	.28	-.0040	-.0037	-.04	.04	.13	-.00005
ACCEL IA ALINE									
- SA									
X	-.20	.98	.85	-.0002	-.0004	-.13	.13	.39	-.00018
Y	-.11	.46	.38	-.0026	.0024	-.08	.08	.17	-.00009
Z	-.06	.35	.32	-.0060	-.0100	-.05	.05	.15	-.00008
3-SIGMA RSS	.72	3.48	3.05	.0547	.0009	.48	.47	1.39	.00063

TABLE AN.3.2-11. - ATO RSS DATA AT OMS-1 CUTOFF

(A) ACTUAL MINUS NOMINAL STATE PARAMETERS

	U (FT)	V (FT)	M (FT)	U-DOT (FPS)	V-DOT (FPS)	M-DOT (FPS)	ALTITUDE (FT)	SPEED (FPS)	M-DOT (FPS)	DR-DOT (FPS)	GAMMA (DEG)
PLATFORM ALINE											
AZIMUTH	-1157.	8993.	19971.	-10.0	1.1	25.2	-1146.	1.1	-1.5	1.1	-.003
TILT	1820.	-11202.	-2439.	13.6	-4.6	-1.5	1823.	-4.6	.1	-4.6	.000
ROLL	-2452.	13653.	-1937.	-16.4	6.7	-1.5	-2447.	6.7	.2	6.7	.000
DRIFT BIAS											
X	-67.	164.	1113.	-.3	.0	1.7	-67.	.0	-.1	.0	-.000
Y	463.	-354.	-193.	.9	-.9	-.1	463.	-.9	.9	-.9	.001
Z	-651.	575.	-199.	-1.4	1.4	-.2	-651.	1.4	-.7	1.4	-.002
O-SENS IA DRIFT											
X	-60.	523.	1476.	-.0	.1	2.1	-60.	.1	-.1	.1	-.000
Y	660.	-570.	-205.	1.5	-1.3	-.1	660.	-1.3	.0	-1.3	.002
Z	-602.	664.	-142.	-1.0	1.2	-.2	-602.	1.2	-.7	1.2	-.002
O-SENS OA DRIFT											
X	-61.	185.	990.	-.3	.0	1.0	-61.	.0	-.1	.0	-.000
Y	580.	-709.	-360.	1.3	-1.2	-.2	580.	-1.2	.4	-1.2	.001
Z	-943.	794.	-229.	-2.1	1.9	-.2	-942.	2.0	-1.1	2.0	-.002
O-SQ SEM DRIFT											
X	-73.	-7.	1171.	-.1	.1	1.7	-73.	.1	-.1	.1	-.000
Y	444.	-156.	-108.	.0	-.9	-.0	443.	-.9	.6	-.9	.001
Z	-388.	230.	-151.	-.6	.6	-.2	-388.	.9	-.3	.9	-.001
ACCEL BIAS											
X	-1954.	-14467.	-102.	14.4	3.2	-.1	-1949.	3.1	-3.1	3.1	-.007
Y	-1222.	-5281.	1124.	59.2	-1.8	1.9	-1155.	-1.8	-5.3	-1.8	-.012
Z	-642.	-36370.	-1725.	48.7	-1.4	-2.8	-611.	-1.4	-3.3	-1.4	-.007
ACCEL SCALE FAC											
X	-1048.	-19373.	-48.	22.2	.9	-.0	-1039.	.9	-1.3	.9	-.003
Y	-839.	-33289.	810.	36.9	-1.0	1.0	-813.	-1.0	-3.4	-1.0	-.008
Z	-280.	-14682.	-828.	18.4	-.5	-1.1	-275.	-.5	-1.4	-.5	-.003
ACCEL IA ALINE											
- OA											
X	-2526.	-25490.	-142.	27.5	3.4	-.1	-2511.	3.4	-3.3	3.4	-.007
Y	-997.	-39910.	974.	44.3	-1.3	1.3	-960.	-1.3	-4.1	-1.3	-.009
Z	-589.	-21706.	-1483.	24.3	-.4	-1.0	-577.	-.4	-2.1	-.4	-.005
ACCEL IA ALINE											
- SA											
X	-1631.	-15797.	-87.	16.9	2.3	-.1	-1625.	2.2	-2.2	2.2	-.005
Y	-1126.	-33478.	959.	37.1	-.4	.7	-1100.	-.4	-3.5	-.4	-.008
Z	-816.	-40963.	-2273.	45.8	-1.4	-2.8	-776.	-1.4	-3.8	-1.4	-.009
3-SIGMA RSS	5798.	110453.	20724.	123.0	10.8	26.0	5744.	10.9	11.6	10.9	.026

TABLE AN.3.2-11. - ATO RSS DATA AT OMS-1 CUTOFF

(B) NAVIGATED MINUS ACTUAL STATE PARAMETERS

	U (FT)	V (FT)	W (FT)	U-DOT (FPS)	Y-DOT (FPS)	M-DOT (FPS)	ALTITUDE (FT)	SPEED (FPS)	M-DOT (FPS)	DR-DOT (FPS)	GAMMA (DEG)
PLATFORM ALINE											
AZIMUTH	1076.	-799.	-19700.	2.5	-9	-24.4	1066.	-1.0	1.5	-1.0	.003
TILT	-1698.	3869.	2334.	-4.8	4.5	1.3	-1898.	4.5	-2	4.5	-.000
ROLL	2305.	-5692.	1843.	6.8	-6.5	1.2	2302.	-6.5	-2	-6.5	-.000
DRIFT BIAS											
X	76.	-32.	-1133.	.2	-1	-1.0	76.	-1	.1	-1	.000
Y	-460.	621.	156.	-1.3	1.0	.8	-660.	1.0	-5	1.0	-.001
Z	859.	-905.	165.	1.8	-1.4	.1	659.	-1.4	.7	-1.4	-.002
0-SENS IA DRIFT											
X	93.	-48.	-1471.	.2	-1	-2.1	93.	-1	.1	-1	.000
Y	-667.	838.	165.	-1.8	1.3	-.0	-667.	1.3	-8	1.3	-.002
Z	818.	-776.	120.	1.7	-1.2	.1	818.	-1.2	.7	-1.2	-.002
0-SENS OA DRIFT											
X	64.	-25.	-1814.	.1	-1	-1.7	64.	-1	.1	-1	.000
Y	-963.	884.	341.	-1.5	1.2	.2	-963.	1.2	-4	1.2	-.001
Z	959.	-1227.	202.	2.6	-1.9	.1	959.	-2.0	1.1	-2.0	-.002
0-SO SEM DRIFT											
X	78.	-37.	-1167.	.1	-0	-1.6	78.	-0	.1	-0	.000
Y	-454.	534.	70.	-1.2	.9	-.1	-454.	.9	-6	.9	-.001
Z	391.	-596.	129.	1.0	-0	.1	390.	-0	.3	-0	-.001
ACCEL BIAS											
X	2248.	-2013.	106.	5.4	-3.5	.2	2248.	-3.5	3.0	-3.5	.007
Y	1694.	1004.	-1146.	3.8	1.2	-1.8	1691.	1.2	5.0	1.2	.011
Z	985.	783.	1768.	2.1	.8	2.8	984.	.9	3.0	.9	.007
ACCEL SCALE FAC											
X	1219.	-1024.	46.	2.4	-1.2	.0	1219.	-1.2	1.1	-1.2	.003
Y	1173.	706.	-798.	2.3	.5	-1.0	1172.	.5	3.2	.5	.007
Z	435.	353.	809.	.8	.3	1.0	435.	.3	1.3	.3	.003
ACCEL IA ALINE											
- OA											
X	2781.	-2502.	135.	6.2	-3.8	.2	2784.	-3.8	3.1	-3.8	.007
Y	1386.	845.	-952.	2.8	.7	-1.2	1385.	.7	3.8	.7	.008
Z	821.	594.	1421.	1.2	.1	.8	821.	.1	2.0	.1	.004
ACCEL IA ALINE											
- SA											
X	1791.	-1619.	88.	4.0	-2.5	.1	1792.	-2.5	2.0	-2.5	.005
Y	1459.	751.	-921.	2.3	-.0	-.5	1458.	-.0	3.2	-.0	.007
Z	1219.	973.	2247.	2.4	.9	2.8	1217.	.9	3.6	.9	.008
3-SIGMA RSS -											
	6442.	8498.	20444.	15.2	10.7	25.2	6440.	10.7	10.8	10.7	.024

TABLE A4.3.2-11. - ATO RSS DATA AT OMS-1 CUTOFF

(C) ACTUAL MINUS NOMINAL VEHICLE PARAMETERS

	LATD (DEG)	LONG (DEG)	AZIM (DEG)	RANGE (MM)	TIME (SEC)	WEIGHT (LBS)	PROP (LBS)	OXID (LBS)	FUEL (LBS)
PLATFORM ALINE									
AZ(MUTH)	.05	-.025	-.039	1.16	.26	-10.	0.	0.	0.
TILY	-.006	-.036	-.022	-1.76	.32	12.	0.	0.	0.
ROLL	-.006	.047	.034	2.13	.36	-14.	0.	0.	0.
DRIFT BIAS									
X	.003	.001	-.003	.03	.01	0.	0.	0.	0.
Y	-.001	-.001	-.001	-.06	.01	0.	0.	0.	0.
Z	-.001	-.002	.002	.09	-.01	0.	0.	0.	0.
O-SENS IA DRIFT									
X	.004	-.002	-.003	.09	.02	-1.	0.	0.	0.
Y	-.001	-.002	-.001	-.09	.01	0.	0.	0.	0.
Z	-.000	.003	.002	.14	.00	0.	0.	0.	0.
O-SENS OA DRIFT									
X	.003	-.001	-.003	.03	.01	0.	0.	0.	0.
Y	-.001	-.003	-.001	-.12	.00	-3.	0.	0.	0.
Z	-.001	-.003	.002	.13	-.01	1.	0.	0.	0.
O-SO SEN DRIFT									
X	.003	.000	-.004	.01	.00	0.	0.	0.	0.
Y	-.000	-.001	-.000	-.03	.01	-1.	0.	0.	0.
Z	-.000	.001	.001	.04	-.01	1.	0.	0.	0.
ACCEL BIAS									
X	.000	-.048	-.033	-2.20	-.68	26.	0.	0.	0.
Y	.006	-.179	-.126	-8.19	-2.11	81.	0.	0.	0.
Z	-.003	-.122	-.077	-5.60	-1.44	55.	0.	0.	0.
ACCEL SCALE FAC									
X	.001	-.065	-.044	-2.97	-.83	32.	0.	0.	0.
Y	-.004	-.112	-.078	-5.12	-1.32	51.	0.	0.	0.
Z	-.002	-.049	-.031	-2.27	-.58	22.	0.	0.	0.
ACCEL IA ALINE									
- OA	.001	-.085	-.058	-3.90	-1.14	44.	0.	0.	0.
Y	.005	-.134	-.094	-6.14	-1.58	61.	0.	0.	0.
Z	-.003	-.073	-.048	-3.36	-.88	34.	0.	0.	0.
ACCEL IA ALINE									
- SA	.001	.53	-.036	-2.42	-.71	27.	0.	0.	0.
Y	.004	-.112	-.078	-5.14	-1.35	52.	0.	0.	0.
Z	-.004	-.138	-.087	-6.31	-1.62	62.	0.	0.	0.
3-SIGMA RSS *	.056	.371	.254	16.99	4.43	170.	0.	0.	0.

TABLE AN.3.2-11. - ATO RSS DATA AT OMS-1 CUTOFF

(D) ACTUAL MINUS NOMINAL ORBITAL PARAMETERS

	MA (MM)	MP (MM)	PERIOD (SEC)	INCLIN (DEG)	ASC MOD (DEG)	ARG PER (DEG)	TRU ANOM (DEG)	SMAJ AXS (MM)	ECCENT (IND)
PLATFORM ALINE									
AZIMUTH	-.10	-.23	-.18	-.0526	.0883	.39	-.43	-.08	.00004
TILT	-1.62	-.28	-1.51	-.0065	-.0054	.97	-.80	-.67	-.00027
ROLL	2.43	-.36	2.33	-.0051	-.0053	-.05	.89	1.04	.00039
DRIFT BIAS									
X	-.80	-.01	-.02	-.0029	-.0061	.04	-.04	-.01	.00000
Y	-.29	-.09	-.23	-.0005	-.0005	-.08	.06	-.10	-.00005
Z	.45	-.12	-.37	-.0005	-.0008	.07	-.06	.16	.00008
O-SENS IA DRIFT									
X	-.09	-.02	-.03	-.0039	.0072	.04	-.05	-.01	.00000
Y	-.42	-.13	-.32	-.0005	-.0003	-.11	.11	-.14	-.00008
Z	.40	-.12	-.32	-.0004	-.0006	.10	-.09	.14	.00007
O-SENS OA DRIFT									
X	.80	-.01	-.01	-.0026	-.0056	.03	-.03	-.01	.00000
Y	-.39	-.10	-.32	-.0010	-.0008	.01	-.01	-.14	-.00007
Z	.63	-.18	-.51	-.0006	-.0007	.14	-.13	.23	.00011
O-SQ SEN DRIFT									
X	.81	-.02	-.01	.0031	.0058	.03	-.04	-.01	.00000
Y	-.26	-.09	-.20	-.0003	-.0001	-.09	.09	-.09	-.00005
Z	.28	-.07	-.24	-.0004	-.0006	-.00	.00	.11	.00005
ACCEL BIAS									
X	-.86	-.41	.43	-.0003	-.0005	.66	-.70	.22	.00010
Y	-1.37	-.39	-2.00	-.0029	-.0068	2.13	-2.28	-.90	-.00014
Z	-.95	-.22	-1.34	-.0045	-.0098	1.35	-1.44	-.80	-.00010
ACCEL SCALE FAC									
X	.02	-.21	.21	-.0001	-.0000	.34	-.39	-.10	.00003
Y	-.04	-.26	-1.25	.0021	.0036	1.34	-1.43	-.56	-.00008
Z	-.38	-.10	-.54	-.0022	-.0037	.56	-.59	-.24	-.00004
ACCEL IA ALINE									
- OA									
X	-.72	-.51	.22	-.0004	-.0005	.72	-.79	.10	.00017
Y	-1.03	-.31	-1.53	-.0026	-.0046	1.62	-1.73	-.68	-.00010
Z	-.84	-.17	-.68	-.0039	-.0034	.79	-.84	-.31	-.00004
ACCEL IA ALINE									
- SA									
X	.49	-.33	.17	-.0002	-.0004	.49	-.52	.08	.00012
Y	-.67	-.30	-1.11	.0026	.0023	1.29	-1.38	-.50	-.00005
Z	-1.03	-.27	-1.49	-.0000	-.0008	1.55	-1.65	-.66	-.00011
3-SIGMA RSS =	4.22	1.23	4.78	.0546	.0912	4.28	4.58	2.14	.00064

TABLE AN-3.2-III. - ATO RSS DATA AT OMS-2 CUTOFF

(A) ACTUAL MINUS NOMINAL STATE PARAMETERS

	U (FT)	V (FT)	W (FT)	U-DOT (FPS)	V-DOT (FPS)	W-DOT (FPS)	ALTIMUDE (FT)	SPEED (FPS)	M-DOT (FPS)	DR-DOT (FPS)	QAMMA (DEG)
PLATFORM ALINE											
AZIMUTH	581.	9180.	-2262.	-9.7	-8	-17.5	588.	-8	1.2	-8	.003
TILT	-8825.	22026.	2739.	-24.4	9.3	.7	-9813.	9.3	1.7	9.3	.004
ROLL	14723.	-30234.	2204.	33.0	-13.6	.7	14744.	-13.5	-2.8	-13.5	-.006
DRIFT BIAS											
X	-12.	811.	-1484.	-6	-8	-1.3	-12.	-8	.1	-8	.000
Y	-1786.	1542.	221.	-1.9	1.7	.1	-1786.	1.7	-1.1	1.7	-.000
Z	2734.	-2898.	244.	3.5	-2.7	.1	2734.	-2.7	.1	-2.7	.000
0-SENS IA DRIFT											
X	-16.	976.	-1814.	-1.0	-8	-1.5	-15.	-8	.1	-8	.000
Y	-2526.	1935.	220.	-2.5	2.5	-8	-2526.	2.5	-2	2.5	-.001
Z	2449.	-2211.	172.	2.8	-2.4	.1	2449.	-2.4	.2	-2.4	.001
0-SENS OA DRIFT											
X	5.	481.	-1337.	-5	-8	-1.2	5.	-8	.1	-8	.000
Y	-2381.	2982.	488.	-3.5	2.3	.1	-2380.	2.3	.1	2.3	.000
Z	3856.	-3551.	265.	4.5	-3.8	.1	3856.	-3.8	.3	-3.8	.001
0-SQ SEM DRIFT											
X	46.	506.	-1521.	-5	-1	-1.2	46.	-1	.1	-1	.000
Y	-1866.	942.	111.	-1.3	1.6	-8	-1866.	1.6	-2	1.6	-.000
Z	1784.	-1868.	181.	2.2	-1.6	.1	1784.	-1.6	-8	-1.6	-.000
ACCEL BIAS											
X	5187.	2484.	132.	-1.0	-5.5	.1	5187.	-5.5	1.9	-5.5	.004
Y	-8437.	49141.	-1508.	-52.1	6.8	-1.1	-8381.	6.8	6.1	6.8	.014
Z	-5832.	38532.	2356.	-32.2	4.7	2.0	-5811.	4.7	3.9	4.7	.009
ACCEL SCALE FAC											
X	146.	9745.	58.	-18.6	-4	.1	148.	-4	.9	-4	.002
Y	-5149.	28515.	-1007.	-38.1	3.9	-6	-5130.	3.9	3.7	3.9	.008
Z	-2299.	13935.	1064.	-14.9	2.0	.8	-2294.	2.0	1.6	2.0	.004
ACCEL IA ALINE											
- OA											
X	4347.	10682.	179.	-18.6	-4.7	.2	4350.	-4.7	2.0	-4.7	.005
Y	-6341.	35871.	-1225.	-37.2	4.8	-7	-6312.	4.8	4.4	4.8	.018
Z	-2678.	18736.	1681.	-20.8	2.1	.5	-2678.	2.2	2.2	2.2	.005
ACCEL IA ALINE											
- SA											
X	2963.	7198.	114.	-7.2	-3.1	.1	2964.	-3.1	1.3	-3.1	.003
Y	-4135.	27288.	-1064.	-28.8	3.8	-1	-4117.	3.8	3.5	3.8	.008
Z	-6325.	33458.	2889.	-35.6	5.0	2.1	-6298.	5.0	4.2	5.0	.009
3-SIGMA RSS	25669.	97999.	26168.	104.4	23.0	18.0	25633.	23.0	16.1	23.0	.027

TABLE A4.3.2-111. - ATO RSS DATA AT OMS-2 CUTOFF
(B) NAVIGATED MINUS ACTUAL STATE PARAMETERS

	U (FT)	V (FT)	W (FT)	U-DOT (FPS)	V-DOT (FPS)	W-DOT (FPS)	ALITUDE (FT)	SPEED (FPS)	H-DOT (FPS)	DR-DOT (FPS)	GAMMA (DEG)
PLATFORM ALINE											
AZIMUTH	-628.	-7853.	24817.	7.2	1.8	16.8	-841.	1.8	-1.2	1.8	-.003
TILT	9888.	-28114.	-2578.	22.2	-9.2	-5	9876.	-8.2	-1.7	-9.2	-.004
ROLL	-14813.	32879.	-2884.	-35.2	13.8	-5	-14845.	13.8	2.8	13.8	.008
DRIFT BIAS											
X	-82.	-523.	1516.	.5	.1	1.3	-81.	.1	-.1	.1	-.000
Y	1824.	-1688.	-183.	2.1	-1.8	.8	1824.	-1.8	.1	-1.8	.000
Z	-2759.	2884.	-198.	-3.5	2.7	-8	-2760.	2.7	-.1	2.7	-.000
0-SENS IA DRIFT											
X	-77.	-888.	1888.	.8	.1	1.5	-77.	.1	-.1	.1	-.000
Y	2582.	-1972.	-157.	2.6	-2.5	.1	2583.	-2.5	.2	-2.5	.001
Z	-2483.	2828.	-134.	-2.8	2.4	-8	-2484.	2.4	-.2	2.4	-.000
0-SENS OA DRIFT											
X	-189.	-334.	1372.	.3	.1	1.2	-189.	.1	-.1	.1	-.000
Y	2388.	-3188.	-374.	3.8	-2.3	-1	2389.	-2.3	-.1	-2.3	-.000
Z	-3878.	3489.	-228.	-4.4	3.7	-1	-3880.	3.7	-.3	3.7	-.001
0-SQ SEN DRIFT											
X	-38.	-555.	1511.	.5	.1	1.1	-38.	.1	-.1	.1	-.000
Y	1688.	-884.	-52.	1.4	-1.8	.1	1681.	-1.8	.2	-1.8	.000
Z	-1771.	2373.	-154.	-2.8	1.7	-1	-1771.	1.7	.8	1.7	.000
ACCEL BIAS											
X	-9438.	-3343.	-135.	2.1	9.9	-1	-9437.	9.9	-1.9	9.9	-.004
Y	8158.	-45697.	1516.	-8.4	-6.4	1.8	8119.	-6.4	-8.1	-6.4	-.014
Z	9876.	-38381.	-2371.	32.1	-4.8	-1.9	9865.	-4.8	-4.8	-4.8	-.009
ACCEL SCALE FAC											
X	-212.	-7677.	-53.	8.2	.8	-1	-218.	.8	-.9	.8	-.002
Y	5184.	-29129.	1881.	38.8	-4.8	.8	5155.	-4.8	-3.8	-4.8	-.008
Z	2284.	-12242.	-1832.	12.9	-1.8	-8	2284.	-1.8	-1.8	-1.8	-.003
ACCEL IA ALINE											
- GA											
X	-4415.	-8516.	-178.	8.1	4.9	-1	-4414.	4.9	-2.8	4.9	-.004
Y	5829.	-3388.	1195.	35.7	-4.5	.7	5813.	-4.5	-4.4	-4.5	-.018
Z	2882.	-18444.	-1582.	17.2	-2.8	-4	2888.	-2.8	-2.2	-2.8	-.005
ACCEL IA ALINE											
- SA											
X	-3889.	-5882.	-118.	4.7	3.3	-1	-3887.	3.3	-1.3	3.3	-.003
Y	3675.	-25588.	1815.	28.7	-2.6	.1	3667.	-2.6	-3.5	-2.6	-.008
Z	5932.	-32684.	-2844.	34.4	-4.6	-2.8	5918.	-4.7	-4.2	-4.7	-.009
3-SIGMA RSS											
	25462.	94885.	25697.	99.6	23.8	17.3	25454.	23.8	12.1	23.8	.027

TABLE 44.3.2-111. - ATO RSS DATA AT OMS-2 CUTOFF

(C) ACTUAL MINUS NOMINAL VEHICLE PARAMETERS

	LATD (DEG)	LONG (DEG)	AZIM (DEG)	RANGE (MM)	TIME (SEC)	WEIGHT (LBS)	PROP (LBS)	OXID (LBS)	FUEL (LBS)
PLATFORM ALINE									
AZIMUTH	-.059	.051	.000	-1.99	.09	-13.	0.	0.	0.
TILT	.021	.070	-.045	-3.41	.06	10.	0.	0.	0.
ROLL	-.014	-.101	-.061	4.04	.09	-17.	0.	0.	0.
DRIFT BIAS									
X	-.003	.003	.001	-.13	-.00	0.	0.	0.	0.
Y	-.002	-.005	-.003	-.24	-.00	0.	0.	0.	0.
Z	-.001	-.010	-.006	.46	-.00	0.	0.	0.	0.
G-SENS 1A DRIFT									
X	-.004	.005	.000	-.20	.00	-1.	0.	0.	0.
Y	-.002	.006	-.004	-.30	.00	0.	0.	0.	0.
Z	-.001	-.007	-.004	.35	-.00	0.	0.	0.	0.
G-SENS 0A DRIFT									
X	-.003	.003	.001	-.11	-.00	0.	0.	0.	0.
Y	-.003	.000	-.006	-.46	-.00	0.	0.	0.	0.
Z	-.002	-.012	-.007	.57	-.00	1.	0.	0.	0.
G-SO SER DRIFT									
X	-.004	.003	.001	-.11	-.00	0.	0.	0.	0.
Y	.001	.003	-.002	-.15	.00	-1.	0.	0.	0.
Z	-.001	-.006	-.004	.30	.02	0.	0.	0.	0.
ACCEL BIAS									
X	.002	.008	-.005	-.48	-.07	29.	0.	0.	0.
Y	.020	.162	-.000	-7.79	.00	70.	0.	0.	0.
Z	.026	.090	-.065	-4.78	-.01	55.	0.	0.	0.
ACCEL SCALE FAC									
X	.006	.032	-.020	-1.53	.05	30.	0.	0.	0.
Y	.016	.094	-.057	-0.54	-.05	52.	0.	0.	0.
Z	.012	.045	-.020	-2.17	.05	20.	0.	0.	0.
ACCEL 1A ALINE									
- OA									
X	.007	.035	-.022	-1.67	.05	42.	0.	0.	0.
Y	.020	.116	-.070	-5.50	-.04	82.	0.	0.	0.
Z	.015	.060	-.038	-2.91	-.06	31.	0.	0.	0.
ACCEL 1A ALINE									
- SA									
X	.005	.023	-.015	-1.12	.06	25.	0.	0.	0.
Y	.015	.090	-.055	-4.34	-.04	53.	0.	0.	0.
Z	.020	.100	-.071	-5.25	-.04	64.	0.	0.	0.
I-SIGMA RSS	.009	.323	.199	15.54	.23	169.	0.	0.	0.

TABLE A4-3.2-1111 - ATO RSS DATA AT OMS-2 CUTOFF

(O) ACTUAL MINUS NOMINAL ORBITAL PARAMETERS

	MA (MM)	MP (MM)	PERIOD (SEC)	INCLIN (DEG)	ASC MOD (DEG)	ARO PER (DEG)	TRU ANOM (DEG)	SMAJ AXS (MM)	ECCENT (MM)
PLATFORM ALINE									
AZIMUTH	-37	-00	-06	.0526	.0004	-23.94	23.00	-04	-.0004
TILT	-01	-1.48	-1.44	-.0065	-.0057	-21.16	21.23	-84	-.0027
ROLL	1.50	-00	2.45	-.0052	-.0049	132.72	227.20	1.00	-.0016
DRIFT BIAS									
X	-03	-00	-02	.0020	.0061	-1.79	1.70	-01	-.0000
Y	-02	-05	-23	-.0005	-.0005	-4.01	4.02	-10	-.0005
Z	-00	-23	.36	-.0005	-.0007	22.57	-22.50	-16	-.0007
0-SEMS IA DRIFT									
X	-04	-00	-03	.0030	.0072	-2.02	2.02	-01	-.0000
Y	-02	-14	-32	-.0006	-.0003	-3.78	3.77	-14	-.0000
Z	-12	-20	.31	-.0004	-.0005	13.57	-13.57	.14	-.0007
0-SEMS OA DRIFT									
X	-03	-00	-02	.0020	.0056	-1.34	1.34	-01	-.0000
Y	-03	-00	-33	-.0010	-.0008	-6.60	6.70	-15	-.0007
Z	-11	-34	.50	-.0006	-.0006	57.00	-57.00	-22	-.0010
0-S0 SEM DRIFT									
X	-03	-00	-01	.0031	.0050	-1.27	1.27	-01	-.0000
Y	-05	-05	-10	-.0003	-.0001	-2.09	2.09	-09	-.0005
Z	-02	-10	.28	-.0004	-.0006	10.30	-10.30	.11	-.0004
ACCEL BIAS									
X	-20	-00	.30	-.0003	-.0005	100.67	100.34	-17	-.0005
Y	-1.00	-1.49	-1.95	.0031	.0055	305.00	34.25	-06	-.0021
Z	-1.43	-04	-1.37	-.0048	-.0006	315.17	44.92	-01	-.0012
ACCEL SCALE FAC									
X	-32	-10	-16	-.0001	-.0002	-16.33	16.36	-07	-.0003
Y	-1.42	-75	-1.33	.0022	.0032	313.00	46.27	-59	-.0009
Z	-32	.06	-.48	-.0022	-.0040	-25.17	25.21	-21	-.0004
ACCEL IA ALINE									
-0A									
X	-41	-66	.27	-.0003	-.0007	204.90	155.13	-12	-.0007
Y	-1.03	-1.10	-1.60	.0026	.0040	310.05	49.24	-71	-.0013
Z	-50	-06	-.03	-.0030	-.0037	-33.73	33.78	-20	-.0005
ACCEL IA ALI.--									
-0A									
X	-43	-43	.22	-.0002	-.0006	300.12	50.00	-10	-.0011
Y	-1.17	-1.33	-1.10	.0026	.0018	312.00	47.99	-52	-.0006
Z	-1.57	-1.07	-1.95	-.0059	-.0104	313.02	47.07	-69	-.0013
3-SIGMA RSS	4.09	3.17	4.06	.0546	.0912	881.25	359.45	2.16	.0052

TABLE AN.3.2-1V. - ATO RSS DATA AT OMS-2 LUTOFF PLUS 1 MINUTE

(A) ACTUAL MINUS NOMINAL STATE PARAMETERS

	U (FT)	V (FT)	W (FT)	U-DOT (FPS)	V-DOT (FPS)	W-DOT (FPS)	ALTITUDE (FT)	SPEED (FPS)	M-DOT (FPS)	DR-DOT (FPS)	GAMMA (DEG)
PLATFORM ALINE											
AZIMUTH	662.	8864.	-26378.	-9.6	-9	-15.8	880.	-9	1.2	-9	.003
TILT	-8881.	23459.	2776.	-25.6	9.2	.4	-8678.	9.2	2.3	9.2	.005
ROLL	14504.	-32351.	2246.	34.0	-13.3	.4	14528.	-13.3	-3.5	-13.3	-.008
DRIFT BIAS											
X	-4.	618.	-1568.	-6	-6	-1.2	-3.	-6	.1	-6	.000
Y	-1708.	1888.	224.	-2.1	1.7	.0	-1708.	1.7	.0	1.7	.000
Z	2734.	-3296.	253.	3.8	-2.7	.1	2734.	-2.7	-.1	-2.7	-.000
G-SEMS IA DRIFT											
X	-6.	874.	-2088.	-1.8	-8	-1.3	-6.	-8	.1	-8	.008
Y	-2538.	2313.	219.	-2.8	2.5	-.0	-2537.	2.5	-.1	2.5	-.000
Z	2459.	-2577.	178.	3.1	-2.4	.1	2459.	-2.4	.1	-2.4	-.000
G-SEMS OA DRIFT											
X	11.	477.	-1416.	-5	-5	-1.1	12.	-5	.1	-5	.000
Y	-2371.	3333.	413.	-3.7	2.3	.1	-2371.	2.3	.2	2.3	.000
Z	3869.	-4125.	271.	5.8	-3.8	.1	3869.	-3.8	.1	-3.8	.000
G SO SEM DRIFT											
X	53.	497.	-1508.	-5	-5	-1.8	53.	-5	.1	-5	.000
Y	-1617.	1103.	188.	-1.5	1.6	-.0	-1617.	1.6	-.1	1.6	-.000
Z	1698.	-2117.	189.	2.4	-1.6	.1	1699.	-1.6	-.1	-1.6	-.000
ACCEL BIAS											
X	5315.	1669.	139.	-5	-5	-1.1	5315.	-5	1.5	-5	.003
Y	-8887.	58268.	-1585.	-53.2	6.3	-1.0	-7848.	6.3	6.4	6.3	.014
Z	-9555.	31308.	2485.	-33.0	4.4	1.8	-5532.	4.4	4.1	4.4	.009
ACCEL SCALE FAC											
X	288.	8688.	81.	-18.6	-5	.0	211.	-5	.9	-5	.002
Y	-4888.	29185.	-1849.	-30.7	3.6	-.5	-4888.	3.6	3.9	3.6	.009
Z	-2187.	14248.	1114.	-15.2	1.8	.7	-2182.	1.8	1.7	1.8	.004
ACCEL IA ALINE											
- OA											
X	4474.	8992.	188.	-10.2	-4.9	-1	4476.	-4.9	1.7	-4.9	.004
Y	-6032.	35988.	-1276.	-38.0	4.5	-.6	-6032.	4.6	4.6	4.6	.010
Z	-2521.	18098.	1787.	-20.3	2.6	.3	-2512.	2.6	2.3	2.6	.005
ACCEL IA ALINE											
- SA											
X	3045.	6733.	122.	-6.8	-3.2	.1	3046.	-3.2	1.1	-3.2	.002
Y	-3892.	27810.	-1874.	-29.4	2.7	-.0	-3873.	2.7	3.6	2.7	.008
Z	-6029.	34382.	3018.	-36.4	4.6	1.8	-6001.	4.6	4.4	4.6	.010
3-SIGMA RSS	25089.	100764.	27313.	186.9	22.4	15.4	25053.	22.4	12.7	22.4	.029

TABLE AN-3.2-IV. - ATO RSS DATA AT OMS-2 CUTOFF PLUS 1 MINUTE

(B) NAVIGATED MINUS ACTUAL STATE PARAMETERS

	U (FT)	V (FT)	W (FT)	U-DOY (FPS)	V-DOY (FPS)	M-DOY (FPS)	ALTITUDE (FT)	SPEED (FPS)	M-DOY (FPS)	DR-DOY (FPS)	GAMMA (DEG)
PLATFORM ALINE											
AZIMUTH	-705.	-6923.	25889.	7.1	1.8	14.3	-719.	1.8	-1.1	1.9	-.002
TILT	8747.	-21545.	-2602.	23.3	-0.2	-3	8742.	-0.2	-2.2	-0.2	-.005
ROLL	-14588.	34218.	-2095.	-36.8	13.4	-3	-14624.	13.3	3.6	13.3	.008
DRIFT BIAS											
X	-89.	-518.	1883.	.5	.1	1.2	-89.	.1	-1.1	.1	-.000
Y	1824.	-1989.	-161.	2.3	-1.8	.8	1825.	-1.8	-1.0	-1.0	-.000
Z	-2758.	3284.	-183.	-3.8	2.7	-8	-2759.	2.7	.1	2.7	.000
0-SEMS 1A DRIFT											
X	-87.	-584.	2884.	.6	.1	1.3	-88.	.1	-1.1	.1	-.000
Y	2573.	-2355.	-151.	2.8	-2.5	.1	2574.	-2.5	.1	-2.5	.000
Z	-2473.	2387.	-135.	-2.8	2.4	-8	-2474.	2.4	-1.1	2.4	-.000
0-SEMS 0A DRIFT											
X	-117.	-318.	1452.	.3	.1	1.1	-117.	.1	-1.1	.1	-.000
Y	2379.	-3461.	-375.	3.8	-2.3	-8	2378.	-2.3	-2	-2.3	-.000
Z	-3883.	4867.	-232.	-4.8	3.8	-1	-3884.	3.8	-1.1	3.8	-.000
0-50 SEN DRIFT											
X	-46.	-548.	1585.	.5	.1	1.0	-46.	.1	-1.1	.1	-.000
Y	1671.	-1243.	-45.	1.6	-1.7	.1	1672.	-1.7	.1	-1.7	.000
Z	-1765.	2832.	-188.	-3.8	1.7	-1	-1766.	1.7	.1	1.7	.000
ACCEL BIAS											
X	-558.	-2473.	-142.	1.4	8.2	-1	-557.	8.2	-1.5	8.2	-.003
Y	7781.	-4672.	1581.	48.8	-8.2	.7	7880.	-8.2	-8.6	-8.2	-.015
Z	5593.	-31188.	-2483.	32.6	-4.5	-1.4	5581.	-4.5	-4.3	-4.5	-.010
ACCEL SCALE FAC											
X	-273.	-7813.	-56.	8.2	.5	-1	-271.	.5	-8	.5	-.002
Y	4881.	-28884.	1844.	31.4	-3.7	.5	4891.	-3.7	-3.8	-3.7	-.069
Z	2184.	-12547.	-1878.	13.2	-1.8	-7	2185.	-1.8	-1.6	-1.8	-.004
ACCEL 1A ALINE											
-0A											
X	-4537.	-7886.	-188.	7.7	4.8	-1	-4535.	4.8	-1.6	4.8	-.004
Y	5521.	-34564.	1245.	36.4	-8.1	.8	5584.	-8.1	-4.6	-8.1	-.010
Z	2448.	-16778.	-1586.	17.6	-1.8	-2	2448.	-1.8	-2.3	-1.8	-.005
ACCEL 1A ALINE											
-5A											
X	-3887.	-4583.	-117.	4.4	3.3	-1	-3886.	3.3	-1.8	3.3	-.002
Y	3431.	-25959.	1023.	27.2	-2.3	.8	3423.	-2.3	-2.6	-2.3	-.008
Z	5637.	-33384.	-2868.	35.2	-4.3	-1.7	5622.	-4.3	-4.4	-4.3	-.010
3-SIGMA RSS	24888.	86763.	26793.	182.1	28.5	14.7	24884.	22.5	12.8	22.5	.029

TABLE AN.3.2-17. - JTO RSS DATA AT SNS-2 CUTOFF PLUS 1 MINUTE
 (C) ACTUAL MINUS NOMINAL VEHICLE PARAMETERS

	LATO (DEC)	LONG (DEC)	AZIM (DEC)	RANGE (FT)	TIME (SEC)	WEIGHT (LBS)	PROP (LBS)	OXID (LBS)	FUEL (LBS)
PLATFORM ALINE									
AZIMUTH	-.061	-.040	-.005	-1.04	.00	-13.	0.	0.	0.
TILT	-.029	-.007	-.041	-3.43	.00	10.	0.	0.	0.
ROLL	-.022	-.112	-.006	5.55	.00	-17.	0.	0.	0.
DRIFT BIAS									
X	-.003	-.004	-.000	-.14	.00	0.	0.	0.	0.
Y	-.002	-.006	-.003	-.20	.00	0.	0.	0.	0.
Z	-.002	-.011	-.006	-.52	.00	0.	0.	0.	0.
G-SENS IA DRIFT									
X	-.004	-.005	-.000	-.10	.00	-1.	0.	0.	0.
Y	-.002	-.007	-.004	-.36	.00	0.	0.	0.	0.
Z	-.002	-.000	-.005	-.39	.00	0.	0.	0.	0.
G-SENS OA DRIFT									
X	-.003	-.003	-.001	-.12	.00	0.	0.	0.	0.
Y	-.004	-.011	-.006	-.54	.00	0.	0.	0.	0.
Z	-.003	-.013	-.000	-.65	.00	1.	0.	0.	0.
G-SP SEN DRIFT									
X	-.004	-.003	-.000	-.12	.00	0.	0.	0.	0.
Y	-.001	-.003	-.002	-.10	.00	-1.	0.	0.	0.
Z	-.002	-.000	-.005	-.40	.00	0.	0.	0.	0.
ACCEL BIAS									
X	-.003	-.011	-.007	-.55	.00	20.	0.	0.	0.
Y	-.035	-.155	-.001	-7.60	.00	70.	0.	0.	0.
Z	-.032	-.007	-.062	-4.02	.00	55.	0.	0.	0.
ACCEL SCALE FAC									
X	-.007	-.026	-.010	-1.33	.00	30.	0.	0.	0.
Y	-.022	-.007	-.057	-4.03	.00	52.	0.	0.	0.
Z	-.013	-.040	-.025	-2.01	.00	20.	0.	0.	0.
ACCEL IA ALINE									
X	-.007	-.027	-.017	-1.36	.00	42.	0.	0.	0.
Y	-.026	-.110	-.009	-5.05	.00	82.	0.	0.	0.
Z	-.010	-.054	-.033	-2.76	.00	31.	0.	0.	0.
ACCEL OA ALINE									
X	-.005	-.016	-.010	-.02	.00	25.	0.	0.	0.
Y	-.020	-.092	-.055	-4.53	.00	53.	0.	0.	0.
Z	-.036	-.100	-.069	-5.54	.00	64.	0.	0.	0.
B-SIGMA RSS *	.104	.322	.192	15.00	.00	100.	0.	0.	0.

TABLE AN-3.2-1V. - ATO RSS DATA AT GMS-2 CUTOFF PLUS 1 MINUTE

(D) ACTUAL MINUS NOMINAL ORBITAL PARAMETERS

	MA (MM)	MP (MM)	PERIOD (SEC)	INCLIN (DEG)	ASC NOD (DEG)	ARG PER (DEG)	TRU ANOK (DEG)	SMAJ AXS (MM)	ECCENT (MD)
PLATFORM ALIGN									
AZIMUTH	-.26	-.00	-.06	-.9525	-.0004	-16.11	16.06	-.04	-.00004
PITCH	-.01	-1.40	-1.44	-.0065	-.0057	-12.01	12.97	-.04	-.00027
ROLL	1.50	-.00	2.45	-.0052	-.0048	135.00	224.23	1.09	.00004
DRIFT BIAS									
X	-.03	-.00	-.02	-.0020	.0001	-1.35	1.35	-.01	-.00000
Y	-.02	-.05	-.23	-.0005	-.0005	-1.02	1.03	-.10	-.00005
Z	-.00	-.22	.36	-.0025	-.0007	4.20	-4.20	.10	-.00000
0-SENS IA DRIFT									
X	-.04	-.00	-.03	-.0030	-.0072	-1.54	1.54	-.01	-.00000
Y	-.02	-.15	-.32	-.0004	-.0003	-.30	.31	-.14	-.00000
Z	-.12	-.20	.31	-.0004	-.0005	.00	-.00	.14	-.00007
0-SENS OA DRIFT									
X	-.03	-.00	-.02	-.0026	-.0056	-1.05	1.05	-.01	-.00000
Y	-.03	-.10	-.33	-.0010	-.0000	-2.71	2.72	-.19	-.00007
Z	-.11	-.33	.50	-.0006	-.0004	3.03	-3.04	.22	-.00012
0-50 SEN DRIFT									
X	-.03	-.00	-.01	-.0031	-.0050	-1.06	1.05	-.01	-.00000
Y	-.05	-.05	-.19	-.0003	-.0001	.33	-.33	-.09	-.00005
Z	-.02	-.20	.25	-.0004	-.0006	3.23	-3.24	.11	-.00005
ACCEL BIAS									
X	-.20	-.00	-.30	-.0003	-.0005	250.26	100.75	.17	-.00014
Y	-1.50	-1.50	-1.05	-.0031	-.0055	310.50	40.63	-.06	-.00021
Z	-1.03	-.04	-1.37	-.0046	-.0006	320.15	31.04	-.01	-.00012
ACCEL SCALE FAC									
X	-.22	-.10	-.16	-.0001	-.0002	-11.40	11.42	-.07	-.00003
Y	-1.41	-.24	-1.33	-.0022	-.0032	327.46	32.62	-.59	-.00010
Z	-.32	-.00	-.40	-.0022	-.0040	-18.45	18.49	-.21	-.00005
ACCEL IA ALIGN									
X	-.42	-.06	-.26	-.0003	-.0007	205.02	75.00	.12	-.00014
Y	-1.03	-1.10	-1.00	-.0026	-.0040	324.65	35.44	-.71	-.00013
Z	-.50	-.00	-.63	-.0030	-.0037	-22.61	22.66	-.20	-.00005
ACCEL OA ALIGN									
X	-.43	-.42	-.22	-.0002	-.0006	24.32	24.33	.10	-.00011
Y	-1.16	-.33	-1.10	-.0026	-.0010	320.71	33.36	-.52	-.00007
Z	-1.57	-1.07	-1.55	-.0050	-.0104	328.39	33.71	-.60	-.00013
3-SIGMA RSS	0.09	3.17	4.06	.0546	.0012	000.95	274.39	2.16	.00053

ORIGINAL PAGE IS
OF POOR QUALITY

TABLE A4.3.3-1.- ATO RSS SUMMARY OF UVW STATE PARAMETERS

(a) Actual minus nominal
 (Actual perturbed minus actual nominal)

Event/case	U, ft	V, ft	W, ft	U-DOT, fps	V-DOT, fps	W-DOT, fps
SRB separation	1	0	C	0.0	0.0	0.0
MECO	2 795	2 455	8 878	13.0	9.0	33.9
OMS-1 cutoff	5 798	110 453	20 724	123.0	10.8	26.0
OMS-2 ignition	25 991	96 095	25 346	102.7	23.5	19.6
OMS-2 cutoff	25 669	97 999	26 168	104.4	23.0	18.0
<u>Fixed time slice</u>						
Nominal MECO + 1 min (GET = 725 sec)	3 511	3 447	11 401	12.9	9.8	32.8
Nominal OMS-1 cutoff + 6 min (GET = 1440 sec)	9 098	55 905	28 315	76.5	10.8	11.6
Nominal OMS-2 cutoff + 1 min (GET = 3965 sec)	25 089	100 764	27 313	106.9	22.4	15.4

TABLE A4.3.3-I.- Concluded

(b) Navigated minus actual

(Navigated perturbed minus actual perturbed)

Event/case	U, ft	V, ft	W, ft	U-DOT, fps	V-DOT, fps	W-DOT, fps
SRB separation	98	200	321	1.9	3.0	6.1
MECO	2 817	3 363	8 922	12.7	8.9	33.0
OMS-1 cutoff	6 442	8 498	20 444	15.2	10.7	25.2
OMS-2 ignition	25 775	92 212	24 907	98.1	23.2	18.8
OMS-2 cutoff	25 462	94 005	25 697	99.6	23.0	17.3
<u>Fixed time slice</u>						
Nominal MECO + 1 min (GET = 725 sec)	3 565	4 213	11 371	12.8	9.3	31.9
Nominal OMS-1 cutoff + 5 min (GET = 1440 sec)	9 996	15 080	27 738	20.2	11.1	11.0
Nominal OMS-2 cutoff + 1 min (GET = 3965 sec)	24 890	96 763	26 793	102.1	22.5	14.7

TABLE A4.3.3-II.- AOA RSS SUMMARY OF TRAJECTORY PARAMETERS

(a) Actual minus nominal
 (Actual perturbed minus actual nominal)

Event/case	Altitude, ft	Velocity magnitude, fps	Altitude rate, fps	Downrange rate, fps	Flightpath angle, fps
SRB separation	1	0.0	0.0	0.0	0.000
MECO	2 795	8.9	10.3	8.9	.023
OMS-1 cutoff	5 744	10.9	11.6	10.9	.026
OMS-2 ignition	25 958	23.5	11.3	23.5	.025
OMS-2 cutoff	25 633	23.0	12.1	23.0	.027
<u>Fixed time slice</u>					
Nominal MECO + 1 min (GET = 725 sec)	3 510	9.7	9.0	9.8	.020
Nominal OMS-1 cutoff + 6 min (GET = 1440 sec)	9 074	10.7	13.8	10.7	.031
Nominal OMS-2 cutoff + 1 min (GET = 3965 sec)	25 053	22.4	12.7	22.4	.028

TABLE A4.3.3-II.- Concluded
 (b) Navigated minus actual
 (Actual perturbed minus actual nominal)

Event/case	Altitude, ft	Velocity magnitude, fps	Altitude rate, fps	Downrange rate, fps	Flightpath angle, fps
SRB separation	98	2.4	1.8	3.0	0.028
MECO	2 817	8.8	10.4	8.9	.024
OMS-1 cutoff	6 440	10.7	10.8	10.7	.024
OMS-2 ignition	25 770	23.2	11.3	23.2	.025
OMS-2 cutoff	25 454	23.0	12.1	23.0	.027
<u>Fixed time slice</u>					
Nominal MECO + 1 min (GET = 725 sec)	3 565	9.3	10.1	9.3	.023
Nominal OMS-1 cutoff + 6 min (GET = 1440 sec)	9 968	11.1	13.8	11.1	.031
Nominal OMS-2 cutoff + 1 min (GET = 3965 sec)	24 884	22.5	12.8	22.5	.029

TABLE A4.3.3-III.- ACA RSS SUMMARY OF VEHICLE PARAMETERS
 (Actual perturbed minus actual nominal)

Event slice	Latitude, deg	Longitude, deg	Azimuth, deg	Range, n. mi.	Time, sec	Weight, lb	Propellant, lb
SRB separation	0.000	0.000	0.000	0.000	0.000	0	0
MECO	.022	.013	.083	.40	.00	0	0
OMS-1 cutoff	.056	.371	.254	16.99	4.43	170	0
OMS-2 ignition	.082	.322	.202	15.22	.00	170	0
OMS-2 cutoff	.089	.323	.199	15.54	.23	169	0
<u>Fixed time slice</u>							
Nominal MECO + 1 min (GET = 725 sec)	.030	.016	.081	.56	.00	0	0
Nominal OMS-1 cutoff + 6 min (GET = 1440 sec)	.071	.062	.028	2.58	.09	170	0
Nominal OMS-2 cutoff + 1 min (GET = 3965 sec)	.104	.322	.192	15.98	.09	169	0

TABLE 4.3.3-IV.- AOA RSS SUMMARY OF ORBITAL PARAMETERS
(Actual perturbed minus actual nominal)

Event/case	Apogee, n. mi.	Perigee, n. mi.	Period, sec	Inclination, deg	Longitude of ascending node, deg	Argument of perigee, deg	True anomaly, deg	Semi- major axis, n. mi.
SRB separation	0.00	0.00	0.00	0.0000	0.0000	0.00	0.00	0.00
MECO	.72	3.48	3.05	.0547	.0909	.48	.47	1.39
OMS-1 cutoff	4.22	1.23	4.78	.0546	.0912	4.28	4.58	2.14
OMS-2 ignition	4.22	1.23	4.78	.0545	.0914	4.42	4.17	2.13
OMS-2 cutoff	4.09	3.17	4.86	.0546	.0912	*	*	2.16
<u>Fixed time slice</u>								
Nominal MECO + 1 min (GET = 725 sec)	.71	3.48	3.06	.0547	.0909	.45	.47	1.39
Nominal OMS-1 cutoff + 6 min (GET = 1440 sec)	4.22	1.23	4.78	.0545	.0913	4.04	4.03	2.14
Nominal OMS-2 cutoff + 1 min (GET = 3965 sec)	4.09	3.17	4.86	.0546	.0912	*	*	2.16

*Undefined for circular orbit.

TABLE A4.3.4-I.- ATO MATRICES AT MECO

(A) Covariance matrix

	U ACT	V ACT	M ACT	U-DOT ACT	V-DOT ACT	M-DOT ACT	U MAV
U ACT	8.6807563+05						
V ACT	-7.4778327+05	6.6980779+05					
M ACT	-3.6642024+05	-1.0911976+05	8.7585290+06				
U-DOT ACT	-3.9877028+03	-3.4200957+03	-1.5493899+03	1.8898197+01			
V-DOT ACT	-2.7318790+03	-4.2187802+02	-4.1271372+02	-1.2677119+01	8.1926355+02		
M-DOT ACT	-1.4484769+03	-7.5374701+05	3.3126444+04	-5.0216581+00	-1.6703881+00	1.4487155+03	8.8184496+05
U MAV	-8.7492419+05	4.9862289+05	3.8705692+05	-4.0220513+03	-2.7541891+03	-7.2170459+02	-6.0656602+05
V MAV	6.0419609+05	-1.0919530+05	-8.8015480+06	1.5594166+03	4.1340125+02	-3.8288189+04	-3.8944991+05
M MAV	-3.8880547+05	3.2398276+03	-1.7939511+03	-1.8019000+01	1.2147598+01	6.7583316+00	-3.8575924+05
U-DOT MAV	1.6281846+03	1.3537550+02	-2.8280562+02	6.9957695+01	-5.3080570+00	-8.3385254+01	-1.6347230+03
V-DOT MAV	1.4254531+03	3.9202103+02	-3.2184865+04	5.7503020+00	1.5614411+00	-1.2436544+02	-1.4427773+03
M-DOT MAV	4.3692671+00	-6.0185782+00	8.2346916+00	1.8375095+02	-1.2601846+02	3.8253181+02	-4.4447649+00
TIME	0.0000000	0.0000000	0.0000000	0.0000000	0.0000000	0.0000000	0.0000000
X ACC BIAS	-5.557840-01	5.1985725-01	-2.6340670-02	-2.2377439-03	1.7339919-03	-7.8614278-05	5.5511571-01
Y ACC BIAS	-1.8751425-01	1.6501724-01	-2.7949041-01	-1.0915423-03	5.5022046-04	8.6363026-04	1.9133140-01
Z ACC BIAS	-8.8572799-02	1.0755203-01	-4.3247783-01	-6.0895923-04	3.6041801-04	-1.3192199-03	9.0647615-02
X MISALIGN	-6.3937391-02	-8.9839781-03	1.2742074+00	-2.6881024-04	-3.9369366-05	5.0265332-03	6.4121533-02
Y MISALIGN	5.8149924-02	-4.3534153-02	-7.6756024-02	2.9513278-04	-1.8588799-04	-1.3570305-04	-5.8680785-02
Z MISALIGN	-7.6691739-02	6.5796671-02	-5.5364110-02	-3.9189966-04	-2.6787509-04	-1.2087615-04	7.7365967-02
U MAV	1.2569580+06						
V MAV	1.9984319+05	8.8448144+06					
M MAV	-3.1623619+03	-1.8048306+03	1.7827389+01				
U-DOT MAV	3.2448373+03	2.8365949+02	-8.4650186+00	8.8008548+00			
V-DOT MAV	7.1764324+02	3.2352513+04	-6.6618182+00	9.4713694-01	1.2100334+02	2.2786458-03	0.0000000
M-DOT MAV	-3.2360583+01	-8.2862502+00	1.6574517-02	-7.1664634-02	-3.7783575-02	0.0000000	0.0000000
TIME	0.0000000	0.0000000	0.0000000	0.0000000	0.0000000	0.0000000	0.0000000
X ACC BIAS	-2.0912099-01	2.6143330-02	1.9136179-03	-6.4451500-04	6.6005047-05	-2.7230598-05	0.0000000
Y ACC BIAS	3.9512154-01	-2.8043611-01	6.4593715-04	1.1306675-03	-8.2375559-04	1.6757691-05	0.0000000
Z ACC BIAS	2.6789117-01	4.3287104-01	3.0438627-04	7.7140244-04	-1.2720429-03	-6.2839643-06	0.0000000
X MISALIGN	-3.1581757-02	-1.2812244+00	3.0392050-04	-3.9778768-05	-4.8979248-03	1.9864143-06	0.0000000
Y MISALIGN	7.8284934-02	7.6474519-02	-3.2214878-04	2.1025664-04	1.1911682-04	-1.8539062-06	0.0000000
Z MISALIGN	-1.1224461-01	5.5220944-02	4.3357338-04	-2.9917745-04	1.0653014-04	3.2038284-06	0.0000000
X ACC BIAS	2.5879156-06						
Y ACC BIAS	0.0000000	2.5879156-06					
Z ACC BIAS	0.0000000	0.0000000	2.5879156-06				
X MISALIGN	0.0000000	0.0000000	0.0000000	2.8720105-07			
Y MISALIGN	0.0000000	0.0000000	0.0000000	0.0000000	3.1276702-08		
Z MISALIGN	0.0000000	0.0000000	0.0000000	0.0000000	0.0000000	2.8097248-08	

TABLE A4.3.4-I.- Concluded
(B) Correlation matrix

	U ACT	V ACT	M ACT	U-DOT ACT	V-DOT ACT	M-DOT ACT	U MAY
U ACT	1.0000000+00						
V ACT	-9.8065789-01	1.0000000+00					
M ACT	-1.401169-01	-9.5031858-02	1.0000000+00				
U-DOT ACT	-9.6132099-01	-1.2043007-01	-1.7805275-01	1.0000000+00			
V-DOT ACT	-9.0139897-01	-9.981085-01	-4.6678280-02	-9.7805275-01	1.0000000+00		
M-DOT ACT	-1.3731096-01	-9.5591651-02	9.899208-01	1.1844289-01	-4.9448463-02	1.0000000+00	
U MAY	-9.9998969-01	9.8074114-01	1.3927178-01	-9.8523833-01	9.0165979-01	-5.6933982-02	1.0000000+00
V MAY	5.7841392-01	-5.4342138-01	-5.9967025-02	1.2374554-01	-5.011363-01	1.3644558-01	-5.7613143-01
M MAY	1.4031665-01	4.4882604-02	9.989797-01	1.2081675-01	4.8529428-02	-9.9025888-01	-1.3944763-01
U-DOT MAY	9.7265950-01	9.3758834-01	1.4355885-01	-9.0189510-01	9.8295669-01	1.4196982-01	9.7291824-01
V-DOT MAY	9.890393-01	-5.5757493-01	-3.2211432-02	9.4245389-01	-5.8887484-01	-2.7841228-02	-5.8679394-01
M-DOT MAY	1.3908345-01	4.3544789-02	-8.8884137-01	1.2024909-01	4.7518928-01	-9.9939068-01	-1.3821834-01
TIME	9.8248693-02	-1.5405666-01	5.8289904-02	8.8548445-02	-8.8368801-02	7.00876395-02	-9.9154918-02
X ACC BIAS	0.0000000	0.0000000	0.0000000	0.0000000	0.0000000	0.0000000	0.0000000
Y ACC BIAS	-3.7086691-01	3.9469974-01	-5.5326880-03	-3.1998177-01	3.6077373-01	-4.3221402-03	3.7018974-01
Z ACC BIAS	-1.2516666-01	1.2533637-01	5.8705159-02	-1.5602291-01	1.1447887-01	4.7481592-02	1.2663280-01
X MISALIGN	-5.9094428-02	8.1688915-02	-8.0838160-02	-8.7024444-02	7.4988610-02	-7.2829487-02	8.0004691-02
Y MISALIGN	-1.5075793-01	-2.4115735-02	9.4566367-01	-1.3584374-01	-2.8048453-02	8.7888372-01	1.5008718-01
Z MISALIGN	3.5290669-01	-3.0077693-01	-1.4665147-01	3.8188114-01	-3.3180843-01	9.7885402-02	-3.5339738-01
X MISALIGN	-4.9106379-01	4.7961062-01	-1.11650428-01	-5.3781488-01	5.3488862-01	-6.3778514-02	4.9149822-01

	Y MAY	M MAY	U-DOT MAY	V-DOT MAY	M-DOT MAY	Z MISALIGN	Y MISALIGN	X MISALIGN	Z ACC BIAS	Y ACC BIAS	X ACC BIAS	Z MISALIGN
Y MAY	1.0000000+00											
M MAY	5.9935565-02	1.0000000+00										
U-DOT MAY	-1.4373026-01	-1.4373026-01	1.0000000+00									
V-DOT MAY	9.7559621-01	3.2151841-02	-6.7500534-01	1.0000000+00								
M-DOT MAY	5.8190158-02	9.8092871-01	-1.4343338-01	2.9223628-02	1.0000000+00							
TIME	-8.8466877-01	-5.8000000	8.2233660-02	-9.8000000	-7.1917736-02	1.0000000+00						
X ACC BIAS	-1.1589225-01	9.8000000	0.0000000	0.0000000	0.0000000	0.0000000	1.0000000+00					
Y ACC BIAS	2.1307623-01	5.4643875-03	2.8173208-01	-1.3505030-01	3.7299535-03	-3.5460407-01	0.0000000	1.0000000+00				
Z ACC BIAS	1.4853308-01	-5.8615777-02	9.5097949-02	2.3691767-01	-4.6529057-02	-2.1821769-01	0.0000000	0.0000000	1.0000000+00			
X MISALIGN	-6.1884219-02	9.0477194-02	4.4813218-02	1.6163802-01	-7.1883304-02	-8.1631709-02	0.0000000	0.0000000	0.0000000	1.0000000+00		
Y MISALIGN	3.9482744-01	-9.4842207-01	1.5813214-01	-2.8457299-02	9.7817703-01	9.0488345-02	0.0000000	0.0000000	0.0000000	0.0000000	1.0000000+00	
Z MISALIGN	-5.9727344-01	1.4539917-01	-4.3142195-01	4.0075303-01	5.1225854-02	0.0000000	0.0000000	0.0000000	0.0000000	0.0000000	0.0000000	1.0000000+00

TABLE AA.3.4-II.- ATO MATRICES AT OMS-2 CUTOFF
(A) Covariance matrix

	U ACT	V ACT	M ACT	U-DOT ACT	V-DOT ACT	M-DOT ACT	U NAV
U ACT	7.3209255+07						
V ACT	-2.2108057+08	1.0670803+09					
M ACT	-1.7696310+06	-2.2075708+07	7.6087208+07				
U-DOT ACT	-1.1398818+06	2.3131277+04	-1.2098832+03				
V-DOT ACT	1.8174278+05	2.5305901+03	1.9755556+02				
M-DOT ACT	-6.9291487+04	-1.2757895+04	5.2044637+04				
U NAV	-1.6915134+03	2.1490508+08	1.9771598+06	-2.3287512+05	5.0861327+01	3.5971548+01	7.2032485+07
V NAV	-2.1705708+09	-1.0215708+09	1.7178608+07	-2.0872455+05	6.4907533+04	1.0113342+03	-2.1127264+08
M NAV	1.7796606+06	2.1686150+07	-7.4712027+07	-2.2727505+04	-1.2918069+05	0.9224941+03	-1.9848301+06
U-DOT NAV	-2.3442781+05	1.0817033+05	-1.7319146+04	-1.1524226+03	-2.3202107+03	-5.1145895+04	-2.2641229+05
V-DOT NAV	6.4978883+04	-1.7541078+05	-2.9712178+03	1.9094632+02	1.9437384+02	-8.8779211+00	-6.4684609+04
M-DOT NAV	1.6233994+03	1.2463075+04	4.8888193+04	-1.3119025+01	-1.9711386+01	-2.3839561+00	-1.7395020+03
TIME	1.0242298+02	1.6947338+06	4.7111365+04	-1.7895082+03	1.9594333+02	3.8371834+01	2.4783016+05
X ACC BIAS	2.7668460+00	1.0693132+02	-1.9389143+02	-1.2016080+01	-9.4393623+02	1.5778933+01	1.0006924+02
Y ACC BIAS	-4.5243124+00	2.6350912+01	7.0794876+02	-5.5419733+04	-2.9650547+03	5.8850440+05	-2.9161879+00
Z ACC BIAS	-3.1275115+00	1.6372292+01	-8.0856831+01	-2.7946694+02	3.6297643+03	-5.9538066+04	4.3746057+00
X MISALIGN	8.5744231+02	1.4513046+00	-3.9025504+00	-1.7292007+02	2.5098374+01	1.0899081+03	3.1511179+00
Y MISALIGN	-7.2488774+01	1.1918910+00	1.5071547+01	-1.3611882+03	1.3046150+04	-2.7744058+03	-1.04522931+01
Z MISALIGN	1.0412881+00	-1.7010743+00	1.2778714+01	1.9172558+03	-9.8051156+04	4.4870169+05	-1.0487446+00
U NAV							
V NAV							
M NAV							
U-DOT NAV							
V-DOT NAV							
M-DOT NAV							
TIME							
X ACC BIAS							
Y ACC BIAS							
Z ACC BIAS							
X MISALIGN							
Y MISALIGN							
Z MISALIGN							
X ACC BIAS	9.8188834+08						
Y ACC BIAS	-1.6802887+07	7.3368122+07					
Z ACC BIAS	-1.403172+00	1.6932783+04					
X MISALIGN	1.7345856+05	2.9593373+03	-1.0848344+02				
Y MISALIGN	-8.6982520+03	4.9034628+04	0.660261+00	5.8824158+01			
Z MISALIGN	-1.6143148+06	-4.6320028+04	1.6941176+03	2.2949584+00			
TIME	3.1969248+01	1.9127783+02	-4.2938658+02	-1.8271618+02	3.3174459+01	3.1844469+03	
X ACC BIAS	-1.7927494+00	7.2125573+02	1.1029544+03	1.0691344+01	-3.5483350+01	4.0895674+02	5.8065255+03
Y ACC BIAS	-2.4504118+01	9.110737+01	2.5753167+02	3.1654330+03	1.5441190+01	1.5532962+02	-3.8751236+05
Z ACC BIAS	-1.6296877+01	-1.2715033+00	1.7192536+02	-3.4326800+03	5.4815412+04	4.1834578+02	4.0845888+05
X MISALIGN	-1.1193206+00	3.9237673+00	1.1314588+03	-2.5637842+03	-1.0255688+03	2.9656217+02	-2.8801395+06
Y MISALIGN	-1.1294987+00	-1.3501630+01	1.2855824+03	6.9440425+04	-2.6754221+03	-1.9788883+03	1.2432112+05
Z MISALIGN	1.7783290+00	-1.1482986+01	-2.0022043+03	9.9333033+04	-1.5442709+05	3.7899843+04	3.2263208+06
X ACC BIAS							
Y ACC BIAS	2.5879156+06						
Z ACC BIAS	0.0000000						
X MISALIGN	0.0000000	2.5879156+06					
Y MISALIGN	0.0000000	0.0000000	2.8523086+07				
Z MISALIGN	0.0000000	0.0000000	0.0000000	1.0638694+07			
X MISALIGN	0.0000000	0.0000000	0.0000000	0.0000000			
Y MISALIGN	0.0000000	0.0000000	0.0000000	0.0000000			
Z MISALIGN	0.0000000	0.0000000	0.0000000	0.0000000			

TABLE A4.3.4-II.- Concluded
(B) Correlation matrix

	U ACT	V ACT	M ACT	U-DOT ACT	V-DOT ACT	M-DOT ACT	U MAY
U ACT	1.000000+00						
V ACT	-7.747765-02	1.000000+00					
M ACT	-2.371060-02	-0.996010-01	1.000000+00				
U-DOT ACT	0.941916-01	7.25117626-01	3.7813377-02	1.000000+00			
V-DOT ACT	-3.2952310-01	-6.5112294-02	9.9472607-01	6.4330733-02	1.000000+00		
M-DOT ACT	-9.9939396-01	7.7514949-01	2.6706794-02	7.8883584-01	4.4623555-02	1.000000+00	
U MAY	0.061756-01	-0.9801911-01	6.2849393-02	9.3787521-01	-7.4532403-02	3.5581627-02	1.000000+00
V MAY	2.4295625-02	7.7505121-02	-0.995719-02	-7.8282759-02	3.0359243-02	-9.9550007-01	-7.9441805-01
M MAY	-0.2448644-01	9.0783226-01	-5.9781875-02	-9.9756148-01	7.6225057-01	-4.4565122-02	-2.7302690-02
U-DOT MAY	9.8017371-01	-7.0013188-01	-4.4412044-02	-6.5402801-02	-9.9905810-01	-5.1620880-02	0.1031687-01
V-DOT MAY	3.2939249-02	6.8240874-02	-9.9237880-01	-6.5402801-02	-4.4560713-02	-9.9800461-01	-3.9584332-02
M-DOT MAY	-5.3913381-01	9.1936971-01	9.5709016-02	-4.5334929-02	-1.6148168-01	1.131620-01	3.9584332-02
WT	1.5713889-01	4.2816237-01	2.9170550-01	-4.5334929-02	-2.402175-01	6.0900034-03	-1.5476225-01
TIME	2.0246732-01	2.5342938-02	5.0451134-03	-4.5334929-02	-2.402175-01	6.0900034-03	-1.5476225-01
X ACC BIAS	-3.2068600-01	5.0144354-01	-5.7621663-02	-4.5944040-01	2.0335331-01	-0.1702660-02	-2.1336844-01
Y ACC BIAS	-2.2721792-01	3.1155592-01	-5.7621663-02	-4.5944040-01	2.0335331-01	-0.1702660-02	-2.1336844-01
Z ACC BIAS	1.0761924-02	0.3108200-02	-6.514495-01	7.0002957-01	-3.1633789-02	1.1286285-01	3.2049528-01
X MISALIGN	-2.5506448-01	1.1030581-01	5.2235432-02	-1.1030887-01	3.7332225-01	-0.6687569-01	-2.3079447-01
Y MISALIGN	3.7311586-01	-1.5965528-01	4.4914564-02	1.8899124-01	-3.9182626-01	2.2934949-02	-3.7884484-01
Z MISALIGN							
U MAY							
V MAY							
M MAY							
U-DOT MAY							
V-DOT MAY							
M-DOT MAY							
WT							
TIME							
X ACC BIAS							
Y ACC BIAS							
Z ACC BIAS							
X MISALIGN							
Y MISALIGN							
Z MISALIGN							

TABLE A4.3.4-III.- ATO MATRICES AT OMS-2 CUTOFF PLUS ONE MINUTE
(A) Covariance matrix

	U ACT	Y ACT	M ACT	U-DOT ACT	V-DOT ACT	M-DOT ACT	U MAY
U ACT	6.9937097+07	1.1291627+09	0.2890569+07	1.2701300+03	5.5965030+01	2.5433704+01	6.8836767+07
Y ACT	-2.2287543+08	-2.2641679+07	-2.3098842+04	-1.9373734+02	1.0300946+00	1.7227581+03	-2.1248378+08
M ACT	2.3020958+05	1.1965052+06	2.8065937+03	1.0902180+01	6.1784258+04	6.8910620+03	-2.2684644+06
U-DOT ACT	-6.2097518+04	1.8067033+05	4.6500247+04	-2.3159487+05	-1.7795071+05	-4.5656077+04	2.2729462+05
V-DOT ACT	-1.6206080+03	1.0260661+04	2.2722985+05	1.4718229+06	-2.8637503+03	-1.9879861+00	-6.1818446+04
M-DOT ACT	-6.0340515+07	2.1576908+08	1.7443371+07	-2.3474949+04	1.6080190+02	-1.9879861+00	-1.6207841+03
U MAY	2.1039941+08	1.0812726+09	1.1303453+07	-1.2094844+03	1.8003540+02	-5.6007024+01	2.3250077+05
Y MAY	2.0630813+06	2.2234649+07	-1.1303453+07	1.8230207+03	1.7801135+02	3.3743207+01	0.0000000
U-DOT MAY	-2.3344357+05	1.1396704+06	-1.7854963+04	1.0402181+01	0.0000000	0.0000000	-2.9802272+00
V-DOT MAY	6.2069287+04	-1.7648002+05	-3.8282856+03	1.8003540+02	-3.839928+03	5.8128049+05	4.1401509+00
M-DOT MAY	1.5300027+03	9.7886553+03	-6.4345361+04	-1.0402181+01	3.3574949+03	-9.1426840+04	2.9990023+00
TIME	-2.4505484+05	1.7282299+06	0.0000000	0.0000000	0.0000000	0.0000000	-1.1728466+01
X ACC BIAS	2.0499876+00	0.9504777+01	7.4497189+02	-2.5409254+04	-3.039928+03	5.8128049+05	0.0000000
Y ACC BIAS	-4.2937496+00	2.6951070+01	-8.4984649+01	-2.8508746+02	3.3574949+03	-5.1426840+04	2.9990023+00
Z ACC BIAS	-2.9709910+00	1.6708170+01	1.3323089+00	-1.7884253+02	-2.3351867+03	9.6503818+04	-1.1728466+01
X MISALIGN	9.8003318+02	1.3480213+00	-1.1688006+00	-1.5150824+03	-1.4950508+04	-2.3842269+03	7.2009330+01
Y MISALIGN	-7.1905800+01	1.3012092+00	1.5282381+01	-1.4475373+03	8.9383002+04	2.1148420+05	-1.0442618+00
Z MISALIGN	1.8370985+00	-1.8583252+00	1.3110670+01	2.0447654+03	-9.7520000+04	3.2200010+05	

	Y MAY	M MAY	U-DOT MAY	V-DOT MAY	M-DOT MAY	WT	TIME
Y MAY	1.0403480+09	7.8765692+07	1.1571680+03	5.6234840+01	2.4140457+01	3.1844469+03	0.0000000
M MAY	-1.7056818+07	1.7455159+04	-1.8743068+02	-1.6659246+00	-3.2374486+01	0.0000000	0.0000000
U-DOT MAY	1.7457667+05	2.8948053+03	6.6594208+00	1.6933430+02	0.6000000	1.532982+02	0.0000000
V-DOT MAY	-6.5510618+03	4.3546803+04	1.7231430+03	-1.6933430+02	0.6000000	4.1834578+02	0.0000000
M-DOT MAY	-1.6458161+06	-4.0498812+04	1.7231430+03	0.0000000	-6.6698800+05	2.9856217+02	0.0000000
TIME	0.0000000	0.0000000	0.0000000	3.3224932+03	3.6426808+04	-1.9748383+03	0.0000000
X ACC BIAS	-1.3260021+00	7.6278004+02	2.3885580+04	-7.2987386+03	2.2840031+03	3.7853650+04	0.0000000
Y ACC BIAS	-2.5080954+01	8.4797389+01	1.71948+02	-2.9310110+03	-2.6437457+06	-8.6756554+04	0.0000000
Z ACC BIAS	-1.8719376+01	1.3316742+00	1.7505244+02	-2.9310110+03	-1.6066699+05		
X MISALIGN	-1.8009423+00	4.8778155+00	1.1297788+03	1.5615988+04	2.2840031+03		
Y MISALIGN	-1.2398524+00	-1.3575142+01	1.3737459+03	-6.9853444+04	-1.6066699+05		
Z MISALIGN	1.8350456+00	-1.1760167+01	-2.1306973+03	9.8173056+04			

	X ACC BIAS	Y ACC BIAS	Z ACC BIAS	X MISALIGN	Y MISALIGN	Z MISALIGN
X ACC BIAS	2.5879156+06	2.5879156+06	2.5879156+06	2.0009217+07	1.1227551+07	1.0824825+07
Y ACC BIAS	0.0000000	0.0000000	0.0000000	0.0000000	0.0000000	
Z ACC BIAS	0.0000000	0.0000000	0.0000000	0.0000000	0.0000000	
X MISALIGN	0.0000000	0.0000000	0.0000000			
Y MISALIGN	0.0000000	0.0000000	0.0000000			
Z MISALIGN	0.0000000	0.0000000	0.0000000			

TABLE A4.3.4-III.- Concluded
(8) Correlation matrix

	U ACT	V ACT	M ACT	U-DOT ACT	V-DOT ACT	M-DOT ACT	U MAY
U ACT	1.00000000						
V ACT	-7.0000720-01	1.00000000					
M ACT	-2.7106550-02	-7.4040849-02	1.00000000				
U-DOT ACT	7.0024207-01	0.0035840-01	7.3654403-02	1.00000000			
V-DOT ACT	-0.0345207-01	7.1725760-01	-1.2410058-02	-7.2730173-01	1.00000000		
M-DOT ACT	-3.7077650-02	-5.9057140-02	0.3307250-01	5.9408774-02	5.0225669-02	1.00000000	
U MAY	-0.0036240-01	7.7427122-01	3.0001714-02	-7.0320005-01	-7.3013751-01	4.1554400-02	1.00000000
V MAY	0.0007656-01	-0.0006372-01	-0.0001714-02	0.0700107-01	4.2090679-02	-0.0420075-01	-7.0401047-01
M MAY	2.7021959-02	7.5120101-02	-0.0005400-01	-7.3751523-02	-7.5074500-01	-0.0439301-02	-3.0013540-02
U-DOT MAY	-0.2050697-01	0.0745037-01	-5.7051177-02	0.0764500-01	-0.0023263-01	-3.1502128-02	0.0334260-01
V-DOT MAY	0.0073681-01	-7.0065933-01	-4.4237716-02	7.1105006-01	-0.0040247-02	-0.0044604-01	-0.0355300-01
M-DOT MAY	3.7431004-02	5.0315006-02	-0.0134061-01	-5.0405240-02	4.2200309-01	1.1030205-01	4.0650000-01
U MAY	-3.1026010-01	0.1170001-01	0.6154002-02	-0.0040074-01	0.0000000	0.0000000	0.0000000
V MAY	0.0000000	0.0000000	0.0000000	0.0000000	0.0000000	0.0000000	0.0000000
M MAY	2.1104300-01	1.0504001-02	5.0004200-03	-4.4450070-03	-2.5202753-01	0.1103507-03	-2.2320733-01
U-DOT MAY	-3.1015950-01	4.0007012-01	-5.0024655-02	4.0725307-01	2.7023320-01	-0.2107755-02	3.1018200-01
V-DOT MAY	-2.2143190-01	3.1070450-01	0.0056240-02	-3.0045002-01	1.0421000-01	1.1607031-01	2.4604002-01
M-DOT MAY	2.2033230-02	7.0507750-02	-0.4260040-01	7.0204120-02	-3.6300150-02	-0.0307005-01	-2.0336037-02
U MISALIGN	-2.5000100-01	1.1561622-01	5.0127004-02	-1.0121040-01	-2.7503000-01	1.2275000-02	-2.6100000-01
V MISALIGN	3.7510702-01	-1.0730065-01	4.3507744-02	1.3350730-01	-3.5974235-01	1.0040717-02	-3.0070559-01
M MISALIGN							
TIME							
X ACC BIAS							
Y ACC BIAS							
Z ACC BIAS							
X MISALIGN							
Y MISALIGN							
Z MISALIGN							

	U-DOT MAY	V-DOT MAY	M-DOT MAY	U MISALIGN	V MISALIGN	M MISALIGN	Z MISALIGN
U-DOT MAY	1.00000000						
V-DOT MAY	-1.1670400-01	1.00000000					
M-DOT MAY	0.0000000	0.0000000	1.00000000				
U MISALIGN	1.7110001-01	0.0000000	0.0000000	1.00000000			
V MISALIGN	4.0003274-01	0.0000000	0.0000000	0.0000000	1.00000000		
M MISALIGN	3.2600005-01	0.0000000	0.0000000	0.0000000	0.0000000	1.00000000	
Z MISALIGN	2.0019201-02	0.0000000	0.0000000	0.0000000	0.0000000	0.0000000	1.00000000

	U-DOT MAY	V-DOT MAY	M-DOT MAY	Y ACC BIAS	Z ACC BIAS	X MISALIGN	Y MISALIGN	Z MISALIGN
U-DOT MAY	1.00000000							
V-DOT MAY	1.3501637-02	1.00000000						
M-DOT MAY	4.7025057-01	0.0000000	1.00000000					
Y ACC BIAS	3.1000500-01	0.0000000	0.0000000	1.00000000				
Z ACC BIAS	0.1050301-02	0.0000000	0.0000000	0.0000000	1.00000000			
X MISALIGN	1.2052102-01	-1.0000000	0.0000000	0.0000000	0.0000000	1.00000000		
Y MISALIGN	-1.0000000	0.0000000	0.0000000	0.0000000	0.0000000	0.0000000	1.00000000	
Z MISALIGN	0.0000000	0.0000000	0.0000000	0.0000000	0.0000000	0.0000000	0.0000000	1.00000000

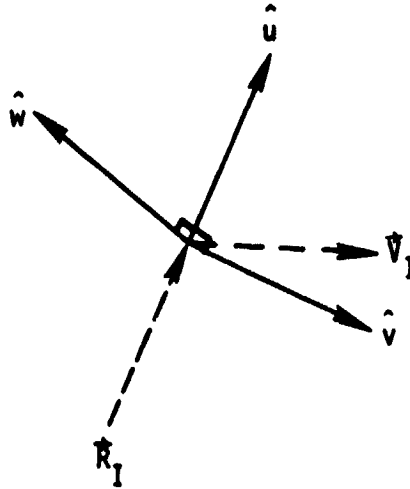

Let R_I be the inertial position vector and V_I be the inertial velocity vector. The local horizontal (LHS) or UVW coordinate system is defined by the following three vector equations.

$$\hat{u} = \vec{R}_I / |\vec{R}_I| \quad (\text{Radial direction})$$

$$\hat{v} = (\vec{R}_I \times \vec{V}_I \times \vec{R}_I) / |\vec{R}_I \times \vec{V}_I \times \vec{R}_I| \quad (\text{Downrange direction})$$

$$\hat{w} = \hat{u} \times \hat{v} \quad (\text{Crossrange direction})$$

aPRTLS results are computed using Earth-relative velocity.

Figure A3.1-1.- Local horizontal (UVW) coordinate system.

- Nominal actual state : $\bar{R}_0, \bar{V}_0, \gamma_0$
- Perturbed actual state : $\bar{R}_p, \bar{V}_p, \gamma_p$
- UVW system constructed at nominal actual state
- Perturbed state (\bar{R}_p, \bar{V}_p) transformed into UVW system (\bar{R}'_p, \bar{V}'_p)

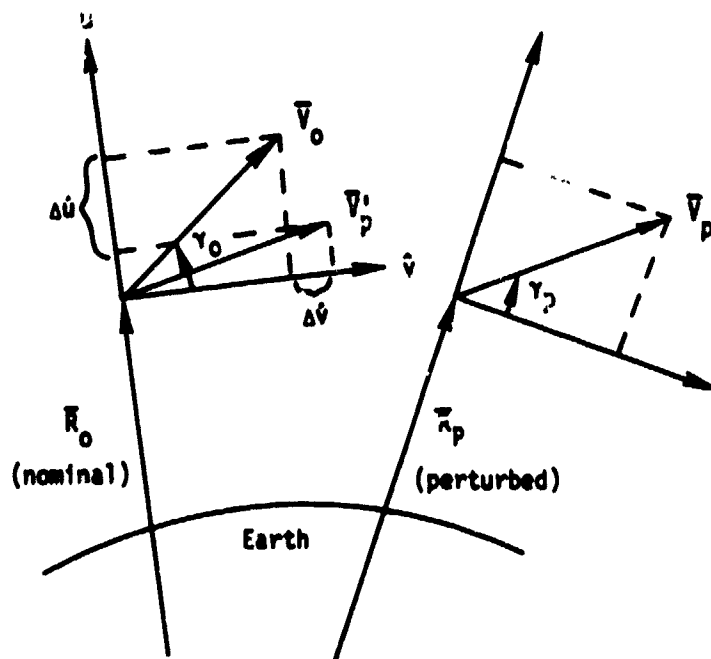

- UVW Errors
 - \dot{u} error = $\Delta \dot{u}$ = u component of \bar{V}'_p - u component of \bar{V}_0
 - \dot{v} error = $\Delta \dot{v}$ = v component of \bar{V}'_p - v component of \bar{V}_0
- Trajectory Errors
 - speed error = $\Delta |\bar{V}| = |\bar{V}_p| - |\bar{V}_0|$
 - altitude rate error = $\Delta \dot{H} = |\bar{V}_p| \sin \gamma_p - |\bar{V}_0| \sin \gamma_0$
 - downrange rate error = $\Delta \dot{R} = |\bar{V}_p| \cos \gamma_p - |\bar{V}_0| \cos \gamma_0$
- Note that due to downrange position error :
 - $\Delta \dot{u} \neq \Delta \dot{H}$
 - $\Delta \dot{v} \neq \Delta \dot{R}$

Figure A4.0-1.- Illustration of velocity errors in UVW and trajectory coordinates.

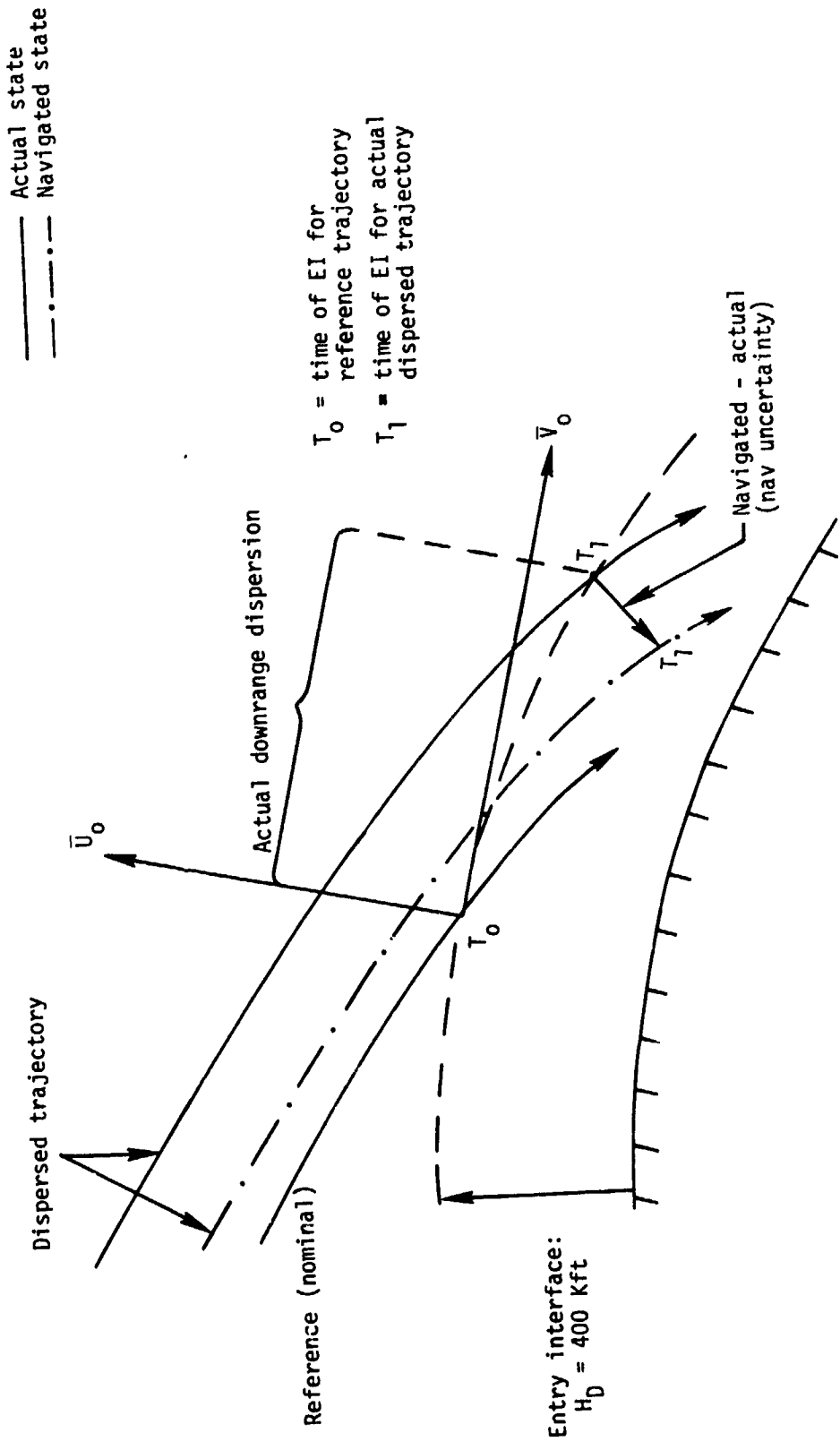

Figure A4.2-1.- Illustration of trajectory errors at entry interface.

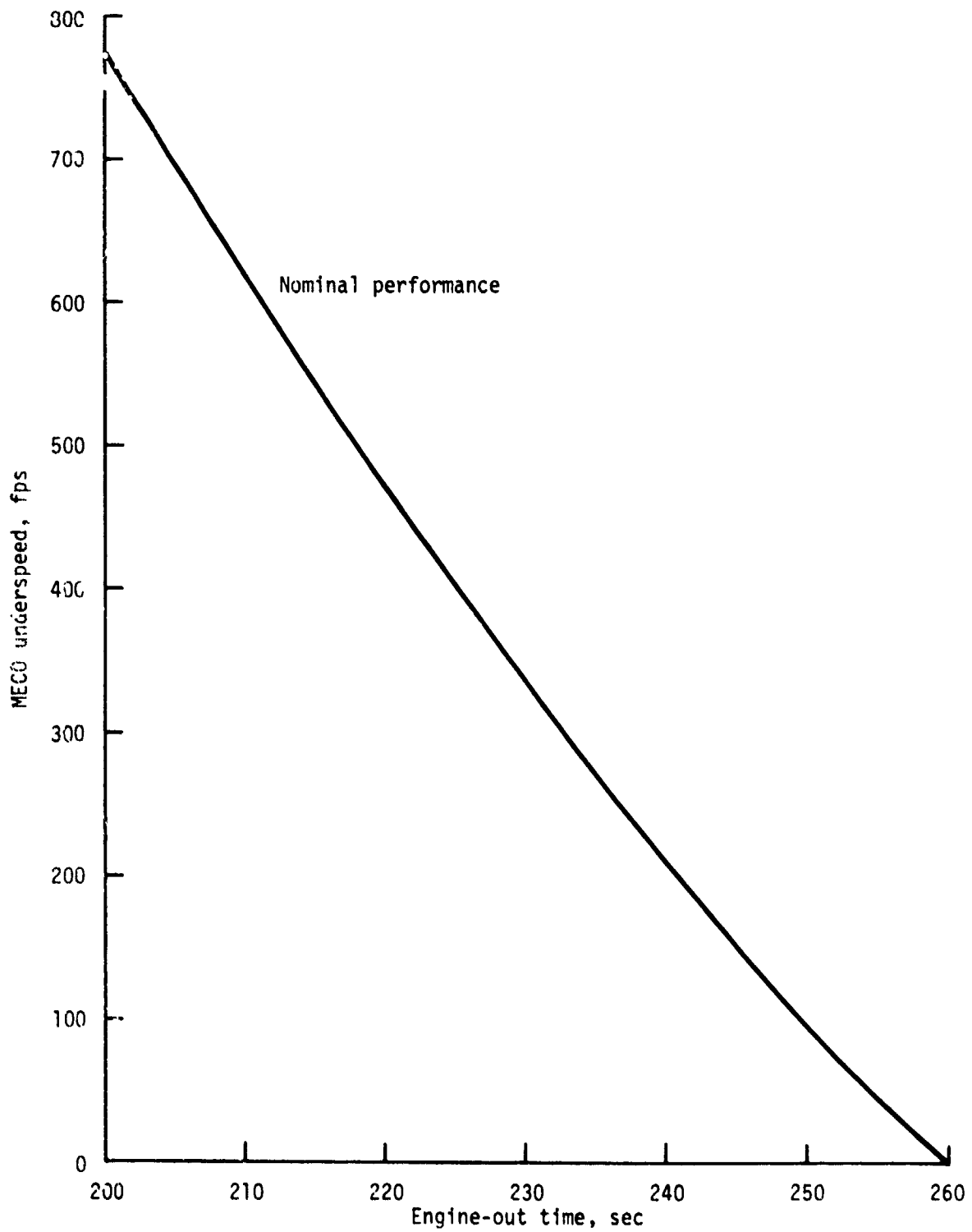

Figure A4.4-1.- Effect of engine-out time on MECO underspeed.