

Flight Procedures Handbook

Approach, Landing, and Rollout

Mission Operations Directorate
Flight Design and Dynamics Division

Basic
November 1992

NASA

National Aeronautics and
Space Administration

Lyndon B. Johnson Space Center
Houston, Texas

Contents

| Section | | Page |
|---------|------------------------------------------------------------------------------------|------|
| 1 | <u>INTRODUCTION</u> | 1-1 |
| 1.1 | <u>PURPOSE</u> | 1-1 |
| 1.2 | <u>SCOPE</u> | 1-1 |
| 2 | <u>GUIDANCE, NAVIGATION, AND CONTROL</u> | |
| | <u>ONBOARD SYSTEMS AND DEDICATED DISPLAYS</u> | 2-1 |
| 2.1 | <u>AIR DATA</u> | 2-1 |
| 2.2 | <u>ACCELEROMETER ASSEMBLIES</u> | 2-2 |
| 2.3 | <u>ELEVONS</u> | 2-3 |
| 2.4 | <u>BODY FLAP</u> | 2-4 |
| 2.5 | <u>SPEEDBRAKE</u> | 2-5 |
| 2.6 | <u>RUDDER</u> | 2-6 |
| 2.7 | <u>T/D AND ROLLOUT DISCRETES</u> | 2-7 |
| 2.8 | <u>NWS</u> | 2-8 |
| 2.9 | <u>PRIORITY RATE LIMITING</u> | 2-9 |
| 2.10 | <u>NAVIGATION</u> | 2-11 |
| 2.11 | <u>DEDICATED DISPLAYS</u> | 2-13 |
| 2.11.1 | <u>ADI</u> | 2-13 |
| 2.11.2 | <u>HSI</u> | 2-19 |
| 2.11.3 | <u>AMI</u> | 2-22 |
| 2.11.4 | <u>AVVI</u> | 2-24 |
| 2.11.5 | <u>SPI</u> | 2-27 |
| 2.11.6 | <u>RCS Command Lights</u> | 2-28 |
| 2.11.7 | <u>Normal Accelerometer (G-Meter)</u> | 2-28 |
| 2.12 | <u>HEAD UP DISPLAY</u> | 2-29 |
| 2.12.1 | <u>HUD Overview</u> | 2-29 |
| 2.12.2 | <u>BFS Differences</u> | 2-35 |
| 2.12.3 | <u>HUD Power Distribution</u> | 2-35 |
| 2.12.4 | <u>HUD System Moding</u> | 2-35 |
| 2.12.5 | <u>HUD Brightness</u> | 2-36 |
| 3 | <u>LANDING AIDS</u> | 3-1 |
| 3.1 | <u>TACTICAL AIRBORNE NAVIGATION</u> | 3-1 |
| 3.2 | <u>MICROWAVE SCANNING BEAM LANDING SYSTEM -</u> <u>GROUND STATION</u> | 3-2 |
| 3.2.1 | <u>MSBLS-Junior</u> | 3-2 |
| 3.2.2 | <u>MSBLS Site Location</u> | 3-2 |
| 3.3 | <u>AIM POINTS</u> | 3-4 |
| 3.3.1 | <u>Aim Point Identification Light System</u> | 3-6 |
| 3.4 | <u>PAPI LIGHT - OGS</u> | 3-8 |
| 3.5 | <u>BALL/BAR LIGHTS - IGS SYSTEM</u> | 3-9 |
| 3.6 | <u>RUNWAY LIGHTING</u> | 3-12 |
| 3.7 | <u>NAVAIDS AND LANDING SITES</u> | 3-13 |
| 4 | <u>A/L TRAJECTORY DESIGN</u> | 4-1 |
| 4.1 | <u>A/L</u> | 4-1 |

| Section | | Page |
|---------|----------------------------------------------------|------|
| 4.1.1 | <u>A/L Geometry</u> | 4-1 |
| 4.2 | HEADING ALIGNMENT CONE AND PREFINAL | 4-9 |
| 4.2.1 | <u>Overview</u> | 4-9 |
| 4.2.2 | <u>Transition</u> | 4-9 |
| 4.3 | OGS | 4-13 |
| 4.3.1 | <u>Overview</u> | 4-13 |
| 4.3.2 | <u>Dispersion Coverage</u> | 4-13 |
| 4.3.3 | <u>Guidance and Control</u> | 4-16 |
| 4.3.4 | <u>Phase Switching</u> | 4-16 |
| 4.4 | SPEEDBRAKE | 4-17 |
| 4.4.1 | <u>Overview</u> | 4-17 |
| 4.4.2 | <u>SB Control During Heading Alignment and OGS</u> | 4-17 |
| 4.4.3 | <u>SB Retract</u> | 4-19 |
| 4.4.4 | <u>SB at T/D</u> | 4-25 |
| 4.5 | FSGS | 4-26 |
| 4.5.1 | <u>Overview</u> | 4-26 |
| 4.5.2 | <u>Landing Gear Deployment</u> | 4-29 |
| 4.5.3 | <u>Sloped Runways</u> | 4-31 |
| 4.5.4 | <u>Transition</u> | 4-31 |
| 4.6 | FF | 4-32 |
| 4.6.1 | <u>Overview</u> | 4-32 |
| 4.7 | LANDING | 4-33 |
| 4.7.1 | <u>Overview</u> | 4-33 |
| 4.7.2 | <u>Nomographs</u> | 4-35 |
| 4.7.3 | <u>Landing Dispersions</u> | 4-38 |
| 4.8 | ROLLOUT | 4-41 |
| 4.9 | CONSTRAINTS AND FLIGHT RULES | 4-42 |
| 4.10 | ATTITUDE HOLD | 4-43 |
| 4.11 | DEROTATION | 4-47 |
| 4.12 | COAST | 4-49 |
| 4.13 | BRAKING | 4-50 |
| 4.13.1 | <u>Flight Experience</u> | 4-50 |
| 4.14 | BARRIER | 4-51 |
| 4.15 | NORMALIZATION AND NOMOGRAPHS | 4-53 |
| 5 | FLIGHT PROCEDURES | 5-1 |
| 5.1 | LANDING AND ROLLOUT SUMMARY | 5-1 |
| 5.2 | FDF | 5-2 |
| 5.2.1 | <u>Landing and Rollout Briefing</u> | 5-2 |
| 5.2.2 | <u>Entry Maneuvers Cue Card</u> | 5-2 |
| 5.2.3 | <u>Other FDF</u> | 5-6 |
| 5.2.4 | <u>Flight Rules Summary</u> | 5-14 |
| 5.3 | NOMINAL EOM LANDING | 5-17 |
| 5.3.1 | <u>Flight Control Summary</u> | 5-17 |
| 5.3.2 | <u>Handling Qualities</u> | 5-22 |
| 5.3.3 | <u>Guidance Summary</u> | 5-23 |
| 5.3.4 | <u>Area Navigation Summary</u> | 5-28 |
| 5.3.5 | SB | 5-32 |
| 5.3.5.1 | SB Command Before OI-22 | 5-32 |
| 5.3.5.2 | SB Command for OI-22 and Subsequent | 5-33 |

| Section | Page |
|---------|-----------------------------------------------------------------|
| 5.3.6 | Crew Procedures 5-33 |
| 5.3.6.1 | Mach = 0.9 Until HAC Intercept 5-38 |
| 5.3.6.2 | On the HAC 5-40 |
| 5.3.6.3 | Approaching the OGS 5-42 |
| 5.3.6.4 | On the OGS 5-44 |
| 5.3.6.5 | Preflare and IGS 5-46 |
| 5.3.6.6 | FF 5-48 |
| 5.3.6.7 | T/D and rollout 5-48 |
| 5.4 | RTLS ABORT LANDING 5-52 |
| 5.4.1 | <u>Overview</u> 5-52 |
| 5.4.2 | <u>RTLS Guidance Differences</u> 5-52 |
| 5.4.3 | <u>RTLS Flying Technique</u> 5-53 |
| 5.5 | OFF NOMINAL CONDITIONS 5-55 |
| 5.5.1 | <u>Overview</u> 5-55 |
| 5.5.2 | <u>BFS Engaged</u> 5-55 |
| 5.5.2.1 | Overview 5-55 |
| 5.5.2.2 | Guidance and Navigation 5-55 |
| 5.5.2.3 | Controls and Displays 5-55 |
| 5.5.2.4 | BFS Flying Technique 5-56 |
| 5.5.3 | <u>HUD Failed</u> 5-57 |
| 5.5.4 | <u>Theta Limits</u> 5-57 |
| 5.5.5 | <u>Manual HAC</u> 5-58 |
| 5.5.5.1 | Conditions for Use 5-58 |
| 5.5.5.2 | Procedure 5-59 |
| 5.5.6 | <u>Stuck SB</u> 5-59 |
| 5.5.7 | <u>MLS Dilemma</u> 5-60 |
| 5.5.8 | <u>APU/Hydraulic System Failures</u> 5-61 |
| 5.5.9 | <u>Tire Failures</u> 5-62 |
| 5.5.9.1 | Leaking/Flat Tire 5-62 |
| 5.5.9.2 | Vehicle Control With Tire Failures and Crosswind 5-62 |
| 5.5.10 | <u>Barrier Engagement</u> 5-64 |
| 5.5.11 | <u>Early Deploy of Landing Gear</u> 5-64 |
| 5.5.12 | <u>No Deploy of Landing Gear</u> 5-64 |
| 5.6 | NEW DEVELOPMENTS 5-68 |
| 5.6.1 | <u>Drag Chute</u> 5-68 |
| 5.6.1.1 | General 5-68 |
| 5.6.1.2 | Benefits 5-68 |
| 5.6.1.3 | Constraints 5-69 |
| 5.6.1.4 | Operational Deployment 5-70 |
| 5.6.2 | <u>GS and T/D Targeting</u> 5-71 |

| Appendix | | Page |
|----------|------------------------------------------------------|------|
| A.1 | <u>LANDING SITES</u> | A-1 |
| B.1 | <u>SEQUENCE OF EVENTS</u> | B-1 |
| B.2 | <u>BASIC CONSTRAINTS</u> | B-14 |
| C.1 | <u>HEADING ALIGNMENT CONE AND PREFINAL</u> | C-1 |
| C.2 | <u>OUTER GLIDESLOPE</u> | C-6 |
| C.3 | <u>FLARE AND SHALLOW GLIDESLOPE</u> | C-11 |
| C.4 | <u>FINAL FLARE</u> | C-15 |
| D.1 | <u>ROLLOUT MARGINS AND BRAKE ENERGY</u> | D-1 |
| D.2 | <u>DEROTATION</u> | D-7 |
| D.3 | <u>BRAKING PROCEDURES AND BRAKE ENERGY</u> | D-11 |
| D.4 | <u>BARRIER ENGAGEMENT</u> | D-17 |
| D.5 | <u>NORMALIZATION AND NOMOGRAPHS</u> | D-21 |
| E | <u>ACRONYMS AND ABBREVIATIONS</u> | E-1 |

TABLES

| Table | | Page |
|-------|-----------------------------------------------|------|
| 2-I | ADI SCALE SELECTION - ENTRY/LANDING | 2-16 |
| 2-II | ADI DISPLAY SEQUENCE | 2-17 |
| 2-III | BFS ADI SEQUENCING | 2-18 |
| 2-IV | BFS RATE AND ERROR SCALING | 2-19 |
| 2-V | FUNCTIONAL/MODE MATRIX | 2-21 |
| 2-VI | AMI DISPLAY VERSUS CONTROLS | 2-25 |
| 2-VII | AVVI DATA SOURCE | 2-27 |
| 4-I | PARTIAL TAEM GUIDANCE SUMMARY | 4-7 |
| 4-II | AUTOLAND GUIDANCE SUMMARY | 4-8 |
| 4-III | T/D ENERGY TARGETS | 4-37 |
| 5-I | LANDING/ROLLOUT CREW PROCEDURES | 5-34 |
| 5-II | LANDING COMM PROTOCOL | 5-36 |

FIGURES

| Figure | | Page |
|--------|--------------------------------------------------------|------|
| 2-1 | ADI display | 2-14 |
| 2-2 | HSI display | 2-20 |
| 2-3 | Alpha/Mach indicator | 2-23 |
| 2-4 | Altitude/VV indicator. | 2-26 |
| 2-5 | HUD Display format | |
| | (a) Pre-WOW | 2-30 |
| | (b) After WOW | 2-31 |
| 3-1 | MLS ground system | 3-3 |
| 3-2 | Typical visual aim point and PAPI | 3-4 |
| 3-3 | PAPI light locations | 3-5 |
| 3-4 | Aim point identification lighting system | 3-7 |
| 3-5 | Illustrative example of PAPI system geometry | 3-8 |
| 3-6 | Bar/ball light assembly | 3-10 |
| 3-7 | Bar and light assemblies locations | 3-11 |
| 4-1 | Typical entry profile | 4-2 |
| 4-2 | A/L profile from 50,000 ft to T/D | 4-4 |
| 4-3 | HAC groundtrack | 4-10 |
| 4-4 | Maximum in-plane dispersion capability | 4-11 |
| 4-5 | Maximum out-of-plane dispersion capability | 4-12 |
| 4-6 | OGS lightweight dispersion coverage | 4-14 |
| 4-7 | OGS heavyweight dispersion coverage | 4-15 |
| 4-8 | SB command block diagram | 4-18 |
| 4-9 | SB retract logic (old vs. current) | 4-20 |
| 4-10 | SB command downrange sensitivity | 4-22 |
| 4-11 | A/L design wind profiles | 4-24 |
| 4-12 | Pullup circle | 4-27 |
| 4-13 | Exponential to the IGS geometry | 4-28 |
| 4-14 | Landing gear aerodynamics | 4-30 |
| 4-15 | STS-31 A/L postflight spatial wind data | 4-34 |
| 4-16 | Energy reserve and tailsrape conditions | 4-36 |
| 4-17 | Effects of landing gear deploy altitude | |
| | on T/D energy | 4-39 |
| 4-18 | Maximum main gear sink rate for design | 4-40 |
| 4-19 | Rollout pictorial | 4-41 |
| 4-20 | Effect of attitude hold on main-gear and | |
| | nose-gear loads | 4-44 |
| 4-21 | T/D and pitchover target speeds | 4-45 |
| 4-22 | SOAS components | 4-52 |
| 5-1 | Entry maneuvers cue card (example only; reference | |
| | flight-specific versions) | 5-3 |
| 5-2 | Braking diagram (example only; reference | |
| | flight-specific versions) | 5-6 |
| 5-3 | DEL PAD (example only; reference | |
| | flight-specific versions) | 5-7 |

FIGURES

| Figure | | Page |
|--------|------------------------------------------------------------------------------------------------|------|
| 5-4 | Orbiter crosswind limits cue card (example only; reference flight-specific versions) | 5-9 |
| 5-5 | Land site data chart (example only; reference flight-specific versions) | 5-10 |
| 5-6 | Entry alpha cue card (example only; reference flight-specific versions) | 5-11 |
| 5-7 | Mach-alpha cue card | 5-12 |
| 5-8 | Entry no-go checklist cue card (example only; reference flight-specific versions) | 5-13 |
| 5-9 | Simplified pitch axis CSS block diagram | |
| | (a) Airborne | 5-19 |
| | (b) Post MGTD | 5-19 |
| 5-10 | Simplified subsonic roll axis CSS block diagram | 5-20 |
| 5-11 | Simplified subsonic yaw axis CSS block diagram | 5-21 |
| 5-12 | Pitch command logic prior to HAC intercept | 5-24 |
| 5-13 | IGS intercept | 5-27 |
| 5-14 | Guidance phases and area navigation displays | 5-31 |
| 5-15 | RTLS Nz command limits | 5-52 |
| 5-16 | Stuck SB procedure | 5-59 |
| 5-17 | Orbiter enveloped by six net elements (elevation) | 5-65 |
| 5-18 | Orbiter enveloped by six net elements (plan) | 5-66 |
| 5-19 | SOAS components | 5-67 |

SECTION 1 INTRODUCTION

1.1 PURPOSE

The purpose of this document is to present shuttle approach, landing, and rollout procedures with sufficient rationale and background information to give the user a good understanding of the crew task for this mission phase. This handbook is intended primarily for use by the crew and flight support personnel during follow-on to shuttle training and real-time support. This publication is written using generic landing data, results from the crew, shuttle training aircraft (STA) training, decisions from the flight techniques panels, results from the space shuttle missions, and techniques developed in the simulators.

1.2 SCOPE

The Approach, Landing, and Rollout Handbook covers the final subset of the entry phase starting at heading alignment cone (HAC) interface and terminating at wheels stop (approximately 4 min of mission time). The guidance, navigation, and flight control (GNC) onboard systems, the landing aids, the trajectory design for approach and landing (A/L), and the landing constraints are summarily covered prior to the detailed discussions of nominal and off-nominal landing procedures.

The crew procedures for the entry, approach, and landing phases may be found in a companion document, Entry Checklist (JSC-48019). For a discussion of the overall entry phase starting at deorbit (D/O) burn minus 30 min and continuing through crew egress, refer to the Entry Flight Procedures Handbook JSC-11542.

This document is written under the authority vested in the Mission Operations Directorate, Flight Design and Dynamics Division, for definition, development, validation, and control of crew procedures for orbiter operations, for NASA manned missions, as specified by Space Shuttle Program Manager Directive 9A, dated September 23, 1974.

SECTION 2

GUIDANCE, NAVIGATION, AND CONTROL ONBOARD SYSTEMS AND DEDICATED DISPLAYS

The following discussion describes the orbiter GNC onboard systems (hardware and software) which have particular importance in their function during the A/L and rollout phases. This includes an overview of the onboard dedicated displays and their respective functions during A/L and rollout. The more detailed discussions of the crew procedures and monitoring techniques for these systems are contained in section 5.

2.1 AIR DATA

The flight control system (FCS) functions best when good air data transducer assembly (ADTA) data are available. FCS gains within the aerojet digital auto pilot (DAP) are scheduled as a function of Mach number and Q-bar. Without ADTA data, bad navigation derived air data (NAVDAD) can cause severe flight control problems by causing the FCS gains to be out of sync with the environment. With good ADTA data incorporated to guidance and control (G&C), auto flight control will (1) command the angle of attack (α) to control normal axis (N_z) and keep Q-bar within limits, and (2) limit the α so as to not stall the vehicle.

Flying with NAVDAD and default air data constrains the capability of the flight control system and places more of the flying responsibility on the commander and pilot. With default air data, α is a fixed value of 7.5° and Q-bar is derived from an I-loaded table as a function of navigation ground Vrel. With these default gains, guidance no longer limits α by protecting the high Q-bar boundary, or the high α limit for stall. Procedurally, when on default air data, the crew must fly theta limits keeping the pitch attitude between the NOSE HI and NOSE LOW limits on the vertical situation (VERT SIT) display. The lower limit protects for max. vehicle Q-bar and the upper limit avoids stall (max. lift to drag ratio (L/D)). The speedbrake (SB) should be manually managed (below Mach 0.95) to control energy when trying to maintain theta within limits. For example, if flying the nose low limit, the SB might be full open.

Theta limits are a function of relative velocity (VREL), roll angle, and SB position. SB position affects the limits by causing both limits to increase/decrease by the same amount. Increasing roll angle causes the allowable range for pitch attitude to decrease such that at about 50° bank angle the limits are equal. In this case, flying theta limits is very difficult, if possible. For reference, at Mach 0.9 and zero degree roll angle, the theta limits for 100 percent and 0 percent SB are -33 to -10 and -16 to -6 , respectively. If ADTA data is not incorporated to G&C, then flying theta limits is required from Mach 1.5 to below 10k ft on the OGS.

2.2 ACCELEROMETER ASSEMBLIES

The flight control accelerometer assemblies (AA's) provide Nz and lateral axis (Ny) acceleration feedback data to guidance and to the aerojet DAP, respectively. The Ny feedback is used in the aerojet DAP for turn coordination to help prevent rolloff during stability axis maneuvers. Rolloff can be caused by inertial measurement unit (IMU) errors introduced into the calculation of the stability axis (derived from alpha, which is derived from IMU data), and the Ny feedback is used to counter the effects of IMU errors by preventing BETA buildup. Once ADTA data has been incorporated into G&C, alpha error (and thus stability axis error) is eliminated and the requirement for Ny feedback is reduced. However, the Ny feedback is still used in the ROLL/YAW channel of the DAP, and in addition provides feedback for general purpose computer (GPC) NWS during rollout.

In MM304, the Nz feedback is used for alpha error indications on the attitude display indicator (ADI). In MM305 (and MM602 Nz hold), the normal axis feedback is used by guidance to provide Nz commands to the flight control system. Bad Nz feedback can be removed by engaging control stick steering (CSS) in the pitch axis during MM305.

Failed AA's can be deselected in OPS 3 on SPEC 53 (CONTROLS), and for Nz failures consideration should be given to not deselecting the failed feedback. Rather, after two Nz failures the crew can fly CSS in pitch in MM305 and avoid deselection of a good lateral feedback on that AA. This makes it possible to maintain the required redundancy (3 of 4 lateral axis AA's) for the use of GPC nosewheel steering (NWS).

2.3 ELEVONS

In MM305 pitch attitude commands are generated as a function of altitude error and altitude rate error. Elevon pitch commands are constrained by Q-bar limits during the prefinal guidance phase. In the A/L phase, both Q-bar and energy/weight (E/W) limits are applied. The normal axis acceleration is also filtered to constrain rate of change of E/W to provide further insurance that vehicle Q-bar limits are not exceeded. In other words, the pitch command delta is limited so as to not change N_z by more than 0.5g. The logic in the pitch channel results in a control system that causes the vehicle to appear to fly airspeed as a function of energy.

Roll commands are a function of lateral position (groundtrack) error and are constrained to control altitude rate (H-DOT). For the heading alignment phase, the aerojet DAP limits roll command to 60°; the glide return to landing site (GRTLS) DAP limit is 55° due to vehicle weight on a return to launch site (RTLS).

At main gear T/D (MGTD), aileron commands are generated through the roll channel to balance the loads on the main gear and tires. These commands are computed as a function of true airspeed, N_y , and vehicle yaw rate. Asymmetric loading on the gear/tires is most likely to occur in a crosswind landing. The aileron deflection causes the vehicle to roll into the wind, reducing the sideslip angle, and producing differential lift on the wings.

At MGTD the pitch rate commands for derotation are generated as a function of pitch angle, equivalent airspeed, and vehicle weight. In CSS the pitch axis information drives only the ADI rate needles.

At nose-gear T/D (NGTD), the aileron trim loop is opened (at rollout), so that the load-balance command is faded out over the next 100 sec. The elevon feedback loop is opened, making the elevator command proportional to the rotational hand controller (RHC) deflection. Operational increment (OI) 8 implements software to automatically command the elevons down to relieve main-gear loads (primary avionic software system (PASS) and backup flight system (BFS)) if the pitch axis is in AUTO. At post-NGTD, the DAP modes to AUTO in pitch once the load relief flag is set. This flag is set after the ROLLOUT flag is set. It is important to allow load relief to be performed in AUTO (elevons 10° down) instead of manual (elevons 18° down with RHC forward to hardstop) to ensure that the nose-gear load is reduced as much as possible. Also, during rollout, the RHC pitch detent limit increases 21° to prevent an inadvertent downmode to pitch CSS. Pitch CSS can be reentered by breaking detent or depressing either CSS pushbutton (pb) on panel F2 or F4. AUTO load relief can then be reentered (if desired) by depressing the pitch AUTO pb. After the nose gear is on the ground, turn coordination is no longer used and NWS is enabled if the GPC mode is selected.

2.4 BODY FLAP

When guidance transitions to the A/L phase (5k to 10k ft), the body flap (BF) is commanded to trail. If the BF is not in the auto mode, the crew should return to auto BF, or manually move the BF to trail. Having the BF at trail protects for tailsrape and ensures good pitch axis control. For the nominal case of the BF at trail (at T/D) theta must be less than 14.6° in order to avoid scraping the BF.

2.5 SPEEDBRAKE

The SB command is scheduled above Mach 0.9. Below this, terminal area energy management (TAEM) and A/L guidance modulates the SB to control Q-bar below 340 pounds per square foot (psf) (energy control). The SB position is constrained to a lower limit of 15° to prevent physical binding of mechanical linkages at large rudder deflections and to rudder effectiveness. It is important to remember to take manual control of the SB if good air data is not available to flight control. Bad air data could cause flight control to generate erroneous SB position commands, resulting in off-nominal energy and/or a flight control transient during final and A/L. With no ADTA data available to flight control, the SB command logic uses NAVDAD Q-bar and VREL. At 3000 ft, the SB is closed to a computed value based on wind, weight, density altitude, velocity error, and short-field option. At 500 ft altitude, guidance commands final adjustment of the SB position based on density altitude and wind velocity. Due to the inaccuracy of NAVDAD parameters, it is recommended that the SB be manually controlled below 10,000 ft; it is required below 5000 ft. The SB position should be manually set to the value read in the DEL PAD for 3000 ft. This is the ground processors' best guess calculation based on the vehicle configuration and the best available wind data.

When WOWLON is set just after main gear T/D, the SB is commanded full open for energy and pitch trim control. The crew should, per procedure, manually command the SB full open to protect for a late WOWLON or WOW dilemma. The full open SB is required in order to decrease vehicle derotation rate and there should be no delay in performing this manually as a backup.

2.6 RUDDER

The rudder becomes active at Mach 5 and is used to provide turn coordination. The rate gyro assembly (RGA) rates (roll and yaw), N_y AA feedback, and rudder pedal transducer assembly (RPTA) commands are used to form a rudder surface command. The corrected body roll rate (from RGA's) is used in the aerojet DAP to compute a yaw rate. This yaw rate is summed with the corrected body yaw rate (from RGA's), to form a yaw rate error. The rudder pedal deflection is gained (to zero, unless $M < 3.5$ and roll/yaw CSS) as a function of equivalent airspeed (EAS), and then summed with the N_y feedback (N_y AA) and the N_y trim to form an initial N_y command. This N_y command is compared to the yaw rate error from above, and a new yaw rate command is formed. This command is summed with the rudder trim command (if any) to form the final rudder surface command. Prior to runway rollout, the RPTA inputs will ultimately have relatively minor effects on the rudder surface command.

2.7 T/D AND ROLLOUT DISCRETES

T/D and rollout are two distinct phases of the orbiter landing. At MGTD, the no weight-on-wheels (WOW) discrete on each gear is set to false (zero). When both WOW discrettes on one main gear are set false for more than 1 second, the weight-on-wheels lock-on (WOWLON) discrete is set true. If the other main gear discrettes are not set false within 7.2 sec, a WOW dilemma is annunciated. To clear a WOW dilemma (set WOWLON), the crew must manually mode to ROLLOUT by depressing either the solid rocket booster (SRB) or external tank (ET) separation (sep) pb. A WOW dilemma results from crosswind landings, electrical bus failures, commfaults, or prox box failures. If any no-WOW discrettes are commfaulted or set false (WOW = 0) when the landing standard operating procedures (SOP) becomes active at A/L interface, a redundancy management (RM) dilemma (DLMA) WOW is annunciated. If the discrettes are commfaulted but no other discrettes are set, then a WOW dilemma occurs but is not annunciated by GAX.

When WOWLON is set, the FLATTURN and head-up display (HUD) WOWLON discrettes are also set. WOWLON and FLATTURN cause certain mode changes to occur in the aerojet DAP and on the HUD. The pitch channel modes to slapdown logic. In the roll/yaw (R/Y) channel the following happens: rudder trim goes to zero, aileron trim goes to zero (if in CSS R/Y), and autoload balancing logic becomes active. Procedurally, manual depression of the ET or SRB sep pb to set WOWLON is done at NGTD (versus MGTD). The delay from MGTD is to prevent DAP mode changes from occurring during the derotation, since after pressing the button, the transition to ROLLOUT occurs when theta becomes less than zero.

The flight software performs checks to ensure that WOWLON is not set prematurely, which would likely be catastrophic because of the DAP mode changes. If both weight-on-main-gear and WONG indications are set simultaneously, a WOW dilemma is declared. This logic protects against two ac bus shorts within 7.2 sec, causing WOWLON to be set.

The HUD rollout and groundspeed enable discrettes are nominally set at NGTD. The flight software checks that WOWLON has been set for 2.08 sec, that the pitch attitude is less than zero degrees, and the no-WONG discrete is set false (indicating NGTD).

When WOWLON is set manually at NGTD, the rollout discrettes are set 2.08 sec later. (If a manual sep pb is depressed at MGTD in response to a WOW dilemma, the rollout discrettes would be set when pitch attitude (theta) decreases to less than zero.) Upon initiation of the rollout discrettes, the DAP no longer performs turn coordination.

2.8 NWS

NWS is available once groundspeed enable (GSENBLE) is set to provide lateral directional control of the orbiter. Three modes are available: OFF, DIRECT, and GPC. In OFF, no steering commands are accepted and the nose-wheel simply casters. In this case, steering is accomplished with rudder pedal deflection and differential braking.

In DIRECT, rudder pedal deflection is directly tied to the NWS angle. No N_y damping is performed; however, the commands are passed through a parabolic shaper to limit nosewheel deflections at high groundspeeds. This mode is only to be used as a backup to GPC because it is overly sensitive and leads to overcontrol.

In the GPC mode, either automatic or manual steering is available. The choice is made via the AUTO R/Y or CSS R/Y pb's on the eyebrow panels (F2, F4). In CSS R/Y, rudder pedal deflections (through RPTA's) are incorporated as biases to the lateral acceleration feedback. This approach prevents overcontrol and aids in responding to tire failures. In AUTO R/Y, steering commands are generated from N_y feedback and azimuth (Az) information from the microwave scanning beam landing system (MSBLS). During rollout, the RPTA's have no affect unless NWS is in the GPC mode and the DAP is in CSS R/Y. The GPC mode should be not used if the lateral acceleration feedback, or the RPTA's are zero fault tolerant. This avoids exposure to the next failure and the DIRECT mode is used for most of these cases. There are exceptions (abort scenarios) where the risks associated with being in one of the other modes (DIRECT or OFF) are greater than the risks associated with the next failure, and for those cases the GPC mode is GO. Also, if nominal end of mission (EOM) landing and GPC mode is NO-GO, the OFF mode is preferred over DIRECT if landing on a lakebed and known directional control problems exist (high crosswinds or tire failure). In all other cases where the GPC mode is NO-GO, the DIRECT mode is preferred as previously stated.

2.9 PRIORITY RATE LIMITING

Aerosurfaces (except the body flap) are rate command limited by priority rate limiting (PRL) software (available in MM's 101 to 103, 601 to 603, 304, and 305), to take full advantage of the available hydraulic system muscle while not overloading these systems. The surface rate limits imposed by PRL as a function of the number of hydraulic systems available is shown as follows:

SURFACE RATE LIMIT
(Deg/sec)

| NHSFa | Elevators | Ailerons | SB | Rudder |
|-------|-------------------|----------|-------|--------|
| 0 | 20.0 ^b | 20.0 | 10.86 | 14.0 |
| 1 | 20.0 ^b | 20.0 | 10.86 | 12.0 |
| 2 | 13.9 | 13.9 | 3.8 | 7.0 |

^a NHSF - number of hydraulic systems failed

^b The elevon rate is 30 deg/sec if true airspeed is less than 600 ft/sec, and 20 deg/sec if true airspeed is >600 ft/s.

Elevon and SB drive rates are not reduced if one hydraulic system fails, but rudder drive rates are reduced slightly. If two systems fail, the rates are significantly reduced on all six surfaces.

Each hydraulic system has three supply pressure transducers. Pressure signals are passed to the GPC's through the flight aft (FA) multiplexers/demultiplexers (MDM's). The hydraulic subsystem operating program (HYD SOP) provides RM for fault detection and isolation of failed transducers. A selection filter is also provided to generate a selected pressure. At the three level, RM will fail a transducer if it differs from that selected by more than 250 pounds per square inch (psi). At the two level, RM annunciates an RM DLMA PRL if the two transducers differ by >250 psi. When a DLMA is declared, the hydraulic system status remains as it was prior to the DLMA.

The HYD SOP declares a hydraulic system failed if the selected system supply pressure drops below 1760 psi. These fail flags are provided to the PRL software, which then rate-limits aerosurface commands based on the number of good systems.

The PRL and hydraulic system statuses are displayed on the GNC 51 OVERRIDE display. For each of the three hydraulic systems, auto (AUT) and deselect (DES) items are provided to allow the crew to (1) place the system in automatic systems management, (2) manually DES (declare failed) a system, or (3) place a system in manual systems management. A system which is automatically downmoded; i.e., declared failed by PRL, displays a down arrow (+) in the system status column. The failed system is forced back into PRL

availability by executing its AUT item entry, which blanks the "+" in the status column and blanks the asterisk "*" next to AUT. This establishes manual systems management. A repeat execution of the AUT item entry restores automatic systems management and restores an "*" in the AUT column.

The DES item entry allows the option of forcing the HYD SOP to declare a system failure. Executing the DES while an "*" is displayed next to AUT removes automatic system management; i.e., an "*" appears next to DES, the "*" next to AUT blanks, and a "+" appears in the system status column. A repeat execution of DES establishes manual systems management by blanking both the "+" and the "*" next to DES. Automatic management, manual deselection, and manual systems management are mutually exclusive modes. Hydraulic system status is initialized in the automatic mode.

A question mark (?) is displayed in the status column when an RM DLMA is declared. The one exception to this occurs when a system is previously declared failed, in which case a "+" is displayed, taking precedence over the "?". When a DLMA is declared (indicated by the RM DLMA PRL fault message), PRL leaves the system status (good or failed) as it was prior to the DLMA.

2.10 NAVIGATION

The entry navigation software processes inputs from the IMU's, ADTA, tactical air command and navigation (TACAN) system, and MSBLS, using a Kalman filter to maintain an estimate of the orbiter state vector. Operating cyclically, the navigation software selects the available sensor measurements each cycle, computes the proper state vector gain based on the measurement via a covariance matrix, applies that gain to the state vector, and then adjusts the covariance matrix to reflect the update.

The navigation software is divided into entry and preland. Entry navigation begins at MM301 and uses sensed delta V from the IMU's to propagate the state vector. Actually, three separate state vectors are maintained by entry navigation (three string), one associated with each IMU. A selected state vector consisting of the midvalue (component by component three vectors) is then sent to user parameter processing (UPP) for use by guidance and other principle functions. In MM304, drag altitude processing begins when drag = 11 feet per second squared (ft/s^2) (approximately 235,000 ft altitude) and continues until 85,200 ft.

At an altitude of approximately 150,000 ft, TACAN processing begins. TACAN provides range and bearing data to the navigation solution, primarily reducing downtrack and crosstrack errors. TACAN processing continues until an altitude of 1500 ft or until the preland navigation phase begins.

At Mach 2.5, altitude measurements from the ADTA probes are also factored into the navigation solution to reduce the altitude errors. ADTA processing is in effect from Mach 2.5 to Mach 1.6, and then continues from Mach 1.1 to 500 ft or until preland navigation begins. Between Mach 1.6 and 1.1, the probes are in the Mach jump region and the pressure static (Pstatic) information for altitude computations becomes invalid.

Entry navigation has proven to be very accurate. By HAC acquisition the navigation filter has nominally converged with errors on the order of 1500 ft. As the orbiter flies around the HAC, errors should continue to improve as better geometry is obtained with respect to the TACAN station (depending on the location of the station).

If Az and range data good flags are sent to navigation from the MSBLS SOP, then preland navigation has begun. Unlike entry navigation, preland navigation maintains only one state vector (single string), but executes twice as fast as entry (every 1.92 sec vs. 3.84 sec). Preland navigation is designed to process MSBLS data and support the requirements of autoland. Still using a Kalman filter scheme, the extremely accurate Az, range, and elevation measurements from MSBLS are used to correct the navigation state and results in one sigma errors of about 5 ft in altitude, 21 ft in downtrack, and 17 ft crosstrack at T/D. Note that both range and Az data good flags are required in order to process any MSBLS data. Without an elevation data good flag, Az and range are still processed, but if either the Az or the range data good indicator is lost, all MSBLS processing ceases. The loss of MSBLS processing is known onboard by blanking of the TACAN data and on the HUD by loss of the microwave landing system (MLS)

indicator. If MSBLS data is lost for any reason (above 1500 ft) after processing has begun, TACAN and ADTA will again become available until 1500 ft and 500 ft, respectively. If MSBLS data is lost below 1500 ft, ADTA processing is not possible. Note, also, that if TACAN data is in the force mode, MSBLS data cannot be processed. Forcing TACAN data or powering OFF MLS (also changing the MLS channel) are the only ways to inhibit processing of MLS, if so desired. The preferred method is powering off the MLS.

2.11 DEDICATED DISPLAYS

This is a brief overview of the orbiter dedicated displays including meters/tapes used during the A/L phases of entry. The following are considered to be GNC dedicated displays: ADI, horizontal situation indicator (HSI), alpha/Mach indicator (AMI), altitude/vertical velocity indicator (AVVI), surface position indicator (SPI), reaction control system (RCS) command lights, and the normal accelerometer (g-meter). The source and display of the information provided on each of these displays during the A/L phases is discussed; however, the processing in other phases (early entry or ascent) is not covered. It is assumed that the reader has a general familiarity with the orbiter crewstation and the location of these displays on panels F6, F7, and F8. Details such as the display locations, power sources, data validity/invalidity, and GPC/data bus interfaces also are not discussed (reference G&C Systems Briefs, and SSSH drawings 9.1 and 20.1 for more details).

2.11.1 ADI

The ADI provides attitude, rate, and error information similar to every other phase of flight. For this discussion reference figure 2-1 for a picture of the ADI. In general, the orbiter attitude is read from the numbers on the ball for pitch and yaw, and on the fixed ADI case for roll. The attitude displayed is a function of the position of the ADI ATTITUDE switch which allows selection of different attitude reference frames (inertial (INRTL), local vertical local horizontal (LVLH), and reference (REF)). However, during MM 305 (and MM 603) the ADI ATTITUDE switch function is overridden in the software, and the attitude processor displays the topodetic pitch and roll attitude, with the yaw driven to zero. In this way the ADI is a "wings-level" display during A/L.

The vehicle rates are displayed as deflections of the ADI roll, pitch, and yaw rate pointers as in other phases of flight. The ADI RATE switch allows selection of the full scale value for the orbiter rates of 10 deg/sec (HIGH), 5 deg/sec (MED), or 1 deg/sec (LOW). This RATE switch function is the same for all phases of flight (10/5/1 deg/sec), and all axes (roll, pitch and yaw) however, the actual rate information displayed is slightly different for entry, compared to other phases of flight. The ADI pitch rate is the selected RGA pitch rate (body axis), the same as in other phases of flight. However, the roll and yaw rates are stability axis roll and yaw rates (vice body axes rates).

The information displayed with the ADI error needles (also referred to as guidance needles) is affected by the ADI ERROR switch (scaling), and it is also dependent on the flight phase. The function of the ERROR switch (scaling), and the information that is actually being displayed by the needles will be covered. Unlike the ADI RATE switch for which the full scale values of the rate pointers remain at 10/5/1 deg/sec (HIGH/MED/LOW, respectively) for all phases and all axes, the ADI ERROR switch function is more complicated. The full scale values for the ERROR needles during A/L prior to main gear touchdown (WOWLON = 0) are 25/25/10° for roll, 1.25/

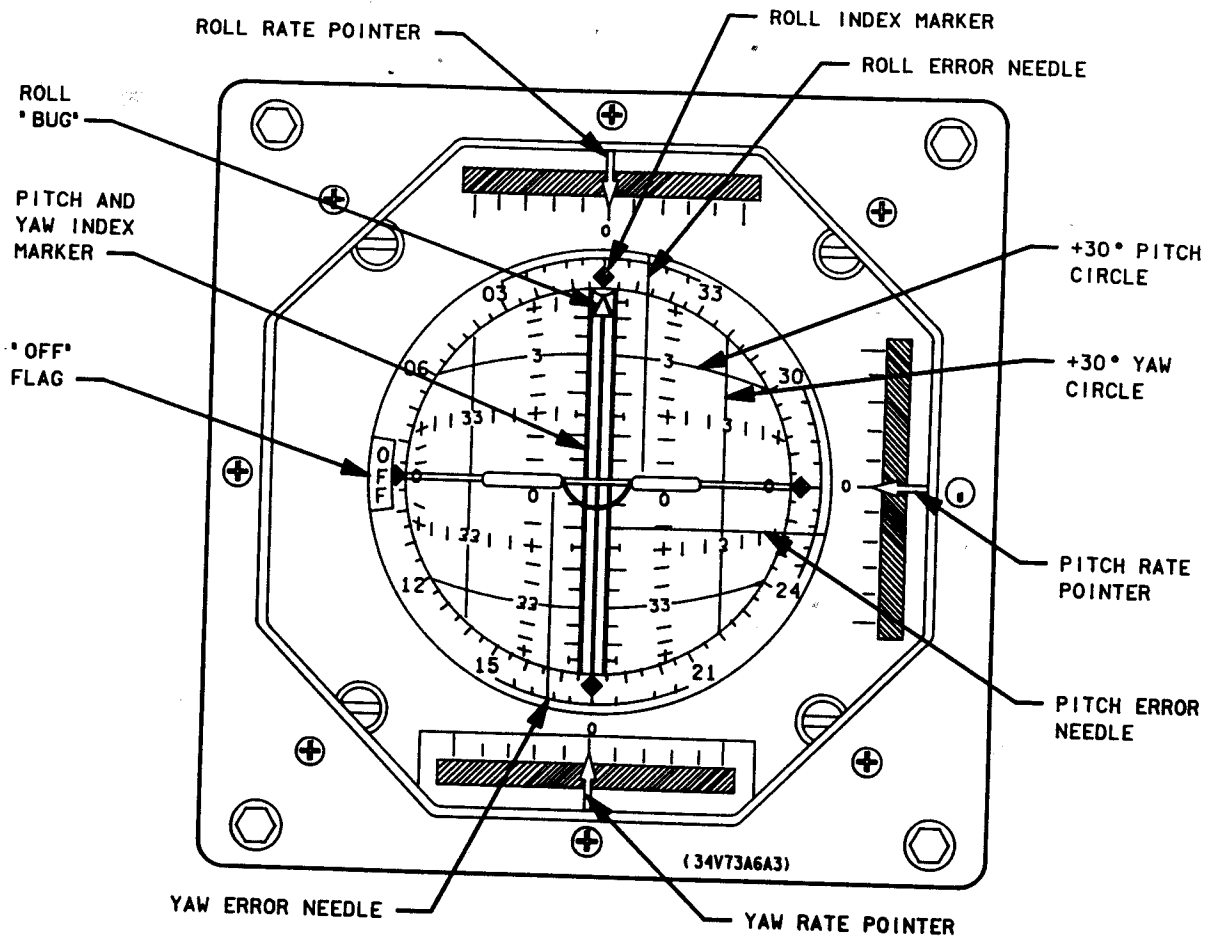

232660001.PNL, 2

Figure 2-1.- ADI display.

1.25/0.5 g's for pitch, and 2.5/2.5/2.5° for YAW, for HIGH/MED/LOW, respectively. At this point it is helpful to reference table 2-I, which is a table of the ADI RATE and ERROR full range deflections as a function of switch position and flight phase. The full scale values for the ERROR needles after MGTD (WOWLON = 1) are 20/5/1° for roll, 10/5/1 deg/sec for pitch, and 2.5/2.5/2.5° for YAW, for HIGH/MED/LOW, respectively. Note that the pitch error needle actually displays a rate error during derotation. This is discussed later.

The source of the actual information displayed by the guidance needles is more complicated than in the case of the ADI rates. The ADI roll error is the body roll attitude error; it is computed in the ADI processor by differencing the body roll attitude with the limited roll command from guidance. The pitch error represents the normal acceleration error (Nz error) computed in the AEROJET DAP (compensated pitch rate trim is subtracted from the body pitch rate, and added to the Nz error). The result is the ADI pitch error signal in g's. At WOW, the pitch error needles assume another meaning, that of slapdown pitch rate error (body pitch rate minus commanded pitch rate of 2 deg/sec.) The yaw error needle has the same meaning throughout MM's 304 and 305, that of estimating the sideslip (BETA). For $Q\text{-bar} > 20$ pounds per square foot (psf), BETA is computed in the DAP and sent to the ADI processor. The algorithm for estimated BETA ($Q\text{-bar} > 20$ psf) is based on N_y and yaw jet effectiveness. Full scale on the display is equivalent to the yaw produced by the side force of 2.5 yaw jets (reference ENTRY FPH for more details on ADI yaw error and scaled (A_y) during entry). Tables 2-II and 2-III summarize the PASS and BFS ADI displayed information for different entry phases. The BFS has some slight differences in the ADI processing, which can be seen in comparison to the information in tables 2-II and 2-III. The major differences to remember are that the full scale values for the rates and errors cannot be changed, and that the guidance needles are stowed at 2000 ft altitude when BFS guidance terminates. Table 2-IV shows the BFS ADI RATE and ERROR full range deflections as a function of ADI switch position and flight phase.

TABLE 2-I.- ADI SCALE SELECTION - ENTRY/LANDING

| Switch position | Full scale value | | | | | |
|----------------------------------------------------------------------------|------------------|-------|-----|----------------|---------|-----|
| | Attitude rate | | | Attitude error | | |
| | Roll | Pitch | Yaw | Pitch | Yaw | |
| | Deg/sec | | | Deg | | |
| Major Modes 301-303 | | | | | | |
| High | 10 | 10 | 10 | 10 | 10 | 10 |
| Med | 5 | 5 | 5 | 5 | 5 | 5 |
| Low | 1 | 1 | 1 | 1 | 1 | 1 |
| Entry (304) or (602) when IPHASE = 4 or 6 | | | | | | |
| | Deg/sec | | | Deg | | |
| High | 10 | 10 | 10 | 25 | 5 | 2.5 |
| Med | 5 | 5 | 5 | 25 | 2 | 2.5 |
| Low | 1 | 1 | 1 | 10 | 1 | 2.5 |
| TAEM or A/O WOWLON = 0 (3050 or (602/603) when IPHASE ≠ 4 or 6 | | | | | | |
| | Deg/sec | | | Deg | g's | Deg |
| High | 10 | 10 | 10 | 25 | 1.25 | 2.5 |
| Med | 5 | 5 | 5 | 25 | 1.25 | 2.5 |
| Low | 1 | 1 | 1 | 10 | .5 | 2.5 |
| | Deg/sec | | | Deg | Deg/sec | Deg |
| WOWLON = 1 | | | | | | |
| High | 10 | 10 | 10 | 20 | 10 | 2.5 |
| Med | 5 | 5 | 5 | 5 | 5 | 2.5 |
| Low | 1 | 1 | 1 | 1 | 1 | 2.5 |

NOTE: When WOWLON = 1 (ROLLOUT), the pitch error indicator shows pitch rate error; during TAEM or A/L, when WOWLON = 0, the pitch error indicator shows normal acceleration error.

TABLE 2-II.- ADI DISPLAY SEQUENCE

| MAJOR MODE | 101-103 | | 104-106, 301-303 | 201, 202 | 304 | 305 | | | |
|------------|------------------------------------------------------------|--------------------------------------|------------------------------------------------------|---------------------------|-------|---------------------------|---------------------------------------------------|------------------------------|--|
| PHASE | ASCENT | | TRANSITION | ON - ORBIT | ENTRY | TAEM | A/L | TOUCHDOWN | |
| ATTITUDE | INRTL | INERTIAL REFERENCE FRAME (ARBITRARY) | | → | ROLL | TOPODETTIC ROLL → | | | |
| | LVLH | LV1Y (YAW = ZERO) | LVLH | | PITCH | TOPODETTIC PITCH → | | | |
| | REF | STORED REFERENCE FRAME (ARBITRARY) | | → | YAW | FIXED AT ZERO → | | | |
| ERRORS | LAUNCH GUIDANCE CMD ERRORS (ACTUAL MINUS COMMAND) | | TOTAL ATTITUDE ERRORS (ACTUAL MINUS COMMANDED) | | → | ROLL | ROLL TOTAL ATTITUDE ERROR ($\phi - \phi_{CMD}$) | | |
| | | | | | PITCH | ANGLE OF ATTACK ERROR | NORMAL ACCELERATION ERROR | SLAPDOWN PITCH RATE ERROR | |
| | | | | | YAW | ESTIMATED SIDE SLIP → | | | |
| RATES | SELECTED RGA ROLL, PITCH, AND YAW RATES (BODY AXIS) | | | IMU-DERIVED BODY RATES | → | ROLL | STABILITY ROLL AXIS RATE → | | |
| | | | | | PITCH | SELECTED RGA PITCH RATE → | | | |
| | | | | | YAW | STABILITY YAW AXIS RATE → | | | |

232660008. GRF, 1

2-17

JSC-23266

TABLE 2-III.- BFS ADI SEQUENCING

| MAJOR MODE PHASE | ASCENT | | TRANSITION | ON-ORBIT | ENTRY | | TAEM | A/L | |
|------------------|-------------------------------|---------------------------|---------------------|----------|-------|---------------------------|--------------------|-------------|--------------|
| ATTITUDE | INRTL | INRTL PITCH/YAW/ROLL | → | (NO ADI) | ROLL | TOPODETIC | → | | |
| | LVLH | LVIY PITCH/ROLL (YAW = 0) | LVLH PITCH/YAW/ROLL | | PITCH | TOPODETIC | → | | |
| | REF | REF PITCH/YAW/ROLL | → | | YAW | ZERO | → | | |
| RATES | SELECTED RGA RATES | | SELECTED RGA RATES | (NO ADI) | ROLL | STABILITY AXIS ROLL RATE | → | | |
| | | | | | PITCH | SELECTED RGA PITCH RATE | → | | |
| | | | | | YAW | STABILITY AXIS YAW RATE | → | | |
| ERRORS | TOTAL ATTITUDE ERRORS | | → | (NO ADI) | ROLL | ROLL TOTAL ATTITUDE ERROR | | ROLL ZEROED | |
| | ACTUAL VS COMMANDED ATTITUDE) | | → | | PITCH | ANGLE OF ATTACK ERROR | NORMAL ACCEL ERROR | | PITCH ZEROED |
| | | | | | YAW | ESTIMATED SIDESLIP | | | YAW ZEROED |

232660009. GRF, 2

TABLE 2-IV.- BFS RATE AND ERROR SCALING

| Item | 101-106; 301-303 | 304 | 305 |
|-------|------------------|---------|-----------------|
| Error | Degrees | Degrees | |
| Roll | 5 | 5 | 5° |
| Pitch | 5 | 5 | 5 deg/1.25g/sec |
| Yaw | 5 | 5 | 5° |
| Rate | Deg/sec | Deg/sec | Deg/sec |
| Roll | 5 | 5 | 5 |
| Pitch | 5 | 5 | 5 |
| Yaw | 5 | 5 | 5 |

2.11.2 HSI

The HSI serves several functions including an independent source to compare entry auto guidance, a means of assessing the health of individual NAVAIID's during entry and crew display for flying manually when required. Figure 2-2 is an HSI display. The HSI displays magnetic heading (angle between magnetic North and vehicle direction), course direction (primary runway heading (w.r.t.) magnetic North), course deviation (angular measure of vehicle displacement from extended runway centerline), GS deviation (distance above or below GS), primary and secondary bearing (degrees), and primary and secondary range (miles).

The HSI SELECT SOURCE switches allow selection of the data driving the HSI to come from TACAN, navigation (NAV), or (MSL), and for TACAN and MLS, the individual unit can be selected by line replaceable unit (LRU) 1, 2, or 3. When selecting TACAN data to drive the HSI display the altitude is provided by the ADS barometer (BARO) altitude, since TACAN can provide only slant range and AZ. When the SOURCE switch is in the NAV position, all parameters on the HSI are dependent on the same sources as the NAV software, and the individual LRU select switch is not processed.

The HSI SELECT MODE switch allows the crew to specify the phase (ENTRY, TAEM, or A/L) for which the HSI display is representative. The selected modes are independent of the actual flight phases, except that if the switch remains in the ENTRY position the HSI automatically modes to TAEM and A/L coincident with the guidance moding. Each position of the MODE switch calls for a different set of definitions for the HSI display parameters, which are summarized in table 2-V. A more detailed explanation of the display parameter definitions can be found in the G&C Systems Briefs.

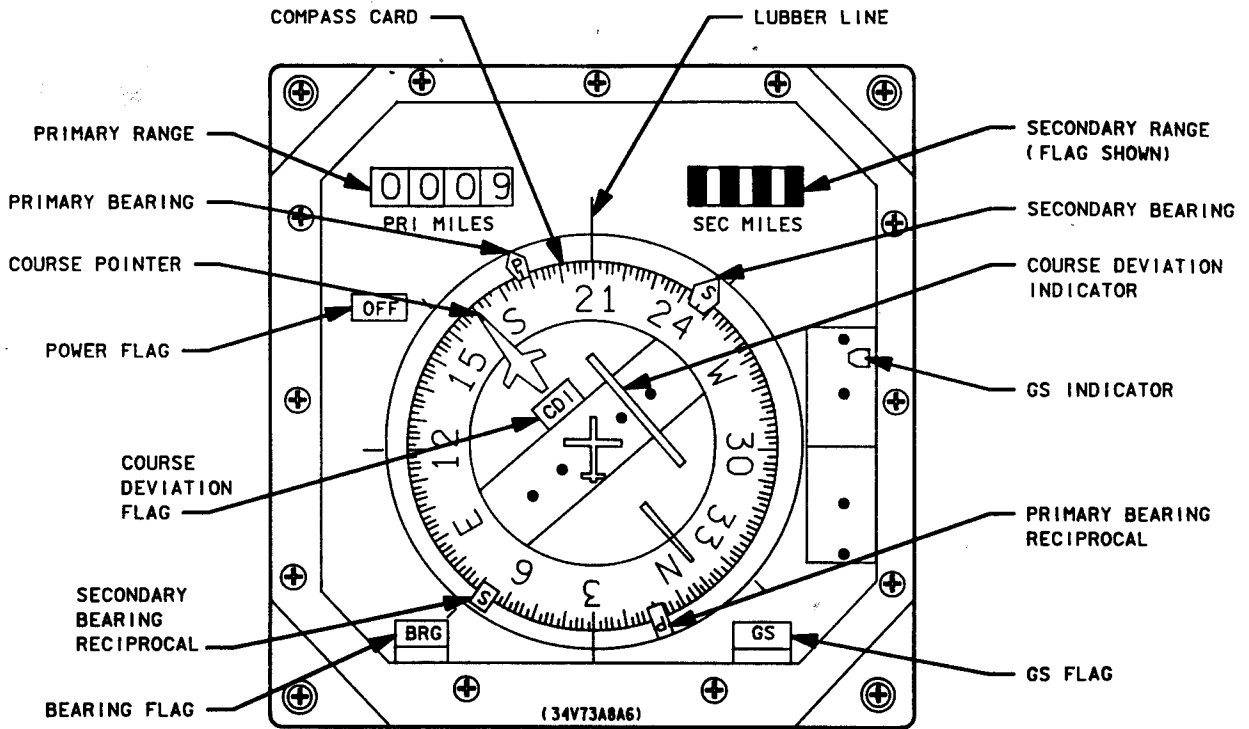

232660002. PNL, 2

Figure 2-2.- HSI display.

TABLE 2-V.- FUNCTIONAL/MODE MATRIX

| HSI mode | Bearing | | Range | | Course deviation (CDI) | Glide slope (GS) deviation (GSI) | Compass card (heading) |
|----------|--------------------------------------------------------------------|----------------------------------------------------------------------|---------------------------------------------------------------------------|-----------------------------------------------------------------------------|---------------------------------------------------------------------------|-----------------------------------------------------------------------------------------------------------------------------|-----------------------------------------------------------|
| | Primary | Secondary | Primary | Secondary | | | |
| Entry | Spherical bearing to WP-1 for NEP at <u>primary</u> landing runway | Spherical bearing to WP-1 for NEP at <u>secondary</u> landing runway | Spherical surface range to WP-2 on <u>primary</u> runway via WP-1 for NEP | Spherical surface range to WP-2 on <u>secondary</u> runway via WP-1 for NEP | A valid software zero (no flag) | GS pointer stowed; flag displayed | Magnetic heading of vehicle relative velocity vector (VV) |
| TAEM | Bearing to WP-1 on selected HAC for primary runway | Bearing to center of selected HAC for primary runway | Horizontal distance to WP-2 on primary runway via WP-1 for selected EP | Horizontal distance to center of selected HAC for primary runway | Deviation from extended runway centerline (full scale = $\pm 10^\circ$) | Deviation from guidance reference altitude for TAEM (full scale = ± 5000 ft) | Magnetic heading of body X-axis |
| Approach | Bearing to WP-2 at primary runway | Bearing to WP-2 at primary runway | Horizontal distance to WP-2 on primary runway | Horizontal distance to WP-2 on primary runway | Deviation from extended runway centerline (full scale = $\pm 2.5^\circ$) | Deviation from guidance reference altitude for A/L (full scale = ± 1000 ft) Not computed below 1500 ft, flag deploys | Magnetic heading of body X-axis |

There are special items for the HSI relative to TAEM and A/L.

- a. At transition of A/L, the range and bearing data are referenced to WP-2.
- b. When below 1500 ft, MLS elevation is set to zero to prevent invalid elevation data during landing and rollout. This is visible on the GSI.
- c. When the CDI becomes active at TAEM, a slight jump is seen on the CDI.
- d. At TAEM interface, the GSI pointer drops into view, since it is not computed during the entry phase.

There are a few differences between the PASS and BFS HSI display processing. In the BFS both HSI's are driven with the same set of commands (no difference between left and right sides). The BFS SOURCE and MODE switch processing is very limited; the MODE switch information is not used, the SOURCE switch works in TACAN or NAV, and the SOURCE (LRU 1, 2, 3) switch information is not used. All HSI parameter definitions are the same as given for the PASS.

2.11.3 AMI

The AMI (fig. 2-3) displays the angle of attack (ALPHA, degrees), the Mach/velocity (M/VEL, ft/sec), EAS, knots (kts), and acceleration (ACCEL, f/s^2). This meter consists of four separate moving tape scales, appropriately marked for the range of the respective parameters.

The leftmost scale displays the angle of attack (ALPHA), using a combination moving scale and moving pointer. For ALPHA -4° to $+28^\circ$, the scale remains stationary and the pointer moves to the correct reading. For ALPHA outside of these limits, the scale moves so that the pointer gives the correct reading. The ALPHA tape ranges from -18° to $+60^\circ$ with no scale changes. The tape has black markings on a white background for negative numbers, and vice versa for the positive ALPHA values.

The first scale to the right of the ALPHA scale is the ACCEL scale. This scale displays vehicle drag acceleration, or ACCEL along the flight path. This is a moving tape read on the fixed lubber line and ranges from -50 to +100 f/s^2 . The scale changes at 0 f/s^2 , where negative values have twice the granularity as the positive values.

The next scale is the M/VEL tape which displays Mach number and relative velocity (vehicle airspeed). This is a moving tape, with the M/VEL read at the fixed lubber line. The tape is rescaled for Mach numbers greater than 4, to read velocity in thousands of ft/sec (above 2500 feet per second (ft/s), Mach = VREL/1000). The scale ranges from 0 to 27, with the scale change at M = 4.

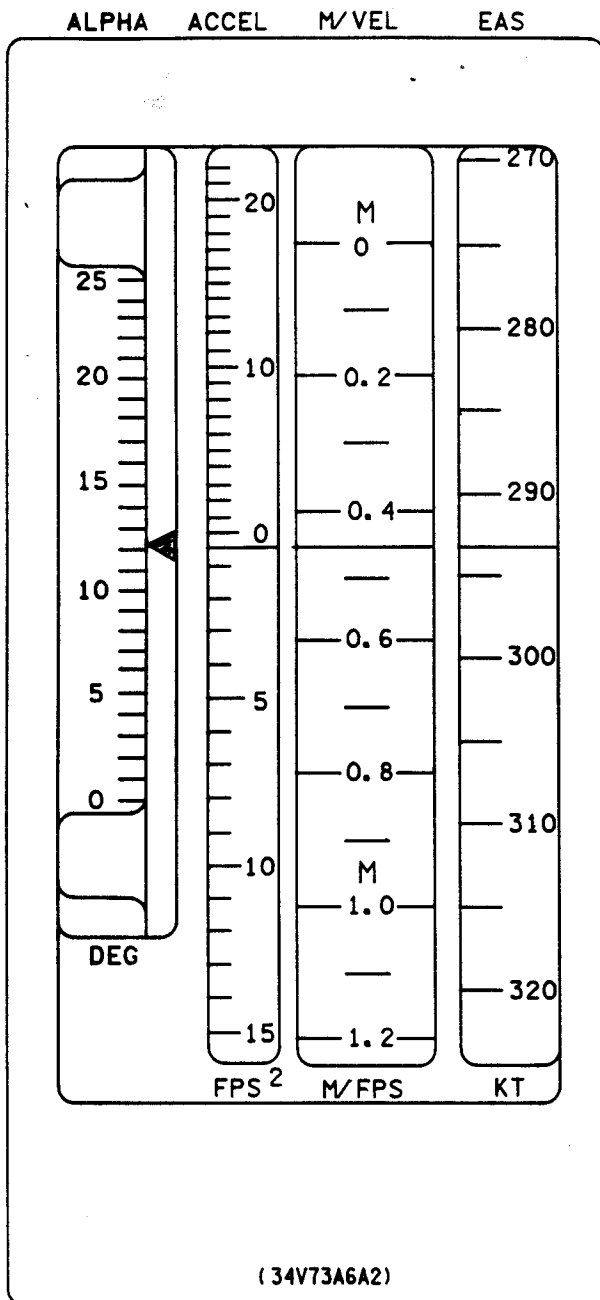

- ALPHA -18 TO +60 DEGREES
- ACCEL -50 TO +100 FT/SEC²
- M/VEL 0-4,
4K TO 27K FT/SEC
- EAS 0-500 KNOTS
- FAILURE WARNING FLAGS
 - MALFUNCTION WITHIN INDICATOR
 - MALFUNCTION IN RECEIVED DATA
 - POWER FAILURE (FLAGS APPEAR)

232660003. PNL, 2

Figure 2-3.- Alpha/Mach indicator.

The scale to the far right on this display is the EAS. The EAS here is the instrument airspeed corrected for instrument error, position error, and compressibility. This is a moving tape, with the EAS read at the fixed lubber line. The range of the tape is from 0 to 500 kts, where 1 inch of tape is equal to 10 kts EAS.

The data driving the AMI tapes are a function of the position of the AIR DATA switch (LEFT, NAV, or RIGHT). With the AIR DATA switch in the LEFT or RIGHT position, the ALPHA, M/VEL, and EAS are driven with the selected data from the left or right probe assembly, assuming the probe is deployed and the data is valid. The ACCEL tape is always driven by the NAV derived acceleration. With the AIR DATA switch in the NAV position, the ALPHA, M/VEL and EAS are driven from the same data being sent to the guidance, flight control, and NAV software users. This is determined by the ADTA SOP parameters, or NAV derived parameters, depending on the probe status, the Mach number, ADTA validity, and the status of the active ADTA to G&C item entry on the HORIZ SIT display (SPEC 50). The ACCEL is still driven by the NAV derived acceleration. A summary of the AMI display vs. controls can be found in table 2-VI.

The BFS has some differences for AMI display processing from the PASS. The major differences to remember are that the AIR DATA switch function is only available from the left (CDR) side, and the AMI displays the average of the left and right probe data when in either the LEFT or RIGHT AIR DATA switch positions.

2.11.4 AVVI

The AVVI (fig. 2-4) displays the altitude acceleration (ALT ACCEL, ft/s^2), the altitude rate (ALT RATE, ft/s), the barometric altitude (ALT, ft), and the radar altimeter altitude (RDR, ALT, ft).

The leftmost scale is the ALT ACCEL and is read where the moving pointer intersects the fixed scale. The scale ranges from -13.3 to $+13.3 \text{ ft/s}^2$, where 1 inch is equal to 6.67 ft/s^2 . The software limits the ALT ACCEL to $\pm 12.75 \text{ ft/s}^2$.

The next scale to the right, ALT RATE is read where the moving tape intersects the fixed lubber line. The scale range is from -2940 to $+2940 \text{ ft/s}$, with scale changes at -740 and $+740 \text{ ft/s}$. The negative numbers are white on a black background, and the positive values are vice versa.

The next scale, ALT is a moving tape read against a fixed lubber line which displays the altitude of the orbiter above the runway (BARO ALT). The scale ranges from -1100 ft to $+165$ nautical miles (n. mi.), with scale changes at -100 ft , 0 ft , 500 ft , and $100\text{k} \text{ ft}$. The scale is in ft from -1000 to $+400\text{k} \text{ ft}$, and in n. mi. from $+40$ to $+165 \text{ n. mi.}$ (ft and n. mi. overlap from -40 n. mi. to $+61 \text{ n. mi.}$).

TABLE 2-VI.- AMI DISPLAY VERSUS CONTROLS

| Air data switch | Prior to probe deploy | | Probe deployed, before Mach 2.5 | | After Mach 2.5 | |
|-----------------|-----------------------|-------------------|---------------------------------------------------------------------|-------------------|------------------------------------------------------------------------------------|-------------|
| | ALPHA, M/VEL, EAS | Accel | ALPHA, M/VEL, EAS | Accel | ALPHA, Mach, EAS | Accel |
| Left/right | Frozen w/flags | NAV data, no flag | Left/right probe data, no flags unless communications (COMM) faults | NAV data, no flag | Left/right probe data, no flags unless COMM faults | Zero w/flag |
| AUT/FOR NAV | NAV data, no flags | NAV data, no flag | NAV data, no flags | NAV data, no flag | Center air data unless redundancy management (RM) dilemma, then NAV data. No flags | Zero w/flag |
| Inhibit (INH) | NAV data, no flags | NAV data, no flag | NAV data, no flags | NAV data, no flag | NAV data, no flag | Zero w/flag |

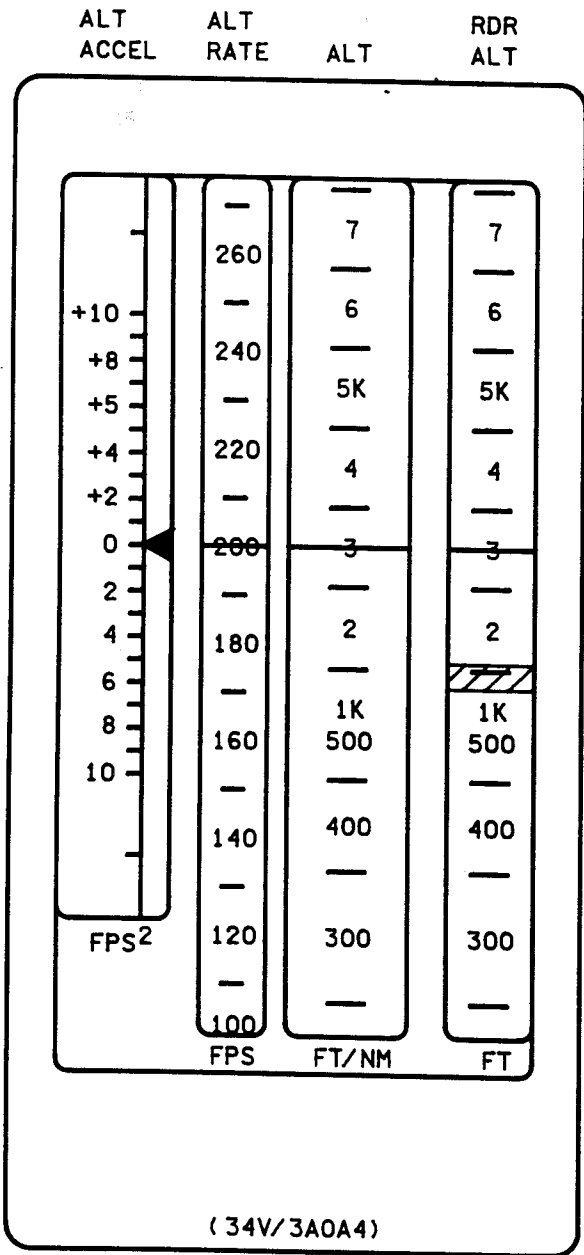

- ALT ACCEL -13.3 TO +13.3 FT/S²
- ALT RATE -2940 TO +2940 FT/S
- ALT -1100 FT TO 165 N. MI.
- RDR ALT 0 TO 9K FT
- FAILURE WARNING FLAGS
 - MALFUNCTION WITHIN INDICATOR
 - MALFUNCTION IN RECEIVED DATA
 - POWER FAILURE (ALL FLAGS APPEAR)

232660004. PNL, 3

Figure 2-4.- Altitude/VV indicator.

The far right scale, RDR ALT is a moving tape read against a fixed lubber line which displays radar altimeter ALT (corrected for main gear) below 9000 ft. However, the altimeters do not normally lock-on until 5000 ft. There is a scale change at 1500 ft. The data displayed on this tape is a function of the RADAR ALTM (RA) switch position, and reflects RA 1 or RA 2 data in position 1 or 2, respectively.

The source of the data driving the AVVI tapes (except for the RDR ALT) is a function of the AIR DATA switch position. With the switch in the LEFT or RIGHT position, the ALT RATE and ALT will be based on the left or right probe data, assuming the probes are deployed and the data is valid. ALT ACCEL is always driven by NAV derived data, and RDR ALT is always driven by the RA data via the RADAR ALTM switch. With the AIR DATA switch in the NAV position, all tapes (except RDR ALT) are driven by NAV derived data. Unlike the AMI display, the AVVI does not depend on the SPEC 50 ADTA to G&C item entries; the AVVI never reflects probe data when the AIR DATA switch is in the NAV position. A summary of the AVVI data sources is referenced in table 2-VII.

TABLE 2-VII.- AVVI DATA SOURCE

| AVVI parameter | AIR DATA switch | |
|----------------|---------------------|--------------|
| | LEFT or RIGHT | NAV |
| ALT ACCEL | NAV derived | NAV derived |
| ALT RATE | Left or right probe | NAV derived |
| ALT | Left or right probe | NAV derived |
| RDR ALT | RA 1 or RA 2 | RA 1 or RA 2 |

In the BFS, the AVVI processing is slightly different. The ALT ACCEL, ALT RATE, and ALT have the same physical quantities as the PASS. The RDR ALT tape is driven by data from RA 1, unless the data is invalid, and then it is driven by RA 2. Similar to the AMI in the BFS, when the AIR DATA switch is in the LEFT or RIGHT position, the average of the probe data drives the tapes for the ALT RATE and ALT (recall ALT ACCEL is NAV derived only). Also similar to the AMI processing, only the left (CDR) AIR DATA switch is functional.

2.11.5 SPI

The discussion of the SPI is very limited here, since this display and the processing of the data does not change for the A/L phase from the other phases of entry. The only exception is the SB. The SB position

(actual position from feedback SOP) and the SB command are displayed on the SPI. Prior to TAEM, the SB command displayed is the DAP auto command (Mach-scheduled SB command), and post TAEM, the SB command displayed on the SPI is the auto guidance SB command. The BFS SPI is no different from the PASS, except that the SB command displayed is driven to zero during A/L since there is no BFS A/L guidance.

2.11.6 RCS Command Lights

This discussion is also limited due to the fact that once the yaw jets are disabled (Mach = 1), the YAW L and R and the ROLL L and R lights no longer have a function. At this point, the PITCH U and D lights are the only lights that are still functioning. The PITCH U and D lights take on a new meaning after $Q\text{-bar} > 50$ psf. Both lights (U and D) are lit whenever the elevon surface drive rate exceeds 20 deg/sec (10 deg/sec for only one hydraulic system remaining). Thus, for A/L (or for entry and $Q\text{-bar} > 50$ psf), these lights will provide indication of high surface drive rates.

2.11.7 Normal Accelerometer (G-Meter)

The g-meter is a self contained accelerometer and display unit, which senses linear acceleration along the Z body axis of the orbiter. This meter requires no power and has no software interface. Like all dedicated displays, it has a variable incandescent lamp.

2.12 HEAD UP DISPLAY

The data presented in this section explains the layout and sequence of the parametric and situational data that is displayed on the HUD during the A/L phase. Data sources will also be presented where applicable. Information on specific crew techniques for flying the HUD guidance are explained in section 5.

2.12.1 HUD Overview

The HUD symbology display in fig. 2-5a is designed to provide the commander (CDR) and pilot (PLT) with the guidance and vehicle configuration information required to accomplish precise and repeatable orbiter A/L. The HUD is designed to sequence different sections of the display area in order to avoid display clutter and to provide an orderly progression of information from the TAEM flight phase to postlanding rollout. The benefit of the HUD is obvious in that it provides the opportunity for integrating the real-world "out the window" scene with parametric guidance and situational information. Redundant data that is displayed on both the HUD and the dedicated displays has the same data source, when practical. When a different data source is used, the source change was made to acquire data for the HUD at a higher update rate than used for the dedicated displays. The following sections reference the numbered display areas shown in figure 2-5b.

- a. Boresight - The boresight symbol position in the display depicts an extension of the orbiter body X-axis. The horizontal bar of the symbol remains parallel to and lies on the orbiter body Y axis at all times. The symbol is positioned 5° above the center of the HUD field of view (FOV).
- b. Runway - The runway symbol consists of a four sided representation of a 300 ft wide by no greater than 15,000 ft long runway with a line along the centerline starting at the steep GS (SGS) intercept point and ending at the shallow GS intercept point. The ends of this line have aim point circles on them. The runway symbol is a 1:1 representation and appears as soon as any part of the runway is in the HUD FOV. A partial, as well as a total runway can be displayed. The symbol is displayed at any time during A/L when the runway is in the FOV, however, once WOW occurs, the runway symbology is blanked. The runway position is determined by the NAV state, so any errors in the state vector appear as an offset between the real (visible) runway and NAV-propogated runway on the HUD.

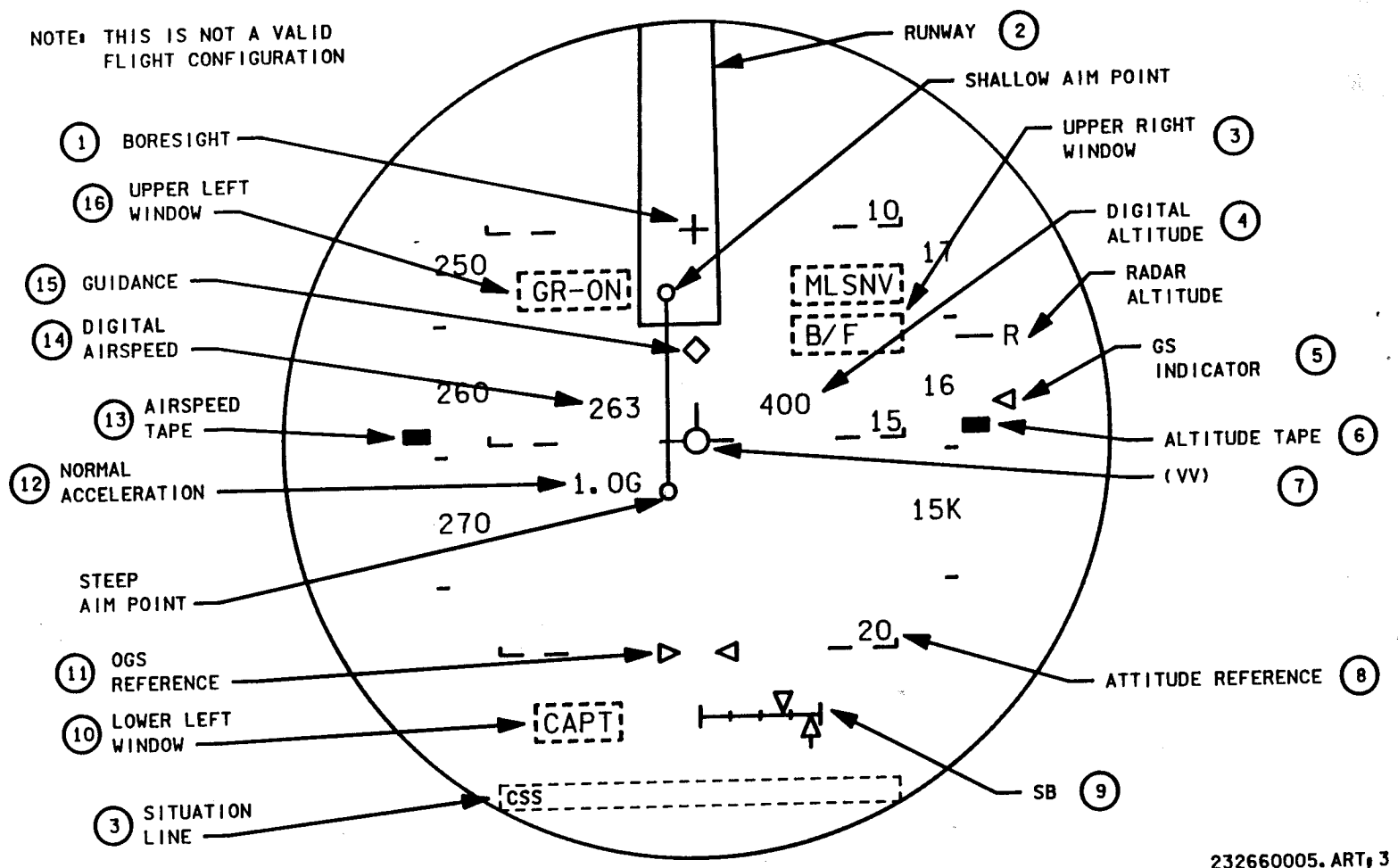

232660005. ART, 3

(a) Pre-WOW.

Figure 2-5.- HUD Display format.

NOTE: THIS IS NOT A VALID
FLIGHT CONFIGURATION

DIGITAL GOUNDSPEED

G 160 +

BORESIGHT

DECELERATION RATE (17)

—
·
△
·
—

SB SCALE

—
·
△
·
—

232660006. ART, 3

(b) After WOW.

Figure 2-5.- HUD Display format.

- c. Upper right windows and situation line - this symbol is composed of two 5-character windows in the upper right corner of the display and a 29-character window at the bottom of the FOV in the center. The upper right windows use large characters while the lower situation lines uses small characters. The messages in the upper right windows are used to display flight control cues or failures. The situation line in the lower center of the HUD is used to display items which persist for more than 5 sec. Both the upper right windows and situation line are blanked at WOW.

| <u>Cue/alert</u> | <u>Comment</u> |
|------------------|--------------------------------|
| CSS | CSS control in all axes |
| MLSNV | NAV is not processing MLS data |
| B/F | B/F not at trail |

- d. Digital altitude - This symbol displays the current altitude (in ft) from the main-gear wheels to the runway altitude. A large "R" is displayed next to the digital altitude whenever radar altimeter data is used as the data source. To make this symbol easy to read it will remain at a fixed distance from the flight director (FD)/velocity vector (VV) symbol and moves with it throughout the HUD FOV. Remember when looking at the following parameter:

- (1) The data is always driven by radar altimeter data if available ($H < 5K$ ft), and
- (2) The digital RA data replaces the altitude tape if the altitude to the wheels is unavailable, but radar altimeter data is available.

The numbers for digital altitude are scaled as follows:

| | | | | |
|---------|-------|----------|---|---------------------------------|
| 1000 ft | < H ≤ | 32767 ft | : | truncated to two hundreds of ft |
| 400 ft | < H ≤ | 1000 ft | : | truncated to hundreds of ft |
| 50 ft | < H ≤ | 400 ft | : | truncated to tens of ft |
| 0 ft | < H ≤ | 50 ft | : | truncated to ft |

- e. GS monitor - This symbol shows the error between the guidance computed reference trajectory altitude and actual altitude. The pointer is referenced to and moves vertically along the right side of the altitude tape. The symbol is displayed prior to WOW.
- f. Altitude tape - This tape displays the current orbiter wheel altitude above the NAV-derived runway altitude. This tape is fixed in length and is symmetrical about the HUD horizontal centerline. The tape is made up of alternating numbers and tic marks. The numbers appear at the following increments:

10,000 ft increments above 100,000 ft
 1000 ft increments between 1000 ft and 100,000 ft
 100 ft increments between 500 ft and 1,000 ft
 50 ft increments between 0 ft and 500 ft

The letter "K" is used to symbolize thousands of feet between 1000 ft and 400,000 ft. An altitude pointer (rectangle) is fixed at the vertical center of the tape. This tape is blanked at WOW.

- g. FD/VV - The flight director is a square shaped stationary symbol until I_PHASE = 3 (TAEM prefinal), when it is automatically uncaged (moved) in the pitch axis. The symbol can then be uncaged/caged in the horizontal axis by depressing the associated attitude (ATT) REF pb (good for crosswind landings). When uncaged in both axes, the symbol becomes a VV (circular), and is a representation of the vehicle flight path.
- h. Attitude reference - This symbol displays the current orbiter pitch angle. Attitude reference lines are displayed relative to the horizon line which is a double width line. The entire symbol is rotated about the center of the HUD FOV corresponding to the vehicle roll angle (positive roll angle results in counter-clockwise direction). The symbol is then adjusted so that the correct pitch angle is read from the boresight. The attitude reference is displayed until WONG.
- i. SB scale - This symbol displays the orbiter SB actual and commanded positions. The scale is a fixed length and has five equally spaced marks that are centered vertically about the scale. Actual SB position is represented by a triangular point above the scale. The SB command (auto or manual) is represented by an arrow pointer below the scale. Any delta of $> 20^\circ$ between the command and position causes the position point to flash. This scale is available throughout A/L.
- j. Lower left window - The lower left window is used to display the guidance mode descriptor prior to WOW.

Mode descriptors are as follows:

S-TRN for I_PHASE = 0
 ACQ for I_PHASE = 1
 HDG for I_PHASE = 2
 PRFNL for I_PHASE = 3
 CAPT for P_MODE = 1
 OGS for P_MODE = 2
 FLARE for P_MODE = 3
 FNLFL for P_MODE = 4

- k. OGS/flare references - The OGS/flare reference consists of two pairs of opposed triangle indices. These triangles provide the following information:
 - (1) The flight path angle references information after prefinal TAEM for OGS acquisition and tracking
 - (2) The flight path angle pitchup from preflare to FF initiation

The two pairs of triangles are free to move vertically, but are laterally tied to the VV when no roll exists. The OGS indices are blanked when the flare indices cross them.

- l. Nz - Nz readout is below and left of the VV symbol, and tracks along the HUD FOV at the same distance from the VV. Data is shown in g's, and the range of the scale is from +9.9 to -5.1 g's. This data is displayed around the HAC and is blanked at TAEM preflare.
- m. Airspeed tape - This tape displays the orbiter EAS. The tape is a mirror image of the altitude tape and is located on the left side of the HUD FOV. The range of the tape is from 0 to 500 kts, numeric values appear in ten kts increments with an additional tic mark at every five kts. An airspeed pointer is fixed vertically in the center of the tape. The tape works throughout A/L and is blanked at WOW.
- n. Digital airspeed - Digital airspeed is displayed in numeric form (corresponds with tape (13)) at a fixed distance left of the VV symbol and moves with it throughout the FOV. The range of values is 0 to 500 kts in increments of one. After WOW, it moves to the upper left corner of the boresight. When WONG occurs, a 'G' appears in front of the readout to indicate a change to groundspeed. Before WOW, the symbol is displayed when the altitude is ≤ 1000 ft or declutter = 2, EAS is available, and the FD/VV is displayed.
- o. Guidance - The guidance symbol is diamond shaped and depicts the direction the orbiter must be flown to satisfy the GPC derived guidance solution. The guidance diamond is constrained to remain in the FOV and flashes when limited to the total FOV. The guidance diamond is available prior to WOW.
- p. Upper left window - The upper left window is used to display gear oriented cues. The window is available prior to WOW and is located above center FOV and to the left of the vertical center.

The gear annunciator (GEAR (GR)) is set whenever the GR is up and the altitude is less than 300 ft (I-load) and airspeed is less than 300 kts (I-load). When set the mnemonic GEAR flashes. The GR mnemonic is set when the gear is in transit. The GR-down (DN) mnemonic is set when all three main landing gears are down and locked as sensed by 28-V discretes from the landing gear prox boxes. The GR-DN mnemonic only remain on for 5 sec.

- q. Deceleration rate - The deceleration scale displays actual and commanded vehicle deceleration. The scale is fixed in length, with five equally spaced tic marks centered horizontally about the scale. Actual vehicle deceleration is represented by a triangular pointer on the left side of the scale. Commanded brake deceleration is represented by an arrow pointer on the right side of the scale. This scale is displayed after WOW.

- r. Horizon - The horizon line consists of a solid line with a 4° gap in the center. It is positioned with respect to the local horizontal.

2.12.2 BFS Differences

The HUD is not supported by the BFS.

2.12.3 HUD Power Distribution

HUD systems power is provided through a HUD POWER switch located inboard of the (PDU) on Panel F3. Power for the CDR's HUD is from MAIN A through control bus AB2. Power for the PLT's HUD is from MAIN C through control bus BC1.

2.12.4 HUD System Moding

A three position MODE switch is located on the front of the HUD. Switch positions are up, TEST; center, NORM; and down, declutter (DCLT). The DCLT position is momentary; the switch is spring loaded to return to NORM from that position. In the NORM position, automatic sequencing of formats and symbology is provided.

The TEST position is used for HUD checkout during on-orbit FCS checkout and is not discussed further. Activation of the MODE switch to the DCLT position initiates a symbol blanking routine. This routine selectively removes different symbols from the currently displayed format. Successive operations of the DCLT switch serially removes display elements in accordance with a program read-only memory (PROM) logic until only the boresight remains. The next operation of the switch reintroduces the original format and reinitialize the DCLT logic.

The DCLT logic prior to TD (WOWLON flag set)

| <u>DCLT level</u> | <u>Result</u> |
|-------------------|------------------------------------------------------------------------------------------------------|
| 1 | Blanks runway |
| 2 | Blanks airspeed scale, alt tape, GS indication attitude scales. Forces digital airspeed and altitude |
| 3 | Only the boresight remains |
| 4 | Reintroduces full-up display |

The declutter logic after WOW

| <u>DCLT level</u> | <u>Result</u> |
|-------------------|------------------------------------|
| 1 | Blanks attitude scales and horizon |
| 2 | Only boresight remains |
| 3 | Reintroduces full-up display |

2.12.5 HUD Brightness

The brightness of the HUD symbology is adjusted by using the rotary brightness control on the front of the HUD PDU (electronics box). The range of the brightness control is determined by a three position switch labeled BRIGHT. In the top (MAN DAY) position, the rotary control covers the full range of HUD brightness. In the bottom (MAN NIGHT) position, the rotary control covers the range from 0 to 2 percent of HUD brightness. In the center (AUTO) position, the rotary control sets a relative contrast level between the HUD symbology and the outside lighting conditions.

SECTION 3
LANDING AIDS

3.1 TACTICAL AIRBORNE NAVIGATION

TACAN is a military omnibearing and distance measuring system. Bearing and distance information is made available to the orbiter navigation system for updating the state vector. The data are accurate to approximately $\pm 0.5^\circ$ in bearing and ± 0.1 n. mi. in range. This information is available from a distance of about 400 n. mi. from the landing site.

During entry, TACAN data are required to update the navigation state and guidance. Without this, the IMU-only state vector does not provide the degree of accuracy necessary for the orbiter to make it safely to the runway.

3.2 MICROWAVE SCANNING BEAM LANDING SYSTEM - GROUND STATION

The MSBLS - ground station (MSBLS-GS) provides Az, elevation (EL), and distance information to the orbiter as it is approaching the landing site. The MSBLS-GS consists of two equipment shelters (fig. 3-1), two monitor poles, and a remote control unit. Physically, a side-by-side configuration is used, one shelter containing the Az and distance measuring equipment (DME) assemblies, the other containing the EL assemblies. Each shelter contains dually redundant sets of equipment, one set forming a primary string, the other a backup string. Field monitor sets are triply redundant. All MSBLS sites are calibrated to a 0.15° in average alignment error.

3.2.1 MSBLS-Junior

The MSBLS-Junior (MSBLS-JR) is a derivative of the MSBLS-ground station system. The JR was intended as a nonredundant approach aid for use at the transoceanic abort landing (TAL) and contingency landing sites.

The single-string JR uses most of the same components as the MSBLS-GS, with the redundant circuit elements removed. The single Az and EL stations have been colocated within one shelter.

The MSBLS-JR station located at the approach end of the runway provides coverage up to the runway threshold but cannot support vehicle rollout. Should redundant MSBLS operation become desirable at a site, two JR's may be operated side-by-side to provide the same automatic backup capability as the MSBLS-GS installation. This has been done at Banjul, and three additional units will provide redundant MSBLS coverage for two runways at Edwards when the units become available.

3.2.2 MSBLS Site Location

The MSBLS-GS is typically located 300 ft left or right of the runway centerline (500 ft right or left on military installations), with the EL station 3360 ft down the runway from the approach threshold. The Az and DME station is located 1300 ft beyond the rollout end of the runway. This type of arrangement provides EL information through T/D and Az information throughout the rollout.

More recent MSBLS-GS installations have been located 300 ft right or left of runway centerline (500 ft military), with the EL station 1500 ft down the runway from the approach threshold and the Az/DME located 1500 ft prior to the rollout end of the runway. This type of installation allows the use of either an MSBLS-GS or JR on the same foundation pads.

The MSBLS-JR installations are single or dual redundant, side-by-side configuration, and all are 300 ft right or left of centerline (500 ft military) and 1500 ft down the runway from the approach threshold.

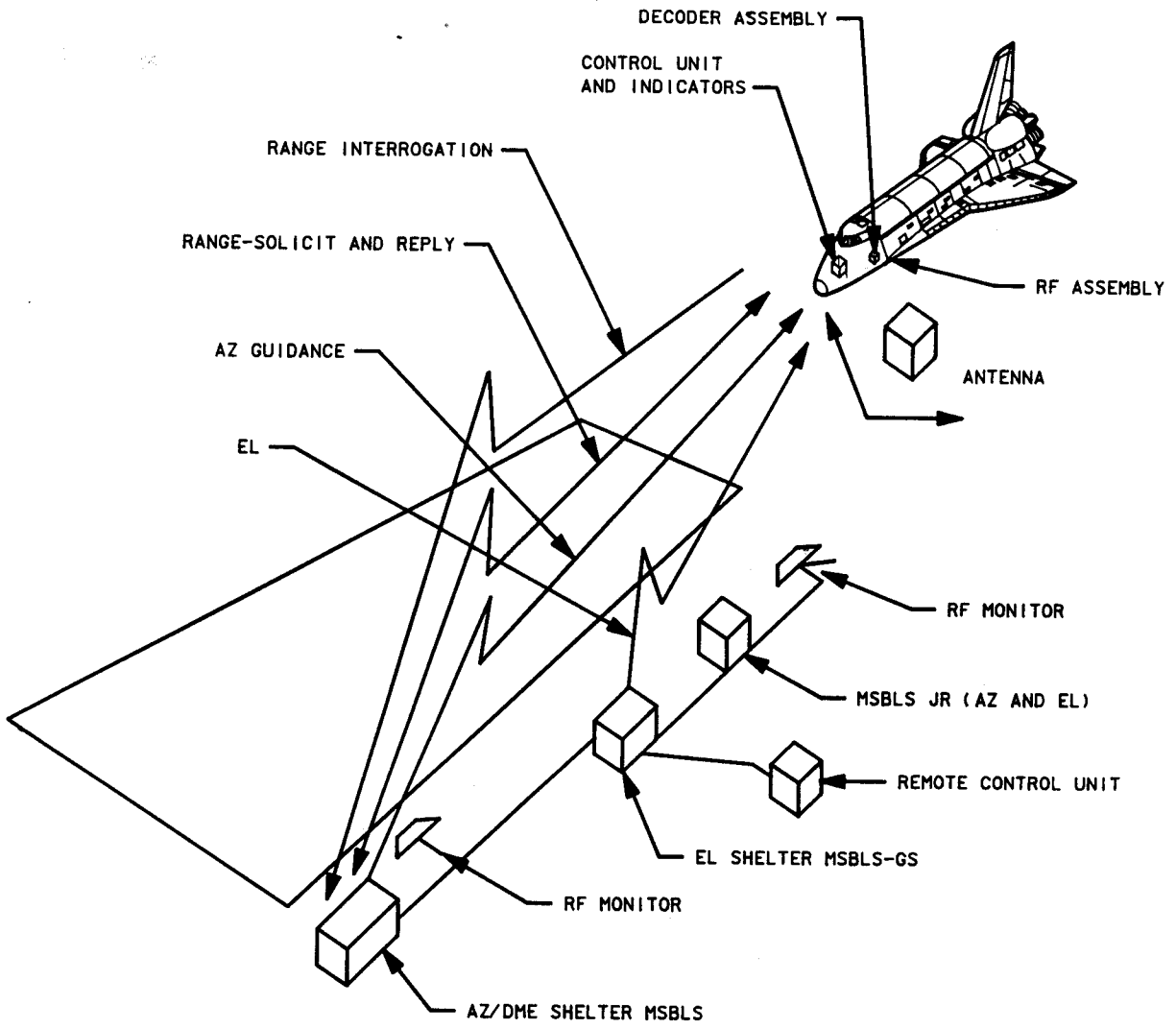

232660101. ART, 3

Figure 3-1.- MLS ground system.

3.3 AIM POINTS

The visual aim point is a triangle (110 ft by 240 ft) located at the high-wind aim point, where practical, to provide visual cues for the OGS during daylight hours. The color is to contrast with the local terrain. A rectangle (100 ft by 200 ft) is located at the nominal aim point.

There is a requirement to provide a dark background for the precision approach path indicator (PAPI) lights. If the natural terrain is light, a darkened rectangle, as specified in figure 3-2, is required. Figure 3-3 shows PAPI locations.

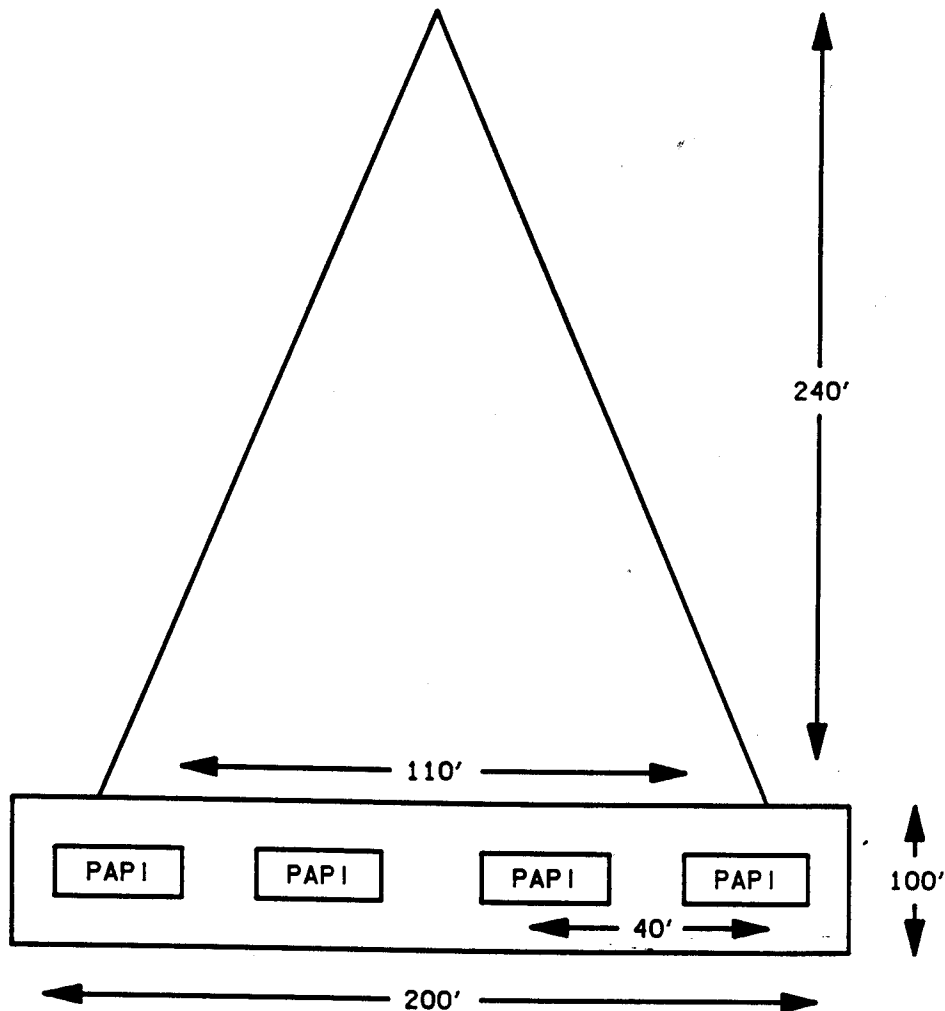

232660102. ART. 1

Figure 3.2.- Typical visual aim point and PAPI.

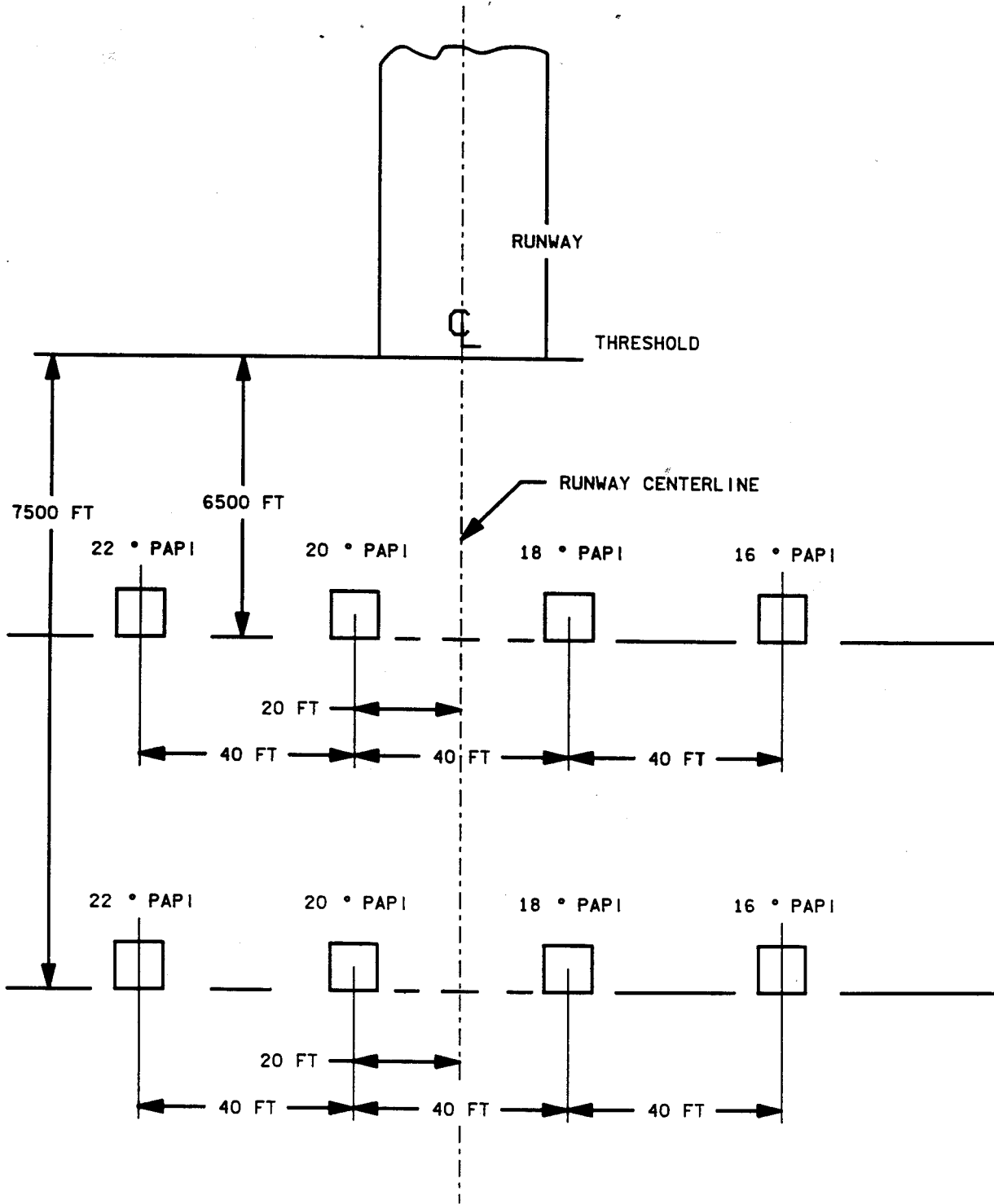

232660105. ART, 1

Figure 3-3.- PAPI light locations.

3.3.1 Aim Point Identification Light System

To enhance the flight crew's ability to acquire the aim points and PAPI lights from higher altitudes under adverse surface contrast or poor visibility conditions, a colocated day and night lighting system has been provided, as shown in figure 3-4.

Six high-intensity, highly directional strobe lights, three each for left- and right-hand HAC's, are installed adjacent to the high-wind (6500 ft) aim points. Flashing at a rate of 90 cycles per minute (cpm), the strobe intensity is approximately 1 million effective candela for daylight, and using a capacitor step reduction with a red filter, 10 k candela for night operations.

This system is installed where visual aim points are not able to provide the visual cues for the PAPI lights or to enhance the aim points at Ben Guerir.

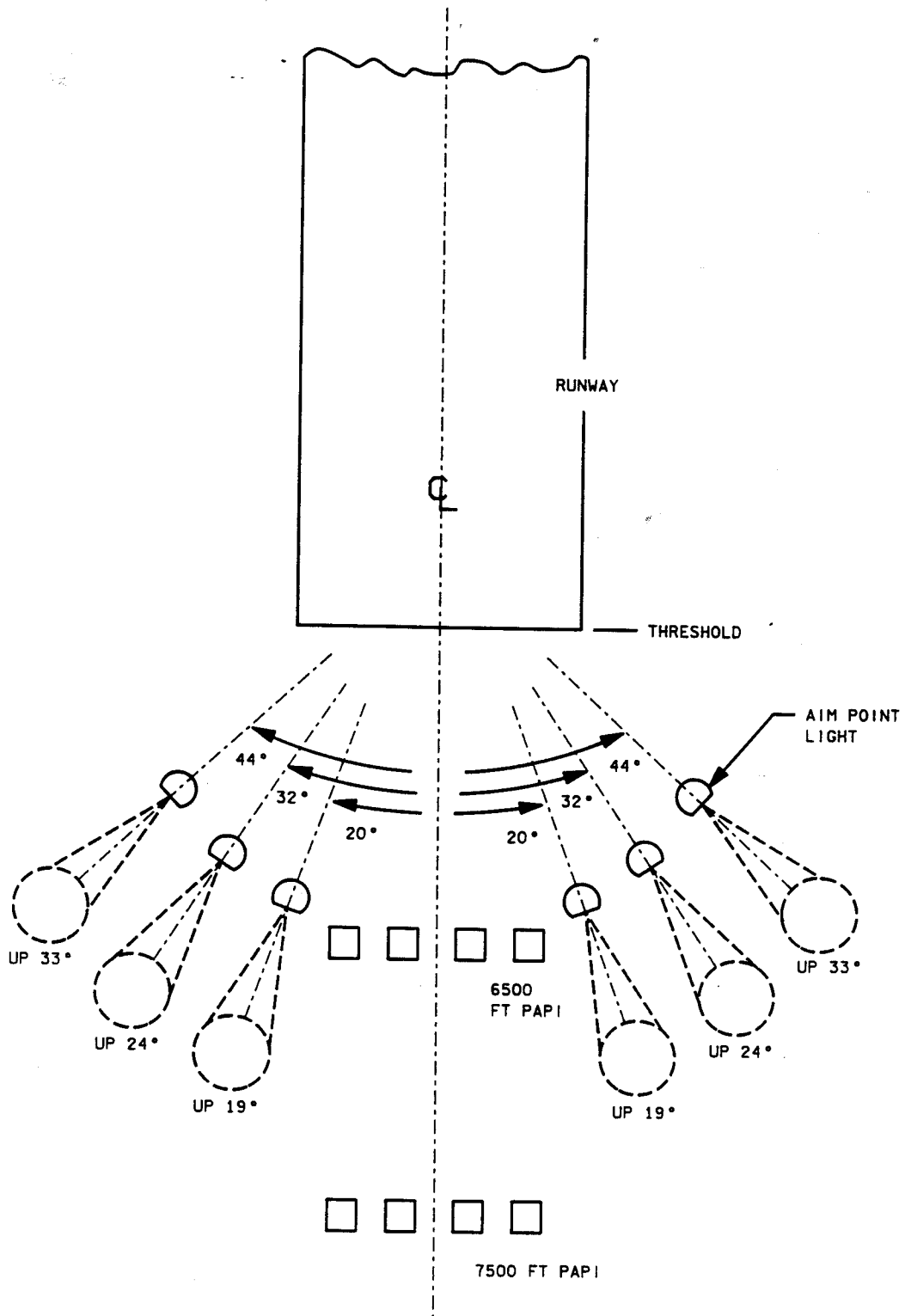

232660103. ART, 1

Figure 3-4.- Aim point identification lighting system.

3.4 PAPI LIGHT - OGS

To assist the crew in identifying the OGS, PAPI lights are installed 6500 ft and 7500 ft from the threshold of the runway, figure 3-5. The PAPI lights are highly directional and OGS cueing is a function of the apparent change in PAPI light color.

There are four PAPI light units, spaced 40 ft apart, at both the 6500-ft (high wind) and 7500-ft locations, perpendicular to the runway centerline*. When the orbiter is on the 19° GS the pilot sees two red and two white PAPI lights. Each of the PAPI light units is set to a different angle: 22°, 20°, 18°, and 16° from left to right as viewed by the pilot.

If the GS is high, the pilot sees three white and one red or four white lights. If the GS is low the pilot sees one white and three red or four red lights. To assist the crew in locating the PAPI lights during night operations, two directional strobe lights are provided, one on each side of the PAPI light array, at the 7500-ft sites.

The PAPI system has the capability to vary the light intensity to day setting (100 percent rated, 6.6 amp), dawn/dusk setting (75 percent, 4.0 amp), and night setting (50 percent rated, 3.2 amp).

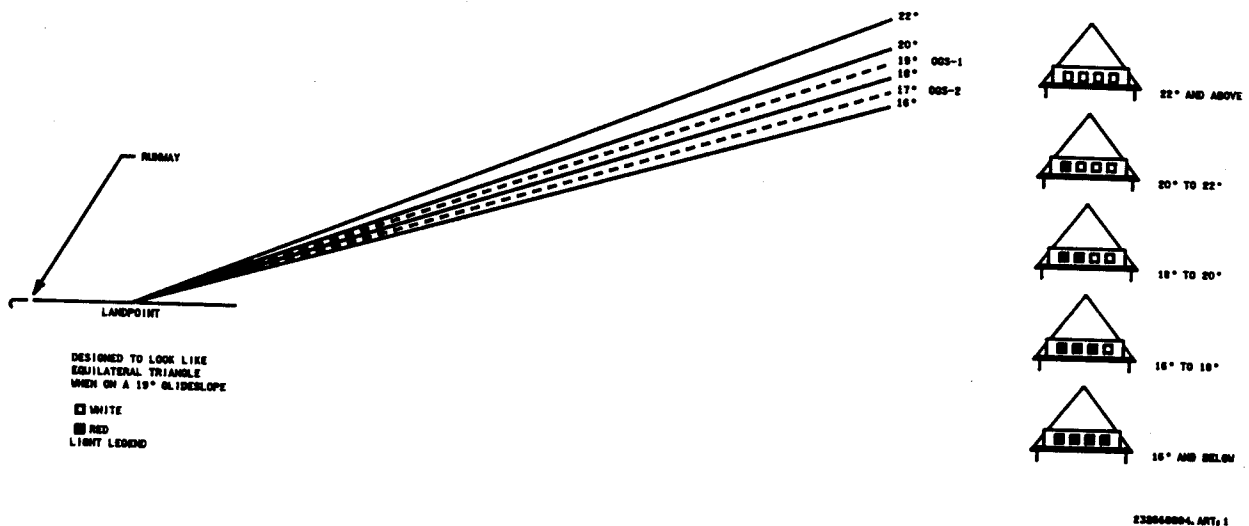

Figure 3-5.- Illustrative example of PAPI system geometry.

*Due to local conditions and constraints, some PAPI sites may be offset slightly. Refer to specific runway layouts in the appendix for details.

3.5 BALL/BAR LIGHTS - IGS SYSTEM

The ball/bar light system provides the orbiter pilot with a visual means of attaining and maintaining the proper IGS angle during shuttle landing operations up to the point of T/D.

The geometry of the height and spacing of the ball/bar is such that when the white ball lights are superimposed on the red bar lights, they exhibit a 1-1/2° IGS, as viewed by the pilot during his approach. If the energy managed GS is maintained, the ball lights appear to move from the inner bar light to the left, superimposing the white ball lights on each set of red bar lights consecutively as the orbiter nears T/D.

The IGS angle of 1-1/2° is identified by the use of precisely positioned ball/bar light assemblies.

The bar lights comprise six assemblies mounted on frangible stanchions; each assembly has four 200-watt lamps with red filters. The bar light assemblies are spaced 15 ft from each other, perpendicular to the runway centerline at 2200 ft from the threshold. The first bar segment is 200 ft off the runway centerline. The exception to this is at Banjul where the ball and first bar segment are 178 ft off the runway centerline. The elevation of the bar lights is 2 ft above the runway centerline elevation at 2200 ft from threshold (fig. 3-6).

The ball light assembly consists of three 200-watt white lamps affixed to a single frangible stanchion (fig. 3-7). The stanchion is located 200 ft to the left of the runway centerline, 1700 ft from the threshold. Because of variations in runway elevations, the elevation of the lamps are 15 ft, referenced to the runway centerline elevation at 2200 ft from the threshold.

All lights are angled up 4° (plus or minus 15 min) from the horizontal.

The ball/bar system is capable of varying the light intensity from a day setting to a dawn/dusk setting and to a night setting.

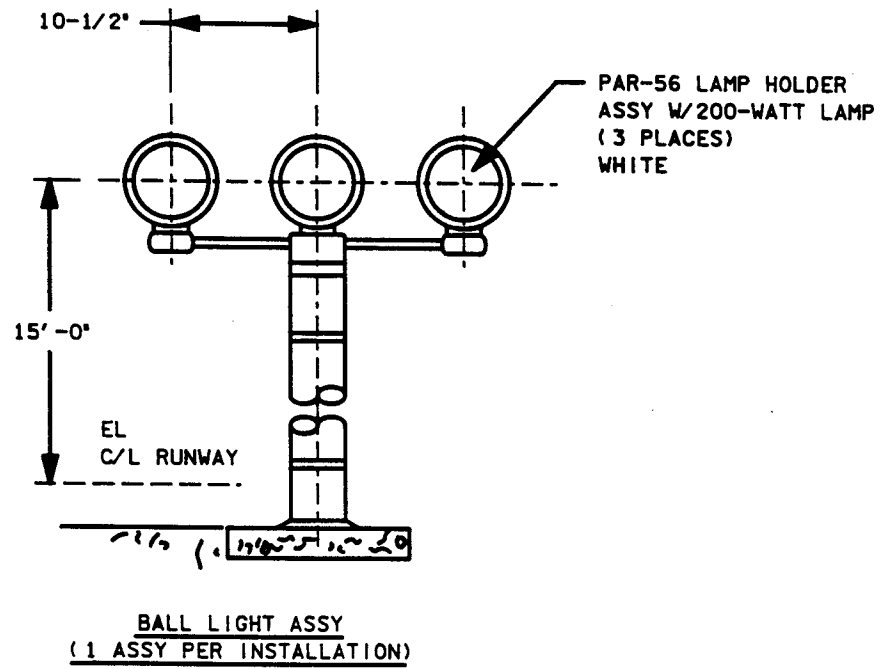
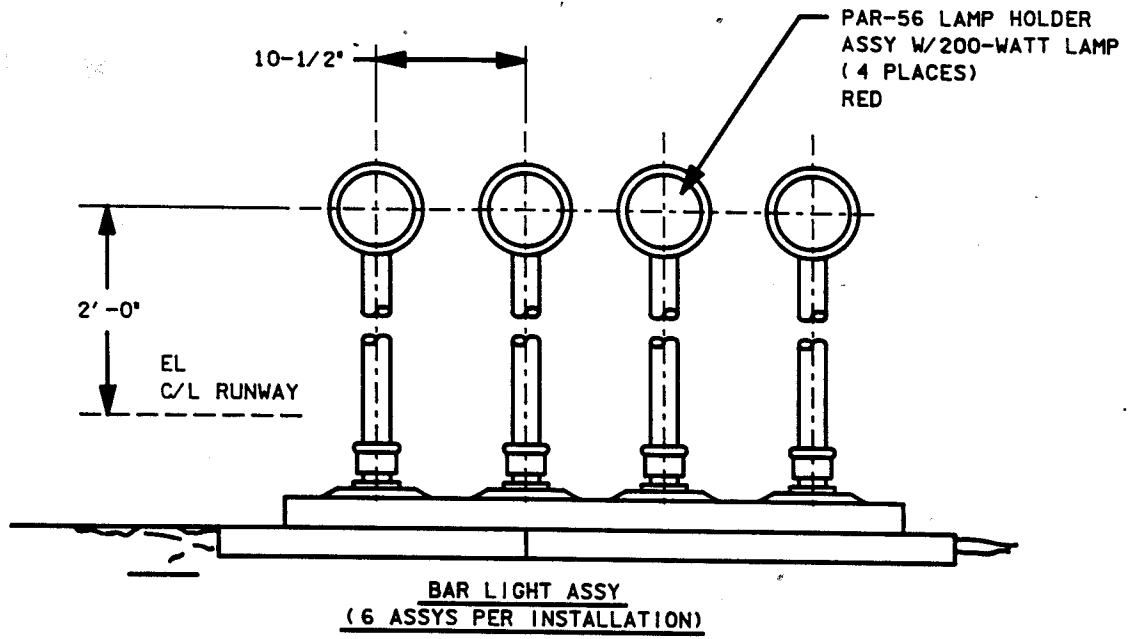

232660300. ART, 1

Figure 3-6.- Bar/ball light assembly.

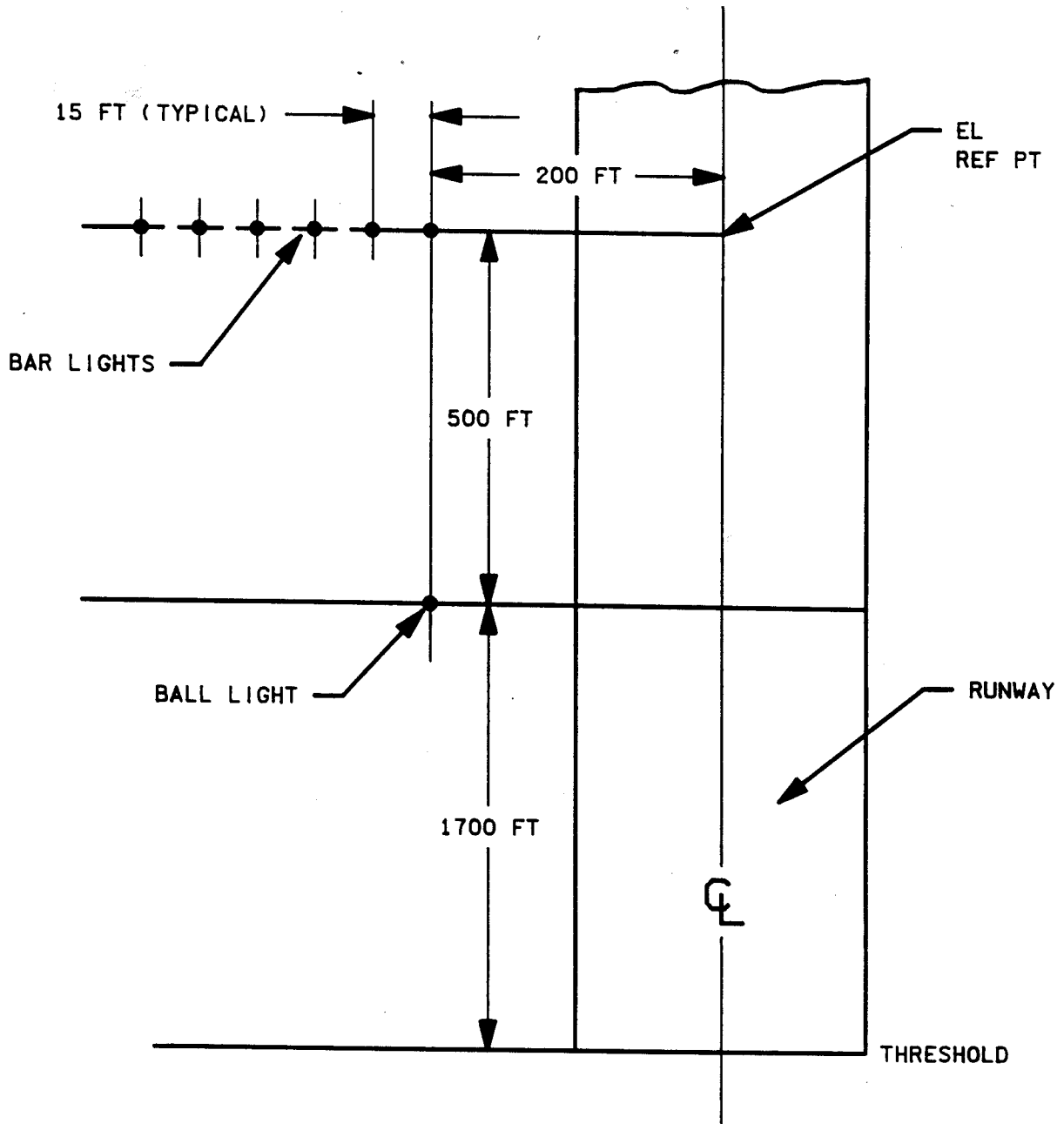

232660007. ART, 2

Figure 3-7.- Bar and light assemblies locations.

3.6 RUNWAY LIGHTING

Where available, the existing runway edge lights are used for night operations. Reflective edge markers are spaced at 200 ft intervals on the MSBLS equipped lakebed runways and at Ben Guerir. A setting of three on a five-step control is desired for orbiter night landing operations.

Approach lighting is required for night landing operations. A Federal Aviation Administration (FAA), military, or International Civil Aviation Organization (ICAO) approach lighting system is adequate for night landing operations. If no approach lighting system is available, it is necessary to implement a portable, fluorescent lantern-type system developed for EDW as described in the attachment. The reef runway at Honolulu International is the only exception.

Xenon light is used for night landing opportunity only. Lights are placed on each side of the runway and elevated to a height necessary to illuminate the T/D and rollout area.

Runway distance remaining markers provide information to pilots during takeoff and landing operations. The marker inscriptions consist of a number denoting in thousands of feet the runway distance remaining.

Shuttle orbiter arresting system (SOAS) runway barriers are provided at preselected sites where surface available for the orbiter landing rollout is less than 12,800 ft. The barrier is located at the departure end of the runway and stops the orbiter within 800 ft of engagement.

3.7 NAVAIDS AND LANDING SITES

Tables A-I and A-II (appendix A) show landing sites available for low and high inclination orbits. All landing sites have at least a TACAN available, while some sites have additional NAVAIDS and landing aids, as shown in table A-III (appendix A).

SECTION 4

A/L TRAJECTORY DESIGN

Approach, landing, and rollout constitute the final phases of the orbiter flight profile. The A/L trajectory was designed to T/D the vehicle safely on the runway within specified constraints. The major constraints at T/D are downrange distance, airspeed, and altitude rate. During rollout, the crew will bring the orbiter to a stop within a specified stopping margin, using a deceleration profile designed to prevent the brakes from overheating.

A typical entry profile (fig. 4-1) enters the atmosphere at an altitude of 400,000 ft, a range from the runway of 4200 n. mi., and a velocity of Mach 26. Twenty-eight minutes later, the vehicle will line up with the runway heading, 42,000 ft downrange of the runway threshold at an altitude of 12,000 ft. At 10,000 ft, the vehicle flies to a reference dynamic pressure of 285 lb/ft², which corresponds to an EAS of 290 kts. T/D occurs 90 sec later. After T/D, the vehicle rolls out and nominally stops 9000 to 11,000 ft down the runway.

4.1 A/L

A/L, as defined in this text, is the approach to the runway beginning at an altitude of approximately 34,000 ft on the HAC and ending at T/D.

The A/L trajectory design allows the orbiter to handle a large variety of dispersions and land safely while adhering to specified ground rules and constraints, including orbiter parameters such as weight (WT) and c.g. Also included are aerodynamic limits and T/D parameters such as distance past the runway threshold, velocity, altitude rates, lateral rates, and energy reserve margin.

4.1.1 A/L Geometry

The A/L trajectory geometry is divided into five segments which are jointly designed to allow the orbiter to handle dispersions and land safely. The first segment is defined in this text as the HAC geometry, from 34,000 to 12,000 ft; the second segment is the prefinal geometry, from 12,000 to 10,000 ft. The other three segments are the OGS, flare and shallow glideslope (FSGS), and FF segments which are defined as the autoland geometry from 10,000 ft to the surface. The A/L geometry is shown in the two sheets of figure 4-2. The first sheet is a perspective of the HAC at prefinal and the three autoland segments. The second sheet depicts these four segments from 12,000 ft to T/D.

The first trajectory segment is the HAC, which is designed to align the orbiter with the runway from any approach heading. The overhead HAC design also provides a geometric means of responding to low-energy dispersions. The second segment is the prefinal geometry, designed to align the orbiter with the runway centerline and provide a transition to autoland guidance.

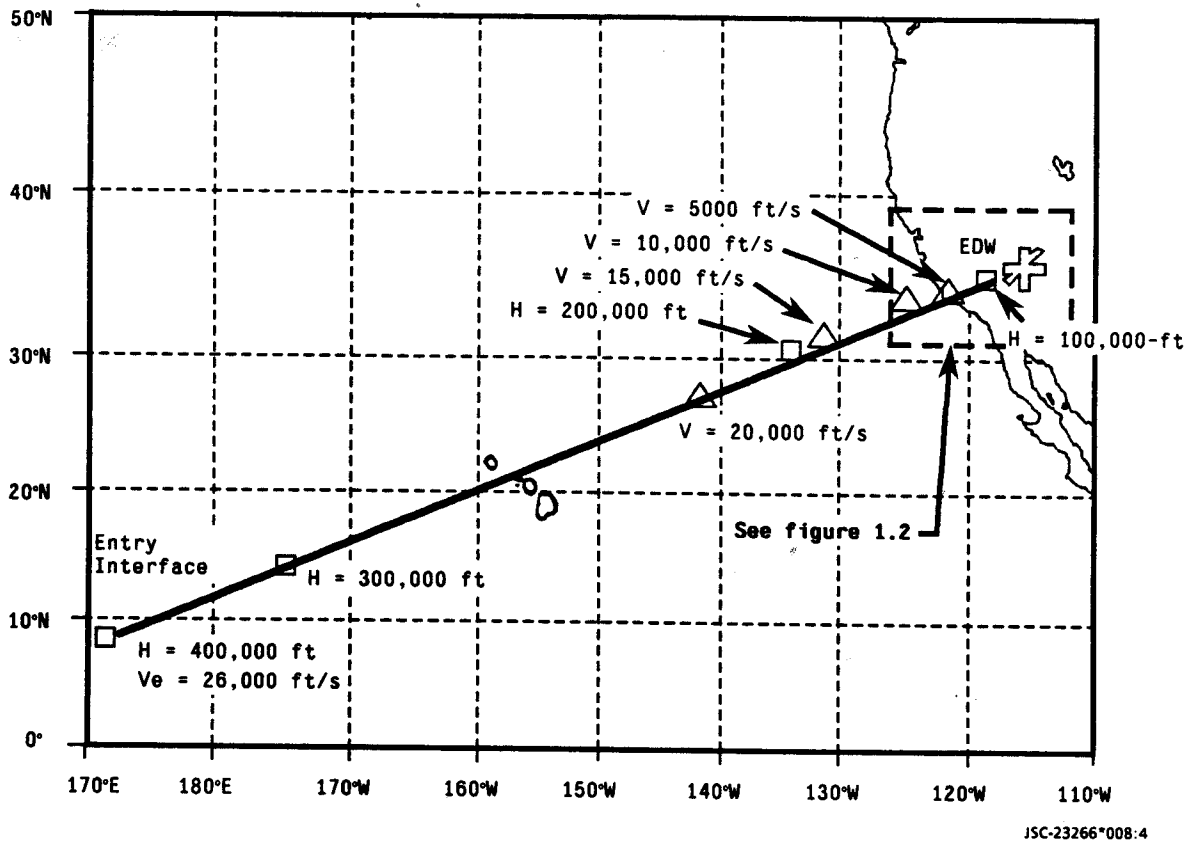
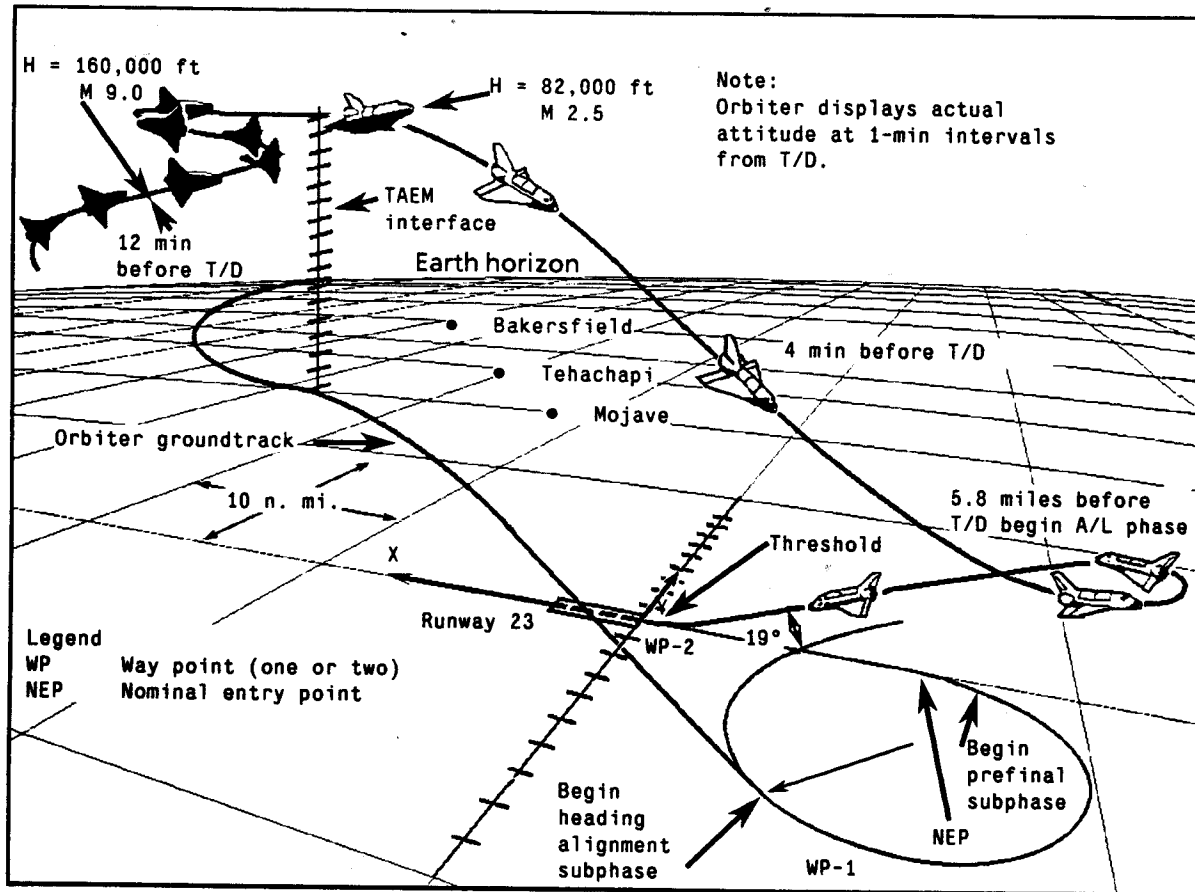

Figure 4-1.- Typical entry profile.



JSC-23266*009

Figure 4-1.- Concluded.

APPROACH AND LANDING PROFILE FROM 50,000 FT TO TOUCHDOWN

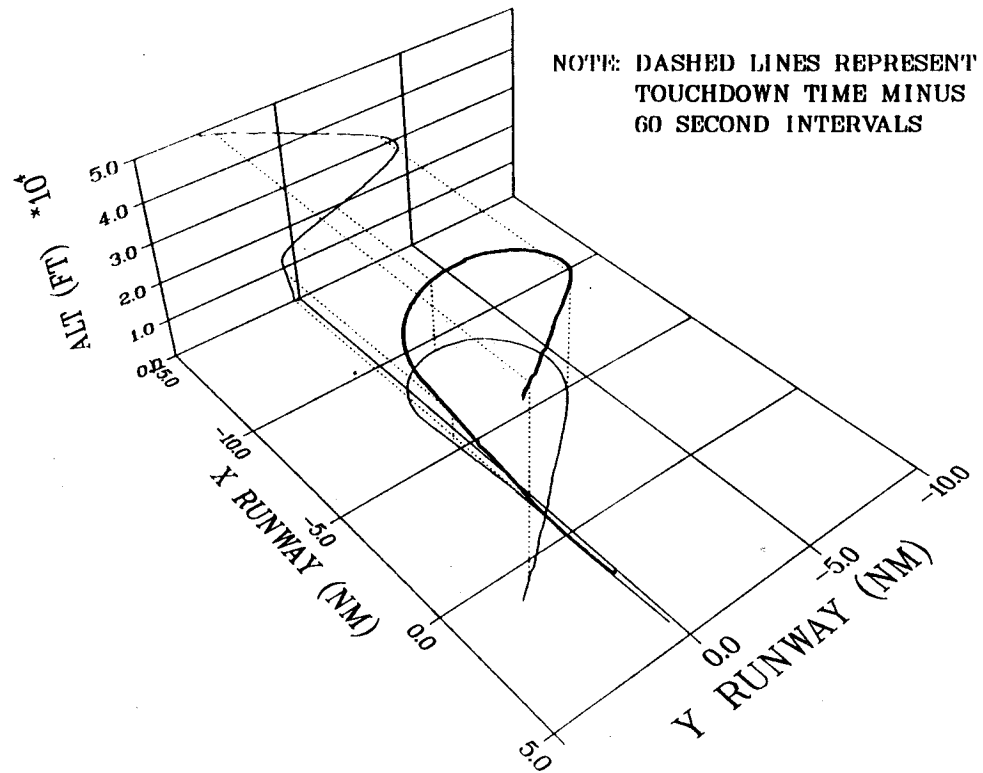

4-4

Figure 4-2.- A/L profile from 50,000 ft to T/D.

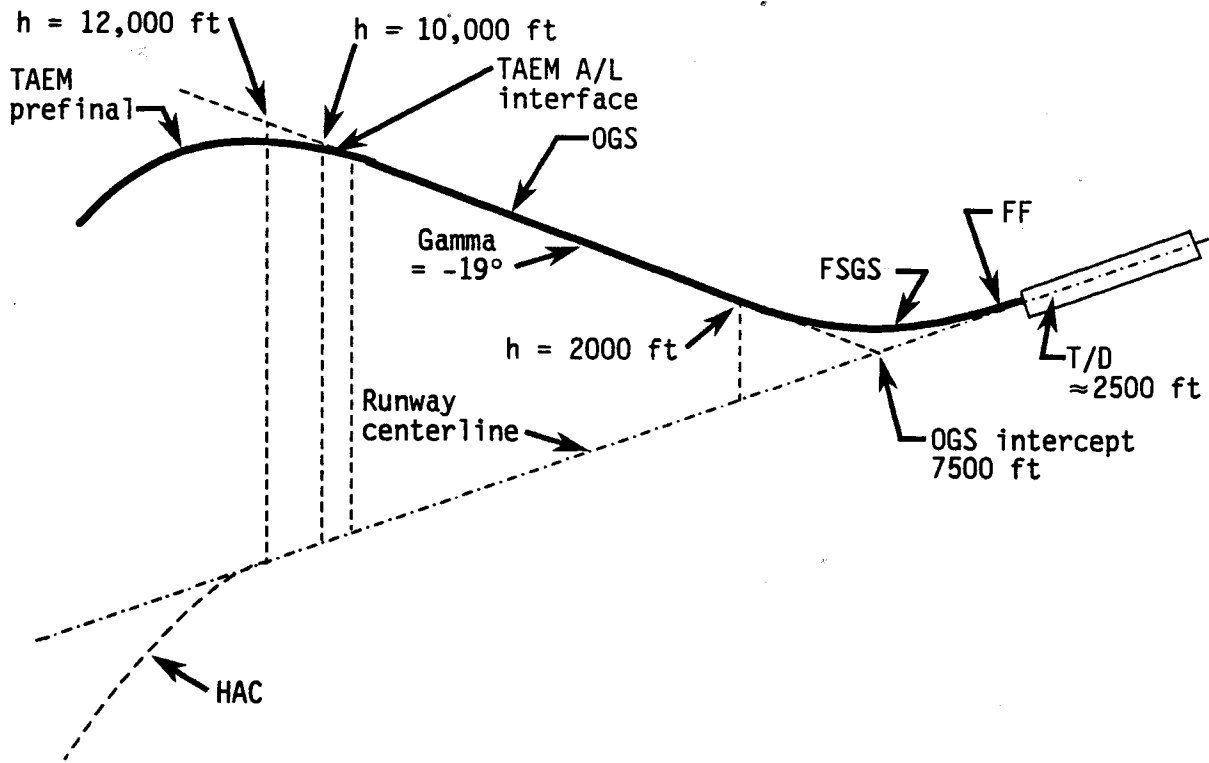

JSC-23266*011:4

Figure 4-2.- Concluded.

These two geometries correspond to the last two phases of TAEM guidance. The purposes of these two phases of TAEM guidance are to maintain a reference energy profile and to meet the autoland transition criteria, reference geometry, and velocity shortly after acquiring the runway centerline. Normally, this portion of the approach is flown manually with CSS, while the pilot monitors the guidance commands. A partial summary of TAEM guidance is shown in table 4-I.

The remaining three geometry segments were designed to allow A/L guidance to control the orbiter energy state, enabling the vehicle to meet the landing ground rules and constraints. These segments correspond to the autoland guidance subphases. A summary of autoland guidance laws is shown in table 4-II. This portion of the trajectory is generally flown in CSS. The OGS (steep) is designed to maintain an equilibrium glidepath which should provide sufficient energy at preflare to result in a safe landing. The FSGS provides a smooth transition between the OGS and IGS. The IGS (shallow) is designed to provide time for final adjustments to prepare for landing. FF is designed to reduce the altitude rate for T/D.

Appendix B lists the vehicle constraints during A/L. Detailed discussions of the A/L geometry are in sections 4.2 through 4.6. These discussions include design history, current design, and performance. Section 5.4 is a discussion of the SB operation, which is the energy controller for the orbiter during the A/L trajectory. The final discussion, section 5.7, is the overall landing performance capability for A/L.

TABLE 4-I.- PARTIAL TAEM GUIDANCE SUMMARY

| | | |
|-----------------------|------------------------------------------------------------------------------------------------------------------------------------------------------------------------------------------------------------------------------------------------------------------------------------------------------------------------------------------------------------------------------------------------------------------------------------------------------------------------|-------------------------------------------------------------------------------------------------------------------------------|
| Phase | Heading alignment IPHASE = 2 | Prefinal IPHASE = 3 |
| Purpose | Final energy adjustment, line up for autoland | Acquire center line. Prepare for autoland |
| Guidance laws | <p style="text-align: center;">L o n g i t u d i n a l</p> $Nz_c = F(\Delta H, \Delta H)$ <p>limited by \bar{q} and, energy over-weight (E/W) corridors vs. Mach priority $\bar{q} \rightarrow EOW \rightarrow$ (altitude) H δSB is const, $M > .95$ $\delta SB = NOM - G1\Delta\bar{q} - G2f\Delta\bar{q}$, $M < .g$</p> | limited by \bar{q} corridor |
| | <p style="text-align: center;">L a t e r a l</p> $\phi_C = [YSGN^* \tan^{-1} \frac{V^2}{g r_{turn}} + GR \Delta R + GR \Delta R]$ <p>YSGN=+1 RT HAC, -1 LT HAC</p> | $\phi_C = -G\gamma\gamma - G\gamma\gamma$ |
| Exit transition logic | $RPRED < RPRED3$ or $H < HMIN3$ $(RPRED3 = -XHAC + DR3)$ | $\{ HERROR < (H D1 - D2)$ $ Y < (H Y1 - Y2)$ $ GAMMA ERR < (HG1 - G2)$ $ QBERR < Q1$ $(H1 > H)\}$ or $H < H2$ |
| Nav sensors | IMU's ¹ TACAN MSBLS | IMU's TACAN MSBLS |

¹Inertial measurement units.

TABLE 4-II.- AUTOLAND GUIDANCE SUMMARY

| Subphase | | TRAJ. capture Pmode=1 | Steep glide Pmode=2 | FSGS Pmode=3 | | | FF Pmode=4 |
|------------------------------------------------------------------------------------------------------|-------------------------------|----------------------------------------------------------------------------------------------------------------------------------------------------------------------------------------------------------------------------------------------------------------------------------------------------------------------------|--------------------------------------------------------------------------|-------------------------------------------------------------------------|-------------------------------------------------------------------------|--------------------------------------------------------------------------------|------------------------------------------------------|
| Subfunction | | N.A. | N.A. | Pullup Fmode=1 | Circularize Fmode=2 | Exp. capture Fmode=3 | N.A. |
| Purpose | | Acquire OGS | Track OGS and establish preflare speed | Initiate first flare | Track constant load flare circle | Exponential capture of IGS | Reduce HDOT to desired T/D value |
| Guidance laws (H > 7500' $\phi_{MAX} = 45^\circ$ H < 7500' $\phi_{max} = 20^\circ$) | Δ N Z C | $K_H \Delta H + K_H \dot{\Delta H}$ | $K_H \Delta H + K_H \dot{\Delta H} + K_f \dot{f} \Delta H$ SEE NOTE 2 | Open loop f(time, speed, and radius) | $K_H \Delta H + K_H \dot{\Delta H} + NZOPENLOOP + K_f \dot{f} \Delta H$ | Reference function change | $K_H \Delta H + NZOPENLOOP$ |
| | δ S B C | $K_{EAS} \Delta EAS + SB_REF$ | $K_{EAS} \Delta EAS + SB_REF + K_f \dot{f} \Delta EAS$ SEE NOTE 3 | SB retract at H = 3000 ft $\delta SBC = \text{const}$ fwind dt | SB adjust at H = 500 ft 50° max. limit; TAL no limit | | $\delta SBC = \text{const}$ |
| | ϕ C M D | $K_Y \Delta Y + K_Y \dot{\Delta Y} + K_f \dot{f} \Delta Y$ SEE NOTE 1 | → | → | → | → | → |
| Exit transition logic | | $\Delta \gamma < 2^\circ$ and $\Delta H < 50$ ft or $\Delta \gamma < 2^\circ$ for 4 sec (continuously) | H < HFLARE (2000') | H < H_CLOOP (1700') | X > X_EXP (-4562') [lightweight, nominal X_zero] | H < H_FF (80') and H < H_FINAL [A f(HDOT)] or H < H_MIN (30') | Flat turn = 1 and NZC = 0. at WOWLON = 1 |
| Navigation sensors | | The IMU is used to propagate the state vector. TACAN AND BARO altitude OR MSBLS are used for refinement via the Kalman filter. MSBLS is always prime if data good. If MSBLS is lost above 1500 ft or never acquired, use TACAN to 1500 ft and BARO to 500 ft. If MSBLS is lost below 1500 ft, just propagate the IMU only. | | | | | |

① Notes:

1. If autory=off; Y_INT=0.
2. If autop=off; NZ_C2I=0.
3. If $\delta SBC > 98.6$ OR $< 0.$;
DEL_INT=0.

- ΔNZC controls alpha
- δSBC controls EAS on the OGS
- δSB retract angle controls T/D energy

- Landing gear deployed
at H = 300 ft (NON FSSR)
- Body flap retracted first
pass in autoland

4.2 HEADING ALIGNMENT CONE AND PREFINAL

4.2.1 Overview

After the orbiter speed decreases below Mach 2.5, the vehicle enters the terminal area energy management (TAEM) phase of descent guidance. TAEM guidance delivers the vehicle from an altitude of 82,000 ft (fig. 4-3), at a range to the runway of 60 n. mi. and a speed of Mach 2.5, down to an altitude of 10,000 ft, a range of 6 n. mi., and a speed of 290 KEAS. The orbiter should be ready to enter the final A/L phase of descent guidance. This document addresses only the last two segments of TAEM guidance (the heading alignment segment for descending around the HAC and the prefinal segment used to align the trajectory for A/L). Appendix C.1 contains a discussion of the design and history of the HAC and prefinal portions of the trajectory.

4.2.2 Transition

The orbiter nominally acquires A/L guidance at 10,000 ft. Under certain conditions, though (trajectory errors, navigation errors, excessive HAC winds), the orbiter may fall outside the A/L transition envelope listed in table C-I (appendix C.1). Figures 4-4 and 4-5 show max. in-plane, out-of-plane trajectory errors which can be tolerated and still allow the orbiter to achieve a safe T/D energy.

HAC GROUNDTRACK (WITH ALTITUDE MARKS)

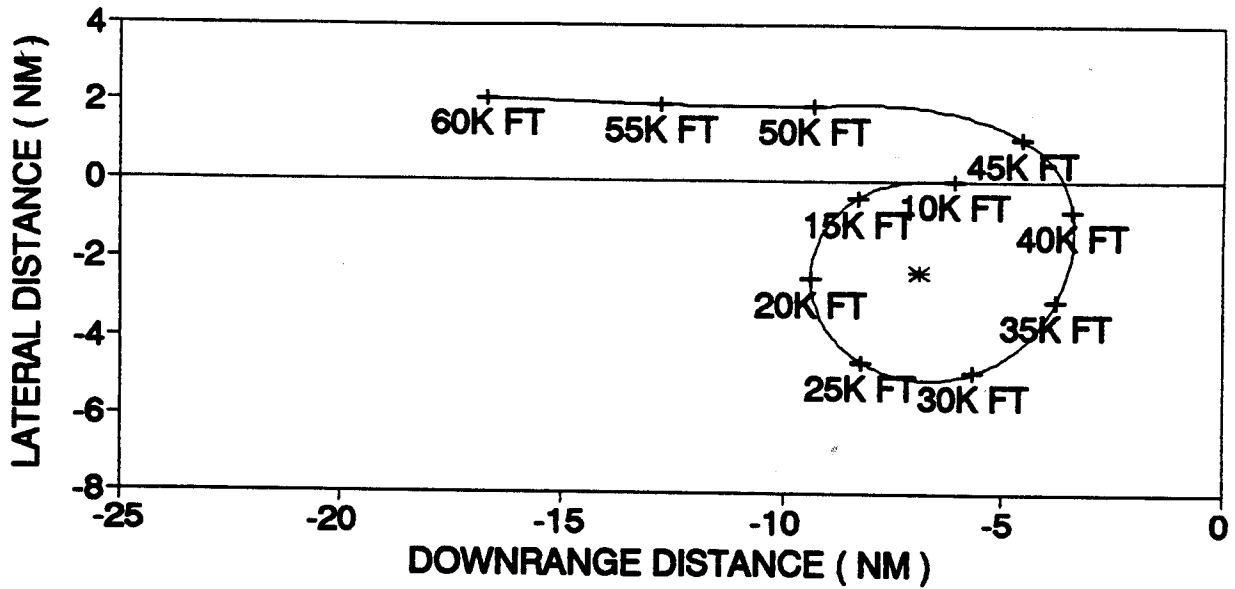

+ VEHICLE ALTITUDE * HAC CENTER

Figure 4-3.- HAC groundtrack.

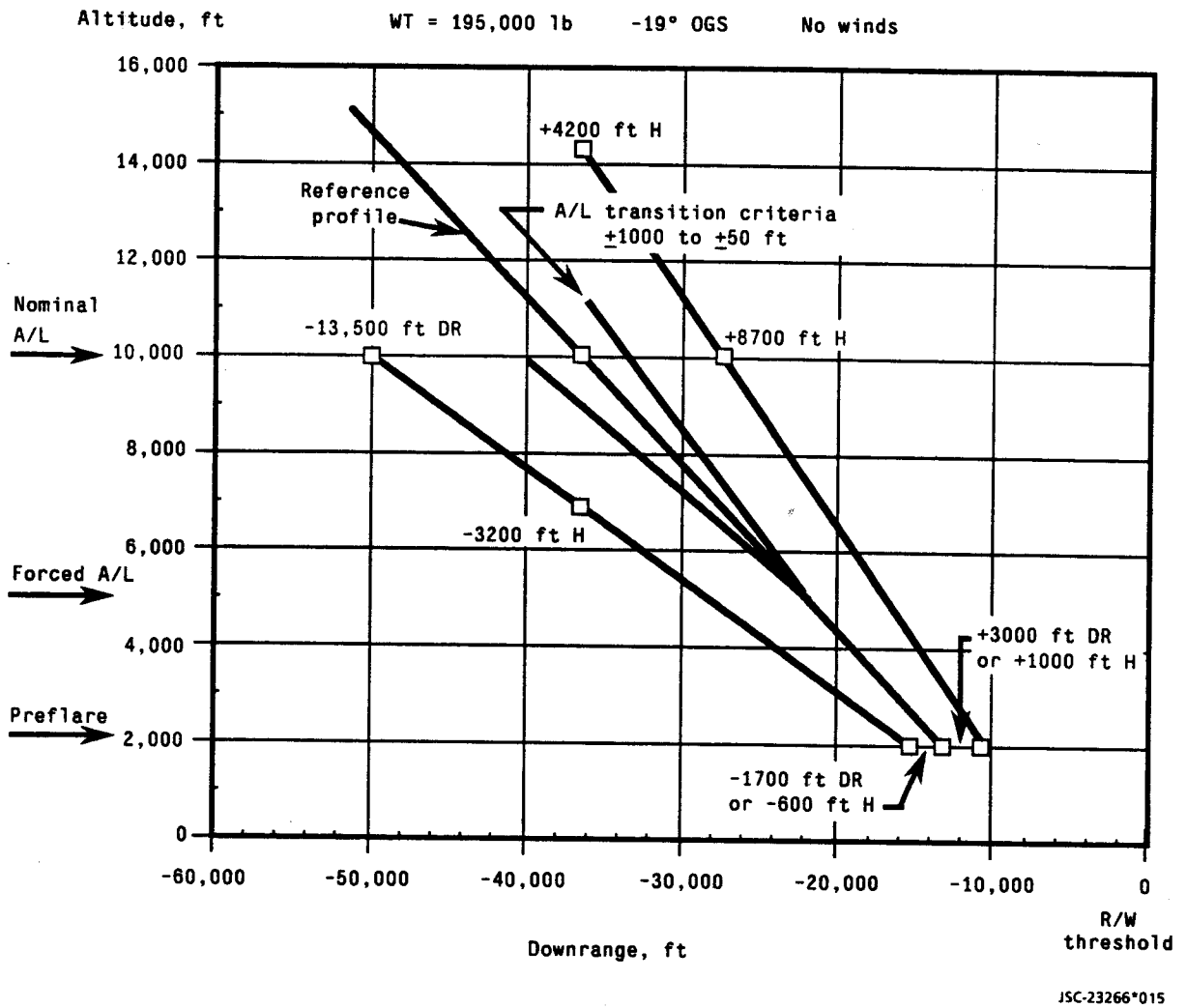
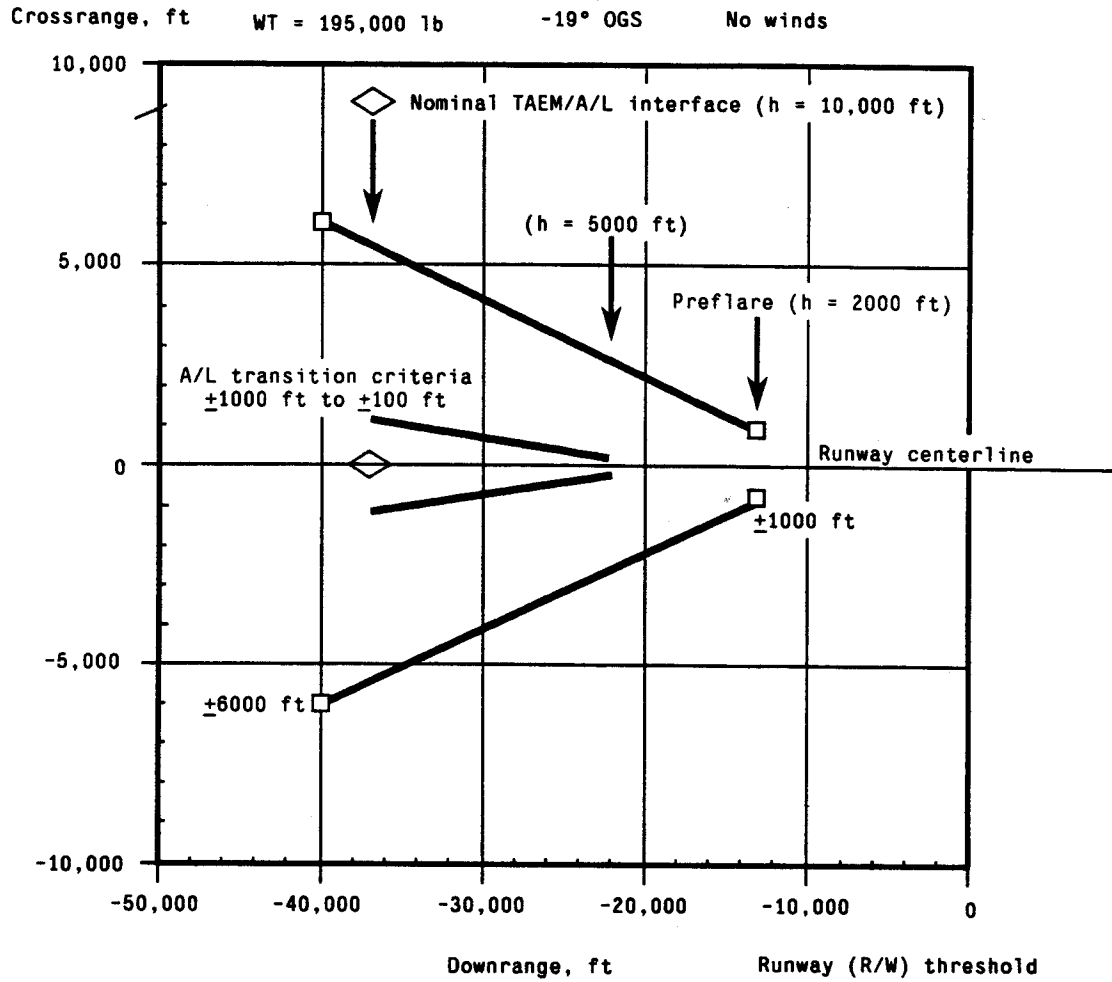

Figure 4-4.- Maximum in-plane dispersion capability.



JSC-23266*016.4

Figure 4-5.- Maximum out-of-plane dispersion capability.

4.3 OGS

4.3.1 Overview

The main purpose of the OGS is to provide an equilibrium glidepath that results in sufficient energy at preflare, which is one of the prerequisites for a safe landing. Preflare is defined as a constant g pullup maneuver, beginning at 2000 ft to arrest the vehicle altitude rate.

The OGS consists of a sloped-line segment that intercepts the ground at a specified distance from the runway threshold. The OGS is nominally acquired at 10,000 ft, autoland interface, but the OGS may be acquired as early as 12,000 ft, which is the altitude of HAC tangency to the runway centerline. The vehicle flies the OGS while maintaining a constant reference velocity until preflare or 2000 ft. The OGS ground intercept is also referred to as the aim point.

Appendix C.2 contains a discussion of the design and history of the OGS portion of the trajectory.

4.3.2 Dispersion Coverage

Figures 4-6 and 4-7 depict OGS dispersion coverage for light and heavyweight vehicles (i.e., 19° and 17° OGS).

a. Dispersion evaluation

Dispersion coverage limits are evaluated in terms of T/D margins greater than 1000 ft for low energy dispersions and rollout margins greater than 2000 ft for high energy dispersions. Low energy cases are evaluated for light vehicle weights, close-in OGS aim point, cold atmosphere, and an early landing gear deploy altitude, while high energy cases are evaluated for heavyweight vehicles, short runways, short-field SB option, hot atmosphere, and a late gear deployment.

The Sperry Design wind is the chosen wind profile for dispersion coverage evaluation. A plot of the profile is located in section 4.4.3. This wind profile has an average integrated windspeed of 38 kts. The wind profile effects are evaluated separately and in combination with WOW dispersed initial conditions that include altitude, velocity, flight-path angle, and pitch attitude.

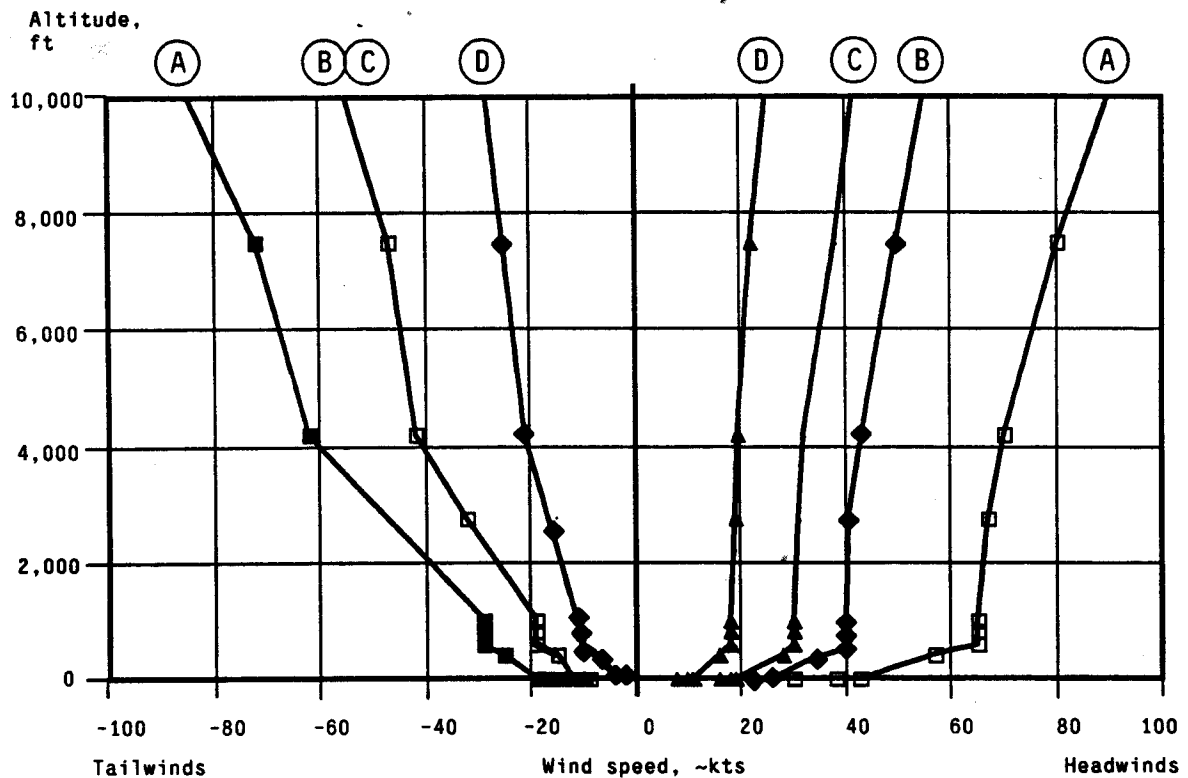

High-Energy Cases - WT = 218,000 lb

- A. 150 percent design tailwinds, EOM field (15,000 ft runway R/W), H-GEAR = 200 ft, H-RHO = 3000 ft, -9 ft/s^2 at VGS = 140 kts
Achieving: 2000-ft rollout margin (B.E.~42M ft-lb)
- B. 100 percent design tailwind profile (reference)
- C. 100 percent design tailwinds, 14,000 ft R/W, Dispersed (IC's), max. Q-bar profile and 1000 ft high, H-GEAR = 200 ft, H-RHO = 3000 ft, -9 ft/s^2 at VGS = 140 kts
Achieving : 2000-ft rollout margin (B.E.~38M ft-lb)
- D. 50 percent design tailwinds, short field ZZA/12,120 ft R/W, -9 ft/s^2 at VGS = 140 kts
Achieving: 2000-ft rollout margin (B.E.~37M ft-lb)

Low-Energy Cases - WT = 202,000 lb
All Used the Close-in X-ZERO

- A. 165 percent design headwinds (only dispersion)
Achieving: 157 KEAS at X = 0 ft (tailscape velocity at the R/W threshold)
- B. 100 percent design headwind profile (reference)
- C. 75 percent design headwinds (only dispersion)
Achieving: 195 KEAS at X = 1000 ft
- D. 45 percent design headwinds, dispersed IC's, min. Q-bar profile and 1000 ft low, H-GEAR = 400 ft, H-RHO = -1000 ft
Achieving: 195 KEAS at X = 1000 ft

JSC-23266*019:4

Unless stated otherwise: H-GEAR = 300 ft and H-RHO = 2000 ft

Figure 4-6.- OGS lightweight dispersion coverage.

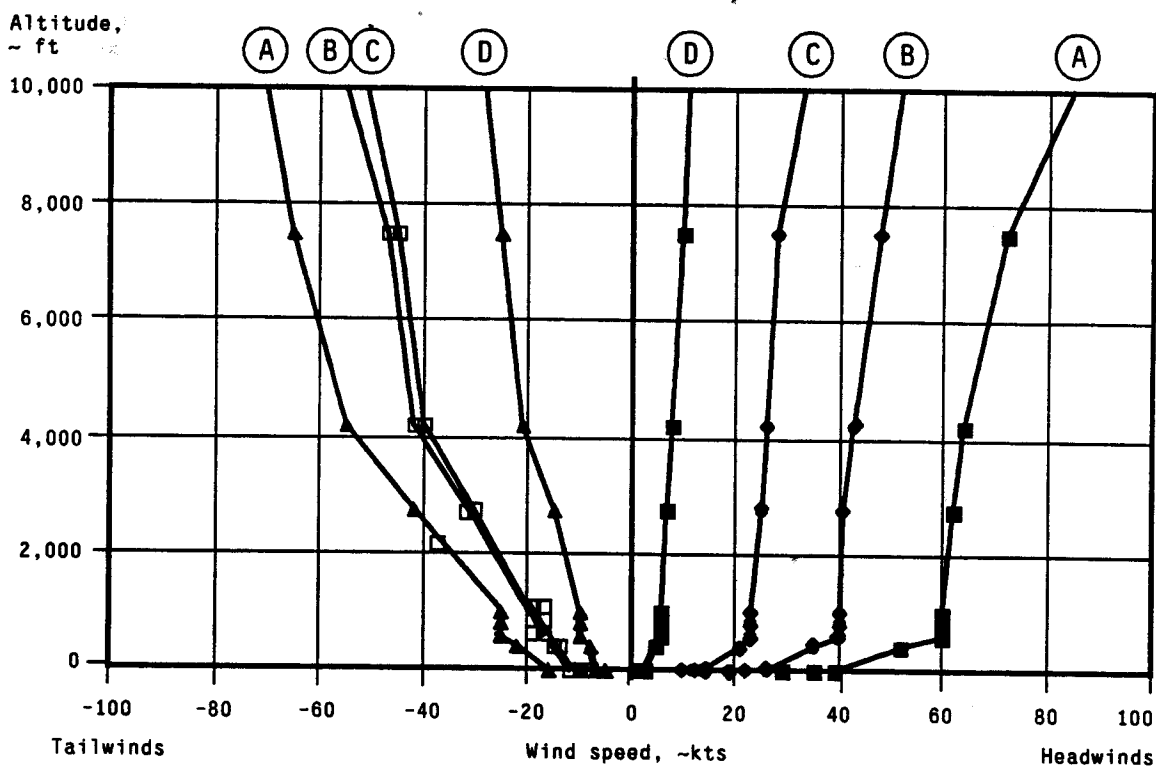

High Energy Cases - WT = 245,000 lb

Low Energy Cases - WT = 230,000 lb
All Used the Close-in X-ZERO

- | | |
|----------------------------------------------------------------------------------------------------------------------------------------------------------------------------------------------------------------------------------------------------------------------------------------------------------------------------------------------------------------------------------------------------------------------------------------------------------------------------------------------------------------------------------------------------------------------------------------------------------------------------------------------------------------------------------------------------------------------------------------|---------------------------------------------------------------------------------------------------------------------------------------------------------------------------------------------------------------------------------------------------------------------------------------------------------------------------------------------------------------------------------------------------------------------------------------------------------------------|
| <p>A. 130 percent design tailwinds (only dispersion) EOM field (15,000 ft R/W), -9 fps² at V = 140 kts Achieving: 2000 ft rollout margin</p> <p>B. 100 percent design tailwind profile (reference)</p> <p>C. 95 percent design tailwinds, EOM field (15,000 ft R/W), dispersed IC's, max. Q-bar profile and 1000 ft high, H-GEAR = 200 ft, H-RHO = 3000 ft, -9 ft/s² at VGS = 140 kts Achieving: 2000 ft ROLLOUT MARGIN (B.E.-42M ft-1b)</p> <p>D. 50 percent design tailwinds, short field, dispersed IC's, max. Q-bar profile and 1000 ft high, BEN/12,730 ft R/W, -9 ft/s² at 5,000 ft remaining, H-GEAR = 200 ft, H-RHO = 3000 ft, Achieving: 2000 ft rollout margin (B.E.-42M ft-1b)</p> | <p>A. 150 percent design headwinds (only dispersion) Achieving: 168 KEAS at X = 0 ft (tailsrape velocity at the R/W threshold)</p> <p>B. 100 percent design headwind profile (reference)</p> <p>C. 60 percent design headwinds (only dispersion) Achieving: 205 KEAS at X = 1000 ft</p> <p>D. 20 percent design headwinds, dispersed IC's, min. Q-bar profile and 1000 ft low, H-GEAR = 400 ft, H-RHO = -1000 ft Achieving: 205 KEAS at X = 1000 ft</p> |
|----------------------------------------------------------------------------------------------------------------------------------------------------------------------------------------------------------------------------------------------------------------------------------------------------------------------------------------------------------------------------------------------------------------------------------------------------------------------------------------------------------------------------------------------------------------------------------------------------------------------------------------------------------------------------------------------------------------------------------------|---------------------------------------------------------------------------------------------------------------------------------------------------------------------------------------------------------------------------------------------------------------------------------------------------------------------------------------------------------------------------------------------------------------------------------------------------------------------|

Unless stated otherwise: H-GEAR = 300 ft AND H-RHO = 2000 ft

JSC-23266*020:4

Figure 4-7.- OGS heavyweight dispersion coverage.

b. Dispersion coverage

High energy performance limits are quite large due to the current SB retract logic's being specifically designed to reduce excess energy. EOM runway lengths tolerated 100 and 95 percent design tailwinds for 19° and 17° OGS, respectively, but the shorter TAL runways tolerated only 50 percent design tailwinds for the same GS. Tolerated is defined in this instance as greater than 2000 ft rollout margin.

The low energy performance limits are not as large as high energy. With wind as the only dispersion, 75 and 60 percent design headwinds can be tolerated by the 19° and 17° GS, where tolerated is defined as a T/D margin of 1000 ft. With combined WOW conditions only 50 and 20 percent design headwinds can be tolerated. WOW days can tolerate only small headwinds.

4.3.3 Guidance and Control

The goal of guidance during the OGS is to maintain the reference airspeed of 290 KEAS and the reference GS of -19° or -17°. Guidance computes a normal acceleration command to guide the orbiter along the steep GS trajectory. This is converted to a pitch command. If the pitch command results in a velocity that is different from the reference, the SB responds to correct the velocity error. If the filtered velocity is below the reference velocity, the SB closes proportional to the velocity error. If the filtered velocity is higher than the reference, the SB opens.

Generally, the pilot will fly pitch and R/Y in the CSS flight control mode and the SB in the auto mode. The next section discusses SB in detail. The BF is also flown in AUTO and is commanded to retract to the trail position (0°) on the first autoland guidance pass.

4.3.4 Phase Switching

The OGS normal altitude range is from 10,000 to 2000 ft. The beginning of the OGS is a function of meeting autoland interface transition criteria. This is discussed in the heading alignment section. The termination of the phase is at preflare, which in autoland guidance is the beginning of the FSGS geometry phase (altitude less than 2000 ft).

4.4 SPEEDBRAKE

4.4.1 Overview

The purpose of the SB during A/L is to actively control the orbiter EAS on the HAC and OGS and control the orbiter energy at T/D. To control the orbiter EAS on the HAC, the SB is commanded to maintain a reference dynamic pressure. On the OGS the SB responds directly to errors in EAS to maintain the reference value of 290 kts. To control the orbiter T/D energy, the SB is retracted at 3000 ft to a value calculated by onboard guidance that targets the remaining velocity profile to a fixed T/D energy. This calculated SB retract angle is a function of the windspeed, vehicle WT, velocity error, and density altitude. The retract value is maintained until 500 ft, when the autoland guidance calculates an adjustment to the retract angle. This adjustment is based on any changes in winds and predicted density altitude since the 3000-ft calculation. No more adjustments are made until T/D. At the WOWLON indication the SB is commanded full open. Generally, the SB is in auto throughout A/L. Figure 4-8 is a block diagram of the SB commands during A/L.

4.4.2 SB Control During Heading Alignment and OGS

SB commands during the heading alignment phase are proportional to the filtered dynamic pressure error. This error is the difference between the actual dynamic pressure (Q -bar) and the reference Q -bar, which is a function of range. The heading alignment reference Q -bar is designed to maintain acceptable margins between the structural maximum Q -bar limit and the aerodynamic minimum Q -bar limit. The final segment of the heading alignment reference Q -bar profile is designed to ramp up to the same velocity as the autoland reference EAS to ensure a smooth SB command transition at autoland guidance interface.

From A/L interface to 3000 ft altitude the SB is modulated to maintain the reference EAS. The SB and pitch commands on the OGS are interrelated. If the pitch command results in an airspeed that is different from the OGS reference value of 290 KEAS, the SB responds to correct the error. Onboard the airspeed is filtered before it is used in guidance calculations to avoid overcontrolling for small wind gusts. When the filtered airspeed is below or above the reference value, the SB closes or opens, respectively, to the error magnitude.

Since the OGS design results in a mid-SB effectiveness of 65° for a midrange WT, the SB can respond to both high and low energy dispersions. Figure C.2-2 (presented in the OGS section of appendix C.2) shows the variation of trimmed SB with WT along constant GS lines.

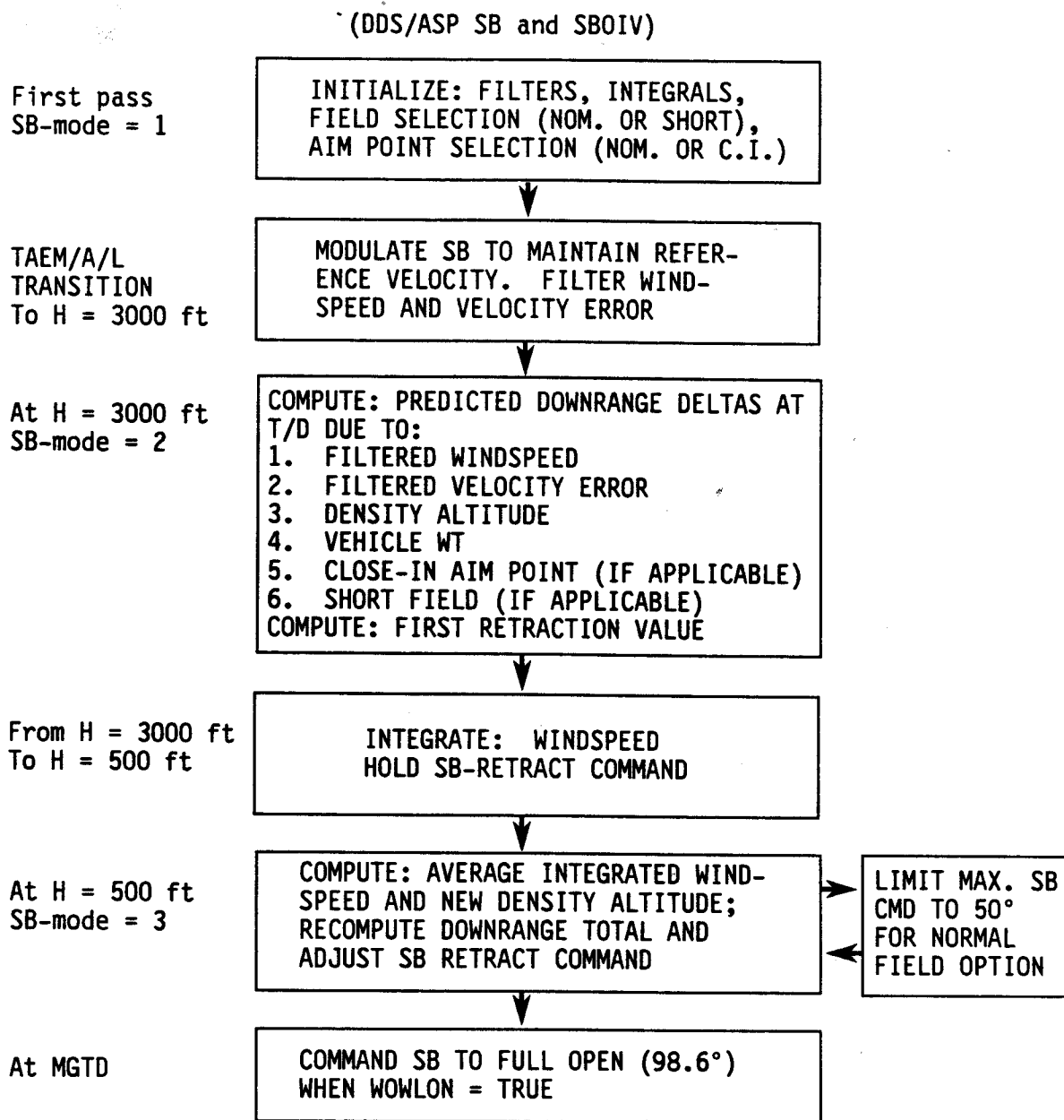

JSC-23266*021:4

Figure 4-8.- SB command block diagram.

4.4.3 SB Retract

The current SB retract logic was first used on STS-51D. The SB is retracted at 3000 ft to an angle that is a function of the windspeed, vehicle WT, velocity error, and density altitude. The retract angle is maintained until 500 ft when an adjustment is made that is a function of any changes in winds and predicted density altitude that occurred since the 3000-ft calculation.

a. Early retract logic

Prior to the current SB logic there were three retraction altitudes: 2500 ft nominal, 1000 ft high energy, and 4000 ft low energy. The first four flights retracted the SB to 5°. The minimum SB angle (during entry) for OV-099 had to be increased to 15°. Starting with STS-5, the minimum SB angle was software limited to 15° for all vehicles for continuity.

The top of figure 4-9 is an illustration of the early SB logic. Example: If the filtered SB position was $>40^\circ$ at 4000 ft, the SB did not retract. If the filtered position was $<40^\circ$, the SB retracted to 15°. There were several shortcomings with this logic, primarily that the filtered SB position was used to determine which retraction altitude to use. The retract decision was too susceptible to wind shears/gusts and was very unpredictable. Once the SB was retracted, it could not be adjusted. This retraction logic was capable of causing the opposite effect than desired due to the SB behavior in changing winds.

Large trajectory energy deviations could be manually compensated for on the lakebeds, but on concrete runways everything was more critical. A manual SB retract technique existed for TAL landings, but the availability of good atmospheric data and/or communications was questionable. Also, the primary TAL landing site for most flights required using a runway that was less than 12,000 ft long. This short runway was creating rollout margin and brake energy problems. The pilots expressed a need for tighter T/D energy control and possibly a short-field landing option for autoland guidance.

b. Development of current retract logic

The current SB retract logic was developed to reduce T/D energy dispersions. The first step in developing the logic was determining the major parameters that caused errors in T/D energy. These were identified as winds, vehicle WT, velocity error, and density altitude.

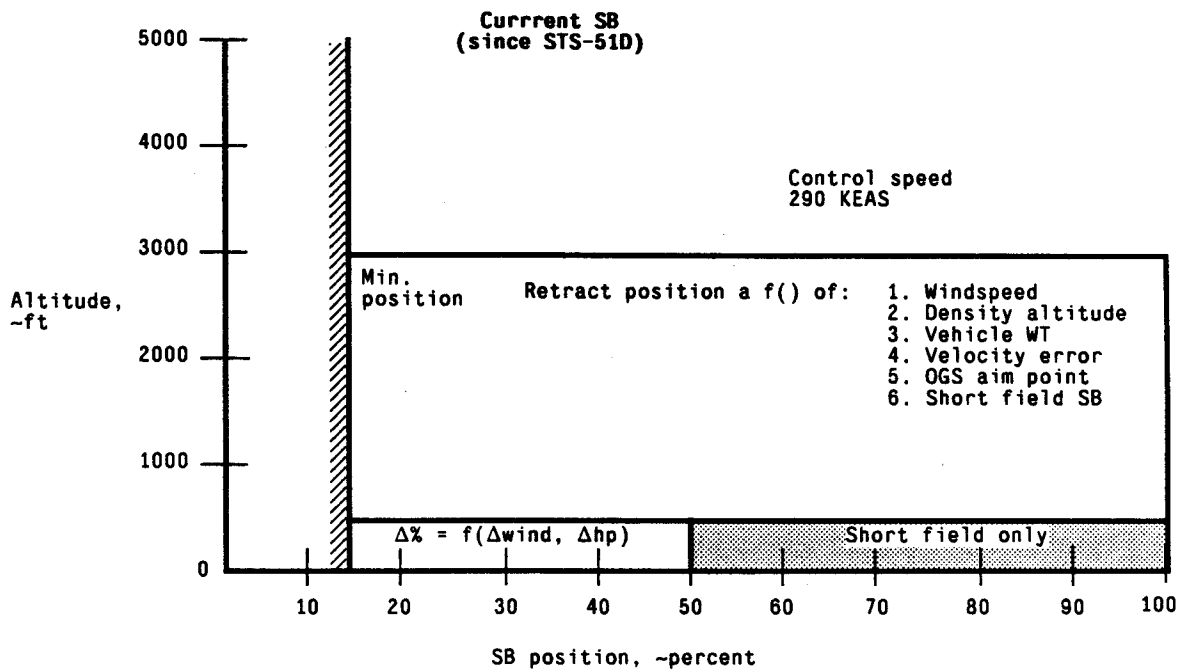
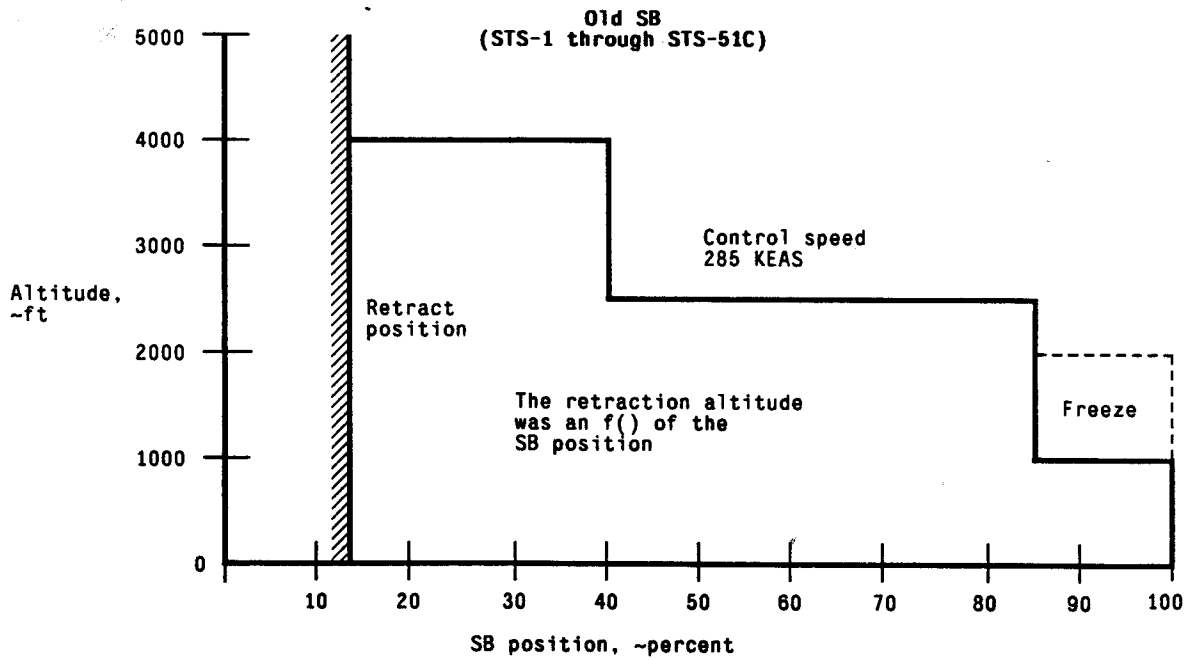

JSC-23266*022:4

Figure 4-9.- SB retract logic (old vs. current).

The next step was to build into autoland guidance the sensitivity of each of these parameters on T/D performance, and then develop an algorithm to calculate an SB retract value which would result in a constant T/D energy. An existing concept (see nomographs in sec. 4.15 and appendix D.5) which used measured wind and density altitude data and known vehicle WT converted each parameter effect into a downrange delta. The downrange deltas were added together, and if the total delta was positive, then excess energy existed and an SB retract position was calculated that would eliminate this delta. If the downrange delta was negative, the SB was retracted to the minimum position (15°) so as to minimize the velocity losses. Also included in this overall downrange delta, besides the previously mentioned parameters, were the close-in aim point and short-field option effects.

The final step was determining a method to predict this information onboard using available data. The downrange delta concept was rewritten to use onboard parameters to calculate the perturbing factors, the downrange deltas, and the retract position.

The current SB logic uses one retraction altitude, 3000 ft. An adjustment to the SB retract angle is made at 500 ft altitude. The 500 ft adjustment altitude was selected because the time to fly from 3000 to 500 ft is approximately the same time as the time to fly from 500 ft to the surface. This altitude selection allows time for the adjustment to have an effect on the vehicle energy state. Nominally, it takes 17 sec to fly from 3000 to 500 ft and 23 sec from 500 ft to the surface.

The bottom of figure 4-9 is an illustration of the current SB retraction logic. The downrange sensitivities of the different parameters used to calculate the SB retract angle are presented in figure 4-10. Each of the parameters used in calculating the downrange total for this logic is discussed below.

c. Downrange delta sensitivities

(1) Windspeed

Windspeed is the major driver of SB position. Windspeed can dramatically change the energy state of the vehicle. The effects of wind must be measured over time. Predicting downrange deltas based on an instantaneous value of wind does not account for wind shears and direction changes. This was the primary reason for adding the SB retract adjustment altitude at 500 ft.

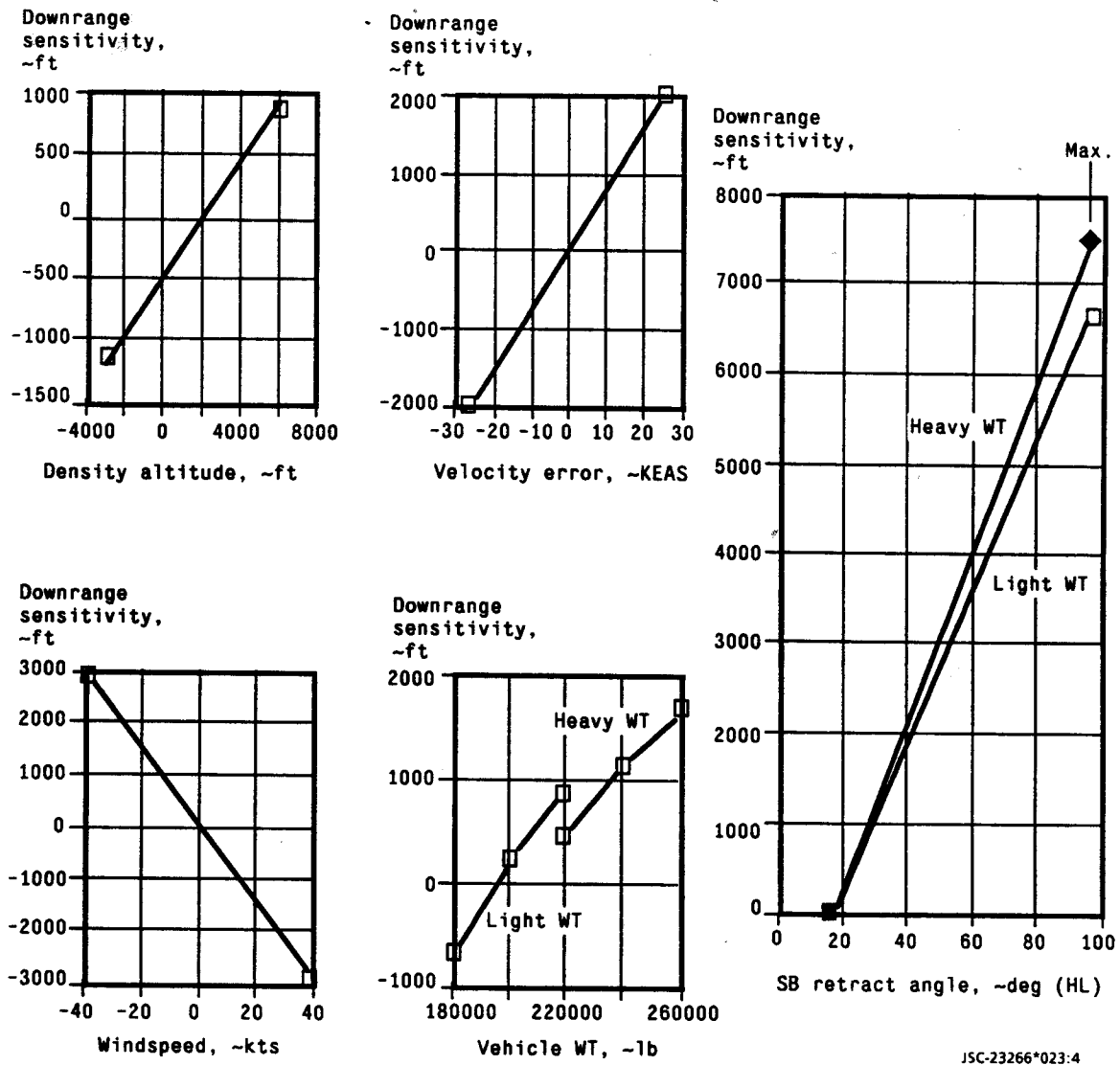

Figure 4-10.--SB command downrange sensitivity.

The filtered windspeed is used to predict a downrange delta for the 3000-ft SB retraction calculation. The windspeed equation computes the difference between the horizontal component of the filtered true airspeed (TAS) and the groundspeed. The calculated windspeed is filtered to reduce the effects of wind gusts, particularly for the 3000-ft retraction calculation. Starting at 3000 ft, the filtered windspeed is integrated until 500 ft, when the accumulated total is divided by the total time of guidance passes. This average integrated windspeed is used in the 500-ft adjustment to the SB retract angle. An assumption made in calculating the downrange delta, based on calculated windspeed, was the shape of the remaining (last 500 ft) wind profile. The design profile shape is assumed to exist. The design wind profile is shown in figure 4-11. If the actual wind profile differs significantly from the design profile shape, the downrange delta for windspeed may be overcompensating (or undercompensating).

The predicted downrange delta for windspeed works best for large winds. The guidance-calculated windspeed for small winds may be inaccurate, but the corresponding downrange delta are small and insignificant.

(2) Velocity error

The downrange delta term for velocity error is added to correct for velocity errors that occur at 3000 ft due to off-nominal trajectory deviations or wind gusts. This downrange delta is determined by differencing the filtered EAS and the reference value of 290 KEAS at 3000 ft. This term does not change at 500 ft, since velocity error is no longer calculated onboard after 3000 ft. There is no reference velocity profile after 3000 ft.

(3) Density altitude

The downrange delta for density altitude is added to account for the fairly significant effect it has on T/D energy. The density altitude is calculated as the squared ratio of filtered EAS divided by the filtered TAS. The EAS and TAS used in guidance are calculated by the air data subsystem operating program (ADSOP). There are slight errors in this calculation onboard, since the TAS is a function of temperature, and temperature is a table lookup from

onboard I-loads instead of the air-data-probe-measured temperature. The accuracy of the density altitude prediction depends on the slope of the actual atmosphere being similar to the 62 standard atmosphere slope. This slope is used to predict the density at the surface. The downrange delta term is recalculated at 500 ft to account for any temperature and density slope changes since 3000 ft.

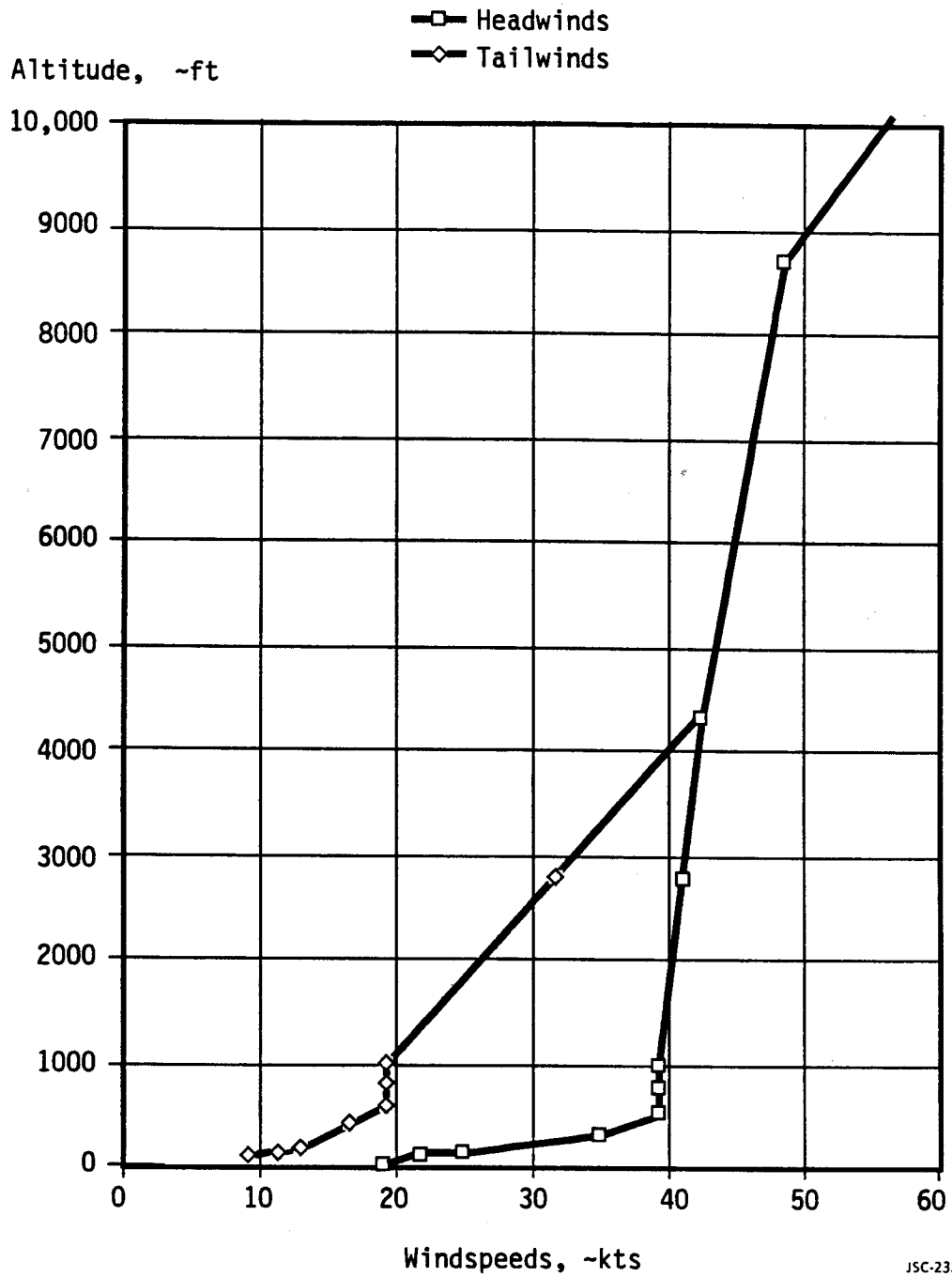

JSC-23266*024:4

Figure 4-11.- A/L design wind profiles.

There is an interrelationship between the wind calculation and density altitude calculation. This relationship is advantageous; if one undercompensates, the other overcompensates. Approximately half the downrange delta prediction error due to density altitude is counterbalanced by an error in windspeed calculation. These errors are due to using two sets of ADSOP temperature profiles for all flights.

(4) Vehicle WT

The downrange delta for vehicle WT targets all vehicles to land with the same T/D energy. This fixed target energy was designed to reduce T/D dispersions and allow for much better velocity monitoring after preflare compared to the previous retract logic.

(5) Close-in aim point

When the close-in aim point is selected, 1000 ft is directly added to the downrange total. The idea is to keep the same T/D energy target when the geometry is shifted in by 1000 ft and let the vehicle respond to the atmospheric conditions that required the close-in aim point.

(6) Short-field option

Also, when the short-field option is selected, 1000 ft is directly added to the downrange total. This, though, changes the target T/D energy. The short-field option is used to decrease energy from the trajectory and decreases rollout distances by 1000 ft. This option is usually selected for TAL runways of less than 13,000 ft to maintain the 2000-ft rollout margin.

d. Maximum SB

The maximum allowable SB retract angle from 500 ft to T/D is 50° for the nominal field-SB retract option. This maximum value is set because of the degradation of orbiter handling qualities near T/D with SB retract angles greater than 50°. This maximum limit is not set with the short-field option. The short-field SB retract option has no special limit.

4.4.4 SB at T/D

After the SB retraction angle is adjusted at 500 ft, the guidance command remains constant until WOWLON. At WOWLON the SB is commanded full open.

4.5 FSGS

4.5.1 Overview

The purpose of the FSGS phase is to transition the trajectory from the OGS to the IGS. The flightpath geometry consists of a giant pullup circle and an exponential to the IGS (figs. 4-12 and 4-13). On the OGS the altitude rate is approximately -190 ft/s which must be arrested to -3 ft/s at T/D. The FSGS phase nominally reduces the altitude rate to -12 ft/s, leaving the remainder to be arrested during the FF phase. Appendix C.3 contains a discussion of the design and history of the FSGS portion of the trajectory.

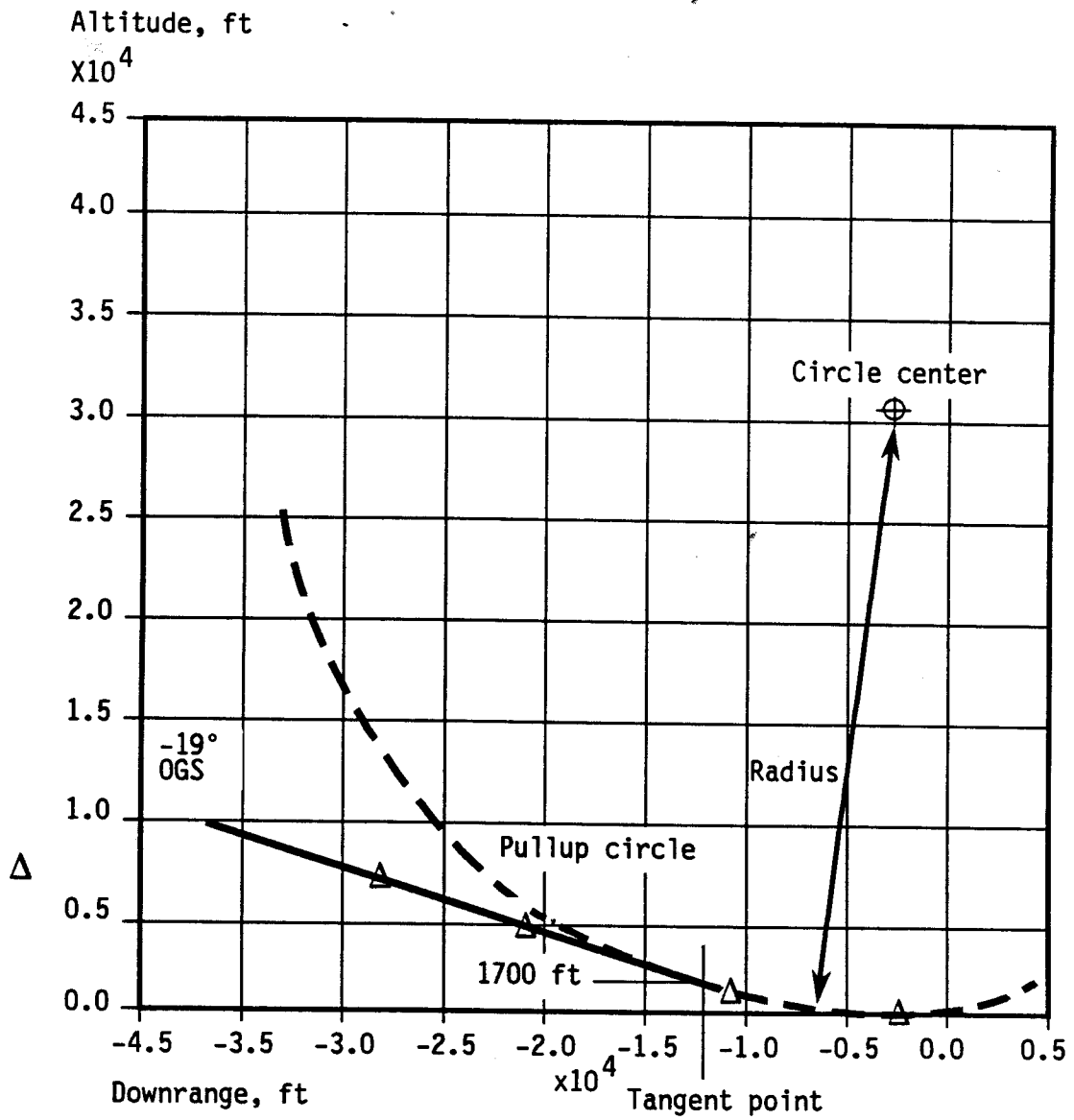

— Plot 1

JSC-23266*025:4

Figure 4-12.- Pullup circle.

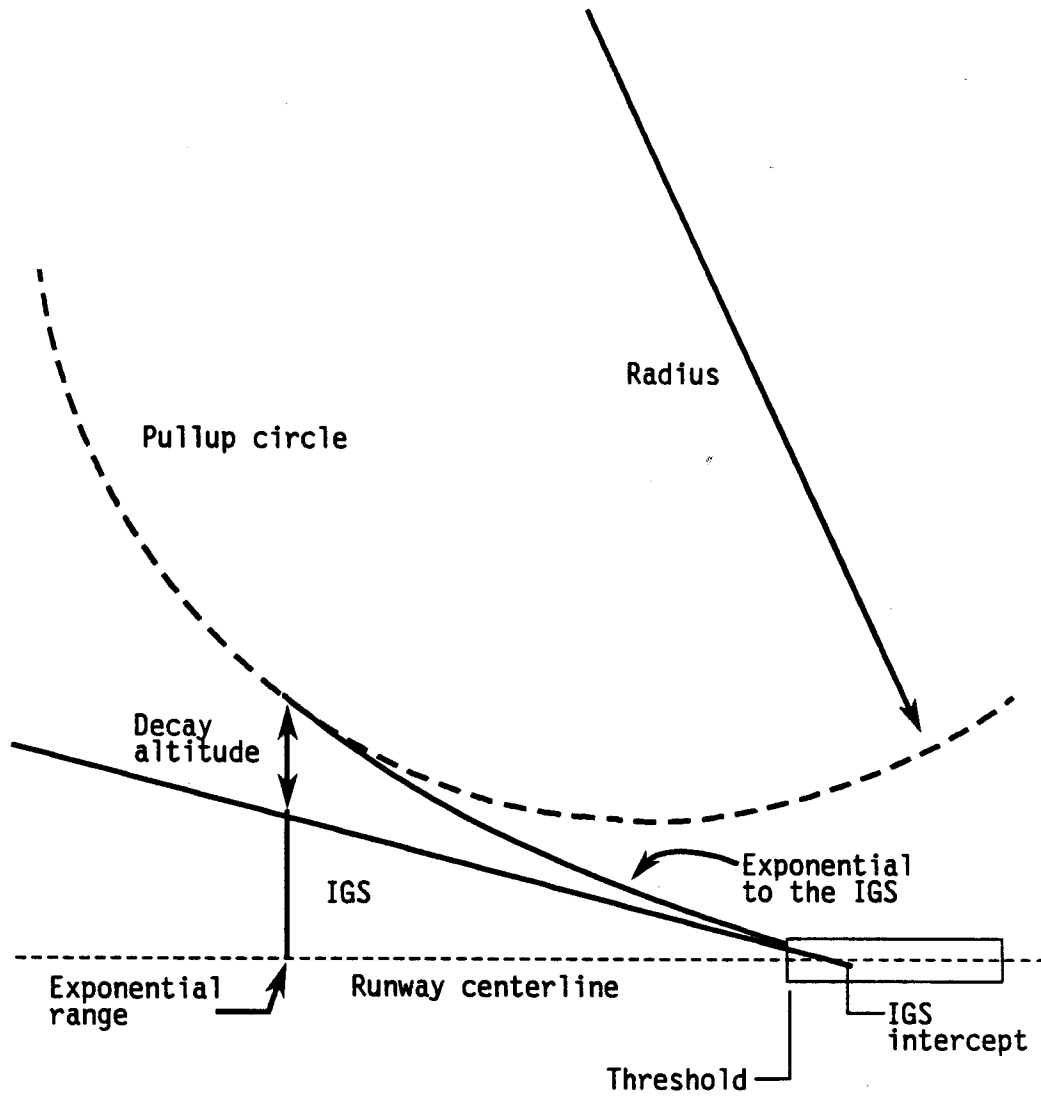

Note: Not drawn to scale

JSC-23266*026:4

Figure 4-13- Exponential to the IGS geometry.

4.5.2 Landing Gear Deployment

Another important event that takes place during the latter part of the FSGS is the deployment of the landing gear. Early space shuttle flights used velocity as a deploy cue, but altitude was later selected. The cue is very important because the landing gear is a very large aerodynamic liability. Using the wrong cue can significantly alter the T/D energy. The landing gear deploy cue for STS-1 through STS-4 occurred when the velocity decelerated through 270 KEAS. This corresponded to an altitude of 200 ft on the nominal energy trajectory. Flight STS-1 followed the velocity cue procedure which, due to its much higher than expected energy, did not occur until an altitude of 85 ft. Had the gear been deployed at 200 ft, some of that excess energy would have been dissipated. Flight STS-2 was very low on energy, reaching a maximum velocity of only 274 KEAS at 1100 ft altitude. The 270 KEAS cue occurred at 600 ft, but the actual deploy occurred at 400 ft, adding to the already existing low energy condition. Lower energy occurred since the nominal altitude for gear deploy would have occurred at 200 ft on a nominal trajectory. Flight STS-3 was high on energy, not decelerating through 270 KEAS until an altitude of 87 ft. T/D occurred earlier than expected on STS-3 and the gear was actually down and locked only a couple of seconds before first wheel contact. It was after STS-3 that altitude was selected as the gear deploy cue because it would compensate for off-nominal energy conditions, not make them worse, and still satisfy safety concerns. Downrange was also considered as a gear deploy cue, and it too, had advantages over velocity.

Flight STS-5 was the first to use altitude as the cue to deploy the gear. Still, some pilots preferred to deploy the gear at 400 ft and others at 200 ft. Current flight procedures are to nominally deploy the gear at an altitude of 300 ± 100 ft. The only requirement in the design was to have the gear down and locked at least 5 sec before T/D. The flight rule states that the gear should be deployed 15 sec before T/D. The rationale was to allow the down-and-locked signal to occur 5 sec prior to T/D. A typical preflight time between gear deploy and T/D is 20 sec.

Figure 4-14 shows the L/D history during the time the gear is deployed and indicates why it affects T/D energy so much. Studies have shown that manually retracting the SB to 60° (compared to 15° closed) is aerodynamically equivalent to deploying the landing gear. The sensitivity of T/D energy to landing gear deploy altitude is discussed in section 4.7.3.

Preflight performance predictions from the descent flight design team are based on the following gear deployment algorithm:

- a. Initiate gear deployment at 300 ft altitude
- b. Delay looking-up aero increments for 1 sec
- c. Use a constant rate of deployment which results in the gear's being fully deployed in 4 sec (5 sec total)

The 1- sec delay simulates the time when the command is given to when the landing gear doors are open. Aerodynamic increments for the landing gear

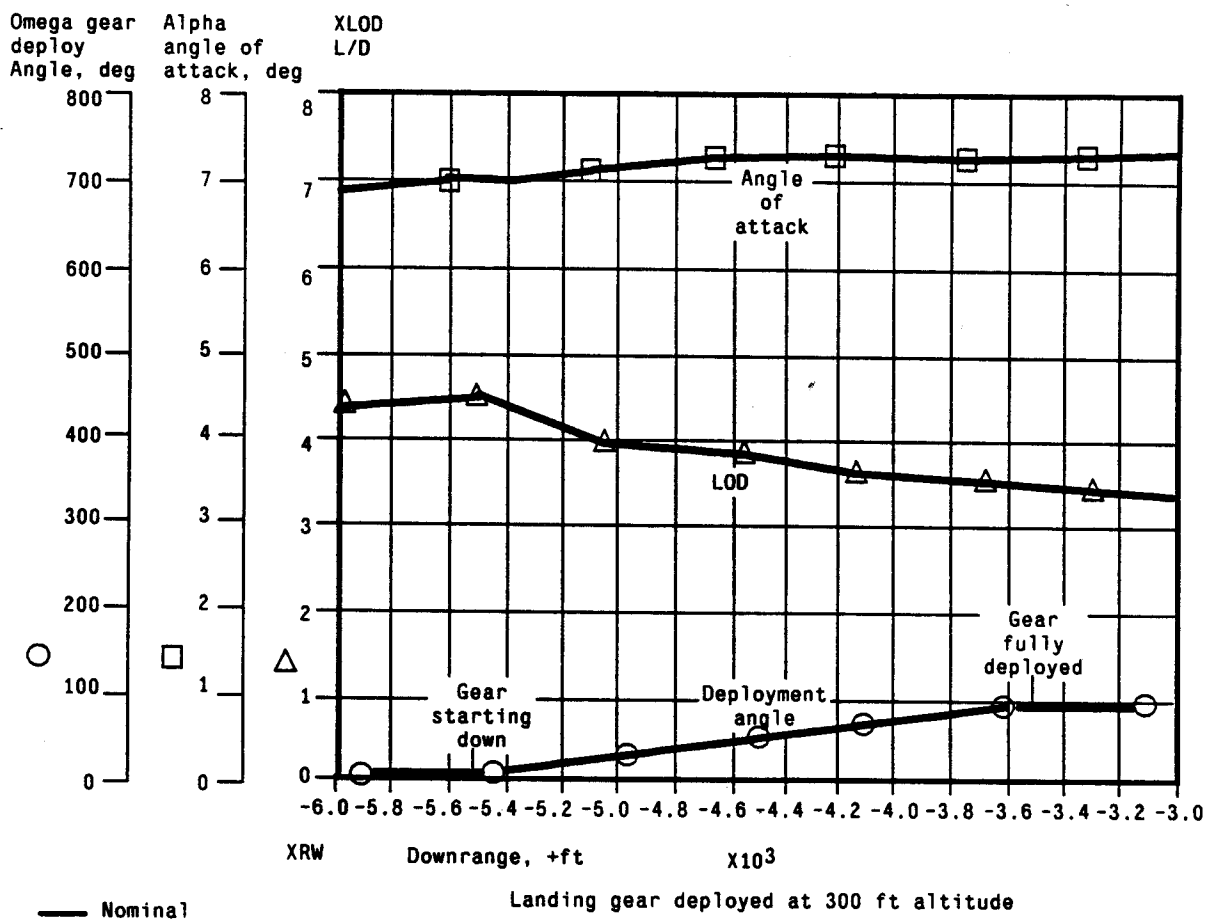

JSC-23266*029;4

Figure 4-14.- Landing gear aerodynamics.

are a function of the deploy angle. Actual flight time between the deploy command and the down-and-locked time may be longer than 5 sec, but based on visual timings, the 5-sec total deploy time is valid to use in simulations from an aerodynamic performance standpoint.

4.5.3 Sloped Runways

A change in the onboard navigated altitude calculation during the FSGS subphase has been incorporated to accommodate sloping runways. The 0.5-deg slope on the Vandenberg AFB (VAFB) runway is the driver for making this change. This change involves fading in the slope of the runway starting at the 10,000-ft range to the threshold. Using the fader results in auto-T/D performance that is much closer to the nominal flat runway data, and the fader chosen results in the least T/D dispersion.

4.5.4 Transition

The autoland guidance transition from the FSGS to FF is based on an altitude computation that is a function of altitude rate (fig. C.3-2, App. C). The higher the altitude rate the higher the FF altitude. The highest the auto transition can occur is 80 ft. If the transition has not occurred by 30 ft, it is forced. The switching logic is designed to typically occur at 55 ft, but if a higher than nominal altitude rate is present, a higher FF is commanded to allow more time to arrest the high rate. If the altitude rate is below nominal, the FF maneuver is delayed, but never lower than the 30-ft minimum.

4.6 FF

4.6.1 Overview

The FF maneuver reduces the altitude rate on the IGS to an acceptable value at T/D. The design of FF involves determining the altitude at which the flare maneuver is initiated and an altitude-altitude rate reference profile. The FF maneuver should be a smooth increase in pitch attitude started at an altitude high enough to result in a timely decrease in altitude rate before T/D. Appendix C.4 contains a discussion of the design and history of the FF portion of the trajectory.

4.7 LANDING

4.7.1 Overview

The A/L trajectory is designed to nominally T/D the orbiter 2500 ft downrange at a safe speed and small altitude rate. The IGS angle and intercept provide the trajectory path that results in this nominal downrange distance. The autoland SB retract logic guides the orbiter to a targeted T/D energy of 195 KEAS at 2500 ft for all vehicle weights. Ideally, this normalized T/D energy (sec. 4.15 and appendix D.5) is achieved if some SB is carried to T/D. If the SB retract angle is 15°, a low-energy situation may exist and the orbiter may land with less than the nominal T/D energy. The SB retract logic is designed to limit the high-energy T/D conditions but can do nothing to help the low-energy conditions when the SB is fully retracted. There are some manual techniques to increase T/D energy on days when the minimum energy is not achieved, but these techniques can be considered only for contingency landings.

The mission rules were written to limit the minimum T/D energy as a function of the vehicle weight. Midweight vehicles (between 200 and 220k lb) must have a normalized T/D energy (sec. 4.15 and appendix D.5) greater than 195 KEAS at 1000 ft downrange. The 1000 ft is intended to cover unforeseen dispersions, including trajectory errors, changing winds and density altitudes, and air data system errors. Pilots have also stated that 1000 ft should be the minimum downrange T/D point.

The wind dispersion allowance is designed to cover wind changes between the final balloon release (approximately 1 hour before landing) and the orbiter landing. Postflight data analysis has shown that another wind component to be considered is the spatial wind dispersion between the balloon path and the orbiter path. Figure 4-15 shows the STS-31 orbiter trajectory and the path of the T/D balloons. Because of the different flightpaths of the orbiter and the balloons, the wind profile used to predict the orbiter T/D point differed from the wind profile actually seen by the orbiter. As a result of the different wind profiles, the predicted T/D point differs from the actual T/D point by over 800 ft. This spatial wind effect occurs at landing sites where nearby mountainous terrain can give widely varying wind conditions. Landing sites susceptible to spatial wind dispersions include EDW, Northrup AFB, and Zaragoza AFB. A larger database of flight data will be necessary to better understand the effects of spatial wind dispersions. Analysis of postflight data since STS-26 has proven 1000 ft to still be a good total estimate of the required low-energy T/D margin.

If the predicted SB retraction positions at 3000 and 500 ft are calculated to be closed at landing, the close-in aim points will be considered. The close-in aim points add 1000 ft extra energy to the approach profile and may allow some SB to be carried to landing. If the close-in aim points are used and the 1000 ft T/D energy still is not achieved, the runway is considered unusable. Over one-third of the missions have used the close-in aim point.

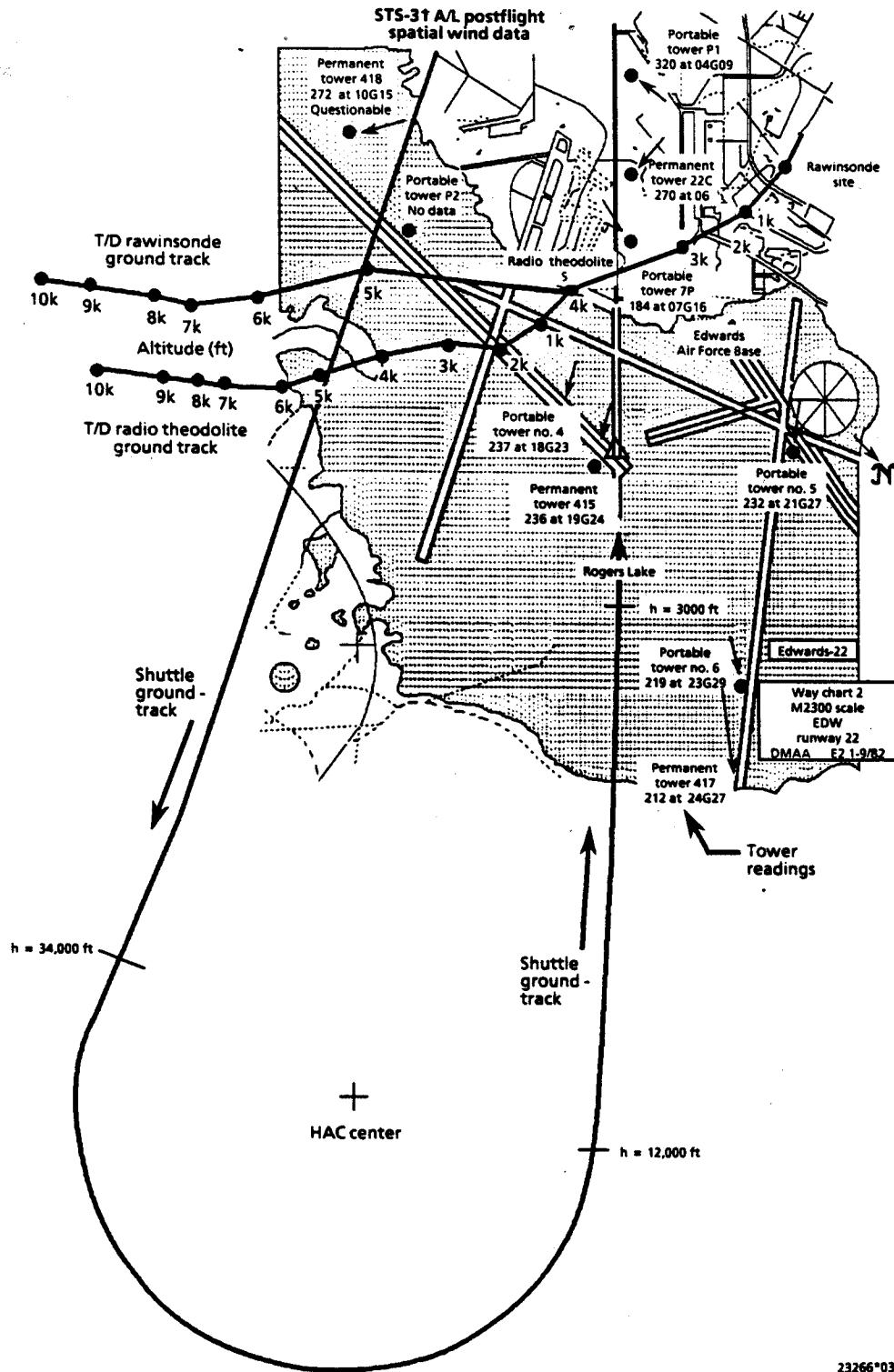

23266*034

Figure 4-15.- STS-31 A/L postflight spatial wind data.

Prior to STS-41, the close-in aim points were used only if the normalized T/D energy for the nominal aim points was less than 1000 ft. On STS-31, spatial wind effects caused the crew to T/D shorter on the runway than expected. To better protect for dispersions which would cause low-energy T/D scenarios, the criteria for using close-in aim points is based on the SB retraction position.

An exception to the 1000-ft T/D energy requirement occurs for daylight lakebed landings. Since lakebeds have long underruns (greater than 1000 ft), ample distance is available for low energy situations. The T/D energy is evaluated, but the 1000-ft T/D margin requirement can be waived based on the landing conditions and STA recommendations.

Although the auto-SB-retract logic targets the orbiter T/D energy to be 2500 ft downrange and 195 KEAS, three different CSS desired T/D speeds are used to provide the orbiter with a more consistent energy reserve and vehicle pitch attitude at T/D. The energy reserve is defined as the amount of time after T/D the orbiter could have flown until the pitch attitude reaches the tailscrape angle (14.6°). The energy reserve concept and assumptions are described in figure 4-16. The tailscrape velocity varies with WT, since a heavier vehicle must fly faster than a lighter vehicle has to fly to produce an aerodynamic lift equal to its weight. A consistent energy reserve and a consistent pitch attitude at T/D are two very important factors that help the pilots land with small altitude rates.

The desired CSS T/D speeds, which are also used for runway acceptability evaluations, have been broken down into three weight ranges (table 4-III). To achieve other CSS desired T/D speeds, the commander must make adjustments to his final approach which allows the downrange distance correspond to the desired speed. If the vehicle weight is less than 200k lb, the nominal T/D speed is 195 KEAS, although a T/D evaluation speed as low as 185 KEAS will be considered before a runway is declared unacceptable. If the weight is between 200 and 220k lb, the T/D speed will be 195 KEAS, and if the weight is greater than 220k lb, the T/D speed will be 205 KEAS. Since the SB still directs the T/D energy to be 2500 ft at 195 KEAS, T/D speeds for light vehicles landing at 185 KEAS and heavy vehicles landing at 205 KEAS results in the T/D points being longer and shorter, respectively, than the 2500-ft design point. A rough rule of thumb is 90 ft of T/D distance corresponds to each kt of airspeed. For the lightweight vehicle touching down at 185 KEAS, the orbiter is manually guided to T/D approximately 3400 ft down the runway. The heavy vehicle which touches down at 205 KEAS will now be guided to T/D at 1600 ft. The three CSS T/D speeds (185, 195, and 205 KEAS) are also the landing evaluation speeds required at 1000 ft.

4.7.2 Nomographs

The three biggest factors which influence vehicle T/D energy are windspeed and profile shape, density altitude, and the vehicle weight. For a known average windspeed, vehicle weight, and density altitude, a useful tool in

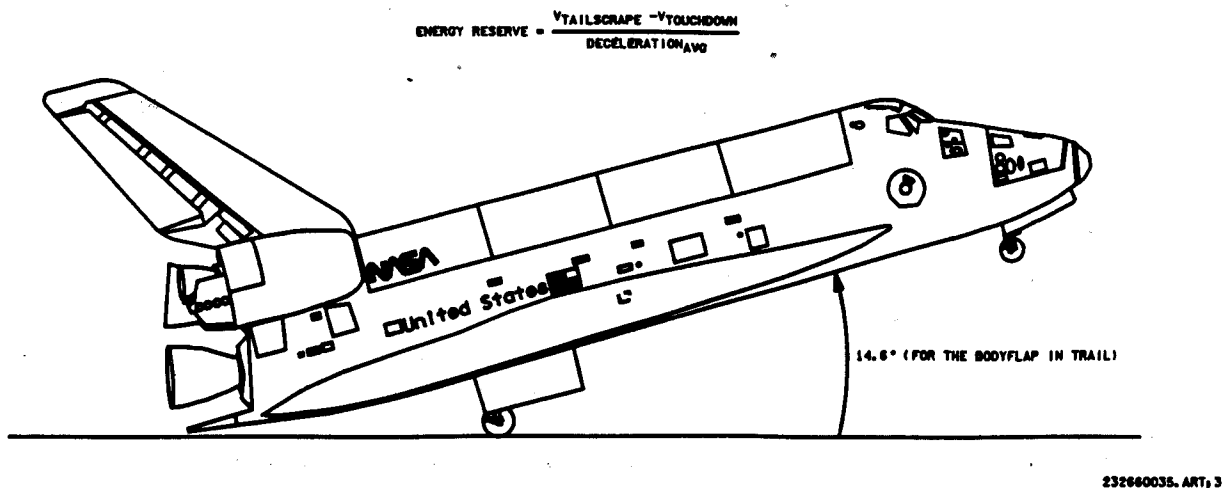

Tailscape - The maximum pitch attitude (deg) at which the vehicle can land and not scrape the tail (body flap trailing edge).

Energy reserve - The time (sec) the vehicle could continue flying after T/D until the tailscape condition. Early requirements were to have at least 5 sec energy reserve in the WOW conditions so that the pilot could manually take over just prior to T/D and still have adequate time to set up a new T/D point. The time was later decreased to 4 sec and then the concept was dropped. Today there are evaluation T/D speeds, as an $f(WT)$ that must be satisfied at 1000 ft downrange for a "GO" decision. It is now known that tailscape is not always the most conservative condition that leads to the minimum acceptable T/D velocity. If elevon control authority is lost during derotation, an uncontrolled slapdown will result, and with the right combination of vehicle weight, c.g., and rolling friction, the altitude rate at NGTD may exceed the vehicle structural capability. The MM and the runway rolling friction coefficient should be evaluated to determine the most conservative energy reserve value.

- Assumptions:**
1. Lift = WT
 2. Angle of attack = pitch attitude
 3. Mach < 0.25
 4. Nominal aerodynamics (L/D)
 5. Static gear compression
 6. Static tire compression
 7. Roll angle = 0
 8. Pitching moment = 0

Figure 4-16.- Energy reserve and tailscape conditions.

TABLE 4-III.- T/D ENERGY TARGETS

| Guidance mode | Vehicle WT | | |
|---------------------------------------|-------------------------------|---------------------|---------------------|
| | <200k | 200k - 220k | > 220k |
| | T/D PT T/D speed | T/D PT T/D speed | T/D PT T/D speed |
| Nominal guidance, all aim points | AUTO 2500 ft 195 KEAS | 2500 ft 195 KEAS | 2500 ft 205 KEAS |
| | CSS* 2500 ft** 195 KEAS | 2500 ft 195 KEAS | 2500 ft 205 KEAS |
| Short-field SB all WT AUTO or CSS* | 1500 ft 195 KEAS | | |

*CSS T/D points and velocities are not directed by onboard SB guidance. T/D points are only approximate values based on the T/D velocity.

**For vehicles weighing less than 200k lb, a T/D speed of 185 KEAS is considered acceptable for GO/NO-GO criteria.

determining a quick approximation for the T/D energy and the SB retract setting is the nomograph. Section 4.15 and appendix D.5 give a full explanation of how these tools are used. Off-nominal factors not included in these predictions are deviations in the landing gear deployment altitude, tile damage, stuck aerosurfaces, navigational errors, and large deviations from the reference trajectory.

4.7.3 Landing Dispersions

Postflight analysis has shown that winds, density altitude, and lack of accurate navigation data (MSBLS) continue to cause dispersions in T/D energy. On flight STS-1 the aerodynamic dispersions were a major error source to T/D energy. Today the aerodynamic uncertainties that affect the A/L performance are thought to produce T/D energy dispersions of less than ± 300 ft (based on postflight analysis). One known aerodynamic variation is the increased drag due to the flexible reusable surface insulation (FRSI) blanket on vehicles OV-103 and OV-104. This drag decreases the T/D energy by 250 ft. The c.g. location and silts pods have little effect on the T/D energy.

Although guidance can control some wind and density altitude dispersions, guidance has no provision to handle off-nominal vehicular situations including stuck aerosurfaces, tile damage, or extreme landing gear deployment altitudes. For these situations, T/D energies may vary widely.

Deploying the landing gear increases the total drag on the orbiter. Figure 4-17 shows the sensitivity of T/D energy to gear deploy altitude. If the landing gear deploys earlier than the 300-ft design altitude, the orbiter experiences higher drag for a longer period of time, resulting in a decrease in the orbiter T/D energy. Conversely if the gear is deployed later than the design altitude, the vehicle has an increase in T/D energy. A 100-ft difference in deploy altitude equals approximately 250 ft of T/D energy.

Studies have shown that added drag can be caused by tile erosion due to orbiter flight through moisture laden clouds. Passage through these clouds increases the drag which corresponds to a trimmed SB setting 10° greater than the nominal setting on the OGS. Since the SB retraction logic (sec. 4.4.3) does not account for this added drag, the orbiter T/D energy decreases by 1100 ft. Mission weather rule (4-64) is strictly defined to prevent an orbiter from flying through clouds.

Two consequences of off-nominal T/D energies are high T/D groundspeed or excessive T/D altitude rates. High GS at T/D cause excessive tire wear during the initial spinup, which may result in a tire failure. The shuttle tires are certified to T/D at GS, up to 225 kts. Test results have demonstrated the tires' ability to withstand higher groundspeeds, and work is currently underway to raise the allowable GS to 245 kts.

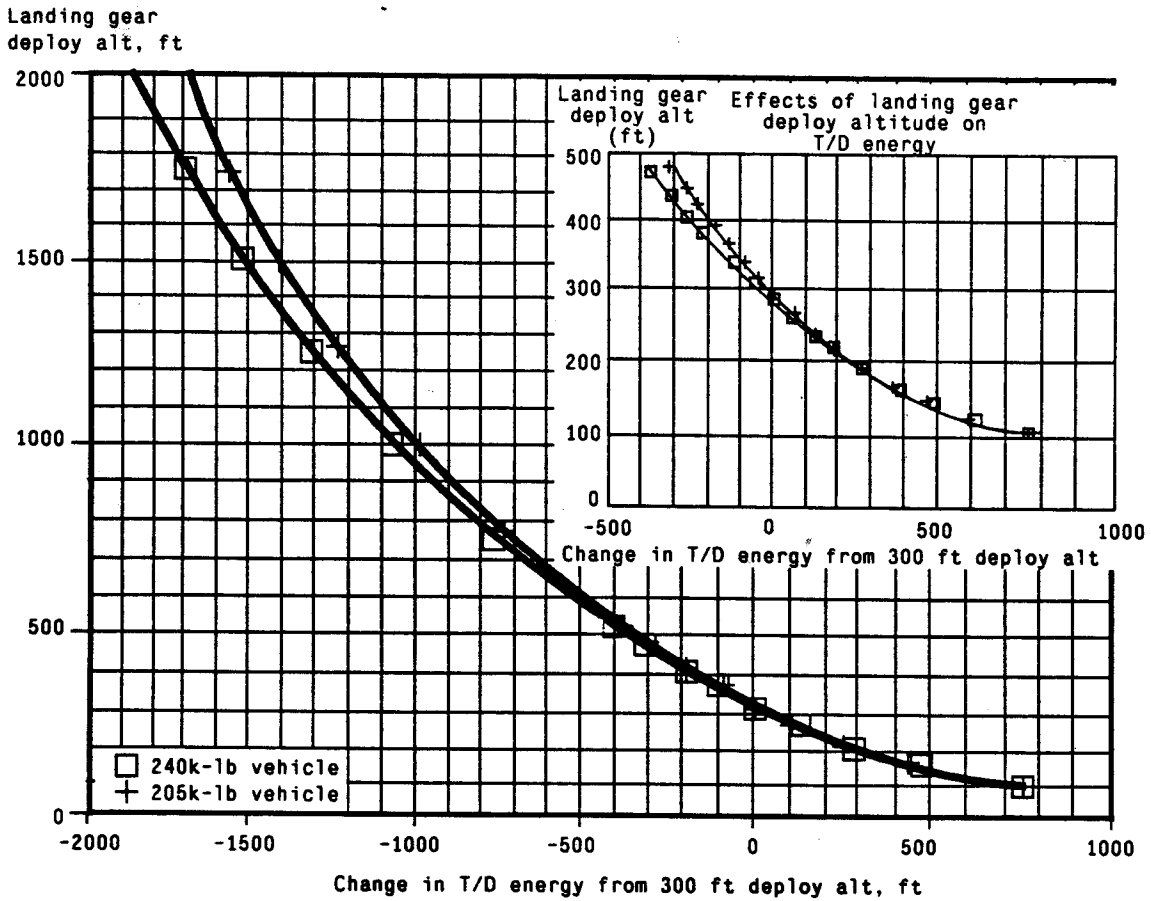

JSC-23266*037:4

Figure 4-17.- Effects of landing gear deploy altitude on T/D energy.

The maximum altitude rate at T/D is designed to protect the main gear struts from unacceptable loadings. Each strut can withstand up to 207k lb, although the actual altitude rate is a function of vehicle WT (fig. 4-18). As explained in section 4.6 and appendix C.4, during the FF phase of autoland guidance, the vehicle sink rate is reduced from 12 ft/s to 2 ft/s. The average T/D altitude rate has been 1.5 ft/s, while the maximum rate was 5.7 ft/s on STS-3.

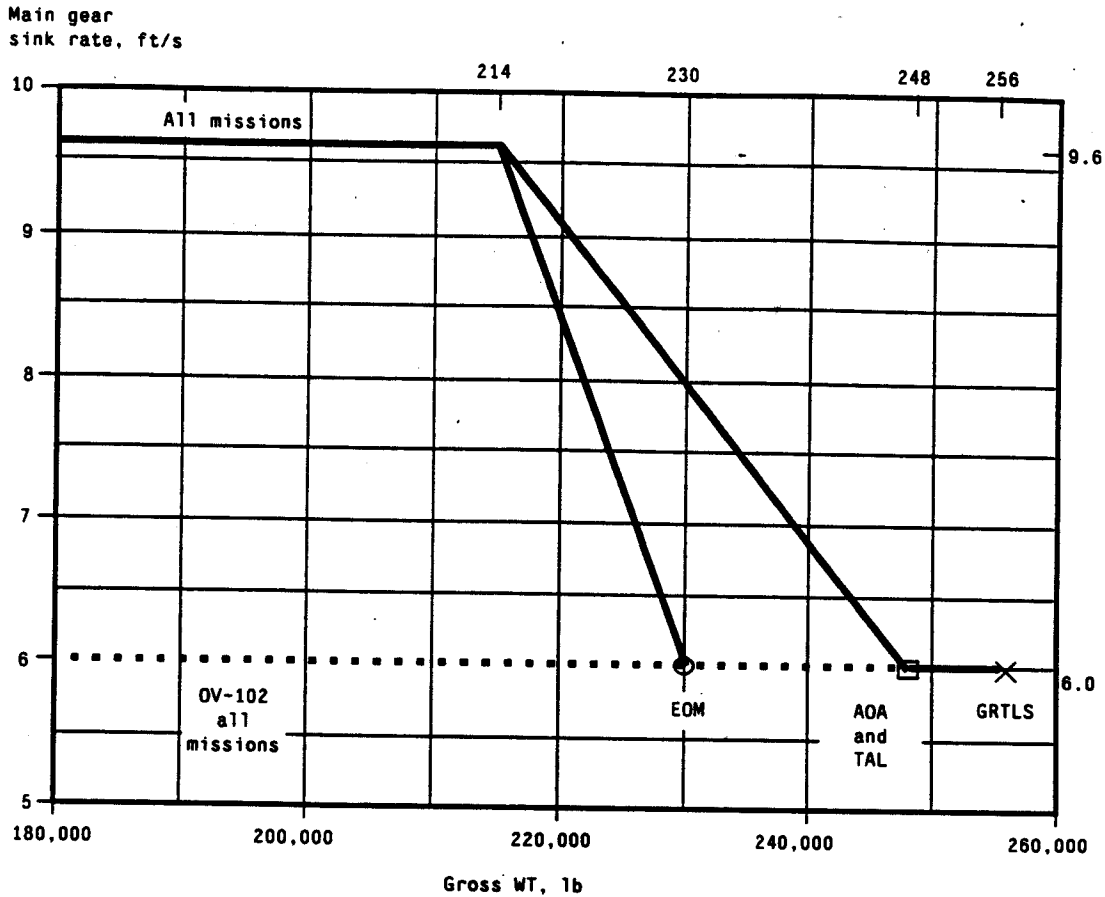

NOTE: OV-102 is scheduled for a structural upgrade before it flies again, and this 6 ft/s limit will change.

JSC-23266*039

Figure 4-18.- Maximum main gear sink rate for design.

4.8 ROLLOUT

The rollout flight phase is depicted in figure 4-19 and consists of the motion of the orbiter between the T/D of the main gear (WOWLON) and the complete stop of the wheels. The four phases of the rollout are the attitude hold, derotation, coast, and braking. The rollout distance is controlled by the EAS at the start of the derotation, the derotation rate, the start of braking, and the deceleration during the braking. The values shown in figure 4-19 are taken from the crew procedures cue cards and are used in all analysis of the rollout unless otherwise specified.

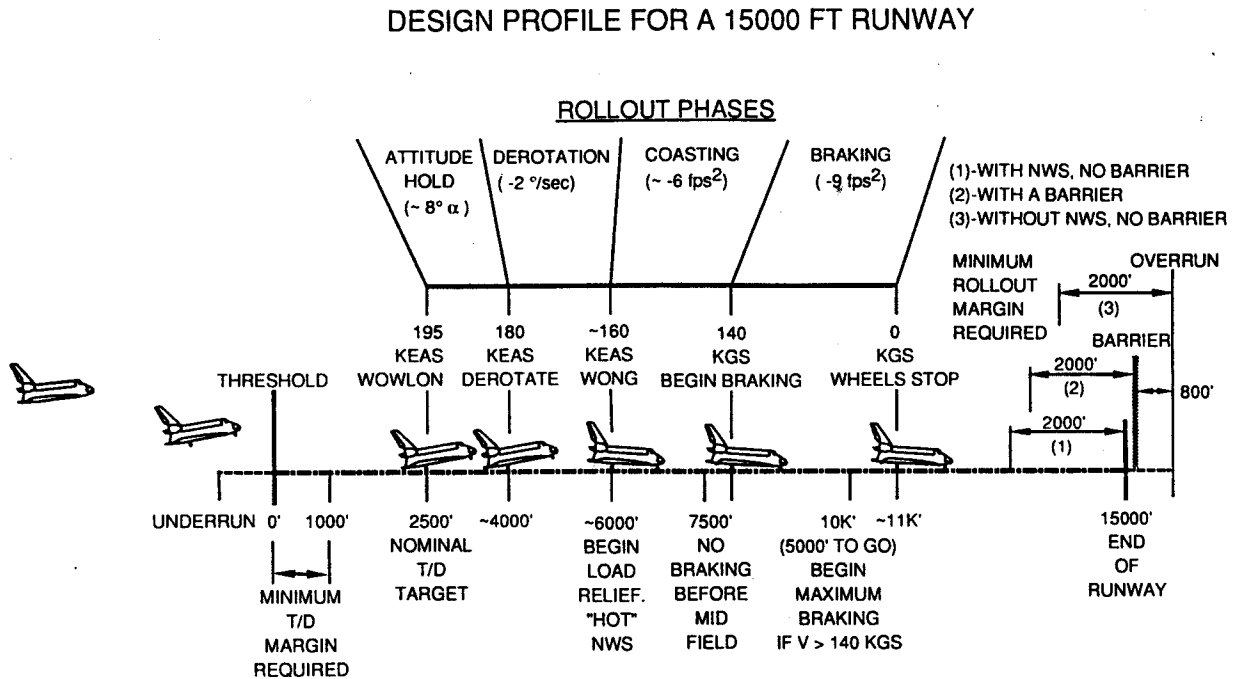

Figure 4-19.- Rollout pictorial.

4.9 CONSTRAINTS AND FLIGHT RULES

The rollout margin and brake energy limits have been designed to ensure that the orbiter can stop within the runway limitations. The rollout margin is meant to account for environmental and procedural variations that directly impact the vehicle stopping distance. The brake energy limits protect the capability of the brakes to stop the orbiter. Appendix D.1 contains further discussion and data for rollout margin and brake energy limits.

4.10 ATTITUDE HOLD

The chief purpose of the attitude hold phase is to reduce the maximum loads that are imposed on the main landing gear. The attitude of the orbiter at T/D is held constant until the EAS decreases to a specified value. This value is selected to achieve a compromise between the maximum load on the main gear and the maximum load on the nose gear. The effects of varying the start of the derotation is shown in figure 4-20. In figure 4-20, the start of the derotation varies between T/D and loss of control (fallthrough). The peak load on the main gear decreases as the derotation is delayed, but the peak load on the nose gear increases. The start of the braking, which cannot occur until the nose gear is on the runway, may be delayed by a later derotation. The significance of such a delay must be determined for each specific case, but the delay is not generally desirable.

The attitude hold phase begins at WOWLON. Ideally, this occurs when both main gears have had WT on them continuously for six cycles of the landing SOP (0.96 sec). The WOWLON signal is generated at this time and is the reference for any time increments. Although the opening of the SB begins when the WOWLON signal is sensed, the flight data have shown that the opening of the SB may be delayed as much as 5 sec after the tire spinup. This is probably caused by the quite small altitude rates at T/D and light loading on the main gear. These factors result in strut deflections that are not long enough to trigger the proximity switches. The total distance of the rollout may be increased as much as 400 ft by this delay. The delayed opening of the SB has been eliminated by the crew's manually commanding the SB to open after MGTD.

The present procedure is to attempt to maintain the initial T/D attitude instead of decreasing it to some intermediate value. One reason for doing this is shown in figure 4-20. The deflection of the elevons at the start of the derotation cause an increase in the lift of the orbiter (a decrease in the load on the main gear). This can be seen at the start of each derotation. The increased lift developed during an immediate derotation probably exceeds the weight and cause the orbiter to leave the ground for a short time (skip). A skip similar to this could be one cause of the delay in the WOWLON signal that was discussed earlier. When the derotation speed is decreased, the increased lift will not be great enough to cause a skip.

The target value of the EAS at the start of the derotation is a compromise that considers the strut loads, the time between T/D and the start of derotation, and the need to have the nose gear on the runway surface in time to start the braking procedure. The target EAS at T/D and derotation is shown in figure 4-21 as a function of the WT. The start of the derotation was selected to give a minimum of approximately 5 sec between T/D and derotation and to maintain control of the derotation. The derotation EAS is given for a forward location of the c.g. and a lakebed runway (coefficient of rolling resistance of 0.05). The safe derotation speed is reduced if the c.g. is moved aft or the rolling resistance is reduced. A single derotation speed of 180 KEAS was selected to simplify the crew procedures. The derotation speed could be safely reduced to 170 KEAS if the T/D speed is reduced to 185 KEAS for weights less than 200,000 lb. A reliable value of the safe

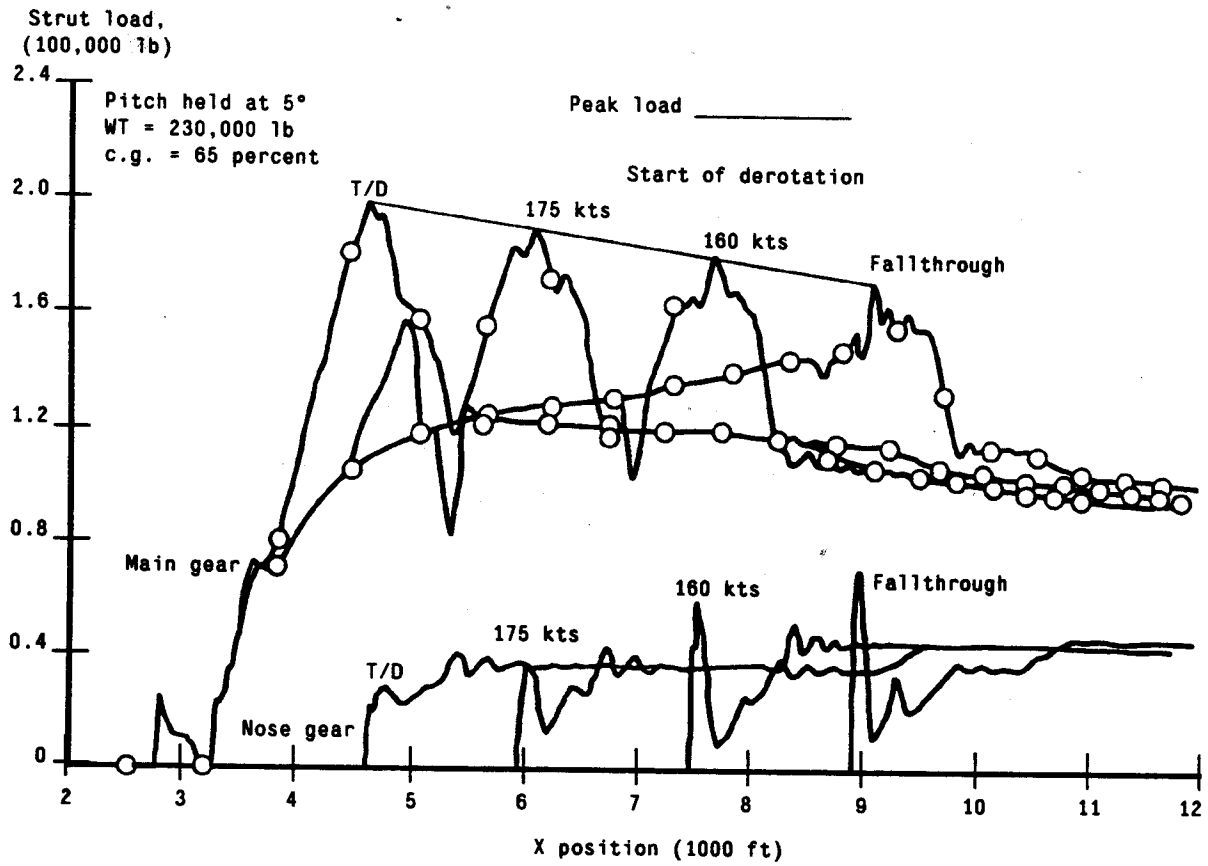
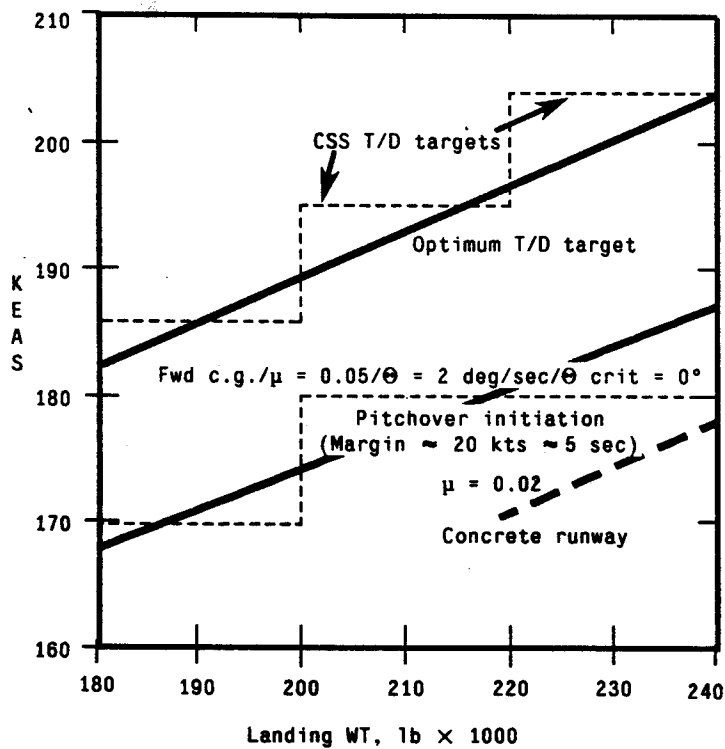

Figure 4-20.- Effect of attitude hold on main-gear and nose-gear loads.



- Use of 195 KEAS T/D speed for vehicles lighter than 200,000 lb results in landing waveoffs in moderate conditions.
 - 190,000-lb vehicle
 - 41° F at EDW (1000 ft dens alt)
 - 20 kts avg headwind (3000 ft to SFC) (Type SFC wind = 10 kts)
 - Close-in aim point
- 185 KEAS at T/D for vehicle WT's <200,000 lb maintains energy margins while increasing tire and braking margins
- Safe pitchover speeds decrease as WT's decrease
- 170 kts should be a safe pitchover speed for lightweight vehicles
- 180 kts is safe for heavy vehicles on concrete runways

JSC-23266*043;4

Figure 4-21.- T/D and pitchover target speeds.

derotation speed is not well defined because of the variables involved and the approximations used in the analysis. The lakebed rolling coefficient may increase significantly near NGTD when the vertical loads are the largest. The increased pitching moment causes the loads on the nose gear to exceed acceptable limits for certain combinations of the location of the center of mass and the WT. To protect for the higher loads, vehicles with MM's greater than 1.55M ft-lb are required to land on concrete runways. The equation for calculating the MM is

$$MM = WT (1172.3 - X\text{-c.g.})/12$$

where

MM = Vehicle MM (ft-lb)

WT = Vehicle WT at T/D (lb)

X-c.g. = Vehicle X c.g. location at T/D (in.)

Since concrete runways have a lower rolling coefficient than the lakebed, landing on a concrete runway yields a lower nose-gear load than a lakebed landing.

4.11 DEROTATION

The derotation is an attempt to decrease the pitch of the orbiter at a controlled rate until the nose gear is on the ground. The design pitch rate for the manual mode is -2 deg/sec. The flight control derotation logic commands a pitch rate that is a function of the WT and the pitch attitude (fig. D.2-1, appendix D). The division between the light and heavy WT's is 6838 slugs (approximately 220,000 lb). The heavier weight vehicles are allowed to derotate to a higher rate so as not to command high up-elevon deflections which increase the peak main gear loads at NGTD. The increase in the pitch rate is limited by the resulting increase in the loads on the nose gear at T/D.

The drag coefficient begins to decrease as the pitch decreases but increases as the pitch becomes negative. The lift coefficient decreases and becomes negative by the time the nose gear is on the ground. The change in the lift coefficient is a combined effect of the decreasing pitch angle and the increasing up deflection of the elevons, which are required to control the pitch rate. The combined effect of the changes in the aerodynamic coefficients and the decreasing velocity during the pitchdown is that the deceleration decreases until a minimum value is reached at about 4° pitch and then increases until the nose gear is on the ground. Maximum nonbraking deceleration during the rollout is quite often at NGTD with the elevons at 20° up, which is the software (S/W) limit.

It may be impossible to maintain a constant pitch rate at the lower attitudes because of factors such as the dynamic pressure, the rolling resistance of the runway, the WT, and the c.g. The rolling resistance and the moment caused by the WT causes a nose-down pitch. This must be counteracted by the aerodynamic moments which depend upon the dynamic pressure and the aerodynamic properties of the orbiter. Any delay in the start of pitchdown or a decrease in the pitch rate causes a decrease in the dynamic pressure near the end of the derotation. Normally, an increase in the upward (positive) deflection of the elevon causes an increase in the nose-up (positive) pitching moment but when the upward deflection exceeds -20° to -25° this is no longer true. The lift continues to decrease, but the aerodynamic moment does not continue to increase. The result is that the nose-up aerodynamic pitching moment about the point of contact of the tires with the runway decreases and the pitch attitude (or rate) cannot be controlled. The loss of elevon effectiveness is important because it influences the loads on the nose gear. The maximum deflection of the elevons is limited to -20° in order to decrease the loading at NGTD.

For the purposes of this discussion, the loss of elevon effectiveness is defined as the velocity at which the elevon is deflected upwards at 20° for an angle of attack of zero. This velocity is shown in figure D.2-2, appendix D as a function of the longitudinal c.g. position. The coefficient of friction is 0.025 and the WT is between 190,000 and 200,000 lb. The velocity varies between 119 KEAS for the aft limit of the center of mass (1109 in.) and 148 KEAS for the forward limit (1076.6 in.). The velocity increases as the WT or the rolling resistance is increased.

Figure D.2-3 presents the relation between the vertical speed of the NGTD and the estimated coefficient of friction for a number of flights. The sloping line represents a least-squares approximation to the relationship of the two variables. The results for two of the landings (STS-9 and STS 51-G) seemed to be unreasonable and were ignored in the discussion. The derotation for STS-9 was begun at a low EAS which resulted in an uncontrolled derotation. The landing of flight 51-G was on a wet lakebed. The mean vertical rate for landings on concrete runways was slightly less than 4 ft/s and corresponds to a coefficient of friction of 0.02. This is approximately equal to the assumed preflight value of 0.025. The vertical speed of the nose gear varied between 4.5 and 7.8 ft/s and the coefficient of friction varied between 0.06 and 0.12 for landings on the lakebed. The vertical speed at nose contact with the runway was less than the limit for all the flights, although it was close for STS-9. The effect of the variation in the rolling resistance on the length of the rollout on the lakebed is not of significance since the rollout margin on the lakebed runway is not a constraint.

The observed values of the maximum lakebed rolling coefficients for 16 flights are given in table D-II, appendix D. The values for the first two flights are meaningless, since it was assumed that the maximum possible value was 0.062. Earlier estimates of the rolling coefficient were between 0.04 and 0.06 and were based on aircraft operations. The lakebed rolling coefficient appears to be a function of the landing gear loads rather than a constant value. The larger loads causes deeper ruts, which increase the resistance. The rolling coefficients during the first part of the rollout are believed to be comparable to the values observed for aircraft operations. The rolling coefficient increases near NGTD when the total loads increase.

4.12 COAST

The procedures used between the NGTD and the end of the rollout consists of several compromises between the necessity of stopping on the runway and possible damage that might be caused by heavy braking. The coast phase is considered to begin when the WONG signal is generated. The elevons are moved from the position required to control the derotation to the final position of 10° down to reduce the loads on the main landing gear. The deceleration at the initial attitude at T/D is approximately the same as the deceleration during the coast phase. The deceleration decreases to a minimum as the attitude is reduced to about 4° and then increases until the final pitch attitude is achieved. One of the results of the almost equal deceleration during the attitude hold and the coast is that variations in the start of the derotation and the pitch rate do not have much effect on position at a given groundspeed during the coast. The velocity at the start of the derotation of a 240,000-lb orbiter at sea level and zero wind varies between 190 and 170 KEAS, and the pitch rate varies between 1 and 4 deg/sec. The position of the orbiter at 140 kts groundspeed (KGS) varies less than 300 ft.

4.13 BRAKING

4.13.1 Flight Experience

Prior to modifications, the brakes of the orbiter were damaged on almost every flight. This damage resulted from vibration caused by coupling between hydraulics and brake dynamics and from the thermal energy absorbed by the brakes and tires. The vibration damage occurred at moderate brake pressures and was independent of brake energy; whereas, the thermal structural failures occur after considerable energy has been absorbed. Consequently, the failures caused by thermal energy occur at low speeds (less than 50 KGS). The vibrational damage did not cause the main landing gear wheels to lock, but thermal damage has caused the wheels to lock on two flights and also caused a tire to fail at low speeds on one flight. The thermal plug melted after the rollout was completed on another flight. The design of the system has been changed in an attempt to correct some of these problems, but the thermal energy absorbed by the brakes can be minimized by controlling the braking techniques. Appendix D.3 contains a discussion of the braking procedures, including brake energy discussions and data. Section 5 should also be referenced for more details.

4.14 BARRIER

The shuttle orbiter arresting system (barrier) is intended to protect the crew by arresting the orbiter in a safe manner during a landing. The arresting system consists of three main components: the net, the positioning system, and the energy absorbers (fig. 4-22). The positioning system consists of two hydraulically operated stanchions which support the net in its preengage position near the far end of the runway. The net is made of 36 separate component nets that are bundled together at the top and bottom. As the orbiter engages the net, the nose of the orbiter passes through the vertical straps. As the straps catch on the wings, the net is pulled down from the positioning system. The straps spread out uniformly over the wings and provide a distributed retarding load. On each side of the runway two spools of nylon tape are attached to the side of the net. As the orbiter pulls the net, the spools unwind and play out tape. The spools drive water turbines that convert the kinetic energy of the orbiter into heat. The system is capable of arresting an orbiter weighing 260,000 lb that engages the net at a groundspeed of 100 kts and of absorbing a minimum of 120M ft-lb of energy. The barrier is placed 800 ft from the end of the overrun to keep structural damage within acceptable limits. Some damage occurs during any arrestment (i.e., gear doors, probes, and tiles). The arresting system is transported in a C-130 and stored under normal warehouse conditions at the landing site. It can be set up from storage in 6 hr using an eight-man crew. The stanchion can be raised or lowered within 10 sec. Appendix D.4 contains more discussion and data on barriers.

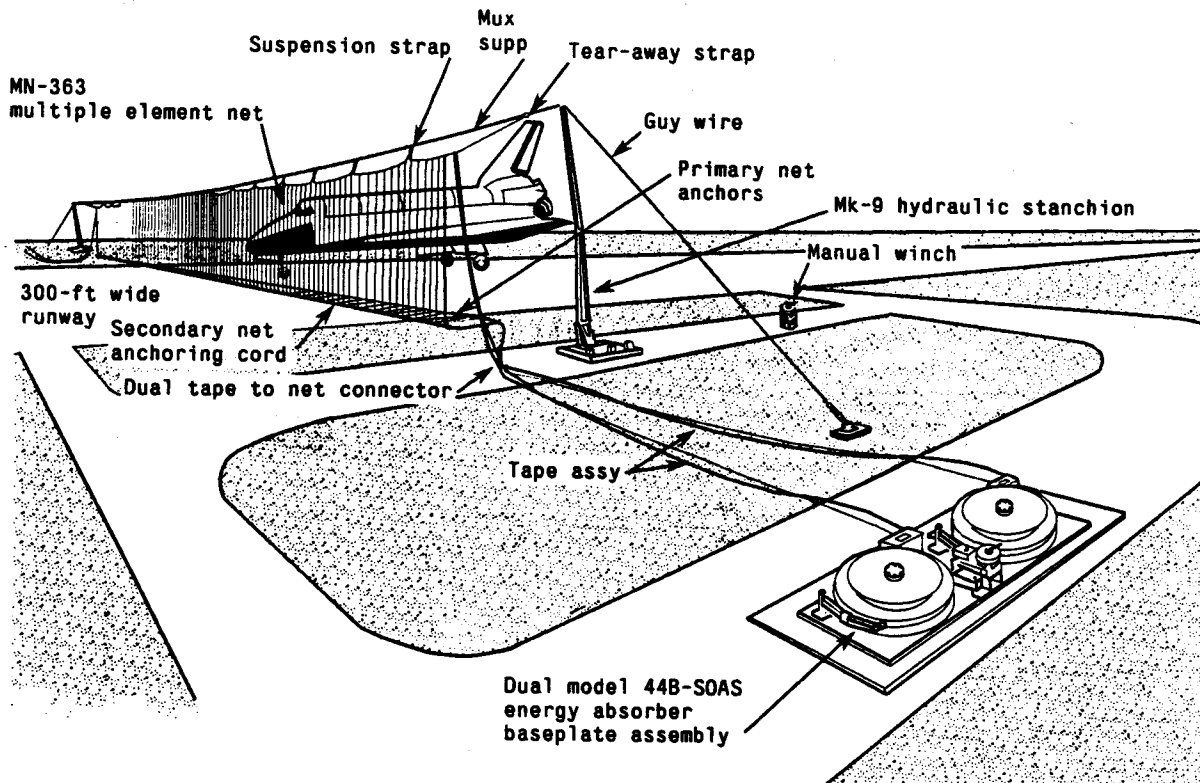

JSC-23266*050

Figure 4-22.- SOAS components.

4.15 NORMALIZATION AND NOMOGRAPHS

The concept of normalization of T/D energy began just prior to flight STS-1. The nomographs, which are used to predict normalized T/D energy, came about shortly thereafter. The purpose of normalized T/D energy was to provide a meaningful method of evaluating a T/D energy point from a single trajectory or to obtain a relative comparison of T/D energies from several trajectories. It became very confusing when the only measure of energy was the T/D point itself. If another simulation was run, and the T/D point was shorter and slower, one could definitely say it had less energy. But just how bad it was could not be readily stated. A similar problem was declaring a T/D condition unacceptable because one parameter was clearly outside its limit, but had T/D occurred a little sooner or later, all parameters would have been acceptable. In real life, in the manual guidance mode, the pilots have altered the actual T/D range from that used during preflight in order to T/D at a desired target velocity. Current real-time support goals are to aid the pilots in determining the T/D range. The normalization concept is used extensively in that process. The phrase T/D energy in A/L refers to the combination of downrange and velocity at T/D or near T/D. In these discussions all references to velocity are with respect to the EAS. Appendix D.5 contains detailed discussion on normalization and nomographs, and includes several examples.

5.2 FDF

5.2.1 Landing and Rollout Briefing

The "deorbit prep" timeline allows a period of time for an entry briefing. This period, labeled "Entry Review", typically occurs about 1 hr 40 min before the deorbit burn. Landing and rollout briefing items should include, but are not limited to, the items in the bottom third of the DEL PAD. These are

- a. Altimeter setting
- b. Type of HAC; overhead or straight-in, left or right turn
- c. Degrees of turn on the HAC
- d. Runway
- e. TACAN and MLS channels
- f. Aim point; nominal or close
- g. Winds at 50k, 38k, 28k, 20k, 12k, 7k, and the surface
- h. The predicted SB setting at 3k ft

The crew will have already developed a standard plan established in training and will use this brief to discuss any changes required by the conditions on landing day.

5.2.2 Entry Maneuvers Cue Card

The entry maneuvers cue card contains all the required procedures for landing and rollout. Starting at Mach = 0.9, the procedures and supporting rationale are presented here in figure 5-1.

M = 0.9 **P, R/Y - CSS as reqd**

The crew takes CSS in all axes to fly the orbiter to a landing. CSS is entered by pushing either set (CDR or PLT) of the two CSS PB; one for pitch and one for roll/yaw, or by deflecting either RHC at least 6° out of detent in both axes. The CSS axes are engaged independently. Regardless of the method of engaging, CSS should be verified by observing the illumination of both CSS PB's.

(Check) SPDBK CMD vs POS

| FLIGHT CONDITIONS | MANEUVER | | | |
|----------------------------------------------|----------------------------------------------------------------------------------------------------------------------------------------------------------------------------------------------------------------|--|---|--|
| V = 7K | ✓ TACAN status | | | |
| V = 5K | ADTA PROBES - DEPLOY(✓HEAT) Begin AIL and RUD trim monitoring | | | |
| M = 4 | Begin \dot{H} monitoring (✓ < 500 fps) | | | |
| M = 2.7 | ✓APUs HUD PWR (two) - ON | | | |
| * If M < 2.5; P CSS for ADTA to G&C incorp * | | | | |
| M = 2.0 | Ensure ADTA to G&C else ✓Theta limits | | | |
| M = 0.9 | P, R/Y - CSS as reqd ✓SPDBK CMD vs POS ✓R FLT CNTRLR - ON ✓NWS - 1 MAX Nz <table border="1" style="display: inline-table; vertical-align: middle;"><tr><td> </td><td>.</td><td> </td></tr></table> | | . | |
| | . | | | |
| M = 0.7 | ✓LG EXTEND ISOL VLV - OP | | | |
| h = 15K | ✓MLS | | | |
| h = 10K | ✓A/L, LES VISORS - DOWN (KSC) | | | |
| MAIN GEAR TOUCHDOWN | SPDBK - 100% | | | |
| DEROTATION INIT | DRAG CHUTE pb (two) - ARM,DPY (simo) | | | |
| NOSE GEAR TOUCHDOWN | SRB SEP - MAN/AUTO and depress pb ✓Auto Load Relief ✓HYD BRAKE ISOL VLV (three) - OP | | | |
| | | | | |
| V = 60 KGS | DRAG CHUTE JETT pb - JETT | | | |
| STOP | Go to ENT C/L, POST LANDING PROCEDURES, 5-1 | | | |

Figure 5-1.- Entry maneuvers cue card (example only; reference flight-specific versions).

The crew ensures that the SB is moving to its commanded position by checking the SPI or the GNC SYS SUMM 1 display.

(Check) R FLT CNTRL - ON

Power for NWS is provided through the right flight controller power switch; it is verified ON for landing.

(Check) NWS - 1

On vehicles with the improved NWS system, the GPC and DIRECT switch positions are replaced with NWS1 and NWS2. Each of these modes is equivalent to the current GPC mode, and there is no equivalent to the current DIRECT mode. Normally, NWS1 is used unless system failures render it inoperative, in which case NWS2 is selected.

MAX Nz

This number is transferred from the corresponding block on the DEL PAD. The Mission Control Center (MCC) calculates the maximum predicted normal acceleration on the HAC so that the crew knows the g-loading to expect in the turn.

M = 0.7 (Check) HYD LG ISOL 1,2 - OP

The hydraulic landing gear isolation valves is open by mach 0.7; if not, it is taken manually to the open position. System 1 provides hydraulic pressure to landing gear deploy and NWS, as well as partial brake pressure. System 2 provides partial brake pressure.

Vehicles with the modified landing gear and brake isolation valve system have a separate isolation valve for the landing gear deploy function. The callout for those vehicles are

(Check) LG EXT ISOL VLV - OP

h = 15k (Check) MLS

Check GNC SPEC 50 to ensure that TACAN ratios and residuals are no longer displayed. This indicates that microwave landing system (MLS) data is being incorporated into the navigation state. The "M" status for the MLS on GNC

SYS SUMM 1 also disappears indicating MLS lock-on. The altitude of 15,000 ft for this callout is approximate. The actual governing parameters for MLS acquisition are as follows:

- a. Az Within 13° of approach course
- b. EL Less than 29° above the MLS GS

- c. Range Less than 15 n. mi. to the MLS DME station
- d. Heading Within 40° of runway heading

If MLS data is not incorporated by 15,000 ft, and the above parameters are met, the crew should check with the MCC to verify MLS status.

h = 10k (Check) A/L, LES VISORS - DOWN (KSC)

The approach and land guidance transition can occur at 10,000 ft if other parameters are met (section 5.4.1 and appendix C.1), and will occur by 5000 ft. The crew should note that the transitions have occurred by a flashing "A/L" on the VERT SIT 1 display and note that the body flap has begun moving to the trail position.

Visors are lowered at Kennedy Space Center (KSC) to provide additional protection in the event of a birdstrike to the orbiter windscreen.

MGTD SPDBK - 100%

When WOW is set after MGTD, and if the SB is in the AUTO mode, the SB opens to 100 percent. The commander takes control of the SB by pushing the speedbrake/thruster controller (SBTC) takeover PB and commands the SB to full open by moving the SBTC full aft. This ensures the SB is full open. The open SB aids derotation control by reducing the pitching moment required of the elevons, and provides additional deceleration drag.

NGTD SRB SEP - MAN/AUTO and depress pb

(Check) Auto Load Relief

Taking the SRB SEP switch to auto and depressing the SEP pb (or doing the same with the ET SEP switch and pb) backs up the WOW and WONG discrettes in case one or both have not been set by this time. WOW, WONG, and theta less than zero are required for the GSENBFL flag to be set, which enables the NWS and modes the HUD and software to the rollout mode. Auto load relief occurs immediately after the GSENBFL flag is set, and is indicated by the illumination of the auto pitch PB's on the eyebrow panel, and by the elevons deflecting to 10° down. Auto load relief reduces main gear loads.

On vehicles with the landing gear and brake isolation valve modification, the three brake isolation valves are closed until WOW is set. When WOW is set, the three brake isolation valves are commanded open. For these vehicles a new callout applies.

NGTD

(Check) HYD BRAKE ISOL VLV (3) - OP

Reference figure 5-2 for an example of a braking diagram. The diagram indicates when to start braking, and how hard to brake, based on runway position and groundspeed. The diagram varies from flight to flight, but the procedures are generic: no braking before midfield. Begin braking at the speed adjacent to the solid (nominal) braking profile line: or begin braking at 5000 feet of runway remaining. The braking profile used is based on the groundspeed at 5000 ft of runway remaining. If less than 140 kts of groundspeed (KGS), use the nominal profile. If greater than 140 KGS, use maximum braking, which means depressing the brake pedals fully. In either case, at 40 or 50 KGS (varies from flight to flight) reduce braking to the level indicated on the card. Antiskid functions cease at about 9 to 14 KGS and the reduced braking minimizes skid potential.

5.2.3 Other FDF

a. Del pad (fig. 5-3)

MCC provides information that the crew transcribes onto the DEL PAD. This includes landing and rollout information such as; altimeter setting, the direction of the HAC turn and whether it is overhead or straight-in, the number of degrees of turn on the HAC, and the selected runway. The TACAN and MLS channels, the selected aim point, the expected SB setting at 3000 ft, the maximum expected normal acceleration on the HAC, and the predicted winds at various altitudes from 50,000 ft to the surface are also factors. The winds are given for 50,000 ft, 38,000 ft (270° of HAC turn remaining), 28,000 ft (180° of turn remaining), 20,000 ft (90° of turn remaining), 12,000 ft (established on final), 7000 ft, and at the surface. The maximum expected normal acceleration number is transferred to the Entry Maneuvers Cue Card and the winds are transferred to the Orbiter Xwinds Limits Cue Card.

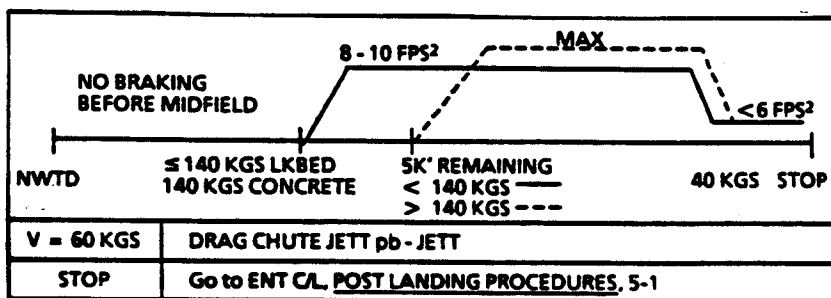

Figure 5-2.- Braking diagram (example only; reference flight-specific versions).

| DEL PAD | | | | | | | | | | |
|-----------------------------------|--|--------|--|--------|--------------------|-----|---------|--|---|--|
| BURN CUE CARD: | | | | | DEORBIT | | | | | |
| OMS TIG'SLIP - NO EXEC > TIG - | | | | | : | | | | | |
| RCS DOWNMODING | | | | | : | | | | | |
| STOP/CONTINUE PRPLT FAIL CUES | | | | | | | | | | |
| | | | | | L OMS HP | | | | | |
| | | | | | R OMS HP | | | | | |
| SAFE HP | | | | | | | | | | |
| TOT AFT QTY 1 (%) | | | | | | | | | | |
| AFT HP | | PRI HP | | B/U HP | | | | | | |
| TOT AFT QTY 2 (%) | | | | | | | | | | |
| FRCS: DUMP TO % (USE TIME AS CUE) | | | | | OX | | FU | | | |
| XCG at EI | | | | | | | | | | |
| XCG at M = 3 | | | | | | | | | | |
| YCG | | | | | () | | | | | |
| EI-5 MM303 | | | | | ENTRY/LANDING | | | | | |
| INRTL ATT (3-30) | | | | | R | | P | | Y | |
| MM304 PREBANK (ENT MNVR Cue Card) | | | | | | | L | | R | |
| — — — AOS | | | | | EI - | | | | | |
| — — — LOS | | | | | EI - | | | | | |
| ALTM SET (3-5) | | | | | | | | | | |
| CLG INIT | | | | | | | | | | |
| VREL 1ST REVERSAL | | | | | | | | | | |
| | | | | | LAND SITE | | | | | |
| L | | OVHD | | deg | | RWY | | | | |
| R | | STRT | | | | | | | | |
| AIM POINT | | | | | TAC | | MLS | | | |
| NOM | | | | | | | | | | |
| CLOSE-IN | | | | | WINDS: | | 50K | | | |
| | | | | | (ENT MNVR | | 38K | | | |
| | | | | | Cue Card) | | 28K | | | |
| SPD BRK | | | | | MAX Nz | | 20K | | | |
| % @ 3K | | | | | | 12K | | | | |
| | | | | | | | 7K | | | |
| | | | | | | | SURFACE | | | |
| REMARKS: | | | | | APU START SEQUENCE | | then | | | |

Figure 5-3.- DEL PAD (example only; reference flight-specific versions).

b. Orbiter Xwind limits cue card (fig. 5-4)

This card contains a diagram for determining crosswind and headwind or tailwind components from the given wind, and a table to transcribe the winds from the DEL PAD.

c. Land site data chart (fig. 5-5)

This chart contains landing site locations and a corresponding site number. The site number corresponds to the number used in item 40/41 on Spec 50. On the land site data chart, each site number has an associated primary and secondary runway. These may be different runways at the same site, or different sites that are in the same geographic area. For sites with more than two runways, such as EDW, two site numbers are assigned, each with primary and secondary runways. The primary and secondary runways correspond to items 3 and 4 on Spec 50. For each runway, the data chart lists the primary and secondary (if applicable) TACAN channels, the MLS channel (if applicable), and the runway length. Primary and secondary TACAN's are selected via item 5 on Spec 50.

d. Entry alpha cue card (fig. 5-6)

This card provides information for monitoring the entry referenced to velocity relative to the landing site. The crew uses this card to assess their energy state and make decisions concerning the landing and rollout phase of flight, such as whether or not to downmode to a lower energy profile (e.g., straight-in versus overhead HAC). The card provides the maximum L/D alpha for Mach numbers of 3, 2, and 1. Subsonic maximum L/D is 10° to 11° alpha.

e. Mach - Alpha cue card (fig. 5-7)

This card is attached to the instrument panel adjacent to the CDR's and PLT's alpha tape of the AMI. Mach numbers on the card have lines pointing to the alpha tape to show the nominal alpha versus mach. Color coded rectangles between mach 3 and 2.5, mach 2.5 and 1, and mach 2 and 0.5 show the allowable alphas for the respective ranges of mach numbers. Smaller, black rectangles show maximum L/D angle of attack regions for mach numbers of 3, 2.5, and 2.

f. Entry no - go checklist cue card (fig. 5-8)

This card specifies no-go criteria for aero PTI's, FCS auto mode, crosswind, and drag chute detail test objective (DTO's). An "x" in the column under the PTI's and DTO's is used to show what system or environmental condition has caused the event to be no-go. Rationale for the card is contained in Flight Rule 2-100.

ORBITER XWIND LIMITS

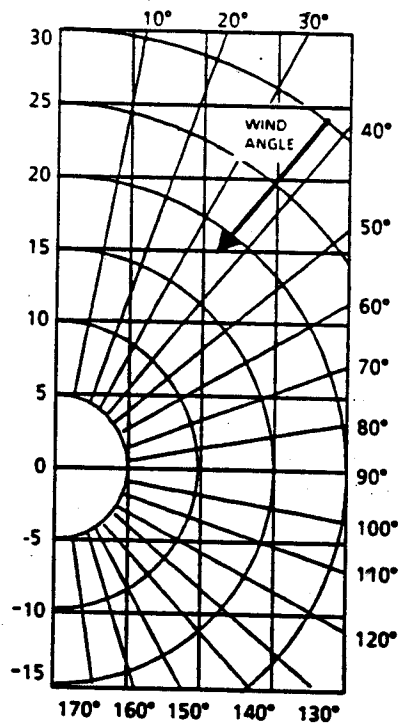

Enter chart using
max Gust Velocity

| | |
|------|---|
| 50K | / |
| 38K | / |
| 28K | / |
| 20K | / |
| 12K | / |
| 7K | / |
| SURF | / |

Figure 5-4.- Orbiter crosswind limits cue card (example only; reference flight-specific versions).

STS-47
LANDING SITE TABLE
(OPS 1/8/3)
(50° to 83.5° INCLINATION)

| SITE | LOCATION | RWY | TACANS | | MLS CH | LG |
|------|-----------------------------|--------------------|--------------|-------------------|-----------|----------------|
| | | | | ITEM 5 | | |
| 1 | KSC | KSC 15 KSC 33 | TTS 59Y | COF 97 | 8 6 | 15000 15000 |
| 2 | BEN GUERIR | BEN 36 BEN 18 | BEN 118 | CBA 116(DME) | 6 - | 13720 12720 |
| 3 | MORON | MRN 20 MRN 02 | MRN 100 | AOG 23 | 6 - | 12000 11800 |
| 4 | ZARAGOZA | ZZA 30L ZZA 12R | ZZA 64 | ZZA 77 (DME) | 6 - | 12397 12197 |
| 5 | MYRTLE BEACH | MYR 35 MYR 17 | MYR 39 | FLO 99 | - - | 9502 9502 |
| 6 | CHERRY POINT | NKT 32L NKT 23R | NKT 75 | NJM 67 | - - | 8400 9000 |
| 7 | OCEANA | NTU 23L NTU 05R | NTU 113 | NGU 48 | - - | 11997 10997 |
| 8 | DOVER | DOV 32 DOV 19 | DOV 37 | SIE 95 | - - | 12902 9590 |
| 9 | OTIS | FMH 32 FMH 14 | FMH 105 | HYA 94 | - - | 9500 9500 |
| 10 | PEASE | PSM 34 PSM 16 | PSM 112 | PSM 112 | - - | 11318 11318 |
| 11 | *BEN GUERIR FAIRFORD | BEN 36 FFA 27 | BEN 118 - | - BZN 56 | 6 - | 13720 9996 |
| 12 | *MORON KOLN-BONN | MRN 20 KBO 32R | MRN 100 - | - NOR 109 | 6 - | 12000 11467 |
| 13 | *ZARAGOZA ESENBOGA | ZZA 30L ESN 03 | ZZA 64 - | - BUX 90 (DME) | 6 - | 12397 11310 |
| 14 | KING KHALID DIEGO GARCIA | KKI 15R JDG 31 | RIY 92 - | - NKW 57 | - - | 12779 12003 |
| 15 | AMBERLEY DARWIN | AM 15 DDN 29 | AM 94 - | - DAR 84 | - - | 10000 10906 |
| 16 | GUAM HAO | GUA 08L HAO 12 | UAM 54 - | - HA 80 | 6 - | 10755 10089 |
| 17 | HONOLULU | HNL 08R HNL 26L | HNL 95 | CKH 86 | 6 - | 10700 11500 |
| 18 | DYESS | DYS 16 DYS 34 | ABI 84 | MQP 124 | - - | 13500 13500 |
| 19 | ROTA | AOG 28 AOG 10 | AOG 23 | MRN 100 | 6 - | 11076 11076 |
| 20 | NORTHROP | NOR 17 NOR 23 | SNG 69 | HMN 92 | 6 - | 15000 15000 |
| 21 | NORTHROP | NOR 05 NOR 35 | SNG 69 | HMN 92 | - - | 15000 15000 |
| 22 | EDWARDS | EDW 05R EDW 33 | EDW 111 | PMD 92 | - - | 15000 16300 |
| 23 | EDWARDS | EDW 04 EDW 18L | EDW 111 | PMD 92 | - - | 13995 15000 |
| 24 | EDWARDS | EDW 23L EDW 15 | EDW 111 | PMD 92 | - 6 | 15000 16300 |
| 25 | EDWARDS | EDW 22 EDW 17L | EDW 111 | PMD 92 | 8 - | 14995 12000 |

*Reduced Crossrange TAL Site

Figure 5-5.- Land site data chart (example only; reference flight-specific versions).

**ENTRY ALPHA
KSC 15
(47 FLT CY)**

| VR | α | R | H | Href | Rref |
|-----|----------|--------|-----|------|------|
| 25 | 40 | 4336 | 400 | | |
| 24 | 40 | 2530 | 245 | -48 | L78 |
| 23 | 40 | 2110 | 240 | -65 | 68 |
| 22 | 40 | 1770 | 235 | -85 | 62 |
| 21 | 40 | 1500 | 225 | -101 | 59 |
| 20 | 40 | 1290 | 220 | -123 | 58 |
| 19 | 40 | 1115 | 210 | -145 | 59 |
| 18 | 40 | 980 | 205 | -166 | 60 |
| 17 | 40 | 865 | 200 | -182 | 60 |
| 16 | 40 | 765 | 195 | -191 | 60 |
| 15 | HI 40 | LO 680 | 185 | -201 | 62 |
| 14 | 43 39 37 | 610 | 180 | -127 | 61 |
| 13 | 43 39 37 | 540 | 175 | -137 | 58 |
| 12 | 43 39 37 | 480 | 170 | -153 | 56 |
| 11 | 42 38 36 | 421 | 167 | -196 | 55 |
| 10 | 41 38 35 | 368 | 161 | -177 | 51 |
| 9 | 39 35 33 | 318 | 154 | -211 | R48 |
| 8 | 36 34 30 | 269 | 148 | -247 | 43 |
| 7 | 33 30 27 | 222 | 137 | -270 | 44 |
| 6 | 29 25 23 | 177 | 125 | -275 | 46 |
| 5 | 26 22 20 | 138 | 113 | -278 | L44 |
| 4 | 22 18 17 | 102 | 100 | -263 | 42 |
| 3 | 14 14 15 | 72 | 86 | -247 | R36 |
| 2.5 | 13 | 61 | 81 | -269 | |
| 2 | 10 | 48 | 74 | -305 | |
| 1.5 | 8 | 37 | 62 | -343 | |
| 1 | 7 | 29 | 49 | -267 | |

α - LD MAX | 17 | 15 | 12
MACH | 3 | 2 | 1

Figure 5-6.- Entry alpha cue card (example only; reference flight-specific versions).

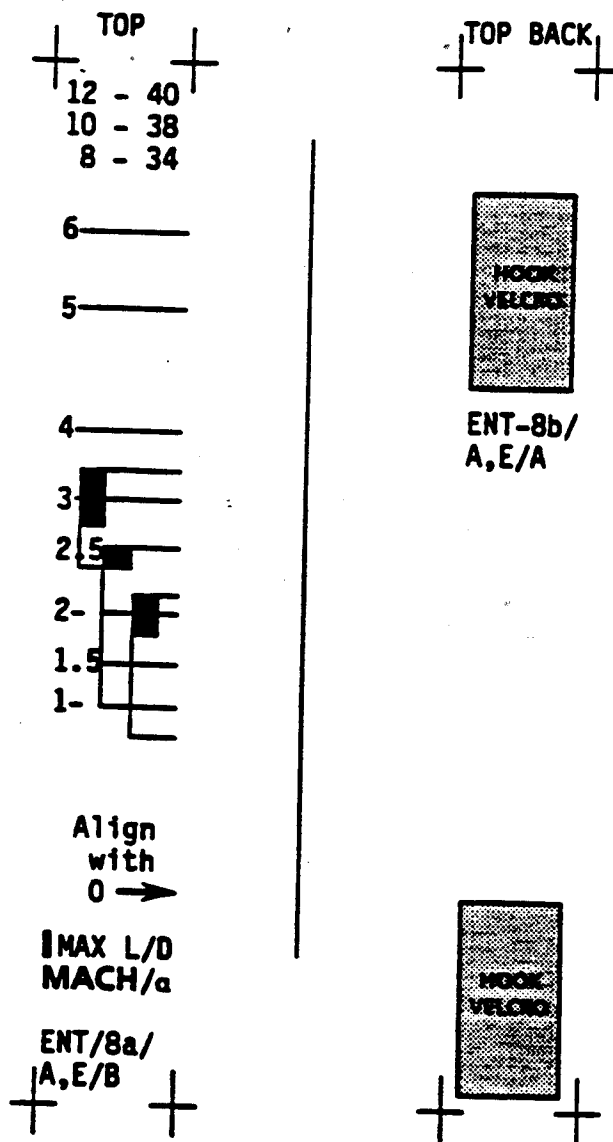

Figure 5-7.- Mach-alpha cue card.

ENTRY NO-GO CHECKLIST

| FAILURE OF: | AERO PTI DTO NO-GO | AUTO MODE NO-GO | XWIND DTO NO-GO ① | DRAG CHUTE DTO NO-GO |
|------------------------------------------|--------------------------|-----------------------|-------------------------|----------------------------|
| APU/HYD: 1 APU | | | X | |
| 2 APUs | X | | X | X |
| DISPLAYS: CDR ADs | | | | |
| 2 ADIs | X | | | |
| 2 HSIs | | | | |
| CDR AMIs | | | | |
| 2 AMIs | | | | |
| 2 AVVis | | | | |
| CDR HUD (if no PAPIS/BALL BAR) | | | X | |
| CONTROLLERS: | | | | |
| RHC: 1L | | | X | |
| LRHC | | | X | |
| 2L & 2R | X | | X | |
| RPTA CH: 2L or 2R | | | X | ② |
| GNC: 2 AAs (LAT) | X | ③ | X | |
| 2 AAs (NORM) | ③ | ③ | | |
| 2 RGAs | X | | X | |
| R DDU 2 PWR SPLY | X | | X | |
| 1 IMU | | | | |
| 2 IMU (or 1 IMU + BITE) | X | | X | |
| 2 ADTAs | | | X | |
| ADTA NOT INCORP | | X (< M2) ④ | | |
| 1 MLS | | | | |
| MLS NOT INCORP | | X (< 6K ft) | | |
| 2 RAs | | | | |
| FCS CH: 2 ELEV | X | | X | |
| 2 S/B | X | | X | |
| 2 RUD | X | | X | |
| 2 BF | X | | X | |
| No SSME repositioning | | | | X |
| DPS: GPC 1 (not rstng) | | | X | |
| GPC 2 (not rstng) | | GPC | X | |
| GPC 3 (not rstng) | | | X | |
| GPC 4 (not rstng) | | | X | |
| 2 GPC (rstng) | X | | X | |
| 2 GPC (not rstng) | X | ③ | X | |
| FF 1 | | | X | |
| FF 2 | | | X | |
| FF 3 | | | X | |
| FF 4 | | | X | |
| 2 FF | X | ③ | X | |
| 2 FA | X | | X | |
| PASS | | | | |
| RCS: 1 YAW JET & CG outside limits | X | | | |
| LEAK | X | | | |
| 2 YAW JETs on same side | X | | | |
| MIN RCS QTY | X | | | |
| TRIM: Ail > ± 1.5° | X | | X | |
| Elev > 3° (from schd) | X | | X | |
| DOWNMODE: FCS problem | X | X | X | X |
| AOA | X | | X | |
| LDG/DECEL: | | | | |
| Tire Leak | | | | X |
| HYD BRAKE ISOL VLV | | | | X |
| < 100% Brakes | | | | X ⑤ |
| NWS | | | | X ⑤ |
| ENERGY - OFF NOMINAL: | | | | |
| Roll Ref Alert | X | | | |
| Above Upper Traj Line | X | | | |
| MCC GCA, or VEL & PSN update | X | X | | |
| No A/L by 6K | X | | | |
| DATA: OPS RECORDERS | X (LOS) | | | |
| WBM RECORDER | | | | |
| XWIND: | | | | |
| < 8 Knots steady state | | | X | |
| > 12 Knots steady state | | | X | X |
| > 15 Knots PK | | | X | X |
| Gusts > 8 | | | X | |
| GROUND SYSTEMS: | | | | |
| No DATA or COMM | | | | X |
| No Runway Aim Point | | | | X |

NOTES

ENT-7a/E/B

- ① Consider runway redesignation (> M6) to avoid Xwind landing
- ② Requires three good channels if bad side is isolated
- ③ Pitch AUTO Mode NO-GO for < M2.5
- ④ MAN SPDBK < 5K ft
- ⑤ Either 100% brake or INWS reqd

Figure 5-8.- Entry no-go checklist cue card (example only; reference flight-specific versions).

5.2.4 Flight Rules Summary

The following flight rules apply to the landing and rollout (and entry) phase of flight. They are included here to provide more detailed information on the history and rationale behind shuttle operating procedures.

a. FR 2 - 86 LANDING SITE SELECTION

Specifies which site/runway is prime for EOM, RTLS abort, and TAL abort. Also specifies priorities for various systems failures. Sets time limits for evaluating multiple runways prior to deorbit burn.

b. FR 2 - 99 NWS GO/NO-GO

Describes what systems failures make NWS no-go. Applies to baseline and improved NWS.

c. FR 2 - 100 ENTRY DTO/AUTO MODE/CROSSWIND DTO GO/NO-GO

Describes what systems failures or external conditions cause PTI's, AUTO FCS mode, crosswind landing and/or drag chute DTO's to be no-go.

d. FR 2 - 101 LANDING DTO's

Specifies restrictions on DTO's during landing and rollout.

e. FR 2 - 102 STA/WEATHER AIRCRAFT RUNWAY APPROACH OPERATIONS FOR SITES WITH ONLY ONE RUNWAY

Describes restrictions to STA operations for single runway sites.

f. FR 2 - 103 NIGHT USE OF EMERGENCY LANDING SITE (ELS)

Prohibits night landings at an ELS.

g. FR 3 - 40 TACAN

Describes minimum ground site TACAN equipment required for RTLS, TAL, primary landing site (PLS), and EOM landing sites.

h. FR 3 - 41 MLS

Describes landing site MLS hardware requirements.

i. FR 3 - 42 LANDING AID REQUIREMENTS

Describes day and night requirements for Xenon lights, PAPI's, and other landing aids at landing sites.

- j. FR 4 - 62 PLS/EOM LANDING OPPORTUNITY REQUIREMENTS
Specifies crossrange limits and other limitations for site selection.
- k. FR 4 - 63 BRAKING AND ROLLOUT REQUIREMENTS
Specifies rollout margin and brake energy constraints.
- l. FR 4 - 64 LANDING SITE WEATHER CRITERIA
- m. FR 4 - 66 AIM POINT SELECTION
Specifies criteria for choosing nominal or close-in aim point for the OGS.
- n. FR 4 - 75 HAC SELECTION CRITERIA
Specifies how the landing runway HAC is chosen and the criteria for performing manual HAC procedures.
- o. FR 4 - 87 ENTRY TAKEOVER RULES
Describes conditions that require CSS during entry.
- p. FR 8 - 7 ACCELEROMETER ASSEMBLIES (AA) FAULT TOLERANCE
Describes fault tolerance requirements for the pitch axis to remain in AUTO during MM305 and MM603.
- q. FR 8 - 19 ENTRY LIMITS
Describes limits on N_z , dynamic pressure (Q -bar), and angle of attached (α) during entry.
- r. FR 8 - 21 EQUIPMENT REQUIRED FOR EMERGENCY AUTOLAND
Lists those onboard systems required for AUTOLAND touchdown.
- s. FR 8 - 22 LANDING SYSTEMS REQUIREMENTS
Describes failure modes that require changes to the runway selection due to degraded orbiter capability.
- t. FR 8 - 23 YAW JET DOWNMODE
Describes when no-yaw-jet entry mode is selected.
- u. FR 8 - 24 ENTRY ELEVON SCHEDULE SELECTION CRITERIA
Details how elevon schedules are I-loaded into the software and how to select a schedule for a center of gravity (c. g.) that is not covered by the I-load.

v. FR 8 - 56 GNC AIR DATA SYSTEM MANAGEMENT

Describes when theta limits procedures are used and the use of CSS during air data incorporation below mach 2.5.

w. FR 10 - 90 NWS

Describes how NWS is used in off-nominal situations and how various failures affect the current and improved NWS systems.

x. FR 10 - 91 TIRE PRESSURE

Defines the indication for a leaking tire and a flat tire. Describes downmode requirements for a confirmed leaking or flat tire.

y. FR 10 - 92 DRAG CHUTE OPERATIONS

z. FR 10 - 93 DRAG CHUTE DEPLOY CONSTRAINTS

aa. FR 10 - 96 BRAKING

Defines nominal and maximum braking profiles.

5.3 NOMINAL EOM LANDING

The nominal EOM landing and rollout phase of flight discussion is divided into separate subject blocks to provide clarity and easy reference for the reader.

5.3.1 Flight Control Summary

The space shuttle orbiter is a control configured vehicle (CCV) with stabilization and control provided by a redundant, fly by wire digital system. RCS jets in the aft section of the vehicle, in conjunction with aerodynamic surfaces, are used for control during entry. Subsonically, and for all of the approach and landing phases of flight, the aero surfaces are the only source of control; RCS jets are all phased out by Mach = 1.0. Aero surfaces include two elevons on each wing, independently powered, but commanded in unison, a two segment rudder split at the chord line so that it can be opened as a SB, and a body flap which is used as a trim device to drive the elevons to the desired trim position. During rollout, in addition to the aero-surface controls, NWS and differential braking provides lateral control.

In the directional axis, the vehicle is statically unstable in the hypersonic and supersonic regimes and statically stable in the subsonic regime. It is always dynamically stable except in, by analysis, some cases when aerodynamic uncertainties are applied. In the longitudinal axis, the vehicle is slightly statically stable supersonic, and unstable subsonic. The longitudinal instability is increased when the main gears are on the runway.

a. Pitch control

Figure 5-9a presents a simplified pitch axis functional block diagram. Pitch rate feedback is employed to provide stability augmentation and a reference for pilot commands introduced through the RHC. The nonlinear quadratic shaped stick signal is scheduled as a function of the Mach number to command a pitch rate appropriate to the flight regime. The error signal, stick command minus rate feedback is compensated by a lead filter network to form a proportional elevator command. The gain of this command is a function of Mach and dynamic pressure.

The elevon command is a conventional proportional - plus - integral function, where the integration is implemented as a lagged elevon position feedback. Lagged position feedback is used to avoid trim runaway during periods of actuator stall/control saturation. Pitch rate feedback is filtered by notch filters for body bending attenuation. The aero-surface command is rate and displacement limited by the PRL function.

Manual trim is controlled by either the RHC beep trim (pitch rate trim) in the CSS mode, or the pitch panel trim switch (elevator trim) active in both the CSS and auto modes (the roll, pitch, and yaw panel trim

switches are on panels L2 (CDR) and C3 (PLT)). The RHC beep trim is the trim switch on the top of the RHC, also referred to as the "cooly hat."

Additional functions include

- (1) SB to elevator interconnect to compensate for pitch transients during SB movement
- (2) Body flap control, auto or manual, to unload the elevon trim
- (3) Up elevon compensation (r_{tan0}) for loss of lift in angles of bank
- (4) A nonlinear filter on the RHC input during subsonic flight to minimize pilot-induced oscillation (PIO)

b. Pitch control on the runway

The pitch axis control law is reconfigured when WOWLON is set, after MGTD, to incorporate an added forward-loop integral function, a higher forward-loop gain schedule, a landing gear notch filter, and a reduced up-elevon command limit (fig. 5-9 (a) and (b)). In addition, for Endeavour and other vehicles after major modification, the RHC sensitivity is cut in half to provide finer control of the derotation rate.

After WONG the rollout software discrete is set and the pitch axis is switched to AUTO. The RHC deflection to engage CSS in pitch is increased to 20° to prevent an inadvertent hot stick to CSS. The autopilot sends an open-loop command to the elevons of 10° trailing edge down to provide main gear load relief.

c. Lateral control

Figure 5-10 presents a simplified lateral axis (roll) block diagram and figure 5-11 presents a simplified lateral axis (yaw) block diagram. For the A/L phase of flight the roll axis employs a conventional, proportional control algorithm and the yaw axis has a conventional, proportional plus integral control scheme. As a side note, in supersonic flight (when yaw RCS jets are active) the yaw jets are used to control roll (positive dihedral effect) and aileron is used to provide coordination (control BETA and BETA-dot). Subsonic, the ailerons control roll while the rudder is used to coordinate the turn.

Roll maneuvers are commanded by the nonlinear, quadratic shaped RHC signal, which is Mach-scheduled to provide the required roll rate per stick deflection. The error signal, shaped roll command minus roll rate feedback, forms the aileron command. The gain of this command is a function of Mach and Q -bar. Notch filters are used to attenuate body bending, similar to the pitch axis.

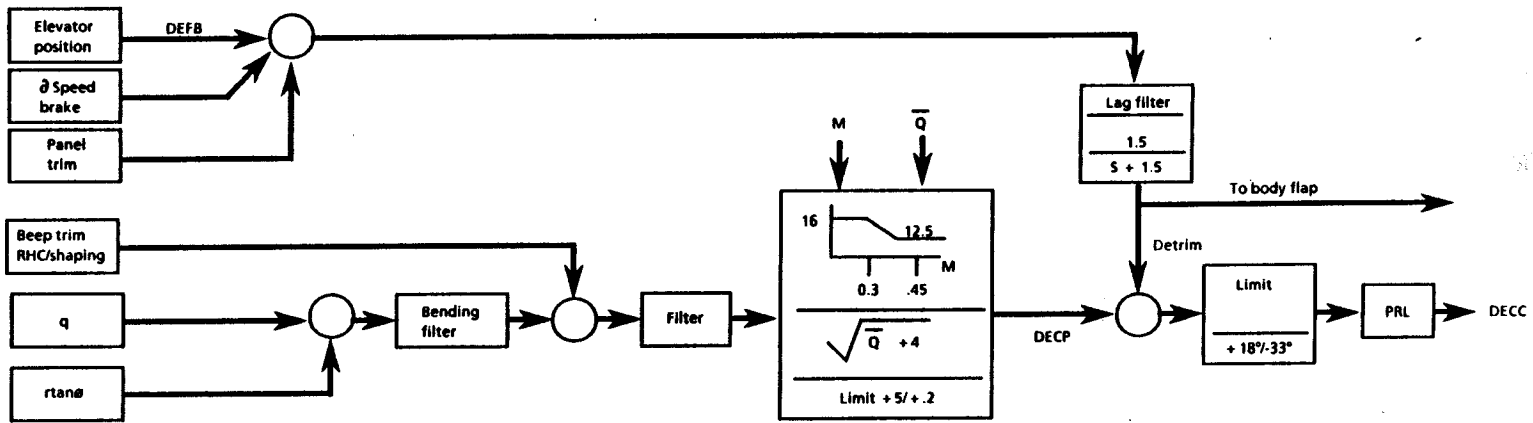

(a) Airborne.

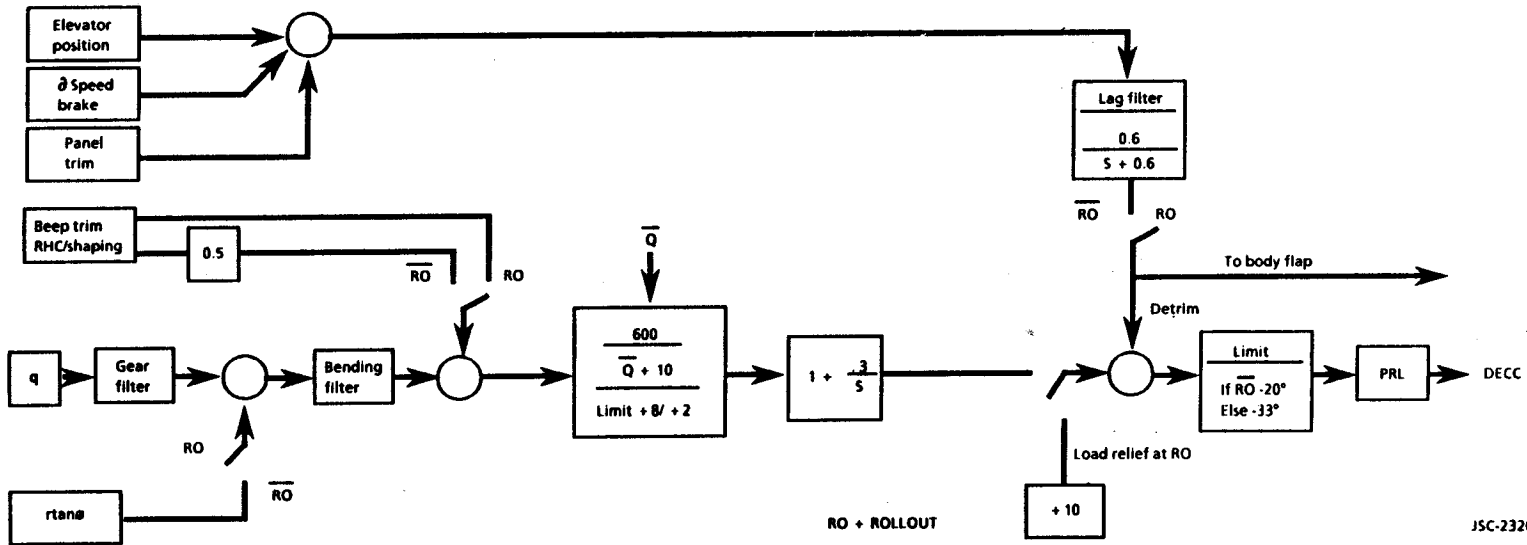

(b) Post MGTD

Figure 5-9.- Simplified pitch axis CSS block diagram.

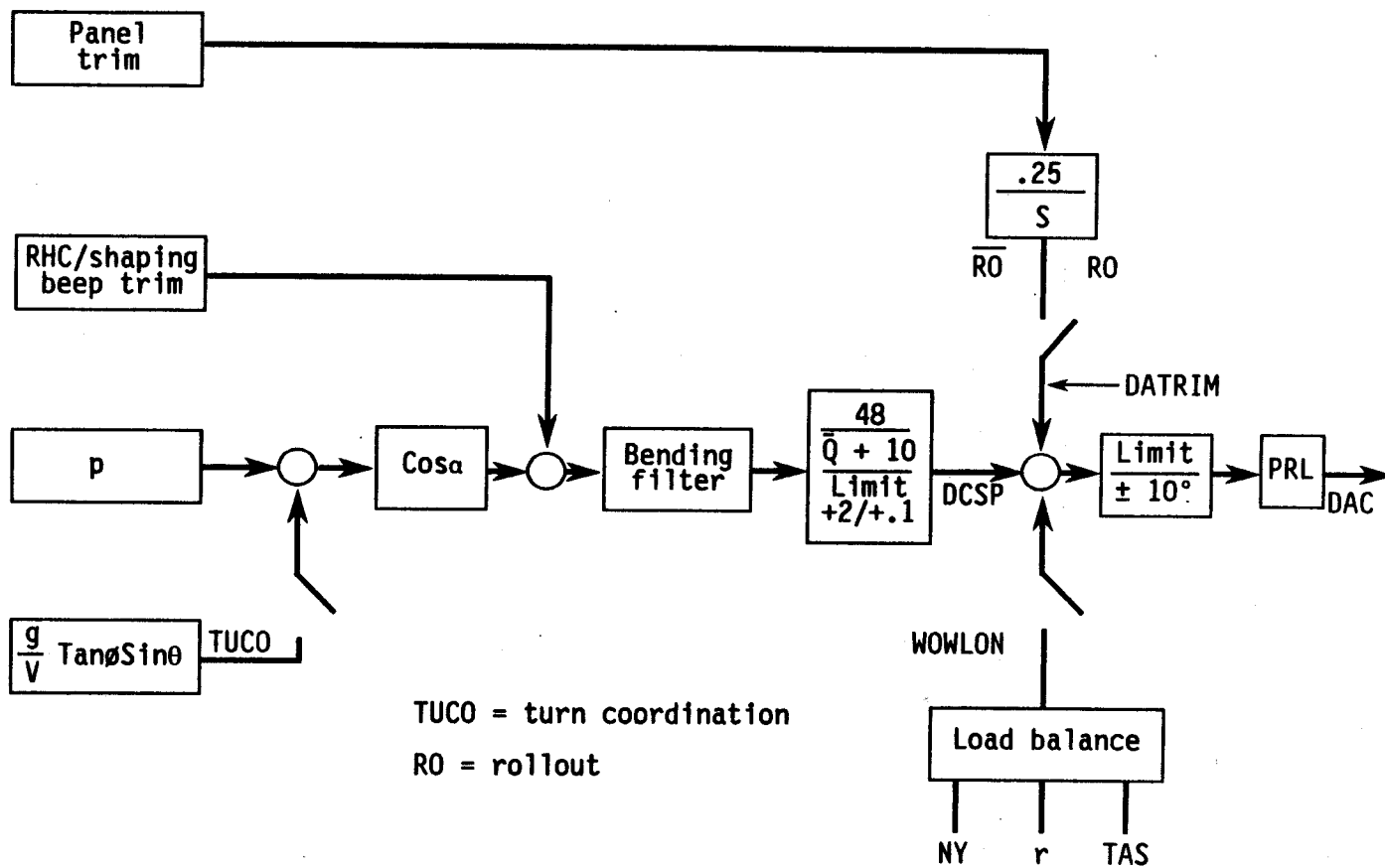

JSC-23266*080

Figure 5-10.- Simplified subsonic roll axis CSS block diagram.

5-21

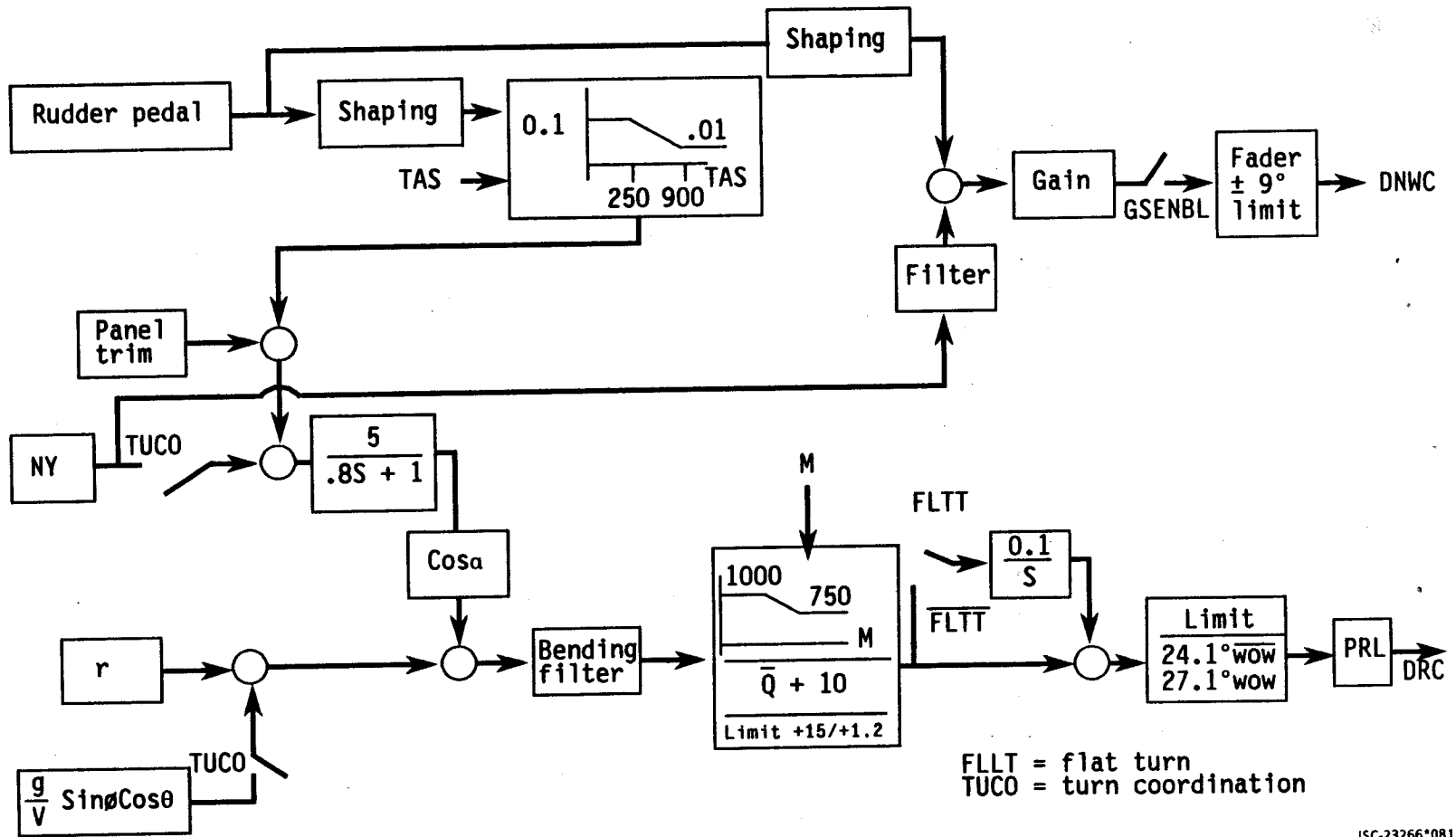

JSC-23266*081

Figure 5-11.- Simplified subsonic yaw axis CSS block diagram.

JSC-23266

Body roll rate and attitudes are supplied to the yaw channel and summed with yaw rate, lateral acceleration, and any rudder pedal input to form a yaw command. The gain of this command is scheduled with Mach and Q-bar and, again, notch filters are used to attenuate body bending.

Roll rate trim is available with the RHC beep trim (CSS mode) and aileron trim is available with the roll panel trim switch (CSS or auto modes). Manual rudder trim is available with the yaw panel trim switch in CSS or auto modes to augment the limited authority auto-trim function.

d. Lateral control on the runway

In the roll axis the aileron is actively controlled after WOWLON using a derived sideslip feedback signal to balance crosswind effects. This process is commonly called load balancing. After WONG, the aileron command for load balancing is faded out over a period of 100 sec. The panel trim and turn coordination functions are disabled after WOWLON.

In the yaw axis the rudder channel is altered after WOWLON to disable the lateral acceleration and attitude feedbacks, and the autotrim control function is switched out. After WONG manual rudder pedal commands effect NWS with filtered lateral acceleration feedback control, and rudder control using proportional yaw rate feedback.

5.3.2 Handling Qualities

Lateral-directional handling qualities are relatively conventional for a large airplane. With large roll rates, significant side force can be generated in the cockpit because of its position above the roll axis. Use of the lateral and directional controls is described in more detail in the crew procedures paragraphs below.

Longitudinal flying qualities are generally good if the pitch task is made simple and if the pilot refrains from making aggressive pitch commands. The vehicle has a pronounced tendency for longitudinal PIO if the pitch task requires high-gain pilot commands. The PIO tendency comes from a number of factors. The center of pitch rotation is near the cockpit, so the pilot receives poor feedback from the pitch rate being generated. The initial flight path response of the vehicle c. g. is opposite the direction of the command. The pilot feels no delta Nz response to the command until after a significant time lag, about 0.5 sec. The flight control software is somewhat complicated; its processing time leads to system response time delays on the order of 120 msec; at the threshold of pilot perception.

The piloting techniques discussed below seek to avoid longitudinal PIO by making the pitch task as simple as possible. Pilots must keep their "gains" low, especially when the vehicle is close to the ground.

5.3.3 Guidance Summary

For the purpose of this discussion, "guidance" is that portion of software that provides direction for the automatic flight control portion of software when the vehicle is in the AUTO mode, or direction for the pilots, in the form of guidance displays, when the vehicle is being flown manually. This section is intended to summarize the previous, detailed discussion of guidance and provide a pilot's point-of-view description of the task that it is doing in the landing and rollout phase of flight.

a. Prior to HAC intercept

At the beginning of the landing and rollout phase of flight, the GPC's are processing, OPS mode 305 software (TAEM guidance), Acquisition subphase. Guidance is directing the vehicle to the HAC tangency point.

b. Pitch guidance prior to HAC intercept

Before the HAC, pitch guidance is an N_z command based on altitude error and altitude rate error as a function of range to T/D, measured around the HAC. The N_z command is limited by vehicle constraints of maximum L/D and maximum dynamic pressure, and trajectory constraints of maximum and minimum allowable energy. Beyond these constraints, the N_z command is independent of airspeed. The N_z command has a delta N_z command limit of $\pm 0.5g$ (-0.75 , -0.5 for RTLS) above or below the equilibrium body axis N_z . The equilibrium body axis N_z is that N_z required to maintain one g in local vertical coordinates. For example, equilibrium N_z in a stabilized wings level glide is 1 g (for small γ) and the maximum N_z command would therefore be 1.5 g's. The equilibrium N_z in a 60° bank is 2.0 g and the limit N_z command would therefore be 2.5 g's. Figure 5-12 is a simplified block diagram of the pitch command logic prior to HAC intercept.

c. Roll guidance prior to HAC intercept

Roll guidance is based on the delta A_z to the HAC tangency point. Subsonic, the roll command is limited to 50° angle of bank.

On the HAC. After intercepting the HAC, the software modes to the heading alignment subphase where guidance directs the vehicle onto the prescribed spiral path at the appropriate altitude with respect to range to T/D.

d. Pitch guidance on the HAC

Pitch guidance on the HAC is unchanged from the prior to HAC intercept, there is no maximum N_z limit. Even so, typical predicted maximum N_z command on the HAC is 1.6 to 1.7 g. Actual (flight history) N_z around the HAC has been no more than 0.2 g above prediction, and averages 0.05 g above prediction.

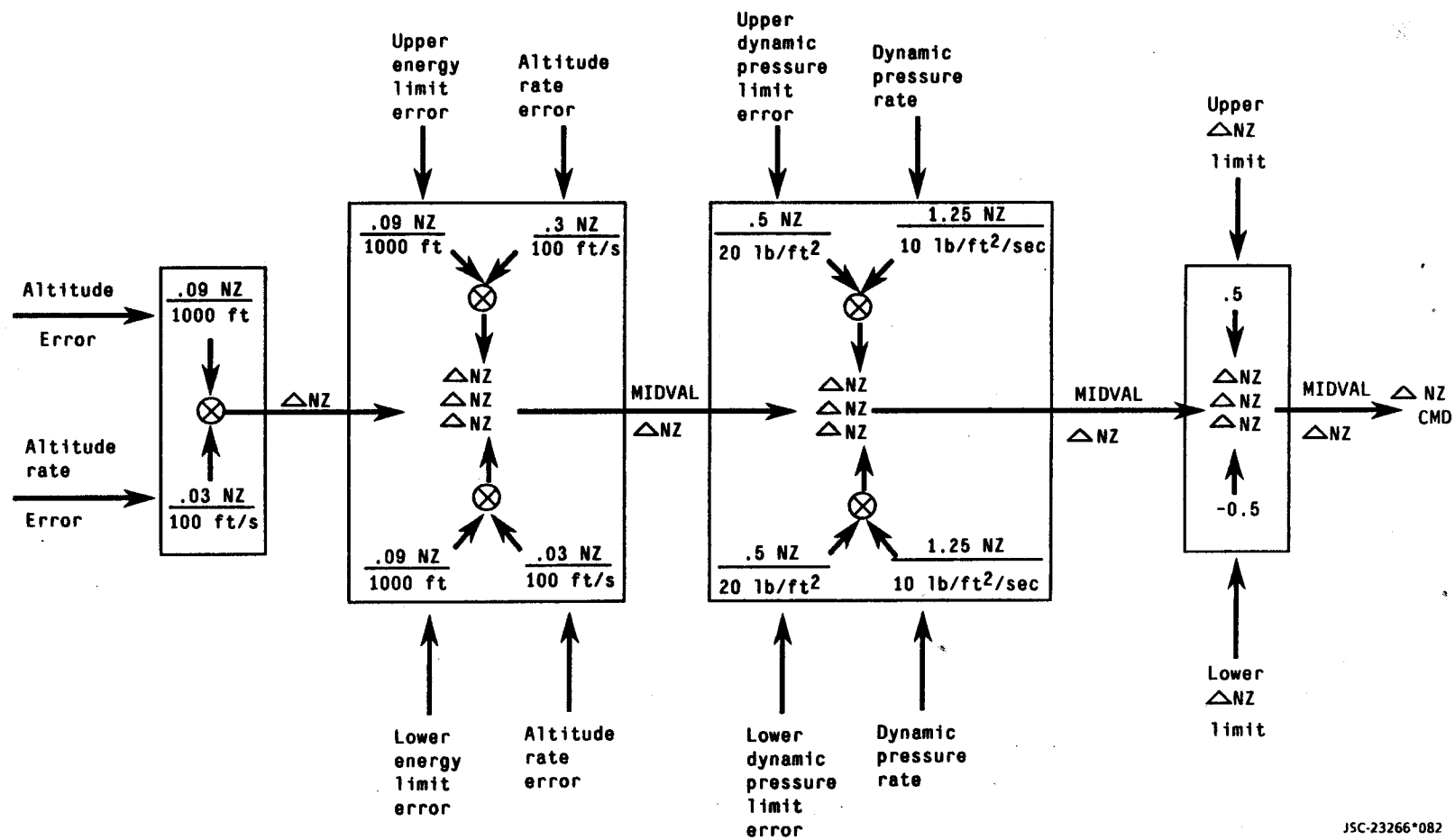

JSC-23266*082

Figure 5-12.- Pitch command logic prior to HAC intercept.

e. Roll command on the HAC

Roll command on the HAC is based on the radial error and radial error rate from the HAC trajectory, and is limited to a maximum bank angle of 60°. If the radial error outside the HAC exceeds 7000 ft, the roll command reverts to the delta AZ reference and is again limited to 50° angle of bank. The reference (no wind) profile, and the size of the HAC are designed to required approximately 43° angle of bank on the HAC.

f. Roll command on the HAC, OI-22 and subsequent

Bank angle command is limited, as a function of Nz command, to constrain the resulting Nz to be within the vehicle certification limit. If the pitch command is approaching the Nz limit on the HAC the roll command will decrease, guiding the vehicle outside the HAC, in order to not exceed the Nz limit. The Nz limit is an I-loaded value based on the estimated vehicle weight at the OPS 3 transition, and includes a 1.4 factor of safety.

(1) Prefinal

The last subphase of TAEM guidance is called prefinal and is entered when the range from the HAC tangency point to the approach course intercept point is less than 5300 ft or vehicle altitude is less than 7000 ft above T/D. The pitch command is unchanged except that the trajectory constraints of allowable energy are removed.

(2) Roll command in prefinal

The roll command changes at prefinal from radial error and rate to one based on runway centerline error and error rate. The bank angle limit is still 60°.

(3) Approach and land phase

At the A/L transition, guidance changes to a new set of modes designed to accomplish the remaining tasks of the landing approach. Pilots can think of the A/L transition as the point at which guidance decides that the vehicle is in a position, with sufficient energy, to complete the remaining maneuvers. The parameters that govern this decision are

- (a) Altitude < 10,000 ft above T/D
- (b) Altitude error ± 1000 ft
- (c) Cross range < 1000 ft
- (d) Flight path angle (γ) error $\pm 4^\circ$
- (e) Airspeed 272 - 297 KEAS (or Q-bar error <24 psf)

If the parameters are not met at 10,000 ft altitude, they continue to be sampled as the vehicle descends until they are met. The altitude, cross range, and gamma error parameters do not remain constant, but gradually decrease as altitude decreases. If the parameters are still not met at 5000 ft altitude, the transition is forced. The reasoning is that the software modes that contain the remaining commands must be selected in time for them to be used regardless of the vehicle energy state. The first subphase of A/L guidance is the capture phase. The second subphase is OGS and is entered when the altitude error is less than 50 ft, or the gamma error is less than 2° for 4 sec. Usually, the capture phase lasts a very short time, and can be considered as synonymous to the OGS phase.

g. Pitch command on the OGS

Several changes in the pitch command from TAEM guidance occur in the capture and OGS phases of A/L guidance, but would not normally be detectable by the crew. The pitch command is no longer limited by Q-bar or energy constraints and the 0.5 delta NZc block (last block of fig. 5-12) is eliminated.

h. Roll command on the OGS

On the OGS, the roll command is based on lateral error and lateral rate error from the runway centerline. The roll command is limited to 45° angle of bank until 3000 ft altitude, after which it is limited to 20° .

i. Preflare

The preflare phase of guidance is entered at 2000 ft above T/D, and is called FSGS.

j. Pitch command during FSGS

At 2000 ft altitude, an open loop pitch command is issued to break the rate of descent. At 1700 feet the pitch command attempts to track a constant 1.3g pull up circle. This circle is tangent to the OGS and tangent to a point 15 ft above the IGS. The open loop command plus the tracking of the pull up circle reduces the 190 ft/s sink rate to about 12 ft/s in preparation for tracking the IGS. When the vehicle gets to a point on the circle 30 ft above the IGS, the pitch command tracks an exponential decay path down to the IGS. This takes about 8 sec and is followed by about 5 sec of tracking the IGS before the FF phase (fig. 5-13).

k. Roll command during FSGS

There is no change in the roll command from that on the OGS.²²

5-27

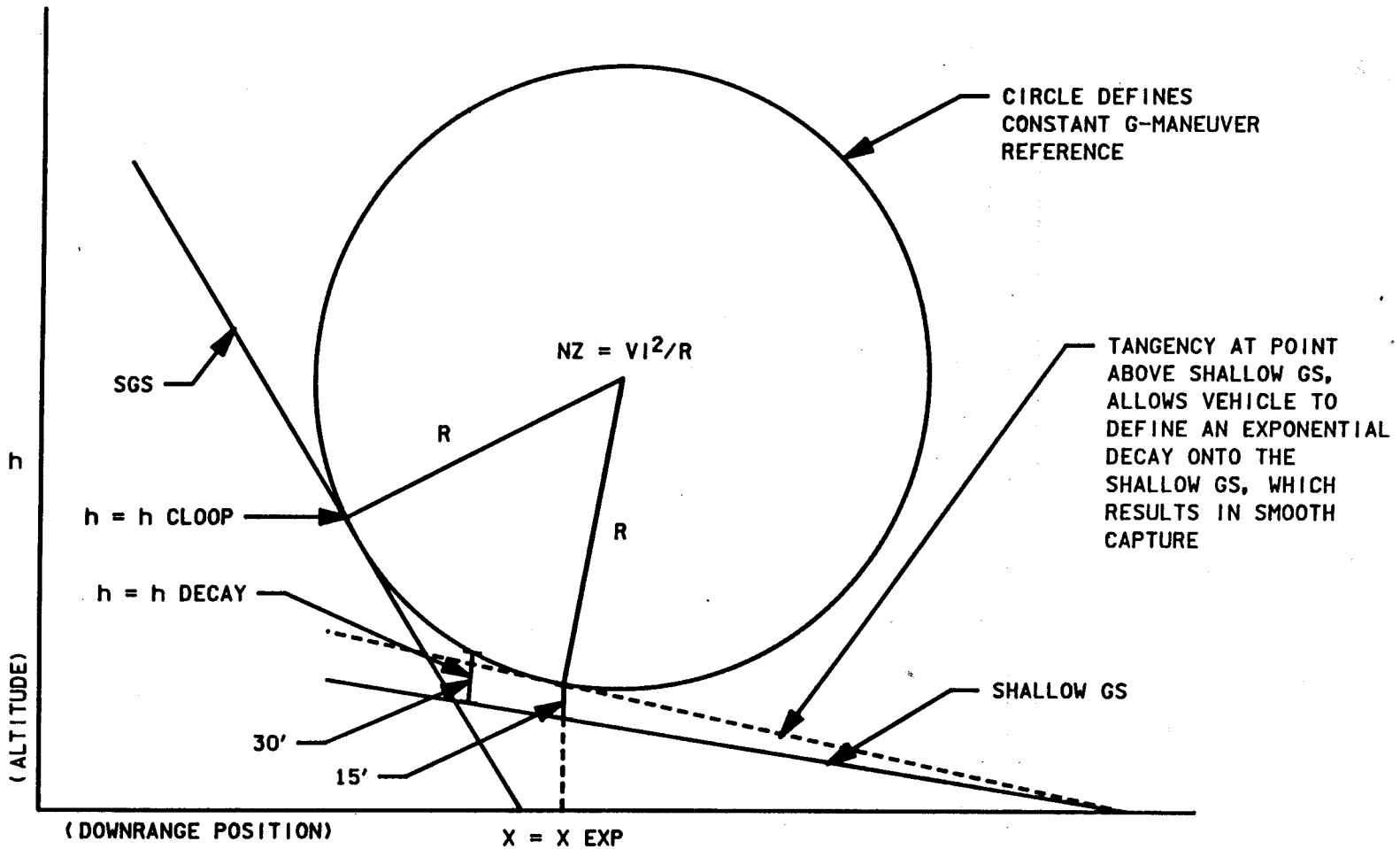

232660085. ART, 1

Figure 5-13.- IGS intercept.

JSC-23266

1. FF

This phase of guidance is entered at an altitude of 30 to 80 ft, depending on the altitude rate. With the vehicle in CSS, the guidance command is removed from the HUD when the FF phase is entered, so there is effectively no guidance provided from that point on. If the vehicle is in auto, the display of guidance is retained.

m. Pitch command in the FF

In the FF phase, the Nz command is based on altitude rate error referenced to a look-up table of desired altitude rates (sink rates) versus altitude. The table is a linear plot of desired sink rate versus altitude which, for example, has a value of 13 ft/s at an altitude of 52 ft and 3 ft/s at 2 ft of altitude. Below 2 ft altitude, the reference is a constant 3 ft/s. Prior to FF, Nz command tries to keep the vehicle at the correct altitude for the current range to T/D. In the FF, pitch guidance no longer cares where the vehicle is with respect to the reference trajectory, but only wants to achieve a vehicle attitude that results in the reference sink rate at T/D. This is different from the philosophy of autoland guidance systems in powered airplanes. In those systems, the desired trajectory is referenced until the airplane is over the runway, because energy is available to achieve it. In a glider, the FF must be accomplished with the available energy, whether the vehicle is over the runway or not.

n. Roll command in the FF

Roll command remains unchanged from that in the OGS phase.

5.3.4 Area Navigation Summary

Area Navigation can be thought of as the subset of software that provides navigation information for display on the two HSI's. The area navigation information is also provided to the HUD altitude and glideslope scales. See section 2 for detailed descriptions of the HSI and HUD displays.

a. Before HAC intercept

Throughout the landing and rollout phase of flight, the HSI compass card is referenced to magnetic north and shows the vehicle heading under the lubber line. The course arrow is aligned with the runway designated on GNC SPEC 50, horizontal situation display (HSD). The course deviation indicator shows the direction to fly horizontally to reach the runway centerline. The altitude reference scale shows the vertical distance above or below the reference altitude profile.

Before HAC intercept, the primary bearing pointer points to waypoint 1, the closest point of HAC tangency ahead of the vehicle, and the secondary bearing pointer points to the center of the HAC. For the purposes of area navigation, the HAC is a circle of fixed 15,500 ft radius. The Primary range window shows range to waypoint 2 measured around the HAC. Waypoint 2 is a point on the runway centerline 1000 ft past the threshold. The secondary range window shows distance to the center of the HAC.

b. On the HAC

The bearing pointers and range windows have the same functions as before the HAC. If the vehicle is on the reference trajectory, the primary bearing pointer is under the lubber line and the secondary bearing pointer is 90° left of the nose (left HAC) or 90° right of the nose for a right HAC. The bearing pointers are not in the above positions rigorously if the vehicle is being flown precisely as commanded by guidance. Guidance uses a variable radius HAC (from 26,000 ft to 5000 ft) based on altitude and energy state, so the bearing pointers, which are referenced to the fixed radius HAC, may not be exactly under the lubber line (primary) and 90° off (secondary).

c. Approach scaling

Approach scaling is the event that prepares the HSI for precisely monitoring GS and AZ on final approach. It should not be confused with the A/L guidance transition. On the HSI, the course deviation indicator (CDI) changes from a scale of 5° AZ per dot to 1 1/4° per dot, and the altitude reference scale changes from 2500 ft altitude error per dot to 500 ft per dot. Both bearing pointers being pointing to waypoint 2, and both range windows show the distance to waypoint 2. Approach scaling occurs when the vehicle is below 18,000 ft (12,000 ft on the minimum entry profile (MEP)) and is within 2.5° of the runway course. If the 2.5° course deviation is not satisfied, approach scaling is forced at 12,000 ft (6000 ft MEP). It is possible to have approach scaling occur, at an altitude above 12,000 ft, and then fly outside the 2.5° course requirement by, for example, overshooting the final approach course. The HSI reverts to the configuration before approach scaling, and a confusing display results (the HSI thinks it should fly around the HAC again). The primary bearing pointer points to the nearest HAC tangency point and the primary range window shows the distance all the way around the HAC to waypoint 2. Since the vehicle is very low for another trip around the HAC, the altitude reference scale shows full deflection up. Because the pilots are looking outside at this point, it is not likely that the confusing HSI display would be noticed. When the vehicle descends below 12,000 ft (6000 ft MEP), approach scaling occurs once again, and the confusing display is removed.

d. Preflare

During the preflare at 1500 ft, one more change occurs on the HSI. The altitude reference scale stops being active and the pointer becomes fixed at the center marker of the display. A small red flag labeled GS appears in the lower right corner of the HSI.

Figure 5-14 provides a summary of guidance phases and area navigation displays from TAEM to T/D.

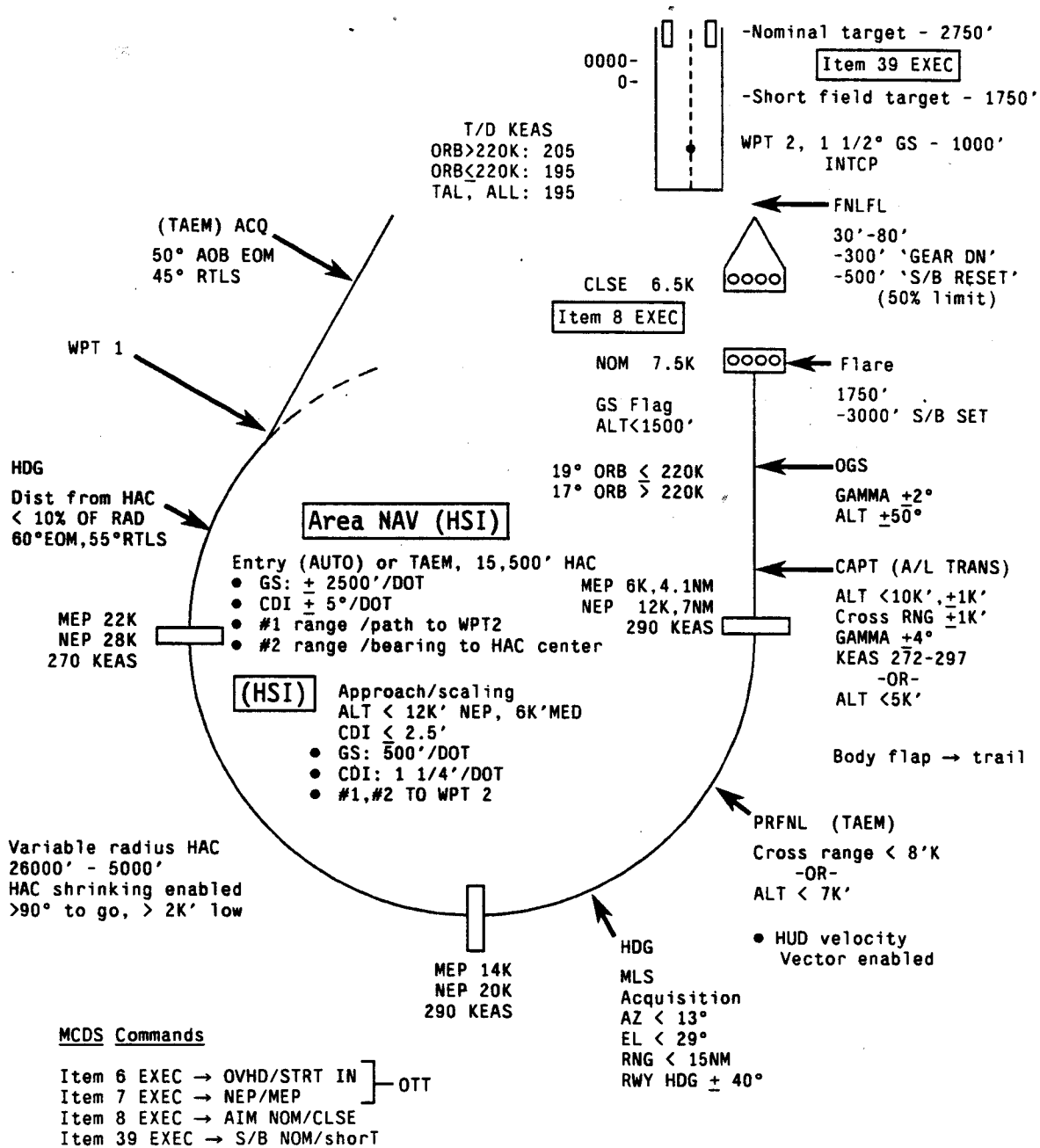

JSC-23266*070:5

Figure 5-14.- Guidance phases and area navigation displays.

5.3.5 SB

5.3.5.1 SB Command Before OI-22

a. Subsonic before OGS

The subsonic SB command is based on the dynamics pressure error from a reference profile. The reference profile is a linear ramp from 175 psf (202 psf for heavy vehicles) at approximately 0.95 mach to 285 psf at 10,000 ft altitude. The maximum SB command is limited as a function of the amount of low energy but the SB is basically trying to control airspeed to the reference profile.

b. On the OGS

On the OGS, the SB is referenced to a constant 290 KEAS (300 KEAS heavyweight). The command is based on the velocity error, and the integral of the velocity error from the 290 (300) KEAS reference, plus a reference SB angle of 65°. The integral term helps the SB to eliminate standoff errors and to efficiently converge to the 290 (300) kts reference.

c. At 3000 ft AGL

At 3000 ft the SB is commanded to a position that gives the vehicle energy to reach approximately 2500 ft past the threshold at 195 KEAS (205 KEAS heavyweight), or 1500 ft past the threshold at 195 KEAS, if the short SB option is selected. This command is based on the aim point that is selected plus these four environmental factors:

- (1) Windspeed (as computed at 3000 ft AGL)
- (2) Vehicle weight
- (3) Density altitude
- (4) Airspeed error (at 3000 ft AGL)

The purpose of this smart SB computation is to provide a constant SB setting, from 3000 ft on, that allows the vehicle to achieve the T/D targets described above.

At 500 ft AGL. At 500 ft, a guidance computation is made to refine the energy prediction. This computation is based only on

- (1) Average integrated windspeed between 3000 and 500 ft AGL
- (2) Density altitude

Flight history shows that the position commanded at 500 ft is within a few degrees of the position commanded at 3000 ft. See section 4 for more details.

5.3.5.2 SB Command for OI-22 and Subsequent

Beginning with OI-22, the subsonic SB command is based on dynamic pressure and vehicle energy divided by weight. The normalized energy term, E/W , is chosen for its simplicity and the fact that it includes an airspeed and altitude term. It is equal to one-half velocity squared divided by the gravitational constant, plus altitude.

From 0.95 Mach until an altitude of approximately 15,000 ft AGL, the SB command is a function of E/W error only. From 15,000 ft to 10,000 ft, the command is a function of both E/W error and dynamic pressure error. From 10,000 ft to T/D, the SB command is identical to previous software releases, including the "smart SB" functions at 3000 ft and 500 ft.

5.3.6 Crew Procedures

This section separates the landing and rollout phase of flight into appropriate subphases or events and discusses what the crew should be doing at those times during a nominal approach. Relevant displays and controls, as well as changes in guidance and navigation will also be discussed.

A brief summary of crew actions and the approved crew communications protocol is presented (tables 5-I and 5-II):

TABLE 5-I.- LANDING/ROLLOUT CREW PROCEDURES

| <u>EVENT</u> | <u>CREW PERSON</u> | <u>ACTION</u> |
|-----------------------------|--------------------|-------------------------------------------------------------------------------------------------------------------------------------------------------------------------|
| √15k ft | CDR & PLT | ✓ PAPI's and HUD overlay on runway. HUD MODE - DCLT as required. |
| | MS | ✓ MLS incorporation (G-50, TACAN ratios and residuals blank). |
| | ALL | Start <u>LANDING COMM PROTOCOL</u> . |
| < 10k ft | MS | ✓ BF to trail and "A/L" on VERT SIT |
| √5k ft | PLT | Compare RADAR ALT 1 vs 2. |
| 3k ft | MS | ✓ SB command %. |
| 2k ft | PLT | <u>GEAR ARM PB - ARM.</u> |
| | CDR | Start PREFLARE and transition onto BALL BAR. |
| 500 ft | MS | ✓ SB command %. |
| On CDR call 300 ± 100 ft | PLT | <u>GEAR DOWN PB - DN.</u> |
| | PLT/MS | ✓ GEAR indicates DOWN. |
| T/D | CDR | Control drift with rudder. Select manual SB full open. |
| | MS | ✓ SB opening. |
| | PLT | ✓ HUD display for WOWLON (pitch bars present, velocity vector disappear). |
| 175 kts (185 lakebed) | CDR | Derotate at 2-3 deg/sec. |
| NWTD | PLT | SRB SEP or ET SEP - MAN/AUTO, PB-PUSH. |
| | CDR | Maintain and/or correct to centerline with NWS. * If no load relief, RHC full FORWARD * |
| | | * If NWS FAIL light comes on steer with * * rudder and brakes. Direct NWS may be * * available, use only if required. Engage * * with rudder pedals neutral. * |
| | MS | ✓ ELEVONS down and NWS FAIL & antiskid FAIL lights off. |
| | MS | Call "NWS FAIL" as necessary |

TABLE 5-I.- CONTINUED

| <u>EVENT</u> | <u>CREW PERSON</u> | <u>ACTION</u> |
|-------------------|--------------------|----------------------------------------------------------------------------------------------------------------------------------|
| MIDFIELD | CDR | ✓ Groundspeed and DECEL on HUD. No braking before midfield on concrete runway. When groundspeed < 140 kts, brake at 8 to 10 ft/s |
| < 5k ft remaining | CDR | If groundspeed > 140 kts, MAX braking |
| < 40 kts | | Reduced braking to < 6 ft/s ² . |
| WHEEL STOP | | SB - CLOSE |

TABLE 5-II.- LANDING COMM .PROTOCOL

NOTE: Silent cockpit except for callouts listed below and problems.

| <u>EVENT</u> | <u>CREW PERSON</u> | <u>ACTION</u> |
|-------------------------------------------------------------------|--------------------|---------------------------------------------------------------------------------|
| MLS to State Vector | MS | "MLS" |
| A/L | MS | "APPROACH & LAND, BF TRAIL" |
| ~5k | PLT | "RADAR ALTIMETER", 1 & 2 CHECK GOOD |
| 4k | PLT | "4,000 ft" |
| 3k ft | PLT | "3,000 ft" |
| | MS | "BOARDS _____%" |
| 2k ft | PLT | "2,000 ft", PREFLARE NEXT |
| | CDR | "PREFLARE, ARM THE GEAR" |
| | PLT | "GEAR IS ARMED" |
| 1k ft | PLT | "1,000 ft" _____ kts (PLT call max. EAS in preflare) |
| 500 ft | PLT | "500 ft" |
| 400 ft | PLT | "400 ft" |
| 300 ± 100 ft | CDR | "GEAR DOWN" |
| | PLT | "GEAR COMING" |
| | MS | "BOARDS _____%, GEAR IS DOWN" |
| 300 | | |
| 200 | | |
| 100 | | |
| ~70 | | |
| ~50 | | |
| ~40 | | |
| ~30 | | |
| ~20 | | |
| ~10 | | |
| ~5 | | |
| 300 200 100 ~70 ~50 ~40 ~30 ~20 ~10 ~5 | --ft | PLT " _____ ft, _____ kts" (steady rhythm) |
| TD | PLT | "TOUCHDOWN" |
| WOWLON | PLT | "WOWLON" (Call WOWLON when it occurs, HUD format changes. XW may delay WOWLON). |
| 175 kts (185 lakebed) | PLT | "175 (185), DEROTATE" (Even without WOWLON) |

TABLE 5-II.- Concluded

| <u>EVENT</u> | <u>CREW PERSON</u> | <u>ACTION</u> |
|-----------------|--------------------|-----------------------------------------------------------------------|
| DEROTATION | PLT | "PITCH RATE ____" (Repeat rate at regular cadence during derotation). |
| NWTD | PLT | "WOW SET" (Manual backup by depressing ET SEP or SRB SEP PB) |
| | MS | "Load Relief" or "No Load Relief" |
| MIDFIELD | PLT | "MIDFIELD" |
| 5k ft remaining | PLT | "5,000 ft remaining" |
| | MS | "BOARDS _____%" |
| 140 | | |
| 130 | | |
| 120 | | |
| 110 | | |
| 100 | --ft | PLT " ____ kts, ____ (Decel reading)" |
| 90 | | |
| 80 | | |
| 70 | | |
| 60 | | |
| 50 | | |
| 40 kts | PLT | "40 kts, EASE OFF" |
| WHEELS STOPPED | CDR | "WHEELS STOPPED" |

5.3.6.1 Mach = 0.9 Until HAC Intercept

Time = 5:00 min before wheel stop

M = 0.9

H = 45,000 ft

R = 24 n. mi.

GUID = TAEM guidance, acquisition phase, MM 305

a. Discussion

At a mach number of about 0.9, the CDR takes manual control of the orbiter by putting the flight control system into CSS. CSS may be engaged by pushing the pitch and roll/yaw PB's on either the CDR's or PLT's eyebrow panel, or by deflecting either RHC greater than 6° out of detent in both pitch and roll axes. Each axis is placed in CSS independently from the other. The buttons are held depressed for up to 300 milliseconds or the RHC must be held out of detent, in each axis, for up to 300 milliseconds for CSS to be engaged. To ensure that the vehicle is in CSS, the crew should verify that the CSS PBI's are illuminated.

Very little control input is required to follow guidance to the HAC tangency point. If desired, the PLT gives control of the vehicle for a short time prior to HAC intercept. Some pilots prefer to fly the ADI guidance cues, rather than the HUD, at this point in the approach. Both sources of guidance are cross checked with each other regardless of the one used for primary reference. A good operating practice is to use the cross check process to gradually shift the CDR's primary scan from the ADI to the HUD by the time the vehicle is on the OGS.

b. HUD

Normally, the HUD's are in the full display mode; no declutter. The key portions of the display are the flight director symbol (square airplane symbol), guidance diamond, altitude reference pointer, and SB command/position scale. The pilot flies so as to keep the diamond exactly centered in the square airplane, while monitoring altitude error and SB position with respect to command. KEAS and altitude AGL can also be monitored on the vertical scales. Window 3 (lower left corner) displays "ACQ" for the acquisition phase of TAEM guidance.

c. ADI

Besides attitude reference, the ADI instrument provides the crew with pitch, roll, and yaw error and rate needles. The rate needles show angular rates on a scale that varies according to the rate sensitivity switch setting. See section 2 for more detail. The pitch and roll error needles provide the guidance commands described in section 5.4.3. The yaw error needle is different from the other two in that it does not

provide any command. Rather, it displays estimated sideslip angle (Beta) computed from lateral acceleration (A_y). This display function is enabled throughout major modes 304 and 305.

The ADI serves as a second source of guidance command display. The crew should be aware that there could be parallax error in the pitch command display. Every effort should be made to ensure that the pitch (and roll) error needles are held precisely in the center of the scale.

d. HSI

The crew should use the HSI bearing pointers as a cross check of guidance information and realize that when following guidance toward the HAC tangency point, the primary bearing pointer is not exactly under the lubber line because of the potentially different HAC sizes being used by guidance and the HSI. The altitude reference scale, when used in conjunction with trajectory and airspeed information, provides the crew with a measure of the vehicle's energy state. It should be emphasized that the altitude reference error displayed on the HSI is only correct when the vehicle is on the correct trajectory. Because of other differences between the trajectory calculations of guidance and area navigation, the altitude reference scale needle may not be centered when the vehicle is on the guidance derived trajectory.

e. AMI and AVVI

The tapes are a second source of airspeed and altitude, and the prime source of angle of attack and altitude rate. On a nominal approach, the crew uses the tapes as an occasional cross check of HUD information.

f. Vertical situation display (VSD)

The VERT SIT 1 display is the default GNC display at 0.9 mach, prior to HAC intercept. On a nominal approach, the VERT SIT display provides primarily a cross check for the vehicle's energy state through the E/W scale and the altitude versus range guidelines.

g. HSD

The HSD (SPEC 50) is available in PASS or BFS throughout the landing and rollout phase of flight. At Mach = 0.9 on a nominal approach, active crew interface with the display is complete. At this point, the crew can use the display to cross check lateral guidance, by observing that the shuttle trajectory predictor dots are aimed at the nearest point of tangency to the HAC. The navigation state of the BFS is roughly determined by a visual comparison of the PASS and BFS SPEC 50 displays.

5.3.6.2 On the HAC

Time = Approximately 4 min 30 sec before wheel stop

M = Approximately 0.84

H = Approximately 40,000 ft

R = Approximately 20 n. mi.

GUID = TAEM guidance, heading phase

a. Discussion

As the HAC is approached, the CDR takes control of the vehicle from the PLT. The crew ensures that they are headed for HAC tangency by cross-checking guidance with the position of the predictor dots on the HSD. Guidance modes to the heading phase when the vehicle is at the tangency point with a radial error of 10 percent of HAC radius or less. In the heading phase, commanded angle of bank can be up to 60°.

The commanded roll onto the HAC is fairly abrupt and requires significant lateral RHC deflection. The crew should anticipate this command (using the HSD predictor dots) and complete the roll smoothly. The guidance commands should be followed rigorously while on the HAC. A majority of CDR's use the ADI needles to intercept the HAC and fly around it. The HUD should be cross-checked with a goal of using the HUD as the primary guidance reference by the time the vehicle is on final. There is nothing wrong with using the HUD for guidance information throughout TAEM and approach and land guidance. The CDR's that prefer the ADI generally do so because they are more comfortable responding to the large guidance commands (such as those rolling onto the HAC) from the needles rather than the HUD diamond. When the guidance commands are smaller, such as on the HAC or on final, the HUD diamond becomes easier to fly.

Flight on the HAC feels uncomfortable to some crew members because of the sometimes steep bank angle combined with the fairly steep nosedown attitude. The key is to follow guidance commands, with a cross check of the HSI, HSD, and VSD to verify that guidance is working okay. In the current software, guidance cannot command more than 0.5 g above the 2.0 g required to fly at 60° bank, so following guidance does not overstress the vehicle (but it may be right on the limit). Future software will provide overstress protection by limiting the bank angle, as discussed in 5.3.3 above.

b. HUD

The HUD may be used just as it was prior to the HAC. The piloting task is now more dynamic and most of the scan time is spent on the square airplane symbol and the guidance diamond while the CDR tries to fly guidance precisely. Guidance on the HUD has the advantage of having no

parallax error. The word heading (HDG) appears in window 3 when the TAEM heading phase is entered.

c. ADI

As described above, the ADI may be the primary source of guidance on the HAC, depending on crew preference.

d. HSI

At the point of HAC tangency, and for most of the flight around the HAC, the primary bearing pointer is pointing roughly straight ahead and the secondary pointer is roughly 90° left or right. The primary pointer gets farther from "straight ahead" the farther the vehicle flies around the HAC because guidance is commanding it around a decreasing radius spiral, while area navigation positions the pointer based on a constant radius HAC. Primary DME is about 20 n. mi. at HAC tangency and decreasing, while secondary DME is almost constant at about 3.3 n. mi. The glideslope indicator (GSI) still shows deviation from the altitude versus range profile and is only valid when the vehicle is on the correct path. For example, with a centered GSI and the vehicle outside the HAC, the vehicle is low energy.

e. VSD

The VERT SIT 1 display is active at HAC intercept and is replaced by VERT SIT 2 when the orbiter symbol descends below 30,000 ft. The trajectory lines provide the crew with a cross check of altitude versus range. The crew can deduce their approximate energy condition by observing their position on the trajectory in conjunction with their current EAS.

The vertical E/W scale shows normalized energy in units of feet. For the nominal approach, the triangle stays very close to the "NOM" reference line. The E/W scale is NOT "fly to".

The vertical theta limits scale is ignored on approaches in which air data information is incorporated into navigation and GNC. It is also NOT a "fly to" scale.

f. HSD

The HSD draws a circle to represent the current radius of the spiral path being flown around the HAC. This circle gradually shrinks in radius as the vehicle descends. The SPEC 50 circle is not drawn tangent to the final approach course until the vehicle is close to intercepting it. The predictor dots should lie slightly inside the SPEC 50 circle when the vehicle is flying the correct spiral path since the circle is drawn with the radius appropriate for the vehicle current, not future, position.

5.3.6.3 Approaching the OGS

Time = 2 min 45 sec before wheel stop

V = 270 KEAS

H = 20,000 ft

R = 9 n. mi.

GUID = TAEM guidance, heading phase

a. Discussion

At 20,000 ft altitude, the vehicle is at the 90° of turn to go point. Several changes in displays, navigation, and guidance begin to occur. The piloting task remains the same; precisely following guidance commands, but the crew workload begins to increase as they monitor the changes in navigation and guidance.

b. MLS acquisition

The vehicle software allows incorporation of MLS data to navigation when vehicle range to the MLS site is less than 15 n. mi. and the vehicle is within the antenna coverage of the MLS transmitters. See section 2 for complete details. MLS data allows a very accurate navigation state to be computed and it is important for the crew to know when the information is being incorporated. The following cues give indication of MLS incorporation:

- (1) TACAN residual and ratio data on the HSD goes blank.
- (2) The missing data "M" flags disappear from system summary 1 display.
- (3) There is a likelihood that a "jump" in the ADI needles and HUD diamond can occur.
- (4) If the HSI data source is selected to MLS before MLS acquisition (not a nominal procedure), the bearing, range, and GS flags disappear from the HSI.

The crew can normally expect to get MLS incorporation at about 18,000 ft altitude. The CDR should anticipate the jump in guidance commands and act as a smoothing filter when it occurs. In particular, the roll command may ask for bank angle changes as it tries to reduce the lateral trajectory error. By observing the runway, if visible, the CDR should make smooth bank angle changes to intercept the extended centerline.

c. Approach scaling on the HSI

When the vehicle is within 2.5° of the final approach course, approach scaling occurs on the HSI (section 5.3.4). Both bearing pointers point to Waypoint 2 on the runway and both distance windows show distance to waypoint 2, about 7 n. mi. The CDI, which has begun to converge, goes almost full scale and the begin to converge again. If there is any GS error being displayed, the altitude reference needle deflects almost full scale (five times the deflection it had before approach scaling). The crew should be aware that if the vehicle is flown to a position outside 2.5° from the final approach course before reaching 12,000 ft, the HSI reverts to the previous scaling, a condition commonly called wraparound. Wraparound can be avoided, if desired, by placing the HSI mode switch to the approach position.

d. VV

When the final phase of TAEM guidance (prefinal) is entered, the flight director symbol (square airplane) on the HUD is replaced with the VV (round airplane). The VV displays the actual direction of flight, within the limits of HUD FOV. If the VV is limited by FOV, an "X" appears in the center of the symbol. The vehicle is typically in an angle of bank, approaching the final approach course, when the transition to VV occurs. The symbol typically "floats" toward the direction of turn, a movement that appears downward because of the angle of bank. At the same time, the roll command begins tracking lateral error to the runway centerline instead of radial error on the HAC. This change can lead to a sudden movement (laterally) of the guidance diamond, usually commanding the vehicle to roll out of the HAC turn and roll towards the runway centerline. Typically, as soon as the roll toward the runway centerline is commanded, the command is reversed as roll guidance senses that the lateral error is being reduced. As with the MLS guidance jump, the CDR should smooth these commands and make a more gradual intercept of runway centerline.

After the VV is active, the pilots have a visual indication of the crosswind component. The VV shows where the vehicle is going, and the boresight cross shows which way the nose is pointed (into the wind) to achieve that flight path.

e. Gamma reference triangles

When the VV becomes active, the gamma reference triangles appear on the display. The triangles are located at an I-loaded value of -19° for lightweight vehicles, or -17° for heavyweight vehicles ($>220,000$ lb). As the vehicle intercepts the OGS on a nominal approach, the gamma triangles are positioned next to the selected aim point, with the VV between them.

f. Energy scale

At 20,000 ft the E/W scale is removed from the trajectory display.

5.3.6.4 On the OGS

Time = 2 min before wheel stop

V = 290 KEAS (300 KEAS heavyweight)

H = 12,000 ft

R = 7 n. mi. (42,000 ft to waypoint 2)

GUID = TAEM guidance, prefinal phase

a. Discussion

The task of flying the OGS is simple but must be performed precisely in order to guarantee sufficient energy to achieve the desired T/D. The crew is provided with ample guidance and visual information to do the job. During training in the STA, pilots should develop their own techniques of evaluating and assimilating the available information.

Upon intercepting the OGS, the CDR and PLT should note how closely the HUD runway overlay corresponds to the runway position. This gives them a quick assessment of the accuracy of navigation, and therefore, guidance. The level of accuracy determines what tools the crew uses to complete the approach. After checking the runway overlay, the HUD may be decluttered if desired. Many pilots decluttered the HUD to the second level to provide a very simple display for the remainder of the approach. This action removes pitch attitude indication from the display.

b. MLS available

If MLS data is incorporated, guidance is very accurate. The HUD guidance diamond is as the primary flight reference with the PAPI lights as a cross check. The PAPI's are true information, but with MLS, the guidance diamond (or needles) provides a simple method of smoothly tracking the OGS and the extended runway centerline. On a nominal approach, the gamma reference triangles are positioned next to the selected aim point, and the guidance diamond is centered in the VV, which overlay the aim point. Of course, there are two red and two white PAPI's for a 19° GS, or three red and one white PAPI for a 17° GS.

GS errors are shown by the HSI and HUD altitude reference scales, the PAPI lights, and the gamma reference triangles. If the vehicle is shallow, the triangles lies short of the selected aim point indicating that the selected GS intersects the ground short of the aim point. The VV is placed beyond the aim point until the triangles are adjacent to the aim point. Once the triangles are next to the aim point, the VV is returned to a position on the aim point. The reverse technique is used for the steep case.

Lineup errors are displayed on the HSI, CDI, and by the visual presentation given by the runway and aim points. With MLS, the CDI display are accurate, and the roll command portion of guidance keeps the vehicle on the approach course. It is important to have corrected any lineup errors while still on the OGS. The pitch tasks of the preflare, IGS, and FF are made more complicated if the crew is also working a lateral task created by a lineup error.

c. MLS not available

When MLS data is not available or not incorporated, navigation and guidance information is only as accurate as the TACAN system. This level of accuracy is adequate for flight around the HAC, but is generally not sufficient to precisely track the OGS. Therefore, the PAPI's are used as the primary GS reference and the overall visual scene is used to determine lineup errors. Even though guidance cannot be used to precisely follow the OGS, the VV and gamma reference triangles can be used to track the OGS.

d. Radar altimeters

At approximately 5000 ft altitude the radar altimeters lock on and provides an altitude readout on the AVVI tapes and HUD's. The typical crew has the PLT evaluate the altitude from both altimeters by selecting each position on his RA select switch. After the initial evaluation, the PLT continues to monitor RA altitude and informs the CDR if the CDR's altitude appears biased. If information from either RA appears biased, the CDR and PLT should select the other RA.

e. Smart SB

At 3000 ft, as discussed in the SB command section, the SB is commanded to a fixed position that is designed to get the vehicle to a point 2500 ft down the runway at 195 (205) KEAS, or 1500 ft down the runway at 195 KEAS if the short SB option is selected.

f. Flare indices

At about 3500 ft altitude, a second set of triangles appear at the bottom of the HUD FOV and move upward toward the gamma reference triangles. These flare indices give the crew warning that the preflare is about to be commanded. At about 2000 ft, the flare indices is superimposed on the gamma reference triangles which then disappear. The flare indices continue moving up and are a visual indication of the open loop portion of the preflare guidance command.

5.3.6.5 Preflare and IGS

Time = 1 min 29 sec before wheel stop

V = 290 to 310 KEAS

H = 2000 ft

R = 12,300 ft to waypoint 2

GUID = A/L Guidance, FSGS phase

a. Discussion

The remainder of the approach, beginning with the preflare, is an art when flown CSS. Although not a very difficult task, the preflare and IGS phase require repetitive practice to ensure consistent, repeatable performance. During the preflare, the pilot assimilates information from several sources and produce a pitch maneuver that smoothly intercepts the IGS.

During preflare, all of the scan is normally heads up. The HUD provides basic attitude, airspeed, and altitude information plus two bits of command information. The guidance diamond continues to provide pitch and roll commands according to the logic described in section 5.4.3. The flare indices provide an approximate 1.3 g open loop pullup command. If the vehicle is on GS and course at the beginning of the preflare and preflare guidance is followed precisely, the guidance diamond, VV, and flare indices smoothly track up the display together. If the preflare is begun early or late, the guidance diamond still provides commands to maneuver the vehicle into the IGS, but the flare indices does not adapt to the off-nominal situation and should be ignored.

The other part of the heads-up scan is the outside world. The approximately 500 STA approaches completed before first flight serve to cement the sight picture of a good approach into the pilot's mind. Cues present in this sight picture are

- (a) the rate of ground rush
- (b) the rate of change of runway aspect angle
- (c) the rate at which the ball approaches the bar

Throughout the preflare, it is important to keep lineup under control. This is easier said than done, since major changes in wind direction and speed can occur below 2000 ft. Deviations from centerline should be corrected immediately, before a large correction is required. Keeping the deviations and the corrections small lets the pilot devote the proper attention to the pitch preflare task.

b. Headsdown scan

On rare occasions, it may be appropriate to include the ADI in the pre-flare scan. If the crosswind component is large enough to cause the VV or guidance diamond to be HUD FOV limited, flying guidance on the HUD is difficult. The pitch task can be completed using only visual references. The lateral task is more difficult because of the crosswind, so a quick look at the ADI roll error needle helps the pilot determine the size and direction of the lateral correction required.

c. SB

The smart SB setting made at 3000 ft is refined at 500 ft. Flight history shows only a small change in setting between 3000 and 500 ft. For EOM, the 500 ft setting is restricted by software to no greater than 50 percent, but is not restricted for TAL approached.

With large SB angles, the vehicle decelerates rapidly during FF, making the maneuver more difficult. For this reason, some CDR's plan to close the SB if the 500 ft setting is greater than some predetermined number, such as 40 percent. This is an acceptable practice provided the crew has determined that the rollout margin allows the additional energy to be put into the approach.

d. IGS

The shuttle approach IGS serves a different purpose than does the instrument landing system (ILS) GS for an airplane approach. The IGS is not a path along which a stabilized portion of the approach is flown, but rather a reference path the vehicle is near after the preflare and before the FF. If the vehicle is flown along a path that approaches that of the IGS, it is in a position to be smoothly flown through the FF. However, the vehicle does not spend more than a few seconds on the IGS, and may only touch the IGS momentarily before starting the FF.

The orbiter is not well suited to performing maneuvers that include a close tolerance pitch task. The pitch response time and the negative flight path steering (vehicle initially goes down with a nose-up command and vice versa) makes flying a very precise vertical profile difficult. The technique for flying the IGS presented next avoids requiring a close tolerance pitch task for that reason.

The pilot should develop a technique on the IGS that gets the vehicle to a consistent threshold crossing height from which repeatable FF maneuvers can be made. The desired threshold crossing height is between 15 and 20 ft, main wheels to runway. A good method to approach this goal is to use the technique that guidance uses on the IGS. Complete the preflare so that the descent rate is broken with the vehicle slightly above the IGS. The ball is slightly below the bar. The pilot allows the vehicle to slowly settle onto the IGS and, as it approaches the runway threshold, allow it to settle just slightly below the IGS (ball just resting on top of the bar). This settling maneuver is not a

close tolerance pitch task. The pilot only has to control the rate the vehicle settles onto, and through the IGS.

5.3.6.6 FF

Time = About 1 min before wheel stop

V = About 220 KEAS

H = 30 to 80 ft

R = Just prior to runway threshold

GUID = A/L Guidance, FF phase

a. Discussion

The FF is used to reduce the sink rate from about 12 ft/s on the IGS to less than 3 ft/s for T/D. It is also used to control the time and point of T/D so that the target T/D airspeed is achieved. Consistent FF performance is a product of repetitive practice in the STA. RHC inputs should be kept small to avoid forcing the main wheels into the ground and to keep from over controlling the vehicle in general. Therefore, the FF must be made a low gain task. This is done by entering the FF with sink rate and lineup under control. Avoid nose-down RHC inputs. If the preflare and IGS were flown properly, FF requires only a small pitch attitude change. The amount of pitch is learned through STA practice. A good pilot technique in FF is to shift the scan to the far end of the runway. The HUD VV can also be used to help find the correct pitch attitude. Pilots may develop a habit of using the VV exclusively in simulators (SMS and VMS) because of the poor visual cues compared to the real world. Pilots are strongly discouraged from this practice in the STA. The FF technique should not be dependent on a properly functioning HUD.

At the initiation of FF guidance, if in CSS, the guidance diamond and gamma reference triangles are removed from the HUD display.

5.3.6.7 T/D and rollout

Time = About 40 sec before wheel stop

V = 195 KEAS (or 205 KEAS)

H = Surface

R = 2500 ft (or 1500 ft) down the runway

GUID = A/L Guidance, FF phase

a. T/D

Several parameters characterize the instant of main wheel contact. The key parameter is airspeed. T/D airspeed is designed to provide a reasonable margin between the planned speed at T/D and the airspeed at which tail scrape occurs. This margin provides about five seconds of excess energy beyond the planned T/D. Since this is not a very large margin, airspeed should be given first priority. If the vehicle has nominal energy, the proper T/D x-position is a byproduct of the correct T/D airspeed. The sink rate, roll angle, delta heading, and y-position at T/D are a result of the atmospheric conditions and how well the CDR flies the vehicle through them. Desired values of T/D parameters are

| | |
|---------------|--------------------------------------------------------|
| Airspeed | - Target +/- kts |
| x-position | - As required to achieve T/D airspeed (nominal energy) |
| Sink rate | - 2 to 3 ft per sec |
| y-position | - Centerline |
| Roll angle | - Zero |
| Delta heading | - As required by crosswind |

The T/D x-position is secondary to T/D airspeed so long as energy is sufficient to land at the target airspeed on the prepared surface. If energy is extremely low, T/D can be safely delayed about five sec, or 25 kts, if required to stretch the glide to the prepared surface. If energy is so low that T/D cannot be made on the prepared surface, quick judgment is required of the CDR to decide how much airspeed is sacrificed to get closer to the runway. In some cases it could be worth risking a tail scrape to get to better terrain or past an obstacle. In general however, it is probably best to T/D near the target airspeed, with the desired sink rate so that the vehicle can be controlled during the ensuing rollout.

b. Crosswind after T/D

It is a good practice to consider every landing a crosswind landing. Even when the crosswind component is small, the pilot who is prepared for this makes a more controlled T/D and rollout. T/D is made in a pure crab, with no lateral drift; therefore, the nose is pointed upwind. During rollout, prior to derotation, the vehicle's response to crosswind is to roll and yaw away from the wind. The wings are held level with lateral RHC and lateral drift is held at zero with rudder into the wind as required.

c. Derotation

The highest main gear and nose gear structural loads occur during derotation and have components that are directly related to pilot technique during derotation. The technique recommended here is designed to minimize main gear loads through smooth RHC use, and to minimize nose-gear loads by getting the nose on the ground before pitch authority is lost. Derotation is begun at 175 (185 lakebed) KEAS regardless of vehicle weight. The CDR should move the RHC forward to

increases to -2 deg/sec over a period of at least one to two sec desired. Once the desired rate of -2 deg/sec is achieved, the RHC is held in position until the nosewheels make contact. The CDR should not attempt to fine tune or tightly control the derotation rate once established. This very smooth and somewhat open loop RHC technique minimizes elevon activity which reduces main gear oscillations that create high peak main gear loads. Excessive nose- gearloads occur when elevon authority is lost with the nose high enough to allow a high pitch rate to develop. This is avoided by ensuring that the full -2 deg/sec derotation rate is positively (and smoothly) developed. The derotation should not be started at an airspeed faster than 185 KEAS. The faster speed creates a higher main gear load component due to aerodynamic force when the pitch attitude goes below zero.

If T/D occurs at or below 185 KEAS, the derotation should be started immediately, but without sacrificing the slow and smooth buildup of derotation rate.

d. Crosswind during derotation

The vehicle responds to crosswind changes during derotation. As the wing angle of attach falls through zero, the tendency to roll and yaw downwind is greatly reduced. A moment later, at nosewheel T/D (NWS engaged), the response to crosswind is reversed. The vehicle tends to weathervane into the wind in yaw. Rolling tendency due to crosswind with the nosewheel on the ground is small. (The most noticeable component is roll due to rudder deflection, which is opposite to the direction of commanded yaw.) The CDR should anticipate the change in response to crosswind between the two-point and the three-point attitude. If any upwind rudder is being held at the beginning of derotation, the CDR should decrease rudder deflection as the pitch attitude passes through zero, and should be prepared to reverse the rudder input once the nosewheel is on the ground.

e. Rollout

For the nominal case rollout, NWS is considered to be functioning in the GPC, or GPC 1/2 mode, depending on the vehicle. In this case, nosewheel steering is the primary control on the runway. As the nosewheels approach contact with the runway, it is probably a good practice to have the rudder pedals near center, if practical. There is a "fader" that protects the vehicle from a sudden NWS input by gradually feeding in any commanded nosewheel deflection over a period of two seconds after nosewheel T/D. However, pilots generally are more comfortable having the pedals in the same position as the nosewheels. The rudder technique described in the preceding paragraph has the pedals near center at nosewheel T/D.

Secondary control on the runway is provided by lateral RHC. After WONG, elevons are all in the 10° down "load relief" position. Deflecting the RHC to the right, for example, reduces right elevon down deflection, increases the wing camber (negative angle of attach), increases the load

and drag on the right main gear, and steers the vehicle to the right. RHC control is not very important when NWS is functioning, but becomes very useful when NWS steering is not available.

f. Crosswind during rollout

With NWS engaged, the vehicle tends to "weathervane" into the wind. Lateral control is not difficult if lateral deviations are not allowed to get large. The pilot's vision should be focused to the far end of the runway so that lateral rates can be quickly detected and nulled. Lateral RHC should be used to keep the wings level and lateral steering should be accomplished with the rudder pedals, NWS engaged. NWS inputs should be positive, but judicious and smooth. Main gear tire wear, which is expected during a crosswind rollout, is accelerated with lateral steering, particularly on the KSC runway. If a lateral error develops, do not aggressively recapture the centerline. Instead, smoothly stop the lateral rate, then steer to slowly return to the centerline.

g. Braking

Braking should be accomplished in accordance with the flight specific Entry maneuvers Cue Card, but generally begins at 140 KGS. The level of braking deceleration depends on the amount of runway remaining. Usually, 5000 ft remaining is the decision point. A deceleration of 6 to 10 ft/s² is normally specified for more than 5000 ft remaining and maximum braking is specified if runway remaining is less than 5000 ft. In either case, braking is reduced at 40 KGS to minimize the possibility of locking a brake, since the antiskid system is bypassed at about 30 KGS.

5.4 RTLS ABORT LANDING

5.4.1 Overview

The RTLS abort landing is designed to present the crew with an approach, landing, and rollout that is virtually identical to a nominal EOM case. The GPC's processes OPS mode 6 software instead of OPS 3, but the guidance phase progression through TAEM and A/L guidance is identical in the two cases.

For RTLS, the short SB option is not selected and the aim point selection is based on the same criterion that is used for EOM. GS selection, which is an I-loaded function, is based on vehicle weight, with vehicles above 220,000 lb normally using 17°.

The RTLS approach, landing, and rollout should be flown just as described for the nominal case in section 5.4. RTLS guidance has some differences from EOM guidance that can have an effect in a low or high energy approach. These differences are described in the following section.

5.4.2 RTLS Guidance Differences

The relevant difference in RTLS guidance is in the Nz command logic. The pitch command in RTLS is structured the same way as in OPS 3. The difference lies in the Nz command limits for high and low dynamic pressure. Refer to figure 5-15.

| | | |
|-------------|---|--------------------------------------------------------------------------------------------------------------------------------------------------|
| Upper limit | = | $-(K1 \cdot (Q_{max} - Q) - Q_{rate}) \cdot K2$ |
| Lower limit | = | $-(K1 \cdot (Q_{min} - Q) - Q_{rate}) \cdot K2$ |
| K1 | = | .075 for EOM .05 for RTLS |
| K2 | = | EOM : .0625 RTLS: Ranges from .066 at .8 mach to .033 at .4 mach and below |
| Q | = | Orbiter dynamic pressure |
| Qrate | = | Dynamic pressure rate |
| Qmax | = | 340 psf for the A/L phase of flight |
| Qmin | = | $(.0233 \cdot \text{orbiter weight}) + \cosine \phi$ cosine ϕ has a lower limit of .707 (45° bank) for EOM and .9 (28° bank) for RTLS |
| ϕ | = | Bank angle |

Figure 5-15.- RTLS Nz command limits.

Two of the constants used in the calculation of the dynamic pressure limits are changed for RTLS guidance with the effect that the dynamic pressure limits are tighter for RTLS than EOM. This means that RTLS guidance does not provide as large an Nz command as EOM guidance to correct for a low or high energy condition.

a. High energy

In a energy case, the dynamic pressure upper limit is active and limit the delta Nz pitch down command being generated. For comparison, the following example is given:

| | | |
|--------------------|---|----------------------------------|
| Mach | = | 0.7 |
| Dynamic pressure | = | 250 psf or 271 KEAS and constant |
| EOM max. delta Nz | = | -0.42 g |
| RTLS max. delta Nz | = | -0.29 g |

The upper limit calculation is independent of orbiter weight.

b. Low energy

In a low energy case, the dynamic pressure lower limit would be active and would limit the delta Nz pitch up command being generated. For comparison, the following example is given:

| | | |
|--------------------|---|----------------------------------------------------------------------------|
| Mach | = | 0.48 |
| Dynamic pressure | = | 250 psf or 271 KEAS and constant |
| Orbiter weight | = | 240,000 lb (The lower limit calculation uses orbiter mass and bank angle.) |
| Bank angle | = | 20° |
| EOM max. delta Nz | = | +0.30g |
| RTLS max. delta Nz | = | +0.13g |

5.4.3 RTLS Flying Technique

Flying the RTLS approach, landing, and rollout is identical to the EOM case if the vehicle energy state is maintained close to nominal. The delta Nz commands that are generated are small and the tighter RTLS dynamic pressure limits are not invoked. If the energy state is above or below nominal far enough to cause the tighter RTLS dynamic pressure limits to be invoked, significant differences are noted between the character of RTLS and EOM Nz commands. In general, below $M = 0.9$, the RTLS Nz command generates a trajectory that takes longer to return to nominal.

a. High energy

In the high energy case, as discussed above, RTLS guidance provides a leisurely return to nominal compared to EOM guidance. The proper pilot response however, is to fly the guidance command. The return to nominal energy may be slower than desired, but an attempt to lead the command with a larger pitch-down input could lead to an overshoot of nominal and

a low energy condition. The quicker return to nominal using this technique is not worth the risk of creating a low energy condition, and should not be necessary anyway.

b. Low energy

In the low energy case, the RTLS Nz command provides a return to nominal so slow it creates an unsafe situation. For example, suppose the vehicle is low on the HAC. The Nz command generates a trajectory that has the vehicle back on energy by 10,000 ft. However, at 15,000 ft the strong tailwind that is persistent around the HAC, drops off steadily and becomes a moderate headwind on the OGS. This is a low energy situation which can be handled if the vehicle is on energy when it is encountered. However, the vehicle is still recovering from the previous low energy condition and a short landing results.

The solution to this situation is for the crew to lead the guidance command and fly maximum L/D angle of attack until the nominal trajectory is intercepted, then the crew can return to following guidance. This reduces the amount of time the vehicle remains low energy and improve its ability to handle any subsequent low energy conditions.

Experience in the STA shows that when the pilot leads the pitch-up guidance command, the pitch command needle at first deflects downward, reflecting that the pilot is applying more Nz than commanded. However, once the desired angle of attack and pitch attitude is achieved and remains relatively constant, the pitch command needle moves to the center, agreeing with the pilot's input. This is because the desired Nz command is achieved, no significant delta Nz is required, and the dynamic pressure lower limit is no longer being invoked.

5.5 OFF NOMINAL CONDITIONS

5.5.1 Overview

The discussion of all off-nominal situations attempts to not repeat that already made for the nominal case. Only the differences in procedures and techniques required by the off-nominal case are presented.

5.5.2 BFS Engaged

5.5.2.1 Overview

For the purposes of this discussion assume that the BFS has been engaged before mach = 0.9 because of a problem in the PASS or the PASS GPC's. This enables a study of the effect of BFS on flying the approach, landing, and rollout without considering the effect of other failures (such as IMU's) that contributes to the BFS engage decision. Also assume that the crew has correctly managed the use of IMU, TACAN, and air data information to the BFS and that the resulting state vector is reasonable.

5.5.2.2 Guidance and Navigation

The BFS only supports TAEM guidance. There is no A/L guidance and therefore no A/L transition as described in section 5.4.3. The BF is driven to trail based on an altitude of 10,000 ft instead of the A/L guidance transition. In the BFS, TAEM guidance is terminated at 2,000 ft. The preflare, IGS, and FF must be completed using visual reference to the landing aids and runway environment. There is no AUTO capability in the BFS in operations mode 3. There is no smart SB logic and no short-field option on SPEC 50.

The AUTO SB function (except for smart SB) is supported in BFS. At 2,000 ft the SB is commanded closed regardless of energy state. AUTO load relief is supported in BFS.

Upon reaching Mach = 0.9, the BFS is using TACAN and air data information to propagate the navigation state and to drive the area navigation display on the HSI. The BFS does not support the use of MSBLS data.

5.5.2.3 Controls and Displays

a. RHC

Both RHC's are supported. There is no fault detection identification recovery (FDIR) or COMMFAULT checks post MECO and for all entry operations there is no AUTO, only CSS.

b. SB/throttle controller

The CDR and PLT SB/throttle controller (SBTC's) both operate for SB control with BFS engaged in the same way as in PASS.

c. ADI

Both forward ADI's are supported in BFS operations; the aft ADI is not. The CDR's attitude switch and attitude REF pb controls both of the forward ADI's. The PLT's switches are not functional. The error needles are stowed at 2,000 ft when TAEM guidance is terminated.

d. AMI and AVVI

The tapes work normally in BFS but the right air-data select switch is not functional. The left switch controls both sets of tapes. The OFF flags are not functional (remain stowed) in BFS.

e. HSI

Both HSI's are functional in BFS and both are controlled by the CDR's switches (SOURCE and DATA). The mode select switches are not supported, however, the BFS provides auto transitions from ENTRY to TAEM (at initiation of TAEM guidance) and from TAEM to A/L (at 10,000 ft).

f. HUD

The HUD's are not supported with BFS engaged.

5.5.2.4 BFS Flying Technique

All entry BFS operations are flown in CSS. No difference in flying qualities are discernable from a PASS approach.

The main impact of flying a BFS approach is the lack of HUD's. This is not a serious impact and the approach is flown just as practiced during no-HUD STA approaches. No guidance is provided below 2,000 ft. The preflare must be performed with visual references. The IGS and FF are performed just as practiced in no-HUD STA approaches. The remaining instruments and CRT displays provide information in a near-identical format to PASS.

Although not used for navigation in either PASS or BFS, the radar altimeters are supported in BFS. The BFS displays the first RA to lock-on on both AVVI's. The RA select switch is not functional.

At 5,000 ft, the PLT evaluates RA data. If the altitude data appear to be bad (compared with NAV altitude), the PLT attempts to get data from the other RA. Since there is no direct indication of which RA is providing the bad data, the PLT and MS2 will make the determination by trial and error. The first step is to power off RA 1 on panel 08. If there is no data

change, then RA 2 is the one that is locked-on and providing the bad data. On panel 08, power off RA-2 and power on RA 1.

Since there is no smart SB function, the SB is not repositioned at 3,000 ft, but continues to attempt to control airspeed to 290 (300) KEAS. The recommended procedure is to manually close the SB at 3,000 ft, provided that the rollout margin is not in question. If energy is high and the rollout margin is too low, the SB can be manually set at 3,000 ft to a position calculated by MCC. If no action is taken, the SB retracts at 2,000 ft. At MGTD, the SB is manually opened, as in a PASS landing.

After T/D, derotation is performed normally and auto load relief occurs after NGTD. The SRB SEP switch and pb are used to backup WOW and WONG after NGTD. NWS and antiskid function the same as in the PASS.

5.5.3 HUD Failed

This section expands on the no-HUD discussion in the BFS engaged section. To reiterate, the lack of a HUD display is not a critical safety issue; flight prior to and around the HAC is virtually unaffected. The crew obviously obtains all guidance information from the ADI and the scan pattern is entirely head down. Approaching the OGS, the crew begins to include the visual landing aids in their scan. The division of attention between the ADI and the landing aids depends on whether MSBLS data has been incorporated or not. With MSBLS data, guidance on the ADI is very accurate and the ADI should remain in the scan. The error needles (along with the altitude reference scale) provide earlier detection of GS deviation trends than the PAPI's can. If the guidance is TACAN only, the ADI should be phased out of the scan pattern when on the OGS with the PAPI's visible. Each instantaneous scan of the PAPI lights yields only the current angle above the horizon. The PAPI's are scanned over a period of time to determine the real glide-path. Therefore, the PAPI's require a significant percentage of scan time on the OGS.

The preflare is flown heads-up using STA experience for the rate of pullup. The ADI is cross checked quickly to adjust the pullup rate if required. The CDR may relay more on the verbal callout of altitude to initiate the preflare and to call for the landing gear. The IGS and FF should be flown visually, with the CDR focusing on the far end of the runway once the ball-bar is no longer used.

5.5.4 Theta Limits

The vehicle is flown with the constraints of theta limits if air data is not incorporated to GN&C by Mach 2.0. Theta limits are also used if only one ADTA is remaining unless

- a. Winds on the HAC are greater than 80 kts,
- b. Navigation is bad.

- c. BFS is engaged.
- d. Crew workload is too high to add another constraint.

Flying theta limits simply means controlling pitch attitude as a method of keeping the vehicle in a safe region when air data are not available, or when air data redundancy is lost.

To fly theta limits, the crew follows guidance until the bug on the theta scale reaches either the nose-low or nose-high limit, at which time pitch attitude is controlled to keep theta within limits. Once the bug moves away from a limit, guidance is again followed. On the HAC, pitch attitude is constrained when flying theta limits. Additionally, the crew should not exceed 50° angle of bank on the HAC when flying theta limits. Once the vehicle is on the OGS, theta limits are abandoned for the remainder of the approach.

SB

It may be possible to fly with the SB in auto. This is desirable from a crew workload point of view. However, if the SB does not control q-bar then it should be commanded manually to fly the correct airspeed schedule. A simple method to do this is to close the SB when at the nose-high limit and fully open it when at the nose-low limit. After the vehicle is on the OGS, the SB is commanded to attain/maintain 290 (300) KEAS. In any case, take manual SB by 5,000 ft. At 3,000 ft the PLT commands the SB to the setting on the DEL PAD; i.e., the predicted 3,000 ft SB setting.

5.5.5 Manual HAC

5.5.5.1 Conditions for Use

The manual HAC procedure described in this section is to be used only when directed by MCC. It is used when energy is predicted low as the OGS is intercepted. The criteria for manual HAC is contained in Flight Rule 4-75. In summary, manual HAC is recommended if the A/L transition is predicted to occur below 9,000 ft, but above 6,000 ft, and the selection of other runways or the straight-in approach does not provide a transition above 9,000 ft. If none of the options meet the 6,000 ft constraint, then the site is no-go, requiring a one-day wave off or selection of a secondary landing site.

The criteria to perform a manual HAC is usually caused by high winds on the HAC. However, note that the manual HAC procedure is not invoked for some arbitrary limit wind on the HAC.

It is expected that the manual HAC procedure is no longer necessary after OI-22 when the SB logic is revised and the SB controls energy, as well as airspeed, on the HAC.

5.5.5.2 Procedure

- a. Take CSS at mach = 0.95, leave the SB in AUTO.
- b. Fly 220 to 230 KEAS, expect to get two or more dots high on the GS indicator.
- c. Use the 20, 40, and 60 sec predictors on the HSD, SPEC 50, to initiate the turn and to modulate bank on the HAC. Maintain the low airspeed and keep the HAC. Maintain the low airspeed and keep the predictors on the SPEC 50 circle.
- d. At 120° turn to go, resume flying guidance commands.

Note: It is important to maintain the low airspeed, especially when transitioning from a head or tail wind to a crosswind, or vice versa. For example, when coming off a tailwind into a crosswind, a rapid buildup of normal acceleration can occur if a nose-up pitch is not made to hold the low EAS.

5.5.6 Stuck SB

The stuck SB procedure outlined in figure 5-16 considered a general guide. It is a procedure designed to be applicable to all vehicle weights. However, assigned crews need to refine the procedure in the SMS using their mission mass properties and various wind conditions. For example, with vehicle WT between 205,000 and 220,000 lb (heavy end of the 19° OGS) the tendency is to overspeed the vehicle on final during the stuck-greater-than-50 percent case. The crew may want to compensate by flying one dot high instead of two. Conversely, in the stuck 30 to 40 percent case for the same vehicle, the tendency is to land short and slow.

| SB setting (stuck) | TAEM | A/L | Aim point |
|--------------------|------------------------------------------|----------------------------------|-----------|
| > 60 | Fly 1 to 2 dots hi throughout TAEM | <220K : 25° GS >220K : 21° GS | * 4000 ft |
| 40 to 60 | AUTO P, R/Y | Fly needles | CLSE |
| 30 to 40 | FLY 1 to 2 dots lo Mtn EAS < 300 | 15° GS | CLSE |
| < 30 | AUTO P, R/Y At M < .95 deploy gear | Fly needles | CLSE |

* Aim 1/2 way between 7500 ft aim point and threshold.

Figure 5-16.- Stuck SB procedure.

5.5.7 MLS Dilemma

Miscompares of MLS data is annunciated as RM DLMA MLS in OPS 305. There is no MLS FDIR in OPS 603 and MLS is not supported if BFS is engaged.

The specific MLS parameter (range, AZ, or EL) that is in dilemma is determined by the rules and sequence of data incorporation and by observing the TACAN residual and ratio window on the SPEC 50 display. The software incorporates MLS data to navigation (which causes the TACAN residuals and ratios window to go blank) only if MLS range and AZ are both good. From this, the following is deduced:

- a. Residuals blank + RM DLMA MLS = Dilemma in EL
- b. Residuals present + RM DLMA MLS = Dilemma in Range and/or AZ.

Since range data is available for incorporation before AZ and EL data, time of occurrence and SPEC 50 can be used to further define the parameter in dilemma with the following rules:

- a. Heading $> 40^\circ$ to runway + Residuals present = range
- b. Heading $< 40^\circ$ to runway + residuals present = AZ or range
- c. Heading $< 40^\circ$ to runway + residuals blank = EL

Determining the specific parameter in dilemma is largely academic for the crew, but cues them to which parameter to watch while performing the procedure presented below. If the runway and landing aids are in sight, the crew may choose to ignore the dilemma and complete the landing. If the MLS data are needed or desired, the crew must quickly determine which is the offending MLS unit and secure the power to that unit. The following procedure can be used:

- a. Note previous losses: i.e., define which two LRU's are in dilemma
- b. HSI source switches: Select first LRU number
- c. HSI source switches: Select NAV
- d. HSI source switches: Select MLS
- e. HSI: Watch for a jump in the appropriate parameter
- f. HSI source switches: Reselect NAV
- g. HSI source switches: Select second LRU number

- h. HSI source switches: Select MLS
- i. HSI: Watch for a jump
- j. Which LRU showed the worst jump?
- k. Remove power from the LRU
- l. PASS I/O reset

5.5.8 APU/Hydraulic System Failures

Hydraulic power is required for flight control surface actuation including SB and BF, for landing gear extension (primary method), for NWS, and for braking. Loss of one APU/hydraulic system usually has little effect. Loss of two systems may have significant effects and requires crew action to help ensure satisfactory system performance.

This book does not attempt to detail all the off-nominal procedures required by APU/hydraulic system failures, but describes the basic actions that are required and the flight characteristics that result from these failures. Reference section 2 for more information on PRL.

a. Single system failure

A single failure causes no change in flight control capability and there are no changes to the way the vehicle is flown for the A/L. The off-nominal procedures have the crew reduce the possibility of having a second system shut down by inhibiting the automatic shutdown feature of the other two systems. The other two APU's are taken to high speed at TAEM interface to provide the most hydraulic capacity possible.

b. Two systems failed

Operating with only one hydraulic system is a more serious situation. As before, the automatic shutdown feature is inhibited and the remaining good APU is run at high speed. Rapid, aggressive control inputs causes elevon saturation by exceeding the hydraulic power available. However, if a smooth open loop approach is flown, the pilot may not detect any difference in flying qualities. The approach should be planned to cross the threshold a little lower than normal so that T/D and derotation can be made about ten kts faster than normal. This helps ensure that sufficient elevon control is available to flare and derotate. If System 1 is one of the failed systems in vehicles before major mod, NWS is lost. In Endeavour and other vehicles after major mod, NWS is unavailable if Systems 1 and 2 are failed. If Systems 1 and 3 (or 2 and 3) are failed, braking power is one half of normal.

5.5.9 Tire Failures

Origin of Procedures

All of the recommended procedures for dealing with tire failures have been developed at the Ames Research Center's VMS. The one tire failure that has occurred on an orbiter occurred near enough to the end of rollout to not require any crew action. Consequently, these procedures are not flight proven. The magnitude of the control inputs differs between what is determined in the simulator and what is needed in the real world. Pilot perception of vehicle behavior and response is also different in the real world. However, for this phase of flight, the VMS is the best emulator of the shuttle available and it is believed that the procedures developed there allows control of the vehicle with tire failures.

5.5.9.1 Leaking/Flat Tire

If a main tire is known to be leaking or flat prior to landing, it is very likely that it, and the tire adjacent to it, will fail during the derotation. If possible, a concrete runway is selected and a landing is planned that places any crosswind on the same side as the bad tire(s). The crosswind tends to lift the upwind wing, reducing main gear strut loads, and possibly prevents the remaining good tire from failing during derotation. If after derotation both tires failed, having the failed tires on the upwind side is the better case for vehicle control.

5.5.9.2 Vehicle Control With Tire Failures and Crosswind

a. Before derotation

Before derotation, the yaw force due to tire failures is not strong. The effect of any crosswind is likely to be larger. The vehicle tends to roll and yaw away from the wind. The RHC is used to hold the wings level (upwind deflection) while the rudder is used to track straight down the runway. In the VMS, a small brake application (tap) is used to quickly stop a yawing motion. The crew must not allow any lateral error or rate to build before or during derotation. See the discussion in section 5.4.6.7.

b. After derotation

Serious directional control problems begin at the completion of derotation. The yawing force of the failed tires increases, and the yawing force due to crosswind reverses from what it was before the derotation NWS operation. If the failed tires are upwind, the yawing forces due to failed tires and due to crosswind are upwind and a large rudder pedal input may be required to maintain control. Even though the control input is large, fewer cases of loss of control or runway departure occurs during VMS runs with failed tires on the upwind side. If the failed tires are on the downwind side, the yawing forces of the failed

tires and of the crosswind are opposite to each other (balancing) and the rudder pedal input required for control is small. If the crosswind component is large, the required pedal deflection may even be in the direction of the failed tires. During VMS runs, pilots have a tendency to overcontrol the first rudder pedal input and subsequently lose control and/or depart the runway. The higher frequency of control loss during VMS runs with failed tires on the downwind side, along with the beneficial effects for strut loads of having the failed tires upwind, has led to the policy of placing a leaking or flat tire on the upwind side.

c. Rudder pedal inputs

The space shuttle rudder is a large, slow moving control surface that cannot respond rapidly to large pilot inputs. Pilots who use small rudder pedal inputs perform the best during VMS runs. Large inputs can be used, and may be necessary for upwind tire failures, but are taken out before an undesired yaw rate develops. If a large pedal input is sustained until the yaw rate is well under way, loss of control is probable; the slow surface rate does not allow an opposite input to be effected quick enough. Large rudder deflections cause roll opposite to yaw which should be countered by RHC deflection in the same direction as the pedal input.

Tire failures on the downwind side requires very cautious use of the ruder. At the moment of failure the vehicle appears to lunge toward the failed tires, stimulating an instinctive reaction by the pilot of rudder opposite the failure. As previously discussed, this reaction can easily be too large, or even in the wrong direction. Pilots must be very alert to the development of yaw rates and make quick, small rudder inputs in response.

d. RHC inputs

After nosewheel T/D, differential elevon (aileron) deflection is a useful tool for directional control. The wing is at a negative angle of attack, about 4°, during rollout. As seen by the relative wind, wing camber is increased by up-elevon deflection and decreased by down-elevon deflection. Aileron deflection, therefore, has proverse yaw; the vehicle yaws in the direction of RHC deflection. Additionally, the main gear in the direction of RHC deflection is loaded more, all other factors being equal, than the gear on the other side. The increased normal force creates more friction (drag) force and tends to yaw the vehicle in the direction of RHC deflection. The elevon surfaces have quicker response than the rudder and directional control with aileron can feel more responsive. After nosewheel T/D, lateral RHC is used to hold the wings level, if required, and to augment the rudder/NWS for directional control. With failed tires, the vehicle is in a small angle of bank. Holding lateral RHC in an attempt to level the wings creates the desired yawing force away from the failed tires and unloads the failed side, possibly reducing further damage.

e. Brake inputs

Differential braking is required to augment rudder, NWS, and aileron for directional control, and is required for control if NWS is not available. In VMS runs some pilots use brief taps of one brake to stop a developing yaw rate. This method may be quicker than rudder or aileron inputs. Braking is not required or desired on the wheels with the failed tires. In order to be ready to use the brakes, pilots need to consider taking their heels off the floor and placing their toes on the brakes after MGTD and before derotation.

5.5.10 Barrier Engagement

Barriers are located at the TAL sites with the exception of Ben Guerir. Figures 5-17, 5-18, and 5-19 show the barrier erected and prepared for engagement and a top and side view of an orbiter engaged in the barrier. Procedures for barrier engagement are straight forward. The maximum design engagement speed is 100 KGS. Attempt to engage as close to centerline as possible and with no lateral drift. Engage the barrier as slow as possible and continue braking and steering until the wheels are stopped. Off center engagements greater than about 45 ft require steering to remain on the runway. Damage to the nose and main gear doors can be expected as well as tile damage. Engagements greater than 100 KGS may damage/buckle the payload bay doors.

5.5.11 Early Deploy of Landing Gear

Certain failures of the contacts within the landing gear arm and deploy push-button indicators (pbi's) can cause the gear to deploy when the arm pbi is depressed. If this occurs, the SB should be closed immediately. Expect low energy crossing the threshold and target a slightly lower than normal threshold crossing height of about 10 ft.

5.5.12 No Deploy of Landing Gear

Failure of hydraulic system one, and both prox boxes results in failure of the landing gear to deploy. Although this is considered unlikely, the subject is worth a few brief notes. Of course, if the failures occur too late, a gear-up landing is the only alternative. Little is known about the consequences of a gear-up landing, but many in the community would expect the orbiter to break up. If the problem with hydraulic system one is the auxiliary propulsion unit (APU), it is believe that the circ pump would provide enough power to open the gear doors. If the failures are discovered early enough MCC would likely call for a bailout and provide a heading to fly.

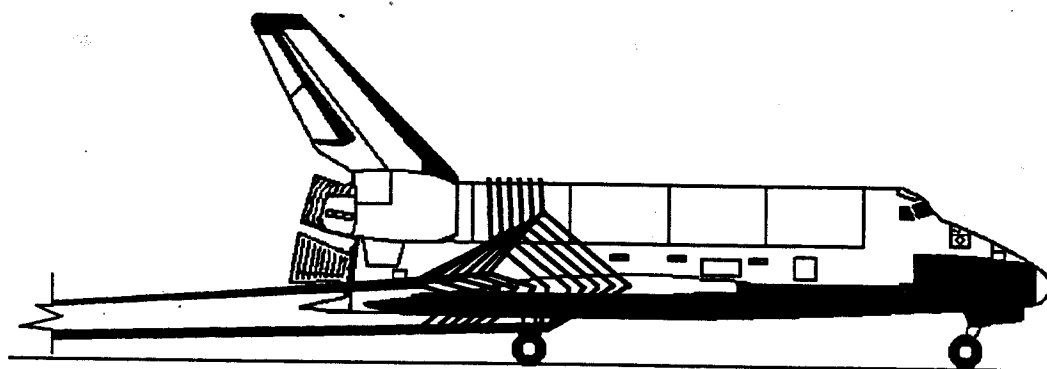

23266*075

Figure 5-17.- Orbiter enveloped by six net elements (elevation).

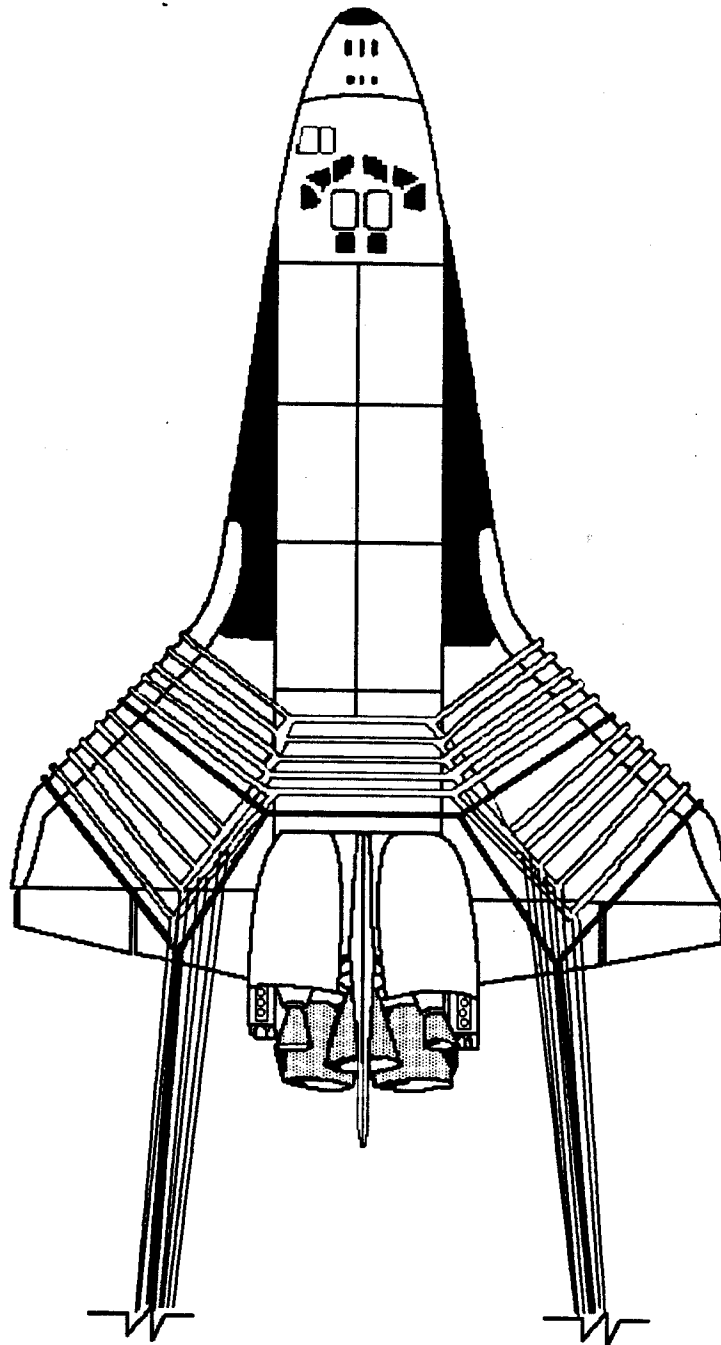

JSC-23266*074

Figure 5-18.- Orbiter enveloped by six net elements (plan).

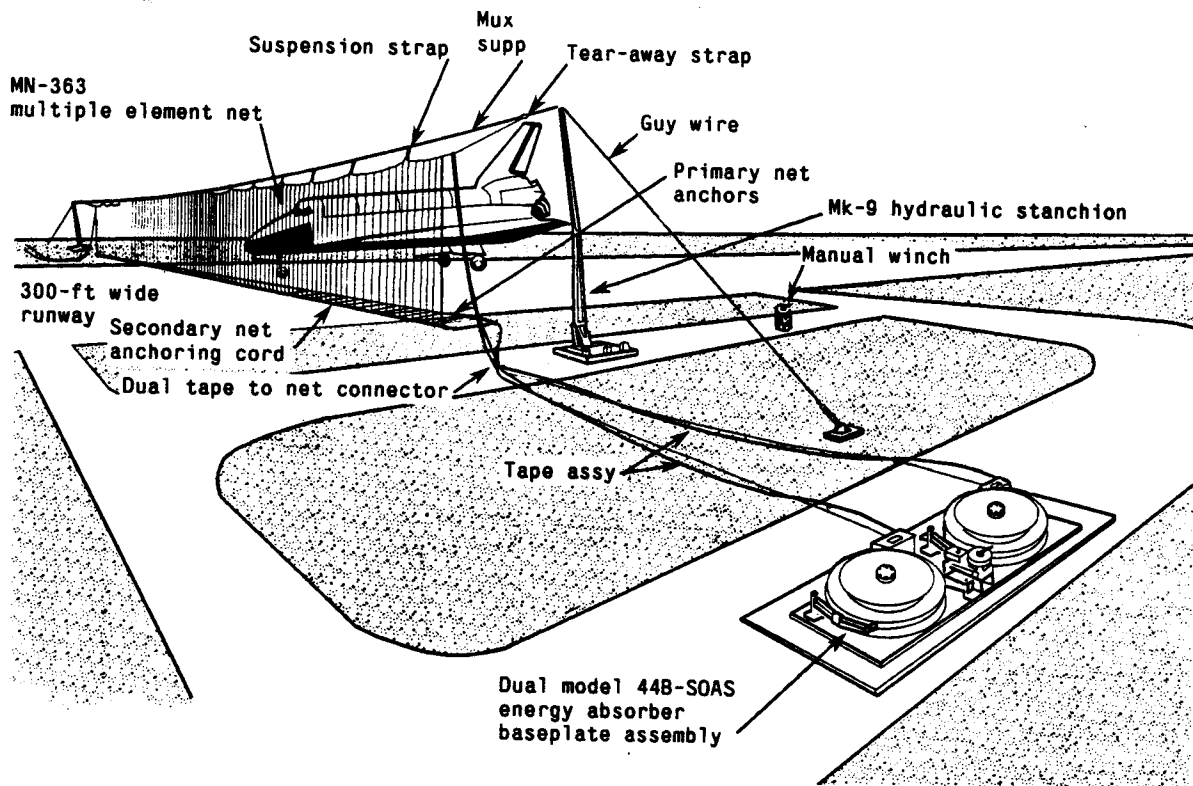

JSC-23266*083

Figure 5-19.- SOAS components.

5.6 NEW DEVELOPMENTS

5.6.1 Drag Chute

5.6.1.1 General

A drag chute has been incorporated on Endeavour (OV-105) and will be added to the other vehicles during their first major modification period. The drag chute is a 40 ft diameter parachute which, when deployed, is initially reefed to a diameter that provides about 40 per cent of the drag force capability. Deployment to the reefed diameter takes about 1.5 secs. After another 3.45 secs, the chute is disreefed to full diameter.

The drag chute is housed in a container built into the base of the vertical fin. It is controlled by either of two sets of pb's located adjacent to the CDR's HUD and the PLT's HUD. The pb's are labeled ARM, DPLY, and JETT. The ARM pb must be pushed and illuminated before the chute can be deployed or jettisoned. When the ARM and DPLY pb's (from either set of buttons) are pushed, a mortar is fired which launches the pilot chute rearward, knocking the compartment door off in the process. The pilot chute inflates and extracts the main chute from the compartment. The main chute is restrained to the reefed diameter by a line running the circumference of the chute hem. The chute is disreefed by cutting this line.

5.6.1.2 Benefits

The benefits of the drag chute are based on the best information available from the Ames simulations and may be modified after flight data are collected.

a. Decreased rollout

The most obvious benefit. The drag chute allows rollout with reduced braking requirements or reduced rollout distance when current levels of braking are used. This helps avoid barrier engagement in the case of a TAL abort, particularly on a high energy day.

b. Reduced main gear load

Because the drag chute is attached to the orbiter at a point above the c.g., the deployed chute creates a nose-up pitching moment. The equilibrium trim position of the elevons with the chute deployed and the vehicle in the two point attitude, is about 6° further down than it would be without the chute. During derotation with a deployed chute less up elevon is required to control the derotation rate, and therefore, less load due to elevon deflection is applied to the main gear. Achieving this main gear load reduction requires having the chute deployed (inflated) during the derotation. The amount of main gear load reduction may be sufficient to not cause failure of the tire adjacent to a leaking/flat main gear tire.

c. Reduced tire wear

If the crosswind component is moderate (15 kts or less according to Ames simulation results) a deployed drag chute should decrease tire wear in a nominal landing by decreasing the time of rollout. In landings with blown tires, tire wear on the remaining good tires can be greatly reduced because the chute stabilizes the vehicle laterally and reduces tire slip angle excursions. In crosswinds greater than 15 kts, the stabilizing effect of the chute can be overpowered by the "weathervaning" effect, leading to increased tire slip angle and wear over the no-chute configuration.

d. Directional stability

The deployed drag chute acts as a large vertical fin located behind the orbiter providing powerful, positive directional stability. The presence of this stabilizing force tends to minimize the effects of directional upsets caused by failed tires. However, because of the strong directional stability of the chute, the weathervane tendency may be amplified in response to crosswinds. As a result, the chute itself becomes a directional problem in strong crosswind.

5.6.1.3 Constraints

a. Mass moment

The powerful pitching moment provided by the chute can overpower the ability of the elevons to control pitch rate or pitch attitude in light vehicles with aft c.g. This manifests itself as elevon rate, or position saturation, and is exacerbated by other commands to the elevons as required in a crosswind landing. Tests in the Ames VMS have determined that objectionable elevon saturation occurs in vehicles with a MM of less than 1.53 million ft-lb if the chute is deployed before the initiation of derotation. This constraint is the reason for the difference between a "nominal" and "contingency" deploy.

b. Crosswind

Handling qualities with a deployed drag chute were investigated in the Ames simulation in crosswinds up to 20 kts steady state with gusts up to 27 kts total crosswind. The tests included runs with failed tires and/or on narrow "TAL" runways. All simulated landings in 15 kts crosswind were easily controlled and, in the failed tire cases, were better when the chute was deployed. In some runs at 20 kts steady state crosswind with failed tires, the powerful "weathervaning" effect of the chute made control more difficult than without it. In some runs without tire failures, main gear strut loads were higher when the chute was deployed in 20 kts crosswind than they were in runs without the chute. The data are not yet conclusive. It is not known at what exact crosswind speed the use of the chute becomes counterproductive. A 15 kts crosswind

placard was selected because all 15 kt-runs were easily controlled and the current basic crosswind placard for the vehicle is 15 kts.

5.6.1.4 Operational Deployment

After the DTO program, the handling qualities and drag chute force profile behind the orbiter will be better understood. There are four methods for deployment of the drag chute that may be used on any landing if the crosswind is less than or equal to 15 kts.

a. Nominal deployment procedure

The CDR should initiate derotation, with open loop pitch RHC techniques using smooth control inputs and call for chute deployment at 185 KEAS. This procedure should be used for all normal energy landings, at the discretion of the CDR, and it is independent of the MM placard boundary. By deploying the chute at the initiation of derotation, the problems associated with handling qualities degradation with nose-up deployments are eliminated. Also, the beneficial stabilizing effects of the chute during derotation and rollout are preserved. Some reduction of normal force on the main gear during derotation is also preserved. The only disadvantage of this nominal deployment procedure is that the maximum deceleration capability, which is not required for a normal energy landing is given up by delaying chute deployment until the initiation of derotation.

b. Contingency deployment procedure

Contingency drag chute deployment is defined as deployment between MGTD and derotation. This deployment procedure is used only as a contingency (for high energy landings, or leaking/flat tires, less than 100 percent brakes, etc.) at the discretion of the CDR. It is only be used when the MM of the orbiter is greater than the limit boundary of 1.53 million ft-lb. The CDR should use open loop pitch RHC techniques, and initiate derotation at 185 KEAS using smooth control inputs.

c. Late deployment procedure

Late drag chute deployment is defined as deployment after NGTD. It is performed when the orbiter makes a low energy landing (MGTD less than 175 KEAS). During orbiter landings deceleration happens quickly, trailing edge-up saturation occurs, and it is difficult to control derotation precisely. These factors cause high-pitch down rates and excessive nose-gear strut loads. Late deployment of the chute still allows some of the benefits of the chute to be retained.

d. Emergency deployment procedure

Emergency drag chute deployment is defined as nominal/contingency/late deployment with space shuttle main engine (SSME) repositioning incomplete. Emergency drag chute deployment performed only in the event of

2. Leaking/flat tire
2. Inadequate braking capability
3. Landing with insufficient rollout margin
4. Single APU landing
5. Directional control problem

Deployment of the drag chute without SSME repositioning risks damage to bells. Analysis shows that the most likely contact point would be between the top edge of the center main engine bell and the risers, when the risers are at full line stretch. Additional analysis shows that drag chute performance is not impaired if SSME repositioning is not performed. For certain cases, the benefits of the chute outweigh the risk of potential damage to the SSME bells.

5.6.2 GS and T/D Targeting

After two space shuttle landings that reached the point of T/D without enough energy to land onspeed at least 1,000 ft down the runway, T/D energy margin was reevaluated. A decision was made to provide the vehicle with more energy at the preflare, to give more T/D margin. At the same time, a decision was made to target heavy vehicles for a 205 KEAS T/D 2500 ft, instead of 1500 ft for nominal EOM landings.

The first step in this process was to change the T/D target for a mission with a heavy EOM landing. To provide the energy required to achieve the target, that mission (STS-50) will fly a 17° OGS at 300 KEAS. As of this writing, effort is under way to evaluate the suitability of using 18° and 20° OGS flown at 300 KEAS (possibly 290 KEAS for the 20° OGS) for all future space shuttle missions.

APPENDIX A.1
LANDING SITES

TABLE A-I.- INDEX OF ETR (HIGH INCLINATION)

| Code | TACAN/ICAO | Name | Var | Field elev | Lat | Lon | Tower freq |
|-------|------------|-----------------------------|-----|------------|--------|---------|-----------------|
| 1,2 | TTS/KSC | Kennedy | 2W | 9 | 28-37N | 80-42W | |
| 2,3* | SNG/NOR | Northrup | 11E | 4100 | 32-56N | 106-25W | |
| 2 | EDW/KEDW | Edwards | 14E | 2300 | 34-54N | 117-52W | 120.7 236.6 |
| 1,2 | MRN/LEMO | Moron, Spain | 4W | 287 | 37-10N | 05-37W | 122.1 323.0 |
| 1,2 | ZZA/LEZA | Zaragoza, Spain | 4W | 860 | 41-40N | 01-03W | 139.3 257.8 |
| 1,2 | BEN | Ben Guerir | 6W | 1350 | 32-08N | 007-53W | ---- |
| | | | | | | | 257.6 |
| 2 | DN/ADDN | Darwin | 3E | 103 | 12-25S | 130-53E | 118.3 257.8 |
| 1,2,4 | BUK/LTAC | Esenboga | 4E | 3127 | 40-08N | 33-00E | 118.1 257.8 |
| 2 | UAM/PGUA | Guam | 2E | 612 | 13-35N | 144-56E | 126.2 236.6 |
| 2,5 | HA/NNTO | Hao | 12E | 15 | 18-05S | 140-57W | 118.3 |
| 2 | HS/FAHS | Hoedspruit | 15W | 1750 | 24-22S | 31-03E | 122.0 |
| 2 | HNL/PHNL | Honolulu | 11E | 13 | 21-19N | 157-55W | 118.1 257.8 |
| 2 | NKW/FJDG | Diego Garcia | 8W | 9 | 07-19S | 72-25E | 126.2 340.2 |
| 1,2,4 | KBO/EDDK | Koln/Bonn, GR | 1W | 300 | 50-52N | 07-09E | 118.9 249.1 |
| 2,3* | EPH/MWH | Moses Lake/ Grant County | 19E | 1185 | 47-13N | 119-19W | 118.1 257.8 |
| 3* | RCA/KRCA | Ellsworth | 11E | 3278 | 44-09N | 103-06W | 126.05 236.6 |
| 2 | KIA/OERK | King Khalid Intl | 2E | 2049 | 24-58N | 46-43E | 118.8 342.6 |

*EDW underburn landing.

**KSC underburn landing.

Code: 1. OPS 1/6 (includes TAL WX alt)
2. OPS 3
3. Underburn
4. Downrange sites
5. OMS-1 fail

TABLE A-I.- Concluded

| Code | TACAN/ICAO | Name | Var | Elev | Lat | Lon | Tower Freq |
|------|------------|-----------------------------------|-----|------|--------|---------|-----------------|
| 2,4 | SUD/LGSA | Souda, Crete (@ 45° inc. only) | 2E | 492 | 35-32N | 24-09E | 122.1 257.8 |
| 2 | AM/ABAM | Amberley, Aust | 11E | 92 | 27-38S | 152-43E | 118.3 257.8 |
| 3* | MUO/KMUO | Mt. Home | 17E | 2996 | 43-03N | 115-52W | 126.2 253.5 |
| 3* | LNK/KLNK | Lincoln Muni | 6E | 1214 | 40-51N | 96-46W | 118.5 253.5 |
| 2 | ABI/KDYS | Dyess | 8E | 1789 | 32-25N | 99-51W | 295.7 |
| 1*** | ARL/ESSA | Arlanda, Sweden | 3E | 123 | 59-40N | 17-56E | 118.5 |
| | NKT/KNKT | Cherry Point | 9W | 29 | 34-54N | 76-53W | 121.3 340.2 |
| | DOV/KDOV | Dover | 11W | 28 | 39-08N | 75-28W | 126.35 327.5 |
| | MYR/KMYR | Myrtle Beach | 7W | 26 | 33-41N | 78-56W | 126.2 255.9 |
| | NTU/KNTU | Oceana | 10W | 22 | 36-49N | 76-02W | 126.2 360.2 |
| | FMH/KFMH | Otis | 16W | 111 | 41-40N | 70-31W | 121.0 294.7 |
| | PSM/KPSM | Pease | 16W | 101 | 43-05N | 70-49W | 128.4 255.9 |

*EDW underburn landing.

**KSC underburn landing.

***Above 57°.

Code: 1. OPS 1/6 (includes TAL WX alt)
 2. OPS 3
 3. Underburn
 4. Down range sites
 5. OMS-1 fail

TABLE-A-II.- INDEX OF ETR (LOW INCLINATION)

| Code | TACAN/ICAO | Name | Var | Field elev | Lat | Lon | Tower freq |
|------|------------|-----------------------------|-----|------------|--------|---------|----------------|
| 1,2 | TTS/KSC | Kennedy | 2W | 9 | 28-37N | 80-42W | |
| 2,3* | SNG/NOR | Northrup | 11E | 4100 | 32-56N | 106-25W | |
| 2 | EDW/KEDW | Edwards | 14E | 2302 | 34-54N | 117-52W | 120.7 236.6 |
| 1,2 | BYD/GBYD | Banjul | 13W | 95 | 13-21N | 16-40W | 118.3 |
| 1,2 | MRN/LEMO | Moron, Spain | 4W | 287 | 37-10N | 05-37W | 122.1 323.0 |
| 1,2 | BEN/ | Ben Guerir | 6W | 1350 | 32-08N | 07-53W | ---- |
| 1,2 | CVS/GVAC | Amilcar Cabral | 16W | 177 | 16-45N | 22-57W | 119.7 |
| 2,5 | DN/ADDN | Darwin | 3E | 103 | 12-25S | 130-53E | 118.3 257.8 |
| 1,2 | GDV/GCLP | Las Palmas/ Gran Canaria | 9W | 76 | 27-56N | 15-23W | 118.3 257.8 |
| 2 | UAM/PGUA | Guam | 2E | 612 | 13-35N | 144-56E | 126.2 236.6 |
| 2 | HA/NNTO | Hao | 12E | 10 | 18-05S | 140-57W | 118.3 |
| 2,4 | HS/FAHS | Hoedspruit | 15W | 1750 | 24-22S | 31-03E | 122.0 |
| 2 | HNL/PHNL | Honolulu | 11E | 13 | 21-19N | 157-55W | 118.1 257.8 |
| 2 | NKW/FJOG | Diego Garcia | 8W | 9 | 07-19S | 72-25E | 126.2 340.2 |
| 2,4 | KW/FZAA | Kinshasa | 5W | 1027 | 04-23S | 15-27E | 118.1 |
| 2 | KIA/OERK | King Khalid Intl | 2E | 2049 | 24-58N | 46-43E | 118.8 342.6 |
| 2 | ROB/GLRB | Monrovia/Roberts | 10W | 31 | 06-14N | 10-22W | 118.3 121.9 |
| 3** | ZQA/MYNN | Nassau | 2W | 10 | 25-02N | 77-28W | 119.5 |
| 4 | BDA/TXKF | Bermuda | 15W | 12 | 32-22N | 64-41W | 118.1 291.0 |
| 1*** | TMS/DAAT | Tamarasset | 4W | 4518 | 22-49W | 05-28E | 118.1 |

*EDW underburn landing.

**KSC underburn landing.

***34° inclination.

Code: 1. OPS 1/6 (includes TAL WX alt)
 2. OPS 3
 3. Underburn
 4. Down range sites
 5. OMS-1 fail

TABLE A-III.- NAVAIDS/LANDING AIDS HI/LO INCLINATION

As of March 27, 1991
LSO x31941

| | MLS | PAPI 7500 ft (nominal) | PAPI 6500 ft (close-in) | Marking 7500 ft | Aim pt. 6500 ft | Ball bar | TACAN (primary) | TACAN (backup) | Remarks |
|---------|---------------|------------------------------|-------------------------------|--------------------|--------------------|-------------|--------------------|-------------------|--------------------------------------------------|
| EDW 17L | √JR CH 6 | √ | √ | √ | √ | √ | EDW 111 (SS) | PMD 92 (SS) | Xenon |
| EDW 23L | - | * | √ⓐ | √ | √ | * | | | Threshold and TD MK |
| EDW 35R | - | * | * | √ | √ | * | | | Threshold and TD MK |
| EDW 05R | - | - | * | - | √ | * | | | Threshold and TD MK |
| EDW 15 | - | * | √ | √ | √ | √ | | | Threshold and TD MK Xenon** |
| EDW 33 | - | * | * | √ | √ | * | | | Threshold and TD MK |
| EDW 22 | √SR CH 8 | √ | √ | √ | √ | √ | | | Xenon |
| EDW 04 | - | * | √ | √ | √ | √ | | | Underrun unusable/displaced threshold Xenon** |
| EDW 18L | - | * | * | √ | √ | * | | | Threshold and TD MK Xenon** |
| KSC 15 | √SR CH 8 | √ | √ | - | ⓐ | √ | TTS 59Y (DS) | COF 97 (DS) | Xenon |
| KSC 33 | √SR CH 6 | √ | √ | - | ⓐ | √ | | | Xenon |
| NOR 17 | √JR CH 6 | √ | √ | √ | √ | √ | SNG 121Y (SS) | HMN 92 (SS) | Xenon |
| NOR 23 | - | √ | √ | √ | √ | √ | | | |
| NOR 35 | - | √ | - | √ | √ | √ | | | |
| NOR 05 | - | - | - | √ | √ | - | | | |
| BEN 36 | √SR CH 6 | √ | √ | √ | √ⓐ | √ | BEN 118 (DS) | CBA 116 (DME) | Xenon |
| BEN 18 | - | √ | √ | √ | √ⓐ | √ | | | |
| MRN 21 | √SR CH 6 | √ | √ | | ⓐ | √ | MRN 100 (SS) | AOG 23 (DS) | Barrier 800 ft from end of overrun, Xenon** |
| ZZA 30 | √SR CH 6 | √ | √ | - | ⓐ | √ | ZZA 64 (DS) | MLA 58 (DME) | Barrier 800 ft from end of overrun, Xenon** |
| BYD 32 | √2JRS CH 6 | √ | √ | - | ⓐ | √ | BYD 121Y (DS) | BJ76 (DME) | Barrier 800 ft from end of overrun, Xenon** |
| HNL 08R | - | - | - | - | ⓐ | √ | HNL 95 | CKH 86 | Barrier 800 ft from end of rwy, Xenon** |
| GUA 06L | √JR CH 6 | - | √ | - | ⓐ | √ | UAM 54 | UNZ 100 | Barrier 800 ft from end of overrun, Xenon** |

NOTE

This chart reflects capabilities and configurations which are dependent on mission characteristics; i.e., inclination and day vs. night RTLS, TAL, AOA cases. *Surveyed points where PAPI lights/ball bar can be installed. ⓐ Aim point identification light system (APILS) available. **Xenon lights can be installed at these locations for mission requirements. Aim point marking at 6500 ft is a triangle, 7500 ft marking is a rectangle. ⓐ Single generator only. (DS) refers to dual string TACAN transponders, (SS) is a single string unit.

APPENDIX B.1
SEQUENCE OF EVENTS

The sequence of events (SOE) is a chronological listing of significant entry events. The SOE reference the charts (ambiguous), as contained in the Descent FDF. The Descent FDF contains mission-specific entry trajectory data generated by six-degree-of-freedom (DOF) space vehicle dynamic simulations (SVDS). The data are displayed in a variety of formats to satisfy their many users. The SOE section lists the significant events and the coinciding values of meaningful trajectory parameters. The SOE is also shown in summary form in table B.1-I.

The SOE in the Descent FDF contains guidance and communication events. The communication events listed pertain to the acquisition and loss of signal (LOS) from ground stations which track the orbiter. The guidance events listed denote changes in guidance phases, availability of navigation aids, and flight control commands. The following is a brief description of the guidance events occurring from TAEM until wheel stop, including a reference to the section of this document where they are discussed in greater detail.

a. Initiate air data system updating

This updating occurs at a navigated velocity of 2500 ft/s. At this point, ambient and dynamic pressure data from the air data probes are used to calculate angle of attack, Mach number, corrected pressure altitude, EAS, and TAS. These parameters are then used to update the navigated state of the orbiter.

b. Entry/TAEM interface

This interface occurs at an Earth-relative velocity of 2500 ft/s. It is the point when the orbiter switches from entry guidance to TAEM guidance.

c. Initiate payload bay venting

This venting occurs when the navigated velocity reaches 2400 ft/s. The payload bay vent doors are opened to equalize pressures on the bulkheads. The vent doors are closed during reentry for aeroheating concerns.

d. Initiate programmed test input (PTI) maneuver 7 (Mach 2.0-1.0)

The PTI maneuver 7 occurs when a PTI maneuver is initiated. In this example, the seventh maneuver is initiated between Mach 2.0 and Mach 1.0. PTI maneuvers, which can be performed throughout the entry trajectory, provide data which is used to decrease orbiter aerodynamic uncertainties. The type of maneuvers and when they occur can vary from flight to flight. Upon completion of the maneuver, the event TERMINATE PTI 7 occurs.

- e. Edwards Air Force Base (EDW) tactical air command and navigational system (TACAN) elevation $>35^\circ$

This elevation occurs when the TACAN elevation angle becomes greater than 35° signifying that the orbiter has entered the TACAN cone of confusion and TACAN bearing data is not to update the orbiter navigated state. The orbiter exits the cone of confusion when the elevation angle goes below 35° and the event EDW TACAN ELEVATION $<35^\circ$ occurs.

- f. Altitude = 50,000 ft

This occurs when the geodetic altitude reaches 50,000 ft. This event is used as a reference point to check the trajectory (i.e., comparison with other simulations).

- g. Deactivate reaction control system (RCS) yaw thrusters

Deactivation occurs when the air data Mach number is 1.0. The yaw thrusters are deactivated because the rudder is sufficient for yaw control.

- h. Initiate speedbrake (SB) modulation

SB modulation occurs when the air data Mach number is 0.95. At this point, guidance begins calculating SB commands based on dynamic pressure errors. Previously, the SB command was determined according to a Mach/SB schedule.

- i. Initiate heading alignment phase

When the orbiter acquires the HAC, this is a TAEM guidance phase in which the orbiter rolls to follow the HAC.

- j. Initiate MSBLS updating

When the orbiter is within MSBLS antenna limits and the heading with respect to the runway is less than 40° , the updating occurs. MSBLS provides the AZ, EL angle, and the slant range used to update the orbiter navigated state.

- k. Initiate prefinal phase

When the orbiter is within a minimum range of the runway centerline or reaches a minimum altitude, then initiate prefinal phase occurs. The current values are 5300 ft downrange (of the runway centerline) and 7000 ft altitude. This is the final TAEM guidance phase. It provides for a smooth transition to A/L guidance by acquiring the OGS and aligning the orbiter with the runway.

l. TAEM A/L interface; initiate BF to 0°

This occurs nominally at an altitude of 10,000 ft but may occur as low as 5000 ft. This is when the orbiter switches from TAEM guidance to A/L guidance. At TAEM A/L interface A/L the BF retracts to the trail position (0°).

m. Initiate SB retraction

This retraction occurs at an altitude of 3000 ft above the runway. The SB is commanded to a calculated value based on wind, density altitude, vehicle weight, EAS error at 3000 ft, aim point selection, and SB guidance option.

n. Initiate preflare

Preflare occurs at an altitude of 2000 ft. At this point the A/L guidance subfunction, FSGS, commences. During this subfunction, the orbiter transitions from the SGS onto the shallow GS. The subfunction is further divided into three subphases: pullup initialization, circularization, and exponential capture. The initiation of the exponential capture subphase marks the event COMPLETION OF PREFLARE.

o. Initiate landing gear deployment

Landing gear deployment occurs nominally at an altitude of 300 ft. This event is important because of the effect on T/D energy. Approximately 5 seconds after landing gear deployment is initiated, the event GEAR DOWN AND LOCKED occurs.

p. Initiate FF

FF occurs at an altitude between 80 and 30 ft (it is a function of the altitude rate). It is an A/L guidance subphase designed to reduce the altitude rate to approximately 3 ft/s.

q. MSBLS AZ/distance measuring equipment (DME) LOS

This LOS occurs when the AZ angle of the AZ antenna is greater than 13.5°. MSBLS data are no longer used to update the orbiter navigated state.

r. WT on main gear; SB to 100 percent deployment

This SB deployment occurs when the WOWLON flag is set. The SB is commanded to full open, increasing the aerodynamic drag of the orbiter during rollout.

s. Initiate controlled pitchdown

This pitchdown occurs at an EAS of 180 kts. The controlled pitchdown or derotation decreases the pitch rate of the orbiter at a rate that varies with the pitch attitude until NGTD.

t. Nosewheel contact

Contact occurs when the WONG signal is generated. Nosewheel contact marks the beginning of NWS, providing orbiter lateral directional control.

u. Initiate braking

This action occurs when the groundspeed decelerates to 140 kts and the orbiter is past the runway midfield point. Braking is initiated at 5000 ft of runway remaining if the groundspeed has not reached 140 kts.

v. Wheel stop

Wheel stop occurs when the relative velocity is less than 0.9 ft/s. This is the end of the rollout.

TABLE B.1-I.- SOE FOR STS-40 OF NETWORK OUTPUT MULTIPLEXER (NOM) EOM TO EDW

(a) TAEM interface to A/L interface environmental data

Event

1. TBD
2. Initiate air data system updating
3. Entry/TAEM interface
4. Initiate payload bay venting
5. Initiate PTI maneuver 7 (Mach = 2.0-1.0)
6. Goldstone (GDX) S-band, acquisition of signal (AOS)
7. Terminate PTI maneuver 7
8. San Nicholas Island (SNI) C-band, LOS
9. Vandenberg (VAFB) C-band, LOS
10. EDW TACAN elevation greater than 35°
11. EDW TACAN elevation less than 35°
12. Alt = 50,000 ft
13. Deactivate RCS yaw thrusters
14. Initiate SB modulation
15. Initiate heading alignment phase
16. Point Magu (PMF) C-band, LOS
17. GDX S-band, LOS
18. Initiate MSBLS updating
19. Goldstone (GDS) S-band, LOS
20. Initiate prefinal phase

TABLE B.1-I.- Continued

(a) TAEM interface to A/L interface
environmental data

| Variable | Unit | 1 | 2 | 3 | 4 |
|----------------------|--------------------|-----|-----------------------------------|----------------------|------------------------------|
| | | TBD | Initiate air data system updating | Entry/TAEM interface | Initiate payload bay venting |
| MET ¹ | HMS | | 219:24:55.67 | 219:24:56.63 | 219:25: 1.91 |
| GMT ² | DHMS | | 237:15:24:55.67 | 237:15:24:56.63 | 237:15:25: 1.91 |
| EI ³ time | HMS | | 0:25:15.08 | 0:25:16.04 | 0:25:21.32 |
| Altitude | ft | | 80204.1 | 79970.6 | 78692.9 |
| Range-runway | n. mi. | | 59.3 | 58.9 | 57.1 |
| VREL | ft/s | | 2497.7 | 2482.1 | 2393.3 |
| REL AZ | deg | | 102.5882 | 102.5915 | 100.0688 |
| Gamma REL | deg | | -5.5410 | -5.5915 | -5.5439 |
| Longitude | deg W | | 118.5406 | 118.5329 | 118.4909 |
| Geod lat | deg N | | 35.1611 | 35.1597 | 35.1530 |
| Mach | n. mi. | | 2.55 | 2.53 | 2.44 |
| TAS | kts | | 1479.9 | 1470.6 | 1418.0 |
| EAS | kts | | 282.8 | 282.7 | 281.2 |
| Alpha | deg | | 13.3 | 13.3 | 14.2 |
| Dyn pressure | lb/ft ² | | 270.8 | 270.5 | 267.8 |

¹Mission elapsed time.²Greenwich mean time.³Entry interface.

| Variable | Unit | 5 | 6 | 7 | 8 |
|--------------|--------------------|---------------------------------------------|--------------------|--------------------------|--------------------|
| | | Initiate PTI maneuver 7 (Mach = 2.0-1.0) | GDX S-band, AOS | Terminate PTI maneuver 7 | SNI C-band, LOS |
| MET | HMS | 219:25:34.55 | 219:25:38.87 | 219:25:49.43 | 219:26:23.99 |
| GMT | DHMS | 237:15:25:34.55 | 237:15:25:38.87 | 237:15:25:49.43 | 237:15:26:23.99 |
| EI time | HMS | 0:25:53.96 | 0:25:58.28 | 0:26: 8.84 | 0:26:43.40 |
| Altitude | ft | 72983.5 | 72025.0 | 69235.1 | 58105.1 |
| Range-runway | n. mi. | 45.7 | 44.2 | 41.2 | 32.6 |
| VREL | ft/s | 1889.8 | 1839.4 | 1722.1 | 1337.4 |
| REL AZ | deg | 104.4118 | 104.9604 | 106.5180 | 107.2150 |
| Gamma REL | deg | -6.2915 | -7.2987 | -9.6691 | -13.8000 |
| Longitude | deg W | 118.2658 | 118.2400 | 118.1804 | 118.0157 |
| Geod lat | deg N | 35.1146 | 35.1090 | 35.0953 | 35.0535 |
| Mach | n. mi. | 1.94 | 1.89 | 1.78 | 1.41 |
| TAS | kts | 1119.6 | 1089.8 | 1020.3 | 792.4 |
| EAS | kts | 255.7 | 254.8 | 256.0 | 265.9 |
| Alpha | deg | 9.5 | 9.3 | 9.2 | 7.6 |
| Dyn pressure | lb/ft ² | 221.3 | 219.8 | 221.9 | 239.3 |

TABLE B.1-I.- Continued

(a) continued

| Variable | Unit | 9 | 10 | 11 | 12 |
|--------------|--------------------|--------------------|---------------------------------------|------------------------------------|-----------------|
| | | VDB C-band, LOS | EDW TACAN elev greater than 35° | EDW TACAN elev less than 35° | ALT-50,000 ft |
| MET | HMS | 219:26:29.27 | 219:26:39.35 | 219:26:41.27 | 219:26:50.87 |
| GMT | DHMS | 237:15:26:29.27 | 237:15:26:39.35 | 237:15:26:41.27 | 237:15:26:50.87 |
| EI time | HMS | 0:26:48.68 | 0:26:58.76 | 0:27:.68 | 0:27:10.28 |
| Altitude | ft | 56429.2 | 53321.1 | 52745.1 | 49963.0 |
| Range-runway | n. mi. | 31.6 | 29.6 | 29.2 | 27.5 |
| VREL | ft/s | 1278.7 | 1168.2 | 1147.9 | 1050.2 |
| REL AZ | deg | 107.2235 | 107.3148 | 107.2877 | 107.2178 |
| Gamma REL | deg | -14.1886 | -14.9002 | -15.0156 | -15.3762 |
| Longitude | deg W | 117.9944 | 117.9564 | 117.9496 | 117.9172 |
| Geod lat | deg N | 35.0481 | 35.0384 | 35.0367 | 35.0284 |
| MACH | n. mi. | 1.35 | 1.23 | 1.21 | 1.10 |
| TAS | kts | 757.6 | 692.2 | 680.1 | 622.2 |
| EAS | kts | 265.9 | 263.7 | 263.1 | 256.9 |
| Alpha | deg | 7.3 | 6.8 | 6.8 | 7.0 |
| Dyn pressure | lb/ft ² | 239.4 | 235.5 | 234.3 | 223.5 |

| Variable | Unit | 13 | 14 | 15 | 16 |
|--------------|--------------------|---------------------------------|--------------------------------------|------------------------------------|--------------------|
| | | Deactivate RCS yaw thrusters | Initiate speedbrake modulation | Init heading alignment phase | PMF C-band, LOS |
| MET | HMS | 219:27: 1.43 | 219:27: 8.15 | 219:27:28.31 | 219:27:54.23 |
| GMT | DHMS | 237:15:27: 1.43 | 237:15:27: 8.15 | 237:15:27:28.31 | 237:15:27:54.23 |
| EI time | HMS | 0:27:20.84 | 0:27:27.56 | 0:27:47.72 | 0:28:13.64 |
| Altitude | ft | 47121.4 | 45375.4 | 40514.6 | 34417.6 |
| Range-runway | n. mi. | 25.9 | 24.9 | 22.2 | 18.9 |
| VREL | ft/s | 956.0 | 910.3 | 832.7 | 765.3 |
| REL AZ | deg | 107.1032 | 106.9442 | 106.2658 | 68.2871 |
| Gamma REL | deg | -15.8121 | -16.5745 | -6.2473 | -17.5624 |
| Longitude | deg W | 117.8847 | 117.8656 | 117.8120 | 117.7473 |
| Geod lat | deg N | 35.0202 | 35.0154 | 35.0023 | 35.0002 |
| Mach | n/ mi. | 1.00 | .94 | .85 | .76 |
| TAS | kts | 566.4 | 539.3 | 493.4 | 453.4 |
| EAS | kts | 249.2 | 246.6 | 250.2 | 257.6 |
| Alpha | deg | 6.6 | 6.8 | 7.2 | 9.2 |
| Dyn pressure | lb/ft ² | 210.2 | 205.9 | 211.9 | 224.7 |

TABLE B.1-I.- Continued

(a) Concluded

| Variable | Unit | 17 | 18 | 19 | 20 |
|--------------|--------------------|--------------------|----------------------------|--------------------|-------------------------------|
| | | GDX S-band, LOS | Initiate MSBLS updating | GDS S-band, LOS | Initiate prefinal phase |
| MET | HMS | 219:29:18.23 | 219:29:19.67 | 219:29:23.51 | 219:29:28.31 |
| GMT | DHMS | 237:15:29:18.23 | 237:15:29:19.67 | 237:15:29:23.51 | 237:15:29:28.31 |
| EI time | HMS | 0:29:37.64 | 0:29:39.08 | 0:29:42.92 | 0:29:47.72 |
| Altitude | ft | 174444.2 | 17178.1 | 16474.0 | 15613.6 |
| Range-runway | n. mi. | 9.6 | 9.4 | 9.0 | 8.5 |
| VREL | ft/s | 638.2 | 636.2 | 630.6 | 623.6 |
| REL AZ | deg | -127.7124 | -131.0899 | -140.0393 | -151.1968 |
| Gamma REL | deg | -16.7390 | -16.7406 | -16.5717 | -16.4322 |
| Longitude | deg W | 117.7899 | 117.7922 | 117.7976 | 117.8031 |
| Geod lat | deg N | 35.0820 | 35.0805 | 35.0760 | 35.0694 |
| Mach | n. mi. | .59 | .59 | .58 | .57 |
| TAS | kts | 378.1 | 376.9 | 373.6 | 369.4 |
| EAS | kts | 284.0 | 284.3 | 284.8 | 285.3 |
| Alpha | deg | 7.5 | 7.5 | 7.6 | 7.4 |
| Dyn pressure | lb/ft ² | 273.1 | 273.6 | 274.6 | 275.6 |

TABLE B.1-I.- Continued

(b) A/L Interface to main gear landing
environmental data

Event

21. TAEM-A/L interface; initiate BF retract to 0°
22. Initiate SB retraction
23. EAF C-band, LOS
24. Initiate preflare
25. FRC C-band, LOS
26. Initiate landing gear deployment
27. Completion of preflare
28. Gear down and locked
29. Initiate FF
30. MSBLS LOS AZ/DME
31. WT on main gear; SB to 100 percent deployment

TABLE B.1-I.- Continued

(b) Continued

| Variable | Unit | 21 | 22 | 23 | 24 |
|----------------------------|--------|---------------------------------------------------|---------------------------|--------------------|----------------------|
| | | TAEM-A/L inter- face; init BF retract to 0° | Initiate SB retraction | EAF C-band, LOS | Initiate preflare |
| MET | HMS | 219:29:48.47 | 219:30:29.59 | 219:30:35.67 | 219:30:35.83 |
| GMT | DHMS | 237:15:29:48.47 | 237:15:30:29.59 | 237:15:30:35.67 | 237:15:30:35.83 |
| EI time | HMS | 0:30: 7.88 | 0:30:49.00 | 0:30:55.08 | 0:30:55.24 |
| Altitude | ft | 12006.3 | 5098.4 | 4130.0 | 4104.6 |
| Range-runway | ft | -39708.8 | -17301.0 | -14158.8 | -14075.0 |
| VREL | ft/s | 606.9 | 540.7 | 542.8 | 542.9 |
| REL AZ | deg | 170.0210 | -169.9477 | -169.8966 | -169.8979 |
| Gamma REL | deg | -17.2964 | -16.8636 | -16.8769 | -16.8641 |
| Longitude | deg W | 117.8139 | 117.8268 | 117.8286 | 117.8287 |
| Geod lat | deg N | 35.0383 | 34.9777 | 34.9692 | 34.9690 |
| Mach | n. mi. | .55 | .48 | .48 | .48 |
| TAS | kts | 359.6 | 320.4 | 321.6 | 321.7 |
| EAS | kts | 293.0 | 289.4 | 294.6 | 294.8 |
| Alt above R/W ¹ | ft | 9899.8 | 2984.2 | 2019.5 | 1994.0 |
| Alt rate | ft/s | -181.1 | -158.0 | -158.8 | -158.8 |

¹Runway.

| Variable | Unit | 25 | 26 | 27 | 28 |
|---------------|--------|--------------------|----------------------------------------|---------------------------|-------------------------|
| | | FRC C-band, LOS | Initiate landing gear deployment | Completion of preflare | Gear down and locked |
| MET | HMS | 219:30:37.75 | 219:30:51.51 | 219:30:55.03 | 219:30:56.47 |
| GMT | DHMS | 237:15:30:37.75 | 237:15:30:51.51 | 237:15:30:55.03 | 237:15:30:56.47 |
| EI time | HMS | 0:30:57.16 | 0:31:10.92 | 0:31:14.44 | 0:31:15.88 |
| Altitude | ft | 3800.4 | 2405.3 | 2267.5 | 2231.9 |
| Range-runway | ft | -13077.3 | -5947.9 | -4226.5 | -3547.9 |
| VREL | ft/s | 544.0 | 501.4 | 477.8 | 466.2 |
| REL AZ | deg | -169.9378 | -169.9343 | -169.8686 | -169.8960 |
| Gamma REL | deg | -16.4685 | -5.6030 | -3.2337 | -2.4684 |
| Longitude | deg W | 117.8292 | 117.8334 | 117.8344 | 117.8348 |
| Geod lat | deg N | 34.9663 | 34.9470 | 34.9423 | 34.9405 |
| Mach | n. mi. | .48 | .44 | .42 | .41 |
| TAS | kts | 322.3 | 297.1 | 283.1 | 276.2 |
| EAS | kts | 296.7 | 278.9 | 266.3 | 260.0 |
| Alt above R/W | ft | 1690.8 | 298.3 | 161.3 | 126.0 |
| Alt rate | ft/s | -155.5 | -50.4 | -28.3 | -21.4 |

TABLE B.1⁴I.- Continued

(b) Concluded

| Variable | Unit | 29 | 30 | 31 | 32 |
|---------------|--------|----------------|----------------------|--------------------------------------------------------|----|
| | | Initiate FF | MSBLS LOS AZE/DME | WT on main gear; SB to 100 percent deployment | |
| MET | HMS | 219:31: .63 | 219:31:03.19 | 219:31:10.87 | |
| GMT | DHMS | 237:15:31: .63 | 237:15:31:03.20 | 237:15:31:10.87 | |
| EI time | HMS | 0:31:20.04 | 0:31:21.82 | 0:31:30.28 | |
| Altitude | ft | 2164.8 | 213.60 | 2104.7 | |
| Range-runway | ft | -1679.8 | -595.84 | 2359.4 | |
| VREL | ft/s | 433.0 | 413.5 | 358.4 | |
| REL AZ | deg | -169.9232 | -169.8408 | -169.8866 | |
| Gamma REL | deg | -1.5014 | -1.0962 | .1642 | |
| Longitude | deg W | 117.8359 | 117.8365 | 117.8383 | |
| Geod lat | deg N | 34.9354 | 34.9325 | 34.9245 | |
| Mach | n. mi. | .38 | .36 | .32 | |
| TAS | kts | 256.6 | 245.0 | 212.4 | |
| EAS | kts | 241.7 | 230.87 | 200.2 | |
| Alt above R/W | ft | 58.4 | 29.5 | -3.3 | |
| Alt rate | ft/s | -12.7 | -9.2 | -.1 | |

TABLE B.1-I.- Continued
(c) Main gear T/D through rollout
environmental data

Event

1. WT on main gear; SB to 100 percent deployment
2. Initiate controlled pitchdown
3. Nosewheel contact
4. Initiate braking
5. Wheel stop

TABLE B.1-I.- Concluded

(c) Concluded

| Variable | Unit | 1 | 2 | 3 | 4 |
|----------------------------|------|--------------------------------------------------------|-------------------------------------|-----------------------|---------------------|
| | | WT on main gear; SB to 100 percent deployment | Initiate controlled pitchdown | Nose wheel contact | Initiate braking |
| MET | HMS | 219:31:10.87 | 219:31:17.91 | 219:31:22.07 | 219:31:32.47 |
| GMT | DHMS | 237:15:31:10.87 | 237:15:31:17.91 | 237:15:31:22.07 | 237:15:31:32.47 |
| EI time | HMS | 0:31:30.28 | 0:31:37.32 | 0:31:41.48 | 0:31:51.88 |
| Time from WOW ¹ | sec | .00 | 7.04 | 11.20 | 21.60 |
| VREL | kts | 212.4 | 188.4 | 174.6 | 139.0 |
| EAS | kts | 200.2 | 177.6 | 164.6 | 131.1 |
| Range-runway | ft | 2359.4 | 4739.2 | 6014.0 | 8750.3 |
| Rollout dist | ft | .0 | 2379.8 | 3654.6 | 6390.9 |
| Alpha | deg | 8.5 | 8.0 | -3.5 | -4.1 |

¹Weight on wheels.

| Variable | Unit | 5 | 6 | 7 | 8 |
|---------------|------|-----------------|---|---|---|
| | | Wheels stop | | | |
| MET | HMS | 219:31:58.45 | | | |
| GMT | DHMS | 237:15:31:58.45 | | | |
| EI time | HMS | 0:32:17.86 | | | |
| Time from WOW | sec | 47.58 | | | |
| VREL | kts | .5 | | | |
| EAS | kts | .5 | | | |
| Range-runway | ft | 11806.6 | | | |
| Rollout dist | ft | 9447.2 | | | |
| Alpha | deg | -4.2 | | | |

B.2 BASIC CONSTRAINTS

a. WT

WT is one of the most important factors in designing the orbiter reference trajectory profiles. The current A/L geometry (I-loads) was designed for orbiter WT's between 190,000 and 245,000 lb. The upper WT limit has steadily increased over the years and is currently being increased again due to new load analysis. Heavier WT's have been tested many times, but the resulting performance was always degraded. When WT's become lighter than 185,000 lb or heavier than 250,000 lb, serious consideration will have to be given to changing the OGS geometry and/or the targeted T/D speeds to retain the desired dispersion capability and energy margins. Other areas of A/L will also have to be investigated, particularly rollout.

b. C.G.

The longitudinal center of gravity (x-c.g.) limits for the orbiter have more influence on the design of the earlier phases of entry than A/L. The aft x-c.g. limit is 1109 in. (67.5 percent) and the forward limit is 1076.6 in. (65.0 percent). During A/L, the x-c.g. position affects the trimmed eleven deflection, and its biggest handling ramifications occur immediately prior to T/D and during derotation. Landing with a forward x-c.g. typically results in higher T/D altitude rates and makes the derotation task more demanding.

c. Dynamic pressure

There are several areas which have a maximum dynamic pressure (Q-bar) constraint during A/L (Mach <1). The flight control Q-bar restriction is 342 lb/ft² (318 kts KEAS). The structural Q-bar restriction is 300 lb/ft² (298 KEAS). The structural restriction does allow for transients up to the 342-lb/ft² limit for periods of less than 15 sec. The 300-lb/ft² value is exceeded on a nominal A/L trajectory after SB retraction, but generally for only 6 to 9 sec. The landing gear door (deployed) Q-bar limit is also 300 lb/ft². The nominal Q-bar at landing gear deploy is approximately 273 lb/ft² (284 KEAS). The minimum Q-bar is not directly computed by A/L guidance as it was in TAEM guidance. However, A/L guidance does limit the max. altitude error to 300 ft (H_ERROR_MAX), which, in effect, limits the min. flightpath angle "auto" would fly and, indirectly, the minimum Q-bar. Regardless of the mode of flight, manual or auto, there is a Q-bar lower limit. This limit is a function of vehicle WT which results in a trajectory that puts the vehicle aerodynamically at the maximum L/D configuration. The resulting EAS lower limit varies from approximately 215 kts for lightweight vehicles to 230 kts for heavyweight vehicles. These values are based on the SB's being fully closed, the landing gear not deployed, and no winds.

d. Load factor

The load factor constraints have a more direct application on the earlier phases of entry, particularly GRTLs. The original A/L design constrained the pullup circle design due to the 0.5g nominal design limit. Flying the current nominal trajectory profile results in approximately 0.25g during pullup; therefore, the 0.5g load limit did not influence the current design.

e. Other constraints

Many of the A/L constraints have several qualifiers or are not single valued. Note that some parameters have an * which means that subsequent paragraphs, shown in parentheses, go into more detail on that specific constraint. Because flight rules, ground rules and constraints, vehicle configuration, etc., will change, the values listed below may not be current.

- | | |
|--------------------------------------------------------------|--------------------|
| 1. Gear deploy initiate* (5.5.3) | >15 sec before T/D |
| 2. T/D pitch angle | <14.6° |
| 3. Max. certified ^a T/D groundspeed | <225 kts |
| 4. Min. T/D speed at 1000 ft downrange* ^b (5.7.1) | |
| Weight <200,000 lb | = 185 KEAS |
| 200,000 lb ≤ weight ≤ 220,000 lb | = 195 KEAS |
| Weight >220,000 lb | = 205 KEAS |
| 5. Surface tailwinds ^{c,d} | ≤15 kts |

^aEngineering hardware tests have included successful runs at much higher speeds:

VGS = 255 kts with 240,000-lb load and 10-kts crosswind effects

VGS = 240 kts with 256,000-lb load and 15-kts crosswind effects

^bThese constraints may be relaxed for daylight lakebed landings.

^cThese are peak winds which include gusts.

^dThe steady-state tailwind must be ≤10 kts.

^eThere are reduced limits for night landings, extended duration orbiter (EDO) missions, EOM to KSC, and TAL to Ben Guerir when no low-level wind data are available.

| | |
|-------------------------------------------------------------------------------|------------------------------------------------------------------------------------------------------------------------------|
| 6. Surface crosswinds ^{ce} | ≤15 kts |
| 7. Surface headwinds ^c | ≤25 kts |
| 8. Energy reserve* (5.7.2) | ≅ 5 sec |
| 9. Main gear T/D altitude rate* (5.7.3) | <9.6 ft/s |
| 10. Peak vertical main gear strut load* (5.7.3) | <207,000 lb/strut |
| 11. Pitch attitude rate at NGTD ^f (but not to exceed "1" below) | <8.5 - 11.5 deg/sec |
| 12. Nose gear strut load | <90,000 lb |
| 13. Nose gear groundspeed | <217 kts |
| 14. Brake energy* (per wheel) (5.9.2, 3) | <42M ft-lb EOM (3.1) [same for carbon] <55M ft-lb aborts [82 for carbon] <65M ft-lb absolute [TBD for carbon] |
| 15. Rollout margin* (5.9.1) | >2000 ft |

^fThis range covers a combination of x-c.g. locations and vehicle WT's. The lower value applies to heavy WT's with forward x-c.g.'s. The resulting maximum strut load must always be protected.

APPENDIX C.1
HEADING ALIGNMENT CONE AND PREFINAL

Before STS-5 the orbiter flew around a heading alignment circle. After STS-4 the reference profile was changed from a circle to an inverted cone (fig. C.1-1), where the orbiter would fly a 42° bank angle. This allowed the orbiter to fly more constant bank angles during large turns and also to better manage high-energy situations.

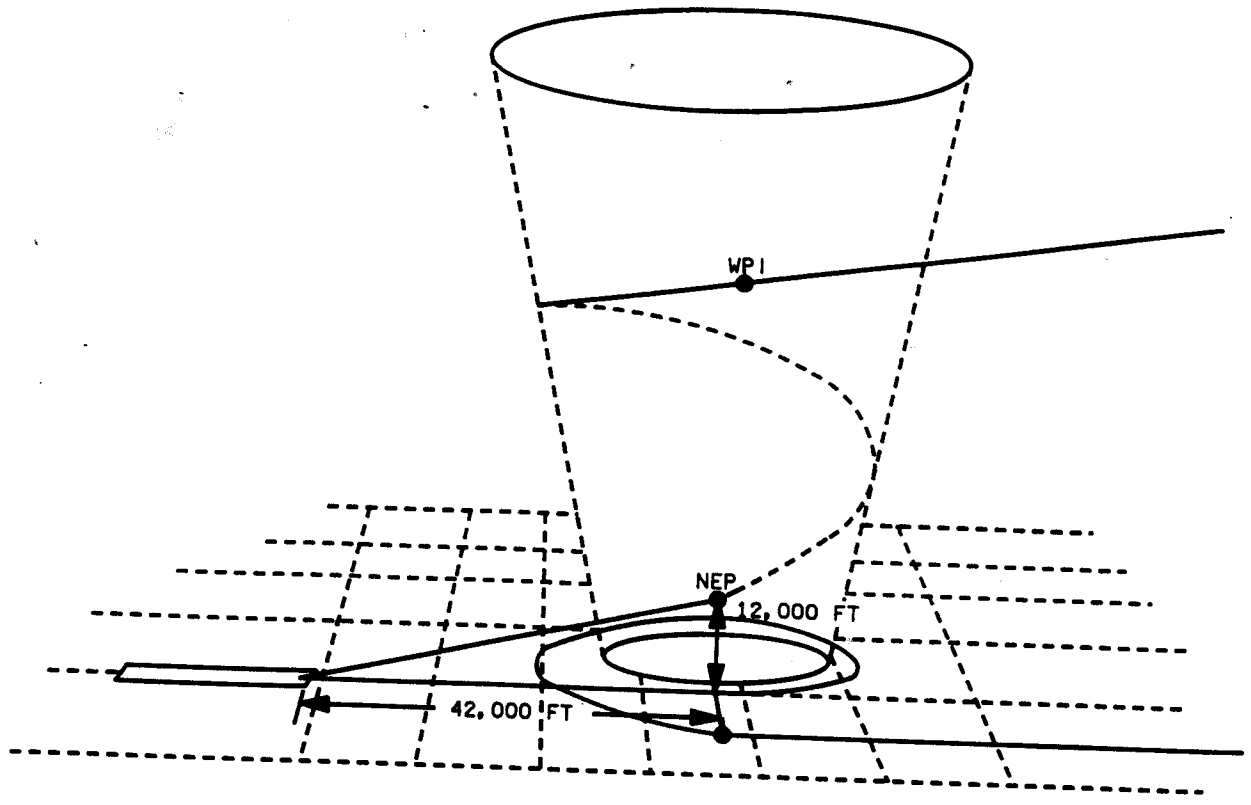

232660013. ART, 1

Figure C.1-1.- HAC profile.

Profile options were also included to improve low-energy situations. These options included straight-in approach, radius adjust, and minimum entry point (MEP) HAC. Of the three, only the radius adjust occurs automatically in guidance. In a straight-in approach, the HAC turn angle is never greater than 180° (fig. C.1-2). For a radius adjust the HAC radius shrinks allowing the orbiter to fly a shorter approach profile. A radius adjust will never occur if the HAC approach angle is less than 90° . The MEP option moves the HAC center point 3 n. mi. closer to the runway. The range savings when using a straight-in approach or flying the MEP will vary according to the HAC approach angle (fig. C.1-3). These three changes are not nominal procedures and will be used only when the vehicle is in a low-energy situation.

Prior to reaching the nominal entry point, the orbiter enters the prefinal phase of TAEM guidance. Guidance now manages the altitude, crossrange, and dynamic pressure until the vehicle acquires A/L guidance, which nominally occurs at 10,000 ft. To acquire A/L guidance at 10,000 ft, trajectory errors must fall within the parameters listed in table C-I. Except for the dynamic pressure error, the error limits decrease gradually as a function of altitude until the altitude decreases to 5000 ft (table C-I). A/L guidance is forced at 5000 ft regardless of the trajectory errors.

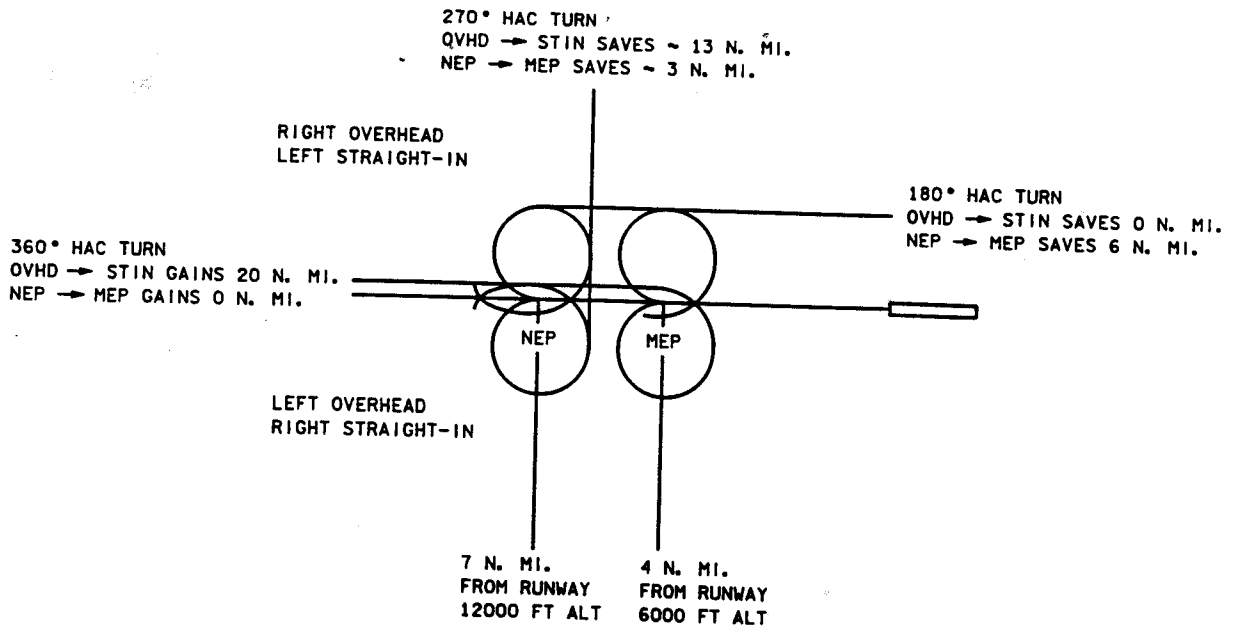
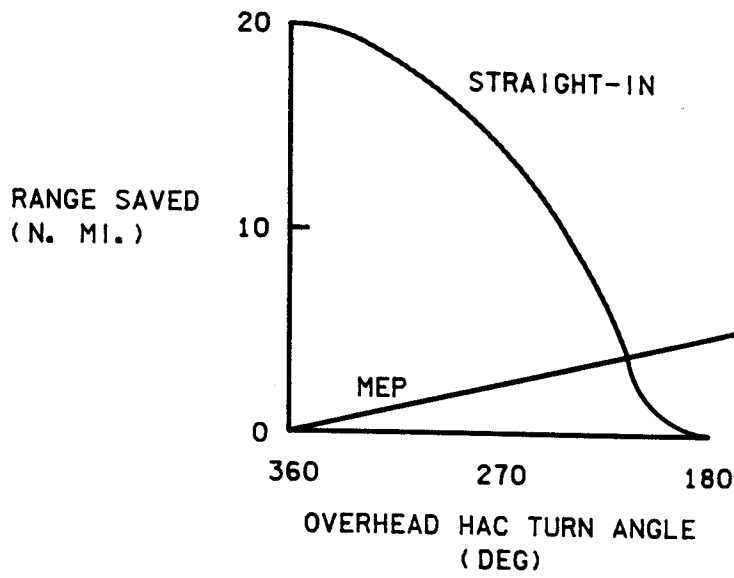

Figure C.1-2.- HAC groundtrack.



232660014.GRF, 1

Figure C.1-3.- HAC downmode.

TABLE C-I.- TAEM A/L TRANSITION CRITERIA

| TAEM A/L transition criteria | | |
|------------------------------|-------------------------|------------------------|
| 10,000 ft | | 5,000 ft |
| <4° | Flight path angle error | <0.5° |
| <1000 ft | Crossrange error | <100 ft |
| <1000 ft | Altitude error | <50 ft |
| <24 lb/ft ² | Dynamic pressure error | <24 lb/ft ² |

APPENDIX C.2
OUTER GLIDESLOPE

The main design goal for the OGS is to develop an equilibrium glidepath that provides sufficient energy at preflare for a safe landing. Sufficient energy is defined as enough energy to compensate for the deceleration between preflare and T/D and to provide the pilots with adequate time on the IGS to make any final corrections before T/D. Deceleration is a consequence of reducing the -170-ft/s altitude rate on the OGS to 2 ft/s at T/D and of allowing for 5 sec of stable flight time on the IGS.

In order to provide sufficient energy at preflare, the OGS design has to handle both high and low energy dispersions over the entire WT span of the orbiter. Since all three OGS components (slope, aim point, and reference velocity) directly affect the preflare energy, a design had to be found that best satisfied the requirements and yet did not violate any of the restrictions.

a. Altitude

Time to correct trajectory dispersions is provided by the altitude at which the OGS is acquired. The straight-in portion of the OGS was designed to start at an altitude of 12,000 ft to allow sufficient time to correct for expected trajectory dispersions after completing the HAC turn. The prefinal phase of TAEM guides the orbiter to the same OGS and reference airspeed that autoland guidance uses. Transition from TAEM to autoland normally occurs at 10,000 ft, but if the transition criteria have not been satisfied by 5000 ft, transition is forced. The 5000-ft altitude allows autoland equations time to cycle through the initial transients and time for the rate terms to reach their damping values before preflare.

b. Reference velocity

The reference velocity of the OGS is 290 KEAS. This velocity is required to compensate for the expected deceleration on the IGS. The design goal is to fly as fast as possible without hitting vehicle maximum Q-bar limits (appendix B).

The reference velocity has varied 5 to 10 kts since the original design. Two hundred and ninety KEAS was the original velocity of the early STS-1 design period. However, after the STS-1 I-loads were frozen, the maximum tire speed was reduced significantly. Since the flight was to be flown manually during A/L, the reference velocity trained to and actually flown was reduced to 280 KEAS to protect the maximum tire speed at T/D. The reference velocity was set at 285 KEAS and remained fixed through STS 51-C. The velocity was then increased by 5 kts to its current value of 290 with the introduction of the operational instructions (OI's) SB logic (discussed in section 4.4). This was to increase the energy state before preflare and provide more margin for low energy

dispersions. A portion of this speed is converted to more stable time on the IGS, which is also part of the design goal.

c. Slope

Two slopes are used for light and heavyweight vehicles, -19° and -17° , respectively; 220,000 lb is the breakpoint between light and heavy (fig. C.2-1). Current geometry (I-loads) is designed for orbiter WT's between 190,000 and 245,000 lb. If WT's ever become less than 185,000 lb or heavier than 250,000 lb, serious considerations should be given to changing the OGS to retain dispersion capability.

In the early STS-1 design period, the reference slope was -22° . Pilots expressed a concern that the resulting altitude rate, -220 ft/s, was almost unacceptably high. An aerodynamic data update based on wind tunnel results allowed a reduction of the OGS from -22° to -20° . Due to better L/D than predicted from A/L test (ALT) flights, STS-2 OGS was reduced to -19° , where it remains today for lightweight vehicles.

The primary design consideration of the OGS slope is to make it as shallow as possible while still maintaining sufficient SB reserve to cope with winds and initial trajectory dispersion. The slope of the OGS is to provide capability to compensate for both high and low energy dispersions. This capability is obtained by selecting a slope which results in the mid-SB effectiveness value of 65° for a midrange WT. Figure C.2-2 shows the variation of trim SB with WT and GS values.

The slope must not be too shallow, since it is necessary that the vehicle stay on the front side of the L/D curve. To protect this, the vehicle must not fly slower than the minimum Q-bar profile. In autoland the guidance equations limit the maximum value of altitude error used in the normal acceleration commands (N_z)_c to ± 300 ft. The smaller altitude error in combination with the altitude rate error damping term and the associated gains provide a pseudominimum Q-bar protection. One of the reasons for not forcing TAEM transition to autoland guidance until 5000 ft, in the presence of large trajectory errors, is that TAEM has direct Q-bar control limits that keep the orbiter on the front side of the L/D curve.

d. Aim point

The OGS aim point or intercept location is determined by energy requirements for landing and geometry constraints for transition between the two GS's. The distance from preflare to T/D is proportional to the vehicle deceleration time. This distance is directly related to the aim point location. The current nominal aim point value is 7500 ft before the runway threshold. Another aim point for off-nominal or low-energy situations is the close-in or high-wind aim point. This is located at 6500 ft before the runway threshold. Use of the close-in aim point provides immediate energy increase by moving the OGS intercept 1000 ft closer to the runway. The close-in aim point is often selected because

landing in high headwind is preferred over landing in high tailwind or crosswind.

STS-1 and STS-2 used 6500 ft as the nominal aim point. STS-1 post-flight results allowed the nominal aim point to be moved out an additional 1000 ft, again due to better than predicted aerodynamic L/D ratio. STS-3 and all subsequent flights have had a 7500-ft nominal aim point.

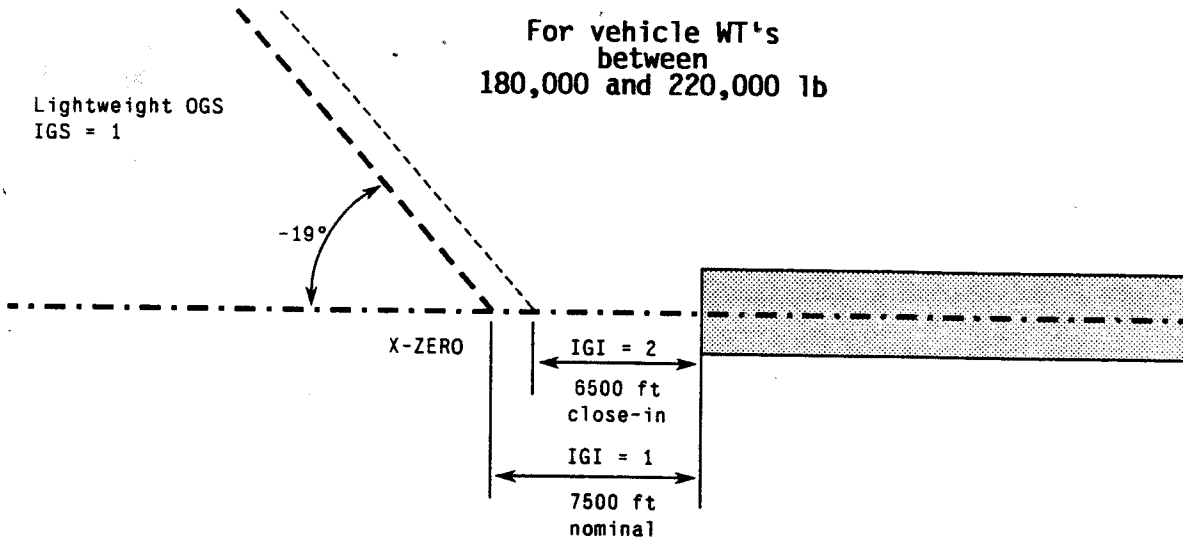

EOM, AOA, and TAL test on "vehicle"; if WT > "WT _ GS1" (220,000 lb), IGS = 2. GRTLS OGS is decided on and loaded onboard before launch; IGS = 1. The close-in/high-wind aim point is selected on the day of landing for a predicted low-energy T/D via the "HORZ SIT" item entry no 8, IGI = 2.

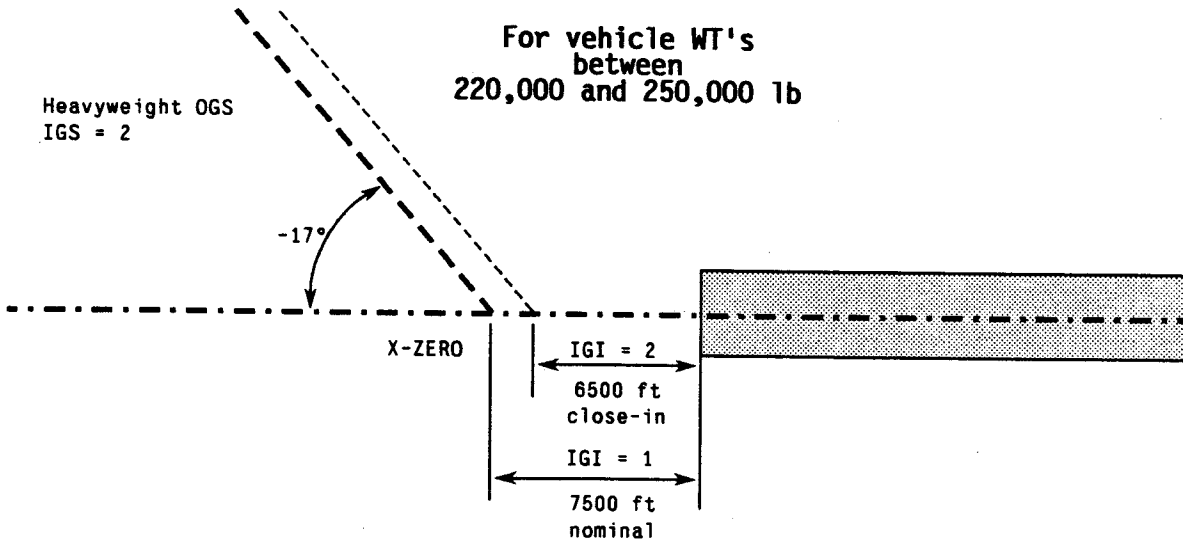

JSC-23266*017:4

Figure C.2-1.- OGS geometries.

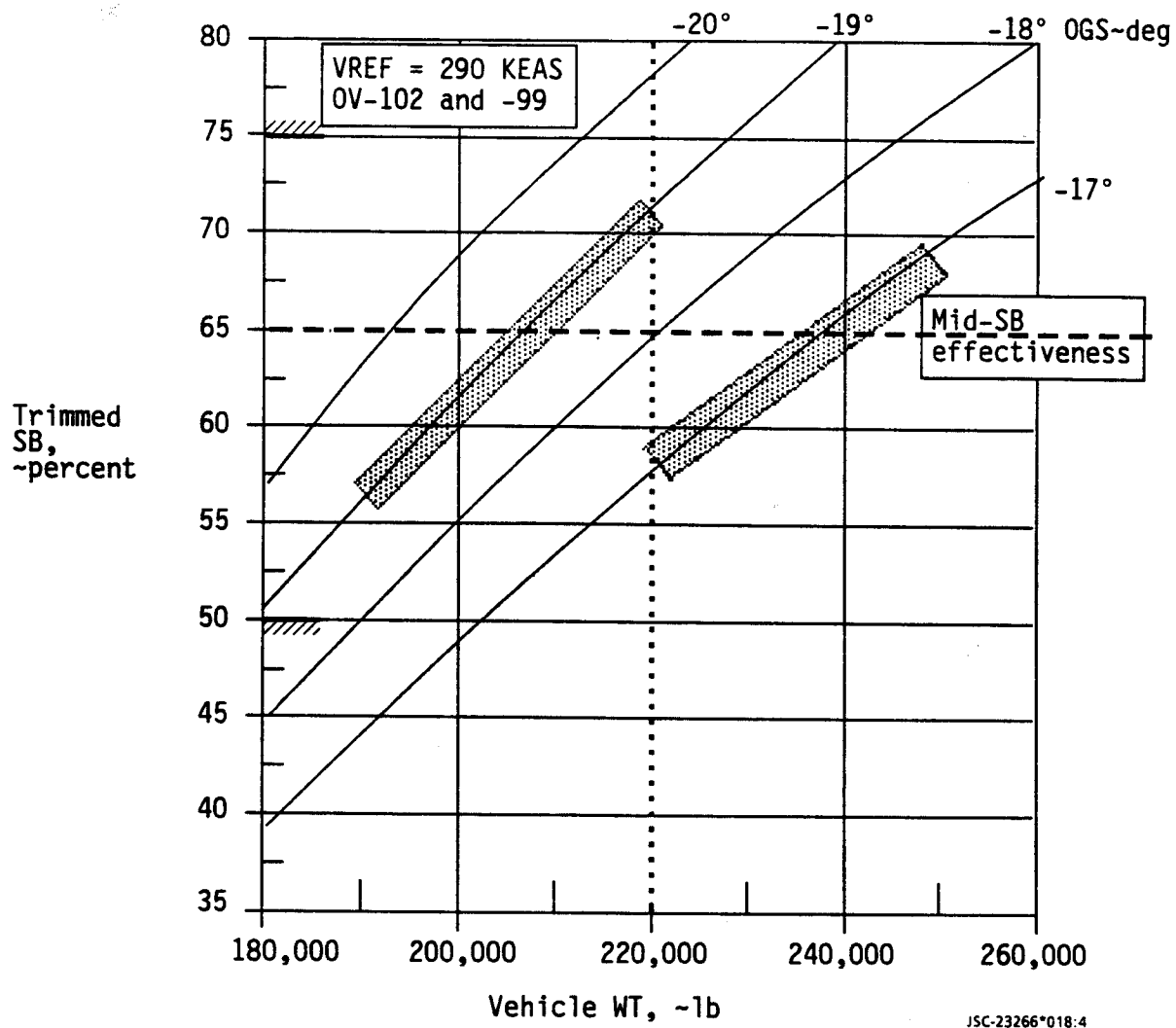

Figure C.2-2.- Trimmed SB on the OGS.

APPENDIX C.3
FLARE AND SHALLOW GLIDESLOPE

In the early design of the FSGS geometry, it was decided to use a two-flare approach instead of one flare. The one-flare design was more sensitive to trajectory and vehicle disturbances near the ground, and it provided no stable flight time just prior to T/D. Using an initial pullup circle for a reference profile minimizes the maximum load factor and eases the monitoring task because the pullup g's are nearly constant. Also, using an IGS before an FF provided a stable flight time, which was strongly desired by the shuttle pilot in both the CSS and AUTO mode of flight. This time is used to make a final energy assessment and to establish a controlled approach to the runway T/D zone.

With the decrease of the OGS from -24° in the pre-ALT days to the current -19° , the pullup circle radius has increased so that the nominal pullup g's are now approximately 0.25 compared to 0.5 pre-ALT. The 0.5g value is the nominal design limit, but with today's geometry it no longer affects the trajectory design. The initial preflare altitude has increased since that same time, due to the pilot's concern that a few seconds delay in the start of the flare while descending at -190 ft/s can make the pullup maneuver very demanding and can result in an uncomfortably low pullout altitude.

The autoland guidance FSGS phase starts at 2000 ft altitude. In the reference geometry the pullup circle tangent to the OGS is at 1700 ft altitude. An early STS-1 design had the flare altitude at 1750 ft because, among other reasons, that was halfway between the cockpit instrumented altitude readouts. Some people still refer to the 1750 ft altitude as the preflare altitude.

During the early part of the FSGS phase, the velocity is increasing to ~ 300 KEAS due to the SB's retraction at 3000 ft altitude. As the flightpath angle nears the minimum steady-state value (approximately -12° at approximately 1300 ft altitude), the velocity begins to decrease. Generally the transition to the IGS begins at 200 ft altitude.

The FSGS exponential and the FF trigger geometries are designed to give the pilot at least 5 sec of stable flight time on the IGS before the FF maneuver on the nominal trajectory. Stable flight time is defined as the time when the pitch rate is less than 0.5 deg/sec (fig. C.3-1). The lightweight nominal trajectory yields 7 sec stable time on the IGS. Once the vehicle is on the IGS and the landing gear is down and locked, the deceleration is fairly constant at just over 4 KEAS/sec. Each additional second the vehicle remains airborne results in a 4 kts slower T/D velocity. The stable flight time must be curtailed due to the velocity lost during that time. But a minimum amount of stable time is required for the crew to assess the trajectory-energy state and to make any final adjustments necessary to achieve a smooth, safe landing. For an autoland to T/D flight mode, this stable time is also required for the crew to assess the auto guidance final approach to the runway.

Another time measurement that has a similar connotation is stable time to T/D. Stable time to T/D is defined as when the pitch rate is less than 0.5 deg/sec until T/D. The nominal trajectory yields 16 sec of stable time to T/D. There are several conditions which compress these stable times: winds, atmosphere, energy, SB retract angle, and the close-in aim point geometry. The main reason for using the close-in aim point is to increase T/D energy by 1000 ft. This is partially achieved by cutting in half the time spent on the IGS. Any attempt by the crew to try to maintain the normal 7 sec of stable time on the IGS, when flying the close-in aim point, will negate some of the expected T/D energy gain.

The pilot can visually monitor the tracking of the IGS with the ball/bar landing aid. The height and separation of these lights are computed so that the pilot's eye position is such that he sees the ball superimposed on the bar if the vehicle is ideally tracking the reference IGS geometry. Most runways also have painted markers at the nominal 2500-ft T/D location to give the pilots a downrange point of reference.

The IGS intercept is currently anchored at 1000 ft downrange. The intercept used for the first two space shuttle flights was 1500 ft. The stronger than predicted aerodynamic ground effects are the reason for moving the IGS back 500 ft. The STS-2 preflight predicted auto T/D range was 4000 ft, which was beyond the nominal designed range of 3000 ft predicted for STS-1. Using the current aerodynamic data modifications results in an auto T/D range of 2500 ft.

The IGS design has buried in it a concept explained by the late A. Moyles/Rockwell International (RI) that involves time to go and a comfort zone. Time to go is the altitude divided by the altitude rate. Coming off the pullup circle to the exponential, the pilot is comfortable with a trajectory that has 4 to 7 sec time to go. Trajectories that have less than 4 sec time to go give the pilot a feeling that there is not enough time to make a correction before the vehicle hits the ground. Conversely when the time to go is greater than 7 sec, the pilot feels that the trajectory is being stretched and too much energy is being dissipated before T/D. The nominal trajectory is designed to give 5 to 6 sec time to go on the IGS (fig. C.3-2).

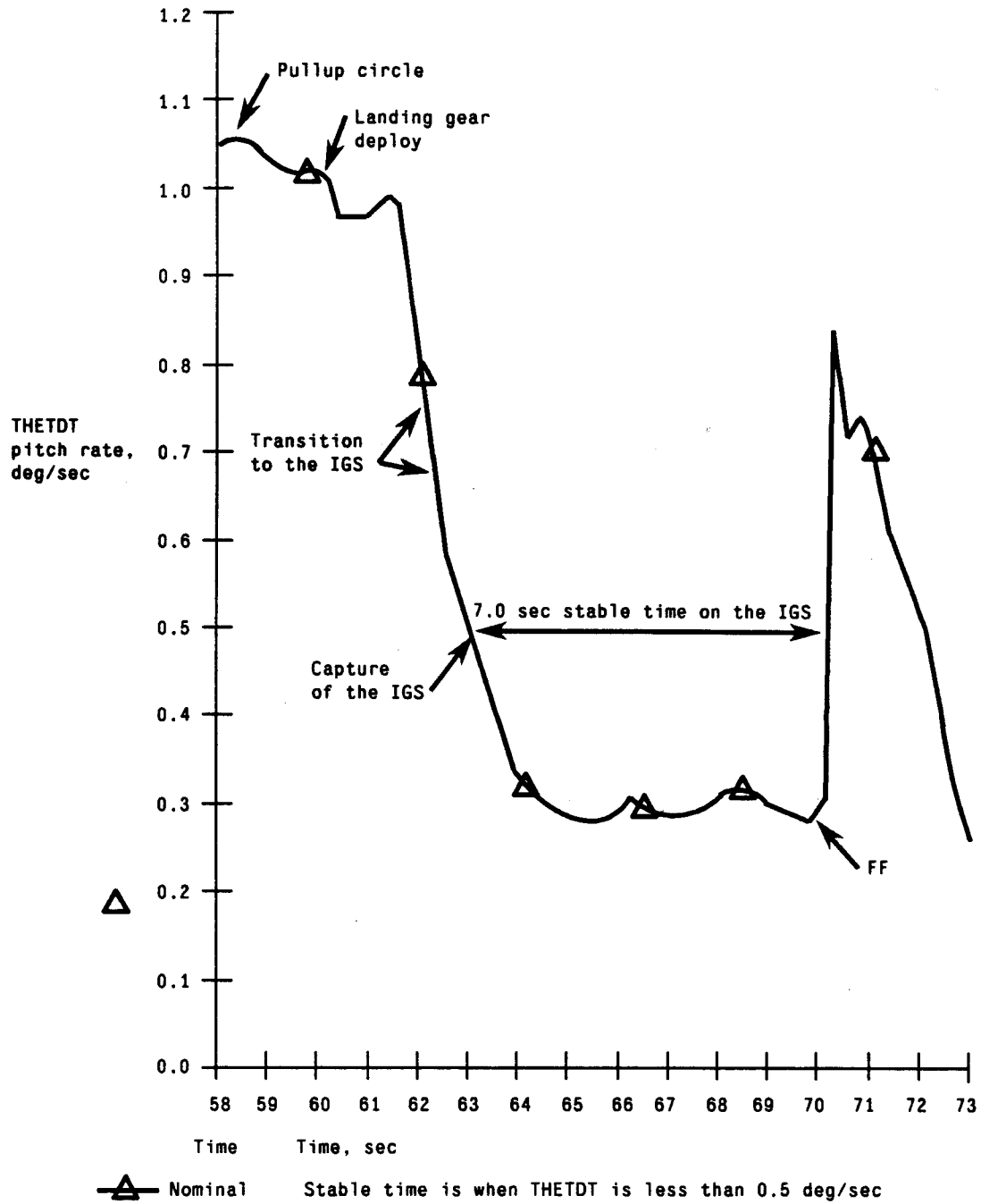

JSC-23266*027:C

Figure C.3-1.- Stable time on the IGS (5 sec minimum).

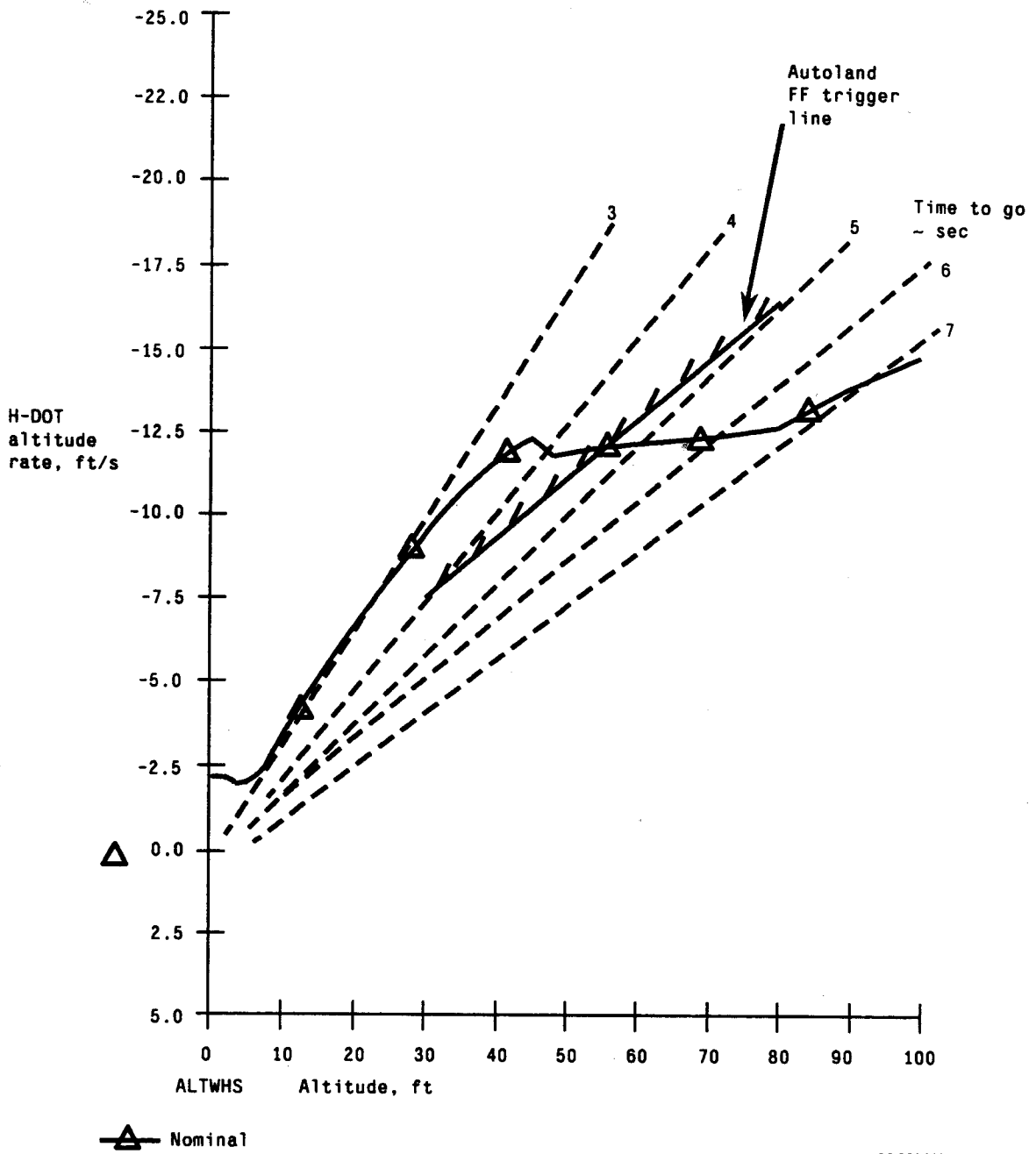

Figure C.3-2.- FF altitude-altitude rate design profile.

Appendix C.4
FINAL FLARE

Very important factors in arresting the altitude rate are the powerful aerodynamic ground effects of the orbiter. These ground effects grow exponentially as the altitude decreases, and the resulting increase in L/D is approximately 25 percent, which eases the landing task for the pilot (and guidance) at this very critical stage of flight. Figure C.4-1 compares the altitude-altitude rate history of two trajectories, one with ground effects and one without ground effects; the resulting altitude rate at T/D without ground effects is marginally acceptable. Another trajectory was simulated which was forced to never initiate the FF phase. The resulting altitude history is compared to the nominal profile in figure C.4-2. Again the T/D altitude rate is marginal and to quote one pilot, "It would be a very scary ride." The altitude range profiles of the nominal and of the two off-nominal simulations is shown in figure C.4-3. The -1.5° IGS design is a compromise in that it does not require a large maneuver to land and yet maintains a reasonable ground clearance when coming out of preflare.

A negative landing/handling quality of the shuttle is the initial vehicle response to pitch control inputs is backwards from the desired end condition due to the relative locations of the c.g., the aerodynamic center, the control surfaces, and the pilot seat. For example, if a positive (NZ)C input is given, the first response is that the elevons deflect upward. The up elevon initially causes a decrease in lift, approximately 2000 lb/deg, and the wheels actually move closer to the ground at a faster rate. A pilot trying to arrest a high altitude rate, in fact increases the rate initially and if timed wrong, can cause T/D to occur sooner than expected when the opposite is intended. That expected positive lift increment does not occur until the vehicle rotates and a higher angle of attack is achieved. To make matters worse, the pilot altitude history just prior to landing is almost constant; therefore, the out-the-window observation is that very little is happening to the altitude or altitude rate after a positive input is made. In summary, all inputs are kept to a minimum as the shuttle nears the ground to avoid early T/D or balloon effects.

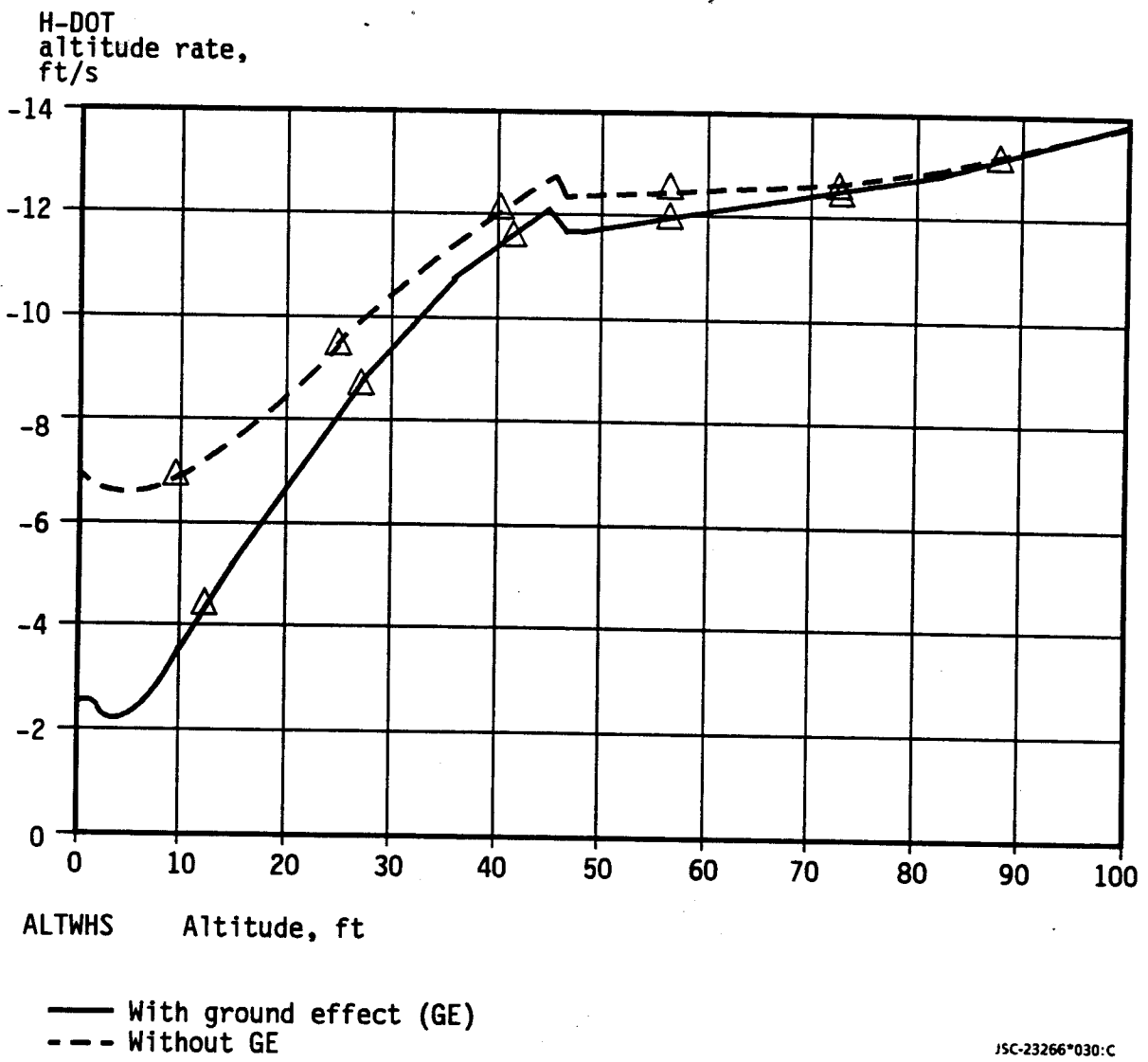

Figure C.4-1.- Altitude rate profile with no GE.

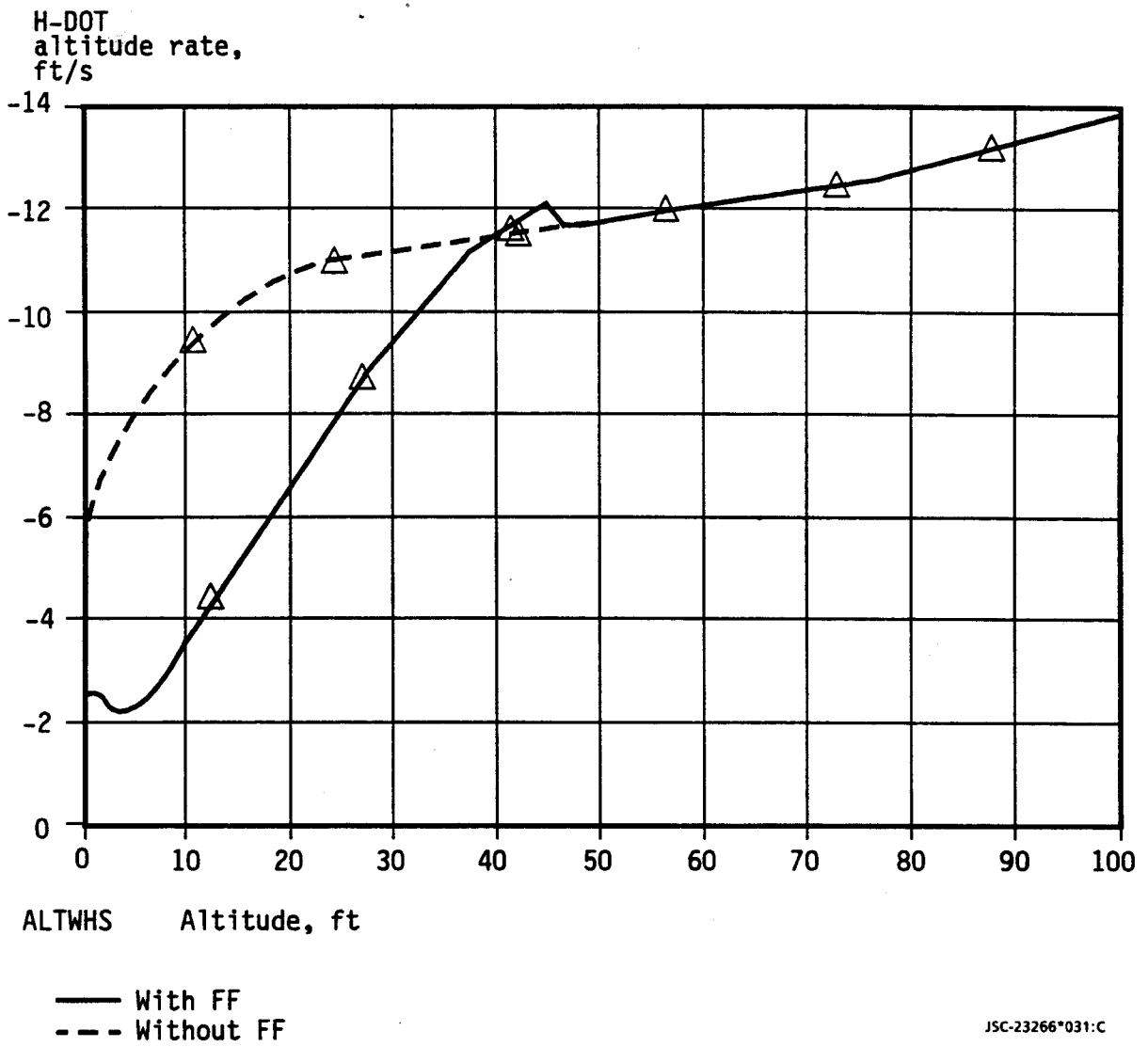
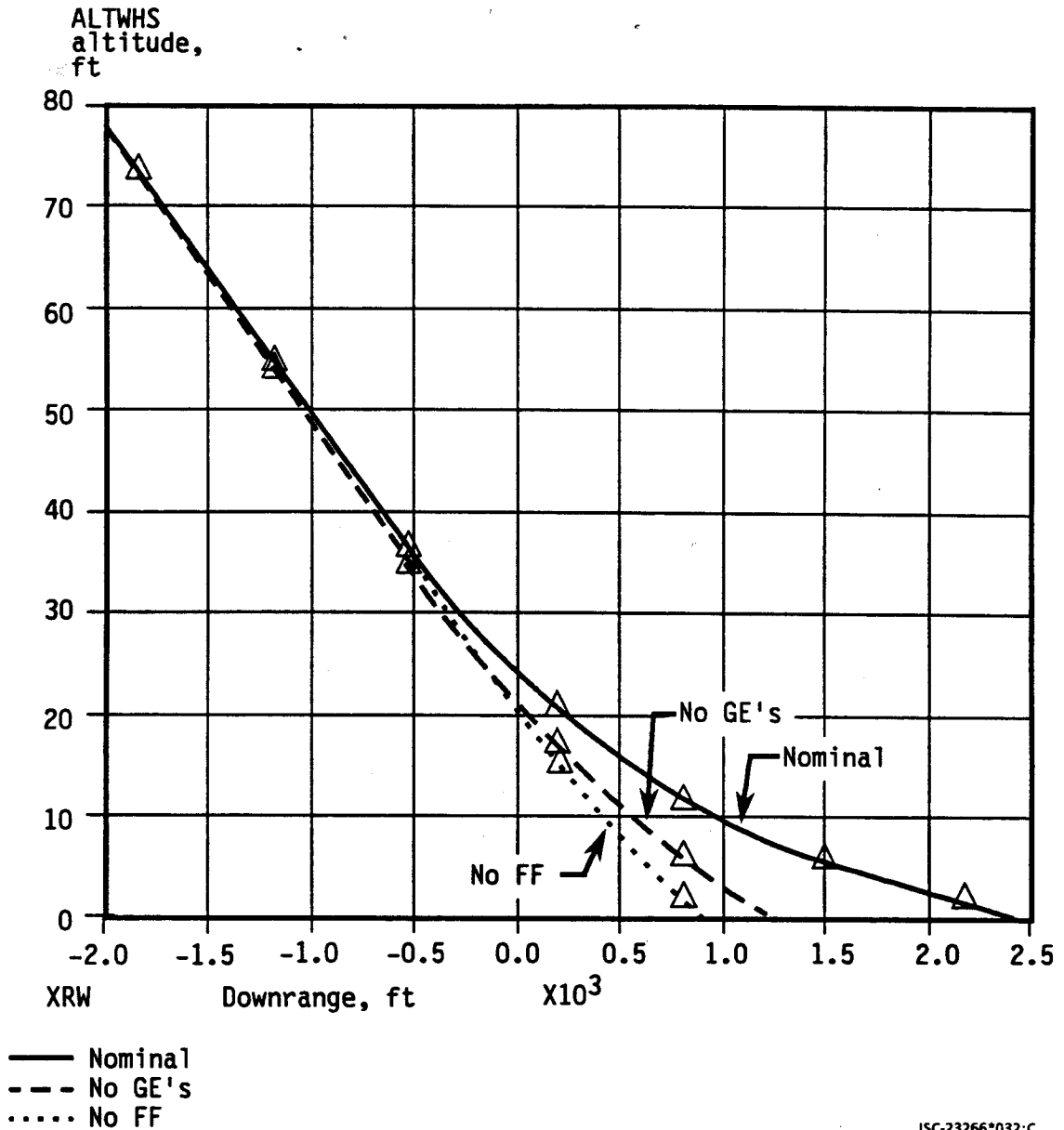

Figure C.4-2.- Altitude-altitude rate profile without an FF.



JSC-23266*032:C

Figure C.4-3.- Altitude profiles near T/D.

It should be noted that the CSS pilot technique for the final phase of landing is somewhat different from what auto FF is doing. This does not mean that either should be changed, because they both achieve the same end condition, a small altitude rate at T/D. Certain auto commands are incorporated to aid the pilots in monitoring a pure auto T/D. Visual cues can be used by the pilots to achieve the desired T/D attitude; whereas, autoland guidance uses only navigated altitude and altitude rate data. The resulting auto FF must be smooth and predictable so that a pilot monitoring its performance feels comfortable with what auto is doing. Moving base simulations, set up

to study late pilot takeovers, have shown that the lower the altitude when takeover occurs, the harder the task to perform a good landing. Also, large deviations in T/D position to offset large energy dispersions can and have been performed by the pilots in the CSS mode; whereas, autoland has no capability to alter the reference profile based on low-energy conditions. Autoland guidance inherently lands short in low-energy situations and long in high-energy conditions but not to the extent desired in extreme situations. The first two shuttle flights landed approximately 3000 ft long and short, respectively, to offset relatively large unexpected energy deviations. Both flights landed fairly close to the targeted T/D velocity. If those same two flights had landed in auto, the ranges would have been closer to predicted, but the T/D velocities would have been quite fast and quite slow, respectively.

A special study was conducted by four shuttle pilots to gather information on how they fly the FF profile. The STA was used, and the pilots were asked to save the flight data from four CSS approaches for which they felt comfortable. The sets of four runs were averaged and compared to a nominal autoland guidance profile (fig. C.4-4). The autoland nominal profile generally falls inside the four averaged profiles, lending support to the present design.

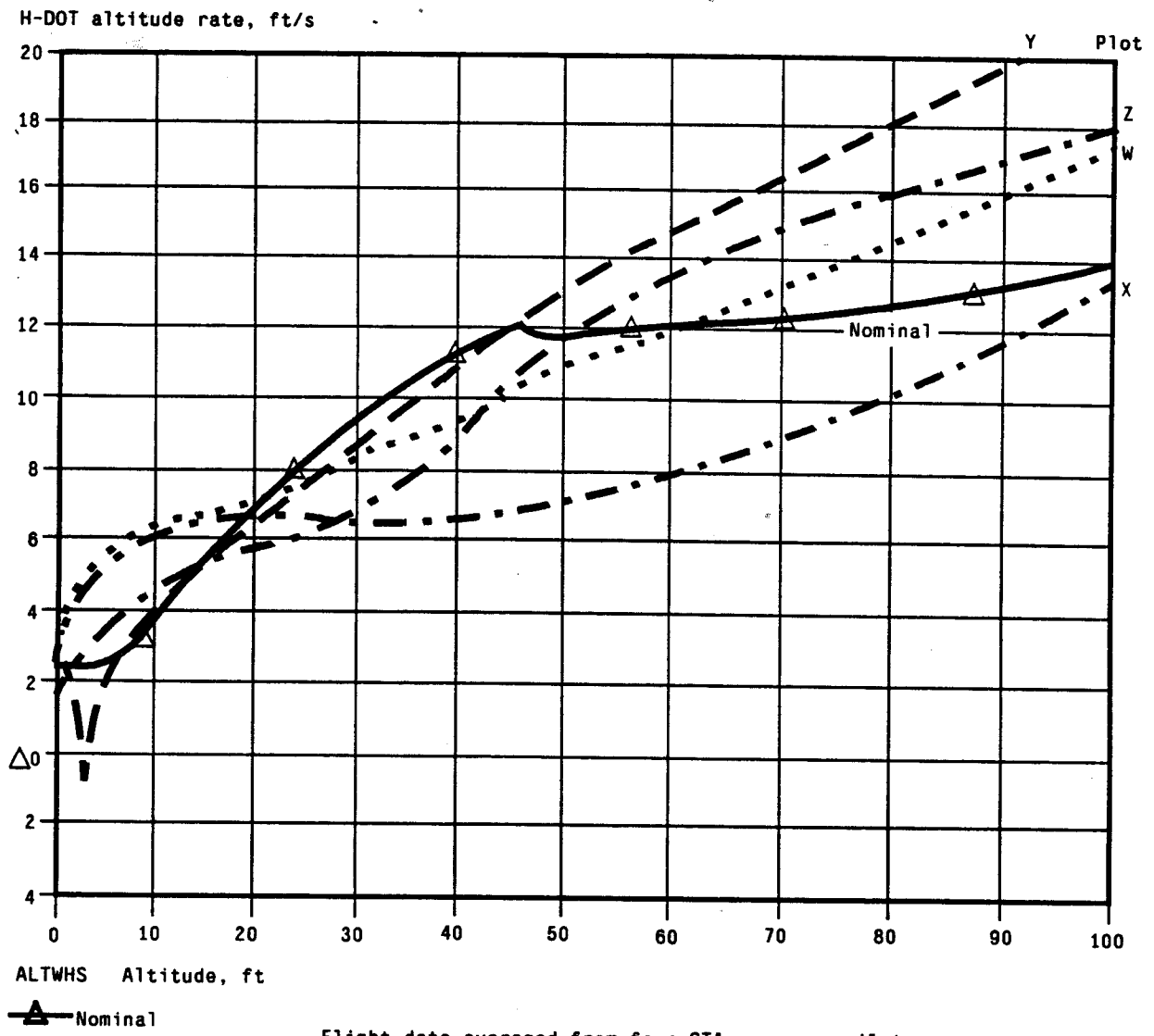

Figure C.4-4.- FF altitude-altitude rate design profile.

APPENDIX D.1
ROLLOUT MARGINS AND BRAKE ENERGY

a. Rollout Margin

The size of the rollout margin was selected using the individual contributions presented in table D-I. The errors in the environment reflect the effect of changes between the last measurement and the actual landing. There are several sources of errors for rollout that are not considered in the development of the T/D margin. These are the deviation in the surface wind, the start of the opening of the SB, the pitchdown procedure, and the braking procedure. The sum of the WOW errors is 3200 ft; the root sum square (RSS) of the errors is 1633 ft (three sigma). The bias of the air data system increases the error to 1934 ft. For convenience, the high-energy rollout margin is considered to be 2000 ft. The rollout margin is measured from the stopping point to one of three places: (1) the end of the runway, (2) the barrier, or (3) the end of the usable overrun. The logic that is used to evaluate the rollout margin and brake energy limits is presented in figure D.1-1.

b. Brake Energy Limits

If the NWS fails prior to EOM deorbit, the brake energy is limited to 42M ft-lb for the worst brake. This energy causes the fuse plugs to melt and is independent of the type of brakes. After commitment to the deorbit burn, the options available for reducing the brake energy are limited. Should the NWS fail after this commitment and the brake energy exceeds 42M ft-lb, runway redesignation will be considered prior to Mach 6. Redesignation is recommended if the brake energy reduction is not significant or if the alternate is less desirable for other reasons (no landing aids, runway condition, crosswinds, etc.). Flight rules state runway redesignation will not be recommended later than Mach 6 in order to protect against inducing a trajectory energy error which is not corrected by entry/TAEM interface.

c. Flight Rule

The reference point for the rollout margin is the barrier, if one exists. The rollout margin and brake energy must meet the most constraining of the following conditions:

1. Full-braking capability, use of NWS, and brake energy not to exceed 55M ft-lb (82M ft-lb for carbon brakes) for aborts or 42M ft-lb for nominal EOM.

TABLE D-I.- BUDGET FOR HIGH ENERGY ROLLOUT MARGIN PLACARD

| | Error source | Est. 3 sigma, ft | Comments |
|-----------------------------------------------------|---------------------------------|-------------------------------------|--------------------------------------------------------------------|
| E n v i r o n m e n t | Average wind (3K ft to surface) | 200 | 20 kts decreasing to 15 kts |
| | Wind shear below 500 ft | 350 | Fools smart SB |
| | Surface wind deviation | 600 | -5 kts through rollout |
| | Density altitude | 200 | Including T/D and rollout |
| | Air data system error | 400 | 6 KEAS (2 percent of 290) |
| | | <u>1750 WOW</u> | |
| P r o c e d u r e | Trajectory deviations | 150 | Off-nominal H/R profile |
| | Rollout SB opening | 200 | Delayed SB opening |
| | Late landing gear deploy | 250 | At 200 ft instead of 300 ft |
| | Pitchover procedure | 150 | Low rate pitchover from T/D |
| | Braking procedure | 700 | Differential brake or decel |
| | | <u>1450 WOW</u> | |
| = | ===== | <u>3200 WOW</u> 1633 RSS 1934 | ===== |
| | | | Includes 1.4 sample size factor ADTA bias + remaining 3-sig RSS |

Notes: Additional margin is provided by real-time prediction assumption of 9 ft/s² as maximum braking deceleration. Correction factor of 1.4 adjusts for limited flight experience. MSBLS assumed to be available.

Recommendation: Use 2000-ft placard.

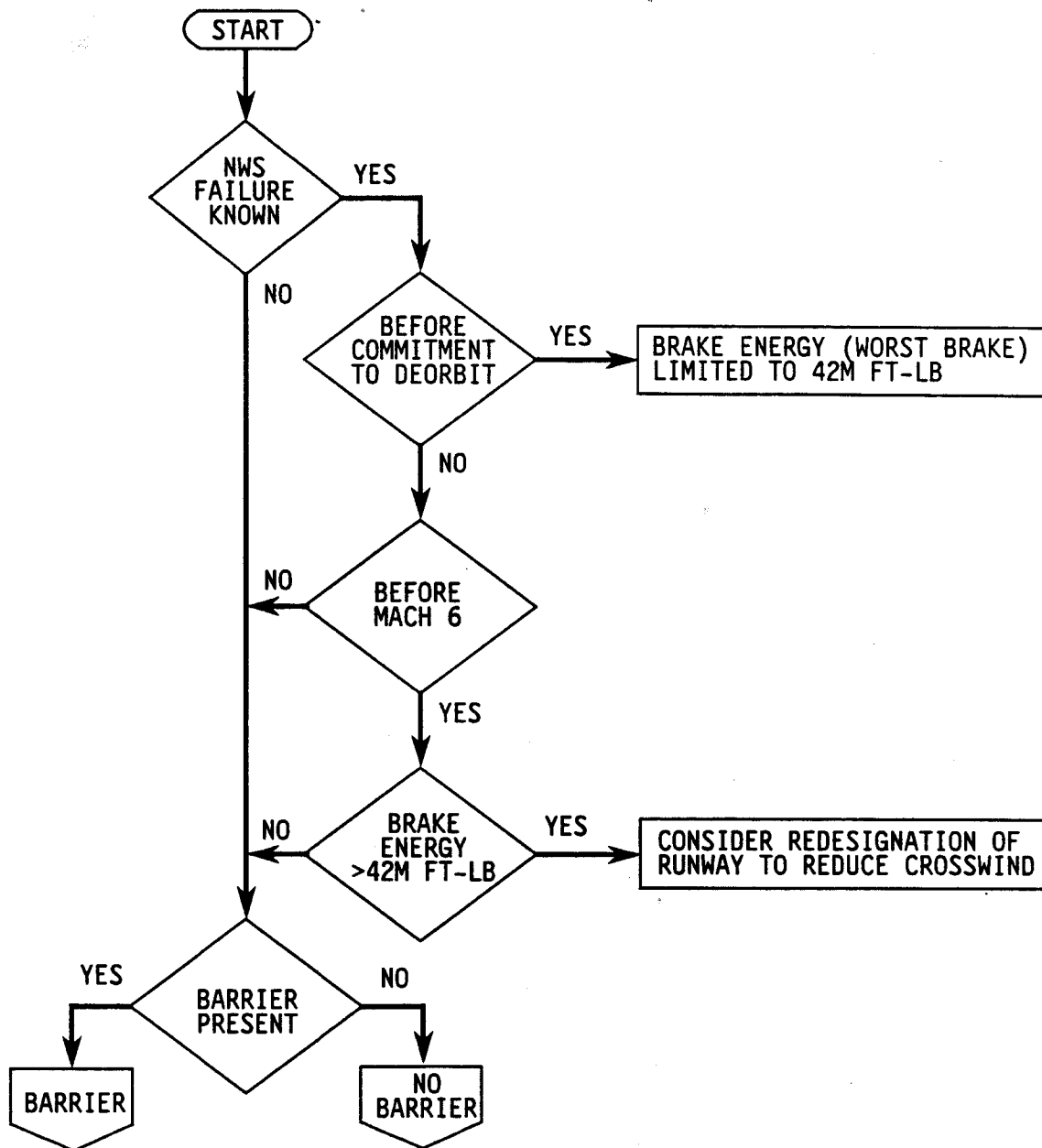

1. When necessary to meet the rollout margin and brake energy constraints, the short-field landing logic will be used.
2. For all cases, the real-time analysis will model the standard braking procedures. The deceleration used in the braking analysis is 9.0 ft/s².

JSC-23266*001:D

Figure D.1-1.- Logic used to evaluate the rollout margin and brake energy limits.

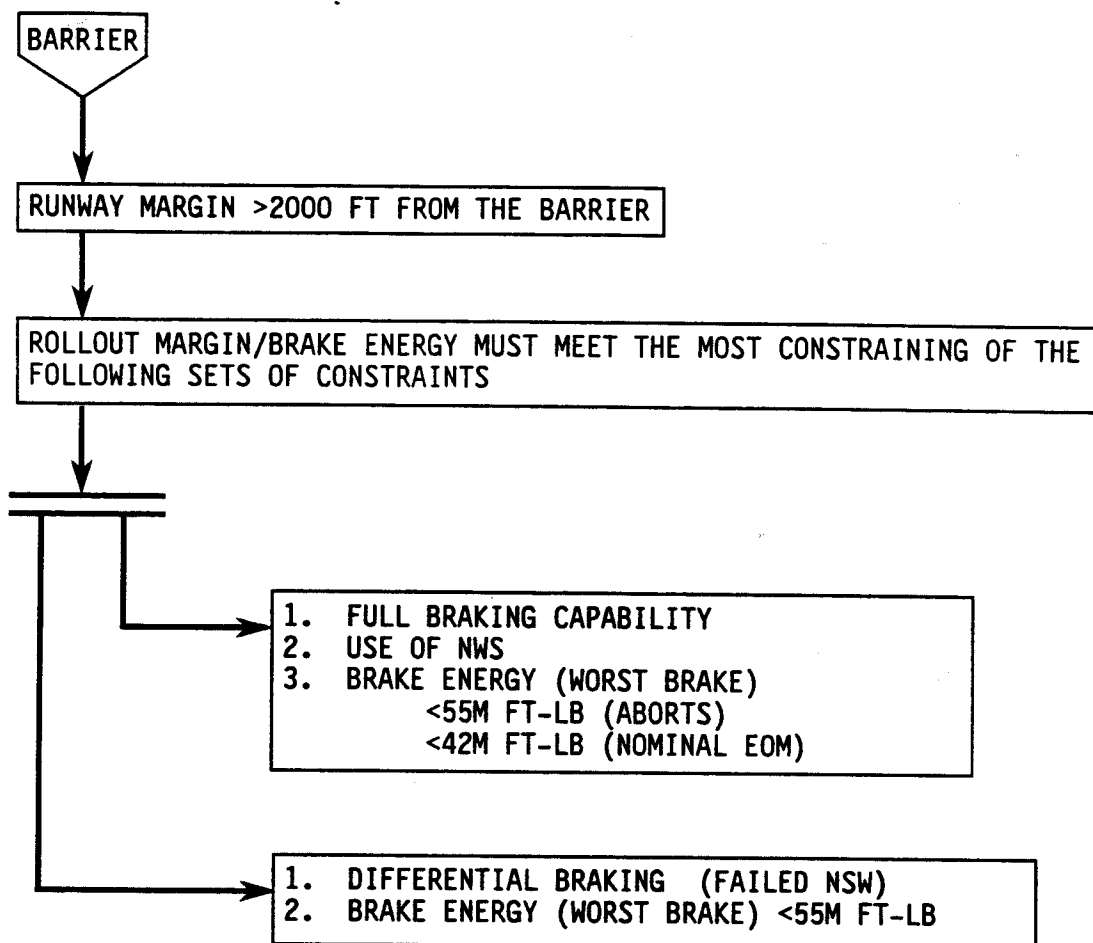

JSC-23266*002:0

Figure D.1-1.- Continued.

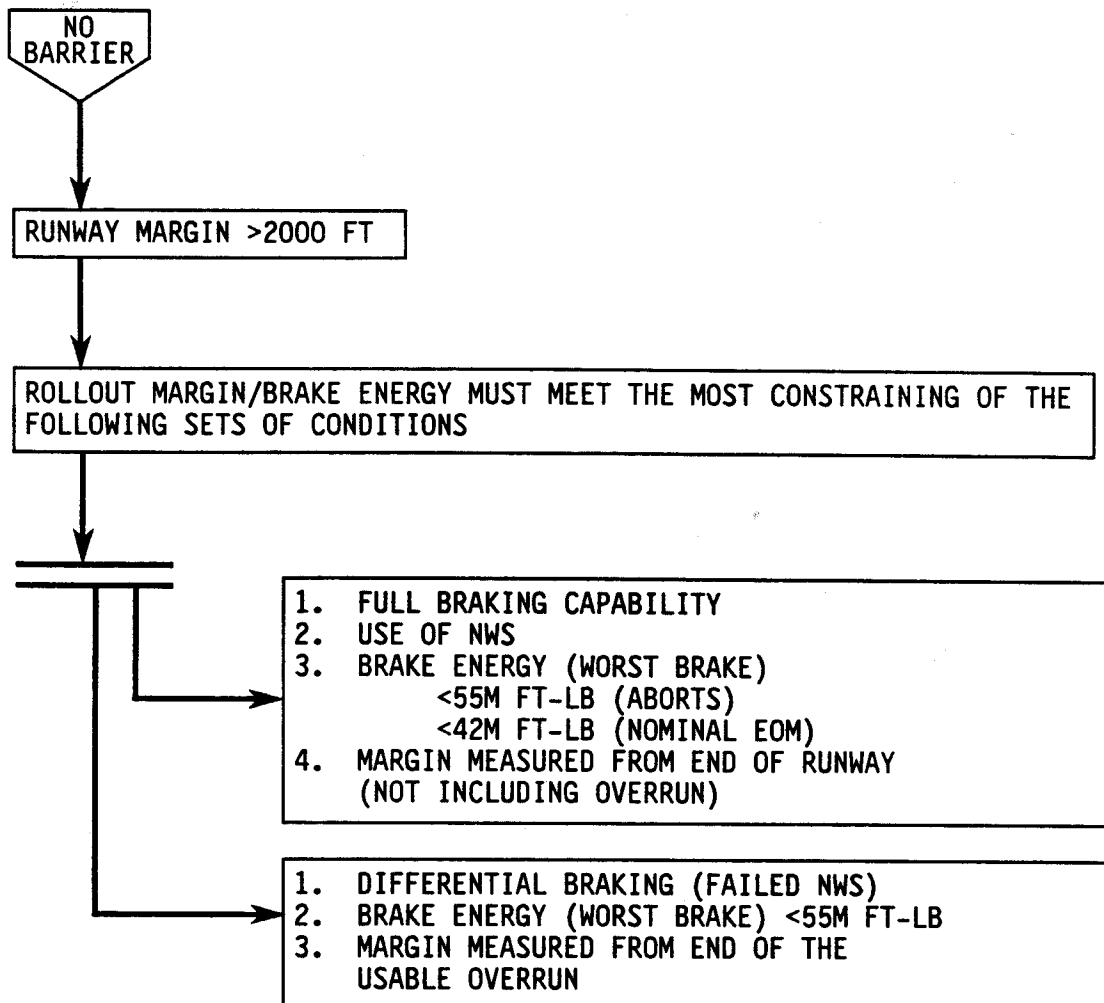

JSC-23266*003:D

Figure D.1-1- Concluded.

2. Differential braking (failed NWS) and brake energy not to exceed 55M ft-lb (82M ft-lb for carbon brakes) (worst brake). For a runway with a barrier, failures that affect the stopping distance are not accounted for, other than remaining within the brake energy limitations. The barrier accounts for the loss of braking or stopping capability.

A larger brake energy is allowed for aborts because of the heavier orbiter WT'S and shorter runways. The risk of a tire fire because of brake energies exceeding 55M ft-lb (70M ft-lb for carbon brakes) is accepted on an abort but not for the nominal EOM. The tire blowout plugs deflate the tire(s) shortly after wheel stop if the energy exceeds 42M ft-lb for either carbon or beryllium brakes. This is not a safety concern. Monte Carlo analysis of the landings of a heavy orbiter on a short runway indicate that the tire-fire limit of 70M ft-lb should never be exceeded, assuming all four brakes are operating normally.

Although the barrier is available to account for braking failures, the brake energy must be low enough to support the differential braking requirements. The 55M ft-lb (82M ft-lb for carbon brakes) limit provides a margin to account for potential early use of the brakes in crosswinds. Crosswinds directly increase the resulting brake energy when differential braking is used for lateral control during rollout.

If a runway does not have a barrier, the overrun can be used for failure cases that impact the stopping distance. The overrun is not used when assessing the rollout margin for landings that do not have any failures (i.e., full braking and NWS). The two sets of conditions referred to earlier are still applicable if there is not a barrier, except that the margin is measured from the end of the usable overrun.

The short-field SB retract logic may be selected to achieve the necessary rollout margin or brake energy limits. The short-field option decreases the targeted T/D point by 1000 ft. The short-field option is default for declared TAL's but is unlikely to be used for any other mode of entry.

APPENDIX D.2
DEROTATION

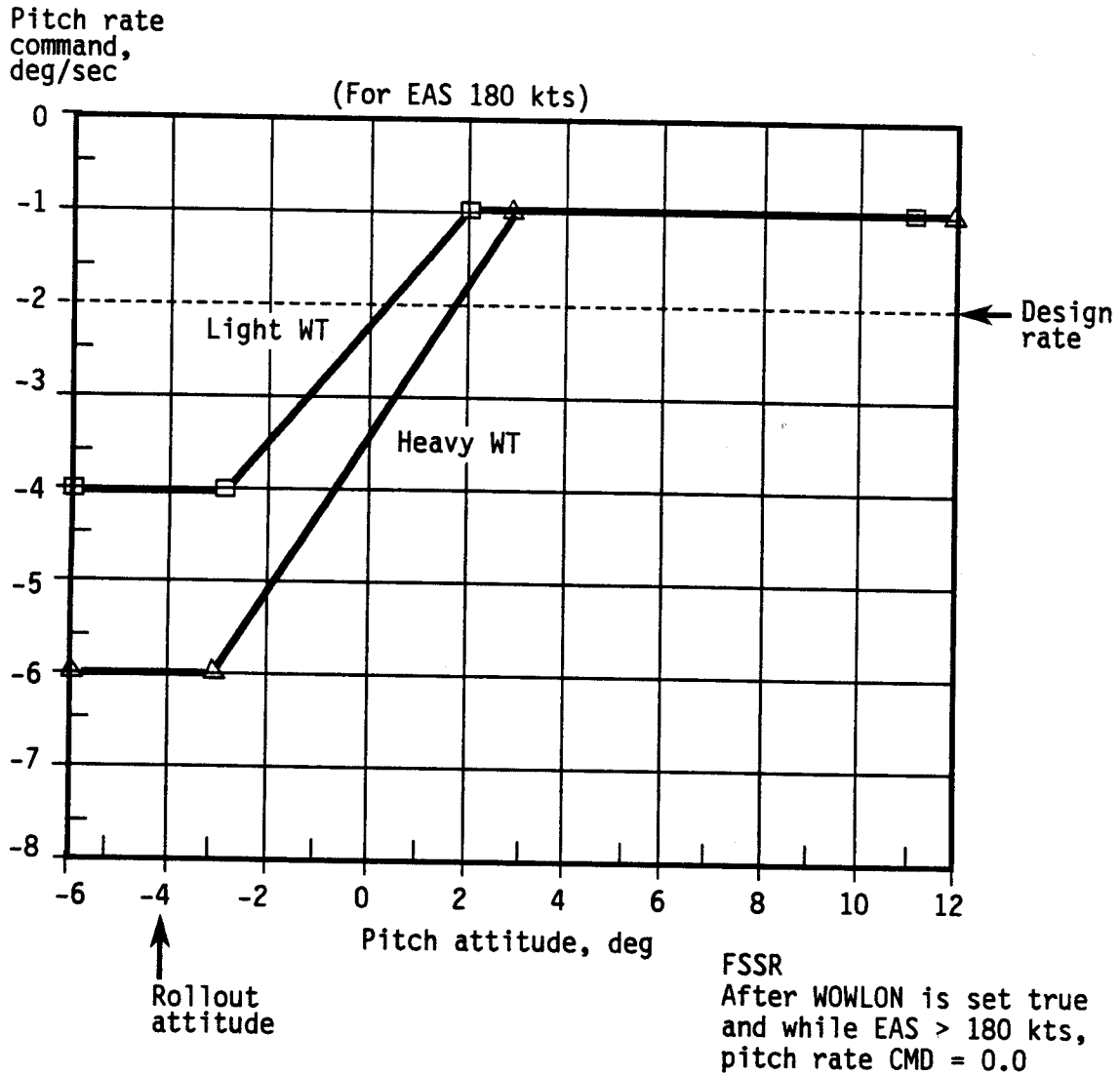

JSC 24737*044:D

Figure D.2-1.- FSSR pitch rate command during rollout.

- Maintaining 0° angle of attack
- Rolling friction coefficient = .025
- Speed at which elevon deflection went through 20° (UP)
- Data applicable for vehicle WT's 190,000 to 200,000 lb

EAS,
-kts

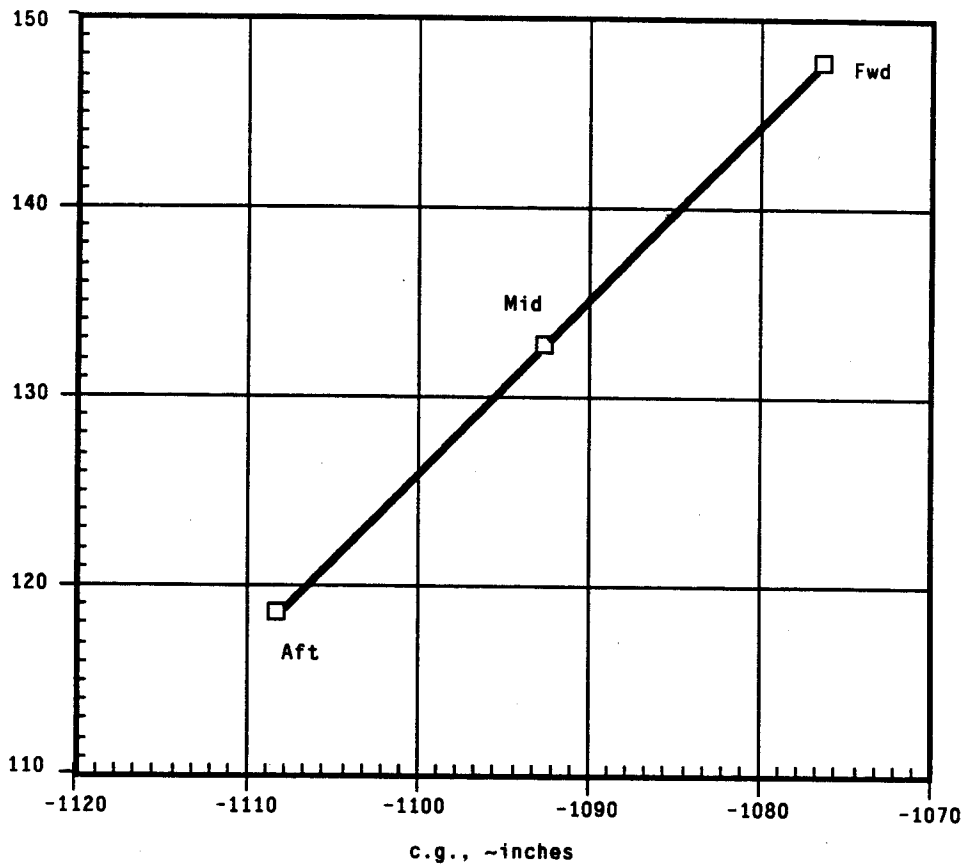

Using DDS/ASP

JSC-23266*045:0

Figure D.2-2.- Airspeed at which loss of elevon effectiveness occurs during rollout.

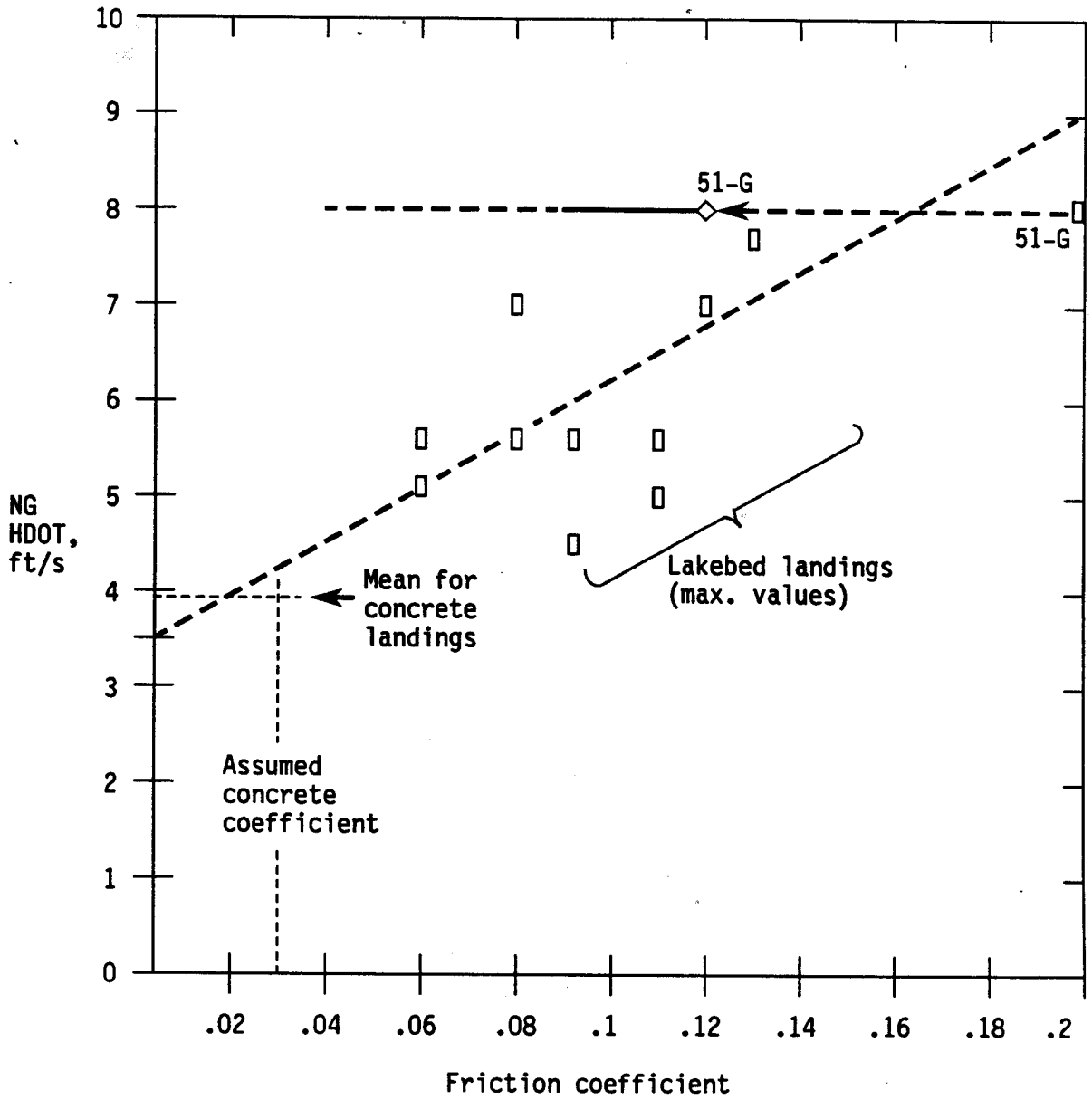

JSC-23266*005:D

Figure D.2-3.- Vertical speed of the nose gear at T/D as a function of rolling resistance.

TABLE D-II.- LAKEBED ROLLING COEFFICIENTS

| Flight | Date | Vehicle | Runway | Roll coeff |
|--------|----------|---------|----------|------------|
| STS-01 | 04/14/81 | OV-102 | EAFB-23 | 0.062* |
| STS-02 | 11/14/81 | OV-102 | EAFB-23 | 0.062* |
| STS-07 | 06/24/83 | OV-099 | EAFB-15 | 0.110 |
| STS-09 | 12/08/83 | OV-102 | EAFB-17 | 0.090 |
| 41-C | 01/23/84 | OV-099 | EAFB-17 | 0.090 |
| 41-D | 09/05/84 | OV-103 | EAFB-17 | 0.090 |
| 51-B | 05/06/85 | OV-099 | EAFB-17 | 0.120 |
| 51-G | 06/24/85 | OV-103 | EAFB-23 | 0.120 |
| 51-F | 08/06/85 | OV-099 | EAFB-23 | 0.080 |
| 51-I | 09/03/85 | OV-103 | EAFB-23 | 0.110 |
| 51-J | 10/10/85 | OV-104 | EAFB-23 | 0.085 |
| 61-A | 11/06/85 | OV-099 | EAFB-17 | 0.120 |
| STS-26 | 10/03/88 | OV-103 | EAFB-17 | 0.120 |
| STS-27 | 12/06/88 | OV-104 | EAFB-17 | 0.110 |
| STS-28 | 08/13/89 | OV-102 | EAFB-17 | 0.110 |
| STS-34 | 10/23/89 | OV-103 | EAFB-23L | 0.105 |

*Presupposed 0.062 maximum possible rolling coefficient. New runway 23L parallel to previous runway 23.

APPENDIX D.3
BRAKING PROCEDURES AND BRAKE ENERGY

a. Brake Procedures

The start of braking is determined by the groundspeed, although the position on the runway is also considered. The braking begins when the groundspeed decreases to 140 kts and the orbiter has passed the midfield point. The braking starts if the distance to the end of the runway decreases to 5000 ft before the groundspeed decreases to 140 kts. The selection of 140 kts for the nominal start of braking is an arbitrary compromise between the maximum possible braking speed, the necessity of limiting the energy absorbed by the brakes, and the desire to stop the orbiter quickly. Nominal braking begins after the NGTD. The start of the braking is limited by the energy that the brakes can absorb. Originally, this limit was 36M ft-lb if the brakes were to be reused. The selected value of 140 KGS is a value optimizing both rollout performance and ease of operations.

A deceleration between 8 and 10 ft/s² is attempted during the braking unless the braking is started because the distance remaining is less than 5000 ft. In this case, the maximum braking force is applied. The average torque developed by each beryllium brake is approximately 20,000 ft-lb. This torque and the other forces are sufficient to achieve the desired deceleration (9 ft/s²) at the start of the braking, but it may not be sufficient when the aerodynamic forces decrease. The average torque developed by the carbon brakes is increased approximately 25 percent, allowing the deceleration to be increased to 10 ft/s².

b. Brake Energy

The NWS is used to control the orbiter after the nose gear is on the ground. With NWS the total brake energy is distributed equally between the four sets of brakes, wheels, and tires. Differential braking is used to control the orbiter if the NWS is not working and may be required before the nominal start of braking. The need for steering is caused by the crosswind, the crown of the runway, lateral forces generated by the tires, and other causes. Generally, the energy is distributed equally between the brakes, so it is necessary to be able to estimate the maximum energy absorbed by a single brake. The percent of the total brake energy absorbed by the worst pair of brakes is shown in figure D.3-1 as a function of the crosswind. The upwind pair of brakes absorbed the most energy on all of the flights except two. The line on the figure represents the linear least-squares approximation to the relation of the ratio of the energy to the crosswind. This approximation is used to estimate the crosswind that causes one of the brakes to reach the energy limit.

The energy distribution predicted by the mean line is not equal when there is not any crosswind. Seven landings did not have any measurable

because the large unbalance caused doubt about the validity of the results. The remaining six flights were evenly divided between landings on a lakebed and landings on a runway. The right set of brakes absorbed the most energy on four flights. It is not possible to explain the unbalance with the data available, but it could be caused by things such as the crown of the runway or the construction of the tires. The unbalance for at least two of the flights may be the result of inaccuracies in the calculation of the energy.

There is not any convenient method to accurately predict the information in figure D.3-1. The total energy absorbed by all of the brakes can be calculated with reasonable accuracy, and the least-squares approximation can be calculated based on the maximum energy absorbed by a single brake. This comparison is shown in figure D.3-2 for brake energy limits of 42M, 55M, and 65M ft-lb. The average energy absorbed by a single brake would be 40M ft-lb if the total energy were 160M ft-lb. The maximum energy absorbed by a single brake is 55M ft-lb if the crosswind is approximately 7.7 kts (fig. D.3-2)

c. Differential Braking

It may be necessary to begin differential braking shortly after NGTD if the NWS has failed. The present rules require the brakes to be used continuously after the initial application. Although this rule was explicitly written for beryllium brakes now that the entire fleet is equipped with carbon brakes, the rule needs to be readdressed. The two extremes are to apply the brakes just enough to steer or to begin the nominal deceleration immediately. Although the brakes absorb more energy in either case, the latter option is the most severe. The effects of beginning the nominal deceleration above 140 kts is shown in figure D.3-3 for a 240,000-lb orbiter at a density altitude of 3000 ft. The crosswind is 0, 5, or 10 kts, and the tailwind is 0, 4, or 8 kts. The brake energy placard for the beryllium brakes is 55M ft-lb, and the absolute brake energy limit is 65M ft-lb. The use of differential braking to control the rollout to the centerline increases the rollout distance by less than 200 ft for the worst case.

d. Brake Failure (Loss of Torque)

The increase in the rollout distance expected because of a decrease in the braking is presented in figure D.3-4. If a failure results in a 50 percent loss in braking, there is 40 percent decrease in the braking torque. In this figure, a loss of either 12.5 or 25 percent braking corresponds to an equal loss in the braking torque. The largest increase in the rollout distance is approximately 1600 ft for a 260,000-lb orbiter and a 10-kts tailwind. The increase in the rollout distance is 520 ft for a vehicle WT of 180,000 lb. The maximum effect of a change in the density altitude is approximately 50 ft for a 1000-ft increase in the density altitude.

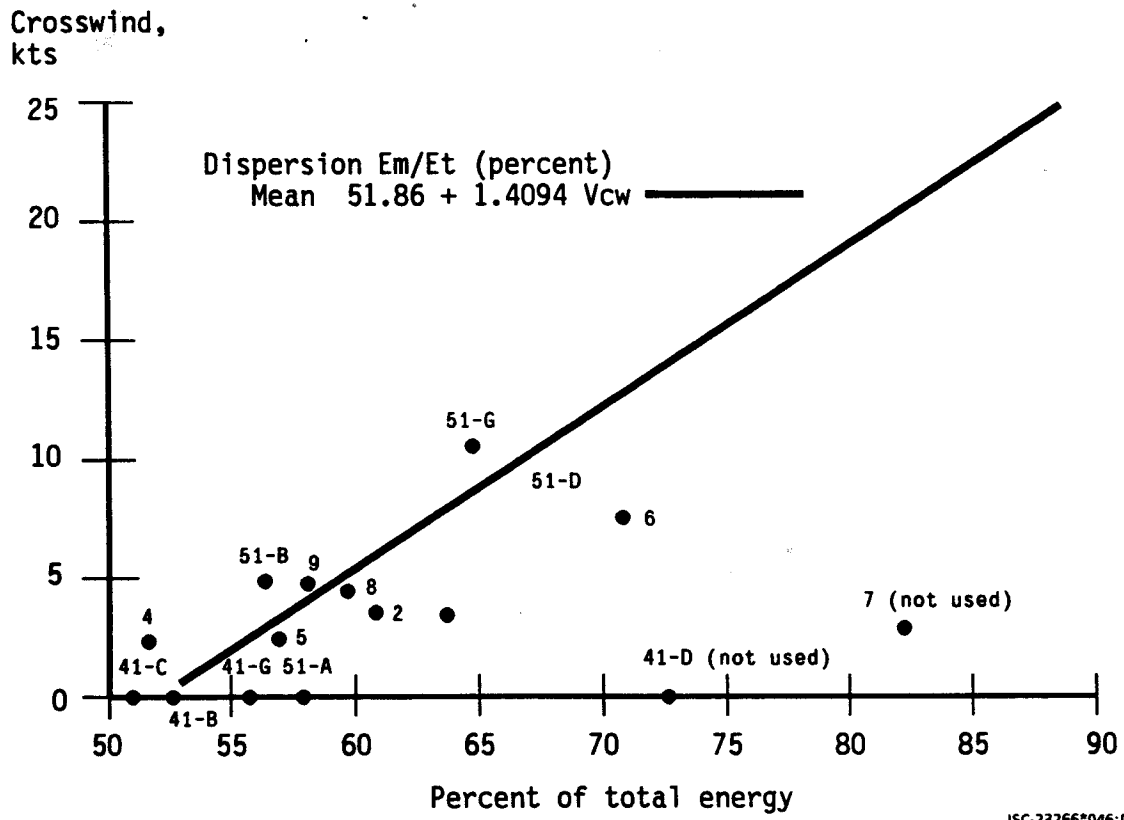

JSC-23266*046:D

Figure D.3-1.- Percent of total energy absorbed.

Energy per
brake,
ft-lb*E6

(Linear)

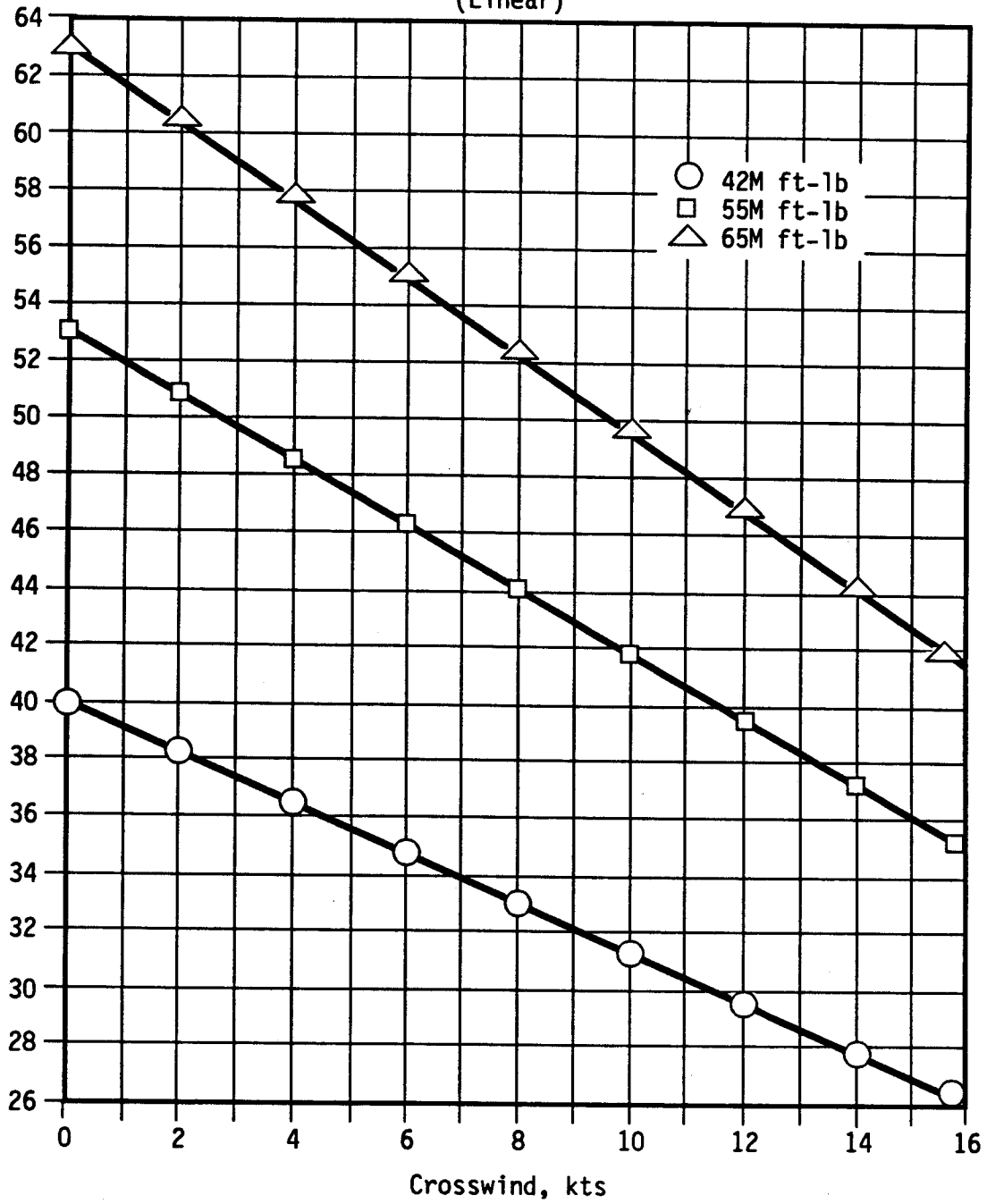

$$EPB = \frac{50 E_{Limit}}{51.86 + 1.4094 V_{CW}}$$

JSC 23266*047-D

Figure D.3-2.- Maximum allowable energy per brake.

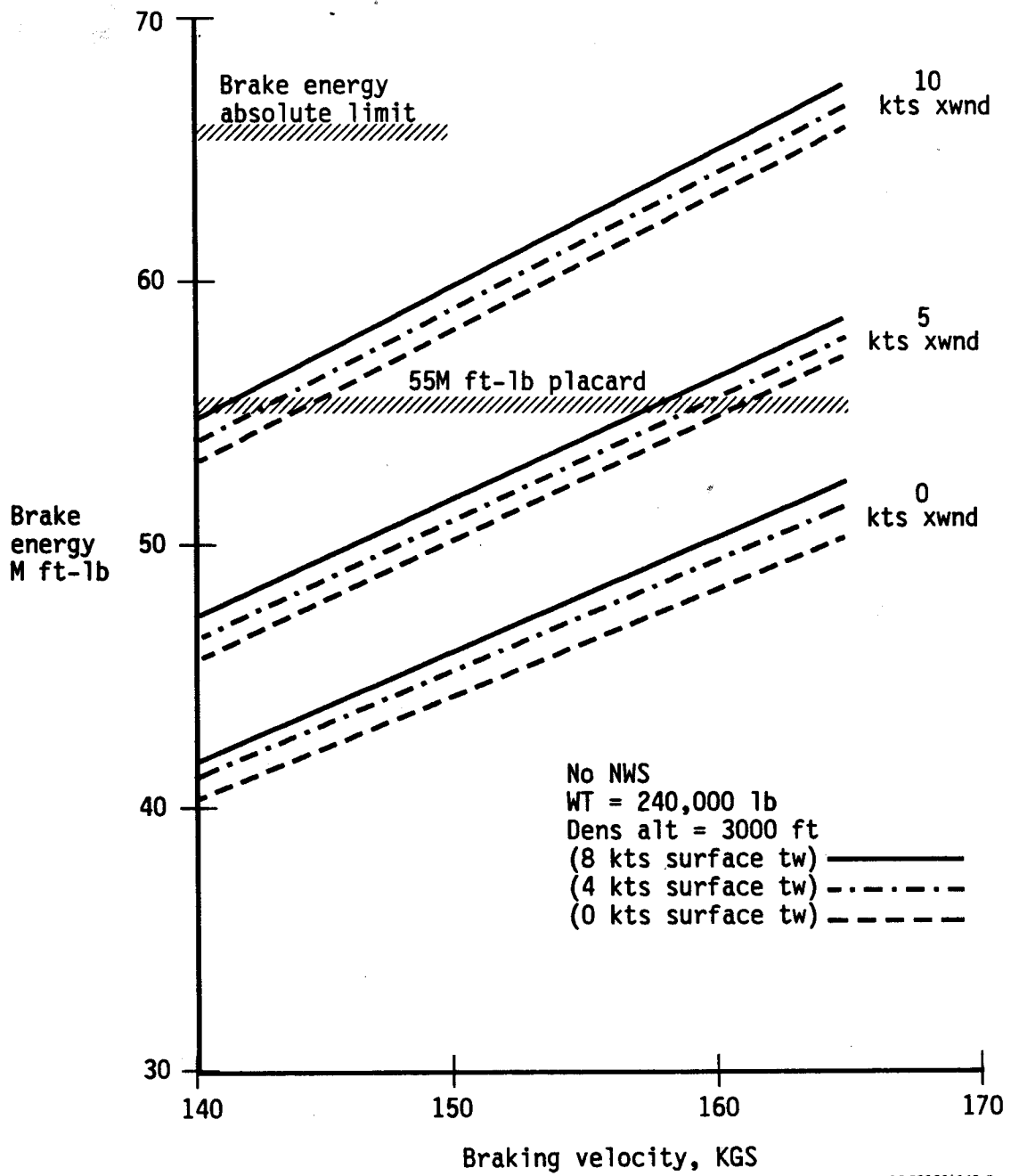

JSC-23266*048:0

Figure D.3-3.- Brake energy/brake velocity relationship for a deceleration of 9.0 ft/s².

$V_b = 140$ KGS
 $V = -9$ ft/s²
 Sea level

$\frac{dR}{d(\text{density altitude})} \approx 50$ ft/1000 ft

Increase in rollout distance, 1000 ft

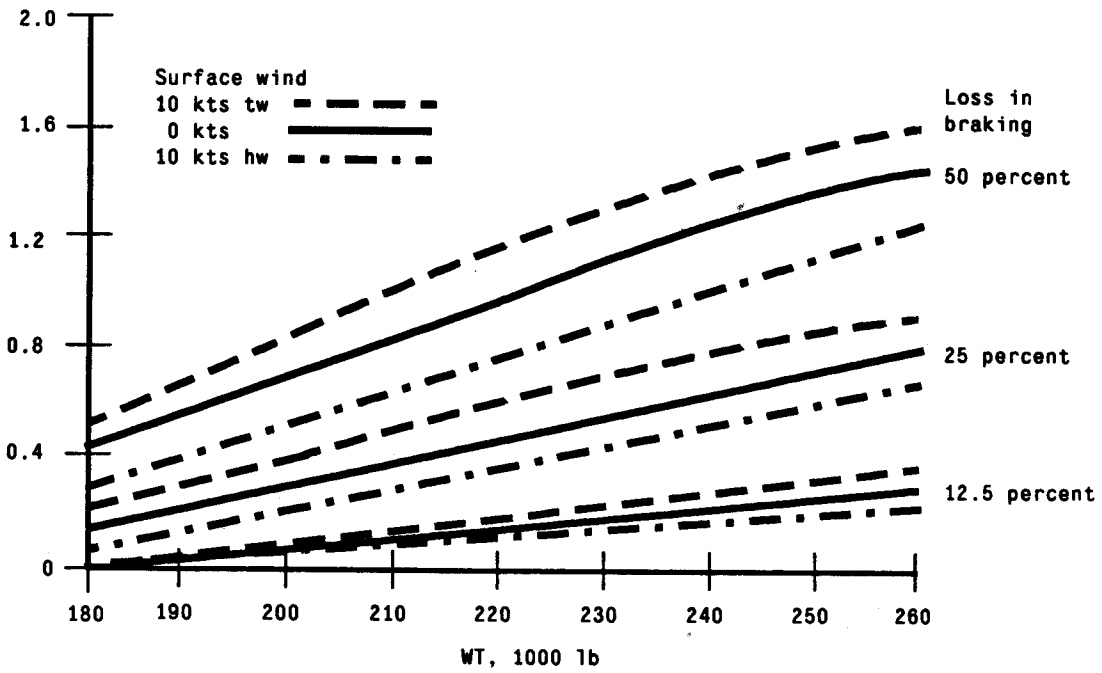

JSC-23266*049:D

Figure D.3-4.- Increase in rollout distance caused by loss in braking.

APPENDIX D.4
BARRIER ENGAGEMENT

a. Barrier Engagement Recommendations

If net arrestment appears imminent, efforts should be made to engage the net near the runway centerline. Steering input with the nose gear or brakes is needed to stay on a 200-ft-wide runway at speeds above 50 kts for offcenter engagements of 44 ft. For engagements at the edge of a 200-ft-wide runway, (88 ft from the runway centerline) there is a likelihood that the vehicle will depart the runway side during the rollout, with the possible exception of a quick steering input back towards the runway centerline.

b. Examples of Barrier Engagement

The groundspeed of the orbiter is presented in figure D.4-1 as a function of the position on the runway. The WT of the orbiter is 256,000 lb, and the density altitude is 2000 ft. The runway is 12,000 ft long with an 800-ft overrun. This combination of WT and runway length is unlikely, but it is used to emphasize the effects on the rollout. The short-field targeting is used. If there is a surface tailwind of 10 kts, the final position of the orbiter is 11,042 ft, provided the full capability of the brakes is available. This is less than the required rollout margin (2000 ft). The orbiter will engage the barrier at 66 KGS if the brakes are only 50 percent effective. A complete failure of the brakes will cause the orbiter to contact the barrier at 115 KGS. The design limit of the barrier system is 100 KGS. The 2000-ft rollout margin is achieved if the full braking is available and there is a surface headwind of at least 4 kts. Each brake absorbs 44.8M ft-lb of energy. This is greater than the limit for a nominal EOM landing (42M ft-lb) but substantially less than the limit for abort landings (55M ft-lb). The orbiter will stop before the barrier is reached, even if only one-half of the braking torque is available. The orbiter still engages the barrier when there is a complete failure of the brakes, but the groundspeed (91 KGS) is less than the design limit.

Similar results are presented in figure D.4-2 for landings on a 15,000-ft runway with a 10-kts tailwind at the surface. The comparison is between regular and short-field targeting. For regular targeting, the velocity and position at T/D are 205 KEAS and 2160 ft, respectively. The values are 195 KEAS and 1620 ft if the short-field targeting is used. The rollout margin are not satisfied if the regular targeting is used, even if the full braking is available. The rollout margin is satisfied if the short-field targeting is used. In addition, the barrier is not engaged if half the brakes fail. The barrier is engaged below the design limit if the brakes fail completely. Each brake absorbs 46.7M ft-lb of energy when the full braking and short-field targeting are used.

| | | |
|--------------------------|------------------|------------|
| Short-field targeting | 12,000 ft runway | 256,000 lb |
| 2000-ft density altitude | Wind | EAS, T/D |
| ----- | 10 kts TW | 195 |
| ----- | 4 kts HW | 195 |
| | | Range, T/D |
| | | 1620 |
| | | 1730 |

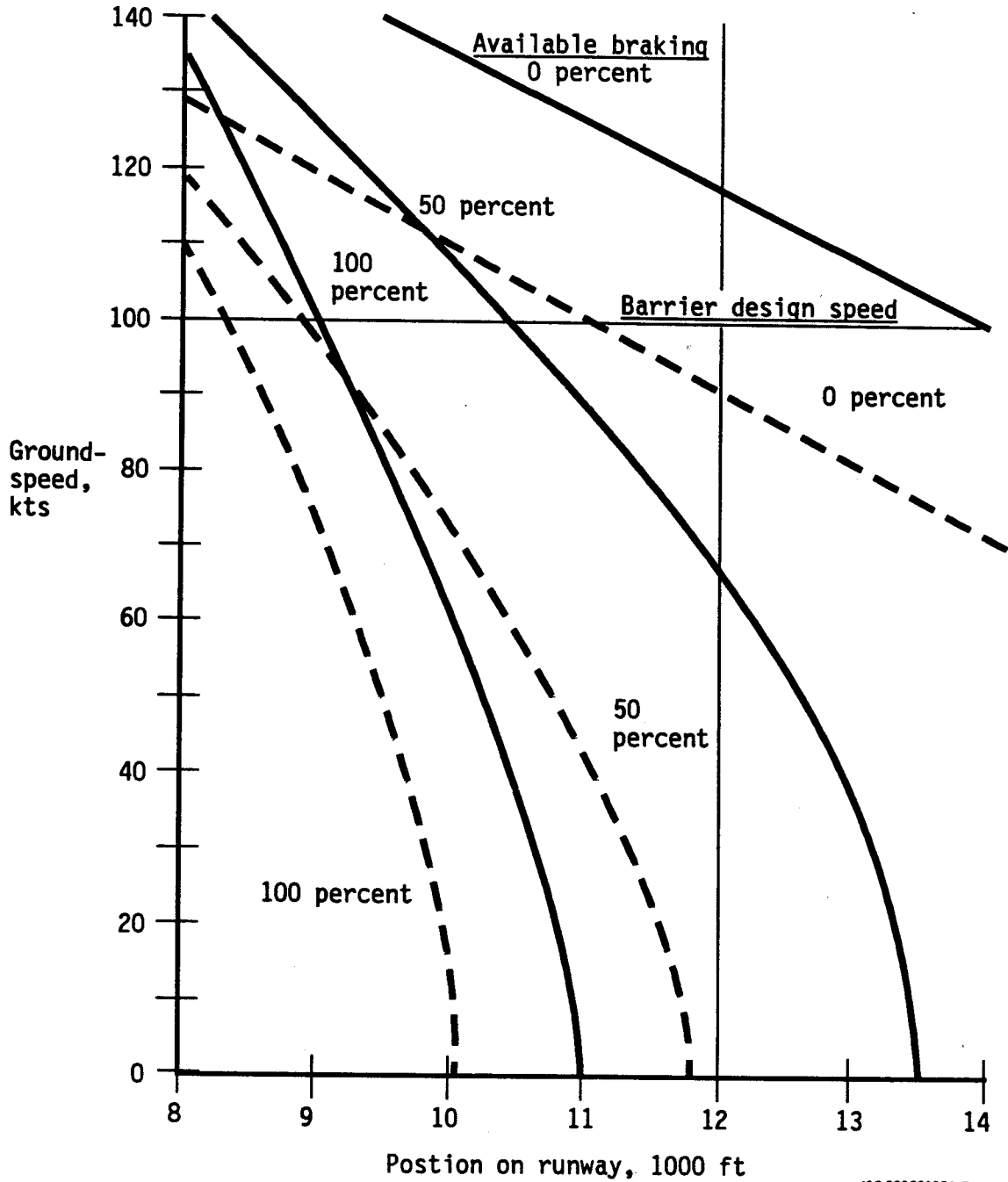

JSC-23266*051:D

Figure D.4-1.- Orbiter groundspeed sensitivity to wind on a 12,000-ft runway.

Some of the effects of the length of the runway are seen by comparing the rollout on the 12,000-ft runway with the rollout on the 15,000-ft runway. The only differences result from the interaction of the braking procedures and the length of the runway. The braking starts at 7000 ft and 160 KGS on the 12,000-ft runway and at 9135 ft and 140 KGS on the 15,000-ft runway. The maximum deceleration is 11 ft/s² on the 12,000-ft runway and 9 ft/s² on the 15,000-ft runway. The energy absorbed by each brake is 58.86M ft-lb for the shorter runway and 46.71M ft-lb for the longer. The final position is 11,042 ft and 12,400 ft, respectively.

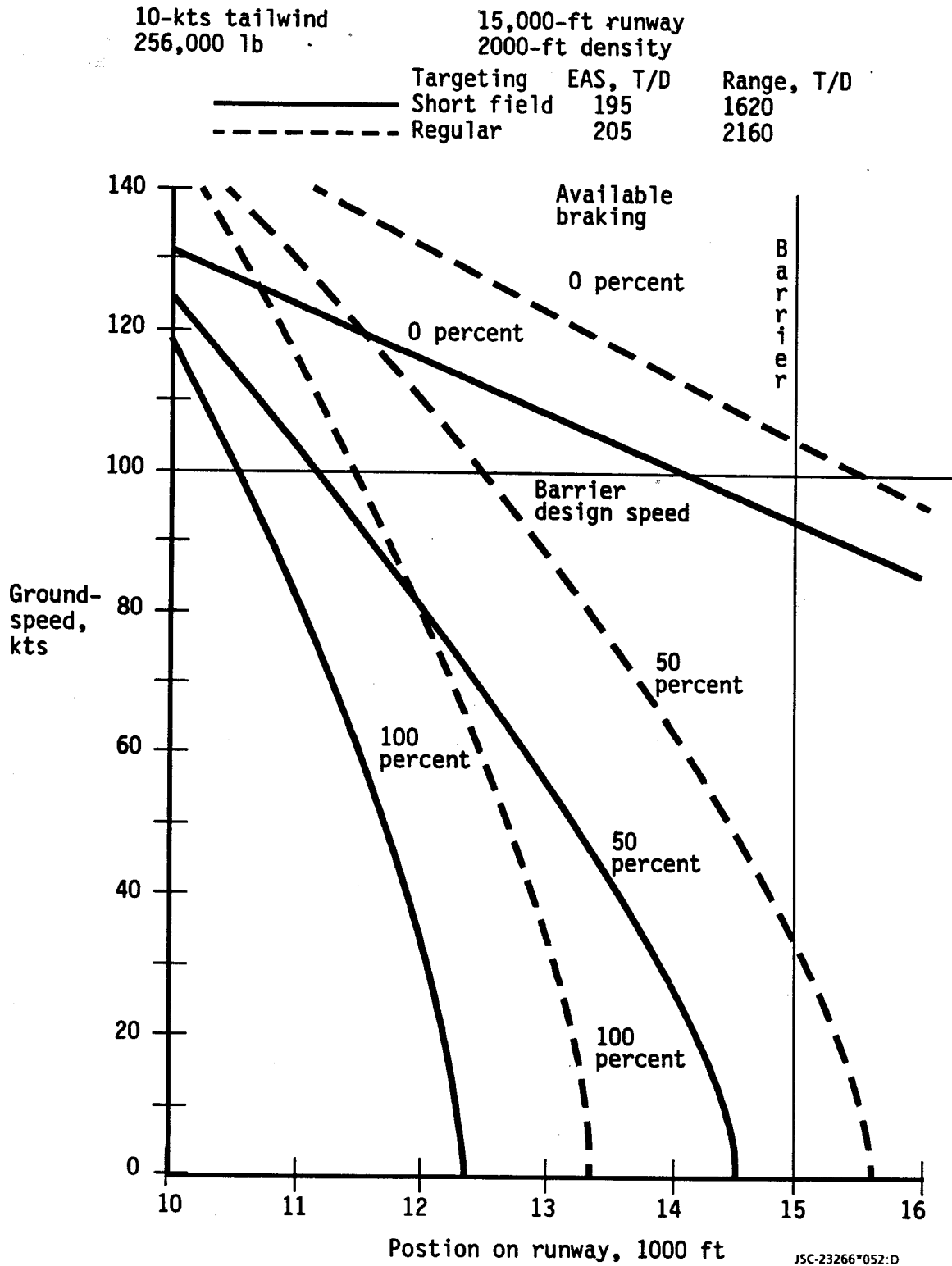

Figure D.4-2.- Orbiter groundspeed sensitivity to SB option on a 15,000-ft runway.

APPENDIX D.5
NORMALIZATION AND NOMOGRAPHS

a. Normalization

There were two basic parameters that were normalized, downrange and velocity. The early crew input was to normalize to velocity because they wanted to land at a velocity that resulted in an angle of attack of approximately 7° to 8° . This angle of attack relates to an acceptable energy margin and generally a small altitude rate at T/D. The task was to determine the downrange at which the vehicle would decelerate through that desired T/D velocity. This normalized downrange would be very beneficial information to the pilot in setting up the final approach and aim point so that T/D would occur at that downrange. Ideally, this results in landing at the desired velocity and angle of attack. This discussion has already referred to the real-time support aspect of A/L; it is one of the most important applications of the normalization process.

There are some assumptions made about the trajectory that allow this concept to yield accurate results. First, the shape of the velocity profile just prior to T/D is nearly linear with respect to downrange. Any wind gust during that timeframe causes that linearity to go away. The first assumption is that the data used to normalize should contain only steady state winds. Secondly, the shape of the velocity profile is nearly the same whether the vehicle is in the air or has already touched down in the attitude hold phase. If the vehicle remains in the air, it must increase the angle of attack to maintain lift equal to WT, since the velocity is decreasing over 4 kts/s. This is not bad because the vehicle angle of attack is nearing its maximum L/D attitude. The end result is that deceleration remains almost constant. After the vehicle has made contact with the ground, the first phase of the rollout calls for constant attitude hold. During this phase the deceleration is nearly constant and is almost equal to the deceleration that the vehicle experiences while in the air. It is this nearly constant deceleration relationship that allows the normalization concept to work.

Normalizing a given trajectory velocity/range profile to a given velocity and then calling that the normalized T/D range does not mean to imply that T/D occurred at that range. It simply means that if one interpolates the downrange/velocity data, that was the range where the velocity passed through the desired value. Figure D.5-1 has three velocity profiles shown, and their normalized T/D energies can be assessed by comparing the three normalized ranges at the given 195 KEAS value. The method used by the Descent Design group for normalizing is to save velocity/range data pairs from a simulation at 20 ft altitude, down to T/D. A linear regression of the data yields an equation that can be used to normalize T/D conditions to some fixed velocity or range. If the given range happens to be greater than the actual T/D range or the velocity less than the actual T/D velocity, the equation is still used because it is assumed that the deceleration is fairly constant and equal on either side of the actual T/D point. It is highly probable

that the normalized T/D point is never the simulated or actual T/D point. The normalized data is accurate if the extrapolation does not go backwards past the landing gear down-and-locked point or beyond the derotation point during rollout.

b. Nomographs

The graphical term nomograph refers to the method used to present landing pad estimates. These graphs have been used since STS-2. They are a way to combine four sets of sensitivity data onto one chart and provide a means to quickly predict normalized T/D energy and SB retract angles. To generate these nomographs, several assumptions are made. The accuracy of the resulting T/D energy estimates from the nomographs is very dependent on these assumptions. Experience has shown environmental conditions, particularly winds, to be the one factor that degrades the accuracy of the T/D energy predictions. Predicting the winds that the shuttle actually encounters is still one of the major error sources.

Having a method of predicting the normalized T/D energy on the day of landing or launch is very important. On the day of landing there are available measured atmospheric data and vehicle WT data that are not used in the preflight; thus, the expected landing energy may differ from what is published in the preflight. The atmospheric conditions may be severe enough to result in either very low or very high T/D energy conditions, which might warrant postponing landing or launching. The most accurate method of predicting T/D energy is to take the measured atmospheric data and vehicle WT and incorporate them into a high-fidelity trajectory simulation program such as the approach and landing shaping processor (ASP). Experience has shown that the ASP-generated T/D energies have been a fair predictor of actual flight data results. However, the results are only as good as the measured, predicted atmospheric conditions input to the program. The next best tool to predict T/D energy is the nomograph. A time may come when the ASP tool is not available due to a computer or an electrical power failure, or the support personnel may not be present to run the ASP. This is when the nomograph must be used to predict T/D energy. A very common use of the nomograph is during pilot training flights in the STA; the pilots sometimes want an estimate of what to expect for T/D energy. The STA-predicted T/D data have not been consistent enough to be totally reliable. The STA, though, provides a more complete, broader picture of the final approach, including the best visual report of the actual landing conditions the shuttle will encounter, including cloud cover, haze, precipitation, turbulence, blowing sand obscuring the runway, Sun angle, etc.

The normalized T/D energy sensitivities to winds, density altitude, and vehicle WT were computed during early shuttle analysis, and the results were presented on separate graphs. It was observed that these separate trajectory sensitivities could be expressed in terms of a delta from the nominal and the three values added together to form a single deviation

D-23

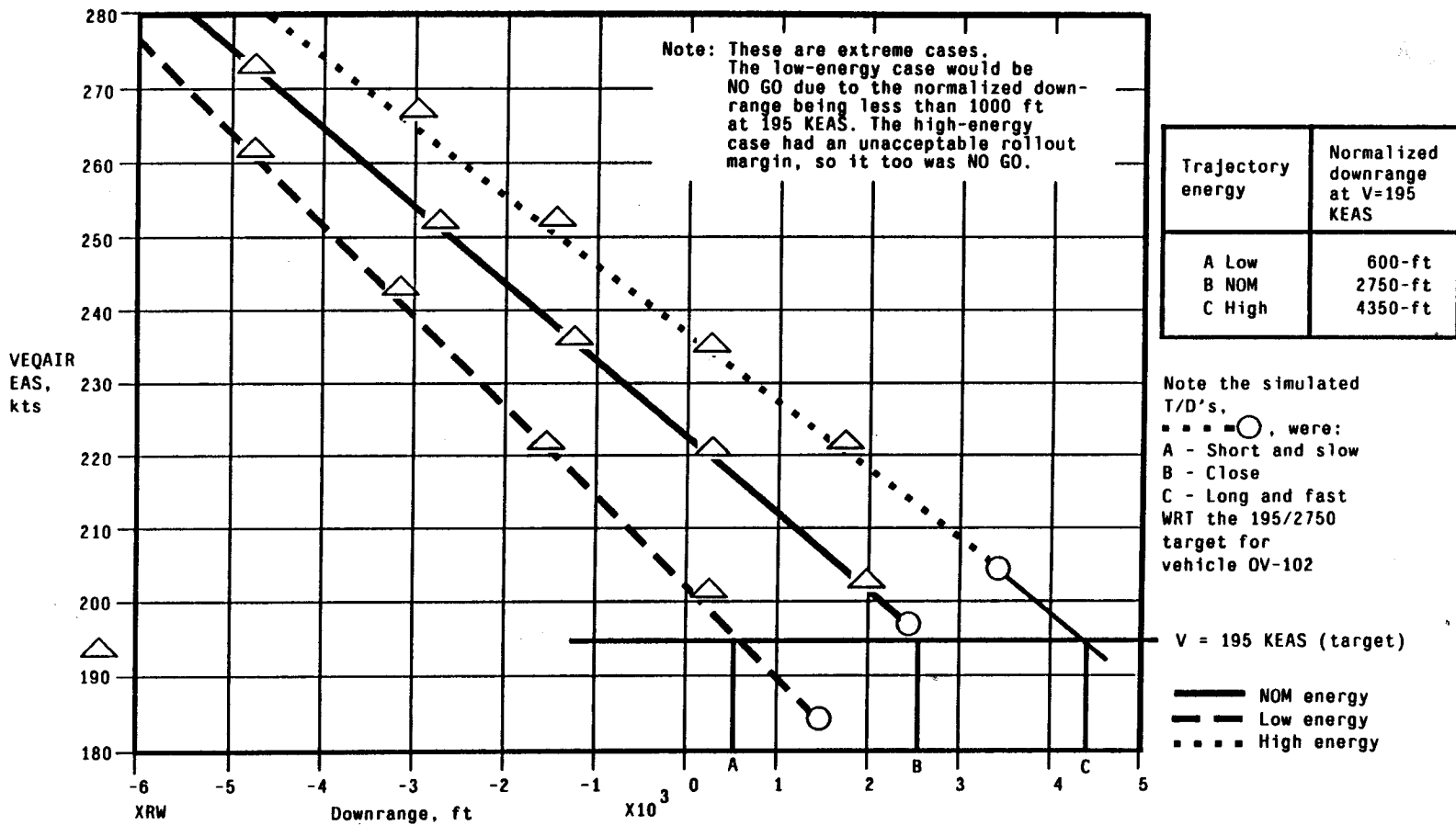

JSC-23266*054

Figure D.5-1.- Normalized T/D energy.

JSC-23266

from the nominal T/D energy. In other words, when the sensitivity to each of the three conditions is run separately, the sum of the three resulting delta T/D energies is approximately equal to the delta T/D energy from one simulation where all three conditions were incorporated.

Several assumptions need to be discussed. Only the headwind/tailwind component, with respect to the runway heading, affects T/D energy. The sensitivity of T/D energy to winds is computed using the shape of the design headwind profile. Engineering analysis indicates that the average integrated windspeed, from SB retraction to T/D, is the best single value to compute T/D energy sensitivity. This concept allows for some variation in wind profile shape. But again, flight experience shows that some wind shapes result in T/D energy deviations quite different from the prediction. The largest single factor that makes the predictions inaccurate is the ground shear or the wind direction twisting near the ground. The design wind profile ground shear has a surface windspeed one-half of the value at 500 ft. Landings have occurred in wind profiles where headwinds at altitude switched to tailwinds on the surface and vice versa. Needless to say, the nomograph accuracy is degraded when this happens. That is why it is always better to incorporate known atmospheric data into the ASP and integrate the real response of the vehicle behavior in the presence of these off-nominal wind profiles.

There is concern about using too few wind-data points as input for the average integrated windspeed. Determining the minimum number of data points is difficult, since the wind profile may vary significantly in direction and magnitude. It is highly desirable to have at least three wind-data points between 3000 ft (SB retract) and the surface. The more data points, the better the prediction results. It also stands to reason that the closer to the landing site the atmospheric data are gathered/measured, the more accurate the prediction of T/D energy. This applies to the ASP results also. For example, atmospheric data gathered 16 miles from the landing site probably is not representative of what the shuttle will encounter the last 3000 ft of flying. It has been postulated that in some instances, only the surface wind will be available. It then becomes questionable whether to use no wind or to predict the T/D energy based on one data point. If the surface wind must be used, it is recommended that to estimate the average integrated speed, the surface windspeed should be doubled. The design wind profile used to generate the T/D energy sensitivity data has that relationship; the surface wind is approximately one-half the average integrated windspeed. There are no accuracy limits given for using the nomograph under these conditions. But to quote one pilot, "Is it not better to use something rather than to do nothing?" This conversation dealt with a contingency landing scenario.

The density altitude assumption is not as susceptible. The sensitivity data were generated using the 1962 standard atmosphere data. So far, the low-altitude density profiles have been fairly consistent with the shape of the reference profile. Vehicle weight is also very well behaved. The need for including this factor is that normalized T/D

energy is directly proportional to vehicle weight. There may be days when a payload is not deployed, or, for whatever reason, the landing weight is significantly different from the preflight value. Also, including weight as one of the dependent parameters allows one nomograph to be used for an entire weight range and does not require a graph for each flight.

Nomographs are constructed with several other basic assumptions. The landing gear is always deployed at 300 ft altitude. The normalized T/D energy does vary with gear deploy altitude and is addressed in the main text. The November 1988 nomographs are constructed for the drag configuration of OV-103, and subsequent vehicles, OV-103 and OV-104, have different aerodynamic properties than OV-102; namely, more drag, which reduces T/D energy. The nomographs are used for flights with OV-102; just follow the notes on the nomographs that say to add 250 ft from the normalized T/D energy obtained. All the T/D performance has been based on ASP simulations where autoland guidance followed the reference trajectory. Off-nominal simulations have shown that initiating preflare up to 500 ft from the reference value did not significantly alter the T/D energy. The closer the pilot follows the reference path, the more accurate the T/D prediction will be. Navigation errors can result in significant T/D energy deviations. If, for example, the SB retraction altitude is different from the preflight value due to not having the highly accurate MSBLS available to update the navigation data, the resulting T/D energy will deviate accordingly. Four of the last seven flights (STS 51-D through STS 61-C) did not have MSBLS data and the T/D energy estimates computed onboard were not as accurate. This inaccuracy results in a sloppy SB retract value which may eventually cause the actual T/D energy to deviate from the desired value. This deviation is expected to be of second order magnitude and auto SB retract is still recommended, even when no MSBLS is present; large energy deviation error sources will still be compensated for in the right direction.

Enclosed are eight nomographs (fig. D.5-2 through D.5-9) for a light, mid, and heavyweight vehicle nominal and close-in aim points and nominal and short-field SB options. Line 1, line 2, and the notes on the graphs are examples of how to use the data. First, the following three inputs must be given or known:

- (1) The average integrated windspeed (head/tail component) from 3000 ft (SB retraction) to the surface, in kts
- (2) The density altitude or predicted density altitude at the time of expected landing, in feet
- (3) The vehicle WT, in pounds

If any of these data are not available, the preflight values can be used as substitutes. The method of drawing the lines is the same for all cases. First, start with the average integrated windspeed axis on the left (headwinds are positive and tailwinds negative) and draw a straight line to the density altitude axis (line 1). Next, start a new line from

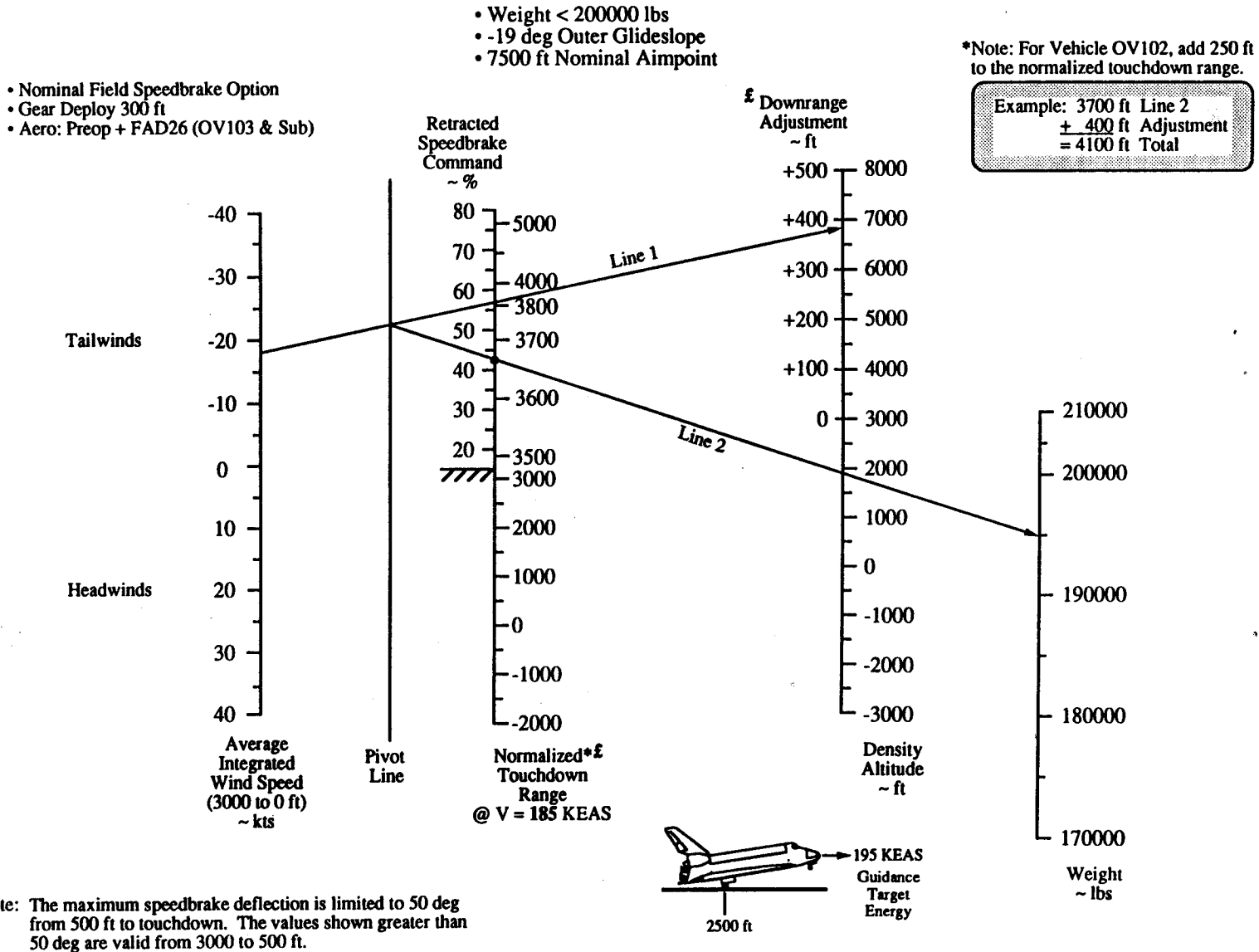

Note: The maximum speedbrake deflection is limited to 50 deg from 500 ft to touchdown. The values shown greater than 50 deg are valid from 3000 to 500 ft.

Figure D.5-2.- Lightweight nominal aim point nomograph.

- Nominal Field Speedbrake Option
- Gear Deploy 300 ft
- Aero: Preop + FAD26 (OV103 & Sub)

- Weight < 200000 lbs
- -19 deg Outer Glideslope
- 6500 ft Close-in Aimpoint

*Note: For Vehicle OV102, add 250 ft to the normalized touchdown range.

Example: 1700 ft Line 2
 + 0 ft Adjustment
 = 1700 ft Total

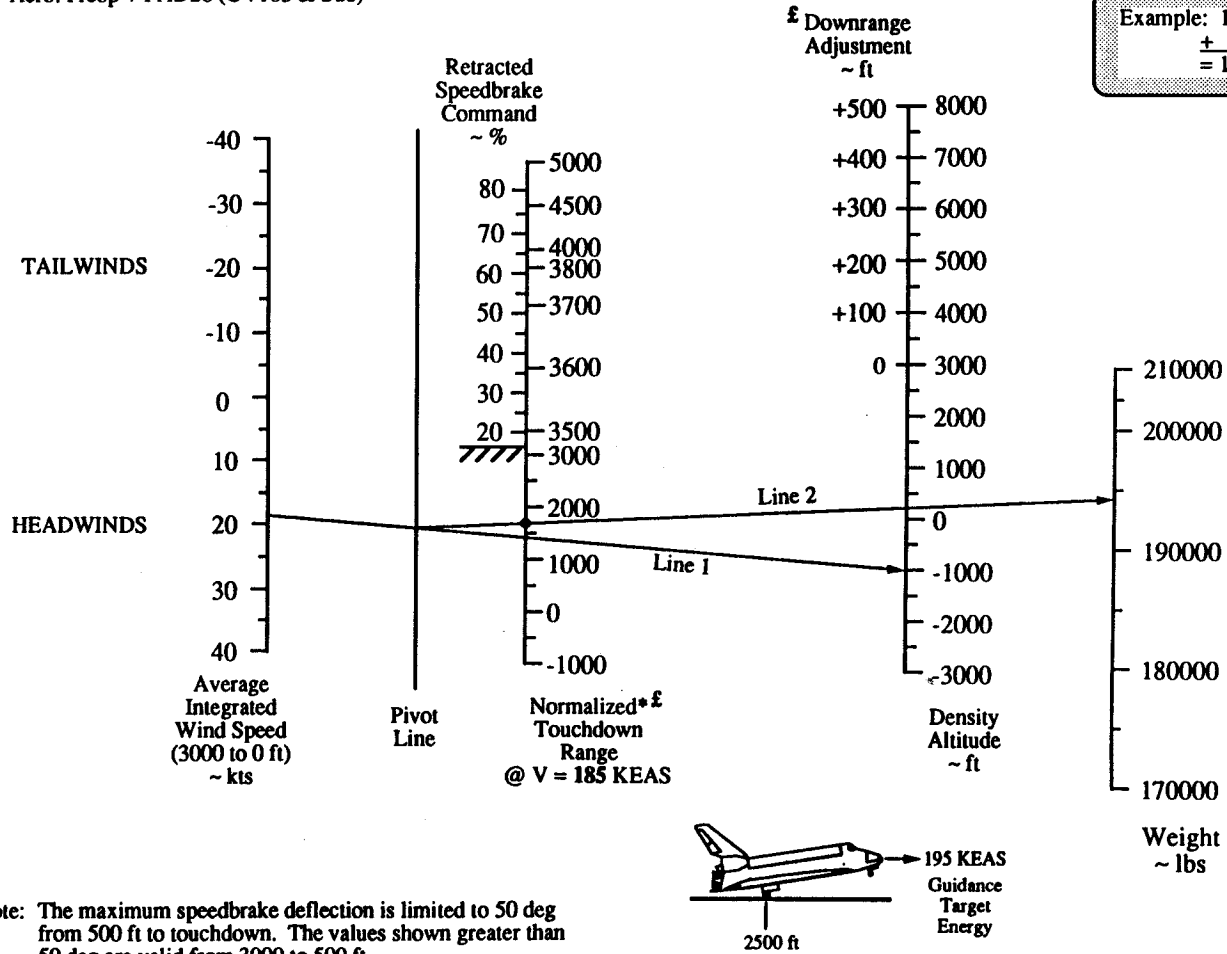

Figure D.5-3.- Lightweight close-in aim point nomograph.

- Nominal Field Speedbrake Option
- Gear Deploy 300 ft
- Aero: Preop+FAD26 (OV103 & Sub)

- Weight ≤ 220000 lbs
- -19 deg Outer Glideslope
- 7500 ft Nominal Aimpoint

*Note: For Vehicle OV102, add 250 ft to the normalized touchdown range.

Example: 2700 ft Line 2
 ± 200 ft Adjustment
 = 2900 ft Total

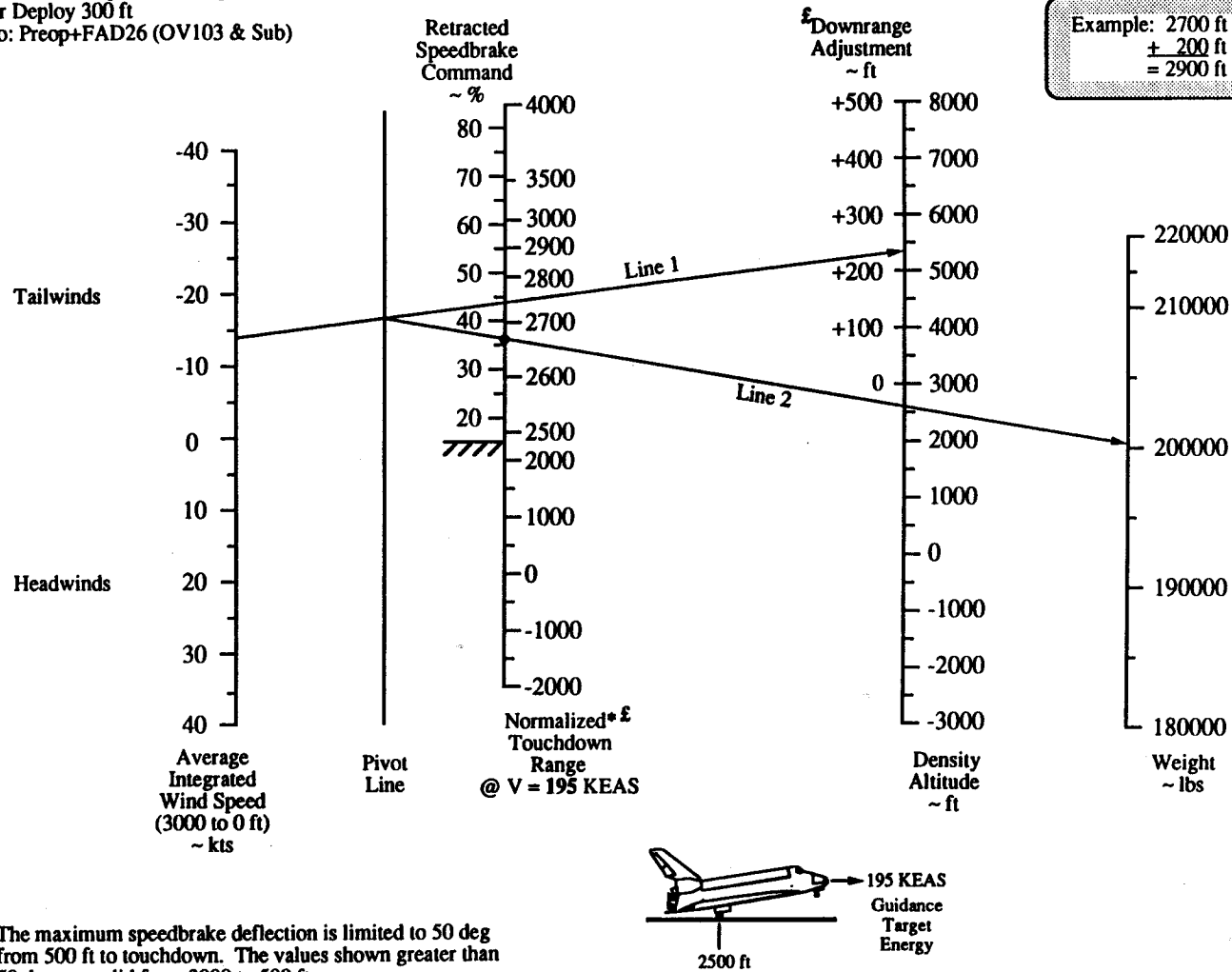

Note: The maximum speedbrake deflection is limited to 50 deg from 500 ft to touchdown. The values shown greater than 50 deg are valid from 3000 to 500 ft.

Figure D.5-4.- Midweight nominal aim point nomograph.

- Nominal Field Speedbrake Option
- Gear Deploy 300 ft
- Aero: Preop + FAD26 (OV103 & Sub)

- Weight ≤ 220000 lbs
- -19 deg Outer Glideslope
- 6500 ft Close-in Aimpoint

*Note: For Vehicle OV102, add 250 ft to the normalized touchdown range.

Example: 1700 ft Line 2
 + 0 ft Adjustment
 = 1700 ft Total

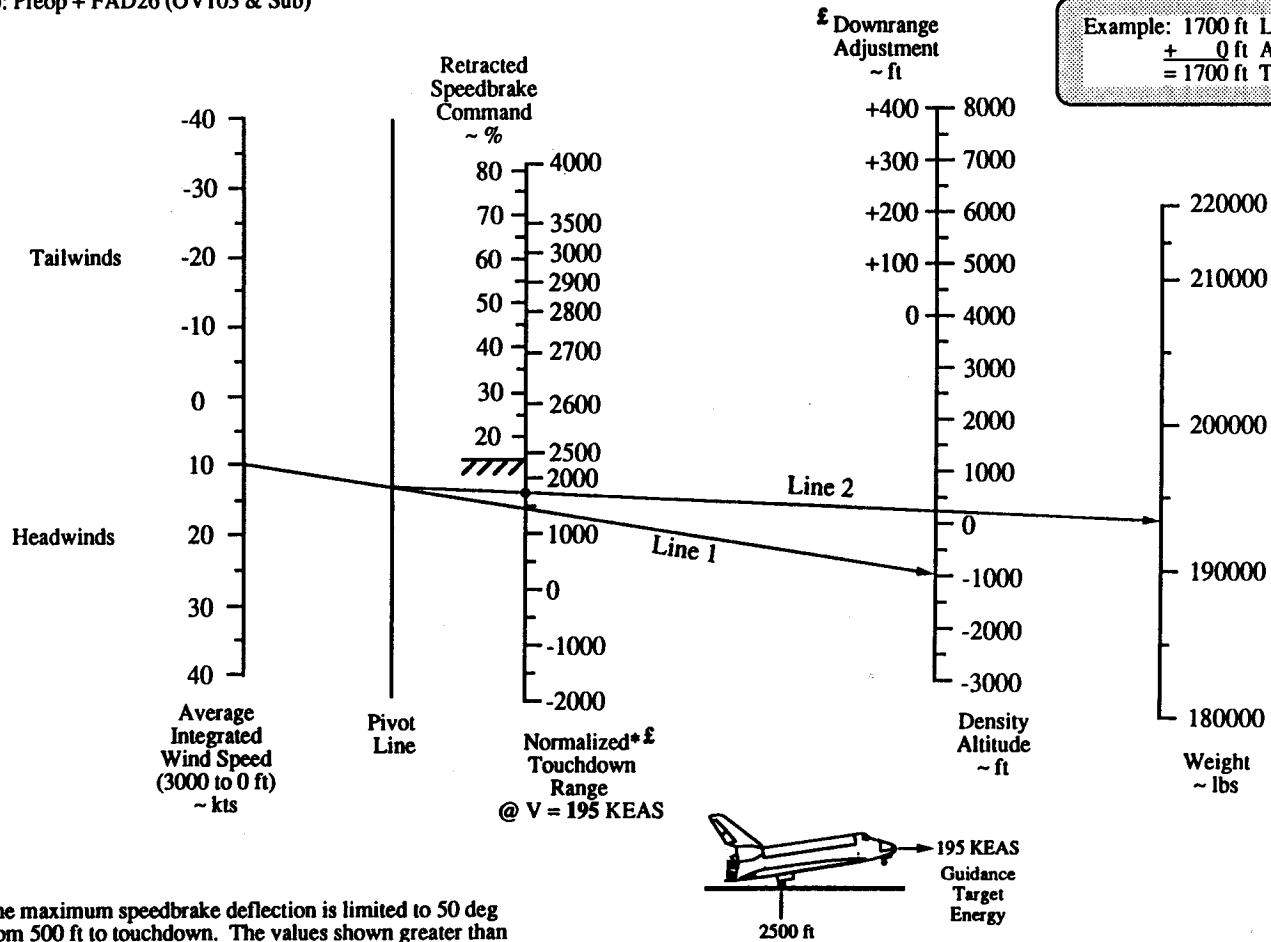

Note: The maximum speedbrake deflection is limited to 50 deg from 500 ft to touchdown. The values shown greater than 50 deg are valid from 3000 to 500 ft.

Figure D.5-5.- Midweight close-in aim point nomograph.

- Nominal Field Speedbrake Option
- Gear Deploy 300 ft
- Aero: Preop + FAD26 (OV103 & Sub)

- Weight > 220000 lbs
- -17 deg Outer Glideslope
- 7500 ft Nominal Aimpoint

*Note: For Vehicle OV102, add 250 ft to the normalized touchdown range.

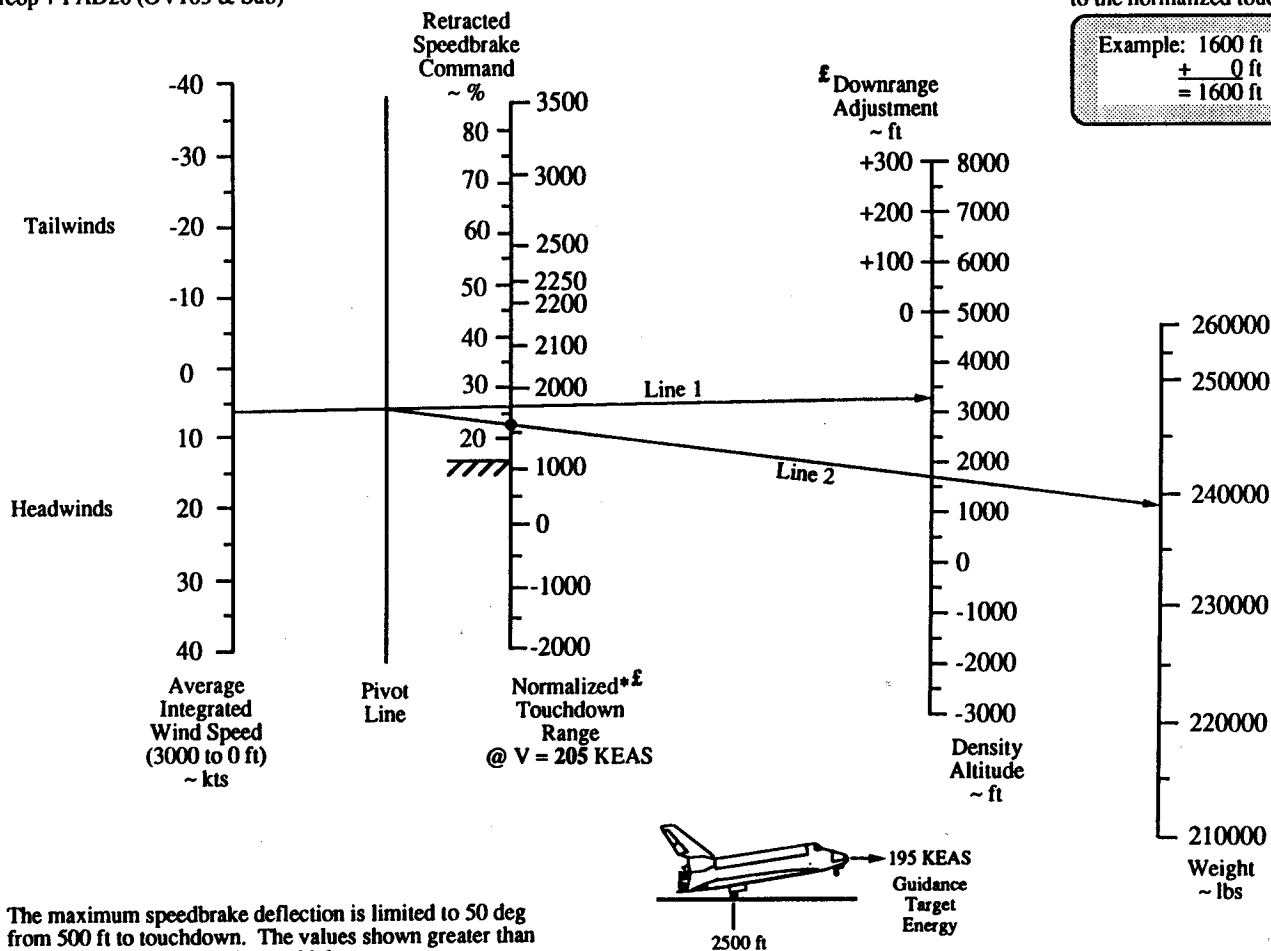

Figure D.5-6.- Heavyweight nominal aim point nomograph.

- Nominal Field Speedbrake Option
- Gear Deploy 300 ft
- Aero: Preop + FAD26 (OV103 & Sub)

- Weight > 220000 lbs
- -17 deg Outer Glideslope
- 6500 ft Close-in Aimpoint

*Note: For Vehicle OV102, add 250 ft to the normalized touchdown range.

Example: 1200 ft Line 2
 + 0 ft Adjustment
 = 1200 ft Total

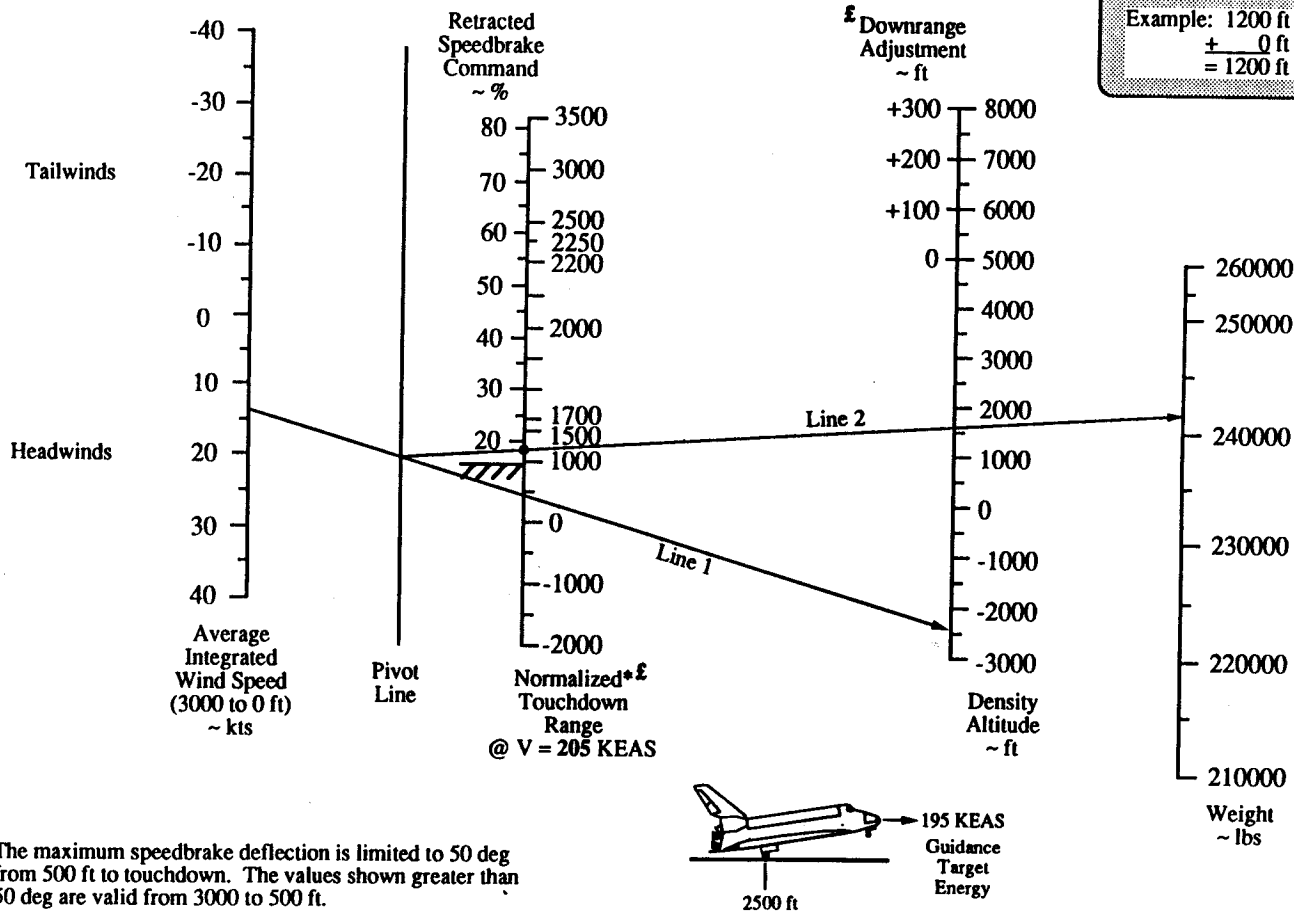

Note: The maximum speedbrake deflection is limited to 50 deg from 500 ft to touchdown. The values shown greater than 50 deg are valid from 3000 to 500 ft.

Figure D.5-7.- Heavyweight close-in aim point nomograph.

- Gear Deploy 300 ft
- Aero: Preop + FAD26 (OV103 & Sub)

- Short Field Speedbrake
- Weight ≤ 220000 lbs
- -19 deg Outer Glideslope
- 7500 ft Nominal Aimpoint

*Note: For Vehicle OV102, add 250 ft to the normalized touchdown range.

Example: 1750 ft Line 2
 ± 150 ft Adjustment
 = 1900 ft Total

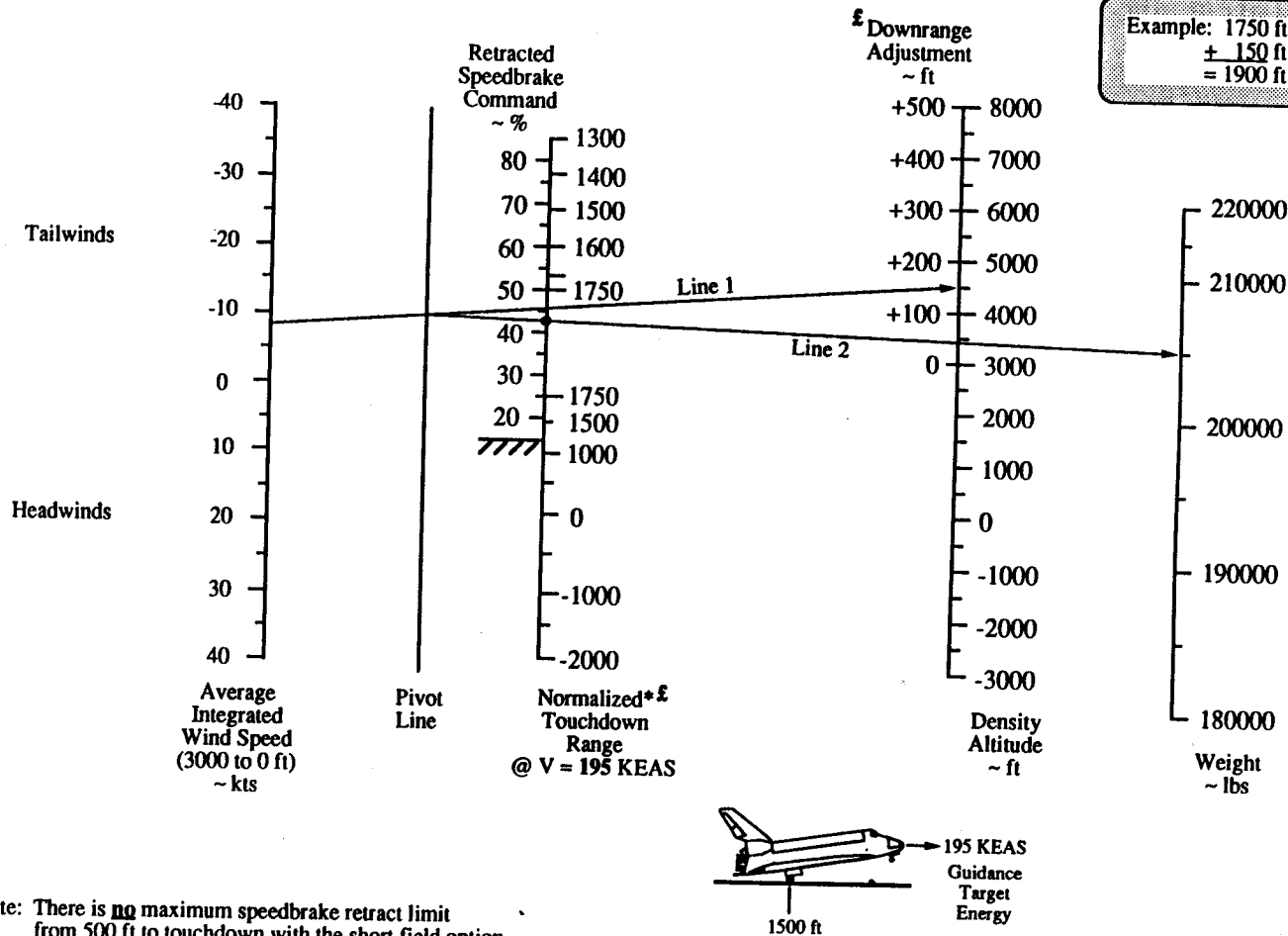

Note: There is **no** maximum speedbrake retract limit from 500 ft to touchdown with the short field option.

Figure D.5-8.- Light-midweight nominal aim point short-field SB nomograph.

- Gear Deploy 300 ft
- Aero: Preop + FAD26 (OV103 & Sub)
- Short Field Speedbrake
- Weight > 220000 lbs
- -17 deg Outer Glideslope
- 7500 ft Nominal Aimpoint

*Note: For Vehicle OV102, add 250 ft to the normalized touchdown range.

Example: 1900 ft Line 2
 ± 200 ft Adjustment
 = 2100 ft Total

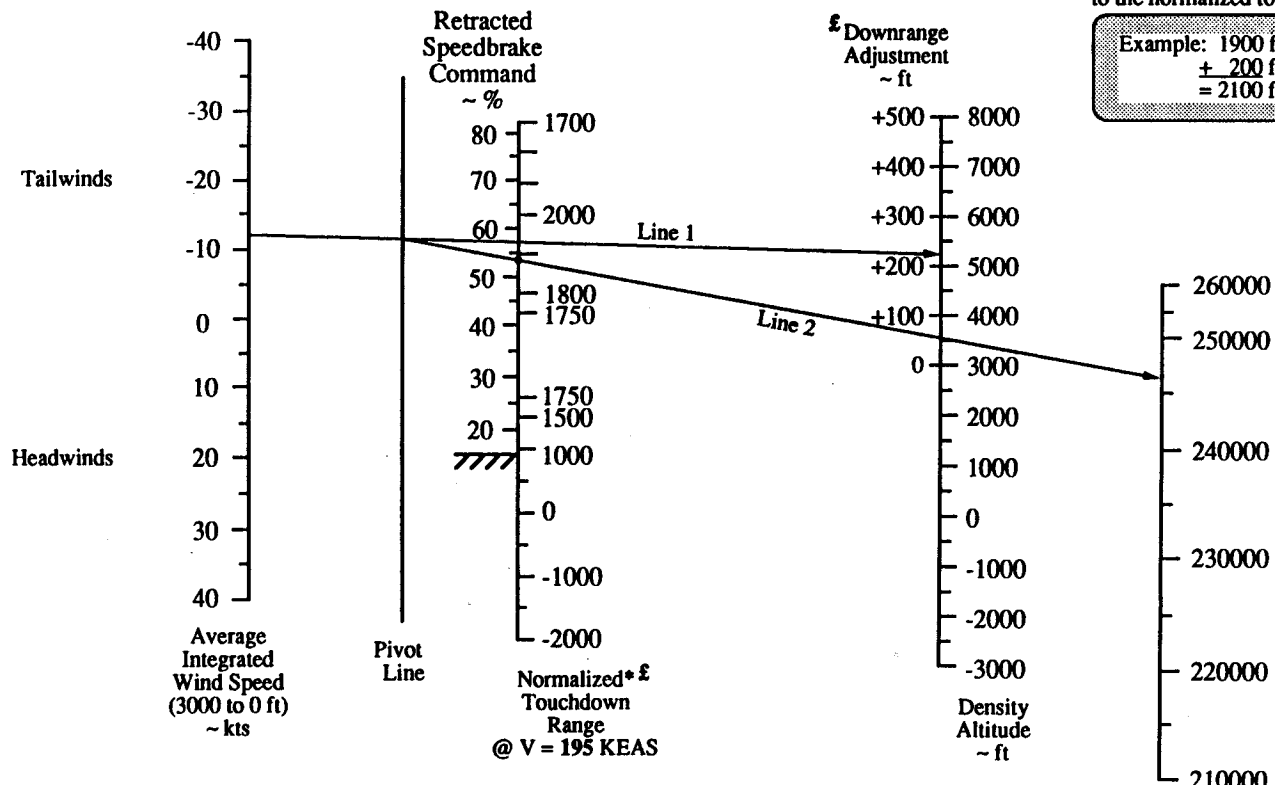

Note: There is no maximum speedbrake retract limit from 500 ft to touchdown with the short field option.

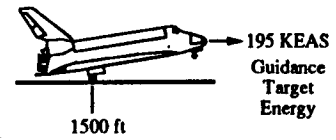

Figure D.5-9.- Heavyweight nominal aim point short-field SB nomograph.

where line 1 intercepts the pivot line and draw it to the vehicle WT axis (line 2). The point at which this second line (line 2) intercepts the normalized T/D range axis is the predicted T/D energy. The predicted SB retract angle can also be read just on the other side of the axis. For high density altitudes, an adjustment to the normalized range must be made. The adjustment is obtained by reading the downrange adjustment value where line 1 intercepts the density altitude axis. An example is shown on each nomograph.

For conditions where line 2 is under the 15 percent SB lower limit, the predicted normalized T/D energy is less than the desired value. To achieve the T/D evaluation velocity (185, 195, or 205 KEAS) the actual range at T/D has to be shorter than desired, as shown. If the SB value is between 15 and ~50 percent, in general, the desired T/D energy is achieved. The SB value shown is the SB retraction angle that is predicted to be carried from 3000 ft to T/D. The third condition is when the SB value is greater than ~50 percent. In this case the desired T/D range is estimated to be longer than desired when normalized to the stated evaluation velocity; also, the SB value shown is the predicted retract percentage carried from 3000 ft to 500 ft. However, from 500 ft to T/D, the maximum value is restricted to 50°. The exception to this last condition is when the short-field SB option is used (the last two nomographs). The short-field option has no SB maximum restriction from 500 ft to T/D, and, in general, the T/D energy should not exceed the desired value. In very-high-energy cases, the short-field option may overkill the excess energy and result in a T/D energy shorter than the target value. These very-high-energy cases usually require this overkill to stop before burning up the brakes and/or running off the runway. This particular type of low-energy T/D should not be confused with a trajectory which has fully retracted the SB and lands short of the desired T/D energy. The very-high-energy overkill case should not use the close-in aim point option to regain T/D energy. It is highly probable that a trajectory carrying a large SB retract angle and then selecting the close-in aim point increases the overkill and lands with even lower T/D energy. The downrange sensitivity coefficients (I-loads) to SB retract angle are a compromise between cases using the 50° limit and those not using the limit. When the short-field SB option is used and the retract angles are $\gg 50^\circ$, the overkill comes into play. This is the opposite situation to the 50° limited case's exceeding the desired T/D energy, as noted earlier.

The use of degrees and percent SB has been intermixed in this discussion. The performance graphs, trajectory displays, onboard displays, and, in general, discussion of SB deflection is usually in terms of percent of full deployment. The actual I-loads pertaining to the SB are in units of degrees (hingeline). So whenever the limit is referred to, the actual value is 50°. Since the full deflection value is 98.6°, the percent value can, for discussion purposes, be interchanged with the value in degrees.

APPENDIX E
ACRONYMS AND ABBREVIATIONS

| | |
|-------|--------------------------------------|
| A/L | approach and landing |
| AA | accelerometer assemblies |
| ACCEL | acceleration |
| ACQ | acquisition |
| ADI | attitude display indicator |
| ADSOP | air data system operating program |
| ADTA | air data transducer assembly |
| AGL | above ground level |
| ALT | altitude |
| | approach and landing test |
| AMI | Alpha/Mach indicator |
| AOA | abort once around |
| AOS | acquisition of signal |
| APU | auxiliary propulsion unit |
| ASP | A/L shaping processor |
| ATT | attitude |
| AUT | auto |
| AVVI | altitude/vertical velocity indicator |
| Ay | lateral acceleration |
| AZ | azimuth |
| | |
| BARO | barometer |
| BF | body flap |
| BFS | backup flight system |
| | |
| c.g. | center of gravity |
| CCV | control configuration |
| CDI | course deviation indicator |
| CDR | commander |
| COMM | communication |
| CPM | cycles per minute |
| CRT | cathode ray tube |
| CSS | control stick steering |
| | |
| D/O | deorbit |
| DAP | digital auto pilot |
| DCLT | declutter |
| DES | deselect |
| DLMA | dilemma |
| DME | distance measuring equipment |
| DN | down |
| DOF | degree of freedom |
| DS | dual string |
| DTO | detail test objective |

| | |
|-------------------|---------------------------------------------------------|
| E/Q | energy to weight ratio |
| E/W | energy/weight |
| EAS | equivalent airspeed |
| EDO | extended duration orbiter |
| EDW | Edwards Air Force Base |
| EL | elevation |
| | elimination |
| ELS | emergency landing site |
| EOM | end of mission |
| EOW | energy over weight |
| ET | external tank |
| ft/s ² | feet per second square |
| ft/s | feet per second |
| FA | flight aft |
| FAA | Federal Aviation Administration |
| FCS | flight control system |
| FD | flight director |
| FDF | Flight Data File |
| FDIR | fault detection identification recover |
| | fault detection, isolation, and reconfiguration |
| FF | final flare |
| | flight forward |
| FOV | field of view |
| FRSI | flexible reusable surface insulation |
| FSGS | flare and shallow glideslope |
| G&C | guidance and control |
| GCA | ground control approach |
| GDS | Goldstone |
| GDX | Goldstone |
| GE | ground effect |
| GNC | guidance and navigation and flight control computer |
| GPC | general purpose computer |
| GR | gear |
| GRTLS | glide return to launch site (glide phase of RTLS abort) |
| GS | glideslope |
| GSENB | groundspeed enable |
| GSI | glideslope indicator |
| HAC | heading alignment cone |
| HDG | heading |
| HSD | horizontal situation display |
| HSI | horizontal situation indicator |
| HUD | head up display |
| HYD SOP | hydraulic subsystem operating program |
| ICAO | International Civil Aviation Organization |
| IGS | inner glideslope |
| ILS | instrument landing system |
| IMU | inertial measurement unit |
| INRTL | inertial |

| | |
|----------|----------------------------------------|
| KEAS | knots equivalent airspeed |
| KGS | knots of groundspeed |
| KSC | Kennedy Space Center |
| mts | knots |
| L/D | lift-to-drag ratio |
| LOS | loss of signal |
| LRU | line replaceable unit |
| LVLH | local vertical local horizontal |
| M/VEL | Mach/velocity |
| max. | maximum |
| MCC | Mission Control Center |
| MDM | multiplexer/demultiplexer |
| MEP | minimum energy point |
| MGTD | main gear touchdown |
| min. | minimum |
| MLS | microwave landing system |
| MM | mass moment |
| MS | mission specialist |
| MSBLS | microwave scanning beam landing system |
| MSBLS-GS | MSBLS - ground station |
| MSBLS-JR | MSBLS - Junior |
| n. mi. | nautical miles |
| NAV | navigation |
| NAVADAD | navigation derived air data |
| NEP | nominal entry point |
| NGTD | nose gear touchdown |
| NHSF | number of hydraulic failed |
| NOM | network output multiplexer |
| NWS | nosewheel steering |
| Ny | lateral acceleration |
| Nz | normal acceleration |
| O/IGS | outer/inner glideslope |
| OGS | outer glideslope |
| OI | operational increment |
| OVHD | overhead |
| PAPI | precision approach path indicator |
| PASS | primary avionics software system |
| pb | pushbutton |
| PBI | push-button indicator |
| PIO | pilot-induced oscillation |
| PLS | primary landing site |
| PLT | pilot |
| PRL | priority rate limiting |
| PROM | program read-only memory |
| PSF | pounds per square foot |

| | |
|---------|-----------------------------------|
| psi | pounds per square inch |
| Pstatic | pressure static |
| PTI | programmed test input |
| R/W | runway |
| R/Y | roll/yaw |
| RA | radar altimeter |
| RCS | reaction control system |
| RDR | raw data recorder |
| REF | reference |
| RGA | rate gyro assembly |
| RHC | rotational hand control |
| RI | Rockwell International |
| RM | redundancy management |
| RPTA | rudder pedal transducer assembly |
| RSS | root sum square |
| RTLS | return to launch site |
| S/W | software |
| SB | speedbrake |
| SBTC | speedbrake/throttle controller |
| sep | separation |
| SGS | steep glideslope |
| SMS | shuttle mission simulator |
| SNI | San Nicholas Island |
| SOAS | shuttle orbiter arresting system |
| SOE | sequence of events |
| SOP | standard operating procedure |
| SPI | surface position indicator |
| SRB | solid rocket booster |
| SS | single string |
| SSME | space shuttle main engine |
| STA | shuttle training aircraft |
| SVDS | space vehicle dynamics simulation |
| T/D | touchdown |
| TACAN | tactical air navigation system |
| TAEM | terminal area energy management |
| TAL | transoceanic abort landing |
| TAS | true airspeed |
| UPP | user parameter processing |
| VAFB | Vandenberg Air Force Base |
| VERTSIT | vertical situation |
| VMS | vertical motor simulator |
| VREL | relative velocity |
| VSD | vertical situation display |
| VV | velocity vector |

| | |
|--------|--------------------------------|
| WONG | weight on nose gear |
| WOW | weight on wheels |
| WOWLON | weight-on-wheels lock-on |
| WT | weight |
| x-c.g. | longitudinal center of gravity |