

FDO Console Handbook

Volume IV Deorbit/Entry and EMCC

Mission Operations Directorate
Flight Design and Dynamics Division

Final, Rev D, PCN-2
6/01/06

Verify this is the correct version before use.

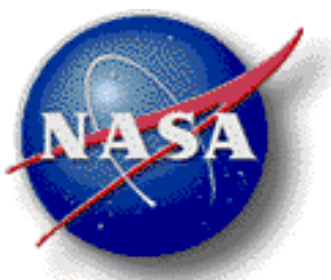

**National Aeronautics
and Space Administration**

**Lyndon B. Johnson Space Center
Houston, Texas**

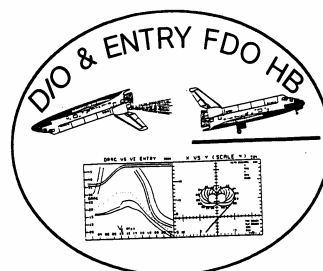

FDO CONSOLE HANDBOOK

VOLUME IV
DEORBIT/ENTRY and EMCC

Final, REV D, PCN-2

6/01/06

Prepared by

Original Signed by

Keith W. Fletcher
Book Manager

Approved by

Original Signed by

William E. Powers
Group Lead, Ascent/Entry Flight Dynamics Group

Original Signed by

P. Jeff Bertsch
Chief, Ascent/Descent Dynamics Branch

**NATIONAL AERONAUTIC AND SPACE ADMINISTRATION
LYNDON B. JOHNSON SPACE CENTER
HOUSTON, TEXAS**

FDO CONSOLE HANDBOOK

VOLUME IV DEORBIT/ENTRY and EMCC

DESCRIPTION OF CHANGES

PCN #	DATE	DESCRIPTION	PAGES AFFECTED
BASIC	6/1/90	Baseline: First standalone Entry FDO Handbook. Prior Handbook (1983) was a consolidated version with Ascent, Orbit, and Entry.	----
BASIC REV A	8/1/91	Baseline: Various additions throughout the book, including many new checklists.	Replace All
1	4/13/94	DEL PAD, ILC, DOL, and Entry Summary Message sections; all new checklists.	Replace Front Cover Replace Signature Page Replace Preface Replace Table of Contents Replace pages 4.3-97 through 4.3-111 Add pages 4.3-112 and 4.3-113 Replace entire section 4.5
2	7/7/94	Real-time ballast comps, Anytime Deorbit, Entry and Touchdown Evaluation, checklist modifications.	Replace Front Cover Replace Signature Page Replace Table of Contents pages 4-v & 4-vi Replace pages 4.3-55 through 4.3-60 Replace pages 4.3-71 through 4.3-80 Replace pages 4.3-105 & 4.3-106 Insert new pages 4.3-105a & 4.3-106a Replace pages 4.5-5 through 4.5-8 Replace pages 4.5-23 & 4.5-24 Add pages 4.5-30-4.5-32
3	6/29/95	All new section 4.4, update checklists, new appendix on Delta T Processing, and appendix on Unplanned Payload Return.	Replace Front Cover Replace Signature Page Replace Table of Contents pages 4-v & 4-vi Replace pages 4.1-1 through 4.1-6 Replace pages 4.3-5 through 4.3-8 Replace pages 4.3-81 through 4.3-86 Replace pages 4.3-89 through 4.3-108 Delete pages 4.3-109 through 4.3-113 Replace entire section 4.4 Replace pages 4.5-3 through 4.5-37 Add Appendix C Add Appendix D

PCN #	DATE	DESCRIPTION	PAGES AFFECTED
4	10/11/95	New DEL PAD and DEL PAD Checklist.	Replace Front Cover Replace Signature Page Replace pages 4.3-93 through 4.3-100 Replace pages 4.5-16 through 4.5-19
5	8/8/96	New additions to Special Cases section, Auto Maneuver PAD, Winds and Weather sheet, new checklists.	Replace Front Cover Replace Signature Page Replace Table of Contents Replace pages 4.3-89 through 4.3-108 Insert new pages 4.3-109 through 4.3-113 Replace pages 4.5-1 through 4.5-37 Insert new pages 4.5-38 through 4.5-45
6	1/27/98	New displays in section 4.3; checklist updates.	Replace Front Cover Replace Signature Page Replace Table of Contents Replace entire section 4.3 Replace pages 4.5-17, 4.5-18, 4.5-21 through 4.5-24 Insert new pages 4.5-24a and 4.5-24b
7	4/15/98	Updated checklists, added Auto DEL PAD checklist, updated EMCC section.	Replace Front Cover Replace Signature Page Replace Preface Replace Table of Contents Replace pages 4.3-87 and 4.3-88 with 4.3-87 and Blank Replace entire section 4.5 Replace entire section 4.6 Replace Appendices A-E with A-C
BASIC REV B	5/13/99	Baseline: New DEL PAD, reorganization of sections, elimination of redundancy, and additional appendices.	Replace All

BASIC REV C	4/02/02	Baseline: Modified for TSU.	Replace All
BASIC REV D	9/09/03	Updates throughout	Replace All
1	4/08/05	Updates throughout	Replace Front Cover Replace Signature Page Replace Preface Replace Table of Contents Replace pages 4.3-6 through 4.3-15 Replace pages 4.3-19 Replace pages 4.6-2 through 4.6-3 Replace pages 4.7-36 through 4.7-40 Insert new pages 4.7-41 through 4.7-61 Replace pages 4.9-3 through 4.9-11 Replace pages 4.9-16 through 4.9-17 Replace pages 4.9-26 through 4.9-27 Replace pages 4.10-1 through 4.10-9 Insert new pages 4.10-10 through 4.10-11
2	6/01/06	Updates throughout	Replace Front Cover Replace Signature Page Replace Preface Replace Table of Contents Replace pages 4.7-9 through 4.7-62 Replace pages 4.9-13 through 4.9-36 Delete 4.9-37 through 4.9-48

PREFACE

Volume IV of the Flight Dynamics Officer Console Handbook was created through the efforts of many people within the Flight Design and Dynamics Division (DM). It documents Flight Dynamics Officer and Trajectory Officer information and procedures for the deorbit and entry phases of flight as well as Emergency Mission Control Center (EMCC) operations. Below are some of the names of the people who contributed to this volume:

G. T. (Greg) Oliver, NASA	P. J. (Jan) McCoy, NASA
E. P. (Ed) González, NASA	K. M. (Kerry) Soileau, NASA
B. R. (Bruce) Hilty, NASA	N. J. (Nick) Tolomeo, USAF
N. E. (Nick) Combs, USAF	R. A. (Dick) Theis, USA
W. H. (Bill) Tracy, USA	J. D. (Doug) Rask, NASA
M. J. (Mark) Riggio, RSOC	K. W. (Keith) Fletcher, USA
D. A. (Debbie) Kessler, NASA	C. W. (Carson) Sparks, USA
M. R. (Matt) Abbott, NASA	E. J. (Eric) Hammer, NASA
R. S. (Richard) Jones, NASA	J. C. (Chris) Edelen, USA
M. A. (Mark) McDonald, USA	J. R. Spencer, NASA

This is a living document. Any changes or questions should be directed to DM46/Keith Fletcher, Ascent/Entry Flight Dynamics Group, NASA JSC, Houston, TX77058, telephone(281)483-1940

TABLE OF CONTENTS

4.1 INTRODUCTION 1

 4.1.1 DEORBIT TO LANDING OVERVIEW 1

 4.1.1.1 *Entry Guidance Phase* 2

 4.1.1.2 *TAEM Guidance Phase* 3

 4.1.1.3 *Approach and Landing (A/L) Guidance Phase* 4

 4.1.1.4 *Aerosurfaces* 5

 4.1.1.5 *Range To Go (RGO) Computations* 7

 4.1.2 ENTRY FLIGHT DYNAMICS OFFICER (FDO) RESPONSIBILITIES 8

 4.1.3 ENTRY FDO INTERFACES 8

4.2 DEORBIT AND ENTRY PLANNING PROCESSORS 1

 4.2.1 FUNCTIONAL DESCRIPTION 1

 4.2.2 DEORBIT MANEUVER PLANNING PROCESSOR 1

 4.2.2.1 *Entry Target Generator* 3

 4.2.2.2 *Targeting Options* 4

 4.2.2.3 *DMP Processing* 5

 4.2.2.4 *DMP Output* 6

 4.2.3 ENTRY DYNAMICS SIMULATOR (EDS) 6

 4.2.3.1 *EDS Processing* 6

 4.2.3.1.1 *EDS Elements* 7

 4.2.3.1.1.1 *EDS Input Menu* 7

 4.2.3.1.1.2 *Entry Constraints Table* 8

 4.2.3.1.1.3 *Entry Attitudes Processor* 9

 4.2.3.1.1.4 *Entry Elapsed Time* 10

 4.2.3.1.1.5 *Entry Digitals* 13

 4.2.3.1.2 *EDS Procedures* 13

 4.2.3.1.2.1 *TAL Procedure* 14

 4.2.3.1.2.2 *Deorb Procedure* 16

 4.2.3.1.3 *Orb Normal* 18

4.3 MANEUVER GENERATION 1

 4.3.1 MASS PROPERTIES 1

 4.3.1.1 *Entry Phase Mass Properties Configuration* 1

 4.3.1.2 *Postlanding Mass Properties* 2

 4.3.1.3 *Supporting Information for Entry Phase Mass Properties* 3

 4.3.1.4 *Wraparound Digital Autopilot (Wrap DAP)* 5

 4.3.1.5 *Mass Properties Reference Data Chart* 5

 4.3.2 TRACKING VECTOR UPDATE GUIDELINES 5

 4.3.2.1 *General* 6

 4.3.2.2 *Ephemeris Update* 6

 4.3.2.3 *Onboard Update* 6

 4.3.3 TABLE SETUP 7

 4.3.3.1 *Deorbit Constraints Table* 7

 4.3.3.3 *Landing Site Table* 9

 4.3.3.4 *Deorbit Targeting Constraints* 9

 4.3.3.5 *Atmosphere Tables* 12

 4.3.3.6 *Miscellaneous Tables* 13

 4.3.4 MANEUVER OBJECTIVES 14

 4.3.5 MANEUVER GENERATION GUIDELINES AND RULES 15

 4.3.5.1 *Deorbit Targeting Priorities* 15

 4.3.5.2 *Other Constraints Affecting Deorbit Targeting* 15

4.3.6	MANEUVER GENERATION AND EVALUATION	18
4.3.6.1	<i>Nominal Procedures</i>	18
4.3.6.2	<i>Maneuver Evaluation</i>	19
4.3.6.3	<i>Entry Profile Generation</i>	20
4.4	SITE/RUNWAY SELECTION	1
4.4.1	SYSTEMS AVAILABLE FOR WIND DATA MEASUREMENTS	1
4.4.2	ENTRY AND TOUCHDOWN EVALUATION	5
4.5	PRELIMINARY ADVISORY DATA (PAD) GENERATION.....	1
4.5.1	DEORBIT/LANDING DATA (DOL).....	1
4.5.2	ENTRY SUMMARY MESSAGE	7
4.5.3	DEORBIT MANEUVER PAD	13
4.5.4	DEORBIT/ENTRY/LANDING (DEL) PAD.....	14
4.6	PRE-DEORBIT THROUGH LANDING.....	1
4.6.1	MANEUVER CONFIRMATION.....	1
4.6.2	HIGH-SPEED DISPLAYS.....	1
4.6.2.1	<i>VREL vs. RGO</i>	1
4.6.2.2	<i>Entry Groundtrack</i>	4
4.6.2.3	<i>EOW vs. RGO</i>	6
4.6.2.4	<i>Altitude vs. RGO</i>	8
4.6.2.5	<i>Log Log</i>	8
4.6.2.6	<i>Entry Digitals</i>	9
4.6.3	HIGH-SPEED OPERATIONS	10
4.6.3.1	<i>FDO Responsibilities</i>	10
4.6.3.2	<i>TRAJECTORY Responsibilities</i>	17
4.6.3.3	<i>NAV Failures</i>	18
4.7	OFF-NOMINAL PROCEDURES.....	1
4.7.1	DEORBIT TARGETING	1
4.7.1.1	<i>Off-Nominal Procedure for Propellant and CG</i>	1
4.7.1.2	<i>ARCS Completion</i>	1
4.7.1.3	<i>Special Cases for Entry Mass Properties</i>	6
4.7.1.4	<i>Special Cases</i>	9
4.7.2	PRE-DEORBIT THROUGH LANDING.....	14
4.7.2.1	<i>PRE-TIG ANOMALIES</i>	14
4.7.2.2	<i>Deorbit Burn</i>	14
4.7.2.2.1	<i>IMU Dilemma</i>	15
4.7.2.2.2	<i>OMS Engine Failure</i>	16
4.7.2.2.3	<i>OMS Propellant Failure</i>	16
4.7.2.2.4	<i>Recovery Prebank</i>	19
4.7.2.3	<i>GCA Techniques</i>	22
4.7.2.4	<i>No Yaw Jet (or any CSS) Entry</i>	33
4.7.2.5	<i>Bailout Assessment Procedures</i>	34
4.7.2.5.1	<i>Bailout Criteria and Calls</i>	34
4.7.2.5.2	<i>Crew Bailout Procedures</i>	36
4.7.2.6	<i>BFS Engage</i>	38
4.7.2.7	<i>Single APU Entry</i>	39
4.7.2.8	<i>Air Data Failures</i>	39
4.7.2.9	<i>Leaking/Flat Tire Runway Selection Guidelines</i>	41
4.7.3	OFF NOMINAL ENTRY ANALYSIS REQUIREMENTS	42
4.7.4	ENTRY OVERFLIGHT AND ENTRY THERMAL OPTIONS.....	47

4.7.4.1 Entry Public Risk Assessment	48
4.7.4.2 Entry Thermal Options.....	50
DESCRIPTION	59
V97U0482 - 84C	60
4.8 SIM SUPPORT	1
4.8.1 INTEGRATED LOAD CHECKOUT PROCEDURES	1
4.8.2 DEORBIT PREP SIM SUPPORT	1
4.8.3 D/O - 30 MIN RUN	2
4.8.4 200K SIM INITIALIZATION	2
4.9 USE OF CHECKLISTS	1
4.9.1 L-1 DAY CHECKLIST	2
4.9.3 DEORBIT PREP TIMELINE CHECKLIST (PAGE 1 OF 2)	3
4.9.4 DEORBIT WAVE-OFF CHECKLIST	5
4.9.6 DEORBIT TARGETING CHECKLIST (PAGE 1 OF 5).....	6
4.9.7 EDS CHECKLIST (PAGE 1 OF 2).....	11
4.9.8 DEL PAD CHECKLIST (PAGE 1 OF 7).....	13
4.9.9 AUTO DEL PAD PROCEDURES CHECKLIST	20
4.9.10 NOMINAL STCOMP CHECKLIST.....	21
4.9.11 UNBALANCED STCOMP CHECKLIST	22
4.9.12 RCS COMPLETION CHECKLIST	23
4.9.13 RCS DEORBIT TARGETING CHECKLIST	24
4.9.14 D/O BURN CHECKLIST	25
4.9.15 ENTRY PHASE HIGH SPEED CHECKLIST.....	26
4.9.16 TAEM HIGH SPEED CHECKLIST	27
4.9.17 GCA CHECKLIST.....	28
4.9.18 BAILOUT CHECKLIST	29
4.9.19 POSTLANDING MASS PROPERTIES CHECKLIST	30
4.9.20 EOM HIGH SPEED TRACKING SCHEDULING GUIDELINES (PAGE 1 OF 2).....	31
4.9.21 ILC CHECKLIST - ENTRY	33
4.9.22 FLIGHT LOAD CHECKLIST	34

4.10 EMERGENCY MISSION CONTROL CENTER (EMCC)..... 1

4.10.1 FLIGHT DYNAMICS TEAM ACTIVATION AND DEPLOYMENT	1
4.10.2 EMCC FDO DEPLOYMENT CHECKLIST	6
4.10.3 EMCC PORTABLE WORKSTATION	7
4.10.4 GSFC INTERFACE.....	8
4.10.5 EMCC FLIGHT DYNAMICS TEAM RESPONSIBILITIES.....	9
4.10.6 FURTHER RESOURCES.....	10
4.A FDO CONSOLE HANDBOOK DOCUMENTATION CHANGE PROCESS	1
4.B DMP DIAGNOSTICS	1

4.1 INTRODUCTION

The purpose of this section is to provide the reader with some basic tools for understanding the deorbit targeting philosophy, methods, and procedures, as well as an overview of the entry process and displays. This chapter is intended to be generic and as flight independent as possible. Variations and improvements for specific flights will be addressed in flight techniques and flight rules. The format of this section is intended to serve as a guide to completing the deorbit and entry process with little prior knowledge.

4.1.1 *Deorbit to Landing Overview*

The purpose of this overview is to discuss the events which occur during the deorbit to landing phase. A brief overview of how the Mission Control Center (MCC) and the crew structure their activities to support these events is included.

The main events during entry include the deorbit burn, Entry guidance phase, Terminal Area Energy Management (TAEM) guidance phase, and Approach and Landing guidance phase. During each of these phases, many orbiter systems are relied upon to react to the physical forces encountered during descent. The orbiter's Flight Control System (FCS) enables it to respond to the forces encountered during entry by executing the commands generated by the guidance system. Guidance generates commands for the FCS based on the navigation state. Load factor, speedbrake, and roll angle influence the FCS as inputs into the guidance system.

The first major event to prepare for is the deorbit maneuver. This maneuver places the orbiter at the edge of the atmosphere with the correct velocity, Range To Go (RGO) to the landing site, and flight path angle. Meeting these conditions will ensure aerocapture with sufficient energy to reach the runway threshold. The deorbit maneuver is targeted with a closed-loop guidance scheme known as Powered Explicit Guidance Mode 4 Descent (PEG 4D). Throughout the deorbit maneuver, PEG 4D recomputes the required thrust remaining in order to meet the desired conditions at atmospheric interface.

After the deorbit burn is completed, the Reaction Control System (RCS) thrusters are used to maneuver the orbiter to the attitude required for Entry Interface (EI). The attitude of the orbiter is typically a 40° angle of attack, wings level configuration for the last 5 minutes prior to EI. This is known as the EI - 5 attitude. At this point, initiation of Major Mode (MM) 304 occurs, the forward RCS jets are inhibited, and the onboard Entry guidance begins to operate. After the deorbit maneuver, the vehicle will reach EI at an altitude of about 400,000 ft with an RGO of approximately 4200 nautical miles (nmi) from the landing site. The velocity of the orbiter at this time is close to 25,000 feet per second (ft/sec).

4.1.1.1 Entry Guidance Phase

This discussion of the Entry guidance phase will include the relationships of certain physical influences on the orbiter during entry, as well as the responses of the orbiter's FCS to these forces

Entry guidance commands the orbiter's FCS to fly a profile which dissipates the orbital energy, yet ensures that the orbiter reaches the desired touchdown point. There are five phases of Entry guidance in which energy, atmospheric drag, and roll angle are maintained within the thermal, structural, and control limitations of the orbiter. The five phases of Entry guidance are Pre-entry phase, Entry Thermal Control phase, Equilibrium Glide phase, Constant Drag phase, and Transition phase. Prior to discussion of these phases, it is important to understand the interactions of the forces acting on the orbiter as it descends. During entry, energy is dissipated by the atmospheric drag of the orbiter. Higher atmospheric drag levels enable faster energy dissipation. Normally, the angle of attack and roll angle enable the atmospheric drag of any flight vehicle to be controlled. For the orbiter, using the angle of attack alone as a means of controlling atmospheric drag is not acceptable because of excessive thermal conditions. As a result, the angle of attack scheduled during entry is driven largely by the relative velocity with small variations to supplement energy control. This leaves the roll angle as the primary driver for energy control. Increasing the roll angle decreases the vertical component of lift, causing a faster sink rate and faster energy depletion rate. Increasing the roll angle also raises the surface temperature of the orbiter. Entry guidance, using bank angle to control drag, directly controls energy. If the orbiter is low on energy (current RGO is much greater than nominal RGO at current velocity), then Entry guidance will command lower than nominal drag levels. If the orbiter has too much energy (current RGO is much less than nominal RGO at the current velocity), then entry guidance will command higher than nominal drag levels in order to dissipate the extra energy. The descent rate and drag level are controlled by bank angle. A steeper bank angle produces a greater descent rate, resulting in higher drag. Conversely, the minimum drag configuration is wing level.

Another term important to Entry guidance is azimuth offset, referred to as DELAZ (delta azimuth). This is the angle between the plane containing the orbiter position vector and the Heading Alignment Cone (HAC) tangency point, and the plane containing the orbiter position and velocity vectors. When DELAZ exceeds a threshold value, the orbiter roll angle is reversed. This threshold value is a function of the relative velocity. Roll reversals are also used to control crossrange. As stated previously, Entry guidance becomes active at the EI - 5 timeframe. This is the Pre-entry phase. During this phase, a constant Local Vertical Local Horizontal (LVLH) attitude is maintained, no ranging commands are generated (open loop), and the Aft Reaction Control System (ARCS) roll jets remain active until a dynamic pressure of 10 pounds per square foot (psf) is sensed. At a dynamic pressure of 2 psf, the orbiter elevons become active for control. The ARCS pitch jets are deactivated at a dynamic pressure of 40 psf.

At a total acceleration of 4.25 ft/sec^2 (0.132 G's), the Entry Thermal Control phase occurs. During this phase, guidance begins active energy control while keeping the vehicle temperatures within the design limits. When total acceleration is equal to 4.25 (drag ~ 3), closed loop guidance is initiated. A constant heating rate is established until the orbiter reaches an Earth-relative velocity below about 19,000 ft/sec.

The Equilibrium glide phase provides for the orbiter transition from the rapidly increasing drag levels of the Temperature Control phase to a constant level of drag, which is characteristic of the Constant Drag phase. Equilibrium glide flight is defined as the condition in which the flight path angle remains constant. Maximum downrange capability is provided during equilibrium gliding flight. This phase will continue until a drag acceleration of 33 ft/sec^2 is reached. Constant Drag phase occurs at this point.

During Constant Drag phase, the angle of attack is ramped down from 40° . At the end of this phase, the angle of attack will be about 36° . Beginning at Mach 10, the speedbrake leaves its post-burn position and enters a predefined schedule. At Mach 5, the rudder becomes an active aerodynamic control surface. The final phase of Entry guidance is known as the Transition phase. During this event, the transition to TAEM guidance begins. The angle of attack continues to ramp down until it reaches approximately 14° at TAEM interface. The orbiter encounters TAEM interface at an altitude of about 83,000 ft, 60 nmi RGO, and a velocity of Mach 2.5 (2500 ft/sec). At this point, control is transferred to TAEM guidance.

4.1.1.2 TAEM Guidance Phase

The four phases occurring during the TAEM guidance mode begin at the switch to MM 305. These events are referred to as the S-turn, Acquisition, Heading Alignment, and Pre-final phases. TAEM guidance steers the orbiter to one of two HAC's, which are located tangent to and on either side of the approach end of the runway centerline. While supersonic, the speedbrake follows a schedule which serves to enhance the vehicle pitching moment and allows the elevons to drop more as a means of increasing aileron effectiveness. During subsonic flight, the speedbrake command is generated from energy error until final approach where it is based on dynamic pressure error. The S-turn phase is required only when energy is high. In Operational Sequence (OPS) 3, additional constraints on the S-turn phase are that the HAC turn angle must be less than 200 degrees and the RGO must be greater than 20 nmi. During this phase, the vehicle is turned away from the HAC until sufficient energy has been dissipated to allow Approach and Landing constraints to be met. If the orbiter is faced with an extreme low-energy situation, the guidance software recommends the crew take action to switch the HAC to the Minimum Entry Point (MEP) location.

The overhead (OVHD) approach is the most frequently used type of approach in which the orbiter is targeted to the most distant HAC. This causes the orbiter to fly over the extended runway centerline on the way to the HAC. The straight-in (STIN) approach is the term applied to the orbiter flying to the nearest HAC, thus providing a shorter route to the runway. Since it is easier to dissipate energy than to add energy, the OVHD approach is initially targeted providing low energy downmode options.

During Acquisition phase, the orbiter is turned until it is aimed at a point tangent to the selected HAC. A roll angle command is given that is proportional to the orbiter heading deviation from tangency to the selected HAC. The orbiter will fly directly to the tangency point, known as Waypoint One (WP-1).

At WP-1, the Heading Alignment phase begins. The orbiter follows the HAC until it is approximately 400 ft in crossrange from the runway centerline, and vehicle heading is within 20° of the runway azimuth. During this phase, the roll angle command is generated to ensure that the orbiter performs a turn that follows the heading alignment spiral. The spiral is the ground plane projection of the cone.

The Pre-final phase begins when the orbiter transitions from the HAC to the runway centerline. The orbiter pitches down to acquire the glideslope, increases airspeed, and banks to acquire the runway centerline. This phase continues until the orbiter is on the runway centerline, on the outer glideslope (OGS), and on airspeed (300 knots). During this phase, the roll angle command is generated to maintain runway centerline.

4.1.1.3 Approach and Landing (A/L) Guidance Phase

The A/L guidance phase is divided into four events: Trajectory Capture, Steep Glideslope, Flare and Shallow Glideslope, and Final Flare phases. The Trajectory Capture phase begins by terminating TAEM phase and continues until guidance captures the OGS. The OGS is anchored at the aimpoint on the ground in front of the runway threshold and is inclined either 18 (heavyweight vehicle) or 20 (lightweight vehicle) degrees. The nominal aimpoint is 7500 ft from the threshold while the close-in aimpoint is 6500 ft. The nominal altitude of the orbiter at the beginning of this phase is 10,000 ft.

The Steep Glideslope phase begins approximately 7 nmi from the runway threshold. The orbiter continues to track the OGS and increases airspeed to 300 knots (kts). The descent rate in the later portion of this phase is roughly 190 ft/sec (11,400 ft/min). At 3000 ft Above Ground Level (AGL), the speedbrake targets the orbiter energy for a touchdown at 195 kts (or 205 kts for heavyweight) Equivalent Airspeed (KEAS) and 2500 ft down the runway.

At 2000 ft AGL, the Flare and Shallow Glideslope phase begins. A pre-flare maneuver is started to place the orbiter in a 1.5° glideslope anchored 1000 ft past the threshold. This shallow glideslope is also known as the Inner Glideslope

(IGS). For detailed diagrams of the OGS and IGS geometry as well as landing aids (e.g. Precision Approach Path Indicator, or PAPI lights), reference the Shuttle Crew Operations Manual (SCOM), section 7.4.

During the Final Flare phase, guidance abandons the shallow glideslope, reduces the sink rate to less than 6 ft/sec, and maintains position over the runway centerline. The crew deploys the landing gear at an altitude of roughly 300 ft AGL.

4.1.1.4 Aerosurfaces

Elevons - The term "elevons" was adopted for the control surfaces on the orbiter's wing trailing edge since they function as both elevators and ailerons. The left and right elevons move symmetrically to provide orbiter longitudinal control, and asymmetrically for lateral/directional control. Beginning at a q-bar of 2.0 psf, the elevons are blended in with PRCS pitch jets, which provide the sole exoatmospheric pitch control prior to this. The PRCS pitch jets are finally deactivated at a q-bar of 40 psf, when sufficient pitch control authority is available with the elevons alone. The pitch channel surface deflection is proportional to commanded pitch rate (from either the RHC or guidance), plus a forward loop trim integrator. The integrator prevents elevon pitch deflection from being zero'ed out when the desired rate is achieved (which would immediately null the desired rate). The commanded pitch rate goes through a fourth-order body bending filter, which prevents structural high-frequency oscillations from inducing greater elevon deflections. The body bending filter is selectable on SPEC 51. Normally the NOM filter is selected. The ALT body bending filter is selected if a flexible payload or one > 10,000 lbs is returned in the payload bay. This information is provided by GNC and is included on the Entry Summary Message.

Differential deflection of the elevons provides roll control, plus assistance to the yaw jets for lateral control during roll reversals and when No Yaw Jet (NYJ) is selected. The elevons become active for roll control at a q-bar of 2 psf to assist the RCS roll jets. The elevons then become prime for roll when the roll jets are deactivated at q-bar equal to 10 psf. Through most of entry, bank maneuvers require a combination of roll and yaw body rates. The reason is that bank maneuvers are performed about the velocity vector, not the orbiter's x-axis. Otherwise a roll maneuver at an appreciable angle-of-attack would result in excessive heating on the backside of the orbiter. This feature is controlled by the flight control gain GALR, and is ramped out beginning about Mach 4 as angle-of-attack decreases and the orbiter transitions to conventional aircraft control. For example, when a left bank is commanded, GALR causes the elevons to briefly deflect for a right bank. This left elevon downward deflection, coupled with left yaw jet firings, causes sideslip angle to build (wind from right of the nose). Now adverse yaw initiates the desired left roll rate. The elevon deflection is reversed by GALR to continue the left bank. Yaw jets and elevons work together to coordinate the turn, maintaining correct body yaw and roll rates. Similar actions in reverse halt the maneuver at the desired bank angle.

Elevons also provide lateral-directional trim to handle offset y-c.g. and bent-airframe. In either of these cases, a combination of rolling and yawing moments will be present during entry. It will be up to the RCS jets, elevons, and eventually rudder to balance, or "trim" the condition. Since RCS jets use a finite consumable, it is preferred to let the elevons handle lateral-directional trim via "aileron trim", which is computed by flight control based on integrated jet firings. For example, a +1 inch y-c.g. offset requires about 1 deg of left aileron trim to trim out the rolling and yawing moment. A steady-state sideslip angle may also be part of the trim solution. Aileron trim angle is displayed on SPEC 50. Yaw jet activity can be monitored with the RCS activity lights, and sideslip angle (in equivalent yaw jet force) can be monitored with the scaled A_y needle at the bottom of the ADI. Flight control limits aileron trim to a maximum value of ± 3 deg.

Bodyflap - The bodyflap (BF) serves dual purposes by assisting in pitch trim during entry, as well as shielding the SSME nozzles from aerodynamic heating. OI-20 software implemented smart BF logic to improve how the BF helps the elevons provide pitch trim. When the AUTO elevon schedule is selected on SPEC 51, the BF drives to keep the elevons on an I-loaded schedule. This schedule is delivered by Descent Flight Design based on a mid-c.g. mass configuration. However, the smart logic limits BF deflections in order to avoid excessive hinge moments or SSME nozzle heating. That is, the BF assists the elevons in following their proper schedule, while protecting itself against excessive deflections. The FIXED elevon schedule may be selected to provide pre-OI-20 elevon/BF behaviour. In this case, the BF will deflect to drive the elevons to the fixed schedule, irregardless of hinge moments or SSME nozzle heating. This is useful for PTIs where known aerosurface deflections are desired. On flights where no PTIs are scheduled, the aft-c.g. elevon schedule is loaded into the FIXED slot. This pushes the elevons downward, lower into the airflow, increasing control authority for roll and yaw. For this reason, the Entry Checklist has the crew select FIXED elevons whenever in NYJ entry mode (unless a PTI elevon schedule was loaded into FIXED). This helps the elevons take over the role of controlling yaw when the RCS jets are turned off.

Rudder - The rudder is nearly useless for directional control at velocities greater than Mach 5. The orbiter's high angle-of-attack blankets the tail, thus reducing rudder effectiveness. For this reason, RCS yaw jets remain active until Mach 1. The rudder becomes active at Mach 5 to assist in yaw control for coordinating bank manoeuvres and assisting in lateral-directional trim. The rudder takes over the yaw function from the RCS jets at Mach 1.

Speedbrake - The speedbrake is commanded closed during the early part of entry to minimize heating to the surface and mechanisms. At Mach 10, the speedbrake is commanded to 81% in order to provide a nose up pitching moment. FCS counters this by trimming the elevons downward, more into the

flow to improve control authority. Beginning about Mach 3, the speedbrake slowly retracts to 65% as lower angle-of-attack increases its effectiveness. Finally at Mach 1, the speedbrake transitions from pitch trim to a true L/D control device, being commanded by guidance based on E/W error. If energy is high, the speedbrake will open up to decrease L/D; the opposite occurs in the case of low energy. The speedbrake is commanded 100% in case of an S-turn to assist in bleeding off energy. From 14000 ft to 9000 ft, guidance transitions from computed speedbrake deflection based on E/W error to q-bar error. By 9000 ft, the speedbrake command is strictly a function of q-bar (read: EAS) error. For example, if airspeed is low on final approach, the speedbrake setting is reduced.

At 3000 ft, a speedbrake "retract setting" is computed by guidance based on range error predicted at touchdown. This factors in the effects of integrated windspeed during A&L, density altitude, vehicle weight, and EAS on achieving the targeted touchdown point at 2500 ft and 195 kts (205 kts if heavyweight). If short field speedbrake option was selected, then a 1000 ft range bias is included in the calculations to force a larger speedbrake setting. Note that in actuality the crew will stretch for the 2500 ft touchdown point, resulting in an airspeed 10 kts slower at contact. Selection of close-in aimpoint also has the same effect since the close-in aimpoint is 1000 ft closer to the threshold than the nominal aimpoint. These calculations are repeated at 500 ft for a final "adjust setting". Note that the minimum speedbrake setting is 15%--any commanded setting of 15% or less is considered "closed". Upon touchdown, or specifically Weight-on-wheels or WOW, the speedbrake is commanded full open to increase drag and decrease pitch-down rate for nose gear contact.

The speedbrake is controlled manually under several special scenarios. If only one APU is operating, then the speedbrake is manually set to the average of the predicted 3000 ft and 500 ft adjust settings, and left there. This is to decrease the workload on the remaining hydraulic system during pre-flare and inner glideslope. Note also that only 50% braking is available if either APU 1 or 2 is the sole operational APU. If APU 3 is the only one running, then 100% braking is available but NWS will not work.

4.1.1.5 Range To Go (RGO) Computations

RGO computations are a function of the guidance phase. During the Entry guidance phase, RGO is computed by first determining the great circle distance from the Orbiter to the HAC, then adding the arc length along the HAC to the final approach plane, and then adding the fixed distance from this point to the runway threshold.

During the Acquisition subphase of TAEM, the RGO is computed by geometrical equations which assume that the Orbiter path during the acquisition turn is a logarithmic spiral. This distance is added to a straight line from the Orbiter after the acquisition turn is completed to the HAC tangency point. Then the distance

around the HAC is computed from the turn angle and the alignment spiral radius. All the above distances are then added to the fixed distance from where the HAC intersects the runway centerline to the runway threshold.

For both the Pre-final and A/L guidance phases, a simplified RGO is computed. The RGO is the straight line distance from the Orbiter to the runway threshold.

4.1.2 Entry Flight Dynamics Officer (FDO) Responsibilities

Duties of the FDO include:

1. Evaluate and recommend landing site.
2. Evaluate and recommend deorbit opportunities.
3. Evaluate and recommend orbit adjust maneuvers for optimization of end of mission.
4. Evaluate and recommend landing runway and configuration (aimpoint, speedbrake logic).
5. Perform deorbit targeting (balance tradeoffs: target steepness, propellant available, thruster downmoding time, center of gravity (CG) management).
6. Generate the Deorbit, Entry, and Landing (DEL) Preliminary Advisory Data (PAD), the Deorbit Maneuver PAD, and the entry profile summary.
7. Evaluate the planned entry profile.
8. Ensure the deorbit plan conforms to all known thermal and structural constraints.
9. Interface with weather personnel and identify any weather flight rule violations.
10. Evaluate the effects of wind on touchdown points and rollout margins.
11. Retarget a previously planned deorbit if required.
12. Keep the ground ephemeris as accurate as possible.
13. Plan tracking arc to be used for State Vector (SV) determination and manage remote site scheduling.
14. Provide trajectory evaluation during entry. Provide ground controlled approach (GCA) support as required. Manage group displays during entry.
15. Interface with the Landing Support Officer (LSO) for any ground support activities

4.1.3 Entry FDO Interfaces

These are shown on Figure 4.1-1.

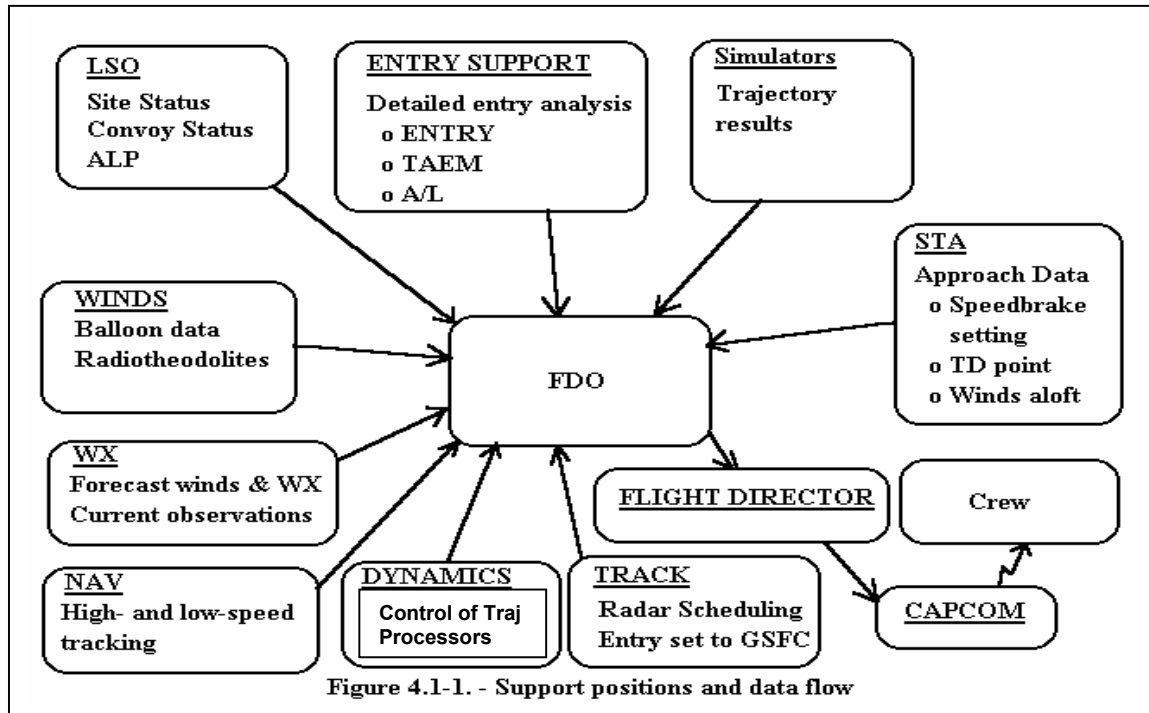

4.2 DEORBIT AND ENTRY PLANNING PROCESSORS

Anytime after Main Engine Cutoff (MECO), a deorbit is fair game and as a FDO you must be capable of producing the data required for completing a safe deorbit maneuver and entry. To begin the process you must have a complete acquaintance with the trajectory processors involved in generating the deorbit solution and entry evaluation. The two primary processors associated with this activity are the Deorbit Maneuver Processor (DMP) and Entry Design Simulator (EDS).

4.2.1 *Functional Description*

Deorbit planning is accomplished by the use of the DMP processor. It is designed to target a maneuver and provide data about the maneuver. EDS is a front end on the set of entry analysis tools called the Descent Design System (DDS). It provides a GUI and links the various parts of DDS together. The DMP and EDS processors provide most of the planning and evaluation functions necessary to make a GO/NO-GO decision prior to any deorbit maneuver.

4.2.2 *Deorbit Maneuver Planning Processor*

The DMP calculates guidance targets for a deorbit maneuver and verifies the maneuver to EI. The planned deorbit maneuver considers thermal and structural constraints by integrating a trajectory through a predetermined number of guidance cycles, called N-cycles, until drag equals referenced drag. The number of guidance cycles (1.92 sec each) between the initiation of closed loop guidance and the first nonzero bank command are the N-cycles. The DMP processor then stores information associated with the deorbit maneuver, the burnout vector, the EI vector, the PEG 4/PEG 7 targets, the fuel usage/ ΔV for the selected engine configuration, the Entry Target Generator (ETG) V/γ /range from entry interface (REI), and post maneuver CG, weight, crossrange and perigee. The vectors associated with the deorbit solution are accessible for generation of an entry profile either by transferring the maneuver to an ephemeris or by queuing the EDS DORB option. A summary of the data associated with a particular deorbit solution is displayed on the Deorbit Summary Table (DST) and a more comprehensive set can be displayed in Deorbit Digitals (DOD).

Figure 4.2-1 shows the DMP process. The computation uses data as specified in the Deorbit Constraints Table (DCT), or from a maneuver stored in the DMDT.

The DMP processor calls the ETG subroutine to calculate PEG 4D targets that satisfy the EI conditions for VEI, γ EI, and REI. The DMP will generate a solution which conforms to the following guidelines:

1. The guidance targets calculated by the DMP processor are compatible with the onboard powered flight guidance.

2. The planned deorbit maneuver results in the achievement of a correlated V , γ , and range set at EI. This target set is calculated by ETG after being called by the DMP processor.
3. The deorbit maneuver is targeted to burn a specified amount of propellant, allowing achievement of landing weight or CG constraint.
4. The targeting is such that if the primary propulsion system fails to ignite, then a pre-designated backup propulsion system can perform the maneuver with no change in input guidance targets (including time of ignition (TIG)) and achieve nominal entry conditions.
5. In the TIG-free mode, the TIG is selected so that the same amount of Orbital Maneuvering System (OMS) propellant will be required for either prime or backup propulsion system with or without propellant wasting. A positive or zero propellant margin will result if the prime system fails during the burn.
6. The targeting ensures that minimal guidance and control transients will occur for a switchover from prime to backup thrusters anytime during the burn. Consequently, body attitude changes for fuel wasting must be small when reverting to the backup propulsion system.
7. If it is not desired to find the guidance targets that are biased for both prime and backup propulsion systems, a solution can be found for any single designated propulsion system by setting the backup equal to the primary.
8. Entry crossrange will be computed, and in the event that excess fuel is burned out-of-plane (OOP), it will be burned in a direction that will decrease crossrange.
9. The deorbit solution for any future orbit may be computed by inputting the appropriate TIG threshold time.
10. A TIG-free or TIG-fixed mode can be designated.
11. A minimum Time of Free Fall (TFF) (time from burnout to EI) constraint will be enforced by relaxing the requirement for equal OOP thrust angles until the TFF exceeds or equals the minimum TFF.

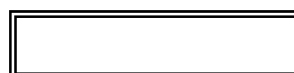
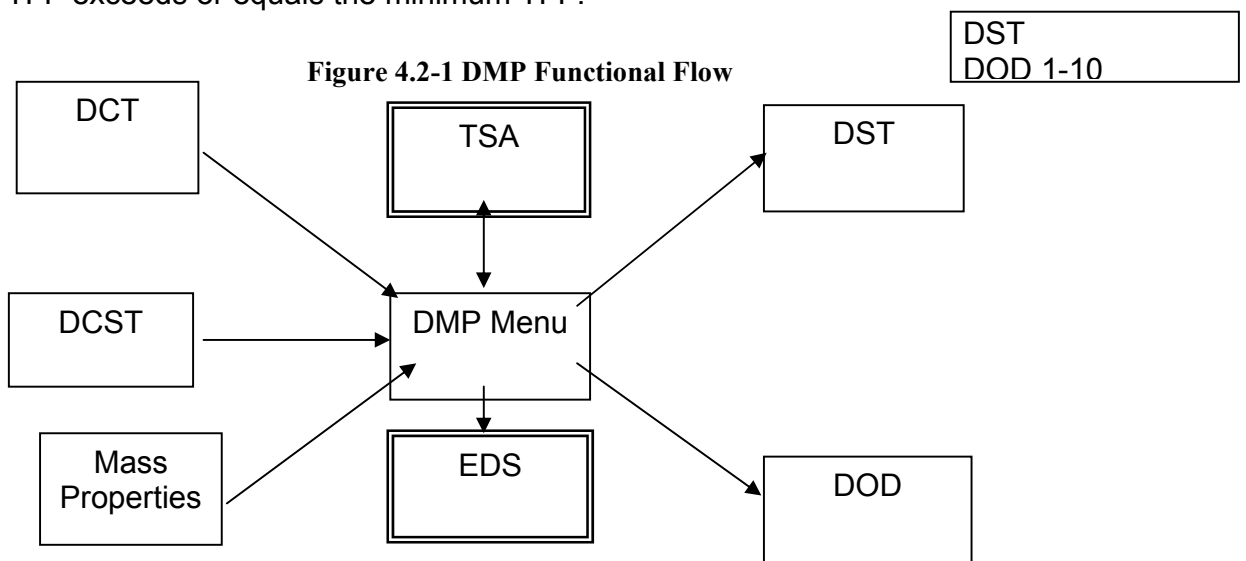

4.2.2.1 Entry Target Generator

The primary function of the ETG is to define EI conditions that result in a guided entry trajectory which is acceptable in terms of orbiter surface temperature, load factor, and maneuver capability constraints. These constraints are predetermined for a given mission in the drag acceleration-VREL plane, and an entry drag acceleration profile is defined which satisfies the constraints. The function of the ETG is to define EI conditions that result in an entry trajectory converging to this desired drag acceleration profile as the trajectory is stabilized following the initial atmospheric entry. The ETG accomplishes this by integrating entry trajectories to EI, comparing the resulting cycle (N-cycle) of the first nonzero roll command to the desired value, and adjusting the EI conditions accordingly. In simple terms, the N-cycle represents a method of timing the drag acceleration buildup required to meet the reference drag profile. An N-cycle, or guidance cycle, is 1.92 sec in duration and begins at the initiation of closed-loop guidance (CLG Init), when total acceleration equals approximately 4.25 ft/sec^2 (drag ~ 3). When drag acceleration reaches a desired value, a bank command will be generated by guidance to ensure the drag acceleration continues to build and that drag will meet the reference profile. The N-cycle, usually between 7 and 11, will directly reflect the flight path angle (γ) selected for entry. If the computed N-cycle for an entry is too small or too large, the ETG will compute a new γ which will adjust the drag acceleration until the N-cycles required match the reference N-cycle. The output of the ETG is;

- a. REI - range at EI to the landing site
- b. γ_{EI} - desired flight path angle at EI
- c. VEI - desired EI velocity
- d. C1 - ordinate intercept of EI velocity (inertial target line)
- e. C2 - slope of EI velocity V_{HORIZ}/V_{VERT} (inertial target line)

The detailed logic of the DMP Processor is specified in 76-FM-93.

4.2.2.2 Targeting Options

Table 4.2-1 shows the targeting options which are available in the DMP. These options allow a range of TIG modes, propellant usage, and thruster combinations to be made to accommodate operational situations.

Table 4.2-1 DMP Targeting Options

<u>Level I TIG Mode</u>	<u>Level II Propellant Usage</u>	<u>Level III Thruster Selection</u>
1. TIG free	1. Propellant wasting	1. Solution biased for prime and backup thruster (not available in TIG- fixed)
2. TIG fixed	2. In plane	2. Solution for any designated thruster

The following comments are provided to help explain the various combinations of levels I and II.

- a. 1,1 - A specified amount of OMS propellant will be expended. Solution will be such that the OOP thrust angle is the same for primary and backup systems.
- b. 1,2 - Computes a solution such that the amount of OMS propellant expended is the same for both primary and backup systems.
- c. 2,1 - Solution expends a specified amount of propellant to attain a specific CG or weight at EI.
- d. 2,2 - Computes a solution to a nominal EI target that lies in the trajectory plane.

Table 4.2-2 DMP Thruster Combinations

<u>Primary thruster</u>	<u>Backup thruster</u>	<u>Allowed for TIG-free</u>	<u>Allowed for TIG-fixed</u>
2 OMS	1 OMS	Yes	Yes
2 OMS	2 OMS	Yes	Yes (parallel-CG or CG-parallel not allowed)
1 OMS	1 OMS	Yes	Yes (left-right or right-left not allowed)
PX4/3/2*	PX4/3/2*	Yes	Yes
2 OMS	PX4/3/2*	No (No optimum solution exists for these combinations)	Yes
1 OMS	PX4/3/2*	No (No optimum solution exists for these combinations)	Yes

* PX3/PX3 or PX2/PX2 optimum solutions can be computed only by manually iterating using the TIG-fixed mode. PX3 and PX2 thrusters have excessive burn time and require lots of propellant.

After selecting the proper combination of levels I and II, you must also specify a level III option. The allowable thruster combination for prime and backup are limited for TIG-free solutions since the difference in engine initial specific impulse (Isp) for OMS and RCS do not allow for equal propellant solutions. Any allowed thruster configuration may be designated for a TIG-fixed solution. The primary/backup combinations for each TIG mode are shown in Table 4.2-2 above.

4.2.2.3 DMP Processing

The DMP processor actually consists of a small family of programs. The heart of DMP is the DMP Menu, from which DMP processing is queued. A Deorbit Constraints Table (DCT) and DCT Summary (DCST) provide access to 6 sets of constraint inputs to the DMP Menu. A Mass Properties Menu allows the user to select entry mass profiles from Paperless Mass Properties (PMP) used by the DMP Menu. In addition to the input menus are 2 display programs. The Deorbit Summary Table (DST) gives a summary of all 20 possible solution generated by the DMP Menu. The Deorbit Digitals (DOD) display gives a detailed look at all of the data from a single solution of the DMP Menu.

Prior to executing DMP, the following must be initialized:

- a. Deorbit Constraints Table (DCT) (Initialized by Dyn).
- b. PMP - The processor will access a Paperless Mass Properties text file that provides OMS depletion data and weight/cg data at various points in the re-entry trajectory (Initialized by Lead FDO/Trj).
- c. Landing Site Table (LST) - The processor accesses the TSA Landing site table for landing site data (Initialized by Recon).

Note: Reference Appendix B for DMP diagnostics.

4.2.2.4 DMP Output

The result of DMP processing is displayed on DST/DOD. The DST is the first output used for evaluation of deorbit capabilities. It gives the FDO the calculated TIG, the ΔV and weight of propellant used for the selected thruster configuration, REI, VEI, γEI , first roll command, and the post maneuver height of perigee (HP). DOD, provide a more comprehensive evaluation of the deorbit maneuver. It displays the following: the PEG 4 and PEG 7 targets, primary/backup solutions, and event times and attitudes for TIG and MM 303/304. Either FDO or DYN has to put the desired solution from the DST in the DOD.

4.2.3 Entry Dynamics Simulator (EDS)

EDS is a real time tool used by the Fight Dynamics team (FDO, DYN, Entry, etc.) for day of launch and day of landing support. EDS takes as input an EI-5 state vector (for EOM) or an ET separation state vector (for TAL) and simulates the flight of the orbiter through landing and rollout, using the Descent Design System (DDS) processors. EDS then post processes the DDS trajectory data to generate entry ephemeris data. This entry ephemeris data is sent to the Trajectory Server and TSA Primary Entry Ephemeris (EphR) using the EPSEND processor. The data from this entry ephemeris is then displayed on various digital and graphical displays to evaluate the entry trajectory. The entry ephemeris that is sent to the Trajectory Server is used for acquisition processing, and sent out over the network for ground station acquisition planning.

4.2.3.1 EDS Processing

EDS is cued from the EDS Input Display. While the EDS Input Display is available to both the FDO and Dynamics it is generally the case that the Dynamics will be making all inputs and running this processor (as well as for the DMP). To do otherwise introduces a significant risk of getting incorrect results since some of the data used to drive the processors may not reside in a common data area. Dynamics inputs to EDS are monitored by FDO on the Entry Constraints Table. Evaluation of the of the entry is accomplished with Entry

Analysis Digitals and Drag vs. Ve the display. Timeline information on the entry is available on the Entry Elapsed Time.

4.2.3.1.1 EDS Elements

4.2.3.1.1.1 EDS Input Menu

The EDS input window includes four areas which allow the user to select the inputs required to execute Descent Design System (DDS) simulations, generate entry profiles, and then write those profiles out to TSU and TSA

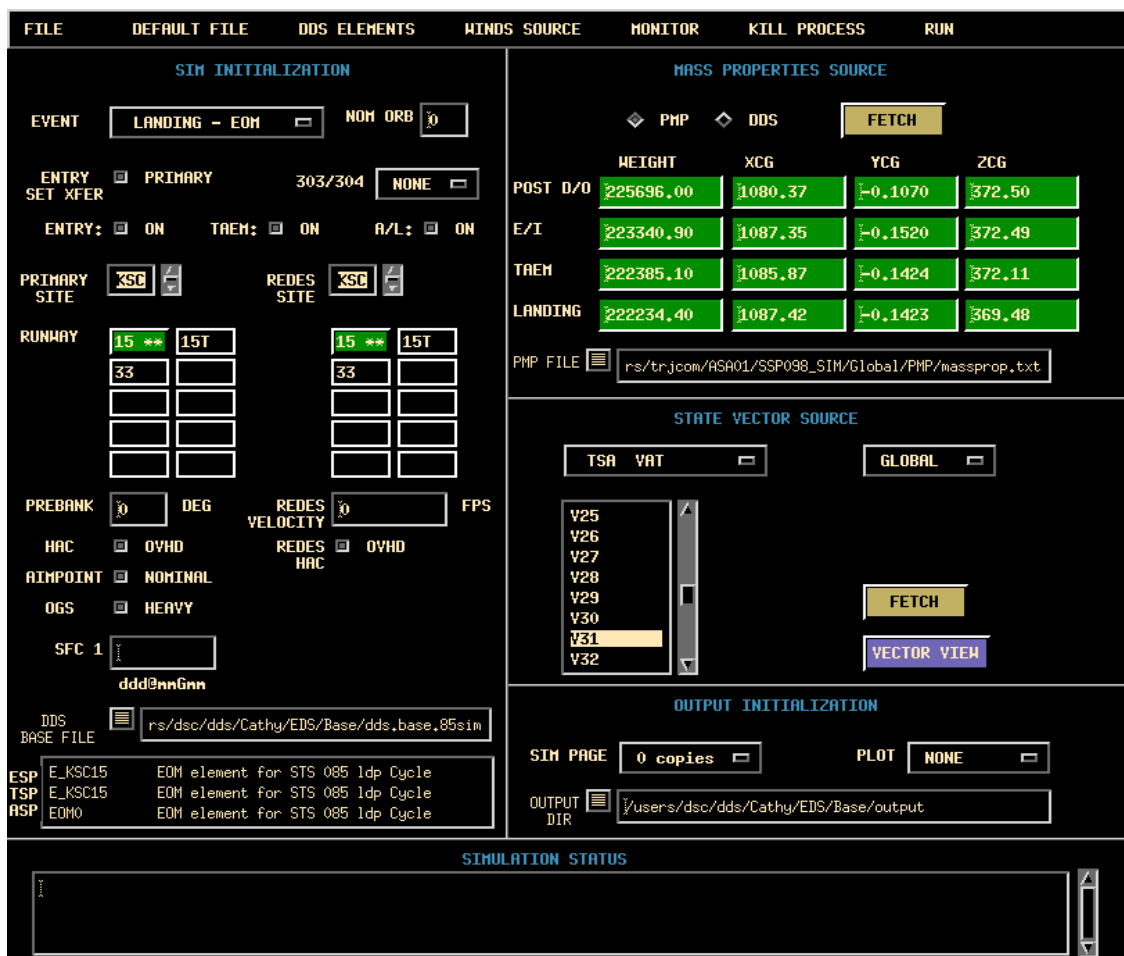

There are four primary areas of data entry. The SIM INITIALIZATION area allows the user to set the simulation sequence. The WINDS SOURCE area allows the user to select meteorological data. The STATE VECTOR SOURCE and MASS PROPERTIES SOURCE area allows the user to acquire the state vector data and mass property data. The OUTPUT INITIALIZATION area allows the user to set the simulation output conditions.

4.2.3.1.1.2 Entry Constraints Table

The EDS Entry Constraint Table provides the FDO with a method of reviewing Dynamics inputs to the EDS processor before the processing is started. The display shows the content of a specified EDS selection and Entry Attitudes MM 303/304. Selection of the file to be displayed is made from the “File” pull-down menu”. The display dynamically updates on a one second cycle.

File				
GMTR	217:06:14.51	W/S MIRROR	*****	GMT 218:06:42:00.497
ENTRY & TAEM CONFIGURATION			APPROACH & LANDING CONFIGURATION	
PHASE CONTROL	ENTRY	ON	E_KSC15	PHASE CONTROL
	TAEM	OFF	E_KSC16	A&L
				ON
				EOM
ENTRY SET XFER	PRIMARY		SURFACE WIND	
			320@12p15	
PLSID	KSC15	OVHD	GLIDESLOPE	
			18	
RLSID	KSC33	STIN	BRAKING	
			100%	
REDES VE	10000		DRAG CHUTE	
			OFF	
PREBANK	-90			
AIMPOINT	NOMINAL			
MASS PROPERTIES				
	WT	XCG	YCG	ZCG
EI	232000	1078.2	-0.7	371.9
TAEM	231500	1079.2	-0.8	372.9
A&L	231510	1079	-0.9	373.9
WINDS & ATMOSPHERE				
UPPER WIND	winds..L-03.5.RS..KSC..1020Z.102095..80000.484			
A&L ATMOS	atmos..L-03.5.RS..KSC..1020Z.102095..80000.484			
DENSITY ALTITUDE	-4956			

4.2.3.1.1.3 Entry Attitudes Processor

The Entry Attitude Processor propagates a given state vector to Entry Interface, calculates the orbiter's MM 303/304 attitudes, and creates a file with those attitudes and the EI-5 min state vector .

Control of the display is exercised through five pushbuttons and four toggle buttons.

Pushbuttons:

ACT Pushbutton: The 'ACT' pushbutton will call up the Attitudes Constraints Table dialog. The ACT dialog will display and allow the user to update the MM303 and MM304 delta T, alpha, beta, and phi attitude constraints. This input dialog will also have a 'SUBMIT' and an 'EXIT' pushbutton. The SUBMIT pushbutton is used to submit new constraint values. The EXIT pushbutton is used to exit the dialog without updating any of the constraints.

PRINT Pushbutton: The 'PRINT' pushbutton will basically provide the user with a hard copy of the main input window.

MASS Pushbutton: The 'MASS' pushbutton will fetch a vehicle weight.

RUN Pushbutton: The 'RUN' pushbutton will begin the execution of the state vector propagation provided all proper inputs have been submitted.

EXIT Pushbutton: The 'EXIT' pushbutton will terminate the Entry Attitudes Processor application and close all open windows.

Toggle buttons:

VECTOR SOURCE toggle button: The user is able to select from GLOBAL, LOCAL, MOC, and DWNLST. The selected option will be where EAP will attempt to fetch an input state vector.

Time

There are four options under Time.

MET - Displays data in the Time field in Mission Elapsed Time (MET). This is the default setting for the display.

GMT - Displays data in the Time field in Greenwich Mean Time (GMT).

CDT - Displays data in the Time field in Central Daylight Time (CDT).

CST - Displays data in the Time field in Central Standard Time (CST).

Options

There are six search options under Options.

Mach #...

Displays a dialog box for entering the Mach number. The search can be done in increasing or decreasing order. The returned data is the first occurrence of the value closest to the entered number.

An error is returned if the limits are exceeded or the value is not within the file.

The Mach number limits are 0.0 – 28.0.

Time...

Displays a dialog box for entering the Time in MET format. The time is always in increasing order. The returned data is the first occurrence of the time closest to the entered time.

An error is returned for an invalid time format or the value is not within the file.

Latitude...

Displays a dialog box for entering the Latitude. The search can be done in increasing or decreasing order. The returned data is the first occurrence of the value closest to the entered number.

An error is returned if the limits are exceeded or the value is not within the file.

The Latitude limits are -90 to 90.

Longitude...

Displays a dialog box for entering the Longitude. The search can be done in increasing or decreasing order. The returned data is the first occurrence of the value closest to the entered number.

An error is returned if the limits are exceeded or the value is not within the file.

The Longitude limits are -180 to 180.

Velocity...

Displays a dialog box for entering Velocity. The search can be done in increasing or decreasing order. The returned data is the first occurrence of the value closest to the entered number.

An error is returned if the limits are exceeded or the value is not within the file.

The Velocity limits are 0 to 28000.

Altitude...

Displays a dialog box for entering Altitude. The search can be done in increasing or decreasing order. The returned data is the first occurrence of the value closest to the entered number.

An error is returned if the limits are exceeded or the value is not within the file.

The Altitude limits are 0 to 800000.

Range...

Displays a dialog box for entering Range. The search can be done in increasing or decreasing order. The returned data is the first occurrence of the value closest to the entered number.

An error is returned if the limits are exceeded or the value is not within the file.

The Range limits are 0 to 10000.

4.2.3.1.1.5 Entry Digitals

The Entry Digitals display is directly tied to EPHR, and provides the information used to evaluate the entry profile.

Entry Digitals V1.00															
File Options DB										340/14:25:57					
GMTR	000:00:00:00			VID	FLT1000		METV	000:00:00:00.000			GMTV	000:00:00:00.000			
RUN##	DIRN	REDES	VE	####	to	RUN##	DIRN					DEORB	slot ##		
HM 303	MET	000:00:00:00				HM 304	MET	000:00:00:00							
		INERTIAL			LVLH			INERTIAL			LVLH				
	α	000	0000	0000			α	000	0000	0000					
	β	000	0000	0000			β	000	0000	0000					
	ϕ	000	0000	0000			ϕ	000	0000	0000					
ENTRY															
TFF	###														
ENTRY INTERFACE	XR	00	A/L	VI	000000	γ	+0.0000	R	00000	MET					
PERFORMANCE				ROLL	DIR	VE	ROLCHD	NCYCLE							
DELTA TTL	00.0	deg		1st	L	000000	-00	#	000:00:00:00						
MAX CP3	0000	deg		RR#	R	000000	-00		000:00:00:00						
(> 3220)	0000	sec		RR#	L	000000	-00		000:00:00:00						
MAX QBAR	0000	psf		RR#	R	000000	-00		000:00:00:00						
MAX NZ	00	g		RR#	L	000000	-00		000:00:00:00						
				ALPHA PROFILE	LOW-E	DISENGAGE	VE		000:00:00:00						
				##/##/##	#####										
TAEM															
PERFORMANCE				Alt	RCD (nm)	MACH	PSHA	WIND	MET						
HAC TURN	d path	TAEM INTERFACE		000000	00.0	0.00	000	00 T / 00 L	000:00:00:00						
MAX NZ	0.0	g	MACH 0.95	000000	00.0	0.00	000	00 T / 00 L	000:00:00:00						
MAX QBAR	000	psf	HAC ACQUISITION	000000	00.0	0.00	000	00 T / 00 L	000:00:00:00						
(> 20K)	000	psf				ERR @ PSHA		HAC SHRINK	S-TURN						
CSS TIME	00:00	mn:ss	MAX ALT ERR HI	000000	00.0	000 @ 00		RCD 00000	RCD 00000						
			MAX ALT ERR LOW	000000	00.0	000 @ 00		Alt 00000	Alt 00000						
APPROCH & LANDING															
A&L	INTERFACE	HD	00000	MET	000:00:00:00	SUN ANGLE	00	SUN CLARE	CDR	OCS	00 / ICS-Y	PLT	OCS	00 / ICS	00
	SB	PDS %		NORMALIZED TD		ROLLOUT MARGIN		BRAKE ENERGY	QBAR	SURFACE WINDS					
	(3K/500)			(POS/KEAS/KCS)		(END RWY/BARR/OVERRUN)		(MAX/HGEAR)	(DIR/HACPGUST	KTS)					
NOM/NOM	00.0/00.0	0000/	000 /0000	0000/	NA /0000	00 / 00	000/000	000/00P00	1P2	T	10P00	R			
CI/NOM	00.0/00.0	0000/	000 /0000	0000/	NA /0000	00 / 00	000/000	000/00P00	1P2	T	10P00	R			
NOM/SF	00.0/00.0	0000/	000 /0000	0000/	0000 / NA	00 / 00	000/000	000/00P00	1P2	T	10P00	R			
FG BLACK # = 0. (0)															

4.2.3.1.1.2 EDS Procedures

There are three general ways to run the entry tools. They are:

1. TAL
2. Deorb
3. Orb Normal

The steps recommended to run the procedures are detailed below.

4.2.3.1.2.1 TAL Procedure

TAL processing is time critical. After declaration of TAL it is imperative to quickly generate an Entry set and send it out to the network to protect TDRSS command and communications. The EDS TAL Display is a separate/independent version of the display that is set up for TAL.

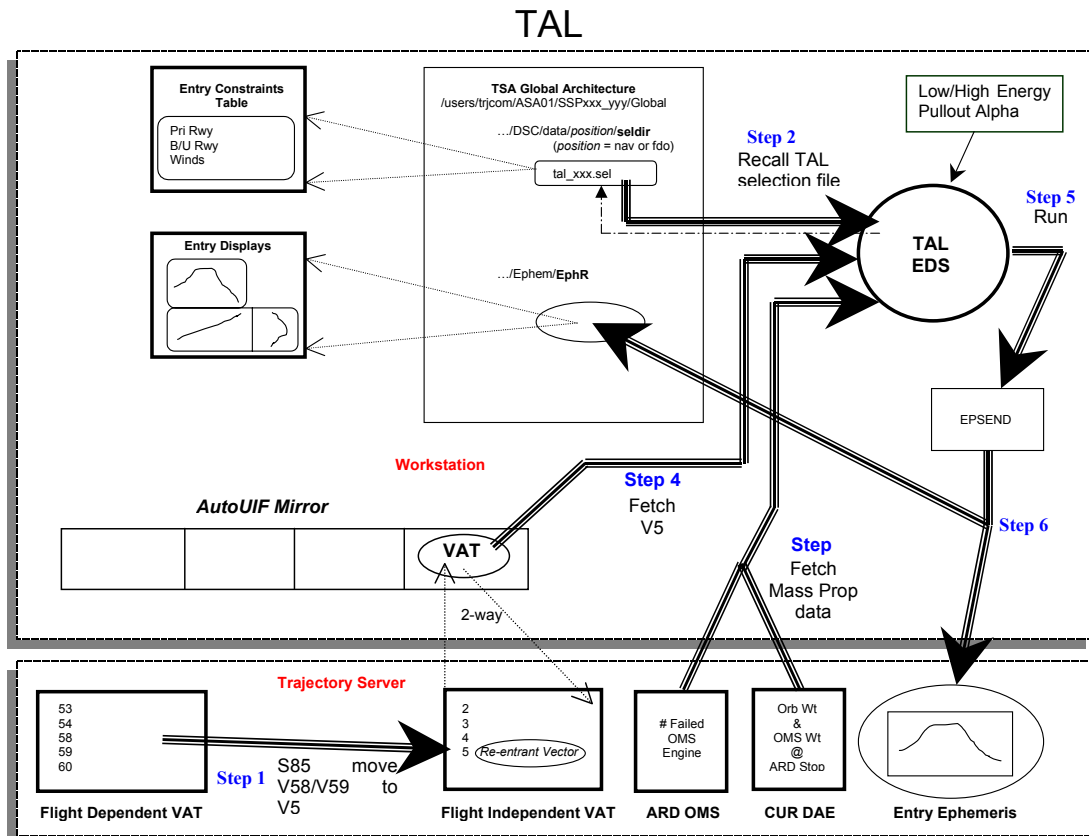

1. Dynamics moves onboard vector to VAT slot 5. Using the S85 MED the dynamics transfers an onboard vector (V53/V58/V59), specified by FDO, to V5.
2. Dynamics recalls TAL Selections
On the EDS Input display, the Dynamics selects the specific TAL selection file for the TAL site under consideration. Each site is configured pre-launch with site specific wind, atmosphere, and mass properties data.

For an ELS case, the MRN selection file will be used. The site designated by FDO will be selected by dynamics and zero winds will be specified.

3. Dynamics Fetches Mass Properties and OMS Engine Data

On the EDS Input Menu the Dynamics fetches the ET-Sep orbiter weight and OMS weight at ARD stop

4. Dynamics Fetches vector from V5
Dynamics selects the vector moved in step 1.

In addition, any special inputs for Low/High Energy, Alpha Profile, or any other special configurations are made.

5. Dynamics Initiates EDS Processing

The Dynamics now initiates EDS processing with the "Run" pulldown.

6. "EPSEND" - EPSEND processor runs

The EPSEND processor populates the TSU Entry Ephemeris and TSA EPHR ephemeris locations and creates a named TSA Ephemeris

4.2.3.1.2.2 Deorb Procedure

The Deorb is the normal usual method of generating entry data. It is based on initializing entry processing with data generated or used by the DMP for a specific deorbit solution. The first two steps of the process are concerned with running the DMP for generation of the data.

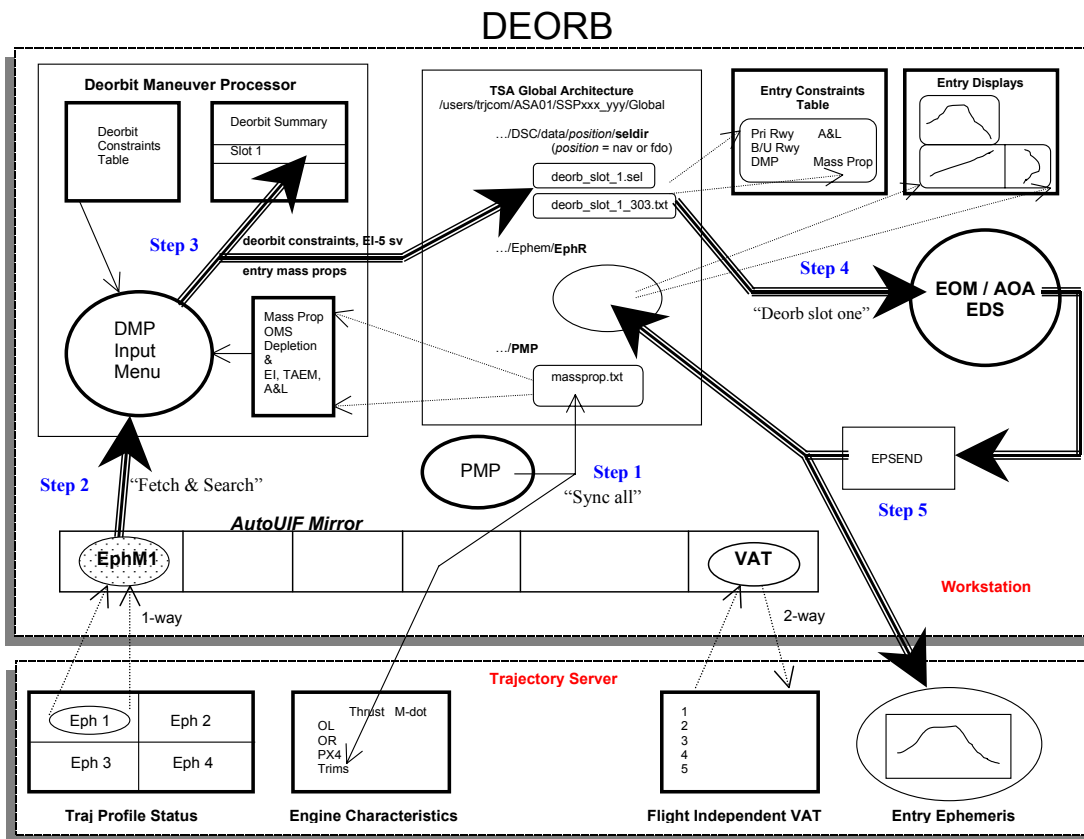

1. "Sync All" - Configure the mass properties file

The "massprop.txt" file that is generated by PMP is referenced by DMP for its processing, and is then used when generating the element that is used by EDS.

2. "Fetch and Search" - Generate a DMP solution

3. Deorbit Processing

The DMP, after coming up with a deorbit solution, creates a EDS selection file that contains the information needed to run the EDS processor. The runway, mass properties, an EI-5 state vector, Major Mode 303/304 data are all contained in this file, the contents of which can be viewed in the Entry

4. "Deorb Slot One" – Run the EDS processors

The Dynamics recalls the selections file associated with whatever slot is specified by FDO. The FDO can view these selections on the Entry Constraints Table. Dynamics then initiates EDS processing from the "Run" pull-down.

5. "EPSEND" - EPSEND processor runs

The EPSEND processor populates the TSU Entry Ephemeris and TSA EPHR ephemeris locations and creates a named TSA Ephemeris.

4.2.3.1.3 Orb Normal

The Orb Normal procedure is used for cases when an entry set needs to be generated from a re-entrant vector. This option would be used for AOA cases.

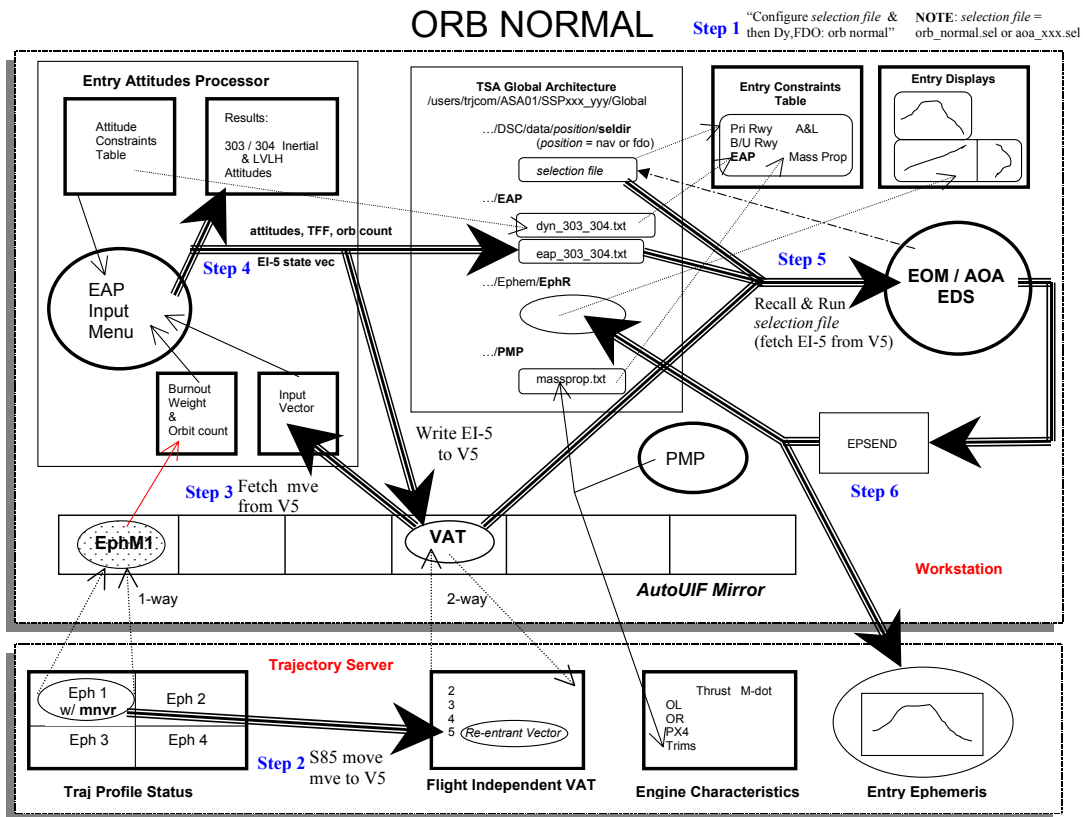

1. "Configure selection file"

Dynamics sets up the EDS Input Menu with. After recalling the "orb_normal.sel" or "aoa_XXX.sel" file the Dynamics will select the correct runway, fetch mass properties, and configure winds (if desired).

2. "S85 move MVE to V5"

Dynamics moves the burn out vector of a deorbit maneuver to V5. If it has not been done for this case, PMP should be used to configure the Massprop.txt file at this point

3. "Fetch MVE from V5"

Dynamics configures the Entry Attitudes display by fetching the Maneuver burn out vector from V5 and fetching a burnout weight and orbit count (from

ephemeris 1 at the time of the maneuver). The option exists to over ride these numbers In addition, for a pre-bank case the degree of bank would be put in at this point.

4. Run Entry Attitudes Processor

The Entry attitudes processor will propagate the vector to EI, save a EI-minus 5 state vector to Vat slot 5, and configure the EAP 303/304 files.

5. Run EDS Processor

The Dynamics then fetches the EI-5 vector stored in V5 and the EAP 303/304 files. The FDO can view these selections on the Entry Constraints Table. Dynamics then initiates EDS processing from the “Run” pulldown.

6. “ EPSEND” - EPSEND processor runs

The EPSEND processor populates the TSU Entry Ephemeris and TSA EPHR ephemeris locations and creates a named TSA Ephemeris.

4.3 MANEUVER GENERATION

This section presents standard entry phase mass properties configuration, vector update guidelines, and miscellaneous table initialization. Following these preliminary steps, deorbit maneuver planning philosophy and detailed information/procedures required to generate the deorbit maneuver are discussed.

4.3.1 *Mass Properties*

The purpose of the mass properties task for deorbit prep and entry phase operations is to compute predicted orbiter mass properties at the following points; before and after the deorbit burn, EI, TAEM, and landing. These include weight, CG's, and engine trims. The predicted weights and CG's at EI and Mach 3.5 (M3) are also of interest to the Guidance, Navigation, and Control (GNC) Flight Controller for glideslope, elevon schedule, and body bending filter selection requirements during entry.

Other interfaces for mass properties planning for EOM include the flight controller positions of Environmental and Consumables Management (EECOM), Electrical Generation and Integrated Loading (EGIL), and MMACS. These positions are responsible for providing much of the predicted consumables information required for EOM mass properties predictions.

The Close to Launch (CTL) mass properties are contained in the PROP-31 product (ARD Data). This product contains data necessary to complete the entry phase mass properties task. This data package has the official inert orbiter, consumables, and usable weights and CG values associated with the particular flight.

The Paperless Mass Properties (PMP) processor is used to generate mass properties data. Once generated, this data is used to update the Trajectory Server Engine Characteristics Table (ECT) and a file is created that is used by the DMP, EDS, and Entry Support. Refer to section 3.6 of Volume III of the FDO Console Handbook for examples of mass properties displays and related data, procedures for configuring mass properties for on-orbit operations, and for real-time ballast computation procedures.

4.3.1.1 Entry Phase Mass Properties Configuration

The DMP and EDS processors use massprop.txt file created by PMP. The DMP processor accesses the OMS Fuel Depletion Table in order to predict post D/O burn orbiter CG's. EDS interfaces with the file in order to access the EI, TAEM, and landing weights and CG's. Entry Support uses the file to manually configure DDS, in the same manner as EDS, for their evaluations. The updated Trajectory Server Engine Characteristics Table (ECT) is used for burn modeling and eventual Command Load builds (trims).

For entry, several modifications are made that are different from the on-orbit configuration. The primary difference is that the mass properties and OMS gimbal trims should reflect a burn that is being performed with the payload bay doors in the closed configuration.

The DEORBIT TARGETING CHECKLIST in Section 9 indicates six (6) items which should be verified.

- √ CUR WT: E1
- √ PRED WT: E1 → WGL @ TIG - 1HR; E2-E6 → INIT
- √ DOORS CLOSED
- √ TRIMS (DOORS CLOSED, Δ OMS = 0)
- √ massprop.txt Δ OMS = D/O PRPLT, FDUMP, USABLES, PTI'S, CG's

The Planning Team is responsible for configuring the mass properties as indicated above. The mass properties task for the Entry team is primarily that of reviewing the work completed on the planning shift, and verifying the configuration is as expected.

4.3.1.2 Postlanding Mass Properties

Postlanding, the actual vehicle weight and CG must be computed. This will reflect actual entry consumables usage. The postlanding quantities from EGIL, MMACS, EECOM, and PROP are obtained by use of PMP immediately after wheels stop.

The postlanding CG must reflect the landing gear extended. The inert orbiter postlanding weight and CG with landing gear down are found in the Abbreviated Report labeled ORB LG DWN. This line is incorporated into the mass properties and appears on the CG SUM page labeled INERT ORB (G DN).

The other deltas from nominal orbit mass properties procedures include using the correct value for pressurants (entry pressurants) and using somewhat different equations for computing the OMS XCG's. This must be done because the equations in the Mass Properties Processor for onorbit operations assume the vehicle has a +X acceleration which forces the propellant to the aft portion of the tank. However, shortly after EI, the normal acceleration (N_z) begins to build, forcing the propellant through the screen and into the forward end of the tank. This causes a significant forward shift in the OMS XCG. Reference figure 4.3-1 to see how much the forward shift can be. PMP, when configured for postlanding operations, computes the proper OMS XCG values. Refer to the POSTLANDING MASS PROPERTIES checklist in section 4.9 for complete details.

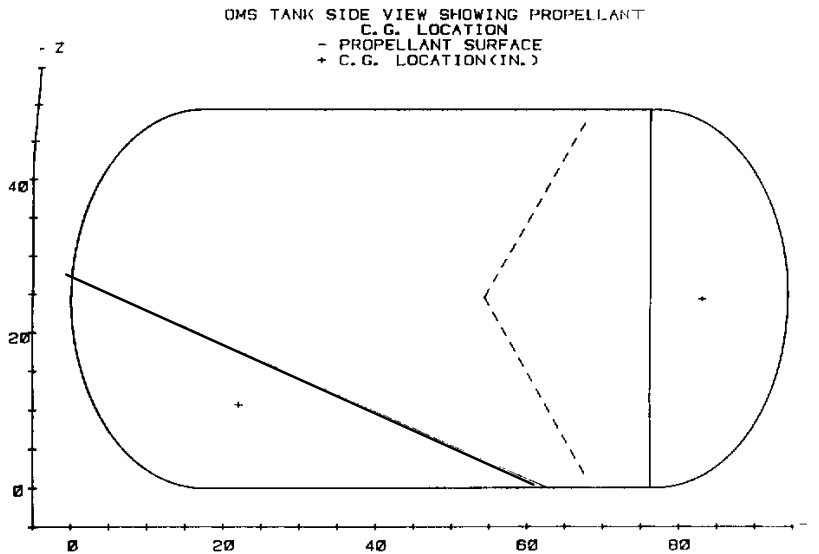

Figure 4.3-1 OMS tank CG shift.

4.3.1.3 Supporting Information for Entry Phase Mass Properties

- a. The mass property changes from the deorbit burn until landing can be thought of as several discrete events. We are most interested in the mass properties before and after the deorbit burn, Entry Interface, Mach 3, and Landing. These are obtained by accurately predicting the mass properties at the beginning of the deorbit burn, modeling the amount of propellant used for the deorbit burn, and by modeling the consumables usage (propellant and non-propellant) between deorbit and EI, EI and M3, and M3 to landing. The format of the CG SUM display for D/O and entry planning is structured to represent this profile.

Each of these segments is represented in the appropriate line on the CG SUM display. Setting up the display such that it corresponds to the profile helps to serve as a reminder of the order in which to sum the usables, dumps, and others to obtain the predictions for EOM weights and CG's. The remaining lines on the display (185-188) are used for extra events or for calculations to support planning and anomalies.

PMP uses the following equations:

- $FU\ XCG = 1380.276 + 1.8833E-2 * (FU\ WT) - 1.123E-5 * (FU\ WT)^2 + 3.8716E-9 * (FU\ WT)^3$
- $OX\ XCG = 1380.276 + 1.1443E-2 * (OX\ WT) - 4.15E-6 * (OX\ WT)^2 + 8.7E-10 * (OX\ WT)^3$

b. Dumping FRCS to zero (full dump)

There may be a requirement to perform an FRCS dump between burnout and EI due to weight or CG concerns (an FRCS dump will move the CG aft). PROP will designate the quantity of FRCS available, and the full dump quantity may be calculated by using either of the following methods:

- (1) OX/FU mixture ratio for RCS is 1.6. Take lowest quantity available and divide (using OX) or multiply (using FU) by 1.6 to obtain the OX or FU number used. This will yield the total amount of FRCS to dump to zero quantity. Use this result in the CG SUM display in the summation process for EOM weight and CG determination. Note: PMP will default to this on the OMS depletion menu.
- (2) There is 22 lb/percent of FRCS. Obtain lowest percentage of FRCS and multiply by the conversion factor to obtain pounds of FRCS to dump to zero.

c. Planning to hit a target XCG

On various flights, consideration has been given to trying to target the pre-mission CG for two reasons. First, in some cases where DTO's are being flown (e.g., aerosurface deflections or RCS jet firings) during the entry phase, they often consist of PTI's which can be combinations of ARCS or FRCS jet firings or aerosurface deflections. The purpose of the PTI's is to determine the effects on vehicle stability and control and to obtain an aero data base for the vehicle. A CG at the pre-mission number may make post-flight analysis easier. Second, keeping the CG at the same location, or close to the same location, that the Crew used for training has been considered a positive thing and used as a tie breaker. Only in these uncommon cases should one be concerned with using the CG management tools to acquire the exact targeted preplanned CG. Otherwise, nominal CG planning should be exercised to achieve the desired EOM conditions.

d. Landing weight constraints

During D/O and entry phase planning of mass properties, care should be taken to ensure that orbiter landing weight (or downweight) constraints are not exceeded unless the specified Program Office Level I or II waiver has been obtained. The Flight Director office usually obtains this waiver (if needed) prior to flight. The decision to obtain a waiver is based on preflight mass properties data and predictions. The lead FDO should brief the other FDO's about any known waivers on a flight. Inclusion of any weight or CG anomalies associated with off-nominal retained payloads is usually part of the premission analysis performed as a part of Commit to Flight.

The landing weight constraints are documented in Flight Rule A4.1.4-9.

4.3.1.4 Wraparound Digital Autopilot (Wrap DAP)

Since STS-94, a new entry DAP has been in use that dramatically reduces entry propellant usage. The major difference is seen in the EI to M3 usables. Wrap DAP flights have generally used 300-400 pounds, which equates to more than a 500 pound reduction from the baseline DAP.

4.3.1.5 Mass Properties Reference Data Chart

Table 4.3-2 is a summary of the data acquired from the an old graph that showed CG shifts as a function consumables quantity (ref. Figure 3.6.5.2-1 in Volume III). The numbers in the columns of the chart are values in terms of pounds per inch for both the X and Y CG's. To use the chart, locate the conversion number which corresponds to the orbiter weight and simply divide the off-nominal change in the consumable by this conversion number. The resulting value is the change in the X and/or Y CG. This number is then added or subtracted to the initially planned CG to yield the final location of the X and/or Y CG.

TABLE 4.3-2 MASS PROPERTIES REFERENCE DATA RULE OF THUMB CG DELTAS (LB PER IN.)

ORB WGT	----- X -----						----- Y -----	
	FRCS	OMS	ARCS	POT* H ₂ O	APU	HYD** H ₂ O	OMS	ARCS
240	-307	805	990	-404	800	882	2450	2750
235	-300	790	970	-404	783	863	2400	2700
230	-293	773	950	-388	767	845	2350	2650
225	-287	755	930	-381	750	827	2300	2600
220	-280	742	910	-373	733	808	2250	2550
215	-273	728	890	-365	713	786	2190	2490
210	-267	710	870	-358	700	772	2150	2450
205	-260	695	850	-350	683	753	2100	2400
200	-253	680	830	-342	667	735	2050	2350
195	-247	662	810	-335	650	717	2000	2300
190	-240	650	790	-327	633	698	1950	2250

*Potable (POT)

**Hydraulic (HYD)

4.3.2 Tracking Vector Update Guidelines

Ground ephemeris updates and orbiter SV uplinks are a function of mission activity, tracking, and communications capability. The last two factors are especially important during the deorbit prep time period and are greatly influenced by mission inclination.

The Navigation Controller (NAV) processes the available tracking data through the third orbit prior to deorbit to determine a preliminary SV which is used by the FDO to compute the preliminary PAD's (maneuver PAD and DEL PAD). (Note: The PAD's include the deorbit burn targets, the ΔV 's, the burn and entry attitudes, landing site info and winds/weather data) The PAD's and SV are uplinked to the orbiter on the orbit prior to deorbit (TIG - 2:00 for high inc, TIG - 1:50 for low and mid inc).

NAV processes the Tracking and Data Relay Satellite (TDRS) tracking data from this orbit plus any Pacific Ocean ground data and United States west coast data (if available and time permits) to provide a final deorbit SV to FDO in time to support an uplink during the last pass of the orbiter over the United States (east coast) or Bermuda. The uplink includes the SV and any changes to the MNVR PAD. The uplink usually goes through TDRS but the east coast stations are used as backup. The following sections provide guidelines for FDO action regarding this last uplink opportunity. (Note: Uplinking a SV to the orbiter is a Guidance and Procedures Officer (GPO) call; the FDO can only recommend one.)

4.3.2.1 General

Even with TDRSS fully operational and certified for supporting the tracking and communications requirements of the deorbit time period, the FDO should be aware of which ground sites are scheduled for EOM tracking.

Procedurally, an ephemeris update and SV uplink should be scheduled (and practiced in sims). It can be called off in real time if it is not required. It is much more difficult to add something to the standard procedures than it is to delete something from them.

4.3.2.2 Ephemeris Update

Since the ground ephemeris can be easily updated without much impact to other controllers, it should always be done if NAV has confidence in the new vector. If time is a factor, however, the following guideline should be applied.

Update if: Absolute (ABS) $(-10*(\Delta a) + \Delta v) > 3000$ ft where Δa and Δv are the semi-major axis and downtrack position differences between the latest ground solution and the current ephemeris.

4.3.2.3 Onboard Update

Uplink if: ABS $(-10*(\Delta a) + \Delta v) > 10,000$ ft

Note: See flight rule for maximum NAV error to be go-for-deorbit (20 nmi downtrack at D/O TIG).

4.3.3 Table Setup

Several tables must be configured by the FDO in order to compute an accurate deorbit and entry plan. Most of the data found in these tables are defined pre-mission (data located in the FDO Data Book) and are not normally changed throughout a mission. However, all parameters contained in the tables can be displayed and updated.

4.3.3.1 Deorbit Constraints Table

The Deorbit Constraints Table (DCT) used to initialize the DMP. Parameters that are typically changed in real-time are included on this display to allow flight controllers a convenient method to view and modify DMP input data. The DCT is generally set up pre-mission via Init Pad to reflect nominal targeting options as follows:

Column	1	2	3	4	5	6
Site	EDW	EDW	EDW	KSC	KSC	KSC
Thruster	2 OMS/1 OMS	1 OMS/1 OMS	2 OMS/1 OMS	2 OMS/1 OMS	1 OMS/1 OMS	2 OMS/1 OMS
Pre-bank	0 (ST)	0 (ST)	90 (SH)	0 (ST)	0 (ST)	90 (SH)

LOCAL	DEORBIT CONSTRAINTS TABLE						CURRENT
DEORBIT	COL 3			DEORBIT	COL 4		
TDOOR (1) 02:40 (HH:MM)	TDOOR (1) 02:40 (HH:MM)			TDOOR (1) 02:40 (HH:MM)			
THR-PR/BU (2) OBP / (3) OL	THR-PR/BU (2) OBP / (3) OL			THR-PR/BU (2) OBP / (3) OL			
TRIMS (4) SYSP	TRIMS (4) SYSP			TRIMS (4) SYSP			
PROPUSAGE (5) IPLANE	PROPUSAGE (5) IPLANE			PROPUSAGE (5) IPLANE			
GUIDMODE (6) PEG4	GUIDMODE (6) PEG4			GUIDMODE (6) PEG4			
TVROLL (7) 180	TVROLL (7) 180			TVROLL (7) 180			
C1 (8) 0 C2 (9) 0	C1 (8) 0 C2 (9) 0			C1 (8) 0 C2 (9) 0			
REI (10) 0 TFF (11) 09:00	REI (10) 0 TFF (11) 09:00			REI (10) 0 TFF (11) 09:00			
POSTBURN	POSTBURN			POSTBURN			
MM303 MM304	MM303 MM304			MM303 MM304			
DT (12) 02:00 (13) 05:00	DT (12) 02:00 (13) 05:00			DT (12) 02:00 (13) 05:00			
ALPHA (14) 40.0 (15) 40.0	ALPHA (14) 40.0 (15) 40.0			ALPHA (14) 40.0 (15) 40.0			
BETA (16) 0 (17) 0	BETA (16) 0 (17) 0			BETA (16) 0 (17) 0			
PHI (18) 0 (19) -90	PHI (18) 0 (19) -90			PHI (18) 0 (19) 0			
ENTRY	ENTRY			ENTRY			
NCYCLE (20) 8 D23C (21) 28.27	NCYCLE (20) 8 D23C (21) 28.27			NCYCLE (20) 8 D23C (21) 28.27			
ELEVON SCHEDULE (22) -3	ELEVON SCHEDULE (22) -3			ELEVON SCHEDULE (22) -3			
ATMOS (23) AT5	ATMOS (23) AT5			ATMOS (23) AT5			
VR (24) 0	VR (24) 0			VR (24) 0			
APPR	APPR			APPR			
PLSID (25) EDW22 (26) OVHD	PLSID (25) KSC15 (26) OVHD			PLSID (25) KSC15 (26) OVHD			
RLSID (27) EDW04 (28) OVHD	RLSID (27) KSC33 (28) OVHD			RLSID (27) KSC33 (28) OVHD			

Deorbit Constraint Table (DCT)

Using this display and the MED controls, the FDO can specify D/O target inputs for the DMP. Keyboard inputs are normally performed by Dynamics using the Global DCT.

DMP's Quad Option will automatically compute the C1, C2, and REI targets (items 8-10); therefore, C1, C2, and REI are usually set to zero in the DCT. Using non-zero values will bypass the Quad Option. This is sometimes required for elliptical or low altitude orbits to get the DMP to converge. The landing sites (prime and redesignation) and the atmosphere profile are configured on a case-by-case basis depending on the overall D/O plan. The following items should be checked to ensure they are correct for the desired deorbit plan:

1. TDR = Time before D/O TIG that the payload bay doors (PLBD) are to be closed. Typically 2:40.
2. THR-PRI/BU = Thrusters (primary/backup) to be used for the deorbit burn
3. TRIMS = Gimbal trim source (computed or system - defaults to system)
 - a. PROPUSAGE = Fuel usage mode (inplane, out-of-plane wasting, fuel critical)
 - b. GUIDMODE = PEG 4 or PEG 7 (PEG 4D)
 - c. ROLLTIG = Thrust vector roll at TIG (180°)
 - d. C1, C2, REI = Usually set to zero. For highly elliptical orbits, first guess values for C1, C2, and REI may be required for processor convergence in non-optimized TIG cases. Obtain first guess values from the plots in the Emergency Deorbit Checklist (section 4.9). Notice that the values are a function of inclination and the altitude at TIG.
 - e. TFF = Time of free fall from burnout (B/O) to EI in minutes (9 minutes is minimum)
 - f. ΔT MM303, MM304 = Time from B/O to MM303 (2 minutes), time from MM304 to EI (5 minutes)
 - g. ALPHA = Angle of attack (40°)
 - h. BETA = Angle of sideslip (0°)
 - i. PHI = Bank angle (entry prebank in MM304)
 - j. PLSID = Primary runway identifier (ID) and HAC. The HAC defaults to overhead.
 - k. RLSID = Redesignation runway ID and HAC. This runway is only used when a DEORB is executed. This runway is unimportant if VR = 0.
 - l. AWM = Atmospheric wind model
 - m. V1, V2, V3, Mach = Velocities and Mach number used for output when a DEORB is executed. The default values of 24K, 16K, 8K, and Mach 10 are rarely changed.
 - n. VR = Redesignation velocity. Used by the EPP (DEORB mode) to retarget from the prime runway to the redesignation runway. Defaults to zero.

4.3.3.3 Landing Site Table

The R03 MED is used to update the trajectory Server Landing Site Table (LST). The table is arranged by slots (one runway per slot) and is kept in sync with the onboard table. The Trajectory Server high speed processors rely on this synchronization for knowledge of which site Onboard Guidance is currently using (the down list indicates which slot is in use). Currently, the Trajectory Server LST has 100 slots (the onboard has 90, the additional 10 in the ground table are used by ONAV/GPO for evaluation). The GPO is responsible for LST maintenance. Copies of the O/B LST are in the Ascent and Entry Checklists. NOTE: The TSU LST does not accept landing sites with IDs that begin with the letter X.

4.3.3.4 Deorbit Targeting Constraints

Several input parameters are utilized by the DMP to assure that computed deorbit targets satisfy vehicle trajectory, thermal, and guidance constraints during entry. The parameters are determined pre-mission by Descent Flight Design for the anticipated trajectory, and published in DSCT-30. Real-time checks and updates are made by the Entry Console Officer (ECO) on the day before landing, and as required following any unexpected trajectory changes. These parameters are input into the DMP via the DCT.

NCYCLE - This is the number of guidance cycles following closed loop guidance (CLG) initiation during which a zero deg roll command is output. It is closely related to the EI flight path angle, and can be thought of as a measure of trajectory steepness. A normal entry profile has the orbiter entering the atmosphere with a slightly excessive altitude rate (H-dot). Guidance outputs a zero bank angle to keep the lift vector pointed vertically to arrest the sink rate. After a number of guidance cycles (NCYCLES), the desired altitude rate is achieved, and the orbiter begins banking towards the site to maintain the reference H-dot. Excessively low NCYCLES are undesirable since an early roll command indicates a shallow trajectory where the orbiter is not descending quickly enough, and may be in danger of phoungouding, or even skipping out of the atmosphere. Excessively large NCYCLES are also undesirable since a steep trajectory is more expensive ΔV -wise, and leads to slightly higher surface temperature and pullout loads.

DSCT-30 specifies the NCYCLE to use in deorbit targeting for various trajectory scenarios and landing sites (e.g. nominal EOM to KSC, FD1 PLS to EDW, etc). NCYCLES in DSCT-30 provide 3σ protection against having a roll command greater than 25 deg on the first guidance cycle following CLG init (referred to as "3-sigma NCYCLE"). Effects of $\pm 3\sigma$ atmospheric dispersions are RSSed with a term that accounts for the effects of alpha deadbanding (± 1 deg) to arrive at the desired NCYCLE. DFD selects the desired NCYCLE considering inclination, month, and approach direction. Reduced NCYCLES may be used if insufficient ΔV is available, but this is a much lower priority than other options, such as performing an orbit adjust burn with the FRCS, targeting shallow, etc. An

NCYCLE of 2 provides 3σ protection against skipout, which is defined as roll command 60 deg or greater during the first guidance cycle after CLG init. This is referred to as the “Minimum NCYCLE”. The resultant entry profile is thermally more severe and converges to the reference drag profile later. See “Insufficient Propellant Procedure” in section 4.9.6 Deorbit Targeting Checklist, and also FR A4-152.

D23C - This is the targeted drag acceleration at velocity VB1 (17,000 fps). It is used to “anchor” the reference drag profile within the Drag-Vrel constraints corridor. A higher D23C causes a higher Dref profile and leads to a shorter range capability, along with increased surface temperatures. A lower D23C causes a lower Dref profile and longer range, resulting in higher backface (structural) temperatures. The D23C “sweet spot” is defined by the Thermal Tradeoff Line (TTOL) that properly balances surface vs backface temperatures. This curve is based on CP5 (chine) surface temp versus Panel 2 backface temp (see Figure TBD). DFD’s “D23 scanner” is used to iterate on D23C such that the resultant entry profile is within 1 deg of the TTOL. The inputs to this program are post-deorbit burn Ha, inclination, approach direction and crossrange, vehicle mass props, and landing month. Targeting the TTOL provides the most thermal margin in the presence of flight path angle and range dispersions.

THERMAL TRADE-OFF LINE

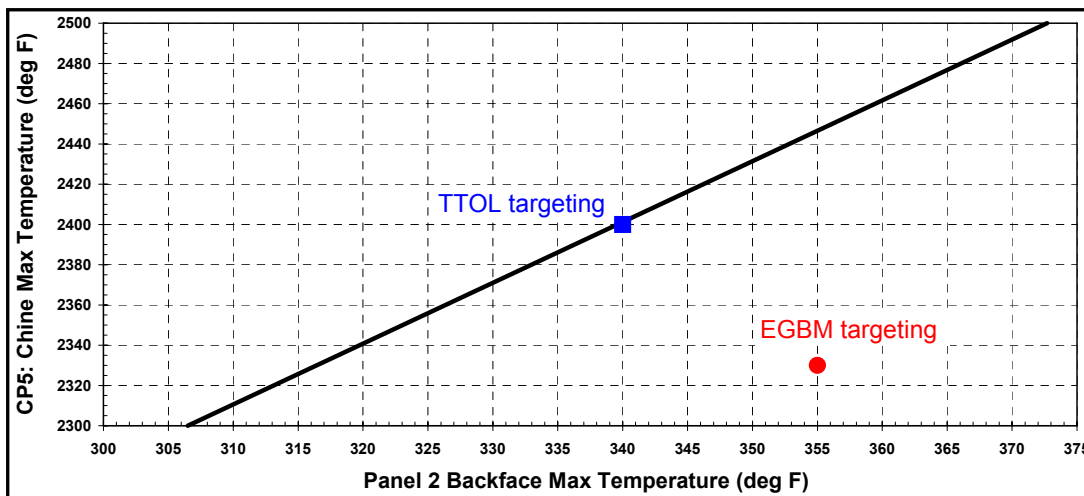

Thermal Tradeoff Line

FDO and ESE must verify that the DMP deorbit solution indeed satisfies these targeting parameters. This is done by running an EDS simulation and checking output on the Entry Digitals display. EDS-predicted NCYCLES should be equal to the value input on the DCT (NCYCLES+1 is also acceptable). Degrees off the thermal trade line is shown as Δ TTL (up to 5 deg is acceptable). D23C can be graphically checked on the Drag vs Vrel plot. Maximum WLE temperature (CP3) should also be below 2950 deg (100 mission re-use maximum). The single-use contingency limit is 3120 deg, or 3220 deg with less than 40 sec above 3120

deg. The 100 mission re-use temperature limit should be exceeded only in a contingency scenario, such as recovery pre-bank. Be aware that EDS results do not account for potential dispersions. Atmosphere, nav, and other uncertainties could potentially add about 100 deg to CP3 for a 3σ dispersed EOM entry. Vehicle weight is another big driver to entry thermal conditions. The EOM landing weight limit in the flight rules is based, in part, on backface thermal concerns. For landings above the certified weight limit, 6-DOF Shuttle Trajectory Analysis and Mission Planning System (STAMPS) and Thermal Structural Envelope Program (TSEP) simulations will be required to accurately predict thermal results. DDS provides a thermal summary for the entry, including surface temperatures for several body locations, plus Panel 2 backface temperature and total heat load for a measure of structural temperatures. However, STAMPS/TSEP results are more accurate, and should be checked anytime thermal concerns exist.

Although the TTOL method is normally used for deorbit targeting, another technique is certified for shuttle operations. Equilibrium Glide Boundary Margin (EGBM) method provides a lower drag profile that results in slightly lower surface temps. This technique targets a minimum margin between the planned trajectory and the equilibrium glide boundary on the Drag vs Vrel plot (see Figure TBD). The minimum margin used for generic dispersion protection is 2 fps/s. This results in lower vehicle deceleration, longer range at entry interface to the landing site, and thus higher heat load. EGBM targeting can be employed for deorbit targeting simply by having ECO change the methodology used to select D23C.

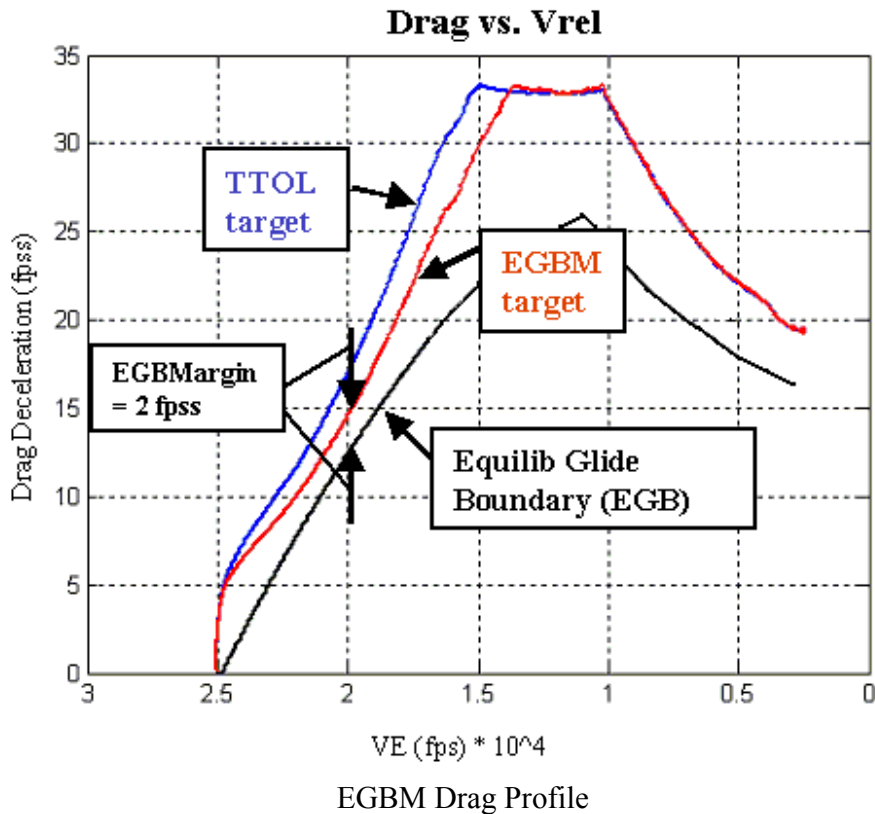

4.3.3.5 Atmosphere Tables

The DMP utilizes one of seven atmosphere profiles in evaluating the atmospheric effects on the predicted orbiter entry. Multiple atmospheres are required to provide accurate orbiter D/O targeting and entry profile evaluation for available flight inclinations, seasonal effects, and landing sites. The selection of an inappropriate atmosphere in D/O processing may result in inaccurate D/O delta velocity predictions on the order of tens of feet per second. Any of the nine atmospheres are available for use by the DMP. The nine profiles will contain altitude-related atmospheric conditions (pressure, density, temperature, wind speed, and direction) ranging from 0 to approximately 123 km. The step sizes of this data will vary from 1-km increments in the 0- to 20-km range to 2-km increments in the 20- to 123-km range. The lower (0-20 km) wind data comprises the Entry Winds Table.

The names of the seven atmospheres and the criteria for the selection of the profile will be found in the matrix below (table 4.3-3). Use table 4.3-4 for a landing at a Southern hemisphere ELS. The matrix will require the following inputs in order to correctly identify the table:

- a. Hemisphere of the landing site (Northern or Southern)
- b. Inclination

- c. Season or Month
- d. Approach (ascending or descending).

TABLE 4.3-3 ATMOSPHERE SELECTION FOR **NORTHERN HEMISPHERE** LANDINGS

Atmosphere ID, name	Inclination	Season	Approaches
AT1, 62 STANDARD	All	All year	All
AT2, KSC39A-NOV	20 to ≤ 40	All year	Ascending
AT3, EDW39D-DEC	20 to ≤ 40	Oct - Feb	Descending
AT4, KSC39D-MAR	20 to ≤ 40	Mar - Sep	Descending
AT5, KSC57A-JUN	>40 to 57	All year	Ascending
AT6, KSC57D-DEC	>40 to 57	Oct - Mar	Descending
AT7, KSC57D-SEP	>40 to 57	Apr - Sep	Descending
AT8, 62 STANDARD	All	All year	All
AT9, 62 STANDARD	All	All year	All

TABLE 4.3-4 ATMOSPHERE SELECTION FOR **SOUTHERN HEMISPHERE** LANDINGS

Atmosphere ID, name	Inclination	Season	Approaches
AT2, KSC39A-NOV	20 to ≤ 40	All year	Descending
AT3, EDW39D-DEC	20 to ≤ 40	Mar - Sep	Ascending
AT4, KSC39D-MAR	20 to ≤ 40	Oct - Feb	Ascending
AT5, KSC57A-JUN	>40 to 57	All year	Descending
AT6, KSC57D-DEC	>40 to 57	Apr - Sep	Ascending
AT7, KSC57D-SEP	>40 to 57	Oct - Mar	Ascending

4.3.3.6 Miscellaneous Tables

The following tables support the DMP/EPP:

PLBD Status (see vol. III, FDOCH) shows the status of the PLBD (i.e., open or closed at various times). The P41 MED controls the data in this table. This table is referenced whenever variable area drag is used to integrate vectors (e.g., A selected as part of an ephemeris integration option). Depending on door status, different sets of area coefficients will be used in the drag acceleration computation during free-flight propagation. Updates to this table are only incorporated into the vehicle ephemeris when an ephemeris update is performed. The PLBD is typically closed 2.75 hr prior to D/O TIG. The mechanical, maintenance, arm, and crew systems (MMACS) position is responsible for orbiter PLBD operations.

Attitude Timeline (see vol. III, FDOCH) – The ATL displays the sequence of vehicle attitudes planned and executed in the mission. These attitudes are used in free-flight propagation to determine drag frontal area for integration and vehicle orientation for vent (VTL/RVTL) events. All updates to the ATL are handled by the POINTING controller and/or the DYN controller for some sims. NAV updates the VTL and RVTL.

The ATL is updated via MED in order to reflect the deorbit burn attitude specified in the DMT or DOD of the deorbit burn. MM 303/304 attitudes not incorporated into the ATL, since there is no discernable accuracy gain to the ephemeris in doing so.

Vent Timeline (see vol. III, FDOCH) – The VTL contains the timeline of orbiter vent used in the free-flight integrator to compute applied forces resulting from systems vents and RCS attitude control maneuvers. The NAV position controls the VTL via the P42/43/44 MED's.

The VTL contains up to 200 orbiter vent events from mission start to just prior to EI. The VTL access the Vent Initialization Table to pick up the force components (in body coordinates) for the vent selected. The VTL is time referenced to Greenwich mean time (GMT)/phase elapsed time (PET. Typical vents in the D/O-entry timeframe are auxiliary power unit (APU) vent events. However, due to the short timeframe that the APU vents are active prior to EI these vents are no longer modeled (negligible effect VTL updates require an EPH TUP in order to be incorporated for DMP/EPP processing.

MISC Table dependencies - The vehicle ephemeris may be accessed by the DMP or EDS. The FDO must configure all miscellaneous EPH support tables for the planned deorbit (ref. vol. III of FDOCH, sec. 3.3, Ephemeris Maintenance, Orbit).

4.3.4 Maneuver Objectives

Several variables and constraints enter into the planning of the deorbit maneuver. One must consider meet entry thermal and load constraints, optimization of the burn for the propellant available, control of the orbiter CG, and engine downmode protection.

The deorbit maneuver is normally planned as a 2 OMS engine burn using PEG 4 guidance (closed loop, targeted burn guidance). The maneuver is executed in MM302. The deorbit burn can also be targeted to use 1 OMS engine or 4 AFT RCS jets. The capability exists in the O/B software to downmode engines (from 2 OMS to 1 OMS, from 1 OMS to RCS, and from 2 OMS to 1 OMS to RCS) to complete the maneuver if engine failures occur during the burn. The ground deorbit burn processor, however, is not able to downmode engines; it must use the same engine configuration for the entire burn.

The TIG is selected so that if one of the OMS engines fails at TIG (or at any time after ignition) the deorbit maneuver can be successfully completed using the remaining OMS engine. If sufficient propellant is available and other constraints are met, TIG may be backed up earlier by choosing a TIG 1 min before the 1 OMS optimum TIG. The deorbit maneuver may include an OOP component (a propellant wasting burn) in order to achieve an acceptable CG, weight, cross range condition, or some combination of all three at landing.

4.3.5 Maneuver Generation Guidelines and Rules

The purpose of this section is to define the constraints and rules that influence the deorbit targeting process. The overall aim in deorbit targeting is to balance the benefits of engine and OMS tank failure protection with the resulting effects on the CG, landing weight, and the burn propellant requirements.

4.3.5.1 Deorbit Targeting Priorities

The deorbit targeting and CG management flight rules (A4-152 and A4-153, respectively) document the constraints used in the deorbit targeting process. These are factored into the DEORBIT TARGETING CHECKLIST. These priorities influence the final TIG selection.

4.3.5.2 Other Constraints Affecting Deorbit Targeting

a. Deorbit propellant vs. time

Since each of the OMS engines has essentially the same Isp and mixture ratio (MR), the optimal propellant quantity required for deorbit is approximately equal for either engine configuration. However, since the burn arc and time are twice as long for a one-OMS engine burn as for a two-OMS engine burn, the optimal (least propellant) TIG is later for two-OMS engine burns. (The optimum impulsive TIG is fixed. The finite burn arc computation would produce a later TIG for two-OMS than one-OMS.) For TIG's earlier or later than the optimum, the propellant requirement increases. The PEG 4 deorbit guidance has closed loop logic that targets for an EI condition at a given range from the site. Therefore, non-optimal TIG's will generally result in the burn having a larger radial component. See figure 4.3-2 for an example of the deorbit propellant versus time plots. This shows that 2 OMS optimum TIG typically around 2 minutes later than the 1 OMS optimum. It also shows that the PX4 optimum is typically over two minutes earlier than the 2 OMS/1 OMS cross over point.

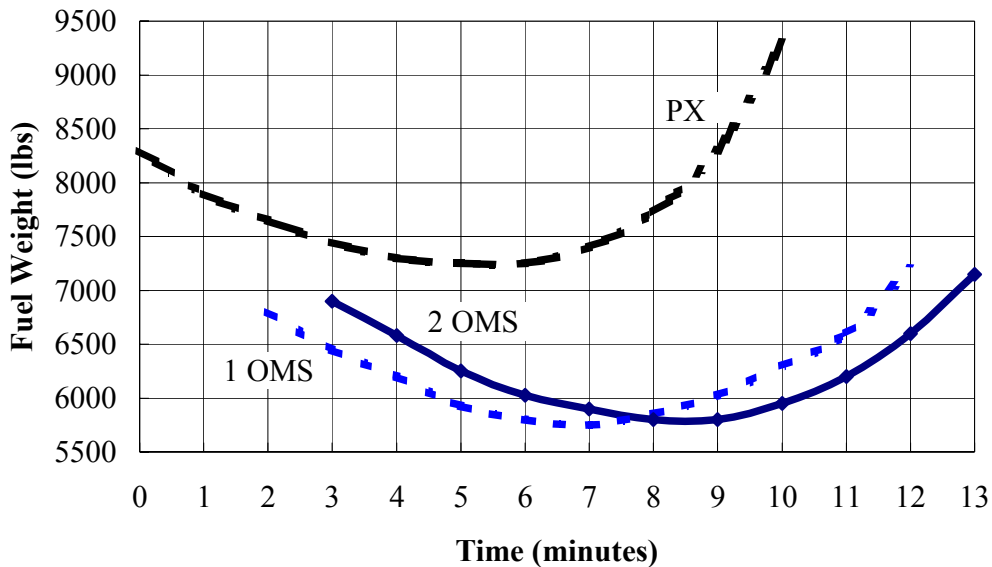

Figure 4.3-2 Deorbit PROP vs. time curves

b. Downmoding

To protect against an OMS engine failure or other problem that prevents an on-time burn, it is desirable to make the TIG early enough to allow at least 5 minutes of TIG delay and still meet the targets with one OMS engine. Five minutes is considered to be a maximum reasonable length of time to attempt to start the burn. Trying to determine TIG slips greater than 5 minutes has caused DMP convergence problems. Providing 5 minutes of downmoding time from 2 OMS to 1 OMS is generally achieved if TIG is at or before the 1 OMS optimum point minus 1 minute. However, the exact downmoding time to 1 OMS is a function of the OMS propellant available. While in the past it was desirable to provide double downmoding capability (i.e., from 2 OMS to 1 OMS to ARCS), this is no longer protected, partially because in trying to protect this (by targeting at the ARCS OPT – 1 min), we did not protect ARCS completion at safe HP.

c. Contingency Protection

Two other downmode options need to be considered for nominal operations; OMS Tank Fail (evaluated with STCOMP) and ARCS Completion at Safe HP (see procedure in sec 4.7.1.2). Check the OMS Tank Fail numbers early in the targeting procedure because this is usually the constraining case if you are targeting at the 1 OMS OPT – 1 minute point.

d. Out Of Plane Deorbit Burns

If the deorbit targeting constraints allow or dictate using more propellant than that required at 1 minute prior to the 1 OMS optimum TIG, then an OOP burn will be targeted. Two minutes prior to the 1 OMS optimum TIG is the limit for backing up the burn in-plane. The primary reasons for backing up the burn are: (1) to provide TIG slip capability at TIG, and (2) to use more OMS propellant. At 1 minute prior to the 1 OMS optimum point, there usually exists at least 5 minutes of TIG slip capability to the 1 OMS thruster. This is adequate time. Backing up the TIG further in-plane than 1 OMS optimum TIG minus 2 minutes will continue to increase the propellant required for deorbit using one or two OMS engines. This increase in single OMS requirement for deorbit adversely affects the tank failure completion capability. This increase in the single OMS ΔV requirement causes the tank fail Hp's to decrease; i.e., more of the burn must be executed on two OMS engines/tanks before completion is possible with an OMS tank failure. Therefore, an OOP burn will be targeted if more OMS propellant must be used than can be burned at the 1 OMS optimum minus 2 minutes in-plane TIG. The OOP burn may use the 1 OMS optimum minus 1 minute as the TIG. In practice, if any OOP burn is likely, the TIG is initially set to 1 OMS optimum minus 1 minute. Then the deorbit targeting priorities are reviewed/checked to verify that the mandatory steps are satisfied and the TIG is adjusted if required.

Note: Do not burn OOP if the amount being wasted is less than 250 lb. Doing so may produce attitude direction indicator (ADI) yaw errors onboard during the first part of the burn. The desired thrust direction (LAMC) may be based on an unconverged guidance solution. The Trans DAP uses this thrust direction to determine the desired pre-burn attitude. LAMC also drives the ADI attitude errors. The velocity-to-be-gained vector, VGO, that is sent to the Deorb Mnvr DIP, however, is based on the final converged solution. The net effect is that the yaw component of VGO on the Deorb Mnvr DIP will be excessive and erratic between T_G-15 sec and TIG, and the ADI Yaw attitude error needle may peg at ignition.

In summary, this section has discussed many constraints and rules that influence the deorbit targeting process. The overall aim in deorbit targeting is to balance the benefits of engine and OMS tank failure protection with the resulting effects on the CG, landing weight, and the burn propellant requirements. However, in situations when all of the desired criteria cannot be satisfied, priorities must be applied and compromises accepted as defined in the deorbit targeting and CG management priorities flight rules.

4.3.6 Maneuver Generation and Evaluation

The maneuver generation process is simply a matter of reviewing the tables for proper configuration and establishing a TIG for the selected landing site. For EOM, the DCT is usually configured with 2 OMS/1 OMS in column 1, 1OL/1OL in column 2, and 2 OMS/1 OMS shallow in column 3. The primary runway should be selected for the landing site. The first activity is to determine the optimum deorbit ΔV requirements for steep and shallow targets. The propellant required to deorbit is passed to PROP and is used to determine the preliminary deorbit mass properties and CG. PROP will provide a PROP TO FDO form, which details the RCS and OMS quantities available for use in the deorbit maneuver. This is now obtained using Netscape under the SHUTTLE/PROP menu. The OMS on the PROP TO FDO form is all the propellant in the tanks. We typically only burn the OMS propellant down to approximately 5 or 6 percent remaining. However, we will burn down to zero usable if required to satisfy the ΔV required for steep targets.

Using the correct elevon schedule is important for the entry trajectory. There are two elevon schedules onboard. They are the AUTO and ALTERNATE schedules. For most cases, the AUTO schedule will be selected.

4.3.6.1 Nominal Procedures

The second activity in maneuver generation is the selection of the TIG, which is a function of propellant required/available and thruster selection. The preferred option is 2 OMS because this allows a downmode capability to 1 OMS and/or RCS. The following procedure describes normal TIG selection and burn targeting.

- a. Configure the ephemeris using the most current SV and weights for the vehicle, OMS, and RCS. To run a deorbit solution, the FDO must fetch a vector from the ephemeris and begin a search for the TIG. This is called fetch and search. Normally, the fetch-and-search time is 30 to 45 minutes prior to the estimated TIG listed in the Deorbit Opportunities Table (DOT).
- b. Run DMP TIG free (all 3 columns). This will compute the 2 OMS/1 OMS crossover point TIG and ΔV for steep and shallow as well as the 1 OMS optimum TIG and ΔV .
- c. Run 2 OMS/1 OMS TIG fixed at the 1 OMS optimum TIG minus 1 minute . This solution will be the targeted deorbit TIG and ΔV if there is enough OMS propellant available. If the ΔV required is greater than the ΔV available, the TIG will have to be later. Iterate with TIG-fixed mode until ΔV required = (ΔV available - 3). The 3 fps is a bias to account for possible ΔV increase with a later state vector update. Once this step has been completed, the solution will provide the preliminary TIG

- d. Determine 1 OMS TIG slip capability. This is done by holding the targets from the solution in step c, overriding the thruster to 1 OMS and using a TIG fixed at the targeted TIG plus X minutes. Initially, X is set to 5 minutes. If the ΔV required with the 5 minutes of TIG slip is greater than the ΔV available (provided by PROP), then decrement the X until the ΔV required = ΔV available. This TIG represents the maximum TIG slip allowed with the available propellant. TIG slips longer than 5 minutes may cause problems with PEG convergence. Therefore, five minutes is the maximum one OMS TIG slip used.

Note: The crew **must not** input a new TIG if TIG slips. Changing TIG on a PEG 4D burn changes the reference for θT .

- e. OMS Tank Fail and RCS Completion capability need to be checked. Refer to the checklists for details on how to compute these numbers. If either are less than 80 nmi, the TIG or OOP may need to be changed.

At the completion of targeting, the PROP Officer will need several ΔV 's so that a determination can be made if the desired burn can be supported with the available PROP, and that the desired contingency downmodes can be supported. These ΔV 's include:

- ΔV of targeted burn
- steep and shallow ΔV 's for selected deorbit opportunity
- ΔV to Safe HP, then ΔV to Target HP based on PX4 thrusters (RCS Completion procedures)
- TIG Slip ΔV 's

4.3.6.2 Maneuver Evaluation

Evaluation of the maneuver can be accomplished by reviewing the DMDT data on the Deorbit Summary Table and on DOD. The maneuver can also be displayed on one of the Detailed Maneuver Tables (DMT's) after it has been transferred to the ephemeris. Exact evaluation of the maneuver will depend on the circumstances of the maneuver, but in general the key items are ΔV , TIG, attitude, C1, C2, V_{EI} , γ_{EI} , R_{EI} and PRPLT. The Trajectory Server values can be compared to the Descent Flight Design (DFD) computed values as a cross-check. The DFD values can be found in the product DSCT 13.

CAUTION

PEG4D GUIDANCE CODE IN TSA IS NOT PRIME IMPLEMENTATION. DO NOT USE TSA EPH TO EVALUATE DEORBIT TARGETS. USE TRS EPH ONLY.

4.3.6.3 Entry Profile Generation

Normally, entry profile generation will consist of the Dynamics executing EDS. FDO should check the ATL, ECT, and mass properties to ensure they are properly configured. Mass properties must have the massprop.txt file correct to complete EDS operations. To run the DORB requires referencing the DMDT slot with the deorbit maneuver. After evaluating the resulting entry profile, the FDO can transfer the maneuver to the prime ephemeris and display it in the DMT. POINTING, in the Flight Activities Officer (FAO) Multi Purpose Support Room (MPSR), will take the burn attitude from the DMT attitudes from the DOD and update the ATL. MM303/304 attitudes are not used in the ATL, because doing so would make the process more cumbersome and complicated and with a negligible accuracy increase. Dynamics will TUP the ephemeris with the new ATL. This ATL update will properly configure the various TSU orbit ephemerides for acquisition processing.

This step will generate the final nominal lines, entry profile, and EPSAT. Evaluation of the profile is accomplished with Entry Digitals and Drag vs. Ve displays. The entry profile generation process is simple, but the FDO must take great care to configure the tables accessed during the EDS operation. Experience will help the FDO develop the capability to spot the numerous subtle variations and problems, which occur in the deorbit and entry generation process.

4.4 SITE/RUNWAY SELECTION

The FDO must make an evaluation of the orbiter entry profile that results from the planned deorbit burn. This evaluation includes an assessment of the ranging potential (which is of most concern in the TAEM and Autoland guidance phases). During these phases, off-nominal crew procedures may be required to compensate for energy dispersions and guidance system limitations. Examples of off-nominal procedures include runway redesignation, STIN approaches, and selection of the close-in aimpoint or Short Field (SF) speedbrake logic.

The onboard TAEM and Autoland guidance systems have no knowledge of the current winds affecting the trajectory. Consequently, these systems will not maintain an energy reserve to compensate for wind profile variations, shears, or turbulence. The FDO must incorporate the best known winds and atmospheric data into the evaluation process. The results may dictate nonstandard crew procedures.

The following sections address the sources and processing of wind data, the timeline of expected events, and methods of evaluating the entry trajectory.

4.4.1 *Systems Available for Wind Data Measurements*

There are two types of wind measurement systems: balloon tracking systems and wind profile radar.

a. Balloon tracking systems

Monitoring of winds and atmospheric activity with the use of various balloon tracking systems has been available and in use for many years. Balloon tracking is the method currently used to monitor winds and on which to base wind-related decisions for both ascent and entry flight phases.

The various balloon tracking systems available can be categorized according to the tracking technique (radar vs. transponder vs. optical) used. Table 4.4-1 summarizes the various balloon tracking systems currently used. Included are the instrument type identifications, altitude range/resolution capabilities, and the wind vector accuracy's. As shown in the table, the Jimsphere balloon using ground radar tracking represents the most accurate balloon tracking technique available for measuring upper level winds. The Jimsphere balloon is a 2-meter(m) (diameter) aluminized mylar sphere which is equipped with a pressure release system for maintaining a constant rise rate (~250 m/min). Jimspheres can be tracked to altitudes as high as 18 km. The accurately controlled rise rate, coupled with ground radar capabilities, result in wind measurement accuracy's of 0.5 m/sec with 30-m altitude resolution. The Jimsphere is used primarily as a prelaunch wind measuring tool where both altitude resolution and wind vector accuracy's are critical. The high resolution and accurate wind measurements are

essential for detecting any wind shears that may be present during the high dynamic pressure flight phase.

The second balloon tracking technique makes use of a meteorological sounding system (MSS) and a transponder (transmitter/receiver) package. The MSS windsonde system consists of a dual frequency transmitter/ receiver package suspended below a 2-m (diameter) neoprene balloon. The MSS ground system processes the transmitted and returned signals from the balloon to yield a measure of the winds. Windsonde tracking will give wind measurement accuracy's of 0.7 m/sec to altitudes of 25 km at 90-m resolution. The windsonde balloons are released during the prelaunch activities and used as a backup to the Jimsphere should a radar system or Jimsphere balloon failure occur. Windsondes are also used late in the prelaunch count (L - 2 hr to L + 15 minutes) when the range radar system has been reconfigured for launch and is no longer available for Jimsphere tracking.

The MSS rawinsonde employs the same ground support system as the MSS windsonde. However, due to the heavier transponder package carried for measuring temperature and relative humidity, a heavier lift balloon (3 m) is required. The temperature and relative humidity are used for calculating pressure and density. Rawinsonde balloons produce wind measurement accuracy's of 0.8 m/sec to altitudes of 30 km with 600 m resolution. The reduction in wind measurement accuracy and resolution over the windsonde is attributed to the reduced tracking response of the heavier transponder package and the extra time required for processing the temperature and relative humidity measurements. The rawinsonde balloons are used during the prelaunch phase as a source of atmospheric data (temperature, pressure, and others). Rawinsonde wind measurements are also used to supplement existing Jimsphere/windsonde data bases. During the on-orbit and near EOM phases, the rawinsonde balloons provide the only source of upper level winds and atmospheric data for entry planning purposes.

The third balloon tracking technique involves the use of a theodolite (optical) system. As shown in table 4.4-1, the use of the double theodolite system can yield wind measurement accuracy's of 1.0 m/sec at 60-m altitude resolution. However, altitude restrictions (due to visibility), coupled with the mechanics of collecting data, prevent using this technique during real-time support.

TABLE 4.4-1 BALLOON TRACKING SYSTEM SUMMARY

Instrument Type	Altitude/Resolution	Climb rate	Error estimate
Jimsphere with FPS-16 radar	0-18 km (59k ft)/30 m (100 ft)	0.5 m/sec (0.97 kt)	+1.0% vector 1 Knot accuracy
MSS windsonde w/transponder	0-25 km (82k ft)/90 m (300 ft)	0.7 m/sec (1.36 kt)	+1.0% vector 1.4 Knot accuracy
MSS rawindsonde w/radiosonde	0-30 km (98k ft)/600 m (2000 ft)	0.8 m/sec (1.55 kt)	+1.5% vector 1.6 Knot accuracy
Pilot balloon (pibal) double theodolite	0-4 km (13k ft)/60 m (200 ft)	1.0 m/sec (1.94 kt)	+3.0% vector 1.9 Knot accuracy
Pilot balloon (pibal) single theodolite	0-10 km (33k ft)/60 m	3.0 m/sec (5.82 kt)	+6.0% vector

b. Wind profile radar

The wind profile radar systems (wind profilers) operate on the Doppler principle. However, instead of using sound energy, the wind profilers operate using much higher frequency (50-400 MHz) radio waves to measure atmospheric activity. The transmitted radio waves bounce off the layers of the atmosphere and return to a large matrix (50 by 50 m) of antennae located on the ground. The returned signals are processed to yield vertical/horizontal wind components. Wind measurement accuracy's for the wind profilers are comparable to the sounder systems (<0.5 m/sec). Systems currently in use operate in the 80-200k watt (peak power) range and are capable of measuring winds from near the surface (~150 m) to 16-18 km. Altitude resolutions of 45 m at the surface to 300 m at 18 km are possible. Altitude resolutions and antennae grid sizes required for these systems are dictated by the operating power and frequencies selected.

c. Balloon and weather briefing timeline

The WINDS position is responsible for scheduling, tabulating, and distributing balloon data. The period of entry support is generally from the TD - 11 hr balloon release to TD + 1 hr. Balloon releases are coordinated and confirmed by WINDS.

Table 4.4-2 is an example of a typical balloon and weather briefing timeline used to support landing.

Table 4.4-2 Typical KSC landing balloon schedule

Balloon Type	Release Time TD + / -	Data In Time TD + / -	Max Altitude (KFT)
RAW	TD-13:00	TD-9:15	80
RAW	TD-6:30	TD-4:45	80
RAW	TD-4:30 *	TD-2:45	80
RAW	TD-2:30	TD-2:00	20
RAW	TD-1:00	TD-0:45	10
RAW	TD+0:00	TD+2:30	100

* Partial run (10 or 20 K ft) Transmitted to the MCC for A&L assessment, followed by a complete set

Table 4.4-3 Typical EDW landing balloon schedule

Balloon Type	Release Time TD + / -	Data In Time TD + / -	Max Altitude (KFT)
RAT	TD-13:00	TD-9:15	80
RAT	TD-6:30	TD-4:45	80
RAT	TD-4:30	TD-2:45	80
RAT	TD-2:30	TD-2:00	20
RAT	TD-1:00	TD-0:45	10
RAT	TD+0:00	TD+2:30	100

From the time of balloon release to reception, processing, and implementation of updates to programs used in the MPSR to determine landing performance, about 3 to 3 1/2 hr is usually required for the higher altitude balloons to 30 to 45 minutes for the low altitude balloons.

The ascent rate for the balloons averages about 1 minute for every 1000 ft. Therefore, the balloon release schedule is a function of the time to rise through the altitudes of interest and the time required to process the data and transmit back to the WINDS console. If the winds are high, the balloon drift rate is excessive, resulting in less accurate data measurements due to the elevation angle from the tracking site. In addition, the winds being measured at upper altitudes may not be representative of the landing site. Data is lost whenever the electronics package faults or the balloon explodes.

The TD - 6.5 hr balloon may be tracked to 100,000 ft, which requires about 1.5 hr ascent time. The time required for data processing and for data transmission is about 25 minutes. Usually this balloon is tracked to 80,000 ft because the tracking site radar must be released to track the TD - 4.5 hr balloon. The TD - 4.5 hr release is similarly observed to about 22,000 ft, the TD - 2.5 hr balloon is

released, and so forth, through landing. Depending on the late hour of the MCC shift schedule time of landing, the data from the TD + 0 minutes release may not be accessed by the WINDS console operators until the following day.

As winds data arrive in Building 30, a file is created by SMG, which also contains atmospheric density profiles. In addition, files representing the SMG upper level forecasts are created. These files are then sent to the MCC and are then used by DDS (EDS or LATX) and STAMPS for analysis. Normally, the Dynamics should use the latest forecast file for EDS evaluations, while Entry Support will run LAX on both the forecast and balloon files to generate their trends charts.

4.4.2 Entry and Touchdown Evaluation

The processors used for evaluation of entry through landing are the DDS (controlled by LAX or EDS), the ALP, and stamps. In addition, the SMS is available to evaluate the effects of crew inputs. While the Entry FDO is not required to run these himself, the tools are available along with support personnel to assist the FDO in the evaluation. Each one of these processors is covered in a section below. First, we should cover how the target runway is selected.

a. Landing Site Selection

The targeted landing site and runway is selected by reviewing the runway priorities, runway status, actual and forecast winds and weather, and landing analyses. The runway priorities for a flight will be the generic priorities developed over the years unless a specific test (e.g., crosswind or braking DTO's) or the landing weight and XCG combination requires a change.

In general the priority will be to land at KSC thereby minimizing turn around costs and schedule impacts associated with flying the orbiter back from western sites

b. Runway Selection

There are several factors that must be considered for determining the prime runway once the prime site is selected. These include avoiding sun angle violations, avoiding sun glare, avoiding large HAC's (> 300° turns), avoiding large speedbrakes if possible and choosing the runway that will result in a left turn.

Keep in mind that the intent of these procedures is to give the crew the "best", or most benign, landing conditions if all Flight Rule requirements are satisfied for more than one runway. What constitutes the "best" landing condition can be a fairly subjective call, can be strongly influenced by crew preferences on specific flights, and has a tendency to go through cycles over time. Some things that could play into this list, such as the desire to land into a headwind, are not explicitly listed because they are "built in" to various Flight Rules. The bottom

line is the the FDO will be called on to make a recommendation taking all of these considerations into account.

Currently, the priorities, in descending order, for runway selection are:

1. Avoid sun glare
2. Avoid large HAC's
3. Avoid large speedbrakes (below 3K)
4. Left turn on HAC

For a runway to be GO, flight rule A4.1.4-5, Sun Angle Limits and Glare Criteria for Inner and Outer Glide Slopes, requires the Sun on final approach to be outside a "box" which is $<10^\circ$ in azimuth from centerline and from 0 to 20° in elevation. This restriction prevents direct sunlight from obscuring the crew's vision on final approach. Sun angle violations are computed by the DOPS, and a copy is kept on console in the FDO Data Book. Sun angle violations at EDW are generally only a problem on runways 04 and 05 for early morning landings in the summer and on runways 22 and 23 for late afternoon landings in the winter. At Northrop, the same applies for runways 23 and 05. KSC never has Sun angle violation problems.

A related phenomenon, which could also obscure the crew's view of the runway and visual landing aids on final approach, is called Sun "flare". However, it is commonly referred to as sun "glare". Sun glare appears as diffusely scattered light across the orbiter windows if the windows are dirty and sunlight strikes them at an angle. The worst glare occurs when the Sun is at an angle of 40° from the normal to the window and is less severe for angles greater than or less than that. For analysis purposes, the glare zone is defined as the angular Region between 30° and 50° from the window's normal. Any runway at any site is subject to Sun glare. Note, however, for sky conditions of broken to overcast, glare may not be a factor.

Glare was examined in some detail for the Ascent/Entry Flight Techniques Panel, and crewmembers were interviewed to determine whether or not glare has been a problem in the past. Although glare has never significantly interfered with a landing, the panel decided that it could still be a nuisance level problem which is worthy of notice. Therefore, if the crew notices streaked or dirty windows on orbit or they ask for an advisory, the FDO will tell them whether or not the targeted runway has a glare problem. Although flight rule A4.1.4-5 states that glare will not be reason to NO-GO a runway, there is a strong crew preference to avoid it when possible.

The FDO has four methods for determining if glare will be present. The TSA Deorbit Opportunities Processor (DOPS) for both Inner and Outer Glide Slope (OGS) glare, as well as the Approach and Landing Processor (ALP) for the Outer Glide Slope glare. The other method is to use six graphs, two for each CONUS

landing site. These appear in figures 4.4-1 through 4.4-3. The graphs are actually site-specific yearly solar ephemerides. Sun azimuth (AZ) and elevation (EL) are determined using two families of curves. The flattened arcs are day-of-year curves. These are bounded at the bottom by the winter solstice (12/21) and at the top by the summer solstice (6/21). The arcs in between are for the first of each month. The dashed curves marked "VE" and "AE" are the vernal and autumnal equinoxes, respectively. The S-shaped curves are for the time of day, on the hour. These would be figure eights if they had not been broken down into two curves per site, one for the first half of the year and one for the second half. Otherwise, you could not tell which half of the figure eights to use for Sun position.

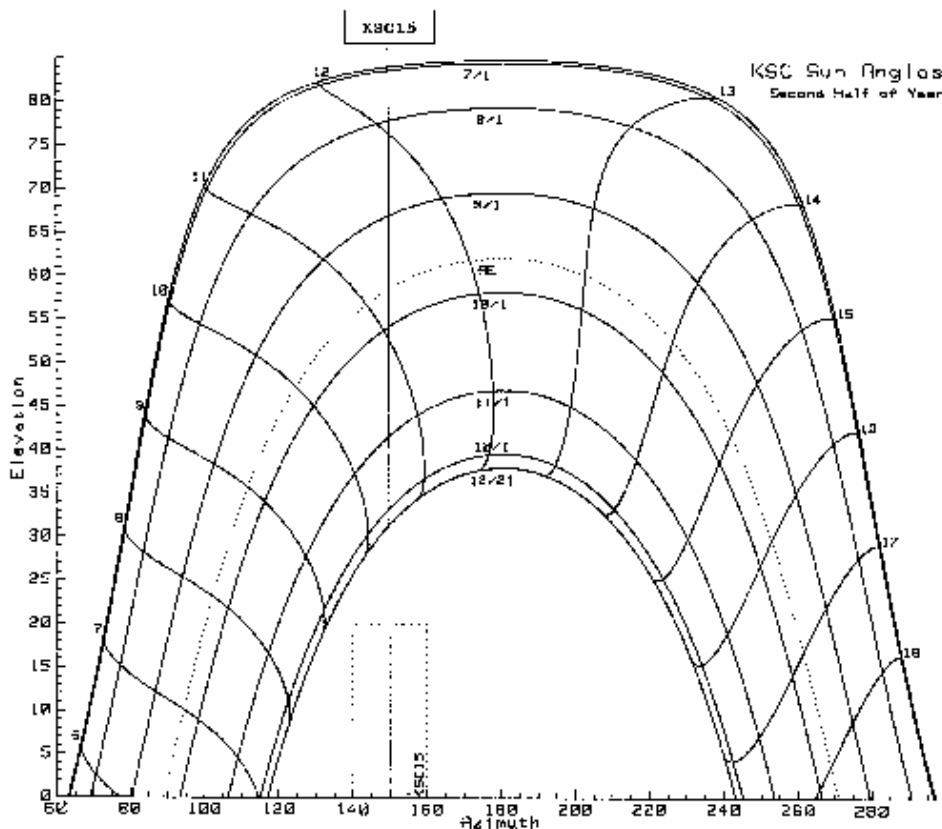

Figure 4.4-1 KSC Sun angles (first half of year).

The glare overlay for OGS, shown in figure 4.4-2, is a projection onto the sky of the loci of points which are 30°, 40°, and 50° from the normals to the CDR's and pilot's (PLT's) front windows. The curves would be circles if drawn on a sphere but are distorted because of the flat AZ/EL projection. The Sun AZ/EL plots and the overlay are kept in a folder on the FDO console with instructions.

When requested by the FD or the crew, use the following procedure to determine the potential presence of Sun glare:

- (1) Convert the GMT landing time from DOPS to local standard time at the site. EDW is GMT-8, NOR is GMT-7, and KSC is GMT-5. Ignore daylight savings time.
- (2) Find the time on the applicable graph and then move parallel to the time curves until you come to the day of year and mark the Sun's position on the graph.
- (3) Place the OGS overlay over the graph so that the vertical line on the overlay covers the runway azimuth you want on the graph. Also align the applicable horizon line on the overlay with the AZ scale on the graph.
- (4) If the Sun position plotted in (2) above lies within the zone from 30° to 50° from the normal to a window, shown as + signs on the overlay, the Sun is in that window's glare zone.
- (5) Repeat step 1 through 4 using the IGS overlay instead of the OGS overlay.
- (6) Inform the FD and CAPCOM of the presence of glare in for the CDR's or the PLT's (or both) and which on glide slope it is present.

Note that if the Sun is inside the 30° oval for one of the windows, it is outside of that window's glare zone. Note also that the glare zones overlap at the top and bottom of the overlay. If the Sun ever appears in the bottom overlap, it will also create a Sun angle violation, and the runway will be NO-GO. The top overlap, where both the CDR and the PLT see glare, is a concern for late morning through early afternoon landings.

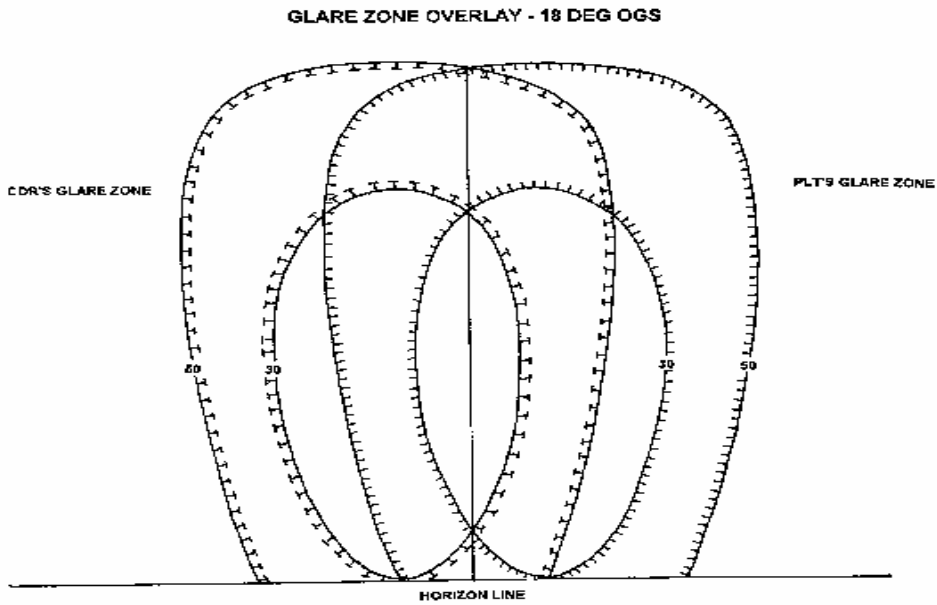

Figure 4.4-2 Glare Zone Overlay for outer glide slope

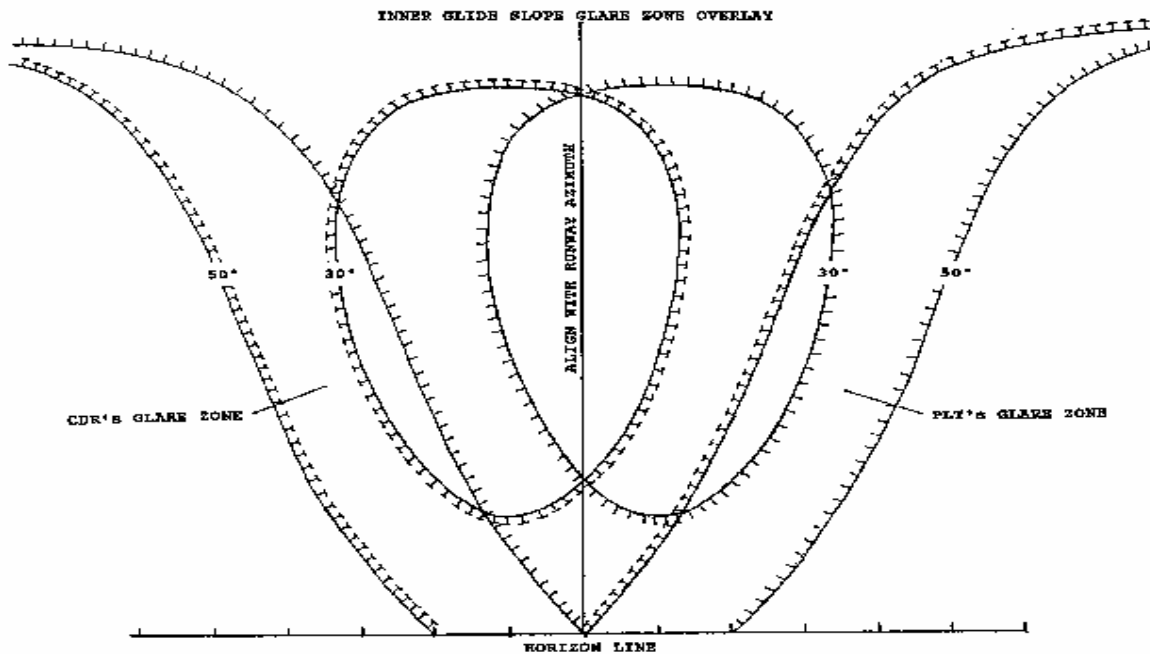

Figure 4.4-3 Glare Zone Overlay for inner glide slope

c. Proper HAC selection

There are four HAC's available, a left/right for heavyweight and a left/right for lightweight. Both the orbiter and EDS/DDS software perform a test to determine which HAC to use. The orbiter entry guidance software compares the weight with a weight switchpoint I-load (WT_GS1). If the weight is less than the I-load, then a lightweight HAC is used. Otherwise, a heavyweight HAC is used. A typical value for WT_GS1 is 6838 slugs (220,006 lb). However, the value may be set to that value ± 2000 lb in order to allow some margin between the expected weight and the switchpoint weight. EDS/DDS performs the same test using system parameter **MCWGS1** to choose the proper HAC.

The orbiter does not track RCS usage post deorbit in its mass computations but will account for the propellant usage during the deorbit burn. Therefore, the orbiter uses the post deorbit burn weight in the test to determine which HAC to use.

There are cases where the orbiter ends up heavier than planned at EOM. This may cause the orbiter to use the heavyweight glideslope while the crew may have trained assuming lightweight for EOM. In this case, the crew should be advised that a different HAC will be used. This advisory can be placed on the DEL PAD.

If the expected post deorbit burn weight is very close to the weight switchpoint (within 200 lb), it may be desirable to bias the weight that is uplinked with the PEG 4 targets, which would allow some margin between the burnout weight and the switchpoint weight. If the burnout weight is just below the switchpoint weight, the preburn weight may be biased 1000-lb low in order to guarantee that the orbiter will use the lightweight glideslope. This could be done by first having GPO build the PEG 4 command load automatically per standard procedures, then modify the weight on the command load with the C13 MED. The 0.02 percent weight error would have no significant effect on the propellant usage or burn accuracy. Alternately, a WGL (Weight Gain Loss) could be applied to the ephemeris prior to building the command load, alleviating the need to modify the command load.

d. Descent Design System (DDS)

The DDS processors consist of a three degrees of freedom (3 DOF) entry and TAEM simulation. The A/L flight segment is a three degree of freedom simulation. These simulations are call ESP, TSP, and ASP for Entry Shaping Processor, TAEM Shaping Processor and A/L Shaping Processor respectively. These sims include the logic for guidance and the AUTO mode of flight. No manual or CSS capabilities are provided.

The FDO provides a SV to the ENTRY SUPPORT personnel in the Flight Dynamics MPSR. The SV is time tagged at approximately 5 minutes prior to EI. The sim is initialized with this vector and with the EI weight and CG data provided by TRAJ. Wind data is usually provided by electronic transfer from SMG's computer system (MIDDS) to FADS. The WINDS position, also in the MPSR, is responsible for insuring that the winds files get transferred for use by the Landing Analyst. Using this data, the program "flies" the entry trajectory through landing and rollout.

For the Entry/TAEM DDS provides a complete analysis, including a roll reversal history, surface and backface temperatures, dynamic pressure, max load factor, Mach at HAC intercept (I/C) and time from M = 0.95 to HAC I/C.

The DDS also provides detailed information on the TD and rollout phase. Figure 4.4-4 is an example of the DDS approach/landing prediction output. ENTRY SUPPORT personnel commonly refer to this output as the "trends chart". An explanation of each item on this display follows.

DDS Approach & Landing Predictions (FDDP/PH2 MPSR Entry Support)
Mission: STS-66 DATE: Thu Nov 3 06:09:30 1994

Time Tag (Bal/For)	Runway ID	Aimpoint /SBret Option	SB Pos. & (3000 / 500)	Normalized TD (Fos/KEAS/KGS)	Normalized TD (Fos/KEAS/KGS)	Rollout Margin (End Rwy/Barr/ Overrun)	Brake Energy (NWS/ NoNWS)	Max/ HCEAR QBAR	Surface Winds (Dir/Mag Gust/ 5S H-T/R-L Gust H-T/R-L)
L-08.5 FT	BEN36	NOM/NOM	39.7/ 37.5	2439/ 195/ 201	3293/ 185/ 191	3305/ NA / 4805	37/ 42	331/ 284	266905 0T/ 5L
L-06.0 FC	BEN36	NOM/NOM	39.7/ 35.3	2615/ 195/ 200	3471/ 185/ 189	3310/ NA / 4810	37/ 45	331/ 288	280908 1H/ 8L
L-08.5 RT	BEN36	CI /NOM	52.9/ 50.2	2428/ 195/ 201	3245/ 185/ 191	3470/ NA / 4970	37/ 42	324/ 274	266905 0T/ 5L
L-06.0 FC	BEN36	CI /NOM	52.9/ 48.0	2581/ 195/ 200	3400/ 185/ 189	3498/ NA / 4998	37/ 45	324/ 277	280908 1H/ 8L
L-08.5 RT	BEN36	NOM/ SF	46.3/ 43.9	1909/ 195/ 201	2737/ 185/ 191	3802/ NA / 5302	36/ 41	328/ 279	266905 0T/ 5L
L-06.0 FC	BEN36	NOM/ SF	46.3/ 41.7	2083/ 195/ 200	2916/ 185/ 189	3811/ NA / 5311	36/ 44	328/ 282	280908 1H/ 8L
L-06.0 FC	EDW04	NOM/NOM	15.0/ 15.0	2510/ 195/ 192	3381/ 185/ 182	4075/ NA / 5875	33/ 36	317/ 280	020810 9H/ 4L
L-06.0 FC	EDW04	CI /NOM	23.6/ 26.1	3059/ 195/ 192	3917/ 185/ 182	3885/ NA / 5685	34/ 38	316/ 278	020810 9H/ 4L
L-06.0 FC	EDW22	NOM/NOM	45.5/ 44.7	2626/ 195/ 211	3496/ 185/ 200	3467/ NA / 3469	38/ 43	325/ 286	020810 9T/ 4R
L-06.0 FC	EDW22	CI /NOM	59.7/ 50.5	2821/ 195/ 211	3673/ 185/ 200	3352/ NA / 3352	38/ 43	316/ 275	020810 9T/ 4R
L-05.5 RS	KSC15	NOM/NOM	25.6/ 26.5	2666/ 195/ 196	3522/ 185/ 186	4575/ NA / 5575	35/ 39	321/ 287	072804 1H/ 4L
L-08.5 RS	KSC15	NOM/NOM	27.7/ 27.2	2412/ 195/ 197	3267/ 185/ 187	4644/ NA / 5644	35/ 44	321/ 281	062810 0H/ 10L
L-04.0 RS	KSC15	NOM/NOM	29.4/ 31.3	2379/ 195/ 201	3245/ 185/ 190	4487/ NA / 5487	37/ 38	313/ 276	003803 3T/ 2L
L-06.0 FC	KSC15	NOM/NOM	15.0/ 18.6	2441/ 195/ 196	3114/ 185/ 186	4662/ NA / 5662	34/ 44	310/ 277	070810 1H/ 10L
L-05.5 RS	KSC15	CI /NOM	38.6/ 39.4	2787/ 195/ 196	3610/ 185/ 186	4602/ NA / 5602	35/ 39	316/ 278	072804 1H/ 4L
L-08.5 RS	KSC15	CI /NOM	40.9/ 40.1	2537/ 195/ 197	3359/ 185/ 187	4667/ NA / 5667	34/ 44	317/ 273	062810 0H/ 10L
L-06.0 FC	KSC15	CI /NOM	25.4/ 31.6	2825/ 195/ 196	3675/ 185/ 186	4567/ NA / 5567	35/ 45	310/ 273	070810 1H/ 10L

Figure 4.4-4 DDS Approach and Landing Predictions

Note: Each row in the table above is the summary of separate analysis runs.

- (1) TIME TAG - This is the time of the balloon or forecast for this row of data. For prelaunch cases, this time is L - for launch minus X hours. For pre-deorbit cases, the times are TD - for touchdown minus X hours. Also

included in this block is the description of the data type used in the analysis for each row: FC indicates forecast data used, RT indicates radio theodolite data, and RS indicates rawinsonde data.

- (2) RUNWAY ID - This is the runway used in the touchdown and rollout analysis for this row.
- (3) AIMPOINT/SB ret Option - This shows the aimpoint used (either nominal or close-in) and the speedbrake retraction guidance option (either nominal or shortfield).
- (4) SB POS % - The position of the speedbrake, in percent, when it automatically retracts at 3000 feet and then adjusts at 500 feet.
- (5) NORMALIZED TD - These two columns lists the touchdown parameters (position/ airspeed/ and groundspeed in that order) for both the prime and alternate landing speeds.
- (6) ROLLOUT MARGIN - Distance from the end of the runway/barrier (if applicable)/overrun in feet.
- (7) BRAKE ENERGY - The total energy absorbed during braking in mega-foot pounds assuming nosewheel steering (NWS) is used and no nosewheel steering (NoNWS).
- (8) MAX/HGEAR QBAR - These numbers are the maximum and gear deploy dynamic pressure in pounds per square foot.
- (9) SURFACE WINDS - These are the surface winds used in the analysis. The direction that the wind is coming from and magnitude of the wind are shown along with the steady state and gust (if applicable) wind components (head or tailwind, left or right crosswind) are also shown.

Speedbrake performance on the OGS and TD point/speed are used to evaluate selection of the proper aimpoint for the approach. A large headwind may result in a TD point close to the runway threshold. The aimpoint that results in a predicted touchdown closest to the target touchdown point (2500 feet) will usually be selected.

The DDS also provides braking distance and braking energy data. These are used to evaluate runway stopping margins and to ensure that adequate braking capability exists for the situation in question.

The DDS has the capability to vary many of the initial conditions. The runway selected, close-in or NOM aimpoint, TD speed, brake deceleration, and gear deploy altitude are examples. In addition to these, some off-nominal situations

can be modeled, such as a stuck speedbrake. The DDS is limited in this respect, however, to trajectory/aerosurface problems. Less than 100 percent braking capability can also be modeled. MMACS is always interested in knowing whether 50% braking is acceptable (rollout margin and brake energy) to determine the APU start plan.

DDS takes approximately 10 minutes to perform a run. The actual time depends on the initial conditions and any off-nominal conditions requested. The DDS is considered the primary source of data for runway GO/NO-GO decisions.

e. ALP

The ALP provides a quick look at TD position and runway margins based on input wind conditions. This program is operated by the LSO's is a simplified simulation of the trajectory from 10k ft to the ground. It does provide much of the same data that the DDS provides; but, since the model is simplified, it can do so far more quickly (although at the expense of some fidelity).

The ALP has the capability to deal with sets of wind data. These data are stored and can be used to generate landing data on demand. The LSO will input the wind data from the selected landing site that was acquired through the use of weather balloons. A series of balloons are released at various intervals at the landing site. The ALP can also deal with forecast winds as well as measured winds. Wind tables are divided into upper level, lower level, and surface winds. The landing data can be generated using any combination of these tables.

In addition to wind data, the program requires density altitude (which is a function of runway elevation, altimeter setting, and temperature), approach direction (left or right turn, OVHD or STIN approach), and the turn angle around the HAC. These data (density altitude) are provided by the weather office and by the FDO.

The ALP basically provides two output pages. The first page consists of output TD/rollout data for the selected runway. The TD/rollout data is similar to that produced by the DDS. This data is provided for three scenarios: Nominal aimpoint using nominal speedbrake, close-in aimpoint using nominal speedbrake, and nominal aimpoint using SFD speedbrake. The program will recommend an aimpoint/speedbrake combination based on TD point and speedbrake settings.

The second page of output consists of a graphical depiction of the approach to the runway including the turn about the HAC. Wind direction and velocity are included in this display at various points along the approach path. The winds used for the computation are repeated and an area (lower left) is provided for comments. Some digital data from the first output page is repeated along with some of the initial conditions.

f. Shuttle Mission Simulator

The SMS is a full-scale, high fidelity simulator used for shuttle crew training in all phases of a mission. This facility resides in Building 5 at JSC and is available to the FDO on call. Reference the FCOH to see how this is done. The SMS provides the capability to evaluate crew procedures as well as vehicle performance. It can take into consideration such items as system malfunctions, procedural changes due to unforeseen circumstances, energy evaluations, consumables usages, and crew responses in the CSS mode of flight.

The SMS requires an EI - 9 minute SV along with the predicted mass properties of the orbiter at that time. Predicted winds can also be modeled. The process of creating a reset point for the SMS is somewhat complicated; therefore, adequate time must be given to call in the appropriate personnel and allow them to generate the data. The reset point generation is generally done based on the TD - 11 hr wind data. The SMS personnel should be alerted at this time if they are required. An additional reset point can be generated based on the L - 6.5 hr wind data assuming the SMS has been called up at L - 11 hr. There is insufficient time after the L - 3.5 hr wind data to generate a reset point and evaluate the data.

Several data stores are made based on this reset point for later evaluation. These are made for EI - 5 minutes, Mach 5, and 50,000 ft altitude.

The utility of the SMS lies in the ability to simulate system failures. Examples that have been used in the past are landings with a general purpose computer (GPC) down or dedicated display units (DDU's) malfunctioning. This enables crew procedures to be adjusted accordingly. It also allows for evaluation of the trajectory based on manual techniques. Adjustments for day of landing wind conditions by the crew can be accounted for to give accurate approach, TD, and rollout data.

g. STAMPS (Spacecraft Trajectory And Mission Planning Simulation)

This is a full up 6 DOF simulation. STAMPS used in conjunction with EDS/DDS, due to its greater fidelity, and is considered prime for calls/predictions in the TAEM/HAC Region.

h. Max Range Lines

The Maximum Range Line displayed on E/W vs. RGO is generated After the maximum range line is input, FDO can also perform quality assurance (QA) on the line by comparing E/W vs. RGO with a plot provided by ENTRY SUPPORT.

4.5 PRELIMINARY ADVISORY DATA (PAD) GENERATION

Several products are generated by the FDO prior to landing day to provide the crew and the Mission Management Team with preliminary data on the deorbit and entry. These include the Deorbit/Landing (DOL's) sheets and the Entry Summary Message. During the deorbit prep on landing day, two additional PAD's are generated in support of the deorbit burn and subsequent entry. These are the Maneuver PAD and the Deorbit/Entry/Landing PAD. Each is discussed below.

4.5.1 Deorbit/Landing Data (DOL)

One of the standard jobs required to be performed by the FDO's on the day before entry is generating the Deorbit/Landing Data sheets. This data along with the groundtrack plots are then sent out through REPRO using standard distribution list D. The Auto Deorbit-Landing Data Sheet (Auto-DOL) application is now used on the workstation to generate this sheets.

The Auto-DOL application streamlines generation of Deorbit-Landing Datasheets (DOL's) by fetching deorbit/entry data and displaying it electronically for FDO's and other flight controllers in the CCC. To create a sheet, the FDO must generate a DMP deorbit solution, transfer it to an ephemeris and DMT, generate an EDS entry profile, and place a TDRS AOS state vector in the checkout monitor display. The application fetches data from DMT, DMP, the TSA Ephr ephemeris, and C/O Monitor tables. Any other discipline can view DOL sheets, but only a FDO user may generate or modify a sheet.

The application uses Netscape for the user interface, and DataAcq for parameter retrieval. Netscape in the CCC is NOT connected to the world wide web--it is a stand-alone CCC internal "intranet". There are two types of sheets: global and local. Global sheets are view-only and can be accessed by external users. Local sheets can only be accessed by FDO's--they can be used for temp storage, training, and analysis. Sheets are permanently stored off by flight in the MIS database. Existing sheets for a particular flight are available anytime that flight is selected as the workstation activity. The lead FDO for a mission should execute the application pre-flight or early in the mission to delete unwanted files that may have accumulated during integrated simulations or user comp runs.

To execute the application, FDO users select *Auto DOL* from the Applications menu on the FDO DNAV.

Non-FDO users access DOL sheets on the MASTER DNAV under the Shuttle pull down in the FDO/Applications area.

External users will see a list of global sheets previously saved by FDO. Click on desired opportunity to view.

FDO users have three menu choices:

- Retrieve Existing Sheet - View previously generated data
- Generate New Sheet - Executes single-shot retrieval of deorbit/entry data. Follow on-line instructions to set up proper display config prior to data fetch. Select "Proceed" to initiate data retrieval. Editable sheet will be displayed next. For low crossrange cases, verify direction of 1st roll command by looking at Entry Analysis Digitals V1 RRF (neg=left) or delaz plot and correct sheet if necessary. Save options: Global (external users can view), Local (FDO user access only--use for temp storage, training, analysis, etc).
- Sheet Administration - Can delete sheets & copy Global ↔ Local

Hints: Right mouse button brings up menu with "Back" option for previous page.

To print, select File/Print & use greyscale on the print menu.

● Don't mess with the default fonts--some fonts will cause the first character typed on a line to be blanked out. If this problem occurs, under the Netscape menu bar select Options/General Preferences and use the following fonts: Proportional Font: Times (Adobe) Fixed Font: Courier (Adobe).

Detailed Instructions for non-FDO users:

From the Master DNAV menu, select "Deorbit-Landing Data Sheets" under Shuttle/FDO/Applications.

A list of global sheets is displayed as illustrated in Figure 4.5-1. Click on the desired deorbit opportunity to view (sorted by site, D/O orbit, and MET generated). An example sheet is shown in Figure 4.5-2. To print, select File/Print (use greyscale on the print menu). To exit, select File/Exit.

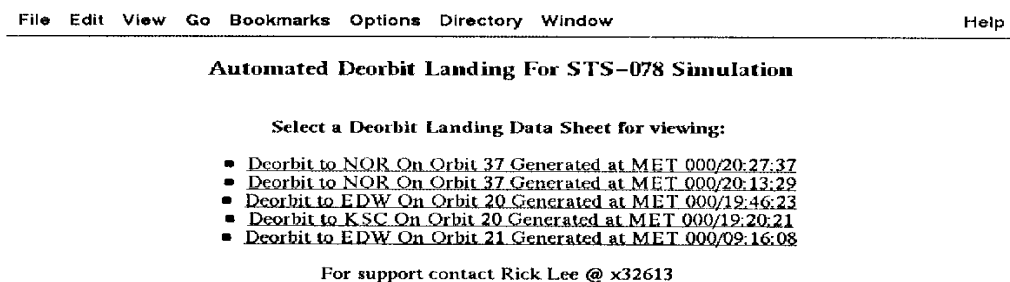

Figure 4.5-1 Example List of Global DOL Sheets

Automated Deorbit Landing For STS-078 Simulation

**Deorbit To EDW On Orbit 20
Generated MET 000/19:46:23**

Event	Time MET/Central	Latitude (D:M)	Longitude (D:M)	H	Velocity (KFPS)	Comments
Deorbit TIG	001/05:30:05 180/15:19:05	38 : 56 S	64 : 03 E	154.4 NM	25.4 VI	$\Delta V = 261$ fps $\Delta T = 05 : 26$ M:S XR = R 178 NM
TDRS-W AOS	001/05:34:45 180/15:23:45	35 : 10 S	85 : 39 E	152.5 NM	25.2 VI	EI Minus 22 : 53 MM:SS
EI	001/05:57:38 180/15:46:38	16 : 32 N	161 : 01 E	415.1 KFT	24.6 VREL	Range 4435 NM
MACH 2.5 TAEM	001/06:23:14 180/16:12:14	35 : 11 N	118 : 39 W	76.8 KFT	2.4 VREL	
MACH 1	001/06:25:21 180/16:14:21	35 : 06 N	117 : 59 W	45.5 KFT	.9 VREL	HAC I/C 01 : 28 MM:SS
HAC I/C	001/06:26:50 180/16:15:50	35 : 04 N	117 : 46 W	25.1 KFT	.7 VREL	Turn Angle 134 DEG
Landing	001/06:29:26 180/16:18:26					Runway EDW22
Roll Schedule				Roll (DEG)	VREL (KFPS)	GMT (H:M:S)
1st Roll Command (To The Right)				80	24.5	180/20:52:09
1st Roll Reversal (R To L)				55	19.4	180/21:00:30
2nd Roll Reversal (L To R)					10.0	
3rd Roll Reversal (R To L)					5.0	

FDO:
James C.Edelen

Figure 4.5-2 Example Deorbit/Landing Data Sheet

Detailed Instructions for FDO users:

From the FDO DNAV menu, select "Auto-DOL" under Applications.

The FDO Auto-DOL main menu appears as shown in Figure 4.5-3:

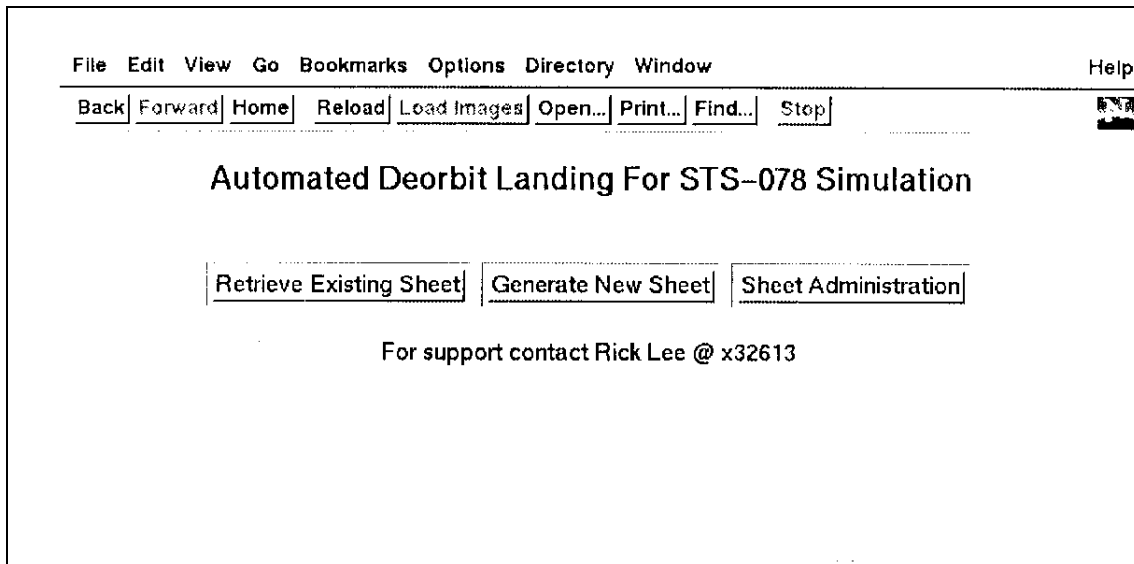

Figure 4.5-3 FDO Auto-DOL Main Menu

To view a sheet:

Select "Retrieve Existing Sheet" from the main menu. A menu similar to Figure 1 is presented, however, both global and local sheets are displayed (non-FDO users only see global sheets). A list of all existing sheets for the current flight is presented by site, D/O orbit, and MET generated. Click on the desired opportunity to view the DOL. Global sheets are view only, while local sheets may be edited. If a local sheet is selected, it will be displayed in a blue-field edit mode. If a print-quality version of a local sheet is desired, select "Continue" at the bottom of the blue-field display to bring up the print quality DOL format.

Sheet Administration

Select "Sheet Administration" to delete sheets, copy from local to global, or vice versa.

To copy: The copy menu will show a sheet currently selected to be copied. Click on this window to show all sheets in order to choose a different sheet to be copied if desired. Click "Copy". If a global sheet was selected, it will be copied to local. If a local sheet was selected, it will be copied to global. The original sheet remains unchanged.

To delete: The delete menu lists all sheets, global and local. Click on as many sheets as desired to be deleted. Then select "Delete". The sheet(s) will be flushed from the MIS database.

To generate a sheet:

Select "Generate New Sheet" from the main menu. The following menu appears:

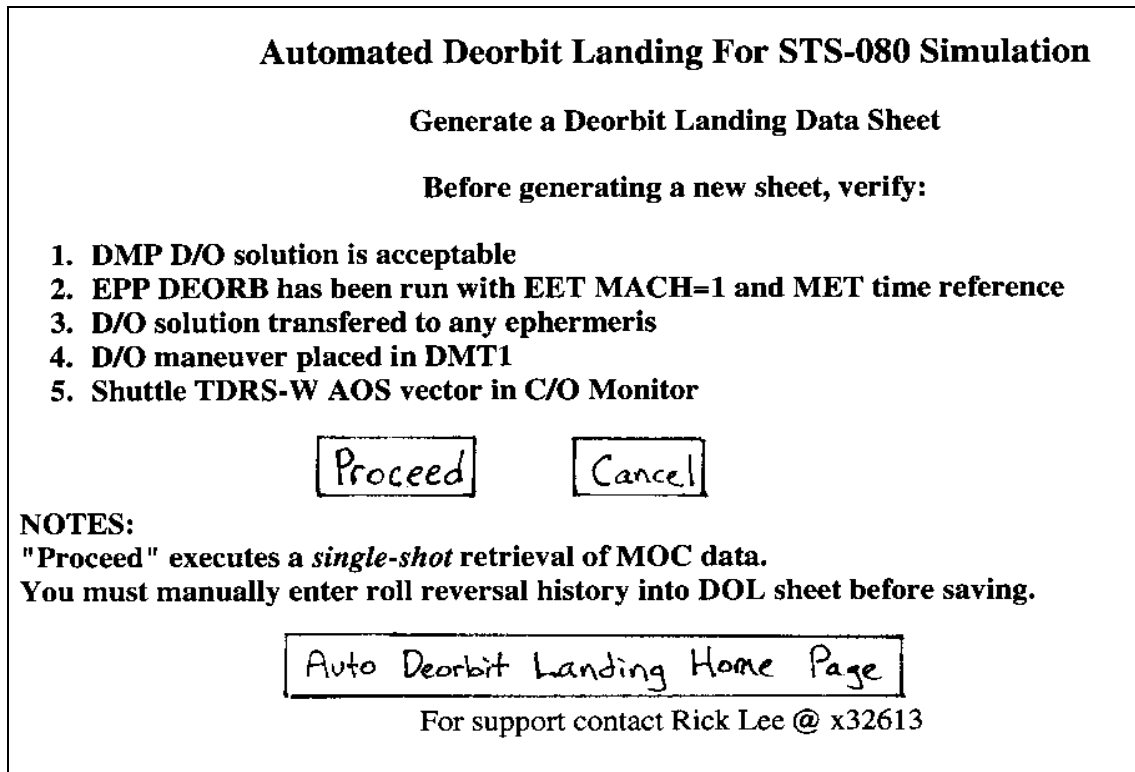

Figure 4.5-4 Auto-DOL Generation Menu

Follow the on-line instructions to properly configure EDS, DST, DMT, and Checkout Monitor output tables. The steps are as follows:

- 1) Run a DMP deorbit solution (using the planned deorbit targeting philosophy and PROP quantity).
- 2) Run an EDS DEORB.
- 3) Transfer the solution to any ephemeris and place the deorbit maneuver in DMT-1.
- 4) Determine TDRS-W AOS time from EPSAT, then place an orbiter vector in Checkout Monitor 1 at this time.

Click on "Proceed" to initiate a *single-shot* retrieval of TSU data via GDR and a direct fetch from TSA EPHR. Following data fetch, an editable DOL sheet with data filled in is displayed. The deorbit/entry configuration can be changed after this point without affecting Auto-DOL output.

Figure 4.5-5 illustrates the editable sheet; dark fields in the figure are actually blue fields on the workstation with MOC data filled in. These blue fields are all

editable. Some data (e.g. "E" or "W" for lat/long) can also be changed via push-buttons. Any parameter retrieved from the MOC and displayed on the sheet can be manually changed.

Event	Time MET/Central	Latitude (D:M)	Longitude (D:M)	H	Velocity (KFPS)	Comments
Deorbit TIG	[redacted]	[redacted] : [redacted] ∨N ◇S	[redacted] : [redacted] ◇E ∨W	NM	VI	ΔV = [redacted] fps ΔT = [redacted] : [redacted] M:S XR = ◇L ∨R [redacted] NM
TDRS-W AOS	[redacted]	[redacted] : [redacted] ∨N ◇S	[redacted] : [redacted] ◇E ∨W	NM	VI	EI Minus [redacted] : [redacted] MM:SS
EI	[redacted]	[redacted] : [redacted] ◇N ∨S	[redacted] : [redacted] ◇E ∨W	KFT	VREL	Range [redacted] NM
MACH 2.5 TAEM	[redacted]	[redacted] : [redacted] ◇N ∨S	[redacted] : [redacted] ∨E ◇W	KFT	VREL	
MACH [redacted]	[redacted]	[redacted] : [redacted] ◇N ∨S	[redacted] : [redacted] ∨E ◇W	KFT	VREL	HAC I/C [redacted] : [redacted] MM:SS
HAC I/C	[redacted]	[redacted] : [redacted] ◇N ∨S	[redacted] : [redacted] ∨E ◇W	KFT	VREL	Turn Angle [redacted] DEG

Figure 4.5-5 Format of Deorbit/Landing Datasheet

Verify 1st roll command direction for low crossrange cases. Auto-DOL uses Deorbit Summary Table crossrange which may yield a different result from onboard guidance. Use Entry Analysis Digitals V1 RRF roll angle sign (negative = left) to determine direction of 1st roll command or look at the delaz plot from Entry Groundtrack application to determine initial bank direction. Correct the sheet if necessary by changing the direction of 1st roll command. Subsequent roll

reversal directions will be corrected automatically after proceeding. For the second and third roll reversals, the velocity can be easily determined by calling up VREL vs. RGO application and using the DELAZ plot. Using the SEQUENCE pull down menu, look at the different displays until you find the second and third places where DELAZ changes direction. Using the left mouse button, click and drag a box around the DELAZ where it changes. This will zoom-in on that Region and allow the user to easily read the VREL where the DELAZ crosses 17.5 degrees. The right mouse button clicked anywhere within the VREL vs. RGO window will un-zoom the plot.

Click on "Proceed" at the bottom of the sheet to incorporate changes. This will bring up a DOL sheet that shows what the final product looks like. Any parameter that was modified or manually input on the previous page is highlighted with a different color and flashing characters. Verify all changes to the sheet.

Select "Save Global" if the sheet is to be accessed by external users. Select "Save Local" if the sheet is to be for FDO use. It may be promoted later to global using the Sheet Administration copy function described above. A dialogue box is posted when the save is complete.

To exit, select File/Exit from the Netscape menu bar. User may exit from any menu in the application.

Ops Notes:

- 1) Netscape navigation commands such as back and forward may be used if desired (right mouse button).
- 2) Use greyscale when printing.
- 3) Don't mess with the default fonts--some fonts will cause the first character typed on a line to be blanked out. If this problem occurs select Options/General Preferences and use the following fonts: Proportional Font: Times (Adobe) Fixed Font: Courier (Adobe).

4.5.2 Entry Summary Message

On entry day, the crew is sent an entry summary message. The FDO is responsible for about 90 percent of the data on the message. The Planning team needs to get the first draft of the message done on the shift prior to entry. Reference figure 4.5-6 for an example of the form used to make the message. The blank forms are available on the MODM server under U:/work/fdo/stsxx/entry or on the DM server in the DM46/FORMS directory. The file "entsumk" is the blank form for KSC and the file "entsume" is the one for EDW and "KSC_EDW" for the dual site message. Make sure to delete the part in the first paragraph that describes the deorbit burn that does not apply (inplane or OOP). Also, delete the HAC turn and aimpoint that will not be used. The Entry team will review it after handover. Once the Planning team has finalized the first draft of the message, TRAJ should send it to FAO using the Electronic Flight Note (EFN) system. The

Entry team will review and modify the message if required before the final version is sent to the crew. To assist in reviewing the message, the Planning team should have all the hardcopies and other supporting data attached to a hardcopy of the message.

Some of the data required for the message can be obtained from the Deorbit/Landing Data form. The parameters that are on that form are deorbit ΔV , crossrange, roll reversal history, deorbit TIG, landing time, winds, weather, and the HAC turn angle. The OOP thrust angle can be found on the Deorbit Digitals or the Deorbit Summary displays. The FRCS dump percent and CG's should all have been determined earlier during the mass properties computations. The elevon schedule should have been determined prior to the deorbit targeting process. The forecast winds aloft and density altitude will come from WEATHER. The HAC turn direction may be determined by using the Entry Groundtrack application, after the entry ephemeris has been generated, to see which HAC is being used. However, you need to ensure that the correct runway has been selected as the prime on the K51 MED in order to see the groundtrack. Using the left mouse button, click and drag a box around the landing site. This will zoom-in on that Region and allow the user to easily determine the turn direction. The right mouse button clicked anywhere within the Entry Groundtrack window will un-zoom the plot. The ALP may be executed in order to compute the aimpoint, TD point, and speedbrake setting at 3 KFT. For the lakebed status, use the latest available from LSO. Reference figure 4.5-7 for an example of an Entry Summary Message with actual data.

A dual site entry summary message (KSC/EDW) may be generated for cases where KSC weather is marginal. This was done on STS-80 for the first time. This combined message was done instead of doing two separate messages. See figure 4.5-8 for an example form for the dual site message. Figure 4.5-9 is an example dual site entry summary message with data.

NOTE: Consideration can be given to uplinking a preliminary Entry Summary Message on the landing minus one day shift that the entry team supports in order to give the crew an early heads up. Also include an Entry Groundtrack plot for the nominal deorbit opportunity.



1 MSG XXX - ENTRY SUMMARY
 2 PAGE X OF X, XX LINES THIS PAGE
 3
 4 GOOD MORNING XXXXXXXXXXXX,
 5 EVERYTHING IS GO FOR A NOMINAL DEORBIT PREP AND ENTRY. ORBIT IS ___X__.
 6 DEORBIT DELTA V WILL BE APPROXIMATELY ___ FPS **INPLANE** or **WITH AN OUT OF PLANE**
 7 **THRUST ANGLE OF ___ DEG.** CROSS RANGE WILL BE ___ NM. AT THE DEORBIT BURN, YOU
 8 WILL HAVE:
 9 L OX = ___ R OX = ___
 10 L FU = ___ R FU = ___
 11
 12 THE PREDICTED POST DEORBIT BURN OMS QUANTITIES ARE AS FOLLOWS:
 13 L OX = ___ R OX = ___
 14 L FU = ___ R FU = ___
 15
 16 FORWARD RCS DUMP TO ___%
 17
 18 ROLL REVERSAL HISTORY: V = ___ FPS
 19 V = ___ FPS
 20 V = ___ FPS
 21
 22 CG AT EI: X = ___
 23 CG AT M3.5: X = ___
 24 Y = ___
 25
 26 ATMOS ITEM: _____
 27 ELEV. SCHED: _____
 28 BODY BENDING FILTER: _____
 29
 30 DEORBIT TIG _____
 31 LANDING APPROX. _____
 32
 33 KSC WX CURRENT _____
 34 KSC WX FCST _____
 35 KSC WIND FCST _____
 36 50K _____
 37 38K _____
 38 28K _____
 39 20K _____
 40 12K _____
 41 7K _____
 42 SFC _____
 43 ALTIMETER _____
 44 DENSITY ALTITUDE ___ FT
 45
 46 HAC PROCEDURES: NOMINAL
 47 **OVHD** OR **STIN** TO KSC ___
 48 TURN ANGLE ___ DEG
 49 **NOMINAL** OR **CLOSE-IN** AIM POINT
 50 ALL NAV AIDS ARE OPERATIONAL
 51 KSC ___ TD ___ FT AT ___ KTS.
 52 3K SPEEDBRAKE: ___%
 53
 54 LAKEBED STATUS:
 55 EDW:
 56 NOR:
 57 END OF PAGE X OF X, MSG XXX

Figure 4.5-6 Entry Summary Message form

1 MSG XXX - ENTRY SUMMARY
2 PAGE X OF X, XX LINES THIS PAGE
3
4 GOOD MORNING COLUMBIA,
5 EVERYTHING IS GO FOR A NOMINAL DEORBIT PREP AND ENTRY.
6 ORBIT IS 138 X 104. DEORBIT DELTA V WILL BE APPROXIMATELY 215 FPS INPLANE. CROSS
7 RANGE WILL BE 116 NM. AT THE DEORBIT BURN, YOU WILL HAVE:
8 L OX = 27.97% R OX = 28.41%
9 L FU = 27.97% R FU = 28.79%
10
11 THE PREDICTED POST DEORBIT BURN OMS QUANTITIES ARE AS FOLLOWS:
12 L OX = 8.99% R OX = 9.30%
13 L FU = 8.86% R FU = 9.96%
14
15 FORWARD RCS DUMP TO 0%
16
17 ROLL REVERSAL HISTORY: V = 19800 FPS
18 V = 10100 FPS
19 V = 4500 FPS
20
21 CG AT EI: X = 1084.8
22 CG AT M3.5: X = 1083.0
23 Y = -0.7
24
25 ATMOS ITEM: 22
26 ELEV. SCHED: AUTO
27 BODY BENDING FILTER: ALTERNATE
28
29 DEORBIT TIG 13/22:23:52
30 LANDING APPROX. 13/23:16:52
31
32 KSC WX CURRENT 25 SCT 250 SCT
33 KSC WX FCST 25 SCT 250 SCT
34 KSC WIND FCST
35 50K 260/40
36 38K 270/30
37 28K 290/25
38 20K 270/20
39 12K 250/15
40 7K 250/10
41 SFC 210/5P10
42 ALTIMETER 30.03
43 DENSITY ALTITUDE -635 FT
44
45 HAC PROCEDURES: NOMINAL
46 R OVHD TO KSC 33
47 TURN ANGLE 212 DEG
48 NOMINAL AIM POINT
49 ALL NAV AIDS ARE OPERATIONAL
50 TD 2800 FT AT 205 KTS.
51 3K SPEEDBRAKE: 15%
52
53 LAKEBED STATUS:
54 EDW: RUNWAYS 15/33 ARE GREEN
55 NOR: RWYS 17/35 ARE GREEN, 23/05 ARE UNCERTIFIED BUT USABLE.
56 END OF PAGE 1 OF 1, MSG 112



Figure 4.5-7 Entry Summary Message example

GOOD AFTERNOON COLUMBIA,
EVERYTHING IS GO FOR A NOMINAL DEORBIT PREP AND ENTRY. ORBIT IS ___ X ___ NM.
DEORBIT DELTA V WILL BE APPROX. ___ FPS **INPLANE** or **WITH AN OUT OF PLANE**

THRUST ANGLE OF ___ DEG. AT THE DEORBIT BURN, YOU WILL HAVE (%):

L OX = ___ R OX = ___
L FU = ___ R FU = ___

THE PREDICTED POST DEORBIT BURN OMS QUANTITIES ARE AS FOLLOWS (%):

L OX = ___ R OX = ___
L FU = ___ R FU = ___

FORWARD RCS DUMP OX TO ___%

CG AT EI: X = ___
CG AT M3.5: X = ___ Y = ___

ATMOS ITEM: ___
ELEV. SCHED: ___
BODY BENDING FILTER: ___

KSC

CROSS RANGE WILL BE ___ NM LEFT.

ROLL REVERSAL HISTORY: V= ___ FPS
V= ___ FPS
V= ___ FPS

DEORBIT TIG: _____
LANDING APPROX.: _____

WX CURR: _____
WX FCST: _____
WIND FCST:

50K ___/___
38K ___/___
28K ___/___
20K ___/___
12K ___/___
7K ___/___
SFC ___/___

ALTIMETER _____
DENSITY ALTITUDE: _____ FT
HAC PROCEDURES:

NOMINAL
_ **OVHD** OR **STIN** TO KSC ___
TURN ANGLE ___ DEG
NOMINAL OR **CLOSE-IN** AIM POINT
ALL NAV AIDS ARE OPERATIONAL
KSC ___ TD ___ FT AT ___ KTS.
3K SPEEDBRAKE: ___%

EDW

CROSS RANGE WILL BE ___ NM LEFT.

ROLL REVERSAL HISTORY: V= ___ FPS
V= ___ FPS
V= ___ FPS

DEORBIT TIG: _____
LANDING APPROX.: _____

WX CURR: _____
WX FCST: _____
WIND FCST:

50K ___/___
38K ___/___
28K ___/___
20K ___/___
12K ___/___
7K ___/___
SFC ___/___

ALTIMETER _____
DENSITY ALTITUDE: _____ FT
HAC PROCEDURES:

NOMINAL
_ **OVHD** OR **STIN** TO EDW ___
TURN ANGLE ___ DEG
NOMINAL OR **CLOSE-IN** AIM POINT
ALL NAV AIDS ARE OPERATIONAL
EDW ___ TD ___ FT AT ___ KTS.
3K SPEEDBRAKE: ___%

LAKEBED STATUS:

EDW:
NOR:
END OF PAGE X OF X, MSG XXX

Figure 4.5-8 Dual Entry Summary Message form

GOOD AFTERNOON COLUMBIA,
EVERYTHING IS GO FOR A NOMINAL DEORBIT PREP AND ENTRY. ORBIT IS 203 X
184 NM. DEORBIT DELTA V WILL BE APPROX. 315 FPS WITH AN OUT-OF-PLANE
ANGLE OF 25 DEGREES. AT THE DEORBIT BURN, YOU WILL HAVE (%):

L OX = 36.27 R OX = 36.12
L FU = 35.39 R FU = 35.94

THE PREDICTED POST DEORBIT BURN OMS QUANTITIES ARE AS FOLLOWS (%):

L OX = 8.15 R OX = 7.74
L FU = 7.23 R FU = 7.96

FORWARD RCS DUMP OX TO 0%

CG AT EI: X = 1080.7
CG AT M3.5: X = 1080.0 Y = -0.6

ATMOS ITEM: 22
ELEV. SCHED: AUTO
BODY BENDING FILTER: ALT

KSC

CROSS RANGE WILL BE 74 NM LEFT.

ROLL REVERSAL HISTORY: V=21700 FPS
V=11000 FPS
V= 4400 FPS

DEORBIT TIG: 17/14:47:10
LANDING APPROX.: 17/15:53:34

WX CURR: FEW042 7
180/02 PTCHY F
WX FCST: SCT V BKN010 BKN250 7
WIND FCST:

50K 270/80
38K 270/95
28K 270/80
20K 260/45
12K 250/30
7K 240/25

SFC 220/05P10

ALTIMETER 29.98
DENSITY ALTITUDE: 337 FT
HAC PROCEDURES:

NOMINAL
R OVHD TO KSC33
TURN ANGLE 231 DEG
NOMINAL AIM POINT
ALL NAV AIDS ARE OPERATIONAL
KSC33 TD 3125 FT AT 205 KTS.
3K SPEEDBRAKE: 17%

EDW

CROSS RANGE WILL BE 546 NM LEFT.

ROLL REVERSAL HISTORY V=13300 FPS
V= 7000 FPS
V= 3600 FPS

DEORBIT TIG: 17/17:52:10
LANDING APPROX: 17/18:57:54

WX CURR: FEW050 BKN120 BKN200 7
220/12
WX FCST: SCT060 SCT120 BKN250
WIND FCST:

50K 250/35
38K 260/55
28K 250/45
20K 260/35
12K 260/25
7K 250/20

SFC VRB05

ALTIMETER 30.06
DENSITY ALTITUDE: 1460 FT
HAC PROCEDURES:

NOMINAL
L OVHD TO EDW22
TURN ANGLE 204 DEG
NOMINAL AIM POINT
ALL NAV AIDS ARE OPERATIONAL
EDW22 TD 2617 FT AT 205 KTS.
3K SPEEDBRAKE: 16%

LAKEBED STATUS:

EDW: 15/33 GREEN; ALL OTHERS RED
NOR: 17/35 GREEN; 05/23 UNCERTIFIED
END OF PAGE X OF X, MSG XXX

Figure 4.5-9 Dual Entry Summary Message Example

4.5.3 Deorbit Maneuver PAD

The DEORBIT MNVR PAD contains the D/O burn data required by O/B guidance. The PAD is structured in the same manner as the O/B MNVR EXE display in order to aid the crew in the manual input of the burn data if a key-in is required. Normally, the D/O burn targets are uplinked using a command load. If the targets are uplinked, then the only items read off the DEORBIT MNVR PAD are TGO, any notes, and TIG if it has changed from what was given to the crew earlier. If command capability is lost, the entire left side of the PAD would then be read to the crew for manual entry. Reference the FCOH for the Maneuver PAD Policy.

The PAD is completed after the D/O burn has been computed and transferred to the EPH and the Entry Profile has been generated. The DEORBIT MNVR PAD is generated using the Netscape based Auto MANEUVER PAD application. Refer to the "Netscape Auto Maneuver PAD User Guide" for complete details. The data is pulled from the user-specified DMT and ENTRY DIGITALS displays. Notes can be typed at the bottom of the PAD. The FDO/TRAJ should perform a QA of the PAD (compare to the DMT and ENTRY DIGITALS displays). When finalized, the PAD can then be PUBLISHED so that FD and CAPCOM can access it. Once PUBLISHED, FDO should notify FD that the PAD has been completed and is available for his/her review. Figure 4.5-10 is an explanation of the items found on the DEORBIT MNVR PAD.

- a. Thrusters desired - Nominally OMS both parallel. Found on DMT.
- b. Thrust vector roll - Nominally 180 degrees. Found on DMT.
- c. OMS engine trims and orbiter weight at TIG. Found on DMT.
- d. TIG in MET. Found on DMT.
- e. PEG 4D targets. Found on DMT.
- f. Inertial burn attitude. Found on DMT.
- g. Range to the PLS at EI (NM). Found on ENTRY DIGITALS.
- h. Time of free fall from D/O burn to EI in MM:SS. Found on ENTRY DIGITALS.
- i. Total delta V of the maneuver in ft/sec. Found on DMT.
- j. Total burn time in MM:SS - DMT (TGO).
- k. Body-centered velocity to go in feet per second - DMT.
- l. Targeted Ha and Hp in NM - DMT.
- m. RCS interconnect plan is obtained from PROP.

File Pad PEGTargets

MNVR PAD: E2BPD01DO

STATIC DMT1 DMT2 PUBLISH

1 OMS Both
 2 OMS Left
 3 OMS Right
 4 RCS Select

TV ROLL 5 180 DEG
TRIM LOAD
 PITCH 6 0.4 DEG
 LEFT YAW 7 -5.7 DEG
 RIGHT YAW 8 5.7 DEG
 WEIGHT 9 225781 LBS
 TIC 10 008/22.35.43.0
PEG 4 TARGETS
 C1 14 14631 FPS
 C2 15 -0.5847
 HT 16 65.832 NM
 T 17 146.545 DEG
 PRPLT 18 -08500 LBS

MNVR ATTITUDE
 ROLL 24 246 DEG
 PITCH 25 335 DEG
 YAW 26 323 DEG
 R 4390 NM
 TFP 32:25 MM:SS

ΔV Total: 269.0 FPS
 T00: 02:33 MM:SS
 VGO X: 372.80 FPS
 VGO Y: 000.19 FPS
 VGO Z: 102.70 FPS
 HA HP
 TARGET 218 081 NM

NOTES
RCS I'CONNECT
 L OMS -> RCS
 R OMS -> RCS
 NONE

FLIGHT NOTES

Figure 4.5-10 DEORBIT MNVR PAD

4.5.4 Deorbit/Entry/Landing (DEL) PAD

The DEL PAD contains data to be used during deorbit and entry by the crew in order to control and monitor the deorbit burn and entry guidance commands and to relay runway/weather information to the crew. The PAD is used to cue the crew on critical Deorbit/Entry/Landing items.

In the event STAMPS data is available, it may replace DDS data for the MAX NZ input (item aa on the following list). Ensure that the .1 bias for 3 DOF limitations has not been applied. The only other STAMPS data that may be used on the DEL PAD are ALT ERROR HIGH, ALT ERROR LOW, or QBAR, which would be used in the notes section, if it was decided that the crew needed to be aware of this output. (Ref. STF No. DFD-97-42350-016 dated March 10, 1997)

The Auto DEL PAD application streamlines operations during the deorbit prep timeframe by automating the generation of the DEL PAD and decreasing the QA requirements. The application has the ability to fetch MOC parameters, retrieve

published PROP to FDO data and Winds Aloft, and run STCOMP. With the addition of some manually entered data that is still required, an electronic version of the DEL PAD may be published that is viewable by all flight controllers.

Prior to executing the application, several items need to be computed:

1. The targeted solution must be in DMT 1.
2. The single OMS inplane solution must be in the backup thruster section of DOD1 (ref. STCOMP procedures in sec 4.9).
3. Entry set must be generated for targeted solution, displayed in MET in the Entry Elapsed Time display.
4. The PERM and CG SUM tables must reflect the targeted burn and entry.

Once the 4 items above have been performed, the application can be executed. From the FDO DNAV under the *Applications* pull-down, select Auto DEL PAD. A menu will be displayed which gives the user the option of retrieving an existing PAD, generating a new PAD, or going to PAD administration. Selecting generate a new PAD will bring up a display similar to figure 4.5-11 below.

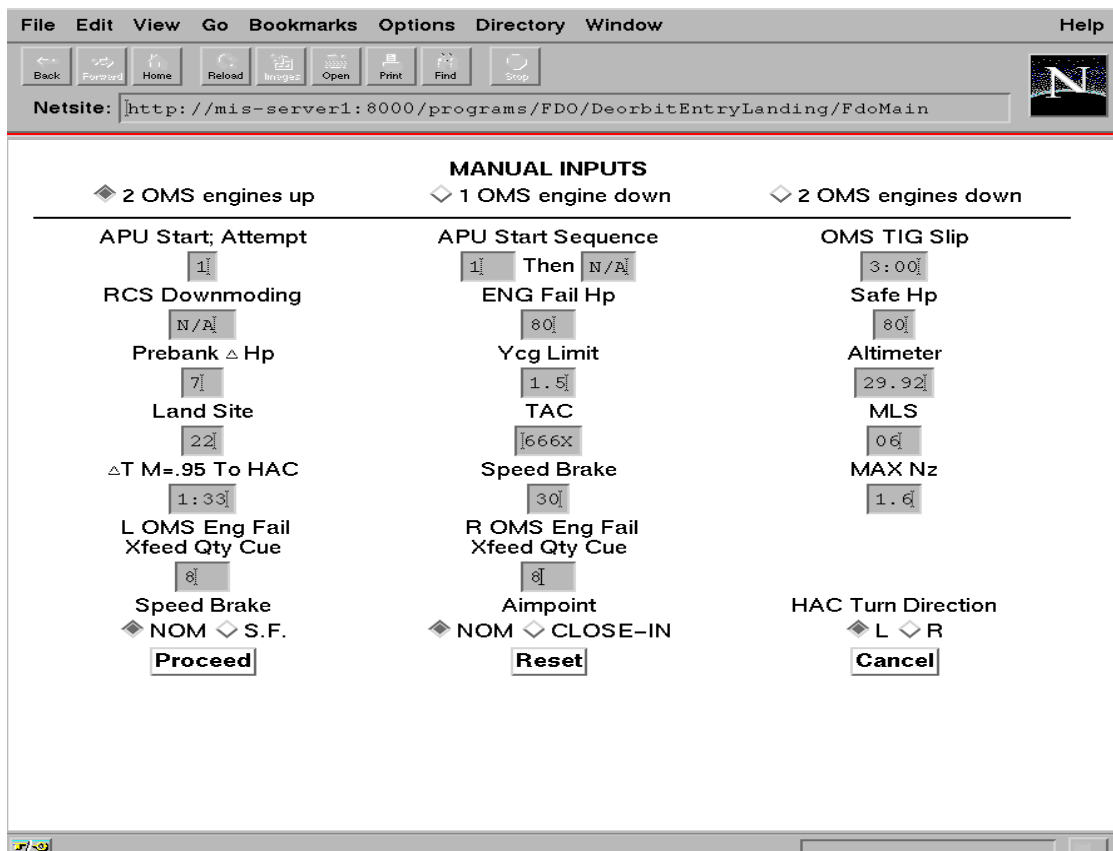

Figure 4.5-11 Auto DEL PAD Inputs Page

At a minimum, in order for you to proceed to the next step in the DEL PAD generation process, the Prebank Δ Hp and YCG Limit must be supplied. Following the execution of the *PROCEED* button, a page with the following frames is brought up:

1. PROP to FDO

This frame will be initialized in one of two ways. If no PROP to FDO data has been published, blank editable fields for the applicable PROP to FDO data will be present. If one or more PROP to FDO sheets has been published, hypertext links to these sheets, as well as a hypertext link to a blank PROP to FDO will be present.

2. MOC data

This frame will always be initialized with blank editable fields. The user has the option of either entering data, or automatically grabbing MOC data via the GRAB button in the control Panel frame.

3. STCOMP

This frame is initially blank. Upon execution of the STCOMP button from the Control Panel frame, STCOMP will be executed.

4. Computation

This frame is initially blank. Upon execution of the COMPUTE button from the Control Panel frame, several additional parameters will be calculated; Flip/Prebank HP, Aft HP, Dump to % (OX or FU), Nz Limit, and B/U Site.

5. Manual Inputs

This frame will contain the data that was entered on the initial page (fig. 4.5-11).

6. Winds

This frame will be initialized in one of two ways. If no Winds data has been published, blank editable fields will be present. If one or more Winds files has been published, hypertext links to these sheets, as well as a hypertext link to a blank winds sheet will be present. NOTE: winds files must exist in the following directory:

/users/dsc/data/SSPNNN_AAA/exdata_fdo where NNN=3 digit flt # and AAA=SIM or MIS

7. Control Panel

This frame contains the buttons that control execution of the Auto DEL PAD application.

Figure 4.5-12 below represents the Auto DEL PAD frames page with sample data filled in.

PROP TO FDO
MET: 000/01:05:48 Deorbit TIG: 00/02:05:00

L OMS	R OMS	FRCS	L RCS	R RCS
ΔV Avail	ΔV Avail	ΔV Avail	ΔV Avail	ΔV Avail
349.0	345.1	66.7	32.1	32.1
Aft Quant	Aft Quant	FRCS OX	FRCS FU	Aft Hp
1 (%)	2 (%)	(lbs)	(lbs)	ΔV
99	54	1188	748	32.8

Pre Burn	Post Burn	Landing	TAEM	Landing
Ycg	Weight	Weight	Ycg	Xcg
-1.11	257959	232704	(-1.2)	0.0

Deorbit Digitals (MSK503)

1 OMS	MM303 ATT		
ΔV Req'd	Roll	Pitch	Yaw
120.2	296	28	56

Entry Digitals (MSK506)

MM304	VRR	Target ΔV	Hp Final
Prebank	20500	119.9	21.8
L			

Entry Analysis Digitals (MSK507)

Detailed Maneuver Table 1 (MSK476)

CLG Init	RWY	PSHA
04:16:19	HNL08	302

Entry Elapsed Time (MSK505)

L OMS	R OMS	L OMS	R OMS	L OMS	R OMS
Ycg Hp	Ycg Hp	Fail Hp	Fail Hp	Hp	Hp
-510	-15	933	942	80	80

STCOMP Results

Flip Hp	Aft Hp	Dump to %	Nz Limit	B/U Site
65	40	OX	2.2	N/A

MANUAL INPUTS
2 OMS engines up

APU Start: Attempt	APU Start Sequence	OMS TIG Slip
1	1 Then N/A	3:00
RCS Downmoding	ENG Fail Hp	Safe Hp
N/A	80	80
Prebank Δ Hp	Ycg Limit	Altimeter
7	1.5	29.92
Land Site	TAC	MLS
22	666X	06
ΔT M=.95 To HAC	Speed Brake	MAX Nz
1:33	30	1.6
L OMS Eng Fail	R OMS Eng Fail	
Xfeed Qty Cue	Xfeed Qty Cue	
8	8	
Speed Brake	Aimpoint	HAC Turn Direction
NOM	NOM	L

Source File

50K	38K	28K
250 / 45	240 / 70	220 / 75
20K	12K	7K
210 / 75	210 / 35	180 / 20
		Surface
3K	1K	130 / 10 P 015
140 / 15	130 / 10	

Buttons: Grab, STCOMP, Flip Hp, Prebank Hp, Compute, Transfer

Figure 4.5-12 Auto DEL PAD Frames Page

Once the user has filled in the frames page as much as desired (there is no minimum amount of data required to execute the Transfer button), the Transfer page should be executed. The result will be an editable DEL PAD. The user then should make any final changes, then execute either the Safe or Publish button. Below in figure 4.5-13 is a published DEL PAD.

File Edit View Go Bookmarks Options Directory Window Help

Back Forward Home Reload Inspec Open Print Find Stop

Netsite: <http://mis-server1:8000/programs/FDO/DeorbitEntryLanding/Save>

PRE-DEORBIT

APU START: SINGLE APU START, ATTEMPT 1 APU(s)
APU START SEQUENCE 1 THEN N/A

DEORBIT

BURN CUE CARD:
OMS TIG SLIP - NO EXEC > TIG+ 3:00
RCS DOWNMODING N/A
STOP/CONTINUE CUES: L OMS FAIL HP 080
R OMS FAIL HP 080
OMS ENG FAIL XFEED QTY CUE %L 08 %R 08
ENGINE FAIL HP 080
SAFE HP 80
TOT AFT QTY 1 (%) 099
TOT AFT QTY 2 (%) 54
FLIP HP 65 AFT HP 40 B/U SITE N/A
FRCS: DUMP TO % (USE TIME AS CUE) ✓OX FU 00

ENTRY / LANDING

EI - 5 MM303 INRTL ATT R 296 P 028 Y 056
MM304 PREBANK (ENT MNVR Cue Card) ✓L R 000
ALTM SET 29.92
CLG INIT 04:16:19
EXPECTED AIL TRIM L ✓R 1.2
VREL 1ST REVERSAL 20500
XCG AT TD 0000.0
LAND SITE 22 RWY HNL08 50K 250 / 45
38K 240 / 70
✓L ✓OVHD 302 deg 06 MLS 28K 220 / 75
R STRT 666X TAC 20K 210 / 75
△ T MACH .95 TO HAC MAX Nz Nz LIMIT 12K 210 / 35
1:33 1.6 2.2 7K 180 / 20
AIMPOINT SPEEDBRAKE 3K 140 / 15
✓NOM ✓NOM 30 % @ 3K 1K 130 / 10
CLOSE-IN S.F. SURFACE 130 / 10 P 15

Document: Done.

Figure 4.5-13 Published Auto DEL PAD

4.6 PRE-DEORBIT THROUGH LANDING

4.6.1 *Maneuver Confirmation*

Deorbit maneuvers are confirmed using delta Vs computed by the GSO. OPS 3 burn confirmation delta Vs must be computed using the accumulated delta Vs on the MNVR MONITOR display. The auto comps in the TSA application RMM for confirming a burn do not work in OPS 3 because the parameters used are not available. RMM can still be used if desired to perform the subtractions of the pre burn from the post burn delta Vs.

The confirmation of the deorbit burn is not mandatory, but is highly desirable. The burn should be confirmed to have a record of the actual burn delta Vs. Once the confirmation is completed, the hardcopy of the actual burn DMT should be put on the maneuvers clipboard.

Also, after the confirmation the ORB Normal should be re-run to generate new nominal lines. If the confirmed burn is significantly different than the planned, then the new entry set should be sent out to the network.

4.6.2 *High-Speed Displays*

This section describes the FDO's high-speed entry displays. The standard set of enhanced displays for use from EI to landing are brought up by selecting High Speed Entry FDO from the displays menu. The displays include VREL (and Delaz) vs. RGO, Altitude vs. RGO, EOW vs. RGO, Entry Groundtrack, Log Log, and Entry Digitals. The four parameters that are plotted against RGO, as well as the Entry Groundtrack, are sequenced and re-sized automatically during entry to provide optimal viewing. The Log Log plot may be manually resized to determine precisely the orbiter's position with respect to the glideslope and centerline. The red dots represent the orbiter's state based on the selected source (TLM or FLTR), and the yellow pluses (+) represent the state based on telemetry (V53), set to CUR (PASS) unless BFS engaged, then it is switched to BFS. Therefore, if the selected source is TLM, the pluses and the dots will be superimposed. When an entry set is created, nominal lines representing the trajectory are also created and are shown on the VREL, Altitude, EOW, and Entry Groundtrack. This is the expected trace that the applicable parameter should follow for a nominal trajectory. If the entry set is changed after these plots have been called up, they either need to be dropped and recalled, or the Retrieve Static Data option needs to be used under the File pull down menu.

4.6.2.1 VREL vs. RGO

The VREL vs. RGO plot shows the orbiter's energy state with respect to several limiting energy states for velocities from Mach 22 down to Mach 2.5. DELAZ as a function of velocity is also plotted on this display

Figure 4.6-1 below is an example of VREL vs. RGO for Mach between 22 and 15. The left-most line represents the thermal re-use limit line for the wing leading edge temperature (CP3) of 2950 degrees. The right two lines are minimum bank angle lines of 37/20 deg and 0 deg respectively. Equilibrium Glide = 37/20: This line bounds the maximum range the shuttle can fly and still make the runway. The 37 and 20 degrees are the minimum bank angles required to protect the maximum crossrange case and maintain the DEL AZ within limits. It also assumes 3 sigma bad winds. The transition fro 37 to 20 degrees happens around MACH 11. Equilibrium Glide = 0; This line bounds the maximum range the shuttle could fly if it went zero bank, or max lift. It does not control DEL AZ or crossrange, and therefore does not guarantee making the site. These lines are redelivered each flight and are based on vehicle weight. The line that is drawn in the middle represents the nominal, or expected, trace that the orbiter energy will follow. It is generated by EPP. Notice that the VREL scale for the VREL vs RGO plot decreases from top to bottom, while the VREL scale for the DELAZ vs VREL plot increases. So, during entry as the VREL is decreasing, the VREL vs RGO plot goes down the page while the DELAZ vs VREL goes up the page.

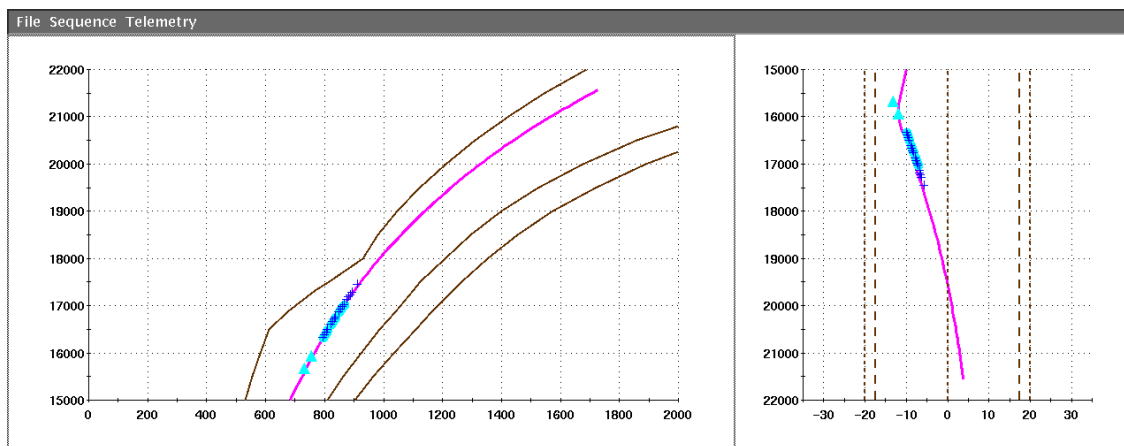

Figure 4.6-1 VREL vs RGO (high)

From a VREL of Mach 14 to Mach 2.5, the outer lines are a reference of guidance limitations, but the inner lines become GCA exceedence criteria. Auto Guidance Limit Lines - These lines are the maximum energy that guidance will be able to make up. The upper limit is a function of the guidance del az limit and max NZ. Guidance will never open the Del Az limits to bleed off energy, a frequently used technique in high energy GCAs. Opening the limits to 25 or 30 degrees allows the FDO to use less steep banks, and control the G-loads while still bleeding off energy, the onboard guidance will never command less than what is required to control the del az. A FDO will most likely call early roll reversals to make up energy The GCA take over lines were empirically derived to be the maximum amount of energy that could be recovered in order to converge back to nominal by Mach 6. It is our experience that these lines are not

conservative. Mach 6 was chosen because at this point the energy has not converged to nominal then the decision to redes or not can be made. This does not mean that GCAs will not be performed after Mach 6. GCAs can occur all the way up until rolling onto final. It is greatly preferred to converge back to nominal and terminate the GCA prior to Mach 2.5.

Figures 4.6-2 and 4.6-3 show the VREL vs. RGO for Mach regions from 10-5 and from 5 to 2.5.

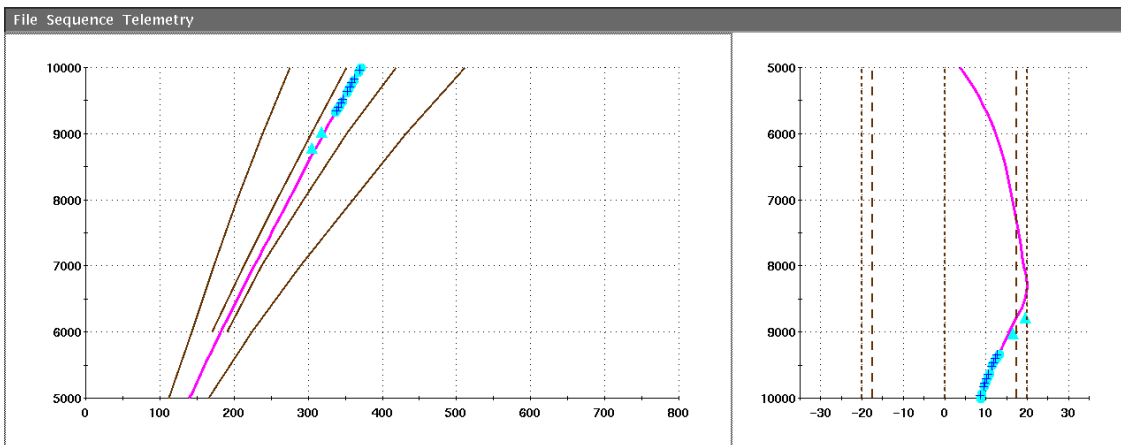

Figure 4.6-2 VREL vs. RGO (med)

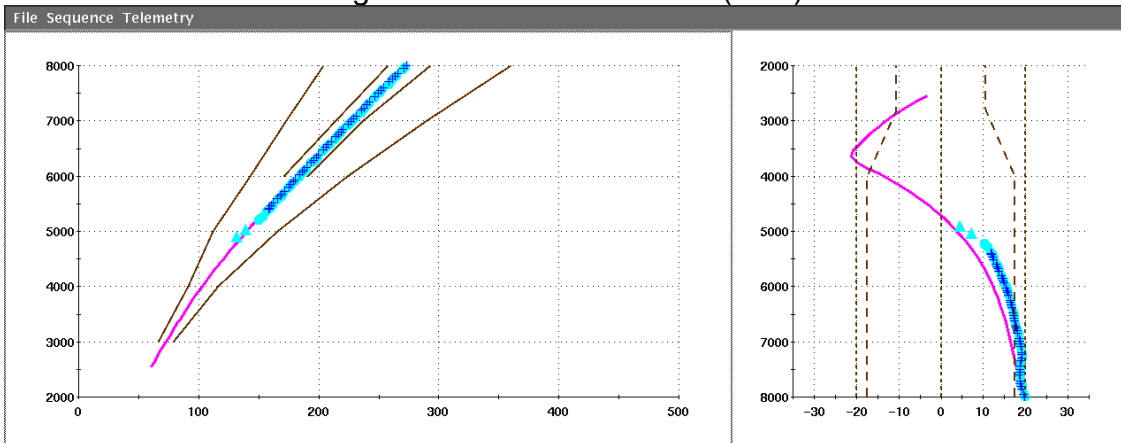

Figure 4.6-3 VREL vs. RGO (low)

4.6.2.2 Entry Groundtrack

The Entry Groundtrack shows the orbiter's position over the earth. As with the VREL vs. RGO, the nominal trace is drawn with generation of the entry set, and the selected source and telemetry states are plotted. Below are three views (figures 4.6-4 to 4.6-6), each progressively closer to the landing site. Note that for the HAC to be drawn, the targeted runway must be specified in the K51 MED. Also be aware that many options exist in the enhanced Entry groundtrack display such as the ability to display TACAN's and Runways for a specified area and to project the extended runway centerline.

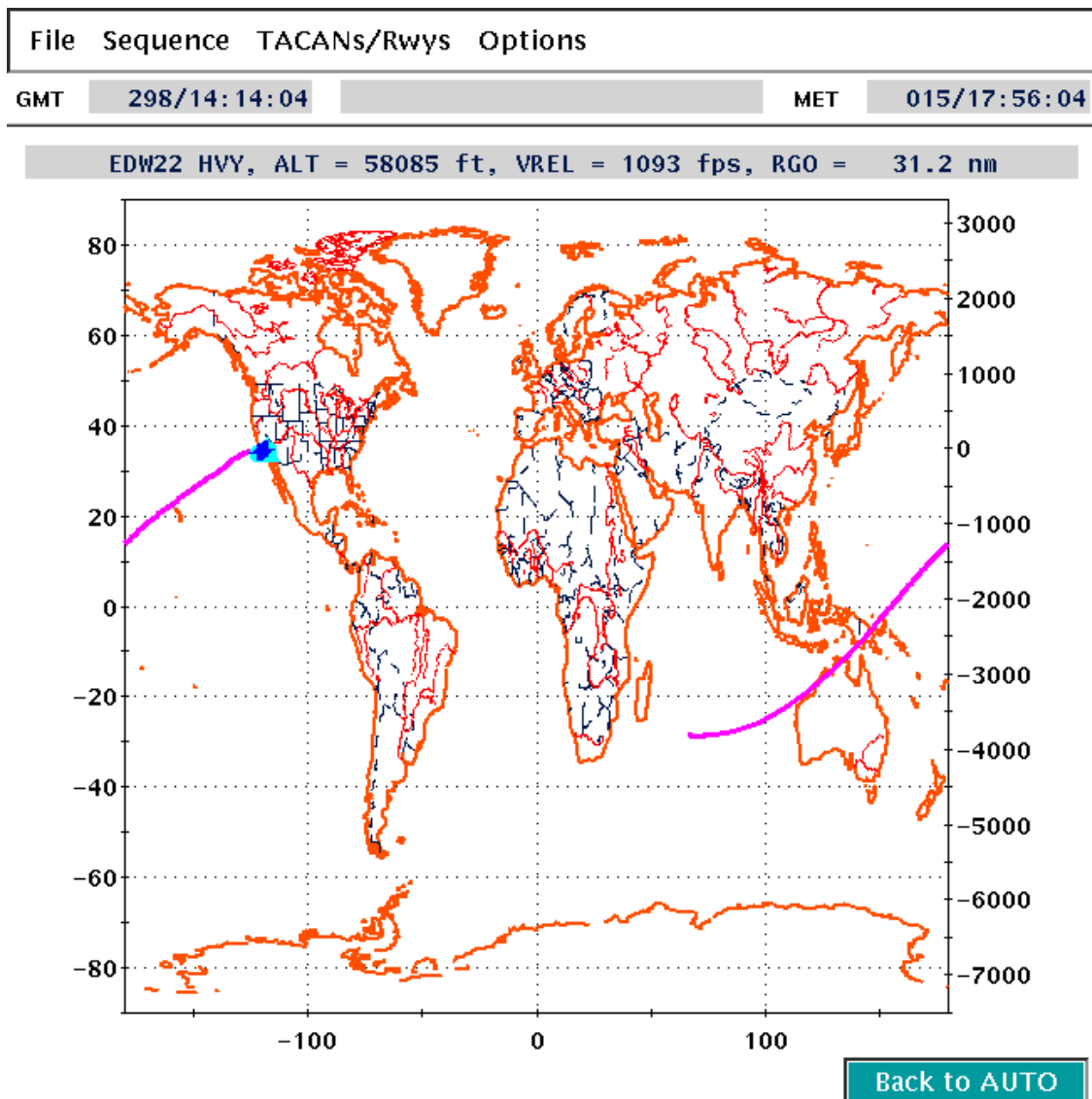

Figure 4.6-4 Entry Groundtrack (high)

File	Sequence	TACANs/Rwys	Options
------	----------	-------------	---------

GMT 298/14:09:21 MET 015/17:51:21

EDW22 HVY, ALT = 123221 ft, VREL = 6024 fps, RGO = 177.9 nm

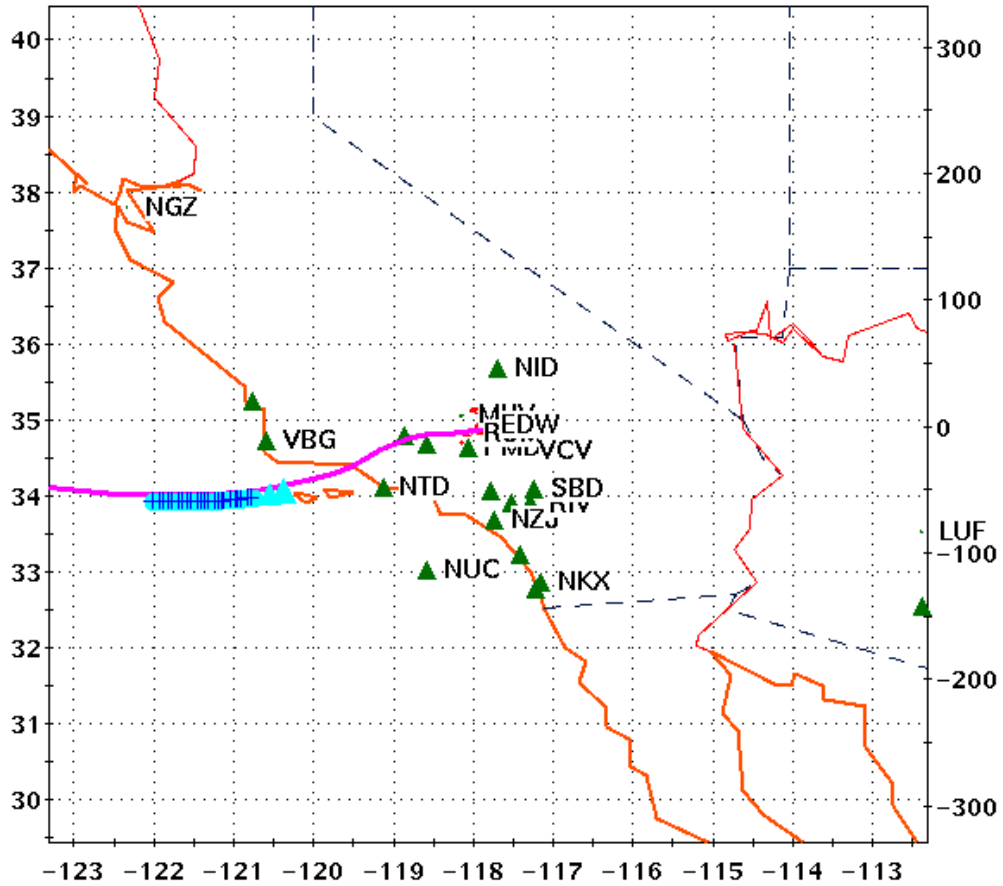

Figure 4.6-5 Entry Groundtrack (med)

File	Sequence	TACANs/Rwys	Options
GMT	298/14:17:16		MET 015/17:59:16
EDW22 HVY, ALT = 9869 ft, VREL = 609 fps, RGO = 6.7 nm			

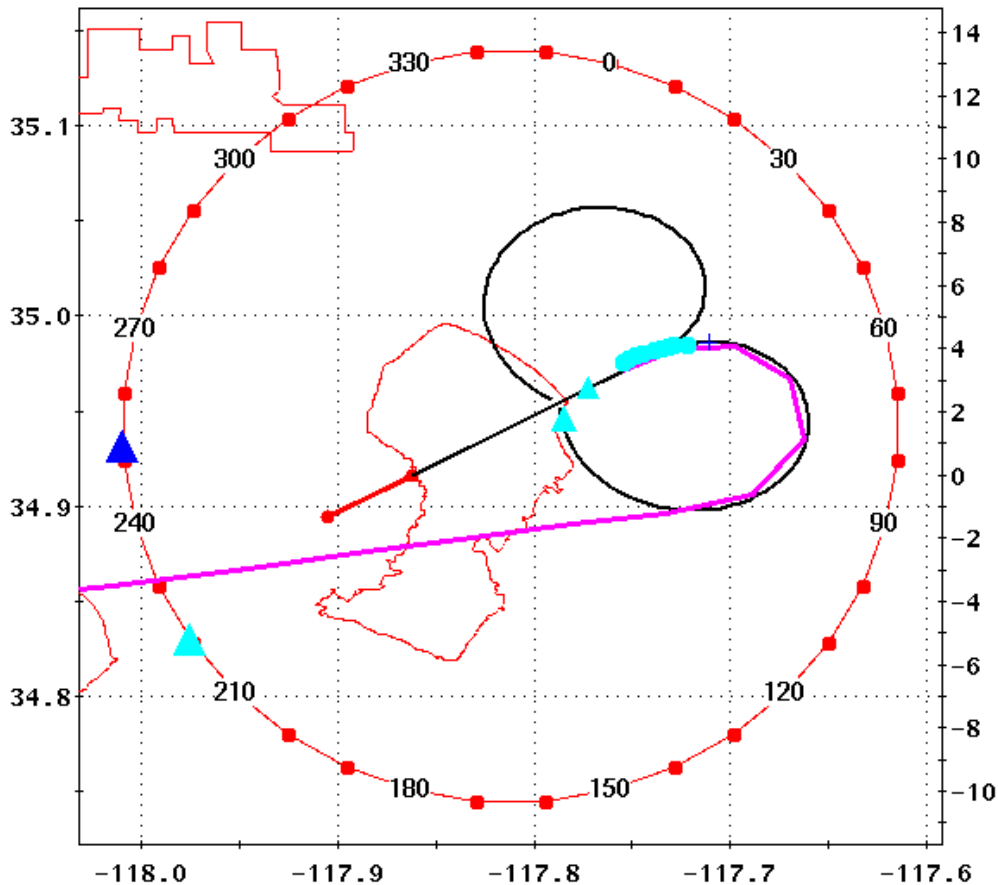

Figure 4.6-6 Entry Groundtrack (low)

4.6.2.3 EOW vs. RGO

The EOW plot is used as the prime energy evaluation tool from transition to TAEM guidance phase until on the HAC. At higher altitudes, the orbiter's energy state was primarily a function of its velocity. However, in these lower regions, the potential (altitude) energy must also be considered. Thus, EOW is more a measure of kinetic plus potential energy, whereas the VREL vs. RGO was more a measure of kinetic alone.

Figure 4.6-7 below shows the EOW plot. Four lines are drawn in addition to the plotted line which is drawn in realtime. The lowest line represents the BAILOUT line. For mission support, an additional line is generated which would be the next line above the BAILOUT line. This line is called the MAX RANGE line. Above

that is the STIN line. The nominal line follows, with the S-TURN line at the top. Following are the assumptions that go into generation of each of these lines:

BAILOUT – 3 sigma good wind, max L/D, STIN, HAC shrink

MAX RANGE – computed by Entry Support; STIN approach, latest winds aloft, A/L transition no later than 6k ft, partial HAC shrink, max lift/drag (L/D) angle of attack, and NEP. EOW grabs this file from a directory (it should be the only file in that directory). If the runway changes, Entry Support will need to put the correct file into the directory, delete the old file, and “Refresh Static Data” will need to be selected on the display. Entry Support should know whether there is sufficient difference between the files to warrant the change.

STIN – STIN approach, NEP, nominal energy by A/L transition; if energy continues to diverge after STIN is selected, this line is used to determine when to downmode to MEP

NOMINAL – generated by the entry simulation, includes latest winds aloft

S-TURN – this line is generated using the same constraints that are used onboard; PSHA must be < 200 degrees and RGO > 20 nmi

File Sequence Options

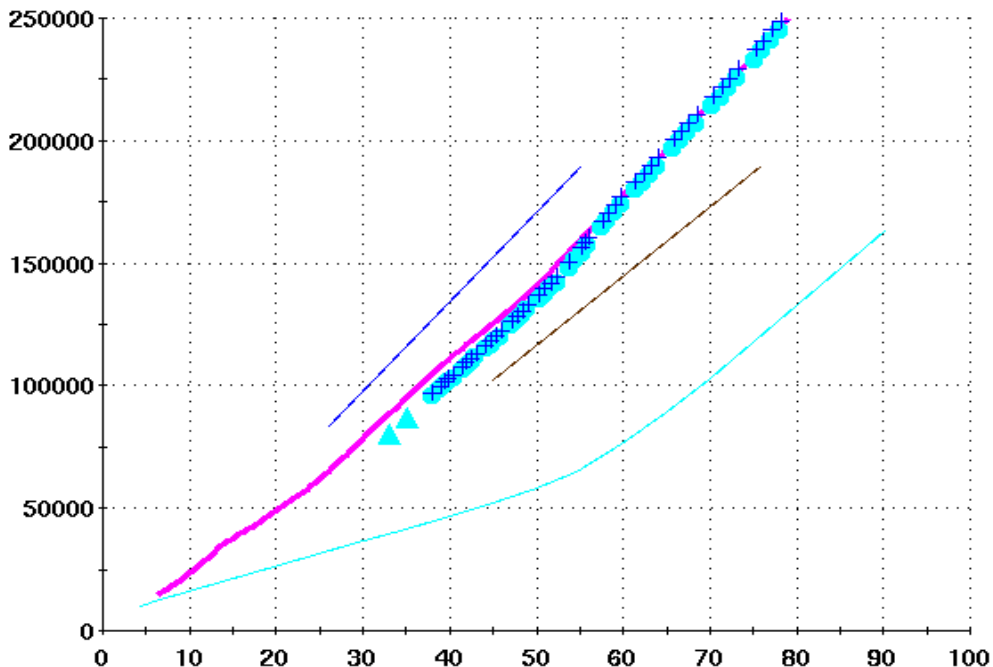

Figure 4.6-7 EOW vs. RGO

4.6.2.4 Altitude vs. RGO

The Altitude vs. RGO plot is only used in TAEM. The primary function is to compare the orbiter's altitude with the reference altitude. This data is used to make altitude high or low calls while on the HAC. See figure 4.6-8 below.

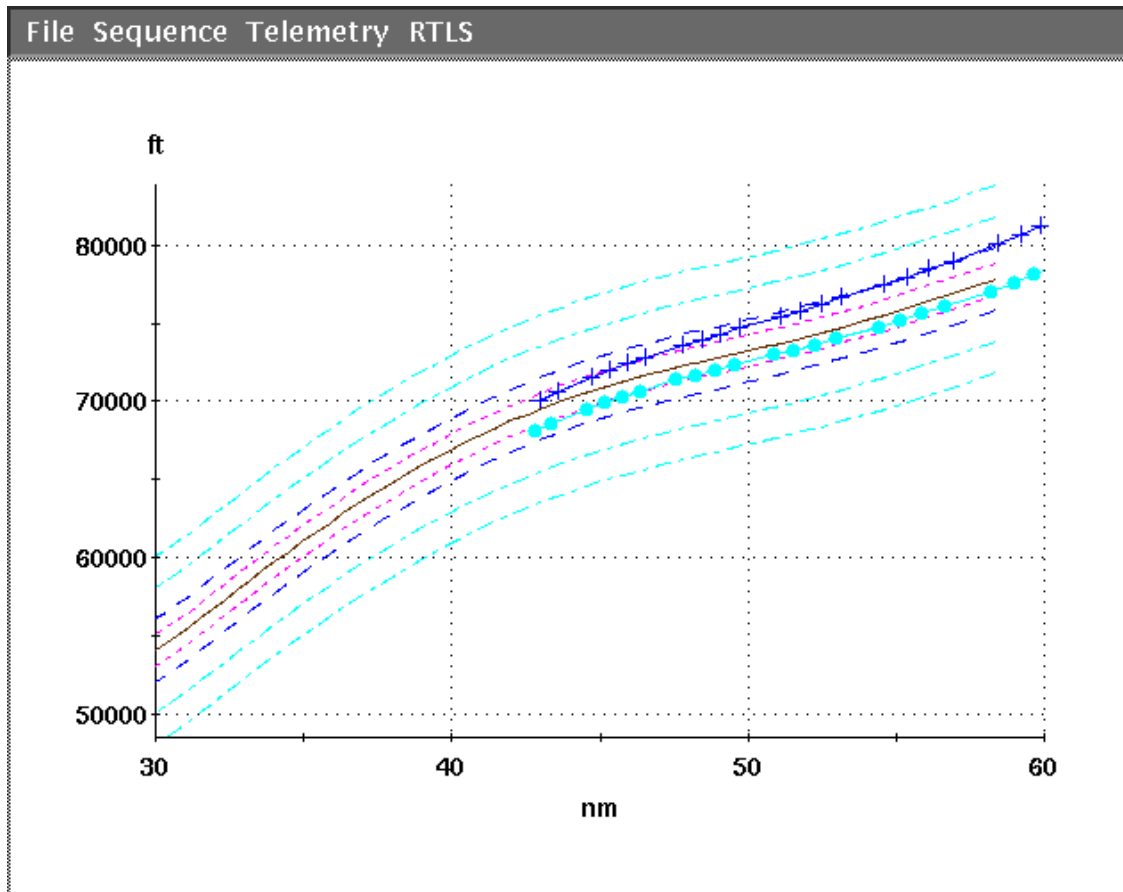

Figure 4.6-8 Altitude vs. RGO

4.6.2.5 Log Log

The Log Log plot (figure 4.6-9) depicts the orbiter's position relative to the glideslope and centerline while on final approach. The four glideslopes that are shown from steepest to shallow are as follows:

- 300 kts, 100% speedbrake
- 20 degree OGS
- 18 degree OGS
- 200 kts, 15% speedbrake

The two groundtraces of the HAC represent those flown with a heavyweight orbiter (18 degree glideslope), and that of a lightweight orbiter (20 degree glideslope). The lightweight HAC groundtrace is furthest to the left in the plot,

making it closer to the runway threshold and thus resulting in a steeper approach.

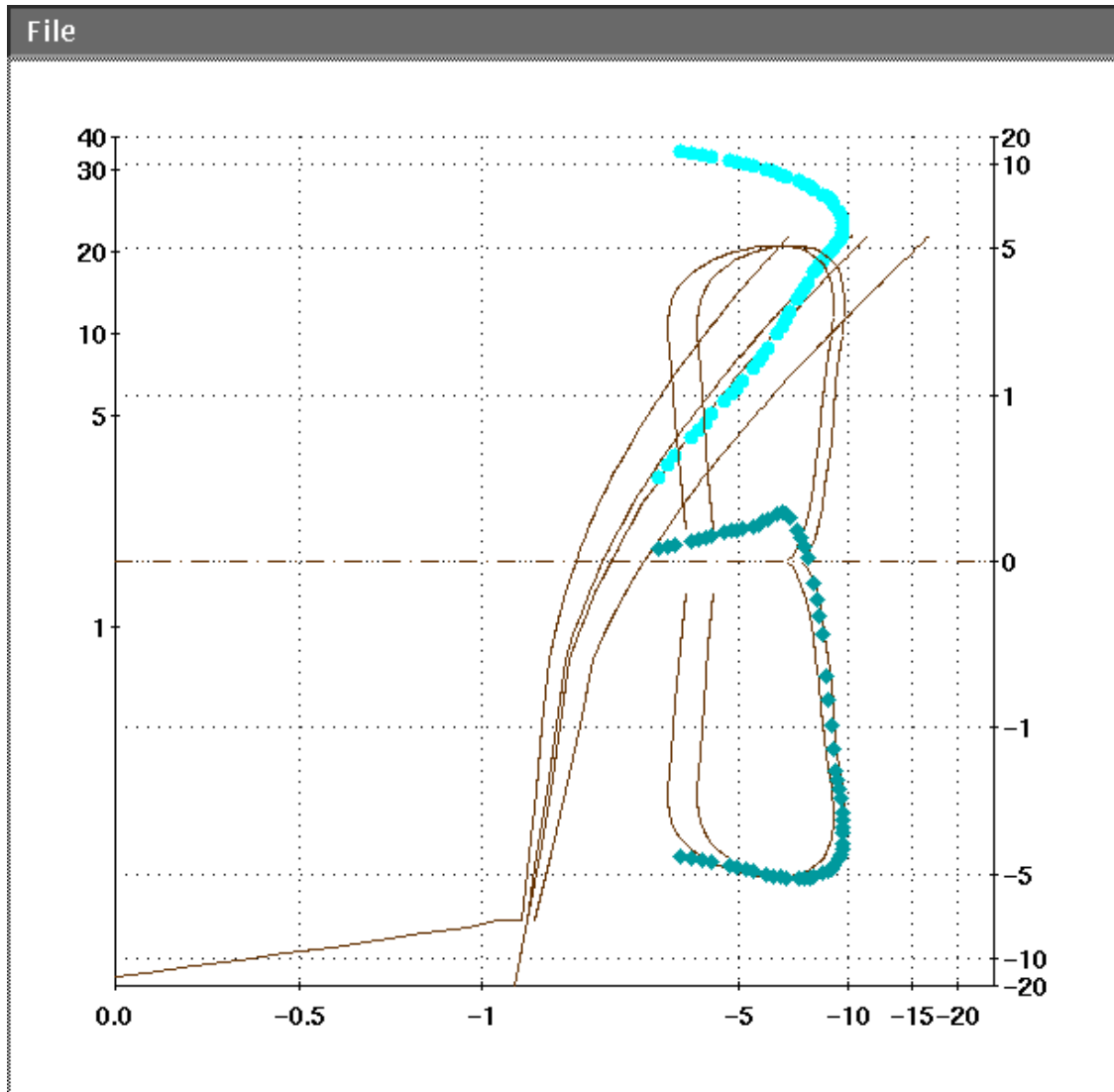

Figure 4.6-9 Log Log Plot

4.6.2.6 Entry Digitals

The Entry Digitals display is the FDO's primary source of digital data during entry. The primary digital parameters for entry are displayed in rows for easy comparison between tracking data, PASS data, and BFS data. In the upper left corner of the display, the runway and approach selections are shown for both the ground and onboard. This allows for quick determination of whether the ground configured is in synch with as the onboard. PBI's to the right of the display are used to make energy evaluations for different approaches and different runways. The PBI in the upper right corner is a toggle button between MANUAL and

AUTO. Selection of AUTO will allow automatic phase transitions during entry, provided downlist data is available. Figure 4.6-10 below shows an example of the display.

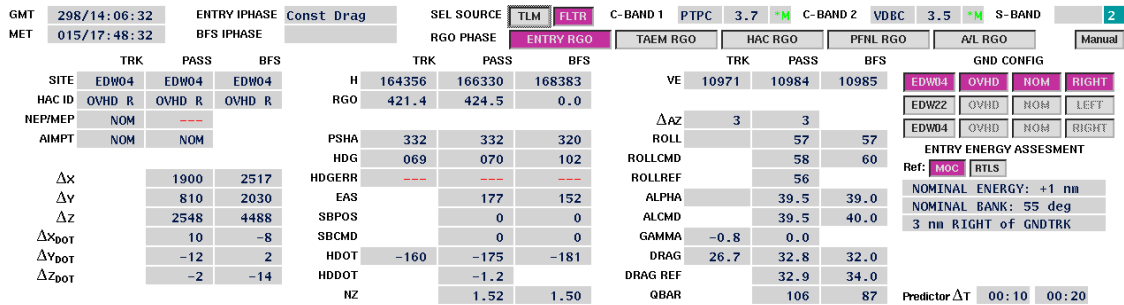

Figure 4.6-10 Entry Digitals

4.6.3 High-Speed Operations

High-speed OPS (either ascent or entry) from the FDO console require that the FDO and the TRAJ work together as a team. The FDO's main responsibility during the high-speed OPS is to evaluate the trajectory. The energy and groundtrack are checked and compared to the expected nominal lines. Console displays, DDD's, and Group Displays are configured automatically by selection from the DNAV pull-down menu.

4.6.3.1 FDO Responsibilities

Have DYN input the runways which will be used in the RGO computations in the primary (PRI), secondary (SEC), and alternate (ALT) slots in the MOC. This is done using the K51 MED. The FDO must chose the runways to put in these slots. The runway that was passed to the crew on the DEL PAD should go in the PRI slot. If later in the entry a delta state is required to update the orbiter SV, the runway in the PRI slot must be the same as the runway currently selected onboard. This is required in order to do a delta state because the MOC delta state processor and orbiter navigation both work in the runway coordinate system for the selected runway. There is more freedom in choosing the SEC and ALT runways. If the landing is at the KSC, the other end of the runway should be put in the SEC slot, and then either the primary runway should be repeated in the ALT slot, or another runway at a different site could even be used. If the landing is at EDW, the SEC runway should be one which has most of the navigation/landing aids available. This is done because the navigation and landing aids are highly desirable and it is preferable to have these aids on the secondary runway in case the winds do not favor the primary runway. The ALT runway is usually one which will be the most useful in a low energy case. The K51 MED also defines the HAC that is displayed on the Entry groundtrack display.

The SV selection PBI's must also be configured for the entry. This must be done prior to moding the MOC to LANDING PHASE. The BFS must be selected on V54 (PBI in the middle of the top row) and user parameter processing (UPP) selected for CUR O/B (PBI in the middle of the middle row). If the correct PBI's are not selected the GPO will not get all the vectors needed for evaluating the orbiter navigation state.

Next, have DYN mode the MOC to LANDING PHASE. This is done with the P81 MED. FDO can verify that this has been done via feedback on the DDD panel. Going to LANDING PHASE is usually done at approximately EI-5 minutes.

On the Entry Digitals display, several items need to be verified. First, another check that the proper primary runway is selected and that it agree with what is selected onboard. Next, verify the approach direction (OVHD or STIN) matches what was expected and that which is selected onboard. The FDO should also check that the entry phase RGO (ENTRY RGO PBI) has been selected and that AUTO and TLM are selected. The transition to landing phase should have initialized the RGO to the entry phase. Also, check to be certain that the PBI's for vector selection are still correct. The correct configuration is as follows:

V54 - BFS
V56 - CUR O/B
CUR O/B - UPP
V53 - CUR UPP FILTER.

For a BFS engage case, V56 would need to be changed to BFS O/B, and V53 would need to be changed to BFS GND.

The high-speed trajectory determination (HSTD) processor, commonly referred to as the FILTER, is the ground radar data processor for determining the vehicle state during ascent and entry mission phases. The vehicle trajectory is determined through a Kalman filter algorithm which can process data simultaneously from two C-band and one S-band radar tracking station at a data rate of 10 samples per sec. The output of this processor is at the display rate of 2 sec and is in the form of estimated position, velocity, acceleration, and measurement biases. From these estimated state elements, vehicle-related information (i.e., altitude and groundtrack) may be derived for display monitoring, onboard comparison, and ancillary processing. HSTD processing is controlled by the NAV position in the FLIGHT DYNAMICS MPSR; NAV assesses the health of the HSTD output and relays this information to the TRAJ. General NAV criteria for a GOOD FILTER are:

- a. A minimum of two agreeing sources (ground stations);
- b. A minimum elevation angle for each ground station of 3°;

- c. At least 80% of the tracking data flagged "good" from each ground station being processed;
- d. Estimated biases, computed by the ground Kalman filter, for each of the tracking data measurement types for each ground station are within NAV's expected $1-\sigma$ mean values.

Typical $1-\sigma$ estimates of position and velocity accuracy for a GOOD FILTER solution are 500 ft and 10 ft/sec, respectively.

TLM may be used to drive the high-speed plots prior to getting tracking data. The selected source (FLTR or TLM) PBI is used to choose the data source.

Once high-speed tracking data is available, the FDO should select FLTR as the selected source unless advised otherwise by NAV. The FDO must also keep the Flight Director advised on the status of the trajectory and ground RADAR processing. The first call is usually one to inform FLIGHT that tracking data from a single C-band is being received in the MCC. Example: "FLIGHT, FDO; single C-band, no filter." After a second source of SV data becomes available (another C-band, an S-band, or confirmed onboard SV), NAV should inform TRAJ that two sources are now being received and also whether the ground filter is good or not. Two sources may be available and the data can be suspect due to low elevation. An example call for this case is "FLIGHT, FDO; we now have two C-bands, low elevation. No filter yet." FLIGHT must be informed about any changes to the tracking data availability and impacts on the ground filter status. Once NAV makes the GOOD FILTER call, TRAJ must verify that the FDO is aware of this fact. The FDO should verify that FLTR is the selected source. The FDO then informs FLIGHT that the filter is GO and gives a status concerning the energy and groundtrack.

If ground station or ground system failures occur which result in only one available tracking source, there is no way to evaluate energy or onboard navigation status with confidence, due to the fact that deltas seen between the filter and the onboard could be due to dispersions in either or both. There will be no "Good Filter" call made in this case.

A single S-band radar can have range biases due to a phenomenon called a "tone shift", resulting in a bias which manifests itself in multiples of 300 meters, S-band angle measurement quality is generally low, and keyholes due to antenna hardware limits can cause significant problems.

A single C-band radar can have false locks, especially over terrain, due to multipath and refraction errors induced by low elevation. High elevation C-band flyovers can require filter restarts due to the high antenna slew rate.

One-sigma accuracy for a "good filter" is represented by about 500 ft in position error. A single tracking source can be especially troublesome at KSC due to numerous flyover and keyhole regions. Generally, energy evaluations and GCA's will NOT be performed off of a single-source filter. However, if the filter and onboard states are initially in good agreement and an onboard systems failure (e.g., IMU, RGA, etc.) causes divergence, the single radar may be the only source with which to correct the NAV state or provide GCA commands. In the event that any failures or significant ground vs. onboard deltas occur while on a single unconfirmed radar, it is the responsibility of the FDO, GPO, NAV, and ONAV to attempt to determine the best state vector source and take the appropriate action.

Once the filter is good, the FDO uses the VREL vs. RGO display to determine the orbiter energy status. Energy status is determined by taking the difference of the nominal and the actual RGO at a common velocity. The FDO reports this difference to FLIGHT in terms of number of nautical miles high or low in energy. The centerline on the plot is the nominal profile. The innermost set of lines on either side of the nominal are used as a criteria for manually correcting the trajectory using GCA techniques, assuming onboard navigation errors exist. GPO is responsible for the onboard navigation status; therefore, FDO should periodically poll GPO for an updated navigation status. The outermost lines indicate that guidance, even with perfect navigation, will not be able to correct the energy deviation by TAEM, and therefore manual intervention is required. GCA procedures are discussed in detail in section 4.7.2.4.

Groundtrack evaluation is made using the Entry Groundtrack display. Once there is a good filter, the FDO compares the orbiter groundtrack to the nominal groundtrack. If the groundtrack is different, the FDO determines the magnitude in nautical miles (if significant). When the FDO reports the energy status to FLIGHT, a groundtrack status should also be given. This is done by reporting the number of nautical miles the actual groundtrack is from the nominal and the direction (e.g., 30 n. mi. to the north). This call, as well as the energy status call, is made to the crew to inform them of their trajectory status. An example call after NAV has made a GOOD FILTER call is "FLIGHT, FDO; we now have a good filter. Energy is 10 miles high, and the groundtrack is 30 miles south of the nominal."

The FDO and TRAJ monitor the DELAZ to verify that the orbiter guidance system is properly executing the roll reversals. DELAZ is the difference between the orbiter current heading and the desired heading to reach the HAC tangency point. DELAZ usually remains within a window between plus and minus 20°. Roll reversals are executed as a function of the DELAZ. The first roll reversal occurs at a DELAZ of 10.5°. Subsequent roll reversals occur on a DELAZ versus Mach number schedule, but the DELAZ is around 17.5°. If the DELAZ gets much higher than about 20°, it will cause the energy to start deviating rapidly. The VREL vs. RGO plot shows the selected source and TLM DELAZ vs. VREL.

Prior to Mach 6, the FDO needs to review the latest surface winds and weather to determine if there is a need to redesignate the orbiter to a different runway. This would only be done in rare situations, such as a tire leak with the crosswind on the opposite side, or perhaps if a thunderstorm threatened the approach to the selected runway.

If redesignation is required, the K51 is sent again to place the new selected runway in the PRI slot. FDO must notify FLIGHT that he/she recommends redesignating to another runway and explain the rationale behind the recommendation. FDO and GPO should then both verify that the crew has redesignated to the correct runway.

The FDO will toggle the PBI's and then view the deltas to the energy to evaluate the options. These options include such things as downmoding from an OVHD approach to a STIN approach, downmoding from the NEP to the MEP, or downmoding to the SEC or ALT runways. The MOC defaults to NEP. The difference between NEP and MEP can easily be seen in figure 4.6-11. The NEP intersects the extended runway centerline at 12,000-ft altitude, and the MEP intersects it at 6,000 ft. Downmoding to MEP would be of most value when the approach to the runway would require a 180° HAC turn. If an energy downmoding option or options must be used, the downmode from OVHD to STIN would be done first, and then downmode from NEP to MEP would be considered if required.

Care should be used when toggling between PRIMARY, SECONDARY, and ALTERNATE PBI's to remember that the only part of our displays that change when these PBI's are used is the energy portions of the VREL and EOW plots. The DELAZ portion of these displays and Entry Digitals are always driven by whatever is in the primary slot, regardless of the PBI's. This can be confusing in some cases, as a HAC wrap in the Secondary/Alternate is invisible on Entry Digitals and the DELAZ can lie to you if the Pri and Sec sites are sufficiently far apart

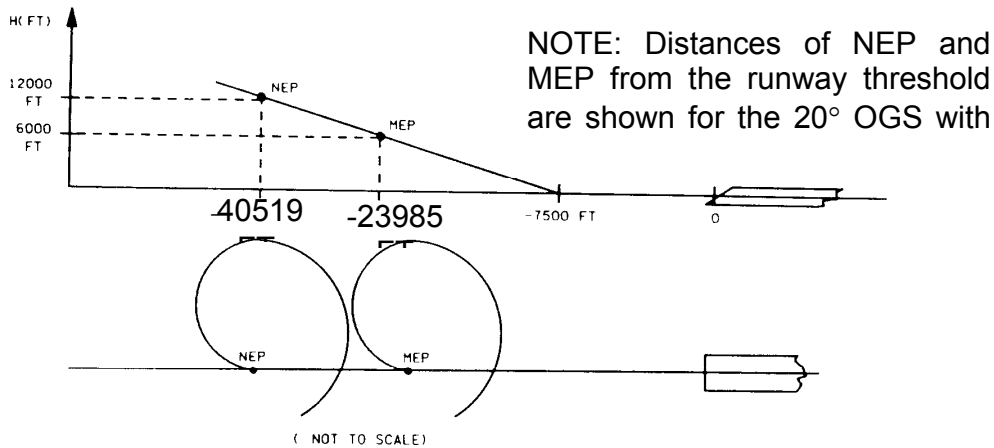

Figure 4.6-11 NEP and MEP

At Mach 3 the FDO also shifts from monitoring the VREL vs. RGO plot to the EOW vs. RGO and ALT vs. RGO. Also, the compass rose on the Entry Groundtrack display becomes visible and the FDO uses this to verify that the orbiter is heading toward the proper HAC. The compass rose would be used to determine the magnetic heading to give the crew in case of a GCA.

At TAEM I/F, TRAJ informs FDO that TAEM guidance is now active. This occurs at Mach 2.5 for EOM, and Mach 3.2 for RTLS and should be followed by the automatic transition in the entry PBI's to TAEM if downlist is available. This tells the MOC to use the TAEM phase RGO computations. DYN has the capability to back up these PBI inputs via MED. If the PBI fails, you can have DYN input the ACQ RGO PBI. FDO should tell DYN to send the acquisition RGO PBI MED. Saying "acquisition" is highly recommended because ACQ and HAC sound very similar on the loop.

NOTE

Once the ACQ PBI is input, the DELAZ vs. VREL plot stops updating

At around Mach 1.5, TRAJ will request a final update to the surface wind, altimeter setting, and weather from WEATHER. The TRAJ will compute the head, tail, and crosswind components. FDO will report these updates, along with a current energy status to FLIGHT. Negligible changes to the weather, surface wind or altimeter setting can be passed as "No change to winds and weather".

Example: "Energy looks good approaching the HAC. Winds are now from 250 at 10 knots, which breaks down to 9 head, and 4 from the right. Altimeter is 29.95."

Approaching the HAC, FDO pays close attention to the ALT vs. RGO plot to evaluate any altitude deviations from the reference altitude. At HAC acquisition, FDO verifies that the orbiter is actually doing the HAC turn.

Energy calls in TAEM will be made based on the high speed ground filter. For an OVHD approach, calls will be made at the following points:

- a. In TAEM, approaching the HAC
- b. At the 270° turn-to-go point
- c. At the 180° turn-to-go point
- d. At the 90° turn-to-go point
- e. At the transition to the OGS (centerline and glideslope status)

For a STIN approach, calls will be made at the following points:

- a. In TAEM, approaching the HAC
- b. At 40k altitude
- c. At 30k altitude
- d. At 20k altitude
- e. At the transition to the OGS (centerline and glideslope status)

The criteria for making off-nominal energy calls on the HAC will be altitude deviations from the HAC reference profile according to the table and examples given below. If off-nominal energy is the result of an onboard nav error, that fact will be included in the call. If a nav error is not identified as the cause, the crew should consider the call an advisory to fly the needles more closely. If energy is clearly diverging from or converging to the nominal, that fact will be included in the call. Converging energy will not be cause for withholding a call. FDO will make the calls in hundreds of feet, and CAPCOM will pass the calls to the crew using the following terminology.

DELTA ALTITUDE	HAC ENERGY CALL TERMINOLOGY
DH < 1000 FT	ON ENERGY
1000 FT < DH < 2000 FT	SLIGHTLY HIGH/LOW
DH > 2000 FT	HIGH/LOW

Examples:

FDO: "1500 feet low at the 180 due to nav but converging."

CAPCOM: "You are slightly low at the 180 because of nav but converging."

The GPO reports the size and nature of the nav error to FLIGHT. If there is no MLS, or the GPO expects a nav error to persist for some reason, the crew will be given a "heads up" to expect a displacement to the right or left of centerline rolling onto final, along with the energy advisories.

CAUTION

It should be emphasized that the crew should always follow the guidance commands on the HAC, even with a nav error present, unless a GCA has been declared.

On final, FDO uses the Log Log display to evaluate the orbiter's position with respect to the centerline and glideslope. An example call here is "FLIGHT, FDO; slightly above glideslope and slightly left of centerline but converging to both."

After touchdown, have NAV stop the filter and have DYN take the MOC to OPS PHASE.

4.6.3.2 TRAJECTORY Responsibilities

The TRAJ is the prime interface with NAV during entry and keeps the FDO informed on the high-speed filter status. TRAJ should periodically check with NAV on the current ground filter status. Prior to TAEM, the TRAJ needs to monitor the same parameters that the FDO is monitoring. The TRAJ should carefully monitor the DELAZ keeping the FDO informed about the DELAZ progress, inform FDO when a roll reversal is coming up, and inform FDO of the orbiter navigation status (both PASS and BFS).

TACAN data is usually incorporated into the navigation data around Mach 8. Usually by Mach 6, the TACAN's should have taken out most of the orbiter navigation errors. However, GPO will have to determine if TACAN will correct the error or if a delta state will be required. If a delta state is required, TRAJ needs to be sure GPO is aware of the Filter status. A Delta State may only be built if a Good Filter exists.

Should the crew engage the BFS or is in the No Yaw Jet mode, TRAJ needs to keep the FDO informed about roll reversals. Additionally, for BFS engage TRAJ needs to change the state vector PBI's.

With the development of the enhanced entry displays, the responsibilities of the TRAJ have dramatically decreased, and in a general sense, the TRAJ now is basically a second set of eyes for the FDO in the high speed timeframe.

4.6.3.3 NAV Failures

The following is a discussion of possible failures that could affect high-speed tracking:

ROCC - The Range Operations Control Center (ROCC) at KSC is responsible for collecting all high-speed C-band tracking data, statistically choosing the two best sources, and then shipping that data to the MCC. The ROCC performs this function for KSC as well as EDW and NOR landings. Typically, data from four or more radars are fed to the ROCC, where prime and backup computers process the data redundantly. If the ROCC is unable to perform this function, then no C-band data will be received in the MCC. Eastern Range radars are wired directly to the ROCC. Western Range and NOR radars are routed along dual lines to the ROCC with 4 radars (2 for NOR) on each. Having dual lines provides data transmission redundancy. However, if the same radar is routed on both lines, and the ROCC chooses this as best source, then the MCC will receive 2 copies of the radar. This is effectively a case of single-source tracking data, in which a "good filter" call cannot be made. To prevent this from occurring, ROCC personnel must inhibit the port containing any duplicate radar data.

Ground-to-Ground FEP - Tracking data come into the MCC via the Ground-to-Ground Front End Processor (FEP). Failure of this box will cause the filter to go static and plot unusable data. Select TLM with the PBI in this case until the FEP is brought back up.

S-band - S-band tracking data is typically available only at KSC (MILS and MLXS). EDW S-band is for comm only. S-band data is routed through GSFC, and therefore is not affected by problems at the ROCC. The two S-band systems, MILA System 1 and 2, have opposite keyhole patterns (E-W and N-S). Selection of the optimum system can be made to provide comm/tracking with as little interruption as possible. In the event of failure of either system, a switch to the backup can be made in real-time, but this may result in late acquisition due to the keyholes.

Refraction - Atmospheric conditions affect radar performance, especially at low elevations. Refraction correction for known effects is performed at most C-band sites. MCC Navigation personnel can also perform this correction if required. Any radar that does not have atmospheric correction outputs biased data that should be readily apparent to Ground Nav. In this case, Nav can have INDAT switch out the radar, or can elect to perform the correction in-house.

Noise - Noisy data is typically encountered at lower elevations. This can be seen on the Vrel vs. Rgo plot as "scatter" in the points. Nav's "good filter" criteria requires that at least 80% of the incoming tracking data be flagged as "good" before a filter call may be made.

Biases and Disagreeing Radars- Biased radar data (range, angles, or range-rate) can be caused by inaccuracies in the radar mechanisms. The HSTD automatically solves for biases, and extremely biased radars can be switched out manually. A filter re-start can be commanded if the HSTD has built up inaccurate biases during a period of low elevation or flyover. In the case of disagreeing C-bands, Nav may switch out one of the radars with a new source to see if this provides better agreement. GPS, S-band, or onboard nav-state comparisons may also be employed to help resolve disagreements.

Flyover - At high elevation angles, the accuracy of angle measurements degrades due to rapid slew rates of the radar. The Kalman filter identifies this condition and will exclude the noisy measurements. However, in the case where both C-band sources are co-located and slewing rapidly, this could result in either no azimuth or no elevation angles being accepted into the Kalman filter. In this circumstance, the HSTD will continue to propagate the state vector, but without the latest (edited) angle information. This will most likely result in an erroneous trajectory. The workaround to avoid this problem is for Nav to perform one or more filter re-starts, which will force the Kalman filter to accept the noisy angle measurements. In this case the point is, noisy data is better than no data. Failure to perform filter re-starts during the STS-111 entry at EDW resulted in the filter showing a left turn on the HAC when in reality the vehicle was turning correctly to the right.

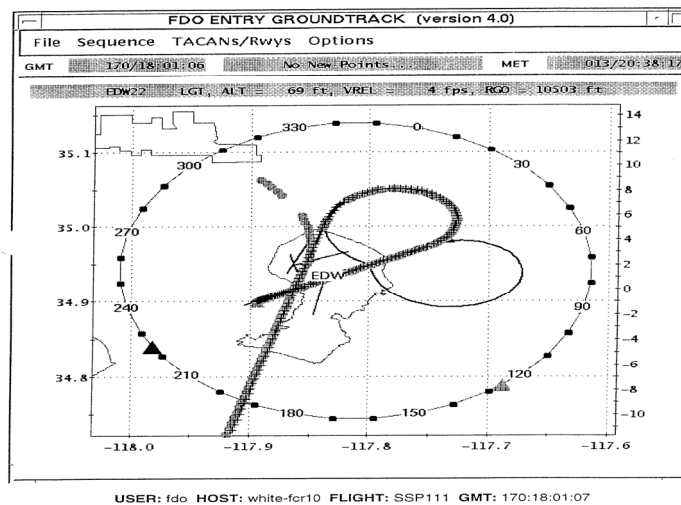

Figure 4.6-12 STS-111 Groundtrack

Acquisition Data - Track takes FDO's entry ephemeris and transmits it to GSFC, which in turn processes the data to generate site-specific range, azimuth, and elevation data. The individual radars utilize this for initial pointing directions to acquire the orbiter. Any error in this process could result in delayed acquisition, or even acquisition of a different target, as happened during the STS-36 entry where an airliner was tracked instead of the orbiter.

4.7 OFF-NOMINAL PROCEDURES

Much of what a trainee learns in the course of the certification process is how to handle anomalies. Simulations will present a wide variety of malfunctions relating to the deorbit targeting process as well as post burn high speed operations.

4.7.1 *Deorbit Targeting*

Common anomalies seen in the deorbit targeting process include insufficient propellant, off-nominal CG locations, and busted burns. Although more likely to occur when an Orbit FDO is on console, Emergency and Anytime Deorbits are also discussed.

4.7.1.1 Off-Nominal Procedure for Propellant and CG

Selecting the TIG for cases where there is not sufficient propellant available to meet the targeted ΔV or where we must use more than the targeted ΔV for CG and landing weight constraints will require special attention. For insufficient propellant, the FDO has the option to shallow the deorbit targets until the ΔV /propellant available is achieved. Before targeting to shallow targets, the FDO must consider the propellant available in the FRCS, ARCS above Quantity 1, and OMS. Shallow targets will provide limited ΔV recovery of up to approximately 20 to 50 ft/sec. Options available before downmoding to shallow targets include: Burning OMS propellant below 5% down to 0% usable, FRCS and/or ARCS perigee adjust > two orbits prior to TIG. Reference the deorbit targeting priorities flight rule for more details.

In order to minimize the landing weight, the fuel wasting option is often used and requires the FDO to input the amount of propellant to be used at the targeted TIG. The fuel usage mode in the DMP will have to be changed to OP (out-of-plane, fuel wasting). This can be done either by changing it in the DCT (appropriate column) or can be overwritten on the R08 MED, which is the more common method. The DMP will compute the OOP attitude required for the burn. However, the OOP direction may be bad for communications through TDRS. POINTING can evaluate the burn attitude for comm. If the opposite OOP direction is desired, the only way to get this result is to direct input the PEG4D targets into the ephemeris with the opposite sign on the propellant quantity (PRPLT). This may be done if time permits.

4.7.1.2 ARCS Completion

Under certain circumstances, such as OMS propellant failures or tank leaks, there can be too little OMS propellant remaining to deorbit, and the burn must be completed using the ARCS. The FRCS is only used to perform a perigee adjust maneuver, prior to deorbit, to reduce the total OMS/ARCS deorbit cost. This precludes having to use the FRCS during entry, eliminating the need for a fast flip maneuver.

The Deorbit Targeting Priorities flight rule places ARCS completion fairly low on the list of techniques to consider if there is insufficient ΔV available to achieve nominal EOM deorbit targets. ARCS completion using RCS propellant down to Aft Quantity 1 is considered only if there will not be enough propellant in the OMS even after performing an FRCS perigee adjust. An ARCS completion could be performed without having done an FRCS perigee adjust if the propellant problem occurred within two orbits of deorbit and a perigee adjust burn could not be confirmed. Using the ARCS down to Quantity 2 is last on the list; it is below using shallow deorbit targets.

Use the following procedures to model deorbit burns with ARCS completion. An abbreviated guide to ARCS completion burn modeling is included as a checklist in section 4.5.8.

- a. Obtain the ΔV s available for deorbit out of the OMS and the ARCS from PROP and run the DMP TIG free, using OMS thrusters (1OL, 1OR, or OBP).
- b. Transfer the maneuver to an ephemeris and perform a ΔV override, using the OMS-only portion of the total ΔV . Find the time of burnout of this first maneuver.
- c. Anchor a second ephemeris on the burnout vector of the first maneuver, but use a static start time about 10 minutes before the original TIG. Set the ephemeris weight to the burnout weight of the first ephemeris.
- d. There are two methods of modeling the RCS completion part of the burn. Both are covered here, however the method in step d.2 below will not work for a burn that is started with fuel wasting. Therefore, step d.1 is usually used (it works for both inplane and OOP deorbit burns.). This is the procedure (step d.1) used in the RCS COMPLETION C/L that can be found in section 4.5.8.

(1) Direct input the RCS completion of the deorbit into the second ephemeris. Use the PEG 4D targets from the first burn without the propellant quantity (no fuel wasting). Have DYN use the TIG from the first maneuver as the Target TIG on the M40 MED. Also on the M40, change the thruster to PX4. Then have DYN use the first maneuver burnout plus 20 sec as the Ignition Time on the M66 MED. Verify the correct target TIG (TIGT) and actual TIG (PETI) on the DMT.

(2) Rerun the DMP using the second ephemeris. Use a fetch time before the original TIG. Hold the targets from the original maneuver, fix the TIG at the first maneuver burnout plus 10 sec, and override the thrusters (PX4, PX3, or PX2).

It is important to realize that we cannot correctly transfer this second maneuver to an ephemeris. This is because the target TIG is part of the original target set. The DMP will use the input TIG as the actual TIG for the RCS portion of the burn. The DMP does take into account the fact that the target TIG and the actual TIG are not equal. However, if the resulting RCS completion is transferred to an ephemeris, the resulting maneuver in the ephemeris will be invalid. The ephemeris does not know that the transferred solution has a target TIG that was different from the actual TIG. If the solution is transferred to an ephemeris, an erroneous REI, ΔV , and entry profile will result.

- e. Verify that ΔV is approximately equal to the total deorbit ΔV minus the OMS-only ΔV , that deorbit targets were held from the original solution, etc.
- f. Run entry mass properties using the special RCS burn completion procedure found in section 4.7.1.3b. If the problem leading to the limited propellant situation was a tank failure, check with PROP to find out if a mixed crossfeed will be used for the OMS part of the deorbit. For a mixed crossfeed, use the special procedure in section 4.7.1.3a, but include the ARCS postburn quantities in step d.
- g. If you did not direct input the ARCS part of the deorbit burn to an ephemeris, obtain the entry displays, nominal lines, and EPSAT by running a DEORB on the DMP solution of the RCS completion.

If a single OMS engine is available for deorbit and RCS downmoding at TIG is not available, then the FDO should determine the point in the deorbit burn at which it can be completed using OMS propellant interconnected through the RCS, plus ARCS propellant down to Aft Quantity 1, if the remaining OMS engine should fail.

In section 4.3.6.5.1, we knew the size of the OMS portion of the burn in advance, and only RCS fuel was being used with RCS thrusters. However, in this case the deorbit burn would occur in three segments: OMS only, OMS fuel through RCS, and RCS only. Burn modeling is done a little differently, and considerable iteration is necessary to determine the delta V's. This is because the OMS propellant already burned through the OMS engine is no longer available for use with the RCS; and, since the RCS thrusters have a lower Isp than the OMS, less total ΔV is available through the RCS for the same propellant quantity. In other words, a different number of pounds per foot per second results if we burn the OMS propellant through the RCS system. The propellant breakdown looks like this:

Pounds OMS propellant used through one OMS engine before failure +
Pounds OMS propellant remaining for use through RCS thrusters +
Pounds RCS propellant available for use through RCS thruster +

Total pounds of propellant available for deorbit

Initially, the first two quantities in the propellant breakdown are unknowns. We need to iteratively find the earliest point at which the targeted burn could be completed after the OMS engine failure, using the remaining OMS propellant through the ARCS, and RCS propellant down to Aft Quantity 1.

Use the following procedures to model a broken deorbit burn with OMS interconnected through the ARCS. First, make sure the EOM orbit mass properties have been updated and the latest predicted quantities are available for PROP.

- a. Compute the approximate pounds of propellant burned per foot per second of ΔV for the OMS and for the RCS. Use ordinary steep and shallow examples for 1 OMS and PX4 thrusters from the DST. The values are a function of orbiter weight, but typical numbers are 22 lb/ft/sec for OMS and 25 lb/ft/sec for RCS. These numbers will come in handy later for converting propellant weights to ΔV s during the iterations.

$$(\text{Pounds of propellant used (OFUP on DST)}) / (\Delta V \text{ ft/sec}) = \text{lb/ft/sec}$$

- b. Configure DCT column 1 for 1 OMS/1 OMS thrusters, run the DMP at the targeted TIG, and transfer the solution to an ephemeris.
- c. Override the ΔV to a first guess of ΔV obtained before the OMS engine failure. From the DMT, record the ΔWT to get pounds of OMS propellant used before the failure. Subtract this from the total pounds of OMS available above 5 percent (from PROP) to get pounds of OMS remaining for use through the RCS.
- d. Direct input a PEG 4D maneuver into the same ephemeris as follows:

TIG - First maneuver cutoff + 15 sec. This is the actual TIG for the M66 MED. The target TIG from the OMS part of the burn must be entered on the M40 MED. If this is not done, THETA will be referenced to the wrong point, and the EPP will compute an erroneous entry profile.

Thrusters - PX4 (or PX3, or PX2 as appropriate).

PEG 4D targets (C1, C2, THETA, HT, Target TIG) - Same as for the OMS part of the burn.

- e. View the second maneuver segment in the DMT and verify that PETI and TIGT are correct.
- f. From the DMT, record the $\Delta W T$ to get the propellant quantity burned through the RCS. (Although OMS propellant is being used for part of it and the DMT is assuming all RCS propellant, the difference in mixture ratio is not great enough to make a big difference in computed propellant usage.)
- g. If pounds of propellant used in the second burn are less than the OMS weight remaining (from step c above) plus pounds of RCS above Aft Quantity 1, then decrease the ΔV of the first maneuver and repeat steps c through f until pounds of propellant used for the second burn equals OMS weight remaining from step c plus the weight of RCS available above Aft Quantity 1.

If pounds of propellant used in the second burn are greater than the OMS weight remaining from step c plus pounds of RCS above Aft Quantity 1, then increase the ΔV of the first maneuver and iterate as above.

Note: Here the computation in step a comes in handy. You can estimate how much to decrease or increase the ΔV of the first maneuver by dividing the $\Delta W T$ obtained in step g by the conversion factor for pounds of OMS per foot per second of ΔV .

When we have converged on the size of the first maneuver, we need to break up the second maneuver into an OMS propellant through RCS thrusters part and an RCS propellant through RCS thrusters part.

- h. Divide the pounds of OMS propellant available for use through the RCS (obtained in step c) by the RCS pounds of propellant per foot per second conversion factor. Use the result to ΔV override the second maneuver.
- i. Anchor another ephemeris on the burnout vector of the second maneuver, using the same procedure outlined in section 4.3.6.5.1, steps c and d.2, to model the RCS only part of the deorbit burn.
- j. Obtain pounds of RCS propellant used for the burn from the DST (OFUP). This should be approximately equal to the RCS propellant available for deorbit above Aft Quantity 1. If the RCS propellant used is greater than this, we must increase the size of the first maneuver and iterate all the way through again from step c. When we have converged on propellant usage values for all parts of the burn, we may proceed with the applicable parts of the procedure given in section 4.3.6.5.1, steps e through g, to obtain an entry profile.

- k. The above process identifies the minimum single OMS ΔV and maximum H_p (DMT of first part of the burn) at which the targeted deorbit burn could be completed using OMS interconnected through the RCS, plus RCS down to Aft Quantity 1 after the OMS engine fails. Give PROP the results, which may go on the burn PAD as a note to the crew.

4.7.1.3 Special Cases for Entry Mass Properties

During the D/O to entry timeframe, conditions may develop such that the Trajectory Officer (TRAJ) will have to rearrange the mass properties to obtain a more accurate value for CG's. The situations which affect the nominal mass properties setup are OMS tank failures, RCS burn completions, and partial FRCS dumps.

a. OMS tank failures

X and Y CG problems occur because of OMS tank failures or leaks. Propulsive failures have a larger effect on mass properties than any other orbiter consumable. OMS tank failures will require using either of the following:

- Mixed crossfeed (using OX or FU from unfailed side to burn with FU or OX out of failed side).
- Completely burning propellant out of one side. Setting up the displays to reflect the particular failure will assist the FDO in obtaining a more accurate CG value.

For tank leak cases, if it is possible to determine that all propellant has leaked overboard (not into the pod), then set the propellant quantities to zero for the failed side (right or left, FU or OX). Otherwise, leave the failed propellant quantity in the ORBITER BUILD-UP display for worst case CG assumption (remember that the stuck propellant cannot be used for delta-V purposes, and you must assume it remains in the tank).

(1) Mixed crossfeed

To set up the mass properties to reflect weights and CG's for a mixed crossfeed burn, use the ORBITER BUILD-UP display to do the following (many of these tasks are performed automatically by PMP, but a thorough understanding of the sequence is required):

- (a) Input the preburn propellant quantities into the ORBITER BUILD-UP.
- (b) Sum the ORBITER BUILD-UP to obtain the preburn weight from line 25.

- (c) Obtain the postburn propulsion quantities expected for the mixed crossfeed case.
- (d) Replace the OMS quantities in the ORBITER BUILD-UP display with the postburn quantities.
- (e) Sum ORBITER BUILD-UP.
- (f) The new line 25 is the TVC WT POST D/O to be used in the CG SUM display for completing the summation task.

Note: The OMS DEPLETION is not used for this procedure because it will not yield correct CG's for the DMP. The CG's from the new line 25 should be used to override CG's when executing the DMP in this scenario.

(2) Straight feed

If an OMS tank fails such that only the propellant (FU and OX) out of one side is going to be used for the burn, use the ORBITER BUILD-UP (MSK 490) and OMS FUEL DEPLETION (PERM) (MSK 485) to perform the following:

- (a) Enter the preburn quantities of propellant into ORBITER BUILD-UP.
- (b) Sum ORBITER BUILD-UP to obtain new line 25.
- (c) In the OMS FUEL DEPLETION table, verify the display contains the correct information for the physical situation occurring (TANKS RIGHT or LEFT). Run the depletion using the new line 25 weight and CG's.
- (d) Enter the Δ OMS for computation of the postburn CG's.
- (e) Transfer the new line 201, TVC WT POST D/O, to the corresponding line on the CG SUM display.
- (f) Resume the entry sequence on the CG SUM display to obtain the new EOM CG's. Inform GNC and PROP of the results.

For tank fail cases, when propellant failures occur during the burn, a rough estimate of the CG's can be obtained by using the reference data (table 4.3-3) with the amount of propellant remaining in the tank. When the "failed" amount of the consumable is known, use the rule-of-thumb conversion numbers to compute how much the X and/or Y CG will change from what is reflected in the CG SUM display or the Abbreviated Report. The result is the delta to add or subtract from

the nominal CG's to obtain the new estimated CG. The same principle can be applied for cases of unscheduled FRCS and ARCS usage.

b. RCS burn completions

Completion of the D/O burn using the ARCS can be modeled by using the following procedure:

- (1) Obtain the quantities of ARCS to be used to complete the D/O burn. Subtract these from the current quantities in the ORBITER BUILD-UP display. Replace the ARCS quantities in the display with the resulting differences.
- (2) Sum the ORBITER BUILD-UP to obtain a new line 25.
- (3) In the OMS FUEL DEPLETION table, verify that the display contains all of the correct information for the physical situation occurring (TANKS RIGHT, LEFT, or BOTH).
- (4) Run the depletion table using the new line 25 weight and CG's. Be sure to make any necessary updates to the OMS propulsion quantity required for the D/O burn (i.e., use the correct Δ OMS).
- (5) Transfer the new line 201, TVC WT POST D/O, to the corresponding line on the CG SUM display.
- (6) Perform the deorbit-to-landing computations to obtain the new EOM CG's, and coordinate with GNC and PROP as to what the results are.

c. Partial FRCS dumps

If a partial FRCS dump is required (most likely for XCG purposes), an adjustment to the CG SUM display will be required to obtain accurate EOM CG values. This can be accomplished using one of two methods: using the CG SUM display or estimating the CG using the reference data (table 4.3-3). To obtain the EOM CG's using the CG SUM display, enter in the amount of FRCS to be dumped on the appropriate line and resume the entry sequence to obtain the EOM CG's. This process is an iterative one and may require repetition to acquire the desired CG's. A quick method for obtaining an estimate of the CG resulting from a partial dump is to use the reference data. Take the amount to be dumped and divide that number by the reference data number (lb/in.). The resulting number

should be added to the previous nominal XCG (an FRCS dump moves the CG aft). This will yield the final EOM CG's due to the partial dump. The example under OMS TANK FAILURES provides an idea on how to apply the reference data. Anytime new CG's are calculated, always inform GNC and PROP of the resulting values.

d. Modeling an Unbalanced Deorbit Burn

An unbalanced deorbit burn means that there are significant differences in the amount of propellant available on the two sides of the spacecraft. As a result, special procedures are required. The first part of the burn involves a crossfeed while the second part of the burn is a straight feed. To model this type of a burn

- (1) Obtain post-burn quantities for PROP.
- (2) Input post-burn quantities in PMP Orbiter Build Up.
- (3) Execute OMS Depletion sequence with $\Delta\text{OMS}=0$, then sync the MOC.
- (4) Run DMP and override CG's with line 25 of Orbiter Build Up.

4.7.1.4 Special Cases

This section serves to address several unusual cases that may be encountered. To a large extent this section is a list of lessons learned and/or limitations of either the MCC processors or onboard software.

a. Double Toggle to get a Left Turn

With OVHD selected, the HAC will be chosen based on the HAC on the opposite side of the extended runway centerline with respect to the orbiter location. The OVHD selection will automatically switch HAC's every time the extended runway centerline is crossed until VREL = 9 KFPS. At that point (9K), the selected HAC is locked in.

With STIN selected, the HAC chosen is always the HAC on the same side of the extended runway centerline with respect to the Orbiter location. This STIN logic will continuously change HAC's every time the extended runway centerline is crossed.

On certain trajectories that zigzag along the extended runway centerline during entry, a left turn may result if a double toggle is executed below a VREL of 9K. A "double toggle" is the crew procedure of changing from OVHD to STIN and back to OVHD. If the double toggle is performed below a VREL of 9K and the orbiter has crossed the extended runway centerline, the opposite turn direction can be selected. This can be done to change a R OVHD to a L OVHD. See figure 4.7-3 for an example of this case. For STS-76 Flight Cycle, we could

change the prime opportunity to KSC to a L OVHD with a double toggle at Mach 5. However, the one orbit late opportunity had a 195° R OVHD and the vehicle never crossed the extended runway centerline until below Mach 2. In that case the double toggle would not work.

To model the double toggle on the ground, run the EPP with the RLSID set to the same runway as the PLSID and VR set to the desire velocity for the double toggle. Look at the DELAZ vs VREL portion of the Entry Groundtrack display to determine the best velocity for the double toggle.

During high-speed entry when the crew performs the double toggle, FDO should do the same by going OVHD to STIN and back to OVHD. This will keep the ground in sync with the onboard.

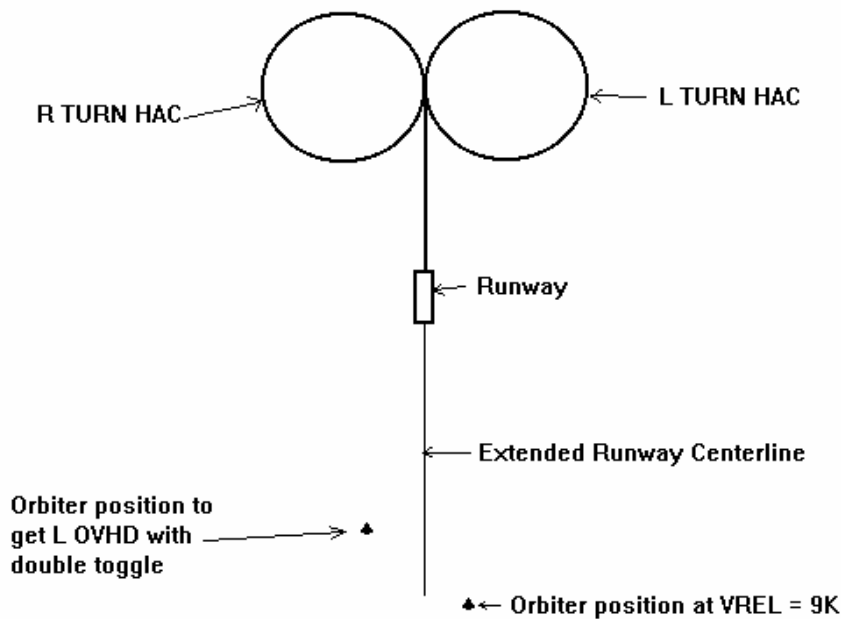

Figure 4.7-3 Geometry for Double Toggle to get a Left OVHD

b. High-speed HAC selection

Normally, the ground HAC selection is easily configured using the OVHD/ STIN pushbutton indicators (PBI's), ensuring a match with the onboard selection. However, for the cases where the vehicle crosses the extended runway centerline prior to the first selected source (SS) SV being available, the FDO must use special procedures to configure the ground to match the onboard

selection. The high-speed entry processor determines the OVHD HAC when the first SS SV is available. For entry profiles that result in the groundtrack crossing the extended runway centerline prior to the first SS SV being available, the OVHD/STIN PBI's may not allow selection of the proper HAC. For these cases, the left/right HAC PBI should be pressed after the OVHD/STIN PBI is set to OVHD. This process forces an OVHD approach selection to the HAC on the side of the runway where the vehicle currently is.

c. REI differences

In some cases, the REI produced by the DMP or EPP is significantly different from the REI displayed onboard. The onboard REI is computed by the maneuver execute display processor (MAN XXDIP). The display interface processor takes the predicted EI vector and computes the central angle between it and the landing site threshold vector. This angle is converted to a distance using the Earth radius. This gives the great circle distance to the runway threshold along the ground.

The DMP/EPP uses a more sophisticated computation. Since it is doing an entry guidance simulation, it uses an entry guidance routine called Entry Range and Bearing (ERGB). This task uses the predicted EI vector but biases the landing site threshold vector to the HAC intercept point. The distance to this point is computed; the distance around the HAC from the intercept to the OGS is computed and added to the first distance. Finally, the distance from the OGS intercept to the threshold is computed and summed into the total. This results in the DMP REI being much more representative of the actual distance the orbiter must fly. The bottom line is the onboard guidance REI can be as much as 30 n. mi. different from the ground computation. This difference should be ignored.

d. TGO differences

The deorbit burn is usually long enough for a several second difference to appear between the onboard and the ground computed TGO. The reason for this is simple. The onboard uses "spec" values for Isp while the MOC uses the actual Isp's for both OMS. The difference is noticed when looking at TGO on the DMT and comparing it to the TGO on MNVR MONITOR. The real OMS are more efficient than the "spec" values. Even the worst OMS engine in the fleet has a higher Isp than the "spec" values. Typically, the higher the Isp the more thrust an engine will produce. A higher thrust will require less time to hit a desired ΔV . Therefore, the TGO on the DMT will be more accurate and smaller than the onboard value.

e. Overhead HAC Evaluation Criteria

Monte Carlo analysis was presented at the February 27, 1997 Ascent/Entry Flight Techniques Panel that indicated TAEM Guidance is unable to control

QBAR/Alt Error Low for large HAC's in the presence of significant winds. The study was performed using a modified Monte Carlo technique that varied the vehicle navigation and environment state, aerodynamics, atmosphere, and navigation and control sensor inputs, but did not vary the winds of the day.

Large HAC's (over 300 degrees) are prone to undesirable trajectory dynamics due to minimum Q-Bar limiting. The NZ command becomes saturated and is unable to control the I-loaded Q-bar limit of 350. In addition large altitude errors are likely that could trigger a HAC shrink. These affects are not present on smaller HAC's as the NZ command does not saturate and Entry Guidance is able to control the trajectory.

Flight Rule A4.1.4-6 specifies the Q-bar and altitude low limits that have been established.

The Q-bar limit specified is an additional constraint to the limit set in A4.1.5-7, ENTRY LIMITS, for MACH < 1. These specific limits provide 3 sigma protection for the vehicle from violating the certified Q-bar limit, as set forth in SODB Volume V of 375 psf in the subsonic region. The All Flights rule, and the onboard I-load, have a 25 psf knockdown from the 375 limit, due to AA dispersions.

Exceeding the listed maximum altitude error low criteria will result in greater than 35% chance (roughly one sigma protection) of triggering a HAC shrink.

To get the best possible data to implement this rule, STAMPS (6-DOF) evaluations were run from the 600 Gemini building.

The flight team (here consisting of the Flight Director, FDO and ENTRY SUPPORT) will select and prioritize the STAMPS requests based on probability of approach, HAC size and wind conditions. Although any approach may be requested, those with HAC turns greater than 300 deg will be the norm since that is where the 3-DOF analysis breaks down. Unusual environmental conditions (such as a large wind shear) may result requests for 6-DOF data even for HAC's < 300 deg.

Since STAMPS lacks flight critical certification, it will always be used in conjunction DDS/TSP. Under no circumstances will STAMPS data be used in the real-time decision process unless the results have been correlated with the corresponding DDS results. STAMPS may be used to make GO/NO-GO calls as long as the 3-DOF to 6-DOF comparison shows the expected trends (as identified through generic analysis). If unexpected differences arise from the comparison which cannot be explained prior to the deorbit decision, STAMPS will be declared unavailable and the DDS results will be used exclusively.

For simulations of HAC's greater than 300 deg, the STAMPS results will be used when available. The specific STAMPS performance parameters to be used in

support of the overhead HAC GO/NO-GO evaluation are: maximum dynamic pressure and maximum altitude error low, both applicable between HAC initiation and 20,000 ft AGL. These two parameters, along with the max normal load factor on the HAC and altitude error high in TAEM may be forwarded to the crew via the DEL PAD. Reference FR A4.1.4-6, HAC SELECTION CRITERIA.

f. HAC Wrap

The High Speed Entry Processor (HSEP) Range-To-Go (RGO) output has a limitation that periodically causes problems. Logic was added in the original delivery of the software to handle HAC turns of greater than 360 degrees, but no upper bound was established. This is a result of a formulation limitation, the software is coded per the requirements. As a result, the RGO comp will add an additional 360 degrees of HAC turn for some geometry's (resulting in obviously erroneous RGO (energy) computations). Previous experience with this problem was associated with starting the comp very close (within a degree) of the extended runway centerline. However in some cases the problem occurred when the orbiter was approximately 60 degrees from the centerline. An operational workaround exists that calls for the comp to be stopped and restarted. That procedure involves going to another phase (e.g. ENTRY to TAEM, or TAEM to ENTRY) and then back to the original phase to restart the comp. This workaround will work for both the HAC wrap and negative HAC turn cases.

A processor fix, instituted in 1998, has significantly reduced the frequency, but not completely eliminated, this problem.

g. Initial Roll Direction Uncertainty

The initial roll direction the orbiter makes following closed loop guidance initiation is primarily a function of crossrange and post-burn apogee. However, inclination, approach direction (ascending/descending), mass properties, and to some degree, landing site and runway selection, are a factor. For example, on STS-87, the EOM crossrange was approximately 70 nmi descending left for KSC. The initial roll direction depended on the direction of the prop wasting from the deorbit burn as well as the runway selected. With negative prop wasting, the roll was to the left if KSC15 was selected. However, with negative prop wasting and KSC33 selected, the initial roll was to the right. With positive prop wasting, the initial roll was to the left for both runways. If KSC33 was selected, there was only a 2 second time difference between the first roll command and the crossing of the zero DELAZ. In this case, a slight variation in the NCYCLES could result in the initial roll being in the opposite direction from the expected direction. As a result of this incident, a study was directed and carried out by DM46/Christine Boykin to determine crossrange regions which present the greatest degree of uncertainty as to which direction the orbiter will actually roll. Appendix F contains a reference to this study.

4.7.2 Pre-deorbit through Landing

4.7.2.1 PRE-TIG ANOMALIES

Pre-TIG anomalies may cause the FDO to recommend delaying the deorbit burn. The two most probable scenarios include loss of high speed tracking capability and the loss of the MOC. While tracking data is only highly desirable (see Flight Rule A3.1.2-4) if redundancy in orbiter systems exist, it may be desirable to delay the burn if the ETRO is in the near future. Loss of the MOC means loss of trajectory determination and RGO computation capability. In this situation, immediately notifying the FD is required. The deorbit burn would most likely be delayed in this case while efforts to regain the MOC are initiated. FDO must be prepared with PAD's in case a one orbit late waive-off occurs.

4.7.2.2 Deorbit Burn

During the deorbit burn, several different failures, if they occur, have a big impact on the Entry FDO. If prior to the burn, an IMU failure has already occurred and the burn will be performed on two IMU's, the potential exists for an IMU dilemma. Procedures for recovery from this case must be reviewed, and will affect the Deorbit Burn Flight Rules which are reviewed in the FCR prior to the burn. A tank failure or an engine failure require specialized crew procedures, summarized in the Deorbit Burn Cue Cards in the Entry Checklist. These failures may result in the requirement for RCS Completion, Fast Flip, Recovery Prebank, or Capture Hp. The FDO must be fully prepared in the event of any of these failures, and ready to provide quick and concise recommendations to the Flight Director. This section will describe proper response to these and other potential deorbit burn anomalies.

Figure 4.7-4 shows the Deorbit Burn Flight Rules for STS-121 (typical), which document the proper response to orbiter system failures prior to or during the deorbit burn. Pre-TIG, most failures affecting the ability to deorbit and enter the atmosphere will result in waveoff of one rev or more. The purpose is to provide time to diagnose the failure and reconfigure the orbiter to maximize safety margins. Once the burn has started, only the most serious problems will result in terminating the burn above Safe Hp. Among these are GPC redundant set split, failure of 2 main electrical buses, IMU dilemma, OMS propellant fail, or both OMS engine fail. DPS and EGIL are responsible for the first two, respectively, but the remainder affect FDO in a more direct manner and will be described in more detail.

FAILURE		PRE TIG		POST TIG	
		Delay (max)		Stop Burn > Safe HP	
		One Orbit	One Day		
ENT-1a/D/K					
BURN CARDS	1	APU/HYD No APU operatingX		
	2	DPS RDNT fail, SplitX	..X
	3	1 GPCX		
	4	BFSX	
	5	GPC BITE (Multiple GPCs)X	
	ECLS				
	6	2 Av Bay Fans in Bay 3X		
	7	2 Av Bay Fans in Bay 1 or 2X	
	ELEC				
	8	H2 Manf or TK leak (not in depleted tk(s)X		
	9	2 MN BusesX	..X
	10	CNTL CA1 (No BFS Engage In GPC 3/5)X	
	11	Multi Φ AC BUS (unshorted)X		
	GNC				
	12	1 MLS (If reqd), IMU, or TACAN (C-band/GPS redun not avall)X		
	13	IMU DilemmaX	..X
	14	RHC DilemmaX		
	15	2 IMUs (Not targeting EDW/NOR)X	
	16	2 ADTAs (Winds>80kts or Dynamic Wx)X		
	HOOK VELCRO				HOOK VELCRO
	17	2 FCS Channels (same surface) (Not targeting NOR/EDW)X		
	18	2 AAs, RGAs (Not targeting EDW/NOR)X		
	OMS				
	19	Prpirt TankX		..X ①
	20	Ignition (neither eng ignites)X		..X ②
	21	Both OMS Eng failX ②
22	Prpirt Lk after LAST LOS		perigee adjust		
AFT RCS					
23	2 jets, same direction, same podX			
24	Prpirt Lk after LAST LOSX			
25	1 AFT RCS PROP TK failX			
COMM					
26	MCC GO for DEORBIT not rovdX		

① Stop Burn > OMS PRPLT FAIL HP (Ref: DEL PAD/BURN Card)
② Stop Burn > OMS ENG FAIL HP (Ref: DEL PAD/BURN Card)

MS ONLY

3-18

ENT/ALL/GEN G

Figure 4.7-4 Deorbit Burn Flight Rules

4.7.2.2.1 IMU Dilemma

An IMU dilemma can only occur after a previous IMU failure such that RM is checking two IMUs against each other. A dilemma between the two indicates a potentially serious problem, as the GNC software may not be able to achieve the desired burn targets. GNC and/or GPO will always call to “stop the burn” above Safe Hp. Once below Safe Hp, however, there is no choice but to continue the burn and cut off on the stopwatch timer. If GPO is able to diagnose the problem on the fly, then the crew may be instructed to deselect the bad IMU, or cutoff on BFS VGOs if the BFS is on the good IMU. If the onboard attitude is in error, then the crew should fly ~0/0/0 on the ADI to keep a reasonable attitude. Another option is to terminate the OMS burn, and quickly examine IMU output under zero G’s in order to psych out the bad one. FDO should closely monitor these steps to assure proper execution of the deorbit burn.

4.7.2.2.2 OMS Engine Failure

Proper response to OMS failures during the burn are documented in the Deorbit Burn Cue Cards (Figure 4.7-5). Assuming a 2 eng deorbit burn, failure of a single OMS is fairly straightforward--the crew notes ΔV_{tot} remaining at the time of failure and continues burning. At $1/2 \Delta V_{\text{tot}}$ remaining, the crossfeed valves are opened in order to feed the failed engine's propellant to the remaining OME. This assures completion of the deorbit burn while balancing residual OMS propellant in the two pods for Y c.g. control. In the event of a second OME failure, the burn will be terminated above Safe Hp in order to re-target at the PX4 optimum TIG. However, if below Safe Hp, then "RCS Completion" will be performed with the RCS jets interconnected to the OMS pod with the most remaining propellant. The +X burn will be performed until just prior to OMS prop depletion, then a tank switch performed if any appreciable prop remains in the other pod. When both pods have been depleted, the +X burn will be continued, if necessary, using RCS gas above Aft Quantity 1*.

4.7.2.2.3 OMS Propellant Failure

An OMS propellant failure (sometime referred to as "tank fail") could arise from blockage in one of the propellant lines, or at the inlet valve in the tank. The flight rule table above calls for immediate termination of the burn if above Safe Hp as long as one rev late (or later) deorbit is available. Thus, Prop will call "stop the burn" if a propellant fail occurs prior to the "Safe Hp" call, even if below technical STCOMP "tank fail" capability (ref section 4.9.10). This allows time to set up a mixed crossfeed to better balance the pods, and to re-target the deorbit burn (e.g. shallow entry, cheapest CONUS opportunity). Once below Safe Hp, the burn must continue. The crew will zero out any out-of-plane prop wasting if applicable, and burn the remaining OMS to depletion. Then the RCS Completion will be executed, using any remaining OMS from the non-failed side, followed by +X to Aft Quantity 1. The TSA application STCOMP computes the highest Hp at which the deorbit burn can be successfully completed following a propellant failure. This includes burning all the remaining OMS on the good side, all RCS propellant above Aft Quantity 1, all FRCS available for fast flip, and pre-bank up to the contingency thermal limit (CTL) to the prime landing site (or redes to NOR if EDW planned entry).

* Aft Quantity 1 is the minimum amount of RCS propellant to assure a survivable entry. This quantity provides sufficient propellant remaining in the tanks up to Nz 0.05 G's to meet the on-orbit expulsion efficiency of the RCS tanks (about 18%). Below this quantity and in a zero G environment, propellant may become separated from inlet screens and fail to feed the jets, resulting in LOC. After Nz 0.05 G's and in the proper entry attitude, propellant pools in entry sump, which allows the jets to be fed prop well below 18%. Aft Quantity 1 protects for 97.5% confidence shallow usage from EI to 0.05 G's Nz. Aft Quantity 1 also protects for a fast flip maneuver and attitude hold, if applicable. Refer to FR A6-305 for more detail.

Several stopping cues are included on the Deorbit Burn Cue Card for RCS Completion. They appear in ascending order of preference, and begin when Aft Quantity 1 is reached. First, if current Hp is above Capture Hp, the crew has no choice but to continue burning until reaching Capture Hp (or Aft Quantity 2, whichever comes first). Capture Hp is defined as the highest perigee altitude at which aerocapture is assured, but requires redesignation to a downrange ELS. If FRCS is available for a fast flip, Capture Hp will include the Hp-equivalent FRCS ΔV . Once current Hp is at or below Capture Hp, the +X portion of the burn is terminated, and a fast flip is performed if available. Following this, the crew exits the Deorbit Burn Cue Card and goes to the Prebank Table to determine the redes landing site and pre-bank (more on this in a minute).

In the case that more ΔV was available for the deorbit burn, the next preferred stopping cue is Flip Hp. This is the highest Hp at which a fast flip can be performed to achieve the primary landing site (or EDW -> NOR redes) at the CTL. This is computed from target Hp + FRCS-equivalent ΔHp + circled ΔHp from the DSCT-28 pre-bank product. If FRCS is not available, this cue is referred to as Pre-bank Hp, and is computed from target Hp + the circled ΔHp from the DSCT-28 pre-bank product. Ref section 4.9.8. The first point in the deorbit burn at which RCS Completion can be continued to target Hp is Aft Hp. Aft Hp is the altitude cue that assures target Hp will be achieved without having to do a fast flip. This essentially allows the +X to be continued below Aft Quantity 1, using up the budget that was reserved for the fast flip and -X attitude hold. Obviously, if the crew reaches target Hp prior to Aft Quantity 1, then the burn is terminated with plenty of gas remaining.

DEORBIT BURN (2 ENG)

```

√MM302  √OMS BOTH
Enter TGO + 5 sec
√TRIM per MNVR PAD or P +0.0, LY -5.7, RY +5.7
L,R OMS He PRESS/VAP ISOL A (two) - GPC
B (two) - OP

√DAP - AUTO(PASS)/DISC
ADI - LVLH(REF)/HI/MED
FLT CNTLR PWR (two) - ON

TIG-2  OMS ENG (two) - ARM/PRESS
- :15 EXEC (NO EXEC > TIG + [ ]:[ ])
- :15 If OMS AFT QTY < 11%, THC +X to OMS IGN + 1 sec
:00 TIG Start watch (√P0 ΔVTOT, ENG VLVs)
If no OMS Ignition: APUs - SHUT DN

* OMS PRPLT FAIL: *
* Failed OMS ENG - OFF *
* STOP BURN: *
* L OMS R OMS Good OMS ENG - OFF *
* FAIL HP FAIL HP APUs - SHUT DN *
* [ ][ ] [ ][ ] Secure aft OMS *
* ----- *
* CONTINUE BURN: *
* ITEM 18 +Q EXEC *
* When good OMS QTY: *
* 5%: L,R OMS XFEED (four) - OP *
* 4%: Good OMS TK ISOL (two) - CL *
* If OMS P0 < 80 or OMS TEMP, *
* OMS ENG - OFF *
* √ADI - LVLH, center needles *
* RCS COMPLETION *

* OMS ENG FAIL: *
* Failed OMS ENG - OFF *
* OMS XFEED at 1/2 ΔVTOT at fail [ ][ ][ ][ ] *
* or OMS QTY [ ][ ] %L or [ ][ ] %R *

* 2nd OMS FAIL (ENG or PRPLT): *
* Failed OMS ENG - OFF *
* If PRPLT FAIL: *
* Secure aft OMS *
* ITEM 18 +Q EXEC *
* Both Either *
* ENG FAIL PRPLT FAIL *
* HP (SAFE) HP *
* [ ][ ][ ][ ] STOP BURN: *
* [ ][ ][ ][ ] APUs - SHUT DN *
* ----- *
* CONTINUE BURN: *
* √ADI - LVLH, center needles *
* Interconnect good OMS to RCS *
* THC +X (√OMS% vs RCS Burn Time) *
* RCS /CNCT TK SW (N/A PRPLT FAIL) *
* THC +X (√OMS% vs RCS Burn Time) *
* AFT RCS RECONFIG *
* RCS COMPLETION *

* RCS COMPLETION: *
* THC +X to TGT HP or TOT AFT QTY 1 [ ][ ][ ][ ] % *
* At AFT QTY 1 THC +X to CAPTURE HP or *
* If CUR HP: TOT AFT QTY 2 [ ][ ][ ][ ] % then *
* PREBANK/FRCS COMPLETION *
* to downrange site *
* ----- *
* CAPTURE PREBANK/FRCS COMPLETION *
* HP [ ][ ][ ][ ] to downrange site *
* ----- *
* PREBANK/FLIP PREBANK/FRCS COMPLETION *
* HP [ ][ ][ ][ ] *
* ----- *
* AFT THC +X to TGT HP *
* HP [ ][ ][ ][ ] *
* ----- *
* TGT *
* HP [ ][ ][ ][ ] *
* ----- *

* FRCS COMPLETION (if applicable): *
* MNVR to -X Att (pitch up at 3°/sec to VGOz = +1/4 ΔVTOT) *
* THC -X to TGT HP or FRCS depletion (JETS FAIL OFF) *

CUTOFF
+ :02 OMS ENG(s) - OFF (if < 3 IMU, at [ ][ ][ ][ ] )
* AFT RCS RECONFIG if INTERCONNECT *
Trim X,Z residuals < 2 fps (< 0.5 fps if shallow)
ENT-4aa/D/K

```

Figure 4.7-5

4.7.2.2.4 Recovery Prebank

For deorbit burnout conditions with current Hp above target Hp, some amount of pre-bank will be required to help bleed off the excess energy. The pre-bank table in the Entry Checklist (Figure 4.7-6) specifies pre-bank as a function of ΔHp (current - target), and also includes redes information for “Capture Hp” scenarios. The DSCT-28 table is flight-specific, and is generated for the prime EOM KSC and EDW deorbit opportunities. For each site, the circled DHP represents the highest DHP that allows the NASA PLS to be achieved within the CTL (CP3 WLE temp ≤ 3120 deg, which includes a 100 deg backoff for DDS). Above this value, the table recommends redesignation to a downrange site for thermal relief. For example, for a KSC underburn of 22 nmi, Gander (YQX) should be selected and a pre-bank of 135 deg utilized at EI-5 (subject to EDS/DDS confirmation of course).

NOTE

If an underburn does result and recovery prebank is required, the benefit of a site resignation from EDW to NOR is shown in the Entry Checklist. However, if the inclination is above 39 degrees and the approach direction is opposite of that which is documented in the checklist, the ΔHp is invalid. Entry Support can compute a pre-bank bias to correct for this.

If the nominal EOM approach is descending, but the actual approach is ascending, the actual benefit of the redesignation will NOT be as much as documented in the Entry Checklist. Conversely, if the documented approach is ascending, but the actual approach is descending, the benefit will be larger. (This note was taken from an informal message written by David Mains.)

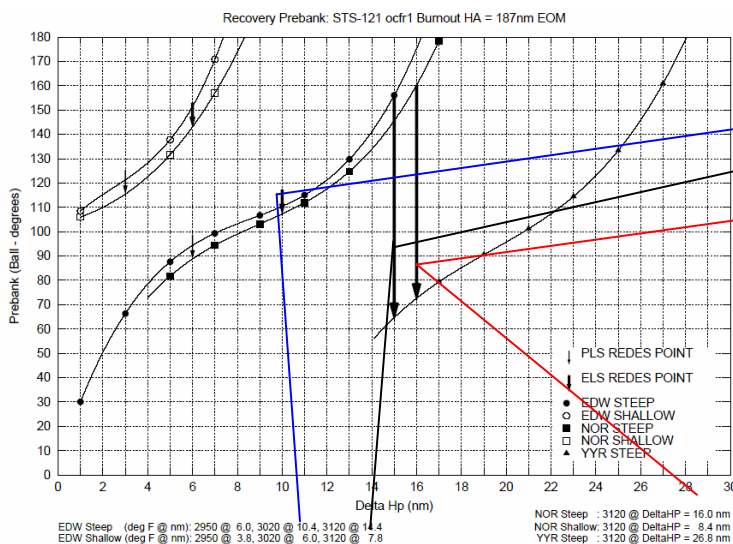

* PREBANK TABLE EDW (HA = 187 NM) *

* EDW *											
ΔHP	0	3	6	9	REDES.	11	12	(14)	REDES.		
PREBANK	0	65	95	105	NOR ELS	115	120	140	YYR		
* NOR NOGO *											
* G50 ITEM 41+ 4 2, √RWY 17 SET TACAN tw (three) 121Y *											
ΔHP	6	8	10	12	14	15	(16)	REDES.			
PREBANK	90	100	105	120	135	150	170	YYR			
* YYR *											
* G50 ITEM 41+ 2 2, √RWY 26 SET TACAN tw (three) 040X *											
ΔHP						14	17	20	24	(26)	28
PREBANK						55	80	95	125	145	180

* PREBANK TABLE KSC (HA = 188 NM) *

* KSC *											
ΔHP	0	2	4	6	8	10	12	(14)	REDES.		
PREBANK	0	50	75	95	100	110	125	145	YYR		
* YQX *											
* G50 ITEM 41+ 2 1, √RWY 21 SET TACAN tw (three) 074X *											
ΔHP						15	22	(25)	RED.		
PREBANK						90	135	170	INN		
* INN *											
* G50 ITEM 41+ 2 6, √RWY 06 SET TACAN tw (three) 080X *											
ΔHP						26	28				
PREBANK						135	180				

Figure 4.7-6 STS-121 DSCT 28 Table and Pre-bank Table

For a severe KSC underburn, all of the Newfoundland landing sites (Gander, St. John's, Stephenville) should be evaluated in order to maximize chance of safe landing. Entry Support and Dynamics should be directed to run simulations to any site with GO weather in order to pick the site with lowest thermal violations and acceptable energy. This process can be continued until EI-5, at which point the crew must dial in the pre-bank and select the best landing site. Capture Hp analysis conducted by Descent Flight Design shows that at least Gander will be available for all 51.6 deg ascending approaches into KSC with crossrange within ± 800 nmi, and with ΔH_p above the circled value for KSC. Above the circled value for Gander, a further downrange site (INN, or Shannon, Ireland) must be selected to avoid CTL violations. The maximum ΔH_p shown for Shannon represents Capture Hp.

Capture Hp was determined based on DDS analysis of flight time from EI to Nz 0.05 G's as a function of DHp (KSC curves shown in Figure 4.7-7). The curves exhibit a dramatic increase as skipout approaches. At a slope of 130 sec/nmi, it is equally effective to use remaining ARCS propellant to +X lower as it is to hold attitude for the extended flight time. Therefore, this line is the breakpoint between +Xing and stopping (Capture Hp). Assuming mean ARCS usage over the extended flight time from Capture Hp indicates sufficient ARCS propellant is barely available at Aft Quantity 1. Burning below Aft Quantity 1 to reach Capture Hp is appropriate since, as mentioned above, it is more prop-efficient to +X than it is to accept the drastically higher flight times above Capture Hp. DDS was also used to verify acceptable thermal results at Capture Hp for a 180 deg pre-bank entry to the appropriate landing site for the range of crossranges considered (INN for KSC or YYR (Goose Bay) for EDW/NOR). Finally, STAMPS Monte-Carlo analysis was also conducted to verify DDS-generated Capture Hp's had 2σ confidence of no skipout (defined for this study as no positive H-dot after EI for 100 out of 100 runs). The final Capture Hp curve was computed by taking the lowest of either the DDS flight time curve or STAMPS results. A rounding error of 0.5 nmi up was also protected in Capture Hp, as the crew's MNVR EXEC display rounds current Hp to the nearest integer. Figure 4.7-8 and -9 show Capture Hp curves for KSC and EDW, respectively, and show good agreement between the two approaches of flight time and STAMPS Monte-Carlo. These curves should be used on console for all ISS EOM deorbit planning. For intermediate crossranges, estimate Capture Hp from the curve to the nearest decimal place, then truncate after FRCS $\Delta V/1.8$ is added.

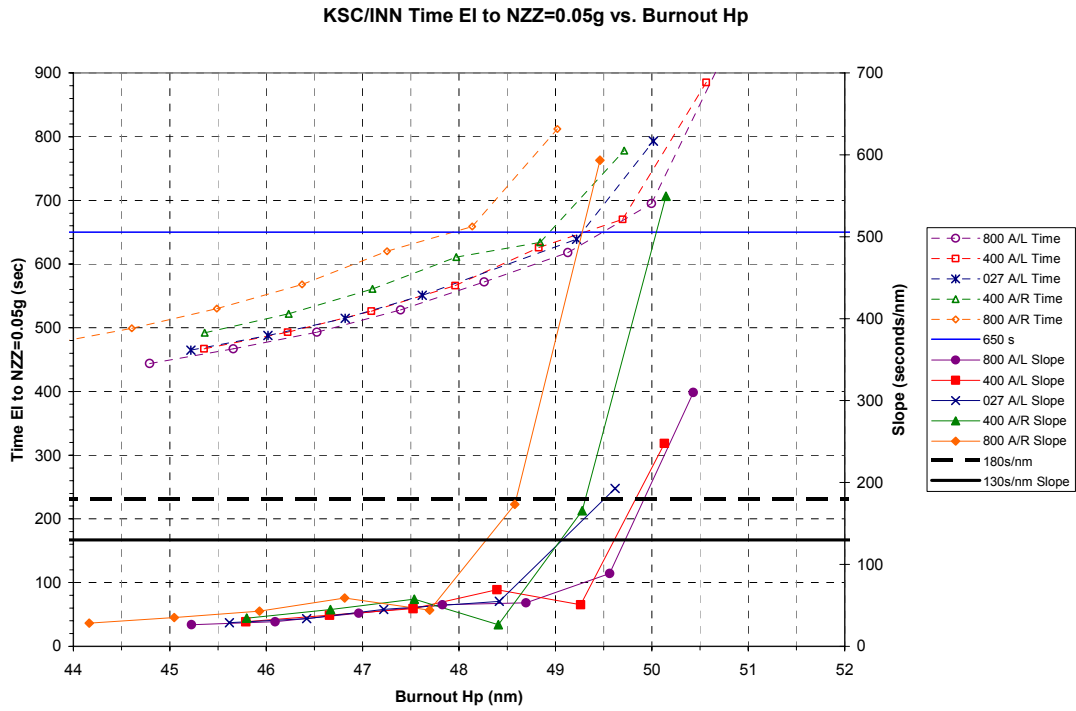

Figure 4.7-7 KSC Flight Time Curve (typical)

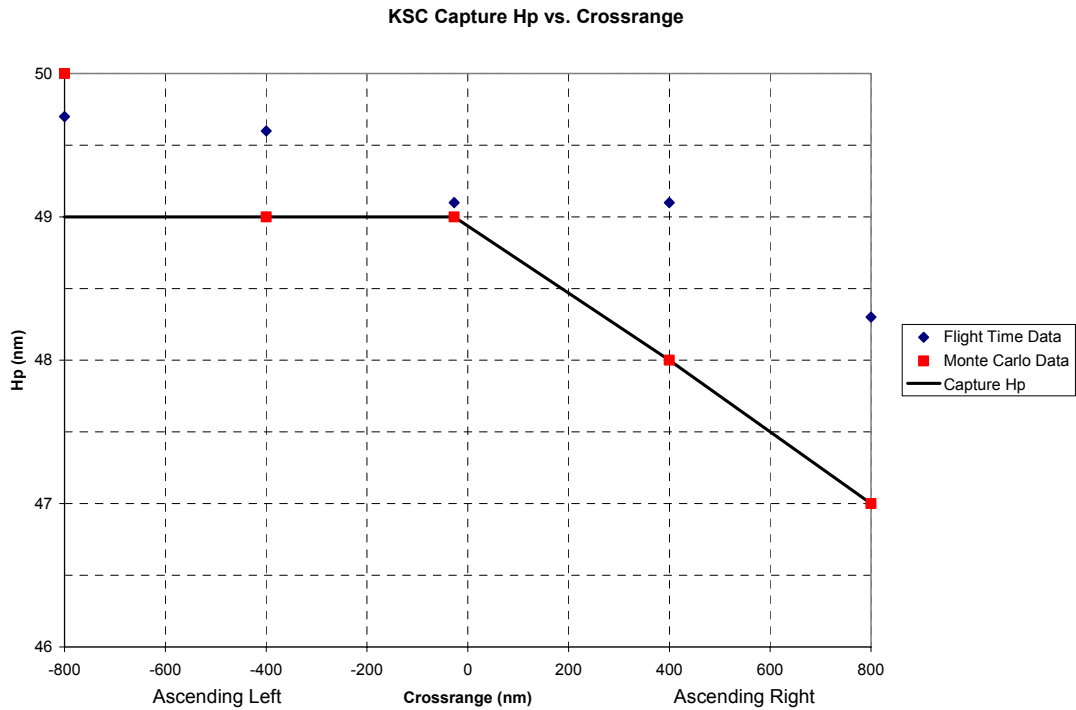

Figure 4.7-8 KSC Capture Hp Curve

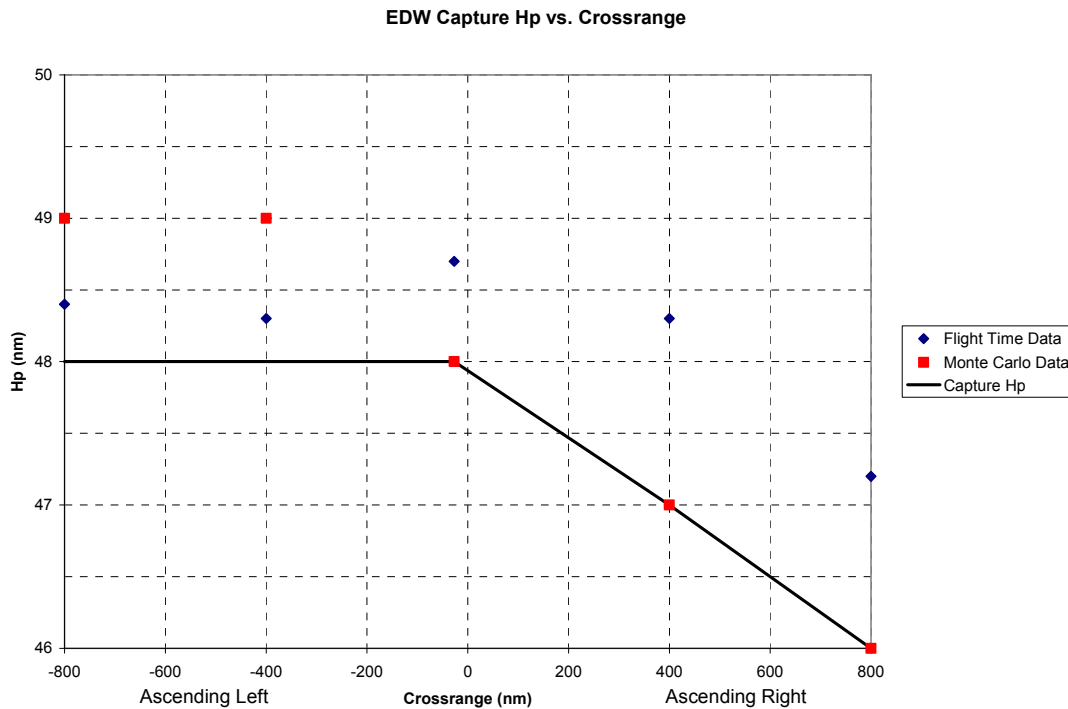

Figure 4.7-9 EDW Capture Hp Curve

A sensitivity analysis found that recovery pre-bank for both KSC -> YQX and EDW -> YYT are relatively insensitive to crossrange. Therefore, the pre-bank table in the Entry Checklist can be used as a good initial guess, to be verified and refined with DDS, or can be used in a no-comm situation by the crew. For EDW, the same range of crossranges, 800 nmi left to right, was analyzed. As long as NOR is GO, then positive overlap for a redes from EDW -> NOR -> YYR is available which protects the CTL. If NOR is down, then a coverage gap exists from ΔHp of 14-17 nmi for some crossranges. In this range, EDW is above the CTL, while YYR is too low energy to make. In this range, FDO should evaluate another downrange ELS, such as Ellsworth, SD, which must be uplinked to the O/B LST.

A specific table was not provided for Northrup because the analysis indicated that the Northrup curves are very close to the Edwards data so the Edwards numbers can be used until Entry Support generates case specific numbers. A modification of the table will be needed, however. In the top, EDW, block cross out EDW, REDES NOR ELS, and NOR NO-GO. Write NOR next to where EDW is crossed out. Cross out the entire NOR block.

4.7.2.3 GCA Techniques

The previous section discussed the normal monitoring task of the FDO during the high-speed entry. For all anticipated situations, the FDO's role is to evaluate the vehicle energy and provide advisories. However, in the event of a large onboard

navigation error or any unexpected trajectory deviation, the entry FDO must be trained in GCA techniques. During a GCA, the crew is dependent upon the FDO for commands to correct or maintain energy conditions for achieving an acceptable runway. There are many keys to providing a successful GCA. Some of the most significant ones are as follows:

Developing and maintaining a scanning technique to ensure that none of the FDO tools are neglected

Clearly stating each GCA call following the standard nomenclature

Anticipating upcoming events and leading each call accordingly

Maintaining an awareness to the TRAJ and the GPO, since they can significantly support your activities

GCA techniques vary throughout entry. Therefore, this section is organized to start with GCA initiation and GCA termination, and then discuss the techniques associated with entry, transition, TAEM, and final approach phases of flight.

a. GCA initiation

The first step is to evaluate the need for a GCA as dictated by the energy or trajectory deviation. The criteria used for making this evaluation will be discussed for each region of the entry. However, independent of the region, the FDO must clearly declare that the GCA is required and give the reason why. Although this may seem obvious, many bad energy cases (in sims) have been unnecessarily worsened by FD and CAPCOM confusion over whether the FDO had really declared a GCA. The standard terminology for declaring a GCA is:

FDO: "GCA required due to high energy. Increase bank angle to ..."

A typical CAPCOM echo of this call will be

CAPCOM: "You are now under GCA control because of high energy.
Increase bank angle to ..."

It cannot be stressed enough that clear and concise calls are essential for a successful GCA. Through experience in doing GCA's, the FDO will find that it is better, in many cases, to initiate the GCA and start correcting the problem before totally violating the absolute GCA take-over energy limit.

b. GCA termination

During a GCA, the FDO has to monitor the progress of the update to the onboard navigation state (delta state). Once the navigation state has been corrected

(confirmed by GPO) and the energy is within the guidance capability, the GCA must be clearly terminated. However, prior to making the GCA termination call, the crew should be set up with a configuration which, if delayed in reselecting AUTO or following the guidance, will not adversely affect the energy state. Examples of cases where a GCA may continue beyond the delta-state correction include

- (1) Energy not yet within the guidance capability
- (2) Approaching a bank reversal
- (3) Diverging energy (FDO's judgment)
- (4) Approaching interception of the HAC

These are the main cases in which, if the crew is delayed in reselecting AUTO or following the guidance, the energy could quickly diverge.

The terminology used for terminating the GCA follows:

FDO: "Terminate the GCA, center the needles and select AUTO."

CAPCOM: "Your NAV and guidance are GO onboard. The GCA is terminated."

In most cases, the FDO should make an energy status call to the FD shortly after GCA termination. This call serves to log the energy situation which resulted from the GCA.

c. Entry phase GCA

The GCA techniques used for controlling vehicle energy during entry phase (post blackout to VREL = 2.5k ft/sec) directly correlate to those used by entry guidance. The root of entry guidance is to control the vehicle by constraining the energy to a corridor on a drag acceleration vs. Earth VREL plot. The premission-designed profile is bounded by thermal constraints, load limits, dynamic pressure limits, and minimum bank angle limits. The guidance controls the entry trajectory (and adjusts the drag vs. velocity profile, fig. 4.7-4) by bank angle modulation while using a preselected angle-of-attack profile. Therefore, downtrack or energy errors are corrected by the magnitude of the bank angle, and crossrange errors are contained by bank reversals which limit the azimuth error (delta azimuth or DELAZ). The DELAZ is the angular difference between the current velocity vector heading and the heading which points directly (via the great circle arc) to the HAC intercept point.

The entry phase GCA techniques also utilize the bank angle and reversals as the tools for correcting energy errors. The crew should always follow the canned angle-of-attack profile. Even with large NAV errors, the angle-of-attack will be very close to nominal (approximately 50 nmi. of downtrack error equals 1° of angle-of-attack error). All of the techniques assume that the standard alpha profile is followed. Therefore, the crew should leave the pitch axis in AUTO.

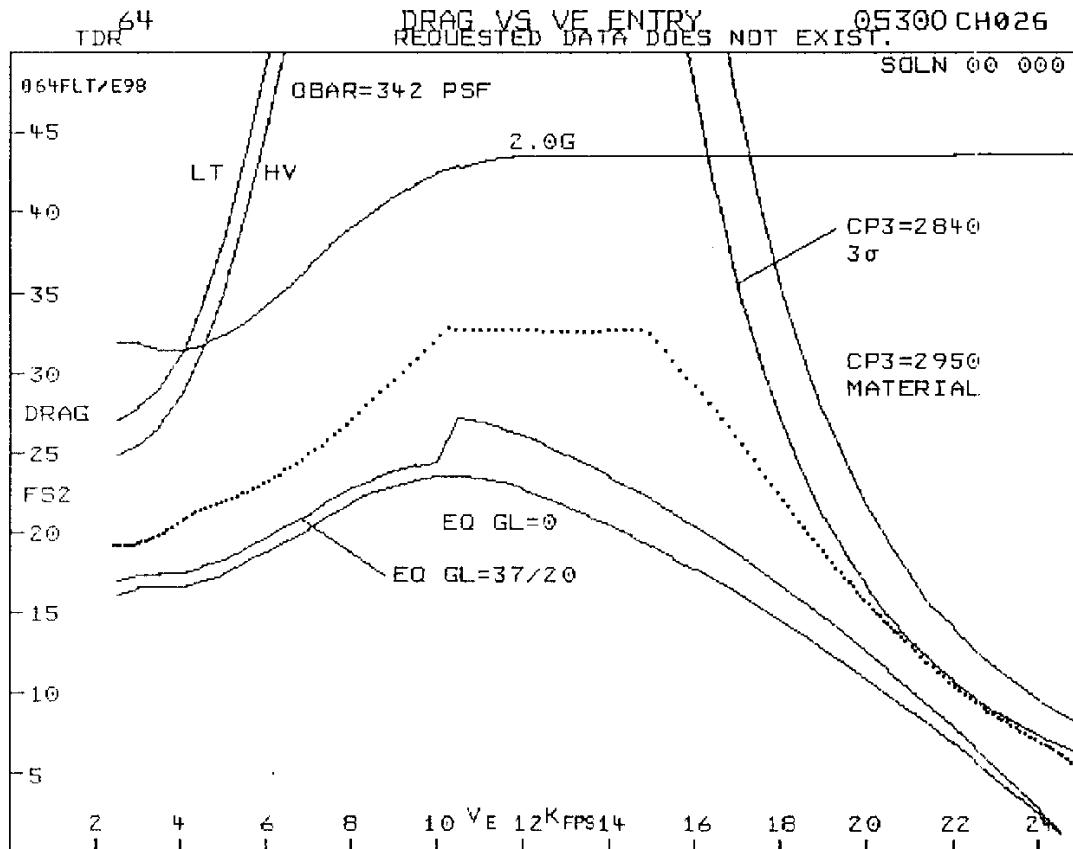

Figure 4.7-4 Drag vs. VREL plot

(1) Nominal energy

Before an off-nominal energy case can be corrected, the nominal energy GCA techniques must be understood. The vehicle drag acceleration is a function of the angle of attack, the bank angle, and the altitude. While following the standard 40° angle-of-attack profile, the following bank angles will maintain nominal energy:

<u>VREL (ft/sec)</u>	<u>Bank angle magnitude (deg)</u>
14k	60
13k	60
12k	60

11k	55
10k	50
9k	45
8k	40
<u>VREL (ft/sec)</u>	<u>Bank angle magnitude (deg)</u>
7k	40
6k	40
5k	40
4k	40
3k	40

Entry guidance controls crossrange errors by commanding bank reversals when the azimuth error reaches the limits of the "deadband". The azimuth limits which invoke a bank reversal are shown in figure 4.7-5. Note that the first reversal is always initiated at 10.5° DELAZ. Each subsequent reversal is initiated at 17.5° DELAZ until the deadband ramps down just prior to the entry/TAEM interface.

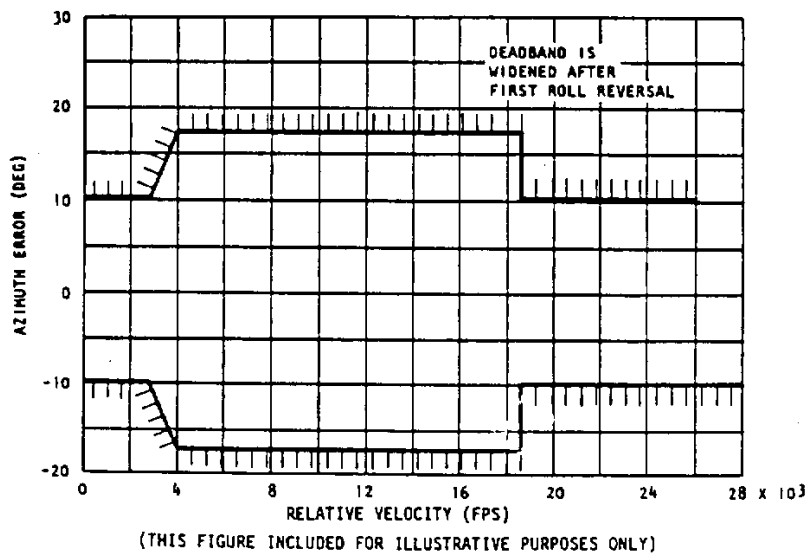

Figure 4.7-5 DELAZ Deadband as a function of V_{REL}

After declaring the initiation of the GCA, the standard calls made during entry phase must include the magnitude and the direction of the recommended bank angle. Additionally, the bank reversals must be anticipated, sufficiently led, and clearly stated.

Examples of these standard calls for bank angle commands are

FDO: "Increase bank right to five, zero, degrees," or "Shallow bank left to three, five, degrees."

For bank reversals

FDO: "Reverse bank to right five, five, degrees," or "Reverse bank now!
Come left to five, five, degrees."

When energy has converged close to nominal but the GCA is still required (bad NAV state), the bank angles and bank reversals should closely follow what guidance would command. Calls should be made periodically so the crew stays informed of the desired bank angle, reversals, and energy. If no change in the bank angle is required and it has been more than about 20 sec from the last call, make a status call.

FDO: "Maintain left bank of four, zero, degrees. Energy is still nominal."
During entry phase, the FDO uses the VREL versus RGO plots, MSK's 533 and 534, to evaluate the energy state. Although energy is usually made up of potential and kinetic energy, altitude variations do not significantly change the potential energy contribution to the total energy. Therefore, VREL vs. RGO is a valid evaluation tool for assessing the vehicle energy status. The DELAZ vs. VREL plots on those same MSK's are used for calling bank reversals and identifying DELAZ trends.

(2) Low energy

Low energy trajectories require a GCA when either of the following conditions occurs:

(a) The GCA takeover line is reached and the onboard navigation state is invalid.

(b) The trajectory reaches the guidance capability limits.

The objective of the low energy GCA is to minimize the drag and maintain a low DELAZ. For very low energy cases, a minimum drag profile should be used with the option to redesignate runways or HAC's at TAEM interface, if required. Bank angles for low energy GCA cases must be shallower than normal. Twenty degrees is the minimum bank angle used by the FDO in a GCA, hence avoiding the possibility of a phugoid. A phugoid is a low frequency oscillation in altitude which causes periods of low or positive altitude rates (H-dots) and periods of high negative H-dots. The 20° bank provides almost as much lift as wings level flight does. Procedurally, once the low energy GCA is initiated, the FDO will continue the GCA until the NAV is corrected and the site is within the guidance footprint capability. The plan of attack on the low energy GCA is to recommend shallow bank angles and yet minimize the DELAZ. It is desirable to reverse the bank at 10° DELAZ and maintain approximately a 20° bank angle. If the DELAZ is already greater than about 15°, a larger bank angle will be required to ensure

that the DELAZ does not continue to increase. The following list is the minimum bank angles which will maintain a constant (15°) DELAZ as a function of VREL.

VREL (ft/sec)	Bank angle (deg)
14k	40
13k	40
12k	40
11k	40
10k	40
9k	40
8k	35
7k	30
6k	25
5k	25
4k	20
3k	20

As the energy converges back on nominal, the bank commands will have to transition to the nominal energy magnitudes. If the energy is still low at Mach 3.5 or 4, use the runway/HAC PBI's to evaluate redesignation possibilities. While evaluating these possibilities, keep in mind which runways the winds favor and which runways are equipped with landing aids. The actual redesignation should not be recommended until approximately TAEM interface (VREL = 2.5k ft/sec). Redesignation earlier in entry phase (above Mach 4) compromises the chance of achieving the desired runway too early. Redesignation between M = 4 and TAEM interface are not recommended (especially with the crew in AUTO) because the last phase of entry guidance is very aggressive at nulling energy errors and could cause severe attitude transients.

(3) High energy

As with the low energy GCA, the high energy GCA is initiated when either of the following conditions occurs:

- (a) The energy reaches or exceeds the GCA takeover limit and the onboard navigation state is bad.
- (b) The energy reaches the guidance capability line.

The objective of the high energy GCA is to increase the drag using larger bank angles and increasing the RGO by reversing the bank at a larger DELAZ. Special attention must be given to not requesting bank angles that are too large. When the bank angle is too large, excessive H-dots and increased loading will result which can cause structural damage, as well as lead to possible loss of control. Nz should not exceed 2.0g. Most of the orbiter fleet will not experience

structural damage until at least 2.5g; however, 2.0g should be the anticipated maximum to provide a small amount of dispersion protection. For high energy cases between the nominal and the GCA takeover line, increasing the bank angle will adequately converge the energy back toward nominal. The bank reversals should be recommended following the limits in DELAZ that guidance uses. The maximum bank angles that will not exceed 2.0g loading and do not lead to diverging H-dots are listed as follows:

VREL(ft/sec)	Bank angle(deg)
14k	70
13k	70
12k	65
11k	65
10k	65
9k	65
8k	65
7k	60
6k	60
5k	60
4k	60
3k	60

The FDO may choose to have the crew maintain 2g loading. A sample call using this option is

FDO: "Reverse bank right to fifty degrees, then hold 2g's."

In any high energy case it is imperative that the H-dot and Nz be closely monitored. If the H-dot begins to rapidly increase, the bank angle must be shallowed. If, however, the H-dot becomes stable at or below 500 ft/sec and the Nz is maintained close to 2g, then energy is being dissipated properly. For energy problems which are above the GCA takeover line, the bank reversals should be delayed such that the DELAZ gets to 30°. Delaying the reversal dissipates energy by increasing the RGO. To achieve a reversal at 30° DELAZ, it will be required to make the reversal call at approximately 25°. This 5° lead on the reversal call accounts for the lag time required for the crew to receive the call and to begin to take action. Allowing the DELAZ to get much greater than 35° frequently leads to a low energy case. The 2g bank angles should be used with the delayed reversal technique until energy begins converging back toward nominal. In any of the high energy cases much attention is required to smoothly transition back on the nominal energy profile. The energy dissipation techniques may initially seem only slightly effective in correcting the problem; however, the increased drag and ranging effects eventually rapidly dissipate the energy.

(4) Very High Energy

For very high energy cases with energy above the guidance capability line, it will be necessary to use a different GCA technique. This technique increases the DELAZ to approximately 30° to 35° and maintains this constant DELAZ until the energy is within guidance limits. Then the bank angle is increased to bring DELAZ back within $\pm 20^\circ$ and conventional high energy GCA techniques can be used. This technique results in a spiral type of groundtrack which will probably not converge on nominal energy until Mach = 1. The bank angle required to maintain this DELAZ will increase as the range to the site decreases. This technique can recover energy cases as much as 75 n. mi. high (RGO error) above the guidance capability. This technique can be performed by having the crew maintain the constant DELAZ, once a valid DELAZ reference is available to them. If the onboard navigation state is invalid, the crew should select TACAN as the source for the horizontal situation indicator (HSI) once TACAN data is available. As a general rule, the GCA should continue until the onboard navigation state is corrected and guidance can be followed.

d. Transitioning to TAEM

Independent of the type of GCA being performed, the FDO must start redirecting his/her focus from the entry phase techniques to the TAEM techniques at about VREL = 3.5k ft/sec. This transition should include changing to the TAEM displays as the monitoring allows. The TAEM GCA techniques use EAS, magnetic headings, and speedbrake settings (when $M < 1$) for controlling energy. The details of the TAEM GCA techniques will be discussed in the next section. If the energy situation will clearly prohibit achieving the planned runway, the redesignation decision should be made at this time, and subsequent TAEM calls should reflect this redesignation. If a redesignation is called, be sure to reconfigure the prime ground runway (K51) with the selected runway. However, do not change the prime ground runway until the crew has selected it onboard.

e. TAEM phase GCA

As mentioned earlier, the TAEM GCA techniques are different from those used in entry phase. Between approximately VREL = 3k ft/sec and $M = 1$, the FDO will make heading and EAS calls. The heading will generally direct the vehicle to the HAC tangent point, and the EAS will control energy. In TAEM guidance, the pitch axis is used primarily for controlling energy, and bank angles are used to null heading errors with respect to the HAC tangency point.

For high energy cases, the FDO will primarily dissipate energy by calling higher EAS's. Increasing the EAS will require the crew to pitch down and decrease the angle-of-attack. The maximum recommended EAS is 300 kt, which results in aerodynamic forces approximately equal to the dynamic pressure limit for the vehicle. The effectiveness of the EAS commands in correcting the energy error

will be a function of the winds to which the vehicle is subjected. High upper level winds (>120 kt) can distort the standard EAS recommendations. If the energy is very high (i.e., above the S-turn initiate line), the GCA should supplement the pitch axis capability with an increase in the RGO. This is performed by commanding headings which point the vehicle approximately 10° to 15° away from the HAC intercept point. This heading bias must be in the direction to decrease the resulting turning angle (PSHA) on the HAC. Much attention will be required to promptly return the EAS and heading commands back to nominal as the energy begins to approach the nominal line on the E/W vs. RGO plot. These cases with the manual S-turn tend to have energy converge to nominal very rapidly. Additionally, the FDO will have to continue to evaluate the HAC/runway redesignation options.

For low energy cases, the EAS commands will preserve energy by causing the vehicle to pitch up and increase the angle-of-attack. The most effective EAS is obtained by flying at the maximum L/D ratio. For the orbiter, the maximum L/D occurs when the EAS is approximately 210 to 220 kt. Procedurally, the crew will fly a maximum L/D angle-of- attack (α) when on a low energy case. The maximum L/D α vs. Mach number are in the Entry Checklist. Additionally, the heading error should be nulled early and a straight approach directed to the HAC intercept point. As with the high energy case, the HAC/runway redesignation options should be evaluated frequently when the energy indicates the inability to obtain the desired HAC or runway. The standard terminology for TAEM GCA calls follows:

FDO: "Come left to a heading of zero six zero degrees and increase airspeed to 250 knots."

During all of entry down to $M = 1$, the speedbrake follows a canned schedule. Below $M = 1$, the speedbrake position is used to provide additional energy control. Generally, in mild upper level winds and with nominal energy, the EAS will be about 250 kt and the speedbrake position will be approximately 50 percent. The speedbrake position is added to the EAS call during the subsonic portion of a GCA. The EAS and speedbrake position are directly correlated; if high on energy, the GCA EAS may be 300 kt with a speedbrake of 100 percent, or alternately, an EAS of 210 kt with a speedbrake of 15 percent (closed). The standard subsonic GCA calls must include the energy control portion and the directional portion. An example of a standard subsonic call is as follows:

FDO: "Come left to a heading of zero three zero degrees. Increase airspeed to 280 knots and open speedbrake to 80 (eight zero) percent," or "Continue left to a heading of three six zero degrees, decrease airspeed to 220 knots, and close the speedbrake."

Whether in a GCA or not, only a limited amount of energy error can be corrected using the EAS, ranging, and speedbrake authority. In most cases, a

runway/HAC redesignation should be recommended, when necessary, by approximately $M = 6$. However, in some cases it will be necessary to redesignate later in entry. Just prior to TAEM interface ($M = 4$ to $M = 2.5$) is not a good time to redesignate, if not in a GCA. The reason is that entry guidance is very aggressive at correcting any energy error before $M = 2.5$ and severe attitude transients/maneuvers can occur. If the FDO is already GCA'ing, the FDO has license to change the targeted runway with the GCA calls even during this pre-TAEM period. Early in TAEM is a prime time for evaluating and recommending HAC or runway redesignation. The FDO should focus on the redesignation options whenever an energy error exists. The runway (PRI, SEC, and ALT), OVHD/STIN, and NOM/MEP PBI's provide the evaluation capability on the E/W vs. RGO plot. If none of the three runways provide acceptable energy options, other runways can also be evaluated by changing the SEC or ALT runway definitions (K51 MED). Be sure to maintain the PRI runway equal to the onboard selected runway at all times. Valid delta states cannot be generated if the ground runway does not equal the onboard runway.

There are two cases where a GCA would be performed in TAEM. One is the continuation of a GCA that started in Entry phase. The other would be anytime an onboard nav or guidance problem appears that causes the vehicle to deviate significantly from the desired heading. An example of this second case is a BFS engage in TAEM with a BFS state vector that's out of limits. Another example is a large crosstrack error (> 6000 feet) that is forcing the vehicle to a point that is either inside or outside of the true Waypoint 1. In this case a GCA may be performed to adjust the heading while GPO works on a delta state (probably position only).

f. HAC intercept to final approach

As the vehicle approaches the HAC, the FDO must start anticipating how the HAC will be flown. Generally, it is recommended that the heading calls allow the groundtrack to closely follow the standard HAC. Directing the GCA along the standard HAC provides continual energy assessment using the HAC overlays (nominal altitudes at given RGO's), as well as providing the crew with a familiar approach geometry. The key to "flying" a standard HAC during a GCA is knowing how much to lead the calls. Making calls for every 30° or 40° of heading change is recommended. Extending or cutting the HAC may be necessary when the energy is not close to nominal. By approximately 14k-ft altitude, the vehicle must start pitching down to increase the EAS as it rolls onto final approach. At this altitude the FDO must transition his focus to the X vs. Y scale 1 (logarithmic plot) display. The goal is to transition the profile onto the OGS at 300 kt EAS. Once the vehicle has been turned onto final approach, the EAS and speedbrake are used to converge the profile back to the glideslope. When a GCA is required while on final approach, the call terminology must also include glideslope information. An example of a final approach call is as follows:

"Hold the heading of three three zero degrees. Decrease airspeed to 270 knots with 40 percent speedbrake. We show them below the glideslope and diverging."

The GCA should be terminated when the crew has good visual contact of the runway. The lowest altitude that the FDO can effectively GCA down to is approximately 7k ft. Below this altitude, the preflare to touchdown events occur too quickly for ground assistance. If the crew achieves a good visual on the runway at 12 or 15k ft, the crew will announce this fact and the GCA should be terminated.

To be proficient at GCA techniques, it will take lots of practice with the above guidelines. Timing and a good scanning routine are some of the more essential skills that come only from experience.

g. GCA Termination

In all cases, a GCA should be terminated once the onboard nav is fixed, energy is within auto guidance limits and the onboard guidance commands are determined to be good. Exceptions to this would be when a roll reversal is imminent. FDO should then GCA through the roll reversal in insure that a delayed roll reversal will not occur. The call to terminate GCA must be crisp and clear. If the vehicle is still supersonic, the call should include words that tell to crew to null errors and then return to AUTO. If subsonic, the call will include words about following the needles and returning the speedbrake to AUTO. Examples are:

Supersonic GCA Termination:

"Flight, FDO: Terminate GCA, center the needles, GO for AUTO."

Subsonic GCA Termination:

"Flight, FDO: Terminate GCA, follow the needles and take Speedbrake to AUTO."

4.7.2.4 No Yaw Jet (or any CSS) Entry

A special procedure exists to allow the crew to fly the entry without RCS yaw jets after aero capture has occurred. The "No Yaw Jet Entry" procedure is documented in the flight supplement of the Entry Checklist on the RCS Critical Entry cue card. For more details on the crew's procedure, reference the SCOM section 7.3 or the Entry Flight Procedures Handbook.

The vehicle rolls sluggishly while flying in the no yaw jet (NYJ) mode. This is due to the way the flight control system works while in NYJ. The use of NYJ mode requires the crew to fly CSS. The sluggishness of the vehicle can cause

problems with DELAZ getting much larger than usual, potentially causing a loss of energy. Therefore, the following is the FDO procedure for preventing that from happening.

IF No Yaw Jet or CSS during Entry phase:

FDO: Make a **“15 seconds to roll reversal”** call on the FD loop when the 20 second predictor bug hits the DELAZ deadband.

This call will be made for all roll reversals to remind the crew that the roll reversal is coming up soon. This allows the crew to be prepared to execute the roll reversal immediately when the roll reversal is commanded. It was determined in a study in the SES that the crew does not need to lead the roll reversal. As long as the crew is “ahead of the airplane” and executes the maneuver on time, there was no problem with DELAZ getting too large and the resulting loss in energy. This was true even for the last roll reversal where the DELAZ is changing very quickly.

Making the **“15 seconds to roll reversal”** call should be made using the 20 second predictor bug. This will allow for a 5 second delay between the FDO’s call and the crew hearing the call from CAPCOM.

4.7.2.5 Bailout Assessment Procedures

In the event that the orbiter energy during entry is clearly not sufficient to carry the vehicle to a runway, a bailout will be recommended. Crew escape is only available for situations where vehicle control is maintained. The following outlines the criteria used, the responsible positions and calls, and the crew procedures invoked.

4.7.2.5.1 Bailout Criteria and Calls

It is assumed, at this point, that the orbiter is in an energy situation which may not permit a runway landing. When possible, all other energy management techniques should be employed before recommending bailout.

Any bailout requirement is assessed using the E/W vs. RGO display (MSK 443) (fig. 4.7-6). The two lines of interest are the maximum range and the bailout lines. The maximum range line is computed by ENTRY SUPPORT using the DDS with the winds of the day, STIN, A/L forced at 6k ft, maximum HAC shrink, and maximum L/D capability without aero dispersions included. This data is then input to the dynamic limit line table for use by the E/W vs. RGO display. The bailout line is a generic line computed using the same criteria as the maximum range line with the exception that the wind profile used is different. The winds of the day are not used but rather a 3-sigma favorable wind was applied resulting in the best ranging capability.

Based on these lines, MCC bailout calls take the form of green, yellow, and red energy zones as described below.

In the green zone, the vehicle energy is above the maximum range line. Standard Entry FDO procedures will apply and a bailout should not be necessary. A green zone call is not made to the FD unless the vehicle has recovered from the yellow zone below.

In the yellow zone, vehicle energy is below the maximum range line but above the bailout line. This will be reported to the FD as "bailout yellow zone." Where possible, the following will be requested in order to regain energy capability above the maximum range line:

- a. Runway/HAC redesignation (reduce RGO, minimize HAC turn angle).
- b. Manual stretch techniques (maximum L/D).
- c. Relaxation of Nz, surface wind, TD, brake energy, and rollout margin constraints (increase available runways).

Below the maximum range line there is less than a 50 percent chance (no aero dispersions accounted for in the line design) of reaching the field. The MCC will only advise the crew of the energy situation, bailout is then a crew call.

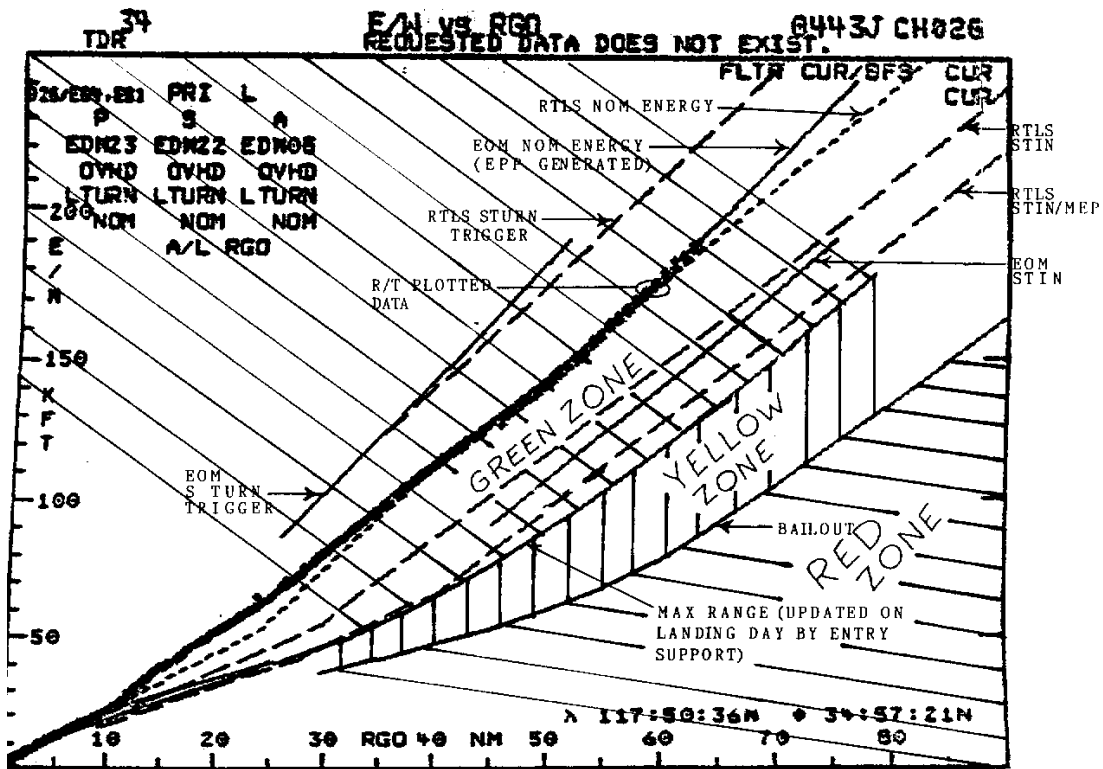

Figure 4.7-6 Bailout zones on E/W vs. RGO display

In the red zone the vehicle energy is below the bailout line. This will be reported to the FD as "bailout red zone". In this case, there is no chance of reaching the runway threshold, and the MCC will recommend bailout to the crew. The MCC may recommend utilizing a bank angle (not greater than 10°) to be set prior to bailout software engage in order to avoid vehicle impact on populated areas. Greater than 10° bank angles have been shown to result in the vehicle turning a full 360° of heading and impacting in the crew bailout landing area. Best judgment is used to assess the need for a bank angle. Once it is confirmed that the crew will bailout, hard copies of the E/W vs. RGO display should be obtained when the vehicle reaches 18 KFT altitude in order to capture latitude/longitude for the center of the 15 NM radius bailout SAR area for the SAR forces. Also record lat/long at 10 KFT increments from 50 KFT to impact and as each crewmember bails out. The value of 18 KFT and 15 NM radius was computed using the crew bailout procedures coupled with the following assumptions:

- a. Nav error >5 n. mi.
- b. Wind 99 percent KSC
- c. Crewmember - 200 lb, H-dot = 22 ft/sec
- d. Parachute opening - 14k ft
- e. No ocean currents

The crew is equipped with C-band transponders, and the SAR forces have an approximately 80-n. mi. C-band receive range at 10k ft.

The CDR is ultimately responsible for making the bailout decisions and taking bailout action as described in the following section.

4.7.2.5.2 Crew Bailout Procedures

The crew is equipped with several energy evaluation displays and procedures. For low energy TAL aborts, the crew will perform manual low alpha stretch techniques and site redesignations. For nominal entries the crew will use the Entry TRAJ and Vert SIT displays to assess their energy. With loss of communications, the crew will use the "rule of thumb" of RGO greater than 55 n. mi. at 50k ft as the criterion for bailout. The crew can also rely on visual estimations of runway capability.

If bailout is certain, the crew procedures are as follows (fig. 4.7-7):

- a. Vent the cabin at 40k ft

- b. Jettison the hatch at 25k - 30k ft
- c. Set auto bailout logic guidance and begin crew escape at 20k f

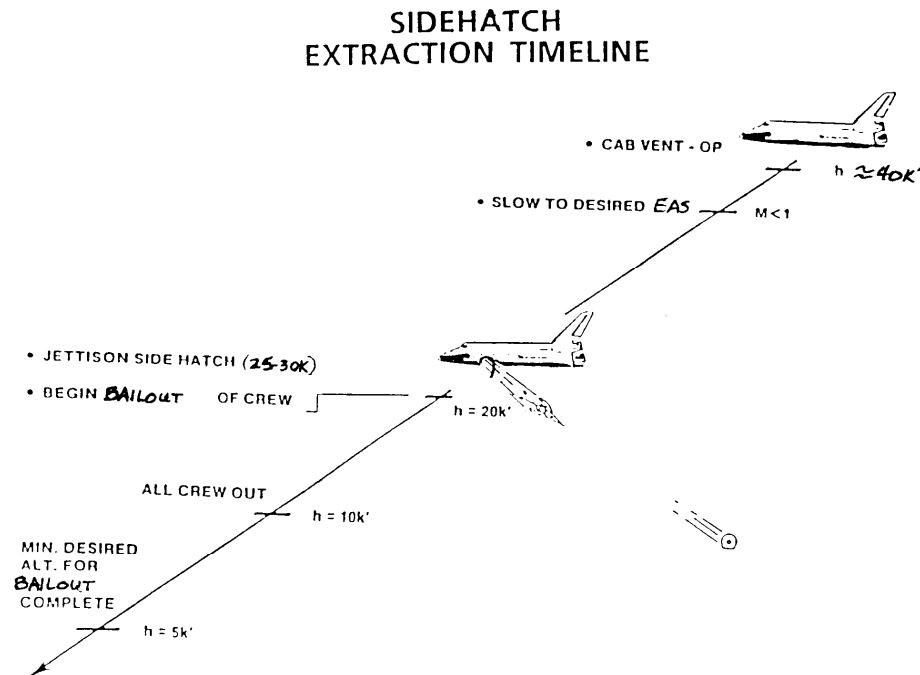

Figure 4.7-7 Crew bailout procedures

4.7.2.6 BFS Engage

The first action after BFS engage is for Traj to push the V53 & V56 state vector PBIs. This action switches the onboard vector source from PASS to BFS for the HSEP and Delta-state Processor. Immediately upon BFS engage, the DAP will downmode to CSS since BFS guidance has no auto DAP capability, therefore the crew will fly the remainder of entry manually. In response to this, FDO must provide a “heads up” to the crew prior to roll reversals, to help prevent any ΔAZ excursions. The procedure here is the same as for any CSS roll/yaw scenario: when the 20 second predictor bug crosses the ΔAZ limit, call “15 sec to roll reversal”. CAPCOM will relay this to the crew. FDO should closely monitor the roll reversal to assure it is executed promptly.

BFS has no capability to incorporate MLS data into its nav state. For reduced ceiling and/or visibility, FDO/GPO should consider taking GPS to auto prior to the HAC. Another limitation of BFS is that it has no Approach & Land guidance. TAEM “pre-final” guidance commands continue to be computed based on acquiring the outer glideslope. At 2,000 ft, the ADI needles stow and BFS would normally drive the SB closed. Instead, the crew selects manual SB at 3,000 ft and sets it to the 3k setting specified on the DEL PAD. In the event that the 3k

and 500 ft SB predictions are significantly different, the SB should be set to the average of the two to minimize TD energy dispersions. FDO should always inform the FD of the preferred 3k speedbrake setting. Time permitting; a DDS evaluation of the touchdown, with the proposed setting, should be accomplished. Ref. A/E FTP #154, 1/27/99.

Finally, BFS engage takes out the HUD, eliminating an important guidance cue for the crew. Per Flight Rules this makes both PAPIs and ballbar mandatory. The pre-flare maneuver is performed at 2,000 ft using outside visual cues, plus the ADI pitch rate needle (which is still good, as opposed to the pitch error needle). Once the IGS is acquired, the crew flies the remainder of the approach using the ball-bar for reference (see Approach, Landing, and Rollout Flight Procedures Handbook, sec 5.5.2). Since the crew is “flying the ball”, it is highly desirable to ensure an aimpoint/speedbrake combination that has the orbiter touching down as close to 2500 ft as possible (the touchdown point to which the ballbar is calibrated).

4.7.2.7 Single APU Entry

In the event the Orbiter is flying with a single APU there is concern that hydraulic demand will outstrip supply, resulting in reduced response from the orbiter’s control surfaces. To off-load the system as much as possible, prior to touchdown the crew should manually set the speedbrake to the average of the 3000 ft and 500 ft predictions. This will provide relief for the gear deploy time period. In TD analysis, a minimum TD distance of 1500 ft should be used to reflect a full 3-sigma budget (1400 ft) and to protect for possible dispersion in the manual SB set position. It should be noted that at touchdown the SB will open to at least 25 deg, even if the SB is in manual due to an orbiter K-Load. This will result in an over demand on the hydraulic system at WOW. This condition will remain until OI-29 when the K-Load will be changed to 15 deg. This will provide less than 3-sigma protection for rudder seals, for closed SB cases. The overall hydraulic flow management for single APU will be dealt with in a future OI. Ref. A/E FTP #154, 1/27/99.

4.7.2.8 Air Data Failures

Air data probes are located on either side of the orbiter’s nose to provide data to GN&C in TAEM and A&L. Each of the two probes outputs data to two Air Data Transducer Assemblies (ADTAs), which process the raw measurements and feed data to the GPCs. Each probe has three ram pressure ports, one static port, and two temperature sensors which allow measurement of alpha, q-bar, Mach, altitude, EAS, and TAS. The crew deploys the air data probes at Mach 5, and then performs a reasonableness compare of the data against onboard nav. The ground assists in this effort as well, with additional comparisons against tracking (altitude). If the data looks good, then air data to G&C and Nav is set to Auto on SPEC 50 (a.k.a. “take air data”). At Mach 2.5 the data will automatically

be incorporated into flight control and nav if in Auto. If for some reason air data is not taken to Auto prior to Mach 2.5, the crew must select pitch CSS prior to incorporating air data in order to avoid possible guidance transients. During the "Mach jump" region from Mach 1.6 to 1.1, altitude data is not incorporated due to errors in measured static pressure. Thus, nav's altitude error may grow during this timeframe, prior to being corrected below Mach 1.1.

In the event of disagreeing air data, GNC and the crew will attempt to determine the bad probe and/or ADTA. This may result in re-stowing one of the probes, or deselecting one or more bad ADTAs. If troubleshooting has not resolved the dilemma by TAEM, or if no air data is available at all (e.g. both probes failed to deploy), then guidance and nav will continue using nav-derived air data parameters (EAS, TAS, q-bar, and Mach). Below VREL of 1500 fps, flight control will use default air data (DEFAD) which is essentially a fixed alpha and canned q-bar assuming a nominal trajectory. This presents a dangerous flight control situation, since alpha and q-bar are not being actively measured and limited. To alleviate this, the crew must fly "theta limits" below Mach 2.0 in order to protect against stalling the vehicle (excessive nose-high) or exceeding max q-bar (excessive nose-low). Theta limits is also called for in case of only one ADTA available. This is done to protect against failure of the sole remaining unit, which could result in LOC.

Pitch measurements come from the IMUs, and are considered accurate enough to safely land the vehicle in most cases. To fly theta limits, the crew takes CSS pitch and roll/yaw, and flies the guidance needles while keeping theta between nose-high and low limits shown on the attitude indicator (ADI) when air data is inhibited to G&C. The Vert Sit display also shows brackets for theta limits. The Upper and lower theta limits converge as bank angle is increased, so the crew is limited to 50 deg bank while on the HAC. The crew may secure from theta limits once on final approach, as the nominal trajectory from this point on assures a good range of alpha. Auto speedbrake control is acceptable under theta limits, although the setting should be evaluated for reasonableness.

Trajectory control is diminished when flying theta limits, since guidance commands are superseded by the crew manually staying within theta limits. Furthermore, the nav altitude error may be larger than normal due to the absence of barometric altitude measurements. Additional nav errors can also lead to bad data getting into flight control and guidance, and exacerbate the trajectory problem. Another case where theta limits is dangerous is if strong upper winds are present (≥ 80 kts) and/or energy dump/pull-up maneuver prior to the HAC, as either of these may lead to LOC. For any of these scenarios, air data should be taken to G&C and nav if at all possible. FR A8-111 allows use of a single ADTA in the event of bad nav, high winds, BFS (the backup software does not have DEFAD), or if the crew deems necessary due to high workload. If flying theta limits, FDO should advise the FD of any energy and/or nav concerns early in TAEM so that this fallback may be utilized if available. In the event of no air data

available, the ability to correct an energy error is significantly degraded. If a GCA must be performed, FDO should provide heading per standard procedures and advise the crew to fly the “nose high” or “nose low” theta limits as necessary to fix energy, then have them fly normal airspeeds once back on energy. Note that theta limits override FDO’s EAS calls as long as air data is inhibited to G&C. Guidance should take GPS or uplink a delta state ASAP to fix the nav state so that the GCA may be terminated. Bottom line is that FDO should be cognizant of the air data situation and how this relates to overall trajectory control. Prompt communicate to the FD is essential if energy trends away from nominal and/or if the nav exceeds delta state limits.

4.7.2.9 Leaking/Flat Tire Runway Selection Guidelines

The orbiter has two tires on each main gear strut, and either is capable of supporting the full load for that strut under benign landing conditions. In the event of a leaking or flat tire, the good tire will have to carry most or all of the loads for that side of the vehicle. This increases the possibility of the remaining tire failing, which could result in loss of vehicle control upon landing and/or departure from the runway. To minimize these chances, runway redesignation may be required in order to optimize touchdown conditions for the good tire. Responses for leaking/failed main gear tires are listed below. No action is required for leaking/failed nose gear tires.

- For leaking/flat main gear tire, it is highly desirable to land with the crosswind from the side of the affected tire (FR A10-142). This applies only to crosswinds greater than about 3 kts (undocumented rule-of-thumb), and has higher priority over groundspeed. Also, concrete is preferred above lakebed, according to FR A2-207.
- If there is any concern with a MLG tire (pressures below nominal but above the tire fail limit) avoid high groundspeed landings and attempt to place the degraded tire on the upwind side. If desired runway for crosswind results in high groundspeed, then have ESE check landing conditions with SF speedbrake. It may be desirable to select SF in order to reduce groundspeed by approximately 10 kts.
- If the tire is below the 277 psia fail limit, in addition to above techniques, the crew should simultaneously mode to auto pitch for derotation and deploy the drag chute at 185 knot EAS, then perform a full lateral RHC roll toward the good strut at nose gear touchdown. Additionally, the drag chute will always be deployed for cases where the tire is below the fail limit. (Note: AMES VMS testing showed these mitigation techniques consistently saved the second tire for all cases except for a very high groundspeed case (223 knot groundspeed/205 knot touchdown)).
- For “heavy” lightweight missions, assure O/B weight is between 220k and 222k, since lightweight derotation I-load (220k breakpoint) uses a lower target derotation rate that results in higher MLG loads.

[Reference A/E Flight Techniques Panel #194 minutes, Oct. 31, 2003.]

4.7.3 Off Nominal Entry Analysis Requirements

Several products and analyses, that are accomplished by Descent Flight Design and are used in deorbit/entry planning, are generated with flight specific end of mission conditions assumed. In the event that an unplanned payload return, early mission termination, or any thing else occurs that alters the assumed entry conditions beyond the limits listed below, special analysis is required. Generally, the cases that have problems are those that have heavier than planned landing weights. The heavier landing weight may cause thermal problems during entry for some deorbit opportunities. Each potential deorbit opportunity needs to be evaluated with the Thermal Structural Envelope Program (TSEP). The thermal environment is a function of altitude, weight, inclination, approach type (ascending versus descending), approach direction and crossrange. Thermal violations flagged in TSEP are an indication that the thermal environment exceeds the certification database. In the case of an emergency deorbit thermal violations will not be considered or protected.

EOM Landing Weight Limits

FR A4.1.4-3 , para 2 lists the absolute landing weight constraints for the orbiter, as set by NSTS-07700 X. Entries that will result in landing in excess of these weights must be evaluated by the community to ensure Flight Control, Thermal, Stress, SSME heating, and Landing Gear & Tire loading constraints are met. The thermal assessment is done by FDD Descent personnel using TSEP and generally been the most critical element in being able to clear these cases for use. (Most of the other stakeholders are usually go for their systems if the Thermal analysis is acceptable). If the expected landing weight is within 500 lb. of the limit, it is recommended that it be treated as a violation to protect against late increases in the touchdown weight prediction.

Bondline Temperature Limits

FR A18.1.9-1 (THERMAL PROTECTION SYSTEM (TPS) BONDLINE TEMPERATURES) defines the orbiter's bondline temperature limits that EECOM's back room protects using their Simplified Thermal Evaluation Program (STEP) program. We provide orbiter body temperatures at entry interface for initialization of the analyses via the DSCT-29 product. This data, to minimize re-work, represents "worst case" temperatures expected to be encountered by adding 3000 lb. to the expected orbiter weight and moving the expected orbiter CG three inches forward. The product will always be delivered in Flight cycle. At FRR cycle (or, potentially, when CTL mass properties are delivered) the Descent engineer will make an assessment on whether or not this product needs to be redelivered. In the event of significant weight growth, forward CG movement, or a launch slip that moves the flight into a thermally worse month, the product will be re-

delivered.(in this event, the Entry FDO and EECOM will get a heads up call). In either case, the mass properties(from PROP-02) used to generate the final Dsct-29 should be shown on the FRR and LDP cycle DSCT-05. The intent of inclusion of mass props on the max. crossrange table is to ensure the FDO and EECOM know the design conditions used in the last EI Temps table delivered.

For real time there are two things to consider. First, if the expected EI weight is more than 3000 lb. heavier or there is a X cg shift of more than an three inches forward from what is documented in the CTL DSCT-05, TSEP will have to be run to redeliver the EI temperatures.

Second, there is the potential that the EI temperatures we are supplying will cause problems for the EECOM. To meet the bondline thermal constraints, they drive a cold soak attitude requirement to the ATL that could conflict with payload desires. Since the temperatures in the product represent worst case, it is possible to either use the supplied data (the product has nominal and worst case, so you can interpolate or use the nominal data) to provide relief or, in an extreme case, regenerate the DSCT 29 product with actual conditions. This should not be an issue on most flights, but if it does work closely with the Entry Support team to determine your options.

The EECOM needs the data approximately 48 hours prior to the deorbit opportunity, so they have time to run STEP, assess the impact of the changes in bondline temperature, and make any needed modifications to the ATL for thermal conditioning of the Orbiter prior to deorbit.

Entry Thermal Limits

As part of its Commit To Flight process Descent Flight Design is required to do a thermal assessment of the expected shuttle entry (actually, the nominal and up to three crossrange cases are looked at). Any violations of SODB constraints are forwarded to Boeing for clearance. For the FRR cycle, changes from the design cycle conditions will be assessed to determine if a reassessment is required.

During the flight, another look is needed to ensure changes from the design profile do not result in violations. Since violation clearances need to be done by Boeing, the analysis needs to be kicked off early. At landing minus two business days, the FDO should request this assessment from the ECO. The ECO would look at the probable landing opportunities and compare them to the conditions from the last preflight assessment (i.e., design or FRR cycle), and a decision made on the necessity for a new assessment. Any violations detected in a real-time thermal assessment would be forwarded by the FDO to Boeing through the MER.

Note: The Flight Rules do not contain specific entry thermal constraints, although there are several indirect references. In practice, violation of limits documented in

the SODB Volume V must be waived. For the vast majority of shuttle mass property and trajectory combinations this should not be a problem as Downey can trade off a violation in a specific area for margin in another.

Recovery Prebank Charts

If the expected target HA is ± 10 N.M from the pre-mission assumed HA or the deorbit approach (ascending/descending) changes the table needs to be re-evaluated. The altitude assumed is listed at the top of the Recovery Prebank Table, the approach assumed is the nominal EOM case for the flight.

Procedures

Approximately three days (and no later the two business days) before expected EOM, the Entry FDO should coordinate with the planning team to ensure that the EOM conditions are as expected. Specifically the planning team should:

- a) Check the expected Landing weight vs. FR A4.1.4-3.
- b) Check the expected Entry weight and XCG vs. the values documented in the Descent 29 Product (see the Deorbit Constraints Tab in the Console Data Book).
- c) Check the expected target HA in the Entry Checklist, Recovery Prebank Table.
- d) Talk to the ECO about Entry Thermal assessments

Once it is clear that the mission is in an unplanned payload return/early mission termination scenario, or that the EOM conditions violate the landing weight, apogee, or cg constraints, the Entry FDO will contact the ENTRY SUPPORT personnel so that they can perform the required analysis. For each deorbit opportunity being considered for EOM, FDO needs to provide ENTRY SUPPORT with the following:

- EI-5 state vector
- Entry mass properties
- Crossrange
- Approach type and direction (e.g. AL)
- Post burn apogee

For Landing Weight violations, a CHIT should be opened to alert the community and to allow them time to review their analysis requirements. The CHIT should provide the best estimated EOM weight and C.G.. Attaching the detailed Mass Properties Build-up tables from PMP is recommended (see sample CHIT below).

For generic information on the thermal limitations in an unplanned payload return case, reference appendix D of this book. This generic data can be used if time does not permit the TSEP analysis to be done.

In the event that TSEP does not clear all the cases, a CHIT should be written that actions Boeing to analyze the cases that do not pass. The CHIT should include 1) A definition of the case (i.e. Deorbit on Orbit 59/Land on Orbit 60, at KSC, Crossrange of 750 NM) we are asking for help with, 2) an EI vector and mass properties, 3) a summary of what TSEP saw as a problem, and 4) if Descent has transferred a binary trajectory file to Boeing, say so and tell who it was sent to (send the EI and mass property data in any case, there may be more than one group looking at the data). The CHIT will be received by Boeing management, so be as clear as possible and specify what you want them to do. If the opportunities cannot be cleared by Boeing, either a Level II waiver will be needed, or the opportunity cannot be used

If the violation cannot be cleared, log it, annotate the excluded opportunities in DOPS, and follow-up with a flight note to the Flight Director indicating which opportunities are excluded. Note: This analysis will exclude individual opportunities, but will not establish a new crossrange limit. Ensure that any opportunities with similar characteristics to the excluded opportunities have been evaluated by TSEP.

For EOM Landing Weight cases where TSEP is go for all opportunities, the FDO should document it by publishing a Information-only CHIT stating the particular opportunities cleared, and that TSEP was used to do so.

For a new Bondline Temperature Limit - Forward the new limits to the EECOM, follow up with a flight note to EECOM and FD.

For a new Recovery Prebank table, get with the Entry GPO and make sure the new table is uplinked with any other Entry Checklist delta's.

Options For Mitigating Thermal Impacts

The following options might be considered to reduce thermal impacts, if needed:

- 1) Chose the lower crossrange opportunities. Small crossranges cause less alpha droop which is the main factor in thermal violations
- 2) Ascending passes are thermally better than descending.
- 3) Depending on the season and predominant wind direction, an A/R may be better than A/L and D/L better than DR (Winter). Summer is usually the opposite, but not to the extreme since wind magnitudes are less in summer (winds affect alpha - can push it lower which causes increases in thermal).
- 4) Focus on limiting qbar and g's. Many areas of the vehicle are both thermal and mechanical load dependent. Minimizing qbar and g's on the HAC and at landing would provide extra margin. This might can be accomplished by choosing straight-in, selecting the opposite end of the runway, or going to another site.

CHITs

The Mission Action request (MAR), which is known as CHIT, is a formal method of conveying information of various forms between the various members of the Shuttle and Station Program. The term “chit” has its origin in the US Naval Service and was a piece of paper documenting a question and answer between various functions aboard a naval vessel

We are currently using a web based personal computer (PC) system for CHITs that is accessed from the MCC-H MISSION CONTROL CENTER page. Select the appropriate activity from “MISSION” or “SIMS”, then “STS USERS” for Shuttle Operations. See that app for detailed instructions on how to fill out the form.

The CHIT form consists of a request section and a response section. When a new CHIT is saved, it will be given a PRELIMINARY status and is assigned a temporary control number. FDO should then inform the MOIR Manager on the SPAN loop that a CHIT has been saved. The MOIR will review the CHIT, upgrade it’s status to OPEN, and assign it an official number. After the MER has entered their response, the MOIR should inform FDO that the response is ready. If there are no further actions required, the CHIT status will be CLOSED.

SAMPLE CHIT

TS-112 **MISSION ACTION REQUEST (CHIT)** Launch Date 08/07/97
Vehicle ID OV-103(23)

GMT TIME 224:23:02:31	ACTION TIME 227:23:00:00	REQUEST ORG MER	RESPONSE ORG MOD	CONTROL NUMBER 005
SUBJECT: EOM Mass Properties Analysis				
Request (MOD): FDO/DM32/C. P. Barrett				
Page 1		0 pages in hardcopy file.		0 graphic attachments.
The current best estimate mass properties for nominal EOM (deorbit orbit 255) are:				
Event	Weight (lbs)	XCG (in)	YCG (in)	ZCG(in)
Post Deorbit	235218	1076.07	-0.60	371.97
Entry Interface	234216	1078.27	-0.62	371.91
TAEM Interface	233738	1077.37	-0.61	371.75
Landing	233657	1078.92	-0.60	369.28
Detailed Mass Properties Build-up tables are available at the FDO console (244-5956) for both of these cases if needed for structural analysis.				

This weight is in violation of Flight Rule A4-159 (ORBITER LANDING WEIGHT) which specifies that the landing weight for the Orbiter should be less than or equal to 233000 lbs for a 39 deg. inclination orbit. For this case there is no requirement for any propulsive ballast (OMS or ARCS).

Request information on what type of analysis is required and how long that analysis is expected to take in order to grant a waiver to his rule for STS-107. Also be prepared to proceed with this analysis if directed by the Friday morning (1/24) MMT.

SPAN MANAGER: Allison L. McIntyre, 244-75115,2003/224:23:24:25

*** END OF MOD REQUEST ***

4.7.4 Entry Overflight and Entry Thermal Options

As a result of the CAIB report following the Columbia accident two new elements were added to Shuttle entry considerations, Shuttle Entry public risk assessment and new techniques to reduce Shuttle Entry thermal loads.

Adding consideration of the estimated public risk in selection of Shuttle entry opportunities was driven by CAB observation O10.1-1: "NASA should develop and implement a public risk acceptability policy for launch and re-entry of space vehicles and unmanned aircraft." The general philosophy on how NASA was going to approach this for Shuttle operations was established by NASA HQ AA for Space Operations, Bill Readdy, in a meeting in June of 2004.

In that meeting it was reiterated that the long standing nominal, EOM landing site priority of KSC, followed by Edwards, and then Northrop strip would be maintained. Basically, the position of Headquarters was that the risk to the public was mitigated by the extensive work NASA has done for STS hardware improvements, launch and orbit imagery capability, and post launch vehicle inspections and that the numerous advantages to the Shuttle program of landing at KSC remained. For cases where there was damage to Orbiter entry critical systems or the probability of a nominal entry is significantly reduced, the landing opportunities would be selected that mitigated the public risk as much as possible while also providing the crew the best chance of landing the vehicle successfully.

For entries where additional thermal margin is desired or required, a number of options were developed that could be considered to improve the vehicle heating profile. This was driven by the studies that were done that indicated that for some orbiter damage or repair cases there was a benefit to exercising these options.

4.7.4.1 Entry Public Risk Assessment

For the purposes of assessing Entry Public risk, the flight rule (A2-207 Flight Rule Part C, D, and E) breaks Shuttle Entries into three major categories:

- Nominal EOM with no significant failures.
- EOM with significant entry critical systems failures.
- Compromised Orbiter, where the probability of a nominal entry is (significantly) reduced.

End Of Mission (EOM)

For Nominal EOM given no significant Orbiter or systems anomalies, the landing site selection priorities are:

- KSC, prime.
- Edwards AFB (EDW), first alternate.
- Northrup (NOR), second alternate.

Since the entry public risk for all KSC opportunities is acceptable, per the Headquarters policy, we will restrict the usage of EDW or NOR to avoid opportunities with risk greater than the KSC opportunity with the highest risk. This will be done “to the extent possible, while managing other critical considerations including weather, deorbit opportunities, Orbiter consumables, crew health, etc”..

See All Flights Flight Rules, A2-207 C., for the cross range restrictions.

The crossranges restrictions will generally apply to first EDW opportunity of the day and occur when the shuttles entry crosses the LA basin. There is a small crossrange placard for Northrup that is driven by overflight of the LA basin and Phoenix/Tuscon.

It is expected that an orbit adjust burn(s) will be performed to move opportunities out of the restricted ranges. In practical terms, EOM orbit shaping will have a number of constraints, including these entry overflight restrictions, first roll uncertainty crossranges, and normal crossrange targeting (to ensure the right number of EOM opportunities). The Entry FDO will need to work closely with the Orbit FDOs, Props, and Entry Flight Director to ensure an optimal plan, starting soon after docking.

Special Note: The EDW 04 crossrange limit was modified from A/L 0-11 to A/L 0-20 to protect for an intersection between the Entry Public Risk crossrange and the Initial Roll Direction Uncertainty crossrange. If you end in a case where an EDW 04 entry is targeted with left crossranges from 8 nm to 35 nm, both conditions need to be evaluated.

EOM Crossrange Placards

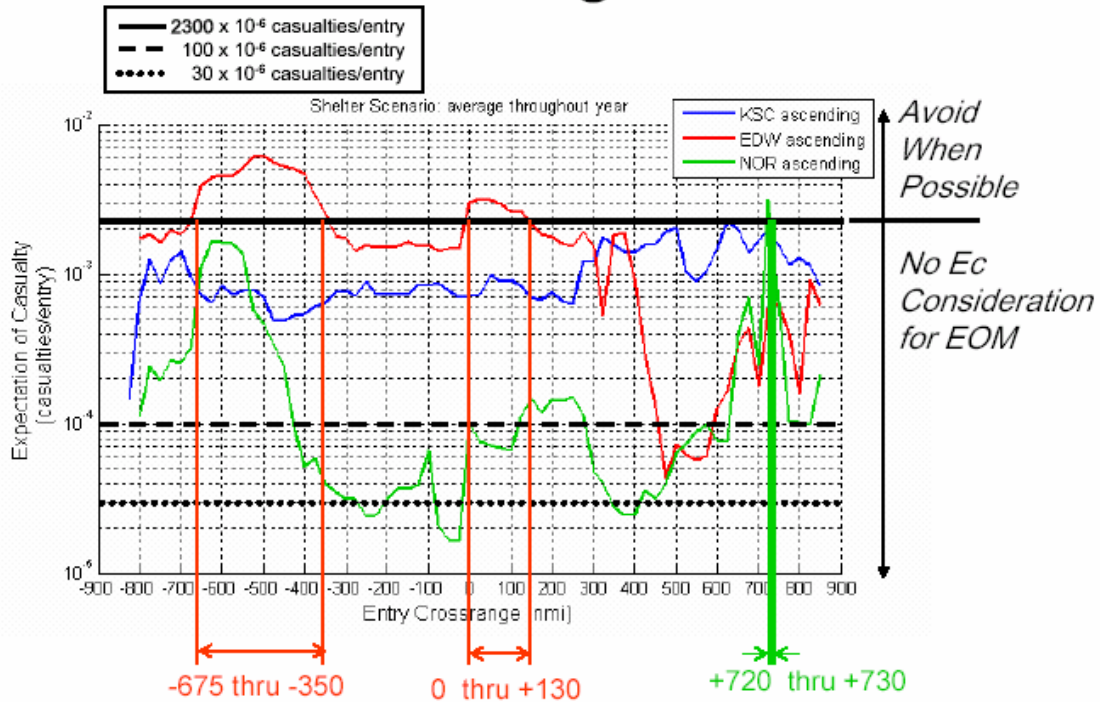

EOM With Failures

For EOM cases with specific systems failures the existing flight rules provide guidelines to provide optimum landing site and runway downmode conditions that maximize the probability of a safe landing (crew safety) given the specific system(s) failure and the associated next-worst-failure.

Reasonable attempts will be made to avoid higher risk EDW and NOR approaches (per EOM crossranges) when required, and to the extent possible while maintaining other priority constraints.

- NOTE: If the systems failures are determined to be the result of common cause, or generic failure modes in an entry-critical system, then Compromised Orbiter considerations will apply.

Compromised Orbiter

Compromised Orbiter is defined as those cases where the probability of executing a nominal entry and landing is substantially reduced. The obvious candidates for this designation are TPS damage/repair or from multiple failure cases where a generic failure mode has occurred in an entry-critical system. For

these cases, assuming that a CSCS option is not available or not used, every reasonable attempt will be made to reduce entry public risk by selecting NOR (prime) or EDW approaches with at least an order of magnitude less risk than the highest risk KSC opportunity.

Note that we are attempting to land inside of these crossranges, rather than avoiding them as in the nominal case.

See All Flights Flight Rules, A2-207 E., for the cross range targets.

If the risk of a nominal entry is considered exorbitant and landing must be attempted with the crew onboard, then consideration will be given to landing at an ELS that has zero or close to zero public risk. A straight in approach to Vandenberg provides near zero public risk as do landings at Diego Garcia, Easter Island or some other island would be good candidates.

4.7.4.2 Entry Thermal Options

Several options are available to reduce entry heating on the orbiter in the event of TPS damage. FR A2-TBD defines three levels of action, ordered by thermal benefit and difficulty/risk of implementation. First and second level actions will be considered in order to provide margin in case of suspected TPS damage, repaired damage, or where repair has not been completely successful. Third level options will be considered for more severe TPS damage scenarios where crew survivability is in question, and Contingency Shuttle Crew Support (CSCS) aboard ISS is not an option. Selection of which techniques to employ will be highly dependent on engineering assessment of damage type and location. Analysis results included in this section were generated by USA Descent Flight Design personnel N. Lamotte, J. Burton, J. Moore, and S. Hekel, and are documented in STF ADFD-05-012.

Level One - First level thermal options are defined as those that are within the shuttle's certified flight envelope. As such, they provide the least benefit and risk. The two main drivers are reducing vehicle weight as much as practical, and employing EGBM targeting (described in section 4.3.3.4). Lowering weight reduces temperatures for all vehicle locations. EGBM lowers surface temps at the cost of higher total heat load for most body points. Employment of EGBM would have to be based on an engineering assessment that minimizing surface temps was a higher priority than reducing heat load¹. Other lower priority options for level one are moving the c.g. aft within the certified envelope, and maximizing lower surface cold soak time. Note that control surface temps increase as c.g. moves aft, so again, employment of this technique would be a function of damage location. Analysis of thermal benefits for level one techniques can be

¹ For EGBM entry, the crew should be informed that the shuttle bug will not track down the nominal line on the OPS 3 ENTRY TRAJ display since the display I-loads are generated for a TTOL entry.

conducted using STAMPS and TSEP for the most part, with verification by Boeing.

When a decision is made to pursue first level weight/c.g. changes, Traj should coordinate with systems controllers to obtain new EOM predicts for use in analysis and planning. Cargo off-loads may be handled using normal PMP procedures. Potential non-cargo middeck and avionics bay weight off-loads could account for up to 2,000 and 1,400 lbs respectively. Since these components are already included in the PMP dry orbiter weight, special procedures are required. The Cargo Transfer Spreadsheet, used for ISS re-supply missions, must be expanded to allow for each component to be off-loaded. A new row is added for each item, and a negative weight is entered with the appropriate c.g. location. The spreadsheet adds all of the off-loaded weights and c.g.'s to the previously existing payload return weight. The grand total from the Summary page ("Return Total") is then entered into PMP cargo buildup. Note that this number will be *negative* if off-loaded mass is greater than returned payload. These procedures are also applicable to level two and three weight reductions. Consumables off-loads are handled with normal procedures (obtain predicted weight at TIG from appropriate flight control disciplines). Detailed procedures are documented in Orbit FDO Console Handbook section 3.6.7.1 and FCOH SOP TBD.

Level Two - Second level options are those outside of normal shuttle operating practice, and should be considered "near cert" rather than certified. At this level, vehicle weight should be reduced as much as *possible*, for example leaving an MPLM attached to ISS for re-supply missions plus middeck offloads. The other option possibly employed at this level is to increase alpha during entry (up to SODB GNC cert limits) to reduce wing leading edge (WLE) temps². For Level two, concern over TPS damage and the desire to add extra thermal margin outweighs programmatic issues with leaving behind an MPLM and/or risk of flying outside normal alpha experience base. Thermal benefits are greater than that available with level one, at a cost of increased risk and complexity.

The baseline alpha profile for level two starts at 43 deg, ramping down as shown in Figure 4.7-4. This profile provides 1 deg margin against violating the SODB upper alpha limit of 44 deg, in order to protect for the effects of winds, IMU misalignment, and deadbanding. In order to fly the highest alpha allowable within the GNC cert envelope, alpha modulation is disabled. This also provides a more predictable alpha profile which in turn improves the accuracy of thermal predictions. While technically within SODB GNC limits, this alpha profile does fall outside the SODB certified thermal envelope. Special Boeing analysis would be required to quantify the expected thermal benefit and verify safe entry (TSEP is only valid for a 40 deg alpha profile with some alpha modulation). Guidance

² It should be noted that a higher angle-of-attack moves the stagnation point lower on the WLE, which should be factored in with damage location to determine if this is the appropriate course of action. This is where Boeing aerothermal analysis would be essential.

and trajectory performance were found to be acceptable in a 500 cycle STAMPS Monte-Carlo study for the baseline level two alpha. The 3σ range error at TAEM interface was only 2.2 nmi, well within the capability of TAEM guidance. Since higher alpha decreases L/D, crossrange capability at level two is about 100 less than limits specified in DSCT-05 (see Fig 4.7-5).

To avoid manual pitch control during entry, it is highly desired to perform a General Memory update (GMEM) to change the entry I-loads to support the modified alpha profile. The PASS I-loads may be modified via uplink to the G3 archive in OPS 2 (PASS doesn't allow GMEM uplink while in OPS 3). BFS I-loads, on the other hand, can be uplinked directly in OPS 3. A/E GPO and DPS have responsibility for making this happen and verifying a good uplink. If the GMEM can't be performed, then the crew will have to carefully fly the higher alpha profile in pitch CSS. They can select pitch auto after M9 to return to the nominal profile. The modified alpha profile must also be modeled in MCC processors in order to accurately target the deorbit burn and generate the planned entry profile. Detailed console procedures for configuring MCC tools for an off-nominal alpha profile are provided later in this section.

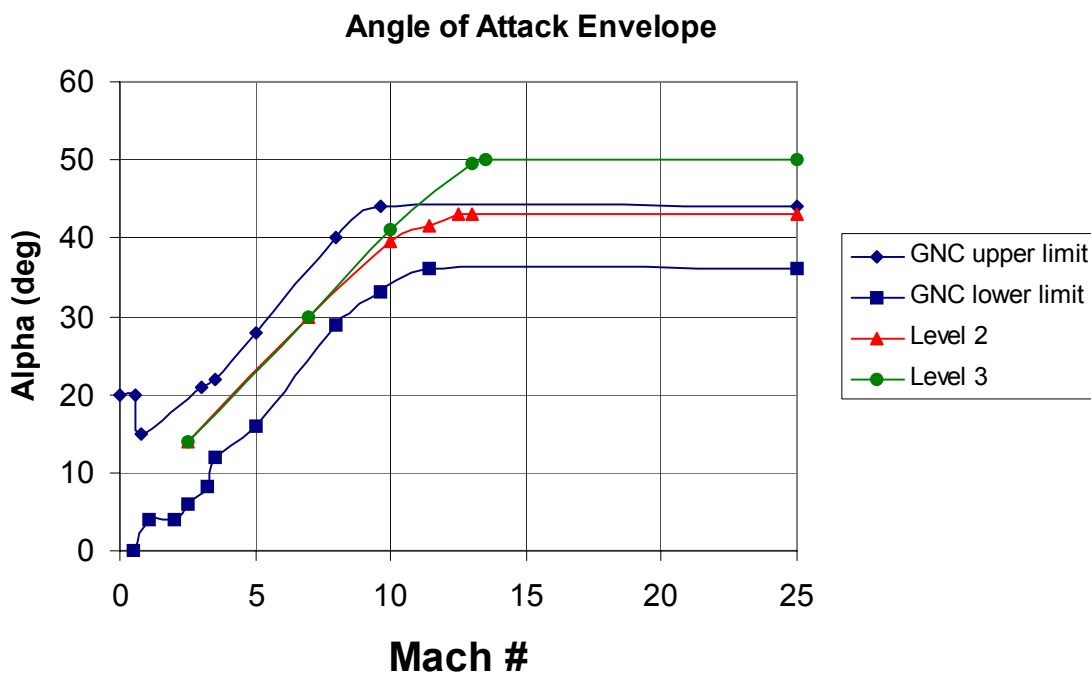

Figure 4.7-4 Alpha envelope (ref SODB figure 4.2.2-1)

Level Three - Third level options should be employed for only the most severe damage scenarios, and where Contingency Shuttle Crew Support (CSCS, aka "safe haven") on ISS is not an option. Since CSCS is zero-fault tolerant, it's quite possible that it could become unavailable during a mission as a result of some

ECLSS failure aboard the station. CSCS also depends on launch of a rescue shuttle within approximately 50 days, which may also run into problems. CSCS may also become unavailable post-undock if FRCS quantities drop below the level required to support re-rendezvous. For any of these cases, if a damaged orbiter has to enter with a crew onboard, it is essential to reduce entry heating as much as possible. Extreme weight reduction would be employed here, including hardware offloads that could result in zero fault tolerance on entry-critical avionics, and consumables for one deorbit opportunity only. The same procedures outlined above would be used to model this in PMP. A higher alpha profile, up to 50 deg, could be used to reduce temps for WLE damage, but with significant uncertainties in vehicle aerodynamics and flight control (see Figure 4.7-4). Again, case-specific aerothermal and GNC analysis by Boeing would be essential. Procedures for modifying FDO software would be the same as those used for level two.

Another strategy employed at level three which has been shown to decrease heat rate is the use of “minimum drag” targeting,. Generally speaking, this refers to flying the vehicle along the equilibrium glide boundary on the Drag vs. Vrel corridor. EGBM is normally quoted against the so-called “37-20” line which defines the drag profile for a 37 deg bank until Mach 10, then 20 deg down to Mach 2.5. These minimum bank angles provide max ranging while steering out crossrange at the dispersed limit, with 3σ low L/D and 40 deg angle of attack. For min drag targeting, the idea is to target below this line with a small crossrange in order to fly a smaller bank angle and hence less drag. For level three an EGBM of -3.5 to -5.0 fps should be targeted in order to absolutely minimize drag (and therefore surface temps). Several 500 cycle STAMPS Monte-Carlo studies in this EGBM range showed increased stress to guidance in the form of extended periods of unconverged drag, zero roll command, and abbreviated or non-existent constant drag phase. Confidence of making the runway is also reduced, with 3σ range error at TAEM interface being 4.6 nmi, and a worst-case range of 20 nmi (EGBM -5.0, 200 nmi ascending approach). Heat load is higher for min drag entries too, since the vehicle decelerates more slowly, and REI is larger than normal. This may not be desirable for some TPS damage scenarios. For entries with small bank angles, the predicted trajectory should be examined closely to determine if phugoid oscillations occur (check STAMPS H-dot versus velocity plot).

Another concern is the potential for high RCS propellant usage due to roll oscillations. Some sims showed total usage more than twice the entry redline. In the guidance equations, roll command becomes more sensitive to drag errors as L/D is decreased, and as overall bank angle decreases³. Both of these aggravating factors are present for Level three--decreased L/D due to higher

³ In guidance, the first step in calculating roll cmd is $x = (a+b*DD)/LOD$ where DD is the drag error. Therefore a lower LOD magnifies the effect of DD. The second step in calculation of roll cmd is to compute bank cmd = $\arccos(x)$. The arccos function changes more rapidly around a bank angle of 0 than the usual 50-60 deg. So bank cmd becomes overgained and fluxuates more.

angle-of-attack, and generally lower bank angle due to min drag targeting. Thus there is an overall tendency towards decreased trajectory damping and increased roll activity. This condition can be identified by examining STAMPS roll command output vs velocity plot. Fortunately, it can be alleviated by modifying the C16 gain in entry guidance to reduce the sensitivity. Two I-loads have been "re-tuned" for the 50 deg alpha profile, and should be uplinked via GMEM if possible (see Table 4.7-2). This change should also be made to STAMPS, but does not affect other MCC processors. While no RCS redline has been computed for entry thermal options, it is prudent to preserve a greater amount of propellant to cover for this and other factors that may drive up prop usage. This should be communicated to the Prop Officer as soon as entry thermal options are being discussed, so that aft margin is preserved until a decision is made for how much gas with which to enter.

Additional roll oscillations may be observed when ΔAZ is near zero and zero bank angle is commanded to satisfy ranging. Recall that guidance's minimum allowable bank command is zero degrees whenever ΔAZ is increasing, but switches to 15 deg whenever ΔAZ is decreasing, such as after a roll reversal has occurred and the vehicle is banking back towards the site. Once relative velocity drops below 10 kfps, the min bank command becomes 20 deg. On a min drag trajectory, commanded bank angle may slowly decrease to zero deg after capture is achieved and when drag reference falls significantly below actual drag (this will occur around 21 kfps for EGBM -5.0). For "high" crossrange approaches (200-300 nmi), guidance will limit the minimum bank angle to 15 deg to reduce ΔAZ . But if actual drag remains above drag ref when ΔAZ crosses zero, bank command will immediately switch to zero deg. Simulations have shown a tendency for ΔAZ to then trend back away from zero, resulting in 15 deg bank command. This cycle may repeat itself until drag actual converges to drag ref, and a bank angle greater than 15 deg is commanded. Significant amounts of RCS can be used in a short timeframe due to these rapid "roll reversals" (1000 lbs in some sims). Refer to Figure TBD for an example of this phenomenon.

Crew procedures are available to avoid the adverse propellant impacts of this so-called "roll jitter". If plots of STAMPS roll command vs. velocity show more than a couple cycles between 15 and 0 deg at ΔAZ of zero, then the manual procedures below should be read up to the crew. These steps assure that the original roll direction is continued after the interruption at ΔAZ of zero. This is to assure the planned groundtrack is preserved. The procedures are as follows:

From _____ to _____ fps Vrel:

When bank goes to zero deg, select ROLL/YAW CSS & maintain 0 deg bank (± 5 deg).

When Roll Ref on ENTRY TRAJ display increases above 15 deg, bank vehicle in same direction as previous bank, center the needles and go auto.

Use of minimum drag entry targeting requires Entry Support to compute a D23C that is much lower than normal. Procedures similar to those employed for certified EGBM are utilized (section 4.3.3.4), however, the D23C Scanner may have to be augmented with some manual iteration. As D23C is iterated upon, Entry Support checks predicted EGBM from DDS to determine if the desired margin was actually achieved. Be aware that decreasing D23C approximately 1 fps^2 below the EGBM = -5.0 limit may cause guidance failure resulting in 70 deg max bank and q-bar limiting during transition phase.

WARNING

Do not target below EGBM -5.0 for alpha 50 deg. Attempting to enter at lower drag level may result in guidance failure, characterized by negative drag reference and excessive bank command.

Crossrange must be restricted to ± 300 nmi for EGBM = -3.5, or ± 200 nmi for EGBM = -5.0 for 51.6 deg inclination ascending approaches. This is based on the STAMPS Monte-Carlo studies cited above. Effects of increased alpha and reduced drag on crossrange capability are shown in Figure 4.7-5. Note that the standard dispersed crossrange limit does not apply for alpha's > 40 deg. Instead, worst-case monte-carlo results (shown with error bars) are used to assure that the 1st roll reversal will occur no later than Mach 2.5.

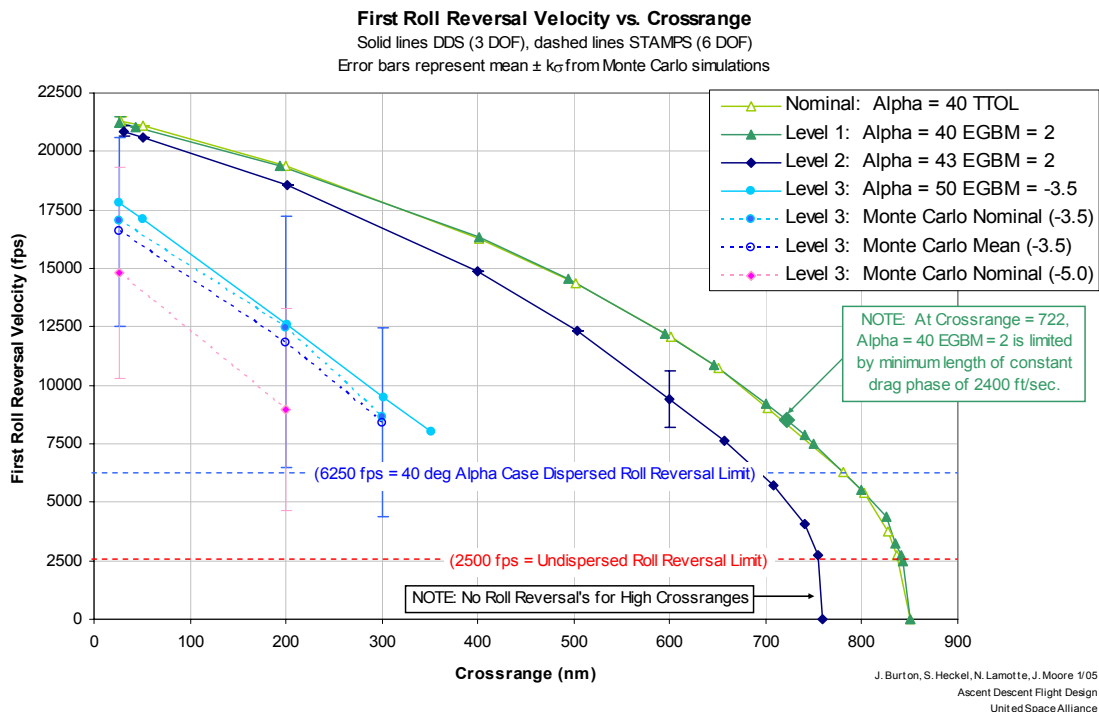

Figure 4.7-5 Effects of drag and alpha on crossrange capability

Console Tool Reconfiguration for Non-standard Alpha Profile

The following procedures apply to both level two and level three non-standard entry alpha.

DMP - The Entry Target Generator (ETG) module in DMP requires hypersonic aerodynamic coefficients in order to include aero effects in the propagation from EI to first roll command. Alpha must be correctly modeled since the aero coefficients are a function of alpha and mach number. The Deorbit Targeting Module (DTM) also requires alpha in order to compute MM303 and 304 attitudes. The DMP incorporates a “pre-op aero” database which dates to early in the shuttle program (STS-1 timeframe), and does not match either DDS or STAMPS. DMP’s aero database includes data up to 50 deg alpha. The following steps are required to implement a non-standard alpha:

1. In DCT, set MM303 and 304 alpha to planned initial alpha value (deg).
2. Load appropriate entry guidance I-loads file “eguidcon.xx” into TSA, where xxx=low, mid, or hi inclination. The proper file for inclinations in the range of 28.5-52.0 deg is “eguidcon.lo”. This file is to be loaded into the local ASA database on the workstation that is running DMP, so for normal flight support Dynamics will have to perform this step. Replace the default file under the directory path /mcc/rw_local/nav/ TSAxx/DMP/. Several canned eguidcon.lo files are provided by USA DFD for level two and three pre-planned alpha profiles. These are part of the standard TSA recon in the baseline DMP directory, and can be identified as their filenames are appended with the alpha reference value (e.g. “eguidcon.lo.43”). After verifying the canned file contains the correct I-loads, use XDir to rename the desired file “eguidcon.lo” and say “yes” to overwrite the existing file (assumes inclination 28.5-52.0 deg). Figure 4.7-6 shows eguidcon.lo file with the alpha I-loads shown in **bold** font. Table 4.7-1 describes the pertinent I-loads and their location in the file. Note that both flight design units and DMP input units are included in case it is necessary to manually generate a “custom” eguidcon.lo file using I-load inputs from DFD. In this case, *be careful that units conversions are performed correctly*.
3. Turn on debug flags in ci.dtmctg file in order to route alpha output to workstation. File is located in same directory as above. Variable names are DTMDBG for DTM output flag (item 42) and AFLG for ETG output flag (item 43). The default value is zero; set them to 1 for debug on. Figure 4.7-7 shows the default ci.dtmctg file with these two variables shown in **bold** font. Use xedit or vi text editor to manually make the changes.

CAUTION

DMP static database files contain parameters critical to the generation of safe deorbit targets. Extreme caution is warranted when replacing or modifying these files. Obtain file hardcopies before and after making changes in order to verify only the desired parameters were modified.

4. Correct alpha can be verified on the DOD MM303/304 alpha, and debug output routed to the DX Console Window on the executing workstation.

```

*/ Entry guidance system parameters for inclinations
   between 28.5 and 52 degrees. (28.5<= inclination <52)

*/
TYPE = R
SIZE = 147
'DATEG      =',147,
  5.00000E+01, -2.59191E+00, -4.21429E+00,  3.30000E+01,  8.78682E-02,
-2.41125E-01,  6.98131E-01,  6.98131E-01,  6.98131E-01,  6.98131E-01,
  6.98131E-01,  6.98131E-01,  6.98131E-01,  6.98131E-01,  6.25911E-05,
  1.53348E-04,  0.00000E+00,  0.00000E+00,  0.00000E+00,  0.00000E+00,
  0.00000E+00,  0.00000E+00,  0.00000E+00,  0.00000E+00,  0.00000E+00,
-6.25911E-09,  0.00000E+00,  0.00000E+00,  0.00000E+00,  0.00000E+00,
  0.00000E+00,  0.00000E+00,  0.00000E+00,  0.00000E+00,  2.00000E+00,
  0.00000E+00,  2.00000E+00,  2.60000E+01,  0.00000E+01,  2.00000E+06,
  5.99002E+07,  0.00000E+00,  9.99999E-06,  0.00000E+00,  0.00000E+00,
  1.74931E+05,  2.74326E+04,  7.25000E+03,  1.22500E+04,  1.45000E+04,
  1.45000E+04,  1.45000E+04,  1.45000E+04,  1.45000E+04,  1.45000E+04,
  1.45000E+04,  2.10000E+04,  2.69627E+04,  1.70000E+04,  5.00000E+03,
  2.30033E+04,  2.30000E+04,  2.50000E+03,  1.05000E+04,  2.30000E+04,
  7.08399E+01,  7.98635E-01,  9.65925E-01,  9.39689E-01,  1.00000E+00,
  4.25000E+00,  1.50000E+03,  2.00000E+03,  1.80000E-01,  7.82999E-02,
-4.67819E-01,  2.24314E+00,  9.00000E-05,  4.48628E+00, -4.67819E-01,
  1.35399E-01, -1.00000E-01,  6.00000E-03,  1.53700E-02, -5.81459E-01,
  2.49999E-02,  3.50000E-01,  2.49999E-03,  1.39999E-02, -1.30900E-01,
  1.09082E-04,  2.30000E+03, -9.11417E+03,  8.00000E-03,  1.00000E-02,
  2.05000E+04,  1.80750E+04,  2.70000E+04,  4.55834E+04,  7.25000E-01,
-9.44499E-01,  5.00000E-01,  0.00000E+00,  1.00000E+04,  8.00000E+03,
  1.23103E+04,  1.22173E+00,  1.22173E+00,  0.00000E+00,  1.00000E+04,
  2.79251E+04,  2.3598E-01,  2.75000E+04,  9.6755E+04,  2.57661E+04,
  2.39000E+04,  3.00000E-02,  6.99999E-02,  1.88259E-01,  1.74499E-01,
  3.05432E-01,  6.00000E-01,  0.00000E+00,  1.63240E-01,  5.33860E-05,
  6.45771E-01,  0.00000E+00,  1.33808E-01,  3.89789E-05,  4.00000E+00,
  1.32999E-03,  7.50000E-01,  3.43774E+00, -5.72956E-02,  2.43500E-04,
  5.72957E-01,  5.72957E-01,  0.00000E+00,  0.00000E+00,  7.50491E-01,
  8.72664E-02,  2.30000E+04,  2.50000E+03,  0.00000E+00,  1.49999E-01,
  2.09439E-01,  9.00000E+00

```

Figure 4.7-6 - eguidcon.lo file for 40 deg alpha profile

```

*/ PROCESSOR CONSTANT DATA ELEMENT

*/
TYPE =
SIZE = 80
'PROCON  =', 80
3.95190E+04, 2.00000E+04, 1.00000E+01, 5.00000E+01, 1.44862E-04,
1.00000E+01, 1.00000E+02, 2.40000E+02, 1.74532E+00, 5.00000E+01,
8.72664E-03, 1.74532E-05, 1.74533E-02, 1.74533E-02, 5.00000E+03,
5.23598E-01, 6.10865E+00, 5.00000E+01, 2.00000E+01, 7.50000E-01,
1.00000E-03, 6.00000E+00, 0.00000E+00, 1.00000E+02, 2.00000E+00,
3.81964E-01, 2.00000E+01, 2.00712E+00, 9.99999E-12, 1.00000E-04,
1.00000E-04, 1.00000E+01, 9.99999E-11, 9.99999E-11, 0.00000E+00,
1.00000E+02, 5.72960E+04, 2.00000E+01, 2.8322844E-03, -5.027996E-05,
9.999959878E-01, 0.00000E+00, 0.00000E+00, 1.80000E+03, 4.00000E+05,
0.00000E+00, 1.00000E+01, 1.00000E-07, 1.00000E-07, 1.00000E-07,
1.00000E-07, 2.00000E+00, 1.50000E+02, 1.50000E+02, 2.19999E+00,
2.19999E+00, 4.00000E+00, 5.00000E-01, 1.00000E-01, 1.00000E+00,
0.00000E+00, 0.00000E+00, 0.00000E+00, 0.00000E+00, 0.00000E+00,
0.00000E+00, 0.00000E+00, 0.00000E+00, 6.45771E-01, 3.28083E+04,
3.49084E-01, 3.49065E-01, 1.00000E+00, 0.00000E+00, 0.00000E+00,
0.00000E+00, 0.00000E+00, 0.00000E+00, 0.00000E+00, 0.00000E+00

```

Figure 4.7-7 - Default ci.dtmctg file

Table 4.7-1 I-load changes for 43 and 50 deg alpha profile (FLIGHT DESIGN UNITS)

FSSR NAME	VALUE (43 DEG PROF)	VALUE (50 DEG PROF)	MSID
CALP0 (1)	+5.0493846E+00	+5.0000000E+00	V97U0043C GDE 03
CALP0 (2)	-1.8440641E+01	-6.7600000E+01	V97U0044C GDE 03
CALP0 (3)	+4.3000000E+01	+5.0000000E+01	V97U0045C GDE 03
CALP0 (4)	+4.3000000E+01	+5.0000000E+01	V97U0046C GDE 03
CALP0 (5)	+4.3000000E+01	+5.0000000E+01	V97U0047C GDE 03
CALP0 (6)	+4.3000000E+01	+5.0000000E+01	V97U0048C GDE 03
CALP0 (7)	+4.3000000E+01	+5.0000000E+01	V97U0049C GDE 03
CALP0 (8)	+4.3000000E+01	+5.0000000E+01	V97U0479C GDE 03
CALP0 (9)	+4.3000000E+01	+5.0000000E+01	V97U0480C GDE 03
CALP0 (10)	+4.3000000E+01	+5.0000000E+01	V97U0481C GDE 03
CALP1 (1)	+3.5802457E-03	+3.6000000E-03	V97U0050C GDE 03
CALP1 (2)	+9.3802502E-03	+1.6800000E-02	V97U0051C GDE 03
CALP2 (2)	-3.5802481E-07	-6.0000000E-07	V97U0058C GDE 03
VALP (1)	+8.1000000E+03	+1.1000000E+04	V97U0422C GDE 03
VALP (2)	+1.3100000E+04	+1.4000000E+04	V97U0423C GDE 03
ACLAM1	+0.0000000E+00	+0.0000000E+00	V97U0495C ZFI 03
ACLIM1	+0.0000000E+00	+0.0000000E+00	V97U0497C ZFI 03
DLALLM	+0.0000000E+00	+0.0000000E+00	V97U0504C ZFI 03

Table 4.7-2 I-loads to define angle-of-attack profile & guidance gains

FSSR Name	MSID	Fit Des Units	Pos in File	DMP Units	Description
ACLAM1	V97U0495C	deg	124	rad	Entry guidance bias term for determination of the alpha modulation, upper alpha cmd limit, ACLAM.
ACLAM2	V97U0496C	deg-sec/ft	125	rad-sec/ft	Entry guidance slope used for determination of the alpha modulation, upper alpha cmd limit, ACLAM.
ACLIM1	V97U0497C	deg	126	rad	Entry guidance max allowed magnitude for the negative delta alpha increment invoked in determination of the alpha modulation, lower alpha cmd limit, ACLIM.
ACLIM2	V97U0498C	deg	127	rad	Entry guidance bias term for the determination of the alpha modulation, lower alpha cmd limit, ACLIM.
ACLIM3	V97U0499C	deg-sec/ft	128	rad-sec/ft	Entry guidance slope used in the determination of the alpha modulation, lower alpha cmd limit, ACLIM.
DLALLM	V97U0504C	deg	140	rad	Entry guidance constraint on the positive delta alpha increment allowed for the positive angle-of-attack cmd limit, ACLAM, with respect to the nominal cmd reference, ACMD1, once alpha modulation has been initiated (i.e., ICT = 1) or if the contingency low-energy mode is in effect (i.e., ICNTAL = ON).
CALP0 (1)	V97U0043C	deg	5	rad	The CALP0J = 1 to 10 array provides the values for the bias terms or constant
CALP0 (2)	V97U0044C	"	6	"	coefficients used to compute Entry Guidance's second order angle-of-attack
CALP0 (3)	V97U0045C	"	7	"	nominal cmd reference (= f(relative velocity)).
CALP0 (4)	V97U0046C	"	8	"	V97U0043 - 49C
CALP0 (5)	V97U0047C	"	9	"	
CALP0 (6)	V97U0048C	"	10	"	
CALP0 (7)	V97U0049C	"	11	"	
CALP0 (8)	V97U0479C	"	12	"	V97U0479 - 81C
CALP0 (9)	V97U0480C	"	13	"	
CALP0 (10)	V97U0481C	"	14	"	
CALP1 (1)	V97U0050C	deg-sec/ft	15	rad-sec/ft	The CALP1J = 1 to 10 array provides the values for the first order coefficients
CALP1 (2)	V97U0051C	"	16	"	used to compute Entry Guidance's second order angle-of-attack nominal cmd
CALP1 (3)	V97U0052C	"	17	"	reference (= f(relative velocity)).
CALP1 (4)	V97U0053C	"	18	"	V97U0050 - 56C
CALP1 (5)	V97U0054C	"	19	"	
CALP1 (6)	V97U0055C	"	20	"	

FSSR Name	MSID	Flt Des Units	Pos in File	DMP Units	Description
CALP1 (7)	V97U0056C	"	21	"	
CALP1 (8)	V97U0482C	"	22	"	V97U0482 - 84C
CALP1 (9)	V97U0483C	"	23	"	
CALP1 (10)	V97U0484C	"	24	"	
CALP2 (1)	V97U0057C	deg-sec ² /ft ²	25	rad-sec ² /ft ²	The CALP2J = 1 to 10 array provides the values for the second order coefficients
CALP2 (2)	V97U0058C	"	26	"	used to compute Entry Guidance's second order angle-of-attack nominal cmd
CALP2 (3)	V97U0059C	"	27	"	reference (= f(relative velocity)).
CALP2 (4)	V97U0060C	"	28	"	V97U0057 - 63C
CALP2 (5)	V97U0061C	"	29	"	
CALP2 (6)	V97U0062C	"	30	"	
CALP2 (7)	V97U0063C	"	31	"	
CALP2 (8)	V97U0485C	"	32	"	V97U0485 - 87C
CALP2 (9)	V97U0486C	"	33	"	
CALP2 (10)	V97U0487C	"	34	"	
VALP(1)	V97U0422C	fps	48	fps	VALP(1-9) are the Entry Guidance nominal angle-of-attack cmd reference
VALP(2)	V97U0423C	"	49	"	velocity boundaries.
VALP(3)	V97U0424C	"	50	"	V97U0422-27C
VALP(4)	V97U0425C	"	51	"	
VALP(5)	V97U0426C	"	52	"	
VALP(6)	V97U0427C	"	53	"	
VALP(7)	V97U0488C	"	54	"	V97U0488-90C
VALP(8)	V97U0489C	"	55	"	
VALP(9)	V97U0490C	"	56	"	
CT16(1)	V97U0078C	sec ² /ft	N/A	N/A	Controller gain coefficients for the vertical L/D cmd required in the roll cmd equation.
CT16(3)	V97U0080C	Sec ⁴ /ft ²	N/A	N/A	

DDS/EDS/LAX - DDS is the engine that drives both EDS and Entry Support's Landing Analyst Expert System (LAX). DDS uses the so-called "FAD26" aero database, which consists of pre-op aero plus deltas based on flight-derived aerodynamics that were developed in the STS-26 timeframe. The delta's are available only to an alpha of 45 deg; outside this regime the deltas applied to pre-op aero remain constant. Nonetheless, this makes DDS aero more accurate than DMP, since it applies actual flight-derived data to the pre-op data. As with DMP, alpha of 50 deg is the limit in the aero database files. To implement a non-standard alpha profile in DDS, Entry Support executes a script which updates the appropriate I-loads in the DDS element files. A verified script is available for each planned alpha profile for level two and three. In order for EDS to access the new profile, the following steps must be performed:

1. Manually enter the desired MM303/304 alpha into EAP's attitude constraint table.
2. Copy ECO's updated dds.bnr file to the TSA Global directory under the DSC/data/nav/. XDir may be used to do this, but someone with Nav permissions must perform this step.
3. On the EDS EOM/TAL Input Display, under the "DDS Elements" menu, click "Show All Sites", then select the appropriate ESP and TSP elements. The ESP element should have a descriptive filename, such as "E_K15A43" for KSC15 alpha 43 deg. Dynamics can save selections to avoid having to repeat this step. FDO can verify selections which are displayed on the upper left corner of the ECT.
4. EAP and EDS may now be executed.
5. Initial alpha can be verified on Entry Digitals in the MM303/304 attitude block. The entire entry alpha profile can be verified by inspection of the trajc output file located in TSA Global under DSC/data/nav/output. Double-click on XDir to view the text file, which includes a column showing Alpha versus MET. Consider this QA step mandatory each time EDS is run with a non-standard alpha.

STAMPS - This 6-DOF, high-fidelity sim provides trajectory output files that Boeing utilizes to determine vehicle heating. This is the essential step in estimating the payoff from the various thermal redu

ction strategies employed. It can also be used for Flight Control and GN&C analysis as well. STAMPS uses the latest operational aero database which includes data up to alpha 60 deg. The alpha profile is defined by I-loads contained in the iload.descent.d file which is part of the input data to STAMPS. MPSR personnel will update the alpha profile by including instructions in the STAMPS execution script to fetch the appropriate delta-I-loads file. Files have been created and verified for alpha 43 and 50 deg profiles. After STAMPS is executed, the resultant alpha profile can be easily verified on the alpha vs. Vrel plot.

4.8 SIM SUPPORT

4.8.1 Integrated Load Checkout Procedures

In order to verify that a Trajectory Server software load is ready to support a flight, an integrated load checkout (ILC) is usually performed. The Entry software is usually checked by running either a TAL or RTLS through landing. The FDO should check to verify proper operation of the entry profile generation and high-speed tools during the entry. Reference the Entry ILC Checklist in section 4.9.

4.8.2 Deorbit Prep Sim Support

Supporting deorbit prep sims requires that the SMS and the Trajectory Server have the same data (i.e., SV's and mass properties) at sim start. The FDO should have all the standard data and FDO help tools with him at sim start. The following is a checklist of items that need to be done prior to sim start:

- a. Load the entry mass properties into the file into PMP and execute the "Dump to TSU". Cross check the data with the Abbreviated Report, which may be found on the console.
- b. Check the MOC data base for incorrect numbers using the interface control document (ICD) data. The data that should be checked is the MED input data (e.g., DCT, DEPD, FFT, and ODT) and the MOC system parameters for the descent data (e.g., SPASCT, SPDATA, SPDEOR, SPDSCT, SPNAVG, and TAST).
- c. Follow the standard set of deorbit planning and landing guidelines outlined in sections 4.3 and 4.4.

SV's are transferred to the SMS environment electronically prior to sim start.

There is a recurring issue with D/O Preps (and D/O – 30 min runs), where the FDF (specifically the stars and times expected in the timeline) that the FAO's distribute for use in the Sim do not match the trajectory that the SMS and FDO are expecting. Typically this occurs because the flight is extended (or shortened) after the OCF cycle has been delivered. Typically, the FAO's will update the FDF as changes occur, Orbit FDO's will generally generate vectors reflecting the current plan and use them for orbit sims.

4.8.3 D/O - 30 min run

NOTE

The Trajectory Server should be available at sim start minus 1.5 hours for FDO to perform targeting and PAD generation for a deorbit - 30 minute run. FDO must have the PROP-to-FDO form available to generate the DEL PAD.

- a. Use the L-100 (1 hour & 40 minute) state vector from DCST 13 to anchor EPH 1.
- b. Generate the deorbit targets using the Deorbit Targeting Checklist (ref. section 4.9).
- c. Generate the DEORBIT MNVR PAD and the DEL PAD.
- d. Configure PBI's for landing (BFS selected for V54, CUR O/B set to UPP).
- e. After NAV is ready, go green for checkpoint.
- f. Check Sun Angle/Glare using TSA DOPS. Cross-check with HipTOC or Glare charts.

See the note at the end of the D/O Prep section concerning a possible sim start up problem.

4.8.4 200K Sim Initialization

For all high-speed entry sims, ENTRY SUPPORT should obtain the winds from FDO MONITOR a couple of days prior to the sim. They will then use DDS to generate the touchdown and rollout data.

- a. Load either a pre-deorbit or a post deorbit burn state vector into the VAT. The easiest method is to use the EI-5 state vector from the DCST 13 product.
- b. If your state vector is pre-burn, you must model a deorbit burn. This can be done by either running the DMP or direct input of the burn into the ephemeris. The best option would be the direct input because you can use the targets from the DCST 13 product which are the same ones used to build the SMS data store.
- c. Set GICH according to the selected aimpoint for the first run.

- d. Run EDS to generate the nominal entry trajectory data. If the DMP was used, a DEORB will work. If a burn was modeled in the ephemeris, an ORB Normal can be executed. An ORB Normal can also be run using a deorbit burnout vector.
- e. Set up runways and heavy or lightweight HAC with the K51 MED.
- f. Configure PBI's for landing (BFS selected for V54, CUR O/B set to UPP).
- g. After NAV is ready, go green for checkpoint.
- h. After returning from Checkpoint, the SMS winds may be entered by Dynamics and incorporated into the entry set

The Winds and Weather PAD is filled out by the FiGMO and FDO for entry sims. FIGMO will fill out the winds and weather. FDO will fill out the prime and alternate runways for each case along with a summary of the DDS approach and land data for each runway. Once completed, FIGMO will then get a copy of the PAD and fax it to the SMS for the crew. FDO will distribute copies.

Winds and Weather for STS-88 Entry #2

(Flight Cycle, Ascending Opportunities - EDW rev 171 TIG)

All runs to EDW	wt#27	wt #32	wt #37
50K	260/110	210/90	070/65
38K	260/125	210/105	080/55
28K	260/95	210/70	080/40
20K	260/65	210/50	090/25
12K	260/35	210/25	100/20
7K	250/20	200/15	070/10
3K	190/15	220/10	050/10
1K	130/10	280/10	030/10
Surface	060/10p15*	300/12*	020/07
Clouds	SKC	OVC120	SCT100 BKN250
Visibility	12	8	5
Altimeter	29.73	30.24	29.92
Temperature	65	71	60
Runway			
	EDW04	EDW22	EDW22
aimpt / spdbk	NOM / NOM	NOM / NOM	NOM / NOM
Touchdown / EAS	3100 @ 195	2600 @ 195	3000 @ 195
spdbk @ 3Kft	34 %	15 %	30 %
Groundspeed	195 kts	201 kts	210 kts
wind breakdown	10P14H 4R	3H 12R	6T 3R
HAC	L OVHD	R OVHD	R OVHD
turn angle	315 deg	225 deg	225 deg
Max Nz / Nz limit	1.4 / 2.5	1.7 / 2.5	1.3 / 2.5

Alt error high/low	1300 ft high	N/A	N/A
alt runway	EDW22	EDW04	EDW04
aimpt / spdbk	NOM / S.F.	NOM / NOM	NOM / NOM
Touchdown / EAS	3000 @ 185	3000 @ 195	2900 @ 195
spdbk @ 3Kft	23 %	34 %	15 %
Groundspeed	204 kts	207 kts	197 kts
wind breakdown	10P14T 4L	3T 12L	6H 3L
HAC	R OVHD	L OVHD	L OVHD
turn angle	225 deg	315 deg	315 deg
Max Nz / Nz limit	1.6 / 2.5	1.6 / 2.5	1.5 / 2.5
Alt error high/low	N/A	2200 ft high 1200 ft low	N/A

*This is NOT the standard value from the wind table.

GLARE - CDR on Inner & Outer Glideslope for EDW04

Figure 4.8-1 Winds and Weather PAD

4.9 USE OF CHECKLISTS

The purpose of these checklists is to provide a quick reference to information necessary for safe and efficient operation of the FDO console. These instructions assume the operator has a general knowledge of nominal and emergency procedures, limitations, and characteristics of the MOC processors and the shuttle orbiter.

As a general rule, these checklists provide the best operating instructions under most circumstances, but they are not intended to be used as a substitute for sound judgment. Multiple emergencies, weather, or systems failures may require modification of the procedures.

Every effort is made to keep these checklists updated and current; however, you must remain aware of changes to processors and procedures which may affect the use of the checklist. Changes will be documented and distributed as quickly as possible, with changes noted by a change bar next to the affected area.

The following definitions apply to warnings and notes found in the checklists:

WARNING: Operating procedures, techniques, etc., which will result in crew injury or loss of life if not carefully followed.

NOTE: May contain advisory information that is pertinent to the procedures being performed. May recommend alternate procedures based upon observed system responses.

CAUTION: Contains advisory information and a strong recommendation to prevent undesirable system responses.

4.9.1 L-1 DAY CHECKLIST

REVIEW

- DOL DATA - DISTRIBUTE IN TIME FOR MMT
- ORBIT ADJUST PLAN, IF APPLICABLE
- BALLOON SCHEDULE
- RADAR AND SITE SCHEDULE WITH TRACK
- WX, SUN ANGLE VIOLATIONS, SUN GLARE POTENTIAL

FLIGHT/PROP

- LANDING SITE STRATEGY
- TARGETING OPTIONS (E.G., OOP, TIG SELECTION PLAN, ETC.)

PRELIMINARY DEORBIT MANEUVER PLANNING

- COMPARISON TO PREFLIGHT (SANITY CHECK)
 - $\Delta V S$
 - MASS PROPERTIES ($\sqrt{\text{CG SUM USABLES}}$)
 - ENTRY PROFILE (TIG, EI CONDITIONS, GEOMETRY)
- D/O MANEUVER TIG AND ATTITUDE TO POINTING

ENTRY SUPPORT (ON CONSOLE LAST HALF OF SHIFT)

- PRELIMINARY ENTRY ANALYSIS
- D23C, NCYCLE, X-RANGE LIMITS

HANDOVER SHEET

- PROVIDE DETAILED TARGETING INSTRUCTIONS FOR PLANNING TEAM
- PROVIDE LIST OF SPECIFIC TASKS TO BE COMPLETED, IN ORDER OF PRIORITY

4.9.3 DEORBIT PREP TIMELINE CHECKLIST (PAGE 1 OF 2)

TIG-	EVENTS	BALLOONS	FDO	TRAJ
6:00	FDO On Console			
5:50				
5:40				
5:30	H/O Begins	L-6.5 RLS	Prelim TIG to FD,CAPCOM,GC,DPS (follow up with Flight Note)	TRAJ Handover Complete Review/Dist Entry Summary
5:20				
5:10				Mass Props QA Predicted Weights Predicted weight to PROP WT's/CG's to Ent SPT, GNC TAEM CG to WX CAPCOM LND WT- LSO, WX CAPCOM
5:00	H/O Complete		Dist. WX Sheets Finalize Entry Summary MSG	
4:50			Prelim SV Update/Tracking Plan Update EPH SV	
4:40				
4:30				√ Data Base √ MCC Countdown Clocks
4:20	WX Brief		Receive PROP-TO-FDO	
4:10			<u>D/O Targeting</u> Complete targeting and DEORB for all OPPTYs being considered for	FOR EACH OPPORTUNITY: Entry Set (TRACK) EI-5 SV (ENT SUPT) PSHA , Mach 4 data (LSO)
4:00				
3:50				
3:40	T-38 Takeoff	L-6.5 DATA IN		FOR PRIME SITE/ORBIT: Pred Post D/O SV (USSPACECOM) DOD (PTG), EPSAT (INCO) EVENT TIMES (GC)
3:30		L-6.5 ANALYSIS L-4.5 RLS		
3:20				FOR PRIME OPPORTUNITY:
3:10			FOR PRIME OPPORTUNITY: Generate Entry Profile (Special/Normal)	GO for Command Loads (GPO) <u>DEL PAD, STCOMP</u> <u>MNVR PAD</u>
3:00	WX Brief			
2:50	GO PLBD		√ PLBD Close Time	

DEORBIT PREP TIMELINE CHECKLIST (PAGE 2 OF 2)

TIG-	EVENTS	BALLOONS	FDO	TRAJ
2:40				
2:30	GO OPS 3		Finalize WX ALT Plan Eliminate any N0-Go Landing Site	
2:20			QA/Distribute PADS for prime oppty	FOR FIRST ALT: DEORB GO for Command Loads (GPO) <u>DEL PAD, STCOMP</u> <u>MNVR PAD</u>
2:10	OPS 301 PRO		SV PBI'S	
2:00	Uplink Tgts, SV (high incl)		QA PADS for FIRST ALT	
1:50	Uplink Tgts, SV (lo-mid i)		Checkpoint (ZOE)	
1:40	STA takeoff (1:45)	L-4.5 DATA IN		FOR SECOND ALT: DEORB GO for Command Loads (GPO) <u>DEL PAD, STCOMP</u> <u>MNVR PAD</u>
1:30	WX Brief Eval Single Site Only	L-4.5 ANALYSIS L-2.5 RLS Entry/TAEM GPO Package	QA PADS for SECOND ALT SV Update/Tracking Plan	
1:20				
1:10	Convoy Status			
1:00		L-2.5 DATA IN	Select Prime Site for Upcoming TIG	RESET FOR PRIME SITE Post Prime & B/U Entry EPH to FDO Traj WEB Site ✓ Winds ✓ MAX Range Line Set GICH Entry Set (TRACK)
0:50			PAD DELTAS Poll Team for GO/NO-GO	
0:40	WX Brief Update TD, GRDSPD, Uplink SV	L-2.5 ANALYSIS	SV Update, Final Entry Profile	
0:30				
0:20	GO FOR D/O			Hardcopies
0:10				
TIG		L-1 RLS		USSPACECOM Confirm Burn
L-45		L-1 DATA IN		Run Entry Sets for Prime and B/U Runways
L-30	Update SB Aimpoint	L-1 ANALYSIS		

4.9.4 DEORBIT WAVE-OFF CHECKLIST

1 OR 2 ORBIT WAVE-OFF

- DELETE THE DEORBIT MANEUVER FROM EPH 1
- NOTIFY SPADOC
- POINTING: UPDATE ATL; VERIFY
- TUP ATL INTO ALL EPHEMERIDES
- PAYLOAD BAY DOOR STATUS: CLOSED @ CORRECT TIME
- TRANSFER THE NEW DEORBIT SOLUTION TO EPH 1
- ENTRY PLANNING
 - RUN ORB NORMAL
 - ENTRY SET → TRACK FOR NETWORK
- DISTRIBUTE MNVR AND DEL PADS FOR NEW DEORBIT BURN
- WINDS: SCHEDULE A NEW TD-1 HR BALLOON
- ENTRY SUPPORT/LSO: VERIFY PREVIOUS TD-1 HR DATA (NOW TD-2.5 HR) ARE BEING RUN WITH NEW SFC WINDS AND DENSITY ALTITUDE

1 DAY WAVE-OFF

- DELETE THE DEORBIT MANEUVER FROM EPH 1
- NOTIFY SPADOC
- NAV: UPDATE VTL (ON-ORBIT VENTS)
- POINTING: UPDATE ATL
- UPDATE FUTURE WGL FOR PREDICTED DEORBIT WEIGHT
- VERIFY ATL UPDATES (INCLUDING ON-ORBIT LVLH VENTS)
- TUP ATL INTO ALL EPHEMERIDES
- GENERATE PRIME AND B/U DEORBIT SOLUTION FOR 1 DAY LATE
- POST PRIME AND B/U ENTRY EPH TO FDO TRAJ WEB SITE

NOTE

IF ORBIT ADJUST REQUIRED AND STILL IN OPS3:
THE 410 COMMAND LOAD CAN BE USED TO UPLINK PEG 7 TARGETS. THERE MUST BE A MM303 ATTITUDE IN ENTRY DIGITALS (LEFT SIDE). ANY DEORB WILL COMPUTE THIS ATTITUDE.

- GO TO **L-1 DAY CHECKLIST**

4.9.6 DEORBIT TARGETING CHECKLIST (PAGE 1 OF 5)

EPHEMERIS

- √ SV: UPDATE AS REQUIRED
- √ OMS, RCS WTS
- √ ATL (POINTING)
- NO BURN EPH = 48 hrs → TRACK
- PLBD CL @ TIG - 2:40

PROCESSOR INIT

- √ DCT: NCYCLES, D23C, SITE, ATM, PHI MM304
- √ ECT: SITE, ATM, PHI MM304

2 OMS DEORBIT BURN:

COL 1	COL 2	COL 3
2 OMS/1 OMS	1 OMS/1 OMS	2 OMS/1 OMS
Steep	Steep	Shallow

1 OMS DEORBIT BURN:

COL 1	COL 2	COL 3
1 OMS/1 OMS	PX4/PX4	1 OMS/1 OMS
Steep	Steep	Shallow

RCS DEORBIT BURN (SEE RCS DEORBIT TARGETING CHECKLIST):

COL 1	COL 2	COL 3
PX4/PX4	PX3/PX3	PX4/PX4
Steep	Steep	Shallow

MASS PROPS

- √ CUR WT: E1
- √ PRED WT: E1 → WGL @ TIG - 1HR; E2-E6 → INIT
- √ DOORS CLOSED
- √ TRIMS (DOORS CLOSED, ΔOMS = 0)
- √ ΔOMS = D/O PRPLT
- √ CG SUM (FDUMP, USABLES, PTI'S, CG's)

DEORBIT TARGETING CHECKLIST (Page 2 of 5)

INITIAL TARGETING

GET **PROP-TO-FDO** AND Δ **OMS** AVAILABLE

GENERATE INITIAL DMP SOLUTIONS

- 2 OMS/1 OMS STEEP OPTIMUM --- (COL. 1)
- 1 OMS/1 OMS STEEP OPTIMUM --- (COL. 2)
- 2 OMS/1 OMS SHALLOW OPTIMUM --- (COL. 3)

IF PROP AVAIL (Δ OMS) < PROP REQ'D FOR
2 OMS/1 OMS STEEP OPTIMUM:

GO TO **INSUFFICIENT PROP PROCEDURE**

- 2 OMS/1 OMS STEEP @ 1 OMS OPT - 1 MIN

NOTE

FOR HIGHLY ELLIPTICAL ORBITS, FIRST GUESS VALUES FOR C1, C2, AND REI MAY BE REQUIRED FOR PROCESSOR CONVERGENCE IN NON-OPTIMIZED TIG CASES. OBTAIN FIRST GUESS VALUES FROM THE OUTPUT VALUES OF A 45° PREBANK CASE. IF NO JOY, OBTAIN VALUES FROM PLOTS IN EMERGENCY DEORBIT CHECKLIST.

NOTE: TIG SELECTION

- * TIG FOR 2 OMS DEORBIT SHOULD BE BETWEEN THE 1 OMS OPT- 2 MIN AND THE 2 OMS/1 OMS CROSSOVER POINT.
- * TIG FOR 1 OMS OR RCS DEORBIT SHOULD BE NO EARLIER THAN RCS OPT - 1 MIN.

IF OUT-OF-PLANE FUEL WASTING DESIRED:

- PROP USAGE = "OPLANE"
- PROPELLANT TO BE USED = DESIRED PRPLT
- 2 OMS/1 OMS STEEP @ 1 OMS OPT - 1 MIN (INITIAL TIG) W/WASTING

CAUTION

DO NOT PERFORM OOP FUEL WASTING IF (OOP PROP REQUIRED MINUS INPLANE PROP REQUIRED AT SAME TIG) < 250 LBS. OTHERWISE, THE INITIAL O/B BURN ATT COULD BE IN ERROR AND A TRANSIENT WILL OCCUR AT TIG.

DEORBIT TIG SELECTION PRIORITIES

THE FINAL TIG SHOULD BE SELECTED TO BEST ACHIEVE THE FOLLOWING OBJECTIVES, IN ORDER OF PRIORITY FROM HIGHEST TO LOWEST.

RUN STCOMP TO VERIFY OMS TANK FAIL Hp's > SAFE Hp (ref. STCOMP CHECKLIST)

- IF L OR R TANK FAIL Hp < SAFE Hp
 - REDUCE WASTING UNTIL TANK FAIL Hp's > SAFE Hp, AND/OR ADJUST TIG FORWARD NO LATER THAN 2OMS/1OMS OPT. IF SIGNIFICANT REDUCTION, UPDATE MASS PROPS.

DEORBIT TARGETING CHECKLIST (Page 3 of 5)

COMPUTE RCS COMPLETION AT SAFE HP USAGE (See RCS Completion Checklist)

- IF RCS COMPLETION CANNOT BE ACCOMPLISHED AT SAFE HP,
 - REDUCE WASTING UNTIL RCS COMPLETION AT SAFE HP AND/OR ADJUST TIG FORWARD NO LATER THAN 2OMS/1OMS OPT. IF SIGNIFICANT REDUCTION UPDATE MASS PROPS.

COMPUTE THE AVAILABLE TIG SLIP

- FOR 1 ENGINE FAIL CASE
 - REPROCESS SOLN, HOLD TGTS, TIG-FIXED @ TIG + 5 MIN, THRUSTERS = OMS LEFT
 - IF PROP REQ'D > PROP AVAIL (Δ OMS PROVIDED BY PROP OFFICER) THEN DECREASE TIG SLIP UNTIL PROP REQ'D = PROP AVAIL.
- FOR RCS DOWNMODE CASE
 - REPROCESS SOLN, HOLD TGTS, THRUSTERS = PX4, TO VERIFY RCS DOWNMODE AT TIG
 - IF RCS DOWNMODE AT TIG, THEN REPROCESS SOLN, HOLD TGTS, TIG-FIXED @ TIG + 2 MIN, THRUSTERS = PX4
 - IF PROP REQ'D > PROP AVAIL (Δ OMS PROVIDED BY PROP OFFICER) THEN DECREASE TIG SLIP UNTIL PROP REQ'D = PROP AVAIL.
- NO FAIL TIG SLIP
 - IF TIG SLIP WITH DOWNMODE IS UNAVAILABLE, THEN RECOMPUTE WITHOUT DOWNMODE
 - NOTE ON DELPAD THAT TIG SLIP IS WITHOUT DOWNMODE AND THAT CREW MUST STOP BURN ABOVE SAFE HP FOR AN OMS ENGINE FAIL IF TIG SLIP IS USED

VERIFY EACH OMS POD BELOW THE POD LIFTING LIMIT

- ADD POST-BURN OMS AND AFT RCS PER SIDE, VERIFY WITH PROP OFFICER

CHECK COMM, (TDRS-E, TDRS-W, and TDRS-Z WRT THE BURN)

- HAVE POINTING CHECK THE BURN ATTITUDE FOR COMM (DMT # ___)
- IF BAD COMM ATTITUDE AND WASTING OOP, TRY WASTING IN THE OTHER DIRECTION TO GET BETTER COMM. MANUALLY INPUT THE SAME PEG 4 TGTS W/PRLPT = -PRLPT.

REVIEW TARGETING WITH PROP

- TIG AND WHY SELECTED (i.e. OMS OPTIMUM MINUS A MIN, NOMINAL TARGET POINT)

DEORBIT TARGETING CHECKLIST (Page 4 of 5)

- PASS ΔV 's FOR RELAVENT D/O SOLUTIONS
 - 2 OMS/1 OMS STEEP OPTIMUM
 - 2 OMS/1 OMS SHALLOW OPTIMUM
 - 2 OMS/1 OMS STEEP AT TARGET
 - 2 OMS COST TO SAFE HP & RCS COST THEREAFTER TO SAFE HP

 - 2OMS COST TO SAFE HP & RCS COST THEREAFTER TO SAFE HP
 - STCOMP RESULTS

ENTRY PROFILE GENERATION

- OPTIONAL: DEORB OF FINAL DMP SOLUTION, EVALUATE
- TRANSFER SOLUTION TO EPHEMERIS, \checkmark DMT 1
- RUN ORB NORMAL

EVALUATE PROFILE

- DRAG VS VE
- ENTRY ELAPSED TIME
- ENTRY DIGITALS
- ENTRY ANALYSIS DIGITALS
- VREL/EOW//GROUNDTRACK PLOTS

ENT DIGS EVAL CRITERIA	
\checkmark SITE/RNWY	\checkmark VID
DELTA TTL \leq 5	RR1 \geq 6250
MAX CP3 \leq 2950	\checkmark NCYCLE
\checkmark TAEM COND	\checkmark ALT ERR

INFORM CUSTOMERS

- GPO: GO TO BUILD PEG-4 TARGET COMMAND LOAD
- DFE: ENTRY SET TO NETWORK
- GC: EVENT TIMES ON ENTRY ELAPSED TIME
- INCO: EPSAT IS GO
- ENTRY SUPPORT: EI-5 SV (IF REQ'D)

DEORBIT TARGETING CHECKLIST (Page 5 of 5)

INSUFFICIENT PROPELLANT PROCEDURE (FR. A4.1.4-2)

THIS REQUIRES DOWNMODING THROUGH THE LIST BELOW UNTIL SUFFICIENT ΔV IS AVAILABLE.

1. TARGET AT 2 OMS / 1 OMS OPTIMUM (OR AT THE OPT FOR THE AVAILABLE ENGINES).
2. USE OMS DOWN TO ZERO USABLE IN THE CRITICAL OMS SYSTEM **[FROM PROP]**.
3. PERFORM A MULTI-STAGE DEORBIT BY EXECUTING A FRCS OR ARCS PERIGEE ADJUST. IT IS HIGHLY DESIRABLE TO PERFORM THIS MANEUVER AT LEAST 2 ORBITS PRIOR TO DEORBIT. IT MAY BE PERFORMED < 2 ORBITS PRIOR TO DEORBIT, IF TELEMETRY COVERAGE WILL PROVIDE MANEUVER CONFIRMATION.
 - IF PERIGEE ADJUST PRIOR TO DEORBIT IS NOT POSSIBLE, PLAN ON ARCS COMPLETION DOWN TO AFT QTY 1 + THE AFT HP QUANTITY, IF SUFFICIENT TO COMPLETE THE TARGET.
4. UTILIZE C.G. MANAGEMENT TECHNIQUES IN FR A.4.1.4-3 TO MAXIMIZE THE AVAILABLE PROPELLANT.
 - ONLY EFFECTIVE FOR CASES WITH UNBALANCED OMS LOADS OR BALLAST
5. CONSIDER OTHER CONUS OPPORTUNITIES, IF $\Delta V_{\text{REQUIRED}}$ IS LOW ENOUGH TO ACHIEVE STEEP TARGETS.
6. SHALLOW THE ENTRY TARGETS UP TO 90 DEGREES PREBANK WITH 3 SIGMA N-CYCLES
 - CHANGE MM304 ϕ TO DESIRED PREBANK IN BOTH DEORBIT CONSTRAINTS TABLE AND THE ENTRY CONSTRAINTS TABLE
7. UTILIZE THE FORWARD RCS FOR PLANNED FAST FLIP COMPLETION OF THE TARGETS, IF AVAILABLE
8. TARGET WITH 90 DEGREES PREBANK AND DOWN TO MINIMUM N-CYCLES TO PREVENT SKIPOUT (N-CYCLE = 2)
9. IF POSSIBLE, INCREASE THE AMOUNT OF PROPELLANT AVAILABLE BY EXPANDING THE C.G. LIMITS TO THE CONTINGENCY BOX.
 - ONLY EFFECTIVE IF UNBALANCED IN Y-AXIS.
10. BURN THE OMS TANKS TO DEPLETION
 - GET EXPECTED $\Delta V_{\text{AVAILABLE}}$ FROM PROP
11. SHALLOW THE TARGETS UP TO THE THERMAL LIMIT (WITH A PLANNED REDES TO NOR, IF AVAILABLE, FOR EDW)
IF EXCEEDING 2950, WARN THE CREW THAT THEY WILL BE ABOVE THE HIGH ENERGY TRAJ LINE ON THEIR DISPLAY
12. INCREASE RCS PROP AVAILABLE BY BURNING DOWN TO AFT QTY 2. **[FROM PROP]**

4.9.7 EDS CHECKLIST (PAGE 1 OF 2)

DEORB

- 1) Requires a valid DMP deorbit solution.
- 2) Request Dynamics "DEORB solution number x".
- 3) Dynamics make following inputs on EDS Input Menu:
 - File / Recall Selections / choose deorb_slot_x.sel
 - Entry Set Transfer = PRIMARY unless FDO requests "don't make prime"
 - Run / Submit Run
- 4) Run is complete when entry data is written to Traj Server, Global named ephem, and Global EphR (if PRIMARY was selected).

Notes:EDS will access selections files output by DMP containing deorbit constraints (including atmosphere), EI-5 vector, entry mass props, orb number, and 303/304 attitudes. Dynamics should refrain from making any changes to the input menu after selections are recalled, other than Entry Set Transfer.

ORB NORMAL

- 1) Requires a deorbit maneuver in an ephemeris, or re-entrant vector in VAT. PMP mass props must be synched, and VAT mirror must be on.
- 2) Verify entry constraints on ECT:
File / Open Selections / choose orb_normal.sel
Review all inputs and notify Dynamics of any desired changes: site/rwy, HAC, prebank, mass props, winds.
Note: Request Dynamics fetch PMP mass props whenever entry predicts are updated.
Note: Request Dynamics update winds table whenever new forecast/balloon file available from WINDS coordinator (format winds..TD-time.UF/RT/RS..site..GMT..date..max alt..sequence)
- 2) Request Dynamics "ORB NORMAL eph x mnvr yy" or "ORB NORMAL vector zz "
Note: EAP is required unless vector is post-EI-5. Tell Dynamics if EAP is not req'd.
Be sure and specify any desired change from ECT orb_normal settings.
- 3) If ORB NORMAL off deorbit mnvr in eph, Dynamics move MVExyy to V5.
- 4) If EAP required, Dynamics make following inputs on EAP menu:
 - Set vector source & output to MOC V5. Orb count & veh weight grabbed from Eph 1 at time of vector. FDO must notify Dynamics if default orb count or weight is to be overridden.
 - Select ACT and enter desired pre-bank (positive bank angle=right bank)
 - Run. This computes/outputs 303/304 attitudes, propagates vector to EI-5, and stores in MOC V5.
- 4) Dynamics makes following inputs on EDS Input Menu:
 - File / Recall Selections / choose orb_normal.sel (grabs EAP attitudes & orb count)

EDS Checklist (Page 2 of 2)

- Entry Set Transfer = PRIMARY unless FDO requests "don't make prime"
 - If EAP run, verify 303/304 = EAP, otherwise select NONE
 - Enter same pre-bank from EAP, if appropriate (positive bank angle=right bank)
 - If requested by FDO, update site/rwy, HAC, mass props (PMP), winds
 - Fetch vector from MOC V5
 - Save selections
 - Run / Submit Run
- 5) Verify updates to ECT
- 6) Run is complete when entry data is written to Traj Server, Global named ephem, and Global EphR (if PRIMARY was selected).

Notes: To switch lightweight ↔ heavyweight in EDS, have Dynamics run script. Ignore glideslope indicator on ECT. Verify desired setting with Entry Groundtrack displayed HAC. ORB NORMAL uses DDS GRAM95 atmosphere delivered in DSCT-66 (site, inclination, approach, month-specific). Applies to CONUS, TAL, AOA, GRTLS sites. For other sites, EDS will default to E_ELS1=AT1. To override:

DDS Elements / Select DDS Elements / set E_ELS# to desired file corresponding to AT#. Do this for both entry (ESP) and TAEM (TSP).

4.9.8 DEL PAD CHECKLIST (PAGE 1 OF 7)

SINGLE APU START, ATTEMPT_APU(S) - REFERENCES THE APPROPRIATE PROCEDURE FOR THE CREW TO USE (EITHER 1 OR 2 APU'S). OBTAINED FROM MMACS.

APU START SEQUENCE - OBTAINED FROM MMACS.

OMS TIG SLIP - AMOUNT OF TIME THE D/O BURN MAY BE SLIPPED AND THEN COMPLETED ON ONE OMS ENGINE. THIS ITEM IS COMPUTED IN THE SINGLE OMS DOWNMODE PROCEDURE OUTLINED IN THE **DEORBIT TARGETING CHECKLIST**. MAXIMUM VALUE IS 5 MINUTES.

RCS DOWNMODING - AMOUNT OF TIME THE D/O BURN MAY BE SLIPPED AND THEN COMPLETED ON THE ARCS ONLY. COMPUTED ONLY IF ONE OMS IS DOWN. **N/A IF BOTH OMS ARE GO**. ENTER A MAXIMUM OF 2 MINUTES IF COMPUTED.

L AND R OMS FAIL HP - THE REQUIRED HP TO BE ATTAINED IF THE D/O BURN IS TO BE COMPLETED ON THE REMAINING OMS, ARCS ABOVE AFT QUANTITY 1, FRCS, AND USE OF RECOVERY PREBANK IF AN OMS (L OR R) PROPELLANT FAILURE OCCURS DURING THE D/O BURN. THESE VALUES ARE COMPUTED USING THE SINGLE TANK COMPLETION (STCOMP) PROGRAM. SEE **STCOMP CHECKLIST**. ALL THE PROPELLANT QUANTITIES SHOULD BE OBTAINED FROM THE PROP TO FDO FORM (REF. FIG. 4.9-1). **IF THE BURN IS TARGETED AS A SINGLE ENGINE BURN, THIS ITEM IS NOT APPLICABLE AND N/A SHOULD BE ENTERED.**

OMS ENG FAIL XFEED QTY CUE L AND R - THIS VALUE IS OBTAINED FROM PROP AND REPRESENTS THE QUANTITY AT WHICH A XFEED WOULD BE INITIATED FOR AN ENGINE FAILURE DURING THE DEORBIT BURN.

ENG FAIL HP - THE REQUIRED HP TO BE ATTAINED IF THE D/O BURN IS TO BE COMPLETED ON THE ARCS JETS, USING THE REMAINING OMS AND RCS PROPELLANT ABOVE AFT QTY 1. SEE **RCS COMPLETION CHECKLIST**. THIS APPLIES TO BOTH 2 ENGINE AND SINGLE ENGINE DEORBIT BURNS. ENG FAIL HP WILL INITIALLY BE EVALUATED AT SAFE HP UNLESS NO DEORBIT WAVE-OFF CAPABILITY EXISTS (I.E. WX GOING BAD, CONSUMABLES RUNNING SHORT, NO ONE ORBIT LATE AVAILABLE, SYSTEMS FAILURES REQUIRING LANDING NOW, ETC.). OTHERWISE, ACTUAL ENG FAIL CAPABILITY (THE HIGHEST POINT FROM WHERE THE BURN CAN BE COMPLETED WITH THE +X RCS THRUSTERS) SHOULD BE ENTERED ON THE DEL PAD. IF TIME DOES NOT ALLOW THIS HP TO BE COMPUTED, MAKE ENG FAIL HP = SAFE HP. **THIS ITEM IS N/A FOR AN RCS DEORBIT BURN.**

DEL PAD CHECKLIST (Page 2 of 7)

PROP to FDO FORM

1e Mar 14 03:44:38 199!

sts-67 ORBIT 3
Current MET: 011:22:43:00

Deorbit TIG: 013:16:05
Deorbit Weight: 232689 lbs

Predicted at Deorbit	RCS						OMS			
	L		R		F		L		R	
	OX	FU	OX	FU	OX	FU	OX	FU	OX	FU
Gaged % lb	62.0 837	62.0 527	58.3 787	59.2 503	24.0 324	25.5 217	52.83 4255	53.07 2598	54.15 4362	53.37 2613
Deorbit Redlines	41.2 906		41.2 906		N/A		N/A		N/A	
Usable lbs OMS Deorbit	N/A		N/A		N/A		6254		6370	
Delta V Av OMS Deorbit	N/A		N/A		N/A		276.7		280.4	
Usable lbs RCS Deorbit	1364		1283		462 --a-----b-- 442 399		6144		6271	
Delta V Av RCS Deorbit	N/A		N/A		18.5 --a-----b-- 17.7 15.9		226.3		231.1	
Usable lbs Above Entry R/L	458 --a--c--b-- 332 974		376 --a--c--b-- 251 893		N/A		N/A		N/A	
Delta V Av Above Entry R/L	16.7 --a--c--b-- 12.1 35.5		13.7 --a--c--b-- 9.1 32.5		N/A		N/A		N/A	

	Protect lbs	Quantity lbs	Quantity pct	Total Delta-V Straight	Total Delta-V Icnct
a) Aft Quantity 1:	1430	1994	91	596.0	496.3
b) Aft Quantity 2:	146	710	32	641.1	541.4
c) Aft Hp:		404	18	14.7	

Flight Vernier Usages FRCS->2-X (T/O)

Figure 4.9-1 PROP to FDO Sheet

SAFE HP - THE MINIMUM HP WHERE THE D/O BURN CAN BE SAFELY TERMINATED AND RESULT IN AN ORBIT WHICH IS SAFE FOR 24 HOURS. NAV IS THE POINT OF CONTACT FOR OBTAINING THIS DATA. TYPICAL VALUE IS 80 NMI. DUE TO UNCERTAINTIES IN MODELS AND VECTOR INTEGRATION, 80 NMI IS THE LOWEST VALUE THAT WILL BE USED FOR SAFE HP.

DEL PAD CHECKLIST (Page 3 of 7)

TOT AFT QTY 1 - THE ARCS GAUGE PERCENT THAT WILL PROVIDE 97.5 PERCENT CONFIDANCE OF PROTECTING ENTRY USAGE. OBTAINED FROM PROP TO FDO FORM (REF. FIG. 4.9-1).

TOT AFT QTY 2 - THIS IS THE ARCS GAUGE PERCENT THAT PROTECTS AERO CAPTURE (NO YAW JET ENTRY). OBTAINED FROM PROP TO FDO FORM (REF. FIG. 4.5-3).

CAPTURE HP - THIS IS THE HIGHEST PERIGEE THAT ASSURES AERO CAPTURE, ASSUMING ALL AVAILABLE FRCS IS USED FOR FAST FLIP PLUS PRE-BANK TO DOWNRANGE ELS. FIGURE 4.9-2 PROVIDES CAPTURE HP AS A FUNCTION OF CROSSRANGE TO THE TARGETED SITE. ADD FRCS HP THEN TRUNCATE THE RESULT FOR THE DEL PAD.

$$\text{CAPTURE HP} = \text{HP VALUE FROM PLOT} + \text{FRCS } \Delta V / 1.8$$

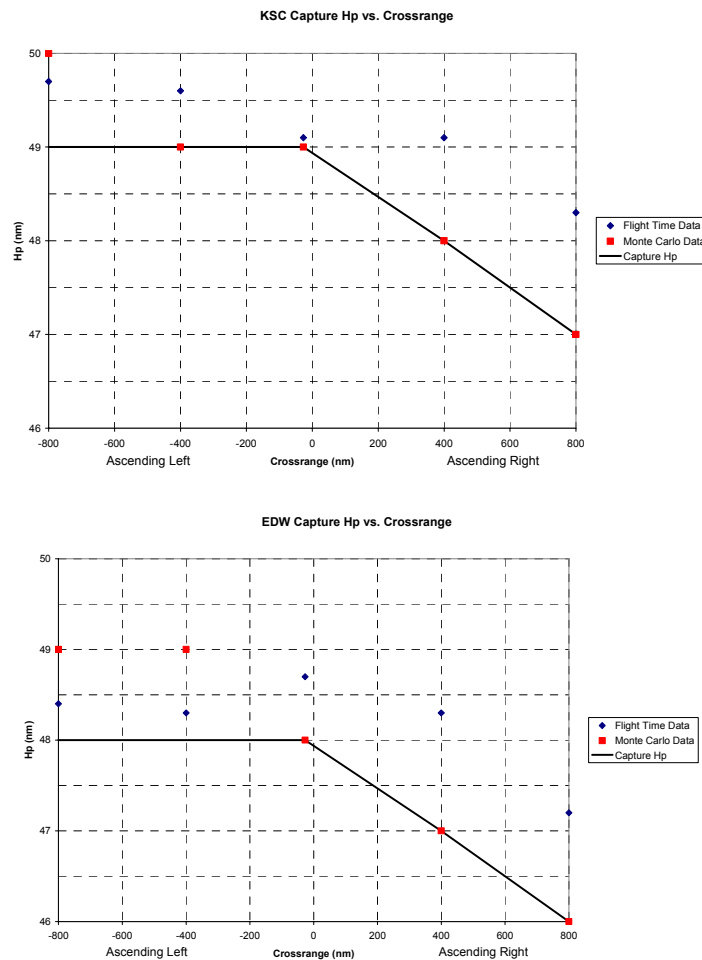

FIGURE 4.9-2 CAPTURE HP CURVES FOR ASCENDING CONUS

DEL PAD CHECKLIST (Page 4 of 7)

FLIP HP - THIS IS THE CUE USED BY THE CREW TO DETERMINE WHEN THEY CAN COMPLETE A BROKEN BURN WITH FRCS AND RECOVERY PREBANK. THESE RECOVERY PROCEDURES WOULD ALLOW THE CREW TO MAKE THE BACKUP (UNDERBURN) SITE, OR THE PRIME SITE IF NO BACKUP SITE IS AVAILABLE. THE RECOVERY PREBANK USED FOR THIS CALCULATION REPRESENTS EITHER THE ORBITER THERMAL LIMIT OR 135 DEGREES, WHICHEVER IS SMALLER. THE VALUE IS COMPUTED BY USING THE FOLLOWING EQUATION:

$$\text{FLIP HP} = \text{TARGET HP (FROM DMT)} + \text{PREBANK } \Delta\text{HP} + \text{FRCS HP}$$

FRCS HP IS THE AMOUNT OF ALTITUDE CHANGE OBTAINED IF ALL FRCS PROPELLANT IS USED IN THE D/O PROCESS. THE VALUE IS DETERMINED BY CONVERTING THE FRCS ΔV (FROM THE PROP TO FDO SHEET) TO ΔHP (FRCS $\Delta V/1.8$).

NOTE: IF THE FRCS QUANTITY IS < 16% (CHECK WITH PROP):

WE DO NOT WANT THE CREW TO PERFORM A FAST FLIP, THEREFORE THE FOLLOWING CHANGES MUST BE DONE:

1. COMPUTE FLIP HP WITH FRCS $\Delta V = 0$
2. CHANGE THE WORDS FLIP HP TO PREBANK HP ON THE DEL PAD. PUT THE NUMBER COMPUTED IN THE STEP ABOVE IN THE BOX FOR PREBANK HP.
3. PUT IN NOTES: "CIRCLE PREBANK IN FOUR PLACES ON THE DEORBIT BURN CUE CARD" (GPO CALL)

PREBANK ΔHP IS DETERMINED BY LOOKING AT THE PREBANK TABLES (ENTRY C/L PG FS3-33, REF. FIGURE 4.9-3). IF EDW IS THE LANDING SITE AND NOR IS AVAILABLE, THEN THE ΔHP IS THE CIRCLED PREBANK NUMBER IN THE REDES PORTION OF THE TABLE.

DEL PAD CHECKLIST (Page 5 of 7)

NOTE

THE ΔHP IF EDW IS PRIME AND NOR IS AVAILABLE SHOULD BE CROSSCHECKED WITH THE RECOVERY PREBANK PRODUCT (DSCT 28). REFERENCE THE EOM PLOT AND READ THE ΔHP AT THE BOTTOM OF THE PAGE (NOR STEEP : 3120 DEG. @ DELTA HP = XX NM). THIS NUMBER FROM THE PLOT WILL BE CORRECT.

IF EDW IS THE LANDING SITE BUT NOR IS NOT AVAILABLE (E.G. WET LAKEBED), THEN THE ΔHP IS THE CIRCLED VALUE IN THE EDW PREBANK TABLE.

IF KSC IS THE PRIME SITE, THE ΔHP IS DETERMINED FROM THE KSC PREBANK TABLE. THE ΔHP IS THE CIRCLED NUMBER IN THE KSC PREBANK TABLE.

IF NOR IS THE PRIME SITE, USE THE EDW ΔHP (NO REDES) DATA.

REDES portion of the Prebank Tables (EDW REDES to NOR) →

* PREBANK TABLE EDW (HA = 187 NM)									
* EDW									
ΔHP	0	3	8	10	REDES.	11	12	(13)	REDES.
PREBANK	0	65	95	110	NOR ELS	115	120	130	YR
* NOR									
* NOR NOGO									
* (350) ITEM 41+ 4 2, √RWY 17 SET TACAN tw (three) 121Y									
ΔHP	8	9	11	12	13	14	(15)	REDES.	
PREBANK	90	105	115	120	125	135	145	YR	
* YYR									
* (350) ITEM 41+ 2 2, √RWY 28 SET TACAN tw (three) 040X									
ΔHP					14	18	20	24	(28) 28
PREBANK					55	75	95	125	145 180
* PREBANK TABLE KSC (HA = 188 NM)									
* KSC									
ΔHP	0	2	4	6	8	10	12	(14)	REDES.
PREBANK	0	50	75	95	100	110	120	140	YQX
* YQX									
* (350) ITEM 41+ 2 1, √RWY 21 SET TACAN tw (three) 074X									
ΔHP						15	22	(25)	RED.
PREBANK						90	135	170	INN
* INN									
* (350) ITEM 41+ 2 0, √RWY 08 SET TACAN tw (three) 080X									
ΔHP								28	28
PREBANK								135	180

FIGURE 4.9-3

AFT HP - THIS IS USED BY THE CREW TO DETERMINE WHEN THEY CAN COMPLETE A BROKEN DEORBIT BURN TO THE TARGETED HP USING ONLY ARCS (+X) JETS. BELOW AFT HP, THE PROPELLANT WHICH WOULD HAVE BEEN USED TO DO A FAST FLIP AND TO MAINTAIN ATTITUDE DURING THE FRCS TRANSLATION CAN BE COMMITTED TO COMPLETING WITH THE AFT. TO COMPUTE AFT HP, OBTAIN **THE AFT HP DELTA V** FROM PROP, DIVIDE IT BY 1.8 TO CONVERT IT TO AN HP, AND ADD THE RESULT TO TARGETED HP.

$$\text{AFT HP} = \text{TARGET HP} + \text{AFT HP } \Delta V / 1.8$$

DEL PAD CHECKLIST (Page 6 of 7)

B/U SITE - THIS IS THE BACKUP (UNDERBURN) SITE ID. NOTE: VERIFY B/U SITE IS WITHIN XRNG LIMIT. THIS IS N/A IF NO BACKUP SITE IS AVAILABLE.

FRCS DUMP TO PERCENT - THIS IS THE QUANTITY OF THE FRCS AT DUMP STOP. TOTAL DUMP WEIGHT IS DETERMINED BY THE FDO IN ORDER TO ADJUST THE ORBITER XCG OR LANDING WEIGHT. IT IS COMPUTED BY SUBTRACTING THE DUMPED WEIGHT FROM THE INITIAL WEIGHT AND THEN CONVERTING THE RESULTING WEIGHT TO PERCENT. IF NO FRCS DUMP IS REQUIRED, THEN N/A SHOULD BE ENTERED FOR THIS ITEM ON THE PAD. PROP WILL TELL YOU WHETHER TO USE OX OR FU AS THE CUTOFF CUE.

EI - 5 MINUTES MM 303 INERTIAL ATTITUDE - OBTAINED FROM THE EPP ENTRY DIGITALS (MSK 506).

MM 304 PREBANK - PREBANK ANGLE (DEG) USED IN THE DMP PROCESS AND DISPLAYED ON THE DOD OF THE D/O MANEUVER. THE PREBANK DIRECTION IS THE SAME AS THE FIRST ROLL DIRECTION AND MUST ALWAYS BE INDICATED, EVEN IF THE PREBANK IS ZERO.

ALTIMETER SETTING - OBTAINED FROM WEATHER.

CLG INIT - TIME OF CLOSED-LOOP GUIDANCE INITIATION. OBTAINED FROM THE CLG INIT LINE ON THE ENTRY ELAPSED TIME DISPLAY (MSK 505). THIS ENTRY ON THE PAD SHOULD BE HH:MM:SS IN MET.

EXPECTED AIL TRIM - THIS VALUE SHOULD BE EQUAL IN MAGNITUDE TO THE YCG AT M3.5, BUT IN THE OPPOSITE DIRECTION.

VREL 1ST REVERSAL - RELATIVE VELOCITY OF FIRST ROLL REVERSAL. OBTAINED ON THE ENTRY ANALYSIS DIGITALS (VRR ON MSK 507).

XCG AT TD - OBTAINED FROM CG SUM (MSK 496).

LAND SITE - O/B LANDING SITE AREA ID FROM GPO OR THE ENTRY CHECKLIST, FLIGHT SUPPLEMENT PAGE 3-2 OR 3-3.

LEFT/RIGHT TURN - FROM GROUNDTRACK PLOT

OVERHEAD/STRAIGHT IN - FROM ENTRY ELAPSED TIME (MSK 505).

HAC TURN ANGLE - PSHA FROM MSK 505.

RUNWAY ID - FROM MSK 505.

TAC - TACTICAL AIR COMMAND AND NAVIGATION SYSTEM (TACAN) CHANNEL NUMBER FOR THE FIRST TACAN CONTACT. OBTAINED FROM GPO.

DEL PAD CHECKLIST (Page 7 of 7)

MLS - MICROWAVE LANDING SYSTEM CHANNEL NUMBER FOR THE PLANNED RUNWAY. OBTAINED FROM GPO.

ΔT MACH .95 TO HAC - THIS IS THE TIME FROM MACH .95 (CSS INIT) TO HAC INTERCEPT. OBTAINED FROM ENTRY SUPPORT (TAEM SUMMARY).

MAX NZ - THE MAXIMUM EXPECTED LOAD FACTOR DURING ENTRY. THIS IS OBTAINED EITHER FROM DDS. A 0.1G BIAS IS ADDED BY ENTRY SUPPORT TO THE MAX LOAD FACTOR OBTAINED FROM THE SIM TO ACCOUNT FOR PILOTING DISPERSIONS.

N_z LIMIT - MAX CERTIFIED NORMAL LOAD FACTOR LIMIT.

IF LANDING WEIGHT \leq 211 KLB, THE N_z LIMIT IS 2.5 GS.

IF LANDING WEIGHT $>$ 211 KLB, THE N_z LIMIT IS COMPUTED AS FOLLOWS:

$NZMAX = 4.563 - (9.778 \times 10^{-6} \times WT)$

NOTE: IF M3.5 XCG RESULTING FROM BALLAST BASELINE QUANTITY COMPUTATION IS $<$ 1076.7, SEE FR A4.1.4-3 FOR FURTHER DETAILS.

AIMPOINT - NOM/CLOSE-IN AIMPOINT AS COMPUTED BY THE TOAST ALP OR ENTRY SUPPORT'S DDS. ENTRY SUPPORT AND ALP USES THE CRITERIA IN FLIGHT RULE A4.1.4-6 TO RECOMMEND THE BEST OPTION.

SPD BRK - THE EXPECTED SPEEDBRAKE SETTING AT 3000 FT IN PERCENT AS COMPUTED BY DDS OR ALP, AS WELL AS NOMINAL OR SHORT FIELD SELECTION.

WINDS ALOFT - THESE ARE THE LATEST FORECAST WINDS, WHERE WIND DIRECTIONS ARE REFERENCED TO TRUE NORTH, EXCEPT FOR THE SURFACE WIND WHICH IS REFERENCED TO MAGNETIC NORTH. WIND MAGNITUDES ARE REFERENCED IN KNOTS. THE VALUES HERE ARE ROUNDED TO THE NEAREST 5 KT AND 10 DEGREES FOR ALL ENTRIES EXCEPT THE SURFACE, WHICH IS ONLY ROUNDED TO THE NEAREST 10 DEGREES.

4.9.9 AUTO DEL PAD PROCEDURES CHECKLIST

1. TRANSFER DEORBIT SOLUTION TO AN EPHEMERIS AND DISPLAY IN DMT 1.
2. SUMM (MSK 496) CONFIGURATION.
3. VERIFY CORRECT ENTRY SET EXISTS TRANSFER INPLANE (OR 1 OMS/1 OMS) SOLUTION TO DOD 1.
4. VERIFY A GOOD CG AND IS DISPLAYED IN MET.
5. SELECT **AUTO DEL PAD** FROM THE FDO DNAV UNDER APPLICATIONS PULL DOWN.
6. SELECT *GENERATE NEW SHEET*.
7. PROVIDE AT LEAST THE MINIMUM INPUTS (PREBANK Δ HP AND YCG LIMIT).
8. PRESS THE *PROCEED* BUTTON.
9. IF PROP TO FDO FORMS HAVE BEEN PUBLISHED BY PROP, THEY WILL BE VISIBLE AS HYPERTEXT LINKS IN THE PROP TO FDO SECTION. SELECT THE APPROPRIATE SHEET. OTHERWISE, MANUALLY INPUT DATA.

NOTE

IN THE CASE WHERE BALLAST IS BEING HELD BACK IN THE OMS TANKS, CARE MUST BE TAKEN IN USING THE PROPER OMS Δ V AVAILABLE. THE QUANTITIES TO BE USED SHOULD NOT ASSUME ANY PROP IS BEING HELD BACK FOR BALLASTING PURPOSES.

10. PRESS THE *GRAB* BUTTON.
11. PRESS THE *STCOMP* BUTTON (THIS BUTTON WILL ONLY BE ACTIVE IF THE "2 OMS ENGINES AVAILABLE" RADIAL BUTTON HAS BEEN SELECTED). ENTER THE APPROPRIATE HS @ TIG - 180.
12. EVALUATE THE OMS FAIL NUMBERS AND ITERATE UNTIL HAPPY.
13. PRESS THE *COMPUTE* BUTTON TO CALCULATE FLIP (OR PREBANK) HP, AFT HP, DUMP TO COMPONENT, NZ LIMIT, AND THE B/U SITE.
14. IF UPPER LEVEL WIND FORCASTS HAVE BEEN QA'D BY THE WINDS OFFICER, THEY WILL BE VISIBLE AS HYPERTEXT LINKS IN THE WINDS SECTION. SELECT THE APPROPRIATE FORECAST. OTHERWISE, MANUALLY INPUT WIND DATA FOLLOWING EXECUTION OF THE *TRANSFER* BUTTON.
15. PRESS THE *TRANSFER* BUTTON TO TRANSFER ALL DEL PAD DATA TO AN EDITABLE DEL PAD PAGE.
16. MANUALLY INPUT CAPTURE HP COMPUTED IN SOP 4.9.8
17. VERIFY ALL DEL PAD INPUTS, MAKE NECESSARY CHANGES, ADD APPROPRIATE REMARKS, AND SAVE OR PUBLISH.

4.9.10 NOMINAL STCOMP CHECKLIST

HS AT TIG MINUS 180 - OBTAIN A CHECKOUT MONITOR 180 DEGREES PRIOR TO TIG.

HP FINAL - FINAL HP FROM THE ACTUAL TARGETED DEORBIT BURN FROM THE DMT.

1 OMS ΔV REQUIRED - THE **INPLANE** 1 OMS ΔV REQUIRED AT THE TARGET TIG.

L AND R OMS ΔV 'S AVAILABLE - OBTAIN FROM THE PROP TO FDO FORM. REFERENCE FIGURE 4.9-1 TO SEE WHERE THESE NUMBERS COME FROM.

FRCS AND ARCS ΔV 'S AVAILABLE - OBTAIN FROM THE PROP TO FDO FORM. REFERENCE FIGURE 4.9-1 TO SEE WHERE THESE NUMBERS COME FROM.

TARGET ΔV - THE ΔV FROM THE TARGETED TWO OMS SOLUTION, REGARDLESS OF WHETHER THE BURN IS OOP OR INPLANE.

PREBANK HP - OBTAIN FROM THE PREBANK TABLE IN THE ENTRY C/L. REFERENCE FIGURE 4.9-2 TO SEE HOW THIS IS DONE.

PRE-BURN YCG - OBTAIN FROM TOP OF THE OMS DEPLETION TABLE.

Y CG LIMIT - 2 INCHES IS THE DEFAULT (NOMINAL CG BOX PLUS UNCERTAINTIES).

NOTE: IF XCG RESULTING FROM BALLAST BASELINE QUANTITY COMPUTATION IS < 1076.7 INCHES, USE 1.5 INCHES AS LIMIT.

POST-BURN VEHICLE WEIGHT - OBTAIN THIS FROM CG SUM, LINE 176 (TVC WEIGHT).

SAFE HP - OBTAIN FROM NAV. THIS IS A FUNCTION OF THE POST BURN HA AND IS THE LOWEST HP THAT WILL ALLOW AT 24 HOURS OF ORBITAL LIFETIME (48 HOURS TO EI). FOR $HA \geq 160$, SAFE HP = 80. THIS IS THE DEFAULT.

4.9.11 UNBALANCED STCOMP CHECKLIST

NOTE

THESE PROCEDURES ARE REQUIRED IF THE DEORBIT BURN WILL USE BOTH OMS ENGINES, BUT THE PODS ARE UNBALANCED. THE CREW WILL BEGIN THE BURN USING BOTH OMS ENGINES FEEDING FROM THE HEAVY POD AND GO TO TWO-POD FLOW WHEN THE PODS ARE BALANCED. IF A PROPELLANT FAILURE OCCURS BEFORE THIS POINT, THE CREW WILL STOP THE BURN IF ABOVE SAFE HP. ONCE TWO-POD FLOW HAS BEGUN, THE DELTA V AVAILABLE ON BOTH SIDES IS EQUAL AND THE L AND R OMS HP'S WILL BE EQUAL (UNLESS A YCG OFFSET IS PRESENT). THE L AND R OMS HP'S APPLY ONLY TO THE PART OF THE DEORBIT BURN WHICH REMAINS AFTER TWO-POD FLOW HAS BEGUN.

1. MODEL THE PLANNED DEORBIT BURN AND OVERRIDE THE ΔV SO THAT ΔV TOTAL EQUALS THE DIFFERENCE IN ΔV AVAILABLE BETWEEN THE HEAVY AND LIGHT OMS PODS. THIS REPRESENTS THE PART OF THE BURN WHICH OCCURS WITH BOTH OMS ENGINES BEING FED OUT OF THE HEAVY POD.

HS AT TIG MINUS 180 - OBTAIN A CHECKOUT MONITOR 180 DEGREES PAST TIG.

1 OMS ΔV REQUIRED - THIS IS THE 1 OMS ΔV REQUIRED FROM THE POINT THAT TWO POD FLOW BEGAN. TO DETERMINE THIS ΔV , PERFORM SINGLE OMS COMPLETION OFF THE BURNOUT OF THE MANEUVER FROM STEP 1. THIS IS SIMILAR TO THE RCS COMPLETION PROCEDURE BUT USING 1OMS INSTEAD OF PX4.

L AND R OMS ΔV 'S AVAILABLE - BOTH ARE SET TO THE LIGHT POD'S ΔV AVAILABLE FROM THE PROP TO FDO FORM.

TARGET ΔV - THE ΔV FROM THE TARGETED TWO OMS SOLUTION, MINUS THE ΔV ALREADY BURNED IN STEP (1) ABOVE.

PRE-BURN YCG - NOMINAL, BALANCED OMS VALUE.

2. REFER TO **NOMINAL STCOMP CHECKLIST** FOR ALL OTHER INPUTS.

4.9.12 RCS COMPLETION CHECKLIST

THIS PROCEDURE IS USED TO COMPUTE **ENG FAIL HP** OR VERIFY THAT RCS COMPLETION EXISTS FROM SAFE HP.

- 1) TRANSFER FINAL DMP SOLUTION TO AN EPHEMERIS
- 2) PERFORM A ΔV OVERRIDE OF THE MNVR. ITERATE UNTIL BURNOUT H_p = DESIRED H_p TO DETERMINE THE RCS COMPLETION.
- 3) ANCHOR A SECOND EPHEMERIS ON THE BURNOUT OF THE FIRST MNVR. STATIC START ABOUT 10 MIN PRIOR TO ORIGINAL TIG WITH A WEIGHT TRANSFER.
- 4) DIRECT INPUT THE RCS COMPLETION OF THE DEORBIT INTO THE SECOND EPH:
M40 MED: PEG 4D TARGETS FROM FIRST MNVR **W/O FWASTING**
 - I. INPUT TARGET TIG (TIG FROM FIRST MNVR)M66 MED: INPUT TIG (IGNITION TIME) TO BURNOUT OF FIRST MNVR PLUS 20 SEC
 - II. SET THRUSTERS TO PX4 (OR PX3)
- 5) VERIFY CORRECT TARGET TIG (TIGT) AND ACTUAL TIG (TIG) ON THE DMT
- 6) VERIFY THAT THE PROPELLANT REQUIRED TO DO THE TWO PARTS OF THE BURN IS LESS THAN THE TOTAL PROPELLANT AVAILABLE FOR DEORBIT:
- 7) TOTAL PROP AVAILABLE FOR DEORBIT= POUNDS AVAILABLE IN THE OMS + POUNDS AVAILABLE IN THE RCS ABOVE AFT QTY 1.
- 8) IF PROP REQUIRED > PROP AVAILABLE, THEN RETURN TO STEP 2 WITH A LARGER ΔV OVERRIDE.
- 9) IF COMPUTING ENG FAIL H_p AND PROP REQUIRED < PROP AVAILABLE, THEN RETURN TO STEP 2 WITH A SMALLER ΔV OVERRIDE.

NOTE: ENG FAIL HP MUST BE > SAFE HP
--

4.9.13 RCS DEORBIT TARGETING CHECKLIST

NOTE

IF PX3 OR PX2:

- MANUALLY ITERATE USING TIG FIXED MODE TO COMPUTE THE OPTIMUM TIG.
- VERIFY THAT THE MAXIMUM RCS BURN TIME CONSTRAINT IS NOT VIOLATED. IF BURN TIME IS TOO LONG, CONSIDER TWO-STAGE DEORBIT.
- SUBSTITUTE PX3 OR PX2 IN PLACE OF PX4 BELOW

INITIAL TARGETING

GET **PROP-TO-FDO** AND Δ **OMS** AVAILABLE

GENERATE INITIAL DMP SOLUTIONS

- PX4/PX4 STEEP OPTIMUM --- (COL. 1)
- PX3/PX3 STEEP OPTIMUM --- (COL. 2)
- PX4/PX4 SHALLOW OPTIMUM --- (COL. 3)

IF PROP AVAIL (Δ OMS) < PROP REQ'D FOR PX4/PX4 STEEP OPTIMUM:

GO TO **INSUFFICIENT PROP PROCEDURE** ON PAGE 5 OF DEORBIT TARGETING CHECKLIST

FINAL TARGETING

IF SUFFICIENT PROP AVAILABLE TO BACK UP TIG:

- PX4/PX4 STEEP @ PX4/PX4 OPT - 1 MIN

IF OUT-OF-PLANE FUEL WASTING DESIRED:

- R01 or R08: FUEL (USAGE MODE) = "OP" (FWASTE)
- R08: FUELWT = DESIRED PRPLT
- PX4/PX4 STEEP @ PX4/PX4 OPT - 1 MIN (INITIAL TIG) W/WASTING

VERIFY THE PRIME SOLUTION (SOLN # _____) IS GOOD

- PUT IT IN A DOD
- RUN A DEORB
 - DRAG VS. VE, ENT ELAPSED TIME, ENT DIGS, ENT ANALYSIS DIGS, GNDTRK, VREL, AND EOW
- TRANSFER IT TO AN EPHEMERIS, AND VIEW IT IN A DMT

4.9.14 D/O BURN CHECKLIST

Verify correct O/B targets/burn solution
Note O/B TGO. TRAJ set up count-up clock.
Mnvr to attitude @ TIG-20 min
FDF (burn card, pre-bank chart)
Activate DV Sensor,
ROSS 3D att, GPO ADI/HIS

Deorbit Burn

FA1 or FA2 ↓ 2 +X jets lost
FA3 or FA4 ↓ posbl no dwnmd
Any 2 MDMs ↓ posbl man s/d
High RCS usage → ENG fail
 $\Delta V > 30$: re-string to re-gain PX4

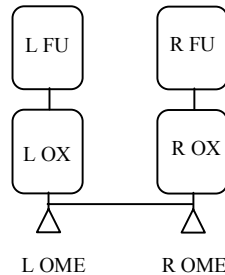

IMU Dilemma:
If below Safe Hp:
Cutoff on TGO cue*
If deselect IMU, can cutoff on Hp.
If GPO can verify BFS on good IMU, cutoff on BFS VGOs.
Post-burn, get on good IMU; trim Hp to within 1 nmi of Tgt Hp (5 fps ~ 2.8 nmi)
*TGO+5 if 2 OMS/FRCS avail TGO+0
TGO+10 if 1 OMS/FRCS avail no FRCS
Note: ≈2 fps/sec (2 OME), 0.5 fps/sec (PX4)

Note ΔV_{tot} if eng fail
Trim to 2 fps (0.2 fps if SH)
If burn terminated Hp > 80: ✓OL; update DOPS, DCT, D23C/NCYCLES, USSTRATCOM, re-run mass props (if req'd), request updated PROP-TO-FDO

Post-burn: FDO

Check GPO/Grnd Nav for best Nav State (O/B=V53)
Grab O/B wt @ MM303 (verify EDS in synch w/O/B)
If nominal (target Hp achieved):

Run Orb Normal off best Nav State
Evaluate entry

If overburn (below target Hp):
Trim w/FRCS if available, otherwise:
Fast flip/trim w/aft for VGOX above -5 fps

If underburn (Tgt < Hp ≤ circled value):
Pass crew prelim pre-bank from Entry C/L
Run Orb Normal w/prelim pre-bank (EAP & EDS)
Have ECO run pre-bank scanner (Right=pos)
Evaluate entry & update pre-bank if req'd
Update DEL PAD params

If unacceptable entry or Hp > circled value:
Pass crew prelim site & pre-bank from Entry C/L
Update EDS w/ ELS element files (E_ELS5 for AT5)
Continue w/ above steps

Store CLG init vector in VAT
Run no-dump DAE off vector
Check footprint on Outplane Plot
Redes to best site on forward half of footprint, re-run EDS w/appropriate ELS element files

If redes req'd: Check site status w/LSO
Send out entry set/check tracking
GPO uplink landing site/TACAN if req'd

TRAJ

Confirm burn
Notify USSTRATCOM of burn
Burnout vector to USSTRATCOM
If prop fail: update mass props

Protects EGBM = 2 fpss & min const drag phase length(2200 fps). Exceed entry guid limits if VGOX above -20 fps.

ECO actions if pre-bank req'd:

- Run pre-bank scanner off EI-5 vector (V5 from EAP)
- Convert act pre-bank to ball angle
- If NOR redes: ✓ ΔH_p bias

Entry Evaluation Criteria:
CP3 < 2950 deg (100 re-use limit)
CP3 < 3320 (1 time cont limit)
and < 40 sec above 3220 deg
DDS limits: CP3 < 3020 (redes limit)
CP3 < 3120 (1 time cont limit)
Drag vs Vrel plot inside limits
NCYCLE > 0
Vrel 1st RR ≥ 6250 fps

Get WX/winds aloft info
Update DEL PAD parameters
Notify USSTRATCOM

4.9.15 ENTRY PHASE HIGH SPEED CHECKLIST

√ PBI's: V56→CUR; V54→BFS; V56 →CUR; UPP/FILT→
UPP

IF BFS ENGAGE:
SELECT BFS PBI

√ K51 RUNWAYS

WARNING
Incorrect runway PBI configuration will result in invalid energy evaluation.

AFTER EI - GO TO LANDING PHASE(HSEP RECOVERY: OPS
PHASE; IF HAC WRAP: TOGGLE ENTRY ↔ TAEM PBIs

TD-1.0 Balloon Data

Read to FD and
Crew:
TD point and SB

SELECT **AUTO** AND **TLM** ON FDO ENTRY DIGITALS

√ **ENTRY RGO**

√ SELECTED SOURCE -- TLM PRIOR TO C-BAND ACQ
CONFIGURE FRONT SCREENS (GROUP ENTRY DISPLAYS)
VERIFY MATCH W/ O/B: R/W, HAC, PSHA, AIMPOINT, TURN DIR

NOTE
IF CSS DURING ENTRY:
WHEN 20 SEC PREDICTOR BUG CROSSES THE DELAZ DEADBAND,
MAKE A "15 SECONDS TO ROLL REVERSAL" CALL

ROLL REVERSALS @ 10.5 DEG, THEN 17.5 DEG UNTIL M<4

AT C-BAND ACQ:

SELECT **FILTER**

√ PREDICTOR BUGS (10, 20)

ADVISE FD: "n LOW-ELEVATION C-BANDS"

BFS ENGAGE
TOGGLE SV PBIs
CSS (CALL ROLL
REVERSALS)
MAN SPBK @ 3k
NO MLS NO HUD

WHEN FLTR GO:

√ FILTER SELECTED

NOTIFY GPO

NOTIFY FD: FILTER, ENERGY, GROUNDTRACK STATUS

IF ENERGY OUT OF LIMITS → **GCA**

FLAT TIRE
GET LATEST WINDS
XWID ON FLAT TIRE SID
(IF > 3 KTS)
CHECK GS w/SF SPBK

DELTA STATE POS:	H > 130K	48K/48K/12K
	H=90K-130K	6K/ 6K/ 6K
	H < 90K	6K/ 6K/ 3K
DELTA STATE VEL:	ΔVEL > 75 FPS	

M8 √ SFC WINDS, WX, AND ENERGY: EVAL FOR REDES

M2.5 GOTO **TAEM CHECKLIST**

R/W REDES
CHECK ENERGY, WX
K51 (AFTER CREW REDES
TRAJ MAKE PRI
REFRESH STATIC DATA
TOGGLE KRATOS (RTL5)
NOTIFY LSO (XENONS)
RESEND ENTRY SET

4.9.16 TAEM HIGH SPEED CHECKLIST

M2.5 ✓ ACQ RGO

- ✓ DELTA STATES AND PBI CONFIG
- EVAL ENERGY
- MONITOR HDG, EAS, ALT

NOTE: POST REDESIGNATION ACTIONS

- K51 AFTER CREW SELECTS R/W ONBOARD
- MAKE APPROPRIATE ENTRY SET PRIME
 - REFRESH STATIC DATA ALL PLOTS
 - TOGGLE RTLS/TSU ON EDIGS
- **If Night** ✓ **XENONS**
- NOTIFY LSO

M1.5 FINAL WX UPDATE

- CALL: "<ENERGY STATUS> APPROACHING THE HAC; WX _____ SFC WIND _____ @ _____ (_____ H/T, _____ L/R), ALTIMETER _____"
NOTE: ONLY PASS WINDS, WX AND ALTIMETER IF CHANGED
- MONITOR ENERGY DUMP/PULLUP, IF EXPECTED

- ✓ DELTA STATE -- GPO

AT HAC I/C ✓ HAC RGO

EVAL ENERGY

MONITOR EAS, BANK, H, SB

WARNING AT 70K, IF
RGO > 54:
BAILOUT YELLOW
AT 50K, IF RGO > 55:
BAILOUT RED

HAC IF $|\Delta\text{ALT}| < 1000$ FT: "ON ENERGY AT THE 270/180/90"

ELSE " ΔALT HI/LO AT THE 270/180/90"

STIN
40, 30, 20K

15K ✓ PREFINAL RGO

MON HDG, EAS (PITCHOVER), SB

CLOUDS?
FIELD IN SIGHT?

11K "GLIDESLOPE AND CENTERLINE" CALL

10K ✓ A/L RGO

TD AT WHEELS STOP:

STOP FLTR, OPS PHASE

GO TO **POSTLANDING MASS PROPERTIES CHECKLIST**

4.9.17 GCA CHECKLIST

ENTRY PHASE

- HIGH ENERGY
 - **INCREASE BANK 5 TO 10 DEG OVER NOM**
 - "ROLL REVERSALS WILL BE LATE"
 - INCREASE DELAZ LIMIT TO ≤ 25 DEG
 - **WATCH G'S, HDOT**
 - "MODULATE BANK TO HOLD 2 Gs" IF REQ'D
 - IF HDOT > 500 FPS BELOW 100K: SHALLOW BANK

- LOW ENERGY
 - **DECREASE BANK 5 TO 10 DEG BELOW NOM; 20 DEG MIN**
 - "ROLL REVERSALS WILL BE EARLY"
 - DECREASE DELAZ LIMIT, HEAD FOR ± 10 DELAZ
 - (MAY REQUIRE VERY EARLY ROLL REVERSAL)
 - G AND HDOT NO FACTOR

- TERMINATE WHEN: O/B NAV & GUIDANCE GO, AND ROLL REVERSAL OR OTHER SIGNIFICANT MNVR **NOT IMMINENT**
CALL: "CENTER THE NEEDLES AND TERMINATE GCA"
IF "GO FOR AUTO", INFORM FD

↑ IF NO CHANGE TO COMMANDS FOR ≈ 20 SEC → "MAINTAIN ..." ↓

TAEM PHASE

- √ GPO: HSI SOURCE SWITCH TO TACAN

- HDG CHANGE (BASED ON ENTRY FDO DIGS OUTPUT)
 - "TURN L/R TO HDG OF ___ DEGREES " (e.g., "ZERO-SIX-FIVE DEGREES")
 - STD TURN = 30 DEG BANK -- IF MORE/LESS REQ'D THEN
 - "INCR/DECR BANK TO ___ DEG, ROLL OUT ON HDG ___"

- ENERGY: LO ENERGY -- DECR EAS MIN ≈ 200 KTS (MAX L/D)
 HI ENERGY -- INCR EAS MAX ≈ 300 KTS

IF MACH < 1, PROVIDE SB MIN: CLOSED W/200 KTS EAS
CORRESPONDING TO EAS MAX: 100% W/300 KTS EAS

- MAKE POS CALLS TO HELP CREW VISUALIZE POS WRT HAC/RWY
- TERMINATE: O/B NAV&GUID GO; ON FINAL & FIELD IN SIGHT; OR @ 5K;
CALL: "CENTER THE NEEDLES (UNLESS ON FINAL) AND TERMINATE GCA"

4.9.18 BAILOUT CHECKLIST

- ONCE IN TAEM, VERIFY ACQ RGO
- EVALUATE ENERGY/WEIGHT (E/W) USING **STRAIGHT-IN** APPROACH AND **MEP** TO MINIMUM RANGE RUNWAY
- BAILOUT ZONES
 - RED
 - E/W < "BAILOUT" LINE
 - CALL: "**BAILOUT RED ZONE**"
 - **RECOMMEND BAILOUT**. NOTE: MAKE THIS CALL PRIOR TO 50K ALT (70K FOR ECAL) IF POSSIBLE
 - YELLOW
 - E/W > "BAILOUT" LINE BUT < "MAX RANGE" LINE (OR "RTLS MIN ENERGY" LINE IF NOT EOM)
 - CALL: "**BAILOUT YELLOW ZONE**"
 - **PROVIDE ENERGY STATUS ONLY: BAILOUT IS CREW CALL**
 - GREEN
 - E/W > "MAX RANGE" LINE (OR "RTLS MIN ENERGY" LINE IF NOT EOM)
 - **STANDARD ENTRY OPERATIONS APPLY**
 - CALL: "**BAILOUT GREEN ZONE**" ONLY AFTER RECOVERING FROM THE YELLOW ZONE
- IF REQUIRED, PROVIDE REQUEST A HEADING OR UP TO 10 DEG BANK PRIOR TO ENGAGING BAILOUT IF POST-BAILOUT ORBITER IMPACT IS LIKELY IN A POPULATED AREA
- ECAL ONLY: REQUEST HEADING OF 120° OR PARALLEL THE COAST (IF POSSIBLE)
- POST-BAILOUT DECISION ACTIONS
 - EXECUTE THE BAILOUT W/S APPLICATION:
 - AUTOMATICALLY RECORDS DATA EVERY 10K FT FROM 50K
 - NOTIFY LSO WHEN APPLICATION IS ACTIVE
 - TRAJ: AS EACH CREWMEMBER BAILS OUT, PRESS THE **CREW BAILOUT** PBI. USER CAN CHANGE TACAN FOR DETERMINING BEARING
 - PRESS **RECORD EVENT** PBI TO CAPTURE DATA FOR ANY OTHER EVENT (E.G. HATCH BLOWN)
 - IF ASCENT CONTINGENCY, NOTIFY FCO UPON ORBITER IMPACT

4.9.19 POSTLANDING MASS PROPERTIES CHECKLIST

ASAP AFTER WHEEL STOP:

- OPS PHASE
- ACTIVATE PMP , SNAP DATA (CHECK WITH PROP TO VERIFY GOOD QUANTITIES), CALCULATE POSTLANDING CG'S

√ PRESSURANTS ON PMP LINE 69 MATCH "ENTRY" VALUE (SODB DATA)

SAVE OFF COPY OF PMP FILE WITH APPROPRIATE NAME

PRINT PMP ORB B/U, CARGO, NON-PROP, AND CRYO

POST HARDCOPIES (ORB B/U, CARGO, NON-PROP, AND CRYO) IN MASS PROPS TAB OF CLIPBOARD NOTEBOOK

TELL ENTRY SUPPORT POSTLANDING MASS PROPERTIES IS COMPLETE

ENTRY SUPPORT: HARDCOPY ORBITER BUILD-UP FOR A/L POSTFLIGHT

MAKE A COPY OF POSTLANDING MASS PROPERTIES FOR **MER WEIGHTS** (THEY WILL CALL OR SHOW UP TO PICK UP THE HARDCOPIES SOMETIME AFTER LANDING)

RECORD THE LANDING WEIGHT AND CG IN THE LOG

4.9.20 EOM HIGH SPEED TRACKING SCHEDULING GUIDELINES (PAGE 1 OF 2)

KSC LANDINGS	EDW LANDINGS	NOR LANDINGS
ER (4 C-Bands) (see note 2)	PMTC (1 C-Band) (see note 3)	WSMR (3 C-Bands out of 3; 3 at WSMR) (see notes 6 and 7)
	WSMC/WR (3 C-Bands out of 4) Dryden/AFFTC(3 C-Bands out of 4) (see notes 4 and 5)	

GENERAL SCHEDULING NOTES:

1. End of mission (EOM) tracking support will be scheduled for both KSC and EDW.
2. WSMR radars will not be scheduled for early energy assessment for low inclination KSC landings. No early acquisition sites are available for high inclination KSC landings. No Kwajalein or Kaena Point C-band radars will be scheduled for early energy assessment for EDW landings.
3. Highly desirable for early acquisition on high inclination ascending approaches.
4. The NASA operated DRYDEN radars are preferred for cost savings.
5. Link to VAFB required for AFFTC radars to get acquisition data.
6. NOR tracking will not be scheduled unless waive-off occurs on EOM+1 and NOR becomes an option for EOM+2 days.
7. EOM+1 scheduling is the same as EOM for KSC and EDW.
8. EDW tracking may be released on EOM-1 if KSC is prime and the weather forecast for KSC is good for the both EOM and EOM+1 days. This decision needs to be made on EOM-2 if EOM is on a Sunday. This decision must have Flight Director approval.

EOM HIGH SPEED TRACKING SCHEDULING GUIDELINES (PAGE 2 OF 2)

ACRONYM LIST AND SCHEDULING DETAILS:

PMTC: Pacific Missile Test Center

7 C-Band stations (4 at Pt. Mugu, and 3 at San Nicolas Island). Costs include communications, computer system, and microwave link to Vandenberg.

AFFTC: Air Force Flight Test Center - Edwards Complex

1 C-Band station (EFFC). Costs include communications, computer system, and microwave link to Vandenberg.

Scheduling: One C-Band scheduled for EDW EOM landing if one Dryden radar is down.

DFRC: Dryden Flight Research Center (NASA) - Edwards Complex

3 C-Bands (FDRC, FRCC, and FRFC)). These are owned and operated by NASA, and incur no extra cost for shuttle support. Data transmission can be directly to the Eastern Range Central Computer Complex (CCC), or through Vandenberg. Direct routing for only two sources is available

Scheduling: Three C-Bands scheduled for any EDW landing. Because of cost, Dryden radars are preferred to AFFTC radars for EDW area tracking, but the AFFTC radar may substitute if a Dryden radar is down.

WSMC/WR: Western Space and Missile Center/Western Range - Vandenberg Complex

6 C-Bands (4 C's at Vandenberg, 2 C's at Point Pillar). Costs include communications, computer system, and microwave link.

Scheduling: 3 C-Bands scheduled for EDW EOM landings.

WSMR: White Sands Missile Range

3 C-Bands (HOLC, WHSC, and WSSC), 2 telemetry only S-Bands, and 2 UHF stations. Costs include communications, computer system, and microwave link.

Scheduling: 3 C-Bands scheduled for any NOR landing.

ESMC/ER: Eastern Space and Missile Center/Eastern Range - Kennedy Space Center Complex

4 DoD C-Bands (MLAC, MLMC, PATC, CMTC), [CNVC is available in "hot standby" mode], 5NASA C-Bands (4 Wallops, 1 Bermuda), 3S-Bands (2 MILA, 1 Wallops).

Scheduling: 4 C-Bands for KSC EOM.

4.9.21 ILC CHECKLIST - ENTRY

STS-_____, _____ CYCLE ENTRY PHASE ILC CHECKLIST

1. Mass Properties Processor

_____ Verify the values on the Entry Init PAD.

2. Deorbit and Entry Processors

MAKE HARDCOPIES OF THE FOLLOWING DISPLAYS FOR VERIFICATION

_____ Deorbit Constraints Table - Verify that the constraints table is set up properly.

_____ D23C - Check the value of this parameter against value in DSCT 30.

_____ N-cycles - Check the value of these parameters against the values in DSCT 30.

_____ Deorbit Maneuver Processor -Run a deorbit solution using the L-100 vector in DSCT 13

_____ Entry Design Simulator Planning - Run a DEORB on the DMP solution, then run an Orrb Normal using the EI-5 state vector from DSCT 13 and check the output for reasonableness.

_____ Drag vs Ve

NOTE

A run from 200K is sufficient to verify high speed entry trajectory processing.

3. High Speed Processors

- SMS Performance Comparison

_____ Verify that the SMS tracks the MOC groundtrack and energy plot output.

_____ Verify that high speed tracking works properly (NAV)

- Limit lines and nominal scribes - Visually check the lines on the displays below. During high speed entry runs, ensure that the displays are updating correctly.

_____ Vrel vs. Rgo (+ DELAZ vs. VREL)

_____ Groundtrack

_____ Alt vs. Rgo

_____ E/W vs. Rgo

_____ X vs. Y (log-log) - Verify that the correct OGS is flown

_____ FDO Entry Digitals

4. Verify ROSS and GPS Alarms function properly.

_____ Is this load acceptable for use during integrated entry sims (yes or no)? If no, attach a separate sheet with reasons and copies of DR's.

Signature

Date

4.9.22 FLIGHT LOAD CHECKLIST

STS-____ DEORBIT/ENTRY FLIGHT LOAD CHECKLIST

Trajectory Ops CCB Required Disclaimer

All applicable software items on the FDO DNAV pulldown menu should be verified using the Flight Load Checklist (FLC) between L-30 days and L-15 days. The FLC must be performed using a "CERT" ("MIS" or "SIM") activity for the flight of interest. If possible, applications should be used during a simulation run to verify functionality. It is the responsibility of the discipline to identify or arrange for an appropriate activity in which to perform the FLC. The objective of the FLC is to ensure that all required applications are available and properly configured in their flight support environment. This objective is met by actually running the applications on some representative input data and observing the results to be consistent within the context of available data and functions exercised. No qualitative or specific criteria are required to either prove or document success. There is no expectation to either execute or verify all of the functionality associated with each application. This check relies on the engineering judgement and training of the operator executing the FLC to select which functions to exercise and subsequently determine that the application appears to perform properly. As such, the operator executing the FLC must be a prime user from the responsible discipline. This checklist must minimally document each application on the FDO DNAV pulldown menu and exhibit a pass/fail indication. It is responsibility of discipline to reconcile incompletes or failures via waivers, workarounds or resolutions. Any such actions should be documented with the FLC. It is responsibility of the discipline to accept the results of the FLC and archive all the associated documentation for future reference (for at least 3 months after launch).

1. Limit lines and nominal scribes - Visually check the lines on the displays below.
 Note: The title of the displays should reflect the flight number and recon cycle (picked up from the delivered product title) and the delivered version of the display currently in use (i.e. VREL vs. RGO – STS-109 Cycle OCF (version 4.1)).
 VREL vs. RGO (+ DELAZ vs. VREL)
 GROUNDTRACK (BOTH FDO AND GROUP)
 ALT vs. RGO
 E/W vs. RGO
 Drag vs. Ve

2. Verify that the DNAV scripts still work properly
 HiSpeed Entry (FDO)
 Large Screen Entry Displays
 Remove All Displays

3. During high speed entry runs, ensure that the displays are updating correctly.
 VREL vs. RGO (BOTH FDO AND GROUP)
 DELAZ vs. VREL (BOTH FDO AND GROUP)
 GROUNDTRACK (BOTH FDO AND GROUP)
 ALT vs. RGO
 E/W vs. RGO
 HAC PLOT (log-log) - Verify that the right OGS is flown
 FDO ENTRY DIGITALS (Verify that PBI's work properly)
 GROUP ENTRY DIGITALS
 BAILOUT (Verify that PBI's work properly)

- GPS ROSS ALARMS
- ENTRY ROSS ALARMS

4. Verify that AUTO DEL PAD, AUTO MANEUVER PAD (PEG 4D option), ADOL and STATE VECTOR PBI's work correctly during deorbit prep sim.

- AUTO DEL PAD
- AUTO MANEUVER PAD
- ADOL
- STATE VECTOR PBI'S AND OTHER ROSS ALARMS

5. On the DEORBIT and ENTRY DNAV pulldown, call up all the displays once to verify that data acq connects properly. Note any discrepancies.

6. Verify operation of Entry Tools

- EDS
- EPSEND
- Entry Attitude Processor
- WET
- Entry Digitals
- Entry Elapsed Time Display

Is this load acceptable for use during the mission (yes or no)? If no, attach a separate sheet with reasons and copies of DR's.

STS-____ Entry FDO

Date

4.10 EMERGENCY MISSION CONTROL CENTER (EMCC)

The purpose of EMCC is to provide a backup control and monitoring capability for the shuttle in the event the MCC becomes unusable. EMCC operations are conducted in one of the firing rooms at the Launch Control Complex (LCC) at KSC. Possible activation scenarios include fire, sabotage, hurricane, or terrorist attack that renders the MCC inoperable for greater than 10 hrs*. The EMCC team is made up of approximately 17 flight controllers, including all front room operators, plus Weather, Entry Support, LSO, Pointing, and MOD. Following activation, the team must report to Ellington Field within 3 hrs for transport to KSC aboard the NASA C-9 aircraft.

The EMCC FCT plus all of their equipment is delivered to the Shuttle Landing Facility (SLF) at KSC, and then trucked over to the LCC. Firing room consoles are configured to receive orbiter downlist telemetry, plus provide voice and a rudimentary command capability. This enables EMCC systems operators to monitor shuttle systems with the aid of KSC counterparts. The EMCC flight dynamics team unpacks and sets up their portable workstation, which is capable of performing all necessary trajectory processing. The EMCC team then monitors the mission until the Houston MCC (MCC-H) can be brought back on-line. In the event MCC-H is unrecoverable, the EMCC is capable of executing a deorbit prep and entry in order to bring the crew safely home.

4.10.1 Flight Dynamics Team Activation and Deployment

The EMCC flight dynamics team consists of FDO, GPO, Traj, Entry Support Engineer (ESE), and LSO. The entire team must be entry-certified in case the EMCC is called upon to land the orbiter. Once the decision has been made to activate EMCC, the on-console flight director will notify their team and direct them to begin working EMCC activation steps in the 450-CAP-EMCC document. The on-console orbit FDO is responsible for alerting the EMCC flight dynamics team via pager or telephone. Other steps specified in appendix 3.B of the FDO Console Handbook Vol III are performed at this time by the orbit team. These include notifying USSTRATCOM and other external organizations, sending a current ephemeris to GSFC, and making copies of console data.

Note

ESE and LSO are mandatory if a landing will be conducted by the EMCC. If a landing is not anticipated, then they probably won't accompany the original team, but instead would be on-call. If the decision is made later to land from the EMCC, ESE and LSO would travel to KSC via commercial airline. For hurricane scenarios, ESE and LSO are mandatory regardless of weather forecasts, since conditions at Houston may not allow them to be flown out later to support subsequent landing operations.

*For a hurricane, EMCC activation normally occurs at the same time the decision is made to close JSC. The trigger point for this is a forecast of winds 50 kts or greater within the next 36 hrs.

Upon call-up, the EMCC FDO and Traj will typically report to JSC in order to gather equipment for deployment. This consists of retrieving the both portable workstations, SPOC computer, and EMCC documentation from storage and placing them in designated staging areas for pickup by ground transportation personnel. EMCC FDO may also conduct a quick tagup with the on-console FDO in order to assure that all necessary trajectory data has been hardcopied and placed in the EMCC briefcases. The standard staging area is at the front of the white FCR. An additional pickup location is the B4N loading dock (between B4N and B5). This is for FAO's spare FDF crate and FDO's spare workstation, which is stored in the Pointer Lab in B4N. EMCC FDO or Traj must move the B4N workstation downstairs to the loading dock ASAP, since this will be the first stop for the ground transport folks on their way to the white FCR. An informal agreement has been made with the FAO shop that someone from their department will safeguard all the equipment until it has been picked up. Detailed activation steps are documented in the EMCC Deployment Checklist in the following section (4.10.2). Be aware that the portable workstations are stored in rooms with cipher locks. Contact the EMCC lead or DM46 group lead to find where the combinations are kept.

Once all DM equipment has been placed in the staging area(s), EMCC FDO and Traj must immediately proceed to Ellington Field in order to board the C-9 aircraft. They should each have a previously-packed "go bag"--a small soft-sided duffle bag with essential personal items for their deployment (12 lbs max). (Helpful hint: the aircraft can get somewhat chilly, so you may want to include a light jacket in your "go bag"). At the conclusion of the 2 hour flight to KSC, the EMCC team is badged and bussed over to the LCC. There to meet each EMCC operator is one or more designated KSC counterparts who provides expertise in LCC console equipment as well as shuttle systems. For the flight dynamics team, the KSC counterparts are a NASA Shuttle Project Engineer (SPE) and USA Test Project Engineer (TPE); these personnel normally support the Integration console. The EMCC layout in the LCC firing room is shown in Figure 4.10-1. Note that the flight dynamics team is co-located with GPO and DPS, while LSO is located at the LRD console. Figure 4.10-2 shows the FDO console during the 2003 activation exercise at KSC. A brief description of LCC console equipment is included next.

- Digital Operational Intercommunication System (OIS-D) - Several OIS-D units are available at the FDO/GPO console, allowing each operator a dedicated unit. Headsets specific to the LCC are provided by KSC personnel. The OIS-D's are only capable of handling 4 channels, so loop allocation must be chosen carefully. FDO and Traj must coordinate (along with LSO) to ensure the necessary voice loops are being monitored. Table 3-1 in the 450-CAP-EMCC document lists OIS loop assignments.
- ESA Displays - The FDO/GPO console is configured with a "management" software load that provides overview displays for all sub-systems. These are displayed on the built-in console monitors, which your TPE assistant can configure. While very "systems-centric", a few of the displays are slightly useful: "Orbiter Systems Overview" off the Integrated Menu, "GPS PASS Display Mon" from the NAVAIDS Menu, and "OMS Engine Control" from the OMS/RCS Menu. Samples of these displays may be

found in the EMCC FDO Handbook, which is kept in one of the black hardbody briefcases in the DM46 Group Lead's office.

- PC GOAL - Each console has a couple PCs capable of displaying additional data. KSC TPE personnel have custom-built several displays of special interest to FDO/GPO. These are: "OPS 2 State Vector", "Deorbit MNVR", "Orbiter Pointing", and "PASS Entry Guidance". *These are the main FDO/GPO interface to onboard telemetry in the EMCC*, and are used for such tasks as: obtaining an onboard state vector, verifying PEG target load, and checking onboard SPEC50 config. However, these displays have **several significant limitations**. First, all double precision parameters must be multiplied by 10 (e.g. state vector position, GMT time--anything marked with an '*'). Second, all times are displayed in GMT seconds. An Excel application is available on the EMCC laptop PC to convert seconds to day:hrs:min:sec format. Finally, GMT decimal seconds are not included (GMT is truncated), so time is only good to ± 1 sec. The inability to resolve decimal seconds means that a vector compare between onboard and ground will be larger than normal. Display examples and data content are described in detail in the A/E GPO Console Handbook section **TBD**. If in doubt about the quality of the onboard state vector prior to entry, have the crew voice read the onboard state vector while in Ops 2 by freezing the SPEC 34 display (state vector is displayed in kft and kfps).
- BASIS PCs - Additional PCs are provided for internet access. This is used principally for a groundtrack display provided by GSFC FDF (more on this below).

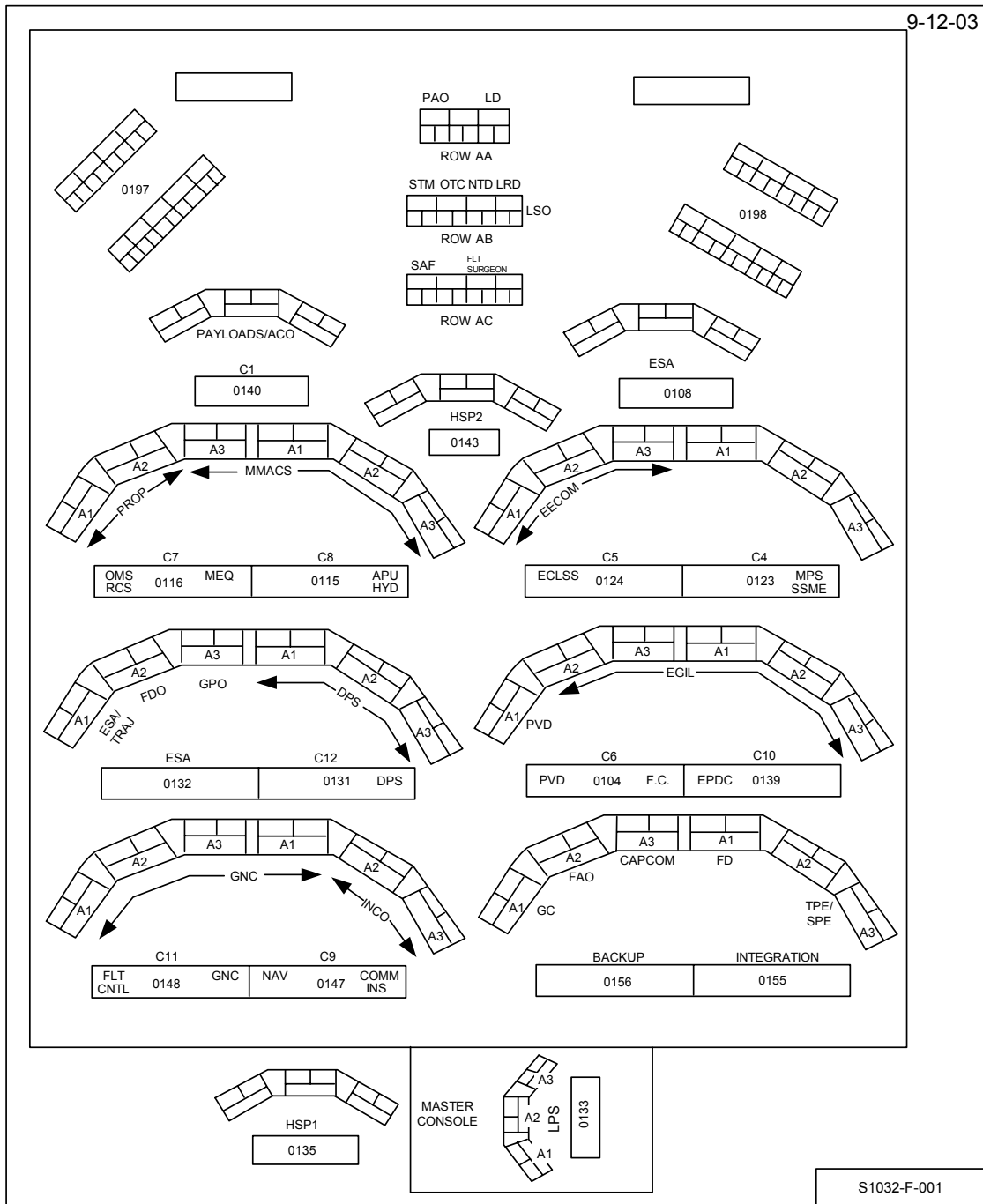

Figure 4.10-1 Firing Room Layout

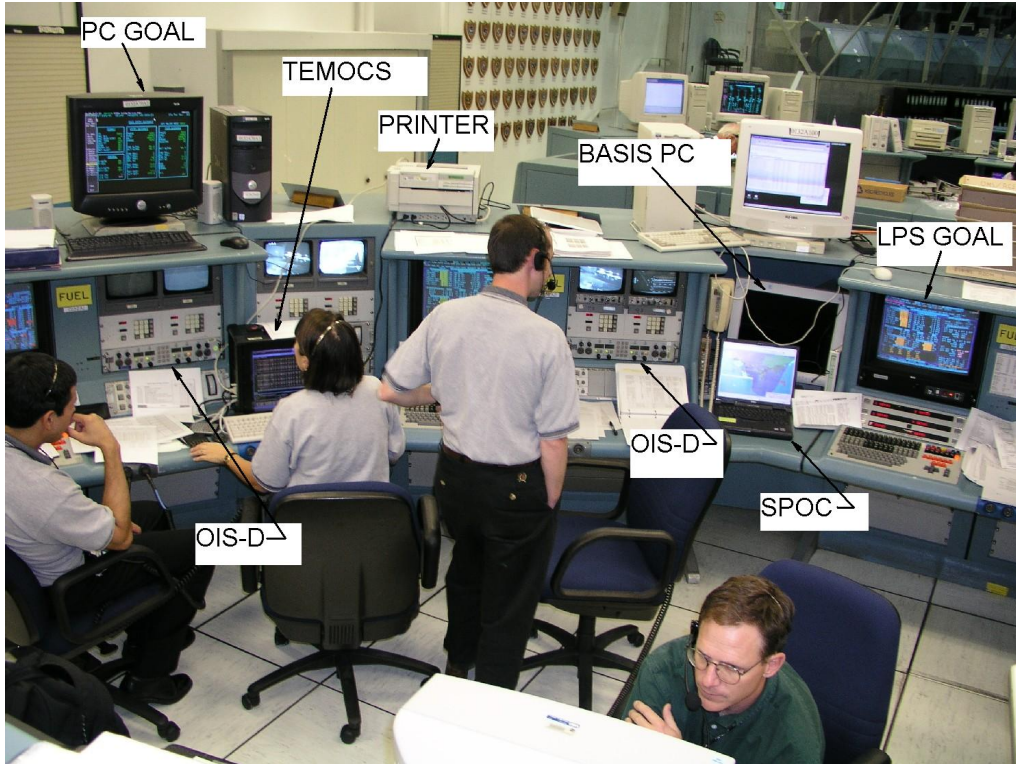

Figure 4.10-2 Flight Dynamics EMCC Console

4.10.2 EMCC FDO Deployment Checklist

Upon EMCC activation, the on-console FDO/Traj will page the EMCC FDO, GPO, Traj, ESE, LSO & begin copying databook material detailed below. The EMCC FDO &/or Traj will report to JSC to collect hardware listed below & place in the designated staging area at the front of the WFCR (one exception noted below). If insufficient time is available for the EMCC FDO/Traj to make it to JSC, then the on-console FDO/Traj will gather all materials if at all possible. **EMCC FDO & Traj should retain a copy of this checklist to assure required equipment is loaded onto aircraft at Ellington Field.** See pertinent procedures in FDO Console Handbook section 4.10.4 & appendix 3.B.

- ___ TEMOCS W/S from **TOCSS Lab*** located under A/E Trainer table
- ___ Printer/accessories box from **TOCSS Lab*** located under A/E Trainer table
- ___ Laptop PC (B30A/3062B) located in right hand cabinet of gray credenza (key magnetically attached to underside of middle of credenza)
- ___ Two black hardbody briefcases for documentation (B30A/3062B): EMCC CAP, EMCC databook, FDO Console Handbook, TEMOCS User's Guide
- ___ TEMOCS W/S from **B4N/3044*** located at far end of room under table. **Deposit at B4N loading dock where FAO personnel collect EMCC FDF material.**



TEMOCS workstation

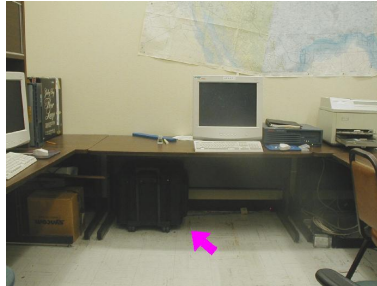

TEMOCS location in B4N



TEMOCS location in TOCSS

Orbit team will copy the following documents to make up an EMCC databook. Place these in the black hardbody briefcases obtained above.

- ___ Console Logbook (as required)
- ___ Pager list
- ___ USSPACECOM vector delivery schedule and phone list (as required)
- ___ Current DOPS data (DOT, chronological, sun angle/glare, ascending nodes)
- ___ Deorbit constraints (DSCT-05, DSCT-30)
- ___ Recovery pre-bank (DSCT-28)
- ___ LSO Nav and Landing Aids chart
- ___ Current PADJ curve
- ___ Current orbiter/target/TDRS state vectors & prop data (wt, area, KCON, F10.7, Kp)
- ___ Prop products (PROP-TO-FDO, TANK FAIL) & OMS ballast baseline worksheet
- ___ Current, predicted, and baseline entry PMP hardcopies
- ___ Mass properties data (PROP-31)

*Cipher combos available from DM46 Group Lead or EMCC Lead

4.10.3 EMCC Portable Workstation

The heart of EMCC trajectory operations is the portable Trajectory Emergency Mission Control Station, or "TEMOCS". This hardened, ruggedized, UNIX-compatible workstation has all the necessary tools and applications to perform mandatory trajectory processing in a stand-alone environment. A printer is also deployed with the workstation. This section provides an overview of the tools available on TEMOCS. For detailed work instructions, consult the EMCC Users Guide located in the EMCC black hardbody briefcases.



Figure 4.10-3 TEMOCS

- Trajectory Software Applications (TSA) - The latest TSA version is resident on TEMOCS. This provides the capability to input vectors, generate an ephemeris, compute deorbit targets, generate acquisitions data, perform a vector compare, plus many other functions.
- Paperless Mass Props (PMP) - TEMOCS is loaded with PMP so the EMCC team can compute vehicle weight and c.g. information. In a deployment scenario, MCC-H PMP hardcopies would be used to initialize EMCC PMP via manual input. During later operations, the EMCC team must manually generate current and predicted mass props using inputs from systems operators.
- Winds Evaluation Tool (WET) - WET allows users to manually input winds aloft data, so that EDS can incorporate it during its TAEM and A&L simulation. This is important for evaluating HAC dynamics and runway selection. All weather data is obtained from an SMG meteorologist, remotely located at the Range Operations Control Center (ROCC) weather facility. Winds aloft data comes to ESE via fax. Note that the latest EDS version allows winds to be typed in directly without using WET.
- Entry Dynamics Simulator/Entry Attitude Processor (EDS/EAP) - These tools allow the EMCC team to evaluate DMP-generated deorbit targets by simulating the resultant entry profile. As mentioned above, winds data can be incorporated to evaluate TEAM and A&L conditions. EDS/EAP is the prime tool for runway selection, groundtrack prediction, HAC dynamics prediction, and speedbrake/aimpoint selection.

Prior to EMCC activation, the TEMOCS workstation database will not necessarily be configured for the flight in progress. Database updates are only performed occasionally, in concert with new software drops, and are only done for OCF cycle vice LDP. This is to minimize EMCC software maintenance cost. However, a workaround is available for the EMCC team to obtain the desired LDP data. At approximately L-2 days, the TOCSS GA

burns a CD containing the entire /users/trj/Database/ which has all necessary files to update TEMOCS for that mission (TSA baseline, PMP files, DDS element files, etc). A prime and spare CD are stored with the EMCC briefcases. Upon arrival at KSC, the EMCC team inserts the CD into TEMOCS, and runs a script to load the files into their proper locations. Then the user initializes local TSA and restores the Global database from the new Baseline using the checkpoint tool. After that, the EMCC team can make manual inputs as necessary to get TEMOCS up to speed (e.g. state vectors, PMP mass props, deorbit constraints, etc). Note that Backup procedures are available for manually configuring TEMOCS in the event the CD does not load. Refer to the TEMOCS Users Guide for more detail.

4.10.4 GSFC Interface

Goddard Space Flight Center (GSFC) performs several critical functions in support of shuttle flights. GSFC is in charge of the network that routes command, voice, and telemetry from the TDRS ground terminal at White Sands to JSC. In an EMCC scenario, GSFC reconfigures the network to transfer control of these services from JSC to KSC. Also, the GSFC Flight Dynamics Facility (FDF) takes over prime responsibility for orbit determination during EMCC ops. Telephone numbers for the FDF are contained in the 450-EMCC-CAP Supplement. It is a good idea for FDO to establish voice contact with the FDF soon after deployment to KSC. The remainder of this section focuses on FDF responsibilities and their interface with EMCC FDO.

- Orbit Determination - FDF performs OD with ground-based C-band radars plus TDRS S-band doppler. FDF faxes TDR state vectors to the EMCC every orbit.
- Ground site scheduling - FDF schedules ground S- and C-band sites as necessary. TDRS scheduling is also performed at GSFC.
- Entry acquisitions planning - The EMCC is incapable of electronically transmitting an entry ephemeris for acquisitions planning. Therefore, an abbreviated set of vectors from the TSA entry ephemeris is printed and manually faxed instead (post-D/O burn, plus landing-30, -20, and -10 minutes). See section 2.6.5 in 450-CAP-EMCC document. FDF sends these vectors to White Sands for TDRS antenna pointing. A hardcopy of the Entry PSAT is also sent in order to plan for the handdown from TDRS to MILA S-band prior to touchdown, which will be planned for the next even minute past AOS plus one minute. FDF manually computes MILA antenna pointing coordinates based on the vector set.
- Worldmap/Groundtrack Display - An FDF application "SN BEAMS" is used to generate a "worldmap" type display and publish the output over the internet (Figure 4.10-4). This allows the EMCC FCT to obtain the display on their BASIS PCs using Internet Explorer (PC must be JAVA enabled). Shuttle orbital groundtrack is superimposed on a world map. The current ISS/orbiter and TDRS bugs are driven based on the FDF ephemeris. MET and GMT are shown along with other trajectory data. The display updates every 8 seconds, but sometimes blanks briefly for unknown reasons. FDO is the EMCC point of contact with FDF regarding display configuration and coordination

with the EMCC FCT. FDO should notify the EMCC FCT of the url address so that the team may access the display (<http://fdfhome.gsfc.nasa.gov> select video 1 or 2 as directed by FDF).

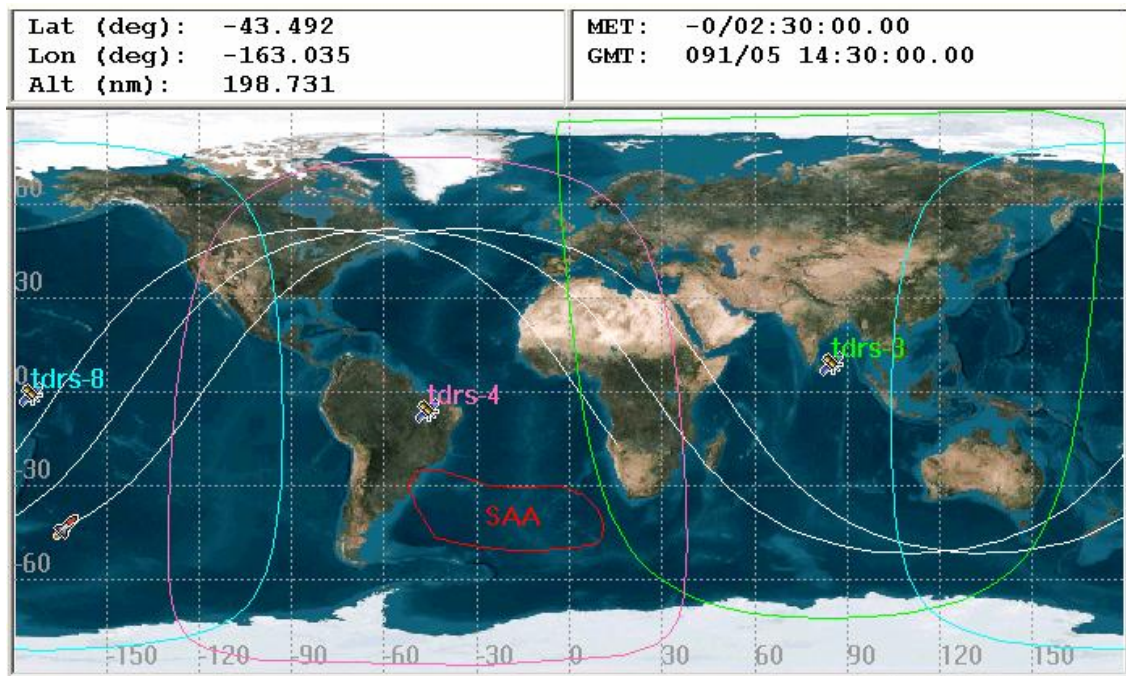

Figure 4.10-4 Example SN-BEAMS worldmap display

4.10.5 EMCC Flight Dynamics Team Responsibilities

The EMCC Flight Dynamics team is responsible for the following:

- a. Maintaining an accurate TSA ground ephemeris for trajectory planning and acquisitions support. FDF is an important player in this function by performing orbit determination and providing anchor vectors. USSTRATCOM and GPS are also available as backups.
- b. Maintaining an accurate onboard navigation state. GPS is the prime method for updating the onboard vector. FDO is responsible for verifying a good vector by comparing the onboard against the latest ground ephemeris. FDO may also be called upon to generate a manual HEX state vector command load or voice delta-state should GPS be unavailable.
- c. Provide regular updates to ACQMON and SPOC state vector data to the EMCC FCT.
- d. Coordinate with USSTRATCOM to insure no collisions with orbital debris.
- e. Generate deorbit opportunities, deorbit targets, DEL PAD, and MNVR PAD to support deorbit/entry operations.
- f. Conduct entry, TAEM, and A&L performance analysis and runway selection.
- g. Coordinate activities with landing site(s), DOD, FAA, and State Department

FDO has overall responsibility for trajectory operations in the EMCC. Traj provides assistance for many of the tasks above, and is generally responsible for operating the

TEMOCs workstation. Landing site coordination is conducted by LSO, with FDO kept apprised of landing site status and availability. ESE inputs balloon data and performs detailed entry, TAEM, and A&L analysis based on winds of the day, and advises FDO on runway, aimpoint, and speedbrake selection.

4.10.6 Further Resources

This section of the FDO Console Handbook is generally intended to provide an overview of FDO EMCC procedures and capabilities. More detailed “step instructions” are contained in the following documents.

450-CAP-EMCC - Official governing document for EMCC operations. May be accessed on-line from the FDO website, plus a copy is kept in the EMCC FDO Handbook in one of the black EMCC hardbody briefcases. This includes activation steps, KSC firing room procedures, coordination with external organizations, and other operational instructions. It is essential that EMCC-qualified operators read this document, and have a thorough understanding of sections governing FDO procedures for state vector uplink, deorbit target generation, and coordination with GSFC.

FDO Console Handbook Vol III Appendix 3.B - EMCC activation steps for on-console (orbit) team. Orbit FDOs should be well familiar with these procedures.

FDO Console Handbook Vol IV section 4.10.2 - Activation steps for EMCC team. EMCC-qualified operators should not only read this checklist, but also step through the procedures and make sure they can find all of the equipment.

EMCC FDO Portable Workstation Users Guide - Detailed instructions for operating the TEMOCs workstation. A copy is available in the EMCC FDO Handbook which is kept in one of the black EMCC hardbody briefcases. EMCC-qualified operators should be capable of performing all steps in this document.

A/E GPO Console Handbook Vol I GPO EMCC Checklist - TBD . This section of the GPO handbook is contained in the EMCC FDO Handbook which is located in one of the black EMCC hardbody briefcases. Also included are printouts of some useful ESA displays.

4.A FDO CONSOLE HANDBOOK DOCUMENTATION CHANGE PROCESS

- 1) The change initiator fills out a change request (CR) form. The CR form is available on the dm server under S:division/private/dm46/forms/fdochcr. See page 4.E-3 for an example of this form. At a minimum, the initiator supplies the submission date, a short descriptive title, a detailed description of the change, rationale for the change, and the initiator's organization/name.
- 2) The initiator transmits the CR form to the pertinent documentation editor.
- 3) The editor reviews the CR and formulates recommendations for implementation. These include whether or not to implement some or all of the change and a competent technical author designated to draft documentation changes.
- 4) The editor reviews implementation recommendations with the pertinent group lead, who annotates the CR as approved or disapproved for implementation.
- 5) If the CR is disapproved for implementation, the initiator is informed of its disposition. The editor may elect to retain the CR on file for future reference or dispose of the CR completely.
- 6) If the CR is approved for implementation, the editor assigns it a tracking number.
- 7) The author submits draft documentation to the editor.
- 8) The editor reviews and modifies the draft for technical correctness and consistency with related documentation. Additional contributions from the author may be requested by the editor during this process.
- 9) The editor submits the modified draft to selected technical experts for additional peer review.
- 10) Technical experts submit draft feedback to the editor.
- 11) The editor absorbs appropriate peer review feedback into a final draft. Additional contributions from the author may be requested by the editor during this process.
- 12) The editor incorporates the final draft into a page change notice (PCN) original. The PCN may also contain final drafts related to other CR's and appropriate changes to the affected document's table of contents or revision history.

- 13) The editor reviews PCN content with the group lead, mapping changes into CR's authorized for implementation. If a CR is found to be addressed by the PCN such that it has been completely implemented, the lead annotates the CR as closed. Some CR's may be left open because they must be implemented with multiple PCN's. When satisfied with PCN content, the group lead and Branch Chief approve the document by signing the Signature Page. The editor must fill out both JSC Form 31 and 1410 prior to delivery of the PCN to the Printing Management Branch for formal printing.

- 14) The editor supervises PCN reproduction and distribution. This includes posting the PCN to "general use" console and office copies of the affected document.

FDO Console Handbook Change Request (CR)

Submit Date:	Volume:	CR #
<small>For Administrative Use Only</small>		

Subject:
Description of Change or Addition:

Reason for Change or Addition:	
Initiated By:	Assigned To:

For Administrative Use Only

Group Lead Authorization Signatures	
IMPLEMENT	CLOSE (PCN =)

Revised July 1996

4.B DMP DIAGNOSTICS

PEG DIAGNOSTICS

- B01 NORMAL SOLUTION
- B02 NO PHYSICAL SOLUTION IN LTVCON
- B03 HYPERBOLIC TRAJECTORY IS LTVCON
- B04 VGO=0
- B05 MAX ITERS EXCEEDED - NO CONVERGENCE
- B06 INPUT THRUSTER N/A FOR PEG GUIDANCE

ENTRY CAPTURE DIAGNOSTICS

- C01 NORMAL SOLUTION
- C02 NO CONVERGENCE ON DRAG PROFILE
- C03 MAX TIME REACHED BEFORE VREF
- C04 MAX TIME REACHED IN PRE-ENTRY PHASE
- C05 GAMMA TOO STEEP IN FIXED GAMMA MODE
- C06 MAX TIME REACHED BEFORE EI (OFF-TGT)
- C07 MAX TIME REACHED BEFORE EI (BRNSEQ)
- C08 TIG VEC INTRPOL ERR, TGT EPH IN DTM
- C09 CORE NOT AVAIL FOR TGT EPH GEN

SOLUTION ACCEPTABILITY IDS

- F00 PRECISION VERIFICATION INCOMPLETE
- F01 REQUIRED WASTING ACHIEVED
- F02 WASTING NOT ACHIEVED - SHORT ON FUEL
- F03 REQUESTED INPLANE ACHIEVED
- F04 FUEL CRIT NOT ACHIEVED - EXCESS FUEL
- F05 REQUESTED FUEL CRITICAL ACHIEVED
- F06 FUEL CRIT NOT ACHIEVED - MIN DV SOLN
- F07 FUEL CRITICAL ACHIEVED - UNACC ENTRY
- F08 FC N/A - MIN DV COMPUTED - UNACC ENTRY
- F09 FC N/A - NO TARG RECOMP - NO VALID ACC

MAX ITERATION DIAGNOSTIC

- M01 ACCEPTABLE SOLUTION
- M02 FUEL CRIT TARG LINE INCRMT - TIG FREE
- M03 MIN DV SEARCH OPTIMIZATION
- M04 RANGE CONVERGENCE ITERATION
- M05 EQUAL PSI-ANGLE ITERATION
- M06 EQUAL OMS PROP ITERATION
- M07 ITERATION TO HIT TFF CONSTRAINT
- M08 CROSSRANGE ITERATION
- M09 OFFSET TARGETING ITERATION
- M10 INCREMENT OF TIG BY ONE ORBIT
- M11 RANGE TOLERANCE ITERATION IN PREVER
- M12 FUEL CRIT TARG LINE INCRMT - TIG FIXED

- M13 ETG RANGE ERR ITER WITH CANNED GUID
- M14 ETG RANGE ERR ITER WITH ACTUAL GUID
- M15 ETG PFA ITERATON
- M16 RANGE ERROR ITER IN EIPOS
- M17 RANGE ERROR ITER IN CCOMP

DTM PROCESSING LOCATION IDENTS

- P01 INITIALIZATION COMPLETE
- P02 TIG-FIX/TIG-FREE SOLN COMPLETE
- P03 OFFSET TARGETING COMPLETE

TIG-FREE

- P04 FUEL WASTING, MIN DV SOLN FOUND
- P05 FUEL WASTING, INPUT DATA SOLN FOUND
- P06 F-WAST, EQ OMS, APPROX ETG SOLN FOUND
- P07 FUEL WASTING, EQ OMS SOLN NOT AVAIL
- P08 F-WAST, SWITCH TO INPL, INP DATA FOUND
- P09 INPLANE, MIN DV SOLN FOUND
- P10 INPLANE, INPUT DATA FOUND
- P11 FUEL CRIT, MIN DV SOLN FOUND
- P12 FUEL CRIT, INPUT DATA SOLN FOUND
- P13 FUEL CRIT, APPROX ETG SOLN FOUND
- P14 FUEL CRIT, TARGT LINE RAISED
- P15 APPROX ETG SOLN FOUND

TIG-FIXED

- P16 FUEL WAST, INPUT DATA SOLN FOUND
- P17 INPLANE, INPUT DATA SOLN FOUND
- P18 FUEL CRIT, INPUT DATA SOLN FOUND
- P19 FUEL CRIT, APPROX ETG SOLN FOUND
- P20 FUEL CRIT, TARGET LINE RAISED
- P21 APPROX ETG SOLN FOUND

ETG ABORT FLAGS

- S01 NORMAL ETG TERMINATION
- S02 EI PFA CANNOT BE DEFINED
- S03 ABORT IN RANGING INTEGRATION (PRED)
- S04 MAX ITERS EXCEEDED IN CORRECT FUNC
- S05 ABORT IN RANGING INTEGRATION (CORR)
- S06 MAX ITERS EXCEEDED IN CORRECT FUNC
- S07 NO C1/C2 DETERMINED - MAX ITERS

TFF CONSTRAINT INDICATORS

- T01 NORMAL SOLUTION
- T02 TFF FORCED TO CONSTRAINT

T03 TFF FORCED TO CONSTRAINT - UNACCEPT SOLN BECAUSE DV
G.T. AVAIL DV
T04 TFF CONSTRAINT EXCEEDED

VECTOR ACCEPTABILITY INDICATOR

V01 NORMAL SOLUTION
V02 ANC VECT TIME LATER THAN RATL BEGIN