



1. REPORT NO. NASA TM X-64675	2. GOVERNMENT ACCESSION NO.	3. RECIPIENT'S CATALOG NO.	
4. TITLE AND SUBTITLE SPACE SHUTTLE EARTH ORBITAL RENDEZVOUS TARGETING TECHNIQUES FOR NEAR CIRCULAR TARGET SATELLITE ORBITS		5. REPORT DATE June 27, 1972	6. PERFORMING ORGANIZATION CODE
7. AUTHOR(S) A. W. Deaton		8. PERFORMING ORGANIZATION REPORT NO.	
9. PERFORMING ORGANIZATION NAME AND ADDRESS George C. Marshall Space Flight Center Marshall Space Flight Center, Alabama 35812		10. WORK UNIT NO.	11. CONTRACT OR GRANT NO.
12. SPONSORING AGENCY NAME AND ADDRESS NASA Washington, D.C. 20546		13. TYPE OF REPORT & PERIOD COVERED Technical Memorandum	
15. SUPPLEMENTARY NOTES		14. SPONSORING AGENCY CODE	
16. ABSTRACT  This report develops the targeting techniques required to achieve space shuttle rendezvous with a target satellite in a near circular orbit.			
17. KEY WORDS Targeting Techniques Orbital Insertion Surface Target Ephemeris Isolation Logic		18. DISTRIBUTION STATEMENT Unclassified - Unlimited  <i>E. D. Geissler</i> E. D. Geissler Director, Aero-Astrodynamic Laboratory	
19. SECURITY CLASSIF. (of this report) Unclassified	20. SECURITY CLASSIF. (of this page) Unclassified	21. NO. OF PAGES 27	22. PRICE \$3.00

### ACKNOWLEDGEMENT

The author would like to express his thanks for the work performed by Mrs. P. D. Brandon and Mr. T. L. McLeish of S&E-AERO-GG in establishing the shuttle orbital insertion surface and acknowledge the fine effort by Mr. Earl Bentley of Northrop Services, Inc. for taking the equations and flow charts of the author and efficiently verifying and programming them.

## LIST OF ILLUSTRATIONS

<u>Figure</u>		<u>Page</u>
1	Near Circular Shuttle Rendezvous Maneuver Sequence for Targeting . . . . .	3
2	Shuttle Rendezvous Inplane Launch Geometry . . . . .	5
3	Shuttle Orbital Insertion Surface . . . . .	8
4	Shuttle Orbital Insertion Surface . . . . .	9
5	Orbital Inclination Versus Latitude . . . . .	11
6	Space Shuttle On-Board Targeting Flow Diagram . . . . .	18
7	Elliptical Shuttle Rendezvous Maneuver Sequence for Targeting . . . . .	20

# SPACE SHUTTLE EARTH ORBITAL RENDEZVOUS TARGETING TECHNIQUES FOR NEAR CIRCULAR TARGET SATELLITE ORBITS

## SUMMARY

This report develops the targeting techniques required to determine the guidance reference release time of the space shuttle navigation system, the orbital insertion targeting values, and a timeline of orbital maneuvers for the space shuttle to achieve rendezvous with a target satellite in a near circular orbit and includes an extension to achieve rendezvous with a target satellite in an elliptical orbit.

## I. INTRODUCTION

The purpose of this report is to develop targeting techniques for the space shuttle to handle near circular target satellite orbit rendezvous missions in an efficient manner with respect to time and computer storage requirements. The targeting techniques developed in this report make it possible to achieve a total autonomous space shuttle rendezvous system which could satisfy both NASA and Department of Defense (DOD) missions. This report will treat the targeting techniques from a general viewpoint and leave the detailed equations and computer listing of the finished product to a separate report published by Northrop Services Inc., Aero-Astroynamics Laboratory support contractor. The Northrop Services Inc. report entitled "Shuttle On-Orbit Rendezvous Targeting: Circular Orbits" (M-244-1082)\* will be released with this document. The earth orbital rendezvous targeting computer program was developed to satisfy a need for a unified guidance targeting algorithm to cover the total problem of achieving rendezvous from the guidance reference release signal to the terminal rendezvous phase. This guidance targeting algorithm could become a basic part of the MASCOT (Manned Shuttle Comprehensive Optimization and Targeting Program) overall unified steering system; although the targeting data output from the program would also be equally applicable to any guidance system.

This report will address the following subjects:

1. Treatment of the target satellite ephemeris.
2. Development of the shuttle orbital insertion surface.

---

\* Northrop Services Incorporated document M-244-1082 entitled "Shuttle On-Orbit Rendezvous Targeting: Circular Orbits" is dated May 1972, and can be obtained from the Scientific and Technical Information Facility, P. O. Box 33, College Park, Maryland, as NASA CR-123713.

3. On-orbit rendezvous targeting and isolation logic,
4. Output data from targeting program, and
5. Extension to the general elliptical target satellite orbit rendezvous missions.

## II. GENERAL DISCUSSION

Necessary to any detailed treatment of targeting for rendezvous is a discussion of the mission profile to be utilized in the rendezvous flight plan. Justification as to why this particular mission profile was selected will be discussed later in the report. Figure 1 is an illustration of the mission profile selected to demonstrate the targeting techniques. The shuttle orbiter (on-orbit flight configuration) is inserted into a 50 x 100 nautical mile elliptical orbit (location with respect to the target satellite denoted by the numeral "0"). At first apogee passage the orbiter is circularized at 100 n. mi. (numeral "1"). The orbiter remains in the 100 n. mi. circular orbit until the phase relationship with respect to the target satellite is correct for an orbit transfer (numeral "2"). The orbit transfer initiated at position "2" is a near Hohmann transfer designed to permit a maneuver to be performed at position "3" which will place the orbiter in an orbit approximately 10 n. mi. (or whatever is desired) below and behind the target satellite (gross rendezvous). The slight overshoot of the desired gross rendezvous orbit is designed to guarantee that an intersection will exist even if the propulsion system should give an under-speed engine cutoff (thrust decay uncertainty). Position "3" was selected for the maneuver point to allow the greatest time to exist prior to the maneuver so that an onboard navigation update could be performed. Position "4" represents the point in orbit where terminal rendezvous phase initiation (TPI) should begin and represents the stopping point of the on-orbit rendezvous targeting program. The terminal phase portion of the rendezvous is achieved by using Lambert targeting techniques in which the target satellite is advanced through some specified arc ( $130^{\circ}$  -  $140^{\circ}$ ). The radius vector of the orbiter at position "4", the radius vector and time of the target satellite at the end of the specified transfer arc ( $R_1$ ,  $R_2$ , and  $t$ ) are used in the solution of Lambert's problem.

The problem definition simply stated is to determine the space shuttle guidance reference release time (universal time), orbital insertion time and state (position and velocity vector), and a timeline of all on-orbit maneuvers (phase relationship, impulsive velocity, and time) required of the orbiter to achieve the desired relationship of the orbiter and target satellite at terminal rendezvous phase initiation. This information should be based upon a given set of near circular target satellite ephemeris data. An in-depth discussion of the form of the data output from the targeting program will be given later in the report. The assumptions and constraints to be considered in the solution of this problem are listed below:

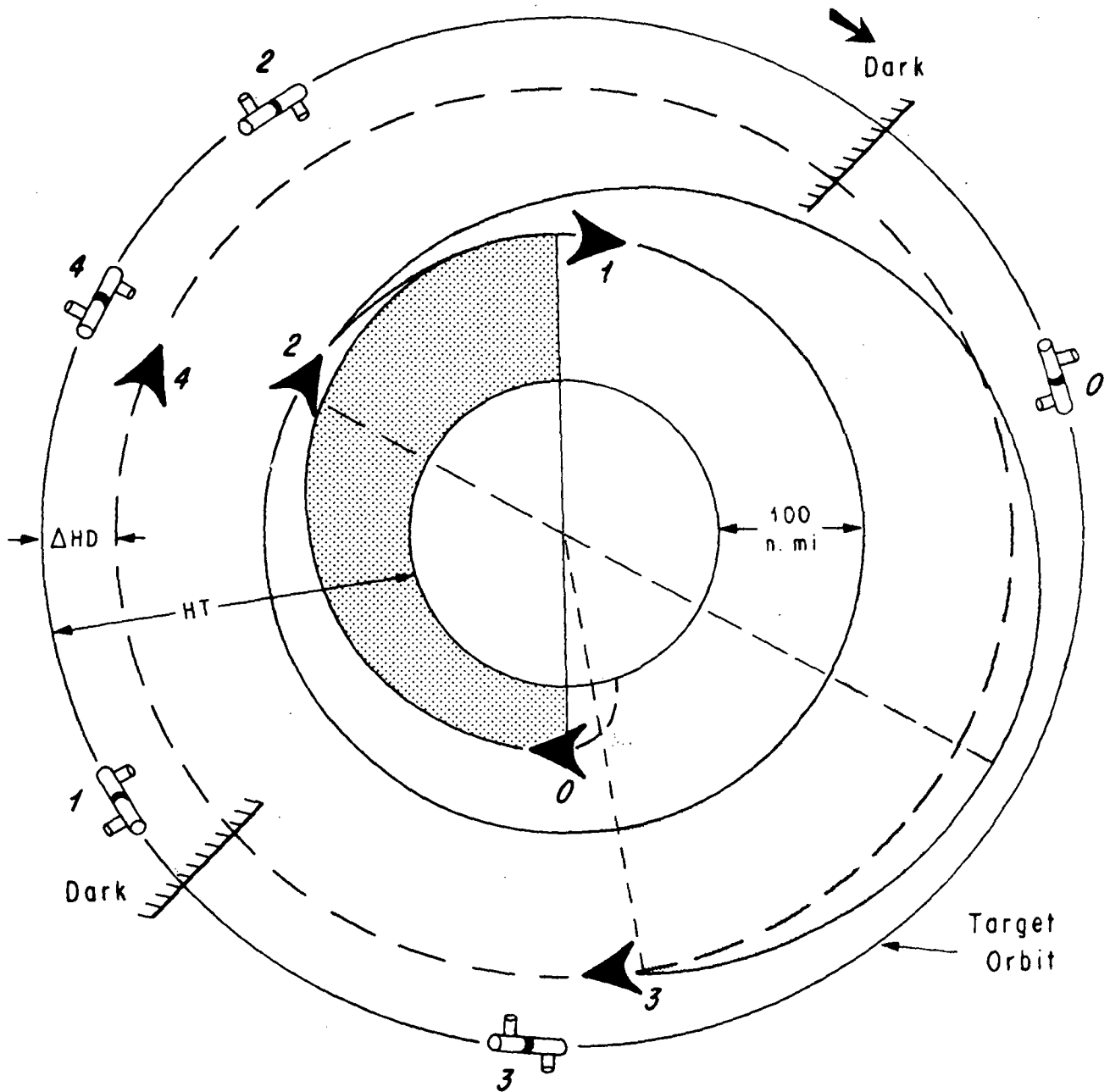

SYMBOLS

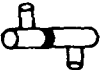
-  Shuttle Orbiter
-  Target Satellite

ORBITER MANEUVERS

- 0. Orbit Insertion (50 X 100)
- 1. Circularization (100 X 100)
- 2. Orbit Transfer
- 3. Gross Rendezvous
- 4. Terminal Phase Initiation

FIG. 1 NEAR CIRCULAR SHUTTLE RENDEZVOUS MANEUVER SEQUENCE FOR TARGETING

1. A rotating oblate earth model
2. Steady state, moment balance, acceleration limited, ascent trajectory computation
3. On-orbit atmospheric forces
4. Nominal on-orbit venting
5. Solar vector lighting constraints
6. On-orbit autonomous navigation update constraints.

### III. SHUTTLE ORBITAL INSERTION SURFACE AND TARGET SATELLITE EPHEMERIS DATA

The space shuttle is presently being designed to be a highly reliable earth orbital payload delivery launch configuration with a high degree of built-in redundancy available in all critical systems. This high reliability should greatly increase the probability of a launch on time over the Saturn vehicles which had several single point failures in the many launch vehicle systems. The Saturn V launch vehicle plus the Apollo spacecraft represents the most complex launch vehicle system ever built, and the launch window option has only been exercised once through the Apollo 16 mission. It appears highly unlikely that an earth orbital rendezvous launch window could be justified for the space shuttle since the reliability of the shuttle will be so high. Since the shuttle is a performance critical vehicle, the amount of propellant that could be allotted to build an earth orbital rendezvous launch window would be so small that very little could be gained in terms of increased launch probability. These facts indicate the space shuttle should be targeted to a minimum plane change on-time launch ascent to orbit flight profile (50 x 100 n. mi.).

Once a target satellite ephemeris is available from the tracking networks, the time consuming task of computing a shuttle ascent trajectory to orbital insertion (or the equivalent) is required before the on-orbit rendezvous targeting problem can be attacked with any success and continuity. If the shuttle is to truly have an autonomous system from the standpoint of guidance, navigation, and targeting, then certainly the task of generating trajectories from liftoff to orbital insertion must be eliminated from the flight computer. This would be necessary to keep the computer storage requirements and lead time prior to liftoff within a reasonable value.

An orbital insertion surface for a minimum plane change ascent trajectory can be generated by computing trajectories for all acceptable launch azimuths from a given launch site as illustrated in Figure 2. It should be obvious from examining Figure 2 that any space shuttle orbital



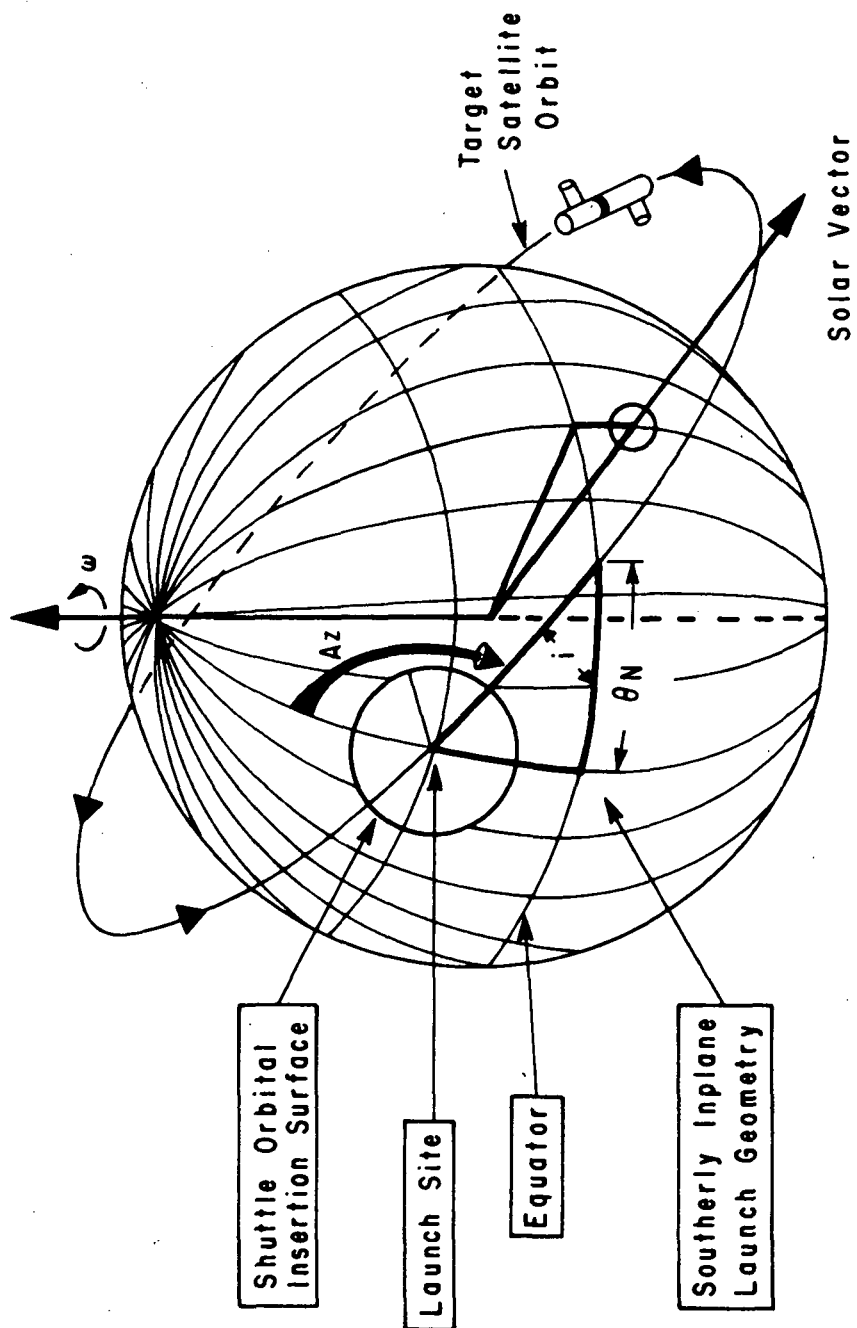

FIG. 2 SHUTTLE RENDEZVOUS INPLANE LAUNCH GEOMETRY

inclination ( $i$ ) greater than the latitude of the site could be achieved by varying the launch azimuth (AZ) from  $0^\circ$  to  $360^\circ$  without requiring any significant yaw steering of the guidance system. The useful information which must be obtained from an orbital insertion surface for rendezvous missions are listed below:

1. orbital inclination ( $i$ ) ... angle between equatorial and orbital plane
2. launch azimuth (AZ) ... measured clockwise from north
3. descending node ( $\theta_N$ ) ... measured from the launch meridian along the equatorial plane to the orbital plane intersection with the equator on the descending leg of the orbit (transit from Northern to Southern Hemisphere)
4. range angle ( $\theta$ ) ... measured in the orbital plane positive in the direction of the velocity vector from the descending node to the radius vector of insertion of the space shuttle orbiter
5. flight time from guidance reference release to orbital insertion ( $t_f$ )
6. geocentric latitude of orbital insertion ( $\psi$ )
7. space shuttle orbiter radius of perigee and apogee.

Using the information furnished by such an orbital insertion surface, it is possible to construct an Apollo 13 coordinate system (time, position, and velocity) at orbital insertion. The orbital insertion surface should be divided into northerly and southerly launch opportunities for total rendezvous flexibility. Detailed trajectory analysis has shown that it is possible to generate an orbital insertion surface for a northerly launch opportunity to cover a span of orbital inclinations (Cape Kennedy) from  $28.4^\circ$  to  $100^\circ$  with only 18 sets of data in table look-up form with the dependent variable being orbital inclination. Further analysis has shown that any inclination in the span of  $28.4^\circ$  to  $100^\circ$  can be selected and if the shuttle ascent targeting is determined from this orbital insertion surface, the payload penalty for not optimally re-targeting from liftoff to orbit insertion is less than 50 pounds. The same number of data points and payload penalty also hold true for southerly launch opportunities ( $AZ \geq 90^\circ$ ).

The next question that might raise some doubts as to the total validity of the orbital insertion surface is, "What impact will a full range of payload variations (empty to fully loaded) have on the orbital insertion surface?" The earth's gravitational oblateness model applied to an increase or decrease in burn time to orbital insertion of a minimum plane change trajectory will

cause the combination of azimuth, orbital inclination, and descending node to vary slightly. The ascent trajectory analysis has verified the payload penalty for not optimally re-targeting for the full range of payload variations is less than 75 pounds. The data from the analysis also indicates the range angle of orbital insertion (burn arc change) change and burn time variation can be accounted for by a simple linear correction based on the payload change from the nominal. This study shows that once a shuttle configuration and its associated propulsion, mass history, center of gravity, engine locations, and aerodynamic characteristics are adequately defined, an orbital insertion surface for a particular launch site can be generated that will make ascent trajectory computation unnecessary for rendezvous mission on-orbit targeting.

The plots of launch azimuth (AZ) and descending node ( $\theta_N$ ) as a function of orbital inclination at orbital insertion are shown by Figure 3. The plots of range angle, geocentric latitude of insertion, and time of orbital insertion from guidance reference release (uncaging of platform gyros and start of navigation computation) as a function of orbital inclination at orbital insertion are shown by Figure 4. The orbital insertion surface, presented in this report, was computed using an earlier MDAC low crossrange shuttle booster/orbiter configuration; but, the trends established in this analysis should be equally applicable to the 156" SRM/orbiter shuttle configuration. Although the data indicates a double valued function for azimuth, descending node, range angle, and geocentric latitude of insertion as a function of orbital inclination (dependent variable), the data will be divided into northerly launch opportunities ( $AZ \leq 90^\circ$ ) and southerly launch opportunities ( $AZ \geq 90^\circ$ ) to be utilized in table look-up form. The need for geocentric latitude of orbiter orbital insertion will become apparent later in the discussion.

The next topic to be discussed will be the desired form of the target satellite ephemeris data. The southerly inplane spherical launch geometry is illustrated by Figure 2 in which the launch site has rotated into the orbital plane of the target satellite orbit. Given an orbital inclination and latitude of a launch site, there exists a relationship between launch azimuth, inclination and descending node that can be solved through the use of spherical trigonometry for either a southerly or northerly launch opportunity. It seems logical that the tracking networks would be required to give the next two inplane times (launch site in target plane) and the orbital elements necessary to establish the target satellite's location and velocity. These spherical trigonometric inplane points merely offer a first guess for the guidance reference release time of the space shuttle. The form of the target satellite ephemeris used in initializing the target satellite state vector (Apollo 13 coordinate system) is given below:

TN, a, e, i,  $\theta_N$ ,  $\alpha_{PL}$ ,  $\phi$

TS, a, e, i,  $\theta_N$ ,  $\alpha_{PL}$ ,  $\phi$

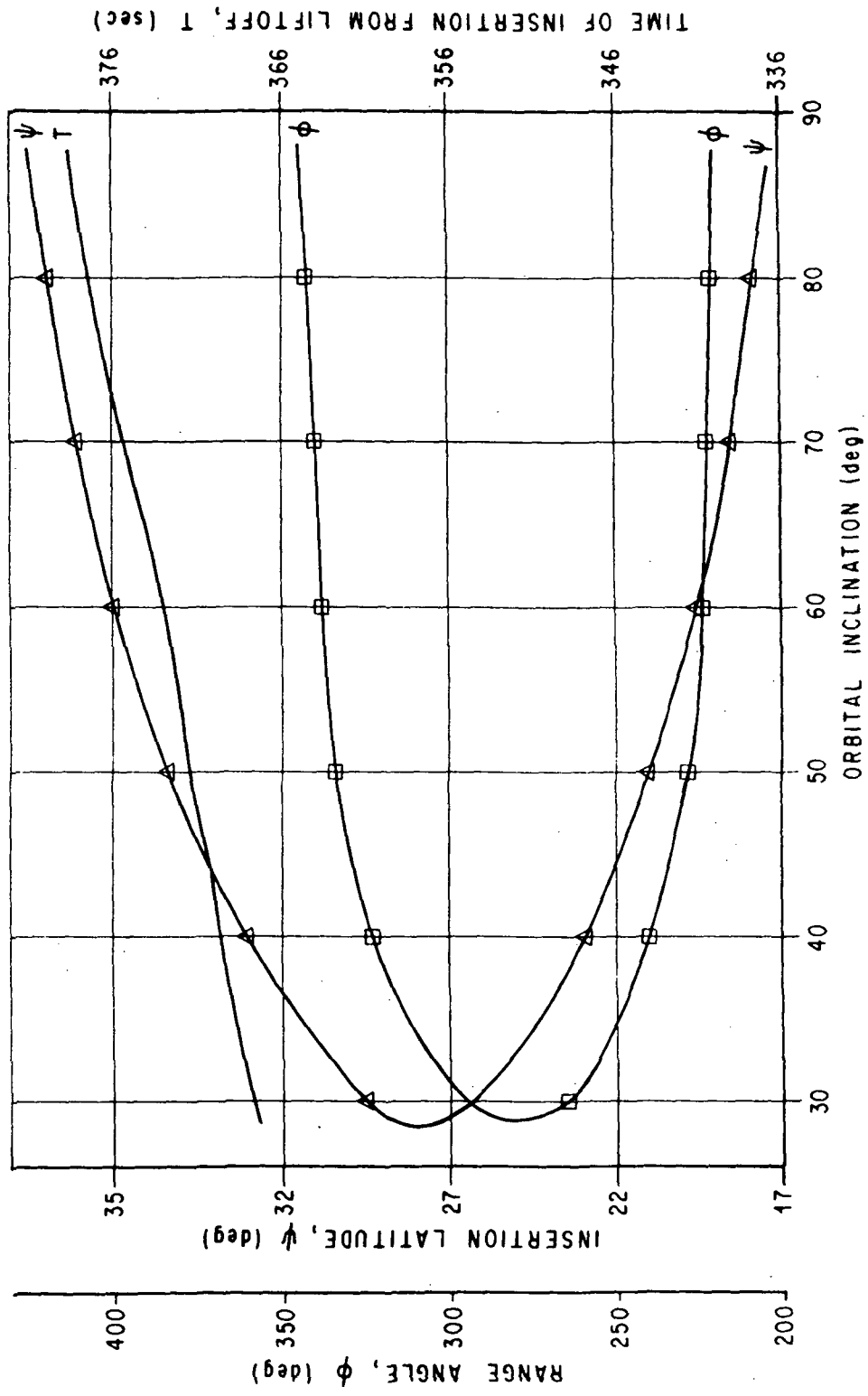

FIG. 3 SHUTTLE ORBITAL INSERTION SURFACE

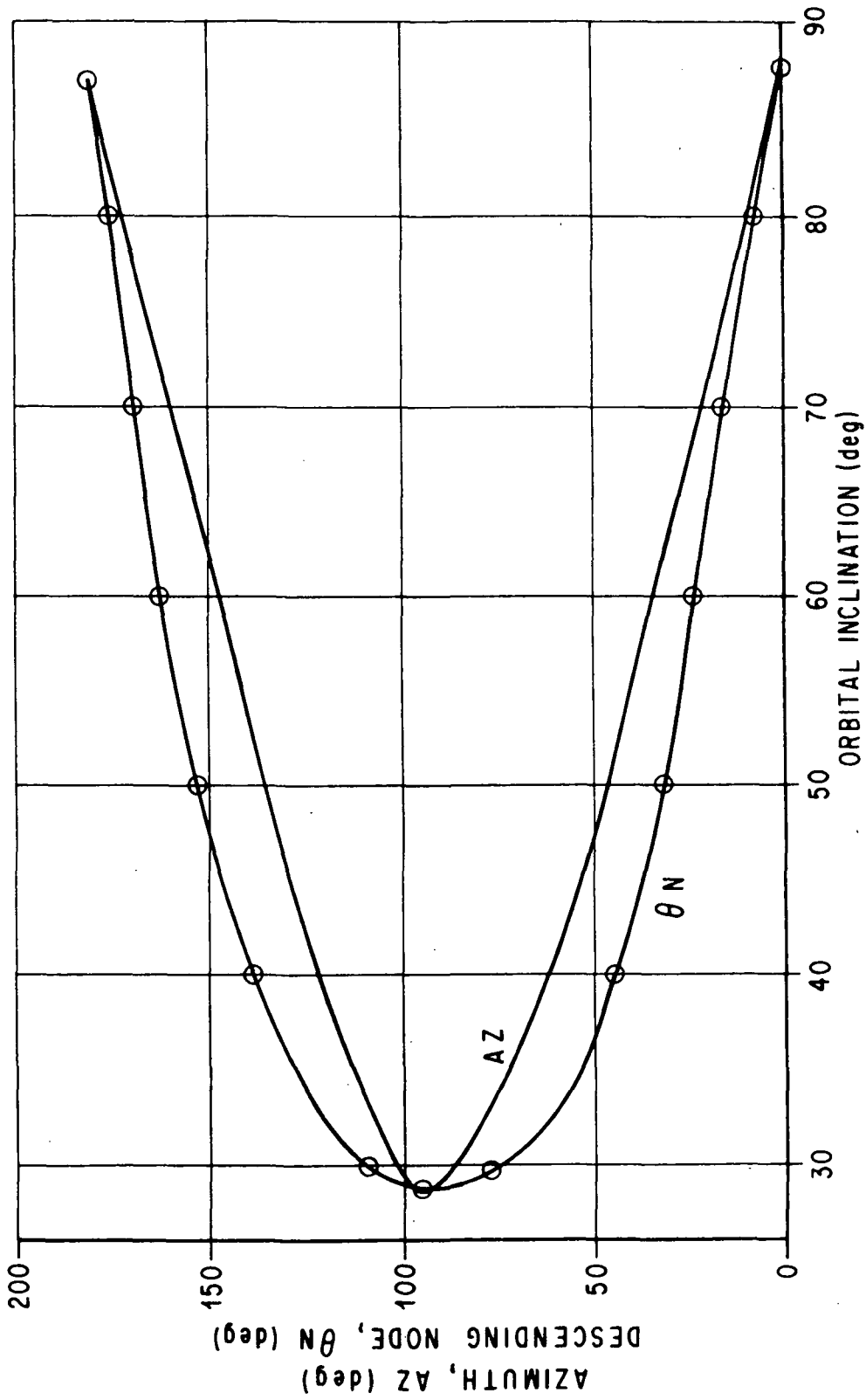

FIG. 4 SHUTTLE ORBITAL INSERTION SURFACE

- TN ... universal time in seconds of northerly inplane launch opportunity.
- TS ... universal time in seconds of southerly inplane launch opportunity.
- a ... target satellite semi-major axis (m).
- e ... target satellite eccentricity.
- i ... target satellite orbital inclination.
- $\Theta_N$  ... target satellite orbital descending node measured from the space shuttle launch meridian along the equatorial plane to the orbital plane intersection with the equator on the descending leg of the orbit.
- $\alpha_{PL}$  ... target satellite argument of perigee angle measured from the descending node in the orbital plane positive in the direction of the velocity vector to the radius of perigee vector.
- $\Phi$  ... target satellite true anomaly angle.

The orbital elements of the target satellite ephemeris are given at the instant the inplane condition exists; but, it must be noted that the target satellite conic is an osculating conic and the orbital elements undergo variations with time. The orbital elements that define the orbital plane are inclination and descending node. The gravitational anomalies due to the earth's oblateness results in a periodic variation in orbital inclination and a secular perturbation effect on the descending and ascending node of any earth satellite. The secular perturbation effect on the descending node will be compensated for by a correction to the first guess (spherical inplane condition) on the guidance reference release time of the space shuttle. The correction for the secular perturbation effect will be treated in greater detail in the next section of this report. The correction for the periodic variation of the orbital inclination is of immediate concern since it influences the manner in which the space shuttle orbital insertion surface is evaluated. The major term in the periodic orbital inclination perturbation equation is the geocentric latitude of the target satellite and the second order effect is the radius vector magnitude of the target satellite orbit for near earth orbits ( $< 1000 \times 1000$  n. mi.). This is illustrated graphically by Figure 5 in which the variations in an orbital insertion of  $55^\circ$  (initialized at the equator) is plotted against geocentric latitude for a  $100 \times 100$  n. mi. and a  $270 \times 270$  n. mi. target orbits. The variation in the orbital inclination is approximately 0.04 degree for either orbit and the differences in the variational effect as a result of the altitude difference is less than .003 degree. The altitude difference effect is an order of magnitude smaller

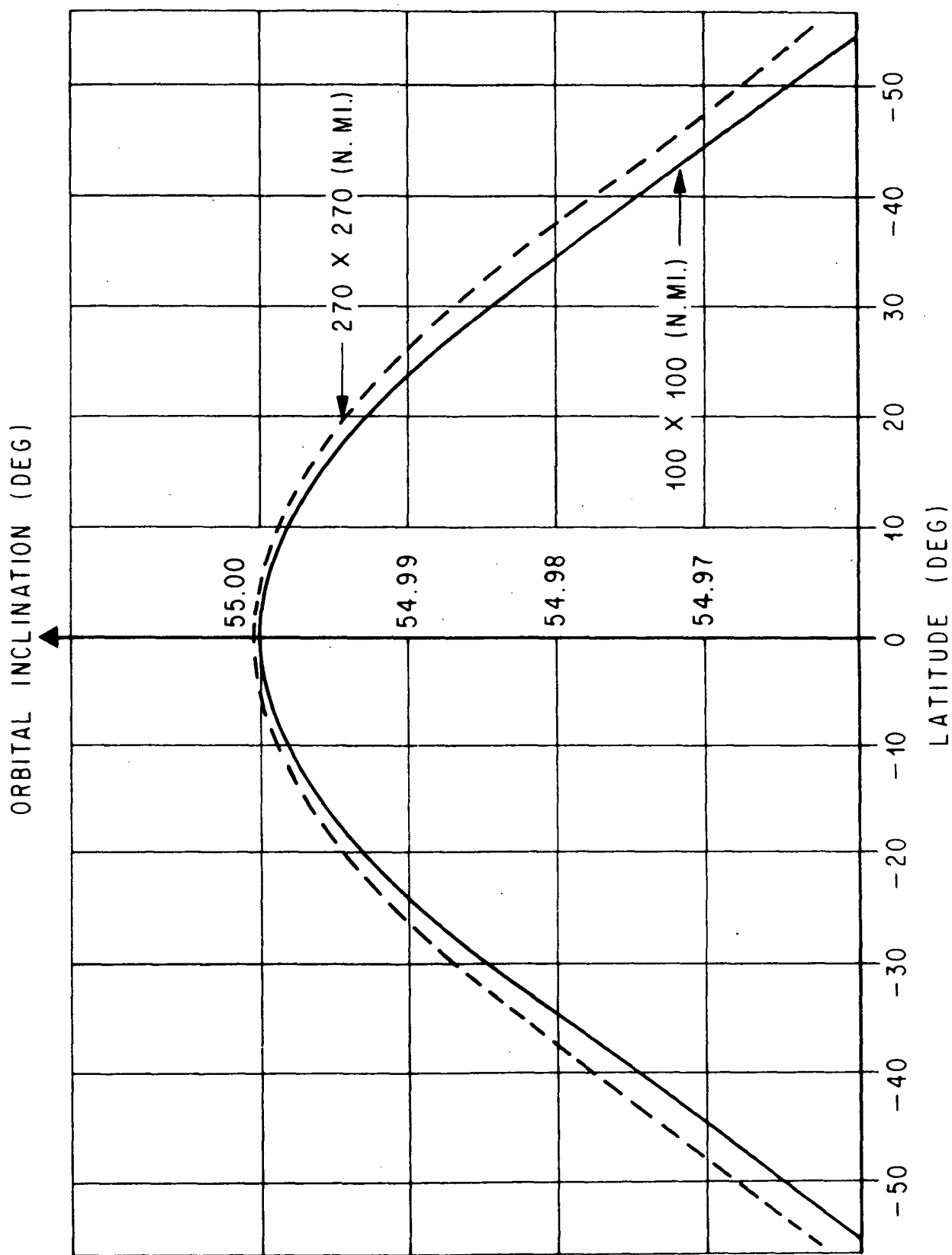

FIG. 5 ORBITAL INCLINATION VS LATITUDE

than the navigational accuracy of the space shuttle at orbital insertion and allows this correction to be ignored in the basic targeting problem. For those missions in which a space tug would be used in a rendezvous mode to much higher orbits after delivery by the space shuttle, the altitude effect can be considered without much additional complexity to the targeting problem.

The space shuttle orbital inclination at insertion can easily be synchronized with the target satellite's orbital inclination by integrating the target satellite's orbit around to the geocentric latitude of insertion of the space shuttle (evaluated from orbital insertion surface). Once the orbital inclination of the target satellite is determined at space shuttle orbital insertion, this inclination ( $I_D$ ) can be used to perform a full evaluation of the space shuttle orbital insertion surface. The Apollo 13 coordinates of the orbiter at orbital insertion can now be determined and the target satellite coordinates at this time can also be determined in the same Apollo 13 coordinate reference frame. It is extremely important that both the orbiter and target satellite have the same coordinate system reference since the targeting techniques developed to solve the targeting problem make exclusive use of vector algebra and rapid orbit integration algorithms.

#### IV. TARGETING TECHNIQUES AND ISOLATION LOGIC

Section III of this report outlined the technique used to generate an Apollo 13 coordinate system in position and velocity for both the space shuttle's orbiter at orbital insertion and the target satellite at the same reference time (orbiter insertion) with the orbital inclination synchronized. Section IV will outline the targeting techniques used to establish an inphase and inplane condition at terminal rendezvous while observing all navigation and lighting constraints.

After the space shuttle's orbiter has been initialized at orbital insertion ( $50 \times 100$  n. mi.), the orbiter is advanced through numerical integration to first apogee passage (multiple revolutions not permitted because of low perigee radius). At this point the orbiter is circularized at the apogee radius magnitude using an impulsive velocity change. The orbiter is next allowed to coast in this circular orbit for as long as would be required to perform an on-board navigation update ( $T_{COAST} = SFN\emptyset 1 T_{CP}$ ).  $SFN\emptyset 1$  represents the scale factor relating to the navigation update requirement and  $T_{CP}$  is the period of the orbiter circular orbit ( $100 \times 100$  n. mi.). A reasonable value for  $SFN\emptyset 1$  would be 0.5 (half an orbit in time). The time and Apollo 13 coordinates ( $T = TSTI$ ,  $\bar{X}_p$ ,  $\bar{Y}_p$ ) are stored at this reference point in space as part of the isolation logic. This will correspond to a point between position "1" and position "2" (see Figure 1). The target satellite's coordinates are also determined at this reference point in time ( $T = TSTI$ ,  $\bar{X}_T$ ,  $\bar{Y}_T$ ). The shuttle orbital plane and the target orbital plane will not necessarily be aligned at this time ( $TSTI$ )



because of the orbital plane regression rate differences. The orbital planes should only be aligned at the terminal phase initiation (TPI) segment of rendezvous. The technique to accomplish this condition will become apparent later.

It is important at this time (TSTI) to make an estimation of the time remaining to TPI and the orbital angular rates ( $\dot{\phi}$ ) of the target orbit as well as the different orbits required of the shuttle to arrive at TPI with the correct phasing relationship. The following terms are defined for clarity:

- $\Delta\dot{\phi}_2$  .... the phasing catch-up rate of the shuttle in a 100 x 100 n. mi. orbit with respect to the target satellite orbit (orbital motion from position "1" to position "2" in Figure 1.
- $\Delta\dot{\phi}_3$  .... the phasing catch-up rate of the shuttle in the orbit transfer conic (position "2" to position "3") with respect to the target satellite orbit.
- SFN $\phi_2$ TP3.. the time in the transfer orbit required for navigation update. SFN $\phi_2$  is a scale factor and TP3 is the period of the transfer conic. SFN $\phi_2$  must be  $\frac{1}{2}$ ,  $1\frac{1}{2}$ , or some interger plus  $\frac{1}{2}$  (near Hohmann transfer).
- $\Delta\dot{\phi}_{CU}$  .... the phasing catch-up rate of the shuttle in the gross rendezvous orbit (position "3" to position "4" approximately 10 n. mi. differential height) with respect to the target satellite orbit.
- SFN $\phi_3$ TP4.. the time in the gross rendezvous orbit required to achieve a navigation update with the rendezvous radar equipment and make corrective maneuvers. SFN $\phi_3$  is a scale factor and TP4 is the period of the gross rendezvous orbit.
- LC .... a constant that is equal to 1.0 if a lighting constraint is to be enforced and 0.0 if no lighting constraint is to be considered.

The amount of phasing required to satisfy the navigational and lighting constraints in terms of a target satellite lead angle is given by the following equation:

$$\Delta\phi_{LEAD} = \Delta\dot{\phi}_3 \cdot \text{SFN}\phi_2\text{TP3} + \Delta\dot{\phi}_{CU} \cdot (\text{SFN}\phi_3 + \text{LC})\text{TP4}.$$

Next the actual phase angle ( $\Delta\phi_A$ ) between the shuttle and the target satellite is computed at time equal to TSTI. These phase angles must be computed with respect to the line of nodes of the two orbits so that any out of planeness will not be reflected in  $\Delta\phi_A$ .  $\Delta\phi_A$  must be greater than  $\Delta\phi_{LEAD}$  in order to satisfy the constraints. If  $\Delta\phi_A$  is not greater than  $\Delta\phi_{LEAD}$ , then  $\Delta\phi_A$  must be redefined as  $\Delta\phi_A = \Delta\phi_A + 360^\circ$ . The phase angle remaining after satisfying the constraints is given as  $\Delta\phi_R = \Delta\phi_A - \Delta\phi_{LEAD} - \Delta\phi_D$ , where  $\Delta\phi_D$  represents the desired phase relationship at TPI.  $\Delta\phi_R$  can be taken out by remaining in the 100 x 100 n. mi. phasing orbit by the time determined from dividing  $\Delta\phi_R$  by  $\dot{\phi}_2$  ( $\Delta T_2 = \Delta\phi_R / \dot{\phi}_2$ ). The estimated mission times from guidance reference release to perform the orbit transfer (position "2") and arrive at TPI is given below:

$$TTEST2 = TSTI + \Delta T_2$$

$$TTPI = TTEST2 + SFN\phi_2 TP_3 + (SFN\phi_3 + LC) TP_4.$$

If  $LC = 0$  (no lighting constraint), then the universal time of TPI is equal to the universal time in seconds past midnight of guidance reference release plus TTPI ( $TUTP = TUL\phi + TTPI$ ). If  $LC = 1$  (lighting constraint), then the target satellite has to be integrated forward in orbit from TSTI to

$$T = \Delta T_2 + SFN\phi_2 TP_3 + SFN\phi_3 TP_4 = TSTART.$$

Once the mission time of TSTART is reached, the target satellite is advanced forward until the desired angle of the target satellite with respect to the solar vector is obtained (satisfying the lighting constraint at TTPI). Again universal time of TPI is defined as

$$TUTP = TUL\phi + TTPI.$$

The universal time of TPI is a fixed time, and the isolation logic must drive any phase or plane error to within acceptable tolerance at TUTP.

The isolation logic is a fairly straightforward procedure once TUTP is defined, and the state of the shuttle and target satellite is defined at the mission time of TSTI. The next step in the targeting techniques is to numerically integrate the shuttle and target satellite forward to  $T = TTEST2$  (Keplerian estimate of orbit transfer time). At time equal to TTEST 2 (position "2", Figure 1), an impulsive orbit transfer is performed based on conic equations and vector algebra in which no out-of-plane velocity increment is permitted to take place. The shuttle and target satellite are advanced to the second intersection of the shuttle with the desired constant height orbit-by-orbit integration. Again, the shuttle's orbit is impulsively changed to place the shuttle in an orbit approximately 10 n. mi. below and behind the target satellite (position "3", Figure 1) with no out-of-plane velocity changes allowed in the geometry.

The shuttle and target satellite are numerically integrated forward to mission time equal to TTPI (universal time equal to TUTP). At this point, the errors in the shuttle's orbital plane and phase relationship with respect to the target satellite can be evaluated.

Section 11 described the technique of synchronizing the shuttle and target satellite orbital inclination so that most of the plane error at TTPI should be in the descending node. The secular perturbation to the orbital plane is a regression of the line of nodes with respect to the equatorial plane. Since the shuttle and the target satellite are in different orbits, there will be a regression rate difference in the two orbital planes. The regression rate differential will be reflected in an error in the descending node since both the shuttle and the target satellite were initialized in nearly the same orbital plane. As previously stated, the shuttle ascent trajectory should not be required to perform a plane change since the space shuttle is a performance limited launch vehicle. The descending node error can be corrected by adjusting the guidance reference release time of the shuttle and keeping the ascent targeting fixed to the original values. The effect of this correction will be to change the launch site with respect to the target satellite descending node point by the rotational rate of the earth times the change in guidance reference release time. This means that an error in descending node at TTPI can be converted into a guidance reference time correction ( $\Delta TL\theta$ ) by the following equation:

$$\Delta TL\theta = \Delta \theta NE / \omega E.$$

where  $\omega E$  = earth's rotational rate.

Since the shuttle ascent targeting does not change and the same navigational constraint still exists, the correction to guidance reference release can be applied at TST1 in the targeting scheme. The target satellite can be integrated through  $\Delta TL\theta$  while leaving the shuttle position and velocity fixed at TST1. The target satellite descending node at  $T = TST1 + \Delta TL\theta$  should be corrected by  $\theta N = \theta N - \Delta \theta NE$  and the central angle traversed during  $\Delta TL\theta$  should be determined for phase error purposes ( $\Delta \theta L\theta C$ ). The Apollo 13 state vector should be reconstructed to reflect the new descending node value and mission time reset to  $T = TST1$ ; but the universal time will be different by  $\Delta TL\theta$ . The mission time at TTPI should be corrected to  $TTPI = TTPI + \Delta TL\theta$  with the universal time at TPI remaining the same to preserve the lighting constraint and simplify the convergence properties of the targeting scheme.

The phase error ( $\Delta \theta E$ ) at TTPI is reduced by applying a linear correction to the time of shuttle orbit transfer (TTEST2, position "2"). This time correction to TTEST2 is determined by dividing the phase error by the differential orbital height rate in the lower orbit minus the catch-up rate in the constant height orbit [ $\Delta T2 = \Delta \theta E / (\Delta \dot{\theta} 2 - \Delta \dot{\theta} CU)$ ].

The phase error ( $\Delta\phi$ ) introduced by changing the guidance reference release time to correct for a descending node error requires a similar type correction.

The first pass through the equations and logic will define an error in both the orbital plane and phase angle at TTPI. A correction is made for both errors as a second pass is made through the equations; but for the subsequent passes, only the phase error will be corrected until the error is driven to zero or an acceptable tolerance. Once the phase error has been driven to an acceptable tolerance, the orbital plane error will again be corrected if it is out of acceptable tolerance; but this is usually not necessary since an orbital plane error will very closely map into a one-to-one correction to the beginning when the end point (TUTP) is held at a fixed value.

Although this program was designed to perform rendezvous targeting for near-circular orbits, the equations were derived for the elliptical case with special care taken to guarantee that no singularities will exist if the eccentricity of either the shuttle or target satellite orbits should go to zero during the isolation. The targeting program will also work for highly elliptical target satellite orbits, but the performance penalty for not performing the maneuvers at the optimal location may be prohibitive. The application of these targeting techniques to the elliptical target satellite orbits will be discussed in Section VI.

## V. DATA OUTPUT FROM TARGETING PROGRAM

The form of the data output from any space mission targeting program is a function of the needs of the particular guidance system to be utilized to complete the mission. The orbit transfer maneuvers of the space shuttle were all performed impulsively. The only information available at these times are the state vectors of the shuttle and target satellite before and after the impulsive maneuvers and the velocity-to-be-gained vector. Quite obviously, the maneuvers could have been performed with the cross product steering of the Apollo spacecraft, the Saturn V Iterative Guidance Mode, or MASCOT, but the computer time required for convergence of the targeting program would have been increased and the program would have been highly restrictive. Rendezvous targeting is completely determined from the geometry and the approach selected to achieve the mission. Care should be taken to select a flight profile that will yield compatibility between the propulsion system and guidance system to be utilized to perform the required maneuvers. Ignition equations can be derived from impulsive velocity solutions to satisfy any of the three systems mentioned without very much difficulty. An example of this would be the circularization maneuver ( $50 \times 100$  to  $100 \times 100$  n. mi.) of the space shuttle

(Figure 1, position "1"). Suppose a low velocity of space shuttle orbital insertion placed the shuttle in a 50 x 95 n. mi. orbit. The ignition equations and on-board targeting should retarget the maneuver to a 95 x 105 n. mi. conic to preserve the major axis magnitude (preserve the period and catch-up rate). From these state vectors at the nominal maneuver times, the on-board shuttle flight computer should be able to correct for any reasonable execution errors and achieve the desired phase relationship at TPI. The terminal rendezvous targeting is achieved through solving Lambert's problem and will have to be solved on-board the shuttle, so there is no need for going beyond TPI in this targeting program.

The basic data output from this computer program are listed below:

1. Universal time of guidance reference release.
2. Space shuttle ascent to orbit targeting parameters.
3. Timeline of required maneuvers.
4. Space shuttle and target satellite state vectors (Apollo 13) before and after on-orbit impulsive maneuvers (velocity-to-be-gained can be derived from these) for all maneuvers through TPI.

A block diagram or flow diagram of how the space shuttle on-board targeting scheme would function in an actual mission is illustrated in Figure 6. The mission inputs, in rather loose terms, would define the space shuttle launch characteristics needed to establish the ascent profile from liftoff to orbital insertion (50 x 100 n. mi.) and determine if the mission is a basic satellite delivery mission (IREN = 0) or a rendezvous mission (IREN = 1). If the mission is a rendezvous mission (IREN = 1), the target satellite ephemeris will be processed through the orbital inclination synchronization techniques discussed in Section II. Once the orbital inclination has been defined (ID), the orbital insertion surface of the space shuttle can be evaluated and the Apollo 13 coordinates of the space shuttle orbital insertion established as given in Section III. A rendezvous mission would send the data flow through the on-orbit rendezvous scheme outlined in Section IV. A satellite delivery mission would require the data flow to pass through the satellite delivery targeting scheme in which special emphasis would be placed on achieving satellite delivery in such a way that return to the desired landing site would be performed in an orderly and timely manner. The output from the targeting program would go to the guidance computer, and an on-board countdown could proceed resulting in eventual guidance reference release and an on-board autonomous mission completion.

Preliminary analysis of a space shuttle ascent load relief guidance system has indicated that it may be possible to handle the full spectrum of space shuttle payloads and launch azimuths with one steering function that would replace the presently used open-loop time-dependent steering

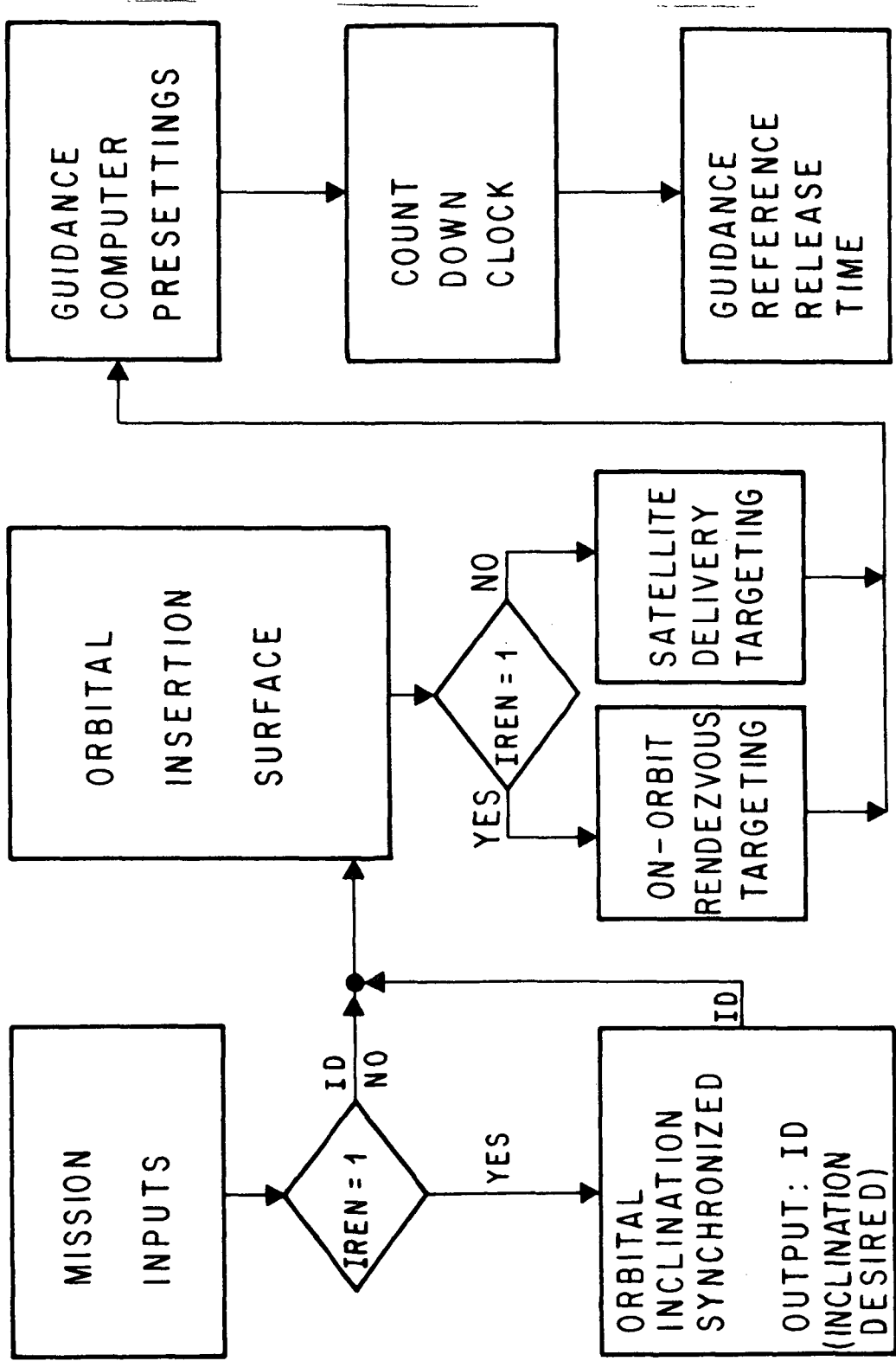

FIG. 6 SPACE SHUTTLE ON-BOARD TARGETING FLOW DIAGRAM

approach of the Saturn/Apollo launch vehicle series. If this approach to atmospheric ascent of the space shuttle is successful, it may be possible to truly achieve an on-board autonomous guidance, targeting and navigation system that would make the time consuming and costly task of preflight analysis obsolete. Documentation of the space shuttle ascent load relief guidance system should be completed within the next two to three months.

## VI. APPLICATION OF THE TARGETING TECHNIQUES TO ELLIPTICAL TARGET SATELLITE ORBITS

It should be pointed out that the targeting techniques developed for rendezvous with target satellites in near circular orbits will also work for elliptical target satellite orbits. The only drawback to the near circular techniques is the cost of the additional propellants ( $\Delta V$ ) that would be required to perform the orbit transfers at the non-optimum points in the circular phasing orbit. In general, all orbit transfer maneuvers should be performed at perigee and apogee (line of apsides) for optimality from an impulsive velocity change standpoint. An impulsive orbit transfer initiated at perigee or apogee would require a velocity magnitude change only; whereas, an orbit transfer away from the line of apsides would require a velocity magnitude and direction (flight path angle) change.

The flight profile selected for applications of the rendezvous targeting techniques for elliptical target satellite orbits is illustrated in Figure 7. The eccentricity or apogee and perigee radius difference required before it is necessary to deviate from the near circular targeting approach would be determined from extensive mission analysis and will not be addressed in this report. Figure 7-A shows the shuttle being inserted into a 50 x 100 n. mi. orbit and indicates a circularization maneuver being performed at position "1" (100 x 100 n. mi.). The shuttle would remain in the circular orbit until it coasted around to position "2" (apogee line of target satellite). The shuttle would execute an elliptical intersection maneuver at position "2". The elliptical intersection maneuver would guarantee that the shuttle would intersect the desired constant differential height orbit (approximately 10 n. mi. below the target orbit at perigee and apogee) by providing for an overspeed to allow the shuttle apogee to overshoot the target satellite perigee radius by a given bias ( $\Delta HB$ ). This bias would be large enough to compensate for any execution error in the orbit transfer maneuver at position "2". The shuttle would remain in this orbit for the required number of revolutions to satisfy the navigation update requirements and phasing requirements and then perform a phase adjustment maneuver at position "3" so that an orbit transfer could occur at position "4" to place the shuttle in the near constant differential height orbit. The shuttle would then coast around to position "5" which is the required phase relationship to

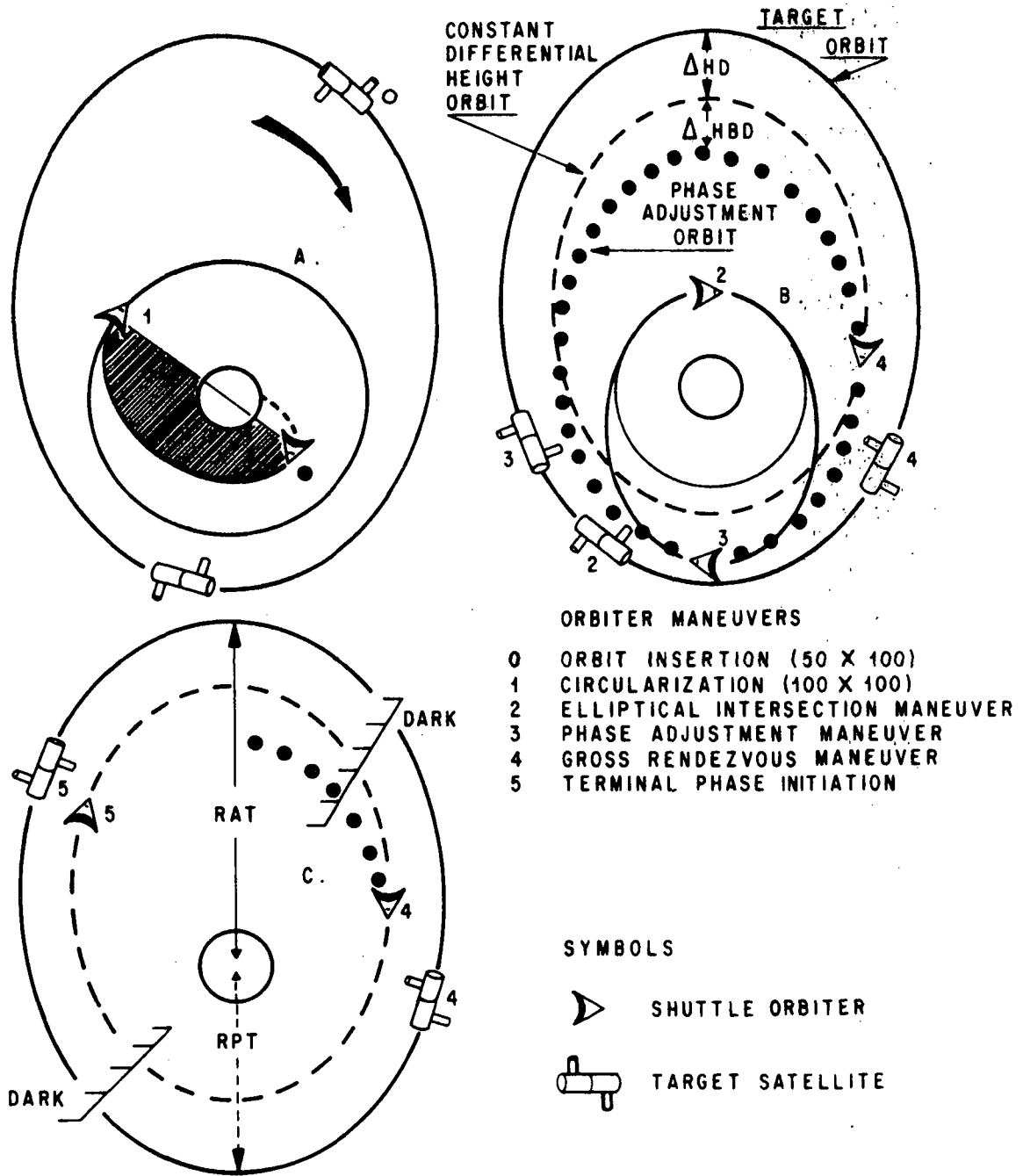

FIG. 7 ELLIPTICAL SHUTTLE RENDEZVOUS MANEUVER SEQUENCE FOR TARGETING



perform TPI and satisfy the lighting constraint (Figure 7-C). This particular flight profile was selected to allow the maximum amount of major axis variation to be available for the phase adjustment orbit.

The equations and logic required to solve this highly restrictive phasing geometry targeting problem with the same navigation update and lighting constraints as the near circular rendezvous targeting problem have been derived by the author and have been given to the support contractor (one person) to program and verify. The detailed documentation of this elliptical rendezvous targeting program will be completed and released at a later date.

## VI. SUMMARY, CONCLUSIONS, AND COMMENTS

This report deals with the flight mechanics problems associated with building an on-orbit rendezvous targeting computer program for the space shuttle from a general description standpoint. The detailed documentation of the resulting computer program can be found in the Northrop Services, Inc. report number M-244-1082 entitled "Shuttle On-Orbit Rendezvous Targeting: Circular Orbits." The data output from the computer program will give the universal time of guidance reference release, the space shuttle orbital insertion targeting values, and a timeline of orbital maneuvers required to arrive at terminal phase initiation of the final rendezvous sequence with the correct orbital plane and phasing conditions for a near circular target satellite orbit while satisfying on-orbit navigation update and lighting constraints.

Also, included in this report is an extension of these targeting principles and techniques to space shuttle rendezvous with target satellites in elliptical orbits in which the perigee and apogee radius difference is great enough to require the shuttle orbit transfers to be placed along the line of apsides to preserve optimality.

It is the conclusion of this author that space shuttle on-board computation of rendezvous targeting is not only possible, but should be considered seriously to meet the demands of NASA as well as Department of Defense mission requirements at low operational cost.

This work in the area of space shuttle rendezvous targeting is being phased out except where there is a direct application to space tug rendezvous missions. The targeting problem is essentially the same for the space tug if the tug is delivered into a low earth orbit and then released to achieve rendezvous as a third stage to the space shuttle. The space tug is a very effective cargo delivery vehicle to high energy earth orbits when used as a space shuttle unmanned third stage (improved mass ratio).

The targeting techniques developed to determine guidance reference release time, orbital insertion targeting, and a timeline and targeting parameters for the on-orbit rendezvous maneuvers were all based on the shuttle ascent to orbit not having to perform a plane change (dog-leg). There may be missions defined in which an excess of propellant could be available for performing an ascent dog-leg flight profile when there is an advantage to be gained in terms of phase angle trade-off. A 25-minute launch delay of an inplane launch geometry would change the phase angle of the shuttle and target at orbital insertion by approximately 90 degrees. This would complicate the orbital insertion surface; but it could still be generated to handle this situation. The targeting techniques did not address the time constraint of 24 hours to achieve rendezvous. There is quite a difference in achieving a minimum time rendezvous and a maximum payload rendezvous. The logic required to make the trade-off between the amount of dog-leg to be performed in the ascent and the geometry to be selected to achieve rendezvous, and still maintain on-board autonomous targeting, would become quite complex, but the details could be worked out if the decision should go that way. Space rescue would be a situation in which minimum time rendezvous would be a necessity.

Special consideration was given to the on-orbit navigation update constraint. The mission profile was selected to allow adequate time for autonomous on-orbit navigation update to take place prior to the next maneuver. These targeting techniques are applicable to other flight profiles.

## REFERENCES

1. Kenehan, M. F., "Mission Analysis of Gemini/Agena Rendezvous with Assigned Targets," 3150-6015-R0000, TRW Systems.
2. Karacsony, P. J., Petty, R.L., Sichi, F. J., Woodruff, P. G., "Apollo Mission AS-207/208A Preliminary Spacecraft Reference Trajectory," 3902-H015-R0-000, TRW Note No. 66 FMT-412.
3. Kahane, J. W., Young, K. A., "Logic for Real-Time Computation, Apollo 208 Targeting Parameters and Recommended Lift-Off Time," MSC Internal Note No. 66-FM-115.
4. Carlson, N. A., "Space Guidance Development," Intermetrics Inc. Interim Report on Orbit Transfer and Rendezvous for Space Shuttle.

APPROVAL

SPACE SHUTTLE EARTH ORBITAL RENDEZVOUS TARGETING  
TECHNIQUES FOR NEAR CIRCULAR TARGET SATELLITE ORBITS

by A. W. Deaton

The information in this report has been reviewed for security classification. Review of any information concerning Department of Defense or Atomic Energy Commission programs has been made by the MSFC Security Classification Officer. This report, in its entirety, has been determined to be unclassified.

This document has also been reviewed and approved for technical accuracy.

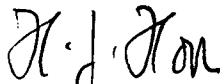

---

 E. D. Gevssler  
Director, Aero-Astrodynamic Laboratory

Distribution

DIR  
DEP-T  
A&TS-PAT  
A&TS-MS-H  
A&TS-MS-IP  
A&TS-MS-IL (8)  
A&TS-TU/Mr. Wiggins (6)  
PM-PR-M/Mr. Goldston

S&E-DIR/Dr. Weidner

S&E-AERO-DIR  
Dr. Geissler  
Mr. Horn

S&E-AERO-G  
Mr. Baker  
Dr. Blair  
Mr. Causey  
Mr. Redus  
Mr. McLeish  
Mrs. Brandon  
Mr. A. Deaton (20)

S&E-AERO-M  
Mr. Lindberg  
Mr. Buckelew

S&E-AERO-D  
Dr. Lovingood  
Dr. Worley

S&E-ASTR-DIR/Mr. Moore

S&E-ASTR-S  
Mr. Brooks  
Mr. E. Deaton

PD-DO  
Mr. Goldsby (2)  
Mrs. Reisz

PD-RV/Mr. Jean

Manned Spacecraft Center  
Houston, TX  
Attn: Mr. Ken Cox (2)  
Mr. R. Nobles

Scientific & Technical Info. Facility (25)  
P. O. Box 33  
College Park, Maryland 20740  
ATTN: NASA Rep. (S-AK/RKT)